

1 Notice before using

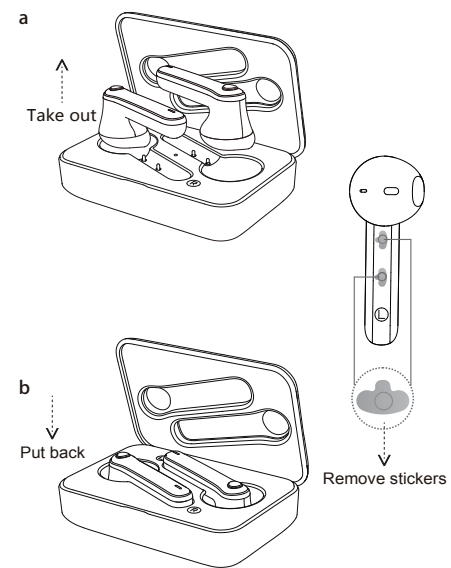

(Optional, please ignore if no stickers here)

2 Wearing method

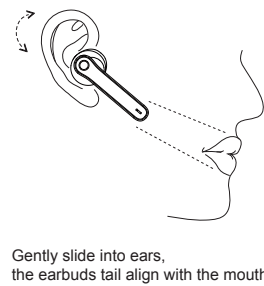

Gently slide into ears, the earbuds tail align with the mouth

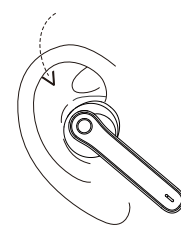

Adjust the earbuds to where it doesn't move while wobbling head

3 Main user interface

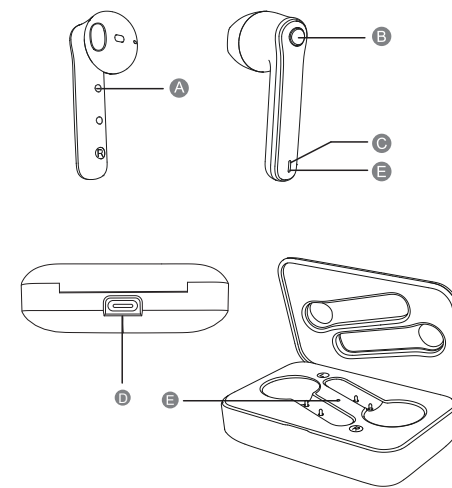

- A. Charging point
- B. Function button
- C. Microphone
- D. Charging USB Port
- E. Status LED

4 Start Here

a. Open Charging Dock case, two earbuds will power on and pair with each other automatically

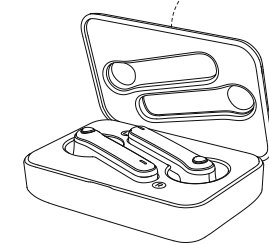

Open the case, earbud LED flash in white, two earbuds will power on and pair with each other automatically
(Voice Notice : Power on ----> TWS connected ----> Pairing)

b. Pairing with cellphone

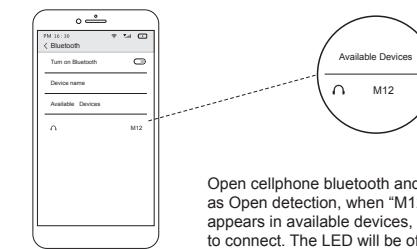

Open cellphone bluetooth and set it as Open detection, when "M12" appears in available devices, press to connect. The LED will be off after connected.
(Voice Notice: Connected)

c. Power off

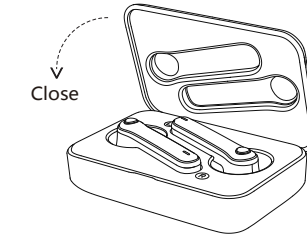

Put back the earbud to the charging dock and close the cap, the earbuds will power off, and the dock will charge the earbuds automatically.
(Voice Notice: Power off)

5 Charging

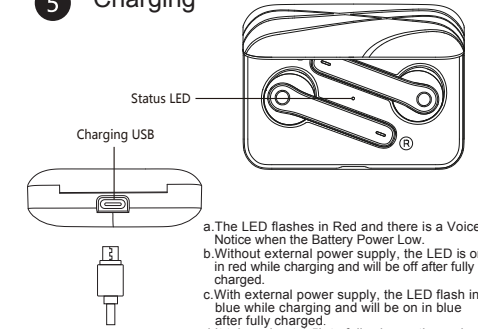

a. The LED flashes in Red and there is a Voice Notice when the Battery Power Low.
b. Without external power supply, the LED is on in red while charging and will be off after fully charged.
c. With external power supply, the LED flash in blue while charging and will be on in blue after fully charged.
d. It takes about 1.5h to fully charge the earbuds and charging dock batteries.

6 More functions

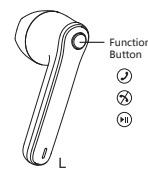

a. Touch the function button once to answer calls, press Function Button twice to reject calls.
b. When playing music, to pause, please press the function button once; to play the previous song, please press and hold 2s for left earbud function button; to play next song, please press and hold 2s for right earbud function button; to increase volume, please press the function button of left earbud twice; to decrease volume, please press function button of the right earbud twice; to activate Siri, please press function button three times.

7 Important Notice for Single Earbud using

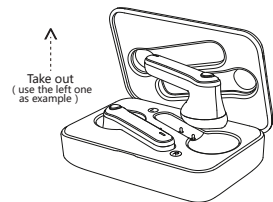

a. The earbuds can be used individually (each earbud pairs to separate cellphone)
b. Open charging Dock cap, take out either earbud, wait for 10s, the LED flashes in white, and then open cellphone bluetooth and set it as open detection, when "M12" appears in available devices, press to connect. The LED will be off.
(Voice Notice: Power on ----> Pairing)
c. It will automatically connect to the cellphone, if it connected previously.

8 Manual pairing

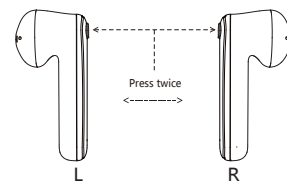

1stly: make sure the earbuds don't connect any bluetooth devices.
2ndly: put two earbuds close within 10cm and press & hold two function buttons for 2s to power on both earbuds.
3rdly: press either function button twice, auto pairing completed when one LED flashes in white the other one is off.
4thly: press & hold either function button for 5s, two earbuds turn off at the same time, manual pairing completed.

Basic Parameter

Product Name: M12 Operation range: 10m
Charging time: 1.5 hours Call time: 5 hours
Music Time: 4 hours Charging Input: 5V ---300mA
Battery Type: Polymer Li-Ion Battery
Earbud weight: 4g+4g

Important Notice

- Please make sure the product is fully charged before initial use.
- Please use the brand adaptor complying safety requirements to charge this product.
- If your cellphone can not find "M12", please double check if your cellphone Bluetooth is at "Equipment visible mode". After initial pairing, the earbuds will be automatically paired for repeat use. If no use for a long time, need to follow up pairing procedures to pair with the cellphone.
- If there is only one earbud has sound while in music mode, please restart the earbuds or re-pair manually.

Questions & Answers

Questions	Reasons	Answers
earbuds not "power on"	power run out	charge the charging dock & earbuds
earbuds pairing failure	program error caused by mal-operation	re-pair manually (pls refer to user manual VII)
charging dock LED not light on while putting in earbuds	can't detect the earbuds while they are fully charged	it will recover proper indication after using for a while
low volume	the volume setting of the earbuds & cellphone not synchronized	turn on cellphone bluetooth & synchronized its volume setting with the connected earbuds
charging dock not charging	charging protection	charge the charging Dock by external power
can't find earbuds pairing name or pairing failure with cellphone	earbuds not in pairing mode cellphone bluetooth App error	Re-"power on" the earbuds power off & re-power on cellphone

Security warning

- Please use the product in the temperature between 0°C-45°C. When the environment temperature is too high or low, it may cause the product malfunction.
- Please keep the product dry, do not contact water or humidity environment
- Please do not drop, throw, pull/drag the product to prevent damage.
- Please power off before clean the product.
- Please use the product at proper volume while listening music or answering call, long time at high volume usage could lead to permanent hearing loss.
- The built-in battery is not dismountable, please do not replace by yourself. If it's really necessary, please ask help from authorized service center.
- Please dispose the product according to local law, can not treat it as domestic garbage.
- Without adult supervision, please keep the product out of reach of children, the swallow of small components included may cause asphyxia.

Warranty

- This product is covered under warranty for a period of one year from the date of purchase limited to normal use and maintenance of the machine parts, materials and functions. Problems and failures verified upon further identification, will be provided free repair and replacement parts.
- Excluding the following:
 - A. Headset is beyond the warranty period;
 - B. User does not follow the instructions, so that the headphone wire and earplug broken.
 - C. Without the authorization to dismount, repair, alteration structures;
 - D. Can't provide proof of purchase.
 - E. Man made damage.
 - F. Due to natural disasters and other force majeure (such as earthquakes, fires) product failure of damage causes;

Warranty Card

User's name _____
 User's telephone# _____
 User's Add _____
 Date of purchase _____
 Invoice # _____
 Dealer's name _____
 Dealer's Add _____
 Dealer's telephone# _____

QC Report info

Model #	
Inspector	
Date	

物料编号 : 16-4BA10101D

名称 : M12-英文说明书

规格 : 70*108mm 共6P, 70g书纸 单色印刷, 风琴折

日期 : 2020年9月2日

FCC Caution:

This device complies with part 15 of the FCC Rules. Operation is subject to the following two conditions: (1) This device may not cause harmful interference, and (2) this device must accept any interference received, including interference that may cause undesired operation.

Any Changes or modifications not expressly approved by the party responsible for compliance could void the user's authority to operate the equipment.

Note: This equipment has been tested and found to comply with the limits for a Class B digital device, pursuant to part 15 of the FCC Rules. These limits are designed to provide reasonable protection against harmful interference in a residential installation. This equipment generates uses and can radiate radio frequency energy and, if not installed and used in accordance with the instructions, may cause harmful interference to radio communications. However, there is no guarantee that interference will not occur in a particular installation. If this equipment does cause harmful interference to radio or television reception, which can be determined by turning the equipment off and on, the user is encouraged to try to correct the interference by one or more of the following measures:

- Reorient or relocate the receiving antenna.
- Increase the separation between the equipment and receiver.
- Connect the equipment into an outlet on a circuit different from that to which the receiver is connected.
- Consult the dealer or an experienced radio/TV technician for help.

The device has been evaluated to meet general RF exposure requirement. The device can be used in portable exposure condition without restriction.