

# FCC TEST REPORT

## FCC ID:2AXK8-SP16

**Report Number.....** : ZHT-240306031E

Date of Test..... : Mar. 06, 2024 to Mar. 15, 2024

Date of issue..... : Mar. 15, 2024

Test Result ..... : PASS

**Testing Laboratory.....** : Guangdong Zhonghan Testing Technology Co., Ltd.

Address ..... : Room 104, Building 1, Yibaolai Industrial Park, Qiaotou Community, Fuhai Street, Bao'an District, Shenzhen, Guangdong, China

**Applicant's name .....** : Dongguan Baolifeng Electronic Technology Co., Ltd

Address ..... : 4 / F, Mingxin Science Park, 138 Qiqiao Road, Qishi Town, Dongguan City

**Manufacturer's name .....** : Dongguan Baolifeng Electronic Technology Co., Ltd

Address ..... : 4 / F, Mingxin Science Park, 138 Qiqiao Road, Qishi Town, Dongguan City

**Test specification.....** :

Standard..... : FCC CFR Title 47 Part 15 Subpart C Section 15.247

Test procedure ..... : KDB558074 D01 15.247 Meas Guidance v05r02  
ANSI C63.10:2013

Non-standard test method ..... : N/A

This device described above has been tested by ZHT, and the test results show that the equipment under test (EUT) is in compliance with the FCC requirements. And it is applicable only to the tested sample identified in the report.

This report shall not be reproduced except in full, without the written approval of ZHT, this document may be altered or revised by ZHT, personal only, and shall be noted in the revision of the document.

**Product name.....** : Bluetooth Headset

Trademark ..... : /

Model/Type reference ..... : SP16,  
AP75

Model difference ..... : SP16 is tested model, other models are derivative models .The models are identical in circuit, only different on the model names and colour. So the test data of SP16 can represent the remaining models, Black and gray, blue, red and rose gold share the model name SP16

Ratings..... : Input: 5 V  1 A



Testing procedure and testing location:

Testing Laboratory .....: Guangdong Zhonghan Testing Technology Co., Ltd.

Address .....: Room 104, Building 1, Yibaolai Industrial Park, Qiaotou Community, Fuhai Street, Bao'an District, Shenzhen, Guangdong, China

Tested by (name + signature) .....: Kevin Yang

Reviewer (name + signature) .....: Baret Wu

Approved (name + signature) .....: Levi Lee





## Table of Contents

	Page
2.1 TEST FACILITY .....	7
2.2 MEASUREMENT UNCERTAINTY .....	7
<b>3. GENERAL INFORMATION .....</b>	<b>8</b>
3.1 GENERAL DESCRIPTION OF EUT .....	8
3.3 Support Equipment .....	10
3.4 Test Mode .....	10
3.5 EQUIPMENTS LIST FOR ALL TEST ITEMS .....	11
<b>4. EMC EMISSION TEST .....</b>	<b>13</b>
4.1 Conducted emissions .....	13
4.1.1 POWER LINE CONDUCTED EMISSION Limits .....	13
4.1.2 TEST PROCEDURE .....	13
4.1.3 DEVIATION FROM TEST STANDARD .....	13
4.1.4 TEST SETUP .....	14
4.1.5 EUT OPERATING CONDITIONS .....	14
4.1.6 TEST RESULTS .....	14
N/A .....	14
EUT charging and Bluetooth functions cannot be used at the same time .....	14
4.2 Radiated emissions .....	15
4.2.1 Radiated Emission Limits .....	15
4.2.2 TEST PROCEDURE .....	15
4.2.3 DEVIATION FROM TEST STANDARD .....	16
4.2.4 TEST SETUP .....	16
4.2.5 EUT OPERATING CONDITIONS .....	17
4.2.6 TEST RESULTS .....	18
5.1 Test Requirement: .....	28
5.2 TEST PROCEDURE .....	28
5.3 DEVIATION FROM TEST STANDARD .....	29
5.4 TEST SETUP .....	29
5.5 EUT OPERATING CONDITIONS .....	29
<b>6. CONDUCTED BAND EDGE AND SPURIOUS EMISSION .....</b>	<b>34</b>
6.1 Limit .....	34
6.2 Test Setup .....	34
6.3 Test procedure .....	34
6.4 DEVIATION FROM STANDARD .....	34
6.5 Test Result .....	34
<b>7. 20DB&amp;99% BANDWIDTH .....</b>	<b>35</b>
7.1 Test Setup .....	35
7.2 Limit .....	35
7.3 Test procedure .....	35
7.4 DEVIATION FROM STANDARD .....	35
7.5 Test Result .....	35
<b>8. MAXIMUM PEAK OUTPUT POWER .....</b>	<b>36</b>
8.1 Block Diagram Of Test Setup .....	36
8.2 Limit .....	36
8.3 Test procedure .....	36
8.4 DEVIATION FROM STANDARD .....	36
8.5 Test Result .....	36
<b>9. HOPPING CHANNEL SEPARATION .....</b>	<b>37</b>
9.1 Test Setup .....	37
9.2 Test procedure .....	37
9.3 DEVIATION FROM STANDARD .....	37
<b>10. NUMBER OF HOPPING FREQUENCY .....</b>	<b>38</b>
10.1 Test Setup .....	38
10.2 Test procedure .....	38
10.3 DEVIATION FROM STANDARD .....	38



10.4 Test Result.....	38
<b>11. DWELL TIME .....</b>	<b>39</b>
11.1 Test Setup.....	39
11.2 Test procedure.....	39
11.3 DEVIATION FROM STANDARD .....	39
11.4 Test Result.....	39
<b>12. ANTENNA REQUIREMENT .....</b>	<b>40</b>
<b>13.APPENDIX BT .....</b>	<b>41</b>
13.1 Dwell Time .....	41
11.2 Maximum Peak Conducted Output Power .....	51
11.3 -20dB Bandwidth.....	62
11.4 Occupied Channel Bandwidth .....	68
11.5 Carrier Frequencies Separation.....	74
11.6 Number of Hopping Channel .....	80
11.7 Band Edge .....	85
11.9 Conducted RF Spurious Emission.....	97
<b>14. TEST SETUP PHOTO .....</b>	<b>107</b>
<b>15. EUT CONSTRUCTIONAL DETAILS .....</b>	<b>107</b>



1. Version

Report No.	Version	Description	Approved
ZHT-240306031E	Rev.01	Initial issue of report	Mar. 15, 2024

## 2. TEST SUMMARY

Test procedures according to the technical standards:

FCC Part15 (15.247) , Subpart C			
Standard Section	Test Item	Result	Remark
FCC part 15.203/15.247 (b)(4)	Antenna Requirement	PASS	
15.207	AC Power Line Conducted Emission	N/A	
15.247 (b)(1)	Conducted Peak Output Power	PASS	
15.247 (a)(1)	20dB Occupied Bandwidth 99% OCB	PASS	
15.247 (a)(1)	Carrier Frequencies Separation	PASS	
15.247 (a)(1)(iii)	Hopping Channel Number	PASS	
15.247 (a)(1)(iii)	Dwell Time	PASS	
15.205/15.209	Radiated Emission and Restricted Band	PASS	
15.247(d)	Conducted Unwanted emissions and Band Edge	PASS	

Note: The RF chips of the left and right earphones are the same, with differences in circuit layout. The RF output power of the left and right earphones is not significantly different, while the RF output power of the right earphone is slightly larger than that of the left earphone. So chose the right earphone for all the tests, while the left earphone was tested for radiation emissions and radiation spurious tests.

**NOTE:**

(1) "N/A" denotes test is not applicable in this Test Report



## 2.1 TEST FACILITY

Guangdong Zhonghan Testing Technology Co., Ltd.  
Add. : Room 104, Building 1, Yibaolai Industrial Park, Qiaotou Community, Fuhai Street, Bao'an District, Shenzhen, Guangdong, China

FCC Registration Number:255941  
Designation Number: CN0325  
IC Registered No.: 29832  
CAB identifier: CN0143

## 2.2 MEASUREMENT UNCERTAINTY

The reported uncertainty of measurement  $y \pm U$ , where expanded uncertainty  $U$  is based on a standard uncertainty multiplied by a coverage factor of  $k=2$ , providing a level of confidence of approximately 95 %.

No.	Item	Uncertainty
1	Conducted Emission Test	$\pm 1.38\text{dB}$
2	RF power conducted	$\pm 0.16\text{dB}$
3	Spurious emissions conducted	$\pm 0.21\text{dB}$
4	All emissions radiated(9k-30MHz)	$\pm 4.68\text{dB}$
5	All emissions radiated(<1G)	$\pm 4.68\text{dB}$
6	All emissions radiated(>1G)	$\pm 4.89\text{dB}$
7	Temperature	$\pm 0.5^{\circ}\text{C}$
8	Humidity	$\pm 2\%$
9	Occupied Bandwidth	$\pm 4.96\%$

### 3. GENERAL INFORMATION

#### 3.1 GENERAL DESCRIPTION OF EUT

Product Name:	Bluetooth Headset
Test Model No.:	SP16
Hardware Version:	V1.2
Software Version:	SDKV125
Sample(s) Status:	Engineer sample
Channel numbers:	79
Channel separation:	Bluetooth: 2402MHz-2480MHz, 79 Channels
Modulation technology:	GFSK, $\pi/4$ DQPSK, 8DPSK
Antenna Type:	Chip Antenna
Antenna gain:	1.7dBi





Operation Frequency each of channel							
Channel	Frequency	Channel	Frequency	Channel	Frequency	Channel	Frequency
1	2402MHz	21	2422MHz	41	2442MHz	61	2462MHz
2	2403MHz	22	2423MHz	42	2443MHz	62	2463MHz
3	2404MHz	23	2424MHz	43	2444MHz	63	2464MHz
4	2405MHz	24	2425MHz	44	2445MHz	64	2465MHz
5	2406MHz	25	2426MHz	45	2446MHz	65	2466MHz
6	2407MHz	26	2427MHz	46	2447MHz	66	2467MHz
7	2408MHz	27	2428MHz	47	2448MHz	67	2468MHz
8	2409MHz	28	2429MHz	48	2449MHz	68	2469MHz
9	2410MHz	29	2430MHz	49	2450MHz	69	2470MHz
10	2411MHz	30	2431MHz	50	2451MHz	70	2471MHz
11	2412MHz	31	2432MHz	51	2452MHz	71	2472MHz
12	2413MHz	32	2433MHz	52	2453MHz	72	2473MHz
13	2414MHz	33	2434MHz	53	2454MHz	73	2474MHz
14	2415MHz	34	2435MHz	54	2455MHz	74	2475MHz
15	2416MHz	35	2436MHz	55	2456MHz	75	2476MHz
16	2417MHz	36	2437MHz	56	2457MHz	76	2477MHz
17	2418MHz	37	2438MHz	57	2458MHz	77	2478MHz
18	2419MHz	38	2439MHz	58	2459MHz	78	2479MHz
19	2420MHz	39	2440MHz	59	2460MHz	79	2480MHz
20	2421MHz	40	2441MHz	60	2461MHz		

## Note:

In section 15.31(m), regards to the operating frequency range over 10 MHz, the Lowest frequency, the middle frequency, and the highest frequency of channel were selected to perform the test, and the selected channel see below:

Test channel	Frequency
The lowest channel	2402MHz
The middle channel	2441MHz
The Highest channel	2480MHz

### 3.2 Test Setup Configuration Radiated Emission

EUT
-----

### 3.3 Support Equipment

The EUT has been tested as an independent unit together with other necessary accessories or support units. The following support units or accessories were used to form a representative test configuration during the tests.

Item	Equipment	Mfr/Brand	Model/Type No.	Series No.	Note

Item	Shielded Type	Ferrite Core	Length	Note

Note:

- (1) The support equipment was authorized by Declaration of Confirmation.
- (2) For detachable type I/O cable should be specified the length in cm in 『Length』 column.

### 3.4 Test Mode

Transmitting mode	Keep the EUT in continuously transmitting mode.
Remark: During the test, the test voltage was tuned from 85% to 115% of the nominal rated supply voltage, and found that the worst case was under the nominal rated supply condition. So the report just shows that condition's data.	

### 3.5 EQUIPMENTS LIST FOR ALL TEST ITEMS

#### Radiation Test equipment

Item	Equipment	Manufacturer	Model	Last Cal.	Next Cal.
1	Receiver	R&S	ESCI	May 12, 2023	May 11, 2024
2	Loop antenna	EMCI	LAP600	May 12, 2023	May 11, 2024
3	Amplifier	Schwarzbeck	BBV 9743 B	May 12, 2023	May 11, 2024
4	Amplifier	Schwarzbeck	BBV 9718 B	May 12, 2023	May 11, 2024
5	Bilog Antenna	Schwarzbeck	VULB9162	May 17, 2023	May 16, 2024
6	Horn Antenna	Schwarzbeck	BBHA9120D	May 17, 2023	May 16, 2024
7	Horn Antenna	A.H.SYSTEMS	SAS574	May 12, 2023	May 11, 2024
8	Amplifier	AEROFLEX	100KHz-40GHz	May 12, 2023	May 11, 2024
9	Spectrum Analyzer	R&S	FSV40	May 12, 2023	May 11, 2024
11	966 Anechoic Chamber	EMToni	9m6m6m	Nov. 25, 2021	Nov. 24, 2024
12	Spectrum Analyzer	KEYSIGHT	N9020A	May 12, 2023	May 11, 2024
13	WIDBAND RADIO COMMUNICATION TESTER	R&S	CMW500	May 12, 2023	May 11, 2024
14	Single Generator	Agilent	N5182A	May 12, 2023	May 11, 2024
15	Power Sensor	MWRftest	MW100-RFCB	May 12, 2023	May 11, 2024
16	Audio analyzer	R&S	UPL	May 12, 2023	May 11, 2024
17	Single Generator	R&S	SMB100A	May 12, 2023	May 11, 2024
18	Power Amplifier Shielding Room	EMToni	2m3m3m	Nov. 25, 2021	Nov. 24, 2024

Conduction Test equipment

Equipment	Manufacturer	Model	Last Cal.	Next Cal.
Receiver	R&S	ESCI	May 12, 2023	May 11, 2024
LISN	R&S	ENV216	May 12, 2023	May 11, 2024
ISN CAT 6	Schwarzbeck	NTFM 8158	May 12, 2023	May 11, 2024
ISN CAT 5	Schwarzbeck	CAT5 8158	May 12, 2023	May 11, 2024
Capacitive Voltage Probe	Schwarzbeck	CVP 9222 C	May 12, 2023	May 11, 2024
Current Transformer Clamp	Schwarzbeck	SW 9605	May 12, 2023	May 11, 2024
CE Shielding Room	EMToni	9m4m3m	Nov. 25, 2021	Nov. 24, 2024

#### 4. EMC EMISSION TEST

##### 4.1 Conducted emissions

Test Requirement:	FCC Part15 C Section 15.207
Test Method:	ANSI C63.10:2013
Test Frequency Range:	150KHz to 30MHz
Receiver setup:	RBW=9KHz, VBW=30KHz, Sweep time=auto

##### 4.1.1 POWER LINE CONDUCTED EMISSION Limits

FREQUENCY (MHz)	Limit (dBuV)		Standard
	Quasi-peak	Average	
0.15 -0.5	66 - 56 *	56 - 46 *	FCC
0.50 -5.0	56.00	46.00	FCC
5.0 -30.0	60.00	50.00	FCC

Note:

- (1) \*Decreases with the logarithm of the frequency.

##### 4.1.2 TEST PROCEDURE

- a. The EUT was placed 0.8 meters from the horizontal ground plane with EUT being connected to the power mains through a line impedance stabilization network (LISN). All other support equipments powered from additional LISN(s). The LISN provide 50 Ohm/ 50uH of coupling impedance for the measuring instrument.
- b. Interconnecting cables that hang closer than 40 cm to the ground plane shall be folded back and forth in the center forming a bundle 30 to 40 cm long.
- c. I/O cables that are not connected to a peripheral shall be bundled in the center. The end of the cable may be terminated, if required, using the correct terminating impedance. The overall length shall not exceed 1 m.
- d. LISN at least 80 cm from nearest part of EUT chassis.
- e. For the actual test configuration, please refer to the related Item –EUT Test Photos.

##### 4.1.3 DEVIATION FROM TEST STANDARD

No deviation

#### 4.1.4 TEST SETUP

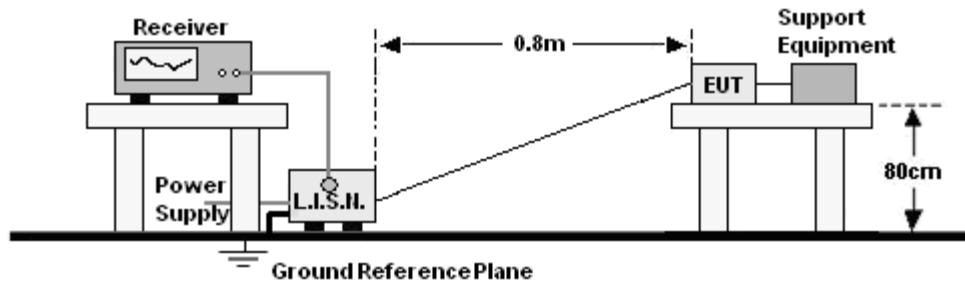

#### 4.1.5 EUT OPERATING CONDITIONS

The EUT was configured for testing in a typical fashion (as a customer would normally use it). The EUT has been programmed to continuously transmit during test. This operating condition was tested and used to collect the included data.

#### 4.1.6 TEST RESULTS

**N/A**

EUT charging and Bluetooth functions cannot be used at the same time



#### 4.2 Radiated emissions

Test Requirement:	FCC Part15 C Section 15.209				
Test Method:	ANSI C63.10:2013				
Test Frequency Range:	9kHz to 25GHz				
Test site:	Measurement Distance: 3m				
Receiver setup:	Frequency	Detector	RBW	VBW	Value
	9KHz-150KHz	Quasi-peak	200Hz	600Hz	Quasi-peak
	150KHz-30MHz	Quasi-peak	9KHz	30KHz	Quasi-peak
	30MHz-1GHz	Quasi-peak	100KHz	300KHz	Quasi-peak
	Above 1GHz	Peak	1MHz	3MHz	Peak
Peak		1MHz	10Hz	Average	

##### 4.2.1 Radiated Emission Limits

Frequencies (MHz)	Field Strength (microvolts/meter)	Measurement Distance (meters)
0.009~0.490	2400/F(KHz)	300
0.490~1.705	24000/F(KHz)	30
1.705~30.0	30	30
30~88	100	3
88~216	150	3
216~960	200	3
Above 960	500	3

##### LIMITS OF RADIATED EMISSION MEASUREMENT

FREQUENCY (MHz)	Limit (dBuV/m) (at 3M)	
	PEAK	AVERAGE
Above 1000	74	54

Notes:

- (1) The limit for radiated test was performed according to FCC PART 15C.
- (2) The tighter limit applies at the band edges.
- (3) Emission level (dBuV/m)=20log Emission level (uV/m).

##### 4.2.2 TEST PROCEDURE

Below 1GHz test procedure as below:

- a. The EUT was placed on the top of a rotating table 0.8 meters above the ground at a 3 meter semi-anechoic chamber. The table was rotated 360 degrees to determine the position of the highest radiation.
- b. The EUT was set 3 meters away from the interference-receiving antenna, which was mounted on the top of a variable-height antenna tower.
- c. The antenna height is varied from one meter to four meters above the ground to determine the maximum value of the field strength. Both horizontal and vertical polarizations of the antenna are set to make the measurement.



- d. For each suspected emission, the EUT was arranged to its worst case and then the antenna was tuned to heights from 1 meter to 4 meters (for the test frequency of below 30MHz, the antenna was tuned to heights 1 meter) and the rotatable table was turned from 0 degrees to 360 degrees to find the maximum reading.
- e. The test-receiver system was set to Peak Detect Function and Specified Bandwidth with Maximum Hold Mode.
- f. If the emission level of the EUT in peak mode was 10dB lower than the limit specified, then testing could be stopped and the peak values of the EUT would be reported. Otherwise the emissions that did not have 10dB margin would be re-tested one by one using peak, quasi-peak or average method as specified and then reported in a data sheet.

Above 1GHz test procedure as below:

- g. Different between above is the test site, change from Semi- Anechoic Chamber to fully Anechoic Chamber and change form table 0.8 metre to 1.5 metre( Above 18GHz the distance is 1 meter and table is 1.5 metre).
- h. Test the EUT in the lowest channel ,the middle channel ,the Highest channel

Note:

Both horizontal and vertical antenna polarities were tested and performed pretest to three orthogonal axis. The worst case emissions were reported

#### 4.2.3 DEVIATION FROM TEST STANDARD

No deviation

#### 4.2.4 TEST SETUP

(A) Radiated Emission Test-Up Frequency Below 30MHz

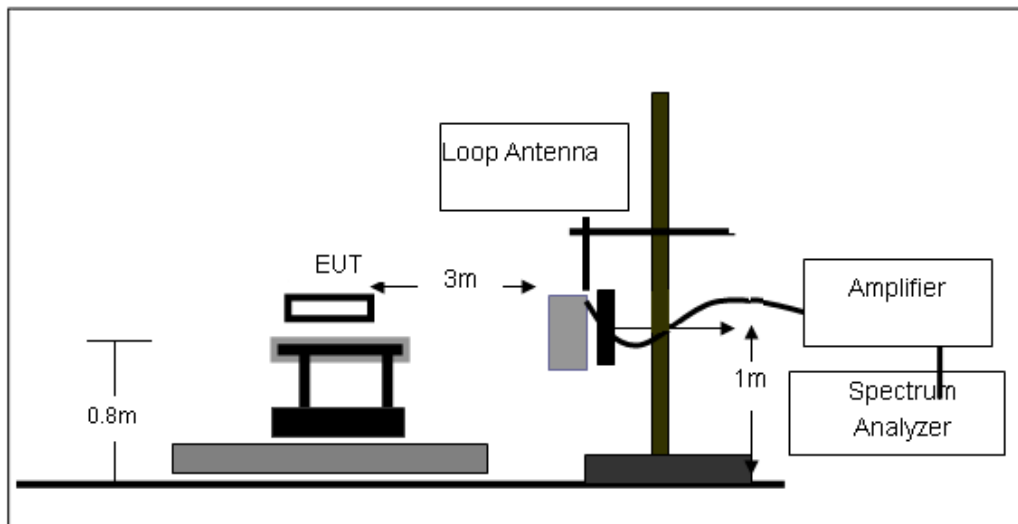

(B) Radiated Emission Test-Up Frequency 30MHz~1GHz

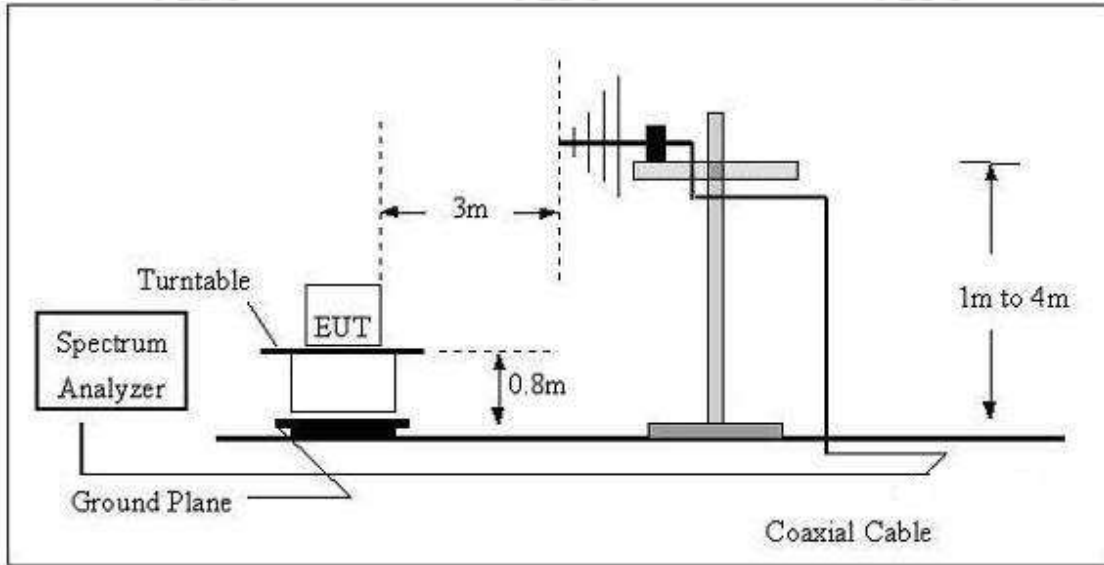

(C) Radiated Emission Test-Up Frequency Above 1GHz

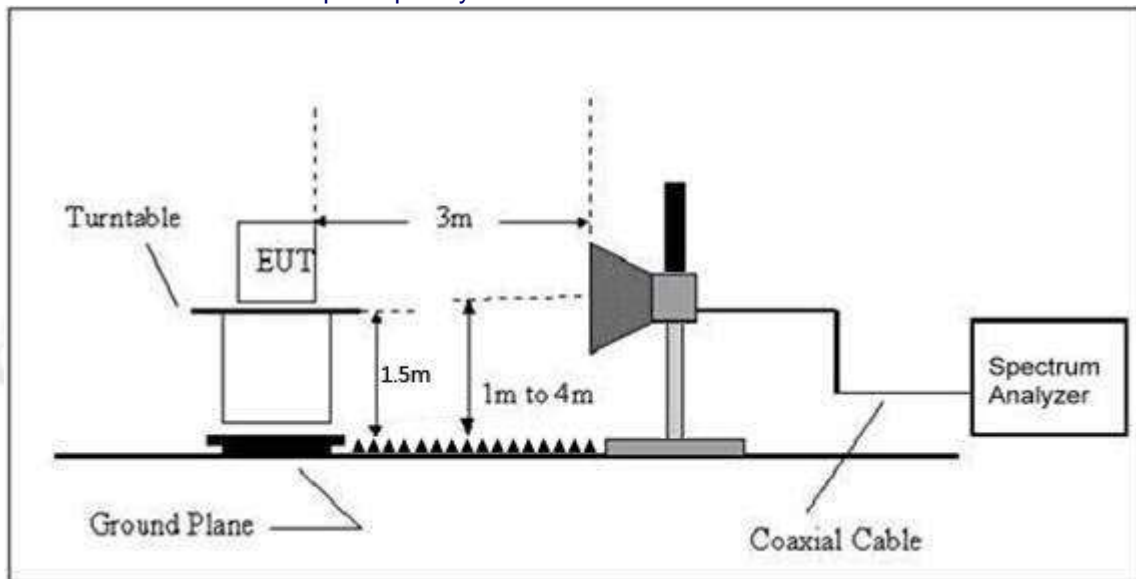

#### 4.2.5 EUT OPERATING CONDITIONS

The EUT tested system was configured as the statements of 2.4 Unless otherwise a special operating condition is specified in the follows during the testing.

#### 4.2.6 TEST RESULTS

Between 9KHz – 30MHz

The emission from 9 kHz to 30MHz was pre-tested and found the result was 20dB lower than the limit, and according to 15.31(o), the test result no need to reported.

#### Between 30MHz – 1GHz (Right earphone)

Temperature:	21.6°C	Relative Humidity:	54.1%
Pressure:	101 kPa	Polarization:	Horizontal
Test Voltage:	DC 3.7 V		

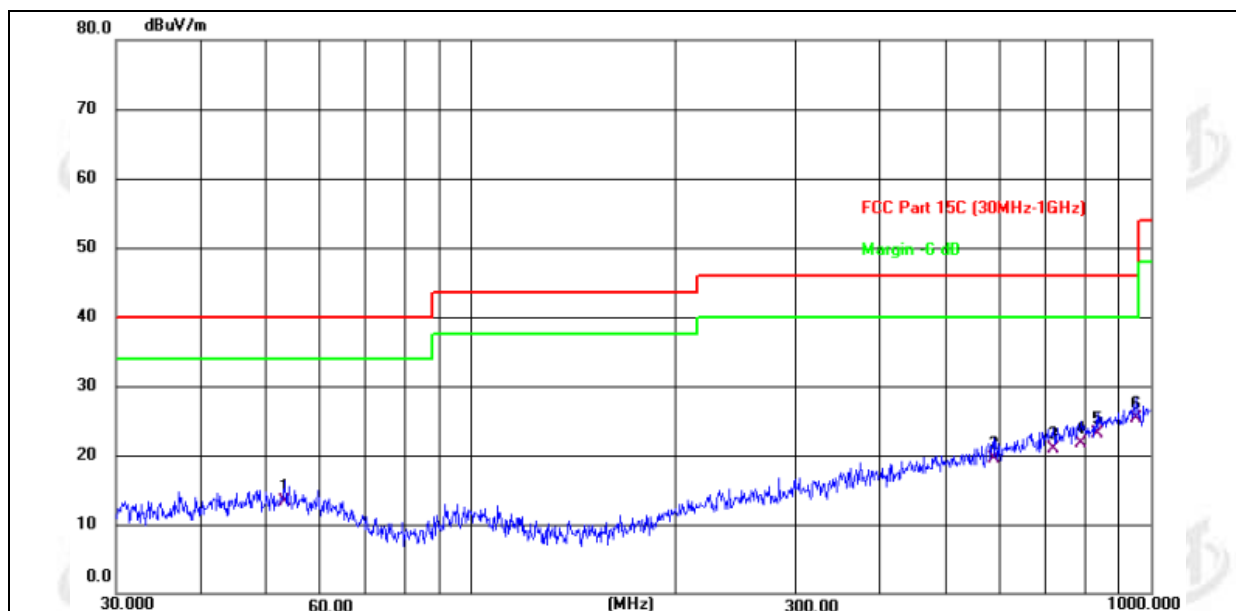

No.	Frequency (MHz)	Reading (dBuV)	Factor (dB/m)	Level (dBuV/m)	Limit (dBuV/m)	Margin (dB)	Detector
1	53.1313	22.47	-9.08	13.39	40.00	-26.61	QP
2	586.8436	22.06	-2.50	19.56	46.00	-26.44	QP
3	719.1995	21.39	-0.39	21.00	46.00	-25.00	QP
4	790.6187	21.24	0.56	21.80	46.00	-24.20	QP
5	833.3171	21.95	1.18	23.13	46.00	-22.87	QP
6 *	952.0937	22.69	2.66	25.35	46.00	-20.65	QP



Temperature:	21.6°C	Relative Humidity:	54.1%
Pressure:	101 kPa	Polarization:	Vertical
Test Voltage:	DC 3.7 V		

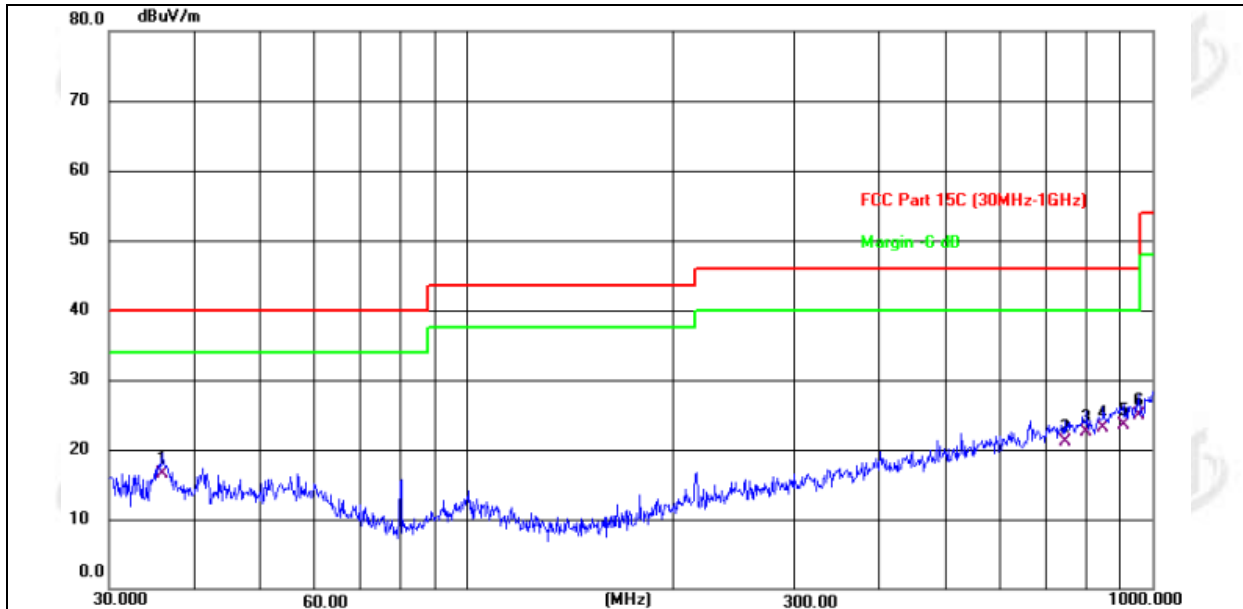

No.	Frequency (MHz)	Reading (dBuV)	Factor (dB/m)	Level (dBuV/m)	Limit (dBuV/m)	Margin (dB)	Detector
1	35.8746	26.93	-10.42	16.51	40.00	-23.49	QP
2	744.8661	21.17	-0.06	21.11	46.00	-24.89	QP
3	801.7863	21.72	0.69	22.41	46.00	-23.59	QP
4	848.0563	21.65	1.40	23.05	46.00	-22.95	QP
5	906.4824	21.26	2.26	23.52	46.00	-22.48	QP
6 *	955.4381	22.23	2.70	24.93	46.00	-21.07	QP



Between 30MHz – 1GHz (Left earpiece)

Temperature:	21.6°C	Relative Humidity:	54.1%
Pressure:	101 kPa	Polarization:	Horizontal
Test Voltage:	DC 3.7 V		

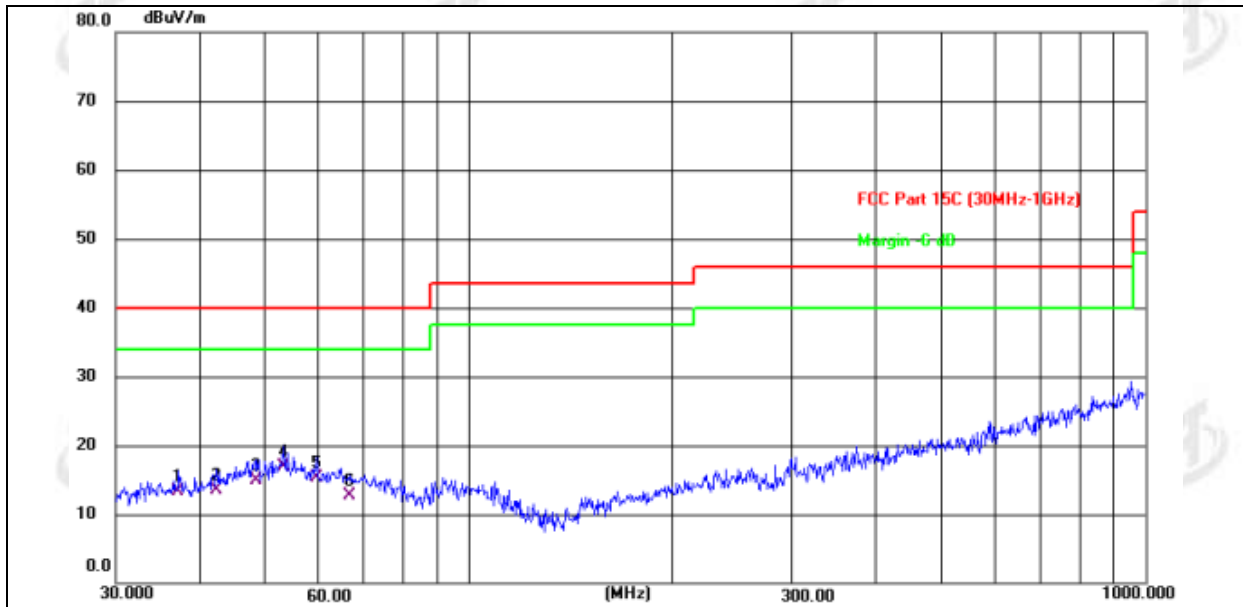

No.	Frequency (MHz)	Reading (dBuV)	Factor (dB/m)	Level (dBuV/m)	Limit (dBuV/m)	Margin (dB)	Detector
1	37.1550	23.42	-10.18	13.24	40.00	-26.76	QP
2	42.3021	22.89	-9.47	13.42	40.00	-26.58	QP
3	48.3316	23.82	-8.90	14.92	40.00	-25.08	QP
4 *	53.1313	25.97	-9.08	16.89	40.00	-23.11	QP
5	59.4405	25.08	-9.78	15.30	40.00	-24.70	QP
6	66.4990	24.59	-11.91	12.68	40.00	-27.32	QP





Temperature:	21.6°C	Relative Humidity:	54.1%
Pressure:	101 kPa	Polarization:	Vertical
Test Voltage:	DC 3.7 V		

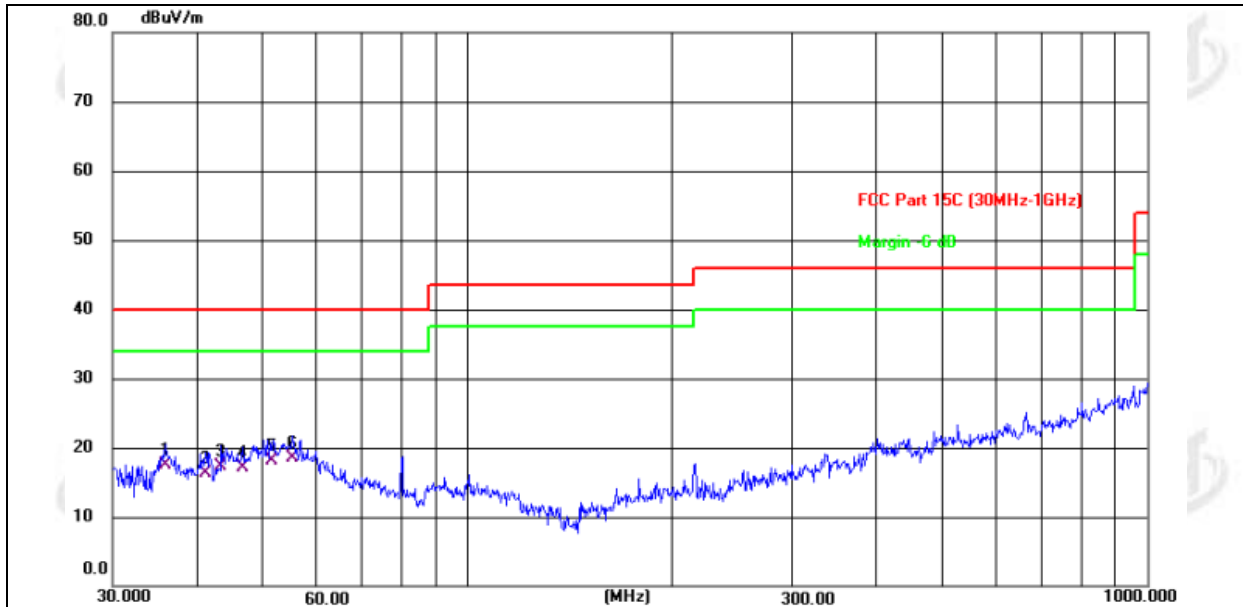

No.	Frequency (MHz)	Reading (dBuV)	Factor (dB/m)	Level (dBuV/m)	Limit (dBuV/m)	Margin (dB)	Detector
1	35.8746	27.93	-10.42	17.51	40.00	-22.49	QP
2	41.1320	25.92	-9.59	16.33	40.00	-23.67	QP
3	43.3534	26.65	-9.37	17.28	40.00	-22.72	QP
4	46.6662	26.24	-9.05	17.19	40.00	-22.81	QP
5	51.6613	27.07	-8.91	18.16	40.00	-21.84	QP
6 *	55.2207	27.91	-9.31	18.60	40.00	-21.40	QP



1GHz~25GHz (Right earphone)

GFSK

Polar (H/V)	Frequency	Meter Reading	Pre-amplifier	Cable Loss	Antenna Factor	Emission Level	Limits	Margin	Detector Type
	(MHz)	(dBuV)	(dB)	(dB)	(dB)	(dBuV/m)	(dBuV/m)	(dB)	
Low Channel:2402MHz									
V	4804	59.47	30.55	5.77	24.66	59.35	74	-14.65	Pk
V	4804	43.31	30.55	5.77	24.66	43.19	54	-10.81	AV
V	7206	57.36	30.33	6.32	24.55	57.9	74	-16.1	Pk
V	7206	41.41	30.33	6.32	24.55	41.95	54	-12.05	AV
H	4804	59.25	30.55	5.77	24.66	59.13	74	-14.87	Pk
H	4804	44.68	30.55	5.77	24.66	44.56	54	-9.44	AV
H	7206	57.55	30.33	6.32	24.55	58.09	74	-15.91	Pk
H	7206	42.15	30.33	6.32	24.55	42.69	54	-11.31	AV
Middle Channel:2441MHz									
V	4882	58.09	30.55	5.77	24.66	57.97	74	-16.03	Pk
V	4882	41.95	30.55	5.77	24.66	41.83	54	-12.17	AV
V	7323	56.33	30.33	6.32	24.55	56.87	74	-17.13	Pk
V	7323	43.88	30.33	6.32	24.55	44.42	54	-9.58	AV
H	4882	55.21	30.55	5.77	24.66	55.09	74	-18.91	Pk
H	4882	41.97	30.55	5.77	24.66	41.85	54	-12.15	AV
H	7323	58.78	30.33	6.32	24.55	59.32	74	-14.68	Pk
H	7323	41.49	30.33	6.32	24.55	42.03	54	-11.97	AV
High Channel:2480MHz									
V	4960	55.16	30.55	5.77	24.66	55.04	74	-18.96	Pk
V	4960	41.93	30.55	5.77	24.66	41.81	54	-12.19	AV
V	7440	58.13	30.33	6.32	24.55	58.67	74	-15.33	Pk
V	7440	41.85	30.33	6.32	24.55	42.39	54	-11.61	AV
H	4960	58.33	30.55	5.77	24.66	58.21	74	-15.79	Pk
H	4960	44.97	30.55	5.77	24.66	44.85	54	-9.15	AV
H	7440	59.31	30.33	6.32	24.55	59.85	74	-14.15	Pk
H	7440	42.73	30.33	6.32	24.55	43.27	54	-10.73	AV





$\pi/4$ DQPSK

Polar (H/V)	Frequency	Meter Reading	Pre-amplifier	Cable Loss	Antenna Factor	Emission Level	Limits	Margin	Detector Type
	(MHz)	(dBuV)	(dB)	(dB)	(dB)	(dBuV/m)	(dBuV/m)	(dB)	
Low Channel:2402MHz									
V	4804	57.03	30.55	5.77	24.66	56.91	74	-17.09	Pk
V	4804	44.36	30.55	5.77	24.66	44.24	54	-9.76	AV
V	7206	55.92	30.33	6.32	24.55	56.46	74	-17.54	Pk
V	7206	41.38	30.33	6.32	24.55	41.92	54	-12.08	AV
H	4804	59.05	30.55	5.77	24.66	58.93	74	-15.07	Pk
H	4804	43.16	30.55	5.77	24.66	43.04	54	-10.96	AV
H	7206	58.96	30.33	6.32	24.55	59.5	74	-14.5	Pk
H	7206	44.71	30.33	6.32	24.55	45.25	54	-8.75	AV
Middle Channel:2441MHz									
V	4882	56.57	30.55	5.77	24.66	56.45	74	-17.55	Pk
V	4882	41.98	30.55	5.77	24.66	41.86	54	-12.14	AV
V	7323	55.27	30.33	6.32	24.55	55.81	74	-18.19	Pk
V	7323	41.73	30.33	6.32	24.55	42.27	54	-11.73	AV
H	4882	59.9	30.55	5.77	24.66	59.78	74	-14.22	Pk
H	4882	41.41	30.55	5.77	24.66	41.29	54	-12.71	AV
H	7323	56.77	30.33	6.32	24.55	57.31	74	-16.69	Pk
H	7323	41.02	30.33	6.32	24.55	41.56	54	-12.44	AV
High Channel:2480MHz									
V	4960	58.68	30.55	5.77	24.66	58.56	74	-15.44	Pk
V	4960	41.55	30.55	5.77	24.66	41.43	54	-12.57	AV
V	7440	55.44	30.33	6.32	24.55	55.98	74	-18.02	Pk
V	7440	44.06	30.33	6.32	24.55	44.6	54	-9.4	AV
H	4960	58.59	30.55	5.77	24.66	58.47	74	-15.53	Pk
H	4960	42	30.55	5.77	24.66	41.88	54	-12.12	AV
H	7440	56.76	30.33	6.32	24.55	57.3	74	-16.7	Pk
H	7440	44.96	30.33	6.32	24.55	45.5	54	-8.5	AV



8DPSK

Polar (H/V)	Frequency	Meter Reading	Pre-amplifier	Cable Loss	Antenna Factor	Emission Level	Limits	Margin	Detector Type
	(MHz)	(dBuV)	(dB)	(dB)	(dB)	(dBuV/m)	(dBuV/m)	(dB)	
Low Channel:2402MHz									
V	4804	58.51	30.55	5.77	24.66	58.39	74	-15.61	Pk
V	4804	44.26	30.55	5.77	24.66	44.14	54	-9.86	AV
V	7206	59.42	30.33	6.32	24.55	59.96	74	-14.04	Pk
V	7206	44.47	30.33	6.32	24.55	45.01	54	-8.99	AV
H	4804	57.99	30.55	5.77	24.66	57.87	74	-16.13	Pk
H	4804	42.53	30.55	5.77	24.66	42.41	54	-11.59	AV
H	7206	59.58	30.33	6.32	24.55	60.12	74	-13.88	Pk
H	7206	42.73	30.33	6.32	24.55	43.27	54	-10.73	AV
Middle Channel:2441MHz									
V	4882	58.14	30.55	5.77	24.66	58.02	74	-15.98	Pk
V	4882	41.07	30.55	5.77	24.66	40.95	54	-13.05	AV
V	7323	56.71	30.33	6.32	24.55	57.25	74	-16.75	Pk
V	7323	44.04	30.33	6.32	24.55	44.58	54	-9.42	AV
H	4882	57.02	30.55	5.77	24.66	56.9	74	-17.1	Pk
H	4882	41.01	30.55	5.77	24.66	40.89	54	-13.11	AV
H	7323	55.14	30.33	6.32	24.55	55.68	74	-18.32	Pk
H	7323	41.28	30.33	6.32	24.55	41.82	54	-12.18	AV
High Channel:2480MHz									
V	4960	57	30.55	5.77	24.66	56.88	74	-17.12	Pk
V	4960	41.6	30.55	5.77	24.66	41.48	54	-12.52	AV
V	7440	57.88	30.33	6.32	24.55	58.42	74	-15.58	Pk
V	7440	42.99	30.33	6.32	24.55	43.53	54	-10.47	AV
H	4960	57.57	30.55	5.77	24.66	57.45	74	-16.55	Pk
H	4960	41.55	30.55	5.77	24.66	41.43	54	-12.57	AV
H	7440	59.01	30.33	6.32	24.55	59.55	74	-14.45	Pk
H	7440	44.57	30.33	6.32	24.55	45.11	54	-8.89	AV



1GHz~25GHz (Left earpiece)

GFSK

Polar (H/V)	Frequency	Meter Reading	Pre-ampli fier	Cable Loss	Antenna Factor	Emission Level	Limits	Margin	Detector Type
	(MHz)	(dBuV)	(dB)	(dB)	(dB)	(dBuV/m)	(dBuV/m)	(dB)	
Low Channel:2402MHz									
V	4804	57.17	30.55	5.77	24.66	57.05	74	-16.95	Pk
V	4804	41.1	30.55	5.77	24.66	40.98	54	-13.02	AV
V	7206	59.15	30.33	6.32	24.55	59.69	74	-14.31	Pk
V	7206	42.65	30.33	6.32	24.55	43.19	54	-10.81	AV
H	4804	58.67	30.55	5.77	24.66	58.55	74	-15.45	Pk
H	4804	43.64	30.55	5.77	24.66	43.52	54	-10.48	AV
H	7206	59.95	30.33	6.32	24.55	60.49	74	-13.51	Pk
H	7206	41.14	30.33	6.32	24.55	41.68	54	-12.32	AV
Middle Channel:2441MHz									
V	4882	58.89	30.55	5.77	24.66	58.77	74	-15.23	Pk
V	4882	41.35	30.55	5.77	24.66	41.23	54	-12.77	AV
V	7323	57.06	30.33	6.32	24.55	57.6	74	-16.4	Pk
V	7323	44.39	30.33	6.32	24.55	44.93	54	-9.07	AV
H	4882	55.21	30.55	5.77	24.66	55.09	74	-18.91	Pk
H	4882	41.86	30.55	5.77	24.66	41.74	54	-12.26	AV
H	7323	58.51	30.33	6.32	24.55	59.05	74	-14.95	Pk
H	7323	41.13	30.33	6.32	24.55	41.67	54	-12.33	AV
High Channel:2480MHz									
V	4960	57.62	30.55	5.77	24.66	57.5	74	-16.5	Pk
V	4960	41.29	30.55	5.77	24.66	41.17	54	-12.83	AV
V	7440	55.01	30.33	6.32	24.55	55.55	74	-18.45	Pk
V	7440	41.27	30.33	6.32	24.55	41.81	54	-12.19	AV
H	4960	55.2	30.55	5.77	24.66	55.08	74	-18.92	Pk
H	4960	43.22	30.55	5.77	24.66	43.1	54	-10.9	AV
H	7440	59.49	30.33	6.32	24.55	60.03	74	-13.97	Pk
H	7440	44.6	30.33	6.32	24.55	45.14	54	-8.86	AV



π/4DQPSK

Polar (H/V)	Frequency	Meter Reading	Pre-amplifier	Cable Loss	Antenna Factor	Emission Level	Limits	Margin	Detector Type
	(MHz)	(dBuV)	(dB)	(dB)	(dB)	(dBuV/m)	(dBuV/m)	(dB)	
Low Channel:2402MHz									
V	4804	59.59	30.55	5.77	24.66	59.47	74	-14.53	Pk
V	4804	43.22	30.55	5.77	24.66	43.1	54	-10.9	AV
V	7206	56.92	30.33	6.32	24.55	57.46	74	-16.54	Pk
V	7206	44.24	30.33	6.32	24.55	44.78	54	-9.22	AV
H	4804	55.62	30.55	5.77	24.66	55.5	74	-18.5	Pk
H	4804	43.66	30.55	5.77	24.66	43.54	54	-10.46	AV
H	7206	58.22	30.33	6.32	24.55	58.76	74	-15.24	Pk
H	7206	43.01	30.33	6.32	24.55	43.55	54	-10.45	AV
Middle Channel:2441MHz									
V	4882	55.32	30.55	5.77	24.66	55.2	74	-18.8	Pk
V	4882	41.6	30.55	5.77	24.66	41.48	54	-12.52	AV
V	7323	55.46	30.33	6.32	24.55	56	74	-18	Pk
V	7323	42.78	30.33	6.32	24.55	43.32	54	-10.68	AV
H	4882	59.02	30.55	5.77	24.66	58.9	74	-15.1	Pk
H	4882	41.48	30.55	5.77	24.66	41.36	54	-12.64	AV
H	7323	55.32	30.33	6.32	24.55	55.86	74	-18.14	Pk
H	7323	41.99	30.33	6.32	24.55	42.53	54	-11.47	AV
High Channel:2480MHz									
V	4960	59.35	30.55	5.77	24.66	59.23	74	-14.77	Pk
V	4960	41.53	30.55	5.77	24.66	41.41	54	-12.59	AV
V	7440	56.46	30.33	6.32	24.55	57	74	-17	Pk
V	7440	42.7	30.33	6.32	24.55	43.24	54	-10.76	AV
H	4960	57.47	30.55	5.77	24.66	57.35	74	-16.65	Pk
H	4960	44.27	30.55	5.77	24.66	44.15	54	-9.85	AV
H	7440	58.69	30.33	6.32	24.55	59.23	74	-14.77	Pk
H	7440	41.39	30.33	6.32	24.55	41.93	54	-12.07	AV



## 8DPSK

Polar (H/V)	Frequency	Meter Reading	Pre-ampli fier	Cable Loss	Antenna Factor	Emission Level	Limits	Margin	Detector Type
	(MHz)	(dBuV)	(dB)	(dB)	(dB)	(dBuV/m)	(dBuV/m)	(dB)	
Low Channel:2402MHz									
V	4804	55.71	30.55	5.77	24.66	55.59	74	-18.41	Pk
V	4804	43.8	30.55	5.77	24.66	43.68	54	-10.32	AV
V	7206	56.14	30.33	6.32	24.55	56.68	74	-17.32	Pk
V	7206	42.77	30.33	6.32	24.55	43.31	54	-10.69	AV
H	4804	56.93	30.55	5.77	24.66	56.81	74	-17.19	Pk
H	4804	44.64	30.55	5.77	24.66	44.52	54	-9.48	AV
H	7206	56.95	30.33	6.32	24.55	57.49	74	-16.51	Pk
H	7206	43.43	30.33	6.32	24.55	43.97	54	-10.03	AV
Middle Channel:2441MHz									
V	4882	58.08	30.55	5.77	24.66	57.96	74	-16.04	Pk
V	4882	41.32	30.55	5.77	24.66	41.2	54	-12.8	AV
V	7323	58.29	30.33	6.32	24.55	58.83	74	-15.17	Pk
V	7323	44.06	30.33	6.32	24.55	44.6	54	-9.4	AV
H	4882	58.85	30.55	5.77	24.66	58.73	74	-15.27	Pk
H	4882	41.2	30.55	5.77	24.66	41.08	54	-12.92	AV
H	7323	56.08	30.33	6.32	24.55	56.62	74	-17.38	Pk
H	7323	41.71	30.33	6.32	24.55	42.25	54	-11.75	AV
High Channel:2480MHz									
V	4960	59.97	30.55	5.77	24.66	59.85	74	-14.15	Pk
V	4960	41.2	30.55	5.77	24.66	41.08	54	-12.92	AV
V	7440	57.56	30.33	6.32	24.55	58.1	74	-15.9	Pk
V	7440	42.21	30.33	6.32	24.55	42.75	54	-11.25	AV
H	4960	59.64	30.55	5.77	24.66	59.52	74	-14.48	Pk
H	4960	43.4	30.55	5.77	24.66	43.28	54	-10.72	AV
H	7440	56	30.33	6.32	24.55	56.54	74	-17.46	Pk
H	7440	43.74	30.33	6.32	24.55	44.28	54	-9.72	AV

## Remark:

1. Emission Level = Meter Reading + Antenna Factor + Cable Loss – Pre-amplifier,  
Margin= Emission Level - Limit
2. If peak below the average limit, the average emission was no test.
3. The amplitude of spurious emissions which are attenuated by more than 20dB below the permissible value has no need to be reported.



## 5. RADIATED BAND EMISSION MEASUREMENT

### 5.1 Test Requirement:

Test Requirement:	FCC Part15 C Section 15.209 and 15.205				
Test Method:	ANSI C63.10: 2013				
Test Frequency Range:	All of the restrict bands were tested, only the worst band's (2310MHz to 2500MHz) data was showed.				
Test site:	Measurement Distance: 3m				
Receiver setup:	Frequency	Detector	RBW	VBW	Value
	Above 1GHz	Peak	1MHz	3MHz	Peak
		Average	1MHz	3MHz	Average

### LIMITS OF RADIATED EMISSION MEASUREMENT (Above 1000MHz)

FREQUENCY (MHz)	Limit (dBuV/m) (at 3M)	
	PEAK	AVERAGE
Above 1000	74	54

Notes:

- (1) The limit for radiated test was performed according to FCC PART 15C.
- (2) The tighter limit applies at the band edges.
- (3) Emission level (dBuV/m)=20log Emission level (uV/m).

Spectrum Parameter	Setting
Attenuation	Auto
Start Frequency	2300MHz
Stop Frequency	2520
RB / VB (emission in restricted band)	1 MHz / 1 MHz for Peak, 1 MHz / 10Hz for Average

### 5.2 TEST PROCEDURE

Above 1GHz test procedure as below:

- a. 1. The EUT was placed on the top of a rotating table 1.5 meters above the ground at a 3 meter camber. The table was rotated 360 degrees to determine the position of the highest radiation.
- b. The EUT was set 3 meters away from the interference-receiving antenna, which was mounted on the top of a variable-height antenna tower.
- c. The antenna height is varied from one meter to four meters above the ground to determine the maximum value of the field strength. Both horizontal and vertical polarizations of the antenna are set to make the measurement.
- d. For each suspected emission, the EUT was arranged to its worst case and then the antenna was tuned to heights from 1 meter to 4 meters and the rota table was turned from 0 degrees to 360 degrees to find the maximum reading.
- e. The test-receiver system was set to Peak Detect Function and Specified Bandwidth with Maximum Hold Mode.
- f. If the emission level of the EUT in peak mode was 10dB lower than the limit specified, then testing could be stopped and the peak values of the EUT would be reported. Otherwise the emissions that did not have 10dB margin would be re-tested one by one using peak, quasi-peak or average method as specified and then reported in a data sheet.
- g. Test the EUT in the lowest channel,the Highest channel

Note:

Both horizontal and vertical antenna polarities were tested and performed pretest to three orthogonal axis. The worst case emissions were reported

5.3 DEVIATION FROM TEST STANDARD

No deviation

5.4 TEST SETUP

Radiated Emission Test-Up Frequency Above 1GHz

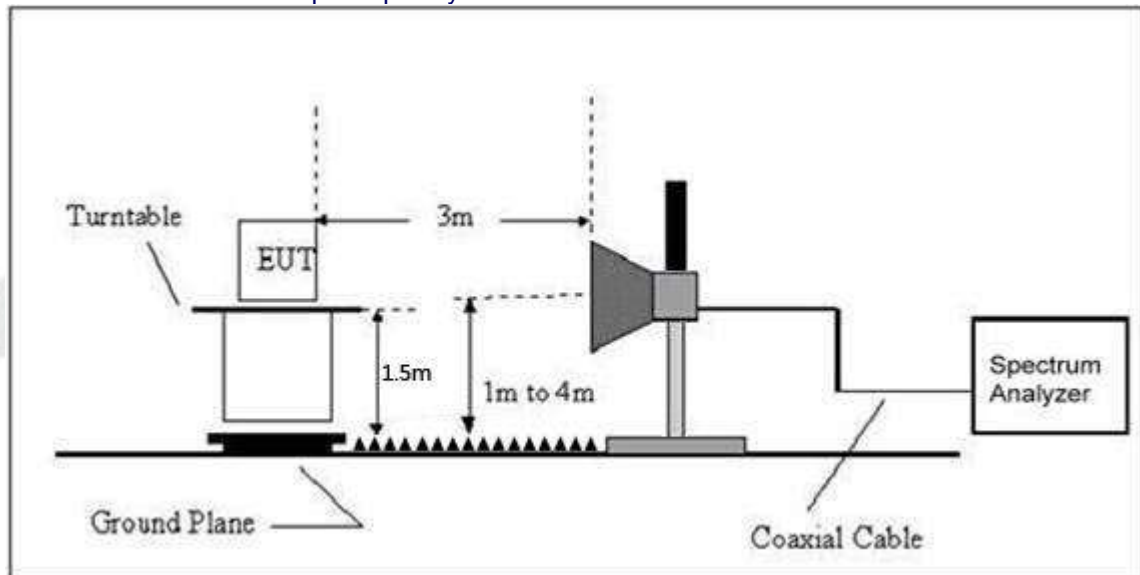

5.5 EUT OPERATING CONDITIONS

The EUT tested system was configured as the statements of 2.3 Unless otherwise a special operating condition is specified in the follows during the testing.





5.6 TEST RESULT

(Right earphone)											
	Polar (H/V)	Frequency (MHz)	Meter Reading (dBuV)	Pre-amplifier (dB)	Cable Loss (dB)	Antenna Factor (dB/m)	Emission level (dBuV/m)	Limit (dBuV/m)	Margin (dB)	Detector Type	Result
GFSK	Low Channel: 2402MHz										
	H	2390.00	60.59	30.22	4.85	23.98	59.20	74.00	-14.80	Pk	PASS
	H	2390.00	46.78	30.22	4.85	23.98	45.39	54.00	-8.61	AV	PASS
	H	2400.00	59.50	30.22	4.85	23.98	58.11	74.00	-15.89	Pk	PASS
	H	2400.00	47.43	30.22	4.85	23.98	46.04	54.00	-7.96	AV	PASS
	V	2390.00	62.85	30.22	4.85	23.98	61.46	74.00	-12.54	Pk	PASS
	V	2390.00	46.81	30.22	4.85	23.98	45.42	54.00	-8.58	AV	PASS
	V	2400.00	61.53	30.22	4.85	23.98	60.14	74.00	-13.86	Pk	PASS
	V	2400.00	47.27	30.22	4.85	23.98	45.88	54.00	-8.12	AV	PASS
	High Channel: 2480MHz										
	H	2483.50	62.39	30.22	4.85	23.98	61.00	74.00	-13.00	PK	PASS
	H	2483.50	46.82	30.22	4.85	23.98	45.43	54.00	-8.57	AV	PASS
	H	2500.00	61.59	30.22	4.85	23.98	60.20	74.00	-13.80	PK	PASS
	H	2500.00	47.16	30.22	4.85	23.98	45.77	54.00	-8.23	AV	PASS
	V	2483.50	62.02	30.22	4.85	23.98	60.63	74.00	-13.37	PK	PASS
	V	2483.50	48.51	30.22	4.85	23.98	47.12	54.00	-6.88	AV	PASS
V	2500.00	61.13	30.22	4.85	23.98	59.74	74.00	-14.26	PK	PASS	
V	2500.00	46.82	30.22	4.85	23.98	45.43	54.00	-8.57	AV	PASS	
π/4DQPSK	Low Channel: 2402MHz										
	H	2390.00	62.24	30.22	4.85	23.98	60.85	74.00	-13.15	PK	PASS
	H	2390.00	48.30	30.22	4.85	23.98	46.91	54.00	-7.09	AV	PASS
	H	2400.00	62.73	30.22	4.85	23.98	61.34	74.00	-12.66	PK	PASS
	H	2400.00	48.17	30.22	4.85	23.98	46.78	54.00	-7.22	AV	PASS
	V	2390.00	61.04	30.22	4.85	23.98	59.65	74.00	-14.35	PK	PASS
	V	2390.00	47.14	30.22	4.85	23.98	45.75	54.00	-8.25	AV	PASS
	V	2400.00	60.59	30.22	4.85	23.98	59.20	74.00	-14.80	PK	PASS
	V	2400.00	46.26	30.22	4.85	23.98	44.87	54.00	-9.13	AV	PASS
	High Channel: 2480MHz										
	H	2483.50	62.26	30.22	4.85	23.98	60.87	74.00	-13.13	PK	PASS
	H	2483.50	46.07	30.22	4.85	23.98	44.68	54.00	-9.32	AV	PASS
	H	2500.00	62.01	30.22	4.85	23.98	60.62	74.00	-13.38	PK	PASS
	H	2500.00	48.49	30.22	4.85	23.98	47.10	54.00	-6.90	AV	PASS
	V	2483.50	61.22	30.22	4.85	23.98	59.83	74.00	-14.17	PK	PASS
	V	2483.50	47.26	30.22	4.85	23.98	45.87	54.00	-8.13	AV	PASS
V	2500.00	59.20	30.22	4.85	23.98	57.81	74.00	-16.19	PK	PASS	
V	2500.00	48.03	30.22	4.85	23.98	46.64	54.00	-7.36	AV	PASS	
8DPSK	Low Channel: 2402MHz										
	H	2390.00	61.65	30.22	4.85	23.98	60.26	74.00	-13.74	PK	PASS
	H	2390.00	48.01	30.22	4.85	23.98	46.62	54.00	-7.38	AV	PASS
	H	2400.00	61.66	30.22	4.85	23.98	60.27	74.00	-13.73	PK	PASS
	H	2400.00	48.44	30.22	4.85	23.98	47.05	54.00	-6.95	AV	PASS
	V	2390.00	61.29	30.22	4.85	23.98	59.90	74.00	-14.10	PK	PASS
	V	2390.00	47.41	30.22	4.85	23.98	46.02	54.00	-7.98	AV	PASS
	V	2400.00	59.30	30.22	4.85	23.98	57.91	74.00	-16.09	PK	PASS
	V	2400.00	48.03	30.22	4.85	23.98	46.64	54.00	-7.36	AV	PASS
	High Channel: 2480MHz										
	H	2483.50	62.91	30.22	4.85	23.98	61.52	74.00	-12.48	PK	PASS
	H	2483.50	48.79	30.22	4.85	23.98	47.40	54.00	-6.60	AV	PASS
H	2500.00	59.49	30.22	4.85	23.98	58.10	74.00	-15.90	PK	PASS	



H	2500.00	47.07	30.22	4.85	23.98	45.68	54.00	-8.32	AV	PASS
V	2483.50	62.38	30.22	4.85	23.98	60.99	74.00	-13.01	PK	PASS
V	2483.50	47.20	30.22	4.85	23.98	45.81	54.00	-8.19	AV	PASS
V	2500.00	60.34	30.22	4.85	23.98	58.95	74.00	-15.05	PK	PASS
V	2500.00	46.03	30.22	4.85	23.98	44.64	54.00	-9.36	AV	PASS



(Left earpiece)											
	Polar (H/V)	Frequency (MHz)	Meter Reading (dBuV)	Pre-amplifier (dB)	Cable Loss (dB)	Antenna Factor (dB/m)	Emission level (dBuV/m)	Limit (dBuV/m)	Margin (dB)	Detector Type	Result
GFSK	Low Channel: 2402MHz										
	H	2390.00	60.08	30.22	4.85	23.98	58.69	74.00	-15.31	Pk	PASS
	H	2390.00	46.91	30.22	4.85	23.98	45.52	54.00	-8.48	AV	PASS
	H	2400.00	59.78	30.22	4.85	23.98	58.39	74.00	-15.61	Pk	PASS
	H	2400.00	46.46	30.22	4.85	23.98	45.07	54.00	-8.93	AV	PASS
	V	2390.00	61.46	30.22	4.85	23.98	60.07	74.00	-13.93	Pk	PASS
	V	2390.00	47.71	30.22	4.85	23.98	46.32	54.00	-7.68	AV	PASS
	V	2400.00	59.76	30.22	4.85	23.98	58.37	74.00	-15.63	Pk	PASS
	V	2400.00	46.51	30.22	4.85	23.98	45.12	54.00	-8.88	AV	PASS
	High Channel: 2480MHz										
	H	2483.50	60.32	30.22	4.85	23.98	58.93	74.00	-15.07	PK	PASS
	H	2483.50	46.00	30.22	4.85	23.98	44.61	54.00	-9.39	AV	PASS
	H	2500.00	60.73	30.22	4.85	23.98	59.34	74.00	-14.66	PK	PASS
	H	2500.00	47.68	30.22	4.85	23.98	46.29	54.00	-7.71	AV	PASS
	V	2483.50	61.28	30.22	4.85	23.98	59.89	74.00	-14.11	PK	PASS
	V	2483.50	46.52	30.22	4.85	23.98	45.13	54.00	-8.87	AV	PASS
	V	2500.00	59.86	30.22	4.85	23.98	58.47	74.00	-15.53	PK	PASS
	V	2500.00	47.70	30.22	4.85	23.98	46.31	54.00	-7.69	AV	PASS
π/4DQPSK	Low Channel: 2402MHz										
	H	2390.00	59.15	30.22	4.85	23.98	57.76	74.00	-16.24	PK	PASS
	H	2390.00	46.19	30.22	4.85	23.98	44.80	54.00	-9.20	AV	PASS
	H	2400.00	62.77	30.22	4.85	23.98	61.38	74.00	-12.62	PK	PASS
	H	2400.00	48.44	30.22	4.85	23.98	47.05	54.00	-6.95	AV	PASS
	V	2390.00	59.20	30.22	4.85	23.98	57.81	74.00	-16.19	PK	PASS
	V	2390.00	48.64	30.22	4.85	23.98	47.25	54.00	-6.75	AV	PASS
	V	2400.00	59.61	30.22	4.85	23.98	58.22	74.00	-15.78	PK	PASS
	V	2400.00	48.94	30.22	4.85	23.98	47.55	54.00	-6.45	AV	PASS
	High Channel: 2480MHz										
	H	2483.50	60.81	30.22	4.85	23.98	59.42	74.00	-14.58	PK	PASS
	H	2483.50	46.50	30.22	4.85	23.98	45.11	54.00	-8.89	AV	PASS
	H	2500.00	60.33	30.22	4.85	23.98	58.94	74.00	-15.06	PK	PASS
	H	2500.00	48.01	30.22	4.85	23.98	46.62	54.00	-7.38	AV	PASS
	V	2483.50	61.37	30.22	4.85	23.98	59.98	74.00	-14.02	PK	PASS
	V	2483.50	46.74	30.22	4.85	23.98	45.35	54.00	-8.65	AV	PASS
	V	2500.00	62.13	30.22	4.85	23.98	60.74	74.00	-13.26	PK	PASS
	V	2500.00	48.87	30.22	4.85	23.98	47.48	54.00	-6.52	AV	PASS
8DPSK	Low Channel: 2402MHz										
	H	2390.00	62.12	30.22	4.85	23.98	60.73	74.00	-13.27	PK	PASS
	H	2390.00	48.65	30.22	4.85	23.98	47.26	54.00	-6.74	AV	PASS
	H	2400.00	61.86	30.22	4.85	23.98	60.47	74.00	-13.53	PK	PASS
	H	2400.00	46.95	30.22	4.85	23.98	45.56	54.00	-8.44	AV	PASS
	V	2390.00	62.35	30.22	4.85	23.98	60.96	74.00	-13.04	PK	PASS
	V	2390.00	47.14	30.22	4.85	23.98	45.75	54.00	-8.25	AV	PASS
	V	2400.00	59.56	30.22	4.85	23.98	58.17	74.00	-15.83	PK	PASS
	V	2400.00	47.47	30.22	4.85	23.98	46.08	54.00	-7.92	AV	PASS
	High Channel: 2480MHz										
	H	2483.50	62.30	30.22	4.85	23.98	60.91	74.00	-13.09	PK	PASS
	H	2483.50	47.90	30.22	4.85	23.98	46.51	54.00	-7.49	AV	PASS
	H	2500.00	60.51	30.22	4.85	23.98	59.12	74.00	-14.88	PK	PASS
	H	2500.00	47.48	30.22	4.85	23.98	46.09	54.00	-7.91	AV	PASS
	V	2483.50	62.15	30.22	4.85	23.98	60.76	74.00	-13.24	PK	PASS



V	2483.50	48.49	30.22	4.85	23.98	47.10	54.00	-6.90	AV	PASS
V	2500.00	59.30	30.22	4.85	23.98	57.91	74.00	-16.09	PK	PASS
V	2500.00	46.02	30.22	4.85	23.98	44.63	54.00	-9.37	AV	PASS

**6. CONDUCTED BAND EDGE AND SPURIOUS EMISSION**

Test Requirement:	FCC Part15 C Section 15.247 (d)
Test Method:	KDB558074 D0115.247 Meas Guidancev05r02

**6.1 Limit**

Regulation 15.247 (d),In any 100 kHz bandwidth outside the frequency band in which the spread spectrum or digitally modulated intentional radiator is operating, the radio frequency power that is produced by the intentional radiator shall be at least 20 dB below that in the 100 kHz bandwidth within the band that contains the highest level of the desired power, based on either an RF conducted or a radiated measurement, provided the transmitter demonstrates compliance with the peak conducted power limits. If the transmitter complies with the conducted power limits based on the use of RMS averaging over a time interval, as permitted under paragraph (b)(3) of this section, the attenuation required under this paragraph shall be 30 dB instead of 20 dB. Attenuation below the general limits specified in §15.209(a) is not required. In addition, radiated emissions which fall in the restricted bands, as defined in §15.205(a), must also comply with the radiated emission limits specified in §15.209(a) (see §15.205(c)).

**6.2 Test Setup**

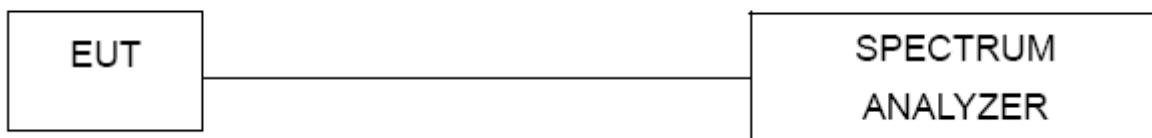

**6.3 Test procedure**

Using the following spectrum analyzer setting:

- A) Set the RBW = 100KHz.
- B) Set the VBW = 300KHz.
- C) Sweep time = auto couple.
- D) Detector function = peak.
- E) Trace mode = max hold.
- F) Allow trace to fully stabilize.

**6.4 DEVIATION FROM STANDARD**

No deviation.

**6.5 Test Result**

Please refer to the Appendix BT



**7. 20DB&99% BANDWIDTH**

Test Requirement:	FCC Part15 C Section 15.247 (a)(1)
Test Method:	ANSI C63.10:2013

7.1 Test Setup

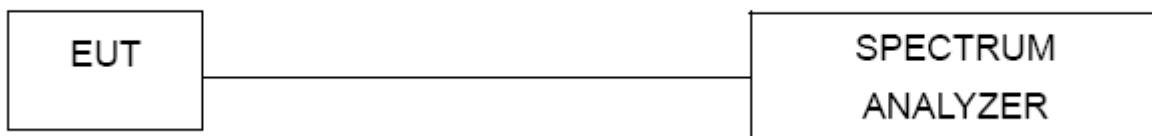

7.2 Limit

N/A

7.3 Test procedure

1. Set RBW = 30 kHz.
2. Set the video bandwidth (VBW)  $\geq 3 \times$  RBW.
3. Detector = Peak.
4. Trace mode = max hold.
5. Sweep = auto couple.
6. Allow the trace to stabilize.
7. Measure the maximum width of the emission that is constrained by the frequencies associated with the two outermost amplitude points (upper and lower frequencies) that are attenuated by 6 dB relative to the maximum level measured in the fundamental emission.

7.4 DEVIATION FROM STANDARD

No deviation.

7.5 Test Result

Please refer to the Appendix BT

### 8. Maximum Peak Output Power

Test Requirement:	FCC Part15 C Section 15.247 (b)(1)
Test Method:	ANSI C63.10:2013

#### 8.1 Block Diagram Of Test Setup



#### 8.2 Limit

For frequency hopping systems operating in the 2400-2483.5 MHz band employing at least 75 non-overlapping hopping channels, and all frequency hopping systems in the 5725-5850 MHz band: 1 watt.  
For all other frequency hopping systems in the 2400-2483.5 MHz band: 0.125 watts.

For FHSS operating in the band 2400-2483.5 MHz, the maximum peak conducted output power shall not exceed 1.0 W if the hopset uses 75 or more hopping channels; the maximum peak conducted output power shall not exceed 0.125 W if the hopset uses less than 75 hopping channels. The e.i.r.p. shall not exceed 4 W.

#### 8.3 Test procedure

The EUT was directly connected to the SPECTRUMANALYZER

#### 8.4 DEVIATION FROM STANDARD

No deviation.

#### 8.5 Test Result

Please refer to the Appendix BT



## 9. HOPPING CHANNEL SEPARATION

Test Requirement:	FCC Part15 C Section 15.247 (a)(1)
Test Method:	ANSI C63.10:2013
Receiver setup:	RBW=30KHz, VBW=100KHz, detector=Peak
Limit:	0.025MHz or 2/3 of the 20dB bandwidth (whichever is greater)

### 9.1 Test Setup

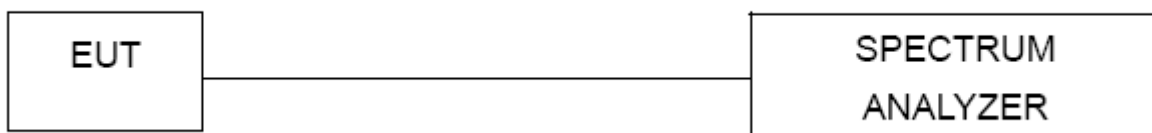

### 9.2 Test procedure

1. Remove the antenna from the EUT and then connect a low RF cable from the antenna port to the spectrum.
2. Set the spectrum analyzer: RBW = 30kHz. VBW = 100kHz , Span = 2.0MHz. Sweep = auto; Detector Function = Peak. Trace = Max hold.
3. Allow the trace to stabilize. Use the marker-delta function to determine the separation between the peaks of the adjacent channels. The limit is specified in one of the subparagraphs of this Section Submit this plot.

### 9.3 DEVIATION FROM STANDARD

No deviation.

### 9.4 Test Result

Please refer to the Appendix BT

### 10. NUMBER OF HOPPING FREQUENCY

Test Requirement:	FCC Part15 C Section 15.247 (a)(1)(iii)
Test Method:	ANSI C63.10:2013
Receiver setup:	RBW=100kHz, VBW=300kHz, Frequency range=2400MHz-2483.5MHz, Detector=Peak
Limit:	15 channels

#### 10.1 Test Setup



#### 10.2 Test procedure

1. Remove the antenna from the EUT and then connect a low RF cable from the antenna port to the spectrum.
2. Set the spectrum analyzer: RBW = 100kHz. VBW = 300kHz. Sweep = auto; Detector Function = Peak. Trace = Max hold.
3. Allow the trace to stabilize. It may prove necessary to break the span up to sections. in order to clearly show all of the hopping frequencies. The limit is specified in one of the subparagraphs of this Section.
4. Set the spectrum analyzer: Start Frequency = 2.4GHz, Stop Frequency = 2.4835GHz. Sweep=auto;

#### 10.3 DEVIATION FROM STANDARD

No deviation.

#### 10.4 Test Result

Please refer to the Appendix BT

## 11. DWELL TIME

Test Requirement:	FCC Part15 C Section 15.247 (a)(1)(iii)
Test Method:	ANSI C63.10:2013
Receiver setup:	RBW=1MHz, VBW=3MHz, Span=0Hz, Detector=Peak
Limit:	0.4 Second

### 11.1 Test Setup

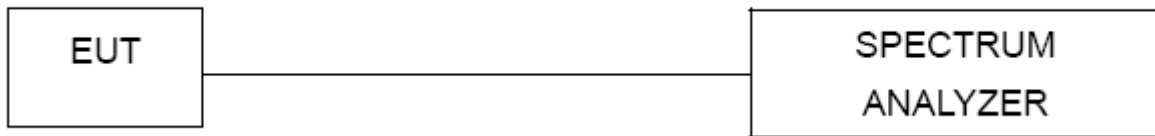

### 11.2 Test procedure

1. Remove the antenna from the EUT and then connect a low RF cable from the antenna port to the spectrum.
2. Set spectrum analyzer span = 0Hz;
3. Set RBW = 1MHz and VBW = 3MHz. Sweep = as necessary to capture the entire dwell time per hopping channel. Set the EUT for DH5, DH3 and DH1 packet transmitting.
4. Use the marker-delta function to determine the dwell time. If this value varies with different modes of operation (e.g.. data rate. modulation format. etc.). repeat this test for each variation. The limit is specified in one of the subparagraphs of this Section. Submit this plot(s).

### 11.3 DEVIATION FROM STANDARD

No deviation.

### 11.4 Test Result

Please refer to the Appendix BT



**12. ANTENNA REQUIREMENT**

Standard requirement:	FCC Part15 C Section 15.203 /247(b)(4)
<p>15.203 requirement: An intentional radiator shall be designed to ensure that no antenna other than that furnished by the responsible party shall be used with the device. The use of a permanently attached antenna or of an antenna that uses a unique coupling to the intentional radiator, the manufacturer may design the unit so that a broken antenna can be replaced by the user, but the use of a standard antenna jack or electrical connector is prohibited.</p> <p>15.247(b) (4) requirement: (4) The conducted output power limit specified in paragraph (b) of this section is based on the use of antennas with directional gains that do not exceed 6 dBi. Except as shown in paragraph (c) of this section, if transmitting antennas of directional gain greater than 6 dBi are used, the conducted output power from the intentional radiator shall be reduced below the stated values in paragraphs (b)(1), (b)(2), and (b)(3) of this section, as appropriate, by the amount in dB that the directional gain of the antenna exceeds 6 dBi.</p>	
EUT Antenna:	
The antenna is Chip Antenna, the best case gain of the antenna is 1.7dBi, reference to the appendix II for details	



13.APPENDIX BT

13.1 Dwell Time

Mode	Frequency (MHz)	Pulse Time (ms)	Total Dwell Time (ms)	Burst Count	Period Time (ms)	Limit (ms)	Verdict
1-DH1	2441	0.382	121.858	319	31600	400	Pass
1-DH3	2441	1.639	270.435	165	31600	400	Pass
1-DH5	2441	2.887	280.039	97	31600	400	Pass
2-DH1	2441	0.391	124.729	319	31600	400	Pass
2-DH3	2441	1.642	269.288	164	31600	400	Pass
2-DH5	2441	2.891	300.664	104	31600	400	Pass
3-DH1	2441	0.39	124.41	319	31600	400	Pass
3-DH3	2441	1.643	249.736	152	31600	400	Pass
3-DH5	2441	2.892	274.74	95	31600	400	Pass

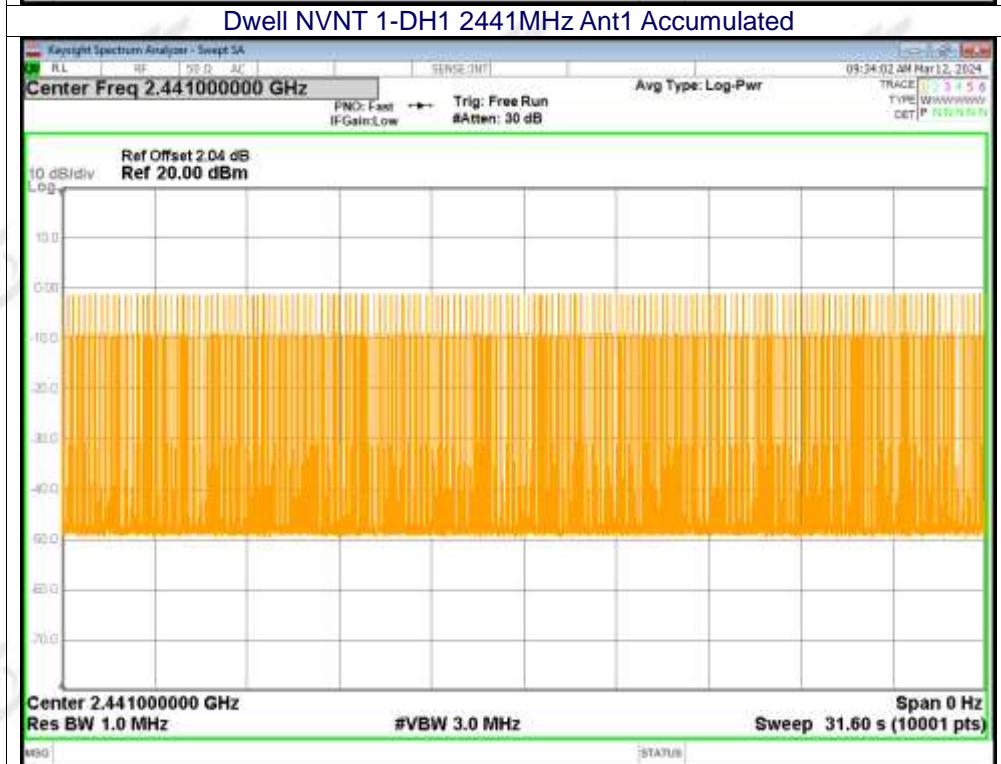
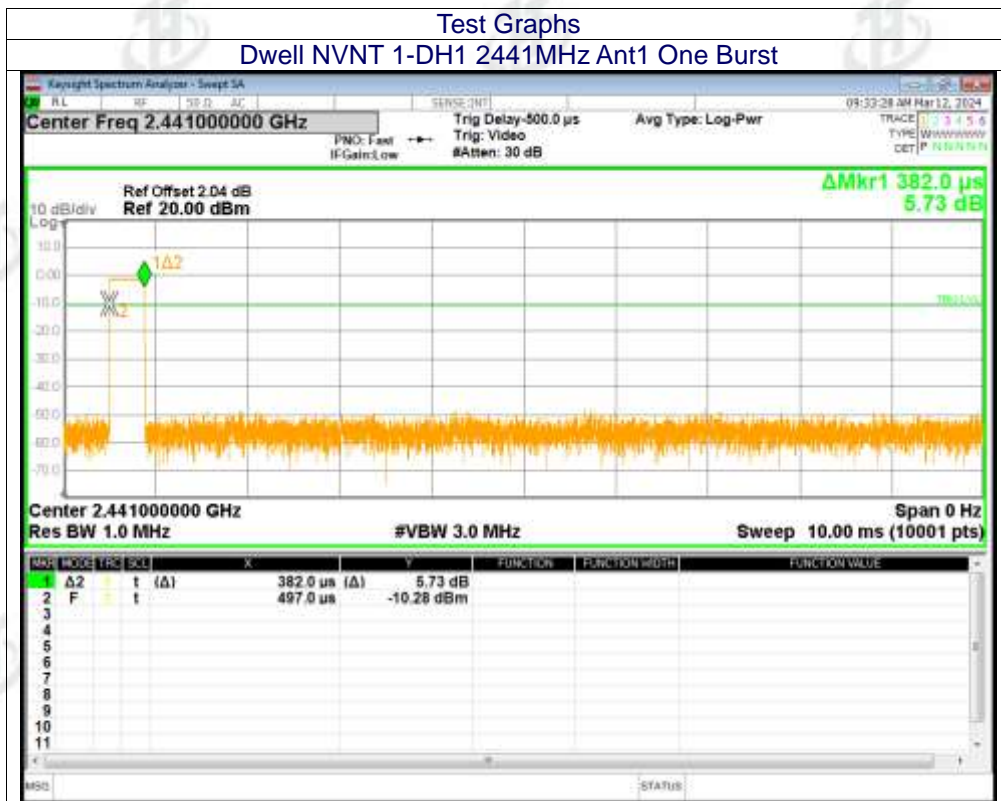



Dwell NVNT 1-DH3 2441MHz Ant1 One Burst

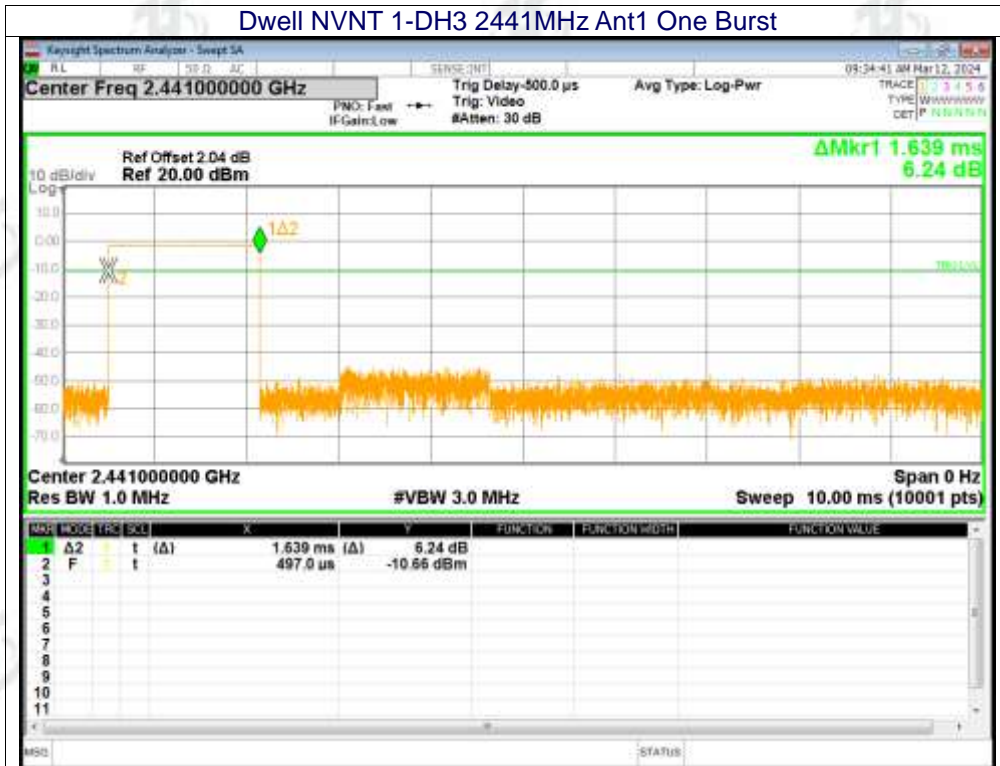

Dwell NVNT 1-DH3 2441MHz Ant1 Accumulated

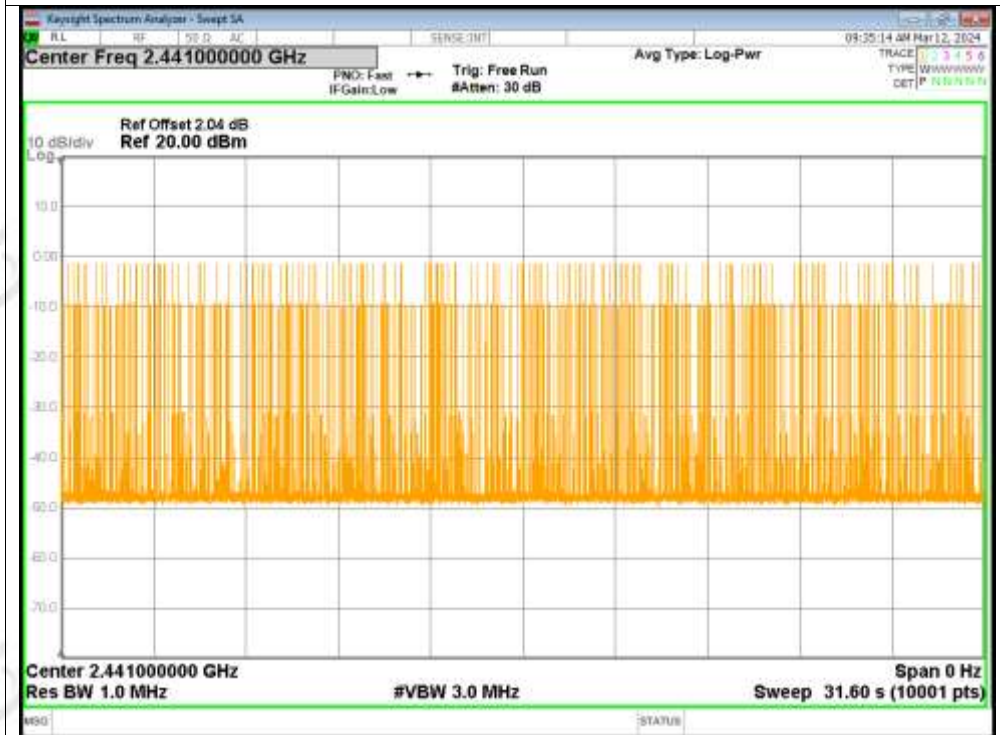

Dwell NVNT 1-DH5 2441MHz Ant1 One Burst

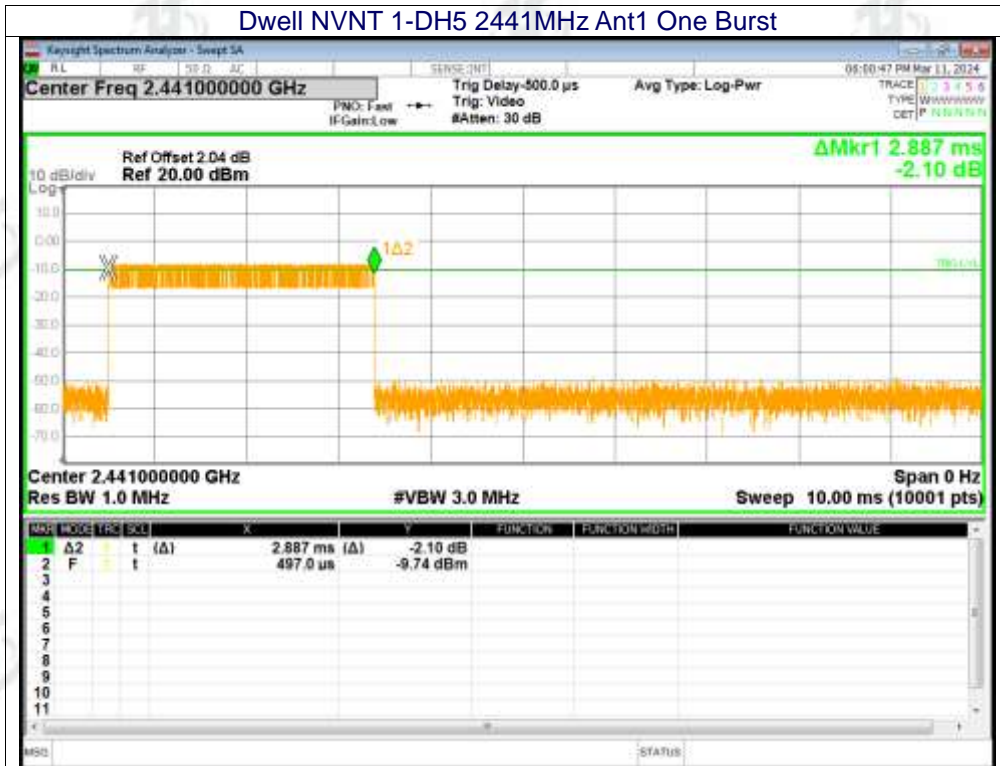

Dwell NVNT 1-DH5 2441MHz Ant1 Accumulated

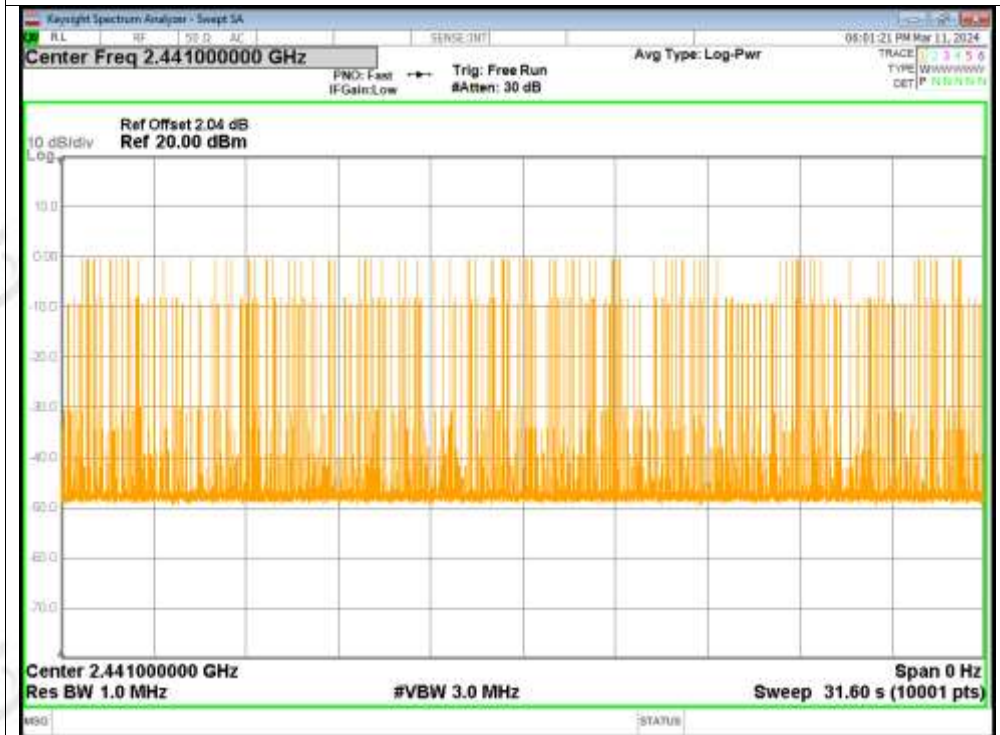

Dwell NVNT 2-DH1 2441MHz Ant1 One Burst

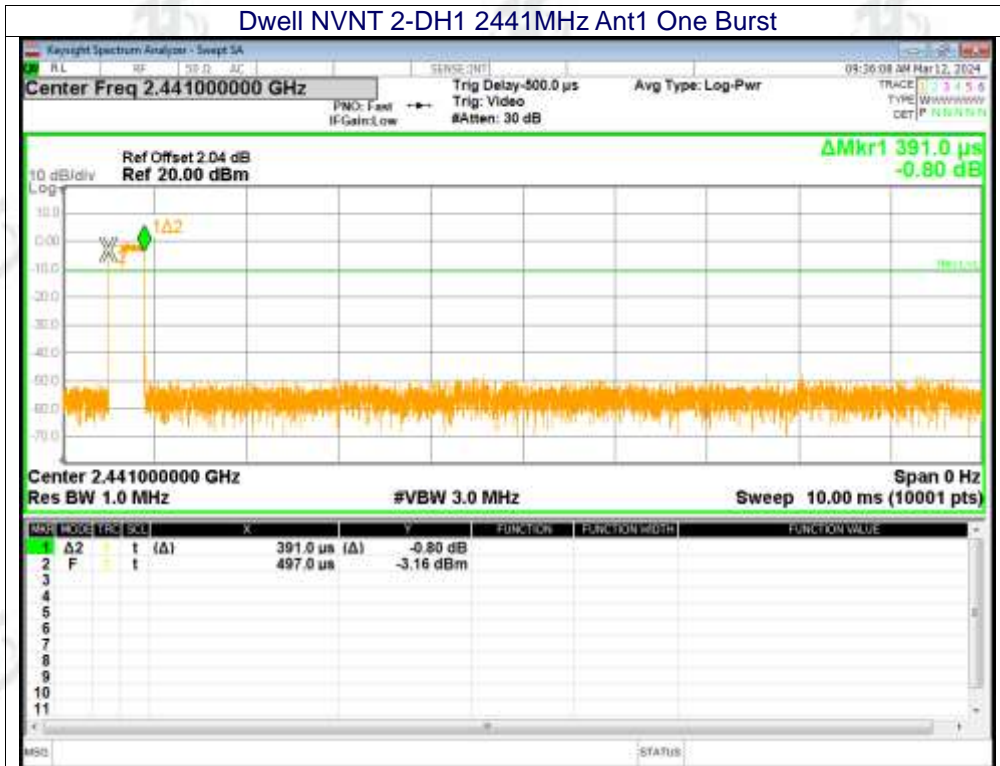

Dwell NVNT 2-DH1 2441MHz Ant1 Accumulated





Dwell NVNT 2-DH3 2441MHz Ant1 One Burst

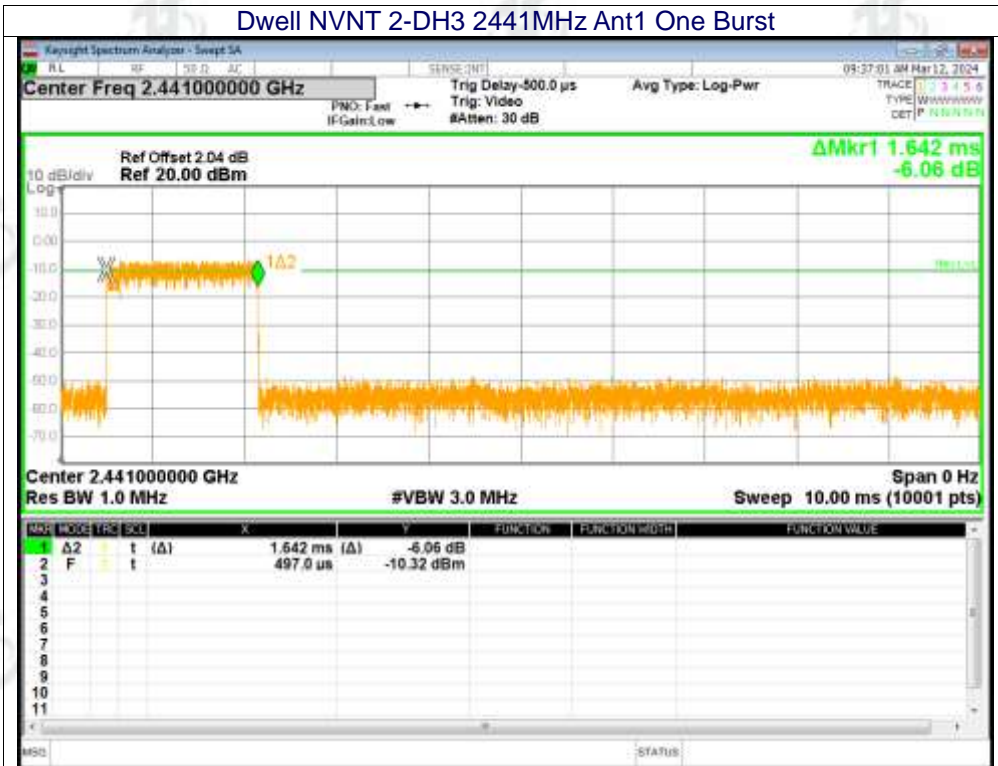

Dwell NVNT 2-DH3 2441MHz Ant1 Accumulated



Dwell NVNT 2-DH5 2441MHz Ant1 One Burst

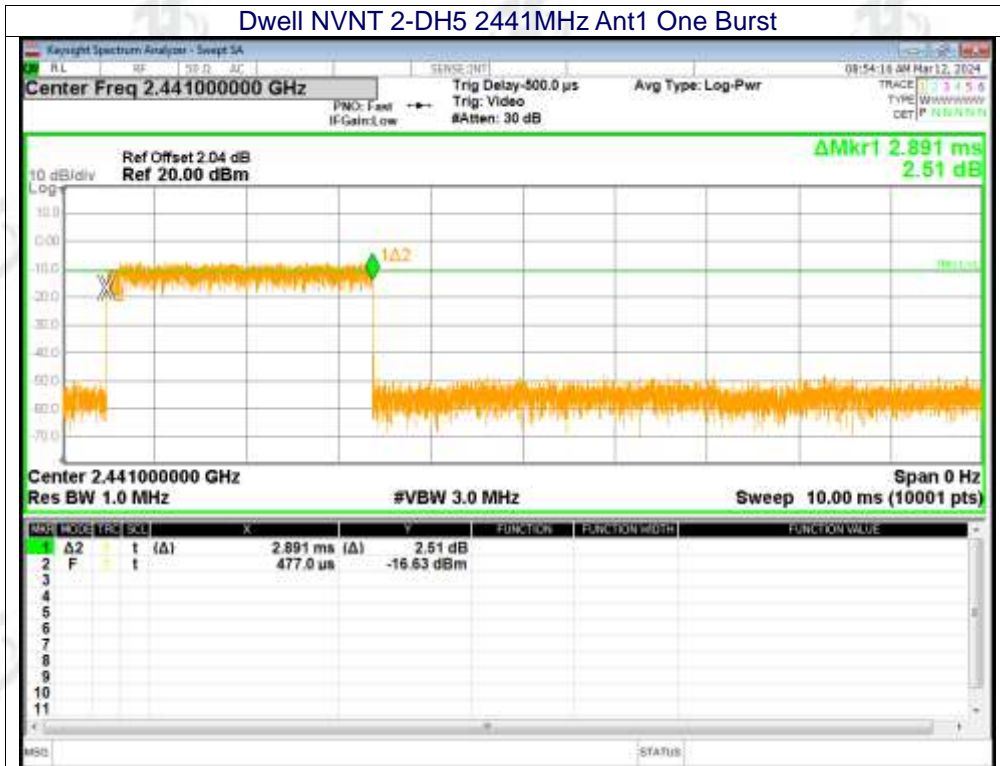

Dwell NVNT 2-DH5 2441MHz Ant1 Accumulated

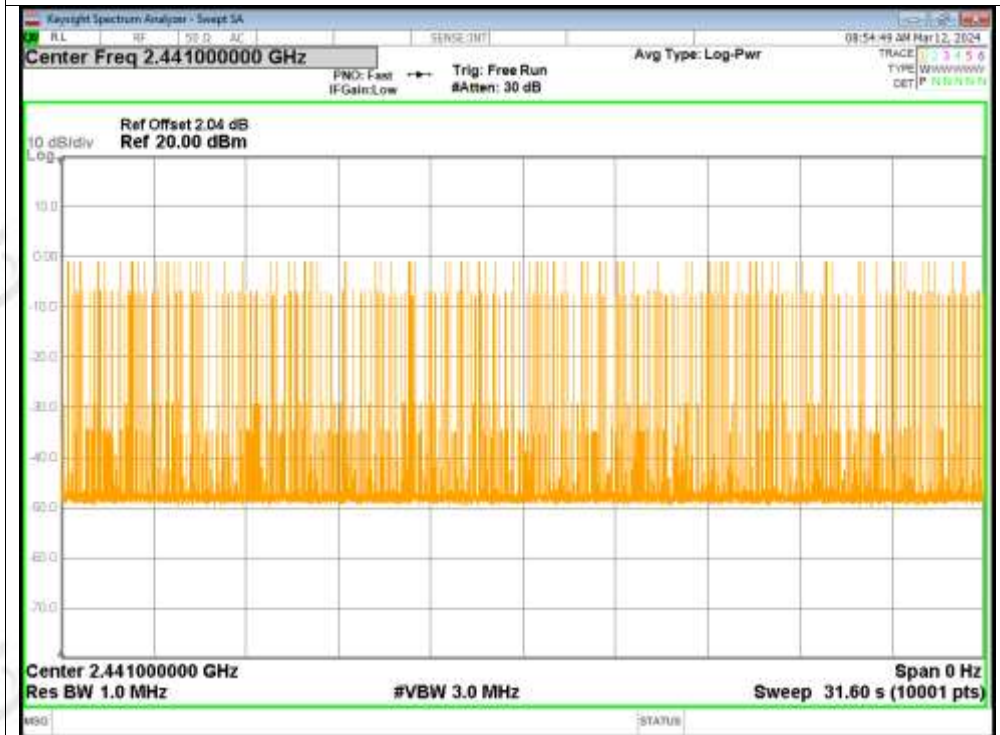

Dwell NVNT 3-DH1 2441MHz Ant1 One Burst

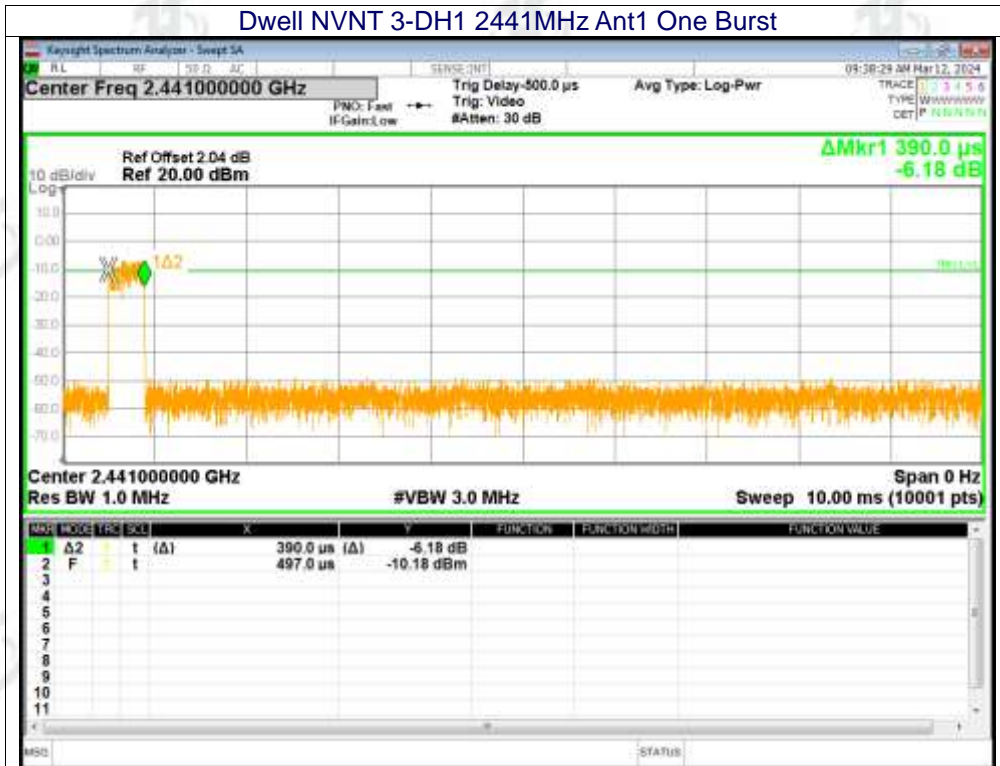

Dwell NVNT 3-DH1 2441MHz Ant1 Accumulated





Dwell NVNT 3-DH3 2441MHz Ant1 One Burst

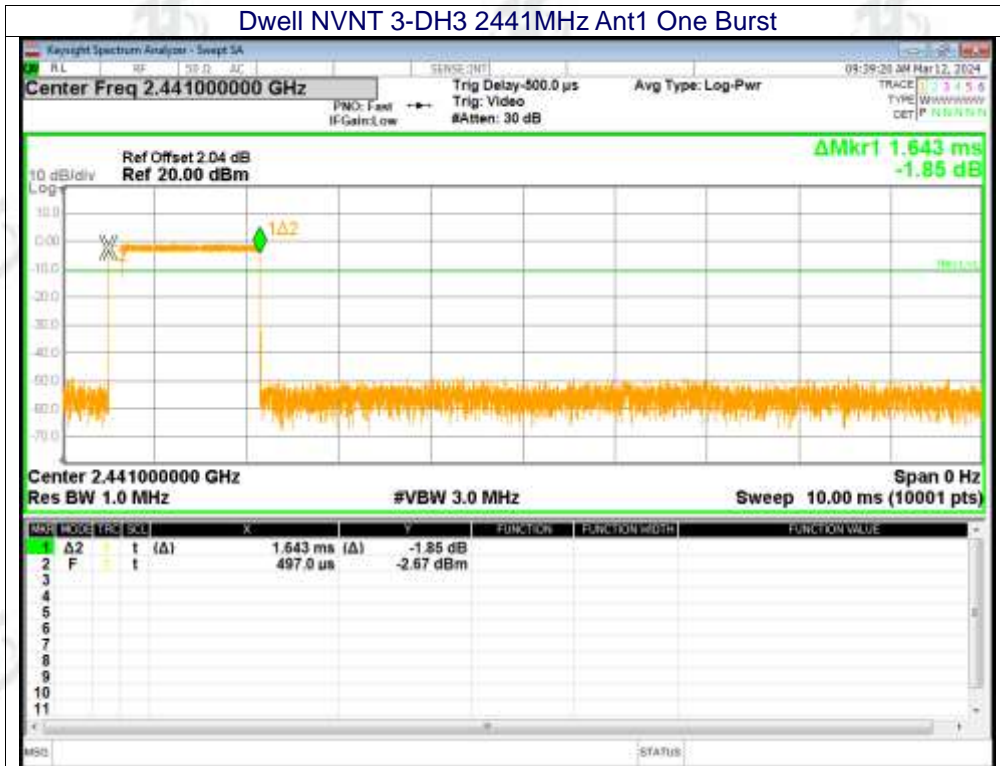

Dwell NVNT 3-DH3 2441MHz Ant1 Accumulated

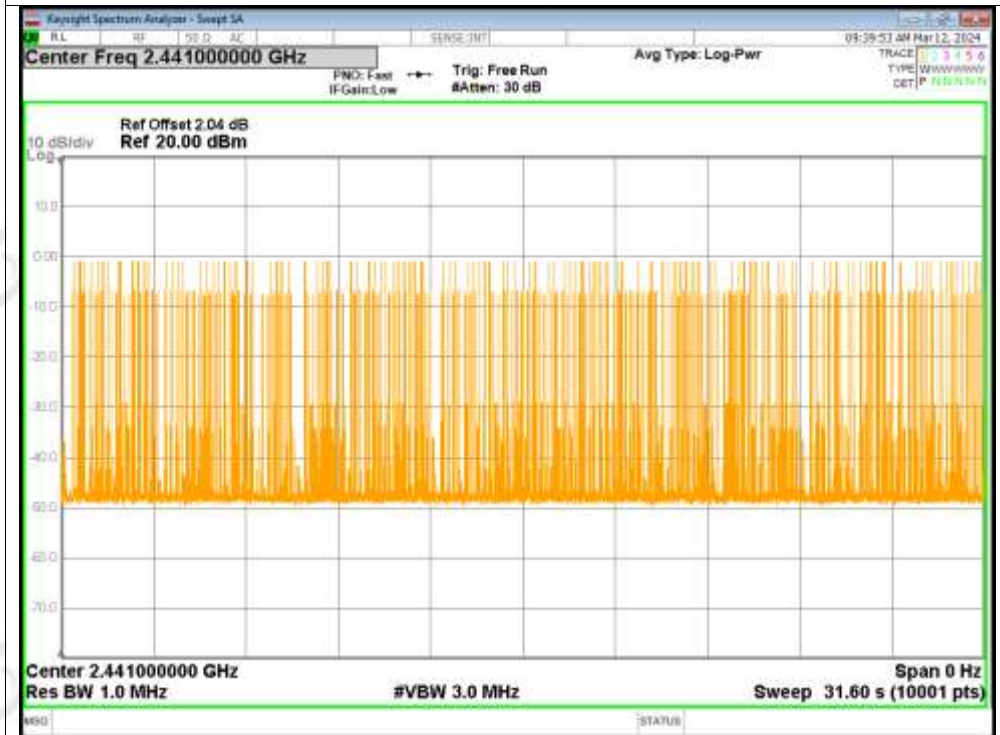

Dwell NVNT 3-DH5 2441MHz Ant1 One Burst

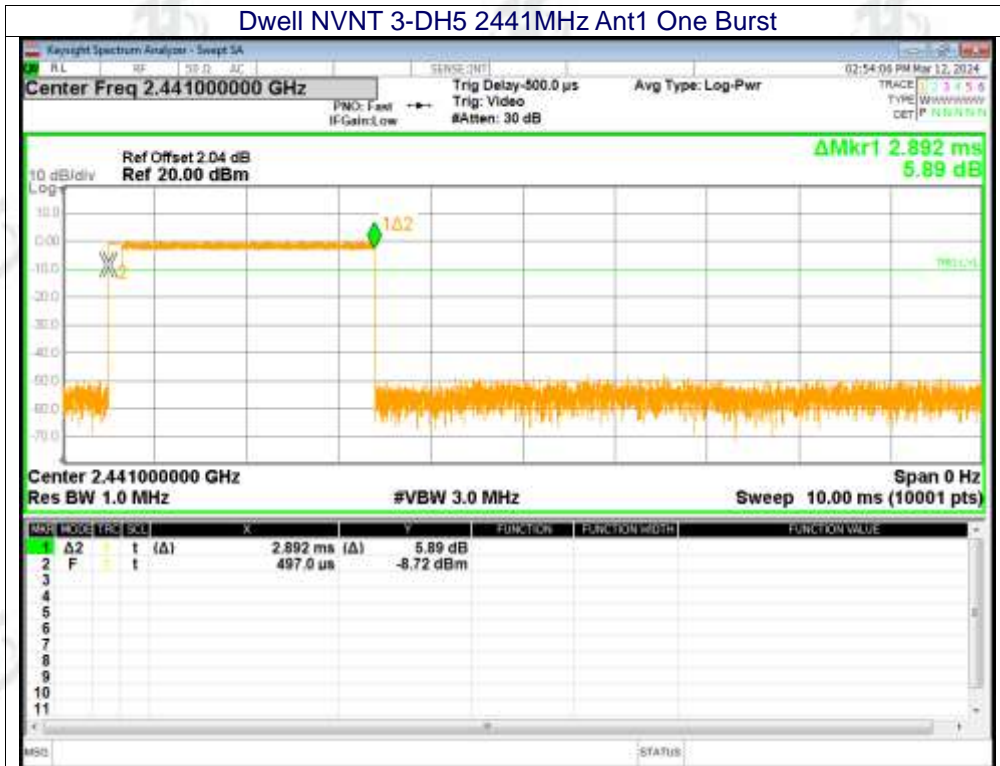

Dwell NVNT 3-DH5 2441MHz Ant1 Accumulated





## 11.2 Maximum Peak Conducted Output Power

Right earphone				
Mode	Frequency (MHz)	Conducted Power (dBm)	Limit (dBm)	Verdict
1-DH5	2402	0.1	21	Pass
1-DH5	2441	-0.41	21	Pass
1-DH5	2480	-1.63	21	Pass
2-DH5	2402	1.32	21	Pass
2-DH5	2441	0.79	21	Pass
2-DH5	2480	-0.42	21	Pass
3-DH5	2402	0.37	21	Pass
3-DH5	2441	-0.1	21	Pass
3-DH5	2480	-1.29	21	Pass

Left earpiece				
Mode	Frequency (MHz)	Conducted Power (dBm)	Limit (dBm)	Verdict
1-DH5	2402	0.08	21	Pass
1-DH5	2441	-0.47	21	Pass
1-DH5	2480	-1.6	21	Pass
2-DH5	2402	0.93	21	Pass
2-DH5	2441	0.45	21	Pass
2-DH5	2480	-0.72	21	Pass
3-DH5	2402	0.07	21	Pass
3-DH5	2441	-0.47	21	Pass
3-DH5	2480	-1.65	21	Pass

Test Graphs

Peak Power NVNT 1-DH5 2402MHz Ant1



Peak Power NVNT 1-DH5 2441MHz Ant1





Peak Power NVNT 1-DH5 2480MHz Ant1

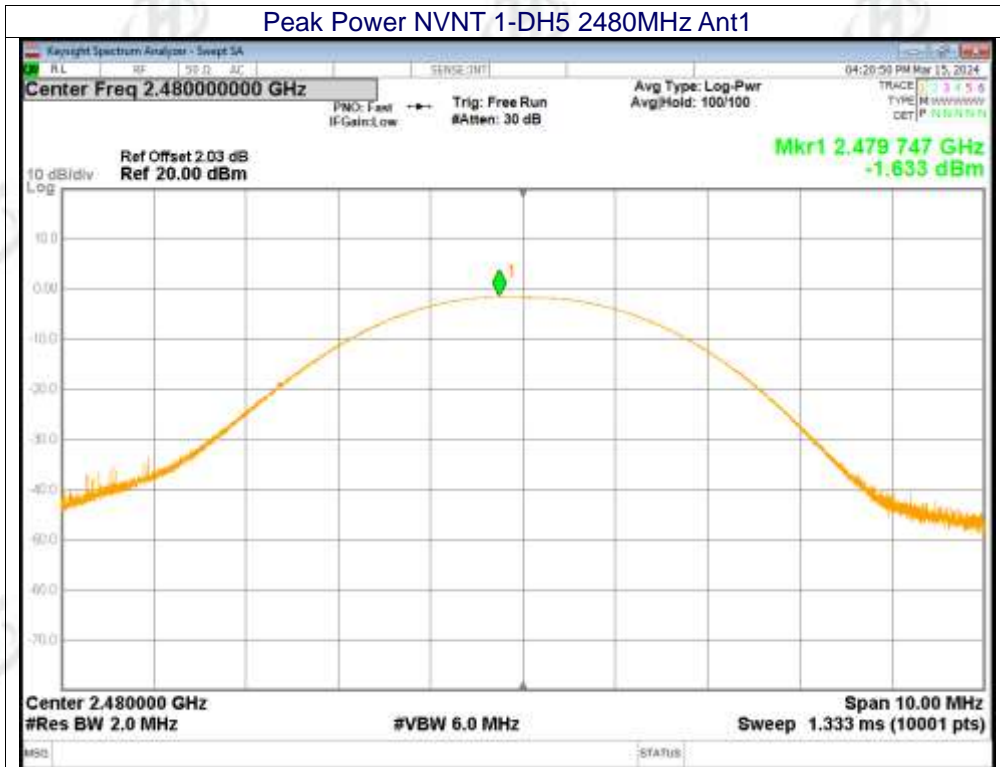

Peak Power NVNT 2-DH5 2402MHz Ant1



Peak Power NVNT 2-DH5 2441MHz Ant1

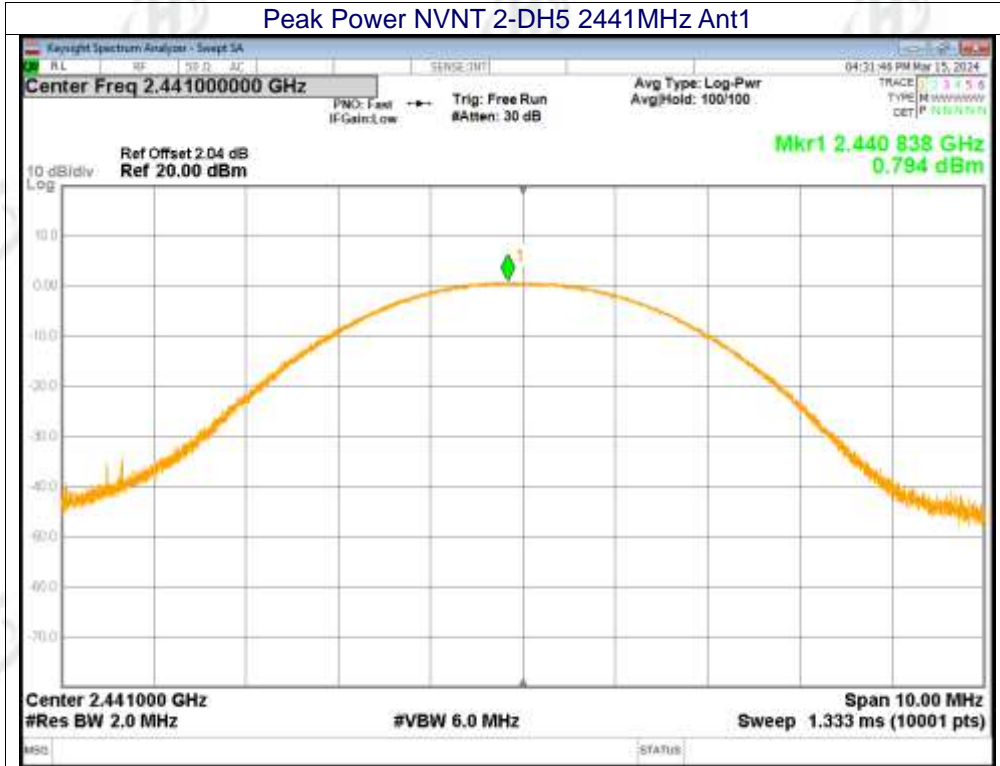

Peak Power NVNT 2-DH5 2480MHz Ant1





Peak Power NVNT 3-DH5 2402MHz Ant1

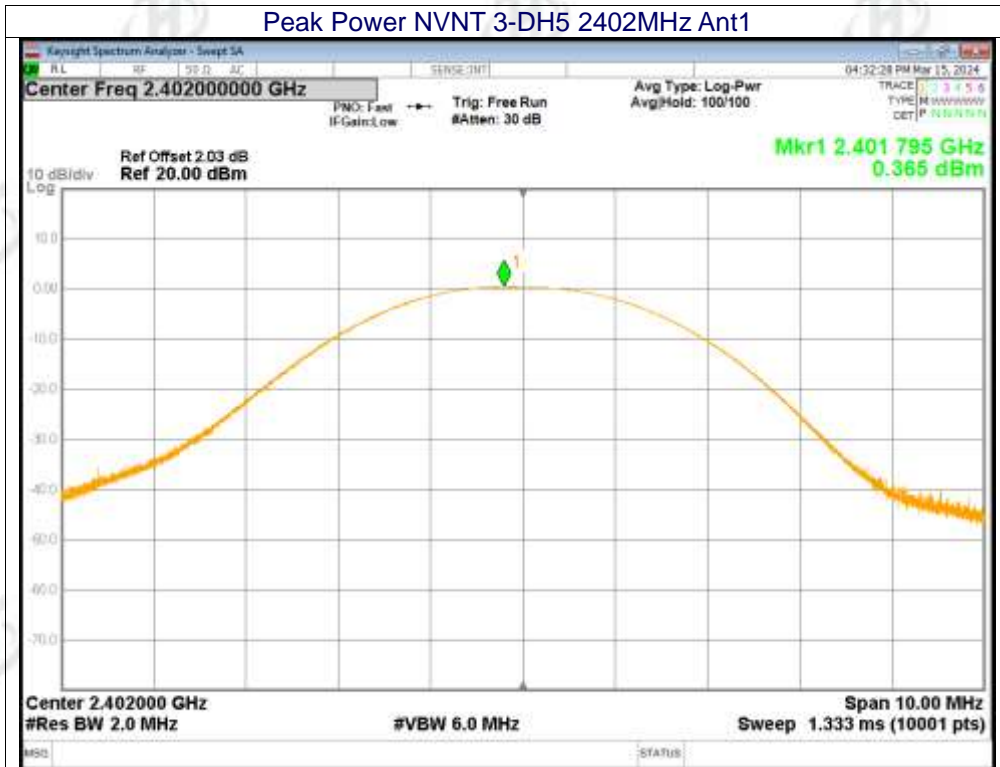

Peak Power NVNT 3-DH5 2441MHz Ant1



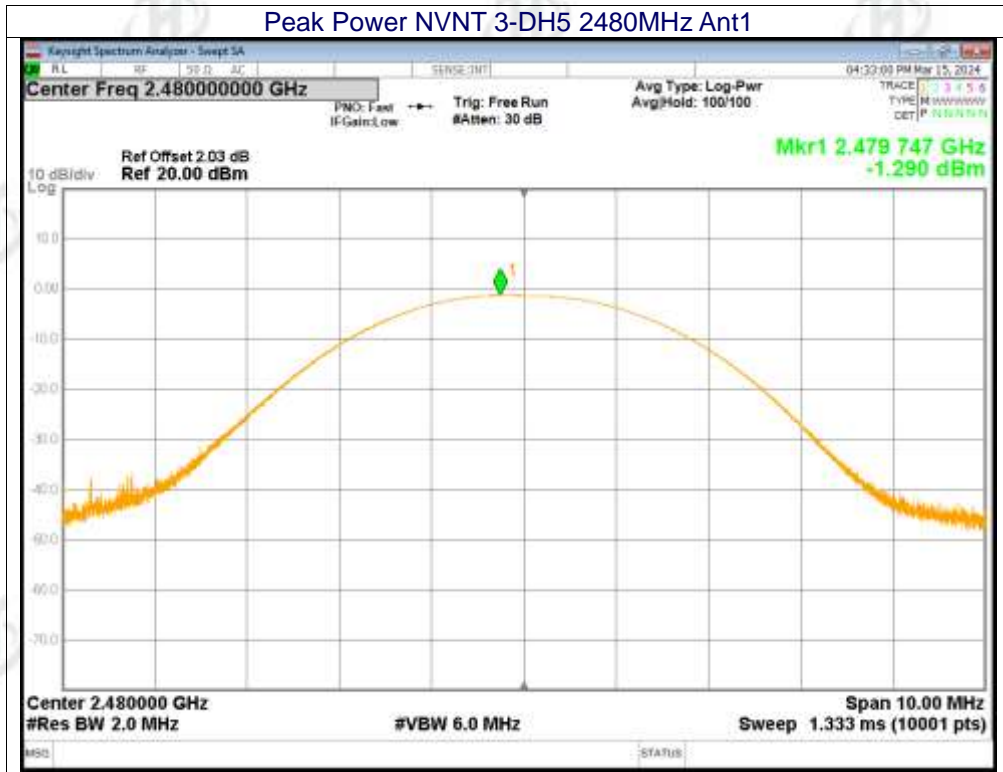

Test Graphs

Peak Power NVNT 1-DH5 2402MHz Ant1



Peak Power NVNT 1-DH5 2441MHz Ant1

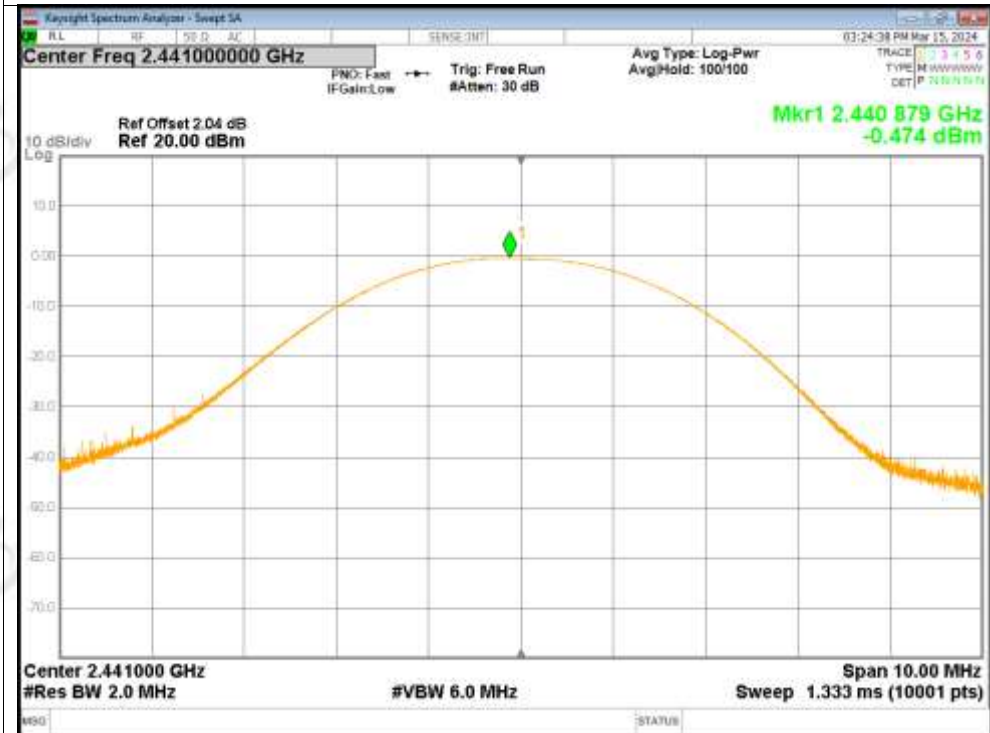

Peak Power NVNT 1-DH5 2480MHz Ant1

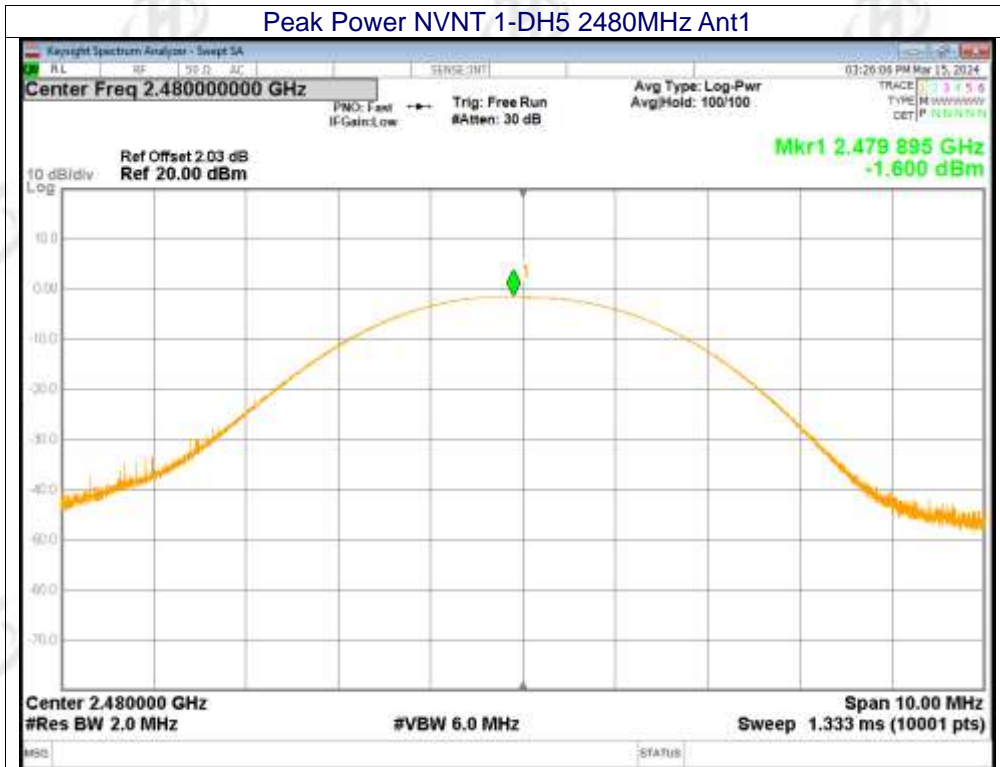

Peak Power NVNT 2-DH5 2402MHz Ant1



Peak Power NVNT 2-DH5 2441MHz Ant1



Peak Power NVNT 2-DH5 2480MHz Ant1





Peak Power NVNT 3-DH5 2402MHz Ant1

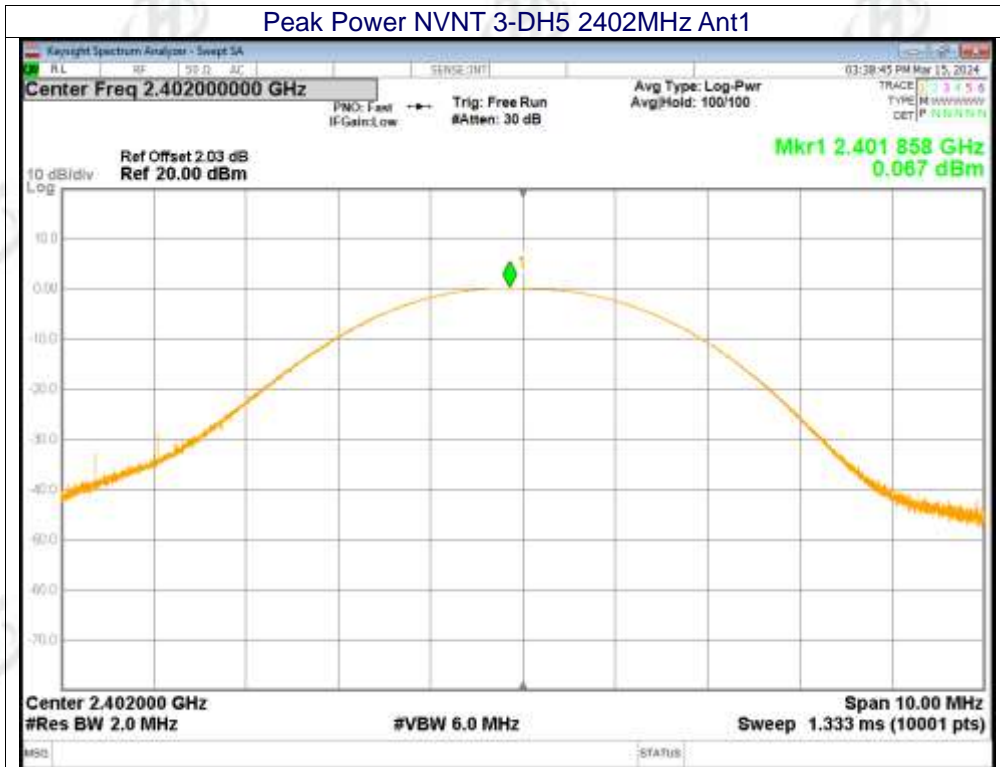

Peak Power NVNT 3-DH5 2441MHz Ant1





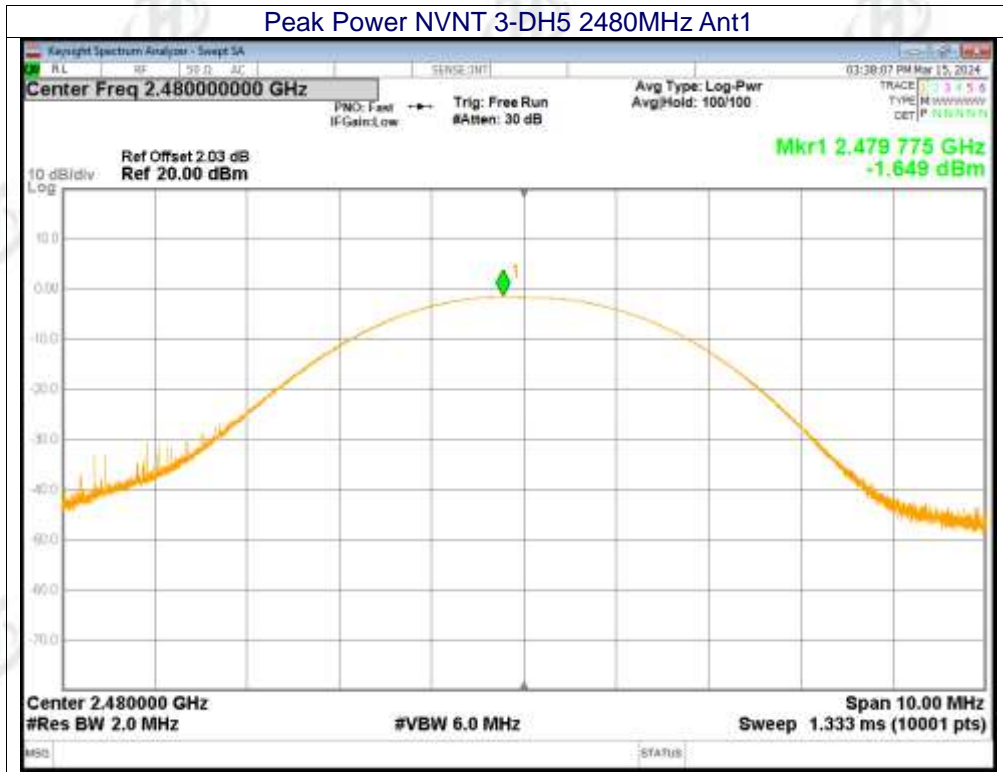



11.3 -20dB Bandwidth

Mode	Frequency (MHz)	-20 dB Bandwidth (MHz)	Verdict
1-DH5	2402	0.946	Pass
1-DH5	2441	0.95	Pass
1-DH5	2480	0.947	Pass
2-DH5	2402	1.319	Pass
2-DH5	2441	1.278	Pass
2-DH5	2480	1.302	Pass
3-DH5	2402	1.299	Pass
3-DH5	2441	1.272	Pass
3-DH5	2480	1.277	Pass

### Test Graphs

-20dB Bandwidth NVNT 1-DH5 2402MHz Ant1

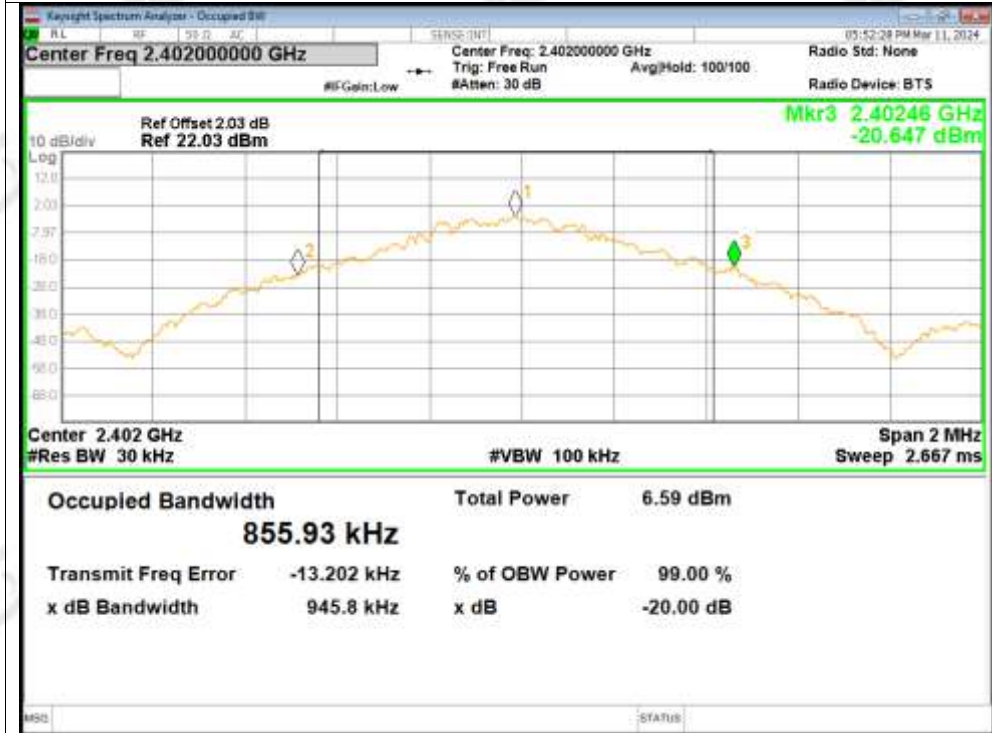

-20dB Bandwidth NVNT 1-DH5 2441MHz Ant1



-20dB Bandwidth NVNT 1-DH5 2480MHz Ant1

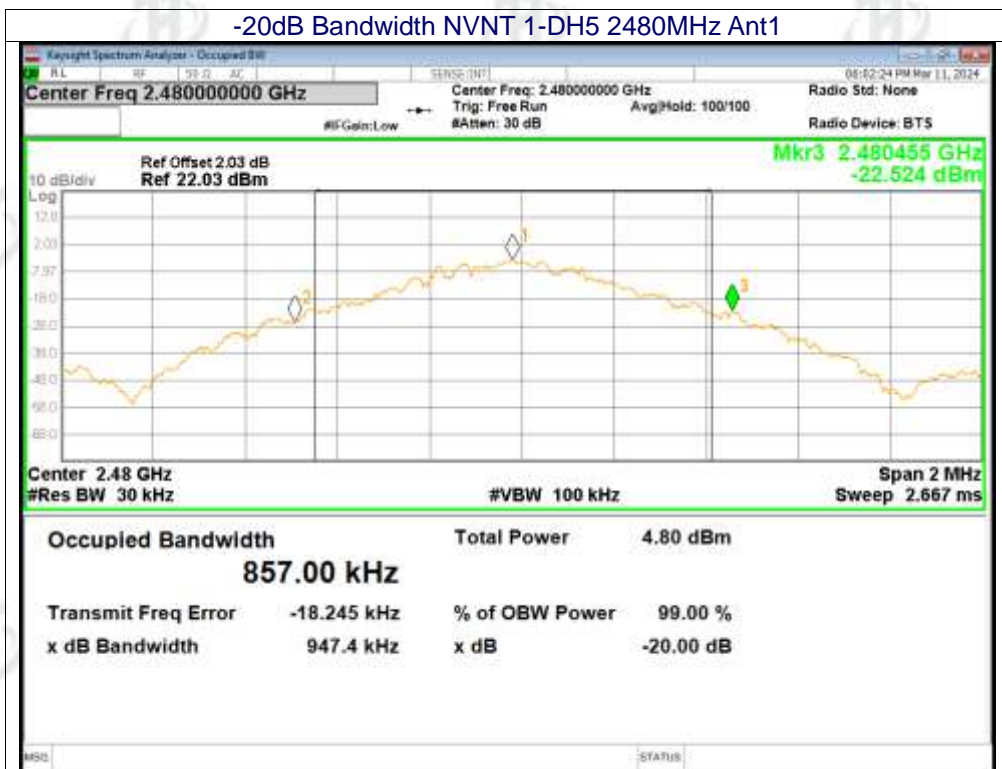

-20dB Bandwidth NVNT 2-DH5 2402MHz Ant1

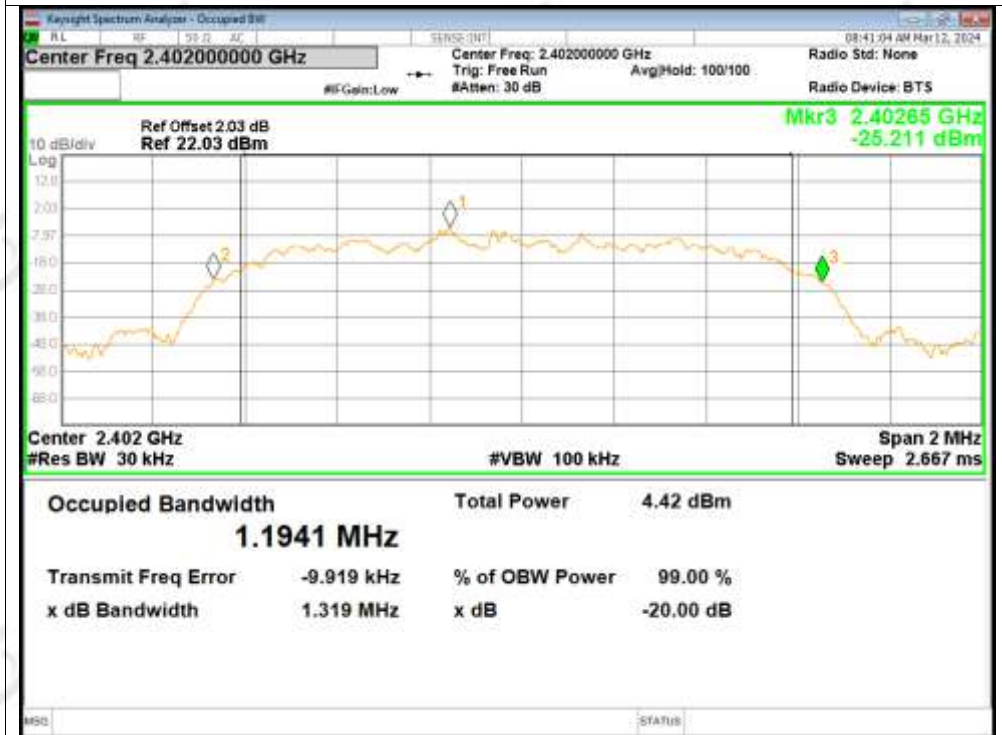

-20dB Bandwidth NVNT 2-DH5 2441MHz Ant1

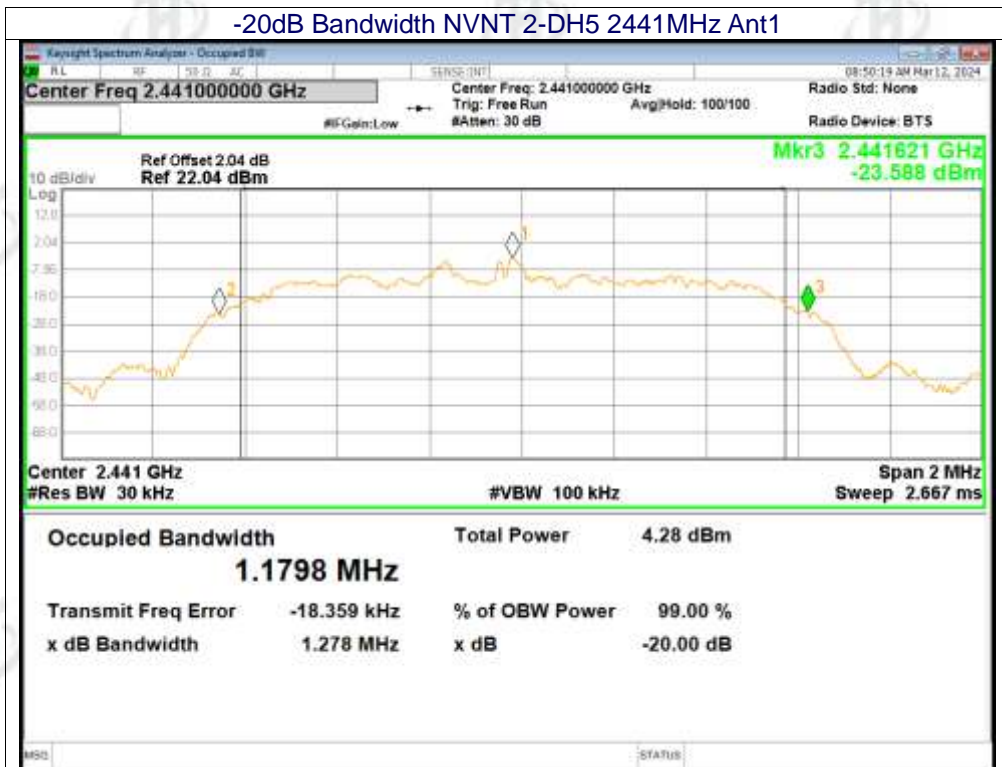

-20dB Bandwidth NVNT 2-DH5 2480MHz Ant1

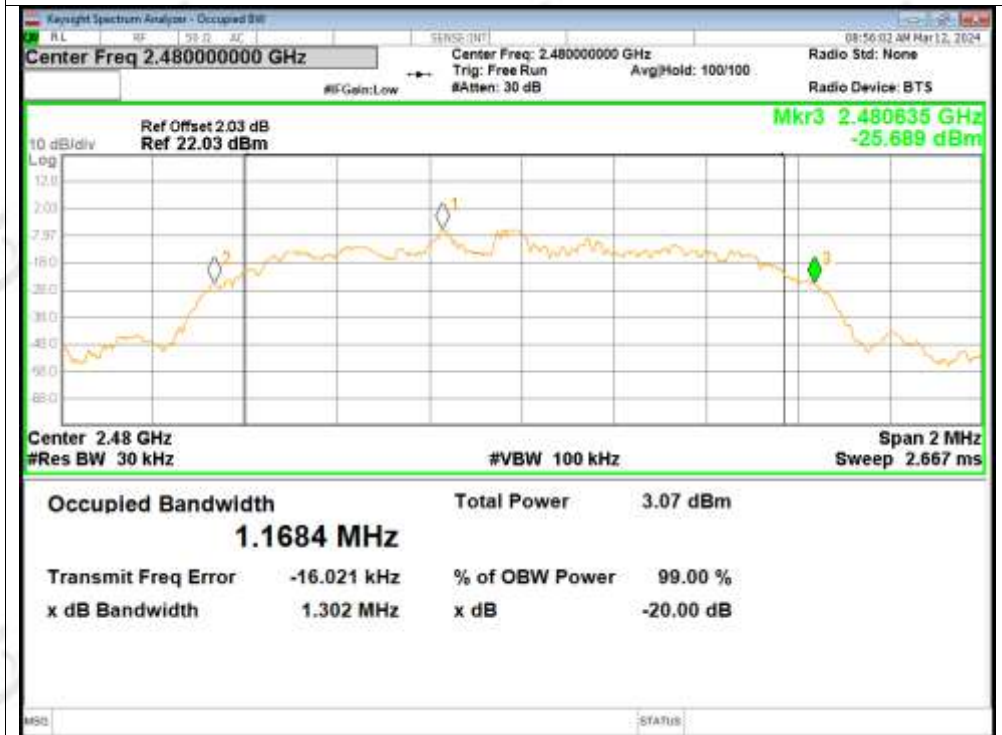



-20dB Bandwidth NVNT 3-DH5 2402MHz Ant1

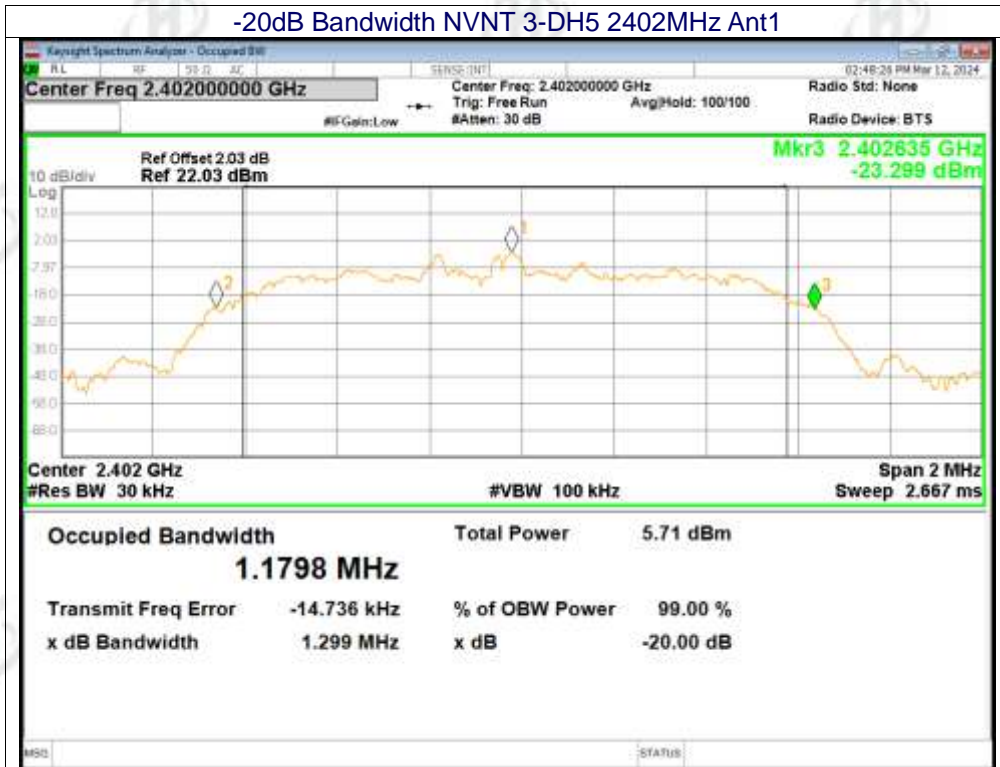

-20dB Bandwidth NVNT 3-DH5 2441MHz Ant1

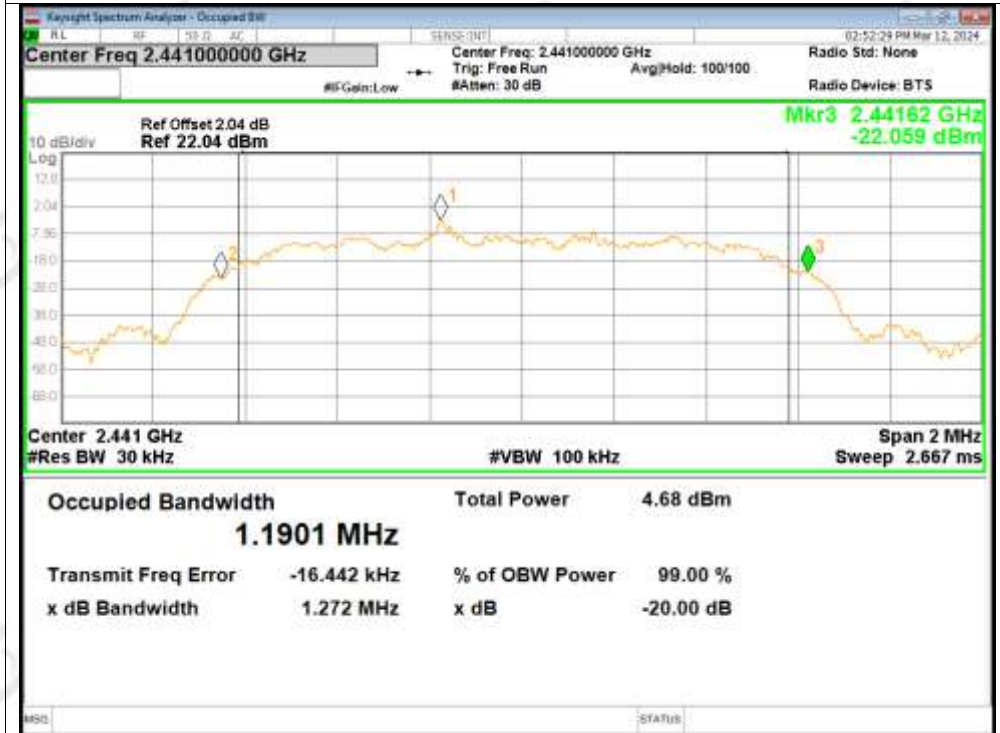

-20dB Bandwidth NVNT 3-DH5 2480MHz Ant1

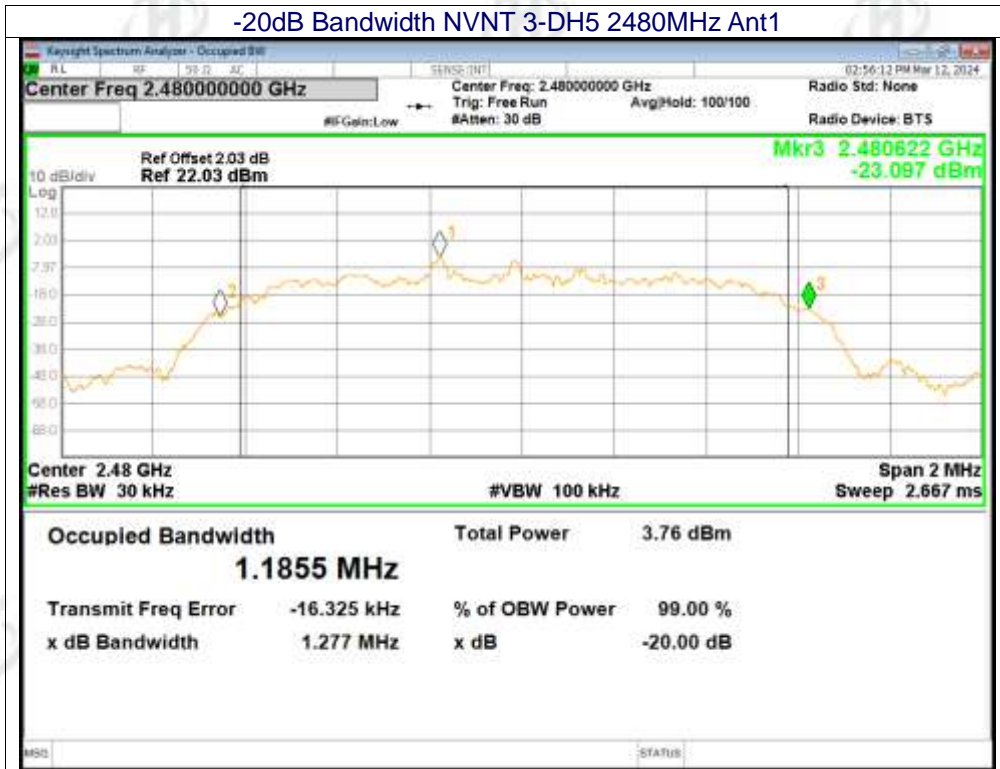



11.4 Occupied Channel Bandwidth

Mode	Frequency (MHz)	99% OBW (MHz)
1-DH5	2402	0.858
1-DH5	2441	0.863
1-DH5	2480	0.85
2-DH5	2402	1.173
2-DH5	2441	1.186
2-DH5	2480	1.186
3-DH5	2402	1.185
3-DH5	2441	1.186
3-DH5	2480	1.177

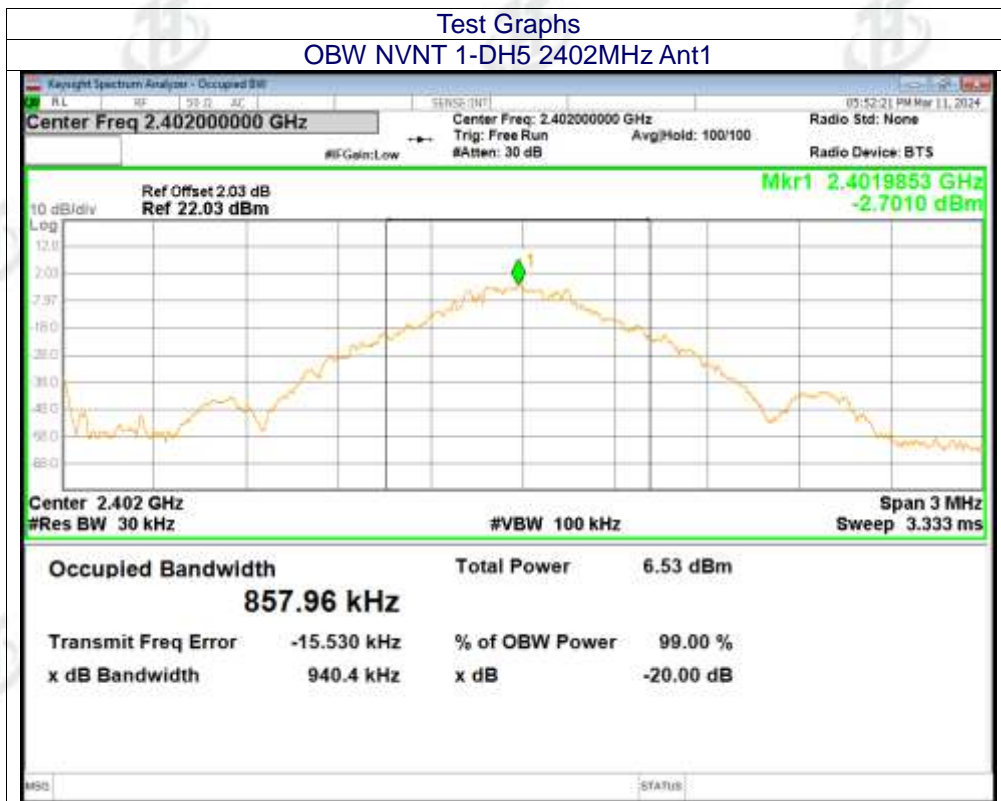

OBW NVNT 1-DH5 2480MHz Ant1

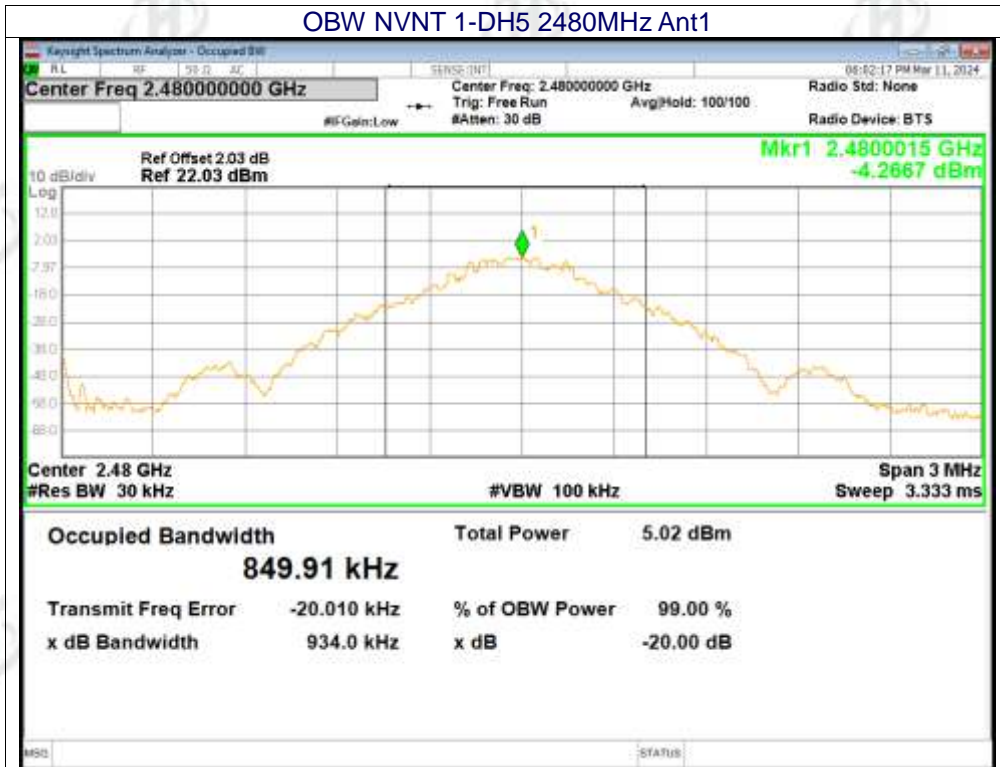

OBW NVNT 2-DH5 2402MHz Ant1

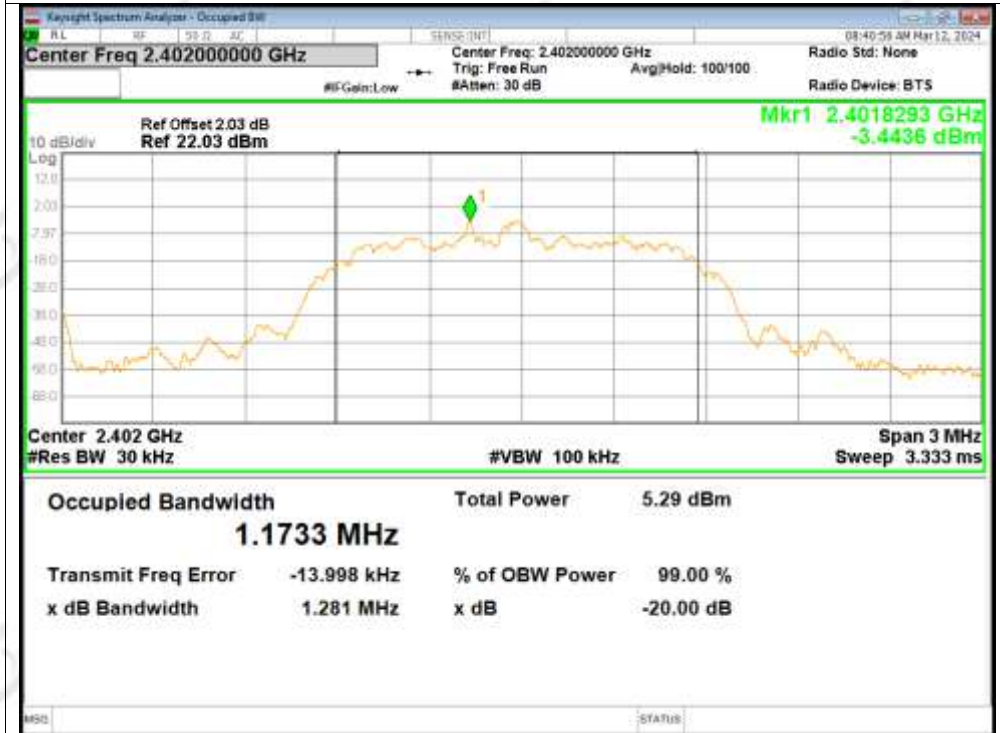



OBW NVNT 2-DH5 2441MHz Ant1

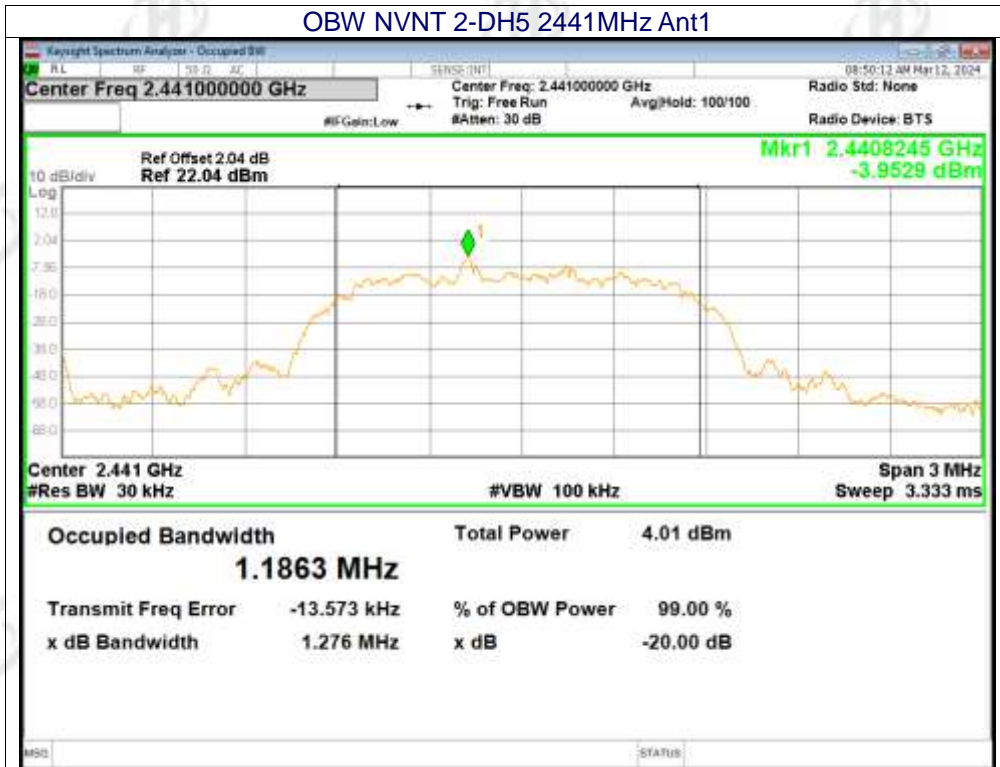

OBW NVNT 2-DH5 2480MHz Ant1

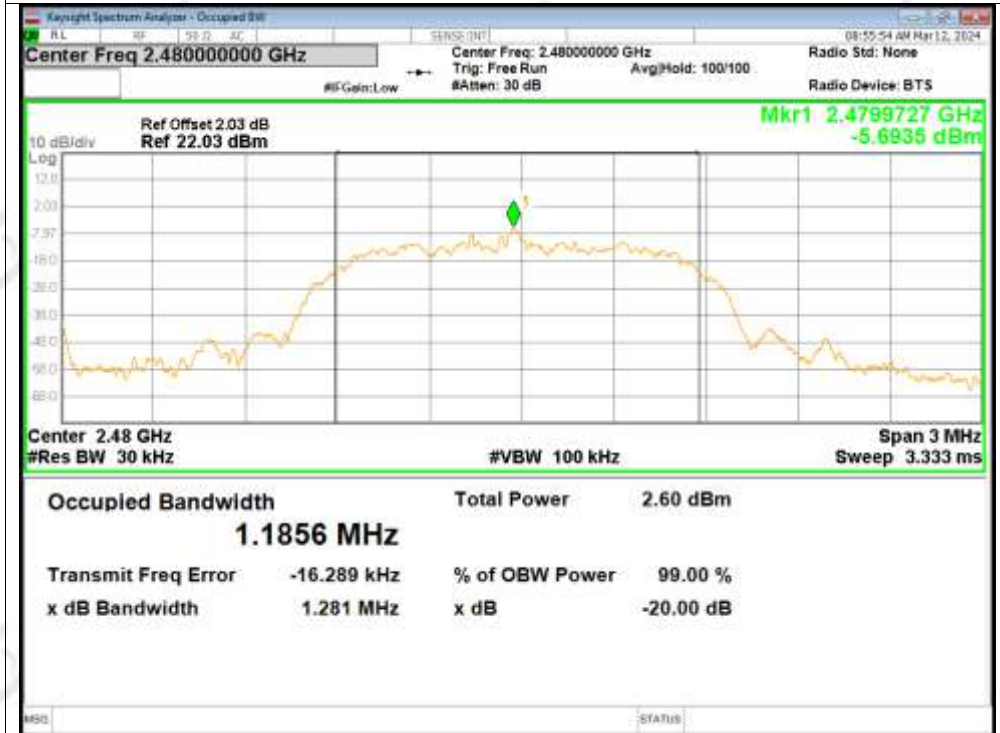

OBW NVNT 3-DH5 2402MHz Ant1



OBW NVNT 3-DH5 2441MHz Ant1



OBW NVNT 3-DH5 2480MHz Ant1

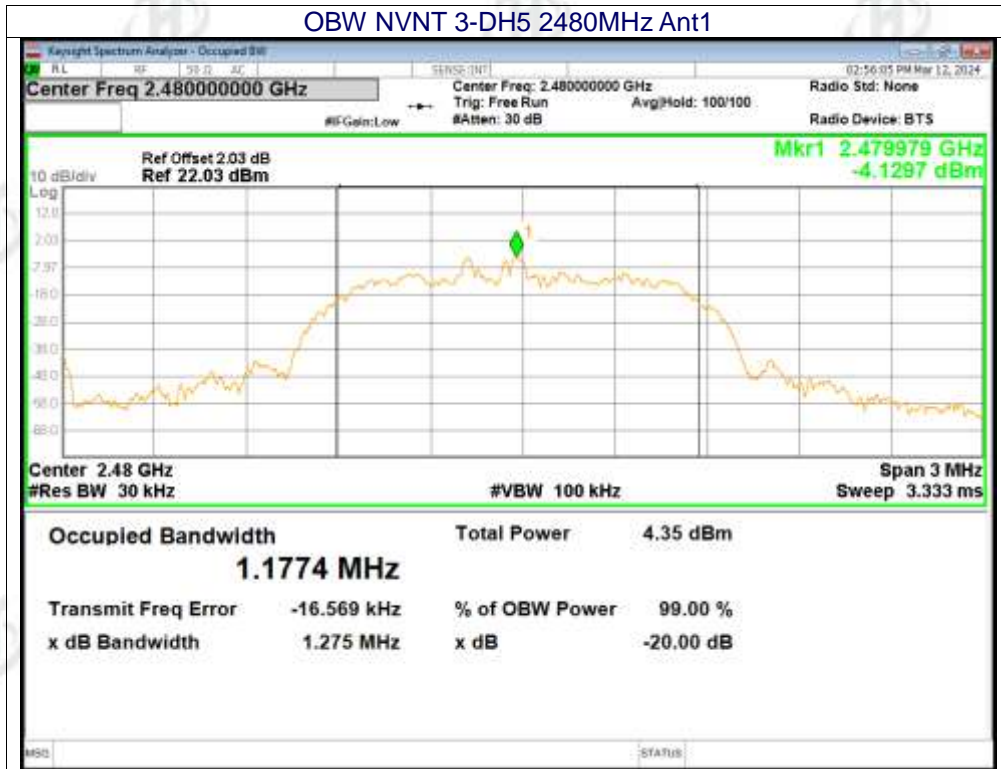



11.5 Carrier Frequencies Separation

Mode	Hopping Freq1 (MHz)	Hopping Freq2 (MHz)	HFS (MHz)	Limit (MHz)	Verdict
1-DH5	2401.96	2402.982	1.022	0.631	Pass
1-DH5	2440.962	2441.978	1.016	0.633	Pass
1-DH5	2478.97	2479.96	0.99	0.631	Pass
2-DH5	2401.828	2402.974	1.146	0.879	Pass
2-DH5	2440.828	2441.974	1.146	0.852	Pass
2-DH5	2478.822	2479.824	1.002	0.868	Pass
3-DH5	2401.826	2402.852	1.026	0.866	Pass
3-DH5	2440.962	2441.818	0.856	0.848	Pass
3-DH5	2478.828	2479.828	1	0.851	Pass

Test Graphs  
CFS NVNT 1-DH5 2402MHz Ant1

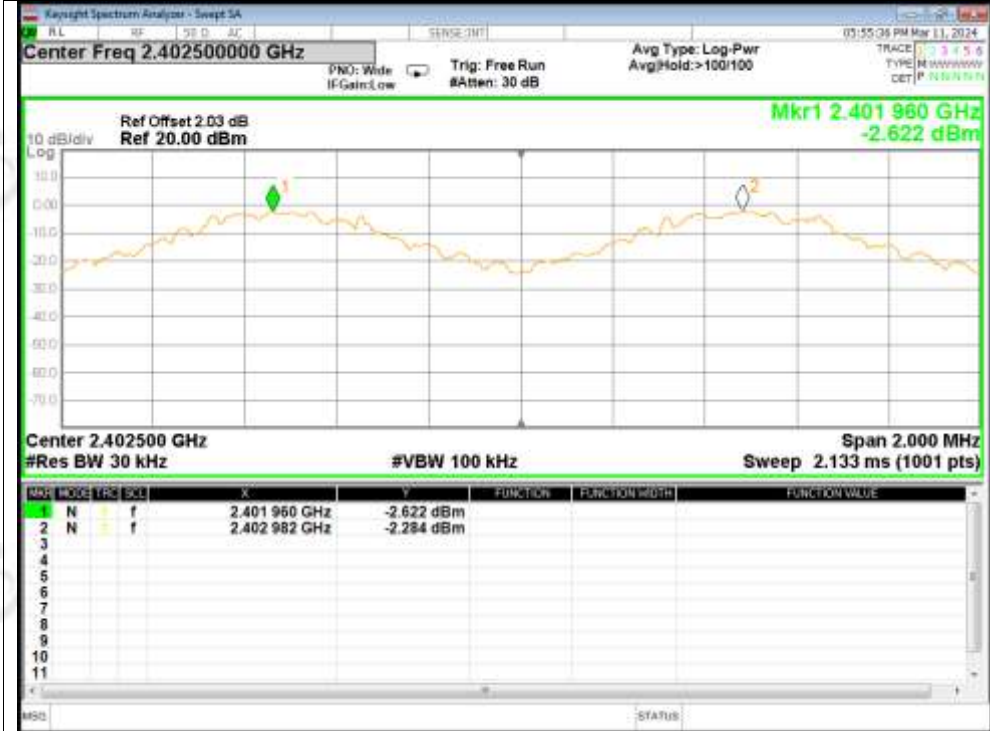

CFS NVNT 1-DH5 2441MHz Ant1





CFS NVNT 1-DH5 2480MHz Ant1



CFS NVNT 2-DH5 2402MHz Ant1

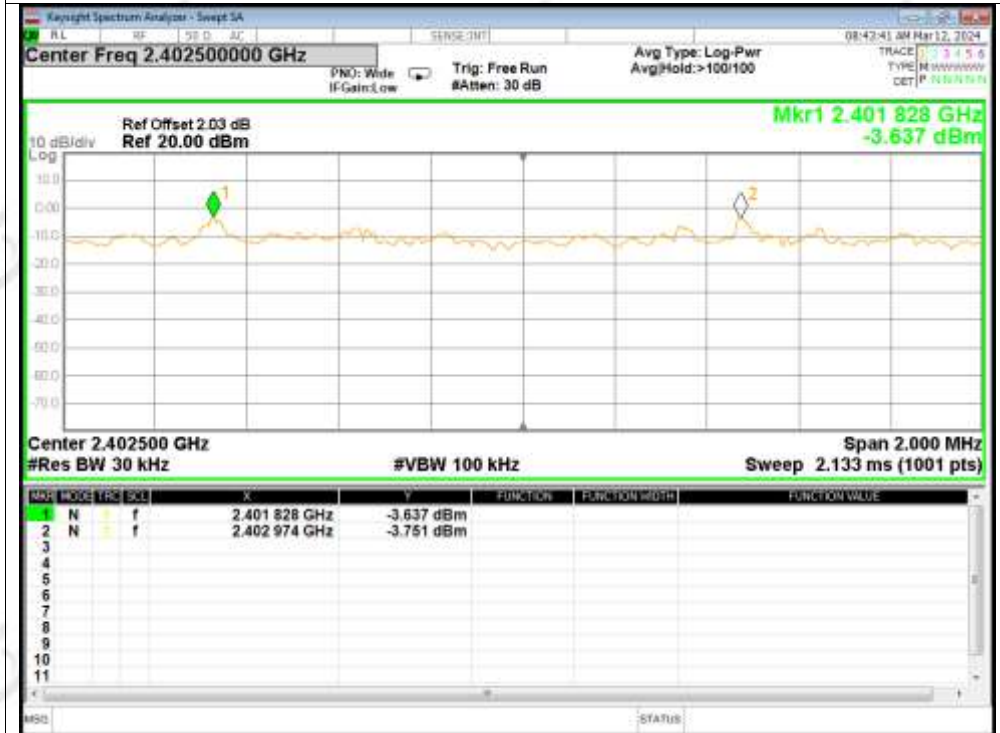

CFS NVNT 2-DH5 2441MHz Ant1



CFS NVNT 2-DH5 2480MHz Ant1

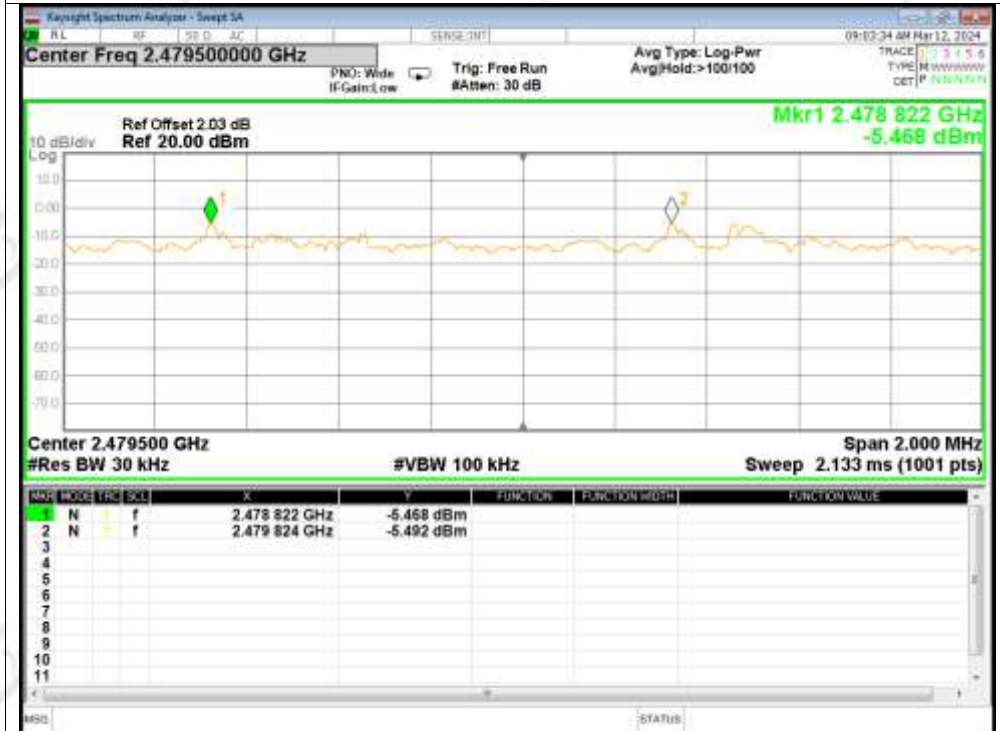

CFS NVNT 3-DH5 2402MHz Ant1



CFS NVNT 3-DH5 2441MHz Ant1

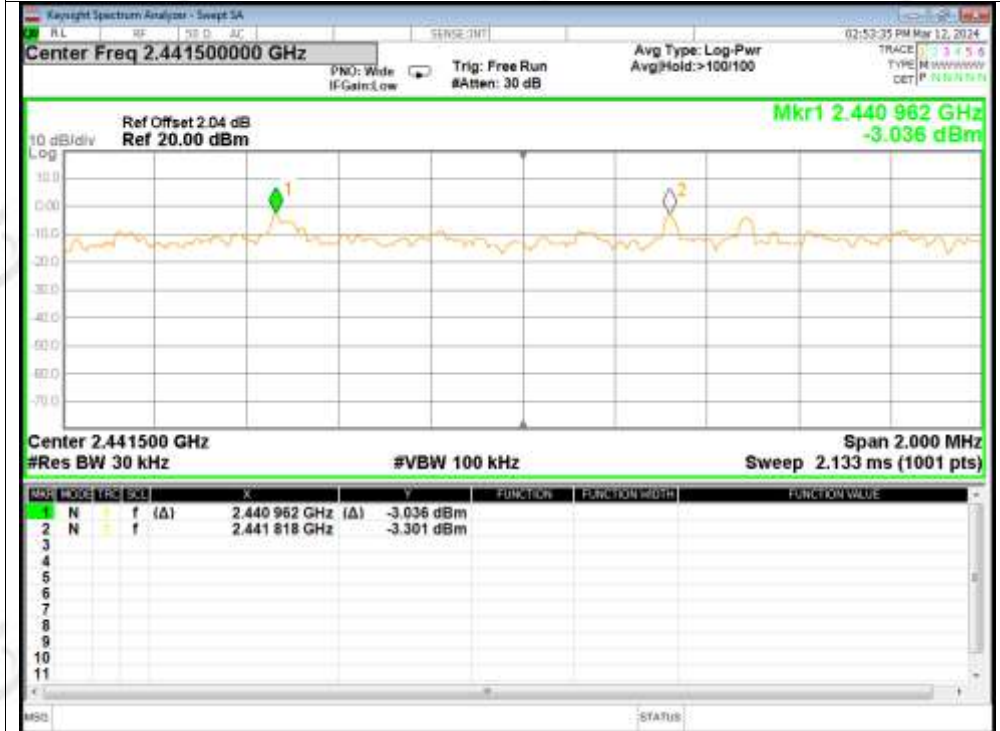

CFS NVNT 3-DH5 2480MHz Ant1





11.6 Number of Hopping Channel

Mode	Hopping Number	Limit	Verdict
1-DH5	79	15	Pass
2-DH5	79	15	Pass
3-DH5	79	15	Pass

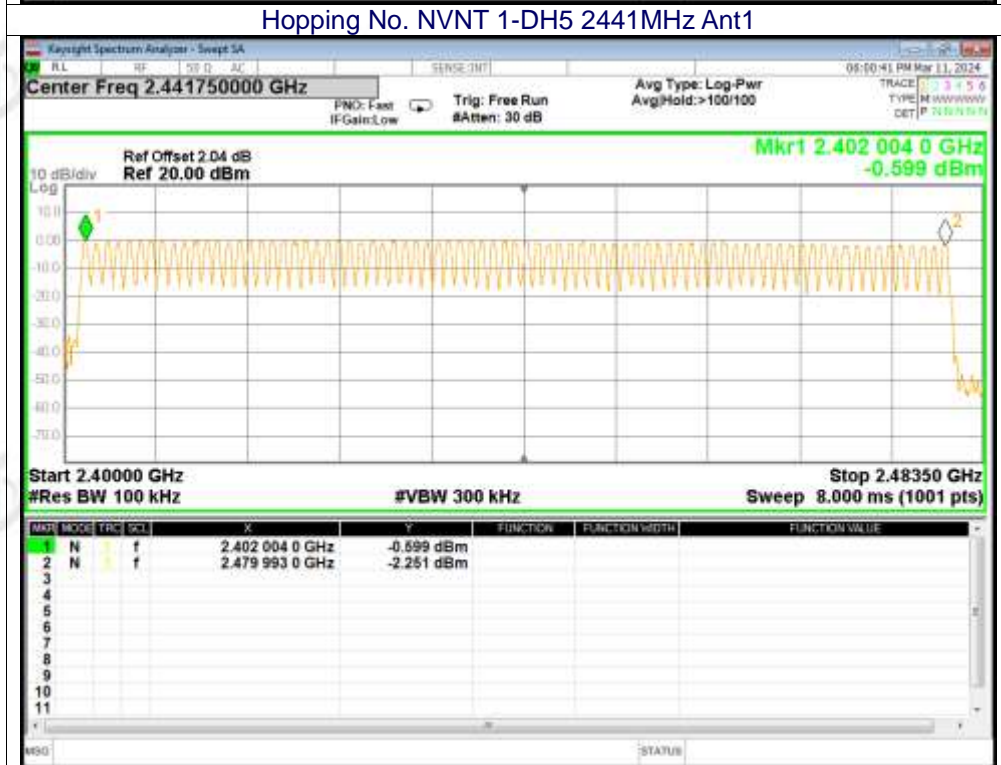
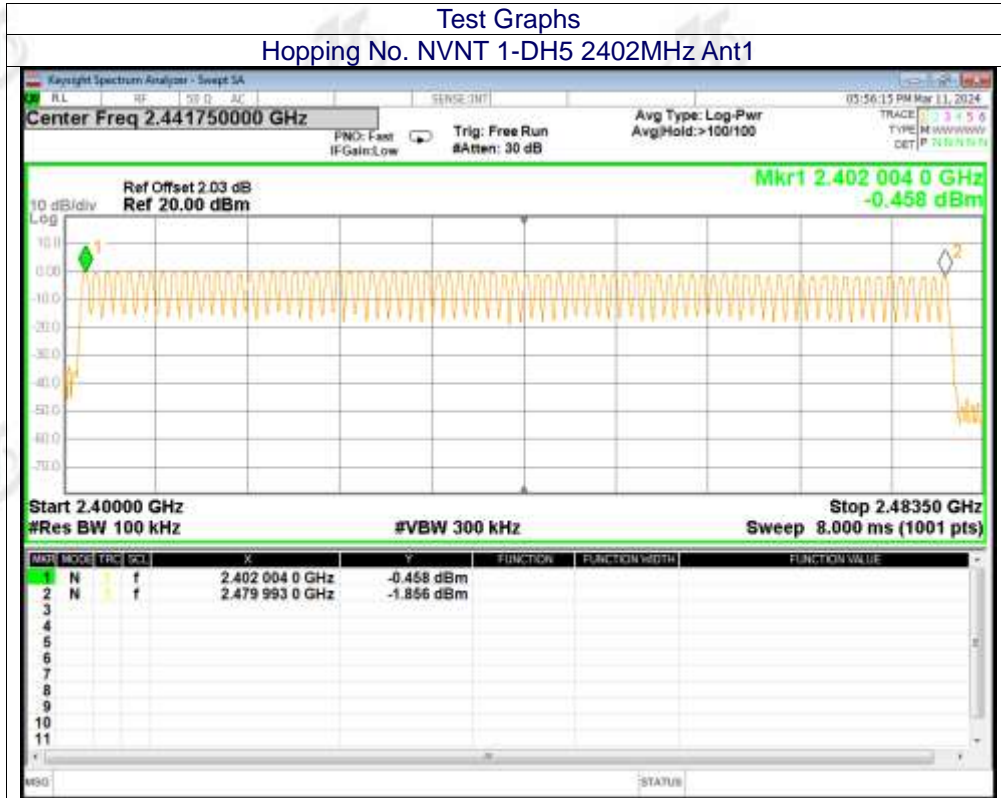



Hopping No. NVNT 1-DH5 2480MHz Ant1

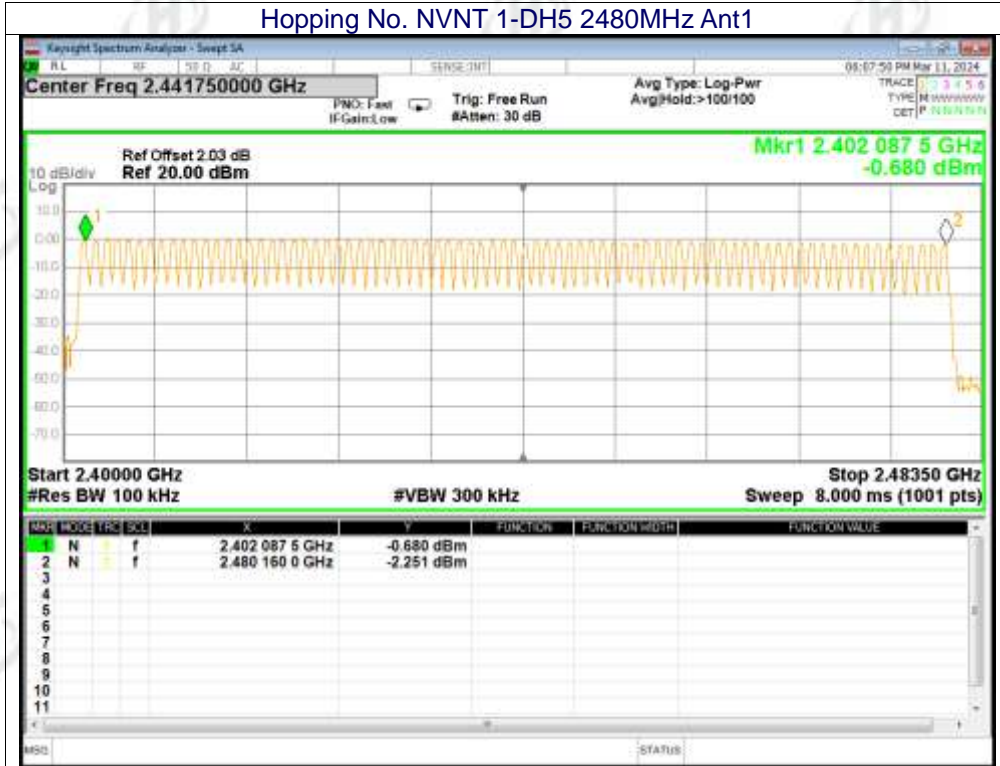

Hopping No. NVNT 2-DH5 2402MHz Ant1

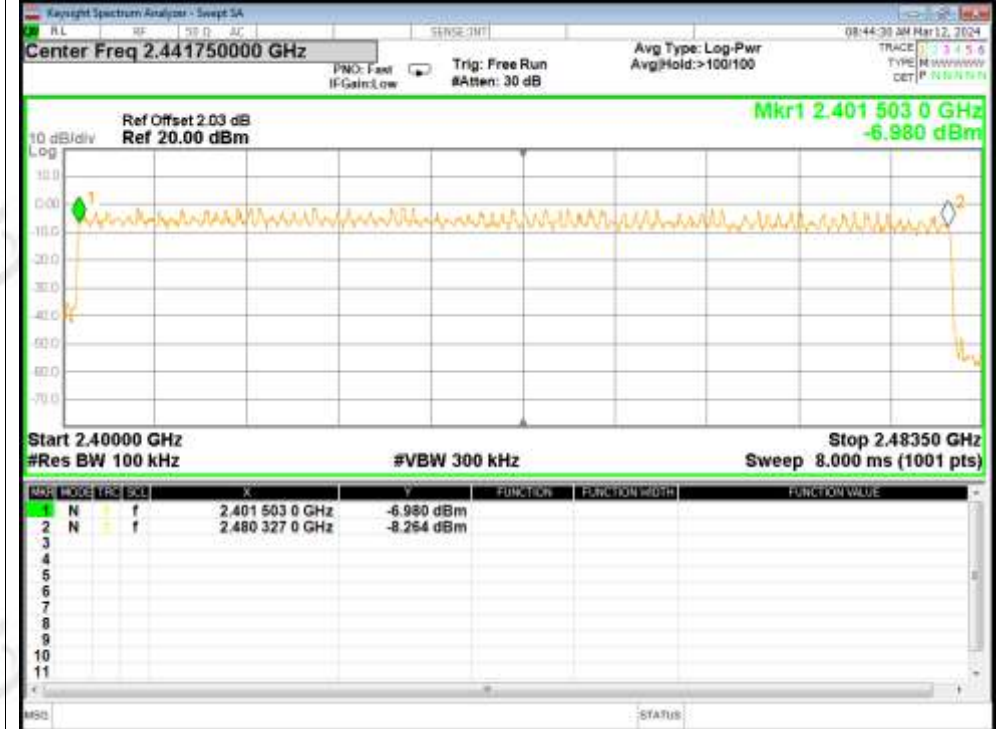

Hopping No. NVNT 2-DH5 2441MHz Ant1

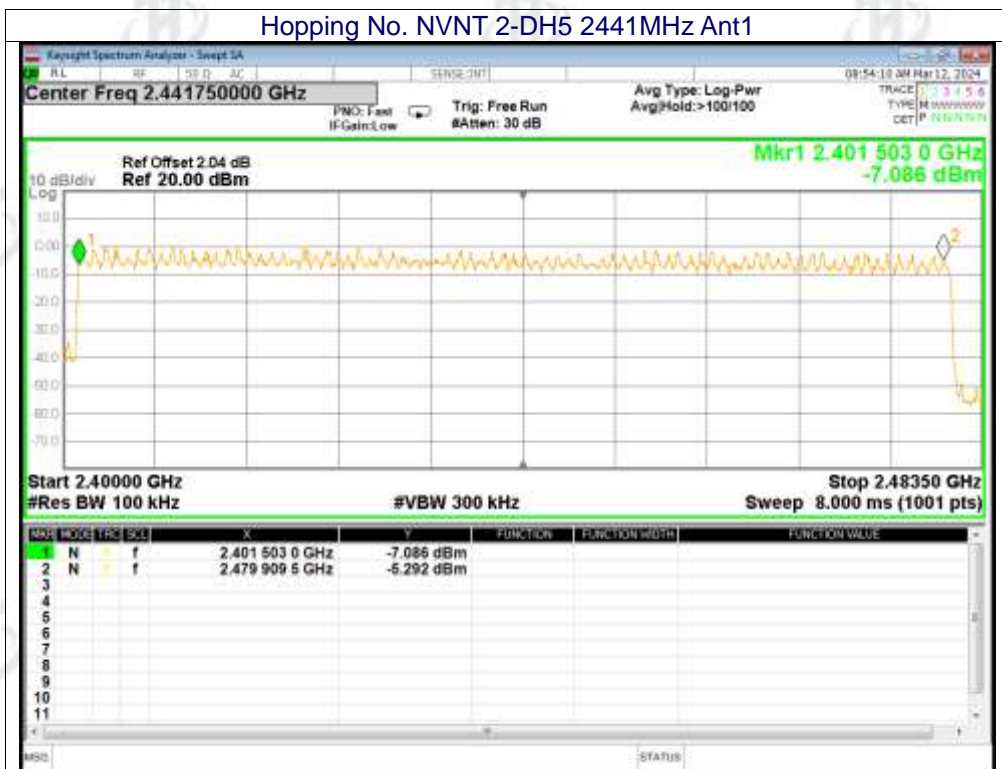

Hopping No. NVNT 2-DH5 2480MHz Ant1



Hopping No. NVNT 3-DH5 2402MHz Ant1

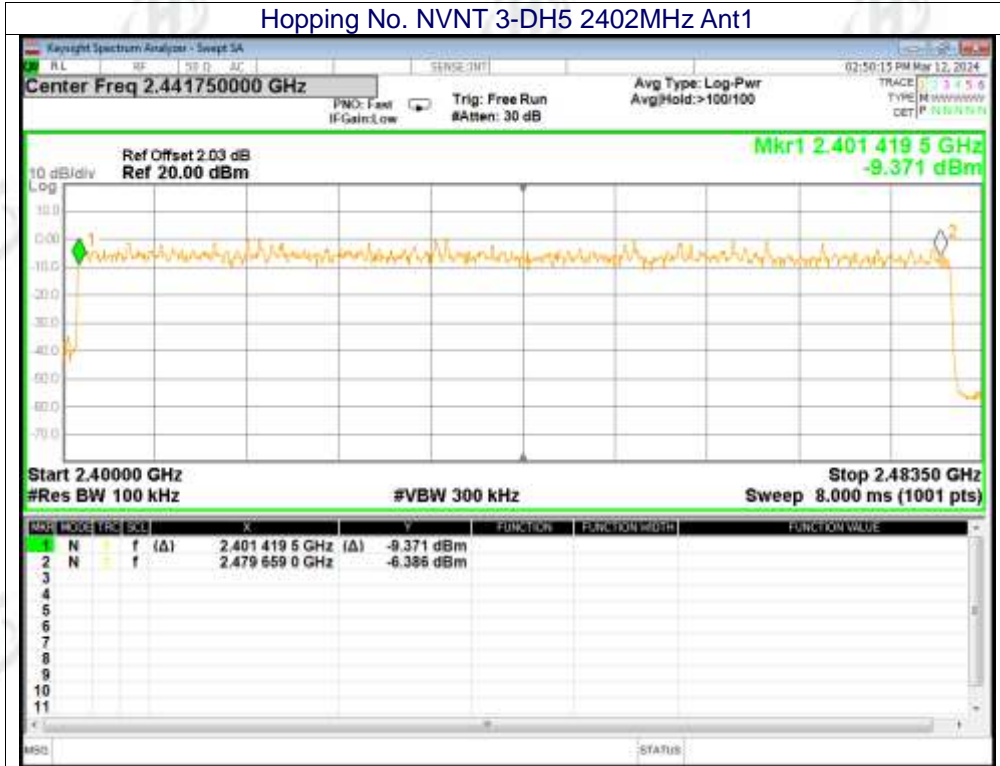

Hopping No. NVNT 3-DH5 2441MHz Ant1



Hopping No. NVNT 3-DH5 2480MHz Ant1

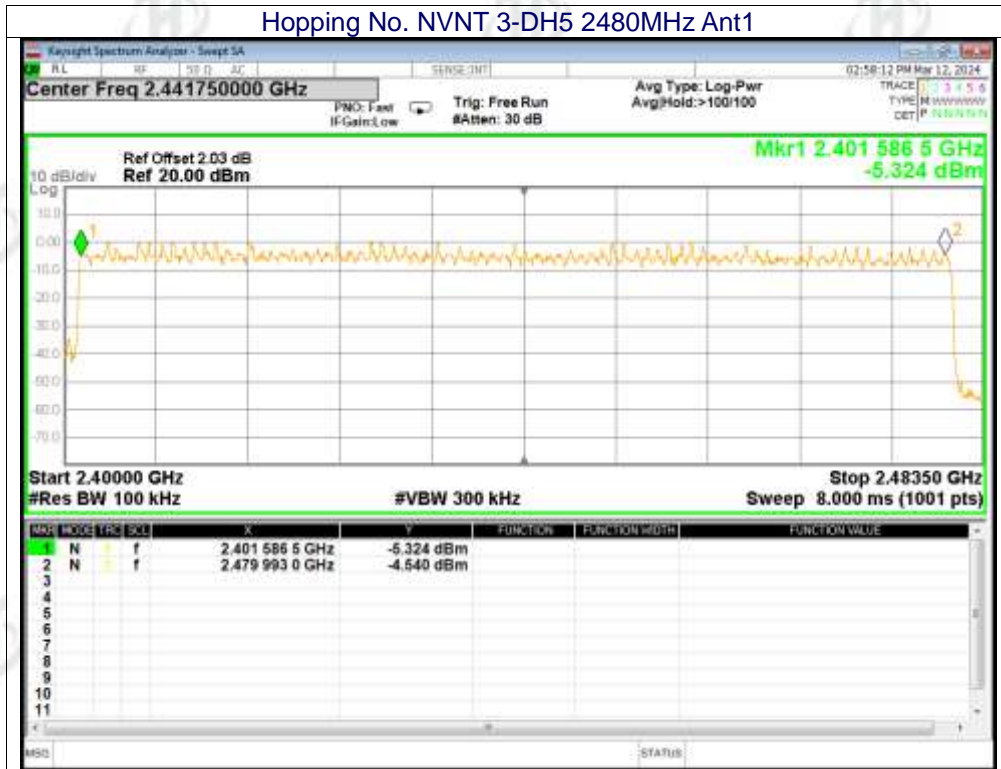



11.7 Band Edge

Mode	Frequency (MHz)	Hopping Mode	Max Value (dBc)	Limit (dBc)	Verdict
1-DH5	2402	No-Hopping	-35.2	-20	Pass
1-DH5	2480	No-Hopping	-47.51	-20	Pass
2-DH5	2402	No-Hopping	-36.01	-20	Pass
2-DH5	2480	No-Hopping	-49.85	-20	Pass
3-DH5	2402	No-Hopping	-37.81	-20	Pass
3-DH5	2480	No-Hopping	-52.38	-20	Pass

Test Graphs

Band Edge NVNT 1-DH5 2402MHz Ant1 No-Hopping Ref



Band Edge NVNT 1-DH5 2402MHz Ant1 No-Hopping Emission

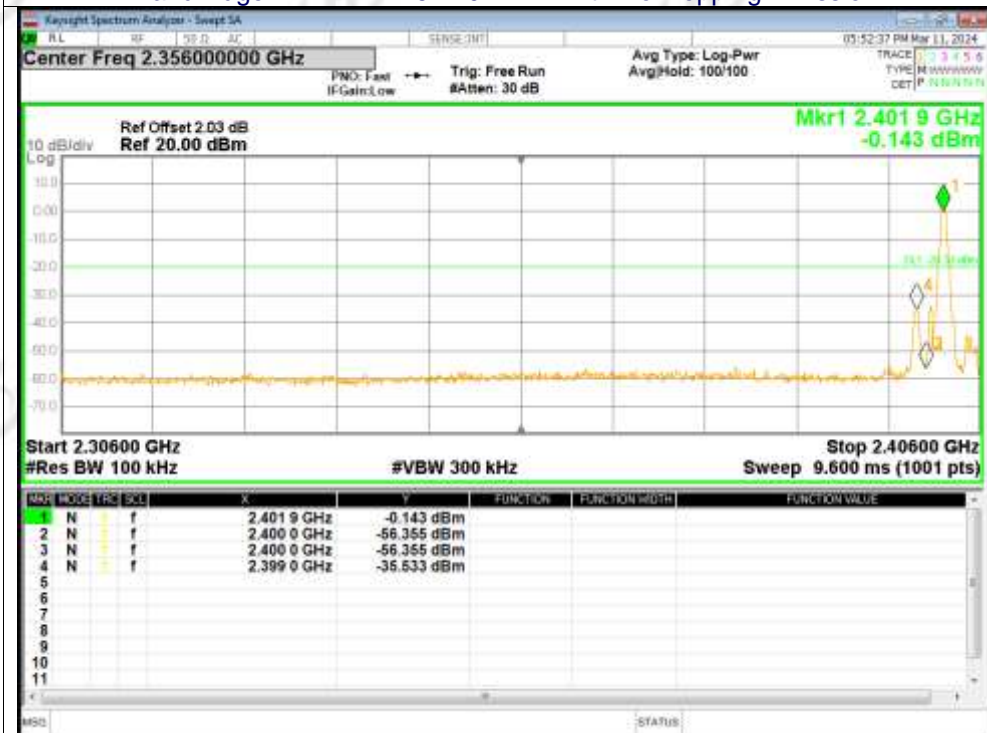



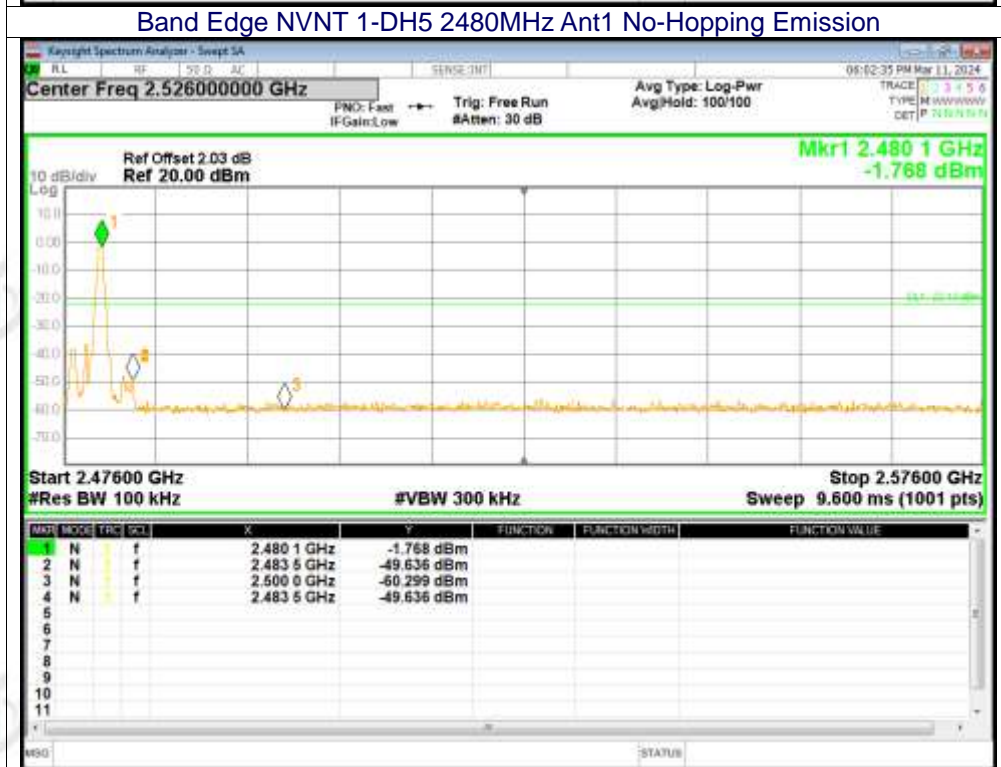

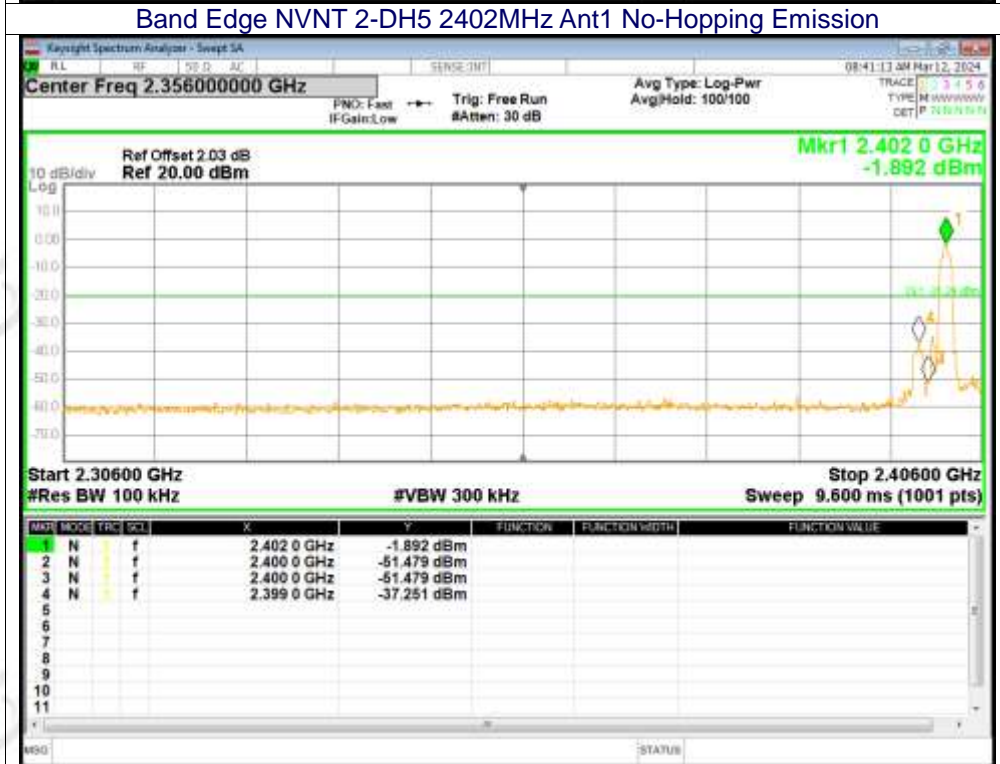
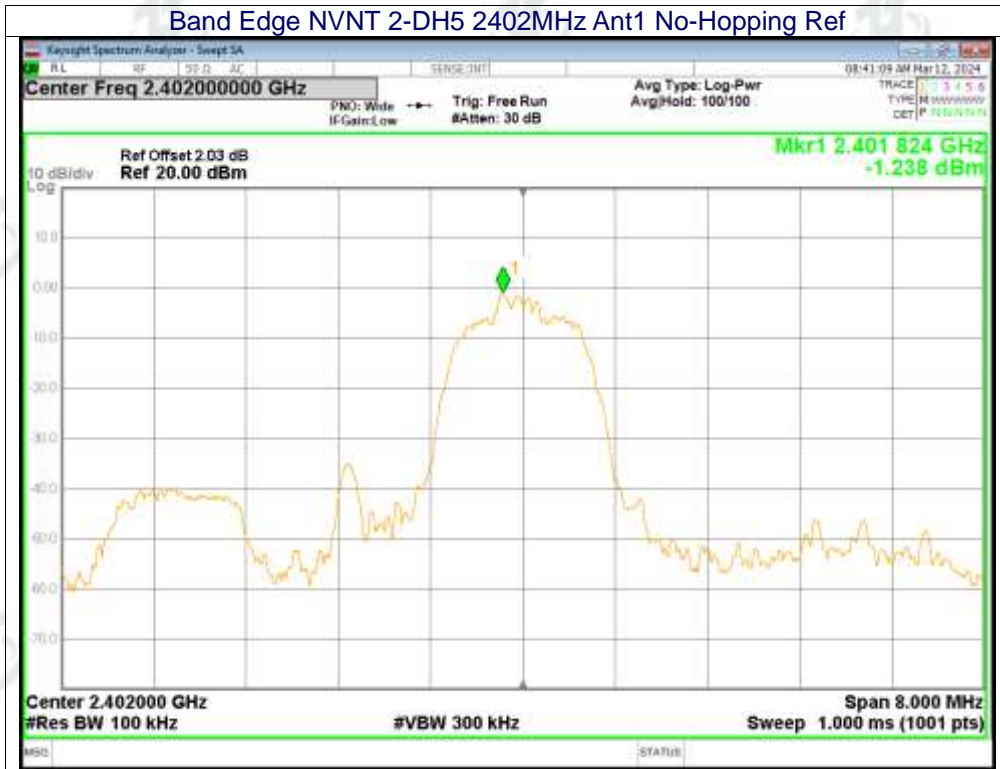

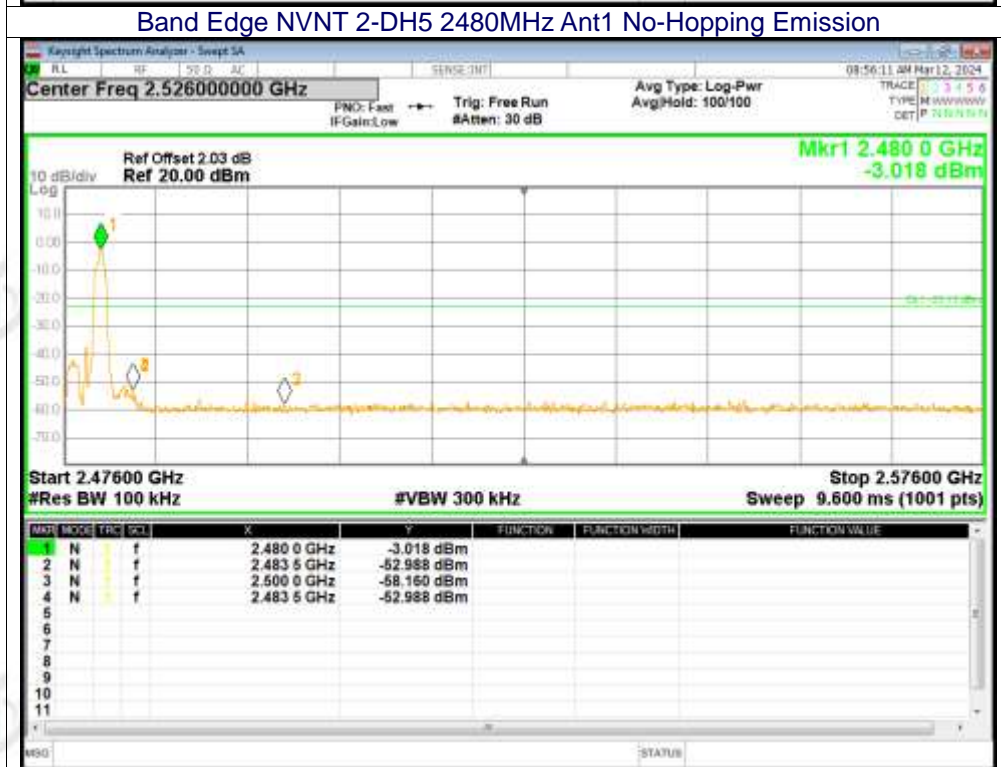

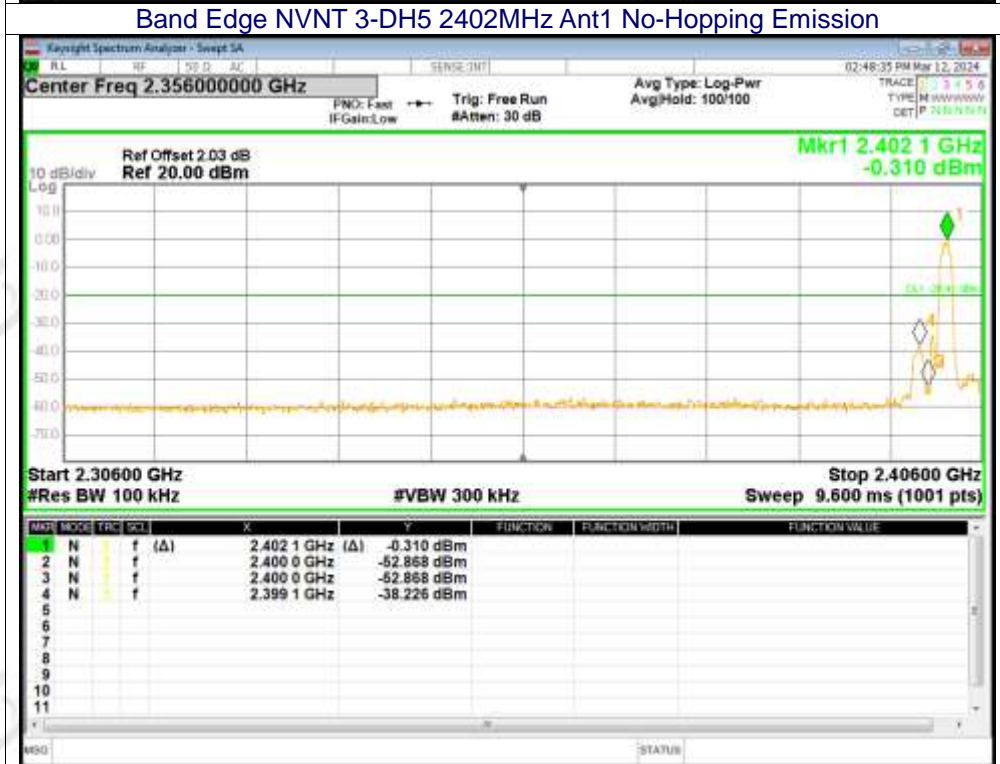
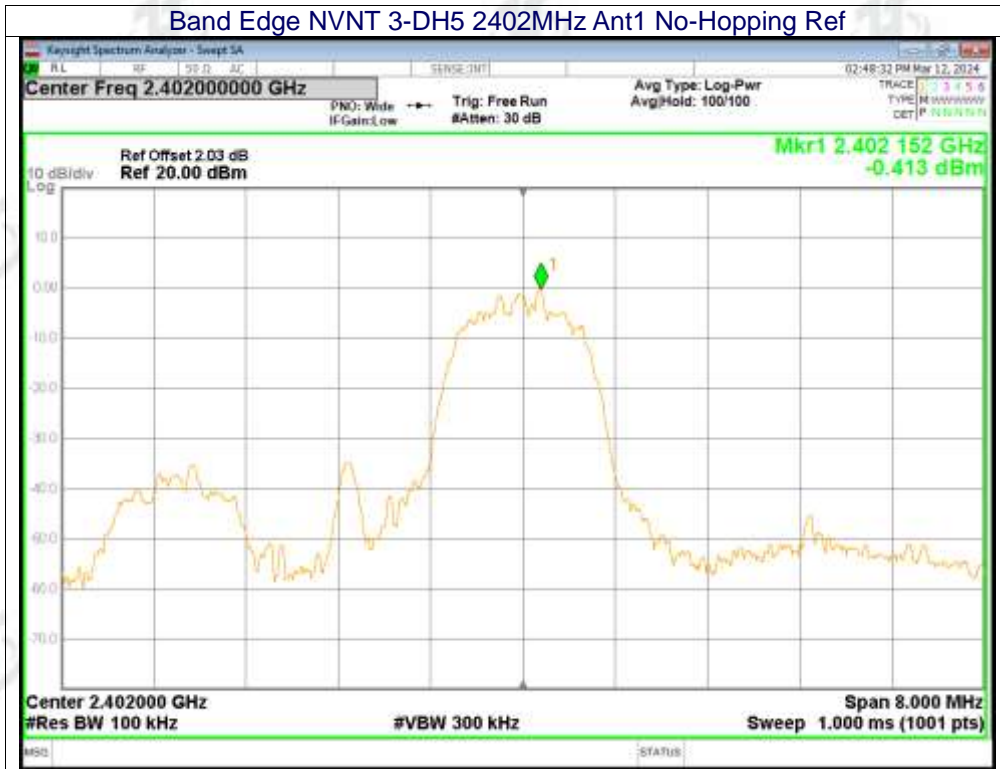



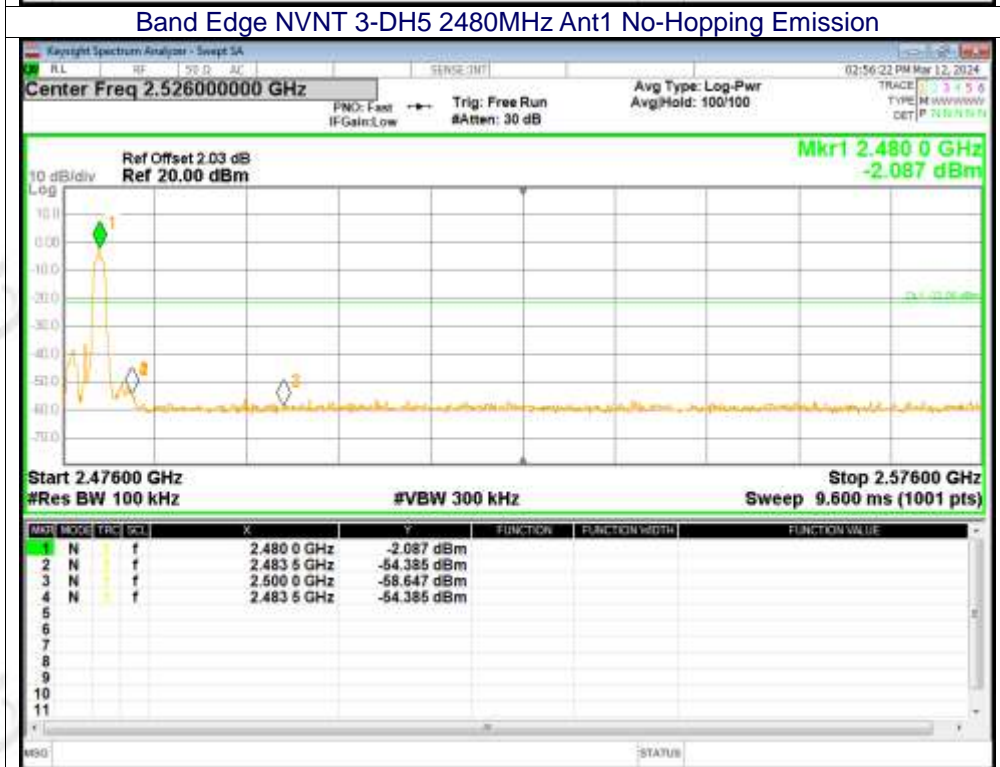
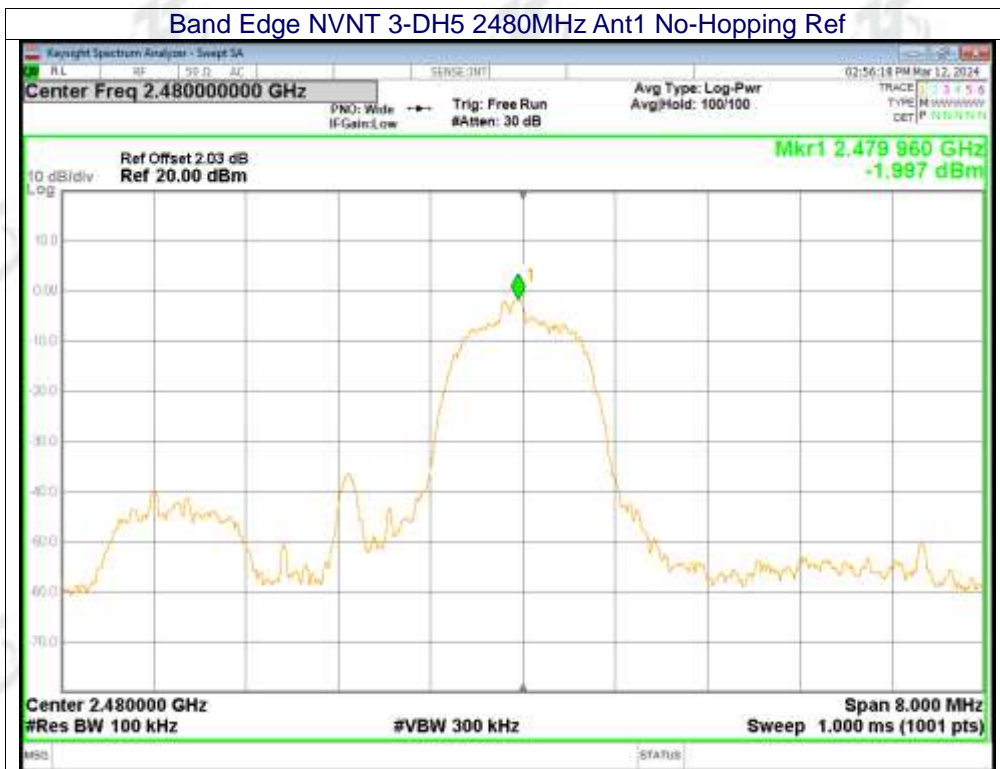



### 11.8 Band Edge(Hopping)

Mode	Frequency (MHz)	Hopping Mode	Max Value (dBc)	Limit (dBc)	Verdict
1-DH5	2402	Hopping	-53.95	-20	Pass
1-DH5	2480	Hopping	-50.41	-20	Pass
2-DH5	2402	Hopping	-54.61	-20	Pass
2-DH5	2480	Hopping	-51.92	-20	Pass
3-DH5	2402	Hopping	-53.75	-20	Pass
3-DH5	2480	Hopping	-52.99	-20	Pass

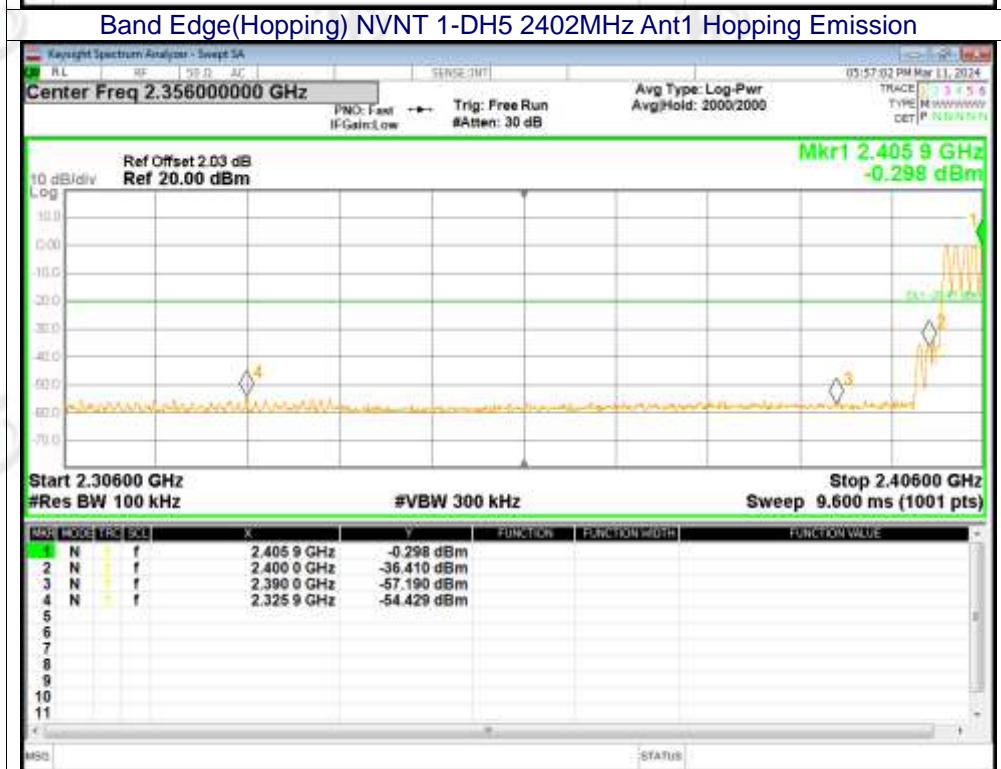
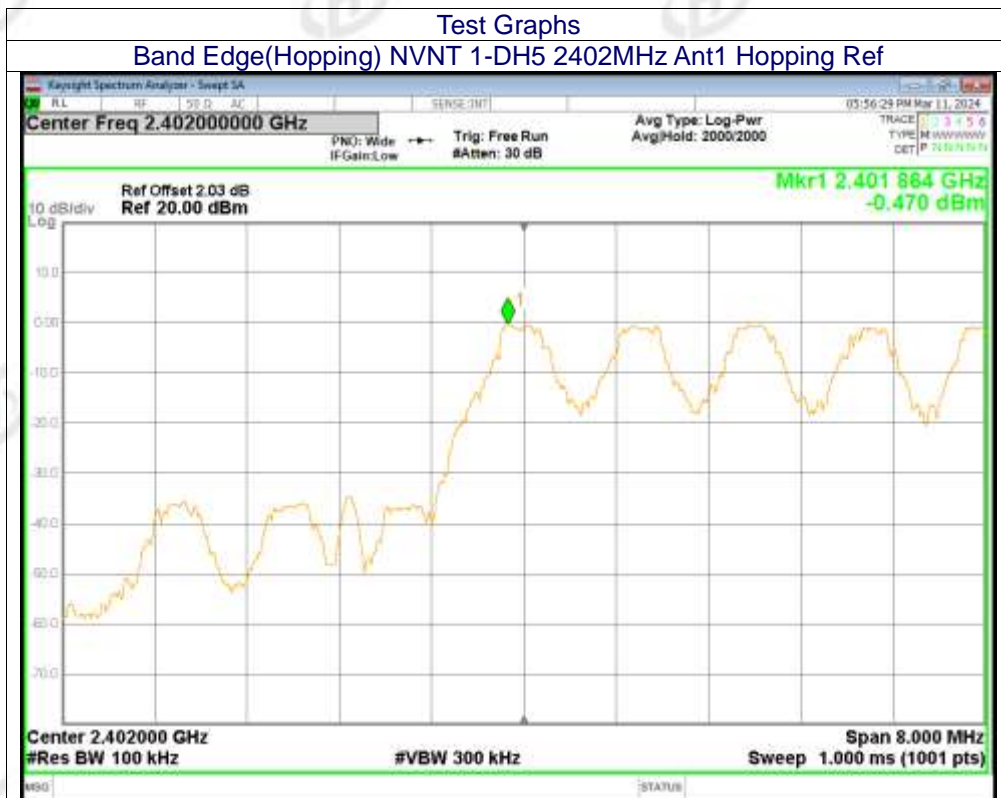

Band Edge(Hopping) NVNT 1-DH5 2480MHz Ant1 Hopping Ref

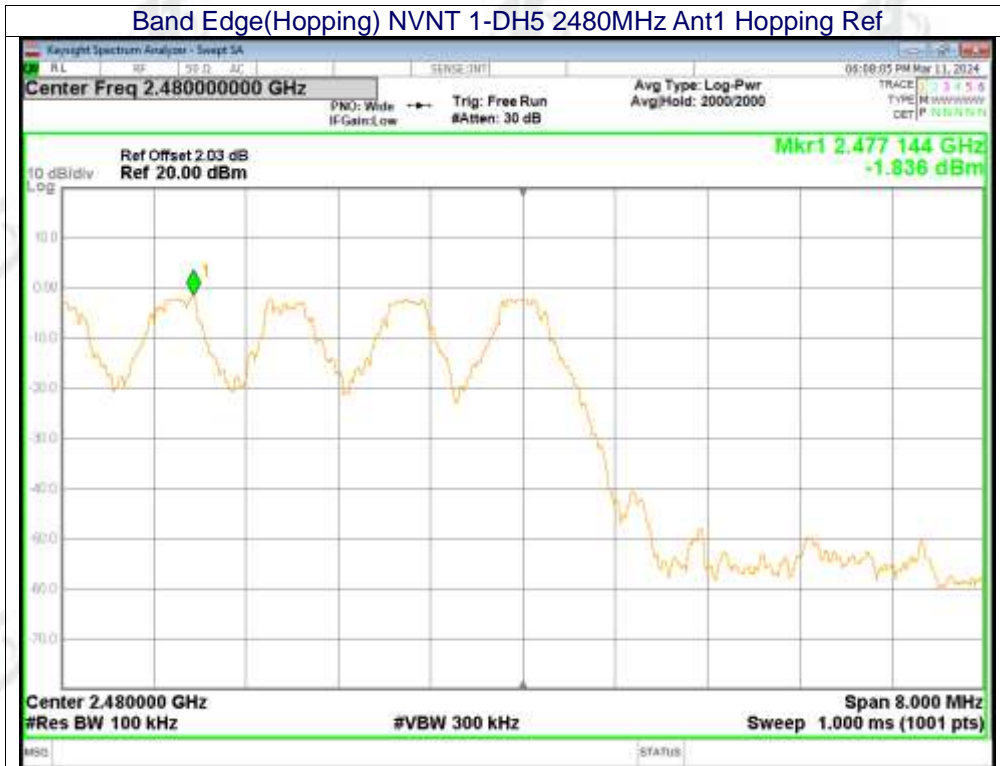

Band Edge(Hopping) NVNT 1-DH5 2480MHz Ant1 Hopping Emission

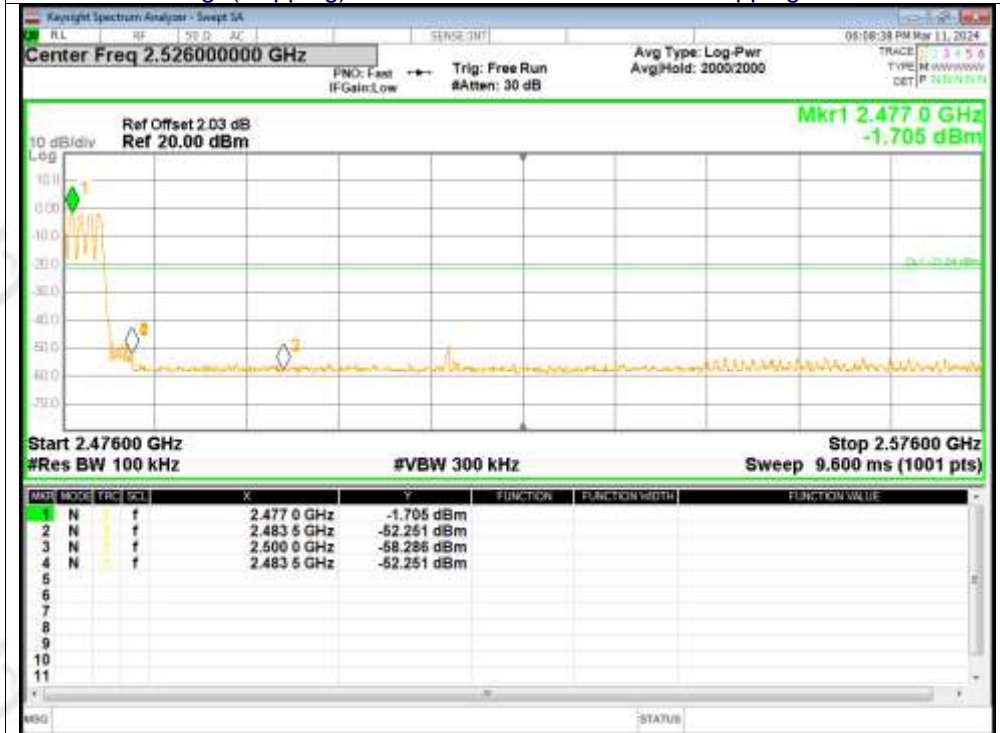

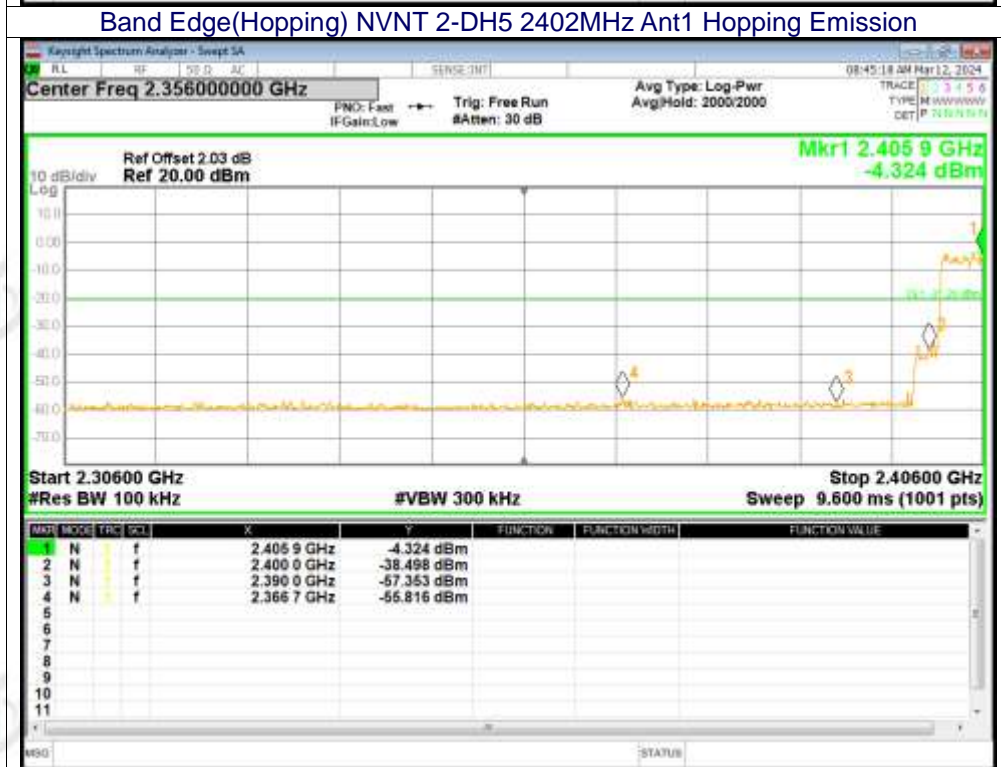
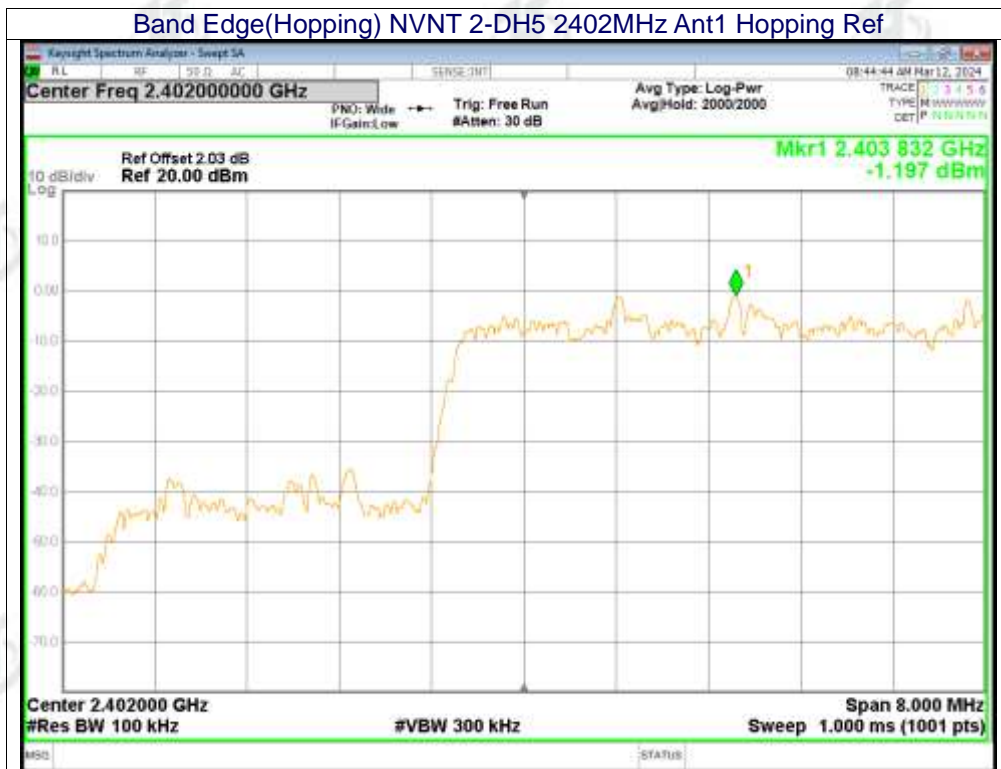

Band Edge(Hopping) NVNT 2-DH5 2480MHz Ant1 Hopping Ref

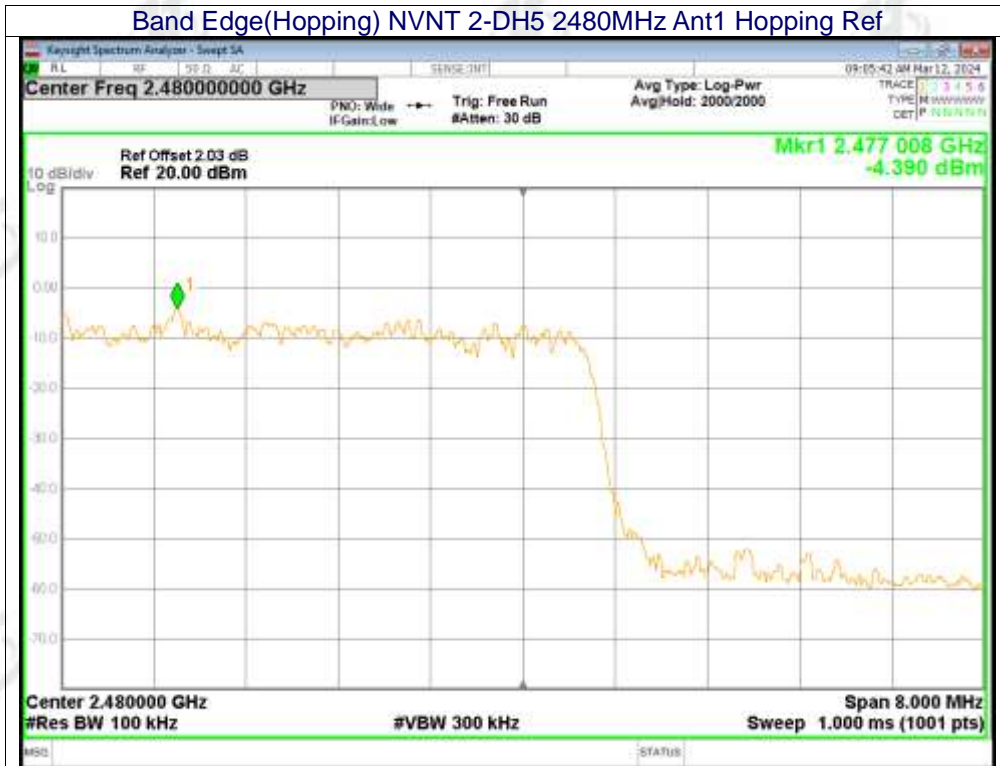

Band Edge(Hopping) NVNT 2-DH5 2480MHz Ant1 Hopping Emission

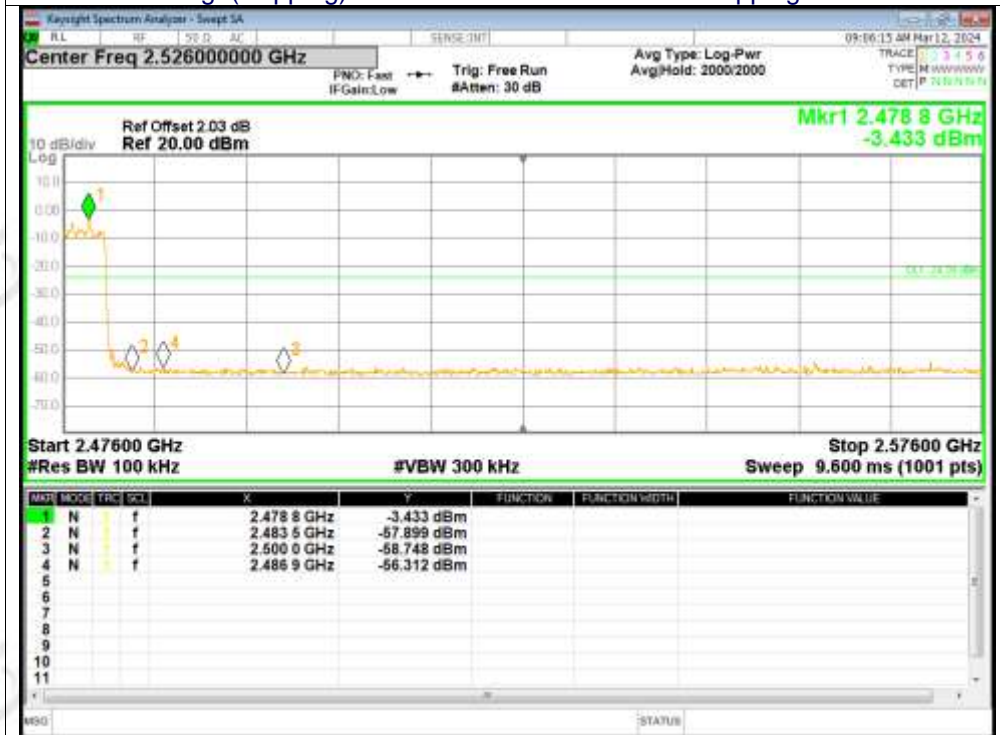



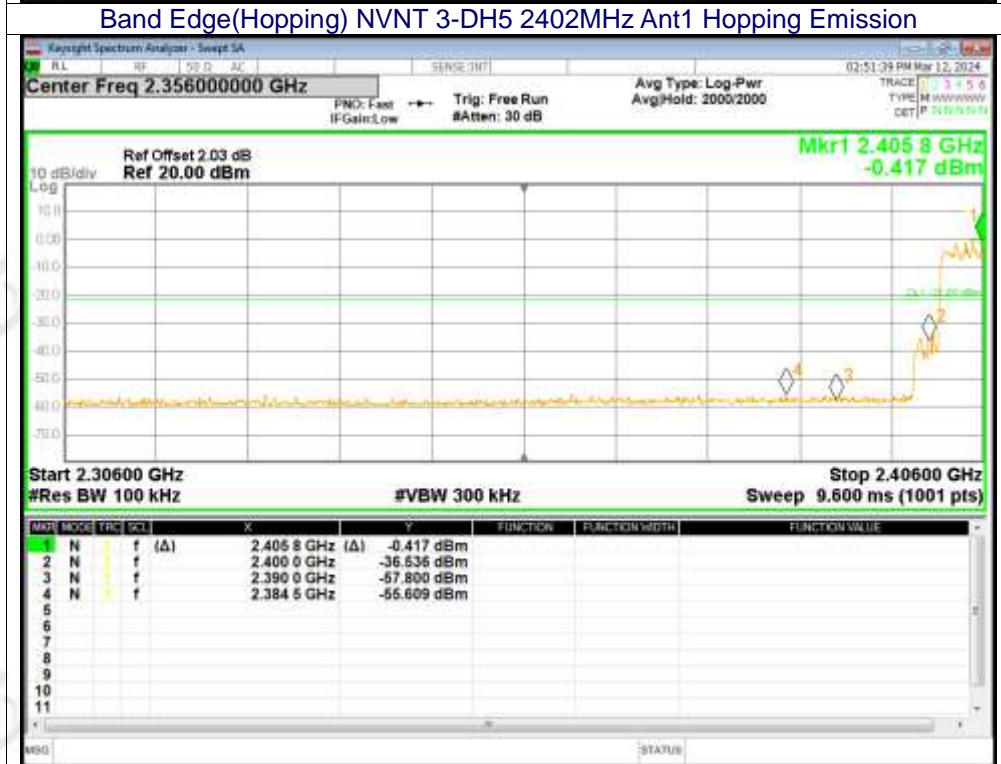
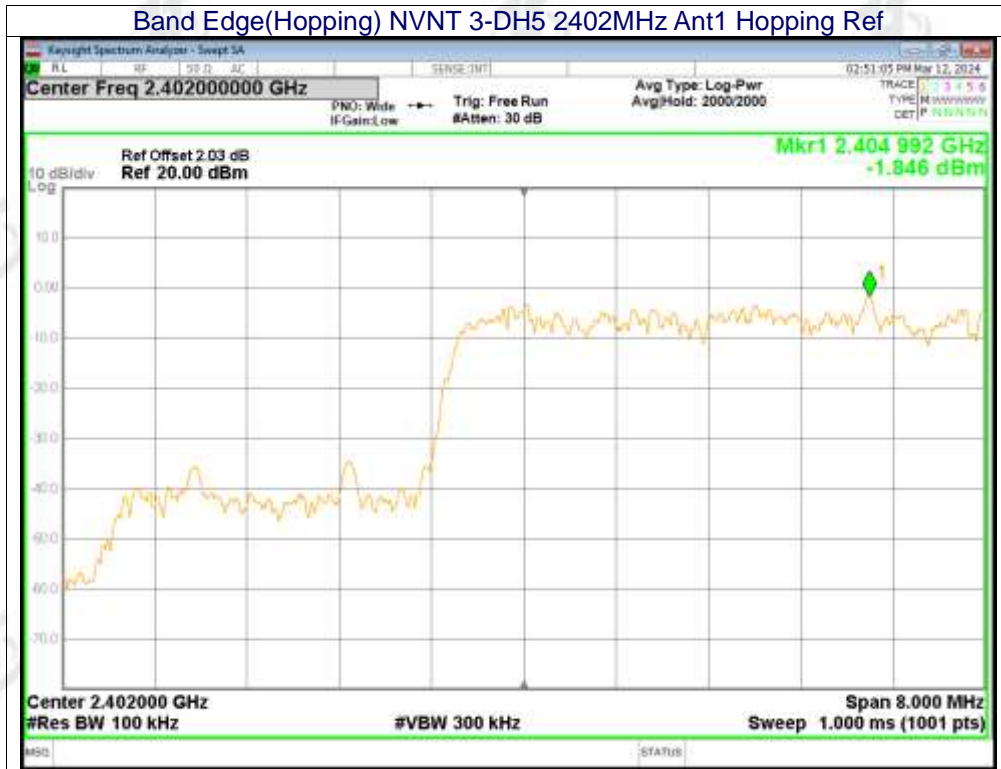



Band Edge(Hopping) NVNT 3-DH5 2480MHz Ant1 Hopping Ref

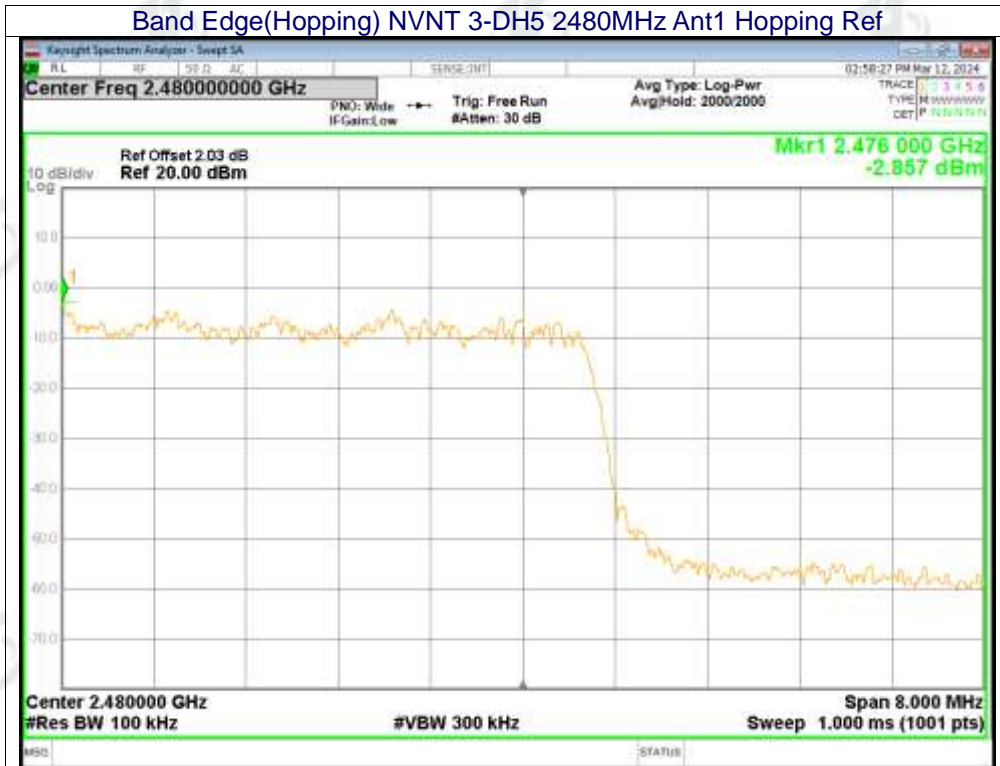

Band Edge(Hopping) NVNT 3-DH5 2480MHz Ant1 Hopping Emission

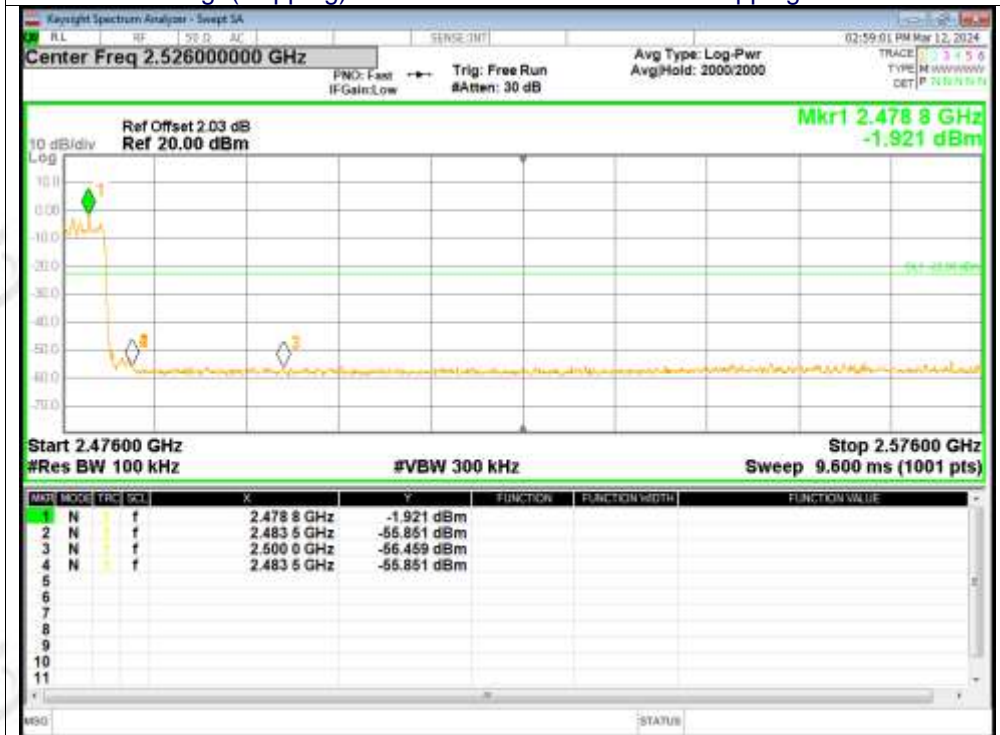



11.9 Conducted RF Spurious Emission

Mode	Frequency (MHz)	Max Value (dBc)	Limit (dBc)	Verdict
1-DH5	2402	-36.55	-20	Pass
1-DH5	2441	-34.94	-20	Pass
1-DH5	2480	-30.31	-20	Pass
2-DH5	2402	-36.62	-20	Pass
2-DH5	2441	-34.14	-20	Pass
2-DH5	2480	-29.05	-20	Pass
3-DH5	2402	-36.16	-20	Pass
3-DH5	2441	-35.02	-20	Pass
3-DH5	2480	-30.55	-20	Pass

Test Graphs

Tx. Spurious NVNT 1-DH5 2402MHz Ant1 Ref



Tx. Spurious NVNT 1-DH5 2402MHz Ant1 Emission

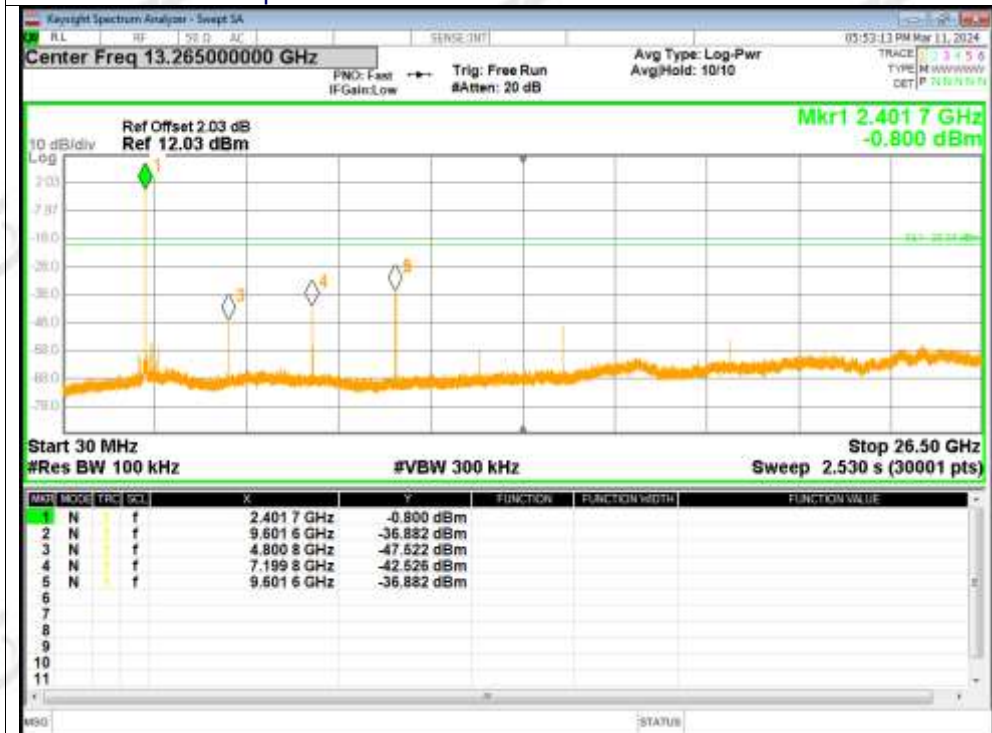

Tx. Spurious NVNT 1-DH5 2441MHz Ant1 Ref

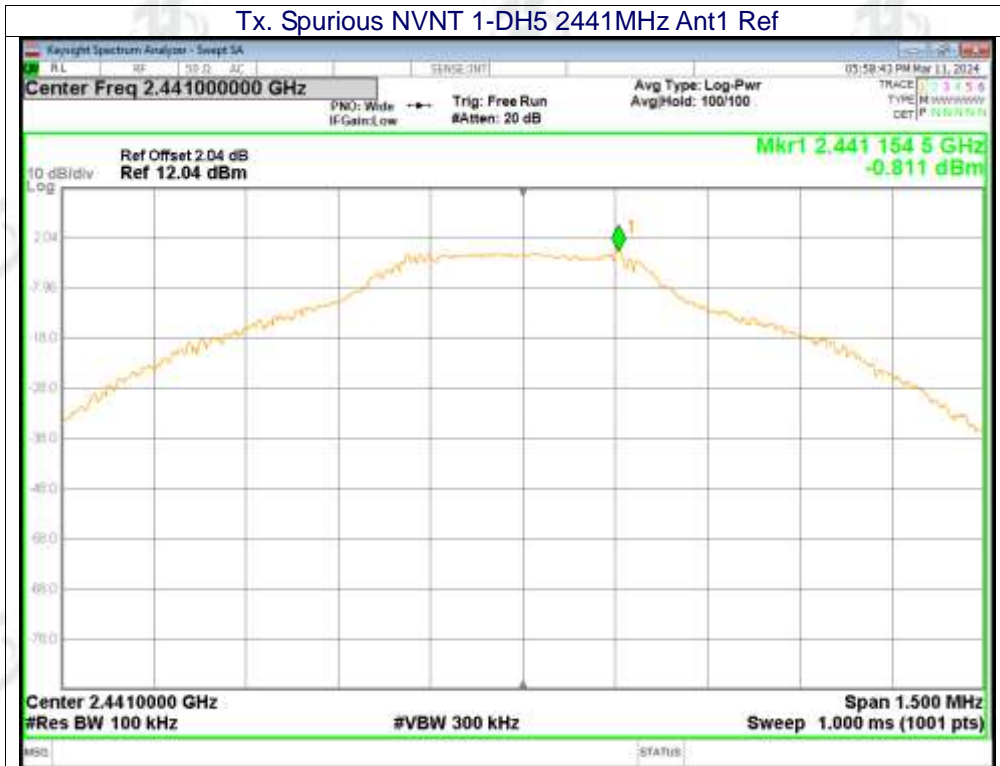

Tx. Spurious NVNT 1-DH5 2441MHz Ant1 Emission

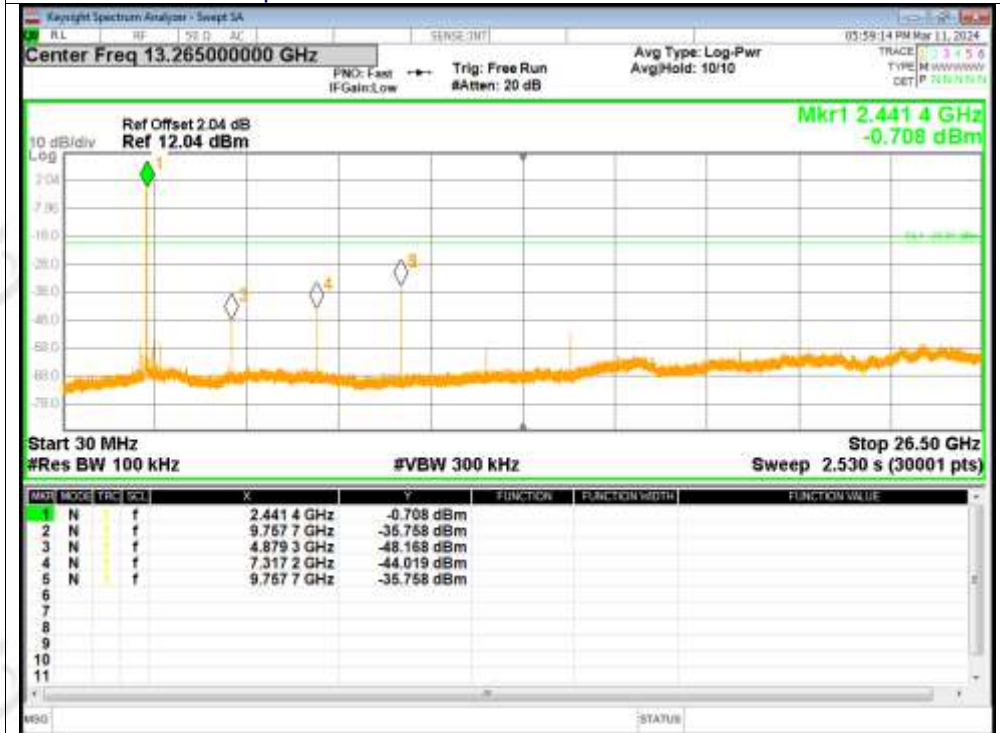



Tx. Spurious NVNT 1-DH5 2480MHz Ant1 Ref

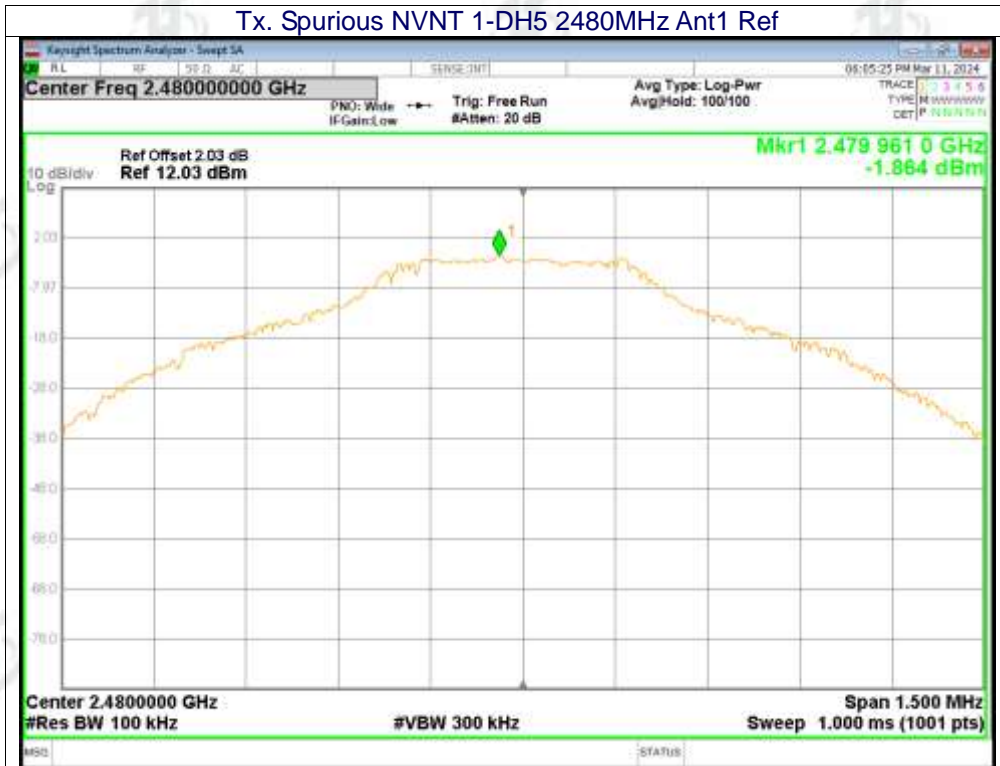

Tx. Spurious NVNT 1-DH5 2480MHz Ant1 Emission

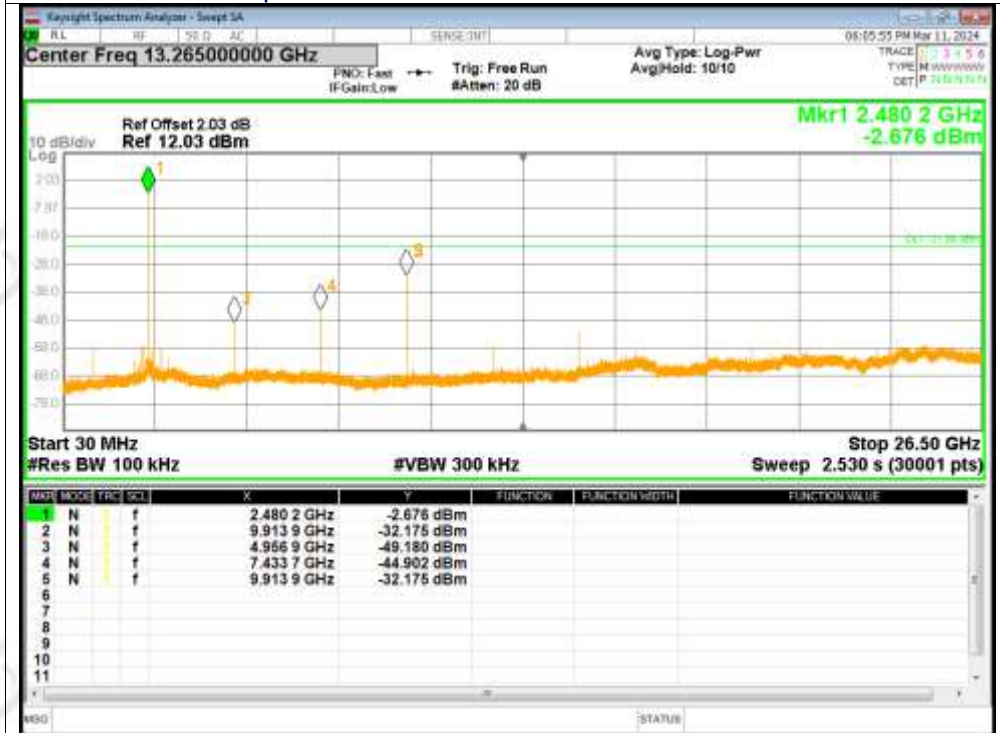



Tx. Spurious NVNT 2-DH5 2402MHz Ant1 Ref

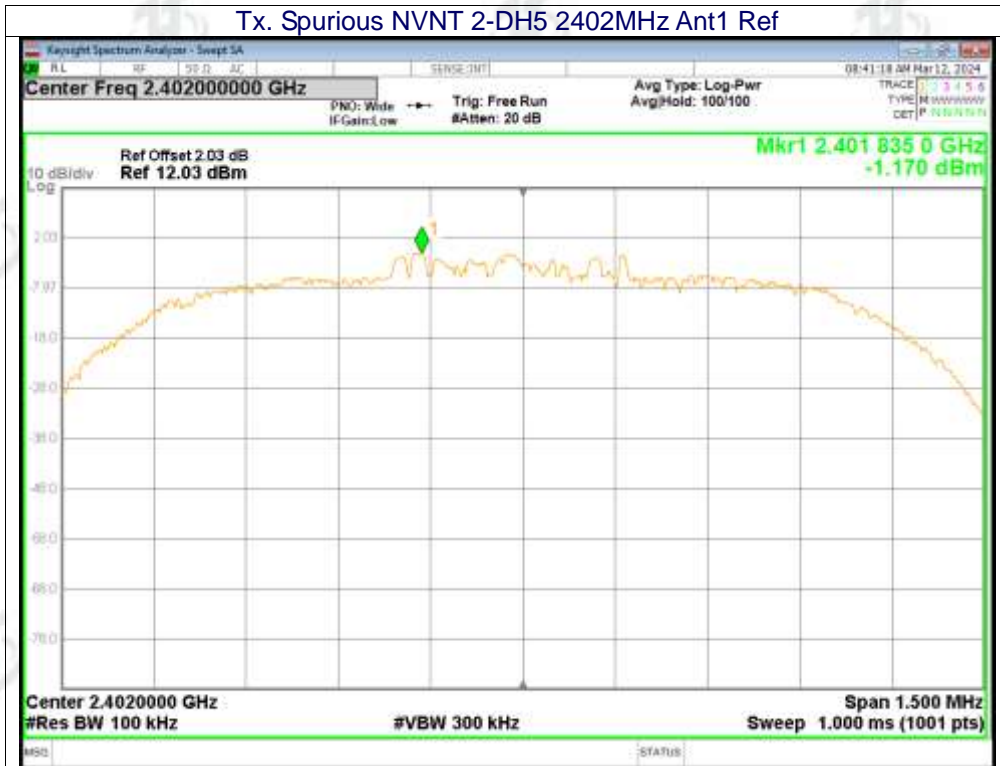

Tx. Spurious NVNT 2-DH5 2402MHz Ant1 Emission

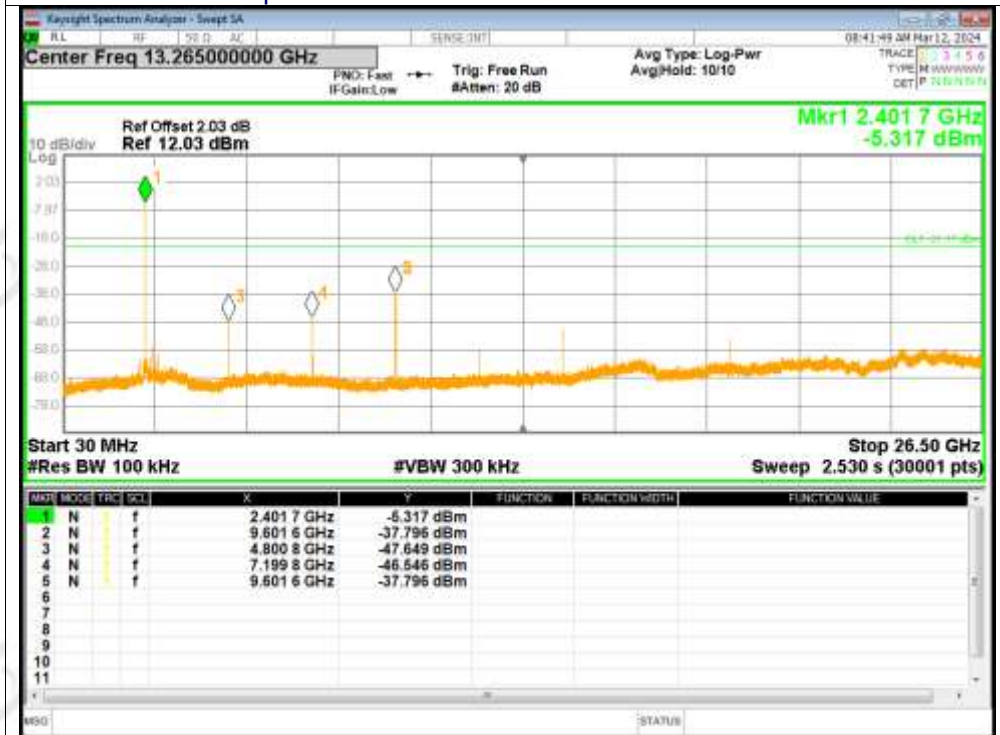

Tx. Spurious NVNT 2-DH5 2441MHz Ant1 Ref

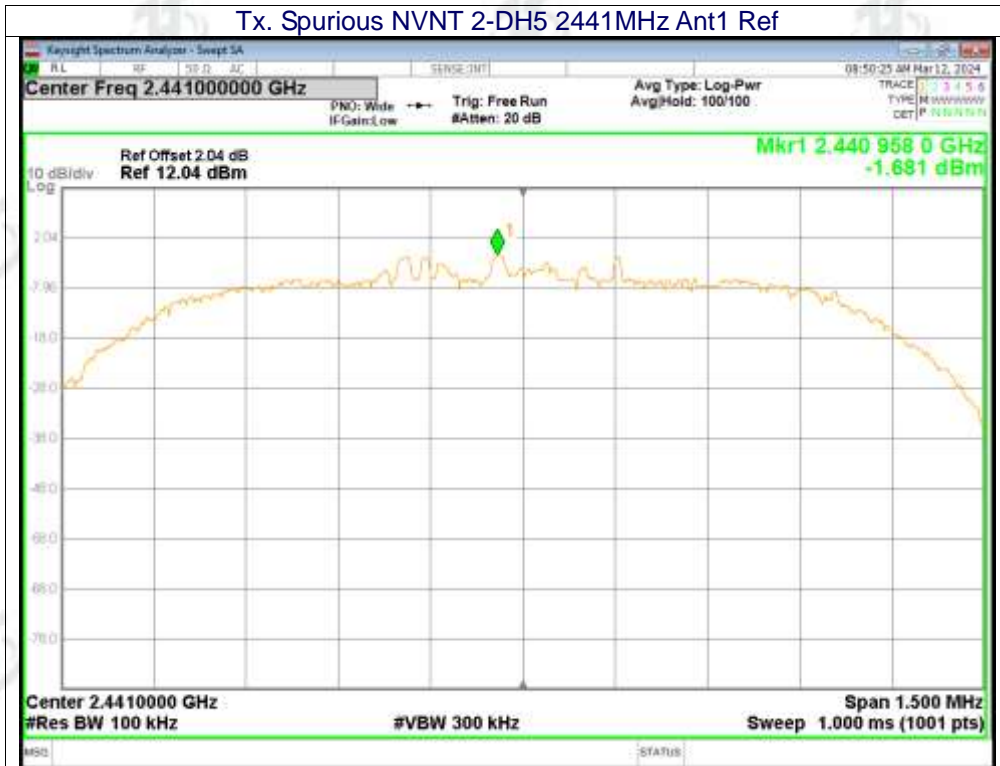

Tx. Spurious NVNT 2-DH5 2441MHz Ant1 Emission

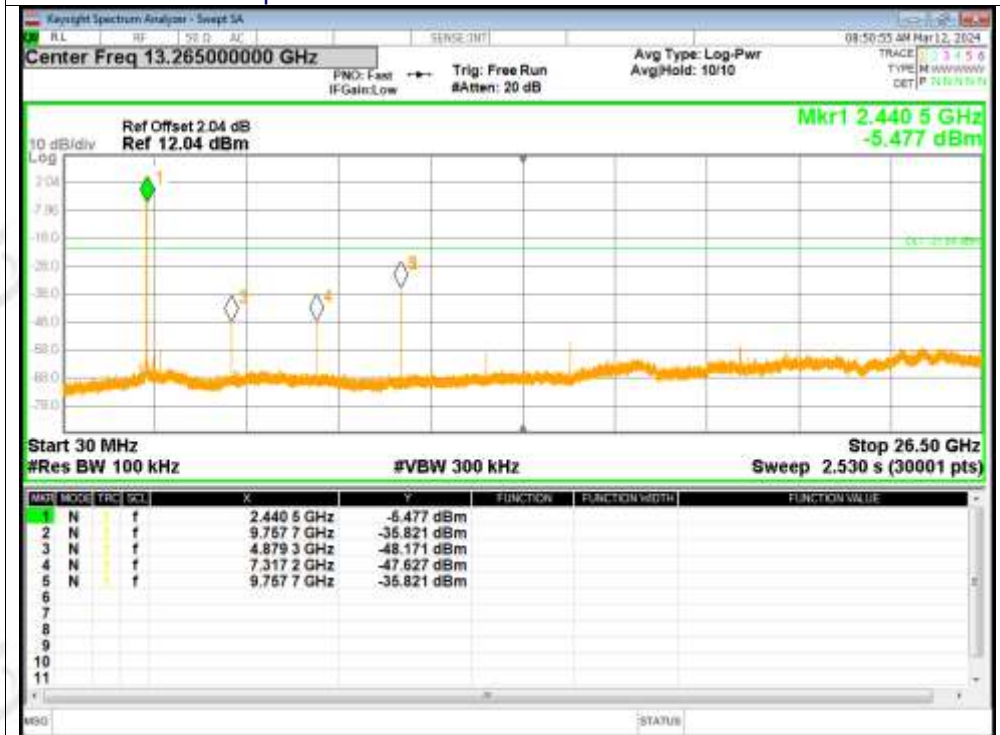

Tx. Spurious NVNT 2-DH5 2480MHz Ant1 Ref

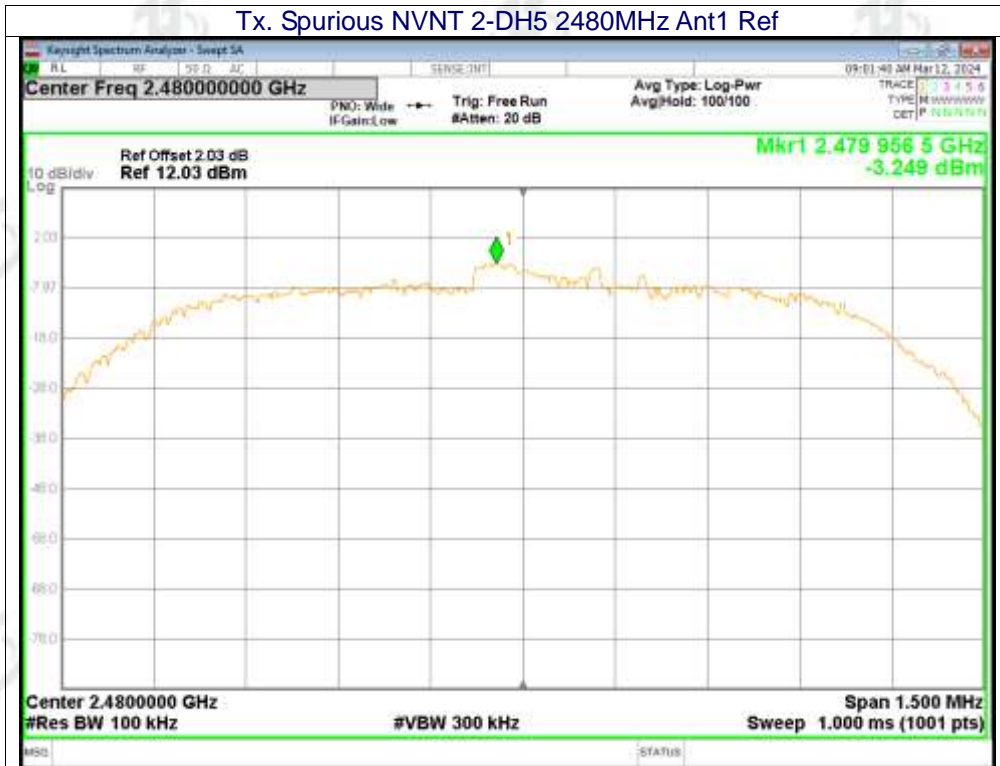

Tx. Spurious NVNT 2-DH5 2480MHz Ant1 Emission

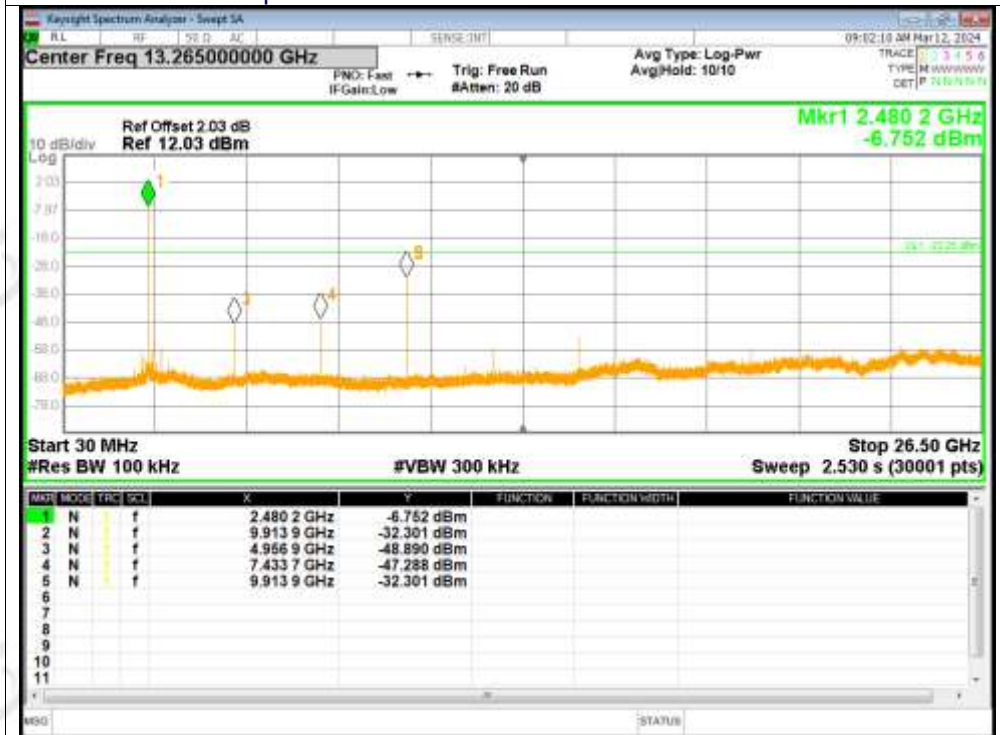

Tx. Spurious NVNT 3-DH5 2402MHz Ant1 Ref

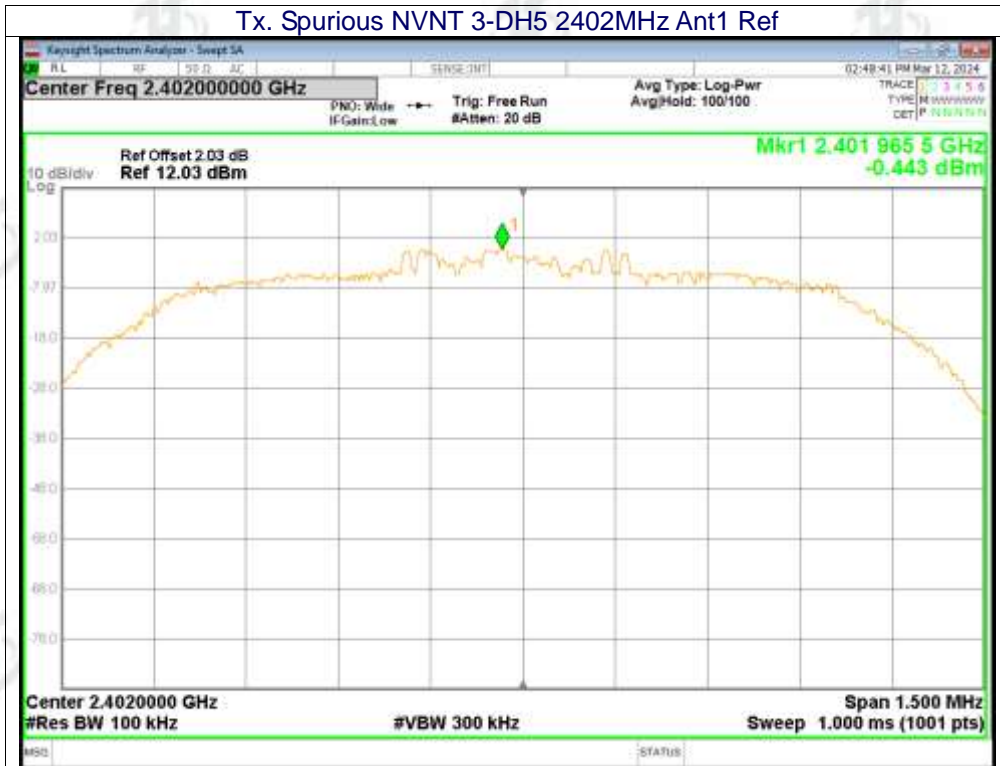

Tx. Spurious NVNT 3-DH5 2402MHz Ant1 Emission

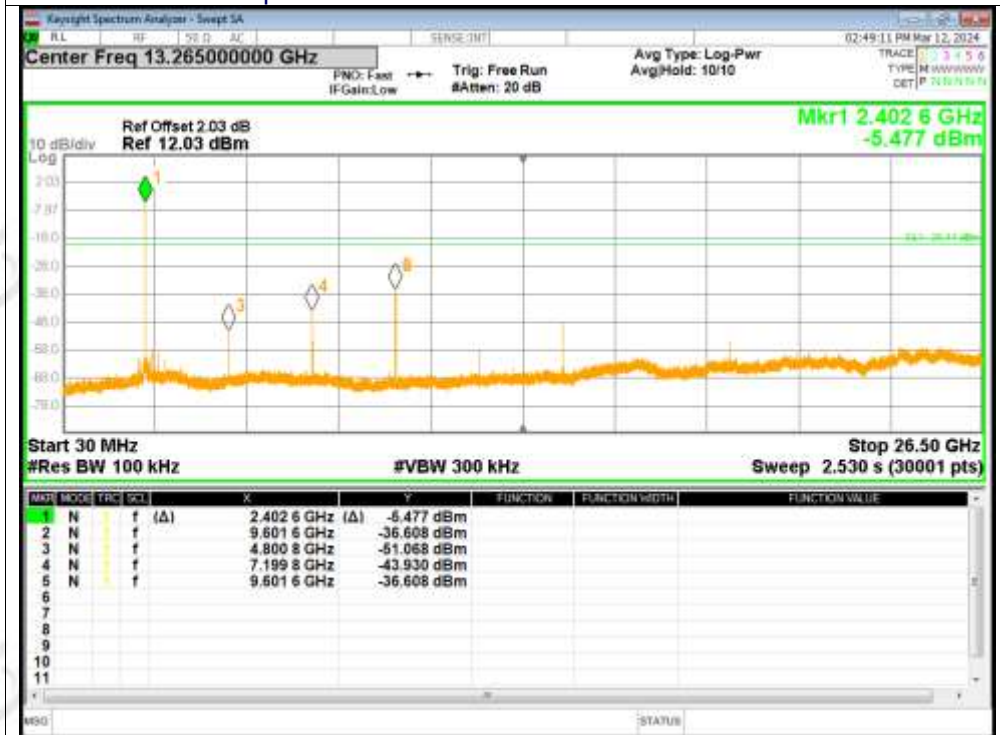



Tx. Spurious NVNT 3-DH5 2441MHz Ant1 Ref

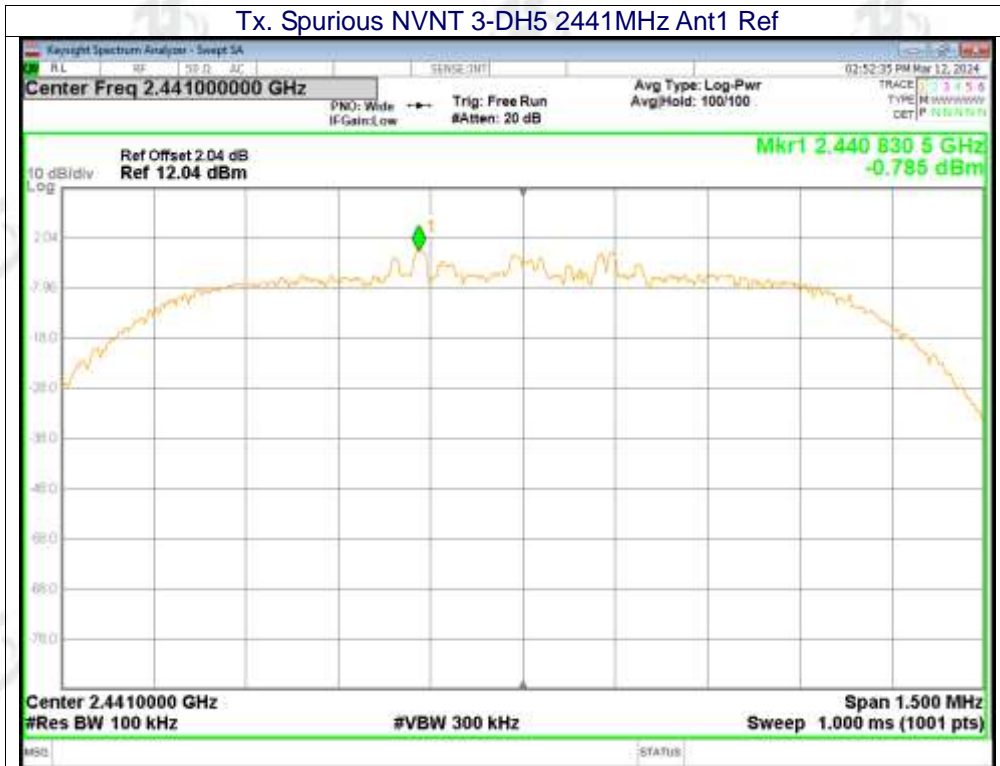

Tx. Spurious NVNT 3-DH5 2441MHz Ant1 Emission

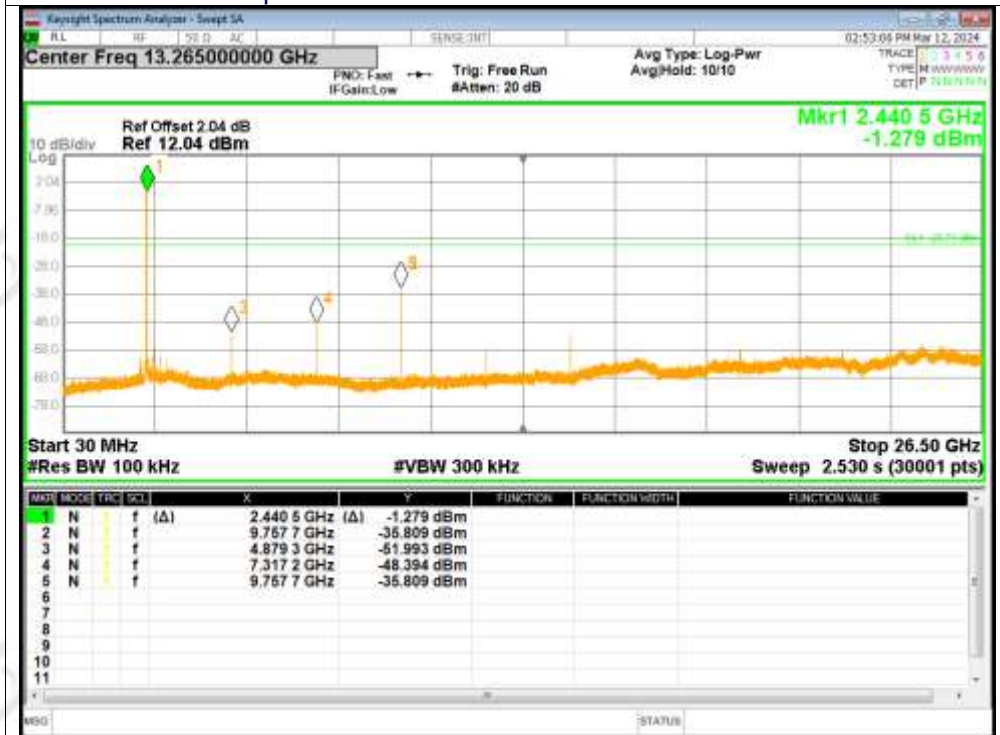



Tx. Spurious NVNT 3-DH5 2480MHz Ant1 Ref

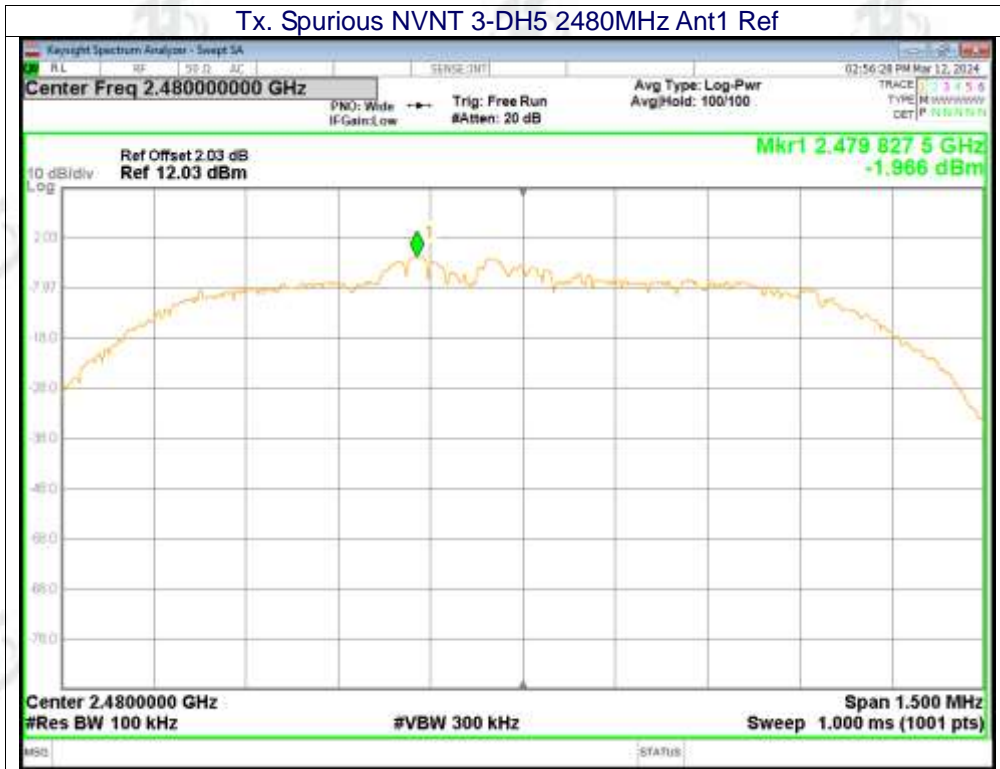

Tx. Spurious NVNT 3-DH5 2480MHz Ant1 Emission

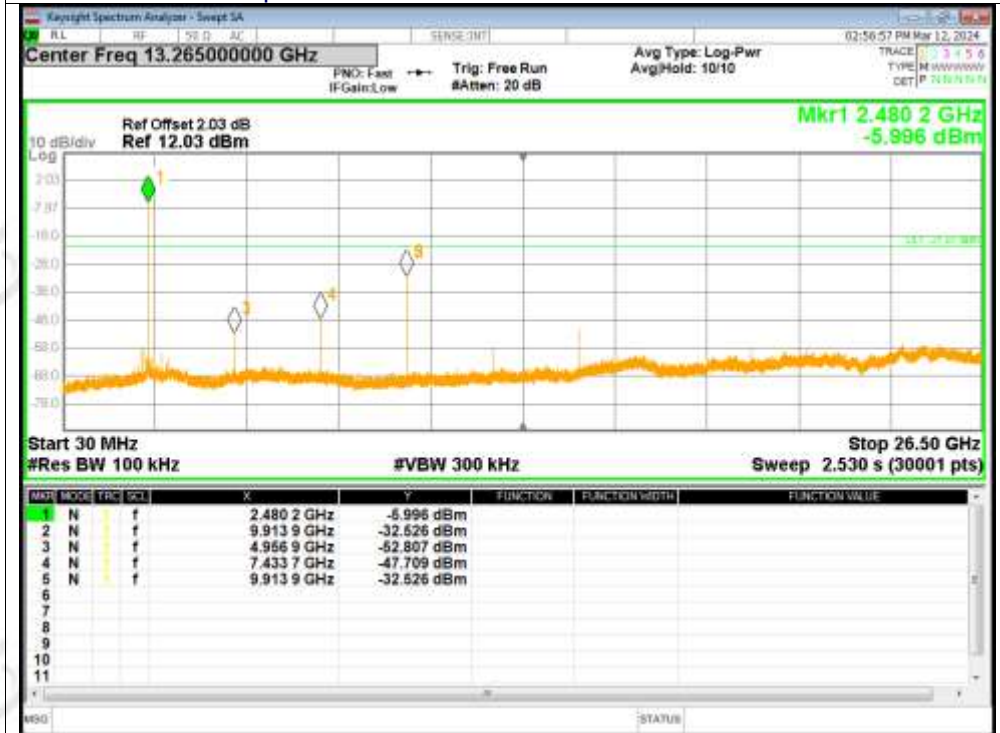

#### 14. Test Setup Photo

Reference to the appendix I for details.

#### 15. EUT Constructional Details

Reference to the appendix II for details.

\*\*\*\*\* END OF REPORT \*\*\*\*\*