

Test Report

Product: Bluetooth Wireless Earphone

Trade Mark: MIXX

Model Number: MIXX StreamBuds Custom 3

FCC ID: 2AXJ7-CUSTOM3

Prepared for

MIXX LIMITED

Unit 5 The Pavilions Brighton Road, Pease Pottage, RH11 9BJ United Kingdom

Prepared by

Shenzhen HongBiao Certification& Testing Co., Ltd

Room 102, 201, Building 2, Yuanwanggu RFID Industrial Park, Tongguan Road, Tianliao Community, Yutang Street, Guangming District, Shenzhen, China

Tel.: +86-755-2998 9321 Fax.: +86-755-2998 5110

Website: <http://www.sz-hongbiao.com>

Table of Contents

1	GENERAL DESCRIPTION	6
1.1	DESCRIPTION OF EUT.....	6
1.2	TEST MODE.....	6
1.3	OPERATION CHANNEL LIST	6
1.4	TEST SETUP	7
1.5	ANCILLARY EQUIPMENT	7
2	SUMMARY OF TEST RESULT	8
3	TEST FACILITIES AND ACCREDITATIONS	9
3.1	TEST LABORATORY	9
3.2	ENVIRONMENTAL CONDITIONS	9
3.3	MEASUREMENT UNCERTAINTY	9
3.4	TEST SOFTWARE	9
4	LIST OF TEST EQUIPMENT	10
5	TEST ITEM AND RESULTS.....	12
5.1	ANTENNA REQUIREMENT	12
5.1.1	<i>Standard Requirement</i>	12
5.1.2	<i>Test Result</i>	12
5.2	CONDUCTED EMISSION.....	13
5.2.1	<i>Limits</i>	13
5.2.2	<i>Test Procedures</i>	13
5.2.3	<i>Test Setup</i>	14
5.2.4	<i>Test Result</i>	14
5.3	RADIATED EMISSION	17
5.3.1	<i>Limits</i>	17
5.3.2	<i>Test Procedures</i>	17
5.3.3	<i>Test Setup</i>	17
5.3.4	<i>Test Result</i>	18
5.3.5	<i>Radiated Band Edge</i>	23
5.4	PEAK OUTPUT POWER.....	24
5.4.1	<i>Limit</i>	24
5.4.2	<i>Test Procedure</i>	24
5.4.3	<i>Test Setup</i>	24
5.4.4	<i>Test Results</i>	24
5.5	20DB OCCUPIED CHANNEL BANDWIDTH.....	26
5.5.1	<i>Limit</i>	26
5.5.2	<i>Test Procedure</i>	26
5.5.3	<i>Test Setup</i>	26
5.5.4	<i>Test results</i>	26
5.6	CARRIER FREQUENCY SEPARATION	30
5.6.1	<i>Limit</i>	30
5.6.2	<i>Test Procedure</i>	30
5.6.3	<i>Test Setup</i>	30
5.6.4	<i>Test Results</i>	30
5.7	HOPPING CHANNEL NUMBER	35
5.7.1	<i>Limit</i>	35
5.7.2	<i>Test Procedure</i>	35
5.7.3	<i>Test Setup</i>	35
5.7.4	<i>Test Results</i>	35
5.8	DWELL TIME.....	37
5.8.1	<i>Limit</i>	37
5.8.2	<i>Test Procedure</i>	37

5.8.3	Test Setup	37
5.8.4	Test Results	37
5.9	CONDUCTED BAND EDGE	41
5.9.1	Limit	41
5.9.2	Test Procedure	41
5.9.3	Test Setup	41
5.9.4	Test Results	41
5.10	SPURIOUS RF CONDUCTED EMISSIONS	46
5.10.1	Limit	46
5.10.2	Test Procedure	46
5.10.3	Test Setup	46
5.10.4	Test Results	46
6.	PHOTOGRAPHS OF THE TEST SETUP.....	49
7	PHOTOGRAPHS OF THE EUT.....	50

TEST RESULT CERTIFICATION

Applicant's Name..... : MIXX LIMITED
Address : Unit 5 The Pavilions Brighton Road, Pease Pottage, RH11 9BJ
United Kingdom
Manufacturer's Name : Shenzhen Kingvie Technology Co., Ltd
Address : 201, 301, No.2 Building, 84# Fuqian Rd., Fumin Community,
Fucheng Street, Longhua District, Shenzhen City

Product description

Product name : Bluetooth Wireless Earphone
Model Number : MIXX StreamBuds Custom 3
Standards..... : FCC Part 15.247
Test procedure..... : IEEE/ANSI C63.10-2020

This device described above has been tested by Shenzhen HongBiao Certification& Testing Co., Ltd and the test results show that the equipment under test (EUT) is in compliance with the EMC requirements. And it is applicable only to the tested sample identified in the report.

Date of Test

Date (s) of performance of tests..... : August 18. 2023 ~ August 29. 2023
Test Result..... : **Pass**

Testing Engineer : 

(Z o e S u)

Technical Manager : 

(G a r y L u)

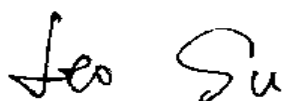
Authorized Signatory : 

(L e o S u)

1 General Description

1.1 Description of EUT

Product name:	Bluetooth Wireless Earphone
Model name:	MIXX StreamBuds Custom 3
Series Model:	SBCU-03-XX-XXX
Different of series model:	The color of appearance and model name of series models listed are different from the main model, but the circuit and the electronic construction are the same, -XX-XXX stands for means different colors, declared by the manufacturer.
Operation frequency:	2402-2480MHz
Modulation type:	GFSK, $\pi/4$ -DQPSK
Bit Rate of transmitter:	1 Mbps, 2Mbps
Antenna type:	FPCB Antenna
Antenna gain:	0.64dBi
Max. output power:	1.53dBm
Hardware version:	V1.0
Software version:	V1.3.5
Battery:	DC 3.7V/30mAh
Power supply:	DC 3.7V by battery, USB 5V charging
Adapter information:	N/A

1.2 Test Mode

Test Mode	Channel	Frequency (MHz)
1	00	2402
2	39	2441
3	78	2480

1.3 Operation Channel List

Channel	Frequency (MHz)	Channel	Frequency (MHz)	Channel	Frequency (MHz)
00	2402	27	2429	54	2456
01	2403	28	2430	55	2457
02	2404	29	2431	56	2458

03	2405	30	2432	57	2459
04	2406	31	2433	58	2460
05	2407	32	2434	59	2461
06	2408	33	2435	60	2462
07	2409	34	2436	61	2463
08	2410	35	2437	62	2464
09	2411	36	2438	63	2465
10	2412	37	2439	64	2466
11	2413	38	2440	65	2467
12	2414	39	2441	66	2468
13	2415	40	2442	67	2469
14	2416	41	2443	68	2470
15	2417	42	2444	69	2471
16	2418	43	2445	70	2472
17	2419	44	2446	71	2473
18	2420	45	2447	72	2474
19	2421	46	2448	73	2475
20	2422	47	2449	74	2476
21	2423	48	2450	75	2477
22	2424	49	2451	76	2478
23	2425	50	2452	77	2479
24	2426	51	2453	78	2480
25	2427	52	2454	--	--
26	2428	53	2455	--	--

1.4 Test Setup

See photographs of the test setup in the report for the actual setup and connections between EUT and support equipment.

1.5 Ancillary Equipment

Equipment	Model	S/N	Manufacturer
Adapter	HW-100225C00	/	Huawei

Equipment	Length (cm)	Shielded/Unshielded	With/Without Ferrite
USB Cable	50	Unshielded	Without Ferrite

2 Summary of Test Result

No.	Standard Section	Test Item	Result	Remark
1	15.203	Antenna requirement	Pass	
2	15.207	Conducted emission	Pass	
3	15.247(d)	Band edge	Pass	
4	15.205/15.209	Spurious emission	Pass	
5	15.247(b)(1)	Peak output power	Pass	
6	15.247(a)(1)	20dB occupied bandwidth	Pass	
7	15.247(a)(1)	Carrier Frequencies Separation	Pass	
8	15.247(a)(1)	Hopping channel number	Pass	
9	15.247(a)(1)	Dwell time	Pass	
10	15.247(d)	Spurious RF Conducted Emissions	Pass	

3 Test Facilities and Accreditations

3.1 Test Laboratory

Test Site	Shenzhen HongBiao Certification& Testing Co., Ltd
Test Site Location	Room 102, 201, Building 2, Yuanwanggu RFID Industrial Park, Tongguan Road, Tianliao Community, Yutang Street, Guangming District, Shenzhen, China
Telephone:	(86-755) 2998 9321
Fax:	(86-755) 2998 5110
FCC Registration No.:	CN1341
A2LA Certificate No.:	6765.01

3.2 Environmental Conditions

During the measurement the environmental conditions were within the listed ranges:

Temperature:	15°C~35°C
Relative Humidity:	20%~75%
Air Pressure:	98kPa~101kPa

3.3 Measurement Uncertainty

The reported uncertainty of measurement $y \pm U$, where expanded uncertainty U is based on a standard uncertainty multiplied by a coverage factor of $k=2$, providing a level of confidence of approximately 95 %.

Measurement Frequency Range	U, (dB)	Note
RF frequency	2×10^{-5}	
RF power, conducted	± 0.57 dB	
Conducted emission(150kHz~30MHz)	± 2.5 dB	
Radiated emission(30MHz~1GHz)	± 4.2 dB	
Radiated emission (above 1GHz)	± 4.7 dB	
Temperature	± 1 degree	
Humidity	± 5 %	

3.4 Test Software

Software name	Manufacturer	Model	Version
EMI Measurement	Farad	EZ-EMC	V1.1.4.2
Conducted test system	MWRF-test	MTS 8310	V2.0.0

4 List of Test Equipment

Radiation emission							
Item	Equipment No.	Equipment name	Manufacturer	Model	Serial No.	Calibration date	Due date
1	HB-E001	Horn Antenna	Schwarzbeck	BBHA 9120D	02592	2022-04-02	2024-04-01
2	HB-E002	Biconical log-periodic composite antenna	Schwarzbeck	VULB 9168	01340	2022-04-06	2024-04-05
3	HB-E003	SHF-EHF Horn	Schwarzbeck	BBHA 91270	01193	2022-04-02	2024-04-01
4	HB-E004	Preamplifier	Noyetec	LAN-0910	NYCM1420101	2023-05-11	2024-05-10
5	HB-E005	Preamplifier	Noyetec	LAN-0118	NYCM1420102	2023-05-12	2024-05-11
6	HB-E006	Preamplifier	Noyetec	LAN-1840	NYCM1420103	2023-06-11	2024-06-10
7	HB-E007	EMI TEST RECEIVER	R&S	ESR7	102520	2023-05-12	2024-05-11
8	HB-E009	POSITINAL COTROLLE R	Noyetec	N/A	N/A	/	/
9	HB-E013	RF switch	Noyetec	NY-RF4	NY0CM1420204	/	/
10	HB-E066	Illuminance Tester	TASI	TA8121	N/A	2023-05-11	2024-05-10
11	HB-E075	Active loop antenna	Schwarzbeck	FMZB 1519B	1519B-245	2022-07-24	2024-07-23
Conduction emission							
Item	Equipment No.	Equipment name	Manufacturer	Model	Serial No.	Calibration date	Due date
1	HB-E014	4 Path V-LISN	Schwarzbeck	NNLK 8121	00770	2023-05-12	2024-05-11
2	HB-E015	Pulse Limiter	Schwarzbeck	VTSD 9561-F	00949	2023-05-12	2024-05-11
3	HB-E016	ZN23201	Noyetec	ZN23201	N/A	2023-05-11	2024-05-10
4	HB-E059	Attenuator	Xianghua	TS2-6-1	220215166	2023-05-12	2024-05-11
5	HB-E069	EMI TEST RECEIVER	R&S	ESCI	N/A	2023-05-12	2024-05-11
RF							
Item	Equipment No.	Equipment name	Manufacturer	Model	Serial No.	Calibration date	Due date
1	HB-E041	MXG Anaioq Signal Generator	Agilent	N5181A	MY47070421	2023-05-11	2024-05-10
2	HB-E042	WIDEBAND RADIO COMMUNICA	R&S	CMW500	132108	2023-05-11	2024-05-10

		TION TESTER					
3	HB-E043	MXG Anaioq Signal Generator	Agilent	N5182A	US46240335	2023-05-11	2024-05-10
4	HB-E044	Signal& spectrum Analyzer	R&S	FSV3044	101264	2023-05-11	2024-05-10
5	HB-E045	RF Control Box	Noyetec	NY100-R FCB	N/A	/	/
6	HB-E058	Thermometer Clock Humidity Monitor	N/A	HTC-1	N/A	/	/

Note: the calibration interval of the above test instruments is 12&24 months and the calibrations are traceable to international system unit (SI).

5 Test Item And Results

5.1 Antenna Requirement

5.1.1 Standard Requirement

15.203 requirement: For intentional device, according to 15.203: an intentional radiator shall be designed to ensure that no antenna other than that furnished by the responsible party shall be used with the device

5.1.2 Test Result

The EUT antenna is FPCB Antenna. It comply with the standard requirement. In case of replacement of broken antenna the same antenna type must be used.

5.2 Conducted Emission

5.2.1 Limits

Limits – Class B		
Frequency (MHz)	Limit (dB μ V)	
	Quasi-Peak	Average
0.15 to 0.5	66 to 56*	56 to 46*
0.5 to 5	56	46
5 to 30	60	50

Note:

- the tighter limit applies at the band edges.
- the limit of " * " marked band means the limitation decreases linearly with the logarithm of the frequency in the range.

5.2.2 Test Procedures

a) EUT Operating Conditions

The EUT was configured for testing in a typical fashion (as a customer would normally use it). The EUT has been programmed to continuously transmit during test. This operating condition was tested and used to collect the included data.

b) The following table is the setting of the receiver

Receiver Parameters	Setting
Attenuation	10 dB
Start Frequency	0.15 MHz
Stop Frequency	30 MHz
IF Bandwidth	9 kHz

- The EUT was placed 0.8 meters from the horizontal ground plane with EUT being connected to the power mains through a line impedance stabilization network (LISN). All other support equipment powered from additional LISN(s). The LISN provide 50 Ohm/ 50uH of coupling impedance for the measuring instrument.
- Interconnecting cables that hang closer than 40 cm to the ground plane shall be folded back and forth in the center forming a bundle 30 to 40 cm long.
- I/O cables that are not connected to a peripheral shall be bundled in the center. The end of the cable may be terminated, if required, using the correct terminating impedance. The overall length shall not exceed 1 m.
- LISN is at least 80 cm from nearest part of EUT chassis.
- For the actual test configuration, please refer to the related Item – photographs of the test setup.

5.2.3 Test Setup

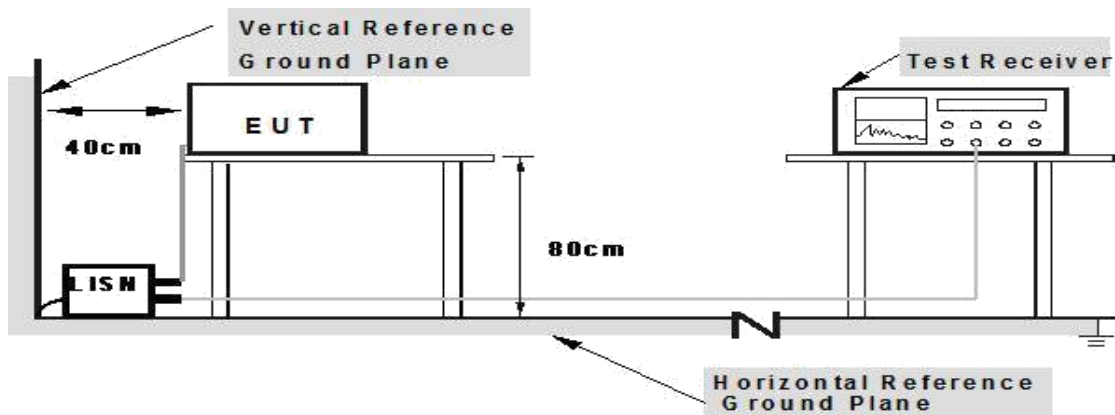

5.2.4 Test Result

EUT:	Bluetooth Wireless Earphone	Model Name:	MIXX StreamBuds Custom 3
Test Mode:	Charging	Phase :	L
Test Voltage:	AC 120V/60Hz		

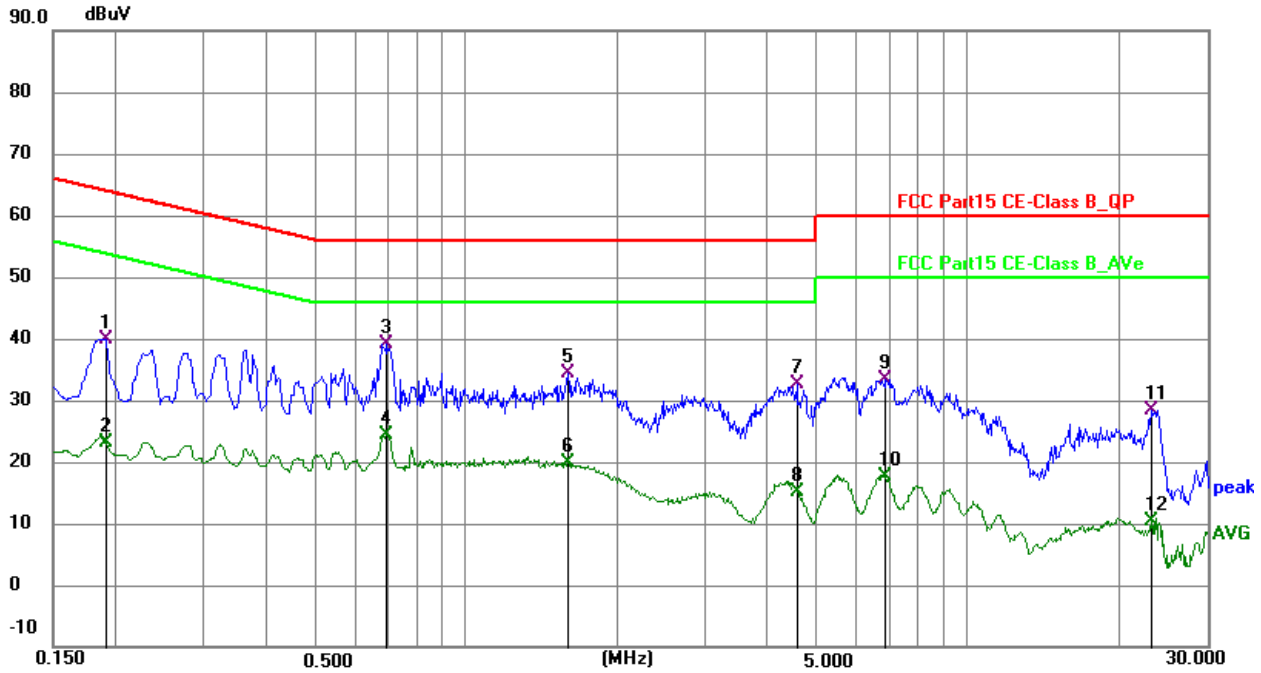

No.	Frequency (MHz)	Reading (dBuV)	Factor (dB)	Level (dBuV)	Limit (dBuV)	Margin (dB)	Detector	P/F	Remark
1	0.1905	30.02	9.76	39.78	64.01	-24.23	QP	P	
2	0.1905	13.45	9.76	23.21	54.01	-30.80	AVG	P	
3 *	0.6945	29.30	9.87	39.17	56.00	-16.83	QP	P	
4	0.6945	14.50	9.87	24.37	46.00	-21.63	AVG	P	
5	1.5945	24.04	10.28	34.32	56.00	-21.68	QP	P	
6	1.5945	9.64	10.28	19.92	46.00	-26.08	AVG	P	
7	4.5690	21.76	10.83	32.59	56.00	-23.41	QP	P	
8	4.5690	4.19	10.83	15.02	46.00	-30.98	AVG	P	
9	6.8730	22.25	11.21	33.46	60.00	-26.54	QP	P	
10	6.8730	6.50	11.21	17.71	50.00	-32.29	AVG	P	
11	23.1405	16.19	12.17	28.36	60.00	-31.64	QP	P	
12	23.1405	-1.79	12.17	10.38	50.00	-39.62	AVG	P	

Notes:

1. An initial pre-scan was performed on the line and neutral lines with peak detector.
2. Quasi-Peak and Average measurement were performed at the frequencies with maximized peak emission.
3. Measurement Level = Reading level + Correct Factor
4. All test modes were pre-tested, but we only recorded the worst case in this report.

EUT:	Bluetooth Wireless Earphone	Model Name:	MIXX StreamBuds Custom 3
Test Mode:	Charging	Phase :	N
Test Voltage:	AC 120V/60Hz		

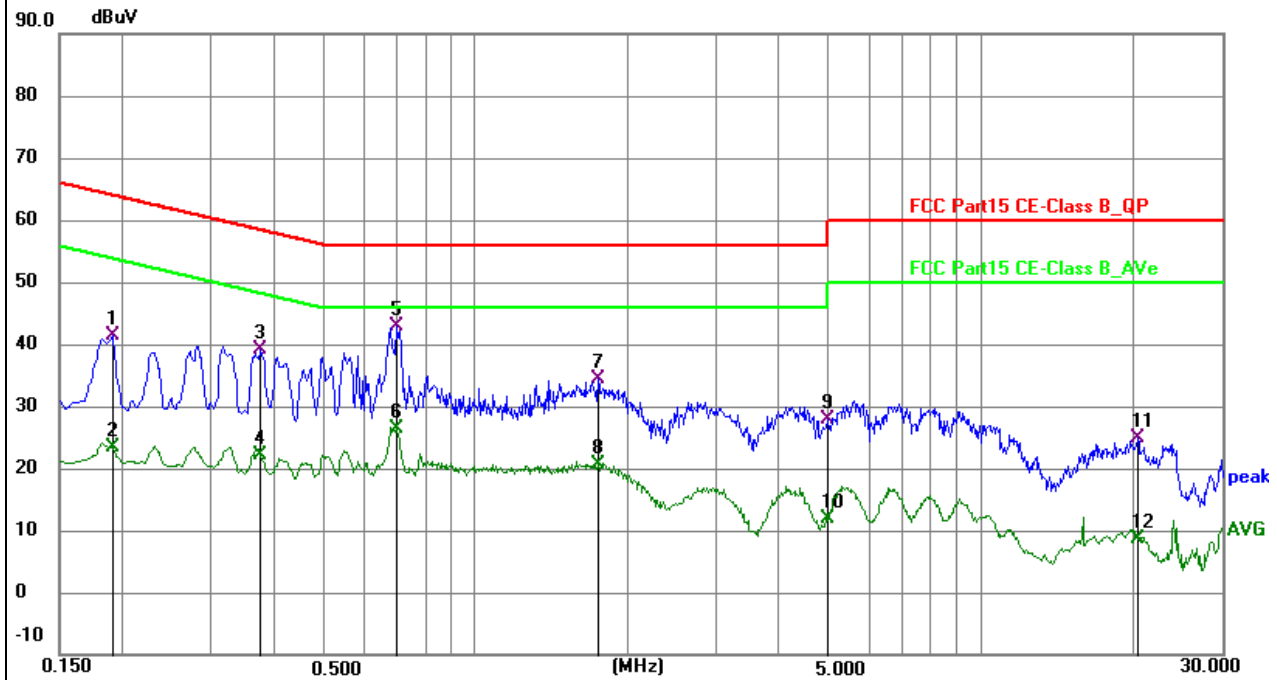

No.	Frequency (MHz)	Reading (dBuV)	Factor (dB)	Level (dBuV)	Limit (dBuV)	Margin (dB)	Detector	P/F	Remark
1	0.1905	31.59	9.67	41.26	64.01	-22.75	QP	P	
2	0.1905	13.62	9.67	23.29	54.01	-30.72	AVG	P	
3	0.3750	29.20	9.90	39.10	58.39	-19.29	QP	P	
4	0.3750	12.27	9.90	22.17	48.39	-26.22	AVG	P	
5 *	0.6990	33.00	9.88	42.88	56.00	-13.12	QP	P	
6	0.6990	16.47	9.88	26.35	46.00	-19.65	AVG	P	
7	1.7475	24.04	10.31	34.35	56.00	-21.65	QP	P	
8	1.7475	10.20	10.31	20.51	46.00	-25.49	AVG	P	
9	4.9650	17.01	10.81	27.82	56.00	-28.18	QP	P	
10	4.9650	1.09	10.81	11.90	46.00	-34.10	AVG	P	
11	20.4585	12.96	11.81	24.77	60.00	-35.23	QP	P	
12	20.4585	-3.23	11.81	8.58	50.00	-41.42	AVG	P	

Notes:

1. An initial pre-scan was performed on the line and neutral lines with peak detector.
2. Quasi-Peak and Average measurement were performed at the frequencies with maximized peak emission.
3. Measurement Level = Reading level + Correct Factor
4. All test modes were pre-tested, but we only recorded the worst case in this report.

5.3 Radiated Emission

5.3.1 Limits

Frequencies (MHz)	Field Strength (micovolts/meter)	Measurement Distance (meters)
0.009~0.490	2400/F(KHz)	300
0.490~1.705	24000/F(KHz)	30
1.705~30.0	30	30
30~88	100	3
88~216	150	3
216~960	200	3
Above 960	500	3

Receiver Parameter	Setting
Attenuation	Auto
Start ~ Stop Frequency	9kHz~150kHz / RB 200Hz for QP
Start ~ Stop Frequency	150kHz~30MHz / RB 9kHz for QP
Start ~ Stop Frequency	30MHz~1000MHz / RB 120kHz for QP

5.3.2 Test Procedures

- a) The radiated emission tests were performed in the 3 meters.
- b) The EUT was placed on the top of a rotating table 0.8 meters above the ground. The table was rotated 360 degrees to determine the position of the highest radiation.
- c) The height of the test antenna shall vary between 1m to 4m. Both horizontal and vertical polarizations of the antenna are set to make the measurement.
- d) If the peak mode measured value compliance with and lower than quasi peak mode limit, the EUT shall be deemed to meet QP limits and then no additional QP mode measurement performed.
- e) If the peak mode measured value compliance with and lower than average mode limit, the EUT shall be deemed to meet average limits and then no additional average mode measurement performed.
- f) For the actual test configuration, please refer to the related item – EUT test photos.

5.3.3 Test Setup

Radiated Emission Test-Up Frequency Below 30MHz

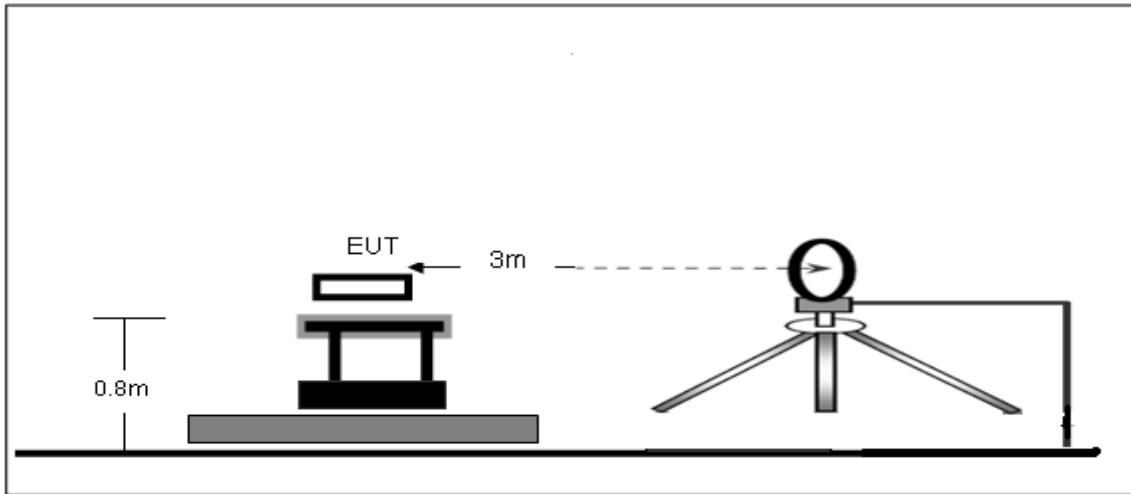

Radiated Emission Test-Up Frequency 30MHz~1GHz

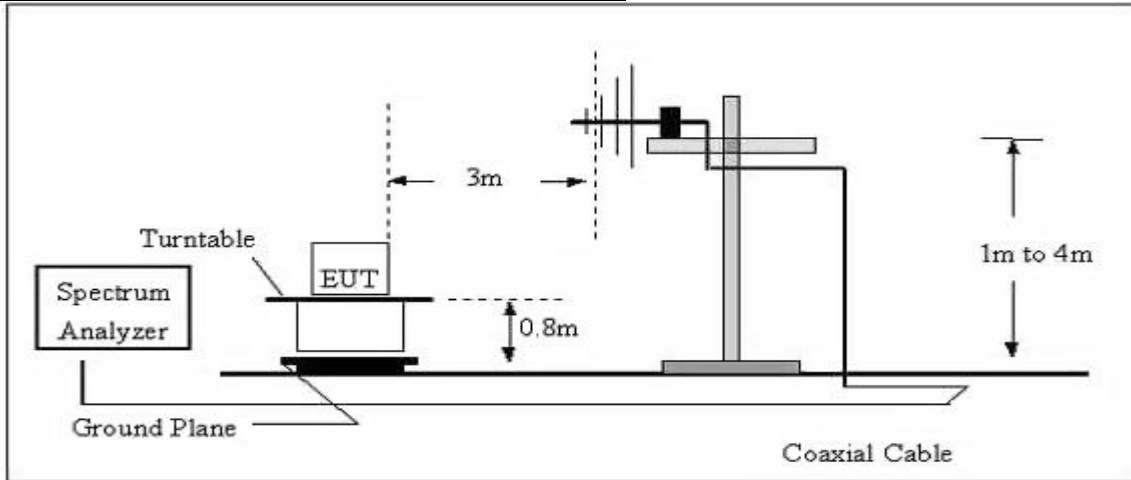

Radiated emission test-up frequency above 1GHz

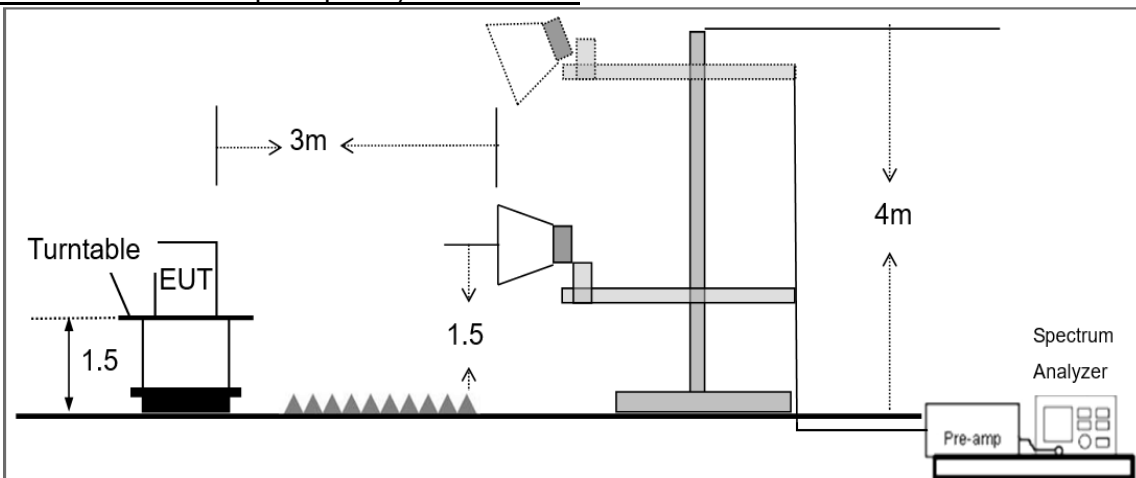

5.3.4 Test Result

Below 30MHz

EUT:	Bluetooth Wireless Earphone	Model Name:	MIXX StreamBuds Custom 3
Pressure:	1010 hPa	Test Voltage:	DC 3.7V from battery
Test Mode:	Working	Polarization:	--

Freq.	Reading	Limit	Margin	State
(MHz)	(dBuV/m)	(dBuV/m)	(dB)	P/F
--	--	--	--	Pass
--	--	--	--	Pass

Note:

1. For 9kHz-30MHz, the amplitude of spurious emissions which are attenuated by more than 20dB below the permissible value has no need to be reported.
2. Distance extrapolation factor = $40 \log (\text{specific distance}/\text{test distance})$ (dB);
3. Limit line = specific limits (dBuV) + distance extrapolation factor.

30MHz – 1GHz

EUT:	Bluetooth Wireless Earphone	Model Name:	MIXX StreamBuds Custom 3
Test Mode:	Working	Phase :	Horizontal
Test Voltage:	DC 3.7V from battery		

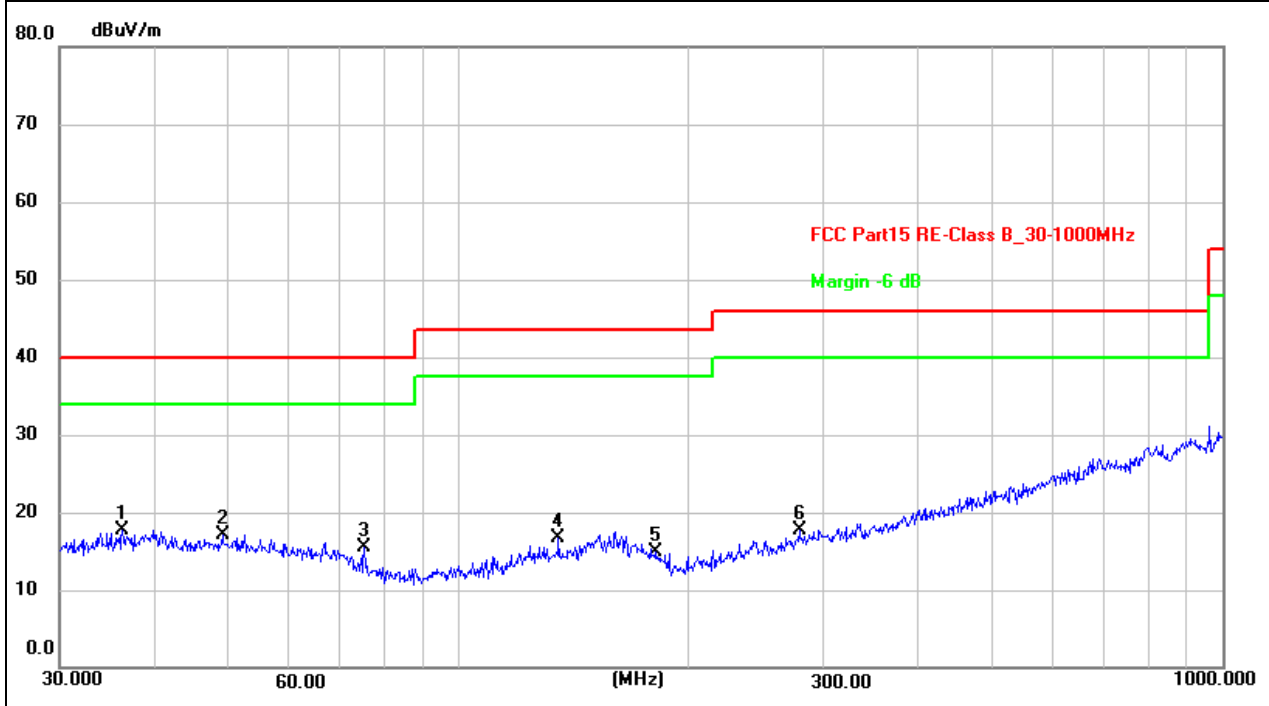

No.	Frequency (MHz)	Reading (dBuV)	Factor (dB/m)	Level (dBuV/m)	Limit (dBuV/m)	Margin (dB)	Detector	Height (cm)	Azimuth (deg.)	P/F	Remark
1 *	36.2541	26.34	-8.68	17.66	40.00	-22.34	QP	100	204	P	
2	49.0145	25.92	-8.88	17.04	40.00	-22.96	QP	100	29	P	
3	75.1822	27.69	-12.22	15.47	40.00	-24.53	QP	100	173	P	
4	135.0319	26.38	-9.67	16.71	43.50	-26.79	QP	100	204	P	
5	181.2834	25.76	-10.93	14.83	43.50	-28.67	QP	100	153	P	
6	279.0436	26.56	-8.88	17.68	46.00	-28.32	QP	100	308	P	

Remarks:
 1. Measurement Level = Reading level + Correct Factor, Margin = Measurement Level – Limit.
 2. The emission levels of other frequencies are very lower than the limit and not show in test report.
 3. All test modes were pre-tested, but we only recorded the worst case in this report.

EUT:	Bluetooth Wireless Earphone	Model Name:	MIXX StreamBuds Custom 3
Test Mode:	Working	Phase :	Vertical
Test Voltage:	DC 3.7V from battery		

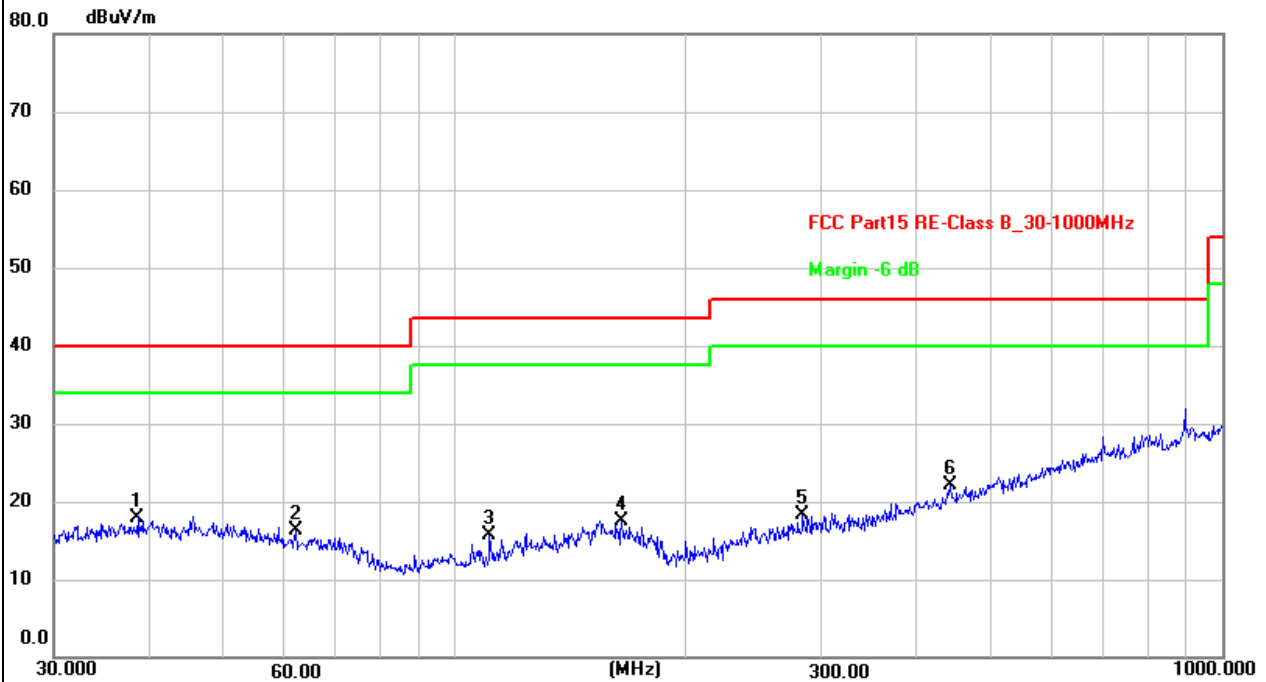

No.	Frequency (MHz)	Reading (dBuV)	Factor (dB/m)	Level (dBuV/m)	Limit (dBuV/m)	Margin (dB)	Detector	Height (cm)	Azimuth (deg.)	P/F	Remark
1 *	38.6160	26.25	-8.30	17.95	40.00	-22.05	QP	100	359	P	
2	61.9951	26.52	-10.12	16.40	40.00	-23.60	QP	100	360	P	
3	110.9571	27.49	-11.74	15.75	43.50	-27.75	QP	100	105	P	
4	164.9075	26.91	-9.34	17.57	43.50	-25.93	QP	100	54	P	
5	283.9791	27.11	-8.74	18.37	46.00	-27.63	QP	100	358	P	
6	441.7426	27.25	-5.16	22.09	46.00	-23.91	QP	100	54	P	

Remarks:

1. Mesurement Level = Reading level + Correct Factor, Margin = Mesurement Level – Limit.
2. The emission levels of other frequencies are very lower than the limit and not show in test report.
3. All test modes were pre-tested, but we only recorded the worst case in this report.

1GHz-25GHz

Frequency	Read Level	Cable loss	Antenna Factor	Preamp Factor	Emission Level	Limits	Margin	Remark	Comment
(MHz)	(dB μ V)	(dB)	dB/m	(dB)	(dB μ V/m)	(dB μ V/m)	(dB)		
Low Channel (2402 MHz)(GFSK)--Above 1G									
4804	66.80	5.21	35.59	44.30	63.30	74.00	-10.70	Pk	Vertical
4804	51.59	5.21	35.59	44.30	48.09	54.00	-5.91	AV	Vertical
7206	59.35	6.48	36.27	44.60	57.50	74.00	-16.50	Pk	Vertical
7206	44.48	6.48	36.27	44.60	42.63	54.00	-11.37	AV	Vertical
4804	66.88	5.21	35.55	44.30	63.34	74.00	-10.66	Pk	Horizontal
4804	51.46	5.21	35.55	44.30	47.92	54.00	-6.08	AV	Horizontal
7206	60.92	6.48	36.27	44.52	59.15	74.00	-14.85	Pk	Horizontal
7206	43.40	6.48	36.27	44.52	41.63	54.00	-12.37	AV	Horizontal
Mid Channel (2441 MHz)(GFSK)--Above 1G									
4882	66.53	5.21	35.66	44.20	63.20	74.00	-10.80	Pk	Vertical
4882	49.95	5.21	35.66	44.20	46.62	54.00	-7.38	AV	Vertical
7323	60.59	7.10	36.50	44.43	59.76	74.00	-14.24	Pk	Vertical
7323	43.30	7.10	36.50	44.43	42.47	54.00	-11.53	AV	Vertical
4882	67.55	5.21	35.66	44.20	64.22	74.00	-9.78	Pk	Horizontal
4882	51.32	5.21	35.66	44.20	47.99	54.00	-6.01	AV	Horizontal
7323	60.30	7.10	36.50	44.43	59.47	74.00	-14.53	Pk	Horizontal
7323	45.05	7.10	36.50	44.43	44.22	54.00	-9.78	AV	Horizontal
High Channel (2480 MHz)(GFSK)-- Above 1G									
4960	67.10	5.21	35.52	44.21	63.62	74.00	-10.38	Pk	Vertical
4960	49.80	5.21	35.52	44.21	46.32	54.00	-7.68	AV	Vertical
7440	59.22	7.10	36.53	44.60	58.25	74.00	-15.75	Pk	Vertical
7440	45.38	7.10	36.53	44.60	44.41	54.00	-9.59	AV	Vertical
4960	66.93	5.21	35.52	44.21	63.45	74.00	-10.55	Pk	Horizontal
4960	50.79	5.21	35.52	44.21	47.31	54.00	-6.69	AV	Horizontal
7440	59.51	7.10	36.53	44.60	58.54	74.00	-15.46	Pk	Horizontal
7440	43.53	7.10	36.53	44.60	42.56	54.00	-11.44	AV	Horizontal

Note:

1. All Readings are Peak Value (VBW=3MHz) and AV Value (VBW=10Hz).
2. Emission Level= Antenna Factor + Cable Loss + Read Level - Preamp Factor.
3. All the modulation modes have been tested, and only the worst results are reflected in the report.

5.3.5 Radiated Band Edge

Frequency	Meter Reading	Cable Loss	Antenna Factor	Preamplifier Factor	Emission Level	Limits	Margin	Detector	Comment
(MHz)	(dBμV)	(dB)	dB/m	(dB)	(dBμV/m)	(dBμV/m)	(dB)	Type	
1Mbps(GFSK)- Non-hopping									
2310.00	59.17	2.40	27.70	40.40	48.87	74.00	-25.13	Pk	Horizontal
2310.00	44.71	2.40	27.70	40.40	34.41	54.00	-19.59	AV	Horizontal
2310.00	59.50	2.40	27.70	40.40	49.20	74.00	-24.80	Pk	Vertical
2310.00	44.65	2.40	27.70	40.40	34.35	54.00	-19.65	AV	Vertical
2390.00	59.44	2.44	28.30	40.10	50.08	74.00	-23.92	Pk	Vertical
2390.00	43.89	2.44	28.30	40.10	34.53	54.00	-19.47	AV	Vertical
2390.00	57.39	2.44	28.30	40.10	48.03	74.00	-25.97	Pk	Horizontal
2390.00	43.20	2.44	28.30	40.10	33.84	54.00	-20.16	AV	Horizontal
2400.00	59.91	2.46	28.30	40.10	50.57	74.00	-23.43	Pk	Vertical
2400.00	43.81	2.46	28.30	40.10	34.47	54.00	-19.53	AV	Vertical
2400.00	58.07	2.46	28.30	40.10	48.73	74.00	-25.27	Pk	Horizontal
2400.00	43.33	2.46	28.30	40.10	33.99	54.00	-20.01	AV	Horizontal
2483.50	59.04	2.48	28.70	39.80	50.42	74.00	-23.58	Pk	Vertical
2483.50	43.50	2.48	28.70	39.80	34.88	54.00	-19.12	AV	Vertical
2483.50	59.38	2.48	28.70	39.80	50.76	74.00	-23.24	Pk	Horizontal
2483.50	41.89	2.48	28.70	39.80	33.27	54.00	-20.73	AV	Horizontal
2500.00	59.27	2.48	28.70	39.80	50.65	74.00	-23.35	Pk	Vertical
2500.00	42.53	2.48	28.70	39.80	33.91	54.00	-20.09	AV	Vertical
2500.00	59.21	2.48	28.70	39.80	50.59	74.00	-23.41	Pk	Horizontal
2500.00	43.16	2.48	28.70	39.80	34.54	54.00	-19.46	AV	Horizontal
1Mbps (GFSK)- hopping									
2400.00	59.59	2.46	28.30	40.10	50.25	74.00	-23.75	Pk	Vertical
2400.00	42.92	2.46	28.30	40.10	33.58	54.00	-20.42	AV	Vertical
2400.00	59.36	2.46	28.30	40.10	50.02	74.00	-23.98	Pk	Horizontal
2400.00	41.98	2.46	28.30	40.10	32.64	54.00	-21.36	AV	Horizontal
2483.50	58.35	2.48	28.70	39.80	49.73	74.00	-24.27	Pk	Vertical
2483.50	43.55	2.48	28.70	39.80	34.93	54.00	-19.07	AV	Vertical
2483.50	58.38	2.48	28.70	39.80	49.76	74.00	-24.24	Pk	Horizontal
2483.50	42.52	2.48	28.70	39.80	33.90	54.00	-20.10	AV	Horizontal

Note:

1. All Readings are Peak Value (VBW=3MHz) and AV Value (VBW=10Hz).
2. Emission Level= Antenna Factor + Cable Loss + Read Level - Preamp Factor.
3. All the modulation modes have been tested, and only the worst results are reflected in the report.

5.4 Peak Output Power

5.4.1 Limit

FCC Part15 Subpart C			
Section	Test Item	Limit	Frequency Range (MHz)
15.247(b)(1)	Peak output power	Power<1W(30dBm)	2400-2483.5

5.4.2 Test Procedure

- (1) The EUT was directly connected to the spectrum analyzer and antenna output port as show in the block diagram above.
- (2) Spectrum Setting:
 RBW=1MHz, VBW=3MHz, Detector=Peak (If 20dB BW ≤1 MHz)
 RBW=3MHz, VBW=8MHz, Detector=Peak (If 20dB BW > 1 MHz)
- (3) The EUT was set to continuously transmitting in the max power during the test.

5.4.3 Test Setup

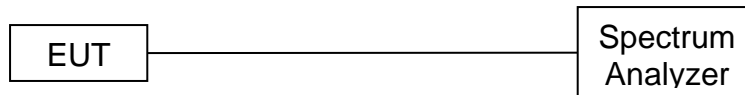

5.4.4 Test Results

EUT:	Bluetooth Wireless Earphone	Model Name:	MIXX StreamBuds Custom 3
Test Mode:	TX Mode /CH00, CH39, CH78	Test Voltage:	DC 3.7V from battery

GFSK

Test Channel	Frequency (MHz)	Maximum Peak Output Power(dBm)	Limit (dBm)
CH00	2402	0.1	20.97
CH39	2441	0.87	20.97
CH78	2480	0.6	20.97

$\pi/4$ -DQPSK

Test Channel	Frequency (MHz)	Maximum Peak Output Power(dBm)	Limit (dBm)
CH00	2402	0.82	20.97
CH39	2441	1.53	20.97
CH78	2480	1.26	20.97

5.5 20dB Occupied Channel Bandwidth

5.5.1 Limit

FCC Part15 (15.247) , Subpart C			
Section	Test Item	Limit	Frequency Range (MHz)
15.247a(1)	20dB bandwidth	N/A	2400-2483.5

5.5.2 Test Procedure

- (1) The EUT was directly connected to the spectrum analyzer and antenna output port as show in the block diagram above.
- (2) Spectrum Setting:
Bandwidth: RBW=30 kHz, VBW=100 kHz, detector= Peak

5.5.3 Test Setup

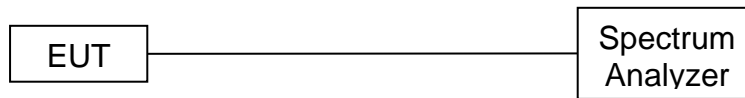

5.5.4 Test results

EUT:	Bluetooth Wireless Earphone	Model Name:	MIXX StreamBuds Custom 3
Test Mode:	TX Mode /CH00, CH39, CH78	Test Voltage:	DC 3.7V from battery

Mode	Frequency (MHz)	20dB Bandwidth (MHz)	99% Occupied Bandwidth (MHz)	Result
GFSK	2402	0.9488	0.882	Pass
	2441	0.9381	0.87078	Pass
	2480	0.9908	0.87724	Pass
$\pi/4$ -DQPSK	2402	1.283	1.1857	Pass
	2441	1.311	1.1919	Pass
	2480	1.28	1.1976	Pass

Test plots

GFSK mode

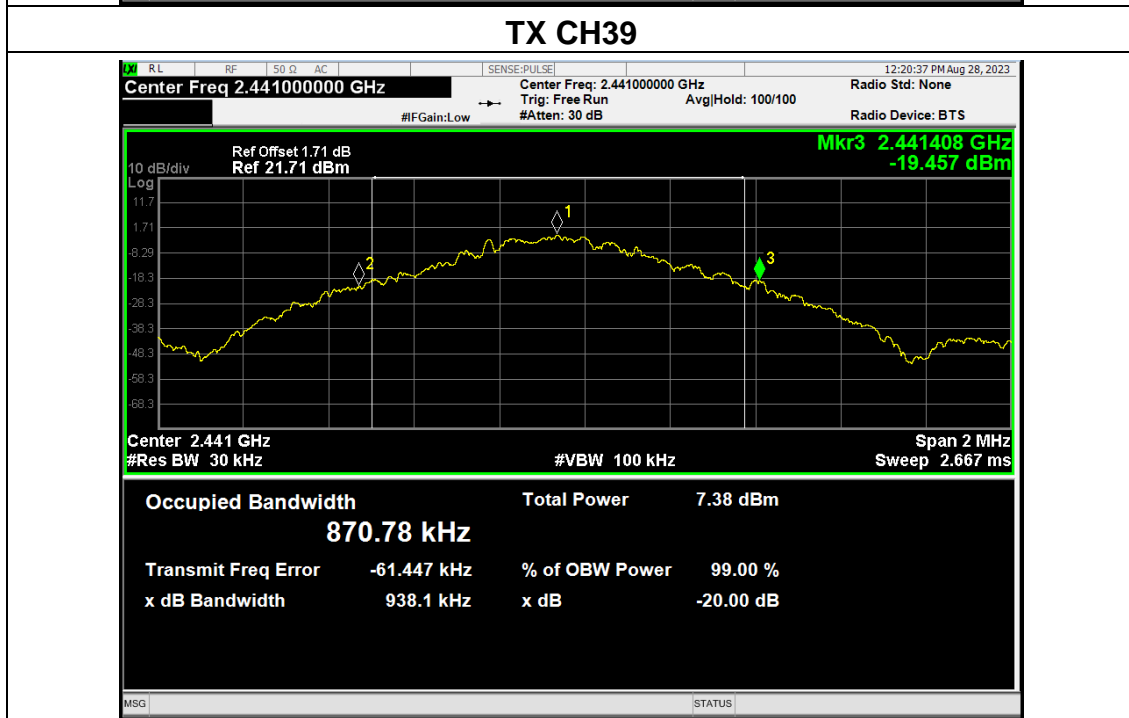
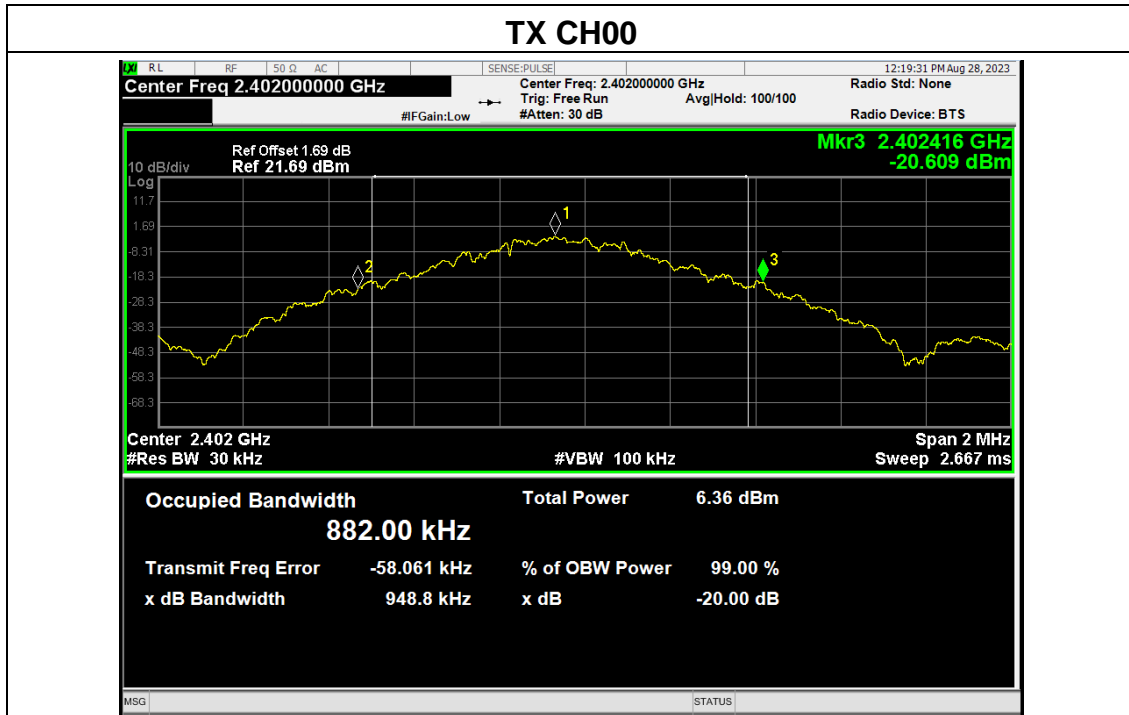

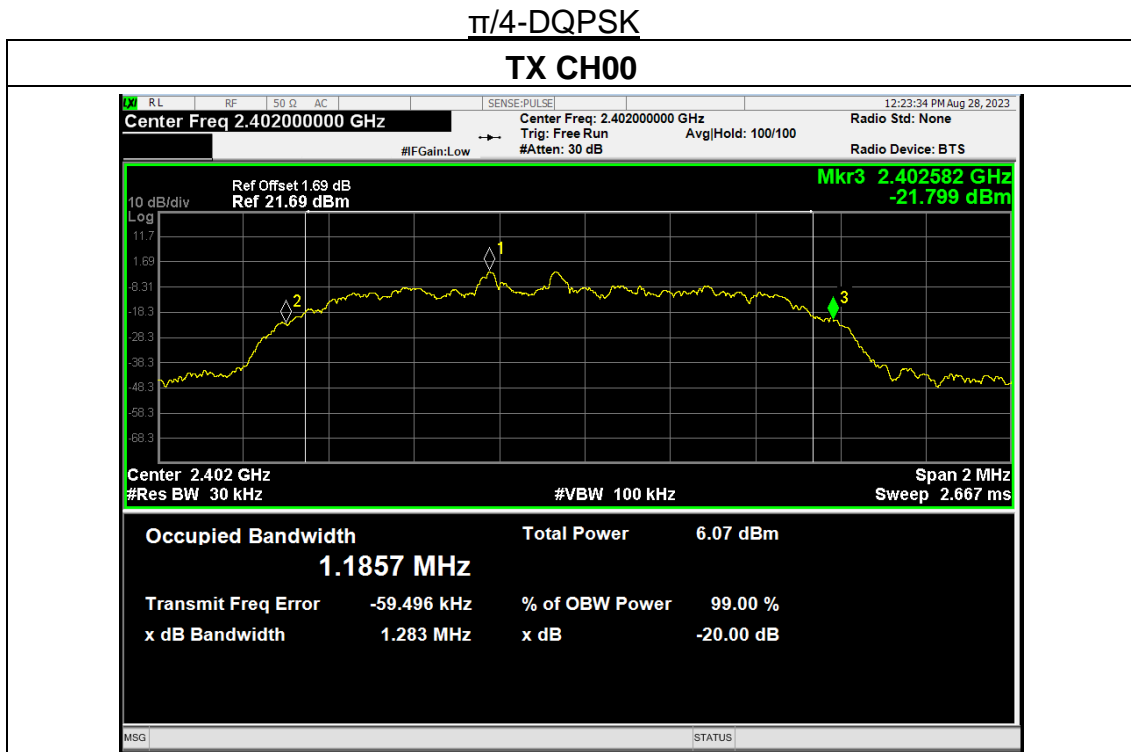
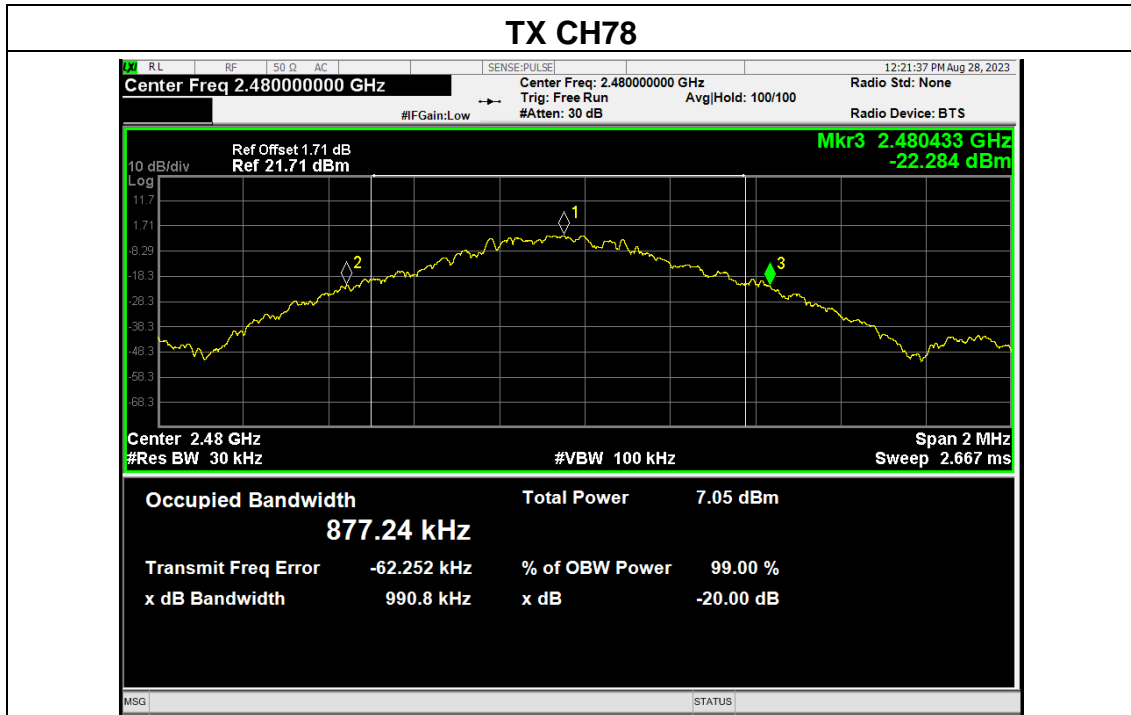

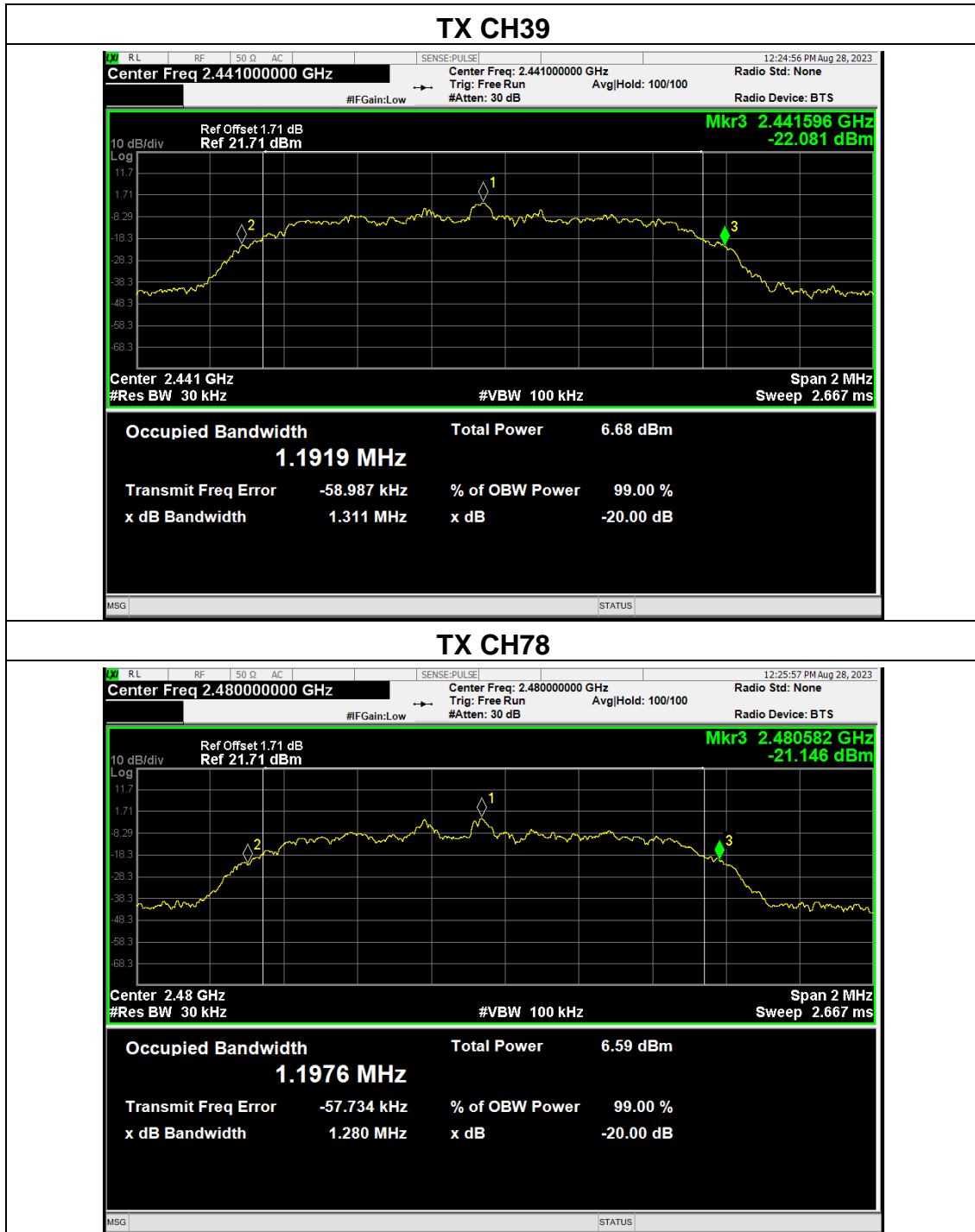

5.6 Carrier Frequency Separation

5.6.1 Limit

FCC Part15 (15.247) , Subpart C			
Section	Test Item	Limit	Frequency Range (MHz)
15.247(a)(1)	Channel Separation	>25kHz or >two-thirds of the 20 dB bandwidth (Which is greater)	2400-2483.5

5.6.2 Test Procedure

- (1) The EUT was directly connected to the spectrum analyzer and antenna output port as show in the block diagram above.
- (2) Spectrum Setting:
RBW=30 kHz, VBW=100 kHz, detector= Peak, Sweep Time =auto.
- (3) The EUT was set to the Hopping Mode for Channel Separation Test and continuously transmitting for the Test.

5.6.3 Test Setup

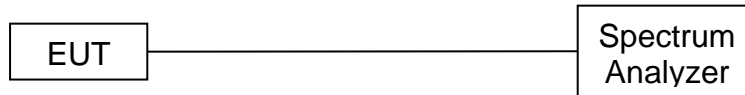

5.6.4 Test Results

EUT:	Bluetooth Wireless Earphone	Model Name:	MIXX StreamBuds Custom 3
Pressure:	1012 hPa	Test Voltage:	DC 3.7V from battery
Test Mode:	GFSK, $\pi/4$ -DQPSK /CH00, CH39, CH78		

Mode	Channel	Frequency (MHz)	Test Result (MHz)	Limit (MHz)		Result
GFSK	Low	2402	1.008	0.633	2/3 of 20dB BW	Pass
	Middle	2441	1	0.625	2/3 of 20dB BW	Pass
	High	2480	1	0.661	2/3 of 20dB BW	Pass
$\pi/4$ -DQPSK	Low	2402	1.162	0.855	2/3 of 20dB BW	Pass
	Middle	2441	1.002	0.874	2/3 of 20dB BW	Pass
	High	2480	0.858	0.853	2/3 of 20dB BW	Pass

Test plots

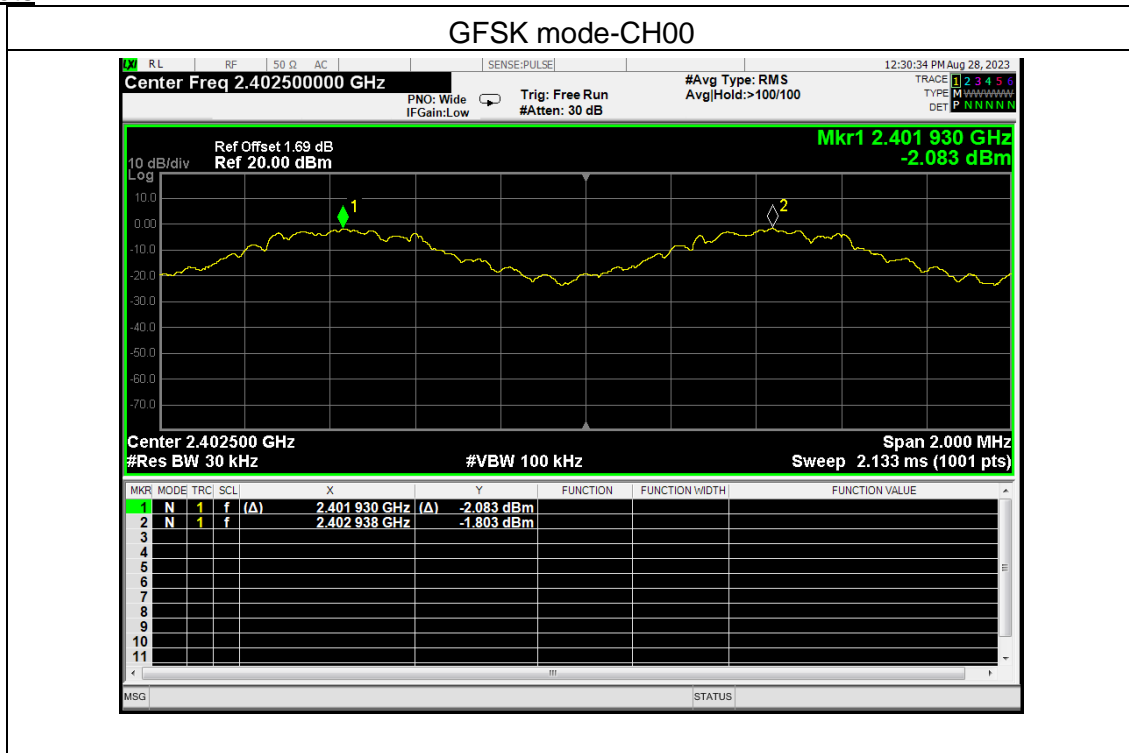

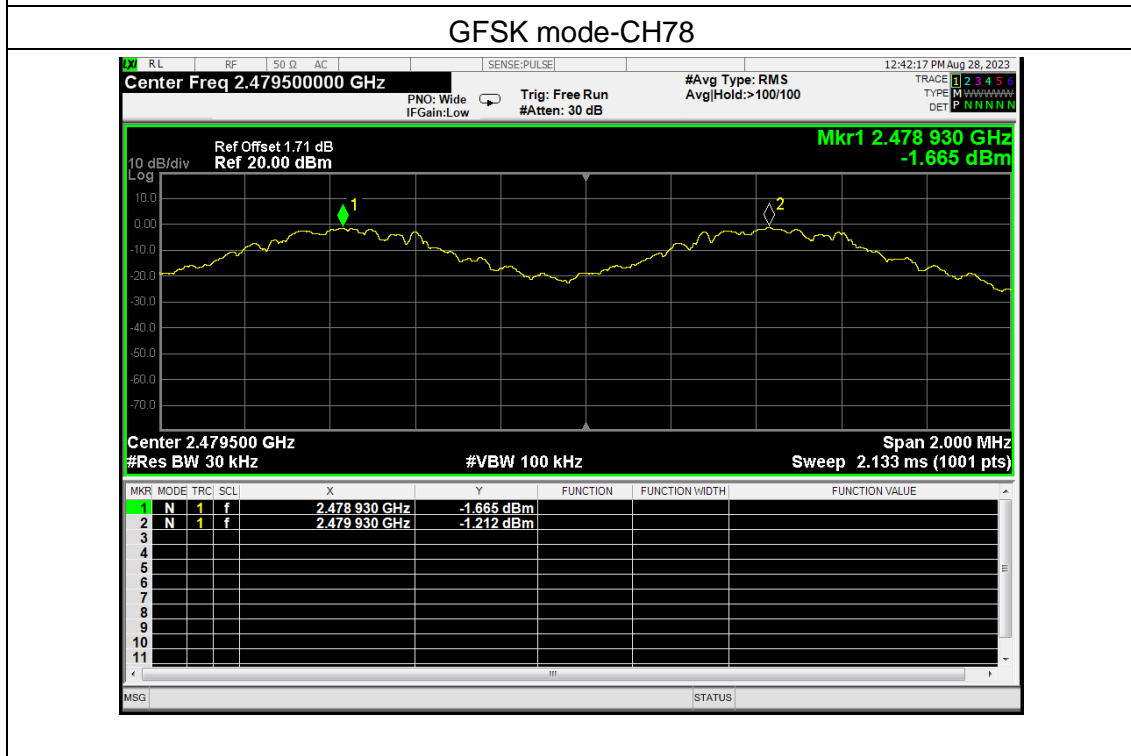
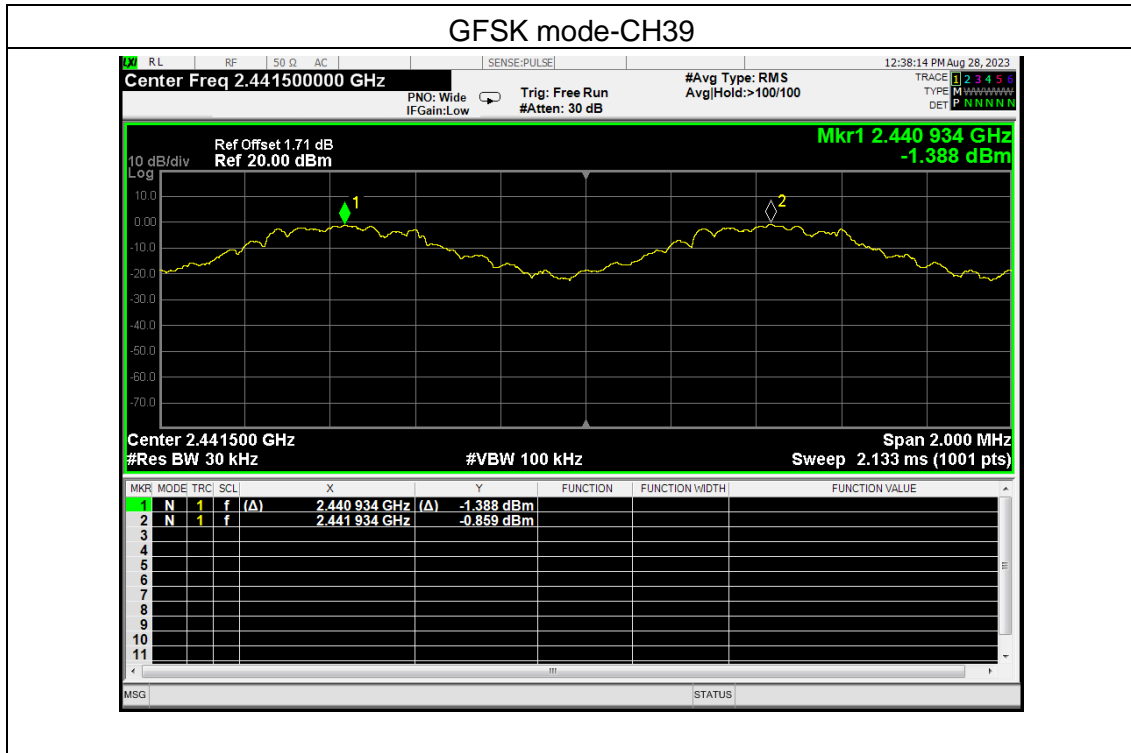

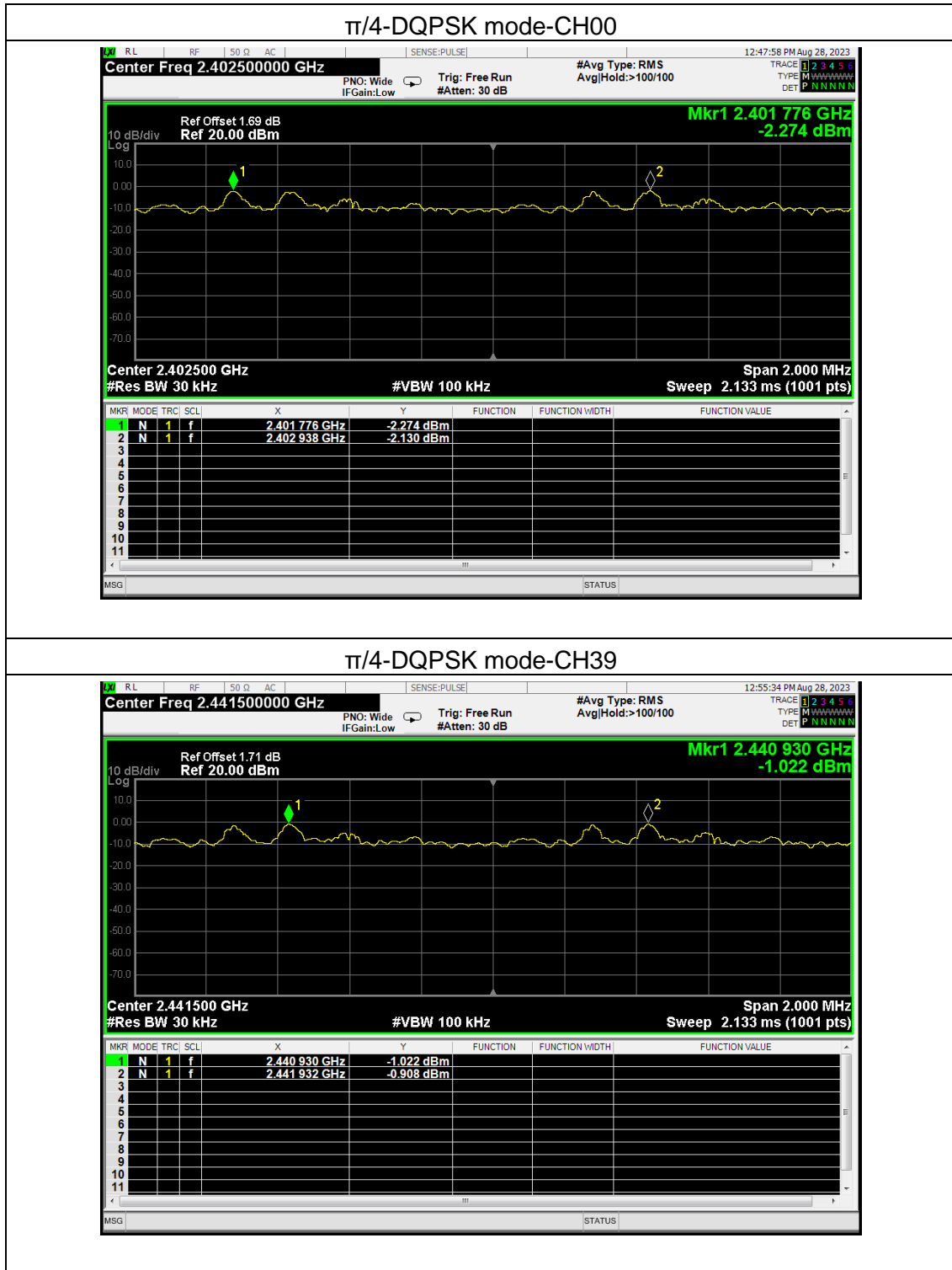

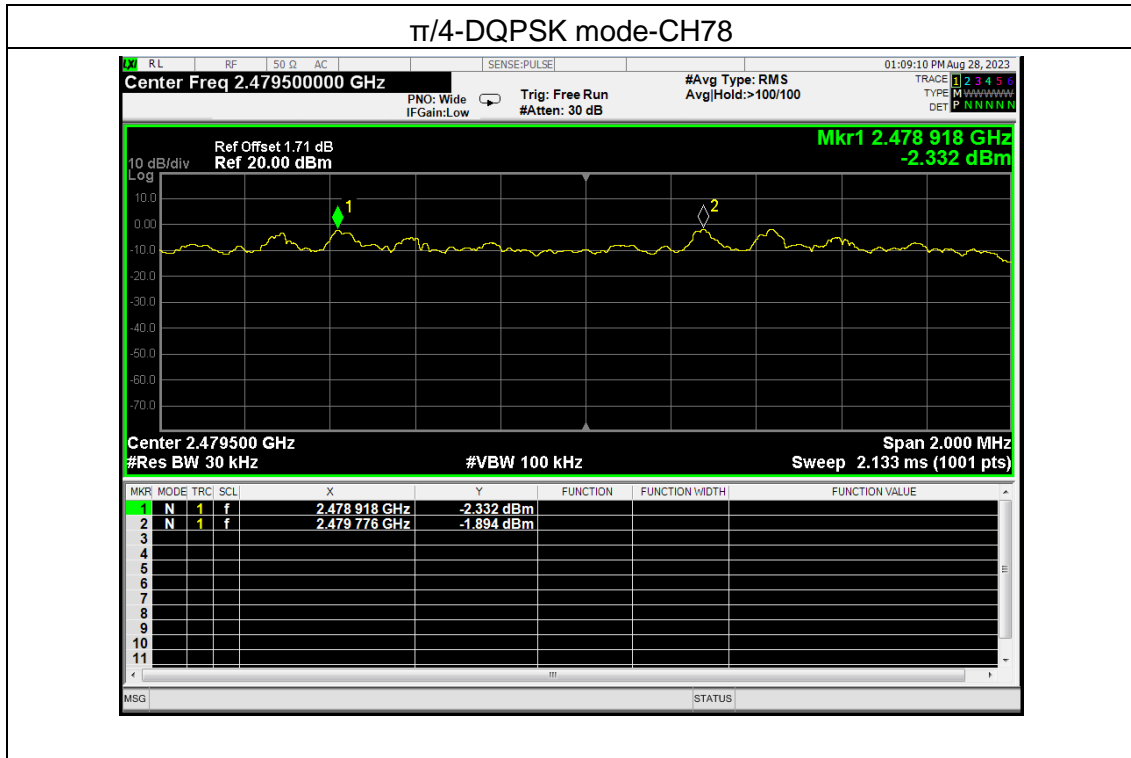

5.7 Hopping Channel Number

5.7.1 Limit

Frequency hopping systems in the 2400-2483.5MHz band shall use at least 15 channels.

5.7.2 Test Procedure

The testing follows IEEE / ANSI C63.10-2020 clause 7.8.3

The RF output of EUT was connected to the spectrum analyzer by RF cable and attenuator.

The path loss was compensated to the results for each measurement.

Set to the maximum power setting and enable the EUT transmit continuously.

The EUT must have its hopping function enabled.

Use the following spectrum analyzer settings:

Span = the frequency band of operation

RBW : To identify clearly the individual channels, set the RBW to less than 30% of the channel spacing or the 20 dB bandwidth, whichever is smaller.

VBW \geq RBW

Sweep = auto

Detector function = peak

Trace = max hold

5.7.3 Test Setup

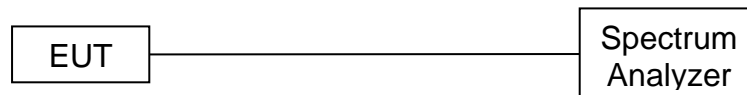

5.7.4 Test Results

Mode	Quantity of Hopping Channel	Limit	Results
GFSK, $\pi/4$ -DQPSK	79	>15	Pass

Test plots

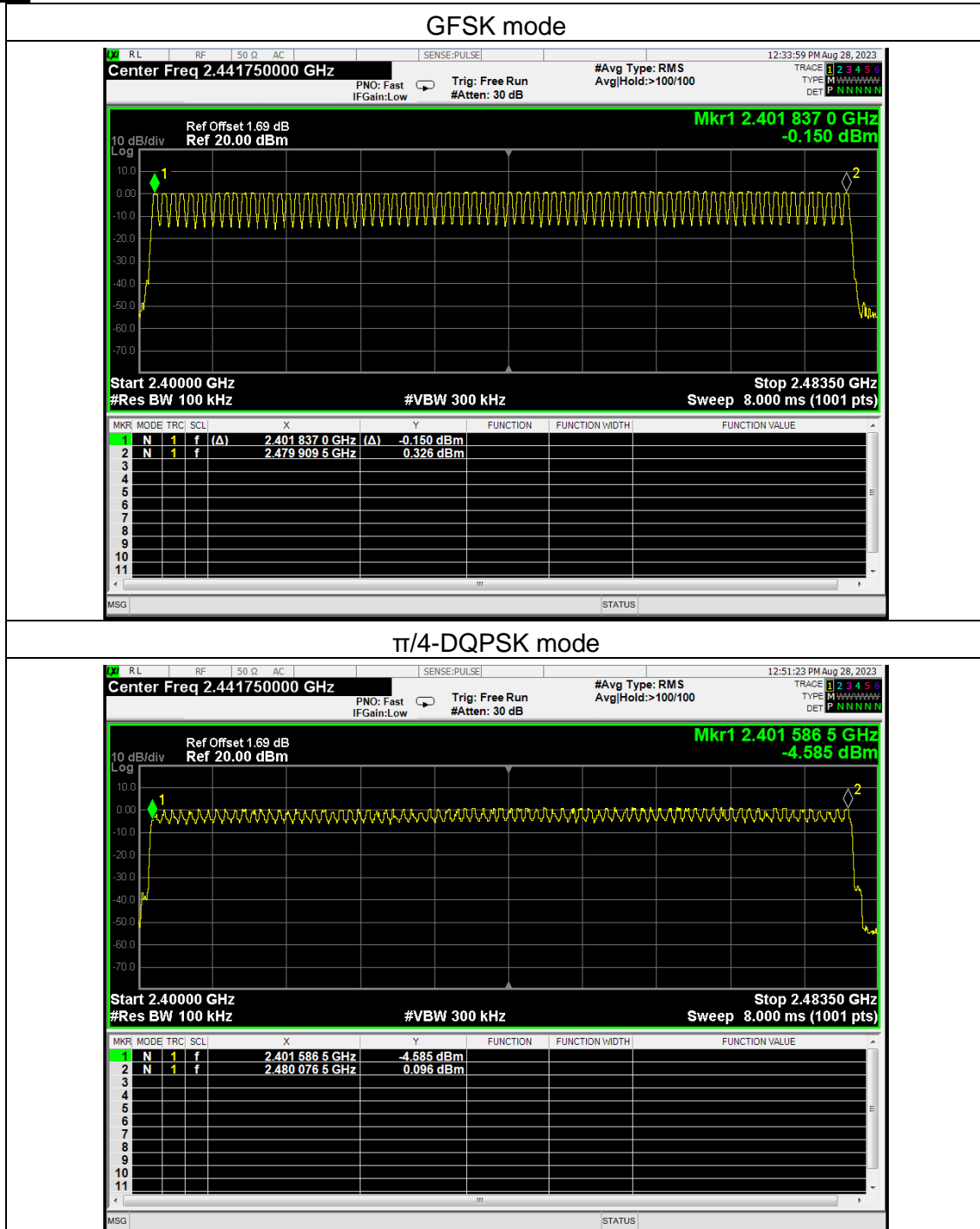

5.8 Dwell Time

5.8.1 Limit

FCC Part15 (15.247) , Subpart C			
Section	Test Item	Limit	Frequency Range (MHz)
15.247(a)(1)	Dwell time	0.4 sec	2400-2483.5

5.8.2 Test Procedure

- (1) The EUT was directly connected to the spectrum analyzer and antenna output port as show in the block diagram above.
- (2) Spectrum Setting: RBW=1MHz, VBW=3MHz, Span=0Hz, Detector=Peak
- (3) Use video trigger with the trigger level set to enable triggering only on full pulses.
- (4) Sweep Time is more than once pulse time.
- (5) Set the center frequency on any frequency would be measure and set the frequency span to zero span.
- (6) Measure the maximum time duration of one single pulse.
- (7) Set the EUT for packet transmitting.
- (8) Measure the maximum time duration of one single pulse.
- (9) The EUT was set to the Hopping Mode for Dwell Time Test.

5.8.3 Test Setup



5.8.4 Test Results

EUT:	Bluetooth Wireless Earphone	Model Name:	MIXX StreamBuds Custom 3
Pressure:	1012 hPa	Test Voltage:	DC 3.7V from battery
Test Mode:	GFSK, $\pi/4$ -DQPSK /CH39		

Mode	Data Packet	Frequency (MHz)	Pulse Duration (ms)	Dwell Time (ms)	Limit(s)	Conclusion
GFSK	DH1	2441	0.384	122.880	<0.4	Pass
	DH3	2441	1.64	262.400	<0.4	Pass
	DH5	2441	2.888	308.053	<0.4	Pass
$\pi/4$ DQPSK	2DH1	2441	0.392	125.440	<0.4	Pass
	2DH3	2441	1.643	262.880	<0.4	Pass
	2DH5	2441	2.893	308.587	<0.4	Pass

Note:

1. A period time = 0.4 (s) * 79 = 31.6(s)

2. DH1 time slot = Pulse Duration * (1600/(2*79)) * A period time

DH3 time slot = Pulse Duration * (1600/(4*79)) * A period time

DH5 time slot = Pulse Duration * (1600/(6*79)) * A period time

3. For GFSK, $\pi/4$ -DQPSK : The test period: T= 0.4 Second/Channel x 79 Channel = 31.6 s

Test plots

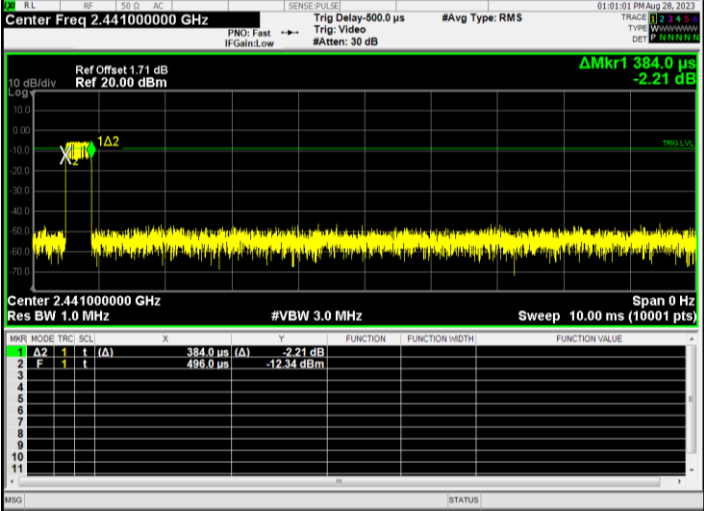
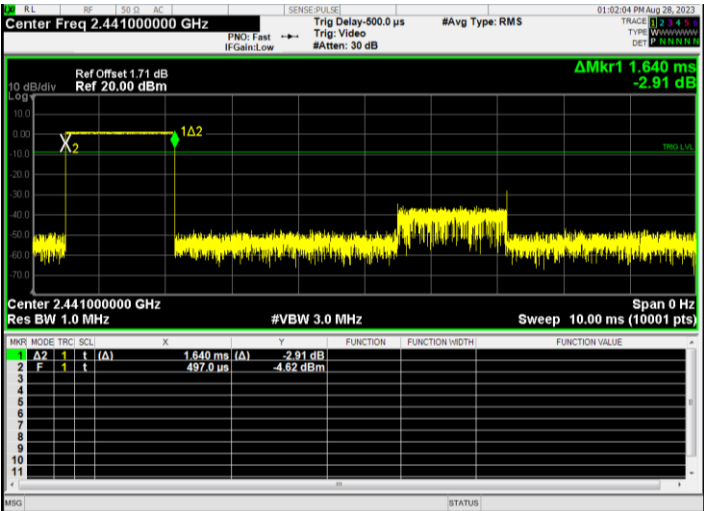
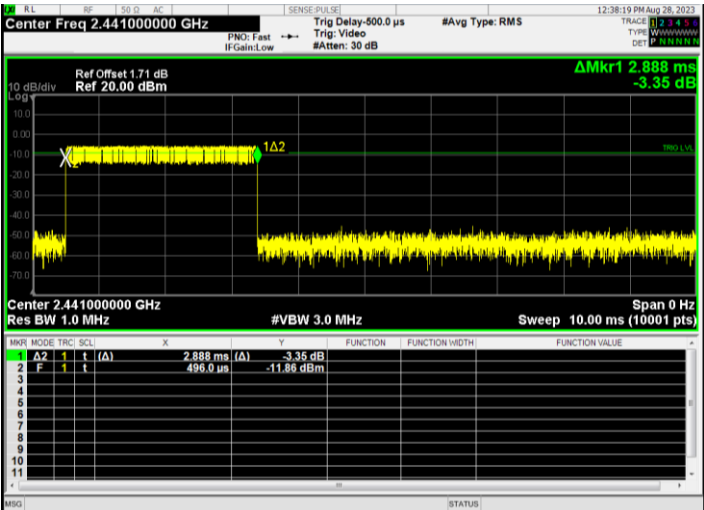
Modulation mode	GFSK mode																											
DH1	 <table border="1" data-bbox="539 719 1246 884"> <thead> <tr> <th>MNR</th> <th>MODE</th> <th>TRC</th> <th>SCL</th> <th>X</th> <th>Y</th> <th>FUNCTION</th> <th>FUNCTION WIDTH</th> <th>FUNCTION VALUE</th> </tr> </thead> <tbody> <tr> <td>2</td> <td>A2</td> <td>1</td> <td>t</td> <td>(A)</td> <td>384.0 μs</td> <td>(A)</td> <td>-2.21 dB</td> <td></td> </tr> <tr> <td>3</td> <td>F</td> <td>1</td> <td>t</td> <td></td> <td>496.0 μs</td> <td></td> <td>-12.34 dBm</td> <td></td> </tr> </tbody> </table>	MNR	MODE	TRC	SCL	X	Y	FUNCTION	FUNCTION WIDTH	FUNCTION VALUE	2	A2	1	t	(A)	384.0 μs	(A)	-2.21 dB		3	F	1	t		496.0 μs		-12.34 dBm	
MNR	MODE	TRC	SCL	X	Y	FUNCTION	FUNCTION WIDTH	FUNCTION VALUE																				
2	A2	1	t	(A)	384.0 μs	(A)	-2.21 dB																					
3	F	1	t		496.0 μs		-12.34 dBm																					
DH3	 <table border="1" data-bbox="539 1272 1246 1438"> <thead> <tr> <th>MNR</th> <th>MODE</th> <th>TRC</th> <th>SCL</th> <th>X</th> <th>Y</th> <th>FUNCTION</th> <th>FUNCTION WIDTH</th> <th>FUNCTION VALUE</th> </tr> </thead> <tbody> <tr> <td>2</td> <td>A2</td> <td>1</td> <td>t</td> <td>(A)</td> <td>1.640 ms</td> <td>(A)</td> <td>-2.91 dB</td> <td></td> </tr> <tr> <td>3</td> <td>F</td> <td>1</td> <td>t</td> <td></td> <td>497.0 μs</td> <td></td> <td>-4.62 dBm</td> <td></td> </tr> </tbody> </table>	MNR	MODE	TRC	SCL	X	Y	FUNCTION	FUNCTION WIDTH	FUNCTION VALUE	2	A2	1	t	(A)	1.640 ms	(A)	-2.91 dB		3	F	1	t		497.0 μs		-4.62 dBm	
MNR	MODE	TRC	SCL	X	Y	FUNCTION	FUNCTION WIDTH	FUNCTION VALUE																				
2	A2	1	t	(A)	1.640 ms	(A)	-2.91 dB																					
3	F	1	t		497.0 μs		-4.62 dBm																					
DH5	 <table border="1" data-bbox="539 1823 1246 1989"> <thead> <tr> <th>MNR</th> <th>MODE</th> <th>TRC</th> <th>SCL</th> <th>X</th> <th>Y</th> <th>FUNCTION</th> <th>FUNCTION WIDTH</th> <th>FUNCTION VALUE</th> </tr> </thead> <tbody> <tr> <td>2</td> <td>A2</td> <td>1</td> <td>t</td> <td>(A)</td> <td>2.888 ms</td> <td>(A)</td> <td>-3.35 dB</td> <td></td> </tr> <tr> <td>3</td> <td>F</td> <td>1</td> <td>t</td> <td></td> <td>496.0 μs</td> <td></td> <td>-11.88 dBm</td> <td></td> </tr> </tbody> </table>	MNR	MODE	TRC	SCL	X	Y	FUNCTION	FUNCTION WIDTH	FUNCTION VALUE	2	A2	1	t	(A)	2.888 ms	(A)	-3.35 dB		3	F	1	t		496.0 μs		-11.88 dBm	
MNR	MODE	TRC	SCL	X	Y	FUNCTION	FUNCTION WIDTH	FUNCTION VALUE																				
2	A2	1	t	(A)	2.888 ms	(A)	-3.35 dB																					
3	F	1	t		496.0 μs		-11.88 dBm																					

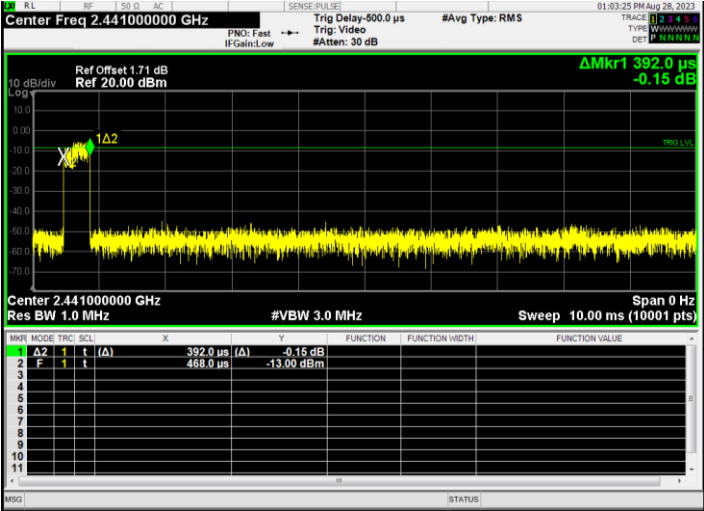
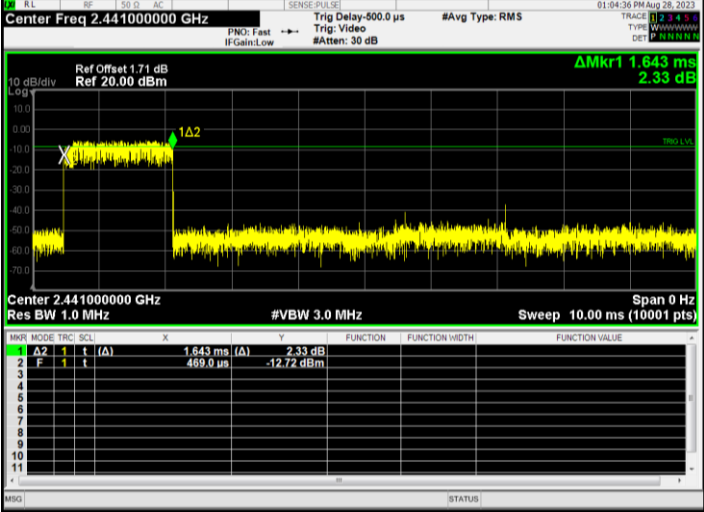
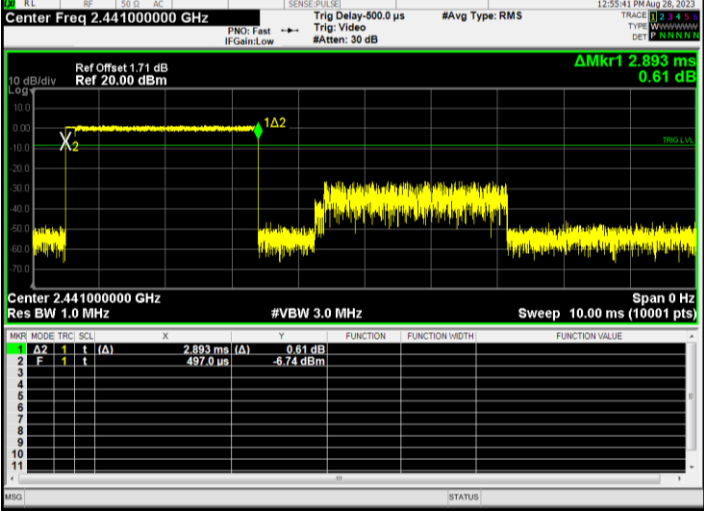
	Modulation mode	$\pi/4$ -DQPSK mode																											
2-DH1	 <p>Center Freq 2.441000000 GHz</p> <p>Ref Offset 1.71 dB Ref 20.00 dBm</p> <p>ΔMkr1 392.0 μs -0.15 dB</p> <p>Center 2.441000000 GHz Res BW 1.0 MHz #VBW 3.0 MHz Sweep 10.00 ms (10001 pts)</p> <table border="1"> <thead> <tr> <th>MNR</th> <th>MODE</th> <th>TRC</th> <th>SCL</th> <th>X</th> <th>Y</th> <th>FUNCTION</th> <th>FUNCTION WIDTH</th> <th>FUNCTION VALUE</th> </tr> </thead> <tbody> <tr> <td>A2</td> <td>1</td> <td>t</td> <td>(A)</td> <td>392.0 μs</td> <td>-9.15 dBm</td> <td></td> <td></td> <td></td> </tr> <tr> <td>F</td> <td>1</td> <td>t</td> <td></td> <td>468.0 μs</td> <td>-13.00 dBm</td> <td></td> <td></td> <td></td> </tr> </tbody> </table>		MNR	MODE	TRC	SCL	X	Y	FUNCTION	FUNCTION WIDTH	FUNCTION VALUE	A2	1	t	(A)	392.0 μ s	-9.15 dBm				F	1	t		468.0 μ s	-13.00 dBm			
MNR	MODE	TRC	SCL	X	Y	FUNCTION	FUNCTION WIDTH	FUNCTION VALUE																					
A2	1	t	(A)	392.0 μ s	-9.15 dBm																								
F	1	t		468.0 μ s	-13.00 dBm																								
2-DH3	 <p>Center Freq 2.441000000 GHz</p> <p>Ref Offset 1.71 dB Ref 20.00 dBm</p> <p>ΔMkr1 1.643 ms 2.33 dB</p> <p>Center 2.441000000 GHz Res BW 1.0 MHz #VBW 3.0 MHz Sweep 10.00 ms (10001 pts)</p> <table border="1"> <thead> <tr> <th>MNR</th> <th>MODE</th> <th>TRC</th> <th>SCL</th> <th>X</th> <th>Y</th> <th>FUNCTION</th> <th>FUNCTION WIDTH</th> <th>FUNCTION VALUE</th> </tr> </thead> <tbody> <tr> <td>A2</td> <td>1</td> <td>t</td> <td>(A)</td> <td>1.643 ms</td> <td>2.33 dB</td> <td></td> <td></td> <td></td> </tr> <tr> <td>F</td> <td>1</td> <td>t</td> <td></td> <td>469.0 μs</td> <td>-12.72 dBm</td> <td></td> <td></td> <td></td> </tr> </tbody> </table>		MNR	MODE	TRC	SCL	X	Y	FUNCTION	FUNCTION WIDTH	FUNCTION VALUE	A2	1	t	(A)	1.643 ms	2.33 dB				F	1	t		469.0 μ s	-12.72 dBm			
MNR	MODE	TRC	SCL	X	Y	FUNCTION	FUNCTION WIDTH	FUNCTION VALUE																					
A2	1	t	(A)	1.643 ms	2.33 dB																								
F	1	t		469.0 μ s	-12.72 dBm																								
2-DH5	 <p>Center Freq 2.441000000 GHz</p> <p>Ref Offset 1.71 dB Ref 20.00 dBm</p> <p>ΔMkr1 2.893 ms 0.61 dB</p> <p>Center 2.441000000 GHz Res BW 1.0 MHz #VBW 3.0 MHz Sweep 10.00 ms (10001 pts)</p> <table border="1"> <thead> <tr> <th>MNR</th> <th>MODE</th> <th>TRC</th> <th>SCL</th> <th>X</th> <th>Y</th> <th>FUNCTION</th> <th>FUNCTION WIDTH</th> <th>FUNCTION VALUE</th> </tr> </thead> <tbody> <tr> <td>A2</td> <td>1</td> <td>t</td> <td>(A)</td> <td>2.893 ms</td> <td>0.61 dB</td> <td></td> <td></td> <td></td> </tr> <tr> <td>F</td> <td>1</td> <td>t</td> <td></td> <td>497.0 μs</td> <td>-6.74 dBm</td> <td></td> <td></td> <td></td> </tr> </tbody> </table>		MNR	MODE	TRC	SCL	X	Y	FUNCTION	FUNCTION WIDTH	FUNCTION VALUE	A2	1	t	(A)	2.893 ms	0.61 dB				F	1	t		497.0 μ s	-6.74 dBm			
MNR	MODE	TRC	SCL	X	Y	FUNCTION	FUNCTION WIDTH	FUNCTION VALUE																					
A2	1	t	(A)	2.893 ms	0.61 dB																								
F	1	t		497.0 μ s	-6.74 dBm																								

5.9 Conducted Band Edge

5.9.1 Limit

In any 100 kHz bandwidth outside the frequency band in which the spread spectrum or digitally modulated intentional radiator is operating, the radio frequency power that is produced by the intentional radiator shall be at least 20 dB below that in the 100 kHz bandwidth within the band that contains the highest level of the desired power, based on either an RF conducted or a radiated measurement, provided the transmitter demonstrates compliance with the peak conducted power limits. If the transmitter complies with the conducted power limits based on the use of RMS averaging over a time interval, as permitted under paragraph (b)(3) of this section, the attenuation required under this paragraph shall be 30 dB instead of 20 dB. Attenuation below the general limits specified in §15.209(a) is not required. In addition, radiated emissions which fall in the restricted bands, as defined in §15.205(a), must also comply with the radiated emission limits specified in §15.209(a) (see §15.205(c)).

5.9.2 Test Procedure

- a) Check the calibration of the measuring instrument using either an internal calibrator or a known signal from an external generator.
- b) Position the EUT without connection to measurement instrument. Turn on the EUT and connect its antenna terminal to measurement instrument via a low loss cable. Then set it to any one measured frequency within its operating range, and make sure the instrument is operated in its linear range.
- c) Set RBW to 100 kHz and VBW of spectrum analyzer to 300 kHz with a convenient frequency span including 100 kHz bandwidth from band edge.
- d) Measure the highest amplitude appearing on spectral display and set it as a reference level. Plot the graph with marking the highest point and edge frequency.
- e) Repeat above procedures until all measured frequencies were complete.

5.9.3 Test Setup

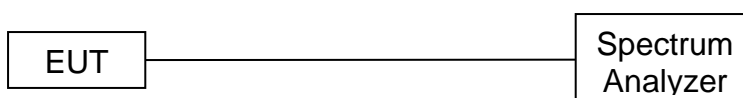

5.9.4 Test Results

EUT:	Bluetooth Wireless Earphone	Model Name:	MIXX StreamBuds Custom 3
Pressure:	1012 hPa	Test Voltage:	DC 3.7V from battery

Test plots

GFSK: Band Edge, Left Side(Non-hopping)

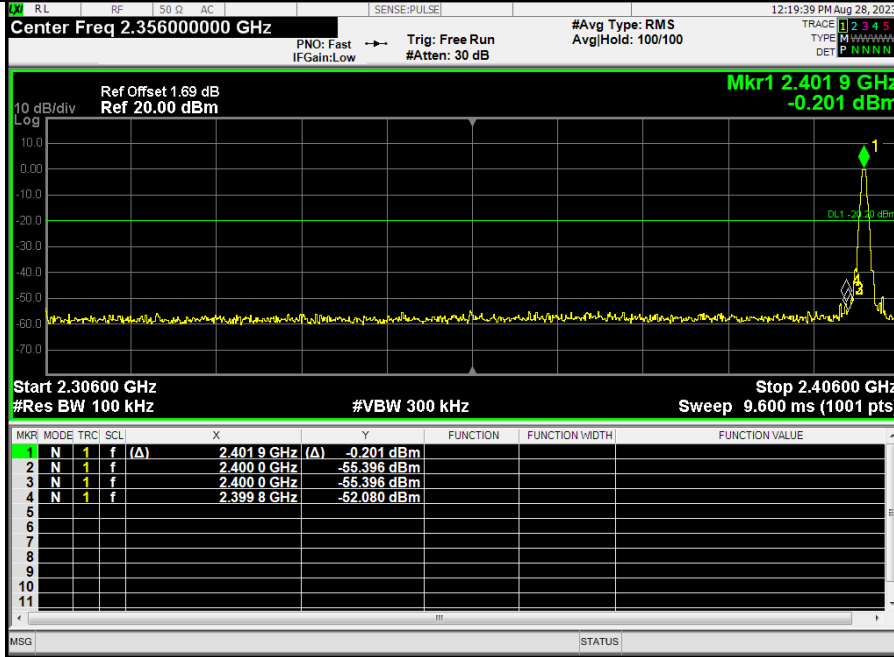

GFSK: Band Edge, Right Side(Non-hopping)

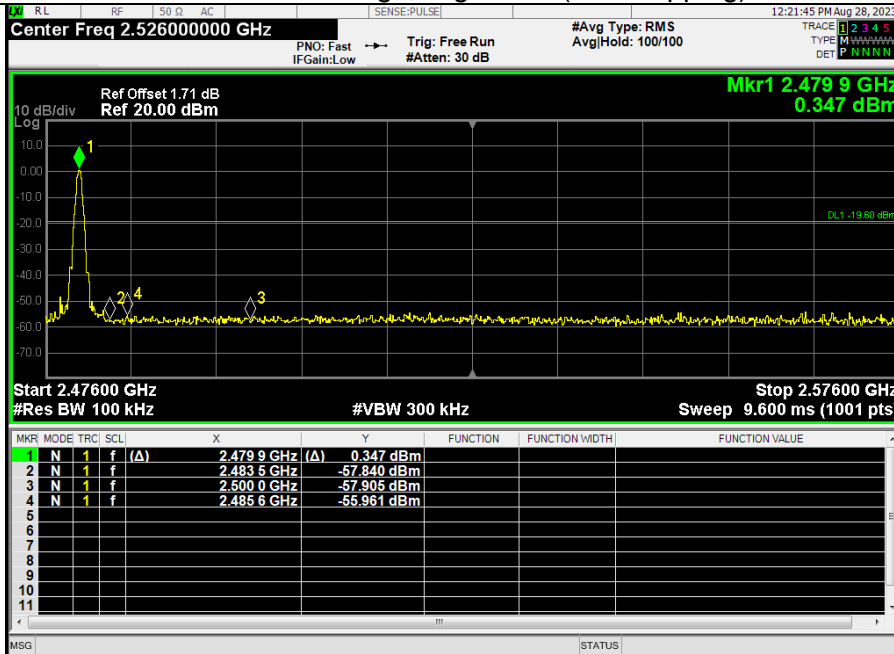

GFSK: Band Edge, Left Side(Hopping)

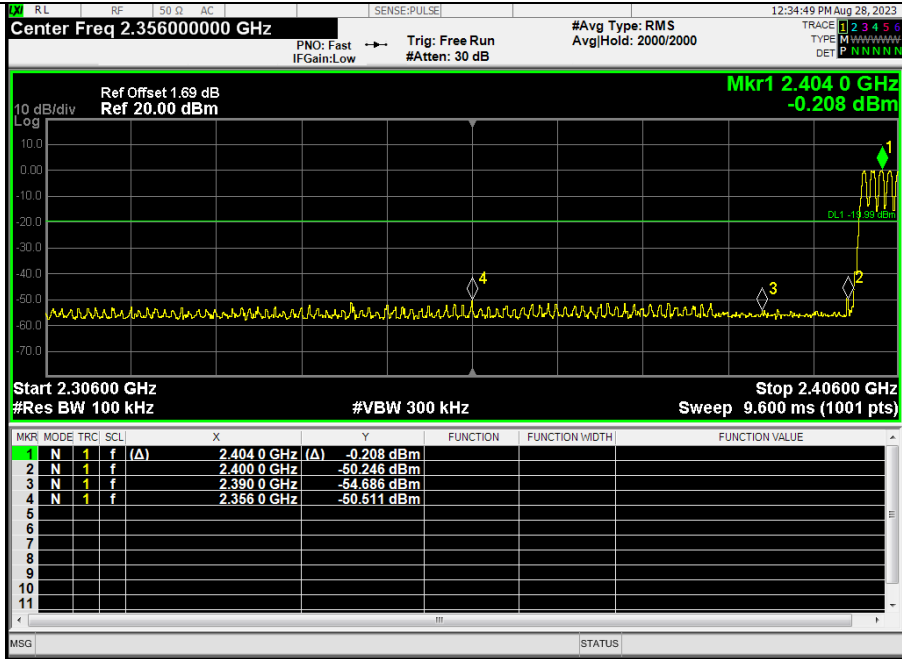

GFSK: Band Edge, Right Side(Hopping)

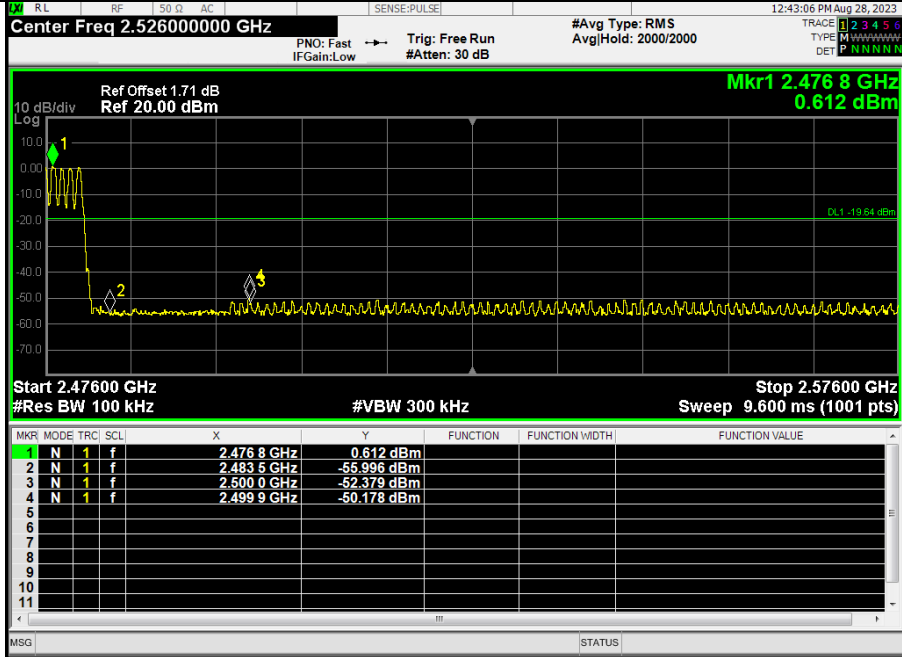

$\pi/4$ -DQPSK: Band Edge, Left Side(Non-hopping)

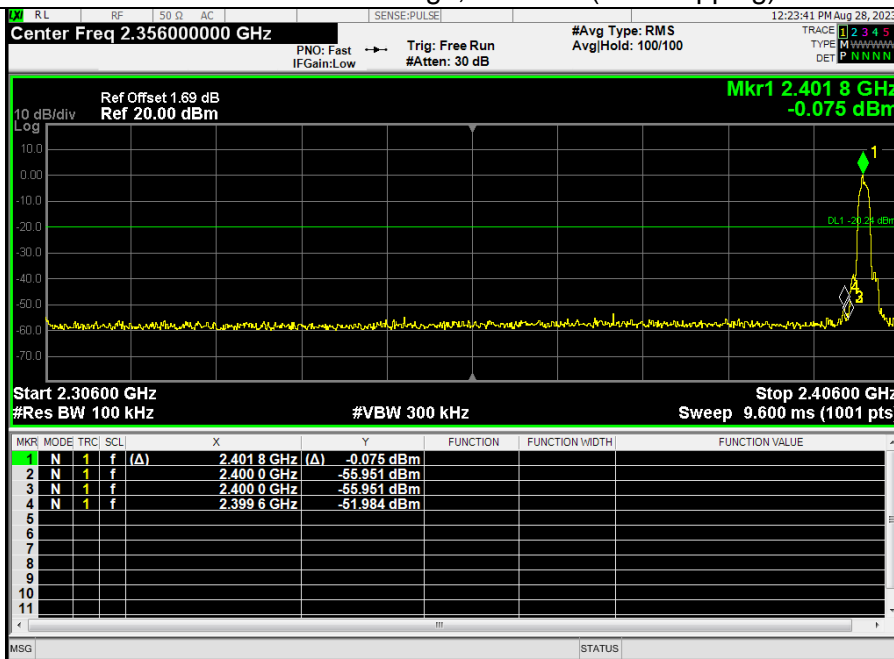

$\pi/4$ -DQPSK: Band Edge, Right Side(Non-hopping)

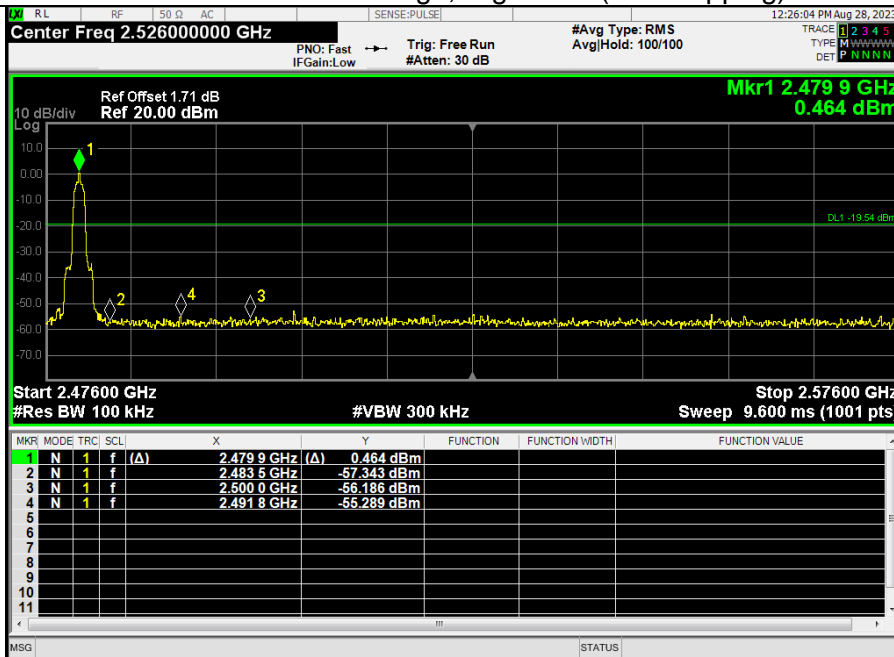

$\pi/4$ -DQPSK: Band Edge, Left Side(Hopping)

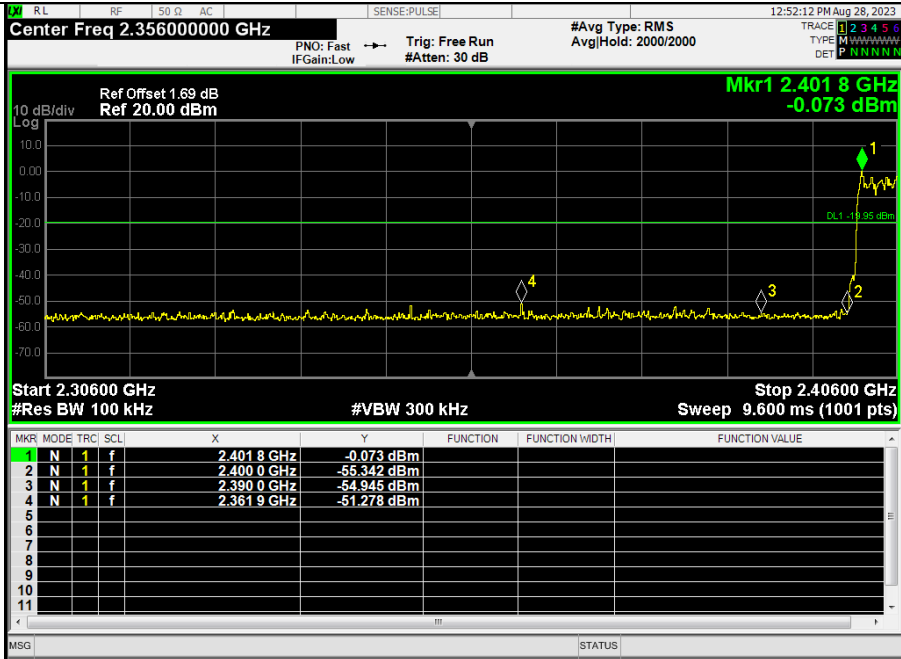

$\pi/4$ -DQPSK: Band Edge, Right Side(Hopping)

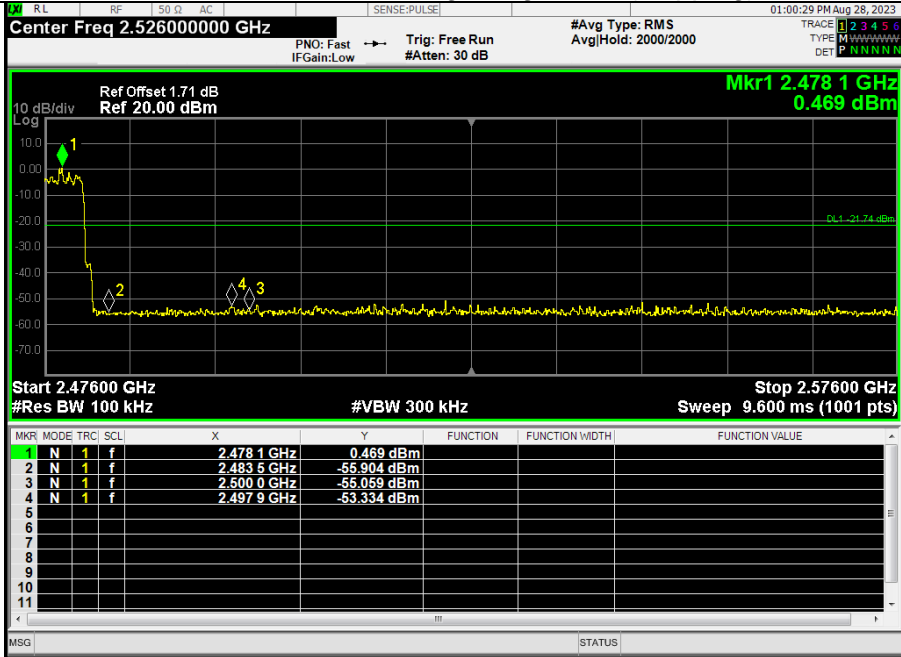

5.10 Spurious RF Conducted Emissions

5.10.1 Limit

Below -20dB of the highest emission level in operating band.

5.10.2 Test Procedure

The Spurious RF conducted emissions compliance of RF radiated emission should be measured by following the guidance in ANSI C63.10-2013 with respect to maximizing the emission by rotating the EUT, measuring the emission while the EUT is situated in three orthogonal planes (if appropriate), adjusting the measurement antenna height and polarization etc. Set RBW=100kHz and VBW=300kHz to measure the peak field strength, and measure frequency range from 9kHz to 26.5GHz.

5.10.3 Test Setup

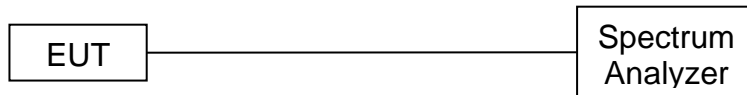

5.10.4 Test Results

Note:

1: The measurement frequency range is from 9kHz to the 10th harmonic of the fundamental frequency. The lowest, middle and highest channels are tested to verify the spurious emissions and band edge measurement data.

GFSK on Channel 00

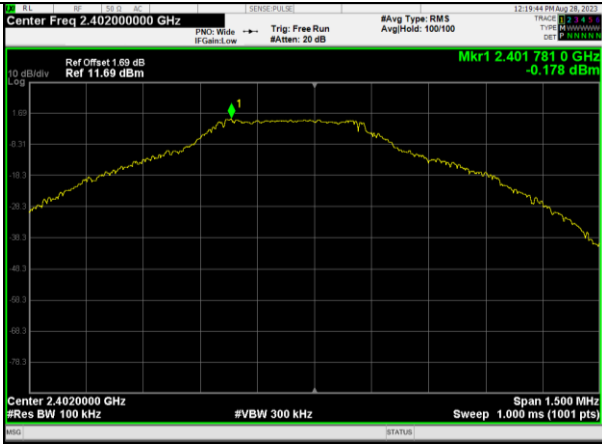

GFSK on Channel 00

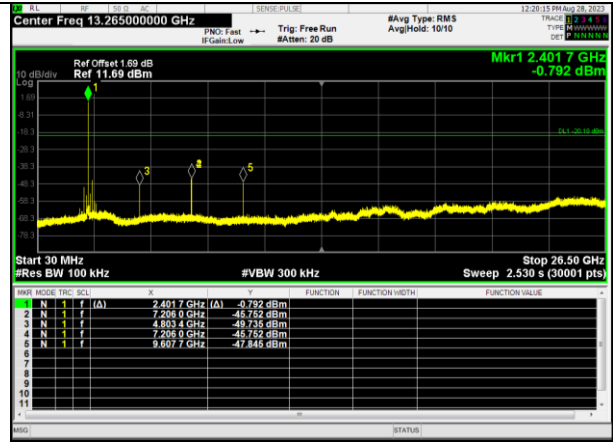

GFSK on Channel 39

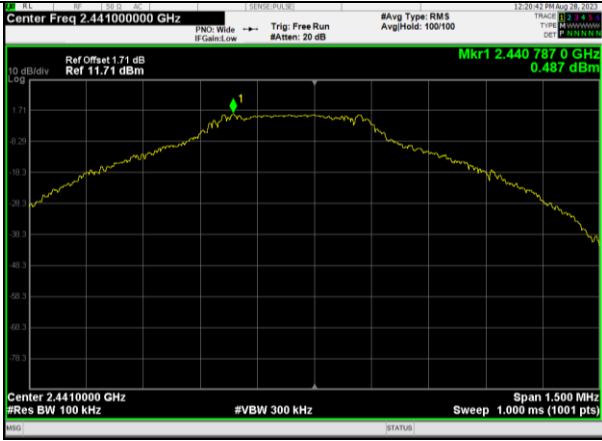

GFSK on Channel 39

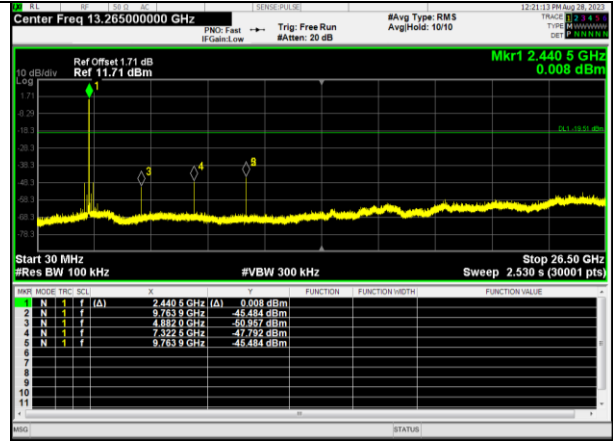

GFSK on Channel 78



GFSK on Channel 78

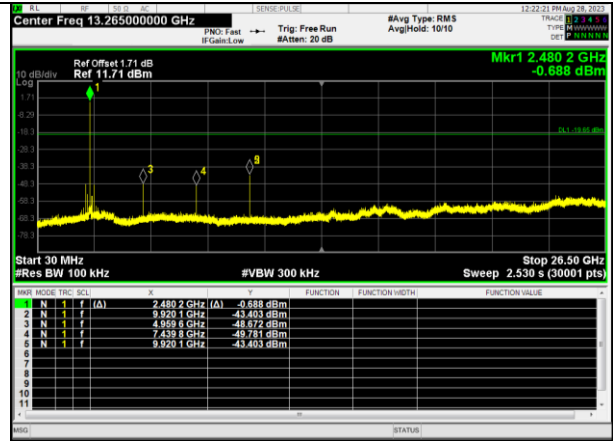

$\pi/4$ -DQPSK on Channel 00

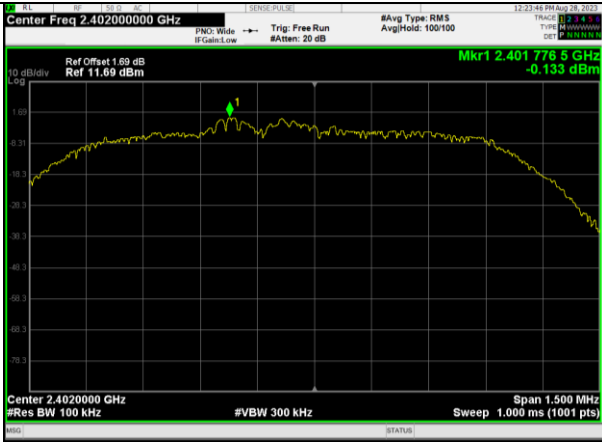

$\pi/4$ -DQPSK on Channel 00

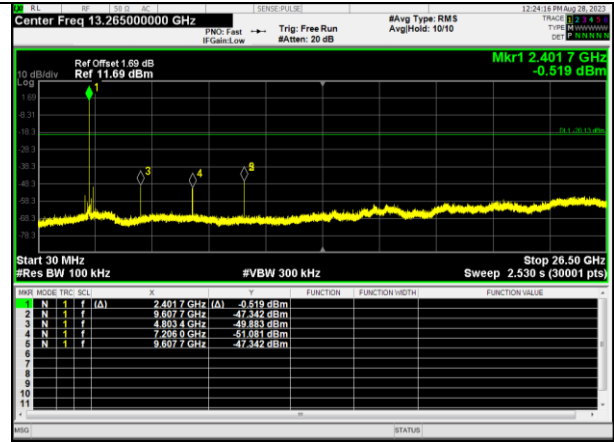

$\pi/4$ -DQPSK on Channel 39

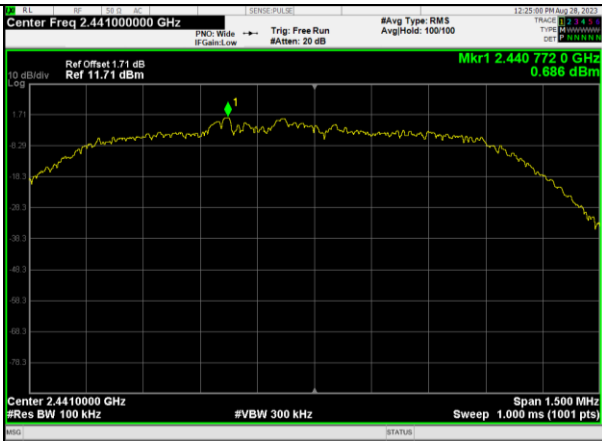

$\pi/4$ -DQPSK on Channel 39

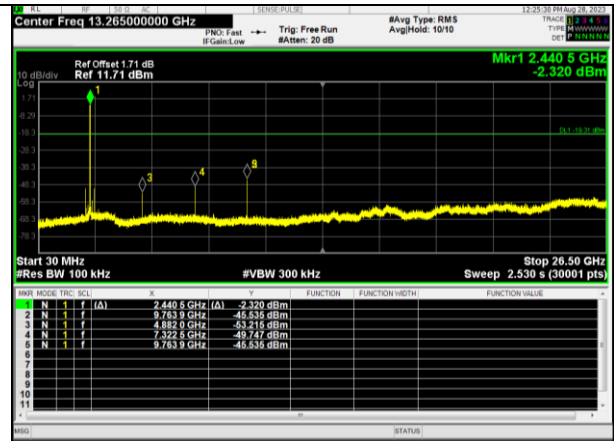

$\pi/4$ -DQPSK on Channel 78

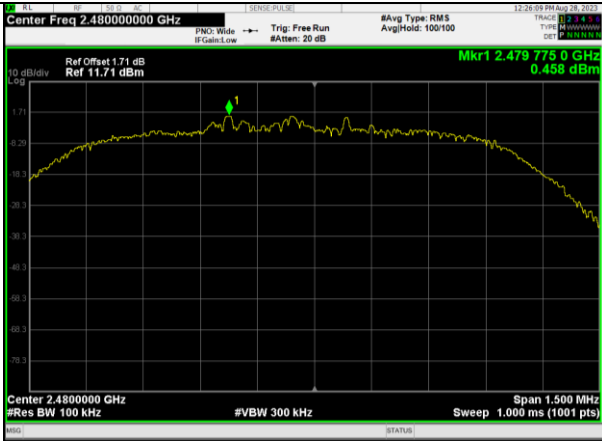

$\pi/4$ -DQPSK on Channel 78

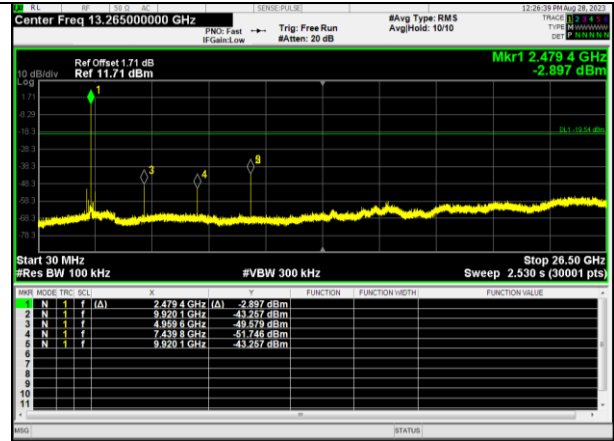

6. Photographs of the Test Setup

Reference to the appendix Test Setup Photos for details.

7 Photographs of the EUT

Reference to the appendix External Photos and Internal Photos for details.

******* END OF REPORT *******