

## RF MEASUREMENT REPORT

---

**FCC ID** : 2AXJ4XE75V2  
**Applicant** : TP-Link Corporation Limited  
**Application Type** : CLASS II PERMISSIVE CHANGE  
**Product** : AXE5400 Whole Home Mesh Wi-Fi 6E System  
**Model No.** : Deco XE75, Deco XE5300  
**Brand Name** : tp-link  
**FCC Classification** : Unlicensed National Information Infrastructure (NII)  
**FCC Rule Part(s)** : Part15 Subpart E (Section 15.407)  
**Received Date** : September 13, 2022  
**Test Date** : September 17 ~ October 12, 2022

**Tested By** : Owen Tsai  
( Owen Tsai )

**Reviewed By** : Paddy Chen  
( Paddy Chen )

**Approved By** : Chenz Ker  
( Chenz Ker )



The test results relate only to the samples tested.

This equipment has been shown to be capable of compliance with the applicable technical standards as indicated in the measurement report and was tested in accordance with the measurement procedures specified in KDB 789033 D02v02r01. Test results reported herein relate only to the item(s) tested.

The test report shall not be reproduced except in full without the written approval of MRT Technology (Taiwan) Co., Ltd.

## Revision History

Report No.	Version	Description	Issue Date	Note
2209TW0106-U4	1.0	Original Report	2022-11-30	Valid

Note: This report is prepared for FCC Class II permissive change supplement based on MRT original "2209TW0106-U2" report to open the 160MHz (Channl 50) via the software.

---

## CONTENTS

Description	Page
<b>General Information</b> .....	<b>6</b>
<b>1. INTRODUCTION</b> .....	<b>7</b>
1.1. Scope .....	7
1.2. MRT Test Location .....	7
<b>2. PRODUCT INFORMATION</b> .....	<b>8</b>
2.1. Equipment Description.....	8
2.2. Product Specification Subjective to this Report.....	8
2.3. Working Frequencies for this report .....	9
2.4. Description of Available Antennas .....	9
2.5. Test Mode .....	9
2.6. Configuration of Test System.....	10
2.7. Test System Details.....	10
2.8. Description of Test Software .....	10
2.9. Applied Standards .....	11
2.10. Duty Cycle .....	11
2.11. Test Configuration .....	11
2.12. EMI Suppression Device(s)/Modifications .....	12
2.13. Labeling Requirements.....	12
<b>3. DESCRIPTION OF TEST</b> .....	<b>13</b>
3.1. Evaluation Procedure .....	13
3.2. AC Line Conducted Emissions .....	13
3.3. Radiated Emissions .....	14
<b>4. ANTENNA REQUIREMENTS</b> .....	<b>15</b>
<b>5. TEST EQUIPMENT CALIBRATION DATE</b> .....	<b>16</b>
<b>6. MEASUREMENT UNCERTAINTY</b> .....	<b>17</b>
<b>7. TEST RESULT</b> .....	<b>18</b>
7.1. Summary .....	18
7.2. 26dB Bandwidth Measurement.....	19
7.2.1. Test Limit .....	19
7.2.2. Test Procedure used.....	19
7.2.3. Test Setting.....	19
7.2.4. Test Setup .....	20
7.2.5. Test Result.....	21

7.3.	Output Power Measurement .....	22
7.3.1.	Test Limit .....	22
7.3.2.	Test Procedure Used .....	22
7.3.3.	Test Setting.....	22
7.3.4.	Test Setup .....	22
7.3.5.	Test Result.....	23
7.4.	Transmit Power Control .....	24
7.4.1.	Test Limit .....	24
7.4.2.	Test Procedure Used .....	24
7.4.3.	Test Setting.....	24
7.4.4.	Test Setup .....	24
7.4.5.	Test Result.....	24
7.5.	Power Spectral Density Measurement .....	25
7.5.1.	Test Limit .....	25
7.5.2.	Test Procedure Used .....	25
7.5.3.	Test Setting.....	25
7.5.4.	Test Setup .....	26
7.5.5.	Test Result.....	27
7.6.	Frequency Stability Measurement.....	28
7.6.1.	Test Limit .....	28
7.6.2.	Test Limit .....	28
7.6.3.	Test Setup .....	29
7.6.4.	Test Result.....	29
7.7.	Radiated Spurious Emission Measurement .....	30
7.7.1.	Test Limit .....	30
7.7.2.	Test Procedure Used .....	30
7.7.3.	Test Setting.....	30
7.7.4.	Test Setup .....	32
7.7.5.	Test Result.....	33
7.8.	Radiated Restricted Band Edge Measurement .....	37
7.8.1.	Test Limit .....	37
7.8.2.	Test Procedure Used .....	38
7.8.3.	Test Setting.....	38
7.8.4.	Test Setup .....	39
7.8.5.	Test Result.....	40
<b>8.</b>	<b>CONCLUSION.....</b>	<b>48</b>
	<b>Appendix A : Test Setup Photograph .....</b>	<b>49</b>
	<b>Appendix B : External Photograph.....</b>	<b>50</b>

**Appendix C : Internal Photograph ..... 51**

## General Information

<b>Applicant</b>	TP-Link Corporation Limited
<b>Applicant Address</b>	Room 901, 9/F., New East Ocean Centre, 9 Science Museum Road, Tsim Sha Tsui, Kowloon, Hongkong
<b>Manufacturer</b>	TP-Link Corporation Limited
<b>Manufacturer Address</b>	Room 901, 9/F., New East Ocean Centre, 9 Science Museum Road, Tsim Sha Tsui, Kowloon, Hongkong
<b>Test Site</b>	MRT Technology (Taiwan) Co., Ltd
<b>Test Site Address</b>	No. 38, Fuxing Second Rd., Guishan Dist., Taoyuan City 333, Taiwan (R.O.C)
<b>MRT FCC Registration No.</b>	291082
<b>FCC Rule Part(s)</b>	Part 15.407

## Test Facility / Accreditations

1. MRT facility is a FCC registered (Reg. No. 291082) test facility with the site description report on file and is designated by the FCC as an Accredited Test Firm.
2. MRT facility is an IC registered (MRT Reg. No. 21723) test laboratory with the site description on file at Industry Canada.
3. MRT Lab is accredited to ISO 17025 by the Taiwan Accreditation Foundation (TAF Cert. No. 3261) in EMC, Telecommunications and Radio testing for FCC (Designation Number: TW3261), Industry Taiwan, EU and TELEC Rules.

# 1. INTRODUCTION

## 1.1. Scope

Measurement and determination of electromagnetic emissions (EMC) of radio frequency devices including intentional and/or unintentional radiators for compliance with the technical rules and regulations of the Federal Communications Commission and the Innovation, Science and Economic Development Canada and Certification and Engineering Bureau.

## 1.2. MRT Test Location

The map below shows the location of the MRT LABORATORY, its proximity to the Taoyuan City. These measurement tests were conducted at the MRT Technology (Taiwan) Co., Ltd. Facility located at No.38, Fuxing 2nd Rd., Guishan Dist., Taoyuan City 33377, Taiwan (R.O.C).

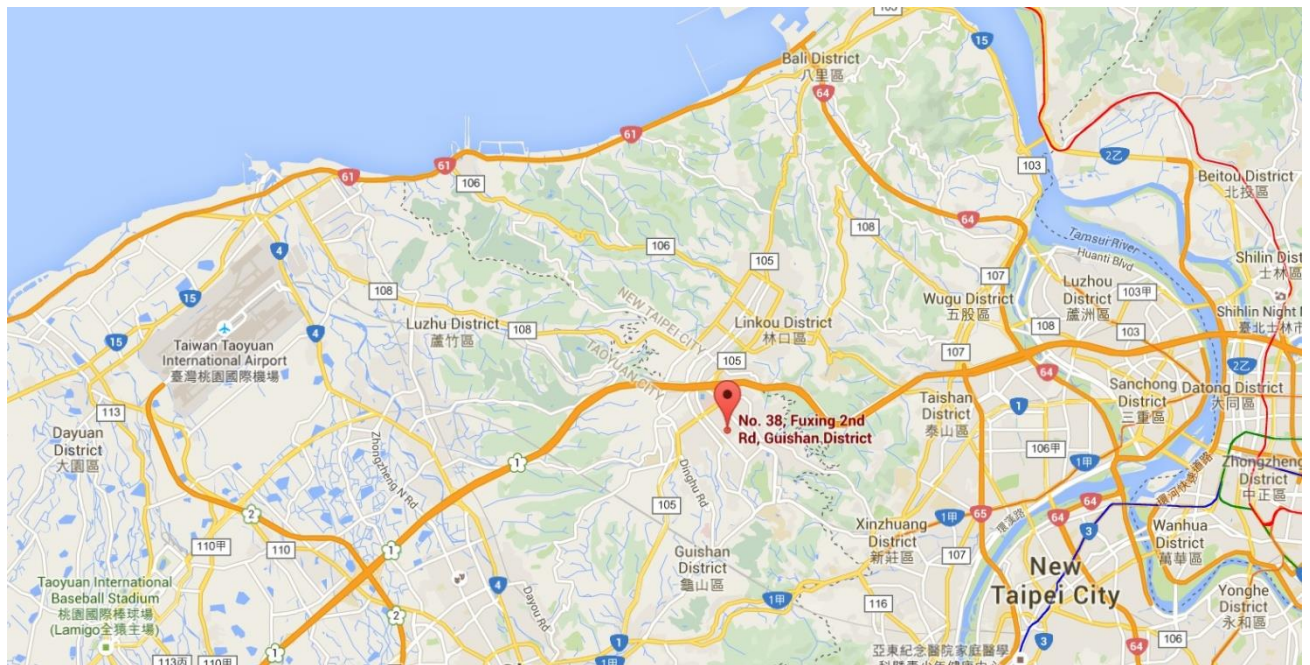

## 2. PRODUCT INFORMATION

### 2.1. Equipment Description

Product Name:	AXE5400 Whole Home Mesh Wi-Fi 6E System
Model No.:	Deco XE75, Deco XE5300
Brand Name:	tp-link
Wi-Fi Specification:	802.11a/b/g/n/ac/ax
EUT Identification No.:	20220913Sample#1-1 (Conducted) 20220913Sample#1-2 (Radiated)
Accessory	
Adapter	MODEL: T120200-2B4 INPUT: 100 - 240V ~ 50/60Hz 0.8A. OUTPUT: 12.0V=2.0A Cable Out: Non-shielding, 1.2m
Remark: Hardware design and PCB layout are the same between the two models, only the model for our marketing strategy is different. Deco XE75 was selected for testing.	

### 2.2. Product Specification Subjective to this Report

Frequency Range:	For 802.11ac-VHT160/ax-HE160: 5250MHz
Type of Modulation:	802.11ac: OFDM 802.11ax: OFDMA
Data Rate:	802.11ac: up to 1733.3Mbps 802.11ax: up to 2402Mbps

Note: For other features of this EUT, test report will be issued separately.



### 2.3. Working Frequencies for this report

802.11ac-VHT160/ax-HE160

Channel	Frequency	Channel	Frequency	Channel	Frequency
50	5250MHz	--	--	--	--

### 2.4. Description of Available Antennas

Antenna Type	Frequency Band (MHz)	T <sub>x</sub> Paths	Max Antenna Gain (dBi)	CDD Directional Gain (dBi)	
				For Power	For PSD
Dipole Antenna	5150 ~ 5350	2	1.00	1.00	4.01
	5725 ~ 5850	2	1.00	1.00	4.01

Note: The EUT supports Cyclic Delay Diversity (CDD) mode, and CDD signals are correlated.

If all antennas have the same gain,  $G_{ANT}$ , Directional gain =  $G_{ANT} + \text{Array Gain}$ , where Array Gain is as follows.

- For power spectral density (PSD) measurements on all devices,

$$\text{Array Gain} = 10 \log (N_{ANT} / N_{SS}) \text{ dB};$$

- For power measurements on IEEE 802.11 devices,

$$\text{Array Gain} = 0 \text{ dB for } N_{ANT} \leq 4;$$

### 2.5. Test Mode

CDD Mode
Mode 1: Transmit by 802.11ac-VHT160_ $N_{SS}=1$ (MCS0)
Mode 2: Transmit by 802.11ax-HE160_ $N_{SS}=1$ (MCS0)
Remark: <ol style="list-style-type: none"> <li>For Radiated emission, the modulation and the data rate picked for testing are determined by the Max. RF conducted power.</li> <li>For CDD mode, this device supports 2 <math>N_{SS}</math> and power level is the same of spatial multiplexing. The worst case is <math>N_{SS}=1</math>.</li> <li>EUT supports one configuration only in 802.11ax full RU mode.</li> </ol>

## 2.6. Configuration of Test System

The device was tested per the guidance ANSI C63.10: 2013 was used to reference the appropriate EUT setup for radiated emissions testing and AC line conducted testing.

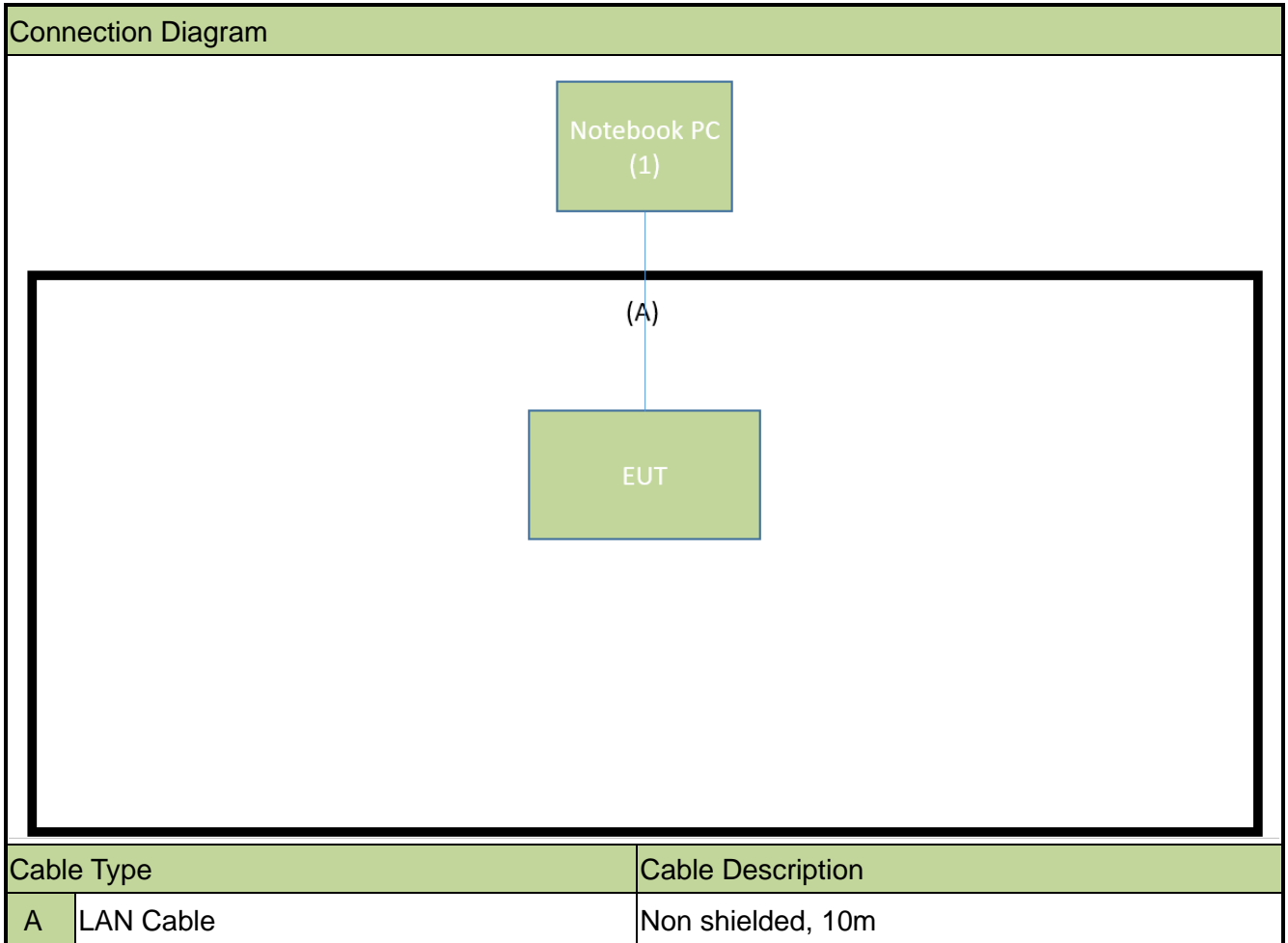

## 2.7. Test System Details

The types for all equipments, plus descriptions of all cables used in the tested system (including inserted cards) are:

Product	Manufacturer	Model No.	Serial No.	Power Cord
1	Notebook PC	Lenovo	20Y7-006KTW	N/A
				Non-Shielded, 0.8m

## 2.8. Description of Test Software

The test utility software used during testing was “QSPR”, the version is ver5.0-00188.

Note: Final power setting please refer to operational description.

## 2.9. Applied Standards

According to the specifications of the manufacturer, the EUT must comply with the requirements of the following standards:

- FCC Part 15.407
- KDB 789033 D02v02r01,
- KDB 662911 D01v02r01
- ANSI C63.10-2013

## 2.10. Duty Cycle

5GHz (NII) operation is possible in 160MHz channel bandwidths. The maximum achievable duty cycles for all modes were determined based on measurements performed on a spectrum analyzer in zero-span mode with RBW = 8MHz, VBW = 50MHz. The RBW and VBW were both greater than 50/T, where T is the minimum transmission duration, and the number of sweep points across T was greater than 100. The duty cycles are as follows:

Test Mode	Duty Cycle
802.11ac-VHT160	89.87%
802.11ax-HE160	89.91%

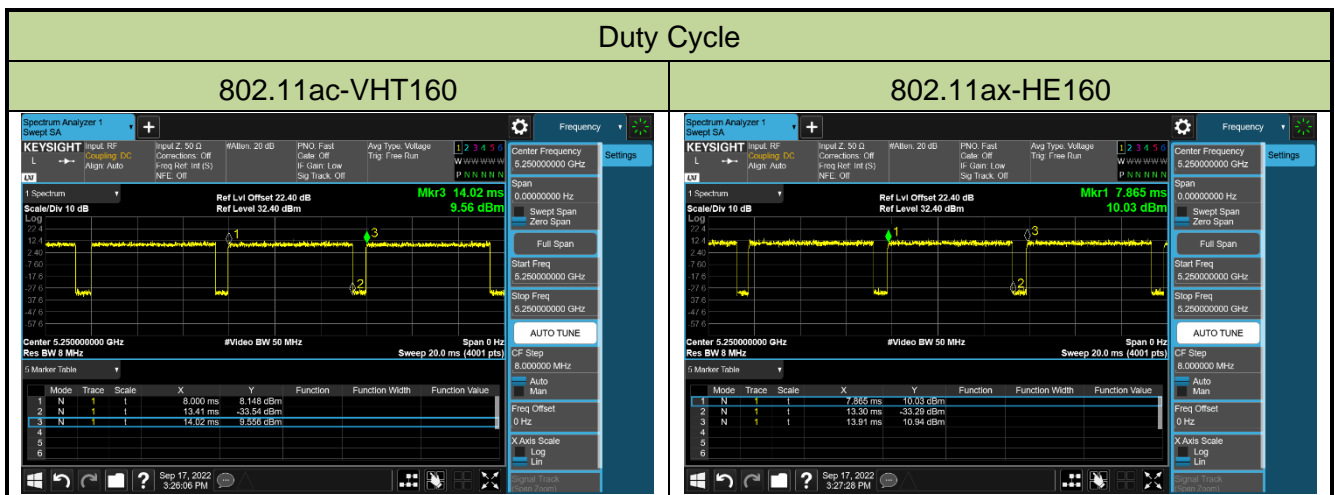

## 2.11. Test Configuration

The device was tested per the guidance of KDB 789033 D02v02r01. ANSI C63.10-2013 was used to reference the appropriate EUT setup for radiated spurious emissions testing and AC line conducted testing.

## **2.12. EMI Suppression Device(s)/Modifications**

No EMI suppression device(s) were added and/or no modifications were made during testing.

## **2.13. Labeling Requirements**

Per 2.1074 & 15.19; Docket 95-19

The label shall be permanently affixed at a conspicuous location on the device; instruction manual or pamphlet supplied to the user and be readily visible to the purchaser at the time of purchase.

However, when the device is so small wherein placement of the label with specified statement is not practical, only the FCC ID must be displayed on the device per Section 15.19(a)(5). Please see attachment for FCC ID label and label location.

### **3. DESCRIPTION OF TEST**

#### **3.1. Evaluation Procedure**

The measurement procedures described in the American National Standard of Procedures for Compliance Testing of Unlicensed Wireless Devices (ANSI C63.10-2013), and the guidance provided in KDB 789033 D02v02r01 were used in the measurement.

#### **3.2. AC Line Conducted Emissions**

The line-conducted facility is located inside an 8'x4'x4' shielded enclosure. A 1m x 2m wooden table 80cm high is placed 40cm away from the vertical wall and 80cm away from the sidewall of the shielded room. Two 10kHz-30MHz, 50Ω/50uH Line-Impedance Stabilization Networks (LISNs) are bonded to the shielded room floor. Power to the LISNs is filtered by external high-current high-insertion loss power line filters. These filters attenuate ambient signal noise from entering the measurement lines. These filters are also bonded to the shielded enclosure.

The EUT is powered from one LISN and the support equipment is powered from the second LISN. All interconnecting cables more than 1 meter were shortened to a 1 meter length by non-inductive bundling (serpentine fashion) and draped over the back edge of the test table. All cables were at least 40cm above the horizontal reference ground-plane. Power cables for support equipment were routed down to the second LISN while ensuring that that cables were not draped over the second LISN.

Sufficient time for the EUT, support equipment, and test equipment was allowed in order for them to warm up to their normal operating condition. The RF output of the LISN was connected to the receiver and exploratory measurements were made to determine the frequencies producing the maximum emission from the EUT. The receiver was scanned from 150kHz to 30MHz. The detector function was set to peak mode for exploratory measurements while the bandwidth of the analyzer was set to 9kHz. The EUT, support equipment, and interconnecting cables were arranged and manipulated to maximize each emission. Each emission was also maximized by varying: power lines, the mode of operation or data exchange speed, or support equipment whichever determined the worst-case emission. Once the worst case emissions have been identified, the one EUT cable configuration/arrangement and mode of operation that produced these emissions are used for final measurements on the same test site. The analyzer is set to CISPR quasi-peak and average detectors with a 9kHz resolution bandwidth for final measurements.

An extension cord was used to connect to a single LISN which powered by EUT. The extension cord was calibrated with LISN, the impedance and insertion loss are compliance with the requirements as stated in ANSI C63.10-2013.

### 3.3. Radiated Emissions

The radiated test facilities consisted of an indoor 3 meter semi-anechoic chamber used for final measurements and exploratory measurements, when necessary. The measurement area is contained within the semi-anechoic chamber which is shielded from any ambient interference. For measurements above 1GHz absorbers are arranged on the floor between the turn table and the antenna mast in such a way so as to maximize the reduction of reflections. For measurements below 1GHz, the absorbers are removed. A MF Model 210SS turntable is used for radiated measurement. It is a continuously rotatable, remote controlled, metallic turntable and 2 meters (6.56 ft.) in diameter. The turn table is flush with the raised floor of the chamber in order to maintain its function as a ground plane. An 80cm high PVC support structure is placed on top of the turntable.

For all measurements, the spectrum was scanned through all EUT azimuths and from 1 to 4 meter receive antenna height using a broadband antenna from 30MHz up to the upper frequency shown in 15.33(b)(1) depending on the highest frequency generated or used in the device or on which the device operates or tunes. For frequencies above 1GHz, linearly polarized double ridge horn antennas were used. For frequencies below 30MHz, a calibrated loop antenna was used. When exploratory measurements were necessary, they were performed at 1 meter test distance inside the semi-anechoic chamber using broadband antennas, broadband amplifiers, and spectrum analyzers to determine the frequencies and modes producing the maximum emissions. Sufficient time for the EUT, support equipment, and test equipment was allowed in order for them to warm up to their normal operating condition. The test set-up for frequencies below 1GHz was placed on top of the 0.8 meter high, 1 x 1.5 meter table; and test set-up for frequencies 1-40GHz was placed on top of the 1.5 meter high, 1 x 1.5 meter table. The EUT, support equipment, and interconnecting cables were arranged and manipulated to maximize each emission. Appropriate precaution was taken to ensure that all emissions from the EUT were maximized and investigated. The system configuration, clock speed, mode of operation or video resolution, if applicable, turntable azimuth, and receive antenna height was noted for each frequency found.

Final measurements were made in the semi-anechoic chamber using calibrated, linearly polarized broadband and horn antennas. The test setup was configured to the setup that produced the worst case emissions. The spectrum analyzer was set to investigate all frequencies required for testing to compare the highest radiated disturbances with respect to the specified limits. The turntable containing the EUT was rotated through 360 degrees and the height of the receive antenna was varied 1 to 4 meters and stopped at the azimuth and height producing the maximum emission. Each emission was maximized by changing the orientation of the EUT through three orthogonal planes and changing the polarity of the receive antenna, whichever produced the worst-case emissions. According to 3dB Beam-Width of horn antenna, the horn antenna should be always directed to the EUT when rising height.

## 4. ANTENNA REQUIREMENTS

### Excerpt from §15.203 of the FCC Rules/Regulations:

“An intentional radiator antenna shall be designed to ensure that no antenna other than that furnished by the responsible party can be used with the device. The use of a permanently attached antenna or of an antenna that uses a unique coupling to the intentional radiator shall be considered sufficient to comply with the provisions of this section.”

- The antenna of the device is **permanently attached**.
- There are no provisions for connection to an external antenna.

### Conclusion:

The unit complies with the requirement of §15.203.

## 5. TEST EQUIPMENT CALIBRATION DATE

### Conducted Emissions

Instrument	Manufacturer	Type No.	Asset No.	Cali. Interval	Cali. Due Date
Two-Line V-Network	R&S	ENV216	MRTTWA00019	1 year	2023/3/7
Two-Line V-Network	R&S	ENV216	MRTTWA00020	1 year	2023/4/20
EMI Test Receiver	R&S	ESR3	MRTTWA00045	1 year	2023/5/9
DIVA PLUS Funk-Wetterstation	TFA	35.1083	MRTTWA00050	1 year	2023/6/16

### Radiated Emissions

Instrument	Manufacturer	Type No.	Asset No.	Cali. Interval	Cali. Due Date
Broadband TRILOG Antenna	SCHWARZBECK	VULB 9162	MRTTWA00001	1 year	2022/11/4
EMI Test Receiver	R&S	ESR3	MRTTWA00009	1 year	2023/3/9
Signal Analyzer	R&S	FSVA3044	MRTTWA00092	1 year	2023/6/23
Active Loop Antenna	Schwarzbeck	FMZB 1519B	MRTTWA00002	1 year	2023/5/24
Broadband Hornantenna	RFSPIN	DRH18-E	MRTTWA00087	1 year	2023/5/10
Breitband Hornantenna	Schwarzbeck	BBHA 9170	MRTTWA00004	1 year	2023/3/29
Broadband Preamplifier	EMC Instruments corporation	EMC118A45SE	MRTTWA00088	1 year	2023/5/9
Broadband Preamplifier	SCHWARZBECK	BBV 9718	MRTTWA00005	1 year	2023/3/30
Cable	HUBERSUHNER	SF106	MRTTWE00034	1 year	2023/6/27

### Conducted Test Equipment

Instrument	Manufacturer	Type No.	Asset No.	Cali. Interval	Cali. Due Date
X-Series USB Peak and Average Power Sensor	KEYSIGHT	U2021XA	MRTTWA00014	1 year	2023/4/20
EXA Signal Analyzer	KEYSIGHT	N9010A	MRTTWA00012	1 year	2023/10/5
EXA Signal Analyzer	KEYSIGHT	N9010B	MRTTWA00074	1 year	2023/7/19
Attenuator	WTI	218FS-20	MRTTWE00026	1 year	2022/11/18
Attenuator	WTI	218FS-10	MRTTWE00027	1 year	2023/6/15
Temperature & Humidity Chamber	TEN BILLION	TTH-B3UP	MRTTWA00036	1 year	2023/6/14
DIVA PLUS Funk-Wetterstation	TFA	35.1083	MRTTWA00050	1 year	2023/6/16

Software	Version	Function
e3	9.160520a	EMI Test Software



## 6. MEASUREMENT UNCERTAINTY

Where relevant, the following test uncertainty levels have been estimated for tests performed on the EUT as specified in CISPR 16-4-2. This uncertainty represents an expanded uncertainty expressed at approximately the 95% confidence level using a coverage factor of  $k = 2$ .

<b>AC Conducted Emission Measurement</b>
Measuring Uncertainty for a Level of Confidence of 95% ( $U=2Uc(y)$ ): 150kHz~30MHz: $\pm 2.53\text{dB}$
<b>Radiated Emission Measurement</b>
Measuring Uncertainty for a Level of Confidence of 95% ( $U=2Uc(y)$ ): 9kHz ~ 1GHz: $\pm 4.25\text{dB}$ 1GHz ~ 40GHz: $\pm 4.45\text{dB}$
<b>Conducted Power (Carrier Power / Power Density)</b>
Measuring Uncertainty for a Level of Confidence of 95% ( $U=2Uc(y)$ ): $\pm 0.84\text{dB}$
<b>Conducted Spurious Emission</b>
Measuring Uncertainty for a Level of Confidence of 95% ( $U=2Uc(y)$ ): $\pm 2.65\text{ dB}$
<b>Occupied Bandwidth</b>
Measuring Uncertainty for a Level of Confidence of 95% ( $U=2Uc(y)$ ): $\pm 3.3\%$
<b>Temp. / Humidity</b>
Measuring Uncertainty for a Level of Confidence of 95% ( $U=2Uc(y)$ ): $\pm 0.82^\circ\text{C} / \pm 3\%$
<b>Frequency Error</b>
Measuring Uncertainty for a Level of Confidence of 95% ( $U=2Uc(y)$ ): $\pm 78.4\text{Hz}$

## 7. TEST RESULT

### 7.1. Summary

FCC Section(s)	Test Description	Test Limit	Test Condition	Test Result	Reference
15.407(a)	26dB Bandwidth	N/A	Conducted	Pass	Section 7.2
15.407(a)(2)	Maximum Conducted Output Power	Refer to section 7.3		Pass	Section 7.3
15.407(h)(1)	Transmit Power Control	$\leq 24$ dBm		Pass	Section 7.4
15.407(a)(2), (12)	Peak Power Spectral Density	Refer to section 7.5		Pass	Section 7.5
15.407(g)	Frequency Stability	N/A		Pass	Section 7.6
15.407(b)(2)	Undesirable Emissions	Refer to Section 7.7	Radiated	Pass	Section 7.7 & 7.8
15.205, 15.209 15.407(b)(8), (9), (10)	General Field Strength Limits (Restricted Bands and Radiated Emission Limits)	Emissions in restricted bands must meet the radiated limits detailed in 15.209		Pass	

Notes:

- 1) Determining compliance is based on the test results met the regulation limits or requirements declared by clients, and the test results don't take into account the value of measurement uncertainty.
- 2) The analyzer plots shown in this section were all taken with a correction table loaded into the analyzer. The correction table was used to account for the losses of the cables and attenuators used as part of the system to connect the EUT to the analyzer at all frequencies of interest.
- 3) The test results shown in the following sections represent the worst-case emissions.

## 7.2. 26dB Bandwidth Measurement

### 7.2.1. Test Limit

N/A

### 7.2.2. Test Procedure used

KDB 789033 D02v02r01- Section II)C)1) (26dB Bandwidth)

KDB 789033 D02v02r01- Section II)D) (99% Bandwidth)

### 7.2.3. Test Setting

#### 26dB Bandwidth

1. The analyzers' automatic bandwidth measurement capability was used to perform the 26dB bandwidth
2. RBW = approximately 1% of the emission bandwidth.
3. VBW > RBW
4. Detector = Peak.
5. Trace mode = max hold.
6. Measure the maximum width of the emission that is 26 dB down from the maximum of the emission. Compare this with the RBW setting of the analyzer. Readjust RBW and repeat measurement as needed until the RBW/EBW ratio is approximately 1%.

#### 99% Bandwidth

1. Set center frequency to the nominal EUT channel center frequency.
2. RBW = 1% to 5% of the OBW
3.  $VBW \geq 3 \times RBW$
4. Span = 1.5 times to 5 times the OBW
5. Detector = peak
6. Trace mode = max hold
7. Allow the trace to stabilize
8. Use the 99% power bandwidth function of the instrument.

### 7.2.4. Test Setup

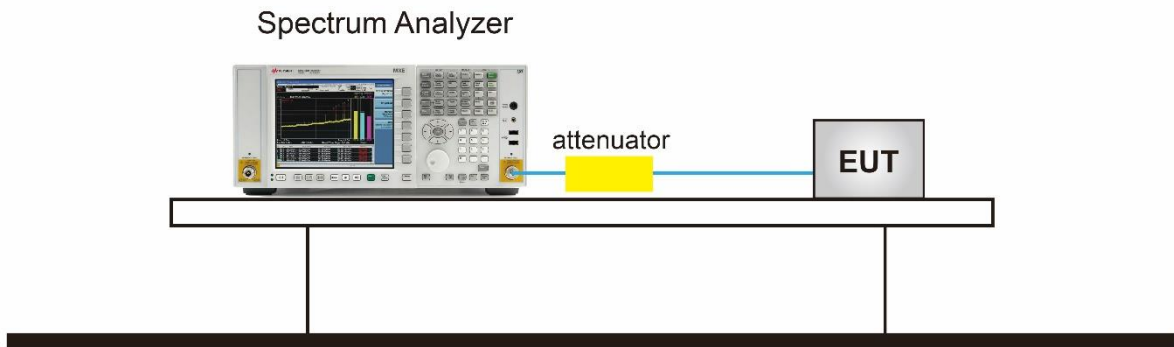

### 7.2.5. Test Result

Product	AXE5400 Whole Home Mesh Wi-Fi 6E System	Test Engineer	Owen
Test Site	SR5	Test Date	2022/9/23

Test Mode	Data Rate/ MCS	Channel No.	Frequency (MHz)	26dB Bandwidth (MHz)	99% Bandwidth (MHz)
Ant 0					
802.11ac-VHT160	MCS0	50	5250	160.600	153.260
802.11ax-HE160	MCS0	50	5250	161.200	154.940

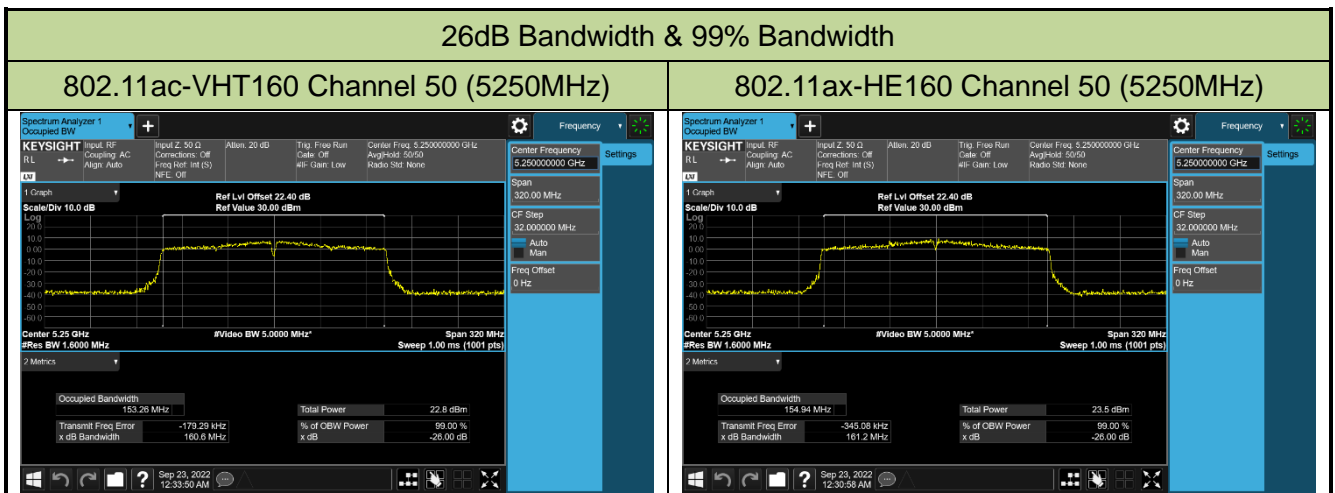

## 7.3. Output Power Measurement

### 7.3.1. Test Limit

For the band 5.15-5.25 GHz, the maximum conducted output power over the frequency band of operation shall not exceed 1 W provided the maximum antenna gain does not exceed 6 dBi.

For the 5.25-5.35 GHz and 5.47-5.725 GHz bands, the maximum conducted output power over the frequency bands of operation shall not exceed the lesser of 250 mW or  $11 \text{ dBm} + 10 \log B$ , where B is the 26 dB emission bandwidth in megahertz.

If transmitting antennas of directional gain greater than 6dBi are used, the maximum conducted output power shall be reduced by the amount in dB that the directional gain of the antenna exceeds 6dBi.

### 7.3.2. Test Procedure Used

KDB 789033D02v02r01- Section II) E)3)b) Method PM-G

### 7.3.3. Test Setting

Average power measurements were performed only when the EUT was transmitting at its maximum power control level using a broadband power meter with a pulse sensor. The power meter implemented triggering and gating capabilities which were set up such that power measurements were recorded only during the ON time of the transmitter.

### 7.3.4. Test Setup

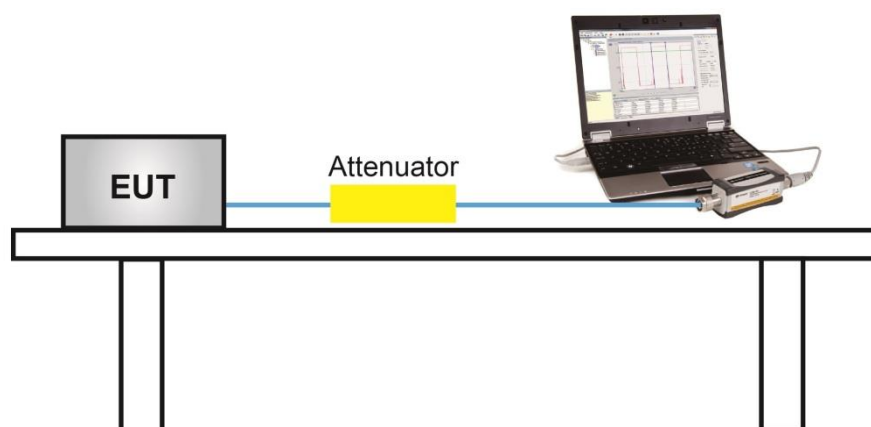

### 7.3.5. Test Result

Product	AXE5400 Whole Home Mesh Wi-Fi 6E System	Test Engineer	Owen
Test Site	SR5	Test Date	2022/9/22~2022/9/23

Test Mode	Data Rate/ MCS	Channel No.	Freq. (MHz)	Average Power (dBm)		Total Average Power (dBm)	Power Limit (dBm)	Result
				Ant 0	Ant 1			
11ac-VHT160	MCS0	50	5250	19.78	19.67	22.74	≤ 23.98	Pass
11ax-HE160	MCS0	50	5250	20.02	19.93	22.99	≤ 23.98	Pass

Note: The Total Average Power (dBm) =  $10 \cdot \log \{10^{(\text{Ant 0 Average Power} / 10)} + 10^{(\text{Ant 1 Average Power} / 10)}\}$ .

## 7.4. Transmit Power Control

### 7.4.1. Test Limit

The U-NII device is required to have the capability to operate at least 6 dB below the mean EIRP value of 30 dBm.

### 7.4.2. Test Procedure Used

KDB 789033 D02v02r01- Section II) E)3)b) Method PM-G

### 7.4.3. Test Setting

Average power measurements were performed only when the EUT was transmitting at its maximum power control level using a broadband power meter with a pulse sensor. The power meter implemented triggering and gating capabilities which were set up such that power measurements were recorded only during the ON time of the transmitter. The trace was averaged over 100 traces to obtain the final measured average power.

### 7.4.4. Test Setup

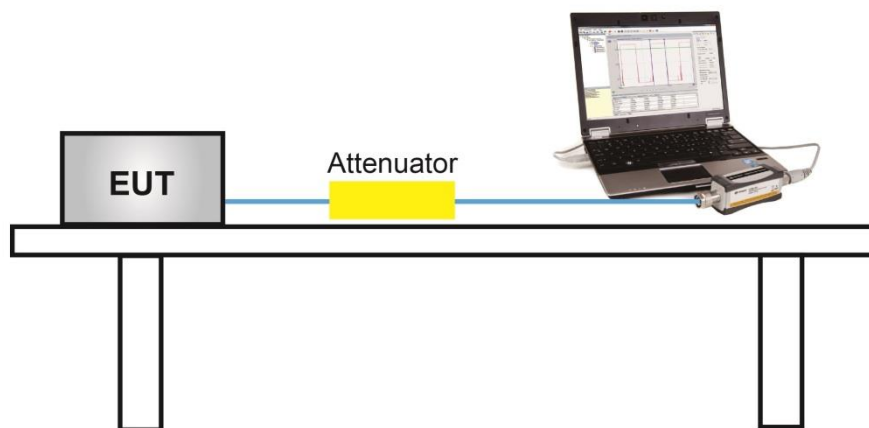

### 7.4.5. Test Result

A TPC mechanism is not required for systems with an e.i.r.p. of less than 500 mW.



## 7.5. Power Spectral Density Measurement

### 7.5.1. Test Limit

For the band 5.15-5.25 GHz, the maximum power spectral density shall not exceed 17 dBm in any 1 megahertz band.

For the 5.25-5.35 GHz and 5.47-5.725 GHz bands, the maximum power spectral density shall not exceed 11 dBm in any 1 megahertz band.

If transmitting antennas of directional gain greater than 6dBi are used, the peak power spectral density shall be reduced by the amount in dB that the directional gain of the antenna exceeds 6dBi.

### 7.5.2. Test Procedure Used

KDB 789033 D02v02r01-Section II)F

### 7.5.3. Test Setting

1. Analyzer was set to the center frequency of the UNII channel under investigation
2. Span was set to encompass the entire 26dB EBW of the signal.
3. RBW = 1MHz, if measurement bandwidth of Maximum PSD is specified in 500 kHz,  
RBW = 510 kHz
4. VBW = 3MHz
5. Number of sweep points  $\geq 2 \times (\text{span} / \text{RBW})$
6. Detector = power averaging (Average)
7. Sweep time = auto
8. Trigger = free run
9. Use the peak search function on the instrument to find the peak of the spectrum and record its value.
10. Add  $10 \cdot \log(1/x)$ , where x is the duty cycle, to the measured power in order to compute the average power during the actual transmission times (because the measurement represents an average over both the on and off times of the transmission). For example, add  $10 \cdot \log(1/0.25) = 6$  dB if the duty cycle is 25 percent.

### 7.5.4. Test Setup

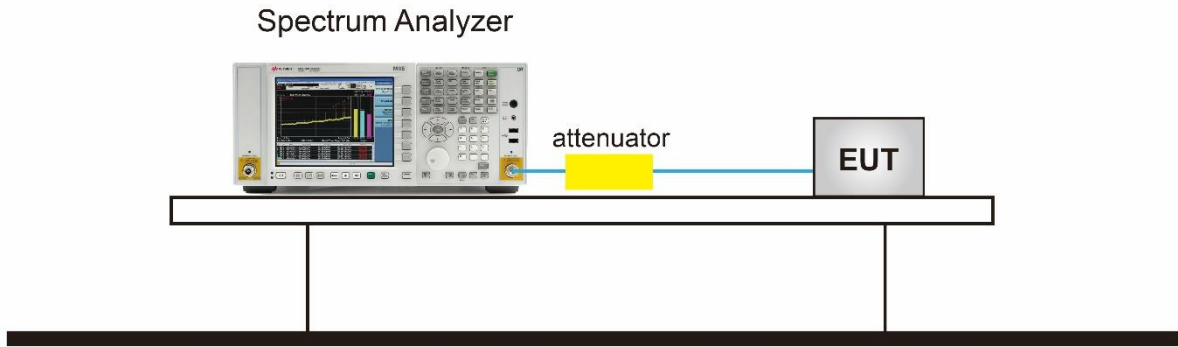

### 7.5.5. Test Result

Product	AXE5400 Whole Home Mesh Wi-Fi 6E System	Test Engineer	Owen
Test Site	SR5	Test Date	2022/9/22~2022/9/23
Mode	Power Spectral Density (U-NII- 1) CDD Mode		

Test Mode	Data Rate/ MCS	Ch. No.	Freq. (MHz)	PSD (dBm/MHz)		Duty Cycle (%)	Total PSD (dBm/ MHz)	Limit (dBm/ MHz)	Result
				Ant 0	Ant 1				
11ac-VHT160	MCS0	50	5250	0.901	0.915	89.97	4.377	≤11.00	Pass
11ax-HE160	MCS0	50	5250	1.044	1.080	89.91	4.534	≤11.00	Pass

Note: When EUT duty cycle < 98%,

the total PSD (dBm/MHz) =  $10 \cdot \log \{10^{(\text{Ant 0 PSD}/10)} + 10^{(\text{Ant 1 PSD}/10)}\} + 10 \cdot \log (1/\text{Duty Cycle})(\text{dBm/MHz})$ .

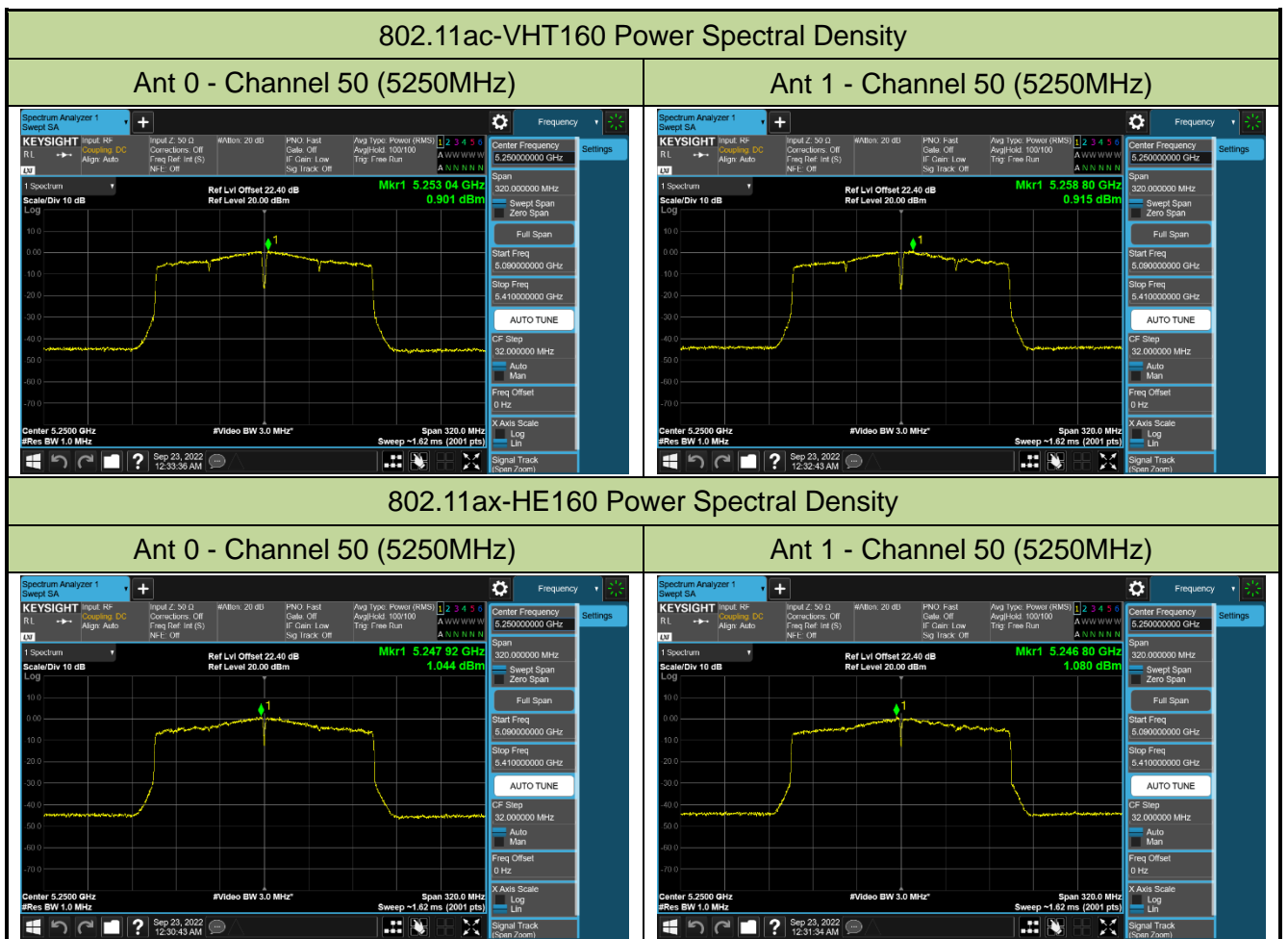

## 7.6. Frequency Stability Measurement

### 7.6.1. Test Limit

Manufacturers of U-NII devices are responsible for ensuring frequency stability such that an emission is maintained within the band of operation under all conditions of normal operation as specified in the user's manual.

### 7.6.2. Test Limit

#### **Frequency Stability Under Temperature Variations:**

The equipment under test was connected to an external AC or DC power supply and input rated voltage. RF output was connected to a frequency counter or spectrum analyzer via feed through attenuators. The EUT was placed inside the temperature chamber. Set the spectrum analyzer RBW low enough to obtain the desired frequency resolution and measure EUT 20°C operating frequency as reference frequency. Turn EUT off and set the chamber temperature to highest. After the temperature stabilized for approximately 30 minutes recorded the frequency. Repeat step measure with 10°C decreased per stage until the lowest temperature reached.

#### **Frequency Stability Under Voltage Variations:**

Set chamber temperature to 20°C. Use a variable AC power supply / DC power source to power the EUT and set the voltage to rated voltage. Set the spectrum analyzer RBW low enough to obtain the desired frequency resolution and recorded the frequency.

Reduce the input voltage to specify extreme voltage variation ( $\pm 15\%$ ) and endpoint, record the maximum frequency change.

### 7.6.3. Test Setup

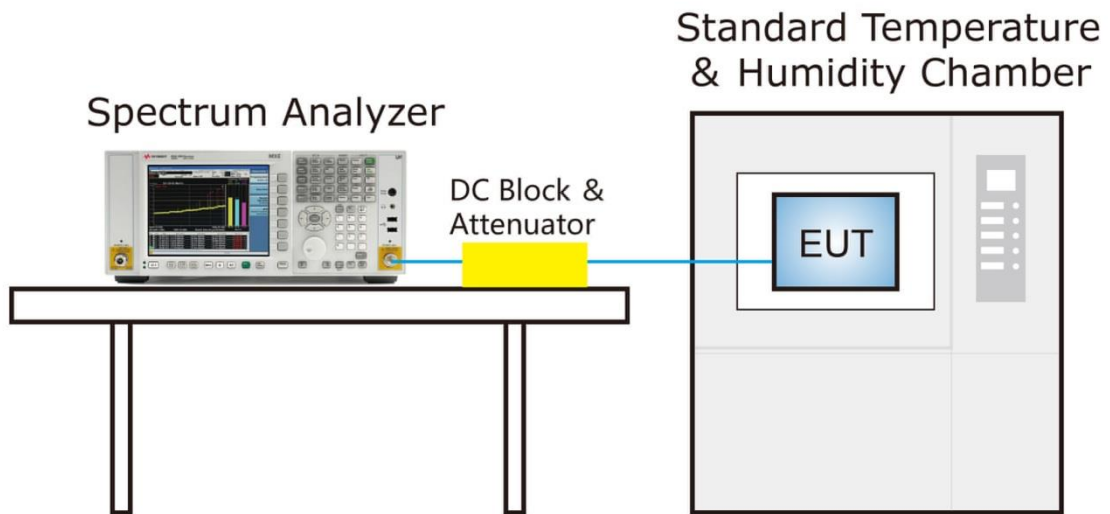

### 7.6.4. Test Result

Grantee ensure that the product meets e-CFR Title 47 section 15.407(g) and KDB 789033 D02v02r01 frequency stability such that the emissions are maintained within the band of operation under all conditions of normal operation as specified in the user's manual.

## 7.7. Radiated Spurious Emission Measurement

### 7.7.1. Test Limit

All out of band emissions appearing in a restricted band as specified in Section 15.205 of the Title 47CFR must not exceed the limits shown in Table per Section 15.209.

FCC Part 15 Subpart C Paragraph 15.209		
Frequency [MHz]	Field Strength [uV/m]	Measured Distance [Meters]
0.009 - 0.490	2400/F (kHz)	300
0.490 - 1.705	24000/F (kHz)	30
1.705 - 30	30	30
30 - 88	100	3
88 - 216	150	3
216 - 960	200	3
Above 960	500	3

### 7.7.2. Test Procedure Used

KDB 789033 D02v02r01- Section II) G

### 7.7.3. Test Setting

Table 1 - RBW as a function of frequency

Frequency	RBW
9 ~ 150 kHz	200 ~ 300 Hz
0.15 ~ 30 MHz	9 ~ 10 kHz
30 ~ 1000 MHz	100 ~ 120 kHz
>1000 MHz	1 MHz

**Quasi-Peak Measurements below 1GHz**

1. Analyzer center frequency was set to the frequency of the radiated spurious emission of interest
2. Span was set greater than 1MHz
3. RBW = as specified in Table 1
4. Detector = CISPR quasi-peak
5. Sweep time = auto couple
6. Trace was allowed to stabilize

**Peak Measurements above 1GHz**

1. Analyzer center frequency was set to the frequency of the radiated spurious emission of interest
2. RBW = 1MHz
3. VBW = 3MHz
4. Detector = peak
5. Sweep time = auto couple
6. Trace mode = max hold
7. Trace was allowed to stabilize

**Average Measurements above 1GHz (Method VB)**

1. Analyzer center frequency was set to the frequency of the radiated spurious emission of interest
2. RBW = 1MHz
3. VBW; If the EUT is configured to transmit with duty cycle  $\geq 98\%$ , set VBW = 10 Hz.  
If the EUT duty cycle is  $< 98\%$ , set VBW  $\geq 1/T$ . T is the minimum transmission duration.
4. Detector = Peak
5. Sweep time = auto
6. Trace mode = max hold
7. Trace was allowed to stabilize

### 7.7.4. Test Setup

#### Below 1GHz Test Setup:

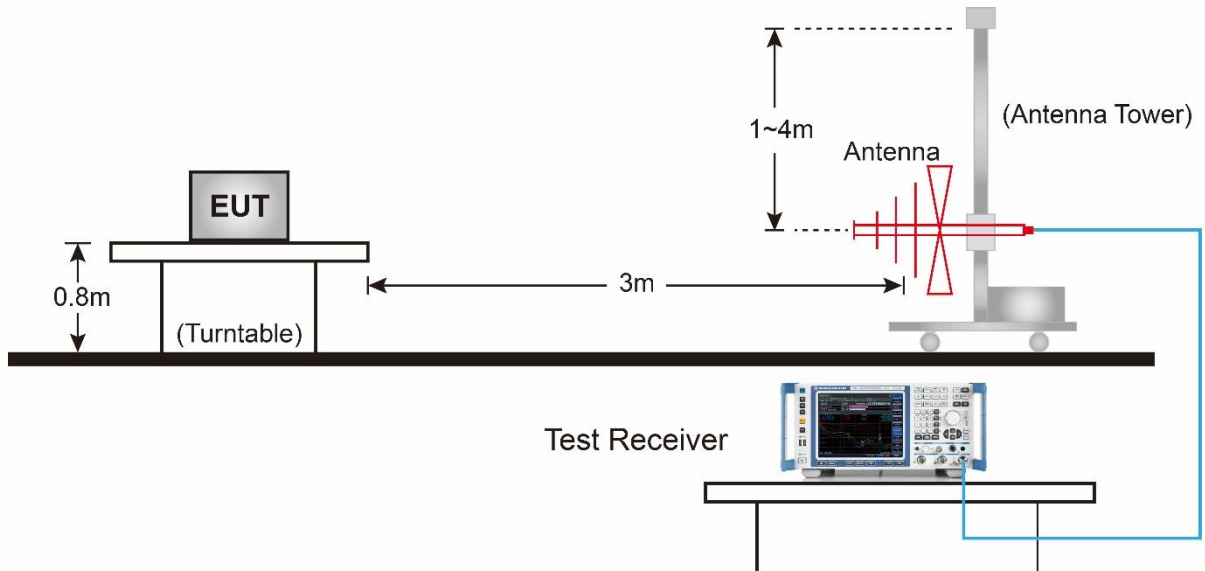

#### Above 1GHz Test Setup:

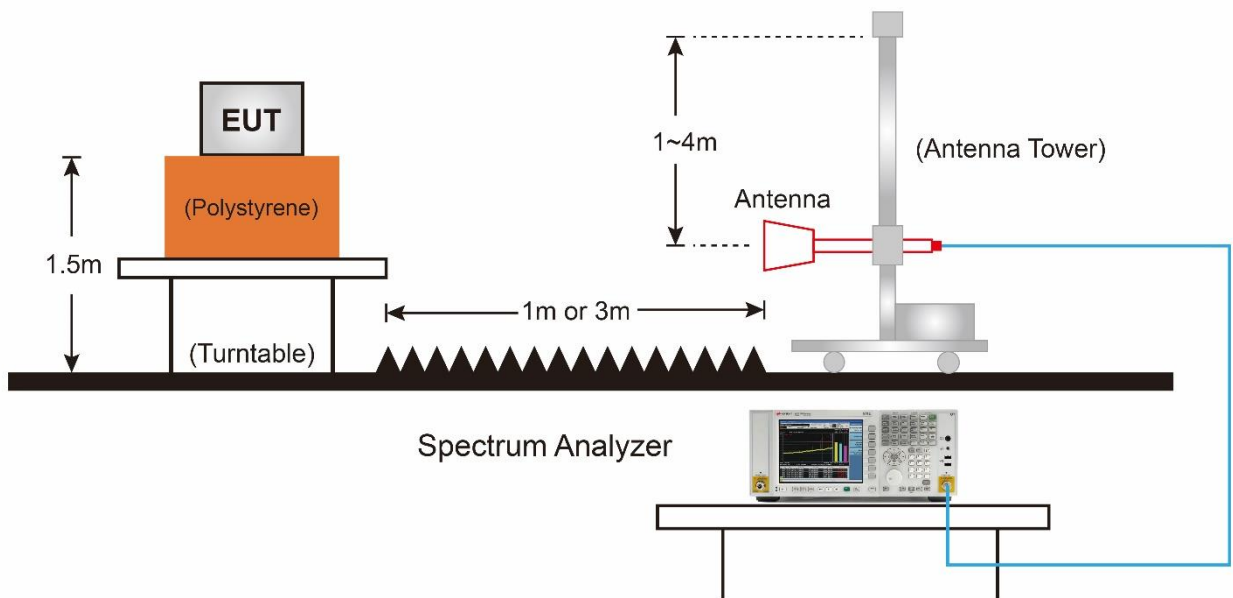



### 7.7.5. Test Result

EUT	AXE5400 Whole Home Mesh Wi-Fi 6E System	Date of Test	2022-10-12
Factor	DRH18-E	Temp. / Humidity	25°C /60%
Polarity	Horizontal	Site / Test Engineer	AC2 / Xuan
Test Mode	802.11ac-160MHz_TX_Band1,2_CH 50_ANT 0+1	Test Voltage	AC 120V/60Hz

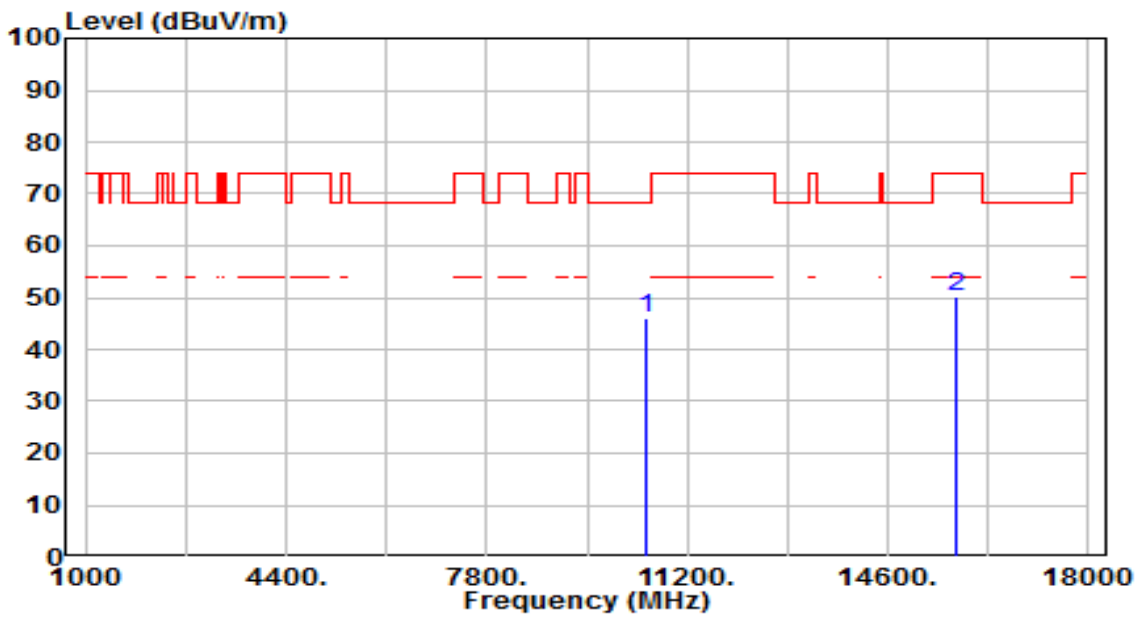

No	Frequency (MHz)	Reading (dBuV)	C.F (dB/m)	Measurement (dBuV/m)	Margin (dB)	Limit (dBuV/m)	Height (cm)	Angle (deg)	Remark (QP/PK/AV)
1	* 10500.000	40.85	5.25	46.10	-22.10	68.20	100	65	Peak
2	15750.000	43.59	6.76	50.36	-23.64	74.00	100	360	Peak

Note:

1. "\*", means this data is the worst emission level.
2. C.F (Correction Factor) = Antenna Factor (dB)+ Cable Loss (dB) – Pre-amplifier(dB).
3. Measurement (dBuV/m) = Reading(dBuV) + C.F (Correction Factor).
4. The emission levels of other frequencies are very lower than the limit and not show in test report.

EUT	AXE5400 Whole Home Mesh Wi-Fi 6E System	Date of Test	2022-10-12
Factor	DRH18-E	Temp. / Humidity	25°C /60%
Polarity	Vertical	Site / Test Engineer	AC2 / Xuan
Test Mode	802.11ac-160MHz_TX_Band1,2_CH 50_ANT 0+1	Test Voltage	AC 120V/60Hz

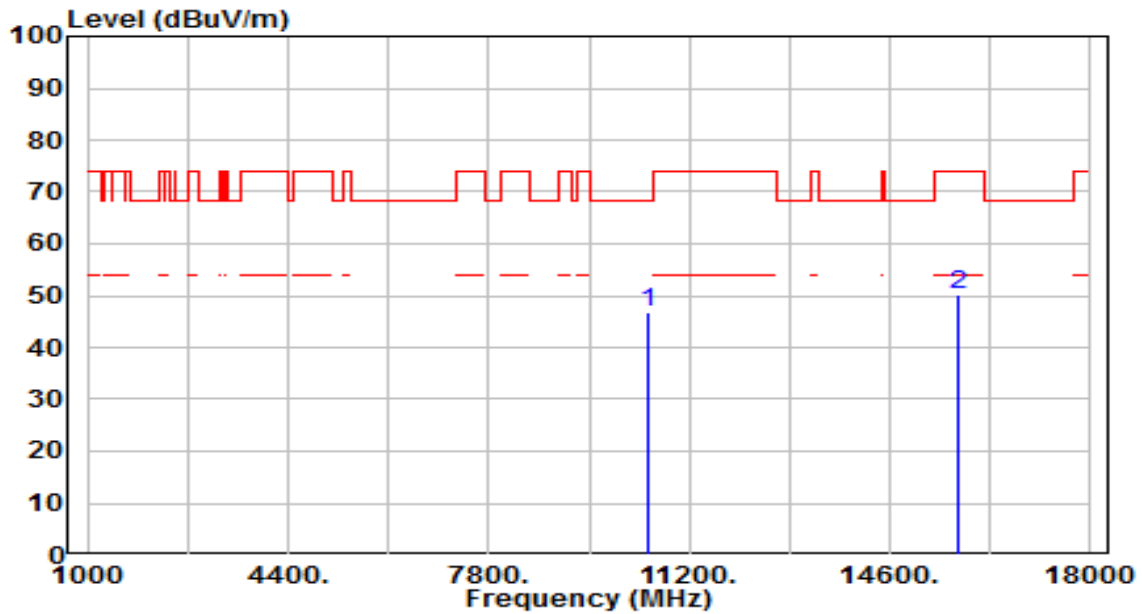

No	Frequency (MHz)	Reading (dBuV)	C.F (dB/m)	Measurement (dBuV/m)	Margin (dB)	Limit (dBuV/m)	Height (cm)	Angle (deg)	Remark (QP/PK/AV)
1	* 10500.000	41.67	5.25	46.92	-21.28	68.20	100	360	Peak
2	15750.000	43.48	6.76	50.24	-23.76	74.00	100	245	Peak

Note:

1. " \*", means this data is the worst emission level.
2. C.F (Correction Factor) = Antenna Factor (dB)+ Cable Loss (dB) – Preamplifier(dB).
3. Measurement (dBuV/m) = Reading(dBuV) + C.F (Correction Factor).
4. The emission levels of other frequencies are very lower than the limit and not show in test report.

EUT	AXE5400 Whole Home Mesh Wi-Fi 6E System	Date of Test	2022-10-12
Factor	DRH18-E	Temp. / Humidity	25°C /60%
Polarity	Horizontal	Site / Test Engineer	AC2 / Xuan
Test Mode	802.11ax-160MHz_TX_Band1,2_CH 50_ANT 0+1	Test Voltage	AC 120V/60Hz

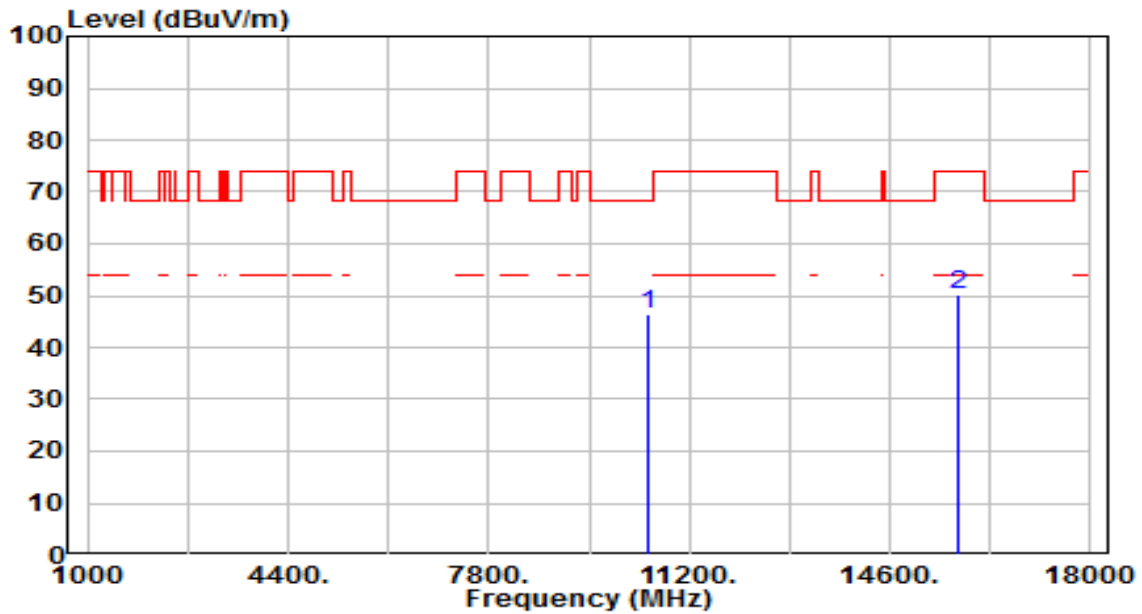

No	Frequency (MHz)	Reading (dBUV)	C.F (dB/m)	Measurement (dBUV/m)	Margin (dB)	Limit (dBUV/m)	Height (cm)	Angle (deg)	Remark (QP/PK/AV)
1	* 10500.000	41.15	5.25	46.40	-21.80	68.20	100	135	Peak
2	15750.000	43.58	6.76	50.35	-23.65	74.00	100	175	Peak

Note:

1. " \*", means this data is the worst emission level.
2. C.F (Correction Factor) = Antenna Factor (dB)+ Cable Loss (dB) – Preamplifier(dB).
3. Measurement (dBUV/m) = Reading(dBUV) + C.F (Correction Factor).
4. The emission levels of other frequencies are very lower than the limit and not show in test report.

EUT	AXE5400 Whole Home Mesh Wi-Fi 6E System	Date of Test	2022-10-12
Factor	DRH18-E	Temp. / Humidity	25°C /60%
Polarity	Vertical	Site / Test Engineer	AC2 / Xuan
Test Mode	802.11ax-160MHz_TX_Band1,2_CH 50_ANT 0+1	Test Voltage	AC 120V/60Hz

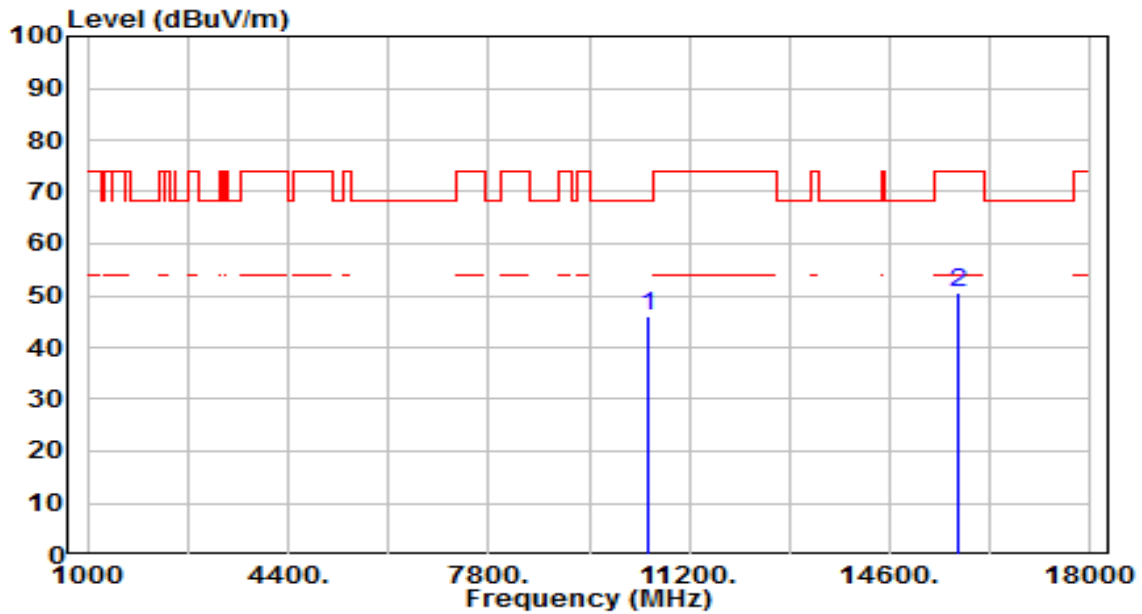

No	Frequency (MHz)	Reading (dBuV)	C.F (dB/m)	Measurement (dBuV/m)	Margin (dB)	Limit (dBuV/m)	Height (cm)	Angle (deg)	Remark (QP/PK/AV)
1	* 10500.000	40.77	5.25	46.02	-22.18	68.20	100	120	Peak
2	15750.000	43.96	6.76	50.72	-23.28	74.00	100	360	Peak

Note:

1. " \*", means this data is the worst emission level.
2. C.F (Correction Factor) = Antenna Factor (dB)+ Cable Loss (dB) – Preamplifier(dB).
3. Measurement (dBuV/m) = Reading(dBuV) + C.F (Correction Factor).
4. The emission levels of other frequencies are very lower than the limit and not show in test report.

## 7.8. Radiated Restricted Band Edge Measurement

### 7.8.1. Test Limit

#### **For 15.205 requirement:**

Radiated emissions which fall in the restricted bands, as defined in Section 15.205(a) of FCC part 15, must also comply with the radiated emission limits specified in Section 15.209(a).

Frequency (MHz)	Frequency (MHz)	Frequency (MHz)	Frequency (GHz)
0.090 - 0.110	16.42-16.423	399.9 - 410	4.5-5.15
<sup>1</sup> 0.495 - 0.505	16.69475-16.69525	608 - 614	5.35-5.46
2.1735-2.1905	16.80425-16.80475	960 - 1240	7.25-7.75
4.125-4.128	25.5 -25.67	1300 - 1427	8.025 - 8.5
4.17725-4.17775	37.5-38.25	1435-1626.5	9.0-9.2
4.20725-4.20775	73-74.6	1645.5-1646.5	9.3-9.5
6.215-6.218	74.8-75.2	1660 - 1710	10.6-12.7
6.26775-6.26825	108-121.94	1718.8-1722.2	13.25-13.4
6.31175-6.31225	123 - 138	2200 - 2300	14.47-14.5
8.291-8.294	149.9-150.05	2310 - 2390	15.35-16.2
8.362-8.366	156.52475-156.525	2483.5 - 2500	17.7-21.4
8.37625-8.38675	156.7-156.9	2690 - 2900	22.01-23.12
8.41425-8.41475	162.0125-167.17	3260 - 3267	23.6-24.0
12.29-12.293	167.72-173.2	3332 - 3339	31.2-31.8
12.51975-12.52025	240 - 285	3345.8 - 3358	36.43-36.5
12.57675-12.57725	322-335.4	3600 - 4400	( <sup>2</sup> )
13.36-13.41	--	--	--

#### **For 15.407(b) requirement:**

For transmitters operating in the 5.15-5.25 GHz band: All emissions outside of the 5.15-5.35 GHz band shall not exceed an e.i.r.p. of -27 dBm/MHz.

For transmitters operating in the 5.25-5.35 GHz band: All emissions outside of the 5.15-5.35 GHz band shall not exceed an e.i.r.p. of -27 dBm/MHz.

Refer to KDB 789033 D02v02r01 G)2)c), as specified in § 15.407(b), emissions above 1000 MHz that are outside of the restricted bands are subject to a maximum emission limit of -27 dBm/MHz (or -17 dBm/MHz as specified in § 15.407(b)(4)). However, an out-of-band emission that complies with both the peak and average limits of § 15.209 is not required to satisfy the -27 dBm/MHz or -17 dBm/MHz maximum emission limit.

All out of band emissions appearing in a restricted band as specified in Section 15.205 of the Title 47CFR must not exceed the limits shown in Table per Section 15.209.

FCC Part 15 Subpart C Paragraph 15.209		
Frequency [MHz]	Field Strength [uV/m]	Measured Distance [Meters]
0.009 - 0.490	2400/F (kHz)	300
0.490 - 1.705	24000/F (kHz)	30
1.705 - 30	30	30
30 - 88	100	3
88 - 216	150	3
216 - 960	200	3
Above 960	500	3

### 7.8.2. Test Procedure Used

KDB 789033 D02v02r01- Section II) G

### 7.8.3. Test Setting

#### Peak Measurements above 1GHz

1. Analyzer center frequency was set to the frequency of the radiated spurious emission of interest
2. RBW = 1MHz
3. VBW = 3MHz
4. Detector = peak
5. Sweep time = auto couple
6. Trace mode = max hold
7. Trace was allowed to stabilize

#### Average Measurements above 1GHz (Method VB)

1. Analyzer center frequency was set to the frequency of the radiated spurious emission of interest
2. RBW = 1MHz
3. VBW; If the EUT is configured to transmit with duty cycle  $\geq 98\%$ , set  $VBW \leq RBW/100$  (i.e., 10 kHz) but not less than 10 Hz. If the EUT duty cycle is  $< 98\%$ , set  $VBW \geq 1/T$ .
4. Detector = Peak

5. Sweep time = auto

6. Allow max hold to run for at least 50 traces if the transmitted signal is continuous or has at least 98% duty cycle. For lower duty cycles, increase the minimum number of traces by a factor of  $1/x$ , where  $x$  is the duty cycle.

#### 7.8.4. Test Setup

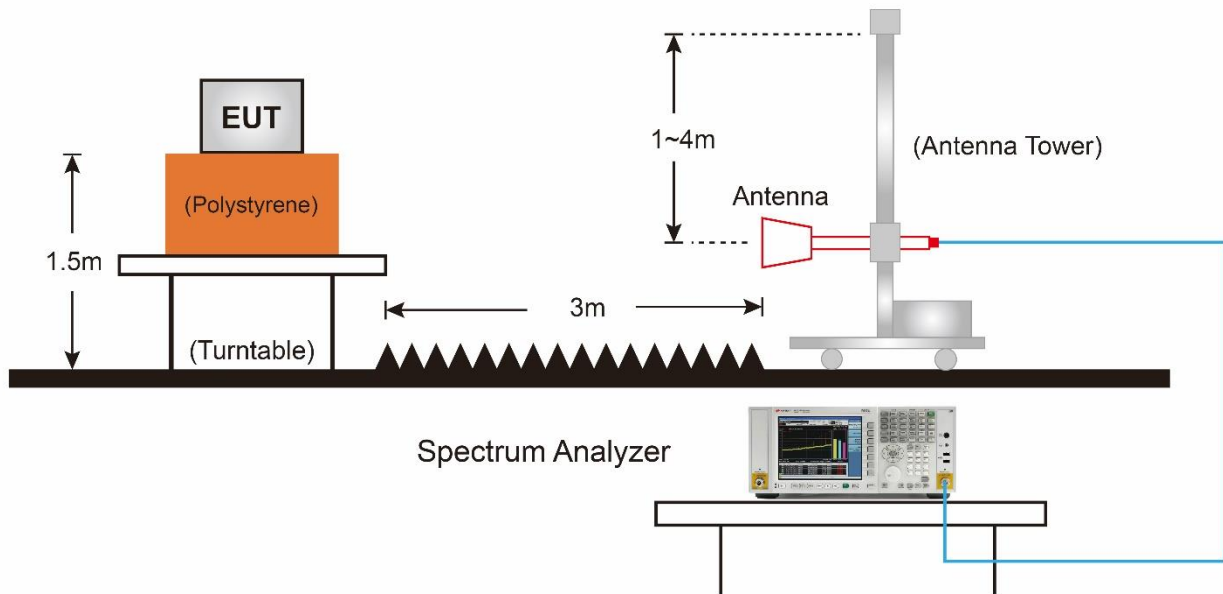

### 7.8.5. Test Result

EUT	AXE5400 Whole Home Mesh Wi-Fi 6E System	Date of Test	2022-10-12
Factor	DRH18-E	Temp. / Humidity	25°C /60%
Polarity	Horizontal	Site / Test Engineer	AC2 / Ares
Test Mode	802.11ac-160MHz_TX_Band1,2_CH 50_ANT 0+1	Test Voltage	AC 120V/60Hz

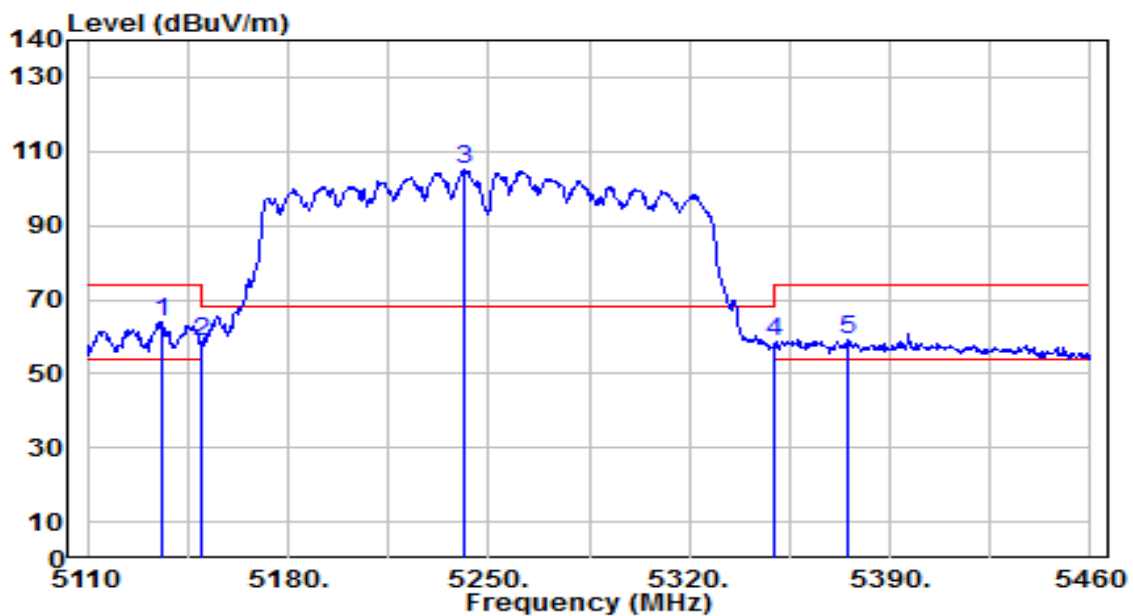

No	Frequency (MHz)	Reading (dBUV)	C.F (dB/m)	Measurement (dBUV/m)	Margin (dB)	Limit (dBUV/m)	Height (cm)	Angle (deg)	Remark (QP/PK/AV)
1	* 5135.900	63.33	0.78	64.11	-9.89	74.00	110	190	Peak
2	5150.000	57.75	0.80	58.55	-15.45	74.00	110	190	Peak
3	5241.250	104.54	0.79	105.33	N/A	N/A	110	190	Peak
4	5350.000	57.83	0.59	58.42	-15.58	74.00	110	190	Peak
5	5375.300	58.41	0.55	58.96	-15.04	74.00	110	190	Peak

Note:

1. " \*", means this data is the worst emission level.
2. C.F (Correction Factor) = Antenna Factor (dB)+ Cable Loss (dB) – Pre-amplifier(dB) + 10dB Attenuation.
3. Measurement (dBUV/m) = Reading(dBUV) + C.F (Correction Factor).
4. The emission levels of other frequencies are very lower than the limit and not show in test report.



EUT	AXE5400 Whole Home Mesh Wi-Fi 6E System	Date of Test	2022-10-12
Factor	DRH18-E	Temp. / Humidity	25°C / 60%
Polarity	Horizontal	Site / Test Engineer	AC2 / Ares
Test Mode	802.11ac-160MHz_TX_Band1,2_CH 50_ANT 0+1	Test Voltage	AC 120V/60Hz

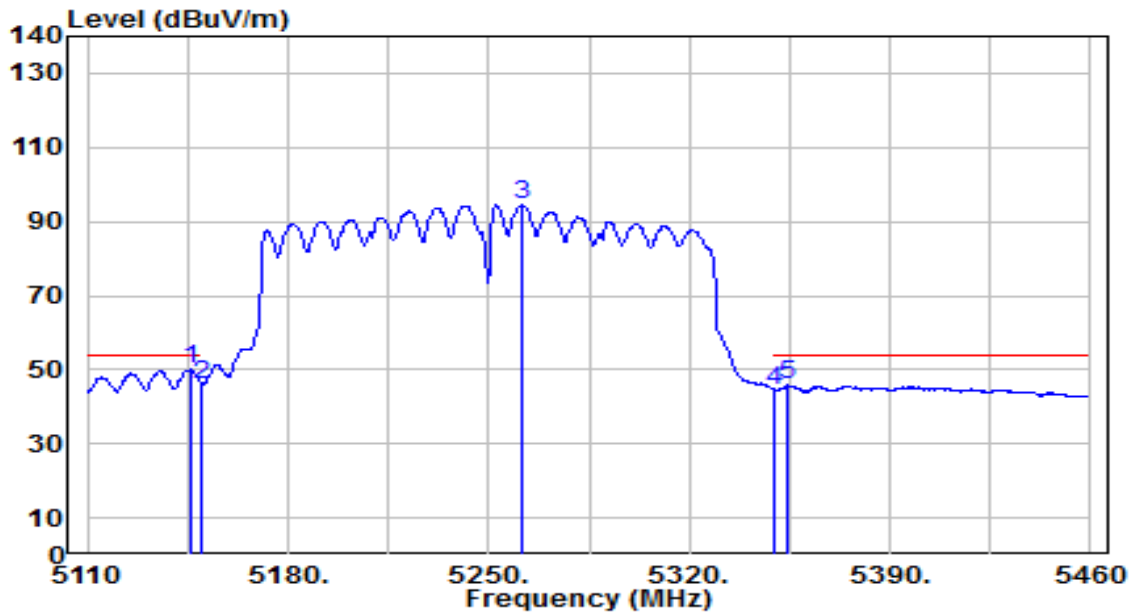

No	Frequency (MHz)	Reading (dBUV)	C.F (dB/m)	Measurement (dBUV/m)	Margin (dB)	Limit (dBUV/m)	Height (cm)	Angle (deg)	Remark (QP/PK/AV)
1	* 5145.700	49.25	0.79	50.04	-3.96	54.00	110	190	Average
2	5150.000	45.23	0.80	46.02	-7.98	54.00	110	190	Average
3	5261.550	93.89	0.75	94.64	N/A	N/A	110	190	Average
4	5350.000	43.91	0.59	44.50	-9.50	54.00	110	190	Average
5	5354.300	45.18	0.59	45.77	-8.23	54.00	110	190	Average

Note:

1. " \*", means this data is the worst emission level.
2. C.F (Correction Factor) = Antenna Factor (dB)+ Cable Loss (dB) – Preamplifier(dB) + 10dB Attenuation.
3. Measurement (dBUV/m) = Reading(dBUV) + C.F (Correction Factor).
4. The emission levels of other frequencies are very lower than the limit and not show in test report.

EUT	AXE5400 Whole Home Mesh Wi-Fi 6E System	Date of Test	2022-10-12
Factor	DRH18-E	Temp. / Humidity	25°C /60%
Polarity	Vertical	Site / Test Engineer	AC2 / Ares
Test Mode	802.11ac-160MHz_TX_Band1,2_CH 50_ANT 0+1	Test Voltage	AC 120V/60Hz

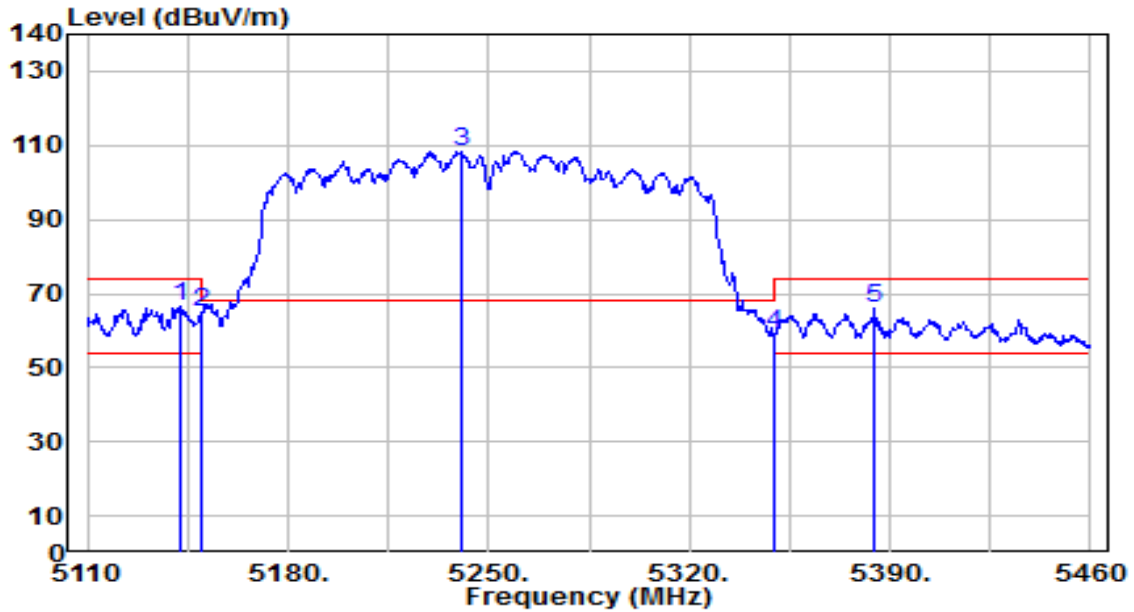

No	Frequency (MHz)	Reading (dBUV)	C.F (dB/m)	Measurement (dBUV/m)	Margin (dB)	Limit (dBUV/m)	Height (cm)	Angle (deg)	Remark (QP/PK/AV)
1	* 5142.200	65.52	0.79	66.31	-7.69	74.00	100	155	Peak
2	5150.000	64.27	0.80	65.07	-8.93	74.00	100	155	Peak
3	5240.550	107.69	0.79	108.47	N/A	N/A	100	155	Peak
4	5350.000	58.60	0.59	59.20	-14.80	74.00	100	155	Peak
5	5384.750	65.25	0.53	65.78	-8.22	74.00	100	155	Peak

Note:

- "\*", means this data is the worst emission level.
- C.F (Correction Factor) = Antenna Factor (dB)+ Cable Loss (dB) – Preamplifier(dB) + 10dB Attenuation.
- Measurement (dBUV/m) = Reading(dBUV) + C.F (Correction Factor).
- The emission levels of other frequencies are very lower than the limit and not show in test report.

EUT	AXE5400 Whole Home Mesh Wi-Fi 6E System	Date of Test	2022-10-12
Factor	DRH18-E	Temp. / Humidity	25°C /60%
Polarity	Vertical	Site / Test Engineer	AC2 / Ares
Test Mode	802.11ac-160MHz_TX_Band1,2_CH 50_ANT 0+1	Test Voltage	AC 120V/60Hz

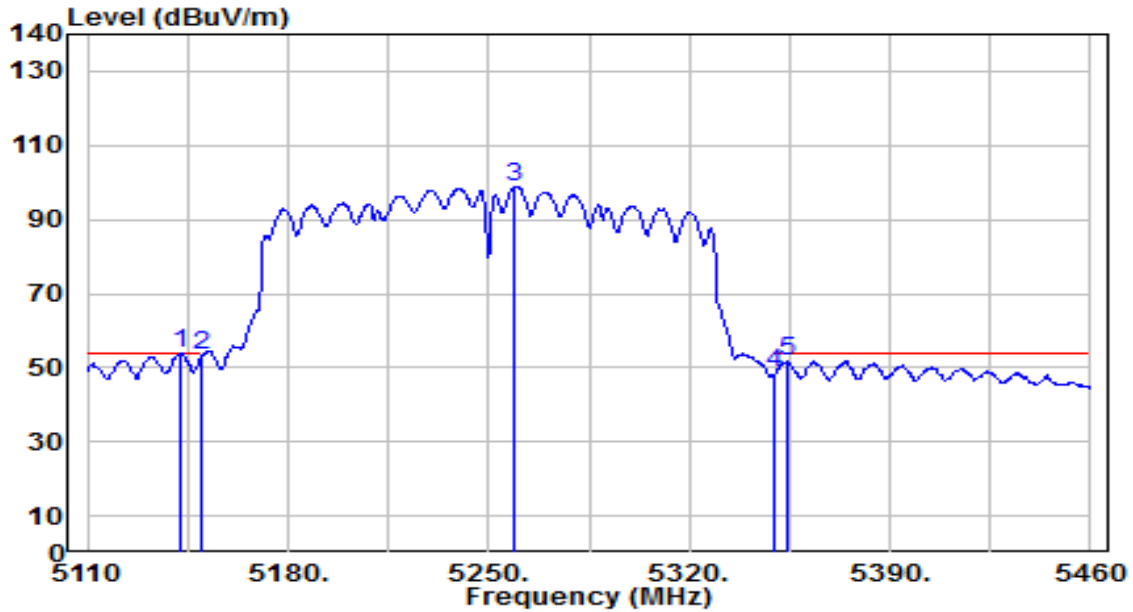

No	Frequency (MHz)	Reading (dBUV)	C.F (dB/m)	Measurement (dBUV/m)	Margin (dB)	Limit (dBUV/m)	Height (cm)	Angle (deg)	Remark (QP/PK/AV)
1	* 5142.550	53.18	0.79	53.96	-0.04	54.00	100	155	Average
2	5150.000	52.64	0.80	53.43	-0.57	54.00	100	155	Average
3	5259.100	98.12	0.75	98.87	N/A	N/A	100	155	Average
4	5350.000	47.92	0.59	48.52	-5.48	54.00	100	155	Average
5	5353.950	51.05	0.59	51.63	-2.37	54.00	100	155	Average

Note:

- "\*", means this data is the worst emission level.
- C.F (Correction Factor) = Antenna Factor (dB)+ Cable Loss (dB) – Preamplifier(dB) + 10dB Attenuation.
- Measurement (dBUV/m) = Reading(dBUV) + C.F (Correction Factor).
- The emission levels of other frequencies are very lower than the limit and not show in test report.

EUT	AXE5400 Whole Home Mesh Wi-Fi 6E System	Date of Test	2022-10-12
Factor	DRH18-E	Temp. / Humidity	25°C /60%
Polarity	Horizontal	Site / Test Engineer	AC2 / Ares
Test Mode	802.11ax-160MHz_TX_Band1,2_CH 50_ANT 0+1	Test Voltage	AC 120V/60Hz

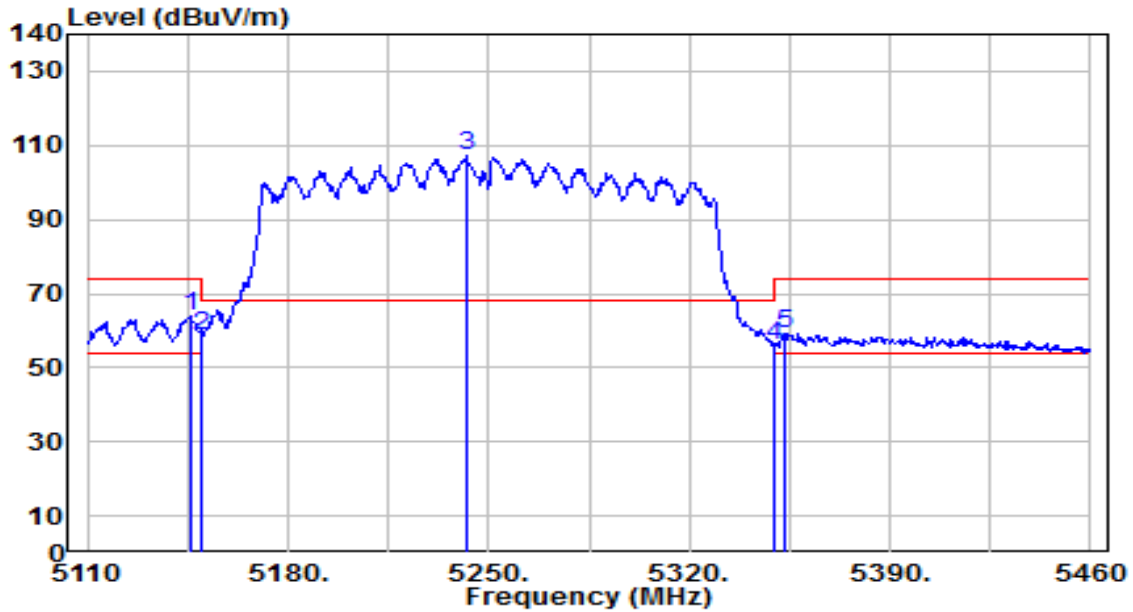

No	Frequency (MHz)	Reading (dBUV)	C.F (dB/m)	Measurement (dBUV/m)	Margin (dB)	Limit (dBUV/m)	Height (cm)	Angle (deg)	Remark (QP/PK/AV)
1	* 5145.700	63.08	0.79	63.87	-10.13	74.00	125	190	Peak
2	5150.000	57.92	0.80	58.72	-15.28	74.00	125	190	Peak
3	5242.300	106.25	0.78	107.04	N/A	N/A	125	190	Peak
4	5350.000	55.23	0.59	55.82	-18.18	74.00	125	190	Peak
5	5353.600	58.79	0.59	59.38	-14.62	74.00	125	190	Peak

Note:

1. " \*", means this data is the worst emission level.
2. C.F (Correction Factor) = Antenna Factor (dB)+ Cable Loss (dB) – Preamplifier(dB) + 10dB Attenuation.
3. Measurement (dBUV/m) = Reading(dBUV) + C.F (Correction Factor).
4. The emission levels of other frequencies are very lower than the limit and not show in test report.

EUT	AXE5400 Whole Home Mesh Wi-Fi 6E System	Date of Test	2022-10-12
Factor	DRH18-E	Temp. / Humidity	25°C /60%
Polarity	Horizontal	Site / Test Engineer	AC2 / Ares
Test Mode	802.11ax-160MHz_TX_Band1,2_CH 50_ANT 0+1	Test Voltage	AC 120V/60Hz

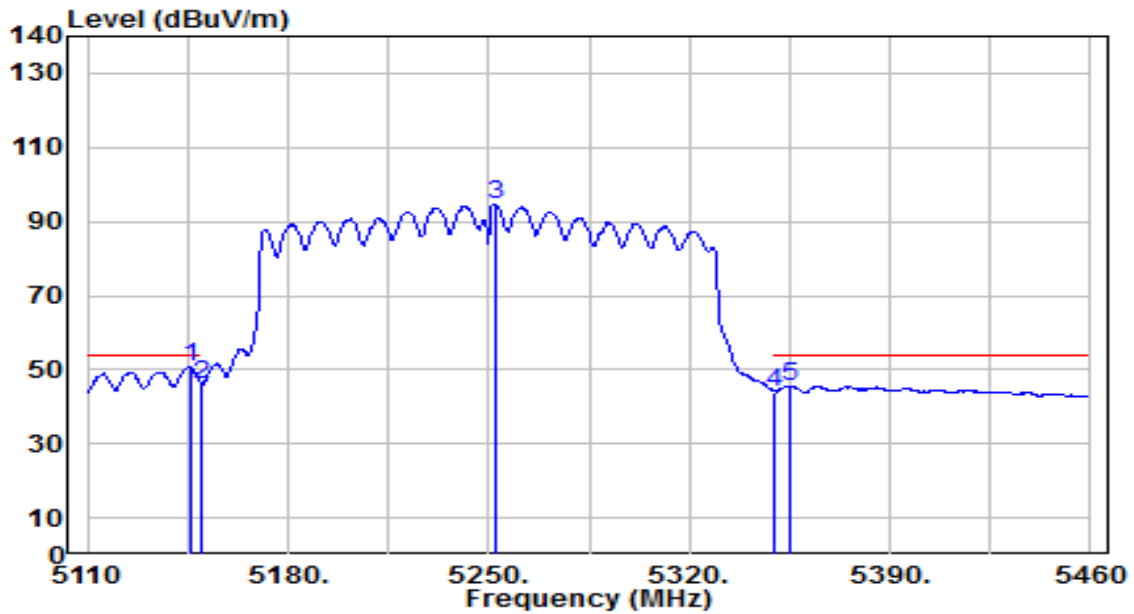

No	Frequency (MHz)	Reading (dBUV)	C.F (dB/m)	Measurement (dBUV/m)	Margin (dB)	Limit (dBUV/m)	Height (cm)	Angle (deg)	Remark (QP/PK/AV)
1	* 5145.700	49.85	0.79	50.64	-3.36	54.00	125	190	Average
2	5150.000	45.26	0.80	46.06	-7.94	54.00	125	190	Average
3	5252.100	94.01	0.77	94.78	N/A	N/A	125	190	Average
4	5350.000	43.49	0.59	44.08	-9.92	54.00	125	190	Average
5	5355.000	45.10	0.59	45.68	-8.32	54.00	125	190	Average

Note:

- " \*", means this data is the worst emission level.
- C.F (Correction Factor) = Antenna Factor (dB)+ Cable Loss (dB) – Preamplifier(dB) + 10dB Attenuation.
- Measurement (dBUV/m) = Reading(dBUV) + C.F (Correction Factor).
- The emission levels of other frequencies are very lower than the limit and not show in test report.

EUT	AXE5400 Whole Home Mesh Wi-Fi 6E System	Date of Test	2022-10-12
Factor	DRH18-E	Temp. / Humidity	25°C /60%
Polarity	Vertical	Site / Test Engineer	AC2 / Ares
Test Mode	802.11ax-160MHz_TX_Band1,2_CH 50_ANT 0+1	Test Voltage	AC 120V/60Hz

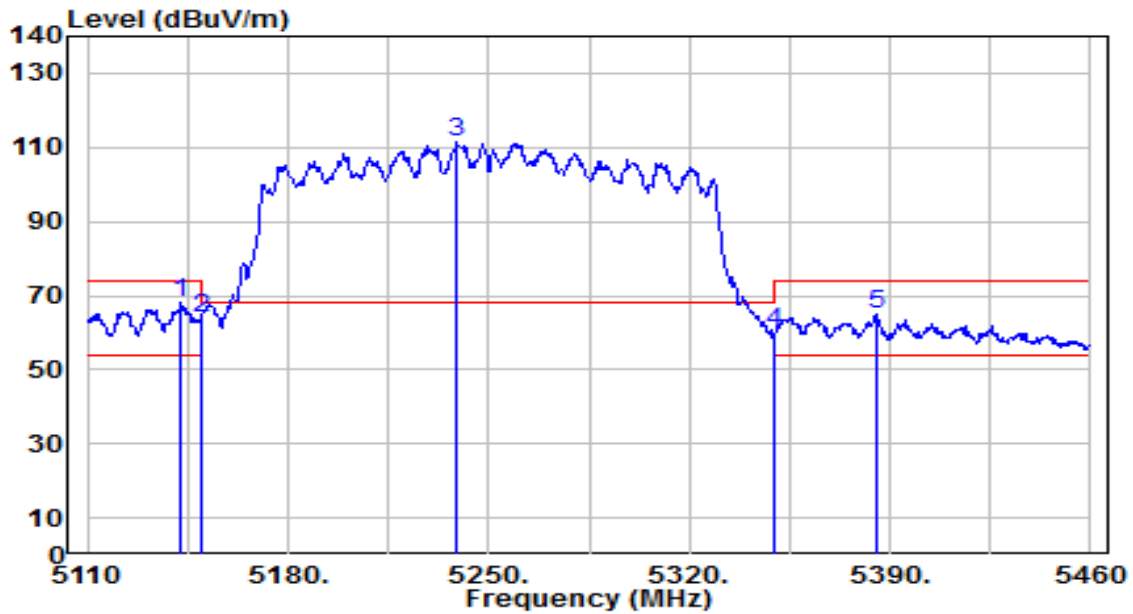

No	Frequency (MHz)	Reading (dBUV)	C.F (dB/m)	Measurement (dBUV/m)	Margin (dB)	Limit (dBUV/m)	Height (cm)	Angle (deg)	Remark (QP/PK/AV)
1	* 5142.550	67.14	0.79	67.92	-6.08	74.00	120	155	Peak
2	5150.000	63.05	0.80	63.85	-10.15	74.00	120	155	Peak
3	5238.800	110.62	0.79	111.41	N/A	N/A	120	155	Peak
4	5350.000	59.55	0.59	60.14	-13.86	74.00	120	155	Peak
5	5385.800	64.36	0.53	64.89	-9.11	74.00	120	155	Peak

Note:

1. " \*", means this data is the worst emission level.
2. C.F (Correction Factor) = Antenna Factor (dB)+ Cable Loss (dB) – Preamplifier(dB) + 10dB Attenuation.
3. Measurement (dBUV/m) = Reading(dBUV) + C.F (Correction Factor).
4. The emission levels of other frequencies are very lower than the limit and not show in test report.

EUT	AXE5400 Whole Home Mesh Wi-Fi 6E System	Date of Test	2022-10-12
Factor	DRH18-E	Temp. / Humidity	25°C /60%
Polarity	Vertical	Site / Test Engineer	AC2 / Ares
Test Mode	802.11ax-160MHz_TX_Band1,2_CH 50_ANT 0+1	Test Voltage	AC 120V/60Hz

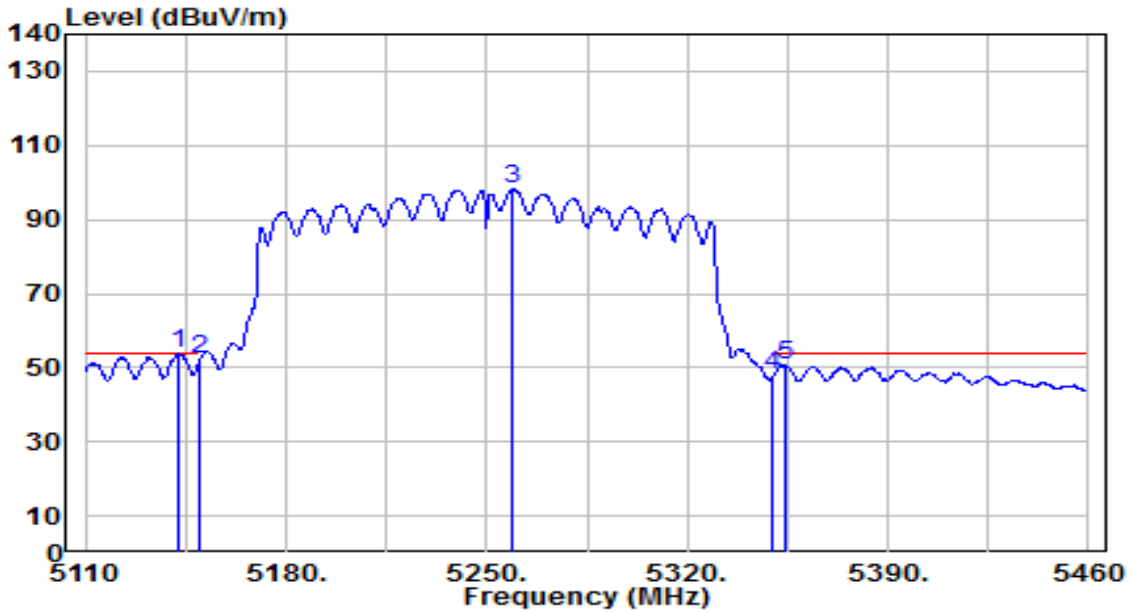

No	Frequency (MHz)	Reading (dBUV)	C.F (dB/m)	Measurement (dBUV/m)	Margin (dB)	Limit (dBUV/m)	Height (cm)	Angle (deg)	Remark (QP/PK/AV)
1	* 5142.550	53.04	0.79	53.83	-0.17	54.00	120	155	Average
2	5150.000	51.42	0.80	52.22	-1.78	54.00	120	155	Average
3	5259.100	97.41	0.75	98.16	N/A	N/A	120	155	Average
4	5350.000	47.52	0.59	48.11	-5.89	54.00	120	155	Average
5	5353.950	50.36	0.59	50.95	-3.05	54.00	120	155	Average

Note:

1. " \*", means this data is the worst emission level.
2. C.F (Correction Factor) = Antenna Factor (dB)+ Cable Loss (dB) – Preamplifier(dB) + 10dB Attenuation.
3. Measurement (dBUV/m) = Reading(dBUV) + C.F (Correction Factor).
4. The emission levels of other frequencies are very lower than the limit and not show in test report.

## 8. CONCLUSION

The data collected relate only the item(s) tested and show that the device is in compliance with Part 15E of the FCC Rules.

\_\_\_\_\_ The End \_\_\_\_\_



## **Appendix A : Test Setup Photograph**

Refer to “2209TW0106-Setup Photo” file.

## **Appendix B : External Photograph**

Refer to “2209TW0106-External Photo” file.

## **Appendix C : Internal Photograph**

Refer to “2209TW0106-Internal Photo” file.