

decoTM | Deco X50-PoE
Multi-Scenario poE Mesh Wi-Fi

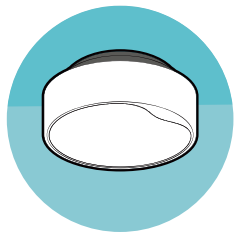

User Guide

AX3000 Whole Home Mesh Wi-Fi 6 System with PoE



Ceiling Mount

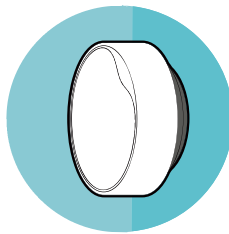

Wall Mount

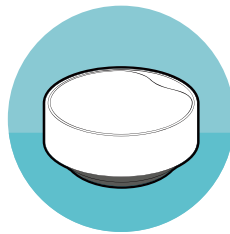

Tabletop



Contents

About This Guide	1	Shortcut	26
Appearance	2	Automation	28
Set Up Your Deco	3	HomeShield	32
Mount Your Deco	6	Wi-Fi Settings	33
Dashboard	10	Guest Network	34
Add More Decos	11	Test Internet Speed	35
Check Deco Status	12	Reboot Schedule	36
Set Main Deco	14	Deny List	37
Remove/Reboot Deco	15	Upgrade Your Deco	38
Manage Connected Devices	16	Advanced Features	39
Sort Devices By Locations	20	WPS	44
Create a New Network	21	Managers	45
Change Network Owner	23	Control Your Deco with Alexa	47
Delete a Network	24	Troubleshooting	48
Add Smart Devices	25	Authentication	49

About This Guide

This guide provides a brief introduction to Whole Home Deco Mesh Wi-Fi 6 System with PoE and the Deco app, as well as regulatory information. Features available in Deco may vary by model and software version. Deco availability may also vary by region or ISP. All images, steps, and descriptions in this guide are only examples and may not reflect your actual Deco experience.

Conventions

In this guide, the following conventions are used:

Convention	Description
Deco	Stands for Deco Whole Home Mesh Wi-Fi System/ Unit.
<u>Underline</u>	Hyperlinks are in teal and underlined. You can click to redirect to a website or a specific section.
Teal	Key information appears in teal, including management page text such as menus, items, buttons and so on.
📌 Note:	Ignoring this type of note might result in a malfunction or damage to the device.
💡 Tips:	Indicates important information that helps you make better use of your device.

More Info

- Specific product information can be found on the product page at <https://www.tp-link.com>.
- A Technical Community is provided for you to discuss our products at <https://community.tp-link.com>.
- Our Technical Support contact information can be found at the [Help](#) center of the Deco app and the [Contact Technical Support](#) page at <https://www.tp-link.com/support>.

Speed/Coverage/Device Quantity Disclaimer

Maximum wireless signal rates are the physical rates derived from IEEE Standard 802.11 specifications. Actual wireless data throughput and wireless coverage, and quantity of connected devices are not guaranteed and will vary as a result of network conditions, client limitations, and environmental factors, including building materials, obstacles, volume and density of traffic, and client location.

MU-MIMO Disclaimer

Use of MU-MIMO requires clients to also support MU-MIMO.

IoT Compatibility Disclaimer

IoT compatibility refers only to smart devices that can be controlled via the Deco app. Other wireless devices can still connect to Deco for normal Wi-Fi use.

Seamless Roaming Disclaimer

Clients need to support 802.11k/v/r and may require additional set up. Performance may vary depending on the client device.

HomeShield Disclaimer

HomeShield includes the Free Basic Plan. Fees apply for the Pro Plan. Visit tp-link.com/homeshield for more information.

Appearance

Each Deco has an LED that changes color according to its status, one Gigabit PoE port, an advanced 2.5 Gbps PoE port, a power slot, and a reset button.

See the explanation below:

 Tip: The product label can be found at the bottom of the product.



- **Pulse Yellow:**
Deco is resetting.
- **Solid Yellow:**
Deco is starting up.
- **Pulse Blue:**
Deco is ready for setup.
- **Solid Blue:**
Deco is setting up.
- **Pulse Green:**
Deco is upgrading firmware.
- **Solid Green:**
Deco is all set up and connected.
- **Pulse Red:**
The satellite Deco is disconnected from the main Deco.
- **Solid Red:**
Deco has an issue.

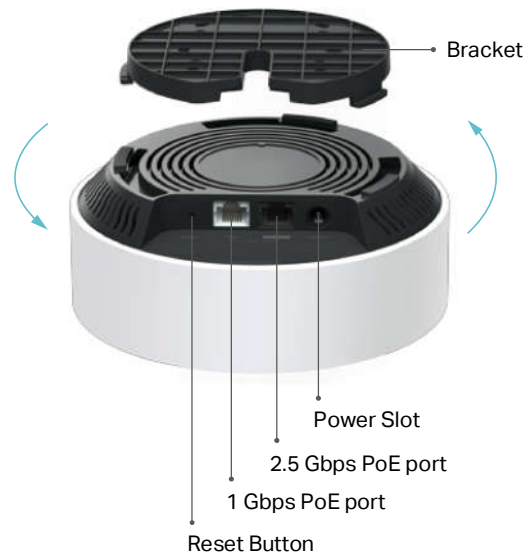

Power Supply:

Deco can be powered via a power adapter or a PSE device (such as a PoE switch).

Multi-Gig Internet Connection:

1× 2.5 Gbps port and 1× Gigabit port make full use of gigabit speeds from your local ISP. WAN/LAN support meets all your internet demands.

Reset:

Press for 1 second and release to reset Deco to factory default settings. The light changing from pulsing yellow to solid yellow indicates a successful reset.

Mounting Options

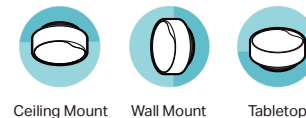

Set Up Your Deco

The intuitive Deco app guides you through an easy setup process that gets each unit up and all your devices connected.

Follow the steps below to set up your Whole Home Deco Mesh Wi-Fi 6 System with PoE .

1. Download and install the Deco app

Scan the QR code below or go to Google Play or the App Store to download the Deco app. Install the app on your Android or iOS smartphone or tablet.



or



2. Log in or sign up with TP-Link ID

Open the app. Use your TP-Link ID to log in. If you don't have a TP-Link ID, sign up first.

Note: If you forgot your login password, tap [Forgot Password?](#). The Deco app will guide you through the rest.

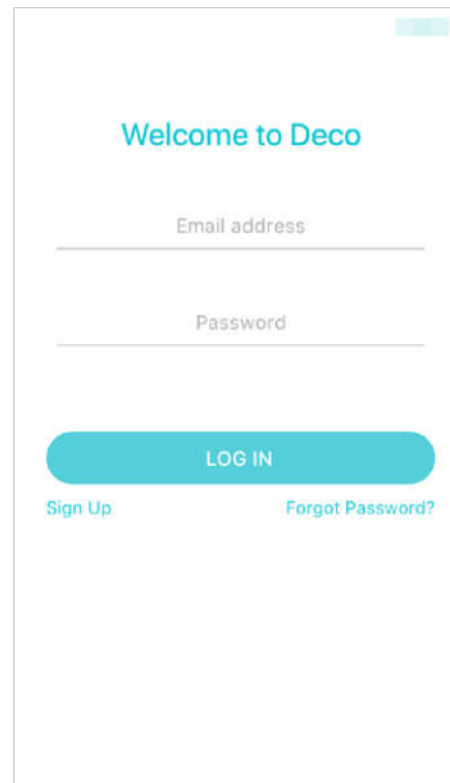

3. Identify your Deco

Choose or search for your Deco model.



4. Connect to your modem

Power off your modem. Connect your Deco to the modem.

If you don't have a modem, connect the Ethernet outlet directly to your Deco.

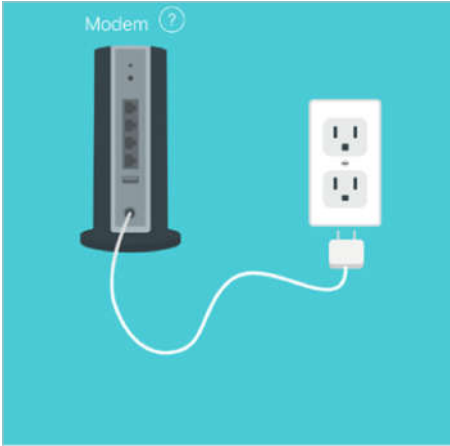

Power off your modem
Power off your modem and remove the backup battery if it has one. Disconnect your old router from the modem before moving on.

NEXT

[I don't have a modem](#)

5. Power up your Deco

Deco can be powered via a power adapter or a PSE device (such as a PoE switch).

Option1: Via PoE Switch (Compliant with 802.3at)

Connect an Ethernet cable from the PoE switch (compliant with 802.3at) to the Deco's Ethernet port. The power should not be less than 18 W.

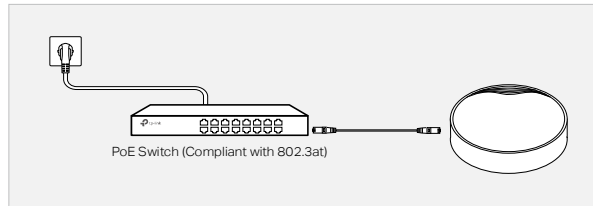

Option2: Via Power Adapter

Plug one end of the provided power adapter into the power port of the Deco and the other end to a standard electrical wall outlet.

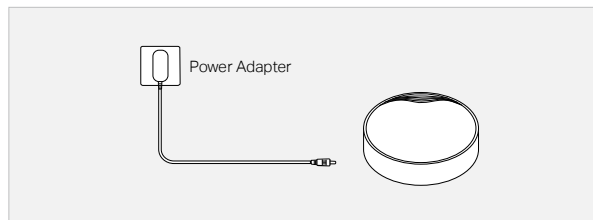

6. Set up internet connection

Select the internet connection type and enter the information. If you are not sure, contact your internet service provider.

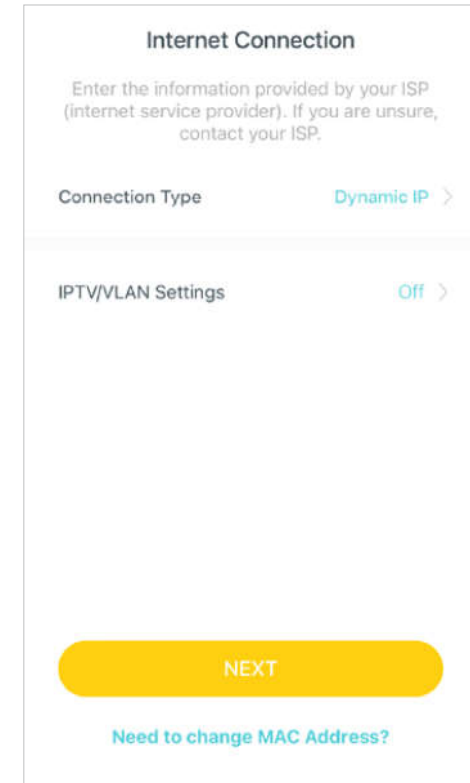

Internet Connection

Enter the information provided by your ISP (internet service provider). If you are unsure, contact your ISP.

Connection Type **Dynamic IP** >

IPTV/VLAN Settings **Off** >

NEXT

[Need to change MAC Address?](#)

7. Create your Wi-Fi network

Set a network name and a password. These will be the name and password you use to connect your devices to Wi-Fi.

Create your Wi-Fi Network

This will be the name and password you'll use to access your network. Your password must be at least 8 characters.

Network Name

Password

It is recommended to set a password using a combination of letters, numbers and symbols.

NEXT

8. Connect to your Wi-Fi network

Connect your phone/tablet to the Deco's Wi-Fi.

Connect to your Deco Wi-Fi

Connect your phone/tablet to the Deco's Wi-Fi to continue the setup.

Network Name
Deco PoE

Password
12345678

CONNECT

9. Setup complete

Your Deco network is now up. Connect all devices to the Deco network. You can also [Add More Decos](#) to expand the Wi-Fi coverage.

Your Deco network is now up

Your Deco is ready to use. Please connect all devices to the Deco network for better connections.

ADD ANOTHER DECO

DONE

Mount Your Deco

Deco can be mounted to the wall, the ceiling, or on a junction box, using the screws in the package. Choose the appropriate mounting methods.

- A: Ceiling/Wall Mount
- B: 3.5" Round Junction Box (US)
- C: Single Gang Outlet Box (US)
- D: Single Gang Outlet Box (EU)

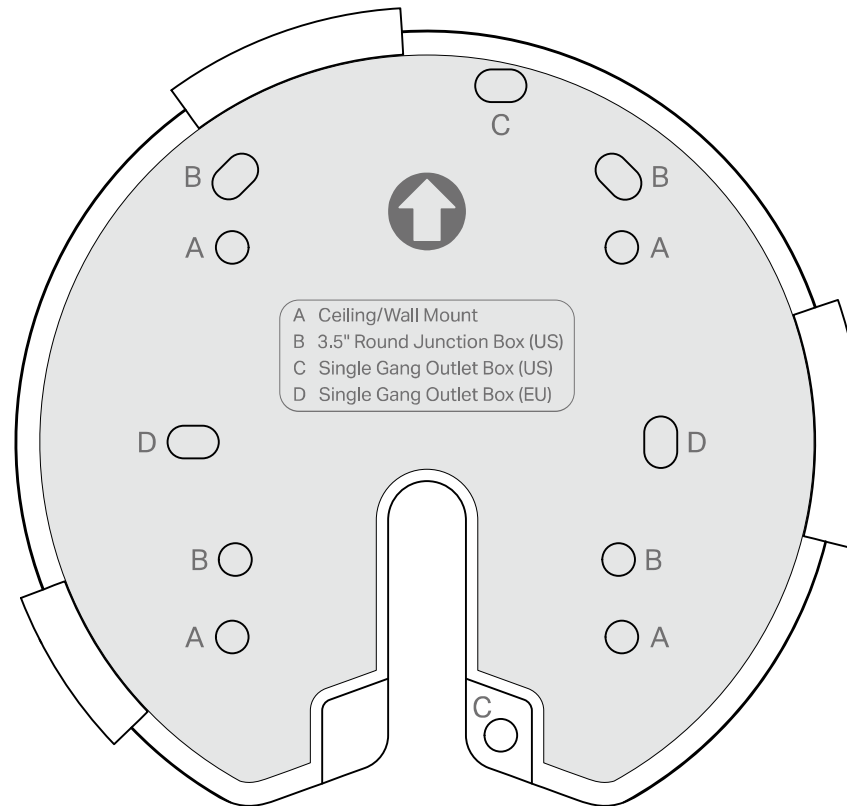

Option 1: On the Wall/Ceiling

The Deco can be mounted to the wall or the ceiling with the screws in the package.



Plastic Wall Anchors *4



Self-tapping Screws *4

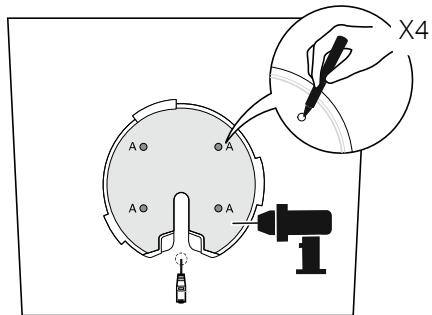

1. If your Ethernet cable feeds through the wall, position the mounting bracket above the cable hole.

Mark four positions for the screw holes and drill four 6 mm (15/64 in) diameter holes at the marked positions.

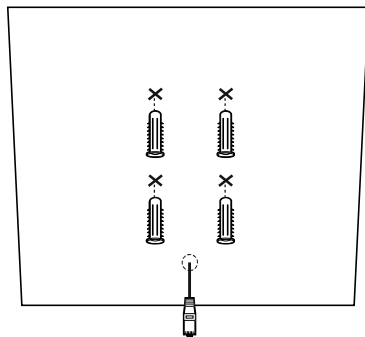

2. Insert the plastic wall anchors into the 6 mm diameter holes.

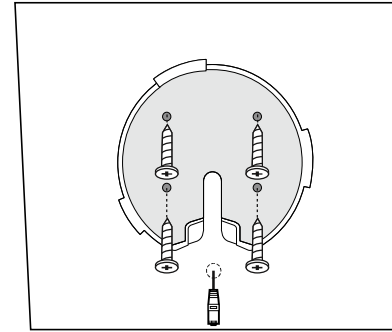

3. Secure the mounting bracket to the wall by driving the self-tapping screws into the anchors.
- Make sure the mounting bracket lies flat against the surface.

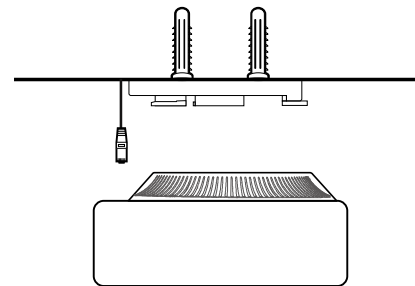

4. Connect the Ethernet cable to the Ethernet port on the Deco.

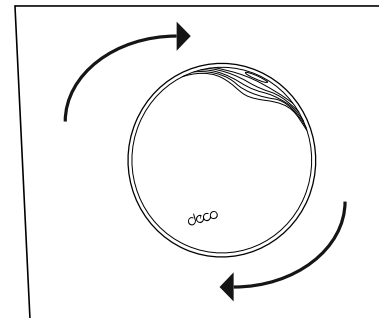

5. Orient the Deco LED according to the image, attach the Deco to the mounting bracket, then rotate it clockwise until it locks into place.

Option 2: On a Wall Junction Box

The Deco can be mounted on a junction box. The junction box should be pre-installed with a running-in-wall Ethernet cable. Ensure that the mounting holes align to your junction box.

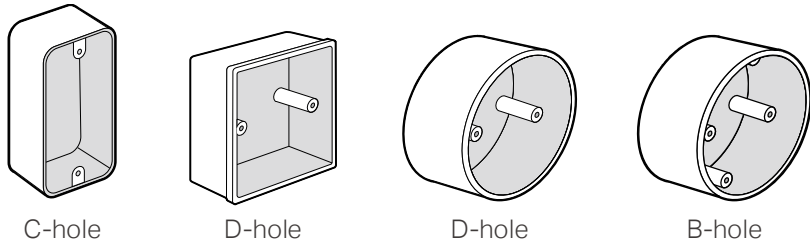

*Here the standard US wall junction box is used as an example.

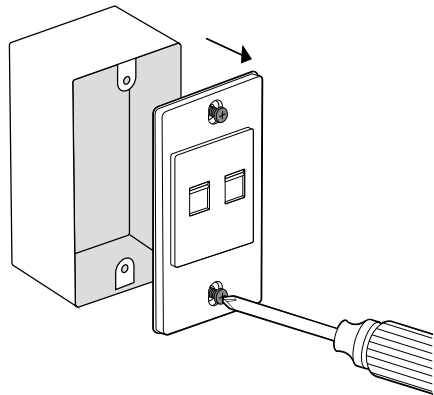

1. Detach the faceplate of the junction box with a Phillips screwdriver.

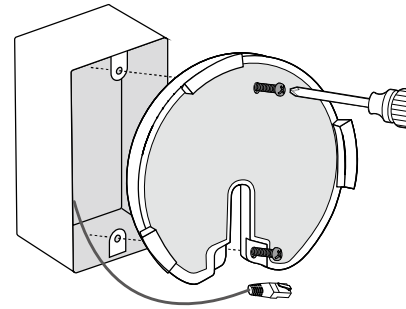

2. Feed the Ethernet cable through the mounting bracket. Insert the enclosed screws and tighten them with a Phillips screwdriver to secure the mounting bracket.

Notes:

1. Do not over tighten the screws.
2. If the enclosed screws do not fit the junction box, use the screws attached to the junction box instead.

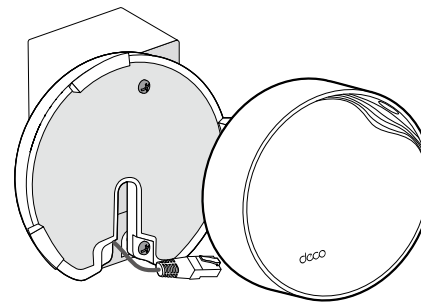

3. Connect the Ethernet cable to the Ethernet port on the Deco.

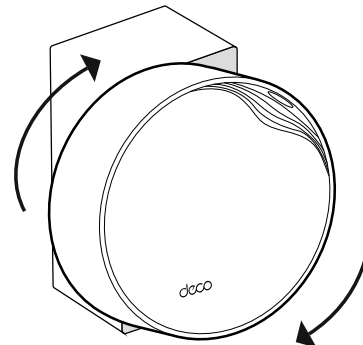

4. Orient the Deco LED according to the image, attach the Deco to the mounting bracket, then rotate it clockwise until it locks into place.

Option 3: In a Ceiling Tile

The Deco can be installed in a ceiling tile with the screws in the package. Make sure the ceiling tile is larger than the Deco.

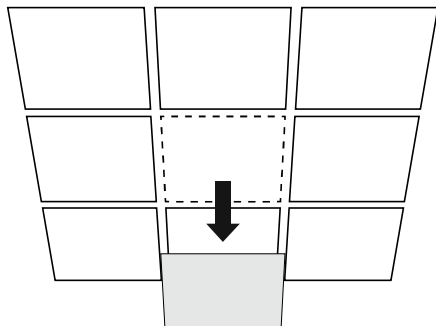

1. Remove the ceiling tile.

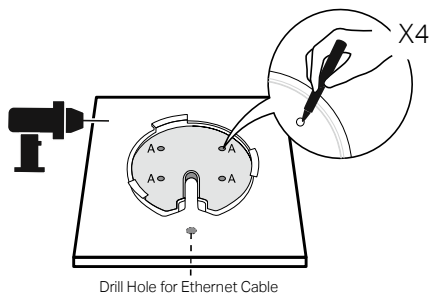

2. Place the mounting bracket in the center of the ceiling tile. Mark four positions for the screw holes and a location for the Ethernet cable hole.

Drill four 4 mm (5/32 in) diameter holes for the screws and a 25 mm (63/64 in) diameter hole for the Ethernet cable at the marked positions.

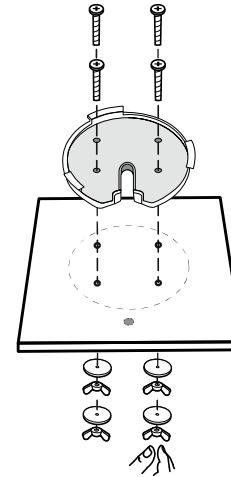

3. Secure the mounting bracket to the ceiling tile using four pan-head screws, washers, and wing nuts.

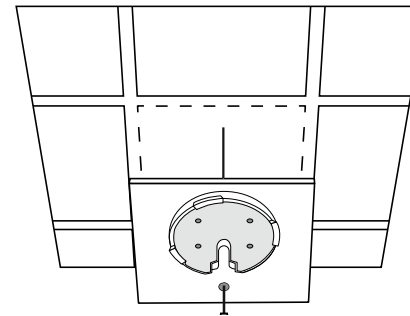

4. Feed the Ethernet cable through the hole and set the ceiling tile back into place.

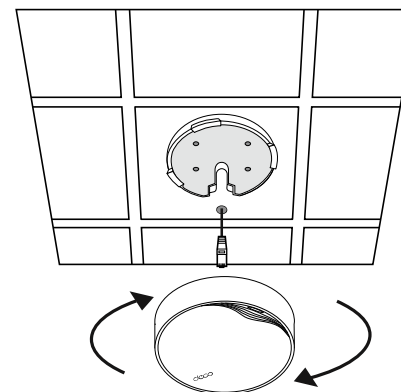



5. Orient the Deco LED according to the image, attach the Deco to the mounting bracket, then rotate it clockwise until it locks into place.

Dashboard

After you successfully set up your Deco network, you will see the dashboard of the Deco app. Here you can get an overview of the network status, create shortcut and automation, customize your home network with enhanced security using a kit of features built to TP-Link HomeShield and set up various advanced features.

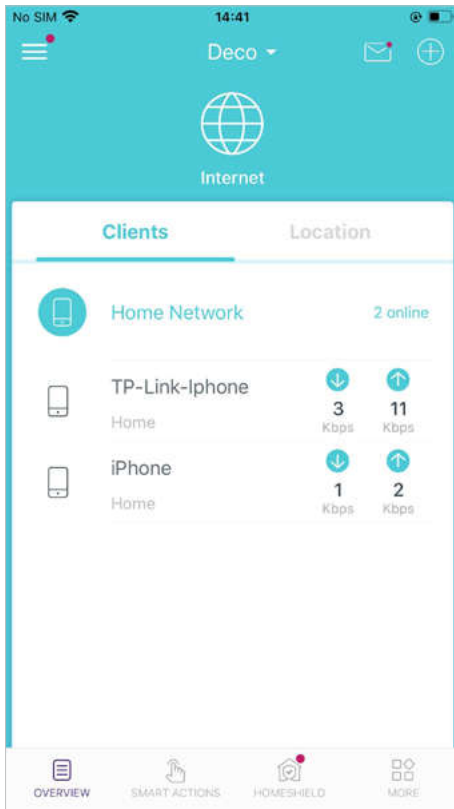
Tap  to get an overview of the network status.



Tap  to create shortcut or automation.

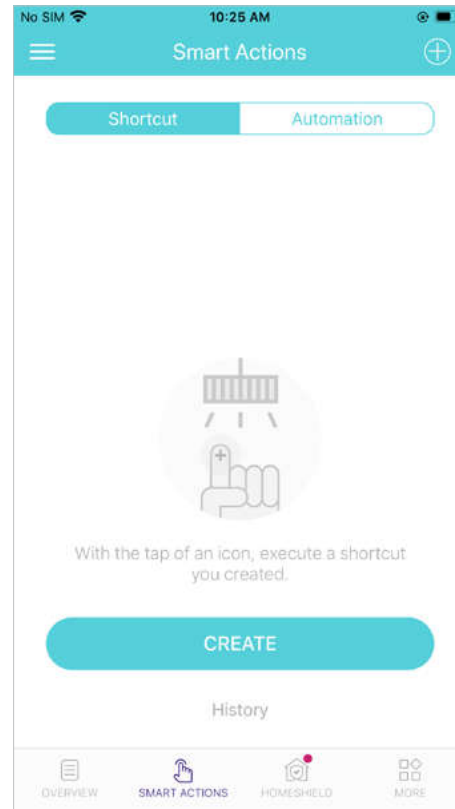

Tap  to enter the [HomeShield](#) page for enhanced security.

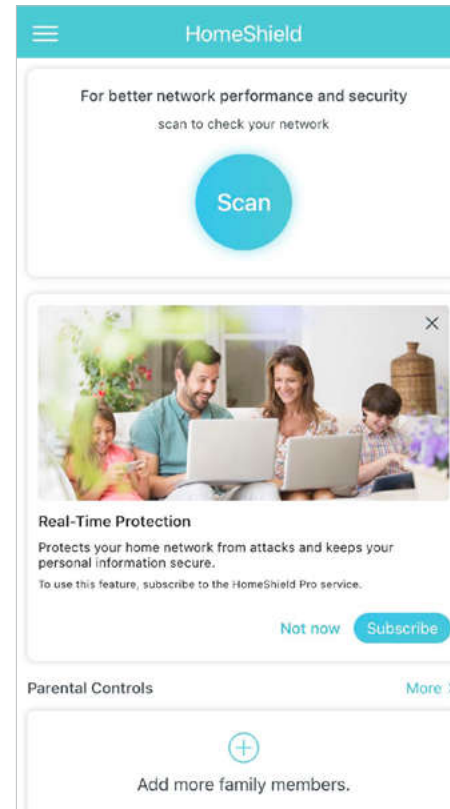

Tap  for more features.

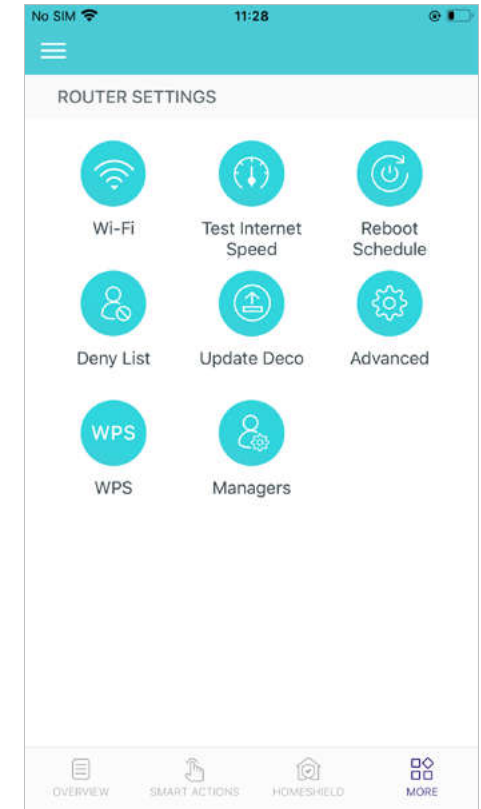

Add More Decos

After creating a Deco network, you can add more Decos to the network to expand the Wi-Fi coverage and manage them easily on your Deco app.

1. In Overview, tap + > DECOS.

2. Select the Deco model you want to add, and follow app instructions to complete the setup.

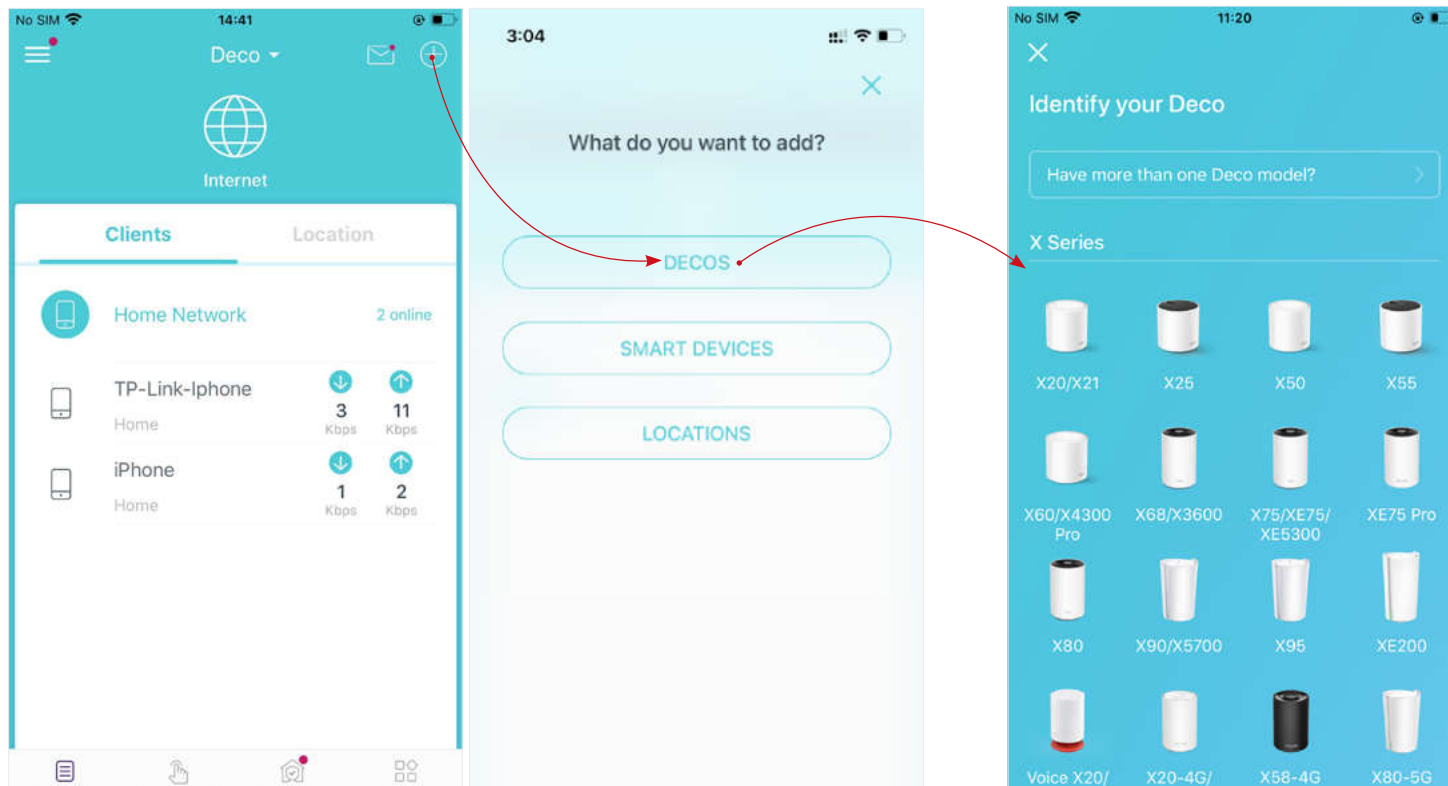

Check Deco Status

In Overview, you can check the working status (online/offline) of all the Decos, check the details (speed/Deco's IP address & MAC address/connected clients) of each Deco, change the Deco's location/name, and more.

Tap  to check all Decos' status.

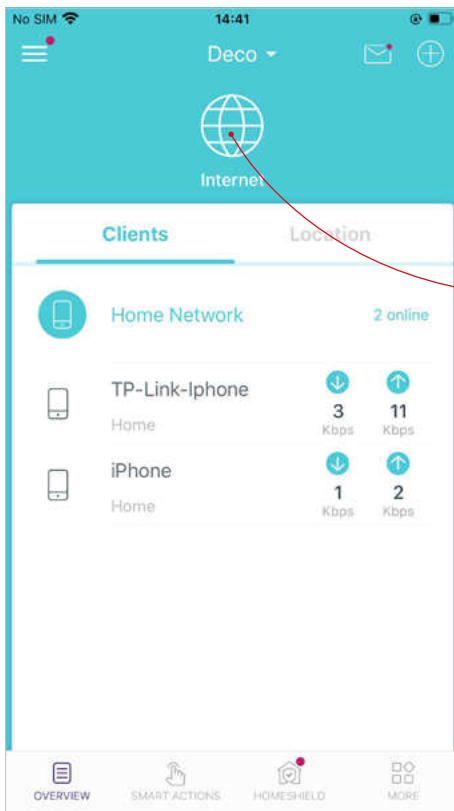

Tap a Deco unit to check more details.

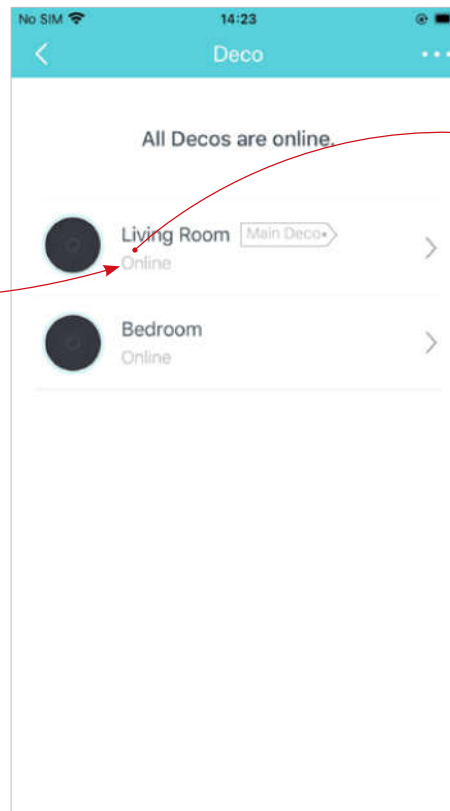

Check download/upload speed of the Deco.

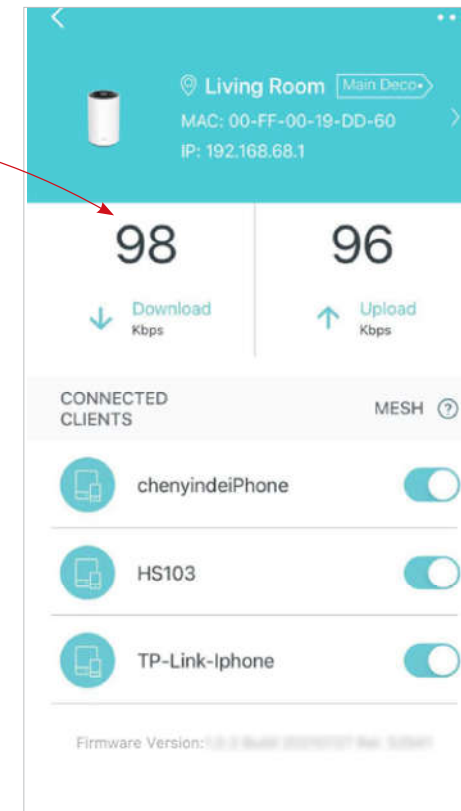

Change or customize the location/name of the Deco.

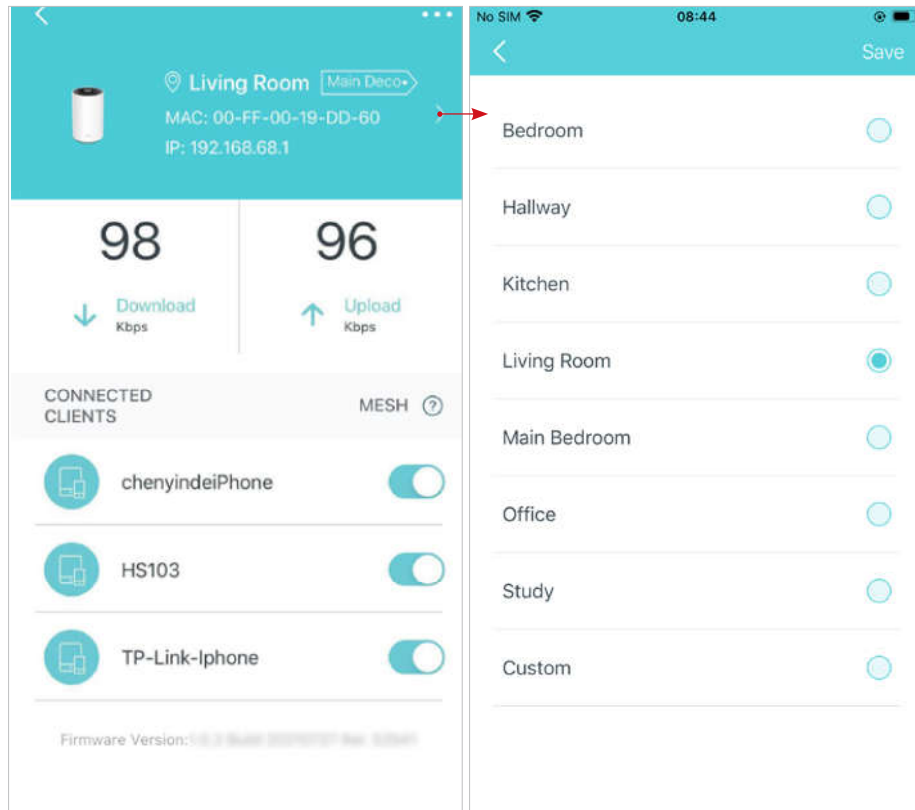

Check the clients connected to the Deco.

Enable the Mesh feature, then the client can seamlessly switch to the Deco that provides the fastest speed as you move around.

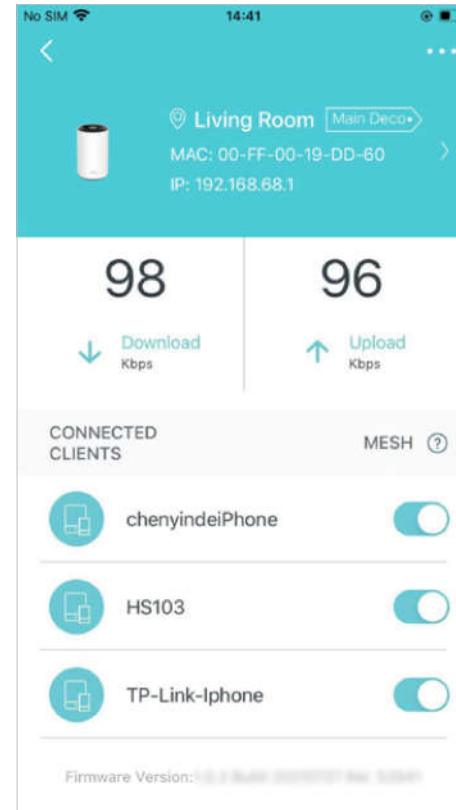

Set Main Deco

After setup, you can replace the main Deco with any satellite Deco without resetting or reconfiguring the whole network.

Follow the steps below to complete the setup process.

■ Note: The main Deco links all the others to the internet. After the main Deco finishes switching, you need to connect the new main Deco to the modem or Ethernet outlet for internet connection. For DSL Deco, connect it to the phone jack or DSL splitter. For 4G/5G Deco, insert a nano SIM card to it.

1. In Overview, tap .

2. Tap  > [Set Main Deco](#).

3. Choose a satellite Deco and follow app instructions to complete the settings.

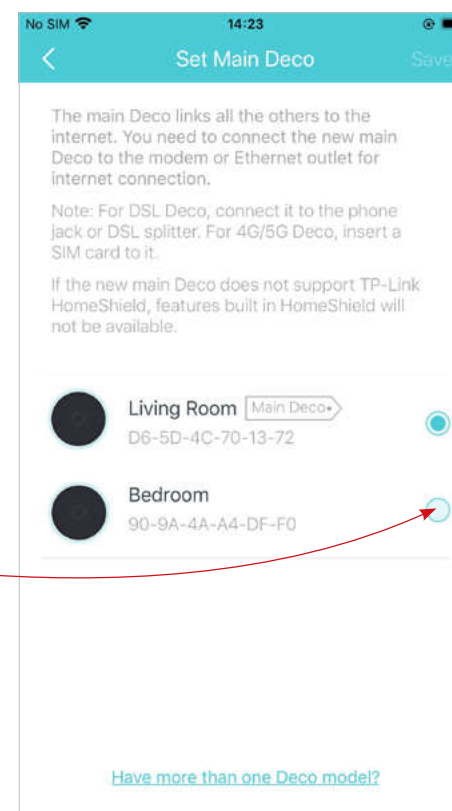
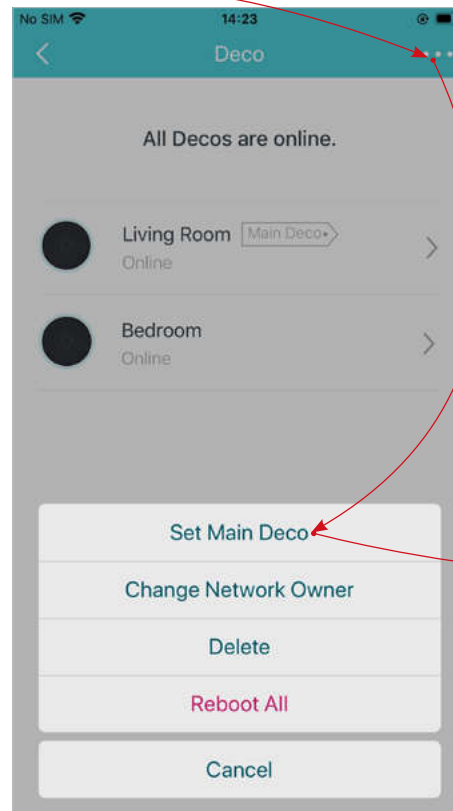
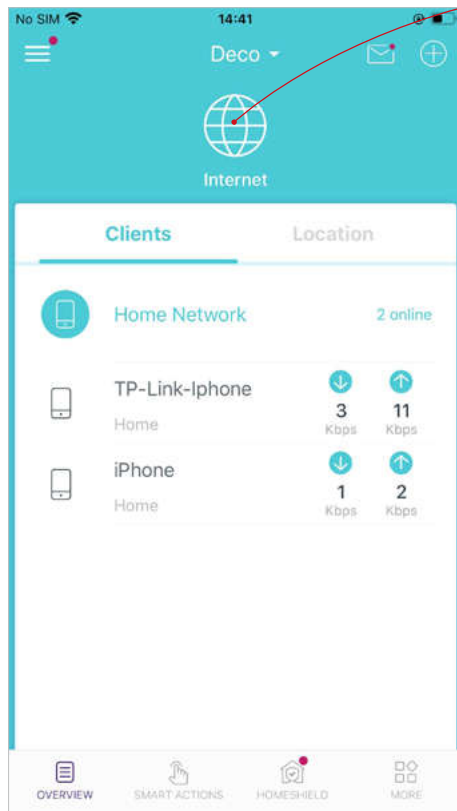

Remove/Reboot Deco

You can reset your Deco to factory default settings or reboot your Deco to clear cache and enhance running performance easily in the Deco app. Follow the steps below.

Note:

Rebooting your Deco will keep the current settings on it.

Removing your Deco will reset it to factory default settings and you will need to set up your Deco again. You can also press the Reset button on the Deco for 1 second to quickly reset your Deco to factory default settings.

1. In Overview, tap .

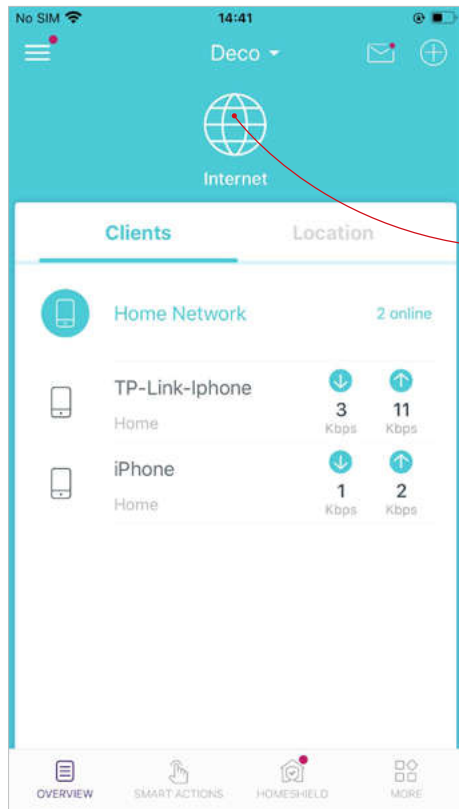

2. Select a Deco unit.

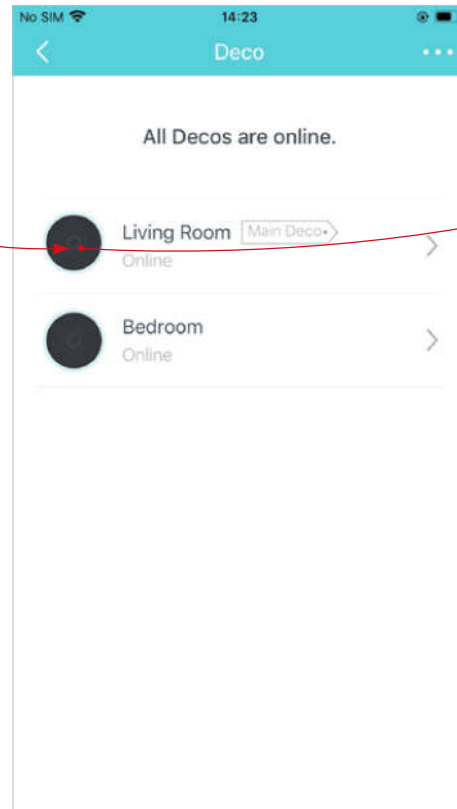

3. Tap  to remove or reboot the Deco.

Note: If the LED light of Deco does not turn pulsing blue after tapping [Remove](#), press the Reset button on the Deco for 1 second to reset it.

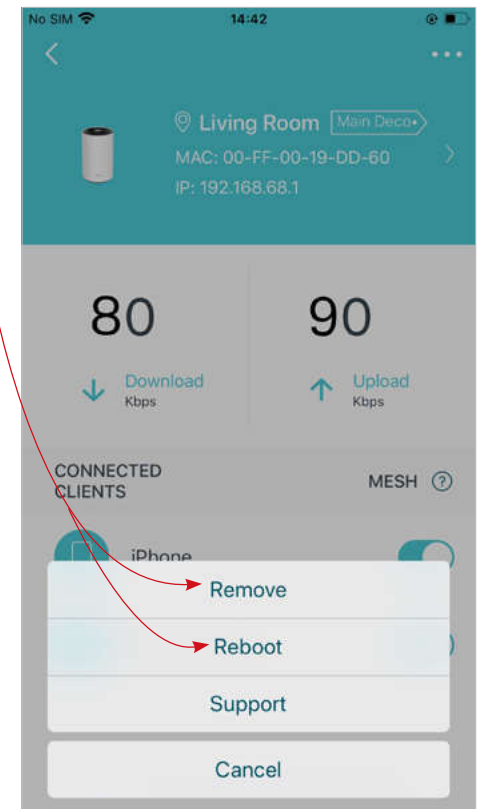
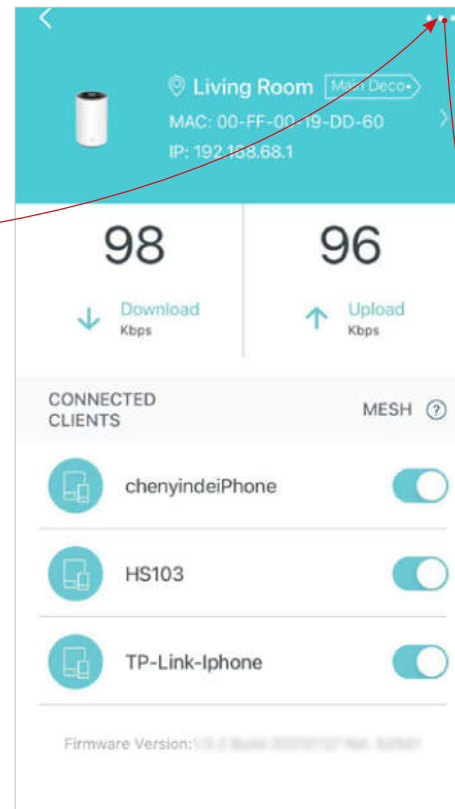

Manage Connected Devices

In Overview, you can manage your connected devices easily, such as changing the device name/type/location, enabling automation, Mesh Technology and high priority for the device, setting a profile to manage its online activities, and more.

Tap a connected device to check the details (e.g. real-time upload and download speeds, device name/location/profile, etc.).

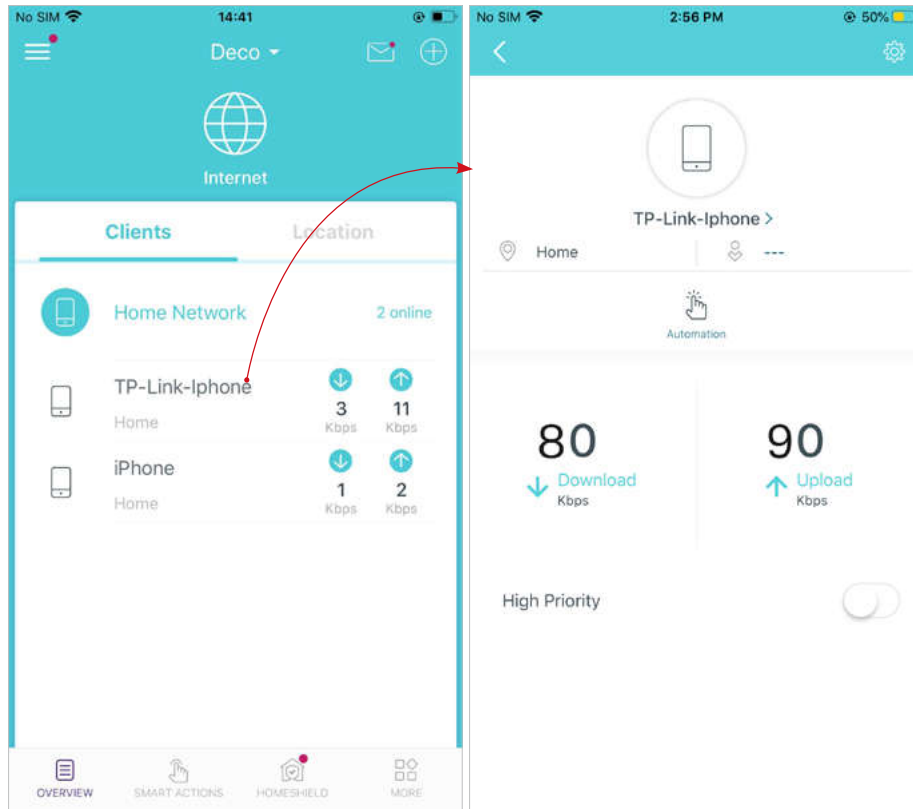

Change the device name as needed.

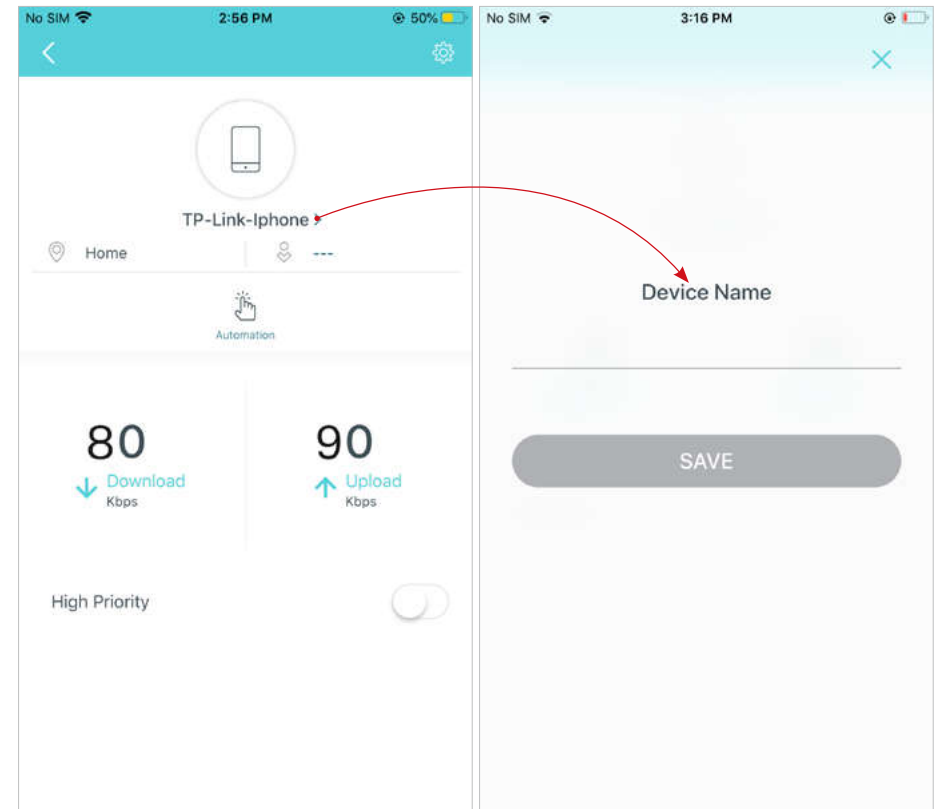

Tap [Automation](#) to enable, disable, or edit it. If you have not set automation yet, follow [Automation](#) to create one.

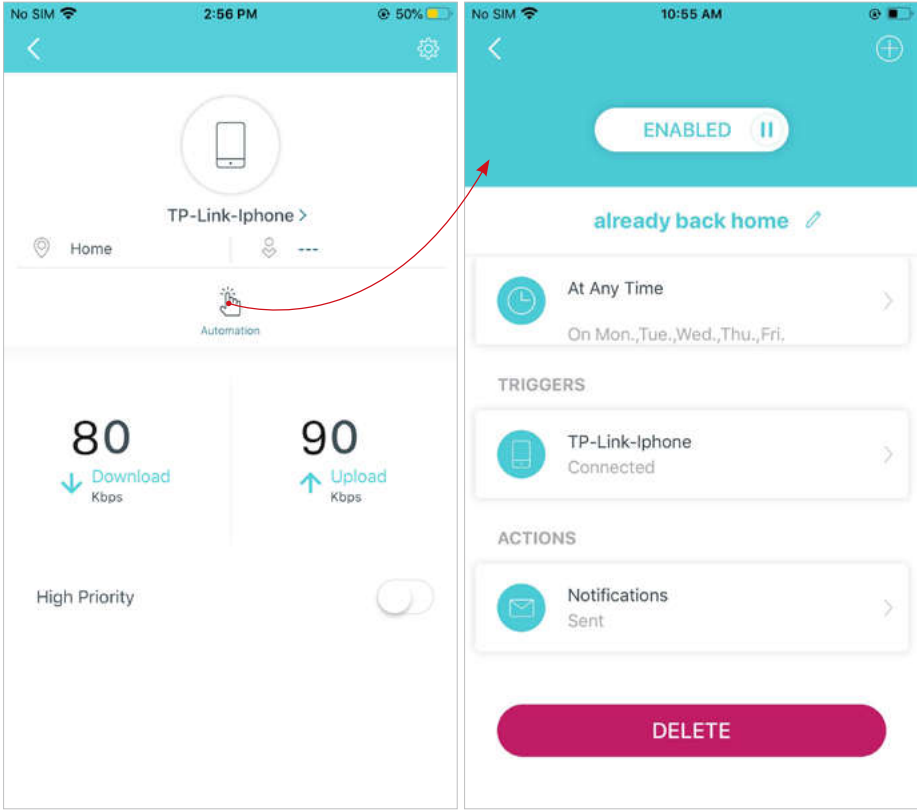

Enable [High Priority](#) and set the [Duration](#) time to prioritize the connection of this device during the time, such as a family member's laptop for one hour during a video call.

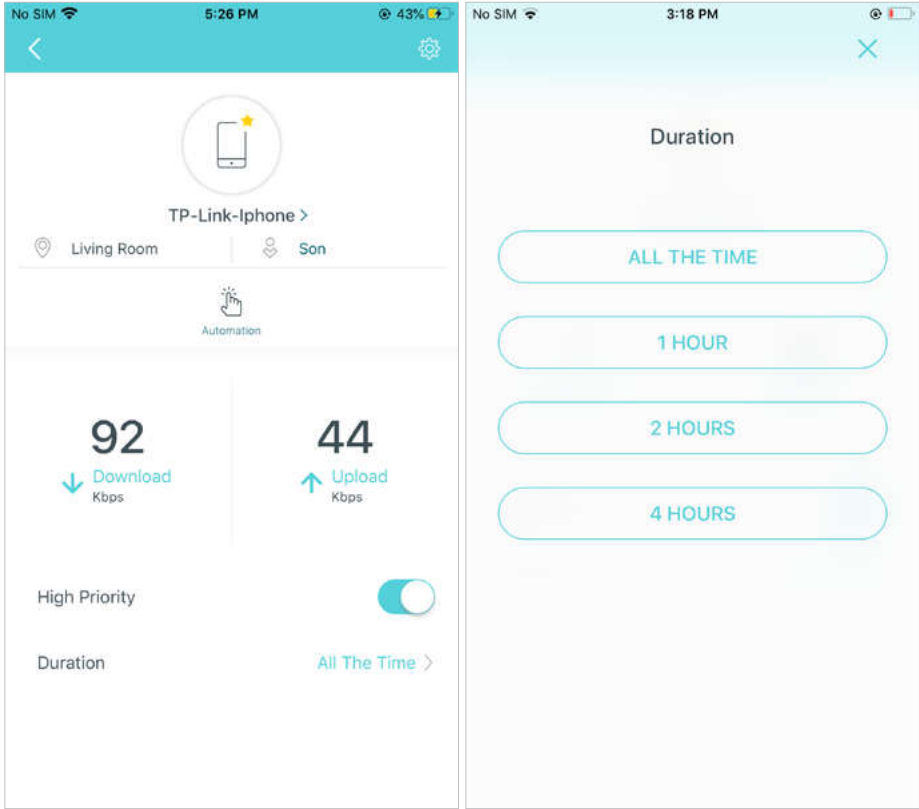

Tap  to manage the device settings, including changing the device name/type, viewing device detailed information (IP address, MAC address, connected network, linked Deco, etc.), and more.

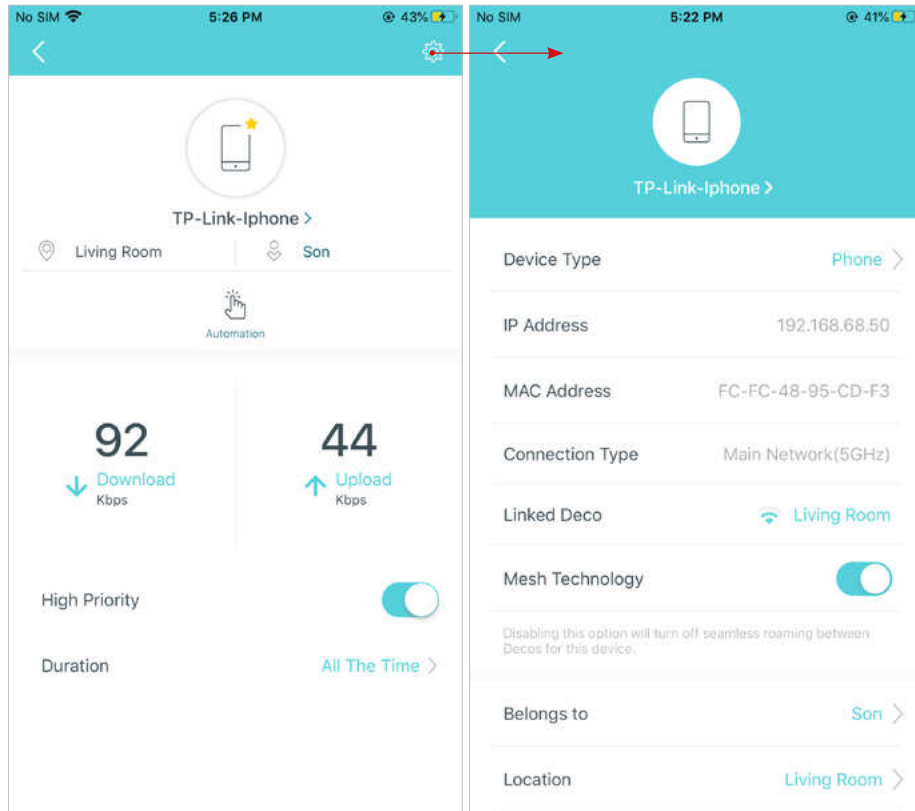

Tap [Location](#) to sort the devices by customized locations so that you can quickly find and manage the devices.

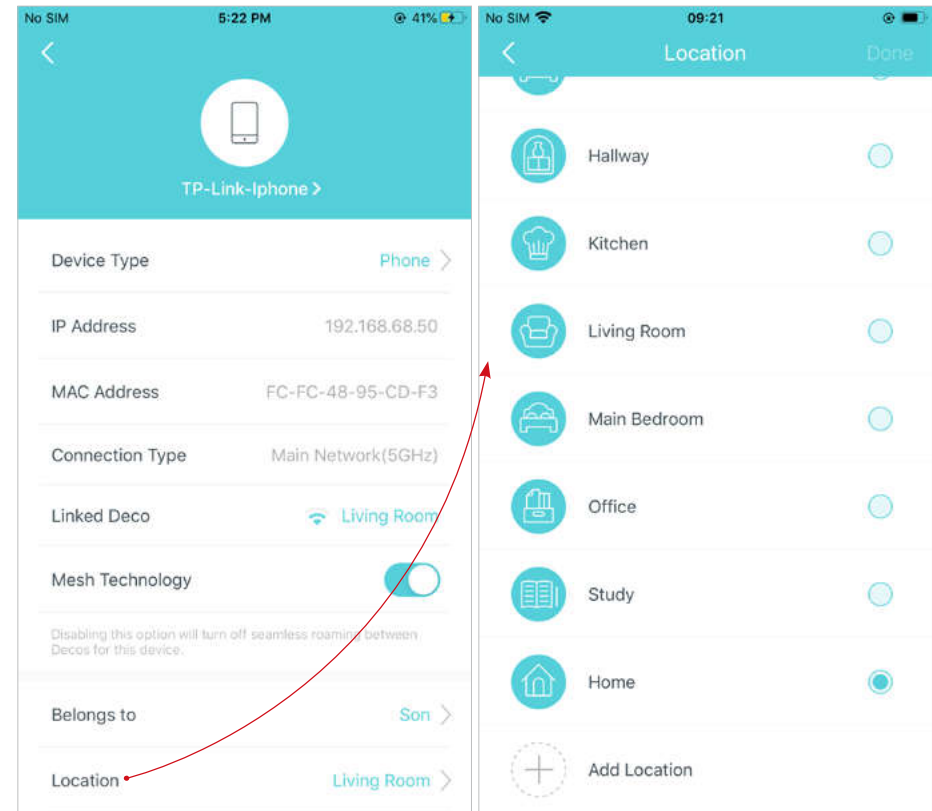

Tap **Belongs to** to add a unique profile for the device and manage its online activities. For example, when and for how long this device can access the internet, block inappropriate content, and pause the internet if necessary. For more information about the feature, refer to [HomeShield](#).

Enable **Mesh Technology** and then the device can seamlessly switch to the Deco that provides the fastest speed as you move around.

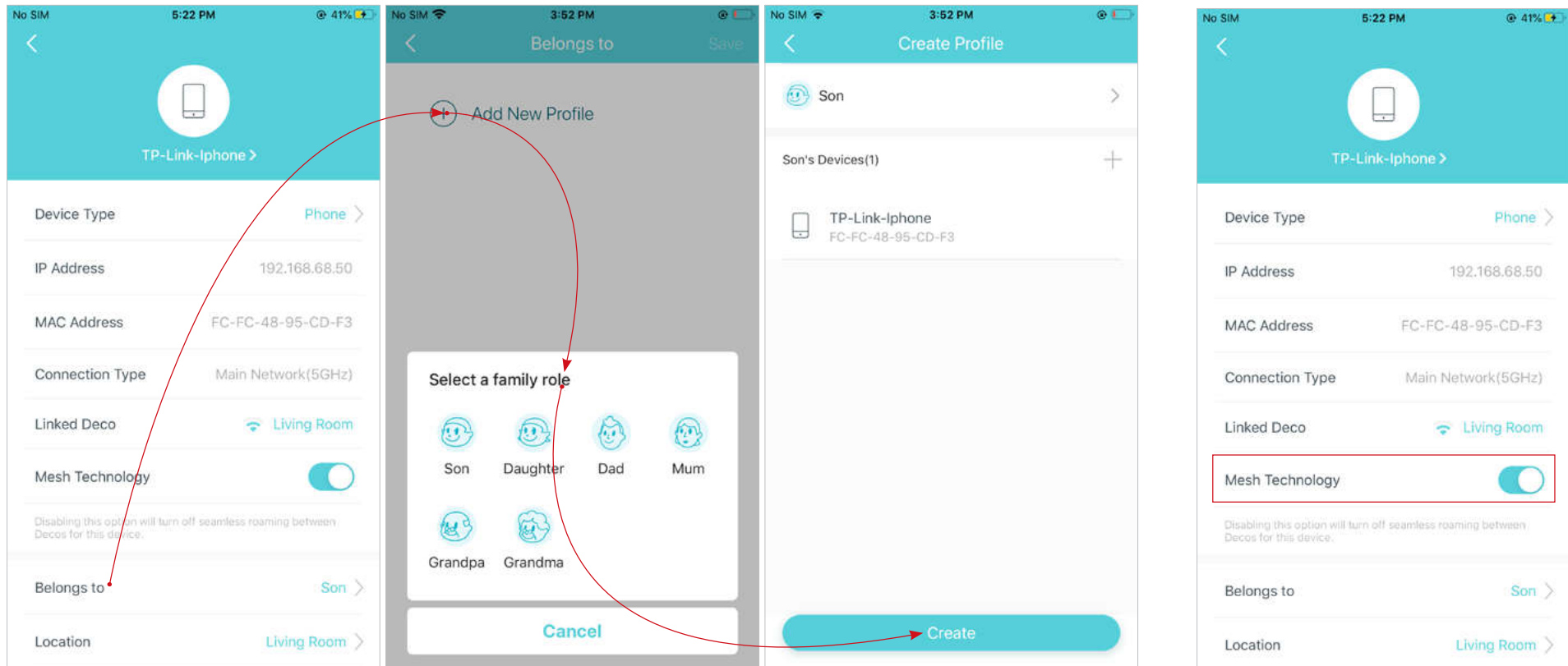

Sort Devices By Locations

After adding your devices to the Deco network, you can sort them by customized locations so that it will be more convenient and efficient to manage your devices. For example, you can add the lights and computer in your bed room to a location set as "Bed Room", so you can quickly find and manage these devices.

In Overview, tap + > [LOCATIONS](#). Follow app instructions to sort your devices by location.

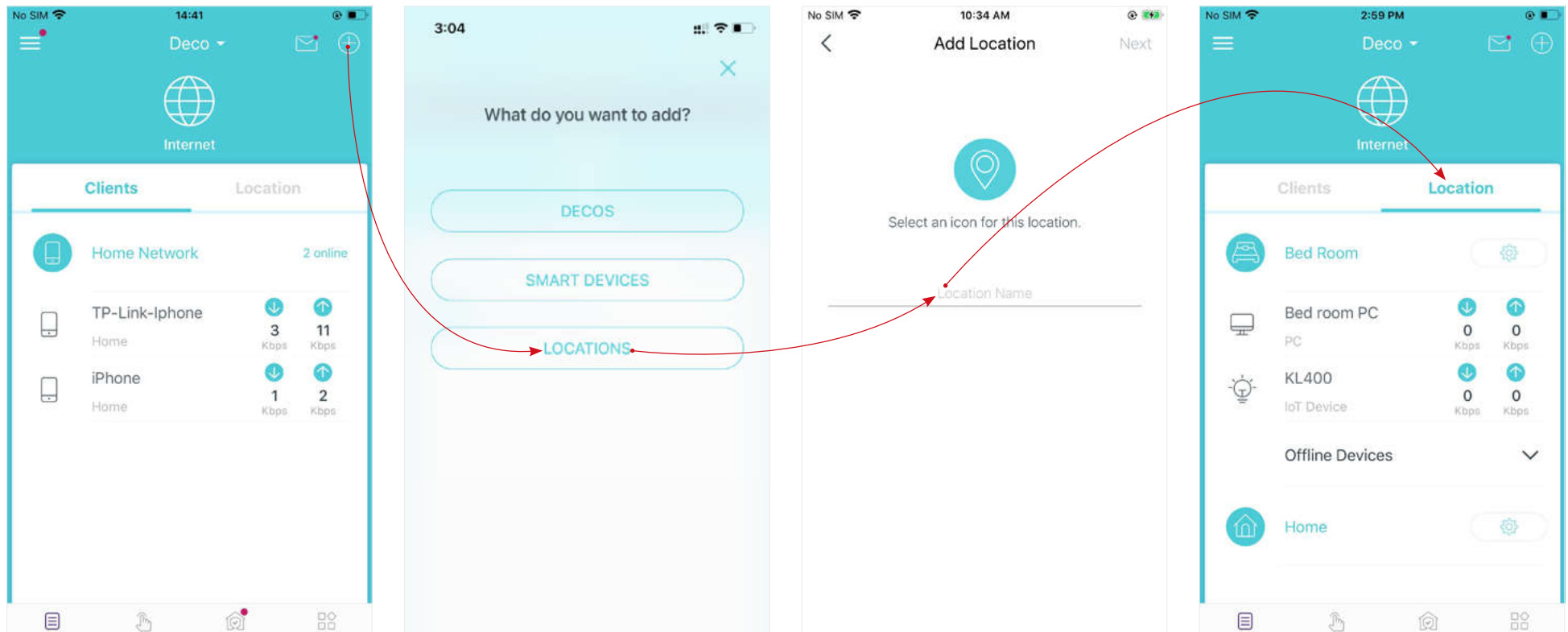

Create a New Network

In the Deco app, you can create different Deco networks with your TP-Link ID and manage them conveniently from the Deco app with one account. You can also help family or friends manage their networks with your Deco app. Two methods are provided as below to create a new network.

Method 1. Create a new network from the Overview page

Tap  > [Create New Network](#). Then follow app instructions to complete the setup.

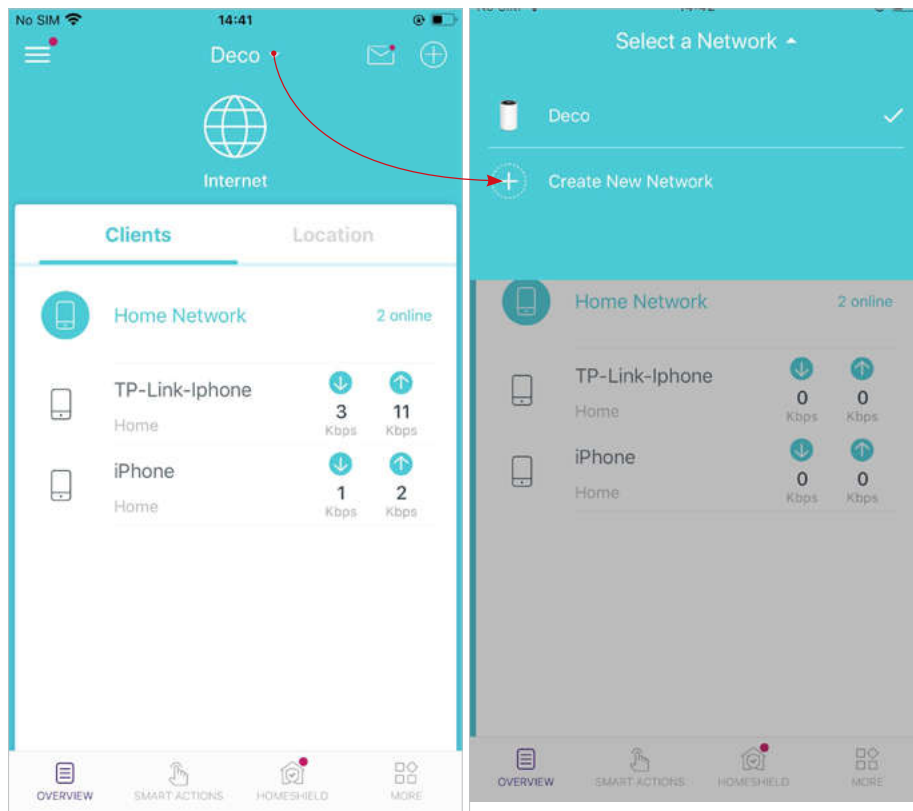

Method 2. Create a new network from the Menu page

1. Tap  to open the menu.

2. Tap  > CREATE NEW NETWORK.

3. Follow app instructions to complete the setup.

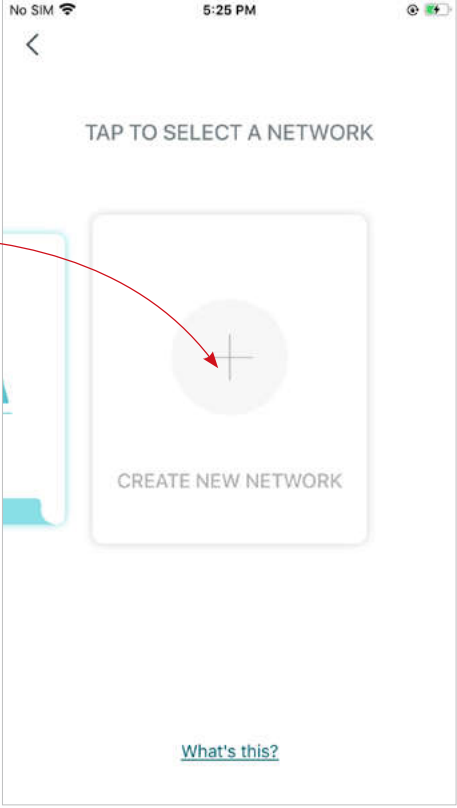
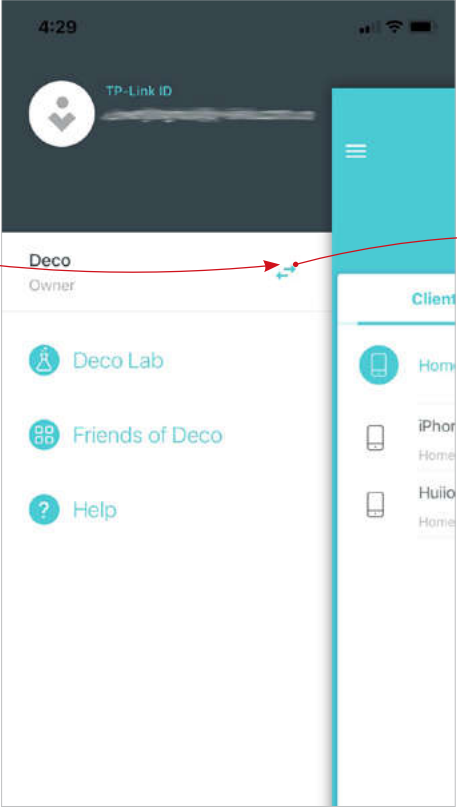
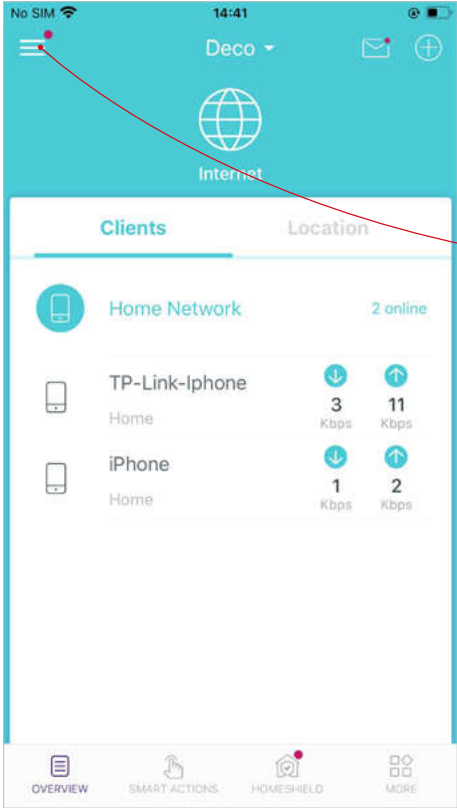

Change Network Owner

You can change the network owner on the Deco app without resetting the whole Deco network. Follow the steps below.

In Overview, tap  >  > [Change Network Owner](#). Follow app instructions to change the network owner. Then you will not be able to manage this network with your account anymore. The new owner needs to follow steps in an email sent from TP-Link to log in and manage the network.

 Note: Changing the network owner will delete the network from the current owner, and this owner will no longer be able to manage this network.

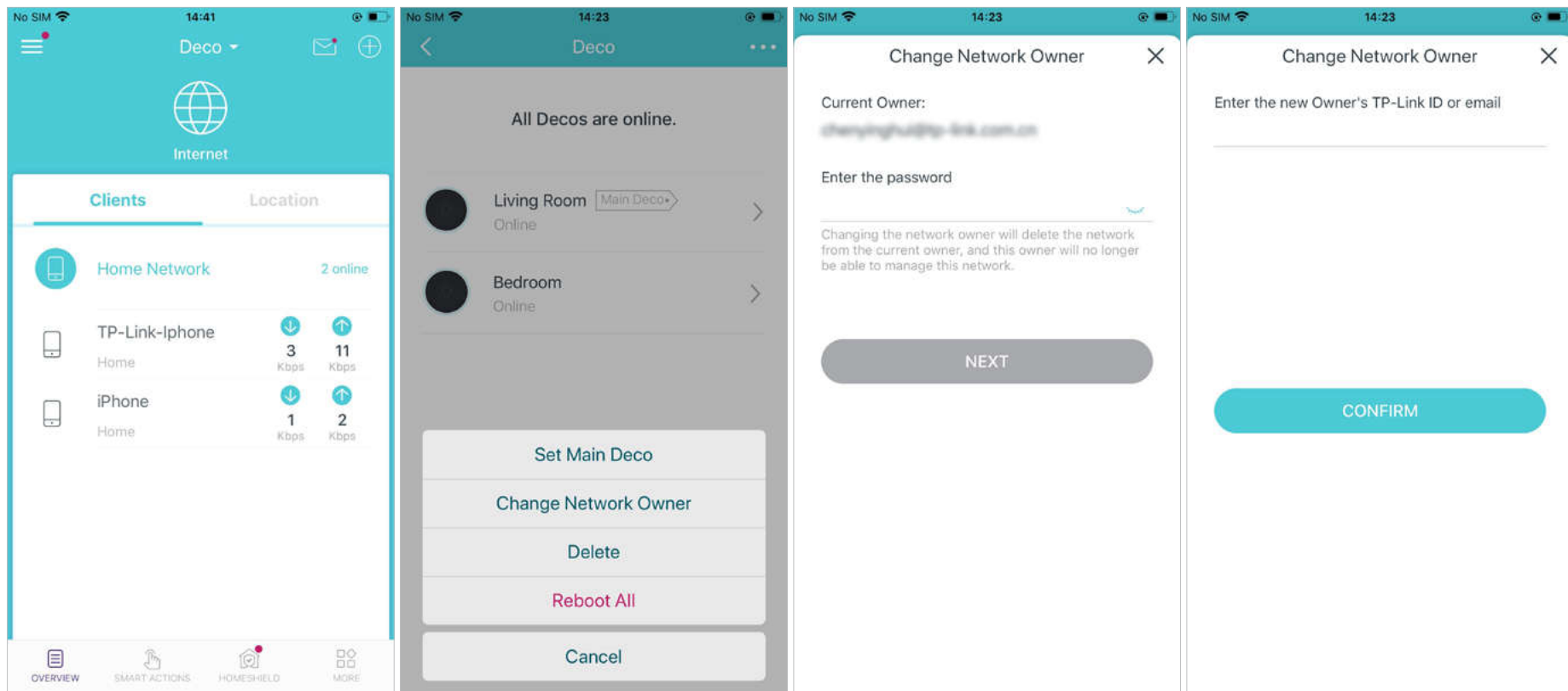

Delete a Network

You can delete a Deco network if you don't need it anymore. Deleting a Deco network will reset all Decos in this network to factory default settings.

1. In Overview, tap .

2. Tap  > Delete.

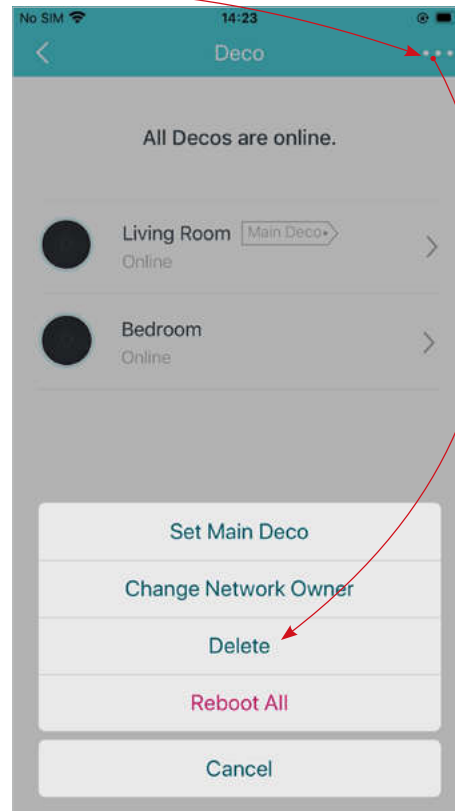
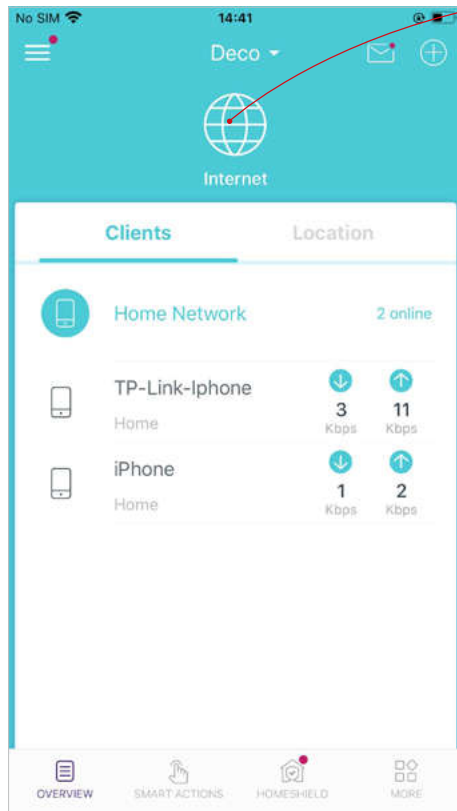

Add Smart Devices

After creating a Deco network, you can add your smart home devices to the network and manage them conveniently on your Deco app.

In Overview, tap + > SMART DEVICES. Follow app instructions to add your smart devices to the network. Then the smart devices will display on the Overview page as shown below.

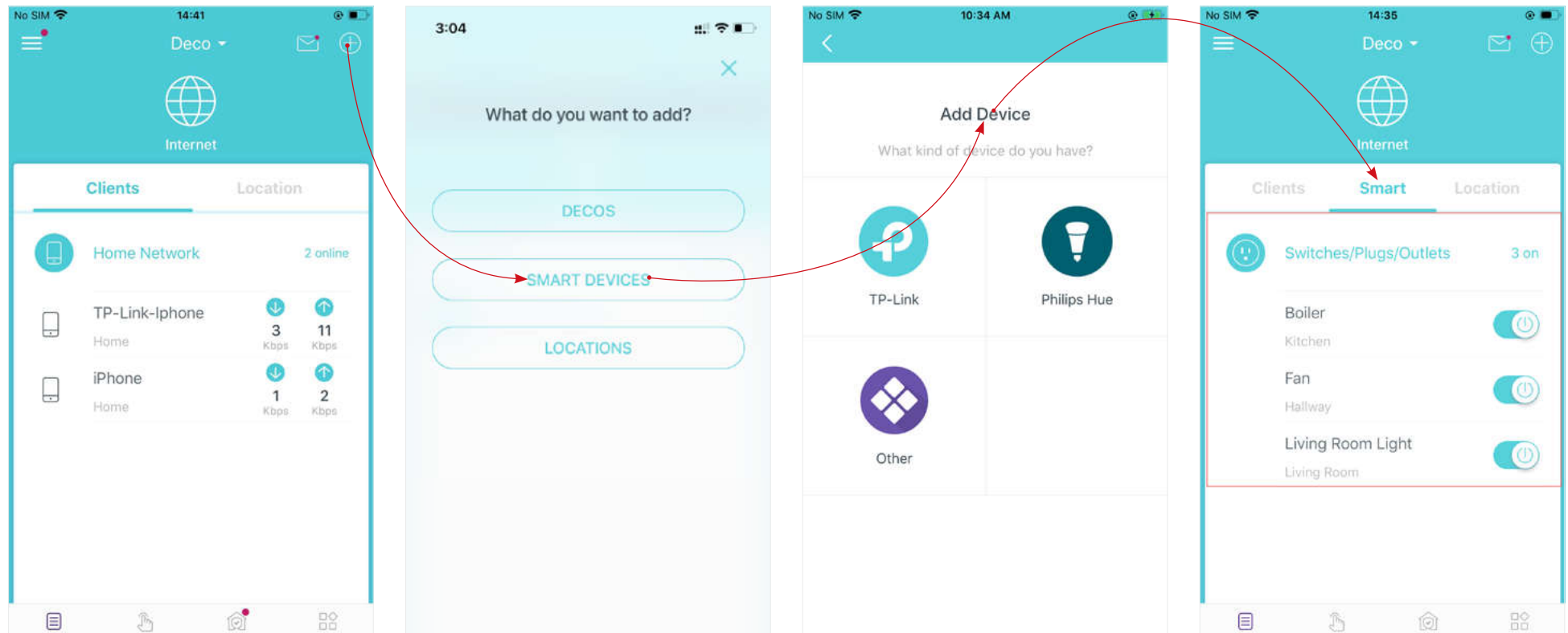

Shortcut

Shortcut lets you achieve an action with a simple tap. For example, if you want to power on your living room light at one tap, follow the steps below.

■ Note: If you want to create shortcuts for your smart devices, follow [Add Smart Devices](#) to add the smart devices to the Deco network first.

1. Tap  > **Shortcut** > **CREATE**.

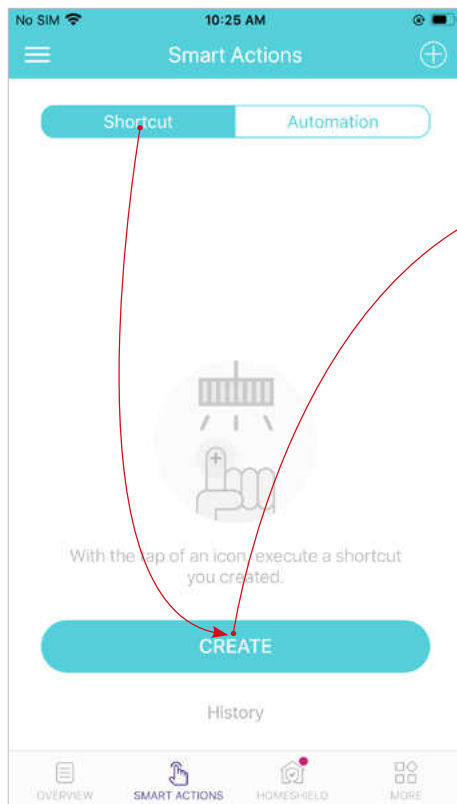

2. Add an action.



3. Choose an action type.

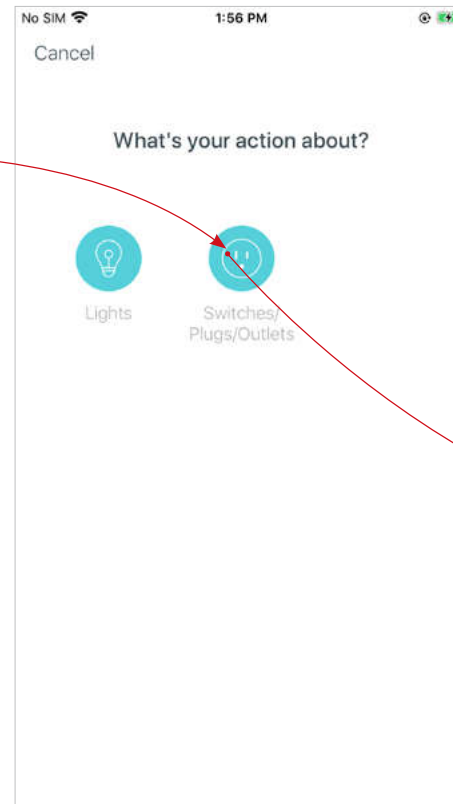

4. Choose the action device.

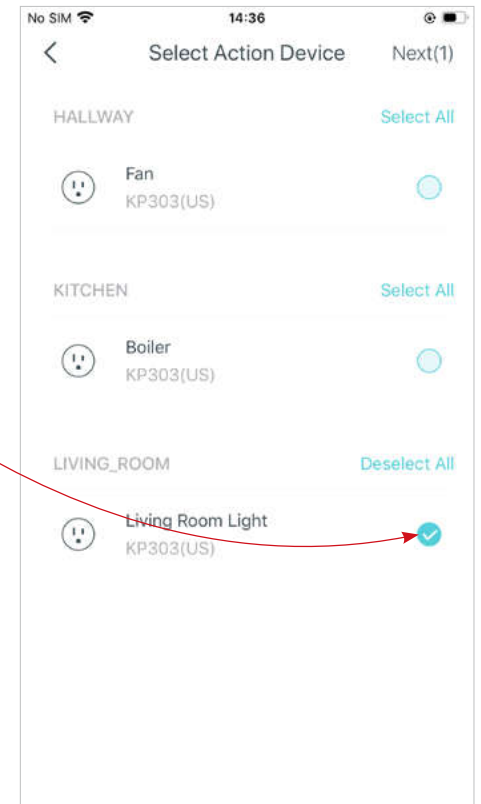

5. Set how the action behaves when executed. For example, set as below then the living room light will turn on 1 minute after you tap the shortcut icon and will turn off automatically after 2.5 hours.

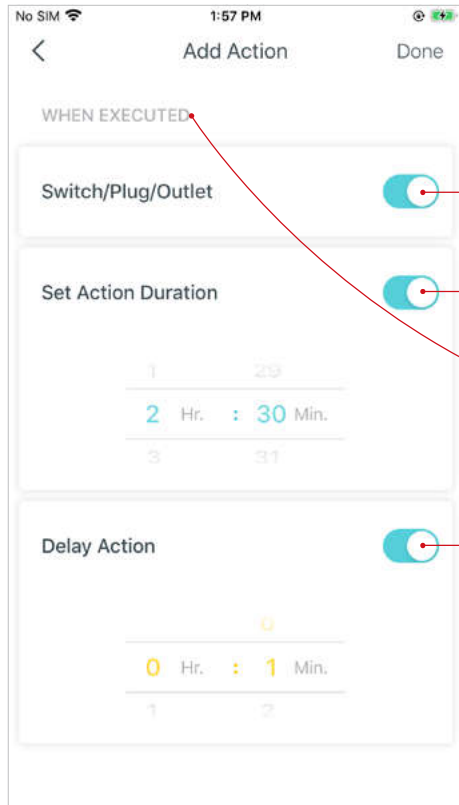

Turn on/off

The effective time of the action

The waiting time before the action starts

6. Select an icon and set a name for the shortcut to finish the settings.

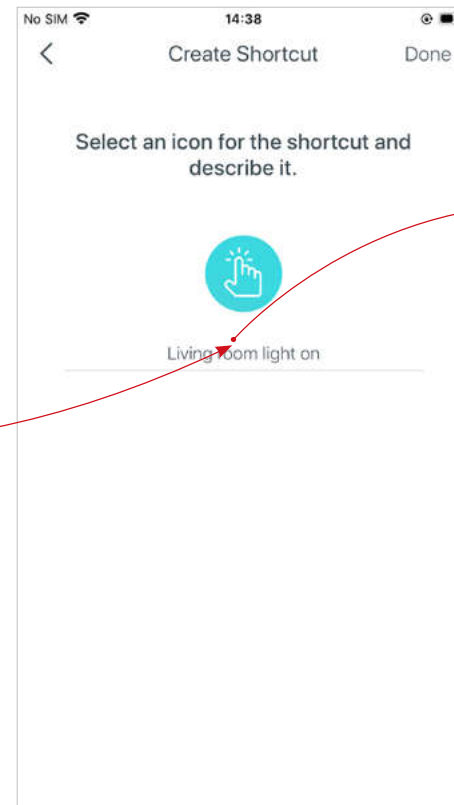

7. Tap the icon to execute the action.

 Tip: If you have set Delay Action, you will need to wait for the time you set before the action takes effect.

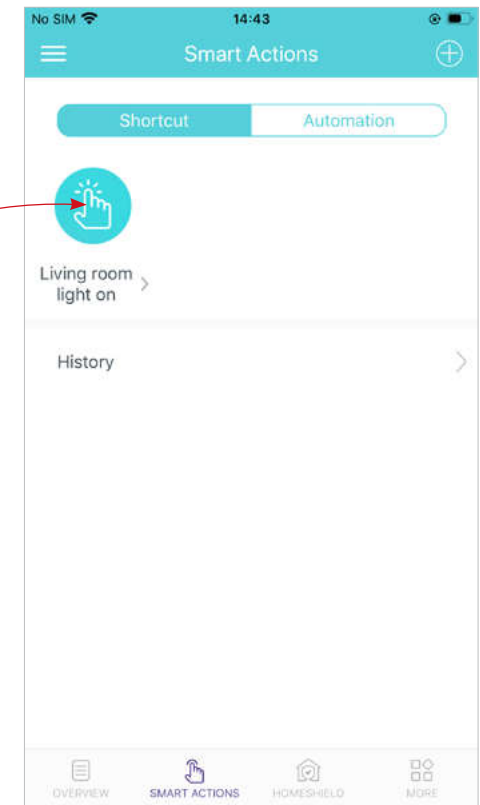

Automation

Automation allows you to set interactions between your devices by adding triggers and actions. For example, when you get home and your smartphone is connected to the Deco network (which is a trigger), the living room plug automatically turns on (which is an action). Then the kettle plugged into the living room plug will start to boil water.

Take this example to show the setup steps as below. Follow the steps to create an automation.

■ Note: If you want to create automations for your smart devices, follow [Add Smart Devices](#) to add the devices to the Deco network first.

1. Tap  > [Automation](#) > [CREATE](#).

2. Set when the automation takes effects.

3. Add a trigger.

4. Select the trigger type.

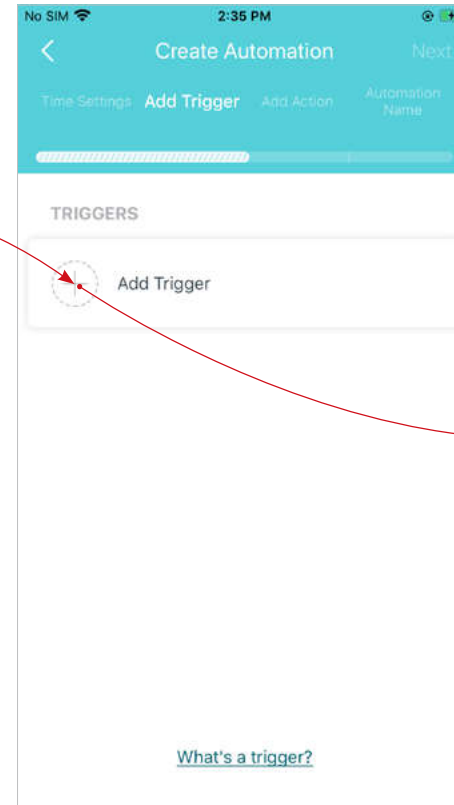
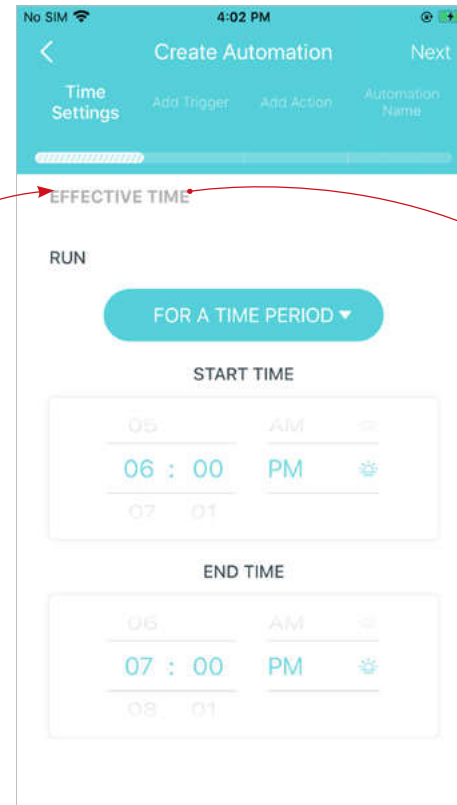
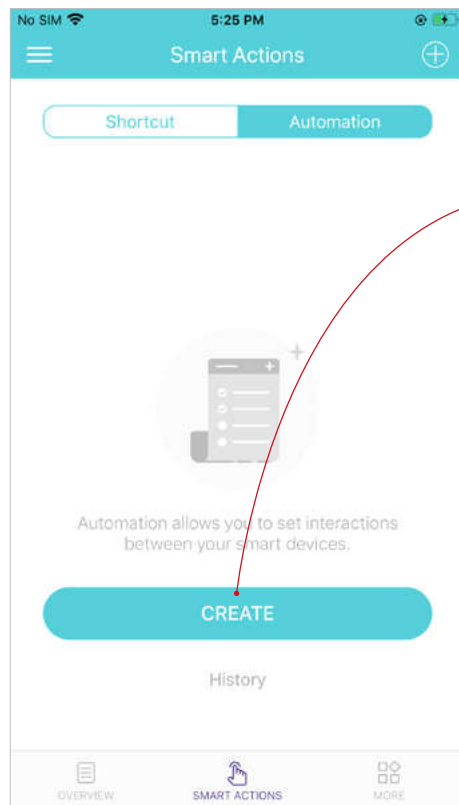

5. Select the trigger device and set the trigger details.

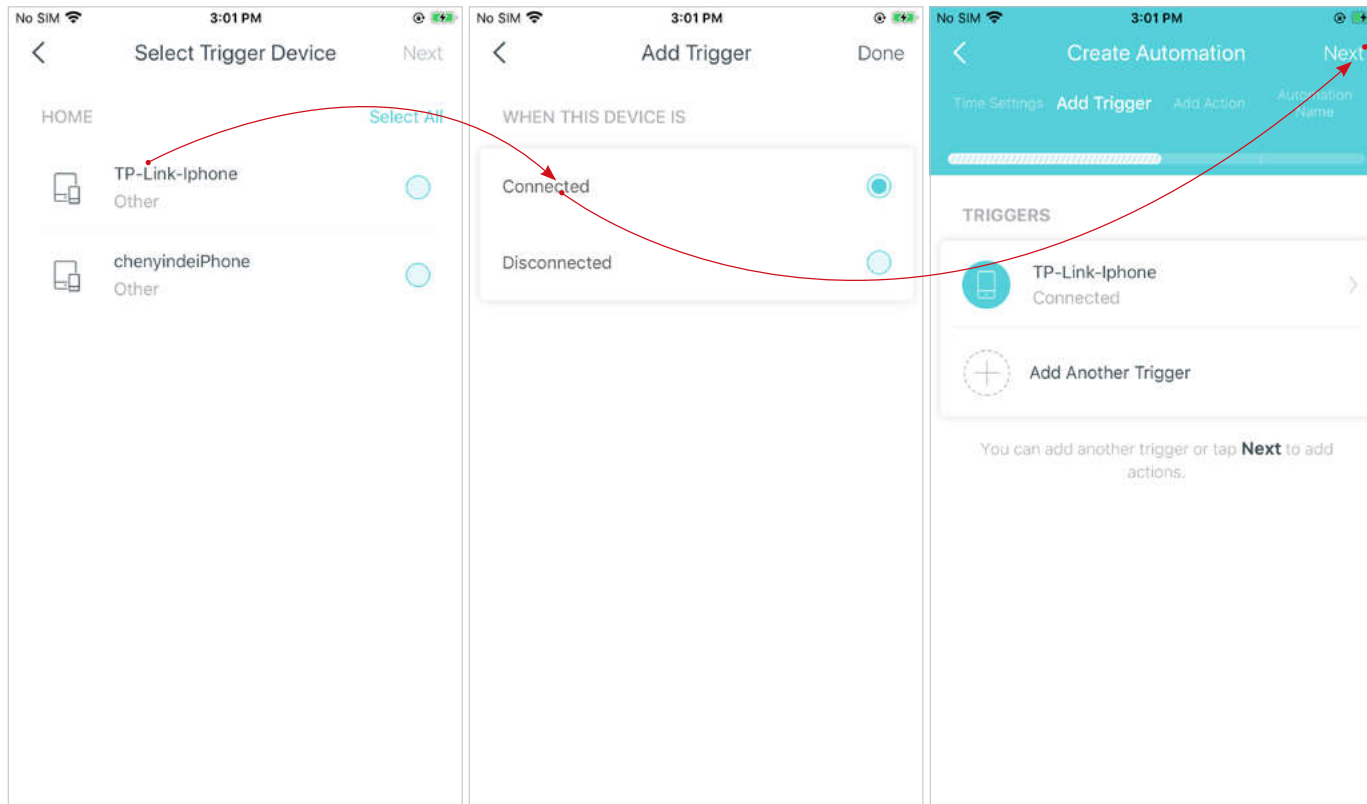

6. Add an action.

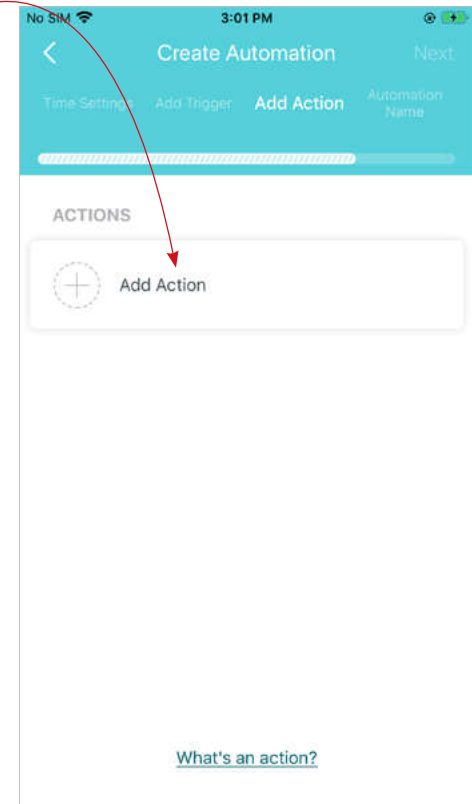

7. Select the action device and set the action details. For example, set the action as below then the living room plug will turn on after you tap the shortcut icon, and will turn off automatically after 1.5 hours.

Tip: If you have set Delay Action, you will need to wait for the time you set before the action takes effect.

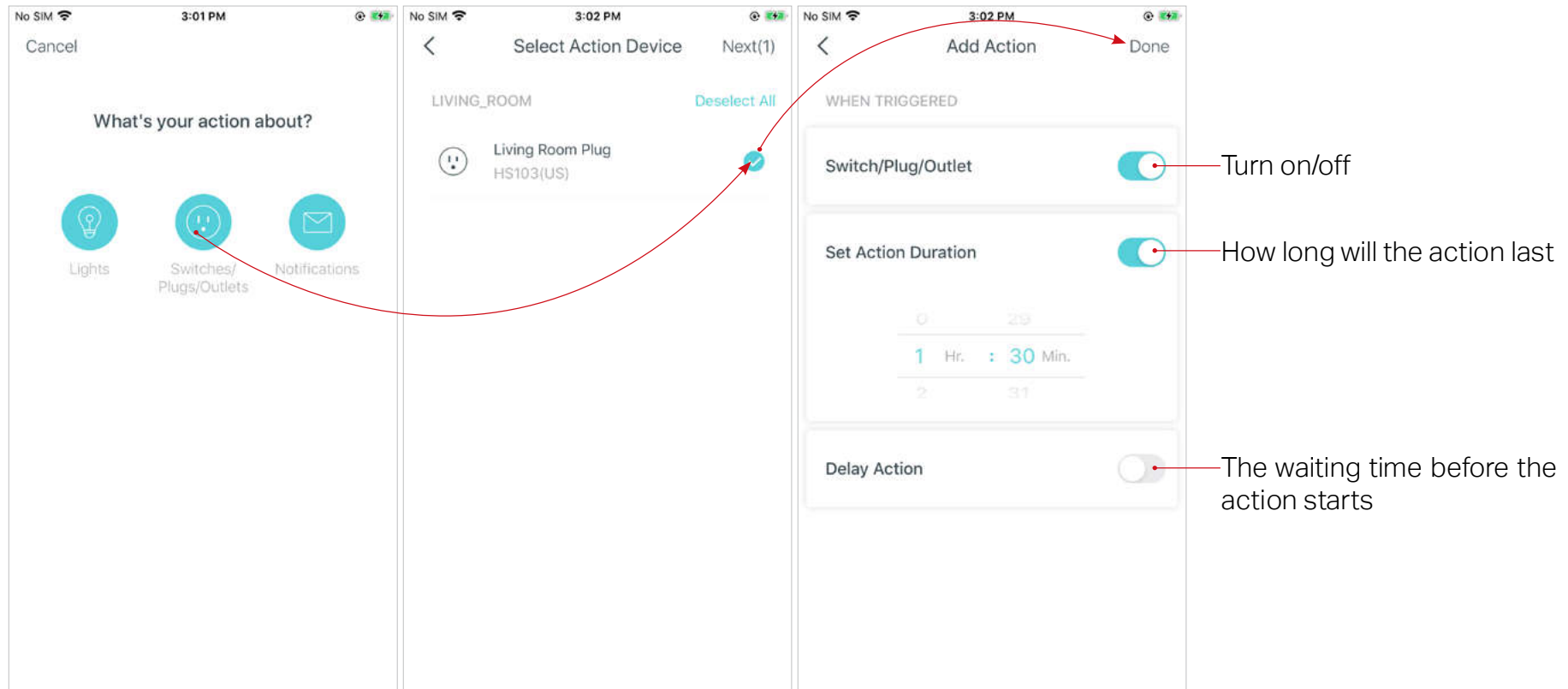

8. Set a name for the automation.

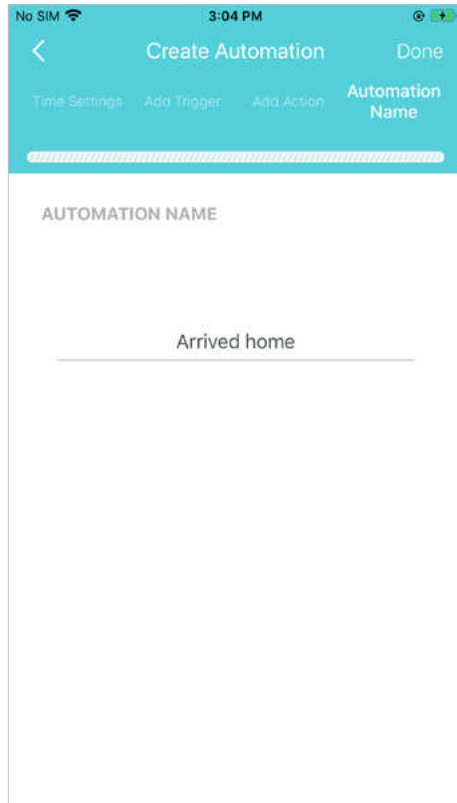

9. Automation setup completed. The automation will take effect when the trigger is executed.

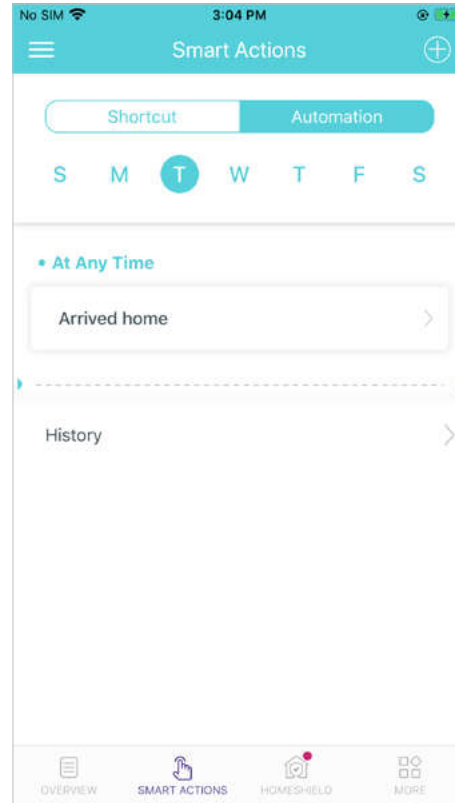

HomeShield

Whether protecting your network from malicious attacks, managing your family's online activities, or prioritizing devices to get better performance, TP-Link HomeShield provides you a kit of basic (free) and Pro (charged) features to enhance your whole home network with enhanced security.

An overview of HomeShield features are shown below.

- **What is HomeShield:** <https://www.tp-link.com/homeshield/>

📌 Note: Please refer to your Deco app to check the Basic and Pro features of your actual model.

- **How to use HomeShield features and upgrade to HomeShield Pro:** go to the product support page at <https://www.tp-link.com> and refer to [TP-Link HomeShield User Guide](#).

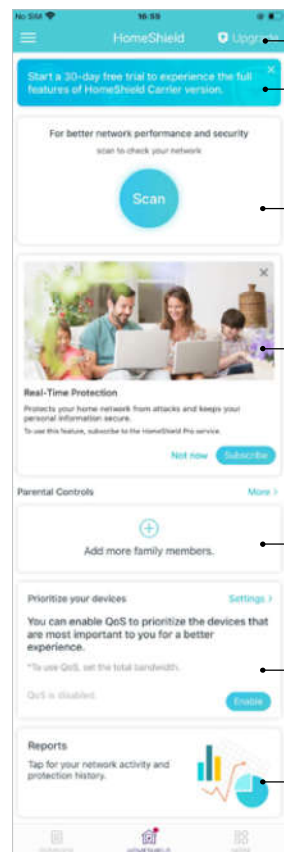

— **HomeShield Pro Subscription:** To enjoy more features, you can upgrade to HomeShield Pro. Check more details about the Basic and Pro features here.

— **Scan:** Examine your network regularly to identify the potential risks, thus improving your network performance and security.

— **Real-Time Protection:** Real-Time Protection is for Pro users only. There are three ways to ensure your home network and your IoT devices remain safe: (1) block malicious websites, protect your home network and applications against external attacks and eliminate vulnerabilities; (2) prevent infected devices from sending sensitive information or security threats to clients outside your network; (3) identify IoT devices and immediately monitor their security performance once they join the network.

— **Parental Controls:** Create profiles for family members and specify the devices that belong to each. Set individualized parental controls including when and for how long each person can access the internet. Block inappropriate content and pause the internet if necessary.

— **QoS:** Prioritize the connection of a particular device for a set duration, such as a family member's laptop for one hour during a video call.

— **Weekly/Monthly Reports:** Review a weekly or a monthly list of usage, such as security threats, top visited contents, and more, to better manage your family's online activities.

Wi-Fi Settings

You can change the network name and password of your main network at any time and share the network easily with family and friends.

Tap  > Wi-Fi.

Manage main network (e.g. change your main network's Wi-Fi name and password, hide the network from Wi-Fi list, etc.).

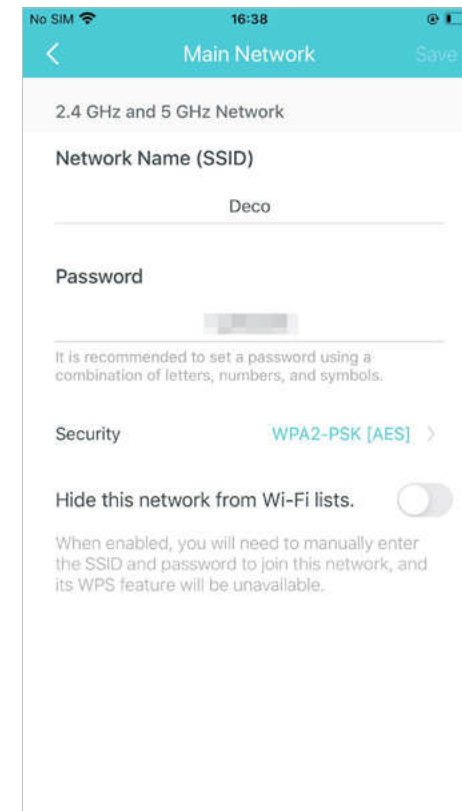
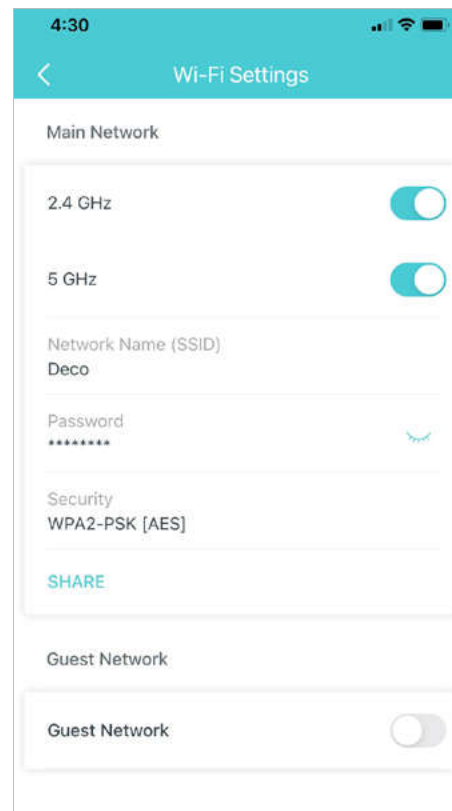
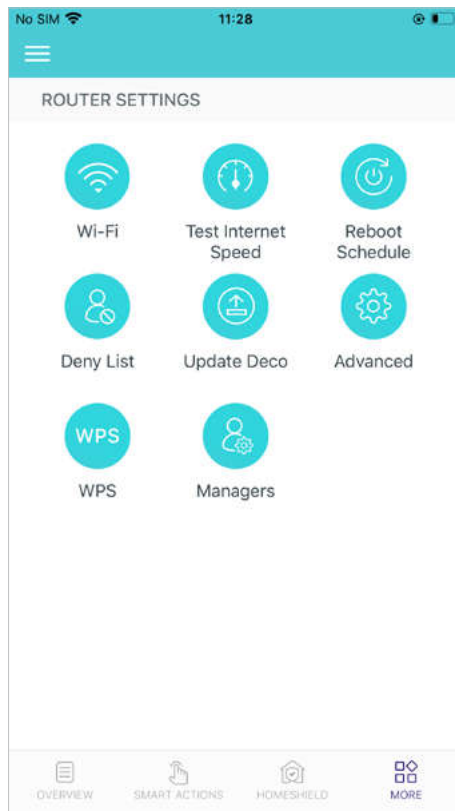

Guest Network

You can create and share a separate network for guests to guarantee the security and privacy of your main network.

Tap  > [Wi-Fi](#) and enable [Guest Network](#).

Manage the guest network. Change the Wi-Fi name or create a password for the guest network,

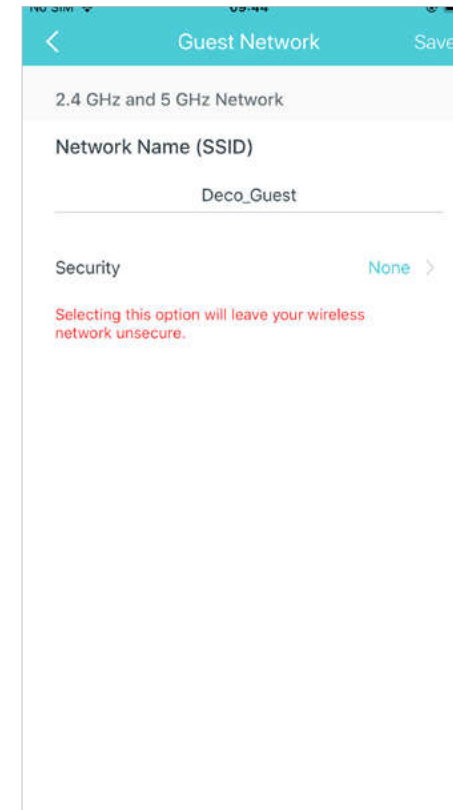
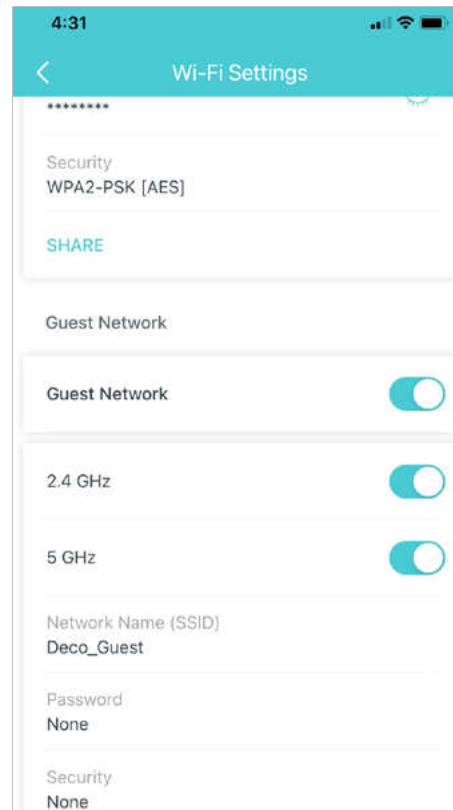
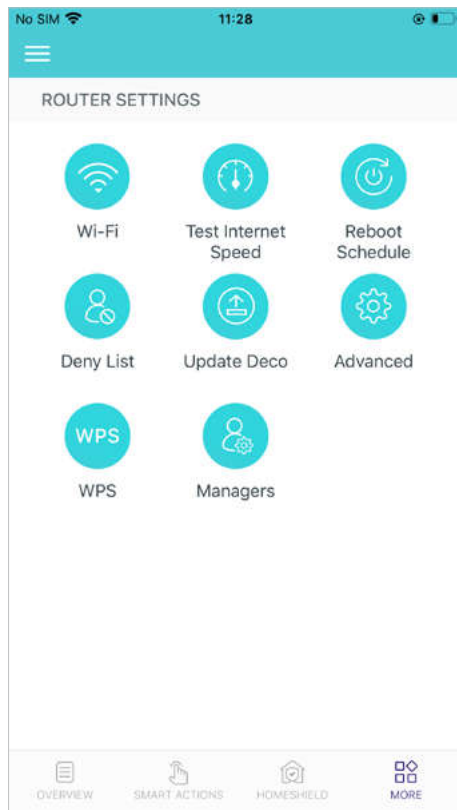

Test Internet Speed

You can test the download and upload internet speed easily.

Tap  > [Test Internet Speed](#).

Test the internet speed with an auto-selected server or a listed test server. Check the speed test history or clear the history.

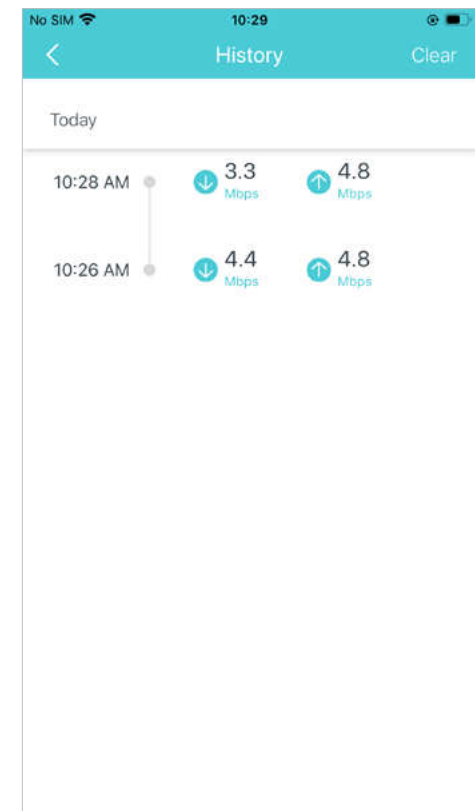
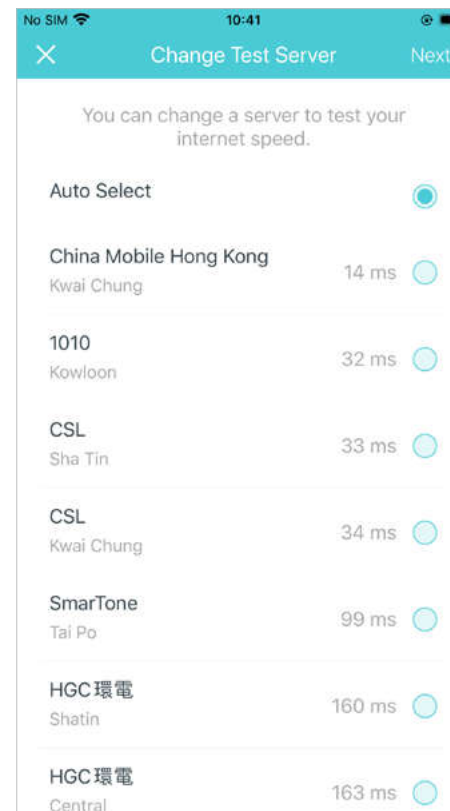
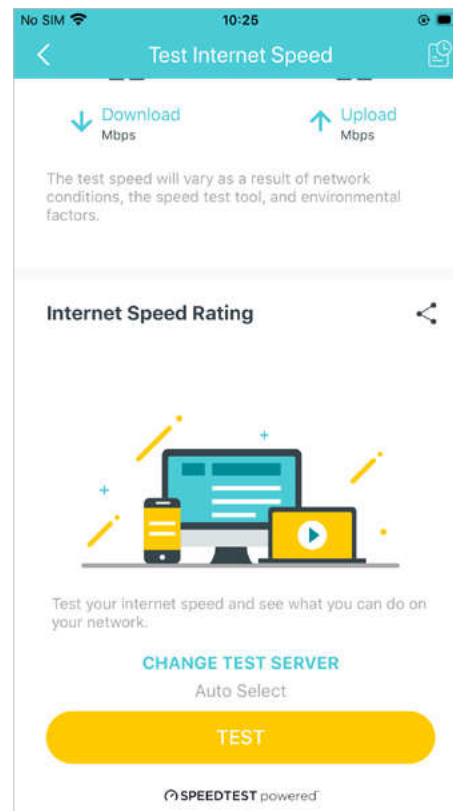
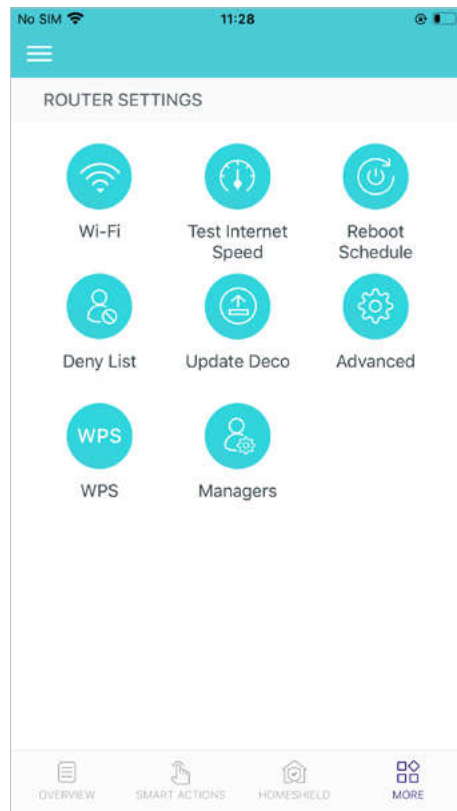

Reboot Schedule

You can set when and how often your Deco reboots regularly.

Tap  > [Reboot Schedule](#).

Toggle on [Reboot Schedule](#). Set how often and when your Deco reboots. Then the next reboot is scheduled at a specific time every day or every week.

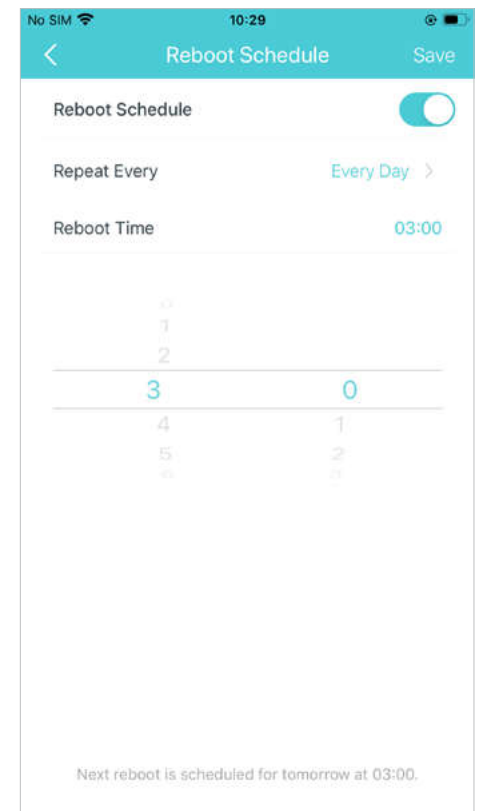
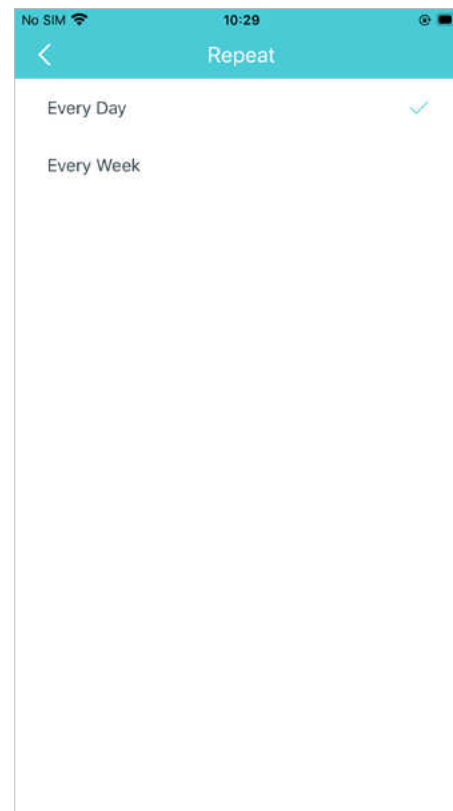
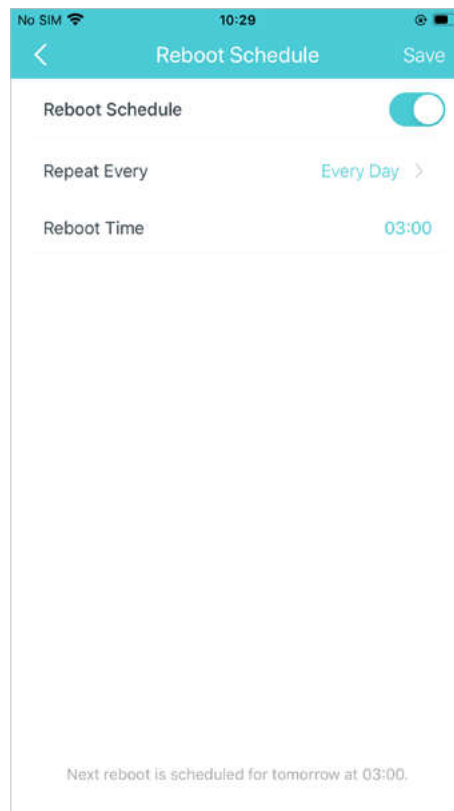
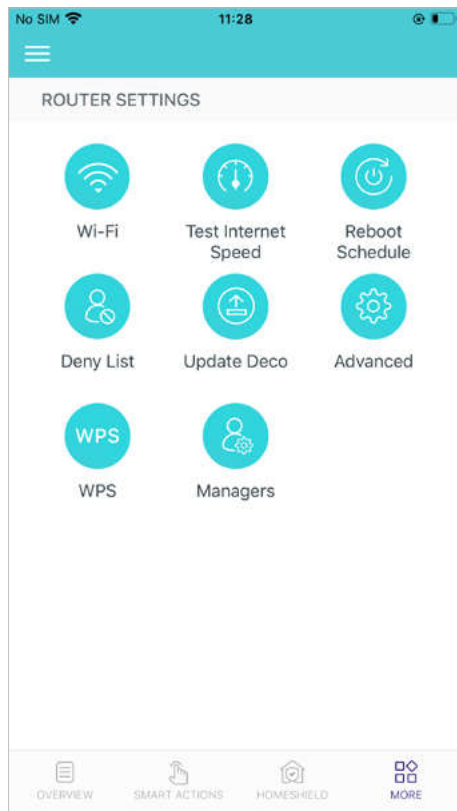

Deny List

Add devices to the deny list to prevent the devices from accessing your network, ensuring the safety of your personal information shared in the network.

Tap  > Deny List.

Tap + and add clients or other devices to the deny list.

Remove devices/clients from deny list.

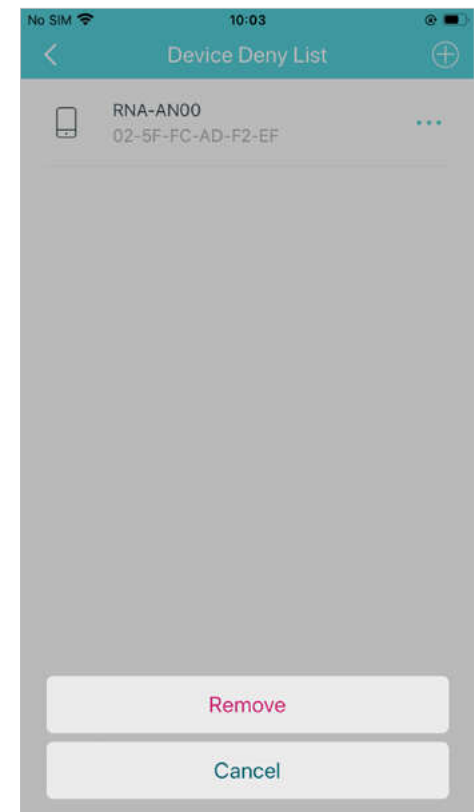
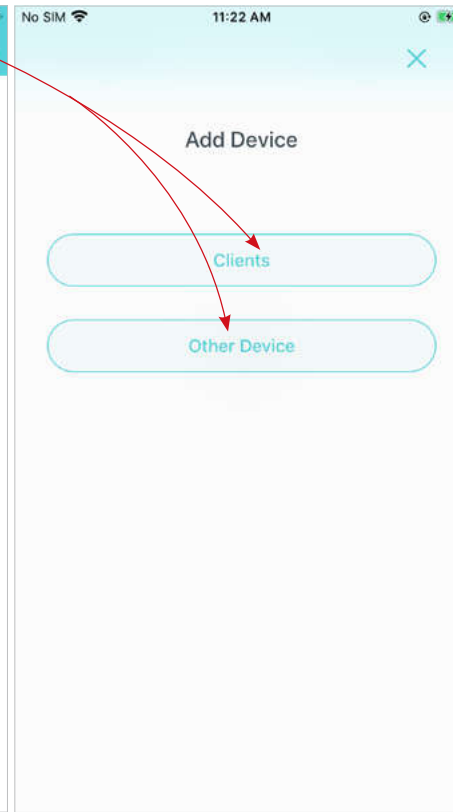
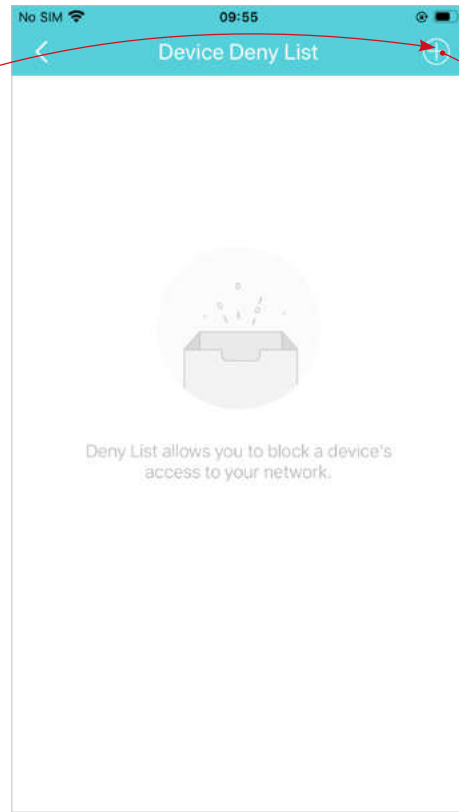
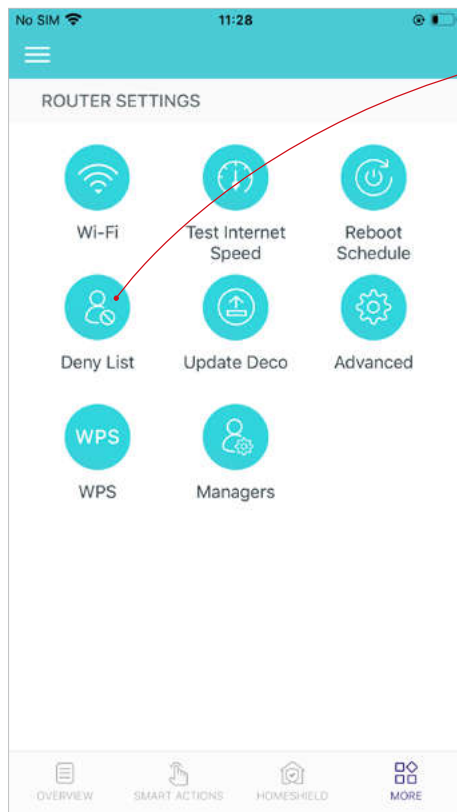

Upgrade Your Deco

TP-Link is dedicated to improving product features and providing a better customer experience. An up-to-date firmware provides better and more stable network performance. Always update your Deco to the latest firmware version when prompted in the Deco app.

1. Tap  > Update Deco

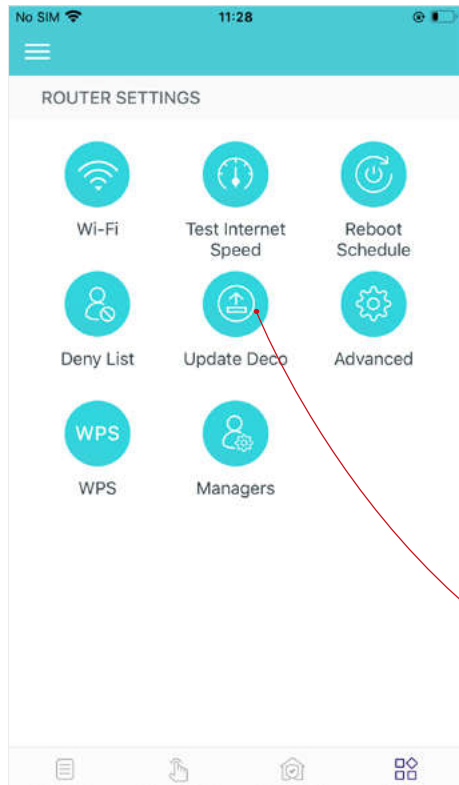

2. Download and install the firmware (if any) and follow app instructions to update your Deco to the latest version.

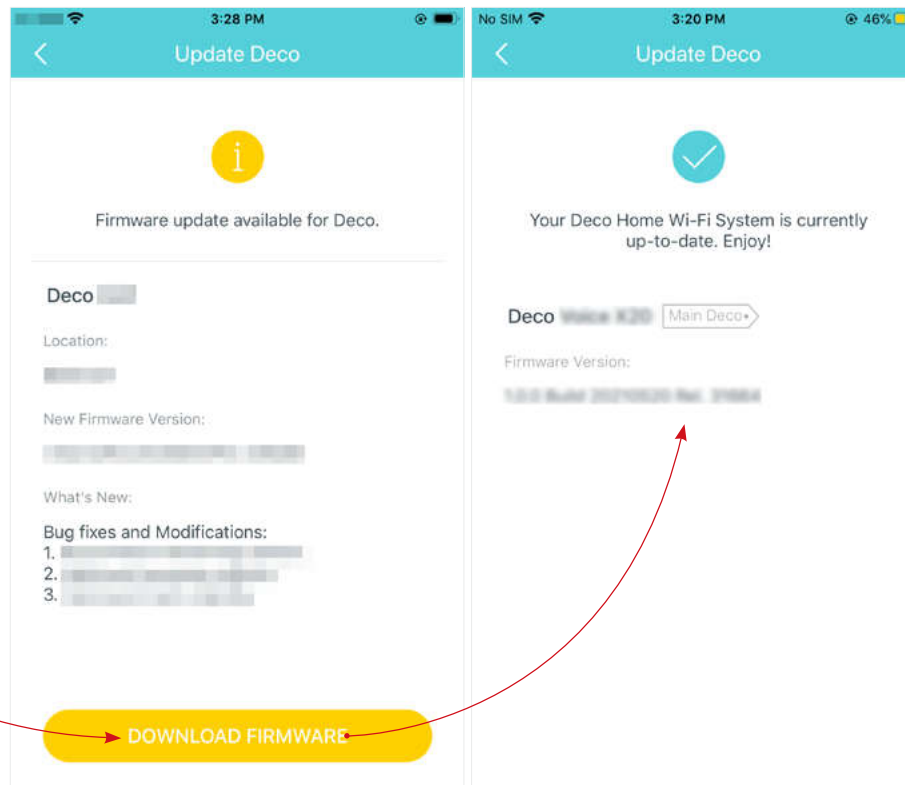

Advanced Features

Additional features are available under the Advanced menu. You can modify WAN settings (IPv4 & IPv6), add IPv6 firewall rules, modify LAN IP, set up DHCP server, enable VLAN/IPTV/MAC Clone mode, reserve the same IP address for a specific device, set up port forwarding rules to make your local computers accessible to other devices over the internet, enable TP-Link DDNS/SIP ALG/UPNP/fast roaming/beamforming, control Deco's LED, change the operation mode, set connection alerts and notifications.

Tap  > [Advanced](#).

View IPv4 details or change the internet connection type.

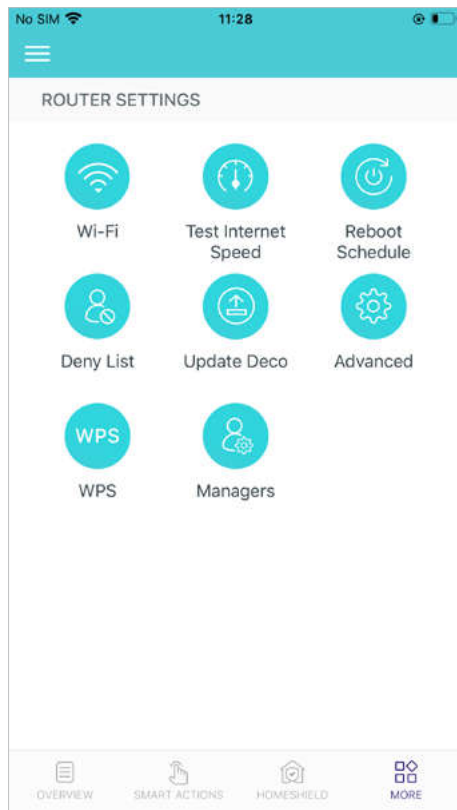

Enable IPv6 to set up an IPv6 internet connection.



Add IPv6 firewall rules to allow specific devices to access the specified services.

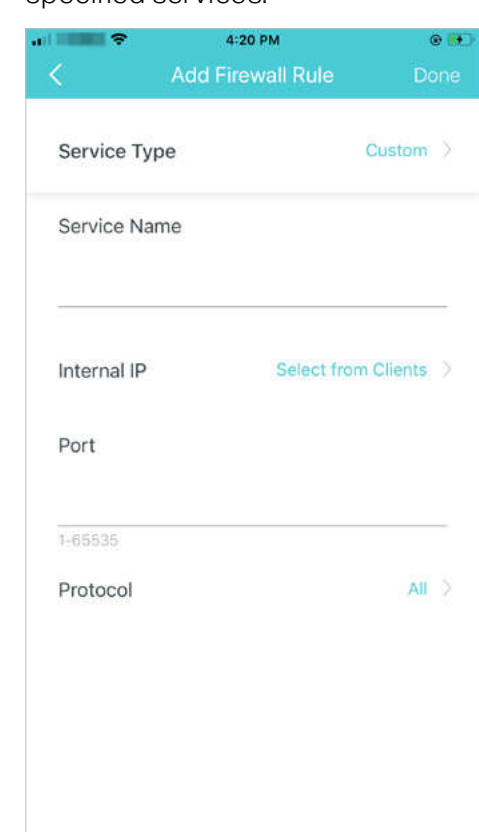
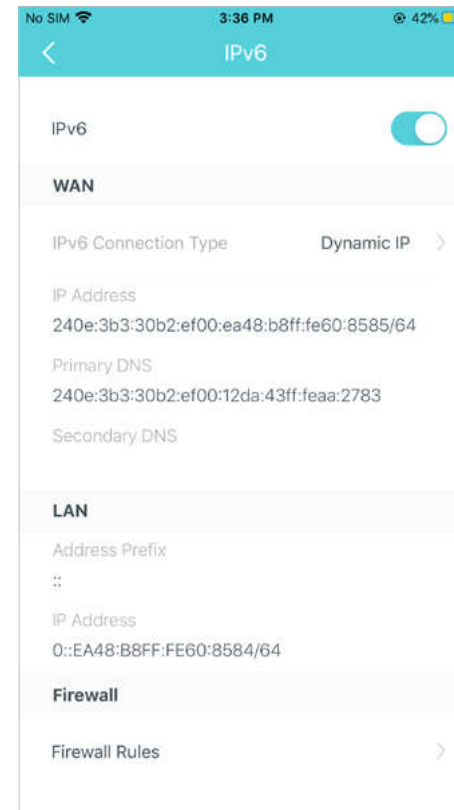

Modify LAN IP to avoid IP address conflict.

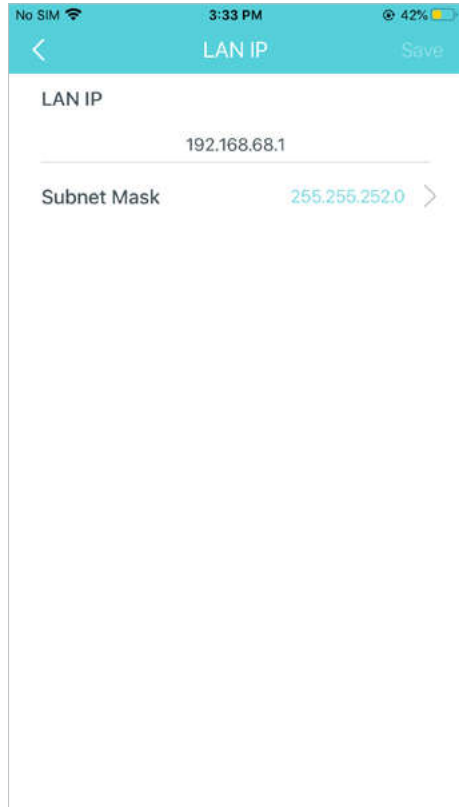

Change DHCP server settings.

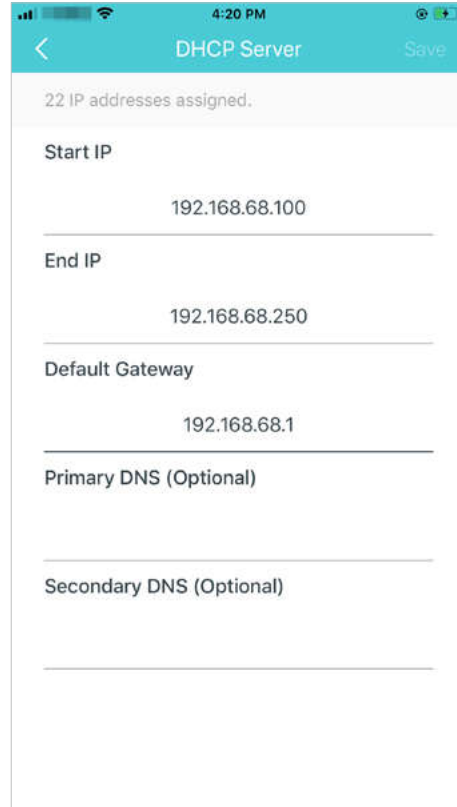

Enable IPTV/VLAN mode to support IPTV services.

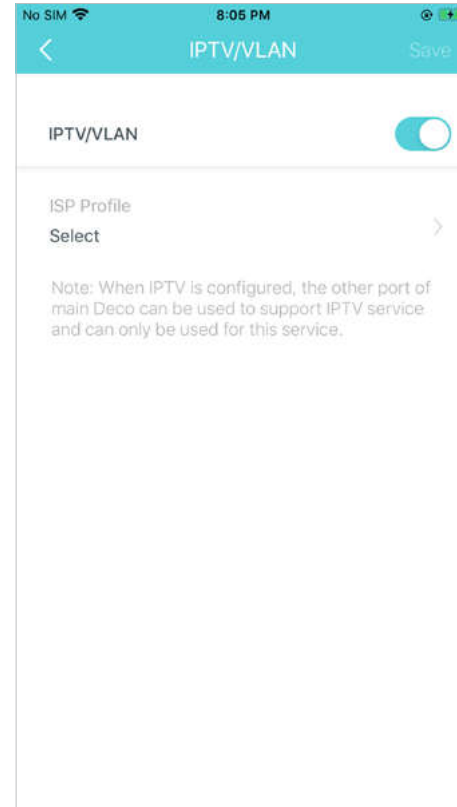

Enable MAC Clone if Deco fails to connect to the internet.

Tip: For more about MAC Clone, refer to <https://www.tp-link.com/support/faq/2925/>

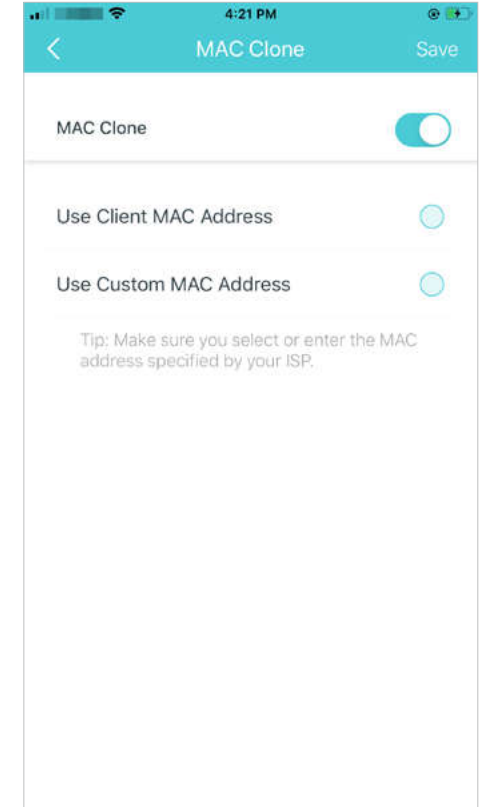

Reserve IP addresses for specific devices to recognize and manage the device more easily.



Set up port forwarding rules to enable devices in your network accessible over the internet with safety.

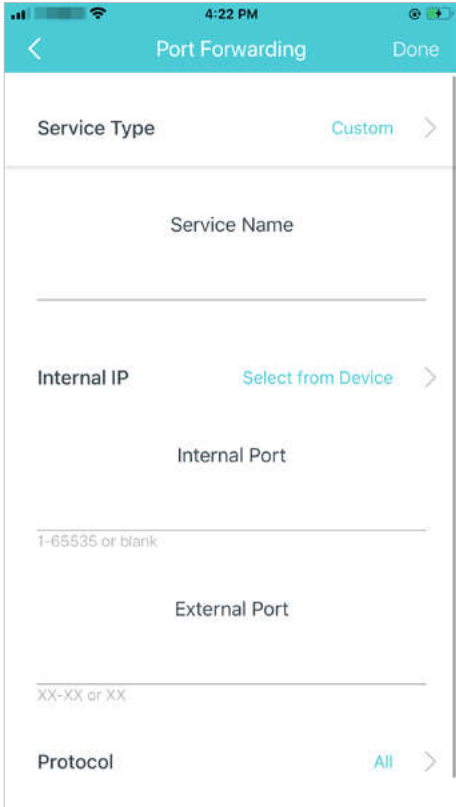

Register a TP-Link DDNS domain name to access your router and local servers using a domain name.

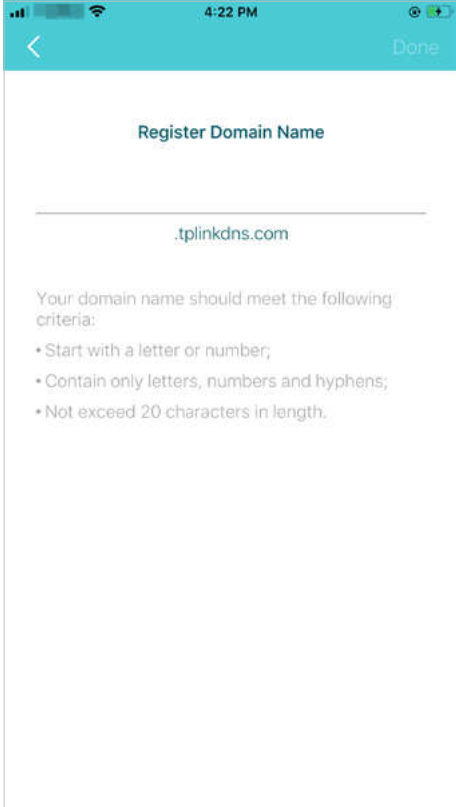

Enable SIP ALG to communicate with SIP (Session Initiation Protocol) servers via NAT).

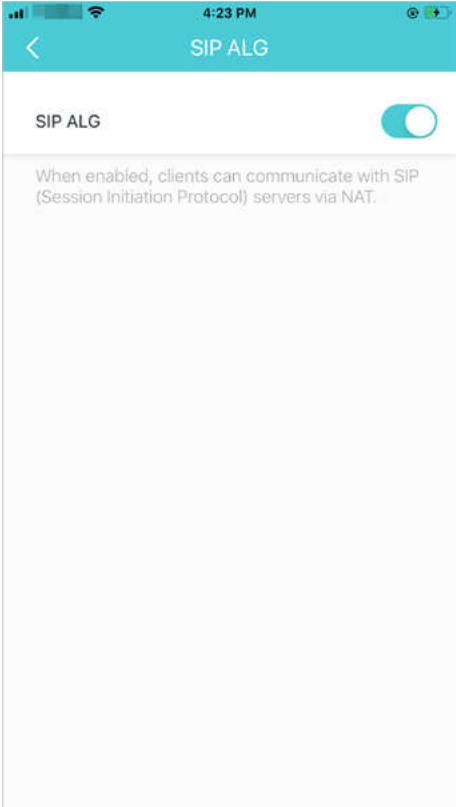

Enable UPNP to allow your local network to dynamically open ports for applications like gaming.



Enable Fast Roaming to allow your wireless devices to switch connection to different Decos.

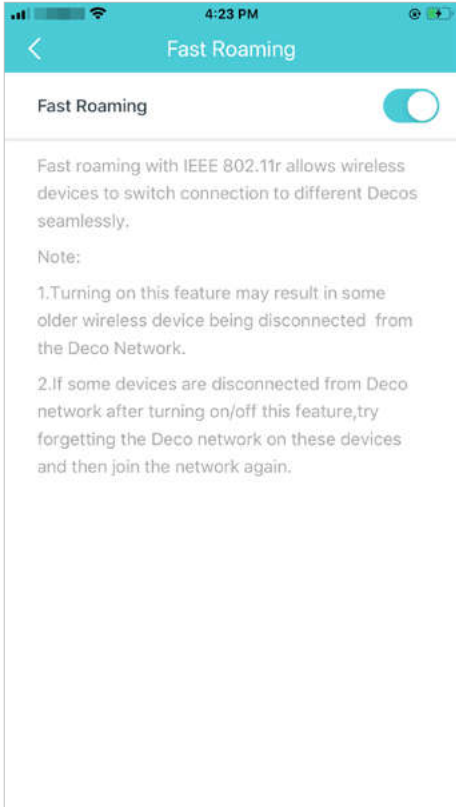

Enable Beamforming to concentrate Wi-Fi signal towards connected devices for stronger connections.

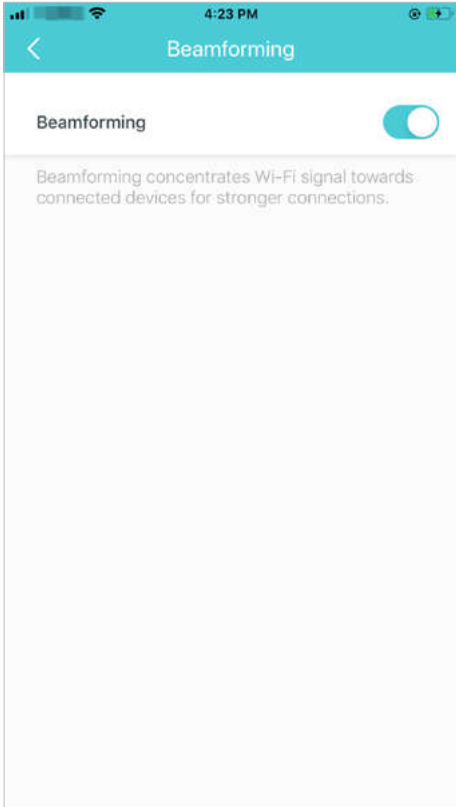

Toggle off LED to turn off the light on Deco. Configure the Night Mode to turn off the LED light at bedtime only.

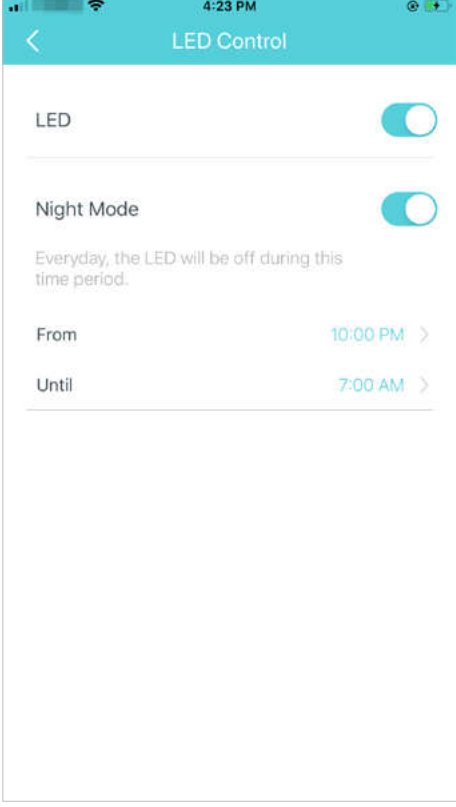

Change the operation mode.

Note: When the Deco works in Access Point mode, advanced features such as IPv4, Address Reservation, Port Forwarding, and DHCP server are not available.

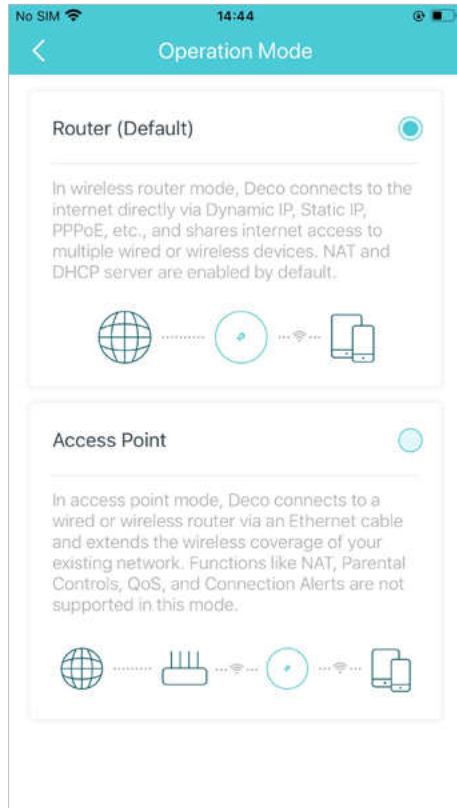

Set connection alerts to receive notifications once the clients connect to or disconnect from Deco.

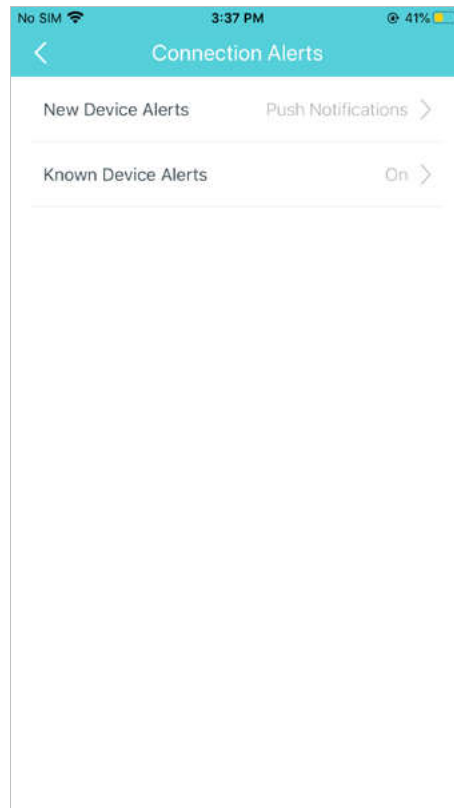

Set notifications to receive alerts in the notification bar.

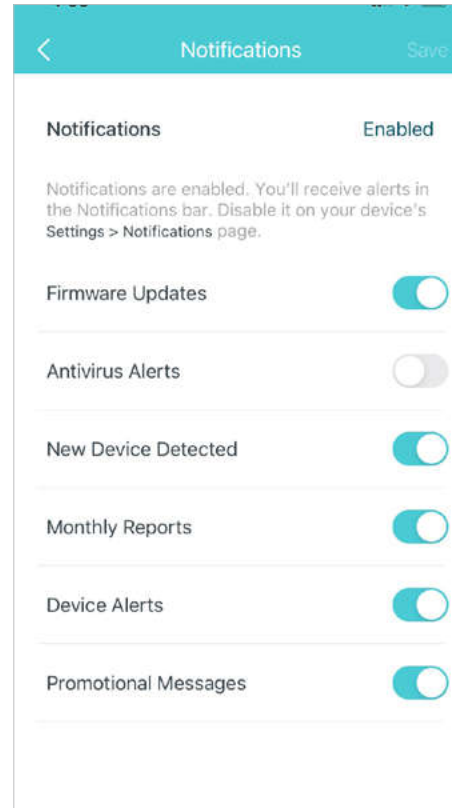

WPS

WPS (Wi-Fi Protected Setup) helps you to quickly and securely connect a client to the network with a tap without entering any password.

1. Tap  > WPS.

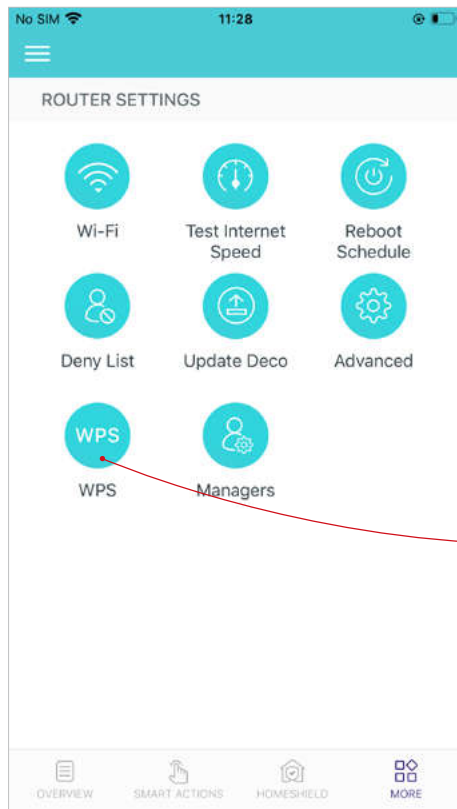

2. Tap the WPS icon on Deco app and then on your client.

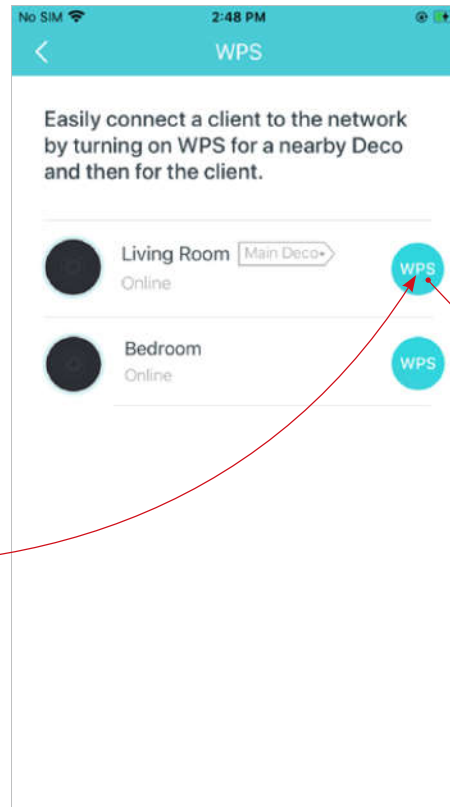

3. Your device has connected to the network successfully if shown as below.

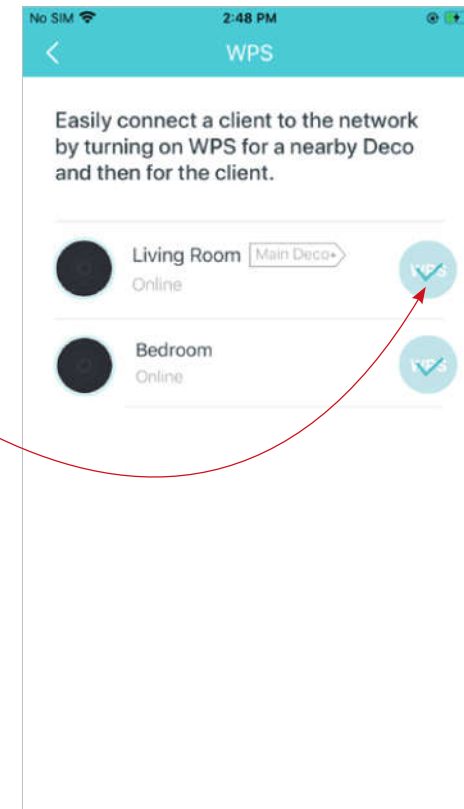

Managers

Add friends and family members to help manage your network. Each manager should have their own TP-Link ID.

Note: Managers can not modify owner's account, add other accounts, or set manager privileges.

Tap  > [Managers](#), and follow app instructions to add other TP-Link ID accounts as managers.

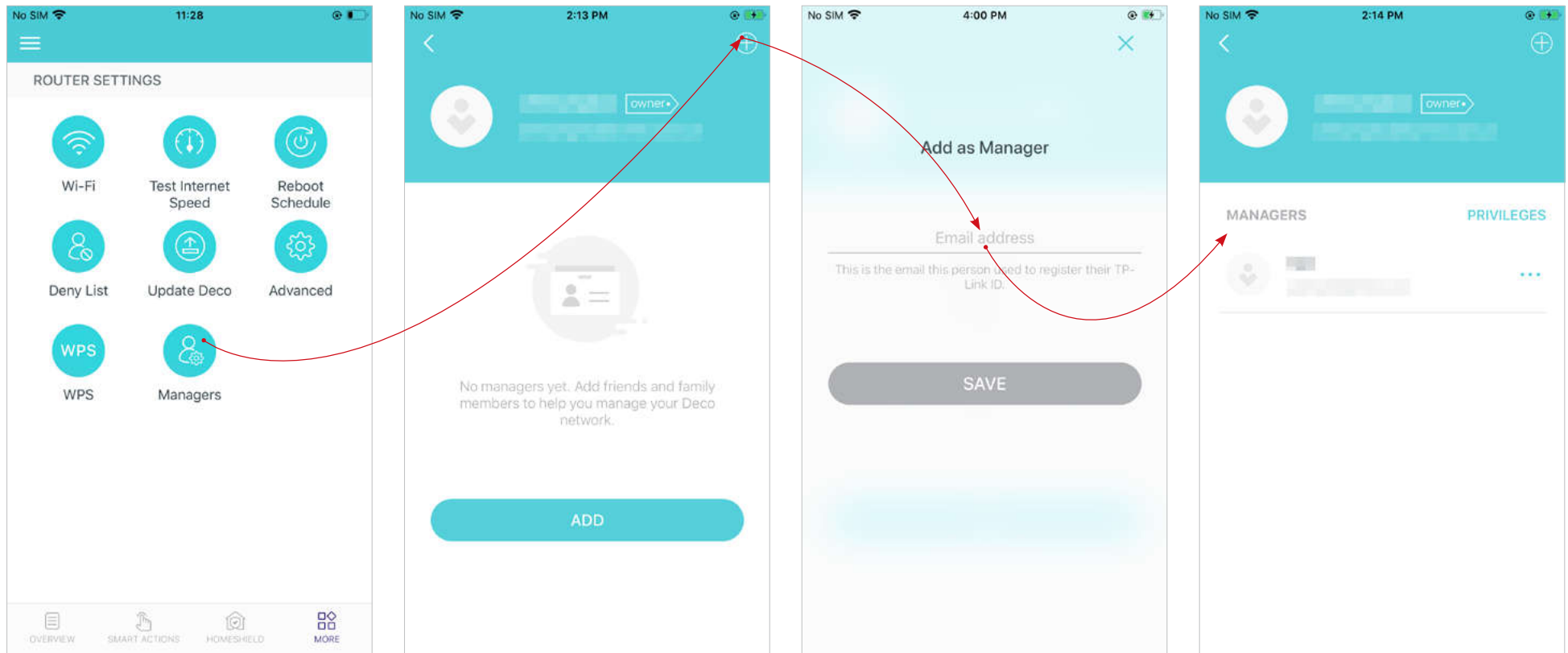

Set privileges for managers.

Note: Privileges may vary slightly depending on the model, the current operation mode, and software version you have.

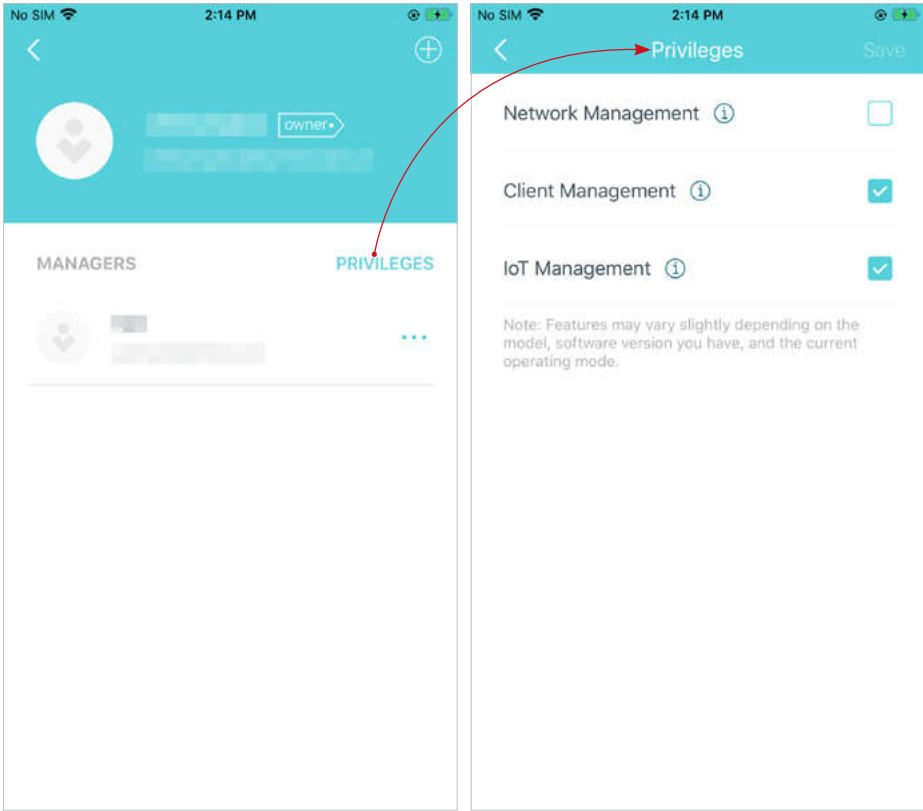

Remove managers.

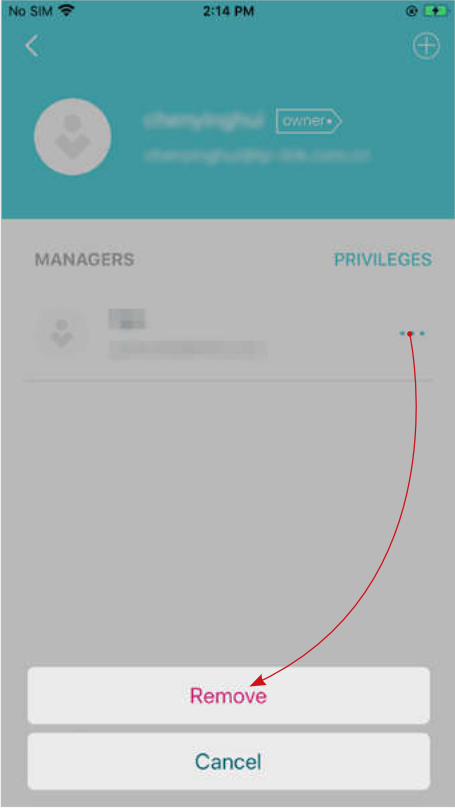

Control Your Deco with Alexa

Alexa Integration allows you to control your Deco using Amazon's Alexa voice service. You can control and customize your home network by giving simple voice commands to Alexa, such as enabling the Guest Network, turning off your Deco LEDs, and more.

Follow the steps below to use Alexa voice commands to control your Deco network.

Tip: To know more about how to set up Alexa Integration in Alexa app, refer to <https://www.tp-link.com/support/faq/1571/>.

Note: This feature is currently available in English (US), English (UK), German and Japanese.

In the Deco app, tap  to open the menu, tap **Friends of Deco** > **Alexa** > **TP-Link Router Skill**, then follow the app instructions to complete the setup.

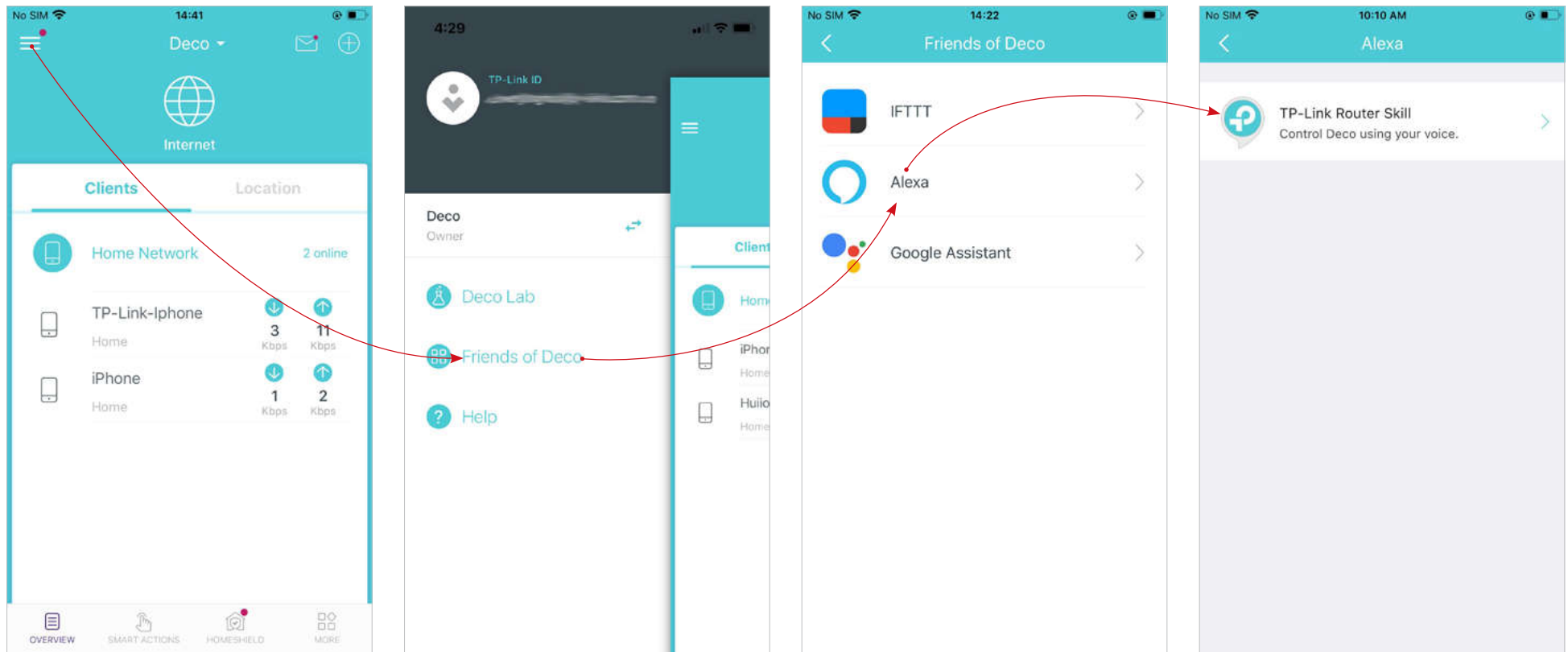

Troubleshooting

Solutions to common problems during setup or use are provided here for reference. Follow the steps and the provided link below to diagnose and solve problems you might experience with your Deco.

If problems still exist, contact us: <https://www.tp-link.com/support>

Q1. What should I do if I fail to configure the main Deco and get stuck on “We couldn't find Deco”?

Refer to the guide <https://www.tp-link.com/support/faq/2239/> or follow the video <https://youtu.be/2HYuEYS9XJM>

Q2. What should I do if I fail to configure the satellite Deco and get stuck on “We couldn't find another Deco”?

Refer to the guide <https://www.tp-link.com/support/faq/1447/> or follow the video <https://youtu.be/iVgDzoo16T4>

Q3. What should I do if I fail to configure the main Deco and get stuck on “Testing Internet Connection”?

Refer to the video <https://youtu.be/OSUrGdWH-i0>

Q4. What should I do if my wireless devices cannot connect to Deco?

Refer to the guide <https://www.tp-link.com/support/faq/2718/>

Q5. What should I do if Deco suddenly lost internet access?

Refer to the guide <https://www.tp-link.com/support/faq/1454/>

Q6. How can I find a suitable spot for my Deco?

Refer to the guide <https://www.tp-link.com//support/faq/1446/>

Q7. What can I do if the Deco app isn't working properly?

Refer to the guide <https://www.tp-link.com/support/faq/1456/>

Authentication

FCC Compliance Information Statement



Product Name: AX3000 Whole Home Mesh Wi-Fi 6 System with PoE

Model Number: Deco X50-PoE

Component Name	Component Model
I.T.E POWER SUPPLY	T120120-2E4

OPERATING FREQUENCY:2412-2462MHz, 5180-5240MHz, 5250MHz, 5745-5825MHz

Responsible party:

TP-Link USA Corporation

Address: 10 Mauchly, Irvine, CA 92618

Website: <http://www.tp-link.com/us/>

Tel: +1 626 333 0234

Fax: +1 909 527 6804

E-mail: sales.usa@tp-link.com

This equipment has been tested and found to comply with the limits for a Class B digital device, pursuant to part 15 of the FCC Rules. These limits are designed to provide reasonable protection against harmful interference in a residential installation. This equipment generates, uses and can radiate radio frequency energy and, if not installed and used in accordance with the instructions, may cause harmful interference to radio communications. However, there is no guarantee that interference will not occur in a particular installation. If this equipment does cause harmful interference to radio or television reception, which can be determined by turning the equipment off and on, the user is encouraged to try to correct the interference by one or more of the following measures:

- Reorient or relocate the receiving antenna.
- Increase the separation between the equipment and receiver.
- Connect the equipment into an outlet on a circuit different from that to which the receiver is connected.

- Consult the dealer or an experienced radio/ TV technician for help.

This device complies with part 15 of the FCC Rules. Operation is subject to the following two conditions:

1. This device may not cause harmful interference.
2. This device must accept any interference received, including interference that may cause undesired operation.

Any changes or modifications not expressly approved by the party responsible for compliance could void the user's authority to operate the equipment.

Note: The manufacturer is not responsible for any radio or TV interference caused by unauthorized modifications to this equipment. Such modifications could void the user's authority to operate the equipment.

FCC RF Radiation Exposure Statement

This equipment complies with FCC RF radiation exposure limits set forth for an uncontrolled environment. This device and its antenna must not be co-located or operating in conjunction with any other antenna or transmitter.

"To comply with FCC RF exposure compliance requirements, this grant is applicable to only Mobile Configurations. The antennas used for this transmitter must be installed to provide a separation distance of at least 20 cm from all persons and must not be co-located or operating in conjunction with any other antenna or transmitter."

We, TP-Link USA Corporation, has determined that the equipment shown as above has been shown to comply with the applicable technical standards, FCC part 15. There is no unauthorized change is made in the equipment and the equipment is properly maintained and operated.

Issue Date: 2022-9-14

FCC Compliance Information Statement



Product Name: I.T.E POWER SUPPLY

Model Number: T120120-2E4

Responsible party:

TP-Link USA Corporation

Address: 10 Mauchly, Irvine, CA 92618

Website: <http://www.tp-link.com/us/>

Tel: +1 626 333 0234

Fax: +1 909 527 6804

E-mail: sales.usa@tp-link.com

This equipment has been tested and found to comply with the limits for a Class B digital device, pursuant to part 15 of the FCC Rules. These limits are designed to provide reasonable protection against harmful interference in a residential installation. This equipment generates, uses and can radiate radio frequency energy and, if not installed and used in accordance with the instructions, may cause harmful interference to radio communications. However, there is no guarantee that interference will not occur in a particular installation. If this equipment does cause harmful interference to radio or television reception, which can be determined by turning the equipment off and on, the user is encouraged to try to correct the interference by one or more of the following measures:

- Reorient or relocate the receiving antenna.
- Increase the separation between the equipment and receiver.
- Connect the equipment into an outlet on a circuit different from that to which the receiver is connected.
- Consult the dealer or an experienced radio/ TV technician for help.

This device complies with part 15 of the FCC Rules. Operation is subject to the following two conditions:

1. This device may not cause harmful interference.
2. This device must accept any interference received, including interference that may cause undesired operation.

Any changes or modifications not expressly approved by the party responsible for compliance could void the user's authority to operate the equipment.

We, TP-Link USA Corporation, has determined that the equipment shown as above has been shown to comply with the applicable technical standards, FCC part 15. There is no unauthorized change is made in the equipment and the equipment is properly maintained and operated.

Issue Date: 2022-9-14

CE Mark Warning



This is a class B product. In a domestic environment, this product may cause radio interference, in which case the user may be required to take adequate measures.

OPERATING FREQUENCY(the maximum transmitted power)

2400 MHz -2483.5 MHz (20dBm)

5150 MHz -5250 MHz (23dBm)

5250 MHz -5350 MHz (23dBm)

EU Declaration of Conformity

TP-Link hereby declares that the device is in compliance with the essential requirements and other relevant provisions of directives 2014/53/EU, 2009/125/EC, 2011 /65/EU and (EU) 2015/863.

The original EU Declaration of Conformity may be found at <https://www.tp-link.com/en/support/ce/>

RF Exposure Information

This device meets the EU requirements (2014/53/EU Article 3.1a) on the limitation of exposure of the general public to electromagnetic fields by way of health protection.

The device complies with RF specifications when the device used at 20 cm from your body.

National restrictions

Attention: This device may only be used indoors in all EU member states and EFTA countries, and Northern Ireland.

	AT	BE	BG	CH	CY	CZ	DE	DK
	EE	EL	ES	FI	FR	HR	HU	IE
	IS	IT	LI	LT	LU	LV	MT	NL
	NO	PL	PT	RO	SE	SI	SK	UK(NI)



UK Declaration of Conformity

TP-Link hereby declares that the device is in compliance with the essential requirements and other relevant provisions of the Radio Equipment Regulations 2017.

The original UK Declaration of Conformity may be found at <https://www.tp-link.com/support/ukca/>

National restrictions

Attention: This device may only be used indoors in Great Britain.



Canadian Compliance Statement

This device complies with Industry Canada license-exempt RSS standard(s). Operation is subject to the following two conditions:

1. This device may not cause interference, and
2. This device must accept any interference, including interference that may cause undesired operation of the device.

Le présent appareil est conforme aux CNR d'Industrie Canada applicables aux appareils radio exempts de licence. L'exploitation est autorisée aux deux conditions suivantes :

1. l'appareil ne doit pas produire de brouillage;
2. l'utilisateur de l'appareil doit accepter tout brouillage radioélectrique subi, même si le brouillage est susceptible d'en compromettre le fonctionnement.

Caution:

The device for operation in the band 5150–5250 MHz is only for indoor use to reduce the potential for harmful interference to co-channel mobile satellite systems;

DFS (Dynamic Frequency Selection) products that operate in the bands 5250- 5350 MHz.

Avertissement:

Le dispositif fonctionnant dans la bande 5150-5250 MHz est réservé uniquement pour une utilisation à l'intérieur afin de réduire les risques de brouillage préjudiciable aux systèmes de satellites mobiles utilisant les mêmes canaux;

Les produits utilisant la technique d'atténuation DFS (sélection dynamique des fréquences) sur les bandes 5250- 5350 MHz.

Radiation Exposure Statement:

This equipment complies with IC radiation exposure limits set forth for an uncontrolled environment. This equipment should be installed and operated with minimum distance 20cm between the radiator & your body.

Déclaration d'exposition aux radiations:

Cet équipement est conforme aux limites d'exposition aux rayonnements IC établies pour un environnement non contrôlé. Cet équipement doit être installé et utilisé avec un minimum de 20 cm de distance entre la source de rayonnement et votre corps.

Industry Canada Statement

CAN ICES-3 (B)/NMB-3(B)

Korea Warning Statements:

당해 무선설비는 운용중 전파혼신 가능성이 있음.

NCC Notice & BSMI Notice:

注意!

取得審驗證明之低功率射頻器材，非經核准，公司、商號或使用者均不得擅自變更頻率、加大功率或變更原設計之特性及功能。

低功率射頻器材之使用不得影響飛航安全及干擾合法通信；經發現有干擾現象時，應立即停用，並改善至無干擾時方得繼續使用。

前述合法通信，指依電信管理法規定作業之無線電通信。

低功率射頻器材須忍受合法通信或工業、科學及醫療用電波輻射性電機設備之干擾。

應避免影響附近雷達系統之操作。

安全諮詢及注意事項

- 請按照本產品注明的電源類型使用本產品。
- 清潔本產品之前請先切斷電源。請勿使用液體、噴霧清潔劑或濕布進行清潔。
- 注意防潮，請勿將水或其他液體潑灑到本產品上。
- 插槽與開口供通風使用，以確保本產品的操作可靠並防止過熱，請勿堵塞或覆蓋開口。
- 請勿將本產品置放於靠近熱源的地方。除非有正常的通風，否則不可放在密閉位置中。
- 不要私自拆開機殼或自行維修，如產品有故障請與原廠或代理商聯繫。

限用物質含有情況標示聲明書

設備名稱： Equipment name:		型號（型式）： Type designation (Type)				
AX3000 Whole Home Mesh Wi-Fi 6 System with PoE		Deco X50-PoE				
單元 Unit	限用物質及其化學符號 Restricted substances and its chemical symbols					
	鉛 Lead (Pb)	汞 Mercury (Hg)	鎘 Cadmium (Cd)	六價鉻 Hexavalent chromium (Cr ⁺⁶)	多溴聯苯 Polybrominated biphenyls (PBB)	多溴二苯醚 Polybrominated diphenyl ethers (PBDE)
PCB	○	○	○	○	○	○
外殼	○	○	○	○	○	○
電源供應器	—	○	○	○	○	○
其他及其配件	—	○	○	○	○	○

備考1. 超出0.1 wt %” 及 “超出0.01 wt %” 系指限用物質之百分比含量超出百分比含量基準值。

Note 1: “Exceeding 0.1 wt %” and “exceeding 0.01 wt %” indicate that the percentage content of the restricted substance exceeds the reference percentage value of presence condition.

備考2. “○” 系指該項限用物質之百分比含量未超出百分比含量基準值。

Note 2: “○” indicates that the percentage content of the restricted substance does not exceed the percentage of reference value of presence.

備考3. “—” 系指該項限用物質為排除項目。

Note 3: The “—” indicates that the restricted substance corresponds to the exemption.



Продукт сертифіковано згідно с правилами системи УкрСЕПРО на відповідність вимогам нормативних документів та вимогам, що передбачені чинними законодавчими актами України.











Safety Information

- Keep the device away from water, fire, humidity or hot environments.
- Do not attempt to disassemble, repair, or modify the device. If you need service, please contact us.
- Do not use damaged charger or USB cable to charge the device.
- Do not use any other chargers than those recommended.
- Do not use the device where wireless devices are not allowed.
- Adapter shall be installed near the equipment and shall be easily accessible.
- This product uses radios and other components that emit electromagnetic fields. Electromagnetic fields and magnets may interfere with pacemakers and other implanted medical devices. Always keep the product and its power adapter more than 15 cm (6 inches) away from any pacemakers or other implanted medical devices. If you suspect your product is interfering with your pacemaker or any other implanted medical device, turn off your product and consult your physician for information specific to your medical device.

- Use only power supplies which are provided by manufacturer and in the original packing of this product. If you have any questions, please don't hesitate to contact us.
- Operating Temperature: 0°C~40°C (32°F~104°F)

Please read and follow the above safety information when operating the device. We cannot guarantee that no accidents or damage will occur due to improper use of the device. Please use this product with care and operate at your own risk.

Explanation of the symbols on the product label

Symbol	Explanation
	Alternating current
	DC voltage
	Caution
	Operator's manual
	Indoor use only
	Class II equipment
	Energy efficiency Marking
	Polarity of d.c. power connector
	<p>RECYCLING</p> <p>This product bears the selective sorting symbol for Waste electrical and electronic equipment (WEEE). This means that this product must be handled pursuant to European directive 2012/19/EU in order to be recycled or dismantled to minimize its impact on the environment.</p> <p>User has the choice to give his product to a competent recycling organization or to the retailer when he buys a new electrical or electronic equipment.</p>