

RF MEASUREMENT REPORT

FCC ID : 2AXJ4X500D
Applicant : TP-Link Corporation Limited
Application Type : Certification
Product : AX3000 Outdoor/Indoor Mesh Wi-Fi 6 Unit
Model No. : Deco X50-Outdoor
Brand Name : tp-link
FCC Classification : Unlicensed National Information Infrastructure (NII)
FCC Rule Part(s) : Part15 Subpart E (Section 15.407)
Received Date : October 17, 2022
Test Date : October 26, 2022 ~ November 3, 2022
Test By : Owen Tsai
(Owen Tsai)
Reviewed By : Paddy Chen
(Paddy Chen)
Approved By : Chenz Ker
(Chenz Ker)



The test results relate only to the samples tested.

This equipment has been shown to be capable of compliance with the applicable technical standards as indicated in the measurement report and was tested in accordance with the measurement procedures specified in KDB 789033 D02v02r01. Test results reported herein relate only to the item(s) tested.

The test report shall not be reproduced except in full without the written approval of MRT Technology (Taiwan) Co., Ltd.

Revision History

Report No.	Version	Description	Issue Date	Note
2210TW0108-U2	1.0	Original Report	2022-11-30	Valid

CONTENTS

Description	Page
General Information	6
1. INTRODUCTION	7
1.1. Scope	7
1.2. MRT Test Location	7
2. PRODUCT INFORMATION	8
2.1. Equipment Description.....	8
2.2. Product Specification Subjective to this Report.....	8
2.3. Working Frequencies for this report	9
2.4. Description of Available Antennas.....	10
2.5. Test Mode	11
2.6. Configuration of Test System.....	12
2.7. Test System Details.....	12
2.8. Description of Test Software	12
2.9. Applied Standards	13
2.10. Duty Cycle	13
2.11. Test Configuration	15
2.12. EMI Suppression Device(s)/Modifications.....	15
2.13. Labeling Requirements.....	15
3. DESCRIPTION OF TEST	16
3.1. Evaluation Procedure	16
3.2. AC Line Conducted Emissions	16
3.3. Radiated Emissions	17
4. ANTENNA REQUIREMENTS	18
5. TEST EQUIPMENT CALIBRATION DATE	19
6. MEASUREMENT UNCERTAINTY	20
7. TEST RESULT	21
7.1. Summary	21
7.2. 26dB Bandwidth Measurement.....	22
7.2.1. Test Limit	22
7.2.2. Test Procedure used.....	22
7.2.3. Test Setting.....	22
7.2.4. Test Setup	23
7.2.5. Test Result.....	24
7.3. 6dB Bandwidth Measurement.....	33
7.3.1. Test Limit	33
7.3.2. Test Procedure used.....	33

7.3.3. Test Setting.....	33
7.3.4. Test Setup	33
7.3.5. TestResult.....	34
7.4. Output Power Measurement.....	39
7.4.1. Test Limit	39
7.4.2. Test Procedure Used	39
7.4.3. Test Setting.....	39
7.4.4. Test Setup	40
7.4.5. Test Result.....	41
7.5. Transmit Power Control	44
7.5.1. Test Limit	44
7.5.2. Test Procedure Used	44
7.5.3. Test Setting.....	44
7.5.4. Test Setup	44
7.5.5. Test Result.....	44
7.6. Power Spectral Density Measurement.....	45
7.6.1. Test Limit	45
7.6.2. Test Procedure Used	45
7.6.3. Test Setting.....	45
7.6.4. Test Setup	46
7.6.5. Test Result.....	47
7.7. Radiated Spurious Emission Measurement	63
7.7.1. Test Limit	63
7.7.2. Test Procedure Used	63
7.7.3. Test Setting.....	63
7.7.4. Test Setup	65
7.7.5. Test Result.....	66
7.8. Radiated Restricted Band Edge Measurement	134
7.8.1. Test Limit	134
7.8.2. Test Procedure Used	135
7.8.3. Test Setting.....	135
7.8.4. Test Setup	136
7.8.5. Test Result.....	137
7.9. AC Conducted Emissions Measurement.....	197
7.9.1. Test Limit	197
7.9.2. Test Procedure	197
7.9.3. Test Setup	198
7.9.4. Test Result.....	199
8. CONCLUSION.....	203

Appendix A : Test Setup Photograph 204
Appendix B : External Photograph 205
Appendix C : Internal Photograph 206

General Information

Applicant	TP-Link Corporation Limited
Applicant Address	Room 901, 9/F., New East Ocean Centre, 9 Science Museum Road, Tsim Sha Tsui, Kowloon, Hongkong
Manufacturer	TP-Link Corporation Limited
Manufacturer Address	Room 901, 9/F., New East Ocean Centre, 9 Science Museum Road, Tsim Sha Tsui, Kowloon, Hongkong
Test Site	MRT Technology (Taiwan) Co., Ltd
Test Site Address	No. 38, Fuxing Second Rd., Guishan Dist., Taoyuan City 333, Taiwan (R.O.C)
MRT FCC Registration No.	291082
FCC Rule Part(s)	Part 15.407

Test Facility / Accreditations

1. MRT facility is a FCC registered (Reg. No. 291082) test facility with the site description report on file and is designated by the FCC as an Accredited Test Firm.
2. MRT facility is an IC registered (MRT Reg. No. 21723) test laboratory with the site description on file at Industry Canada.
3. MRT Lab is accredited to ISO 17025 by the Taiwan Accreditation Foundation (TAF Cert. No. 3261) in EMC, Telecommunications and Radio testing for FCC (Designation Number: TW3261), Industry Taiwan, EU and TELEC Rules.

1. INTRODUCTION

1.1. Scope

Measurement and determination of electromagnetic emissions (EMC) of radio frequency devices including intentional and/or unintentional radiators for compliance with the technical rules and regulations of the Federal Communications Commission and the Innovation, Science and Economic Development Canada and Certification and Engineering Bureau.

1.2. MRT Test Location

The map below shows the location of the MRT LABORATORY, its proximity to the Taoyuan City. These measurement tests were conducted at the MRT Technology (Taiwan) Co., Ltd. Facility located at No.38, Fuxing 2nd Rd., Guishan Dist., Taoyuan City 33377, Taiwan (R.O.C).

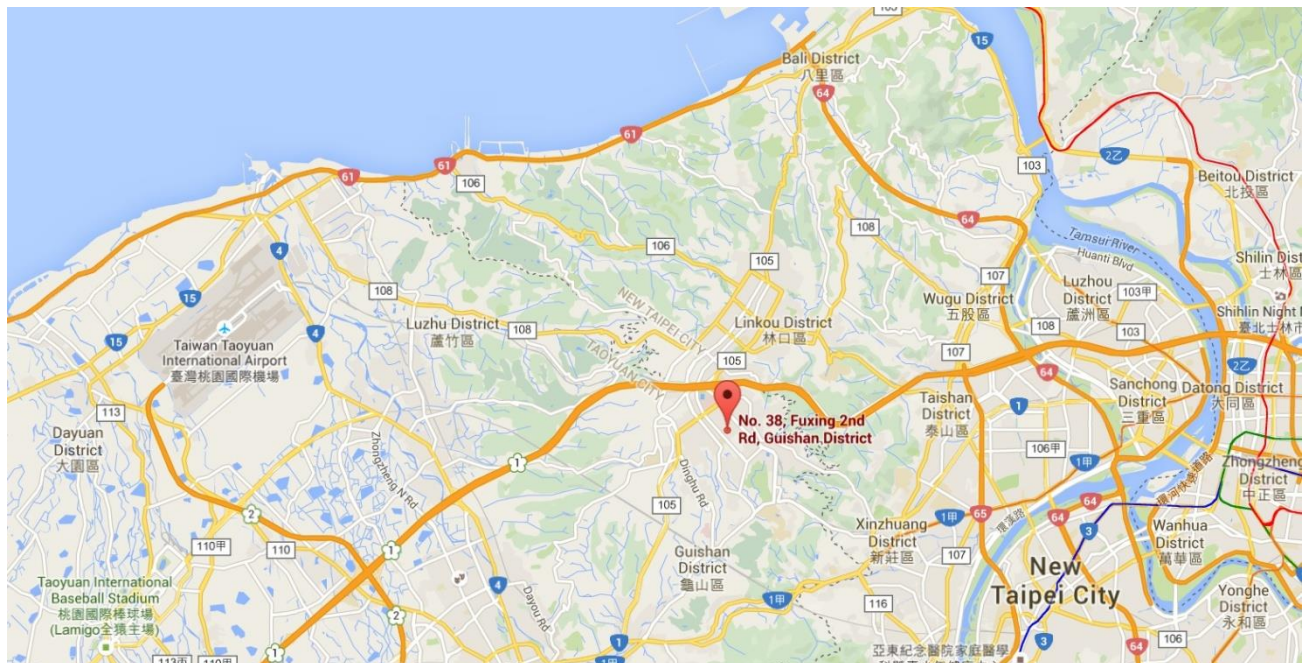

2. PRODUCT INFORMATION

2.1. Equipment Description

Product Name:	AX3000 Outdoor/Indoor Mesh Wi-Fi 6 Unit
Model No.:	Deco X50-Outdoor
Brand Name:	tp-link
Wi-Fi Specification:	802.11a/b/g/n/ac/ax & VHT
EUT Identification No.:	#1-1 (Conducted) #1-2 (Radiated)
Power Supply:	AC100-240V~50/60Hz 0.5A 802.3at PoE: 42.5-57V 0.6A

2.2. Product Specification Subjective to this Report

Frequency Range:	For 802.11a/n-HT20/ac-VHT20/ax-HE20: 5180~5240MHz, 5745~5825MHz For 802.11n-HT40/ac-VHT40/ax-HE40: 5190~5230MHz, 5755~5795MHz For 802.11ac-VHT80/ax-HE80: 5210MHz, 5775MHz For 802.11ac-VHT160/ax-HE160: 5250MHz
Type of Modulation:	802.11a/n/ac: OFDM 802.11ax: OFDMA
Data Rate:	802.11a: 6/9/12/18/24/36/48/54Mbps 802.11n: up to 300Mbps 802.11ac: up to 1733.3Mbps 802.11ax: up to 2402Mbps

Note: For other features of this EUT, test report will be issued separately.

2.3. Working Frequencies for this report

802.11a/n-HT20/ac-VHT20/ax-HE20

Channel	Frequency	Channel	Frequency	Channel	Frequency
36	5180 MHz	40	5200 MHz	44	5220 MHz
48	5240 MHz	149	5745 MHz	153	5765 MHz
157	5785 MHz	161	5805 MHz	165	5825 MHz

802.11n-HT40/ac-VHT40/ax-HE40

Channel	Frequency	Channel	Frequency	Channel	Frequency
38	5190 MHz	46	5230 MHz	151	5755 MHz
159	5795 MHz	--	--	--	--

802.11ac-VHT80/ax-HE80

Channel	Frequency	Channel	Frequency	Channel	Frequency
42	5210 MHz	155	5775 MHz	--	--

802.11ac-VHT160/ax-HE160

Channel	Frequency	Channel	Frequency	Channel	Frequency
50	5250MHz	--	--	--	--

2.4. Description of Available Antennas

Antenna Type	Frequency Band (MHz)	T _X Paths	Max Antenna Gain (dBi)	Max. Antenna Gain (at any elevation angle above 30 degrees) (dBi)	CDD Directional Gain (dBi)	
					For Power	For PSD
Dipole Antenna	5150 ~ 5250	2	1.00	-4.0	1.00	4.01
	5250 ~ 5850	2	1.00	--	1.00	4.01

Note:

- The EUT supports Cyclic Delay Diversity (CDD) mode, and CDD signals are correlated.
If all antennas have the same gain, G_{ANT} , Directional gain = G_{ANT} + Array Gain, where Array Gain is as follows.
 - For power spectral density (PSD) measurements on all devices,
Array Gain = $10 \log(N_{ANT}/ N_{SS})$ dB;
 - For power measurements on IEEE 802.11 devices,
Array Gain = 0 dB for $N_{ANT} \leq 4$;
- All messages of antenna were declared by manufacturer.

2.5. Test Mode

CDD Mode
Mode 1: Transmit by 802.11a_Nss=1 (6Mbps)
Mode 2: Transmit by 802.11ac-VHT20_Nss=1 (MCS0)
Mode 3: Transmit by 802.11ac-VHT40_Nss=1 (MCS0)
Mode 4: Transmit by 802.11ac-VHT80_Nss=1 (MCS0)
Mode 5: Transmit by 802.11ac-VHT160_Nss=1 (MCS0)
Mode 6: Transmit by 802.11ax-HE20_Nss=1 (MCS0)
Mode 7: Transmit by 802.11ax-HE40_Nss=1 (MCS0)
Mode 8: Transmit by 802.11ax-HE80_Nss=1 (MCS0)
Mode 9: Transmit by 802.11ax-HE160_Nss=1 (MCS0)
Remark: <ol style="list-style-type: none">1. For Radiated emission, the modulation and the data rate picked for testing are determined by the Max. RF conducted power.2. This device supports 2 N_{ss} and power level of 2 N_{ss} is less than or equal to the power of 1 N_{ss}. The worst case is N_{ss}=1.3. Due to the same modulation between 802.11n and 802.11ac, so 802.11n-HT20 and HT40 are covered by 802.11ac-VHT20 and VHT40 in this report, meanwhile, power level for 802.11n-HT20 and HT40 will not be greater than 802.11ac-VHT20 and VHT40.4. EUT supports one configuration only in 802.11ax full RU mode.

2.6. Configuration of Test System

The device was tested per the guidance ANSI C63.10: 2013 was used to reference the appropriate EUT setup for radiated emissions testing and AC line conducted testing.

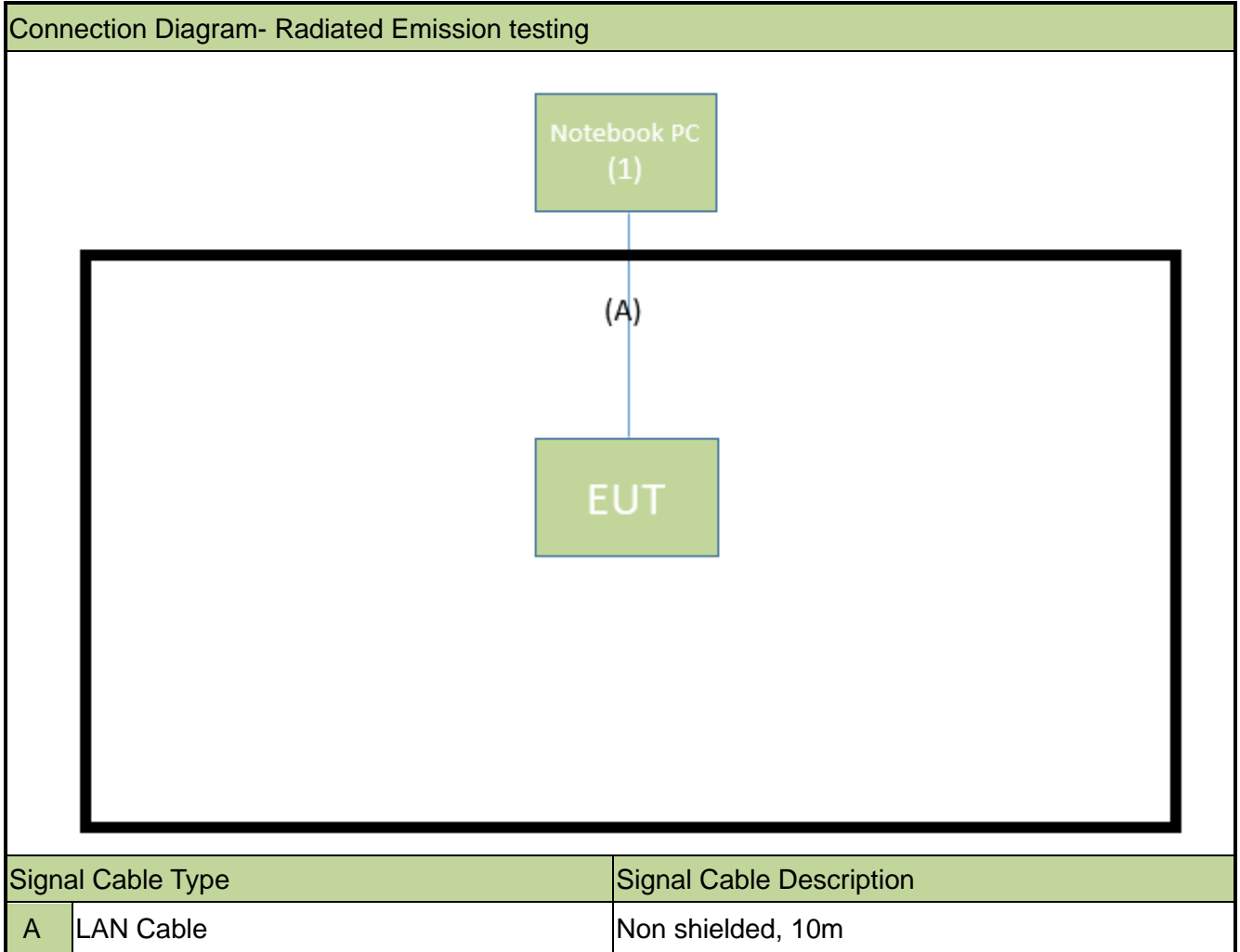

2.7. Test System Details

The types for all equipments, plus descriptions of all cables used in the tested system (including inserted cards) are:

	Product	Manufacturer	Model No.	Serial No.	Power Cord
1	Notebook PC	Lenovo	T450	N/A	Non-Shielded, 0.8m

2.8. Description of Test Software

The test utility software used during testing was “QDART”, the version is ver1.0.67.

Note: Final power setting please refer to operational description.

2.9. Applied Standards

According to the specifications of the manufacturer, the EUT must comply with the requirements of the following standards:

- FCC Part 15.247
- KDB 789033 D02v02r01,
- KDB 662911 D01v02r01
- ANSI C63.10-2013

2.10. Duty Cycle

5GHz (NII) operation is possible in 20MHz, 40MHz, 80MHz and 160MHz channel bandwidths. The maximum achievable duty cycles for all modes were determined based on measurements performed on a spectrum analyzer in zero-span mode with RBW = 10MHz, VBW = 10MHz. The RBW and VBW were both greater than 50/T, where T is the minimum transmission duration, and the number of sweep points across T was greater than 100. The duty cycles are as follows:

Test Mode	Duty Cycle
802.11a	94.24%
802.11ac-VHT20	90.73%
802.11ac-VHT40	88.04%
802.11ac-VHT80	90.61%
802.11ac-VHT160	89.14%
802.11ax-HE20	91.78%
802.11ax-HE40	91.05%
802.11ax-HE80	91.29%
802.11ax-HE160	90.66%

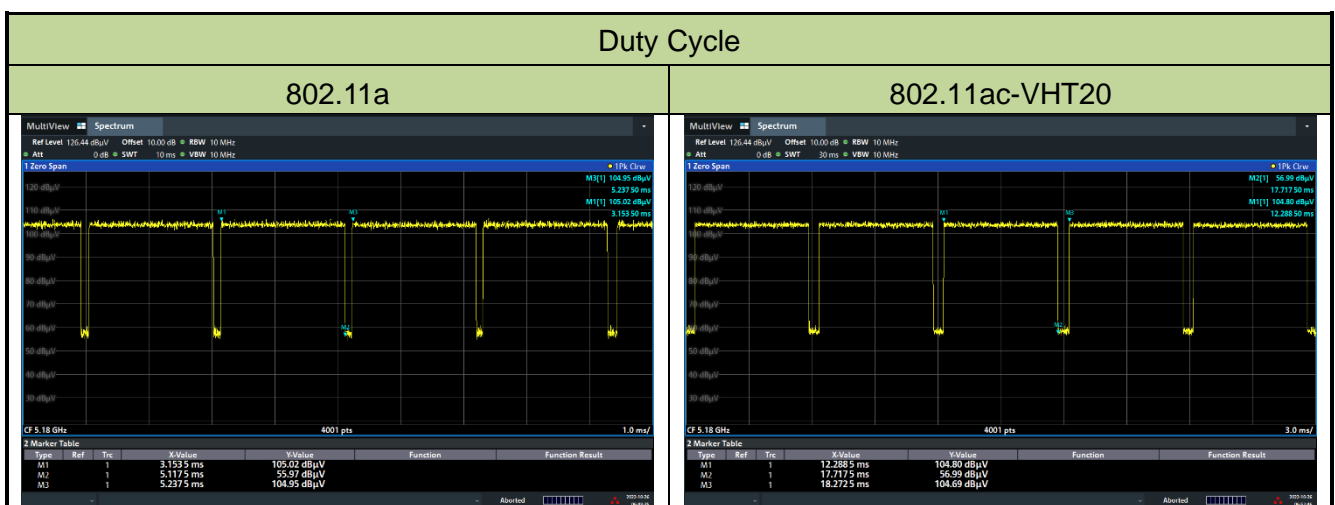

Duty Cycle

802.11ac-VHT40

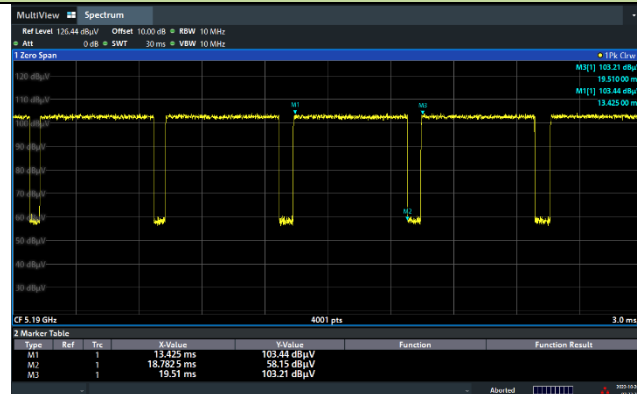

802.11ac-VHT80

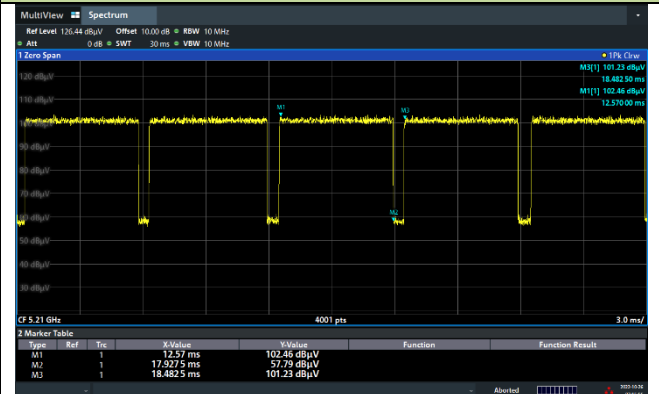

802.11ac-VHT160

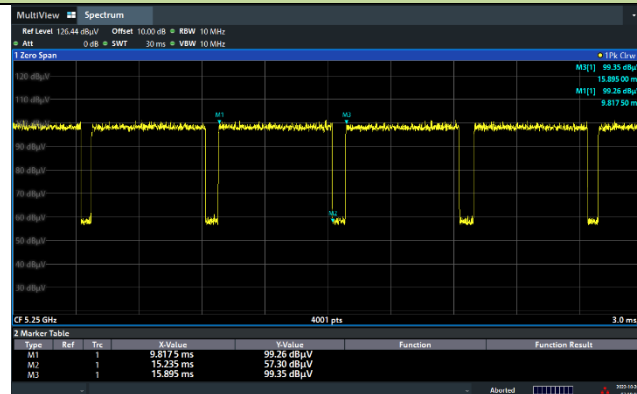

802.11ax-HE20

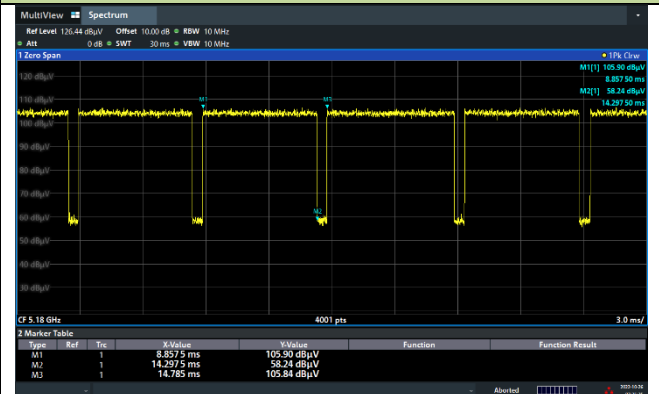

802.11ax-HE40

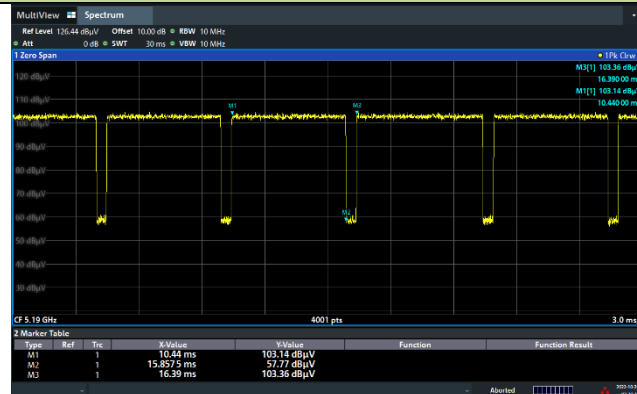

802.11ax-HE80

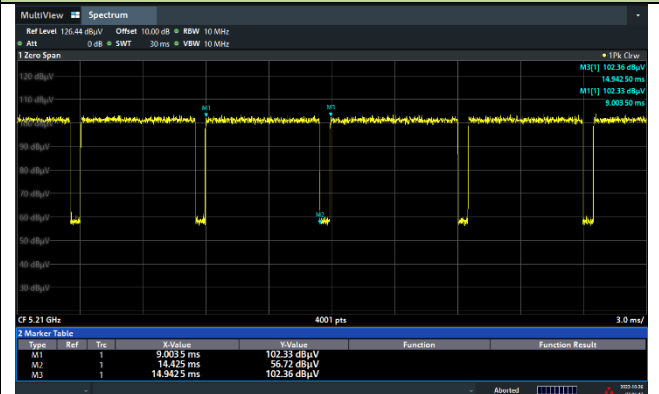

802.11ax-HE160

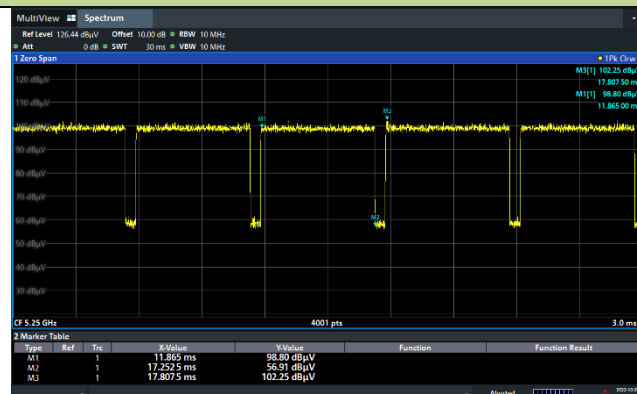

2.11. Test Configuration

The device was tested per the guidance of KDB 789033 D02v02r01. ANSI C63.10-2013 was used to reference the appropriate EUT setup for radiated spurious emissions testing and AC line conducted testing.

2.12. EMI Suppression Device(s)/Modifications

No EMI suppression device(s) were added and/or no modifications were made during testing.

2.13. Labeling Requirements

Per 2.1074 & 15.19; Docket 95-19

The label shall be permanently affixed at a conspicuous location on the device; instruction manual or pamphlet supplied to the user and be readily visible to the purchaser at the time of purchase. However, when the device is so small wherein placement of the label with specified statement is not practical, only the FCC ID must be displayed on the device per Section 15.19(a)(5). Please see attachment for FCC ID label and label location.

3. DESCRIPTION OF TEST

3.1. Evaluation Procedure

The measurement procedures described in the American National Standard of Procedures for Compliance Testing of Unlicensed Wireless Devices (ANSI C63.10-2013), and the guidance provided in KDB 789033 D02v02r01 were used in the measurement.

3.2. AC Line Conducted Emissions

The line-conducted facility is located inside an 8'x4'x4' shielded enclosure. A 1m x 2m wooden table 80cm high is placed 40cm away from the vertical wall and 80cm away from the sidewall of the shielded room. Two 10kHz-30MHz, 50Ω/50uH Line-Impedance Stabilization Networks (LISNs) are bonded to the shielded room floor. Power to the LISNs is filtered by external high-current high-insertion loss power line filters. These filters attenuate ambient signal noise from entering the measurement lines. These filters are also bonded to the shielded enclosure.

The EUT is powered from one LISN and the support equipment is powered from the second LISN. All interconnecting cables more than 1 meter were shortened to a 1 meter length by non-inductive bundling (serpentine fashion) and draped over the back edge of the test table. All cables were at least 40cm above the horizontal reference ground-plane. Power cables for support equipment were routed down to the second LISN while ensuring that that cables were not draped over the second LISN.

Sufficient time for the EUT, support equipment, and test equipment was allowed in order for them to warm up to their normal operating condition. The RF output of the LISN was connected to the receiver and exploratory measurements were made to determine the frequencies producing the maximum emission from the EUT. The receiver was scanned from 150kHz to 30MHz. The detector function was set to peak mode for exploratory measurements while the bandwidth of the analyzer was set to 9kHz. The EUT, support equipment, and interconnecting cables were arranged and manipulated to maximize each emission. Each emission was also maximized by varying: power lines, the mode of operation or data exchange speed, or support equipment whichever determined the worst-case emission. Once the worst case emissions have been identified, the one EUT cable configuration/arrangement and mode of operation that produced these emissions are used for final measurements on the same test site. The analyzer is set to CISPR quasi-peak and average detectors with a 9kHz resolution bandwidth for final measurements.

An extension cord was used to connect to a single LISN which powered by EUT. The extension cord was calibrated with LISN, the impedance and insertion loss are compliance with the requirements as stated in ANSI C63.10-2013.

3.3. Radiated Emissions

The radiated test facilities consisted of an indoor 3 meter semi-anechoic chamber used for final measurements and exploratory measurements, when necessary. The measurement area is contained within the semi-anechoic chamber which is shielded from any ambient interference. For measurements above 1GHz absorbers are arranged on the floor between the turn table and the antenna mast in such a way so as to maximize the reduction of reflections. For measurements below 1GHz, the absorbers are removed. A MF Model 210SS turntable is used for radiated measurement. It is a continuously rotatable, remote controlled, metallic turntable and 2 meters (6.56 ft.) in diameter. The turn table is flush with the raised floor of the chamber in order to maintain its function as a ground plane. An 80cm high PVC support structure is placed on top of the turntable.

For all measurements, the spectrum was scanned through all EUT azimuths and from 1 to 4 meter receive antenna height using a broadband antenna from 30MHz up to the upper frequency shown in 15.33(b)(1) depending on the highest frequency generated or used in the device or on which the device operates or tunes. For frequencies above 1GHz, linearly polarized double ridge horn antennas were used. For frequencies below 30MHz, a calibrated loop antenna was used. When exploratory measurements were necessary, they were performed at 1 meter test distance inside the semi-anechoic chamber using broadband antennas, broadband amplifiers, and spectrum analyzers to determine the frequencies and modes producing the maximum emissions. Sufficient time for the EUT, support equipment, and test equipment was allowed in order for them to warm up to their normal operating condition. The test set-up for frequencies below 1GHz was placed on top of the 0.8 meter high, 1 x 1.5 meter table; and test set-up for frequencies 1-40GHz was placed on top of the 1.5 meter high, 1 x 1.5 meter table. The EUT, support equipment, and interconnecting cables were arranged and manipulated to maximize each emission. Appropriate precaution was taken to ensure that all emissions from the EUT were maximized and investigated. The system configuration, clock speed, mode of operation or video resolution, if applicable, turntable azimuth, and receive antenna height was noted for each frequency found.

Final measurements were made in the semi-anechoic chamber using calibrated, linearly polarized broadband and horn antennas. The test setup was configured to the setup that produced the worst case emissions. The spectrum analyzer was set to investigate all frequencies required for testing to compare the highest radiated disturbances with respect to the specified limits. The turntable containing the EUT was rotated through 360 degrees and the height of the receive antenna was varied 1 to 4 meters and stopped at the azimuth and height producing the maximum emission. Each emission was maximized by changing the orientation of the EUT through three orthogonal planes and changing the polarity of the receive antenna, whichever produced the worst-case emissions. According to 3dB Beam-Width of horn antenna, the horn antenna should be always directed to the EUT when rising height.

4. ANTENNA REQUIREMENTS

Excerpt from §15.203 of the FCC Rules/Regulations:

“An intentional radiator antenna shall be designed to ensure that no antenna other than that furnished by the responsible party can be used with the device. The use of a permanently attached antenna or of an antenna that uses a unique coupling to the intentional radiator shall be considered sufficient to comply with the provisions of this section.”

- The antenna of the device is **permanently attached**.
- There are no provisions for connection to an external antenna.

Conclusion:

The unit complies with the requirement of §15.203.

5. TEST EQUIPMENT CALIBRATION DATE

Conducted Emissions

Instrument	Manufacturer	Type No.	Asset No.	Cali. Interval	Cali. Due Date
Two-Line V-Network	R&S	ENV216	MRTTWA00019	1 year	2023/3/7
Two-Line V-Network	R&S	ENV216	MRTTWA00020	1 year	2023/4/20
EMI Test Receiver	R&S	ESR3	MRTTWA00045	1 year	2023/5/9
DIVA PLUS Funk-Wetterstation	TFA	35.1083	MRTTWA00050	1 year	2023/6/16

Radiated Emissions

Instrument	Manufacturer	Type No.	Asset No.	Cali. Interval	Cali. Due Date
Broadband TRILOG Antenna	SCHWARZBECK	VULB 9162	MRTTWA00001	1 year	2022/12/4
EMI Test Receiver	R&S	ESR3	MRTTWA00009	1 year	2023/3/9
Signal Analyzer	R&S	FSV40	MRTTWA00007	1 year	2023/3/16
Active Loop Antenna	Schwarzbeck	FMZB 1519B	MRTTWA00002	1 year	2023/5/24
Broadband Hornantenna	RFSPIN	DRH18-E	MRTTWA00087	1 year	2023/5/10
Breitband Hornantenna	Schwarzbeck	BBHA 9170	MRTTWA00004	1 year	2023/3/29
Broadband Preamplifier	EMC Instruments corporation	EMC118A45S E	MRTTWA00088	1 year	2023/5/9
Broadband Preamplifier	SCHWARZBECK	BBV 9718	MRTTWA00005	1 year	2023/3/30
Cable	HUBERSUHNER	SF106	MRTTWE00034	1 year	2023/6/27

Conducted Test Equipment

Instrument	Manufacturer	Type No.	Asset No.	Cali. Interval	Cali. Due Date
X-Series USB Peak and Average Power Sensor	KEYSIGHT	U2021XA	MRTTWA00014	1 year	2023/4/20
EXA Signal Analyzer	KEYSIGHT	N9010A	MRTTWA00012	1 year	2023/10/5
EXA Signal Analyzer	KEYSIGHT	N9010B	MRTTWA00074	1 year	2023/7/19
Attenuator	WTI	218FS-20	MRTTWE00026	1 year	2022/11/18
Attenuator	WTI	218FS-10	MRTTWE00027	1 year	2023/6/15
Temperature & Humidity Chamber	TEN BILLION	TTH-B3UP	MRTTWA00036	1 year	2023/6/14
DIVA PLUS Funk-Wetterstation	TFA	35.1083	MRTTWA00050	1 year	2023/6/16

Software	Version	Function
e3	9.160520a	EMI Test Software

6. MEASUREMENT UNCERTAINTY

Where relevant, the following test uncertainty levels have been estimated for tests performed on the EUT as specified in CISPR 16-4-2. This uncertainty represents an expanded uncertainty expressed at approximately the 95% confidence level using a coverage factor of $k = 2$.

AC Conducted Emission Measurement
Measuring Uncertainty for a Level of Confidence of 95% ($U=2Uc(y)$): 150kHz~30MHz: $\pm 2.53\text{dB}$
Radiated Emission Measurement
Measuring Uncertainty for a Level of Confidence of 95% ($U=2Uc(y)$): 9kHz ~ 1GHz: $\pm 4.25\text{dB}$ 1GHz ~ 40GHz: $\pm 4.45\text{dB}$
Conducted Power (Carrier Power / Power Density)
Measuring Uncertainty for a Level of Confidence of 95% ($U=2Uc(y)$): $\pm 0.84\text{dB}$
Conducted Spurious Emission
Measuring Uncertainty for a Level of Confidence of 95% ($U=2Uc(y)$): $\pm 2.65\text{ dB}$
Occupied Bandwidth
Measuring Uncertainty for a Level of Confidence of 95% ($U=2Uc(y)$): $\pm 3.3\%$
Temp. / Humidity
Measuring Uncertainty for a Level of Confidence of 95% ($U=2Uc(y)$): $\pm 0.82^\circ\text{C} / \pm 3\%$
Frequency Error
Measuring Uncertainty for a Level of Confidence of 95% ($U=2Uc(y)$): $\pm 78.4\text{Hz}$

7. TEST RESULT

7.1. Summary

FCC Section(s)	Test Description	Test Limit	Test Condition	Test Result	Reference
15.407(a)	26dB Bandwidth	N/A	Conducted	Pass	Section 7.2
15.407(e)	6dB Bandwidth	$\geq 500\text{kHz}$		Pass	Section 7.3
15.407(a)(1)(i)(ii), (2), (3)	Maximum Conducted Output Power	Refer to section 7.4		Pass	Section 7.4
15.407(h)(1)	Transmit Power Control	$\leq 24 \text{ dBm}$		Pass	Section 7.5
15.407(a)(1)(i)(ii), (2), (3), (12)	Peak Power Spectral Density	Refer to section 7.6		Pass	Section 7.6
15.407(g)	Frequency Stability	$\pm 20 \text{ ppm}$		Pass	Section 7.7
15.407(b)(1), (2), (3), (4)(i)	Undesirable Emissions	Refer to Section 7.8	Radiated	Pass	Section 7.8 & 7.9
15.205, 15.209 15.407(b)(8), (9), (10)	General Field Strength Limits (Restricted Bands and Radiated Emission Limits)	Emissions in restricted bands must meet the radiated limits detailed in 15.209		Pass	
15.207	AC Conducted Emissions 150kHz - 30MHz	< FCC 15.207 limits	Line Conducted	Pass	Section 7.10

Notes:

- 1) Determining compliance is based on the test results met the regulation limits or requirements declared by clients, and the test results don't take into account the value of measurement uncertainty.
- 2) The analyzer plots shown in this section were all taken with a correction table loaded into the analyzer. The correction table was used to account for the losses of the cables and attenuators used as part of the system to connect the EUT to the analyzer at all frequencies of interest.
- 3) For radiated emission test, the test results shown in the following sections represent the worst-case emissions.

7.2. 26dB Bandwidth Measurement

7.2.1. Test Limit

N/A

7.2.2. Test Procedure used

KDB 789033 D02v02r01- Section II)C)1) (26dB Bandwidth)

KDB 789033 D02v02r01- Section II)D) (99% Bandwidth)

7.2.3. Test Setting

26dB Bandwidth

1. The analyzers' automatic bandwidth measurement capability was used to perform the 26dB bandwidth
2. RBW = approximately 1% of the emission bandwidth.
3. VBW > RBW
4. Detector = Peak.
5. Trace mode = max hold.
6. Measure the maximum width of the emission that is 26 dB down from the maximum of the emission. Compare this with the RBW setting of the analyzer. Readjust RBW and repeat measurement as needed until the RBW/EBW ratio is approximately 1%.

99% Bandwidth

1. Set center frequency to the nominal EUT channel center frequency.
2. RBW = 1% to 5% of the OBW
3. VBW $\geq 3 \times$ RBW
4. Span = 1.5 times to 5 times the OBW
5. Detector = peak
6. Trace mode = max hold
7. Allow the trace to stabilize
8. Use the 99% power bandwidth function of the instrument.

7.2.4. Test Setup

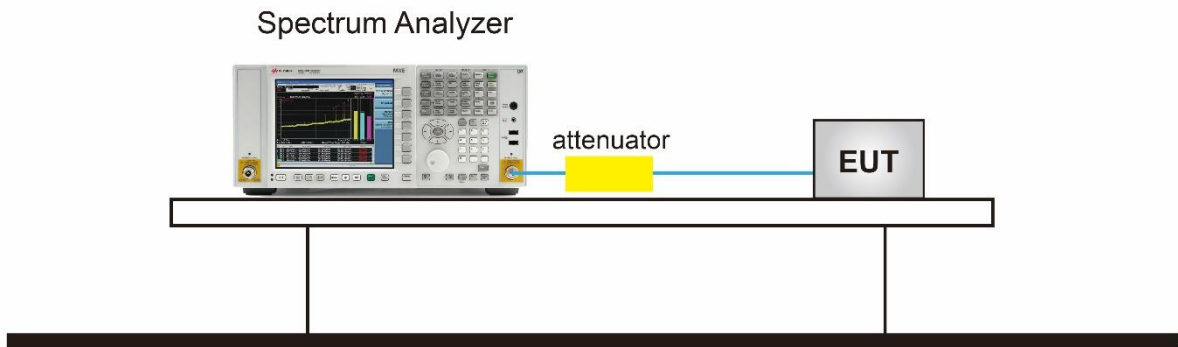

7.2.5. Test Result

Product	AX3000 Outdoor/Indoor Mesh Wi-Fi 6 Unit	Test Engineer	Jay
Test Site	SR5	Test Date	2022/10/14 ~ 2022/11/03

Test Mode	Data Rate/ MCS	Channel No.	Frequency (MHz)	26dB Bandwidth (MHz)	99% Bandwidth (MHz)
Ant 1					
802.11a	6Mbps	36	5180	23.190	16.573
802.11a	6Mbps	44	5220	25.270	16.602
802.11a	6Mbps	48	5240	25.130	16.553
802.11a	6Mbps	149	5745	39.990	30.528
802.11a	6Mbps	157	5785	39.920	29.684
802.11a	6Mbps	165	5825	39.880	31.020
802.11ac-VHT20	MCS0	36	5180	25.290	17.786
802.11ac-VHT20	MCS0	44	5220	21.880	17.739
802.11ac-VHT20	MCS0	48	5240	20.640	17.705
802.11ac-VHT20	MCS0	149	5745	40.000	30.681
802.11ac-VHT20	MCS0	157	5785	40.000	29.614
802.11ac-VHT20	MCS0	165	5825	40.000	31.980
802.11ac-VHT40	MCS0	38	5190	41.640	36.332
802.11ac-VHT40	MCS0	46	5230	43.560	36.355
802.11ac-VHT40	MCS0	151	5755	80.000	64.865
802.11ac-VHT40	MCS0	159	5795	80.000	59.846
802.11ac-VHT80	MCS0	42	5210	85.900	76.090
802.11ac-VHT80	MCS0	155	5775	159.800	78.025
802.11ac-VHT160	MCS0	50	5250	238.800	155.480
802.11ax-HE20	MCS0	36	5180	34.600	19.061
802.11ax-HE20	MCS0	44	5220	22.140	19.028
802.11ax-HE20	MCS0	48	5240	21.310	19.005
802.11ax-HE20	MCS0	149	5745	40.000	30.443
802.11ax-HE20	MCS0	157	5785	40.000	30.001
802.11ax-HE20	MCS0	165	5825	40.000	31.280
802.11ax-HE40	MCS0	38	5190	47.820	37.922
802.11ax-HE40	MCS0	46	5230	44.180	37.905
802.11ax-HE40	MCS0	151	5755	80.000	66.240
802.11ax-HE40	MCS0	159	5795	80.000	60.114

Test Mode	Data Rate/ MCS	Channel No.	Frequency (MHz)	26dB Bandwidth (MHz)	99% Bandwidth (MHz)
Ant 1					
802.11ax-HE80	MCS0	42	5210	87.080	77.654
802.11ax-HE80	MCS0	155	5775	158.900	78.582
802.11ax-HE160	MCS0	50	5250	196.300	157.260

802.11a 26dB Bandwidth & 99% Bandwidth

Channel 36 (5180MHz)

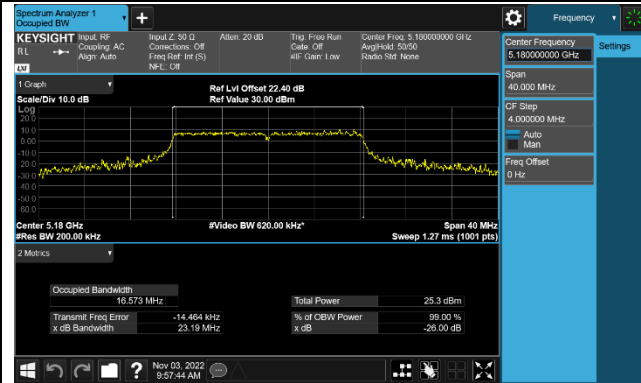

Channel 44 (5220MHz)

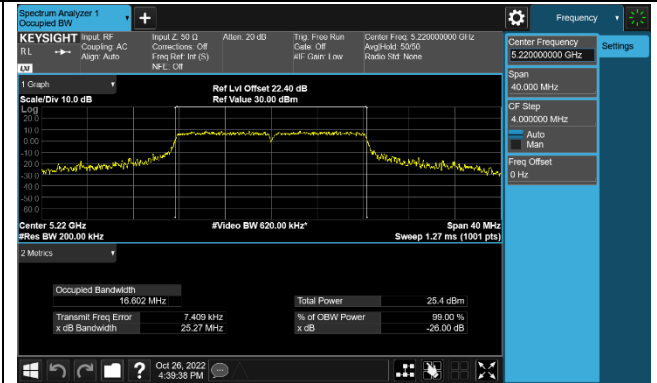

Channel 48 (5240MHz)

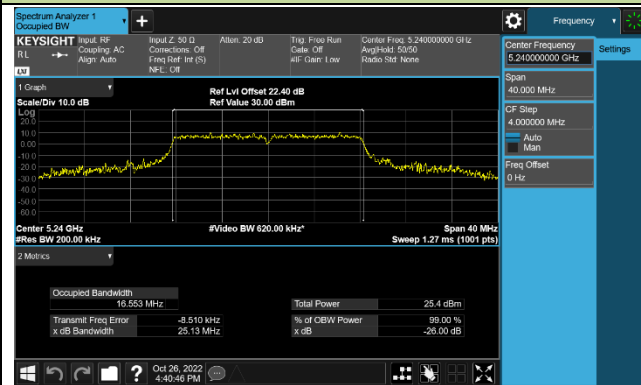

Channel 149 (5745MHz)

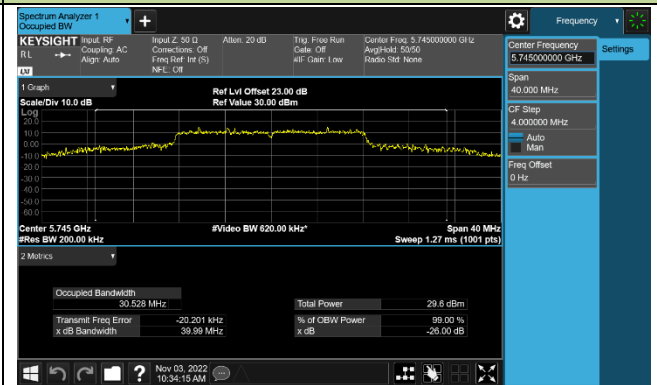

Channel 157 (5785MHz)

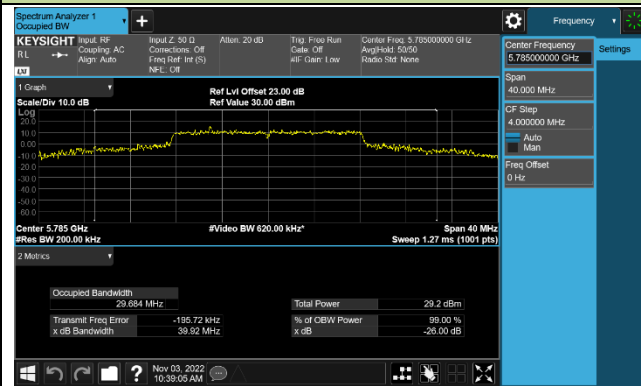

Channel 165 (5825MHz)

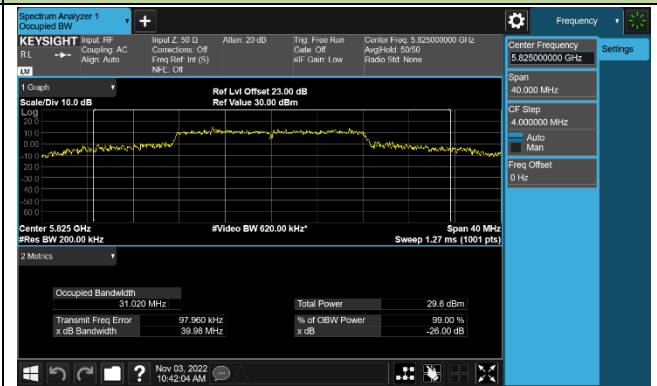

802.11ac-VHT20 26dB Bandwidth & 99% Bandwidth

Channel 36 (5180MHz)

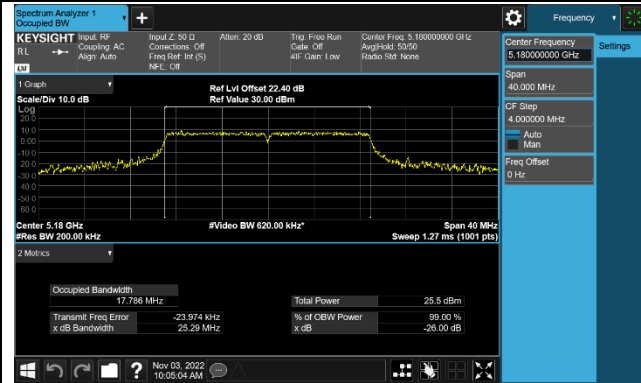

Channel 44 (5220MHz)

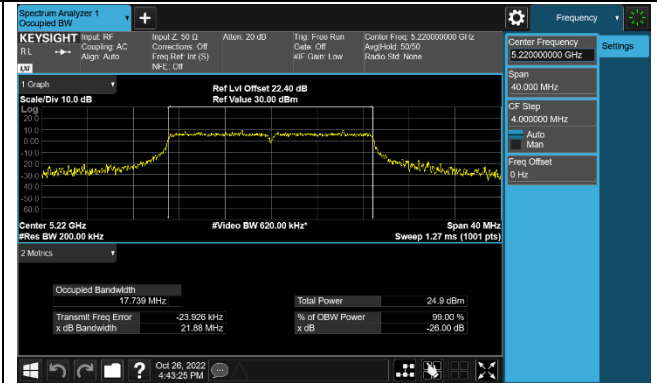

Channel 48 (5240MHz)

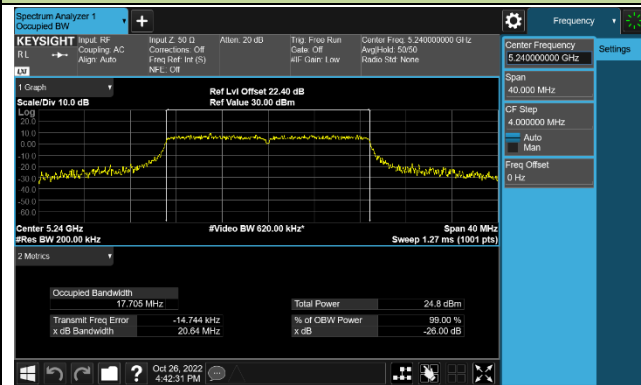

Channel 149 (5745MHz)

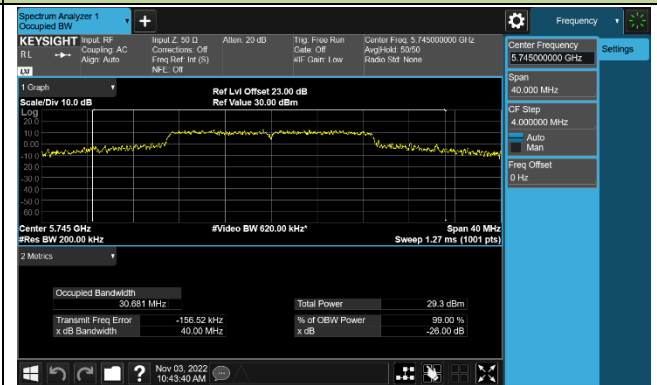

Channel 157 (5785MHz)

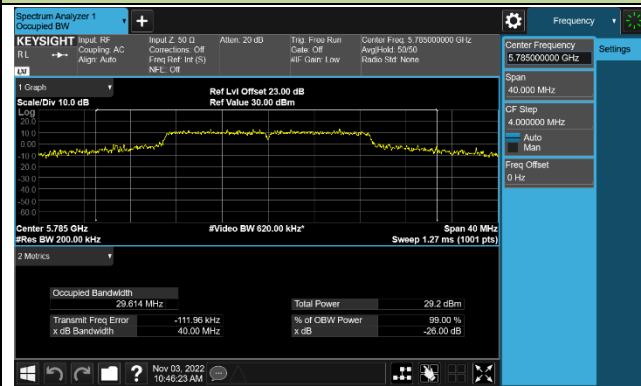

Channel 165 (5825MHz)

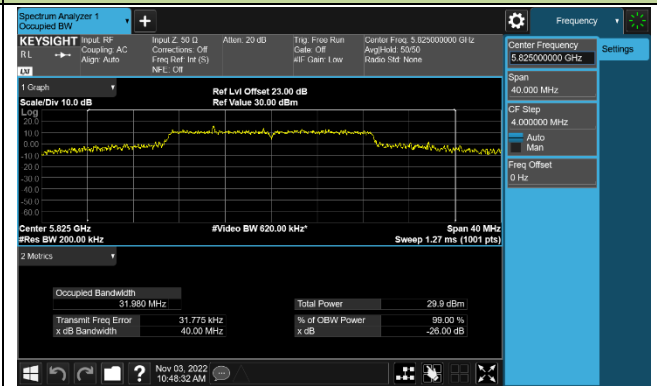

802.11ac-VHT40 26dB Bandwidth & 99% Bandwidth

Channel 38 (5190MHz)

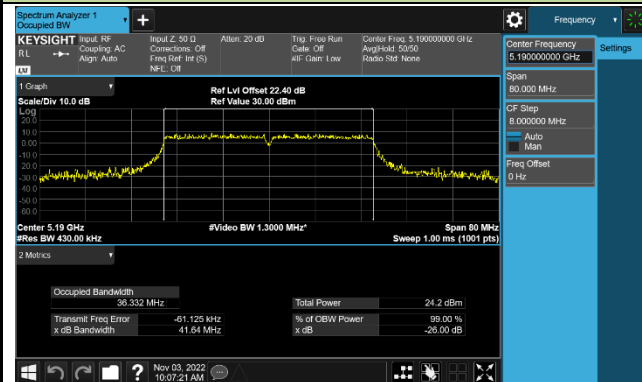

Channel 46 (5230MHz)

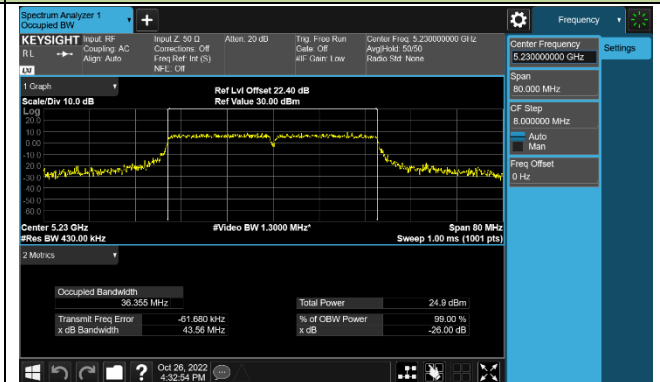

Channel 151 (5755MHz)

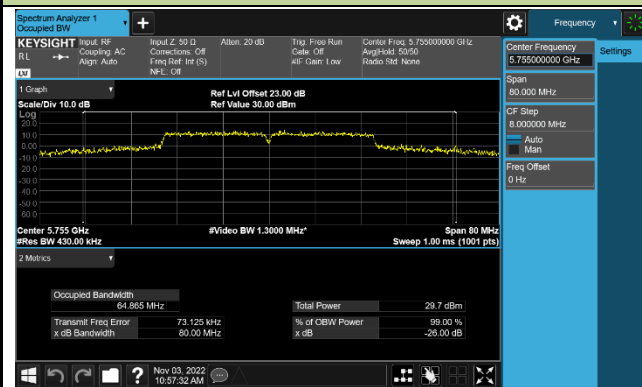

Channel 159 (5795MHz)

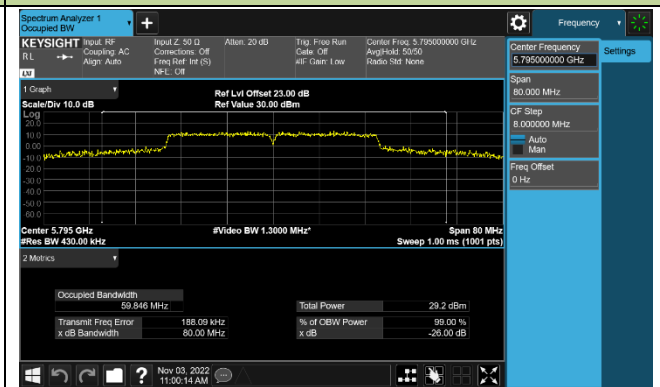

802.11ac-VHT80 26dB Bandwidth & 99% Bandwidth

Channel 42 (5210MHz)

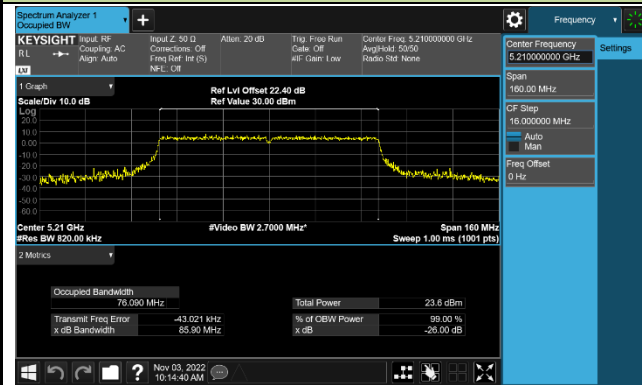

Channel 155 (5775MHz)

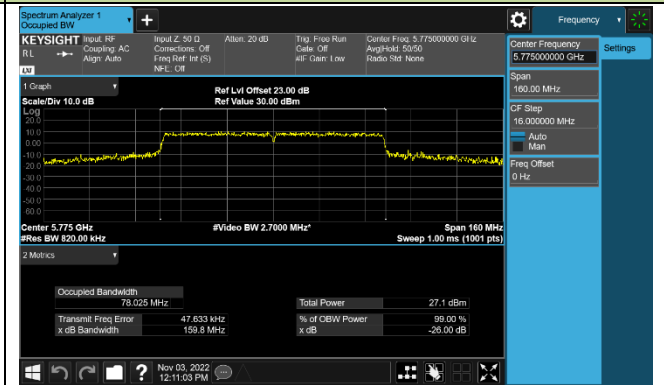

802.11ac-VHT160 26dB Bandwidth & 99% Bandwidth

Channel 50 (5250MHz)

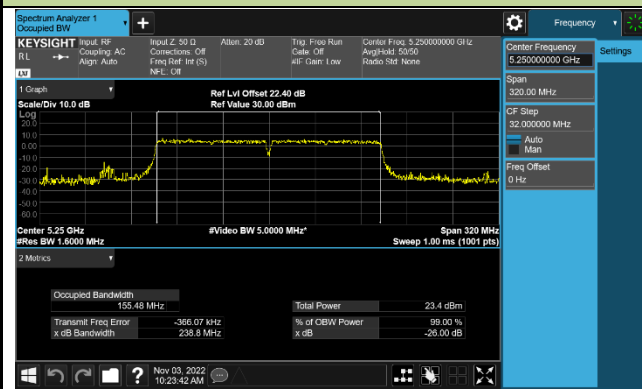

802.11ax-HE20 26dB Bandwidth & 99% Bandwidth

Channel 36 (5180MHz)

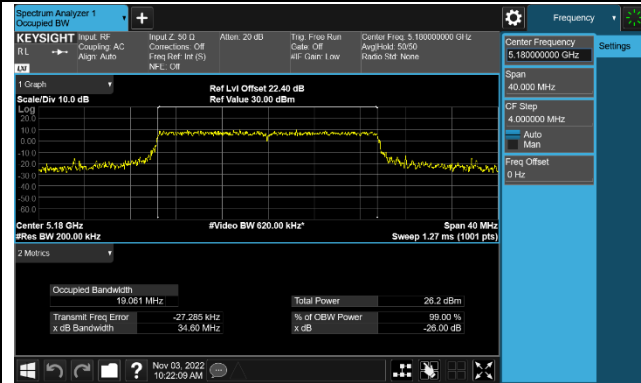

Channel 44 (5220MHz)

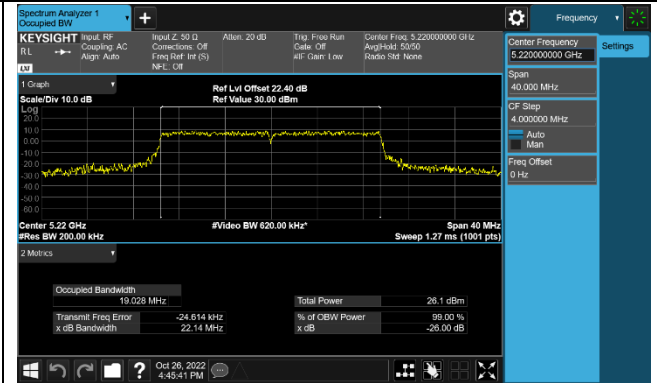

Channel 48 (5240MHz)

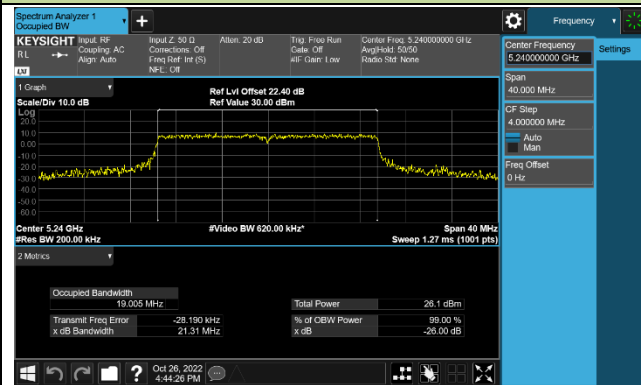

Channel 149 (5745MHz)

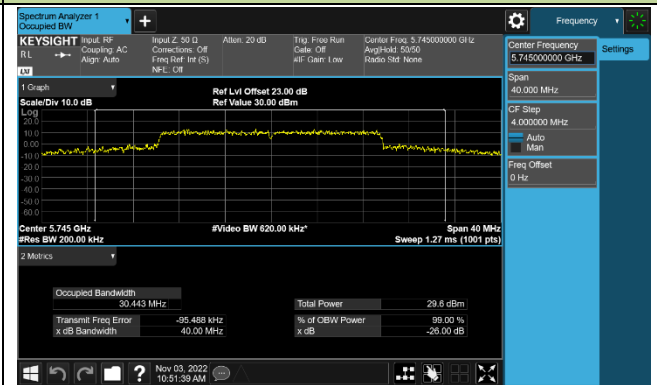

Channel 157 (5785MHz)

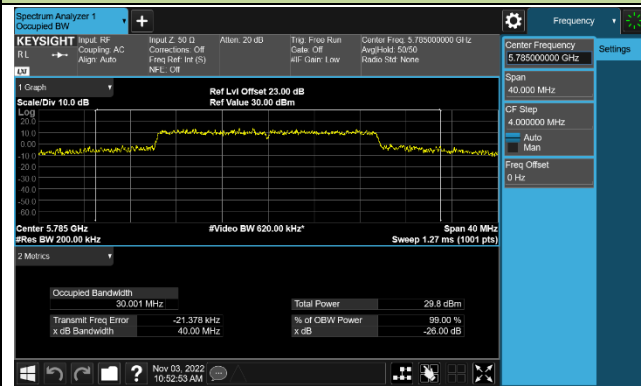

Channel 165 (5825MHz)

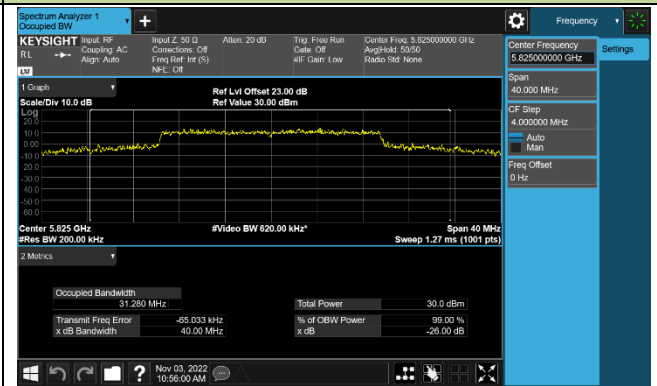

802.11ax-HE40 26dB Bandwidth & 99% Bandwidth

Channel 38 (5190MHz)

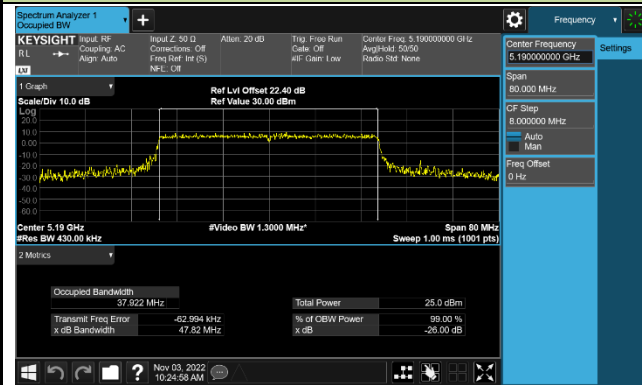

Channel 46 (5230MHz)

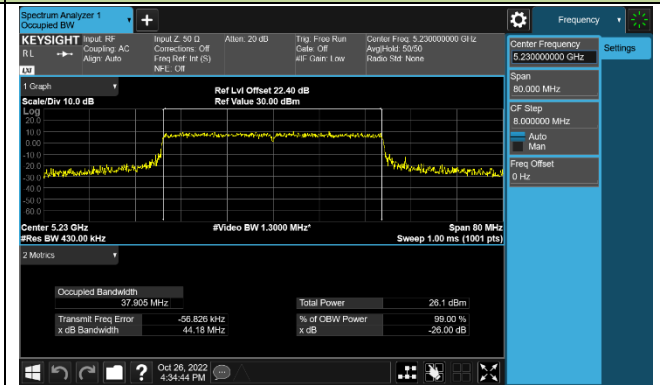

Channel 151 (5755MHz)



Channel 159 (5795MHz)

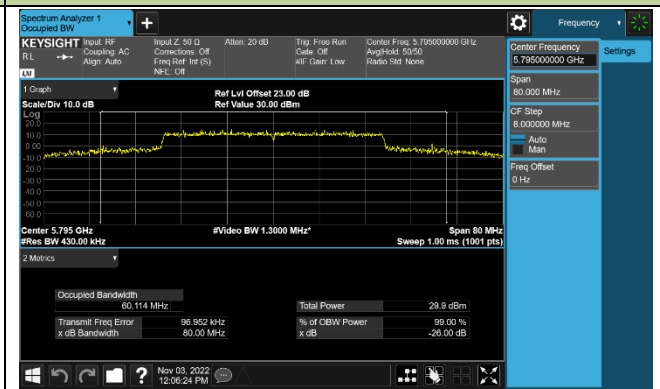

802.11ax-HE80 26dB Bandwidth & 99% Bandwidth

Channel 42 (5210MHz)

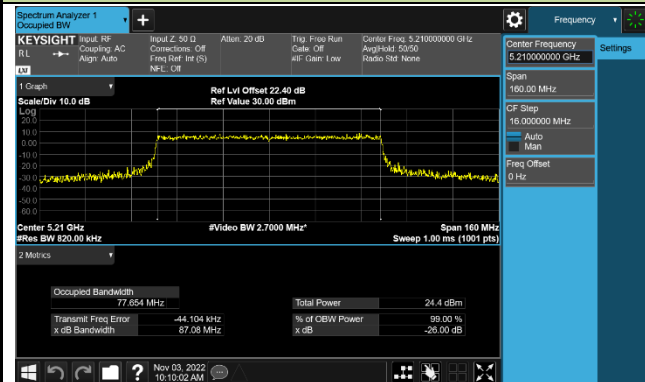

Channel 155 (5775MHz)

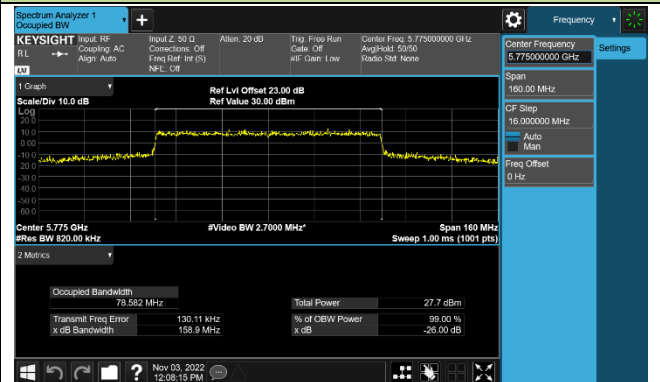

802.11ax-HE160 26dB Bandwidth & 99% Bandwidth

Channel 50 (5250MHz)

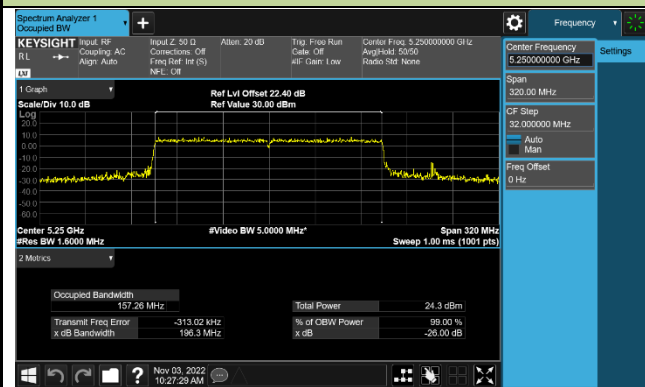

7.3. 6dB Bandwidth Measurement

7.3.1. Test Limit

The minimum 6dB bandwidth shall be at least 500 kHz.

7.3.2. Test Procedure used

KDB 789033 D02v02r01- Section II) C.2

7.3.3. Test Setting

1. Set center frequency to the nominal EUT channel center frequency.
2. RBW = 100 kHz.
3. VBW $3 \times$ RBW.
4. Detector = Peak.
5. Trace mode = max hold.
6. Sweep = auto couple.
7. Allow the trace to stabilize.
8. Measure the maximum width of the emission that is constrained by the frequencies associated with the two outermost amplitude points (upper and lower frequencies) that are attenuated by 6 dB relative to the maximum level measured in the fundamental emission.

7.3.4. Test Setup

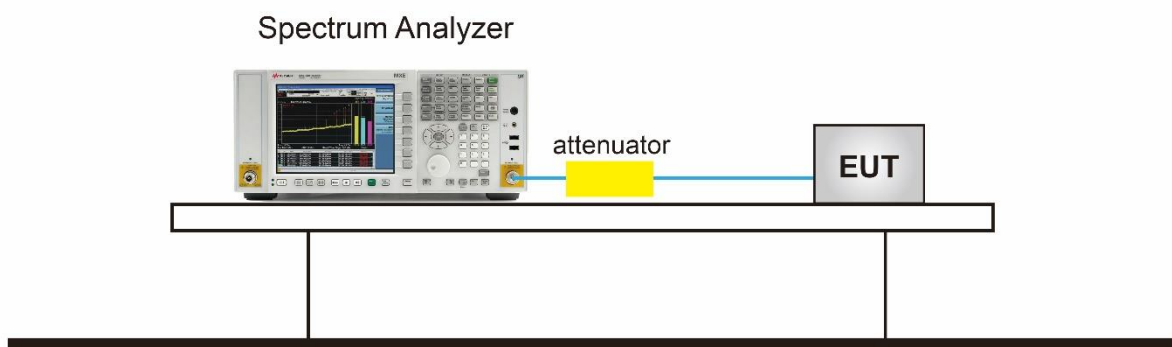

7.3.5.TestResult

Product	AX3000 Outdoor/Indoor Mesh Wi-Fi 6 Unit	Test Engineer	Jay
Test Site	SR5	Test Date	2022/11/03

Test Mode	Data Rate/ MCS	Channel No.	Frequency (MHz)	6dB Bandwidth (MHz)	Limit (MHz)	Result
Ant 1						
802.11a	6Mbps	149	5745	16.370	≥ 0.5	Pass
802.11a	6Mbps	157	5785	16.350	≥ 0.5	Pass
802.11a	6Mbps	165	5825	16.360	≥ 0.5	Pass
802.11ac-VHT20	MCS0	149	5745	17.780	≥ 0.5	Pass
802.11ac-VHT20	MCS0	157	5785	17.780	≥ 0.5	Pass
802.11ac-VHT20	MCS0	165	5825	17.800	≥ 0.5	Pass
802.11ac-VHT40	MCS0	151	5755	36.340	≥ 0.5	Pass
802.11ac-VHT40	MCS0	159	5795	36.470	≥ 0.5	Pass
802.11ac-VHT80	MCS0	155	5775	76.490	≥ 0.5	Pass
802.11ax-HE20	MCS0	149	5745	18.470	≥ 0.5	Pass
802.11ax-HE20	MCS0	157	5785	19.010	≥ 0.5	Pass
802.11ax-HE20	MCS0	165	5825	18.890	≥ 0.5	Pass
802.11ax-HE40	MCS0	151	5755	38.140	≥ 0.5	Pass
802.11ax-HE40	MCS0	159	5795	38.080	≥ 0.5	Pass
802.11ax-HE80	MCS0	155	5775	78.080	≥ 0.5	Pass

802.11a 6dB Bandwidth

Channel 149 (5745MHz)

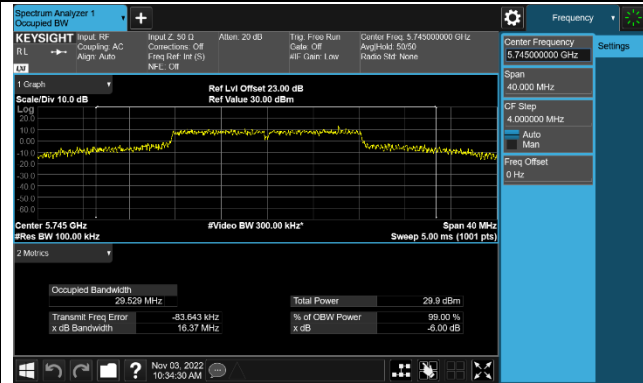

Channel 157 (5785MHz)

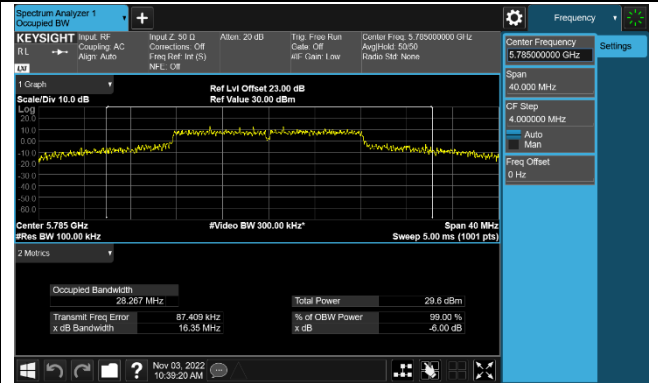

Channel 165 (5825MHz)

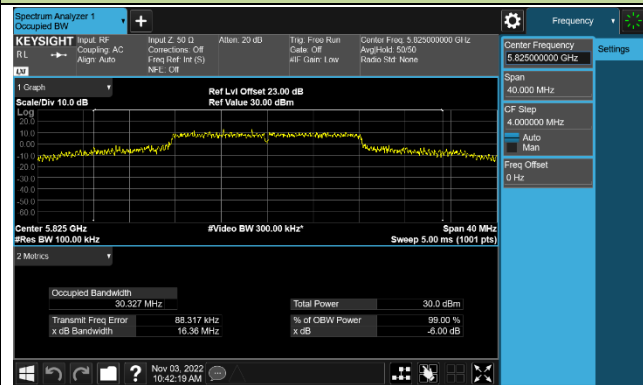

802.11ac-VHT20 6dB Bandwidth

Channel 149 (5745MHz)

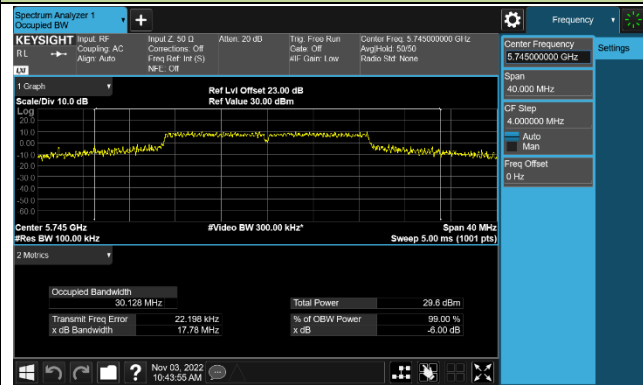

Channel 157 (5785MHz)

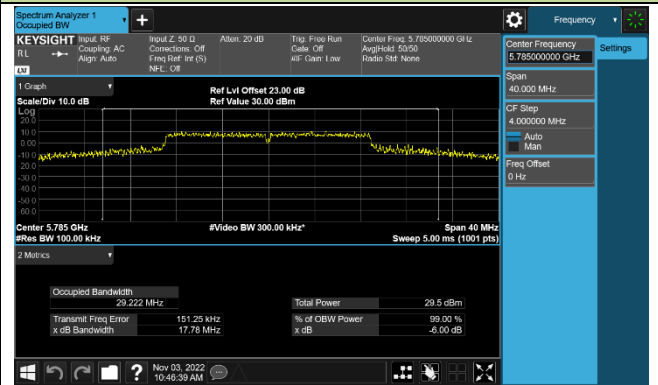

Channel 165 (5825MHz)

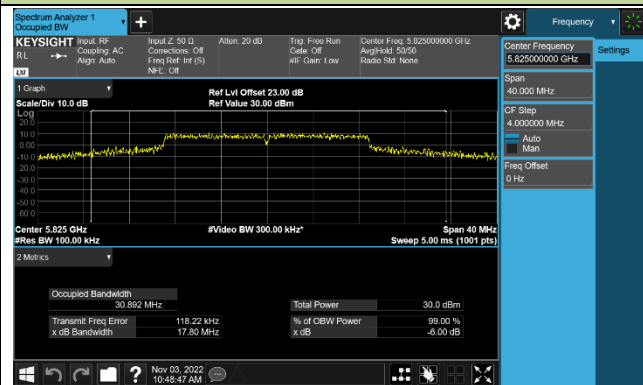

802.11ac-VHT40 6dB Bandwidth

Channel 151 (5755MHz)

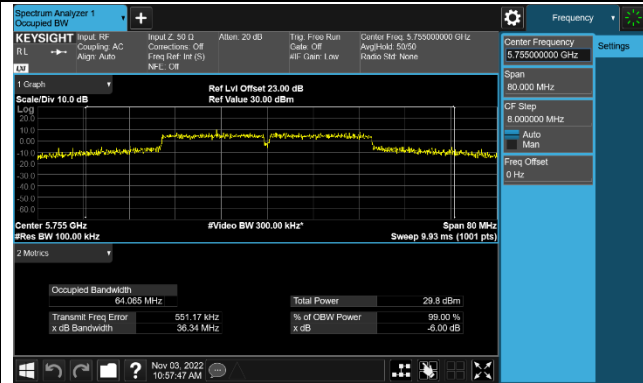

Channel 159 (5795MHz)

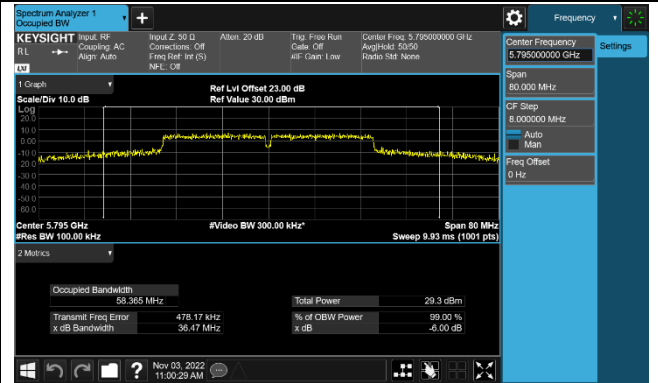

802.11ac-VHT80 6dB Bandwidth

Channel 155 (5775MHz)

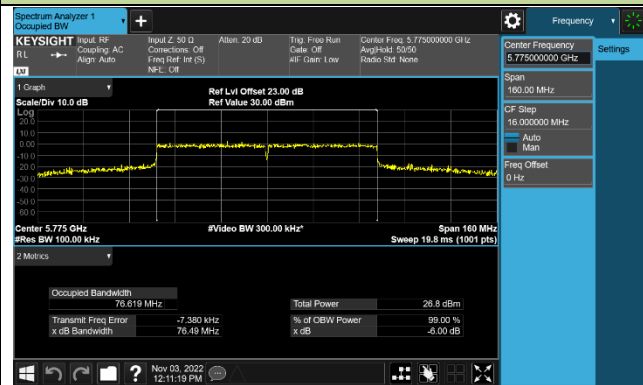

802.11ax-HE20 6dB Bandwidth

Channel 149 (5745MHz)

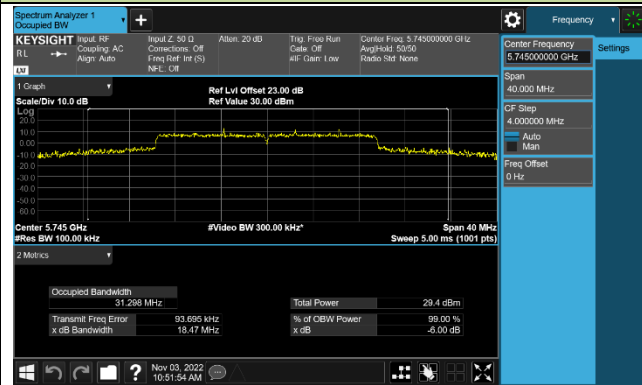

Channel 157 (5785MHz)

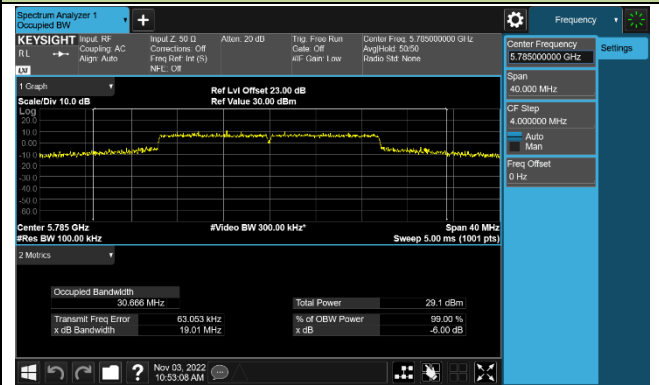

Channel 165 (5825MHz)

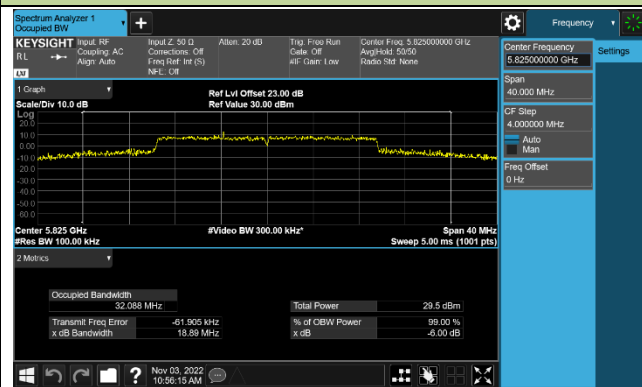

802.11ax-HE40 6dB Bandwidth

Channel 151 (5755MHz)

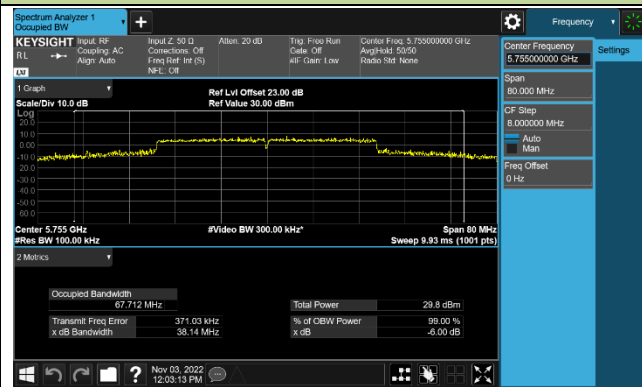

Channel 159 (5795MHz)

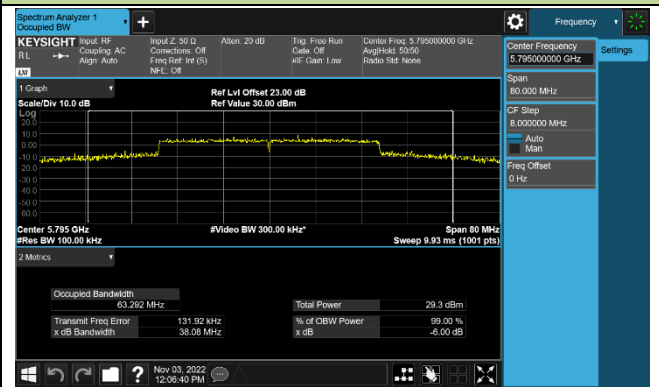

802.11ax-HE80 6dB Bandwidth

Channel 155 (5775MHz)

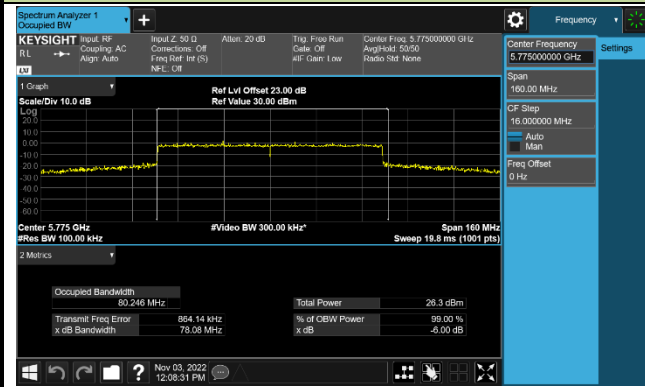

7.4. Output Power Measurement

7.4.1. Test Limit

For the band 5.15-5.25 GHz, the maximum conducted output power over the frequency band of operation shall not exceed 1 W provided the maximum antenna gain does not exceed 6 dBi.

For an outdoor access point operating in the band 5.15-5.25 GHz, the maximum e.i.r.p. at any elevation angle above 30 degrees as measured from the horizon must not exceed 125 mW (21 dBm).

For the 5.25-5.35 GHz and 5.47-5.725 GHz bands, the maximum conducted output power over the frequency bands of operation shall not exceed the lesser of 250 mW or $11 \text{ dBm} + 10 \log B$, where B is the 26 dB emission bandwidth in megahertz.

For the band 5.725-5.85 GHz, the maximum conducted output power over the frequency band of operation shall not exceed 1 W (30dBm).

If transmitting antennas of directional gain greater than 6dBi are used, the maximum conducted output power shall be reduced by the amount in dB that the directional gain of the antenna exceeds 6dBi.

7.4.2. Test Procedure Used

KDB 789033D02v02r01- Section II)E)3)b) Method PM-G

7.4.3. Test Setting

Average power measurements were performed only when the EUT was transmitting at its maximum power control level using a broadband power meter with a pulse sensor. The power meter implemented triggering and gating capabilities which were set up such that power measurements were recorded only during the ON time of the transmitter.

7.4.4. Test Setup

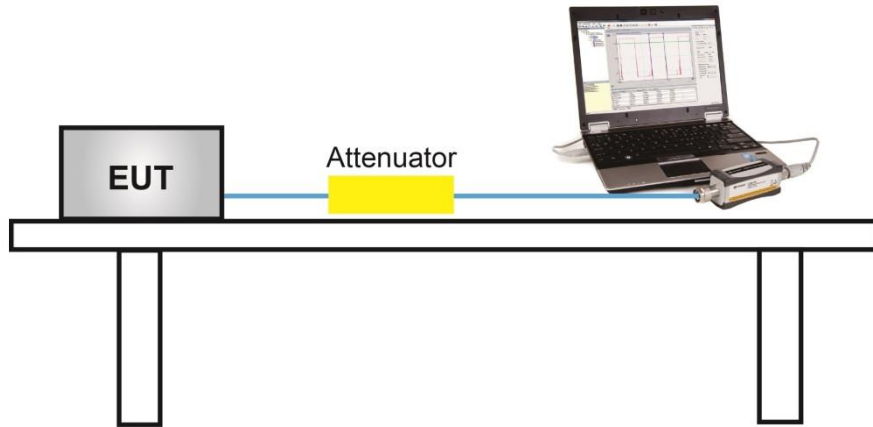

7.4.5. Test Result

Product	AX3000 Outdoor/Indoor Mesh Wi-Fi 6 Unit	Test Engineer	Jay
Test Site	SR5	Test Date	2022/10/31~2022/11/3

Test Mode	Data Rate/ MCS	Channel No.	Freq. (MHz)	Average Power (dBm)		Total Average Power (dBm)	Power Limit (dBm)	Result
				Ant 0	Ant 1			
11a	6Mbps	36	5180	21.31	22.13	24.75	≤ 30.00	Pass
11a	6Mbps	44	5220	21.48	22.12	24.82	≤ 30.00	Pass
11a	6Mbps	48	5240	21.68	22.06	24.88	≤ 30.00	Pass
11a	6Mbps	149	5745	25.84	26.21	29.04	≤ 30.00	Pass
11a	6Mbps	157	5785	26.02	25.66	28.85	≤ 30.00	Pass
11a	6Mbps	165	5825	25.59	26.05	28.84	≤ 30.00	Pass
11ac-VHT20	MCS0	36	5180	21.14	22.18	24.70	≤ 30.00	Pass
11ac-VHT20	MCS0	40	5220	21.30	21.69	24.51	≤ 30.00	Pass
11ac-VHT20	MCS0	48	5240	21.43	21.62	24.54	≤ 30.00	Pass
11ac-VHT20	MCS0	149	5745	26.02	26.39	29.22	≤ 30.00	Pass
11ac-VHT20	MCS0	157	5785	25.89	25.79	28.85	≤ 30.00	Pass
11ac-VHT20	MCS0	165	5825	25.73	26.05	28.90	≤ 30.00	Pass
11ac-VHT40	MCS0	38	5190	20.45	20.93	23.71	≤ 30.00	Pass
11ac-VHT40	MCS0	46	5230	21.22	21.59	24.42	≤ 30.00	Pass
11ac-VHT40	MCS0	151	5755	25.91	26.12	29.03	≤ 30.00	Pass
11ac-VHT40	MCS0	159	5795	25.64	25.69	28.68	≤ 30.00	Pass
11ac-VHT80	MCS0	42	5210	19.80	20.42	23.13	≤ 30.00	Pass
11ac-VHT80	MCS0	155	5775	23.74	23.89	26.83	≤ 30.00	Pass
11ac-VHT160	MCS0	50	5250	20.04	20.28	23.17	≤ 23.98	Pass
11ax-HE20	MCS0	36	5180	21.21	22.29	24.79	≤ 30.00	Pass
11ax-HE20	MCS0	40	5220	21.35	21.75	24.56	≤ 30.00	Pass
11ax-HE20	MCS0	48	5240	21.45	21.71	24.59	≤ 30.00	Pass
11ax-HE20	MCS0	149	5745	25.67	26.33	29.02	≤ 30.00	Pass
11ax-HE20	MCS0	157	5785	25.99	25.91	28.96	≤ 30.00	Pass
11ax-HE20	MCS0	165	5825	25.63	26.19	28.93	≤ 30.00	Pass

Test Mode	Data Rate/ MCS	Channel No.	Freq. (MHz)	Average Power (dBm)		Total Average Power (dBm)	Power Limit (dBm)	Result
				Ant 0	Ant 1			
11ax-HE40	MCS0	38	5190	20.42	21.09	23.78	≤ 30.00	Pass
11ax-HE40	MCS0	46	5230	21.30	21.62	24.47	≤ 30.00	Pass
11ax-HE40	MCS0	151	5755	25.85	26.04	28.96	≤ 30.00	Pass
11ax-HE40	MCS0	159	5795	25.43	25.79	28.62	≤ 30.00	Pass
11ax-HE80	MCS0	42	5210	19.86	20.45	23.18	≤ 30.00	Pass
11ax-HE80	MCS0	155	5775	23.47	23.90	26.70	≤ 30.00	Pass
11ax-HE160	MCS0	50	5250	20.35	20.59	23.48	≤ 23.98	Pass

Note: The Total Average Power (dBm) = $10 \cdot \log \{10^{(\text{Ant 0 Average Power} / 10)} + 10^{(\text{Ant 1 Average Power} / 10)}\}$.

Product	AX3000 Outdoor/Indoor Mesh Wi-Fi 6 Unit	Test Engineer	Jay
Test Site	SR5	Test Date	2022/10/31~2022/11/3

Test Mode	Data Rate/ MCS	Channel No.	Freq. (MHz)	Average Power (dBm)		Total Average Power (dBm)	EIRP (dBm)	EIRP Limit (dBm)	Result
				Ant 0	Ant 1				
EIRP at any elevation angle above 30 degrees									
11a	6Mbps	36	5180	21.31	22.13	24.75	20.75	≤ 21.00	Pass
11a	6Mbps	44	5220	21.48	22.12	24.82	20.82	≤ 21.00	Pass
11a	6Mbps	48	5240	21.68	22.06	24.88	20.88	≤ 21.00	Pass
11ac-VHT20	MCS0	36	5180	21.14	22.18	24.70	20.70	≤ 21.00	Pass
11ac-VHT20	MCS0	40	5220	21.30	21.69	24.51	20.51	≤ 21.00	Pass
11ac-VHT20	MCS0	48	5240	21.43	21.62	24.54	20.54	≤ 21.00	Pass
11ac-VHT40	MCS0	38	5190	20.45	20.93	23.71	19.71	≤ 21.00	Pass
11ac-VHT40	MCS0	46	5230	21.22	21.59	24.42	20.42	≤ 21.00	Pass
11ac-VHT80	MCS0	42	5210	19.80	20.42	23.13	19.13	≤ 21.00	Pass
11ac-VHT160	MCS0	50	5250	20.04	20.28	23.17	19.17	≤ 21.00	Pass
11ax-HE20	MCS0	36	5180	21.21	22.29	24.79	20.79	≤ 21.00	Pass
11ax-HE20	MCS0	40	5220	21.35	21.75	24.56	20.56	≤ 21.00	Pass
11ax-HE20	MCS0	48	5240	21.45	21.71	24.59	20.59	≤ 21.00	Pass
11ax-HE40	MCS0	38	5190	20.42	21.09	23.78	19.78	≤ 21.00	Pass
11ax-HE40	MCS0	46	5230	21.30	21.62	24.47	20.47	≤ 21.00	Pass
11ax-HE80	MCS0	42	5210	19.86	20.45	23.18	19.18	≤ 21.00	Pass
11ax-HE160	MCS0	50	5250	20.35	20.59	23.48	19.48	≤ 21.00	Pass

Note 1: The Total Average Power (dBm) = $10 \cdot \log \{10^{(\text{Ant 0 Average Power} / 10)} + 10^{(\text{Ant 1 Average Power} / 10)}\}$.

Note 2: EIRP (dBm) = Total Average Power (dBm) + Antenna Gain (dBi)

7.5. Transmit Power Control

7.5.1. Test Limit

The U-NII device is required to have the capability to operate at least 6 dB below the mean EIRP value of 30 dBm.

7.5.2. Test Procedure Used

KDB 789033 D02v02r01- Section II)E)3)b) Method PM-G

7.5.3. Test Setting

Average power measurements were performed only when the EUT was transmitting at its maximum power control level using a broadband power meter with a pulse sensor. The power meter implemented triggering and gating capabilities which were set up such that power measurements were recorded only during the ON time of the transmitter. The trace was averaged over 100 traces to obtain the final measured average power.

7.5.4. Test Setup

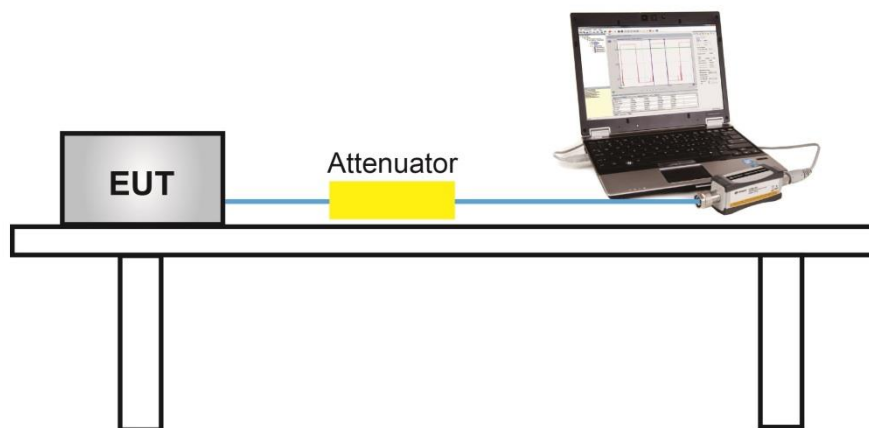

7.5.5. Test Result

A TPC mechanism is not required for systems with an e.i.r.p. of less than 500 mW.

7.6. Power Spectral Density Measurement

7.6.1. Test Limit

For the band 5.15-5.25 GHz, the maximum power spectral density shall not exceed 17 dBm in any 1 megahertz band.

For the 5.25-5.35 GHz and 5.47-5.725 GHz bands, the maximum power spectral density shall not exceed 11 dBm in any 1 megahertz band.

For the band 5.725-5.85 GHz, the maximum power spectral density shall not exceed 30 dBm in any 500-kHz band.

If transmitting antennas of directional gain greater than 6dBi are used, the peak power spectral density shall be reduced by the amount in dB that the directional gain of the antenna exceeds 6dBi.

7.6.2. Test Procedure Used

KDB 789033 D02v02r01-Section II)F

7.6.3. Test Setting

1. Analyzer was set to the center frequency of the UNII channel under investigation
2. Span was set to encompass the entire 26dB EBW of the signal.
3. RBW = 1MHz, if measurement bandwidth of Maximum PSD is specified in 500 kHz,
RBW = 510 kHz
4. VBW = 3MHz
5. Number of sweep points $\geq 2 \times (\text{span} / \text{RBW})$
6. Detector = power averaging (Average)
7. Sweep time = auto
8. Trigger = free run
9. Use the peak search function on the instrument to find the peak of the spectrum and record its value.
10. Add $10 \cdot \log(1/x)$, where x is the duty cycle, to the measured power in order to compute the average power during the actual transmission times (because the measurement represents an average over both the on and off times of the transmission). For example, add $10 \cdot \log(1/0.25) = 6$ dB if the duty cycle is 25 percent.

7.6.4. Test Setup

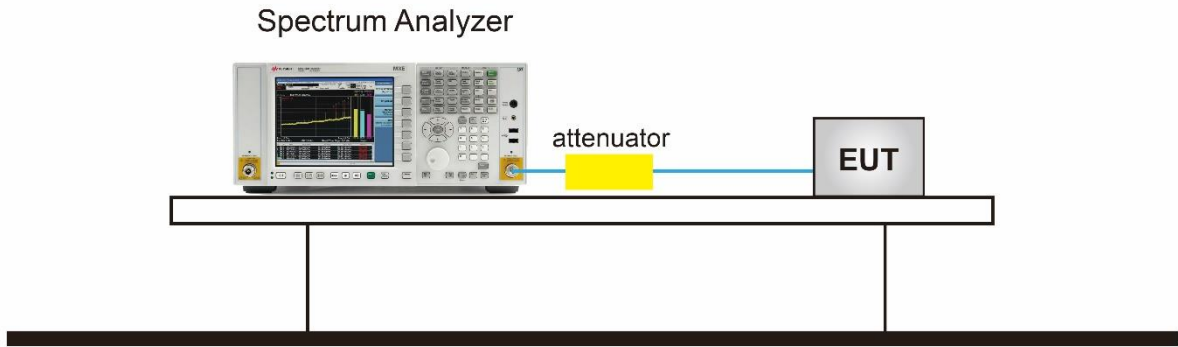

7.6.5. Test Result

Product	AX3000 Outdoor/Indoor Mesh Wi-Fi 6 Unit	Test Engineer	Jay
Test Site	SR5	Test Date	2022/10/31~2022/11/3
Mode	Power Spectral Density (U-NII- 1) CDD Mode		

Test Mode	Data Rate/ MCS	Ch. No.	Freq. (MHz)	PSD (dBm/MHz)		Duty Cycle (%)	Total PSD (dBm/MHz)	Limit (dBm/MHz)	Result
				Ant 0	Ant 1				
11a	6Mbps	36	5180	8.549	9.805	94.24	12.490	≤17.00	Pass
11a	6Mbps	44	5220	9.030	9.944	94.24	12.779	≤17.00	Pass
11a	6Mbps	48	5240	9.480	9.525	94.24	12.771	≤17.00	Pass
11ac-VHT20	MCS0	36	5180	8.143	9.437	90.73	12.271	≤17.00	Pass
11ac-VHT20	MCS0	44	5220	8.311	8.745	90.73	11.966	≤17.00	Pass
11ac-VHT20	MCS0	48	5240	8.607	8.573	90.73	12.023	≤17.00	Pass
11ac-VHT40	MCS0	38	5190	4.205	5.582	88.04	8.511	≤17.00	Pass
11ac-VHT40	MCS0	46	5230	5.482	5.749	88.04	9.181	≤17.00	Pass
11ac-VHT80	MCS0	42	5210	0.593	1.636	90.61	4.584	≤17.00	Pass
11ac-VHT160	MCS0	50	5250	-1.623	-1.261	89.14	2.071	≤11.00	Pass
11ax-HE20	MCS0	36	5180	8.123	9.594	91.78	12.303	≤17.00	Pass
11ax-HE20	MCS0	44	5220	8.036	8.449	91.78	11.630	≤17.00	Pass
11ax-HE20	MCS0	48	5240	8.301	8.672	91.78	11.873	≤17.00	Pass
11ax-HE40	MCS0	38	5190	4.196	5.108	91.05	8.093	≤17.00	Pass
11ax-HE40	MCS0	46	5230	5.685	5.565	91.05	9.043	≤17.00	Pass
11ax-HE80	MCS0	42	5210	1.075	1.617	91.29	4.761	≤17.00	Pass
11ax-HE160	MCS0	50	5250	-1.186	-0.923	90.66	2.384	≤11.00	Pass

Note: When EUT duty cycle < 98%,

the total PSD (dBm/MHz) = $10 \cdot \log \{10^{(\text{Ant 0 PSD}/10)} + 10^{(\text{Ant 1 PSD}/10)}\} + 10 \cdot \log (1/\text{Duty Cycle})$ (dBm/MHz).

Product	AX3000 Outdoor/Indoor Mesh Wi-Fi 6 Unit	Test Engineer	Jay
Test Site	SR5	Test Date	2022/10/31~2022/11/3
Test Item	Power Spectral Density (U-NII-3) CDD Mode		

Test Mode	Data Rate/MCS	Ch. No.	Freq. (MHz)	PSD (dBm/510kHz)		Duty Cycle (%)	Total PSD (dBm/510 kHz)	Limit (dBm/500 kHz)	Result
				Ant 0	Ant 1				
11a	6Mbps	149	5745	10.418	10.795	94.24	13.879	≤ 30.00	Pass
11a	6Mbps	157	5785	10.380	10.738	94.24	13.831	≤ 30.00	Pass
11a	6Mbps	165	5825	10.416	11.324	94.24	14.162	≤ 30.00	Pass
11ac-VHT20	MCS0	149	5745	9.681	10.084	90.73	13.320	≤ 30.00	Pass
11ac-VHT20	MCS0	157	5785	10.130	9.853	90.73	13.426	≤ 30.00	Pass
11ac-VHT20	MCS0	165	5825	10.001	10.698	90.73	13.796	≤ 30.00	Pass
11ac-VHT40	MCS0	151	5755	7.090	7.354	88.04	10.788	≤ 30.00	Pass
11ac-VHT40	MCS0	159	5795	7.081	6.761	88.04	10.487	≤ 30.00	Pass
11ac-VHT80	MCS0	155	5775	2.048	2.600	90.61	5.771	≤ 30.00	Pass
11ax-HE20	MCS0	149	5745	9.591	10.136	91.78	13.255	≤ 30.00	Pass
11ax-HE20	MCS0	157	5785	9.936	10.025	91.78	13.364	≤ 30.00	Pass
11ax-HE20	MCS0	165	5825	9.421	10.023	91.78	13.115	≤ 30.00	Pass
11ax-HE40	MCS0	151	5755	7.345	7.603	91.05	10.893	≤ 30.00	Pass
11ax-HE40	MCS0	159	5795	6.870	7.116	91.05	10.412	≤ 30.00	Pass
11ax-HE80	MCS0	155	5775	2.030	2.152	91.29	5.497	≤ 30.00	Pass

Note: When EUT duty cycle < 98%, the total PSD (dBm/510kHz) = $10 \cdot \log \{10^{(\text{Ant 0 PSD}/10)} + 10^{(\text{Ant 1 PSD}/10)}\}$ (dBm/510kHz) + $10 \cdot \log (1/\text{Duty Cycle})$.

802.11a Power Spectral Density - Ant 0

Channel 36 (5180MHz)

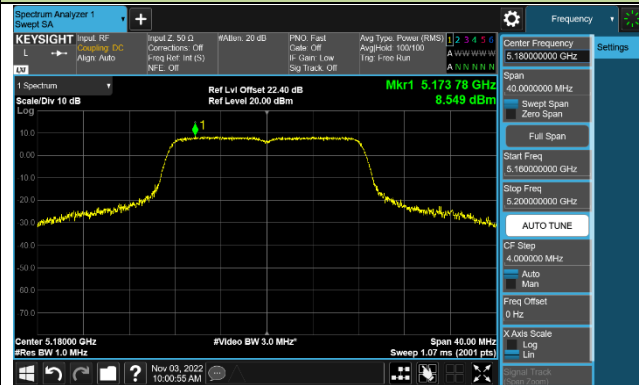

Channel 44 (5220MHz)

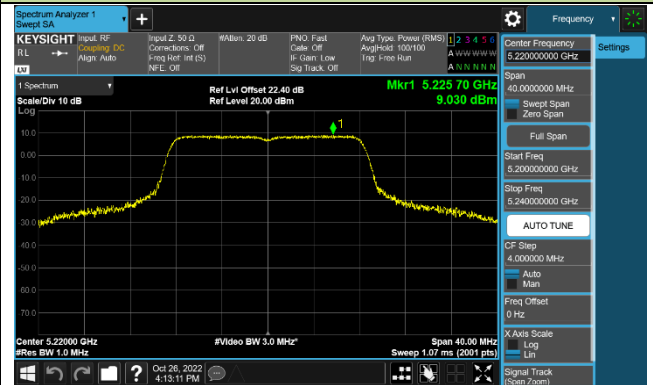

Channel 48 (5240MHz)

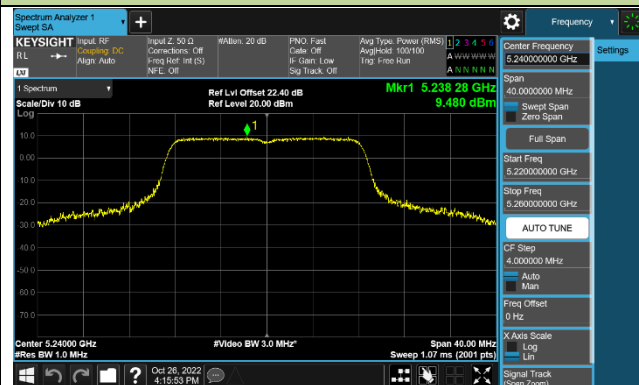

Channel 149 (5745MHz)

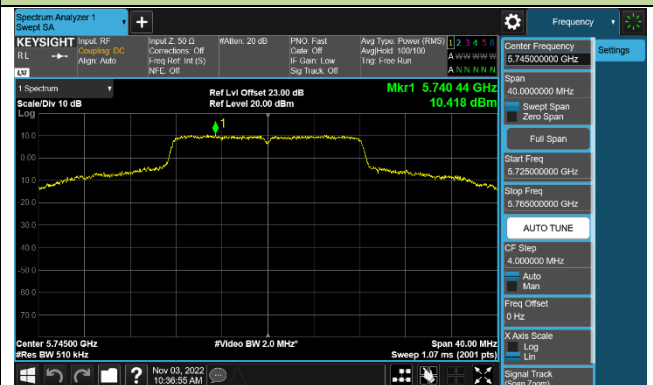

Channel 157 (5785MHz)

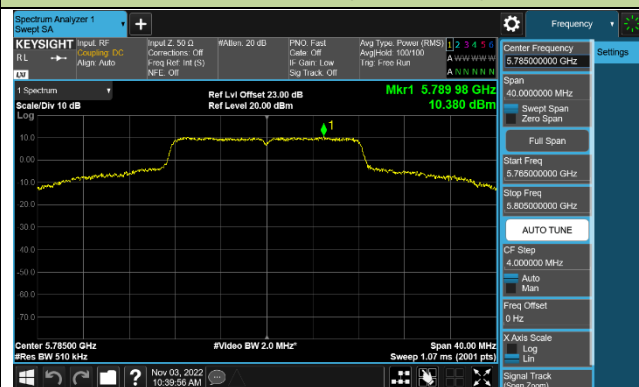

Channel 165 (5825MHz)

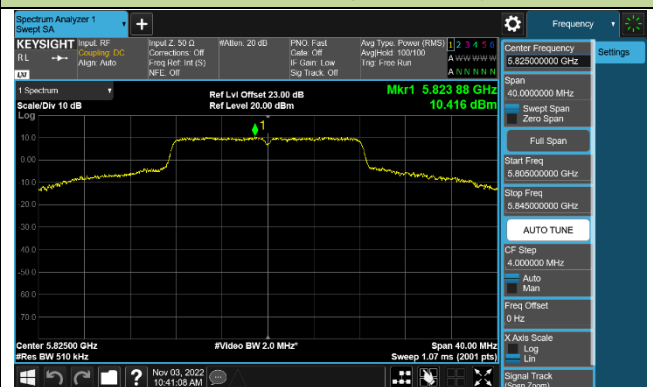

802.11ac-VHT20 Power Spectral Density - Ant 0

Channel 36 (5180MHz)

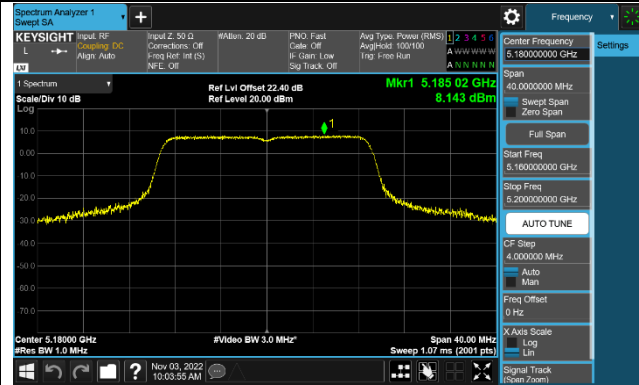

Channel 44 (5220MHz)

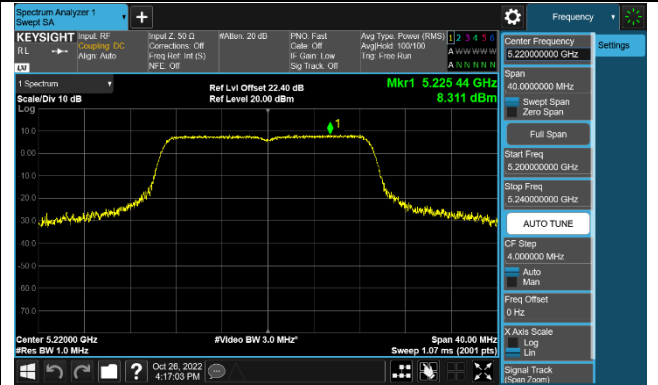

Channel 48 (5240MHz)

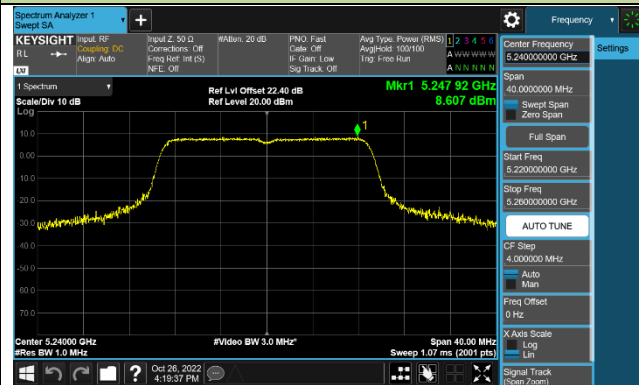

Channel 149 (5745MHz)

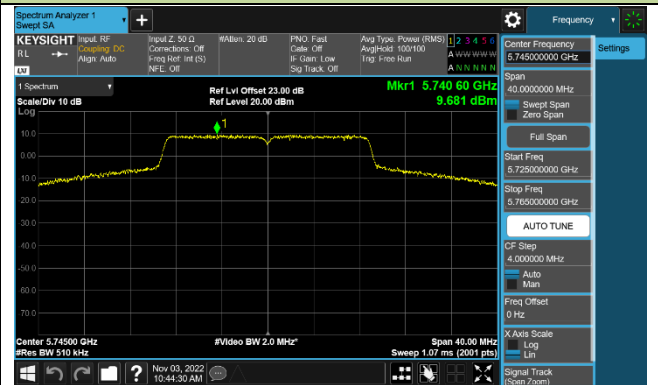

Channel 157 (5785MHz)

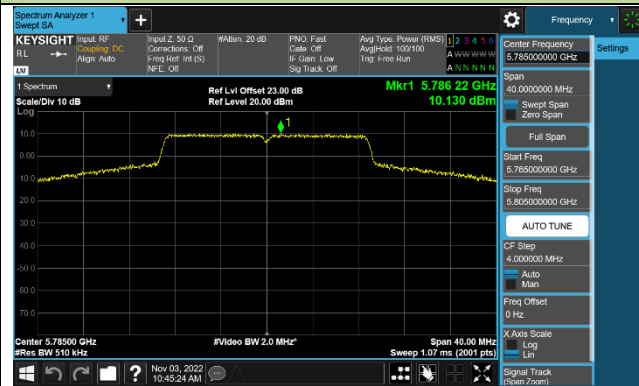

Channel 165 (5825MHz)

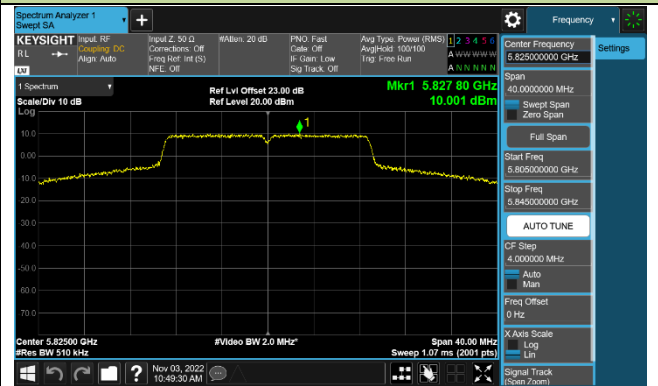

802.11ac-VHT40 Power Spectral Density - Ant 0

Channel 38 (5190MHz)

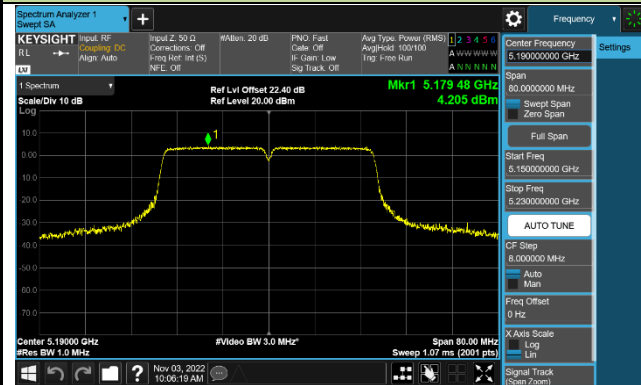

Channel 46 (5230MHz)

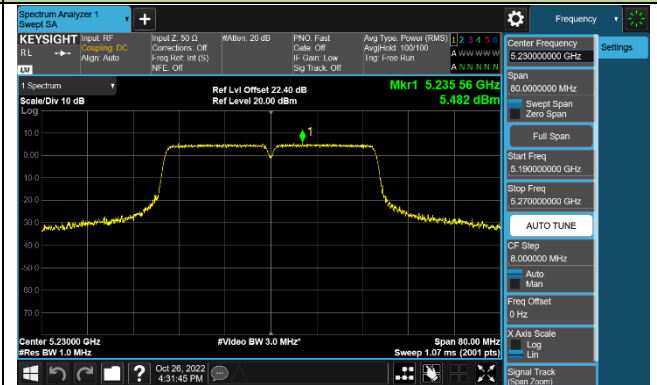

Channel 151 (5755MHz)

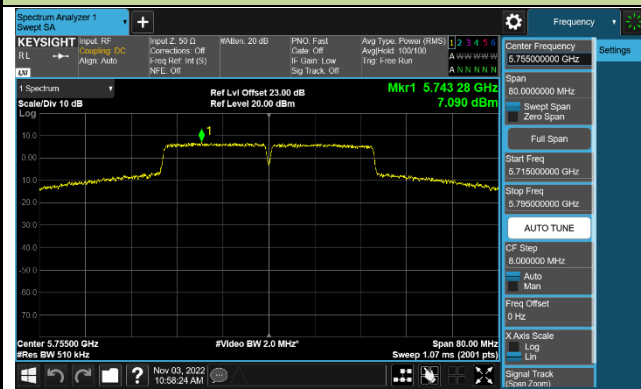

Channel 159 (5795MHz)

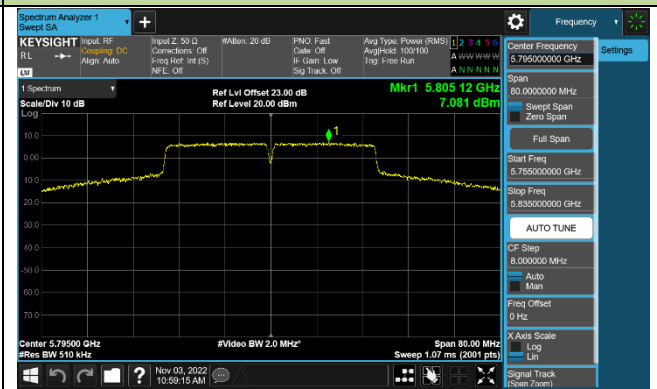

802.11ac-VHT80 Power Spectral Density - Ant 0

Channel 42 (5210MHz)

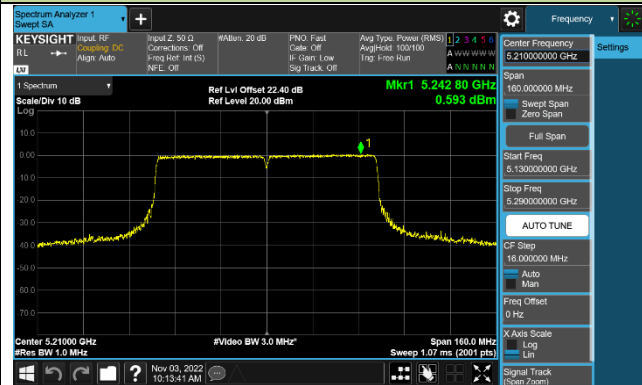

Channel 155 (5775MHz)

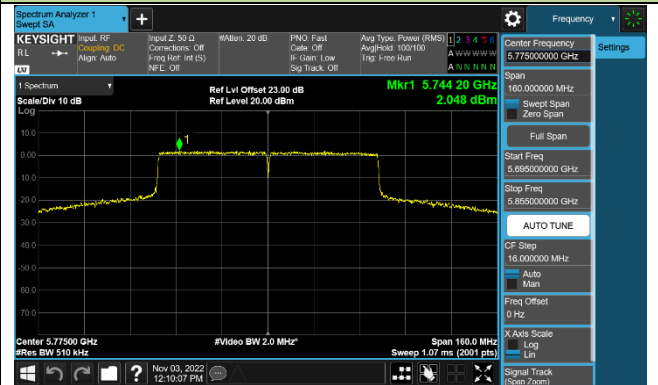

802.11ac-VHT160 Power Spectral Density - Ant 0

Channel 50 (5250MHz)

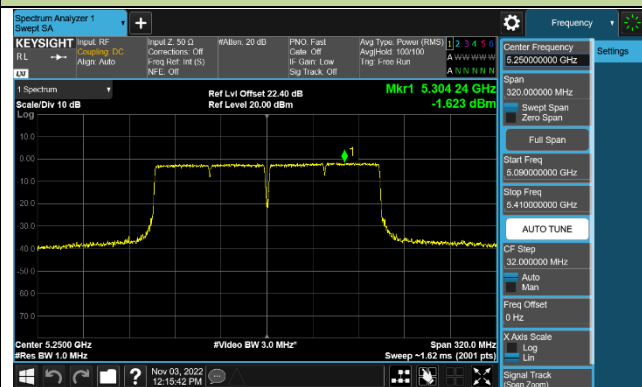

802.11ax-HE20 Power Spectral Density - Ant 0

Channel 36 (5180MHz)

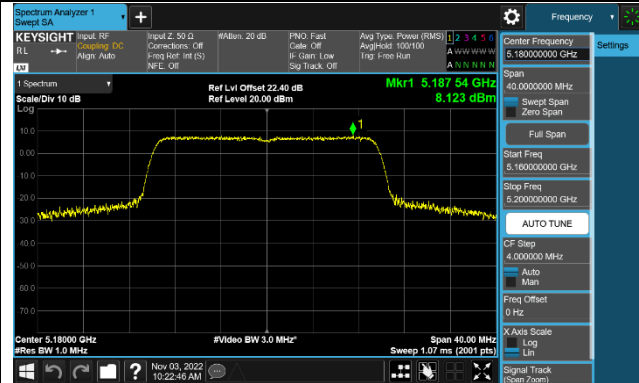

Channel 44 (5220MHz)

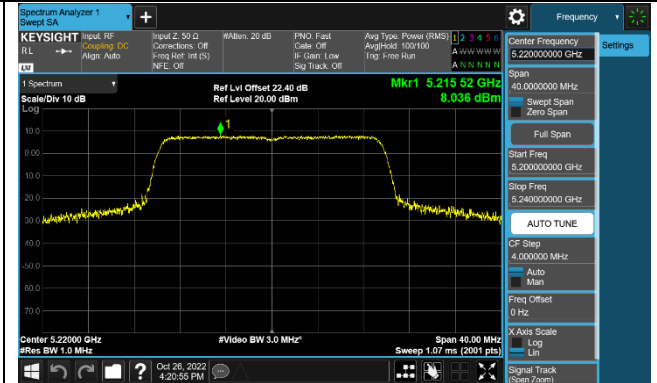

Channel 48 (5240MHz)

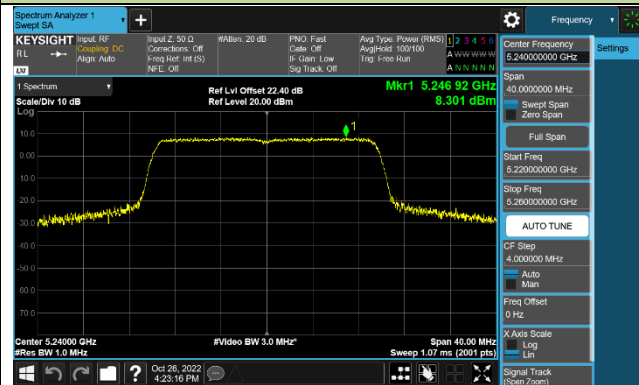

Channel 149 (5745MHz)

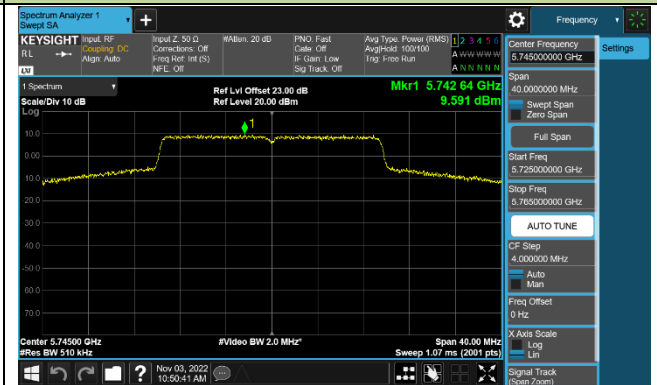

Channel 157 (5785MHz)

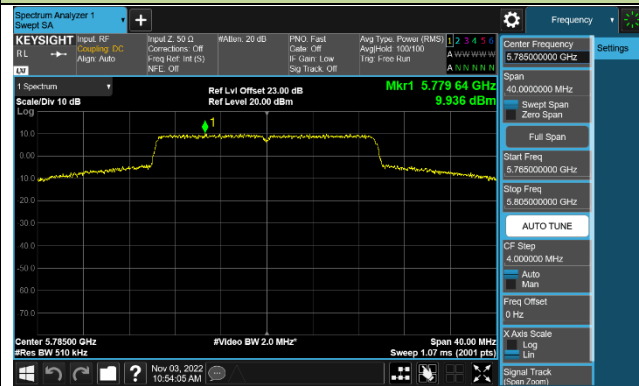

Channel 165 (5825MHz)

