

CFR 47 FCC PART 15 SUBPART E

TEST REPORT

For

AX1800 Gigabit Wi-Fi 6 Access Point

MODEL NUMBER: TL-WA1801

REPORT NUMBER: 4790812814-1-RF-2

ISSUE DATE: May 23, 2023

FCC ID: 2AXJ4WA1801

Prepared for

TP-Link Corporation Limited

**Room 901, 9/F. , New East Ocean Centre, 9 Science Museum Road, Tsim Sha Tsui,
Kowloon, Hong Kong**

Prepared by

UL Verification Services (Guangzhou) Co., Ltd, Song Shan Lake Branch

Building 10, Innovation Technology Park, No. 1, Li Bin Road, Song Shan Lake Hi-Tech Development Zone Dongguan, 523808, People's Republic of China

Tel: +86 769 22038881

Fax: +86 769 33244054

Website: www.ul.com

Revision History

Rev.	Issue Date	Revisions	Revised By
V0	May 23, 2023	Initial Issue	

Summary of Test Results

Test Item	Clause	Limit/Requirement	Result
6dB AND 26dB EMISSION BANDWIDTH AND 99% OCCUPIED BANDWIDTH	KDB 789033 D02 v02r01 Section C.1	FCC Part 15.407 (a)/(e),	Pass
ON TIME AND DUTY CYCLE	ANSI C63.10-2013, Clause 12.2	None; for reporting purposes only.	Pass
CONDUCTED OUTPUT POWER	KDB 789033 D02 v02r01 Section E.3.a (Method PM)	FCC 15.407 (a)	Pass
POWER SPECTRAL DENSITY	KDB 789033 D02 v02r01 Section F	FCC 15.407 (a)	Pass
AC Power Line Conducted Emission	ANSI C63.10-2013, Clause 6.2.	FCC 15.207	Pass
Radiated Emissions and Band Edge Measurement	KDB 789033 D02 v02r01 Section G.3, G.4, G.5, and G.6	FCC 15.407 (b) FCC 15.209 FCC 15.205	Pass
FREQUENCY STABILITY	ANSI C63.10-2013, Clause 6.8.	FCC 15.407 (g)	Pass
Dynamic Frequency Selection (Slave)	KDB 905462 D03 Client Without DFS New Rules v01r02	FCC Part 15.407 (h),	N/A
Dynamic Frequency Selection (Master)	KDB 905462 D02 UNII DFS Compliance Procedures New Rules v02	FCC Part 15.407 (h),	N/A
Antenna Requirement	N/A	FCC 47 CFR Part 15.203/ 15.407(a)(1) (2),	Pass

Note:

1. N/A: In this whole report not applicable.

*This test report is only published to and used by the applicant, and it is not for evidence purpose in China.

*The measurement result for the sample received is <Pass> according to <CFR 47 FCC PART 15 SUBPART E> when <Accuracy Method> decision rule is applied.

CONTENTS

1. ATTESTATION OF TEST RESULTS.....	6
2. TEST METHODOLOGY.....	7
3. FACILITIES AND ACCREDITATION.....	7
4. CALIBRATION AND UNCERTAINTY	8
4.1. <i>MEASURING INSTRUMENT CALIBRATION</i>	<i>8</i>
4.2. <i>MEASUREMENT UNCERTAINTY.....</i>	<i>8</i>
5. EQUIPMENT UNDER TEST	9
5.1. <i>DESCRIPTION OF EUT</i>	<i>9</i>
5.2. <i>CHANNEL LIST</i>	<i>9</i>
5.3. <i>MAXIMUM EIRP</i>	<i>10</i>
5.4. <i>TEST CHANNEL CONFIGURATION.....</i>	<i>10</i>
5.5. <i>THE WORSE CASE POWER SETTING PARAMETER.....</i>	<i>11</i>
5.6. <i>WORSE CASE CONFIGURATIONS.....</i>	<i>13</i>
5.7. <i>DESCRIPTION OF AVAILABLE ANTENNAS</i>	<i>14</i>
5.8. <i>SUPPORT UNITS FOR SYSTEM TEST.....</i>	<i>16</i>
6. MEASURING EQUIPMENT AND SOFTWARE USED.....	17
7. ANTENNA PORT TEST RESULTS	20
7.1. <i>6DB AND 26DB EMISSION BANDWIDTH AND 99% OCCUPIED BANDWIDTH ...</i>	<i>20</i>
7.2. <i>ON TIME AND DUTY CYCLE.....</i>	<i>22</i>
7.3. <i>CONDUCTED OUTPUT POWER.....</i>	<i>23</i>
7.4. <i>POWER SPECTRAL DENSITY</i>	<i>25</i>
7.5. <i>FREQUENCY STABILITY.....</i>	<i>27</i>
8. RADIATED TEST RESULTS.....	29
8.1. <i>RESTRICTED BANDEDGE</i>	<i>38</i>
8.2. <i>SPURIOUS EMISSIONS(1 GHZ~7 GHZ)</i>	<i>59</i>
8.3. <i>SPURIOUS EMISSIONS(7 GHZ~18 GHZ)</i>	<i>71</i>
8.4. <i>SPURIOUS EMISSIONS(9 KHZ~30 MHZ)</i>	<i>107</i>
8.5. <i>SPURIOUS EMISSIONS(18 GHZ~26 GHZ)</i>	<i>110</i>
8.6. <i>SPURIOUS EMISSIONS(26 GHZ~40 GHZ)</i>	<i>112</i>
8.7. <i>SPURIOUS EMISSIONS(30 MHZ~1 GHZ).....</i>	<i>114</i>
8.8. <i>SIMULTANEOUSLY TRANSMISSION SPURIOUS EMISSIONS</i>	<i>116</i>

9.	AC POWER LINE CONDUCTED EMISSION	120
10.	ANTENNA REQUIREMENT	124
11.	TEST DATA.....	125
11.1.	<i>APPENDIX A: EMISSION BANDWIDTH.....</i>	<i>125</i>
11.1.1.	Test Result.....	125
11.1.2.	Test Graphs	126
11.2.	<i>APPENDIX B: OCCUPIED CHANNEL BANDWIDTH.....</i>	<i>138</i>
11.2.1.	Test Result.....	138
11.2.2.	Test Graphs	139
11.3.	<i>APPENDIX C: MIN EMISSION BANDWIDTH</i>	<i>151</i>
11.3.1.	Test Result.....	151
11.3.2.	Test Graphs	152
11.4.	<i>APPENDIX D: MAXIMUM CONDUCTED OUTPUT POWER.....</i>	<i>158</i>
11.4.1.	Test Result.....	158
11.5.	<i>APPENDIX E: MAXIMUM POWER SPECTRAL DENSITY</i>	<i>160</i>
11.5.1.	Test Result.....	160
11.5.2.	Test Graphs	161
11.6.	<i>APPENDIX F: FREQUENCY STABILITY.....</i>	<i>173</i>
11.6.1.	Test Result.....	173
11.7.	<i>APPENDIX G: DUTY CYCLE.....</i>	<i>175</i>
11.7.1.	Test Result.....	175
11.7.2.	Test Graphs	176

1. ATTESTATION OF TEST RESULTS

Applicant Information

Company Name: TP-Link Corporation Limited
 Address: Room 901, 9/F. , New East Ocean Centre, 9 Science Museum Road, Tsim Sha Tsui, Kowloon, Hong Kong

Manufacturer Information

Company Name: TP-Link Corporation Limited
 Address: Room 901, 9/F. , New East Ocean Centre, 9 Science Museum Road, Tsim Sha Tsui, Kowloon, Hong Kong

EUT Information

EUT Name: AX1800 Gigabit Wi-Fi 6 Access Point
 Model: TL-WA1801
 Brand: tp-link
 Sample Received Date: April 12, 2023
 Sample Status: Normal
 Sample ID: 6008492
 Date of Tested: April 19, 2023 to May 23, 2023

APPLICABLE STANDARDS	
STANDARD	TEST RESULTS
CFR 47 FCC PART 15 SUBPART E	Pass

Prepared By:



Fanny Huang
 Engineer Project Associate

Checked By:

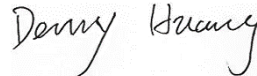

Denny Huang
 Senior Project Engineer

Approved By:



Stephen Guo
 Operations Manager

2. TEST METHODOLOGY

All tests were performed in accordance with the standard CFR 47 FCC PART 15 SUBPART E , ANSI C63.10-2013, CFR 47 FCC Part 2, KDB 789033 D02 v02r01, KDB414788 D01 Radiated Test Site v01, KDB 662911 D01 Multiple Transmitter Output v02r01.

3. FACILITIES AND ACCREDITATION

Accreditation Certificate	<p>A2LA (Certificate No.: 4102.01) UL Verification Services (Guangzhou) Co., Ltd. Song Shan Lake Branch. has been assessed and proved to be in compliance with A2LA.</p> <p>FCC (FCC Designation No.: CN1187) UL Verification Services (Guangzhou) Co., Ltd. Song Shan Lake Branch. Has been recognized to perform compliance testing on equipment subject to the Commission's Declaration of Conformity (DoC) and Certification rules</p> <p>ISED (Company No.: 21320) UL Verification Services (Guangzhou) Co., Ltd. Song Shan Lake Branch. has been registered and fully described in a report filed with ISED. The Company Number is 21320 and the test lab Conformity Assessment Body Identifier (CABID) is CN0046.</p> <p>VCCI (Registration No.: G-20019, R-20004, C-20012 and T-20011) UL Verification Services (Guangzhou) Co., Ltd. Song Shan Lake Branch. has been assessed and proved to be in compliance with VCCI, the Membership No. is 3793. Facility Name: Chamber D, the VCCI registration No. is G-20019 and R-20004 Shielding Room B , the VCCI registration No. is C-20012 and T-20011</p>
---------------------------	--

Note 1:

All tests measurement facilities use to collect the measurement data are located at Building 10, Innovation Technology Park, No. 1, Li Bin Road, Song Shan Lake Hi-Tech Development Zone Dongguan, 523808, People’s Republic of China.

Note 2:

The test anechoic chamber in UL Verification Services (Guangzhou) Co., Ltd. Song Shan Lake Branch had been calibrated and compared to the open field sites and the test anechoic chamber is shown to be equivalent to or worst case from the open field site.

Note 3:

For below 30 MHz, lab had performed measurements at test anechoic chamber and comparing to measurements obtained on an open field site. And these measurements below 30 MHz had been correlated to measurements performed on an OFS.

4. CALIBRATION AND UNCERTAINTY

4.1. MEASURING INSTRUMENT CALIBRATION

The measuring equipment utilized to perform the tests documented in this report has been calibrated in accordance with the manufacturer's recommendations and is traceable to recognized national standards.

4.2. MEASUREMENT UNCERTAINTY

Where relevant, the following measurement uncertainty levels have been estimated for tests performed on the apparatus:

Test Item	Uncertainty
Conduction emission	3.62 dB
Radiated Emission (Included Fundamental Emission) (9 kHz ~ 30 MHz)	2.2 dB
Radiated Emission (Included Fundamental Emission) (30 MHz ~ 1 GHz)	4.00 dB
Radiated Emission (Included Fundamental Emission) (1 GHz to 40 GHz)	5.78 dB (1 GHz ~ 18 GHz)
	5.23 dB (18 GHz ~ 26 GHz)
	5.37 dB (26 GHz ~ 40 GHz)
Duty Cycle	±0.028%
Emission Bandwidth and 99% Occupied Bandwidth	±0.0196%
Maximum Conducted Output Power	±0.766 dB
Maximum Power Spectral Density Level	±1.22 dB
Frequency Stability	±2.76%
Conducted Band-edge Compliance	±1.328 dB
Conducted Unwanted Emissions In Non-restricted Frequency Bands	±0.746 dB (9 kHz ~ 1 GHz)
	±1.328dB (1 GHz ~ 26 GHz)
Note: This uncertainty represents an expanded uncertainty expressed at approximately the 95% confidence level using a coverage factor of k=2.	

5. EQUIPMENT UNDER TEST

5.1. DESCRIPTION OF EUT

EUT Name	AX1800 Gigabit Wi-Fi 6 Access Point
Model	TL-WA1801

Frequency Range:	5180 MHz to 5240 MHz 5745 MHz to 5825 MHz
Type of Modulation:	IEEE 802.11a: OFDM(64QAM, 16QAM, QPSK, BPSK) IEEE 802.11n: OFDM(64QAM, 16QAM, QPSK, BPSK) IEEE 802.11ac: OFDM(256QAM, 64QAM, 16QAM, QPSK, BPSK) IEEE 802.11ax: OFDMA(1024QAM, 256QAM, 64QAM, 16QAM, QPSK, BPSK)
Radio Technology:	IEEE802.11a/n HT20/n HT40/ac VHT20/ac VHT40/ ac VHT80/ax HE20/ax HE40/ax HE80
Normal Test Voltage:	DC 48 V via adapter

5.2. CHANNEL LIST

UNII-1 (For Bandwidth=20MHz)		UNII-1 (For Bandwidth=40MHz)		UNII-1 (For Bandwidth=80MHz)	
Channel	Frequency (MHz)	Channel	Frequency (MHz)	Channel	Frequency (MHz)
36	5180	38	5190	42	5210
40	5200	46	5230		
44	5220				
48	5240				

UNII-3 (For Bandwidth=20MHz)		UNII-3 (For Bandwidth=40MHz)		UNII-3 (For Bandwidth=80MHz)	
Channel	Frequency (MHz)	Channel	Frequency (MHz)	Channel	Frequency (MHz)
149	5745	151	5755	155	5775
153	5765	159	5795		
157	5785				
161	5805				
165	5825				

5.3. MAXIMUM EIRP

UNII-1 BAND(FCC)

IEEE Std. 802.11	Frequency (MHz)	Maximum Average Conducted Power (dBm)
a	5150 ~ 5250	25.68
ax HE20		25.97
ax HE40		27.93
ax HE80		23.70

UNII-3 BAND(FCC)

IEEE Std. 802.11	Frequency (MHz)	Maximum Average Conducted Power (dBm)
a	5725 ~ 5850	27.86
ax HE20		28.18
ax HE40		28.73
ax HE80		28.82

5.4. TEST CHANNEL CONFIGURATION

UNII-1 Test Channel Configuration		
IEEE Std.	Test Channel Number	Frequency
802.11a	CH 36(Low Channel), CH 40(MID Channel), CH 48(High Channel)	5180 MHz, 5200 MHz, 5240 MHz
802.11ax HE20	CH 36(Low Channel), CH 40(MID Channel), CH 48(High Channel)	5180 MHz, 5200 MHz, 5240 MHz
802.11ax HE40	CH 38(Low Channel), CH 46(High Channel)	5190 MHz, 5230 MHz
802.11ax HE80	CH 42(Low Channel)	5210 MHz

UNII-3 Test Channel Configuration		
IEEE Std.	Test Channel Number	Frequency
802.11a	CH 149(Low Channel), CH 157(MID Channel), CH 165(High Channel)	5745 MHz, 5785 MHz, 5825 MHz
802.11ax HE20	CH 149(Low Channel), CH 157(MID Channel), CH 165(High Channel)	5745 MHz, 5785 MHz, 5825 MHz
802.11ax HE40	CH 151(Low Channel), CH 159(High Channel)	5755MHz, 5795MHz
802.11ax HE80	CH 155(Low Channel)	5775 MHz

5.5. THE WORSE CASE POWER SETTING PARAMETER

The Worse Case Power Setting Parameter	
Test Software	MT7915 QA

UNII-1

Mode	Rate	Channel	Soft set value
			ANT 1/ANT 3
11a	6M	36	18.5
		40	18.5
		48	19
11n HT20	MCS0	36	Cover by 11ax HE20
		40	
		48	
11n HT40	MCS0	38	Cover by 11ax HE40
		46	
11ac VHT20	MCS0	36	Cover by 11ax HE20
		40	
		48	
11ac VHT40	MCS0	38	Cover by 11ax HE40
		46	
11ac VHT80	MCS0	42	Cover by 11ax HE80
11ax HE20	MCS0	36	18.5
		40	18.5
		48	19
11ax HE40	MCS0	38	18
		46	21
11ax HE80	MCS0	42	16

UNII-3

Mode	Rate	Channel	Soft set value
			ANT 1/ANT 3
11a	6M	149	21
		157	21
		165	21
11n HT20	MCS0	149	Cover by 11ax HE20
		157	
		165	
11n HT40	MCS0	151	Cover by 11ax HE40
		159	
11ac VHT20	MCS0	149	Cover by 11ax HE20
		157	
		165	
11ac VHT40	MCS0	151	Cover by 11ax HE40
		159	
11ac VHT80	MCS0	155	Cover by 11ax HE80
11ax HE20	MCS0	149	21
		157	21
		165	21
11ax HE40	MCS0	151	21
		159	21
11ax HE80	MCS0	155	21

5.6. WORSE CASE CONFIGURATIONS

The EUT was tested in the following configuration(s):

Controlled in test mode using a software application on the EUT supplied by customer. The application was used to enable a continuous transmission and to select the mode, test channels, bandwidth, data rates as required.

Test channels referring to section 5.4.

Maximum power setting referring to section 5.5.

Worst case Data Rates declared by the customer:

802.11a 20 CDD mode : 6 Mbps
 802.11n HT20 CDD mode : MCS0
 802.11n HT40 CDD mode : MCS0
 802.11ac VHT20 CDD mode : MCS0
 802.11ac VHT40 CDD mode : MCS0
 802.11ac VHT80 CDD mode : MCS0
 802.11ac VHT160 CDD mode : MCS0
 802.11ax HE20 CDD mode : MCS0
 802.11ax HE40 CDD mode : MCS0
 802.11ax HE80 CDD mode : MCS0
 802.11ax HE160 CDD mode : MCS0

All modes support CDD mode.

All modes support TX beamforming mode except 802.11a 20/n HT20/HT40.

802.11n HT20/HT40/ac VHT20/VHT40/VHT80 and 802.11ax HE20/HE40/HE80 were performed on the worst case (802.11ax HE20/HE40/HE80) mode and only the worst data was recorded in this report.

The EUT has 4 separate antennas which correspond to 4 separate antenna ports. Core 1 and Core 3 correspond to antenna 1 and antenna 3 respectively and they support RLAN 5G. Core 2 and Core 4 correspond to antenna 2 and antenna 4 respectively and they support WLAN 2.4G.

The measured additional path loss was included in any path loss calculations for all RF cable used during tested.

The EUT support Cyclic Shift Diversity (CDD) and TX Beamforming and only the worst data was recorded in this report.

The 5 GHz beamforming function is enabled by test program, the carrier wave will be under radio chip phase control and sent to the antennas through the test program.

Simultaneously Transmission Conditions:

Support Technology		Support (YES/NO)
WLAN (2.4G)	WLAN (5G)	YES

Note: The emission of the simultaneous operation has been evaluated and no non-compliance was found.

5.7. DESCRIPTION OF AVAILABLE ANTENNAS

Antenna No.	Frequency Band	Antenna Type	Max Antenna Gain (dBi)
1	5150-5850	Diople Antenna	3
3	5150-5850	Diople Antenna	3

The EUT support Cyclic Shift Diversity(CDD) mode.

MIMO output power port and MIMO PSD port summing were performed in accordance with KDB 662911 D01. For the CDD results the Directional Gain was calculated in accordance with the following method.

For output power measurements:

Directional gain= $G_{ANT} + \text{Array Gain} = 3 \text{ dBi}$

G_{ANT} : equal to the gain of the antenna having the highest gain

Array Gain = 0 dB (i.e., no array gain) for $N_{ANT} \leq 4$

For power spectral density (PSD) measurements:

Directional gain= $G_{ANT} + \text{Array Gain} = 6 \text{ dBi}$

Array Gain = $10 \log(N_{ANT}/N_{SS}) \text{ dB}$.

N_{ANT} : number of transmit antennas

N_{SS} : number of spatial streams, The worst case directional gain will occur when $N_{SS} = 1$

The EUT also support TX Beamforming mode For the Tx beamforming mode results the Directional Gain was calculated in accordance with the following method.

For output power measurements:

Directional gain= $G_{ANT} + 10 \log(N_{ANT}) \text{ dBi} = 6 \text{ dBi}$

G_{ANT} : equal to the gain of the antenna having the highest gain

For power spectral density (PSD) measurements:

Directional gain= $G_{ANT} + 10 \log(N_{ANT}) \text{ dBi} = 6 \text{ dBi}$

G_{ANT} : equal to the gain of the antenna having the highest gain

IEE Std. 802.11	Transmit and Receive Mode	Description
802.11a	<input checked="" type="checkbox"/> 2TX, 2RX	ANT 1 and ANT 3 can be used as transmitting/receiving antenna.
802.11n HT20	<input checked="" type="checkbox"/> 2TX, 2RX	ANT 1 and ANT 3 can be used as transmitting/receiving antenna.
802.11n HT40	<input checked="" type="checkbox"/> 2TX, 2RX	ANT 1 and ANT 3 can be used as transmitting/receiving antenna.
802.11ac VHT20	<input checked="" type="checkbox"/> 2TX, 2RX	ANT 1 and ANT 3 can be used as transmitting/receiving antenna.
802.11ac VHT40	<input checked="" type="checkbox"/> 2TX, 2RX	ANT 1 and ANT 3 can be used as transmitting/receiving antenna.
802.11ac VHT80	<input checked="" type="checkbox"/> 2TX, 2RX	ANT 1 and ANT 3 can be used as transmitting/receiving antenna.
802.11ax HE20	<input checked="" type="checkbox"/> 2TX, 2RX	ANT 1 and ANT 3 can be used as transmitting/receiving antenna.
802.11ax HE40	<input checked="" type="checkbox"/> 2TX, 2RX	ANT 1 and ANT 3 can be used as transmitting/receiving antenna.
802.11ax HE80	<input checked="" type="checkbox"/> 2TX, 2RX	ANT 1 and ANT 3 can be used as transmitting/receiving antenna.

Note: The value of the antenna gain was declared by customer.

5.8. SUPPORT UNITS FOR SYSTEM TEST

SUPPORT EQUIPMENT

Item	Equipment	Brand Name	Model Name	Remarks
1	Laptop	ThinkPad	X230i	/

I/O CABLES

Cable No	Port	Connector Type	Cable Type	Cable Length(m)	Remarks
1	LAN1	RJ45	Unshielded	1.0 m	/

ACCESSORIES

Item	Accessory	Brand Name	Model Name	Description
1	I.T.E. POWER SUPPLY	tp-link	T480038-2B1	Input: AC 100-240 V, 50 / 60 Hz, 0.6 A Output: DC 48.0 V, 0.375 A

TEST SETUP

The EUT can work in engineering mode with a software through a laptop.

SETUP DIAGRAM FOR TESTS

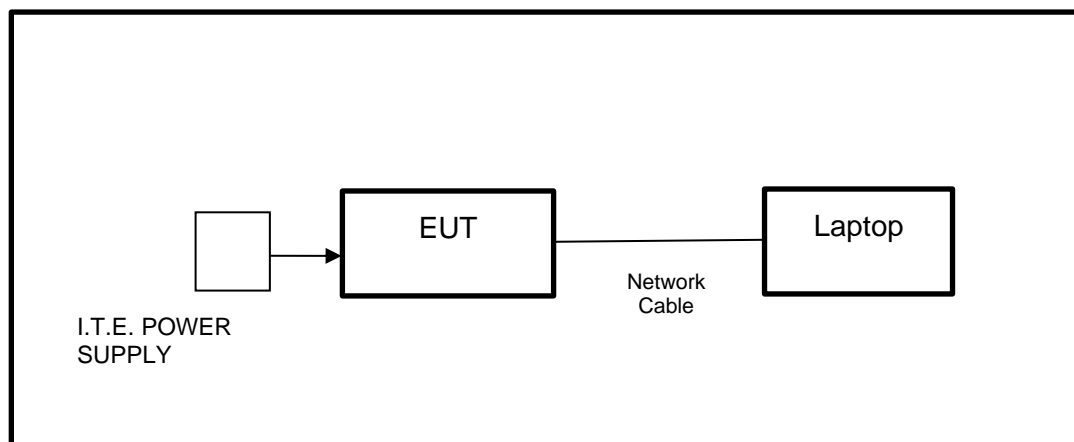

6. MEASURING EQUIPMENT AND SOFTWARE USED

R&S TS 8997 Test System					
Equipment	Manufacturer	Model No.	Serial No.	Last Cal.	Due. Date
Power sensor, Power Meter	R&S	OSP120	100921	Mar.31,2023	Mar.30,2024
Vector Signal Generator	R&S	SMBV100A	261637	Oct.17, 2022	Oct.16, 2023
Signal Generator	R&S	SMB100A	178553	Oct.17, 2022	Oct.16, 2023
Signal Analyzer	R&S	FSV40	101118	Oct.17, 2022	Oct.16, 2023
Software					
Description	Manufacturer	Name		Version	
For R&S TS 8997 Test System	Rohde & Schwarz	EMC 32		10.60.10	
Tonsend RF Test System					
Equipment	Manufacturer	Model No.	Serial No.	Last Cal.	Due. Date
Wideband Radio Communication Tester	R&S	CMW500	155523	Oct.17, 2022	Oct.16, 2023
Wireless Connectivity Tester	R&S	CMW270	1201.0002N75-102	Sep.28, 2022	Sep.27, 2023
PXA Signal Analyzer	Keysight	N9030A	MY55410512	Oct.17, 2022	Oct.16, 2023
MXG Vector Signal Generator	Keysight	N5182B	MY56200284	Oct.17, 2022	Oct.16, 2023
MXG Vector Signal Generator	Keysight	N5172B	MY56200301	Oct.17, 2022	Oct.16, 2023
DC power supply	Keysight	E3642A	MY55159130	Oct.17, 2022	Oct.16, 2023
Temperature & Humidity Chamber	SANMOOD	SG-80-CC-2	2088	Oct.17, 2022	Oct.16, 2023
Attenuator	Aglient	8495B	2814a12853	Oct.18, 2022	Oct.17, 2023
RF Control Unit	Tonscend	JS0806-2	23B80620666	April 18,2023	April 17,2024
Software					
Description	Manufacturer	Name		Version	
Tonsend SRD Test System	Tonsend	JS1120-3 RF Test System		V3.2.22	

Conducted Emissions					
Equipment	Manufacturer	Model No.	Serial No.	Last Cal.	Due Date
EMI Test Receiver	R&S	ESR3	101961	Oct.17, 2022	Oct.16, 2023
Two-Line V-Network	R&S	ENV216	101983	Oct.17, 2022	Oct.16, 2023
Artificial Mains Networks	Schwarzbeck	NSLK 8126	8126465	Oct.17, 2022	Oct.16, 2023
Software					
Description			Manufacturer	Name	Version
Test Software for Conducted Emissions			Farad	EZ-EMC	Ver. UL-3A1

Radiated Emissions					
Equipment	Manufacturer	Model No.	Serial No.	Last Cal.	Due Date
MXE EMI Receiver	KESIGHT	N9038A	MY56400036	Oct.17, 2022	Oct.16, 2023
Hybrid Log Periodic Antenna	TDK	HLP-3003C	130959	Aug.02, 2021	Aug.01, 2024
Preamplifier	HP	8447D	2944A09099	Oct.17, 2022	Oct.16, 2023
EMI Measurement Receiver	R&S	ESR26	101377	Oct.17, 2022	Oct.16, 2023
Horn Antenna	TDK	HRN-0118	130940	July 20, 2021	July 19, 2024
Preamplifier	TDK	PA-02-0118	TRS-305-00067	Oct.17, 2022	Oct.16, 2023
Horn Antenna	Schwarzbeck	BBHA9170	697	July 20, 2021	July 19, 2024
Preamplifier	TDK	PA-02-2	TRS-307-00003	Oct.17, 2022	Oct.16, 2023
Preamplifier	TDK	PA-02-3	TRS-308-00002	Oct.17, 2022	Oct.16, 2023
Loop antenna	Schwarzbeck	1519B	00008	Dec.14, 2021	Dec.13, 2024
Preamplifier	TDK	PA-02-001-3000	TRS-302-00050	Oct.17, 2022	Oct.16, 2023
Preamplifier	Mini-Circuits	ZX60-83LN-S+	SUP01202035	Oct.17, 2022	Oct.16, 2023
High Pass Filter	Wi	WHKX10-2700-3000-18000-40SS	23	/	/
Highpass Filter	Wainwright	WHKX10-5850-6500-1800-40SS	4	/	/
Band Reject Filter	Wainwright	WRCJV12-5695-5725-5850-5880-40SS	4	/	/

Band Reject Filter	Wainwright	WRCJV20-5120-5150-5350-5380-60SS	2	/	/
Band Reject Filter	Wainwright	WRCJV20-5440-5470-5725-5755-60SS	1	/	/
Band Reject Filter	Wainwright	WRCJV8-2350-2400-2483.5-2533.5-40SS	4	/	/
Band Reject Filter	Wainwright	WRCD5-1879-1879.85-1880.15-1881-40SS	1	/	/
Notch Filter	Wainwright	WHJ10-882-980-7000-40SS	1	/	/
Software					
Description			Manufacturer	Name	Version
Test Software for Radiated Emissions			Farad	EZ-EMC	Ver. UL-3A1

Other Instrument					
Equipment	Manufacturer	Model No.	Serial No.	Last Cal.	Due Date
Temperature humidity probe	OMEGA	ITHX-SD-5	18470007	Oct.22, 2022	Oct.21, 2023
Barometer	Yiyi	Baro	N/A	Oct.24, 2022	Oct.23, 2023
Attenuator	Agilent	8495B	2814a12853	Oct.18, 2022	Oct.17, 2023

7. ANTENNA PORT TEST RESULTS

7.1. 6DB AND 26DB EMISSION BANDWIDTH AND 99% OCCUPIED BANDWIDTH

LIMITS

CFR 47 FCC Part15, Subpart E		
Test Item	Limit	Frequency Range (MHz)
26 dB Emission Bandwidth	For reporting purposes only.	5150 ~ 5250
26 dB Emission Bandwidth	For reporting purposes only.	5250 ~ 5350
26 dB Emission Bandwidth	For reporting purposes only.	5470 ~ 5725 (For FCC) 5470 ~ 5600 (For ISED) 5650 ~ 5725 (For ISED)
6 dB Emission Bandwidth	The minimum 6 dB emission bandwidth shall be 500 kHz.	5725 ~ 5850
99 % Occupied Bandwidth	For reporting purposes only.	5150 ~ 5825 (For ISED)

TEST PROCEDURE

Refer to KDB 789033 D02 General U-NII Test Procedures New Rules v02r01 section II.C1. for 26 dB Emission Bandwidth; section II.C2. for 6 dB Emission Bandwidth; section II.D. for 99 % Occupied Bandwidth.

Connect the EUT to the spectrum analyser and use the following settings:

Center Frequency	The center frequency of the channel under test
Detector	Peak
RBW	For 6 dB Emission Bandwidth: RBW=100 kHz For 26 dB Emission bandwidth: approximately 1 % of the EBW. For 99 % Occupied Bandwidth: approximately 1 % ~ 5 % of the OBW.
VBW	For 6 dB Bandwidth: $\geq 3 \times \text{RBW}$ For 26 dB Bandwidth: $> 3 \times \text{RBW}$ For 99 % Bandwidth: $> 3 \times \text{RBW}$
Trace	Max hold
Sweep	Auto couple

- Use the 99 % power bandwidth function of the instrument, allow the trace to stabilize and report the measured bandwidth.
- Allow the trace to stabilize and measure the maximum width of the emission that is constrained by the frequencies associated with the two outermost amplitude points (upper and lower frequencies) that are attenuated by 6/26 dB relative to the maximum level measured in the fundamental emission.

Calculation for 99 % Bandwidth of UNII-2C and UNII-3 Straddle Channel:

For Example: Fundamental Frequency: 5720 MHz

99 % OBW: 21.00 MHz

Turning Frequency: 5725 MHz

99 % Bandwidth of UNII-2C Band Portion = $(5725-(5720-(21.00/2))) = 15.50$ MHz

99 % Bandwidth of UNII-3 Band Portion = $(5720+(21.00/2)-5725) = 5.50$ MHz

Calculation for 26 dB Bandwidth of UNII-2C Straddle Channel:

For Example: Fundamental frequency: 5720 MHz

26 dB BW: 20.00 MHz

FL: 5710.16 MHz

FH: 5730.16 MHz

Turning Frequency: 5725 MHz

26 dB Bandwidth of UNII-2C Band Portion = $5725-5710.16=14.84$ MHz

Calculation for 6dB Bandwidth of UNII-3 Straddle Channel:

For Example: Fundamental frequency: 5720 MHz

6 dB BW: 16.44 MHz

FL: 5711.76 MHz

FH: 5728.2 MHz

Turning Frequency: 5725 MHz

6 dB Bandwidth of UNII-3 band Portion = $5728.2-5725=3.2$ MHz

TEST SETUP

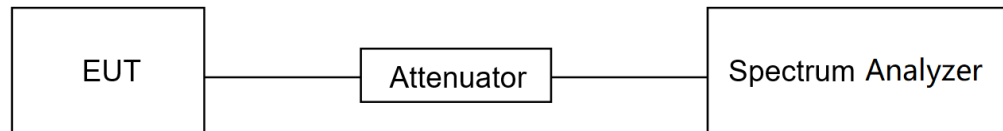

TEST ENVIRONMENT

Temperature	26°C	Relative Humidity	57%
Atmosphere Pressure	101kPa	Test Voltage	DC 48 V

TEST DATE / ENGINEER

Test Date	May 19, 2023	Test By	Walker Yuan
-----------	--------------	---------	-------------

TEST RESULTS

Please refer to section "Test Data" - Appendix A&B&C

7.2. ON TIME AND DUTY CYCLE

LIMITS

None; for reporting purposes only.

TEST PROCEDURE

Refer to KDB 789033 D02 General U-NII Test Procedures New Rules v02r01 section II.B.

The zero-span mode on a spectrum analyzer or EMI receiver, if the response time and spacing between bins on the sweep are sufficient to permit accurate measurements of the on and off times of the transmitted signal. Set the center frequency of the instrument to the center frequency of the transmission. Set $RBW \geq EBW$ if possible; otherwise, set RBW to the largest available value. Set $VBW \geq RBW$. Set detector = peak or average. The zero-span measurement method shall not be used unless both RBW and VBW are $> 50/T$, where T is defined in II.B.1.a), and the number of sweep points across duration T exceeds 100. (For example, if VBW and/or RBW are limited to 3 MHz, then the zero-span method of measuring duty cycle shall not be used if $T \leq 16.7$ microseconds.)

TEST SETUP

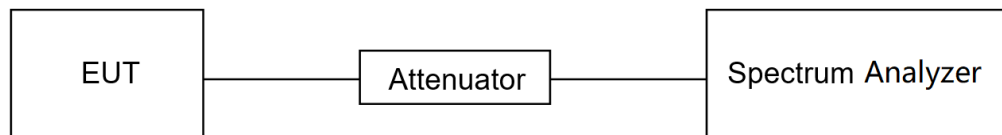

TEST ENVIRONMENT

Temperature	26°C	Relative Humidity	57%
Atmosphere Pressure	101kPa	Test Voltage	DC 48 V

TEST DATE / ENGINEER

Test Date	May 19, 2023	Test By	Walker Yuan
-----------	--------------	---------	-------------

TEST RESULTS

Please refer to section "Test Data" - Appendix G

7.3. CONDUCTED OUTPUT POWER

LIMITS

CFR 47 FCC Part15, Subpart E		
Test Item	Limit	Frequency Range (MHz)
Conducted Output Power	<input type="checkbox"/> Outdoor Access Point: 1 W (30 dBm) <input type="checkbox"/> Indoor Access Point: 1 W (30 dBm) <input type="checkbox"/> Fixed Point-To-Point Access Points: 1 W (30 dBm) <input checked="" type="checkbox"/> Client Devices: 250 mW (24 dBm)	5150 ~ 5250
	Shall not exceed the lesser of 250 mW (24dBm) or 11 dBm + 10 log B, where B is the 26 dB emission bandwidth in megahertz.	5250 ~ 5350 5470 ~ 5725
	Shall not exceed 1 Watt (30 dBm).	5725 ~ 5850

Note:

The above limits are based upon the maximum antenna gain does not exceed 6 dBi. If transmitting antennas of directional gain greater than 6 dBi are used, the maximum conducted output power shall be reduced by the amount in dB that the directional gain of the antenna exceeds 6 dBi.

TEST PROCEDURE

Refer to KDB 789033 D02 General U-NII Test Procedures New Rules v02r01 section II.E.

Method SA-2 (trace averaging across ON and OFF times of the EUT transmissions, followed by duty cycle correction.):

- (a) Measure the duty cycle D of the transmitter output signal.
- (b) Set span to encompass the entire 26 dB EBW or 99% OBW of the signal.
- (c) Set RBW = 1 MHz.
- (d) Set VBW \geq 3 MHz.
- (e) Number of points in sweep \geq $[2 \times \text{span} / \text{RBW}]$. (This gives bin-to-bin spacing \leq RBW / 2, so that narrowband signals are not lost between frequency bins.)
- (f) Sweep time = auto.
- (g) Detector = RMS (i.e., power averaging), if available. Otherwise, use sample detector mode.
- (h) Do not use sweep triggering. Allow the sweep to "free run."
- (i) Trace average at least 100 traces in power averaging (rms) mode; however, the number of traces to be averaged shall be increased above 100 as needed such that the average accurately represents the true average over the ON and OFF periods of the transmitter.
- (j) Compute power by integrating the spectrum across the 26 dB EBW or 99% OBW of the signal using the instrument's band power measurement function with band limits set equal to the EBW or OBW band edges. If the instrument does not have a band power function, then sum the spectrum levels (in power units) at 1 MHz intervals extending across the 26 dB EBW or 99% OBW of the spectrum.
- (k) Add $[10 \log (1 / D)]$, where D is the duty cycle, to the measured power to compute the average power during the actual transmission times (because the measurement represents an average over both the ON and OFF times of the transmission). For example, add $[10 \log (1 / 0.25)] = 6$ dB if the duty cycle is 25%.

Method PM (Measurement using an RF average power meter):

(i) Measurements may be performed using a wideband RF power meter with a thermocouple detector or equivalent if all of the following conditions are satisfied:

- a. The EUT is configured to transmit continuously or to transmit with a constant duty cycle.
- b. At all times when the EUT is transmitting, it must be transmitting at its maximum power control level.
- c. The integration period of the power meter exceeds the repetition period of the transmitted signal by at least a factor of five.

(ii) If the transmitter does not transmit continuously, measure the duty cycle, x , of the transmitter output signal as described in II.B.

(iii) Measure the average power of the transmitter. This measurement is an average over both the on and off periods of the transmitter.

(iv) Adjust the measurement in dBm by adding $10 \log (1/x)$ where x is the duty cycle (e.g., $10 \log (1/0.25)$ if the duty cycle is 25 %).

Note: Method SA-2 was used for straddle channel output power test, and Method PM was used for testing rest channels

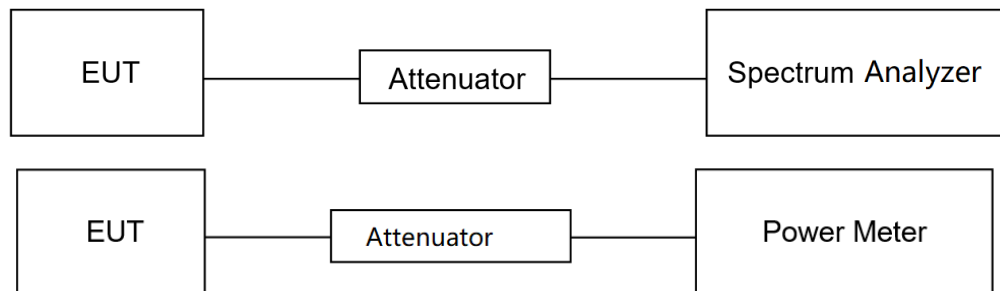
TEST SETUP

TEST ENVIRONMENT

Temperature	26°C	Relative Humidity	57%
Atmosphere Pressure	101kPa	Test Voltage	DC 48 V

TEST DATE / ENGINEER

Test Date	May 19, 2023	Test By	Walker Yuan
-----------	--------------	---------	-------------

TEST RESULTS

Please refer to section "Test Data" - Appendix D

7.4. POWER SPECTRAL DENSITY

LIMITS

CFR 47 FCC Part15, Subpart E		
Test Item	Limit	Frequency Range (MHz)
Power Spectral Density	<input type="checkbox"/> Outdoor Access Point: 17 dBm/MHz <input type="checkbox"/> Indoor Access Point: 17 dBm/MHz <input type="checkbox"/> Fixed Point-To-Point Access Points: 17 dBm/MHz <input checked="" type="checkbox"/> Client Devices: 11 dBm/MHz	5150 ~ 5250
	11 dBm/MHz	5250 ~ 5350 5470 ~ 5725
	30 dBm/500kHz	5725 ~ 5850

Note:

The above limits are based upon the maximum antenna gain does not exceed 6 dBi. If transmitting antennas of directional gain greater than 6 dBi are used, maximum power spectral density shall be reduced by the amount in dB that the directional gain of the antenna exceeds 6 dBi.

TEST PROCEDURE

Refer to KDB 789033 D02 General U-NII Test Procedures New Rules v02r01 section II.F.

Connect the EUT to the spectrum analyser and use the following settings:

For U-NII-1, U-NII-2A and U-NII-2C band:

Center Frequency	The center frequency of the channel under test
Detector	RMS
RBW	1 MHz
VBW	$\geq 3 \times$ RBW
Span	Encompass the entire emissions bandwidth (EBW) of the signal
Trace	Max hold
Sweep time	Auto

For U-NII-3:

Center Frequency	The center frequency of the channel under test
Detector	RMS
RBW	500 kHz
VBW	$\geq 3 \times$ RBW
Span	Encompass the entire emissions bandwidth (EBW) of the signal
Trace	Max hold
Sweep time	Auto

Allow trace to fully stabilize and Use the peak search function on the instrument to find the peak of the spectrum and record its value.
Add $10 \log (1/x)$, where x is the duty cycle, to the peak of the spectrum, the result is the Maximum PSD over 1 MHz / 500 kHz reference bandwidth.

TEST SETUP

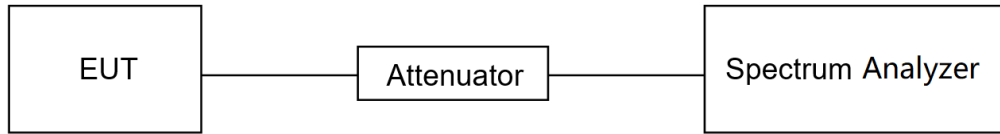

TEST ENVIRONMENT

Temperature	26°C	Relative Humidity	57%
Atmosphere Pressure	101kPa	Test Voltage	DC 48 V

TEST DATE / ENGINEER

Test Date	May 19, 2023	Test By	Walker Yuan
-----------	--------------	---------	-------------

TEST RESULTS

Please refer to section "Test Data" - Appendix E

7.5. FREQUENCY STABILITY

LIMITS

The frequency of the carrier signal shall be maintained within band of operation.

TEST PROCEDURE

1. The EUT was placed inside an environmental chamber as the temperature in the chamber was varied between 0 °C ~ 40 °C (declared by customer).
2. The temperature was incremented by 10 °C intervals and the unit allowed to stabilize at each temperature before each measurement. The center frequency of the transmitting channel was evaluated at each temperature and the frequency deviation from the channel's center frequency was recorded.
3. The primary supply voltage is varied from 85 % to 115 % of the nominal value for non hand-carried battery and AC powered equipment. For hand-carried, battery-powered equipment, primary supply voltage is reduced to the battery operating end point which shall be specified by the manufacturer.

Connect the EUT to the spectrum analyser and use the following settings:

Center Frequency	The center frequency of the channel under test
Detector	Peak
RBW	10 kHz
VBW	$\geq 3 \times \text{RBW}$
Span	Encompass the entire emissions bandwidth (EBW) of the signal
Trace	Max hold
Sweep time	Auto

4. While maintaining a constant temperature inside the environmental chamber, turn the EUT on and record the operating frequency at startup, and at 2 minutes, 5 minutes, and 10 minutes after the EUT is energized.
5. Allow the trace to stabilize, find the peak value of the power envelope and record the frequency, then calculated the frequency drift.

TEST ENVIRONMENT

	Normal Test Conditions	Extreme Test Conditions
Relative Humidity	20 % - 75 %	/
Atmospheric Pressure	100 kPa ~102 kPa	/
Temperature	T _N (Normal Temperature): 25.1 °C	T _L (Low Temperature): 0 °C
		T _H (High Temperature): 40 °C
Supply Voltage	V _N (Normal Voltage): AC 120 V, 60 Hz	V _L (Low Voltage): AC 102 V
		V _H (High Voltage): AC 138 V

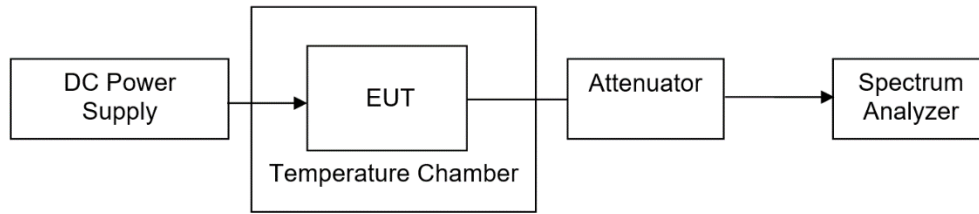
TEST SETUP

TEST ENVIRONMENT

Temperature	26°C	Relative Humidity	57%
Atmosphere Pressure	101kPa	Test Voltage	/

TEST DATE / ENGINEER

Test Date	May 19, 2023	Test By	Walker Yuan
-----------	--------------	---------	-------------

TEST RESULTS

Please refer to section "Test Data" - Appendix F

8. RADIATED TEST RESULTS

LIMITS

Refer to CFR 47 FCC §15.205, §15.209 and §15.407 (b).

Radiation Disturbance Test Limit for FCC (Class B) (9 kHz ~ 1 GHz)

Emissions radiated outside of the specified frequency bands above 30 MHz			
Frequency Range (MHz)	Field Strength Limit (uV/m) at 3 m	Field Strength Limit (dBuV/m) at 3 m	
		Quasi-Peak	
30 - 88	100	40	
88 - 216	150	43.5	
216 - 960	200	46	
Above 960	500	54	
Above 1000	500	Peak	Average
		74	54

FCC Emissions radiated outside of the specified frequency bands below 30 MHz		
Frequency (MHz)	Field strength (microvolts/meter)	Measurement distance (meters)
0.009-0.490	2400/F(kHz)	300
0.490-1.705	24000/F(kHz)	30
1.705-30.0	30	30

FCC Restricted bands of operation refer to FCC §15.205 (a):

MHz	MHz	MHz	GHz
0.090-0.110	16.42-16.423	399.9-410	4.5-5.15
¹ 0.495-0.505	16.69475-16.69525	608-614	5.35-5.46
2.1735-2.1905	16.80425-16.80475	960-1240	7.25-7.75
4.125-4.128	25.5-25.67	1300-1427	8.025-8.5
4.17725-4.17775	37.5-38.25	1435-1626.5	9.0-9.2
4.20725-4.20775	73-74.6	1645.5-1646.5	9.3-9.5
6.215-6.218	74.8-75.2	1660-1710	10.6-12.7
6.26775-6.26825	108-121.94	1718.8-1722.2	13.25-13.4
6.31175-6.31225	123-138	2200-2300	14.47-14.5
8.291-8.294	149.9-150.05	2310-2390	15.35-16.2
8.362-8.366	156.52475-156.52525	2483.5-2500	17.7-21.4
8.37625-8.38675	156.7-156.9	2690-2900	22.01-23.12
8.41425-8.41475	162.0125-167.17	3260-3267	23.6-24.0
12.29-12.293	167.72-173.2	3332-3339	31.2-31.8
12.51975-12.52025	240-285	3345.8-3358	36.43-36.5
12.57675-12.57725	322-335.4	3600-4400	(²)
13.36-13.41			

Note: ¹Until February 1, 1999, this restricted band shall be 0.490-0.510 MHz.

²Above 38.6c

Limits of unwanted/undesirable emission out of the restricted bands refer to CFR 47 FCC §15.407 (b) and ISED RSS-247 6.2.

LIMITS OF RADIATED EMISSION MEASUREMENT (Above 1GHz)		
Frequency Range (MHz)	EIRP Limit	Field Strength Limit (dBuV/m) at 3 m
5150~5250 MHz	PK: -27 (dBm/MHz)	PK: 68.2(dBμV/m)
5250~5350 MHz		
5470~5725 MHz		
5725~5850 MHz	PK: -27 (dBm/MHz) *1 PK: 10 (dBm/MHz) *2 PK: 15.6 (dBm/MHz) *3 PK: 27 (dBm/MHz) *4	PK: 68.2(dBμV/m) *1 PK: 105.2 (dBμV/m) *2 PK: 110.8(dBμV/m) *3 PK: 122.2 (dBμV/m) *4
Note: *1 beyond 75 MHz or more above of the band edge. *2 below the band edge increasing linearly to 10 dBm/MHz at 25 MHz above. *3 below the band edge increasing linearly to a level of 15.6 dBm/MHz at 5 MHz above. *4 from 5 MHz above or below the band edge increasing linearly to a level of 27 dBm/MHz at the band edge.		

TEST PROCEDURE

Below 30 MHz

The setting of the spectrum analyser

RBW	200 Hz (From 9 kHz to 0.15 MHz)/ 9 kHz (From 0.15 MHz to 30 MHz)
VBW	200 Hz (From 9 kHz to 0.15 MHz)/ 9 kHz (From 0.15 MHz to 30 MHz)

Sweep	Auto
-------	------

1. The testing follows the guidelines in ANSI C63.10-2013 clause 6.4.
2. The EUT was arranged to its worst case and then turntable (from 0 degree to 360 degrees) to find the maximum reading. A pre-amp and a high pass filter are used for the test in order to get better signal level. Both Horizontal, Face-on and Face-off polarizations of the antenna are set to make the measurement.
3. The EUT was placed on a turntable with 80 cm above ground.
4. The EUT was set 3 meters from the interference receiving antenna, which was mounted on the top of a 1 m height antenna tower.
5. The radiated emission limits are based on measurements employing a CISPR quasi-peak detector except for the frequency bands 9-90 kHz, 110-490 kHz and above 1000 MHz Radiated emission limits in these three bands are based on measurements employing an average detector.
6. For measurement below 1 GHz, the initial step in collecting conducted emission data is a spectrum analyzer peak detector mode pre-scanning the measurement frequency range. Significant peaks are then marked and then Quasi Peak and average detector mode re-measured. If the emission level of the EUT measured by the peak detector is 3 dB lower than the applicable limit, the peak emission level will be reported. Otherwise, the emission measurement will be repeated using the quasi-peak and average detector and reported.
7. Although these tests were performed other than open field site, adequate comparison measurements were confirmed against 30m open field site. Therefore sufficient tests were made to demonstrate that the alternative site produces results that correlate with the ones of tests made in an open field site based on KDB 414788.
8. The limits in CFR 47, Part 15, Subpart C, paragraph 15.209 (a), are identical to those in RSS-GEN Section 8.9, Table 6, since the measurements are performed in terms of magnetic field strength and converted to electric field strength levels (as reported in the table) using the free space impedance of 377Ω . For example, the measurement frequency X KHz resulted in a level of Y dBuV/m, which is equivalent to $Y-51.5 = Z$ dBuA/m, which has the same margin, W dB, to the corresponding RSS-GEN Table 6 limit as it has to be 15.209(a) limit.

Below 1 GHz and above 30 MHz

The setting of the spectrum analyser

RBW	120 kHz
VBW	300 kHz
Sweep	Auto
Detector	Peak/QP
Trace	Max hold

1. The testing follows the guidelines in ANSI C63.10-2013 clause 6.5.
2. The EUT was arranged to its worst case and then tune the antenna tower (from 1 m to 4 m) and turntable (from 0 degree to 360 degrees) to find the maximum reading. A pre-amp and a high pass filter are used for the test in order to get better signal level. Both horizontal and vertical polarizations of the antenna are set to make the measurement.
3. The EUT was placed on a turntable with 80 cm above ground.
4. The EUT was set 3 meters from the interference receiving antenna, which was mounted on the top of a variable height antenna tower.
5. For measurement below 1 GHz, the initial step in collecting conducted emission data is a spectrum analyzer peak detector mode pre-scanning the measurement frequency range. Significant peaks are then marked and then Quasi Peak detector mode re-measured. If the emission level of the EUT measured by the peak detector is 3 dB lower than the applicable limit, the peak emission level will be reported. Otherwise, the emission measurement will be repeated using the quasi-peak detector and reported.

Above 1 GHz

The setting of the spectrum analyser

RBW	1 MHz
VBW	PEAK: 3 MHz AVG: see note 6
Sweep	Auto
Detector	Peak
Trace	Max hold

1. The testing follows the guidelines in KDB 789033 D02 General U-NII Test Procedures New Rules v02r01 section II.G.3 ~ II.G.6.
2. The EUT was arranged to its worst case and then tune the antenna tower (from 1 m to 4 m) and turntable (from 0 degree to 360 degrees) to find the maximum reading. A pre-amp and a high pass filter are used for the test in order to get better signal level. Both horizontal and vertical polarizations of the antenna are set to make the measurement.
3. The EUT was placed on a turntable with 1.5 m above ground.
4. The EUT was set 3 meters from the interference receiving antenna, which was mounted on the top of a variable height antenna tower.
5. For measurement above 1 GHz, the emission measurement will be measured by the peak detector. This peak level, once corrected, must comply with the limit specified in Section 15.209.
6. For measurements above 1 GHz the resolution bandwidth is set to 1 MHz, then the video bandwidth is set to 3 MHz for peak measurements and 1 MHz resolution bandwidth with 1/T video bandwidth with peak detector for average measurements. For the Duty Cycle please refer to clause 7.2.ON TIME AND DUTY CYCLE.

X axis, Y axis, Z axis positions:

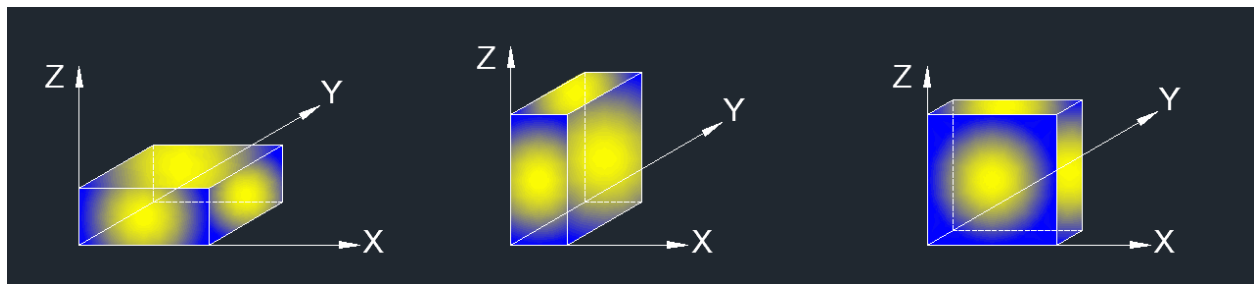

Note 1: For all radiated test, EUT in each of three orthogonal axis emissions had been tested, but only the worst case (X axis) data recorded in the report.

Note 2: The EUT was fully exercised with external accessories during the test. In the case of multiple accessory external ports, an external accessory shall be connected to one of each type of port.

For Band edge:

Note:

1. Measurement = Reading Level + Correct Factor.
2. If the Peak values are less than the Average limit of 54 dBuV/m, the Average result is deemed to comply with Average limit.
3. Peak: Peak detector.
4. AVG: $VBW=1/Ton$, where: Ton is the transmitting duration.
5. For the transmitting duration, please refer to clause 7.2.
6. Only the worst data was recorded, if it complies with the limit, the other emissions deemed to comply with the limit.
7. Horizontal and Vertical have been tested, only the worst data was recorded in the report.
8. All modes, channels and antennas have been tested, only the worst data was recorded in the report.

For Radiate Spurious emission 1GHz-7GHz:

Note:

1. Measurement = Reading Level + Correct Factor.
2. If the Peak values are less than the Average limit of 54 dBuV/m, the Average result is deemed to comply with Average limit.
3. Peak: Peak detector.
4. AVG: $VBW=1/Ton$, where: Ton is the transmitting duration.
5. For the transmitting duration, please refer to clause 7.2.
6. Filter losses were only considered in the spurious frequency bands and the authorized band was not corrected for Band reject filter losses.
7. Proper operation of the transmitter prior to adding the filter to the measurement chain.
8. Since non-restricted band peak emissions are less than the average limit, they also comply with the -27dBm/MHz (68.2dBuV/m) limit.
9. All modes, channels and antennas have been tested, only the worst data was recorded in the report.

For Radiate Spurious emission 7GHz-18GHz:

Note:

1. Measurement = Reading Level + Correct Factor.
2. If the Peak values are less than the Average limit of 54 dBuV/m, the Average result is deemed to comply with Average limit.
3. Peak: Peak detector.
4. AVG: $VBW=1/Ton$, where: Ton is the transmitting duration.
5. For the transmitting duration, please refer to clause 7.2.
6. Filter losses were only considered in the spurious frequency bands and the authorized band was not corrected for High Pass Filter losses.
7. Proper operation of the transmitter prior to adding the filter to the measurement chain.
8. Since non-restricted band peak emissions are less than the average limit, they also comply with the -27dBm/MHz (68.2dBuV/m) limit.
9. All modes, channels and antennas have been tested, only the worst data was recorded in the report.

For Radiate Spurious emission 9kHz-30MHz:

Note:

1. Measurement = Reading Level + Correct Factor
2. If the Peak values are less than the QP limit, the QP result is deemed to comply with QP limit.
3. All 3 polarizations (Horizontal, Face-on and Face-off) of the loop antenna had been tested, but only the worst data recorded in the report.
4. All modes, channels and antennas have been tested, only the worst data was recorded in the report.

For Radiate Spurious emission 18GHz-26GHz:

Note:

1. Measurement = Reading Level + Correct Factor.
2. If the Peak values are less than the Average limit of 54 dBuV/m, the Average result is deemed to comply with Average limit.
3. Peak: Peak detector.
4. All modes, channels and antennas have been tested, only the worst data was recorded in the report.

For Radiate Spurious emission 26GHz-40GHz:

Note:

1. Measurement = Reading Level + Correct Factor.
2. If the Peak values are less than the Average limit of 54 dBuV/m, the Average result is deemed to comply with Average limit.
3. Peak: Peak detector.
4. All modes, channels and antennas have been tested, only the worst data was recorded in the report.

For Radiate Spurious emission 30MHz-1GHz:

Note:

1. Result Level = Read Level + Correct Factor.
2. If the Peak values are less than the QP limit, the QP result is deemed to comply with QP limit.
3. Test setup: RBW: 120 kHz, VBW: 300 kHz, Sweep time: auto.
4. All modes, channels and antennas have been tested, only the worst data was recorded in the report.

TEST SETUP

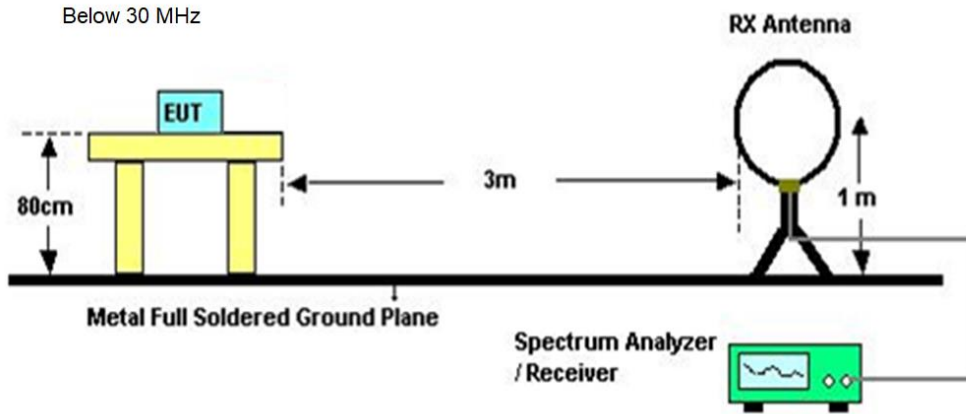

Below 1 GHz and above 30 MHz

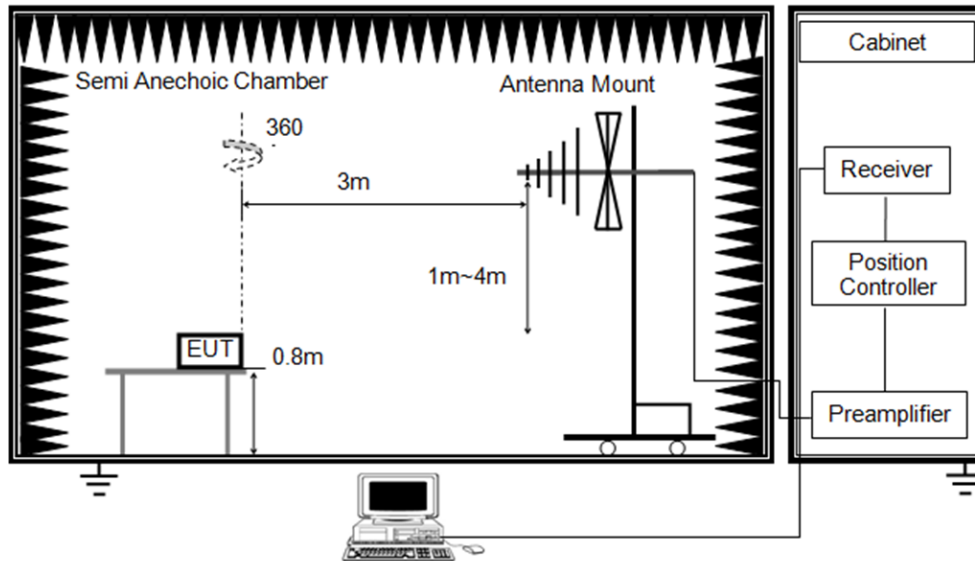

Above 1 GHz

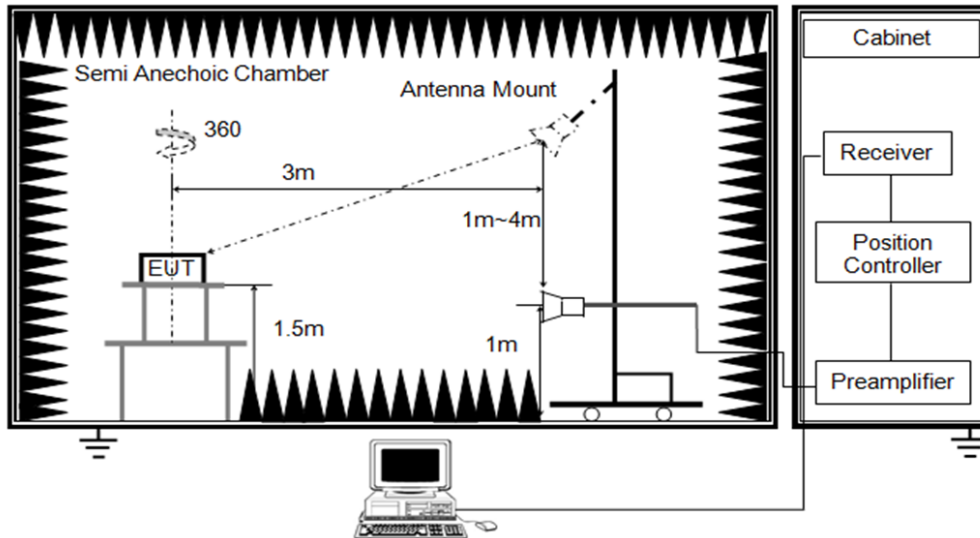

TEST ENVIRONMENT

Temperature	25.3°C	Relative Humidity	61%
Atmosphere Pressure	101kPa	Test Voltage	DC 48 V

TEST DATE / ENGINEER

Test Date	May 17, 2023	Test By	Rex Huang
-----------	--------------	---------	-----------

TEST RESULTS

8.1. RESTRICTED BANDEDGE

Test Mode:	802.11a 20 PK	Channel:	5180
Polarity:	Vertical	Test Voltage:	DC 48 V

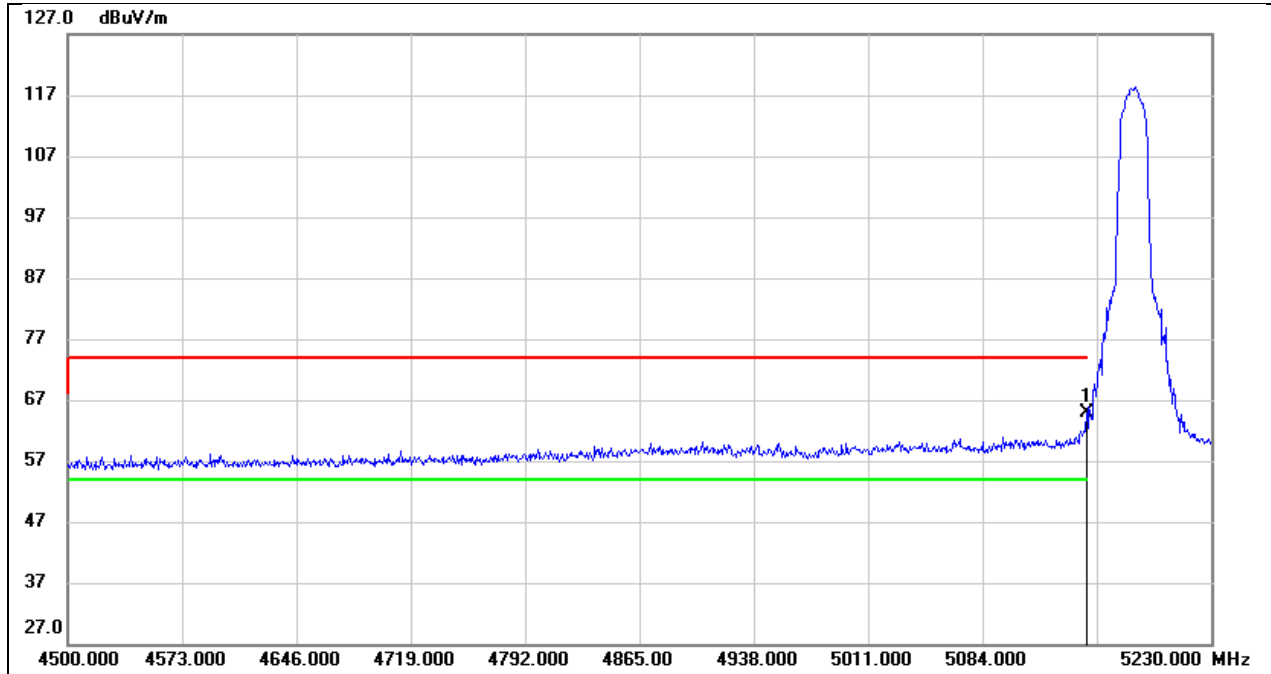

No.	Frequency (MHz)	Reading (dBuV)	Correct (dB/m)	Result (dBuV/m)	Limit (dBuV/m)	Margin (dB)	Remark
1	5150.000	21.51	43.27	64.78	74.00	-9.22	peak

Test Mode:	802.11a 20 AV	Channel:	5180
Polarity:	Vertical	Test Voltage:	DC 48 V

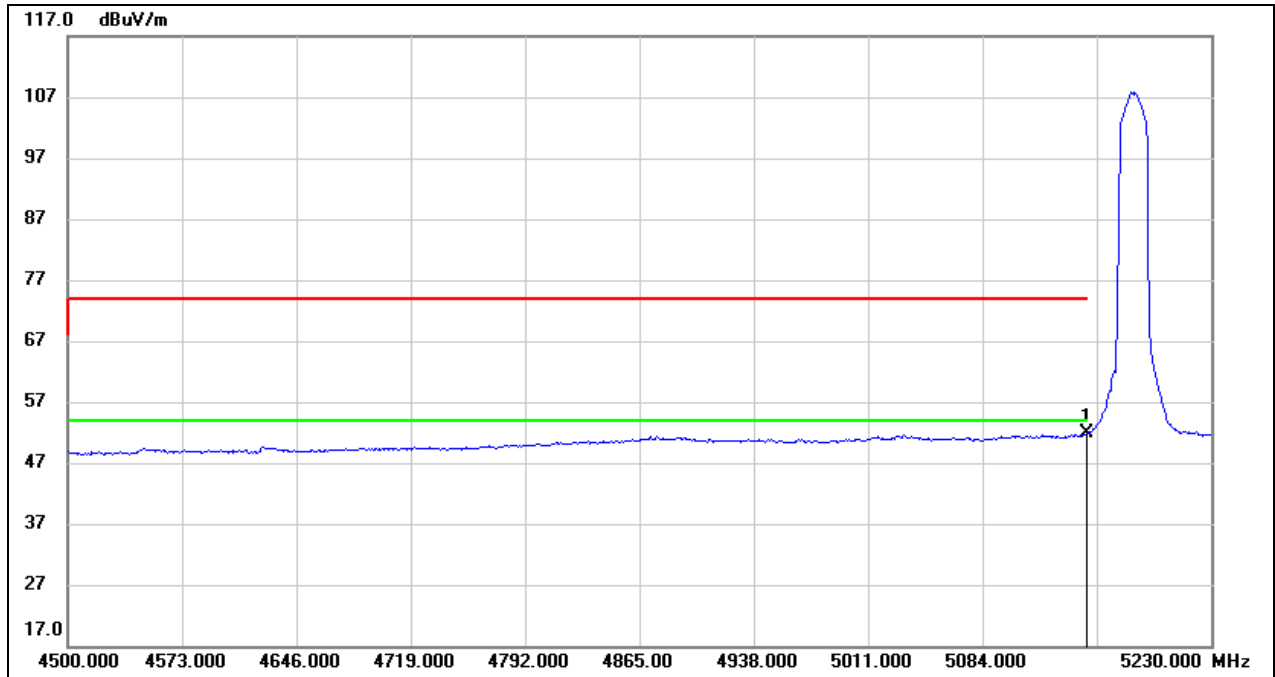

No.	Frequency (MHz)	Reading (dBuV)	Correct (dB/m)	Result (dBuV/m)	Limit (dBuV/m)	Margin (dB)	Remark
1	5150.000	8.57	43.27	51.84	54.00	-2.16	AVG

Test Mode:	802.11a 20 PK	Channel:	5240
Polarity:	Vertical	Test Voltage:	DC 48 V

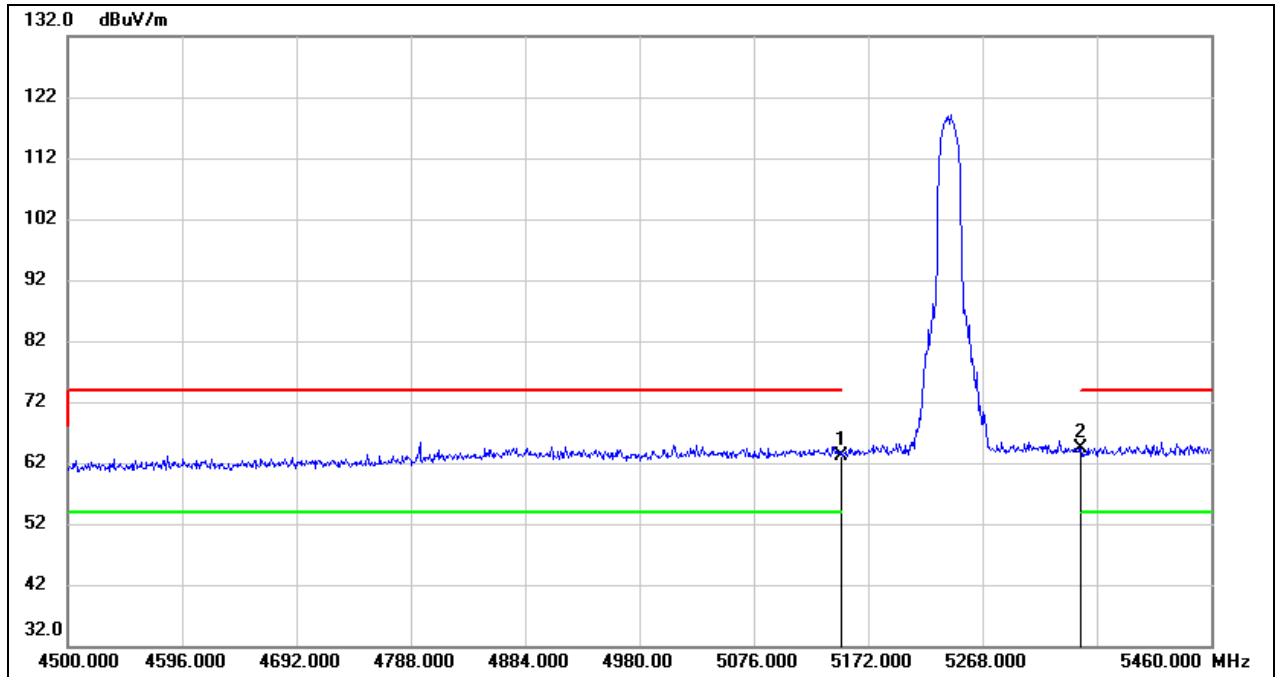

No.	Frequency (MHz)	Reading (dBuV)	Correct (dB/m)	Result (dBuV/m)	Limit (dBuV/m)	Margin (dB)	Remark
1	5150.000	19.88	43.27	63.15	74.00	-10.85	peak
2	5350.000	20.97	43.49	64.46	74.00	-9.54	peak

Test Mode:	802.11a 20 AV	Channel:	5240
Polarity:	Vertical	Test Voltage:	DC 48 V

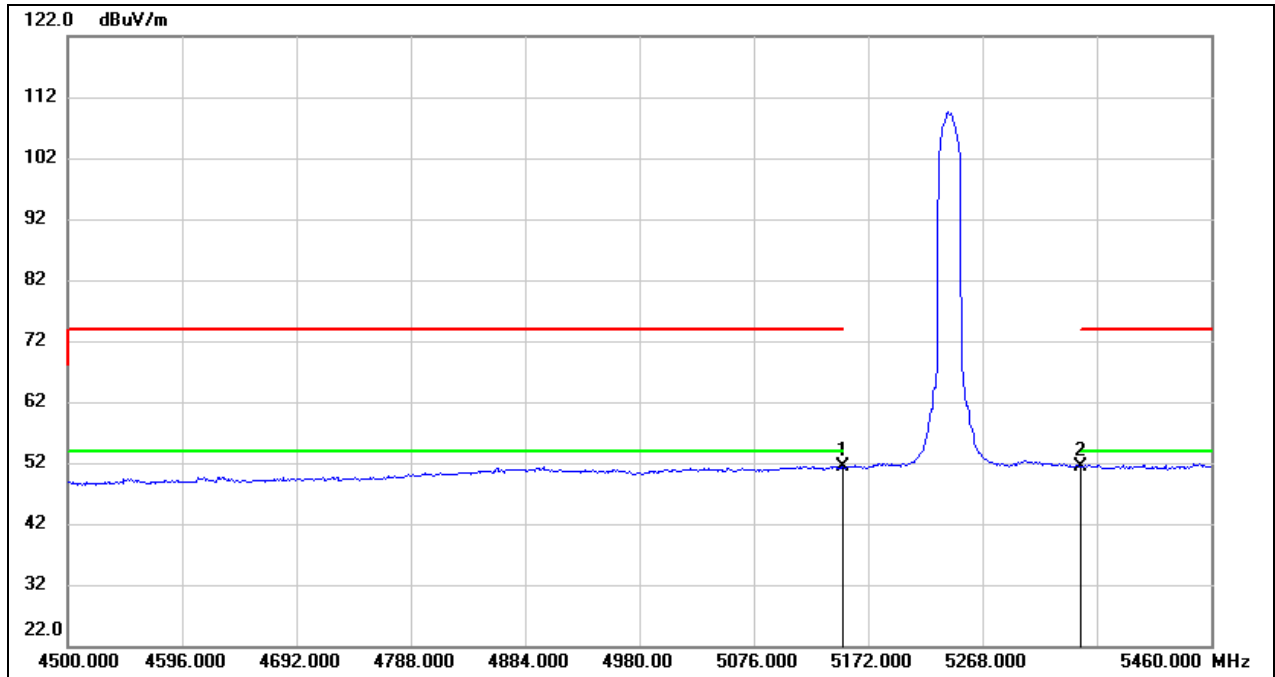

No.	Frequency (MHz)	Reading (dBuV)	Correct (dB/m)	Result (dBuV/m)	Limit (dBuV/m)	Margin (dB)	Remark
1	5150.000	8.04	43.27	51.31	54.00	-2.69	AVG
2	5350.000	7.88	43.49	51.37	54.00	-2.63	AVG

Test Mode:	802.11a 20 PK	Channel:	5745
Polarity:	Vertical	Test Voltage:	DC 48 V

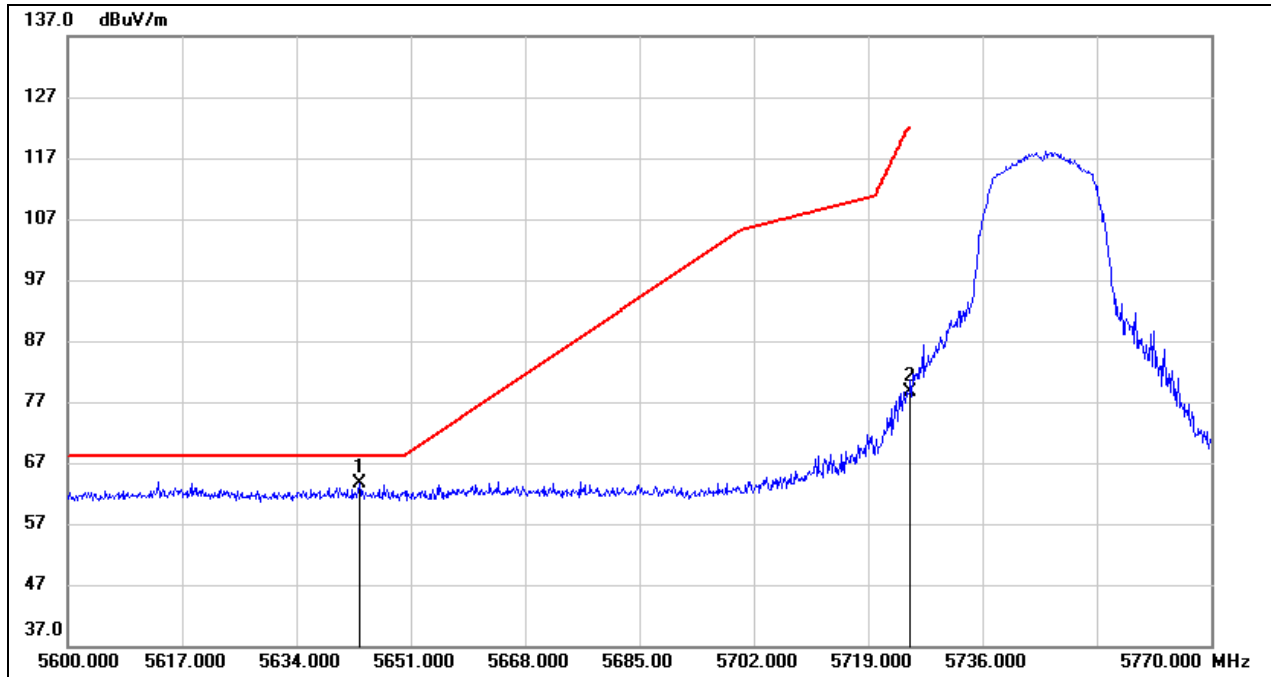

No.	Frequency (MHz)	Reading (dBuV)	Correct (dB/m)	Result (dBuV/m)	Limit (dBuV/m)	Margin (dB)	Remark
1	5643.350	19.49	44.04	63.53	68.20	-4.67	peak
2	5725.000	34.42	44.27	78.69	122.20	-43.51	peak

Test Mode:	802.11a 20 PK	Channel:	5825
Polarity:	Vertical	Test Voltage:	DC 48 V

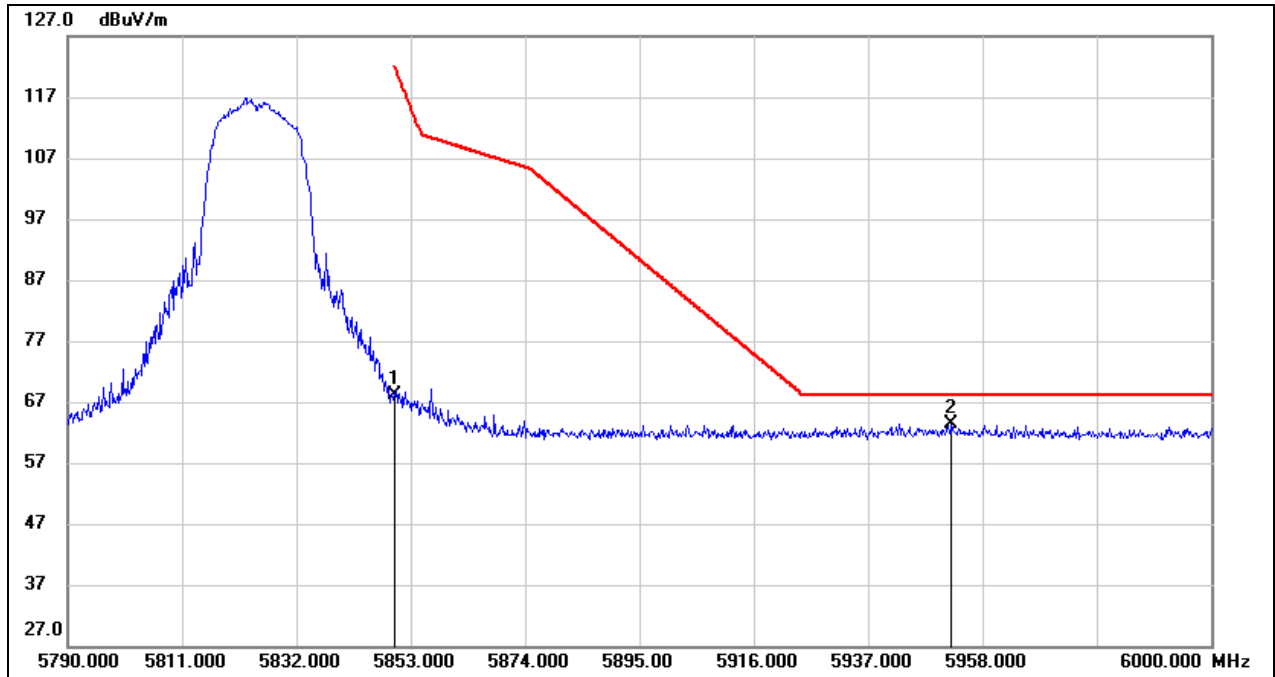

No.	Frequency (MHz)	Reading (dBuV)	Correct (dB/m)	Result (dBuV/m)	Limit (dBuV/m)	Margin (dB)	Remark
1	5850.000	23.58	44.60	68.18	122.20	-54.02	peak
2	5952.330	18.52	44.87	63.39	68.20	-4.81	peak

Test Mode:	802.11ax HE20 PK	Channel:	5180
Polarity:	Vertical	Test Voltage:	DC 48 V

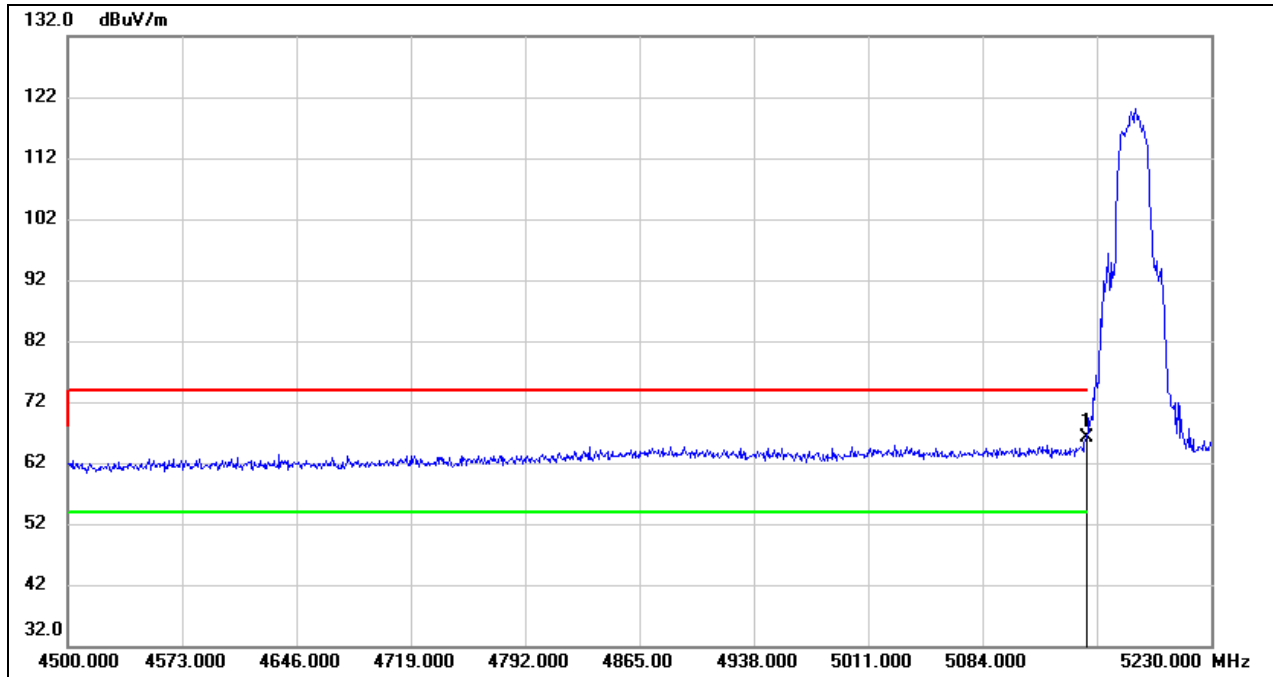

No.	Frequency (MHz)	Reading (dBuV)	Correct (dB/m)	Result (dBuV/m)	Limit (dBuV/m)	Margin (dB)	Remark
1	5150.000	22.96	43.27	66.23	74.00	-7.77	peak

Test Mode:	802.11ax HE20 AV	Channel:	5180
Polarity:	Vertical	Test Voltage:	DC 48 V

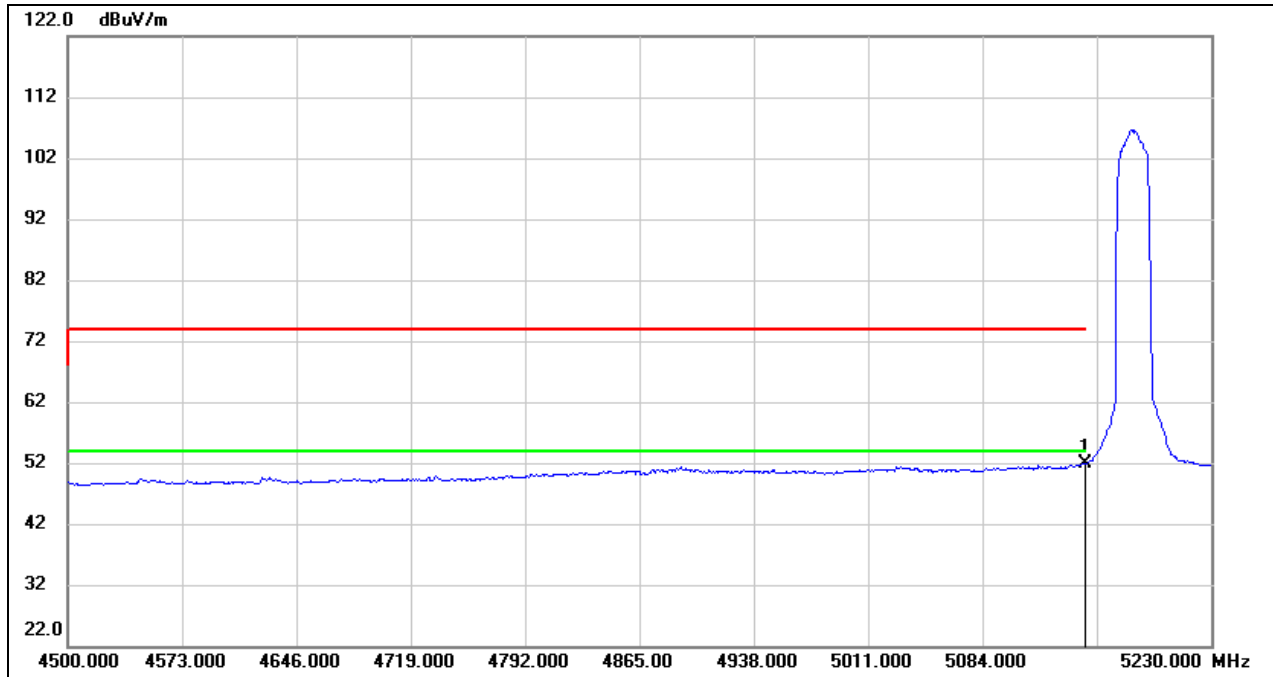

No.	Frequency (MHz)	Reading (dBuV)	Correct (dB/m)	Result (dBuV/m)	Limit (dBuV/m)	Margin (dB)	Remark
1	5150.000	8.64	43.27	51.91	54.00	-2.09	AVG

Test Mode:	802.11ax HE20 PK	Channel:	5240
Polarity:	Vertical	Test Voltage:	DC 48 V

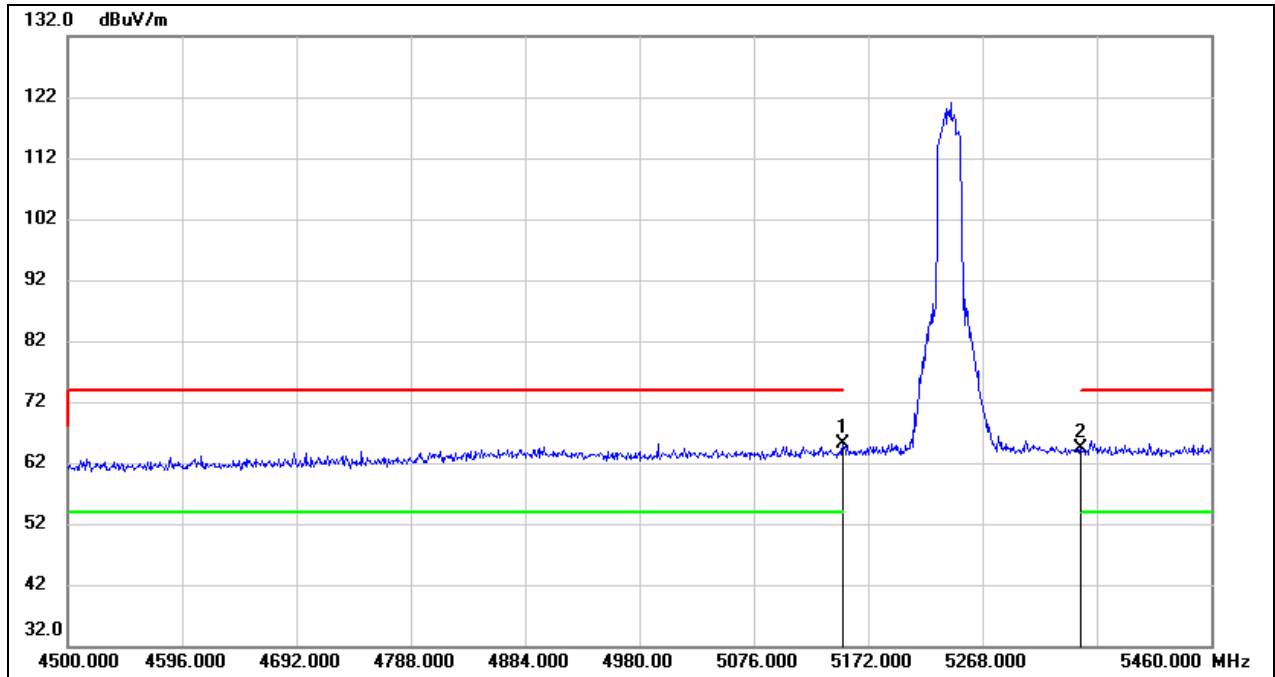

No.	Frequency (MHz)	Reading (dBuV)	Correct (dB/m)	Result (dBuV/m)	Limit (dBuV/m)	Margin (dB)	Remark
1	5150.000	21.87	43.27	65.14	74.00	-8.86	peak
2	5350.000	20.78	43.49	64.27	74.00	-9.73	peak

Test Mode:	802.11ax HE20 AV	Channel:	5240
Polarity:	Vertical	Test Voltage:	DC 48 V

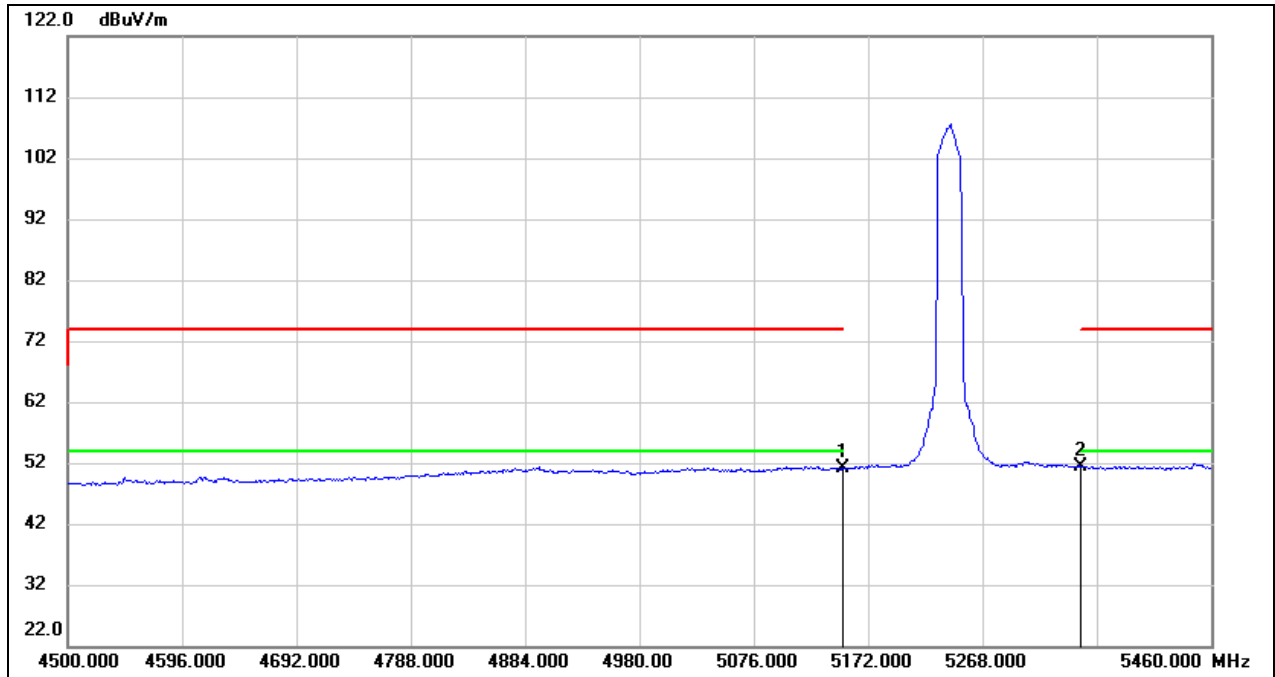

No.	Frequency (MHz)	Reading (dBuV)	Correct (dB/m)	Result (dBuV/m)	Limit (dBuV/m)	Margin (dB)	Remark
1	5150.000	7.77	43.27	51.04	54.00	-2.96	AVG
2	5350.000	7.93	43.49	51.42	54.00	-2.58	AVG

Test Mode:	802.11ax HE20 PK	Channel:	5745
Polarity:	Vertical	Test Voltage:	DC 48 V

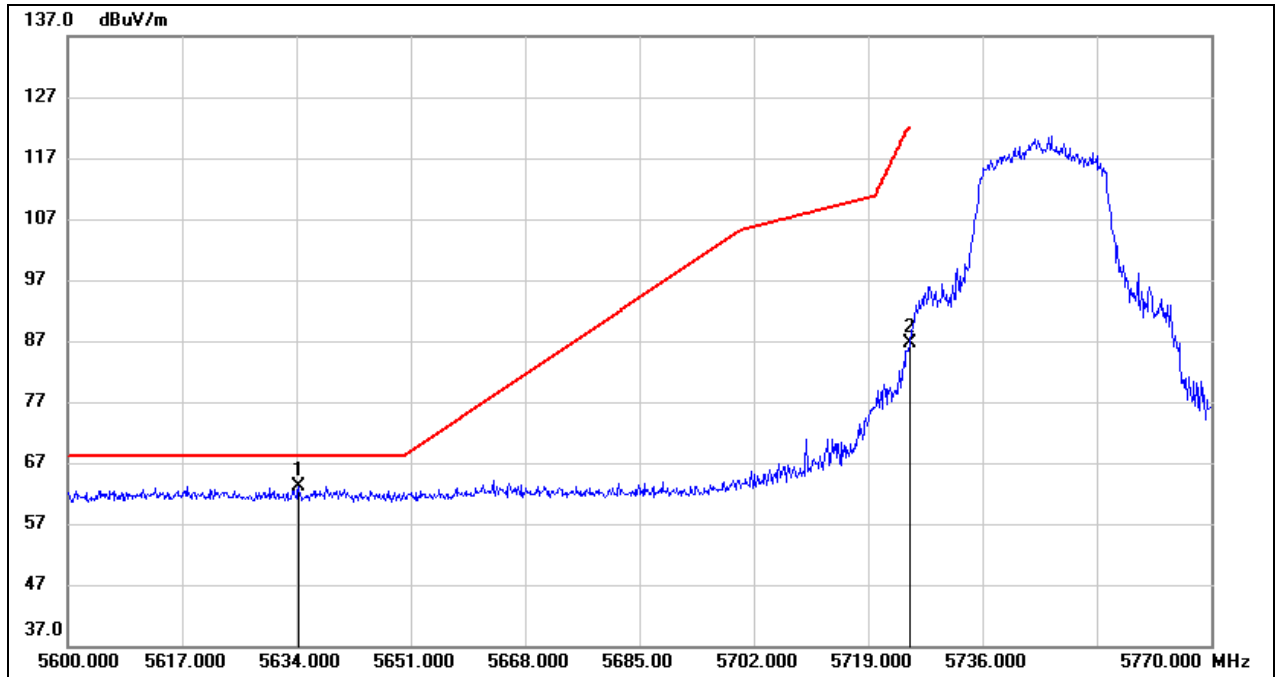

No.	Frequency (MHz)	Reading (dBuV)	Correct (dB/m)	Result (dBuV/m)	Limit (dBuV/m)	Margin (dB)	Remark
1	5634.340	19.13	44.02	63.15	68.20	-5.05	peak
2	5725.000	42.26	44.27	86.53	122.20	-35.67	peak

Test Mode:	802.11ax HE20 PK	Channel:	5825
Polarity:	Vertical	Test Voltage:	DC 48 V

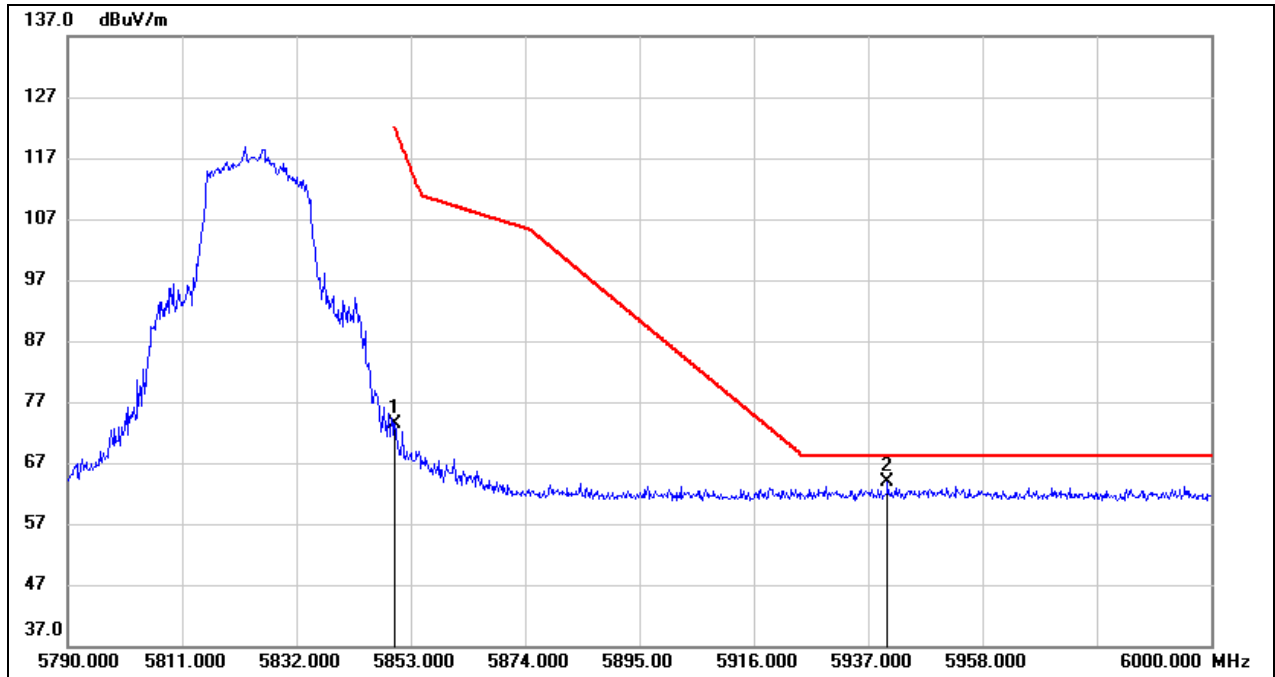

No.	Frequency (MHz)	Reading (dBuV)	Correct (dB/m)	Result (dBuV/m)	Limit (dBuV/m)	Margin (dB)	Remark
1	5850.000	28.87	44.60	73.47	122.20	-48.73	peak
2	5940.570	19.00	44.84	63.84	68.20	-4.36	peak

Test Mode:	802.11ax HE40 PK	Channel:	5190
Polarity:	Vertical	Test Voltage:	DC 48 V

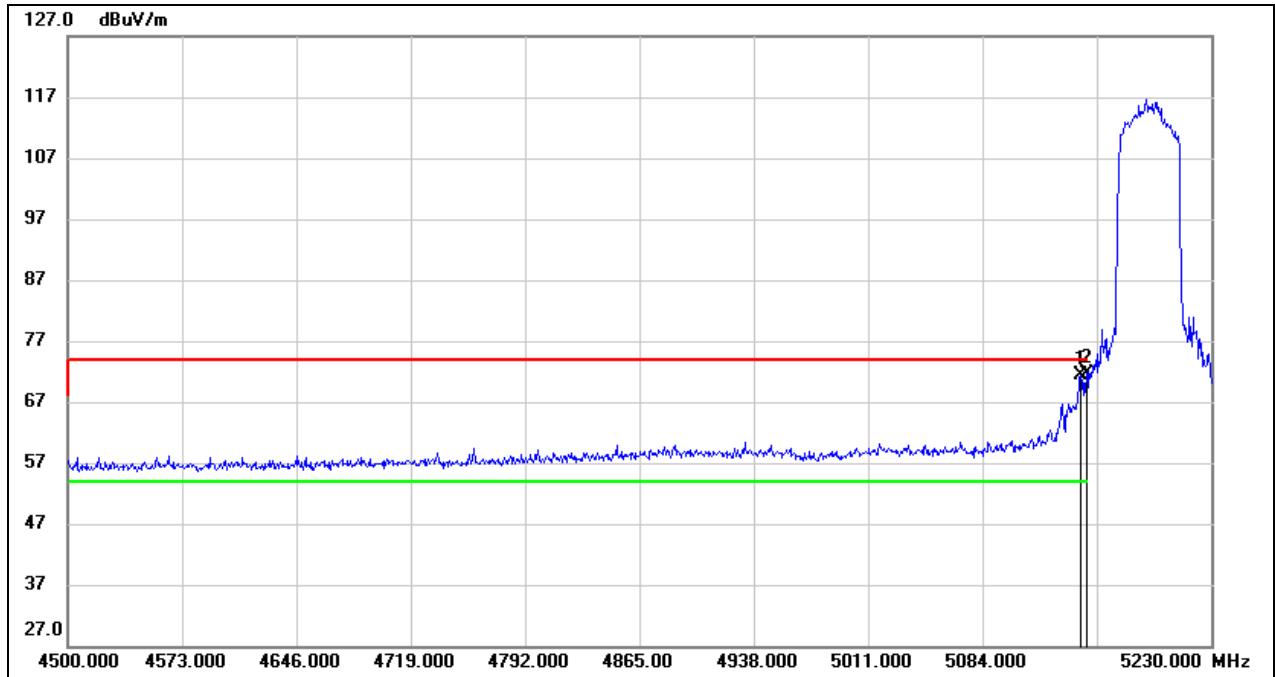

No.	Frequency (MHz)	Reading (dBuV)	Correct (dB/m)	Result (dBuV/m)	Limit (dBuV/m)	Margin (dB)	Remark
1	5146.780	28.04	43.27	71.31	74.00	-2.69	peak
2	5150.000	28.39	43.27	71.66	74.00	-2.34	peak

Test Mode:	802.11ax HE40 AV	Channel:	5190
Polarity:	Vertical	Test Voltage:	DC 48 V

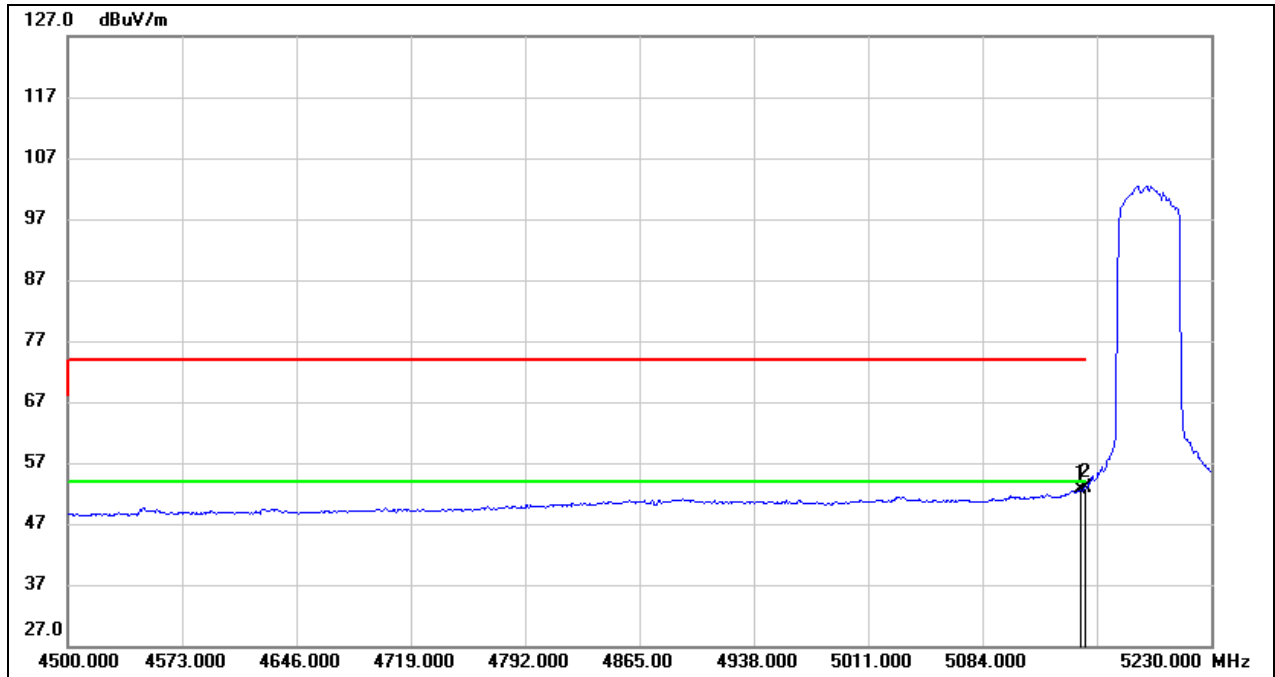

No.	Frequency (MHz)	Reading (dBuV)	Correct (dB/m)	Result (dBuV/m)	Limit (dBuV/m)	Margin (dB)	Remark
1	5146.780	9.32	43.27	52.59	54.00	-1.41	AVG
2	5150.000	9.71	43.27	52.98	54.00	-1.02	AVG

Test Mode:	802.11ax HE40 PK	Channel:	5230
Polarity:	Vertical	Test Voltage:	DC 48 V

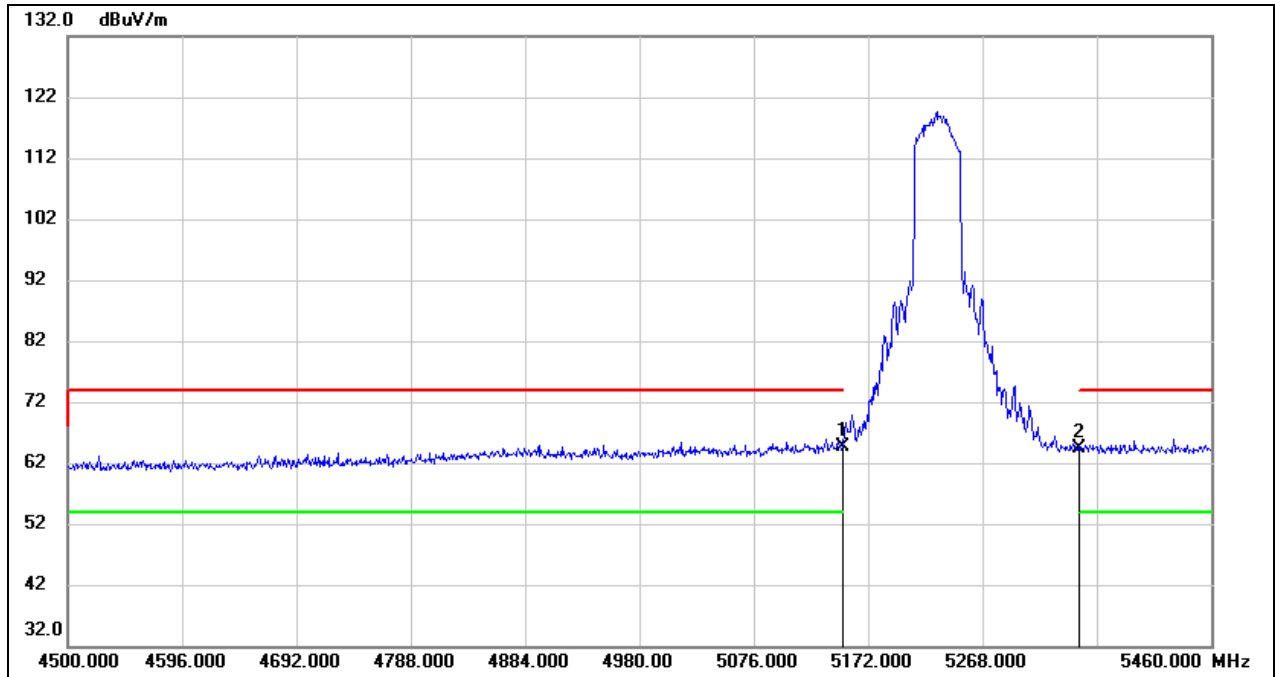

No.	Frequency (MHz)	Reading (dBuV)	Correct (dB/m)	Result (dBuV/m)	Limit (dBuV/m)	Margin (dB)	Remark
1	5150.000	21.46	43.27	64.73	74.00	-9.27	peak
2	5350.000	20.87	43.49	64.36	74.00	-9.64	peak

Test Mode:	802.11ax HE40 AV	Channel:	5230
Polarity:	Vertical	Test Voltage:	DC 48 V

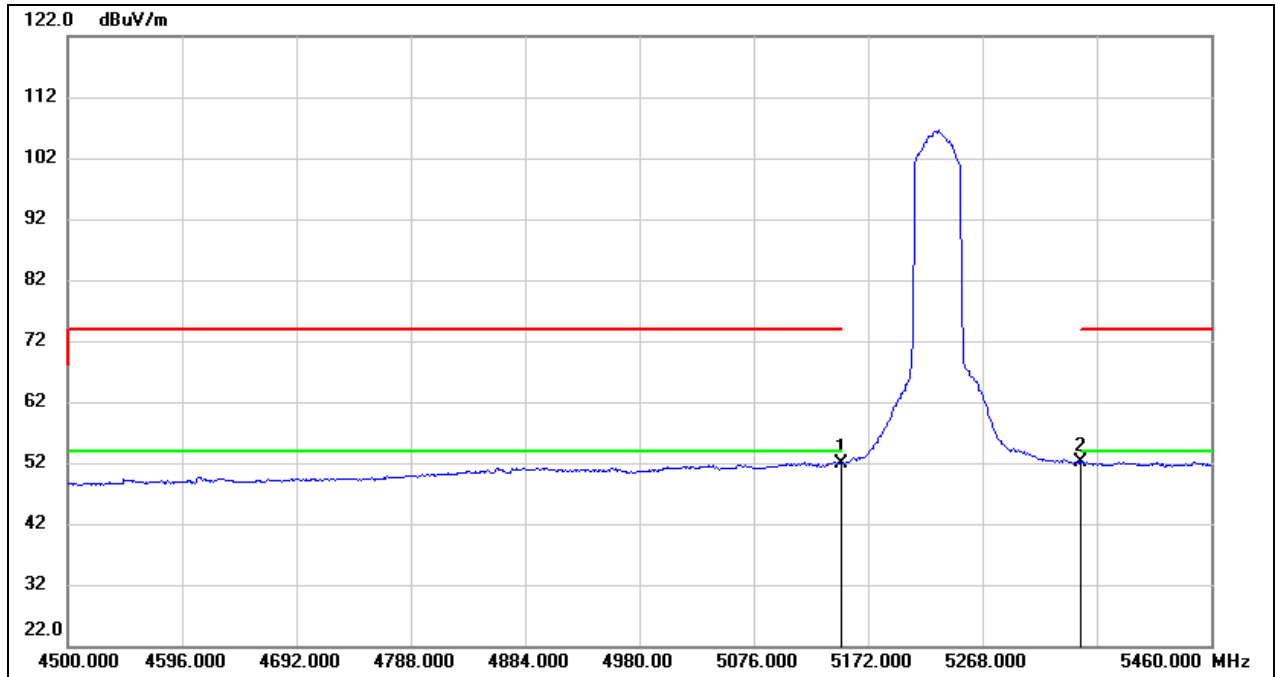

No.	Frequency (MHz)	Reading (dBuV)	Correct (dB/m)	Result (dBuV/m)	Limit (dBuV/m)	Margin (dB)	Remark
1	5150.000	8.60	43.27	51.87	54.00	-2.13	AVG
2	5350.000	8.75	43.49	52.24	54.00	-1.76	AVG

Test Mode:	802.11ax HE40 PK	Channel:	5755
Polarity:	Vertical	Test Voltage:	DC 48 V

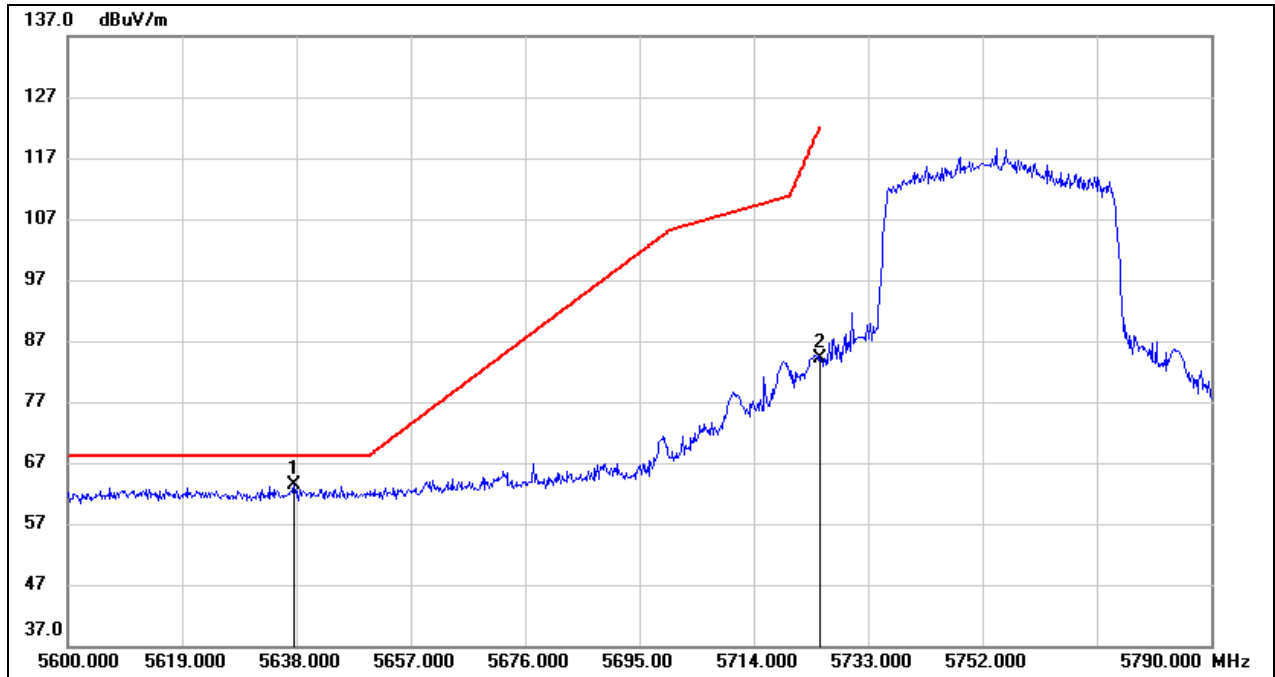

No.	Frequency (MHz)	Reading (dBuV)	Correct (dB/m)	Result (dBuV/m)	Limit (dBuV/m)	Margin (dB)	Remark
1	5637.620	19.39	44.03	63.42	68.20	-4.78	peak
2	5725.000	39.81	44.27	84.08	122.20	-38.12	peak

Test Mode:	802.11ax HE40 PK	Channel:	5795
Polarity:	Vertical	Test Voltage:	DC 48 V

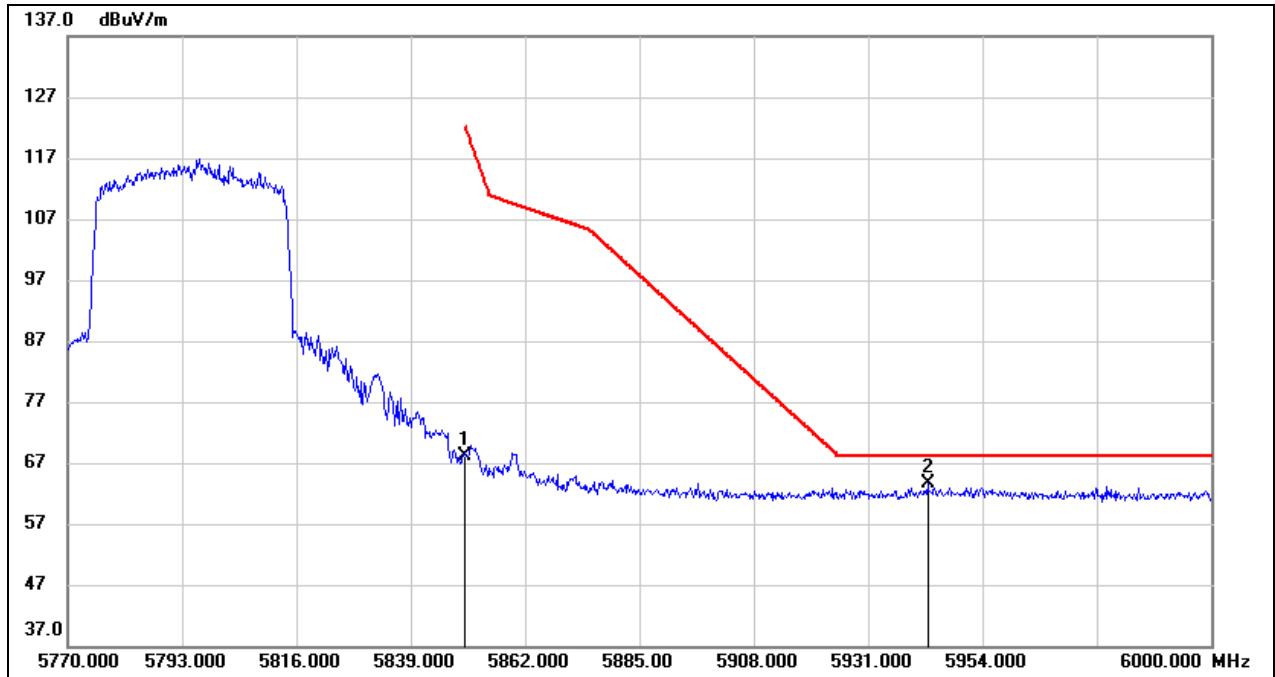

No.	Frequency (MHz)	Reading (dBuV)	Correct (dB/m)	Result (dBuV/m)	Limit (dBuV/m)	Margin (dB)	Remark
1	5850.000	23.47	44.60	68.07	122.20	-54.13	peak
2	5942.960	18.74	44.84	63.58	68.20	-4.62	peak

Test Mode:	802.11ax HE80 PK	Channel:	5210
Polarity:	Vertical	Test Voltage:	DC 48 V

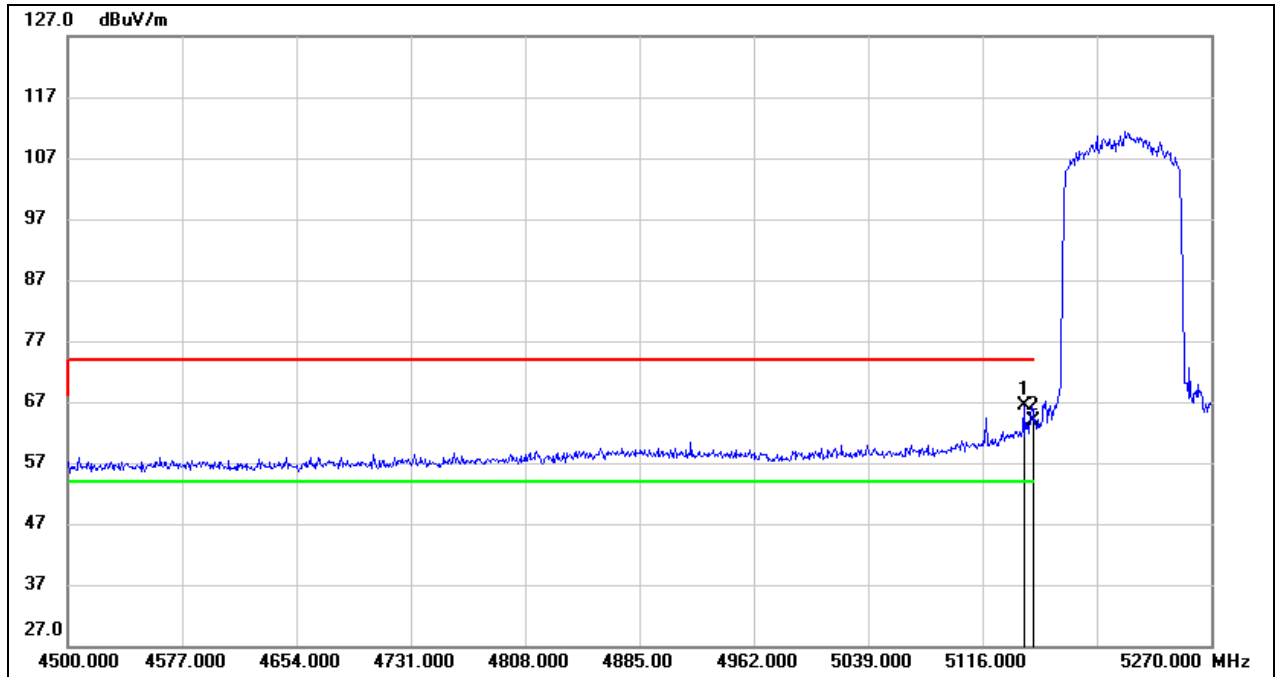

No.	Frequency (MHz)	Reading (dBuV)	Correct (dB/m)	Result (dBuV/m)	Limit (dBuV/m)	Margin (dB)	Remark
1	5143.720	23.08	43.27	66.35	74.00	-7.65	peak
2	5150.000	20.66	43.27	63.93	74.00	-10.07	peak

Test Mode:	802.11ax HE80 AV	Channel:	5210
Polarity:	Vertical	Test Voltage:	DC 48 V

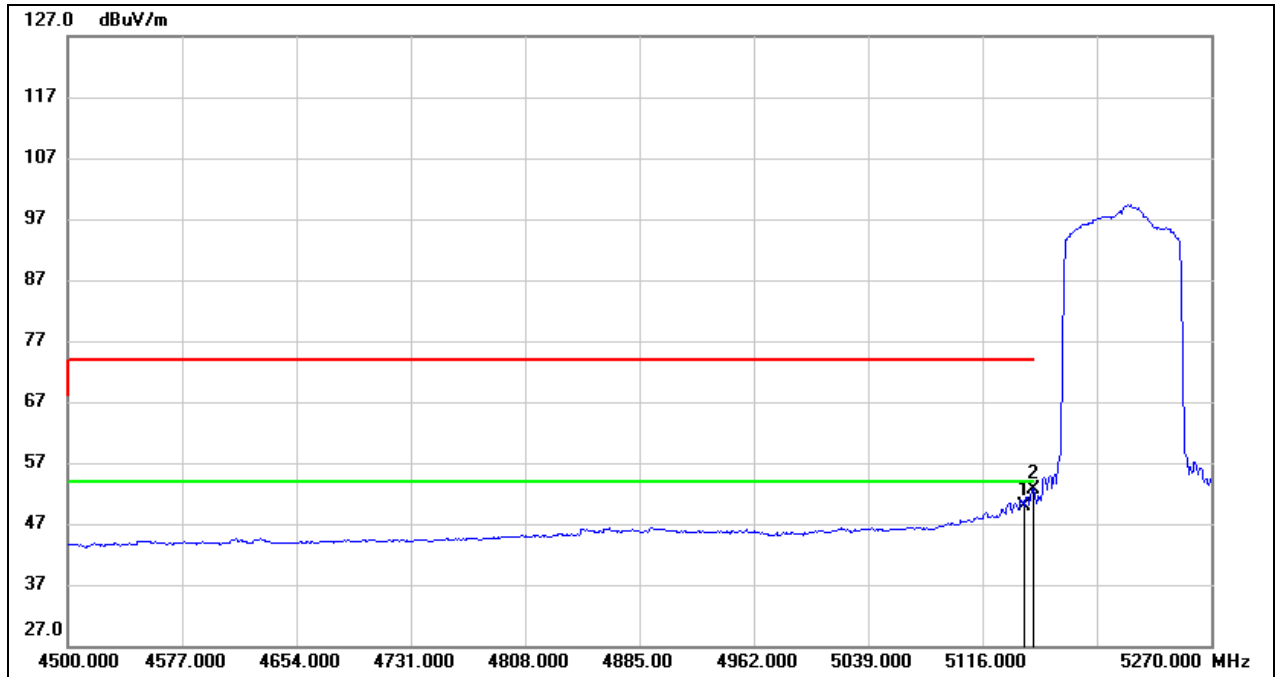

No.	Frequency (MHz)	Reading (dBuV)	Correct (dB/m)	Result (dBuV/m)	Limit (dBuV/m)	Margin (dB)	Remark
1	5143.720	6.56	43.27	49.83	54.00	-4.17	AVG
2	5150.000	9.42	43.27	52.69	54.00	-1.31	AVG

Test Mode:	802.11ax HE80 PK	Channel:	5775
Polarity:	Vertical	Test Voltage:	DC 48 V

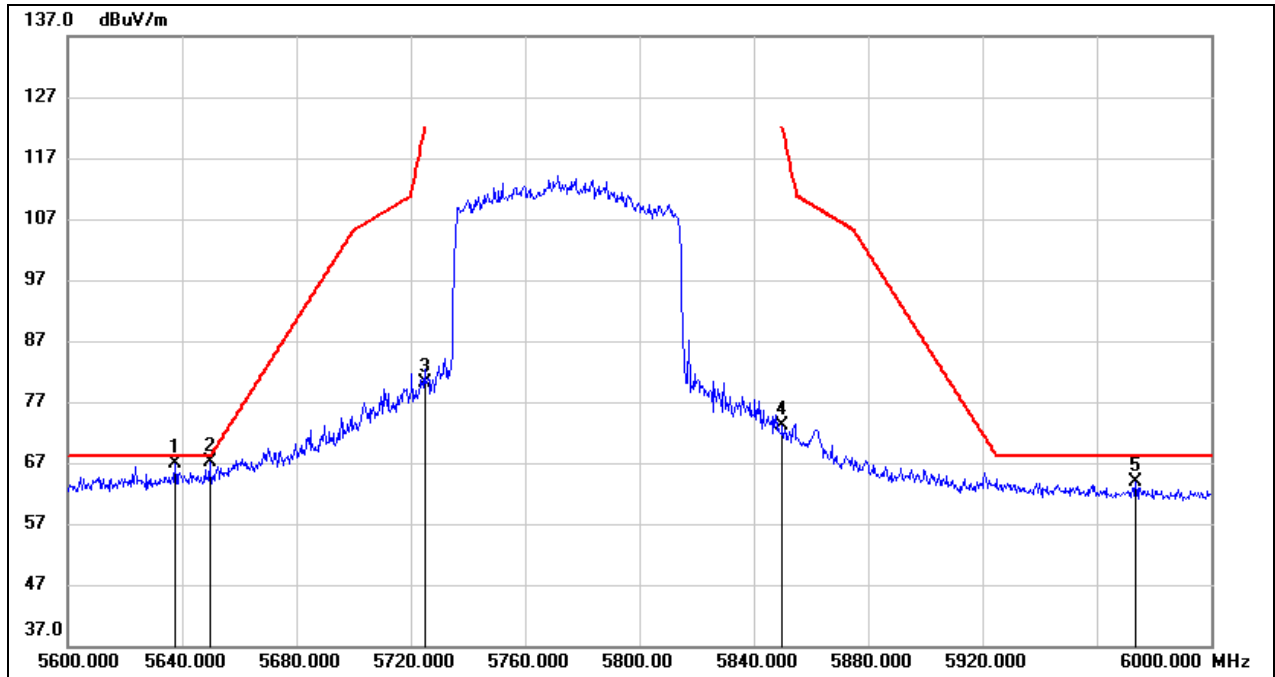

No.	Frequency (MHz)	Reading (dBuV)	Correct (dB/m)	Result (dBuV/m)	Limit (dBuV/m)	Margin (dB)	Remark
1	5637.600	22.88	44.03	66.91	68.20	-1.29	peak
2	5649.600	23.08	44.06	67.14	68.20	-1.06	peak
3	5725.000	35.82	44.27	80.09	122.20	-42.11	peak
4	5850.000	28.59	44.60	73.19	122.20	-49.01	peak
5	5973.600	18.85	44.93	63.78	68.20	-4.42	peak

8.2. SPURIOUS EMISSIONS(1 GHZ~7 GHZ)

Test Mode:	802.11a 20	Channel:	5180
Polarity:	Horizontal	Test Voltage:	DC 48 V

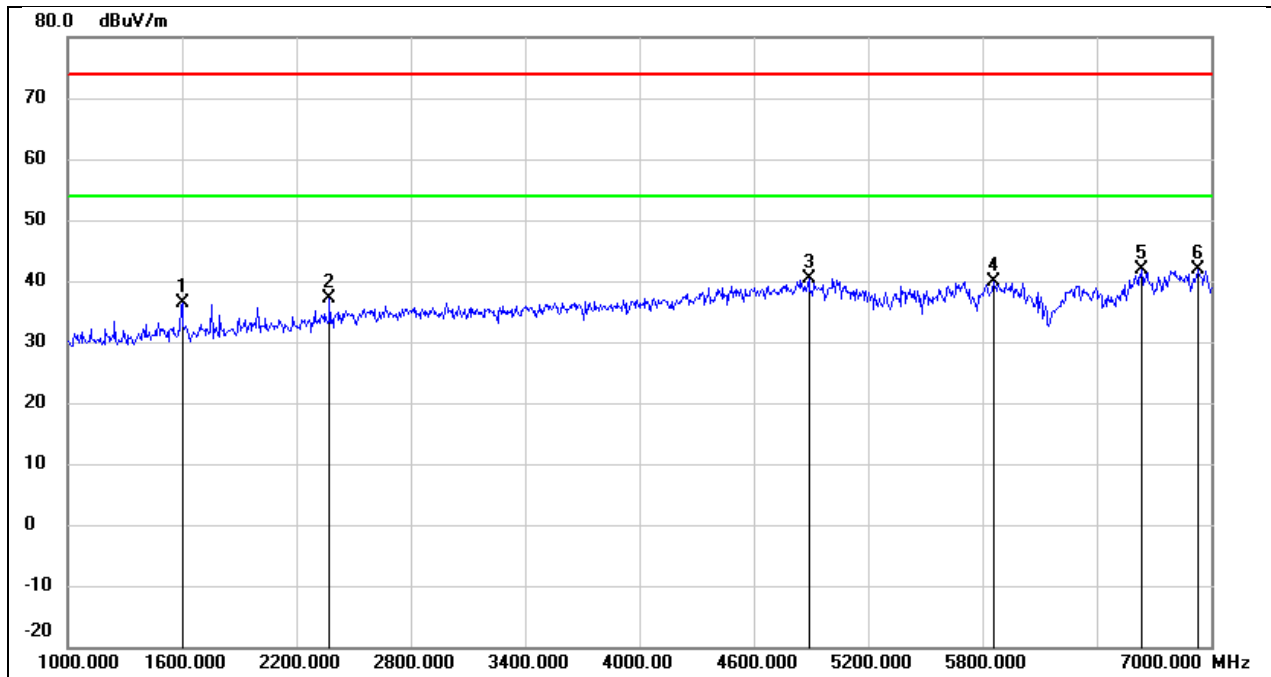

No.	Frequency (MHz)	Reading (dBuV)	Correct (dB/m)	Result (dBuV/m)	Limit (dBuV/m)	Margin (dB)	Remark
1	1600.000	48.79	-12.38	36.41	74.00	-37.59	peak
2	2374.000	46.22	-9.14	37.08	74.00	-36.92	peak
3	4888.000	41.04	-0.60	40.44	74.00	-33.56	peak
4	5860.000	38.51	1.45	39.96	74.00	-34.04	peak
5	6634.000	37.41	4.38	41.79	74.00	-32.21	peak
6	6934.000	35.93	5.87	41.80	74.00	-32.20	peak

Test Mode:	802.11a 20	Channel:	5180
Polarity:	Vertical	Test Voltage:	DC 48 V

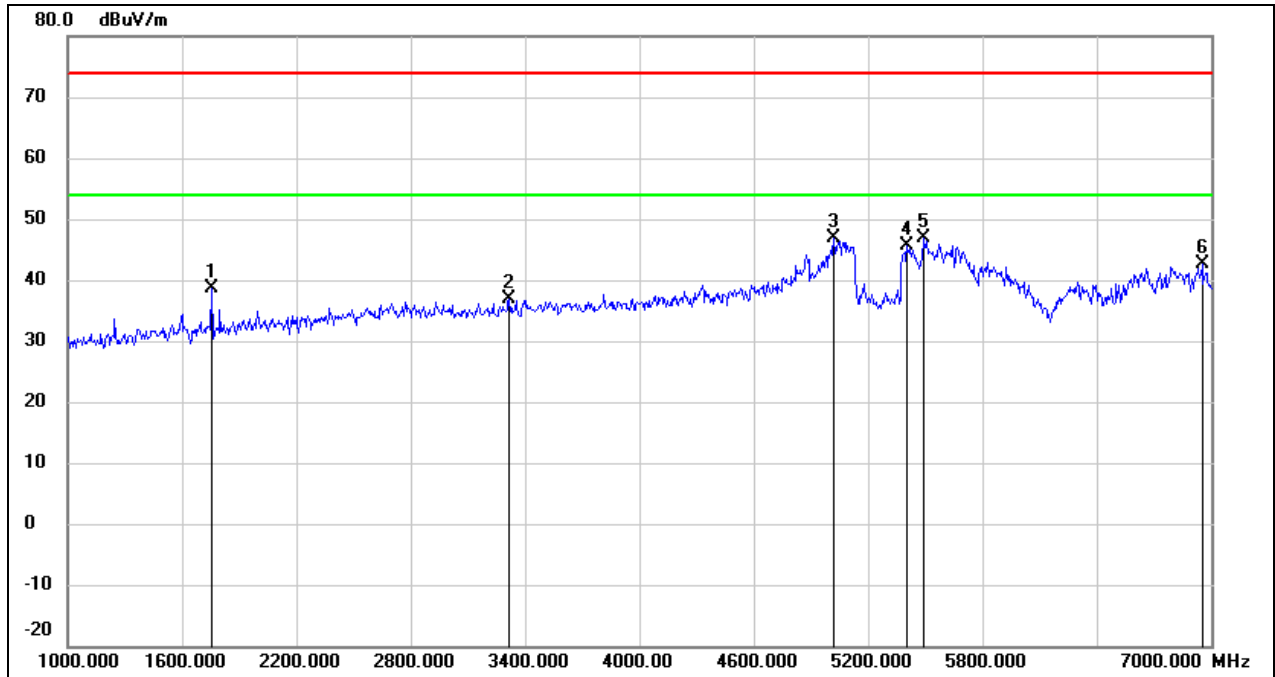

No.	Frequency (MHz)	Reading (dBuV)	Correct (dB/m)	Result (dBuV/m)	Limit (dBuV/m)	Margin (dB)	Remark
1	1756.000	50.46	-11.87	38.59	74.00	-35.41	peak
2	3316.000	43.19	-6.26	36.93	74.00	-37.07	peak
3	5020.000	46.89	-0.13	46.76	74.00	-27.24	peak
4	5404.000	45.28	0.31	45.59	74.00	-28.41	peak
5	5488.000	46.37	0.41	46.78	74.00	-27.22	peak
6	6952.000	36.78	5.96	42.74	74.00	-31.26	peak

Test Mode:	802.11a 20	Channel:	5200
Polarity:	Horizontal	Test Voltage:	DC 48 V

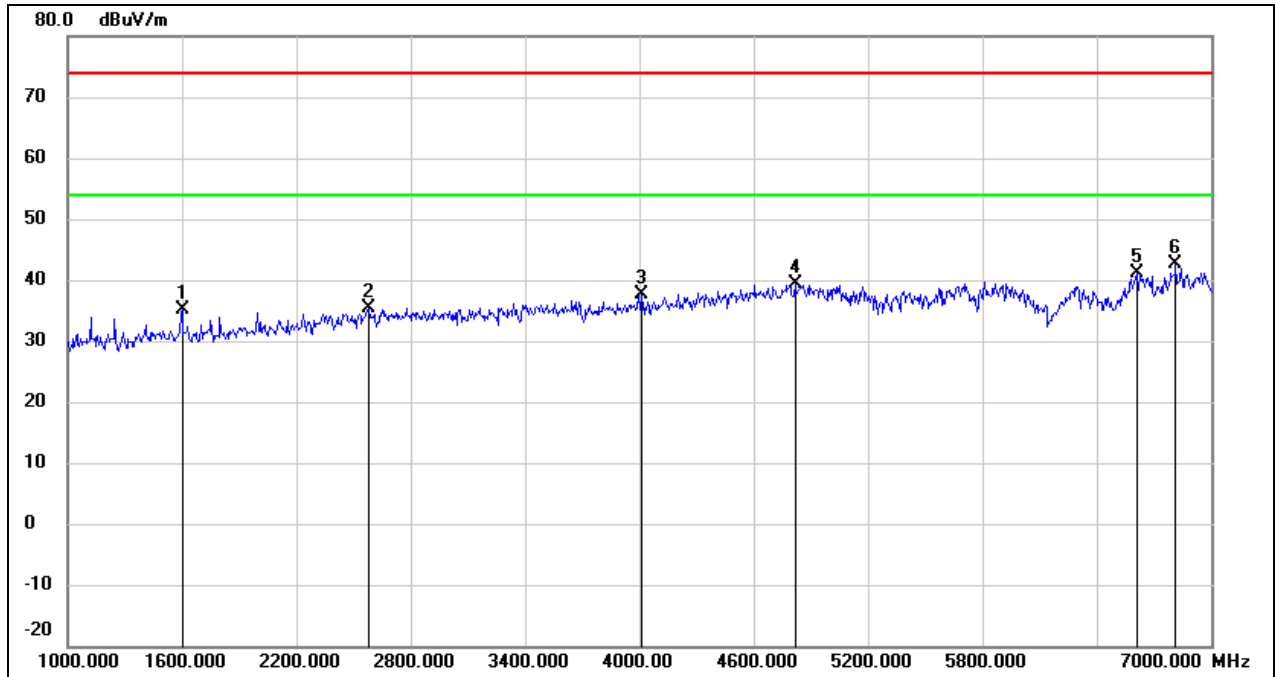

No.	Frequency (MHz)	Reading (dBuV)	Correct (dB/m)	Result (dBuV/m)	Limit (dBuV/m)	Margin (dB)	Remark
1	1600.000	47.47	-12.38	35.09	74.00	-38.91	peak
2	2578.000	43.73	-8.26	35.47	74.00	-38.53	peak
3	4012.000	42.11	-4.43	37.68	74.00	-36.32	peak
4	4816.000	40.16	-0.89	39.27	74.00	-34.73	peak
5	6610.000	36.75	4.27	41.02	74.00	-32.98	peak
6	6814.000	37.47	5.28	42.75	74.00	-31.25	peak

Test Mode:	802.11a 20	Channel:	5200
Polarity:	Vertical	Test Voltage:	DC 48 V

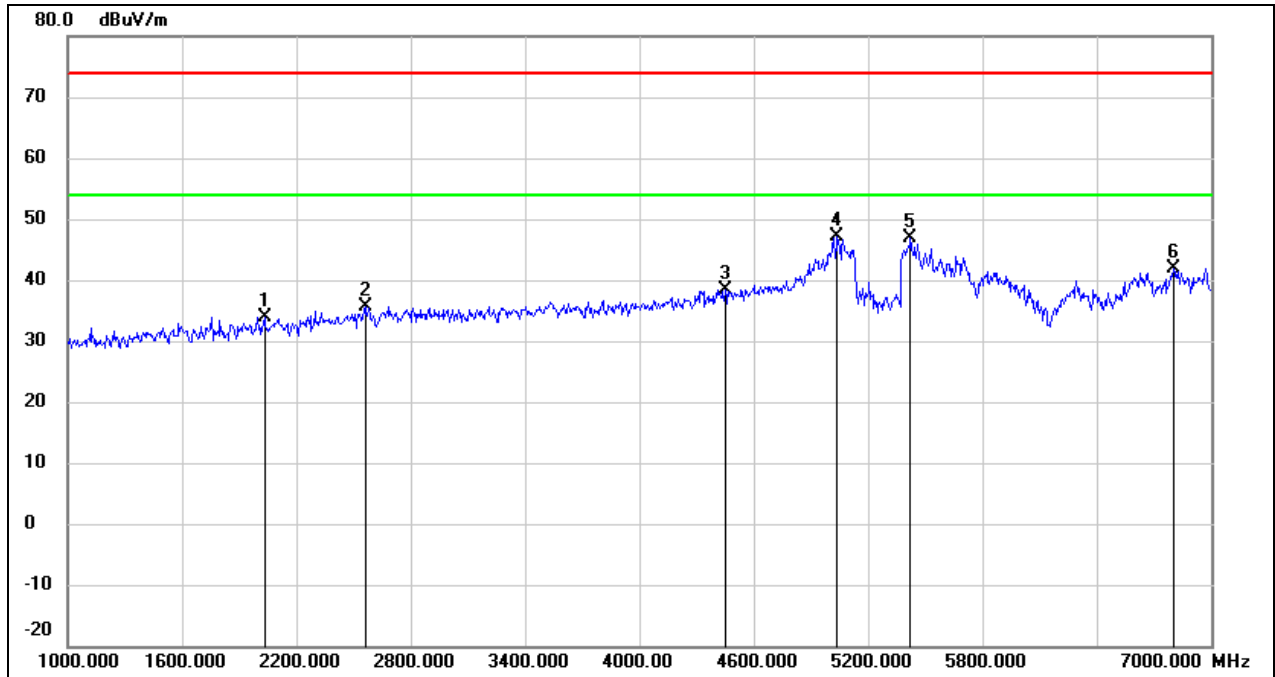

No.	Frequency (MHz)	Reading (dBuV)	Correct (dB/m)	Result (dBuV/m)	Limit (dBuV/m)	Margin (dB)	Remark
1	2032.000	44.82	-10.90	33.92	74.00	-40.08	peak
2	2560.000	44.04	-8.31	35.73	74.00	-38.27	peak
3	4450.000	40.82	-2.37	38.45	74.00	-35.55	peak
4	5038.000	47.15	-0.11	47.04	74.00	-26.96	peak
5	5422.000	46.44	0.32	46.76	74.00	-27.24	peak
6	6802.000	36.62	5.21	41.83	74.00	-32.17	peak

Test Mode:	802.11a 20	Channel:	5240
Polarity:	Horizontal	Test Voltage:	DC 48 V

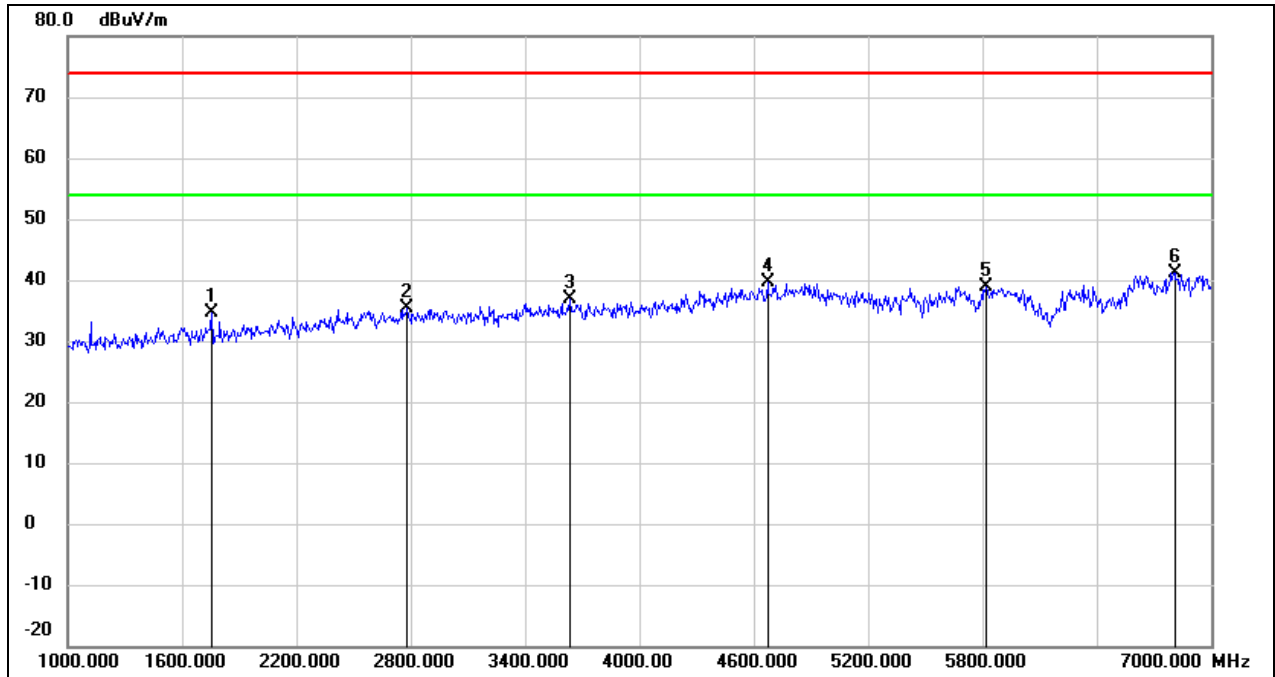

No.	Frequency (MHz)	Reading (dBuV)	Correct (dB/m)	Result (dBuV/m)	Limit (dBuV/m)	Margin (dB)	Remark
1	1756.000	46.41	-11.87	34.54	74.00	-39.46	peak
2	2782.000	42.97	-7.63	35.34	74.00	-38.66	peak
3	3634.000	42.39	-5.48	36.91	74.00	-37.09	peak
4	4672.000	41.19	-1.46	39.73	74.00	-34.27	peak
5	5818.000	37.61	1.33	38.94	74.00	-35.06	peak
6	6808.000	35.90	5.24	41.14	74.00	-32.86	peak

Test Mode:	802.11a 20	Channel:	5240
Polarity:	Vertical	Test Voltage:	DC 48 V

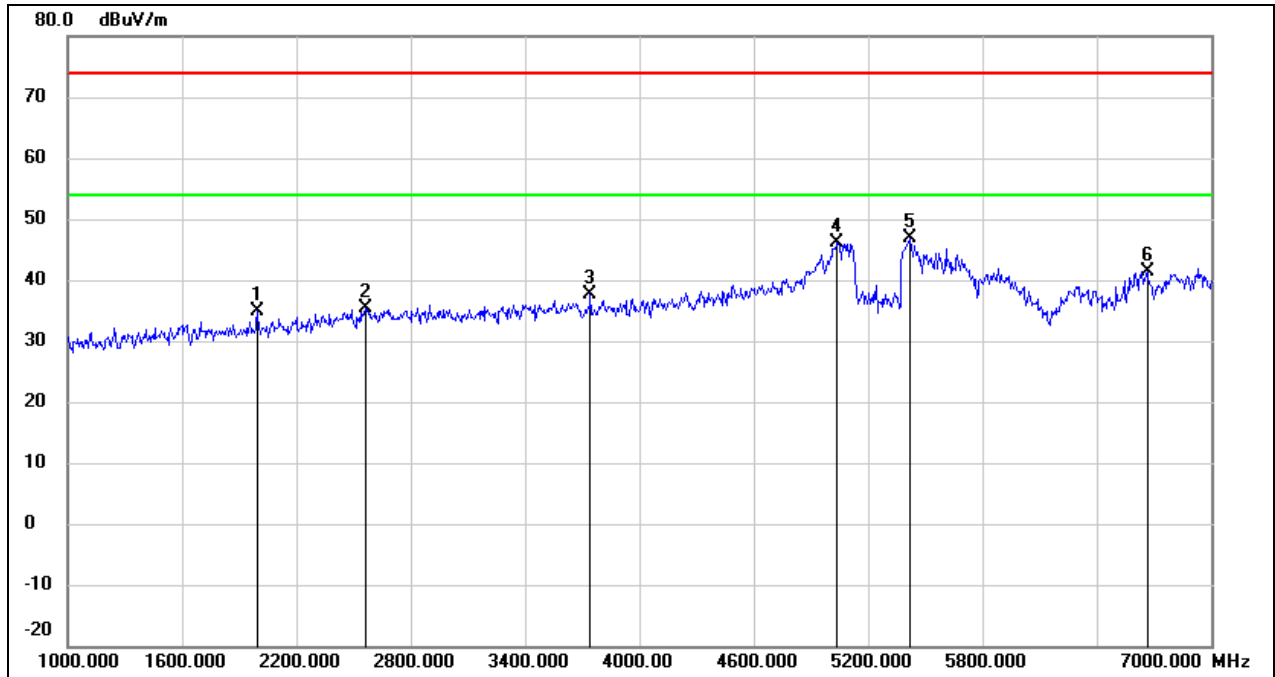

No.	Frequency (MHz)	Reading (dBuV)	Correct (dB/m)	Result (dBuV/m)	Limit (dBuV/m)	Margin (dB)	Remark
1	1996.000	45.99	-11.07	34.92	74.00	-39.08	peak
2	2560.000	43.66	-8.31	35.35	74.00	-38.65	peak
3	3742.000	42.93	-5.19	37.74	74.00	-36.26	peak
4	5038.000	46.31	-0.11	46.20	74.00	-27.80	peak
5	5416.000	46.58	0.32	46.90	74.00	-27.10	peak
6	6664.000	36.92	4.54	41.46	74.00	-32.54	peak

Test Mode:	802.11a 20	Channel:	5745
Polarity:	Horizontal	Test Voltage:	DC 48 V

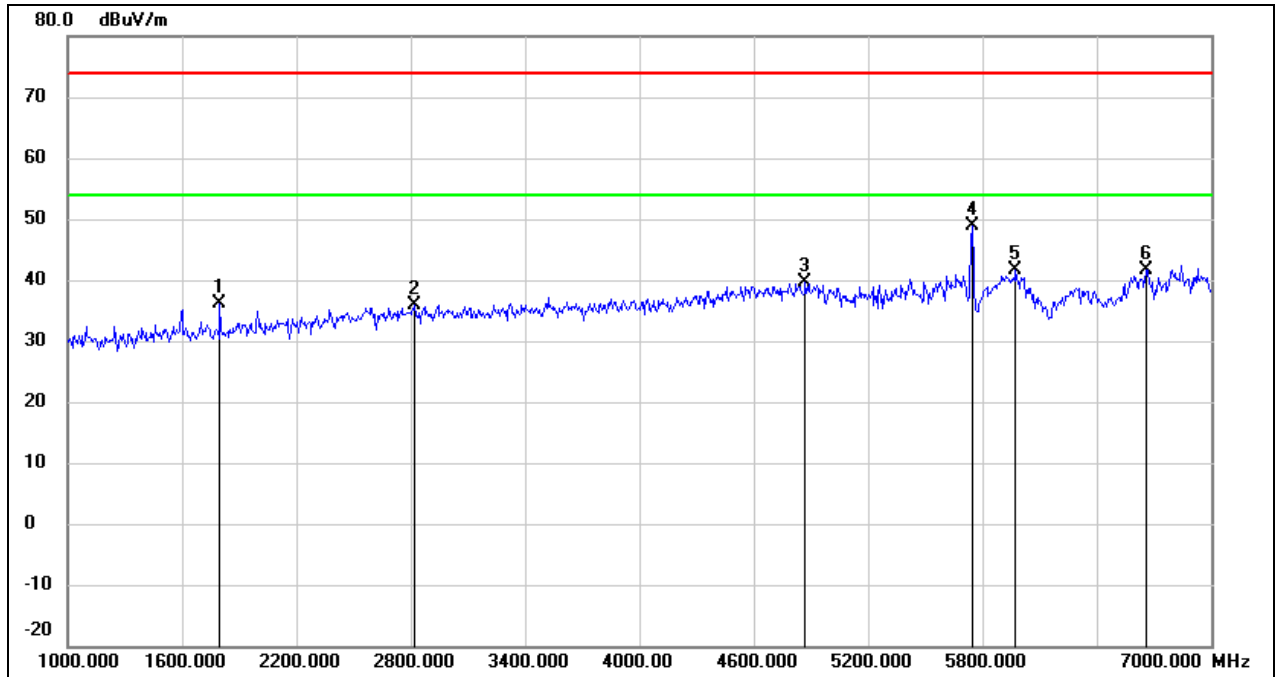

No.	Frequency (MHz)	Reading (dBuV)	Correct (dB/m)	Result (dBuV/m)	Limit (dBuV/m)	Margin (dB)	Remark
1	1798.000	47.84	-11.72	36.12	74.00	-37.88	peak
2	2818.000	43.51	-7.53	35.98	74.00	-38.02	peak
3	4870.000	40.39	-0.66	39.73	74.00	-34.27	peak
4	5746.000	47.78	1.12	48.90	74.00	-25.10	peak
5	5974.000	39.80	1.77	41.57	74.00	-32.43	peak
6	6658.000	37.11	4.49	41.60	74.00	-32.40	peak

Test Mode:	802.11a 20	Channel:	5745
Polarity:	Vertical	Test Voltage:	DC 48 V

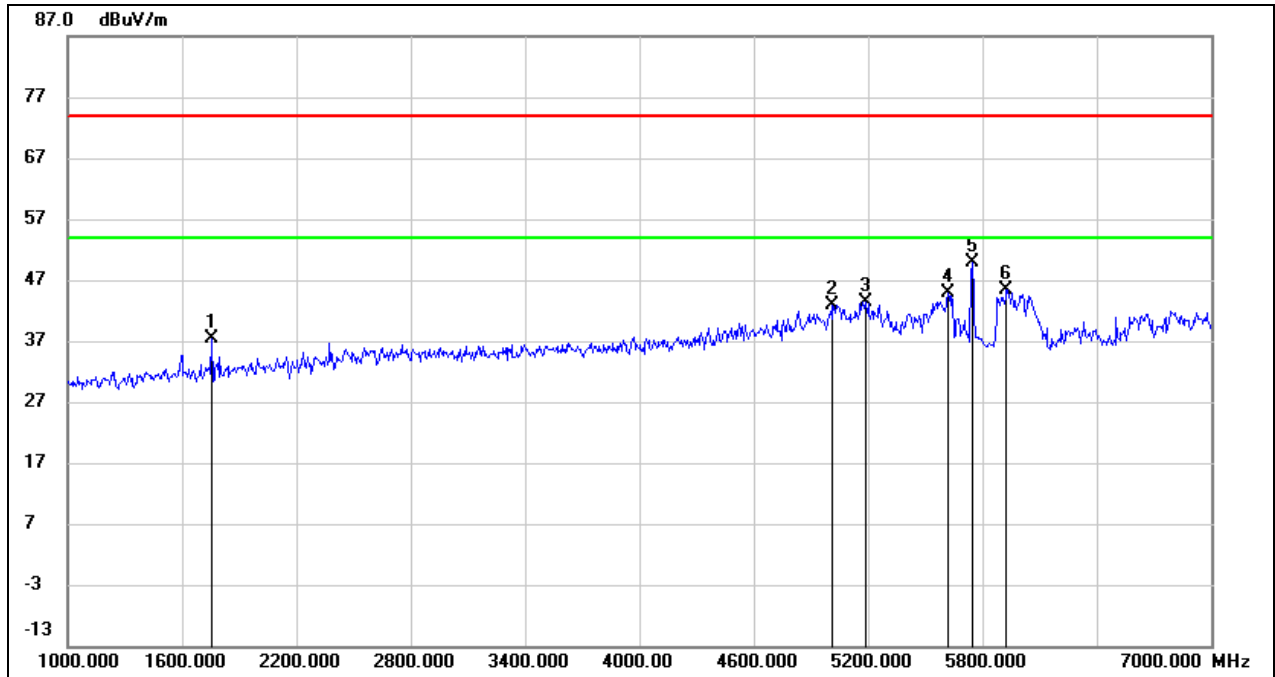

No.	Frequency (MHz)	Reading (dBuV)	Correct (dB/m)	Result (dBuV/m)	Limit (dBuV/m)	Margin (dB)	Remark
1	1756.000	49.31	-11.87	37.44	74.00	-36.56	peak
2	5014.000	43.07	-0.13	42.94	74.00	-31.06	peak
3	5188.000	43.41	0.07	43.48	74.00	-30.52	peak
4	5620.000	44.10	0.76	44.86	74.00	-29.14	peak
5	5746.000	48.83	1.12	49.95	74.00	-24.05	peak
6	5926.000	43.66	1.64	45.30	74.00	-28.70	peak

Test Mode:	802.11a 20	Channel:	5785
Polarity:	Horizontal	Test Voltage:	DC 48 V

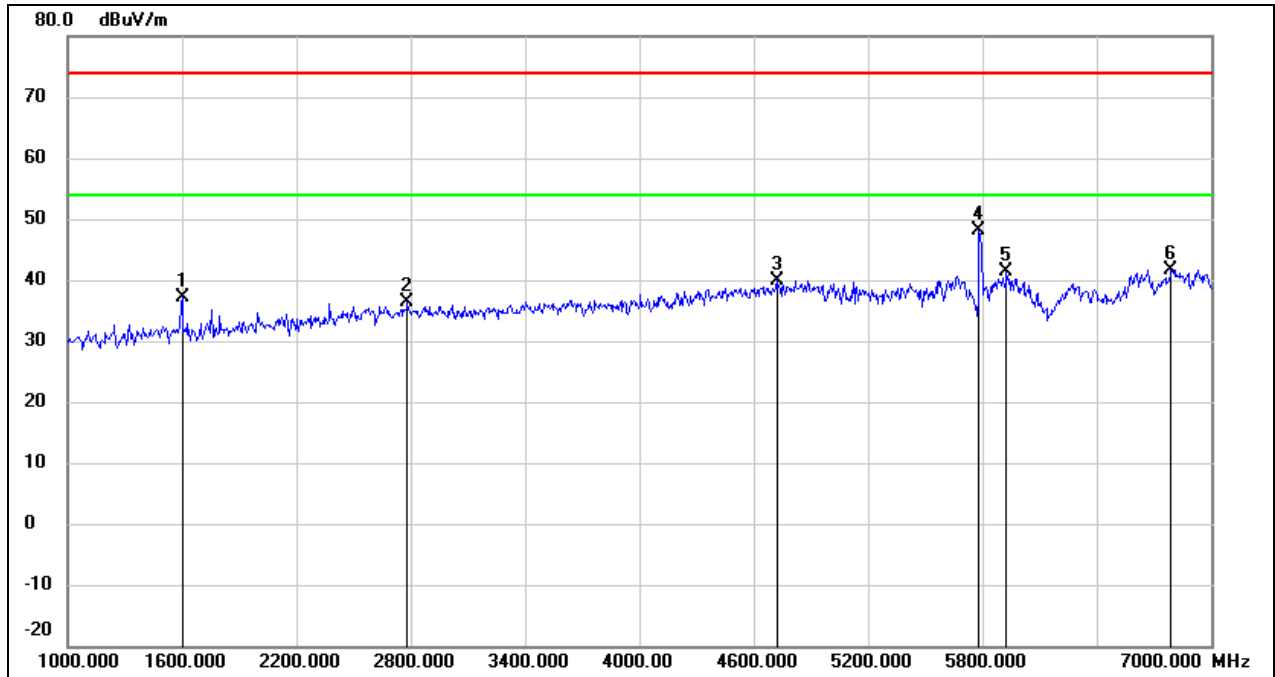

No.	Frequency (MHz)	Reading (dBuV)	Correct (dB/m)	Result (dBuV/m)	Limit (dBuV/m)	Margin (dB)	Remark
1	1600.000	49.44	-12.38	37.06	74.00	-36.94	peak
2	2782.000	43.98	-7.63	36.35	74.00	-37.65	peak
3	4720.000	41.19	-1.27	39.92	74.00	-34.08	peak
4	5782.000	46.79	1.23	48.02	74.00	-25.98	peak
5	5926.000	39.65	1.64	41.29	74.00	-32.71	peak
6	6790.000	36.60	5.15	41.75	74.00	-32.25	peak

Test Mode:	802.11a 20	Channel:	5785
Polarity:	Vertical	Test Voltage:	DC 48 V

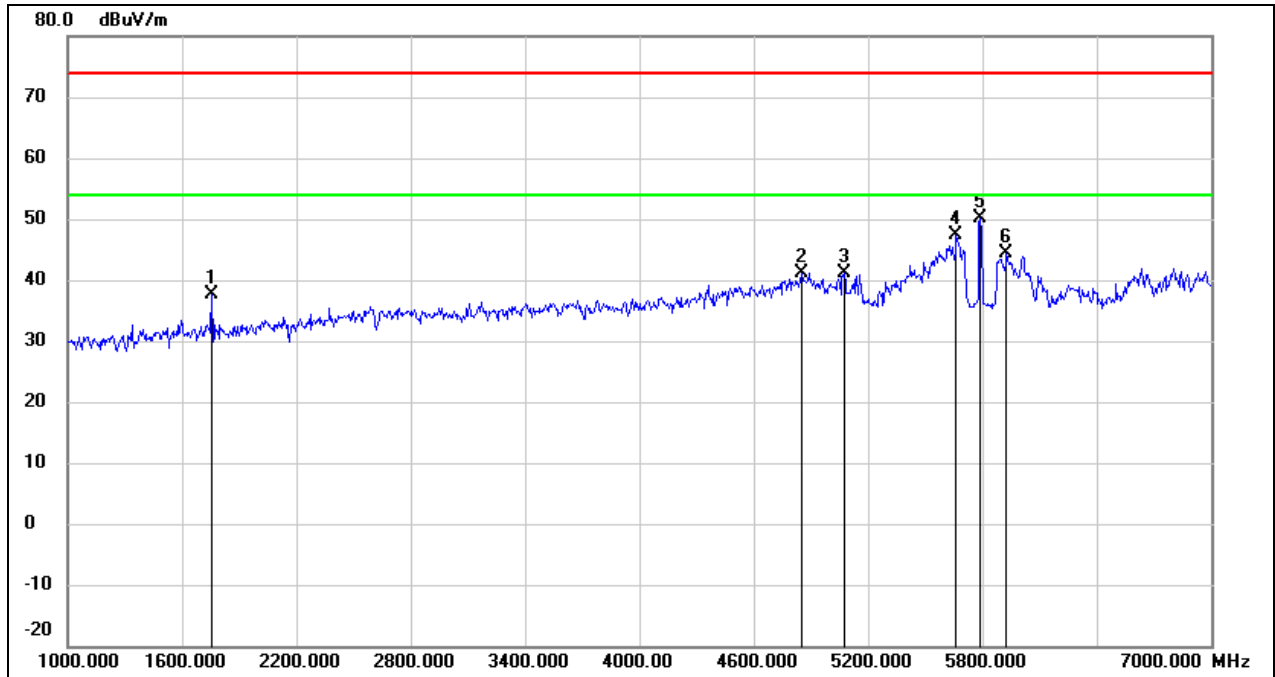

No.	Frequency (MHz)	Reading (dBuV)	Correct (dB/m)	Result (dBuV/m)	Limit (dBuV/m)	Margin (dB)	Remark
1	1756.000	49.44	-11.87	37.57	74.00	-36.43	peak
2	4852.000	41.87	-0.74	41.13	74.00	-32.87	peak
3	5074.000	41.24	-0.06	41.18	74.00	-32.82	peak
4	5662.000	46.37	0.89	47.26	74.00	-26.74	peak
5	5788.000	48.95	1.25	50.20	74.00	-23.80	peak
6	5926.000	42.76	1.64	44.40	74.00	-29.60	peak

Test Mode:	802.11a 20	Channel:	5825
Polarity:	Horizontal	Test Voltage:	DC 48 V

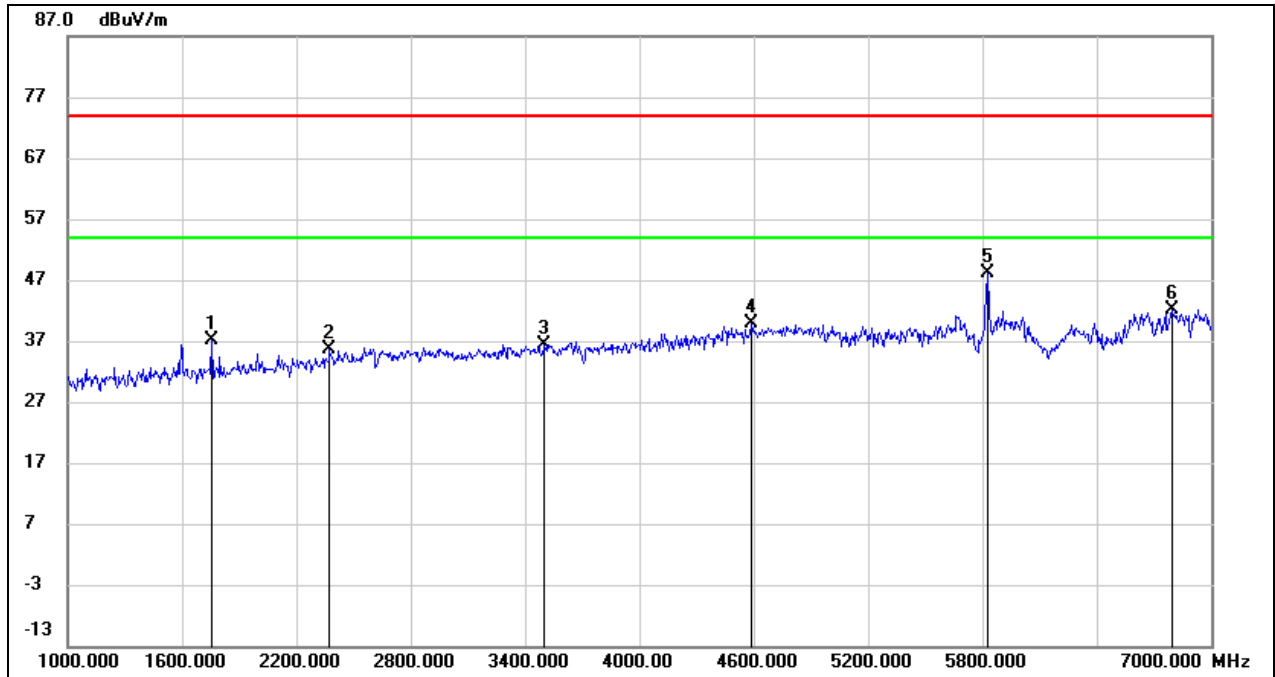

No.	Frequency (MHz)	Reading (dBuV)	Correct (dB/m)	Result (dBuV/m)	Limit (dBuV/m)	Margin (dB)	Remark
1	1756.000	48.97	-11.87	37.10	74.00	-36.90	peak
2	2374.000	44.84	-9.14	35.70	74.00	-38.30	peak
3	3502.000	42.25	-5.85	36.40	74.00	-37.60	peak
4	4588.000	41.55	-1.79	39.76	74.00	-34.24	peak
5	5830.000	46.66	1.36	48.02	74.00	-25.98	peak
6	6796.000	37.06	5.19	42.25	74.00	-31.75	peak

Test Mode:	802.11a 20	Channel:	5825
Polarity:	Vertical	Test Voltage:	DC 48 V

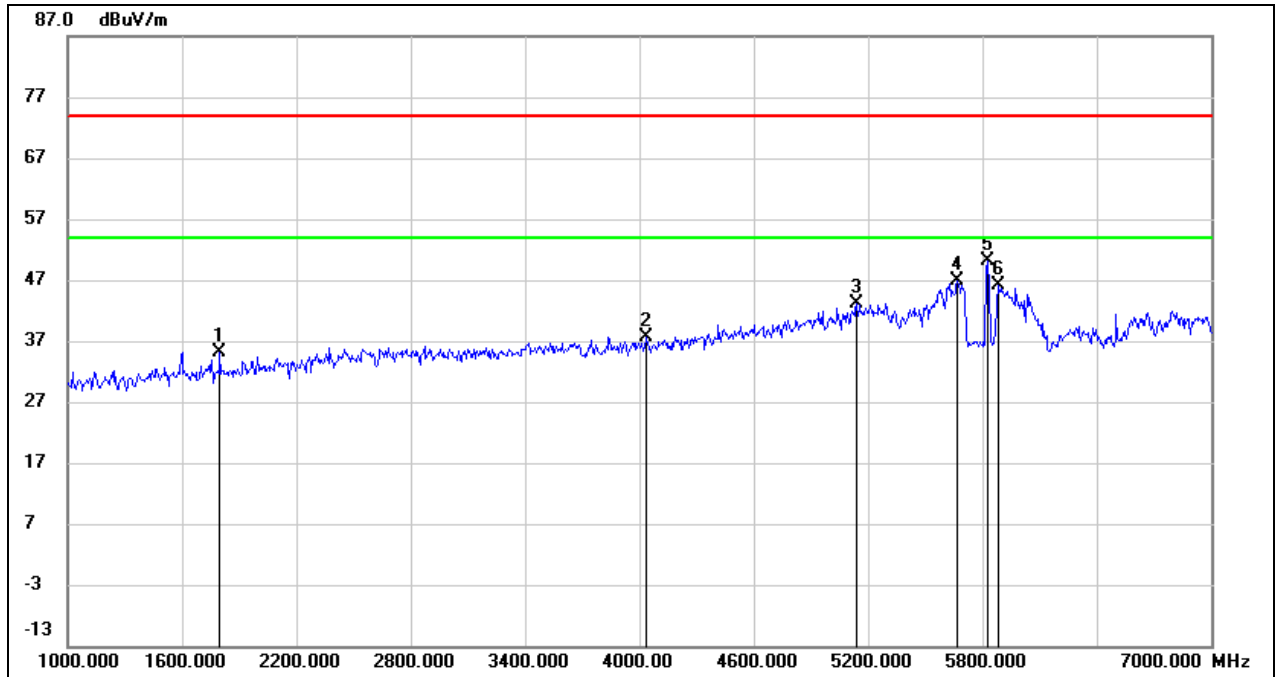

No.	Frequency (MHz)	Reading (dBuV)	Correct (dB/m)	Result (dBuV/m)	Limit (dBuV/m)	Margin (dB)	Remark
1	1798.000	46.89	-11.72	35.17	74.00	-38.83	peak
2	4036.000	42.03	-4.31	37.72	74.00	-36.28	peak
3	5140.000	43.06	0.01	43.07	74.00	-30.93	peak
4	5668.000	45.99	0.91	46.90	74.00	-27.10	peak
5	5830.000	48.86	1.36	50.22	74.00	-23.78	peak
6	5884.000	44.67	1.52	46.19	74.00	-27.81	peak

8.3. SPURIOUS EMISSIONS(7 GHZ~18 GHZ)

Test Mode:	802.11a 20	Channel:	5180
Polarity:	Horizontal	Test Voltage:	DC 48 V

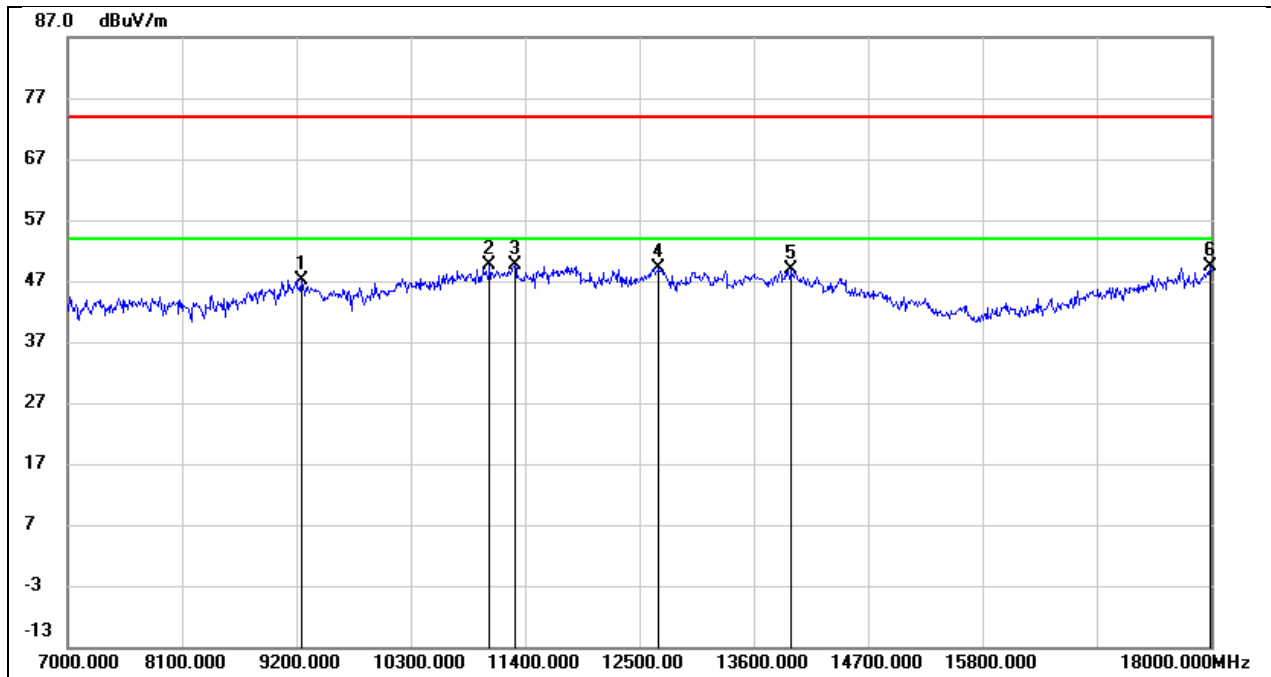

No.	Frequency (MHz)	Reading (dBuV)	Correct (dB/m)	Result (dBuV/m)	Limit (dBuV/m)	Margin (dB)	Remark
1	9244.000	36.72	10.49	47.21	74.00	-26.79	peak
2	11059.000	34.62	14.96	49.58	74.00	-24.42	peak
3	11301.000	33.56	15.95	49.51	74.00	-24.49	peak
4	12687.000	31.07	18.05	49.12	74.00	-24.88	peak
5	13963.000	27.20	21.78	48.98	74.00	-25.02	peak
6	17989.000	23.26	26.04	49.30	74.00	-24.70	peak

Test Mode:	802.11a 20	Channel:	5180
Polarity:	Vertical	Test Voltage:	DC 48 V

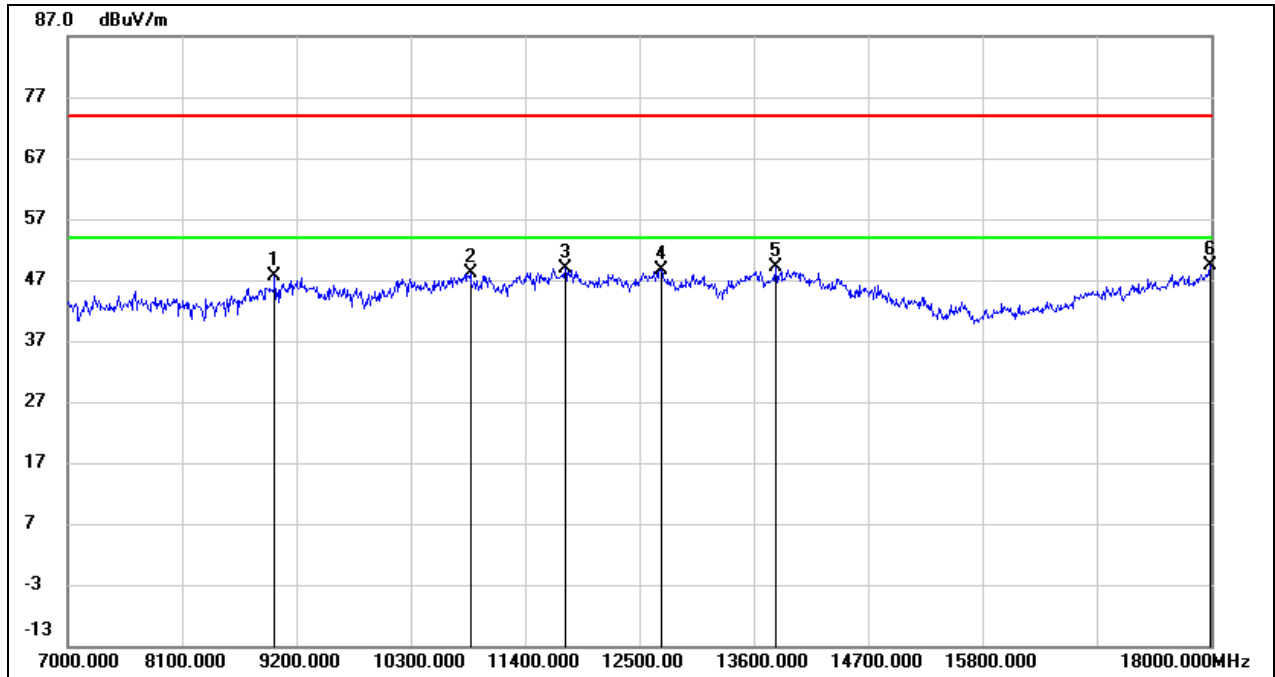

No.	Frequency (MHz)	Reading (dBuV)	Correct (dB/m)	Result (dBuV/m)	Limit (dBuV/m)	Margin (dB)	Remark
1	8991.000	37.28	10.28	47.56	74.00	-26.44	peak
2	10872.000	33.98	14.23	48.21	74.00	-25.79	peak
3	11785.000	31.61	17.30	48.91	74.00	-25.09	peak
4	12709.000	30.66	18.09	48.75	74.00	-25.25	peak
5	13809.000	27.79	21.41	49.20	74.00	-24.80	peak
6	17989.000	23.41	26.04	49.45	74.00	-24.55	peak

Test Mode:	802.11a 20	Channel:	5200
Polarity:	Horizontal	Test Voltage:	DC 48 V

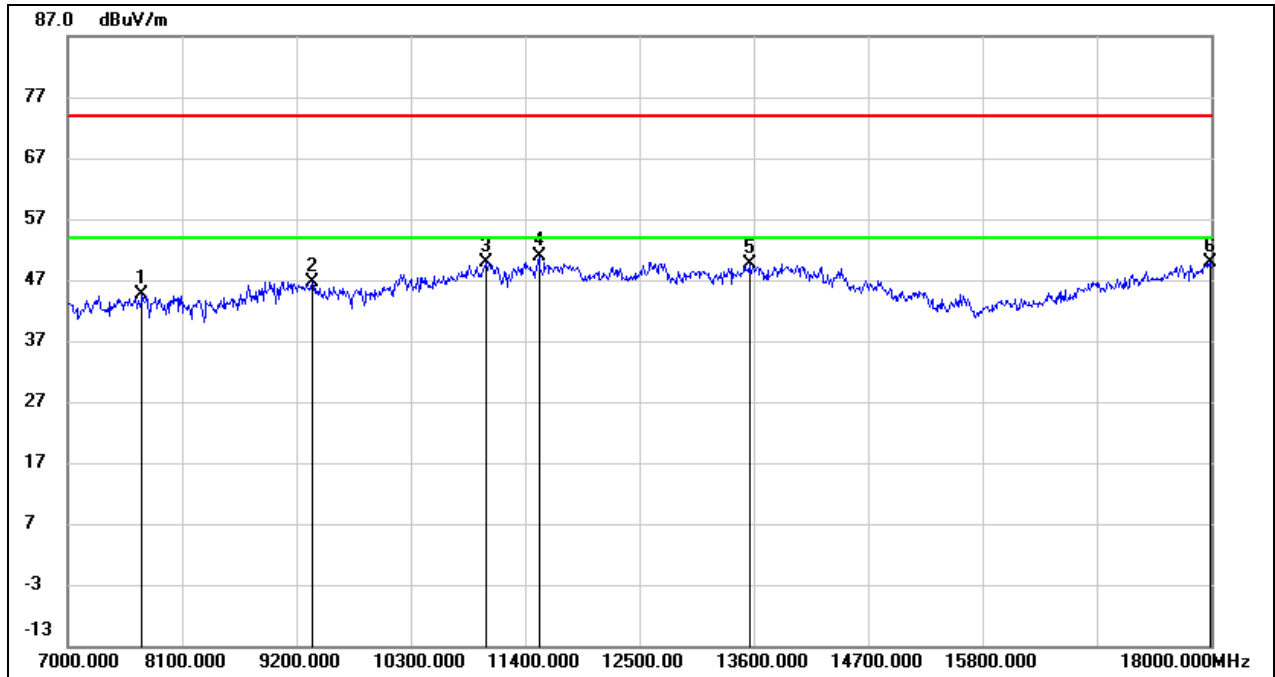

No.	Frequency (MHz)	Reading (dBuV)	Correct (dB/m)	Result (dBuV/m)	Limit (dBuV/m)	Margin (dB)	Remark
1	7715.000	37.88	6.68	44.56	74.00	-29.44	peak
2	9354.000	36.18	10.56	46.74	74.00	-27.26	peak
3	11026.000	35.00	14.82	49.82	74.00	-24.18	peak
4	11532.000	33.97	16.83	50.80	74.00	-23.20	peak
5	13556.000	28.80	20.78	49.58	74.00	-24.42	peak
6	17989.000	23.89	26.04	49.93	74.00	-24.07	peak

Test Mode:	802.11a 20	Channel:	5200
Polarity:	Vertical	Test Voltage:	DC 48 V

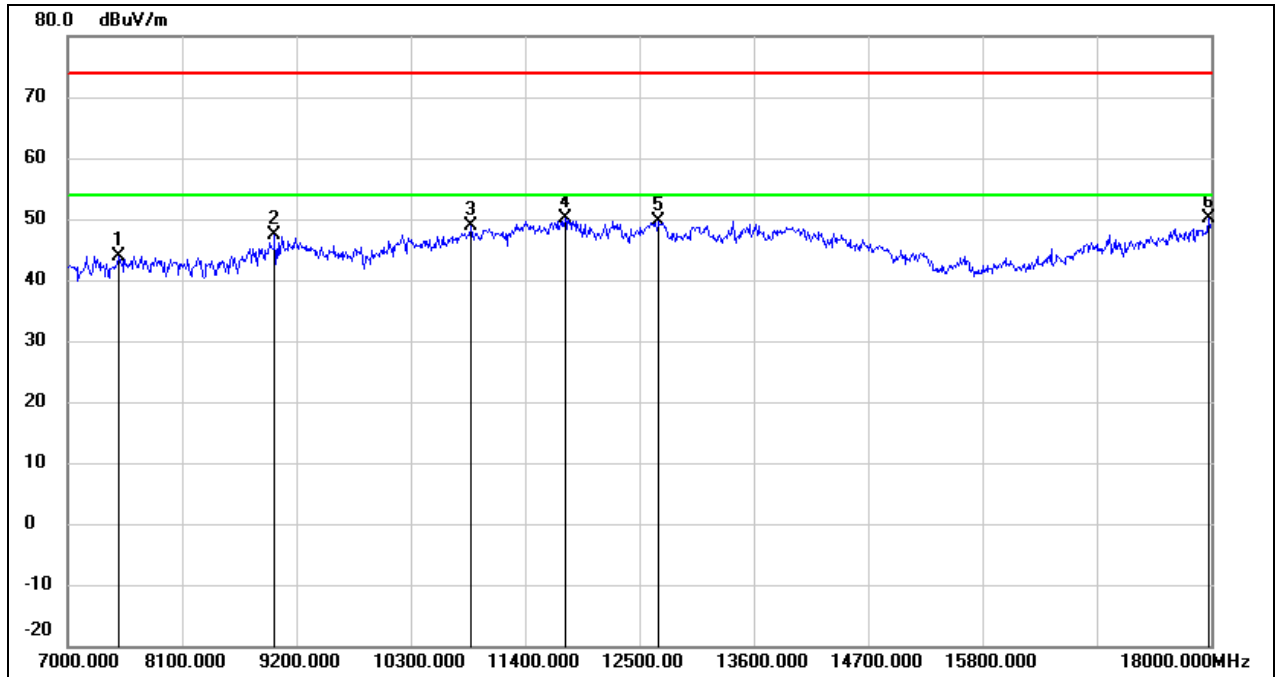

No.	Frequency (MHz)	Reading (dBuV)	Correct (dB/m)	Result (dBuV/m)	Limit (dBuV/m)	Margin (dB)	Remark
1	7495.000	37.12	6.87	43.99	74.00	-30.01	peak
2	8991.000	37.02	10.28	47.30	74.00	-26.70	peak
3	10883.000	34.53	14.27	48.80	74.00	-25.20	peak
4	11785.000	32.72	17.30	50.02	74.00	-23.98	peak
5	12687.000	31.57	18.05	49.62	74.00	-24.38	peak
6	17978.000	24.11	25.97	50.08	74.00	-23.92	peak

Test Mode:	802.11a 20	Channel:	5240
Polarity:	Horizontal	Test Voltage:	DC 48 V

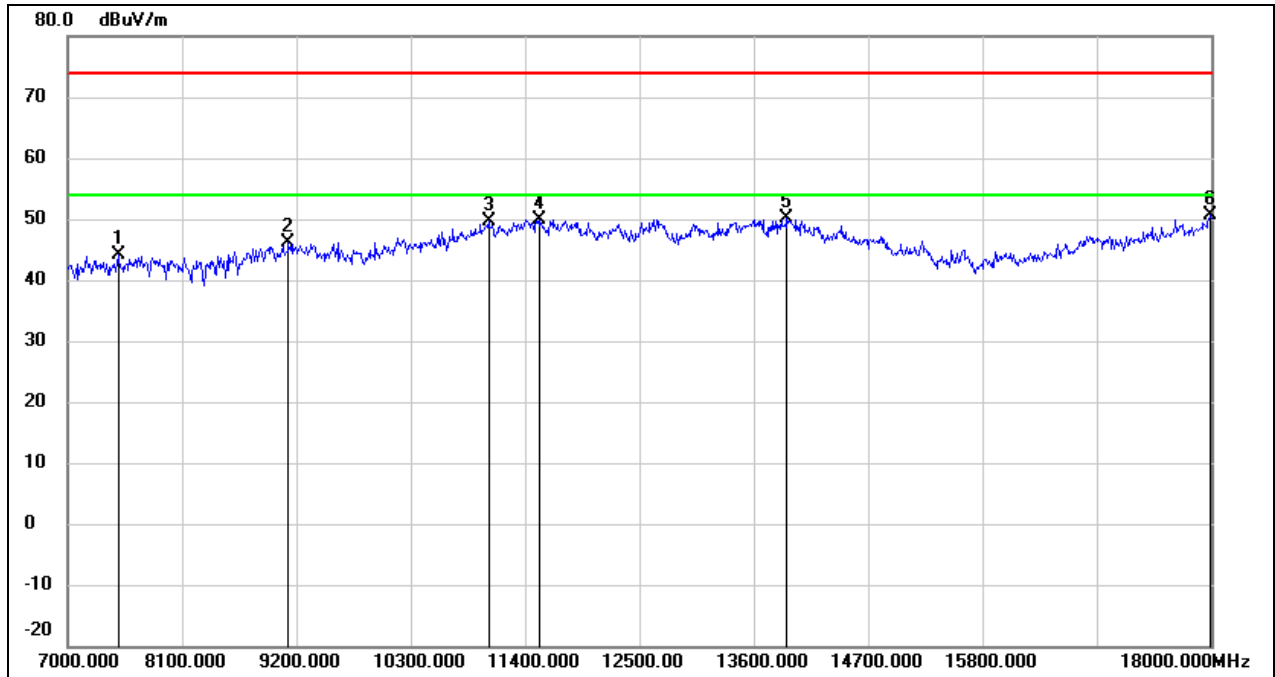

No.	Frequency (MHz)	Reading (dBuV)	Correct (dB/m)	Result (dBuV/m)	Limit (dBuV/m)	Margin (dB)	Remark
1	7484.000	37.38	6.87	44.25	74.00	-29.75	peak
2	9123.000	35.69	10.42	46.11	74.00	-27.89	peak
3	11048.000	34.81	14.91	49.72	74.00	-24.28	peak
4	11543.000	33.05	16.84	49.89	74.00	-24.11	peak
5	13919.000	28.33	21.68	50.01	74.00	-23.99	peak
6	17989.000	24.48	26.04	50.52	74.00	-23.48	peak

Test Mode:	802.11a 20	Channel:	5240
Polarity:	Vertical	Test Voltage:	DC 48 V

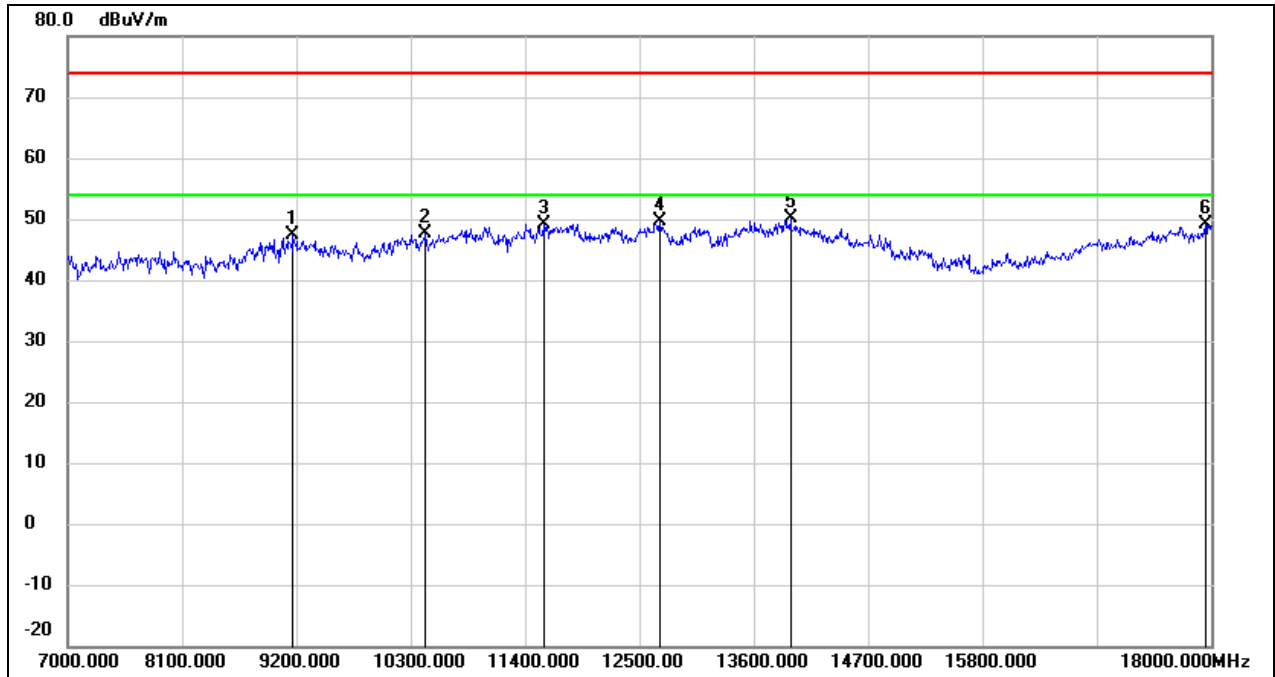

No.	Frequency (MHz)	Reading (dBuV)	Correct (dB/m)	Result (dBuV/m)	Limit (dBuV/m)	Margin (dB)	Remark
1	9167.000	36.91	10.45	47.36	74.00	-26.64	peak
2	10443.000	34.90	12.70	47.60	74.00	-26.40	peak
3	11576.000	32.31	16.91	49.22	74.00	-24.78	peak
4	12698.000	31.59	18.08	49.67	74.00	-24.33	peak
5	13952.000	28.41	21.76	50.17	74.00	-23.83	peak
6	17945.000	23.30	25.75	49.05	74.00	-24.95	peak

Test Mode:	802.11a 20	Channel:	5745
Polarity:	Horizontal	Test Voltage:	DC 48 V

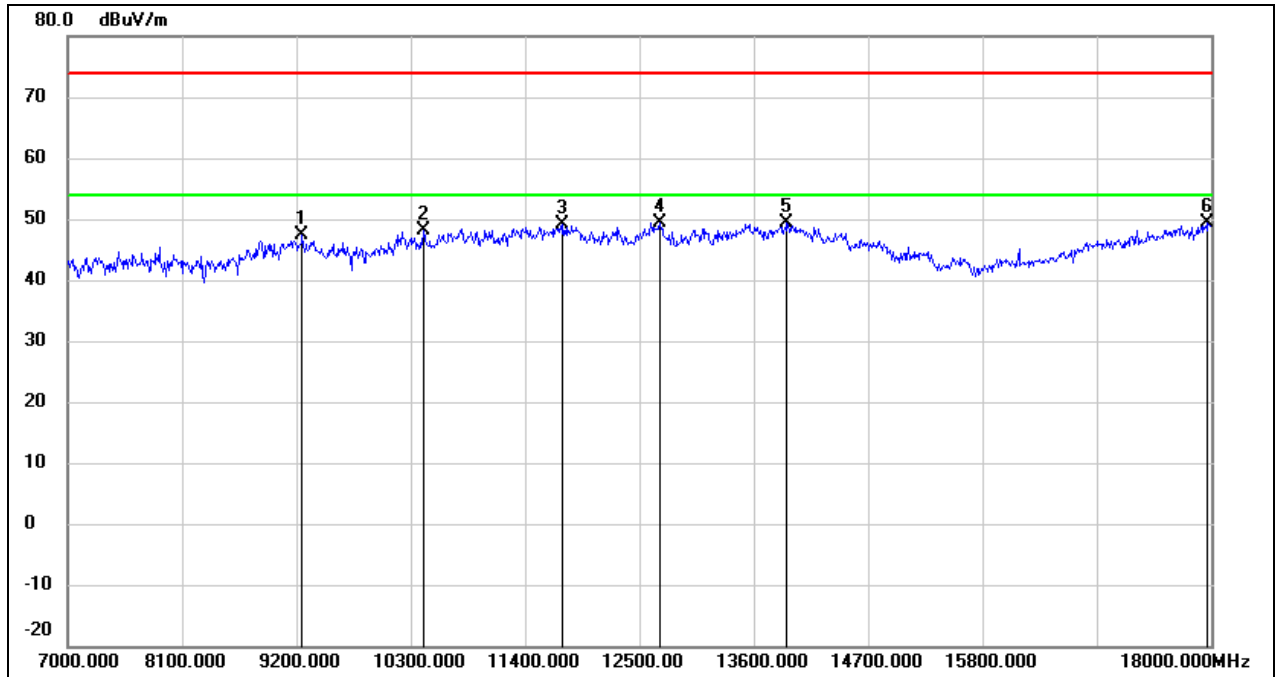

No.	Frequency (MHz)	Reading (dBuV)	Correct (dB/m)	Result (dBuV/m)	Limit (dBuV/m)	Margin (dB)	Remark
1	9255.000	36.86	10.51	47.37	74.00	-26.63	peak
2	10421.000	35.52	12.66	48.18	74.00	-25.82	peak
3	11763.000	31.87	17.26	49.13	74.00	-24.87	peak
4	12698.000	31.42	18.08	49.50	74.00	-24.50	peak
5	13919.000	27.64	21.68	49.32	74.00	-24.68	peak
6	17967.000	23.56	25.89	49.45	74.00	-24.55	peak

Test Mode:	802.11a 20	Channel:	5745
Polarity:	Vertical	Test Voltage:	DC 48 V

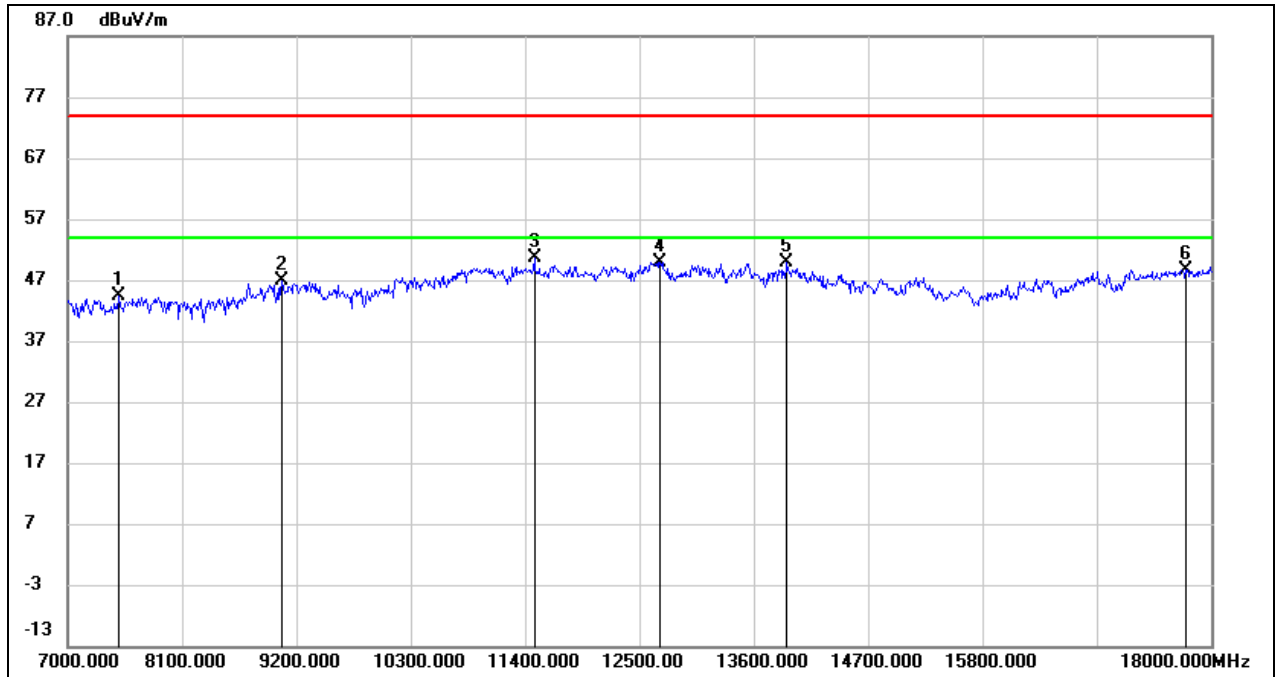

No.	Frequency (MHz)	Reading (dBuV)	Correct (dB/m)	Result (dBuV/m)	Limit (dBuV/m)	Margin (dB)	Remark
1	7495.000	37.50	6.87	44.37	74.00	-29.63	peak
2	9057.000	36.52	10.38	46.90	74.00	-27.10	peak
3	11488.000	33.87	16.72	50.59	74.00	-23.41	peak
4	12698.000	31.90	18.08	49.98	74.00	-24.02	peak
5	13919.000	28.16	21.68	49.84	74.00	-24.16	peak
6	17758.000	24.26	24.46	48.72	74.00	-25.28	peak

Test Mode:	802.11a 20	Channel:	5785
Polarity:	Horizontal	Test Voltage:	DC 48 V

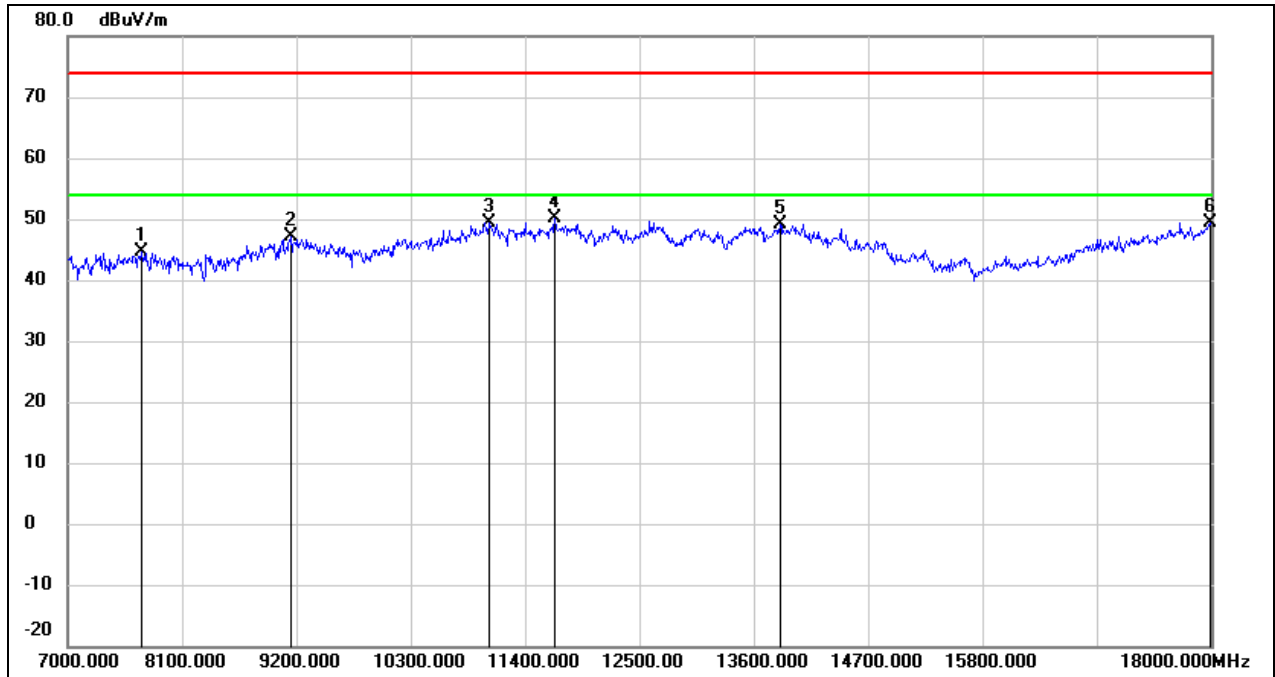

No.	Frequency (MHz)	Reading (dBuV)	Correct (dB/m)	Result (dBuV/m)	Limit (dBuV/m)	Margin (dB)	Remark
1	7715.000	38.06	6.68	44.74	74.00	-29.26	peak
2	9145.000	36.72	10.43	47.15	74.00	-26.85	peak
3	11059.000	34.38	14.96	49.34	74.00	-24.66	peak
4	11686.000	32.94	17.12	50.06	74.00	-23.94	peak
5	13853.000	27.68	21.52	49.20	74.00	-24.80	peak
6	17989.000	23.41	26.04	49.45	74.00	-24.55	peak

Test Mode:	802.11a 20	Channel:	5785
Polarity:	Vertical	Test Voltage:	DC 48 V

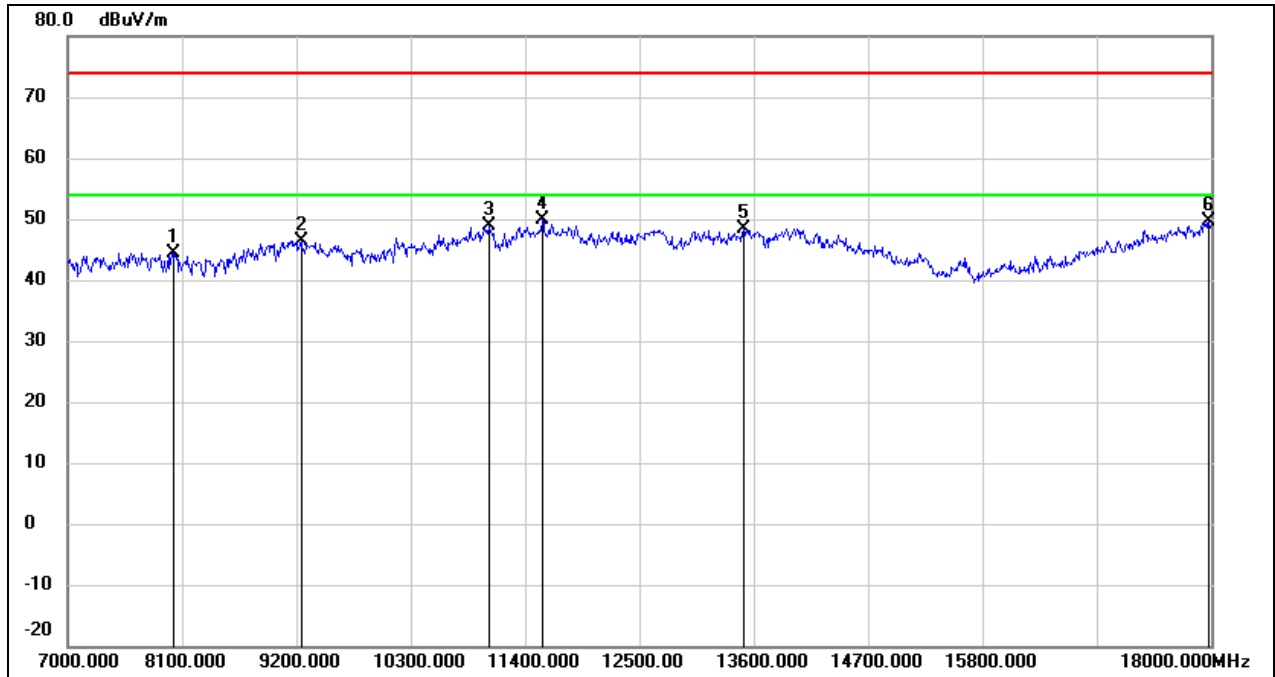

No.	Frequency (MHz)	Reading (dBuV)	Correct (dB/m)	Result (dBuV/m)	Limit (dBuV/m)	Margin (dB)	Remark
1	8023.000	38.00	6.45	44.45	74.00	-29.55	peak
2	9244.000	35.89	10.49	46.38	74.00	-27.62	peak
3	11059.000	33.82	14.96	48.78	74.00	-25.22	peak
4	11565.000	33.09	16.89	49.98	74.00	-24.02	peak
5	13501.000	27.80	20.64	48.44	74.00	-25.56	peak
6	17978.000	23.61	25.97	49.58	74.00	-24.42	peak

Test Mode:	802.11a 20	Channel:	5825
Polarity:	Horizontal	Test Voltage:	DC 48 V

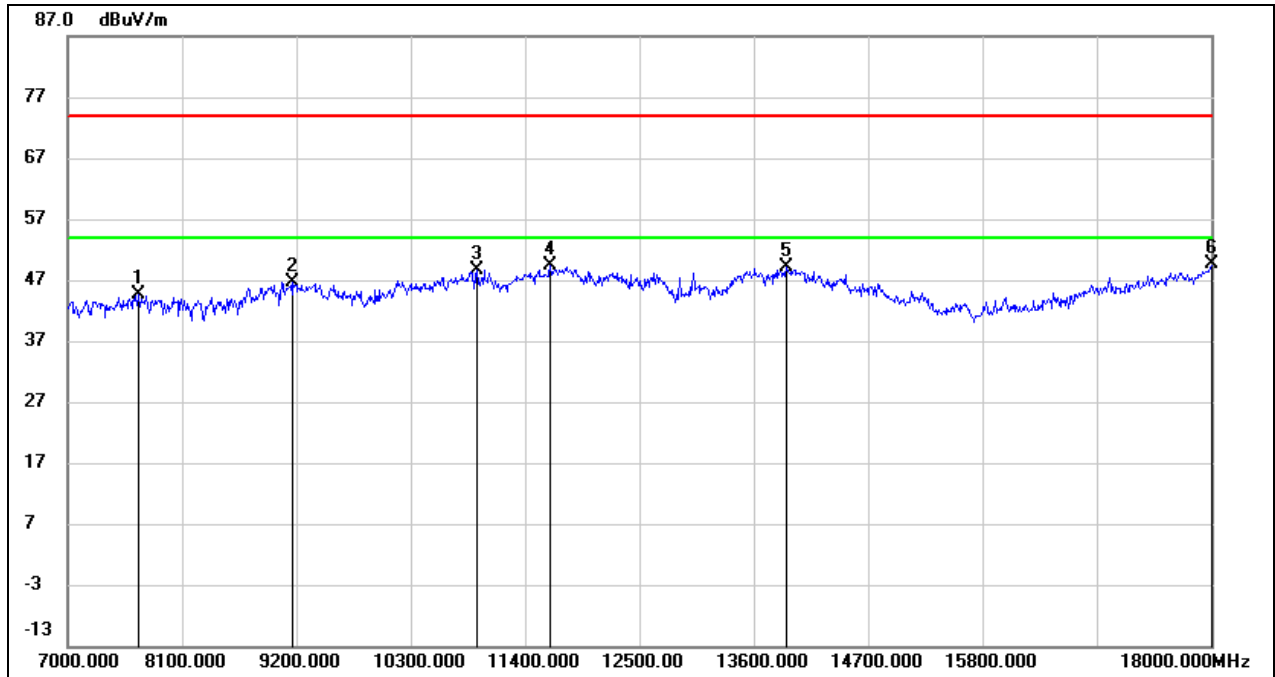

No.	Frequency (MHz)	Reading (dBuV)	Correct (dB/m)	Result (dBuV/m)	Limit (dBuV/m)	Margin (dB)	Remark
1	7682.000	37.81	6.71	44.52	74.00	-29.48	peak
2	9167.000	36.15	10.45	46.60	74.00	-27.40	peak
3	10938.000	34.26	14.48	48.74	74.00	-25.26	peak
4	11642.000	32.26	17.03	49.29	74.00	-24.71	peak
5	13919.000	27.54	21.68	49.22	74.00	-24.78	peak
6	18000.000	23.57	26.12	49.69	74.00	-24.31	peak

Test Mode:	802.11a 20	Channel:	5825
Polarity:	Vertical	Test Voltage:	DC 48 V

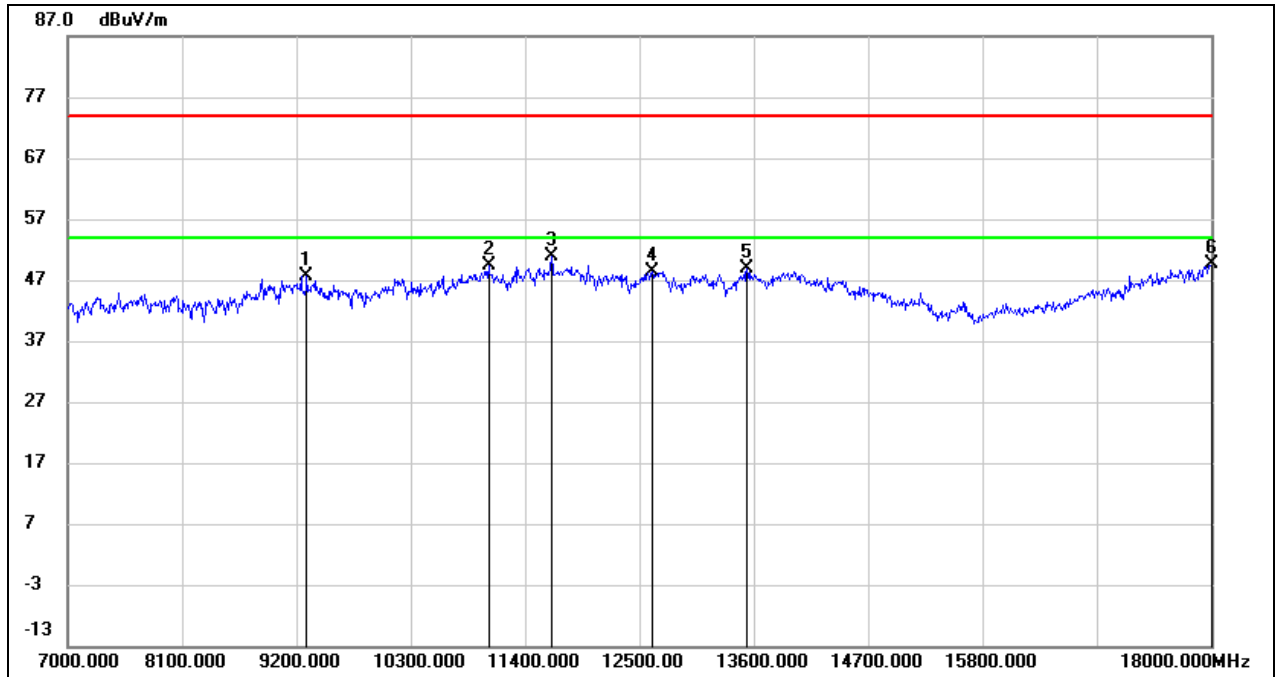

No.	Frequency (MHz)	Reading (dBuV)	Correct (dB/m)	Result (dBuV/m)	Limit (dBuV/m)	Margin (dB)	Remark
1	9299.000	37.11	10.53	47.64	74.00	-26.36	peak
2	11048.000	34.40	14.91	49.31	74.00	-24.69	peak
3	11653.000	33.76	17.05	50.81	74.00	-23.19	peak
4	12621.000	30.44	17.98	48.42	74.00	-25.58	peak
5	13534.000	28.18	20.73	48.91	74.00	-25.09	peak
6	18000.000	23.44	26.12	49.56	74.00	-24.44	peak

Test Mode:	802.11ax HE20	Channel:	5180
Polarity:	Horizontal	Test Voltage:	DC 48 V

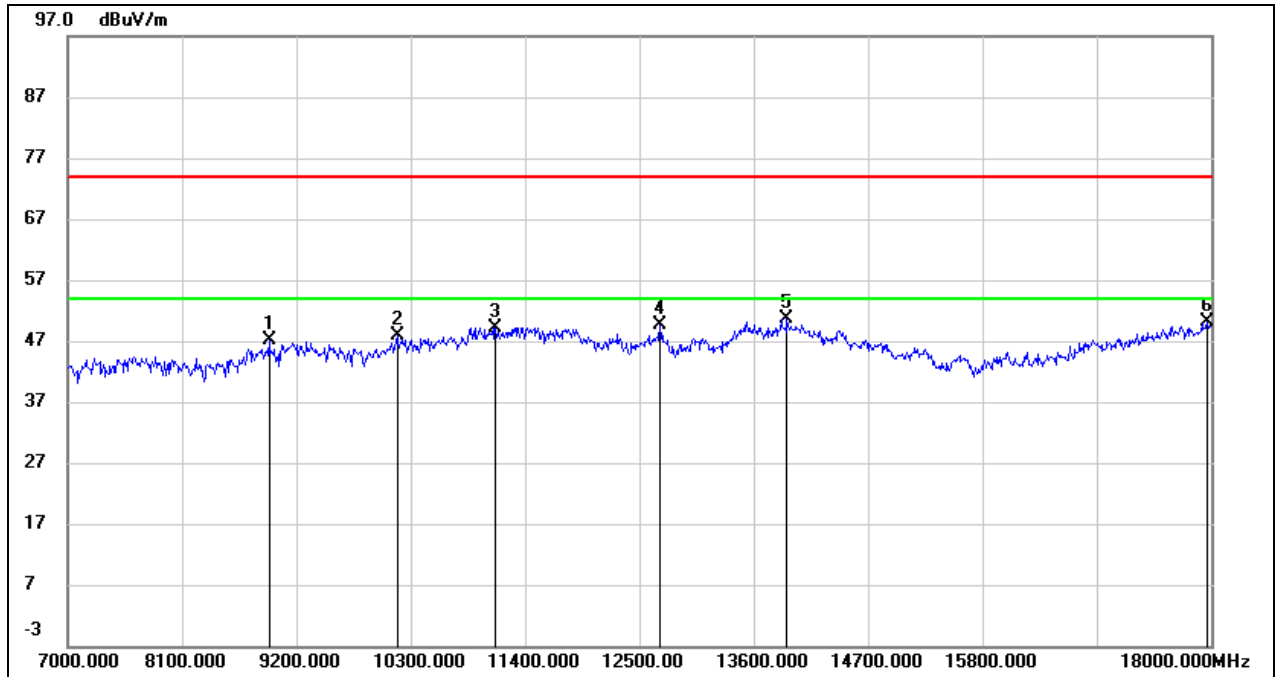

No.	Frequency (MHz)	Reading (dBuV)	Correct (dB/m)	Result (dBuV/m)	Limit (dBuV/m)	Margin (dB)	Remark
1	8936.000	37.30	9.90	47.20	74.00	-26.80	peak
2	10168.000	35.86	12.13	47.99	74.00	-26.01	peak
3	11114.000	34.02	15.19	49.21	74.00	-24.79	peak
4	12698.000	31.53	18.08	49.61	74.00	-24.39	peak
5	13919.000	28.91	21.68	50.59	74.00	-23.41	peak
6	17956.000	24.24	25.82	50.06	74.00	-23.94	peak

Test Mode:	802.11ax HE20	Channel:	5180
Polarity:	Vertical	Test Voltage:	DC 48 V

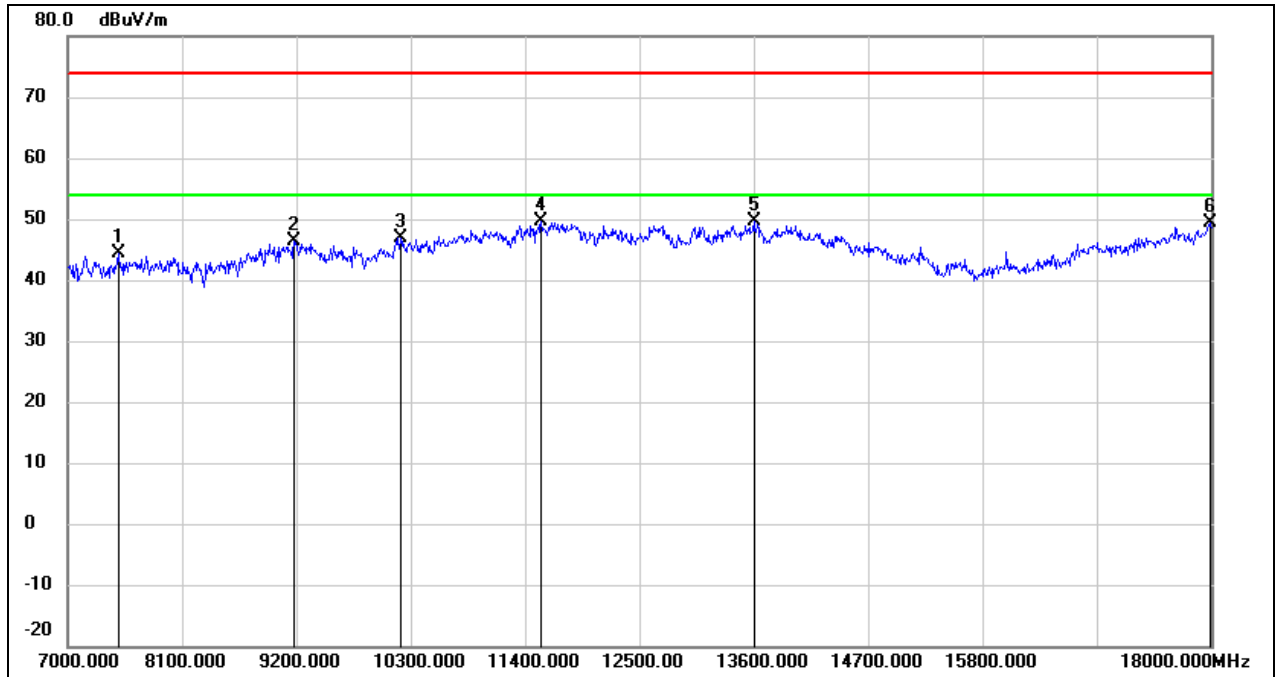

No.	Frequency (MHz)	Reading (dBuV)	Correct (dB/m)	Result (dBuV/m)	Limit (dBuV/m)	Margin (dB)	Remark
1	7484.000	37.51	6.87	44.38	74.00	-29.62	peak
2	9178.000	35.84	10.45	46.29	74.00	-27.71	peak
3	10201.000	34.65	12.19	46.84	74.00	-27.16	peak
4	11554.000	32.79	16.87	49.66	74.00	-24.34	peak
5	13600.000	28.75	20.89	49.64	74.00	-24.36	peak
6	17989.000	23.36	26.04	49.40	74.00	-24.60	peak

Test Mode:	802.11ax HE20	Channel:	5200
Polarity:	Horizontal	Test Voltage:	DC 48 V

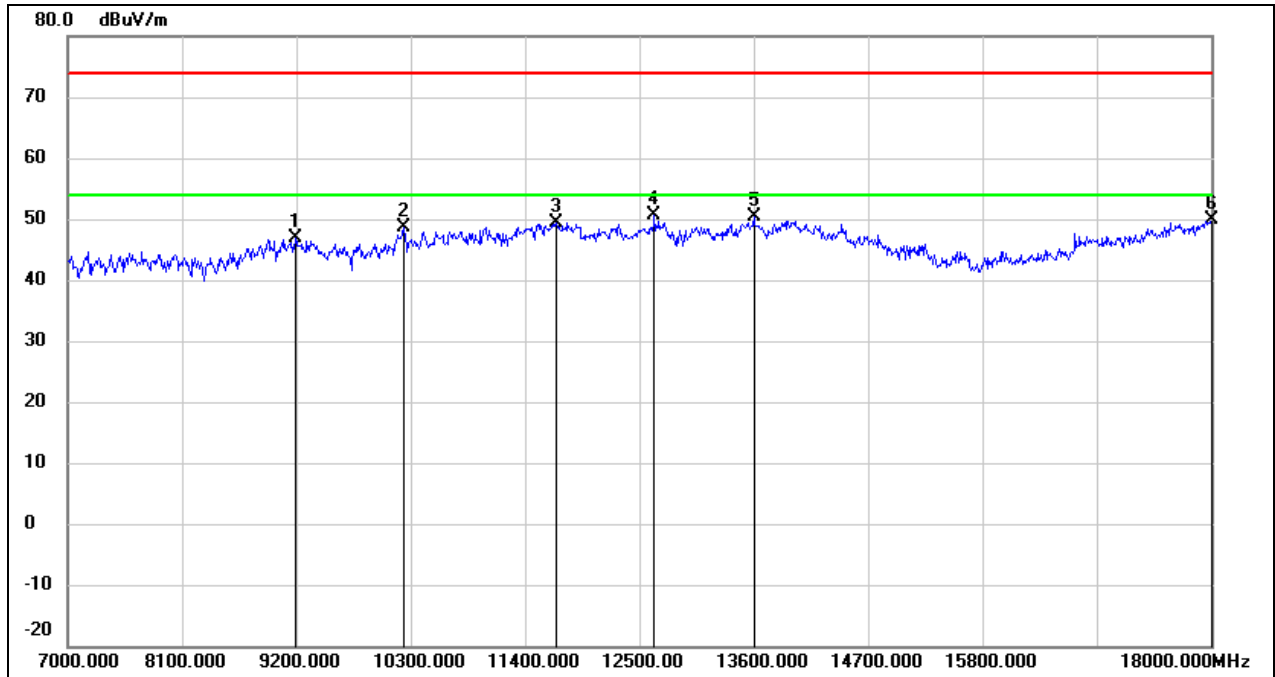

No.	Frequency (MHz)	Reading (dBuV)	Correct (dB/m)	Result (dBuV/m)	Limit (dBuV/m)	Margin (dB)	Remark
1	9189.000	36.35	10.46	46.81	74.00	-27.19	peak
2	10234.000	36.33	12.26	48.59	74.00	-25.41	peak
3	11697.000	32.25	17.13	49.38	74.00	-24.62	peak
4	12643.000	32.59	18.01	50.60	74.00	-23.40	peak
5	13600.000	29.42	20.89	50.31	74.00	-23.69	peak
6	18000.000	23.83	26.12	49.95	74.00	-24.05	peak

Test Mode:	802.11ax HE20	Channel:	5200
Polarity:	Vertical	Test Voltage:	DC 48 V

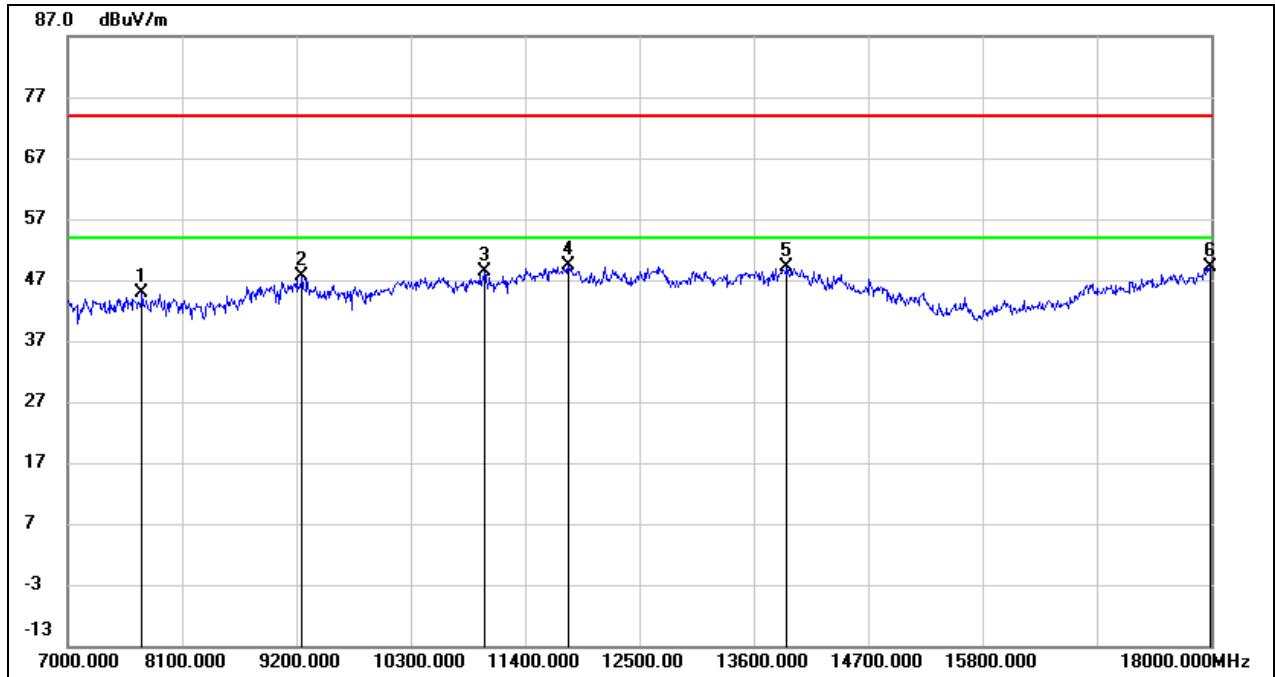

No.	Frequency (MHz)	Reading (dBuV)	Correct (dB/m)	Result (dBuV/m)	Limit (dBuV/m)	Margin (dB)	Remark
1	7715.000	38.16	6.68	44.84	74.00	-29.16	peak
2	9255.000	37.15	10.51	47.66	74.00	-26.34	peak
3	11015.000	33.48	14.79	48.27	74.00	-25.73	peak
4	11818.000	32.03	17.36	49.39	74.00	-24.61	peak
5	13919.000	27.38	21.68	49.06	74.00	-24.94	peak
6	17989.000	23.18	26.04	49.22	74.00	-24.78	peak

Test Mode:	802.11ax HE20	Channel:	5240
Polarity:	Horizontal	Test Voltage:	DC 48 V

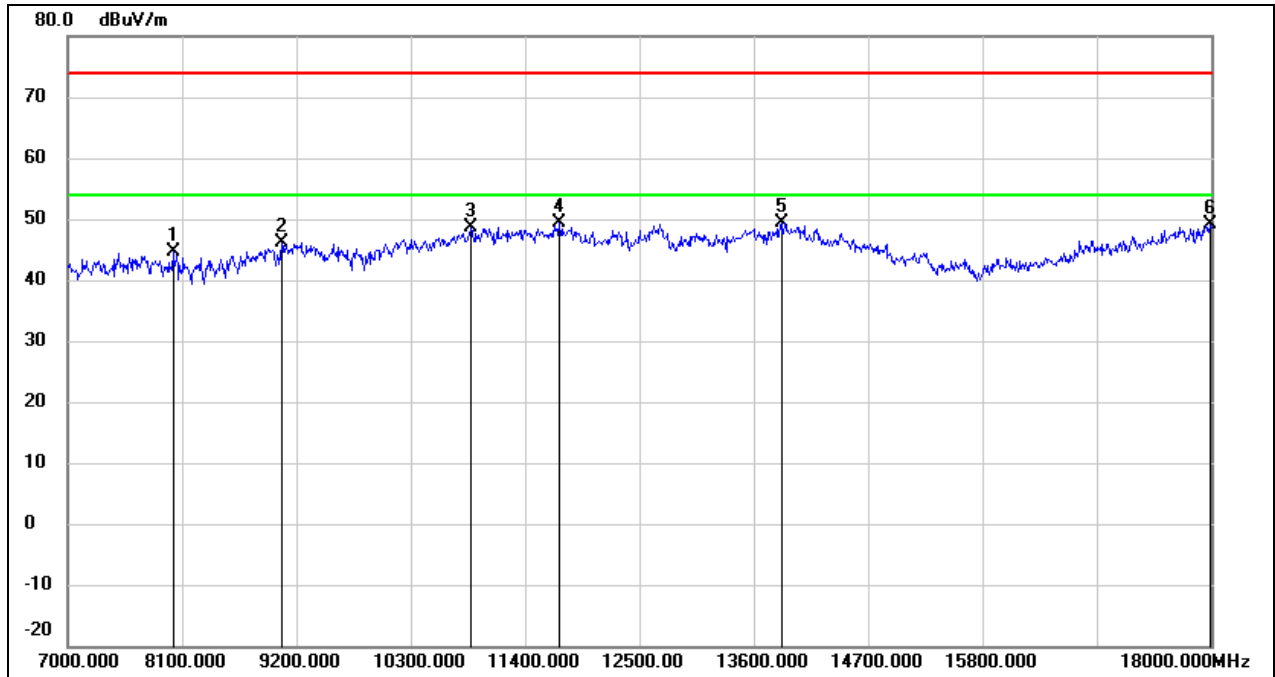

No.	Frequency (MHz)	Reading (dBuV)	Correct (dB/m)	Result (dBuV/m)	Limit (dBuV/m)	Margin (dB)	Remark
1	8012.000	38.25	6.44	44.69	74.00	-29.31	peak
2	9057.000	35.84	10.38	46.22	74.00	-27.78	peak
3	10883.000	34.39	14.27	48.66	74.00	-25.34	peak
4	11730.000	32.20	17.19	49.39	74.00	-24.61	peak
5	13864.000	27.92	21.53	49.45	74.00	-24.55	peak
6	17989.000	22.99	26.04	49.03	74.00	-24.97	peak

Test Mode:	802.11ax HE20	Channel:	5240
Polarity:	Vertical	Test Voltage:	DC 48 V

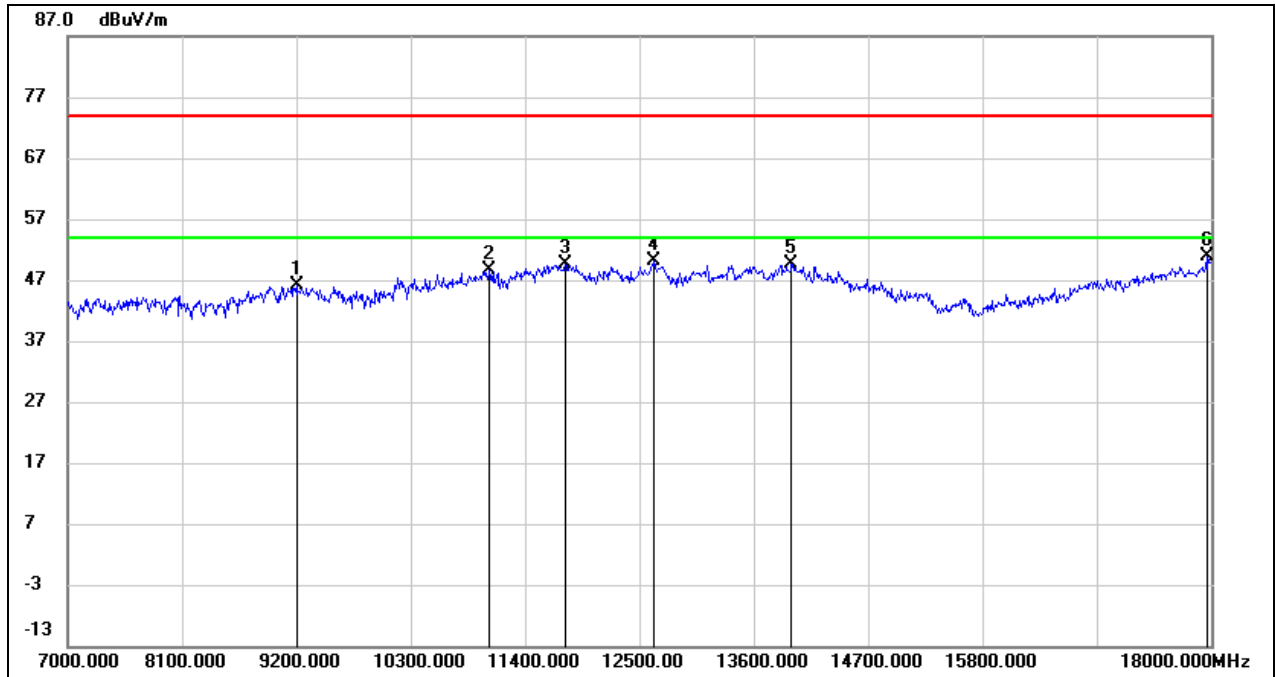

No.	Frequency (MHz)	Reading (dBuV)	Correct (dB/m)	Result (dBuV/m)	Limit (dBuV/m)	Margin (dB)	Remark
1	9200.000	35.64	10.46	46.10	74.00	-27.90	peak
2	11059.000	33.75	14.96	48.71	74.00	-25.29	peak
3	11785.000	32.29	17.30	49.59	74.00	-24.41	peak
4	12643.000	32.17	18.01	50.18	74.00	-23.82	peak
5	13963.000	27.94	21.78	49.72	74.00	-24.28	peak
6	17956.000	25.01	25.82	50.83	74.00	-23.17	peak

Test Mode:	802.11ax HE20	Channel:	5745
Polarity:	Horizontal	Test Voltage:	DC 48 V

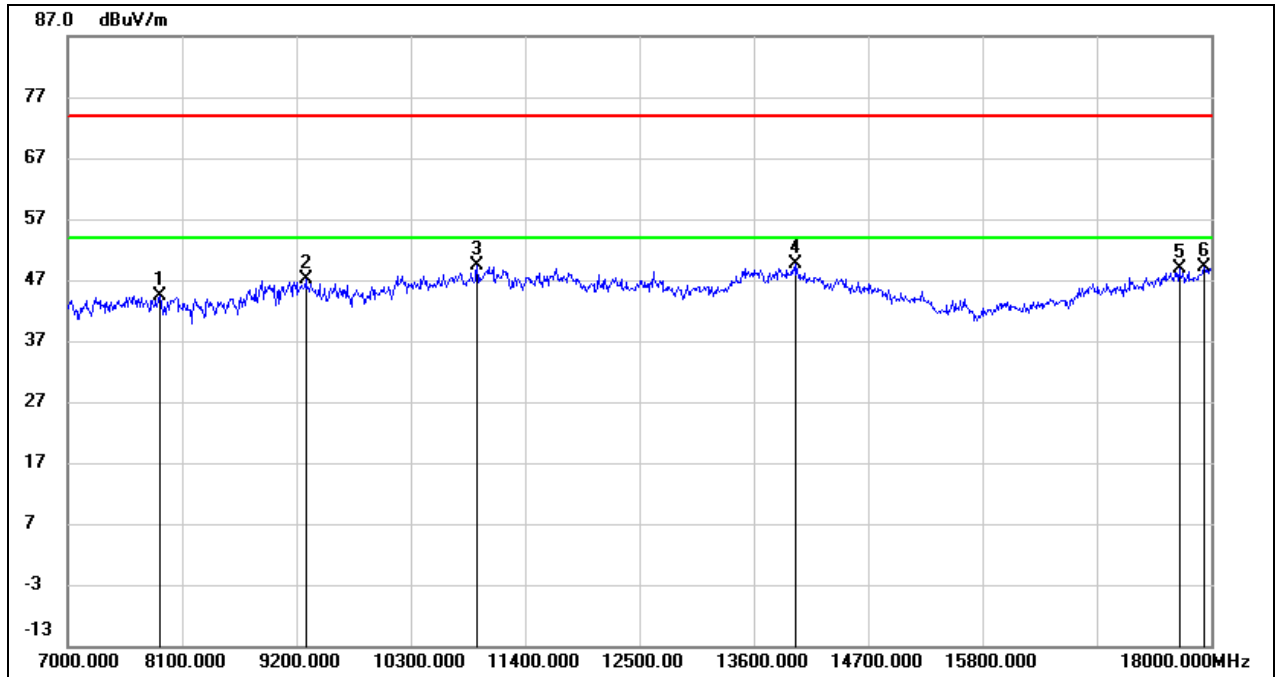

No.	Frequency (MHz)	Reading (dBuV)	Correct (dB/m)	Result (dBuV/m)	Limit (dBuV/m)	Margin (dB)	Remark
1	7880.000	37.92	6.54	44.46	74.00	-29.54	peak
2	9288.000	36.67	10.52	47.19	74.00	-26.81	peak
3	10938.000	34.87	14.48	49.35	74.00	-24.65	peak
4	14007.000	27.81	21.85	49.66	74.00	-24.34	peak
5	17692.000	24.94	24.01	48.95	74.00	-25.05	peak
6	17934.000	23.57	25.67	49.24	74.00	-24.76	peak

Test Mode:	802.11ax HE20	Channel:	5745
Polarity:	Vertical	Test Voltage:	DC 48 V

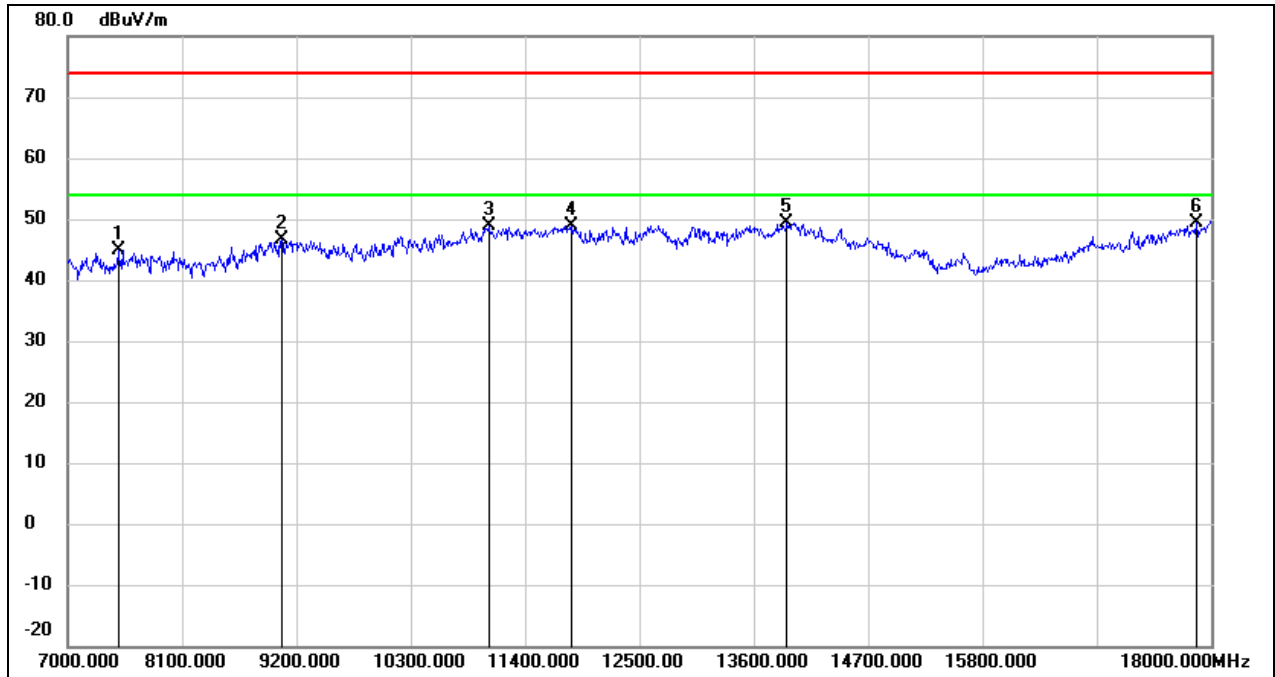

No.	Frequency (MHz)	Reading (dBuV)	Correct (dB/m)	Result (dBuV/m)	Limit (dBuV/m)	Margin (dB)	Remark
1	7484.000	37.94	6.87	44.81	74.00	-29.19	peak
2	9057.000	36.31	10.38	46.69	74.00	-27.31	peak
3	11048.000	34.03	14.91	48.94	74.00	-25.06	peak
4	11851.000	31.54	17.43	48.97	74.00	-25.03	peak
5	13919.000	27.81	21.68	49.49	74.00	-24.51	peak
6	17857.000	24.18	25.14	49.32	74.00	-24.68	peak

Test Mode:	802.11ax HE20	Channel:	5785
Polarity:	Horizontal	Test Voltage:	DC 48 V

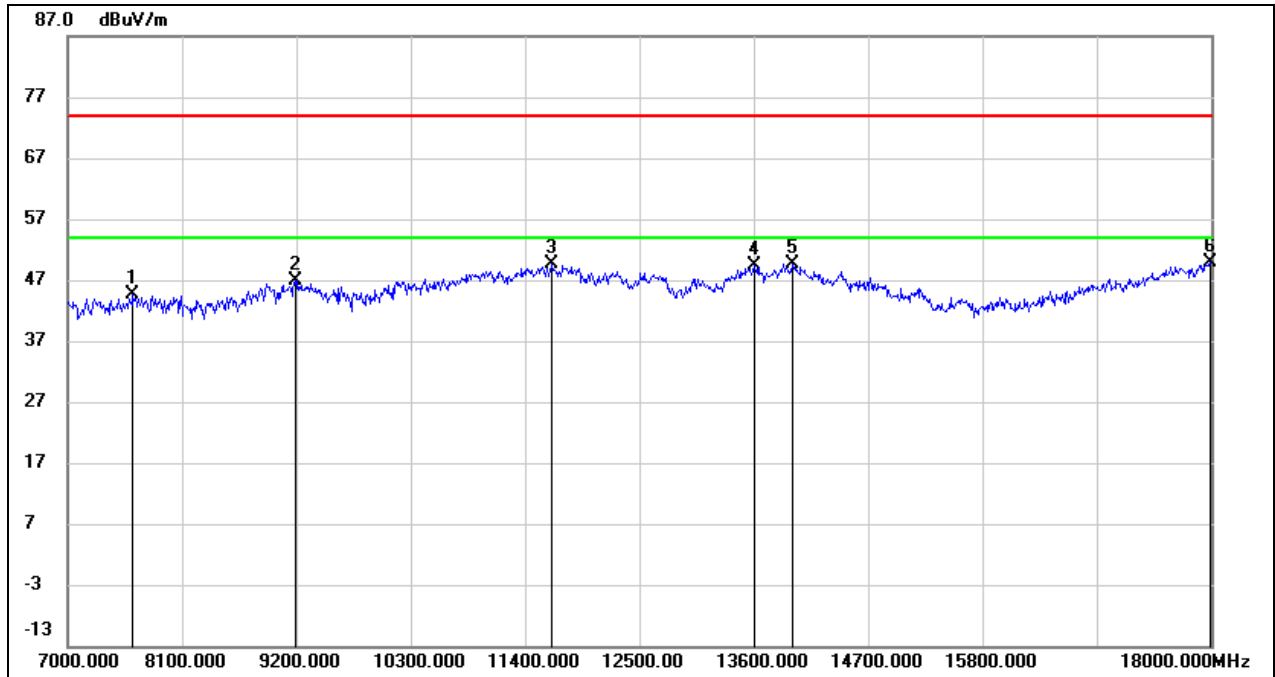

No.	Frequency (MHz)	Reading (dBuV)	Correct (dB/m)	Result (dBuV/m)	Limit (dBuV/m)	Margin (dB)	Remark
1	7627.000	37.86	6.76	44.62	74.00	-29.38	peak
2	9189.000	36.54	10.46	47.00	74.00	-27.00	peak
3	11653.000	32.48	17.05	49.53	74.00	-24.47	peak
4	13600.000	28.40	20.89	49.29	74.00	-24.71	peak
5	13974.000	27.92	21.82	49.74	74.00	-24.26	peak
6	17989.000	23.76	26.04	49.80	74.00	-24.20	peak

Test Mode:	802.11ax HE20	Channel:	5785
Polarity:	Vertical	Test Voltage:	DC 48 V

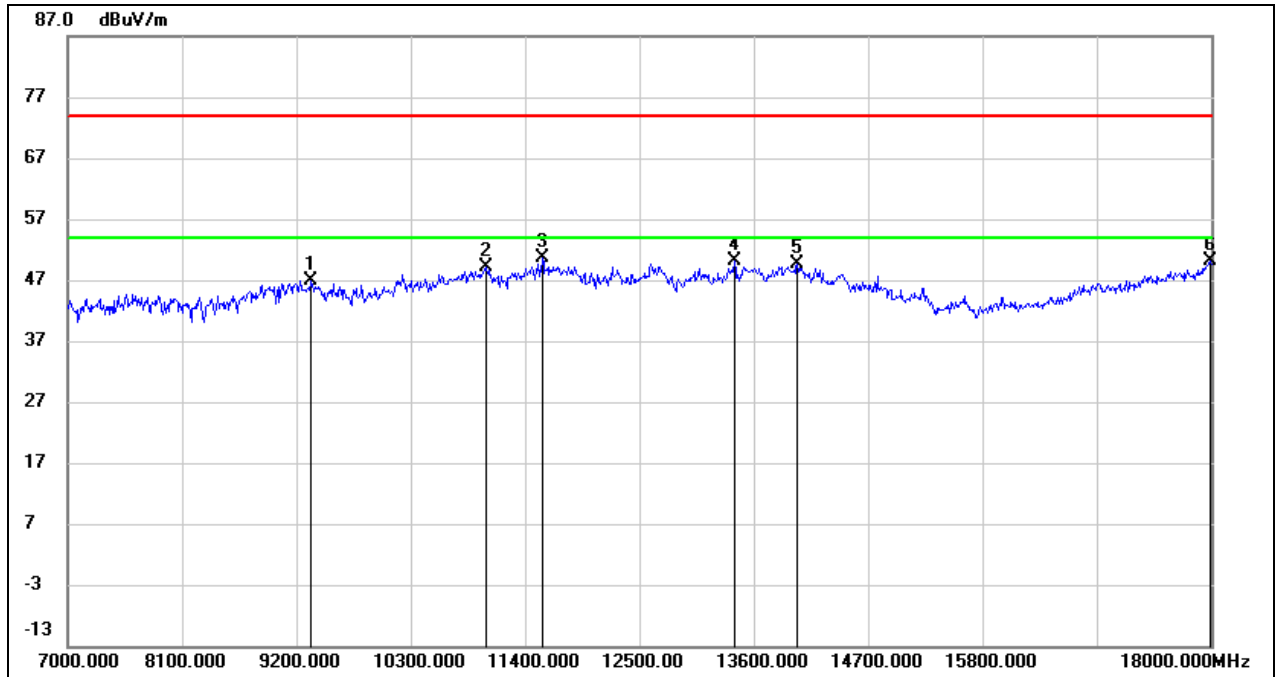

No.	Frequency (MHz)	Reading (dBuV)	Correct (dB/m)	Result (dBuV/m)	Limit (dBuV/m)	Margin (dB)	Remark
1	9343.000	36.39	10.55	46.94	74.00	-27.06	peak
2	11026.000	34.32	14.82	49.14	74.00	-24.86	peak
3	11565.000	33.75	16.89	50.64	74.00	-23.36	peak
4	13413.000	29.75	20.26	50.01	74.00	-23.99	peak
5	14018.000	27.89	21.80	49.69	74.00	-24.31	peak
6	17989.000	24.19	26.04	50.23	74.00	-23.77	peak

Test Mode:	802.11ax HE20	Channel:	5825
Polarity:	Horizontal	Test Voltage:	DC 48 V

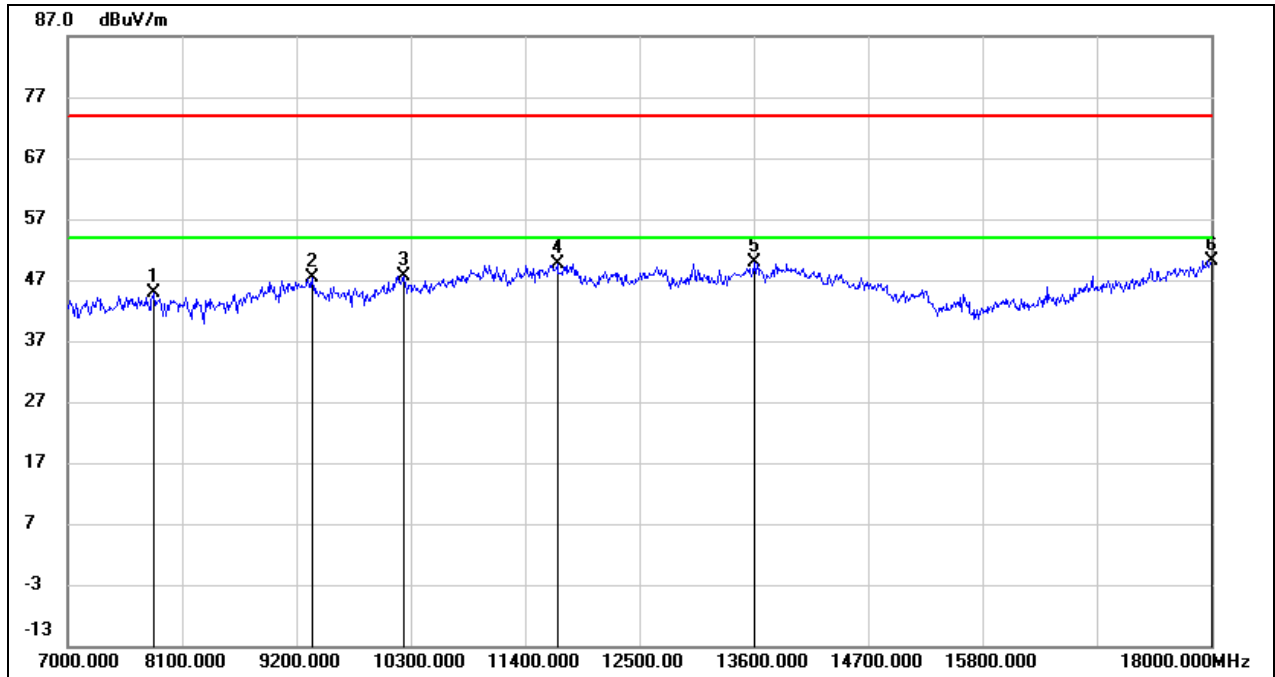

No.	Frequency (MHz)	Reading (dBuV)	Correct (dB/m)	Result (dBuV/m)	Limit (dBuV/m)	Margin (dB)	Remark
1	7825.000	38.31	6.58	44.89	74.00	-29.11	peak
2	9354.000	36.91	10.56	47.47	74.00	-26.53	peak
3	10234.000	35.34	12.26	47.60	74.00	-26.40	peak
4	11708.000	32.45	17.16	49.61	74.00	-24.39	peak
5	13600.000	29.04	20.89	49.93	74.00	-24.07	peak
6	18000.000	24.12	26.12	50.24	74.00	-23.76	peak

Test Mode:	802.11ax HE20	Channel:	5825
Polarity:	Vertical	Test Voltage:	DC 48 V

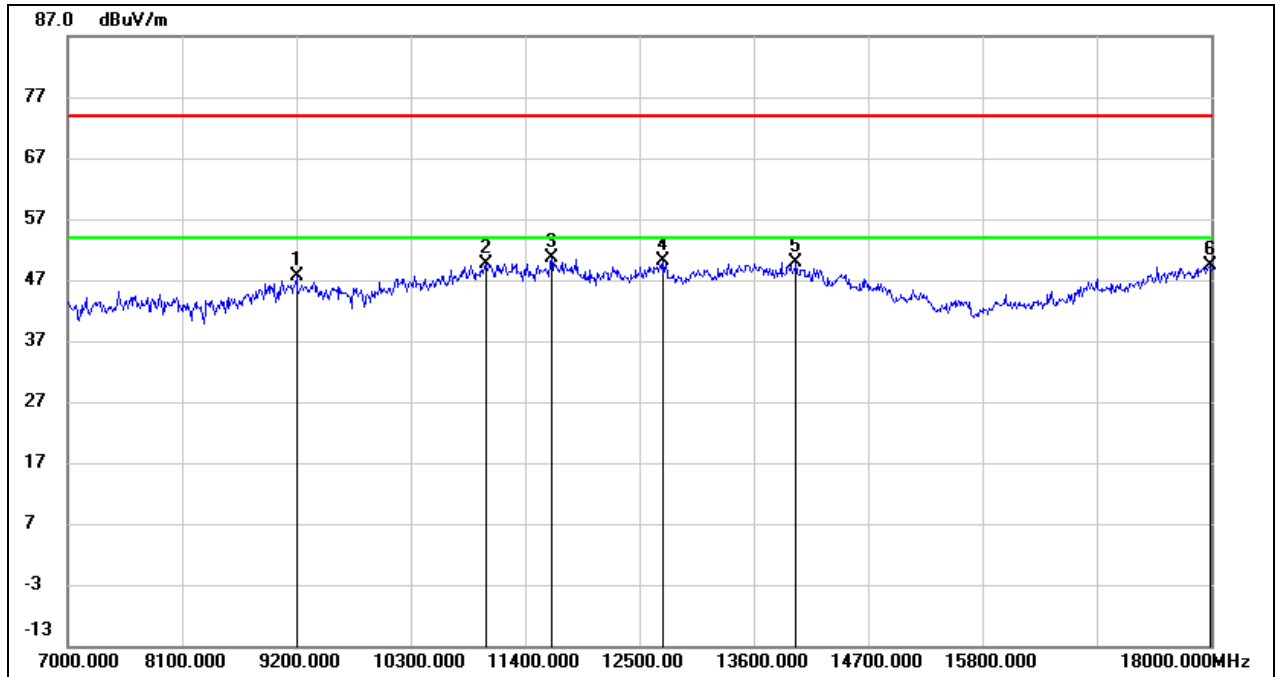

No.	Frequency (MHz)	Reading (dBuV)	Correct (dB/m)	Result (dBuV/m)	Limit (dBuV/m)	Margin (dB)	Remark
1	9200.000	37.06	10.46	47.52	74.00	-26.48	peak
2	11026.000	34.77	14.82	49.59	74.00	-24.41	peak
3	11653.000	33.50	17.05	50.55	74.00	-23.45	peak
4	12731.000	32.07	18.12	50.19	74.00	-23.81	peak
5	14007.000	27.97	21.85	49.82	74.00	-24.18	peak
6	17989.000	23.27	26.04	49.31	74.00	-24.69	peak

Test Mode:	802.11ax HE40	Channel:	5190
Polarity:	Horizontal	Test Voltage:	DC 48 V

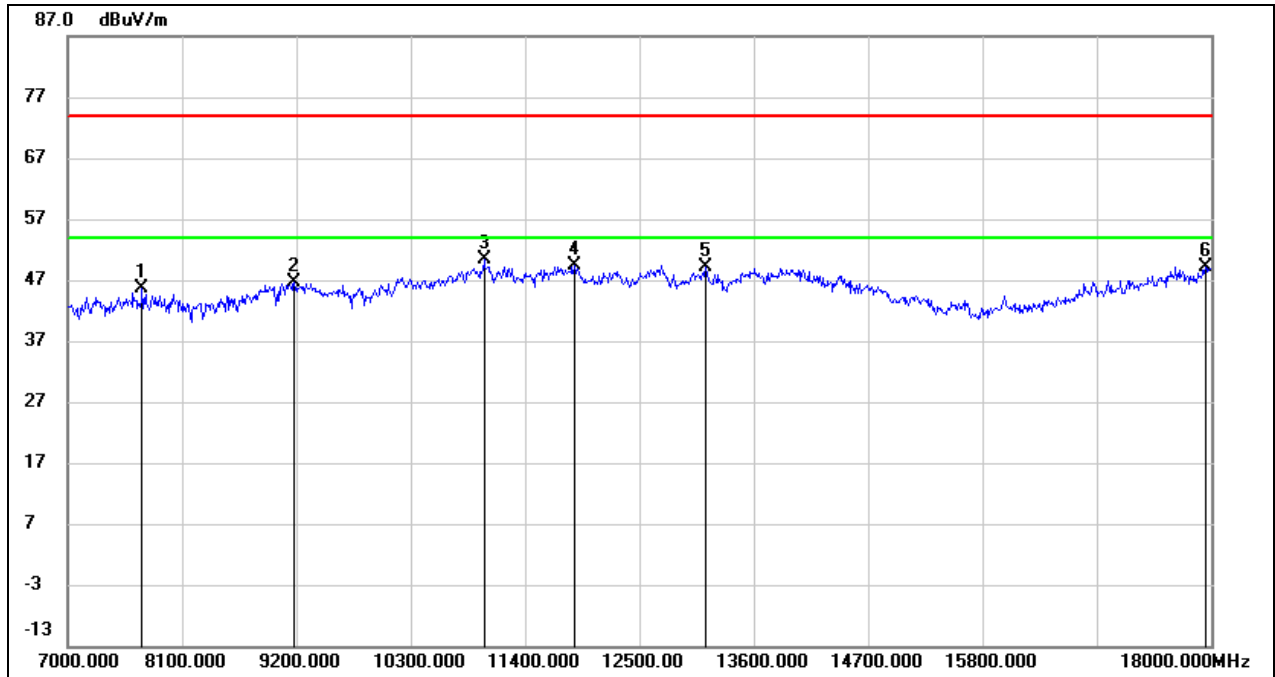

No.	Frequency (MHz)	Reading (dBuV)	Correct (dB/m)	Result (dBuV/m)	Limit (dBuV/m)	Margin (dB)	Remark
1	7715.000	38.88	6.68	45.56	74.00	-28.44	peak
2	9178.000	36.22	10.45	46.67	74.00	-27.33	peak
3	11004.000	35.75	14.74	50.49	74.00	-23.51	peak
4	11873.000	32.00	17.46	49.46	74.00	-24.54	peak
5	13138.000	30.12	19.05	49.17	74.00	-24.83	peak
6	17945.000	23.47	25.75	49.22	74.00	-24.78	peak

Test Mode:	802.11ax HE40	Channel:	5190
Polarity:	Vertical	Test Voltage:	DC 48 V

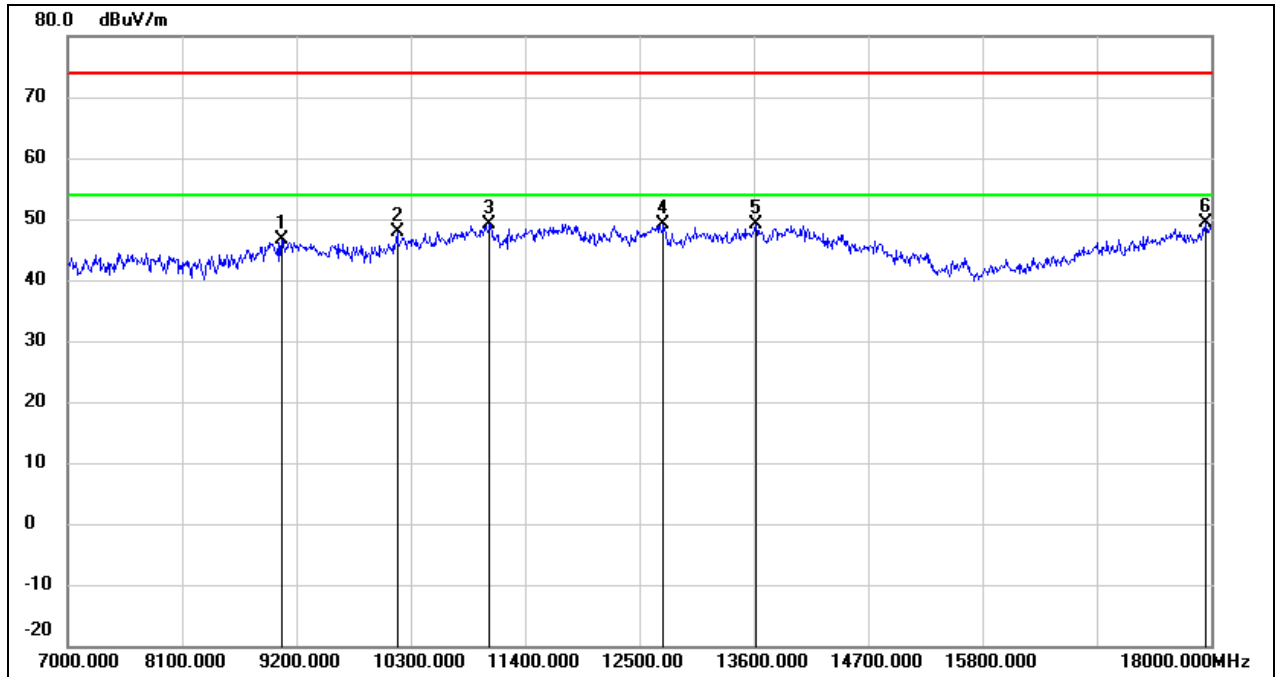

No.	Frequency (MHz)	Reading (dBuV)	Correct (dB/m)	Result (dBuV/m)	Limit (dBuV/m)	Margin (dB)	Remark
1	9057.000	36.26	10.38	46.64	74.00	-27.36	peak
2	10168.000	35.78	12.13	47.91	74.00	-26.09	peak
3	11059.000	34.26	14.96	49.22	74.00	-24.78	peak
4	12731.000	30.99	18.12	49.11	74.00	-24.89	peak
5	13622.000	28.16	20.95	49.11	74.00	-24.89	peak
6	17945.000	23.54	25.75	49.29	74.00	-24.71	peak

Test Mode:	802.11ax HE40	Channel:	5230
Polarity:	Horizontal	Test Voltage:	DC 48 V

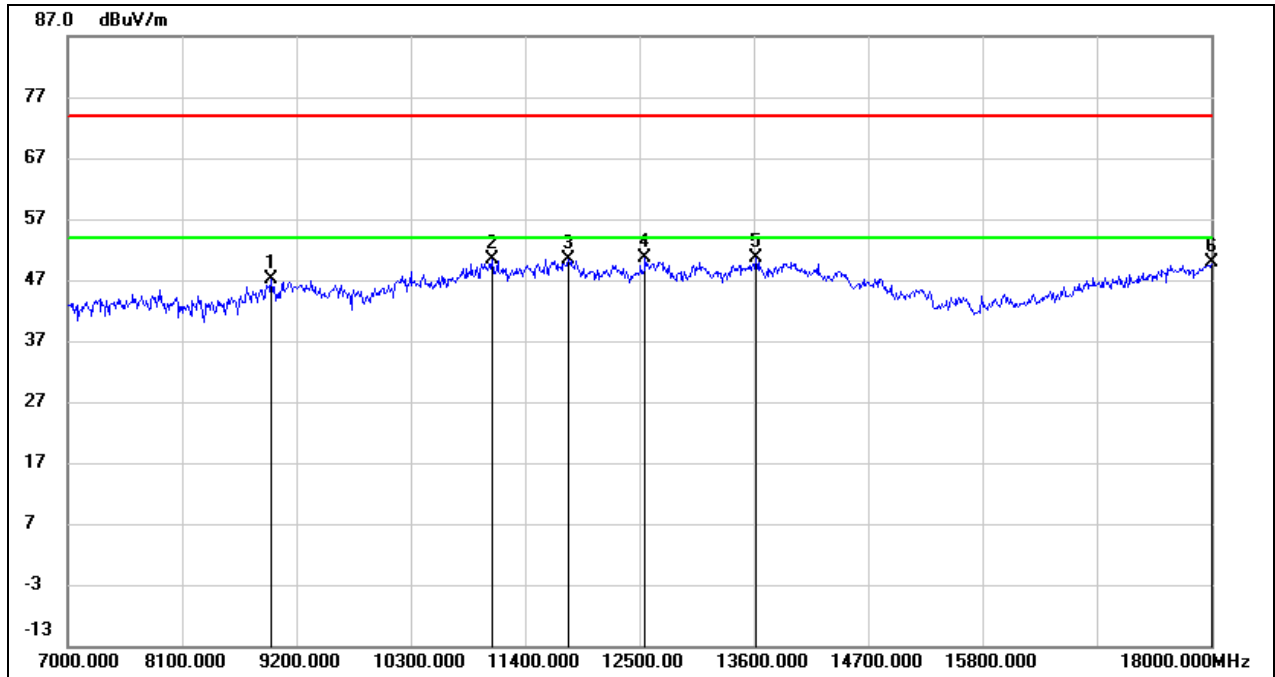

No.	Frequency (MHz)	Reading (dBuV)	Correct (dB/m)	Result (dBuV/m)	Limit (dBuV/m)	Margin (dB)	Remark
1	8958.000	37.05	10.05	47.10	74.00	-26.90	peak
2	11081.000	35.28	15.05	50.33	74.00	-23.67	peak
3	11818.000	33.00	17.36	50.36	74.00	-23.64	peak
4	12555.000	32.76	17.90	50.66	74.00	-23.34	peak
5	13622.000	29.68	20.95	50.63	74.00	-23.37	peak
6	18000.000	23.72	26.12	49.84	74.00	-24.16	peak

Test Mode:	802.11ax HE40	Channel:	5230
Polarity:	Vertical	Test Voltage:	DC 48 V

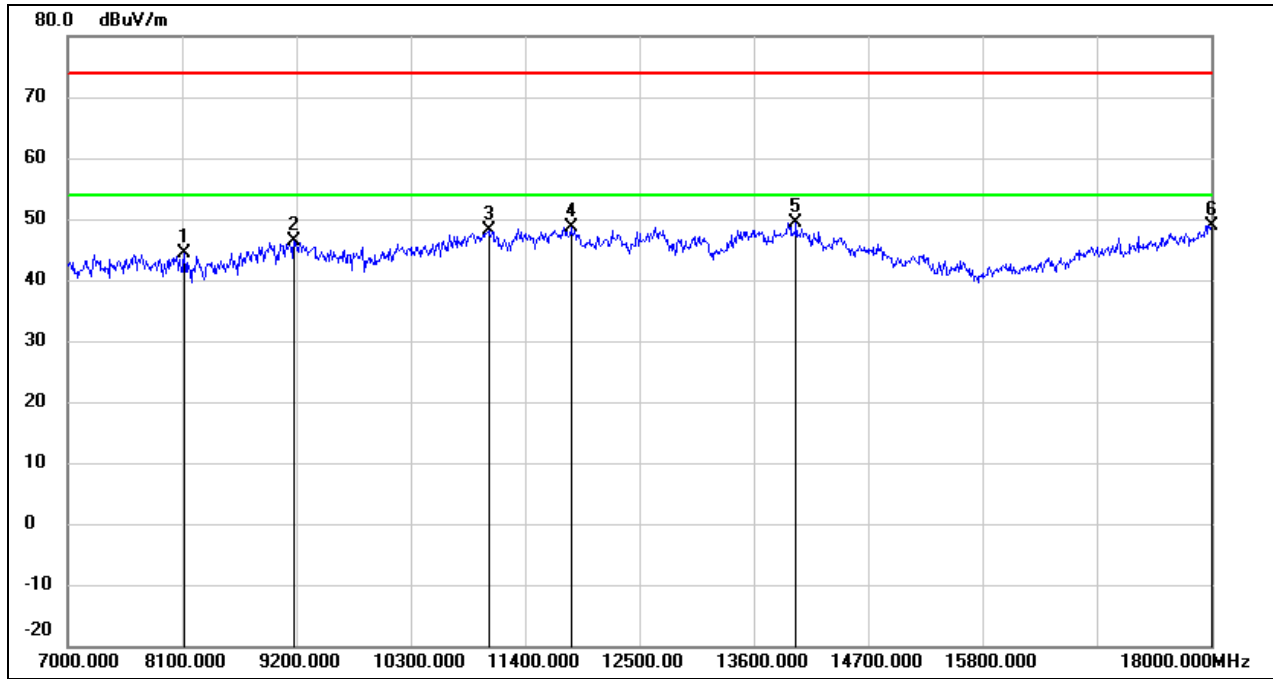

No.	Frequency (MHz)	Reading (dBuV)	Correct (dB/m)	Result (dBuV/m)	Limit (dBuV/m)	Margin (dB)	Remark
1	8122.000	37.88	6.54	44.42	74.00	-29.58	peak
2	9178.000	35.95	10.45	46.40	74.00	-27.60	peak
3	11048.000	33.27	14.91	48.18	74.00	-25.82	peak
4	11840.000	31.17	17.40	48.57	74.00	-25.43	peak
5	14007.000	27.58	21.85	49.43	74.00	-24.57	peak
6	18000.000	22.83	26.12	48.95	74.00	-25.05	peak

Test Mode:	802.11ax HE40	Channel:	5755
Polarity:	Horizontal	Test Voltage:	DC 48 V

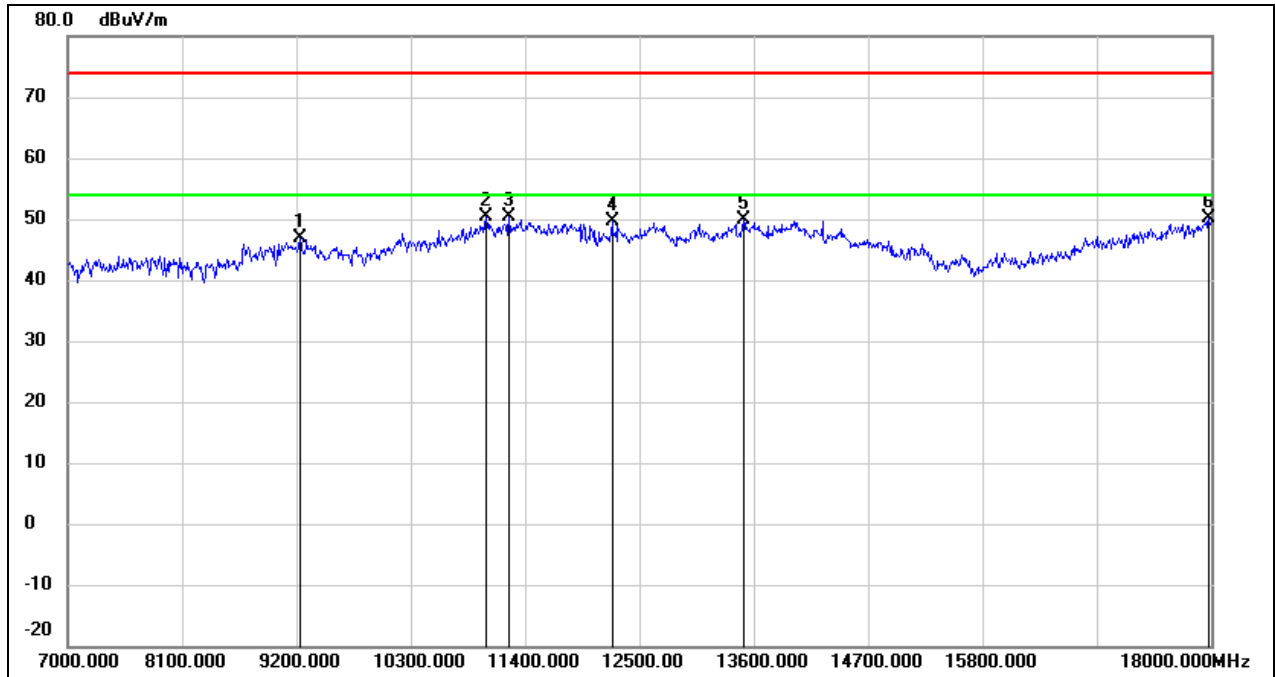

No.	Frequency (MHz)	Reading (dBuV)	Correct (dB/m)	Result (dBuV/m)	Limit (dBuV/m)	Margin (dB)	Remark
1	9233.000	36.29	10.48	46.77	74.00	-27.23	peak
2	11026.000	35.50	14.82	50.32	74.00	-23.68	peak
3	11246.000	34.60	15.73	50.33	74.00	-23.67	peak
4	12236.000	31.76	17.76	49.52	74.00	-24.48	peak
5	13501.000	29.27	20.64	49.91	74.00	-24.09	peak
6	17978.000	24.13	25.97	50.10	74.00	-23.90	peak

Test Mode:	802.11ax HE40	Channel:	5755
Polarity:	Vertical	Test Voltage:	DC 48 V

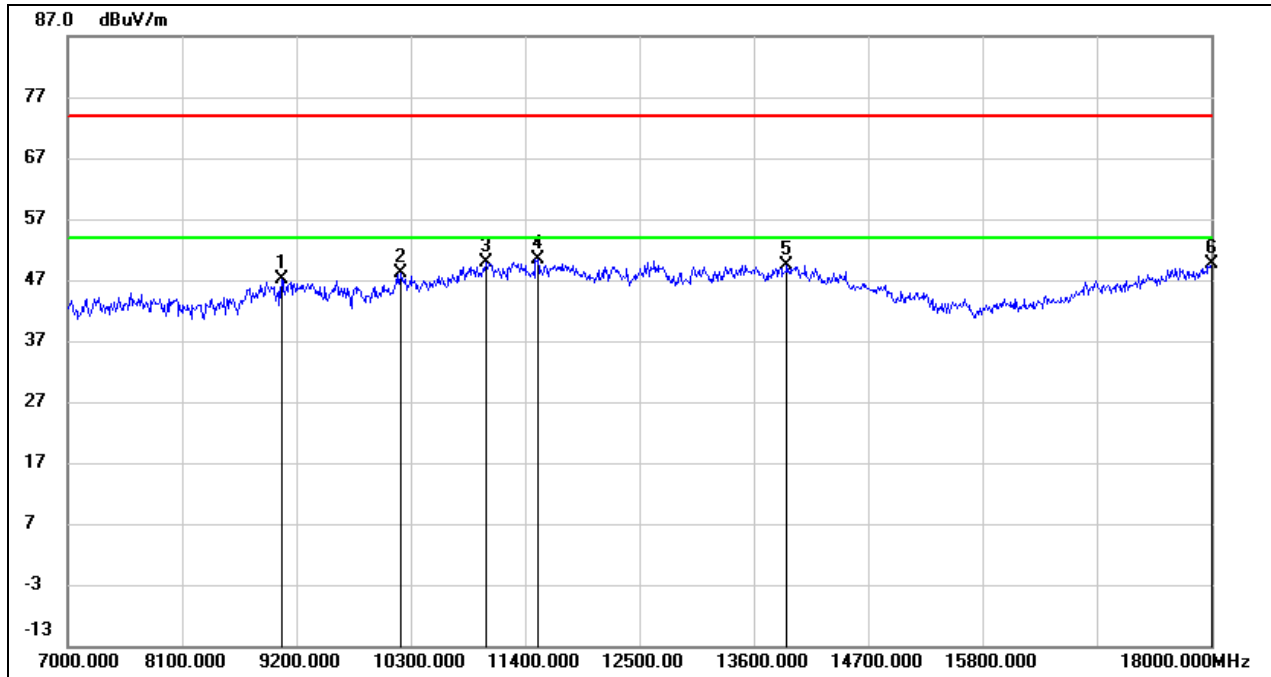

No.	Frequency (MHz)	Reading (dBuV)	Correct (dB/m)	Result (dBuV/m)	Limit (dBuV/m)	Margin (dB)	Remark
1	9057.000	36.87	10.38	47.25	74.00	-26.75	peak
2	10201.000	35.95	12.19	48.14	74.00	-25.86	peak
3	11026.000	35.17	14.82	49.99	74.00	-24.01	peak
4	11521.000	33.63	16.82	50.45	74.00	-23.55	peak
5	13919.000	27.80	21.68	49.48	74.00	-24.52	peak
6	18000.000	23.47	26.12	49.59	74.00	-24.41	peak

Test Mode:	802.11ax HE40	Channel:	5795
Polarity:	Horizontal	Test Voltage:	DC 48 V

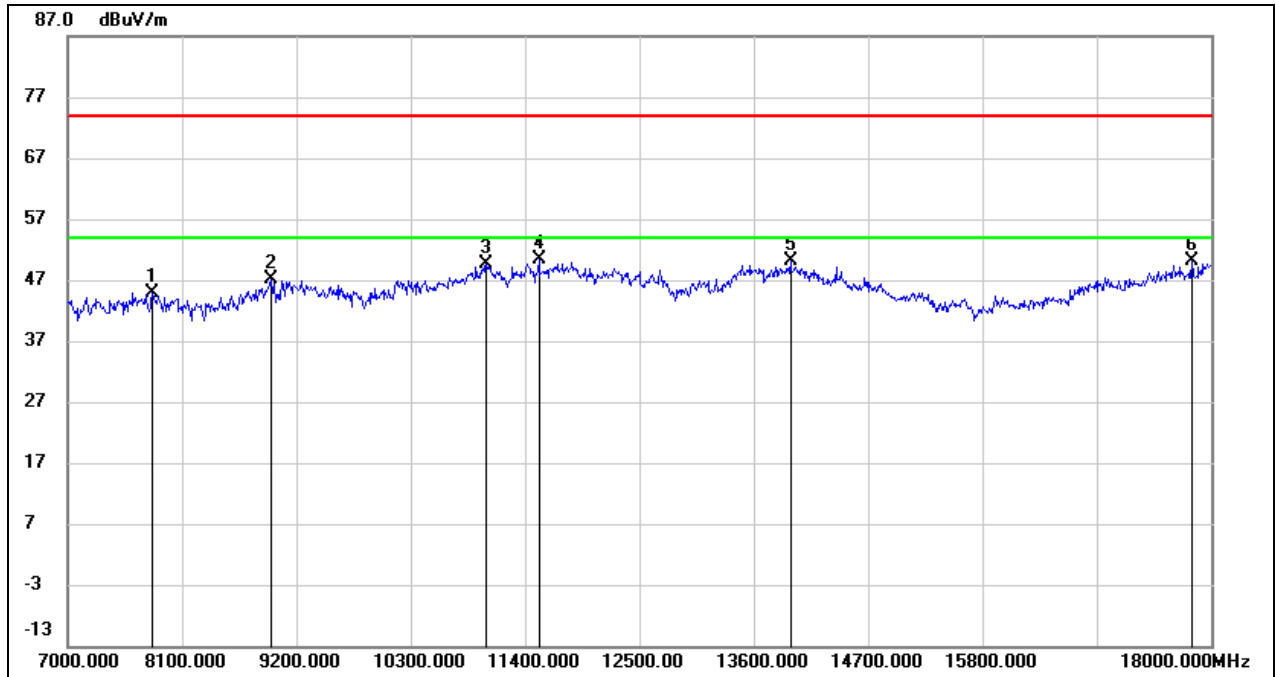

No.	Frequency (MHz)	Reading (dBuV)	Correct (dB/m)	Result (dBuV/m)	Limit (dBuV/m)	Margin (dB)	Remark
1	7814.000	38.30	6.60	44.90	74.00	-29.10	peak
2	8958.000	37.11	10.05	47.16	74.00	-26.84	peak
3	11026.000	34.74	14.82	49.56	74.00	-24.44	peak
4	11532.000	33.47	16.83	50.30	74.00	-23.70	peak
5	13952.000	28.25	21.76	50.01	74.00	-23.99	peak
6	17813.000	25.37	24.84	50.21	74.00	-23.79	peak

Test Mode:	802.11ax HE40	Channel:	5795
Polarity:	Vertical	Test Voltage:	DC 48 V

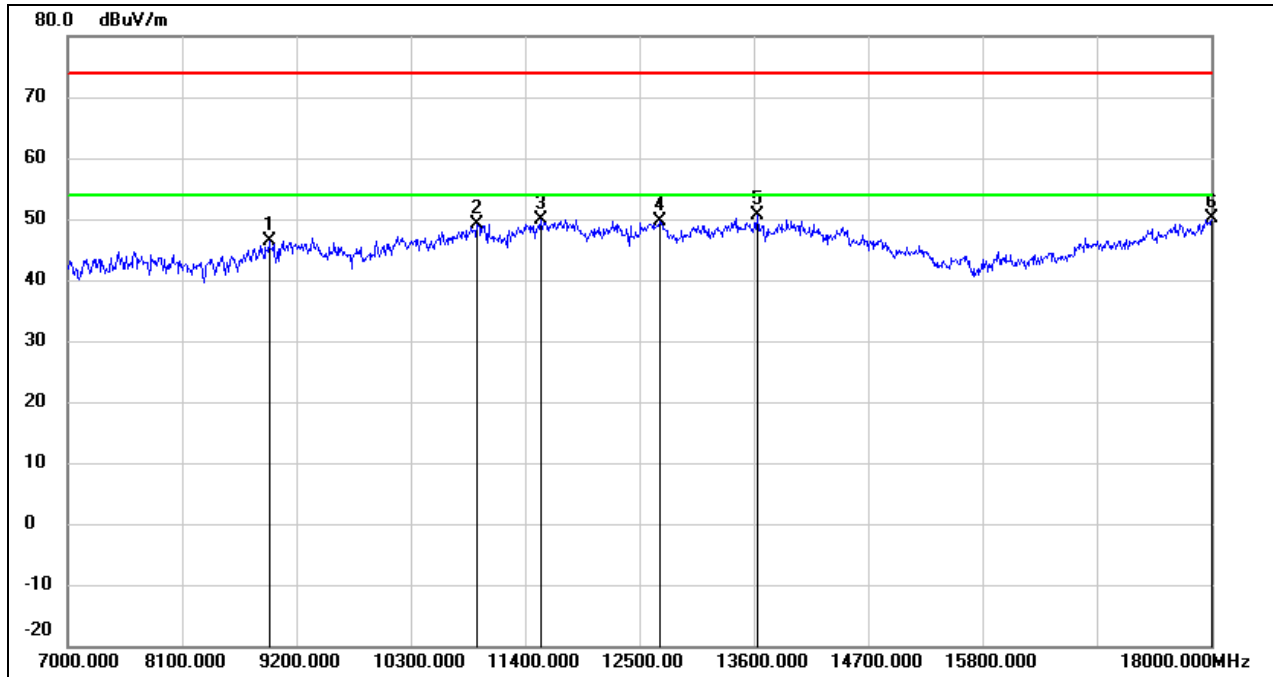

No.	Frequency (MHz)	Reading (dBuV)	Correct (dB/m)	Result (dBuV/m)	Limit (dBuV/m)	Margin (dB)	Remark
1	8936.000	36.42	9.90	46.32	74.00	-27.68	peak
2	10938.000	34.54	14.48	49.02	74.00	-24.98	peak
3	11554.000	33.09	16.87	49.96	74.00	-24.04	peak
4	12698.000	31.51	18.08	49.59	74.00	-24.41	peak
5	13633.000	29.56	20.97	50.53	74.00	-23.47	peak
6	18000.000	23.93	26.12	50.05	74.00	-23.95	peak

Test Mode:	802.11ax HE80	Channel:	5210
Polarity:	Horizontal	Test Voltage:	DC 48 V

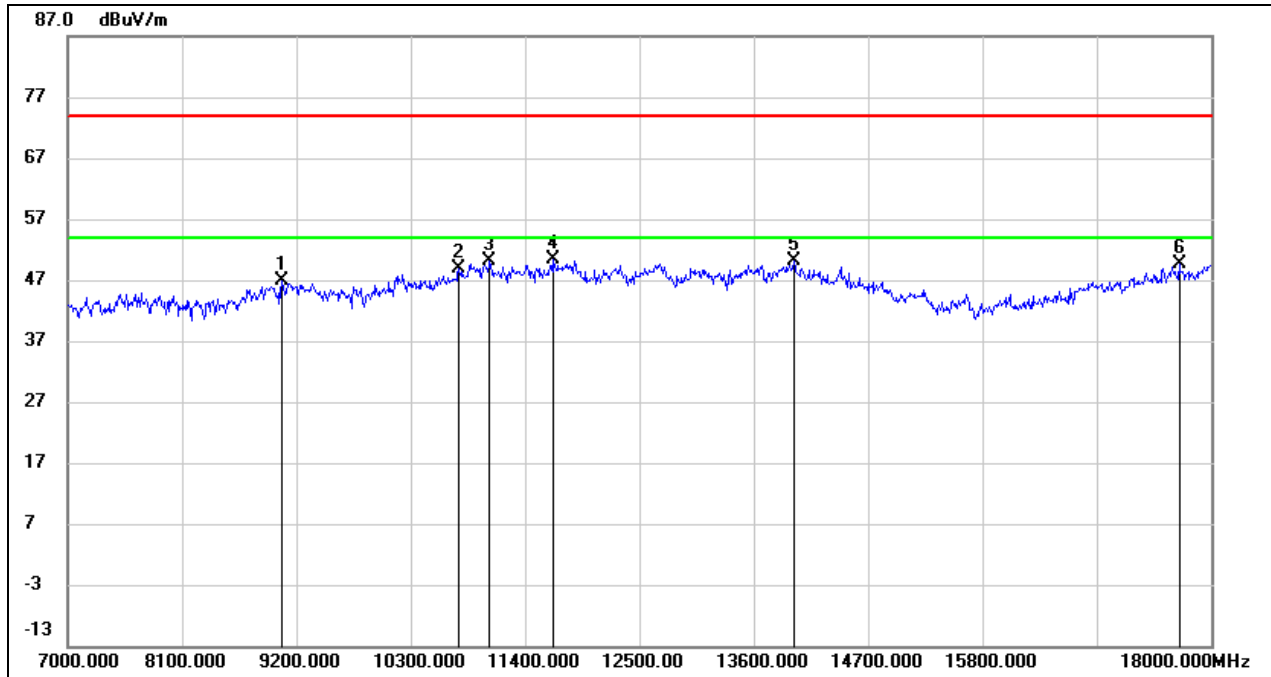

No.	Frequency (MHz)	Reading (dBuV)	Correct (dB/m)	Result (dBuV/m)	Limit (dBuV/m)	Margin (dB)	Remark
1	9057.000	36.48	10.38	46.86	74.00	-27.14	peak
2	10762.000	35.05	13.82	48.87	74.00	-25.13	peak
3	11059.000	35.25	14.96	50.21	74.00	-23.79	peak
4	11664.000	33.30	17.08	50.38	74.00	-23.62	peak
5	13985.000	28.25	21.85	50.10	74.00	-23.90	peak
6	17692.000	25.73	24.01	49.74	74.00	-24.26	peak

Test Mode:	802.11ax HE80	Channel:	5210
Polarity:	Vertical	Test Voltage:	DC 48 V

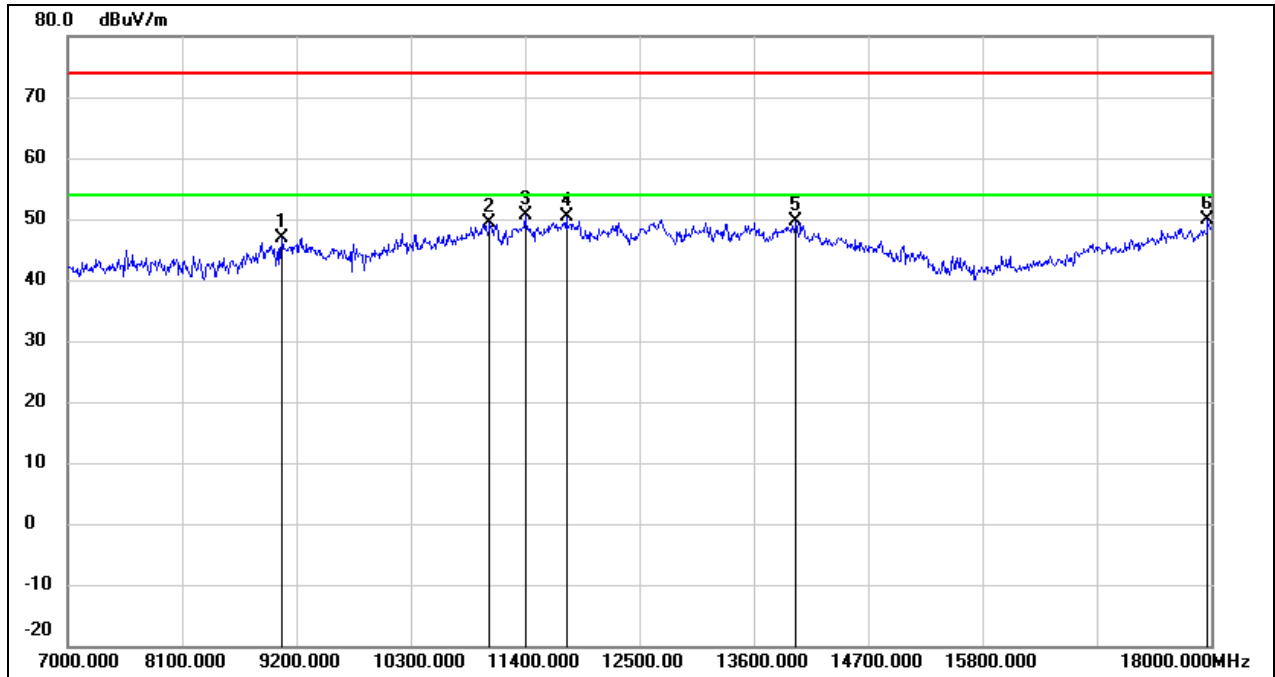

No.	Frequency (MHz)	Reading (dBuV)	Correct (dB/m)	Result (dBuV/m)	Limit (dBuV/m)	Margin (dB)	Remark
1	9057.000	36.41	10.38	46.79	74.00	-27.21	peak
2	11059.000	34.43	14.96	49.39	74.00	-24.61	peak
3	11400.000	34.18	16.36	50.54	74.00	-23.46	peak
4	11796.000	33.01	17.32	50.33	74.00	-23.67	peak
5	14007.000	27.80	21.85	49.65	74.00	-24.35	peak
6	17967.000	23.98	25.89	49.87	74.00	-24.13	peak

Test Mode:	802.11ax HE80	Channel:	5775
Polarity:	Horizontal	Test Voltage:	DC 48 V

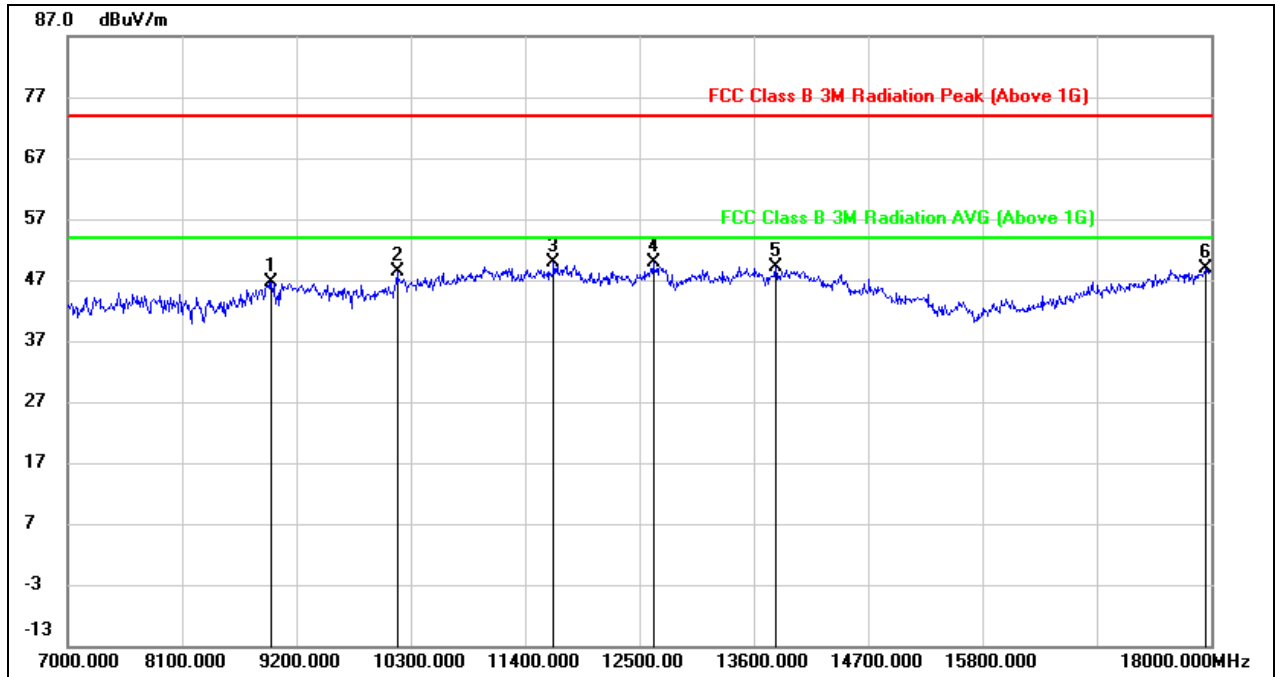

No.	Frequency (MHz)	Reading (dBuV)	Correct (dB/m)	Result (dBuV/m)	Limit (dBuV/m)	Margin (dB)	Remark
1	8958.000	36.65	10.05	46.70	74.00	-27.30	peak
2	10168.000	36.21	12.13	48.34	74.00	-25.66	peak
3	11675.000	32.73	17.10	49.83	74.00	-24.17	peak
4	12632.000	31.90	17.99	49.89	74.00	-24.11	peak
5	13809.000	27.78	21.41	49.19	74.00	-24.81	peak
6	17945.000	23.05	25.75	48.80	74.00	-25.20	peak

The EMC test results obtained during lab rental or witness test are for reference only. They are not official UL EMC test reports. All Official EMC test reports have to be reviewed and signed by our qualified reviewers based on the ISO17025 requirement. Therefore, UL will not accept any liabilities if the customer or manufacturer decides in starting production without waiting for the official UL EMC test reports.

所有 EMC 租场测试或目击测试数据仅供参考,不作为 UL 正式的 EMC 测试报告. 根据 ISO17025 导则的要求, 所有正式的 EMC 测试报告必须经合格的审核员审核并签署. 因此, 如果客户或厂家在没有基于收到 UL 正式的 EMC 测试报告, 而开展生产造成的后果, UL 不会承担任何责任.

Test Mode:	802.11ax HE80	Channel:	5775
Polarity:	Vertical	Test Voltage:	DC 48 V

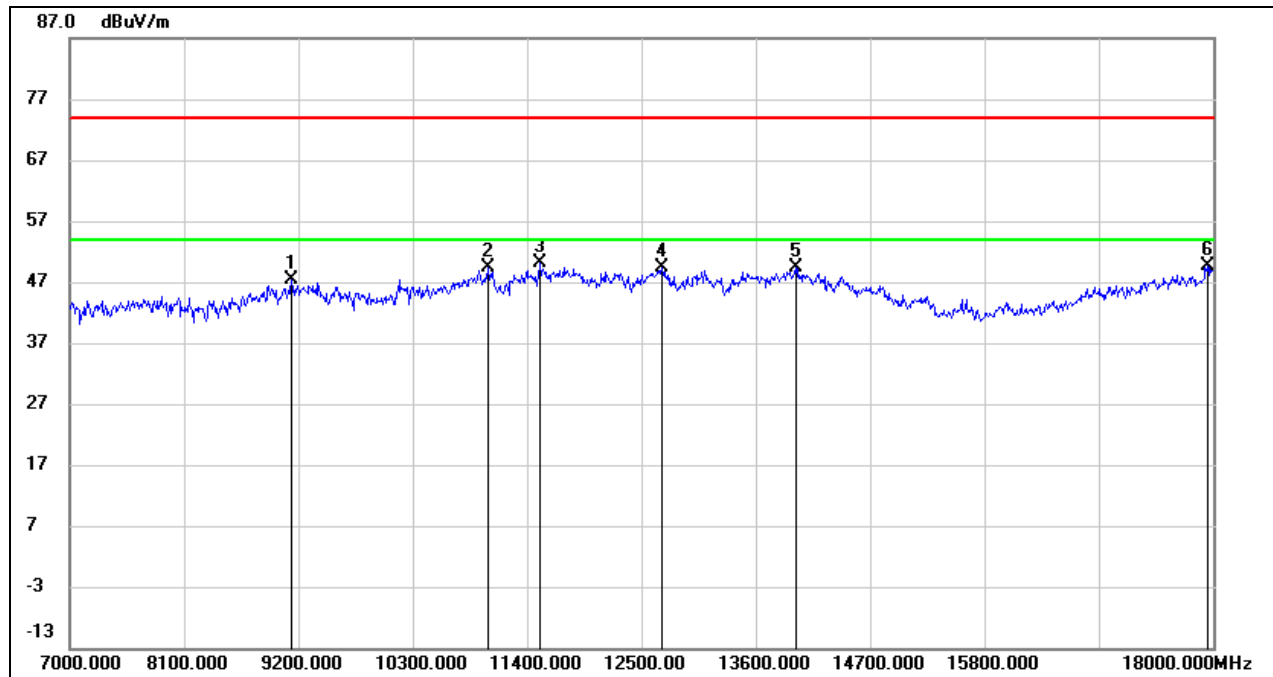

No.	Frequency (MHz)	Reading (dBuV)	Correct (dB/m)	Result (dBuV/m)	Limit (dBuV/m)	Margin (dB)	Remark
1	9134.000	36.94	10.41	47.35	74.00	-26.65	peak
2	11026.000	34.52	14.82	49.34	74.00	-24.66	peak
3	11521.000	33.29	16.82	50.11	74.00	-23.89	peak
4	12698.000	31.41	18.08	49.49	74.00	-24.51	peak
5	13985.000	27.42	21.85	49.27	74.00	-24.73	peak
6	17945.000	23.96	25.75	49.71	74.00	-24.29	peak

8.4. SPURIOUS EMISSIONS(9 KHZ~30 MHZ)

Test Mode:	802.11a20	Channel:	5180
Polarity:	FACE ON	Test Voltage:	DC 48 V

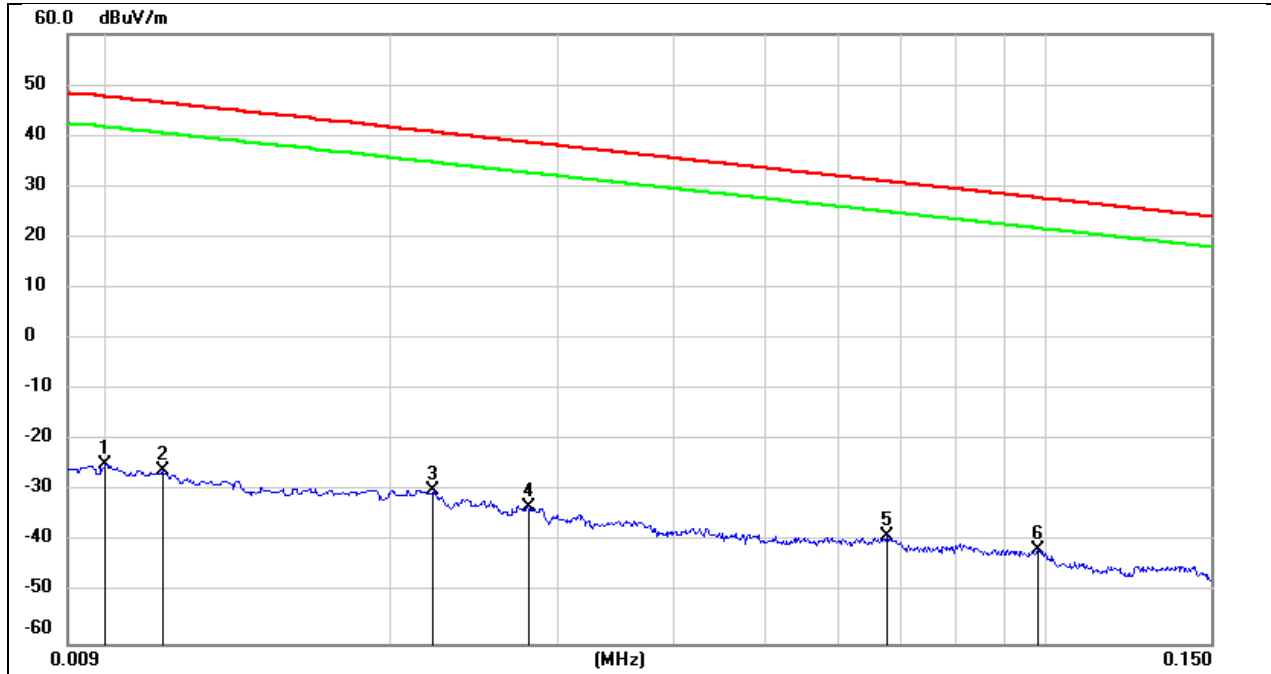

No.	Frequency (MHz)	Reading (dBuV)	Correct (dB/m)	Result (dBuV/m)	Limit (dBuV/m)	Margin (dB)	Remark
1	0.0100	76.72	-101.40	-24.68	47.60	-72.28	peak
2	0.0114	75.38	-101.40	-26.02	46.46	-72.48	peak
3	0.0221	71.63	-101.35	-29.72	40.71	-70.43	peak
4	0.0280	68.29	-101.38	-33.09	38.66	-71.75	peak
5	0.0675	62.64	-101.56	-38.92	31.02	-69.94	peak
6	0.0981	60.27	-101.78	-41.51	27.77	-69.28	peak

Test Mode:	802.11a20	Channel:	5180
Polarity:	FACE ON	Test Voltage:	DC 48 V

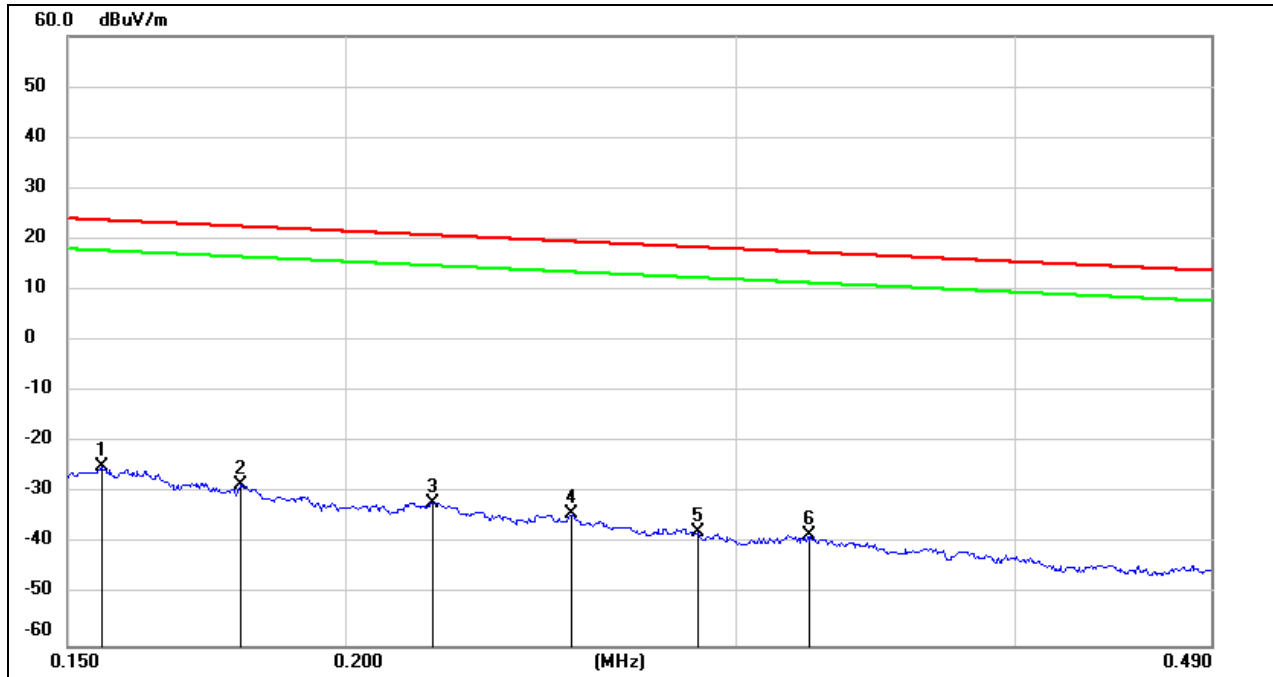

No.	Frequency (MHz)	Reading (dBuV)	Correct (dB/m)	Result (dBuV/m)	Limit (dBuV/m)	Margin (dB)	Remark
1	0.1554	76.77	-101.65	-24.88	23.77	-48.65	peak
2	0.1794	73.27	-101.68	-28.41	22.53	-50.94	peak
3	0.2190	69.77	-101.75	-31.98	20.79	-52.77	peak
4	0.2530	67.64	-101.80	-34.16	19.54	-53.70	peak
5	0.2878	64.22	-101.85	-37.63	18.42	-56.05	peak
6	0.3234	63.48	-101.88	-38.40	17.41	-55.81	peak

Test Mode:	802.11a20	Channel:	5180
Polarity:	FACE ON	Test Voltage:	DC 48 V

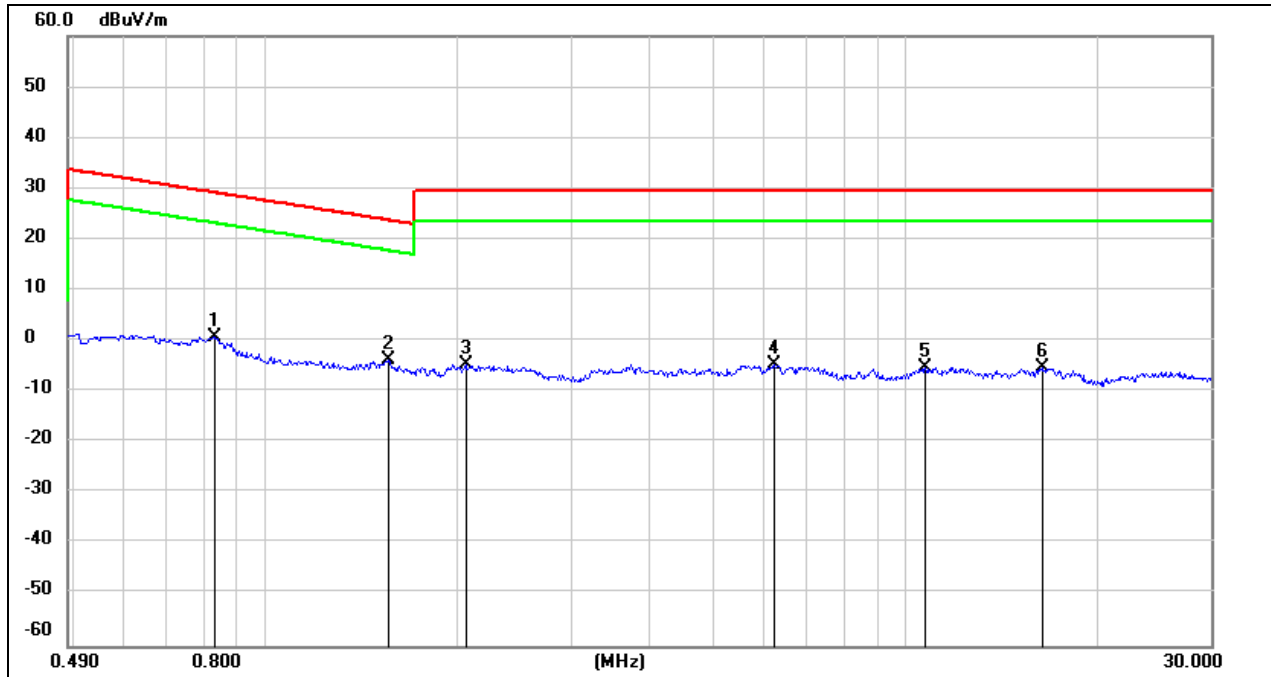

No.	Frequency (MHz)	Reading (dBuV)	Correct (dB/m)	Result (dBuV/m)	Limit (dBuV/m)	Margin (dB)	Remark
1	0.8296	62.94	-62.17	0.77	29.23	-28.46	peak
2	1.5564	58.18	-62.02	-3.84	23.76	-27.60	peak
3	2.0539	57.20	-61.81	-4.61	29.54	-34.15	peak
4	6.2445	56.63	-61.32	-4.69	29.54	-34.23	peak
5	10.7299	55.48	-60.83	-5.35	29.54	-34.89	peak
6	16.3959	55.67	-60.96	-5.29	29.54	-34.83	peak

8.5. SPURIOUS EMISSIONS(18 GHZ~26 GHZ)

Test Mode:	802.11a 20	Channel:	5180
Polarity:	Horizontal	Test Voltage:	DC 48 V

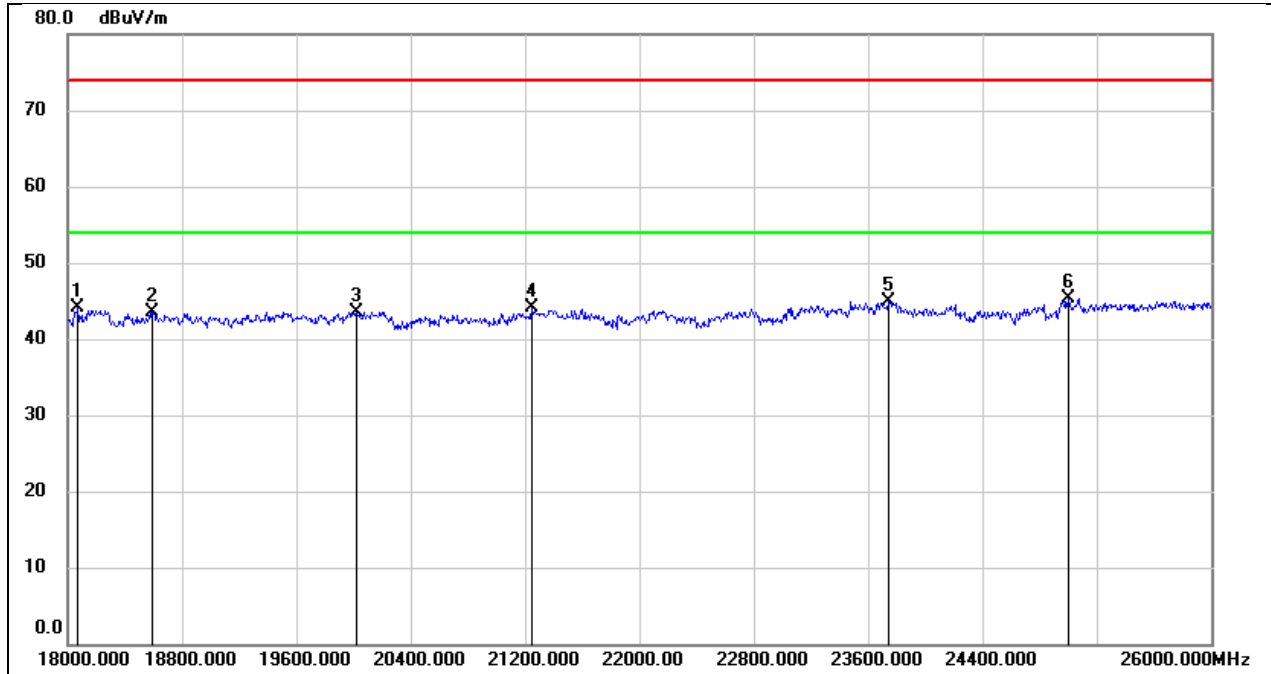

No.	Frequency (MHz)	Reading (dBuV)	Correct (dB/m)	Result (dBuV/m)	Limit (dBuV/m)	Margin (dB)	Remark
1	18072.000	49.45	-5.43	44.02	74.00	-29.98	peak
2	18592.000	48.75	-5.31	43.44	74.00	-30.56	peak
3	20016.000	49.06	-5.47	43.59	74.00	-30.41	peak
4	21248.000	48.79	-4.77	44.02	74.00	-29.98	peak
5	23744.000	48.15	-3.20	44.95	74.00	-29.05	peak
6	25000.000	47.36	-2.10	45.26	74.00	-28.74	peak

Test Mode:	802.11a 20	Channel:	5180
Polarity:	Vertical	Test Voltage:	DC 48 V

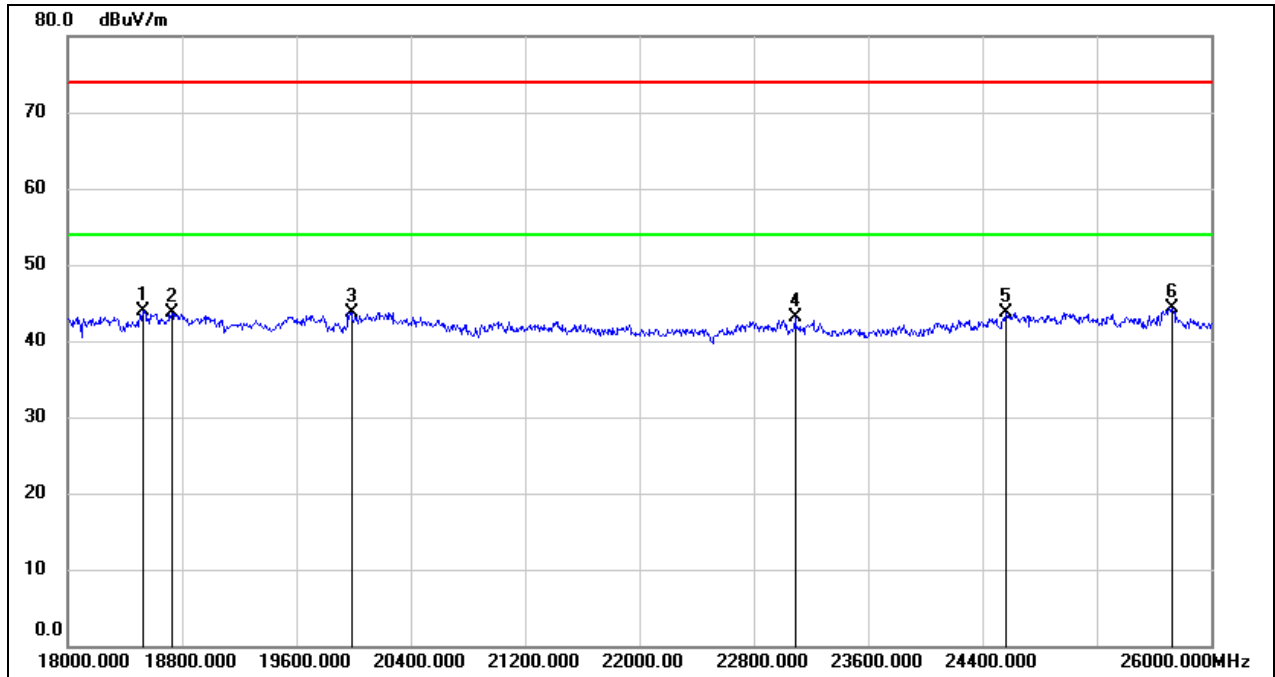

No.	Frequency (MHz)	Reading (dBuV)	Correct (dB/m)	Result (dBuV/m)	Limit (dBuV/m)	Margin (dB)	Remark
1	18528.000	49.11	-5.26	43.85	74.00	-30.15	peak
2	18728.000	49.15	-5.40	43.75	74.00	-30.25	peak
3	19984.000	49.21	-5.44	43.77	74.00	-30.23	peak
4	23088.000	46.52	-3.41	43.11	74.00	-30.89	peak
5	24568.000	46.10	-2.33	43.77	74.00	-30.23	peak
6	25728.000	45.11	-0.72	44.39	74.00	-29.61	peak

8.6. SPURIOUS EMISSIONS(26 GHZ~40 GHZ)

Test Mode:	802.11a 20	Channel:	5180
Polarity:	Horizontal	Test Voltage:	DC 48 V

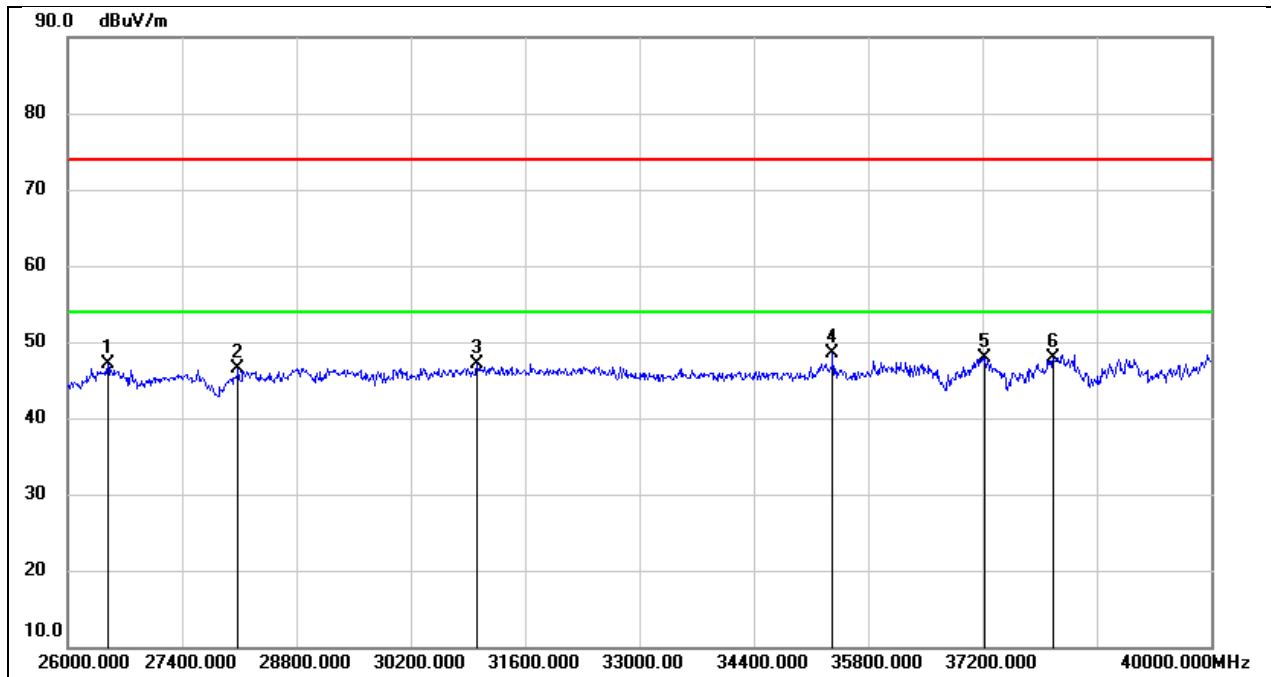

No.	Frequency (MHz)	Reading (dBuV)	Correct (dB/m)	Result (dBuV/m)	Limit (dBuV/m)	Margin (dB)	Remark
1	26490.000	51.79	-4.74	47.05	74.00	-26.95	peak
2	28086.000	49.91	-3.49	46.42	74.00	-27.58	peak
3	31012.000	47.83	-0.71	47.12	74.00	-26.88	peak
4	35366.000	45.90	2.59	48.49	74.00	-25.51	peak
5	37228.000	44.73	3.14	47.87	74.00	-26.13	peak
6	38068.000	44.56	3.42	47.98	74.00	-26.02	peak

Test Mode:	802.11a 20	Channel:	5180
Polarity:	Vertical	Test Voltage:	DC 48 V

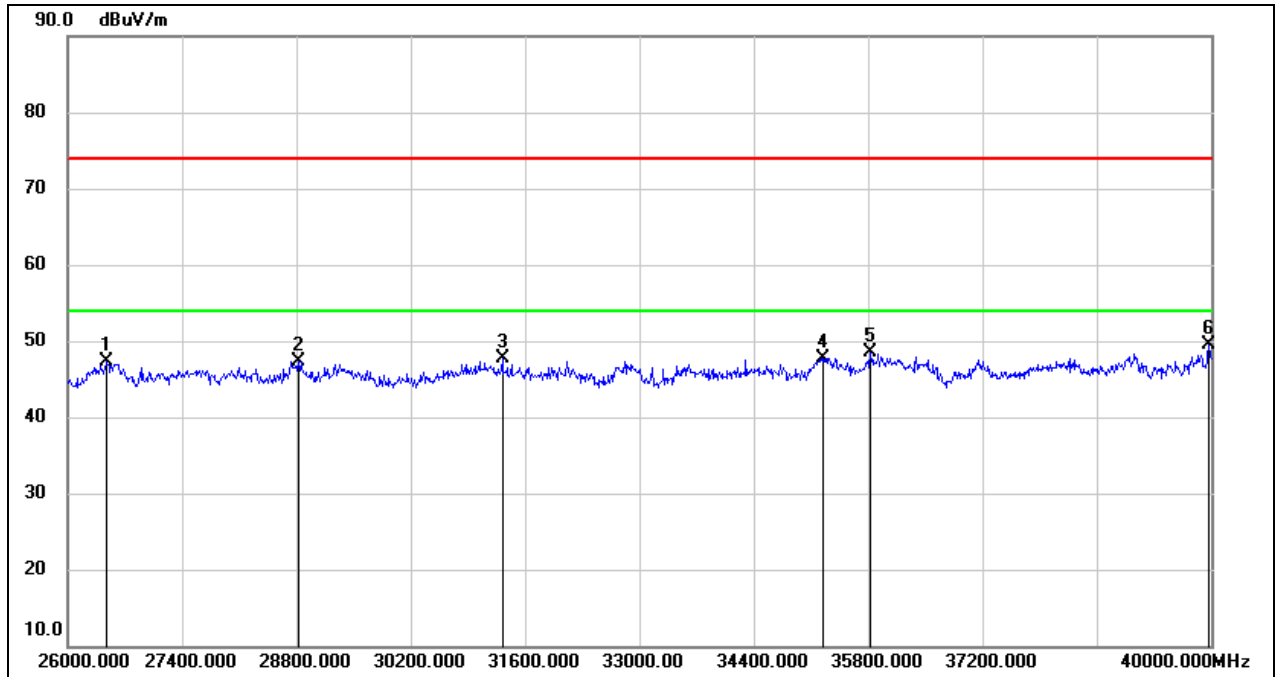

No.	Frequency (MHz)	Reading (dBuV)	Correct (dB/m)	Result (dBuV/m)	Limit (dBuV/m)	Margin (dB)	Remark
1	26476.000	52.03	-4.78	47.25	74.00	-26.75	peak
2	28828.000	48.13	-0.79	47.34	74.00	-26.66	peak
3	31320.000	48.61	-0.93	47.68	74.00	-26.32	peak
4	35254.000	45.12	2.65	47.77	74.00	-26.23	peak
5	35828.000	44.75	3.67	48.42	74.00	-25.58	peak
6	39972.000	44.45	5.13	49.58	74.00	-24.42	peak

8.7. SPURIOUS EMISSIONS(30 MHZ~1 GHZ)

Test Mode:	802.11a 20	Channel:	5180
Polarity:	Horizontal	Test Voltage:	DC 48 V

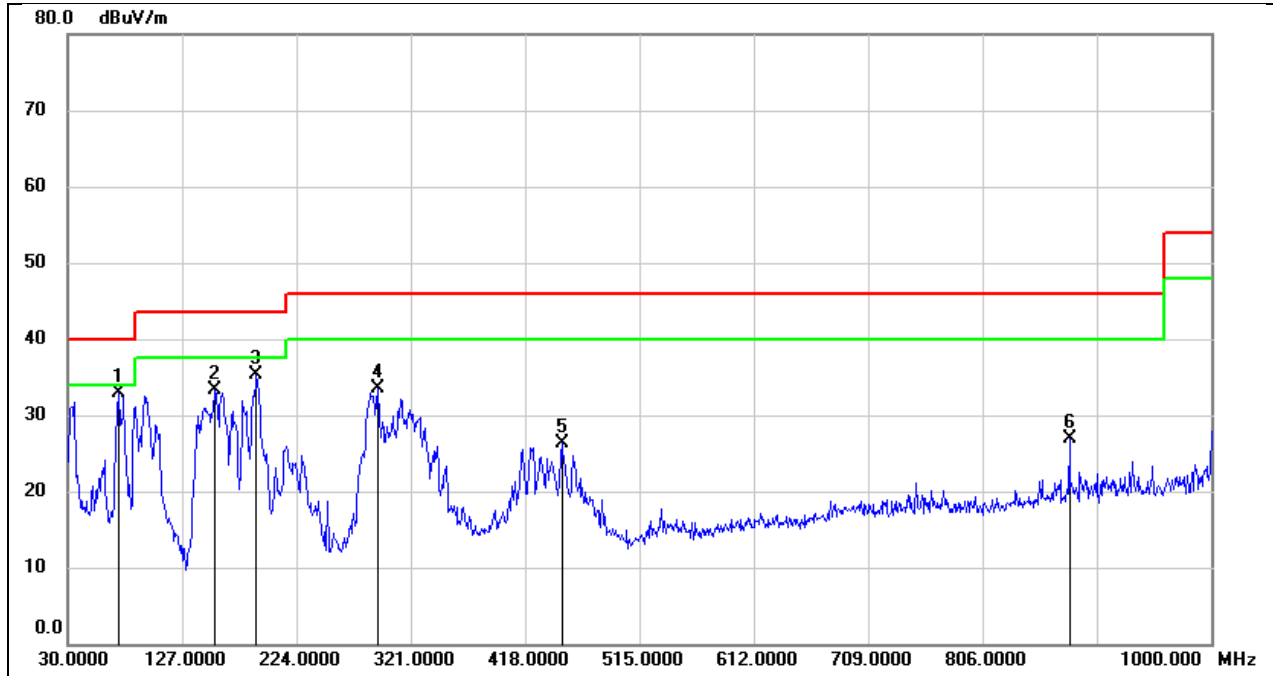

No.	Frequency (MHz)	Reading (dBuV)	Correct (dB/m)	Result (dBuV/m)	Limit (dBuV/m)	Margin (dB)	Remark
1	73.6500	53.90	-21.04	32.86	40.00	-7.14	QP
2	155.1300	51.33	-17.96	33.37	43.50	-10.13	QP
3	190.0500	52.04	-16.70	35.34	43.50	-8.16	QP
4	292.8700	49.22	-15.70	33.52	46.00	-12.48	QP
5	449.0400	38.20	-11.85	26.35	46.00	-19.65	QP
6	879.7200	32.16	-5.30	26.86	46.00	-19.14	QP

Test Mode:	802.11a 20	Channel:	5180
Polarity:	Vertical	Test Voltage:	DC 48 V

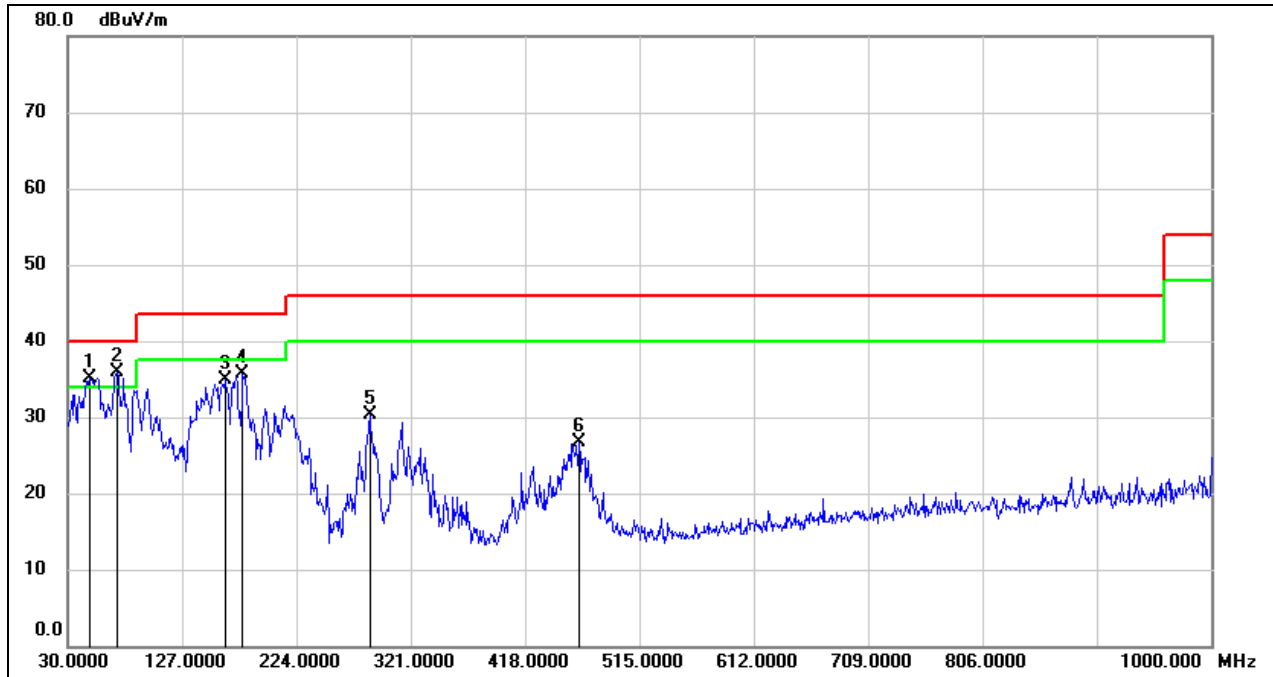

No.	Frequency (MHz)	Reading (dBuV)	Correct (dB/m)	Result (dBuV/m)	Limit (dBuV/m)	Margin (dB)	Remark
1	48.4300	55.60	-20.44	35.16	40.00	-4.84	QP
2	71.7100	56.85	-20.90	35.95	40.00	-4.05	QP
3	163.8600	52.20	-17.31	34.89	43.50	-8.61	QP
4	178.4100	52.22	-16.51	35.71	43.50	-7.79	QP
5	286.0799	46.48	-16.16	30.32	46.00	-15.68	QP
6	463.5900	38.15	-11.38	26.77	46.00	-19.23	QP

8.8. SIMULTANEOUSLY TRANSMISSION SPURIOUS EMISSIONS

(1 GHz~18 GHz) (Worst case)

Test Mode:	WIFI 2.4G 802.11b Mode 2417 MHz & WIFI 5G 802.11ax80 Mode 5775 MHz		
Polarity:	Horizontal	Test Voltage:	DC 48 V

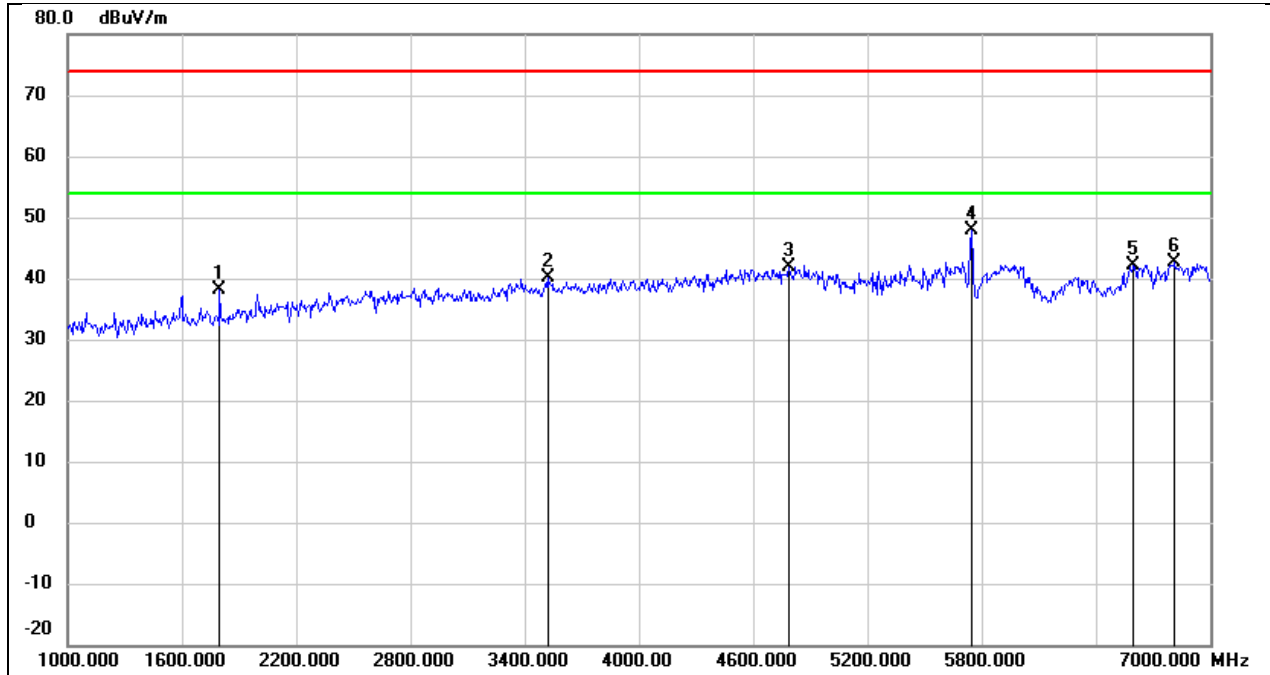

No.	Frequency (MHz)	Reading (dBuV)	Correct (dB/m)	Result (dBuV/m)	Limit (dBuV/m)	Margin (dB)	Remark
1	1798.000	49.84	-11.72	38.12	74.00	-35.88	peak
2	3520.000	45.83	-5.80	40.03	74.00	-33.97	peak
3	4786.000	42.83	-1.00	41.83	74.00	-32.17	peak
4	5746.000	46.78	1.12	47.90	74.00	-26.10	peak
5	6598.000	37.93	4.21	42.14	74.00	-31.86	peak
6	6814.000	37.32	5.28	42.60	74.00	-31.40	peak

Test Mode:	WIFI 2.4G 802.11b Mode 2417 MHz & WIFI 5G 802.11ax80 Mode 5775 MHz		
Polarity:	Vertical	Test Voltage:	DC 48 V

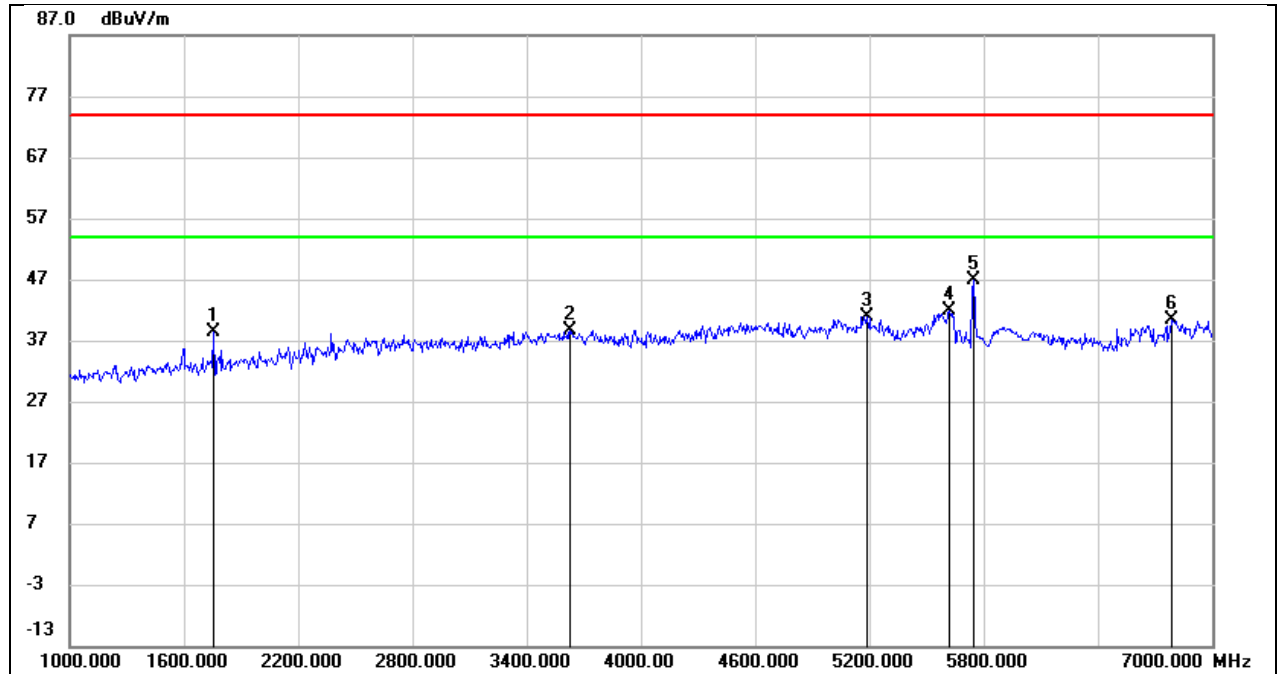

No.	Frequency (MHz)	Reading (dBuV)	Correct (dB/m)	Result (dBuV/m)	Limit (dBuV/m)	Margin (dB)	Remark
1	1756.000	50.31	-11.87	38.44	74.00	-35.56	peak
2	3628.000	44.24	-5.50	38.74	74.00	-35.26	peak
3	5188.000	40.91	0.07	40.98	74.00	-33.02	peak
4	5620.000	41.10	0.76	41.86	74.00	-32.14	peak
5	5746.000	45.83	1.12	46.95	74.00	-27.05	peak
6	6790.000	35.27	5.15	40.42	74.00	-33.58	peak

Test Mode:	WIFI 2.4G 802.11b Mode 2417 MHz & WIFI 5G 802.11ax80 Mode 5775 MHz		
Polarity:	Horizontal	Test Voltage:	DC 48 V

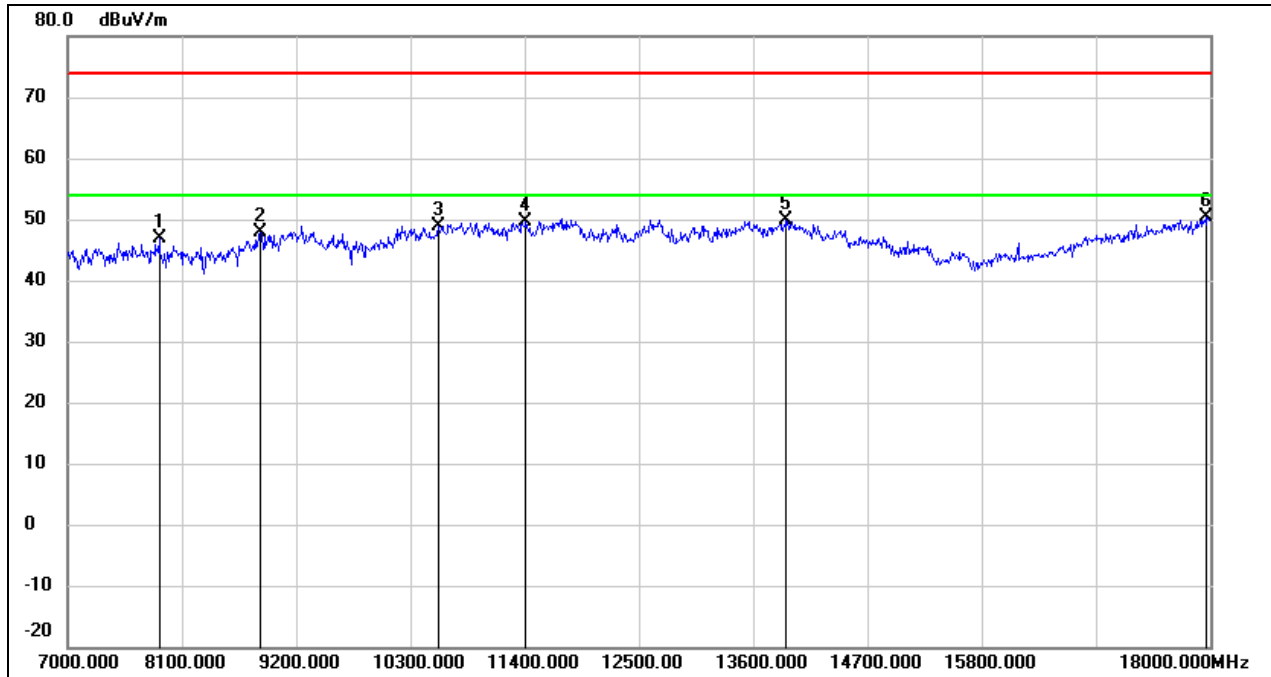

No.	Frequency (MHz)	Reading (dBuV)	Correct (dB/m)	Result (dBuV/m)	Limit (dBuV/m)	Margin (dB)	Remark
1	7880.000	40.23	6.54	46.77	74.00	-27.23	peak
2	8848.000	38.59	9.29	47.88	74.00	-26.12	peak
3	10564.000	35.85	13.06	48.91	74.00	-25.09	peak
4	11411.000	33.15	16.41	49.56	74.00	-24.44	peak
5	13919.000	28.14	21.68	49.82	74.00	-24.18	peak
6	17967.000	24.56	25.89	50.45	74.00	-23.55	peak

Test Mode:	WIFI 2.4G 802.11b Mode 2417 MHz & WIFI 5G 802.11ax80 Mode 5775 MHz		
Polarity:	Vertical	Test Voltage:	DC 48 V

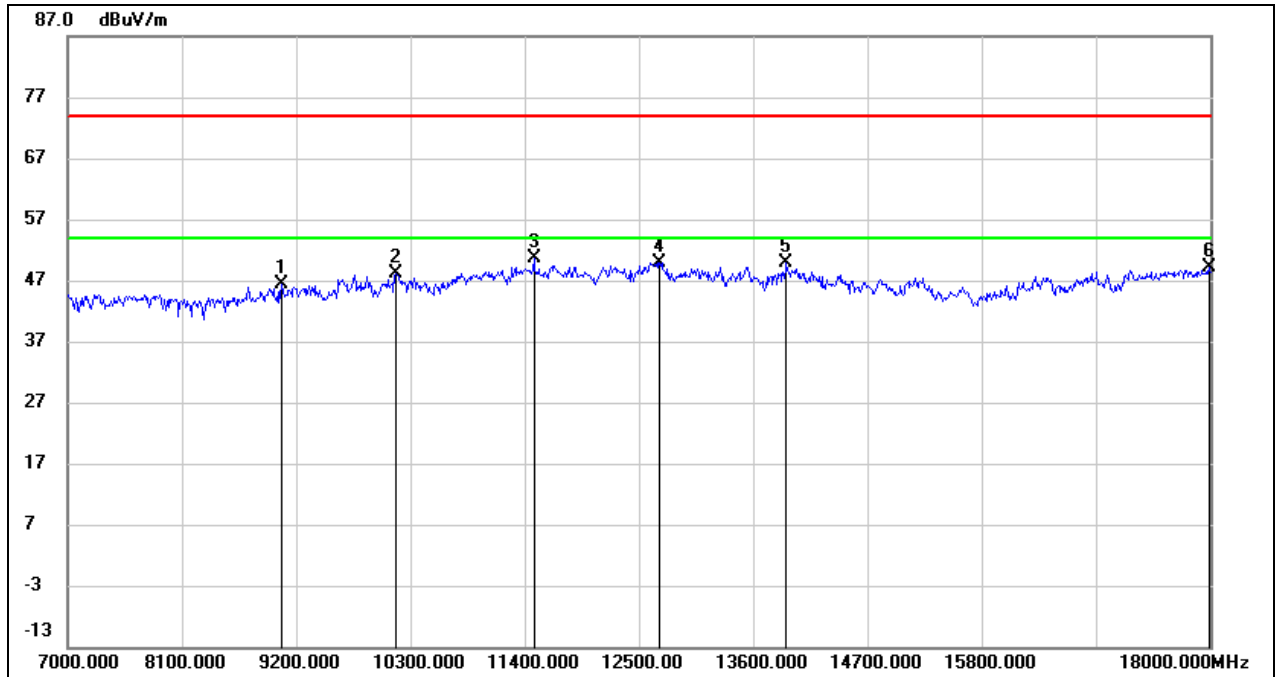

No.	Frequency (MHz)	Reading (dBuV)	Correct (dB/m)	Result (dBuV/m)	Limit (dBuV/m)	Margin (dB)	Remark
1	9057.000	36.02	10.38	46.40	74.00	-27.60	peak
2	10157.000	36.07	12.10	48.17	74.00	-25.83	peak
3	11488.000	33.87	16.72	50.59	74.00	-23.41	peak
4	12698.000	31.90	18.08	49.98	74.00	-24.02	peak
5	13919.000	28.16	21.68	49.84	74.00	-24.16	peak
6	17989.000	23.08	26.04	49.12	74.00	-24.88	peak

9. AC POWER LINE CONDUCTED EMISSION

LIMITS

Please refer to CFR 47 FCC §15.207 (a).

FREQUENCY (MHz)	Quasi-peak	Average
0.15 -0.5	66 - 56 *	56 - 46 *
0.50 -5.0	56.00	46.00
5.0 -30.0	60.00	50.00

TEST PROCEDURE

Refer to ANSI C63.10-2013 clause 6.2.

The EUT is put on a table of non-conducting material that is 80 cm high. The vertical conducting wall of shielding is located 40 cm to the rear of the EUT. The power line of the EUT is connected to the AC mains through a Artificial Mains Network (A.M.N.). A EMI Measurement Receiver (R&S Test Receiver ESR3) is used to test the emissions from both sides of AC line. According to the requirements in Section 6.2 of ANSI C63.10-2013. Conducted emissions from the EUT measured in the frequency range between 0.15 MHz and 30 MHz using CISPR Quasi-Peak and average detector mode. The bandwidth of EMI test receiver is set at 9 kHz.

The arrangement of the equipment is installed to meet the standards and operating in a manner, which tends to maximize its emission characteristics in a normal application.

TEST SETUP

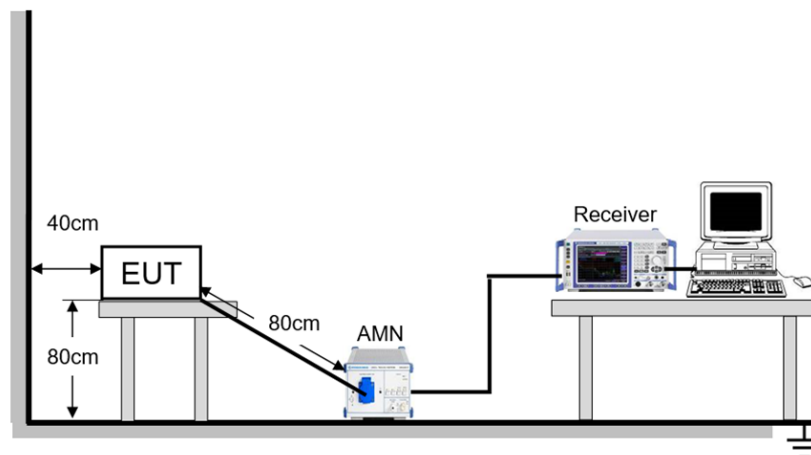

TEST ENVIRONMENT

Temperature	26.1 °C	Relative Humidity	68%
Atmosphere Pressure	101kPa	Test Voltage	AC 120 V, 60 Hz

TEST DATE / ENGINEER

Test Date	May 16, 2023	Test By	Wite Chen
-----------	--------------	---------	-----------

TEST RESULTS

Test Mode:	802.11a20	Channel:	5180
Line:	Line	Test Voltage:	AC 120 V, 60 Hz

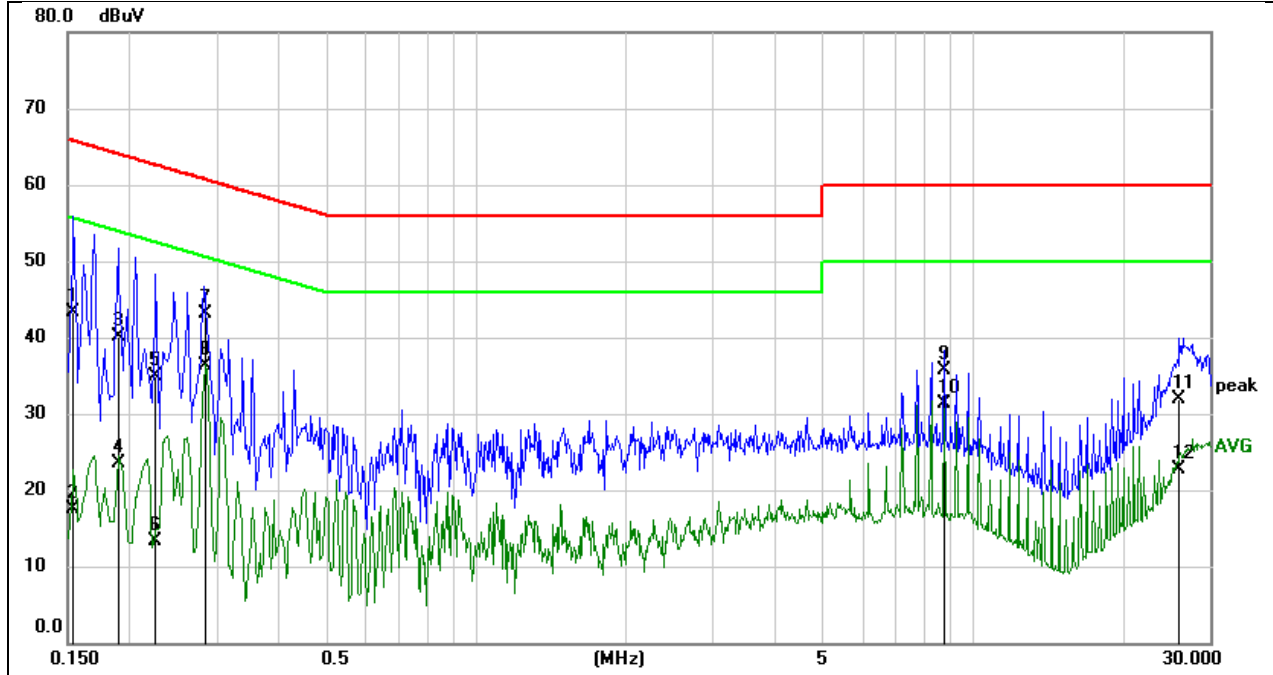

No.	Frequency (MHz)	Reading (dBuV)	Correct (dB)	Result (dBuV)	Limit (dBuV)	Margin (dB)	Remark
1	0.1539	33.75	9.59	43.34	65.79	-22.45	QP
2	0.1539	7.84	9.59	17.43	55.79	-38.36	AVG
3	0.1889	30.48	9.59	40.07	64.08	-24.01	QP
4	0.1889	13.89	9.59	23.48	54.08	-30.60	AVG
5	0.2248	25.28	9.59	34.87	62.64	-27.77	QP
6	0.2248	3.71	9.59	13.30	52.64	-39.34	AVG
7	0.2850	33.46	9.59	43.05	60.67	-17.62	QP
8	0.2850	26.72	9.59	36.31	50.67	-14.36	AVG
9	8.7530	26.00	9.71	35.71	60.00	-24.29	QP
10	8.7530	21.57	9.71	31.28	50.00	-18.72	AVG
11	26.0651	22.26	9.73	31.99	60.00	-28.01	QP
12	26.0651	13.07	9.73	22.80	50.00	-27.20	AVG

Note:

1. Result = Reading + Correct Factor.
2. If QP Result complies with AV limit, AV Result is deemed to comply with AV limit.
3. Test setup: RBW: 200 Hz (9 kHz ~ 150 kHz), 9 kHz (150 kHz ~ 30 MHz).
4. Step size: 80 Hz (0.009 MHz ~ 0.15 MHz), 4 kHz (0.15 MHz ~ 30 MHz), Scan time: auto.

Note: All the modes have been tested, only the worst data was recorded in the report.

Test Mode:	802.11a20	Channel:	5180
Line:	Neutral	Test Voltage:	AC 120 V, 60 Hz

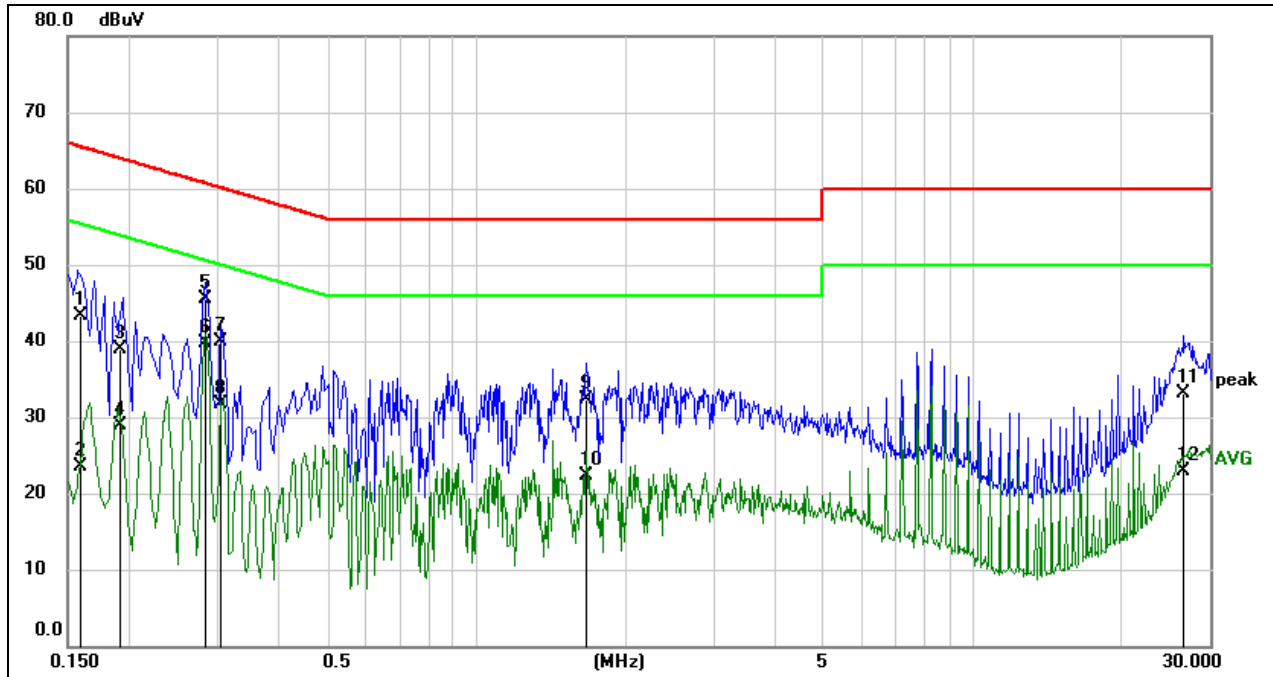

No.	Frequency (MHz)	Reading (dBuV)	Correct (dB)	Result (dBuV)	Limit (dBuV)	Margin (dB)	Remark
1	0.1590	33.76	9.59	43.35	65.52	-22.17	QP
2	0.1590	14.01	9.59	23.60	55.52	-31.92	AVG
3	0.1908	29.31	9.59	38.90	64.00	-25.10	QP
4	0.1908	19.24	9.59	28.83	54.00	-25.17	AVG
5	0.2831	36.01	9.59	45.60	60.72	-15.12	QP
6	0.2831	30.10	9.59	39.69	50.72	-11.03	AVG
7	0.3054	30.37	9.59	39.96	60.09	-20.13	QP
8	0.3054	22.19	9.59	31.78	50.09	-18.31	AVG
9	1.6683	22.60	9.62	32.22	56.00	-23.78	QP
10	1.6683	12.75	9.62	22.37	46.00	-23.63	AVG
11	26.7123	23.30	9.74	33.04	60.00	-26.96	QP
12	26.7123	13.26	9.74	23.00	50.00	-27.00	AVG

Note:

1. Result = Reading + Correct Factor.
2. If QP Result complies with AV limit, AV Result is deemed to comply with AV limit.
3. Test setup: RBW: 200 Hz (9 kHz ~ 150 kHz), 9 kHz (150 kHz ~ 30 MHz).
4. Step size: 80 Hz (0.009 MHz ~ 0.15 MHz), 4 kHz (0.15 MHz ~ 30 MHz), Scan time: auto.

Note: All the modes have been tested, only the worst data was recorded in the report.

10. ANTENNA REQUIREMENT

REQUIREMENT

Please refer to FCC part 15.203

An intentional radiator shall be designed to ensure that no antenna other than that furnished by the responsible party shall be used with the device. The use of a permanently attached antenna or of an antenna that uses a unique coupling to the intentional radiator shall be considered sufficient to comply with the provisions of this section. The manufacturer may design the unit so that a broken antenna can be replaced by the user, but the use of a standard antenna jack or electrical connector is prohibited.

Please refer to FCC part 15.407(a)

For an indoor access point operating in the band 5.15-5.25 GHz, the maximum conducted output power over the frequency band of operation shall not exceed 1 W provided the maximum antenna gain does not exceed 6 dBi. In addition, the maximum power spectral density shall not exceed 17 dBm in any 1 megahertz band. If transmitting antennas of directional gain greater than 6 dBi are used, both the maximum conducted output power and the maximum power spectral density shall be reduced by the amount in dB that the directional gain of the antenna exceeds 6 dBi.

DESCRIPTION

Pass

11. TEST DATA

11.1. APPENDIX A: EMISSION BANDWIDTH

11.1.1. Test Result

Test Mode	Antenna	Channel	26db EBW [MHz]	FL[MHz]	FH[MHz]	Verdict
11A-CDD	Ant1	5180	19.560	5170.200	5189.760	PASS
	Ant3	5180	19.600	5170.240	5189.840	PASS
	Ant1	5200	19.000	5190.520	5209.520	PASS
	Ant3	5200	19.200	5190.440	5209.640	PASS
	Ant1	5240	19.600	5230.240	5249.840	PASS
	Ant3	5240	19.520	5230.160	5249.680	PASS
	Ant1	5745	19.480	5735.120	5754.600	PASS
	Ant3	5745	19.280	5735.360	5754.640	PASS
	Ant1	5785	19.640	5775.200	5794.840	PASS
	Ant3	5785	19.480	5775.080	5794.560	PASS
	Ant1	5825	19.240	5815.360	5834.600	PASS
	Ant3	5825	19.560	5815.120	5834.680	PASS
11AX20MIMO	Ant1	5180	21.320	5169.600	5190.920	PASS
	Ant3	5180	20.880	5169.600	5190.480	PASS
	Ant1	5200	20.800	5190.040	5210.840	PASS
	Ant3	5200	20.680	5189.480	5210.160	PASS
	Ant1	5240	19.720	5230.160	5249.880	PASS
	Ant3	5240	19.840	5230.080	5249.920	PASS
	Ant1	5745	20.640	5734.560	5755.200	PASS
	Ant3	5745	20.480	5734.720	5755.200	PASS
	Ant1	5785	20.760	5774.600	5795.360	PASS
	Ant3	5785	20.920	5774.480	5795.400	PASS
	Ant1	5825	20.960	5814.440	5835.400	PASS
	Ant3	5825	21.120	5814.360	5835.480	PASS
11AX40MIMO	Ant1	5190	39.280	5170.320	5209.600	PASS
	Ant3	5190	39.200	5170.400	5209.600	PASS
	Ant1	5230	39.600	5210.240	5249.840	PASS
	Ant3	5230	39.360	5210.400	5249.760	PASS
	Ant1	5755	39.200	5735.480	5774.680	PASS
	Ant3	5755	39.360	5735.400	5774.760	PASS
	Ant1	5795	39.040	5775.560	5814.600	PASS
	Ant3	5795	39.440	5775.240	5814.680	PASS
11AX80MIMO	Ant1	5210	79.840	5170.160	5250.000	PASS
	Ant3	5210	79.840	5170.160	5250.000	PASS
	Ant1	5775	80.000	5735.160	5815.160	PASS
	Ant3	5775	80.000	5735.160	5815.160	PASS

11.1.2. Test Graphs





11A-CDD_Ant3_5200



11A-CDD_Ant1_5240



11A-CDD_Ant3_5240



11A-CDD_Ant1_5745



11A-CDD_Ant3_5745



11A-CDD_Ant1_5785