

802.11ax-HE40 Power Spectral Density – Ant 1 (Nss=2)

Channel 179 (6845MHz)

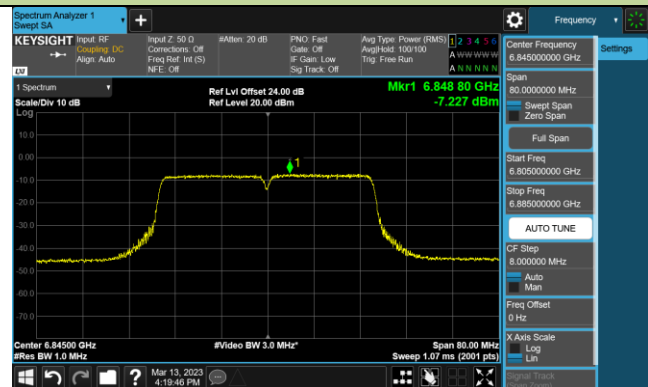

Channel 187 (6885MHz)

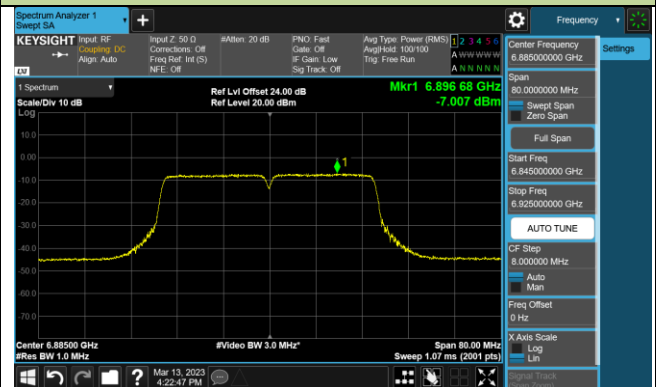

Channel 195 (6925MHz)

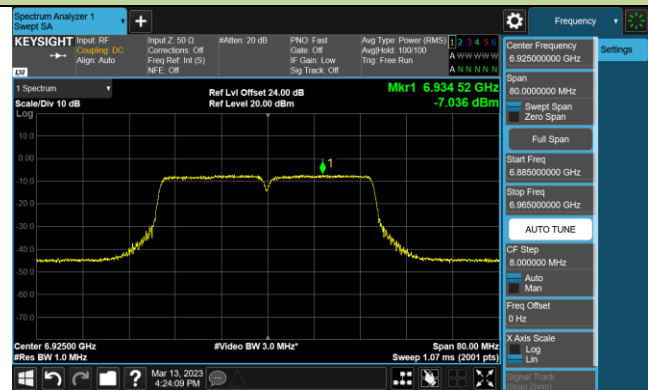

Channel 211 (7005MHz)

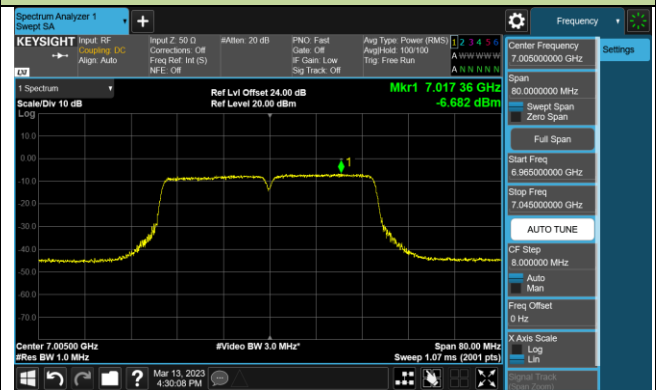

Channel 227 (7085MHz)

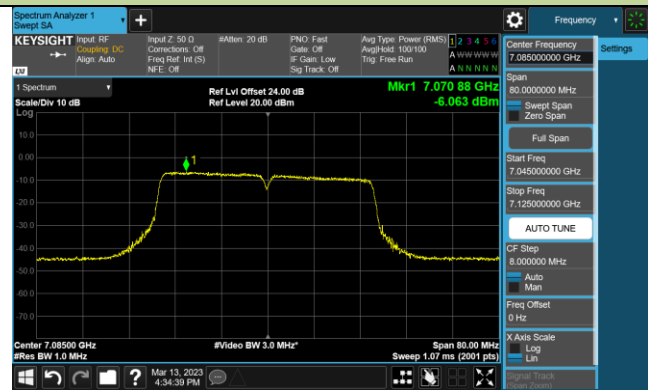

802.11ax-HE80 Power Spectral Density – Ant 1 (Nss=2)

Channel 7 (5985MHz)

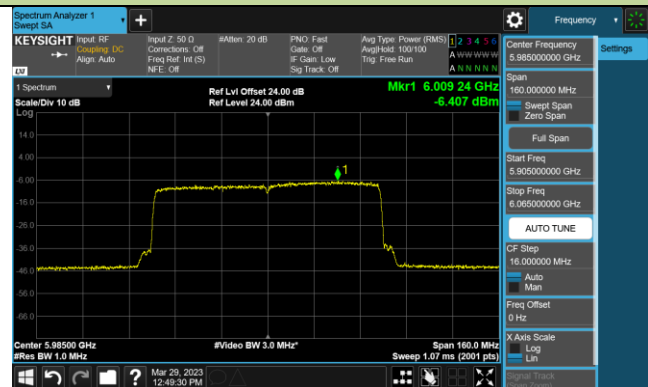

Channel 39 (6145MHz)

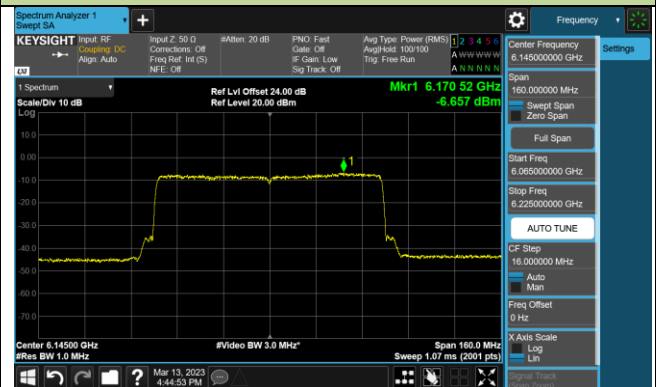

Channel 87 (6385MHz)

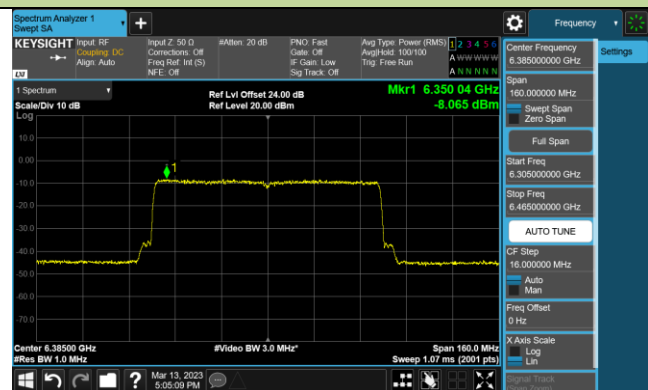

Channel 103 (6465MHz)

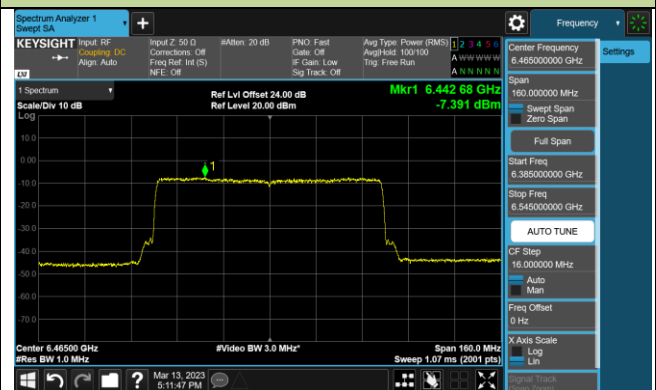

Channel 119 (6545MHz)

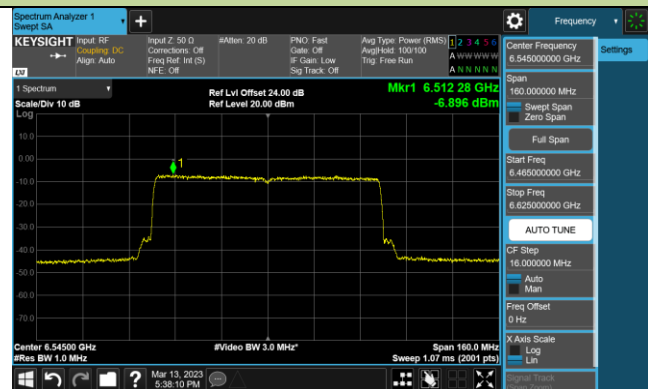

Channel 135 (6625MHz)

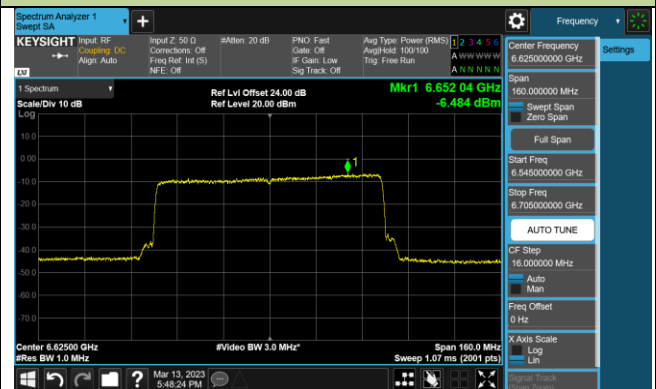

Channel 151 (6705MHz)

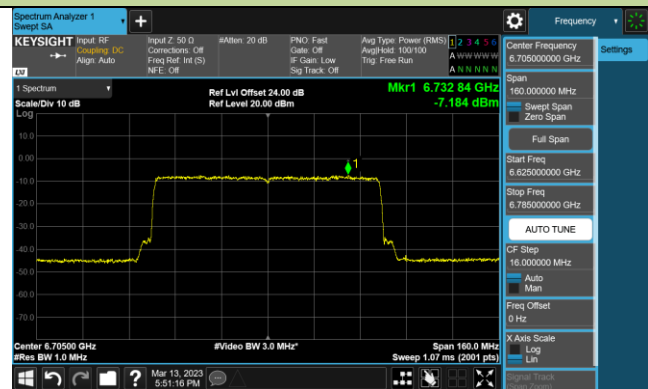

Channel 183 (6865MHz)



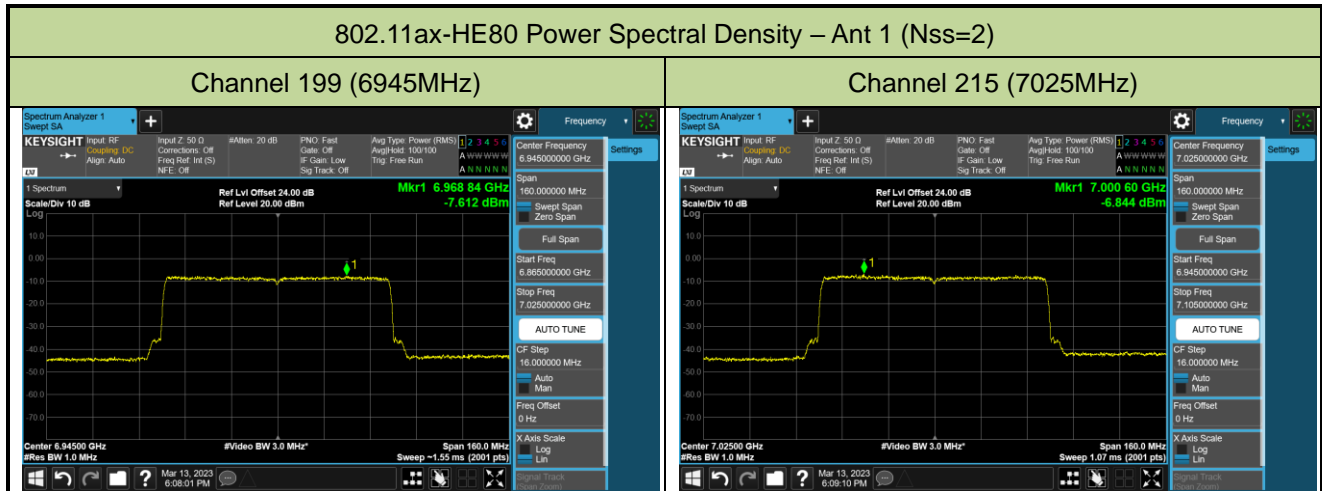

802.11ax-HE160 Power Spectral Density – Ant 1 (Nss=2)

Channel 15 (6025MHz)

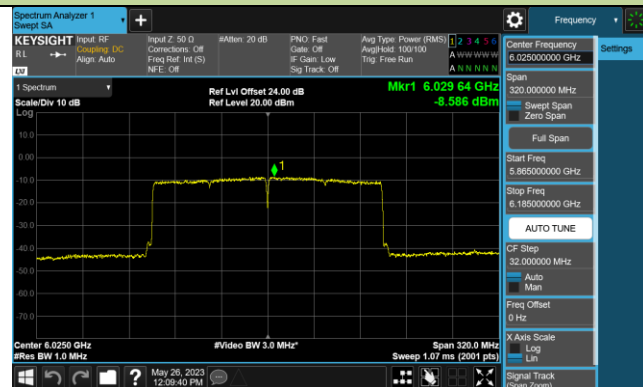

Channel 79 (6345MHz)

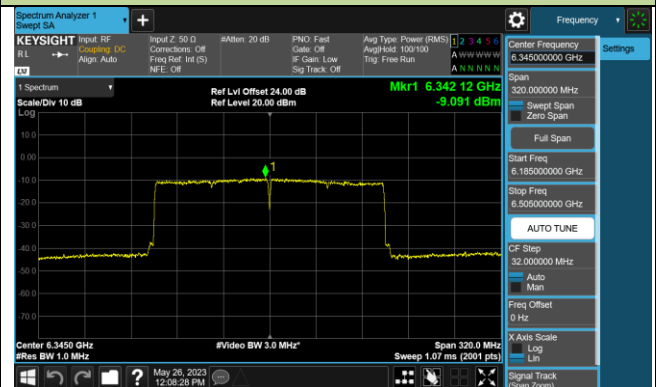

Channel 111 (6505MHz)

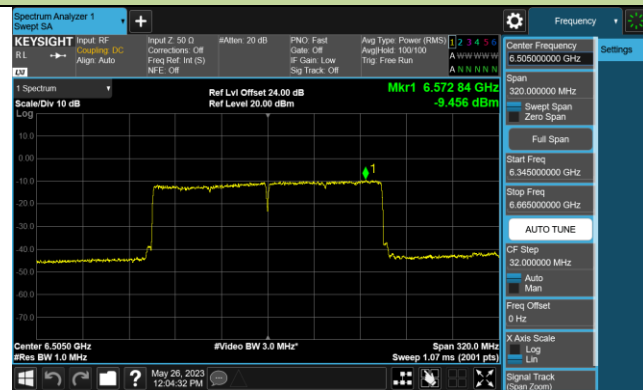

Channel 143 (6665MHz)

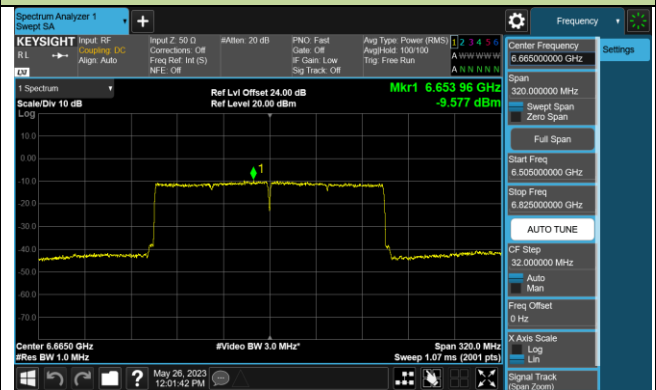

Channel 175 (6825MHz)

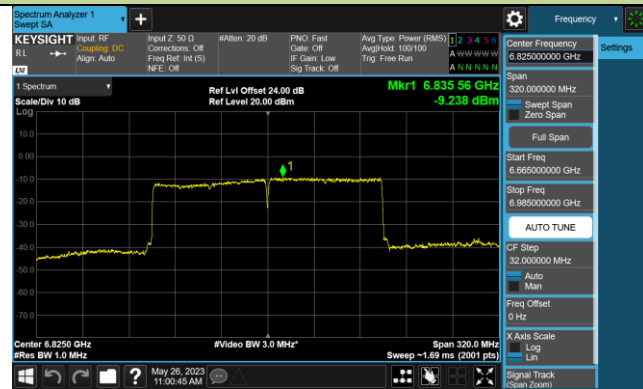

Channel 207 (6985MHz)

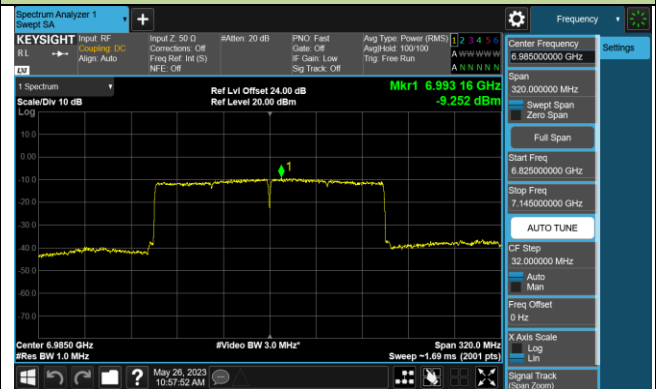

802.11ax-HE20 Power Spectral Density – Ant 2 (Nss=2)

Channel 1 (5955MHz)

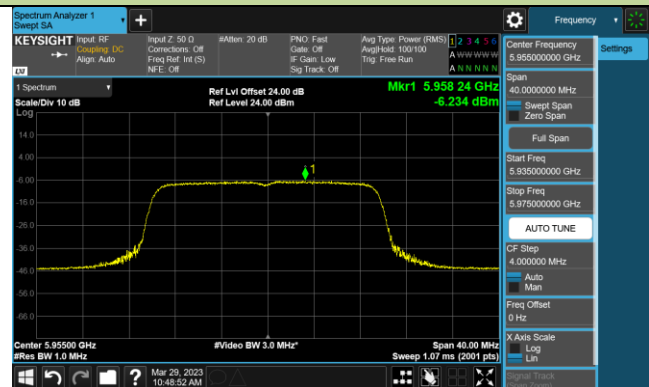

Channel 33 (6115MHz)

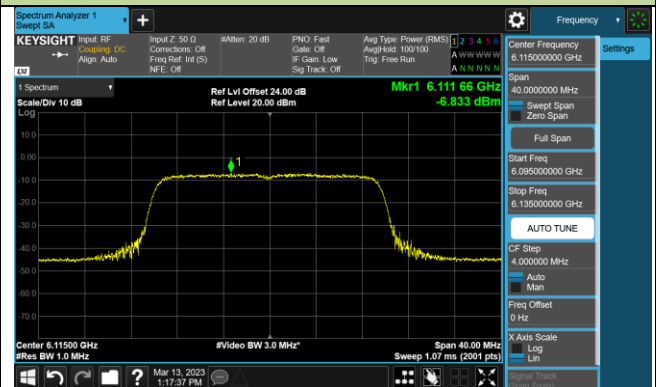

Channel 93 (6415MHz)

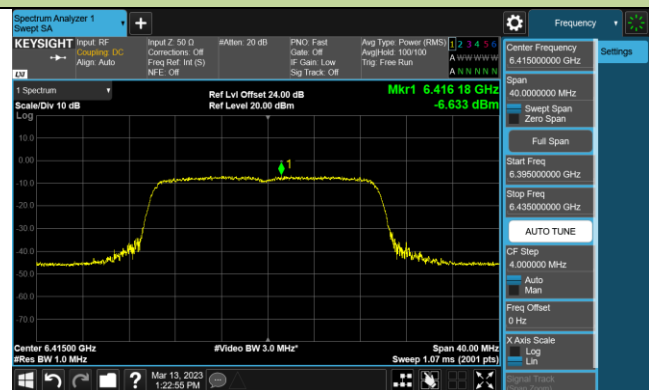

Channel 97 (6435MHz)

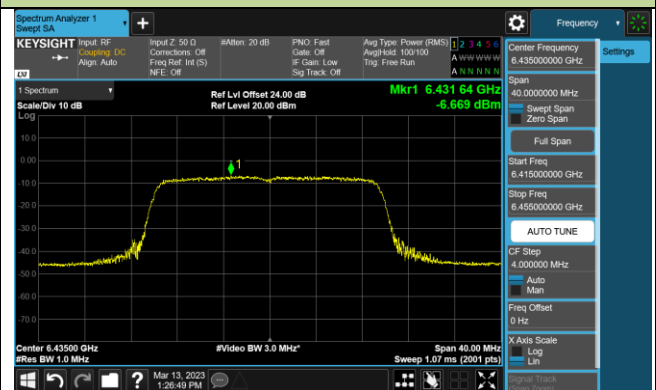

Channel 105 (6475MHz)

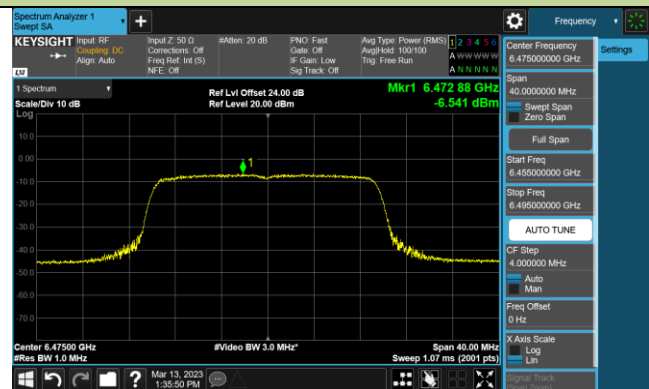

Channel 113 (6515MHz)

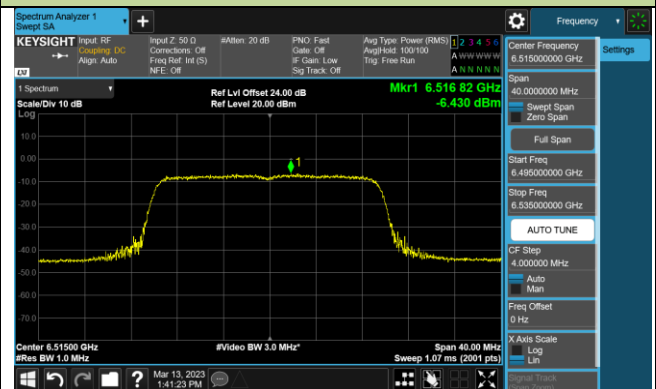

Channel 117 (6535MHz)

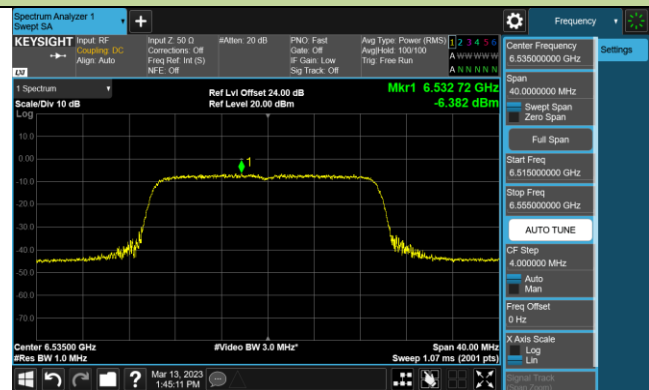

Channel 149 (6695MHz)

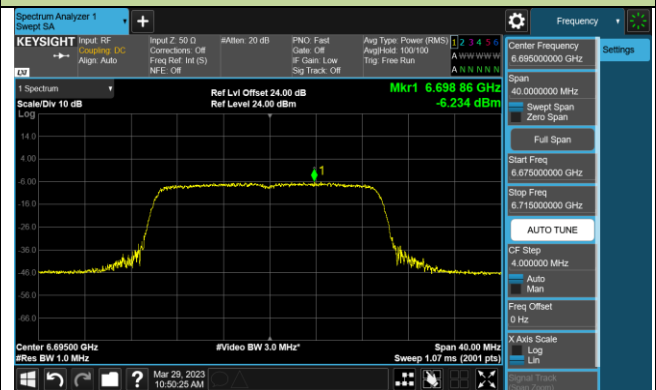

802.11ax-HE20 Power Spectral Density – Ant 2 (Nss=2)

Channel 181 (6855MHz)

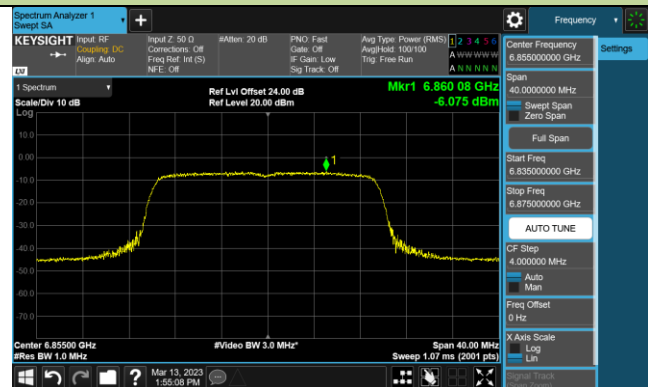

Channel 185 (6875MHz)

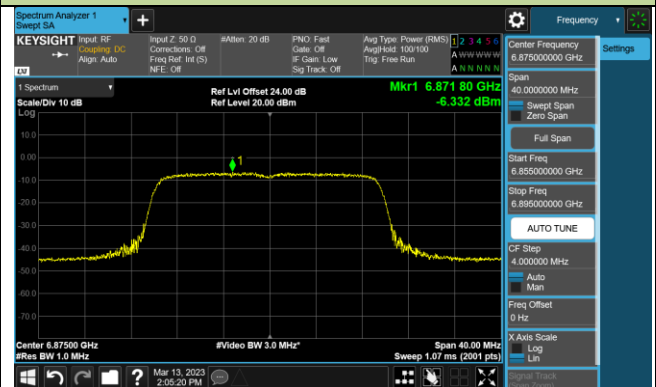

Channel 189 (6895MHz)

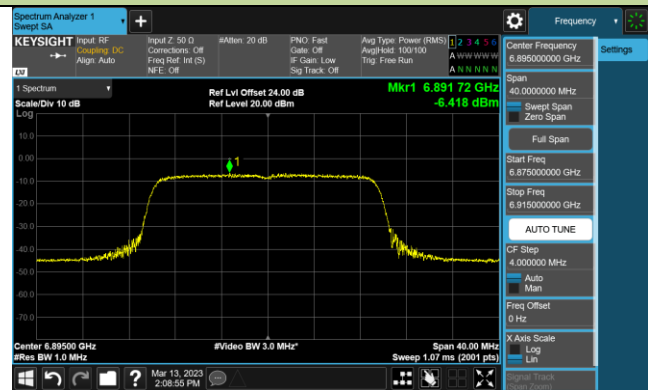

Channel 213 (7015MHz)

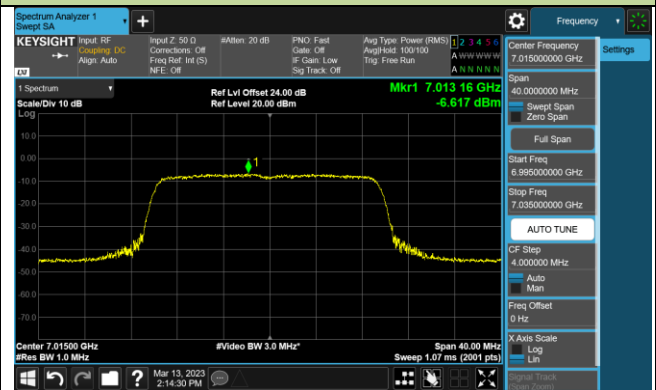

Channel 233 (7115MHz)

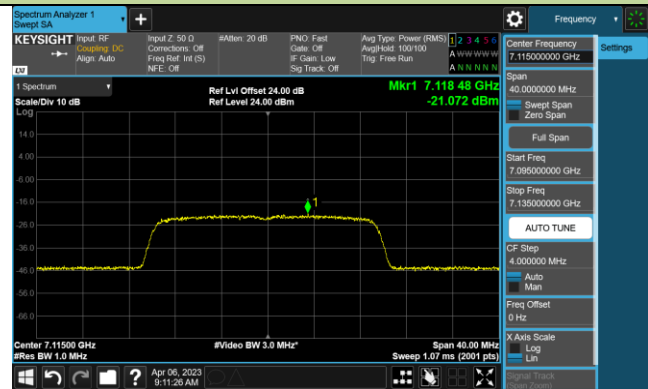

802.11ax-HE40 Power Spectral Density – Ant 2 (Nss=2)

Channel 3 (5965MHz)

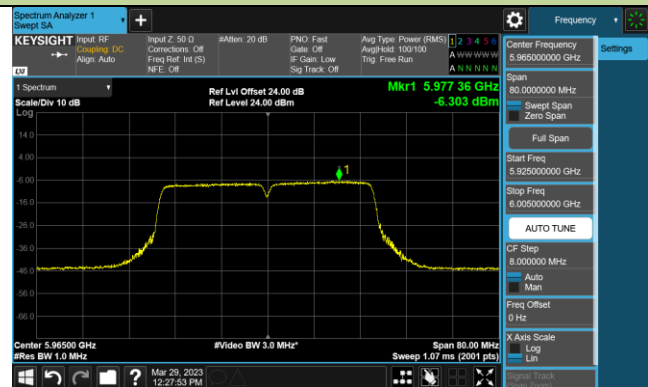

Channel 43 (6165MHz)

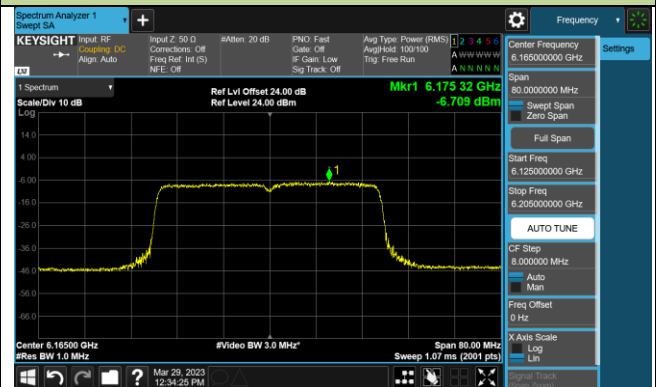

Channel 91 (6405MHz)

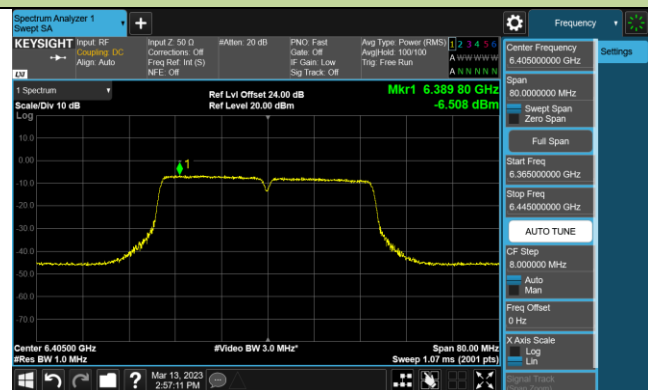

Channel 99 (6445MHz)

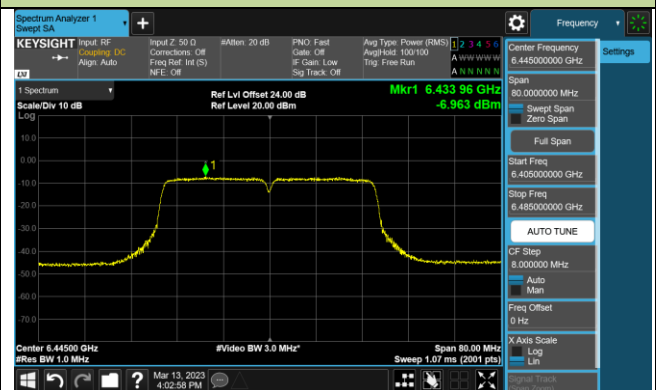

Channel 107 (6485MHz)

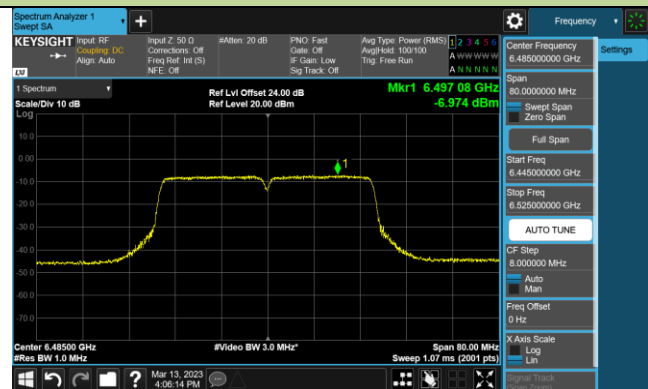

Channel 115 (6525MHz)

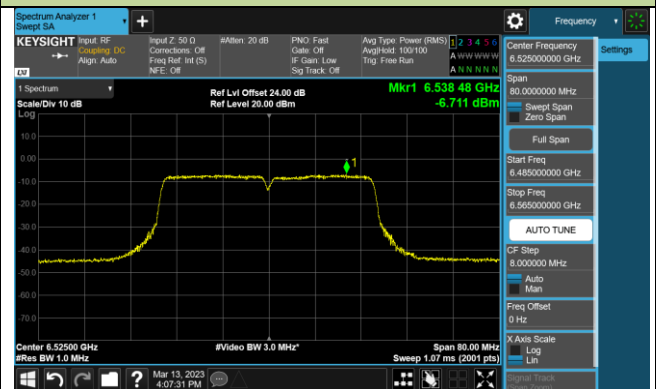

Channel 123 (6565MHz)

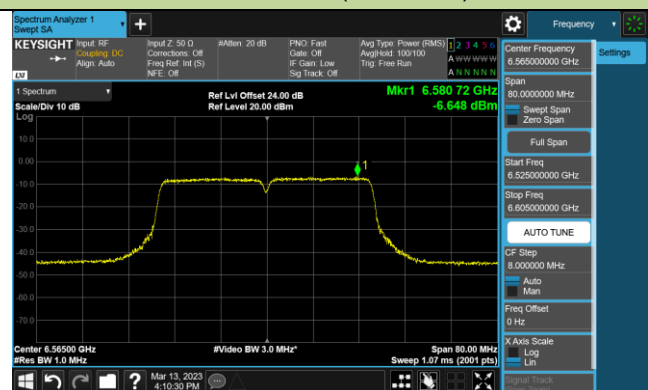

Channel 147 (6685MHz)

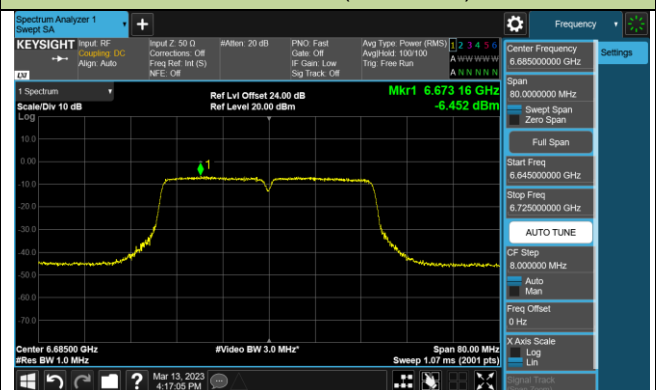

802.11ax-HE40 Power Spectral Density – Ant 2 (Nss=2)

Channel 179 (6845MHz)

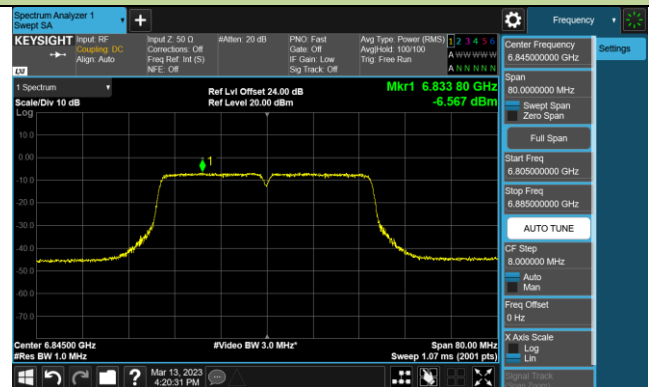

Channel 187 (6885MHz)

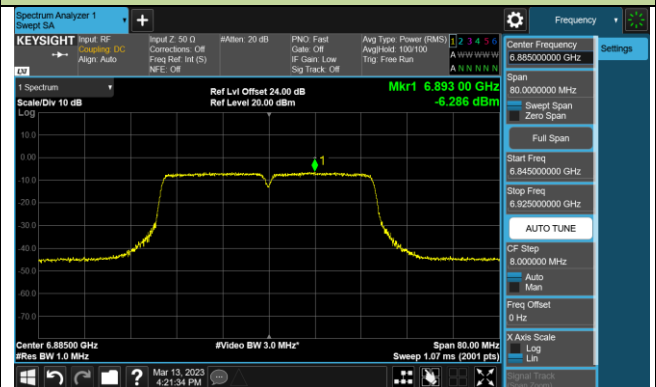

Channel 195 (6925MHz)

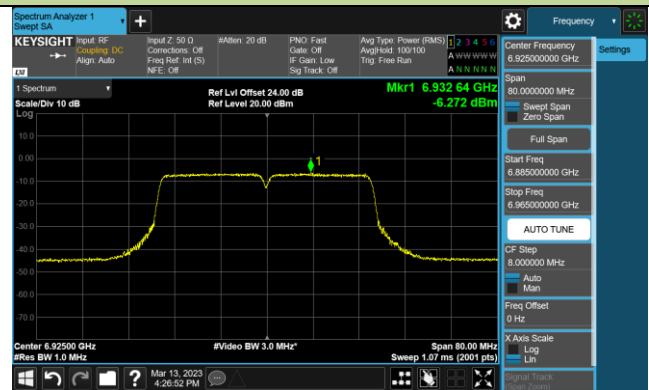

Channel 211 (7005MHz)

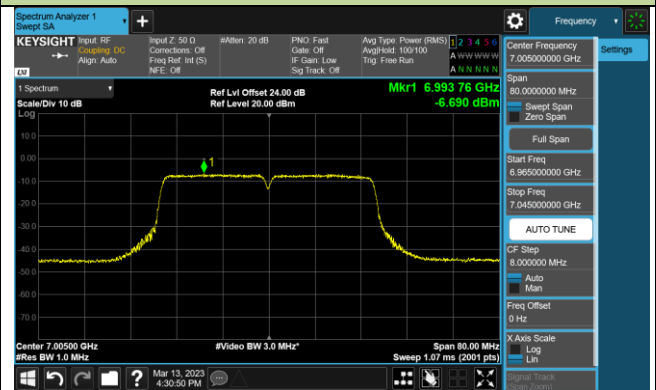

Channel 227 (7085MHz)

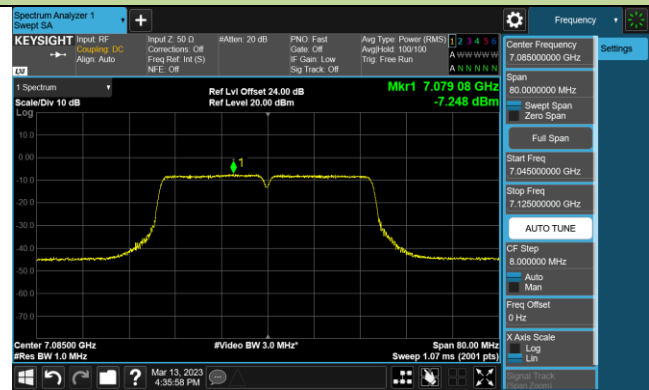

802.11ax-HE80 Power Spectral Density – Ant 2 (Nss=2)

Channel 7 (5985MHz)

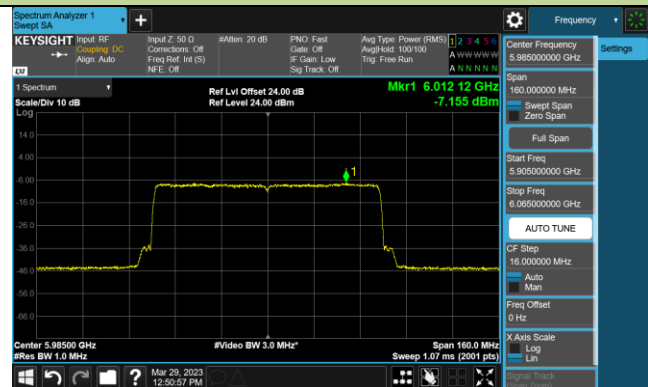

Channel 39 (6145MHz)

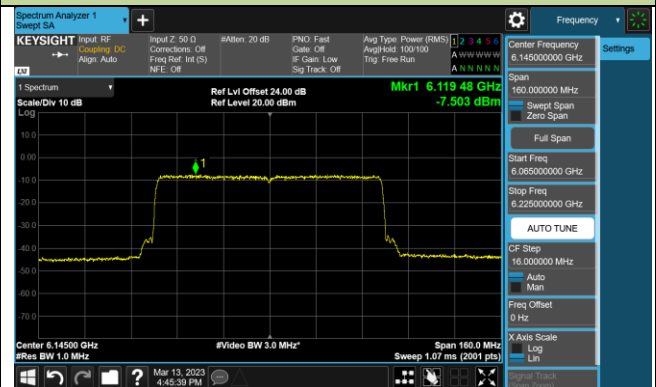

Channel 87 (6385MHz)



Channel 103 (6465MHz)

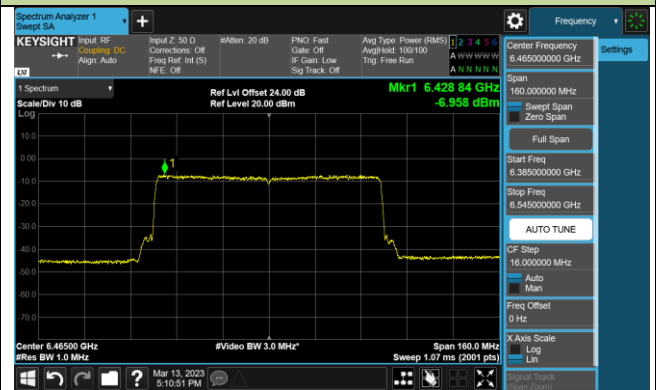

Channel 119 (6545MHz)

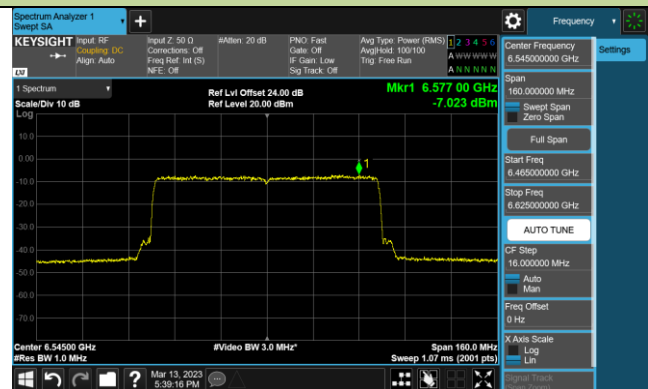

Channel 135 (6625MHz)

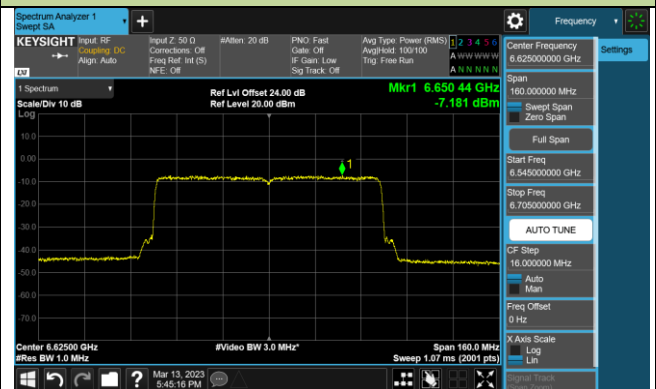

Channel 151 (6705MHz)



Channel 183 (6865MHz)

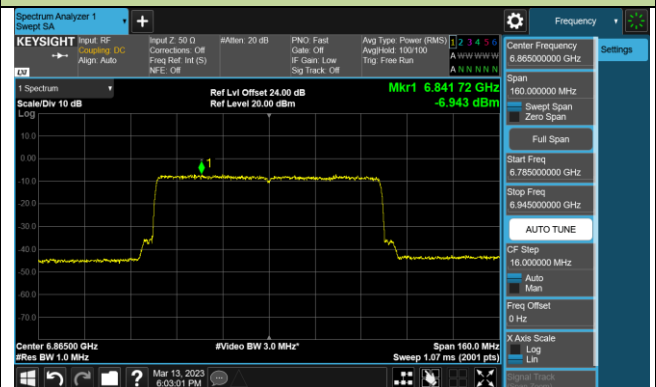

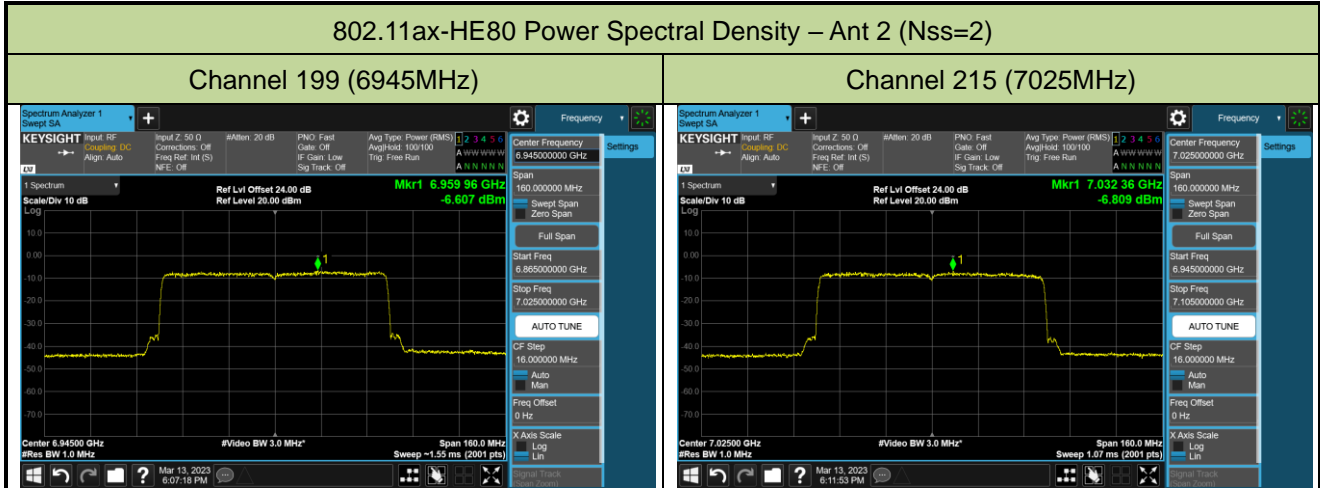

802.11ax-HE160 Power Spectral Density – Ant 2 (Nss=2)

Channel 15 (6025MHz)

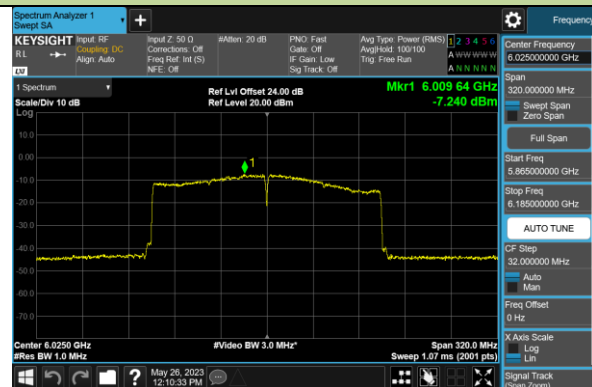

Channel 79 (6345MHz)

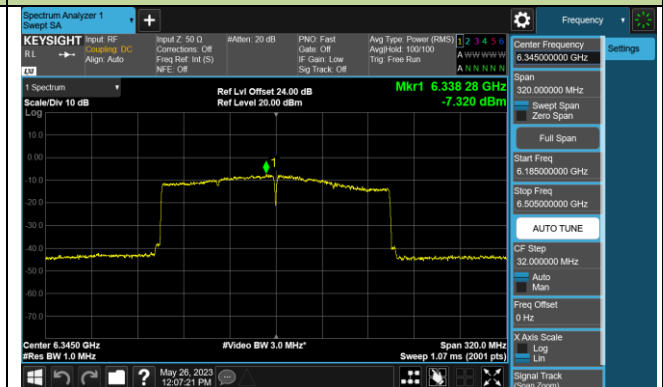

Channel 111 (6505MHz)

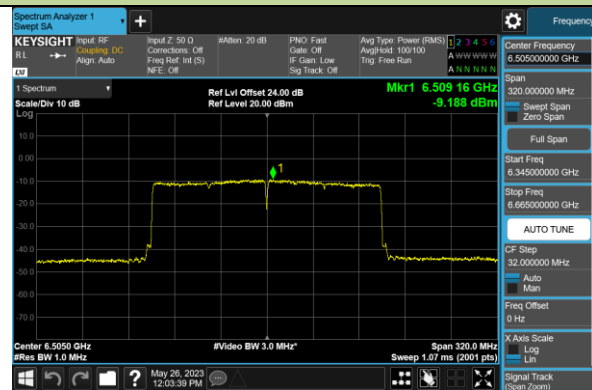

Channel 143 (6665MHz)

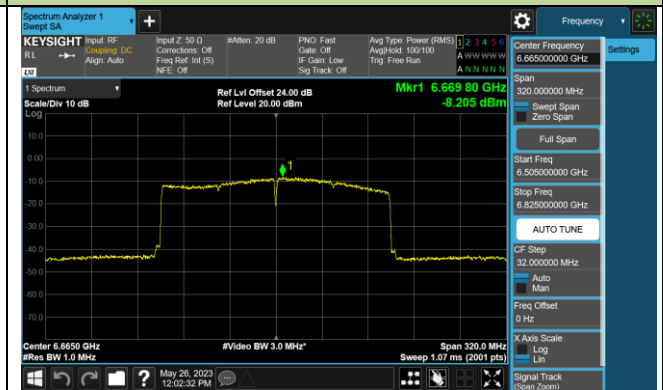

Channel 175 (6825MHz)

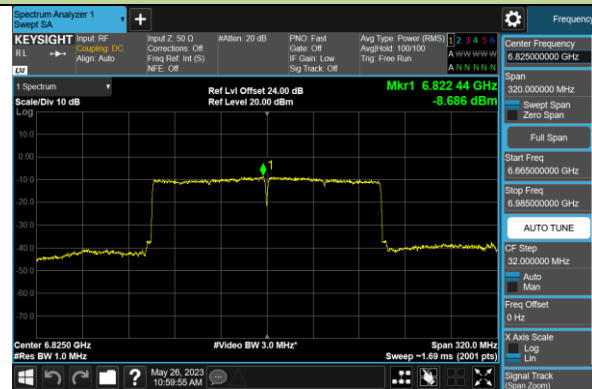

Channel 207 (6985MHz)

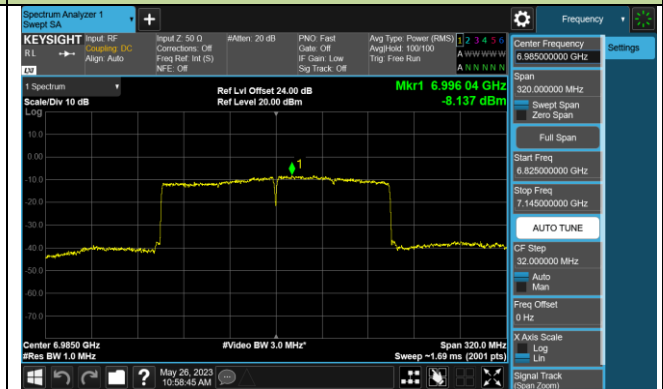

6.5. In-Band Emission Measurement

6.5.1. Test Limit

Suppressed by 20 dB at 1 MHz outside of the channel edge. (The channel edge is defined as the 26-dB point on either side of the carrier center frequency.)

Suppressed by 28 dB at one channel bandwidth from the channel center.

Suppressed by 40 dB at one- and one-half times the channel bandwidth from the channel center.

6.5.2. Test Procedure used

KDB 987594 D02v01r01- Section J

6.5.3. Test Setting

Emissions Mask Reference Level Measurement

1. Set the span to encompass the entire 26 dB EBW of the signal.
2. Set RBW = same RBW used for 26 dB EBW measurement.
3. Set VBW $\geq 3 \times$ RBW.
4. Number of points in sweep $\geq [2 \times \text{span} / \text{RBW}]$.
5. Sweep time = auto.
6. Detector = RMS.
7. Trace average at least 100 traces in power averaging (rms) mode.
8. Use the peak search function on the instrument to find the peak of the spectrum.

In-Band Emission

1. Using the measuring equipment limit line function, develop the emissions mask based on rule.
2. Adjust the span to encompass the entire mask as necessary.
3. Clear trace.
4. Trace average at least 100 traces in power averaging (rms) mode.
5. Adjust the reference level as necessary so that the crest of the channel touches the top of the emission mask.

6.5.4. Test Setup

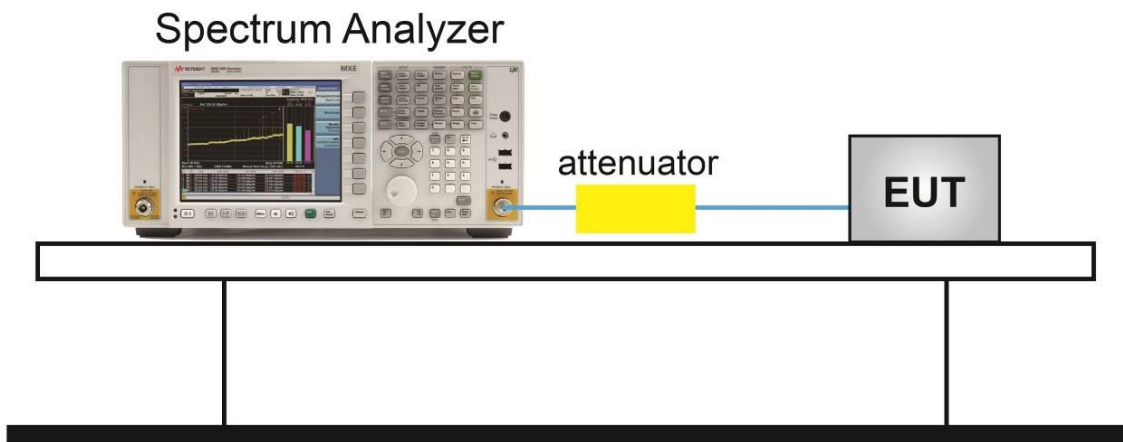

6.5.5. Test Result

Test Site	SR5	Test Engineer	Marvin
Test Date	2023/03/14~2023/03/29		

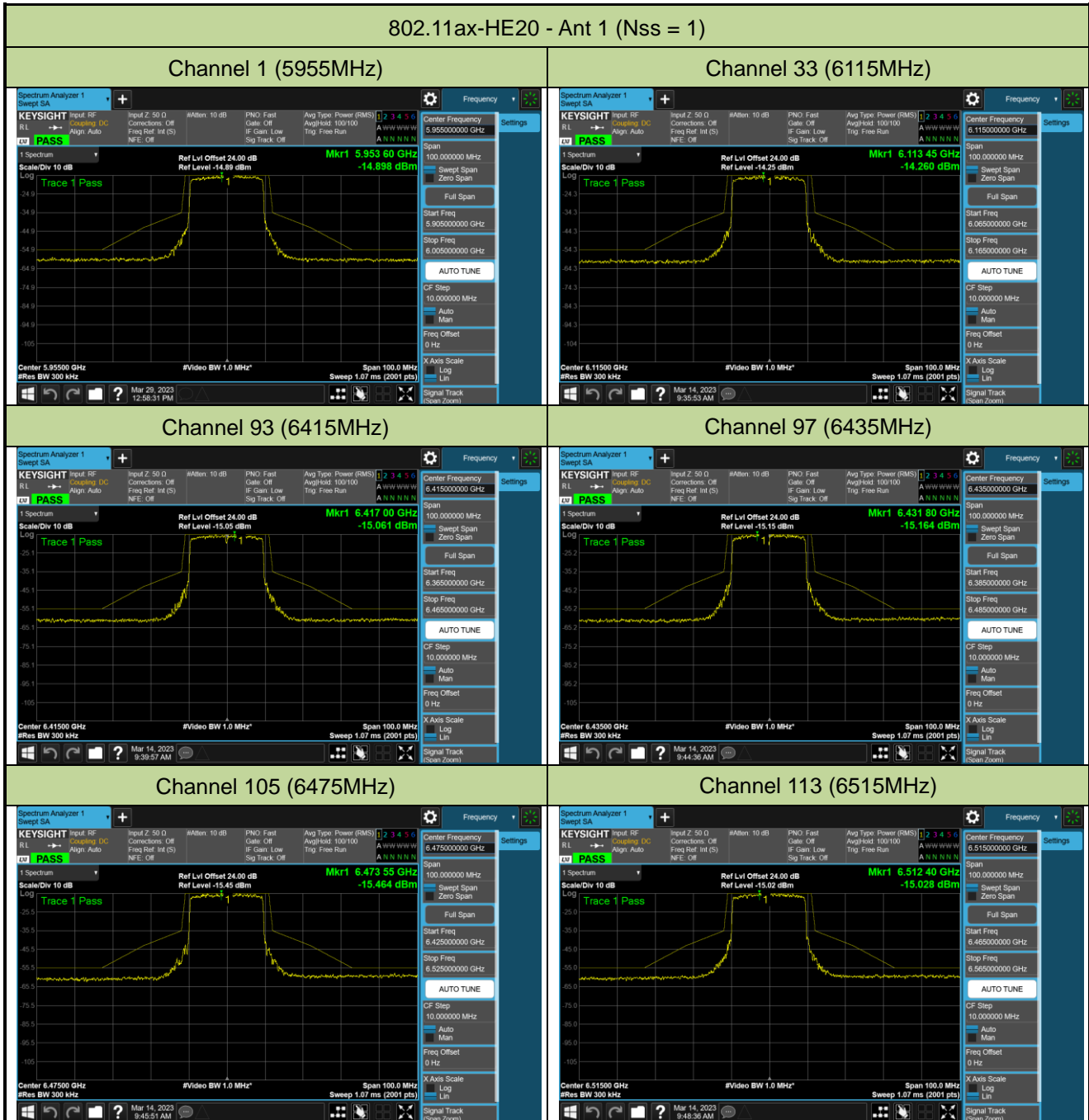

802.11ax-HE20 - Ant 1 (Nss = 1)

Channel 117 (6535MHz)

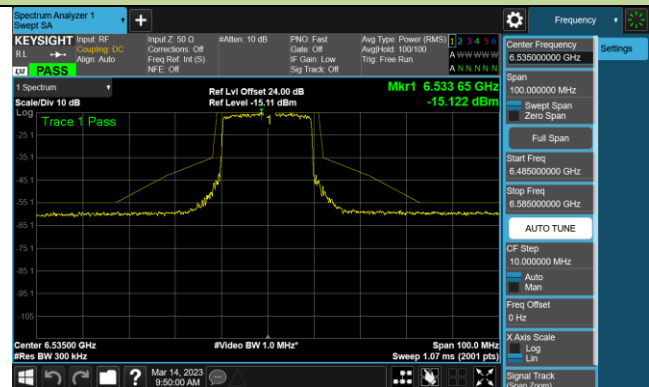

Channel 149 (6695MHz)

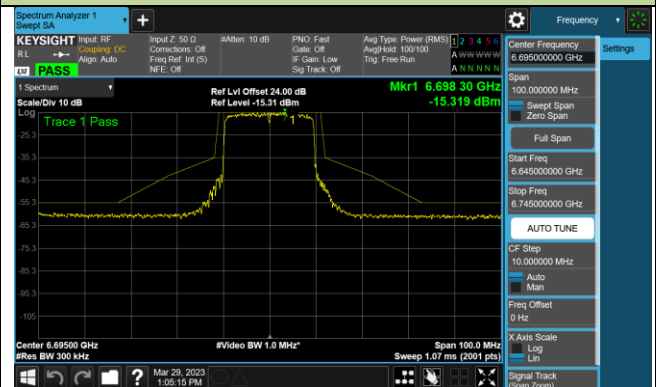

Channel 181 (6855MHz)

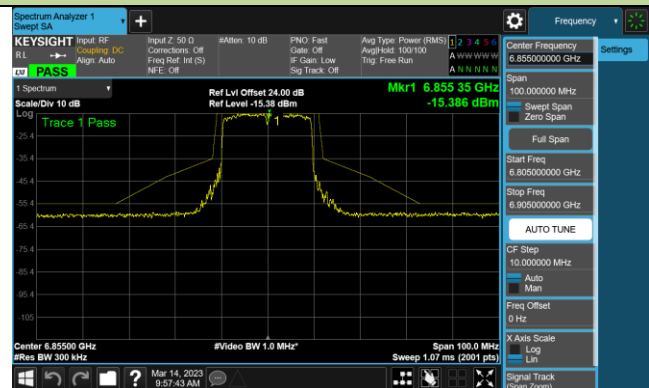

Channel 185 (6875MHz)

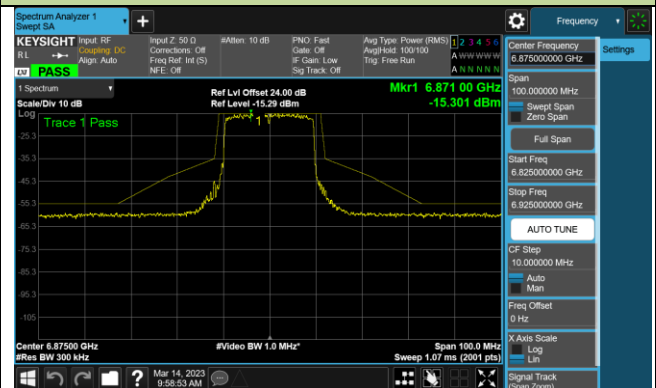

Channel 189 (6895MHz)

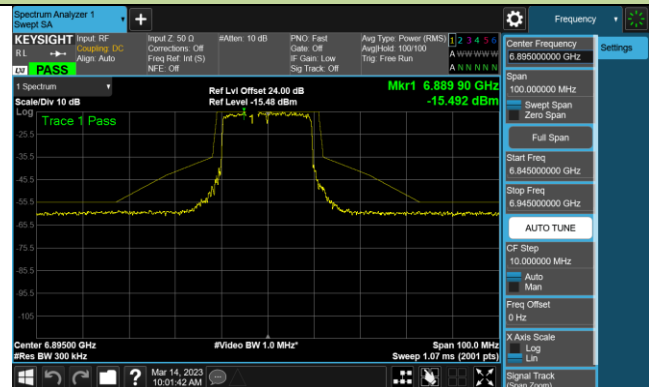

Channel 213 (7015MHz)

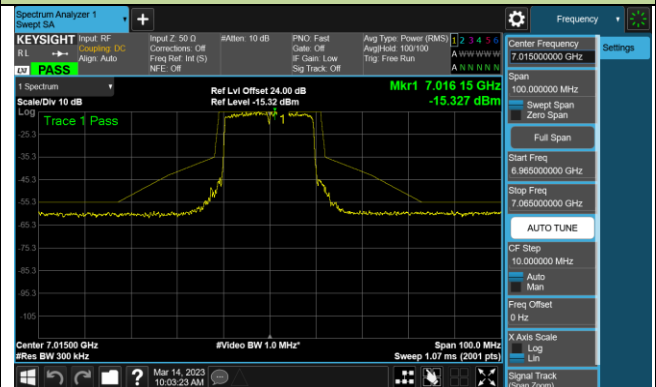

Channel 233 (7115MHz)

