

Test Result of EUT ceased transmission (NII-6 Band)

802.11ax-HE20 / CH101

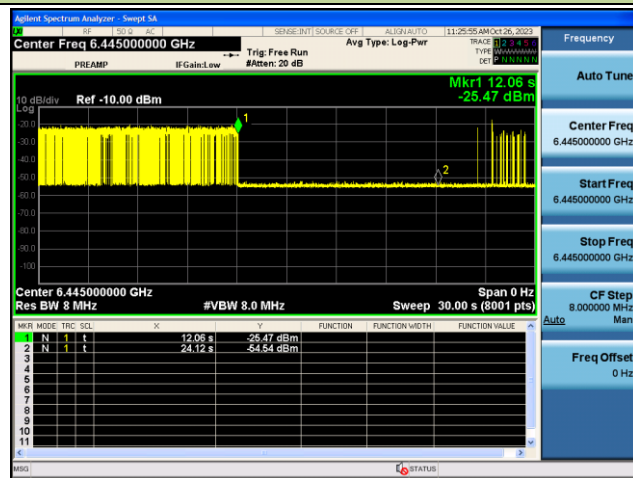

802.11ax-HE80 / CH103 (Low Edge)

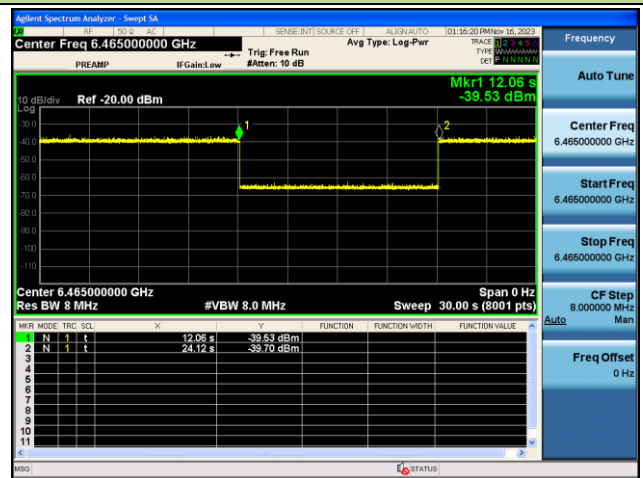

802.11ax-HE80 / CH103 (Middle)

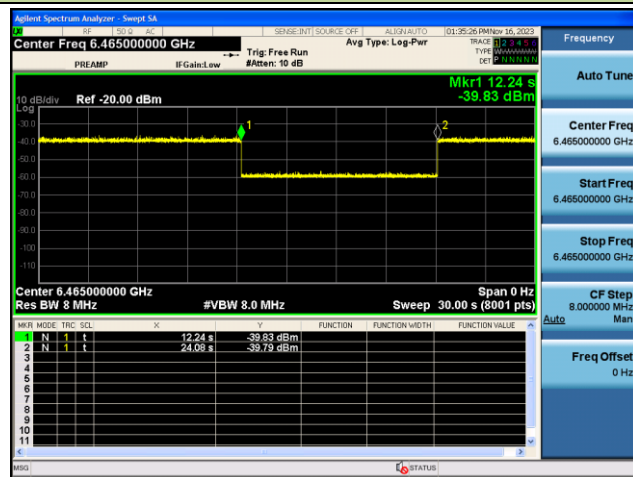

802.11ax-HE80 / CH103 (High Edge)

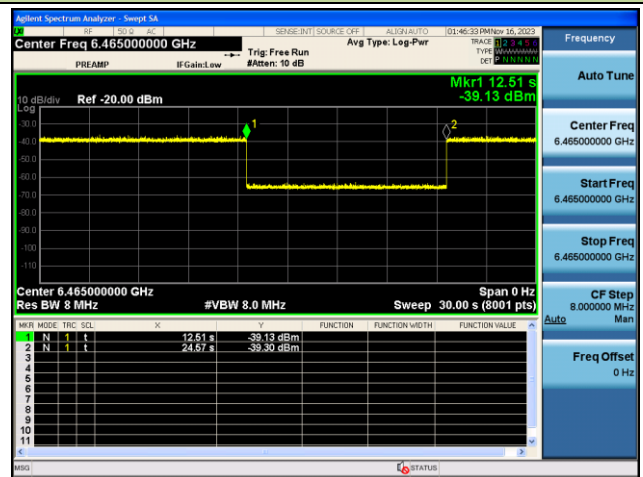

Note – M1: Injection of AWGN Signal, M2: Removal of AWGN Signal

Test Result of EUT ceased transmission (NII-7 Band)

802.11ax-HE20 / CH165

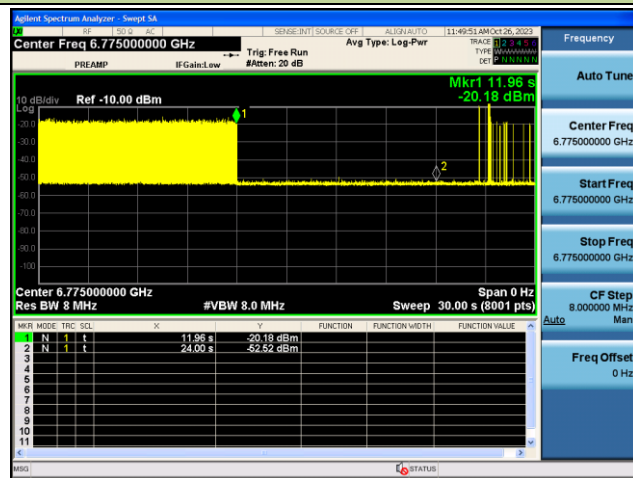

802.11ax-HE80 / CH151 (Low Edge)

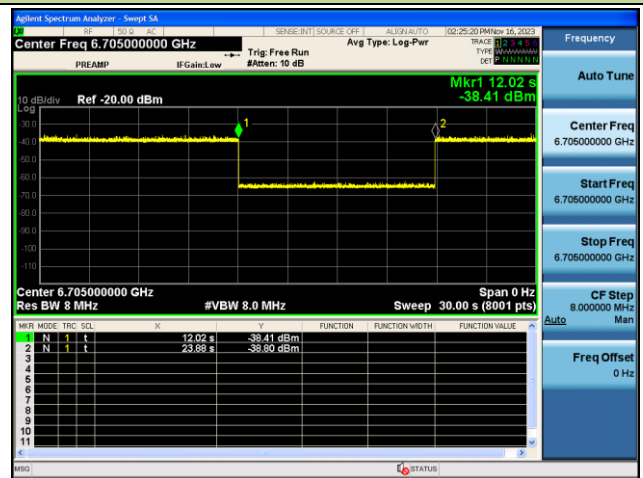

802.11ax-HE80 / CH151 (Middle)

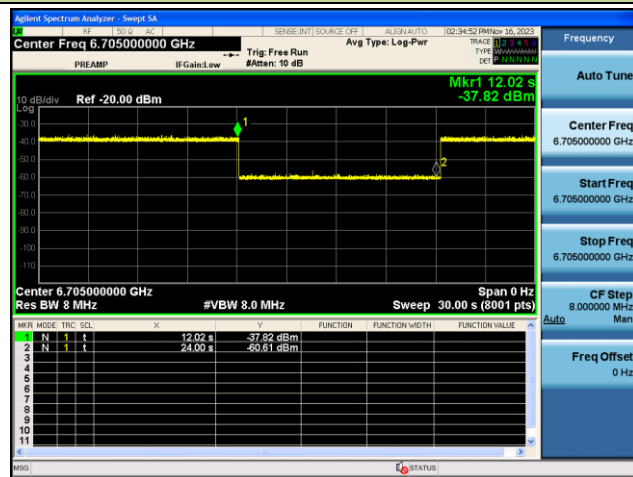

802.11ax-HE80 / CH151 (High Edge)

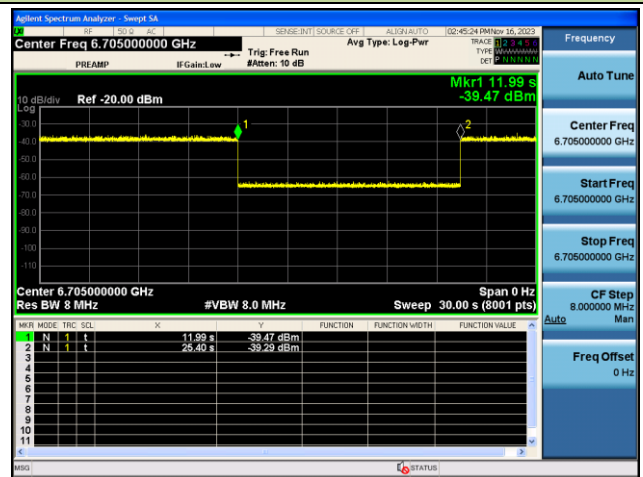

Note – M1: Injection of AWGN Signal, M2: Removal of AWGN Signal

Test Result of EUT ceased transmission (NII-8 Band)

802.11ax-HE20 / CH213

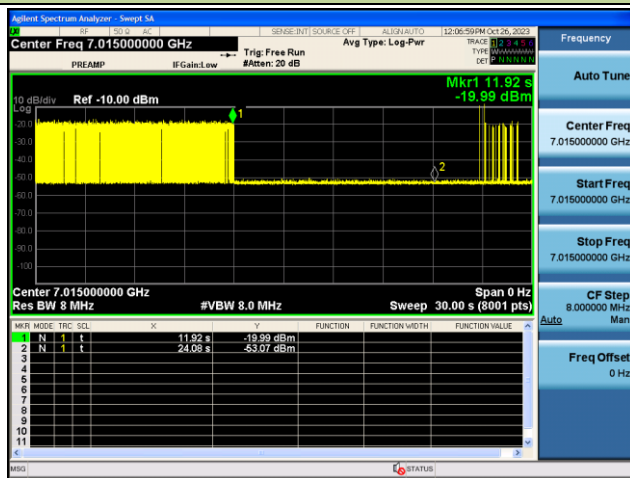

802.11ax-HE80 / CH215 (Low Edge)

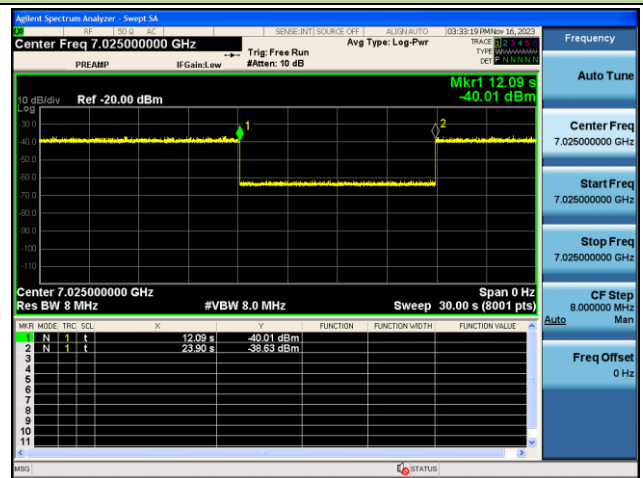

802.11ax-HE80 / CH215 (Middle)

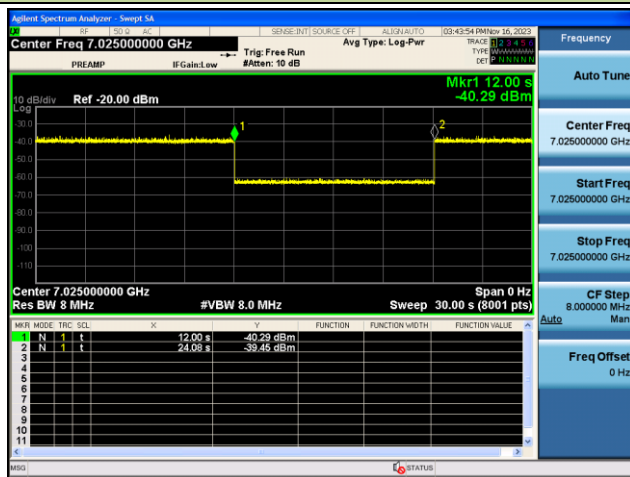

802.11ax-HE80 / CH215 (High Edge)

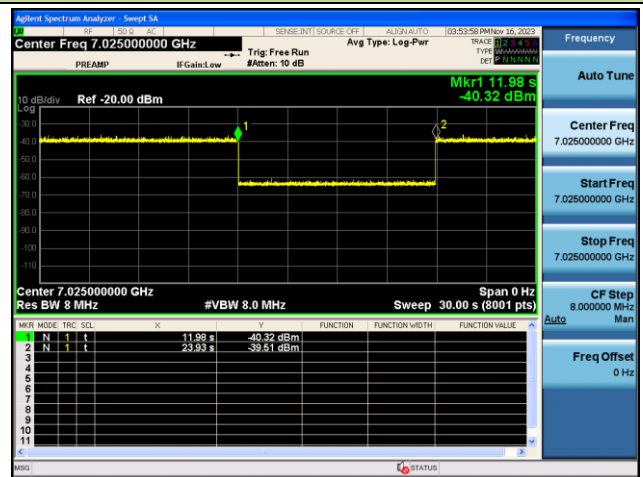

Note – M1: Injection of AWGN Signal, M2: Removal of AWGN Signal

## 6.8. Radiated Spurious Emission

### 6.8.1. Test Limit

For 15.407(b)(5) requirement

For transmitters operating within the 5.925-7.125 GHz band: Any emissions outside of the 5.925-7.125 GHz band must not exceed an e.i.r.p. of  $-27$  dBm/MHz.

Refer to 987594 D02 U-NII 6GHz EMC Measurement v01 clause G

Use guidance in KDB 789033 for measurements below 1000 MHz and above 1000 MHz. Unwanted emissions outside of restricted bands are measured with a RMS detector. In addition, 15.35(b) applies where the peak emissions must be limited to no more than 20 dB above the average limit.

All out of band emissions appearing in a restricted band as specified in Section 15.205 of the Title 47CFR must not exceed the limits shown in Table per Section 15.209.

FCC Part 15 Subpart C Paragraph 15.209		
Frequency [MHz]	Field Strength [uV/m]	Measured Distance [Meters]
0.009 - 0.490	2400/F (kHz)	300
0.490 - 1.705	24000/F (kHz)	30
1.705 - 30	30	30
30 - 88	100	3
88 - 216	150	3
216 - 960	200	3
Above 960	500	3

### 6.8.2. Test Procedure Used

KDB 789033 D02v02r01- Section G

### 6.8.3. Test Setting

Table 1 - RBW as a function of frequency

Frequency	RBW
9 ~ 150 kHz	200 ~ 300 Hz
0.15 ~ 30 MHz	9 ~ 10 kHz
30 ~ 1000 MHz	100 ~ 120 kHz
> 1000MHz	1MHz

**Quasi-Peak Measurements below 1GHz**

1. Analyzer center frequency was set to the frequency of the radiated spurious emission of interest
2. Span was set greater than 1MHz
3. RBW = as specified in Table 1
4. Detector = CISPR quasi-peak
5. Sweep time = auto couple
6. Trace was allowed to stabilize

**Peak Measurements above 1GHz**

1. Analyzer center frequency was set to the frequency of the radiated spurious emission of interest
2. RBW = 1MHz
3. VBW = 3MHz
4. Detector = peak
5. Sweep time = auto couple
6. Trace mode = max hold
7. Trace was allowed to stabilize

**Average Measurements above 1GHz (Method VB)**

1. Analyzer center frequency was set to the frequency of the radiated spurious emission of interest
2. RBW = 1MHz
3. VBW; If the EUT is configured to transmit with duty cycle  $\geq 98\%$ , set VBW = 10 Hz.  
If the EUT duty cycle is  $< 98\%$ , set VBW  $\geq 1/T$ . T is the minimum transmission duration.
4. Detector = Peak
5. Sweep time = auto
6. Trace mode = max hold
7. Trace was allowed to stabilize

### 6.8.4. Test Setup

Below 1GHz Test Setup:

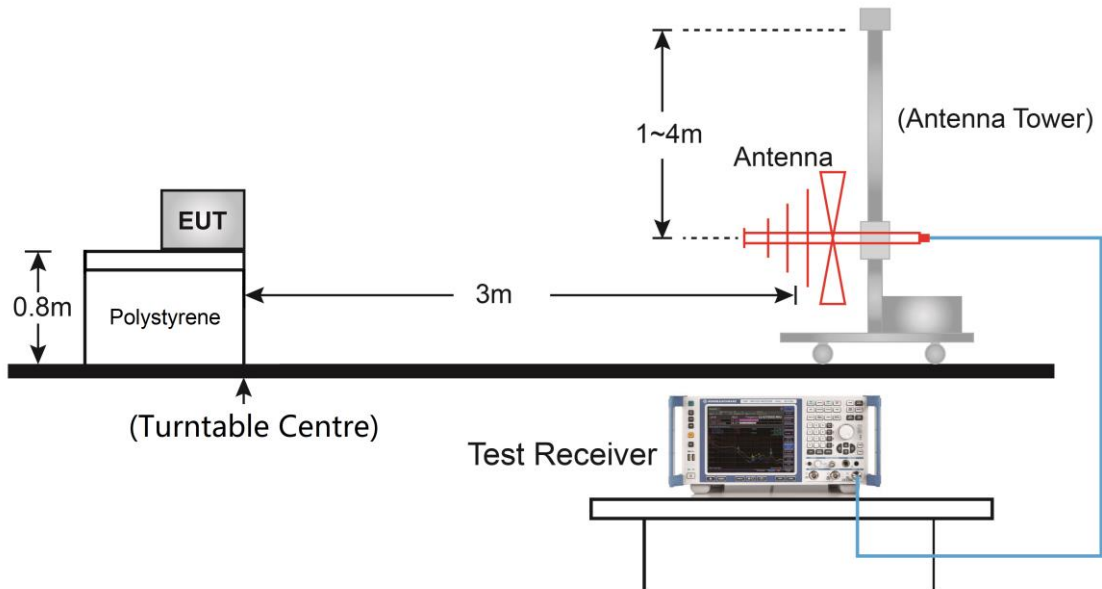

Above 1GHz Test Setup:

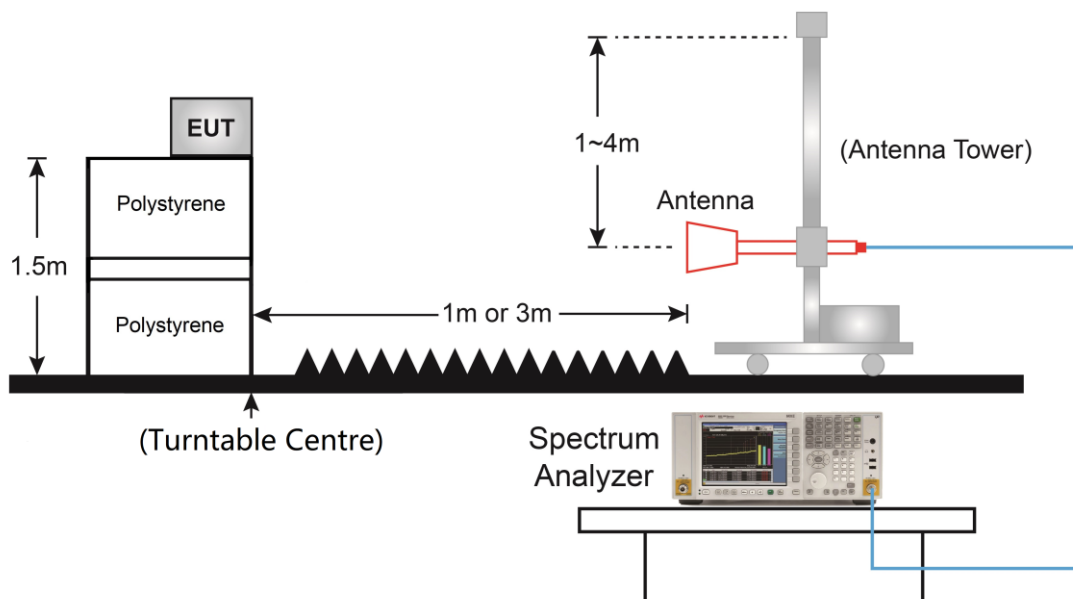

### 6.8.5. Test Result

**Nss=1**

EUT	AXE3000 Wi-Fi 6E High Gain Wireless USB Adapter	Date of Test	2023-10-27
Factor	VULB 9162	Temp. / Humidity	21°C /61%
Polarity	Horizontal	Site / Test Engineer	AC2 / Stanley
Test Mode	802.11ax-20MHz_Band5_TX_CH 1_ANT 1+2	Test Voltage	By Notebook

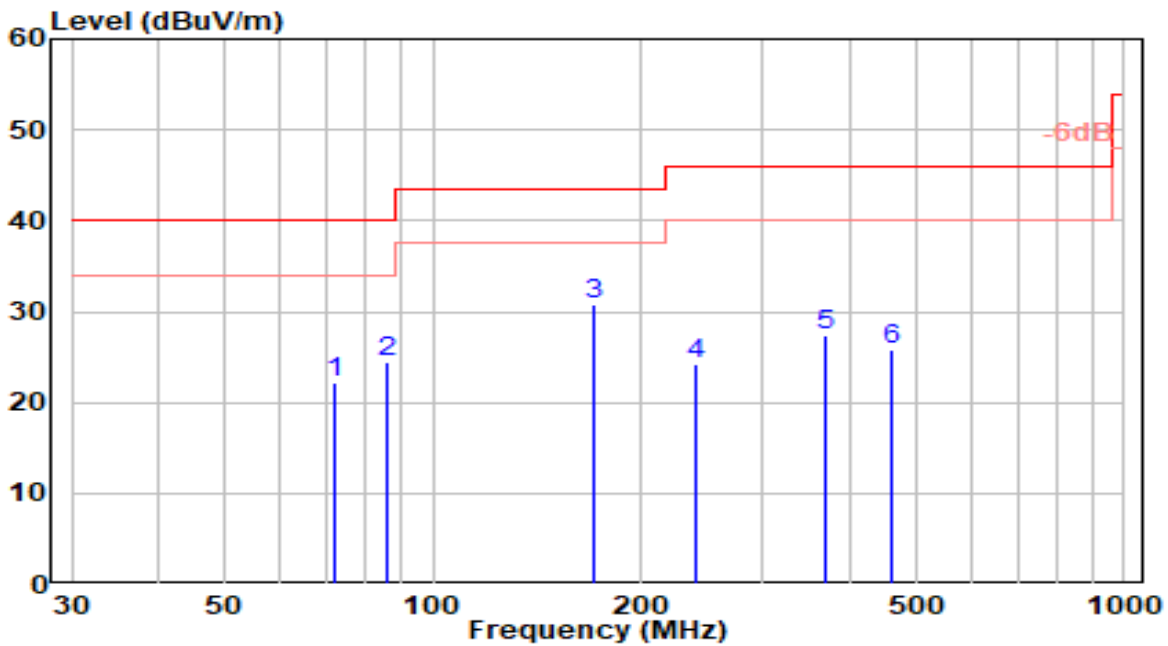

No	Frequency (MHz)	Reading (dBUV)	C.F (dB/m)	Measurement (dBUV/m)	Margin (dB)	Limit (dBUV/m)	Height (cm)	Angle (deg)	Remark (QP/PK/AV)
1	71.820	6.57	15.60	22.16	-17.84	40.00	100	35	QP
2	86.140	8.55	15.83	24.38	-15.62	40.00	150	319	QP
3	* 170.360	14.74	16.05	30.79	-12.71	43.50	200	316	QP
4	240.460	4.29	19.83	24.12	-21.88	46.00	100	35	QP
5	370.040	4.24	23.07	27.31	-18.69	46.00	200	168	QP
6	462.550	1.52	24.25	25.77	-20.23	46.00	150	53	QP

Note:

- "\*", means this data is the worst emission level.
- C.F (Correction Factor) = Antenna Factor (dB/m) + Cable Loss (dB).
- Measurement (dBUV/m) = Reading(dBUV) + C.F (Correction Factor).
- The emission levels of other frequencies are very lower than the limit and not show in test report.

EUT	AXE3000 Wi-Fi 6E High Gain Wireless USB Adapter	Date of Test	2023-10-27
Factor	VULB 9162	Temp. / Humidity	21°C /61%
Polarity	Vertical	Site / Test Engineer	AC2 / Stanley
Test Mode	802.11ax-20MHz_Band5_TX_CH 1_ANT 1+2	Test Voltage	By Notebook

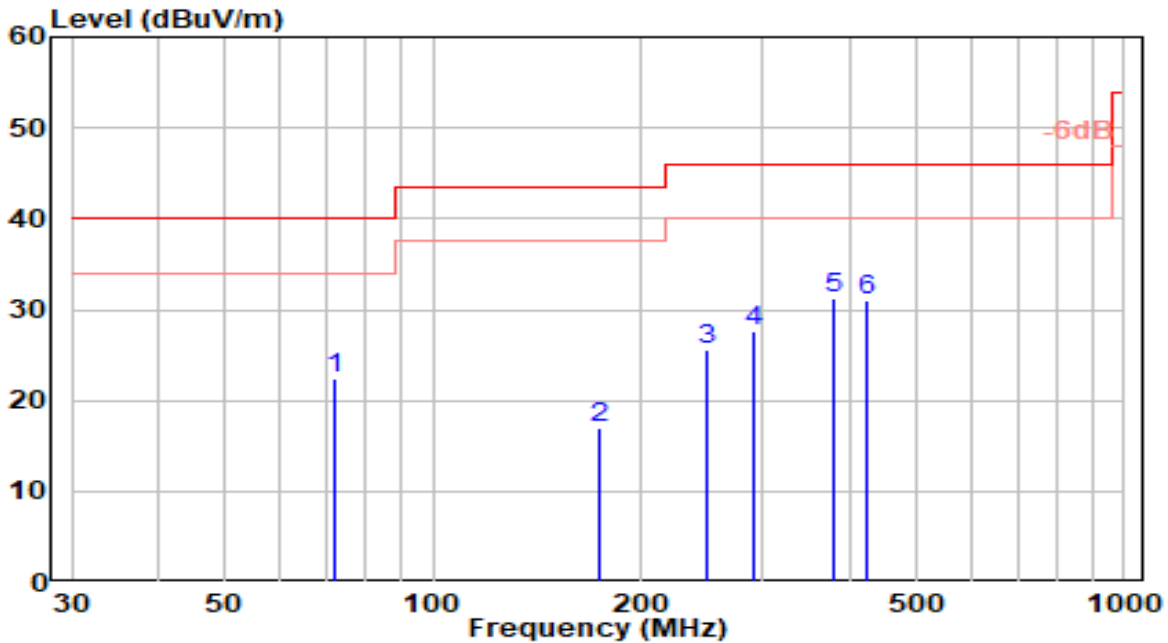

No	Frequency (MHz)	Reading (dBuV)	C.F (dB/m)	Measurement (dBuV/m)	Margin (dB)	Limit (dBuV/m)	Height (cm)	Angle (deg)	Remark (QP/PK/AV)
1	71.820	6.74	15.60	22.34	-17.66	40.00	200	58	QP
2	174.410	0.67	16.26	16.94	-26.56	43.50	150	84	QP
3	248.930	5.31	20.18	25.49	-20.51	46.00	150	323	QP
4	289.930	6.96	20.73	27.70	-18.30	46.00	200	159	QP
5	* 380.710	8.03	23.24	31.27	-14.73	46.00	100	22	QP
6	424.720	7.18	23.73	30.91	-15.09	46.00	100	4	QP

Note:

1. " \*", means this data is the worst emission level.
2. C.F (Correction Factor) = Antenna Factor (dB/m) + Cable Loss (dB).
3. Measurement (dBuV/m) = Reading(dBuV) + C.F (Correction Factor).
4. The emission levels of other frequencies are very lower than the limit and not show in test report.



**Nss=2**

EUT	AXE3000 Wi-Fi 6E High Gain Wireless USB Adapter	Date of Test	2023-10-27
Factor	VULB 9162	Temp. / Humidity	21°C /61%
Polarity	Horizontal	Site / Test Engineer	AC2 / Stanley
Test Mode	802.11ax-20MHz_Band5_TX_CH 1_ANT 1+2	Test Voltage	By Notebook

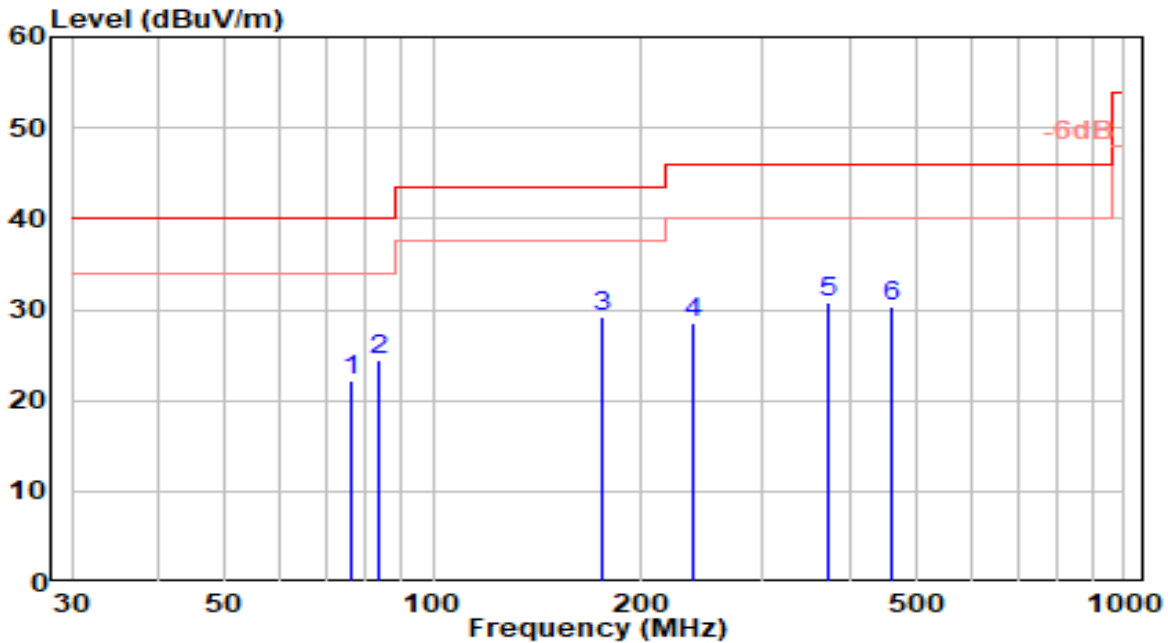

No	Frequency (MHz)	Reading (dBuV)	C.F (dB/m)	Measurement (dBuV/m)	Margin (dB)	Limit (dBuV/m)	Height (cm)	Angle (deg)	Remark (QP/PK/AV)
1	75.810	7.37	14.74	22.11	-17.89	40.00	200	56	QP
2	83.110	9.60	14.85	24.45	-15.55	40.00	150	340	QP
3	* 174.920	12.96	16.29	29.25	-14.25	43.50	200	337	QP
4	237.520	8.90	19.68	28.58	-17.42	46.00	150	56	QP
5	373.490	7.65	23.12	30.77	-15.23	46.00	150	189	QP
6	460.540	6.03	24.20	30.23	-15.77	46.00	200	74	QP

**Note:**

- "\*", means this data is the worst emission level.
- C.F (Correction Factor) = Antenna Factor (dB/m) + Cable Loss (dB).
- Measurement (dBuV/m) = Reading(dBuV) + C.F (Correction Factor).
- The emission levels of other frequencies are very lower than the limit and not show in test report.

EUT	AXE3000 Wi-Fi 6E High Gain Wireless USB Adapter	Date of Test	2023-10-27
Factor	VULB 9162	Temp. / Humidity	21°C /61%
Polarity	Vertical	Site / Test Engineer	AC2 / Stanley
Test Mode	802.11ax-20MHz_Band5_TX_CH 1_ANT 1+2	Test Voltage	By Notebook

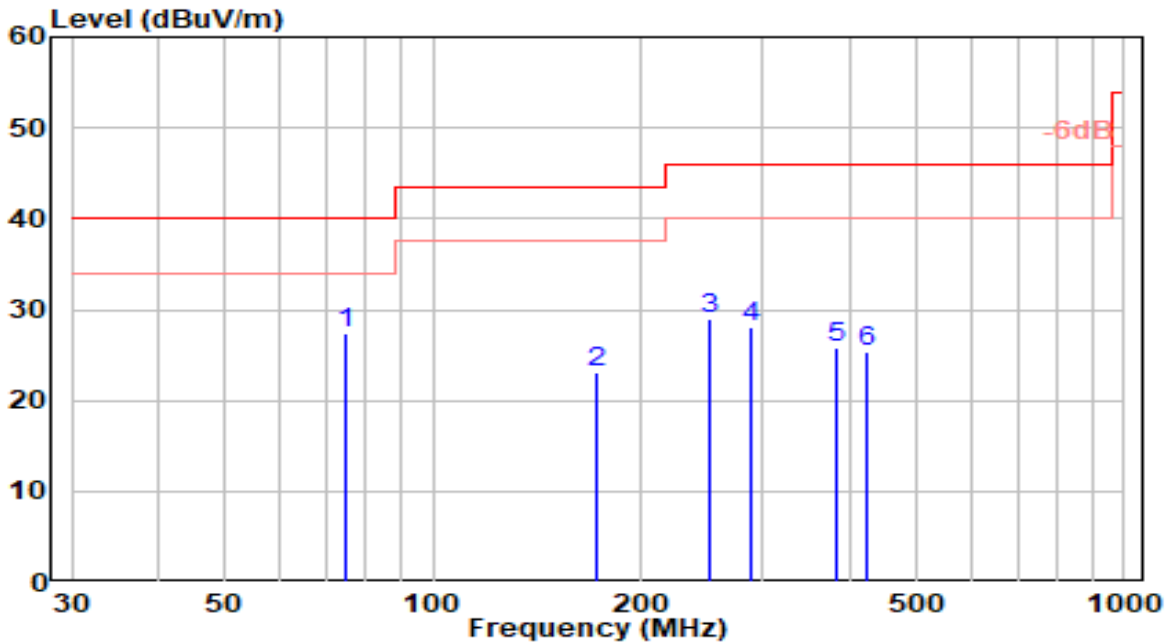

No	Frequency (MHz)	Reading (dBUV)	C.F (dB/m)	Measurement (dBUV/m)	Margin (dB)	Limit (dBUV/m)	Height (cm)	Angle (deg)	Remark (QP/PK/AV)
1	* 74.480	12.43	15.03	27.46	-12.54	40.00	150	72	QP
2	172.390	6.98	16.16	23.14	-20.36	43.50	200	98	QP
3	251.970	8.70	20.25	28.95	-17.05	46.00	100	337	QP
4	287.970	7.49	20.67	28.16	-17.84	46.00	200	173	QP
5	383.010	2.46	23.27	25.73	-20.27	46.00	100	36	QP
6	423.380	1.65	23.72	25.37	-20.63	46.00	150	18	QP

Note:

1. " \*", means this data is the worst emission level.
2. C.F (Correction Factor) = Antenna Factor (dB/m) + Cable Loss (dB).
3. Measurement (dBUV/m) = Reading(dBUV) + C.F (Correction Factor).
4. The emission levels of other frequencies are very lower than the limit and not show in test report.

**Nss=1**

EUT	AXE3000 Wi-Fi 6E High Gain Wireless USB Adapter	Date of Test	2023-10-27
Factor	DRH18-E	Temp. / Humidity	21°C /61%
Polarity	Horizontal	Site / Test Engineer	AC2 / Marvin
Test Mode	802.11ax-20MHz_TX_Band5_CH 1_ANT 1+2	Test Voltage	By Notebook PC

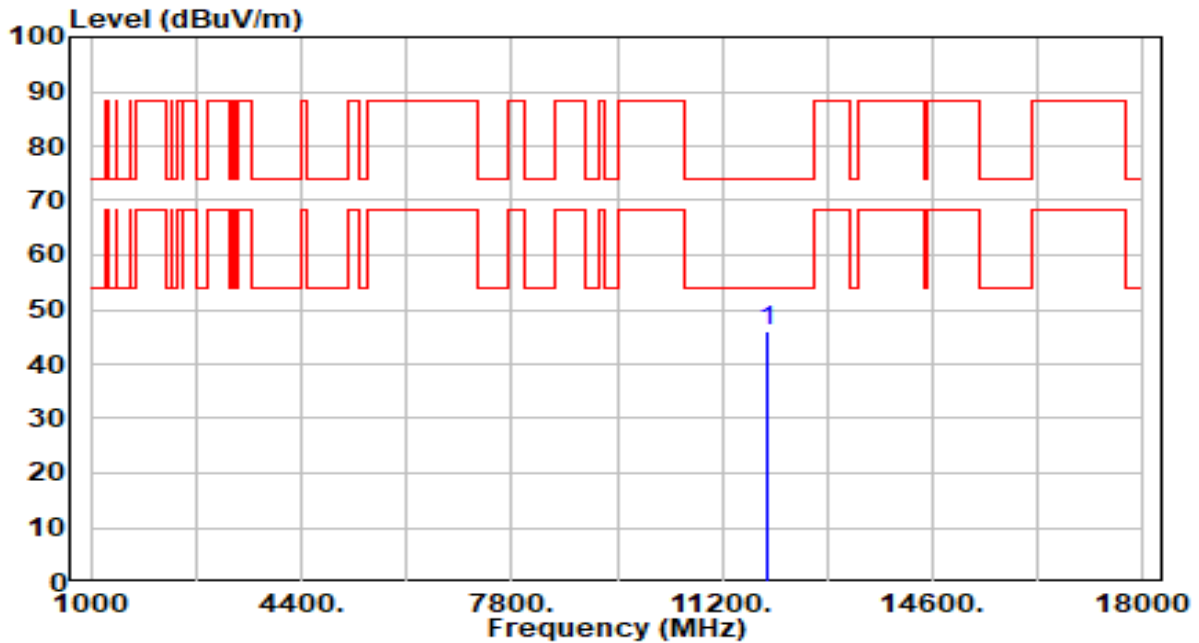

No	Frequency (MHz)	Reading (dBuV)	C.F (dB/m)	Measurement (dBuV/m)	Margin (dB)	Limit (dBuV/m)	Height (cm)	Angle (deg)	Remark (QP/PK/AV)
1	* 11910.000	42.41	3.78	46.19	-27.81	74.00	300	226	Peak

## Note:

1. " \*", means this data is the worst emission level.
2. C.F (Correction Factor) = Antenna Factor (dB/m)+ Cable Loss (dB) – Preamplifier(dB).
3. Measurement (dBuV/m) = Reading(dBuV) + C.F (Correction Factor).
4. The emission levels of other frequencies are very lower than the limit and not show in test report.

EUT	AXE3000 Wi-Fi 6E High Gain Wireless USB Adapter	Date of Test	2023-10-27
Factor	DRH18-E	Temp. / Humidity	21°C /61%
Polarity	Vertical	Site / Test Engineer	AC2 / Marvin
Test Mode	802.11ax-20MHz_TX_Band5_CH 1_ANT 1+2	Test Voltage	By Notebook PC

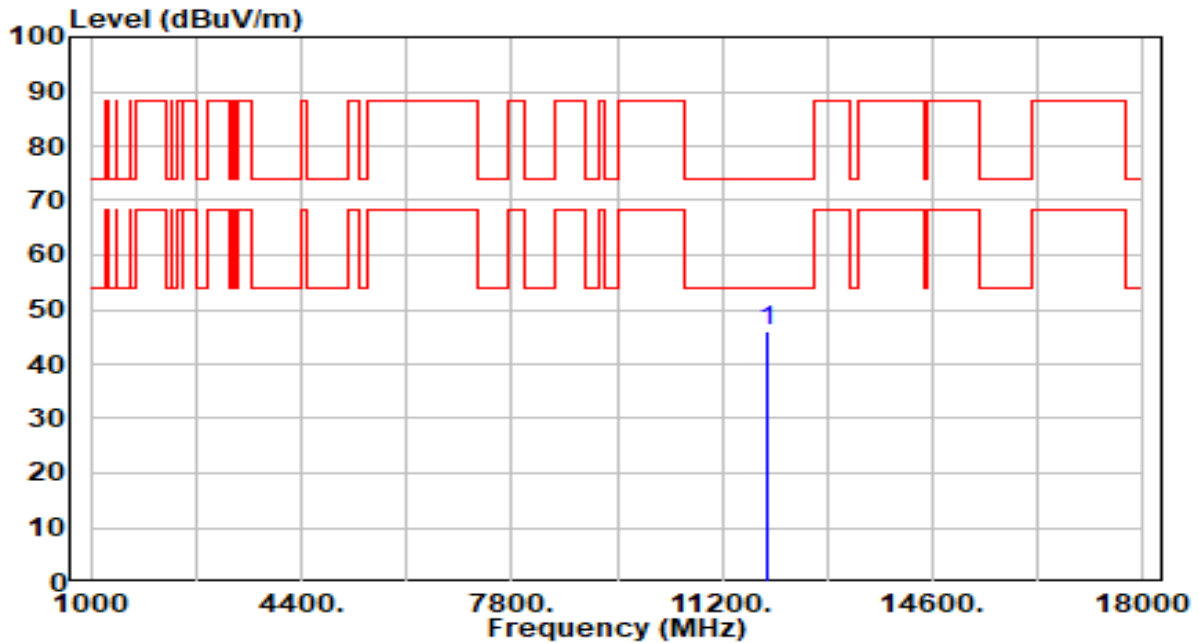

No	Frequency (MHz)	Reading (dBuV)	C.F (dB/m)	Measurement (dBuV/m)	Margin (dB)	Limit (dBuV/m)	Height (cm)	Angle (deg)	Remark (QP/PK/AV)
1	* 11910.000	42.40	3.78	46.17	-27.83	74.00	300	360	Peak

Note:

1. " \*", means this data is the worst emission level.
2. C.F (Correction Factor) = Antenna Factor (dB/m)+ Cable Loss (dB) – Preamplifier(dB).
3. Measurement (dBuV/m) = Reading(dBuV) + C.F (Correction Factor).
4. The emission levels of other frequencies are very lower than the limit and not show in test report.

EUT	AXE3000 Wi-Fi 6E High Gain Wireless USB Adapter	Date of Test	2023-10-27
Factor	DRH18-E	Temp. / Humidity	21°C /61%
Polarity	Horizontal	Site / Test Engineer	AC2 / Marvin
Test Mode	802.11ax-20MHz_TX_Band5_CH 33_ANT 1+2	Test Voltage	By Notebook PC

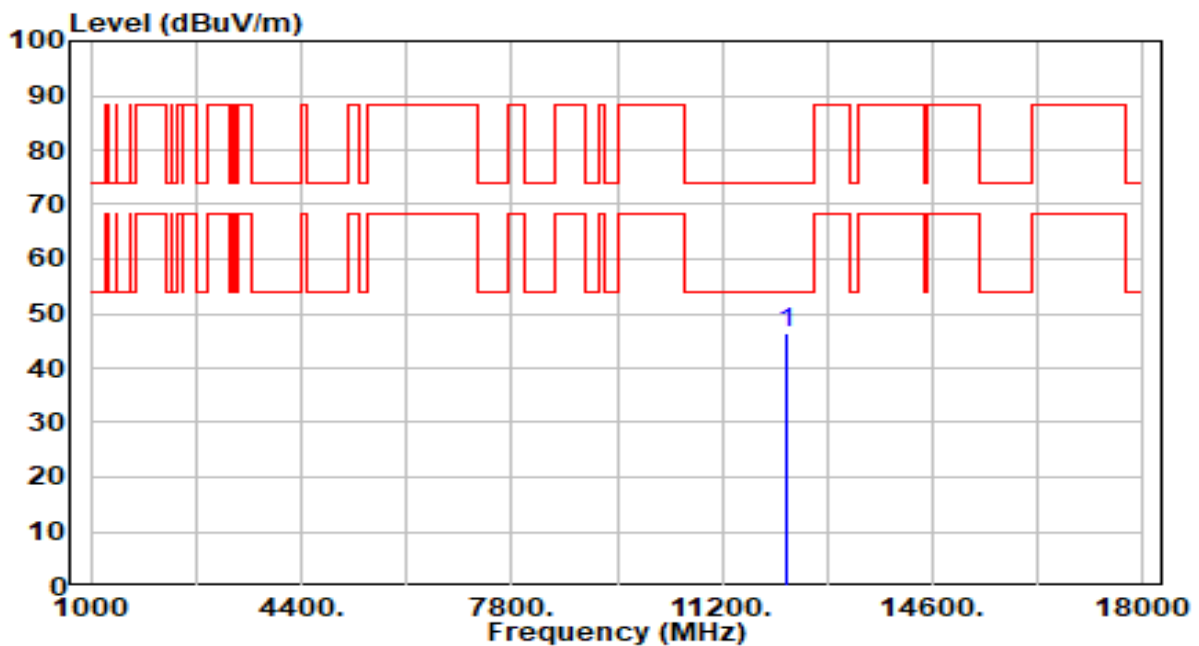

No	Frequency (MHz)	Reading (dBuV)	C.F (dB/m)	Measurement (dBuV/m)	Margin (dB)	Limit (dBuV/m)	Height (cm)	Angle (deg)	Remark (QP/PK/AV)
1	* 12230.000	41.97	4.33	46.30	-27.70	74.00	300	34	Peak

Note:

1. " \*", means this data is the worst emission level.
2. C.F (Correction Factor) = Antenna Factor (dB/m)+ Cable Loss (dB) – Preamplifier(dB).
3. Measurement (dBuV/m) = Reading(dBuV) + C.F (Correction Factor).
4. The emission levels of other frequencies are very lower than the limit and not show in test report.

EUT	AXE3000 Wi-Fi 6E High Gain Wireless USB Adapter	Date of Test	2023-10-27
Factor	DRH18-E	Temp. / Humidity	21°C /61%
Polarity	Vertical	Site / Test Engineer	AC2 / Marvin
Test Mode	802.11ax-20MHz_TX_Band5_CH 33_ANT 1+2	Test Voltage	By Notebook PC

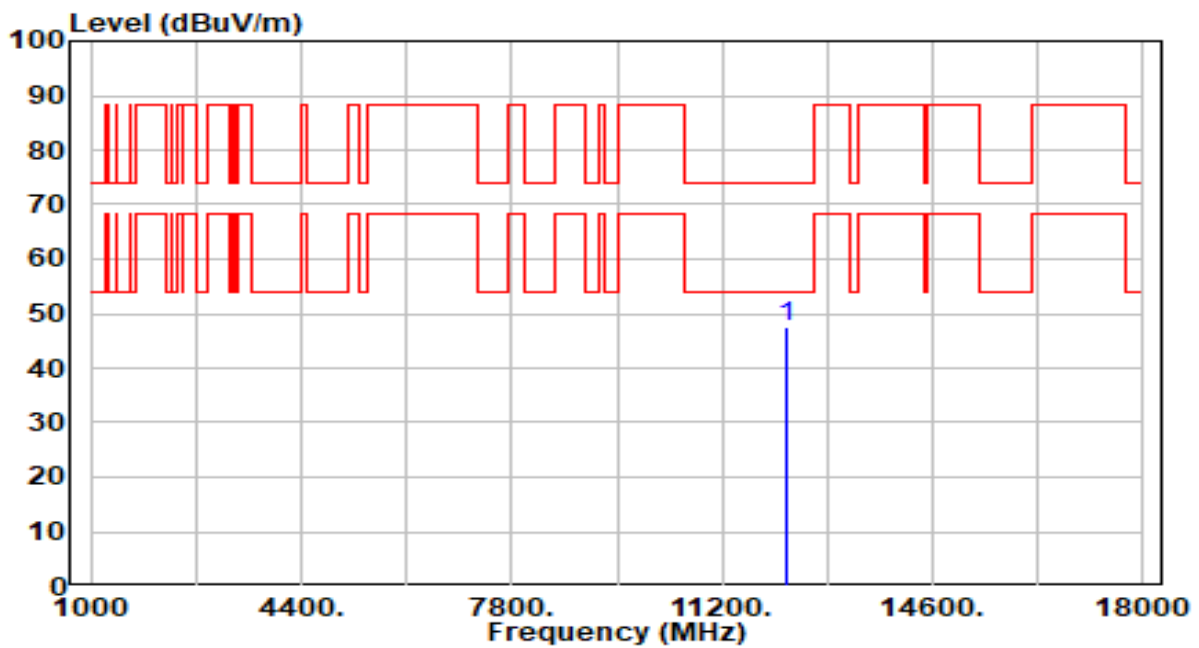

No	Frequency (MHz)	Reading (dBuV)	C.F (dB/m)	Measurement (dBuV/m)	Margin (dB)	Limit (dBuV/m)	Height (cm)	Angle (deg)	Remark (QP/PK/AV)
1	* 12230.000	43.20	4.33	47.53	-26.47	74.00	300	264	Peak

Note:

1. " \*", means this data is the worst emission level.
2. C.F (Correction Factor) = Antenna Factor (dB/m)+ Cable Loss (dB) – Preamplifier(dB).
3. Measurement (dBuV/m) = Reading(dBuV) + C.F (Correction Factor).
4. The emission levels of other frequencies are very lower than the limit and not show in test report.

EUT	AXE3000 Wi-Fi 6E High Gain Wireless USB Adapter	Date of Test	2023-10-27
Factor	DRH18-E	Temp. / Humidity	21°C /61%
Polarity	Horizontal	Site / Test Engineer	AC2 / Marvin
Test Mode	802.11ax-20MHz_TX_Band5_CH 93_ANT 1+2	Test Voltage	By Notebook PC

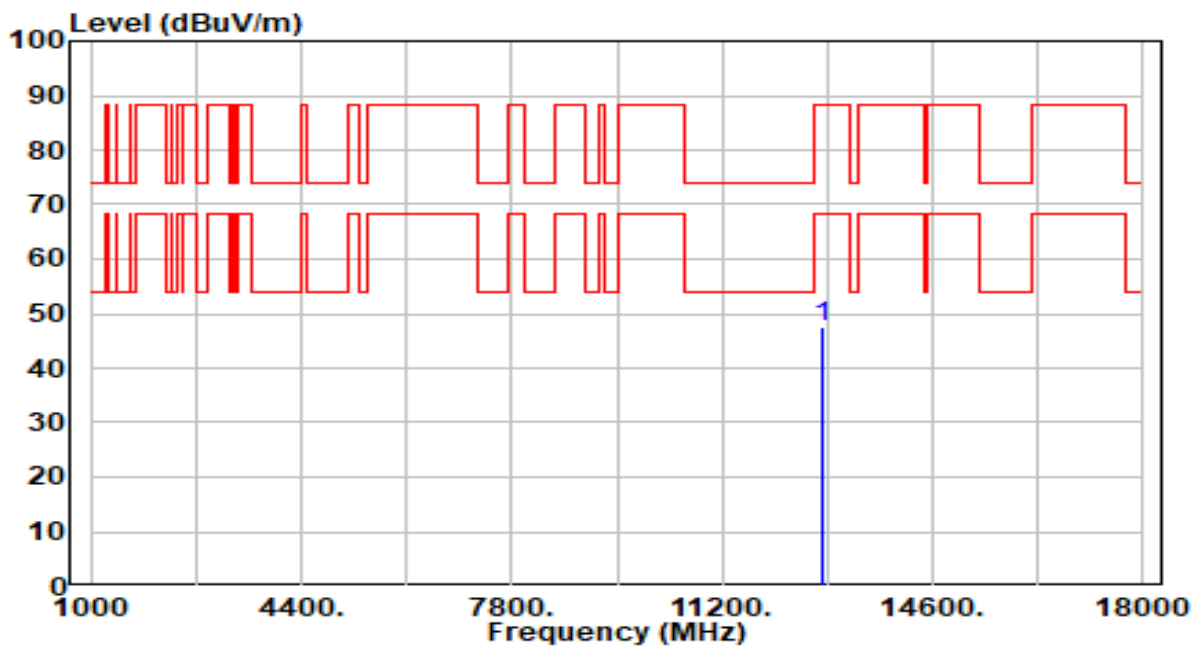

No	Frequency (MHz)	Reading (dBuV)	C.F (dB/m)	Measurement (dBuV/m)	Margin (dB)	Limit (dBuV/m)	Height (cm)	Angle (deg)	Remark (QP/PK/AV)
1	* 12830.000	42.43	5.29	47.72	-40.48	88.20	300	0	Peak

Note:

1. " \*", means this data is the worst emission level.
2. C.F (Correction Factor) = Antenna Factor (dB/m)+ Cable Loss (dB) – Preamplifier(dB).
3. Measurement (dBuV/m) = Reading(dBuV) + C.F (Correction Factor).
4. The emission levels of other frequencies are very lower than the limit and not show in test report.

EUT	AXE3000 Wi-Fi 6E High Gain Wireless USB Adapter	Date of Test	2023-10-27
Factor	DRH18-E	Temp. / Humidity	21°C /61%
Polarity	Vertical	Site / Test Engineer	AC2 / Marvin
Test Mode	802.11ax-20MHz_TX_Band5_CH 93_ANT 1+2	Test Voltage	By Notebook PC

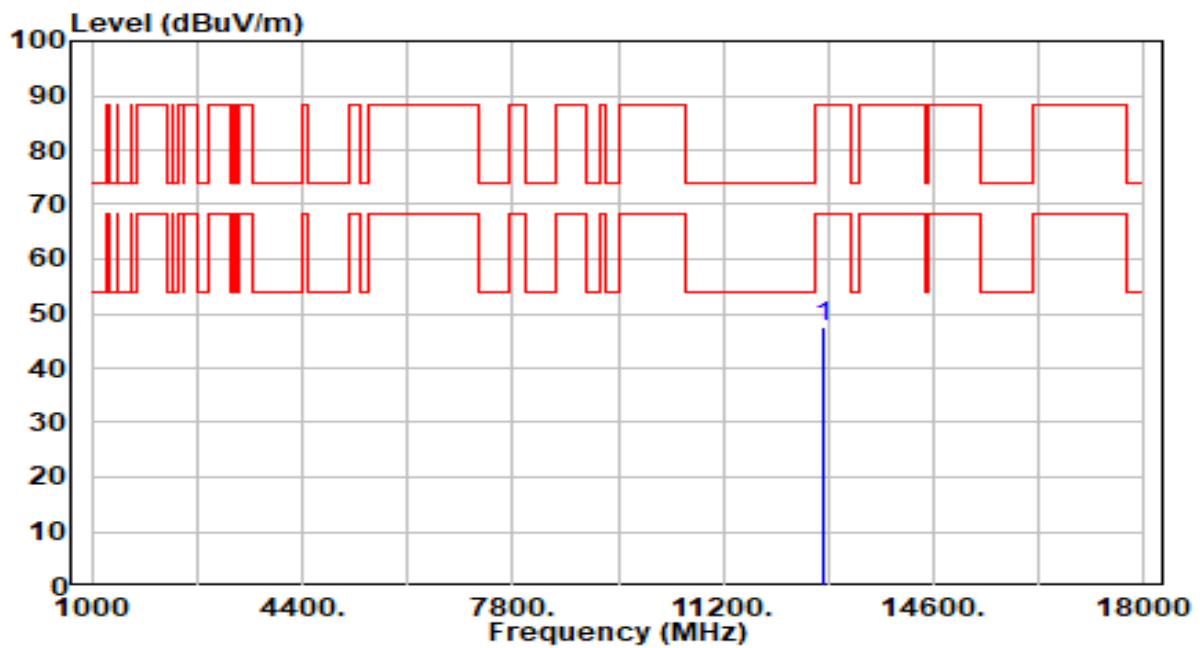

No	Frequency (MHz)	Reading (dBuV)	C.F (dB/m)	Measurement (dBuV/m)	Margin (dB)	Limit (dBuV/m)	Height (cm)	Angle (deg)	Remark (QP/PK/AV)
1	* 12830.000	42.18	5.29	47.48	-40.72	88.20	300	342	Peak

Note:

1. " \*", means this data is the worst emission level.
2. C.F (Correction Factor) = Antenna Factor (dB/m)+ Cable Loss (dB) – Preamplifier(dB).
3. Measurement (dBuV/m) = Reading(dBuV) + C.F (Correction Factor).
4. The emission levels of other frequencies are very lower than the limit and not show in test report.



EUT	AXE3000 Wi-Fi 6E High Gain Wireless USB Adapter	Date of Test	2023-10-27
Factor	DRH18-E	Temp. / Humidity	21°C /61%
Polarity	Horizontal	Site / Test Engineer	AC2 / Marvin
Test Mode	802.11ax-20MHz_TX_Band6_CH 97_ANT 1+2	Test Voltage	By Notebook PC

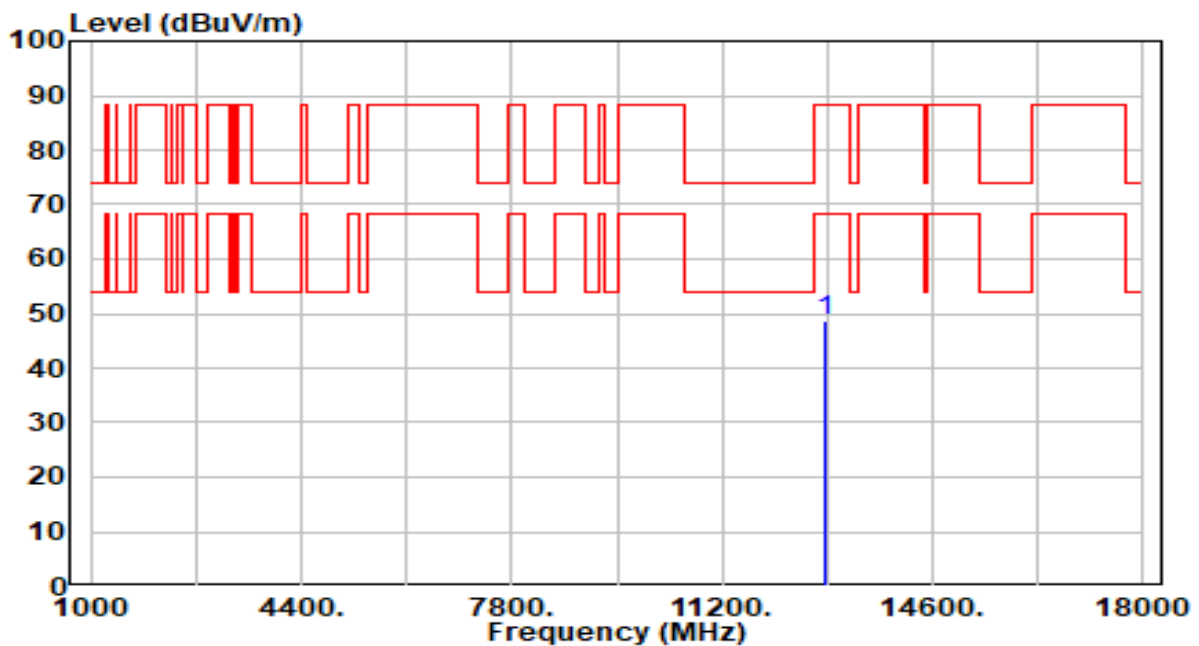

No	Frequency (MHz)	Reading (dBuV)	C.F (dB/m)	Measurement (dBuV/m)	Margin (dB)	Limit (dBuV/m)	Height (cm)	Angle (deg)	Remark (QP/PK/AV)
1	* 12870.000	43.39	5.28	48.68	-39.52	88.20	300	233	Peak

Note:

1. " \*", means this data is the worst emission level.
2. C.F (Correction Factor) = Antenna Factor (dB/m)+ Cable Loss (dB) – Preamplifier(dB).
3. Measurement (dBuV/m) = Reading(dBuV) + C.F (Correction Factor).
4. The emission levels of other frequencies are very lower than the limit and not show in test report.

EUT	AXE3000 Wi-Fi 6E High Gain Wireless USB Adapter	Date of Test	2023-10-27
Factor	DRH18-E	Temp. / Humidity	21°C /61%
Polarity	Vertical	Site / Test Engineer	AC2 / Marvin
Test Mode	802.11ax-20MHz_TX_Band6_CH 97_ANT 1+2	Test Voltage	By Notebook PC

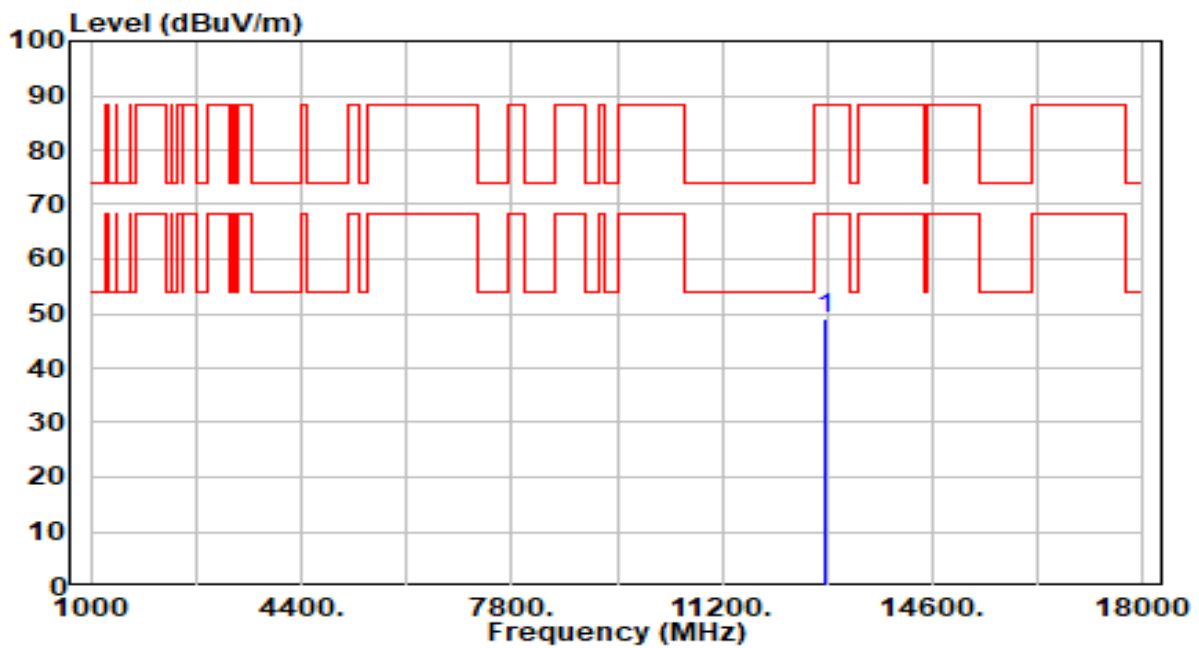

No	Frequency (MHz)	Reading (dBuV)	C.F (dB/m)	Measurement (dBuV/m)	Margin (dB)	Limit (dBuV/m)	Height (cm)	Angle (deg)	Remark (QP/PK/AV)
1	* 12870.000	43.82	5.28	49.10	-39.10	88.20	300	36	Peak

Note:

1. " \*", means this data is the worst emission level.
2. C.F (Correction Factor) = Antenna Factor (dB/m)+ Cable Loss (dB) – Preamplifier(dB).
3. Measurement (dBuV/m) = Reading(dBuV) + C.F (Correction Factor).
4. The emission levels of other frequencies are very lower than the limit and not show in test report.

EUT	AXE3000 Wi-Fi 6E High Gain Wireless USB Adapter	Date of Test	2023-10-27
Factor	DRH18-E	Temp. / Humidity	21°C /61%
Polarity	Horizontal	Site / Test Engineer	AC2 / Marvin
Test Mode	802.11ax-20MHz_TX_Band6_CH 105_ANT 1+2	Test Voltage	By Notebook PC

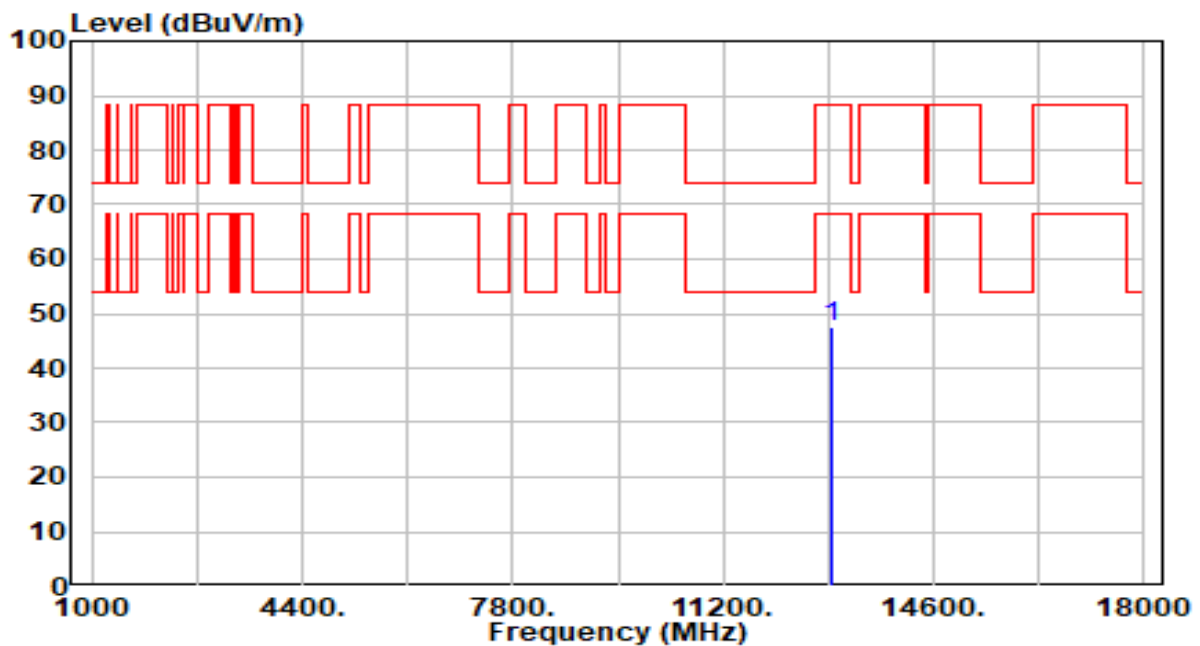

No	Frequency (MHz)	Reading (dBuV)	C.F (dB/m)	Measurement (dBuV/m)	Margin (dB)	Limit (dBuV/m)	Height (cm)	Angle (deg)	Remark (QP/PK/AV)
1	* 12950.000	42.48	5.26	47.73	-40.47	88.20	300	163	Peak

Note:

1. " \*", means this data is the worst emission level.
2. C.F (Correction Factor) = Antenna Factor (dB/m)+ Cable Loss (dB) – Preamplifier(dB).
3. Measurement (dBuV/m) = Reading(dBuV) + C.F (Correction Factor).
4. The emission levels of other frequencies are very lower than the limit and not show in test report.

EUT	AXE3000 Wi-Fi 6E High Gain Wireless USB Adapter	Date of Test	2023-10-27
Factor	DRH18-E	Temp. / Humidity	21°C /61%
Polarity	Vertical	Site / Test Engineer	AC2 / Marvin
Test Mode	802.11ax-20MHz_TX_Band6_CH 105_ANT 1+2	Test Voltage	By Notebook PC

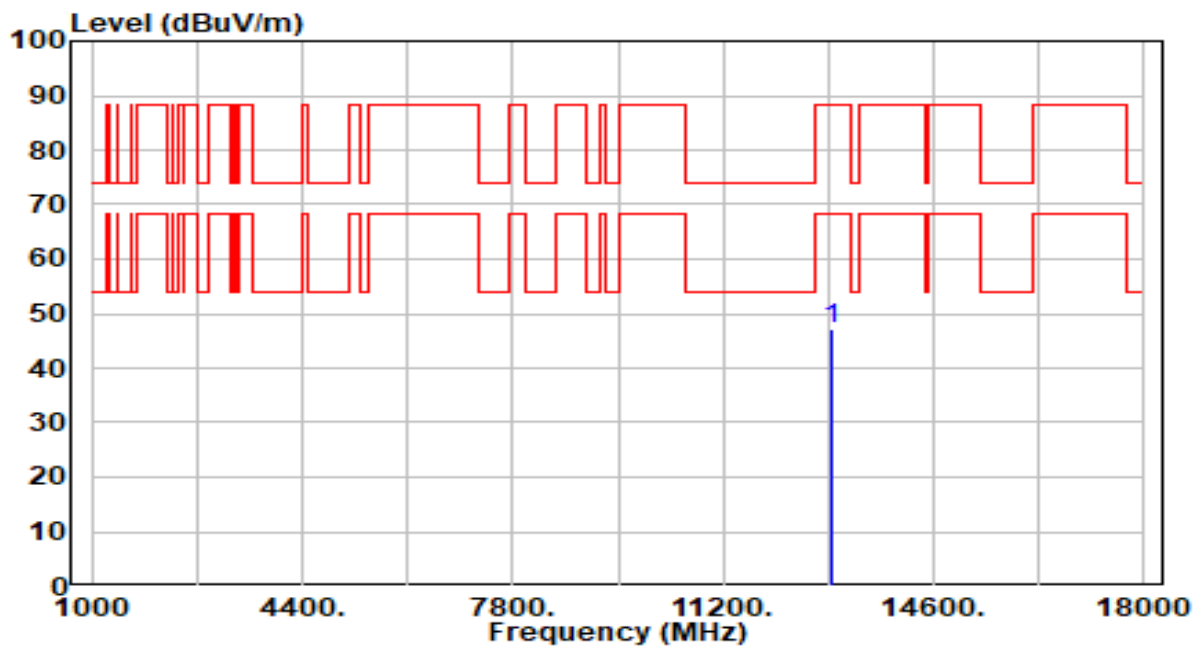

No	Frequency (MHz)	Reading (dBuV)	C.F (dB/m)	Measurement (dBuV/m)	Margin (dB)	Limit (dBuV/m)	Height (cm)	Angle (deg)	Remark (QP/PK/AV)
1	* 12950.000	41.97	5.26	47.22	-40.98	88.20	300	5	Peak

Note:

1. " \*", means this data is the worst emission level.
2. C.F (Correction Factor) = Antenna Factor (dB/m)+ Cable Loss (dB) – Preamplifier(dB).
3. Measurement (dBuV/m) = Reading(dBuV) + C.F (Correction Factor).
4. The emission levels of other frequencies are very lower than the limit and not show in test report.

EUT	AXE3000 Wi-Fi 6E High Gain Wireless USB Adapter	Date of Test	2023-10-27
Factor	DRH18-E	Temp. / Humidity	21°C /61%
Polarity	Horizontal	Site / Test Engineer	AC2 / Marvin
Test Mode	802.11ax-20MHz_TX_Band6_CH 113_ANT 1+2	Test Voltage	By Notebook PC

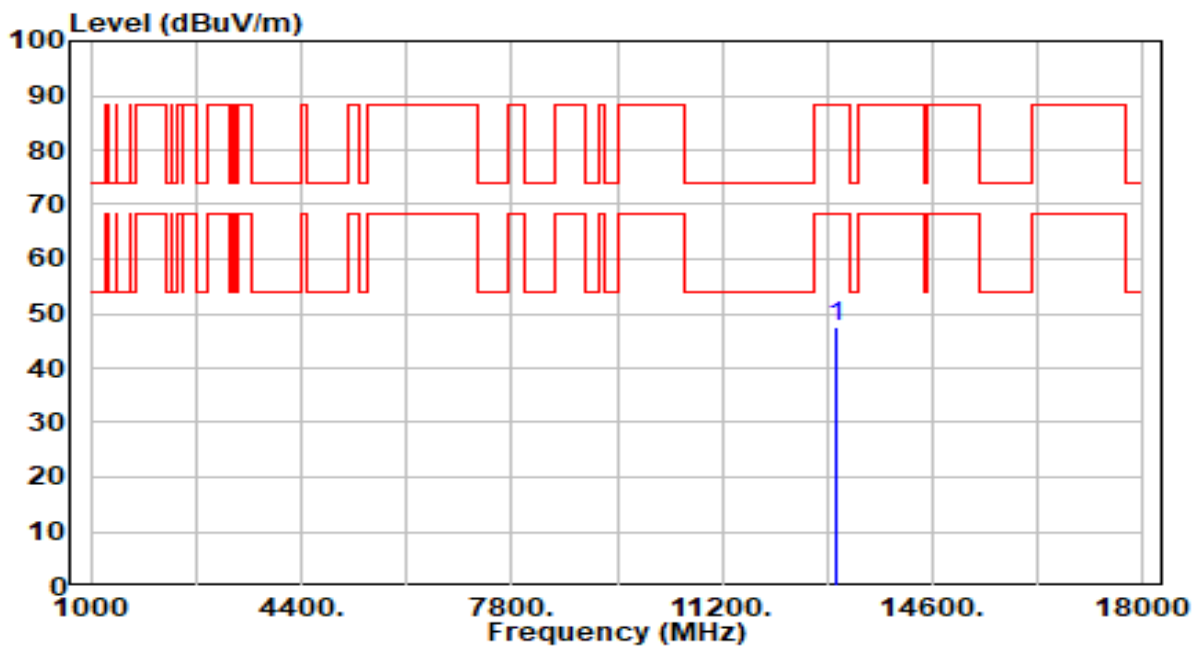

No	Frequency (MHz)	Reading (dBuV)	C.F (dB/m)	Measurement (dBuV/m)	Margin (dB)	Limit (dBuV/m)	Height (cm)	Angle (deg)	Remark (QP/PK/AV)
1	* 13030.000	42.45	5.23	47.69	-40.51	88.20	300	120	Peak

Note:

1. " \*", means this data is the worst emission level.
2. C.F (Correction Factor) = Antenna Factor (dB/m)+ Cable Loss (dB) – Preamplifier(dB).
3. Measurement (dBuV/m) = Reading(dBuV) + C.F (Correction Factor).
4. The emission levels of other frequencies are very lower than the limit and not show in test report.

EUT	AXE3000 Wi-Fi 6E High Gain Wireless USB Adapter	Date of Test	2023-10-27
Factor	DRH18-E	Temp. / Humidity	21°C /61%
Polarity	Vertical	Site / Test Engineer	AC2 / Marvin
Test Mode	802.11ax-20MHz_TX_Band6_CH 113_ANT 1+2	Test Voltage	By Notebook PC

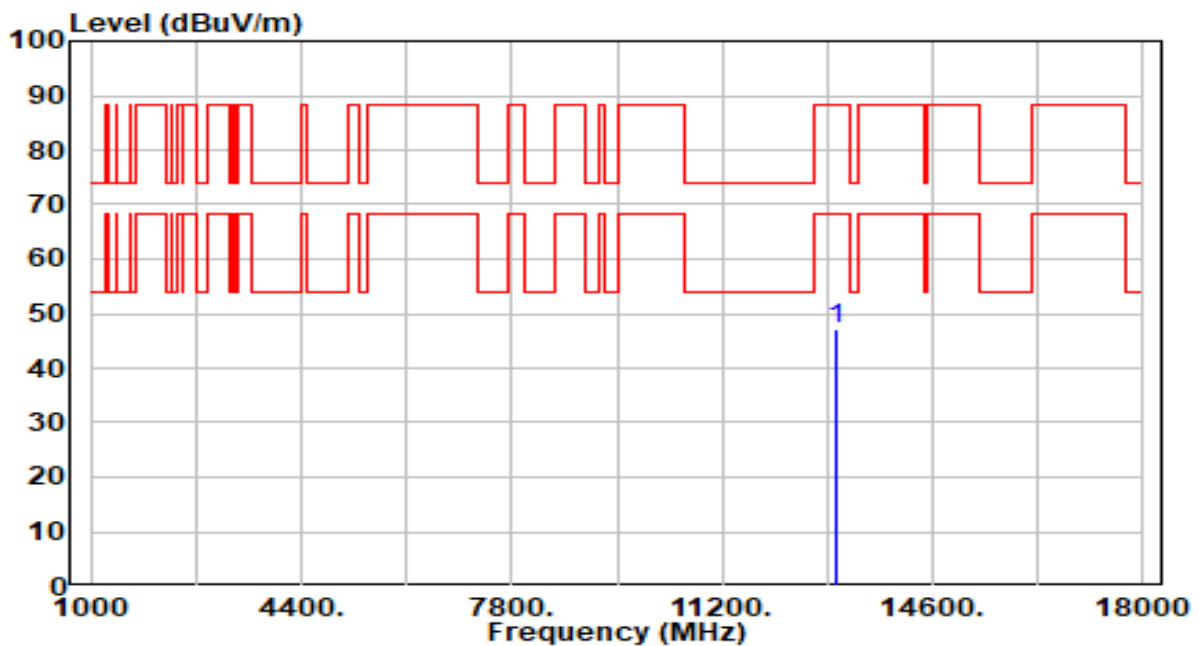

No	Frequency (MHz)	Reading (dBuV)	C.F (dB/m)	Measurement (dBuV/m)	Margin (dB)	Limit (dBuV/m)	Height (cm)	Angle (deg)	Remark (QP/PK/AV)
1	* 13030.000	41.93	5.23	47.16	-41.04	88.20	300	256	Peak

Note:

1. " \*", means this data is the worst emission level.
2. C.F (Correction Factor) = Antenna Factor (dB/m)+ Cable Loss (dB) – Preamplifier(dB).
3. Measurement (dBuV/m) = Reading(dBuV) + C.F (Correction Factor).
4. The emission levels of other frequencies are very lower than the limit and not show in test report.

EUT	AXE3000 Wi-Fi 6E High Gain Wireless USB Adapter	Date of Test	2023-10-27
Factor	DRH18-E	Temp. / Humidity	21°C /61%
Polarity	Horizontal	Site / Test Engineer	AC2 / Marvin
Test Mode	802.11ax-20MHz_TX_Band7_CH 117_ANT 1+2	Test Voltage	By Notebook PC

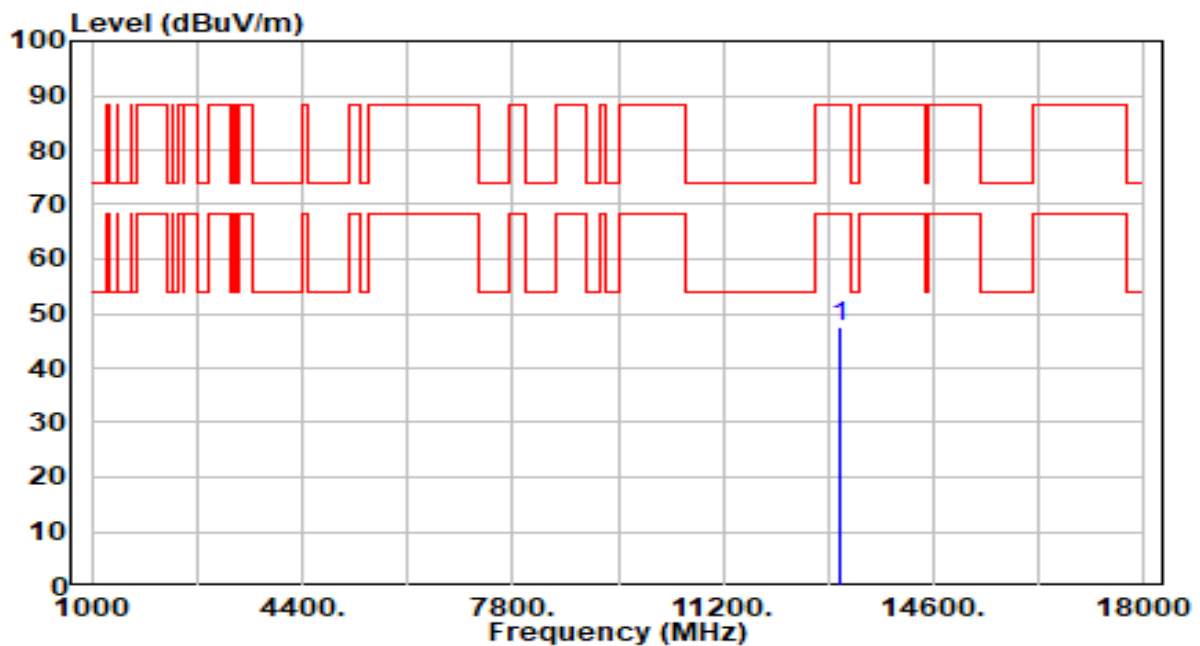

No	Frequency (MHz)	Reading (dBuV)	C.F (dB/m)	Measurement (dBuV/m)	Margin (dB)	Limit (dBuV/m)	Height (cm)	Angle (deg)	Remark (QP/PK/AV)
1	* 13070.000	42.17	5.23	47.39	-40.81	88.20	300	99	Peak

Note:

1. " \*", means this data is the worst emission level.
2. C.F (Correction Factor) = Antenna Factor (dB/m)+ Cable Loss (dB) – Preamplifier(dB).
3. Measurement (dBuV/m) = Reading(dBuV) + C.F (Correction Factor).
4. The emission levels of other frequencies are very lower than the limit and not show in test report.

EUT	AXE3000 Wi-Fi 6E High Gain Wireless USB Adapter	Date of Test	2023-10-27
Factor	DRH18-E	Temp. / Humidity	21°C /61%
Polarity	Vertical	Site / Test Engineer	AC2 / Marvin
Test Mode	802.11ax-20MHz_TX_Band7_CH 117_ANT 1+2	Test Voltage	By Notebook PC

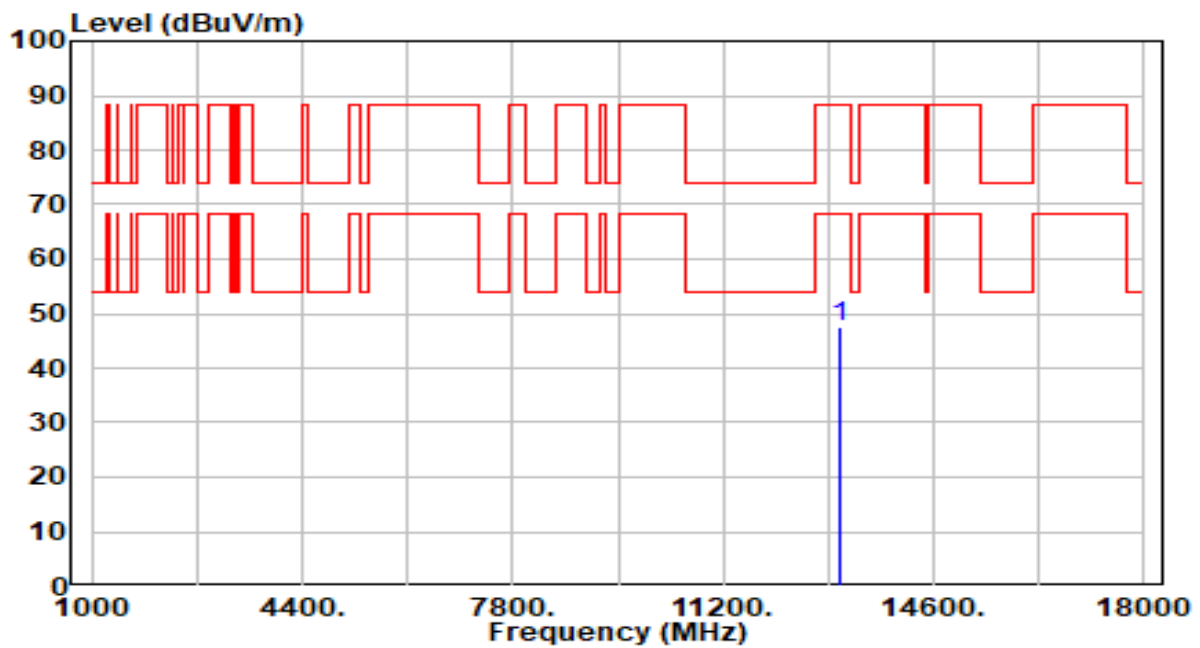

No	Frequency (MHz)	Reading (dBuV)	C.F (dB/m)	Measurement (dBuV/m)	Margin (dB)	Limit (dBuV/m)	Height (cm)	Angle (deg)	Remark (QP/PK/AV)
1	* 13070.000	42.41	5.23	47.64	-40.56	88.20	300	222	Peak

Note:

1. " \*", means this data is the worst emission level.
2. C.F (Correction Factor) = Antenna Factor (dB/m)+ Cable Loss (dB) – Preamplifier(dB).
3. Measurement (dBuV/m) = Reading(dBuV) + C.F (Correction Factor).
4. The emission levels of other frequencies are very lower than the limit and not show in test report.



EUT	AXE3000 Wi-Fi 6E High Gain Wireless USB Adapter	Date of Test	2023-10-27
Factor	DRH18-E	Temp. / Humidity	21°C /61%
Polarity	Horizontal	Site / Test Engineer	AC2 / Marvin
Test Mode	802.11ax-20MHz_TX_Band7_CH 153_ANT 1+2	Test Voltage	By Notebook PC

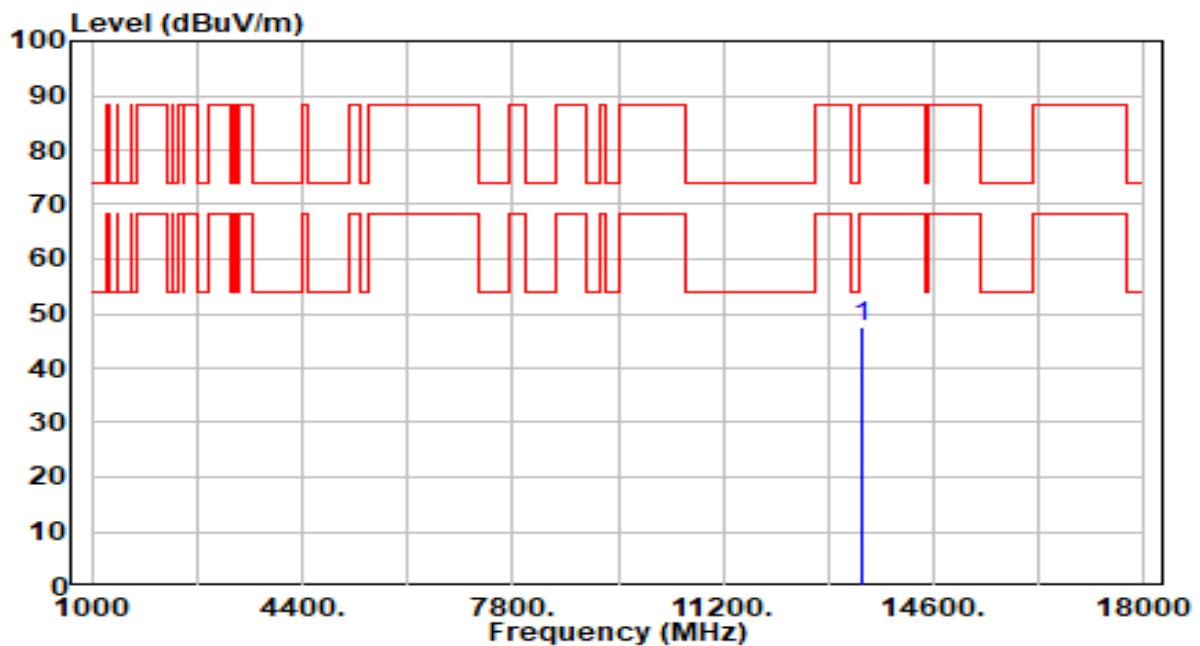

No	Frequency (MHz)	Reading (dBuV)	C.F (dB/m)	Measurement (dBuV/m)	Margin (dB)	Limit (dBuV/m)	Height (cm)	Angle (deg)	Remark (QP/PK/AV)
1	* 13430.000	42.37	5.24	47.61	-40.59	88.20	300	0	Peak

Note:

1. " \*", means this data is the worst emission level.
2. C.F (Correction Factor) = Antenna Factor (dB/m)+ Cable Loss (dB) – Preamplifier(dB).
3. Measurement (dBuV/m) = Reading(dBuV) + C.F (Correction Factor).
4. The emission levels of other frequencies are very lower than the limit and not show in test report.

EUT	AXE3000 Wi-Fi 6E High Gain Wireless USB Adapter	Date of Test	2023-10-27
Factor	DRH18-E	Temp. / Humidity	21°C /61%
Polarity	Vertical	Site / Test Engineer	AC2 / Marvin
Test Mode	802.11ax-20MHz_TX_Band7_CH 153_ANT 1+2	Test Voltage	By Notebook PC

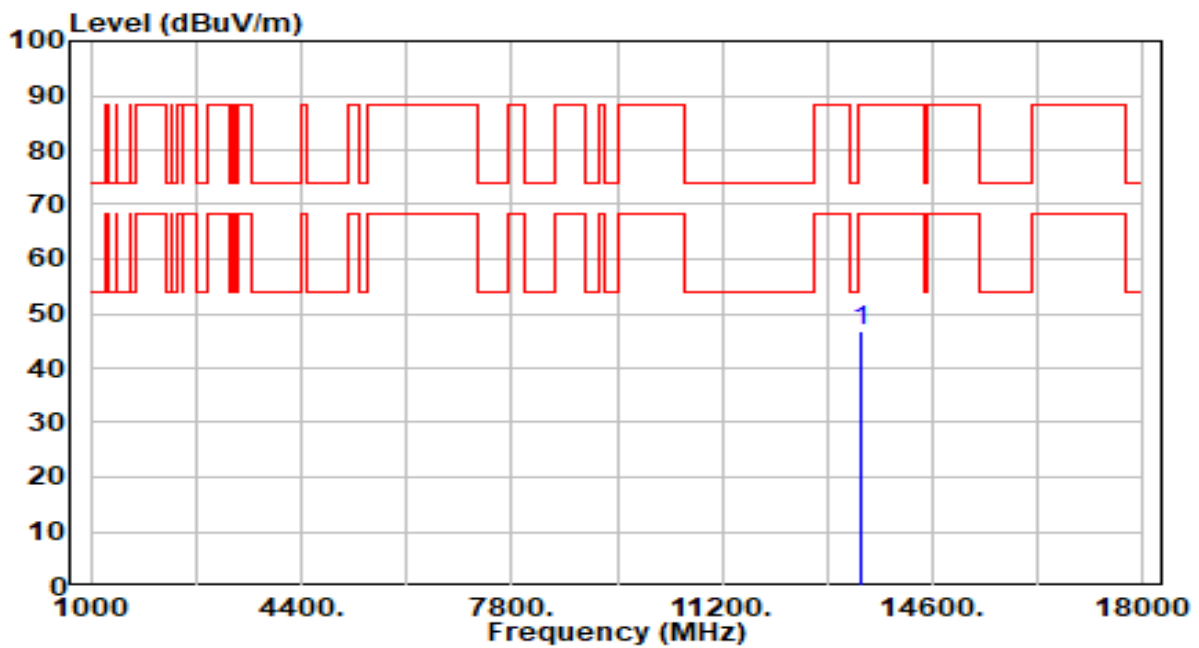

No	Frequency (MHz)	Reading (dBuV)	C.F (dB/m)	Measurement (dBuV/m)	Margin (dB)	Limit (dBuV/m)	Height (cm)	Angle (deg)	Remark (QP/PK/AV)
1	* 13430.000	41.74	5.24	46.98	-41.22	88.20	300	14	Peak

Note:

1. " \*", means this data is the worst emission level.
2. C.F (Correction Factor) = Antenna Factor (dB/m)+ Cable Loss (dB) – Preamplifier(dB).
3. Measurement (dBuV/m) = Reading(dBuV) + C.F (Correction Factor).
4. The emission levels of other frequencies are very lower than the limit and not show in test report.

EUT	AXE3000 Wi-Fi 6E High Gain Wireless USB Adapter	Date of Test	2023-10-27
Factor	DRH18-E	Temp. / Humidity	21°C /61%
Polarity	Horizontal	Site / Test Engineer	AC2 / Marvin
Test Mode	802.11ax-20MHz_TX_Band7_CH 181_ANT 1+2	Test Voltage	By Notebook PC

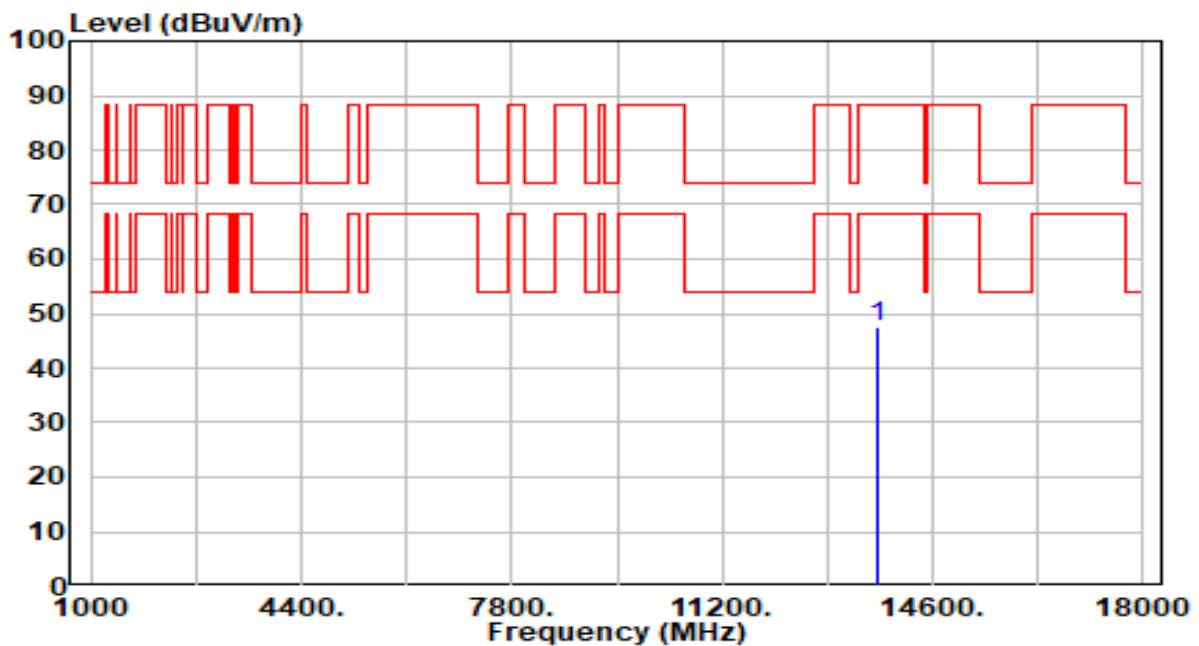

No	Frequency (MHz)	Reading (dBuV)	C.F (dB/m)	Measurement (dBuV/m)	Margin (dB)	Limit (dBuV/m)	Height (cm)	Angle (deg)	Remark (QP/PK/AV)
1	* 13710.000	42.41	5.02	47.43	-40.77	88.20	300	310	Peak

Note:

1. " \*", means this data is the worst emission level.
2. C.F (Correction Factor) = Antenna Factor (dB/m)+ Cable Loss (dB) – Preamplifier(dB).
3. Measurement (dBuV/m) = Reading(dBuV) + C.F (Correction Factor).
4. The emission levels of other frequencies are very lower than the limit and not show in test report.

EUT	AXE3000 Wi-Fi 6E High Gain Wireless USB Adapter	Date of Test	2023-10-27
Factor	DRH18-E	Temp. / Humidity	21°C /61%
Polarity	Vertical	Site / Test Engineer	AC2 / Marvin
Test Mode	802.11ax-20MHz_TX_Band7_CH 181_ANT 1+2	Test Voltage	By Notebook PC

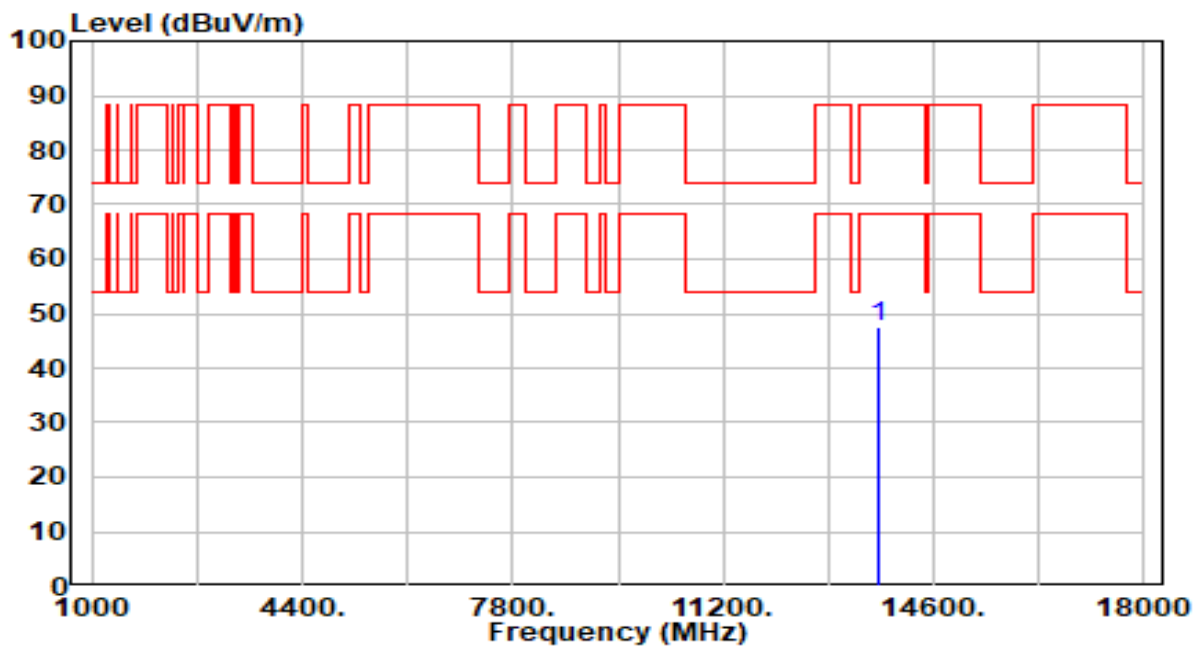

No	Frequency (MHz)	Reading (dBuV)	C.F (dB/m)	Measurement (dBuV/m)	Margin (dB)	Limit (dBuV/m)	Height (cm)	Angle (deg)	Remark (QP/PK/AV)
1	* 13710.000	42.46	5.02	47.48	-40.72	88.20	300	69	Peak

Note:

1. " \*", means this data is the worst emission level.
2. C.F (Correction Factor) = Antenna Factor (dB/m)+ Cable Loss (dB) – Preamplifier(dB).
3. Measurement (dBuV/m) = Reading(dBuV) + C.F (Correction Factor).
4. The emission levels of other frequencies are very lower than the limit and not show in test report.

EUT	AXE3000 Wi-Fi 6E High Gain Wireless USB Adapter	Date of Test	2023-10-27
Factor	DRH18-E	Temp. / Humidity	21°C /61%
Polarity	Horizontal	Site / Test Engineer	AC2 / Marvin
Test Mode	802.11ax-20MHz_TX_Band7_CH 185_ANT 1+2	Test Voltage	By Notebook PC

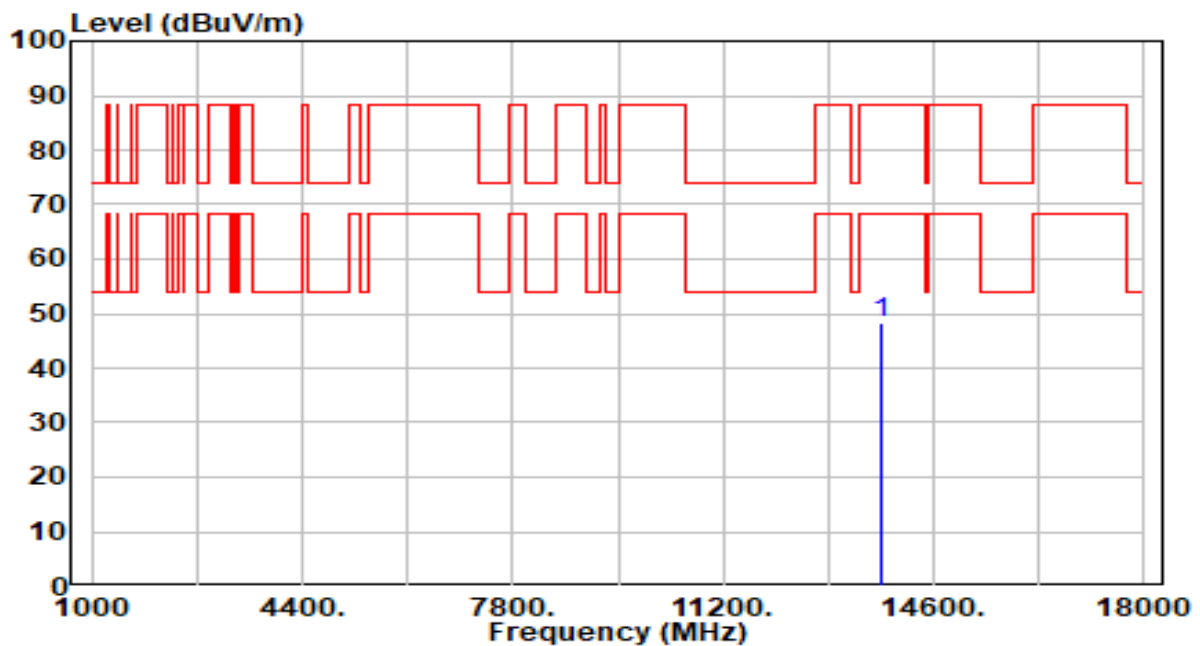

No	Frequency (MHz)	Reading (dBuV)	C.F (dB/m)	Measurement (dBuV/m)	Margin (dB)	Limit (dBuV/m)	Height (cm)	Angle (deg)	Remark (QP/PK/AV)
1	* 13750.000	43.13	5.03	48.16	-40.04	88.20	300	60	Peak

Note:

1. " \*", means this data is the worst emission level.
2. C.F (Correction Factor) = Antenna Factor (dB/m)+ Cable Loss (dB) – Preamplifier(dB).
3. Measurement (dBuV/m) = Reading(dBuV) + C.F (Correction Factor).
4. The emission levels of other frequencies are very lower than the limit and not show in test report.

EUT	AXE3000 Wi-Fi 6E High Gain Wireless USB Adapter	Date of Test	2023-10-27
Factor	DRH18-E	Temp. / Humidity	21°C /61%
Polarity	Vertical	Site / Test Engineer	AC2 / Marvin
Test Mode	802.11ax-20MHz_TX_Band7_CH 185_ANT 1+2	Test Voltage	By Notebook PC

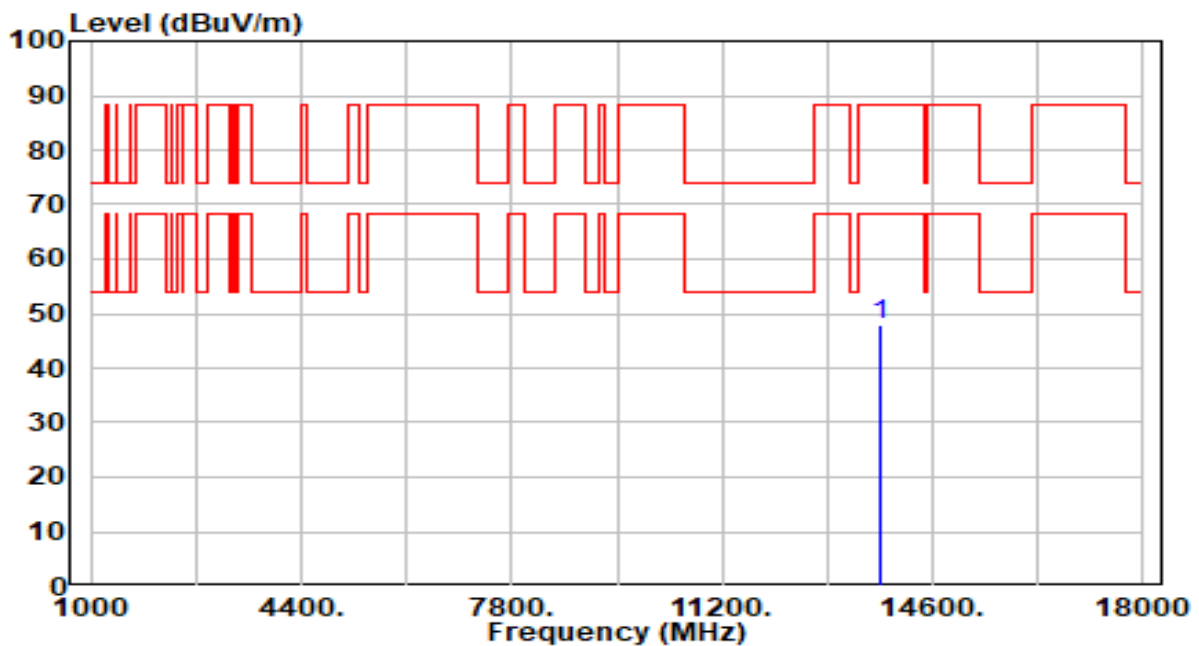

No	Frequency (MHz)	Reading (dBuV)	C.F (dB/m)	Measurement (dBuV/m)	Margin (dB)	Limit (dBuV/m)	Height (cm)	Angle (deg)	Remark (QP/PK/AV)
1	* 13750.000	42.98	5.03	48.01	-40.19	88.20	300	253	Peak

Note:

1. " \*", means this data is the worst emission level.
2. C.F (Correction Factor) = Antenna Factor (dB/m)+ Cable Loss (dB) – Preamplifier(dB).
3. Measurement (dBuV/m) = Reading(dBuV) + C.F (Correction Factor).
4. The emission levels of other frequencies are very lower than the limit and not show in test report.

EUT	AXE3000 Wi-Fi 6E High Gain Wireless USB Adapter	Date of Test	2023-10-27
Factor	DRH18-E	Temp. / Humidity	21°C /61%
Polarity	Horizontal	Site / Test Engineer	AC2 / Marvin
Test Mode	802.11ax-20MHz_TX_Band8_CH 189_ANT 1+2	Test Voltage	By Notebook PC

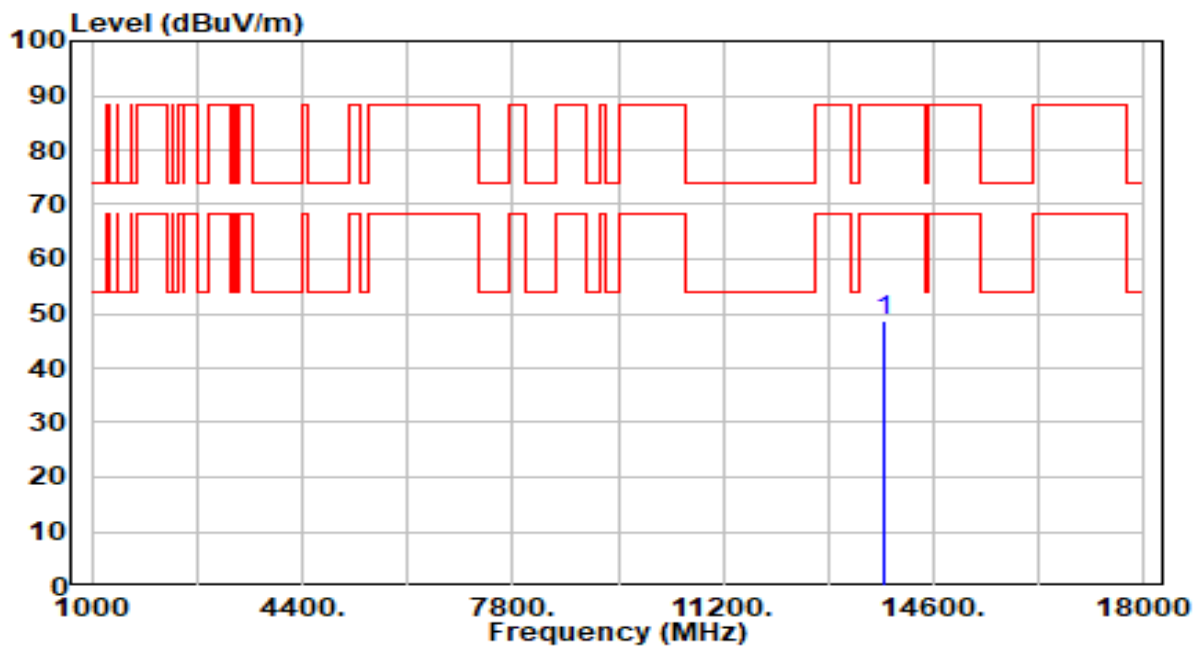

No	Frequency (MHz)	Reading (dBuV)	C.F (dB/m)	Measurement (dBuV/m)	Margin (dB)	Limit (dBuV/m)	Height (cm)	Angle (deg)	Remark (QP/PK/AV)
1	* 13790.000	43.71	5.04	48.75	-39.45	88.20	300	127	Peak

Note:

1. " \*", means this data is the worst emission level.
2. C.F (Correction Factor) = Antenna Factor (dB/m)+ Cable Loss (dB) – Preamplifier(dB).
3. Measurement (dBuV/m) = Reading(dBuV) + C.F (Correction Factor).
4. The emission levels of other frequencies are very lower than the limit and not show in test report.

EUT	AXE3000 Wi-Fi 6E High Gain Wireless USB Adapter	Date of Test	2023-10-27
Factor	DRH18-E	Temp. / Humidity	21°C /61%
Polarity	Vertical	Site / Test Engineer	AC2 / Marvin
Test Mode	802.11ax-20MHz_TX_Band8_CH 189_ANT 1+2	Test Voltage	By Notebook PC

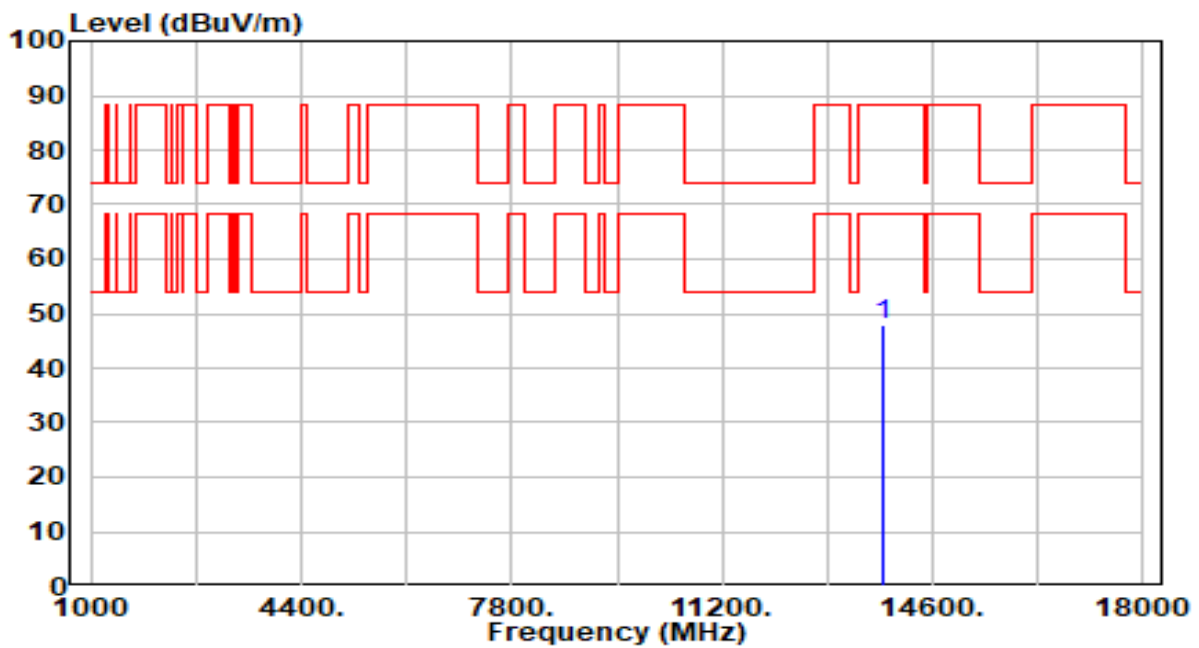

No	Frequency (MHz)	Reading (dBuV)	C.F (dB/m)	Measurement (dBuV/m)	Margin (dB)	Limit (dBuV/m)	Height (cm)	Angle (deg)	Remark (QP/PK/AV)
1	* 13790.000	42.83	5.04	47.86	-40.34	88.20	300	306	Peak

Note:

1. " \*", means this data is the worst emission level.
2. C.F (Correction Factor) = Antenna Factor (dB/m)+ Cable Loss (dB) – Preamplifier(dB).
3. Measurement (dBuV/m) = Reading(dBuV) + C.F (Correction Factor).
4. The emission levels of other frequencies are very lower than the limit and not show in test report.



EUT	AXE3000 Wi-Fi 6E High Gain Wireless USB Adapter	Date of Test	2023-10-27
Factor	DRH18-E	Temp. / Humidity	21°C /61%
Polarity	Horizontal	Site / Test Engineer	AC2 / Marvin
Test Mode	802.11ax-20MHz_TX_Band8_CH 213_ANT 1+2	Test Voltage	By Notebook PC

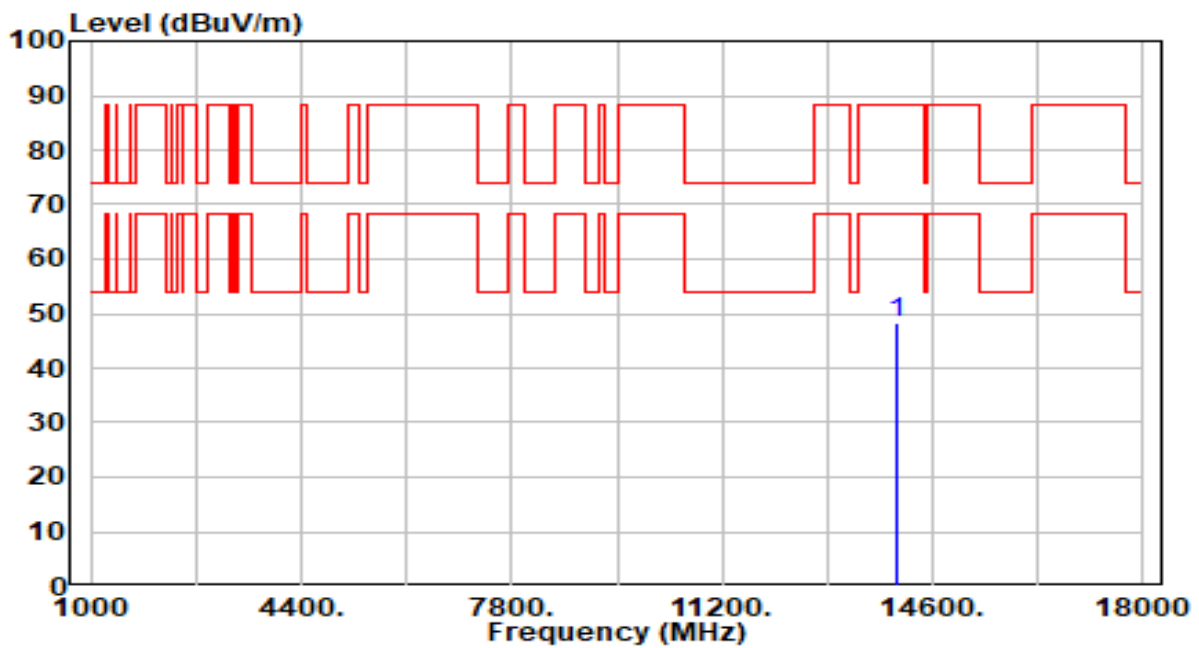

No	Frequency (MHz)	Reading (dBuV)	C.F (dB/m)	Measurement (dBuV/m)	Margin (dB)	Limit (dBuV/m)	Height (cm)	Angle (deg)	Remark (QP/PK/AV)
1	* 14030.000	43.00	5.16	48.16	-40.04	88.20	300	173	Peak

Note:

1. " \*", means this data is the worst emission level.
2. C.F (Correction Factor) = Antenna Factor (dB/m)+ Cable Loss (dB) – Preamplifier(dB).
3. Measurement (dBuV/m) = Reading(dBuV) + C.F (Correction Factor).
4. The emission levels of other frequencies are very lower than the limit and not show in test report.

EUT	AXE3000 Wi-Fi 6E High Gain Wireless USB Adapter	Date of Test	2023-10-27
Factor	DRH18-E	Temp. / Humidity	21°C /61%
Polarity	Vertical	Site / Test Engineer	AC2 / Marvin
Test Mode	802.11ax-20MHz_TX_Band8_CH 213_ANT 1+2	Test Voltage	By Notebook PC

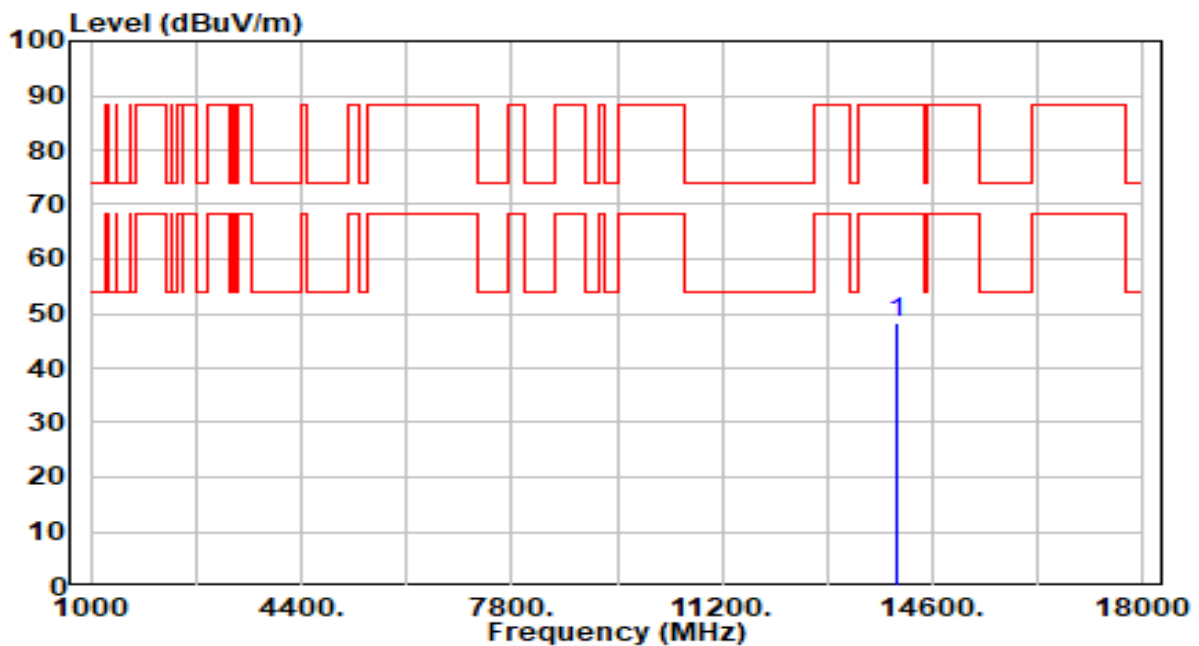

No	Frequency (MHz)	Reading (dBuV)	C.F (dB/m)	Measurement (dBuV/m)	Margin (dB)	Limit (dBuV/m)	Height (cm)	Angle (deg)	Remark (QP/PK/AV)
1	* 14030.000	43.19	5.16	48.35	-39.85	88.20	300	171	Peak

Note:

1. " \*", means this data is the worst emission level.
2. C.F (Correction Factor) = Antenna Factor (dB/m)+ Cable Loss (dB) – Preamplifier(dB).
3. Measurement (dBuV/m) = Reading(dBuV) + C.F (Correction Factor).
4. The emission levels of other frequencies are very lower than the limit and not show in test report.

EUT	AXE3000 Wi-Fi 6E High Gain Wireless USB Adapter	Date of Test	2023-10-27
Factor	DRH18-E	Temp. / Humidity	21°C /61%
Polarity	Horizontal	Site / Test Engineer	AC2 / Marvin
Test Mode	802.11ax-20MHz_TX_Band8_CH 233_ANT 1+2	Test Voltage	By Notebook PC

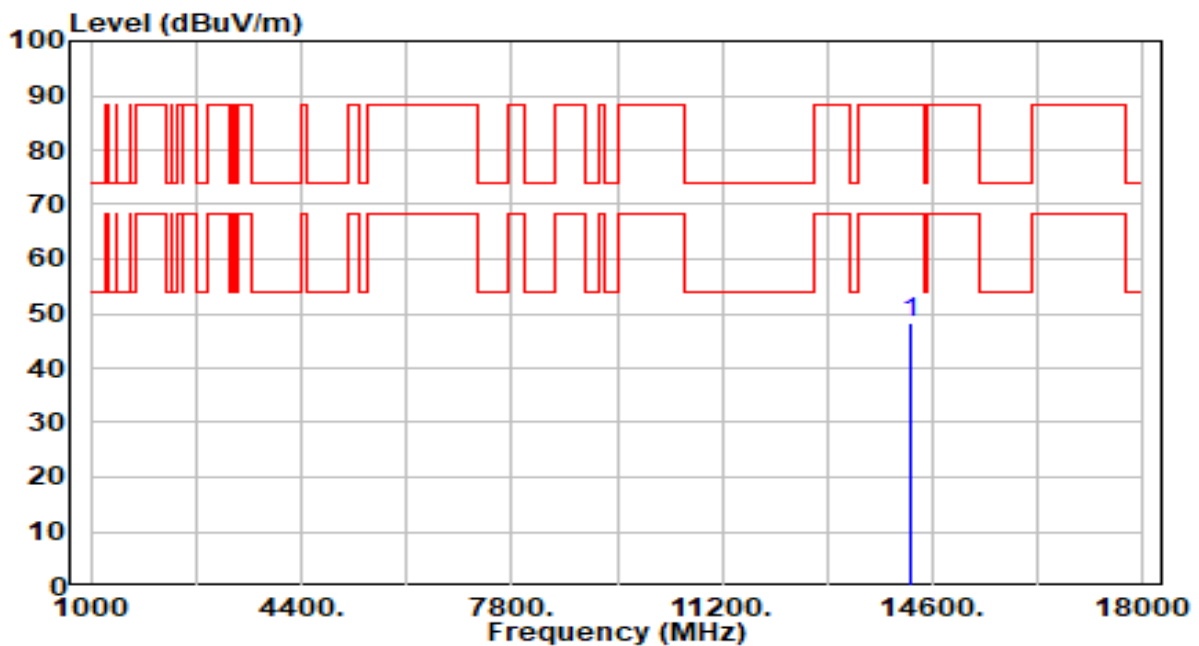

No	Frequency (MHz)	Reading (dBuV)	C.F (dB/m)	Measurement (dBuV/m)	Margin (dB)	Limit (dBuV/m)	Height (cm)	Angle (deg)	Remark (QP/PK/AV)
1	* 14230.000	43.23	5.07	48.30	-39.90	88.20	300	205	Peak

Note:

1. " \*", means this data is the worst emission level.
2. C.F (Correction Factor) = Antenna Factor (dB/m)+ Cable Loss (dB) – Preamplifier(dB).
3. Measurement (dBuV/m) = Reading(dBuV) + C.F (Correction Factor).
4. The emission levels of other frequencies are very lower than the limit and not show in test report.

EUT	AXE3000 Wi-Fi 6E High Gain Wireless USB Adapter	Date of Test	2023-10-27
Factor	DRH18-E	Temp. / Humidity	21°C /61%
Polarity	Vertical	Site / Test Engineer	AC2 / Marvin
Test Mode	802.11ax-20MHz_TX_Band8_CH 233_ANT 1+2	Test Voltage	By Notebook PC

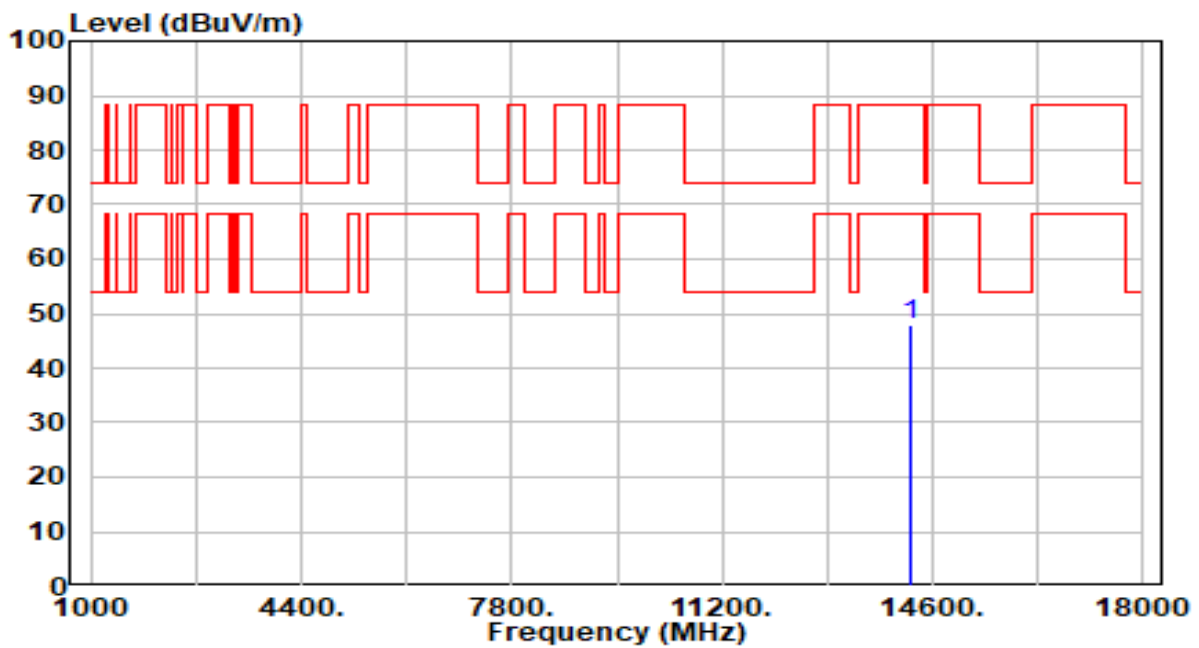

No	Frequency (MHz)	Reading (dBuV)	C.F (dB/m)	Measurement (dBuV/m)	Margin (dB)	Limit (dBuV/m)	Height (cm)	Angle (deg)	Remark (QP/PK/AV)
1	* 14230.000	43.03	5.07	48.10	-40.10	88.20	300	0	Peak

Note:

1. " \*", means this data is the worst emission level.
2. C.F (Correction Factor) = Antenna Factor (dB/m)+ Cable Loss (dB) – Preamplifier(dB).
3. Measurement (dBuV/m) = Reading(dBuV) + C.F (Correction Factor).
4. The emission levels of other frequencies are very lower than the limit and not show in test report.

EUT	AXE3000 Wi-Fi 6E High Gain Wireless USB Adapter	Date of Test	2023-10-27
Factor	DRH18-E	Temp. / Humidity	21°C /61%
Polarity	Horizontal	Site / Test Engineer	AC2 / Marvin
Test Mode	802.11ax-40MHz_TX_Band5_CH 3_ANT 1+2	Test Voltage	By Notebook PC

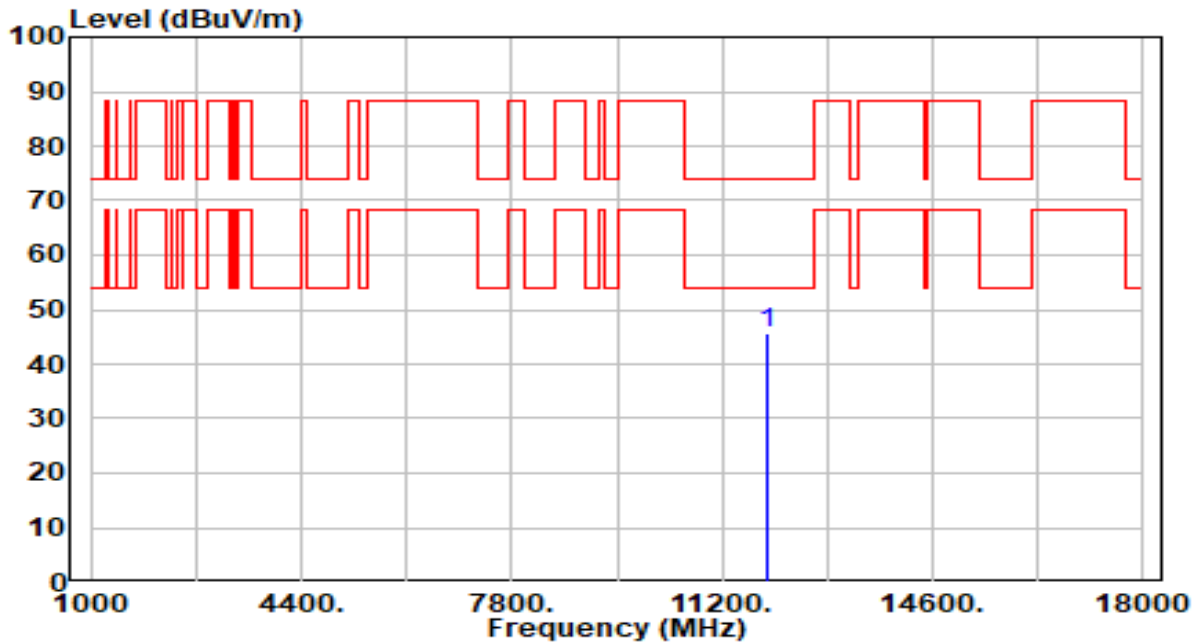

No	Frequency (MHz)	Reading (dBuV)	C.F (dB/m)	Measurement (dBuV/m)	Margin (dB)	Limit (dBuV/m)	Height (cm)	Angle (deg)	Remark (QP/PK/AV)
1	* 11930.000	41.68	3.81	45.49	-28.51	74.00	300	350	Peak

Note:

1. " \*", means this data is the worst emission level.
2. C.F (Correction Factor) = Antenna Factor (dB/m)+ Cable Loss (dB) – Preamplifier(dB).
3. Measurement (dBuV/m) = Reading(dBuV) + C.F (Correction Factor).
4. The emission levels of other frequencies are very lower than the limit and not show in test report.

EUT	AXE3000 Wi-Fi 6E High Gain Wireless USB Adapter	Date of Test	2023-10-27
Factor	DRH18-E	Temp. / Humidity	21°C /61%
Polarity	Vertical	Site / Test Engineer	AC2 / Marvin
Test Mode	802.11ax-40MHz_TX_Band5_CH 3_ANT 1+2	Test Voltage	By Notebook PC

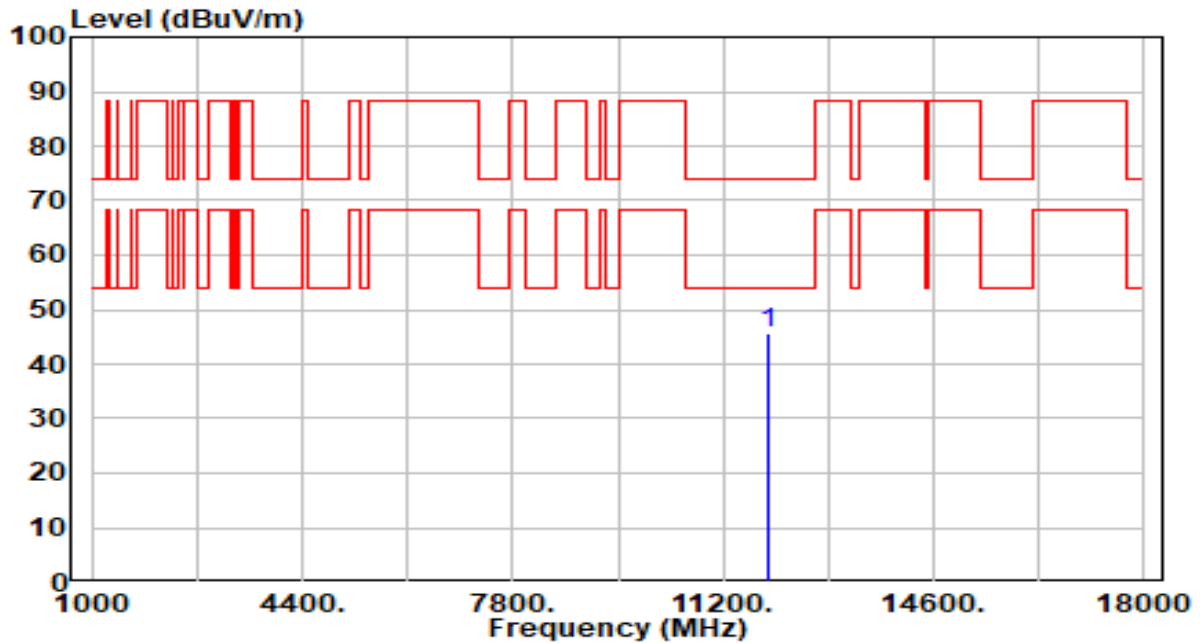

No	Frequency (MHz)	Reading (dBuV)	C.F (dB/m)	Measurement (dBuV/m)	Margin (dB)	Limit (dBuV/m)	Height (cm)	Angle (deg)	Remark (QP/PK/AV)
1	* 11930.000	41.79	3.81	45.60	-28.40	74.00	300	96	Peak

Note:

1. " \*", means this data is the worst emission level.
2. C.F (Correction Factor) = Antenna Factor (dB/m)+ Cable Loss (dB) – Preamplifier(dB).
3. Measurement (dBuV/m) = Reading(dBuV) + C.F (Correction Factor).
4. The emission levels of other frequencies are very lower than the limit and not show in test report.

EUT	AXE3000 Wi-Fi 6E High Gain Wireless USB Adapter	Date of Test	2023-10-27
Factor	DRH18-E	Temp. / Humidity	21°C /61%
Polarity	Horizontal	Site / Test Engineer	AC2 / Marvin
Test Mode	802.11ax-40MHz_TX_Band5_CH 43_ANT 1+2	Test Voltage	By Notebook PC

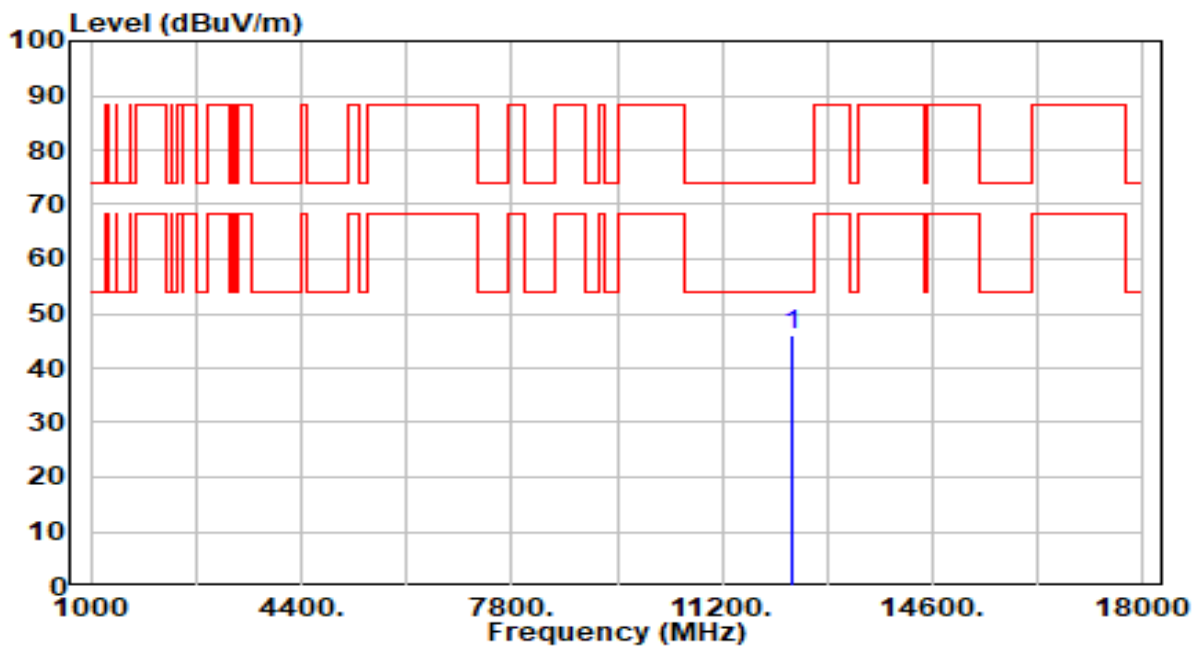

No	Frequency (MHz)	Reading (dBuV)	C.F (dB/m)	Measurement (dBuV/m)	Margin (dB)	Limit (dBuV/m)	Height (cm)	Angle (deg)	Remark (QP/PK/AV)
1	* 12330.000	41.64	4.47	46.11	-27.89	74.00	300	338	Peak

Note:

1. " \*", means this data is the worst emission level.
2. C.F (Correction Factor) = Antenna Factor (dB/m)+ Cable Loss (dB) – Preamplifier(dB).
3. Measurement (dBuV/m) = Reading(dBuV) + C.F (Correction Factor).
4. The emission levels of other frequencies are very lower than the limit and not show in test report.

EUT	AXE3000 Wi-Fi 6E High Gain Wireless USB Adapter	Date of Test	2023-10-27
Factor	DRH18-E	Temp. / Humidity	21°C /61%
Polarity	Vertical	Site / Test Engineer	AC2 / Marvin
Test Mode	802.11ax-40MHz_TX_Band5_CH 43_ANT 1+2	Test Voltage	By Notebook PC

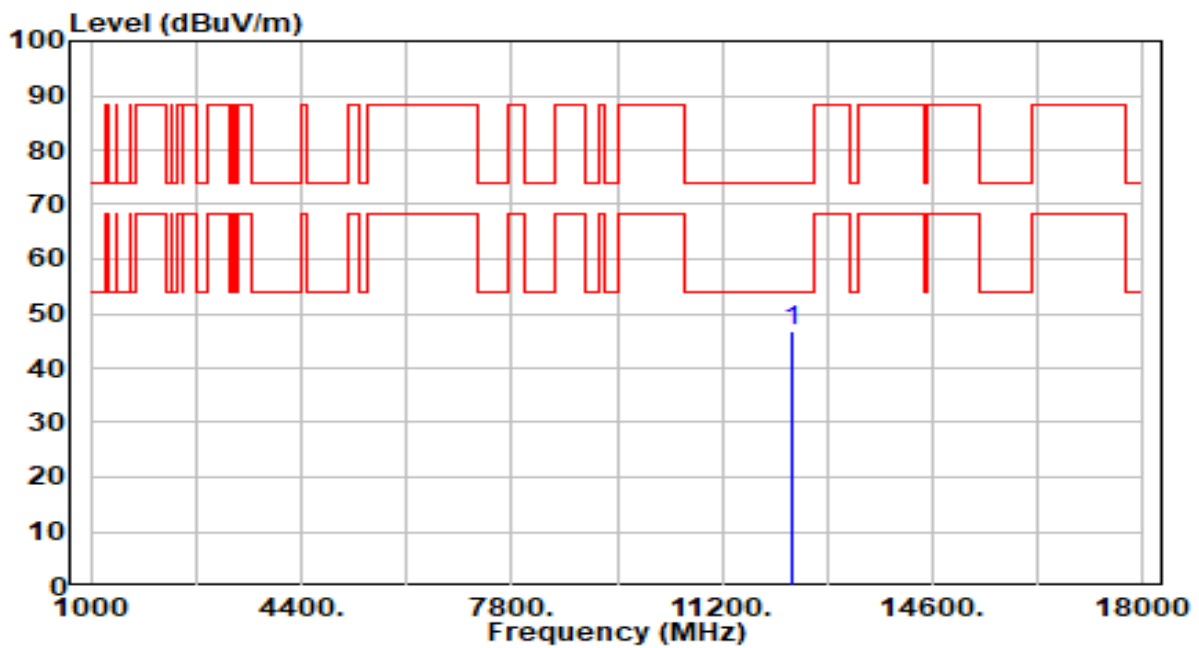

No	Frequency (MHz)	Reading (dBuV)	C.F (dB/m)	Measurement (dBuV/m)	Margin (dB)	Limit (dBuV/m)	Height (cm)	Angle (deg)	Remark (QP/PK/AV)
1	* 12330.000	42.19	4.47	46.66	-27.34	74.00	300	355	Peak

Note:

1. " \*", means this data is the worst emission level.
2. C.F (Correction Factor) = Antenna Factor (dB/m)+ Cable Loss (dB) – Preamplifier(dB).
3. Measurement (dBuV/m) = Reading(dBuV) + C.F (Correction Factor).
4. The emission levels of other frequencies are very lower than the limit and not show in test report.



EUT	AXE3000 Wi-Fi 6E High Gain Wireless USB Adapter	Date of Test	2023-10-27
Factor	DRH18-E	Temp. / Humidity	21°C /61%
Polarity	Horizontal	Site / Test Engineer	AC2 / Marvin
Test Mode	802.11ax-40MHz_TX_Band5_CH 91_ANT 1+2	Test Voltage	By Notebook PC

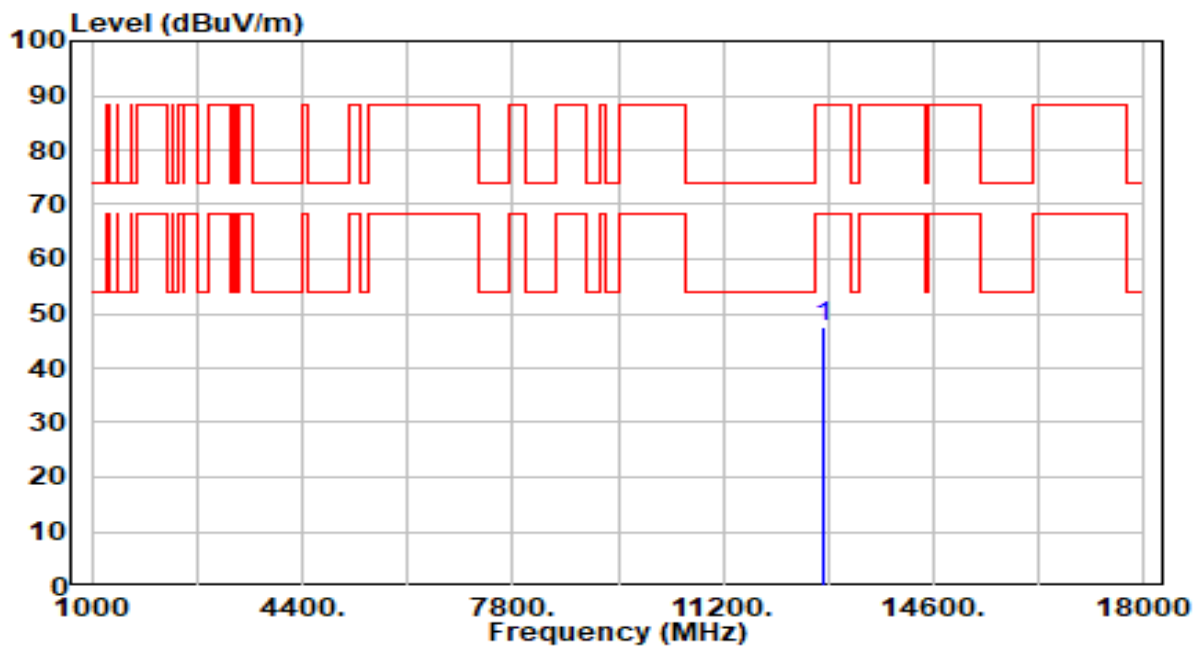

No	Frequency (MHz)	Reading (dBuV)	C.F (dB/m)	Measurement (dBuV/m)	Margin (dB)	Limit (dBuV/m)	Height (cm)	Angle (deg)	Remark (QP/PK/AV)
1	* 12810.000	42.42	5.30	47.72	-40.48	88.20	300	0	Peak

Note:

1. " \*", means this data is the worst emission level.
2. C.F (Correction Factor) = Antenna Factor (dB/m)+ Cable Loss (dB) – Preamplifier(dB).
3. Measurement (dBuV/m) = Reading(dBuV) + C.F (Correction Factor).
4. The emission levels of other frequencies are very lower than the limit and not show in test report.

EUT	AXE3000 Wi-Fi 6E High Gain Wireless USB Adapter	Date of Test	2023-10-27
Factor	DRH18-E	Temp. / Humidity	21°C /61%
Polarity	Vertical	Site / Test Engineer	AC2 / Marvin
Test Mode	802.11ax-40MHz_TX_Band5_CH 91_ANT 1+2	Test Voltage	By Notebook PC

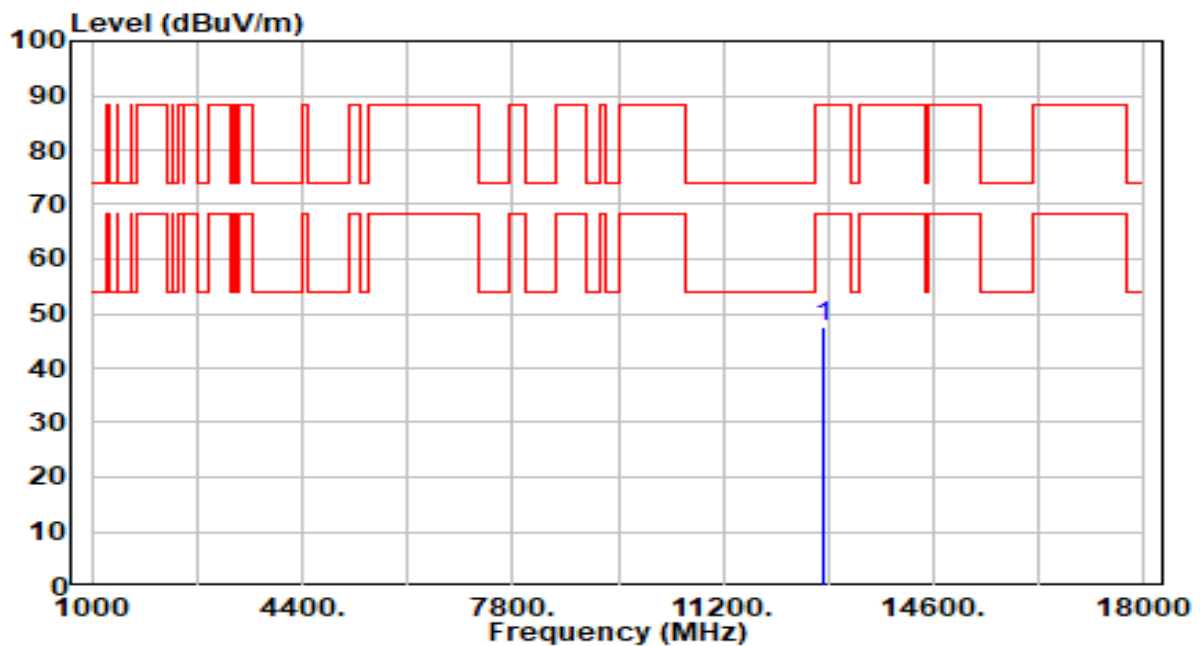

No	Frequency (MHz)	Reading (dBuV)	C.F (dB/m)	Measurement (dBuV/m)	Margin (dB)	Limit (dBuV/m)	Height (cm)	Angle (deg)	Remark (QP/PK/AV)
1	* 12810.000	42.08	5.30	47.38	-40.82	88.20	300	75	Peak

Note:

1. " \*", means this data is the worst emission level.
2. C.F (Correction Factor) = Antenna Factor (dB/m)+ Cable Loss (dB) – Preamplifier(dB).
3. Measurement (dBuV/m) = Reading(dBuV) + C.F (Correction Factor).
4. The emission levels of other frequencies are very lower than the limit and not show in test report.

EUT	AXE3000 Wi-Fi 6E High Gain Wireless USB Adapter	Date of Test	2023-10-27
Factor	DRH18-E	Temp. / Humidity	21°C /61%
Polarity	Horizontal	Site / Test Engineer	AC2 / Marvin
Test Mode	802.11ax-40MHz_TX_Band6_CH 99_ANT 1+2	Test Voltage	By Notebook PC

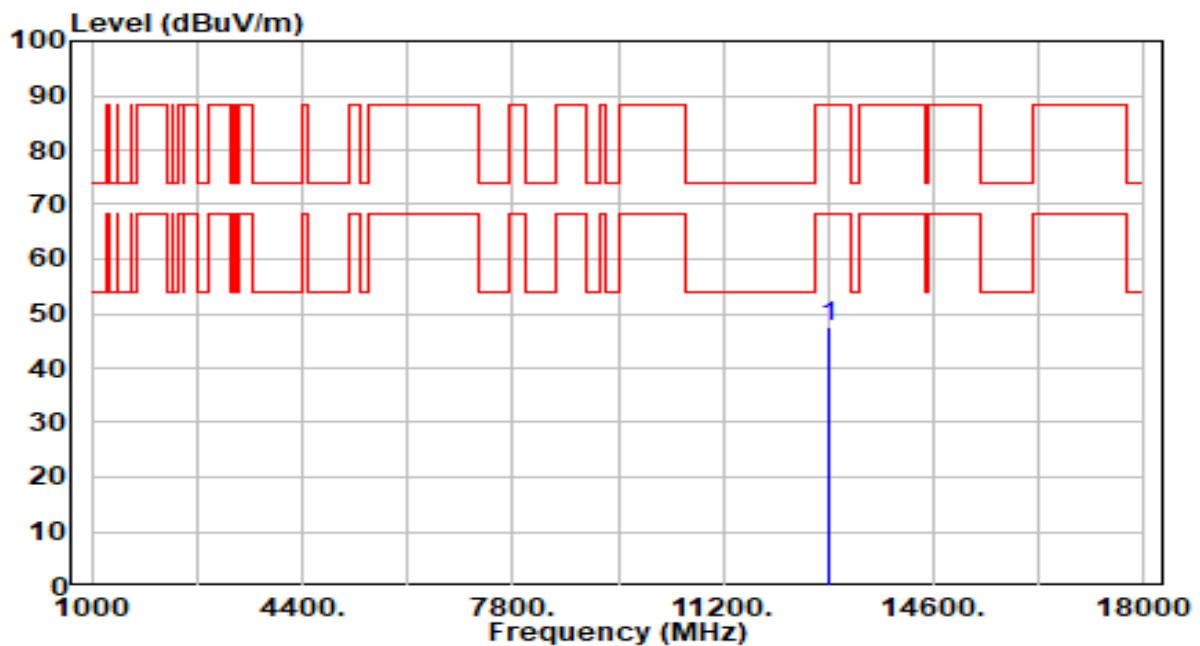

No	Frequency (MHz)	Reading (dBuV)	C.F (dB/m)	Measurement (dBuV/m)	Margin (dB)	Limit (dBuV/m)	Height (cm)	Angle (deg)	Remark (QP/PK/AV)
1	* 12890.000	42.11	5.28	47.38	-40.82	88.20	300	299	Peak

Note:

1. " \*", means this data is the worst emission level.
2. C.F (Correction Factor) = Antenna Factor (dB/m)+ Cable Loss (dB) – Preamplifier(dB).
3. Measurement (dBuV/m) = Reading(dBuV) + C.F (Correction Factor).
4. The emission levels of other frequencies are very lower than the limit and not show in test report.

EUT	AXE3000 Wi-Fi 6E High Gain Wireless USB Adapter	Date of Test	2023-10-27
Factor	DRH18-E	Temp. / Humidity	21°C /61%
Polarity	Vertical	Site / Test Engineer	AC2 / Marvin
Test Mode	802.11ax-40MHz_TX_Band6_CH 99_ANT 1+2	Test Voltage	By Notebook PC

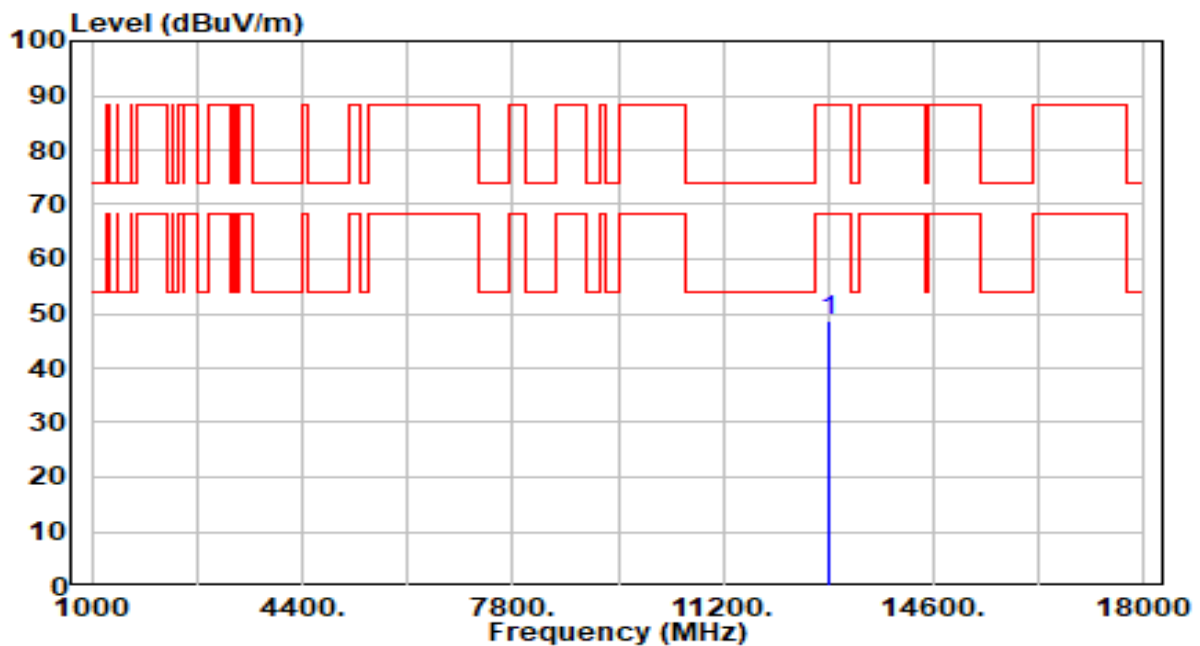

No	Frequency (MHz)	Reading (dBuV)	C.F (dB/m)	Measurement (dBuV/m)	Margin (dB)	Limit (dBuV/m)	Height (cm)	Angle (deg)	Remark (QP/PK/AV)
1	* 12890.000	43.40	5.28	48.68	-39.52	88.20	300	233	Peak

Note:

1. " \*", means this data is the worst emission level.
2. C.F (Correction Factor) = Antenna Factor (dB/m)+ Cable Loss (dB) – Preamplifier(dB).
3. Measurement (dBuV/m) = Reading(dBuV) + C.F (Correction Factor).
4. The emission levels of other frequencies are very lower than the limit and not show in test report.

EUT	AXE3000 Wi-Fi 6E High Gain Wireless USB Adapter	Date of Test	2023-10-27
Factor	DRH18-E	Temp. / Humidity	21°C /61%
Polarity	Horizontal	Site / Test Engineer	AC2 / Marvin
Test Mode	802.11ax-40MHz_TX_Band6_CH 107_ANT 1+2	Test Voltage	By Notebook PC

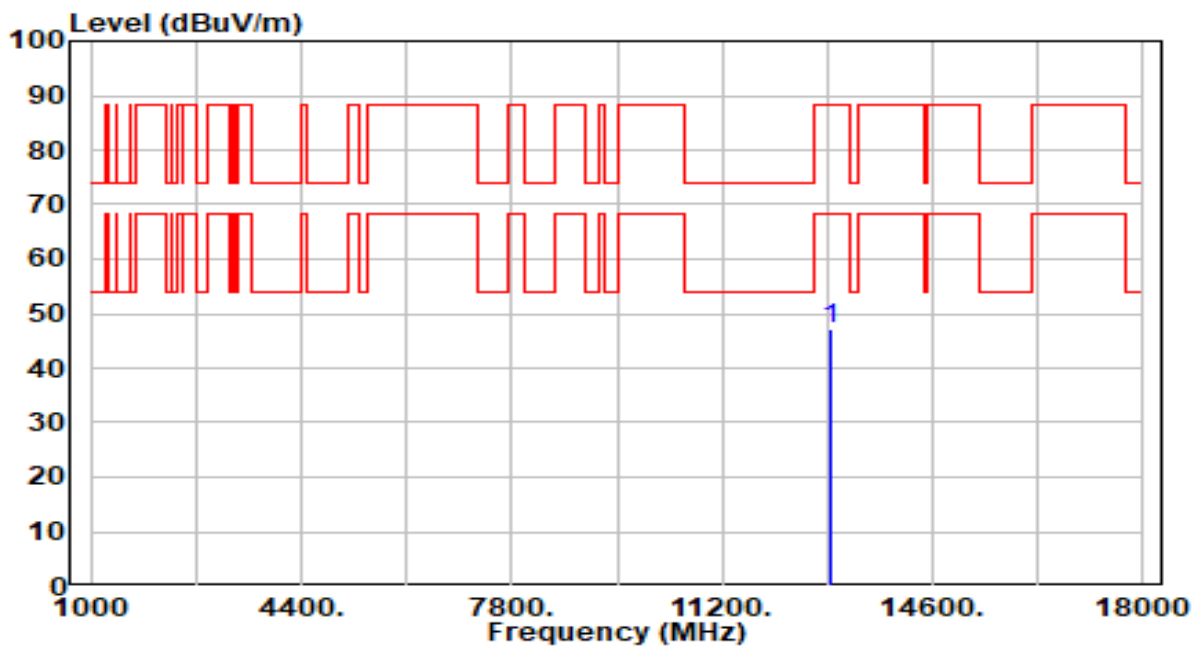

No	Frequency (MHz)	Reading (dBuV)	C.F (dB/m)	Measurement (dBuV/m)	Margin (dB)	Limit (dBuV/m)	Height (cm)	Angle (deg)	Remark (QP/PK/AV)
1	* 12970.000	41.85	5.25	47.10	-41.10	88.20	300	197	Peak

Note:

1. " \*", means this data is the worst emission level.
2. C.F (Correction Factor) = Antenna Factor (dB/m)+ Cable Loss (dB) – Preamplifier(dB).
3. Measurement (dBuV/m) = Reading(dBuV) + C.F (Correction Factor).
4. The emission levels of other frequencies are very lower than the limit and not show in test report.

EUT	AXE3000 Wi-Fi 6E High Gain Wireless USB Adapter	Date of Test	2023-10-27
Factor	DRH18-E	Temp. / Humidity	21°C /61%
Polarity	Vertical	Site / Test Engineer	AC2 / Marvin
Test Mode	802.11ax-40MHz_TX_Band6_CH 107_ANT 1+2	Test Voltage	By Notebook PC

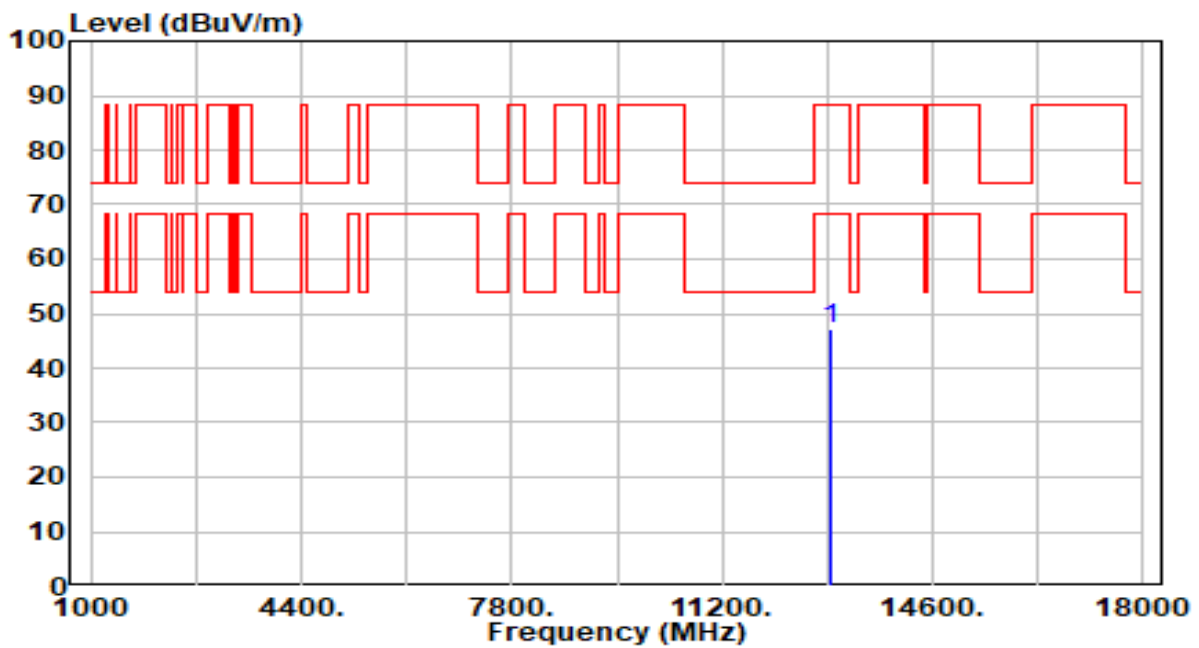

No	Frequency (MHz)	Reading (dBuV)	C.F (dB/m)	Measurement (dBuV/m)	Margin (dB)	Limit (dBuV/m)	Height (cm)	Angle (deg)	Remark (QP/PK/AV)
1	* 12970.000	41.83	5.25	47.08	-41.12	88.20	300	230	Peak

Note:

1. " \*", means this data is the worst emission level.
2. C.F (Correction Factor) = Antenna Factor (dB/m)+ Cable Loss (dB) – Preamplifier(dB).
3. Measurement (dBuV/m) = Reading(dBuV) + C.F (Correction Factor).
4. The emission levels of other frequencies are very lower than the limit and not show in test report.

EUT	AXE3000 Wi-Fi 6E High Gain Wireless USB Adapter	Date of Test	2023-10-27
Factor	DRH18-E	Temp. / Humidity	21°C /61%
Polarity	Horizontal	Site / Test Engineer	AC2 / Marvin
Test Mode	802.11ax-40MHz_TX_Band6_CH 115_ANT 1+2	Test Voltage	By Notebook PC

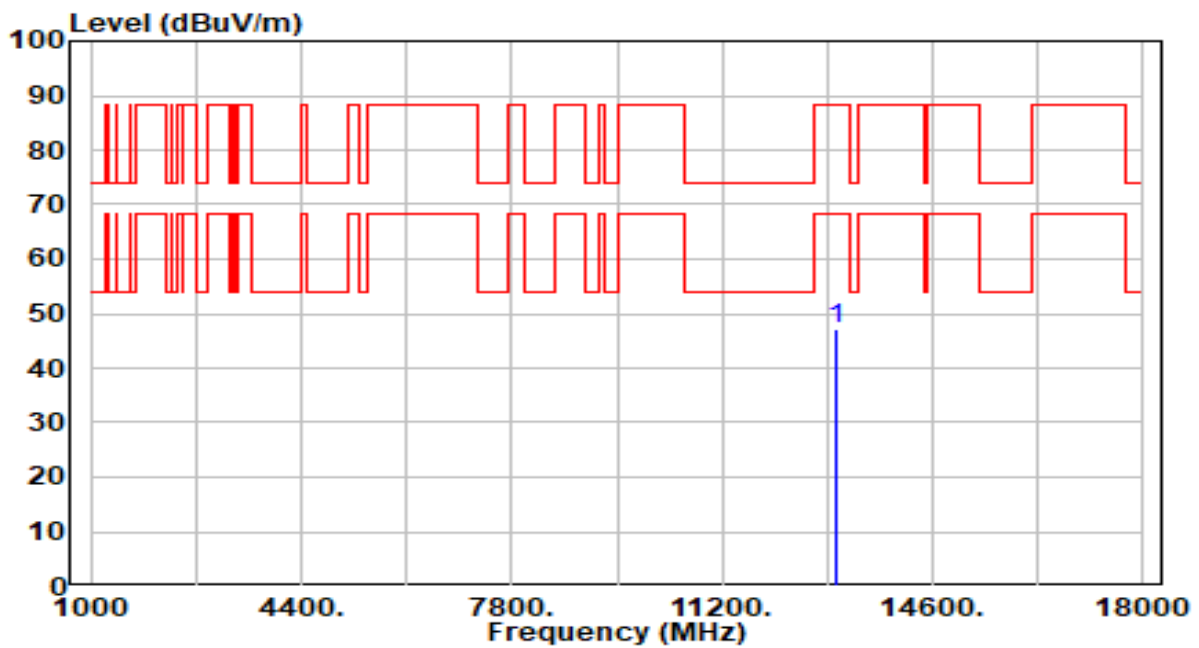

No	Frequency (MHz)	Reading (dBuV)	C.F (dB/m)	Measurement (dBuV/m)	Margin (dB)	Limit (dBuV/m)	Height (cm)	Angle (deg)	Remark (QP/PK/AV)
1	* 13050.000	41.93	5.23	47.16	-41.04	88.20	300	256	Peak

Note:

1. " \*", means this data is the worst emission level.
2. C.F (Correction Factor) = Antenna Factor (dB/m)+ Cable Loss (dB) – Preamplifier(dB).
3. Measurement (dBuV/m) = Reading(dBuV) + C.F (Correction Factor).
4. The emission levels of other frequencies are very lower than the limit and not show in test report.

EUT	AXE3000 Wi-Fi 6E High Gain Wireless USB Adapter	Date of Test	2023-10-27
Factor	DRH18-E	Temp. / Humidity	21°C /61%
Polarity	Vertical	Site / Test Engineer	AC2 / Marvin
Test Mode	802.11ax-40MHz_TX_Band6_CH 115_ANT 1+2	Test Voltage	By Notebook PC

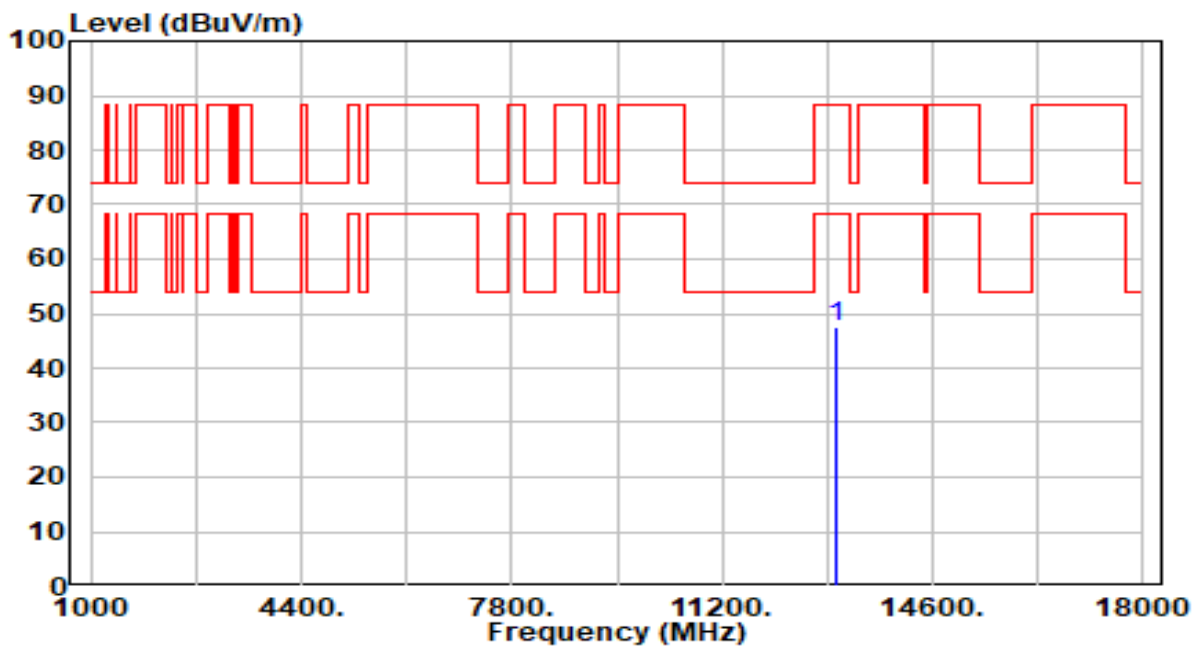

No	Frequency (MHz)	Reading (dBuV)	C.F (dB/m)	Measurement (dBuV/m)	Margin (dB)	Limit (dBuV/m)	Height (cm)	Angle (deg)	Remark (QP/PK/AV)
1	* 13050.000	42.46	5.23	47.69	-40.51	88.20	300	120	Peak

Note:

1. " \*", means this data is the worst emission level.
2. C.F (Correction Factor) = Antenna Factor (dB/m)+ Cable Loss (dB) – Preamplifier(dB).
3. Measurement (dBuV/m) = Reading(dBuV) + C.F (Correction Factor).
4. The emission levels of other frequencies are very lower than the limit and not show in test report.



EUT	AXE3000 Wi-Fi 6E High Gain Wireless USB Adapter	Date of Test	2023-10-27
Factor	DRH18-E	Temp. / Humidity	21°C /61%
Polarity	Horizontal	Site / Test Engineer	AC2 / Marvin
Test Mode	802.11ax-40MHz_TX_Band7_CH 123_ANT 1+2	Test Voltage	By Notebook PC

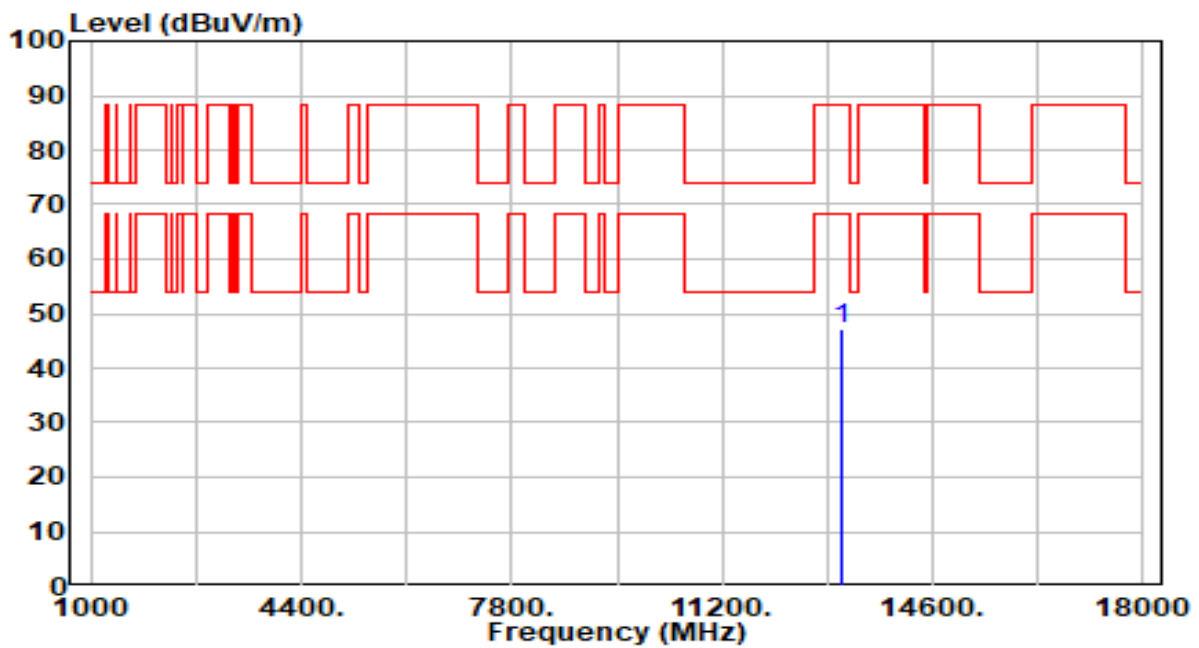

No	Frequency (MHz)	Reading (dBuV)	C.F (dB/m)	Measurement (dBuV/m)	Margin (dB)	Limit (dBuV/m)	Height (cm)	Angle (deg)	Remark (QP/PK/AV)
1	* 13130.000	41.83	5.21	47.05	-41.15	88.20	300	291	Peak

Note:

1. " \*", means this data is the worst emission level.
2. C.F (Correction Factor) = Antenna Factor (dB/m)+ Cable Loss (dB) – Preamplifier(dB).
3. Measurement (dBuV/m) = Reading(dBuV) + C.F (Correction Factor).
4. The emission levels of other frequencies are very lower than the limit and not show in test report.

EUT	AXE3000 Wi-Fi 6E High Gain Wireless USB Adapter	Date of Test	2023-10-27
Factor	DRH18-E	Temp. / Humidity	21°C /61%
Polarity	Vertical	Site / Test Engineer	AC2 / Marvin
Test Mode	802.11ax-40MHz_TX_Band7_CH 123_ANT 1+2	Test Voltage	By Notebook PC

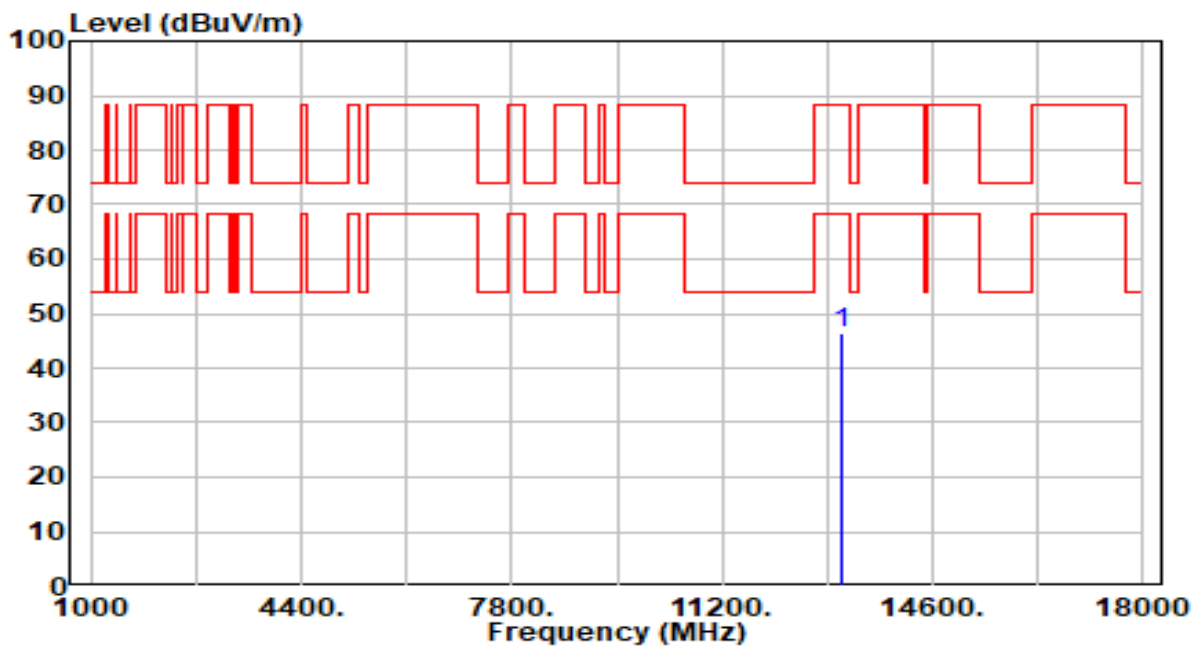

No	Frequency (MHz)	Reading (dBuV)	C.F (dB/m)	Measurement (dBuV/m)	Margin (dB)	Limit (dBuV/m)	Height (cm)	Angle (deg)	Remark (QP/PK/AV)
1	* 13130.000	41.29	5.21	46.50	-41.70	88.20	300	233	Peak

Note:

1. " \*", means this data is the worst emission level.
2. C.F (Correction Factor) = Antenna Factor (dB/m)+ Cable Loss (dB) – Preamplifier(dB).
3. Measurement (dBuV/m) = Reading(dBuV) + C.F (Correction Factor).
4. The emission levels of other frequencies are very lower than the limit and not show in test report.

EUT	AXE3000 Wi-Fi 6E High Gain Wireless USB Adapter	Date of Test	2023-10-27
Factor	DRH18-E	Temp. / Humidity	21°C /61%
Polarity	Horizontal	Site / Test Engineer	AC2 / Marvin
Test Mode	802.11ax-40MHz_TX_Band7_CH 147_ANT 1+2	Test Voltage	By Notebook PC

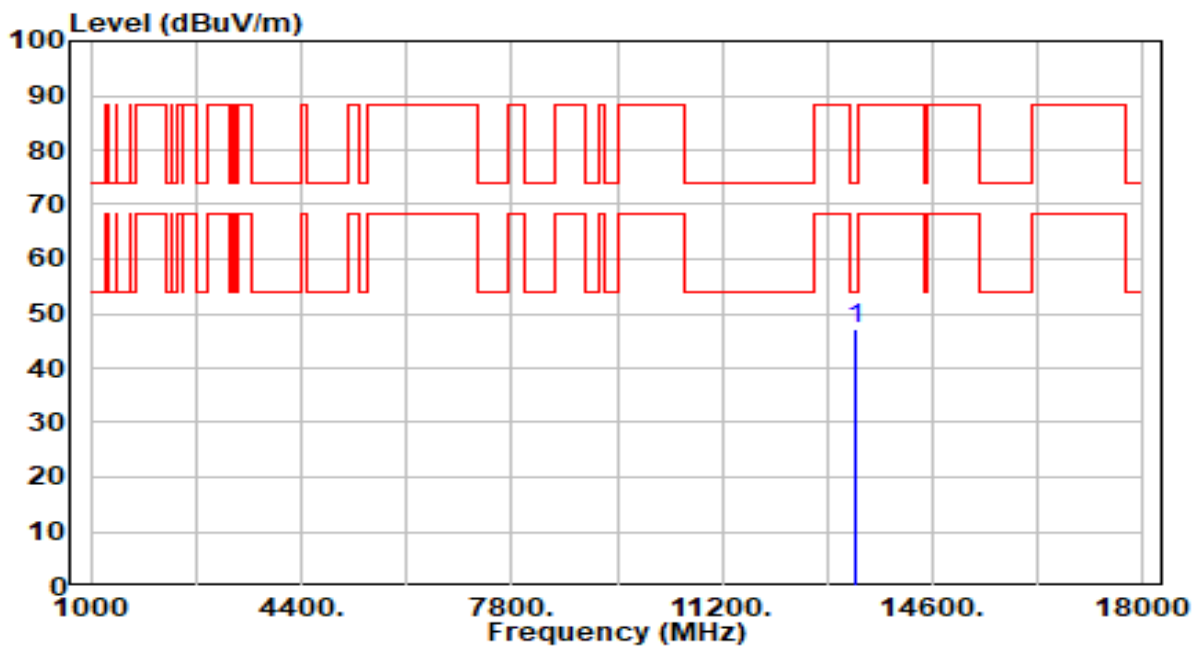

No	Frequency (MHz)	Reading (dBuV)	C.F (dB/m)	Measurement (dBuV/m)	Margin (dB)	Limit (dBuV/m)	Height (cm)	Angle (deg)	Remark (QP/PK/AV)
1	* 13370.000	41.94	5.25	47.19	-26.81	74.00	300	214	Peak

Note:

1. " \*", means this data is the worst emission level.
2. C.F (Correction Factor) = Antenna Factor (dB/m)+ Cable Loss (dB) – Preamplifier(dB).
3. Measurement (dBuV/m) = Reading(dBuV) + C.F (Correction Factor).
4. The emission levels of other frequencies are very lower than the limit and not show in test report.

EUT	AXE3000 Wi-Fi 6E High Gain Wireless USB Adapter	Date of Test	2023-10-27
Factor	DRH18-E	Temp. / Humidity	21°C /61%
Polarity	Vertical	Site / Test Engineer	AC2 / Marvin
Test Mode	802.11ax-40MHz_TX_Band7_CH 147_ANT 1+2	Test Voltage	By Notebook PC

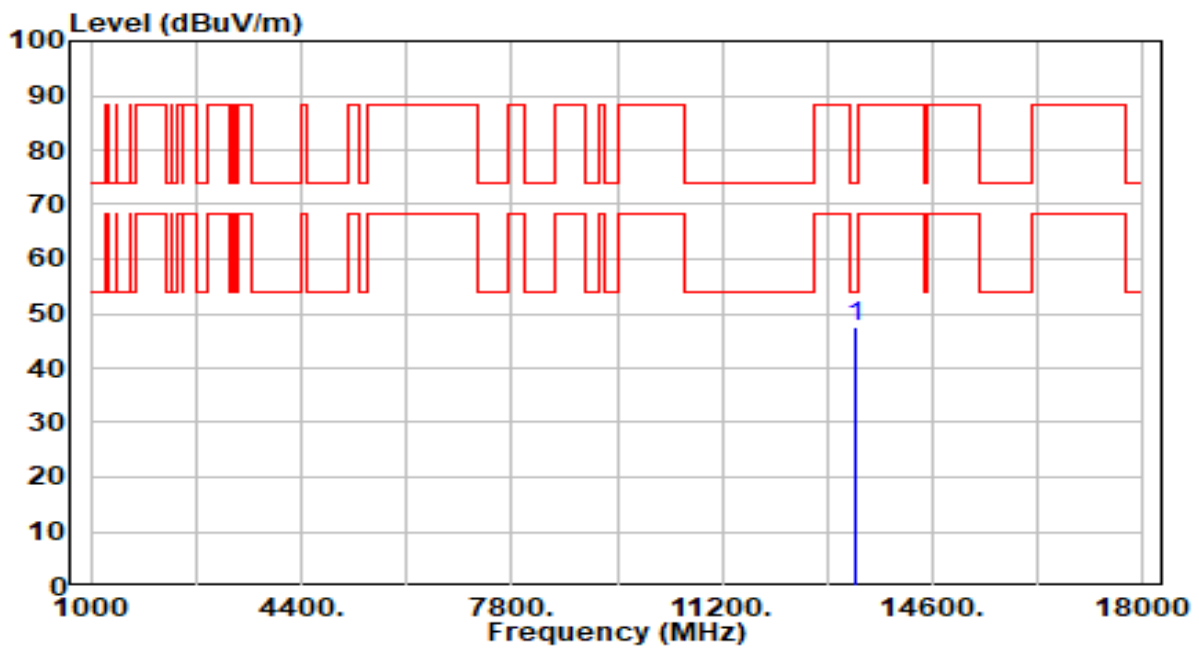

No	Frequency (MHz)	Reading (dBuV)	C.F (dB/m)	Measurement (dBuV/m)	Margin (dB)	Limit (dBuV/m)	Height (cm)	Angle (deg)	Remark (QP/PK/AV)
1	* 13370.000	42.18	5.25	47.43	-26.57	74.00	300	360	Peak

Note:

1. " \*", means this data is the worst emission level.
2. C.F (Correction Factor) = Antenna Factor (dB/m)+ Cable Loss (dB) – Preamplifier(dB).
3. Measurement (dBuV/m) = Reading(dBuV) + C.F (Correction Factor).
4. The emission levels of other frequencies are very lower than the limit and not show in test report.

EUT	AXE3000 Wi-Fi 6E High Gain Wireless USB Adapter	Date of Test	2023-10-27
Factor	DRH18-E	Temp. / Humidity	21°C /61%
Polarity	Horizontal	Site / Test Engineer	AC2 / Marvin
Test Mode	802.11ax-40MHz_TX_Band7_CH 179_ANT 1+2	Test Voltage	By Notebook PC

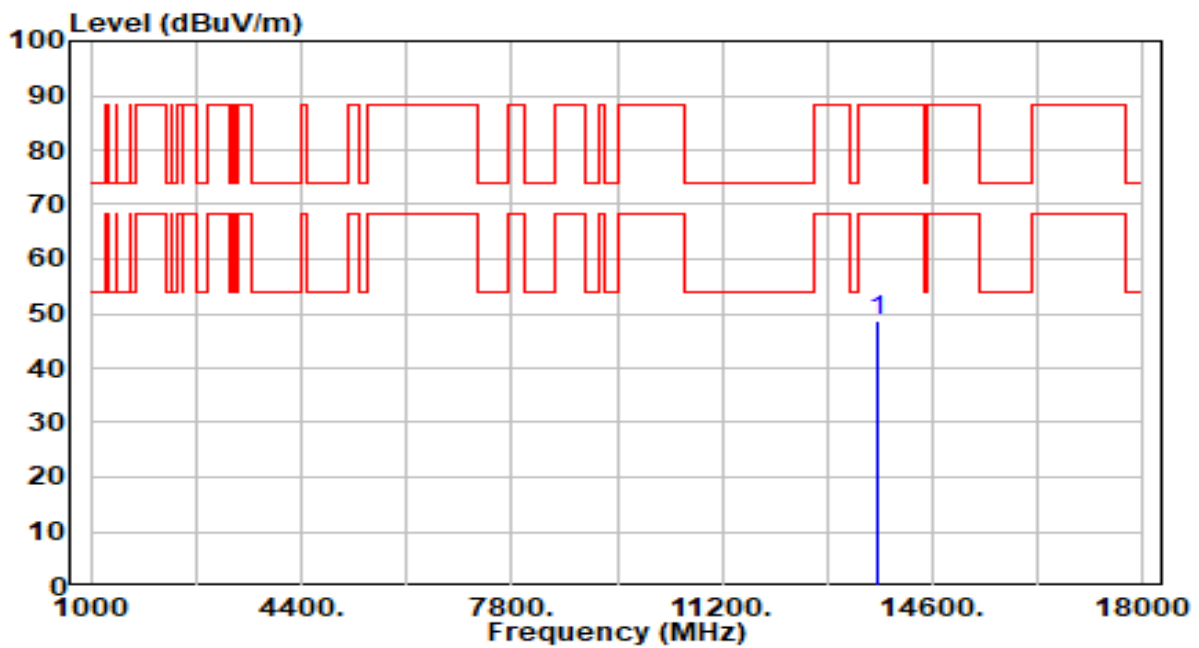

No	Frequency (MHz)	Reading (dBuV)	C.F (dB/m)	Measurement (dBuV/m)	Margin (dB)	Limit (dBuV/m)	Height (cm)	Angle (deg)	Remark (QP/PK/AV)
1	* 13690.000	43.55	5.02	48.57	-39.63	88.20	300	272	Peak

Note:

1. " \*", means this data is the worst emission level.
2. C.F (Correction Factor) = Antenna Factor (dB/m)+ Cable Loss (dB) – Preamplifier(dB).
3. Measurement (dBuV/m) = Reading(dBuV) + C.F (Correction Factor).
4. The emission levels of other frequencies are very lower than the limit and not show in test report.

EUT	AXE3000 Wi-Fi 6E High Gain Wireless USB Adapter	Date of Test	2023-10-27
Factor	DRH18-E	Temp. / Humidity	21°C /61%
Polarity	Vertical	Site / Test Engineer	AC2 / Marvin
Test Mode	802.11ax-40MHz_TX_Band7_CH 179_ANT 1+2	Test Voltage	By Notebook PC

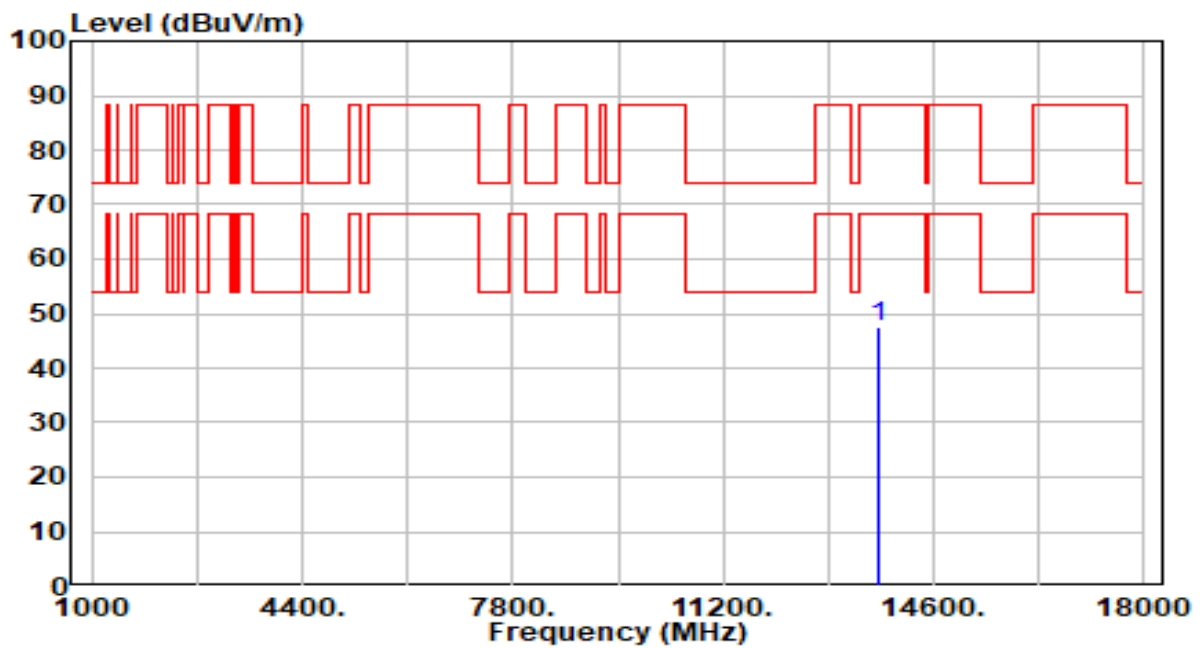

No	Frequency (MHz)	Reading (dBuV)	C.F (dB/m)	Measurement (dBuV/m)	Margin (dB)	Limit (dBuV/m)	Height (cm)	Angle (deg)	Remark (QP/PK/AV)
1	* 13690.000	42.59	5.02	47.61	-40.59	88.20	300	238	Peak

Note:

1. " \*", means this data is the worst emission level.
2. C.F (Correction Factor) = Antenna Factor (dB/m)+ Cable Loss (dB) – Preamplifier(dB).
3. Measurement (dBuV/m) = Reading(dBuV) + C.F (Correction Factor).
4. The emission levels of other frequencies are very lower than the limit and not show in test report.

EUT	AXE3000 Wi-Fi 6E High Gain Wireless USB Adapter	Date of Test	2023-10-27
Factor	DRH18-E	Temp. / Humidity	21°C /61%
Polarity	Horizontal	Site / Test Engineer	AC2 / Marvin
Test Mode	802.11ax-40MHz_TX_Band8_CH 187_ANT 1+2	Test Voltage	By Notebook PC

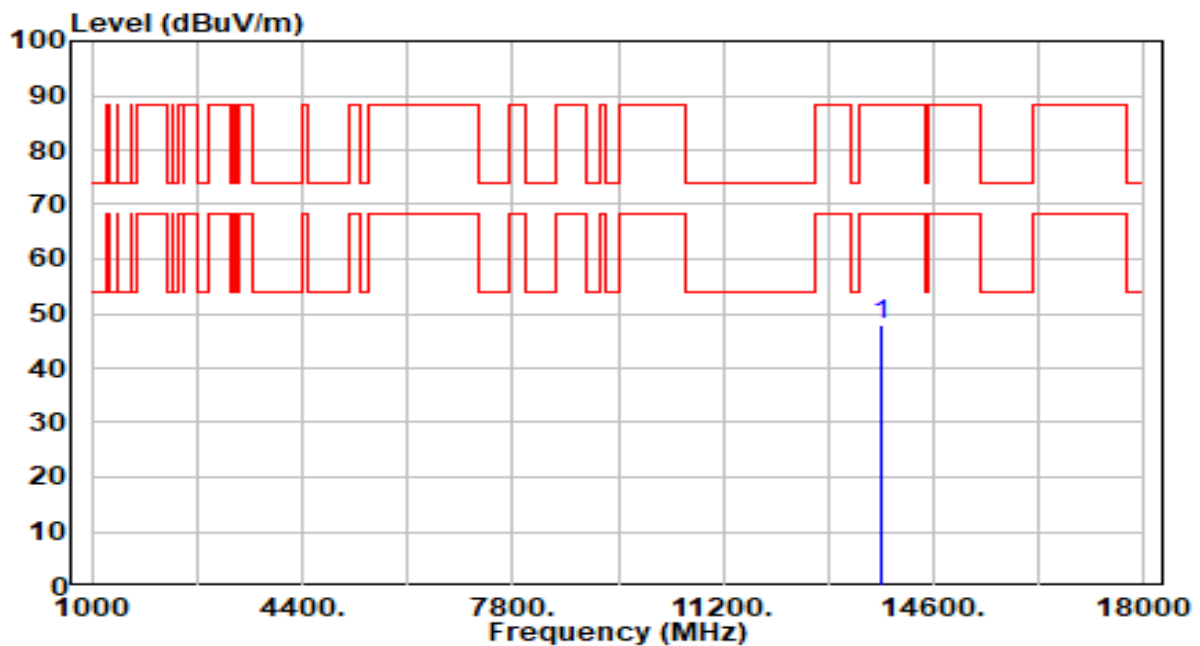

No	Frequency (MHz)	Reading (dBuV)	C.F (dB/m)	Measurement (dBuV/m)	Margin (dB)	Limit (dBuV/m)	Height (cm)	Angle (deg)	Remark (QP/PK/AV)
1	* 13770.000	42.71	5.03	47.74	-40.46	88.20	300	169	Peak

Note:

1. " \*", means this data is the worst emission level.
2. C.F (Correction Factor) = Antenna Factor (dB/m)+ Cable Loss (dB) – Preamplifier(dB).
3. Measurement (dBuV/m) = Reading(dBuV) + C.F (Correction Factor).
4. The emission levels of other frequencies are very lower than the limit and not show in test report.

EUT	AXE3000 Wi-Fi 6E High Gain Wireless USB Adapter	Date of Test	2023-10-27
Factor	DRH18-E	Temp. / Humidity	21°C /61%
Polarity	Vertical	Site / Test Engineer	AC2 / Marvin
Test Mode	802.11ax-40MHz_TX_Band8_CH 187_ANT 1+2	Test Voltage	By Notebook PC

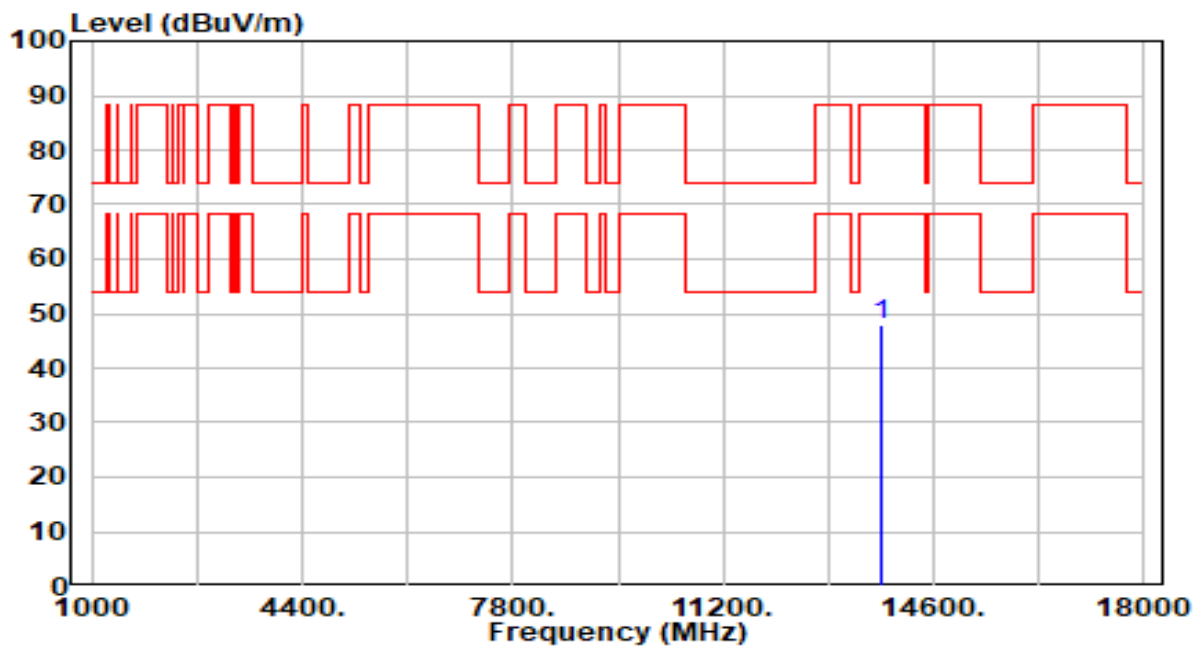

No	Frequency (MHz)	Reading (dBuV)	C.F (dB/m)	Measurement (dBuV/m)	Margin (dB)	Limit (dBuV/m)	Height (cm)	Angle (deg)	Remark (QP/PK/AV)
1	* 13770.000	42.97	5.03	48.01	-40.19	88.20	300	253	Peak

Note:

1. " \*", means this data is the worst emission level.
2. C.F (Correction Factor) = Antenna Factor (dB/m)+ Cable Loss (dB) – Preamplifier(dB).
3. Measurement (dBuV/m) = Reading(dBuV) + C.F (Correction Factor).
4. The emission levels of other frequencies are very lower than the limit and not show in test report.



EUT	AXE3000 Wi-Fi 6E High Gain Wireless USB Adapter	Date of Test	2023-10-27
Factor	DRH18-E	Temp. / Humidity	21°C /61%
Polarity	Horizontal	Site / Test Engineer	AC2 / Marvin
Test Mode	802.11ax-40MHz_TX_Band8_CH 195_ANT 1+2	Test Voltage	By Notebook PC

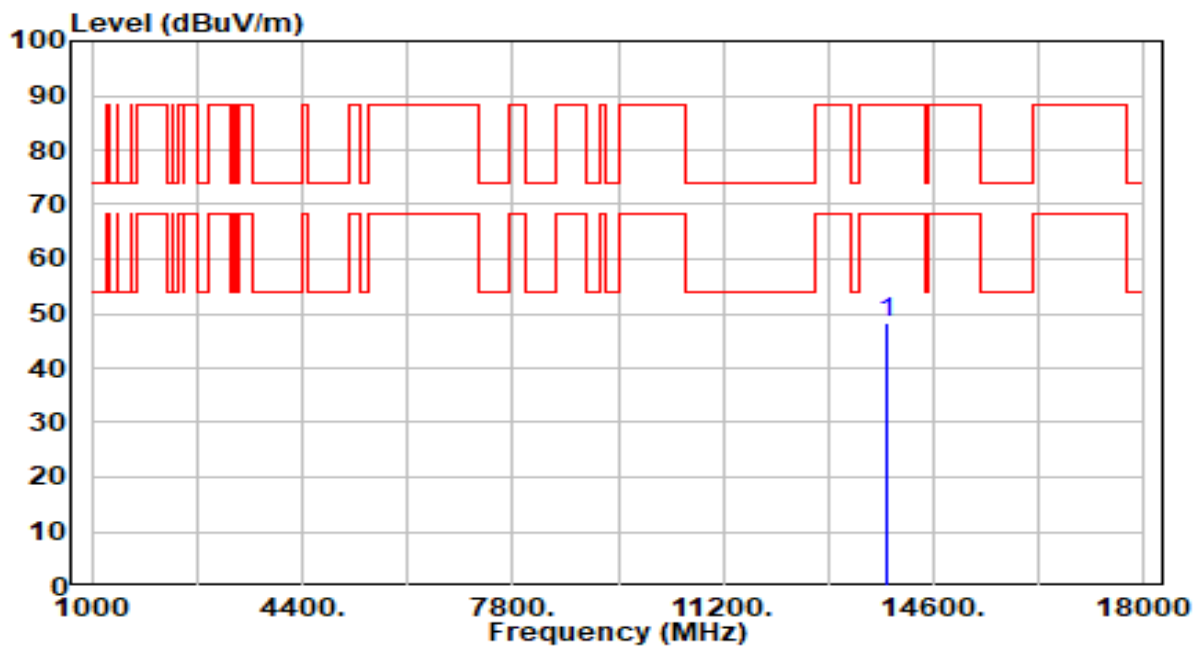

No	Frequency (MHz)	Reading (dBuV)	C.F (dB/m)	Measurement (dBuV/m)	Margin (dB)	Limit (dBuV/m)	Height (cm)	Angle (deg)	Remark (QP/PK/AV)
1	* 13850.000	43.10	5.07	48.17	-40.03	88.20	300	244	Peak

Note:

1. " \*", means this data is the worst emission level.
2. C.F (Correction Factor) = Antenna Factor (dB/m)+ Cable Loss (dB) – Preamplifier(dB).
3. Measurement (dBuV/m) = Reading(dBuV) + C.F (Correction Factor).
4. The emission levels of other frequencies are very lower than the limit and not show in test report.

EUT	AXE3000 Wi-Fi 6E High Gain Wireless USB Adapter	Date of Test	2023-10-27
Factor	DRH18-E	Temp. / Humidity	21°C /61%
Polarity	Vertical	Site / Test Engineer	AC2 / Marvin
Test Mode	802.11ax-40MHz_TX_Band8_CH 195_ANT 1+2	Test Voltage	By Notebook PC

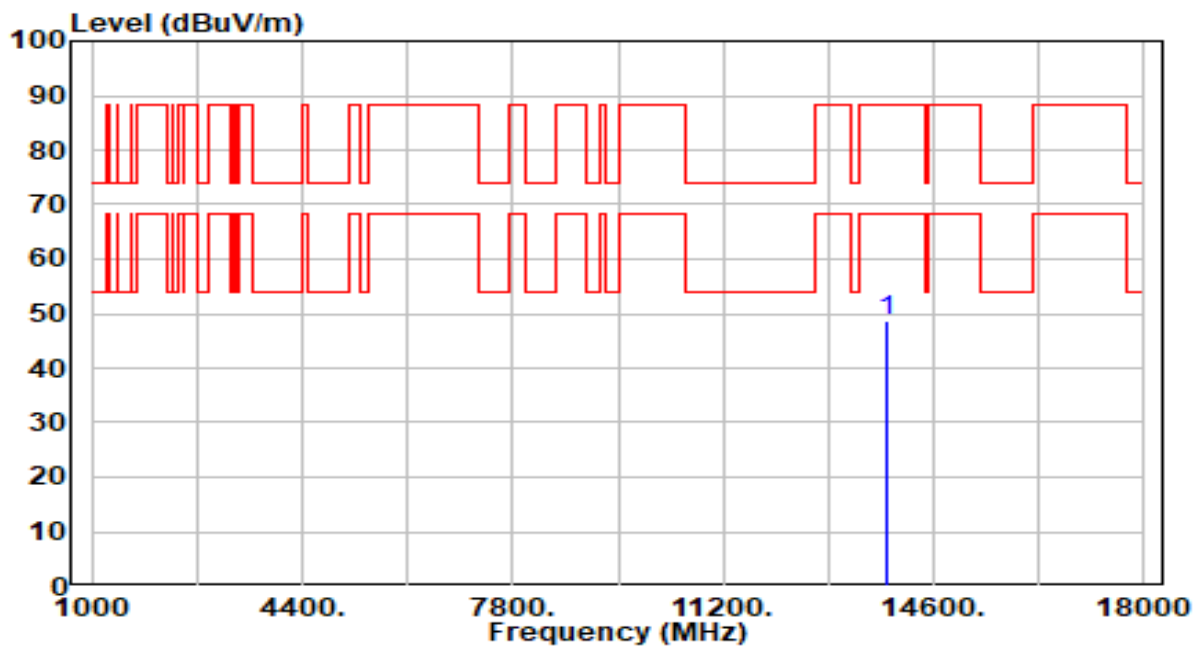

No	Frequency (MHz)	Reading (dBuV)	C.F (dB/m)	Measurement (dBuV/m)	Margin (dB)	Limit (dBuV/m)	Height (cm)	Angle (deg)	Remark (QP/PK/AV)
1	* 13850.000	43.54	5.07	48.61	-39.59	88.20	300	190	Peak

Note:

1. " \*", means this data is the worst emission level.
2. C.F (Correction Factor) = Antenna Factor (dB/m)+ Cable Loss (dB) – Preamplifier(dB).
3. Measurement (dBuV/m) = Reading(dBuV) + C.F (Correction Factor).
4. The emission levels of other frequencies are very lower than the limit and not show in test report.

EUT	AXE3000 Wi-Fi 6E High Gain Wireless USB Adapter	Date of Test	2023-10-27
Factor	DRH18-E	Temp. / Humidity	21°C /61%
Polarity	Horizontal	Site / Test Engineer	AC2 / Marvin
Test Mode	802.11ax-40MHz_TX_Band8_CH 211_ANT 1+2	Test Voltage	By Notebook PC

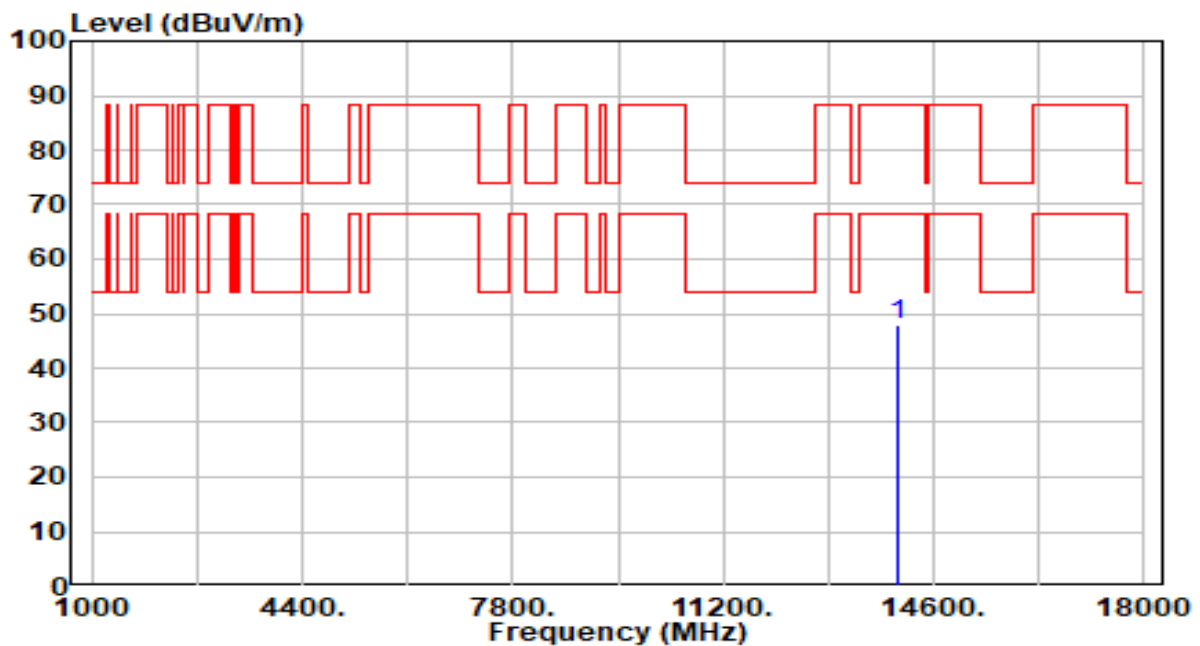

No	Frequency (MHz)	Reading (dBuV)	C.F (dB/m)	Measurement (dBuV/m)	Margin (dB)	Limit (dBuV/m)	Height (cm)	Angle (deg)	Remark (QP/PK/AV)
1	* 14010.000	42.92	5.17	48.08	-40.12	88.20	300	360	Peak

Note:

1. " \*", means this data is the worst emission level.
2. C.F (Correction Factor) = Antenna Factor (dB/m)+ Cable Loss (dB) – Preamplifier(dB).
3. Measurement (dBuV/m) = Reading(dBuV) + C.F (Correction Factor).
4. The emission levels of other frequencies are very lower than the limit and not show in test report.

EUT	AXE3000 Wi-Fi 6E High Gain Wireless USB Adapter	Date of Test	2023-10-27
Factor	DRH18-E	Temp. / Humidity	21°C /61%
Polarity	Vertical	Site / Test Engineer	AC2 / Marvin
Test Mode	802.11ax-40MHz_TX_Band8_CH 211_ANT 1+2	Test Voltage	By Notebook PC

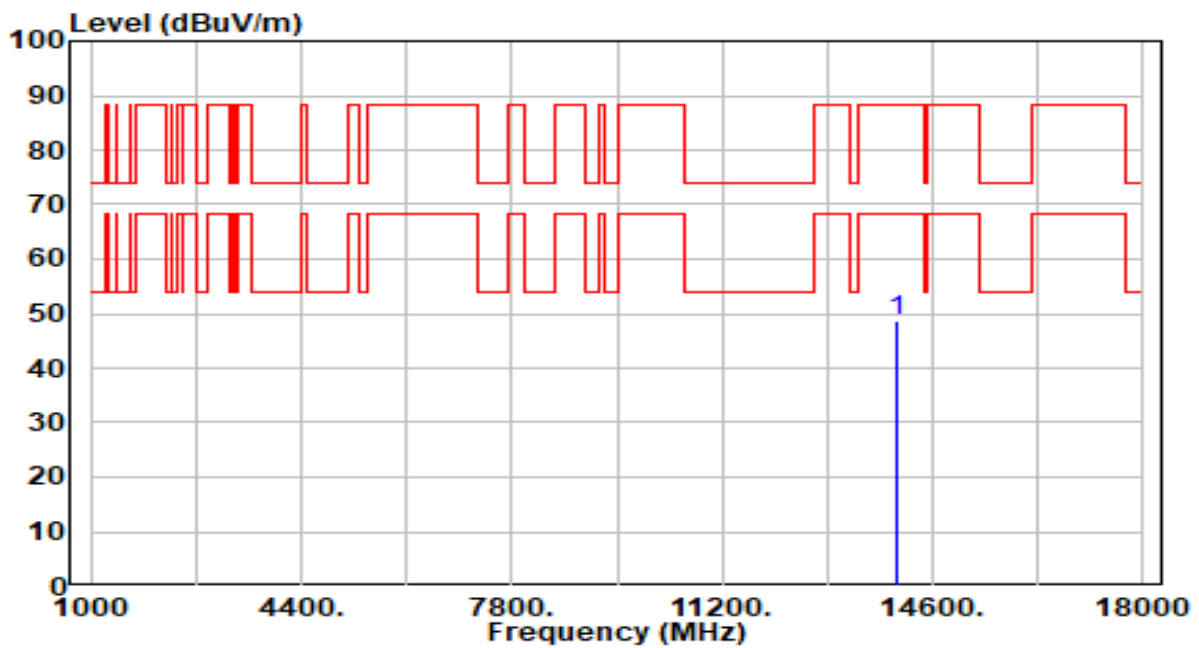

No	Frequency (MHz)	Reading (dBuV)	C.F (dB/m)	Measurement (dBuV/m)	Margin (dB)	Limit (dBuV/m)	Height (cm)	Angle (deg)	Remark (QP/PK/AV)
1	* 14010.000	43.58	5.17	48.74	-39.46	88.20	300	202	Peak

Note:

1. " \*", means this data is the worst emission level.
2. C.F (Correction Factor) = Antenna Factor (dB/m)+ Cable Loss (dB) – Preamplifier(dB).
3. Measurement (dBuV/m) = Reading(dBuV) + C.F (Correction Factor).
4. The emission levels of other frequencies are very lower than the limit and not show in test report.

EUT	AXE3000 Wi-Fi 6E High Gain Wireless USB Adapter	Date of Test	2023-10-27
Factor	DRH18-E	Temp. / Humidity	21°C /61%
Polarity	Horizontal	Site / Test Engineer	AC2 / Marvin
Test Mode	802.11ax-40MHz_TX_Band8_CH 227_ANT 1+2	Test Voltage	By Notebook PC

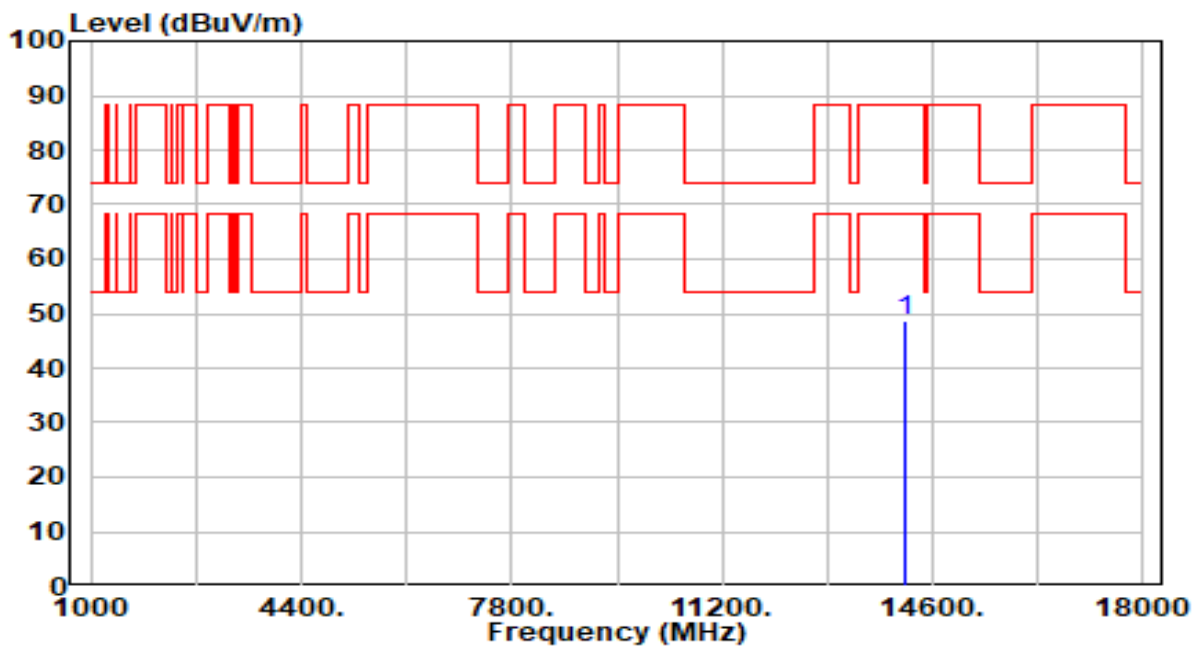

No	Frequency (MHz)	Reading (dBuV)	C.F (dB/m)	Measurement (dBuV/m)	Margin (dB)	Limit (dBuV/m)	Height (cm)	Angle (deg)	Remark (QP/PK/AV)
1	* 14170.000	43.45	5.10	48.54	-39.66	88.20	300	147	Peak

Note:

1. " \*", means this data is the worst emission level.
2. C.F (Correction Factor) = Antenna Factor (dB/m)+ Cable Loss (dB) – Preamplifier(dB).
3. Measurement (dBuV/m) = Reading(dBuV) + C.F (Correction Factor).
4. The emission levels of other frequencies are very lower than the limit and not show in test report.

EUT	AXE3000 Wi-Fi 6E High Gain Wireless USB Adapter	Date of Test	2023-10-27
Factor	DRH18-E	Temp. / Humidity	21°C /61%
Polarity	Vertical	Site / Test Engineer	AC2 / Marvin
Test Mode	802.11ax-40MHz_TX_Band8_CH 227_ANT 1+2	Test Voltage	By Notebook PC

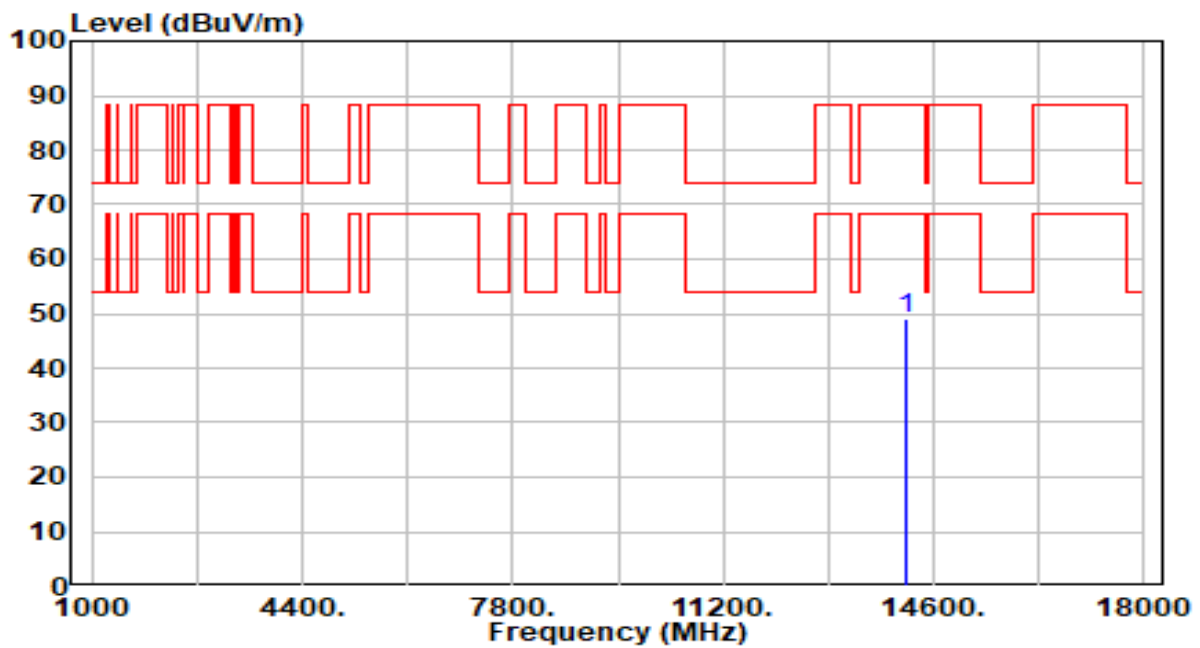

No	Frequency (MHz)	Reading (dBuV)	C.F (dB/m)	Measurement (dBuV/m)	Margin (dB)	Limit (dBuV/m)	Height (cm)	Angle (deg)	Remark (QP/PK/AV)
1	* 14170.000	43.94	5.10	49.03	-39.17	88.20	300	232	Peak

Note:

1. " \*", means this data is the worst emission level.
2. C.F (Correction Factor) = Antenna Factor (dB/m)+ Cable Loss (dB) – Preamplifier(dB).
3. Measurement (dBuV/m) = Reading(dBuV) + C.F (Correction Factor).
4. The emission levels of other frequencies are very lower than the limit and not show in test report.

EUT	AXE3000 Wi-Fi 6E High Gain Wireless USB Adapter	Date of Test	2023-10-27
Factor	DRH18-E	Temp. / Humidity	21°C /61%
Polarity	Horizontal	Site / Test Engineer	AC2 / Marvin
Test Mode	802.11ax-80MHz_TX_Band5_CH 7_ANT 1+2	Test Voltage	By Notebook PC

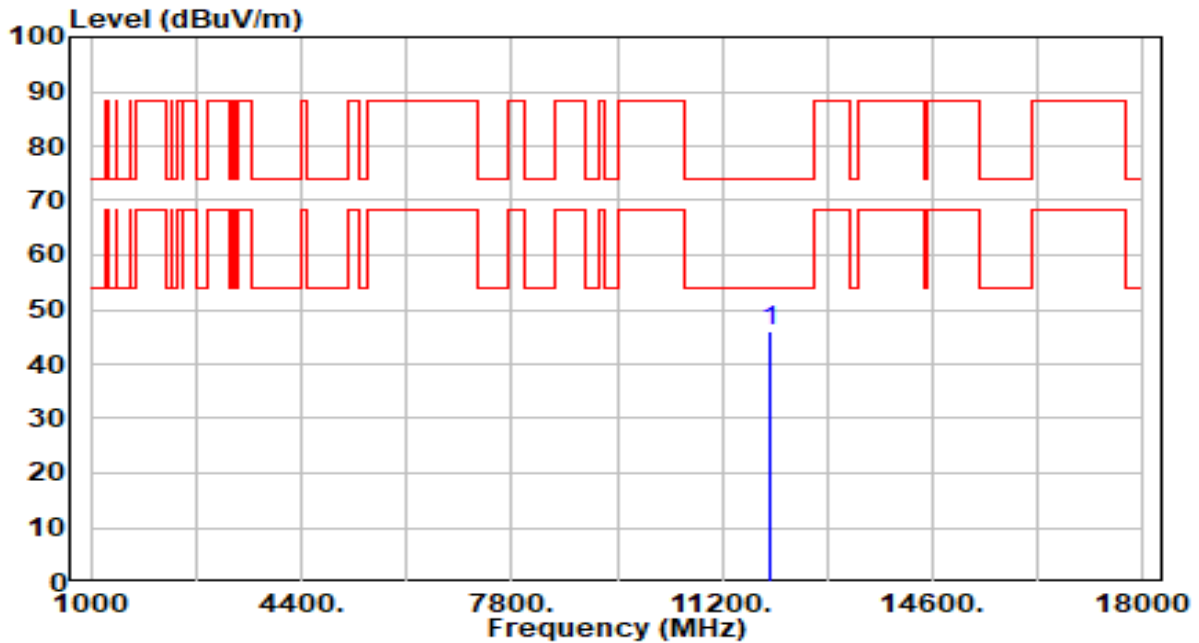

No	Frequency (MHz)	Reading (dBuV)	C.F (dB/m)	Measurement (dBuV/m)	Margin (dB)	Limit (dBuV/m)	Height (cm)	Angle (deg)	Remark (QP/PK/AV)
1	* 11970.000	42.10	3.87	45.97	-28.03	74.00	300	5	Peak

Note:

1. " \*", means this data is the worst emission level.
2. C.F (Correction Factor) = Antenna Factor (dB/m)+ Cable Loss (dB) – Preamplifier(dB).
3. Measurement (dBuV/m) = Reading(dBuV) + C.F (Correction Factor).
4. The emission levels of other frequencies are very lower than the limit and not show in test report.

EUT	AXE3000 Wi-Fi 6E High Gain Wireless USB Adapter	Date of Test	2023-10-27
Factor	DRH18-E	Temp. / Humidity	21°C /61%
Polarity	Vertical	Site / Test Engineer	AC2 / Marvin
Test Mode	802.11ax-80MHz_TX_Band5_CH 7_ANT 1+2	Test Voltage	By Notebook PC

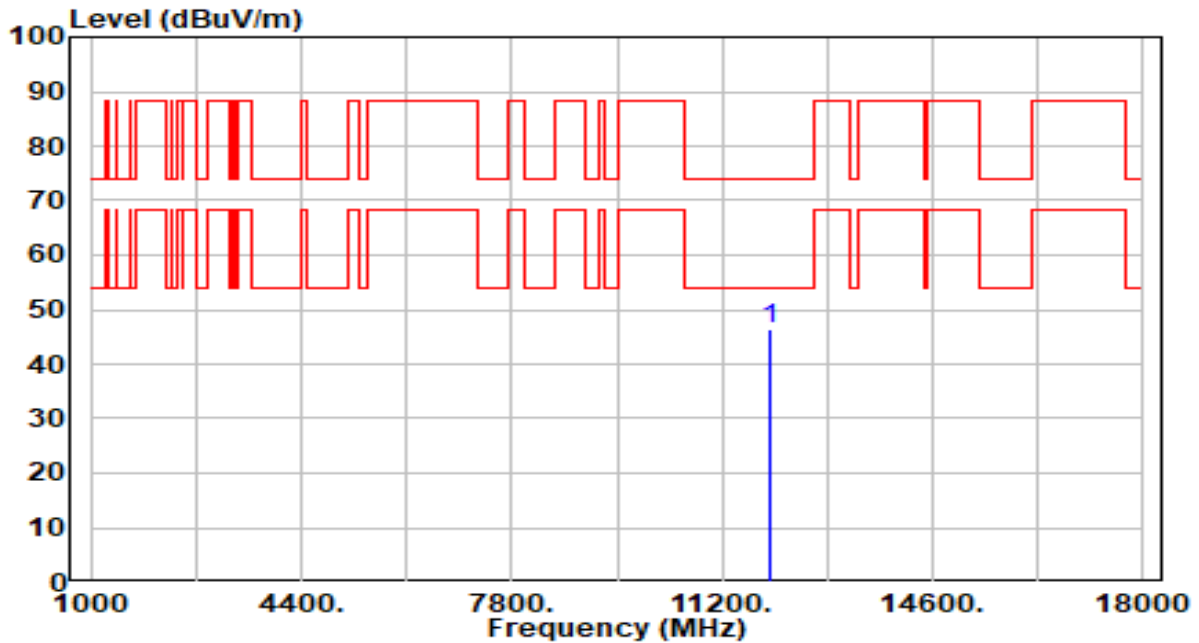

No	Frequency (MHz)	Reading (dBuV)	C.F (dB/m)	Measurement (dBuV/m)	Margin (dB)	Limit (dBuV/m)	Height (cm)	Angle (deg)	Remark (QP/PK/AV)
1	* 11970.000	42.72	3.87	46.59	-27.41	74.00	300	163	Peak

Note:

1. " \*", means this data is the worst emission level.
2. C.F (Correction Factor) = Antenna Factor (dB/m)+ Cable Loss (dB) – Preamplifier(dB).
3. Measurement (dBuV/m) = Reading(dBuV) + C.F (Correction Factor).
4. The emission levels of other frequencies are very lower than the limit and not show in test report.



EUT	AXE3000 Wi-Fi 6E High Gain Wireless USB Adapter	Date of Test	2023-10-27
Factor	DRH18-E	Temp. / Humidity	21°C /61%
Polarity	Horizontal	Site / Test Engineer	AC2 / Marvin
Test Mode	802.11ax-80MHz_TX_Band5_CH 39_ANT 1+2	Test Voltage	By Notebook PC

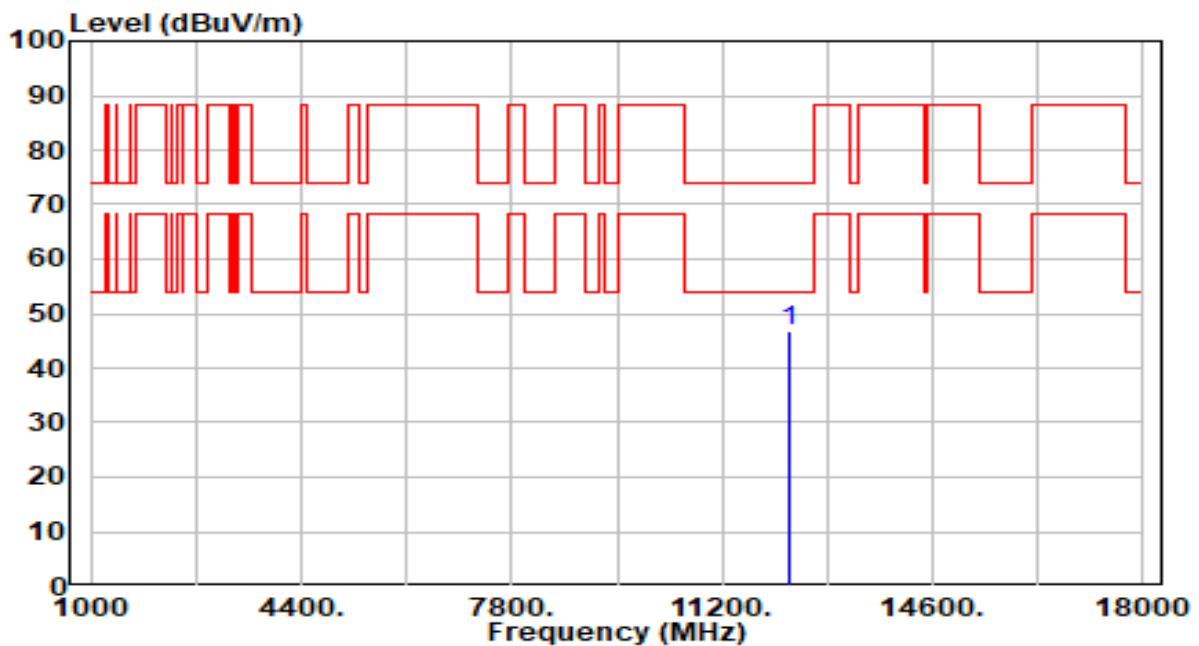

No	Frequency (MHz)	Reading (dBuV)	C.F (dB/m)	Measurement (dBuV/m)	Margin (dB)	Limit (dBuV/m)	Height (cm)	Angle (deg)	Remark (QP/PK/AV)
1	* 12290.000	42.41	4.41	46.82	-27.18	74.00	300	181	Peak

Note:

1. " \*", means this data is the worst emission level.
2. C.F (Correction Factor) = Antenna Factor (dB/m)+ Cable Loss (dB) – Preamplifier(dB).
3. Measurement (dBuV/m) = Reading(dBuV) + C.F (Correction Factor).
4. The emission levels of other frequencies are very lower than the limit and not show in test report.

EUT	AXE3000 Wi-Fi 6E High Gain Wireless USB Adapter	Date of Test	2023-10-27
Factor	DRH18-E	Temp. / Humidity	21°C /61%
Polarity	Vertical	Site / Test Engineer	AC2 / Marvin
Test Mode	802.11ax-80MHz_TX_Band5_CH 39_ANT 1+2	Test Voltage	By Notebook PC

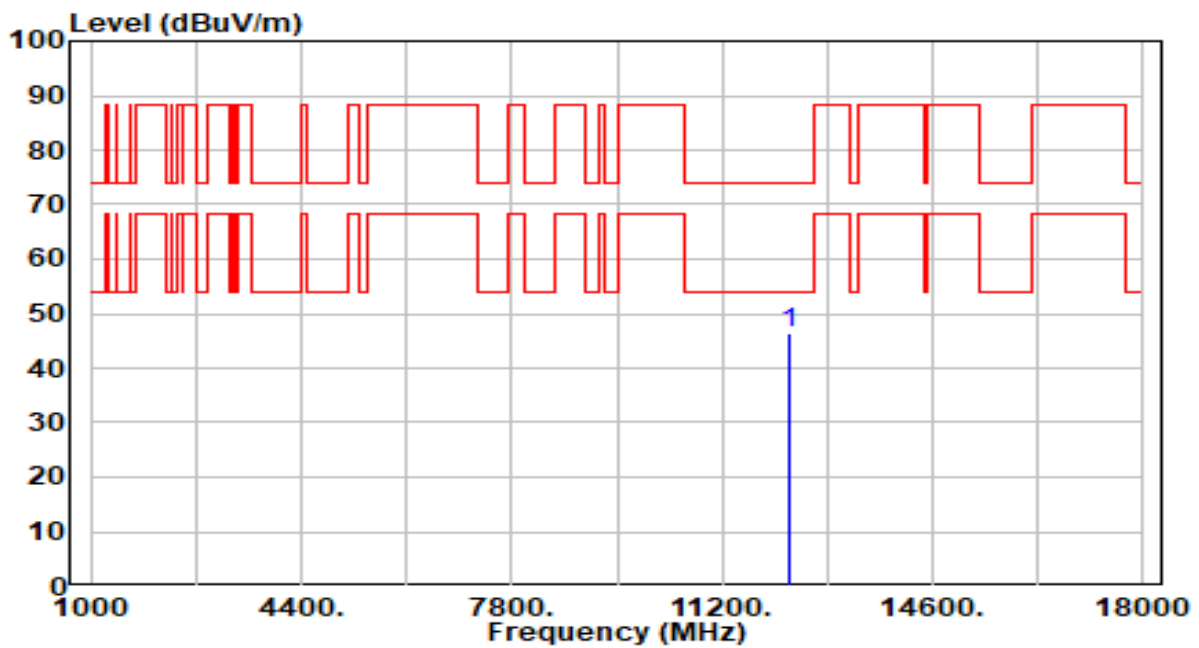

No	Frequency (MHz)	Reading (dBuV)	C.F (dB/m)	Measurement (dBuV/m)	Margin (dB)	Limit (dBuV/m)	Height (cm)	Angle (deg)	Remark (QP/PK/AV)
1	* 12290.000	41.90	4.41	46.31	-27.69	74.00	300	45	Peak

Note:

1. " \*", means this data is the worst emission level.
2. C.F (Correction Factor) = Antenna Factor (dB/m)+ Cable Loss (dB) – Preamplifier(dB).
3. Measurement (dBuV/m) = Reading(dBuV) + C.F (Correction Factor).
4. The emission levels of other frequencies are very lower than the limit and not show in test report.

EUT	AXE3000 Wi-Fi 6E High Gain Wireless USB Adapter	Date of Test	2023-10-27
Factor	DRH18-E	Temp. / Humidity	21°C /61%
Polarity	Horizontal	Site / Test Engineer	AC2 / Marvin
Test Mode	802.11ax-80MHz_TX_Band5_CH 87_ANT 1+2	Test Voltage	By Notebook PC

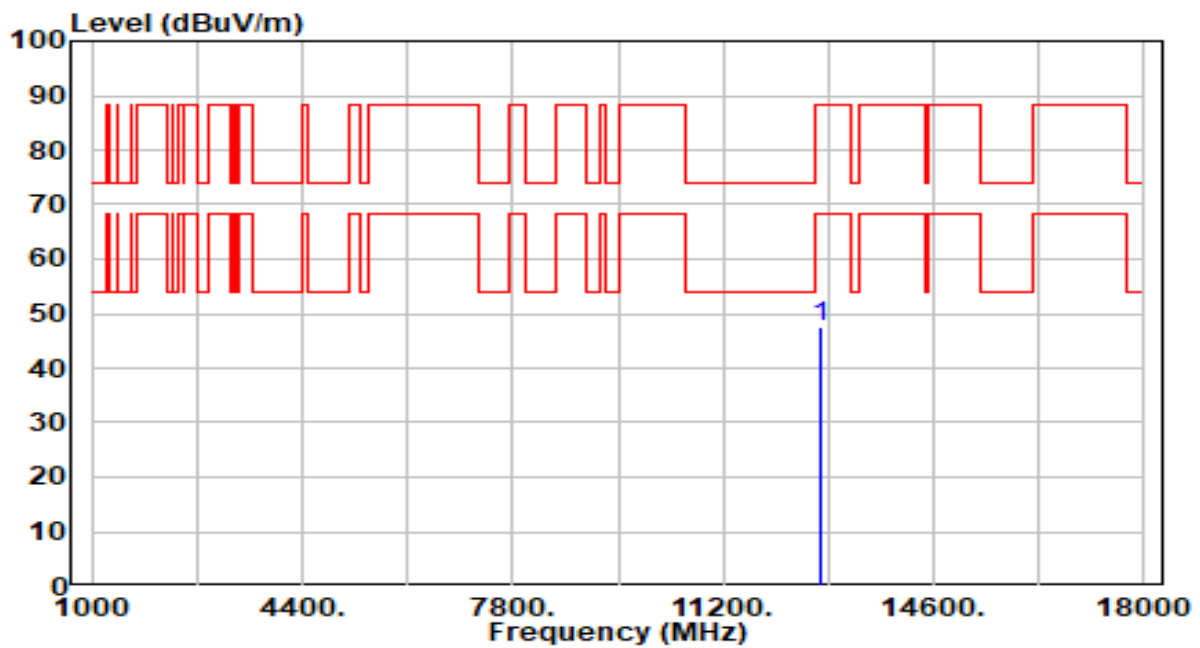

No	Frequency (MHz)	Reading (dBuV)	C.F (dB/m)	Measurement (dBuV/m)	Margin (dB)	Limit (dBuV/m)	Height (cm)	Angle (deg)	Remark (QP/PK/AV)
1	* 12770.000	42.25	5.28	47.53	-40.67	88.20	300	295	Peak

Note:

1. " \*", means this data is the worst emission level.
2. C.F (Correction Factor) = Antenna Factor (dB/m)+ Cable Loss (dB) – Preamplifier(dB).
3. Measurement (dBuV/m) = Reading(dBuV) + C.F (Correction Factor).
4. The emission levels of other frequencies are very lower than the limit and not show in test report.

EUT	AXE3000 Wi-Fi 6E High Gain Wireless USB Adapter	Date of Test	2023-10-27
Factor	DRH18-E	Temp. / Humidity	21°C /61%
Polarity	Vertical	Site / Test Engineer	AC2 / Marvin
Test Mode	802.11ax-80MHz_TX_Band5_CH 87_ANT 1+2	Test Voltage	By Notebook PC

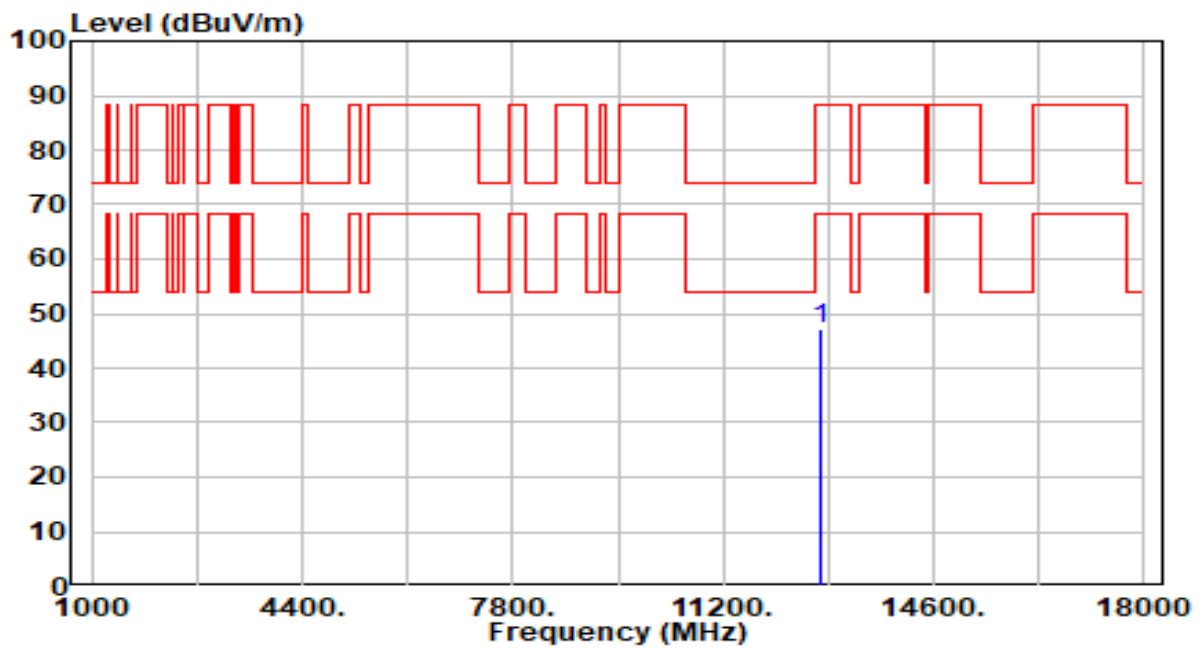

No	Frequency (MHz)	Reading (dBuV)	C.F (dB/m)	Measurement (dBuV/m)	Margin (dB)	Limit (dBuV/m)	Height (cm)	Angle (deg)	Remark (QP/PK/AV)
1	* 12770.000	41.82	5.28	47.10	-41.10	88.20	300	120	Peak

Note:

1. " \*", means this data is the worst emission level.
2. C.F (Correction Factor) = Antenna Factor (dB/m)+ Cable Loss (dB) – Preamplifier(dB).
3. Measurement (dBuV/m) = Reading(dBuV) + C.F (Correction Factor).
4. The emission levels of other frequencies are very lower than the limit and not show in test report.

EUT	AXE3000 Wi-Fi 6E High Gain Wireless USB Adapter	Date of Test	2023-10-27
Factor	DRH18-E	Temp. / Humidity	21°C /61%
Polarity	Horizontal	Site / Test Engineer	AC2 / Marvin
Test Mode	802.11ax-80MHz_TX_Band6_CH 103_ANT 1+2	Test Voltage	By Notebook PC

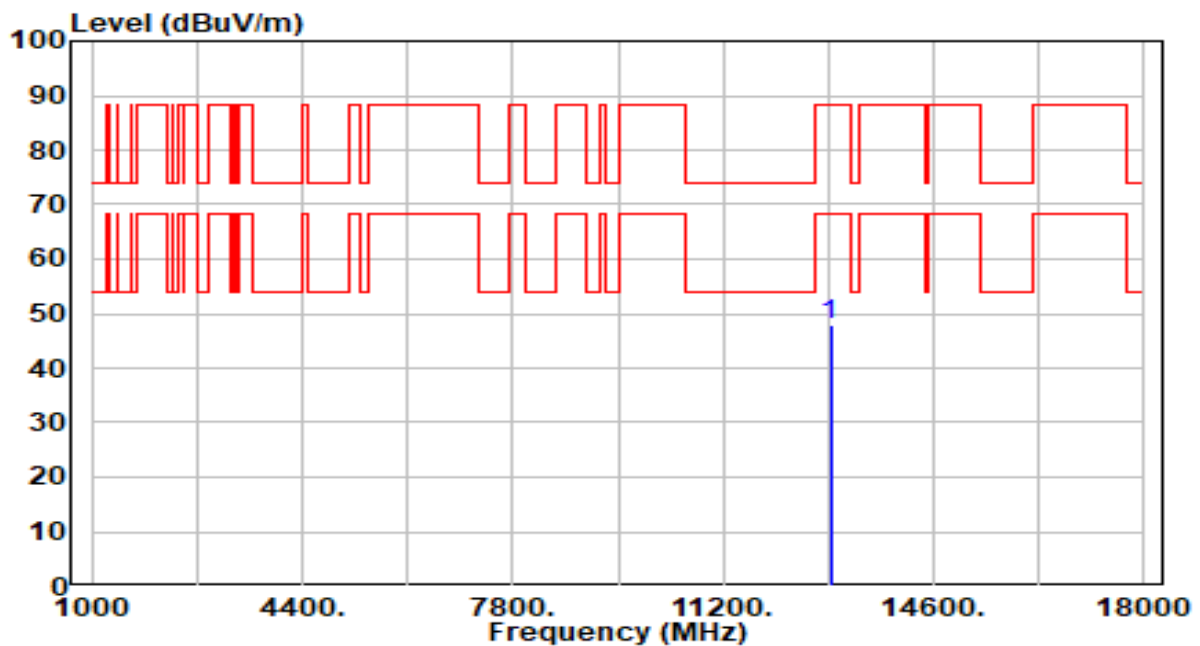

No	Frequency (MHz)	Reading (dBuV)	C.F (dB/m)	Measurement (dBuV/m)	Margin (dB)	Limit (dBuV/m)	Height (cm)	Angle (deg)	Remark (QP/PK/AV)
1	* 12930.000	42.83	5.26	48.10	-40.10	88.20	300	209	Peak

Note:

1. " \*", means this data is the worst emission level.
2. C.F (Correction Factor) = Antenna Factor (dB/m)+ Cable Loss (dB) – Preamplifier(dB).
3. Measurement (dBuV/m) = Reading(dBuV) + C.F (Correction Factor).
4. The emission levels of other frequencies are very lower than the limit and not show in test report.

EUT	AXE3000 Wi-Fi 6E High Gain Wireless USB Adapter	Date of Test	2023-10-27
Factor	DRH18-E	Temp. / Humidity	21°C /61%
Polarity	Vertical	Site / Test Engineer	AC2 / Marvin
Test Mode	802.11ax-80MHz_TX_Band6_CH 103_ANT 1+2	Test Voltage	By Notebook PC

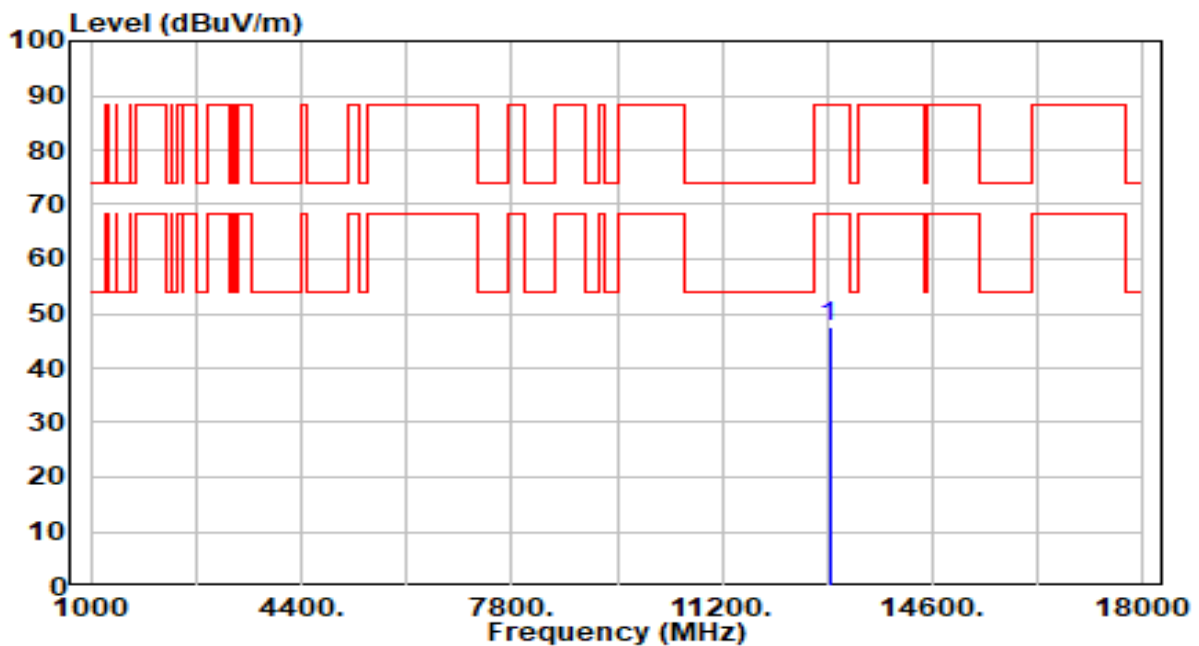

No	Frequency (MHz)	Reading (dBuV)	C.F (dB/m)	Measurement (dBuV/m)	Margin (dB)	Limit (dBuV/m)	Height (cm)	Angle (deg)	Remark (QP/PK/AV)
1	* 12930.000	42.47	5.26	47.73	-40.47	88.20	300	163	Peak

Note:

1. " \*", means this data is the worst emission level.
2. C.F (Correction Factor) = Antenna Factor (dB/m)+ Cable Loss (dB) – Preamplifier(dB).
3. Measurement (dBuV/m) = Reading(dBuV) + C.F (Correction Factor).
4. The emission levels of other frequencies are very lower than the limit and not show in test report.

EUT	AXE3000 Wi-Fi 6E High Gain Wireless USB Adapter	Date of Test	2023-10-27
Factor	DRH18-E	Temp. / Humidity	21°C /61%
Polarity	Horizontal	Site / Test Engineer	AC2 / Marvin
Test Mode	802.11ax-80MHz_TX_Band7_CH 119_ANT 1+2	Test Voltage	By Notebook PC

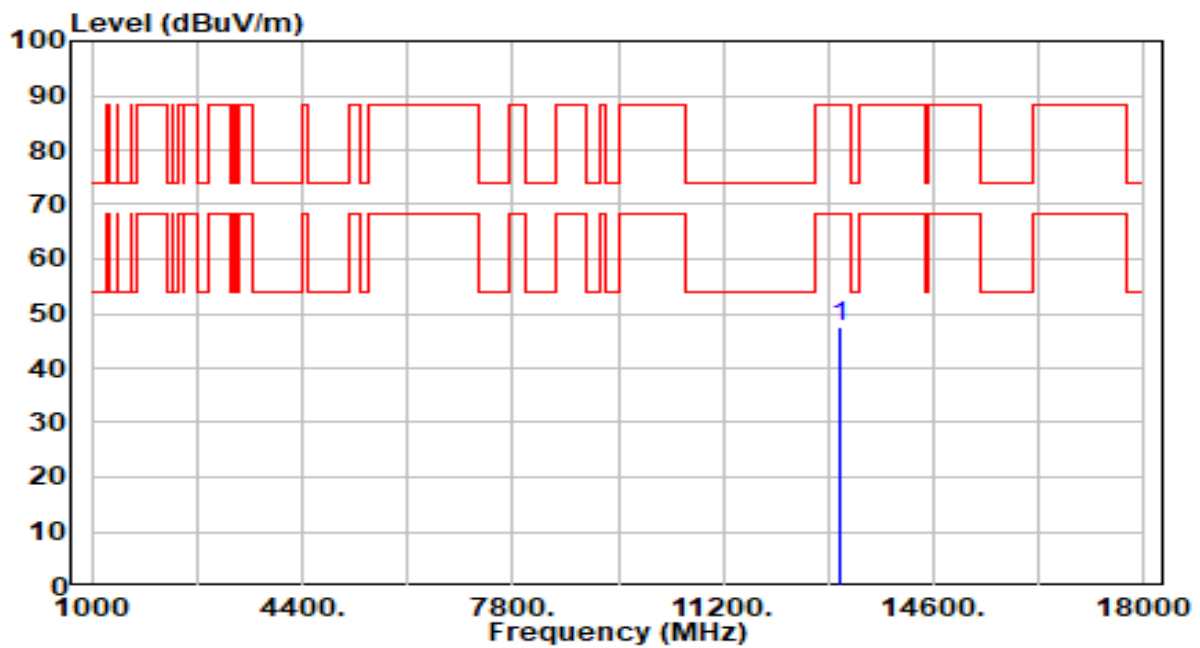

No	Frequency (MHz)	Reading (dBuV)	C.F (dB/m)	Measurement (dBuV/m)	Margin (dB)	Limit (dBuV/m)	Height (cm)	Angle (deg)	Remark (QP/PK/AV)
1	* 13090.000	42.46	5.22	47.68	-40.52	88.20	300	355	Peak

Note:

1. " \*", means this data is the worst emission level.
2. C.F (Correction Factor) = Antenna Factor (dB/m)+ Cable Loss (dB) – Preamplifier(dB).
3. Measurement (dBuV/m) = Reading(dBuV) + C.F (Correction Factor).
4. The emission levels of other frequencies are very lower than the limit and not show in test report.

EUT	AXE3000 Wi-Fi 6E High Gain Wireless USB Adapter	Date of Test	2023-10-27
Factor	DRH18-E	Temp. / Humidity	21°C /61%
Polarity	Vertical	Site / Test Engineer	AC2 / Marvin
Test Mode	802.11ax-80MHz_TX_Band7_CH 119_ANT 1+2	Test Voltage	By Notebook PC

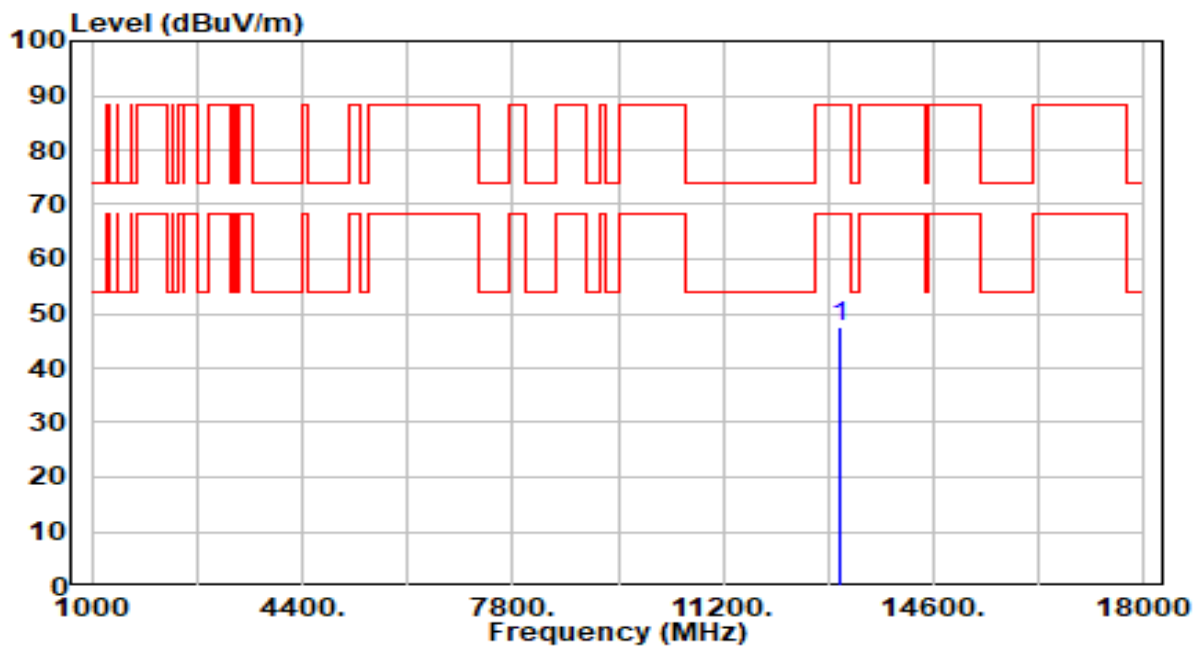

No	Frequency (MHz)	Reading (dBuV)	C.F (dB/m)	Measurement (dBuV/m)	Margin (dB)	Limit (dBuV/m)	Height (cm)	Angle (deg)	Remark (QP/PK/AV)
1	* 13090.000	42.17	5.22	47.39	-40.81	88.20	300	99	Peak

Note:

1. " \*", means this data is the worst emission level.
2. C.F (Correction Factor) = Antenna Factor (dB/m)+ Cable Loss (dB) – Preamplifier(dB).
3. Measurement (dBuV/m) = Reading(dBuV) + C.F (Correction Factor).
4. The emission levels of other frequencies are very lower than the limit and not show in test report.



EUT	AXE3000 Wi-Fi 6E High Gain Wireless USB Adapter	Date of Test	2023-10-27
Factor	DRH18-E	Temp. / Humidity	21°C /61%
Polarity	Horizontal	Site / Test Engineer	AC2 / Marvin
Test Mode	802.11ax-80MHz_TX_Band7_CH 135_ANT 1+2	Test Voltage	By Notebook PC

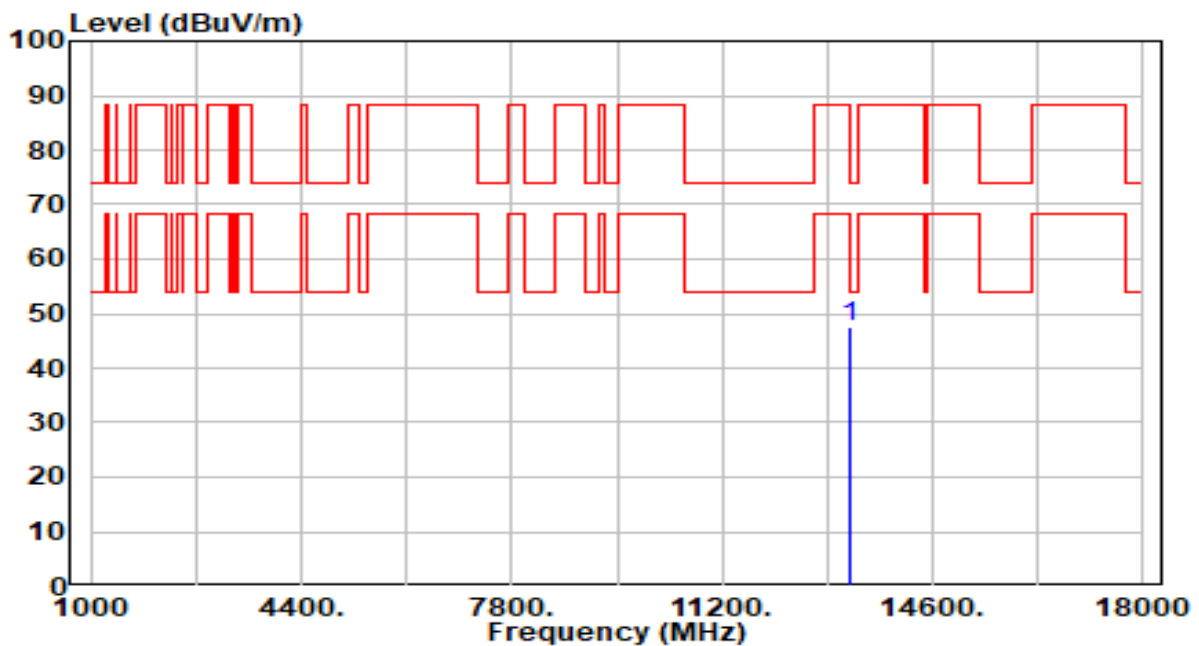

No	Frequency (MHz)	Reading (dBuV)	C.F (dB/m)	Measurement (dBuV/m)	Margin (dB)	Limit (dBuV/m)	Height (cm)	Angle (deg)	Remark (QP/PK/AV)
1	* 13250.000	42.20	5.22	47.42	-26.58	74.00	300	83	Peak

Note:

1. " \*", means this data is the worst emission level.
2. C.F (Correction Factor) = Antenna Factor (dB/m)+ Cable Loss (dB) – Preamplifier(dB).
3. Measurement (dBuV/m) = Reading(dBuV) + C.F (Correction Factor).
4. The emission levels of other frequencies are very lower than the limit and not show in test report.

EUT	AXE3000 Wi-Fi 6E High Gain Wireless USB Adapter	Date of Test	2023-10-27
Factor	DRH18-E	Temp. / Humidity	21°C /61%
Polarity	Vertical	Site / Test Engineer	AC2 / Marvin
Test Mode	802.11ax-80MHz_TX_Band7_CH 135_ANT 1+2	Test Voltage	By Notebook PC

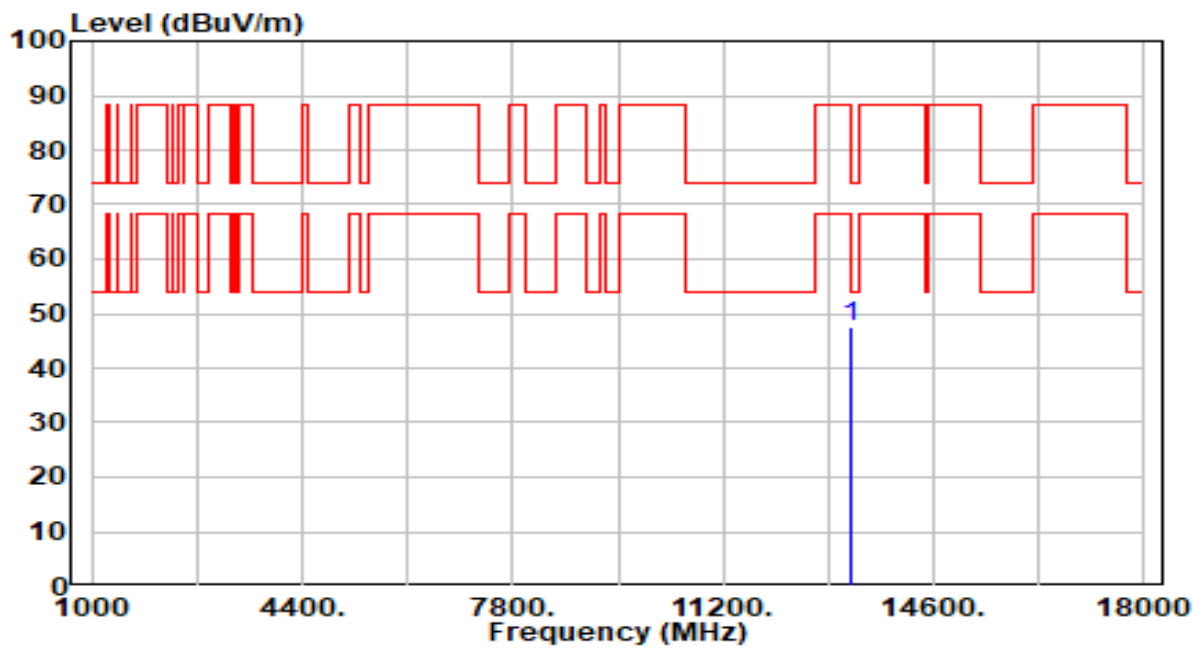

No	Frequency (MHz)	Reading (dBuV)	C.F (dB/m)	Measurement (dBuV/m)	Margin (dB)	Limit (dBuV/m)	Height (cm)	Angle (deg)	Remark (QP/PK/AV)
1	* 13250.000	42.41	5.22	47.63	-26.37	74.00	300	245	Peak

Note:

1. " \*", means this data is the worst emission level.
2. C.F (Correction Factor) = Antenna Factor (dB/m)+ Cable Loss (dB) – Preamplifier(dB).
3. Measurement (dBuV/m) = Reading(dBuV) + C.F (Correction Factor).
4. The emission levels of other frequencies are very lower than the limit and not show in test report.

EUT	AXE3000 Wi-Fi 6E High Gain Wireless USB Adapter	Date of Test	2023-10-27
Factor	DRH18-E	Temp. / Humidity	21°C /61%
Polarity	Horizontal	Site / Test Engineer	AC2 / Marvin
Test Mode	802.11ax-80MHz_TX_Band7_CH 151_ANT 1+2	Test Voltage	By Notebook PC

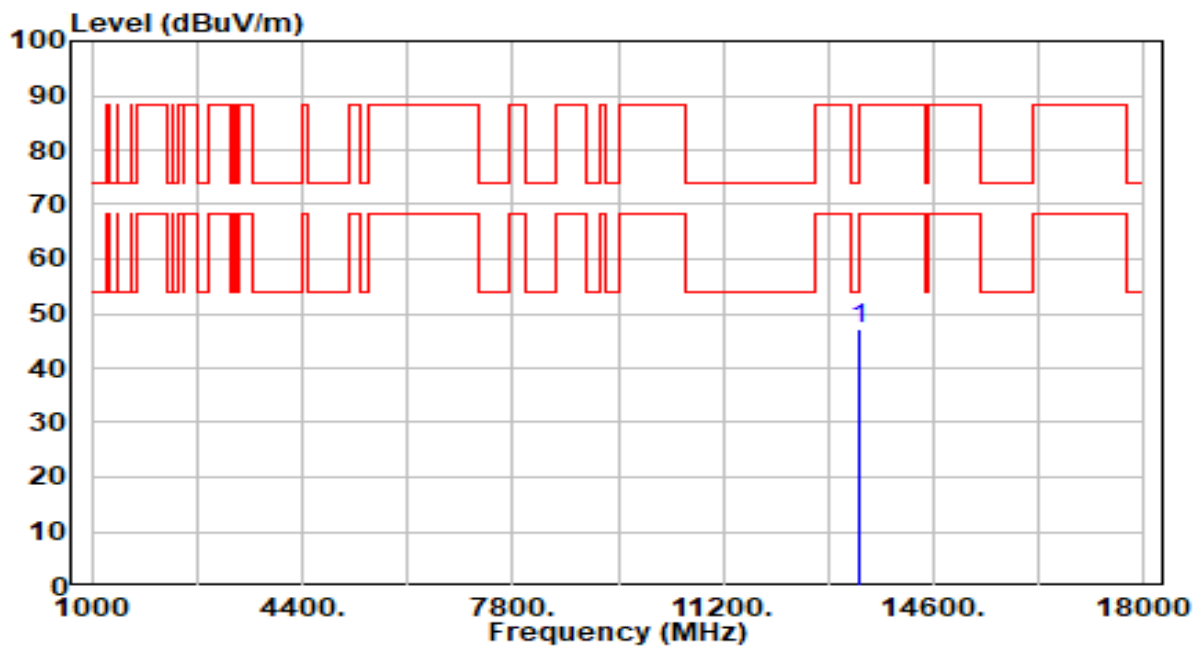

No	Frequency (MHz)	Reading (dBuV)	C.F (dB/m)	Measurement (dBuV/m)	Margin (dB)	Limit (dBuV/m)	Height (cm)	Angle (deg)	Remark (QP/PK/AV)
1	* 13410.000	42.09	5.25	47.34	-40.86	88.20	300	20	Peak

Note:

1. " \*", means this data is the worst emission level.
2. C.F (Correction Factor) = Antenna Factor (dB/m)+ Cable Loss (dB) – Preamplifier(dB).
3. Measurement (dBuV/m) = Reading(dBuV) + C.F (Correction Factor).
4. The emission levels of other frequencies are very lower than the limit and not show in test report.

EUT	AXE3000 Wi-Fi 6E High Gain Wireless USB Adapter	Date of Test	2023-10-27
Factor	DRH18-E	Temp. / Humidity	21°C /61%
Polarity	Vertical	Site / Test Engineer	AC2 / Marvin
Test Mode	802.11ax-80MHz_TX_Band7_CH 151_ANT 1+2	Test Voltage	By Notebook PC

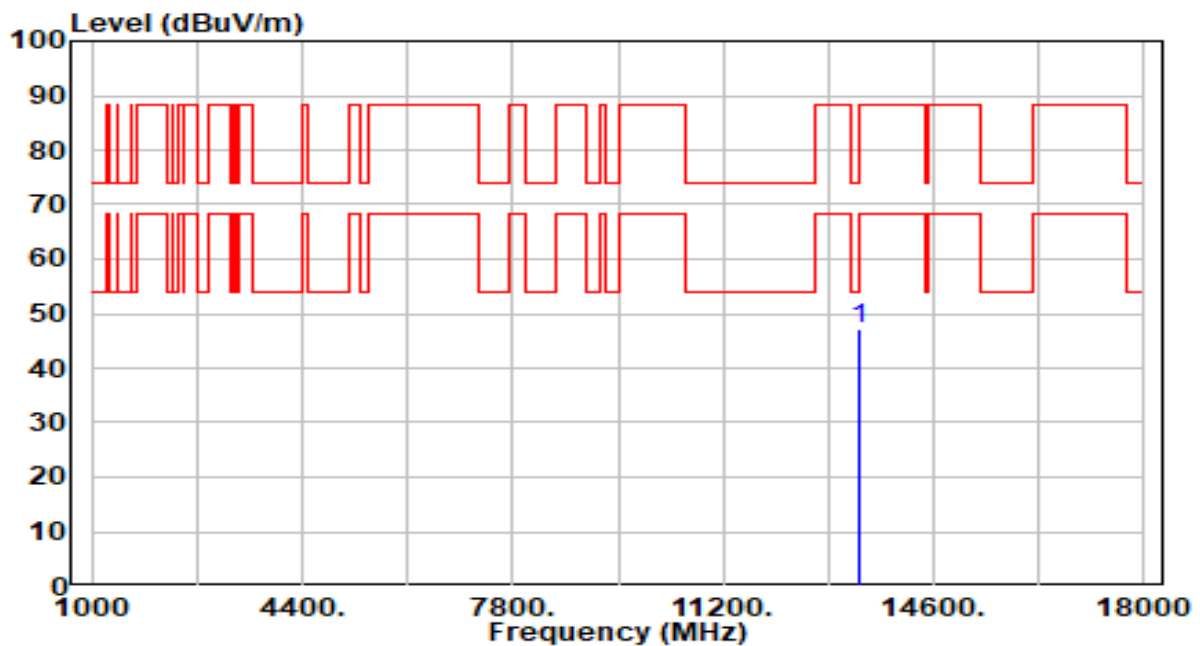

No	Frequency (MHz)	Reading (dBuV)	C.F (dB/m)	Measurement (dBuV/m)	Margin (dB)	Limit (dBuV/m)	Height (cm)	Angle (deg)	Remark (QP/PK/AV)
1	* 13410.000	41.94	5.25	47.20	-41.00	88.20	300	171	Peak

Note:

1. " \*", means this data is the worst emission level.
2. C.F (Correction Factor) = Antenna Factor (dB/m)+ Cable Loss (dB) – Preamplifier(dB).
3. Measurement (dBuV/m) = Reading(dBuV) + C.F (Correction Factor).
4. The emission levels of other frequencies are very lower than the limit and not show in test report.

EUT	AXE3000 Wi-Fi 6E High Gain Wireless USB Adapter	Date of Test	2023-10-27
Factor	DRH18-E	Temp. / Humidity	21°C /61%
Polarity	Horizontal	Site / Test Engineer	AC2 / Marvin
Test Mode	802.11ax-80MHz_TX_Band7_CH 183_ANT 1+2	Test Voltage	By Notebook PC

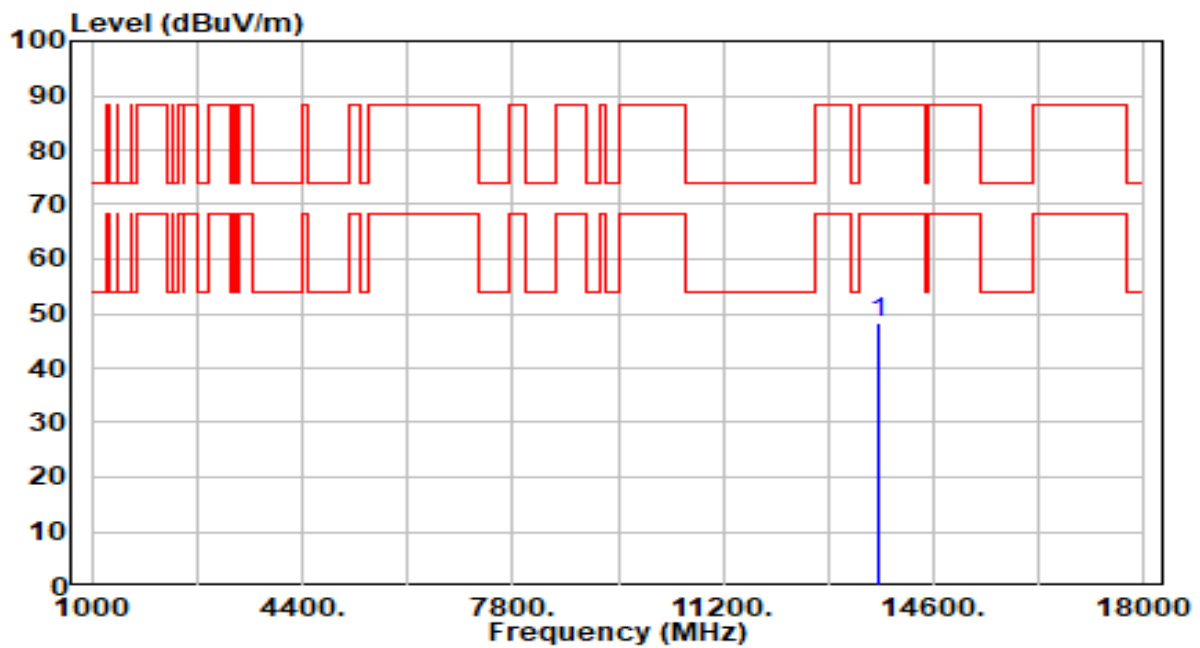

No	Frequency (MHz)	Reading (dBuV)	C.F (dB/m)	Measurement (dBuV/m)	Margin (dB)	Limit (dBuV/m)	Height (cm)	Angle (deg)	Remark (QP/PK/AV)
1	* 13730.000	43.13	5.03	48.16	-40.04	88.20	300	60	Peak

Note:

1. " \*", means this data is the worst emission level.
2. C.F (Correction Factor) = Antenna Factor (dB/m)+ Cable Loss (dB) – Preamplifier(dB).
3. Measurement (dBuV/m) = Reading(dBuV) + C.F (Correction Factor).
4. The emission levels of other frequencies are very lower than the limit and not show in test report.

EUT	AXE3000 Wi-Fi 6E High Gain Wireless USB Adapter	Date of Test	2023-10-27
Factor	DRH18-E	Temp. / Humidity	21°C /61%
Polarity	Vertical	Site / Test Engineer	AC2 / Marvin
Test Mode	802.11ax-80MHz_TX_Band7_CH 183_ANT 1+2	Test Voltage	By Notebook PC

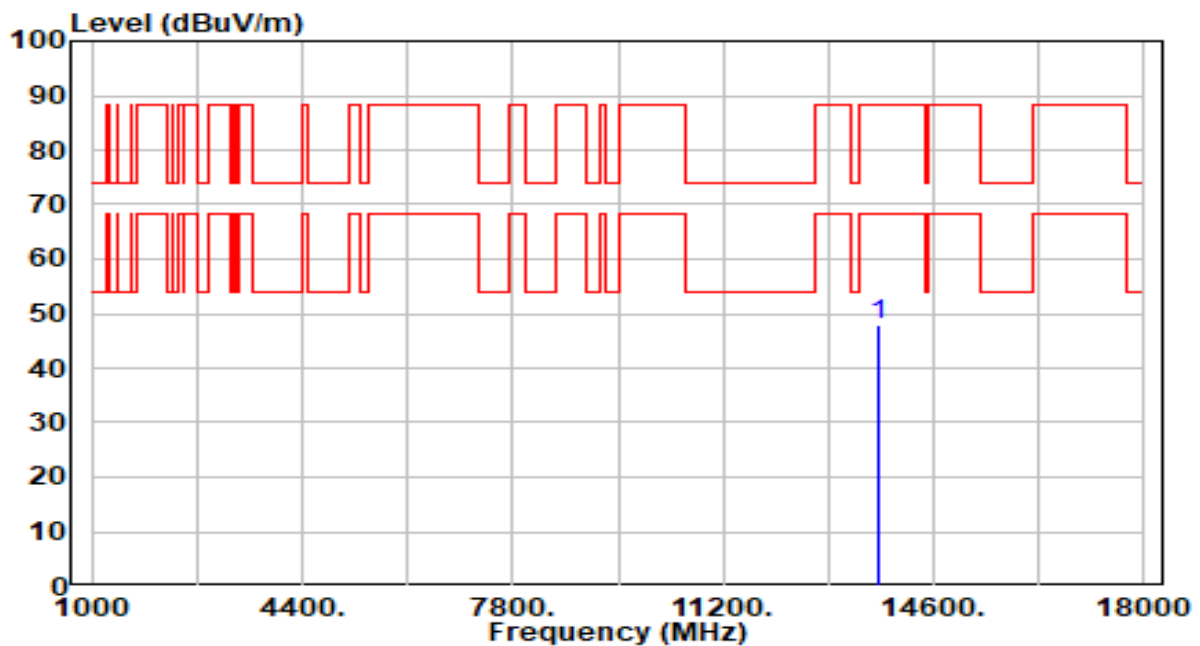

No	Frequency (MHz)	Reading (dBuV)	C.F (dB/m)	Measurement (dBuV/m)	Margin (dB)	Limit (dBuV/m)	Height (cm)	Angle (deg)	Remark (QP/PK/AV)
1	* 13730.000	42.71	5.03	47.74	-40.46	88.20	300	1	Peak

Note:

1. " \*", means this data is the worst emission level.
2. C.F (Correction Factor) = Antenna Factor (dB/m)+ Cable Loss (dB) – Preamplifier(dB).
3. Measurement (dBuV/m) = Reading(dBuV) + C.F (Correction Factor).
4. The emission levels of other frequencies are very lower than the limit and not show in test report.

EUT	AXE3000 Wi-Fi 6E High Gain Wireless USB Adapter	Date of Test	2023-10-27
Factor	DRH18-E	Temp. / Humidity	21°C /61%
Polarity	Horizontal	Site / Test Engineer	AC2 / Marvin
Test Mode	802.11ax-80MHz_TX_Band8_CH 199_ANT 1+2	Test Voltage	By Notebook PC

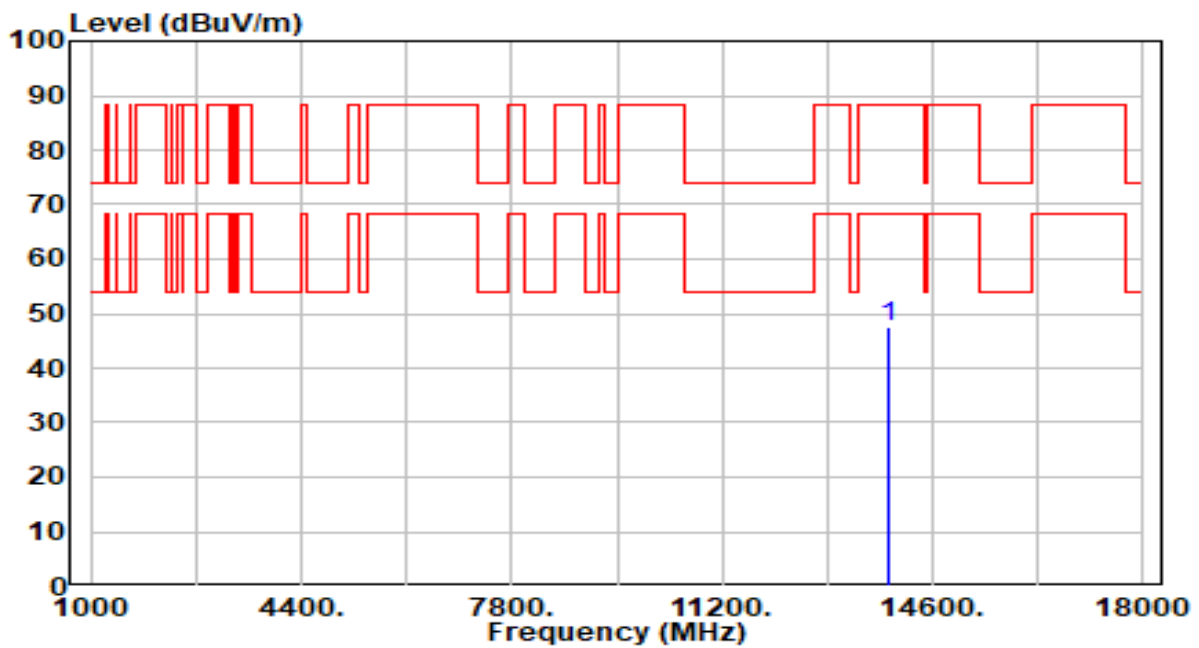

No	Frequency (MHz)	Reading (dBuV)	C.F (dB/m)	Measurement (dBuV/m)	Margin (dB)	Limit (dBuV/m)	Height (cm)	Angle (deg)	Remark (QP/PK/AV)
1	* 13890.000	42.48	5.10	47.58	-40.62	88.20	300	24	Peak

Note:

1. " \*", means this data is the worst emission level.
2. C.F (Correction Factor) = Antenna Factor (dB/m)+ Cable Loss (dB) – Preamplifier(dB).
3. Measurement (dBuV/m) = Reading(dBuV) + C.F (Correction Factor).
4. The emission levels of other frequencies are very lower than the limit and not show in test report.

EUT	AXE3000 Wi-Fi 6E High Gain Wireless USB Adapter	Date of Test	2023-10-27
Factor	DRH18-E	Temp. / Humidity	21°C /61%
Polarity	Vertical	Site / Test Engineer	AC2 / Marvin
Test Mode	802.11ax-80MHz_TX_Band8_CH 199_ANT 1+2	Test Voltage	By Notebook PC

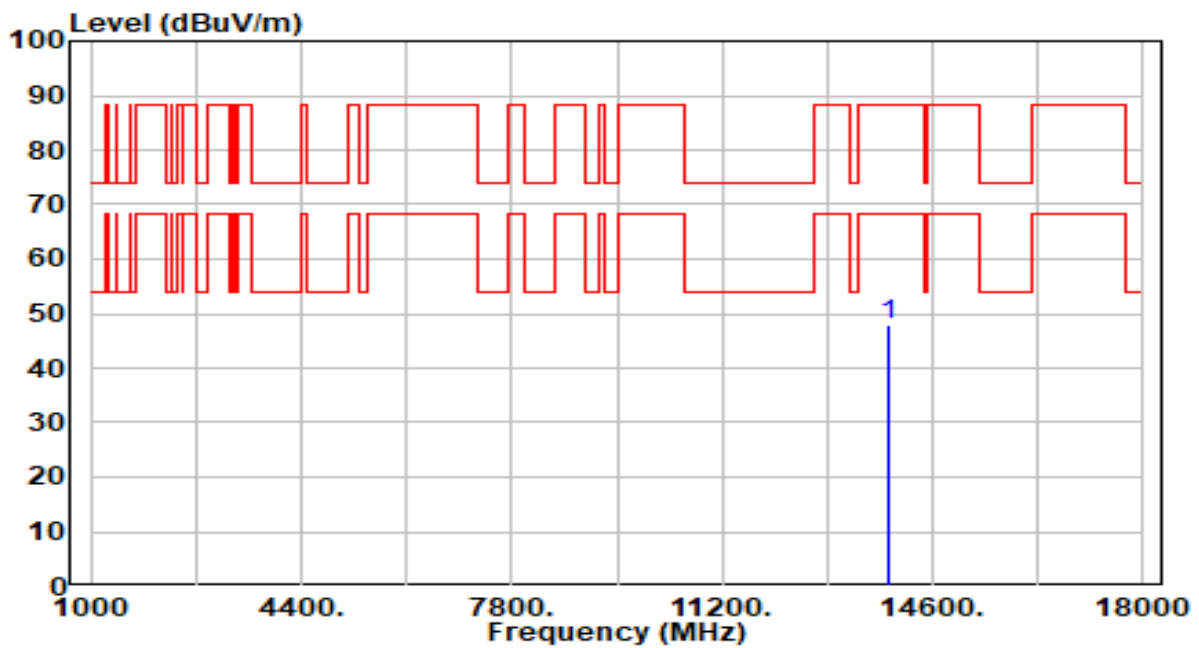

No	Frequency (MHz)	Reading (dBuV)	C.F (dB/m)	Measurement (dBuV/m)	Margin (dB)	Limit (dBuV/m)	Height (cm)	Angle (deg)	Remark (QP/PK/AV)
1	* 13890.000	42.79	5.10	47.89	-40.31	88.20	300	1	Peak

Note:

1. " \*", means this data is the worst emission level.
2. C.F (Correction Factor) = Antenna Factor (dB/m)+ Cable Loss (dB) – Preamplifier(dB).
3. Measurement (dBuV/m) = Reading(dBuV) + C.F (Correction Factor).
4. The emission levels of other frequencies are very lower than the limit and not show in test report.



EUT	AXE3000 Wi-Fi 6E High Gain Wireless USB Adapter	Date of Test	2023-10-27
Factor	DRH18-E	Temp. / Humidity	21°C /61%
Polarity	Horizontal	Site / Test Engineer	AC2 / Marvin
Test Mode	802.11ax-80MHz_TX_Band8_CH 215_ANT 1+2	Test Voltage	By Notebook PC

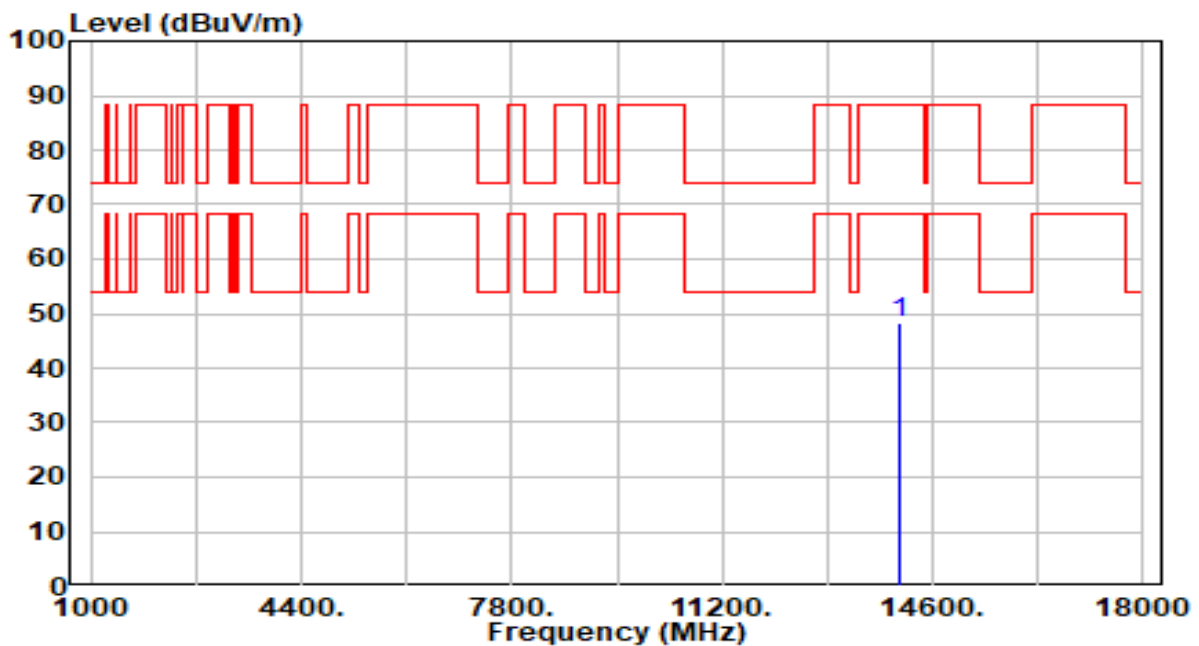

No	Frequency (MHz)	Reading (dBuV)	C.F (dB/m)	Measurement (dBuV/m)	Margin (dB)	Limit (dBuV/m)	Height (cm)	Angle (deg)	Remark (QP/PK/AV)
1	* 14050.000	43.20	5.15	48.35	-39.85	88.20	300	171	Peak

Note:

1. " \*", means this data is the worst emission level.
2. C.F (Correction Factor) = Antenna Factor (dB/m)+ Cable Loss (dB) – Preamplifier(dB).
3. Measurement (dBuV/m) = Reading(dBuV) + C.F (Correction Factor).
4. The emission levels of other frequencies are very lower than the limit and not show in test report.

EUT	AXE3000 Wi-Fi 6E High Gain Wireless USB Adapter	Date of Test	2023-10-27
Factor	DRH18-E	Temp. / Humidity	21°C /61%
Polarity	Vertical	Site / Test Engineer	AC2 / Marvin
Test Mode	802.11ax-80MHz_TX_Band8_CH 215_ANT 1+2	Test Voltage	By Notebook PC

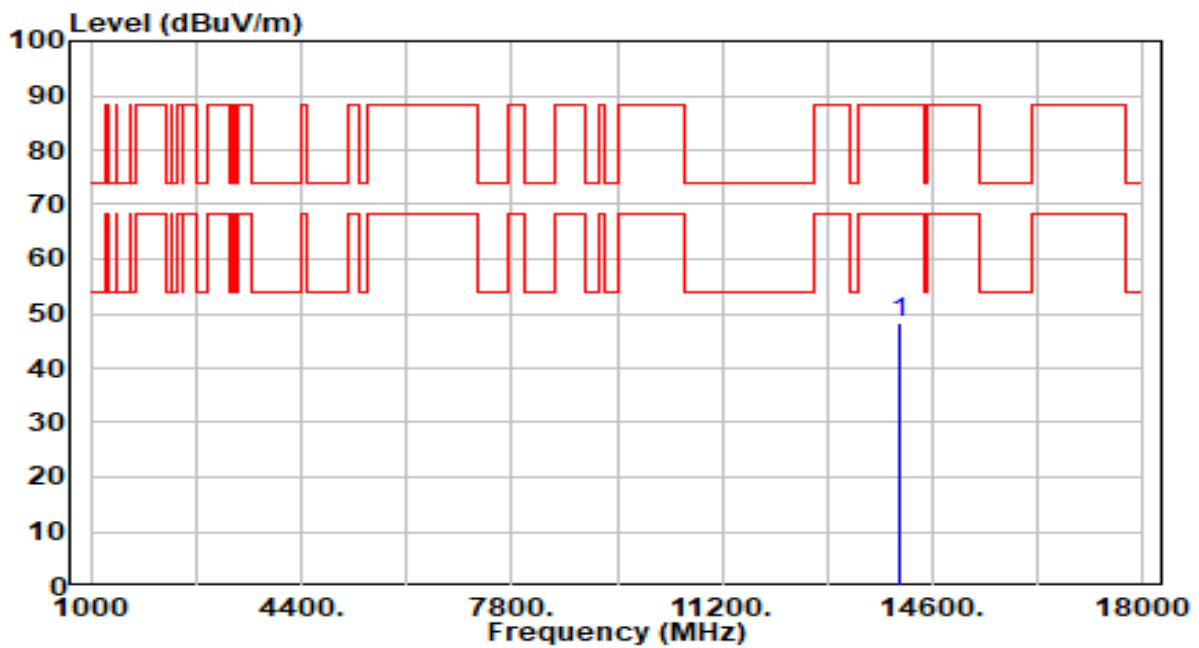

No	Frequency (MHz)	Reading (dBuV)	C.F (dB/m)	Measurement (dBuV/m)	Margin (dB)	Limit (dBuV/m)	Height (cm)	Angle (deg)	Remark (QP/PK/AV)
1	* 14050.000	43.01	5.15	48.16	-40.04	88.20	300	173	Peak

Note:

1. " \*", means this data is the worst emission level.
2. C.F (Correction Factor) = Antenna Factor (dB/m)+ Cable Loss (dB) – Preamplifier(dB).
3. Measurement (dBuV/m) = Reading(dBuV) + C.F (Correction Factor).
4. The emission levels of other frequencies are very lower than the limit and not show in test report.

Nss=2

EUT	AXE3000 Wi-Fi 6E High Gain Wireless USB Adapter	Date of Test	2023-10-27
Factor	DRH18-E	Temp. / Humidity	21°C /61%
Polarity	Horizontal	Site / Test Engineer	AC2 / Marvin
Test Mode	802.11ax-20MHz_TX_Band5_CH 1_ANT 1+2	Test Voltage	By Notebook PC

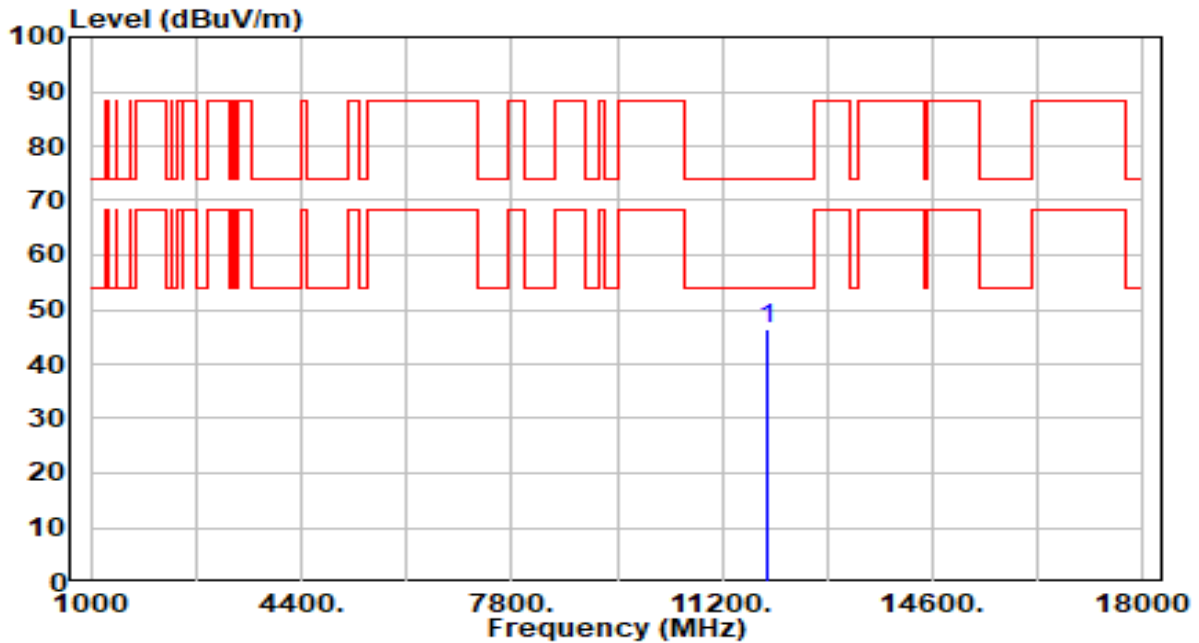

No	Frequency (MHz)	Reading (dBuV)	C.F (dB/m)	Measurement (dBuV/m)	Margin (dB)	Limit (dBuV/m)	Height (cm)	Angle (deg)	Remark (QP/PK/AV)
1	* 11910.000	42.79	3.78	46.57	-27.43	74.00	100	206	Peak

Note:

1. " \*", means this data is the worst emission level.
2. C.F (Correction Factor) = Antenna Factor (dB/m)+ Cable Loss (dB) – Preamplifier(dB).
3. Measurement (dBuV/m) = Reading(dBuV) + C.F (Correction Factor).
4. The emission levels of other frequencies are very lower than the limit and not show in test report.

EUT	AXE3000 Wi-Fi 6E High Gain Wireless USB Adapter	Date of Test	2023-10-27
Factor	DRH18-E	Temp. / Humidity	21°C /61%
Polarity	Vertical	Site / Test Engineer	AC2 / Marvin
Test Mode	802.11ax-20MHz_TX_Band5_CH 1_ANT 1+2	Test Voltage	By Notebook PC

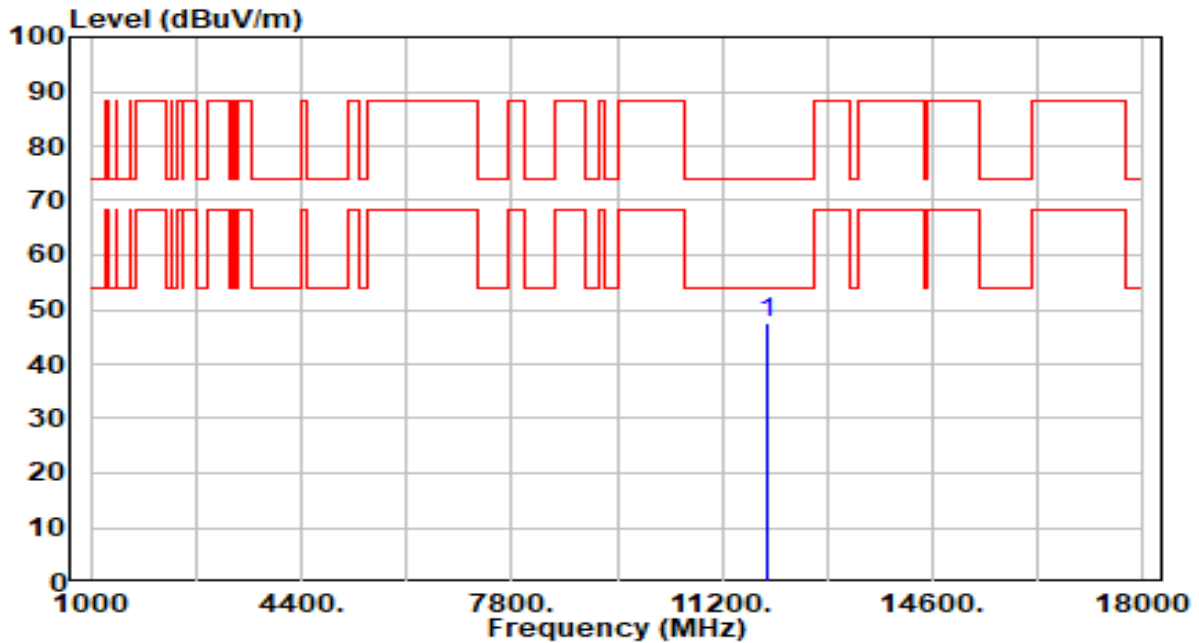

No	Frequency (MHz)	Reading (dBuV)	C.F (dB/m)	Measurement (dBuV/m)	Margin (dB)	Limit (dBuV/m)	Height (cm)	Angle (deg)	Remark (QP/PK/AV)
1	* 11910.000	43.59	3.78	47.36	-26.64	74.00	300	26	Peak

Note:

1. " \*", means this data is the worst emission level.
2. C.F (Correction Factor) = Antenna Factor (dB/m)+ Cable Loss (dB) – Preamplifier(dB).
3. Measurement (dBuV/m) = Reading(dBuV) + C.F (Correction Factor).
4. The emission levels of other frequencies are very lower than the limit and not show in test report.

EUT	AXE3000 Wi-Fi 6E High Gain Wireless USB Adapter	Date of Test	2023-10-27
Factor	DRH18-E	Temp. / Humidity	21°C /61%
Polarity	Horizontal	Site / Test Engineer	AC2 / Marvin
Test Mode	802.11ax-20MHz_TX_Band5_CH 33_ANT 1+2	Test Voltage	By Notebook PC

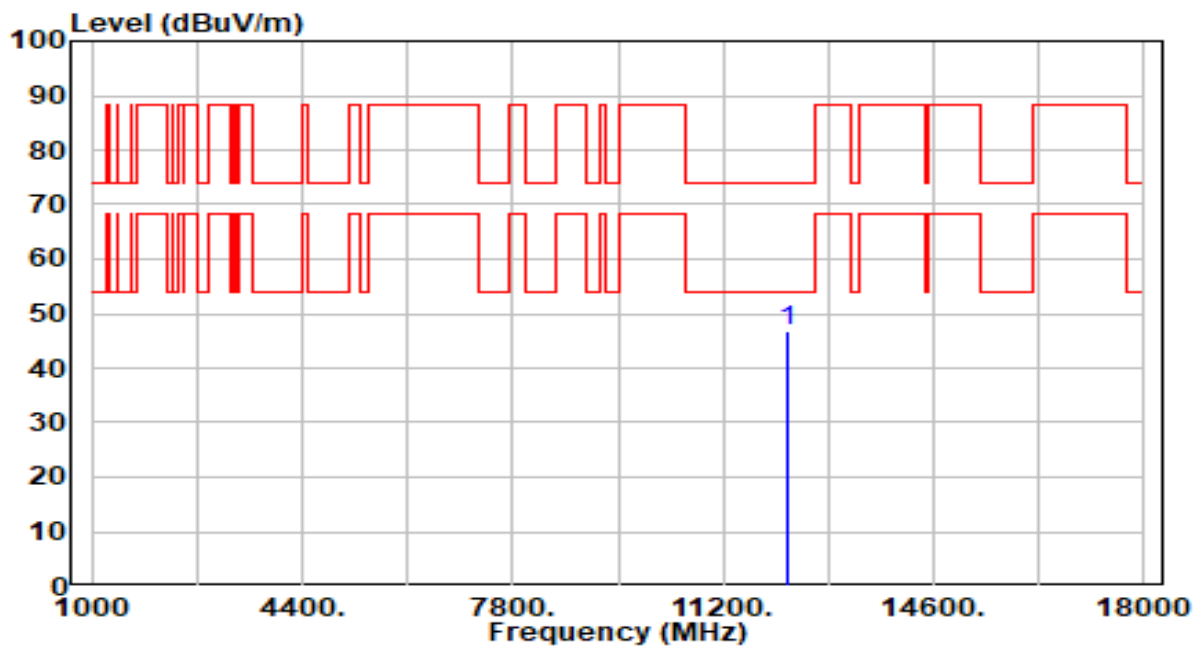

No	Frequency (MHz)	Reading (dBuV)	C.F (dB/m)	Measurement (dBuV/m)	Margin (dB)	Limit (dBuV/m)	Height (cm)	Angle (deg)	Remark (QP/PK/AV)
1	* 12230.000	42.58	4.33	46.91	-27.09	74.00	300	284	Peak

Note:

1. " \*", means this data is the worst emission level.
2. C.F (Correction Factor) = Antenna Factor (dB/m)+ Cable Loss (dB) – Preamplifier(dB).
3. Measurement (dBuV/m) = Reading(dBuV) + C.F (Correction Factor).
4. The emission levels of other frequencies are very lower than the limit and not show in test report.

EUT	AXE3000 Wi-Fi 6E High Gain Wireless USB Adapter	Date of Test	2023-10-27
Factor	DRH18-E	Temp. / Humidity	21°C /61%
Polarity	Vertical	Site / Test Engineer	AC2 / Marvin
Test Mode	802.11ax-20MHz_TX_Band5_CH 33_ANT 1+2	Test Voltage	By Notebook PC

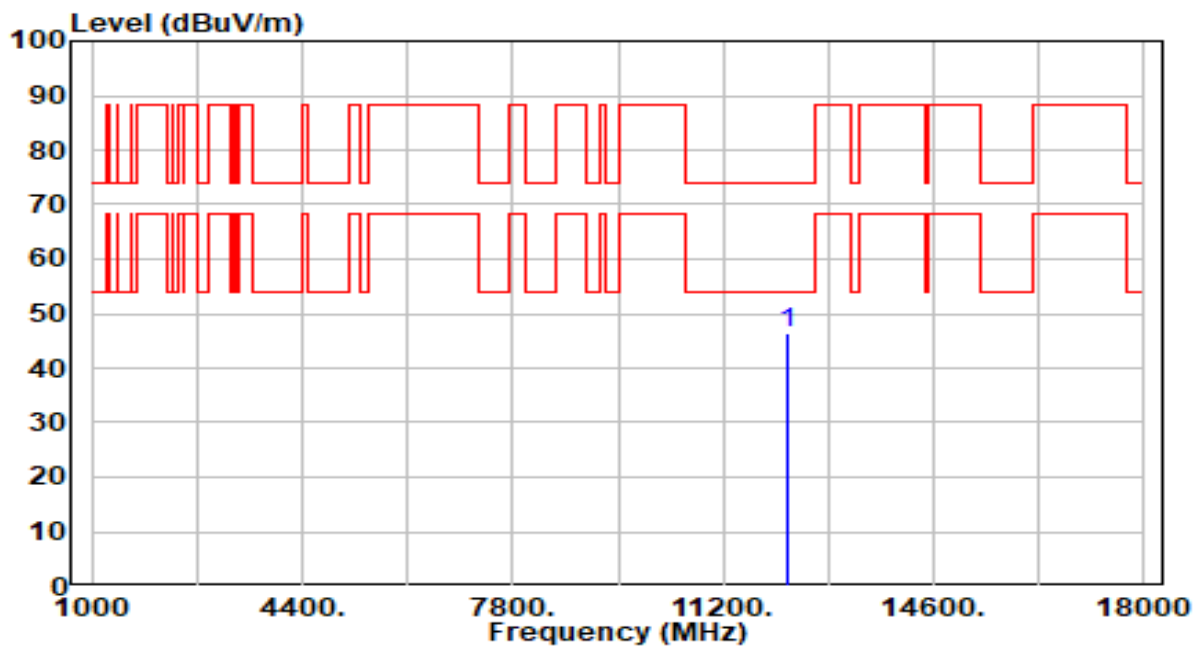

No	Frequency (MHz)	Reading (dBuV)	C.F (dB/m)	Measurement (dBuV/m)	Margin (dB)	Limit (dBuV/m)	Height (cm)	Angle (deg)	Remark (QP/PK/AV)
1	* 12230.000	42.18	4.33	46.52	-27.48	74.00	300	233	Peak

Note:

1. " \*", means this data is the worst emission level.
2. C.F (Correction Factor) = Antenna Factor (dB/m)+ Cable Loss (dB) – Preamplifier(dB).
3. Measurement (dBuV/m) = Reading(dBuV) + C.F (Correction Factor).
4. The emission levels of other frequencies are very lower than the limit and not show in test report.

EUT	AXE3000 Wi-Fi 6E High Gain Wireless USB Adapter	Date of Test	2023-10-27
Factor	DRH18-E	Temp. / Humidity	21°C /61%
Polarity	Horizontal	Site / Test Engineer	AC2 / Marvin
Test Mode	802.11ax-20MHz_TX_Band5_CH 93_ANT 1+2	Test Voltage	By Notebook PC

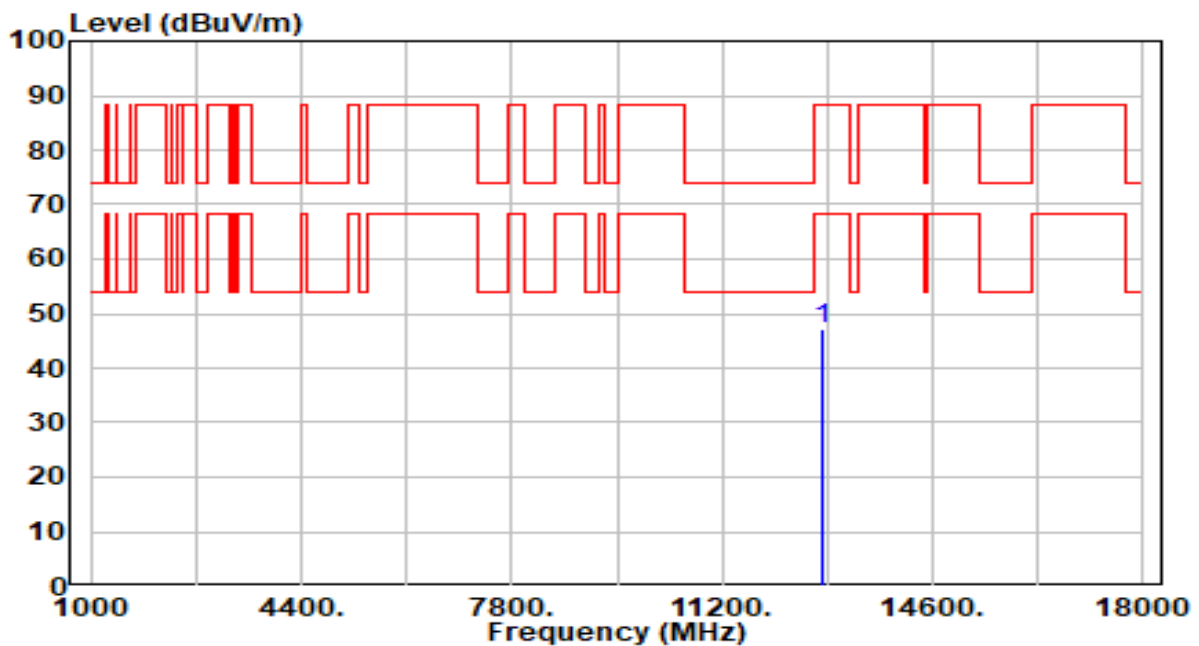

No	Frequency (MHz)	Reading (dBuV)	C.F (dB/m)	Measurement (dBuV/m)	Margin (dB)	Limit (dBuV/m)	Height (cm)	Angle (deg)	Remark (QP/PK/AV)
1	* 12830.000	41.79	5.29	47.08	-41.12	88.20	300	70	Peak

Note:

1. " \*", means this data is the worst emission level.
2. C.F (Correction Factor) = Antenna Factor (dB/m)+ Cable Loss (dB) – Preamplifier(dB).
3. Measurement (dBuV/m) = Reading(dBuV) + C.F (Correction Factor).
4. The emission levels of other frequencies are very lower than the limit and not show in test report.

EUT	AXE3000 Wi-Fi 6E High Gain Wireless USB Adapter	Date of Test	2023-10-27
Factor	DRH18-E	Temp. / Humidity	21°C /61%
Polarity	Vertical	Site / Test Engineer	AC2 / Marvin
Test Mode	802.11ax-20MHz_TX_Band5_CH 93_ANT 1+2	Test Voltage	By Notebook PC

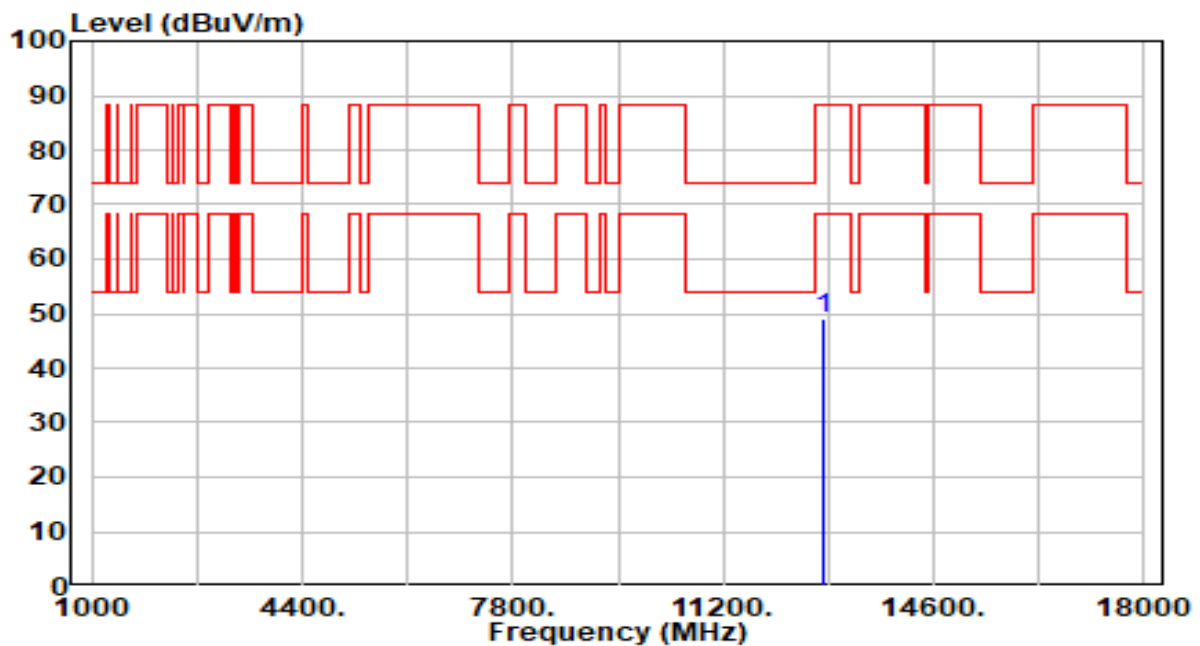

No	Frequency (MHz)	Reading (dBuV)	C.F (dB/m)	Measurement (dBuV/m)	Margin (dB)	Limit (dBuV/m)	Height (cm)	Angle (deg)	Remark (QP/PK/AV)
1	* 12830.000	43.91	5.29	49.21	-38.99	88.20	300	209	Peak

Note:

1. " \*", means this data is the worst emission level.
2. C.F (Correction Factor) = Antenna Factor (dB/m)+ Cable Loss (dB) – Preamplifier(dB).
3. Measurement (dBuV/m) = Reading(dBuV) + C.F (Correction Factor).
4. The emission levels of other frequencies are very lower than the limit and not show in test report.



EUT	AXE3000 Wi-Fi 6E High Gain Wireless USB Adapter	Date of Test	2023-10-27
Factor	DRH18-E	Temp. / Humidity	21°C /61%
Polarity	Horizontal	Site / Test Engineer	AC2 / Marvin
Test Mode	802.11ax-20MHz_TX_Band6_CH 97_ANT 1+2	Test Voltage	By Notebook PC

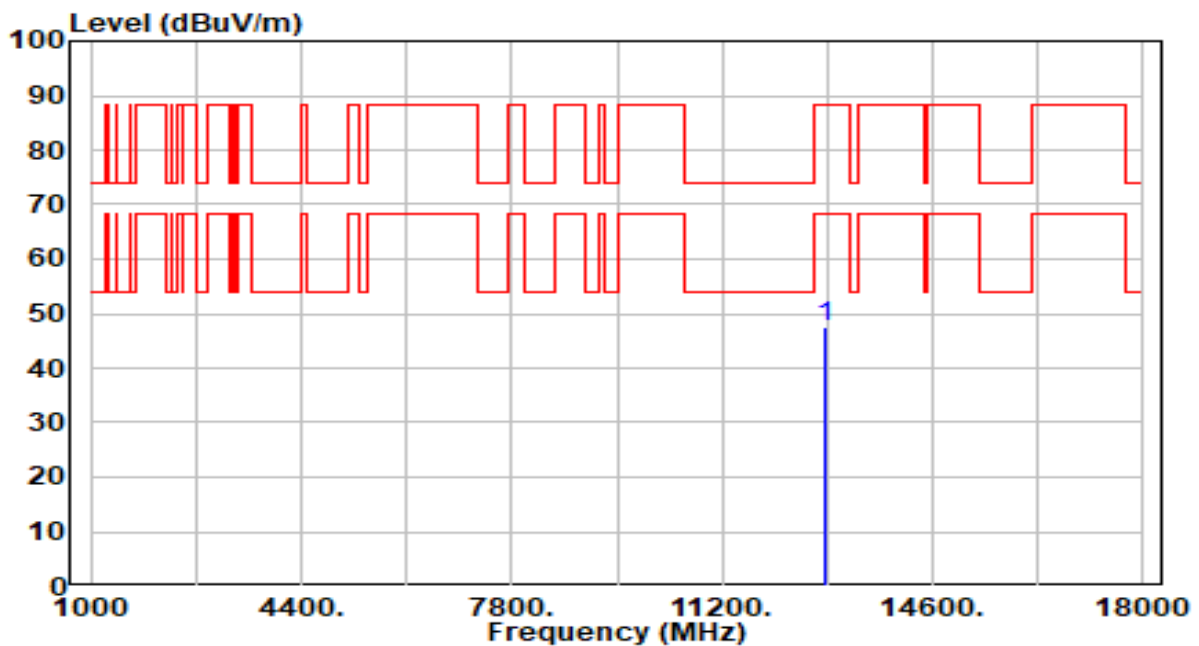

No	Frequency (MHz)	Reading (dBuV)	C.F (dB/m)	Measurement (dBuV/m)	Margin (dB)	Limit (dBuV/m)	Height (cm)	Angle (deg)	Remark (QP/PK/AV)
1	* 12870.000	42.36	5.28	47.64	-40.56	88.20	300	167	Peak

Note:

1. " \*", means this data is the worst emission level.
2. C.F (Correction Factor) = Antenna Factor (dB/m)+ Cable Loss (dB) – Preamplifier(dB).
3. Measurement (dBuV/m) = Reading(dBuV) + C.F (Correction Factor).
4. The emission levels of other frequencies are very lower than the limit and not show in test report.

EUT	AXE3000 Wi-Fi 6E High Gain Wireless USB Adapter	Date of Test	2023-10-27
Factor	DRH18-E	Temp. / Humidity	21°C /61%
Polarity	Vertical	Site / Test Engineer	AC2 / Marvin
Test Mode	802.11ax-20MHz_TX_Band6_CH 97_ANT 1+2	Test Voltage	By Notebook PC

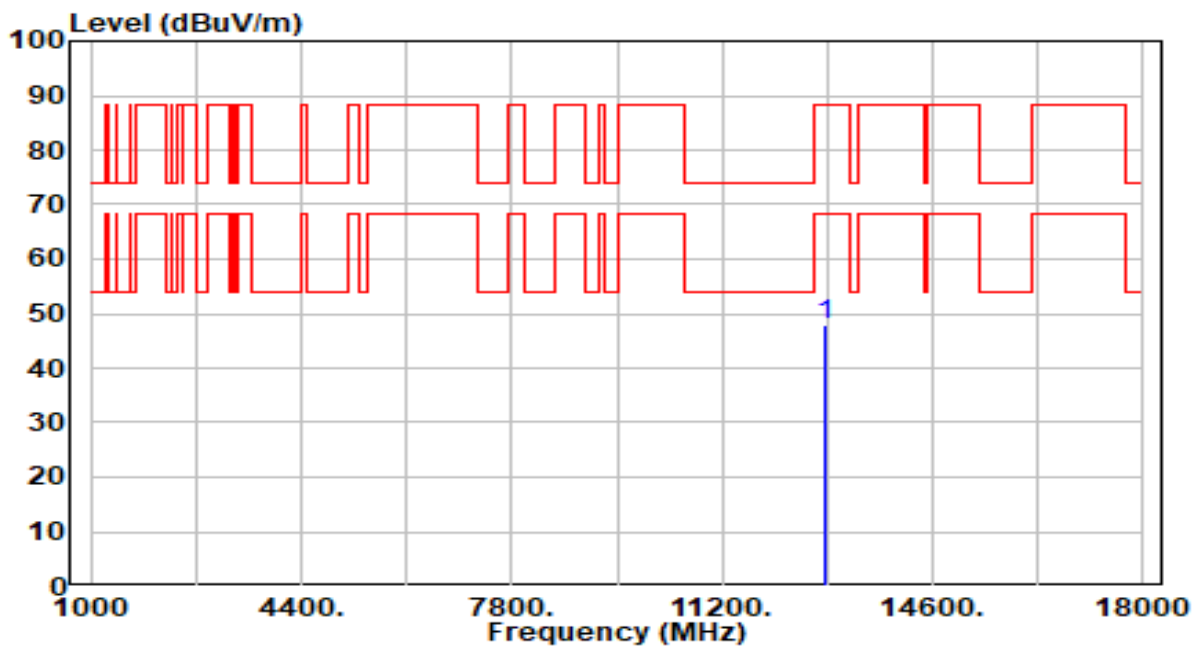

No	Frequency (MHz)	Reading (dBuV)	C.F (dB/m)	Measurement (dBuV/m)	Margin (dB)	Limit (dBuV/m)	Height (cm)	Angle (deg)	Remark (QP/PK/AV)
1	* 12870.000	42.78	5.28	48.07	-40.13	88.20	300	138	Peak

Note:

1. " \*", means this data is the worst emission level.
2. C.F (Correction Factor) = Antenna Factor (dB/m)+ Cable Loss (dB) – Preamplifier(dB).
3. Measurement (dBuV/m) = Reading(dBuV) + C.F (Correction Factor).
4. The emission levels of other frequencies are very lower than the limit and not show in test report.

EUT	AXE3000 Wi-Fi 6E High Gain Wireless USB Adapter	Date of Test	2023-10-27
Factor	DRH18-E	Temp. / Humidity	21°C /61%
Polarity	Horizontal	Site / Test Engineer	AC2 / Marvin
Test Mode	802.11ax-20MHz_TX_Band6_CH 105_ANT 1+2	Test Voltage	By Notebook PC

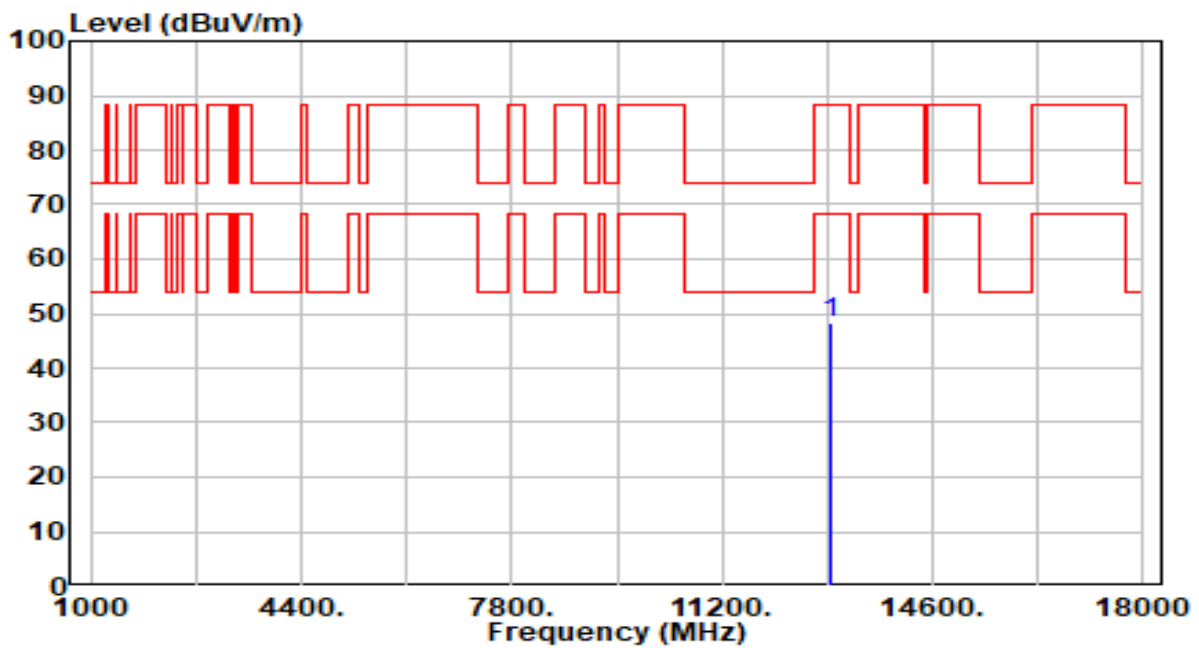

No	Frequency (MHz)	Reading (dBuV)	C.F (dB/m)	Measurement (dBuV/m)	Margin (dB)	Limit (dBuV/m)	Height (cm)	Angle (deg)	Remark (QP/PK/AV)
1	* 12950.000	42.91	5.26	48.16	-40.04	88.20	300	142	Peak

Note:

1. " \*", means this data is the worst emission level.
2. C.F (Correction Factor) = Antenna Factor (dB/m)+ Cable Loss (dB) – Preamplifier(dB).
3. Measurement (dBuV/m) = Reading(dBuV) + C.F (Correction Factor).
4. The emission levels of other frequencies are very lower than the limit and not show in test report.

EUT	AXE3000 Wi-Fi 6E High Gain Wireless USB Adapter	Date of Test	2023-10-27
Factor	DRH18-E	Temp. / Humidity	21°C /61%
Polarity	Vertical	Site / Test Engineer	AC2 / Marvin
Test Mode	802.11ax-20MHz_TX_Band6_CH 105_ANT 1+2	Test Voltage	By Notebook PC

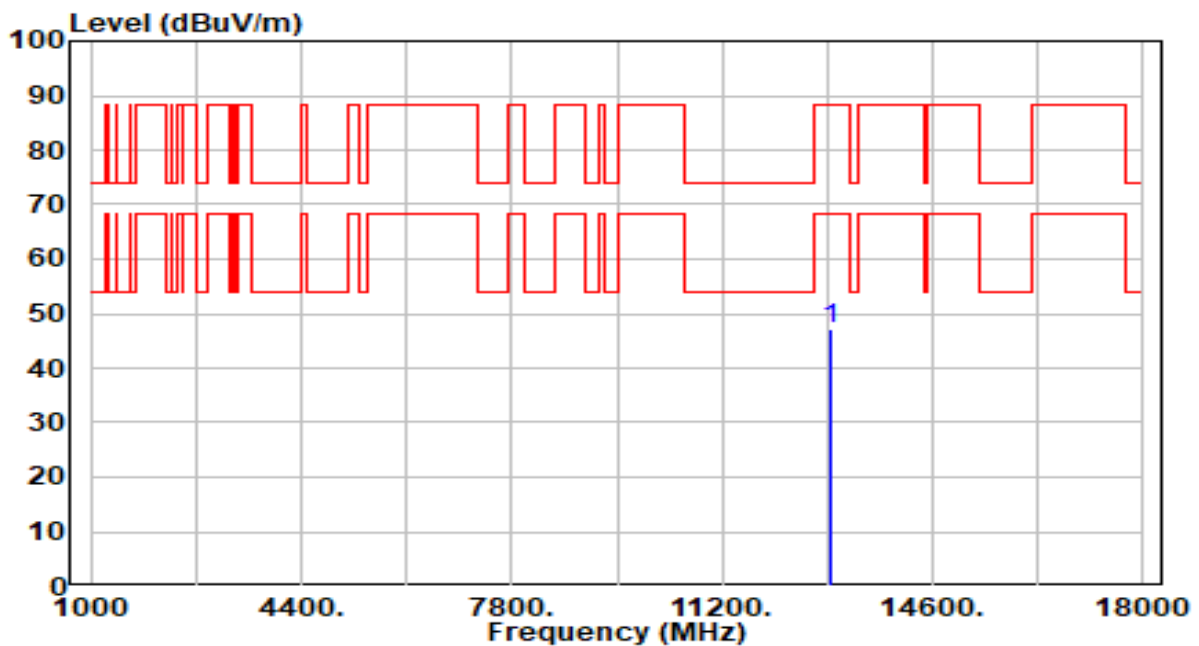

No	Frequency (MHz)	Reading (dBuV)	C.F (dB/m)	Measurement (dBuV/m)	Margin (dB)	Limit (dBuV/m)	Height (cm)	Angle (deg)	Remark (QP/PK/AV)
1	* 12950.000	41.87	5.26	47.13	-41.07	88.20	300	198	Peak

Note:

1. " \*", means this data is the worst emission level.
2. C.F (Correction Factor) = Antenna Factor (dB/m)+ Cable Loss (dB) – Preamplifier(dB).
3. Measurement (dBuV/m) = Reading(dBuV) + C.F (Correction Factor).
4. The emission levels of other frequencies are very lower than the limit and not show in test report.

EUT	AXE3000 Wi-Fi 6E High Gain Wireless USB Adapter	Date of Test	2023-10-27
Factor	DRH18-E	Temp. / Humidity	21°C /61%
Polarity	Horizontal	Site / Test Engineer	AC2 / Marvin
Test Mode	802.11ax-20MHz_TX_Band6_CH 113_ANT 1+2	Test Voltage	By Notebook PC

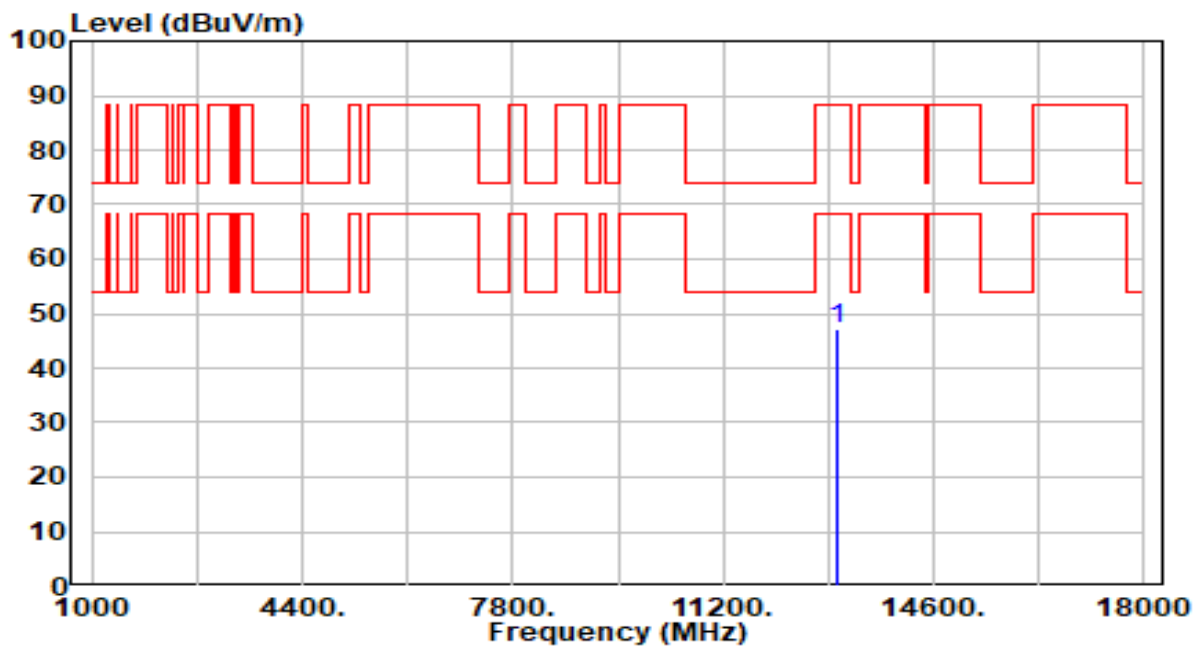

No	Frequency (MHz)	Reading (dBuV)	C.F (dB/m)	Measurement (dBuV/m)	Margin (dB)	Limit (dBuV/m)	Height (cm)	Angle (deg)	Remark (QP/PK/AV)
1	* 13030.000	41.76	5.23	46.99	-41.21	88.20	300	0	Peak

Note:

1. " \*", means this data is the worst emission level.
2. C.F (Correction Factor) = Antenna Factor (dB/m)+ Cable Loss (dB) – Preamplifier(dB).
3. Measurement (dBuV/m) = Reading(dBuV) + C.F (Correction Factor).
4. The emission levels of other frequencies are very lower than the limit and not show in test report.

EUT	AXE3000 Wi-Fi 6E High Gain Wireless USB Adapter	Date of Test	2023-10-27
Factor	DRH18-E	Temp. / Humidity	21°C /61%
Polarity	Vertical	Site / Test Engineer	AC2 / Marvin
Test Mode	802.11ax-20MHz_TX_Band6_CH 113_ANT 1+2	Test Voltage	By Notebook PC

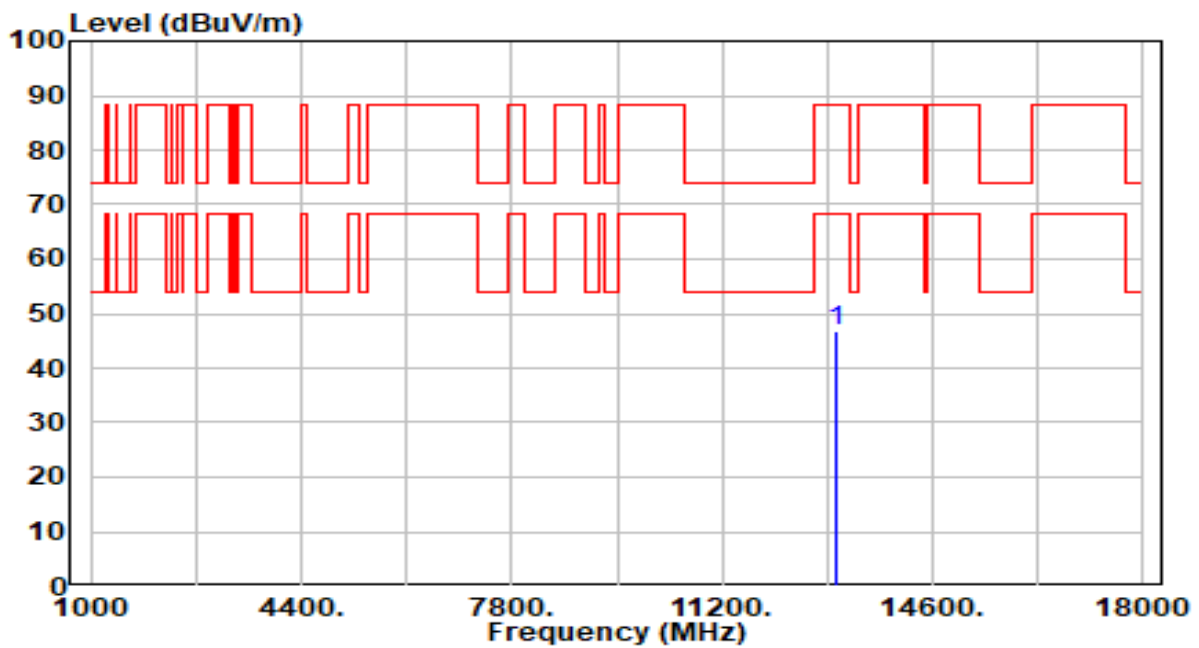

No	Frequency (MHz)	Reading (dBuV)	C.F (dB/m)	Measurement (dBuV/m)	Margin (dB)	Limit (dBuV/m)	Height (cm)	Angle (deg)	Remark (QP/PK/AV)
1	* 13030.000	41.45	5.23	46.69	-41.51	88.20	300	114	Peak

Note:

1. " \*", means this data is the worst emission level.
2. C.F (Correction Factor) = Antenna Factor (dB/m)+ Cable Loss (dB) – Preamplifier(dB).
3. Measurement (dBuV/m) = Reading(dBuV) + C.F (Correction Factor).
4. The emission levels of other frequencies are very lower than the limit and not show in test report.

EUT	AXE3000 Wi-Fi 6E High Gain Wireless USB Adapter	Date of Test	2023-10-27
Factor	DRH18-E	Temp. / Humidity	21°C /61%
Polarity	Horizontal	Site / Test Engineer	AC2 / Marvin
Test Mode	802.11ax-20MHz_TX_Band7_CH 117_ANT 1+2	Test Voltage	By Notebook PC

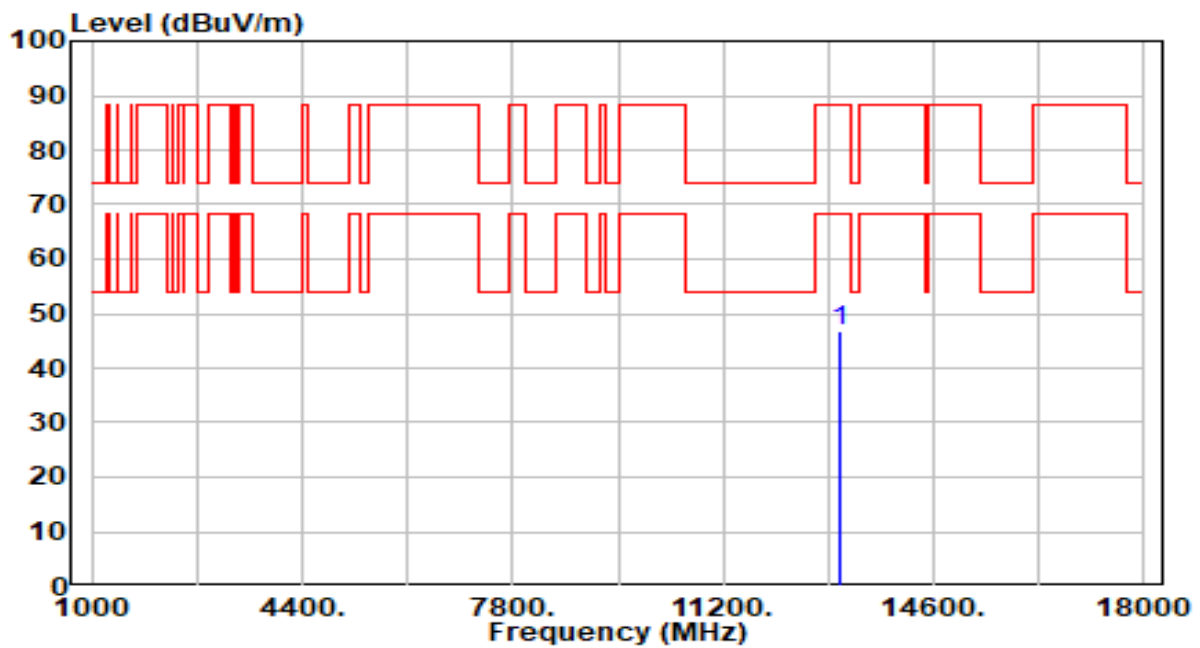

No	Frequency (MHz)	Reading (dBuV)	C.F (dB/m)	Measurement (dBuV/m)	Margin (dB)	Limit (dBuV/m)	Height (cm)	Angle (deg)	Remark (QP/PK/AV)
1	* 13070.000	41.52	5.23	46.74	-41.46	88.20	300	34	Peak

Note:

1. " \*", means this data is the worst emission level.
2. C.F (Correction Factor) = Antenna Factor (dB/m)+ Cable Loss (dB) – Preamplifier(dB).
3. Measurement (dBuV/m) = Reading(dBuV) + C.F (Correction Factor).
4. The emission levels of other frequencies are very lower than the limit and not show in test report.

EUT	AXE3000 Wi-Fi 6E High Gain Wireless USB Adapter	Date of Test	2023-10-27
Factor	DRH18-E	Temp. / Humidity	21°C /61%
Polarity	Vertical	Site / Test Engineer	AC2 / Marvin
Test Mode	802.11ax-20MHz_TX_Band7_CH 117_ANT 1+2	Test Voltage	By Notebook PC

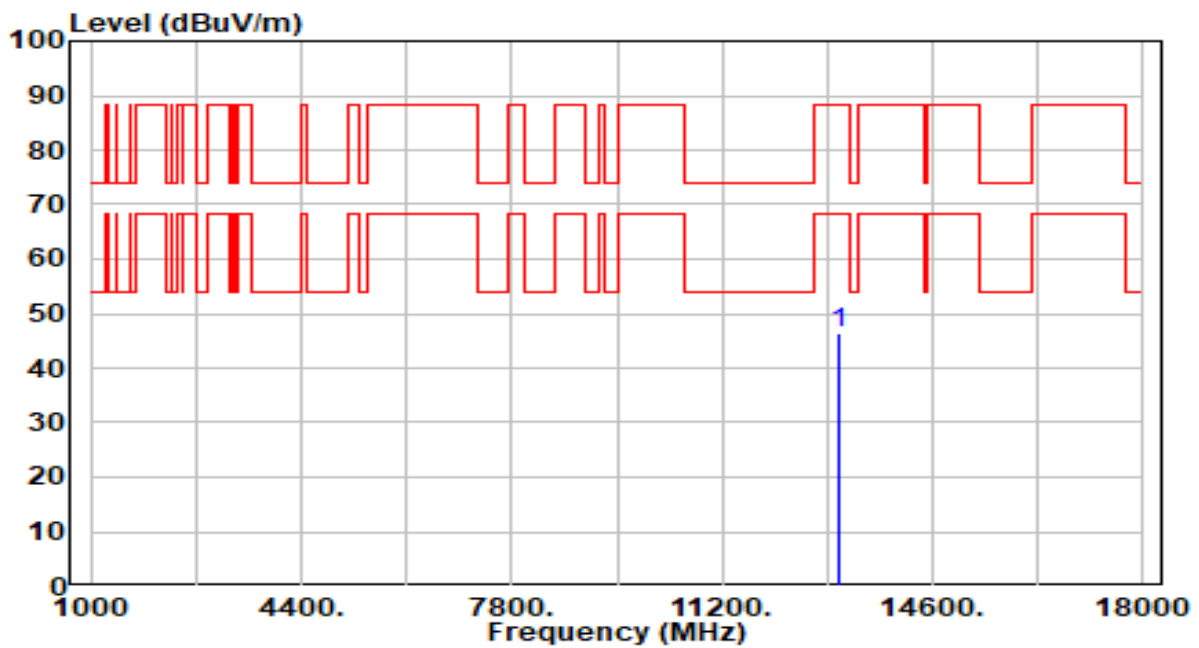

No	Frequency (MHz)	Reading (dBuV)	C.F (dB/m)	Measurement (dBuV/m)	Margin (dB)	Limit (dBuV/m)	Height (cm)	Angle (deg)	Remark (QP/PK/AV)
1	* 13070.000	41.28	5.23	46.50	-41.70	88.20	300	218	Peak

Note:

1. " \*", means this data is the worst emission level.
2. C.F (Correction Factor) = Antenna Factor (dB/m)+ Cable Loss (dB) – Preamplifier(dB).
3. Measurement (dBuV/m) = Reading(dBuV) + C.F (Correction Factor).
4. The emission levels of other frequencies are very lower than the limit and not show in test report.



EUT	AXE3000 Wi-Fi 6E High Gain Wireless USB Adapter	Date of Test	2023-10-27
Factor	DRH18-E	Temp. / Humidity	21°C /61%
Polarity	Horizontal	Site / Test Engineer	AC2 / Marvin
Test Mode	802.11ax-20MHz_TX_Band7_CH 153_ANT 1+2	Test Voltage	By Notebook PC

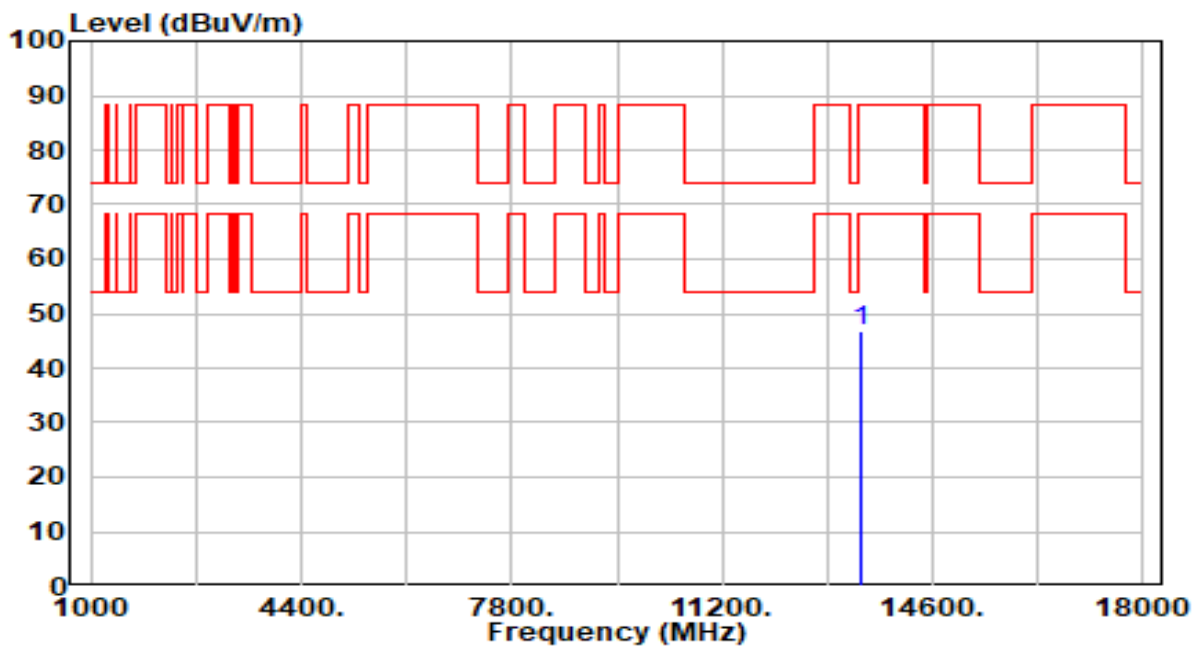

No	Frequency (MHz)	Reading (dBuV)	C.F (dB/m)	Measurement (dBuV/m)	Margin (dB)	Limit (dBuV/m)	Height (cm)	Angle (deg)	Remark (QP/PK/AV)
1	* 13430.000	41.42	5.24	46.65	-41.55	88.20	300	142	Peak

Note:

1. " \*", means this data is the worst emission level.
2. C.F (Correction Factor) = Antenna Factor (dB/m) + Cable Loss (dB) – Preamplifier(dB).
3. Measurement (dBuV/m) = Reading(dBuV) + C.F (Correction Factor).
4. The emission levels of other frequencies are very lower than the limit and not show in test report.

EUT	AXE3000 Wi-Fi 6E High Gain Wireless USB Adapter	Date of Test	2023-10-27
Factor	DRH18-E	Temp. / Humidity	21°C /61%
Polarity	Vertical	Site / Test Engineer	AC2 / Marvin
Test Mode	802.11ax-20MHz_TX_Band7_CH 153_ANT 1+2	Test Voltage	By Notebook PC

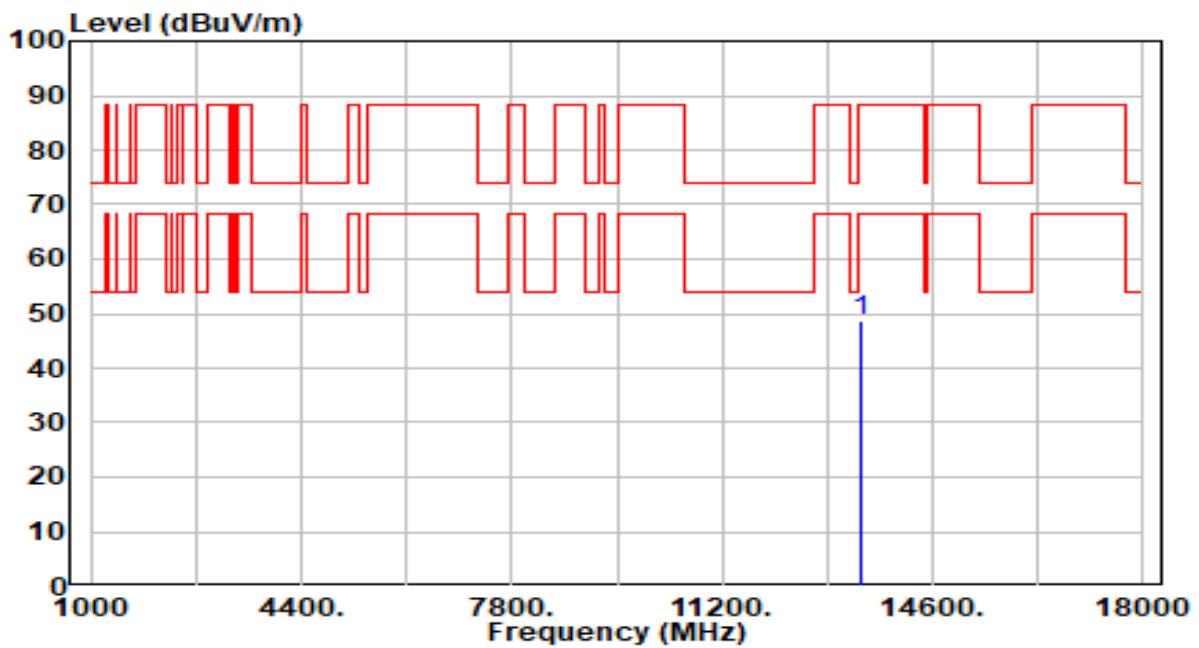

No	Frequency (MHz)	Reading (dBuV)	C.F (dB/m)	Measurement (dBuV/m)	Margin (dB)	Limit (dBuV/m)	Height (cm)	Angle (deg)	Remark (QP/PK/AV)
1	* 13430.000	43.44	5.24	48.68	-39.52	88.20	300	158	Peak

Note:

1. " \*", means this data is the worst emission level.
2. C.F (Correction Factor) = Antenna Factor (dB/m) + Cable Loss (dB) – Preamplifier(dB).
3. Measurement (dBuV/m) = Reading(dBuV) + C.F (Correction Factor).
4. The emission levels of other frequencies are very lower than the limit and not show in test report.

EUT	AXE3000 Wi-Fi 6E High Gain Wireless USB Adapter	Date of Test	2023-10-27
Factor	DRH18-E	Temp. / Humidity	21°C /61%
Polarity	Horizontal	Site / Test Engineer	AC2 / Marvin
Test Mode	802.11ax-20MHz_TX_Band7_CH 181_ANT 1+2	Test Voltage	By Notebook PC

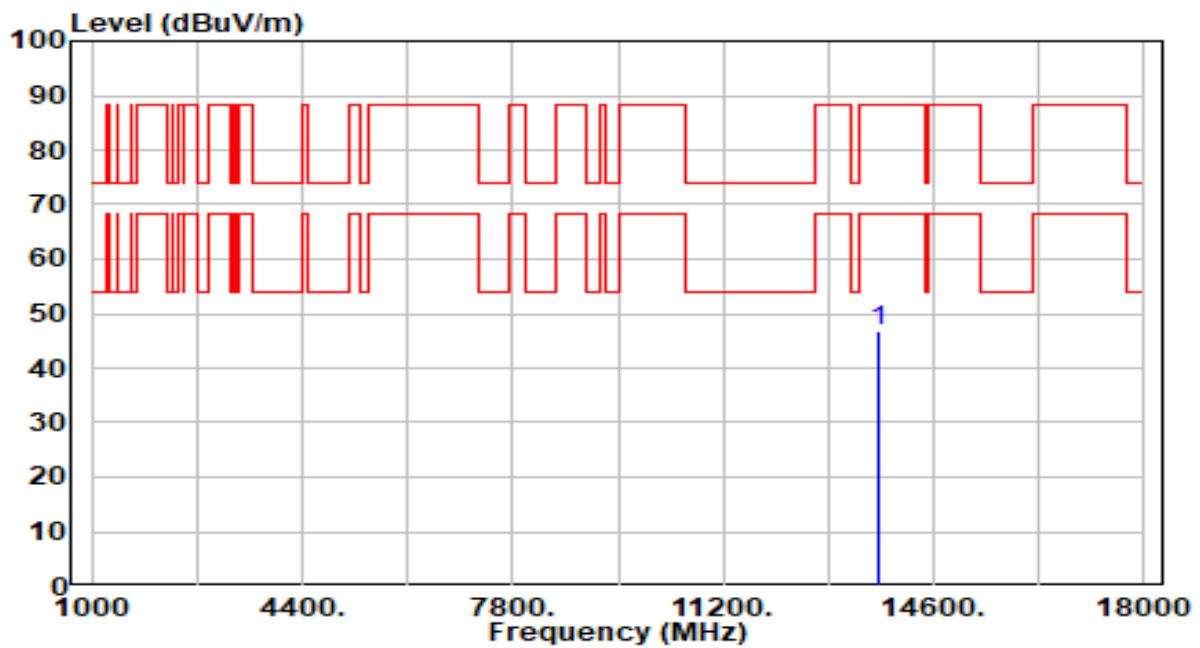

No	Frequency (MHz)	Reading (dBuV)	C.F (dB/m)	Measurement (dBuV/m)	Margin (dB)	Limit (dBuV/m)	Height (cm)	Angle (deg)	Remark (QP/PK/AV)
1	* 13710.000	41.63	5.02	46.66	-41.54	88.20	300	102	Peak

Note:

1. " \*", means this data is the worst emission level.
2. C.F (Correction Factor) = Antenna Factor (dB/m)+ Cable Loss (dB) – Preamplifier(dB).
3. Measurement (dBuV/m) = Reading(dBuV) + C.F (Correction Factor).
4. The emission levels of other frequencies are very lower than the limit and not show in test report.

EUT	AXE3000 Wi-Fi 6E High Gain Wireless USB Adapter	Date of Test	2023-10-27
Factor	DRH18-E	Temp. / Humidity	21°C /61%
Polarity	Vertical	Site / Test Engineer	AC2 / Marvin
Test Mode	802.11ax-20MHz_TX_Band7_CH 181_ANT 1+2	Test Voltage	By Notebook PC

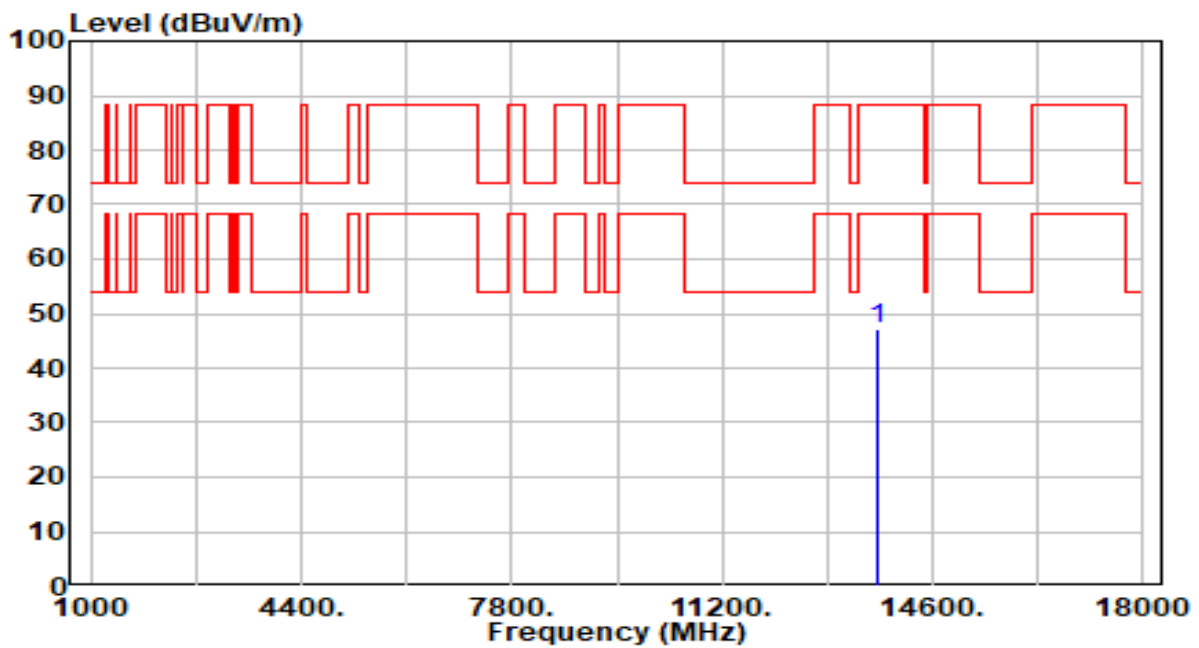

No	Frequency (MHz)	Reading (dBuV)	C.F (dB/m)	Measurement (dBuV/m)	Margin (dB)	Limit (dBuV/m)	Height (cm)	Angle (deg)	Remark (QP/PK/AV)
1	* 13710.000	42.10	5.02	47.13	-41.07	88.20	300	360	Peak

Note:

1. " \*", means this data is the worst emission level.
2. C.F (Correction Factor) = Antenna Factor (dB/m)+ Cable Loss (dB) – Preamplifier(dB).
3. Measurement (dBuV/m) = Reading(dBuV) + C.F (Correction Factor).
4. The emission levels of other frequencies are very lower than the limit and not show in test report.

EUT	AXE3000 Wi-Fi 6E High Gain Wireless USB Adapter	Date of Test	2023-10-27
Factor	DRH18-E	Temp. / Humidity	21°C /61%
Polarity	Horizontal	Site / Test Engineer	AC2 / Marvin
Test Mode	802.11ax-20MHz_TX_Band7_CH 185_ANT 1+2	Test Voltage	By Notebook PC

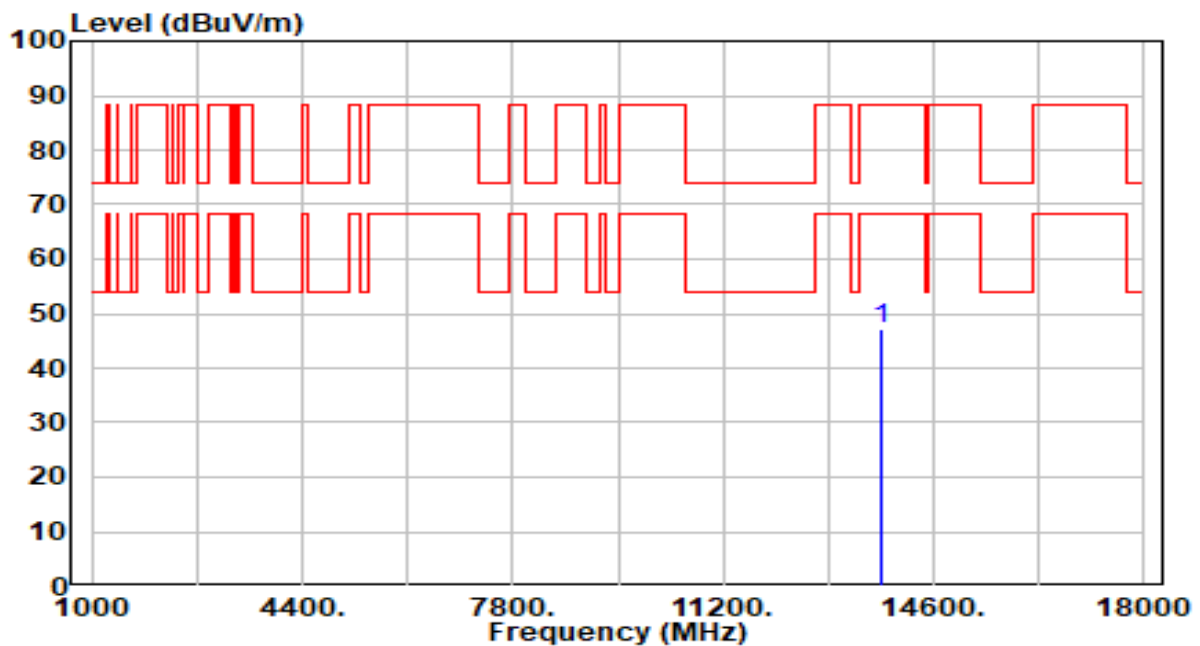

No	Frequency (MHz)	Reading (dBuV)	C.F (dB/m)	Measurement (dBuV/m)	Margin (dB)	Limit (dBuV/m)	Height (cm)	Angle (deg)	Remark (QP/PK/AV)
1	* 13750.000	42.04	5.03	47.07	-41.13	88.20	300	178	Peak

Note:

1. " \*", means this data is the worst emission level.
2. C.F (Correction Factor) = Antenna Factor (dB/m)+ Cable Loss (dB) – Preamplifier(dB).
3. Measurement (dBuV/m) = Reading(dBuV) + C.F (Correction Factor).
4. The emission levels of other frequencies are very lower than the limit and not show in test report.

EUT	AXE3000 Wi-Fi 6E High Gain Wireless USB Adapter	Date of Test	2023-10-27
Factor	DRH18-E	Temp. / Humidity	21°C /61%
Polarity	Vertical	Site / Test Engineer	AC2 / Marvin
Test Mode	802.11ax-20MHz_TX_Band7_CH 185_ANT 1+2	Test Voltage	By Notebook PC

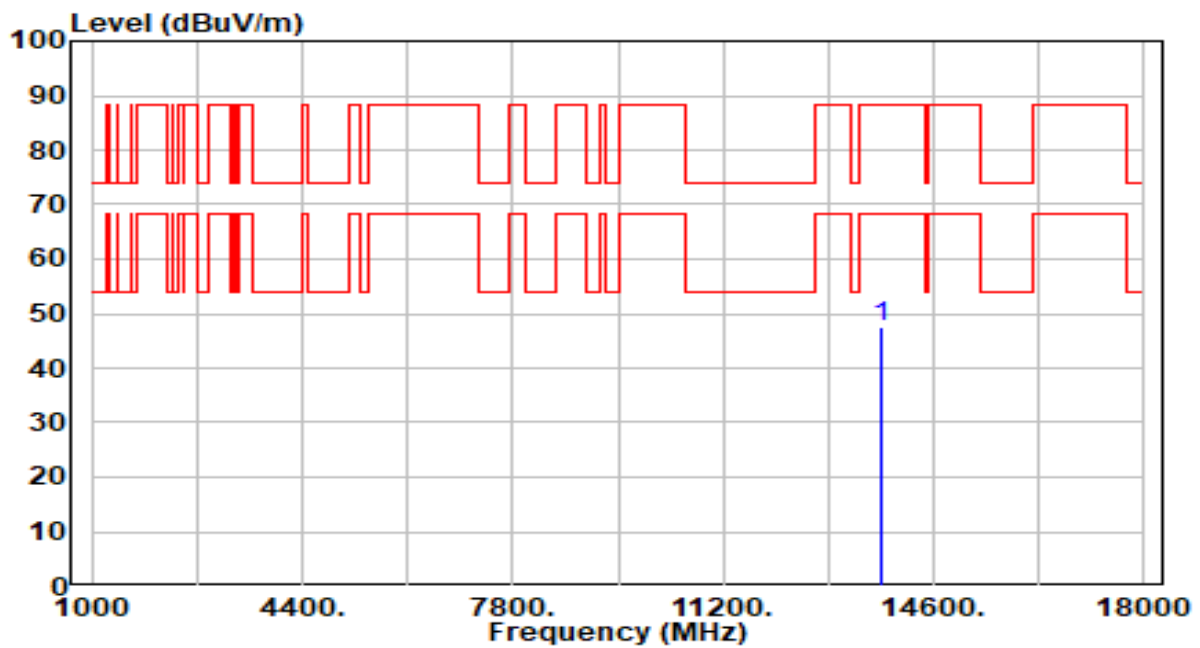

No	Frequency (MHz)	Reading (dBuV)	C.F (dB/m)	Measurement (dBuV/m)	Margin (dB)	Limit (dBuV/m)	Height (cm)	Angle (deg)	Remark (QP/PK/AV)
1	* 13750.000	42.50	5.03	47.53	-40.67	88.20	300	360	Peak

Note:

1. " \*", means this data is the worst emission level.
2. C.F (Correction Factor) = Antenna Factor (dB/m)+ Cable Loss (dB) – Preamplifier(dB).
3. Measurement (dBuV/m) = Reading(dBuV) + C.F (Correction Factor).
4. The emission levels of other frequencies are very lower than the limit and not show in test report.

EUT	AXE3000 Wi-Fi 6E High Gain Wireless USB Adapter	Date of Test	2023-10-27
Factor	DRH18-E	Temp. / Humidity	21°C /61%
Polarity	Horizontal	Site / Test Engineer	AC2 / Marvin
Test Mode	802.11ax-20MHz_TX_Band8_CH 189_ANT 1+2	Test Voltage	By Notebook PC

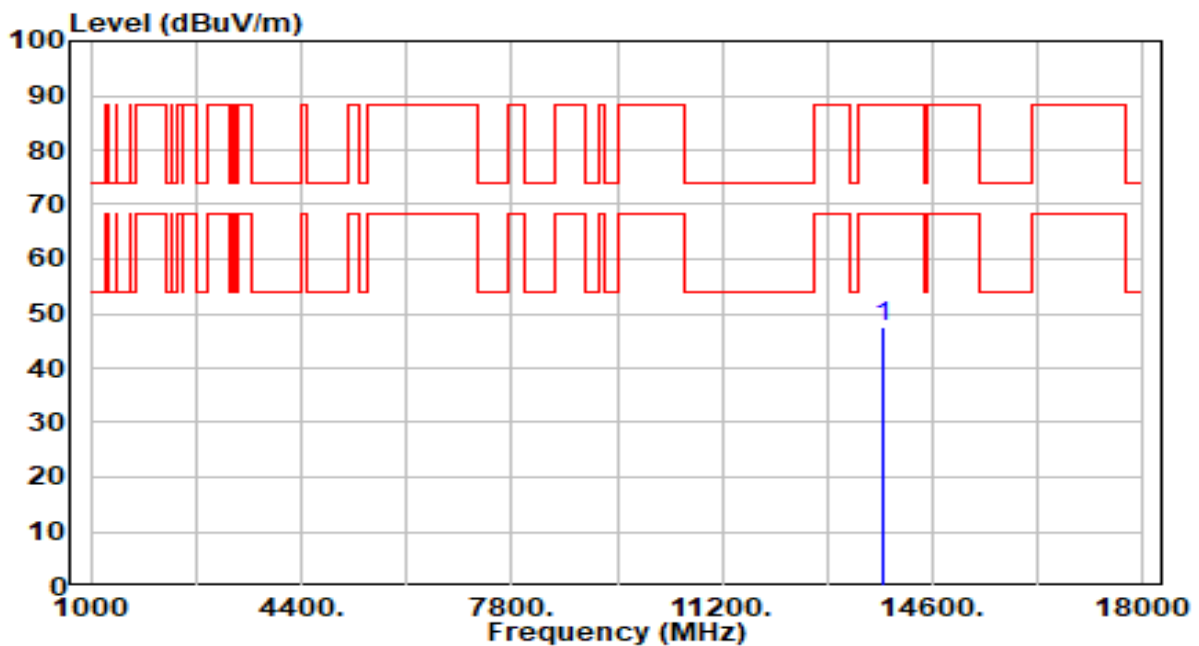

No	Frequency (MHz)	Reading (dBuV)	C.F (dB/m)	Measurement (dBuV/m)	Margin (dB)	Limit (dBuV/m)	Height (cm)	Angle (deg)	Remark (QP/PK/AV)
1	* 13790.000	42.47	5.04	47.51	-40.69	88.20	300	158	Peak

Note:

1. " \*", means this data is the worst emission level.
2. C.F (Correction Factor) = Antenna Factor (dB/m)+ Cable Loss (dB) – Preamplifier(dB).
3. Measurement (dBuV/m) = Reading(dBuV) + C.F (Correction Factor).
4. The emission levels of other frequencies are very lower than the limit and not show in test report.

EUT	AXE3000 Wi-Fi 6E High Gain Wireless USB Adapter	Date of Test	2023-10-27
Factor	DRH18-E	Temp. / Humidity	21°C /61%
Polarity	Vertical	Site / Test Engineer	AC2 / Marvin
Test Mode	802.11ax-20MHz_TX_Band8_CH 189_ANT 1+2	Test Voltage	By Notebook PC

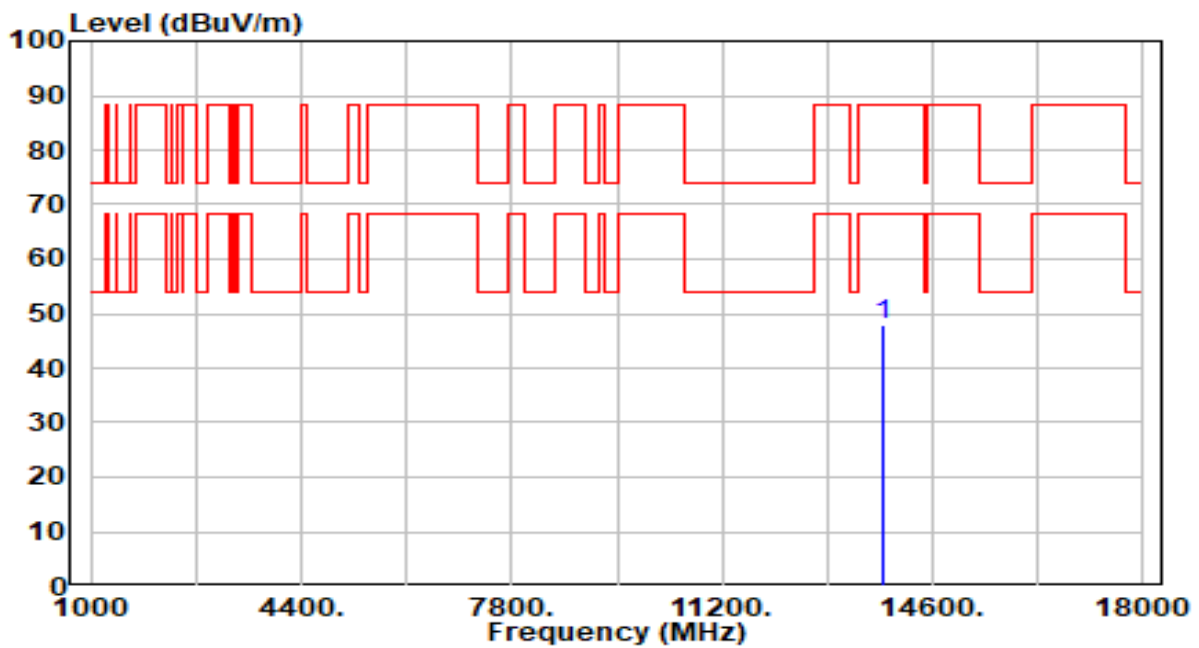

No	Frequency (MHz)	Reading (dBuV)	C.F (dB/m)	Measurement (dBuV/m)	Margin (dB)	Limit (dBuV/m)	Height (cm)	Angle (deg)	Remark (QP/PK/AV)
1	* 13790.000	42.92	5.04	47.95	-40.25	88.20	300	346	Peak

Note:

1. " \*", means this data is the worst emission level.
2. C.F (Correction Factor) = Antenna Factor (dB/m)+ Cable Loss (dB) – Preamplifier(dB).
3. Measurement (dBuV/m) = Reading(dBuV) + C.F (Correction Factor).
4. The emission levels of other frequencies are very lower than the limit and not show in test report.



EUT	AXE3000 Wi-Fi 6E High Gain Wireless USB Adapter	Date of Test	2023-10-27
Factor	DRH18-E	Temp. / Humidity	21°C /61%
Polarity	Horizontal	Site / Test Engineer	AC2 / Marvin
Test Mode	802.11ax-20MHz_TX_Band8_CH 213_ANT 1+2	Test Voltage	By Notebook PC

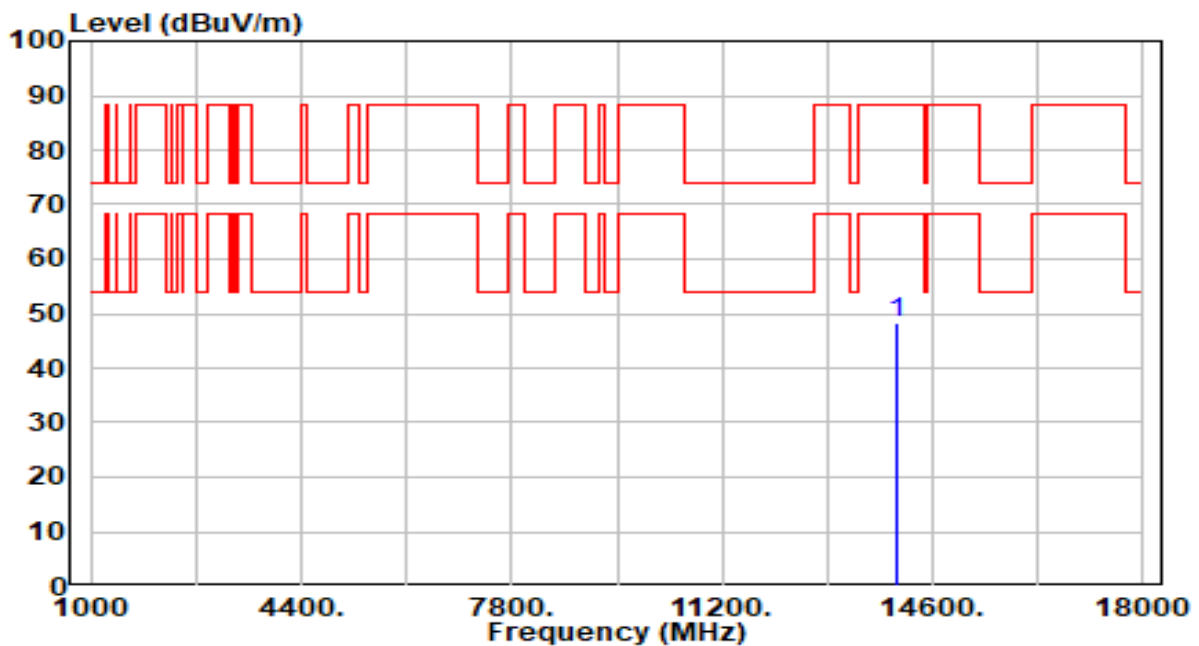

No	Frequency (MHz)	Reading (dBuV)	C.F (dB/m)	Measurement (dBuV/m)	Margin (dB)	Limit (dBuV/m)	Height (cm)	Angle (deg)	Remark (QP/PK/AV)
1	* 14030.000	43.09	5.16	48.25	-39.95	88.20	300	86	Peak

Note:

1. " \*", means this data is the worst emission level.
2. C.F (Correction Factor) = Antenna Factor (dB/m)+ Cable Loss (dB) – Preamplifier(dB).
3. Measurement (dBuV/m) = Reading(dBuV) + C.F (Correction Factor).
4. The emission levels of other frequencies are very lower than the limit and not show in test report.

EUT	AXE3000 Wi-Fi 6E High Gain Wireless USB Adapter	Date of Test	2023-10-27
Factor	DRH18-E	Temp. / Humidity	21°C /61%
Polarity	Vertical	Site / Test Engineer	AC2 / Marvin
Test Mode	802.11ax-20MHz_TX_Band8_CH 213_ANT 1+2	Test Voltage	By Notebook PC

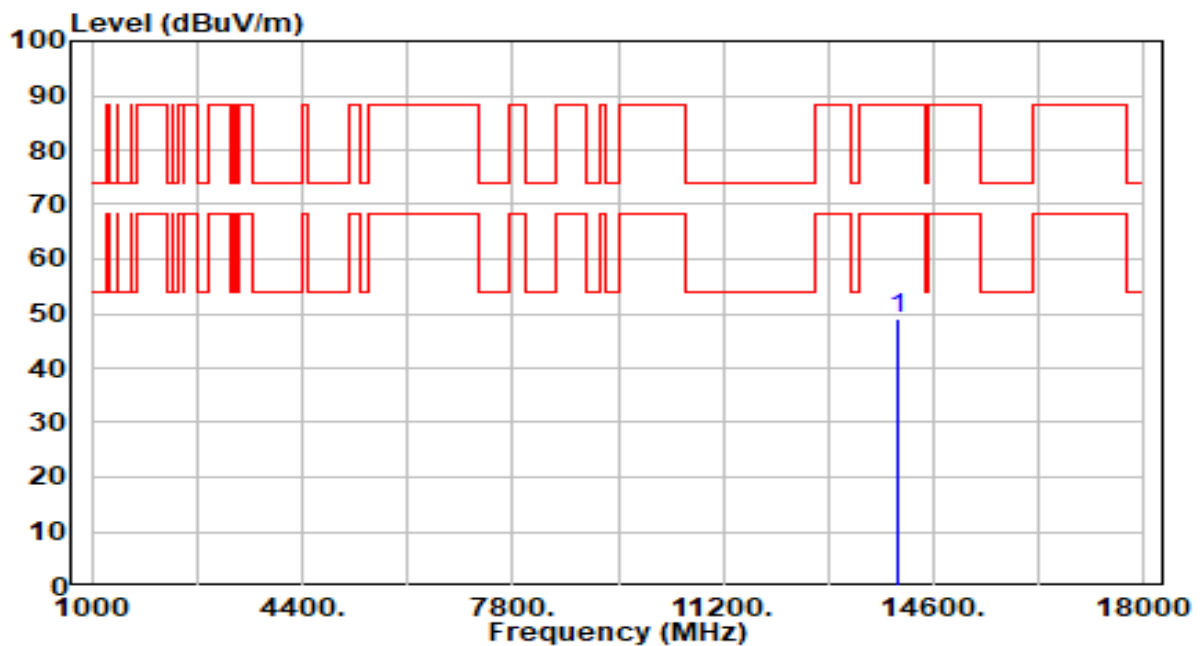

No	Frequency (MHz)	Reading (dBuV)	C.F (dB/m)	Measurement (dBuV/m)	Margin (dB)	Limit (dBuV/m)	Height (cm)	Angle (deg)	Remark (QP/PK/AV)
1	* 14030.000	43.85	5.16	49.01	-39.19	88.20	300	58	Peak

Note:

1. " \*", means this data is the worst emission level.
2. C.F (Correction Factor) = Antenna Factor (dB/m)+ Cable Loss (dB) – Preamplifier(dB).
3. Measurement (dBuV/m) = Reading(dBuV) + C.F (Correction Factor).
4. The emission levels of other frequencies are very lower than the limit and not show in test report.

EUT	AXE3000 Wi-Fi 6E High Gain Wireless USB Adapter	Date of Test	2023-10-27
Factor	DRH18-E	Temp. / Humidity	21°C /61%
Polarity	Horizontal	Site / Test Engineer	AC2 / Marvin
Test Mode	802.11ax-20MHz_TX_Band8_CH 233_ANT 1+2	Test Voltage	By Notebook PC

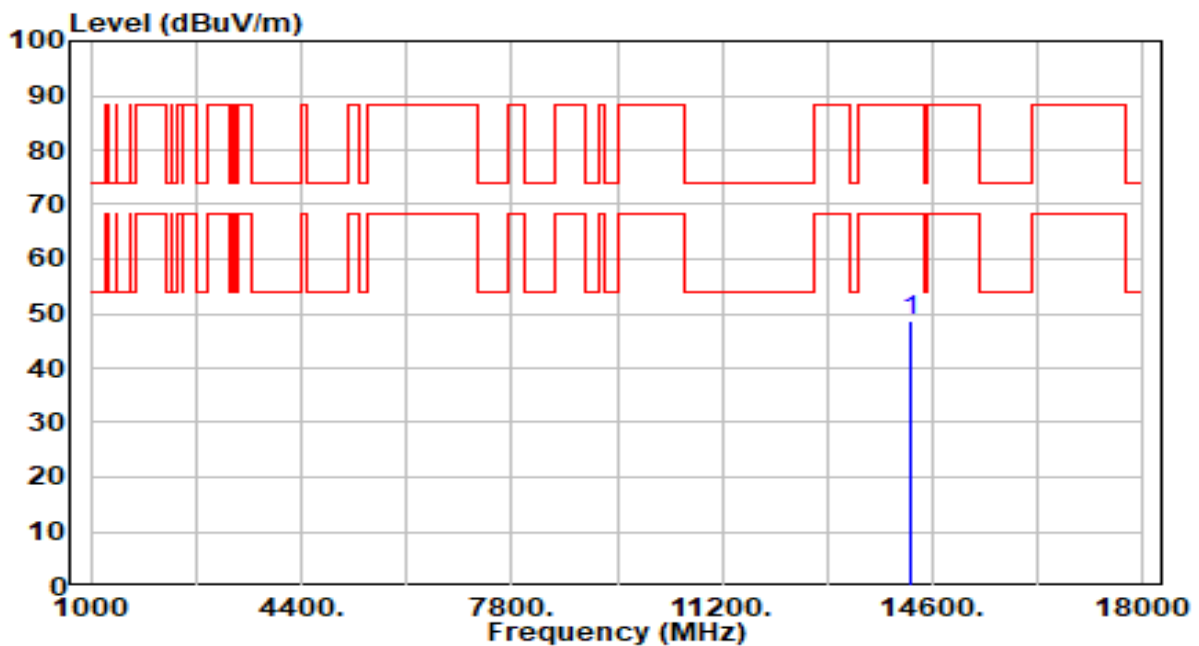

No	Frequency (MHz)	Reading (dBuV)	C.F (dB/m)	Measurement (dBuV/m)	Margin (dB)	Limit (dBuV/m)	Height (cm)	Angle (deg)	Remark (QP/PK/AV)
1	* 14230.000	43.80	5.07	48.87	-39.33	88.20	300	214	Peak

Note:

1. " \*", means this data is the worst emission level.
2. C.F (Correction Factor) = Antenna Factor (dB/m)+ Cable Loss (dB) – Preamplifier(dB).
3. Measurement (dBuV/m) = Reading(dBuV) + C.F (Correction Factor).
4. The emission levels of other frequencies are very lower than the limit and not show in test report.

EUT	AXE3000 Wi-Fi 6E High Gain Wireless USB Adapter	Date of Test	2023-10-27
Factor	DRH18-E	Temp. / Humidity	21°C /61%
Polarity	Vertical	Site / Test Engineer	AC2 / Marvin
Test Mode	802.11ax-20MHz_TX_Band8_CH 233_ANT 1+2	Test Voltage	By Notebook PC

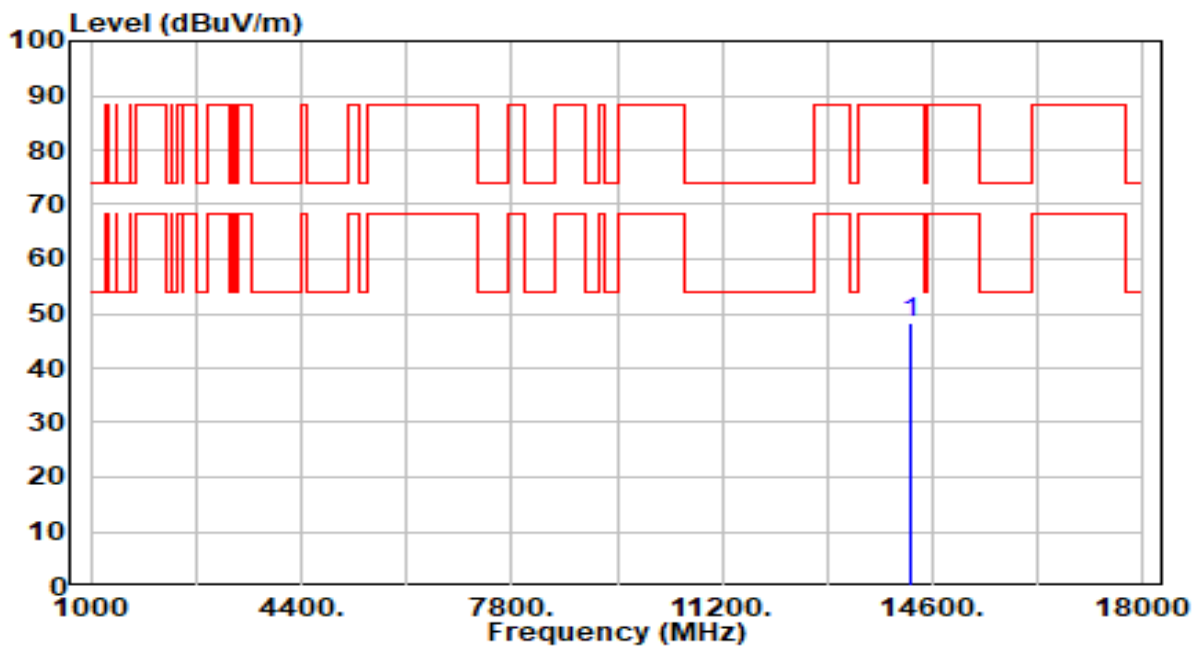

No	Frequency (MHz)	Reading (dBuV)	C.F (dB/m)	Measurement (dBuV/m)	Margin (dB)	Limit (dBuV/m)	Height (cm)	Angle (deg)	Remark (QP/PK/AV)
1	* 14230.000	43.41	5.07	48.48	-39.72	88.20	300	226	Peak

Note:

1. " \*", means this data is the worst emission level.
2. C.F (Correction Factor) = Antenna Factor (dB/m)+ Cable Loss (dB) – Preamplifier(dB).
3. Measurement (dBuV/m) = Reading(dBuV) + C.F (Correction Factor).
4. The emission levels of other frequencies are very lower than the limit and not show in test report.

EUT	AXE3000 Wi-Fi 6E High Gain Wireless USB Adapter	Date of Test	2023-10-27
Factor	DRH18-E	Temp. / Humidity	21°C /61%
Polarity	Horizontal	Site / Test Engineer	AC2 / Marvin
Test Mode	802.11ax-40MHz_TX_Band5_CH 3_ANT 1+2	Test Voltage	By Notebook PC

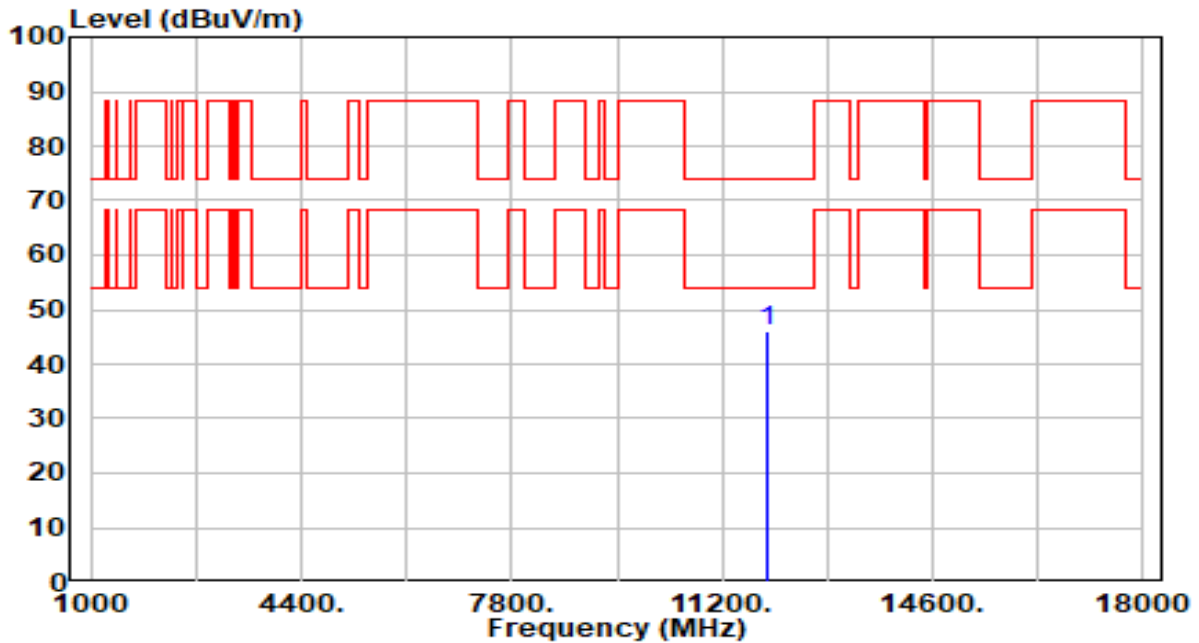

No	Frequency (MHz)	Reading (dBuV)	C.F (dB/m)	Measurement (dBuV/m)	Margin (dB)	Limit (dBuV/m)	Height (cm)	Angle (deg)	Remark (QP/PK/AV)
1	* 11930.000	42.21	3.81	46.02	-27.98	74.00	300	347	Peak

Note:

1. " \*", means this data is the worst emission level.
2. C.F (Correction Factor) = Antenna Factor (dB/m)+ Cable Loss (dB) – Preamplifier(dB).
3. Measurement (dBuV/m) = Reading(dBuV) + C.F (Correction Factor).
4. The emission levels of other frequencies are very lower than the limit and not show in test report.

EUT	AXE3000 Wi-Fi 6E High Gain Wireless USB Adapter	Date of Test	2023-10-27
Factor	DRH18-E	Temp. / Humidity	21°C /61%
Polarity	Vertical	Site / Test Engineer	AC2 / Marvin
Test Mode	802.11ax-40MHz_TX_Band5_CH 3_ANT 1+2	Test Voltage	By Notebook PC

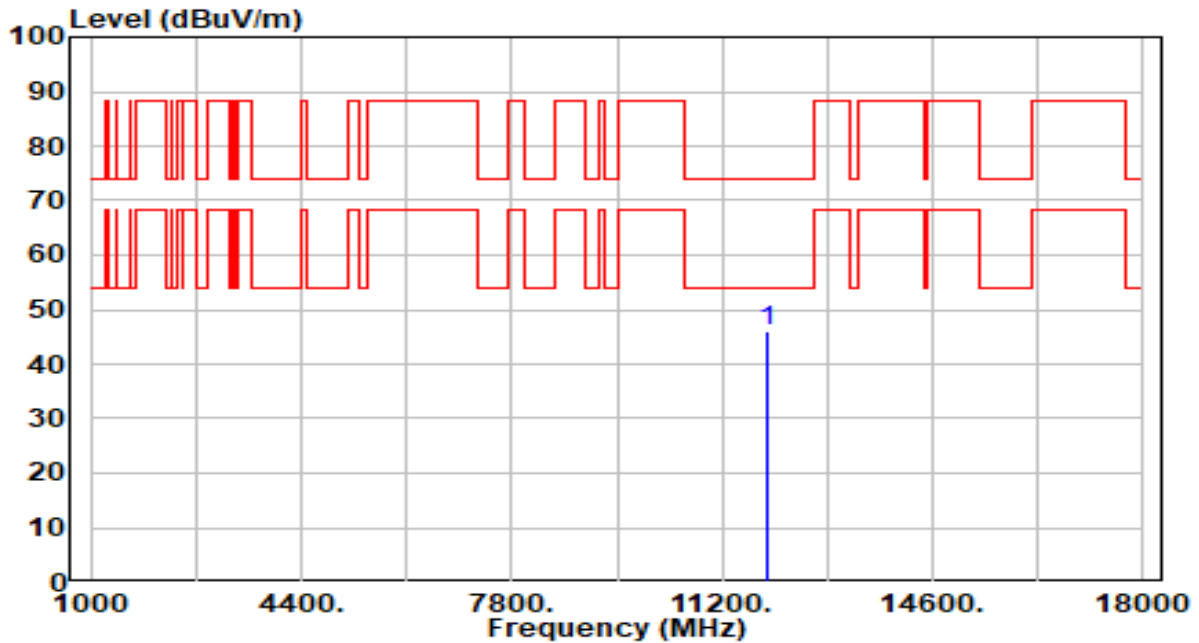

No	Frequency (MHz)	Reading (dBuV)	C.F (dB/m)	Measurement (dBuV/m)	Margin (dB)	Limit (dBuV/m)	Height (cm)	Angle (deg)	Remark (QP/PK/AV)
1	* 11930.000	42.05	3.81	45.86	-28.14	74.00	300	61	Peak

Note:

1. " \*", means this data is the worst emission level.
2. C.F (Correction Factor) = Antenna Factor (dB/m)+ Cable Loss (dB) – Preamplifier(dB).
3. Measurement (dBuV/m) = Reading(dBuV) + C.F (Correction Factor).
4. The emission levels of other frequencies are very lower than the limit and not show in test report.

EUT	AXE3000 Wi-Fi 6E High Gain Wireless USB Adapter	Date of Test	2023-10-27
Factor	DRH18-E	Temp. / Humidity	21°C /61%
Polarity	Horizontal	Site / Test Engineer	AC2 / Marvin
Test Mode	802.11ax-40MHz_TX_Band5_CH 43_ANT 1+2	Test Voltage	By Notebook PC

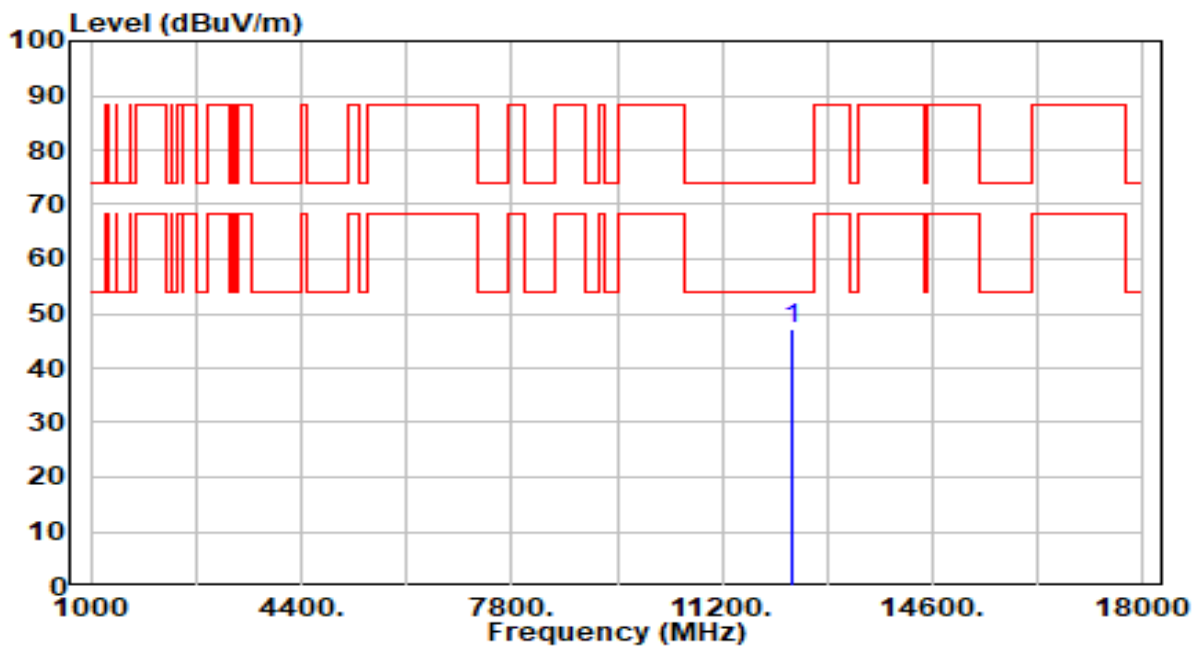

No	Frequency (MHz)	Reading (dBuV)	C.F (dB/m)	Measurement (dBuV/m)	Margin (dB)	Limit (dBuV/m)	Height (cm)	Angle (deg)	Remark (QP/PK/AV)
1	* 12330.000	42.66	4.47	47.13	-26.87	74.00	300	46	Peak

Note:

1. " \*", means this data is the worst emission level.
2. C.F (Correction Factor) = Antenna Factor (dB/m)+ Cable Loss (dB) – Preamplifier(dB).
3. Measurement (dBuV/m) = Reading(dBuV) + C.F (Correction Factor).
4. The emission levels of other frequencies are very lower than the limit and not show in test report.

EUT	AXE3000 Wi-Fi 6E High Gain Wireless USB Adapter	Date of Test	2023-10-27
Factor	DRH18-E	Temp. / Humidity	21°C /61%
Polarity	Vertical	Site / Test Engineer	AC2 / Marvin
Test Mode	802.11ax-40MHz_TX_Band5_CH 43_ANT 1+2	Test Voltage	By Notebook PC

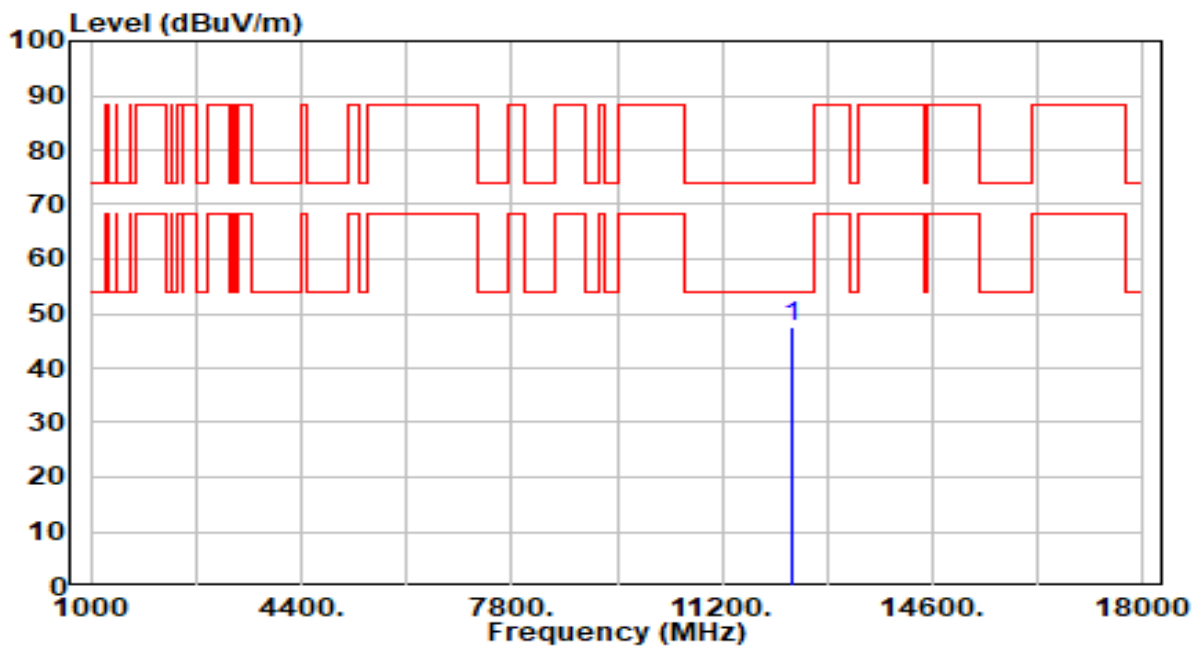

No	Frequency (MHz)	Reading (dBuV)	C.F (dB/m)	Measurement (dBuV/m)	Margin (dB)	Limit (dBuV/m)	Height (cm)	Angle (deg)	Remark (QP/PK/AV)
1	* 12330.000	43.16	4.47	47.63	-26.37	74.00	300	206	Peak

Note:

1. " \*", means this data is the worst emission level.
2. C.F (Correction Factor) = Antenna Factor (dB/m)+ Cable Loss (dB) – Preamplifier(dB).
3. Measurement (dBuV/m) = Reading(dBuV) + C.F (Correction Factor).
4. The emission levels of other frequencies are very lower than the limit and not show in test report.



EUT	AXE3000 Wi-Fi 6E High Gain Wireless USB Adapter	Date of Test	2023-10-27
Factor	DRH18-E	Temp. / Humidity	21°C /61%
Polarity	Horizontal	Site / Test Engineer	AC2 / Marvin
Test Mode	802.11ax-40MHz_TX_Band5_CH 91_ANT 1+2	Test Voltage	By Notebook PC

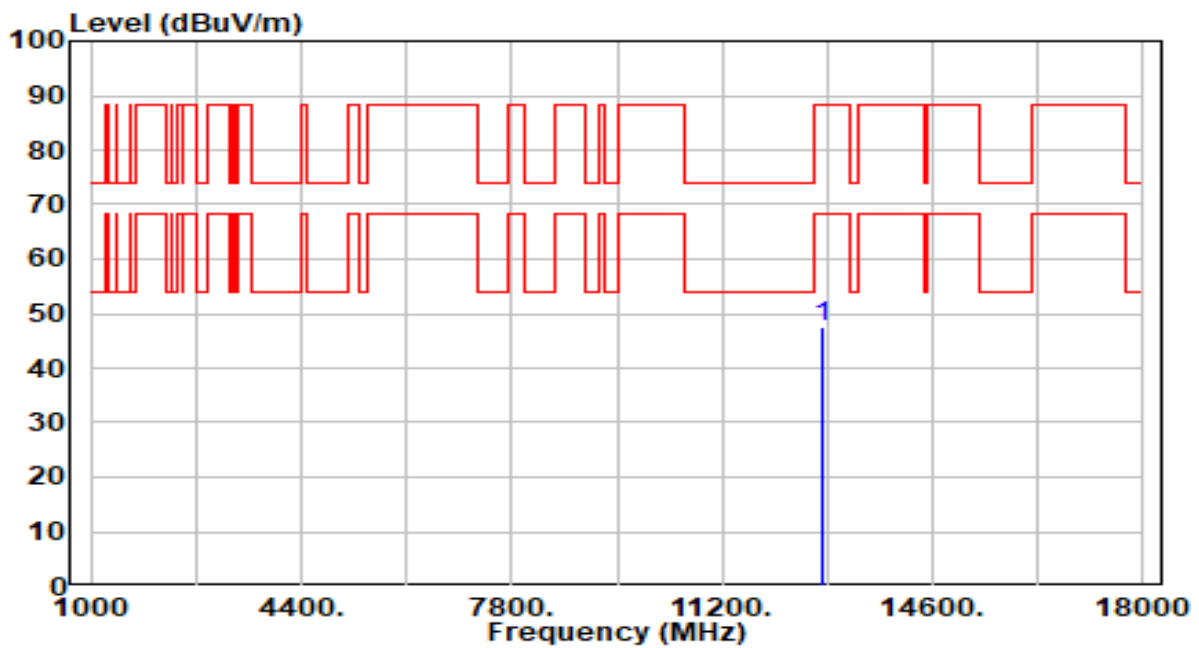

No	Frequency (MHz)	Reading (dBuV)	C.F (dB/m)	Measurement (dBuV/m)	Margin (dB)	Limit (dBuV/m)	Height (cm)	Angle (deg)	Remark (QP/PK/AV)
1	* 12810.000	42.40	5.30	47.70	-40.50	88.20	300	142	Peak

Note:

1. " \*", means this data is the worst emission level.
2. C.F (Correction Factor) = Antenna Factor (dB/m)+ Cable Loss (dB) – Preamplifier(dB).
3. Measurement (dBuV/m) = Reading(dBuV) + C.F (Correction Factor).
4. The emission levels of other frequencies are very lower than the limit and not show in test report.

EUT	AXE3000 Wi-Fi 6E High Gain Wireless USB Adapter	Date of Test	2023-10-27
Factor	DRH18-E	Temp. / Humidity	21°C /61%
Polarity	Vertical	Site / Test Engineer	AC2 / Marvin
Test Mode	802.11ax-40MHz_TX_Band5_CH 91_ANT 1+2	Test Voltage	By Notebook PC

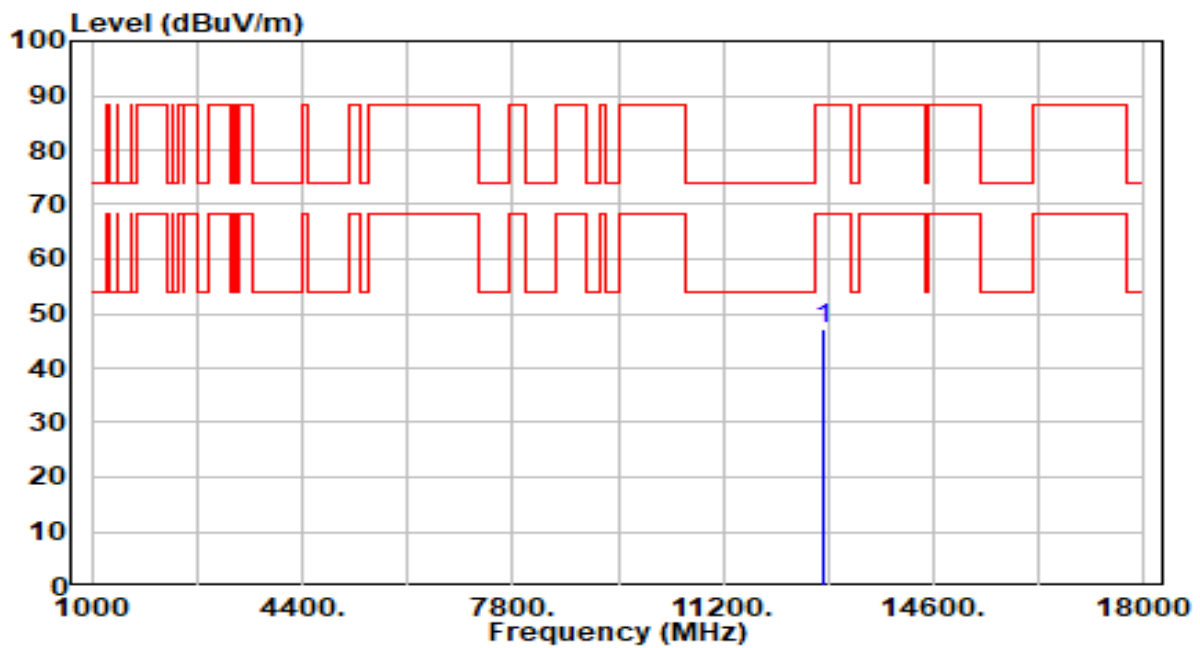

No	Frequency (MHz)	Reading (dBuV)	C.F (dB/m)	Measurement (dBuV/m)	Margin (dB)	Limit (dBuV/m)	Height (cm)	Angle (deg)	Remark (QP/PK/AV)
1	* 12810.000	41.88	5.30	47.18	-41.02	88.20	300	130	Peak

Note:

1. " \*", means this data is the worst emission level.
2. C.F (Correction Factor) = Antenna Factor (dB/m)+ Cable Loss (dB) – Preamplifier(dB).
3. Measurement (dBuV/m) = Reading(dBuV) + C.F (Correction Factor).
4. The emission levels of other frequencies are very lower than the limit and not show in test report.

EUT	AXE3000 Wi-Fi 6E High Gain Wireless USB Adapter	Date of Test	2023-10-27
Factor	DRH18-E	Temp. / Humidity	21°C /61%
Polarity	Horizontal	Site / Test Engineer	AC2 / Marvin
Test Mode	802.11ax-40MHz_TX_Band6_CH 99_ANT 1+2	Test Voltage	By Notebook PC

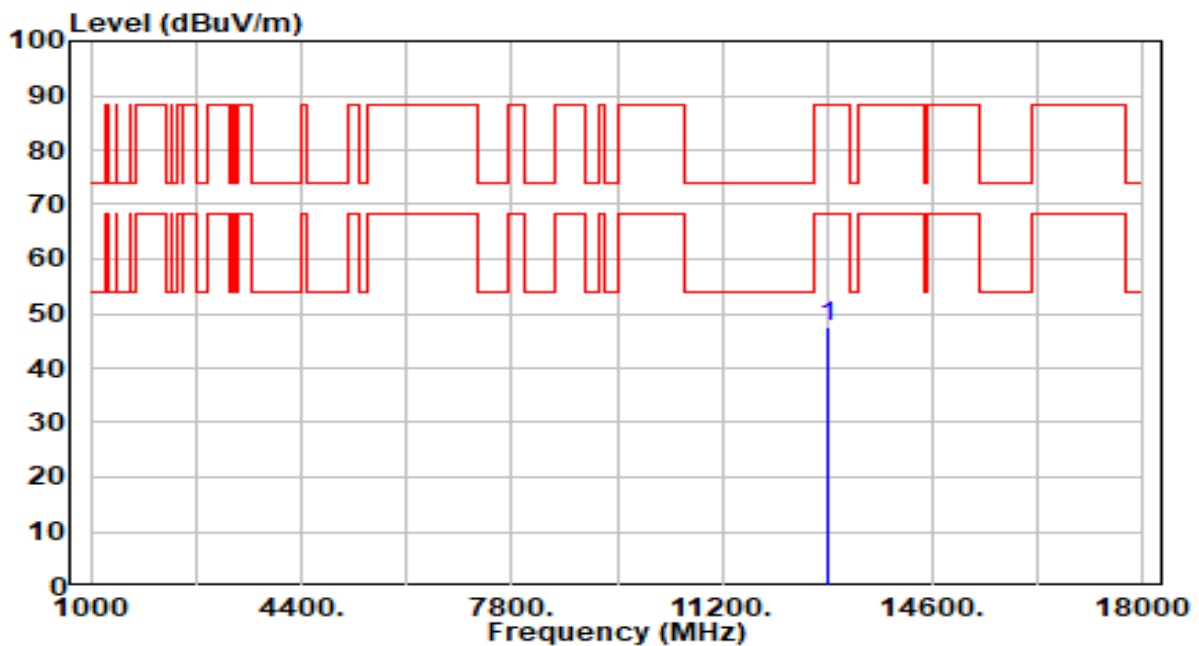

No	Frequency (MHz)	Reading (dBuV)	C.F (dB/m)	Measurement (dBuV/m)	Margin (dB)	Limit (dBuV/m)	Height (cm)	Angle (deg)	Remark (QP/PK/AV)
1	* 12890.000	42.21	5.28	47.49	-40.71	88.20	300	300	Peak

Note:

1. " \*", means this data is the worst emission level.
2. C.F (Correction Factor) = Antenna Factor (dB/m)+ Cable Loss (dB) – Preamplifier(dB).
3. Measurement (dBuV/m) = Reading(dBuV) + C.F (Correction Factor).
4. The emission levels of other frequencies are very lower than the limit and not show in test report.

EUT	AXE3000 Wi-Fi 6E High Gain Wireless USB Adapter	Date of Test	2023-10-27
Factor	DRH18-E	Temp. / Humidity	21°C /61%
Polarity	Vertical	Site / Test Engineer	AC2 / Marvin
Test Mode	802.11ax-40MHz_TX_Band6_CH 99_ANT 1+2	Test Voltage	By Notebook PC

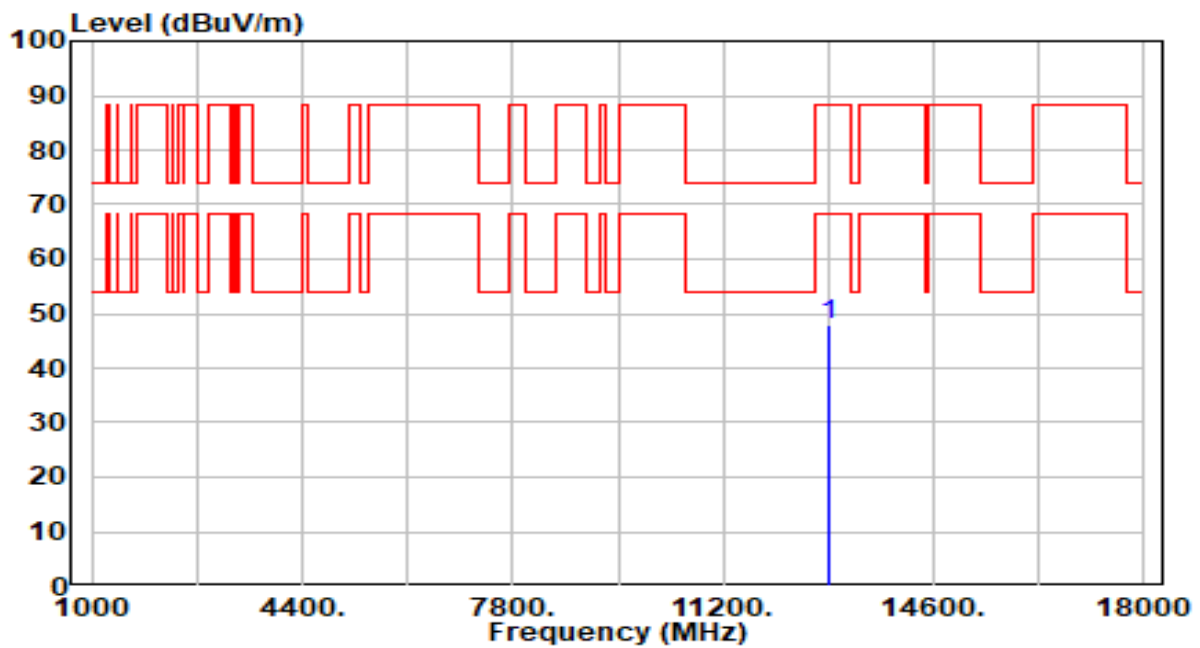

No	Frequency (MHz)	Reading (dBuV)	C.F (dB/m)	Measurement (dBuV/m)	Margin (dB)	Limit (dBuV/m)	Height (cm)	Angle (deg)	Remark (QP/PK/AV)
1	* 12890.000	42.69	5.28	47.97	-40.23	88.20	300	317	Peak

Note:

1. " \*", means this data is the worst emission level.
2. C.F (Correction Factor) = Antenna Factor (dB/m)+ Cable Loss (dB) – Preamplifier(dB).
3. Measurement (dBuV/m) = Reading(dBuV) + C.F (Correction Factor).
4. The emission levels of other frequencies are very lower than the limit and not show in test report.

EUT	AXE3000 Wi-Fi 6E High Gain Wireless USB Adapter	Date of Test	2023-10-27
Factor	DRH18-E	Temp. / Humidity	21°C /61%
Polarity	Horizontal	Site / Test Engineer	AC2 / Marvin
Test Mode	802.11ax-40MHz_TX_Band6_CH 107_ANT 1+2	Test Voltage	By Notebook PC

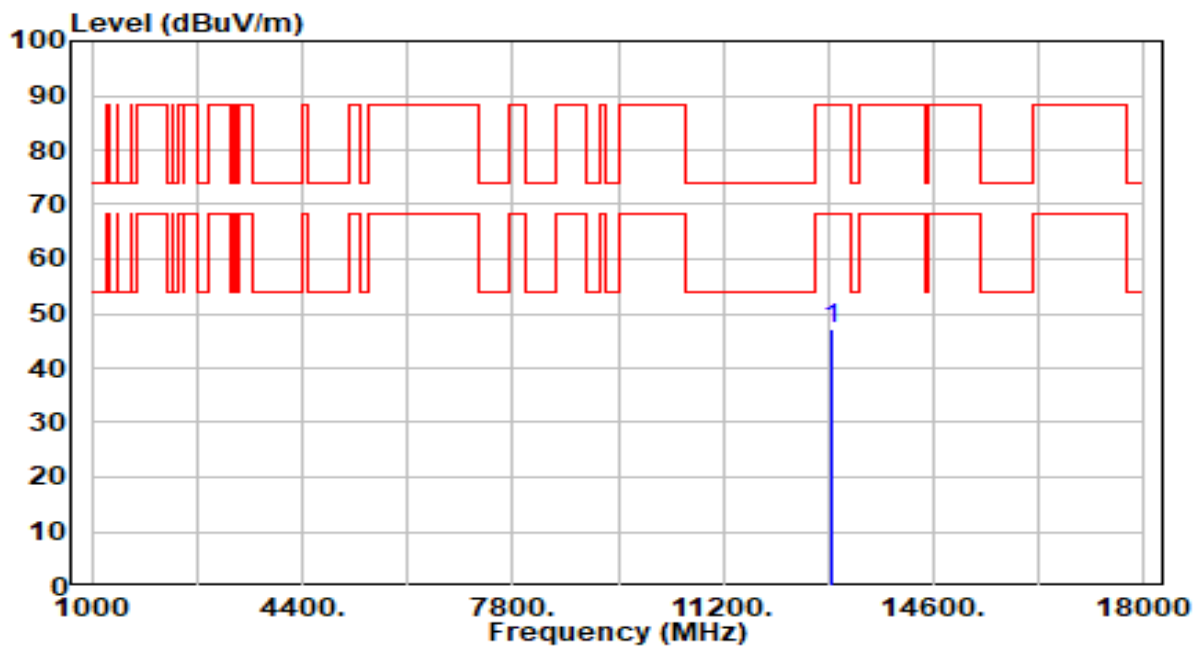

No	Frequency (MHz)	Reading (dBuV)	C.F (dB/m)	Measurement (dBuV/m)	Margin (dB)	Limit (dBuV/m)	Height (cm)	Angle (deg)	Remark (QP/PK/AV)
1	* 12970.000	42.08	5.25	47.33	-40.87	88.20	300	310	Peak

Note:

1. " \*", means this data is the worst emission level.
2. C.F (Correction Factor) = Antenna Factor (dB/m)+ Cable Loss (dB) – Preamplifier(dB).
3. Measurement (dBuV/m) = Reading(dBuV) + C.F (Correction Factor).
4. The emission levels of other frequencies are very lower than the limit and not show in test report.

EUT	AXE3000 Wi-Fi 6E High Gain Wireless USB Adapter	Date of Test	2023-10-27
Factor	DRH18-E	Temp. / Humidity	21°C /61%
Polarity	Vertical	Site / Test Engineer	AC2 / Marvin
Test Mode	802.11ax-40MHz_TX_Band6_CH 107_ANT 1+2	Test Voltage	By Notebook PC

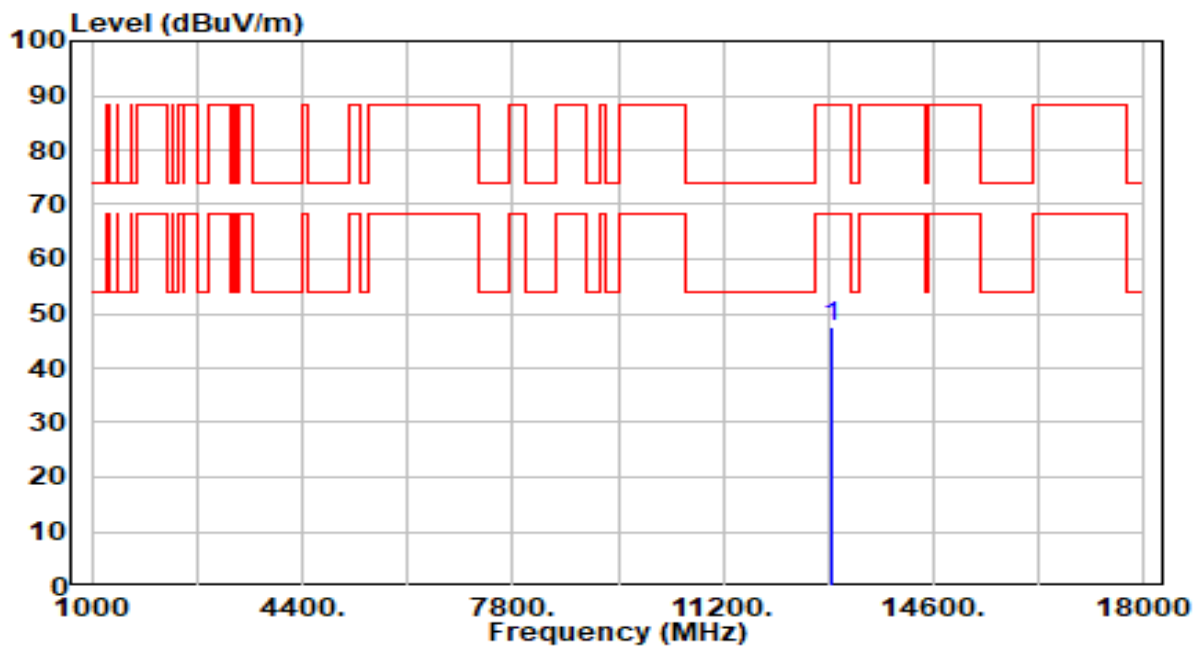

No	Frequency (MHz)	Reading (dBuV)	C.F (dB/m)	Measurement (dBuV/m)	Margin (dB)	Limit (dBuV/m)	Height (cm)	Angle (deg)	Remark (QP/PK/AV)
1	* 12970.000	42.35	5.25	47.60	-40.60	88.20	300	360	Peak

Note:

1. " \*", means this data is the worst emission level.
2. C.F (Correction Factor) = Antenna Factor (dB/m)+ Cable Loss (dB) – Preamplifier(dB).
3. Measurement (dBuV/m) = Reading(dBuV) + C.F (Correction Factor).
4. The emission levels of other frequencies are very lower than the limit and not show in test report.

EUT	AXE3000 Wi-Fi 6E High Gain Wireless USB Adapter	Date of Test	2023-10-27
Factor	DRH18-E	Temp. / Humidity	21°C /61%
Polarity	Horizontal	Site / Test Engineer	AC2 / Marvin
Test Mode	802.11ax-40MHz_TX_Band6_CH 115_ANT 1+2	Test Voltage	By Notebook PC

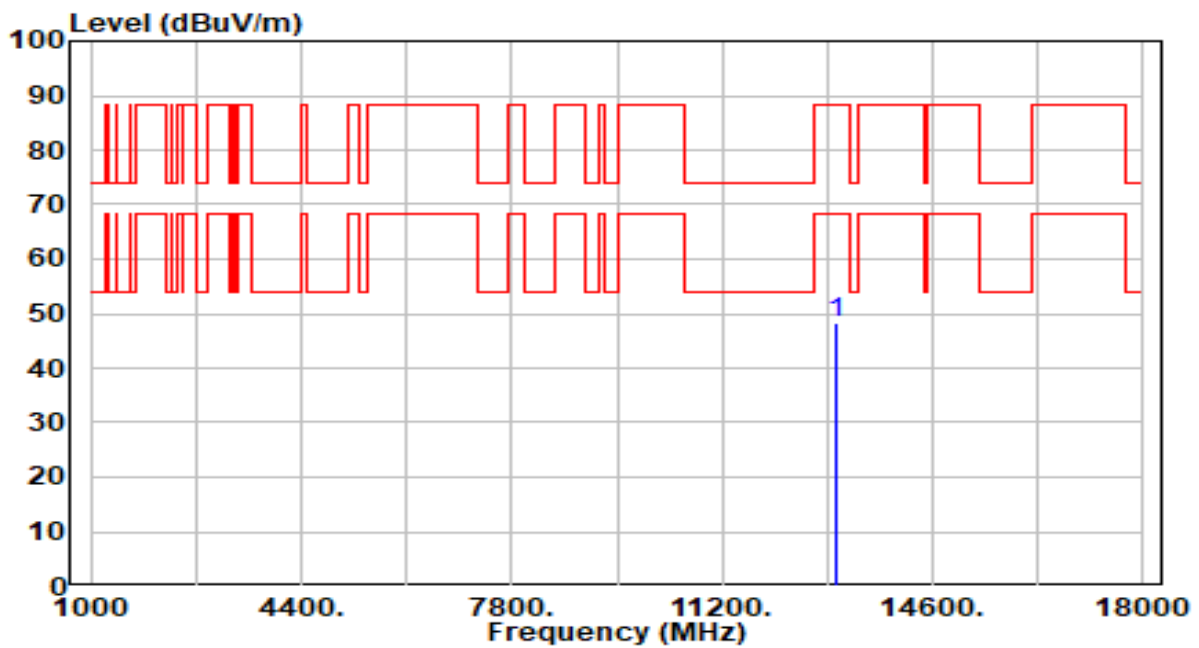

No	Frequency (MHz)	Reading (dBuV)	C.F (dB/m)	Measurement (dBuV/m)	Margin (dB)	Limit (dBuV/m)	Height (cm)	Angle (deg)	Remark (QP/PK/AV)
1	* 13050.000	43.09	5.23	48.32	-39.88	88.20	300	190	Peak

Note:

1. " \*", means this data is the worst emission level.
2. C.F (Correction Factor) = Antenna Factor (dB/m)+ Cable Loss (dB) – Preamplifier(dB).
3. Measurement (dBuV/m) = Reading(dBuV) + C.F (Correction Factor).
4. The emission levels of other frequencies are very lower than the limit and not show in test report.

EUT	AXE3000 Wi-Fi 6E High Gain Wireless USB Adapter	Date of Test	2023-10-27
Factor	DRH18-E	Temp. / Humidity	21°C /61%
Polarity	Vertical	Site / Test Engineer	AC2 / Marvin
Test Mode	802.11ax-40MHz_TX_Band6_CH 115_ANT 1+2	Test Voltage	By Notebook PC

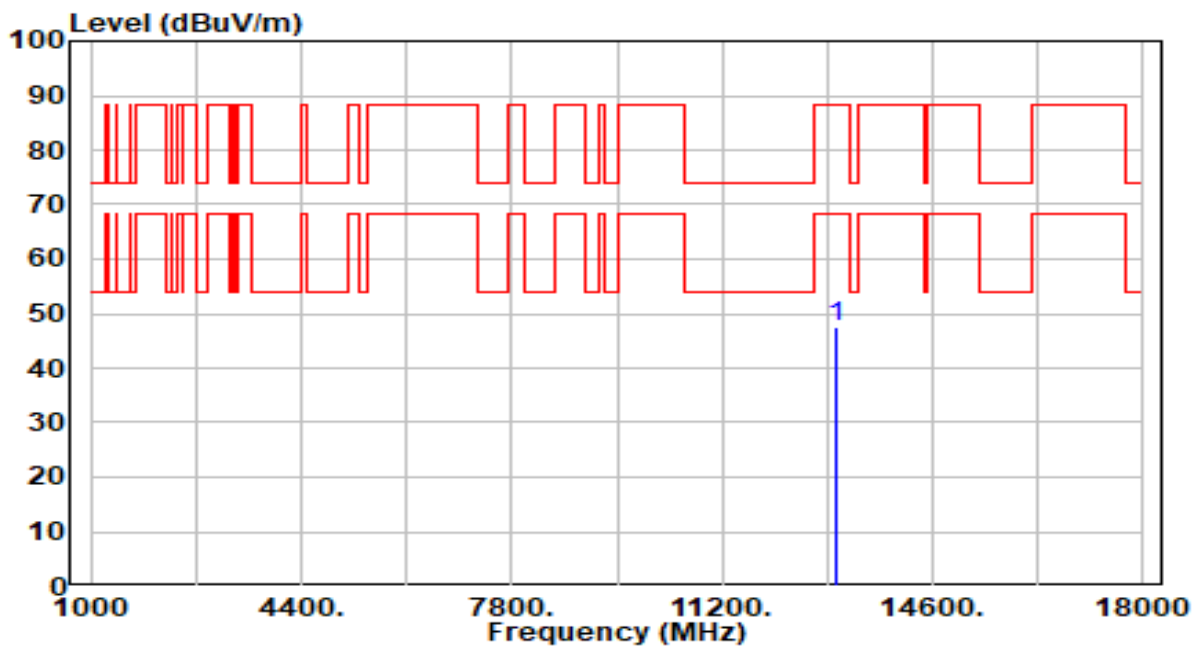

No	Frequency (MHz)	Reading (dBuV)	C.F (dB/m)	Measurement (dBuV/m)	Margin (dB)	Limit (dBuV/m)	Height (cm)	Angle (deg)	Remark (QP/PK/AV)
1	* 13050.000	42.16	5.23	47.39	-40.81	88.20	300	218	Peak

Note:

1. " \*", means this data is the worst emission level.
2. C.F (Correction Factor) = Antenna Factor (dB/m)+ Cable Loss (dB) – Preamplifier(dB).
3. Measurement (dBuV/m) = Reading(dBuV) + C.F (Correction Factor).
4. The emission levels of other frequencies are very lower than the limit and not show in test report.



EUT	AXE3000 Wi-Fi 6E High Gain Wireless USB Adapter	Date of Test	2023-10-27
Factor	DRH18-E	Temp. / Humidity	21°C /61%
Polarity	Horizontal	Site / Test Engineer	AC2 / Marvin
Test Mode	802.11ax-40MHz_TX_Band7_CH 123_ANT 1+2	Test Voltage	By Notebook PC

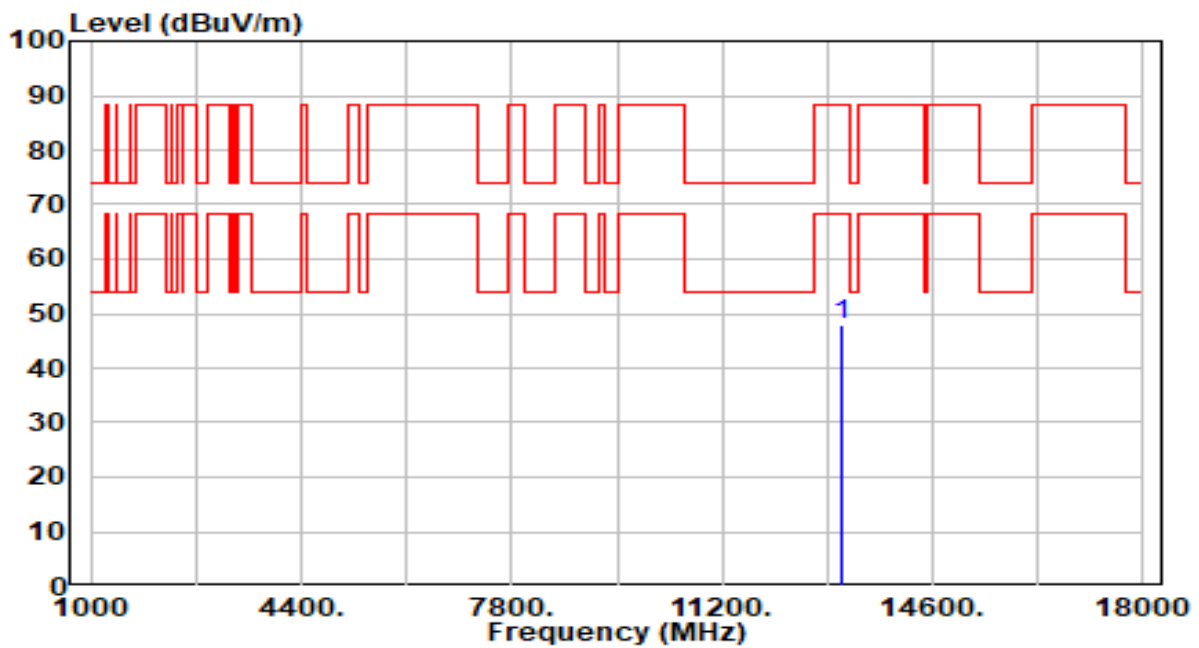

No	Frequency (MHz)	Reading (dBuV)	C.F (dB/m)	Measurement (dBuV/m)	Margin (dB)	Limit (dBuV/m)	Height (cm)	Angle (deg)	Remark (QP/PK/AV)
1	* 13130.000	42.81	5.21	48.03	-40.17	88.20	300	282	Peak

Note:

1. " \*", means this data is the worst emission level.
2. C.F (Correction Factor) = Antenna Factor (dB/m)+ Cable Loss (dB) – Preamplifier(dB).
3. Measurement (dBuV/m) = Reading(dBuV) + C.F (Correction Factor).
4. The emission levels of other frequencies are very lower than the limit and not show in test report.

EUT	AXE3000 Wi-Fi 6E High Gain Wireless USB Adapter	Date of Test	2023-10-27
Factor	DRH18-E	Temp. / Humidity	21°C /61%
Polarity	Vertical	Site / Test Engineer	AC2 / Marvin
Test Mode	802.11ax-40MHz_TX_Band7_CH 123_ANT 1+2	Test Voltage	By Notebook PC

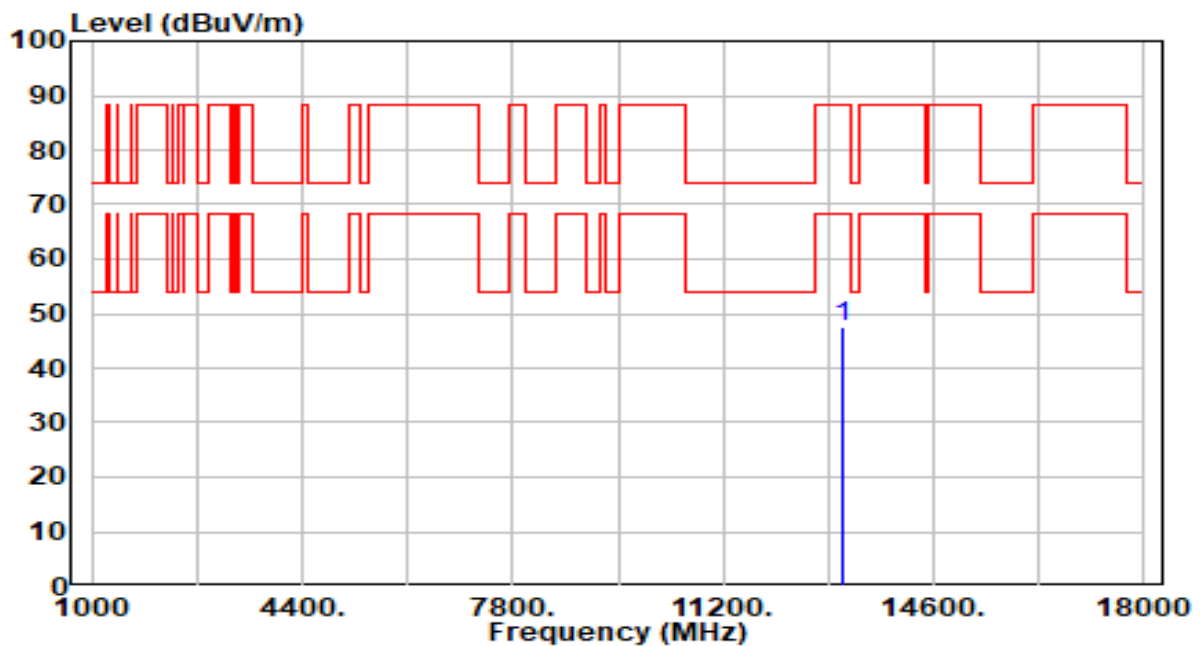

No	Frequency (MHz)	Reading (dBuV)	C.F (dB/m)	Measurement (dBuV/m)	Margin (dB)	Limit (dBuV/m)	Height (cm)	Angle (deg)	Remark (QP/PK/AV)
1	* 13130.000	42.20	5.21	47.41	-40.79	88.20	300	14	Peak

Note:

1. " \*", means this data is the worst emission level.
2. C.F (Correction Factor) = Antenna Factor (dB/m)+ Cable Loss (dB) – Preamplifier(dB).
3. Measurement (dBuV/m) = Reading(dBuV) + C.F (Correction Factor).
4. The emission levels of other frequencies are very lower than the limit and not show in test report.

EUT	AXE3000 Wi-Fi 6E High Gain Wireless USB Adapter	Date of Test	2023-10-27
Factor	DRH18-E	Temp. / Humidity	21°C /61%
Polarity	Horizontal	Site / Test Engineer	AC2 / Marvin
Test Mode	802.11ax-40MHz_TX_Band7_CH 147_ANT 1+2	Test Voltage	By Notebook PC

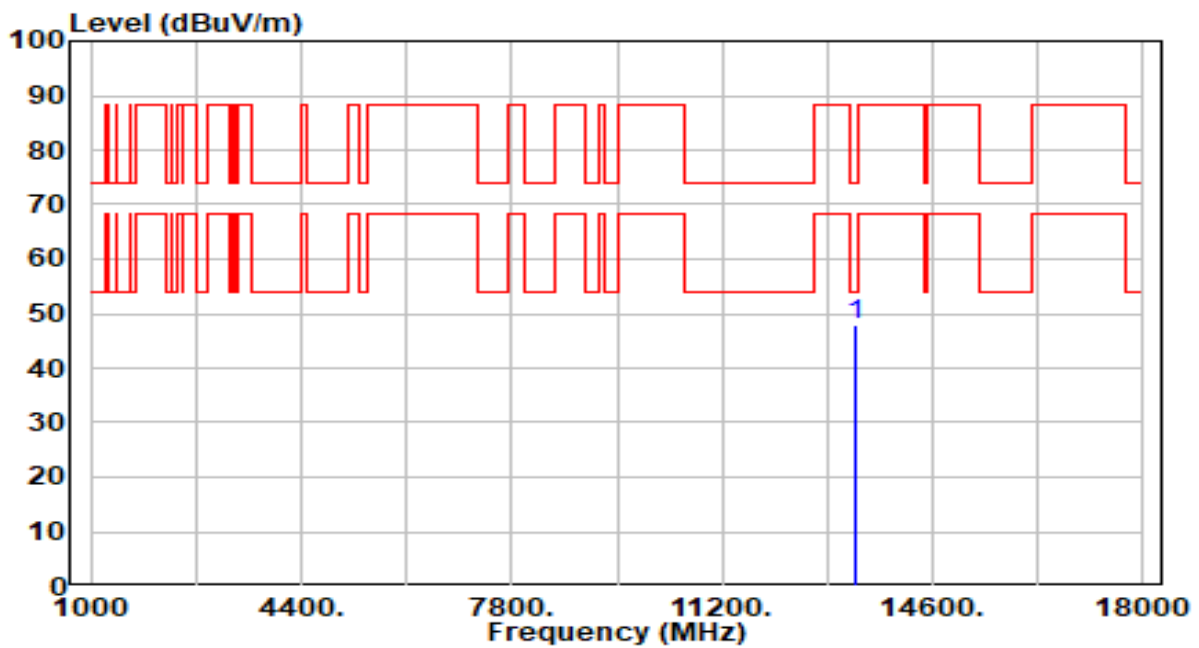

No	Frequency (MHz)	Reading (dBuV)	C.F (dB/m)	Measurement (dBuV/m)	Margin (dB)	Limit (dBuV/m)	Height (cm)	Angle (deg)	Remark (QP/PK/AV)
1	* 13370.000	42.50	5.25	47.76	-26.24	74.00	300	223	Peak

Note:

1. " \*", means this data is the worst emission level.
2. C.F (Correction Factor) = Antenna Factor (dB/m)+ Cable Loss (dB) – Preamplifier(dB).
3. Measurement (dBuV/m) = Reading(dBuV) + C.F (Correction Factor).
4. The emission levels of other frequencies are very lower than the limit and not show in test report.

EUT	AXE3000 Wi-Fi 6E High Gain Wireless USB Adapter	Date of Test	2023-10-27
Factor	DRH18-E	Temp. / Humidity	21°C /61%
Polarity	Vertical	Site / Test Engineer	AC2 / Marvin
Test Mode	802.11ax-40MHz_TX_Band7_CH 147_ANT 1+2	Test Voltage	By Notebook PC

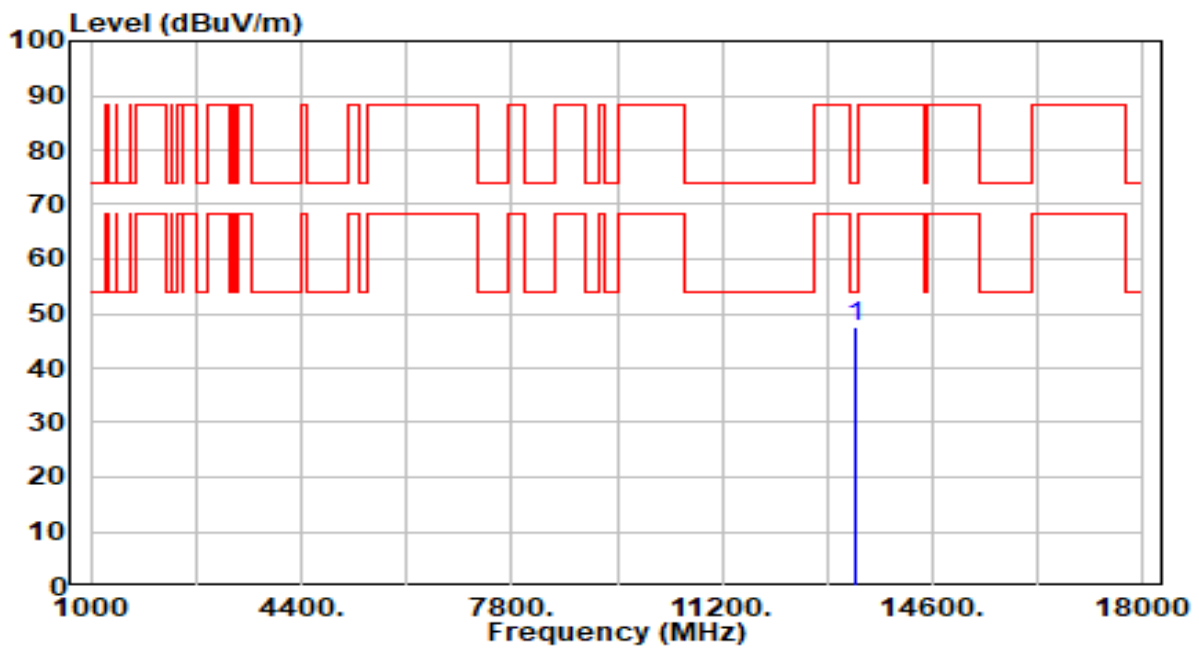

No	Frequency (MHz)	Reading (dBuV)	C.F (dB/m)	Measurement (dBuV/m)	Margin (dB)	Limit (dBuV/m)	Height (cm)	Angle (deg)	Remark (QP/PK/AV)
1	* 13370.000	42.14	5.25	47.39	-26.61	74.00	300	186	Peak

Note:

1. " \*", means this data is the worst emission level.
2. C.F (Correction Factor) = Antenna Factor (dB/m)+ Cable Loss (dB) – Preamplifier(dB).
3. Measurement (dBuV/m) = Reading(dBuV) + C.F (Correction Factor).
4. The emission levels of other frequencies are very lower than the limit and not show in test report.

EUT	AXE3000 Wi-Fi 6E High Gain Wireless USB Adapter	Date of Test	2023-10-27
Factor	DRH18-E	Temp. / Humidity	21°C /61%
Polarity	Horizontal	Site / Test Engineer	AC2 / Marvin
Test Mode	802.11ax-40MHz_TX_Band7_CH 179_ANT 1+2	Test Voltage	By Notebook PC

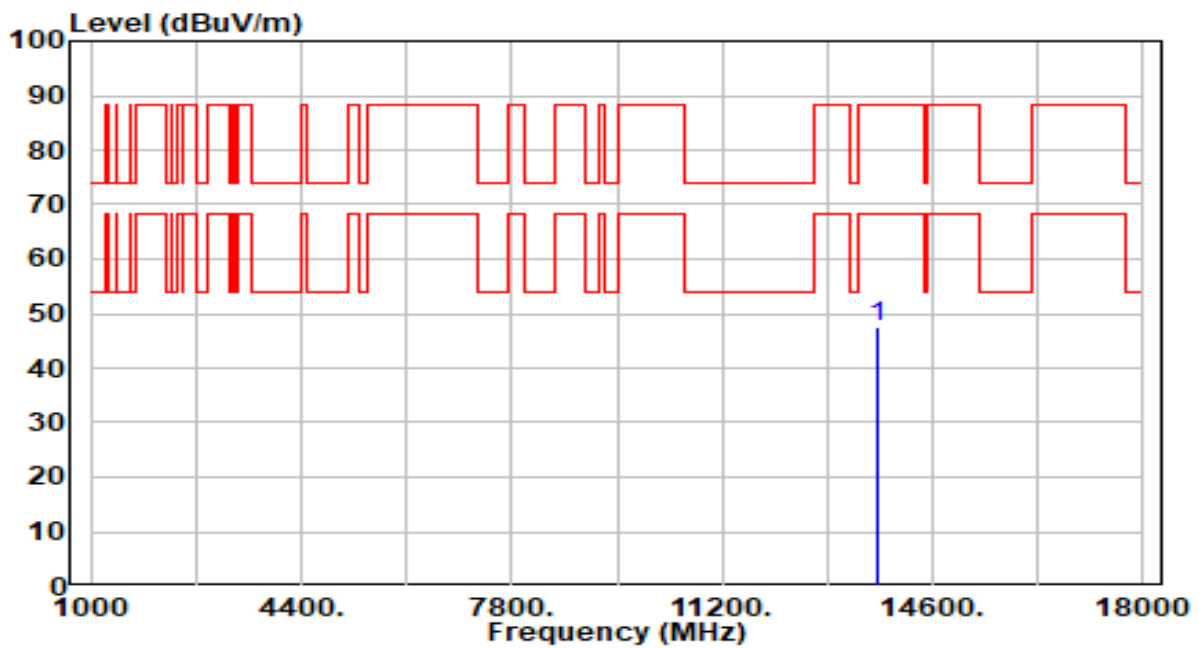

No	Frequency (MHz)	Reading (dBuV)	C.F (dB/m)	Measurement (dBuV/m)	Margin (dB)	Limit (dBuV/m)	Height (cm)	Angle (deg)	Remark (QP/PK/AV)
1	* 13690.000	42.47	5.02	47.49	-40.71	88.20	300	158	Peak

Note:

1. " \*", means this data is the worst emission level.
2. C.F (Correction Factor) = Antenna Factor (dB/m)+ Cable Loss (dB) – Preamplifier(dB).
3. Measurement (dBuV/m) = Reading(dBuV) + C.F (Correction Factor).
4. The emission levels of other frequencies are very lower than the limit and not show in test report.

EUT	AXE3000 Wi-Fi 6E High Gain Wireless USB Adapter	Date of Test	2023-10-27
Factor	DRH18-E	Temp. / Humidity	21°C /61%
Polarity	Vertical	Site / Test Engineer	AC2 / Marvin
Test Mode	802.11ax-40MHz_TX_Band7_CH 179_ANT 1+2	Test Voltage	By Notebook PC

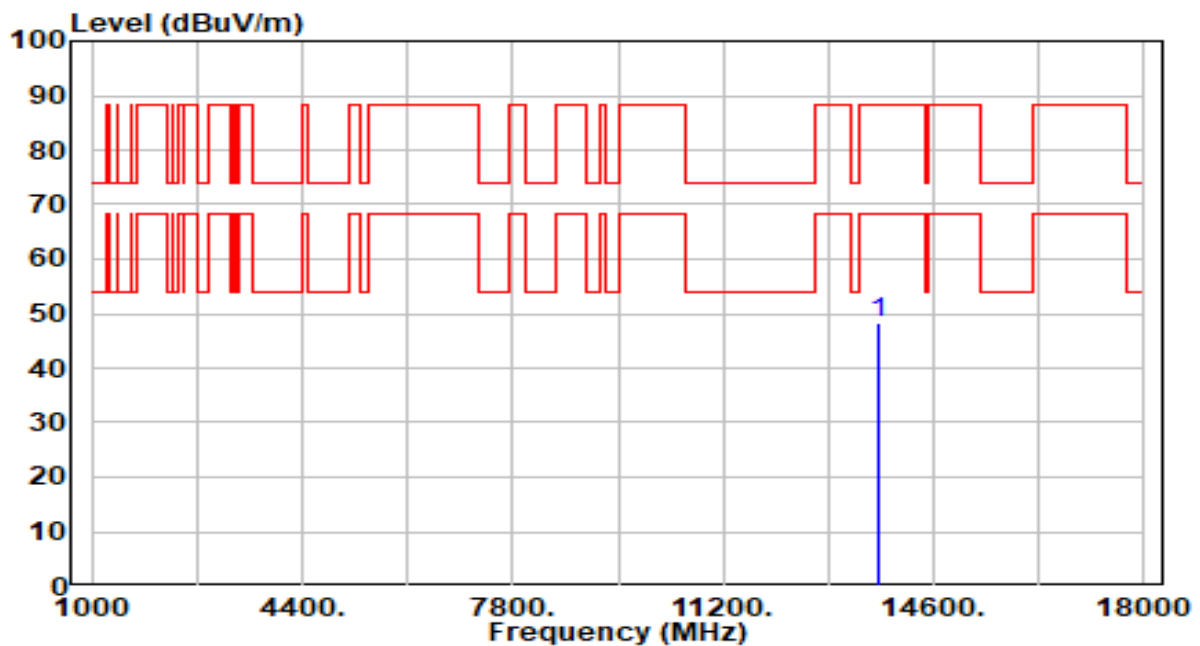

No	Frequency (MHz)	Reading (dBuV)	C.F (dB/m)	Measurement (dBuV/m)	Margin (dB)	Limit (dBuV/m)	Height (cm)	Angle (deg)	Remark (QP/PK/AV)
1	* 13690.000	43.13	5.02	48.15	-40.05	88.20	300	360	Peak

Note:

1. " \*", means this data is the worst emission level.
2. C.F (Correction Factor) = Antenna Factor (dB/m)+ Cable Loss (dB) – Preamplifier(dB).
3. Measurement (dBuV/m) = Reading(dBuV) + C.F (Correction Factor).
4. The emission levels of other frequencies are very lower than the limit and not show in test report.

EUT	AXE3000 Wi-Fi 6E High Gain Wireless USB Adapter	Date of Test	2023-10-27
Factor	DRH18-E	Temp. / Humidity	21°C /61%
Polarity	Horizontal	Site / Test Engineer	AC2 / Marvin
Test Mode	802.11ax-40MHz_TX_Band8_CH 187_ANT 1+2	Test Voltage	By Notebook PC

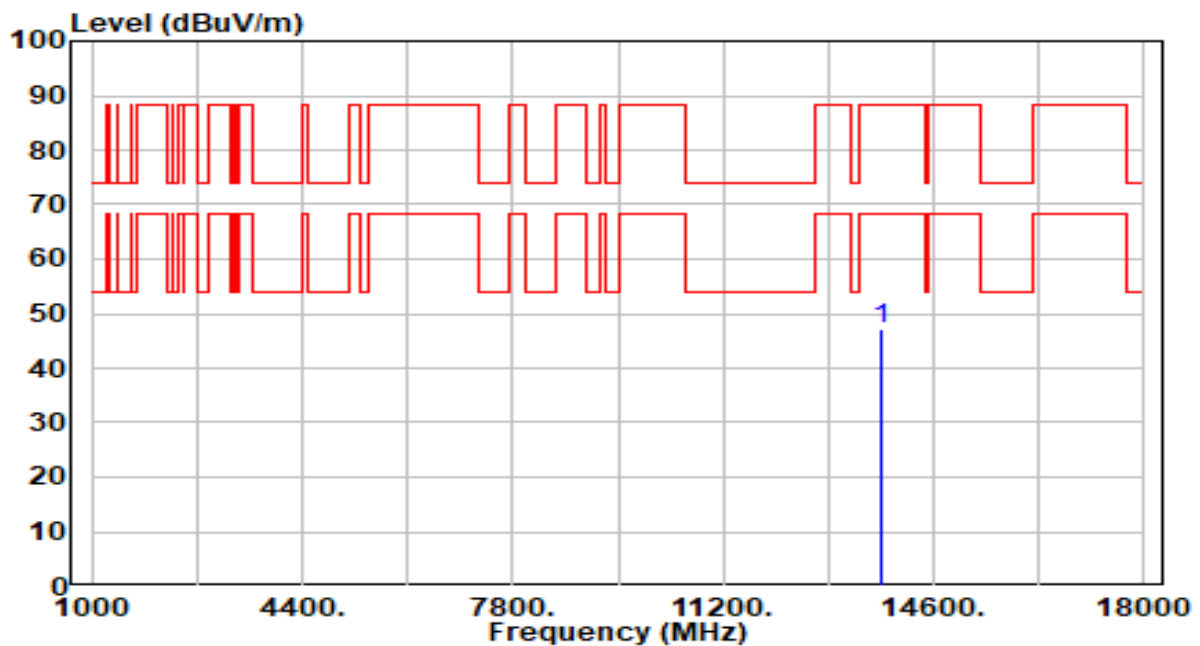

No	Frequency (MHz)	Reading (dBuV)	C.F (dB/m)	Measurement (dBuV/m)	Margin (dB)	Limit (dBuV/m)	Height (cm)	Angle (deg)	Remark (QP/PK/AV)
1	* 13770.000	42.28	5.03	47.31	-40.89	88.20	300	282	Peak

Note:

1. " \*", means this data is the worst emission level.
2. C.F (Correction Factor) = Antenna Factor (dB/m)+ Cable Loss (dB) – Preamplifier(dB).
3. Measurement (dBuV/m) = Reading(dBuV) + C.F (Correction Factor).
4. The emission levels of other frequencies are very lower than the limit and not show in test report.

EUT	AXE3000 Wi-Fi 6E High Gain Wireless USB Adapter	Date of Test	2023-10-27
Factor	DRH18-E	Temp. / Humidity	21°C /61%
Polarity	Vertical	Site / Test Engineer	AC2 / Marvin
Test Mode	802.11ax-40MHz_TX_Band8_CH 187_ANT 1+2	Test Voltage	By Notebook PC

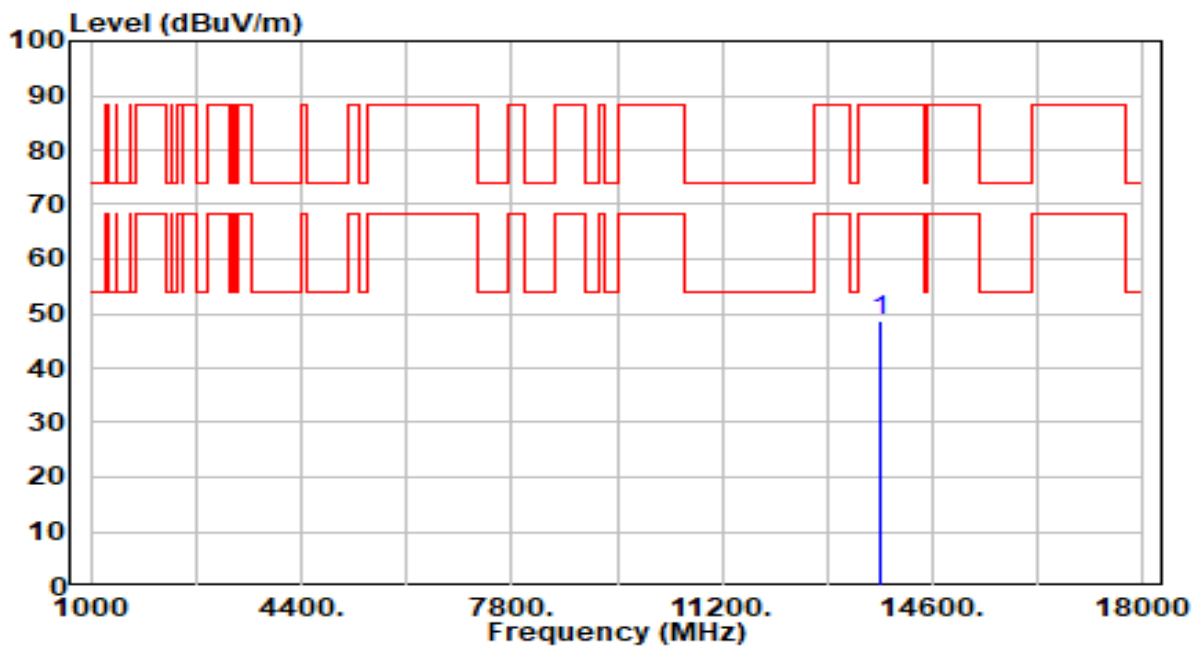

No	Frequency (MHz)	Reading (dBuV)	C.F (dB/m)	Measurement (dBuV/m)	Margin (dB)	Limit (dBuV/m)	Height (cm)	Angle (deg)	Remark (QP/PK/AV)
1	* 13770.000	43.83	5.03	48.87	-39.33	88.20	300	92	Peak

Note:

1. " \*", means this data is the worst emission level.
2. C.F (Correction Factor) = Antenna Factor (dB/m)+ Cable Loss (dB) – Preamplifier(dB).
3. Measurement (dBuV/m) = Reading(dBuV) + C.F (Correction Factor).
4. The emission levels of other frequencies are very lower than the limit and not show in test report.



EUT	AXE3000 Wi-Fi 6E High Gain Wireless USB Adapter	Date of Test	2023-10-27
Factor	DRH18-E	Temp. / Humidity	21°C /61%
Polarity	Horizontal	Site / Test Engineer	AC2 / Marvin
Test Mode	802.11ax-40MHz_TX_Band8_CH 195_ANT 1+2	Test Voltage	By Notebook PC

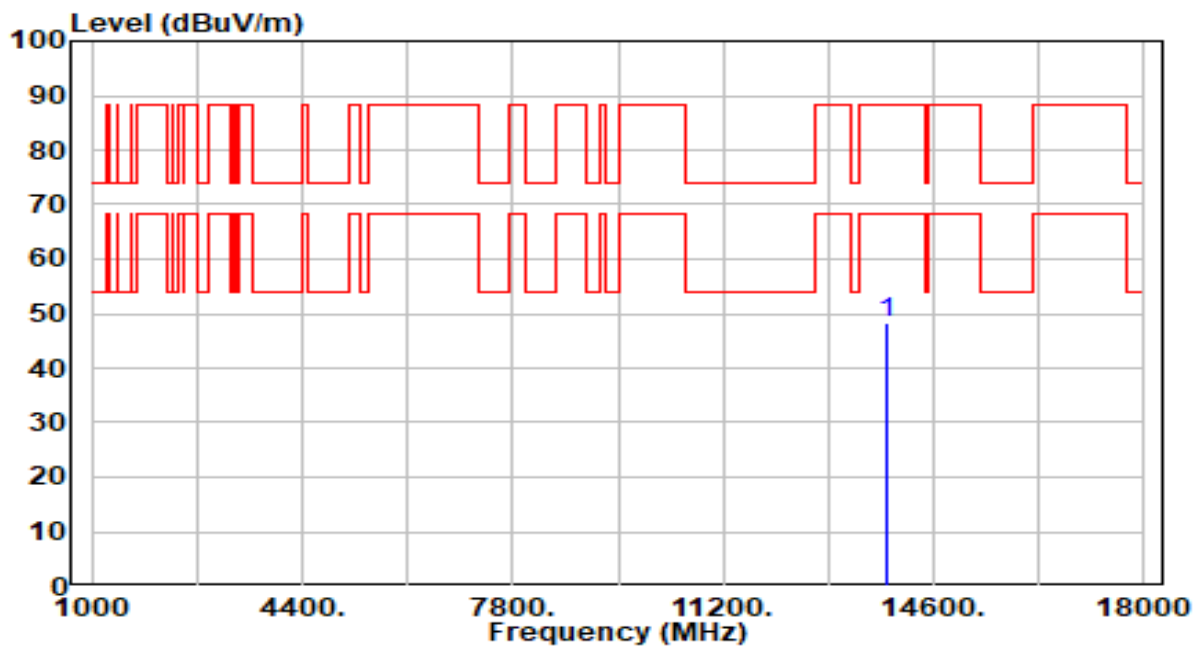

No	Frequency (MHz)	Reading (dBuV)	C.F (dB/m)	Measurement (dBuV/m)	Margin (dB)	Limit (dBuV/m)	Height (cm)	Angle (deg)	Remark (QP/PK/AV)
1	* 13850.000	43.27	5.07	48.34	-39.86	88.20	300	0	Peak

Note:

1. " \*", means this data is the worst emission level.
2. C.F (Correction Factor) = Antenna Factor (dB/m)+ Cable Loss (dB) – Preamplifier(dB).
3. Measurement (dBuV/m) = Reading(dBuV) + C.F (Correction Factor).
4. The emission levels of other frequencies are very lower than the limit and not show in test report.

EUT	AXE3000 Wi-Fi 6E High Gain Wireless USB Adapter	Date of Test	2023-10-27
Factor	DRH18-E	Temp. / Humidity	21°C /61%
Polarity	Vertical	Site / Test Engineer	AC2 / Marvin
Test Mode	802.11ax-40MHz_TX_Band8_CH 195_ANT 1+2	Test Voltage	By Notebook PC

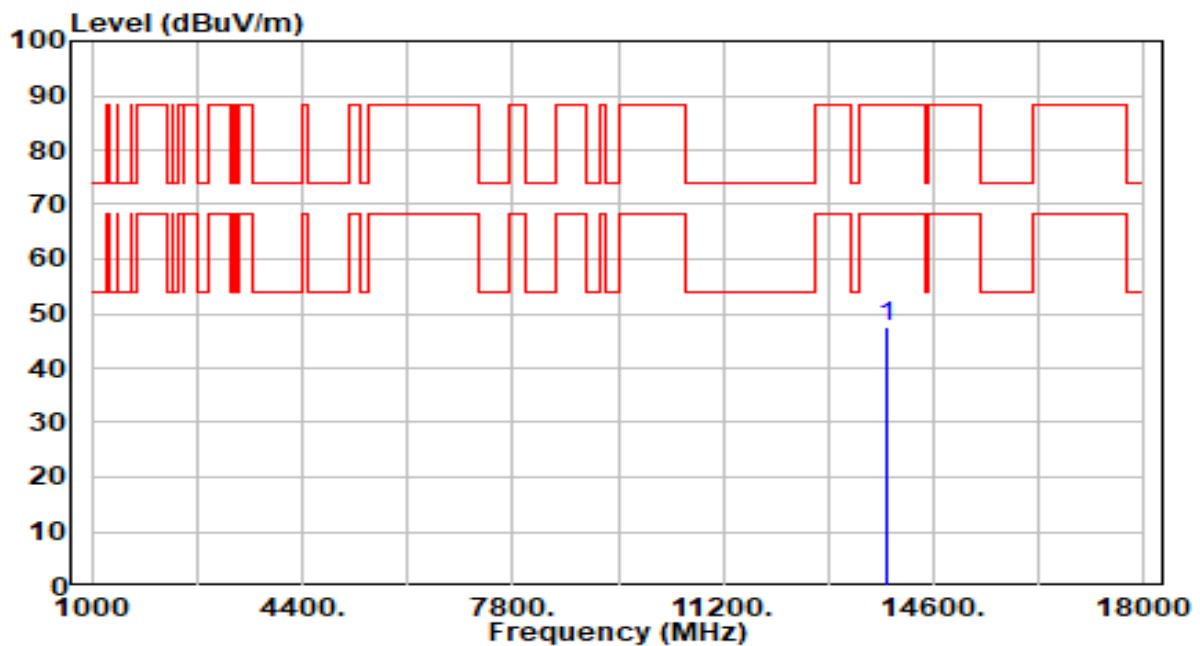

No	Frequency (MHz)	Reading (dBuV)	C.F (dB/m)	Measurement (dBuV/m)	Margin (dB)	Limit (dBuV/m)	Height (cm)	Angle (deg)	Remark (QP/PK/AV)
1	* 13850.000	42.66	5.07	47.73	-40.47	88.20	300	221	Peak

Note:

1. " \*", means this data is the worst emission level.
2. C.F (Correction Factor) = Antenna Factor (dB/m)+ Cable Loss (dB) – Preamplifier(dB).
3. Measurement (dBuV/m) = Reading(dBuV) + C.F (Correction Factor).
4. The emission levels of other frequencies are very lower than the limit and not show in test report.

EUT	AXE3000 Wi-Fi 6E High Gain Wireless USB Adapter	Date of Test	2023-10-27
Factor	DRH18-E	Temp. / Humidity	21°C /61%
Polarity	Horizontal	Site / Test Engineer	AC2 / Marvin
Test Mode	802.11ax-40MHz_TX_Band8_CH 211_ANT 1+2	Test Voltage	By Notebook PC

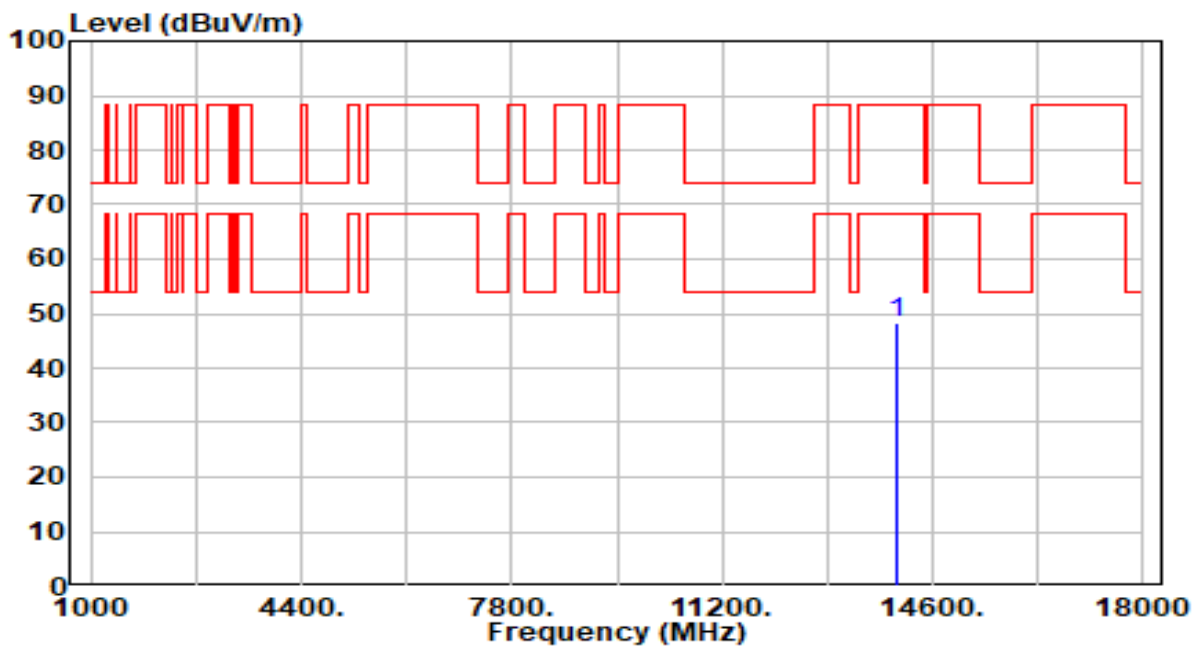

No	Frequency (MHz)	Reading (dBuV)	C.F (dB/m)	Measurement (dBuV/m)	Margin (dB)	Limit (dBuV/m)	Height (cm)	Angle (deg)	Remark (QP/PK/AV)
1	* 14010.000	43.03	5.17	48.19	-40.01	88.20	300	1	Peak

Note:

1. " \*", means this data is the worst emission level.
2. C.F (Correction Factor) = Antenna Factor (dB/m)+ Cable Loss (dB) – Preamplifier(dB).
3. Measurement (dBuV/m) = Reading(dBuV) + C.F (Correction Factor).
4. The emission levels of other frequencies are very lower than the limit and not show in test report.

EUT	AXE3000 Wi-Fi 6E High Gain Wireless USB Adapter	Date of Test	2023-10-27
Factor	DRH18-E	Temp. / Humidity	21°C /61%
Polarity	Vertical	Site / Test Engineer	AC2 / Marvin
Test Mode	802.11ax-40MHz_TX_Band8_CH 211_ANT 1+2	Test Voltage	By Notebook PC

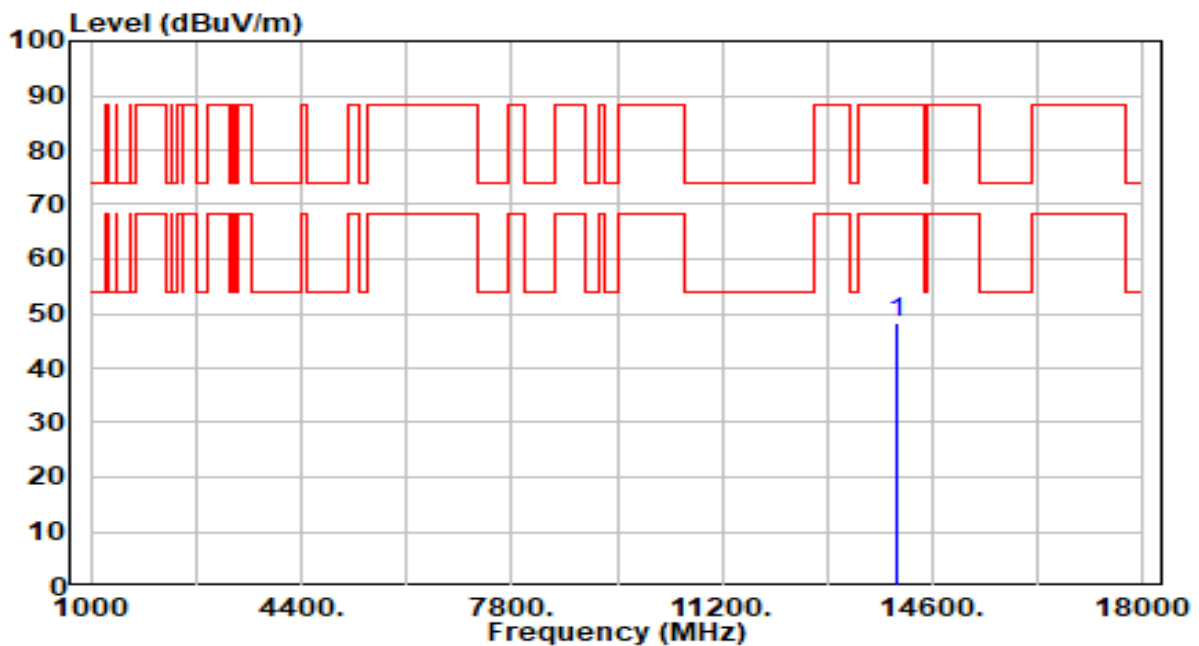

No	Frequency (MHz)	Reading (dBuV)	C.F (dB/m)	Measurement (dBuV/m)	Margin (dB)	Limit (dBuV/m)	Height (cm)	Angle (deg)	Remark (QP/PK/AV)
1	* 14010.000	43.01	5.17	48.18	-40.02	88.20	300	164	Peak

Note:

1. " \*", means this data is the worst emission level.
2. C.F (Correction Factor) = Antenna Factor (dB/m)+ Cable Loss (dB) – Preamplifier(dB).
3. Measurement (dBuV/m) = Reading(dBuV) + C.F (Correction Factor).
4. The emission levels of other frequencies are very lower than the limit and not show in test report.

EUT	AXE3000 Wi-Fi 6E High Gain Wireless USB Adapter	Date of Test	2023-10-27
Factor	DRH18-E	Temp. / Humidity	21°C /61%
Polarity	Horizontal	Site / Test Engineer	AC2 / Marvin
Test Mode	802.11ax-40MHz_TX_Band8_CH 227_ANT 1+2	Test Voltage	By Notebook PC

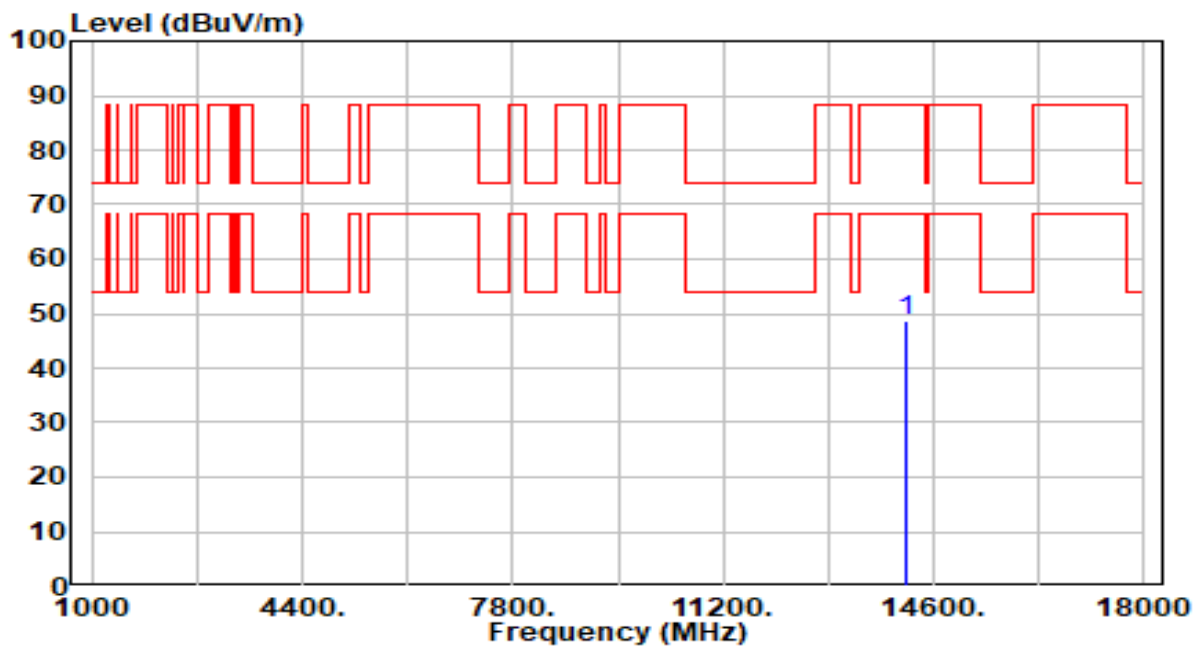

No	Frequency (MHz)	Reading (dBuV)	C.F (dB/m)	Measurement (dBuV/m)	Margin (dB)	Limit (dBuV/m)	Height (cm)	Angle (deg)	Remark (QP/PK/AV)
1	* 14170.000	43.57	5.10	48.66	-39.54	88.20	300	62	Peak

Note:

1. " \*", means this data is the worst emission level.
2. C.F (Correction Factor) = Antenna Factor (dB/m)+ Cable Loss (dB) – Preamplifier(dB).
3. Measurement (dBuV/m) = Reading(dBuV) + C.F (Correction Factor).
4. The emission levels of other frequencies are very lower than the limit and not show in test report.

EUT	AXE3000 Wi-Fi 6E High Gain Wireless USB Adapter	Date of Test	2023-10-27
Factor	DRH18-E	Temp. / Humidity	21°C /61%
Polarity	Vertical	Site / Test Engineer	AC2 / Marvin
Test Mode	802.11ax-40MHz_TX_Band8_CH 227_ANT 1+2	Test Voltage	By Notebook PC

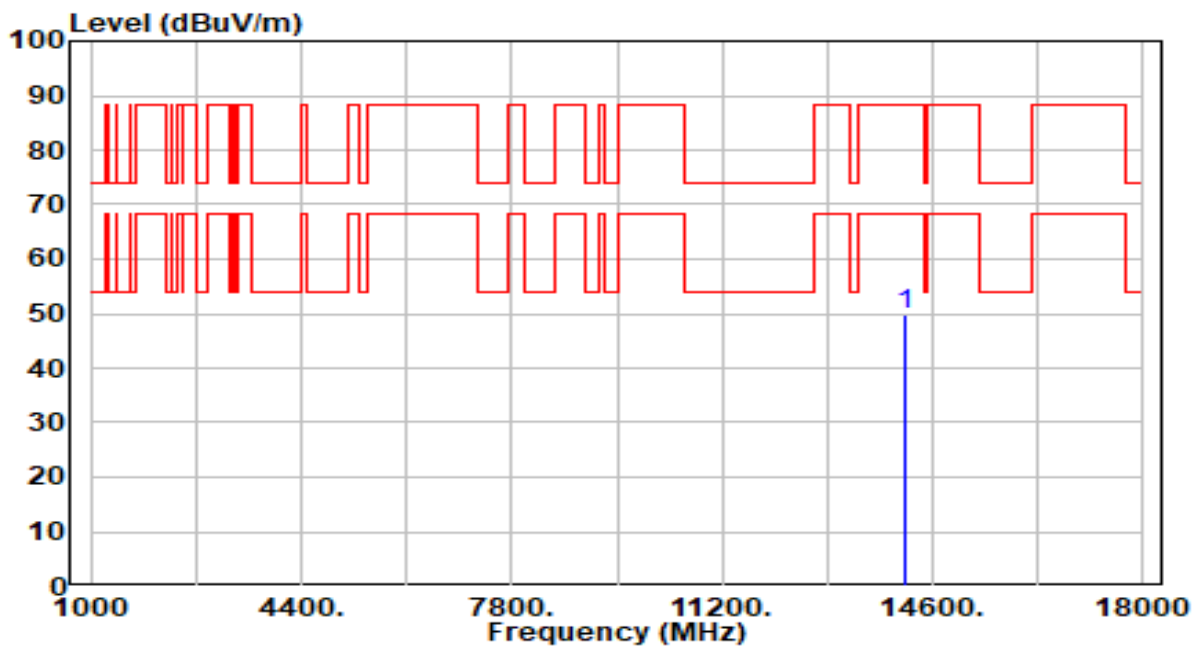

No	Frequency (MHz)	Reading (dBuV)	C.F (dB/m)	Measurement (dBuV/m)	Margin (dB)	Limit (dBuV/m)	Height (cm)	Angle (deg)	Remark (QP/PK/AV)
1	* 14170.000	44.75	5.10	49.85	-38.35	88.20	300	273	Peak

Note:

1. " \*", means this data is the worst emission level.
2. C.F (Correction Factor) = Antenna Factor (dB/m)+ Cable Loss (dB) – Preamplifier(dB).
3. Measurement (dBuV/m) = Reading(dBuV) + C.F (Correction Factor).
4. The emission levels of other frequencies are very lower than the limit and not show in test report.

EUT	AXE3000 Wi-Fi 6E High Gain Wireless USB Adapter	Date of Test	2023-10-27
Factor	DRH18-E	Temp. / Humidity	21°C /61%
Polarity	Horizontal	Site / Test Engineer	AC2 / Marvin
Test Mode	802.11ax-80MHz_TX_Band5_CH 7_ANT 1+2	Test Voltage	By Notebook PC

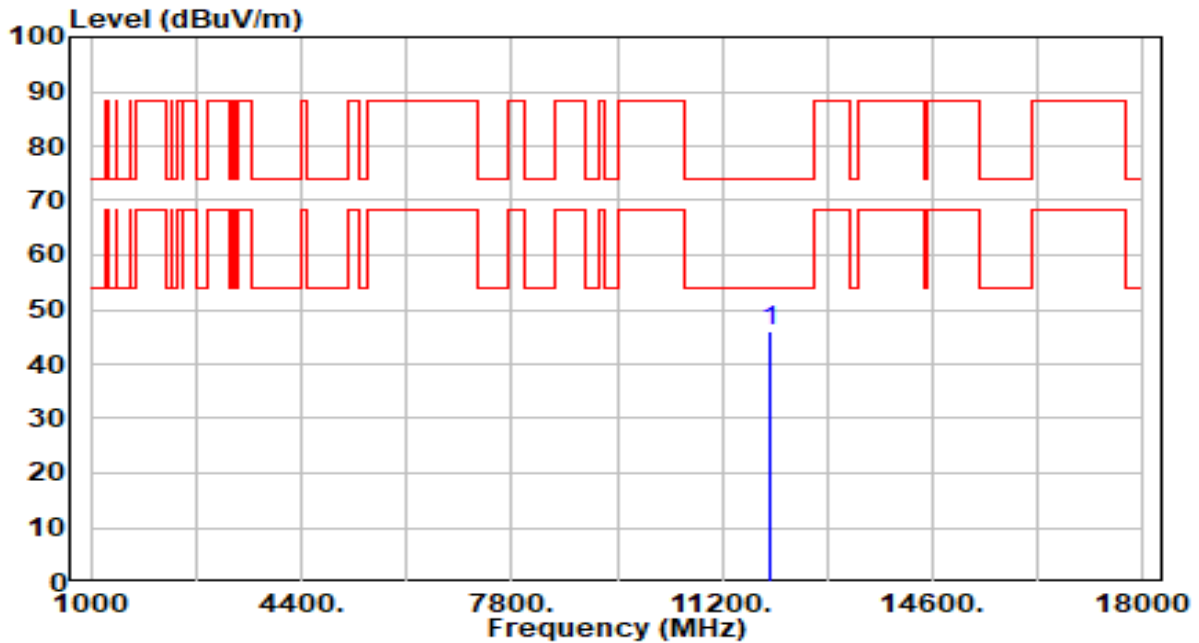

No	Frequency (MHz)	Reading (dBuV)	C.F (dB/m)	Measurement (dBuV/m)	Margin (dB)	Limit (dBuV/m)	Height (cm)	Angle (deg)	Remark (QP/PK/AV)
1	* 11970.000	42.06	3.87	45.93	-28.07	74.00	300	131	Peak

Note:

1. " \*", means this data is the worst emission level.
2. C.F (Correction Factor) = Antenna Factor (dB/m)+ Cable Loss (dB) – Preamplifier(dB).
3. Measurement (dBuV/m) = Reading(dBuV) + C.F (Correction Factor).
4. The emission levels of other frequencies are very lower than the limit and not show in test report.

EUT	AXE3000 Wi-Fi 6E High Gain Wireless USB Adapter	Date of Test	2023-10-27
Factor	DRH18-E	Temp. / Humidity	21°C /61%
Polarity	Vertical	Site / Test Engineer	AC2 / Marvin
Test Mode	802.11ax-80MHz_TX_Band5_CH 7_ANT 1+2	Test Voltage	By Notebook PC

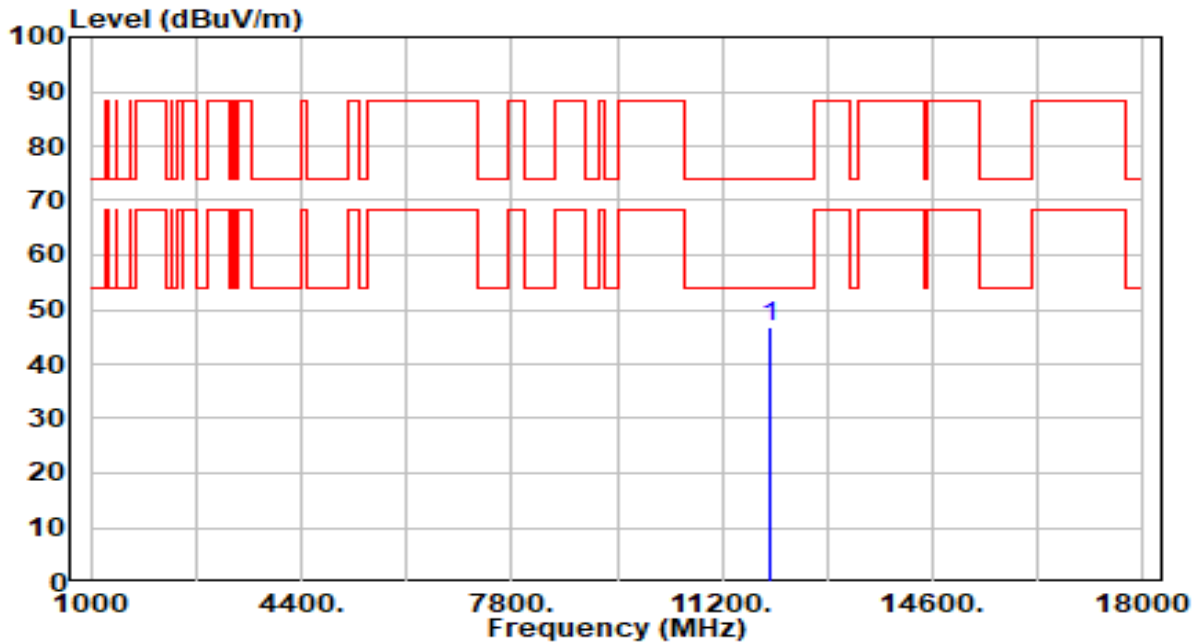

No	Frequency (MHz)	Reading (dBuV)	C.F (dB/m)	Measurement (dBuV/m)	Margin (dB)	Limit (dBuV/m)	Height (cm)	Angle (deg)	Remark (QP/PK/AV)
1	* 11970.000	42.86	3.87	46.73	-27.27	74.00	300	357	Peak

Note:

1. " \*", means this data is the worst emission level.
2. C.F (Correction Factor) = Antenna Factor (dB/m)+ Cable Loss (dB) – Preamplifier(dB).
3. Measurement (dBuV/m) = Reading(dBuV) + C.F (Correction Factor).
4. The emission levels of other frequencies are very lower than the limit and not show in test report.



EUT	AXE3000 Wi-Fi 6E High Gain Wireless USB Adapter	Date of Test	2023-10-27
Factor	DRH18-E	Temp. / Humidity	21°C /61%
Polarity	Horizontal	Site / Test Engineer	AC2 / Marvin
Test Mode	802.11ax-80MHz_TX_Band5_CH 39_ANT 1+2	Test Voltage	By Notebook PC

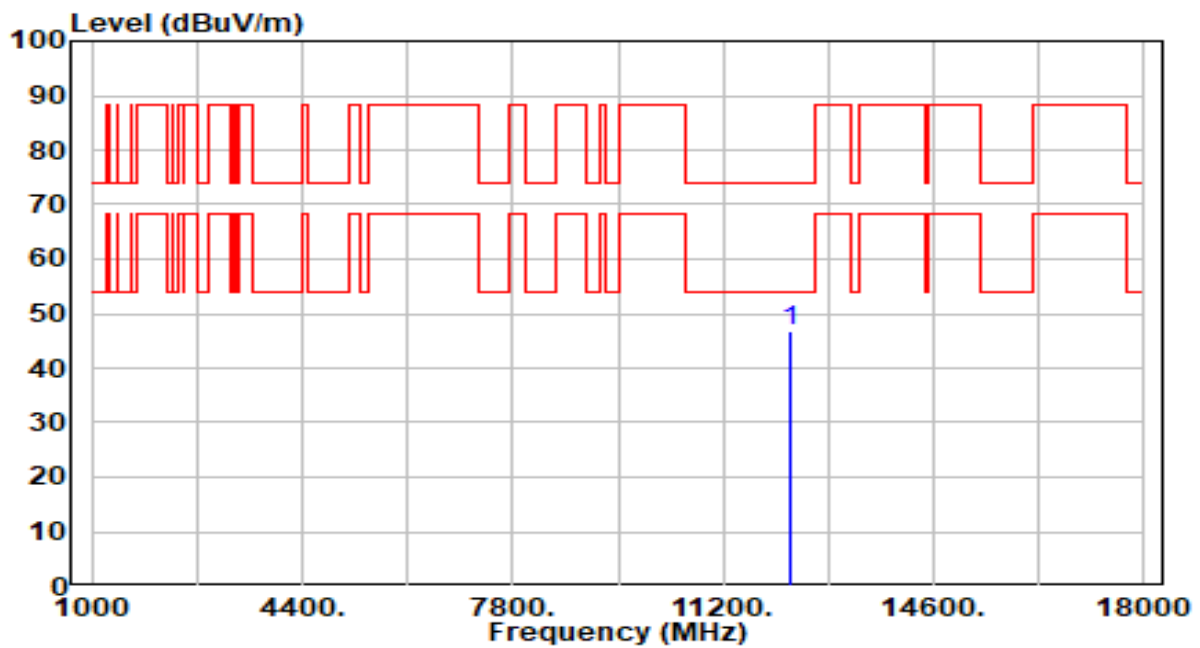

No	Frequency (MHz)	Reading (dBuV)	C.F (dB/m)	Measurement (dBuV/m)	Margin (dB)	Limit (dBuV/m)	Height (cm)	Angle (deg)	Remark (QP/PK/AV)
1	* 12290.000	42.42	4.41	46.84	-27.16	74.00	300	161	Peak

Note:

1. " \*", means this data is the worst emission level.
2. C.F (Correction Factor) = Antenna Factor (dB/m)+ Cable Loss (dB) – Preamplifier(dB).
3. Measurement (dBuV/m) = Reading(dBuV) + C.F (Correction Factor).
4. The emission levels of other frequencies are very lower than the limit and not show in test report.

EUT	AXE3000 Wi-Fi 6E High Gain Wireless USB Adapter	Date of Test	2023-10-27
Factor	DRH18-E	Temp. / Humidity	21°C /61%
Polarity	Vertical	Site / Test Engineer	AC2 / Marvin
Test Mode	802.11ax-80MHz_TX_Band5_CH 39_ANT 1+2	Test Voltage	By Notebook PC

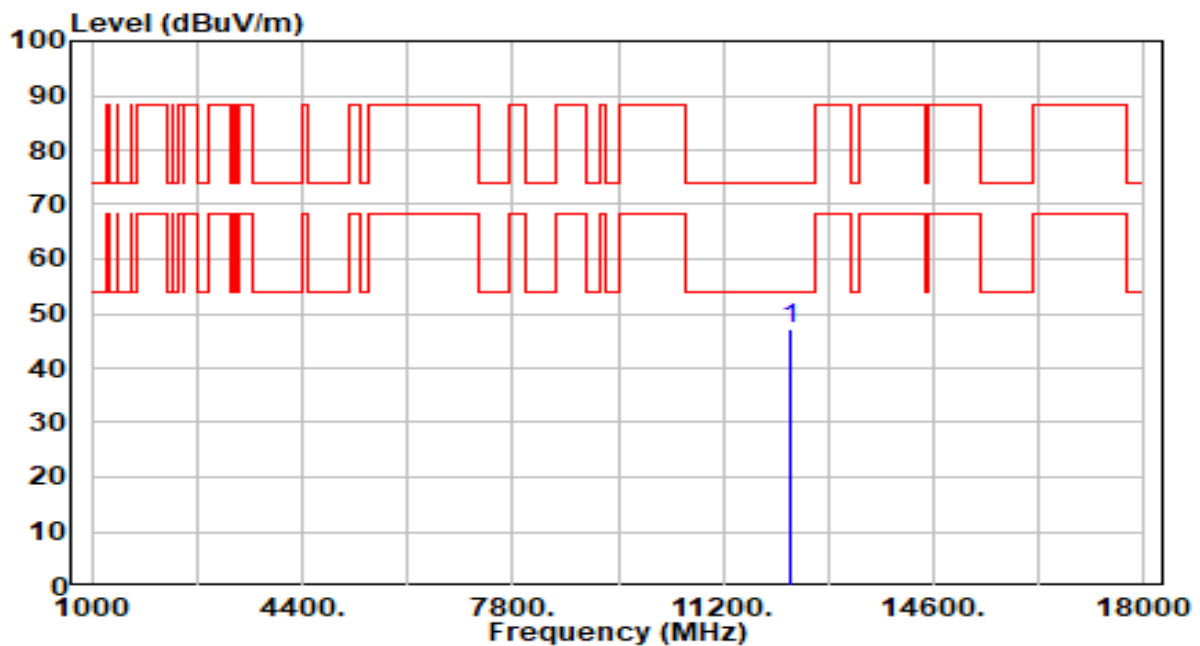

No	Frequency (MHz)	Reading (dBuV)	C.F (dB/m)	Measurement (dBuV/m)	Margin (dB)	Limit (dBuV/m)	Height (cm)	Angle (deg)	Remark (QP/PK/AV)
1	* 12290.000	42.63	4.41	47.04	-26.96	74.00	300	281	Peak

Note:

1. " \*", means this data is the worst emission level.
2. C.F (Correction Factor) = Antenna Factor (dB/m)+ Cable Loss (dB) – Preamplifier(dB).
3. Measurement (dBuV/m) = Reading(dBuV) + C.F (Correction Factor).
4. The emission levels of other frequencies are very lower than the limit and not show in test report.

EUT	AXE3000 Wi-Fi 6E High Gain Wireless USB Adapter	Date of Test	2023-10-27
Factor	DRH18-E	Temp. / Humidity	21°C /61%
Polarity	Horizontal	Site / Test Engineer	AC2 / Marvin
Test Mode	802.11ax-80MHz_TX_Band5_CH 87_ANT 1+2	Test Voltage	By Notebook PC

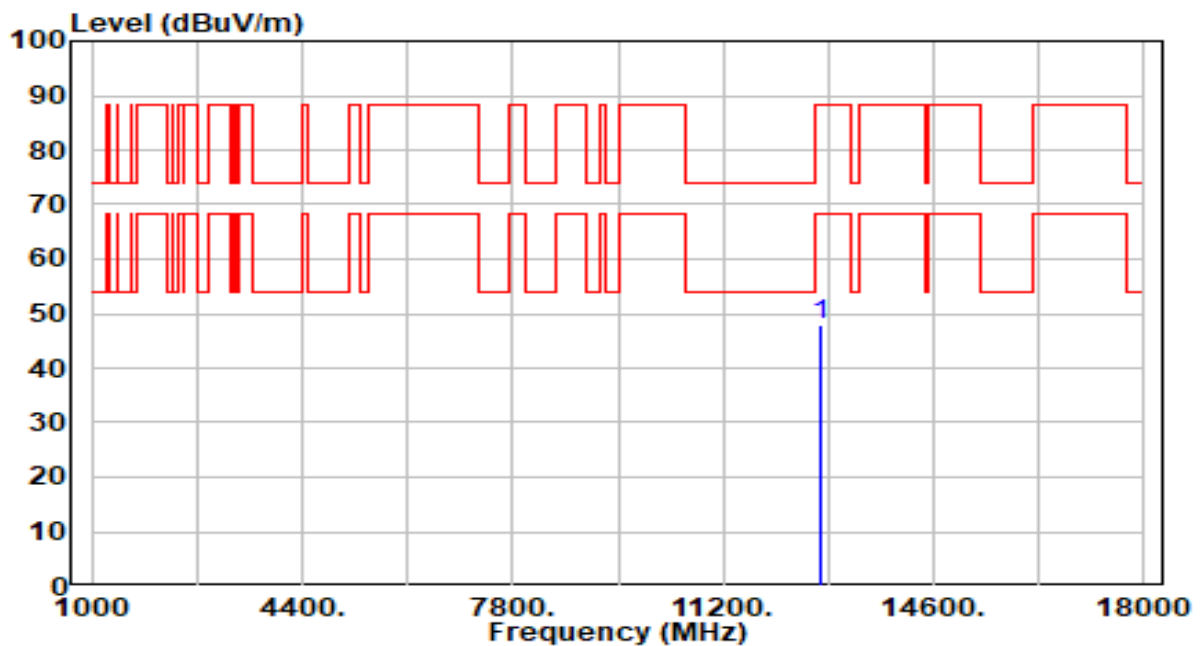

No	Frequency (MHz)	Reading (dBuV)	C.F (dB/m)	Measurement (dBuV/m)	Margin (dB)	Limit (dBuV/m)	Height (cm)	Angle (deg)	Remark (QP/PK/AV)
1	* 12770.000	42.55	5.28	47.83	-40.37	88.20	300	170	Peak

Note:

1. " \*", means this data is the worst emission level.
2. C.F (Correction Factor) = Antenna Factor (dB/m)+ Cable Loss (dB) – Preamplifier(dB).
3. Measurement (dBuV/m) = Reading(dBuV) + C.F (Correction Factor).
4. The emission levels of other frequencies are very lower than the limit and not show in test report.

EUT	AXE3000 Wi-Fi 6E High Gain Wireless USB Adapter	Date of Test	2023-10-27
Factor	DRH18-E	Temp. / Humidity	21°C /61%
Polarity	Vertical	Site / Test Engineer	AC2 / Marvin
Test Mode	802.11ax-80MHz_TX_Band5_CH 87_ANT 1+2	Test Voltage	By Notebook PC

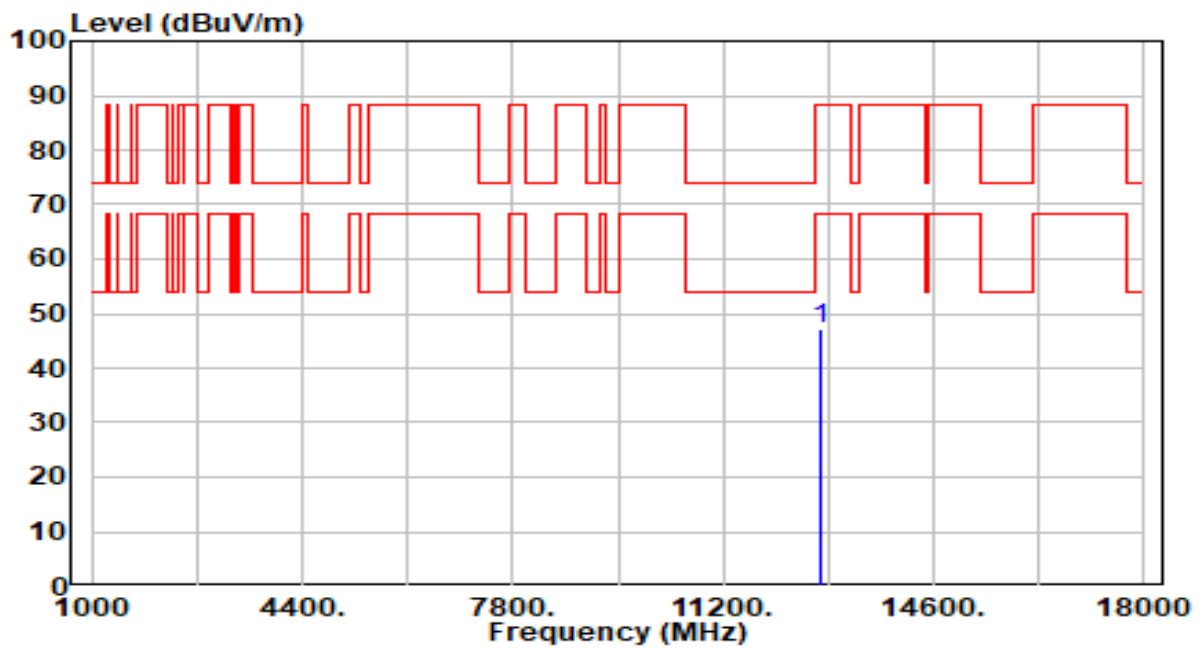

No	Frequency (MHz)	Reading (dBuV)	C.F (dB/m)	Measurement (dBuV/m)	Margin (dB)	Limit (dBuV/m)	Height (cm)	Angle (deg)	Remark (QP/PK/AV)
1	* 12770.000	41.78	5.28	47.07	-41.13	88.20	300	321	Peak

Note:

1. " \*", means this data is the worst emission level.
2. C.F (Correction Factor) = Antenna Factor (dB/m)+ Cable Loss (dB) – Preamplifier(dB).
3. Measurement (dBuV/m) = Reading(dBuV) + C.F (Correction Factor).
4. The emission levels of other frequencies are very lower than the limit and not show in test report.

EUT	AXE3000 Wi-Fi 6E High Gain Wireless USB Adapter	Date of Test	2023-10-27
Factor	DRH18-E	Temp. / Humidity	21°C /61%
Polarity	Horizontal	Site / Test Engineer	AC2 / Marvin
Test Mode	802.11ax-80MHz_TX_Band6_CH 103_ANT 1+2	Test Voltage	By Notebook PC

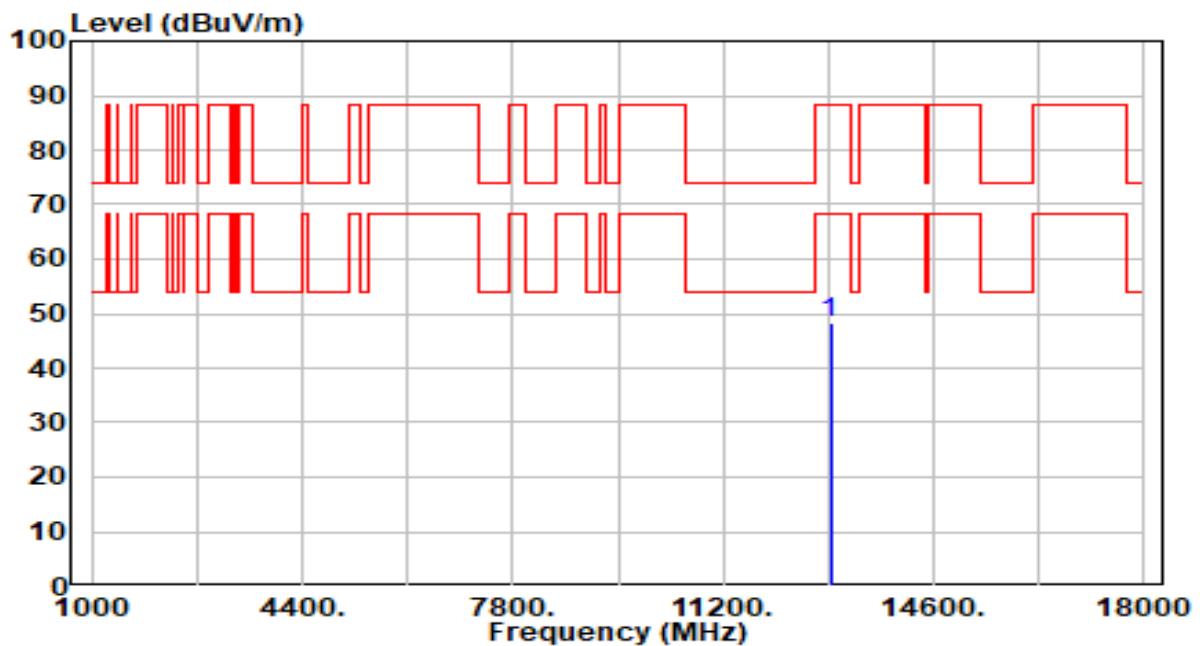

No	Frequency (MHz)	Reading (dBuV)	C.F (dB/m)	Measurement (dBuV/m)	Margin (dB)	Limit (dBuV/m)	Height (cm)	Angle (deg)	Remark (QP/PK/AV)
1	* 12930.000	42.93	5.26	48.19	-40.01	88.20	300	346	Peak

Note:

1. " \*", means this data is the worst emission level.
2. C.F (Correction Factor) = Antenna Factor (dB/m)+ Cable Loss (dB) – Preamplifier(dB).
3. Measurement (dBuV/m) = Reading(dBuV) + C.F (Correction Factor).
4. The emission levels of other frequencies are very lower than the limit and not show in test report.

EUT	AXE3000 Wi-Fi 6E High Gain Wireless USB Adapter	Date of Test	2023-10-27
Factor	DRH18-E	Temp. / Humidity	21°C /61%
Polarity	Vertical	Site / Test Engineer	AC2 / Marvin
Test Mode	802.11ax-80MHz_TX_Band6_CH 103_ANT 1+2	Test Voltage	By Notebook PC

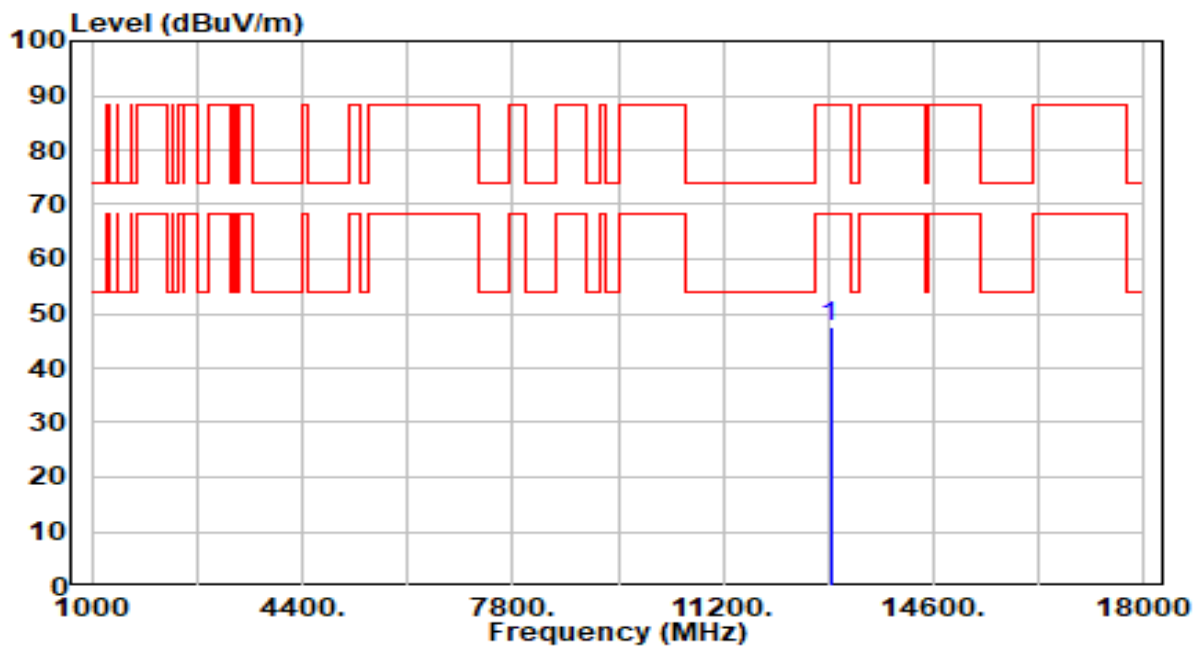

No	Frequency (MHz)	Reading (dBuV)	C.F (dB/m)	Measurement (dBuV/m)	Margin (dB)	Limit (dBuV/m)	Height (cm)	Angle (deg)	Remark (QP/PK/AV)
1	* 12930.000	42.11	5.26	47.37	-40.83	88.20	300	297	Peak

Note:

1. " \*", means this data is the worst emission level.
2. C.F (Correction Factor) = Antenna Factor (dB/m)+ Cable Loss (dB) – Preamplifier(dB).
3. Measurement (dBuV/m) = Reading(dBuV) + C.F (Correction Factor).
4. The emission levels of other frequencies are very lower than the limit and not show in test report.

EUT	AXE3000 Wi-Fi 6E High Gain Wireless USB Adapter	Date of Test	2023-10-27
Factor	DRH18-E	Temp. / Humidity	21°C /61%
Polarity	Horizontal	Site / Test Engineer	AC2 / Marvin
Test Mode	802.11ax-80MHz_TX_Band7_CH 119_ANT 1+2	Test Voltage	By Notebook PC

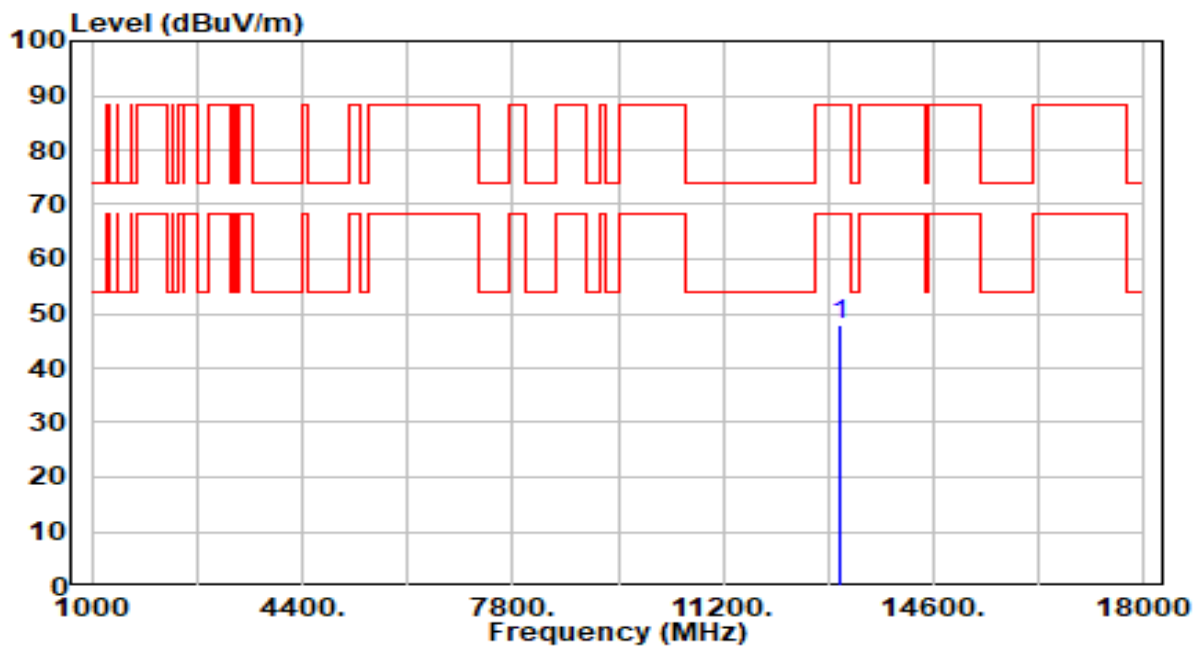

No	Frequency (MHz)	Reading (dBuV)	C.F (dB/m)	Measurement (dBuV/m)	Margin (dB)	Limit (dBuV/m)	Height (cm)	Angle (deg)	Remark (QP/PK/AV)
1	* 13090.000	42.63	5.22	47.85	-40.35	88.20	300	10	Peak

Note:

1. " \*", means this data is the worst emission level.
2. C.F (Correction Factor) = Antenna Factor (dB/m)+ Cable Loss (dB) – Preamplifier(dB).
3. Measurement (dBuV/m) = Reading(dBuV) + C.F (Correction Factor).
4. The emission levels of other frequencies are very lower than the limit and not show in test report.

EUT	AXE3000 Wi-Fi 6E High Gain Wireless USB Adapter	Date of Test	2023-10-27
Factor	DRH18-E	Temp. / Humidity	21°C /61%
Polarity	Vertical	Site / Test Engineer	AC2 / Marvin
Test Mode	802.11ax-80MHz_TX_Band7_CH 119_ANT 1+2	Test Voltage	By Notebook PC

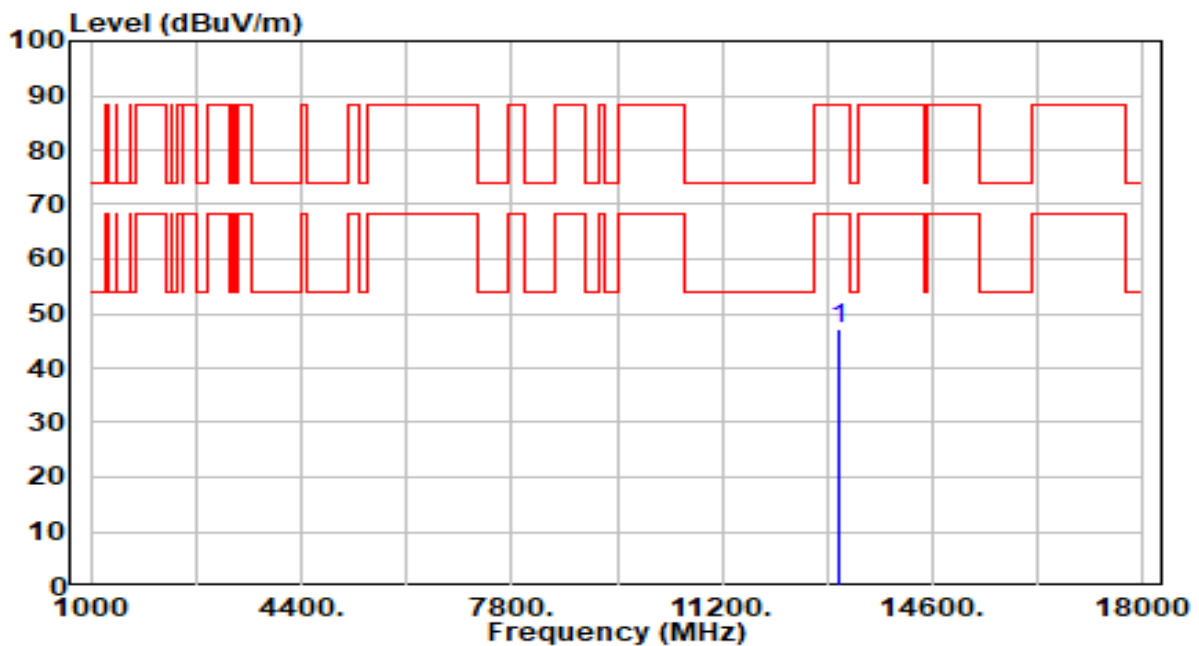

No	Frequency (MHz)	Reading (dBuV)	C.F (dB/m)	Measurement (dBuV/m)	Margin (dB)	Limit (dBuV/m)	Height (cm)	Angle (deg)	Remark (QP/PK/AV)
1	* 13090.000	41.81	5.22	47.03	-41.17	88.20	300	360	Peak

Note:

1. " \*", means this data is the worst emission level.
2. C.F (Correction Factor) = Antenna Factor (dB/m)+ Cable Loss (dB) – Preamplifier(dB).
3. Measurement (dBuV/m) = Reading(dBuV) + C.F (Correction Factor).
4. The emission levels of other frequencies are very lower than the limit and not show in test report.



EUT	AXE3000 Wi-Fi 6E High Gain Wireless USB Adapter	Date of Test	2023-10-27
Factor	DRH18-E	Temp. / Humidity	21°C /61%
Polarity	Horizontal	Site / Test Engineer	AC2 / Marvin
Test Mode	802.11ax-80MHz_TX_Band7_CH 135_ANT 1+2	Test Voltage	By Notebook PC

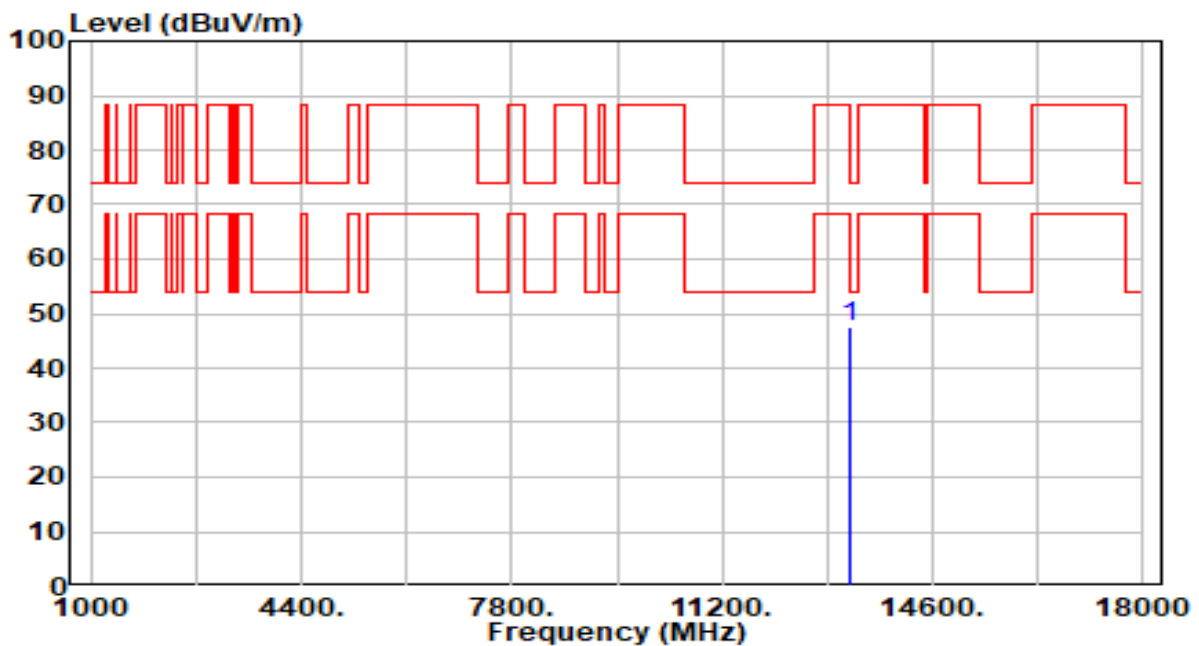

No	Frequency (MHz)	Reading (dBuV)	C.F (dB/m)	Measurement (dBuV/m)	Margin (dB)	Limit (dBuV/m)	Height (cm)	Angle (deg)	Remark (QP/PK/AV)
1	* 13250.000	42.51	5.22	47.72	-26.28	74.00	300	270	Peak

Note:

1. " \*", means this data is the worst emission level.
2. C.F (Correction Factor) = Antenna Factor (dB/m)+ Cable Loss (dB) – Preamplifier(dB).
3. Measurement (dBuV/m) = Reading(dBuV) + C.F (Correction Factor).
4. The emission levels of other frequencies are very lower than the limit and not show in test report.

EUT	AXE3000 Wi-Fi 6E High Gain Wireless USB Adapter	Date of Test	2023-10-27
Factor	DRH18-E	Temp. / Humidity	21°C /61%
Polarity	Vertical	Site / Test Engineer	AC2 / Marvin
Test Mode	802.11ax-80MHz_TX_Band7_CH 135_ANT 1+2	Test Voltage	By Notebook PC

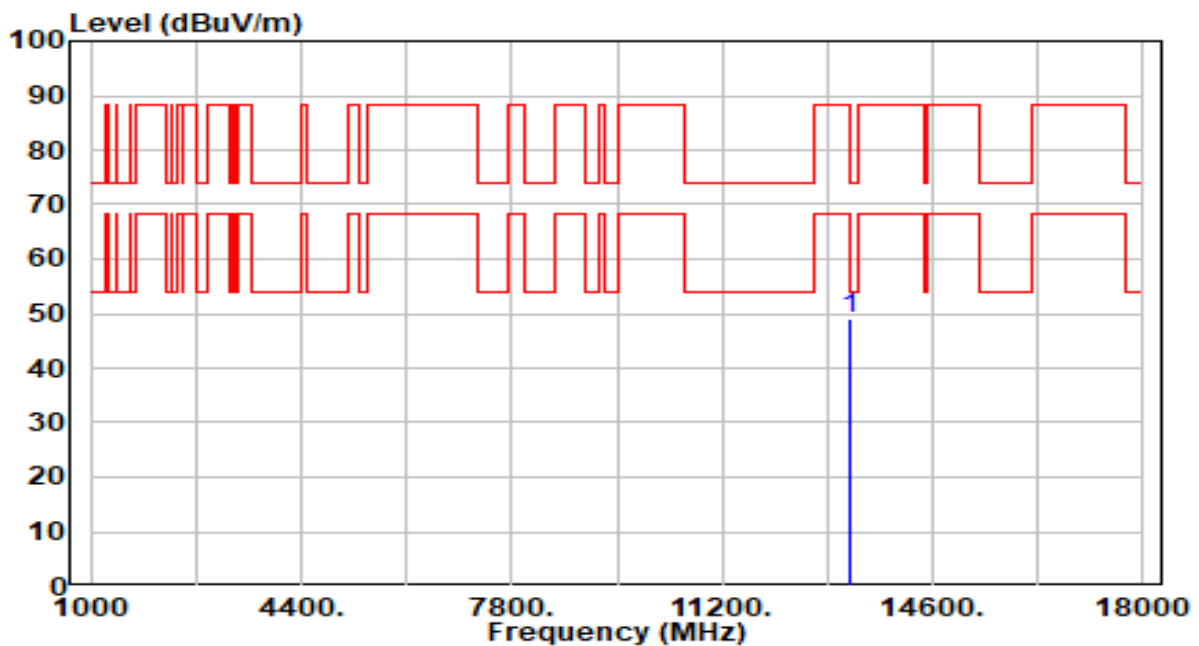

No	Frequency (MHz)	Reading (dBuV)	C.F (dB/m)	Measurement (dBuV/m)	Margin (dB)	Limit (dBuV/m)	Height (cm)	Angle (deg)	Remark (QP/PK/AV)
1	* 13250.000	43.68	5.22	48.89	-25.11	74.00	300	357	Peak

Note:

1. " \*", means this data is the worst emission level.
2. C.F (Correction Factor) = Antenna Factor (dB/m)+ Cable Loss (dB) – Preamplifier(dB).
3. Measurement (dBuV/m) = Reading(dBuV) + C.F (Correction Factor).
4. The emission levels of other frequencies are very lower than the limit and not show in test report.

EUT	AXE3000 Wi-Fi 6E High Gain Wireless USB Adapter	Date of Test	2023-10-27
Factor	DRH18-E	Temp. / Humidity	21°C /61%
Polarity	Horizontal	Site / Test Engineer	AC2 / Marvin
Test Mode	802.11ax-80MHz_TX_Band7_CH 151_ANT 1+2	Test Voltage	By Notebook PC

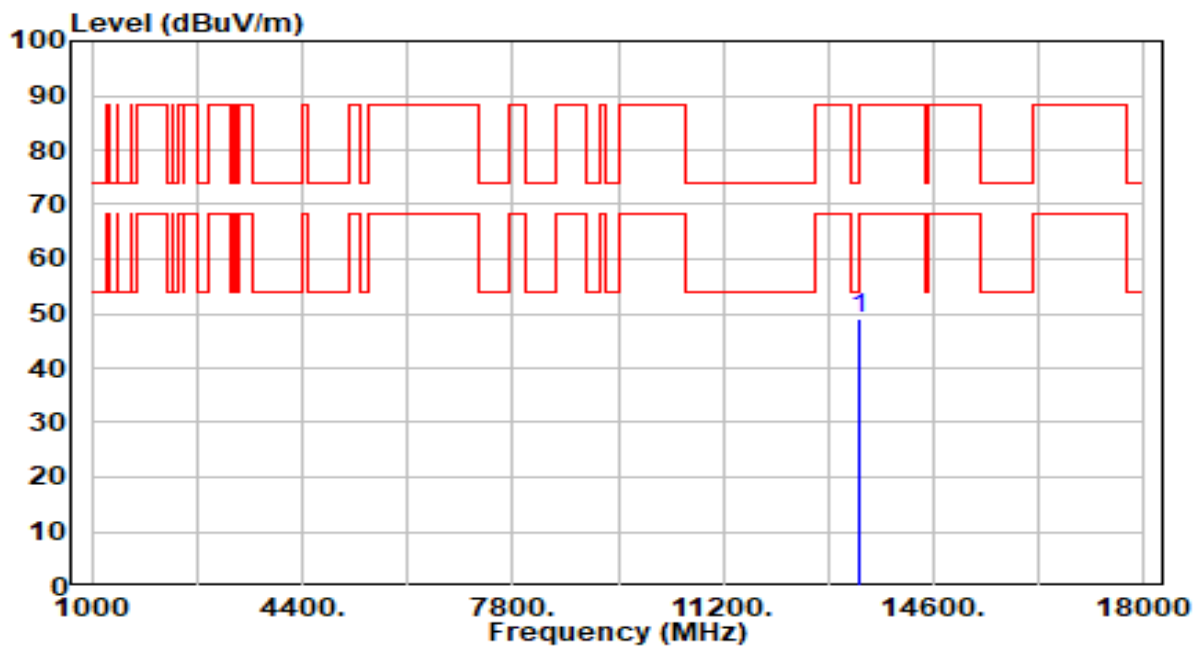

No	Frequency (MHz)	Reading (dBuV)	C.F (dB/m)	Measurement (dBuV/m)	Margin (dB)	Limit (dBuV/m)	Height (cm)	Angle (deg)	Remark (QP/PK/AV)
1	* 13410.000	43.78	5.25	49.04	-39.16	88.20	300	18	Peak

Note:

1. " \*", means this data is the worst emission level.
2. C.F (Correction Factor) = Antenna Factor (dB/m)+ Cable Loss (dB) – Preamplifier(dB).
3. Measurement (dBuV/m) = Reading(dBuV) + C.F (Correction Factor).
4. The emission levels of other frequencies are very lower than the limit and not show in test report.

EUT	AXE3000 Wi-Fi 6E High Gain Wireless USB Adapter	Date of Test	2023-10-27
Factor	DRH18-E	Temp. / Humidity	21°C /61%
Polarity	Vertical	Site / Test Engineer	AC2 / Marvin
Test Mode	802.11ax-80MHz_TX_Band7_CH 151_ANT 1+2	Test Voltage	By Notebook PC

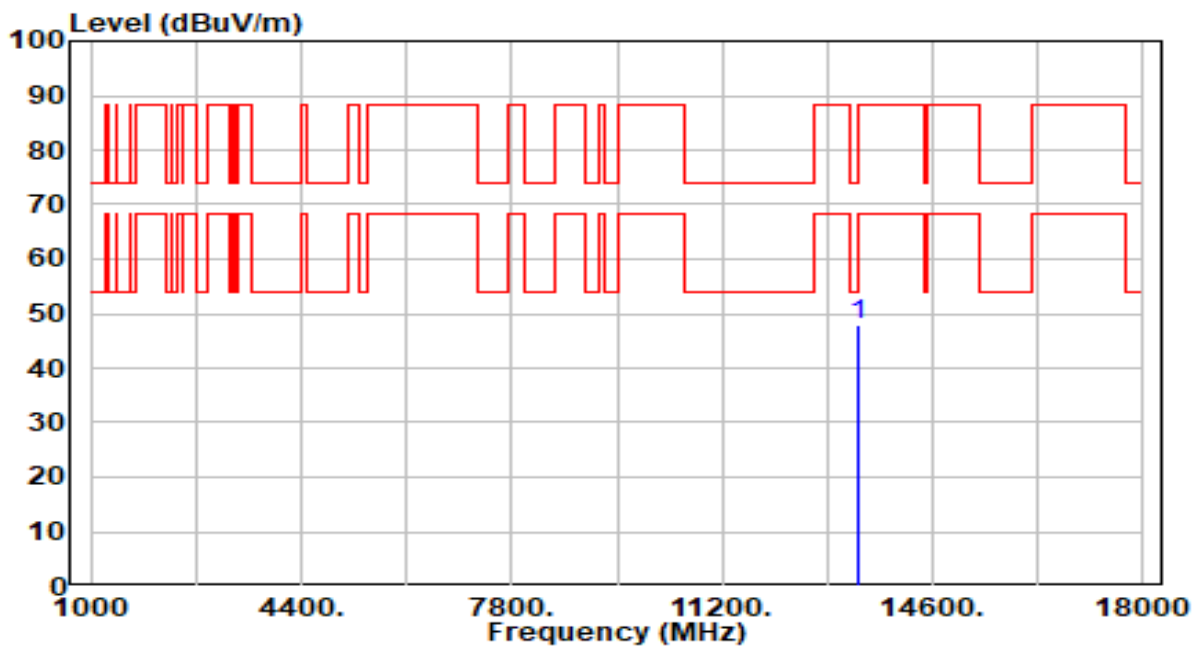

No	Frequency (MHz)	Reading (dBuV)	C.F (dB/m)	Measurement (dBuV/m)	Margin (dB)	Limit (dBuV/m)	Height (cm)	Angle (deg)	Remark (QP/PK/AV)
1	* 13410.000	42.53	5.25	47.79	-40.41	88.20	300	66	Peak

Note:

1. " \*", means this data is the worst emission level.
2. C.F (Correction Factor) = Antenna Factor (dB/m)+ Cable Loss (dB) – Preamplifier(dB).
3. Measurement (dBuV/m) = Reading(dBuV) + C.F (Correction Factor).
4. The emission levels of other frequencies are very lower than the limit and not show in test report.

EUT	AXE3000 Wi-Fi 6E High Gain Wireless USB Adapter	Date of Test	2023-10-27
Factor	DRH18-E	Temp. / Humidity	21°C /61%
Polarity	Horizontal	Site / Test Engineer	AC2 / Marvin
Test Mode	802.11ax-80MHz_TX_Band7_CH 183_ANT 1+2	Test Voltage	By Notebook PC

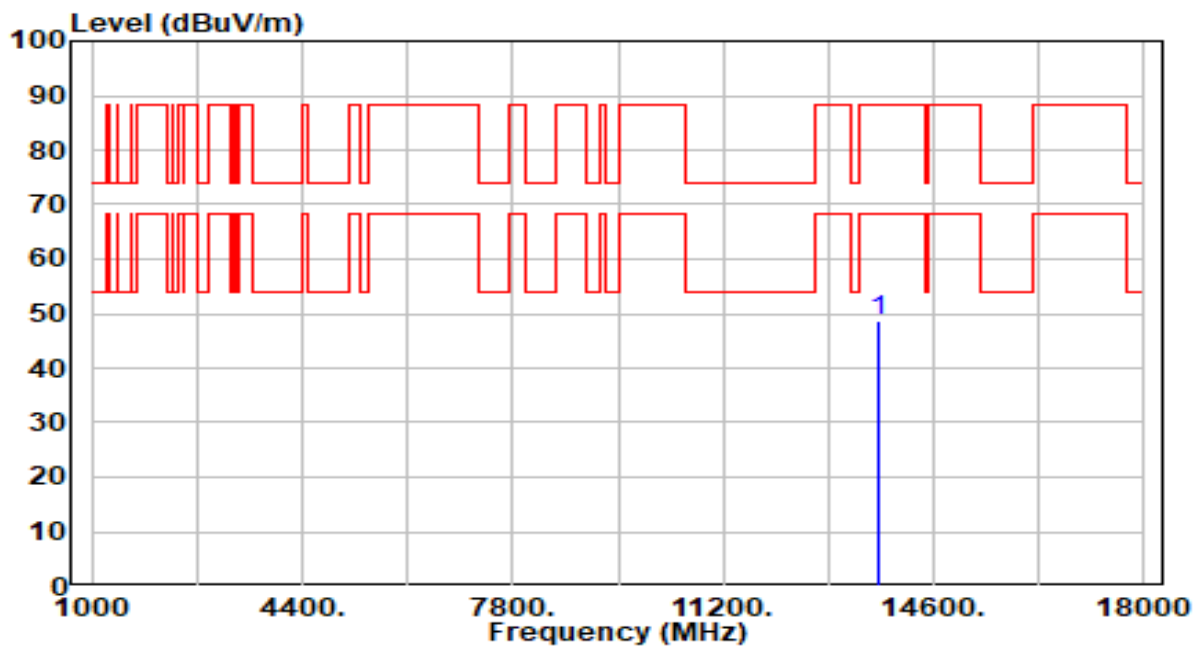

No	Frequency (MHz)	Reading (dBuV)	C.F (dB/m)	Measurement (dBuV/m)	Margin (dB)	Limit (dBuV/m)	Height (cm)	Angle (deg)	Remark (QP/PK/AV)
1	* 13730.000	43.57	5.03	48.60	-39.60	88.20	300	55	Peak

Note:

1. " \*", means this data is the worst emission level.
2. C.F (Correction Factor) = Antenna Factor (dB/m)+ Cable Loss (dB) – Preamplifier(dB).
3. Measurement (dBuV/m) = Reading(dBuV) + C.F (Correction Factor).
4. The emission levels of other frequencies are very lower than the limit and not show in test report.

EUT	AXE3000 Wi-Fi 6E High Gain Wireless USB Adapter	Date of Test	2023-10-27
Factor	DRH18-E	Temp. / Humidity	21°C /61%
Polarity	Vertical	Site / Test Engineer	AC2 / Marvin
Test Mode	802.11ax-80MHz_TX_Band7_CH 183_ANT 1+2	Test Voltage	By Notebook PC

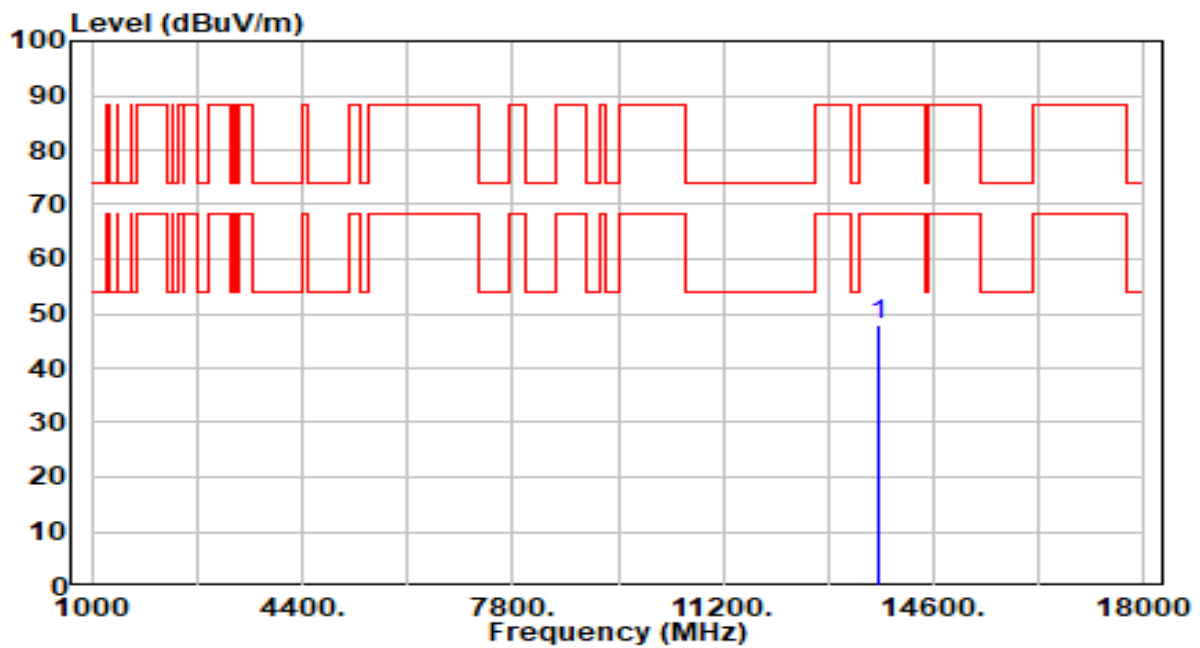

No	Frequency (MHz)	Reading (dBuV)	C.F (dB/m)	Measurement (dBuV/m)	Margin (dB)	Limit (dBuV/m)	Height (cm)	Angle (deg)	Remark (QP/PK/AV)
1	* 13730.000	42.97	5.03	48.00	-40.20	88.20	300	360	Peak

Note:

1. " \*", means this data is the worst emission level.
2. C.F (Correction Factor) = Antenna Factor (dB/m)+ Cable Loss (dB) – Preamplifier(dB).
3. Measurement (dBuV/m) = Reading(dBuV) + C.F (Correction Factor).
4. The emission levels of other frequencies are very lower than the limit and not show in test report.

EUT	AXE3000 Wi-Fi 6E High Gain Wireless USB Adapter	Date of Test	2023-10-27
Factor	DRH18-E	Temp. / Humidity	21°C /61%
Polarity	Horizontal	Site / Test Engineer	AC2 / Marvin
Test Mode	802.11ax-80MHz_TX_Band8_CH 199_ANT 1+2	Test Voltage	By Notebook PC

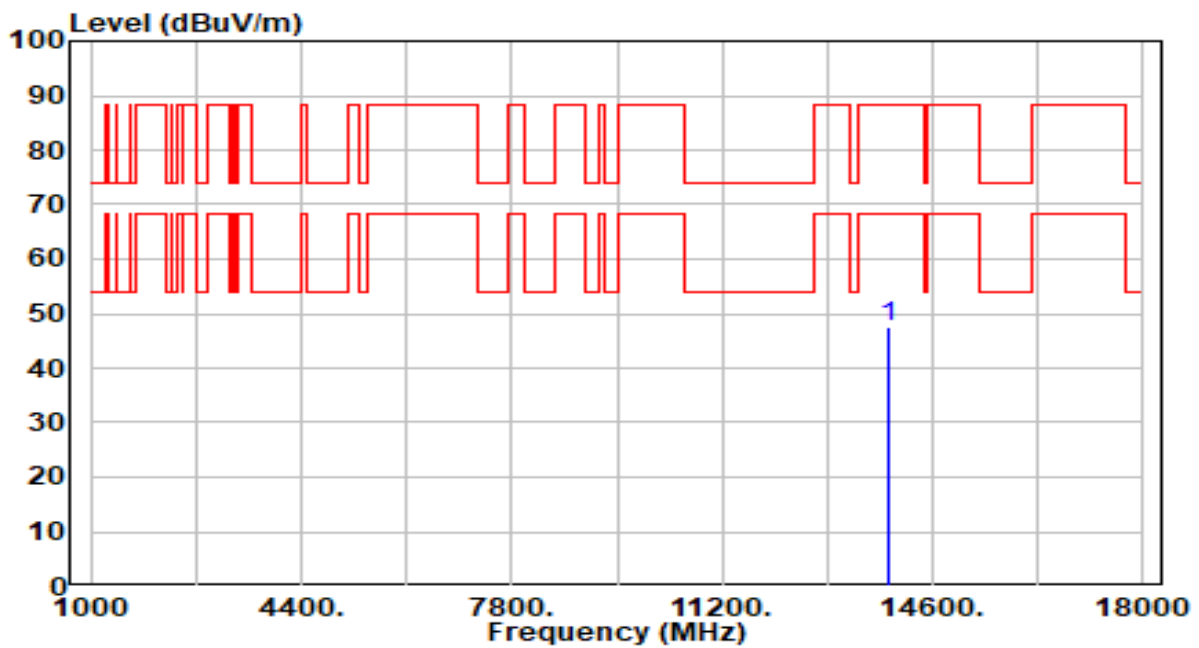

No	Frequency (MHz)	Reading (dBuV)	C.F (dB/m)	Measurement (dBuV/m)	Margin (dB)	Limit (dBuV/m)	Height (cm)	Angle (deg)	Remark (QP/PK/AV)
1	* 13890.000	42.34	5.10	47.43	-40.77	88.20	300	74	Peak

Note:

1. " \*", means this data is the worst emission level.
2. C.F (Correction Factor) = Antenna Factor (dB/m)+ Cable Loss (dB) – Preamplifier(dB).
3. Measurement (dBuV/m) = Reading(dBuV) + C.F (Correction Factor).
4. The emission levels of other frequencies are very lower than the limit and not show in test report.

EUT	AXE3000 Wi-Fi 6E High Gain Wireless USB Adapter	Date of Test	2023-10-27
Factor	DRH18-E	Temp. / Humidity	21°C /61%
Polarity	Vertical	Site / Test Engineer	AC2 / Marvin
Test Mode	802.11ax-80MHz_TX_Band8_CH 199_ANT 1+2	Test Voltage	By Notebook PC

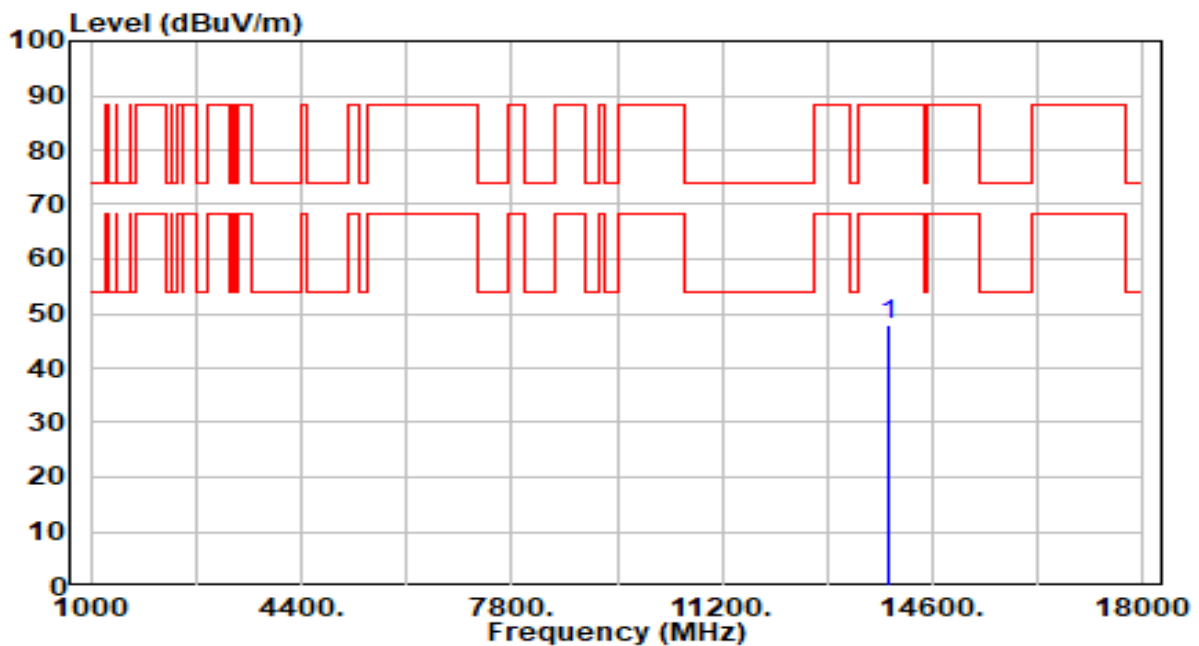

No	Frequency (MHz)	Reading (dBuV)	C.F (dB/m)	Measurement (dBuV/m)	Margin (dB)	Limit (dBuV/m)	Height (cm)	Angle (deg)	Remark (QP/PK/AV)
1	* 13890.000	42.76	5.10	47.85	-40.35	88.20	300	15	Peak

Note:

1. " \*", means this data is the worst emission level.
2. C.F (Correction Factor) = Antenna Factor (dB/m)+ Cable Loss (dB) – Preamplifier(dB).
3. Measurement (dBuV/m) = Reading(dBuV) + C.F (Correction Factor).
4. The emission levels of other frequencies are very lower than the limit and not show in test report.



EUT	AXE3000 Wi-Fi 6E High Gain Wireless USB Adapter	Date of Test	2023-10-27
Factor	DRH18-E	Temp. / Humidity	21°C /61%
Polarity	Horizontal	Site / Test Engineer	AC2 / Marvin
Test Mode	802.11ax-80MHz_TX_Band8_CH 215_ANT 1+2	Test Voltage	By Notebook PC

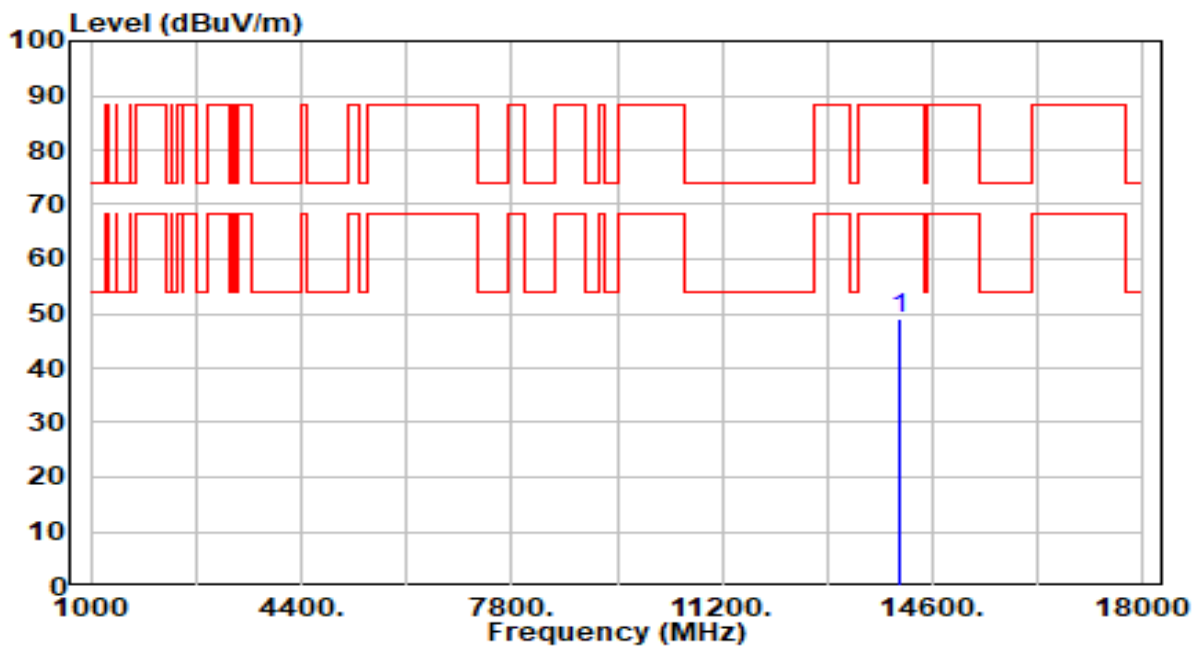

No	Frequency (MHz)	Reading (dBuV)	C.F (dB/m)	Measurement (dBuV/m)	Margin (dB)	Limit (dBuV/m)	Height (cm)	Angle (deg)	Remark (QP/PK/AV)
1	* 14050.000	43.84	5.15	48.99	-39.21	88.20	300	58	Peak

Note:

1. " \*", means this data is the worst emission level.
2. C.F (Correction Factor) = Antenna Factor (dB/m)+ Cable Loss (dB) – Preamplifier(dB).
3. Measurement (dBuV/m) = Reading(dBuV) + C.F (Correction Factor).
4. The emission levels of other frequencies are very lower than the limit and not show in test report.

EUT	AXE3000 Wi-Fi 6E High Gain Wireless USB Adapter	Date of Test	2023-10-27
Factor	DRH18-E	Temp. / Humidity	21°C /61%
Polarity	Vertical	Site / Test Engineer	AC2 / Marvin
Test Mode	802.11ax-80MHz_TX_Band8_CH 215_ANT 1+2	Test Voltage	By Notebook PC

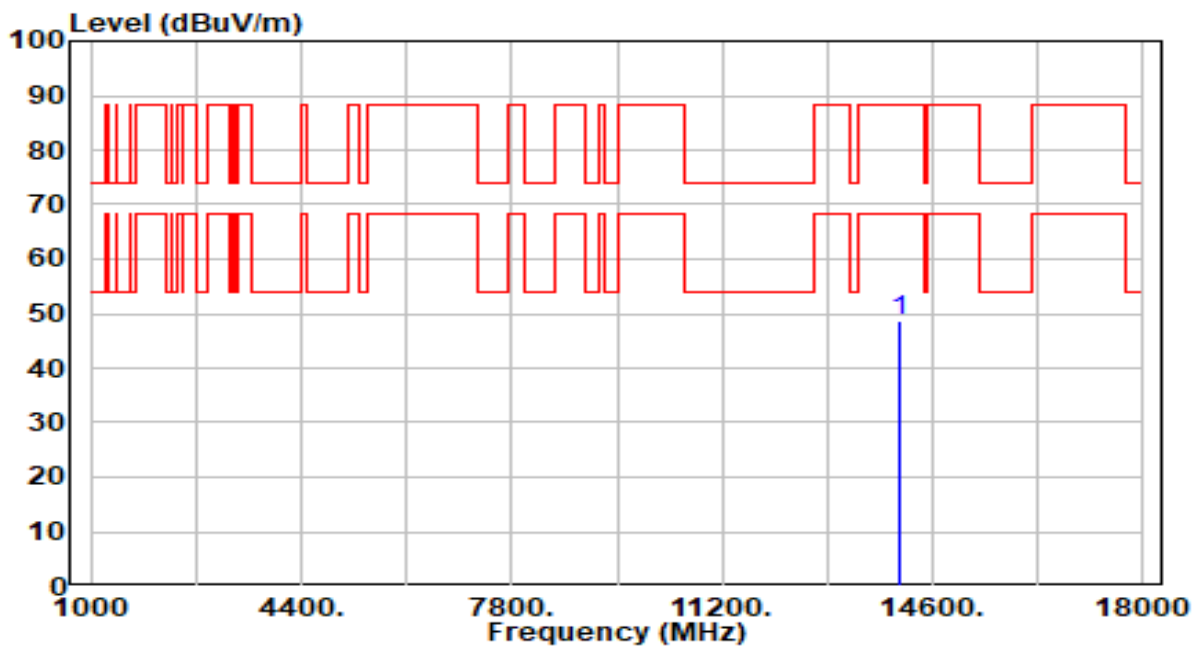

No	Frequency (MHz)	Reading (dBuV)	C.F (dB/m)	Measurement (dBuV/m)	Margin (dB)	Limit (dBuV/m)	Height (cm)	Angle (deg)	Remark (QP/PK/AV)
1	* 14050.000	43.69	5.15	48.84	-39.36	88.20	300	51	Peak

Note:

1. " \*", means this data is the worst emission level.
2. C.F (Correction Factor) = Antenna Factor (dB/m)+ Cable Loss (dB) – Preamplifier(dB).
3. Measurement (dBuV/m) = Reading(dBuV) + C.F (Correction Factor).
4. The emission levels of other frequencies are very lower than the limit and not show in test report.

Nss=1

EUT	AXE3000 Wi-Fi 6E High Gain Wireless USB Adapter	Date of Test	2023-10-27
Factor	BBHA 9170	Temp. / Humidity	21°C /61%
Polarity	Horizontal	Site / Test Engineer	AC2 / Marvin
Test Mode	802.11ax-20MHz_TX_Band5_CH 1_ANT 1+2	Test Voltage	By Notebook PC

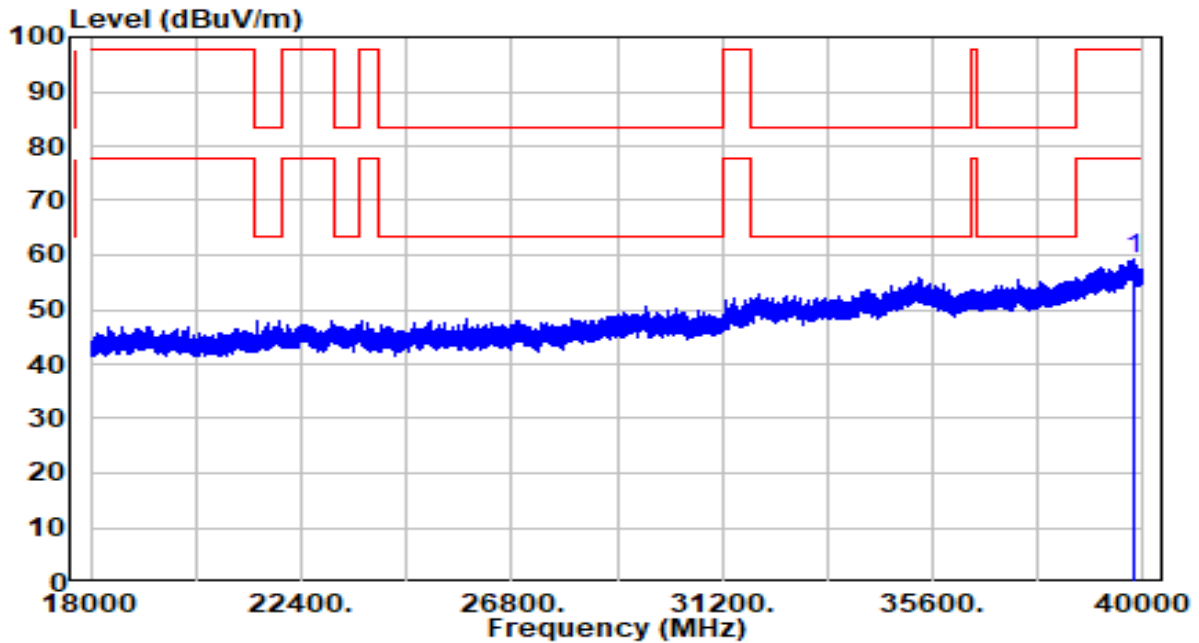

No	Frequency (MHz)	Reading (dBuV)	C.F (dB/m)	Measurement (dBuV/m)	Margin (dB)	Limit (dBuV/m)	Height (cm)	Angle (deg)	Remark (QP/PK/AV)
1	* 39821.940	32.55	26.57	59.12	-38.62	97.74	150	360	Peak

Note:

1. " \*", means this data is the worst emission level.
2. C.F (Correction Factor) = Antenna Factor (dB/m)+ Cable Loss (dB) – Preamplifier(dB).
3. Measurement (dBuV/m) = Reading(dBuV) + C.F (Correction Factor).
4. The emission levels of other frequencies are very lower than the limit and not show in test report.



Nss=2

EUT	AXE3000 Wi-Fi 6E High Gain Wireless USB Adapter	Date of Test	2023-10-27
Factor	BBHA 9170	Temp. / Humidity	21°C /61%
Polarity	Horizontal	Site / Test Engineer	AC2 / Marvin
Test Mode	802.11ax-20MHz_TX_Band5_CH 1_ANT 1+2	Test Voltage	By Notebook PC

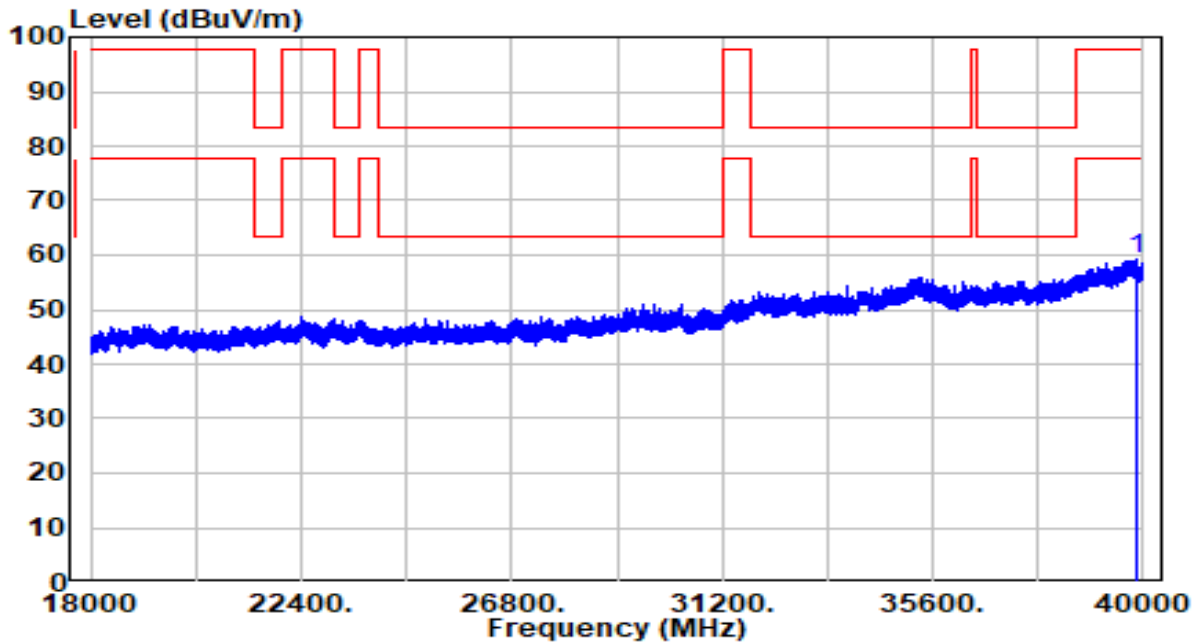

No	Frequency (MHz)	Reading (dBuV)	C.F (dB/m)	Measurement (dBuV/m)	Margin (dB)	Limit (dBuV/m)	Height (cm)	Angle (deg)	Remark (QP/PK/AV)
1	*	32.47	26.60	59.08	-38.66	97.74	150	360	Peak

Note:

1. " \*", means this data is the worst emission level.
2. C.F (Correction Factor) = Antenna Factor (dB/m)+ Cable Loss (dB) – Preamplifier(dB).
3. Measurement (dBuV/m) = Reading(dBuV) + C.F (Correction Factor).
4. The emission levels of other frequencies are very lower than the limit and not show in test report.



## 6.9. Radiated Restricted Band Edge

### 6.9.1. Test Limit

#### For 15.205 requirement:

Radiated emissions which fall in the restricted bands, as defined in Section 15.205(a) of FCC part 15, must also comply with the radiated emission limits specified in Section 15.209(a).

Frequency (MHz)	Frequency (MHz)	Frequency (MHz)	Frequency (GHz)
0.090 - 0.110	16.42 - 16.423	399.9 - 410	4.5 - 5.15
<sup>1</sup> 0.495 - 0.505	16.69475 - 16.69525	608 - 614	5.35 - 5.46
2.1735 - 2.1905	16.80425 - 16.80475	960 - 1240	7.25 - 7.75
4.125 - 4.128	25.5 - 25.67	1300 - 1427	8.025 - 8.5
4.17725 - 4.17775	37.5 - 38.25	1435 - 1626.5	9.0 - 9.2
4.20725 - 4.20775	73 - 74.6	1645.5 - 1646.5	9.3 - 9.5
6.215 - 6.218	74.8 - 75.2	1660 - 1710	10.6 - 12.7
6.26775 - 6.26825	108 - 121.94	1718.8 - 1722.2	13.25 - 13.4
6.31175 - 6.31225	123 - 138	2200 - 2300	14.47 - 14.5
8.291 - 8.294	149.9 - 150.05	2310 - 2390	15.35 - 16.2
8.362 - 8.366	156.52475 - 156.52525	2483.5 - 2500	17.7 - 21.4
8.37625 - 8.38675	156.7 - 156.9	2690 - 2900	22.01 - 23.12
8.41425 - 8.41475	162.0125 - 167.17	3260 - 3267	23.6 - 24.0
12.29 - 12.293	167.72 - 173.2	3332 - 3339	31.2 - 31.8
12.51975 - 12.52025	240 - 285	3345.8 - 3358	36.43 - 36.5
12.57675 - 12.57725	322 - 335.4	3600 - 4400	( <sup>2</sup> )
13.36 - 13.41	--	--	--

For 15.407(b)(5) requirement

For transmitters operating within the 5.925-7.125 GHz band: Any emissions outside of the 5.925-7.125 GHz band must not exceed an e.i.r.p. of -27 dBm/MHz.

Refer to 987594 D02 U-NII 6GHz EMC Measurement v01 clause G - Unwanted Emission Measurement

Use guidance in KDB 789033 for measurements below 1000 MHz and above 1000 MHz. Unwanted emissions outside of restricted bands are measured with a RMS detector. In addition, 15.35(b) applies where the peak emissions must be limited to no more than 20 dB above the average limit.

All out of band emissions appearing in a restricted band as specified in Section 15.205 of the Title 47CFR must not exceed the limits shown in Table per Section 15.209.

<b>FCC Part 15 Subpart C Paragraph 15.209</b>		
Frequency [MHz]	Field Strength [uV/m]	Measured Distance [Meters]
0.009 - 0.490	2400/F (kHz)	300
0.490 - 1.705	24000/F (kHz)	30
1.705 - 30	30	30
30 - 88	100	3
88 - 216	150	3
216 - 960	200	3
Above 960	500	3

### 6.9.2. Test Procedure Used

KDB 789033 D02v02r01- Section G

### 6.9.3. Test Setting

#### Peak Measurements above 1GHz

1. Analyzer center frequency was set to the frequency of the radiated spurious emission of interest
2. RBW = 1MHz
3. VBW = 3MHz
4. Detector = Peak
5. Sweep time = Auto couple
6. Trace mode = Max hold
7. Trace was allowed to stabilize

#### Average Measurements above 1GHz (Method VB)

1. Analyzer center frequency was set to the frequency of the radiated spurious emission of interest
2. RBW = 1MHz
3. VBW; if the EUT is configured to transmit with duty cycle  $\geq 98\%$ , set VBW = 10Hz
4. If the EUT duty cycle is  $< 98\%$ , set VBW  $\geq 1/T$ . T is the minimum transmission duration
5. Detector = Peak



6. Sweep time = Auto
7. Trace mode = Max hold
8. Trace was allowed to stabilize

#### 6.9.4. Test Setup

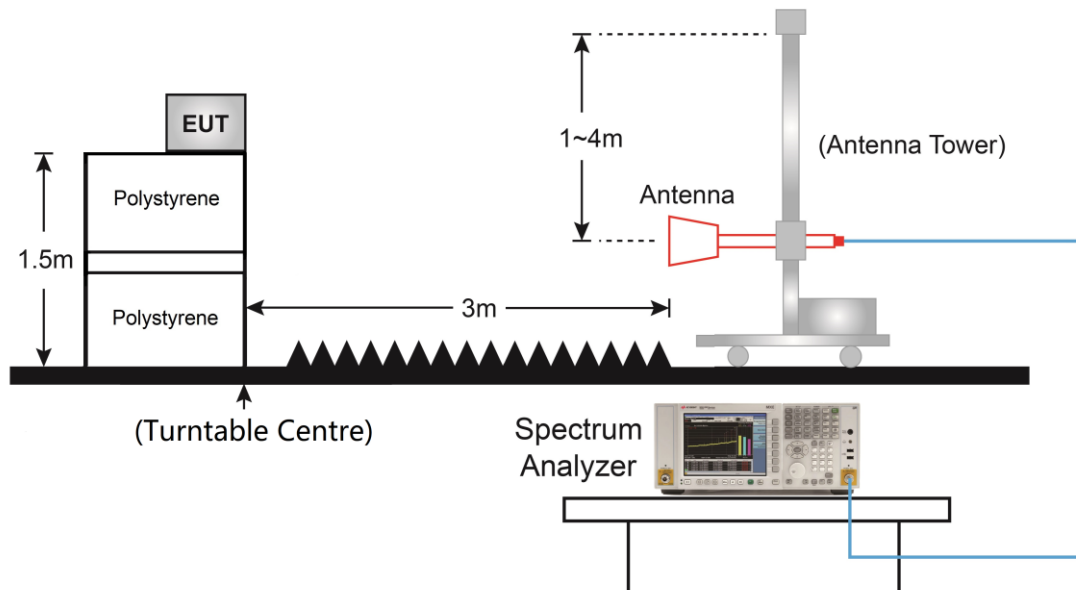

### 6.9.5. Test Result

Nss=1

EUT	AXE3000 Wi-Fi 6E High Gain Wireless USB Adapter	Date of Test	2023-10-27
Factor	DRH18-E	Temp. / Humidity	21°C /61%
Polarity	Horizontal	Site / Test Engineer	AC2 / Marvin
Test Mode	802.11ax-20MHz_TX_Band5_CH 1_ANT 1+2	Test Voltage	By Notebook PC

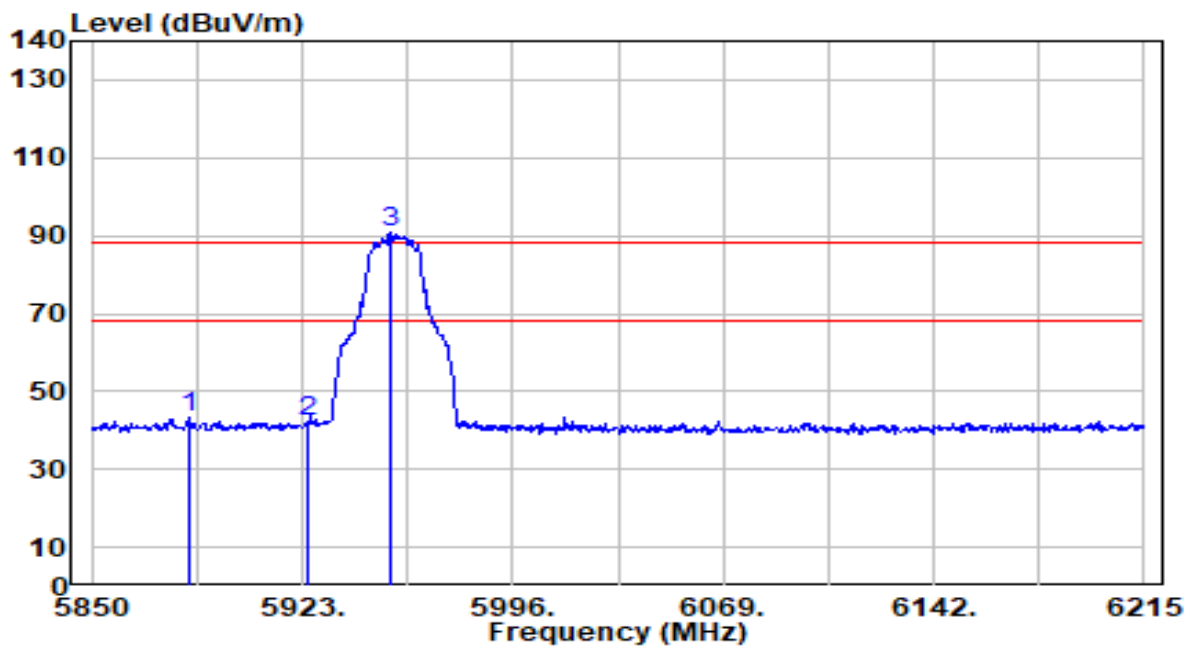

No	Frequency (MHz)	Reading (dBUV)	C.F (dB/m)	Measurement (dBUV/m)	Margin (dB)	Limit (dBUV/m)	Height (cm)	Angle (deg)	Remark (QP/PK/AV)
1	* 5883.945	42.67	0.56	43.23	-44.97	88.20	200	203	Peak
2	5925.000	41.63	0.53	42.15	-46.05	88.20	200	203	Peak
3	5953.660	90.31	0.51	90.82	N/A	N/A	200	203	Peak

Note:

1. " \*", means this data is the worst emission level.
2. C.F (Correction Factor) = Antenna Factor (dB/m)+ Cable Loss (dB) – Preamplifier(dB).
3. Measurement (dBUV/m) = Reading(dBUV) + C.F (Correction Factor).
4. The emission levels of other frequencies are very lower than the limit and not show in test report.

EUT	AXE3000 Wi-Fi 6E High Gain Wireless USB Adapter	Date of Test	2023-10-27
Factor	DRH18-E	Temp. / Humidity	21°C /61%
Polarity	Horizontal	Site / Test Engineer	AC2 / Marvin
Test Mode	802.11ax-20MHz_TX_Band5_CH 1_ANT 1+2	Test Voltage	By Notebook PC

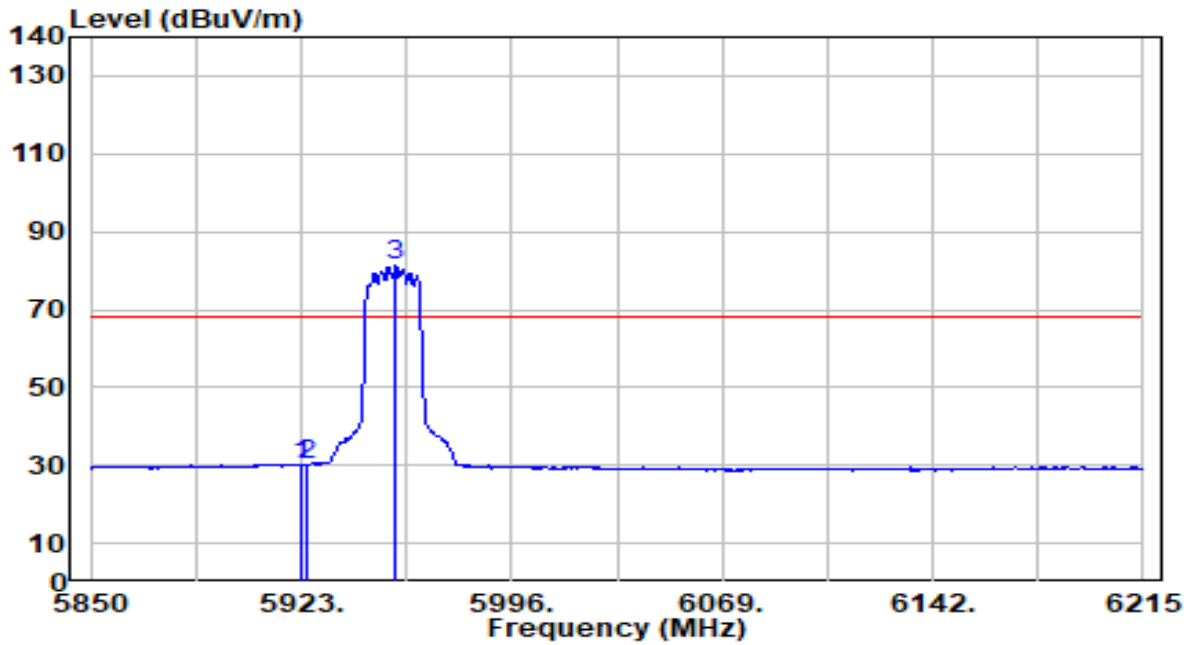

No	Frequency (MHz)	Reading (dBuV)	C.F (dB/m)	Measurement (dBuV/m)	Margin (dB)	Limit (dBuV/m)	Height (cm)	Angle (deg)	Remark (QP/PK/AV)
1	* 5923.000	29.81	0.53	30.34	-37.86	68.20	200	203	Average
2	5925.000	29.64	0.53	30.17	-38.03	68.20	200	203	Average
3	5955.850	80.84	0.50	81.34	N/A	N/A	200	203	Average

Note:

1. " \*", means this data is the worst emission level.
2. C.F (Correction Factor) = Antenna Factor (dB/m)+ Cable Loss (dB) – Preamplifier(dB).
3. Measurement (dBuV/m) = Reading(dBuV) + C.F (Correction Factor).
4. The emission levels of other frequencies are very lower than the limit and not show in test report.

EUT	AXE3000 Wi-Fi 6E High Gain Wireless USB Adapter	Date of Test	2023-10-27
Factor	DRH18-E	Temp. / Humidity	21°C /61%
Polarity	Vertical	Site / Test Engineer	AC2 / Marvin
Test Mode	802.11ax-20MHz_TX_Band5_CH 1_ANT 1+2	Test Voltage	By Notebook PC

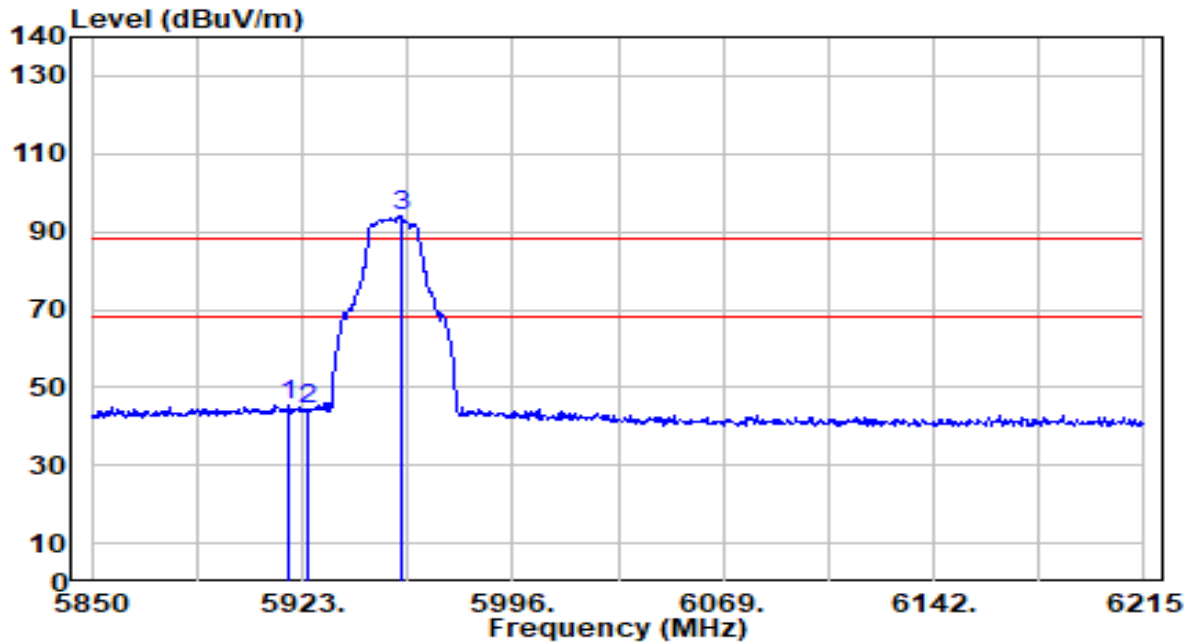

No	Frequency (MHz)	Reading (dBuV)	C.F (dB/m)	Measurement (dBuV/m)	Margin (dB)	Limit (dBuV/m)	Height (cm)	Angle (deg)	Remark (QP/PK/AV)
1	* 5917.890	45.07	0.53	45.60	-42.60	88.20	100	44	Peak
2	5925.000	43.81	0.53	44.34	-43.86	88.20	100	44	Peak
3	5957.310	93.55	0.50	94.05	N/A	N/A	100	44	Peak

Note:

1. " \*", means this data is the worst emission level.
2. C.F (Correction Factor) = Antenna Factor (dB/m)+ Cable Loss (dB) – Preamplifier(dB).
3. Measurement (dBuV/m) = Reading(dBuV) + C.F (Correction Factor).
4. The emission levels of other frequencies are very lower than the limit and not show in test report.

EUT	AXE3000 Wi-Fi 6E High Gain Wireless USB Adapter	Date of Test	2023-10-27
Factor	DRH18-E	Temp. / Humidity	21°C /61%
Polarity	Vertical	Site / Test Engineer	AC2 / Marvin
Test Mode	802.11ax-20MHz_TX_Band5_CH 1_ANT 1+2	Test Voltage	By Notebook PC

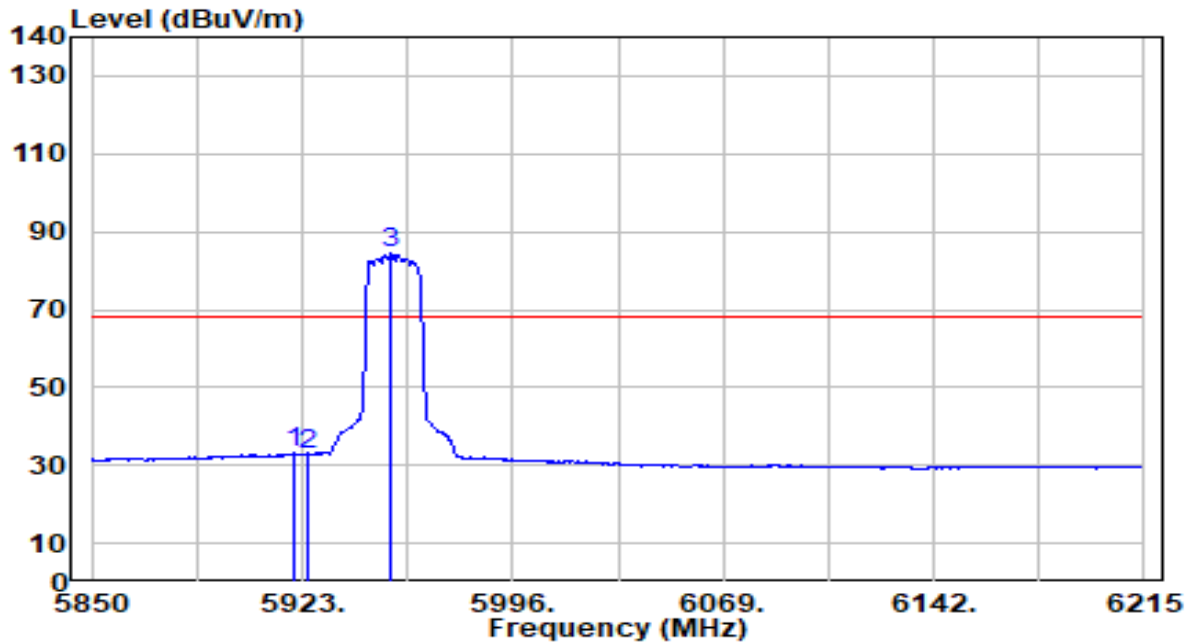

No	Frequency (MHz)	Reading (dBuV)	C.F (dB/m)	Measurement (dBuV/m)	Margin (dB)	Limit (dBuV/m)	Height (cm)	Angle (deg)	Remark (QP/PK/AV)
1	* 5920.445	32.59	0.53	33.12	-35.08	68.20	100	44	Average
2	5925.000	32.42	0.53	32.95	-35.25	68.20	100	44	Average
3	5954.025	83.88	0.50	84.39	N/A	N/A	100	44	Average

Note:

1. " \*", means this data is the worst emission level.
2. C.F (Correction Factor) = Antenna Factor (dB/m)+ Cable Loss (dB) – Preamplifier(dB).
3. Measurement (dBuV/m) = Reading(dBuV) + C.F (Correction Factor).
4. The emission levels of other frequencies are very lower than the limit and not show in test report.

EUT	AXE3000 Wi-Fi 6E High Gain Wireless USB Adapter	Date of Test	2023-10-27
Factor	DRH18-E	Temp. / Humidity	21°C /61%
Polarity	Horizontal	Site / Test Engineer	AC2 / Marvin
Test Mode	802.11ax-20MHz_TX_Band8_CH 233_ANT 1+2	Test Voltage	By Notebook PC

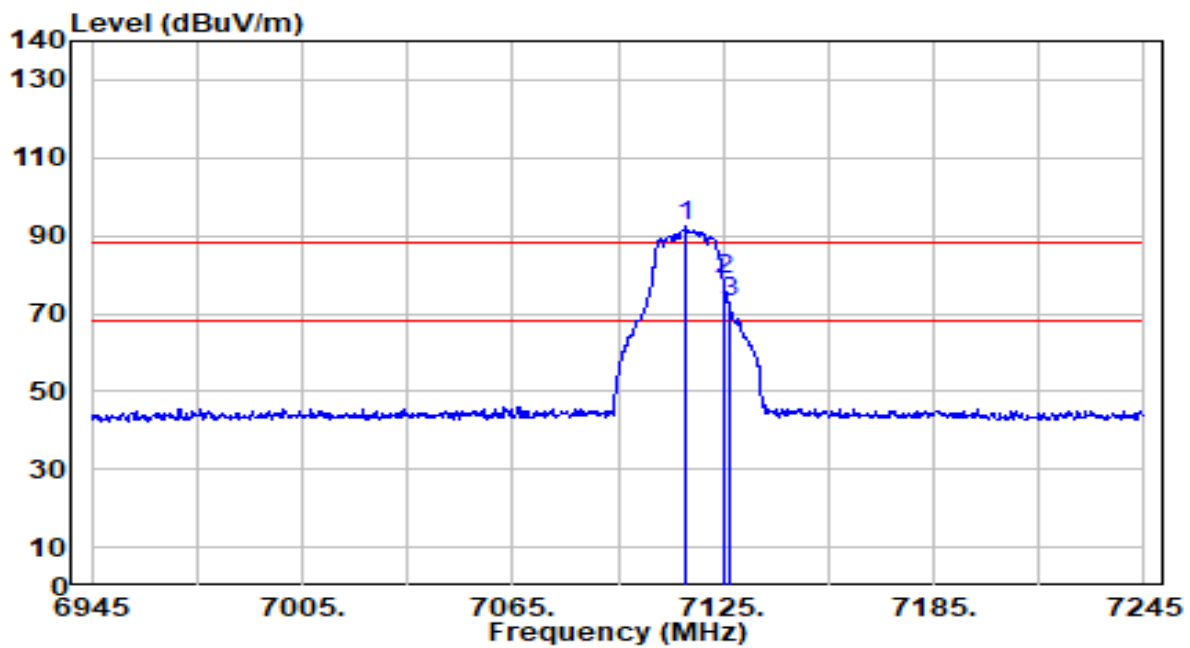

No	Frequency (MHz)	Reading (dBuV)	C.F (dB/m)	Measurement (dBuV/m)	Margin (dB)	Limit (dBuV/m)	Height (cm)	Angle (deg)	Remark (QP/PK/AV)
1	7114.200	88.45	3.88	92.33	N/A	N/A	300	0	Peak
2	* 7125.000	74.98	3.88	78.85	-9.35	88.20	300	0	Peak
3	7126.800	68.80	3.88	72.68	-15.52	88.20	300	0	Peak

Note:

1. " \*", means this data is the worst emission level.
2. C.F (Correction Factor) = Antenna Factor (dB/m)+ Cable Loss (dB) – Preamplifier(dB).
3. Measurement (dBuV/m) = Reading(dBuV) + C.F (Correction Factor).
4. The emission levels of other frequencies are very lower than the limit and not show in test report.

EUT	AXE3000 Wi-Fi 6E High Gain Wireless USB Adapter	Date of Test	2023-10-27
Factor	DRH18-E	Temp. / Humidity	21°C /61%
Polarity	Horizontal	Site / Test Engineer	AC2 / Marvin
Test Mode	802.11ax-20MHz_TX_Band8_CH 233_ANT 1+2	Test Voltage	By Notebook PC

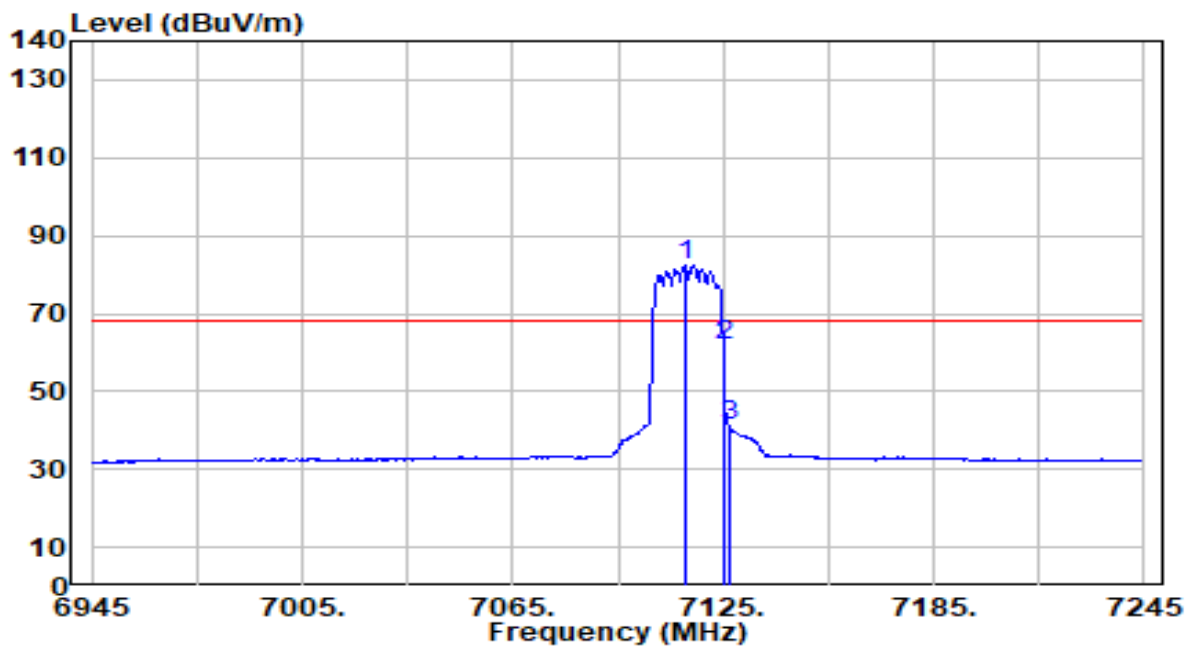

No	Frequency (MHz)	Reading (dBuV)	C.F (dB/m)	Measurement (dBuV/m)	Margin (dB)	Limit (dBuV/m)	Height (cm)	Angle (deg)	Remark (QP/PK/AV)
1	7113.900	78.73	3.88	82.60	N/A	N/A	300	0	Average
2	* 7125.000	58.08	3.88	61.95	-6.25	68.20	300	0	Average
3	7126.800	37.15	3.88	41.03	-27.17	68.20	300	0	Average

Note:

1. " \*", means this data is the worst emission level.
2. C.F (Correction Factor) = Antenna Factor (dB/m)+ Cable Loss (dB) – Preamplifier(dB).
3. Measurement (dBuV/m) = Reading(dBuV) + C.F (Correction Factor).
4. The emission levels of other frequencies are very lower than the limit and not show in test report.

EUT	AXE3000 Wi-Fi 6E High Gain Wireless USB Adapter	Date of Test	2023-10-27
Factor	DRH18-E	Temp. / Humidity	21°C /61%
Polarity	Vertical	Site / Test Engineer	AC2 / Marvin
Test Mode	802.11ax-20MHz_TX_Band8_CH 233_ANT 1+2	Test Voltage	By Notebook PC

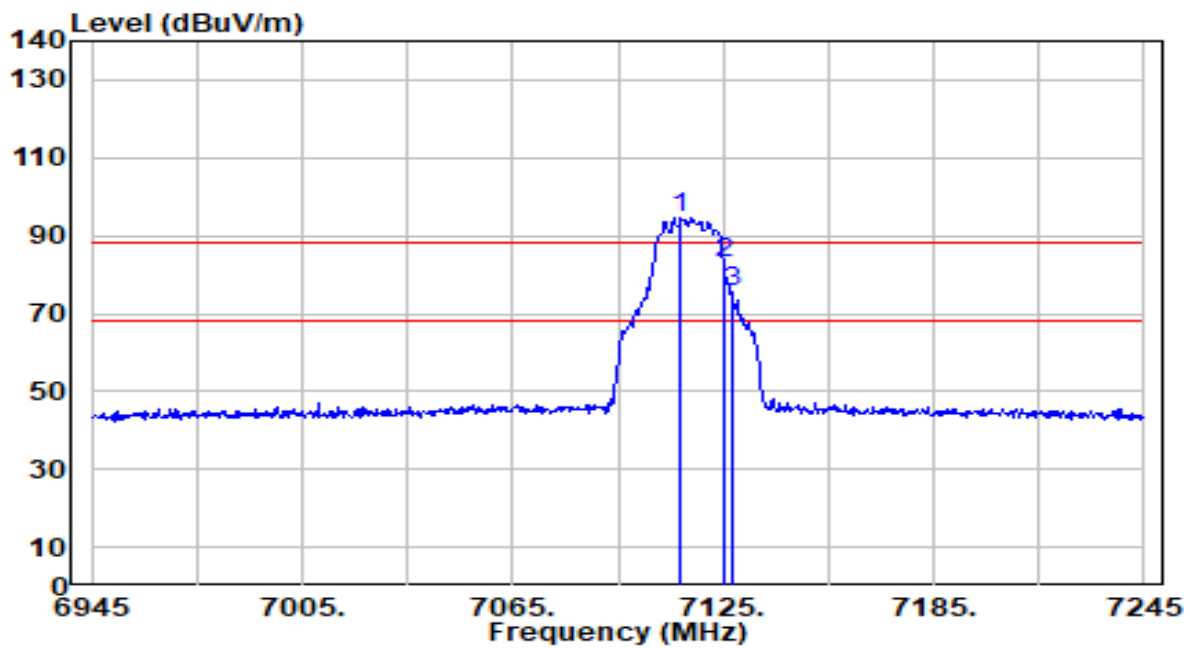

No	Frequency (MHz)	Reading (dBuV)	C.F (dB/m)	Measurement (dBuV/m)	Margin (dB)	Limit (dBuV/m)	Height (cm)	Angle (deg)	Remark (QP/PK/AV)
1	7113.000	90.68	3.87	94.56	N/A	N/A	300	267	Peak
2	* 7125.000	78.92	3.88	82.80	-5.40	88.20	300	267	Peak
3	7127.400	71.45	3.88	75.33	-12.87	88.20	300	267	Peak

Note:

1. " \*", means this data is the worst emission level.
2. C.F (Correction Factor) = Antenna Factor (dB/m)+ Cable Loss (dB) – Preamplifier(dB).
3. Measurement (dBuV/m) = Reading(dBuV) + C.F (Correction Factor).
4. The emission levels of other frequencies are very lower than the limit and not show in test report.



EUT	AXE3000 Wi-Fi 6E High Gain Wireless USB Adapter	Date of Test	2023-10-27
Factor	DRH18-E	Temp. / Humidity	21°C /61%
Polarity	Vertical	Site / Test Engineer	AC2 / Marvin
Test Mode	802.11ax-20MHz_TX_Band8_CH 233_ANT 1+2	Test Voltage	By Notebook PC

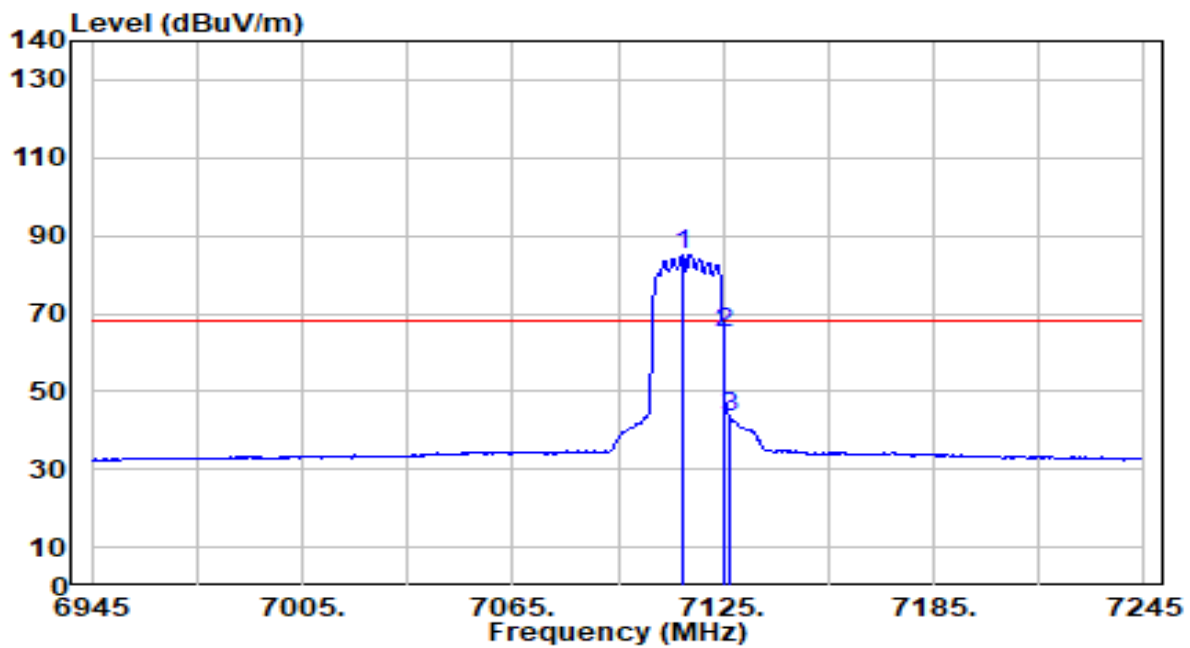

No	Frequency (MHz)	Reading (dBuV)	C.F (dB/m)	Measurement (dBuV/m)	Margin (dB)	Limit (dBuV/m)	Height (cm)	Angle (deg)	Remark (QP/PK/AV)
1	7113.300	81.08	3.87	84.96	N/A	N/A	300	267	Average
2	* 7125.000	60.85	3.88	64.73	-3.47	68.20	300	267	Average
3	7126.800	39.63	3.88	43.51	-24.69	68.20	300	267	Average

Note:

1. " \*", means this data is the worst emission level.
2. C.F (Correction Factor) = Antenna Factor (dB/m)+ Cable Loss (dB) – Preamplifier(dB).
3. Measurement (dBuV/m) = Reading(dBuV) + C.F (Correction Factor).
4. The emission levels of other frequencies are very lower than the limit and not show in test report.

EUT	AXE3000 Wi-Fi 6E High Gain Wireless USB Adapter	Date of Test	2023-10-27
Factor	DRH18-E	Temp. / Humidity	21°C /61%
Polarity	Horizontal	Site / Test Engineer	AC2 / Marvin
Test Mode	802.11ax-40MHz_TX_Band5_CH 3_ANT 1+2	Test Voltage	By Notebook PC

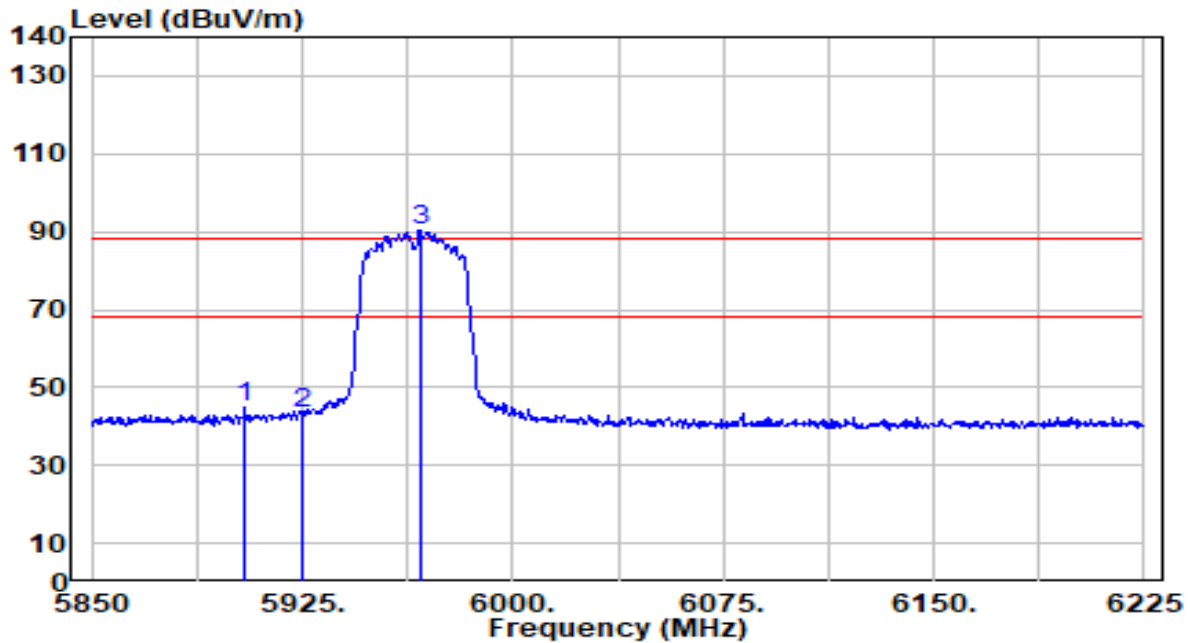

No	Frequency (MHz)	Reading (dBuV)	C.F (dB/m)	Measurement (dBuV/m)	Margin (dB)	Limit (dBuV/m)	Height (cm)	Angle (deg)	Remark (QP/PK/AV)
1	* 5904.750	44.28	0.54	44.82	-43.38	88.20	200	203	Peak
2	5925.000	42.57	0.53	43.10	-45.10	88.20	200	203	Peak
3	5967.000	89.64	0.50	90.13	N/A	N/A	200	203	Peak

Note:

1. " \*", means this data is the worst emission level.
2. C.F (Correction Factor) = Antenna Factor (dB/m)+ Cable Loss (dB) – Preamplifier(dB).
3. Measurement (dBuV/m) = Reading(dBuV) + C.F (Correction Factor).
4. The emission levels of other frequencies are very lower than the limit and not show in test report.

EUT	AXE3000 Wi-Fi 6E High Gain Wireless USB Adapter	Date of Test	2023-10-27
Factor	DRH18-E	Temp. / Humidity	21°C /61%
Polarity	Horizontal	Site / Test Engineer	AC2 / Marvin
Test Mode	802.11ax-40MHz_TX_Band5_CH 3_ANT 1+2	Test Voltage	By Notebook PC

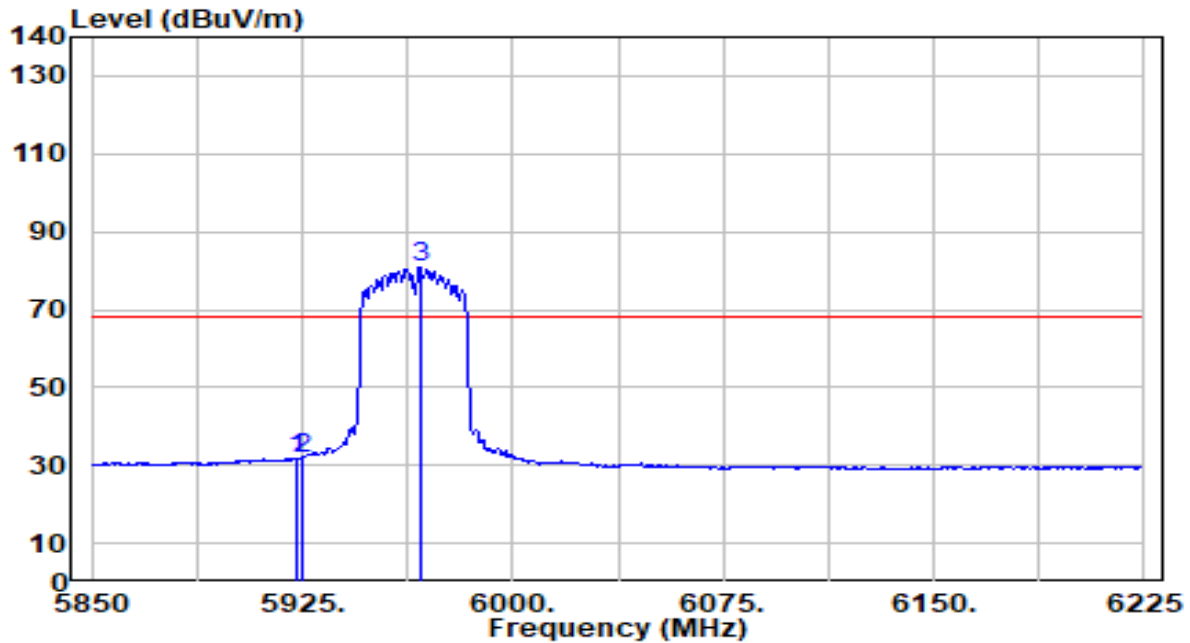

No	Frequency (MHz)	Reading (dBuV)	C.F (dB/m)	Measurement (dBuV/m)	Margin (dB)	Limit (dBuV/m)	Height (cm)	Angle (deg)	Remark (QP/PK/AV)
1	5923.125	31.20	0.53	31.73	-36.47	68.20	200	203	Average
2	* 5925.000	31.38	0.53	31.91	-36.29	68.20	200	203	Average
3	5967.000	80.37	0.50	80.87	N/A	N/A	200	203	Average

Note:

1. " \*", means this data is the worst emission level.
2. C.F (Correction Factor) = Antenna Factor (dB/m)+ Cable Loss (dB) – Preamplifier(dB).
3. Measurement (dBuV/m) = Reading(dBuV) + C.F (Correction Factor).
4. The emission levels of other frequencies are very lower than the limit and not show in test report.

EUT	AXE3000 Wi-Fi 6E High Gain Wireless USB Adapter	Date of Test	2023-10-27
Factor	DRH18-E	Temp. / Humidity	21°C /61%
Polarity	Vertical	Site / Test Engineer	AC2 / Marvin
Test Mode	802.11ax-40MHz_TX_Band5_CH 3_ANT 1+2	Test Voltage	By Notebook PC

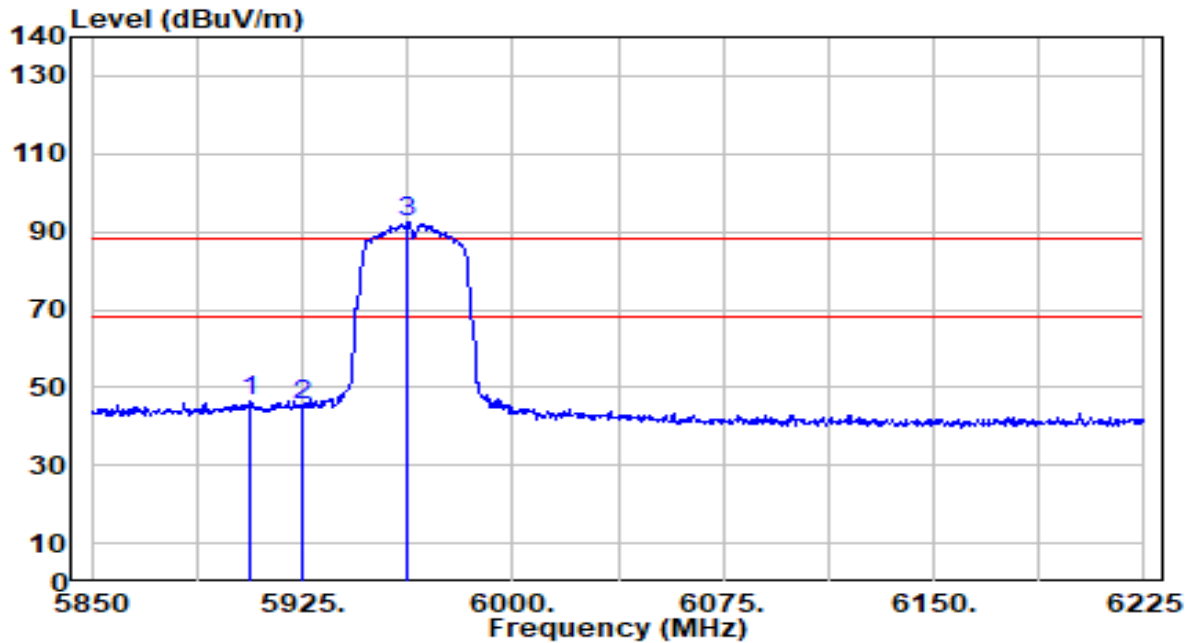

No	Frequency (MHz)	Reading (dBuV)	C.F (dB/m)	Measurement (dBuV/m)	Margin (dB)	Limit (dBuV/m)	Height (cm)	Angle (deg)	Remark (QP/PK/AV)
1	* 5906.250	46.20	0.54	46.74	-41.46	88.20	100	44	Peak
2	5925.000	44.84	0.53	45.37	-42.83	88.20	100	44	Peak
3	5962.500	92.08	0.50	92.58	N/A	N/A	100	44	Peak

Note:

1. " \*", means this data is the worst emission level.
2. C.F (Correction Factor) = Antenna Factor (dB/m)+ Cable Loss (dB) – Preamplifier(dB).
3. Measurement (dBuV/m) = Reading(dBuV) + C.F (Correction Factor).
4. The emission levels of other frequencies are very lower than the limit and not show in test report.

EUT	AXE3000 Wi-Fi 6E High Gain Wireless USB Adapter	Date of Test	2023-10-27
Factor	DRH18-E	Temp. / Humidity	21°C /61%
Polarity	Vertical	Site / Test Engineer	AC2 / Marvin
Test Mode	802.11ax-40MHz_TX_Band5_CH 3_ANT 1+2	Test Voltage	By Notebook PC

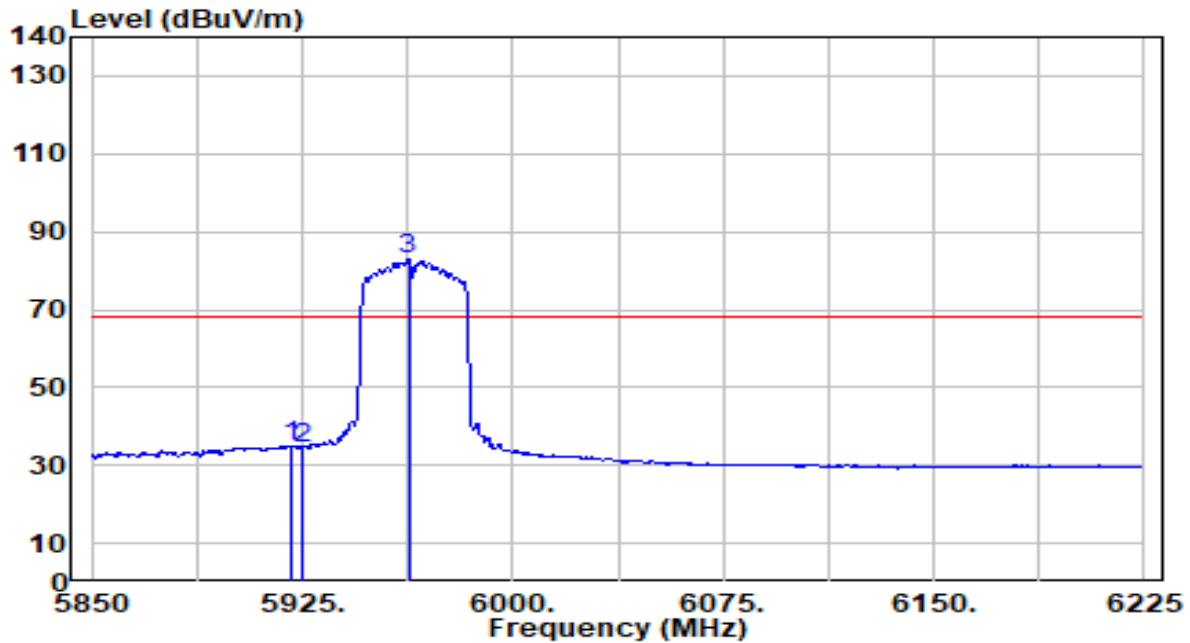

No	Frequency (MHz)	Reading (dBUV)	C.F (dB/m)	Measurement (dBUV/m)	Margin (dB)	Limit (dBUV/m)	Height (cm)	Angle (deg)	Remark (QP/PK/AV)	
1	*	5921.250	34.45	0.53	34.98	-33.22	68.20	100	44	Average
2		5925.000	34.02	0.53	34.55	-33.65	68.20	100	44	Average
3		5962.875	82.24	0.50	82.74	N/A	N/A	100	44	Average

Note:

1. " \*", means this data is the worst emission level.
2. C.F (Correction Factor) = Antenna Factor (dB/m)+ Cable Loss (dB) – Preamplifier(dB).
3. Measurement (dBUV/m) = Reading(dBUV) + C.F (Correction Factor).
4. The emission levels of other frequencies are very lower than the limit and not show in test report.

EUT	AXE3000 Wi-Fi 6E High Gain Wireless USB Adapter	Date of Test	2023-10-27
Factor	DRH18-E	Temp. / Humidity	21°C /61%
Polarity	Horizontal	Site / Test Engineer	AC2 / Marvin
Test Mode	802.11ax-40MHz_TX_Band8_CH 227_ANT 1+2	Test Voltage	By Notebook PC

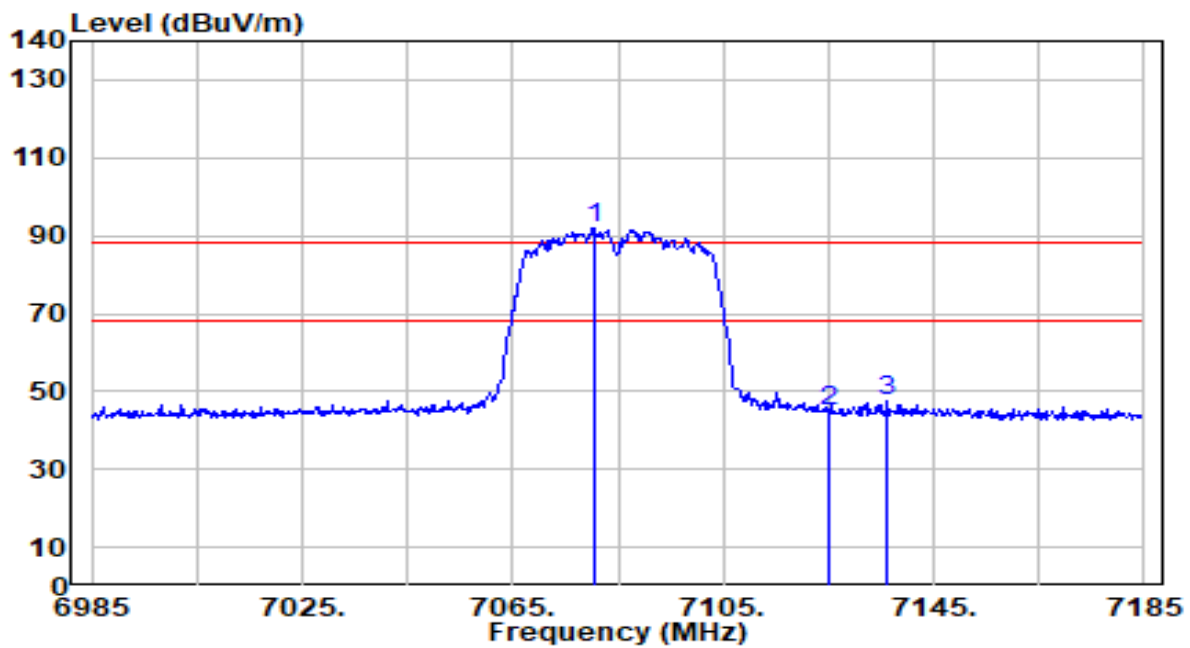

No	Frequency (MHz)	Reading (dBuV)	C.F (dB/m)	Measurement (dBuV/m)	Margin (dB)	Limit (dBuV/m)	Height (cm)	Angle (deg)	Remark (QP/PK/AV)
1	7080.400	88.16	3.87	92.03	N/A	N/A	300	0	Peak
2	7125.000	41.12	3.88	45.00	-43.20	88.20	300	0	Peak
3	* 7136.200	43.44	3.88	47.32	-40.88	88.20	300	0	Peak

Note:

1. " \*", means this data is the worst emission level.
2. C.F (Correction Factor) = Antenna Factor (dB/m)+ Cable Loss (dB) – Preamplifier(dB).
3. Measurement (dBuV/m) = Reading(dBuV) + C.F (Correction Factor).
4. The emission levels of other frequencies are very lower than the limit and not show in test report.

EUT	AXE3000 Wi-Fi 6E High Gain Wireless USB Adapter	Date of Test	2023-10-27
Factor	DRH18-E	Temp. / Humidity	21°C /61%
Polarity	Horizontal	Site / Test Engineer	AC2 / Marvin
Test Mode	802.11ax-40MHz_TX_Band8_CH 227_ANT 1+2	Test Voltage	By Notebook PC

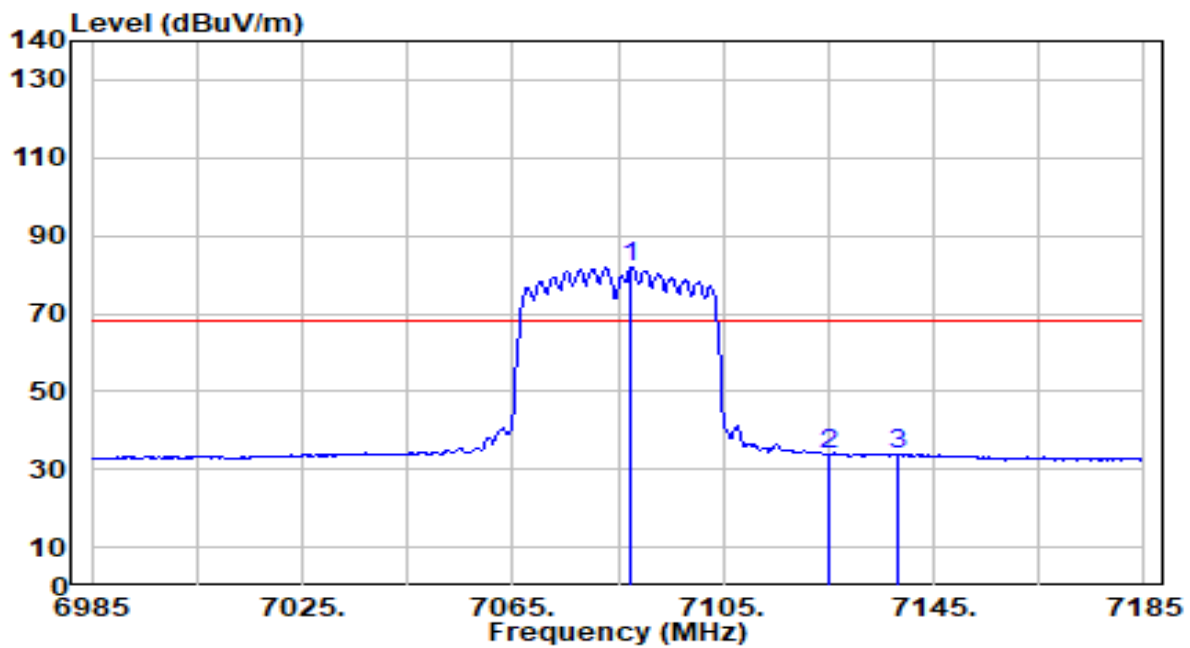

No	Frequency (MHz)	Reading (dBuV)	C.F (dB/m)	Measurement (dBuV/m)	Margin (dB)	Limit (dBuV/m)	Height (cm)	Angle (deg)	Remark (QP/PK/AV)
1	7087.600	78.00	3.87	81.86	N/A	N/A	300	0	Average
2	7125.000	30.11	3.88	33.99	-34.21	68.20	300	0	Average
3	* 7138.000	30.12	3.88	34.00	-34.20	68.20	300	0	Average

Note:

1. " \*", means this data is the worst emission level.
2. C.F (Correction Factor) = Antenna Factor (dB/m)+ Cable Loss (dB) – Preamplifier(dB).
3. Measurement (dBuV/m) = Reading(dBuV) + C.F (Correction Factor).
4. The emission levels of other frequencies are very lower than the limit and not show in test report.

EUT	AXE3000 Wi-Fi 6E High Gain Wireless USB Adapter	Date of Test	2023-10-27
Factor	DRH18-E	Temp. / Humidity	21°C /61%
Polarity	Vertical	Site / Test Engineer	AC2 / Marvin
Test Mode	802.11ax-40MHz_TX_Band8_CH 227_ANT 1+2	Test Voltage	By Notebook PC

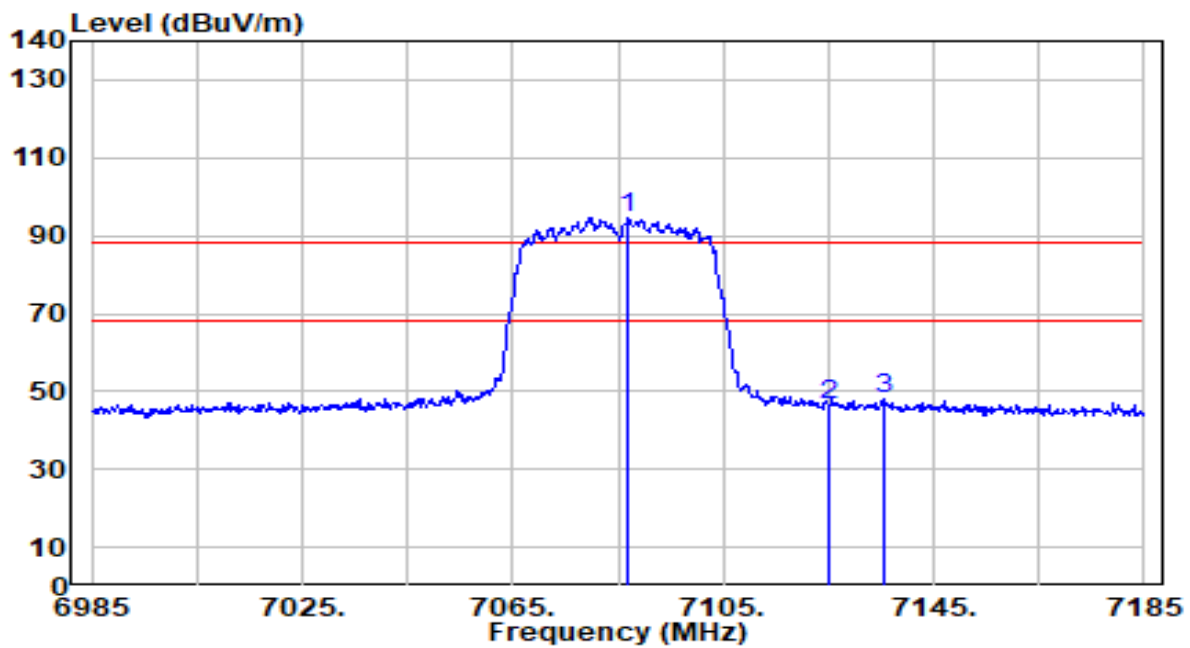

No	Frequency (MHz)	Reading (dBuV)	C.F (dB/m)	Measurement (dBuV/m)	Margin (dB)	Limit (dBuV/m)	Height (cm)	Angle (deg)	Remark (QP/PK/AV)
1	7087.000	90.69	3.87	94.56	N/A	N/A	300	267	Peak
2	7125.000	42.51	3.88	46.39	-41.81	88.20	300	267	Peak
3	* 7135.400	44.09	3.88	47.97	-40.23	88.20	300	267	Peak

Note:

1. " \*", means this data is the worst emission level.
2. C.F (Correction Factor) = Antenna Factor (dB/m)+ Cable Loss (dB) – Preamplifier(dB).
3. Measurement (dBuV/m) = Reading(dBuV) + C.F (Correction Factor).
4. The emission levels of other frequencies are very lower than the limit and not show in test report.



EUT	AXE3000 Wi-Fi 6E High Gain Wireless USB Adapter	Date of Test	2023-10-27
Factor	DRH18-E	Temp. / Humidity	21°C /61%
Polarity	Vertical	Site / Test Engineer	AC2 / Marvin
Test Mode	802.11ax-40MHz_TX_Band8_CH 227_ANT 1+2	Test Voltage	By Notebook PC

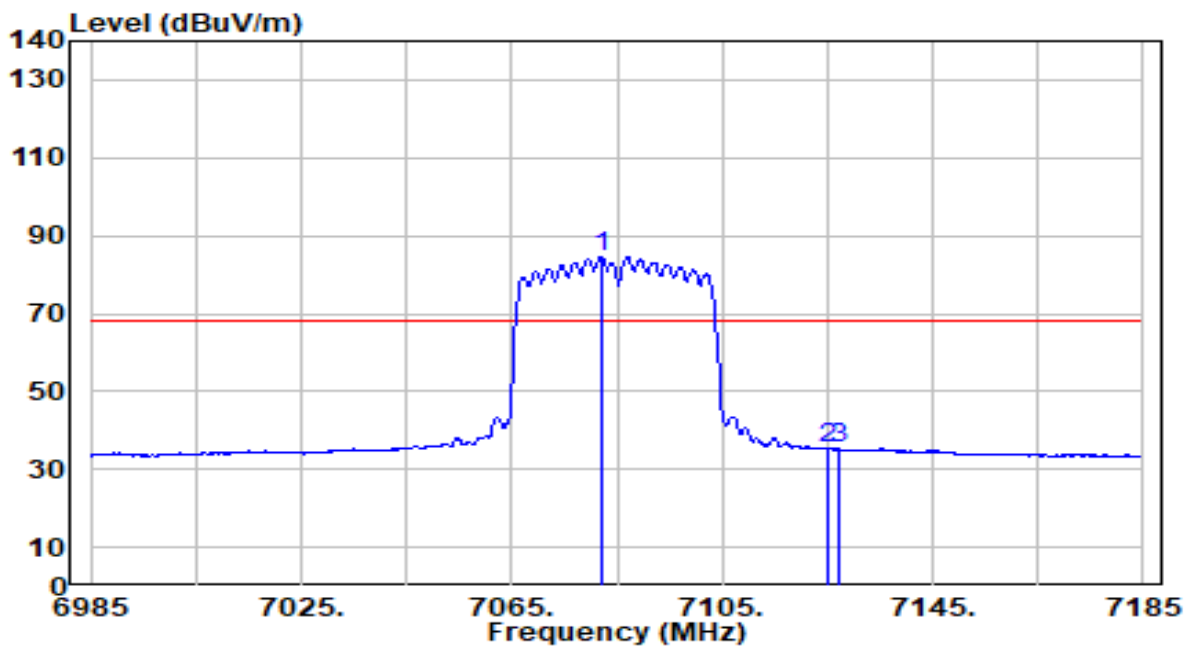

No	Frequency (MHz)	Reading (dBuV)	C.F (dB/m)	Measurement (dBuV/m)	Margin (dB)	Limit (dBuV/m)	Height (cm)	Angle (deg)	Remark (QP/PK/AV)
1	7082.000	80.61	3.87	84.48	N/A	N/A	300	267	Average
2	* 7125.000	31.42	3.88	35.30	-32.90	68.20	300	267	Average
3	7127.200	31.40	3.88	35.27	-32.93	68.20	300	267	Average

Note:

1. " \*", means this data is the worst emission level.
2. C.F (Correction Factor) = Antenna Factor (dB/m)+ Cable Loss (dB) – Preamplifier(dB).
3. Measurement (dBuV/m) = Reading(dBuV) + C.F (Correction Factor).
4. The emission levels of other frequencies are very lower than the limit and not show in test report.

EUT	AXE3000 Wi-Fi 6E High Gain Wireless USB Adapter	Date of Test	2023-10-27
Factor	DRH18-E	Temp. / Humidity	21°C /61%
Polarity	Horizontal	Site / Test Engineer	AC2 / Marvin
Test Mode	802.11ax-80MHz_TX_Band5_CH 7_ANT 1+2	Test Voltage	By Notebook PC

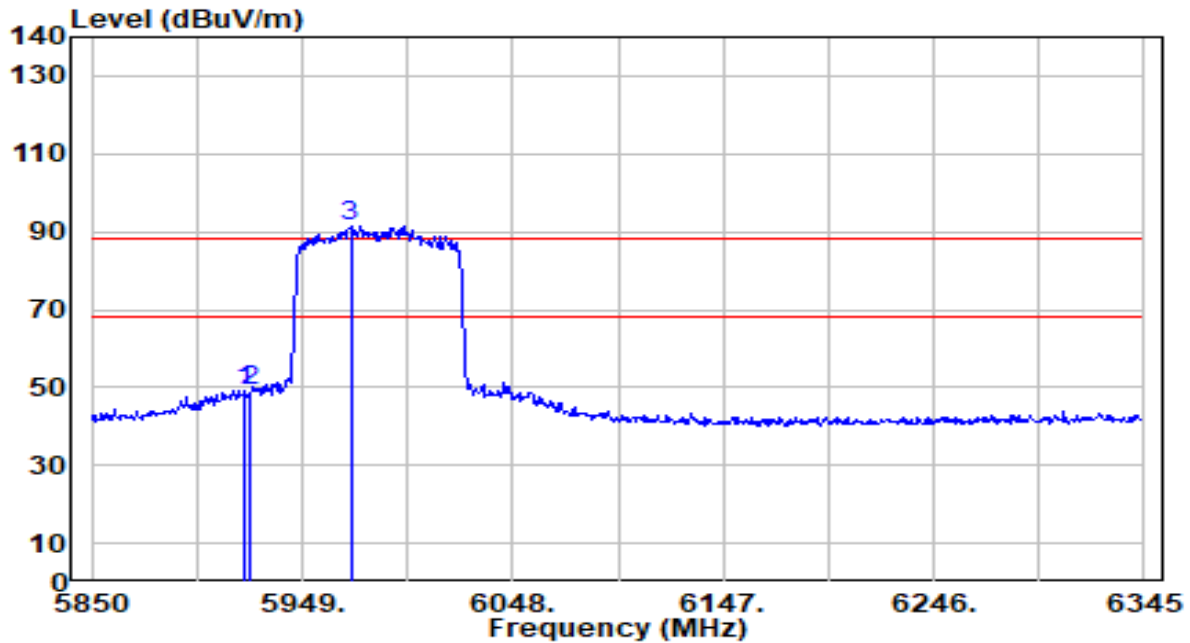

No	Frequency (MHz)	Reading (dBuV)	C.F (dB/m)	Measurement (dBuV/m)	Margin (dB)	Limit (dBuV/m)	Height (cm)	Angle (deg)	Remark (QP/PK/AV)
1	* 5921.775	48.80	0.53	49.32	-38.88	88.20	200	203	Peak
2	5925.000	48.53	0.53	49.06	-39.14	88.20	200	203	Peak
3	5971.770	90.80	0.49	91.29	N/A	N/A	200	203	Peak

Note:

1. " \*", means this data is the worst emission level.
2. C.F (Correction Factor) = Antenna Factor (dB/m)+ Cable Loss (dB) – Preamplifier(dB).
3. Measurement (dBuV/m) = Reading(dBuV) + C.F (Correction Factor).
4. The emission levels of other frequencies are very lower than the limit and not show in test report.

EUT	AXE3000 Wi-Fi 6E High Gain Wireless USB Adapter	Date of Test	2023-10-27
Factor	DRH18-E	Temp. / Humidity	21°C /61%
Polarity	Horizontal	Site / Test Engineer	AC2 / Marvin
Test Mode	802.11ax-80MHz_TX_Band5_CH 7_ANT 1+2	Test Voltage	By Notebook PC

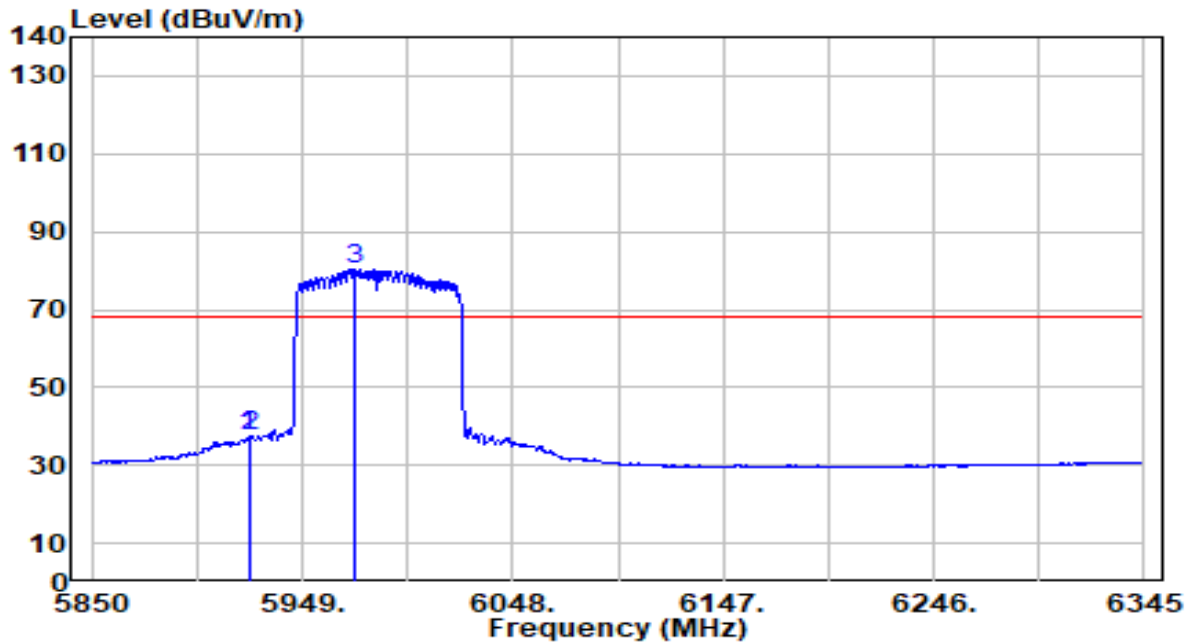

No	Frequency (MHz)	Reading (dBuV)	C.F (dB/m)	Measurement (dBuV/m)	Margin (dB)	Limit (dBuV/m)	Height (cm)	Angle (deg)	Remark (QP/PK/AV)
1	5923.755	36.78	0.53	37.31	-30.89	68.20	200	203	Average
2	* 5925.000	36.89	0.53	37.42	-30.78	68.20	200	203	Average
3	5973.255	79.82	0.49	80.31	N/A	N/A	200	203	Average

Note:

1. " \*", means this data is the worst emission level.
2. C.F (Correction Factor) = Antenna Factor (dB/m)+ Cable Loss (dB) – Preamplifier(dB).
3. Measurement (dBuV/m) = Reading(dBuV) + C.F (Correction Factor).
4. The emission levels of other frequencies are very lower than the limit and not show in test report.

EUT	AXE3000 Wi-Fi 6E High Gain Wireless USB Adapter	Date of Test	2023-10-27
Factor	DRH18-E	Temp. / Humidity	21°C /61%
Polarity	Vertical	Site / Test Engineer	AC2 / Marvin
Test Mode	802.11ax-80MHz_TX_Band5_CH 7_ANT 1+2	Test Voltage	By Notebook PC

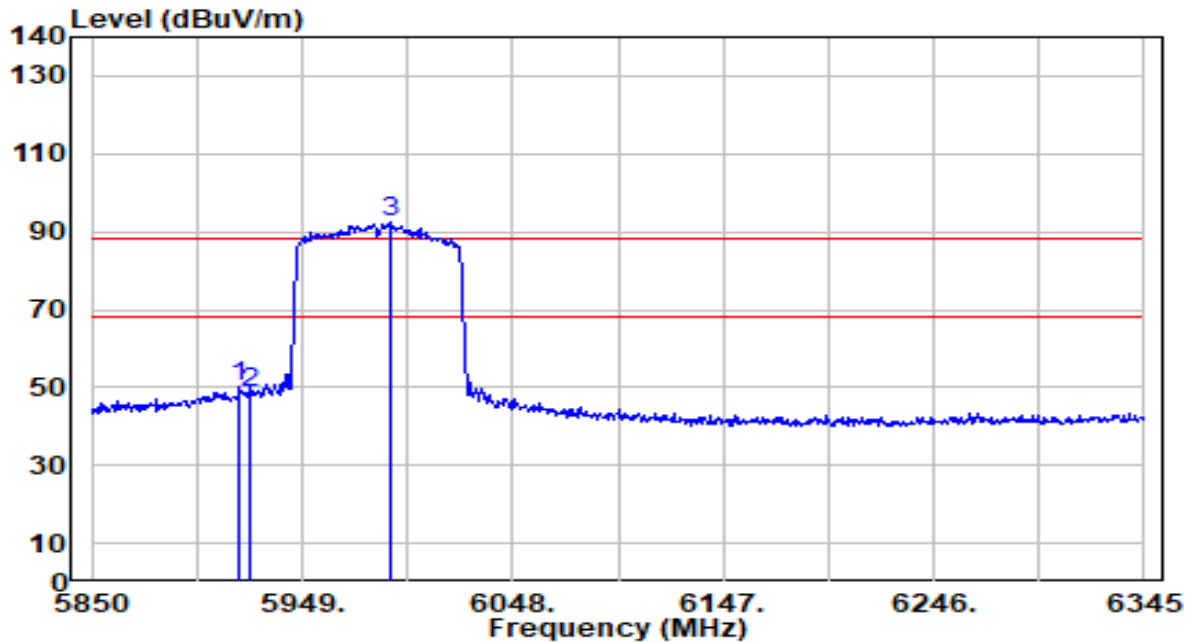

No	Frequency (MHz)	Reading (dBuV)	C.F (dB/m)	Measurement (dBuV/m)	Margin (dB)	Limit (dBuV/m)	Height (cm)	Angle (deg)	Remark (QP/PK/AV)	
1	*	5919.795	49.73	0.53	50.26	-37.94	88.20	100	44	Peak
2		5925.000	47.98	0.53	48.51	-39.69	88.20	100	44	Peak
3		5990.085	91.82	0.48	92.30	N/A	N/A	100	44	Peak

Note:

1. " \*", means this data is the worst emission level.
2. C.F (Correction Factor) = Antenna Factor (dB/m)+ Cable Loss (dB) – Preamplifier(dB).
3. Measurement (dBuV/m) = Reading(dBuV) + C.F (Correction Factor).
4. The emission levels of other frequencies are very lower than the limit and not show in test report.

EUT	AXE3000 Wi-Fi 6E High Gain Wireless USB Adapter	Date of Test	2023-10-27
Factor	DRH18-E	Temp. / Humidity	21°C /61%
Polarity	Vertical	Site / Test Engineer	AC2 / Marvin
Test Mode	802.11ax-80MHz_TX_Band5_CH 7_ANT 1+2	Test Voltage	By Notebook PC

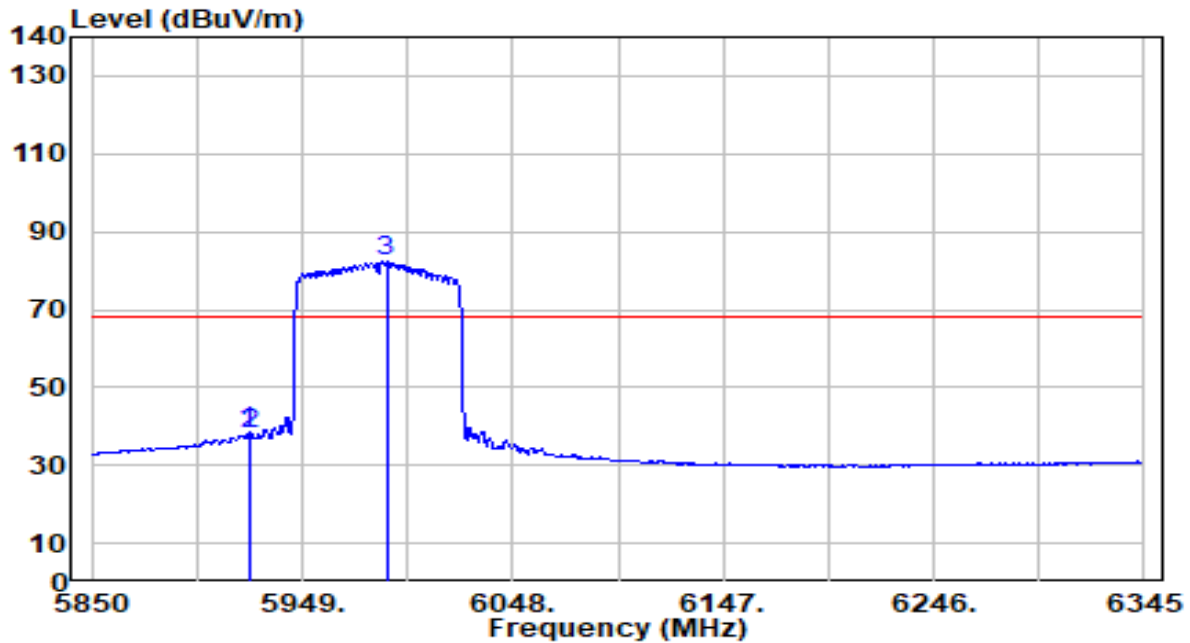

No	Frequency (MHz)	Reading (dBuV)	C.F (dB/m)	Measurement (dBuV/m)	Margin (dB)	Limit (dBuV/m)	Height (cm)	Angle (deg)	Remark (QP/PK/AV)	
1	*	5923.755	38.12	0.53	38.64	-29.56	68.20	100	44	Average
2		5925.000	37.47	0.53	38.00	-30.20	68.20	100	44	Average
3		5988.600	82.04	0.48	82.52	N/A	N/A	100	44	Average

Note:

1. " \*", means this data is the worst emission level.
2. C.F (Correction Factor) = Antenna Factor (dB/m)+ Cable Loss (dB) – Preamplifier(dB).
3. Measurement (dBuV/m) = Reading(dBuV) + C.F (Correction Factor).
4. The emission levels of other frequencies are very lower than the limit and not show in test report.

EUT	AXE3000 Wi-Fi 6E High Gain Wireless USB Adapter	Date of Test	2023-10-27
Factor	DRH18-E	Temp. / Humidity	21°C /61%
Polarity	Horizontal	Site / Test Engineer	AC2 / Marvin
Test Mode	802.11ax-80MHz_TX_Band8_CH 215_ANT 1+2	Test Voltage	By Notebook PC

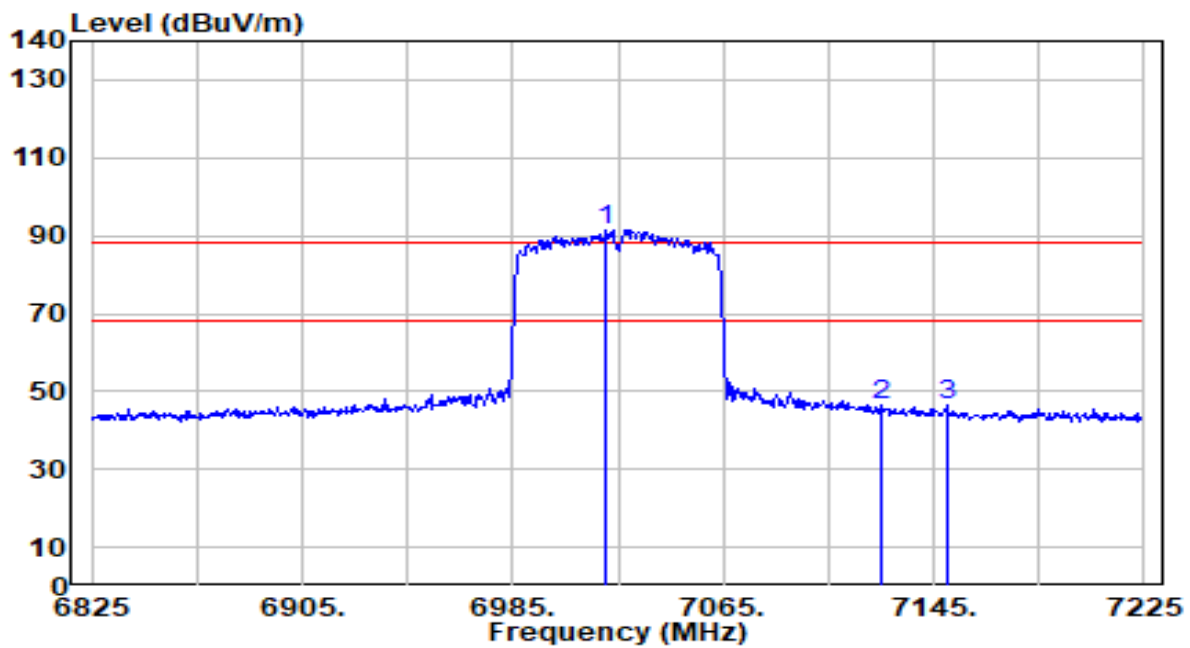

No	Frequency (MHz)	Reading (dBuV)	C.F (dB/m)	Measurement (dBuV/m)	Margin (dB)	Limit (dBuV/m)	Height (cm)	Angle (deg)	Remark (QP/PK/AV)
1	7020.200	87.56	3.85	91.42	N/A	N/A	300	0	Peak
2	7125.000	42.56	3.88	46.44	-41.76	88.20	300	0	Peak
3	* 7150.200	42.68	3.88	46.56	-41.64	88.20	300	0	Peak

Note:

1. " \*", means this data is the worst emission level.
2. C.F (Correction Factor) = Antenna Factor (dB/m)+ Cable Loss (dB) – Preamplifier(dB).
3. Measurement (dBuV/m) = Reading(dBuV) + C.F (Correction Factor).
4. The emission levels of other frequencies are very lower than the limit and not show in test report.

EUT	AXE3000 Wi-Fi 6E High Gain Wireless USB Adapter	Date of Test	2023-10-27
Factor	DRH18-E	Temp. / Humidity	21°C /61%
Polarity	Horizontal	Site / Test Engineer	AC2 / Marvin
Test Mode	802.11ax-80MHz_TX_Band8_CH 215_ANT 1+2	Test Voltage	By Notebook PC

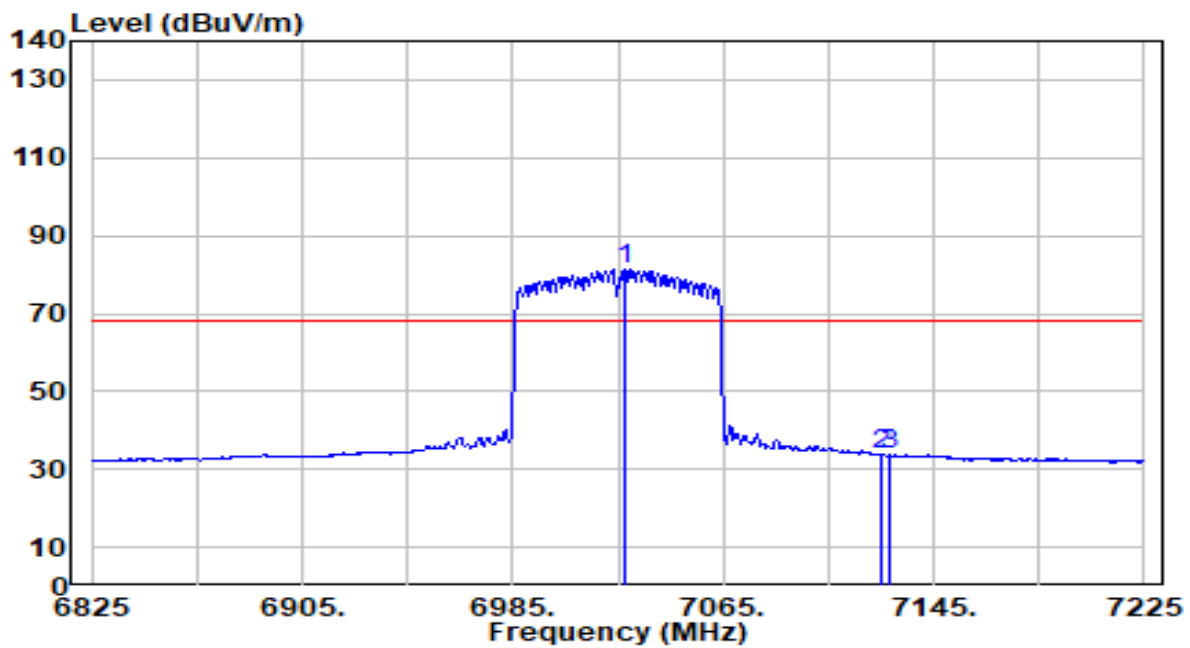

No	Frequency (MHz)	Reading (dBuV)	C.F (dB/m)	Measurement (dBuV/m)	Margin (dB)	Limit (dBuV/m)	Height (cm)	Angle (deg)	Remark (QP/PK/AV)
1	7027.800	77.57	3.86	81.43	N/A	N/A	300	0	Average
2	* 7125.000	30.03	3.88	33.91	-34.29	68.20	300	0	Average
3	7128.200	29.94	3.88	33.81	-34.39	68.20	300	0	Average

Note:

1. " \*", means this data is the worst emission level.
2. C.F (Correction Factor) = Antenna Factor (dB/m)+ Cable Loss (dB) – Preamplifier(dB).
3. Measurement (dBuV/m) = Reading(dBuV) + C.F (Correction Factor).
4. The emission levels of other frequencies are very lower than the limit and not show in test report.

EUT	AXE3000 Wi-Fi 6E High Gain Wireless USB Adapter	Date of Test	2023-10-27
Factor	DRH18-E	Temp. / Humidity	21°C /61%
Polarity	Vertical	Site / Test Engineer	AC2 / Marvin
Test Mode	802.11ax-80MHz_TX_Band8_CH 215_ANT 1+2	Test Voltage	By Notebook PC

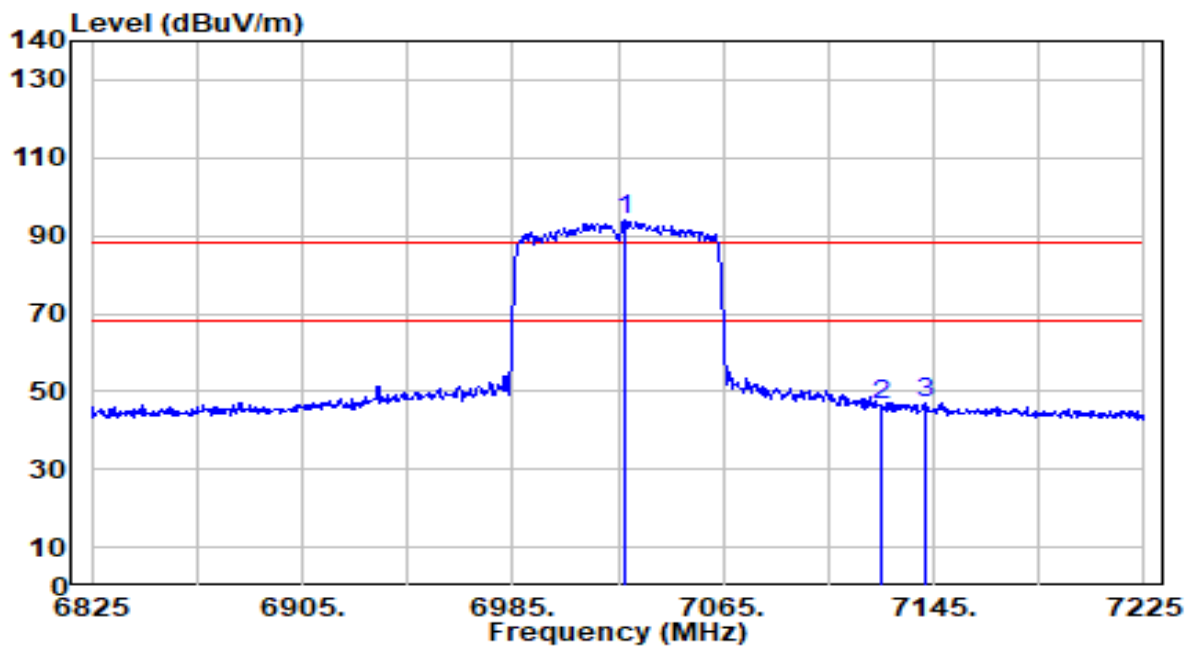

No	Frequency (MHz)	Reading (dBuV)	C.F (dB/m)	Measurement (dBuV/m)	Margin (dB)	Limit (dBuV/m)	Height (cm)	Angle (deg)	Remark (QP/PK/AV)
1	7027.400	89.98	3.86	93.83	N/A	N/A	300	267	Peak
2	7125.000	42.50	3.88	46.37	-41.83	88.20	300	267	Peak
3	* 7141.400	43.35	3.88	47.23	-40.97	88.20	300	267	Peak

Note:

1. " \*", means this data is the worst emission level.
2. C.F (Correction Factor) = Antenna Factor (dB/m)+ Cable Loss (dB) – Preamplifier(dB).
3. Measurement (dBuV/m) = Reading(dBuV) + C.F (Correction Factor).
4. The emission levels of other frequencies are very lower than the limit and not show in test report.



EUT	AXE3000 Wi-Fi 6E High Gain Wireless USB Adapter	Date of Test	2023-10-27
Factor	DRH18-E	Temp. / Humidity	21°C /61%
Polarity	Vertical	Site / Test Engineer	AC2 / Marvin
Test Mode	802.11ax-80MHz_TX_Band8_CH 215_ANT 1+2	Test Voltage	By Notebook PC

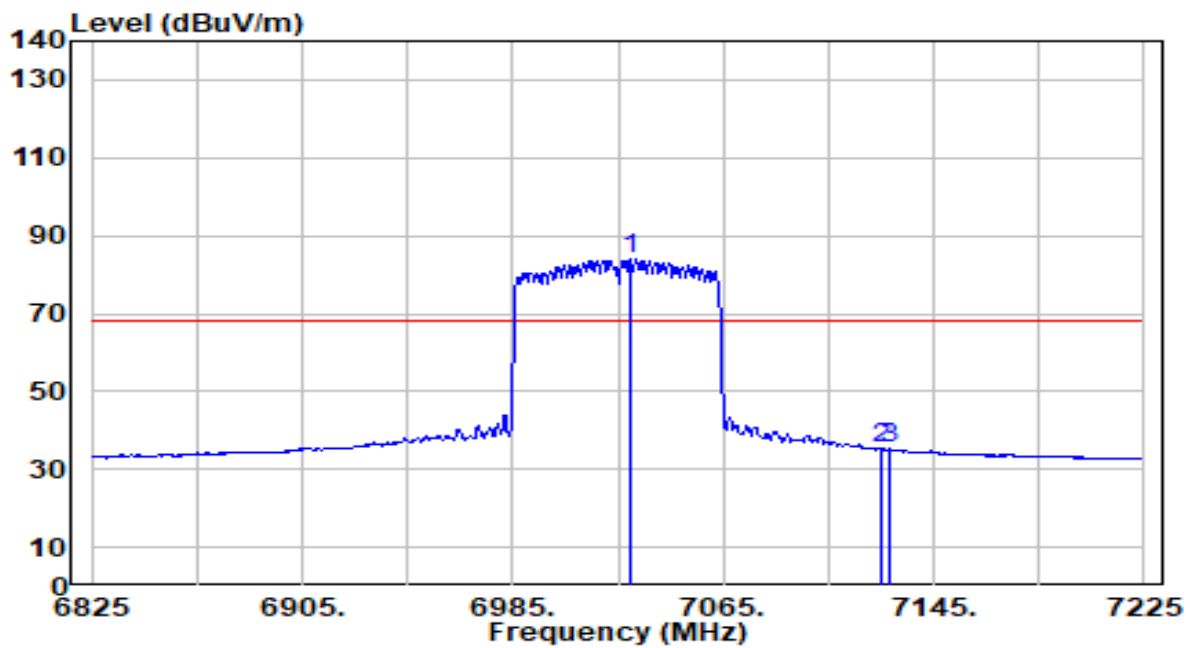

No	Frequency (MHz)	Reading (dBuV)	C.F (dB/m)	Measurement (dBuV/m)	Margin (dB)	Limit (dBuV/m)	Height (cm)	Angle (deg)	Remark (QP/PK/AV)
1	7029.400	80.05	3.86	83.91	N/A	N/A	300	267	Average
2	* 7125.000	31.46	3.88	35.33	-32.87	68.20	300	267	Average
3	7127.800	31.27	3.88	35.15	-33.05	68.20	300	267	Average

Note:

1. " \*", means this data is the worst emission level.
2. C.F (Correction Factor) = Antenna Factor (dB/m)+ Cable Loss (dB) – Preamplifier(dB).
3. Measurement (dBuV/m) = Reading(dBuV) + C.F (Correction Factor).
4. The emission levels of other frequencies are very lower than the limit and not show in test report.

**Nss=2**

EUT	AXE3000 Wi-Fi 6E High Gain Wireless USB Adapter	Date of Test	2023-10-27
Factor	DRH18-E	Temp. / Humidity	21°C /61%
Polarity	Horizontal	Site / Test Engineer	AC2 / Marvin
Test Mode	802.11ax-20MHz_TX_Band5_CH 1_ANT 1+2	Test Voltage	By Notebook PC

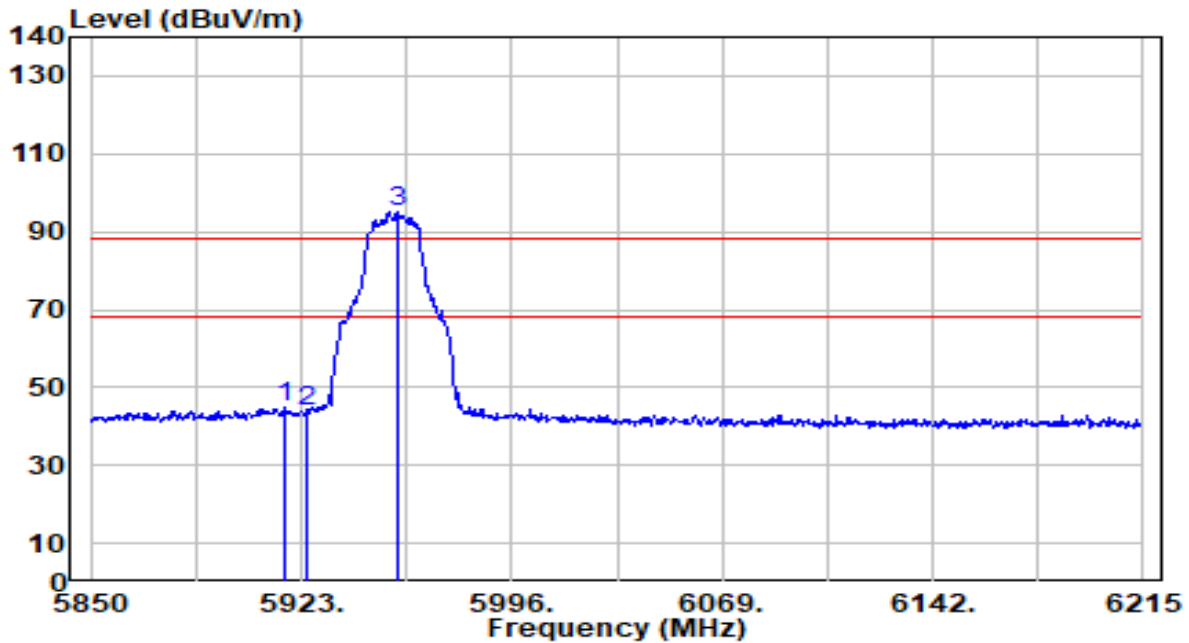

No	Frequency (MHz)	Reading (dBuV)	C.F (dB/m)	Measurement (dBuV/m)	Margin (dB)	Limit (dBuV/m)	Height (cm)	Angle (deg)	Remark (QP/PK/AV)
1	* 5917.160	44.38	0.53	44.91	-43.29	88.20	200	203	Peak
2	5925.000	43.51	0.53	44.04	-44.16	88.20	200	203	Peak
3	5956.215	94.76	0.50	95.26	N/A	N/A	200	203	Peak

**Note:**

1. " \*", means this data is the worst emission level.
2. C.F (Correction Factor) = Antenna Factor (dB/m)+ Cable Loss (dB) – Preamplifier(dB).
3. Measurement (dBuV/m) = Reading(dBuV) + C.F (Correction Factor).
4. The emission levels of other frequencies are very lower than the limit and not show in test report.

EUT	AXE3000 Wi-Fi 6E High Gain Wireless USB Adapter	Date of Test	2023-10-27
Factor	DRH18-E	Temp. / Humidity	21°C /61%
Polarity	Horizontal	Site / Test Engineer	AC2 / Marvin
Test Mode	802.11ax-20MHz_TX_Band5_CH 1_ANT 1+2	Test Voltage	By Notebook PC

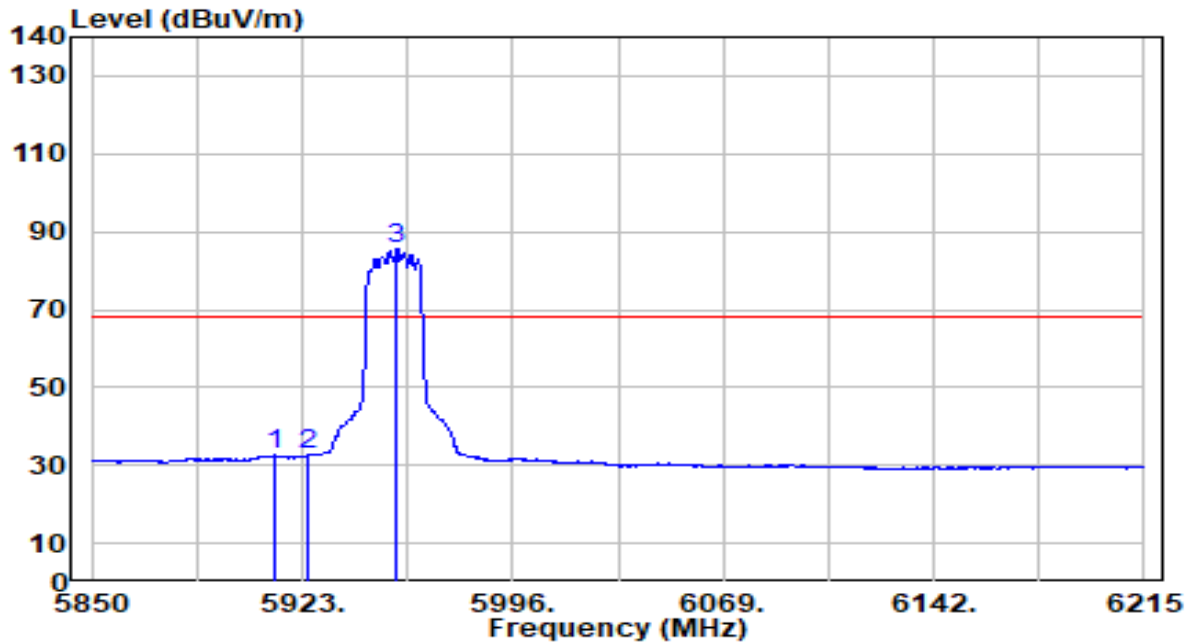

No	Frequency (MHz)	Reading (dBuV)	C.F (dB/m)	Measurement (dBuV/m)	Margin (dB)	Limit (dBuV/m)	Height (cm)	Angle (deg)	Remark (QP/PK/AV)
1	* 5913.145	32.17	0.54	32.70	-35.50	68.20	200	203	Average
2	5925.000	32.06	0.53	32.59	-35.61	68.20	200	203	Average
3	5955.850	85.15	0.50	85.66	N/A	N/A	200	203	Average

Note:

1. " \*", means this data is the worst emission level.
2. C.F (Correction Factor) = Antenna Factor (dB/m)+ Cable Loss (dB) – Preamplifier(dB).
3. Measurement (dBuV/m) = Reading(dBuV) + C.F (Correction Factor).
4. The emission levels of other frequencies are very lower than the limit and not show in test report.

EUT	AXE3000 Wi-Fi 6E High Gain Wireless USB Adapter	Date of Test	2023-10-27
Factor	DRH18-E	Temp. / Humidity	21°C /61%
Polarity	Vertical	Site / Test Engineer	AC2 / Marvin
Test Mode	802.11ax-20MHz_TX_Band5_CH 1_ANT 1+2	Test Voltage	By Notebook PC

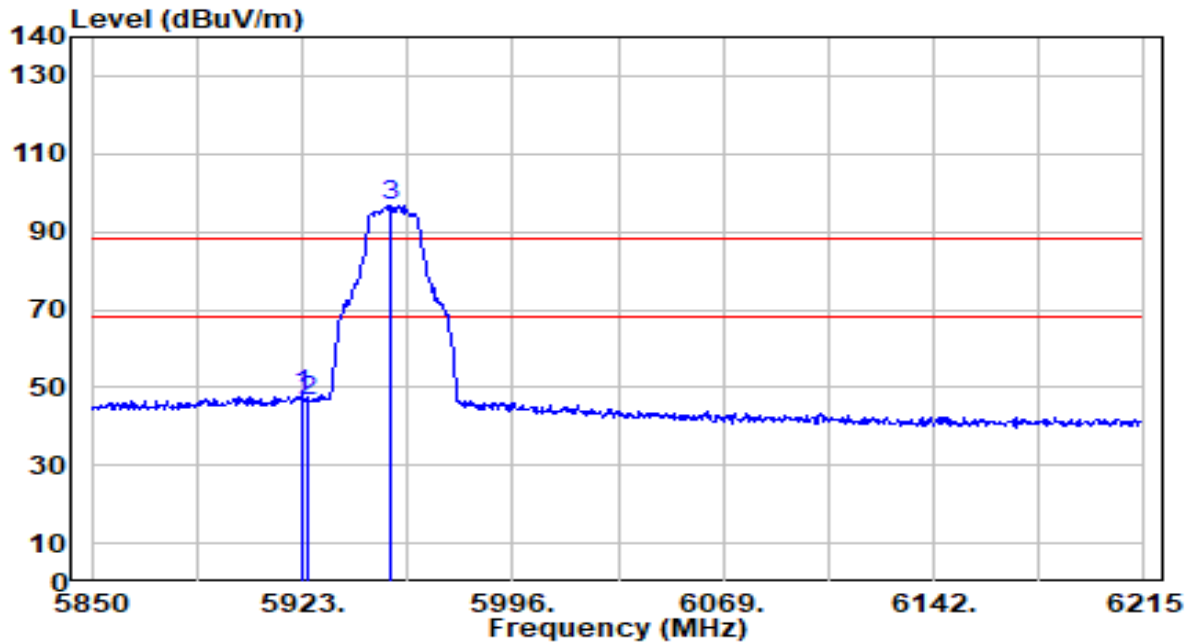

No	Frequency (MHz)	Reading (dBuV)	C.F (dB/m)	Measurement (dBuV/m)	Margin (dB)	Limit (dBuV/m)	Height (cm)	Angle (deg)	Remark (QP/PK/AV)
1	* 5922.635	47.33	0.53	47.86	-40.34	88.20	100	44	Peak
2	5925.000	45.75	0.53	46.28	-41.92	88.20	100	44	Peak
3	5954.025	96.34	0.50	96.84	N/A	N/A	100	44	Peak

Note:

1. " \*", means this data is the worst emission level.
2. C.F (Correction Factor) = Antenna Factor (dB/m)+ Cable Loss (dB) – Preamplifier(dB).
3. Measurement (dBuV/m) = Reading(dBuV) + C.F (Correction Factor).
4. The emission levels of other frequencies are very lower than the limit and not show in test report.

EUT	AXE3000 Wi-Fi 6E High Gain Wireless USB Adapter	Date of Test	2023-10-27
Factor	DRH18-E	Temp. / Humidity	21°C /61%
Polarity	Vertical	Site / Test Engineer	AC2 / Marvin
Test Mode	802.11ax-20MHz_TX_Band5_CH 1_ANT 1+2	Test Voltage	By Notebook PC

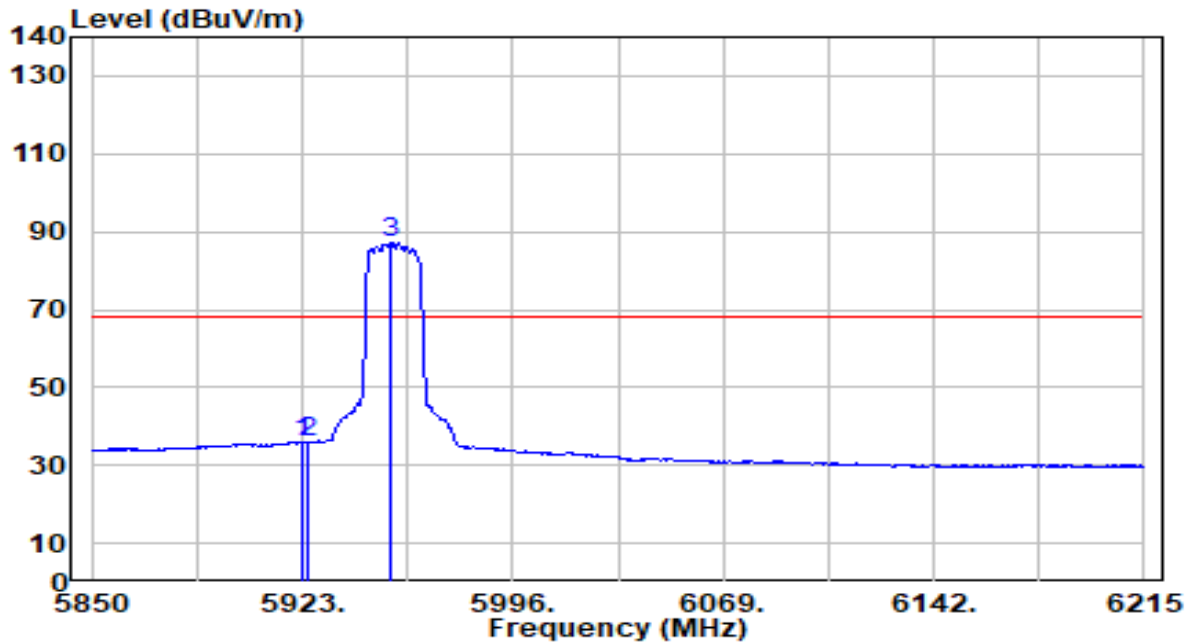

No	Frequency (MHz)	Reading (dBuV)	C.F (dB/m)	Measurement (dBuV/m)	Margin (dB)	Limit (dBuV/m)	Height (cm)	Angle (deg)	Remark (QP/PK/AV)	
1	*	5923.000	35.43	0.53	35.96	-32.24	68.20	100	44	Average
2		5925.000	35.17	0.53	35.70	-32.50	68.20	100	44	Average
3		5953.660	86.87	0.51	87.38	N/A	N/A	100	44	Average

Note:

1. " \*", means this data is the worst emission level.
2. C.F (Correction Factor) = Antenna Factor (dB/m)+ Cable Loss (dB) – Preamplifier(dB).
3. Measurement (dBuV/m) = Reading(dBuV) + C.F (Correction Factor).
4. The emission levels of other frequencies are very lower than the limit and not show in test report.

EUT	AXE3000 Wi-Fi 6E High Gain Wireless USB Adapter	Date of Test	2023-10-27
Factor	DRH18-E	Temp. / Humidity	21°C /61%
Polarity	Horizontal	Site / Test Engineer	AC2 / Marvin
Test Mode	802.11ax-20MHz_TX_Band8_CH 233_ANT 1+2	Test Voltage	by Notebook PC

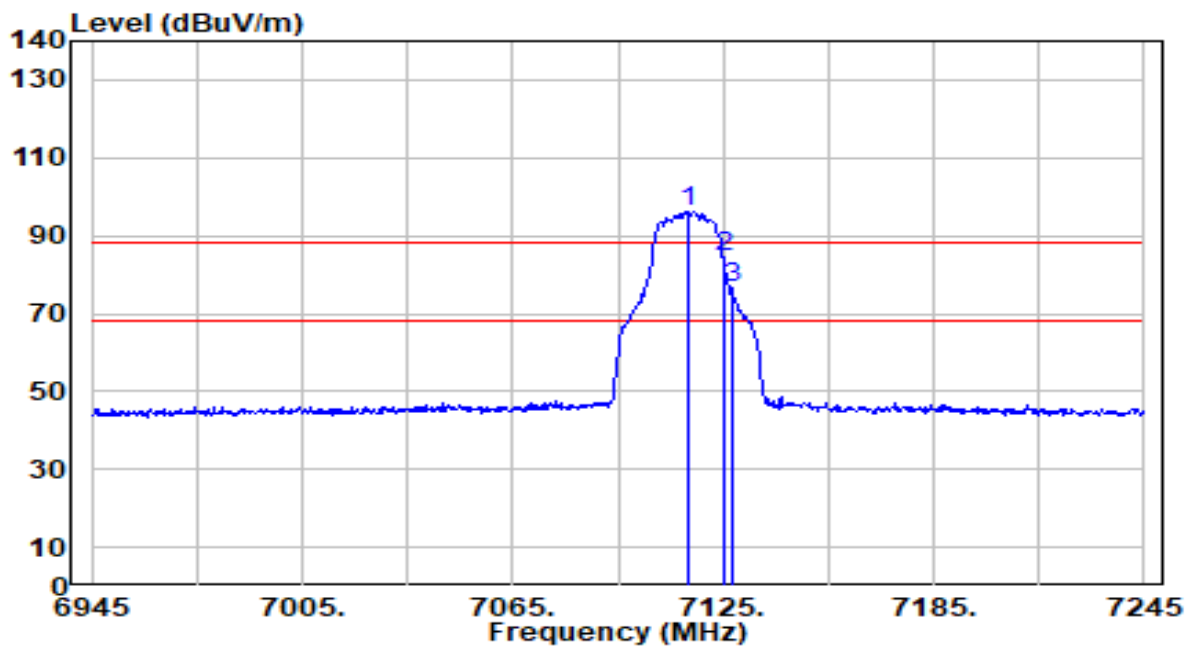

No	Frequency (MHz)	Reading (dBuV)	C.F (dB/m)	Measurement (dBuV/m)	Margin (dB)	Limit (dBuV/m)	Height (cm)	Angle (deg)	Remark (QP/PK/AV)
1	7114.800	92.44	3.88	96.31	N/A	N/A	300	0	Peak
2	* 7125.000	80.82	3.88	84.69	-3.51	88.20	300	0	Peak
3	7127.400	72.49	3.88	76.37	-11.83	88.20	300	0	Peak

Note:

1. " \*", means this data is the worst emission level.
2. C.F (Correction Factor) = Antenna Factor (dB/m)+ Cable Loss (dB) – Preamplifier(dB).
3. Measurement (dBuV/m) = Reading(dBuV) + C.F (Correction Factor).
4. The emission levels of other frequencies are very lower than the limit and not show in test report.

EUT	AXE3000 Wi-Fi 6E High Gain Wireless USB Adapter	Date of Test	2023-10-27
Factor	DRH18-E	Temp. / Humidity	21°C /61%
Polarity	Horizontal	Site / Test Engineer	AC2 / Marvin
Test Mode	802.11ax-20MHz_TX_Band8_CH 233_ANT 1+2	Test Voltage	by Notebook PC

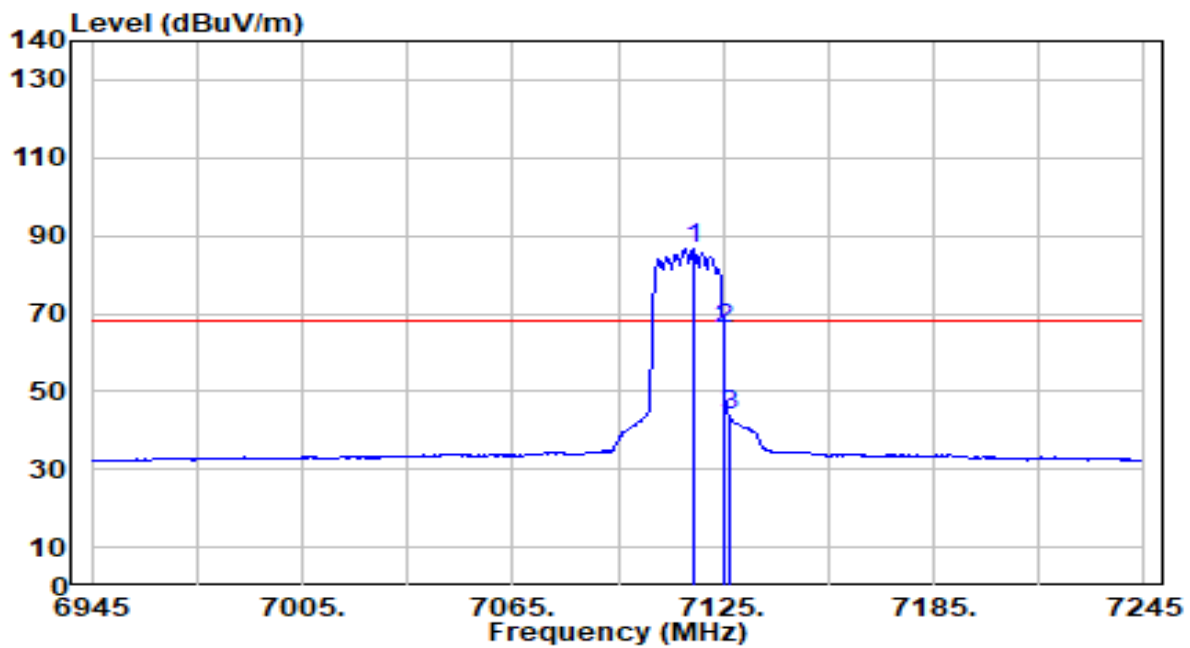

No	Frequency (MHz)	Reading (dBuV)	C.F (dB/m)	Measurement (dBuV/m)	Margin (dB)	Limit (dBuV/m)	Height (cm)	Angle (deg)	Remark (QP/PK/AV)
1	7116.600	82.56	3.88	86.43	N/A	N/A	300	0	Average
2	* 7125.000	62.31	3.88	66.19	-2.01	68.20	300	0	Average
3	7126.800	39.71	3.88	43.59	-24.61	68.20	300	0	Average

Note:

1. " \*", means this data is the worst emission level.
2. C.F (Correction Factor) = Antenna Factor (dB/m)+ Cable Loss (dB) – Preamplifier(dB).
3. Measurement (dBuV/m) = Reading(dBuV) + C.F (Correction Factor).
4. The emission levels of other frequencies are very lower than the limit and not show in test report.

EUT	AXE3000 Wi-Fi 6E High Gain Wireless USB Adapter	Date of Test	2023-10-27
Factor	DRH18-E	Temp. / Humidity	21°C /61%
Polarity	Vertical	Site / Test Engineer	AC2 / Marvin
Test Mode	802.11ax-20MHz_TX_Band8_CH 233_ANT 1+2	Test Voltage	by Notebook PC

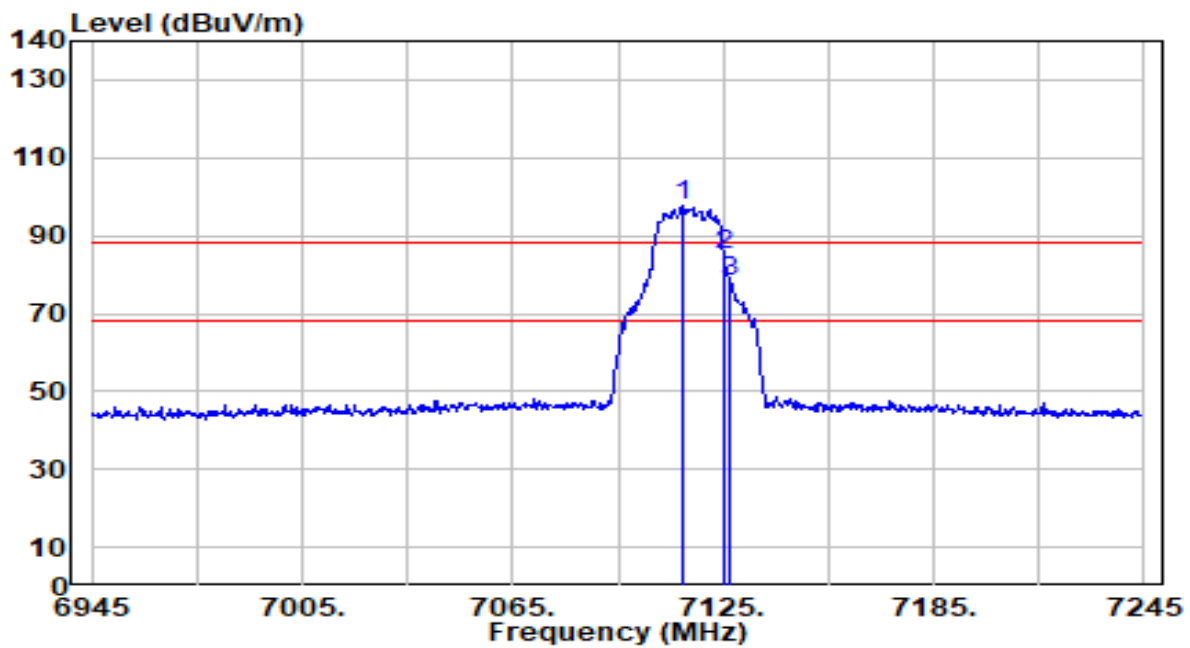

No	Frequency (MHz)	Reading (dBuV)	C.F (dB/m)	Measurement (dBuV/m)	Margin (dB)	Limit (dBuV/m)	Height (cm)	Angle (deg)	Remark (QP/PK/AV)
1	7113.300	93.74	3.87	97.62	N/A	N/A	300	267	Peak
2	* 7125.000	81.09	3.88	84.96	-3.24	88.20	300	267	Peak
3	7126.800	74.55	3.88	78.43	-9.77	88.20	300	267	Peak

Note:

1. " \*", means this data is the worst emission level.
2. C.F (Correction Factor) = Antenna Factor (dB/m)+ Cable Loss (dB) – Preamplifier(dB).
3. Measurement (dBuV/m) = Reading(dBuV) + C.F (Correction Factor).
4. The emission levels of other frequencies are very lower than the limit and not show in test report.



EUT	AXE3000 Wi-Fi 6E High Gain Wireless USB Adapter	Date of Test	2023-10-27
Factor	DRH18-E	Temp. / Humidity	21°C /61%
Polarity	Vertical	Site / Test Engineer	AC2 / Marvin
Test Mode	802.11ax-20MHz_TX_Band8_CH 233_ANT 1+2	Test Voltage	by Notebook PC

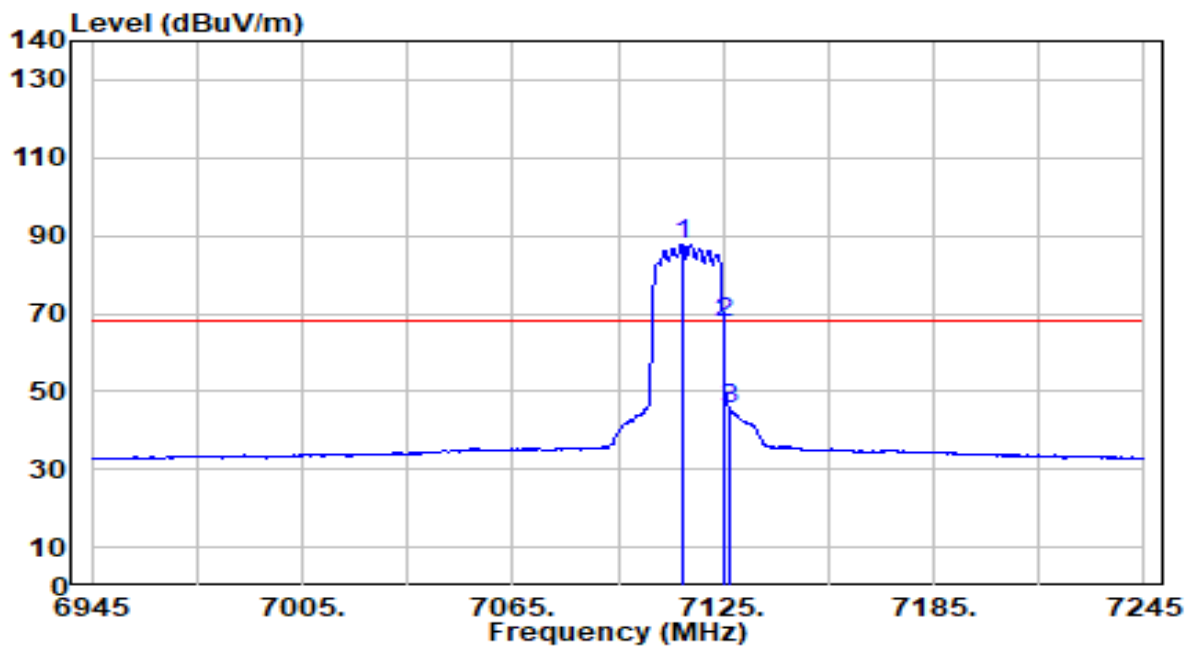

No	Frequency (MHz)	Reading (dBuV)	C.F (dB/m)	Measurement (dBuV/m)	Margin (dB)	Limit (dBuV/m)	Height (cm)	Angle (deg)	Remark (QP/PK/AV)
1	7113.300	83.83	3.87	87.71	N/A	N/A	300	267	Average
2	* 7125.000	63.75	3.88	67.62	-0.58	68.20	300	267	Average
3	7126.800	41.55	3.88	45.43	-22.77	68.20	300	267	Average

Note:

1. " \*", means this data is the worst emission level.
2. C.F (Correction Factor) = Antenna Factor (dB/m)+ Cable Loss (dB) – Preamplifier(dB).
3. Measurement (dBuV/m) = Reading(dBuV) + C.F (Correction Factor).
4. The emission levels of other frequencies are very lower than the limit and not show in test report.

EUT	AXE3000 Wi-Fi 6E High Gain Wireless USB Adapter	Date of Test	2023-10-27
Factor	DRH18-E	Temp. / Humidity	21°C /61%
Polarity	Horizontal	Site / Test Engineer	AC2 / Marvin
Test Mode	802.11ax-40MHz_TX_Band5_CH 3_ANT 1+2	Test Voltage	By Notebook PC

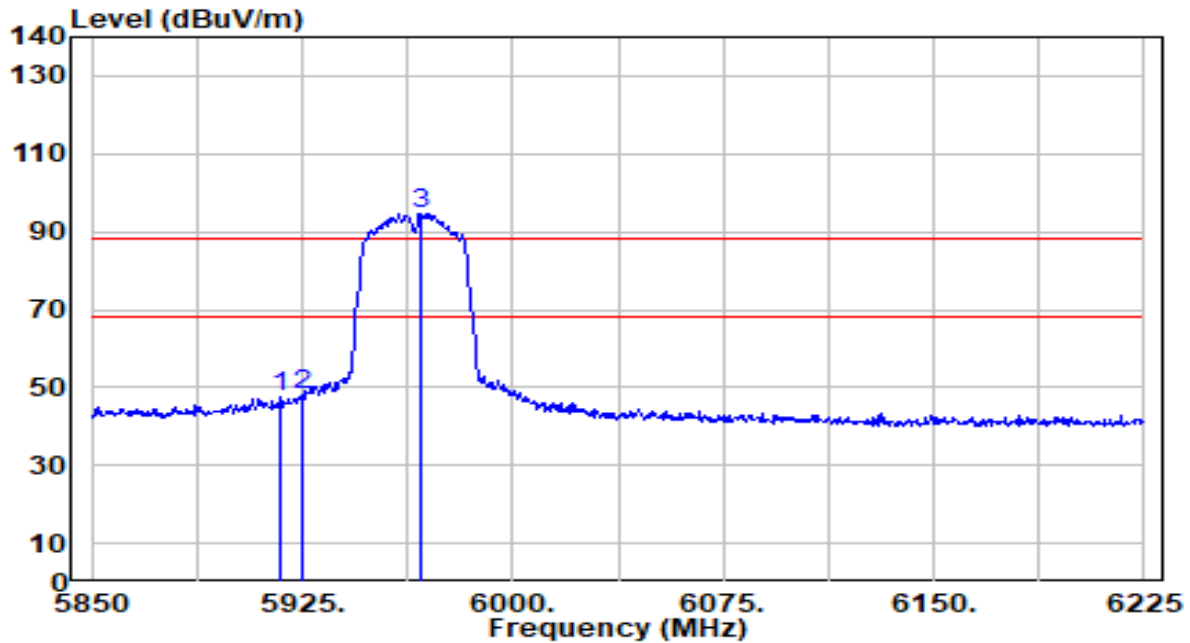

No	Frequency (MHz)	Reading (dBUV)	C.F (dB/m)	Measurement (dBUV/m)	Margin (dB)	Limit (dBUV/m)	Height (cm)	Angle (deg)	Remark (QP/PK/AV)
1	5917.125	47.07	0.53	47.60	-40.60	88.20	200	203	Peak
2	* 5925.000	47.35	0.53	47.88	-40.32	88.20	200	203	Peak
3	5967.000	94.17	0.50	94.67	N/A	N/A	200	203	Peak

Note:

1. " \*", means this data is the worst emission level.
2. C.F (Correction Factor) = Antenna Factor (dB/m)+ Cable Loss (dB) – Preamplifier(dB).
3. Measurement (dBUV/m) = Reading(dBUV) + C.F (Correction Factor).
4. The emission levels of other frequencies are very lower than the limit and not show in test report.

EUT	AXE3000 Wi-Fi 6E High Gain Wireless USB Adapter	Date of Test	2023-10-27
Factor	DRH18-E	Temp. / Humidity	21°C /61%
Polarity	Horizontal	Site / Test Engineer	AC2 / Marvin
Test Mode	802.11ax-40MHz_TX_Band5_CH 3_ANT 1+2	Test Voltage	By Notebook PC

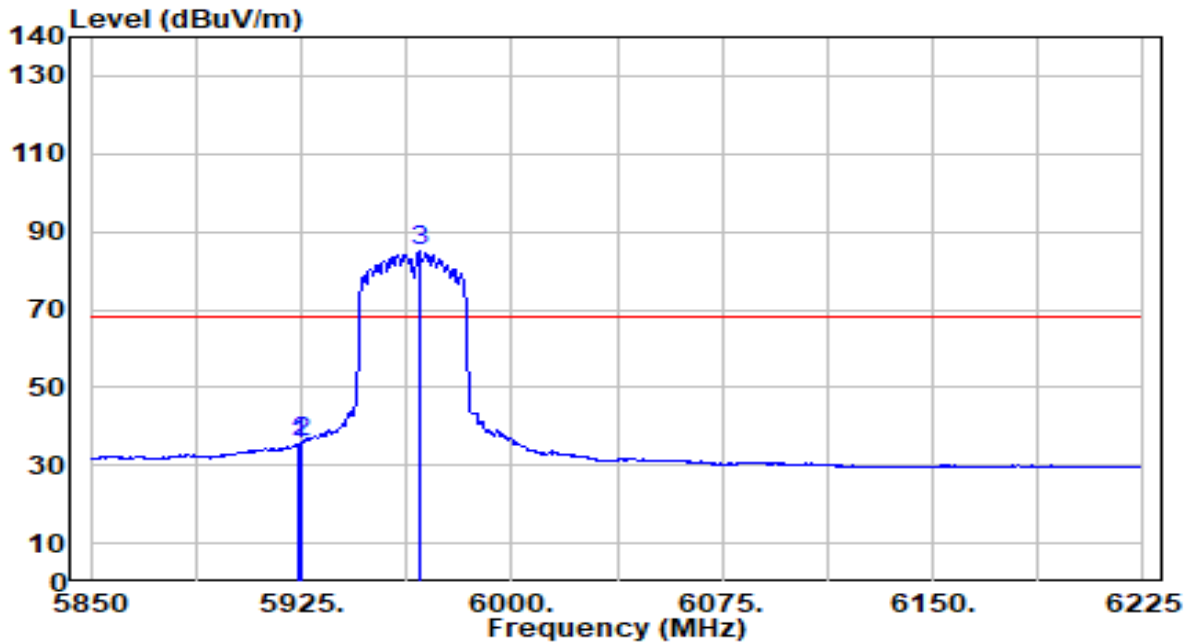

No	Frequency (MHz)	Reading (dBuV)	C.F (dB/m)	Measurement (dBuV/m)	Margin (dB)	Limit (dBuV/m)	Height (cm)	Angle (deg)	Remark (QP/PK/AV)
1	5923.875	34.67	0.53	35.20	-33.00	68.20	200	203	Average
2	* 5925.000	35.19	0.53	35.72	-32.48	68.20	200	203	Average
3	5967.000	84.47	0.50	84.96	N/A	N/A	200	203	Average

Note:

1. " \*", means this data is the worst emission level.
2. C.F (Correction Factor) = Antenna Factor (dB/m)+ Cable Loss (dB) – Preamplifier(dB).
3. Measurement (dBuV/m) = Reading(dBuV) + C.F (Correction Factor).
4. The emission levels of other frequencies are very lower than the limit and not show in test report.

EUT	AXE3000 Wi-Fi 6E High Gain Wireless USB Adapter	Date of Test	2023-10-27
Factor	DRH18-E	Temp. / Humidity	21°C /61%
Polarity	Vertical	Site / Test Engineer	AC2 / Marvin
Test Mode	802.11ax-40MHz_TX_Band5_CH 3_ANT 1+2	Test Voltage	By Notebook PC

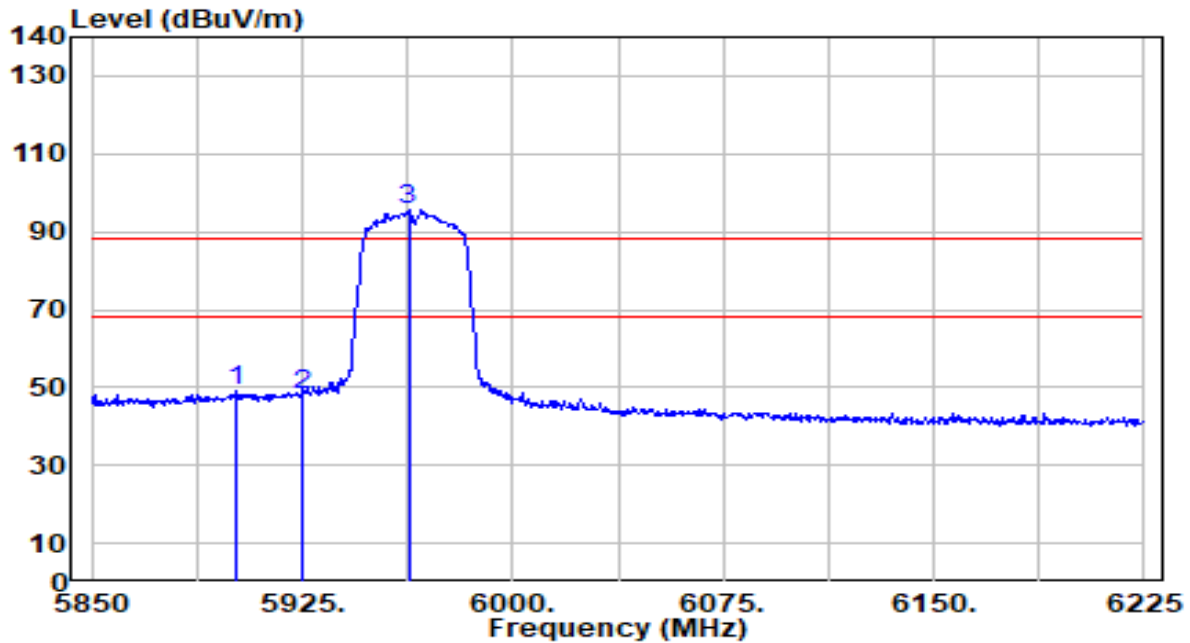

No	Frequency (MHz)	Reading (dBUV)	C.F (dB/m)	Measurement (dBUV/m)	Margin (dB)	Limit (dBUV/m)	Height (cm)	Angle (deg)	Remark (QP/PK/AV)
1	* 5901.750	48.37	0.54	48.92	-39.28	88.20	100	44	Peak
2	5925.000	47.71	0.53	48.24	-39.96	88.20	100	44	Peak
3	5962.875	94.92	0.50	95.42	N/A	N/A	100	44	Peak

Note:

1. " \*", means this data is the worst emission level.
2. C.F (Correction Factor) = Antenna Factor (dB/m)+ Cable Loss (dB) – Preamplifier(dB).
3. Measurement (dBUV/m) = Reading(dBUV) + C.F (Correction Factor).
4. The emission levels of other frequencies are very lower than the limit and not show in test report.

EUT	AXE3000 Wi-Fi 6E High Gain Wireless USB Adapter	Date of Test	2023-10-27
Factor	DRH18-E	Temp. / Humidity	21°C /61%
Polarity	Vertical	Site / Test Engineer	AC2 / Marvin
Test Mode	802.11ax-40MHz_TX_Band5_CH 3_ANT 1+2	Test Voltage	By Notebook PC

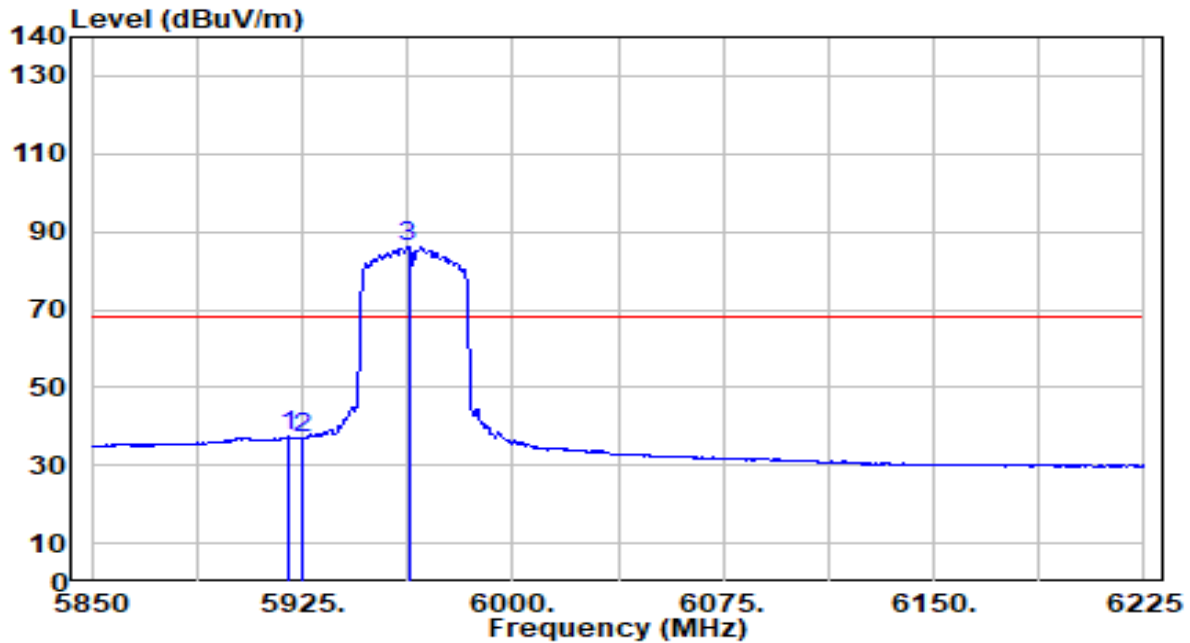

No	Frequency (MHz)	Reading (dBuV)	C.F (dB/m)	Measurement (dBuV/m)	Margin (dB)	Limit (dBuV/m)	Height (cm)	Angle (deg)	Remark (QP/PK/AV)	
1	*	5920.500	36.80	0.53	37.33	-30.87	68.20	100	44	Average
2		5925.000	36.45	0.53	36.97	-31.23	68.20	100	44	Average
3		5962.875	85.70	0.50	86.20	N/A	N/A	100	44	Average

Note:

1. " \*", means this data is the worst emission level.
2. C.F (Correction Factor) = Antenna Factor (dB/m)+ Cable Loss (dB) – Preamplifier(dB).
3. Measurement (dBuV/m) = Reading(dBuV) + C.F (Correction Factor).
4. The emission levels of other frequencies are very lower than the limit and not show in test report.

EUT	AXE3000 Wi-Fi 6E High Gain Wireless USB Adapter	Date of Test	2023-10-27
Factor	DRH18-E	Temp. / Humidity	21°C /61%
Polarity	Horizontal	Site / Test Engineer	AC2 / Marvin
Test Mode	802.11ax-40MHz_TX_Band8_CH 227_ANT 1+2	Test Voltage	By Notebook PC

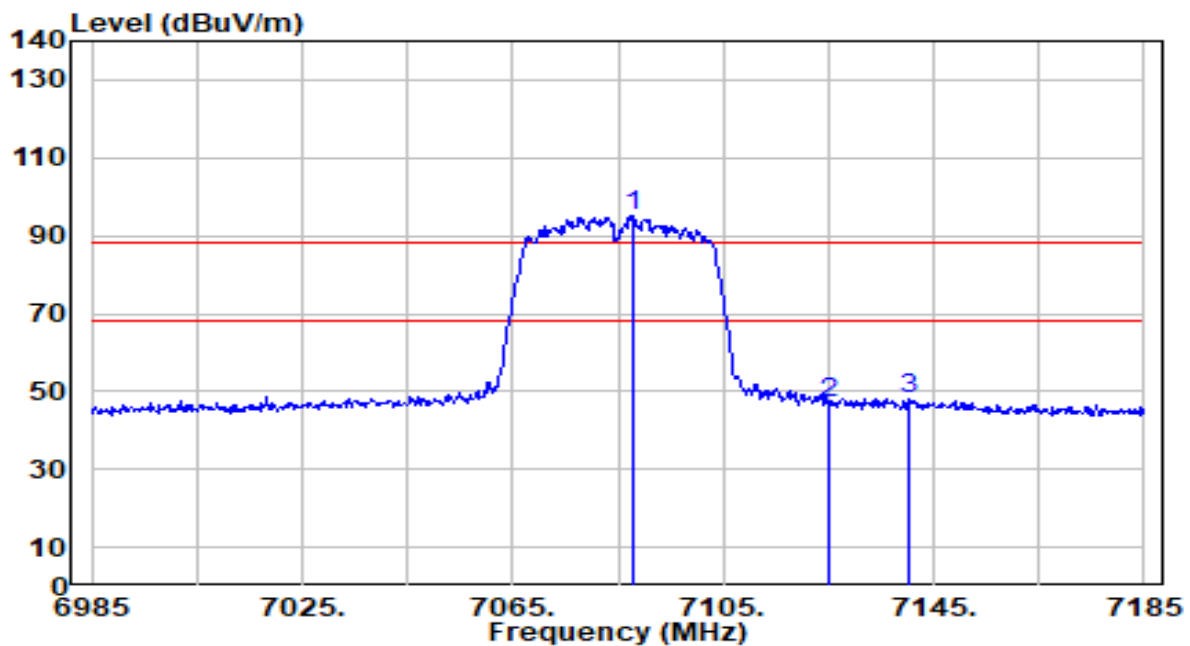

No	Frequency (MHz)	Reading (dBuV)	C.F (dB/m)	Measurement (dBuV/m)	Margin (dB)	Limit (dBuV/m)	Height (cm)	Angle (deg)	Remark (QP/PK/AV)
1	7088.000	91.22	3.87	95.08	N/A	N/A	300	0	Peak
2	7125.000	43.34	3.88	47.21	-40.99	88.20	300	0	Peak
3	* 7140.400	44.42	3.88	48.30	-39.90	88.20	300	0	Peak

Note:

1. " \*", means this data is the worst emission level.
2. C.F (Correction Factor) = Antenna Factor (dB/m)+ Cable Loss (dB) – Preamplifier(dB).
3. Measurement (dBuV/m) = Reading(dBuV) + C.F (Correction Factor).
4. The emission levels of other frequencies are very lower than the limit and not show in test report.

EUT	AXE3000 Wi-Fi 6E High Gain Wireless USB Adapter	Date of Test	2023-10-27
Factor	DRH18-E	Temp. / Humidity	21°C /61%
Polarity	Horizontal	Site / Test Engineer	AC2 / Marvin
Test Mode	802.11ax-40MHz_TX_Band8_CH 227_ANT 1+2	Test Voltage	By Notebook PC

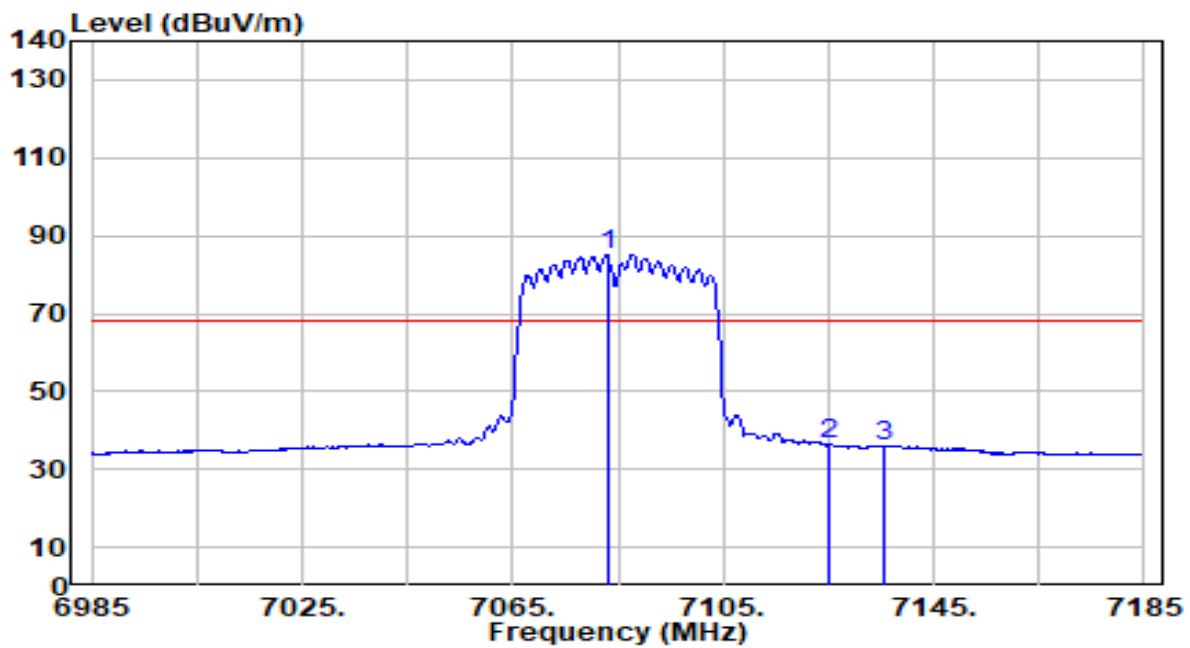

No	Frequency (MHz)	Reading (dBuV)	C.F (dB/m)	Measurement (dBuV/m)	Margin (dB)	Limit (dBuV/m)	Height (cm)	Angle (deg)	Remark (QP/PK/AV)
1	7083.000	81.27	3.87	85.14	N/A	N/A	300	0	Average
2	* 7125.000	32.49	3.88	36.37	-31.83	68.20	300	0	Average
3	7135.600	32.25	3.88	36.13	-32.07	68.20	300	0	Average

Note:

1. " \*", means this data is the worst emission level.
2. C.F (Correction Factor) = Antenna Factor (dB/m)+ Cable Loss (dB) – Preamplifier(dB).
3. Measurement (dBuV/m) = Reading(dBuV) + C.F (Correction Factor).
4. The emission levels of other frequencies are very lower than the limit and not show in test report.

EUT	AXE3000 Wi-Fi 6E High Gain Wireless USB Adapter	Date of Test	2023-10-27
Factor	DRH18-E	Temp. / Humidity	21°C /61%
Polarity	Vertical	Site / Test Engineer	AC2 / Marvin
Test Mode	802.11ax-40MHz_TX_Band8_CH 227_ANT 1+2	Test Voltage	By Notebook PC

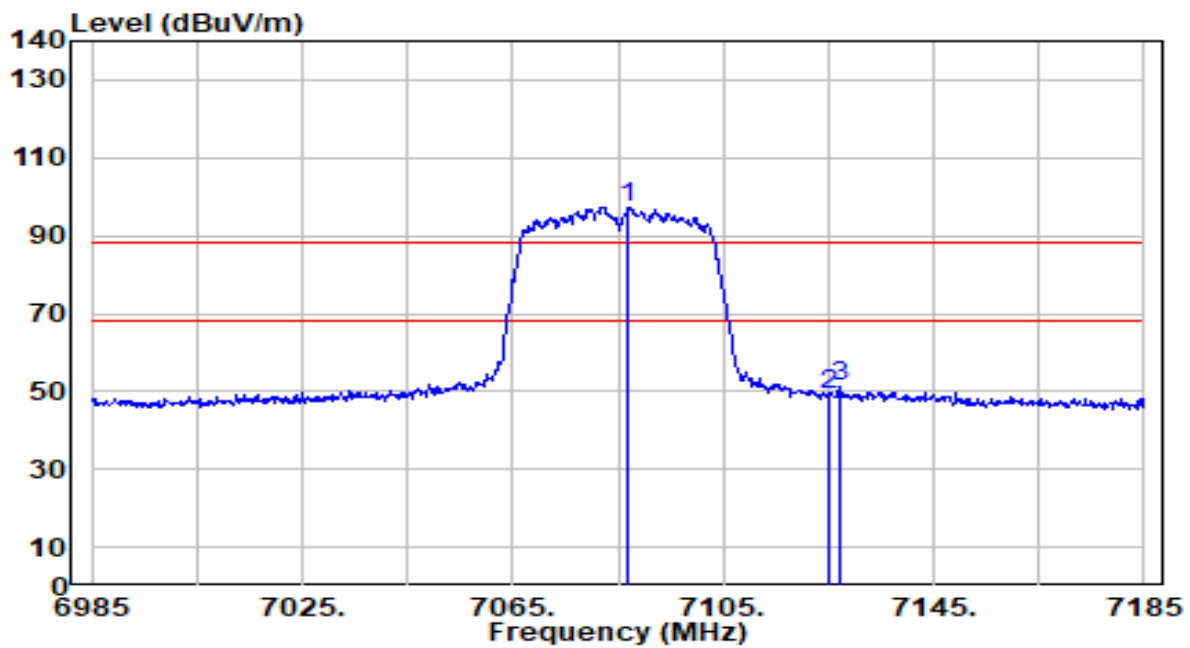

No	Frequency (MHz)	Reading (dBuV)	C.F (dB/m)	Measurement (dBuV/m)	Margin (dB)	Limit (dBuV/m)	Height (cm)	Angle (deg)	Remark (QP/PK/AV)
1	7086.800	93.50	3.87	97.37	N/A	N/A	300	267	Peak
2	7125.000	45.19	3.88	49.07	-39.13	88.20	300	267	Peak
3	* 7127.200	47.46	3.88	51.34	-36.86	88.20	300	267	Peak

Note:

1. " \*", means this data is the worst emission level.
2. C.F (Correction Factor) = Antenna Factor (dB/m)+ Cable Loss (dB) – Preamplifier(dB).
3. Measurement (dBuV/m) = Reading(dBuV) + C.F (Correction Factor).
4. The emission levels of other frequencies are very lower than the limit and not show in test report.



EUT	AXE3000 Wi-Fi 6E High Gain Wireless USB Adapter	Date of Test	2023-10-27
Factor	DRH18-E	Temp. / Humidity	21°C /61%
Polarity	Vertical	Site / Test Engineer	AC2 / Marvin
Test Mode	802.11ax-40MHz_TX_Band8_CH 227_ANT 1+2	Test Voltage	By Notebook PC

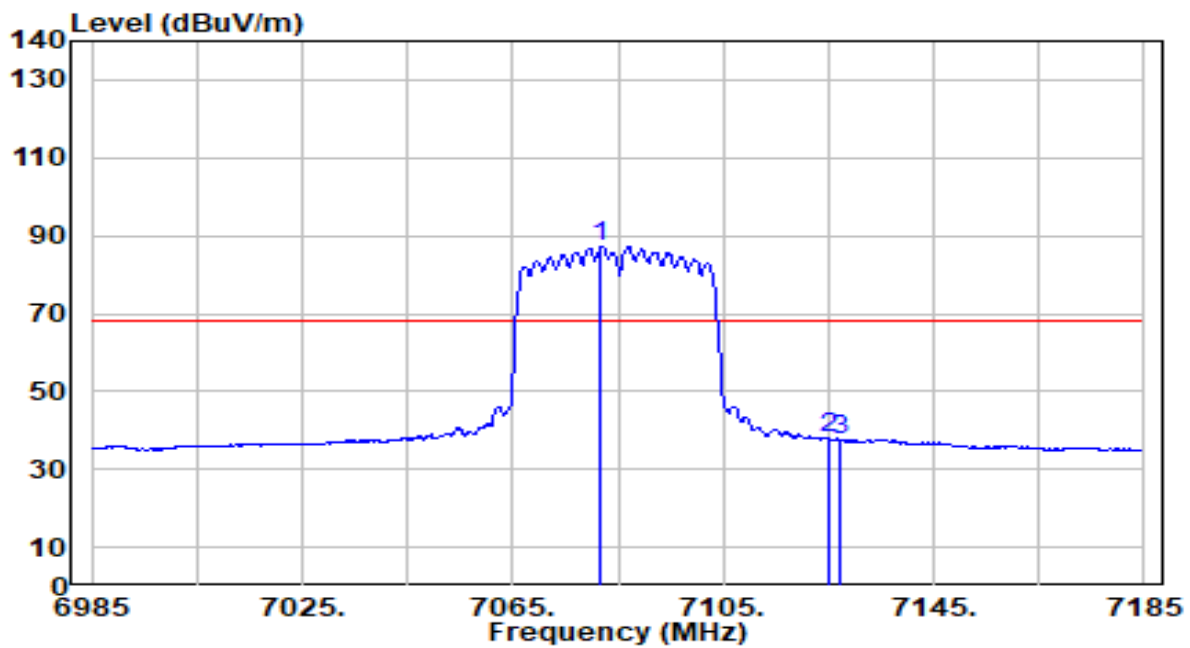

No	Frequency (MHz)	Reading (dBuV)	C.F (dB/m)	Measurement (dBuV/m)	Margin (dB)	Limit (dBuV/m)	Height (cm)	Angle (deg)	Remark (QP/PK/AV)
1	7081.800	83.48	3.87	87.35	N/A	N/A	300	267	Average
2	* 7125.000	34.14	3.88	38.02	-30.18	68.20	300	267	Average
3	7127.200	33.76	3.88	37.63	-30.57	68.20	300	267	Average

Note:

1. " \*", means this data is the worst emission level.
2. C.F (Correction Factor) = Antenna Factor (dB/m)+ Cable Loss (dB) – Preamplifier(dB).
3. Measurement (dBuV/m) = Reading(dBuV) + C.F (Correction Factor).
4. The emission levels of other frequencies are very lower than the limit and not show in test report.

EUT	AXE3000 Wi-Fi 6E High Gain Wireless USB Adapter	Date of Test	2023-10-27
Factor	DRH18-E	Temp. / Humidity	21°C /61%
Polarity	Horizontal	Site / Test Engineer	AC2 / Marvin
Test Mode	802.11ax-80MHz_TX_Band5_CH 7_ANT 1+2	Test Voltage	By Notebook PC

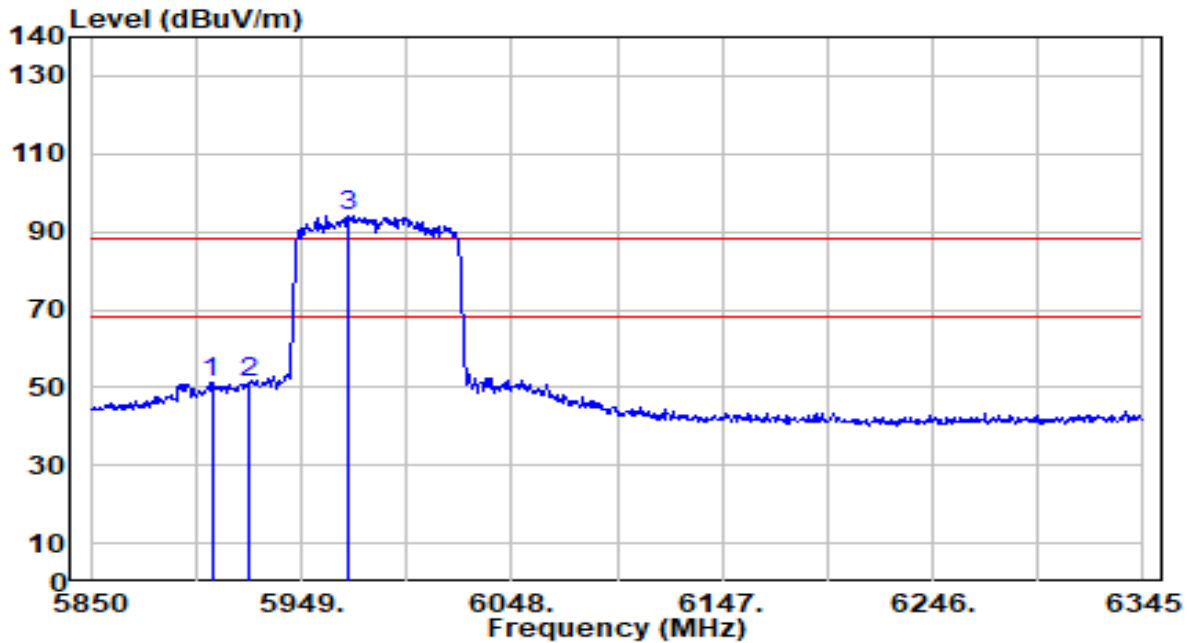

No	Frequency (MHz)	Reading (dBuV)	C.F (dB/m)	Measurement (dBuV/m)	Margin (dB)	Limit (dBuV/m)	Height (cm)	Angle (deg)	Remark (QP/PK/AV)
1	5906.925	50.64	0.54	51.18	-37.02	88.20	200	203	Peak
2	* 5925.000	50.70	0.53	51.22	-36.98	88.20	200	203	Peak
3	5971.275	93.76	0.49	94.25	N/A	N/A	200	203	Peak

Note:

1. " \*", means this data is the worst emission level.
2. C.F (Correction Factor) = Antenna Factor (dB/m)+ Cable Loss (dB) – Preamplifier(dB).
3. Measurement (dBuV/m) = Reading(dBuV) + C.F (Correction Factor).
4. The emission levels of other frequencies are very lower than the limit and not show in test report.

EUT	AXE3000 Wi-Fi 6E High Gain Wireless USB Adapter	Date of Test	2023-10-27
Factor	DRH18-E	Temp. / Humidity	21°C /61%
Polarity	Horizontal	Site / Test Engineer	AC2 / Marvin
Test Mode	802.11ax-80MHz_TX_Band5_CH 7_ANT 1+2	Test Voltage	By Notebook PC

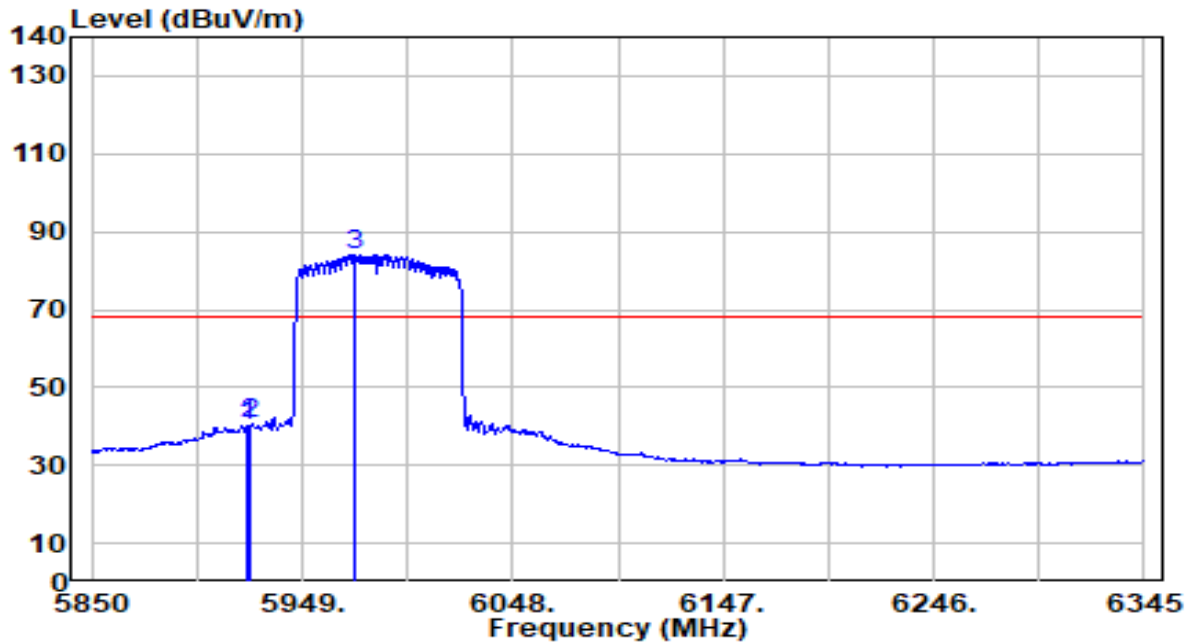

No	Frequency (MHz)	Reading (dBuV)	C.F (dB/m)	Measurement (dBuV/m)	Margin (dB)	Limit (dBuV/m)	Height (cm)	Angle (deg)	Remark (QP/PK/AV)
1	5923.260	39.81	0.53	40.34	-27.86	68.20	200	203	Average
2	* 5925.000	40.07	0.53	40.60	-27.60	68.20	200	203	Average
3	5973.255	83.65	0.49	84.14	N/A	N/A	200	203	Average

Note:

- "\*", means this data is the worst emission level.
- C.F (Correction Factor) = Antenna Factor (dB/m)+ Cable Loss (dB) – Preamplifier(dB).
- Measurement (dBuV/m) = Reading(dBuV) + C.F (Correction Factor).
- The emission levels of other frequencies are very lower than the limit and not show in test report.

EUT	AXE3000 Wi-Fi 6E High Gain Wireless USB Adapter	Date of Test	2023-10-27
Factor	DRH18-E	Temp. / Humidity	21°C /61%
Polarity	Vertical	Site / Test Engineer	AC2 / Marvin
Test Mode	802.11ax-80MHz_TX_Band5_CH 7_ANT 1+2	Test Voltage	By Notebook PC

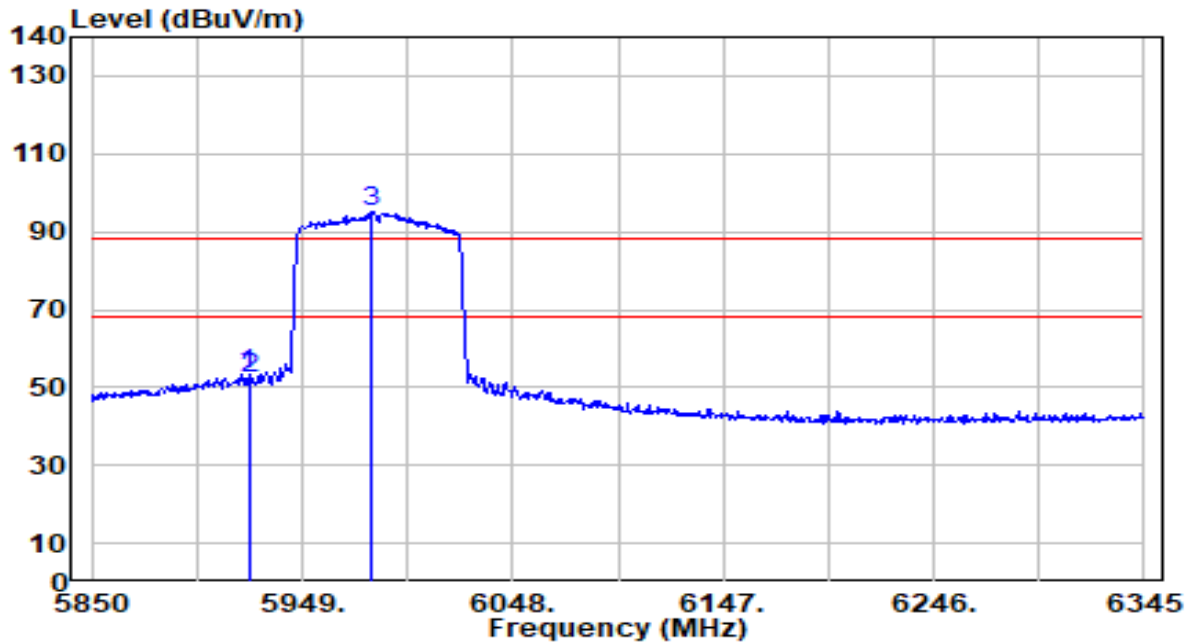

No	Frequency (MHz)	Reading (dBuV)	C.F (dB/m)	Measurement (dBuV/m)	Margin (dB)	Limit (dBuV/m)	Height (cm)	Angle (deg)	Remark (QP/PK/AV)
1	*	52.96	0.53	53.49	-34.71	88.20	100	44	Peak
2		51.71	0.53	52.24	-35.96	88.20	100	44	Peak
3		94.44	0.48	94.92	N/A	N/A	100	44	Peak

Note:

1. " \*", means this data is the worst emission level.
2. C.F (Correction Factor) = Antenna Factor (dB/m)+ Cable Loss (dB) – Preamplifier(dB).
3. Measurement (dBuV/m) = Reading(dBuV) + C.F (Correction Factor).
4. The emission levels of other frequencies are very lower than the limit and not show in test report.

EUT	AXE3000 Wi-Fi 6E High Gain Wireless USB Adapter	Date of Test	2023-10-27
Factor	DRH18-E	Temp. / Humidity	21°C /61%
Polarity	Vertical	Site / Test Engineer	AC2 / Marvin
Test Mode	802.11ax-80MHz_TX_Band5_CH 7_ANT 1+2	Test Voltage	By Notebook PC

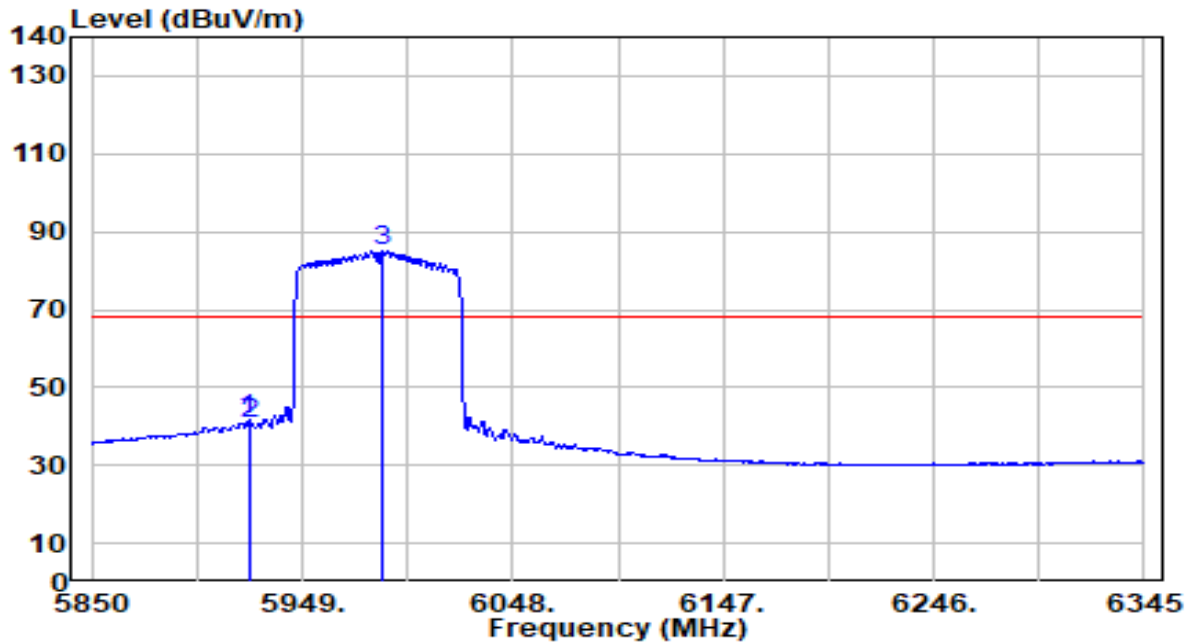

No	Frequency (MHz)	Reading (dBUV)	C.F (dB/m)	Measurement (dBUV/m)	Margin (dB)	Limit (dBUV/m)	Height (cm)	Angle (deg)	Remark (QP/PK/AV)	
1	*	5923.755	40.94	0.53	41.47	-26.73	68.20	100	44	Average
2		5925.000	40.31	0.53	40.84	-27.36	68.20	100	44	Average
3		5986.620	84.73	0.48	85.21	N/A	N/A	100	44	Average

Note:

1. " \*", means this data is the worst emission level.
2. C.F (Correction Factor) = Antenna Factor (dB/m)+ Cable Loss (dB) – Preamplifier(dB).
3. Measurement (dBUV/m) = Reading(dBUV) + C.F (Correction Factor).
4. The emission levels of other frequencies are very lower than the limit and not show in test report.

EUT	AXE3000 Wi-Fi 6E High Gain Wireless USB Adapter	Date of Test	2023-10-27
Factor	DRH18-E	Temp. / Humidity	21°C /61%
Polarity	Horizontal	Site / Test Engineer	AC2 / Marvin
Test Mode	802.11ax-80MHz_TX_Band8_CH 215_ANT 1+2	Test Voltage	By Notebook PC

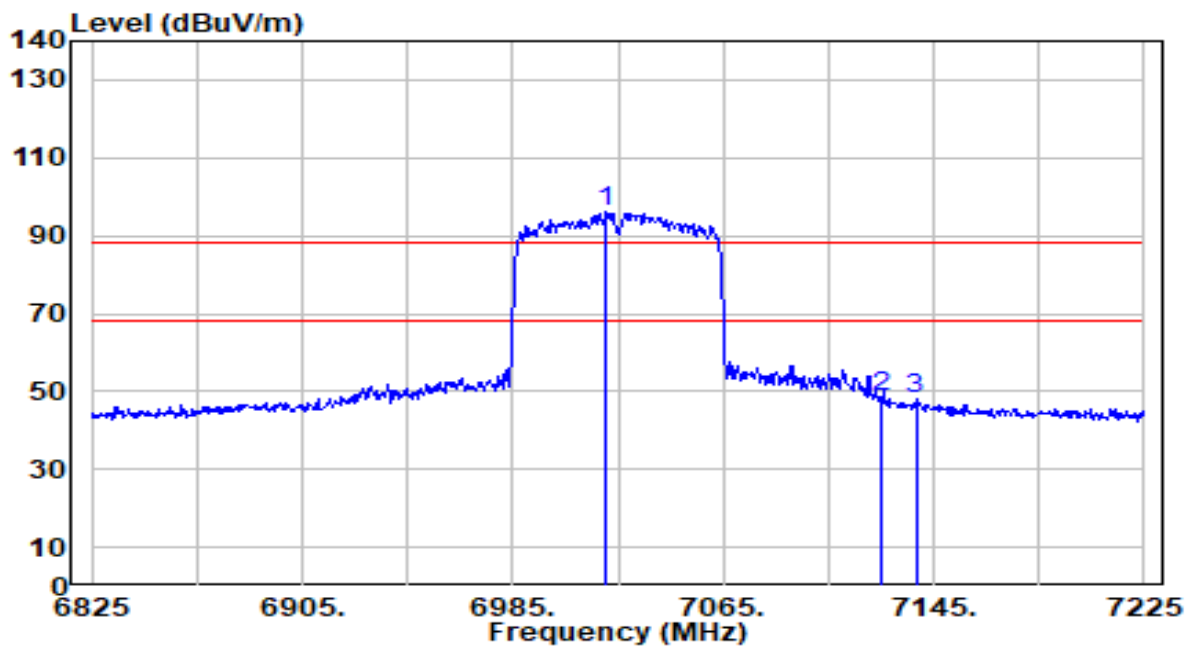

No	Frequency (MHz)	Reading (dBuV)	C.F (dB/m)	Measurement (dBuV/m)	Margin (dB)	Limit (dBuV/m)	Height (cm)	Angle (deg)	Remark (QP/PK/AV)
1	7020.600	92.14	3.85	95.99	N/A	N/A	300	0	Peak
2	* 7125.000	44.74	3.88	48.62	-39.58	88.20	300	0	Peak
3	7138.200	44.20	3.88	48.08	-40.12	88.20	300	0	Peak

Note:

1. " \*", means this data is the worst emission level.
2. C.F (Correction Factor) = Antenna Factor (dB/m)+ Cable Loss (dB) – Preamplifier(dB).
3. Measurement (dBuV/m) = Reading(dBuV) + C.F (Correction Factor).
4. The emission levels of other frequencies are very lower than the limit and not show in test report.

EUT	AXE3000 Wi-Fi 6E High Gain Wireless USB Adapter	Date of Test	2023-10-27
Factor	DRH18-E	Temp. / Humidity	21°C /61%
Polarity	Horizontal	Site / Test Engineer	AC2 / Marvin
Test Mode	802.11ax-80MHz_TX_Band8_CH 215_ANT 1+2	Test Voltage	By Notebook PC

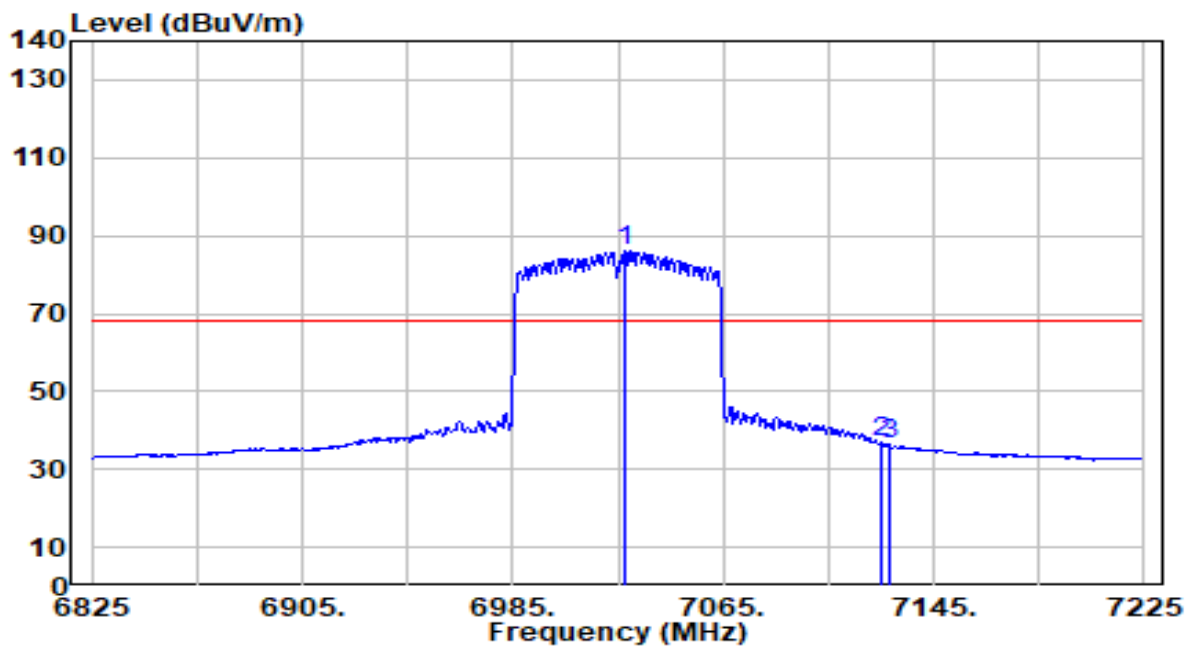

No	Frequency (MHz)	Reading (dBuV)	C.F (dB/m)	Measurement (dBuV/m)	Margin (dB)	Limit (dBuV/m)	Height (cm)	Angle (deg)	Remark (QP/PK/AV)
1	7027.800	82.19	3.86	86.04	N/A	N/A	300	0	Average
2	* 7125.000	33.02	3.88	36.90	-31.30	68.20	300	0	Average
3	7127.800	32.54	3.88	36.42	-31.78	68.20	300	0	Average

Note:

1. " \*", means this data is the worst emission level.
2. C.F (Correction Factor) = Antenna Factor (dB/m)+ Cable Loss (dB) – Preamplifier(dB).
3. Measurement (dBuV/m) = Reading(dBuV) + C.F (Correction Factor).
4. The emission levels of other frequencies are very lower than the limit and not show in test report.

EUT	AXE3000 Wi-Fi 6E High Gain Wireless USB Adapter	Date of Test	2023-10-27
Factor	DRH18-E	Temp. / Humidity	21°C /61%
Polarity	Vertical	Site / Test Engineer	AC2 / Marvin
Test Mode	802.11ax-80MHz_TX_Band8_CH 215_ANT 1+2	Test Voltage	By Notebook PC

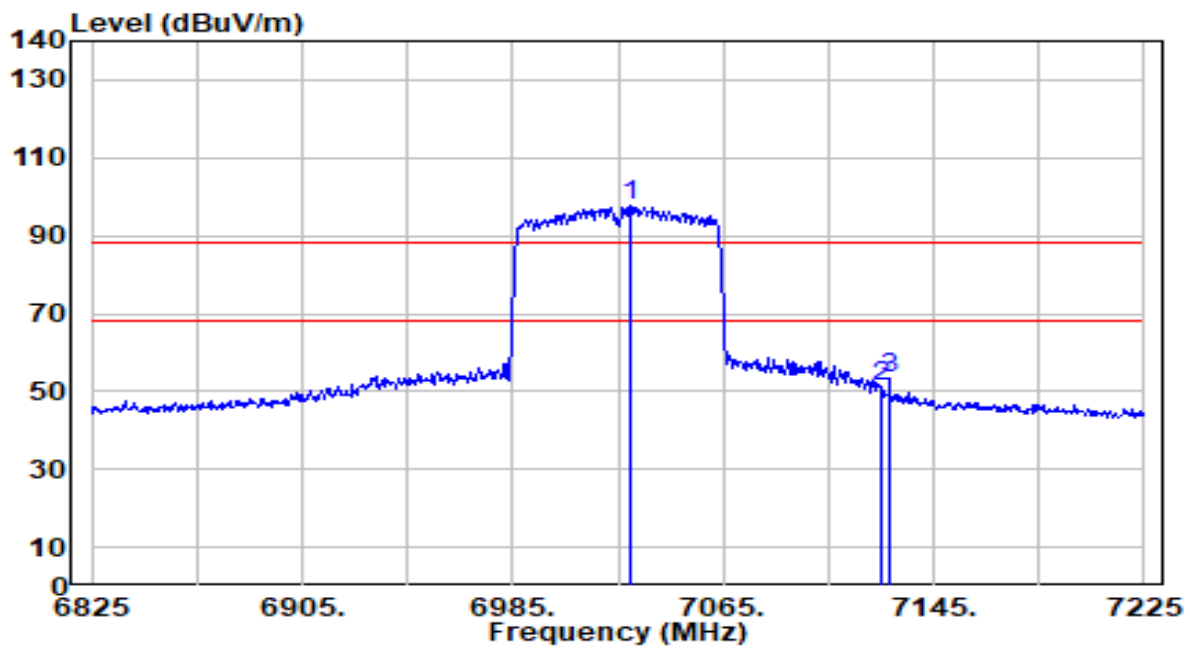

No	Frequency (MHz)	Reading (dBuV)	C.F (dB/m)	Measurement (dBuV/m)	Margin (dB)	Limit (dBuV/m)	Height (cm)	Angle (deg)	Remark (QP/PK/AV)
1	7029.800	93.70	3.86	97.56	N/A	N/A	300	267	Peak
2	7125.000	47.16	3.88	51.04	-37.16	88.20	300	267	Peak
3	* 7128.200	49.27	3.88	53.15	-35.05	88.20	300	267	Peak

Note:

1. " \*", means this data is the worst emission level.
2. C.F (Correction Factor) = Antenna Factor (dB/m)+ Cable Loss (dB) – Preamplifier(dB).
3. Measurement (dBuV/m) = Reading(dBuV) + C.F (Correction Factor).
4. The emission levels of other frequencies are very lower than the limit and not show in test report.



EUT	AXE3000 Wi-Fi 6E High Gain Wireless USB Adapter	Date of Test	2023-10-27
Factor	DRH18-E	Temp. / Humidity	21°C /61%
Polarity	Vertical	Site / Test Engineer	AC2 / Marvin
Test Mode	802.11ax-80MHz_TX_Band8_CH 215_ANT 1+2	Test Voltage	By Notebook PC

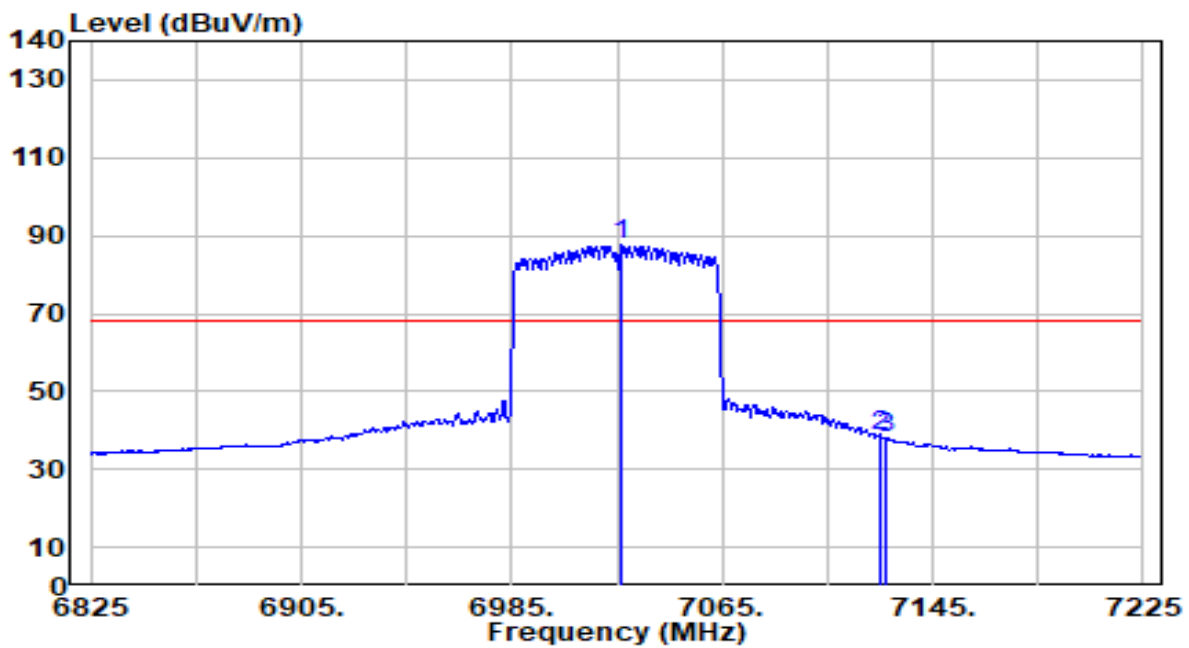

No	Frequency (MHz)	Reading (dBuV)	C.F (dB/m)	Measurement (dBuV/m)	Margin (dB)	Limit (dBuV/m)	Height (cm)	Angle (deg)	Remark (QP/PK/AV)
1	7027.000	83.82	3.86	87.68	N/A	N/A	300	267	Average
2	* 7125.000	34.80	3.88	38.68	-29.52	68.20	300	267	Average
3	7127.400	34.32	3.88	38.19	-30.01	68.20	300	267	Average

Note:

1. " \*", means this data is the worst emission level.
2. C.F (Correction Factor) = Antenna Factor (dB/m)+ Cable Loss (dB) – Preamplifier(dB).
3. Measurement (dBuV/m) = Reading(dBuV) + C.F (Correction Factor).
4. The emission levels of other frequencies are very lower than the limit and not show in test report.

## 6.10. AC Conducted Emissions

### 6.10.1. Test Limit

FCC Part 15.207 Limits		
Frequency (MHz)	QP (dBuV)	AV (dBuV)
0.15 - 0.50	66 - 56	56 - 46
0.50 - 5.0	56	46
5.0 - 30	60	50

Note 1: The lower limit shall apply at the transition frequencies.

Note 2: The limit decreases linearly with the logarithm of the frequency in the range 0.15MHz to 0.5MHz.

### 6.10.2. Test Setup

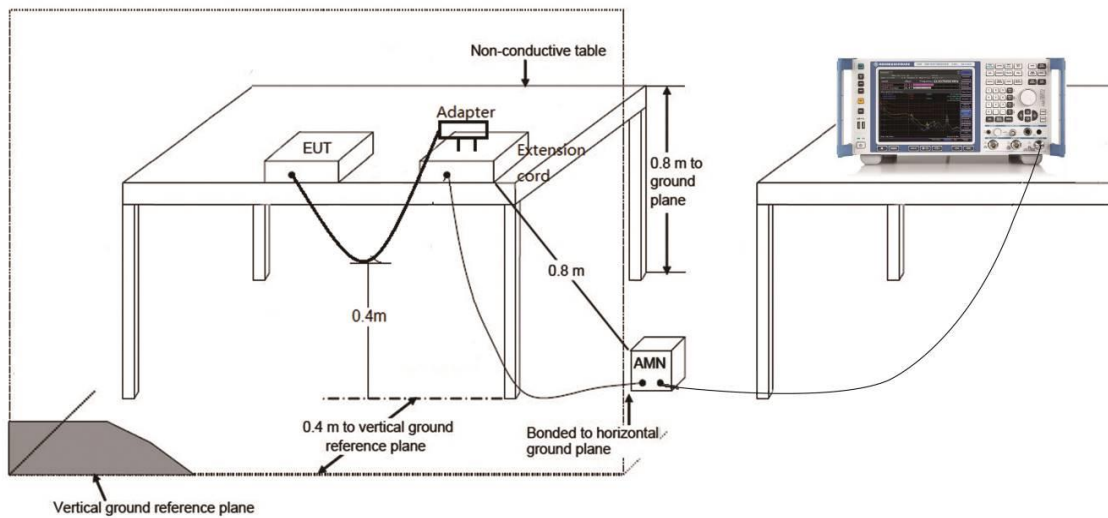

### 6.10.3. Test Result

EUT	AXE3000 Wi-Fi 6E High Gain Wireless USB Adapter	Date of Test	2023-11-10
Factor	CE_ENV216-L1 (Filter ON)	Temp. / Humidity	24.6°C /54%
Polarity	Line1	Site / Test Engineer	SR2 / Bob
Test Mode	802.11ax-HE20_Band5_TX_CH 1_ANT 1+2	Test Voltage	AC 120V/60Hz

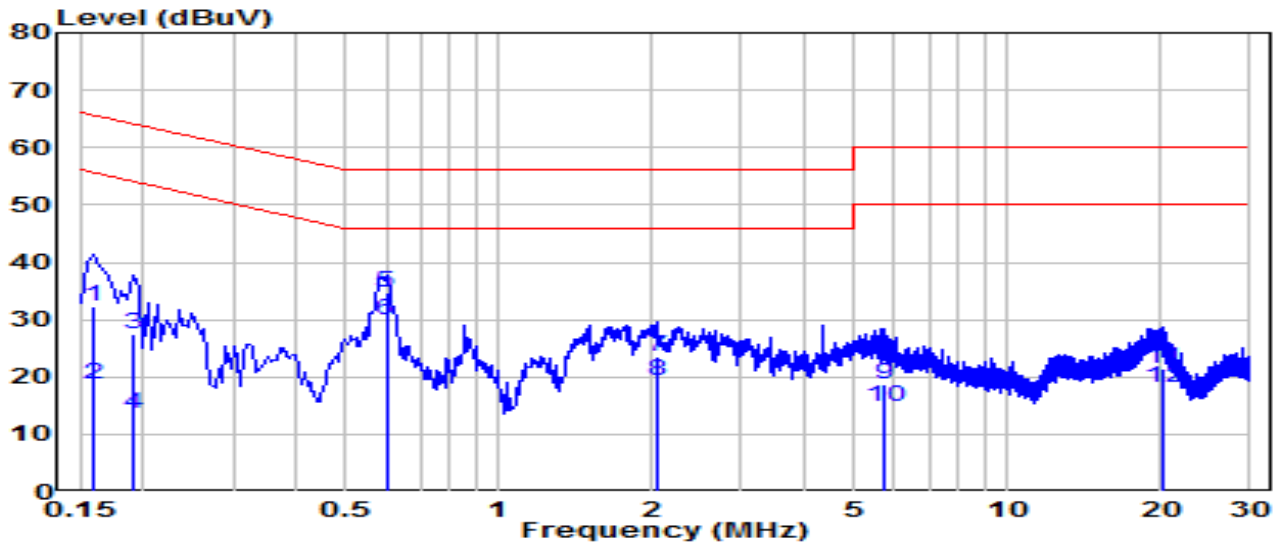

No	Frequency (MHz)	Reading (dBuV)	C.F (dB)	Measurement (dBuV)	Margin (dB)	Limit (dBuV)	Remark (QP/PK/AV)	
1	0.159	22.74	9.62	32.36	-33.16	65.52	QP	
2	0.159	9.17	9.62	18.79	-36.73	55.52	Average	
3	0.190	17.88	9.62	27.50	-36.51	64.01	QP	
4	0.190	3.99	9.62	13.62	-40.40	54.01	Average	
5	*	0.600	24.94	9.65	34.59	-21.41	56.00	QP
6	*	0.600	20.35	9.65	30.00	-16.00	46.00	Average
7	2.053	13.89	9.69	23.58	-32.42	56.00	QP	
8	2.053	9.68	9.69	19.37	-26.63	46.00	Average	
9	5.743	8.85	9.76	18.61	-41.39	60.00	QP	
10	5.743	4.90	9.76	14.66	-35.34	50.00	Average	
11	20.137	11.59	9.93	21.52	-38.48	60.00	QP	
12	20.137	8.08	9.93	18.01	-31.99	50.00	Average	

Note:

1. " \*", means this data is the worst emission level.
2. C.F (Correction Factor) = LISN Factor (dB)+ Cable Loss (dB).
3. Measurement (dBuV) = Reading(dBuV) + C.F (Correction Factor).

EUT	AXE3000 Wi-Fi 6E High Gain Wireless USB Adapter	Date of Test	2023-11-10
Factor	CE_ENV216-N (Filter ON)	Temp. / Humidity	24.6°C /54%
Polarity	Neutral	Site / Test Engineer	SR2 / Bob
Test Mode	802.11ax-HE20_Band5_TX_CH 1_ANT 1+2	Test Voltage	AC 120V/60Hz

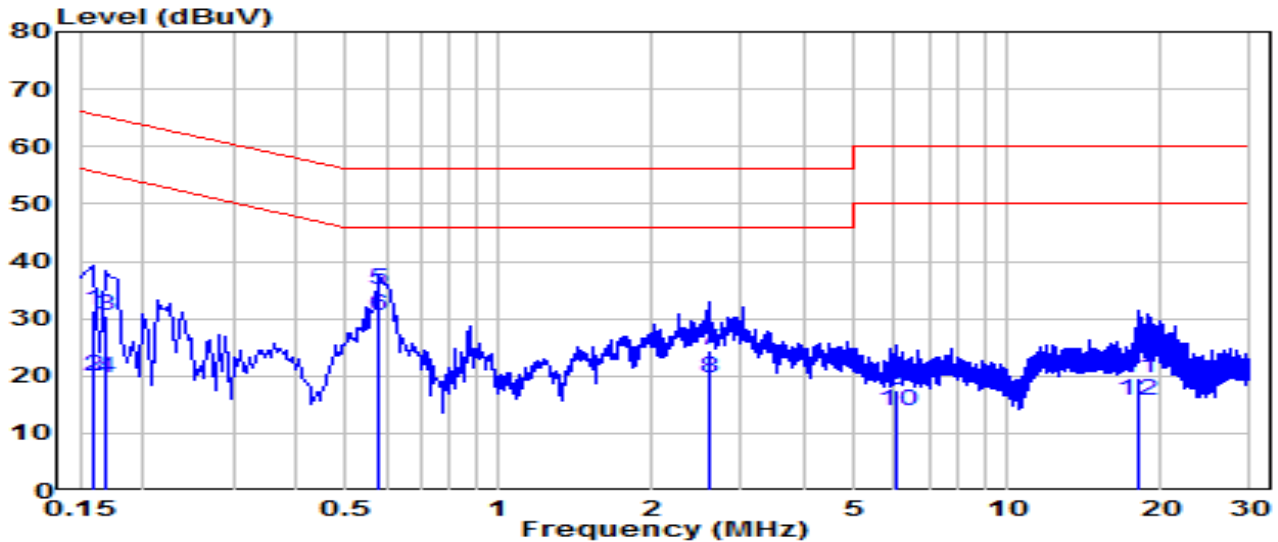

No	Frequency (MHz)	Reading (dBuV)	C.F (dB)	Measurement (dBuV)	Margin (dB)	Limit (dBuV)	Remark (QP/PK/AV)
1	0.159	21.86	9.62	31.48	-34.04	65.52	QP
2	0.159	10.35	9.62	19.97	-35.55	55.52	Average
3	0.168	20.78	9.62	30.40	-34.66	65.06	QP
4	0.168	10.03	9.62	19.65	-35.41	55.06	Average
5	* 0.582	25.32	9.65	34.97	-21.03	56.00	QP
6	* 0.582	20.96	9.65	30.61	-15.39	46.00	Average
7	2.593	14.73	9.70	24.43	-31.57	56.00	QP
8	2.593	9.93	9.70	19.64	-26.36	46.00	Average
9	6.049	7.79	9.77	17.56	-42.44	60.00	QP
10	6.049	4.25	9.77	14.03	-35.97	50.00	Average
11	18.000	9.61	9.97	19.58	-40.42	60.00	QP
12	18.000	5.75	9.97	15.73	-34.27	50.00	Average

Note:

1. " \*", means this data is the worst emission level.
2. C.F (Correction Factor) = LISN Factor (dB)+ Cable Loss (dB).
3. Measurement (dBuV) = Reading(dBuV) + C.F (Correction Factor).

EUT	AXE3000 Wi-Fi 6E High Gain Wireless USB Adapter	Date of Test	2023-11-10
Factor	CE_ENV216-L1 (Filter ON)	Temp. / Humidity	24.6°C /54%
Polarity	Line1	Site / Test Engineer	SR2 / Bob
Test Mode	802.11ax-HE20_Band5_TX_CH 1_ANT 1+2	Test Voltage	AC 240V/60Hz

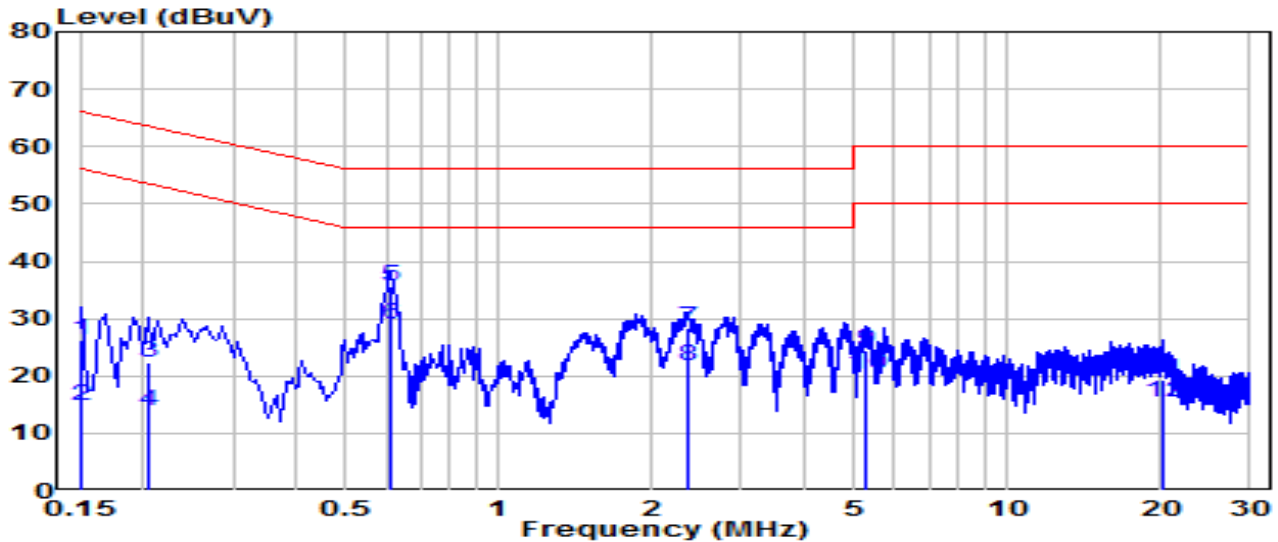

No	Frequency (MHz)	Reading (dBuV)	C.F (dB)	Measurement (dBuV)	Margin (dB)	Limit (dBuV)	Remark (QP/PK/AV)
1	0.150	16.69	9.62	26.31	-39.69	66.00	QP
2	0.150	5.19	9.62	14.81	-41.19	56.00	Average
3	0.204	12.70	9.62	22.32	-41.13	63.45	QP
4	0.204	4.41	9.62	14.03	-39.41	53.45	Average
5	* 0.609	25.87	9.65	35.52	-20.48	56.00	QP
6	* 0.609	19.19	9.65	28.84	-17.16	46.00	Average
7	2.355	18.63	9.70	28.33	-27.67	56.00	QP
8	2.355	12.04	9.70	21.74	-24.26	46.00	Average
9	5.243	14.82	9.75	24.57	-35.43	60.00	QP
10	5.243	10.42	9.75	20.17	-29.83	50.00	Average
11	20.186	9.28	9.93	19.21	-40.79	60.00	QP
12	20.186	5.60	9.93	15.53	-34.47	50.00	Average

Note:

1. " \*", means this data is the worst emission level.
2. C.F (Correction Factor) = LISN Factor (dB)+ Cable Loss (dB).
3. Measurement (dBuV) = Reading(dBuV) + C.F (Correction Factor).

EUT	AXE3000 Wi-Fi 6E High Gain Wireless USB Adapter	Date of Test	2023-11-10
Factor	CE_ENV216-N (Filter ON)	Temp. / Humidity	24.6°C /54%
Polarity	Neutral	Site / Test Engineer	SR2 / Bob
Test Mode	802.11ax-HE20_Band5_TX_CH 1_ANT 1+2	Test Voltage	AC 240V/60Hz

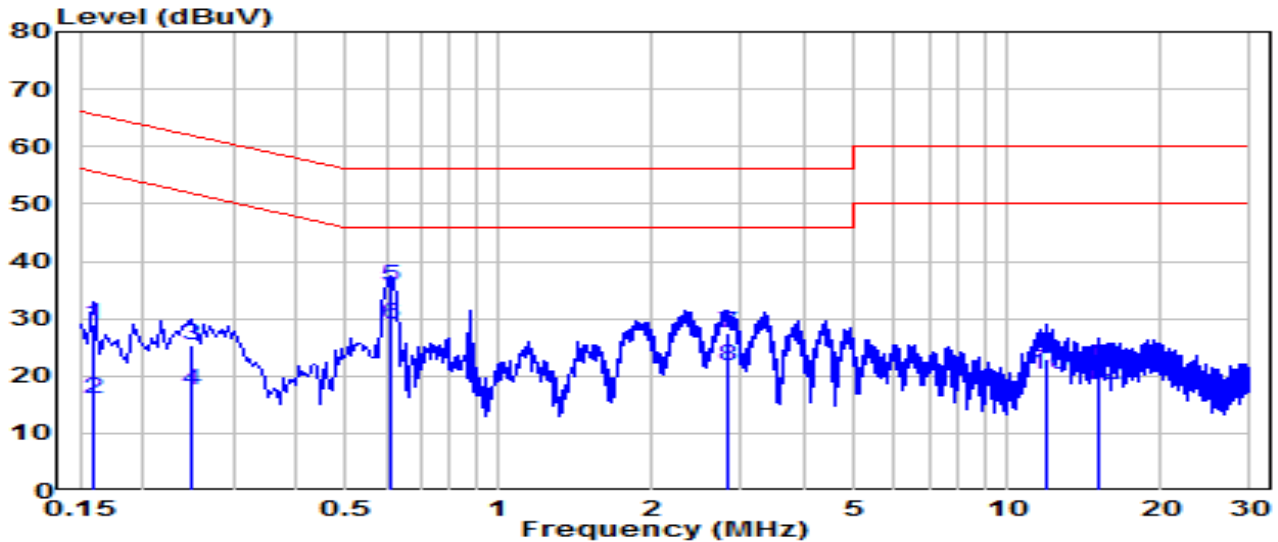

No	Frequency (MHz)	Reading (dBuV)	C.F (dB)	Measurement (dBuV)	Margin (dB)	Limit (dBuV)	Remark (QP/PK/AV)
1	0.159	19.27	9.62	28.89	-36.62	65.52	QP
2	0.159	6.32	9.62	15.95	-39.57	55.52	Average
3	0.249	15.79	9.63	25.41	-36.38	61.79	QP
4	0.249	7.90	9.63	17.52	-34.27	51.79	Average
5	* 0.609	26.05	9.65	35.70	-20.30	56.00	QP
6	* 0.609	19.28	9.65	28.93	-17.07	46.00	Average
7	2.814	17.89	9.71	27.59	-28.41	56.00	QP
8	2.814	11.90	9.71	21.60	-24.40	46.00	Average
9	11.880	13.09	9.89	22.98	-37.02	60.00	QP
10	11.880	10.38	9.89	20.27	-29.73	50.00	Average
11	15.210	11.87	9.93	21.80	-38.20	60.00	QP
12	15.210	8.41	9.93	18.34	-31.66	50.00	Average

Note:

1. " \*", means this data is the worst emission level.
2. C.F (Correction Factor) = LISN Factor (dB)+ Cable Loss (dB).
3. Measurement (dBuV) = Reading(dBuV) + C.F (Correction Factor).

## 7. Conclusion

The data collected relate only the item(s) tested and show that the device is in compliance with Part 15E of the FCC rules.

### **Appendix A : Test Setup Photograph**

Refer to "2307TW0113-UT" file.

### **Appendix B : External Photograph**

Refer to "2307TW0113-UE" file.

### **Appendix C : Internal Photograph**

Refer to "2307TW0113-UI" file.

————— The End —————