

## 802.11ax-HE40 Power Spectral Density - Ant 2

Channel 38 (5190MHz)

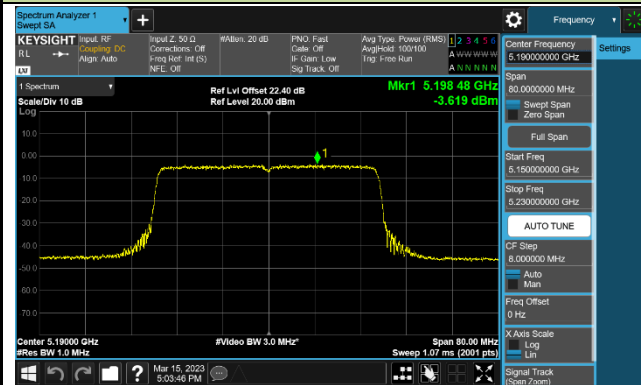

Channel 46 (5230MHz)

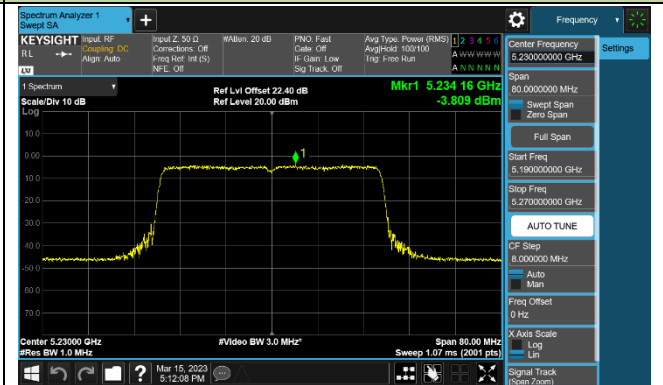

Channel 54 (5270MHz)

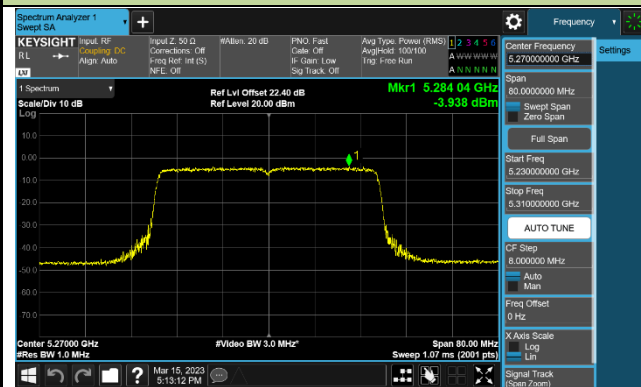

Channel 62 (5310MHz)

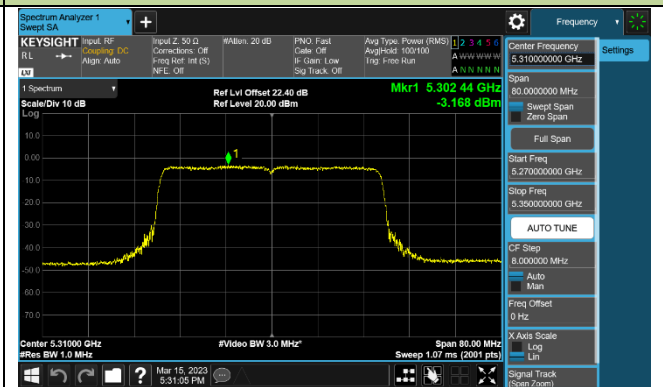

Channel 102 (5510MHz)

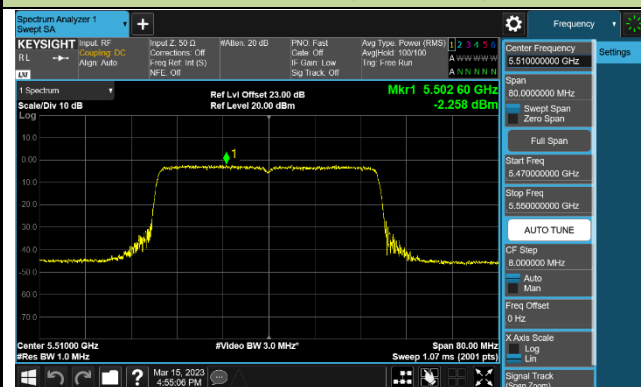

Channel 110 (5550MHz)

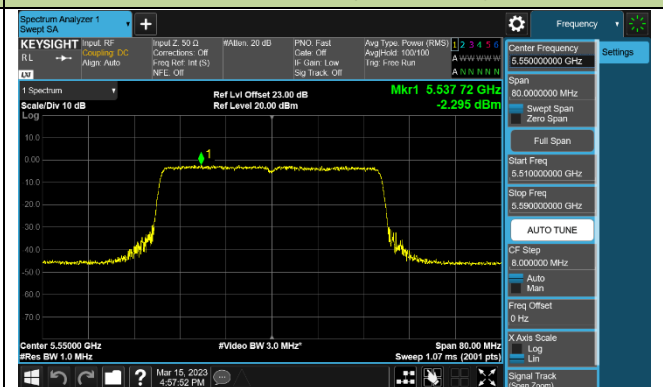

Channel 134 (5670MHz)

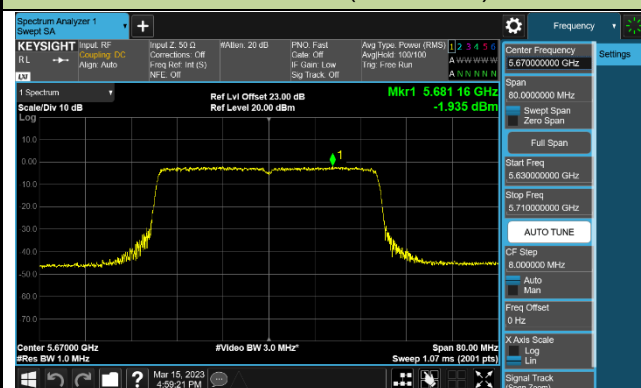

Channel 142 (5710MHz)

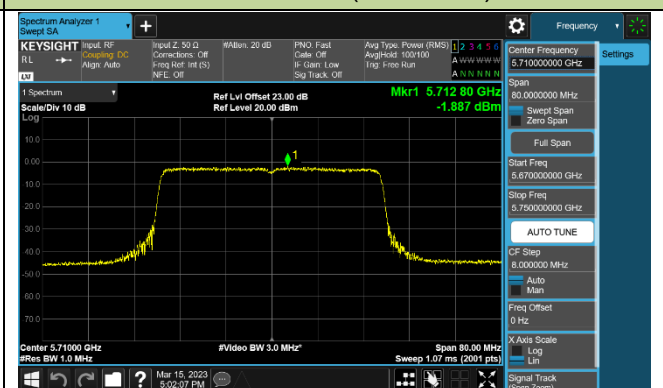



### 802.11ax-HE80 Power Spectral Density - Ant 2

Channel 42 (5210MHz)

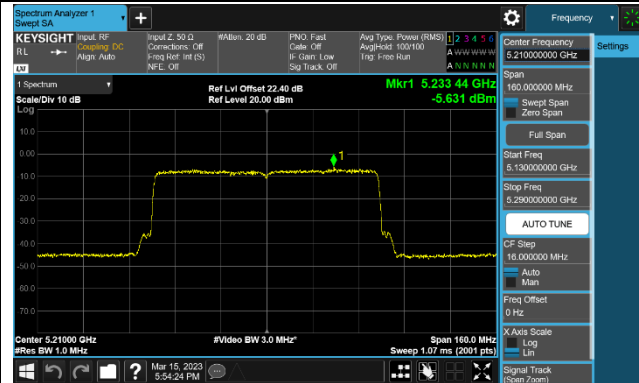

Channel 58 (5290MHz)

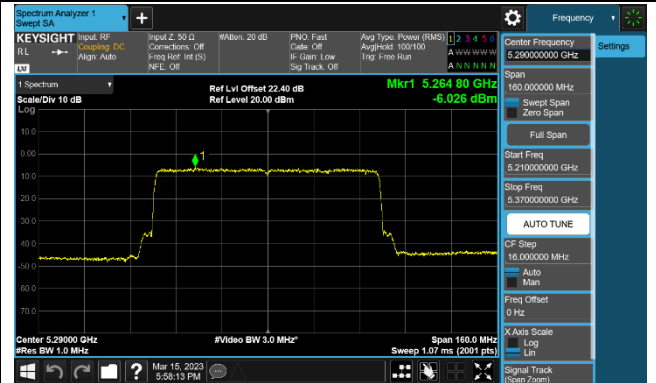

Channel 106 (5530MHz)



Channel 122 (5610MHz)

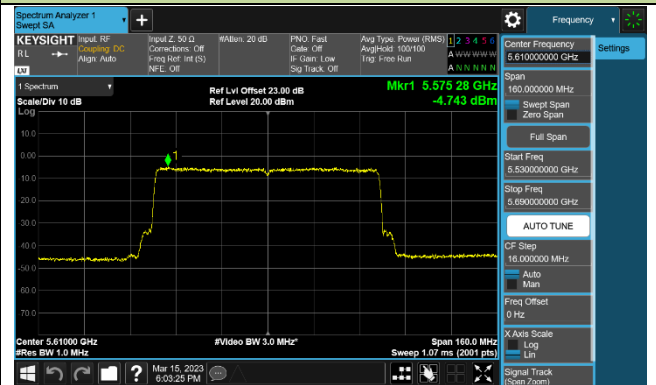

Channel 138 (5690MHz)

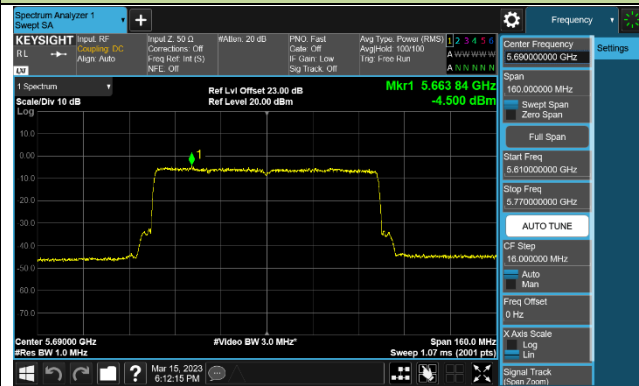

Channel 155 (5775MHz)

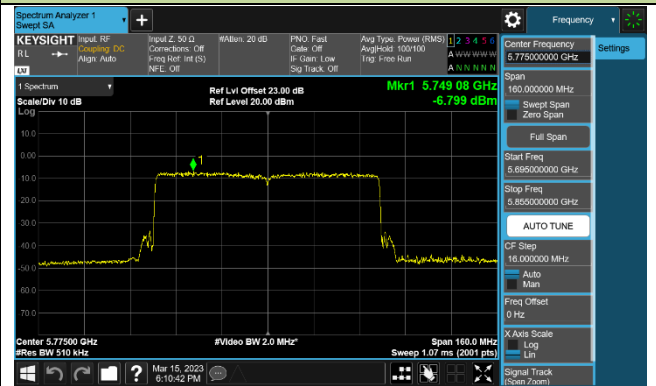

### 802.11ax-HE160 Power Spectral Density - Ant 2

Channel 50 (5250MHz)

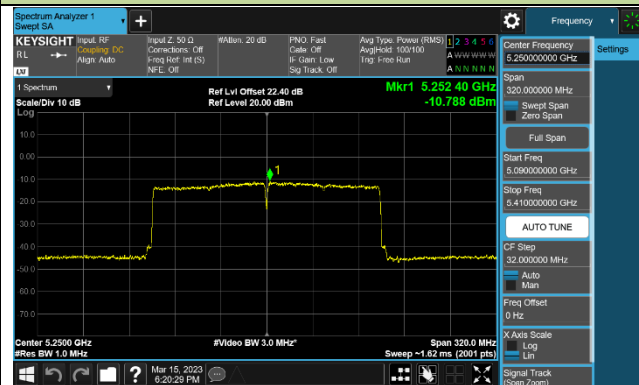

Channel 114 (5570MHz)

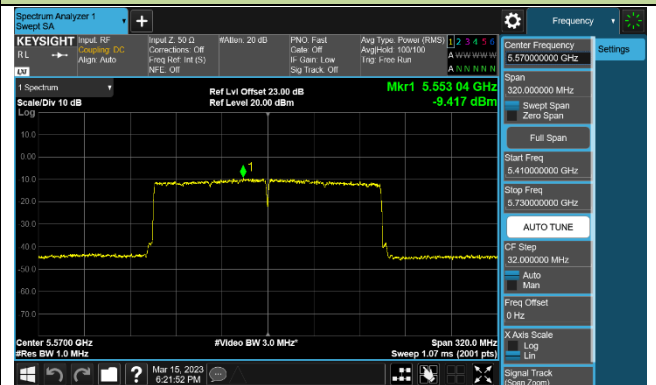

## 7.7. Frequency Stability Measurement

### 7.7.1. Test Limit

Manufactures of U-NII devices are responsible for ensuring frequency stability such that an emission is maintained within the band of operation under all conditions of normal operation as specified in the user's manual.

The transmitter center frequency tolerance shall be  $\pm 20$  ppm maximum for the 5GHz band (IEEE 802.11 specification).

### 7.7.2. Test Limit

#### **Frequency Stability Under Temperature Variations:**

The equipment under test was connected to an external AC or DC power supply and input rated voltage. RF output was connected to a frequency counter or spectrum analyzer via feed through attenuators. The EUT was placed inside the temperature chamber. Set the spectrum analyzer RBW low enough to obtain the desired frequency resolution and measure EUT 20°C operating frequency as reference frequency. Turn EUT off and set the chamber temperature to highest. After the temperature stabilized for approximately 30 minutes recorded the frequency. Repeat step measure with 10°C decreased per stage until the lowest temperature reached.

#### **Frequency Stability Under Voltage Variations:**

Set chamber temperature to 20°C. Use a variable AC power supply / DC power source to power the EUT and set the voltage to rated voltage. Set the spectrum analyzer RBW low enough to obtain the desired frequency resolution and recorded the frequency.

Reduce the input voltage to specify extreme voltage variation ( $\pm 15\%$ ) and endpoint, record the maximum frequency change.

### 7.7.3. Test Setup

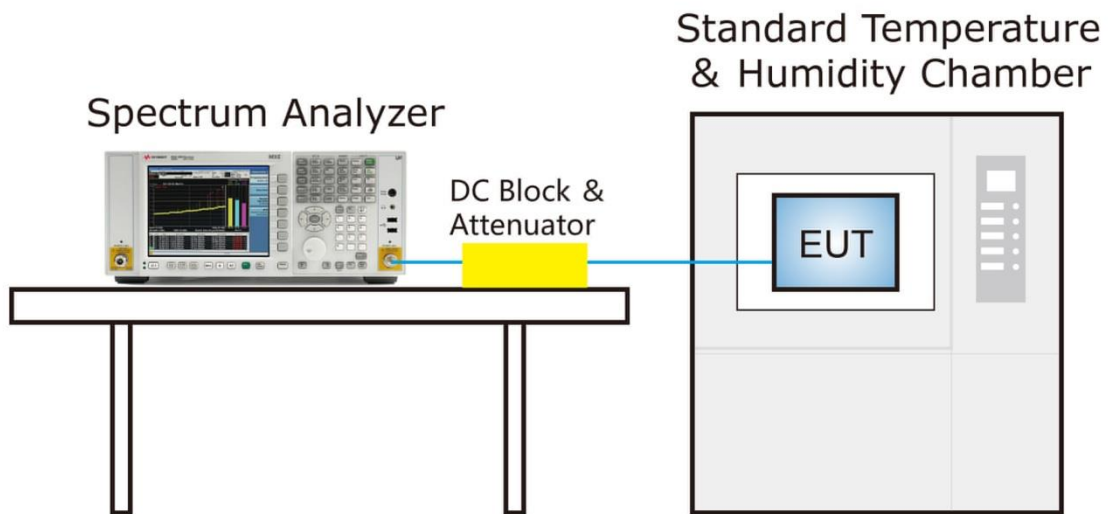

### 7.7.4. Test Result

Grantee ensure that the product meets e-CFR Title 47 section 15.407(g) and KDB 789033 D02v02r01 frequency stability such that the emissions are maintained within the band of operation under all conditions of normal operation as specified in the user's manual.

## 7.8. Radiated Spurious Emission Measurement

### 7.8.1. Test Limit

All out of band emissions appearing in a restricted band as specified in Section 15.205 of the Title 47CFR must not exceed the limits shown in Table per Section 15.209.

FCC Part 15 Subpart C Paragraph 15.209		
Frequency [MHz]	Field Strength [uV/m]	Measured Distance [Meters]
0.009 - 0.490	2400/F (kHz)	300
0.490 - 1.705	24000/F (kHz)	30
1.705 - 30	30	30
30 - 88	100	3
88 - 216	150	3
216 - 960	200	3
Above 960	500	3

### 7.8.2. Test Procedure Used

KDB 789033 D02v02r01- Section G

### 7.8.3. Test Setting

Table 1 - RBW as a function of frequency

Frequency	RBW
9 ~ 150 kHz	200 ~ 300 Hz
0.15 ~ 30 MHz	9 ~ 10 kHz
30 ~ 1000 MHz	100 ~ 120 kHz
>1000 MHz	1 MHz

**Quasi-Peak Measurements below 1GHz**

1. Analyzer center frequency was set to the frequency of the radiated spurious emission of interest
2. Span was set greater than 1MHz
3. RBW = as specified in Table 1
4. Detector = CISPR quasi-peak
5. Sweep time = auto couple
6. Trace was allowed to stabilize

**Peak Measurements above 1GHz**

1. Analyzer center frequency was set to the frequency of the radiated spurious emission of interest
2. RBW = 1MHz
3. VBW = 3MHz
4. Detector = peak
5. Sweep time = auto couple
6. Trace mode = max hold
7. Trace was allowed to stabilize

**Average Measurements above 1GHz (Method VB)**

1. Analyzer center frequency was set to the frequency of the radiated spurious emission of interest
2. RBW = 1MHz
3. VBW; If the EUT is configured to transmit with duty cycle  $\geq 98\%$ , set VBW = 10 Hz.  
If the EUT duty cycle is  $< 98\%$ , set VBW  $\geq 1/T$ . T is the minimum transmission duration.
4. Detector = Peak
5. Sweep time = auto
6. Trace mode = max hold
7. Trace was allowed to stabilize

### 7.8.4. Test Setup

Below 1GHz Test Setup:

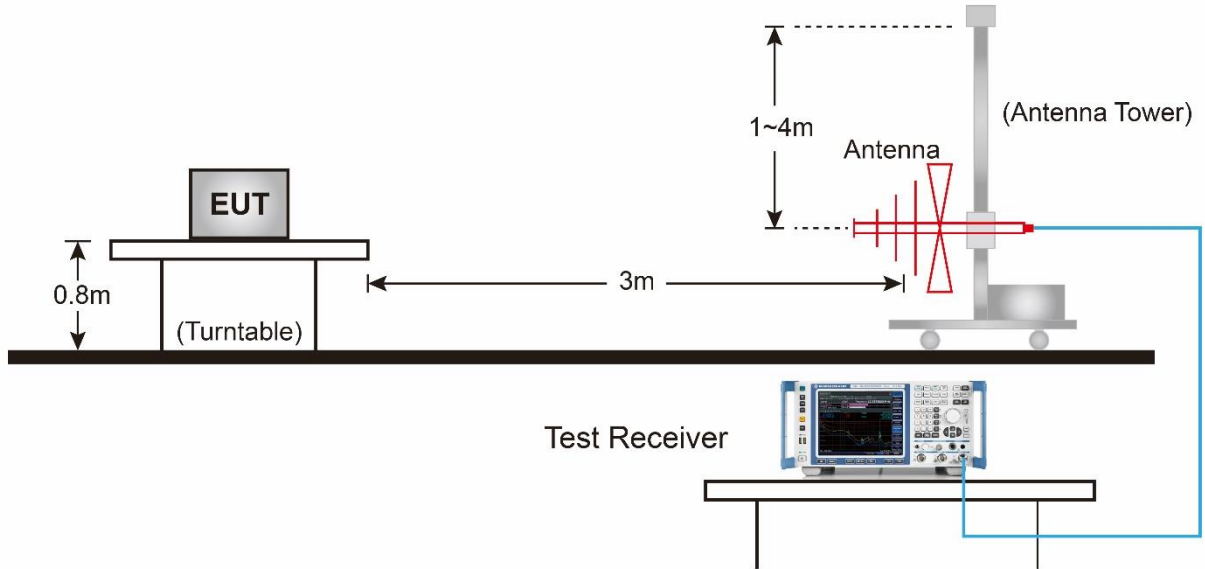

Above 1GHz Test Setup:

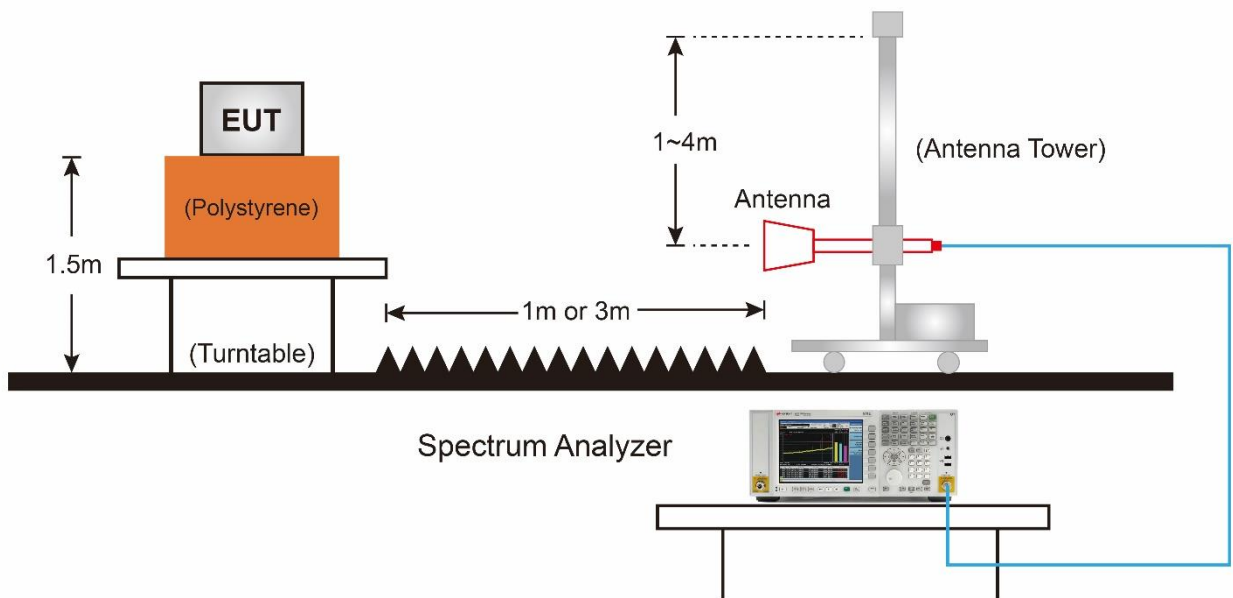



### 7.8.5. Test Result

EUT	AX3000 High Gain Wireless USB Adapter	Date of Test	2023-01-16
Factor	VULB 9162	Temp. / Humidity	20°C /62%
Polarity	Horizontal	Site / Test Engineer	AC2 / Xuan
Test Mode	802.11ac-20MHz_TX_Band1_CH 44_ANT 1+2	Test Voltage	By Notebook PC

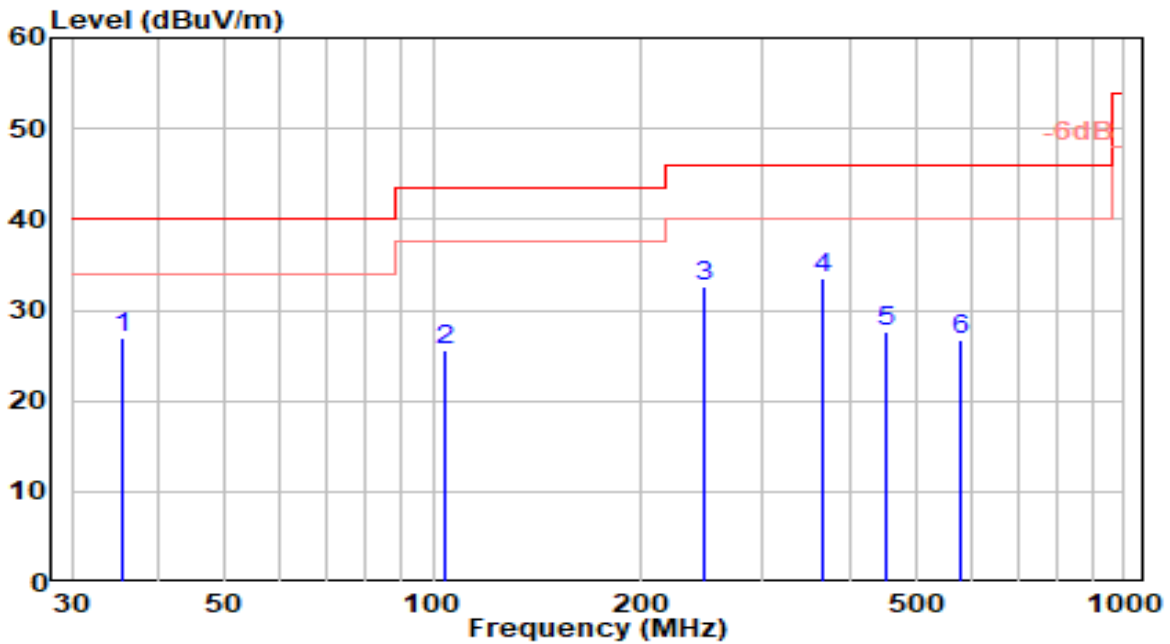

No	Frequency (MHz)	Reading (dBuV)	C.F (dB/m)	Measurement (dBuV/m)	Margin (dB)	Limit (dBuV/m)	Height (cm)	Angle (deg)	Remark (QP/PK/AV)
1	35.570	9.22	17.75	26.97	-13.03	40.00	100	239	QP
2	103.640	7.33	18.29	25.62	-17.88	43.50	150	285	QP
3	247.410	12.78	19.76	32.54	-13.46	46.00	150	322	QP
4	* 365.600	10.87	22.56	33.44	-12.56	46.00	100	61	QP
5	451.340	4.04	23.58	27.63	-18.37	46.00	100	175	QP
6	578.650	0.41	26.32	26.73	-19.27	46.00	150	240	QP

Note:

1. " \*", means this data is the worst emission level.
2. C.F (Correction Factor) = Antenna Factor (dB/m) + Cable Loss (dB).
3. Measurement (dBuV/m) = Reading(dBuV) + C.F (Correction Factor).
4. The emission levels of other frequencies are very lower than the limit and not show in test report.

EUT	AX3000 High Gain Wireless USB Adapter	Date of Test	2023-01-16
Factor	VULB 9162	Temp. / Humidity	20°C /62%
Polarity	Vertical	Site / Test Engineer	AC2 / Xuan
Test Mode	802.11ac-20MHz_TX_Band1_CH 44_ANT 1+2	Test Voltage	By Notebook PC

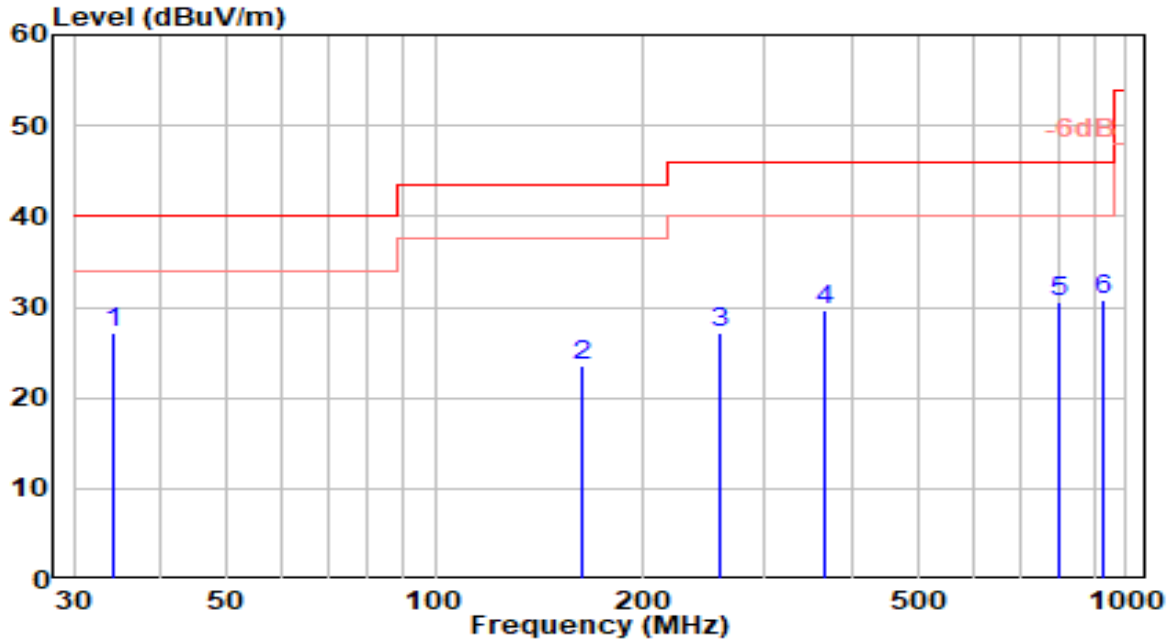

No	Frequency (MHz)	Reading (dBuV)	C.F (dB/m)	Measurement (dBuV/m)	Margin (dB)	Limit (dBuV/m)	Height (cm)	Angle (deg)	Remark (QP/PK/AV)	
1	*	34.240	9.83	17.39	27.22	-12.78	40.00	200	199	QP
2		162.850	8.07	15.56	23.63	-19.87	43.50	100	14	QP
3		257.530	7.16	19.96	27.12	-18.88	46.00	150	313	QP
4		367.550	7.01	22.59	29.60	-16.40	46.00	200	347	QP
5		801.330	1.30	29.31	30.61	-15.39	46.00	150	217	QP
6		923.670	-0.27	30.98	30.71	-15.29	46.00	150	44	QP

Note:

1. " \*", means this data is the worst emission level.
2. C.F (Correction Factor) = Antenna Factor (dB/m) + Cable Loss (dB).
3. Measurement (dBuV/m) = Reading(dBuV) + C.F (Correction Factor).
4. The emission levels of other frequencies are very lower than the limit and not show in test report.

EUT	AX3000 High Gain Wireless USB Adapter	Date of Test	2023-01-19
-----	---------------------------------------	--------------	------------

Factor	DRH18-E	Temp. / Humidity	20°C /62%
Polarity	Horizontal	Site / Test Engineer	AC2 / Ares
Test Mode	802.11a_TX_Band1_CH 36_ANT 1+2	Test Voltage	By Notebook PC

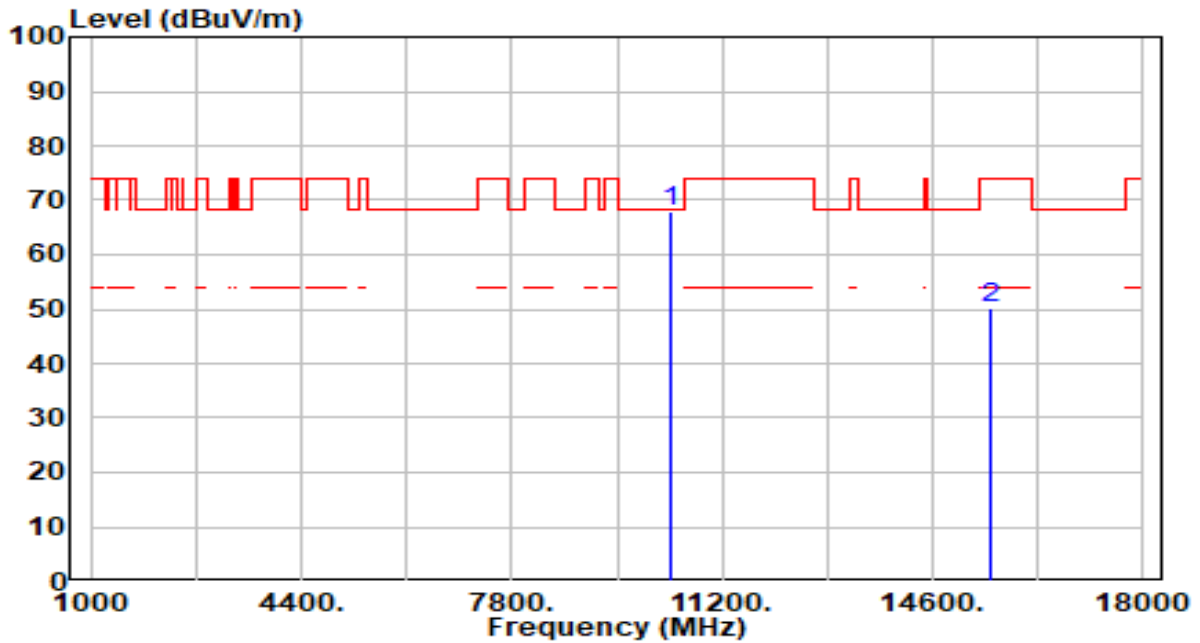

No	Frequency (MHz)	Reading (dBuV)	C.F (dB/m)	Measurement (dBuV/m)	Margin (dB)	Limit (dBuV/m)	Height (cm)	Angle (deg)	Remark (QP/PK/AV)
1	* 10360.000	64.82	3.19	68.01	-0.19	68.20	201	251	Peak
2	15540.000	45.42	4.74	50.16	-23.84	74.00	200	217	Peak

Note:

1. " \*", means this data is the worst emission level.
2. C.F (Correction Factor) = Antenna Factor (dB/m) + Cable Loss (dB) – Pre-amplifier(dB).
3. Measurement (dBuV/m) = Reading(dBuV) + C.F (Correction Factor).
4. The emission levels of other frequencies are very lower than the limit and not show in test report.

EUT	AX3000 High Gain Wireless USB Adapter	Date of Test	2023-01-19
Factor	DRH18-E	Temp. / Humidity	20°C /62%
Polarity	Vertical	Site / Test Engineer	AC2 / Ares
Test Mode	802.11a_TX_Band1_CH 36_ANT 1+2	Test Voltage	By Notebook PC

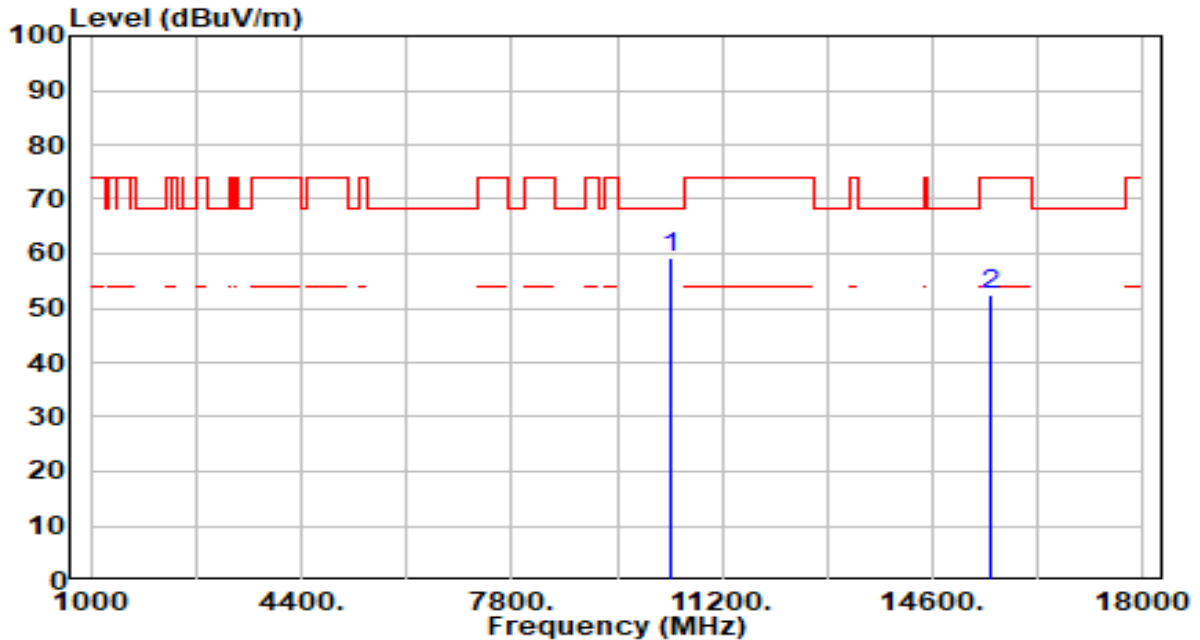

No	Frequency (MHz)	Reading (dBuV)	C.F (dB/m)	Measurement (dBuV/m)	Margin (dB)	Limit (dBuV/m)	Height (cm)	Angle (deg)	Remark (QP/PK/AV)
1	* 10360.000	55.97	3.19	59.16	-9.04	68.20	200	312	Peak
2	15540.000	47.62	4.74	52.37	-21.63	74.00	200	360	Peak

Note:

1. " \*", means this data is the worst emission level.
2. C.F (Correction Factor) = Antenna Factor (dB/m) + Cable Loss (dB) – Pre-amplifier(dB).
3. Measurement (dBuV/m) = Reading(dBuV) + C.F (Correction Factor).
4. The emission levels of other frequencies are very lower than the limit and not show in test report.

EUT	AX3000 High Gain Wireless USB Adapter	Date of Test	2023-01-19
Factor	DRH18-E	Temp. / Humidity	20°C /62%
Polarity	Horizontal	Site / Test Engineer	AC2 / Ares
Test Mode	802.11a_TX_Band1_CH 44_ANT 1+2	Test Voltage	By Notebook PC

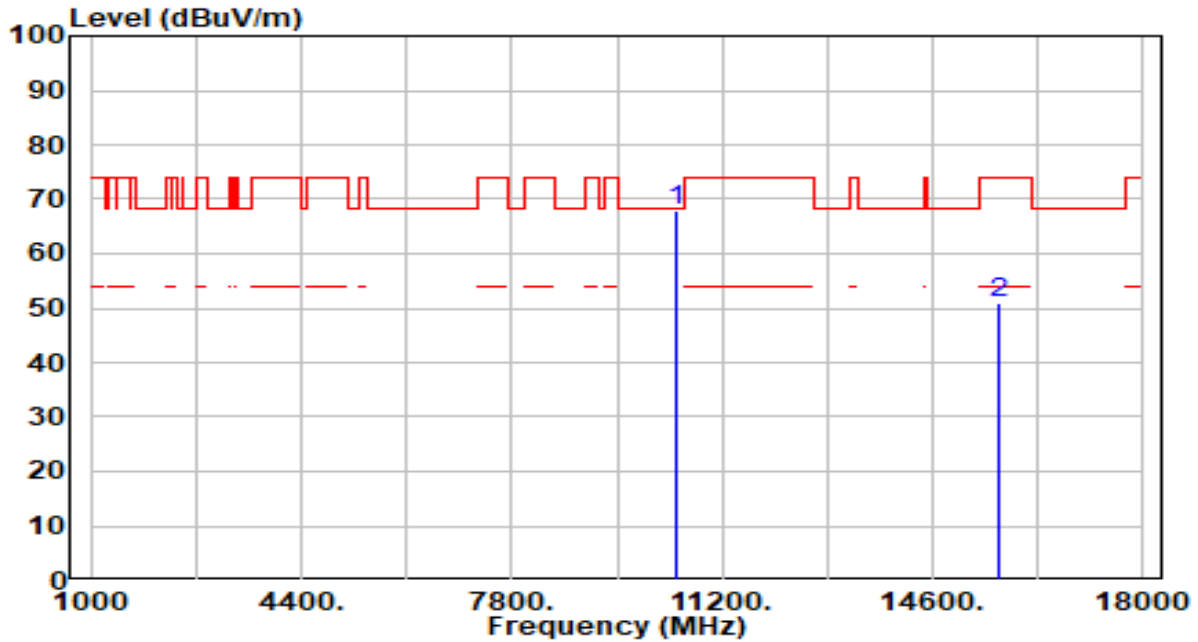

No	Frequency (MHz)	Reading (dBuV)	C.F (dB/m)	Measurement (dBuV/m)	Margin (dB)	Limit (dBuV/m)	Height (cm)	Angle (deg)	Remark (QP/PK/AV)
1	* 10440.000	64.90	3.15	68.05	-0.15	68.20	200	254	Peak
2	15660.000	45.88	4.89	50.77	-23.23	74.00	200	293	Peak

Note:

1. " \*", means this data is the worst emission level.
2. C.F (Correction Factor) = Antenna Factor (dB/m) + Cable Loss (dB) – Pre-amplifier(dB).
3. Measurement (dBuV/m) = Reading(dBuV) + C.F (Correction Factor).
4. The emission levels of other frequencies are very lower than the limit and not show in test report.

EUT	AX3000 High Gain Wireless USB Adapter	Date of Test	2023-01-19
Factor	DRH18-E	Temp. / Humidity	20°C /62%
Polarity	Vertical	Site / Test Engineer	AC2 / Ares
Test Mode	802.11a_TX_Band1_CH 44_ANT 1+2	Test Voltage	By Notebook PC

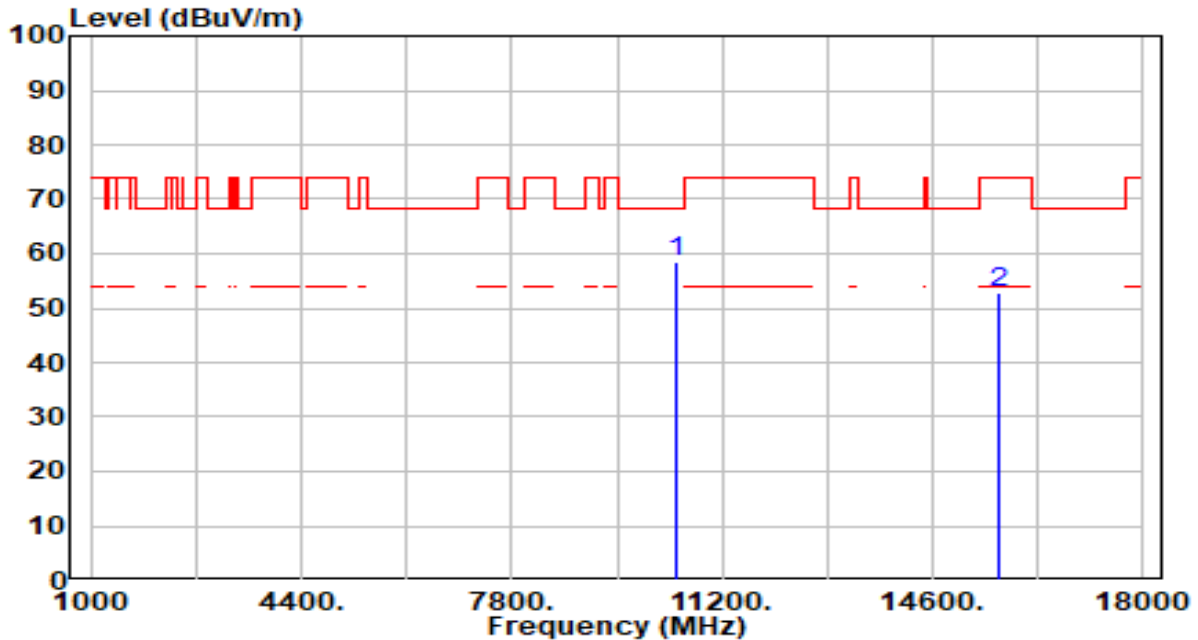

No	Frequency (MHz)	Reading (dBuV)	C.F (dB/m)	Measurement (dBuV/m)	Margin (dB)	Limit (dBuV/m)	Height (cm)	Angle (deg)	Remark (QP/PK/AV)
1	* 10440.000	55.40	3.15	58.55	-9.65	68.20	200	327	Peak
2	15660.000	48.02	4.89	52.91	-21.09	74.00	200	360	Peak

Note:

1. " \*", means this data is the worst emission level.
2. C.F (Correction Factor) = Antenna Factor (dB/m) + Cable Loss (dB) – Pre-amplifier(dB).
3. Measurement (dBuV/m) = Reading(dBuV) + C.F (Correction Factor).
4. The emission levels of other frequencies are very lower than the limit and not show in test report.

EUT	AX3000 High Gain Wireless USB Adapter	Date of Test	2023-01-19
Factor	DRH18-E	Temp. / Humidity	20°C /62%
Polarity	Horizontal	Site / Test Engineer	AC2 / Ares
Test Mode	802.11a_TX_Band1_CH 48_ANT 1+2	Test Voltage	By Notebook PC

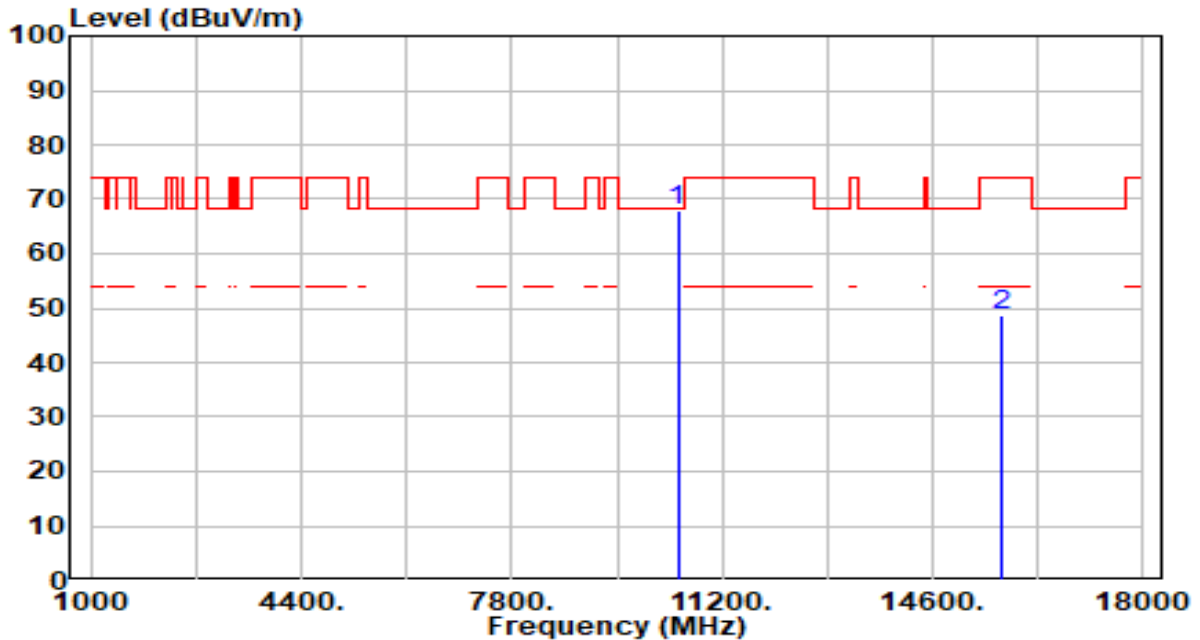

No	Frequency (MHz)	Reading (dBuV)	C.F (dB/m)	Measurement (dBuV/m)	Margin (dB)	Limit (dBuV/m)	Height (cm)	Angle (deg)	Remark (QP/PK/AV)
1	*	64.94	3.11	68.05	-0.15	68.20	200	255	Peak
2		43.77	5.02	48.79	-25.21	74.00	200	300	Peak

Note:

1. " \*", means this data is the worst emission level.
2. C.F (Correction Factor) = Antenna Factor (dB/m) + Cable Loss (dB) – Pre-amplifier(dB).
3. Measurement (dBuV/m) = Reading(dBuV) + C.F (Correction Factor).
4. The emission levels of other frequencies are very lower than the limit and not show in test report.

EUT	AX3000 High Gain Wireless USB Adapter	Date of Test	2023-01-19
Factor	DRH18-E	Temp. / Humidity	20°C /62%
Polarity	Vertical	Site / Test Engineer	AC2 / Ares
Test Mode	802.11a_TX_Band1_CH 48_ANT 1+2	Test Voltage	By Notebook PC

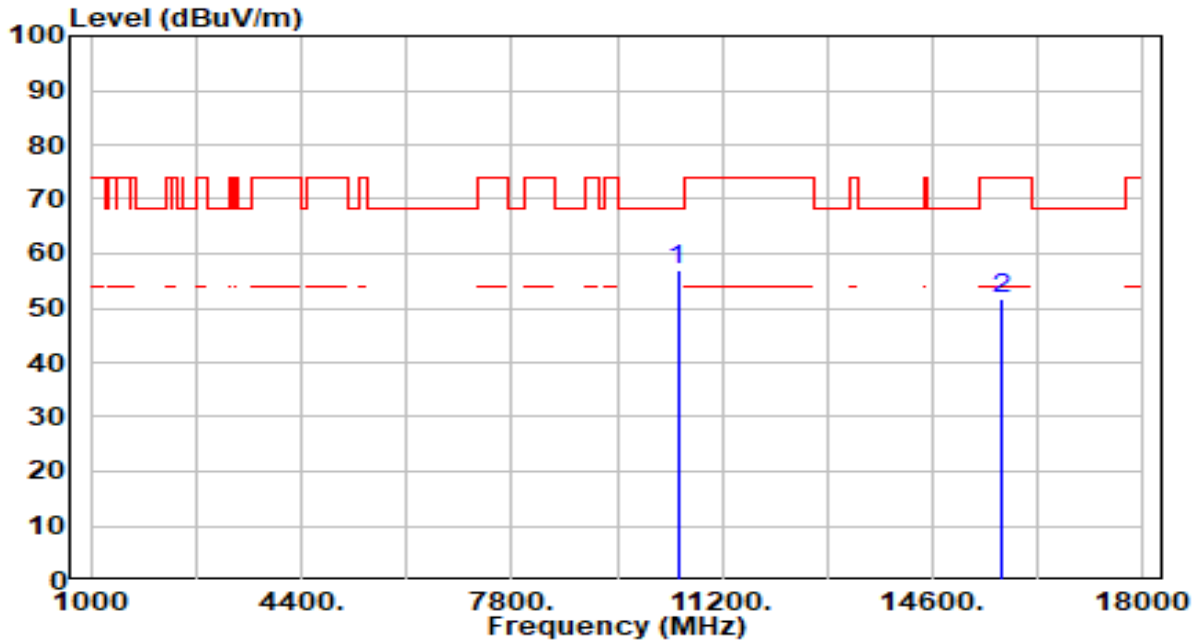

No	Frequency (MHz)	Reading (dBuV)	C.F (dB/m)	Measurement (dBuV/m)	Margin (dB)	Limit (dBuV/m)	Height (cm)	Angle (deg)	Remark (QP/PK/AV)
1	* 10480.000	53.73	3.11	56.84	-11.36	68.20	200	67	Peak
2	15720.000	46.80	5.02	51.82	-22.18	74.00	200	334	Peak

Note:

1. " \*", means this data is the worst emission level.
2. C.F (Correction Factor) = Antenna Factor (dB/m) + Cable Loss (dB) – Pre-amplifier(dB).
3. Measurement (dBuV/m) = Reading(dBuV) + C.F (Correction Factor).
4. The emission levels of other frequencies are very lower than the limit and not show in test report.



EUT	AX3000 High Gain Wireless USB Adapter	Date of Test	2023-01-19
Factor	DRH18-E	Temp. / Humidity	20°C /62%
Polarity	Horizontal	Site / Test Engineer	AC2 / Ares
Test Mode	802.11a_TX_Band2_CH 52_ANT 1+2	Test Voltage	By Notebook PC

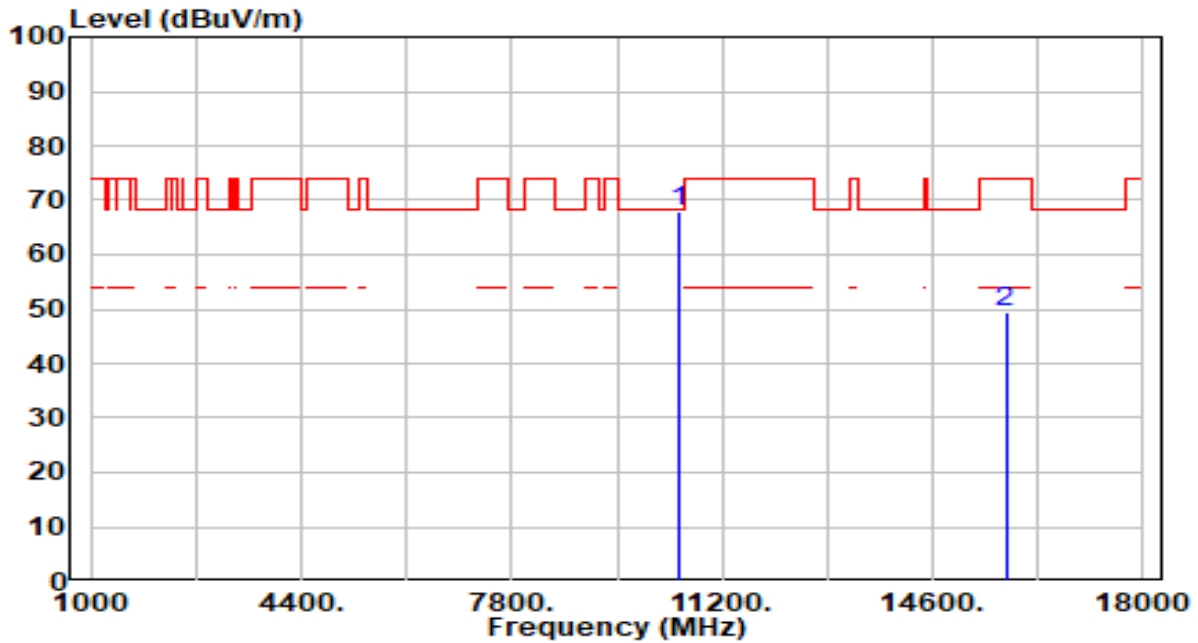

No	Frequency (MHz)	Reading (dBuV)	C.F (dB/m)	Measurement (dBuV/m)	Margin (dB)	Limit (dBuV/m)	Height (cm)	Angle (deg)	Remark (QP/PK/AV)
1	* 10520.000	64.99	3.09	68.08	-0.12	68.20	200	260	Peak
2	15780.000	44.36	5.15	49.51	-24.49	74.00	200	350	Peak

Note:

1. " \*", means this data is the worst emission level.
2. C.F (Correction Factor) = Antenna Factor (dB/m) + Cable Loss (dB) – Pre-amplifier(dB).
3. Measurement (dBuV/m) = Reading(dBuV) + C.F (Correction Factor).
4. The emission levels of other frequencies are very lower than the limit and not show in test report.

EUT	AX3000 High Gain Wireless USB Adapter	Date of Test	2023-01-19
Factor	DRH18-E	Temp. / Humidity	20°C /62%
Polarity	Vertical	Site / Test Engineer	AC2 / Ares
Test Mode	802.11a_TX_Band2_CH 52_ANT 1+2	Test Voltage	By Notebook PC

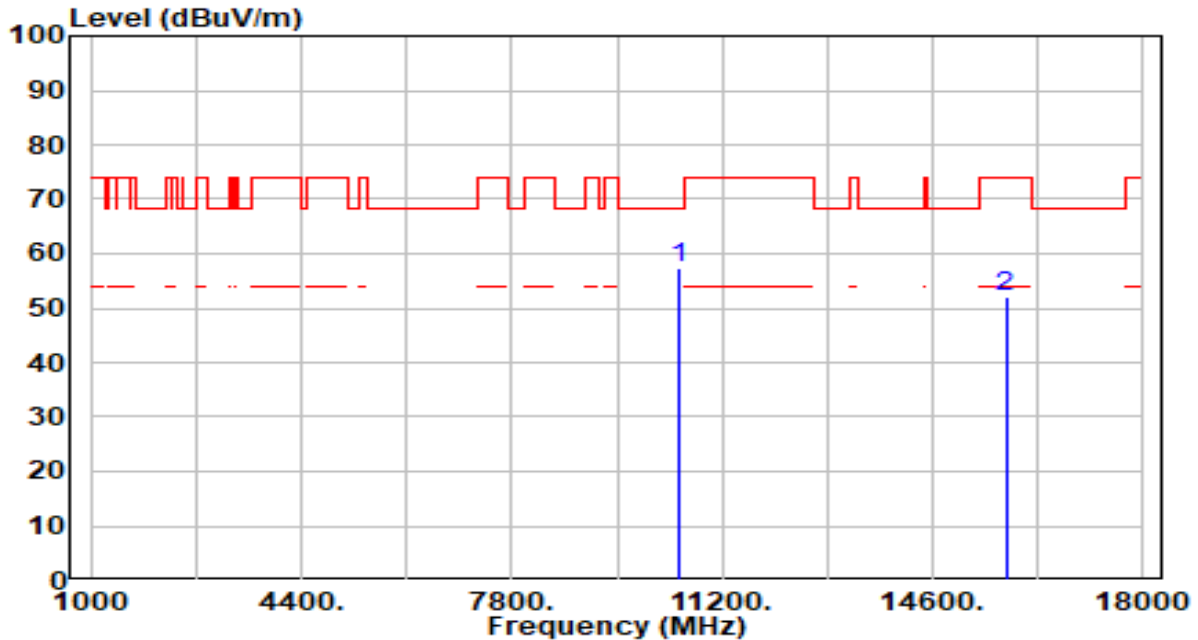

No	Frequency (MHz)	Reading (dBUV)	C.F (dB/m)	Measurement (dBUV/m)	Margin (dB)	Limit (dBUV/m)	Height (cm)	Angle (deg)	Remark (QP/PK/AV)
1	* 10520.000	54.29	3.09	57.38	-10.82	68.20	200	305	Peak
2	15780.000	46.86	5.15	52.01	-21.99	74.00	200	265	Peak

Note:

1. " \*", means this data is the worst emission level.
2. C.F (Correction Factor) = Antenna Factor (dB/m) + Cable Loss (dB) – Pre-amplifier(dB).
3. Measurement (dBUV/m) = Reading(dBUV) + C.F (Correction Factor).
4. The emission levels of other frequencies are very lower than the limit and not show in test report.

EUT	AX3000 High Gain Wireless USB Adapter	Date of Test	2023-01-30
Factor	DRH18-E	Temp. / Humidity	20°C /62%
Polarity	Horizontal	Site / Test Engineer	AC2 / Ares
Test Mode	802.11a_TX_Band2_CH 60_ANT 1+2	Test Voltage	By Notebook PC

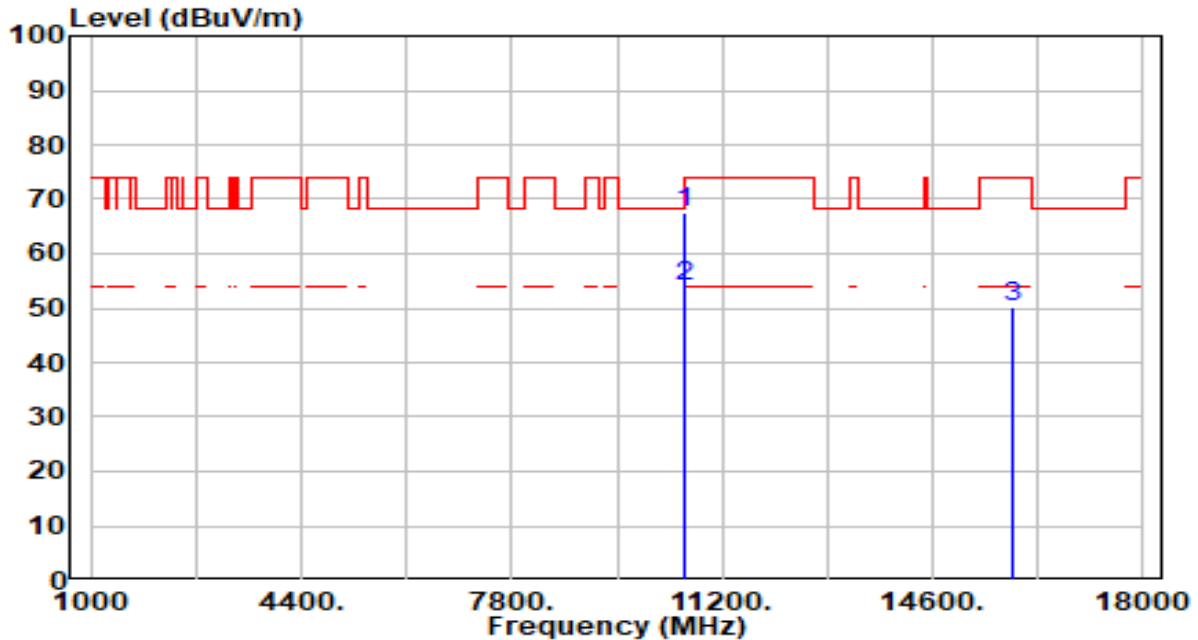

No	Frequency (MHz)	Reading (dBuV)	C.F (dB/m)	Measurement (dBuV/m)	Margin (dB)	Limit (dBuV/m)	Height (cm)	Angle (deg)	Remark (QP/PK/AV)
1	* 10600.000	64.55	3.06	67.61	-6.39	74.00	200	256	Peak
2	* 10600.000	50.84	3.06	53.90	-0.10	54.00	200	256	Average
3	15900.000	44.99	5.27	50.26	-23.74	74.00	200	327	Peak

Note:

1. " \*", means this data is the worst emission level.
2. C.F (Correction Factor) = Antenna Factor (dB/m) + Cable Loss (dB) – Pre-amplifier(dB).
3. Measurement (dBuV/m) = Reading(dBuV) + C.F (Correction Factor).
4. The emission levels of other frequencies are very lower than the limit and not show in test report.

EUT	AX3000 High Gain Wireless USB Adapter	Date of Test	2023-01-30
Factor	DRH18-E	Temp. / Humidity	20°C /62%
Polarity	Vertical	Site / Test Engineer	AC2 / Ares
Test Mode	802.11a_TX_Band2_CH 60_ANT 1+2	Test Voltage	By Notebook PC

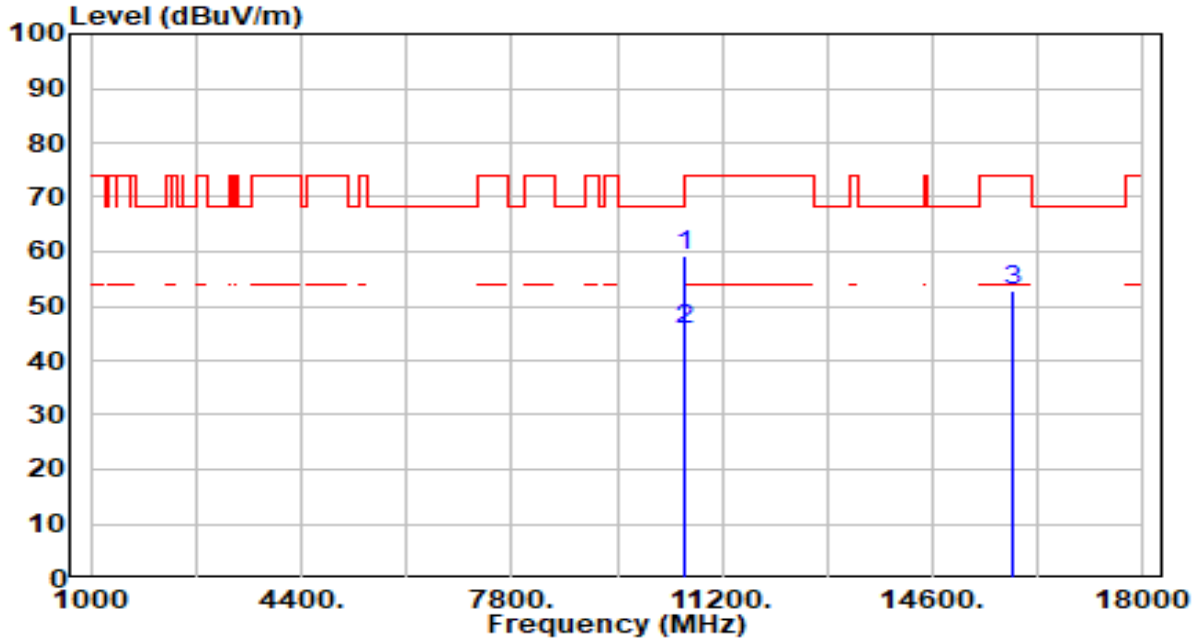

No	Frequency (MHz)	Reading (dBUV)	C.F (dB/m)	Measurement (dBUV/m)	Margin (dB)	Limit (dBUV/m)	Height (cm)	Angle (deg)	Remark (QP/PK/AV)
1	* 10600.000	56.19	3.06	59.25	-14.75	74.00	206	340	Peak
2	* 10600.000	42.49	3.06	45.55	-8.45	54.00	206	340	Average
3	15900.000	47.69	5.27	52.96	-21.04	74.00	200	201	Peak

Note:

1. " \*", means this data is the worst emission level.
2. C.F (Correction Factor) = Antenna Factor (dB/m) + Cable Loss (dB) – Pre-amplifier(dB).
3. Measurement (dBUV/m) = Reading(dBUV) + C.F (Correction Factor).
4. The emission levels of other frequencies are very lower than the limit and not show in test report.

EUT	AX3000 High Gain Wireless USB Adapter	Date of Test	2023-01-19
Factor	DRH18-E	Temp. / Humidity	20°C /62%
Polarity	Horizontal	Site / Test Engineer	AC2 / Ares
Test Mode	802.11a_TX_Band2_CH 64_ANT 1+2	Test Voltage	By Notebook PC

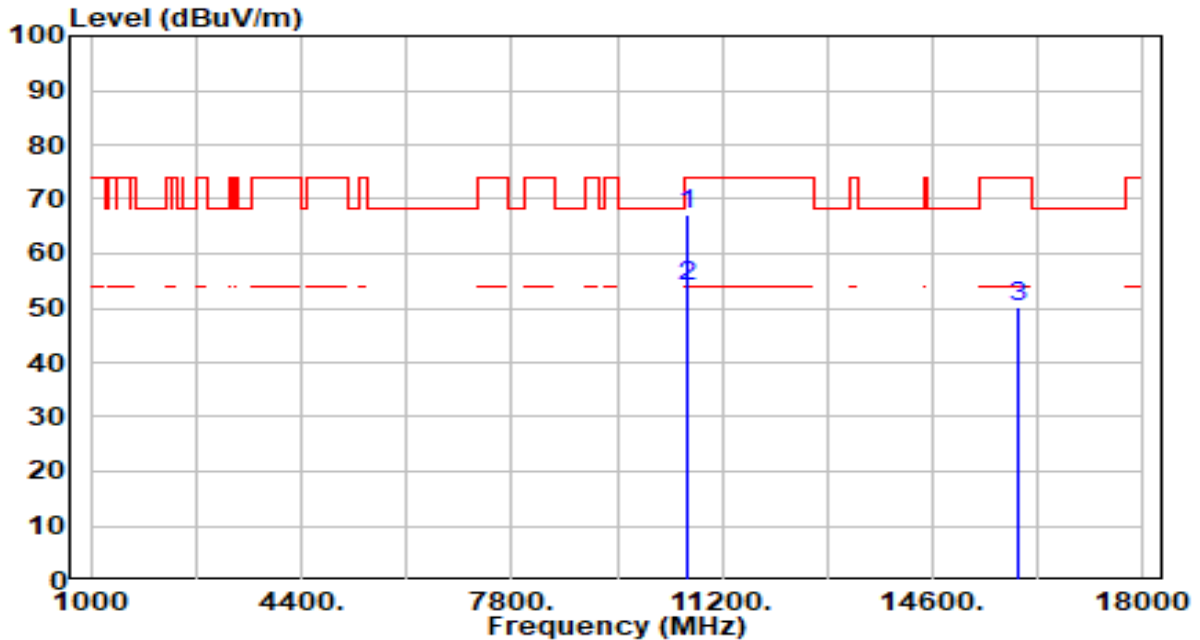

No	Frequency (MHz)	Reading (dBUV)	C.F (dB/m)	Measurement (dBUV/m)	Margin (dB)	Limit (dBUV/m)	Height (cm)	Angle (deg)	Remark (QP/PK/AV)
1	* 10640.000	64.13	3.06	67.19	-6.81	74.00	200	256	Peak
2	* 10640.000	50.84	3.06	53.90	-0.10	54.00	200	256	Average
3	15960.000	45.06	5.31	50.37	-23.63	74.00	200	358	Peak

Note:

1. " \*", means this data is the worst emission level.
2. C.F (Correction Factor) = Antenna Factor (dB/m) + Cable Loss (dB) – Pre-amplifier(dB).
3. Measurement (dBUV/m) = Reading(dBUV) + C.F (Correction Factor).
4. The emission levels of other frequencies are very lower than the limit and not show in test report.

EUT	AX3000 High Gain Wireless USB Adapter	Date of Test	2023-01-19
Factor	DRH18-E	Temp. / Humidity	20°C /62%
Polarity	Vertical	Site / Test Engineer	AC2 / Ares
Test Mode	802.11a_TX_Band2_CH 64_ANT 1+2	Test Voltage	By Notebook PC

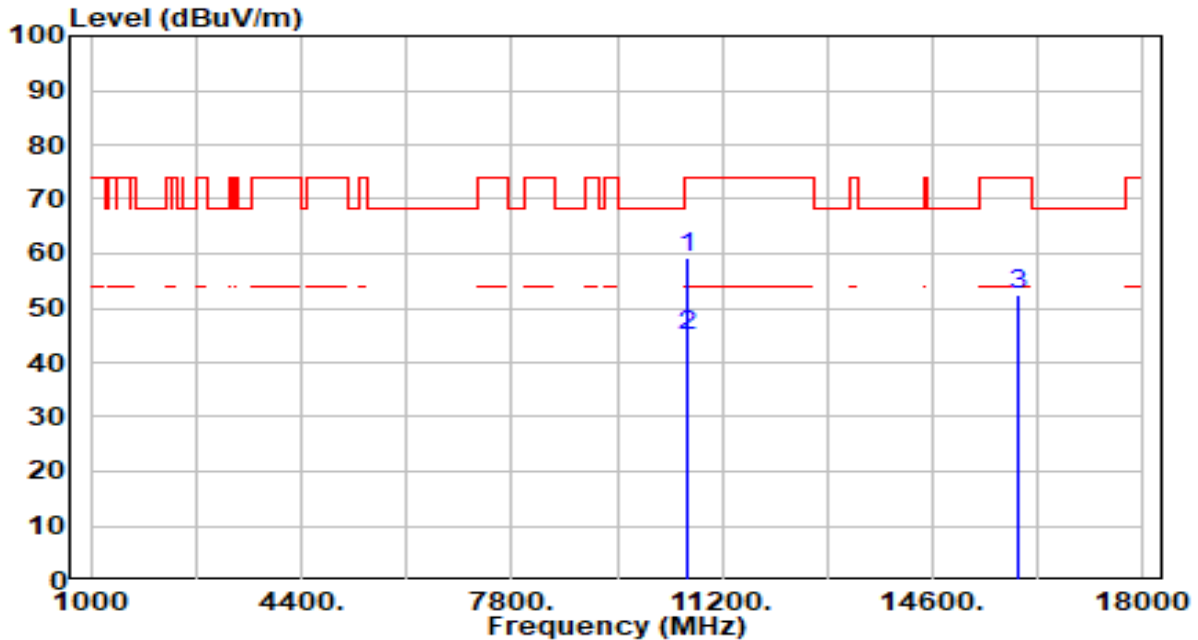

No	Frequency (MHz)	Reading (dBuV)	C.F (dB/m)	Measurement (dBuV/m)	Margin (dB)	Limit (dBuV/m)	Height (cm)	Angle (deg)	Remark (QP/PK/AV)
1	* 10640.000	56.09	3.06	59.15	-14.85	74.00	200	335	Peak
2	* 10640.000	41.98	3.06	45.04	-8.96	54.00	200	335	Average
3	15960.000	47.15	5.31	52.46	-21.54	74.00	200	0	Peak

Note:

1. " \*", means this data is the worst emission level.
2. C.F (Correction Factor) = Antenna Factor (dB/m) + Cable Loss (dB) – Pre-amplifier(dB).
3. Measurement (dBuV/m) = Reading(dBuV) + C.F (Correction Factor).
4. The emission levels of other frequencies are very lower than the limit and not show in test report.

EUT	AX3000 High Gain Wireless USB Adapter	Date of Test	2023-01-19
Factor	DRH18-E	Temp. / Humidity	20°C /62%
Polarity	Horizontal	Site / Test Engineer	AC2 / Ares
Test Mode	802.11a_TX_Band3_CH 100_ANT 1+2	Test Voltage	By Notebook PC

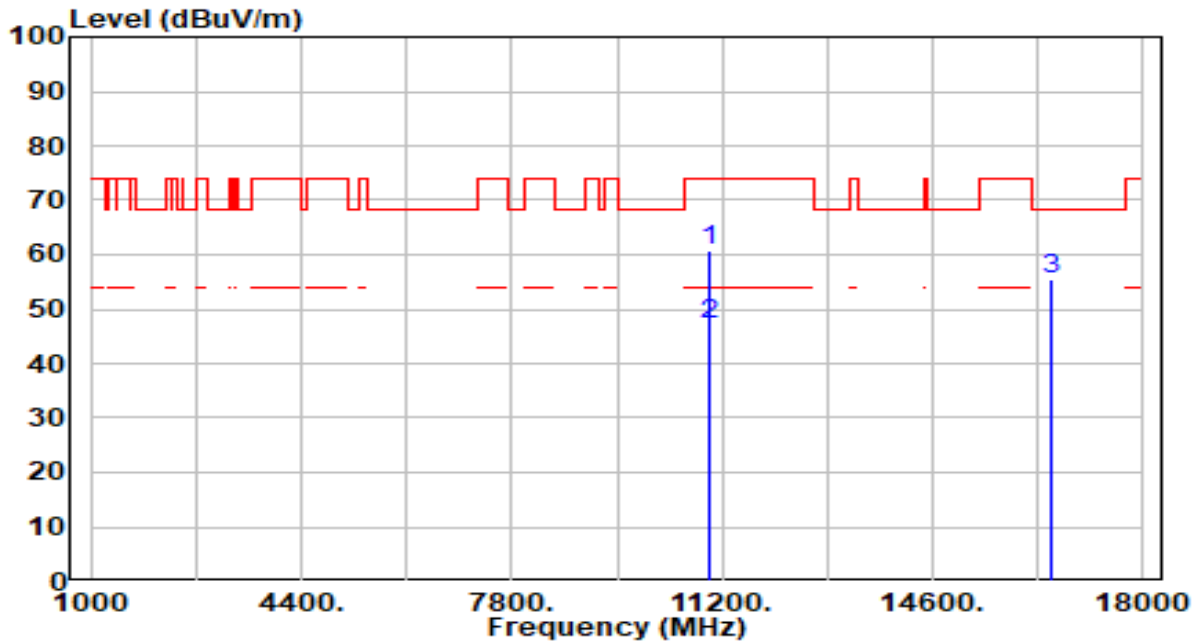

No	Frequency (MHz)	Reading (dBuV)	C.F (dB/m)	Measurement (dBuV/m)	Margin (dB)	Limit (dBuV/m)	Height (cm)	Angle (deg)	Remark (QP/PK/AV)
1	11000.000	57.54	3.21	60.75	-13.25	74.00	182	13	Peak
2	* 11000.000	43.86	3.21	47.07	-6.93	54.00	182	13	Average
3	* 16500.000	50.75	4.61	55.36	-12.84	68.20	200	80	Peak

Note:

1. " \*", means this data is the worst emission level.
2. C.F (Correction Factor) = Antenna Factor (dB/m) + Cable Loss (dB) – Preamplifier(dB).
3. Measurement (dBuV/m) = Reading(dBuV) + C.F (Correction Factor).
4. The emission levels of other frequencies are very lower than the limit and not show in test report.

EUT	AX3000 High Gain Wireless USB Adapter	Date of Test	2023-01-19
Factor	DRH18-E	Temp. / Humidity	20°C /62%
Polarity	Vertical	Site / Test Engineer	AC2 / Ares
Test Mode	802.11a_TX_Band3_CH 100_ANT 1+2	Test Voltage	By Notebook PC

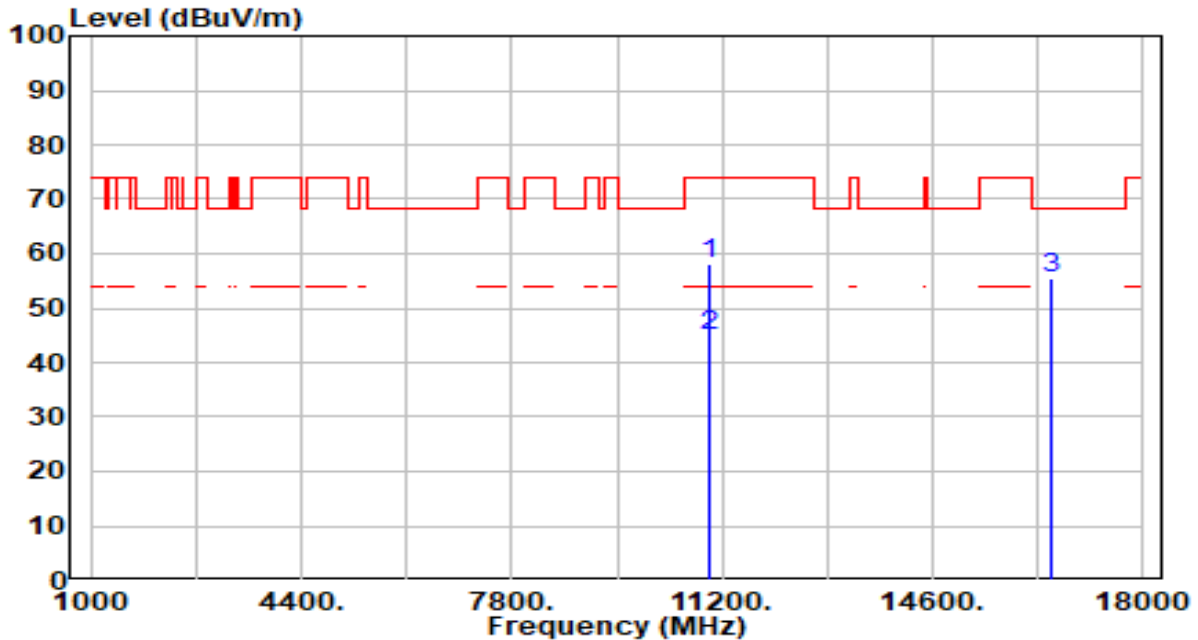

No	Frequency (MHz)	Reading (dBuV)	C.F (dB/m)	Measurement (dBuV/m)	Margin (dB)	Limit (dBuV/m)	Height (cm)	Angle (deg)	Remark (QP/PK/AV)
1	11000.000	55.09	3.21	58.30	-15.70	74.00	216	345	Peak
2	* 11000.000	41.60	3.21	44.81	-9.19	54.00	216	345	Average
3	* 16500.000	50.78	4.61	55.39	-12.81	68.20	200	360	Peak

Note:

1. " \*", means this data is the worst emission level.
2. C.F (Correction Factor) = Antenna Factor (dB/m) + Cable Loss (dB) – Pre-amplifier(dB).
3. Measurement (dBuV/m) = Reading(dBuV) + C.F (Correction Factor).
4. The emission levels of other frequencies are very lower than the limit and not show in test report.



EUT	AX3000 High Gain Wireless USB Adapter	Date of Test	2023-01-19
Factor	DRH18-E	Temp. / Humidity	20°C /62%
Polarity	Horizontal	Site / Test Engineer	AC2 / Ares
Test Mode	802.11a_TX_Band3_CH 116_ANT 1+2	Test Voltage	By Notebook PC

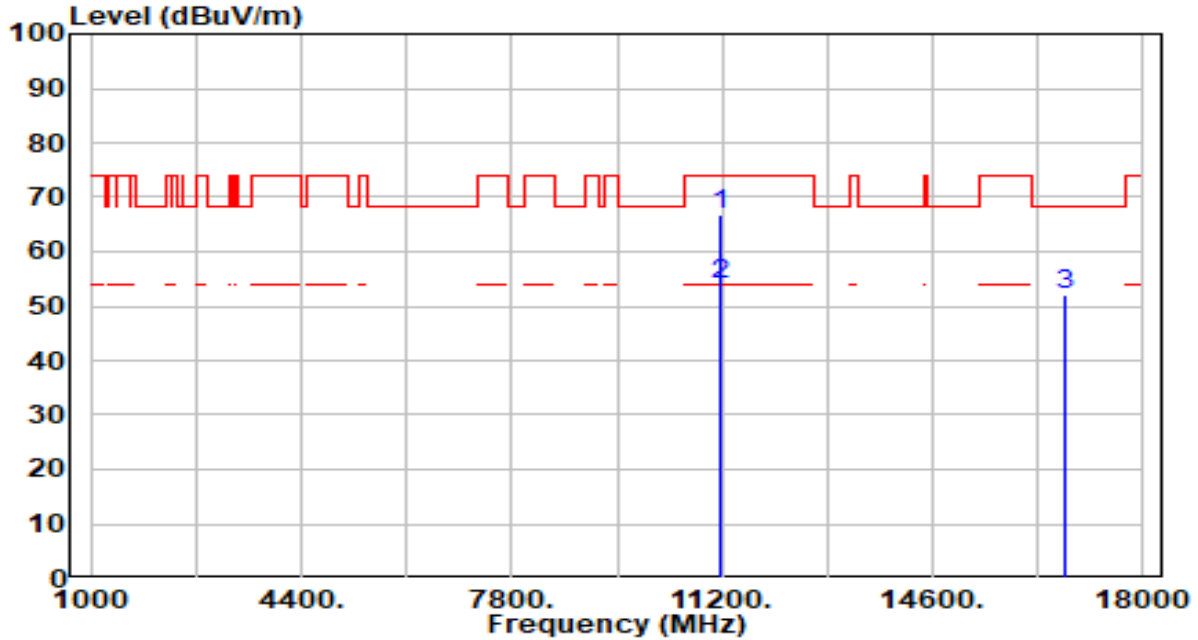

No	Frequency (MHz)	Reading (dBUV)	C.F (dB/m)	Measurement (dBUV/m)	Margin (dB)	Limit (dBUV/m)	Height (cm)	Angle (deg)	Remark (QP/PK/AV)
1	* 11160.000	63.26	3.49	66.75	-7.25	74.00	192	11	Peak
2	* 11160.000	50.36	3.49	53.85	-0.15	54.00	192	11	Average
3	16740.000	47.50	4.48	51.98	-16.22	68.20	200	178	Peak

Note:

- "\*", means this data is the worst emission level.
- C.F (Correction Factor) = Antenna Factor (dB/m) + Cable Loss (dB) – Pre-amplifier(dB).
- Measurement (dBUV/m) = Reading(dBUV) + C.F (Correction Factor).
- The emission levels of other frequencies are very lower than the limit and not show in test report.

EUT	AX3000 High Gain Wireless USB Adapter	Date of Test	2023-01-19
Factor	DRH18-E	Temp. / Humidity	20°C /62%
Polarity	Vertical	Site / Test Engineer	AC2 / Ares
Test Mode	802.11a_TX_Band3_CH 116_ANT 1+2	Test Voltage	By Notebook PC

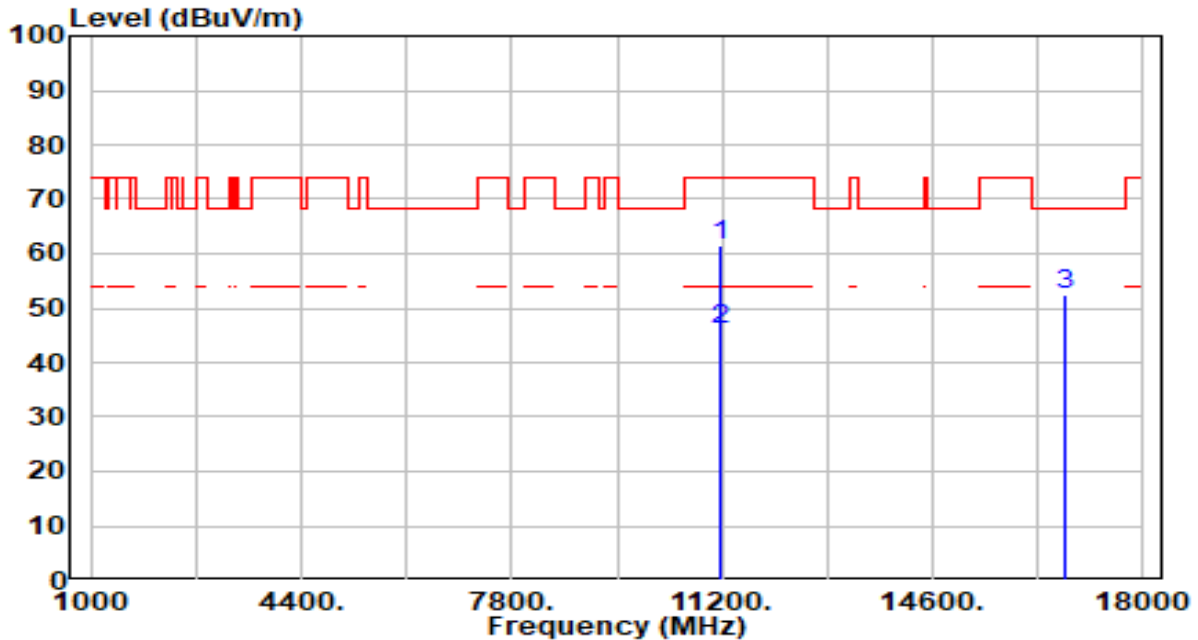

No	Frequency (MHz)	Reading (dBuV)	C.F (dB/m)	Measurement (dBuV/m)	Margin (dB)	Limit (dBuV/m)	Height (cm)	Angle (deg)	Remark (QP/PK/AV)
1	* 11160.000	58.07	3.49	61.56	-12.44	74.00	200	10	Peak
2	* 11160.000	42.44	3.49	45.93	-8.07	54.00	200	10	Average
3	16740.000	48.15	4.48	52.63	-15.57	68.20	200	5	Peak

Note:

1. " \*", means this data is the worst emission level.
2. C.F (Correction Factor) = Antenna Factor (dB/m) + Cable Loss (dB) – Pre-amplifier(dB).
3. Measurement (dBuV/m) = Reading(dBuV) + C.F (Correction Factor).
4. The emission levels of other frequencies are very lower than the limit and not show in test report.

EUT	AX3000 High Gain Wireless USB Adapter	Date of Test	2023-01-19
Factor	DRH18-E	Temp. / Humidity	20°C /62%
Polarity	Horizontal	Site / Test Engineer	AC2 / Ares
Test Mode	802.11a_TX_Band3_CH 140_ANT 1+2	Test Voltage	By Notebook PC

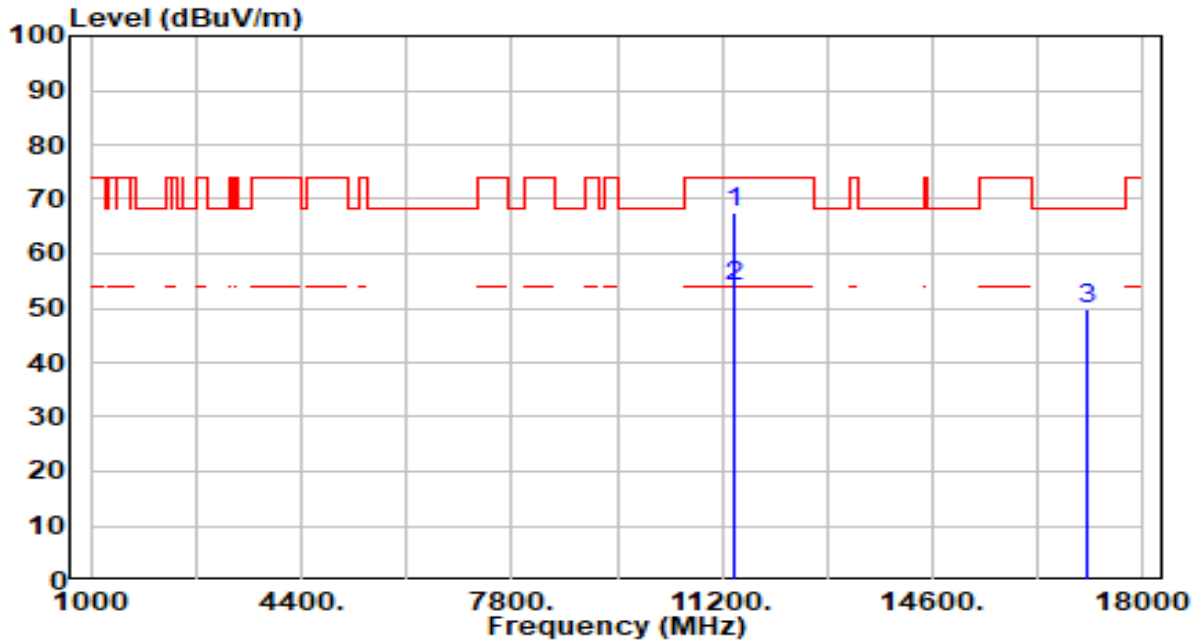

No	Frequency (MHz)	Reading (dBUV)	C.F (dB/m)	Measurement (dBUV/m)	Margin (dB)	Limit (dBUV/m)	Height (cm)	Angle (deg)	Remark (QP/PK/AV)
1	* 11400.000	63.50	3.90	67.40	-6.60	74.00	181	20	Peak
2	* 11400.000	49.98	3.90	53.88	-0.12	54.00	181	20	Average
3	17100.000	45.48	4.48	49.96	-18.24	68.20	200	305	Peak

Note:

1. " \*", means this data is the worst emission level.
2. C.F (Correction Factor) = Antenna Factor (dB/m) + Cable Loss (dB) – Pre-amplifier(dB).
3. Measurement (dBUV/m) = Reading(dBUV) + C.F (Correction Factor).
4. The emission levels of other frequencies are very lower than the limit and not show in test report.

EUT	AX3000 High Gain Wireless USB Adapter	Date of Test	2023-01-19
Factor	DRH18-E	Temp. / Humidity	20°C /62%
Polarity	Vertical	Site / Test Engineer	AC2 / Ares
Test Mode	802.11a_TX_Band3_CH 140_ANT 1+2	Test Voltage	By Notebook PC

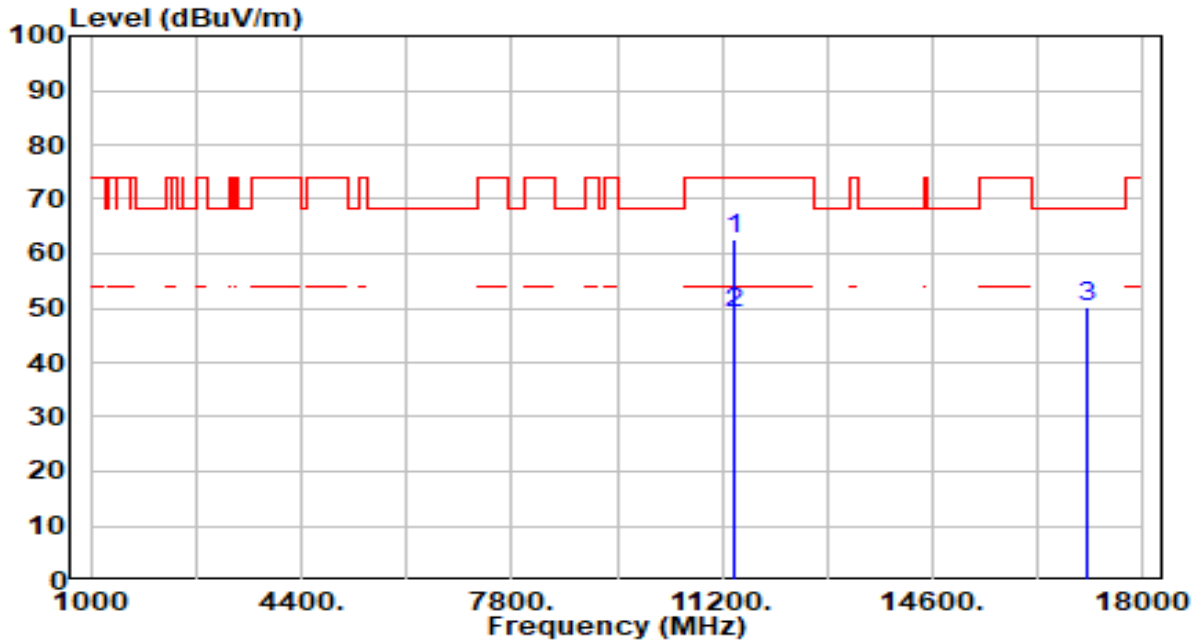

No	Frequency (MHz)	Reading (dBUV)	C.F (dB/m)	Measurement (dBUV/m)	Margin (dB)	Limit (dBUV/m)	Height (cm)	Angle (deg)	Remark (QP/PK/AV)
1	* 11400.000	58.87	3.90	62.77	-11.23	74.00	204	18	Peak
2	* 11400.000	45.14	3.90	49.04	-4.96	54.00	204	18	Average
3	17100.000	45.83	4.48	50.30	-17.90	68.20	200	360	Peak

Note:

1. " \*", means this data is the worst emission level.
2. C.F (Correction Factor) = Antenna Factor (dB/m) + Cable Loss (dB) – Pre-amplifier(dB).
3. Measurement (dBUV/m) = Reading(dBUV) + C.F (Correction Factor).
4. The emission levels of other frequencies are very lower than the limit and not show in test report.

EUT	AX3000 High Gain Wireless USB Adapter	Date of Test	2023-01-19
Factor	DRH18-E	Temp. / Humidity	20°C /62%
Polarity	Horizontal	Site / Test Engineer	AC2 / Ares
Test Mode	802.11a_TX_Band3_CH 144_ANT 1+2	Test Voltage	By Notebook PC

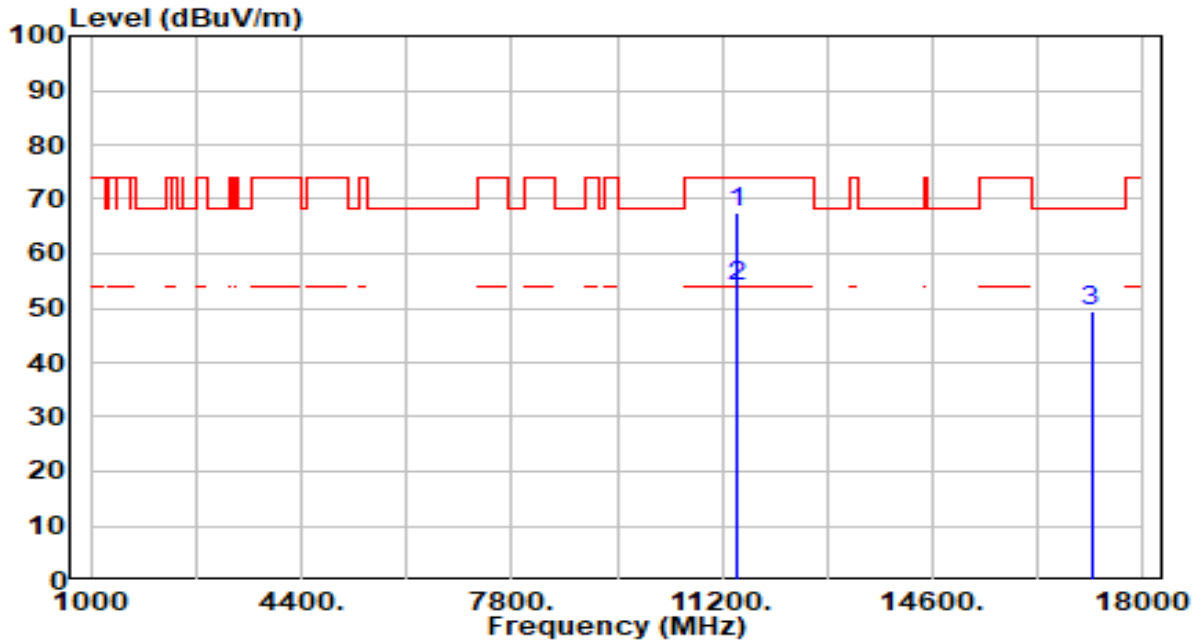

No	Frequency (MHz)	Reading (dBUV)	C.F (dB/m)	Measurement (dBUV/m)	Margin (dB)	Limit (dBUV/m)	Height (cm)	Angle (deg)	Remark (QP/PK/AV)
1	* 11440.000	63.76	3.91	67.67	-6.33	74.00	190	20	Peak
2	* 11440.000	49.90	3.91	53.81	-0.19	54.00	190	20	Average
3	17160.000	45.25	4.28	49.53	-18.67	68.20	200	343	Peak

Note:

1. " \*", means this data is the worst emission level.
2. C.F (Correction Factor) = Antenna Factor (dB/m) + Cable Loss (dB) – Pre-amplifier(dB).
3. Measurement (dBUV/m) = Reading(dBUV) + C.F (Correction Factor).
4. The emission levels of other frequencies are very lower than the limit and not show in test report.

EUT	AX3000 High Gain Wireless USB Adapter	Date of Test	2023-01-19
Factor	DRH18-E	Temp. / Humidity	20°C /62%
Polarity	Vertical	Site / Test Engineer	AC2 / Ares
Test Mode	802.11a_TX_Band3_CH 144_ANT 1+2	Test Voltage	By Notebook PC

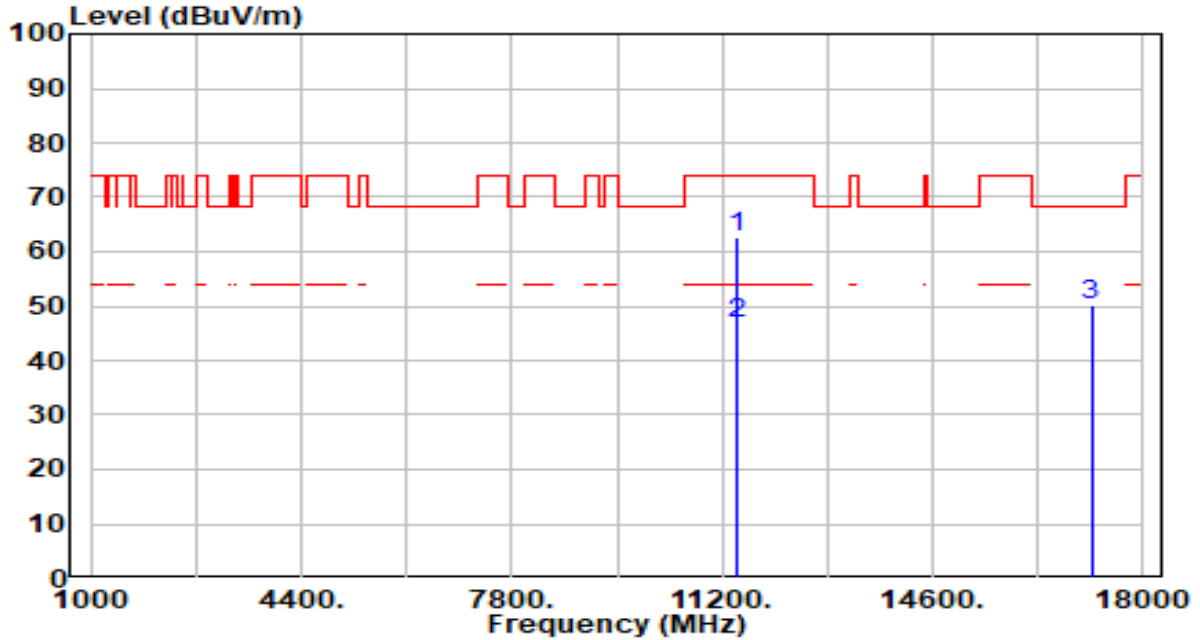

No	Frequency (MHz)	Reading (dBUV)	C.F (dB/m)	Measurement (dBUV/m)	Margin (dB)	Limit (dBUV/m)	Height (cm)	Angle (deg)	Remark (QP/PK/AV)
1	* 11440.000	58.76	3.91	62.67	-11.33	74.00	200	15	Peak
2	* 11440.000	43.01	3.91	46.92	-7.08	54.00	200	15	Average
3	17160.000	46.09	4.28	50.37	-17.83	68.20	200	39	Peak

Note:

1. " \*", means this data is the worst emission level.
2. C.F (Correction Factor) = Antenna Factor (dB/m) + Cable Loss (dB) – Pre-amplifier(dB).
3. Measurement (dBUV/m) = Reading(dBUV) + C.F (Correction Factor).
4. The emission levels of other frequencies are very lower than the limit and not show in test report.

EUT	AX3000 High Gain Wireless USB Adapter	Date of Test	2023-01-19
Factor	DRH18-E	Temp. / Humidity	20°C /62%
Polarity	Horizontal	Site / Test Engineer	AC2 / Ares
Test Mode	802.11a_TX_Band4_CH 149_ANT 1+2	Test Voltage	By Notebook PC

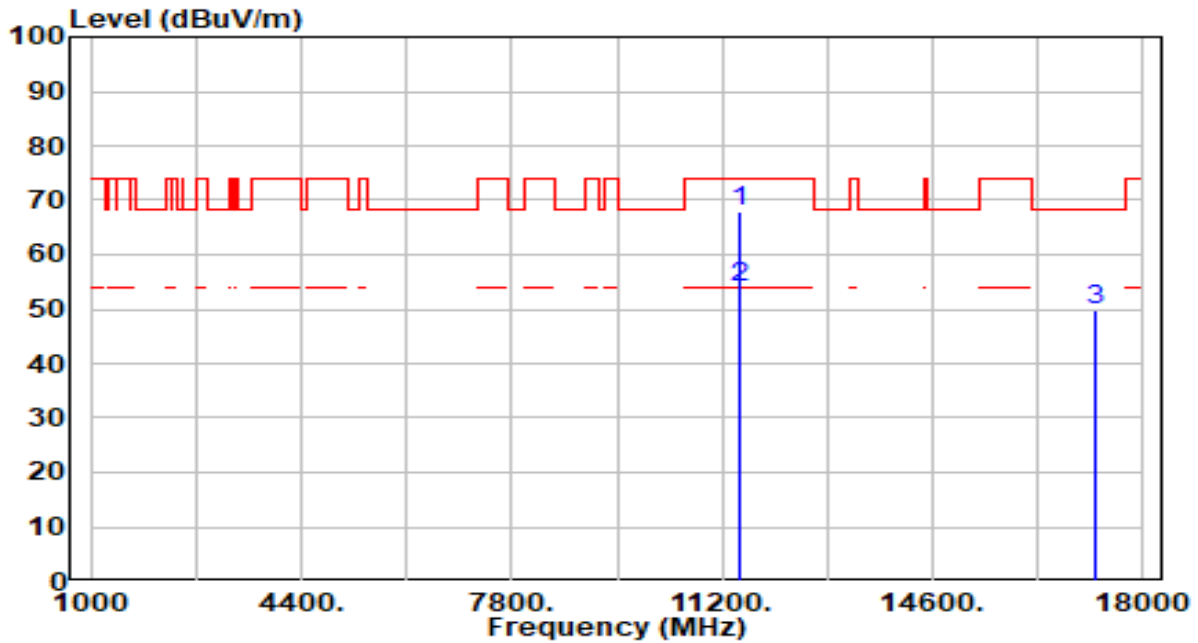

No	Frequency (MHz)	Reading (dBuV)	C.F (dB/m)	Measurement (dBuV/m)	Margin (dB)	Limit (dBuV/m)	Height (cm)	Angle (deg)	Remark (QP/PK/AV)
1	11490.000	63.87	3.92	67.79	-6.21	74.00	176	27	Peak
2	* 11490.000	49.89	3.92	53.81	-0.19	54.00	176	27	Average
3	17235.000	45.73	4.06	49.80	-18.40	68.20	200	163	Peak

Note:

1. " \*", means this data is the worst emission level.
2. C.F (Correction Factor) = Antenna Factor (dB/m) + Cable Loss (dB) – Pre-amplifier(dB).
3. Measurement (dBuV/m) = Reading(dBuV) + C.F (Correction Factor).
4. The emission levels of other frequencies are very lower than the limit and not show in test report.

EUT	AX3000 High Gain Wireless USB Adapter	Date of Test	2023-01-19
Factor	DRH18-E	Temp. / Humidity	20°C /62%
Polarity	Vertical	Site / Test Engineer	AC2 / Ares
Test Mode	802.11a_TX_Band4_CH 149_ANT 1+2	Test Voltage	By Notebook PC

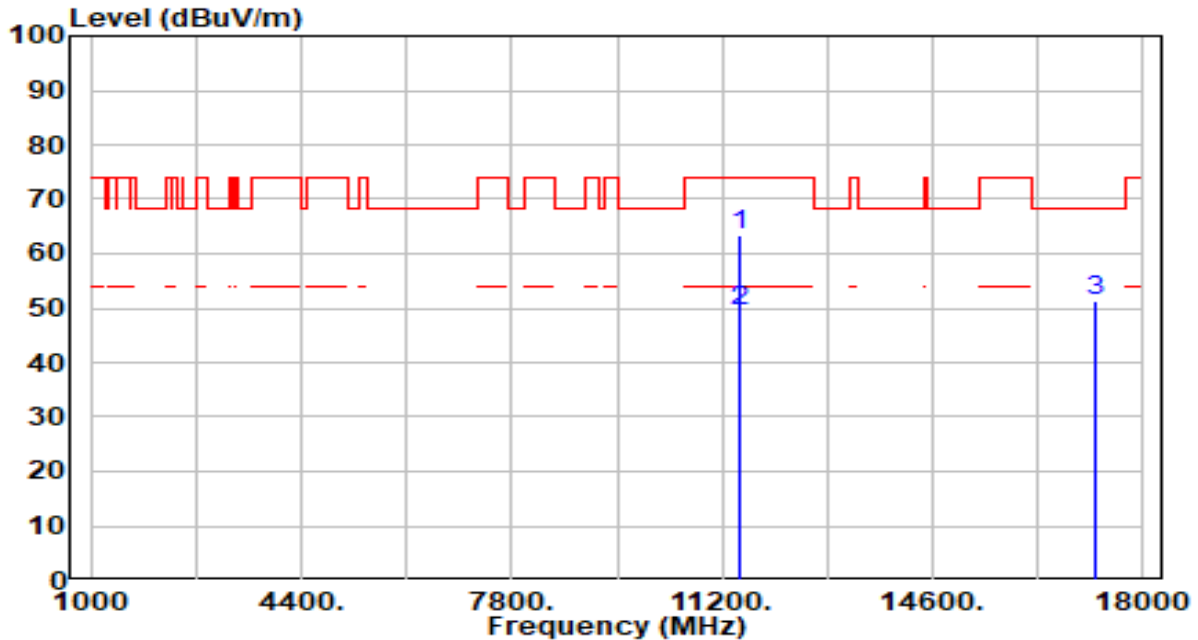

No	Frequency (MHz)	Reading (dBuV)	C.F (dB/m)	Measurement (dBuV/m)	Margin (dB)	Limit (dBuV/m)	Height (cm)	Angle (deg)	Remark (QP/PK/AV)
1	11490.000	59.54	3.92	63.46	-10.54	74.00	226	22	Peak
2	* 11490.000	45.41	3.92	49.33	-4.67	54.00	226	22	Average
3	17235.000	47.14	4.06	51.20	-17.00	68.20	200	285	Peak

Note:

1. " \*", means this data is the worst emission level.
2. C.F (Correction Factor) = Antenna Factor (dB/m) + Cable Loss (dB) – Pre-amplifier(dB).
3. Measurement (dBuV/m) = Reading(dBuV) + C.F (Correction Factor).
4. The emission levels of other frequencies are very lower than the limit and not show in test report.



EUT	AX3000 High Gain Wireless USB Adapter	Date of Test	2023-01-19
Factor	DRH18-E	Temp. / Humidity	20°C /62%
Polarity	Horizontal	Site / Test Engineer	AC2 / Ares
Test Mode	802.11a_TX_Band4_CH 157_ANT 1+2	Test Voltage	By Notebook PC

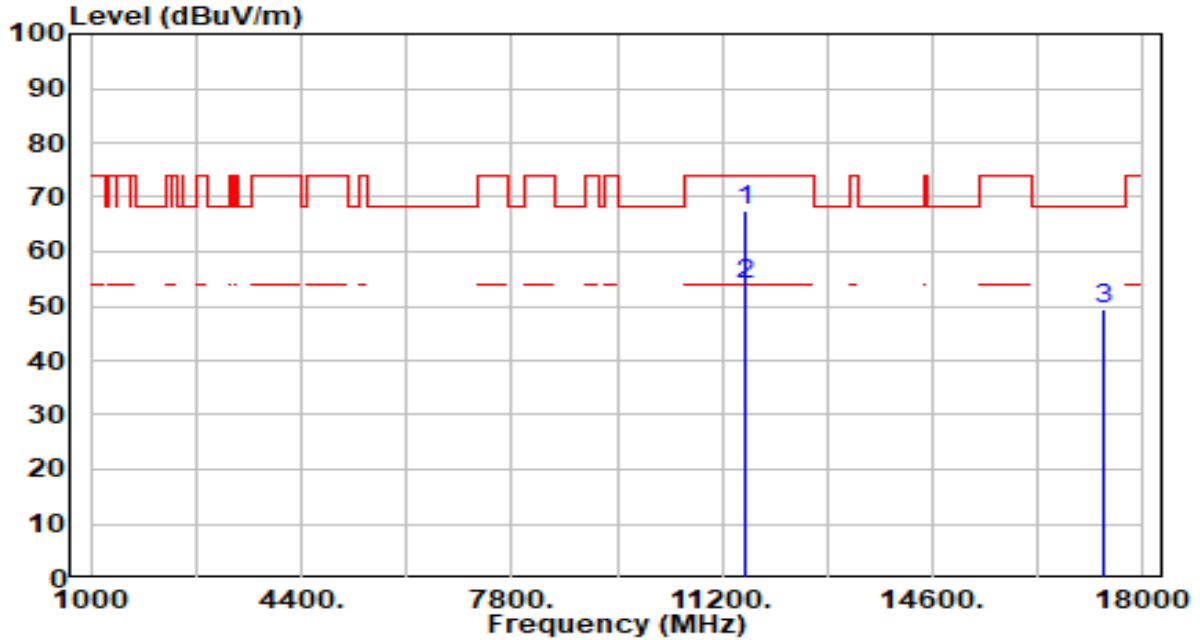

No	Frequency (MHz)	Reading (dBuV)	C.F (dB/m)	Measurement (dBuV/m)	Margin (dB)	Limit (dBuV/m)	Height (cm)	Angle (deg)	Remark (QP/PK/AV)
1	11570.000	63.62	3.94	67.56	-6.44	74.00	169	22	Peak
2	* 11570.000	49.92	3.94	53.86	-0.14	54.00	169	22	Average
3	17355.000	45.60	3.78	49.39	-18.81	68.20	200	335	Peak

Note:

1. " \*", means this data is the worst emission level.
2. C.F (Correction Factor) = Antenna Factor (dB/m) + Cable Loss (dB) – Pre-amplifier(dB).
3. Measurement (dBuV/m) = Reading(dBuV) + C.F (Correction Factor).
4. The emission levels of other frequencies are very lower than the limit and not show in test report.

EUT	AX3000 High Gain Wireless USB Adapter	Date of Test	2023-01-19
Factor	DRH18-E	Temp. / Humidity	20°C /62%
Polarity	Vertical	Site / Test Engineer	AC2 / Ares
Test Mode	802.11a_TX_Band4_CH 157_ANT 1+2	Test Voltage	By Notebook PC

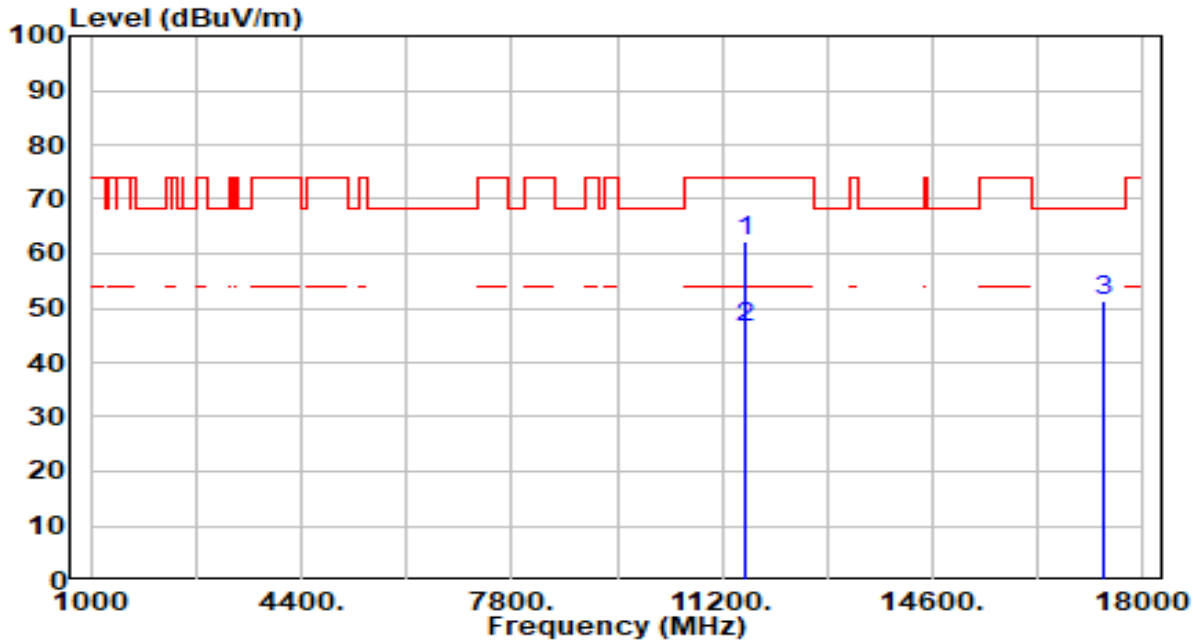

No	Frequency (MHz)	Reading (dBuV)	C.F (dB/m)	Measurement (dBuV/m)	Margin (dB)	Limit (dBuV/m)	Height (cm)	Angle (deg)	Remark (QP/PK/AV)
1	11570.000	58.30	3.94	62.24	-11.76	74.00	200	16	Peak
2	* 11570.000	42.29	3.94	46.23	-7.77	54.00	200	16	Average
3	17355.000	47.66	3.78	51.45	-16.75	68.20	200	286	Peak

Note:

1. " \*", means this data is the worst emission level.
2. C.F (Correction Factor) = Antenna Factor (dB/m) + Cable Loss (dB) – Pre-amplifier(dB).
3. Measurement (dBuV/m) = Reading(dBuV) + C.F (Correction Factor).
4. The emission levels of other frequencies are very lower than the limit and not show in test report.

EUT	AX3000 High Gain Wireless USB Adapter	Date of Test	2023-01-19
Factor	DRH18-E	Temp. / Humidity	20°C /62%
Polarity	Horizontal	Site / Test Engineer	AC2 / Ares
Test Mode	802.11a_TX_Band4_CH 165_ANT 1+2	Test Voltage	By Notebook PC

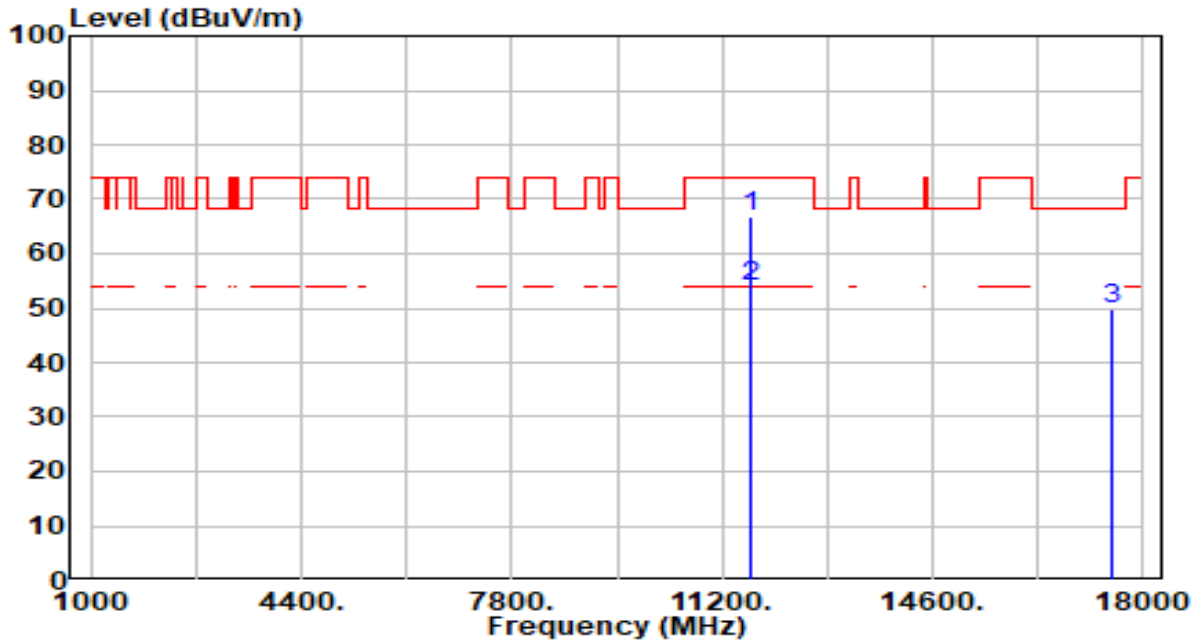

No	Frequency (MHz)	Reading (dBUV)	C.F (dB/m)	Measurement (dBUV/m)	Margin (dB)	Limit (dBUV/m)	Height (cm)	Angle (deg)	Remark (QP/PK/AV)
1	11650.000	62.93	3.94	66.87	-7.13	74.00	166	22	Peak
2	* 11650.000	49.90	3.94	53.84	-0.16	54.00	166	22	Average
3	17475.000	46.22	3.65	49.88	-18.32	68.20	200	200	Peak

Note:

1. " \*", means this data is the worst emission level.
2. C.F (Correction Factor) = Antenna Factor (dB/m) + Cable Loss (dB) – Pre-amplifier(dB).
3. Measurement (dBUV/m) = Reading(dBUV) + C.F (Correction Factor).
4. The emission levels of other frequencies are very lower than the limit and not show in test report.

EUT	AX3000 High Gain Wireless USB Adapter	Date of Test	2023-01-19
Factor	DRH18-E	Temp. / Humidity	20°C /62%
Polarity	Vertical	Site / Test Engineer	AC2 / Ares
Test Mode	802.11a_TX_Band4_CH 165_ANT 1+2	Test Voltage	By Notebook PC

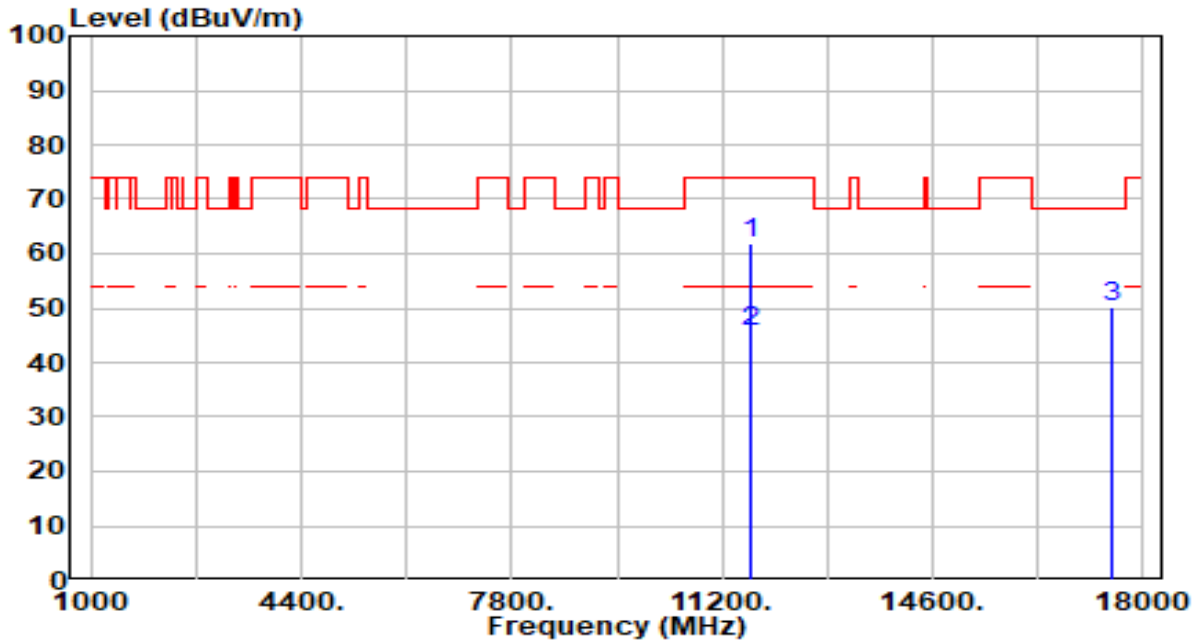

No	Frequency (MHz)	Reading (dBuV)	C.F (dB/m)	Measurement (dBuV/m)	Margin (dB)	Limit (dBuV/m)	Height (cm)	Angle (deg)	Remark (QP/PK/AV)
1	11650.000	57.92	3.94	61.86	-12.14	74.00	200	21	Peak
2	* 11650.000	41.63	3.94	45.57	-8.43	54.00	200	21	Average
3	17475.000	46.55	3.65	50.21	-17.99	68.20	200	360	Peak

Note:

1. " \*", means this data is the worst emission level.
2. C.F (Correction Factor) = Antenna Factor (dB/m) + Cable Loss (dB) – Pre-amplifier(dB).
3. Measurement (dBuV/m) = Reading(dBuV) + C.F (Correction Factor).
4. The emission levels of other frequencies are very lower than the limit and not show in test report.

EUT	AX3000 High Gain Wireless USB Adapter	Date of Test	2023-01-19
Factor	DRH18-E	Temp. / Humidity	20°C /62%
Polarity	Horizontal	Site / Test Engineer	AC2 / Ares
Test Mode	802.11ac-20MHz_TX_Band1_CH 36_ANT 1+2	Test Voltage	By Notebook PC

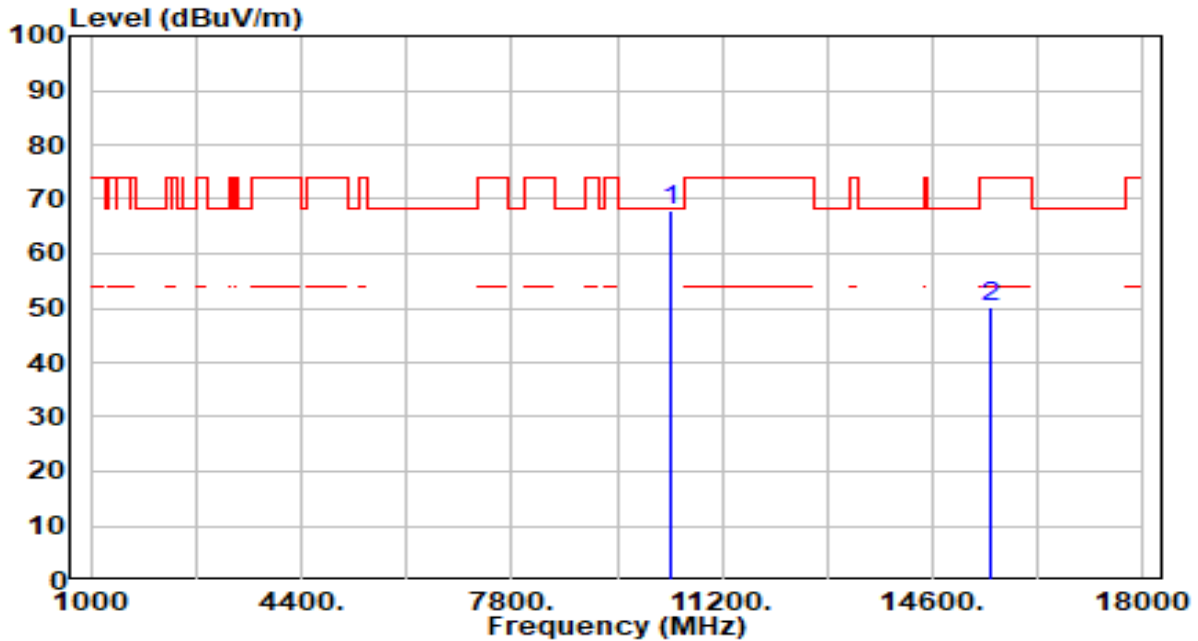

No	Frequency (MHz)	Reading (dBuV)	C.F (dB/m)	Measurement (dBuV/m)	Margin (dB)	Limit (dBuV/m)	Height (cm)	Angle (deg)	Remark (QP/PK/AV)
1	*	64.86	3.19	68.05	-0.15	68.20	200	256	Peak
2		45.58	4.74	50.33	-23.67	74.00	200	259	Peak

Note:

1. " \*", means this data is the worst emission level.
2. C.F (Correction Factor) = Antenna Factor (dB/m) + Cable Loss (dB) – Preamplifier(dB).
3. Measurement (dBuV/m) = Reading(dBuV) + C.F (Correction Factor).
4. The emission levels of other frequencies are very lower than the limit and not show in test report.

EUT	AX3000 High Gain Wireless USB Adapter	Date of Test	2023-01-19
Factor	DRH18-E	Temp. / Humidity	20°C /62%
Polarity	Vertical	Site / Test Engineer	AC2 / Ares
Test Mode	802.11ac-20MHz_TX_Band1_CH 36_ANT 1+2	Test Voltage	By Notebook PC

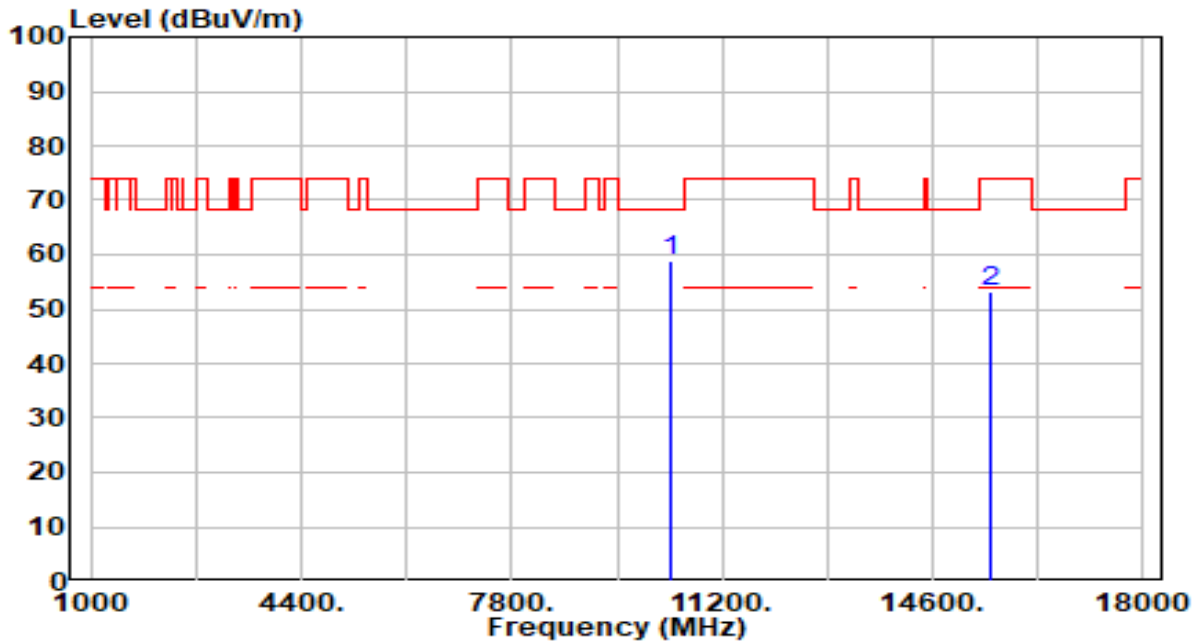

No	Frequency (MHz)	Reading (dBuV)	C.F (dB/m)	Measurement (dBuV/m)	Margin (dB)	Limit (dBuV/m)	Height (cm)	Angle (deg)	Remark (QP/PK/AV)
1	* 10360.000	55.73	3.19	58.92	-9.28	68.20	200	53	Peak
2	15540.000	48.65	4.74	53.39	-20.61	74.00	200	360	Peak

Note:

1. " \*", means this data is the worst emission level.
2. C.F (Correction Factor) = Antenna Factor (dB/m) + Cable Loss (dB) – Pre-amplifier(dB).
3. Measurement (dBuV/m) = Reading(dBuV) + C.F (Correction Factor).
4. The emission levels of other frequencies are very lower than the limit and not show in test report.

EUT	AX3000 High Gain Wireless USB Adapter	Date of Test	2023-01-19
Factor	DRH18-E	Temp. / Humidity	20°C /62%
Polarity	Horizontal	Site / Test Engineer	AC2 / Ares
Test Mode	802.11ac-20MHz_TX_Band1_CH 44_ANT 1+2	Test Voltage	By Notebook PC

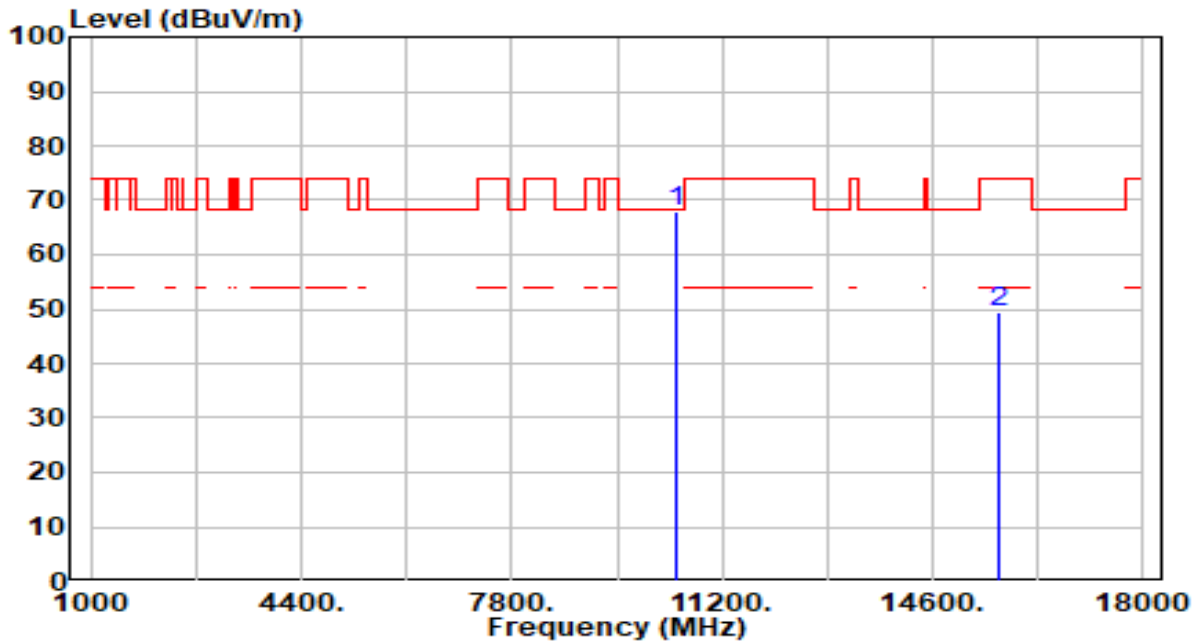

No	Frequency (MHz)	Reading (dBuV)	C.F (dB/m)	Measurement (dBuV/m)	Margin (dB)	Limit (dBuV/m)	Height (cm)	Angle (deg)	Remark (QP/PK/AV)
1	* 10440.000	64.93	3.15	68.08	-0.12	68.20	200	258	Peak
2	15660.000	44.42	4.89	49.31	-24.69	74.00	200	295	Peak

Note:

1. " \*", means this data is the worst emission level.
2. C.F (Correction Factor) = Antenna Factor (dB/m) + Cable Loss (dB) – Pre-amplifier(dB).
3. Measurement (dBuV/m) = Reading(dBuV) + C.F (Correction Factor).
4. The emission levels of other frequencies are very lower than the limit and not show in test report.

EUT	AX3000 High Gain Wireless USB Adapter	Date of Test	2023-01-19
Factor	DRH18-E	Temp. / Humidity	20°C /62%
Polarity	Vertical	Site / Test Engineer	AC2 / Ares
Test Mode	802.11ac-20MHz_TX_Band1_CH 44_ANT 1+2	Test Voltage	By Notebook PC

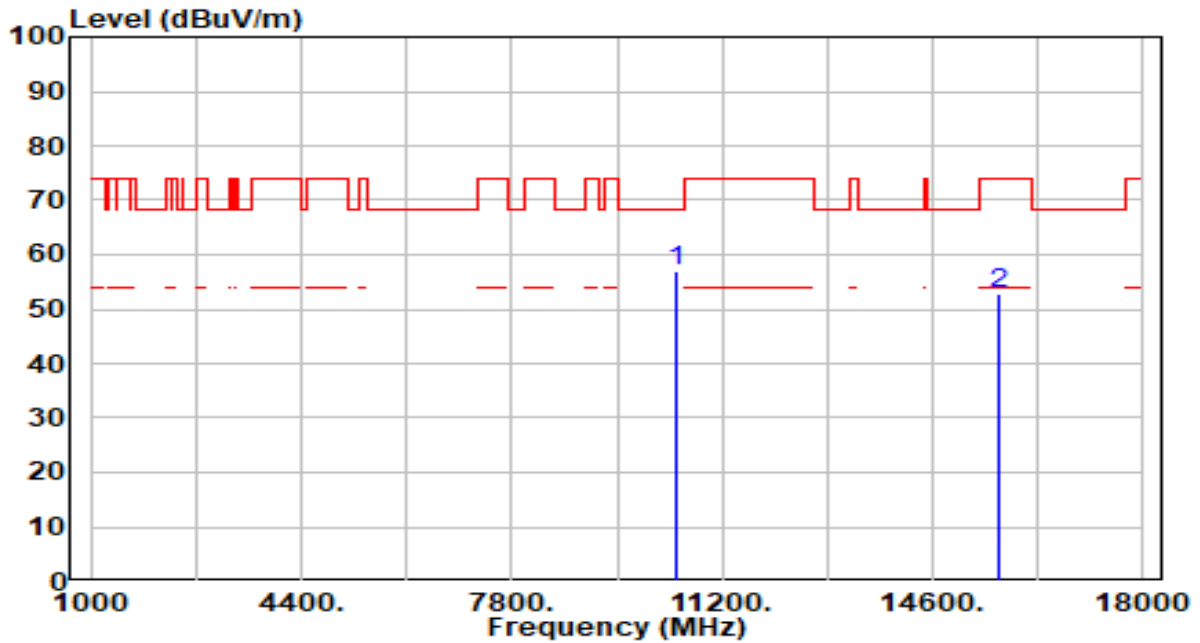

No	Frequency (MHz)	Reading (dBuV)	C.F (dB/m)	Measurement (dBuV/m)	Margin (dB)	Limit (dBuV/m)	Height (cm)	Angle (deg)	Remark (QP/PK/AV)
1	* 10440.000	53.75	3.15	56.89	-11.31	68.20	200	50	Peak
2	15660.000	47.83	4.89	52.72	-21.28	74.00	200	5	Peak

Note:

1. " \*", means this data is the worst emission level.
2. C.F (Correction Factor) = Antenna Factor (dB/m) + Cable Loss (dB) – Pre-amplifier(dB).
3. Measurement (dBuV/m) = Reading(dBuV) + C.F (Correction Factor).
4. The emission levels of other frequencies are very lower than the limit and not show in test report.



EUT	AX3000 High Gain Wireless USB Adapter	Date of Test	2023-01-19
Factor	DRH18-E	Temp. / Humidity	20°C /62%
Polarity	Horizontal	Site / Test Engineer	AC2 / Ares
Test Mode	802.11ac-20MHz_TX_Band1_CH 48_ANT 1+2	Test Voltage	By Notebook PC

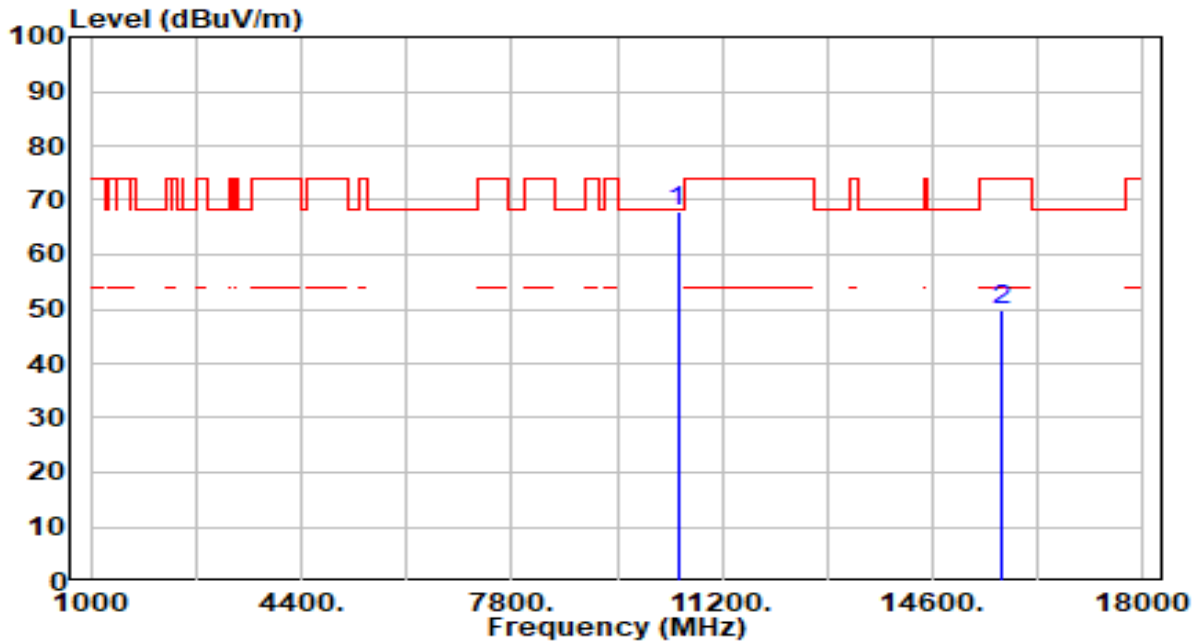

No	Frequency (MHz)	Reading (dBuV)	C.F (dB/m)	Measurement (dBuV/m)	Margin (dB)	Limit (dBuV/m)	Height (cm)	Angle (deg)	Remark (QP/PK/AV)
1	* 10480.000	64.94	3.11	68.05	-0.15	68.20	200	255	Peak
2	15720.000	44.92	5.02	49.94	-24.06	74.00	200	226	Peak

Note:

1. " \*", means this data is the worst emission level.
2. C.F (Correction Factor) = Antenna Factor (dB/m) + Cable Loss (dB) – Pre-amplifier(dB).
3. Measurement (dBuV/m) = Reading(dBuV) + C.F (Correction Factor).
4. The emission levels of other frequencies are very lower than the limit and not show in test report.

EUT	AX3000 High Gain Wireless USB Adapter	Date of Test	2023-01-19
Factor	DRH18-E	Temp. / Humidity	20°C /62%
Polarity	Vertical	Site / Test Engineer	AC2 / Ares
Test Mode	802.11ac-20MHz_TX_Band1_CH 48_ANT 1+2	Test Voltage	By Notebook PC

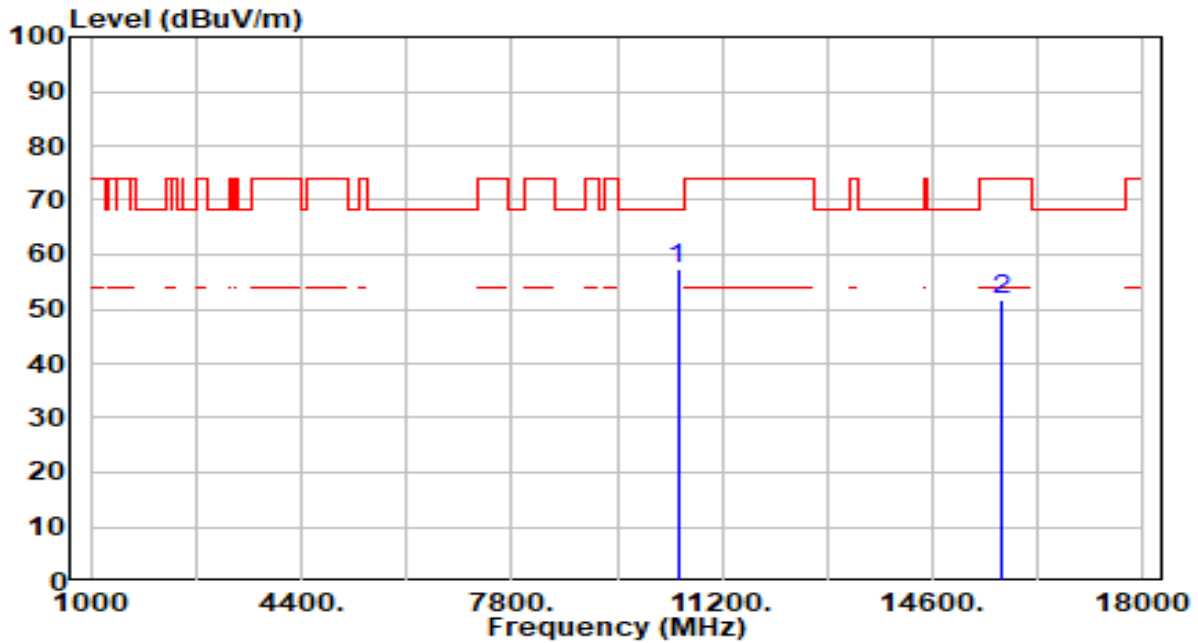

No	Frequency (MHz)	Reading (dBuV)	C.F (dB/m)	Measurement (dBuV/m)	Margin (dB)	Limit (dBuV/m)	Height (cm)	Angle (deg)	Remark (QP/PK/AV)
1	*	54.08	3.11	57.19	-11.01	68.20	200	70	Peak
2		46.57	5.02	51.59	-22.41	74.00	200	360	Peak

Note:

1. " \*", means this data is the worst emission level.
2. C.F (Correction Factor) = Antenna Factor (dB/m) + Cable Loss (dB) – Pre-amplifier(dB).
3. Measurement (dBuV/m) = Reading(dBuV) + C.F (Correction Factor).
4. The emission levels of other frequencies are very lower than the limit and not show in test report.

EUT	AX3000 High Gain Wireless USB Adapter	Date of Test	2023-01-19
Factor	DRH18-E	Temp. / Humidity	20°C /62%
Polarity	Horizontal	Site / Test Engineer	AC2 / Ares
Test Mode	802.11ac-20MHz_TX_Band2_CH 52_ANT 1+2	Test Voltage	By Notebook PC

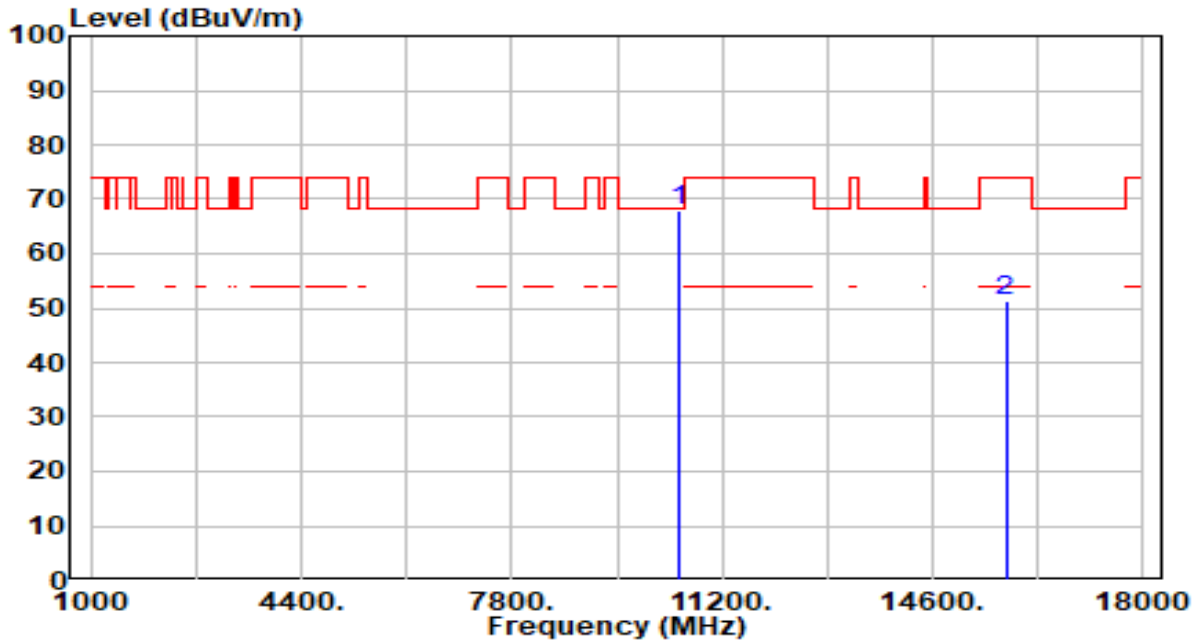

No	Frequency (MHz)	Reading (dBuV)	C.F (dB/m)	Measurement (dBuV/m)	Margin (dB)	Limit (dBuV/m)	Height (cm)	Angle (deg)	Remark (QP/PK/AV)
1	* 10520.000	64.97	3.09	68.06	-0.14	68.20	200	255	Peak
2	15780.000	46.10	5.15	51.25	-22.75	74.00	200	360	Peak

Note:

1. " \*", means this data is the worst emission level.
2. C.F (Correction Factor) = Antenna Factor (dB/m) + Cable Loss (dB) – Pre-amplifier(dB).
3. Measurement (dBuV/m) = Reading(dBuV) + C.F (Correction Factor).
4. The emission levels of other frequencies are very lower than the limit and not show in test report.

EUT	AX3000 High Gain Wireless USB Adapter	Date of Test	2023-01-19
Factor	DRH18-E	Temp. / Humidity	20°C /62%
Polarity	Vertical	Site / Test Engineer	AC2 / Ares
Test Mode	802.11ac-20MHz_TX_Band2_CH 52_ANT 1+2	Test Voltage	By Notebook PC

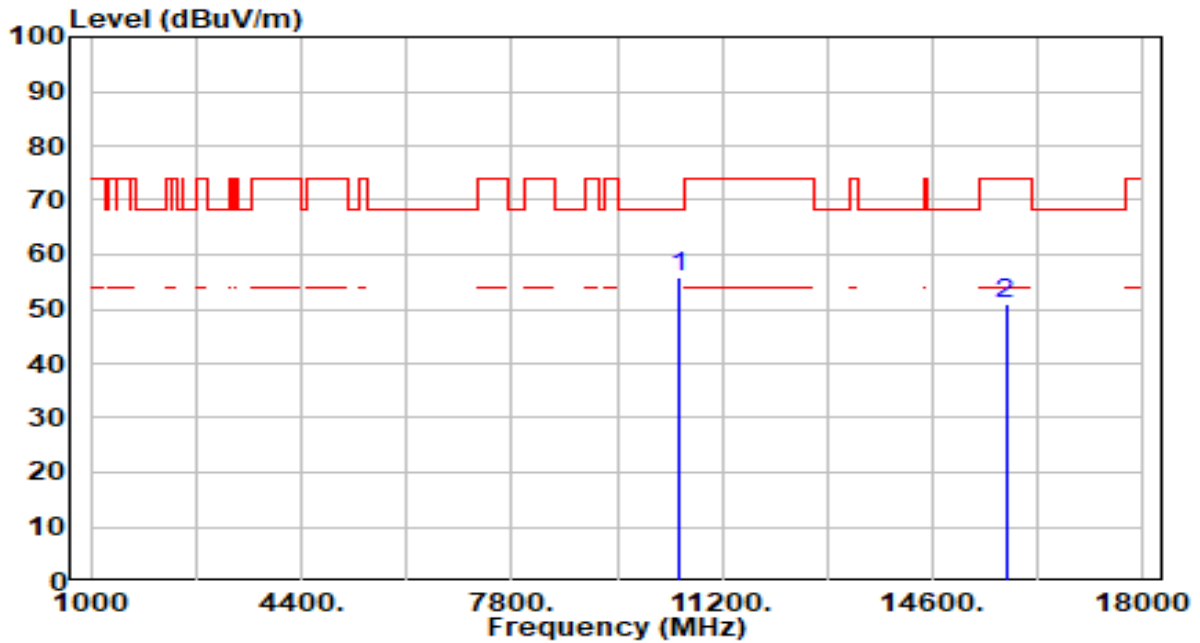

No	Frequency (MHz)	Reading (dBuV)	C.F (dB/m)	Measurement (dBuV/m)	Margin (dB)	Limit (dBuV/m)	Height (cm)	Angle (deg)	Remark (QP/PK/AV)
1	* 10520.000	52.79	3.09	55.88	-12.32	68.20	200	315	Peak
2	15780.000	45.79	5.15	50.94	-23.06	74.00	200	335	Peak

Note:

1. " \*", means this data is the worst emission level.
2. C.F (Correction Factor) = Antenna Factor (dB/m) + Cable Loss (dB) – Pre-amplifier(dB).
3. Measurement (dBuV/m) = Reading(dBuV) + C.F (Correction Factor).
4. The emission levels of other frequencies are very lower than the limit and not show in test report.

EUT	AX3000 High Gain Wireless USB Adapter	Date of Test	2023-01-30
Factor	DRH18-E	Temp. / Humidity	20°C /62%
Polarity	Horizontal	Site / Test Engineer	AC2 / Ares
Test Mode	802.11ac-20MHz_TX_Band2_CH 60_ANT 1+2	Test Voltage	By Notebook PC

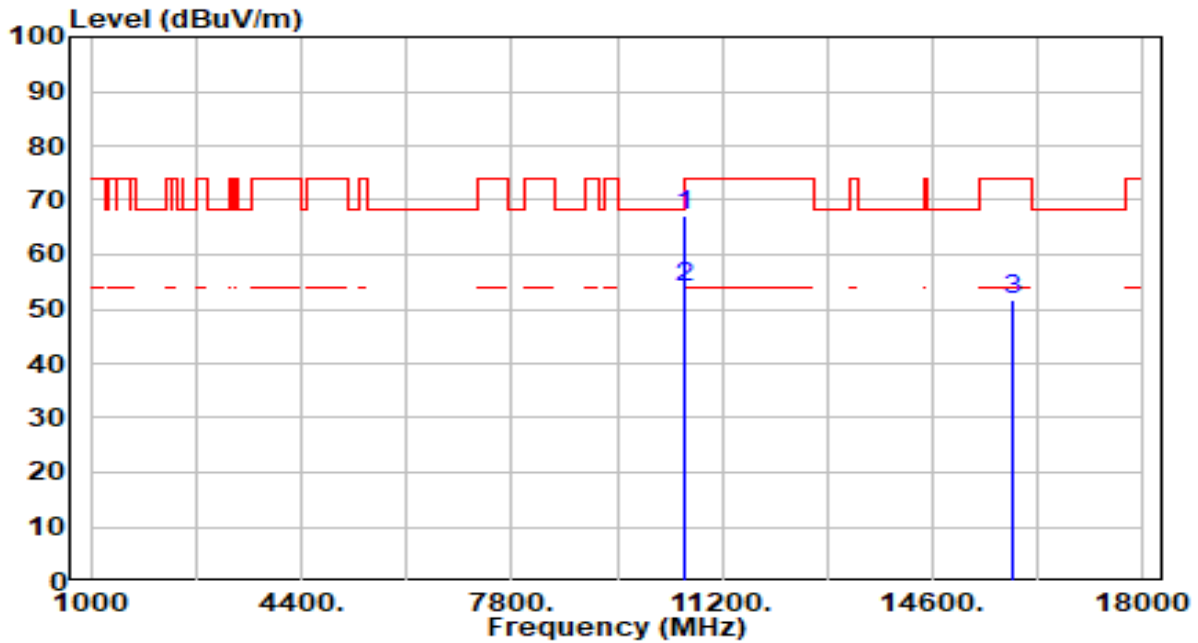

No	Frequency (MHz)	Reading (dBuV)	C.F (dB/m)	Measurement (dBuV/m)	Margin (dB)	Limit (dBuV/m)	Height (cm)	Angle (deg)	Remark (QP/PK/AV)	
1	*	10600.000	64.29	3.06	67.35	-6.65	74.00	200	255	Peak
2	*	10600.000	50.75	3.06	53.81	-0.19	54.00	200	255	Average
3		15900.000	46.38	5.27	51.65	-22.35	74.00	200	308	Peak

Note:

1. " \*", means this data is the worst emission level.
2. C.F (Correction Factor) = Antenna Factor (dB/m) + Cable Loss (dB) – Preamplifier(dB).
3. Measurement (dBuV/m) = Reading(dBuV) + C.F (Correction Factor).
4. The emission levels of other frequencies are very lower than the limit and not show in test report.

EUT	AX3000 High Gain Wireless USB Adapter	Date of Test	2023-01-30
Factor	DRH18-E	Temp. / Humidity	20°C /62%
Polarity	Vertical	Site / Test Engineer	AC2 / Ares
Test Mode	802.11ac-20MHz_TX_Band2_CH 60_ANT 1+2	Test Voltage	By Notebook PC

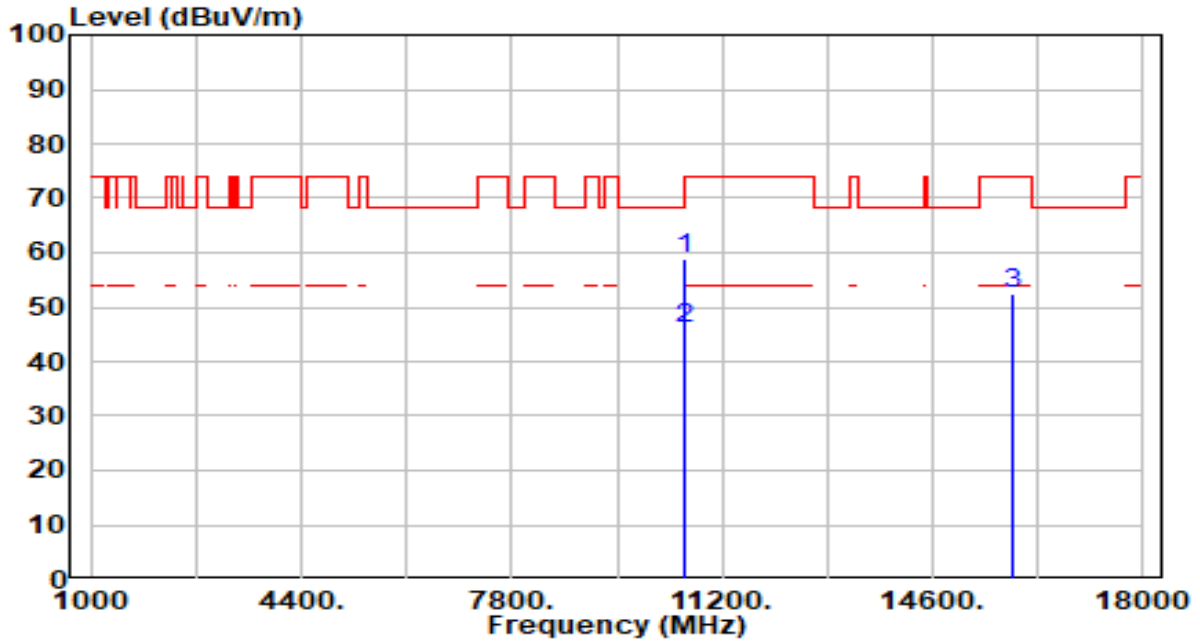

No	Frequency (MHz)	Reading (dBuV)	C.F (dB/m)	Measurement (dBuV/m)	Margin (dB)	Limit (dBuV/m)	Height (cm)	Angle (deg)	Remark (QP/PK/AV)
1	*	55.72	3.06	58.78	-15.22	74.00	200	67	Peak
2	*	42.89	3.06	45.95	-8.05	54.00	200	67	Average
3		47.30	5.27	52.57	-21.43	74.00	200	55	Peak

Note:

1. " \*", means this data is the worst emission level.
2. C.F (Correction Factor) = Antenna Factor (dB/m) + Cable Loss (dB) – Pre-amplifier(dB).
3. Measurement (dBuV/m) = Reading(dBuV) + C.F (Correction Factor).
4. The emission levels of other frequencies are very lower than the limit and not show in test report.

EUT	AX3000 High Gain Wireless USB Adapter	Date of Test	2023-01-19
Factor	DRH18-E	Temp. / Humidity	20°C /62%
Polarity	Horizontal	Site / Test Engineer	AC2 / Ares
Test Mode	802.11ac-20MHz_TX_Band2_CH 64_ANT 1+2	Test Voltage	By Notebook PC

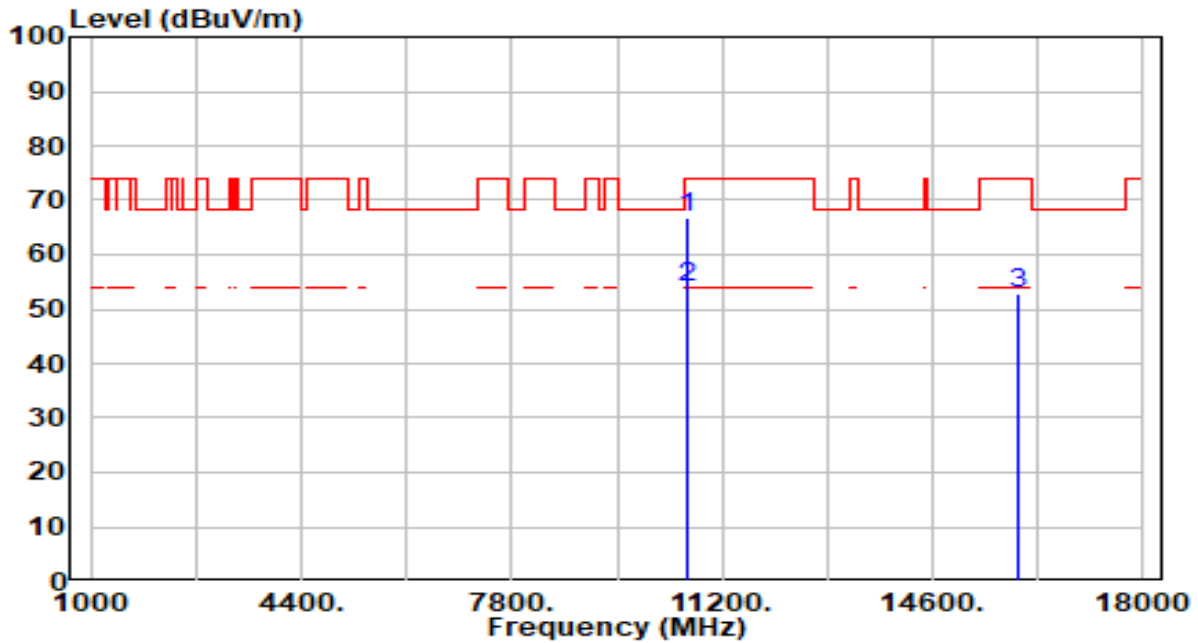

No	Frequency (MHz)	Reading (dBuV)	C.F (dB/m)	Measurement (dBuV/m)	Margin (dB)	Limit (dBuV/m)	Height (cm)	Angle (deg)	Remark (QP/PK/AV)	
1	*	10640.000	63.81	3.06	66.87	-7.13	74.00	200	260	Peak
2	*	10640.000	50.75	3.06	53.81	-0.19	54.00	200	256	Average
3		15960.000	47.69	5.31	53.01	-20.99	74.00	200	324	Peak

Note:

1. " \*", means this data is the worst emission level.
2. C.F (Correction Factor) = Antenna Factor (dB/m) + Cable Loss (dB) – Preamplifier(dB).
3. Measurement (dBuV/m) = Reading(dBuV) + C.F (Correction Factor).
4. The emission levels of other frequencies are very lower than the limit and not show in test report.

EUT	AX3000 High Gain Wireless USB Adapter	Date of Test	2023-01-19
Factor	DRH18-E	Temp. / Humidity	20°C /62%
Polarity	Vertical	Site / Test Engineer	AC2 / Ares
Test Mode	802.11ac-20MHz_TX_Band2_CH 64_ANT 1+2	Test Voltage	By Notebook PC

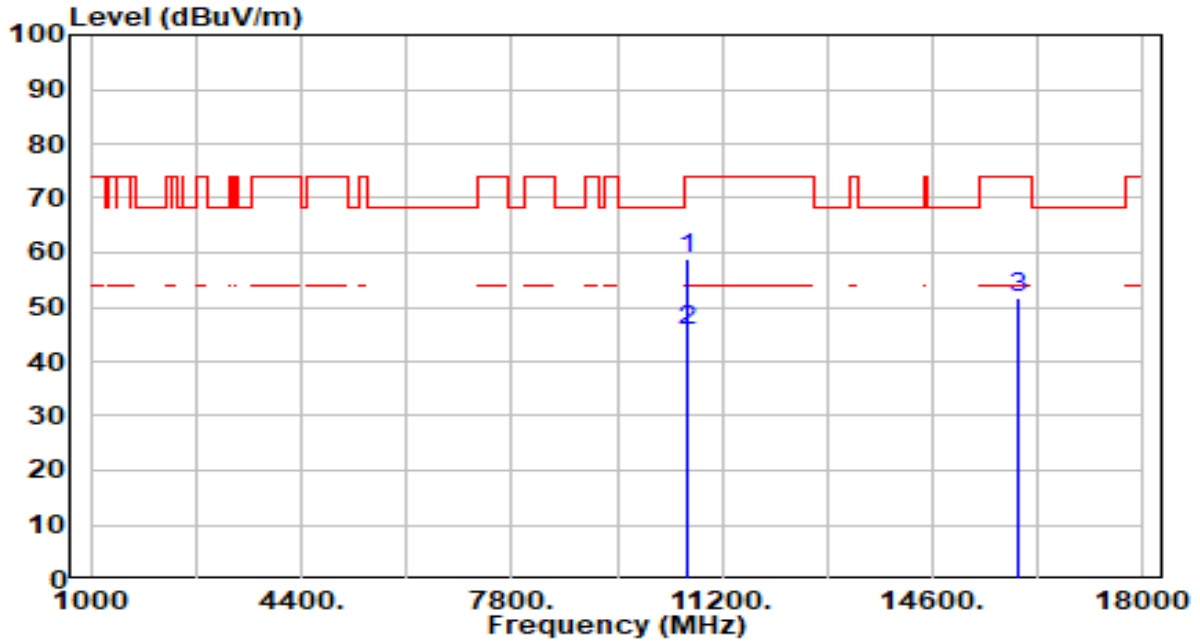

No	Frequency (MHz)	Reading (dBuV)	C.F (dB/m)	Measurement (dBuV/m)	Margin (dB)	Limit (dBuV/m)	Height (cm)	Angle (deg)	Remark (QP/PK/AV)	
1	*	10640.000	55.62	3.06	58.68	-15.32	74.00	200	60	Peak
2	*	10640.000	42.77	3.06	45.83	-8.17	54.00	200	60	Average
3		15960.000	46.28	5.31	51.60	-22.40	74.00	200	10	Peak

Note:

1. " \*", means this data is the worst emission level.
2. C.F (Correction Factor) = Antenna Factor (dB/m) + Cable Loss (dB) – Preamplifier(dB).
3. Measurement (dBuV/m) = Reading(dBuV) + C.F (Correction Factor).
4. The emission levels of other frequencies are very lower than the limit and not show in test report.



EUT	AX3000 High Gain Wireless USB Adapter	Date of Test	2023-01-19
Factor	DRH18-E	Temp. / Humidity	20°C /62%
Polarity	Horizontal	Site / Test Engineer	AC2 / Ares
Test Mode	802.11ac-20MHz_TX_Band3_CH 100_ANT 1+2	Test Voltage	By Notebook PC

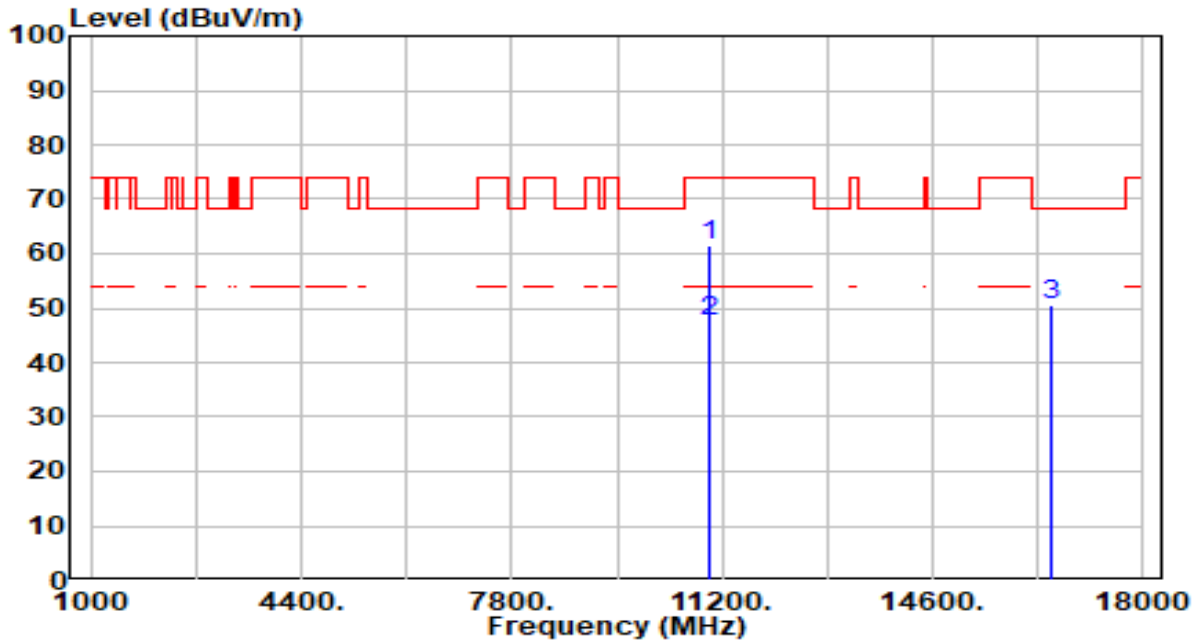

No	Frequency (MHz)	Reading (dBuV)	C.F (dB/m)	Measurement (dBuV/m)	Margin (dB)	Limit (dBuV/m)	Height (cm)	Angle (deg)	Remark (QP/PK/AV)
1	* 11000.000	58.14	3.21	61.35	-12.65	74.00	183	80	Peak
2	* 11000.000	44.36	3.21	47.57	-6.43	54.00	183	80	Average
3	16500.000	45.95	4.61	50.56	-17.64	68.20	200	179	Peak

Note:

1. " \*", means this data is the worst emission level.
2. C.F (Correction Factor) = Antenna Factor (dB/m) + Cable Loss (dB) – Pre-amplifier(dB).
3. Measurement (dBuV/m) = Reading(dBuV) + C.F (Correction Factor).
4. The emission levels of other frequencies are very lower than the limit and not show in test report.

EUT	AX3000 High Gain Wireless USB Adapter	Date of Test	2023-01-19
Factor	DRH18-E	Temp. / Humidity	20°C /62%
Polarity	Vertical	Site / Test Engineer	AC2 / Ares
Test Mode	802.11ac-20MHz_TX_Band3_CH 100_ANT 1+2	Test Voltage	By Notebook PC

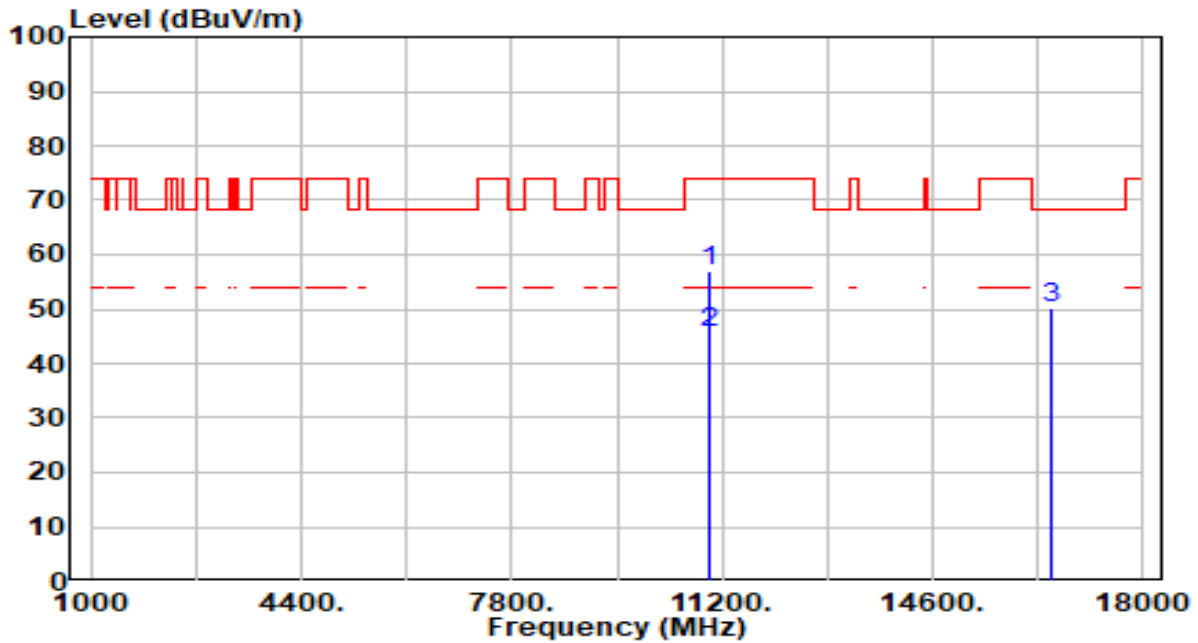

No	Frequency (MHz)	Reading (dBuV)	C.F (dB/m)	Measurement (dBuV/m)	Margin (dB)	Limit (dBuV/m)	Height (cm)	Angle (deg)	Remark (QP/PK/AV)	
1	*	11000.000	53.78	3.21	56.99	-17.01	74.00	229	332	Peak
2	*	11000.000	42.51	3.21	45.72	-8.28	54.00	229	332	Average
3		16500.000	45.54	4.61	50.15	-18.05	68.20	200	0	Peak

Note:

1. " \*", means this data is the worst emission level.
2. C.F (Correction Factor) = Antenna Factor (dB/m) + Cable Loss (dB) – Pre-amplifier(dB).
3. Measurement (dBuV/m) = Reading(dBuV) + C.F (Correction Factor).
4. The emission levels of other frequencies are very lower than the limit and not show in test report.

EUT	AX3000 High Gain Wireless USB Adapter	Date of Test	2023-01-19
Factor	DRH18-E	Temp. / Humidity	20°C /62%
Polarity	Horizontal	Site / Test Engineer	AC2 / Ares
Test Mode	802.11ac-20MHz_TX_Band3_CH 116_ANT 1+2	Test Voltage	By Notebook PC

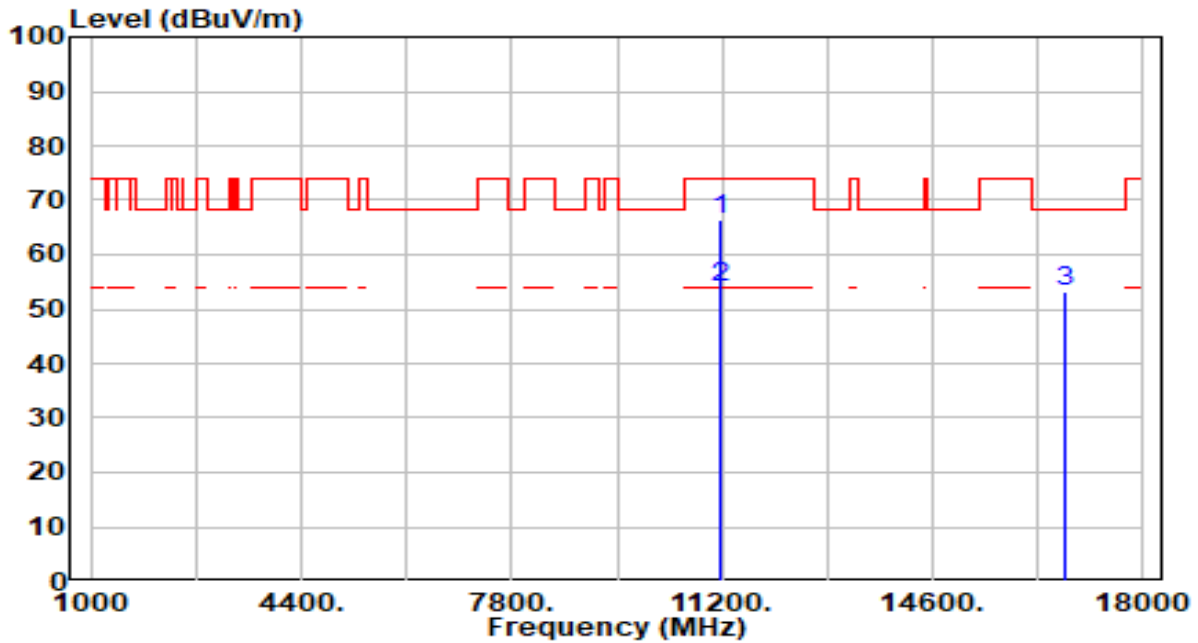

No	Frequency (MHz)	Reading (dBuV)	C.F (dB/m)	Measurement (dBuV/m)	Margin (dB)	Limit (dBuV/m)	Height (cm)	Angle (deg)	Remark (QP/PK/AV)	
1	*	11160.000	62.91	3.49	66.40	-7.60	74.00	189	9	Peak
2	*	11160.000	50.35	3.49	53.84	-0.16	54.00	189	9	Average
3		16740.000	48.84	4.48	53.33	-14.87	68.20	200	16	Peak

Note:

1. " \*", means this data is the worst emission level.
2. C.F (Correction Factor) = Antenna Factor (dB/m) + Cable Loss (dB) – Pre-amplifier(dB).
3. Measurement (dBuV/m) = Reading(dBuV) + C.F (Correction Factor).
4. The emission levels of other frequencies are very lower than the limit and not show in test report.

EUT	AX3000 High Gain Wireless USB Adapter	Date of Test	2023-01-19
Factor	DRH18-E	Temp. / Humidity	20°C /62%
Polarity	Vertical	Site / Test Engineer	AC2 / Ares
Test Mode	802.11ac-20MHz_TX_Band3_CH 116_ANT 1+2	Test Voltage	By Notebook PC

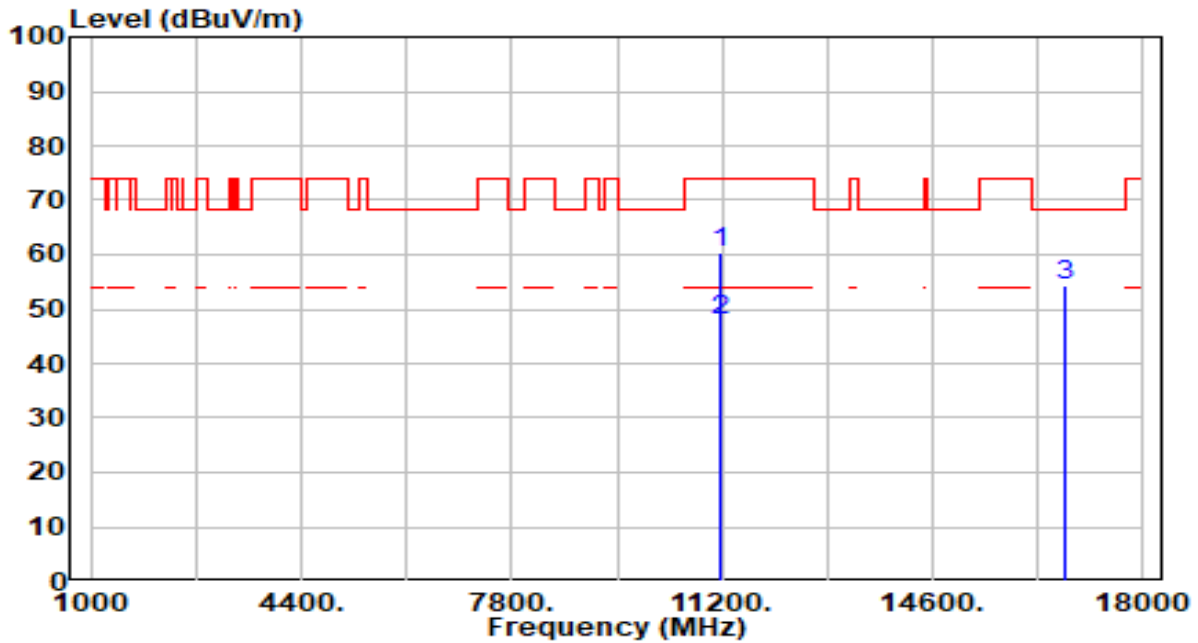

No	Frequency (MHz)	Reading (dBuV)	C.F (dB/m)	Measurement (dBuV/m)	Margin (dB)	Limit (dBuV/m)	Height (cm)	Angle (deg)	Remark (QP/PK/AV)	
1	*	11160.000	56.95	3.49	60.44	-13.56	74.00	200	360	Peak
2	*	11160.000	44.40	3.49	47.89	-6.11	54.00	200	360	Average
3		16740.000	49.94	4.48	54.43	-13.77	68.20	200	360	Peak

Note:

1. " \*", means this data is the worst emission level.
2. C.F (Correction Factor) = Antenna Factor (dB/m) + Cable Loss (dB) – Preamplifier(dB).
3. Measurement (dBuV/m) = Reading(dBuV) + C.F (Correction Factor).
4. The emission levels of other frequencies are very lower than the limit and not show in test report.

EUT	AX3000 High Gain Wireless USB Adapter	Date of Test	2023-01-19
Factor	DRH18-E	Temp. / Humidity	20°C /62%
Polarity	Horizontal	Site / Test Engineer	AC2 / Ares
Test Mode	802.11ac-20MHz_TX_Band3_CH 140_ANT 1+2	Test Voltage	By Notebook PC

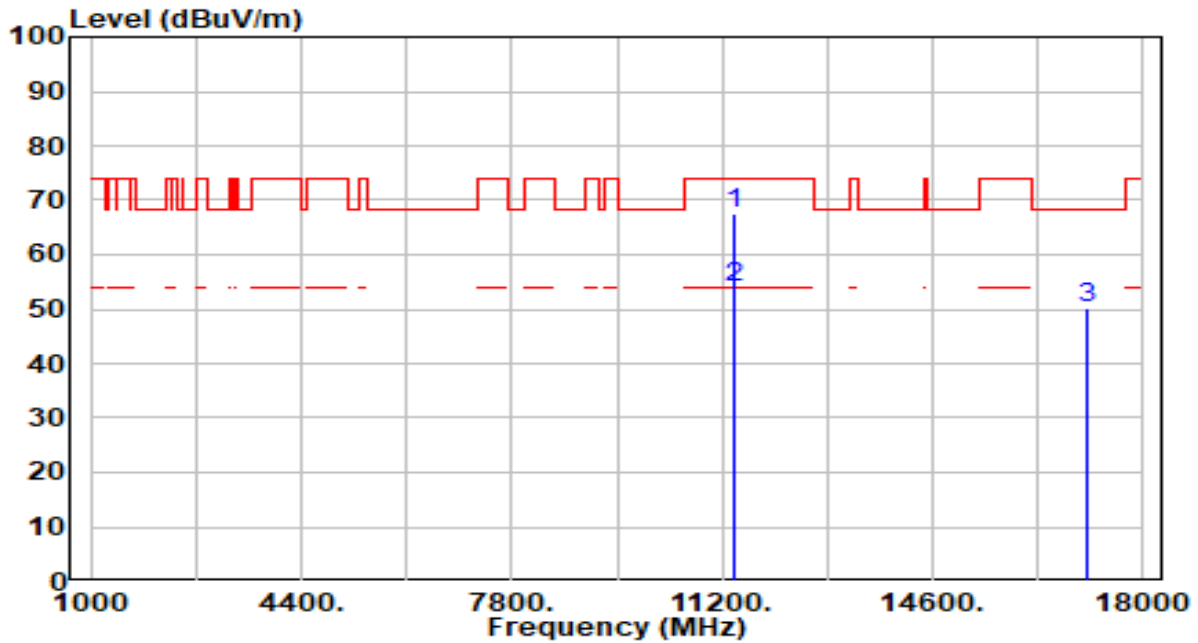

No	Frequency (MHz)	Reading (dBuV)	C.F (dB/m)	Measurement (dBuV/m)	Margin (dB)	Limit (dBuV/m)	Height (cm)	Angle (deg)	Remark (QP/PK/AV)	
1	*	11400.000	63.80	3.90	67.70	-6.30	74.00	190	12	Peak
2	*	11400.000	49.96	3.90	53.86	-0.14	54.00	190	12	Average
3		17100.000	45.88	4.48	50.35	-17.85	68.20	200	206	Peak

Note:

1. " \*", means this data is the worst emission level.
2. C.F (Correction Factor) = Antenna Factor (dB/m) + Cable Loss (dB) – Preamplifier(dB).
3. Measurement (dBuV/m) = Reading(dBuV) + C.F (Correction Factor).
4. The emission levels of other frequencies are very lower than the limit and not show in test report.

EUT	AX3000 High Gain Wireless USB Adapter	Date of Test	2023-01-19
Factor	DRH18-E	Temp. / Humidity	20°C /62%
Polarity	Vertical	Site / Test Engineer	AC2 / Ares
Test Mode	802.11ac-20MHz_TX_Band3_CH 140_ANT 1+2	Test Voltage	By Notebook PC

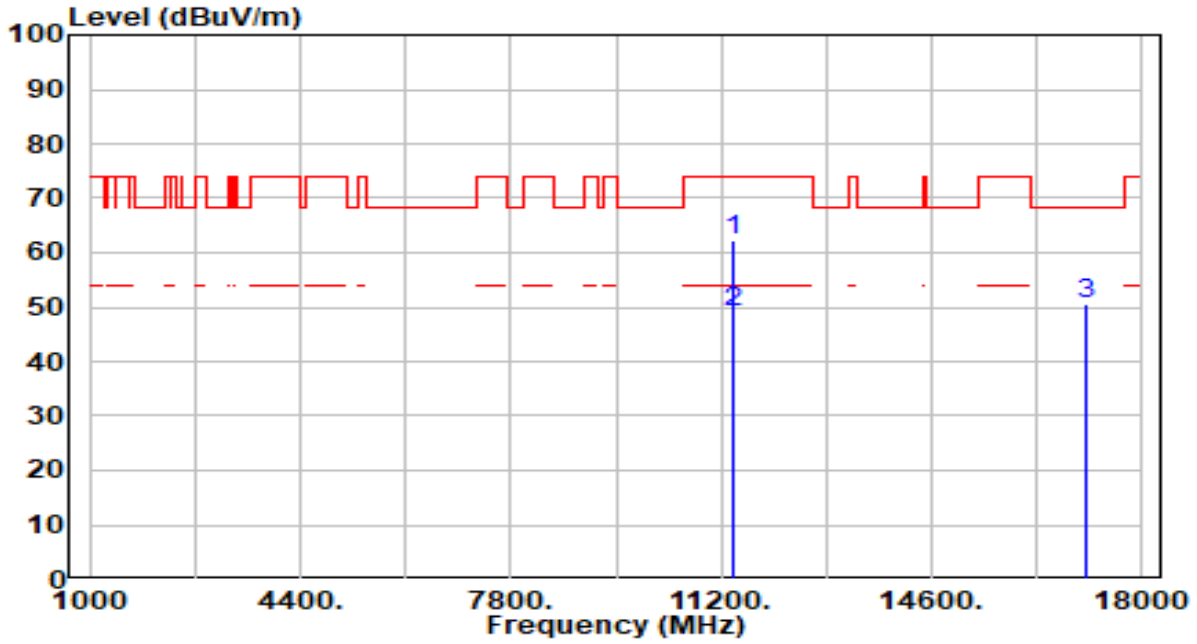

No	Frequency (MHz)	Reading (dBuV)	C.F (dB/m)	Measurement (dBuV/m)	Margin (dB)	Limit (dBuV/m)	Height (cm)	Angle (deg)	Remark (QP/PK/AV)	
1	*	11400.000	58.40	3.90	62.30	-11.70	74.00	200	360	Peak
2	*	11400.000	45.21	3.90	49.11	-4.89	54.00	200	360	Average
3		17100.000	46.15	4.48	50.63	-17.57	68.20	200	360	Peak

Note:

1. " \*", means this data is the worst emission level.
2. C.F (Correction Factor) = Antenna Factor (dB/m) + Cable Loss (dB) – Preamplifier(dB).
3. Measurement (dBuV/m) = Reading(dBuV) + C.F (Correction Factor).
4. The emission levels of other frequencies are very lower than the limit and not show in test report.

EUT	AX3000 High Gain Wireless USB Adapter	Date of Test	2023-01-19
Factor	DRH18-E	Temp. / Humidity	20°C /62%
Polarity	Horizontal	Site / Test Engineer	AC2 / Ares
Test Mode	802.11ac-20MHz_TX_Band3_CH 144_ANT 1+2	Test Voltage	By Notebook PC

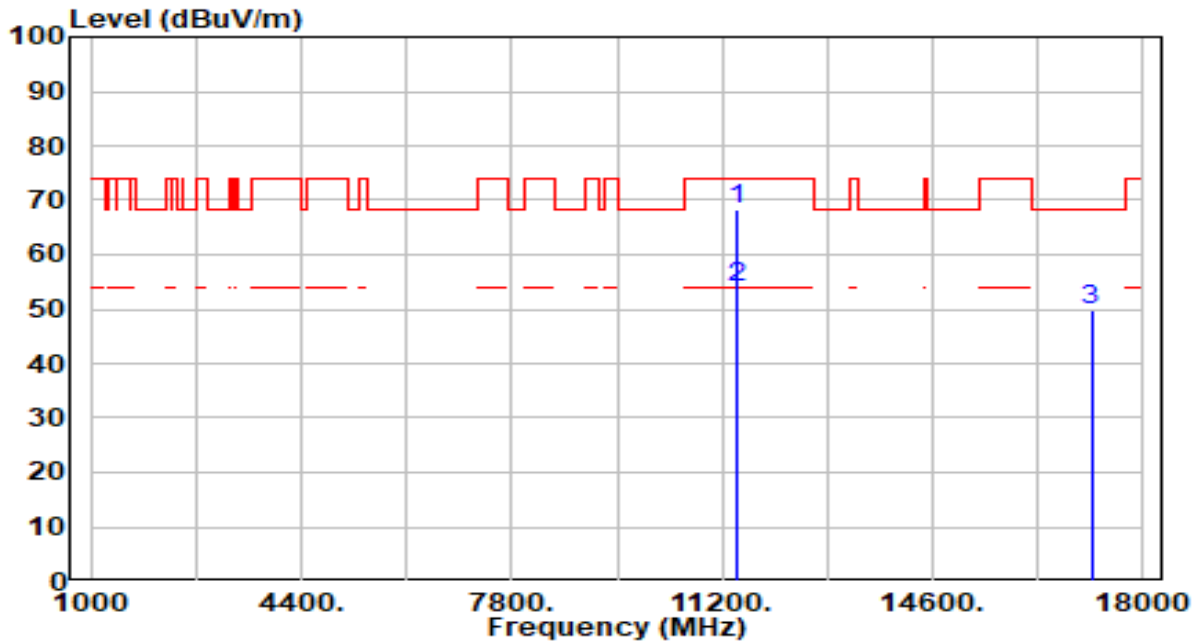

No	Frequency (MHz)	Reading (dBuV)	C.F (dB/m)	Measurement (dBuV/m)	Margin (dB)	Limit (dBuV/m)	Height (cm)	Angle (deg)	Remark (QP/PK/AV)	
1	*	11440.000	64.36	3.91	68.27	-5.73	74.00	180	19	Peak
2	*	11440.000	49.95	3.91	53.86	-0.14	54.00	180	19	Average
3		17160.000	45.38	4.28	49.66	-18.54	68.20	200	25	Peak

Note:

1. " \*", means this data is the worst emission level.
2. C.F (Correction Factor) = Antenna Factor (dB/m) + Cable Loss (dB) – Preamplifier(dB).
3. Measurement (dBuV/m) = Reading(dBuV) + C.F (Correction Factor).
4. The emission levels of other frequencies are very lower than the limit and not show in test report.

EUT	AX3000 High Gain Wireless USB Adapter	Date of Test	2023-01-19
Factor	DRH18-E	Temp. / Humidity	20°C /62%
Polarity	Vertical	Site / Test Engineer	AC2 / Ares
Test Mode	802.11ac-20MHz_TX_Band3_CH 144_ANT 1+2	Test Voltage	By Notebook PC

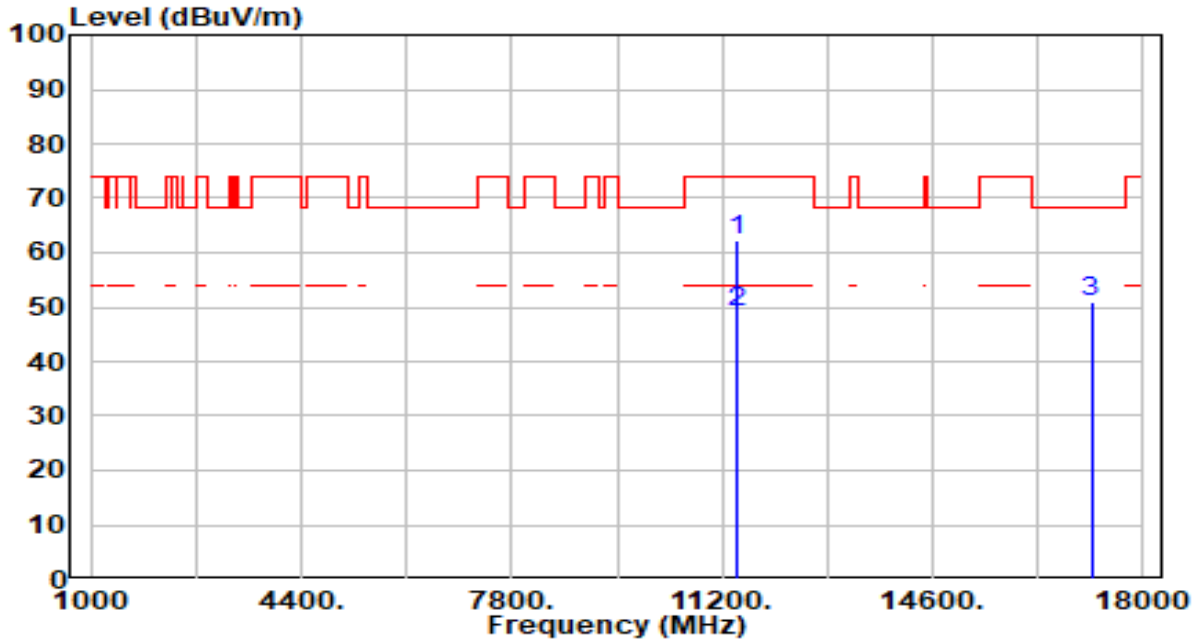

No	Frequency (MHz)	Reading (dBuV)	C.F (dB/m)	Measurement (dBuV/m)	Margin (dB)	Limit (dBuV/m)	Height (cm)	Angle (deg)	Remark (QP/PK/AV)	
1	*	11440.000	58.33	3.91	62.25	-11.75	74.00	200	18	Peak
2	*	11440.000	45.11	3.91	49.02	-4.98	54.00	200	18	Average
3		17160.000	46.56	4.28	50.83	-17.37	68.20	200	180	Peak

Note:

1. " \*", means this data is the worst emission level.
2. C.F (Correction Factor) = Antenna Factor (dB/m) + Cable Loss (dB) – Preamplifier(dB).
3. Measurement (dBuV/m) = Reading(dBuV) + C.F (Correction Factor).
4. The emission levels of other frequencies are very lower than the limit and not show in test report.



EUT	AX3000 High Gain Wireless USB Adapter	Date of Test	2023-01-19
Factor	DRH18-E	Temp. / Humidity	20°C /62%
Polarity	Horizontal	Site / Test Engineer	AC2 / Ares
Test Mode	802.11ac-20MHz_TX_Band4_CH 149_ANT 1+2	Test Voltage	By Notebook PC

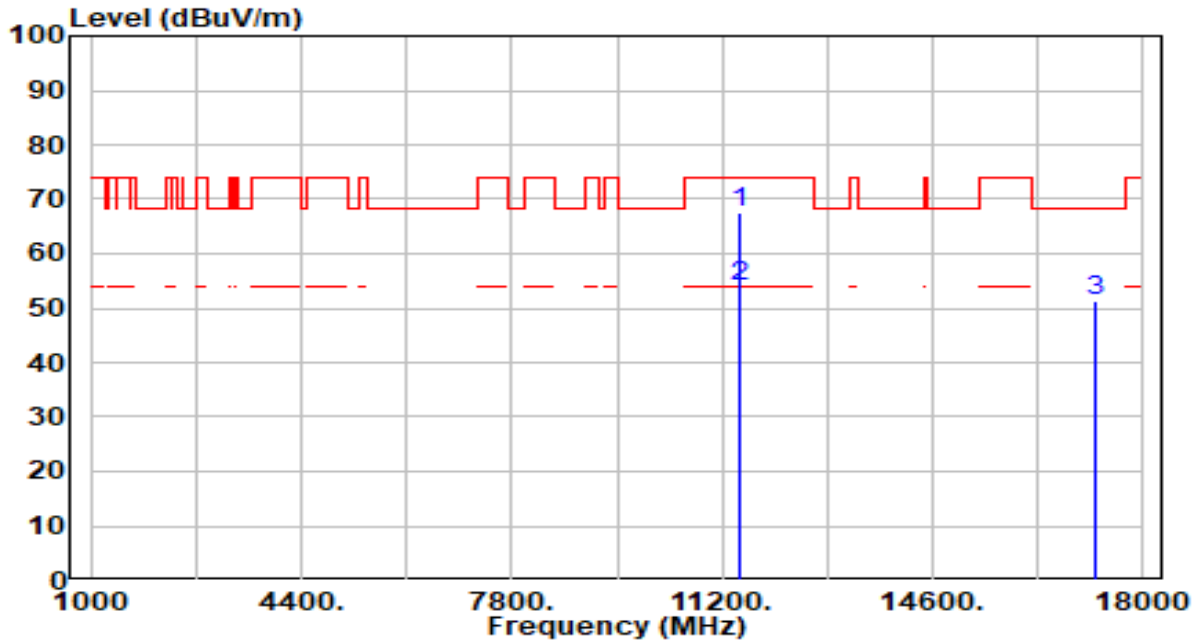

No	Frequency (MHz)	Reading (dBuV)	C.F (dB/m)	Measurement (dBuV/m)	Margin (dB)	Limit (dBuV/m)	Height (cm)	Angle (deg)	Remark (QP/PK/AV)
1	* 11490.000	63.71	3.92	67.63	-6.37	74.00	171	16	Peak
2	* 11490.000	49.90	3.92	53.82	-0.18	54.00	171	16	Average
3	17235.000	47.42	4.06	51.48	-16.72	68.20	200	21	Peak

Note:

1. " \*", means this data is the worst emission level.
2. C.F (Correction Factor) = Antenna Factor (dB/m) + Cable Loss (dB) – Pre-amplifier(dB).
3. Measurement (dBuV/m) = Reading(dBuV) + C.F (Correction Factor).
4. The emission levels of other frequencies are very lower than the limit and not show in test report.

EUT	AX3000 High Gain Wireless USB Adapter	Date of Test	2023-01-19
Factor	DRH18-E	Temp. / Humidity	20°C /62%
Polarity	Vertical	Site / Test Engineer	AC2 / Ares
Test Mode	802.11ac-20MHz_TX_Band4_CH 149_ANT 1+2	Test Voltage	By Notebook PC

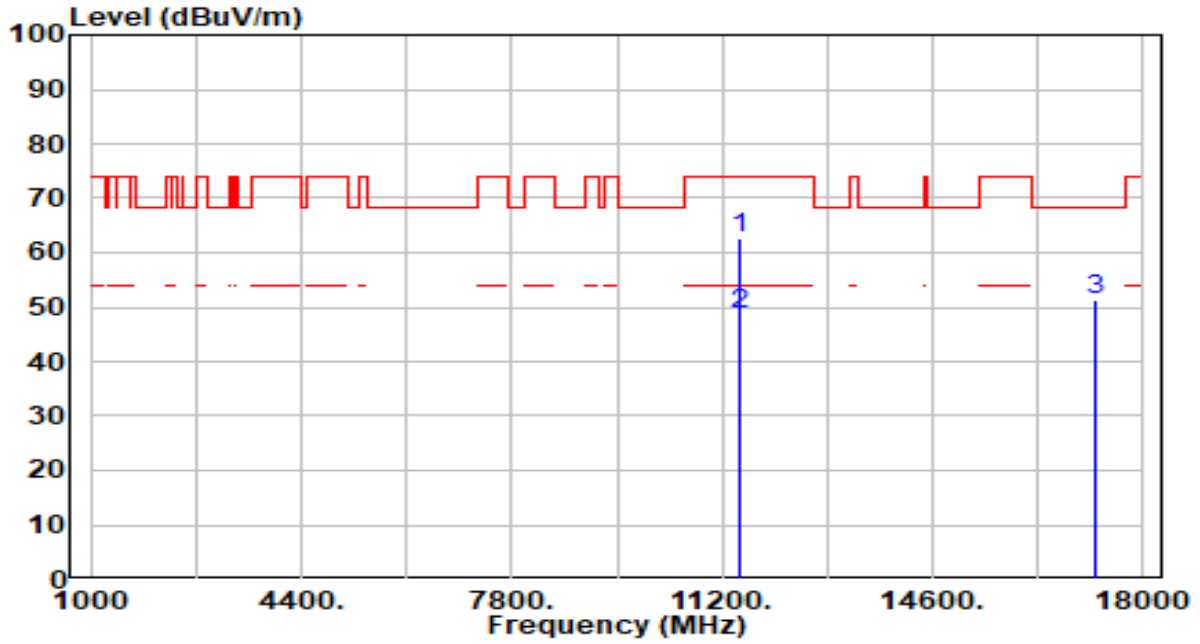

No	Frequency (MHz)	Reading (dBuV)	C.F (dB/m)	Measurement (dBuV/m)	Margin (dB)	Limit (dBuV/m)	Height (cm)	Angle (deg)	Remark (QP/PK/AV)	
1	*	11490.000	58.83	3.92	62.75	-11.25	74.00	200	13	Peak
2	*	11490.000	44.67	3.92	48.59	-5.41	54.00	200	13	Average
3		17235.000	47.31	4.06	51.37	-16.83	68.20	200	360	Peak

Note:

1. " \*", means this data is the worst emission level.
2. C.F (Correction Factor) = Antenna Factor (dB/m) + Cable Loss (dB) – Preamplifier(dB).
3. Measurement (dBuV/m) = Reading(dBuV) + C.F (Correction Factor).
4. The emission levels of other frequencies are very lower than the limit and not show in test report.

EUT	AX3000 High Gain Wireless USB Adapter	Date of Test	2023-01-19
Factor	DRH18-E	Temp. / Humidity	20°C /62%
Polarity	Horizontal	Site / Test Engineer	AC2 / Ares
Test Mode	802.11ac-20MHz_TX_Band4_CH 157_ANT 1+2	Test Voltage	By Notebook PC

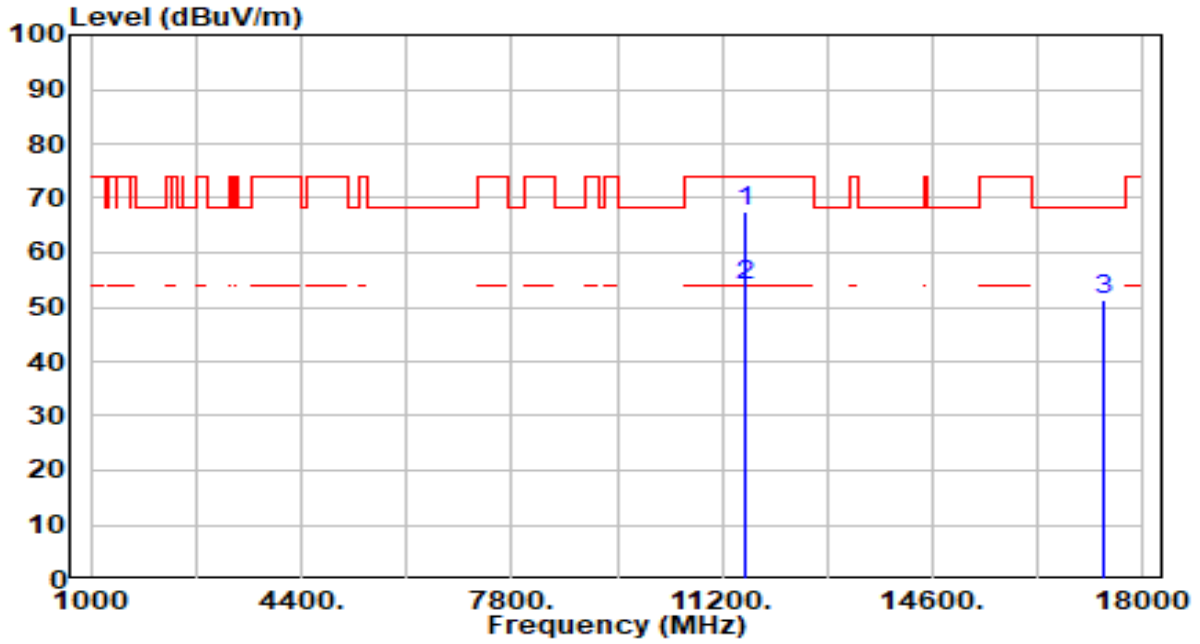

No	Frequency (MHz)	Reading (dBuV)	C.F (dB/m)	Measurement (dBuV/m)	Margin (dB)	Limit (dBuV/m)	Height (cm)	Angle (deg)	Remark (QP/PK/AV)	
1	*	11570.000	63.58	3.94	67.52	-6.48	74.00	170	20	Peak
2	*	11570.000	49.96	3.94	53.90	-0.10	54.00	170	20	Average
3		17355.000	47.58	3.78	51.36	-16.84	68.20	200	19	Peak

Note:

1. " \*", means this data is the worst emission level.
2. C.F (Correction Factor) = Antenna Factor (dB/m) + Cable Loss (dB) – Preamplifier(dB).
3. Measurement (dBuV/m) = Reading(dBuV) + C.F (Correction Factor).
4. The emission levels of other frequencies are very lower than the limit and not show in test report.

EUT	AX3000 High Gain Wireless USB Adapter	Date of Test	2023-01-19
Factor	DRH18-E	Temp. / Humidity	20°C /62%
Polarity	Vertical	Site / Test Engineer	AC2 / Ares
Test Mode	802.11ac-20MHz_TX_Band4_CH 157_ANT 1+2	Test Voltage	By Notebook PC

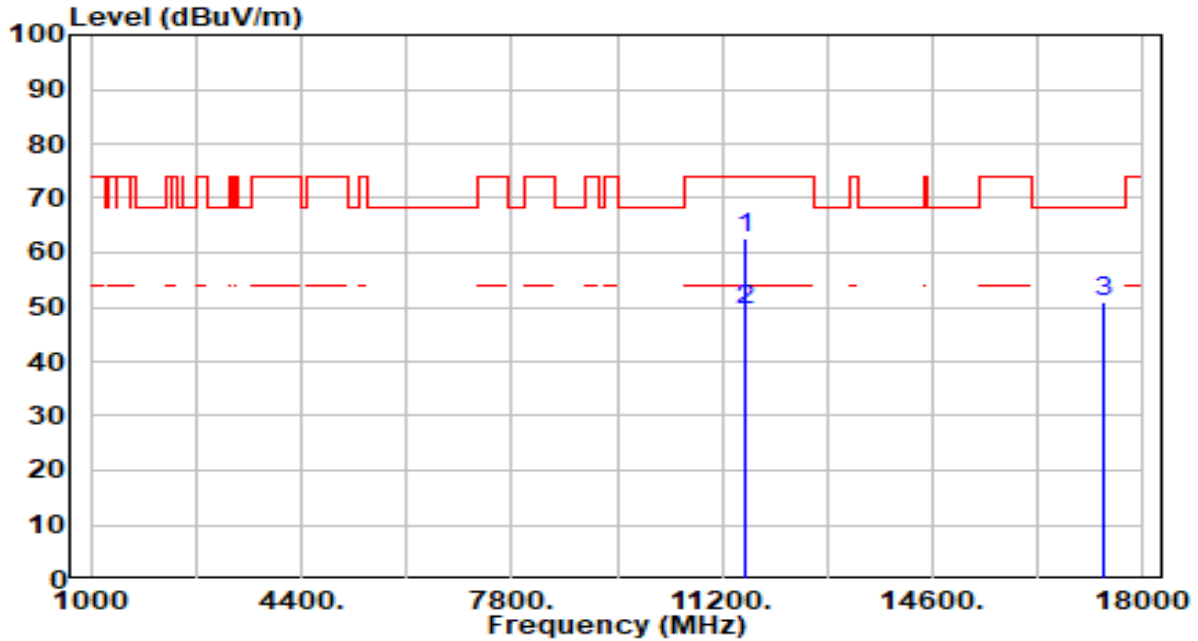

No	Frequency (MHz)	Reading (dBuV)	C.F (dB/m)	Measurement (dBuV/m)	Margin (dB)	Limit (dBuV/m)	Height (cm)	Angle (deg)	Remark (QP/PK/AV)	
1	*	11570.000	58.54	3.94	62.49	-11.51	74.00	200	13	Peak
2	*	11570.000	45.33	3.94	49.27	-4.73	54.00	200	13	Average
3		17355.000	47.20	3.78	50.98	-17.22	68.20	200	327	Peak

Note:

1. " \*", means this data is the worst emission level.
2. C.F (Correction Factor) = Antenna Factor (dB/m) + Cable Loss (dB) – Preamplifier(dB).
3. Measurement (dBuV/m) = Reading(dBuV) + C.F (Correction Factor).
4. The emission levels of other frequencies are very lower than the limit and not show in test report.

EUT	AX3000 High Gain Wireless USB Adapter	Date of Test	2023-01-19
Factor	DRH18-E	Temp. / Humidity	20°C /62%
Polarity	Horizontal	Site / Test Engineer	AC2 / Ares
Test Mode	802.11ac-20MHz_TX_Band4_CH 165_ANT 1+2	Test Voltage	By Notebook PC

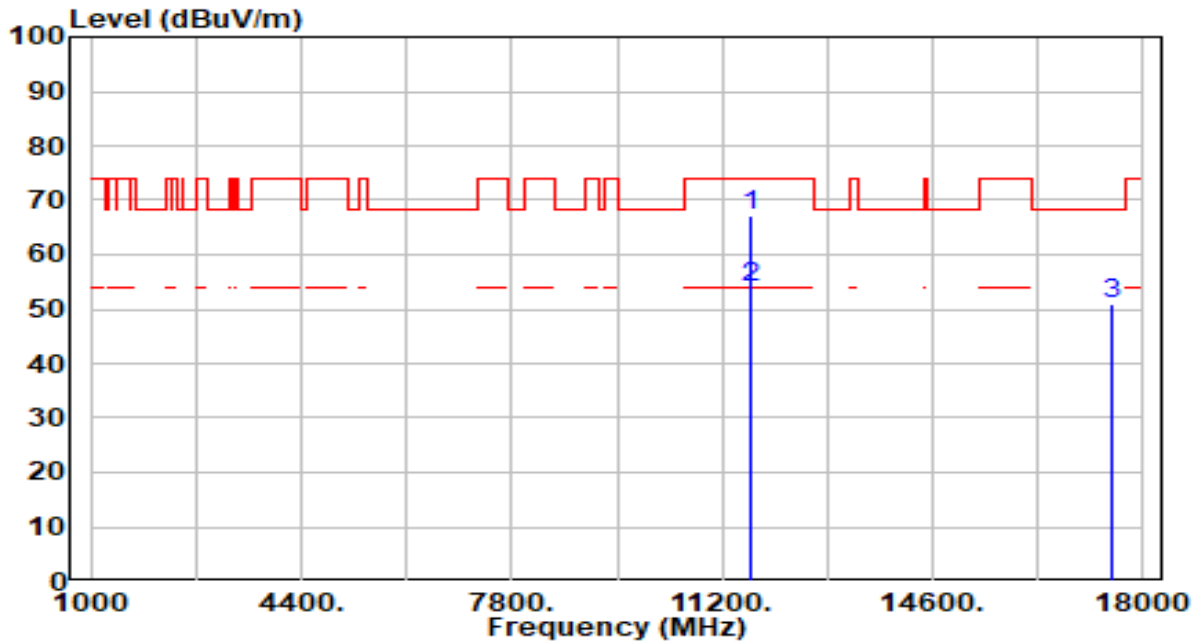

No	Frequency (MHz)	Reading (dBuV)	C.F (dB/m)	Measurement (dBuV/m)	Margin (dB)	Limit (dBuV/m)	Height (cm)	Angle (deg)	Remark (QP/PK/AV)	
1	*	11650.000	63.40	3.94	67.34	-6.66	74.00	177	19	Peak
2	*	11650.000	49.91	3.94	53.85	-0.15	54.00	177	19	Average
3		17475.000	47.42	3.65	51.07	-17.13	68.20	200	21	Peak

Note:

1. " \*", means this data is the worst emission level.
2. C.F (Correction Factor) = Antenna Factor (dB/m) + Cable Loss (dB) – Preamplifier(dB).
3. Measurement (dBuV/m) = Reading(dBuV) + C.F (Correction Factor).
4. The emission levels of other frequencies are very lower than the limit and not show in test report.

EUT	AX3000 High Gain Wireless USB Adapter	Date of Test	2023-01-19
Factor	DRH18-E	Temp. / Humidity	20°C /62%
Polarity	Vertical	Site / Test Engineer	AC2 / Ares
Test Mode	802.11ac-20MHz_TX_Band4_CH 165_ANT 1+2	Test Voltage	By Notebook PC

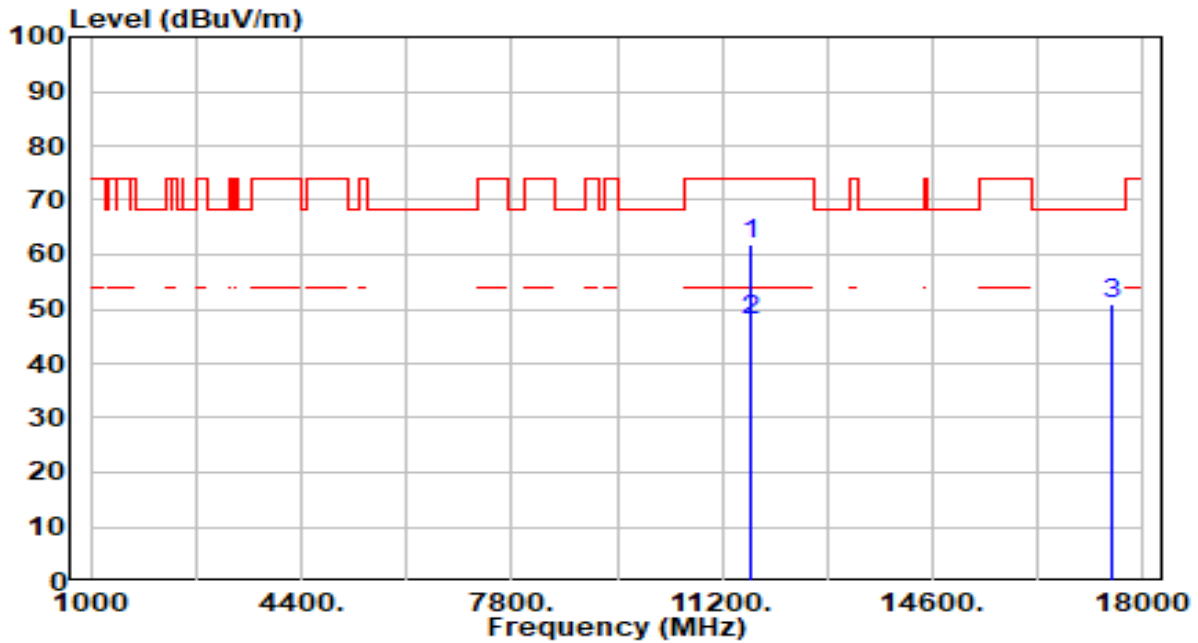

No	Frequency (MHz)	Reading (dBuV)	C.F (dB/m)	Measurement (dBuV/m)	Margin (dB)	Limit (dBuV/m)	Height (cm)	Angle (deg)	Remark (QP/PK/AV)	
1	*	11650.000	57.86	3.94	61.80	-12.20	74.00	200	27	Peak
2	*	11650.000	44.01	3.94	47.95	-6.05	54.00	200	27	Average
3		17475.000	47.35	3.65	51.00	-17.20	68.20	200	357	Peak

Note:

1. " \*", means this data is the worst emission level.
2. C.F (Correction Factor) = Antenna Factor (dB/m) + Cable Loss (dB) – Preamplifier(dB).
3. Measurement (dBuV/m) = Reading(dBuV) + C.F (Correction Factor).
4. The emission levels of other frequencies are very lower than the limit and not show in test report.

EUT	AX3000 High Gain Wireless USB Adapter	Date of Test	2023-01-19
Factor	DRH18-E	Temp. / Humidity	20°C /62%
Polarity	Horizontal	Site / Test Engineer	AC2 / Ares
Test Mode	802.11ac-40MHz_TX_Band1_CH 38_ANT 1+2	Test Voltage	By Notebook PC

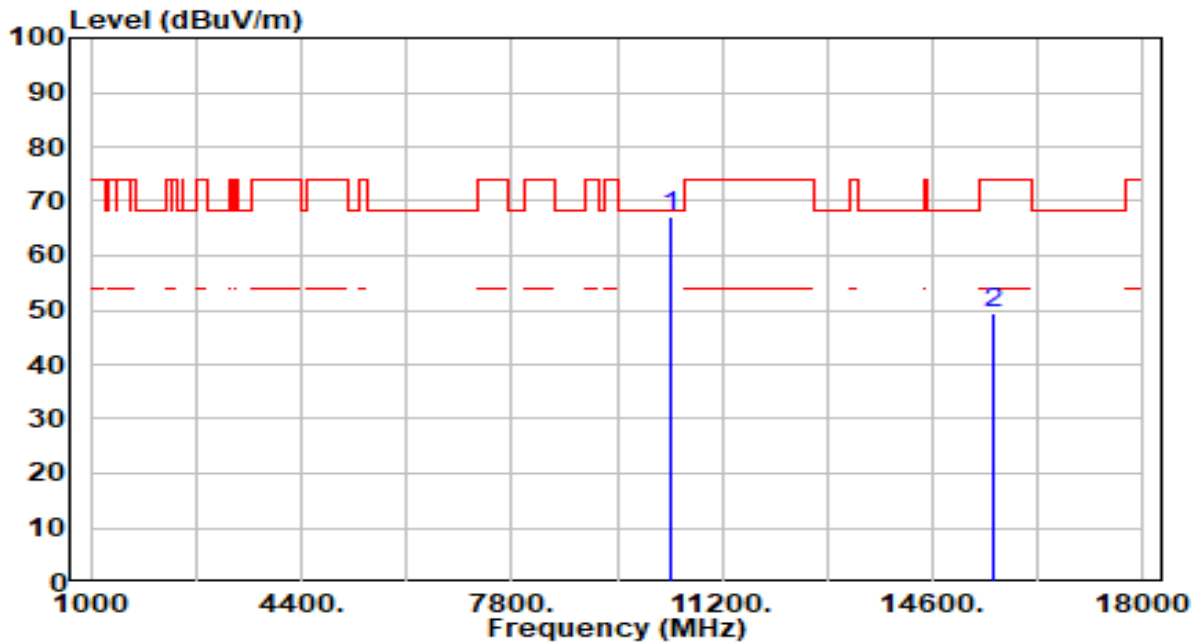

No	Frequency (MHz)	Reading (dBuV)	C.F (dB/m)	Measurement (dBuV/m)	Margin (dB)	Limit (dBuV/m)	Height (cm)	Angle (deg)	Remark (QP/PK/AV)
1	*	63.87	3.19	67.06	-1.14	68.20	200	255	Peak
2		44.77	4.75	49.52	-24.48	74.00	200	308	Peak

Note:

1. " \*", means this data is the worst emission level.
2. C.F (Correction Factor) = Antenna Factor (dB/m) + Cable Loss (dB) – Preamplifier(dB).
3. Measurement (dBuV/m) = Reading(dBuV) + C.F (Correction Factor).
4. The emission levels of other frequencies are very lower than the limit and not show in test report.

EUT	AX3000 High Gain Wireless USB Adapter	Date of Test	2023-01-19
Factor	DRH18-E	Temp. / Humidity	20°C /62%
Polarity	Vertical	Site / Test Engineer	AC2 / Ares
Test Mode	802.11ac-40MHz_TX_Band1_CH 38_ANT 1+2	Test Voltage	By Notebook PC

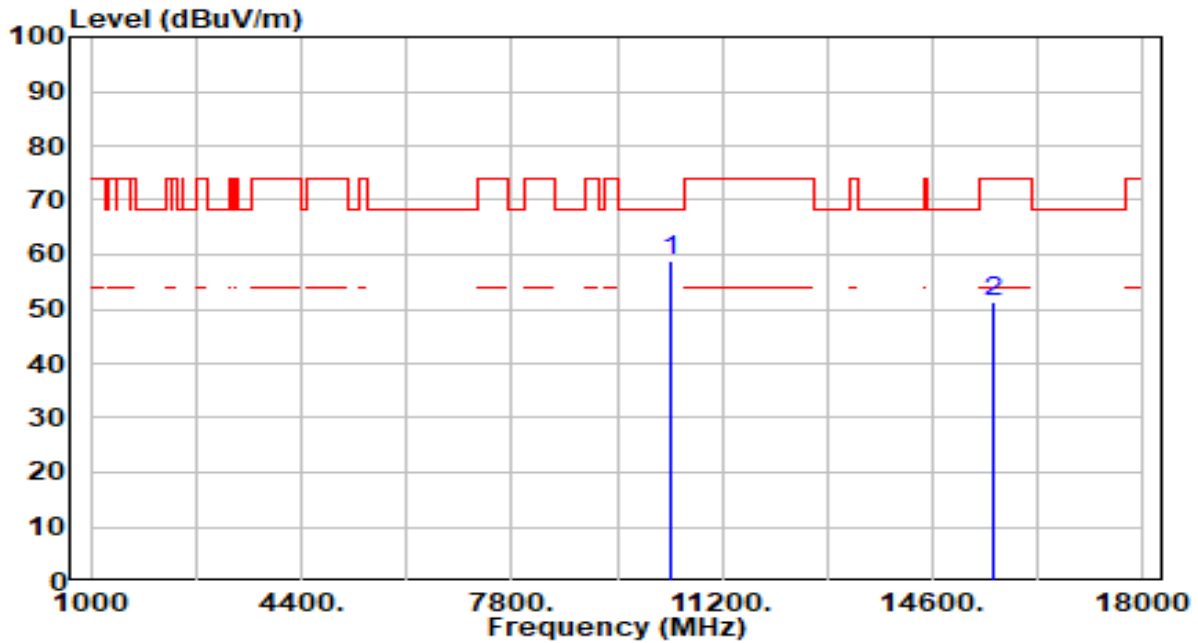

No	Frequency (MHz)	Reading (dBuV)	C.F (dB/m)	Measurement (dBuV/m)	Margin (dB)	Limit (dBuV/m)	Height (cm)	Angle (deg)	Remark (QP/PK/AV)
1	* 10380.000	55.78	3.19	58.96	-9.24	68.20	200	325	Peak
2	15570.000	46.51	4.75	51.26	-22.74	74.00	200	360	Peak

Note:

1. " \*", means this data is the worst emission level.
2. C.F (Correction Factor) = Antenna Factor (dB/m) + Cable Loss (dB) – Pre-amplifier(dB).
3. Measurement (dBuV/m) = Reading(dBuV) + C.F (Correction Factor).
4. The emission levels of other frequencies are very lower than the limit and not show in test report.



EUT	AX3000 High Gain Wireless USB Adapter	Date of Test	2023-01-19
Factor	DRH18-E	Temp. / Humidity	20°C /62%
Polarity	Horizontal	Site / Test Engineer	AC2 / Ares
Test Mode	802.11ac-40MHz_TX_Band1_CH 46_ANT 1+2	Test Voltage	By Notebook PC

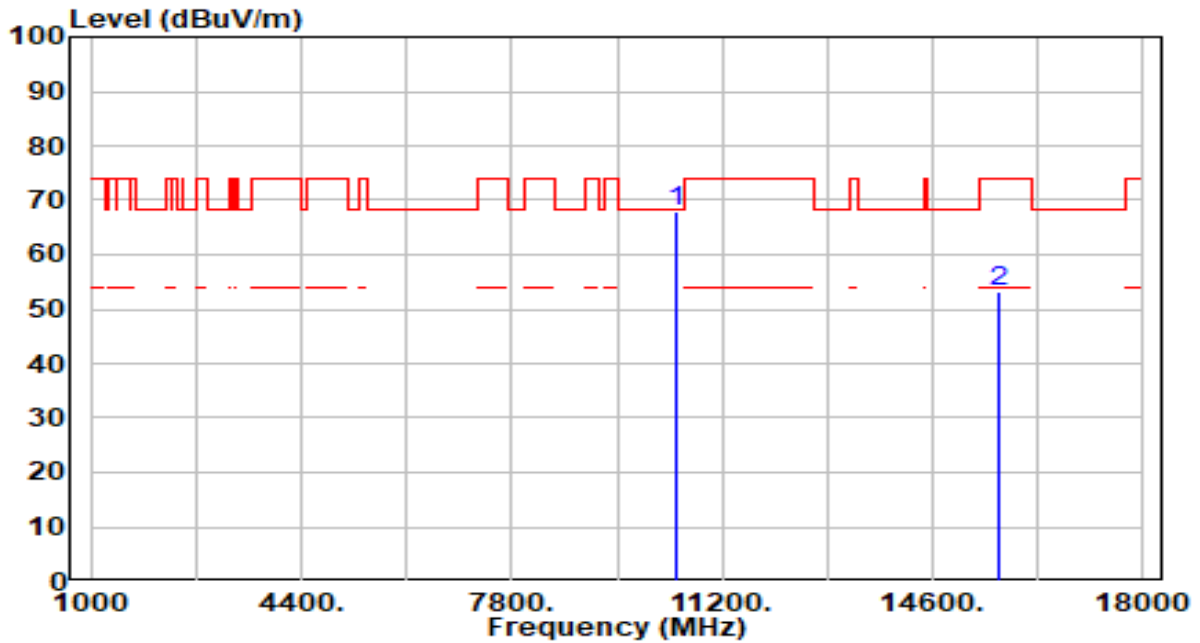

No	Frequency (MHz)	Reading (dBuV)	C.F (dB/m)	Measurement (dBuV/m)	Margin (dB)	Limit (dBuV/m)	Height (cm)	Angle (deg)	Remark (QP/PK/AV)
1	*	64.96	3.13	68.09	-0.11	68.20	200	257	Peak
2		48.38	4.95	53.33	-20.67	74.00	200	310	Peak

Note:

1. " \*", means this data is the worst emission level.
2. C.F (Correction Factor) = Antenna Factor (dB/m) + Cable Loss (dB) – Pre-amplifier(dB).
3. Measurement (dBuV/m) = Reading(dBuV) + C.F (Correction Factor).
4. The emission levels of other frequencies are very lower than the limit and not show in test report.

EUT	AX3000 High Gain Wireless USB Adapter	Date of Test	2023-01-19
Factor	DRH18-E	Temp. / Humidity	20°C /62%
Polarity	Vertical	Site / Test Engineer	AC2 / Ares
Test Mode	802.11ac-40MHz_TX_Band1_CH 46_ANT 1+2	Test Voltage	By Notebook PC

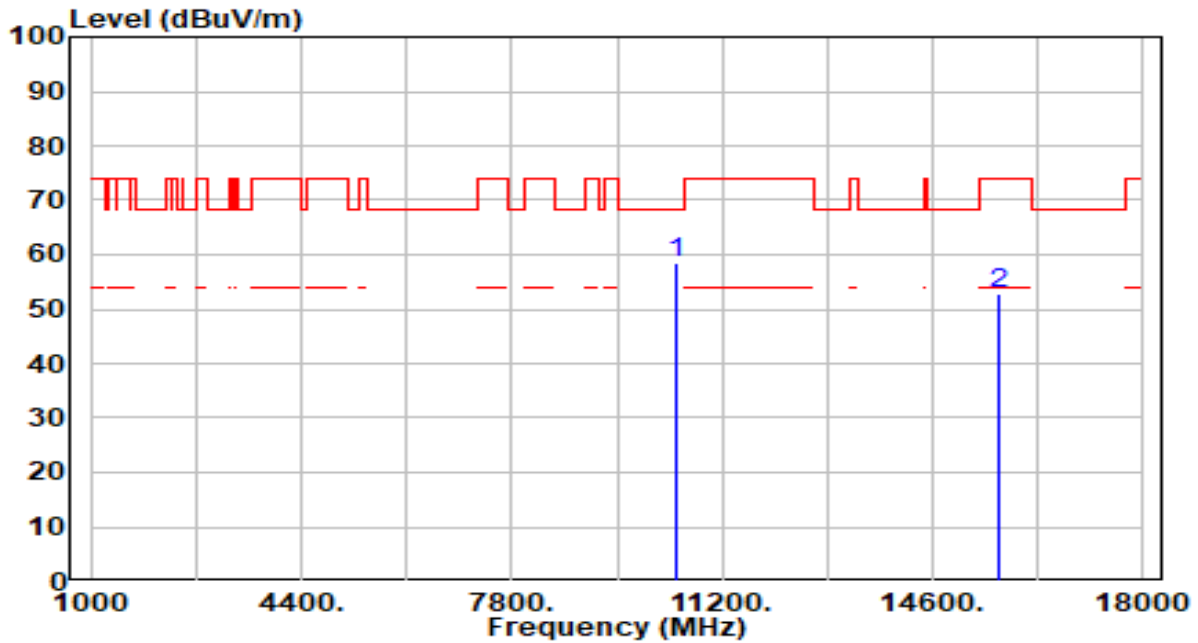

No	Frequency (MHz)	Reading (dBuV)	C.F (dB/m)	Measurement (dBuV/m)	Margin (dB)	Limit (dBuV/m)	Height (cm)	Angle (deg)	Remark (QP/PK/AV)
1	* 10460.000	55.34	3.13	58.47	-9.73	68.20	200	54	Peak
2	15690.000	47.80	4.95	52.76	-21.24	74.00	200	86	Peak

Note:

1. " \*", means this data is the worst emission level.
2. C.F (Correction Factor) = Antenna Factor (dB/m) + Cable Loss (dB) – Pre-amplifier(dB).
3. Measurement (dBuV/m) = Reading(dBuV) + C.F (Correction Factor).
4. The emission levels of other frequencies are very lower than the limit and not show in test report.

EUT	AX3000 High Gain Wireless USB Adapter	Date of Test	2023-01-19
Factor	DRH18-E	Temp. / Humidity	20°C /62%
Polarity	Horizontal	Site / Test Engineer	AC2 / Ares
Test Mode	802.11ac-40MHz_TX_Band2_CH 54_ANT 1+2	Test Voltage	By Notebook PC

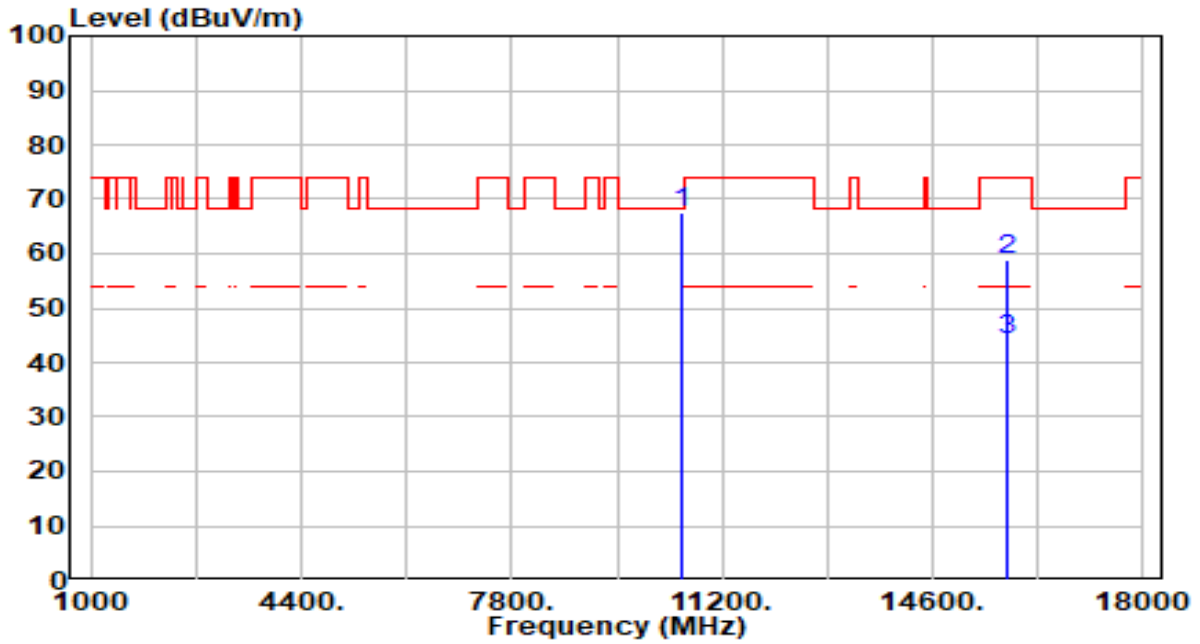

No	Frequency (MHz)	Reading (dBuV)	C.F (dB/m)	Measurement (dBuV/m)	Margin (dB)	Limit (dBuV/m)	Height (cm)	Angle (deg)	Remark (QP/PK/AV)
1	* 10540.000	64.44	3.08	67.52	-0.68	68.20	200	256	Peak
2	15810.000	53.71	5.21	58.91	-15.09	74.00	200	161	Peak
3	* 15810.000	38.81	5.21	44.02	-9.98	54.00	200	16	Average

Note:

1. " \*", means this data is the worst emission level.
2. C.F (Correction Factor) = Antenna Factor (dB/m) + Cable Loss (dB) – Pre-amplifier(dB).
3. Measurement (dBuV/m) = Reading(dBuV) + C.F (Correction Factor).
4. The emission levels of other frequencies are very lower than the limit and not show in test report.

EUT	AX3000 High Gain Wireless USB Adapter	Date of Test	2023-01-19
Factor	DRH18-E	Temp. / Humidity	20°C /62%
Polarity	Vertical	Site / Test Engineer	AC2 / Ares
Test Mode	802.11ac-40MHz_TX_Band2_CH 54_ANT 1+2	Test Voltage	By Notebook PC

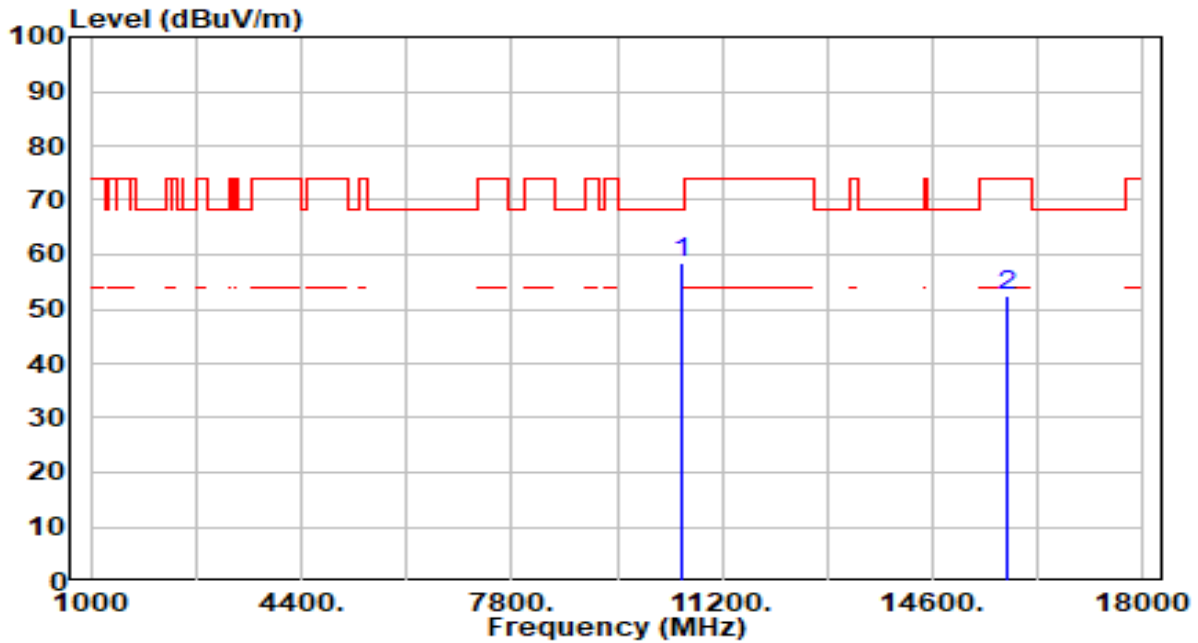

No	Frequency (MHz)	Reading (dBuV)	C.F (dB/m)	Measurement (dBuV/m)	Margin (dB)	Limit (dBuV/m)	Height (cm)	Angle (deg)	Remark (QP/PK/AV)
1	* 10540.000	55.39	3.08	58.47	-9.73	68.20	200	62	Peak
2	15810.000	47.12	5.21	52.33	-21.67	74.00	200	103	Peak

Note:

1. " \*", means this data is the worst emission level.
2. C.F (Correction Factor) = Antenna Factor (dB/m) + Cable Loss (dB) – Pre-amplifier(dB).
3. Measurement (dBuV/m) = Reading(dBuV) + C.F (Correction Factor).
4. The emission levels of other frequencies are very lower than the limit and not show in test report.

EUT	AX3000 High Gain Wireless USB Adapter	Date of Test	2023-01-19
Factor	DRH18-E	Temp. / Humidity	20°C /62%
Polarity	Horizontal	Site / Test Engineer	AC2 / Ares
Test Mode	802.11ac-40MHz_TX_Band2_CH 62_ANT 1+2	Test Voltage	By Notebook PC

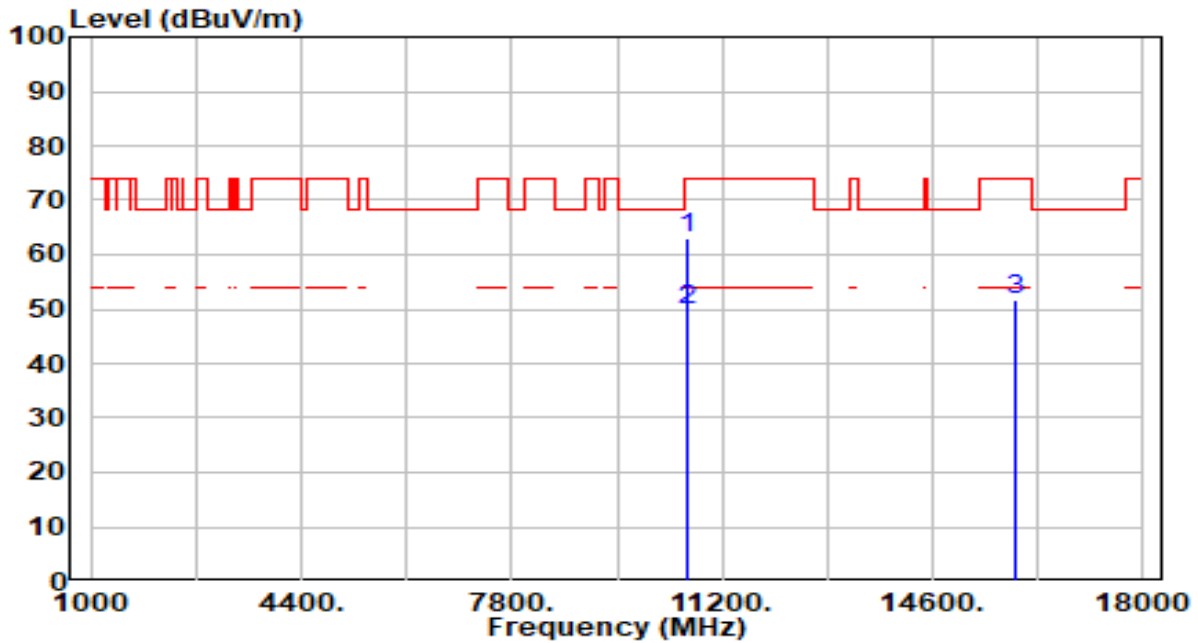

No	Frequency (MHz)	Reading (dBuV)	C.F (dB/m)	Measurement (dBuV/m)	Margin (dB)	Limit (dBuV/m)	Height (cm)	Angle (deg)	Remark (QP/PK/AV)
1	*	60.05	3.06	63.11	-10.89	74.00	200	257	Peak
2	*	46.71	3.06	49.77	-4.23	54.00	200	257	Average
3		46.49	5.29	51.78	-22.22	74.00	200	82	Peak

Note:

1. " \*", means this data is the worst emission level.
2. C.F (Correction Factor) = Antenna Factor (dB/m) + Cable Loss (dB) – Preamplifier(dB).
3. Measurement (dBuV/m) = Reading(dBuV) + C.F (Correction Factor).
4. The emission levels of other frequencies are very lower than the limit and not show in test report.

EUT	AX3000 High Gain Wireless USB Adapter	Date of Test	2023-01-19
Factor	DRH18-E	Temp. / Humidity	20°C /62%
Polarity	Vertical	Site / Test Engineer	AC2 / Ares
Test Mode	802.11ac-40MHz_TX_Band2_CH 62_ANT 1+2	Test Voltage	By Notebook PC

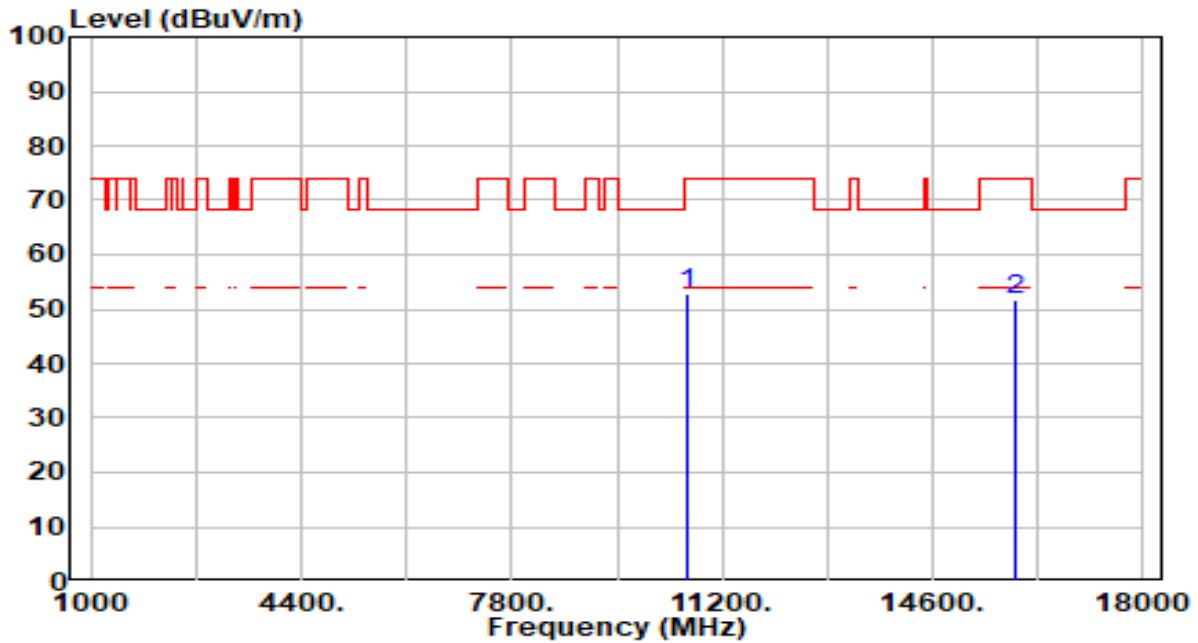

No	Frequency (MHz)	Reading (dBuV)	C.F (dB/m)	Measurement (dBuV/m)	Margin (dB)	Limit (dBuV/m)	Height (cm)	Angle (deg)	Remark (QP/PK/AV)
1	* 10620.000	49.75	3.06	52.81	-21.19	74.00	200	60	Peak
2	15930.000	46.47	5.29	51.76	-22.24	74.00	200	16	Peak

Note:

1. " \*", means this data is the worst emission level.
2. C.F (Correction Factor) = Antenna Factor (dB/m) + Cable Loss (dB) – Pre-amplifier(dB).
3. Measurement (dBuV/m) = Reading(dBuV) + C.F (Correction Factor).
4. The emission levels of other frequencies are very lower than the limit and not show in test report.

EUT	AX3000 High Gain Wireless USB Adapter	Date of Test	2023-01-19
Factor	DRH18-E	Temp. / Humidity	20°C /62%
Polarity	Horizontal	Site / Test Engineer	AC2 / Ares
Test Mode	802.11ac-40MHz_TX_Band3_CH 102_ANT 1+2	Test Voltage	By Notebook PC

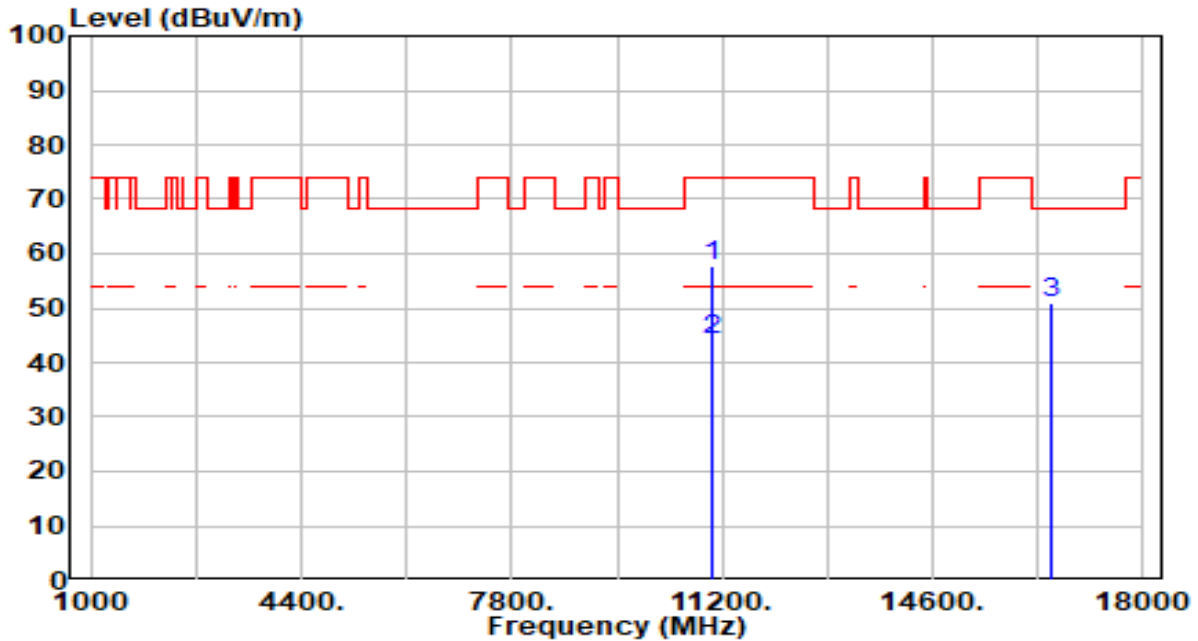

No	Frequency (MHz)	Reading (dBuV)	C.F (dB/m)	Measurement (dBuV/m)	Margin (dB)	Limit (dBuV/m)	Height (cm)	Angle (deg)	Remark (QP/PK/AV)
1	* 11020.000	54.65	3.24	57.89	-16.11	74.00	200	259	Peak
2	* 11020.000	40.97	3.24	44.21	-9.79	54.00	200	259	Average
3	16530.000	46.51	4.59	51.10	-17.10	68.20	200	360	Peak

Note:

1. " \*", means this data is the worst emission level.
2. C.F (Correction Factor) = Antenna Factor (dB/m) + Cable Loss (dB) – Pre-amplifier(dB).
3. Measurement (dBuV/m) = Reading(dBuV) + C.F (Correction Factor).
4. The emission levels of other frequencies are very lower than the limit and not show in test report.

EUT	AX3000 High Gain Wireless USB Adapter	Date of Test	2023-01-19
Factor	DRH18-E	Temp. / Humidity	20°C /62%
Polarity	Vertical	Site / Test Engineer	AC2 / Ares
Test Mode	802.11ac-40MHz_TX_Band3_CH 102_ANT 1+2	Test Voltage	By Notebook PC

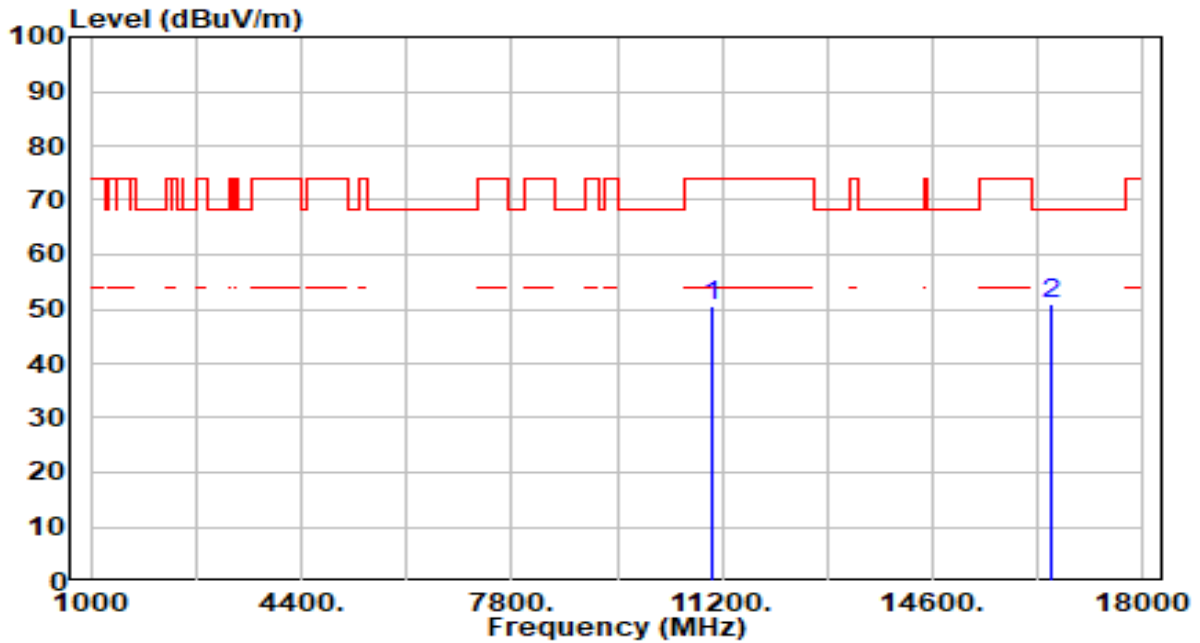

No	Frequency (MHz)	Reading (dBuV)	C.F (dB/m)	Measurement (dBuV/m)	Margin (dB)	Limit (dBuV/m)	Height (cm)	Angle (deg)	Remark (QP/PK/AV)
1	11020.000	47.15	3.24	50.39	-23.61	74.00	200	45	Peak
2	* 16530.000	46.23	4.59	50.83	-17.37	68.20	200	0	Peak

Note:

1. " \*", means this data is the worst emission level.
2. C.F (Correction Factor) = Antenna Factor (dB/m) + Cable Loss (dB) – Pre-amplifier(dB).
3. Measurement (dBuV/m) = Reading(dBuV) + C.F (Correction Factor).
4. The emission levels of other frequencies are very lower than the limit and not show in test report.



EUT	AX3000 High Gain Wireless USB Adapter	Date of Test	2023-01-19
Factor	DRH18-E	Temp. / Humidity	20°C /62%
Polarity	Horizontal	Site / Test Engineer	AC2 / Ares
Test Mode	802.11ac-40MHz_TX_Band3_CH 110_ANT 1+2	Test Voltage	By Notebook PC

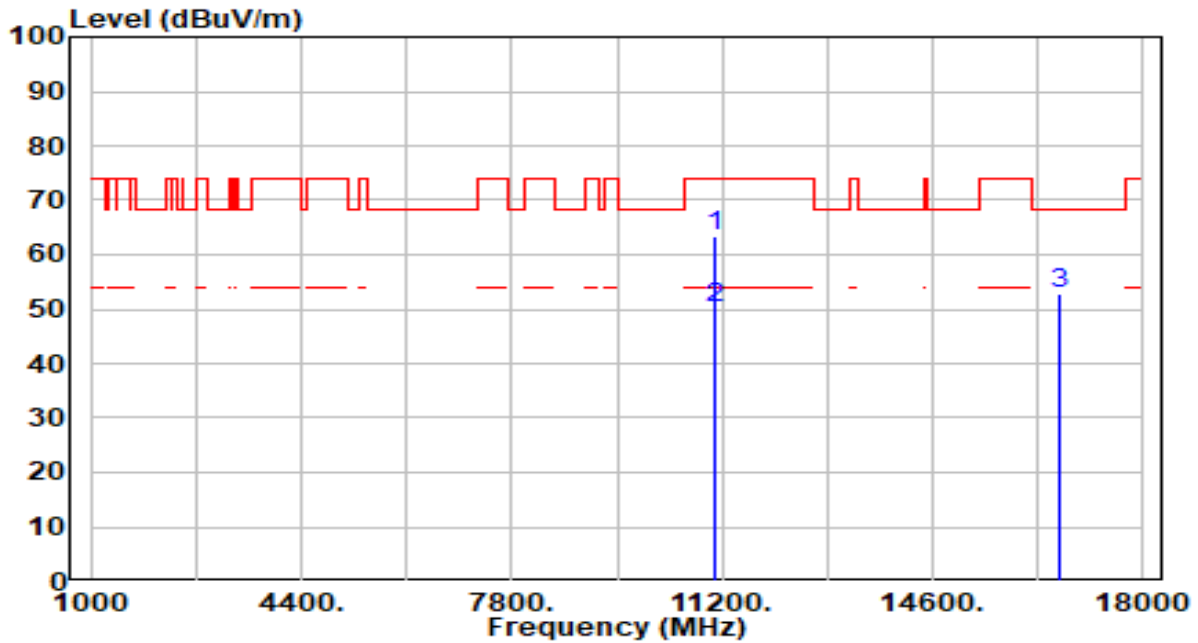

No	Frequency (MHz)	Reading (dBuV)	C.F (dB/m)	Measurement (dBuV/m)	Margin (dB)	Limit (dBuV/m)	Height (cm)	Angle (deg)	Remark (QP/PK/AV)	
1	*	11100.000	60.04	3.38	63.42	-10.58	74.00	166	82	Peak
2	*	11100.000	46.70	3.38	50.08	-3.92	54.00	166	82	Average
3		16650.000	48.22	4.53	52.75	-15.45	68.20	200	27	Peak

Note:

1. " \*", means this data is the worst emission level.
2. C.F (Correction Factor) = Antenna Factor (dB/m) + Cable Loss (dB) – Preamplifier(dB).
3. Measurement (dBuV/m) = Reading(dBuV) + C.F (Correction Factor).
4. The emission levels of other frequencies are very lower than the limit and not show in test report.

EUT	AX3000 High Gain Wireless USB Adapter	Date of Test	2023-01-19
Factor	DRH18-E	Temp. / Humidity	20°C /62%
Polarity	Vertical	Site / Test Engineer	AC2 / Ares
Test Mode	802.11ac-40MHz_TX_Band3_CH 110_ANT 1+2	Test Voltage	By Notebook PC

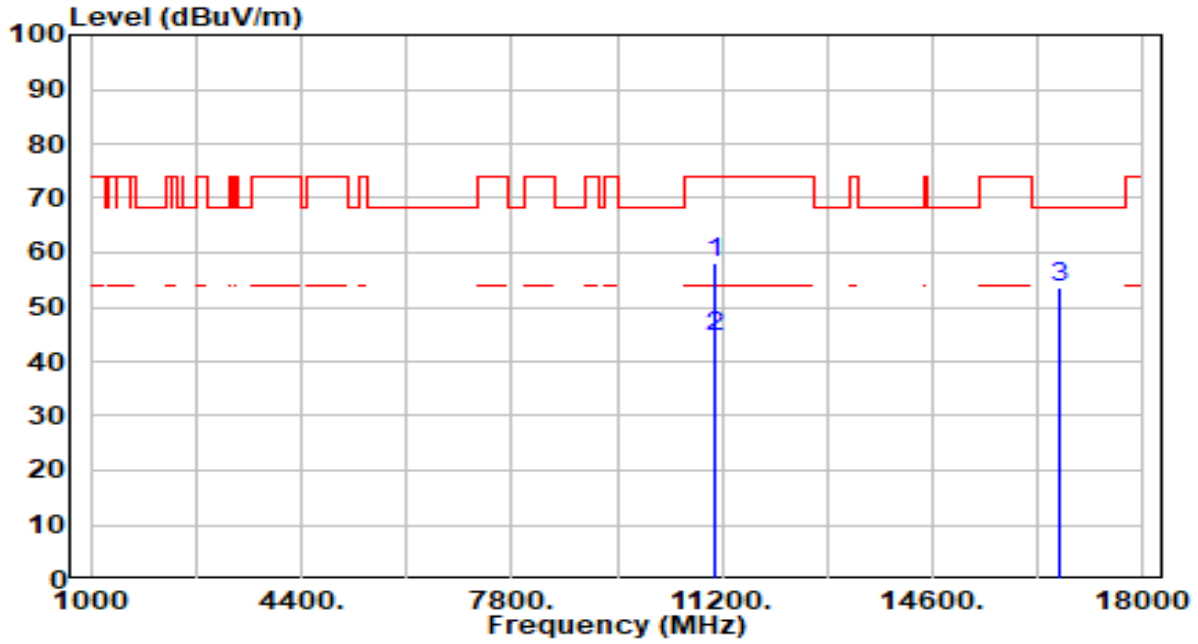

No	Frequency (MHz)	Reading (dBuV)	C.F (dB/m)	Measurement (dBuV/m)	Margin (dB)	Limit (dBuV/m)	Height (cm)	Angle (deg)	Remark (QP/PK/AV)
1	11100.000	54.60	3.38	57.98	-16.02	74.00	196	65	Peak
2	* 11100.000	41.28	3.38	44.66	-9.34	54.00	196	65	Average
3	* 16650.000	49.09	4.53	53.62	-14.58	68.20	200	360	Peak

Note:

1. " \*", means this data is the worst emission level.
2. C.F (Correction Factor) = Antenna Factor (dB/m) + Cable Loss (dB) – Preamplifier(dB).
3. Measurement (dBuV/m) = Reading(dBuV) + C.F (Correction Factor).
4. The emission levels of other frequencies are very lower than the limit and not show in test report.

EUT	AX3000 High Gain Wireless USB Adapter	Date of Test	2023-01-19
Factor	DRH18-E	Temp. / Humidity	20°C /62%
Polarity	Horizontal	Site / Test Engineer	AC2 / Ares
Test Mode	802.11ac-40MHz_TX_Band3_CH 134_ANT 1+2	Test Voltage	By Notebook PC

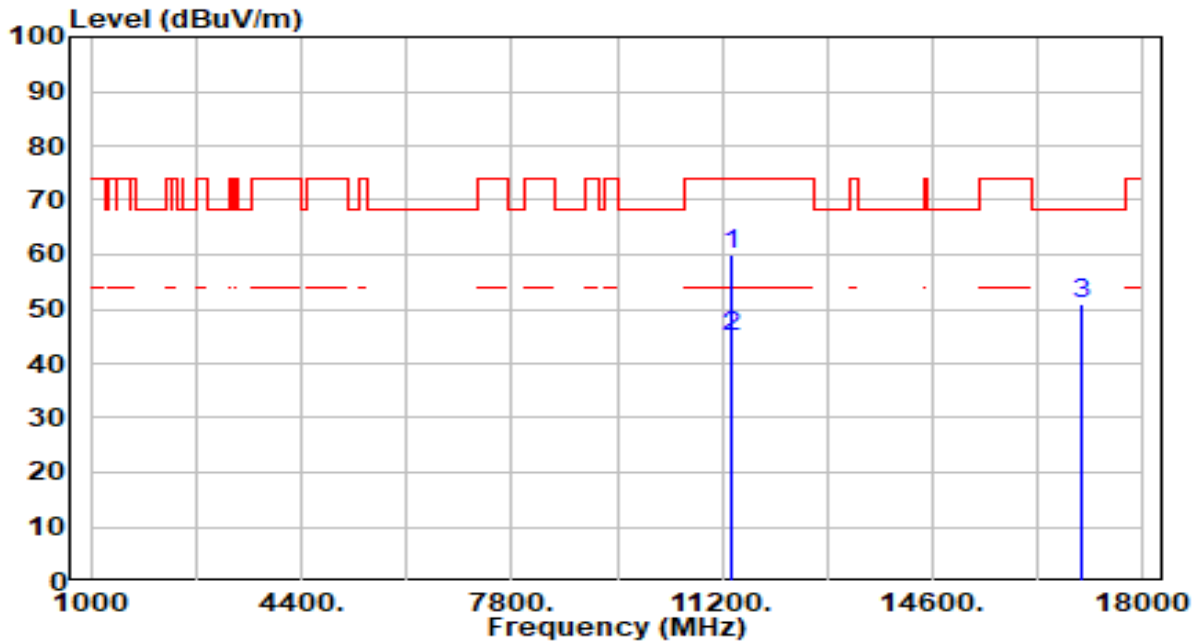

No	Frequency (MHz)	Reading (dBuV)	C.F (dB/m)	Measurement (dBuV/m)	Margin (dB)	Limit (dBuV/m)	Height (cm)	Angle (deg)	Remark (QP/PK/AV)	
1	*	11340.000	56.02	3.80	59.82	-14.18	74.00	200	15	Peak
2	*	11340.000	41.23	3.80	45.03	-8.97	54.00	200	15	Average
3		17010.000	46.13	4.78	50.91	-17.29	68.20	200	291	Peak

Note:

1. " \*", means this data is the worst emission level.
2. C.F (Correction Factor) = Antenna Factor (dB/m) + Cable Loss (dB) – Preamplifier(dB).
3. Measurement (dBuV/m) = Reading(dBuV) + C.F (Correction Factor).
4. The emission levels of other frequencies are very lower than the limit and not show in test report.

EUT	AX3000 High Gain Wireless USB Adapter	Date of Test	2023-01-19
Factor	DRH18-E	Temp. / Humidity	20°C /62%
Polarity	Vertical	Site / Test Engineer	AC2 / Ares
Test Mode	802.11ac-40MHz_TX_Band3_CH 134_ANT 1+2	Test Voltage	By Notebook PC

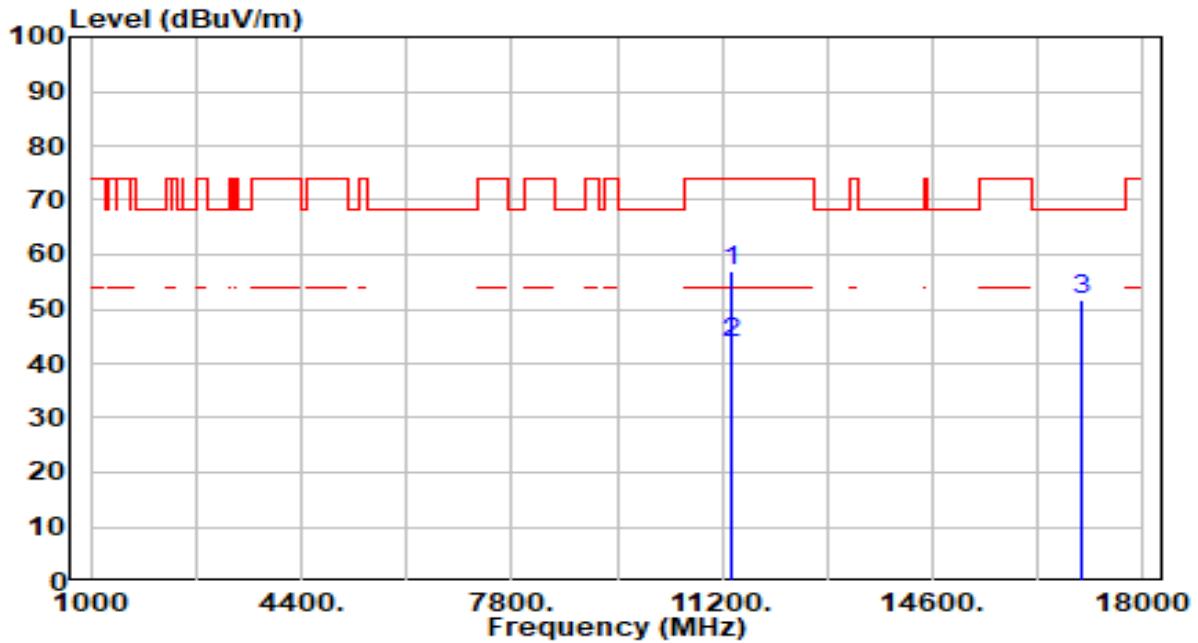

No	Frequency (MHz)	Reading (dBuV)	C.F (dB/m)	Measurement (dBuV/m)	Margin (dB)	Limit (dBuV/m)	Height (cm)	Angle (deg)	Remark (QP/PK/AV)
1	11340.000	53.05	3.80	56.85	-17.15	74.00	200	0	Peak
2	* 11340.000	40.11	3.80	43.91	-10.09	54.00	200	0	Average
3	* 17010.000	47.08	4.78	51.86	-16.34	68.20	200	117	Peak

Note:

1. " \*", means this data is the worst emission level.
2. C.F (Correction Factor) = Antenna Factor (dB/m) + Cable Loss (dB) – Preamplifier(dB).
3. Measurement (dBuV/m) = Reading(dBuV) + C.F (Correction Factor).
4. The emission levels of other frequencies are very lower than the limit and not show in test report.

EUT	AX3000 High Gain Wireless USB Adapter	Date of Test	2023-01-19
Factor	DRH18-E	Temp. / Humidity	20°C /62%
Polarity	Horizontal	Site / Test Engineer	AC2 / Ares
Test Mode	802.11ac-40MHz_TX_Band3_CH 142_ANT 1+2	Test Voltage	By Notebook PC

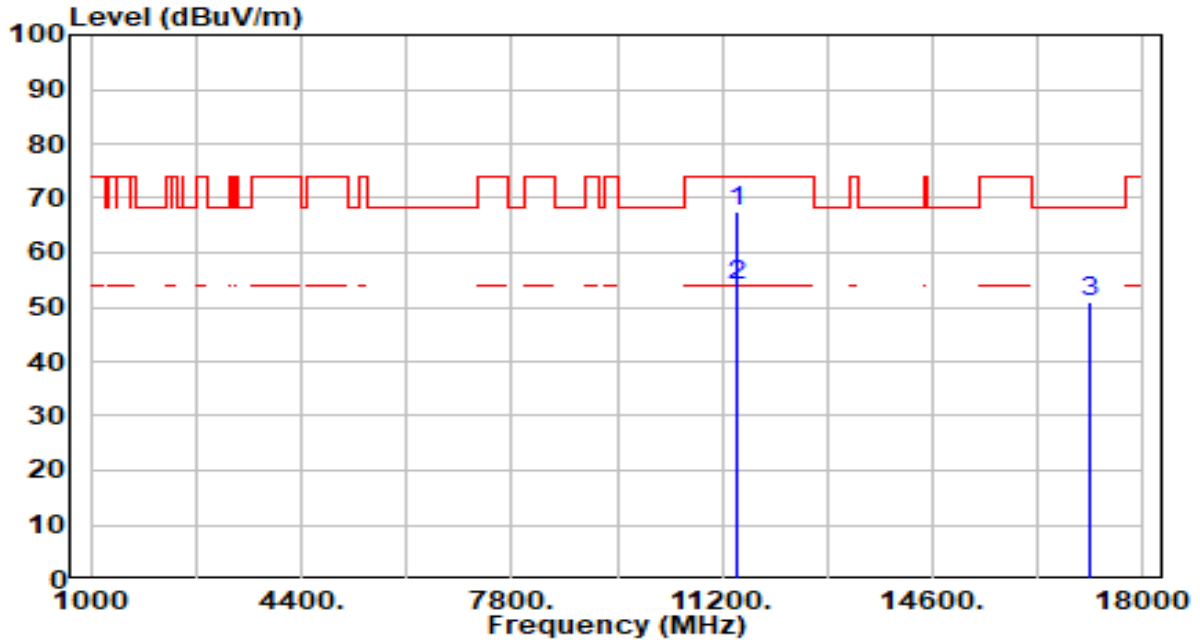

No	Frequency (MHz)	Reading (dBuV)	C.F (dB/m)	Measurement (dBuV/m)	Margin (dB)	Limit (dBuV/m)	Height (cm)	Angle (deg)	Remark (QP/PK/AV)
1	*	63.48	3.91	67.39	-6.61	74.00	184	15	Peak
2	*	49.93	3.91	53.84	-0.16	54.00	184	15	Average
3		46.53	4.38	50.91	-17.29	68.20	200	27	Peak

Note:

1. " \*", means this data is the worst emission level.
2. C.F (Correction Factor) = Antenna Factor (dB/m) + Cable Loss (dB) – Preamplifier(dB).
3. Measurement (dBuV/m) = Reading(dBuV) + C.F (Correction Factor).
4. The emission levels of other frequencies are very lower than the limit and not show in test report.

EUT	AX3000 High Gain Wireless USB Adapter	Date of Test	2023-01-19
Factor	DRH18-E	Temp. / Humidity	20°C /62%
Polarity	Vertical	Site / Test Engineer	AC2 / Ares
Test Mode	802.11ac-40MHz_TX_Band3_CH 142_ANT 1+2	Test Voltage	By Notebook PC

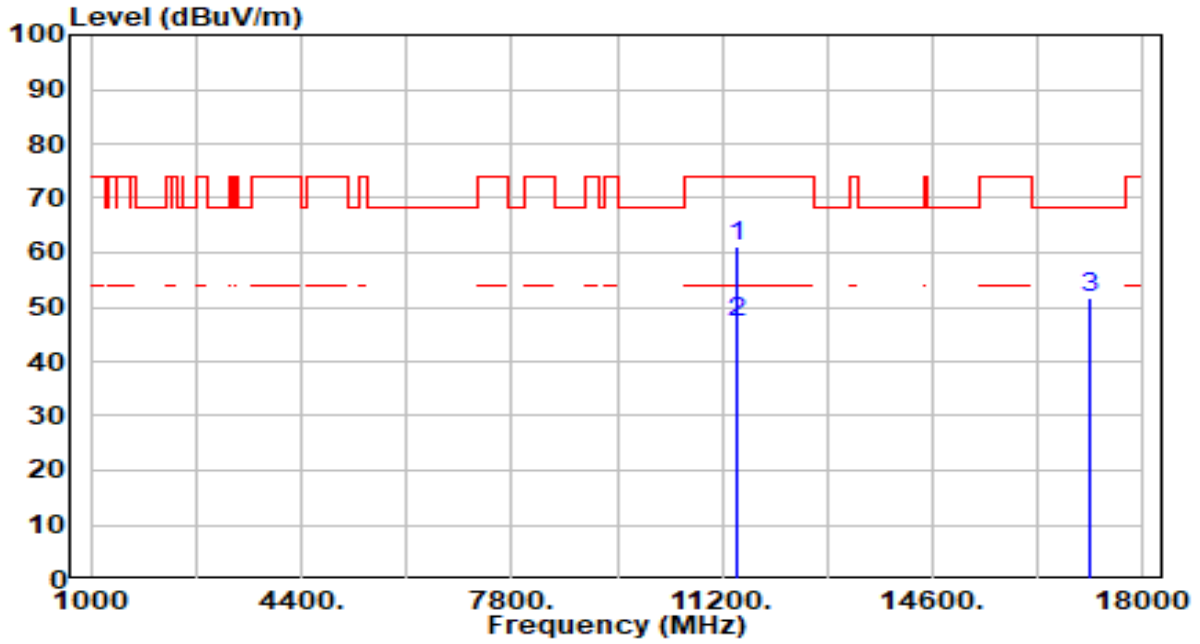

No	Frequency (MHz)	Reading (dBuV)	C.F (dB/m)	Measurement (dBuV/m)	Margin (dB)	Limit (dBuV/m)	Height (cm)	Angle (deg)	Remark (QP/PK/AV)	
1	*	11420.000	57.28	3.91	61.19	-12.81	74.00	200	360	Peak
2	*	11420.000	43.12	3.91	47.03	-6.97	54.00	200	360	Average
3		17130.000	47.36	4.38	51.73	-16.47	68.20	200	339	Peak

Note:

1. " \*", means this data is the worst emission level.
2. C.F (Correction Factor) = Antenna Factor (dB/m) + Cable Loss (dB) – Preamplifier(dB).
3. Measurement (dBuV/m) = Reading(dBuV) + C.F (Correction Factor).
4. The emission levels of other frequencies are very lower than the limit and not show in test report.

EUT	AX3000 High Gain Wireless USB Adapter	Date of Test	2023-01-19
Factor	DRH18-E	Temp. / Humidity	20°C /62%
Polarity	Horizontal	Site / Test Engineer	AC2 / Ares
Test Mode	802.11ac-40MHz_TX_Band4_CH 151_ANT 1+2	Test Voltage	By Notebook PC

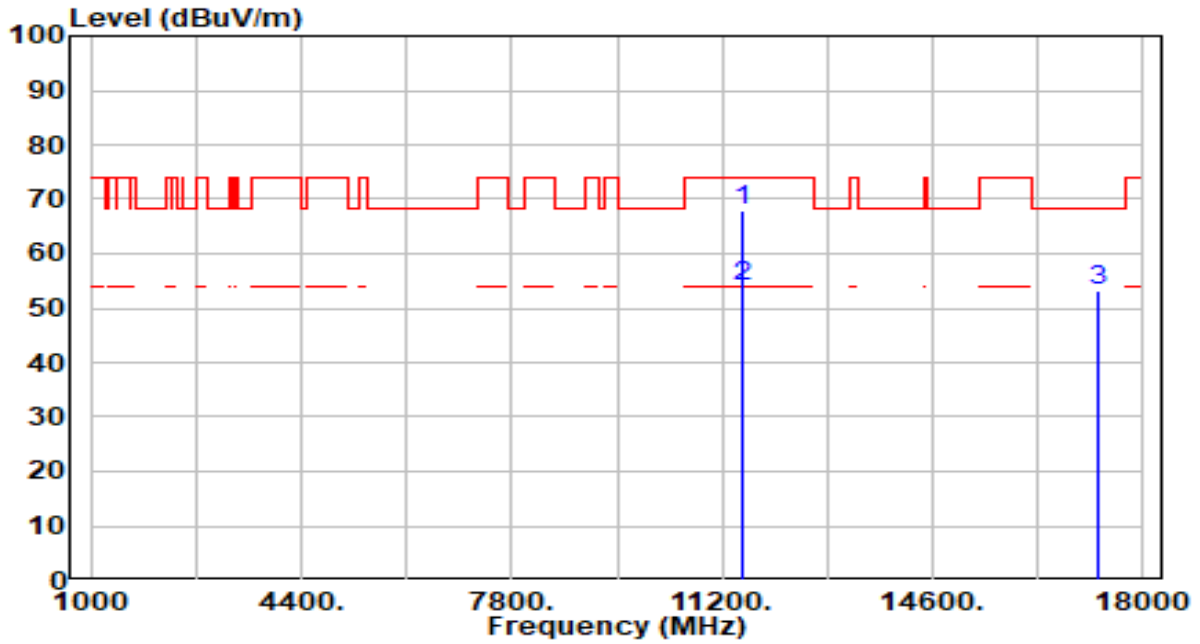

No	Frequency (MHz)	Reading (dBUV)	C.F (dB/m)	Measurement (dBUV/m)	Margin (dB)	Limit (dBUV/m)	Height (cm)	Angle (deg)	Remark (QP/PK/AV)
1	* 11510.000	63.85	3.93	67.78	-6.22	74.00	171	16	Peak
2	* 11510.000	49.87	3.93	53.80	-0.20	54.00	171	16	Average
3	17265.000	49.12	3.99	53.11	-15.09	68.20	200	33	Peak

Note:

1. " \*", means this data is the worst emission level.
2. C.F (Correction Factor) = Antenna Factor (dB/m) + Cable Loss (dB) – Pre-amplifier(dB).
3. Measurement (dBUV/m) = Reading(dBUV) + C.F (Correction Factor).
4. The emission levels of other frequencies are very lower than the limit and not show in test report.

EUT	AX3000 High Gain Wireless USB Adapter	Date of Test	2023-01-19
Factor	DRH18-E	Temp. / Humidity	20°C /62%
Polarity	Vertical	Site / Test Engineer	AC2 / Ares
Test Mode	802.11ac-40MHz_TX_Band4_CH 151_ANT 1+2	Test Voltage	By Notebook PC

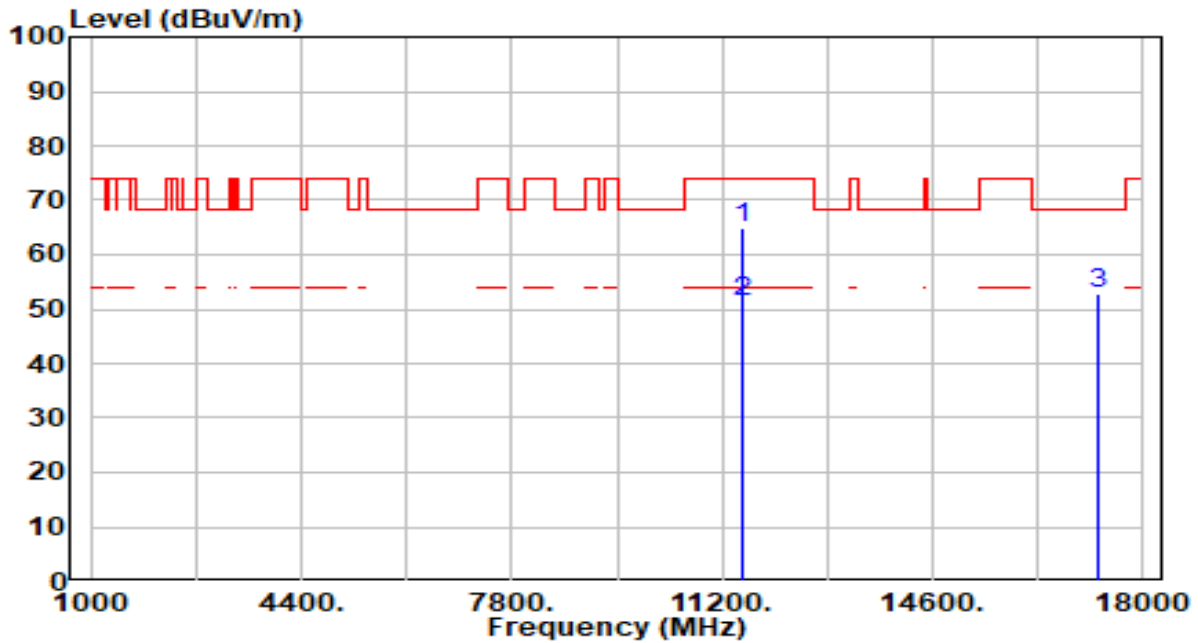

No	Frequency (MHz)	Reading (dBuV)	C.F (dB/m)	Measurement (dBuV/m)	Margin (dB)	Limit (dBuV/m)	Height (cm)	Angle (deg)	Remark (QP/PK/AV)	
1	*	11510.000	60.90	3.93	64.83	-9.17	74.00	219	9	Peak
2	*	11510.000	47.22	3.93	51.15	-2.85	54.00	219	9	Average
3		17265.000	48.84	3.99	52.84	-15.36	68.20	200	350	Peak

Note:

1. " \*", means this data is the worst emission level.
2. C.F (Correction Factor) = Antenna Factor (dB/m) + Cable Loss (dB) – Preamplifier(dB).
3. Measurement (dBuV/m) = Reading(dBuV) + C.F (Correction Factor).
4. The emission levels of other frequencies are very lower than the limit and not show in test report.



EUT	AX3000 High Gain Wireless USB Adapter	Date of Test	2023-01-19
Factor	DRH18-E	Temp. / Humidity	20°C /62%
Polarity	Horizontal	Site / Test Engineer	AC2 / Ares
Test Mode	802.11ac-40MHz_TX_Band4_CH 159_ANT 1+2	Test Voltage	By Notebook PC

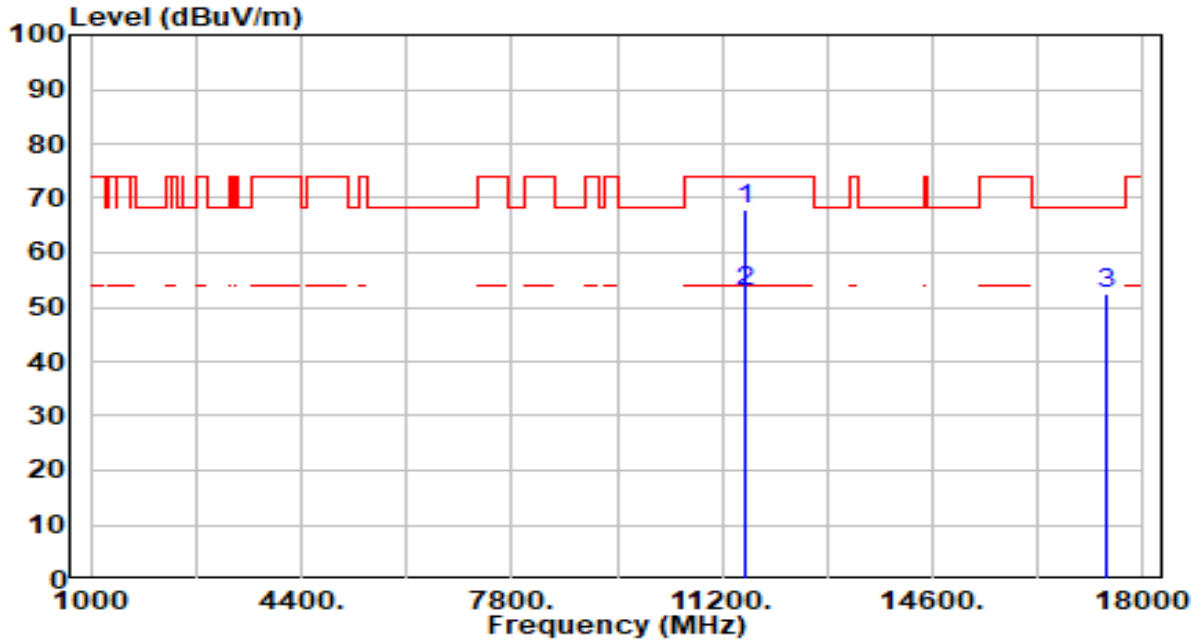

No	Frequency (MHz)	Reading (dBuV)	C.F (dB/m)	Measurement (dBuV/m)	Margin (dB)	Limit (dBuV/m)	Height (cm)	Angle (deg)	Remark (QP/PK/AV)	
1	*	11590.000	63.83	3.95	67.78	-6.22	74.00	171	16	Peak
2	*	11590.000	49.00	3.95	52.95	-1.05	54.00	171	16	Average
3		17385.000	48.84	3.71	52.56	-15.64	68.20	200	157	Peak

Note:

1. " \*", means this data is the worst emission level.
2. C.F (Correction Factor) = Antenna Factor (dB/m) + Cable Loss (dB) – Preamplifier(dB).
3. Measurement (dBuV/m) = Reading(dBuV) + C.F (Correction Factor).
4. The emission levels of other frequencies are very lower than the limit and not show in test report.

EUT	AX3000 High Gain Wireless USB Adapter	Date of Test	2023-01-19
Factor	DRH18-E	Temp. / Humidity	20°C /62%
Polarity	Vertical	Site / Test Engineer	AC2 / Ares
Test Mode	802.11ac-40MHz_TX_Band4_CH 159_ANT 1+2	Test Voltage	By Notebook PC

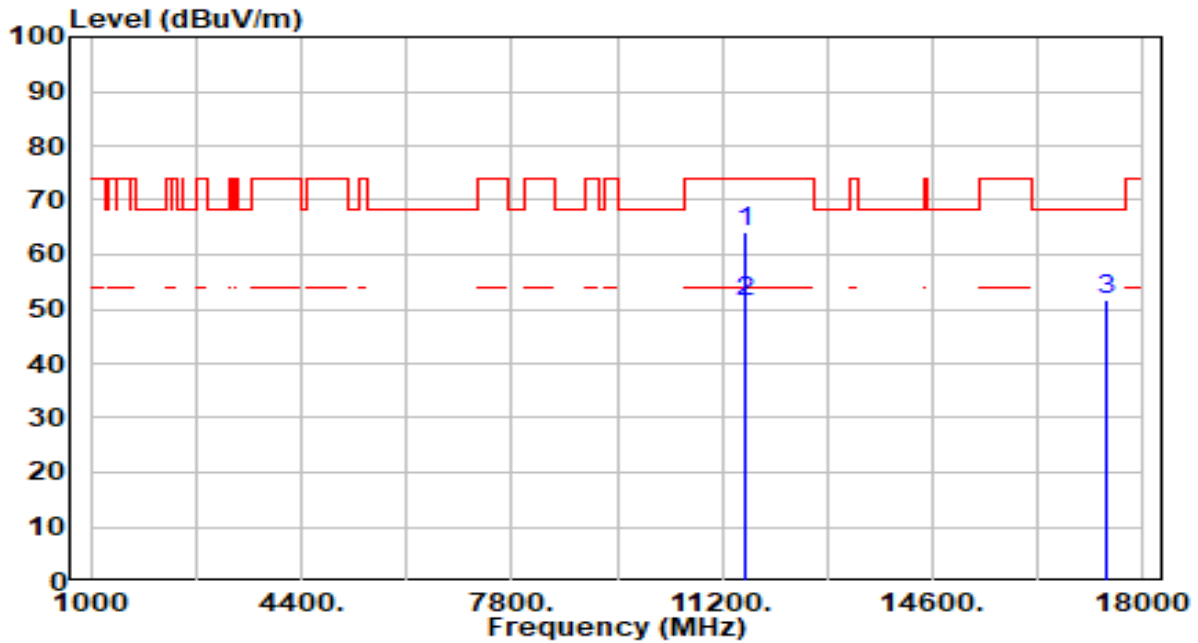

No	Frequency (MHz)	Reading (dBuV)	C.F (dB/m)	Measurement (dBuV/m)	Margin (dB)	Limit (dBuV/m)	Height (cm)	Angle (deg)	Remark (QP/PK/AV)	
1	*	11590.000	60.31	3.95	64.26	-9.74	74.00	200	5	Peak
2	*	11590.000	47.22	3.95	51.17	-2.83	54.00	200	5	Average
3		17385.000	47.91	3.71	51.62	-16.58	68.20	200	192	Peak

Note:

1. " \*", means this data is the worst emission level.
2. C.F (Correction Factor) = Antenna Factor (dB/m) + Cable Loss (dB) – Preamplifier(dB).
3. Measurement (dBuV/m) = Reading(dBuV) + C.F (Correction Factor).
4. The emission levels of other frequencies are very lower than the limit and not show in test report.

EUT	AX3000 High Gain Wireless USB Adapter	Date of Test	2023-01-19
Factor	DRH18-E	Temp. / Humidity	20°C /62%
Polarity	Horizontal	Site / Test Engineer	AC2 / Ares
Test Mode	802.11ac-80MHz_TX_Band1_CH 42_ANT 1+2	Test Voltage	By Notebook PC

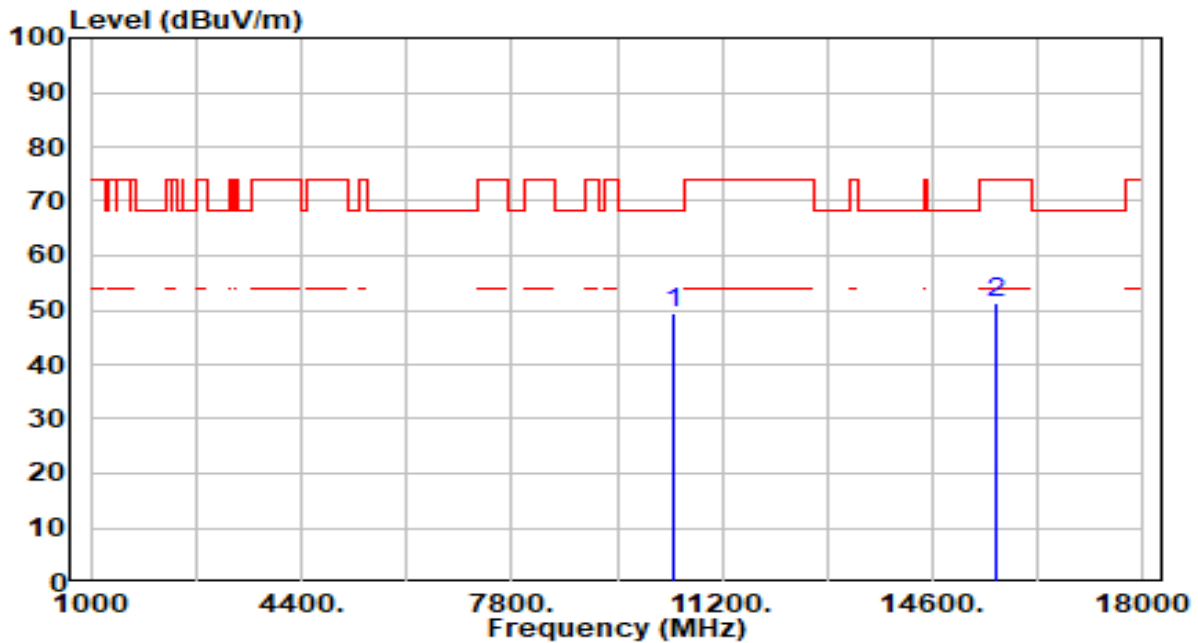

No	Frequency (MHz)	Reading (dBuV)	C.F (dB/m)	Measurement (dBuV/m)	Margin (dB)	Limit (dBuV/m)	Height (cm)	Angle (deg)	Remark (QP/PK/AV)
1	* 10420.000	46.28	3.16	49.44	-18.76	68.20	200	360	Peak
2	15630.000	46.51	4.82	51.33	-22.67	74.00	200	360	Peak

Note:

1. " \*", means this data is the worst emission level.
2. C.F (Correction Factor) = Antenna Factor (dB/m) + Cable Loss (dB) – Pre-amplifier(dB).
3. Measurement (dBuV/m) = Reading(dBuV) + C.F (Correction Factor).
4. The emission levels of other frequencies are very lower than the limit and not show in test report.

EUT	AX3000 High Gain Wireless USB Adapter	Date of Test	2023-01-19
Factor	DRH18-E	Temp. / Humidity	20°C /62%
Polarity	Vertical	Site / Test Engineer	AC2 / Ares
Test Mode	802.11ac-80MHz_TX_Band1_CH 42_ANT 1+2	Test Voltage	By Notebook PC

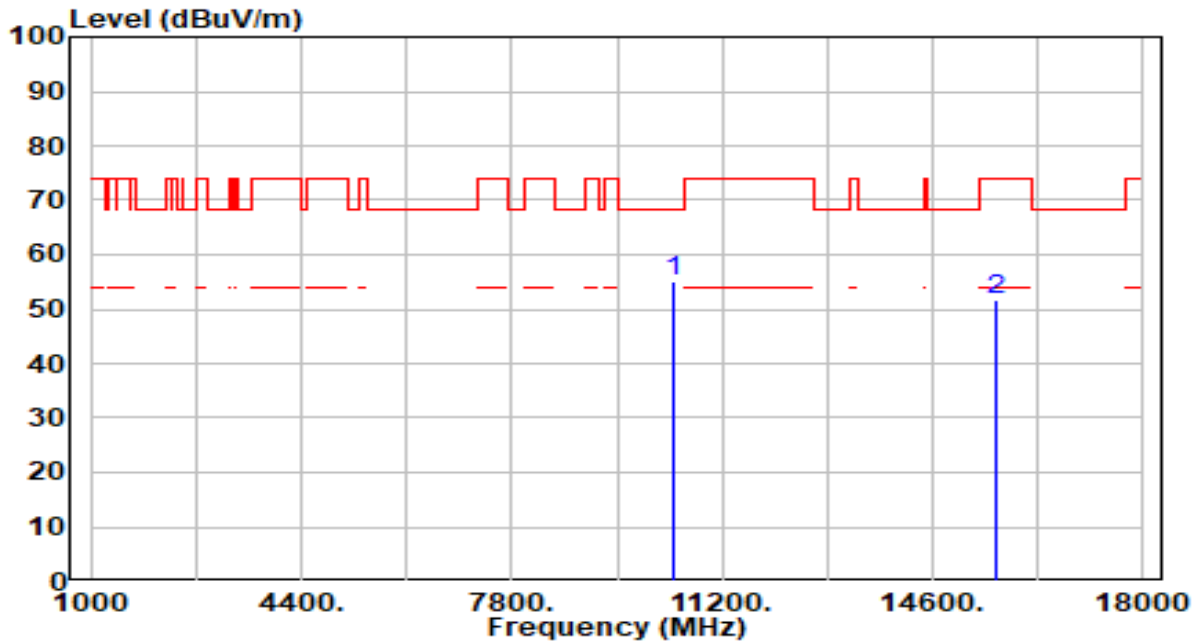

No	Frequency (MHz)	Reading (dBuV)	C.F (dB/m)	Measurement (dBuV/m)	Margin (dB)	Limit (dBuV/m)	Height (cm)	Angle (deg)	Remark (QP/PK/AV)
1	* 10420.000	51.78	3.16	54.94	-13.26	68.20	200	315	Peak
2	15630.000	46.84	4.82	51.66	-22.34	74.00	200	145	Peak

Note:

1. " \*", means this data is the worst emission level.
2. C.F (Correction Factor) = Antenna Factor (dB/m) + Cable Loss (dB) – Pre-amplifier(dB).
3. Measurement (dBuV/m) = Reading(dBuV) + C.F (Correction Factor).
4. The emission levels of other frequencies are very lower than the limit and not show in test report.

EUT	AX3000 High Gain Wireless USB Adapter	Date of Test	2023-01-19
Factor	DRH18-E	Temp. / Humidity	20°C /62%
Polarity	Horizontal	Site / Test Engineer	AC2 / Ares
Test Mode	802.11ac-80MHz_TX_Band2_CH 58_ANT 1+2	Test Voltage	By Notebook PC

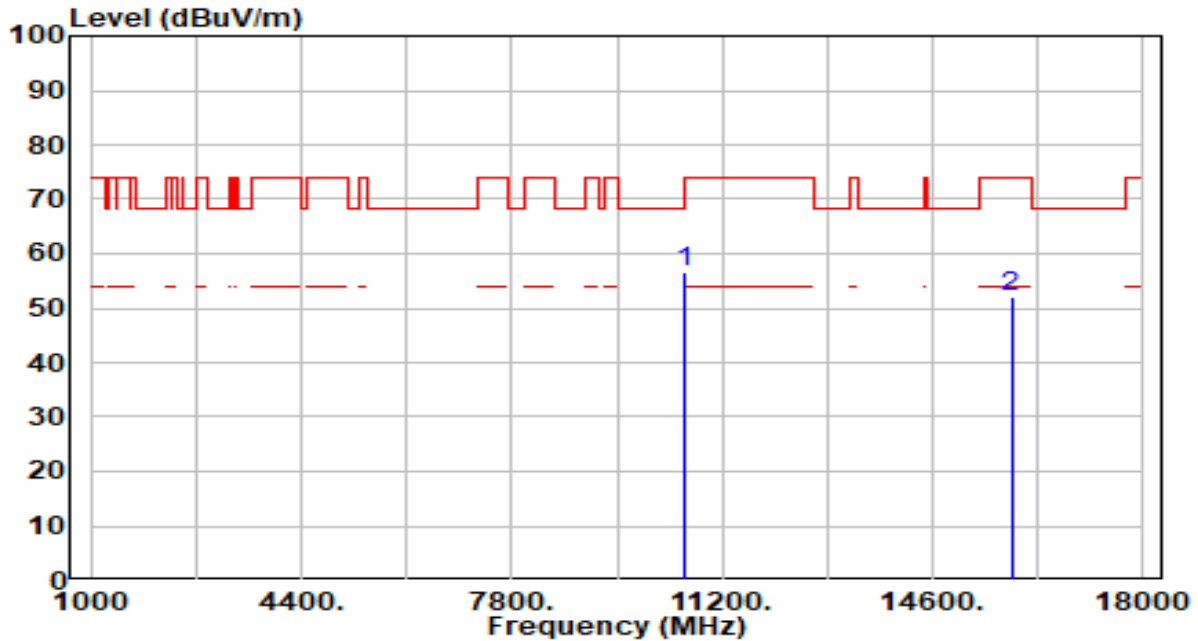

No	Frequency (MHz)	Reading (dBuV)	C.F (dB/m)	Measurement (dBuV/m)	Margin (dB)	Limit (dBuV/m)	Height (cm)	Angle (deg)	Remark (QP/PK/AV)
1	* 10580.000	53.35	3.07	56.42	-11.78	68.20	200	260	Peak
2	15870.000	46.84	5.25	52.09	-21.91	74.00	100	0	Peak

Note:

1. " \*", means this data is the worst emission level.
2. C.F (Correction Factor) = Antenna Factor (dB/m) + Cable Loss (dB) – Pre-amplifier(dB).
3. Measurement (dBuV/m) = Reading(dBuV) + C.F (Correction Factor).
4. The emission levels of other frequencies are very lower than the limit and not show in test report.

EUT	AX3000 High Gain Wireless USB Adapter	Date of Test	2023-01-19
Factor	DRH18-E	Temp. / Humidity	20°C /62%
Polarity	Vertical	Site / Test Engineer	AC2 / Ares
Test Mode	802.11ac-80MHz_TX_Band2_CH 58_ANT 1+2	Test Voltage	By Notebook PC

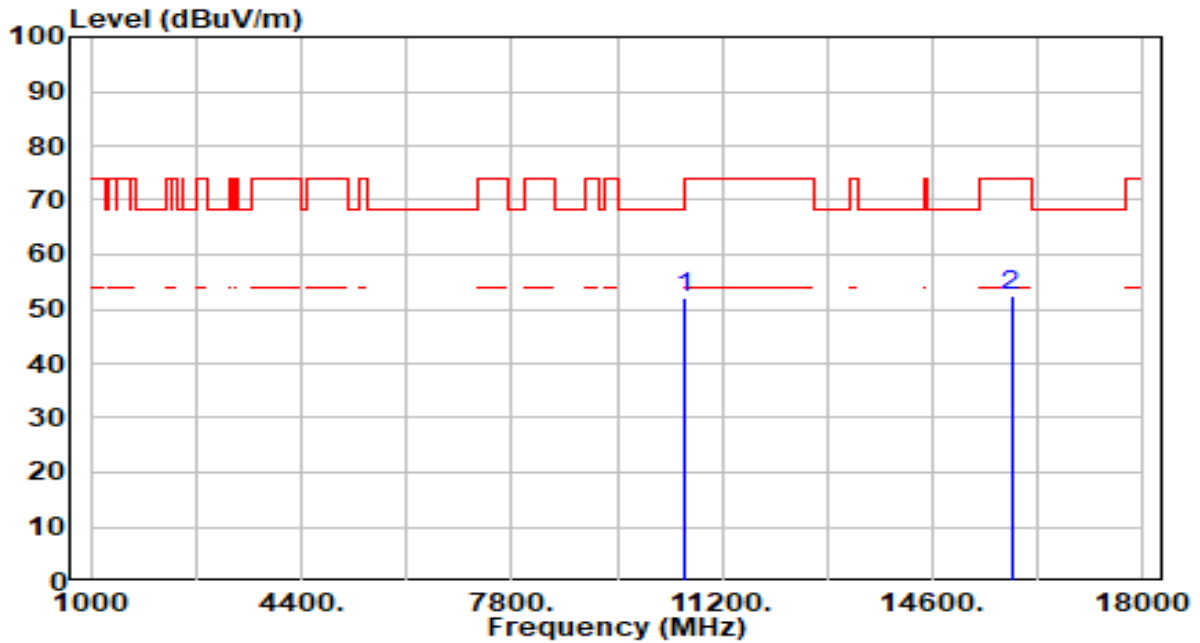

No	Frequency (MHz)	Reading (dBuV)	C.F (dB/m)	Measurement (dBuV/m)	Margin (dB)	Limit (dBuV/m)	Height (cm)	Angle (deg)	Remark (QP/PK/AV)
1	* 10580.000	49.16	3.07	52.22	-15.98	68.20	200	50	Peak
2	15870.000	47.07	5.25	52.32	-21.68	74.00	200	75	Peak

Note:

1. " \*", means this data is the worst emission level.
2. C.F (Correction Factor) = Antenna Factor (dB/m) + Cable Loss (dB) – Pre-amplifier(dB).
3. Measurement (dBuV/m) = Reading(dBuV) + C.F (Correction Factor).
4. The emission levels of other frequencies are very lower than the limit and not show in test report.

EUT	AX3000 High Gain Wireless USB Adapter	Date of Test	2023-01-19
Factor	DRH18-E	Temp. / Humidity	20°C /62%
Polarity	Horizontal	Site / Test Engineer	AC2 / Ares
Test Mode	802.11ac-80MHz_TX_Band3_CH 106_ANT 1+2	Test Voltage	By Notebook PC

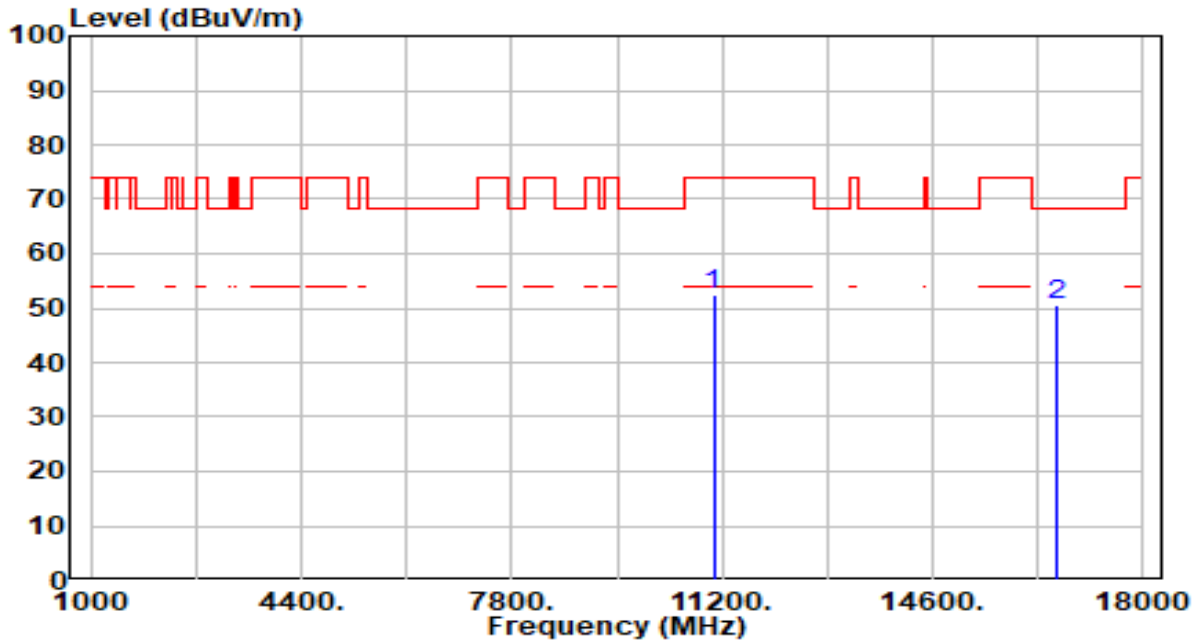

No	Frequency (MHz)	Reading (dBuV)	C.F (dB/m)	Measurement (dBuV/m)	Margin (dB)	Limit (dBuV/m)	Height (cm)	Angle (deg)	Remark (QP/PK/AV)
1	11060.000	49.26	3.31	52.58	-21.42	74.00	200	125	Peak
2	* 16590.000	45.90	4.56	50.47	-17.73	68.20	200	300	Peak

Note:

1. " \*", means this data is the worst emission level.
2. C.F (Correction Factor) = Antenna Factor (dB/m) + Cable Loss (dB) – Preamplifier(dB).
3. Measurement (dBuV/m) = Reading(dBuV) + C.F (Correction Factor).
4. The emission levels of other frequencies are very lower than the limit and not show in test report.

EUT	AX3000 High Gain Wireless USB Adapter	Date of Test	2023-01-19
Factor	DRH18-E	Temp. / Humidity	20°C /62%
Polarity	Vertical	Site / Test Engineer	AC2 / Ares
Test Mode	802.11ac-80MHz_TX_Band3_CH 106_ANT 1+2	Test Voltage	By Notebook PC

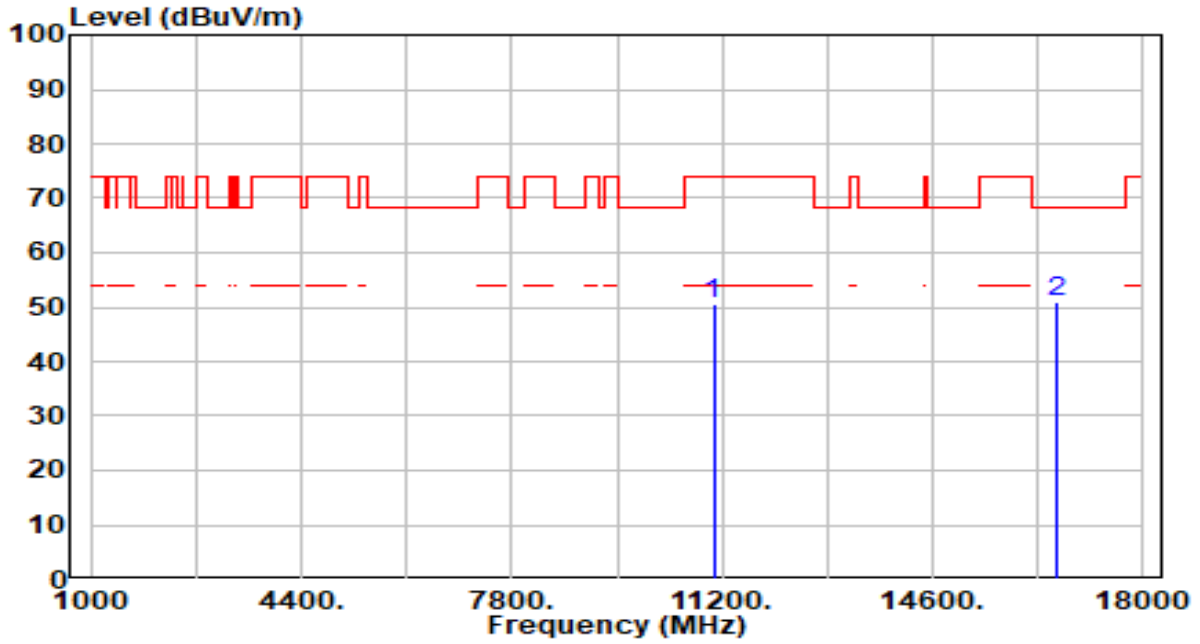

No	Frequency (MHz)	Reading (dBuV)	C.F (dB/m)	Measurement (dBuV/m)	Margin (dB)	Limit (dBuV/m)	Height (cm)	Angle (deg)	Remark (QP/PK/AV)
1	11060.000	47.42	3.31	50.74	-23.26	74.00	200	75	Peak
2	* 16590.000	46.38	4.56	50.94	-17.26	68.20	200	100	Peak

Note:

1. " \*", means this data is the worst emission level.
2. C.F (Correction Factor) = Antenna Factor (dB/m) + Cable Loss (dB) – Pre-amplifier(dB).
3. Measurement (dBuV/m) = Reading(dBuV) + C.F (Correction Factor).
4. The emission levels of other frequencies are very lower than the limit and not show in test report.



EUT	AX3000 High Gain Wireless USB Adapter	Date of Test	2023-01-19
Factor	DRH18-E	Temp. / Humidity	20°C /62%
Polarity	Horizontal	Site / Test Engineer	AC2 / Ares
Test Mode	802.11ac-80MHz_TX_Band3_CH 122_ANT 1+2	Test Voltage	By Notebook PC

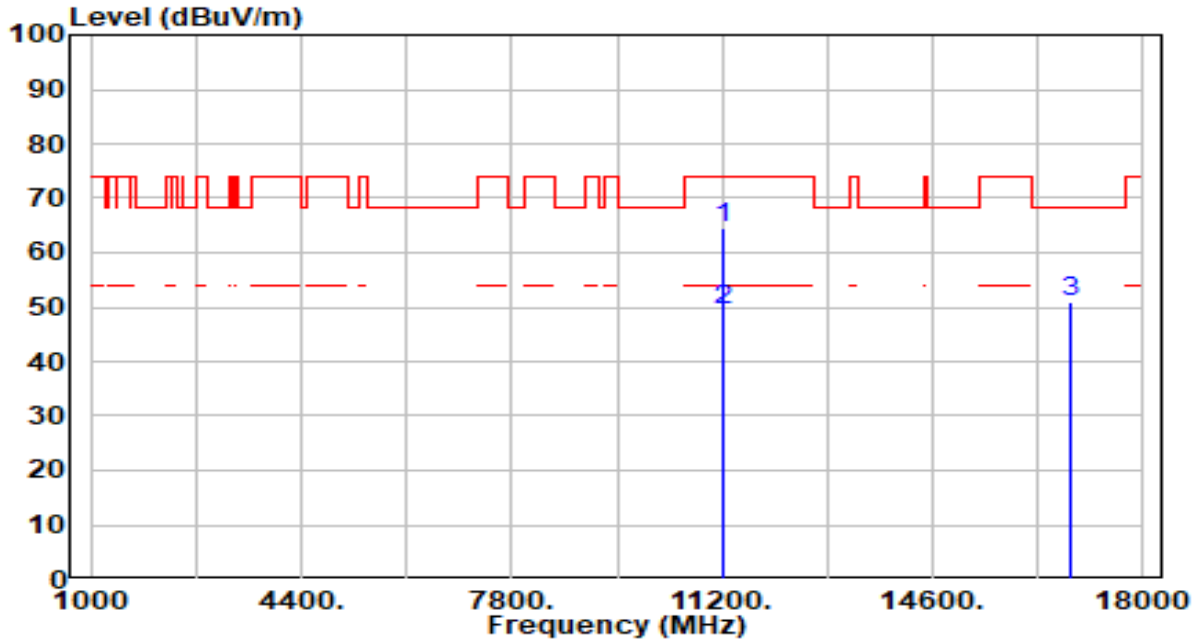

No	Frequency (MHz)	Reading (dBuV)	C.F (dB/m)	Measurement (dBuV/m)	Margin (dB)	Limit (dBuV/m)	Height (cm)	Angle (deg)	Remark (QP/PK/AV)	
1	*	11220.000	61.06	3.59	64.65	-9.35	74.00	200	6	Peak
2	*	11220.000	45.97	3.59	49.56	-4.44	54.00	200	6	Average
3		16830.000	46.59	4.38	50.97	-17.23	68.20	200	261	Peak

Note:

1. " \*", means this data is the worst emission level.
2. C.F (Correction Factor) = Antenna Factor (dB/m) + Cable Loss (dB) – Preamplifier(dB).
3. Measurement (dBuV/m) = Reading(dBuV) + C.F (Correction Factor).
4. The emission levels of other frequencies are very lower than the limit and not show in test report.

EUT	AX3000 High Gain Wireless USB Adapter	Date of Test	2023-01-19
Factor	DRH18-E	Temp. / Humidity	20°C /62%
Polarity	Vertical	Site / Test Engineer	AC2 / Ares
Test Mode	802.11ac-80MHz_TX_Band3_CH 122_ANT 1+2	Test Voltage	By Notebook PC

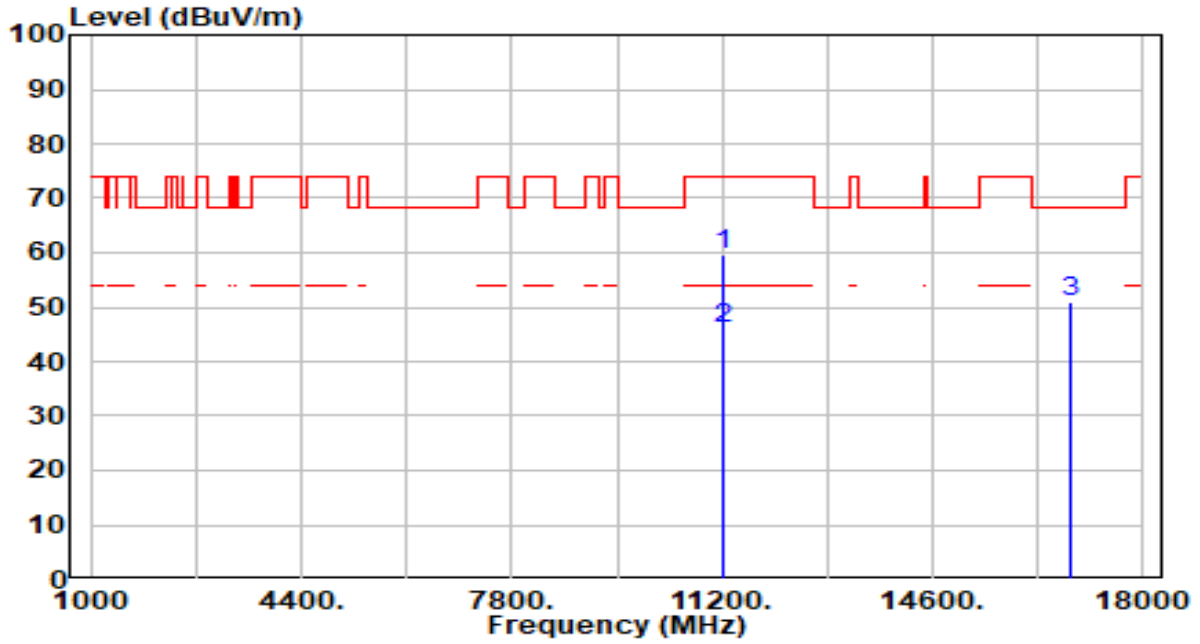

No	Frequency (MHz)	Reading (dBuV)	C.F (dB/m)	Measurement (dBuV/m)	Margin (dB)	Limit (dBuV/m)	Height (cm)	Angle (deg)	Remark (QP/PK/AV)
1	*	56.21	3.59	59.80	-14.20	74.00	200	341	Peak
2	*	42.34	3.59	45.93	-8.07	54.00	200	341	Average
3		46.46	4.38	50.84	-17.36	68.20	200	292	Peak

Note:

1. " \*", means this data is the worst emission level.
2. C.F (Correction Factor) = Antenna Factor (dB/m) + Cable Loss (dB) – Preamplifier(dB).
3. Measurement (dBuV/m) = Reading(dBuV) + C.F (Correction Factor).
4. The emission levels of other frequencies are very lower than the limit and not show in test report.

EUT	AX3000 High Gain Wireless USB Adapter	Date of Test	2023-01-19
Factor	DRH18-E	Temp. / Humidity	20°C /62%
Polarity	Horizontal	Site / Test Engineer	AC2 / Ares
Test Mode	802.11ac-80MHz_TX_Band3_CH 138_ANT 1+2	Test Voltage	By Notebook PC

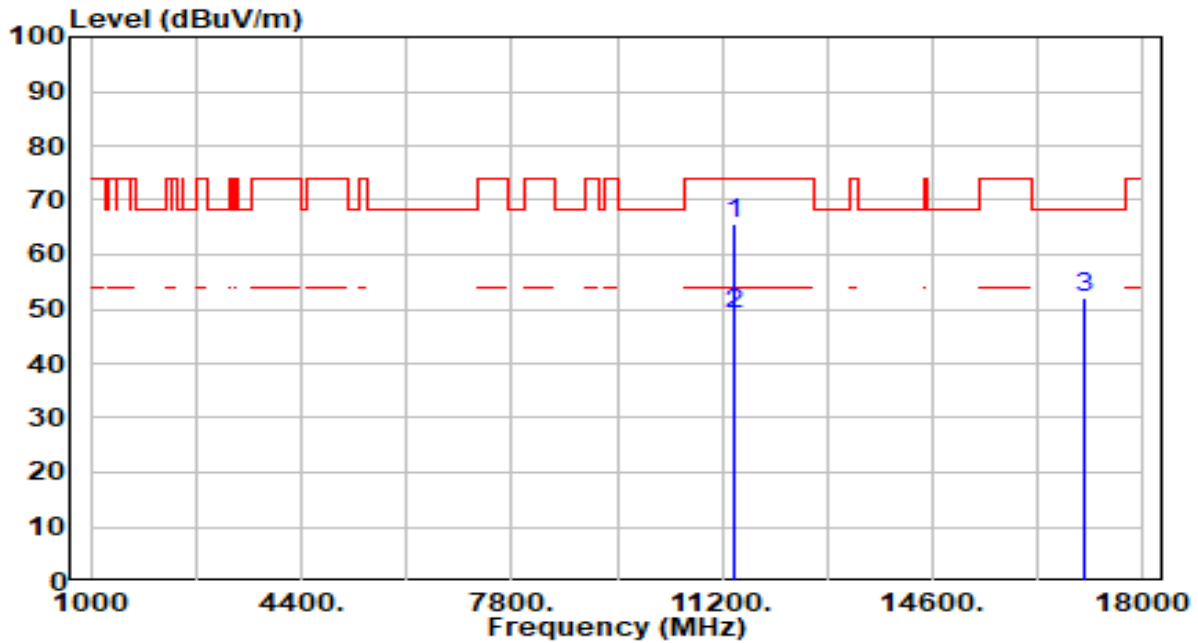

No	Frequency (MHz)	Reading (dBuV)	C.F (dB/m)	Measurement (dBuV/m)	Margin (dB)	Limit (dBuV/m)	Height (cm)	Angle (deg)	Remark (QP/PK/AV)	
1	*	11380.000	61.79	3.87	65.66	-8.34	74.00	200	8	Peak
2	*	11380.000	45.04	3.87	48.91	-5.09	54.00	200	8	Average
3		17070.000	47.57	4.58	52.14	-16.06	68.20	200	0	Peak

Note:

1. " \*", means this data is the worst emission level.
2. C.F (Correction Factor) = Antenna Factor (dB/m) + Cable Loss (dB) – Preamplifier(dB).
3. Measurement (dBuV/m) = Reading(dBuV) + C.F (Correction Factor).
4. The emission levels of other frequencies are very lower than the limit and not show in test report.

EUT	AX3000 High Gain Wireless USB Adapter	Date of Test	2023-01-19
Factor	DRH18-E	Temp. / Humidity	20°C /62%
Polarity	Vertical	Site / Test Engineer	AC2 / Ares
Test Mode	802.11ac-80MHz_TX_Band3_CH 138_ANT 1+2	Test Voltage	By Notebook PC

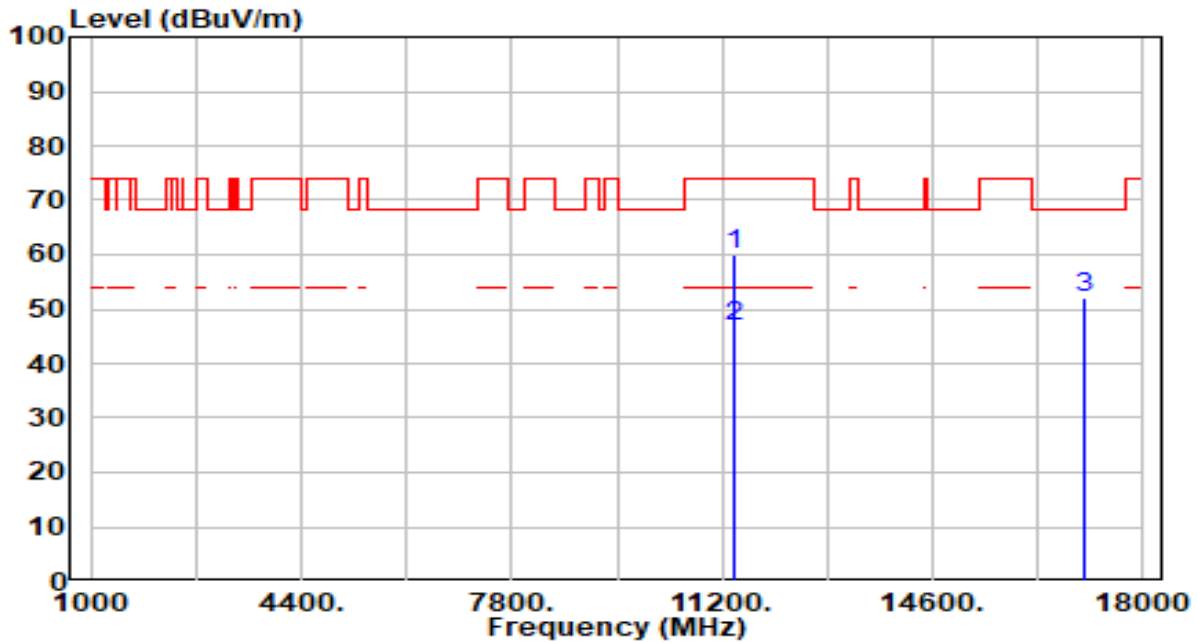

No	Frequency (MHz)	Reading (dBuV)	C.F (dB/m)	Measurement (dBuV/m)	Margin (dB)	Limit (dBuV/m)	Height (cm)	Angle (deg)	Remark (QP/PK/AV)	
1	*	11380.000	56.20	3.87	60.07	-13.93	74.00	200	360	Peak
2	*	11380.000	42.77	3.87	46.64	-7.36	54.00	200	360	Average
3		17070.000	47.54	4.58	52.11	-16.09	68.20	200	360	Peak

Note:

1. " \*", means this data is the worst emission level.
2. C.F (Correction Factor) = Antenna Factor (dB/m) + Cable Loss (dB) – Preamplifier(dB).
3. Measurement (dBuV/m) = Reading(dBuV) + C.F (Correction Factor).
4. The emission levels of other frequencies are very lower than the limit and not show in test report.

EUT	AX3000 High Gain Wireless USB Adapter	Date of Test	2023-01-19
Factor	DRH18-E	Temp. / Humidity	20°C /62%
Polarity	Horizontal	Site / Test Engineer	AC2 / Ares
Test Mode	802.11ac-80MHz_TX_Band4_CH 155_ANT 1+2	Test Voltage	By Notebook PC

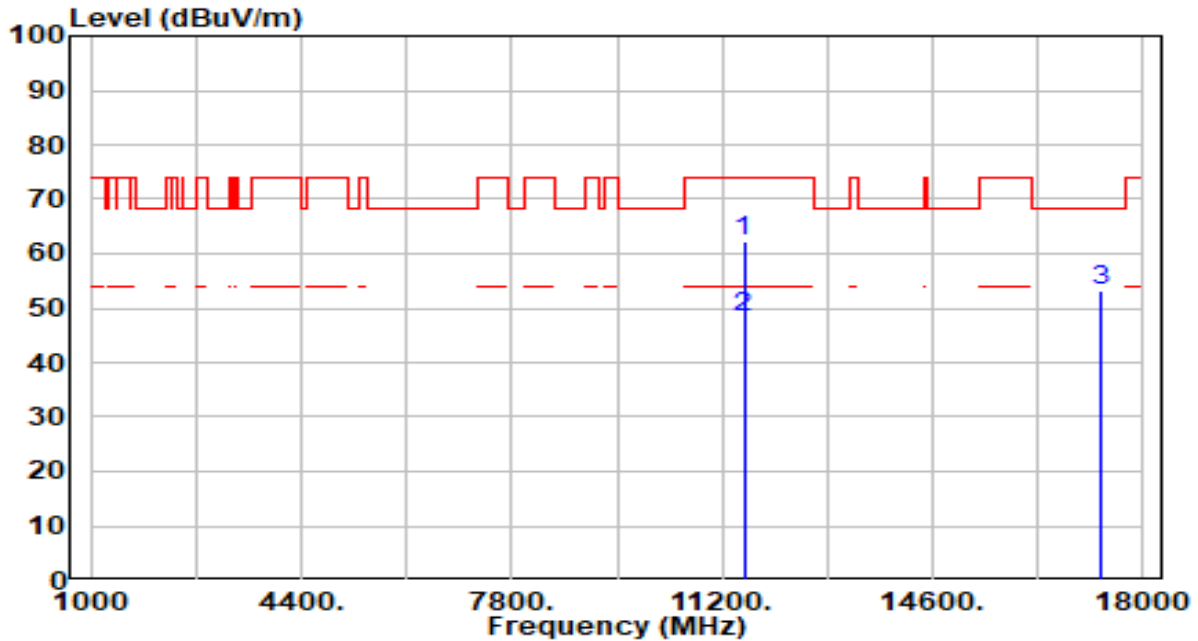

No	Frequency (MHz)	Reading (dBuV)	C.F (dB/m)	Measurement (dBuV/m)	Margin (dB)	Limit (dBuV/m)	Height (cm)	Angle (deg)	Remark (QP/PK/AV)
1	* 11550.000	58.24	3.94	62.18	-11.82	74.00	200	302	Peak
2	* 11550.000	44.23	3.94	48.17	-5.83	54.00	200	302	Average
3	17325.000	49.25	3.85	53.10	-15.10	68.20	200	109	Peak

Note:

1. " \*", means this data is the worst emission level.
2. C.F (Correction Factor) = Antenna Factor (dB/m) + Cable Loss (dB) – Pre-amplifier(dB).
3. Measurement (dBuV/m) = Reading(dBuV) + C.F (Correction Factor).
4. The emission levels of other frequencies are very lower than the limit and not show in test report.

EUT	AX3000 High Gain Wireless USB Adapter	Date of Test	2023-01-19
Factor	DRH18-E	Temp. / Humidity	20°C /62%
Polarity	Vertical	Site / Test Engineer	AC2 / Ares
Test Mode	802.11ac-80MHz_TX_Band4_CH 155_ANT 1+2	Test Voltage	By Notebook PC

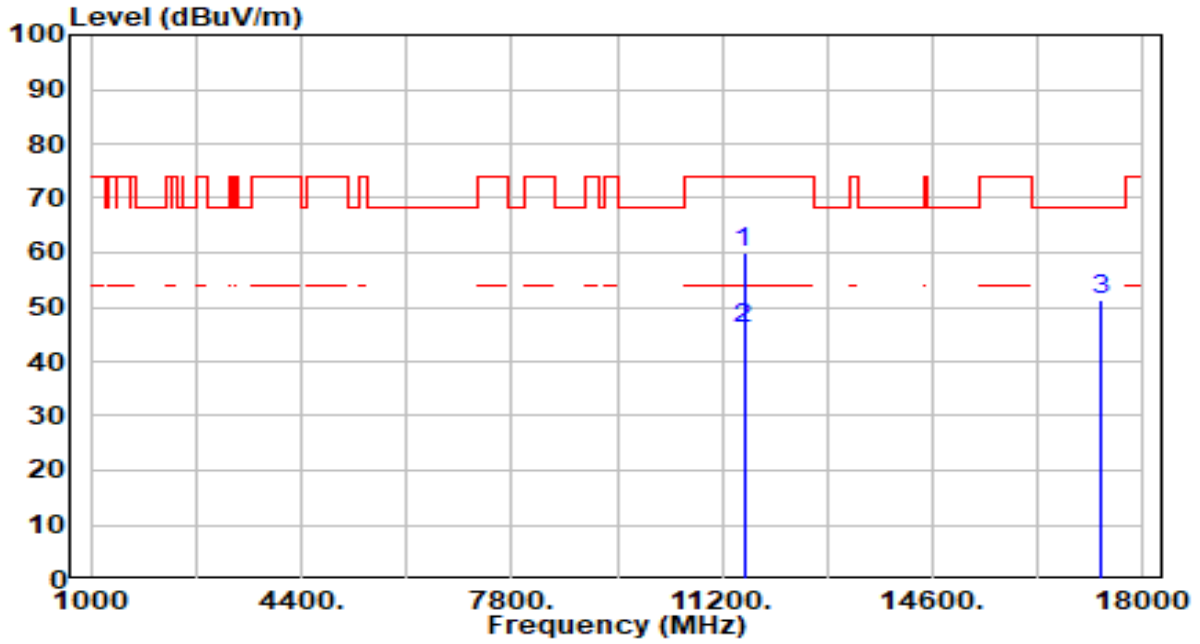

No	Frequency (MHz)	Reading (dBuV)	C.F (dB/m)	Measurement (dBuV/m)	Margin (dB)	Limit (dBuV/m)	Height (cm)	Angle (deg)	Remark (QP/PK/AV)	
1	*	11550.000	55.90	3.94	59.84	-14.16	74.00	200	360	Peak
2	*	11550.000	42.18	3.94	46.12	-7.88	54.00	200	360	Average
3		17325.000	47.31	3.85	51.16	-17.04	68.20	200	336	Peak

Note:

1. " \*", means this data is the worst emission level.
2. C.F (Correction Factor) = Antenna Factor (dB/m) + Cable Loss (dB) – Preamplifier(dB).
3. Measurement (dBuV/m) = Reading(dBuV) + C.F (Correction Factor).
4. The emission levels of other frequencies are very lower than the limit and not show in test report.

EUT	AX3000 High Gain Wireless USB Adapter	Date of Test	2023-01-19
Factor	DRH18-E	Temp. / Humidity	20°C /62%
Polarity	Horizontal	Site / Test Engineer	AC2 / Ares
Test Mode	802.11ac-160MHz_TX_Band1,2_CH 50_ANT 1+2	Test Voltage	By Notebook PC

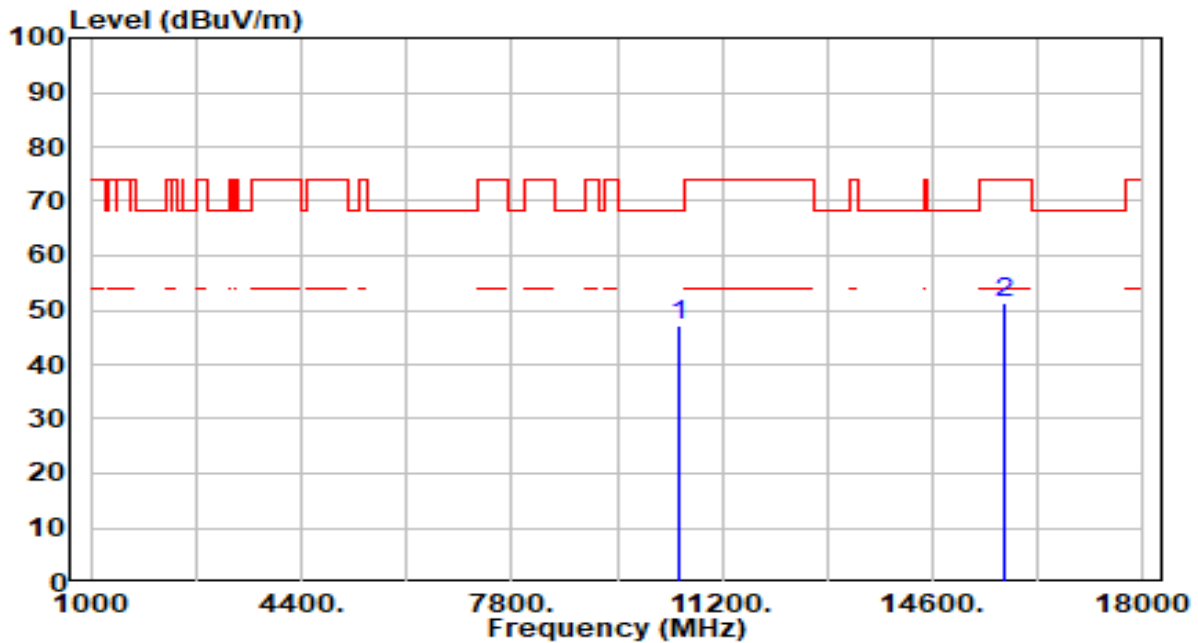

No	Frequency (MHz)	Reading (dBuV)	C.F (dB/m)	Measurement (dBuV/m)	Margin (dB)	Limit (dBuV/m)	Height (cm)	Angle (deg)	Remark (QP/PK/AV)
1	* 10500.000	44.23	3.09	47.33	-20.87	68.20	200	360	Peak
2	15750.000	46.39	5.09	51.48	-22.52	74.00	200	360	Peak

Note:

1. " \*", means this data is the worst emission level.
2. C.F (Correction Factor) = Antenna Factor (dB/m) + Cable Loss (dB) – Pre-amplifier(dB).
3. Measurement (dBuV/m) = Reading(dBuV) + C.F (Correction Factor).
4. The emission levels of other frequencies are very lower than the limit and not show in test report.

EUT	AX3000 High Gain Wireless USB Adapter	Date of Test	2023-01-19
Factor	DRH18-E	Temp. / Humidity	20°C /62%
Polarity	Vertical	Site / Test Engineer	AC2 / Ares
Test Mode	802.11ac-160MHz_TX_Band1,2_CH 50_ANT 1+2	Test Voltage	By Notebook PC

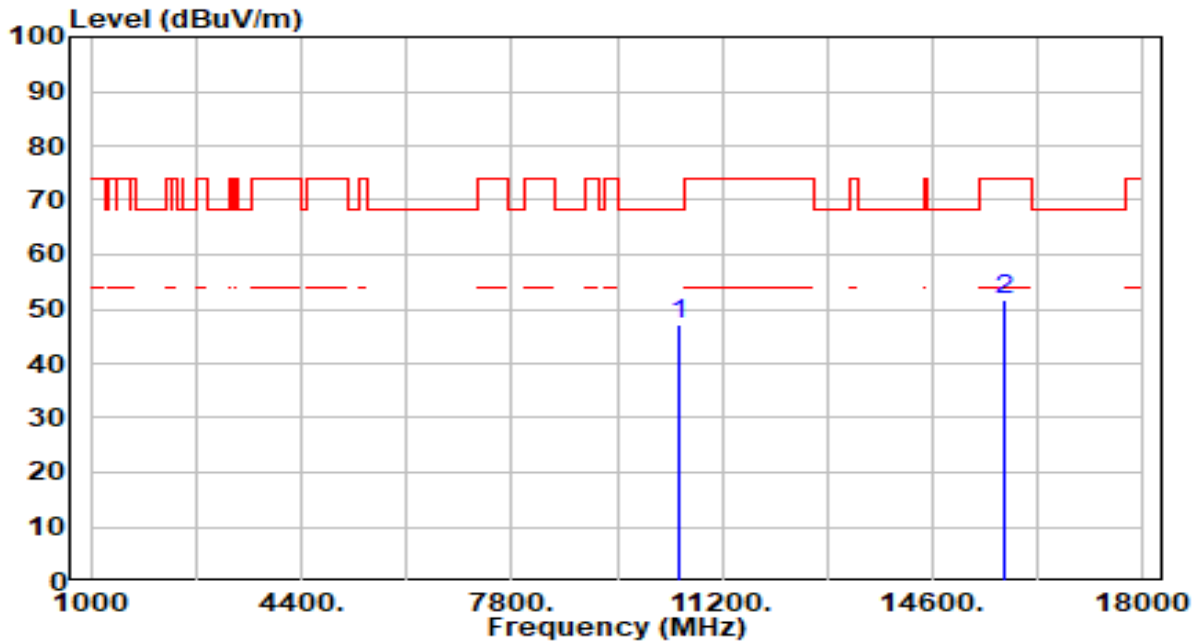

No	Frequency (MHz)	Reading (dBuV)	C.F (dB/m)	Measurement (dBuV/m)	Margin (dB)	Limit (dBuV/m)	Height (cm)	Angle (deg)	Remark (QP/PK/AV)
1	* 10500.000	44.01	3.09	47.11	-21.09	68.20	200	60	Peak
2	15750.000	46.80	5.09	51.88	-22.12	74.00	200	335	Peak

Note:

1. " \*", means this data is the worst emission level.
2. C.F (Correction Factor) = Antenna Factor (dB/m) + Cable Loss (dB) – Pre-amplifier(dB).
3. Measurement (dBuV/m) = Reading(dBuV) + C.F (Correction Factor).
4. The emission levels of other frequencies are very lower than the limit and not show in test report.



EUT	AX3000 High Gain Wireless USB Adapter	Date of Test	2023-01-19
Factor	DRH18-E	Temp. / Humidity	20°C /62%
Polarity	Horizontal	Site / Test Engineer	AC2 / Ares
Test Mode	802.11ac-160MHz_TX_Band3_CH 114_ANT 1+2	Test Voltage	By Notebook PC

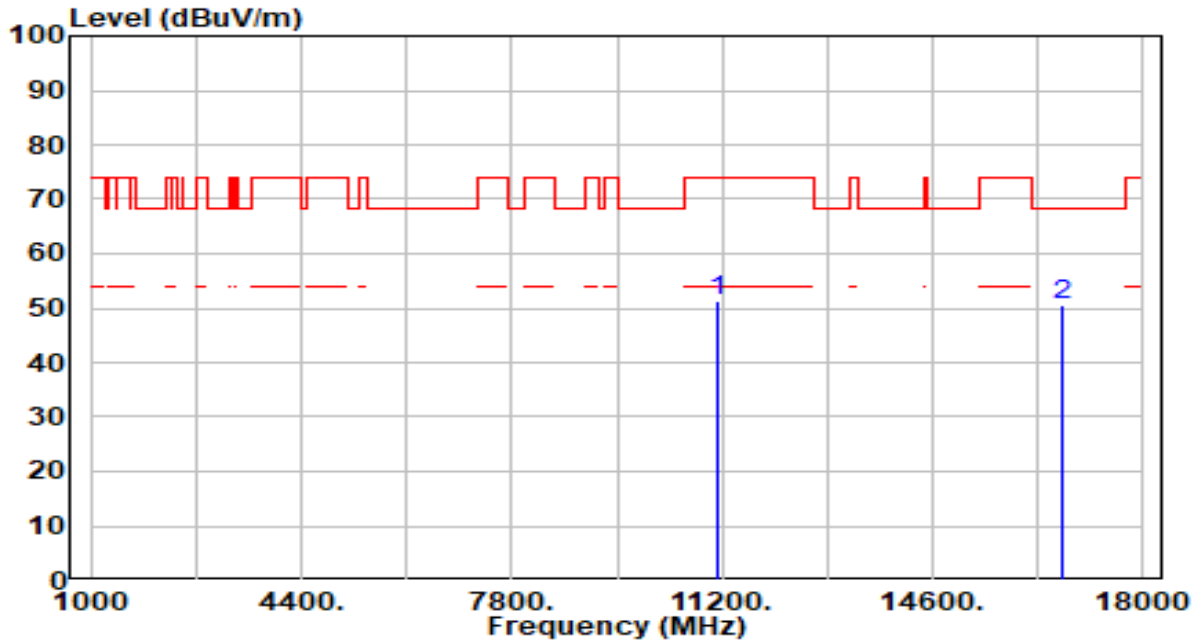

No	Frequency (MHz)	Reading (dBuV)	C.F (dB/m)	Measurement (dBuV/m)	Margin (dB)	Limit (dBuV/m)	Height (cm)	Angle (deg)	Remark (QP/PK/AV)
1	11140.000	48.01	3.45	51.47	-22.53	74.00	200	30	Peak
2	* 16710.000	45.97	4.50	50.47	-17.73	68.20	200	145	Peak

Note:

1. " \*", means this data is the worst emission level.
2. C.F (Correction Factor) = Antenna Factor (dB/m) + Cable Loss (dB) – Pre-amplifier(dB).
3. Measurement (dBuV/m) = Reading(dBuV) + C.F (Correction Factor).
4. The emission levels of other frequencies are very lower than the limit and not show in test report.

EUT	AX3000 High Gain Wireless USB Adapter	Date of Test	2023-01-19
Factor	DRH18-E	Temp. / Humidity	20°C /62%
Polarity	Vertical	Site / Test Engineer	AC2 / Ares
Test Mode	802.11ac-160MHz_TX_Band3_CH 114_ANT 1+2	Test Voltage	By Notebook PC

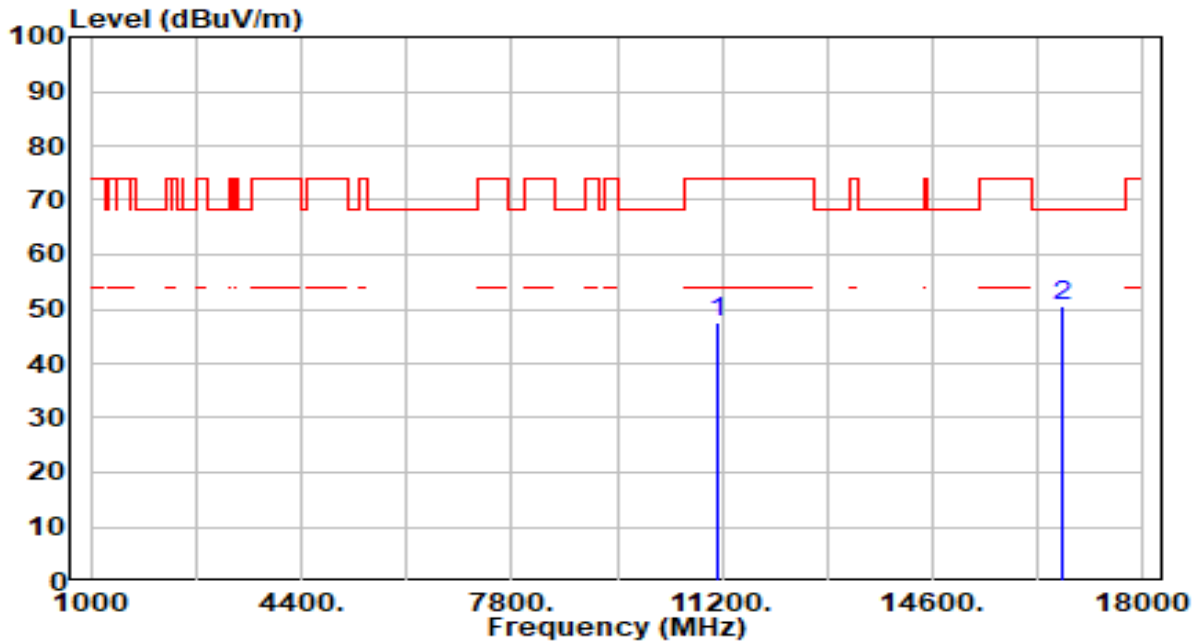

No	Frequency (MHz)	Reading (dBuV)	C.F (dB/m)	Measurement (dBuV/m)	Margin (dB)	Limit (dBuV/m)	Height (cm)	Angle (deg)	Remark (QP/PK/AV)
1	11140.000	44.02	3.45	47.48	-26.52	74.00	200	15	Peak
2	* 16710.000	46.04	4.50	50.54	-17.66	68.20	200	75	Peak

Note:

1. " \*", means this data is the worst emission level.
2. C.F (Correction Factor) = Antenna Factor (dB/m) + Cable Loss (dB) – Pre-amplifier(dB).
3. Measurement (dBuV/m) = Reading(dBuV) + C.F (Correction Factor).
4. The emission levels of other frequencies are very lower than the limit and not show in test report.

EUT	AX3000 High Gain Wireless USB Adapter	Date of Test	2023-01-19
Factor	DRH18-E	Temp. / Humidity	20°C /62%
Polarity	Horizontal	Site / Test Engineer	AC2 / Ares
Test Mode	802.11ax-20MHz_TX_Band1_CH 36_ANT 1+2	Test Voltage	By Notebook PC

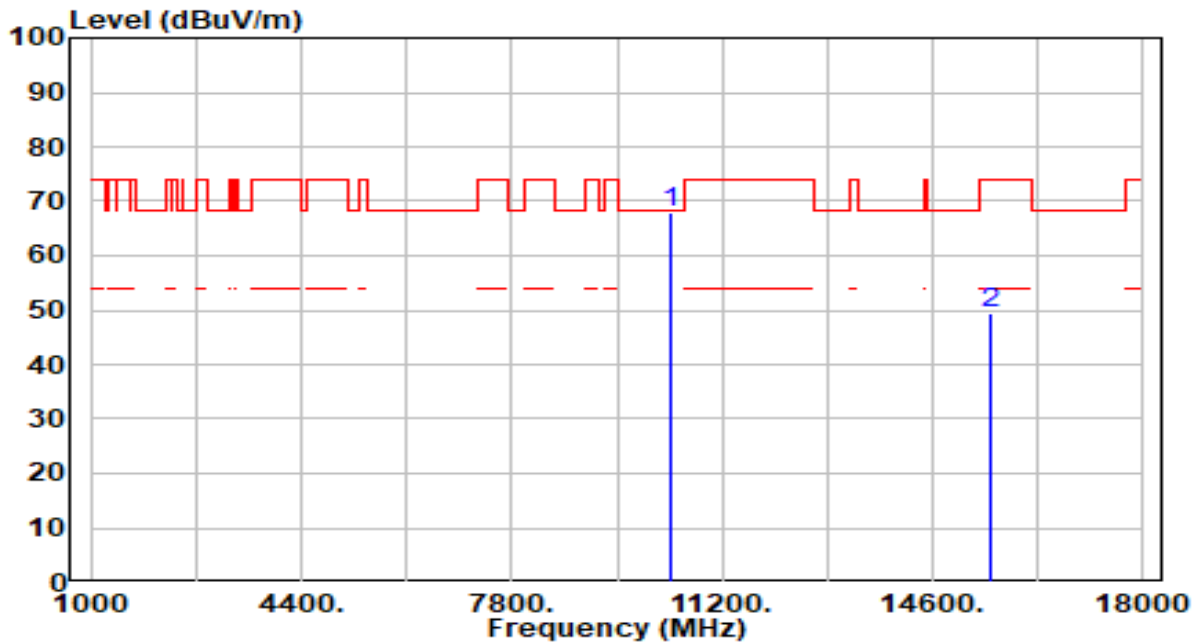

No	Frequency (MHz)	Reading (dBuV)	C.F (dB/m)	Measurement (dBuV/m)	Margin (dB)	Limit (dBuV/m)	Height (cm)	Angle (deg)	Remark (QP/PK/AV)
1	*	64.86	3.19	68.05	-0.15	68.20	200	255	Peak
2		44.77	4.74	49.51	-24.49	74.00	200	360	Peak

Note:

1. " \*", means this data is the worst emission level.
2. C.F (Correction Factor) = Antenna Factor (dB/m) + Cable Loss (dB) – Pre-amplifier(dB).
3. Measurement (dBuV/m) = Reading(dBuV) + C.F (Correction Factor).
4. The emission levels of other frequencies are very lower than the limit and not show in test report.

EUT	AX3000 High Gain Wireless USB Adapter	Date of Test	2023-01-19
Factor	DRH18-E	Temp. / Humidity	20°C /62%
Polarity	Vertical	Site / Test Engineer	AC2 / Ares
Test Mode	802.11ax-20MHz_TX_Band1_CH 36_ANT 1+2	Test Voltage	By Notebook PC

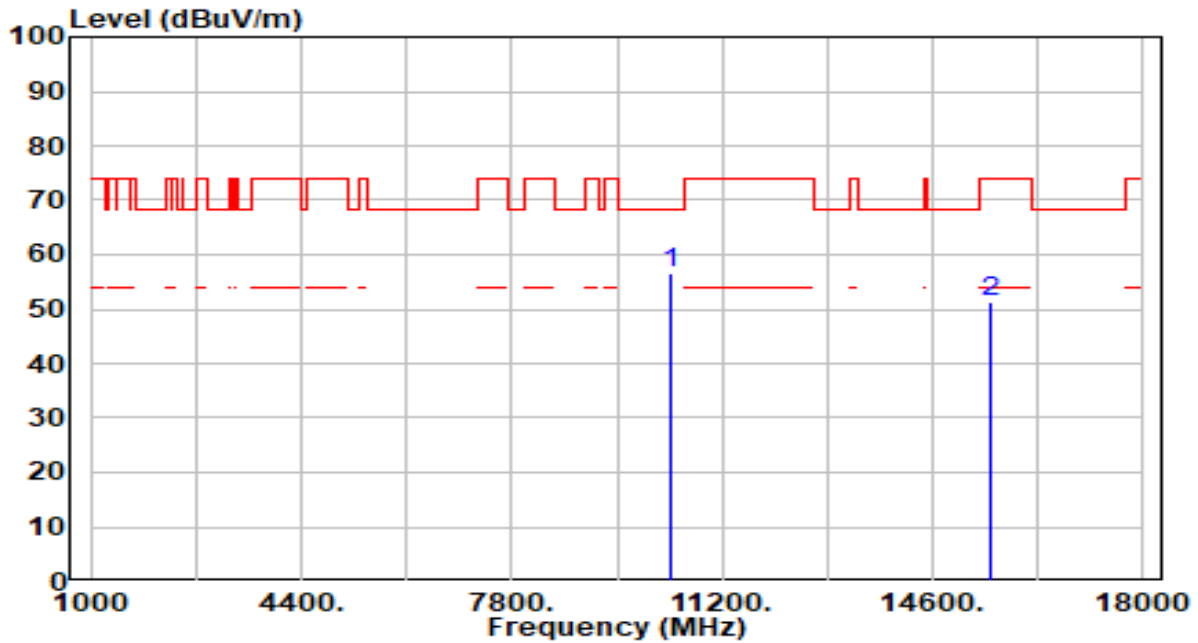

No	Frequency (MHz)	Reading (dBuV)	C.F (dB/m)	Measurement (dBuV/m)	Margin (dB)	Limit (dBuV/m)	Height (cm)	Angle (deg)	Remark (QP/PK/AV)
1	*	53.57	3.19	56.77	-11.43	68.20	200	320	Peak
2		46.56	4.74	51.31	-22.69	74.00	200	200	Peak

Note:

1. " \*", means this data is the worst emission level.
2. C.F (Correction Factor) = Antenna Factor (dB/m) + Cable Loss (dB) – Pre-amplifier(dB).
3. Measurement (dBuV/m) = Reading(dBuV) + C.F (Correction Factor).
4. The emission levels of other frequencies are very lower than the limit and not show in test report.

EUT	AX3000 High Gain Wireless USB Adapter	Date of Test	2023-01-19
Factor	DRH18-E	Temp. / Humidity	20°C /62%
Polarity	Horizontal	Site / Test Engineer	AC2 / Ares
Test Mode	802.11ax-20MHz_TX_Band1_CH 44_ANT 1+2	Test Voltage	By Notebook PC

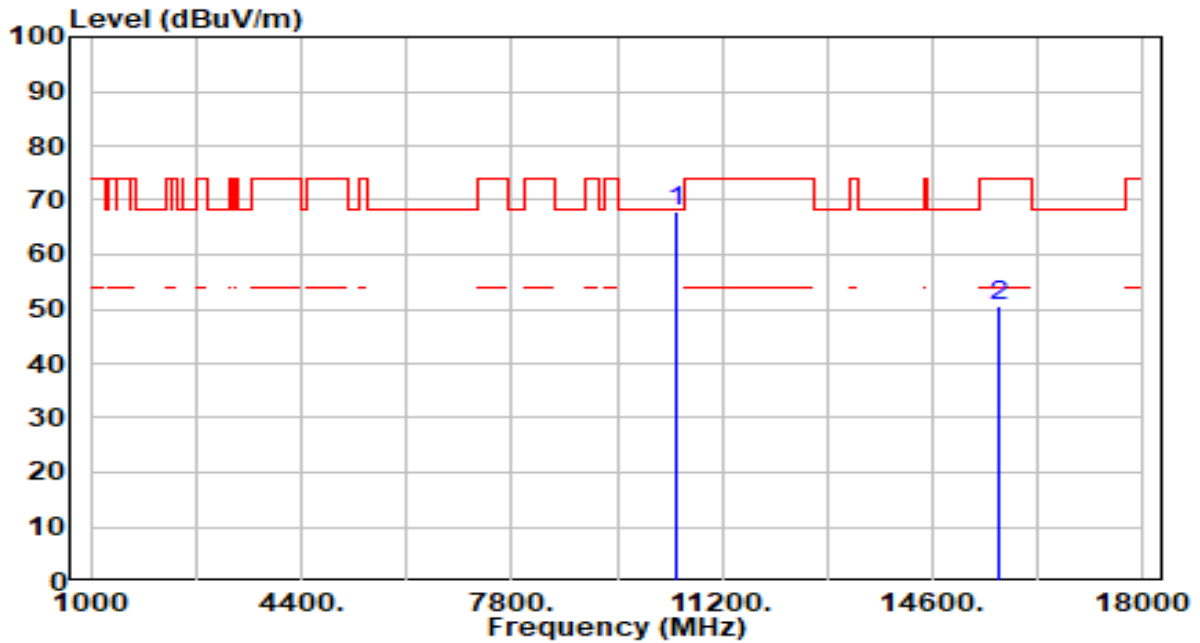

No	Frequency (MHz)	Reading (dBuV)	C.F (dB/m)	Measurement (dBuV/m)	Margin (dB)	Limit (dBuV/m)	Height (cm)	Angle (deg)	Remark (QP/PK/AV)
1	*	64.89	3.15	68.04	-0.16	68.20	200	256	Peak
2		45.62	4.89	50.51	-23.49	74.00	200	286	Peak

Note:

1. " \*", means this data is the worst emission level.
2. C.F (Correction Factor) = Antenna Factor (dB/m) + Cable Loss (dB) – Pre-amplifier(dB).
3. Measurement (dBuV/m) = Reading(dBuV) + C.F (Correction Factor).
4. The emission levels of other frequencies are very lower than the limit and not show in test report.

EUT	AX3000 High Gain Wireless USB Adapter	Date of Test	2023-01-19
Factor	DRH18-E	Temp. / Humidity	20°C /62%
Polarity	Vertical	Site / Test Engineer	AC2 / Ares
Test Mode	802.11ax-20MHz_TX_Band1_CH 44_ANT 1+2	Test Voltage	By Notebook PC

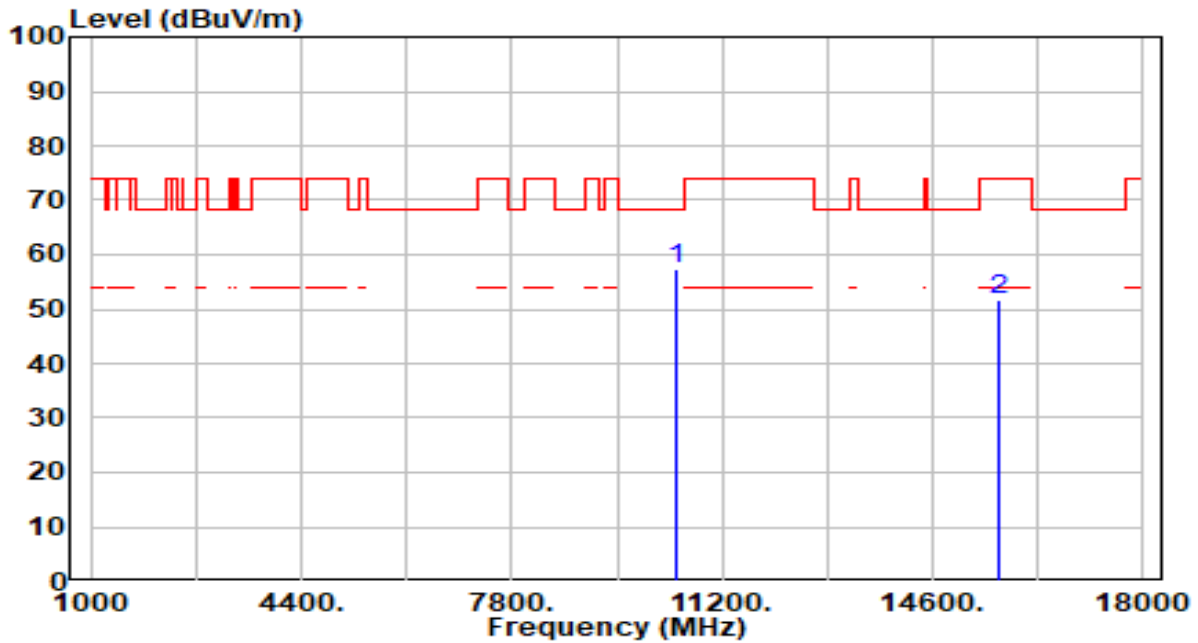

No	Frequency (MHz)	Reading (dBuV)	C.F (dB/m)	Measurement (dBuV/m)	Margin (dB)	Limit (dBuV/m)	Height (cm)	Angle (deg)	Remark (QP/PK/AV)
1	* 10440.000	54.09	3.15	57.24	-10.96	68.20	200	339	Peak
2	15660.000	46.65	4.89	51.54	-22.46	74.00	200	94	Peak

Note:

1. " \*", means this data is the worst emission level.
2. C.F (Correction Factor) = Antenna Factor (dB/m) + Cable Loss (dB) – Pre-amplifier(dB).
3. Measurement (dBuV/m) = Reading(dBuV) + C.F (Correction Factor).
4. The emission levels of other frequencies are very lower than the limit and not show in test report.

EUT	AX3000 High Gain Wireless USB Adapter	Date of Test	2023-01-19
Factor	DRH18-E	Temp. / Humidity	20°C /62%
Polarity	Horizontal	Site / Test Engineer	AC2 / Ares
Test Mode	802.11ax-20MHz_TX_Band1_CH 48_ANT 1+2	Test Voltage	By Notebook PC

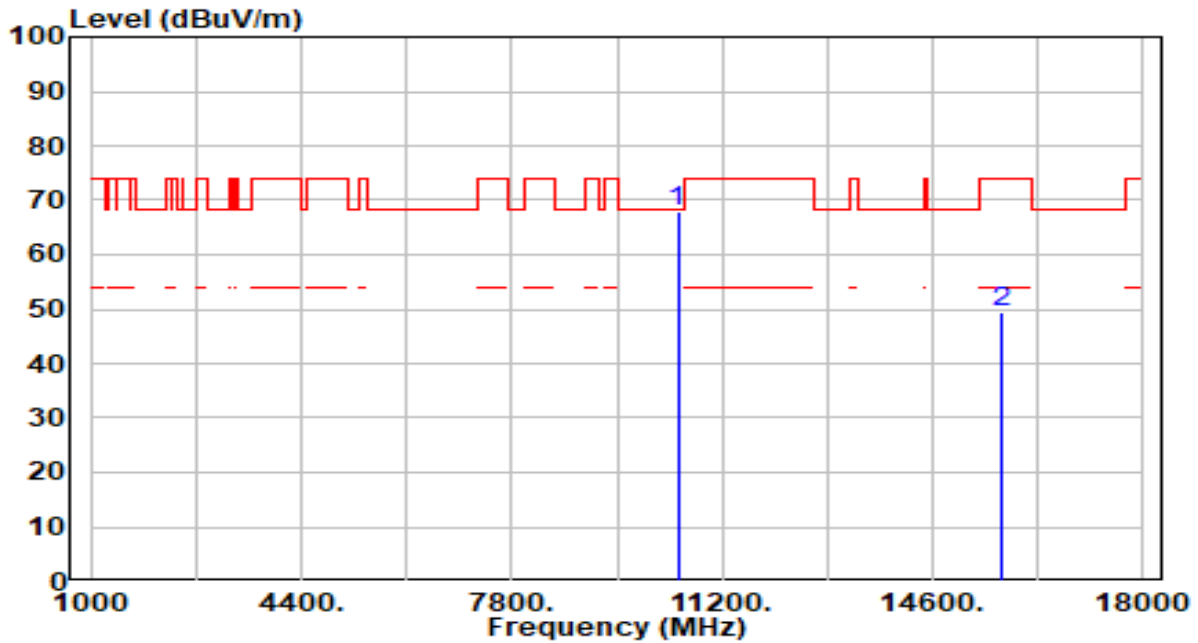

No	Frequency (MHz)	Reading (dBuV)	C.F (dB/m)	Measurement (dBuV/m)	Margin (dB)	Limit (dBuV/m)	Height (cm)	Angle (deg)	Remark (QP/PK/AV)
1	* 10480.000	64.95	3.11	68.06	-0.14	68.20	200	256	Peak
2	15720.000	44.47	5.02	49.49	-24.51	74.00	200	360	Peak

Note:

1. " \*", means this data is the worst emission level.
2. C.F (Correction Factor) = Antenna Factor (dB/m) + Cable Loss (dB) – Pre-amplifier(dB).
3. Measurement (dBuV/m) = Reading(dBuV) + C.F (Correction Factor).
4. The emission levels of other frequencies are very lower than the limit and not show in test report.

EUT	AX3000 High Gain Wireless USB Adapter	Date of Test	2023-01-19
Factor	DRH18-E	Temp. / Humidity	20°C /62%
Polarity	Vertical	Site / Test Engineer	AC2 / Ares
Test Mode	802.11ax-20MHz_TX_Band1_CH 48_ANT 1+2	Test Voltage	By Notebook PC

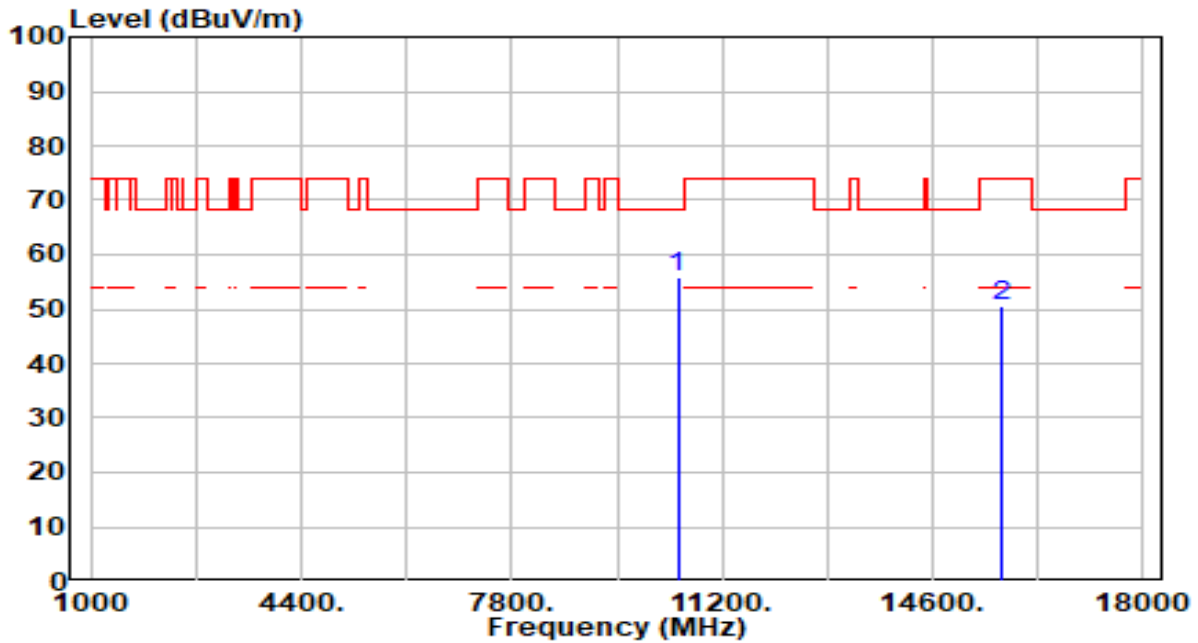

No	Frequency (MHz)	Reading (dBuV)	C.F (dB/m)	Measurement (dBuV/m)	Margin (dB)	Limit (dBuV/m)	Height (cm)	Angle (deg)	Remark (QP/PK/AV)
1	* 10480.000	52.74	3.11	55.85	-12.35	68.20	200	325	Peak
2	15720.000	45.41	5.02	50.44	-23.56	74.00	200	360	Peak

Note:

1. " \*", means this data is the worst emission level.
2. C.F (Correction Factor) = Antenna Factor (dB/m) + Cable Loss (dB) – Pre-amplifier(dB).
3. Measurement (dBuV/m) = Reading(dBuV) + C.F (Correction Factor).
4. The emission levels of other frequencies are very lower than the limit and not show in test report.



EUT	AX3000 High Gain Wireless USB Adapter	Date of Test	2023-01-19
Factor	DRH18-E	Temp. / Humidity	20°C /62%
Polarity	Horizontal	Site / Test Engineer	AC2 / Ares
Test Mode	802.11ax-20MHz_TX_Band2_CH 52_ANT 1+2	Test Voltage	By Notebook PC

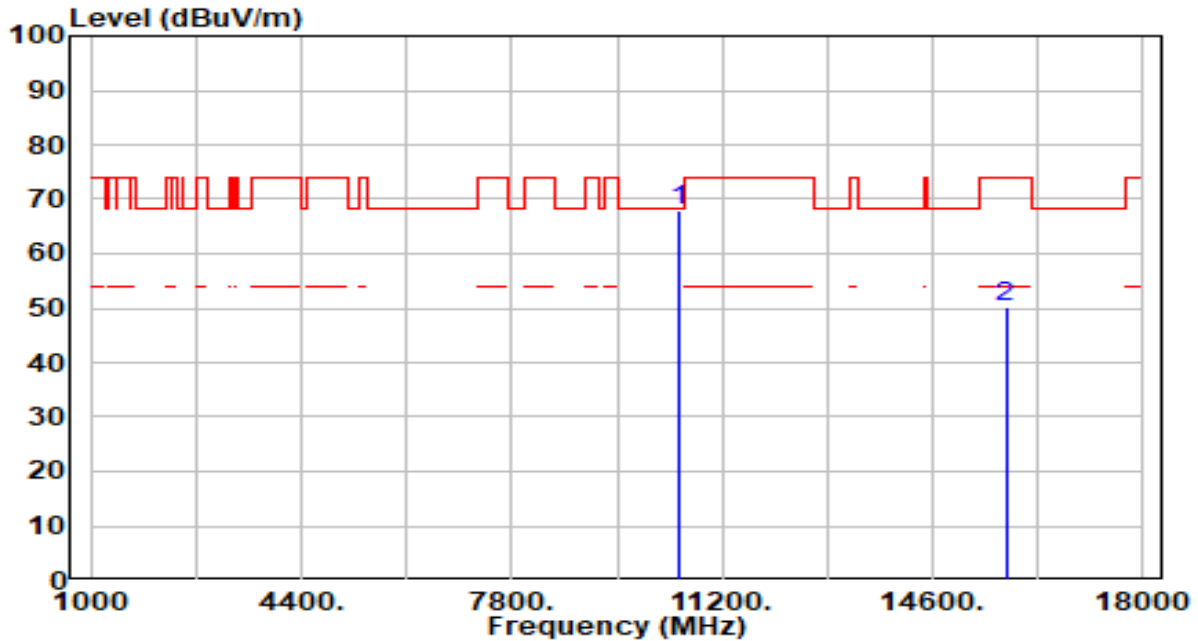

No	Frequency (MHz)	Reading (dBuV)	C.F (dB/m)	Measurement (dBuV/m)	Margin (dB)	Limit (dBuV/m)	Height (cm)	Angle (deg)	Remark (QP/PK/AV)
1	*	64.99	3.09	68.08	-0.12	68.20	200	256	Peak
2		45.04	5.15	50.20	-23.80	74.00	200	343	Peak

Note:

1. " \*", means this data is the worst emission level.
2. C.F (Correction Factor) = Antenna Factor (dB/m) + Cable Loss (dB) – Pre-amplifier(dB).
3. Measurement (dBuV/m) = Reading(dBuV) + C.F (Correction Factor).
4. The emission levels of other frequencies are very lower than the limit and not show in test report.

EUT	AX3000 High Gain Wireless USB Adapter	Date of Test	2023-01-19
Factor	DRH18-E	Temp. / Humidity	20°C /62%
Polarity	Vertical	Site / Test Engineer	AC2 / Ares
Test Mode	802.11ax-20MHz_TX_Band2_CH 52_ANT 1+2	Test Voltage	By Notebook PC

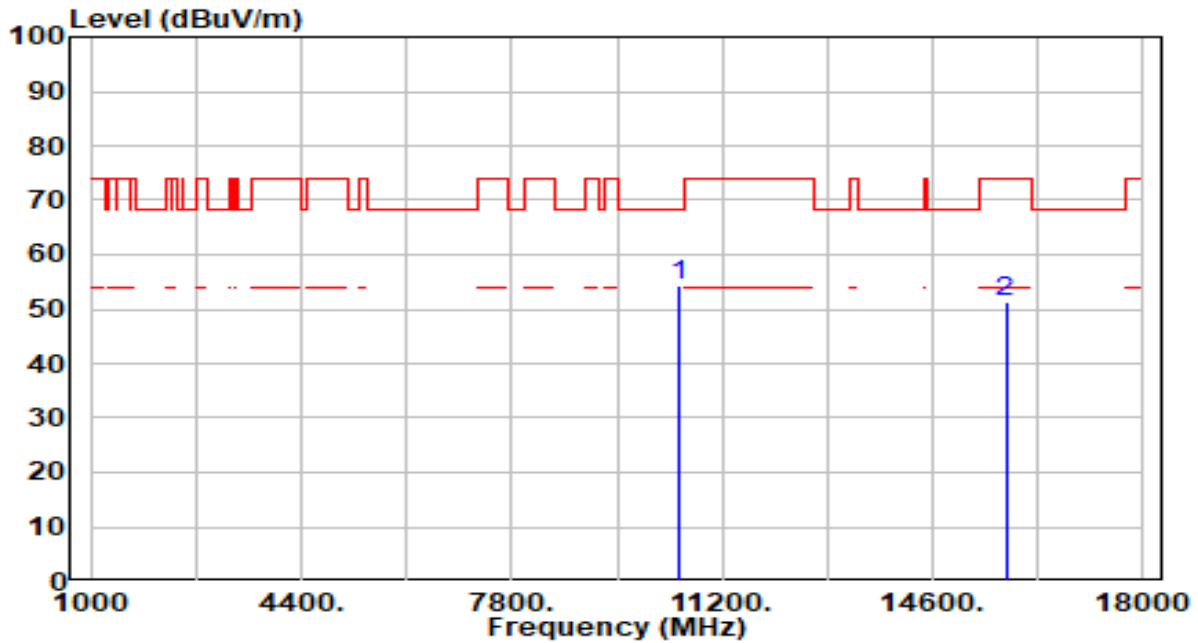

No	Frequency (MHz)	Reading (dBuV)	C.F (dB/m)	Measurement (dBuV/m)	Margin (dB)	Limit (dBuV/m)	Height (cm)	Angle (deg)	Remark (QP/PK/AV)
1	* 10520.000	51.23	3.09	54.31	-13.89	68.20	200	350	Peak
2	15780.000	46.12	5.15	51.28	-22.72	74.00	200	360	Peak

Note:

1. " \*", means this data is the worst emission level.
2. C.F (Correction Factor) = Antenna Factor (dB/m) + Cable Loss (dB) – Pre-amplifier(dB).
3. Measurement (dBuV/m) = Reading(dBuV) + C.F (Correction Factor).
4. The emission levels of other frequencies are very lower than the limit and not show in test report.

EUT	AX3000 High Gain Wireless USB Adapter	Date of Test	2023-01-30
Factor	DRH18-E	Temp. / Humidity	20°C /62%
Polarity	Horizontal	Site / Test Engineer	AC2 / Ares
Test Mode	802.11ax-20MHz_TX_Band2_CH 60_ANT 1+2	Test Voltage	By Notebook PC

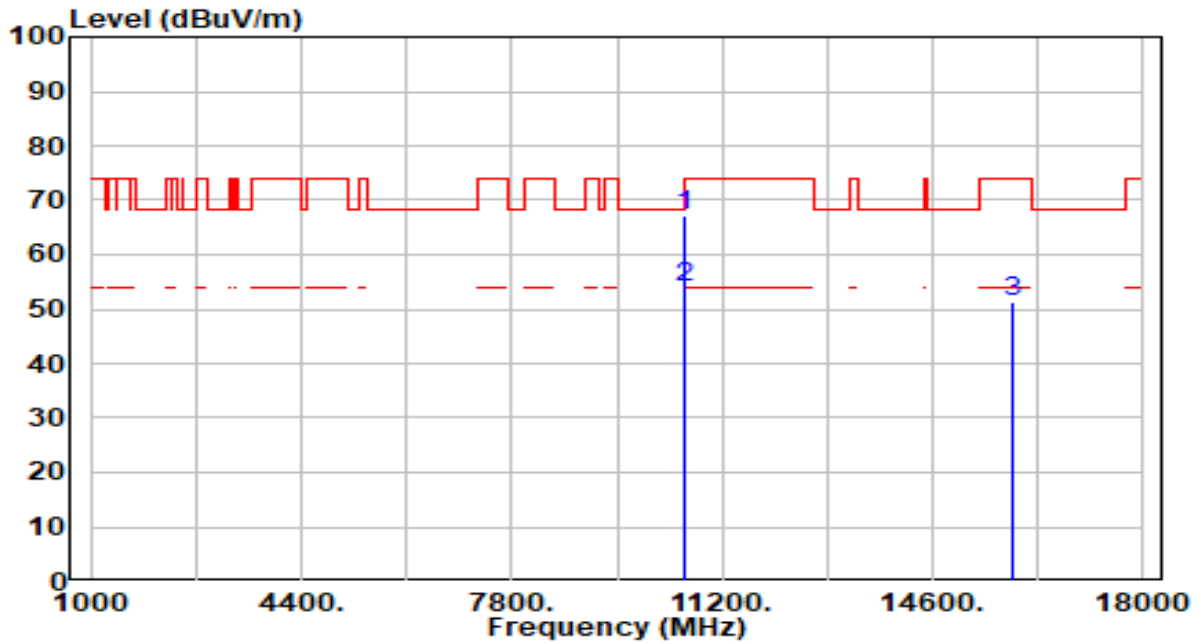

No	Frequency (MHz)	Reading (dBuV)	C.F (dB/m)	Measurement (dBuV/m)	Margin (dB)	Limit (dBuV/m)	Height (cm)	Angle (deg)	Remark (QP/PK/AV)	
1	*	10600.000	64.29	3.06	67.35	-6.65	74.00	200	255	Peak
2	*	10600.000	50.76	3.06	53.82	-0.18	54.00	200	256	Average
3		15900.000	45.94	5.27	51.21	-22.79	74.00	200	322	Peak

Note:

1. " \*", means this data is the worst emission level.
2. C.F (Correction Factor) = Antenna Factor (dB/m) + Cable Loss (dB) – Preamplifier(dB).
3. Measurement (dBuV/m) = Reading(dBuV) + C.F (Correction Factor).
4. The emission levels of other frequencies are very lower than the limit and not show in test report.

EUT	AX3000 High Gain Wireless USB Adapter	Date of Test	2023-01-30
Factor	DRH18-E	Temp. / Humidity	20°C /62%
Polarity	Vertical	Site / Test Engineer	AC2 / Ares
Test Mode	802.11ax-20MHz_TX_Band2_CH 60_ANT 1+2	Test Voltage	By Notebook PC

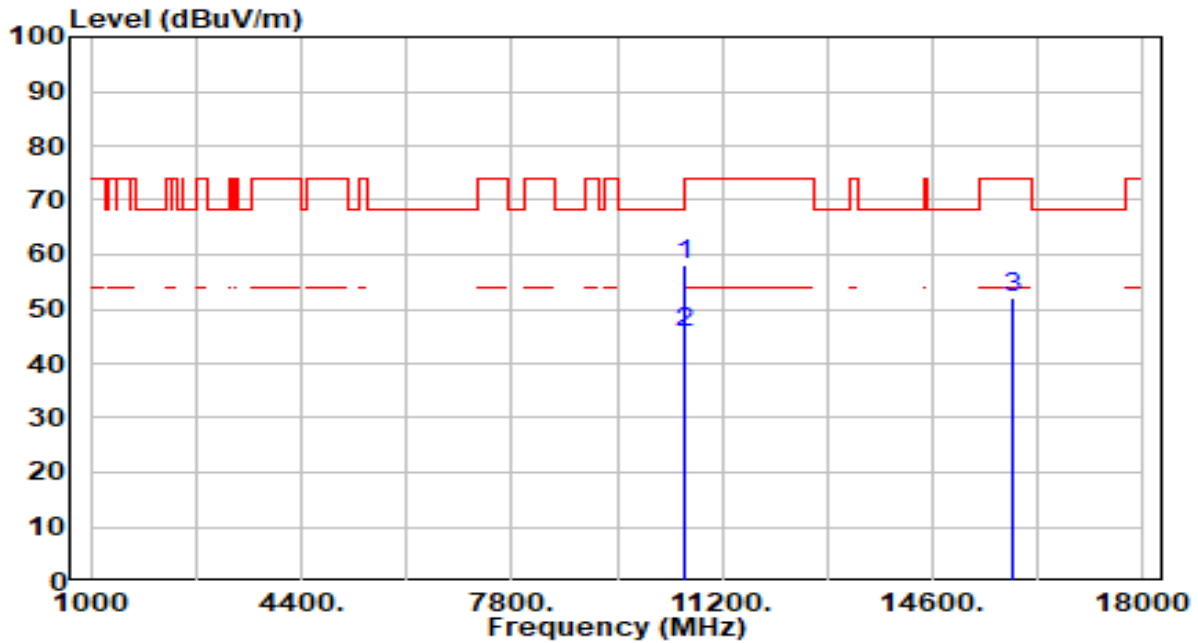

No	Frequency (MHz)	Reading (dBuV)	C.F (dB/m)	Measurement (dBuV/m)	Margin (dB)	Limit (dBuV/m)	Height (cm)	Angle (deg)	Remark (QP/PK/AV)
1	*	55.17	3.06	58.23	-15.77	74.00	200	55	Peak
2	*	42.58	3.06	45.64	-8.36	54.00	200	55	Average
3		46.86	5.27	52.13	-21.87	74.00	200	135	Peak

Note:

1. " \*", means this data is the worst emission level.
2. C.F (Correction Factor) = Antenna Factor (dB/m) + Cable Loss (dB) – Preamplifier(dB).
3. Measurement (dBuV/m) = Reading(dBuV) + C.F (Correction Factor).
4. The emission levels of other frequencies are very lower than the limit and not show in test report.

EUT	AX3000 High Gain Wireless USB Adapter	Date of Test	2023-01-19
-----	---------------------------------------	--------------	------------

Factor	DRH18-E	Temp. / Humidity	20°C /62%
Polarity	Horizontal	Site / Test Engineer	AC2 / Ares
Test Mode	802.11ax-20MHz_TX_Band2_CH 64_ANT 1+2	Test Voltage	By Notebook PC

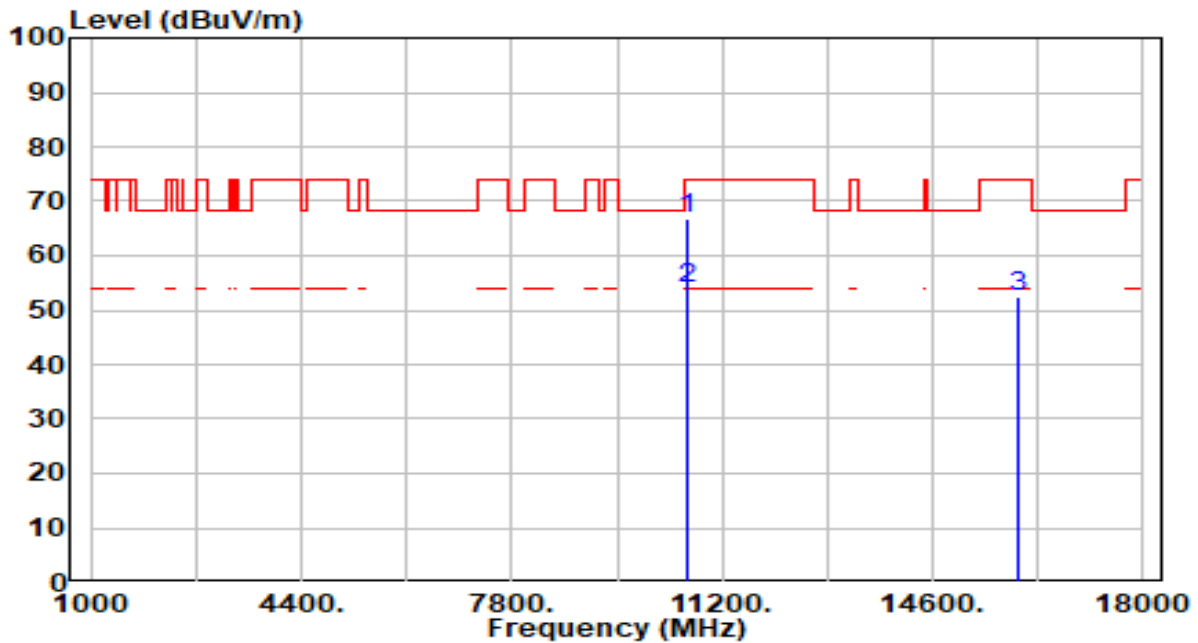

No	Frequency (MHz)	Reading (dBuV)	C.F (dB/m)	Measurement (dBuV/m)	Margin (dB)	Limit (dBuV/m)	Height (cm)	Angle (deg)	Remark (QP/PK/AV)
1	* 10640.000	63.68	3.06	66.74	-7.26	74.00	200	256	Peak
2	* 10640.000	50.80	3.06	53.86	-0.14	54.00	200	256	Average
3	15960.000	46.98	5.31	52.29	-21.71	74.00	200	359	Peak

Note:

1. " \*", means this data is the worst emission level.
2. C.F (Correction Factor) = Antenna Factor (dB/m) + Cable Loss (dB) – Pre-amplifier(dB).
3. Measurement (dBuV/m) = Reading(dBuV) + C.F (Correction Factor).
4. The emission levels of other frequencies are very lower than the limit and not show in test report.

EUT	AX3000 High Gain Wireless USB Adapter	Date of Test	2023-01-19
Factor	DRH18-E	Temp. / Humidity	20°C /62%
Polarity	Vertical	Site / Test Engineer	AC2 / Ares
Test Mode	802.11ax-20MHz_TX_Band2_CH 64_ANT 1+2	Test Voltage	By Notebook PC

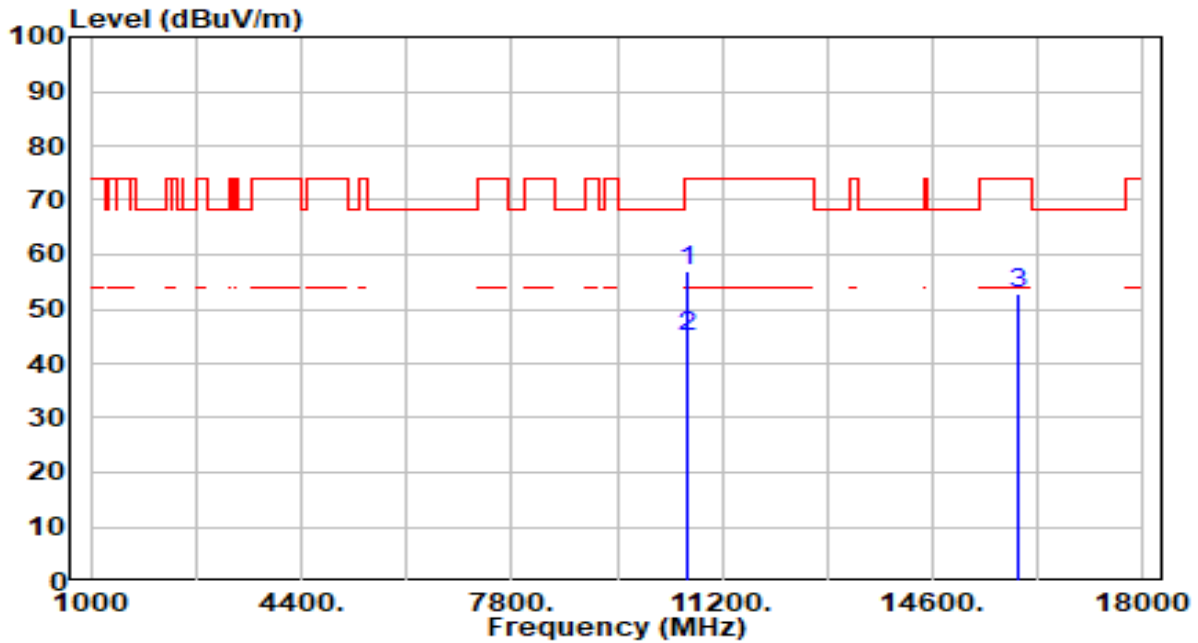

No	Frequency (MHz)	Reading (dBuV)	C.F (dB/m)	Measurement (dBuV/m)	Margin (dB)	Limit (dBuV/m)	Height (cm)	Angle (deg)	Remark (QP/PK/AV)	
1	*	10640.000	54.08	3.06	57.14	-16.86	74.00	200	70	Peak
2	*	10640.000	41.82	3.06	44.88	-9.12	54.00	200	70	Average
3		15960.000	47.44	5.31	52.75	-21.25	74.00	200	85	Peak

Note:

1. " \*", means this data is the worst emission level.
2. C.F (Correction Factor) = Antenna Factor (dB/m) + Cable Loss (dB) – Preamplifier(dB).
3. Measurement (dBuV/m) = Reading(dBuV) + C.F (Correction Factor).
4. The emission levels of other frequencies are very lower than the limit and not show in test report.

EUT	AX3000 High Gain Wireless USB Adapter	Date of Test	2023-01-19
Factor	DRH18-E	Temp. / Humidity	20°C /62%
Polarity	Horizontal	Site / Test Engineer	AC2 / Ares
Test Mode	802.11ax-20MHz_TX_Band3_CH 100_ANT 1+2	Test Voltage	By Notebook PC

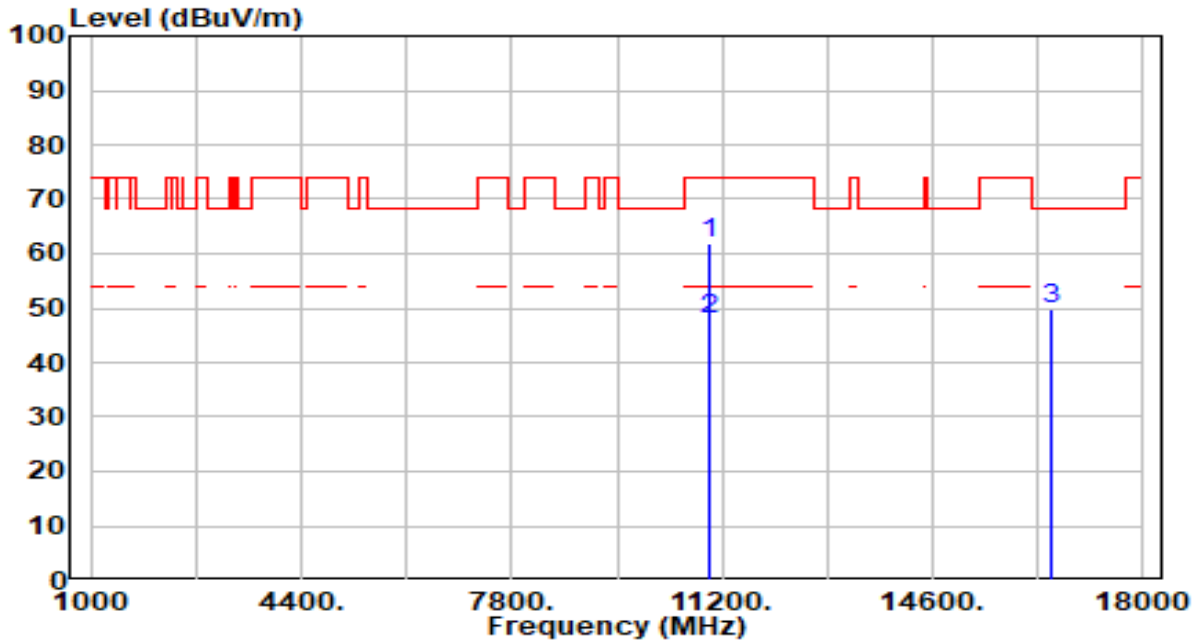

No	Frequency (MHz)	Reading (dBuV)	C.F (dB/m)	Measurement (dBuV/m)	Margin (dB)	Limit (dBuV/m)	Height (cm)	Angle (deg)	Remark (QP/PK/AV)
1	* 11000.000	58.82	3.21	62.03	-11.97	74.00	183	80	Peak
2	* 11000.000	44.77	3.21	47.98	-6.02	54.00	183	80	Average
3	16500.000	45.39	4.61	50.00	-18.20	68.20	200	80	Peak

Note:

1. " \*", means this data is the worst emission level.
2. C.F (Correction Factor) = Antenna Factor (dB/m) + Cable Loss (dB) – Pre-amplifier(dB).
3. Measurement (dBuV/m) = Reading(dBuV) + C.F (Correction Factor).
4. The emission levels of other frequencies are very lower than the limit and not show in test report.

EUT	AX3000 High Gain Wireless USB Adapter	Date of Test	2023-01-19
Factor	DRH18-E	Temp. / Humidity	20°C /62%
Polarity	Vertical	Site / Test Engineer	AC2 / Ares
Test Mode	802.11ax-20MHz_TX_Band3_CH 100_ANT 1+2	Test Voltage	By Notebook PC

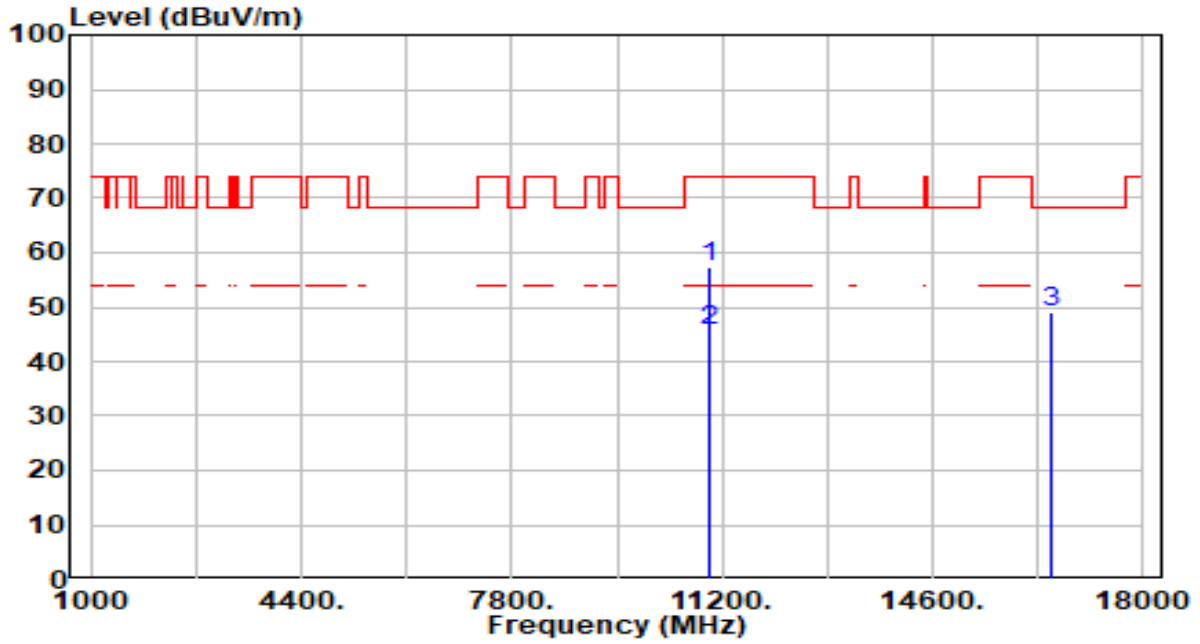

No	Frequency (MHz)	Reading (dBuV)	C.F (dB/m)	Measurement (dBuV/m)	Margin (dB)	Limit (dBuV/m)	Height (cm)	Angle (deg)	Remark (QP/PK/AV)	
1	*	11000.000	54.29	3.21	57.50	-16.50	74.00	200	330	Peak
2	*	11000.000	42.36	3.21	45.57	-8.43	54.00	200	330	Average
3		16500.000	44.58	4.61	49.19	-19.01	68.20	200	0	Peak

Note:

1. " \*", means this data is the worst emission level.
2. C.F (Correction Factor) = Antenna Factor (dB/m) + Cable Loss (dB) – Preamplifier(dB).
3. Measurement (dBuV/m) = Reading(dBuV) + C.F (Correction Factor).
4. The emission levels of other frequencies are very lower than the limit and not show in test report.



EUT	AX3000 High Gain Wireless USB Adapter	Date of Test	2023-01-19
Factor	DRH18-E	Temp. / Humidity	20°C /62%
Polarity	Horizontal	Site / Test Engineer	AC2 / Ares
Test Mode	802.11ax-20MHz_TX_Band3_CH 116_ANT 1+2	Test Voltage	By Notebook PC

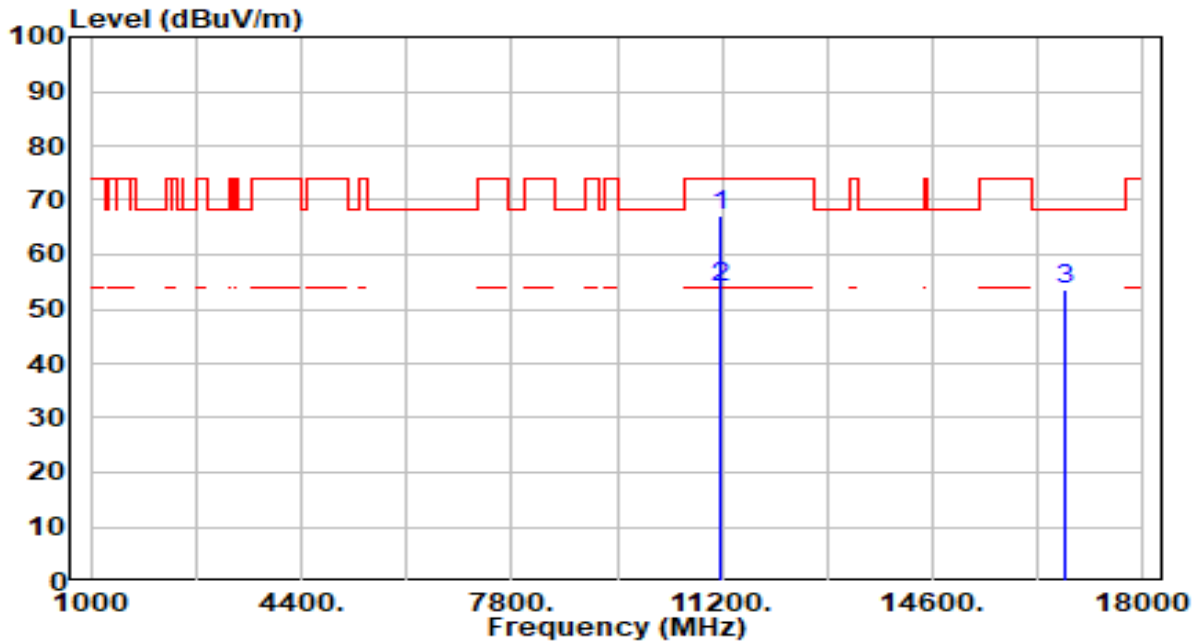

No	Frequency (MHz)	Reading (dBuV)	C.F (dB/m)	Measurement (dBuV/m)	Margin (dB)	Limit (dBuV/m)	Height (cm)	Angle (deg)	Remark (QP/PK/AV)	
1	*	11160.000	63.84	3.49	67.33	-6.67	74.00	189	9	Peak
2	*	11160.000	50.42	3.49	53.91	-0.09	54.00	189	9	Average
3		16740.000	49.13	4.48	53.61	-14.59	68.20	200	335	Peak

Note:

1. " \*", means this data is the worst emission level.
2. C.F (Correction Factor) = Antenna Factor (dB/m) + Cable Loss (dB) – Pre-amplifier(dB).
3. Measurement (dBuV/m) = Reading(dBuV) + C.F (Correction Factor).
4. The emission levels of other frequencies are very lower than the limit and not show in test report.

EUT	AX3000 High Gain Wireless USB Adapter	Date of Test	2023-01-19
Factor	DRH18-E	Temp. / Humidity	20°C /62%
Polarity	Vertical	Site / Test Engineer	AC2 / Ares
Test Mode	802.11ax-20MHz_TX_Band3_CH 116_ANT 1+2	Test Voltage	By Notebook PC

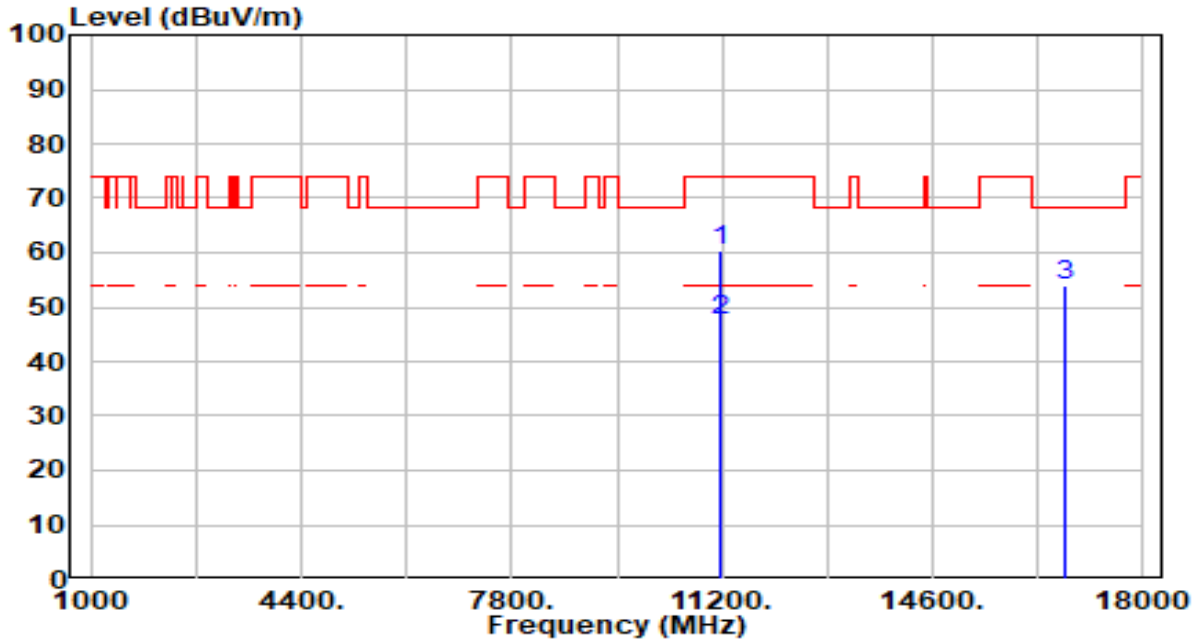

No	Frequency (MHz)	Reading (dBuV)	C.F (dB/m)	Measurement (dBuV/m)	Margin (dB)	Limit (dBuV/m)	Height (cm)	Angle (deg)	Remark (QP/PK/AV)	
1	*	11160.000	56.74	3.49	60.23	-13.77	74.00	200	2	Peak
2	*	11160.000	44.19	3.49	47.68	-6.32	54.00	200	2	Average
3		16740.000	49.33	4.48	53.81	-14.39	68.20	200	360	Peak

Note:

1. " \*", means this data is the worst emission level.
2. C.F (Correction Factor) = Antenna Factor (dB/m) + Cable Loss (dB) – Preamplifier(dB).
3. Measurement (dBuV/m) = Reading(dBuV) + C.F (Correction Factor).
4. The emission levels of other frequencies are very lower than the limit and not show in test report.

EUT	AX3000 High Gain Wireless USB Adapter	Date of Test	2023-01-19
Factor	DRH18-E	Temp. / Humidity	20°C /62%
Polarity	Horizontal	Site / Test Engineer	AC2 / Ares
Test Mode	802.11ax-20MHz_TX_Band3_CH 140_ANT 1+2	Test Voltage	By Notebook PC

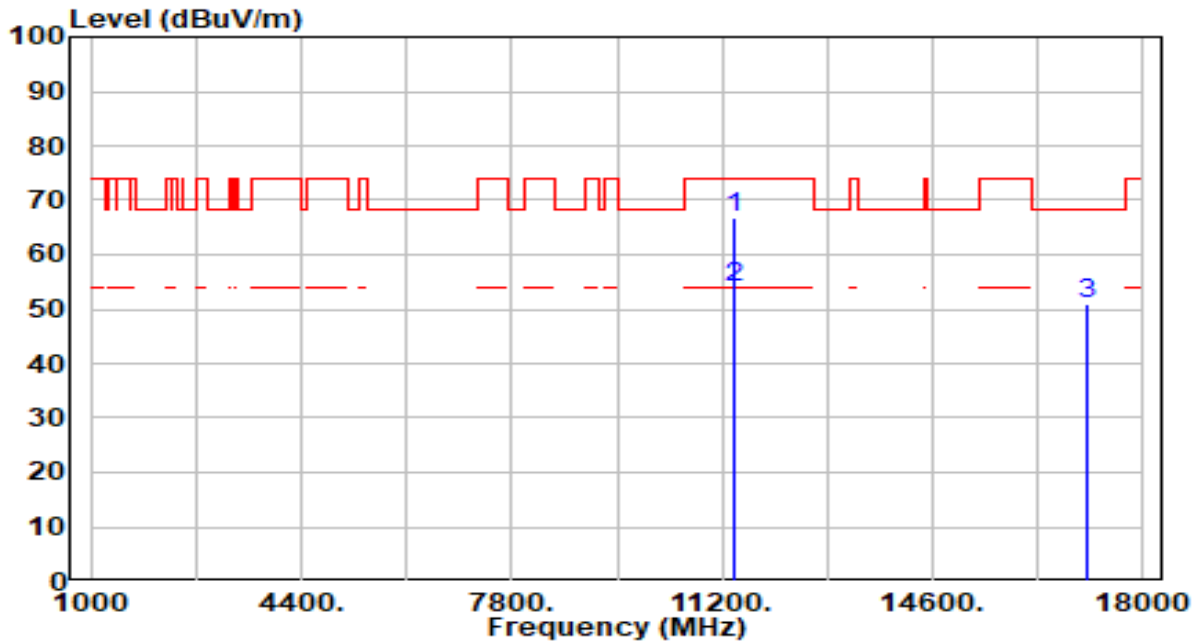

No	Frequency (MHz)	Reading (dBuV)	C.F (dB/m)	Measurement (dBuV/m)	Margin (dB)	Limit (dBuV/m)	Height (cm)	Angle (deg)	Remark (QP/PK/AV)	
1	*	11400.000	62.77	3.90	66.67	-7.33	74.00	192	13	Peak
2	*	11400.000	49.97	3.90	53.87	-0.13	54.00	192	13	Average
3		17100.000	46.49	4.48	50.96	-17.24	68.20	200	360	Peak

Note:

1. " \*", means this data is the worst emission level.
2. C.F (Correction Factor) = Antenna Factor (dB/m) + Cable Loss (dB) – Preamplifier(dB).
3. Measurement (dBuV/m) = Reading(dBuV) + C.F (Correction Factor).
4. The emission levels of other frequencies are very lower than the limit and not show in test report.

EUT	AX3000 High Gain Wireless USB Adapter	Date of Test	2023-01-19
Factor	DRH18-E	Temp. / Humidity	20°C /62%
Polarity	Vertical	Site / Test Engineer	AC2 / Ares
Test Mode	802.11ax-20MHz_TX_Band3_CH 140_ANT 1+2	Test Voltage	By Notebook PC

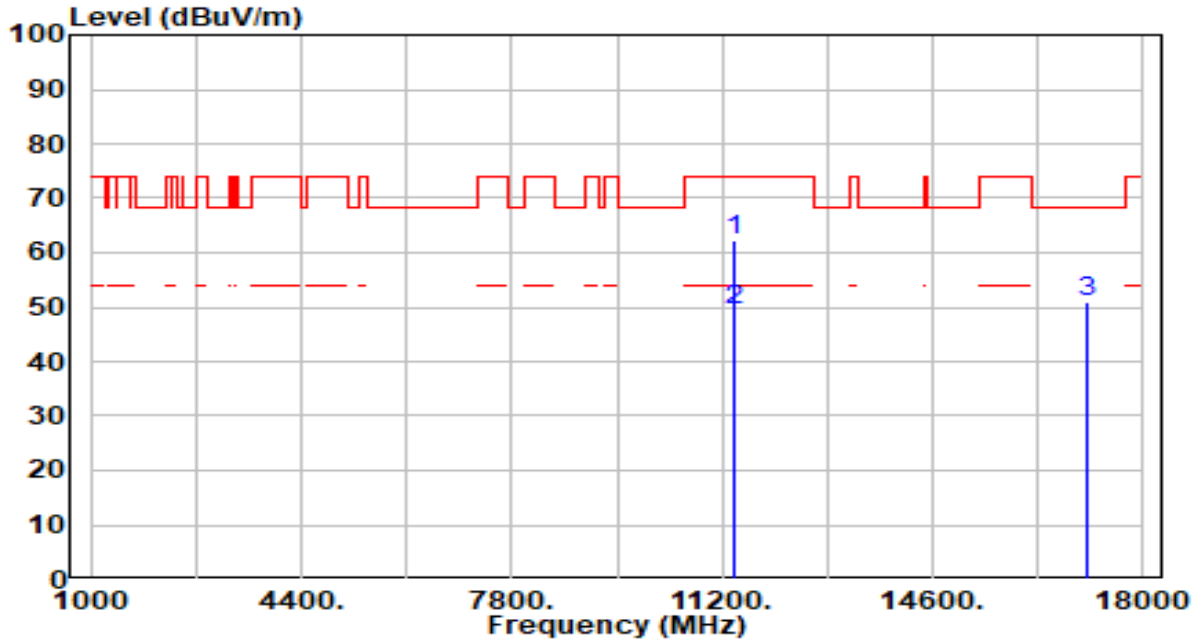

No	Frequency (MHz)	Reading (dBuV)	C.F (dB/m)	Measurement (dBuV/m)	Margin (dB)	Limit (dBuV/m)	Height (cm)	Angle (deg)	Remark (QP/PK/AV)	
1	*	11400.000	58.47	3.90	62.37	-11.63	74.00	200	2	Peak
2	*	11400.000	45.53	3.90	49.43	-4.57	54.00	200	2	Average
3		17100.000	46.37	4.48	50.85	-17.35	68.20	200	349	Peak

Note:

1. " \*", means this data is the worst emission level.
2. C.F (Correction Factor) = Antenna Factor (dB/m) + Cable Loss (dB) – Preamplifier(dB).
3. Measurement (dBuV/m) = Reading(dBuV) + C.F (Correction Factor).
4. The emission levels of other frequencies are very lower than the limit and not show in test report.

EUT	AX3000 High Gain Wireless USB Adapter	Date of Test	2023-01-19
Factor	DRH18-E	Temp. / Humidity	20°C /62%
Polarity	Horizontal	Site / Test Engineer	AC2 / Ares
Test Mode	802.11ax-20MHz_TX_Band3_CH 144_ANT 1+2	Test Voltage	By Notebook PC

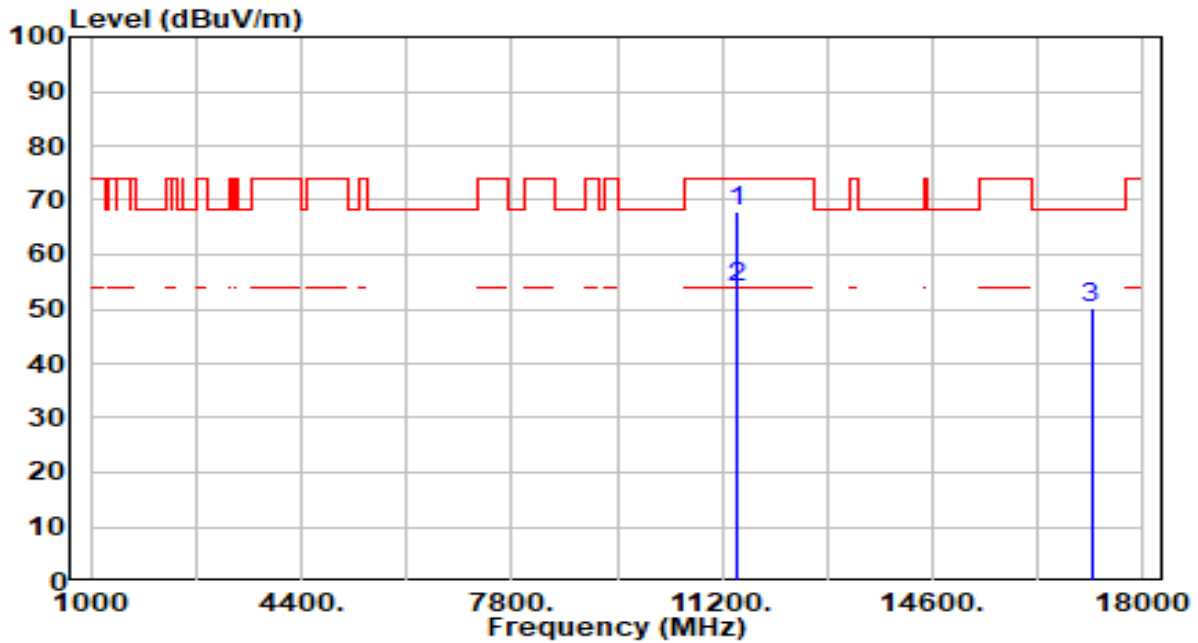

No	Frequency (MHz)	Reading (dBuV)	C.F (dB/m)	Measurement (dBuV/m)	Margin (dB)	Limit (dBuV/m)	Height (cm)	Angle (deg)	Remark (QP/PK/AV)	
1	*	11440.000	63.83	3.91	67.74	-6.26	74.00	190	19	Peak
2	*	11440.000	49.96	3.91	53.87	-0.13	54.00	190	19	Average
3		17160.000	45.98	4.28	50.26	-17.94	68.20	200	332	Peak

Note:

1. " \*", means this data is the worst emission level.
2. C.F (Correction Factor) = Antenna Factor (dB/m) + Cable Loss (dB) – Preamplifier(dB).
3. Measurement (dBuV/m) = Reading(dBuV) + C.F (Correction Factor).
4. The emission levels of other frequencies are very lower than the limit and not show in test report.

EUT	AX3000 High Gain Wireless USB Adapter	Date of Test	2023-01-19
Factor	DRH18-E	Temp. / Humidity	20°C /62%
Polarity	Vertical	Site / Test Engineer	AC2 / Ares
Test Mode	802.11ax-20MHz_TX_Band3_CH 144_ANT 1+2	Test Voltage	By Notebook PC

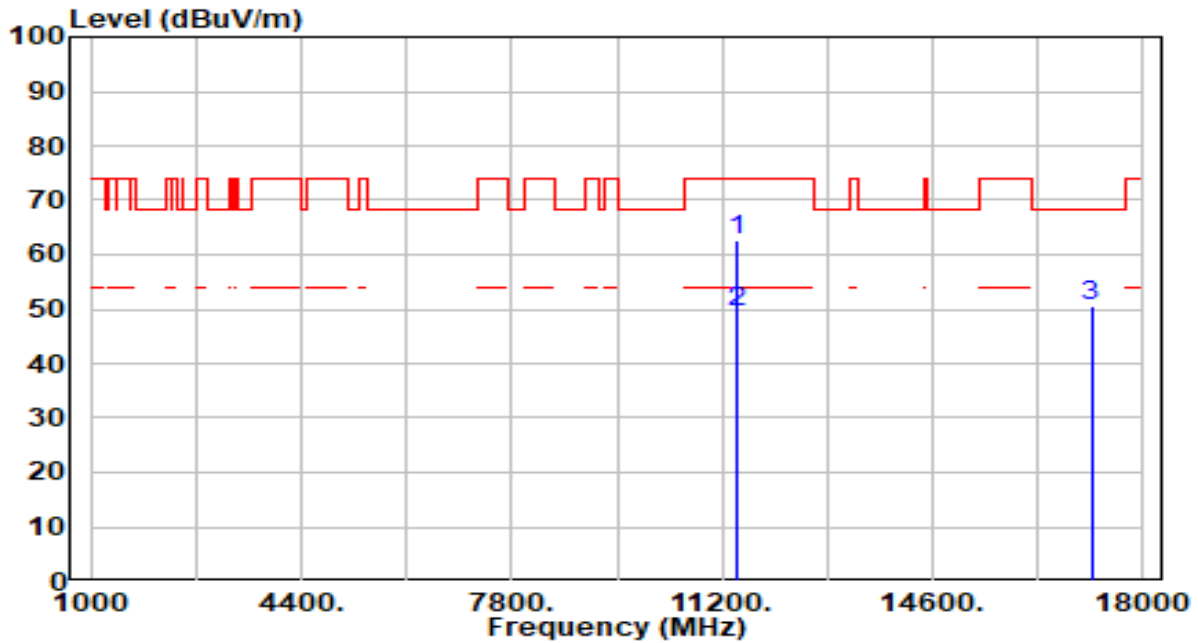

No	Frequency (MHz)	Reading (dBuV)	C.F (dB/m)	Measurement (dBuV/m)	Margin (dB)	Limit (dBuV/m)	Height (cm)	Angle (deg)	Remark (QP/PK/AV)	
1	*	11440.000	58.90	3.91	62.81	-11.19	74.00	200	14	Peak
2	*	11440.000	45.44	3.91	49.35	-4.65	54.00	200	14	Average
3		17160.000	46.46	4.28	50.74	-17.46	68.20	200	214	Peak

Note:

1. " \*", means this data is the worst emission level.
2. C.F (Correction Factor) = Antenna Factor (dB/m) + Cable Loss (dB) – Preamplifier(dB).
3. Measurement (dBuV/m) = Reading(dBuV) + C.F (Correction Factor).
4. The emission levels of other frequencies are very lower than the limit and not show in test report.

EUT	AX3000 High Gain Wireless USB Adapter	Date of Test	2023-01-19
Factor	DRH18-E	Temp. / Humidity	20°C /62%
Polarity	Horizontal	Site / Test Engineer	AC2 / Ares
Test Mode	802.11ax-20MHz_TX_Band4_CH 149_ANT 1+2	Test Voltage	By Notebook PC

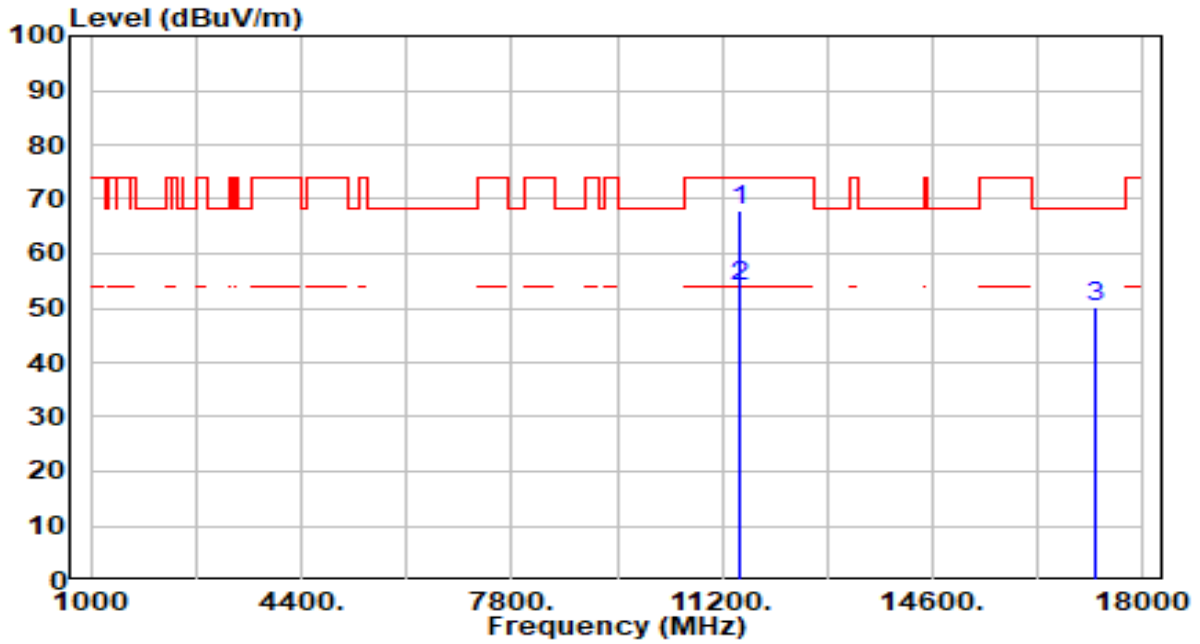

No	Frequency (MHz)	Reading (dBuV)	C.F (dB/m)	Measurement (dBuV/m)	Margin (dB)	Limit (dBuV/m)	Height (cm)	Angle (deg)	Remark (QP/PK/AV)
1	* 11490.000	63.93	3.92	67.85	-6.15	74.00	171	19	Peak
2	* 11490.000	49.92	3.92	53.84	-0.16	54.00	171	19	Average
3	17235.000	46.22	4.06	50.28	-17.92	68.20	200	22	Peak

Note:

1. " \*", means this data is the worst emission level.
2. C.F (Correction Factor) = Antenna Factor (dB/m) + Cable Loss (dB) – Pre-amplifier(dB).
3. Measurement (dBuV/m) = Reading(dBuV) + C.F (Correction Factor).
4. The emission levels of other frequencies are very lower than the limit and not show in test report.

EUT	AX3000 High Gain Wireless USB Adapter	Date of Test	2023-01-19
Factor	DRH18-E	Temp. / Humidity	20°C /62%
Polarity	Vertical	Site / Test Engineer	AC2 / Ares
Test Mode	802.11ax-20MHz_TX_Band4_CH 149_ANT 1+2	Test Voltage	By Notebook PC

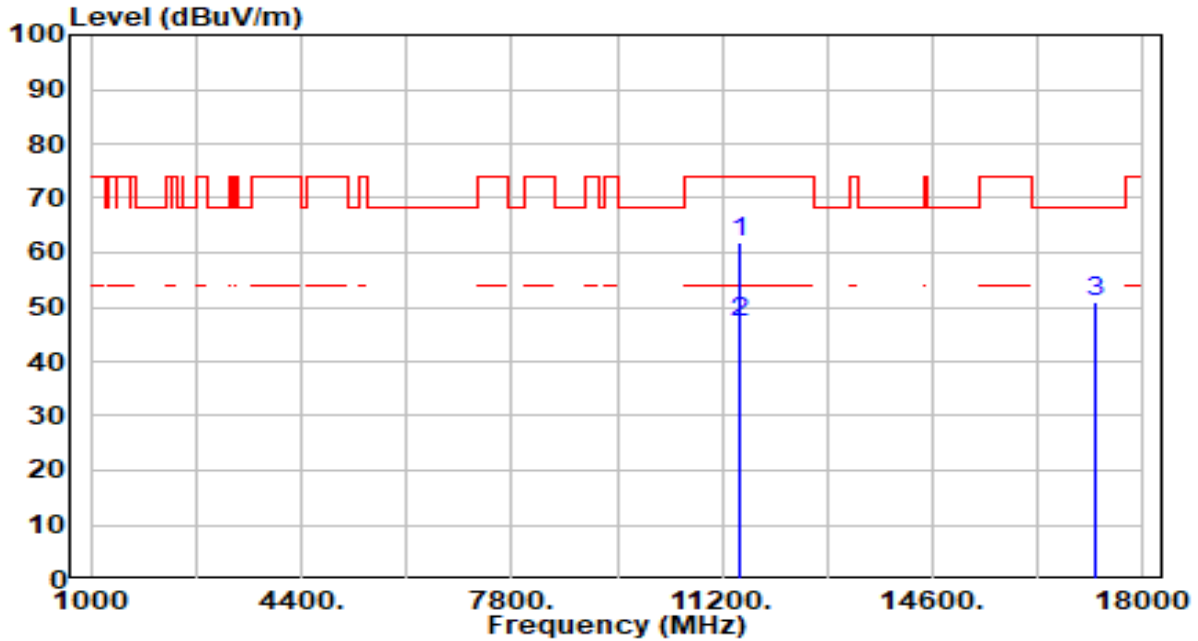

No	Frequency (MHz)	Reading (dBuV)	C.F (dB/m)	Measurement (dBuV/m)	Margin (dB)	Limit (dBuV/m)	Height (cm)	Angle (deg)	Remark (QP/PK/AV)	
1	*	11490.000	57.87	3.92	61.79	-12.21	74.00	200	17	Peak
2	*	11490.000	43.39	3.92	47.31	-6.69	54.00	200	17	Average
3		17235.000	46.72	4.06	50.78	-17.42	68.20	200	276	Peak

Note:

1. " \*", means this data is the worst emission level.
2. C.F (Correction Factor) = Antenna Factor (dB/m) + Cable Loss (dB) – Preamplifier(dB).
3. Measurement (dBuV/m) = Reading(dBuV) + C.F (Correction Factor).
4. The emission levels of other frequencies are very lower than the limit and not show in test report.



EUT	AX3000 High Gain Wireless USB Adapter	Date of Test	2023-01-19
Factor	DRH18-E	Temp. / Humidity	20°C /62%
Polarity	Horizontal	Site / Test Engineer	AC2 / Ares
Test Mode	802.11ax-20MHz_TX_Band4_CH 157_ANT 1+2	Test Voltage	By Notebook PC

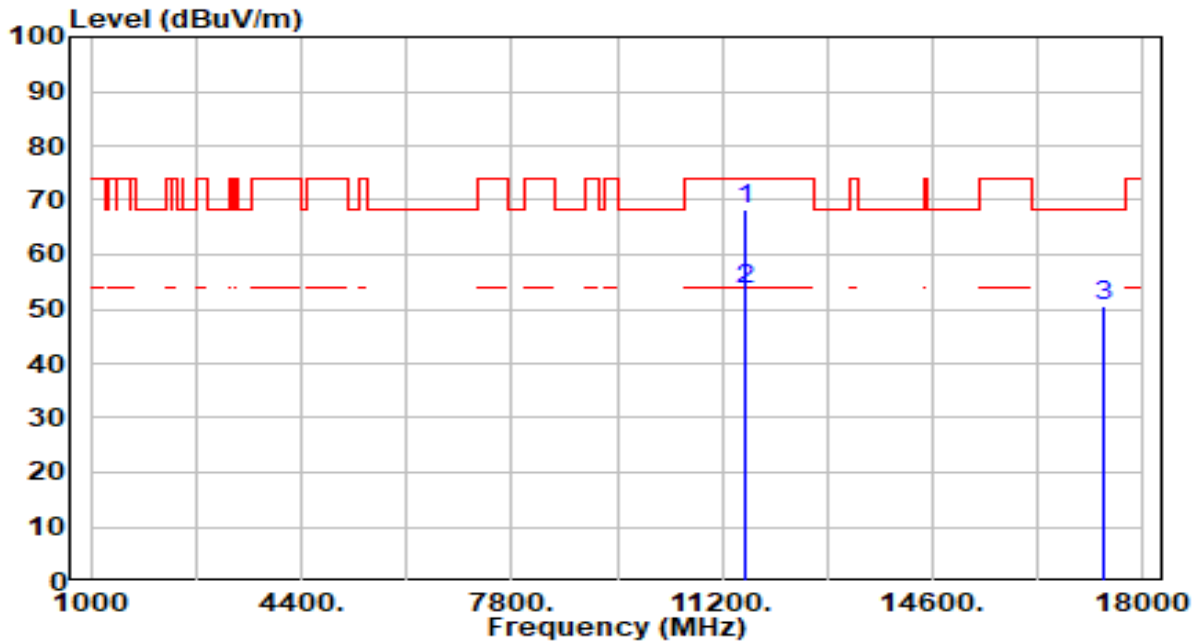

No	Frequency (MHz)	Reading (dBuV)	C.F (dB/m)	Measurement (dBuV/m)	Margin (dB)	Limit (dBuV/m)	Height (cm)	Angle (deg)	Remark (QP/PK/AV)
1	*	64.27	3.94	68.21	-5.79	74.00	175	18	Peak
2	*	49.68	3.94	53.62	-0.38	54.00	175	18	Average
3		46.71	3.78	50.50	-17.70	68.20	200	21	Peak

Note:

1. " \*", means this data is the worst emission level.
2. C.F (Correction Factor) = Antenna Factor (dB/m) + Cable Loss (dB) – Preamplifier(dB).
3. Measurement (dBuV/m) = Reading(dBuV) + C.F (Correction Factor).
4. The emission levels of other frequencies are very lower than the limit and not show in test report.

EUT	AX3000 High Gain Wireless USB Adapter	Date of Test	2023-01-19
Factor	DRH18-E	Temp. / Humidity	20°C /62%
Polarity	Vertical	Site / Test Engineer	AC2 / Ares
Test Mode	802.11ax-20MHz_TX_Band4_CH 157_ANT 1+2	Test Voltage	By Notebook PC

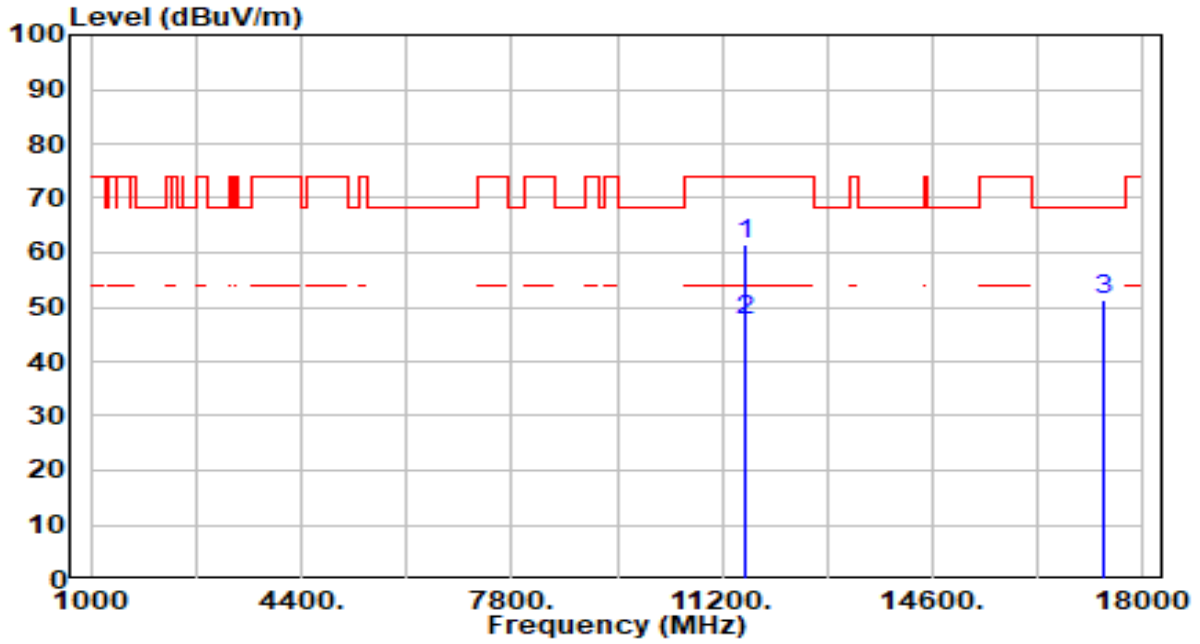

No	Frequency (MHz)	Reading (dBuV)	C.F (dB/m)	Measurement (dBuV/m)	Margin (dB)	Limit (dBuV/m)	Height (cm)	Angle (deg)	Remark (QP/PK/AV)	
1	*	11570.000	57.44	3.94	61.38	-12.62	74.00	200	18	Peak
2	*	11570.000	43.72	3.94	47.66	-6.34	54.00	200	18	Average
3		17355.000	47.47	3.78	51.26	-16.94	68.20	200	360	Peak

Note:

1. " \*", means this data is the worst emission level.
2. C.F (Correction Factor) = Antenna Factor (dB/m) + Cable Loss (dB) – Pre-amplifier(dB).
3. Measurement (dBuV/m) = Reading(dBuV) + C.F (Correction Factor).
4. The emission levels of other frequencies are very lower than the limit and not show in test report.

EUT	AX3000 High Gain Wireless USB Adapter	Date of Test	2023-01-19
Factor	DRH18-E	Temp. / Humidity	20°C /62%
Polarity	Horizontal	Site / Test Engineer	AC2 / Ares
Test Mode	802.11ax-20MHz_TX_Band4_CH 165_ANT 1+2	Test Voltage	By Notebook PC

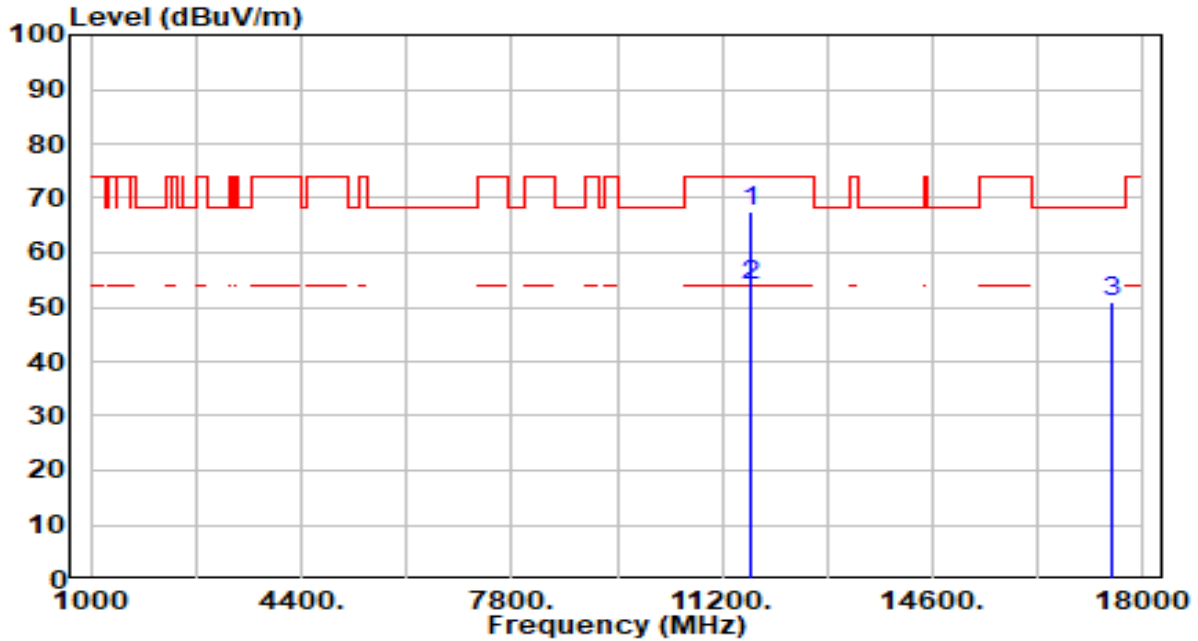

No	Frequency (MHz)	Reading (dBuV)	C.F (dB/m)	Measurement (dBuV/m)	Margin (dB)	Limit (dBuV/m)	Height (cm)	Angle (deg)	Remark (QP/PK/AV)	
1	*	11650.000	63.65	3.94	67.59	-6.41	74.00	176	20	Peak
2	*	11650.000	49.95	3.94	53.89	-0.11	54.00	176	20	Average
3		17475.000	47.29	3.65	50.94	-17.26	68.20	200	232	Peak

Note:

1. " \*", means this data is the worst emission level.
2. C.F (Correction Factor) = Antenna Factor (dB/m) + Cable Loss (dB) – Preamplifier(dB).
3. Measurement (dBuV/m) = Reading(dBuV) + C.F (Correction Factor).
4. The emission levels of other frequencies are very lower than the limit and not show in test report.

EUT	AX3000 High Gain Wireless USB Adapter	Date of Test	2023-01-19
Factor	DRH18-E	Temp. / Humidity	20°C /62%
Polarity	Vertical	Site / Test Engineer	AC2 / Ares
Test Mode	802.11ax-20MHz_TX_Band4_CH 165_ANT 1+2	Test Voltage	By Notebook PC

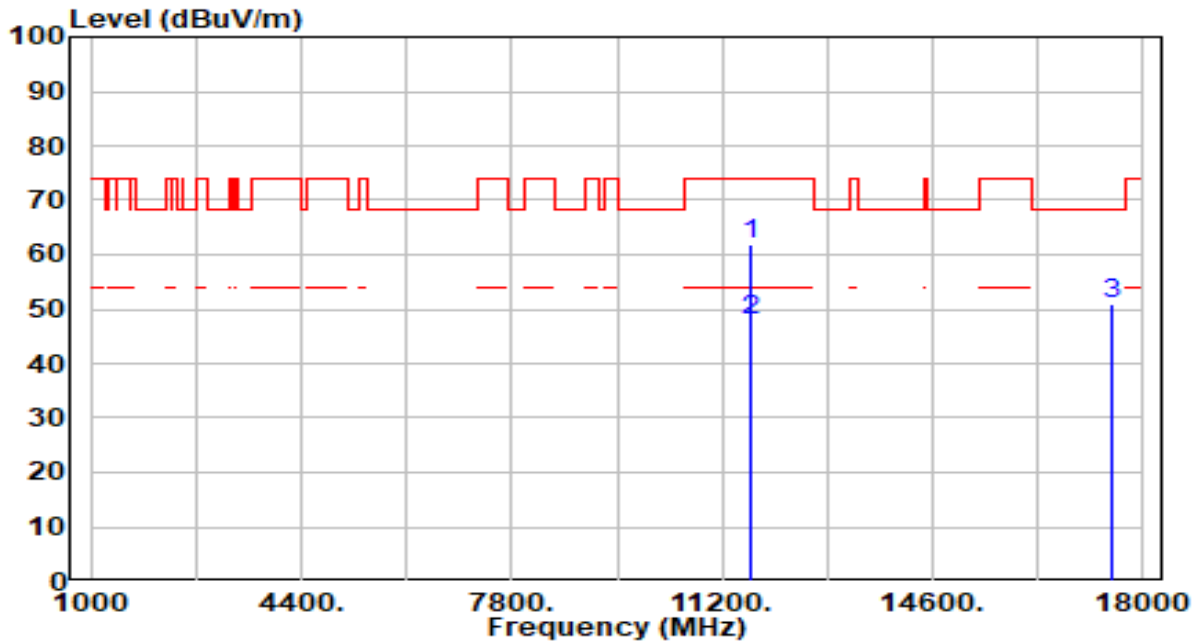

No	Frequency (MHz)	Reading (dBuV)	C.F (dB/m)	Measurement (dBuV/m)	Margin (dB)	Limit (dBuV/m)	Height (cm)	Angle (deg)	Remark (QP/PK/AV)	
1	*	11650.000	58.05	3.94	61.99	-12.01	74.00	200	18	Peak
2	*	11650.000	43.82	3.94	47.76	-6.24	54.00	200	18	Average
3		17475.000	47.45	3.65	51.11	-17.09	68.20	200	18	Peak

Note:

1. " \*", means this data is the worst emission level.
2. C.F (Correction Factor) = Antenna Factor (dB/m) + Cable Loss (dB) – Preamplifier(dB).
3. Measurement (dBuV/m) = Reading(dBuV) + C.F (Correction Factor).
4. The emission levels of other frequencies are very lower than the limit and not show in test report.

EUT	AX3000 High Gain Wireless USB Adapter	Date of Test	2023-01-19
Factor	DRH18-E	Temp. / Humidity	20°C /62%
Polarity	Horizontal	Site / Test Engineer	AC2 / Ares
Test Mode	802.11ax-40MHz_TX_Band1_CH 38_ANT 1+2	Test Voltage	By Notebook PC

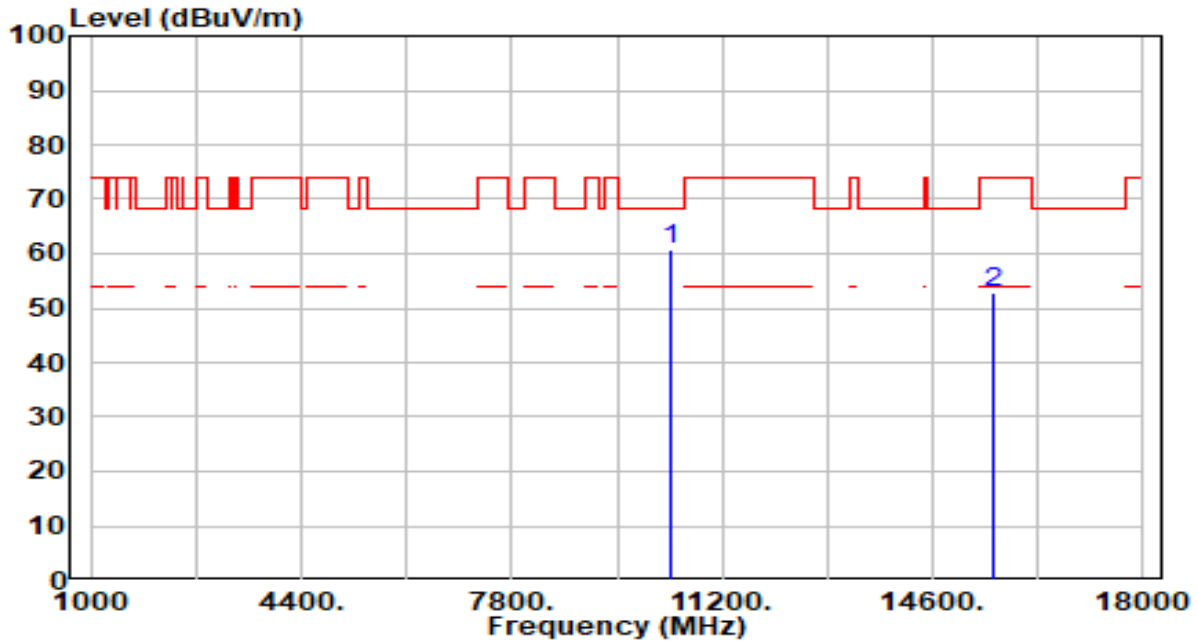

No	Frequency (MHz)	Reading (dBuV)	C.F (dB/m)	Measurement (dBuV/m)	Margin (dB)	Limit (dBuV/m)	Height (cm)	Angle (deg)	Remark (QP/PK/AV)
1	*	57.40	3.19	60.59	-7.61	68.20	200	257	Peak
2		48.02	4.75	52.77	-21.23	74.00	200	245	Peak

Note:

1. " \*", means this data is the worst emission level.
2. C.F (Correction Factor) = Antenna Factor (dB/m) + Cable Loss (dB) – Pre-amplifier(dB).
3. Measurement (dBuV/m) = Reading(dBuV) + C.F (Correction Factor).
4. The emission levels of other frequencies are very lower than the limit and not show in test report.

EUT	AX3000 High Gain Wireless USB Adapter	Date of Test	2023-01-19
Factor	DRH18-E	Temp. / Humidity	20°C /62%
Polarity	Vertical	Site / Test Engineer	AC2 / Ares
Test Mode	802.11ax-40MHz_TX_Band1_CH 38_ANT 1+2	Test Voltage	By Notebook PC

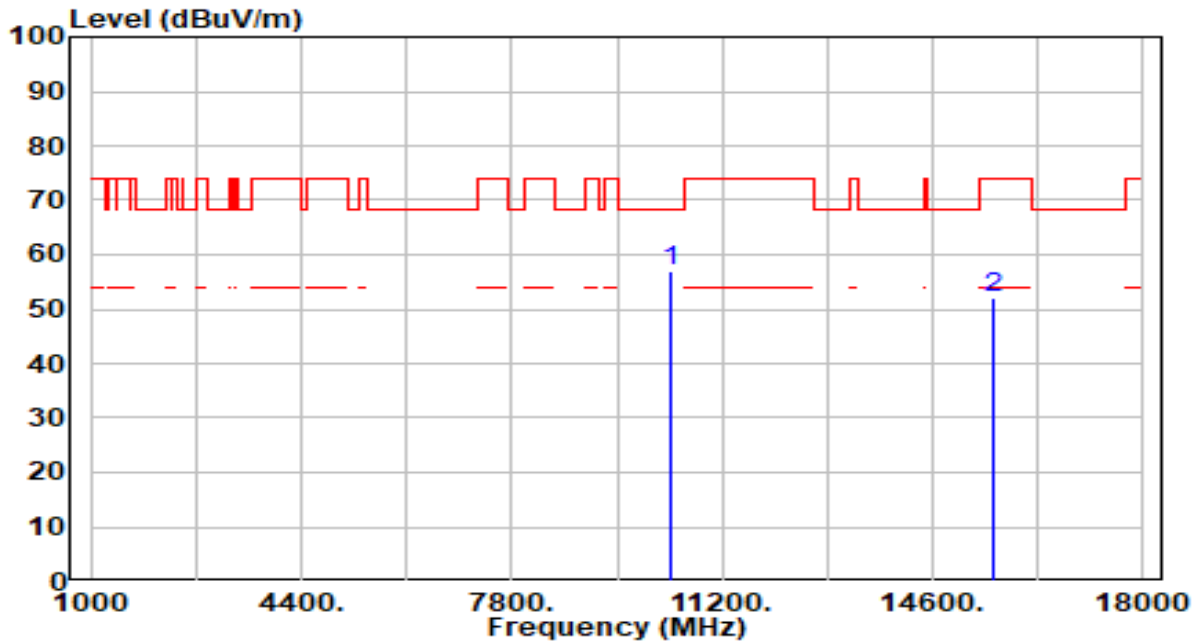

No	Frequency (MHz)	Reading (dBuV)	C.F (dB/m)	Measurement (dBuV/m)	Margin (dB)	Limit (dBuV/m)	Height (cm)	Angle (deg)	Remark (QP/PK/AV)
1	* 10380.000	53.76	3.19	56.94	-11.26	68.20	200	62	Peak
2	15570.000	47.16	4.75	51.91	-22.09	74.00	200	0	Peak

Note:

1. " \*", means this data is the worst emission level.
2. C.F (Correction Factor) = Antenna Factor (dB/m) + Cable Loss (dB) – Pre-amplifier(dB).
3. Measurement (dBuV/m) = Reading(dBuV) + C.F (Correction Factor).
4. The emission levels of other frequencies are very lower than the limit and not show in test report.

EUT	AX3000 High Gain Wireless USB Adapter	Date of Test	2023-01-19
Factor	DRH18-E	Temp. / Humidity	20°C /62%
Polarity	Horizontal	Site / Test Engineer	AC2 / Ares
Test Mode	802.11ax-40MHz_TX_Band1_CH 46_ANT 1+2	Test Voltage	By Notebook PC

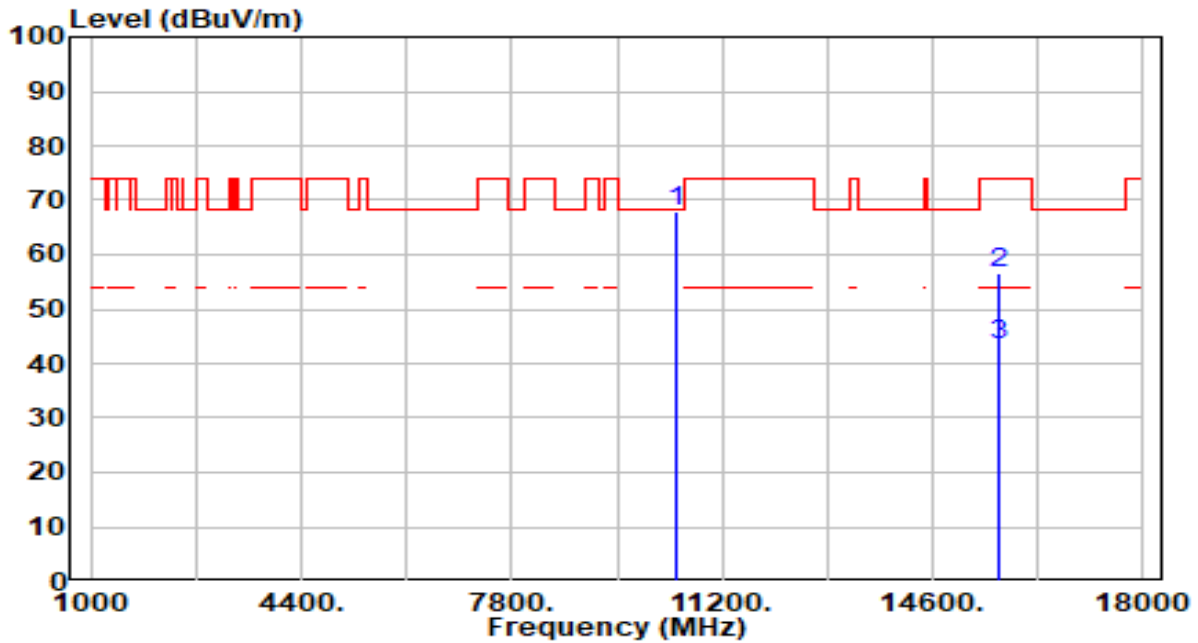

No	Frequency (MHz)	Reading (dBuV)	C.F (dB/m)	Measurement (dBuV/m)	Margin (dB)	Limit (dBuV/m)	Height (cm)	Angle (deg)	Remark (QP/PK/AV)	
1	*	10460.000	64.71	3.13	67.84	-0.36	68.20	200	256	Peak
2	*	15690.000	51.59	4.95	56.55	-17.45	74.00	200	296	Peak
3		15690.000	38.58	4.95	43.53	-10.47	54.00	200	296	Average

Note:

1. " \*", means this data is the worst emission level.
2. C.F (Correction Factor) = Antenna Factor (dB/m) + Cable Loss (dB) – Pre-amplifier(dB).
3. Measurement (dBuV/m) = Reading(dBuV) + C.F (Correction Factor).
4. The emission levels of other frequencies are very lower than the limit and not show in test report.

EUT	AX3000 High Gain Wireless USB Adapter	Date of Test	2023-01-19
Factor	DRH18-E	Temp. / Humidity	20°C /62%
Polarity	Vertical	Site / Test Engineer	AC2 / Ares
Test Mode	802.11ax-40MHz_TX_Band1_CH 46_ANT 1+2	Test Voltage	By Notebook PC

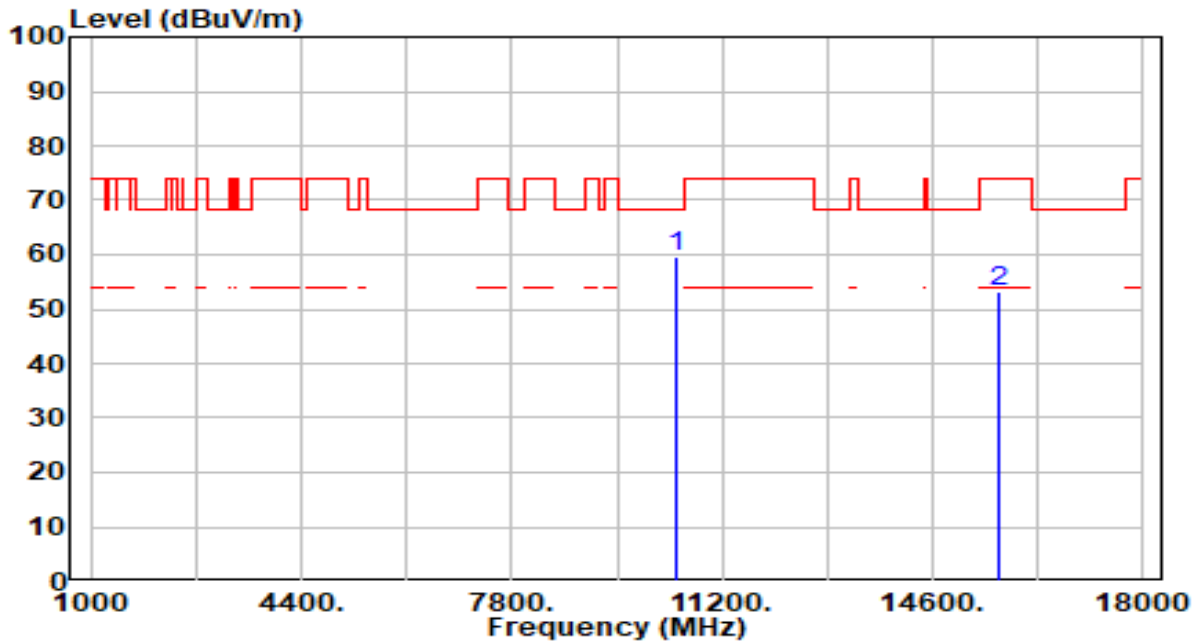

No	Frequency (MHz)	Reading (dBuV)	C.F (dB/m)	Measurement (dBuV/m)	Margin (dB)	Limit (dBuV/m)	Height (cm)	Angle (deg)	Remark (QP/PK/AV)
1	* 10460.000	56.34	3.13	59.47	-8.73	68.20	200	316	Peak
2	15690.000	48.40	4.95	53.36	-20.64	74.00	200	86	Peak

Note:

1. " \*", means this data is the worst emission level.
2. C.F (Correction Factor) = Antenna Factor (dB/m) + Cable Loss (dB) – Pre-amplifier(dB).
3. Measurement (dBuV/m) = Reading(dBuV) + C.F (Correction Factor).
4. The emission levels of other frequencies are very lower than the limit and not show in test report.



EUT	AX3000 High Gain Wireless USB Adapter	Date of Test	2023-01-19
Factor	DRH18-E	Temp. / Humidity	20°C /62%
Polarity	Horizontal	Site / Test Engineer	AC2 / Ares
Test Mode	802.11ax-40MHz_TX_Band2_CH 54_ANT 1+2	Test Voltage	By Notebook PC

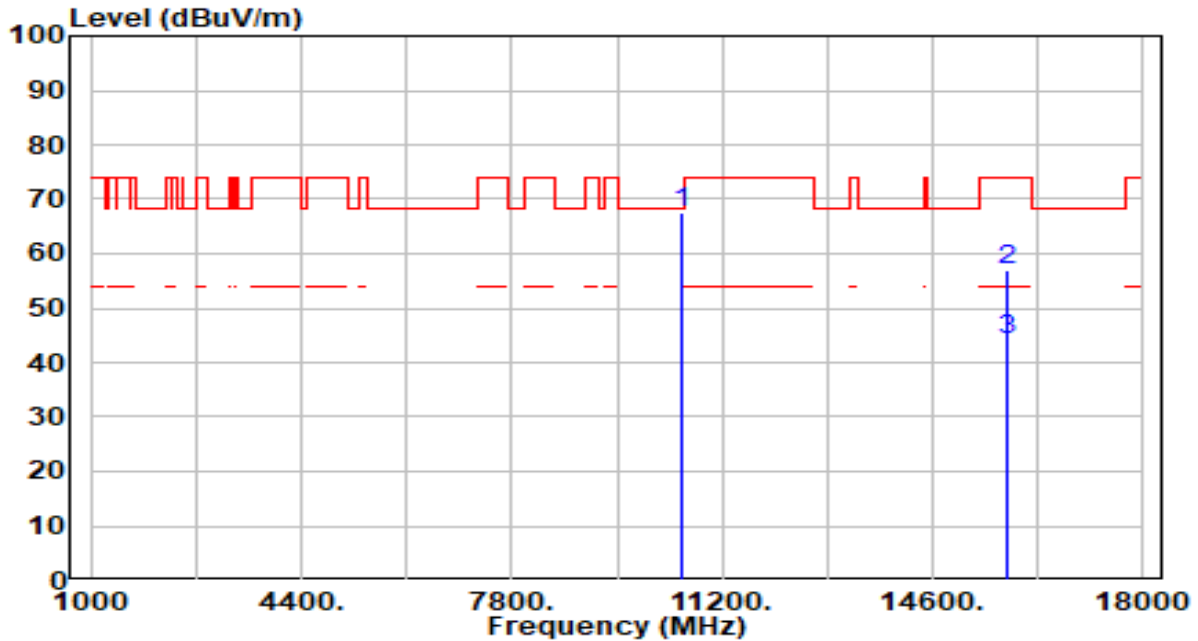

No	Frequency (MHz)	Reading (dBUV)	C.F (dB/m)	Measurement (dBUV/m)	Margin (dB)	Limit (dBUV/m)	Height (cm)	Angle (deg)	Remark (QP/PK/AV)
1	* 10540.000	64.29	3.08	67.37	-0.83	68.20	200	256	Peak
2	15810.000	51.63	5.21	56.83	-17.17	74.00	200	112	Peak
3	* 15810.000	39.02	5.21	44.23	-9.77	54.00	200	112	Average

Note:

1. " \*", means this data is the worst emission level.
2. C.F (Correction Factor) = Antenna Factor (dB/m) + Cable Loss (dB) – Pre-amplifier(dB).
3. Measurement (dBUV/m) = Reading(dBUV) + C.F (Correction Factor).
4. The emission levels of other frequencies are very lower than the limit and not show in test report.

EUT	AX3000 High Gain Wireless USB Adapter	Date of Test	2023-01-19
Factor	DRH18-E	Temp. / Humidity	20°C /62%
Polarity	Vertical	Site / Test Engineer	AC2 / Ares
Test Mode	802.11ax-40MHz_TX_Band2_CH 54_ANT 1+2	Test Voltage	By Notebook PC

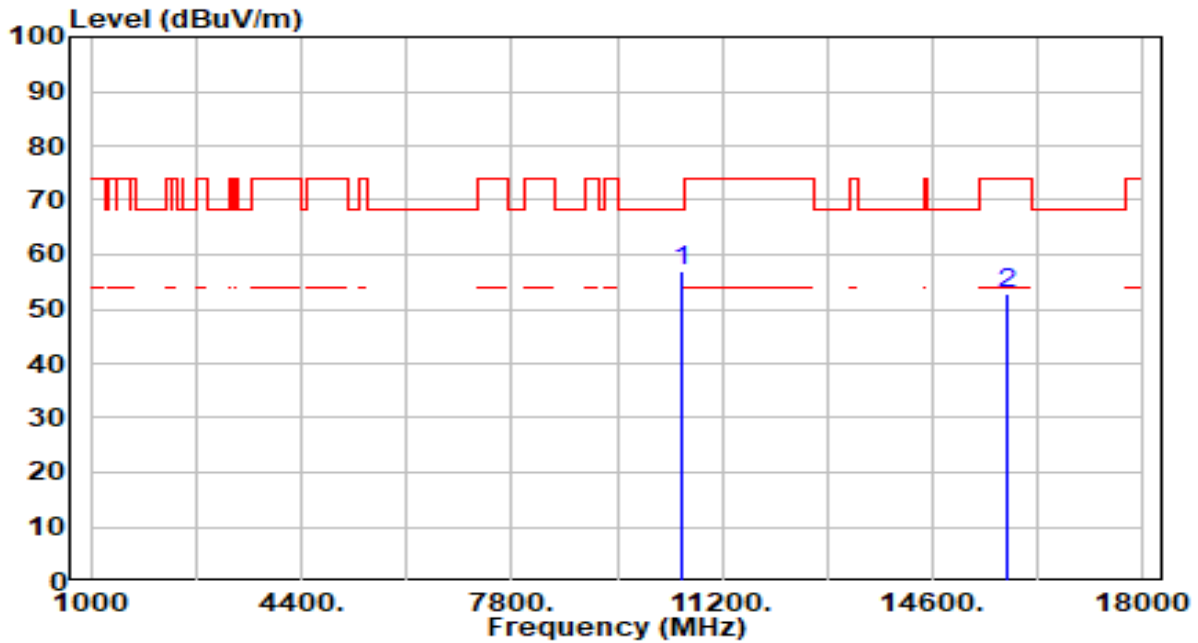

No	Frequency (MHz)	Reading (dBuV)	C.F (dB/m)	Measurement (dBuV/m)	Margin (dB)	Limit (dBuV/m)	Height (cm)	Angle (deg)	Remark (QP/PK/AV)
1	* 10540.000	53.87	3.08	56.96	-11.24	68.20	200	329	Peak
2	15810.000	47.65	5.21	52.85	-21.15	74.00	200	329	Peak

Note:

1. " \*", means this data is the worst emission level.
2. C.F (Correction Factor) = Antenna Factor (dB/m) + Cable Loss (dB) – Pre-amplifier(dB).
3. Measurement (dBuV/m) = Reading(dBuV) + C.F (Correction Factor).
4. The emission levels of other frequencies are very lower than the limit and not show in test report.

EUT	AX3000 High Gain Wireless USB Adapter	Date of Test	2023-01-19
Factor	DRH18-E	Temp. / Humidity	20°C /62%
Polarity	Horizontal	Site / Test Engineer	AC2 / Ares
Test Mode	802.11ax-40MHz_TX_Band2_CH 62_ANT 1+2	Test Voltage	By Notebook PC

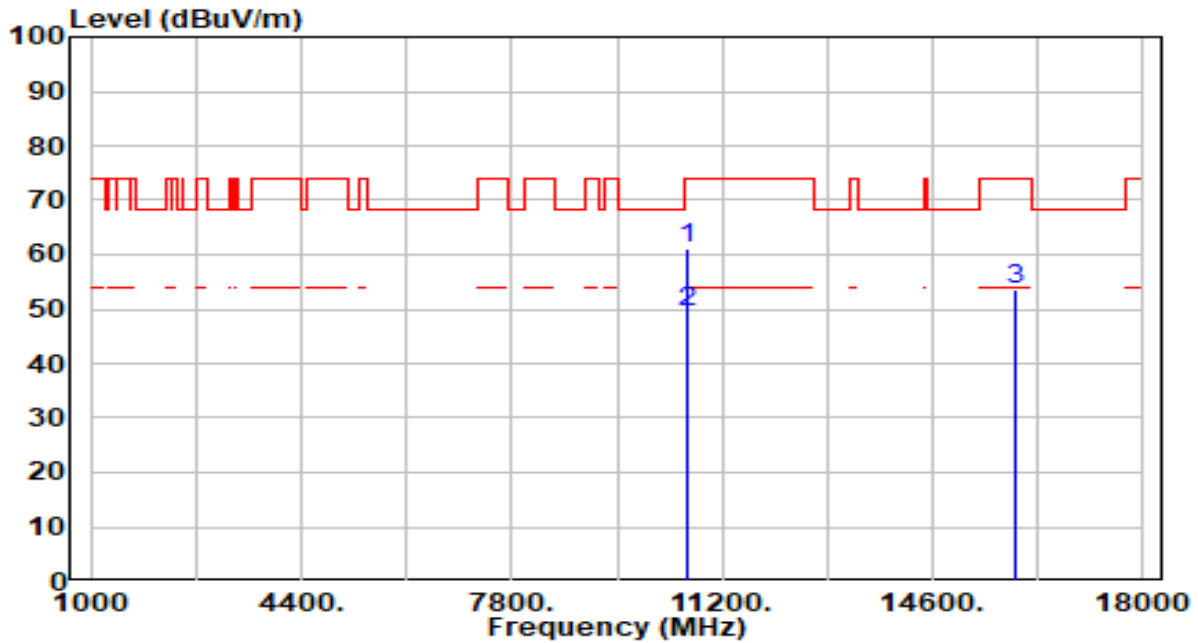

No	Frequency (MHz)	Reading (dBuV)	C.F (dB/m)	Measurement (dBuV/m)	Margin (dB)	Limit (dBuV/m)	Height (cm)	Angle (deg)	Remark (QP/PK/AV)
1	*	58.19	3.06	61.25	-12.75	74.00	200	259	Peak
2	*	46.23	3.06	49.29	-4.71	54.00	200	259	Average
3		48.33	5.29	53.62	-20.38	74.00	200	118	Peak

Note:

1. " \*", means this data is the worst emission level.
2. C.F (Correction Factor) = Antenna Factor (dB/m) + Cable Loss (dB) – Preamplifier(dB).
3. Measurement (dBuV/m) = Reading(dBuV) + C.F (Correction Factor).
4. The emission levels of other frequencies are very lower than the limit and not show in test report.

EUT	AX3000 High Gain Wireless USB Adapter	Date of Test	2023-01-19
Factor	DRH18-E	Temp. / Humidity	20°C /62%
Polarity	Vertical	Site / Test Engineer	AC2 / Ares
Test Mode	802.11ax-40MHz_TX_Band2_CH 62_ANT 1+2	Test Voltage	By Notebook PC

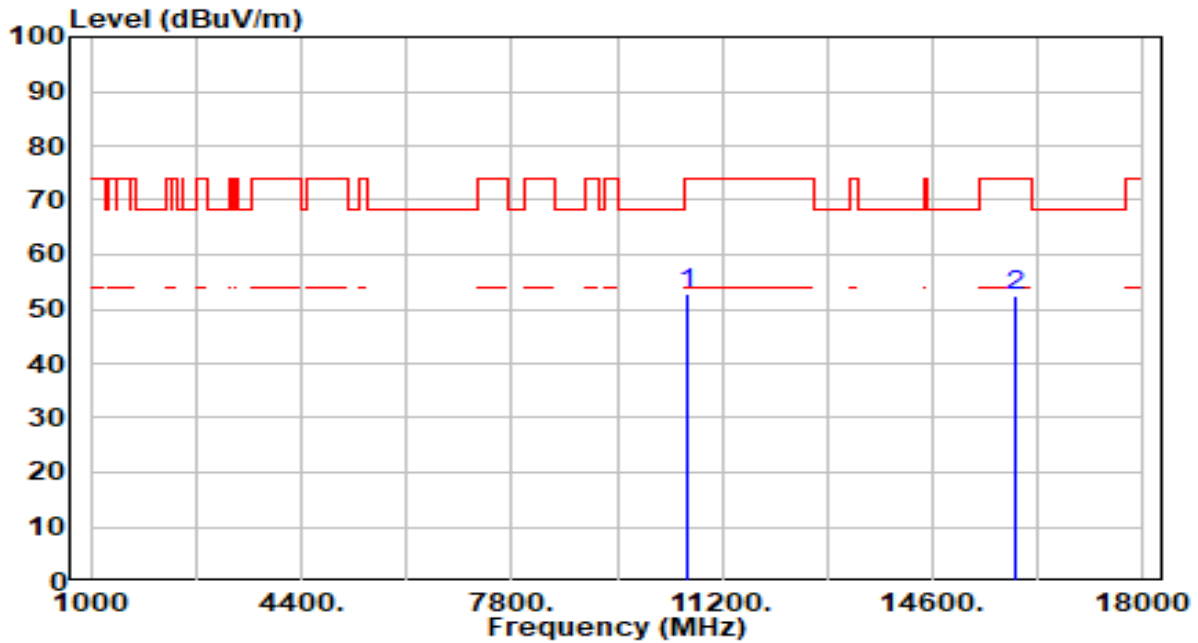

No	Frequency (MHz)	Reading (dBuV)	C.F (dB/m)	Measurement (dBuV/m)	Margin (dB)	Limit (dBuV/m)	Height (cm)	Angle (deg)	Remark (QP/PK/AV)
1	* 10620.000	49.75	3.06	52.81	-21.19	74.00	200	60	Peak
2	15930.000	47.00	5.29	52.29	-21.71	74.00	200	205	Peak

Note:

1. " \*", means this data is the worst emission level.
2. C.F (Correction Factor) = Antenna Factor (dB/m) + Cable Loss (dB) – Pre-amplifier(dB).
3. Measurement (dBuV/m) = Reading(dBuV) + C.F (Correction Factor).
4. The emission levels of other frequencies are very lower than the limit and not show in test report.

EUT	AX3000 High Gain Wireless USB Adapter	Date of Test	2023-01-19
Factor	DRH18-E	Temp. / Humidity	20°C /62%
Polarity	Horizontal	Site / Test Engineer	AC2 / Ares
Test Mode	802.11ax-40MHz_TX_Band3_CH 102_ANT 1+2	Test Voltage	By Notebook PC

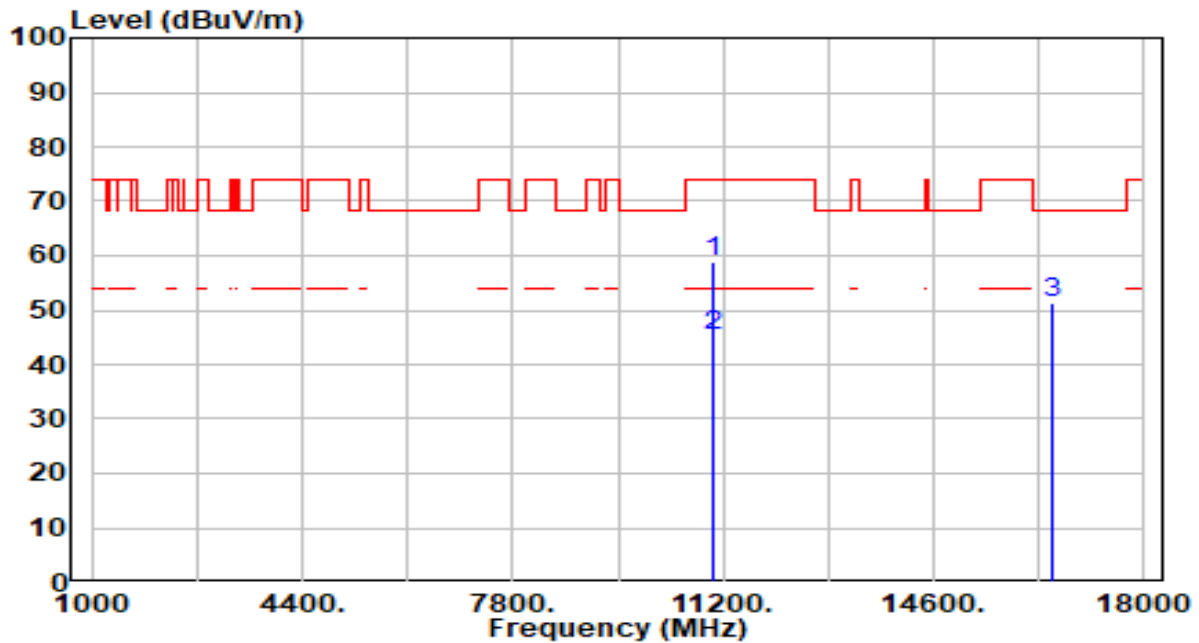

No	Frequency (MHz)	Reading (dBuV)	C.F (dB/m)	Measurement (dBuV/m)	Margin (dB)	Limit (dBuV/m)	Height (cm)	Angle (deg)	Remark (QP/PK/AV)
1	* 11020.000	55.64	3.24	58.88	-15.12	74.00	182	65	Peak
2	* 11020.000	42.20	3.24	45.44	-8.56	54.00	182	65	Average
3	16530.000	46.84	4.59	51.43	-16.77	68.20	200	88	Peak

Note:

1. " \*", means this data is the worst emission level.
2. C.F (Correction Factor) = Antenna Factor (dB/m) + Cable Loss (dB) – Pre-amplifier(dB).
3. Measurement (dBuV/m) = Reading(dBuV) + C.F (Correction Factor).
4. The emission levels of other frequencies are very lower than the limit and not show in test report.

EUT	AX3000 High Gain Wireless USB Adapter	Date of Test	2023-01-19
Factor	DRH18-E	Temp. / Humidity	20°C /62%
Polarity	Vertical	Site / Test Engineer	AC2 / Ares
Test Mode	802.11ax-40MHz_TX_Band3_CH 102_ANT 1+2	Test Voltage	By Notebook PC

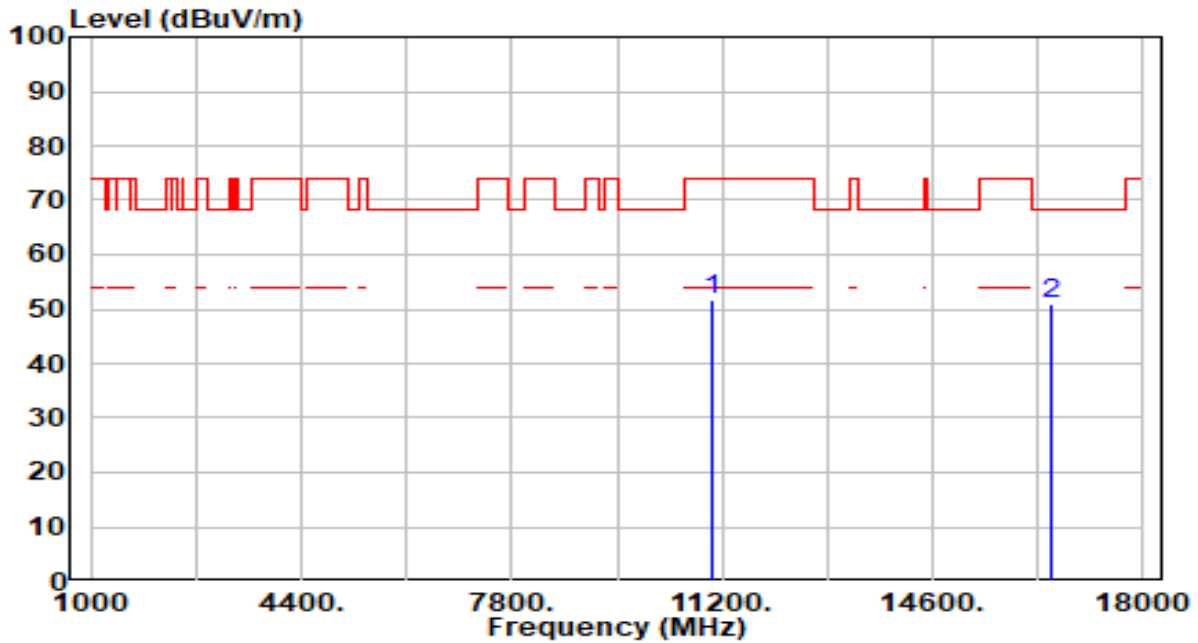

No	Frequency (MHz)	Reading (dBuV)	C.F (dB/m)	Measurement (dBuV/m)	Margin (dB)	Limit (dBuV/m)	Height (cm)	Angle (deg)	Remark (QP/PK/AV)
1	11020.000	48.41	3.24	51.65	-22.35	74.00	200	0	Peak
2	* 16530.000	46.32	4.59	50.92	-17.28	68.20	200	360	Peak

Note:

1. " \*", means this data is the worst emission level.
2. C.F (Correction Factor) = Antenna Factor (dB/m) + Cable Loss (dB) – Pre-amplifier(dB).
3. Measurement (dBuV/m) = Reading(dBuV) + C.F (Correction Factor).
4. The emission levels of other frequencies are very lower than the limit and not show in test report.

EUT	AX3000 High Gain Wireless USB Adapter	Date of Test	2023-01-19
Factor	DRH18-E	Temp. / Humidity	20°C /62%
Polarity	Horizontal	Site / Test Engineer	AC2 / Ares
Test Mode	802.11ax-40MHz_TX_Band3_CH 110_ANT 1+2	Test Voltage	By Notebook PC

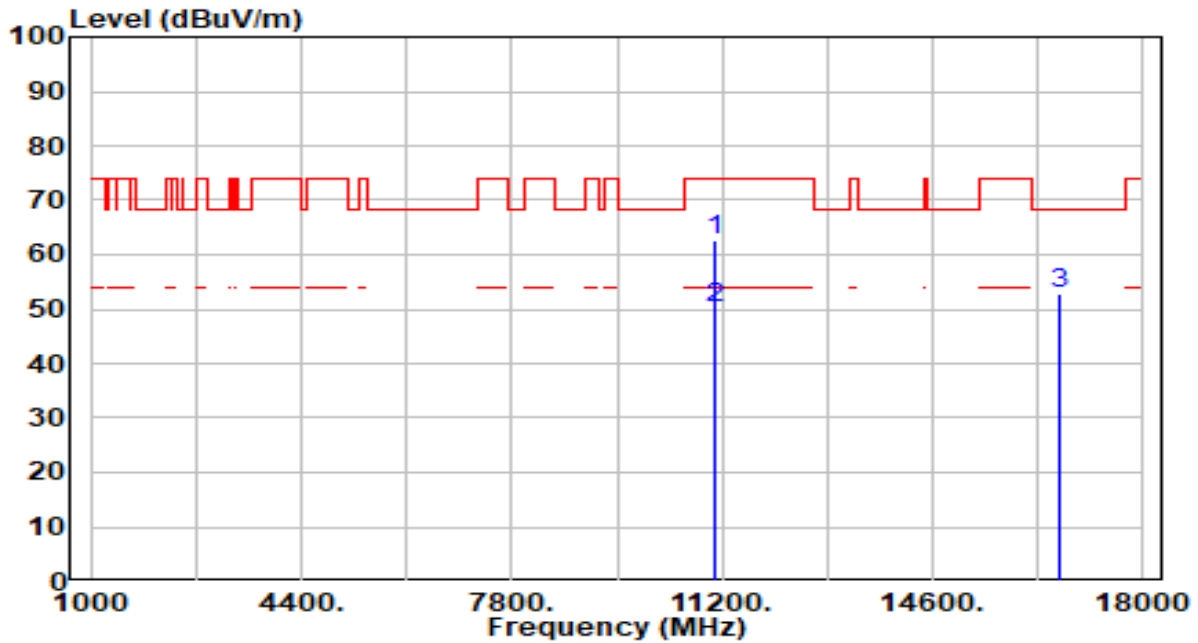

No	Frequency (MHz)	Reading (dBuV)	C.F (dB/m)	Measurement (dBuV/m)	Margin (dB)	Limit (dBuV/m)	Height (cm)	Angle (deg)	Remark (QP/PK/AV)	
1	*	11100.000	59.09	3.38	62.47	-11.53	74.00	166	79	Peak
2	*	11100.000	46.88	3.38	50.26	-3.74	54.00	166	79	Average
3		16650.000	48.34	4.53	52.87	-15.33	68.20	200	112	Peak

Note:

1. " \*", means this data is the worst emission level.
2. C.F (Correction Factor) = Antenna Factor (dB/m) + Cable Loss (dB) – Preamplifier(dB).
3. Measurement (dBuV/m) = Reading(dBuV) + C.F (Correction Factor).
4. The emission levels of other frequencies are very lower than the limit and not show in test report.

EUT	AX3000 High Gain Wireless USB Adapter	Date of Test	2023-01-19
Factor	DRH18-E	Temp. / Humidity	20°C /62%
Polarity	Vertical	Site / Test Engineer	AC2 / Ares
Test Mode	802.11ax-40MHz_TX_Band3_CH 110_ANT 1+2	Test Voltage	By Notebook PC

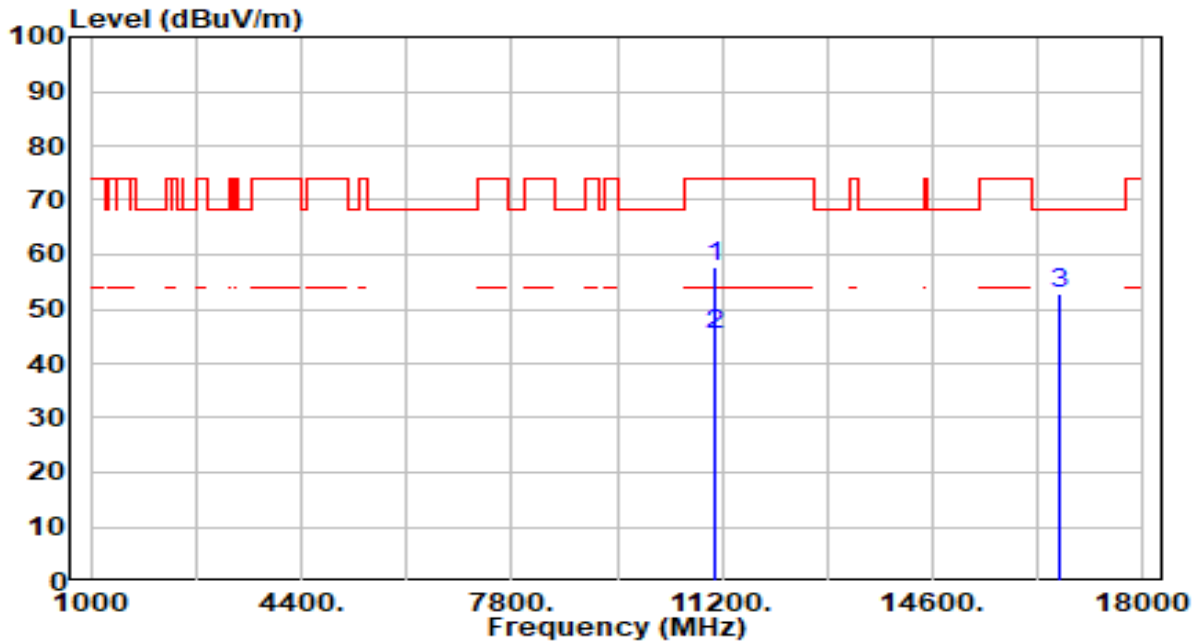

No	Frequency (MHz)	Reading (dBuV)	C.F (dB/m)	Measurement (dBuV/m)	Margin (dB)	Limit (dBuV/m)	Height (cm)	Angle (deg)	Remark (QP/PK/AV)
1	11100.000	54.26	3.38	57.64	-16.36	74.00	200	339	Peak
2	* 11100.000	42.01	3.38	45.39	-8.61	54.00	200	339	Average
3	* 16650.000	48.27	4.53	52.80	-15.40	68.20	200	84	Peak

Note:

1. " \*", means this data is the worst emission level.
2. C.F (Correction Factor) = Antenna Factor (dB/m) + Cable Loss (dB) – Preamplifier(dB).
3. Measurement (dBuV/m) = Reading(dBuV) + C.F (Correction Factor).
4. The emission levels of other frequencies are very lower than the limit and not show in test report.



EUT	AX3000 High Gain Wireless USB Adapter	Date of Test	2023-01-19
Factor	DRH18-E	Temp. / Humidity	20°C /62%
Polarity	Horizontal	Site / Test Engineer	AC2 / Ares
Test Mode	802.11ax-40MHz_TX_Band3_CH 134_ANT 1+2	Test Voltage	By Notebook PC

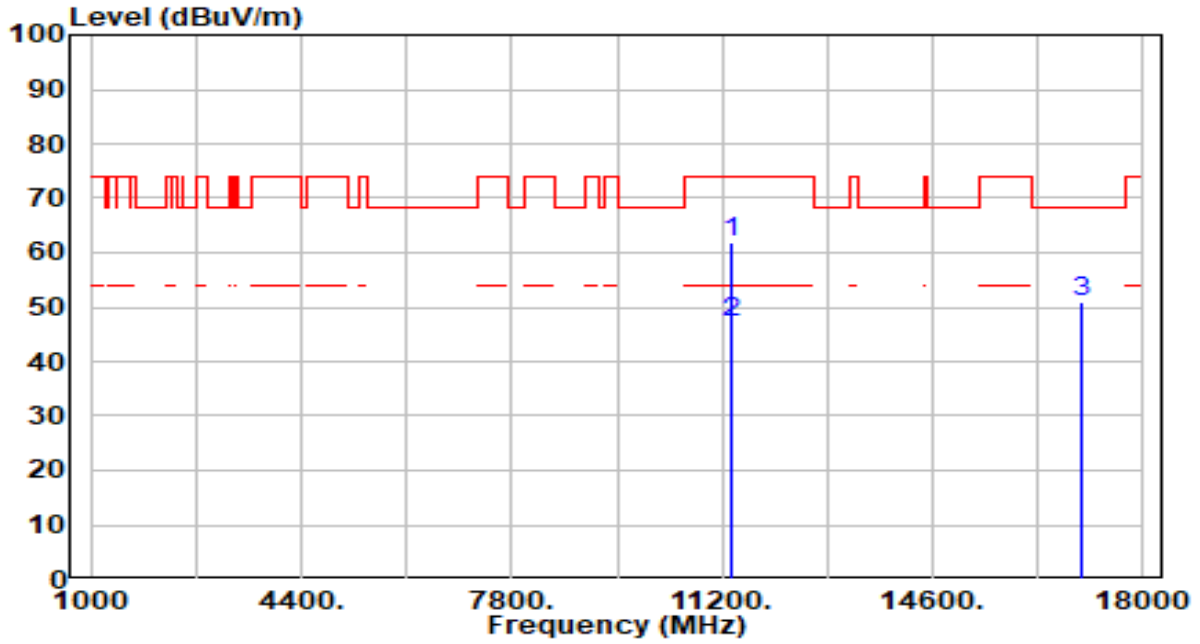

No	Frequency (MHz)	Reading (dBuV)	C.F (dB/m)	Measurement (dBuV/m)	Margin (dB)	Limit (dBuV/m)	Height (cm)	Angle (deg)	Remark (QP/PK/AV)	
1	*	11340.000	58.21	3.80	62.01	-11.99	74.00	200	9	Peak
2	*	11340.000	43.22	3.80	47.02	-6.98	54.00	200	9	Average
3		17010.000	46.05	4.78	50.83	-17.37	68.20	200	42	Peak

Note:

1. " \*", means this data is the worst emission level.
2. C.F (Correction Factor) = Antenna Factor (dB/m) + Cable Loss (dB) – Preamplifier(dB).
3. Measurement (dBuV/m) = Reading(dBuV) + C.F (Correction Factor).
4. The emission levels of other frequencies are very lower than the limit and not show in test report.

EUT	AX3000 High Gain Wireless USB Adapter	Date of Test	2023-01-19
Factor	DRH18-E	Temp. / Humidity	20°C /62%
Polarity	Vertical	Site / Test Engineer	AC2 / Ares
Test Mode	802.11ax-40MHz_TX_Band3_CH 134_ANT 1+2	Test Voltage	By Notebook PC

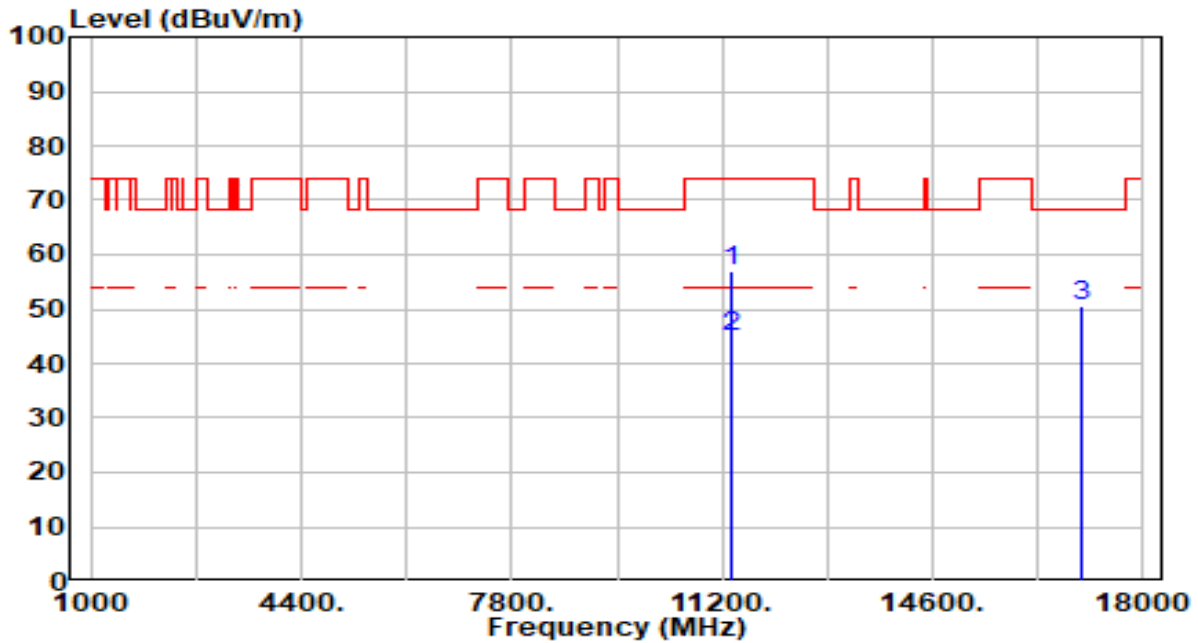

No	Frequency (MHz)	Reading (dBuV)	C.F (dB/m)	Measurement (dBuV/m)	Margin (dB)	Limit (dBuV/m)	Height (cm)	Angle (deg)	Remark (QP/PK/AV)	
1	*	11340.000	53.33	3.80	57.13	-16.87	74.00	200	10	Peak
2	*	11340.000	41.28	3.80	45.08	-8.92	54.00	200	10	Average
3		17010.000	45.63	4.78	50.40	-17.80	68.20	200	108	Peak

Note:

1. " \*", means this data is the worst emission level.
2. C.F (Correction Factor) = Antenna Factor (dB/m) + Cable Loss (dB) – Preamplifier(dB).
3. Measurement (dBuV/m) = Reading(dBuV) + C.F (Correction Factor).
4. The emission levels of other frequencies are very lower than the limit and not show in test report.

EUT	AX3000 High Gain Wireless USB Adapter	Date of Test	2023-01-19
Factor	DRH18-E	Temp. / Humidity	20°C /62%
Polarity	Horizontal	Site / Test Engineer	AC2 / Ares
Test Mode	802.11ax-40MHz_TX_Band3_CH 142_ANT 1+2	Test Voltage	By Notebook PC

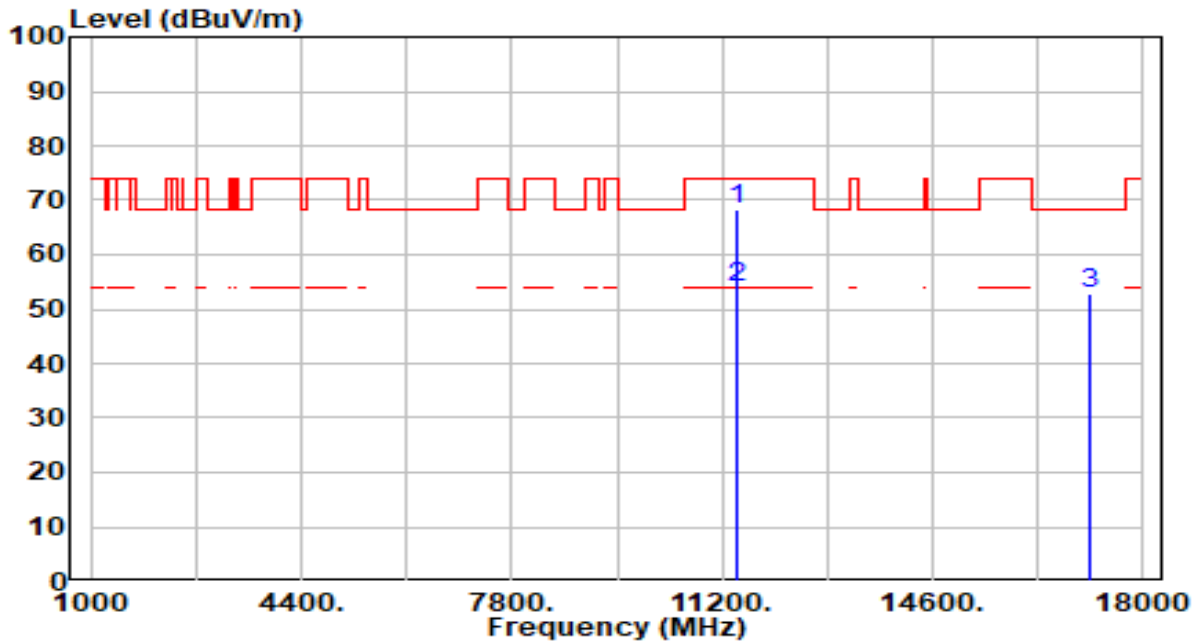

No	Frequency (MHz)	Reading (dBuV)	C.F (dB/m)	Measurement (dBuV/m)	Margin (dB)	Limit (dBuV/m)	Height (cm)	Angle (deg)	Remark (QP/PK/AV)	
1	*	11420.000	64.49	3.91	68.40	-5.60	74.00	171	19	Peak
2	*	11420.000	49.97	3.91	53.88	-0.12	54.00	171	19	Average
3		17130.000	48.40	4.38	52.77	-15.43	68.20	200	330	Peak

Note:

1. " \*", means this data is the worst emission level.
2. C.F (Correction Factor) = Antenna Factor (dB/m) + Cable Loss (dB) – Pre-amplifier(dB).
3. Measurement (dBuV/m) = Reading(dBuV) + C.F (Correction Factor).
4. The emission levels of other frequencies are very lower than the limit and not show in test report.

EUT	AX3000 High Gain Wireless USB Adapter	Date of Test	2023-01-19
Factor	DRH18-E	Temp. / Humidity	20°C /62%
Polarity	Vertical	Site / Test Engineer	AC2 / Ares
Test Mode	802.11ax-40MHz_TX_Band3_CH 142_ANT 1+2	Test Voltage	By Notebook PC

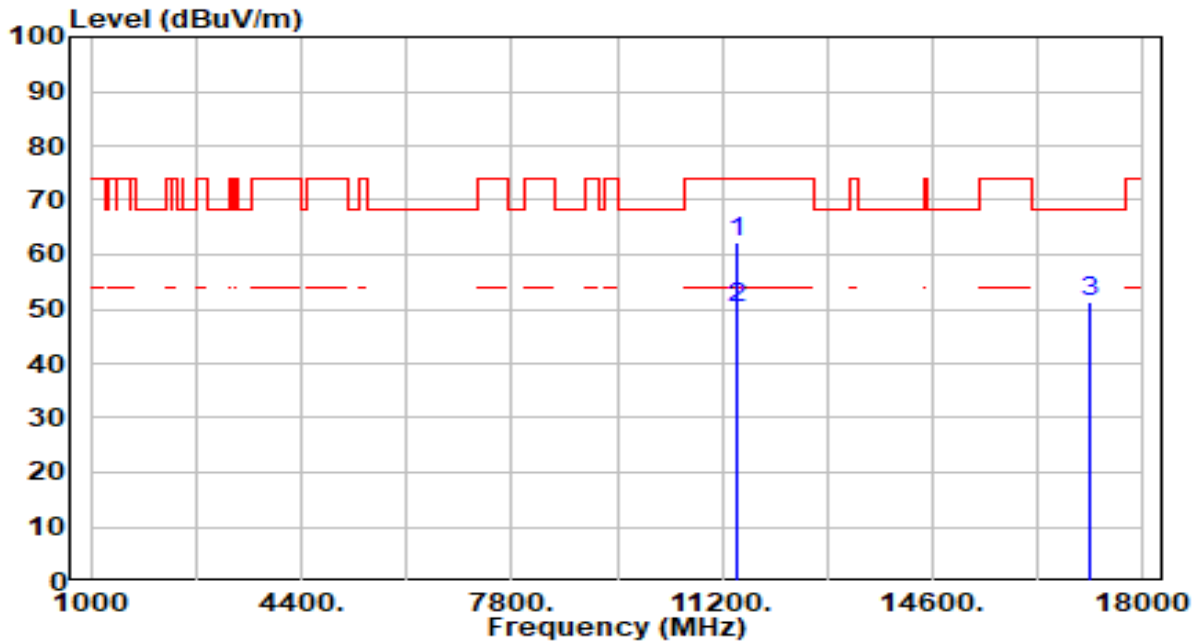

No	Frequency (MHz)	Reading (dBuV)	C.F (dB/m)	Measurement (dBuV/m)	Margin (dB)	Limit (dBuV/m)	Height (cm)	Angle (deg)	Remark (QP/PK/AV)	
1	*	11420.000	58.30	3.91	62.21	-11.79	74.00	200	21	Peak
2	*	11420.000	46.21	3.91	50.12	-3.88	54.00	200	21	Average
3		17130.000	47.04	4.38	51.42	-16.78	68.20	200	254	Peak

Note:

1. " \*", means this data is the worst emission level.
2. C.F (Correction Factor) = Antenna Factor (dB/m) + Cable Loss (dB) – Preamplifier(dB).
3. Measurement (dBuV/m) = Reading(dBuV) + C.F (Correction Factor).
4. The emission levels of other frequencies are very lower than the limit and not show in test report.

EUT	AX3000 High Gain Wireless USB Adapter	Date of Test	2023-01-16
Factor	BBHA 9170	Temp. / Humidity	20°C /62%
Polarity	Horizontal	Site / Test Engineer	AC2 / Xuan
Test Mode	802.11ac-20MHz_TX_Band1_CH 44_ANT 1+2	Test Voltage	By Notebook PC

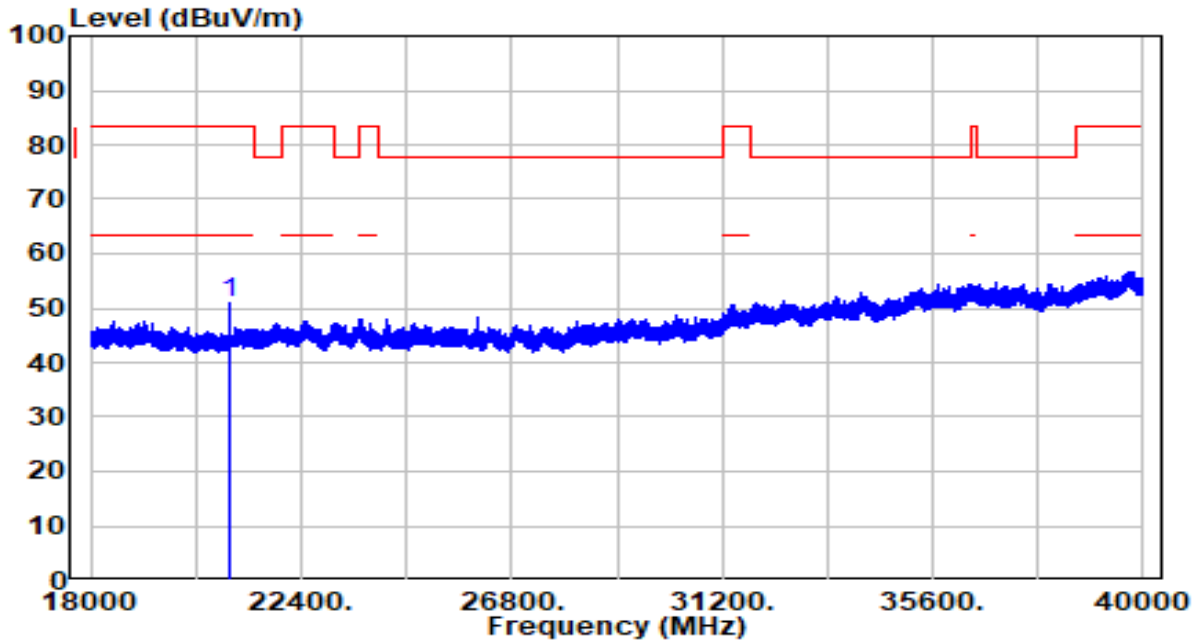

No	Frequency (MHz)	Reading (dBUV)	C.F (dB/m)	Measurement (dBUV/m)	Margin (dB)	Limit (dBUV/m)	Height (cm)	Angle (deg)	Remark (QP/PK/AV)
1	* 20879.250	40.00	10.83	50.83	-32.67	83.50	150	34	Peak

Note:

1. " \*", means this data is the worst emission level.
2. C.F (Correction Factor) = Antenna Factor (dB/m) + Cable Loss (dB) – Pre-amplifier(dB).
3. Measurement (dBUV/m) = Reading(dBUV) + C.F (Correction Factor).
4. The emission levels of other frequencies are very lower than the limit and not show in test report.

EUT	AX3000 High Gain Wireless USB Adapter	Date of Test	2023-01-16
Factor	BBHA 9170	Temp. / Humidity	20°C /62%
Polarity	Vertical	Site / Test Engineer	AC2 / Xuan
Test Mode	802.11ac-20MHz_TX_Band1_CH 44_ANT 1+2	Test Voltage	By Notebook PC

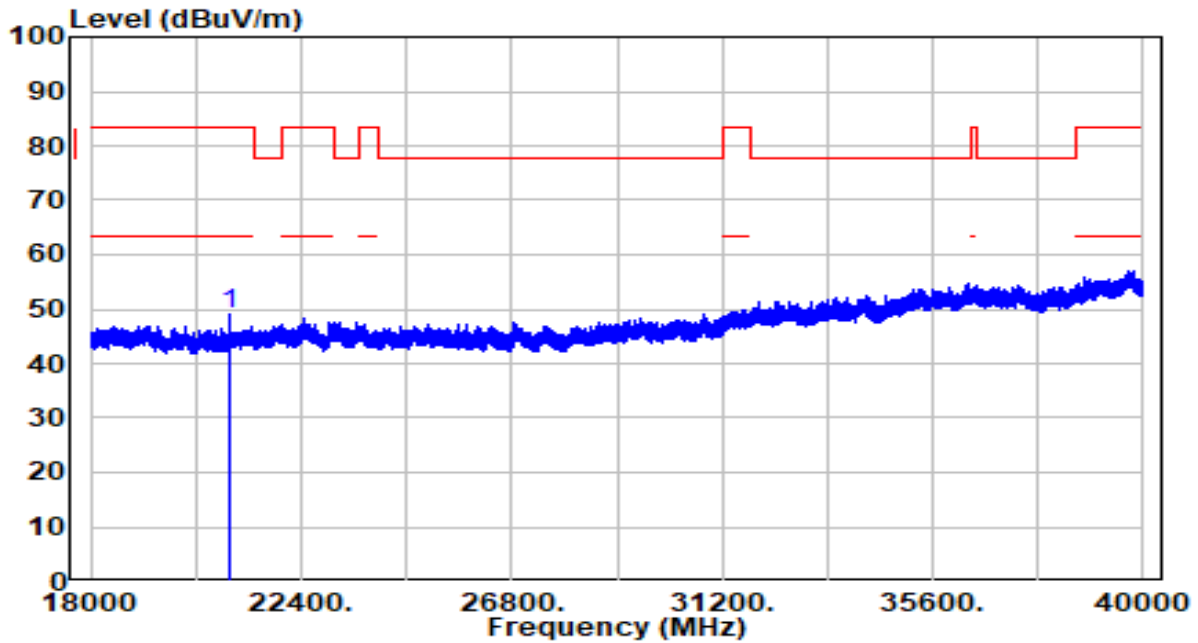

No	Frequency (MHz)	Reading (dBuV)	C.F (dB/m)	Measurement (dBuV/m)	Margin (dB)	Limit (dBuV/m)	Height (cm)	Angle (deg)	Remark (QP/PK/AV)	
1	*	20879.250	38.13	10.83	48.96	-34.54	83.50	150	270	Peak

Note:

1. "\*" , means this data is the worst emission level.
2. C.F (Correction Factor) = Antenna Factor (dB/m) + Cable Loss (dB) – Pre-amplifier(dB).
3. Measurement (dBuV/m) = Reading(dBuV) + C.F (Correction Factor).
4. The emission levels of other frequencies are very lower than the limit and not show in test report.

## 7.9. Radiated Restricted Band Edge Measurement

### 7.9.1. Test Limit

#### **For 15.205 requirement:**

Radiated emissions which fall in the restricted bands, as defined in Section 15.205(a) of FCC part 15, must also comply with the radiated emission limits specified in Section 15.209(a).

Frequency (MHz)	Frequency (MHz)	Frequency (MHz)	Frequency (GHz)
0.090 - 0.110	16.42-16.423	399.9 - 410	4.5-5.15
<sup>1</sup> 0.495 - 0.505	16.69475-16.69525	608 - 614	5.35-5.46
2.1735-2.1905	16.80425-16.80475	960 - 1240	7.25-7.75
4.125-4.128	25.5 -25.67	1300 - 1427	8.025 - 8.5
4.17725-4.17775	37.5-38.25	1435-1626.5	9.0-9.2
4.20725-4.20775	73-74.6	1645.5-1646.5	9.3-9.5
6.215-6.218	74.8-75.2	1660 - 1710	10.6-12.7
6.26775-6.26825	108-121.94	1718.8-1722.2	13.25-13.4
6.31175-6.31225	123 - 138	2200 - 2300	14.47-14.5
8.291-8.294	149.9-150.05	2310 - 2390	15.35-16.2
8.362-8.366	156.52475-156.525	2483.5 - 2500	17.7-21.4
8.37625-8.38675	156.7-156.9	2690 - 2900	22.01-23.12
8.41425-8.41475	162.0125-167.17	3260 - 3267	23.6-24.0
12.29-12.293	167.72-173.2	3332 - 3339	31.2-31.8
12.51975-12.52025	240 - 285	3345.8 - 3358	36.43-36.5
12.57675-12.57725	322-335.4	3600 - 4400	( <sup>2</sup> )
13.36-13.41	--	--	--

#### **For 15.407(b) requirement:**

For transmitters operating in the 5.15-5.25 GHz band: All emissions outside of the 5.15-5.35 GHz band shall not exceed an e.i.r.p. of -27 dBm/MHz.

For transmitters operating in the 5.25-5.35 GHz band: All emissions outside of the 5.15-5.35 GHz band shall not exceed an e.i.r.p. of -27 dBm/MHz.

For transmitters operating in the 5.47-5.725 GHz band: All emissions outside of the 5.47-5.725 GHz band shall not exceed an e.i.r.p. of -27 dBm/MHz.

For transmitters operating in the 5.725-5.85 GHz band: All emissions shall be limited to a level of -27 dBm/MHz at 75 MHz or more above or below the band edge increasing linearly to 10 dBm/MHz at 25 MHz above or below the band edge, and from 25 MHz above or below the band edge increasing

linearly to a level of 15.6 dBm/MHz at 5 MHz above or below the band edge, and from 5 MHz above or below the band edge increasing linearly to a level of 27 dBm/MHz at the band edge.

Refer to KDB 789033 D02v02r01 G)2)c), as specified in § 15.407(b), emissions above 1000 MHz that are outside of the restricted bands are subject to a maximum emission limit of -27 dBm/MHz (or -17 dBm/MHz as specified in § 15.407(b)(4)). However, an out-of-band emission that complies with both the peak and average limits of § 15.209 is not required to satisfy the -27 dBm/MHz or -17 dBm/MHz maximum emission limit.

All out of band emissions appearing in a restricted band as specified in Section 15.205 of the Title 47CFR must not exceed the limits shown in Table per Section 15.209.

FCC Part 15 Subpart C Paragraph 15.209		
Frequency [MHz]	Field Strength [uV/m]	Measured Distance [Meters]
0.009 - 0.490	2400/F (kHz)	300
0.490 - 1.705	24000/F (kHz)	30
1.705 - 30	30	30
30 - 88	100	3
88 - 216	150	3
216 - 960	200	3
Above 960	500	3

**7.9.2. Test Procedure Used**

KDB 789033 D02v02r01- Section G

**7.9.3. Test Setting**

**Peak Measurements above 1GHz**

1. Analyzer center frequency was set to the frequency of the radiated spurious emission of interest
2. RBW = 1MHz
3. VBW = 3MHz
4. Detector = peak
5. Sweep time = auto couple



6. Trace mode = max hold
7. Trace was allowed to stabilize

### **Average Measurements above 1GHz (Method VB)**

1. Analyzer center frequency was set to the frequency of the radiated spurious emission of interest
2. RBW = 1MHz
3. VBW, If the EUT is configured to transmit with duty cycle  $\geq 98\%$ , set  $VBW \leq RBW/100$  (i.e., 10 kHz) but not less than 10 Hz. If the EUT duty cycle is  $< 98\%$ , set  $VBW \geq 1/T$ .
4. Detector = Peak
5. Sweep time = auto
6. Allow max hold to run for at least 50 traces if the transmitted signal is continuous or has at least 98% duty cycle. For lower duty cycles, increase the minimum number of traces by a factor of  $1/x$ , where  $x$  is the duty cycle.

### **7.9.4. Test Setup**

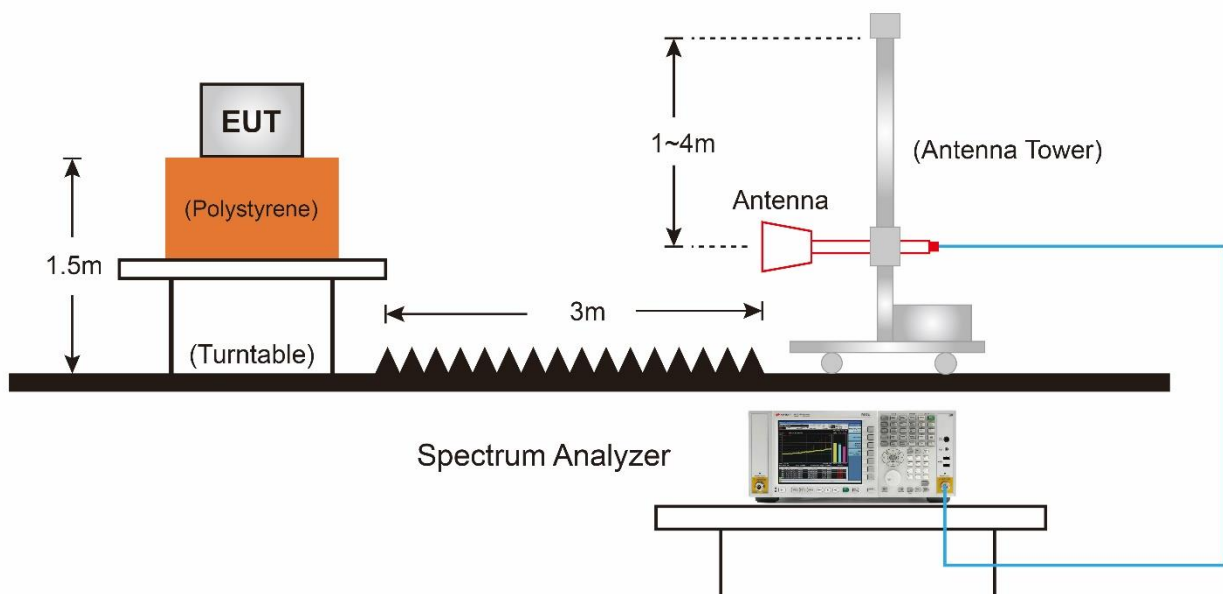

### 7.9.5. Test Result

EUT	AX3000 High Gain Wireless USB Adapter	Date of Test	2023-01-19
Factor	DRH18-E	Temp. / Humidity	20°C /62%
Polarity	Horizontal	Site / Test Engineer	AC2 / Ares
Test Mode	802.11a_TX_Band1_CH 36_ANT 1+2	Test Voltage	By Notebook PC

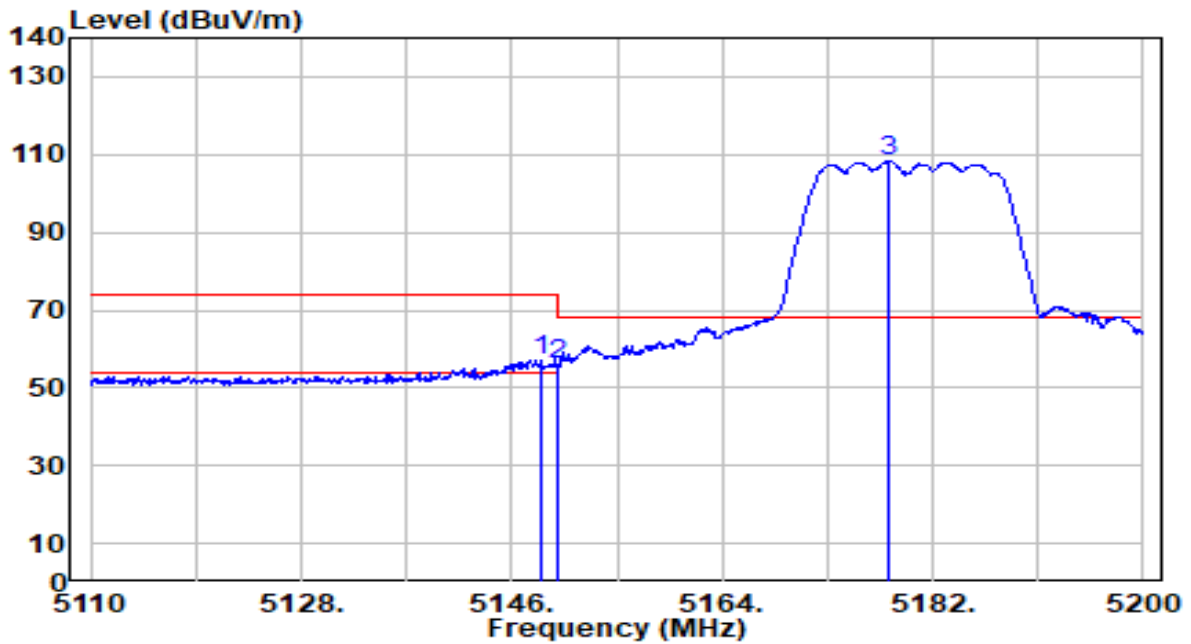

No	Frequency (MHz)	Reading (dBuV)	C.F (dB/m)	Measurement (dBuV/m)	Margin (dB)	Limit (dBuV/m)	Height (cm)	Angle (deg)	Remark (QP/PK/AV)
1	* 5148.430	57.72	-0.73	57.00	-17.00	74.00	250	183	Peak
2	5150.000	56.56	-0.73	55.84	-18.16	74.00	250	183	Peak
3	5178.130	108.85	-0.70	108.15	N/A	N/A	250	183	Peak

Note:

1. " \*", means this data is the worst emission level.
2. C.F (Correction Factor) = Antenna Factor (dB/m) + Cable Loss (dB) – Preamplifier(dB) + 10dB Attenuation.
3. Measurement (dBuV/m) = Reading(dBuV) + C.F (Correction Factor).
4. The emission levels of other frequencies are very lower than the limit and not show in test report.

EUT	AX3000 High Gain Wireless USB Adapter	Date of Test	2023-01-19
Factor	DRH18-E	Temp. / Humidity	20°C /62%
Polarity	Horizontal	Site / Test Engineer	AC2 / Ares
Test Mode	802.11a_TX_Band1_CH 36_ANT 1+2	Test Voltage	AC 120V/60Hz

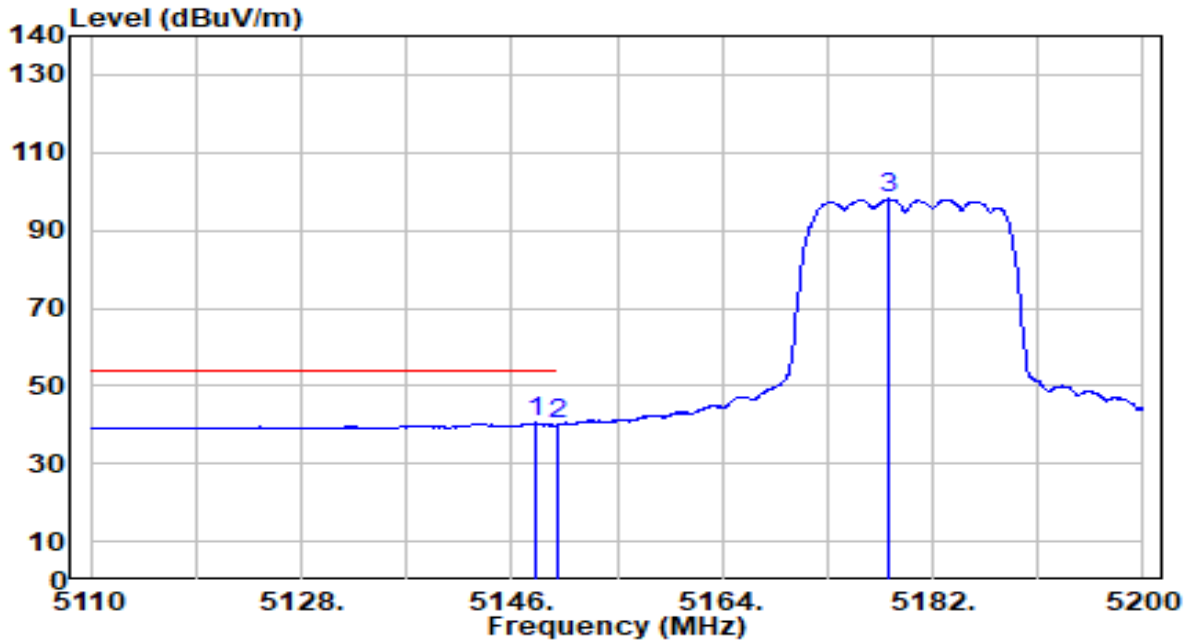

No	Frequency (MHz)	Reading (dBuV)	C.F (dB/m)	Measurement (dBuV/m)	Margin (dB)	Limit (dBuV/m)	Height (cm)	Angle (deg)	Remark (QP/PK/AV)
1	* 5148.160	41.14	-0.73	40.42	-13.58	54.00	250	183	Average
2	5150.000	40.70	-0.73	39.97	-14.03	54.00	250	183	Average
3	5178.220	98.71	-0.70	98.01	N/A	N/A	250	183	Average

Note:

1. " \*", means this data is the worst emission level.
2. C.F (Correction Factor) = Antenna Factor (dB/m) + Cable Loss (dB) – Pre-amplifier(dB) + 10dB Attenuation.
3. Measurement (dBuV/m) = Reading(dBuV) + C.F (Correction Factor).
4. The emission levels of other frequencies are very lower than the limit and not show in test report.

EUT	AX3000 High Gain Wireless USB Adapter	Date of Test	2023-01-19
Factor	DRH18-E	Temp. / Humidity	20°C /62%
Polarity	Vertical	Site / Test Engineer	AC2 / Ares
Test Mode	802.11a_TX_Band1_CH 36_ANT 1+2	Test Voltage	By Notebook PC

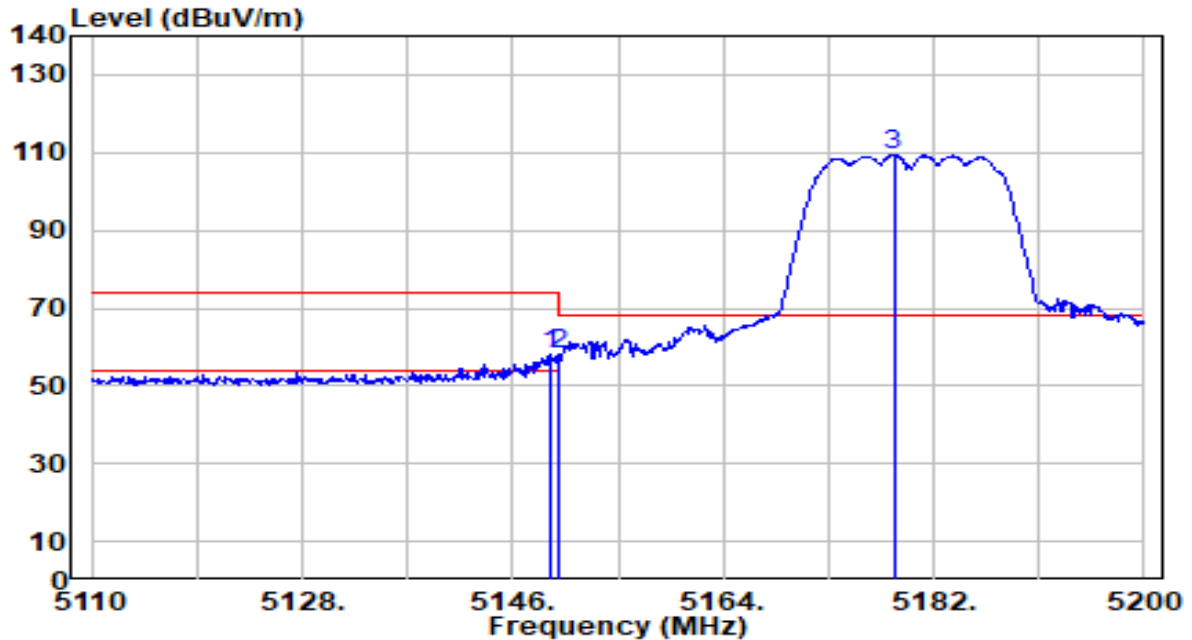

No	Frequency (MHz)	Reading (dBUV)	C.F (dB/m)	Measurement (dBUV/m)	Margin (dB)	Limit (dBUV/m)	Height (cm)	Angle (deg)	Remark (QP/PK/AV)
1	* 5149.240	58.97	-0.73	58.24	-15.76	74.00	302	260	Peak
2	5150.000	58.63	-0.73	57.90	-16.10	74.00	302	260	Peak
3	5178.580	110.20	-0.70	109.50	N/A	N/A	302	260	Peak

Note:

1. " \*", means this data is the worst emission level.
2. C.F (Correction Factor) = Antenna Factor (dB/m) + Cable Loss (dB) – Pre-amplifier(dB) + 10dB Attenuation.
3. Measurement (dBUV/m) = Reading(dBUV) + C.F (Correction Factor).
4. The emission levels of other frequencies are very lower than the limit and not show in test report.

EUT	AX3000 High Gain Wireless USB Adapter	Date of Test	2023-01-19
Factor	DRH18-E	Temp. / Humidity	20°C /62%
Polarity	Vertical	Site / Test Engineer	AC2 / Ares
Test Mode	802.11a_TX_Band1_CH 36_ANT 1+2	Test Voltage	By Notebook PC

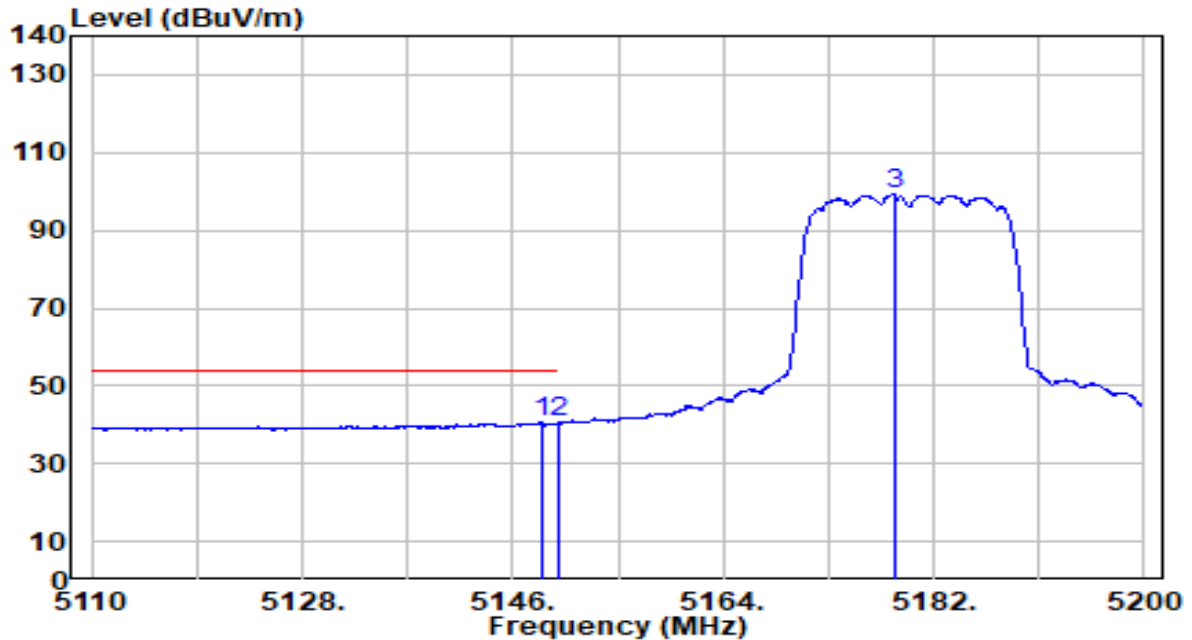

No	Frequency (MHz)	Reading (dBuV)	C.F (dB/m)	Measurement (dBuV/m)	Margin (dB)	Limit (dBuV/m)	Height (cm)	Angle (deg)	Remark (QP/PK/AV)
1	5148.430	41.24	-0.73	40.52	-13.48	54.00	302	260	Average
2	* 5150.000	41.31	-0.73	40.59	-13.41	54.00	302	260	Average
3	5178.760	100.06	-0.70	99.36	N/A	N/A	302	260	Average

Note:

1. " \*", means this data is the worst emission level.
2. C.F (Correction Factor) = Antenna Factor (dB/m) + Cable Loss (dB) – Pre-amplifier(dB) + 10dB Attenuation.
3. Measurement (dBuV/m) = Reading(dBuV) + C.F (Correction Factor).
4. The emission levels of other frequencies are very lower than the limit and not show in test report.

EUT	AX3000 High Gain Wireless USB Adapter	Date of Test	2023-01-19
Factor	DRH18-E	Temp. / Humidity	20°C /62%
Polarity	Horizontal	Site / Test Engineer	AC2 / Ares
Test Mode	802.11a_TX_Band2_CH 64_ANT 1+2	Test Voltage	By Notebook PC

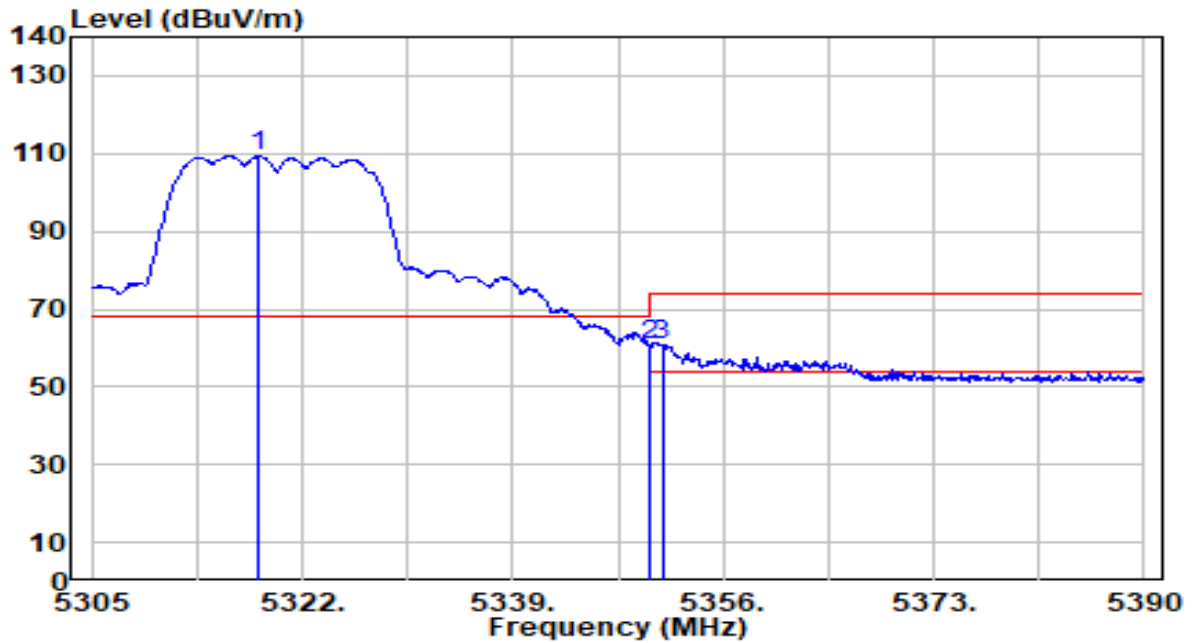

No	Frequency (MHz)	Reading (dBuV)	C.F (dB/m)	Measurement (dBuV/m)	Margin (dB)	Limit (dBuV/m)	Height (cm)	Angle (deg)	Remark (QP/PK/AV)
1	5318.515	110.18	-0.92	109.26	N/A	N/A	250	183	Peak
2	5350.000	61.84	-0.98	60.85	-13.15	74.00	250	183	Peak
3	* 5351.070	61.84	-0.99	60.85	-13.15	74.00	250	183	Peak

Note:

1. " \*", means this data is the worst emission level.
2. C.F (Correction Factor) = Antenna Factor (dB/m) + Cable Loss (dB) – Preamplifier(dB) + 10dB Attenuation.
3. Measurement (dBuV/m) = Reading(dBuV) + C.F (Correction Factor).
4. The emission levels of other frequencies are very lower than the limit and not show in test report.

EUT	AX3000 High Gain Wireless USB Adapter	Date of Test	2023-01-19
Factor	DRH18-E	Temp. / Humidity	20°C /62%
Polarity	Horizontal	Site / Test Engineer	AC2 / Ares
Test Mode	802.11a_TX_Band2_CH 64_ANT 1+2	Test Voltage	By Notebook PC

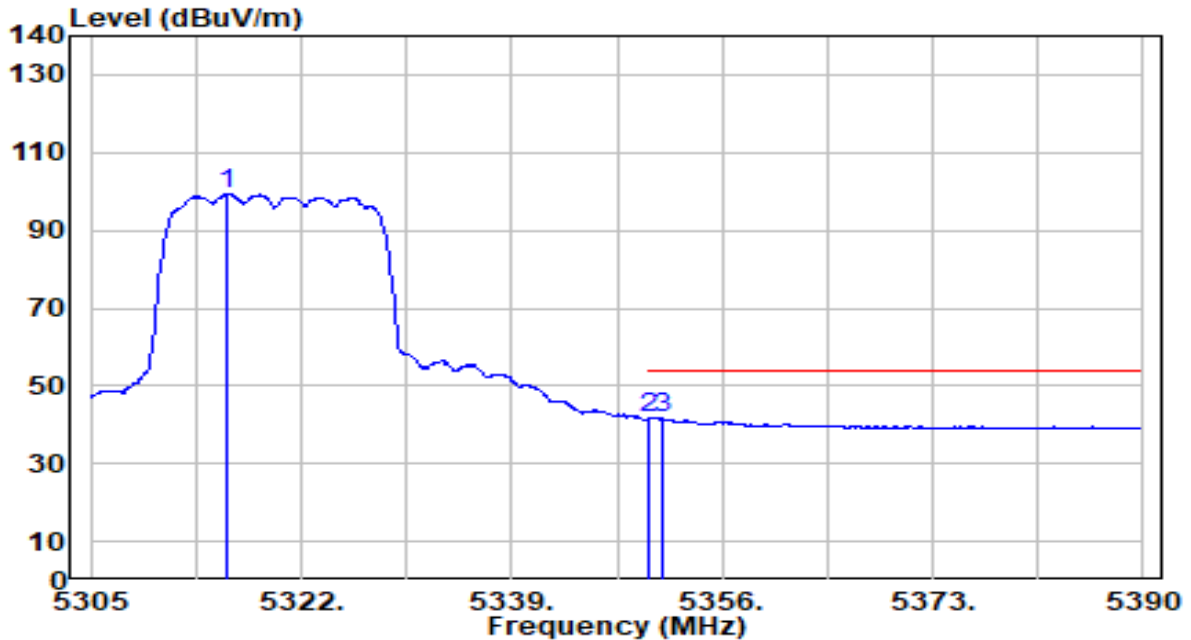

No	Frequency (MHz)	Reading (dBUV)	C.F (dB/m)	Measurement (dBUV/m)	Margin (dB)	Limit (dBUV/m)	Height (cm)	Angle (deg)	Remark (QP/PK/AV)
1	5316.050	100.14	-0.91	99.22	N/A	N/A	250	183	Average
2	* 5350.000	42.54	-0.98	41.56	-12.44	54.00	250	183	Average
3	5351.240	42.50	-0.99	41.51	-12.49	54.00	250	183	Average

Note:

1. " \*", means this data is the worst emission level.
2. C.F (Correction Factor) = Antenna Factor (dB/m) + Cable Loss (dB) – Pre-amplifier(dB) + 10dB Attenuation.
3. Measurement (dBUV/m) = Reading(dBUV) + C.F (Correction Factor).
4. The emission levels of other frequencies are very lower than the limit and not show in test report.

EUT	AX3000 High Gain Wireless USB Adapter	Date of Test	2023-01-19
Factor	DRH18-E	Temp. / Humidity	20°C /62%
Polarity	Vertical	Site / Test Engineer	AC2 / Ares
Test Mode	802.11a_TX_Band2_CH 64_ANT 1+2	Test Voltage	By Notebook PC

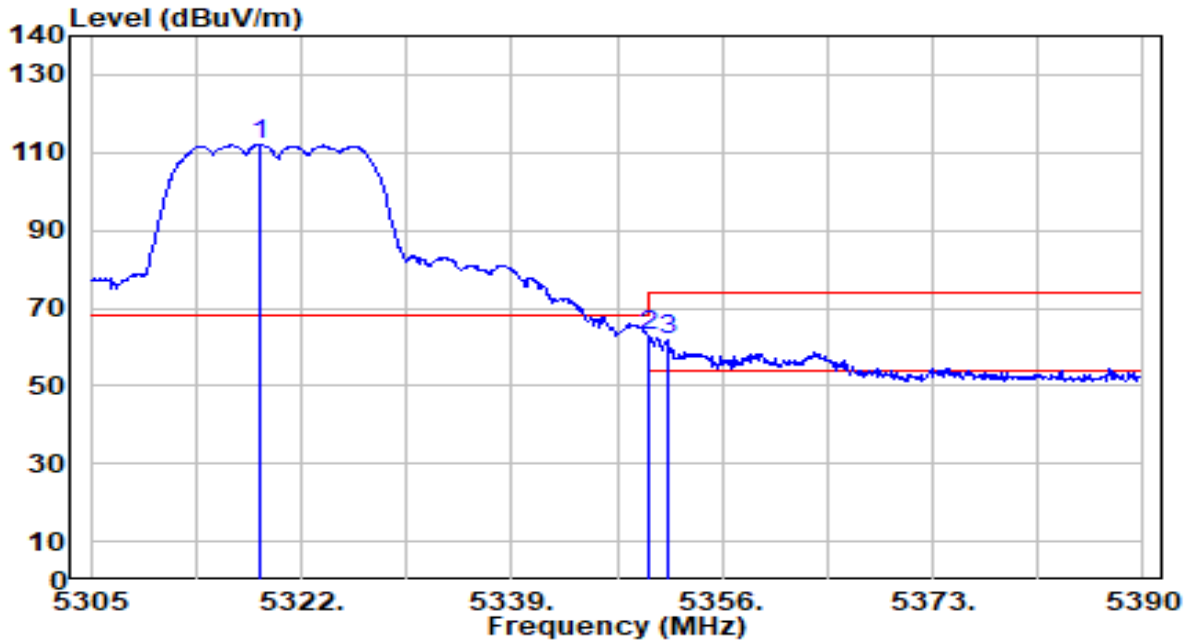

No	Frequency (MHz)	Reading (dBUV)	C.F (dB/m)	Measurement (dBUV/m)	Margin (dB)	Limit (dBUV/m)	Height (cm)	Angle (deg)	Remark (QP/PK/AV)
1	5318.600	112.97	-0.92	112.05	N/A	N/A	302	260	Peak
2	* 5350.000	63.73	-0.98	62.74	-11.26	74.00	302	260	Peak
3	5351.580	62.91	-0.99	61.92	-12.08	74.00	302	260	Peak

Note:

1. " \*", means this data is the worst emission level.
2. C.F (Correction Factor) = Antenna Factor (dB/m) + Cable Loss (dB) – Pre-amplifier(dB) + 10dB Attenuation.
3. Measurement (dBUV/m) = Reading(dBUV) + C.F (Correction Factor).
4. The emission levels of other frequencies are very lower than the limit and not show in test report.



EUT	AX3000 High Gain Wireless USB Adapter	Date of Test	2023-01-19
Factor	DRH18-E	Temp. / Humidity	20°C /62%
Polarity	Vertical	Site / Test Engineer	AC2 / Ares
Test Mode	802.11a_TX_Band2_CH 64_ANT 1+2	Test Voltage	By Notebook PC

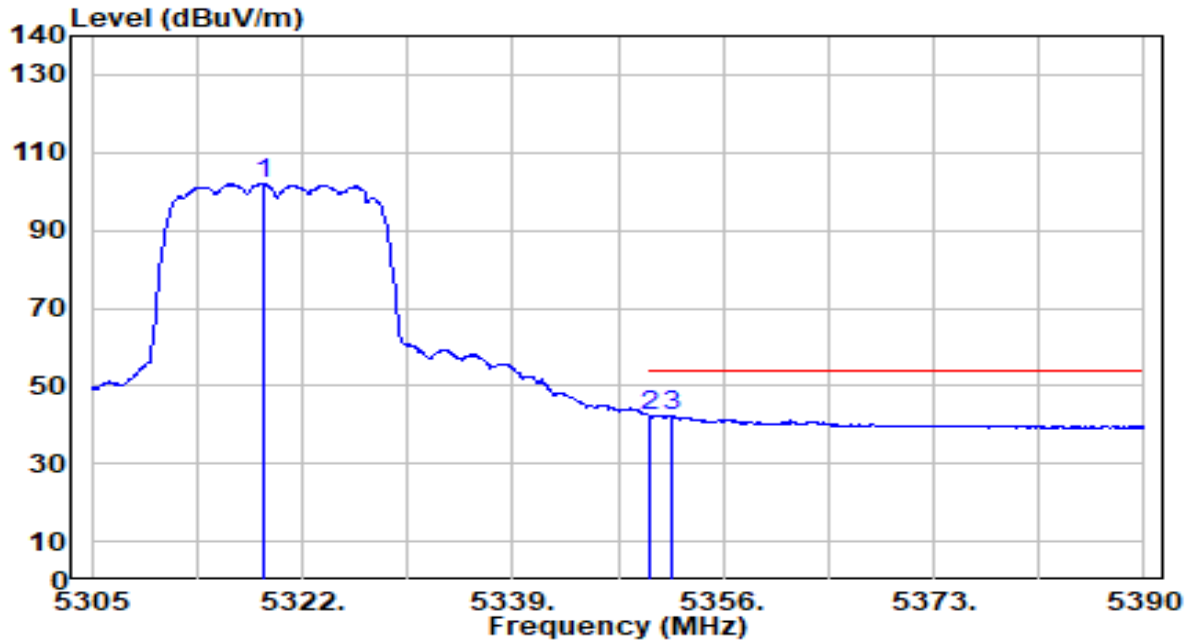

No	Frequency (MHz)	Reading (dBUV)	C.F (dB/m)	Measurement (dBUV/m)	Margin (dB)	Limit (dBUV/m)	Height (cm)	Angle (deg)	Remark (QP/PK/AV)
1	5318.855	103.00	-0.92	102.08	N/A	N/A	302	260	Average
2	* 5350.000	43.42	-0.98	42.44	-11.56	54.00	302	260	Average
3	5351.920	43.21	-0.99	42.22	-11.78	54.00	302	260	Average

Note:

1. " \*", means this data is the worst emission level.
2. C.F (Correction Factor) = Antenna Factor (dB/m) + Cable Loss (dB) – Pre-amplifier(dB) + 10dB Attenuation.
3. Measurement (dBUV/m) = Reading(dBUV) + C.F (Correction Factor).
4. The emission levels of other frequencies are very lower than the limit and not show in test report.

EUT	AX3000 High Gain Wireless USB Adapter	Date of Test	2023-01-19
Factor	DRH18-E	Temp. / Humidity	20°C /62%
Polarity	Horizontal	Site / Test Engineer	AC2 / Ares
Test Mode	802.11a_TX_Band3_CH 100_ANT 1+2	Test Voltage	By Notebook PC

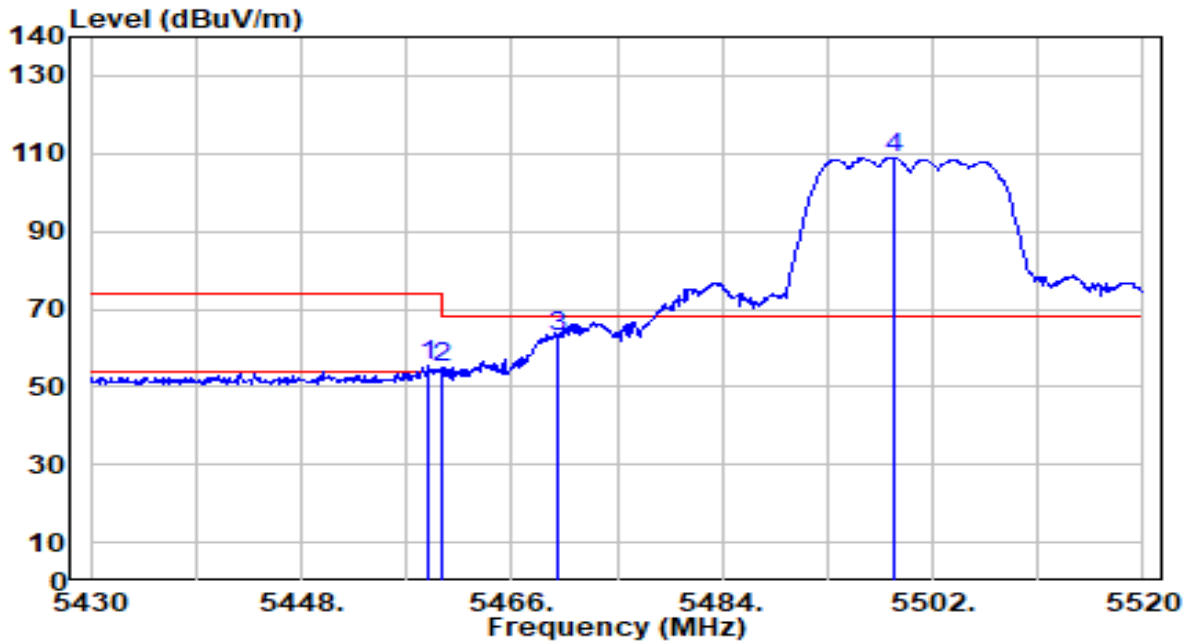

No	Frequency (MHz)	Reading (dBUV)	C.F (dB/m)	Measurement (dBUV/m)	Margin (dB)	Limit (dBUV/m)	Height (cm)	Angle (deg)	Remark (QP/PK/AV)
1	5458.890	56.41	-0.85	55.56	-18.44	74.00	197	173	Peak
2	5460.000	55.57	-0.85	54.72	-19.28	74.00	197	173	Peak
3	* 5470.000	63.89	-0.81	63.08	-5.12	68.20	197	173	Peak
4	5498.670	109.76	-0.70	109.07	N/A	N/A	197	173	Peak

Note:

1. " \*", means this data is the worst emission level.
2. C.F (Correction Factor) = Antenna Factor (dB/m) + Cable Loss (dB) – Preamplifier(dB) + 10dB Attenuation.
3. Measurement (dBUV/m) = Reading(dBUV) + C.F (Correction Factor).
4. The emission levels of other frequencies are very lower than the limit and not show in test report.

EUT	AX3000 High Gain Wireless USB Adapter	Date of Test	2023-01-19
Factor	DRH18-E	Temp. / Humidity	20°C /62%
Polarity	Horizontal	Site / Test Engineer	AC2 / Ares
Test Mode	802.11a_TX_Band3_CH 100_ANT 1+2	Test Voltage	By Notebook PC

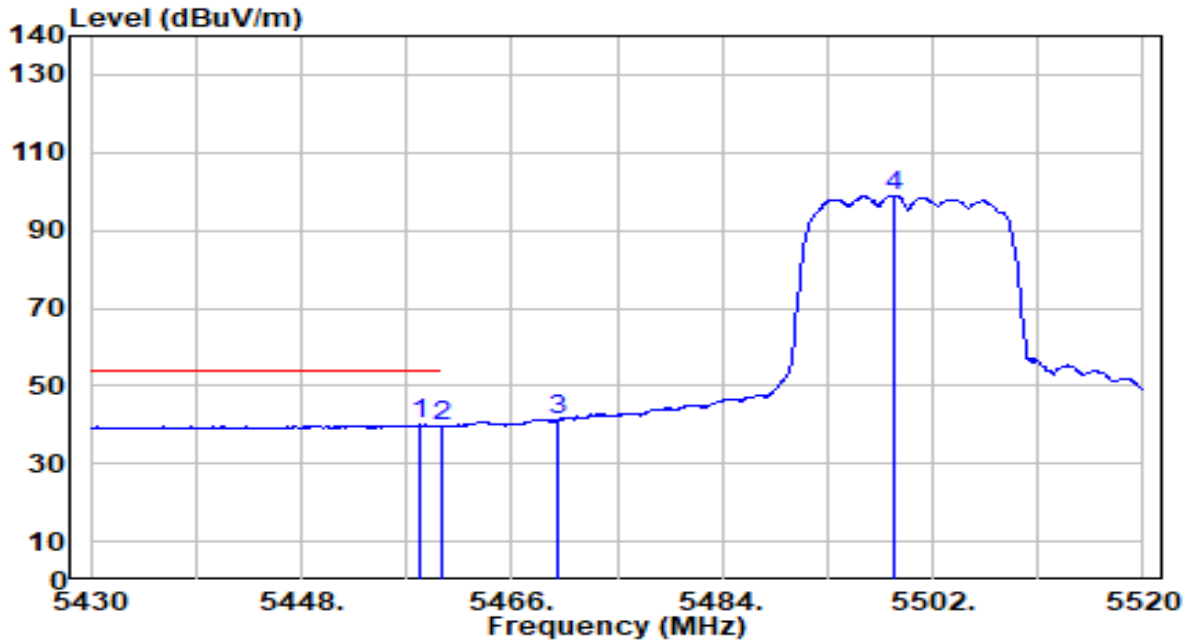

No	Frequency (MHz)	Reading (dBUV)	C.F (dB/m)	Measurement (dBUV/m)	Margin (dB)	Limit (dBUV/m)	Height (cm)	Angle (deg)	Remark (QP/PK/AV)
1	* 5458.260	40.84	-0.86	39.98	-14.02	54.00	197	173	Average
2	5460.000	40.43	-0.85	39.59	-14.41	54.00	197	173	Average
3	5470.000	41.90	-0.81	41.09	N/A	N/A	197	173	Average
4	5498.760	99.52	-0.69	98.82	N/A	N/A	197	173	Average

Note:

1. " \*", means this data is the worst emission level.
2. C.F (Correction Factor) = Antenna Factor (dB/m) + Cable Loss (dB) – Preamplifier(dB) + 10dB Attenuation.
3. Measurement (dBUV/m) = Reading(dBUV) + C.F (Correction Factor).
4. The emission levels of other frequencies are very lower than the limit and not show in test report.

EUT	AX3000 High Gain Wireless USB Adapter	Date of Test	2023-01-19
Factor	DRH18-E	Temp. / Humidity	20°C /62%
Polarity	Vertical	Site / Test Engineer	AC2 / Ares
Test Mode	802.11a_TX_Band3_CH 100_ANT 1+2	Test Voltage	By Notebook PC

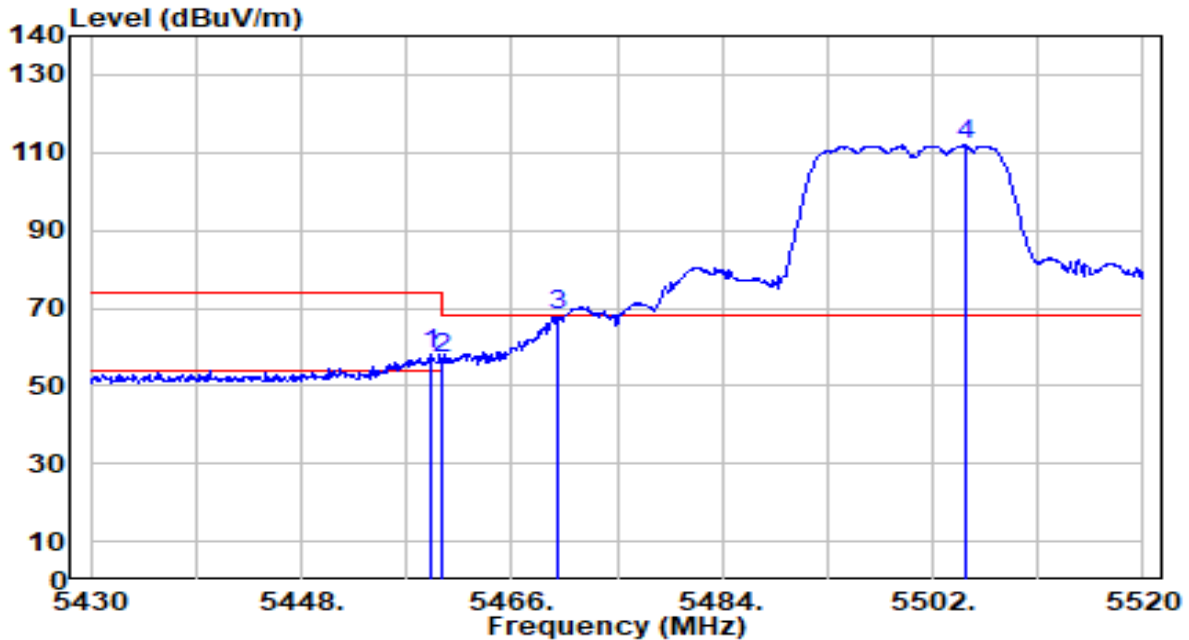

No	Frequency (MHz)	Reading (dBUV)	C.F (dB/m)	Measurement (dBUV/m)	Margin (dB)	Limit (dBUV/m)	Height (cm)	Angle (deg)	Remark (QP/PK/AV)
1	5458.980	58.81	-0.85	57.96	-16.04	74.00	281	259	Peak
2	5460.000	58.09	-0.85	57.24	-16.76	74.00	281	259	Peak
3	* 5470.000	68.88	-0.81	68.07	-0.13	68.20	281	259	Peak
4	5504.790	112.51	-0.67	111.84	N/A	N/A	281	259	Peak

Note:

1. " \*", means this data is the worst emission level.
2. C.F (Correction Factor) = Antenna Factor (dB/m) + Cable Loss (dB) – Preamplifier(dB) + 10dB Attenuation.
3. Measurement (dBUV/m) = Reading(dBUV) + C.F (Correction Factor).
4. The emission levels of other frequencies are very lower than the limit and not show in test report.

EUT	AX3000 High Gain Wireless USB Adapter	Date of Test	2023-01-19
Factor	DRH18-E	Temp. / Humidity	20°C /62%
Polarity	Vertical	Site / Test Engineer	AC2 / Ares
Test Mode	802.11a_TX_Band3_CH 100_ANT 1+2	Test Voltage	By Notebook PC

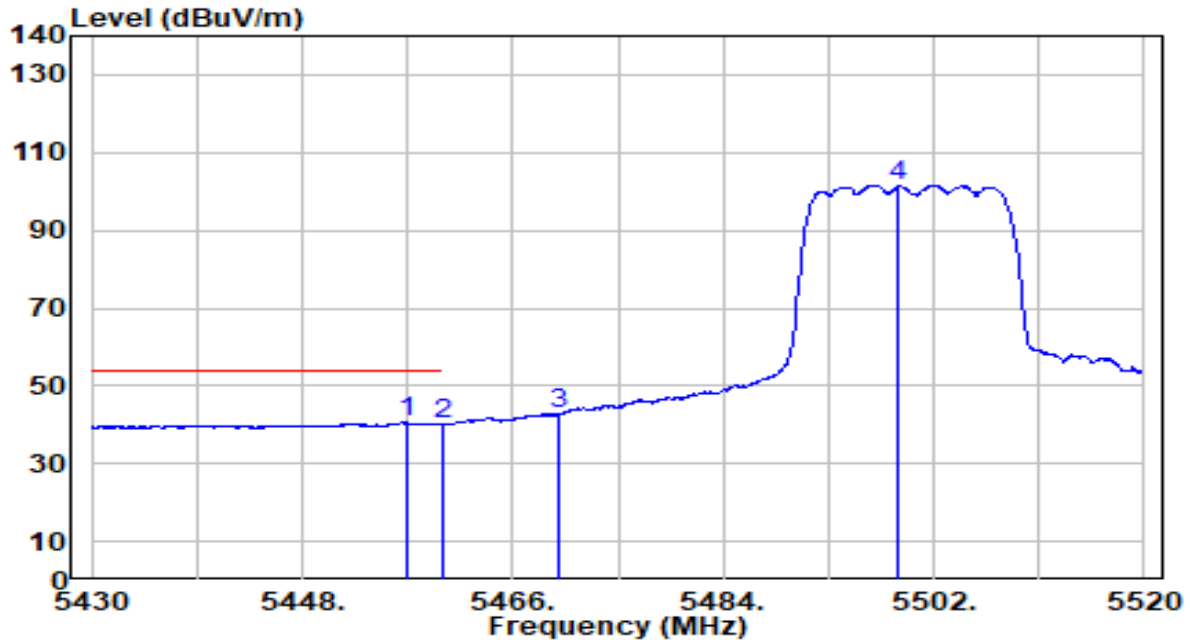

No	Frequency (MHz)	Reading (dBUV)	C.F (dB/m)	Measurement (dBUV/m)	Margin (dB)	Limit (dBUV/m)	Height (cm)	Angle (deg)	Remark (QP/PK/AV)
1	* 5457.000	41.44	-0.86	40.58	-13.42	54.00	281	259	Average
2	5460.000	40.77	-0.85	39.93	-14.07	54.00	281	259	Average
3	5470.000	43.50	-0.81	42.69	N/A	N/A	281	259	Average
4	5499.030	102.15	-0.69	101.45	N/A	N/A	281	259	Average

Note:

1. " \*", means this data is the worst emission level.
2. C.F (Correction Factor) = Antenna Factor (dB/m) + Cable Loss (dB) – Preamplifier(dB) + 10dB Attenuation.
3. Measurement (dBUV/m) = Reading(dBUV) + C.F (Correction Factor).
4. The emission levels of other frequencies are very lower than the limit and not show in test report.

EUT	AX3000 High Gain Wireless USB Adapter	Date of Test	2023-01-19
Factor	DRH18-E	Temp. / Humidity	20°C /62%
Polarity	Horizontal	Site / Test Engineer	AC2 / Ares
Test Mode	802.11a_TX_Band3_CH 140_ANT 1+2	Test Voltage	By Notebook PC

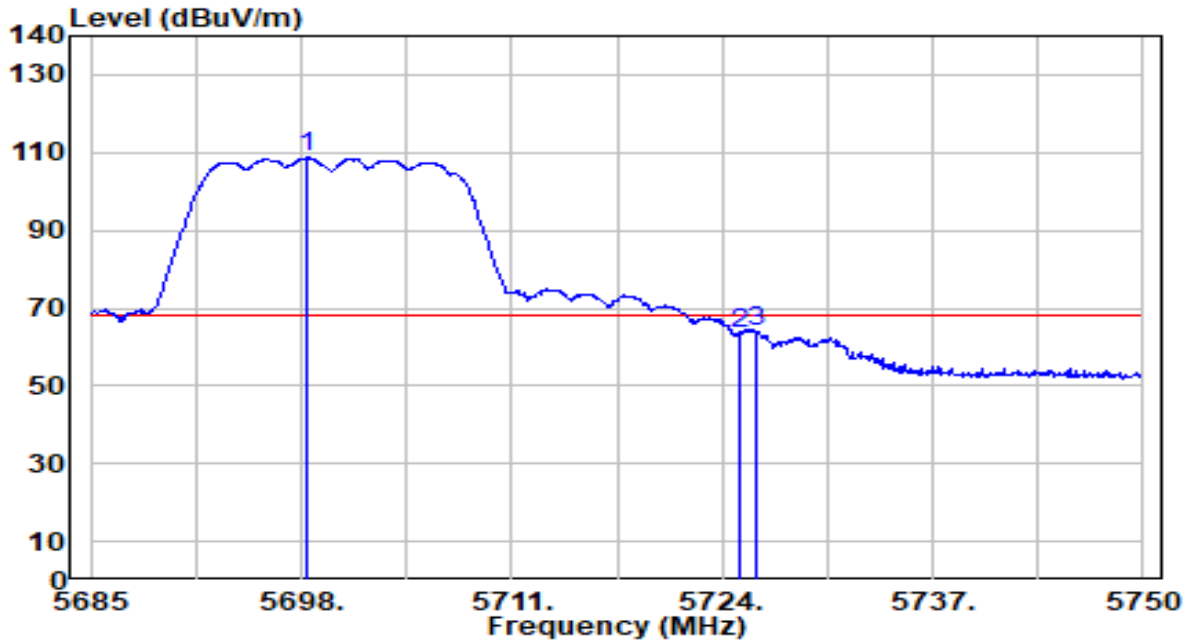

No	Frequency (MHz)	Reading (dBUV)	C.F (dB/m)	Measurement (dBUV/m)	Margin (dB)	Limit (dBUV/m)	Height (cm)	Angle (deg)	Remark (QP/PK/AV)
1	5698.390	108.48	0.11	108.58	N/A	N/A	250	173	Peak
2	5725.000	63.24	0.21	63.44	-4.76	68.20	250	173	Peak
3	* 5726.145	63.84	0.21	64.05	-4.15	68.20	250	173	Peak

Note:

1. " \*", means this data is the worst emission level.
2. C.F (Correction Factor) = Antenna Factor (dB/m) + Cable Loss (dB) – Pre-amplifier(dB) + 10dB Attenuation.
3. Measurement (dBUV/m) = Reading(dBUV) + C.F (Correction Factor).
4. The emission levels of other frequencies are very lower than the limit and not show in test report.

EUT	AX3000 High Gain Wireless USB Adapter	Date of Test	2023-01-19
Factor	DRH18-E	Temp. / Humidity	20°C /62%
Polarity	Vertical	Site / Test Engineer	AC2 / Ares
Test Mode	802.11a_TX_Band3_CH 140_ANT 1+2	Test Voltage	By Notebook PC

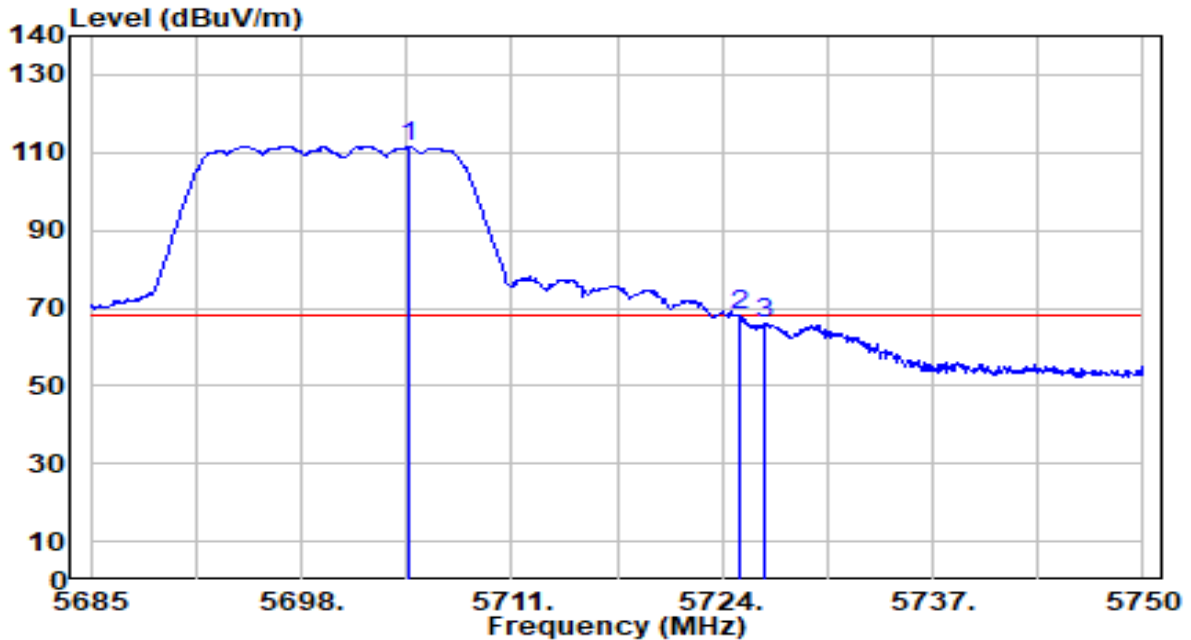

No	Frequency (MHz)	Reading (dBUV)	C.F (dB/m)	Measurement (dBUV/m)	Margin (dB)	Limit (dBUV/m)	Height (cm)	Angle (deg)	Remark (QP/PK/AV)
1	5704.695	111.42	0.13	111.55	N/A	N/A	267	250	Peak
2	* 5725.000	67.97	0.21	68.18	-0.02	68.20	267	250	Peak
3	5726.665	65.98	0.21	66.19	-2.01	68.20	267	250	Peak

Note:

1. " \*", means this data is the worst emission level.
2. C.F (Correction Factor) = Antenna Factor (dB/m) + Cable Loss (dB) – Pre-amplifier(dB) + 10dB Attenuation.
3. Measurement (dBUV/m) = Reading(dBUV) + C.F (Correction Factor).
4. The emission levels of other frequencies are very lower than the limit and not show in test report.

EUT	AX3000 High Gain Wireless USB Adapter	Date of Test	2023-01-19
Factor	DRH18-E	Temp. / Humidity	20°C /62%
Polarity	Horizontal	Site / Test Engineer	AC2 / Ares
Test Mode	802.11a_TX_Band4_CH 149_ANT 1+2	Test Voltage	By Notebook PC

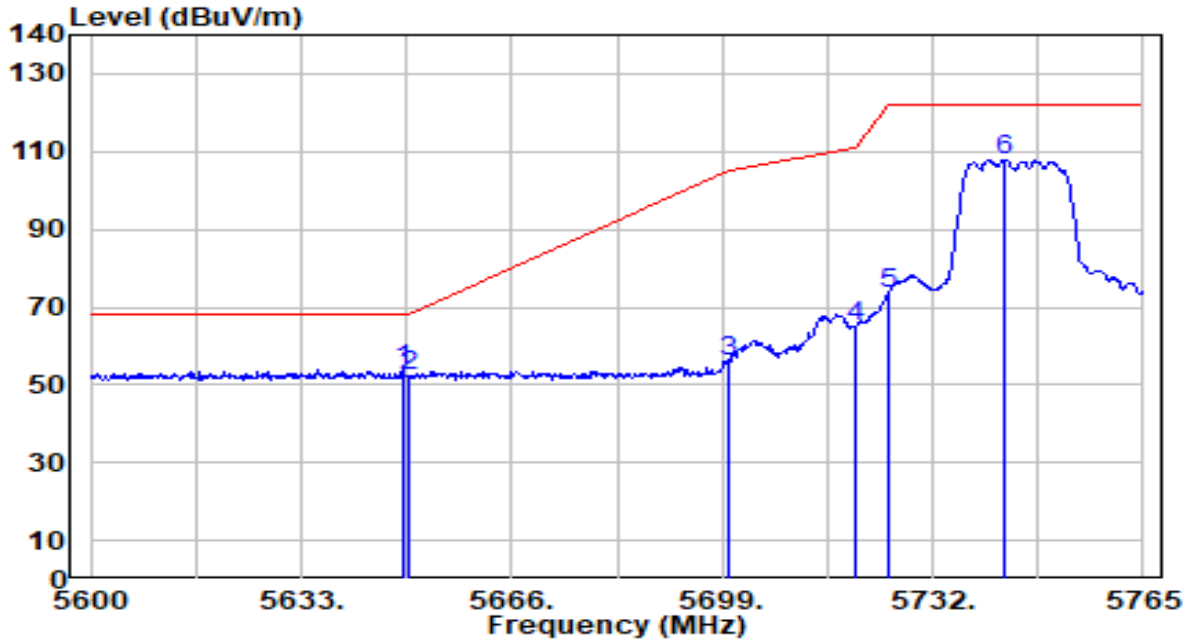

No	Frequency (MHz)	Reading (dBUV)	C.F (dB/m)	Measurement (dBUV/m)	Margin (dB)	Limit (dBUV/m)	Height (cm)	Angle (deg)	Remark (QP/PK/AV)
1	* 5648.840	53.95	-0.08	53.87	-14.33	68.20	266	181	Peak
2	5650.000	52.25	-0.08	52.17	-16.03	68.20	266	181	Peak
3	5700.000	55.86	0.11	55.97	-49.23	105.20	266	181	Peak
4	5720.000	65.00	0.19	65.19	-45.61	110.80	266	181	Peak
5	5725.000	73.43	0.21	73.64	-48.56	122.20	266	181	Peak
6	5743.385	107.68	0.28	107.95	N/A	N/A	266	181	Peak

Note:

1. " \*", means this data is the worst emission level.
2. C.F (Correction Factor) = Antenna Factor (dB/m) + Cable Loss (dB) – Preamplifier(dB) + 10dB Attenuation.
3. Measurement (dBUV/m) = Reading(dBUV) + C.F (Correction Factor).
4. The emission levels of other frequencies are very lower than the limit and not show in test report.



EUT	AX3000 High Gain Wireless USB Adapter	Date of Test	2023-01-19
Factor	DRH18-E	Temp. / Humidity	20°C /62%
Polarity	Vertical	Site / Test Engineer	AC2 / Ares
Test Mode	802.11a_TX_Band4_CH 149_ANT 1+2	Test Voltage	By Notebook PC

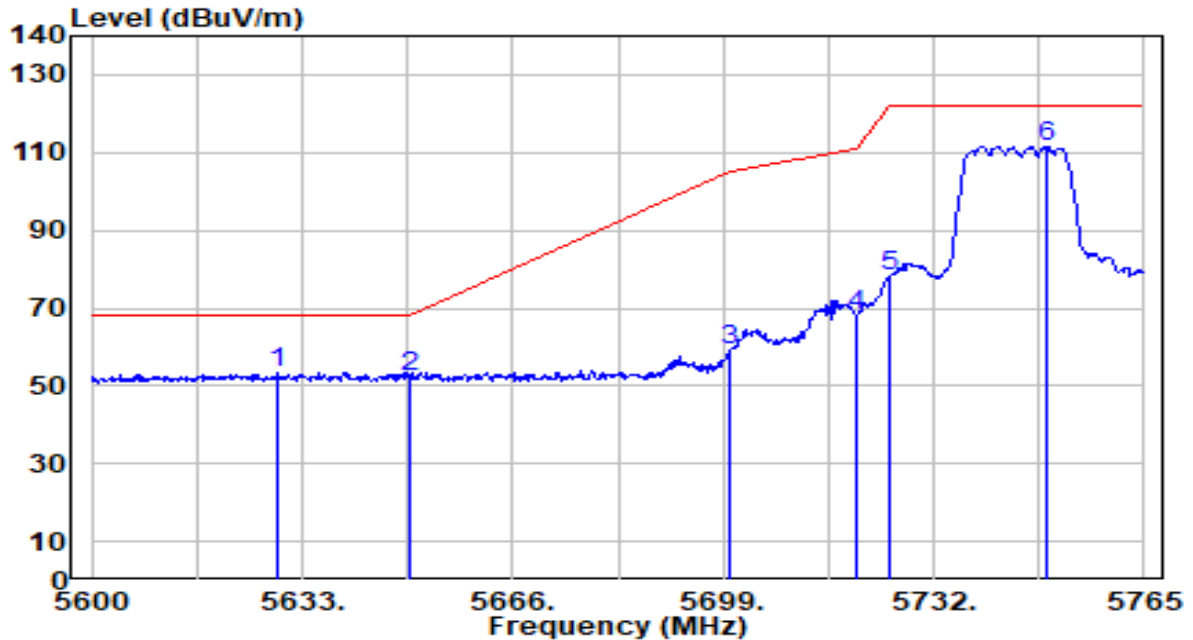

No	Frequency (MHz)	Reading (dBUV)	C.F (dB/m)	Measurement (dBUV/m)	Margin (dB)	Limit (dBUV/m)	Height (cm)	Angle (deg)	Remark (QP/PK/AV)
1	* 5629.040	53.50	-0.15	53.34	-14.86	68.20	263	250	Peak
2	5655.000	52.39	-0.08	52.31	-15.89	68.20	263	250	Peak
3	5700.000	58.86	0.11	58.97	-46.23	105.20	263	250	Peak
4	5720.000	67.80	0.19	67.99	-42.81	110.80	263	250	Peak
5	5725.000	77.96	0.21	78.17	-44.03	122.20	263	250	Peak
6	5749.820	111.29	0.30	111.59	N/A	N/A	263	250	Peak

Note:

1. " \*", means this data is the worst emission level.
2. C.F (Correction Factor) = Antenna Factor (dB/m) + Cable Loss (dB) – Preamplifier(dB) + 10dB Attenuation.
3. Measurement (dBUV/m) = Reading(dBUV) + C.F (Correction Factor).
4. The emission levels of other frequencies are very lower than the limit and not show in test report.

EUT	AX3000 High Gain Wireless USB Adapter	Date of Test	2023-01-19
Factor	DRH18-E	Temp. / Humidity	20°C /62%
Polarity	Horizontal	Site / Test Engineer	AC2 / Ares
Test Mode	802.11a_TX_Band4_CH 165_ANT 1+2	Test Voltage	By Notebook PC

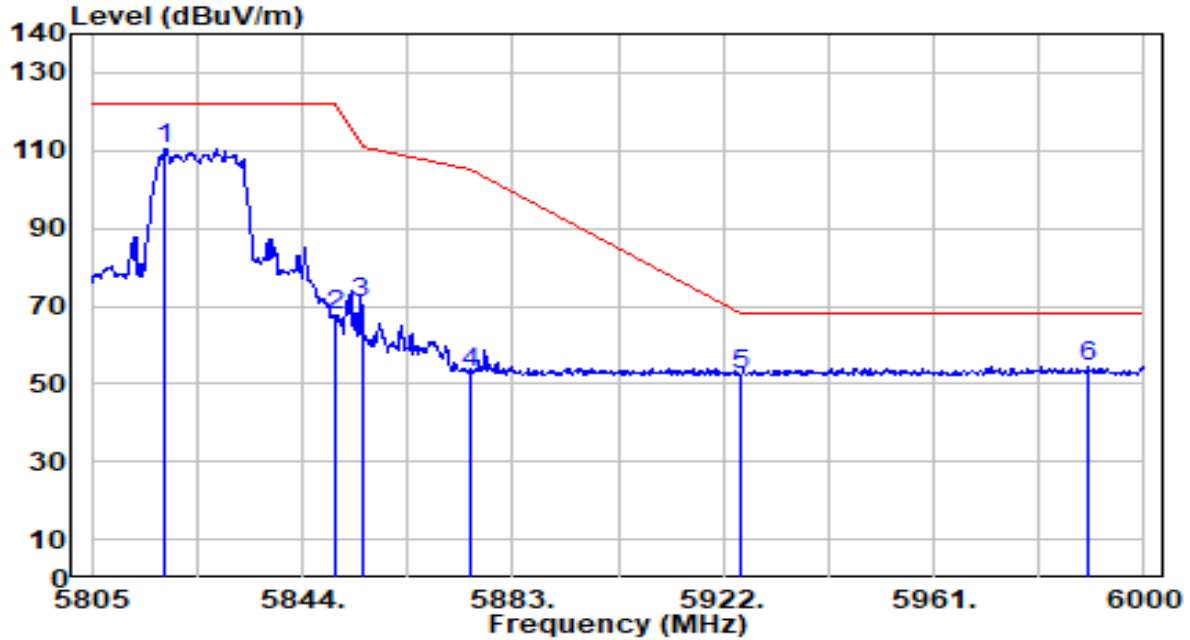

No	Frequency (MHz)	Reading (dBUV)	C.F (dB/m)	Measurement (dBUV/m)	Margin (dB)	Limit (dBUV/m)	Height (cm)	Angle (deg)	Remark (QP/PK/AV)
1	5818.650	109.96	0.51	110.47	N/A	N/A	266	181	Peak
2	5850.000	67.17	0.55	67.73	-54.47	122.20	266	181	Peak
3	5855.000	70.07	0.56	70.63	-40.17	110.80	266	181	Peak
4	5875.000	52.42	0.58	53.00	-52.20	105.20	266	181	Peak
5	5925.000	51.55	0.65	52.19	-16.01	68.20	266	181	Peak
6	* 5989.665	53.89	0.73	54.62	-13.58	68.20	266	181	Peak

Note:

1. " \*", means this data is the worst emission level.
2. C.F (Correction Factor) = Antenna Factor (dB/m) + Cable Loss (dB) – Preamplifier(dB) + 10dB Attenuation.
3. Measurement (dBUV/m) = Reading(dBUV) + C.F (Correction Factor).
4. The emission levels of other frequencies are very lower than the limit and not show in test report.

EUT	AX3000 High Gain Wireless USB Adapter	Date of Test	2023-01-19
Factor	DRH18-E	Temp. / Humidity	20°C /62%
Polarity	Vertical	Site / Test Engineer	AC2 / Ares
Test Mode	802.11a_TX_Band4_CH 165_ANT 1+2	Test Voltage	By Notebook PC

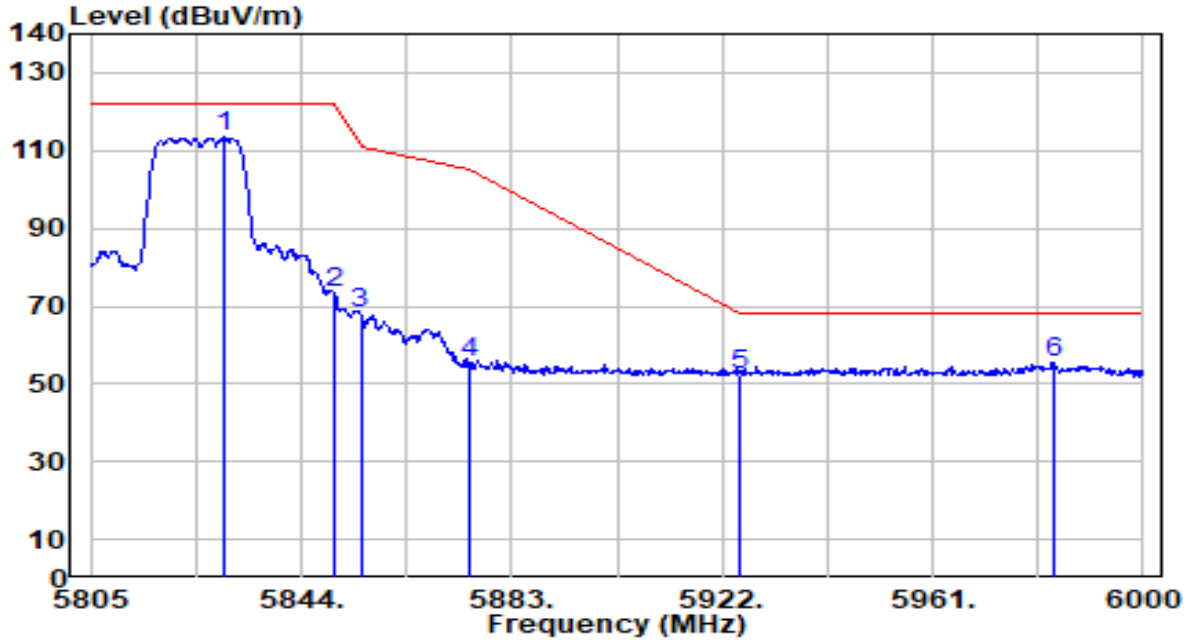

No	Frequency (MHz)	Reading (dBUV)	C.F (dB/m)	Measurement (dBUV/m)	Margin (dB)	Limit (dBUV/m)	Height (cm)	Angle (deg)	Remark (QP/PK/AV)
1	5829.765	112.80	0.53	113.33	N/A	N/A	263	250	Peak
2	5850.000	72.99	0.55	73.54	-48.66	122.20	263	250	Peak
3	5855.000	67.79	0.56	68.35	-42.45	110.80	263	250	Peak
4	5875.000	54.92	0.58	55.50	-49.70	105.20	263	250	Peak
5	5925.000	51.84	0.65	52.49	-15.71	68.20	263	250	Peak
6	* 5983.620	54.58	0.72	55.30	-12.90	68.20	263	250	Peak

Note:

1. " \*", means this data is the worst emission level.
2. C.F (Correction Factor) = Antenna Factor (dB/m) + Cable Loss (dB) – Preamplifier(dB) + 10dB Attenuation.
3. Measurement (dBUV/m) = Reading(dBUV) + C.F (Correction Factor).
4. The emission levels of other frequencies are very lower than the limit and not show in test report.

EUT	AX3000 High Gain Wireless USB Adapter	Date of Test	2023-01-19
Factor	DRH18-E	Temp. / Humidity	20°C /62%

Polarity	Horizontal	Site / Test Engineer	AC2 / Ares
Test Mode	802.11ac-20MHz_TX_Band1_CH 36_ANT 1+2	Test Voltage	By Notebook PC

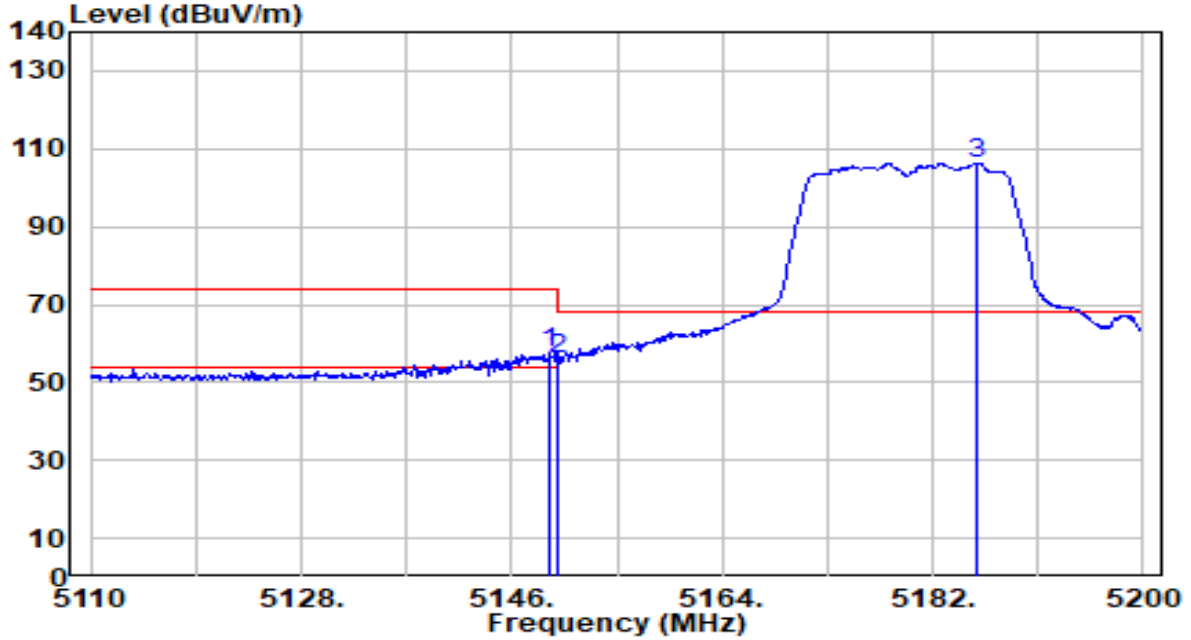

No	Frequency (MHz)	Reading (dBuV)	C.F (dB/m)	Measurement (dBuV/m)	Margin (dB)	Limit (dBuV/m)	Height (cm)	Angle (deg)	Remark (QP/PK/AV)
1	*	58.46	-0.73	57.73	-16.27	74.00	250	183	Peak
2		56.50	-0.73	55.78	-18.22	74.00	250	183	Peak
3		107.14	-0.69	106.45	N/A	N/A	250	183	Peak

Note:

1. " \*", means this data is the worst emission level.
2. C.F (Correction Factor) = Antenna Factor (dB/m) + Cable Loss (dB) – Preamplifier(dB) + 10dB Attenuation.
3. Measurement (dBuV/m) = Reading(dBuV) + C.F (Correction Factor).
4. The emission levels of other frequencies are very lower than the limit and not show in test report.

EUT	AX3000 High Gain Wireless USB Adapter	Date of Test	2023-01-19
Factor	DRH18-E	Temp. / Humidity	20°C /62%
Polarity	Horizontal	Site / Test Engineer	AC2 / Ares
Test Mode	802.11ac-20MHz_TX_Band1_CH 36_ANT 1+2	Test Voltage	By Notebook PC

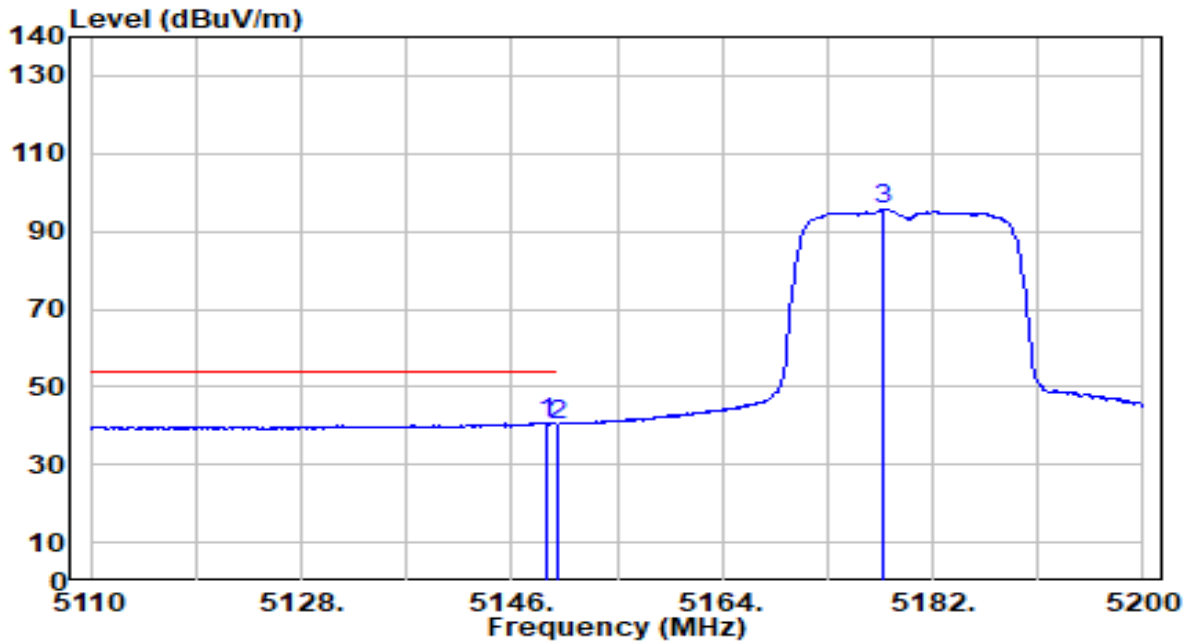

No	Frequency (MHz)	Reading (dBuV)	C.F (dB/m)	Measurement (dBuV/m)	Margin (dB)	Limit (dBuV/m)	Height (cm)	Angle (deg)	Remark (QP/PK/AV)	
1	*	5148.970	41.51	-0.73	40.78	-13.22	54.00	250	183	Average
2		5150.000	41.11	-0.73	40.39	-13.61	54.00	250	183	Average
3		5177.680	96.41	-0.70	95.71	N/A	N/A	250	183	Average

Note:

1. " \*", means this data is the worst emission level.
2. C.F (Correction Factor) = Antenna Factor (dB/m) + Cable Loss (dB) – Preamplifier(dB) + 10dB Attenuation.
3. Measurement (dBuV/m) = Reading(dBuV) + C.F (Correction Factor).
4. The emission levels of other frequencies are very lower than the limit and not show in test report.

EUT	AX3000 High Gain Wireless USB Adapter	Date of Test	2023-01-19
Factor	DRH18-E	Temp. / Humidity	20°C /62%
Polarity	Vertical	Site / Test Engineer	AC2 / Ares
Test Mode	802.11ac-20MHz_TX_Band1_CH 36_ANT 1+2	Test Voltage	By Notebook PC

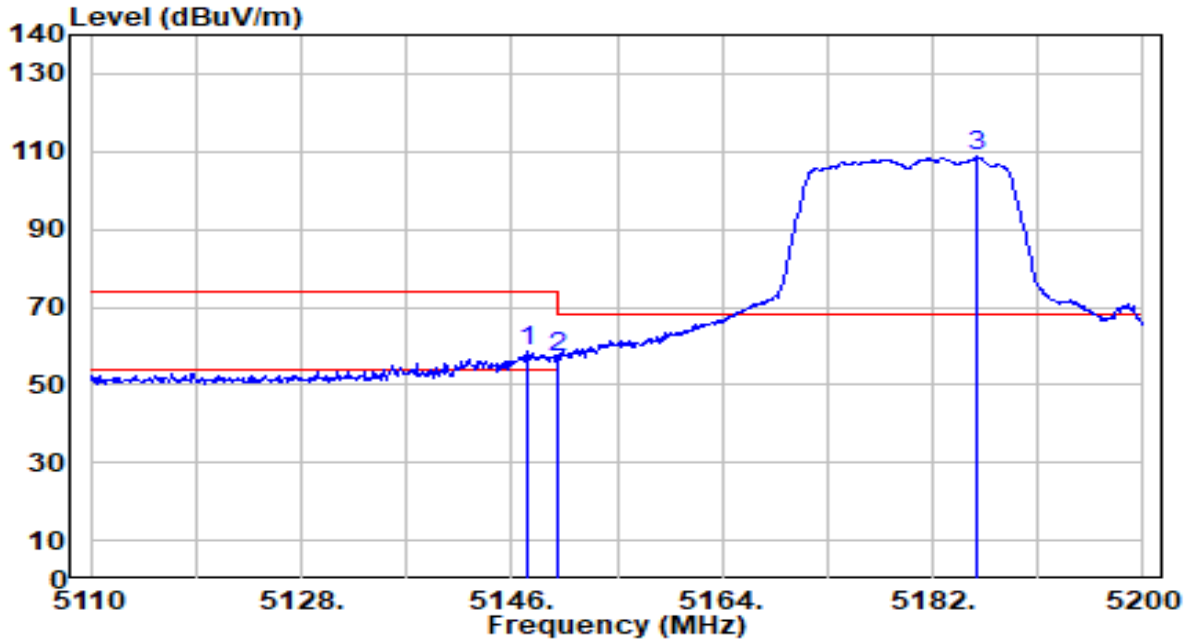

No	Frequency (MHz)	Reading (dBuV)	C.F (dB/m)	Measurement (dBuV/m)	Margin (dB)	Limit (dBuV/m)	Height (cm)	Angle (deg)	Remark (QP/PK/AV)
1	*	59.24	-0.73	58.51	-15.49	74.00	302	260	Peak
2		57.77	-0.73	57.05	-16.95	74.00	302	260	Peak
3		109.31	-0.69	108.62	N/A	N/A	302	260	Peak

Note:

1. " \*", means this data is the worst emission level.
2. C.F (Correction Factor) = Antenna Factor (dB/m) + Cable Loss (dB) – Preamplifier(dB) + 10dB Attenuation.
3. Measurement (dBuV/m) = Reading(dBuV) + C.F (Correction Factor).
4. The emission levels of other frequencies are very lower than the limit and not show in test report.

EUT	AX3000 High Gain Wireless USB Adapter	Date of Test	2023-01-19
Factor	DRH18-E	Temp. / Humidity	20°C /62%
Polarity	Vertical	Site / Test Engineer	AC2 / Ares
Test Mode	802.11ac-20MHz_TX_Band1_CH 36_ANT 1+2	Test Voltage	By Notebook PC

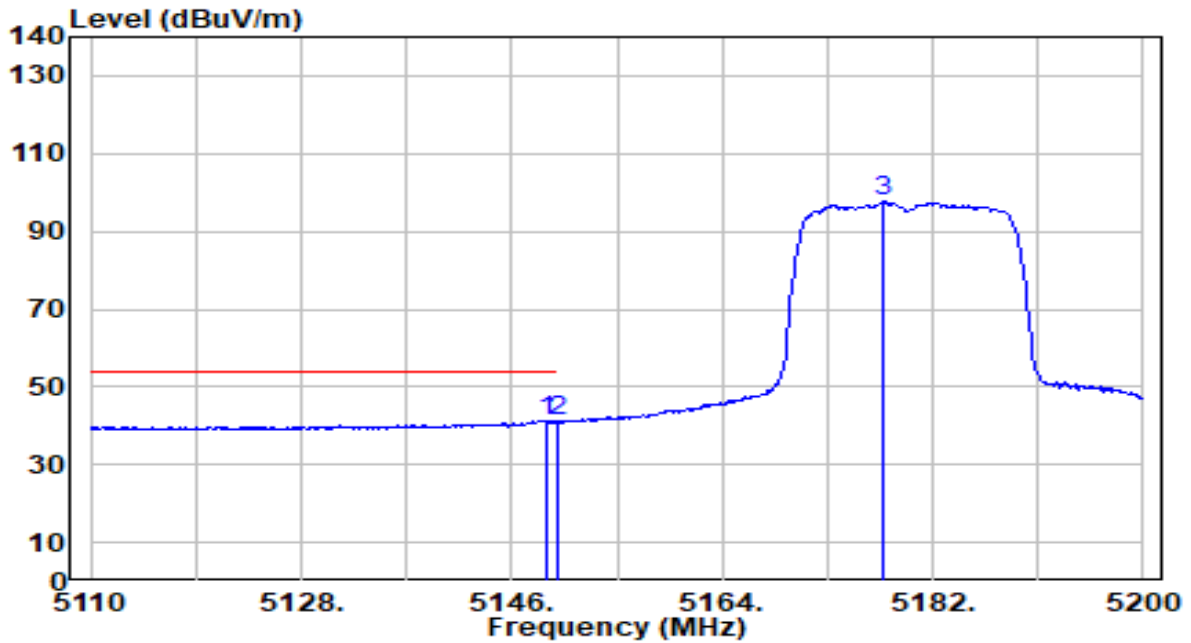

No	Frequency (MHz)	Reading (dBuV)	C.F (dB/m)	Measurement (dBuV/m)	Margin (dB)	Limit (dBuV/m)	Height (cm)	Angle (deg)	Remark (QP/PK/AV)	
1	*	5148.970	41.93	-0.73	41.21	-12.79	54.00	302	260	Average
2		5150.000	41.70	-0.73	40.97	-13.03	54.00	302	260	Average
3		5177.770	98.25	-0.70	97.55	N/A	N/A	302	260	Average

Note:

1. " \*", means this data is the worst emission level.
2. C.F (Correction Factor) = Antenna Factor (dB/m) + Cable Loss (dB) – Preamplifier(dB) + 10dB Attenuation.
3. Measurement (dBuV/m) = Reading(dBuV) + C.F (Correction Factor).
4. The emission levels of other frequencies are very lower than the limit and not show in test report.

EUT	AX3000 High Gain Wireless USB Adapter	Date of Test	2023-01-19
Factor	DRH18-E	Temp. / Humidity	20°C /62%
Polarity	Horizontal	Site / Test Engineer	AC2 / Ares
Test Mode	802.11ac-20MHz_TX_Band2_CH 64_ANT 1+2	Test Voltage	By Notebook PC

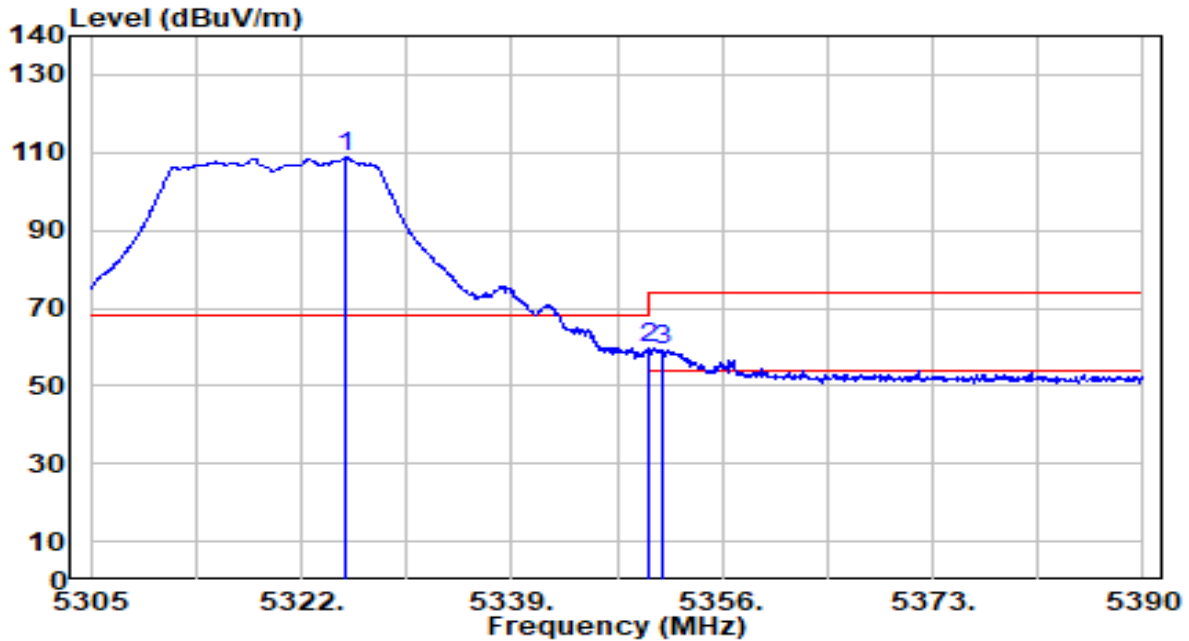

No	Frequency (MHz)	Reading (dBUV)	C.F (dB/m)	Measurement (dBUV/m)	Margin (dB)	Limit (dBUV/m)	Height (cm)	Angle (deg)	Remark (QP/PK/AV)
1	5325.570	109.57	-0.93	108.63	N/A	N/A	250	183	Peak
2	* 5350.000	60.57	-0.98	59.59	-14.41	74.00	250	183	Peak
3	5351.155	60.10	-0.99	59.11	-14.89	74.00	250	183	Peak

Note:

1. " \*", means this data is the worst emission level.
2. C.F (Correction Factor) = Antenna Factor (dB/m) + Cable Loss (dB) – Pre-amplifier(dB) + 10dB Attenuation.
3. Measurement (dBUV/m) = Reading(dBUV) + C.F (Correction Factor).
4. The emission levels of other frequencies are very lower than the limit and not show in test report.



EUT	AX3000 High Gain Wireless USB Adapter	Date of Test	2023-01-19
Factor	DRH18-E	Temp. / Humidity	20°C /62%
Polarity	Horizontal	Site / Test Engineer	AC2 / Ares
Test Mode	802.11ac-20MHz_TX_Band2_CH 64_ANT 1+2	Test Voltage	By Notebook PC

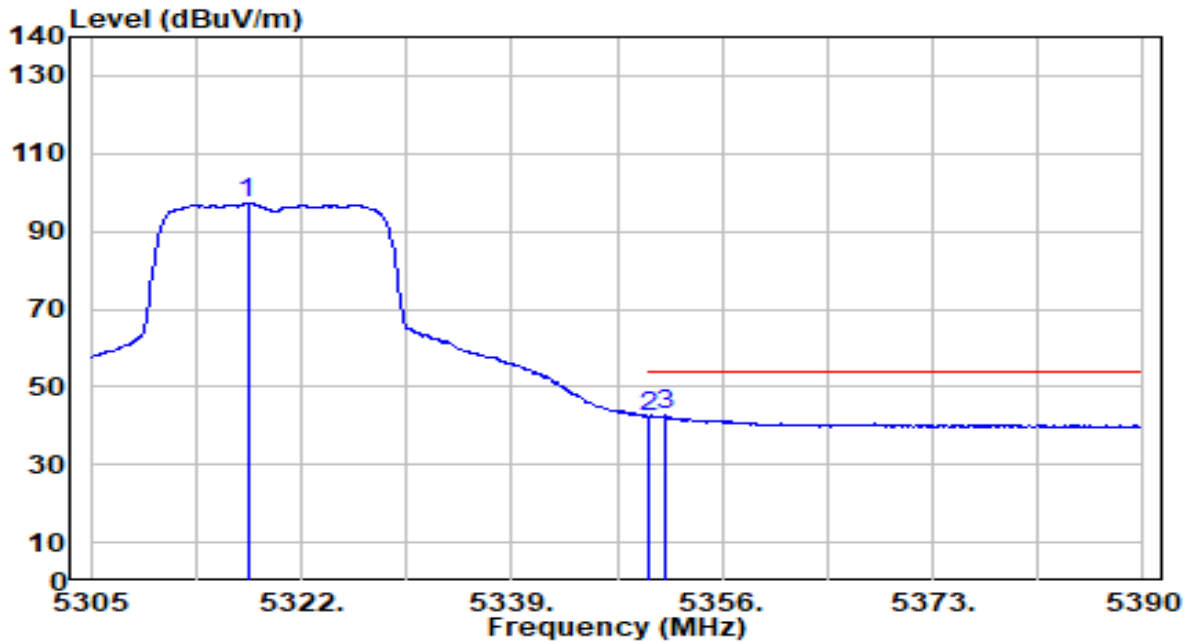

No	Frequency (MHz)	Reading (dBuV)	C.F (dB/m)	Measurement (dBuV/m)	Margin (dB)	Limit (dBuV/m)	Height (cm)	Angle (deg)	Remark (QP/PK/AV)
1	5317.665	98.20	-0.92	97.28	N/A	N/A	250	183	Average
2	5350.000	43.37	-0.98	42.38	-11.62	54.00	250	183	Average
3	* 5351.495	43.55	-0.99	42.56	-11.44	54.00	250	183	Average

Note:

1. " \*", means this data is the worst emission level.
2. C.F (Correction Factor) = Antenna Factor (dB/m) + Cable Loss (dB) – Pre-amplifier(dB) + 10dB Attenuation.
3. Measurement (dBuV/m) = Reading(dBuV) + C.F (Correction Factor).
4. The emission levels of other frequencies are very lower than the limit and not show in test report.

EUT	AX3000 High Gain Wireless USB Adapter	Date of Test	2023-01-19
Factor	DRH18-E	Temp. / Humidity	20°C /62%
Polarity	Vertical	Site / Test Engineer	AC2 / Ares
Test Mode	802.11ac-20MHz_TX_Band2_CH 64_ANT 1+2	Test Voltage	By Notebook PC

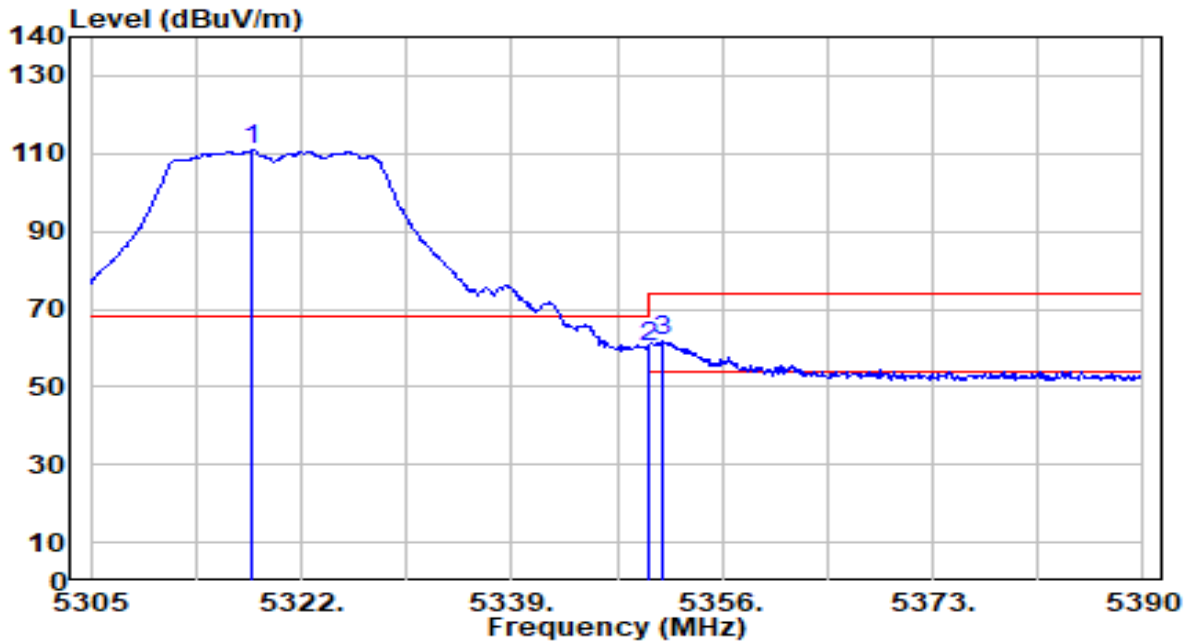

No	Frequency (MHz)	Reading (dBuV)	C.F (dB/m)	Measurement (dBuV/m)	Margin (dB)	Limit (dBuV/m)	Height (cm)	Angle (deg)	Remark (QP/PK/AV)
1	5318.090	111.82	-0.92	110.90	N/A	N/A	302	254	Peak
2	5350.000	61.41	-0.98	60.43	-13.57	74.00	302	254	Peak
3	* 5351.240	62.97	-0.99	61.99	-12.01	74.00	302	254	Peak

Note:

1. " \*", means this data is the worst emission level.
2. C.F (Correction Factor) = Antenna Factor (dB/m) + Cable Loss (dB) – Preamplifier(dB) + 10dB Attenuation.
3. Measurement (dBuV/m) = Reading(dBuV) + C.F (Correction Factor).
4. The emission levels of other frequencies are very lower than the limit and not show in test report.

EUT	AX3000 High Gain Wireless USB Adapter	Date of Test	2023-01-19
Factor	DRH18-E	Temp. / Humidity	20°C /62%
Polarity	Vertical	Site / Test Engineer	AC2 / Ares
Test Mode	802.11ac-20MHz_TX_Band2_CH 64_ANT 1+2	Test Voltage	By Notebook PC

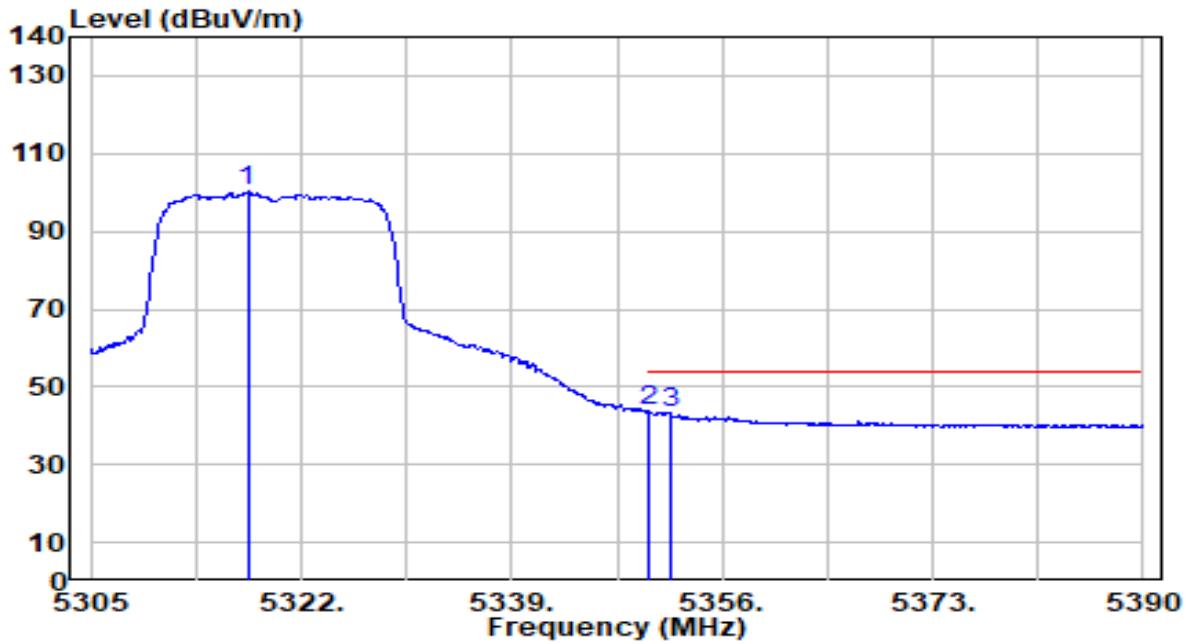

No	Frequency (MHz)	Reading (dBuV)	C.F (dB/m)	Measurement (dBuV/m)	Margin (dB)	Limit (dBuV/m)	Height (cm)	Angle (deg)	Remark (QP/PK/AV)
1	5317.665	101.14	-0.92	100.23	N/A	N/A	302	254	Average
2	* 5350.000	44.74	-0.98	43.76	-10.24	54.00	302	254	Average
3	5351.750	44.56	-0.99	43.57	-10.43	54.00	302	254	Average

Note:

1. " \*", means this data is the worst emission level.
2. C.F (Correction Factor) = Antenna Factor (dB/m) + Cable Loss (dB) – Preamplifier(dB) + 10dB Attenuation.
3. Measurement (dBuV/m) = Reading(dBuV) + C.F (Correction Factor).
4. The emission levels of other frequencies are very lower than the limit and not show in test report.

EUT	AX3000 High Gain Wireless USB Adapter	Date of Test	2023-01-19
Factor	DRH18-E	Temp. / Humidity	20°C /62%
Polarity	Horizontal	Site / Test Engineer	AC2 / Ares
Test Mode	802.11ac-20MHz_TX_Band3_CH 100_ANT 1+2	Test Voltage	By Notebook PC

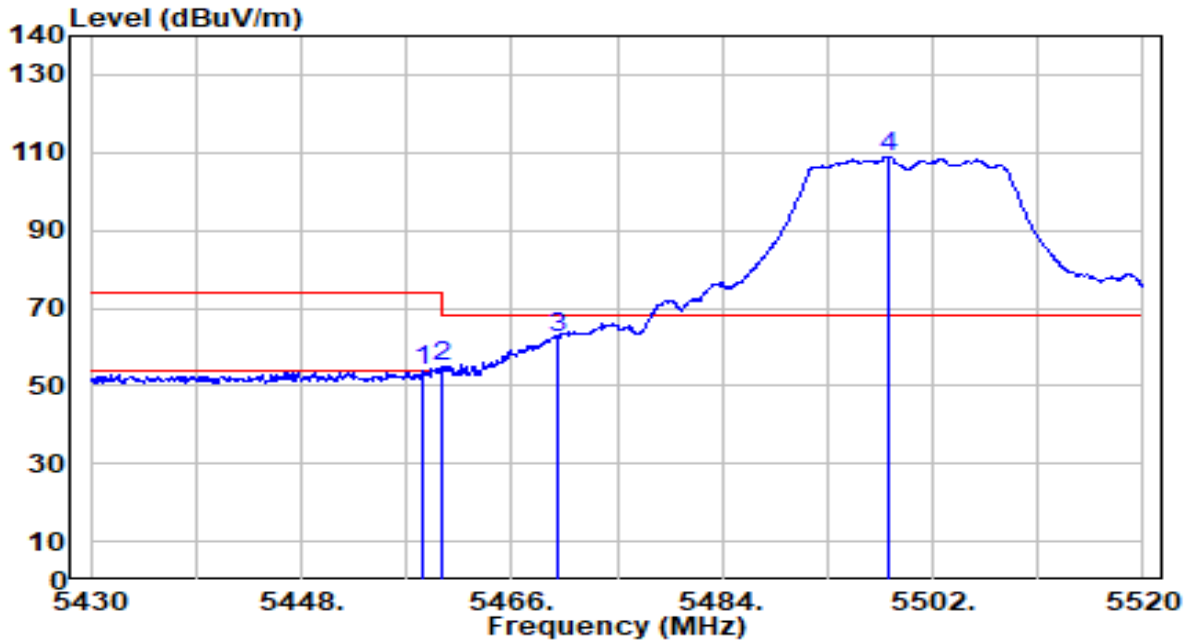

No	Frequency (MHz)	Reading (dBUV)	C.F (dB/m)	Measurement (dBUV/m)	Margin (dB)	Limit (dBUV/m)	Height (cm)	Angle (deg)	Remark (QP/PK/AV)
1	5458.350	54.75	-0.85	53.89	-20.11	74.00	198	178	Peak
2	5460.000	55.72	-0.85	54.87	-19.13	74.00	198	178	Peak
3	* 5470.000	63.19	-0.81	62.38	-5.82	68.20	198	178	Peak
4	5498.220	109.72	-0.70	109.03	N/A	N/A	198	178	Peak

Note:

1. " \*", means this data is the worst emission level.
2. C.F (Correction Factor) = Antenna Factor (dB/m) + Cable Loss (dB) – Preamplifier(dB) + 10dB Attenuation.
3. Measurement (dBUV/m) = Reading(dBUV) + C.F (Correction Factor).
4. The emission levels of other frequencies are very lower than the limit and not show in test report.

EUT	AX3000 High Gain Wireless USB Adapter	Date of Test	2023-01-19
Factor	DRH18-E	Temp. / Humidity	20°C /62%
Polarity	Horizontal	Site / Test Engineer	AC2 / Ares
Test Mode	802.11ac-20MHz_TX_Band3_CH 100_ANT 1+2	Test Voltage	By Notebook PC

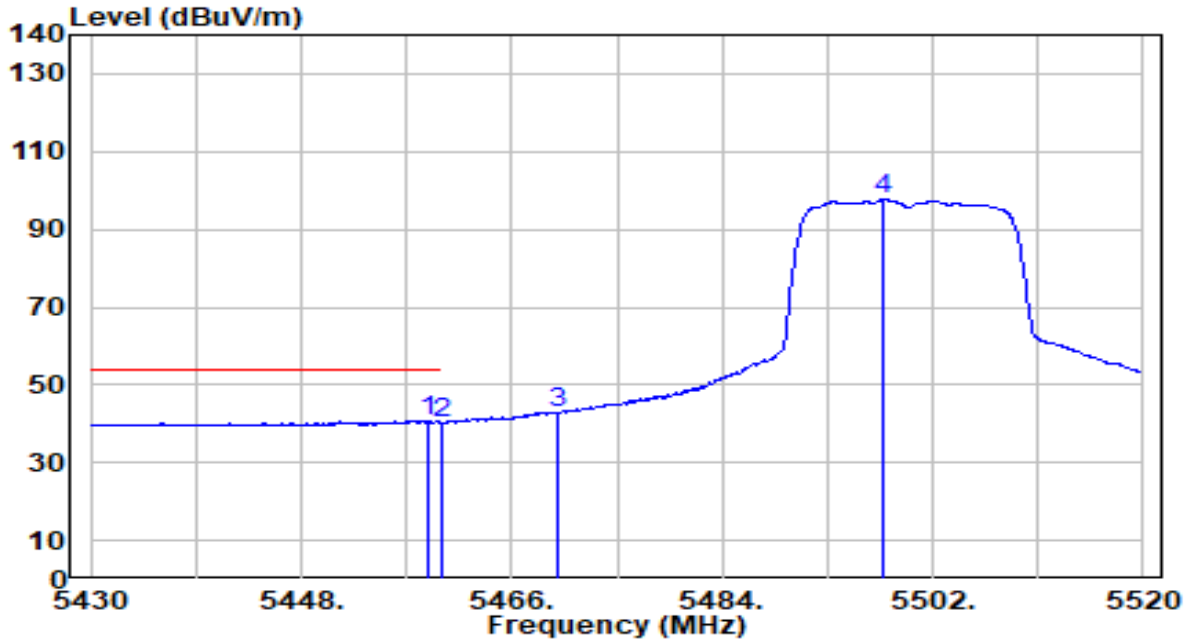

No	Frequency (MHz)	Reading (dBuV)	C.F (dB/m)	Measurement (dBuV/m)	Margin (dB)	Limit (dBuV/m)	Height (cm)	Angle (deg)	Remark (QP/PK/AV)
1	* 5458.890	41.58	-0.85	40.73	-13.27	54.00	198	178	Average
2	5460.000	41.15	-0.85	40.30	-13.70	54.00	198	178	Average
3	5470.000	43.63	-0.81	42.82	N/A	N/A	198	178	Average
4	5497.770	98.44	-0.70	97.74	N/A	N/A	198	178	Average

Note:

1. " \*", means this data is the worst emission level.
2. C.F (Correction Factor) = Antenna Factor (dB/m) + Cable Loss (dB) – Preamplifier(dB) + 10dB Attenuation.
3. Measurement (dBuV/m) = Reading(dBuV) + C.F (Correction Factor).
4. The emission levels of other frequencies are very lower than the limit and not show in test report.

EUT	AX3000 High Gain Wireless USB Adapter	Date of Test	2023-01-19
Factor	DRH18-E	Temp. / Humidity	20°C /62%
Polarity	Vertical	Site / Test Engineer	AC2 / Ares
Test Mode	802.11ac-20MHz_TX_Band3_CH 100_ANT 1+2	Test Voltage	By Notebook PC

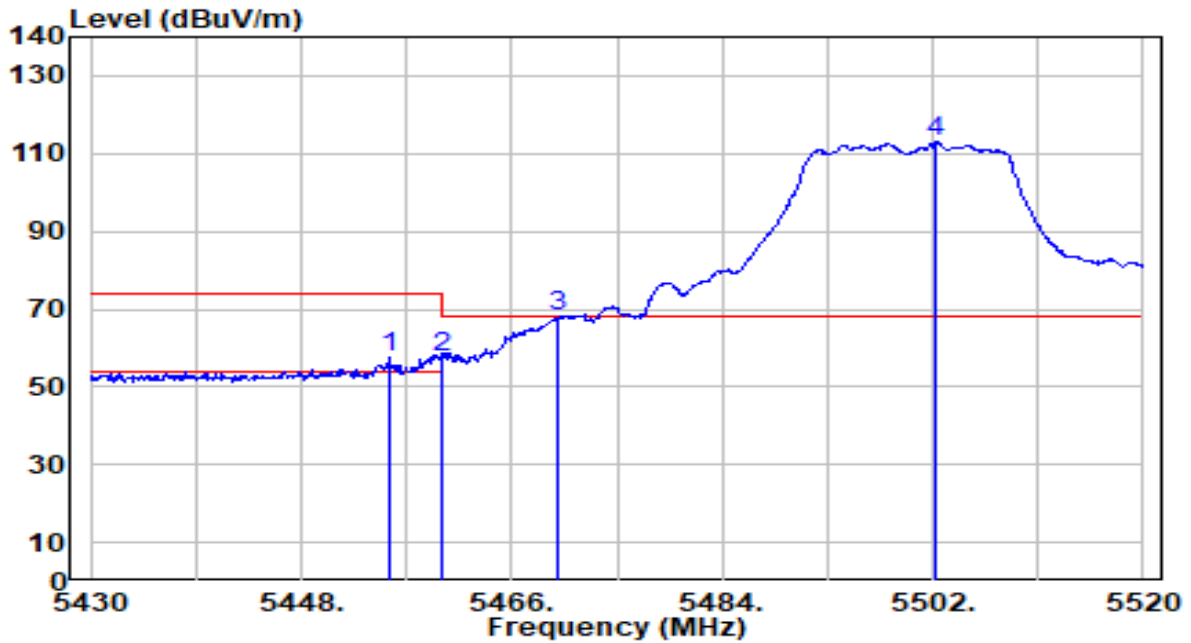

No	Frequency (MHz)	Reading (dBuV)	C.F (dB/m)	Measurement (dBuV/m)	Margin (dB)	Limit (dBuV/m)	Height (cm)	Angle (deg)	Remark (QP/PK/AV)
1	5455.470	58.44	-0.87	57.58	-16.42	74.00	278	252	Peak
2	5460.000	58.42	-0.85	57.57	-16.43	74.00	278	252	Peak
3	* 5470.000	68.90	-0.81	68.09	-0.11	68.20	278	252	Peak
4	5502.180	113.57	-0.68	112.89	N/A	N/A	278	252	Peak

Note:

1. " \*", means this data is the worst emission level.
2. C.F (Correction Factor) = Antenna Factor (dB/m) + Cable Loss (dB) – Pre-amplifier(dB) + 10dB Attenuation.
3. Measurement (dBuV/m) = Reading(dBuV) + C.F (Correction Factor).
4. The emission levels of other frequencies are very lower than the limit and not show in test report.

EUT	AX3000 High Gain Wireless USB Adapter	Date of Test	2023-01-19
Factor	DRH18-E	Temp. / Humidity	20°C /62%
Polarity	Vertical	Site / Test Engineer	AC2 / Ares
Test Mode	802.11ac-20MHz_TX_Band3_CH 100_ANT 1+2	Test Voltage	By Notebook PC

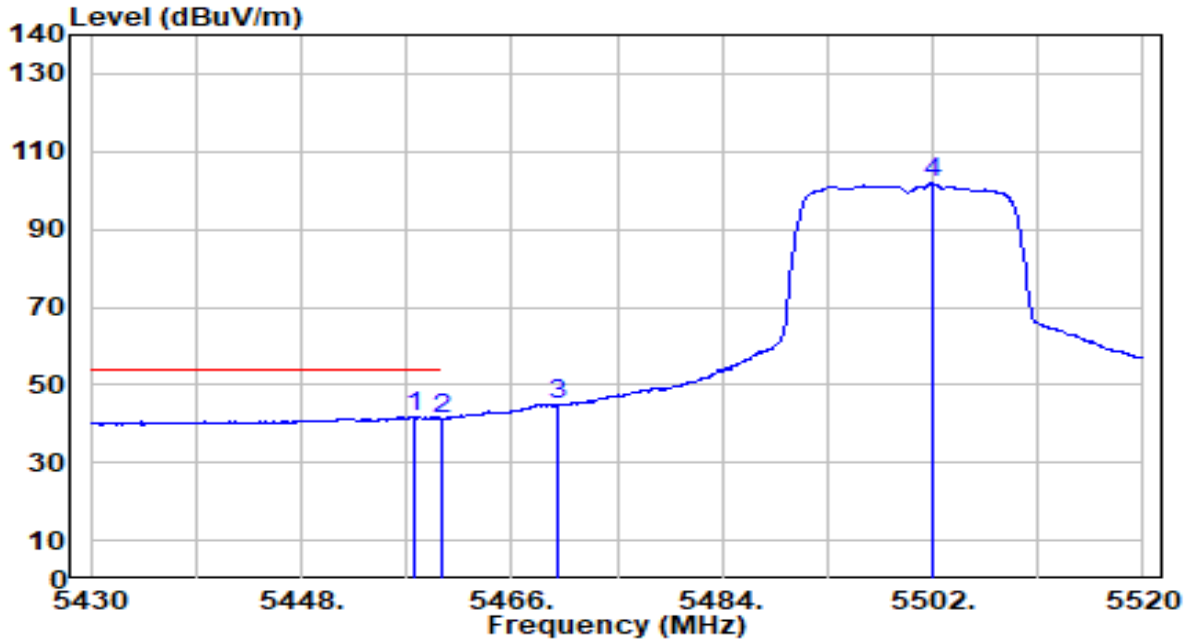

No	Frequency (MHz)	Reading (dBuV)	C.F (dB/m)	Measurement (dBuV/m)	Margin (dB)	Limit (dBuV/m)	Height (cm)	Angle (deg)	Remark (QP/PK/AV)	
1	*	5457.630	42.75	-0.86	41.89	-12.11	54.00	278	252	Average
2		5460.000	42.19	-0.85	41.34	-12.66	54.00	278	252	Average
3		5470.000	45.51	-0.81	44.70	N/A	N/A	278	252	Average
4		5501.910	102.48	-0.68	101.80	N/A	N/A	278	252	Average

Note:

1. " \*", means this data is the worst emission level.
2. C.F (Correction Factor) = Antenna Factor (dB/m) + Cable Loss (dB) – Preamplifier(dB) + 10dB Attenuation.
3. Measurement (dBuV/m) = Reading(dBuV) + C.F (Correction Factor).
4. The emission levels of other frequencies are very lower than the limit and not show in test report.

EUT	AX3000 High Gain Wireless USB Adapter	Date of Test	2023-01-19
Factor	DRH18-E	Temp. / Humidity	20°C /62%
Polarity	Horizontal	Site / Test Engineer	AC2 / Ares
Test Mode	802.11ac-20MHz_TX_Band3_CH 140_ANT 1+2	Test Voltage	By Notebook PC

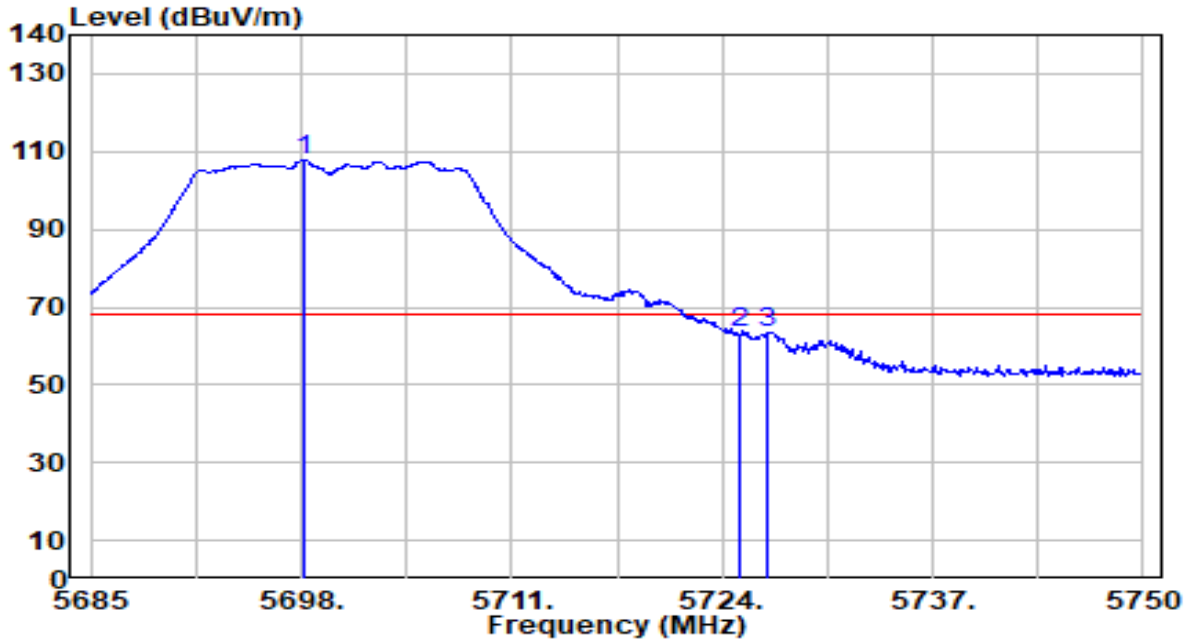

No	Frequency (MHz)	Reading (dBuV)	C.F (dB/m)	Measurement (dBuV/m)	Margin (dB)	Limit (dBuV/m)	Height (cm)	Angle (deg)	Remark (QP/PK/AV)
1	5698.130	107.90	0.10	108.01	N/A	N/A	250	173	Peak
2	5725.000	62.95	0.21	63.16	-5.04	68.20	250	173	Peak
3	* 5726.730	63.37	0.21	63.58	-4.62	68.20	250	173	Peak

Note:

1. " \*", means this data is the worst emission level.
2. C.F (Correction Factor) = Antenna Factor (dB/m) + Cable Loss (dB) – Preamplifier(dB) + 10dB Attenuation.
3. Measurement (dBuV/m) = Reading(dBuV) + C.F (Correction Factor).
4. The emission levels of other frequencies are very lower than the limit and not show in test report.



EUT	AX3000 High Gain Wireless USB Adapter	Date of Test	2023-01-19
Factor	DRH18-E	Temp. / Humidity	20°C /62%
Polarity	Vertical	Site / Test Engineer	AC2 / Ares
Test Mode	802.11ac-20MHz_TX_Band3_CH 140_ANT 1+2	Test Voltage	By Notebook PC

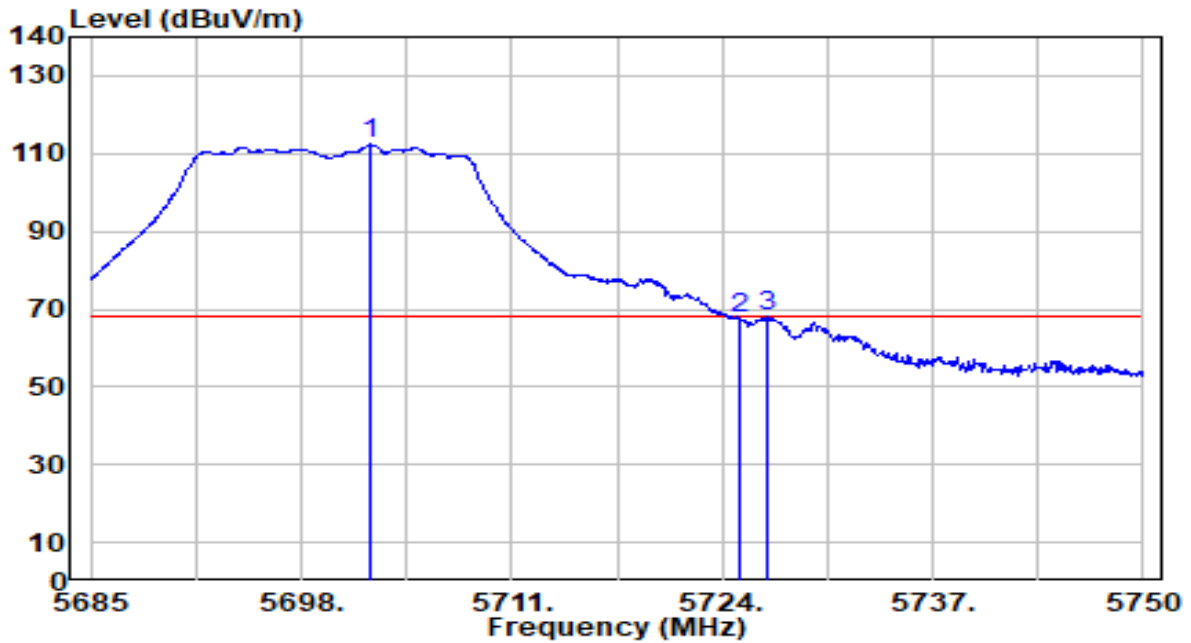

No	Frequency (MHz)	Reading (dBuV)	C.F (dB/m)	Measurement (dBuV/m)	Margin (dB)	Limit (dBuV/m)	Height (cm)	Angle (deg)	Remark (QP/PK/AV)
1	5702.290	112.16	0.12	112.28	N/A	N/A	267	250	Peak
2	5725.000	67.37	0.21	67.57	-0.63	68.20	267	250	Peak
3	* 5726.730	67.80	0.21	68.02	-0.18	68.20	267	250	Peak

Note:

1. " \*", means this data is the worst emission level.
2. C.F (Correction Factor) = Antenna Factor (dB/m) + Cable Loss (dB) – Preamplifier(dB) + 10dB Attenuation.
3. Measurement (dBuV/m) = Reading(dBuV) + C.F (Correction Factor).
4. The emission levels of other frequencies are very lower than the limit and not show in test report.

EUT	AX3000 High Gain Wireless USB Adapter	Date of Test	2023-01-19
Factor	DRH18-E	Temp. / Humidity	20°C /62%
Polarity	Horizontal	Site / Test Engineer	AC2 / Ares
Test Mode	802.11ac-20MHz_TX_Band4_CH 149_ANT 1+2	Test Voltage	By Notebook PC

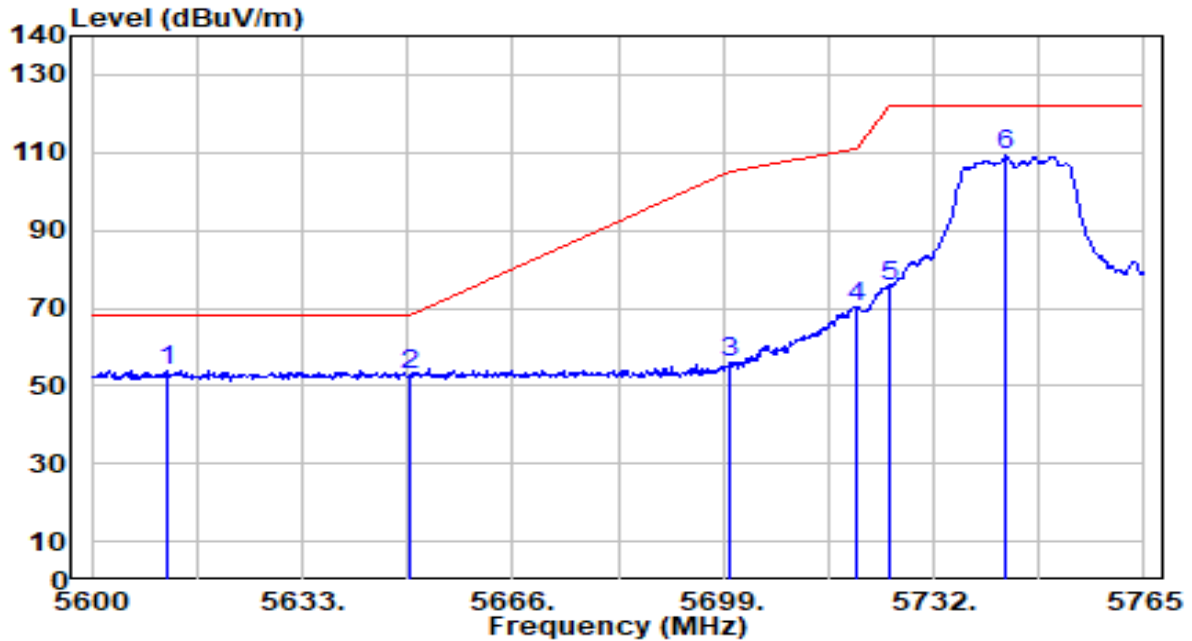

No	Frequency (MHz)	Reading (dBUV)	C.F (dB/m)	Measurement (dBUV/m)	Margin (dB)	Limit (dBUV/m)	Height (cm)	Angle (deg)	Remark (QP/PK/AV)
1	*	54.35	-0.22	54.13	-14.07	68.20	266	181	Peak
2		52.70	-0.08	52.62	-15.58	68.20	266	181	Peak
3		55.71	0.11	55.82	-49.38	105.20	266	181	Peak
4		69.97	0.19	70.16	-40.64	110.80	266	181	Peak
5		75.50	0.21	75.70	-46.50	122.20	266	181	Peak
6		108.96	0.28	109.23	N/A	N/A	266	181	Peak

Note:

1. " \*", means this data is the worst emission level.
2. C.F (Correction Factor) = Antenna Factor (dB/m) + Cable Loss (dB) – Preamplifier(dB) + 10dB Attenuation.
3. Measurement (dBUV/m) = Reading(dBUV) + C.F (Correction Factor).
4. The emission levels of other frequencies are very lower than the limit and not show in test report.

EUT	AX3000 High Gain Wireless USB Adapter	Date of Test	2023-01-19
Factor	DRH18-E	Temp. / Humidity	20°C /62%
Polarity	Vertical	Site / Test Engineer	AC2 / Ares
Test Mode	802.11ac-20MHz_TX_Band4_CH 149_ANT 1+2	Test Voltage	By Notebook PC

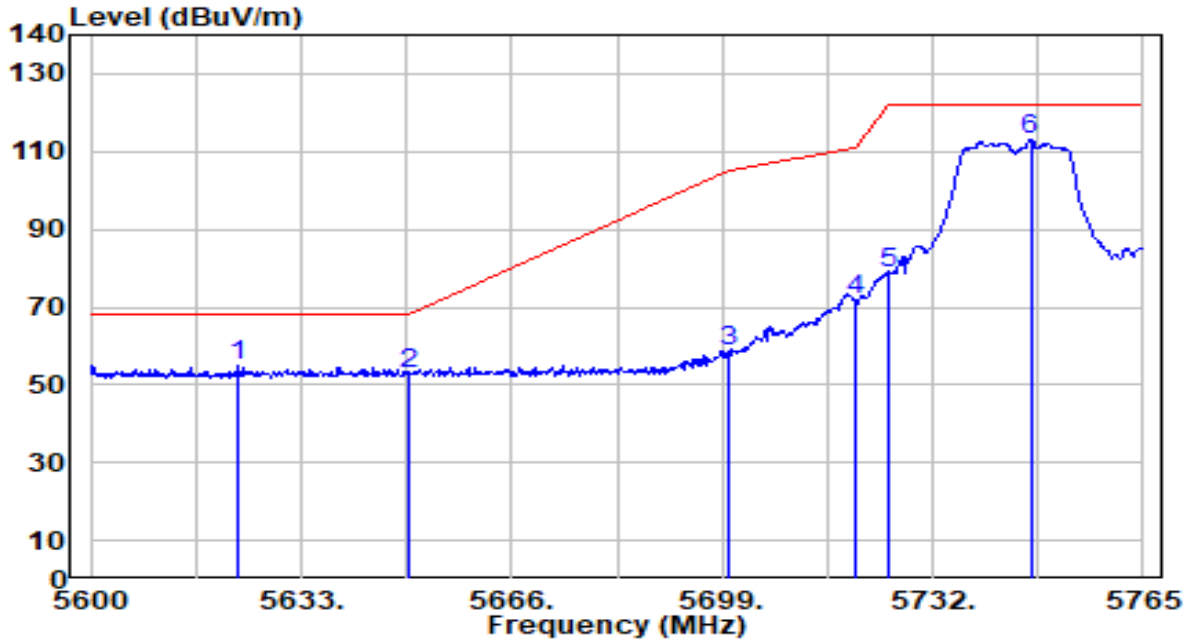

No	Frequency (MHz)	Reading (dBUV)	C.F (dB/m)	Measurement (dBUV/m)	Margin (dB)	Limit (dBUV/m)	Height (cm)	Angle (deg)	Remark (QP/PK/AV)	
1	*	5623.265	54.87	-0.18	54.70	-13.50	68.20	263	250	Peak
2		5650.000	52.88	-0.08	52.80	-15.40	68.20	263	250	Peak
3		5700.000	58.27	0.11	58.38	-46.82	105.20	263	250	Peak
4		5720.000	71.57	0.19	71.76	-39.04	110.80	263	250	Peak
5		5725.000	78.62	0.21	78.83	-43.37	122.20	263	250	Peak
6		5747.345	112.61	0.29	112.90	N/A	N/A	263	250	Peak

Note:

1. " \*", means this data is the worst emission level.
2. C.F (Correction Factor) = Antenna Factor (dB/m) + Cable Loss (dB) – Preamplifier(dB) + 10dB Attenuation.
3. Measurement (dBUV/m) = Reading(dBUV) + C.F (Correction Factor).
4. The emission levels of other frequencies are very lower than the limit and not show in test report.

EUT	AX3000 High Gain Wireless USB Adapter	Date of Test	2023-01-19
Factor	DRH18-E	Temp. / Humidity	20°C /62%
Polarity	Horizontal	Site / Test Engineer	AC2 / Ares
Test Mode	802.11ac-20MHz_TX_Band4_CH 165_ANT 1+2	Test Voltage	By Notebook PC

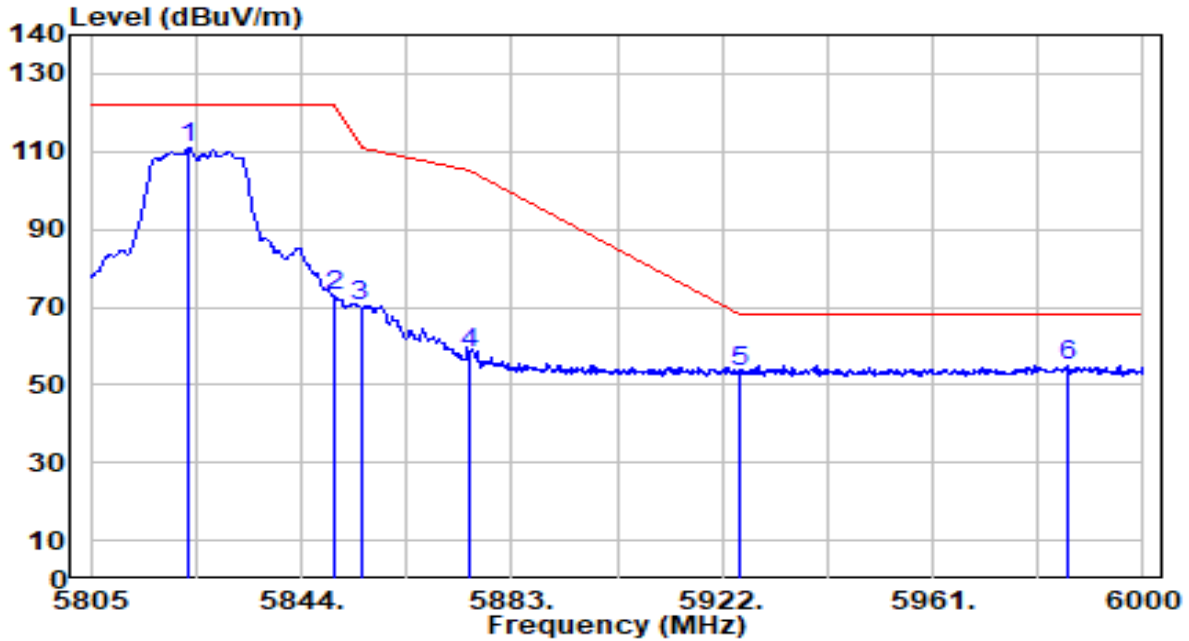

No	Frequency (MHz)	Reading (dBuV)	C.F (dB/m)	Measurement (dBuV/m)	Margin (dB)	Limit (dBuV/m)	Height (cm)	Angle (deg)	Remark (QP/PK/AV)
1	5823.135	110.55	0.52	111.07	N/A	N/A	260	181	Peak
2	5850.000	72.57	0.55	73.12	-49.08	122.20	260	181	Peak
3	5855.000	69.62	0.56	70.18	-40.62	110.80	260	181	Peak
4	5875.000	57.70	0.58	58.28	-46.92	105.20	260	181	Peak
5	5925.000	52.60	0.65	53.24	-14.96	68.20	260	181	Peak
6	* 5985.960	54.30	0.72	55.02	-13.18	68.20	260	181	Peak

Note:

1. " \*", means this data is the worst emission level.
2. C.F (Correction Factor) = Antenna Factor (dB/m) + Cable Loss (dB) – Preamplifier(dB) + 10dB Attenuation.
3. Measurement (dBuV/m) = Reading(dBuV) + C.F (Correction Factor).
4. The emission levels of other frequencies are very lower than the limit and not show in test report.

EUT	AX3000 High Gain Wireless USB Adapter	Date of Test	2023-01-19
Factor	DRH18-E	Temp. / Humidity	20°C /62%
Polarity	Vertical	Site / Test Engineer	AC2 / Ares
Test Mode	802.11ac-20MHz_TX_Band4_CH 165_ANT 1+2	Test Voltage	By Notebook PC

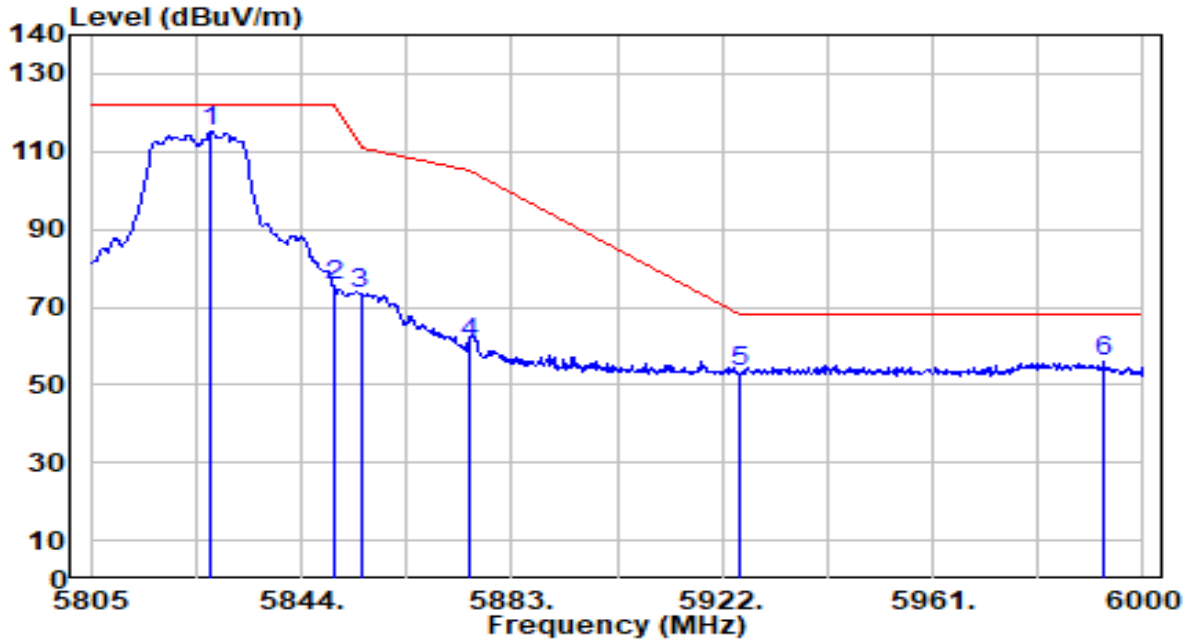

No	Frequency (MHz)	Reading (dBuV)	C.F (dB/m)	Measurement (dBuV/m)	Margin (dB)	Limit (dBuV/m)	Height (cm)	Angle (deg)	Remark (QP/PK/AV)
1	5827.230	114.61	0.52	115.13	N/A	N/A	263	250	Peak
2	5850.000	75.26	0.55	75.81	-46.39	122.20	263	250	Peak
3	5855.000	73.04	0.56	73.60	-37.20	110.80	263	250	Peak
4	5875.000	60.11	0.58	60.69	-44.51	105.20	263	250	Peak
5	5925.000	52.58	0.65	53.23	-14.97	68.20	263	250	Peak
6	* 5992.785	55.10	0.73	55.83	-12.37	68.20	263	250	Peak

Note:

1. " \*", means this data is the worst emission level.
2. C.F (Correction Factor) = Antenna Factor (dB/m) + Cable Loss (dB) – Preamplifier(dB) + 10dB Attenuation.
3. Measurement (dBuV/m) = Reading(dBuV) + C.F (Correction Factor).
4. The emission levels of other frequencies are very lower than the limit and not show in test report.

EUT	AX3000 High Gain Wireless USB Adapter	Date of Test	2023-01-19
-----	---------------------------------------	--------------	------------

Factor	DRH18-E	Temp. / Humidity	20°C /62%
Polarity	Horizontal	Site / Test Engineer	AC2 / Ares
Test Mode	802.11ac-40MHz_TX_Band1_CH 38_ANT 1+2	Test Voltage	By Notebook PC

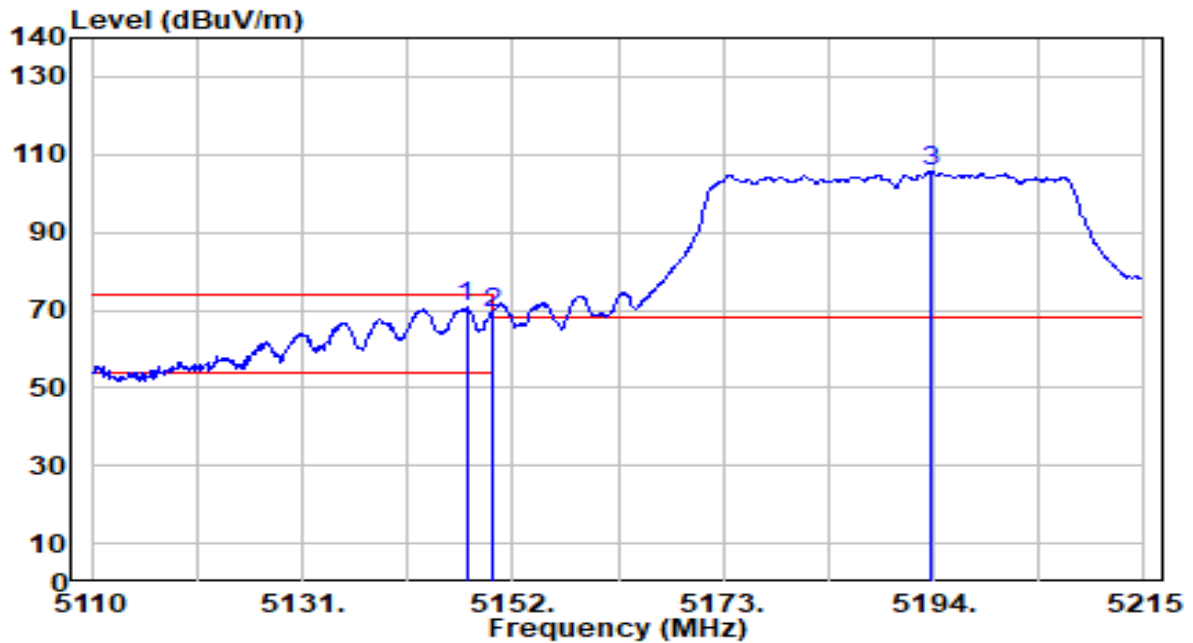

No	Frequency (MHz)	Reading (dBUV)	C.F (dB/m)	Measurement (dBUV/m)	Margin (dB)	Limit (dBUV/m)	Height (cm)	Angle (deg)	Remark (QP/PK/AV)
1	* 5147.380	71.28	-0.73	70.55	-3.45	74.00	227	174	Peak
2	5150.000	70.00	-0.73	69.27	-4.73	74.00	227	174	Peak
3	5193.685	106.48	-0.68	105.80	N/A	N/A	227	174	Peak

Note:

1. " \*", means this data is the worst emission level.
2. C.F (Correction Factor) = Antenna Factor (dB/m) + Cable Loss (dB) – Pre-amplifier(dB) + 10dB Attenuation.
3. Measurement (dBUV/m) = Reading(dBUV) + C.F (Correction Factor).
4. The emission levels of other frequencies are very lower than the limit and not show in test report.

EUT	AX3000 High Gain Wireless USB Adapter	Date of Test	2023-01-19
Factor	DRH18-E	Temp. / Humidity	20°C /62%
Polarity	Horizontal	Site / Test Engineer	AC2 / Ares
Test Mode	802.11ac-40MHz_TX_Band1_CH 38_ANT 1+2	Test Voltage	By Notebook PC

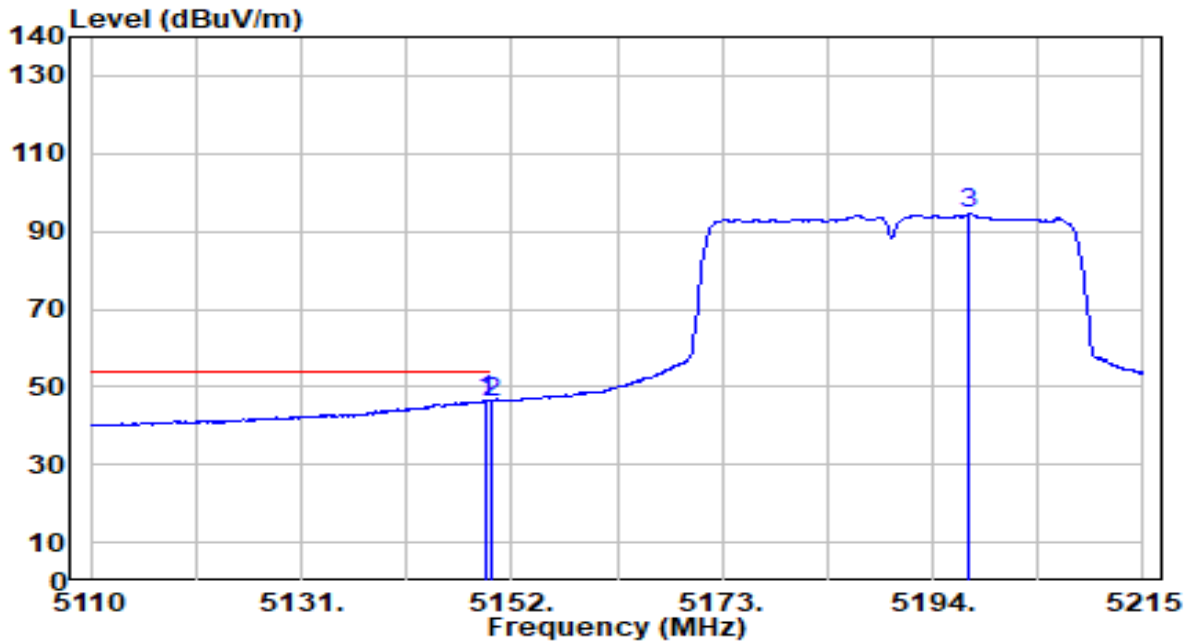

No	Frequency (MHz)	Reading (dBuV)	C.F (dB/m)	Measurement (dBuV/m)	Margin (dB)	Limit (dBuV/m)	Height (cm)	Angle (deg)	Remark (QP/PK/AV)	
1	*	5149.480	47.23	-0.73	46.50	-7.50	54.00	227	174	Average
2		5150.000	46.92	-0.73	46.19	-7.81	54.00	227	174	Average
3		5197.675	95.21	-0.68	94.53	N/A	N/A	227	174	Average

Note:

1. " \*", means this data is the worst emission level.
2. C.F (Correction Factor) = Antenna Factor (dB/m) + Cable Loss (dB) – Preamplifier(dB) + 10dB Attenuation.
3. Measurement (dBuV/m) = Reading(dBuV) + C.F (Correction Factor).
4. The emission levels of other frequencies are very lower than the limit and not show in test report.

EUT	AX3000 High Gain Wireless USB Adapter	Date of Test	2023-01-19
Factor	DRH18-E	Temp. / Humidity	20°C /62%
Polarity	Vertical	Site / Test Engineer	AC2 / Ares
Test Mode	802.11ac-40MHz_TX_Band1_CH 38_ANT 1+2	Test Voltage	By Notebook PC

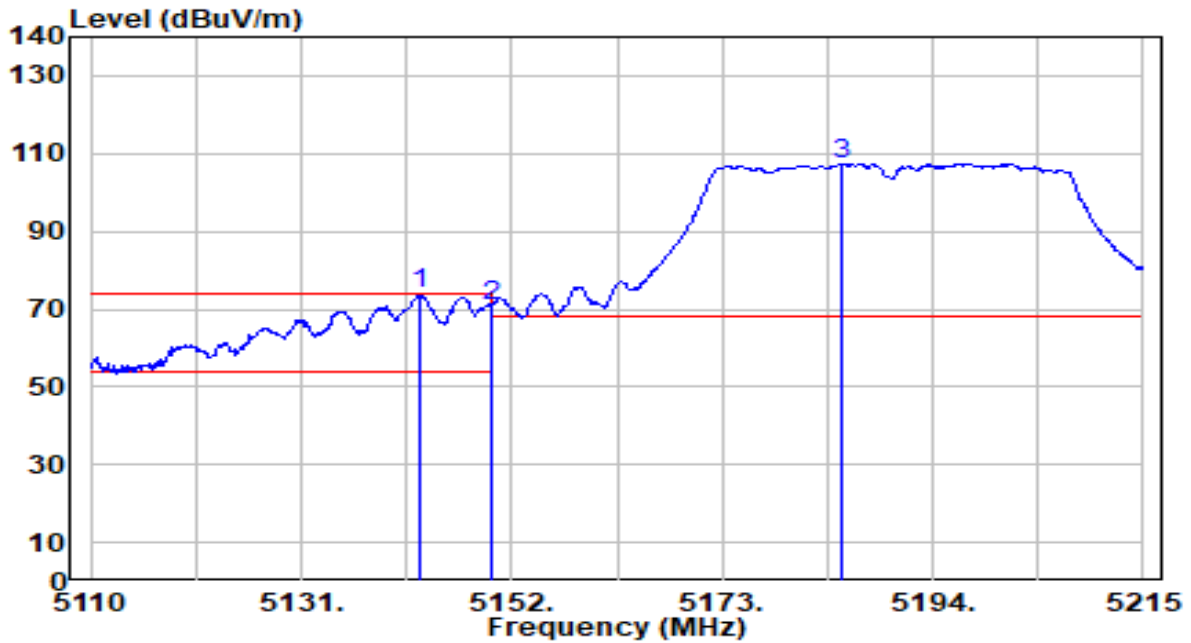

No	Frequency (MHz)	Reading (dBuV)	C.F (dB/m)	Measurement (dBuV/m)	Margin (dB)	Limit (dBuV/m)	Height (cm)	Angle (deg)	Remark (QP/PK/AV)	
1	*	5142.865	74.58	-0.73	73.85	-0.15	74.00	122	44	Peak
2		5150.000	71.76	-0.73	71.03	-2.97	74.00	122	44	Peak
3		5184.970	108.02	-0.69	107.33	N/A	N/A	122	44	Peak

Note:

1. " \*", means this data is the worst emission level.
2. C.F (Correction Factor) = Antenna Factor (dB/m) + Cable Loss (dB) – Preamplifier(dB) + 10dB Attenuation.
3. Measurement (dBuV/m) = Reading(dBuV) + C.F (Correction Factor).
4. The emission levels of other frequencies are very lower than the limit and not show in test report.



EUT	AX3000 High Gain Wireless USB Adapter	Date of Test	2023-01-19
Factor	DRH18-E	Temp. / Humidity	20°C /62%
Polarity	Vertical	Site / Test Engineer	AC2 / Ares
Test Mode	802.11ac-40MHz_TX_Band1_CH 38_ANT 1+2	Test Voltage	By Notebook PC

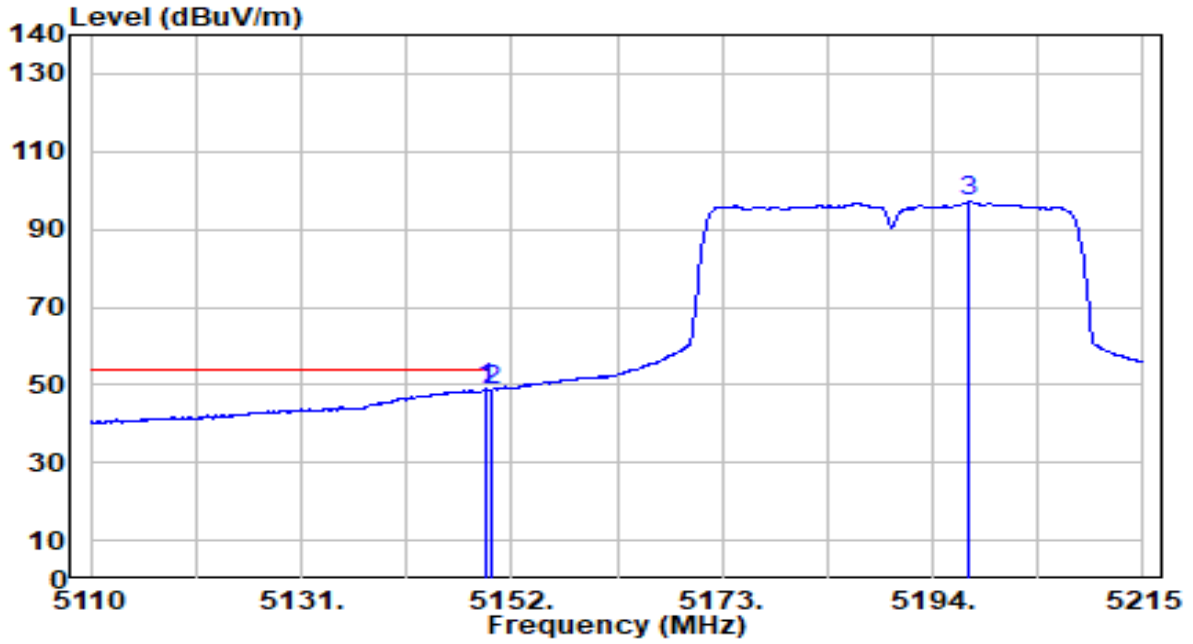

No	Frequency (MHz)	Reading (dBuV)	C.F (dB/m)	Measurement (dBuV/m)	Margin (dB)	Limit (dBuV/m)	Height (cm)	Angle (deg)	Remark (QP/PK/AV)
1	* 5149.480	49.62	-0.73	48.89	-5.11	54.00	122	44	Average
2	5150.000	49.07	-0.73	48.34	-5.66	54.00	122	44	Average
3	5197.675	97.81	-0.68	97.13	N/A	N/A	122	44	Average

Note:

1. " \*", means this data is the worst emission level.
2. C.F (Correction Factor) = Antenna Factor (dB/m) + Cable Loss (dB) – Preamplifier(dB) + 10dB Attenuation.
3. Measurement (dBuV/m) = Reading(dBuV) + C.F (Correction Factor).
4. The emission levels of other frequencies are very lower than the limit and not show in test report.

EUT	AX3000 High Gain Wireless USB Adapter	Date of Test	2023-01-19
Factor	DRH18-E	Temp. / Humidity	20°C /62%
Polarity	Horizontal	Site / Test Engineer	AC2 / Ares
Test Mode	802.11ac-40MHz_TX_Band2_CH 62_ANT 1+2	Test Voltage	By Notebook PC

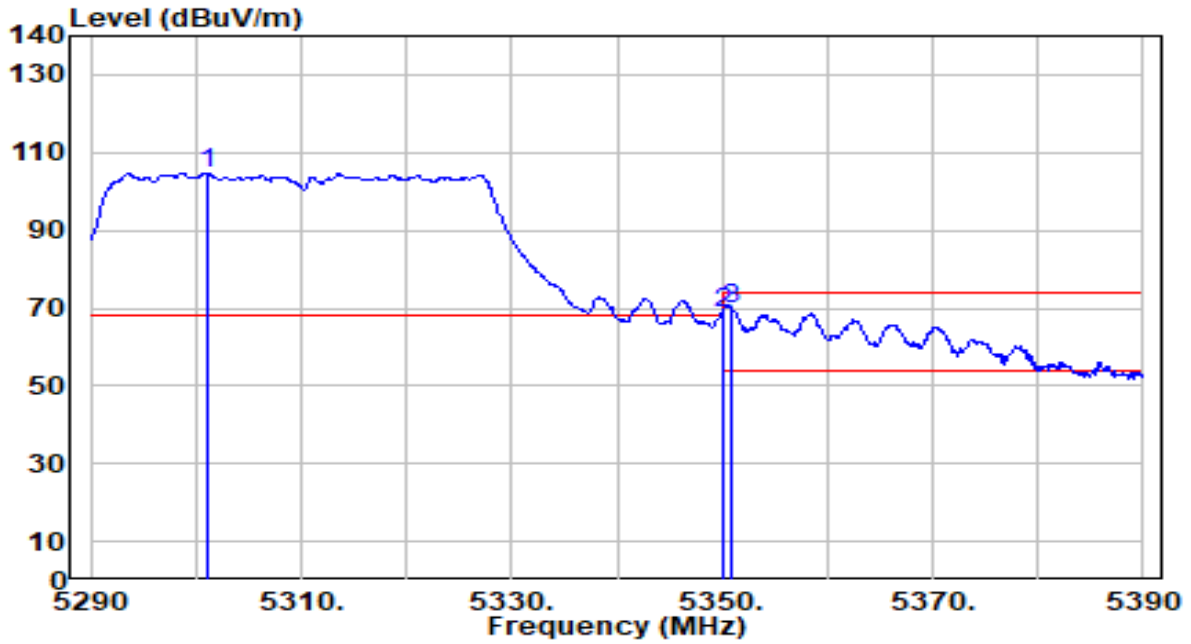

No	Frequency (MHz)	Reading (dBuV)	C.F (dB/m)	Measurement (dBuV/m)	Margin (dB)	Limit (dBuV/m)	Height (cm)	Angle (deg)	Remark (QP/PK/AV)
1	5301.100	105.71	-0.88	104.83	N/A	N/A	250	183	Peak
2	5350.000	69.78	-0.98	68.79	-5.21	74.00	250	183	Peak
3	* 5351.000	70.85	-0.99	69.86	-4.14	74.00	250	183	Peak

Note:

1. " \*", means this data is the worst emission level.
2. C.F (Correction Factor) = Antenna Factor (dB/m) + Cable Loss (dB) – Pre-amplifier(dB) + 10dB Attenuation.
3. Measurement (dBuV/m) = Reading(dBuV) + C.F (Correction Factor).
4. The emission levels of other frequencies are very lower than the limit and not show in test report.

EUT	AX3000 High Gain Wireless USB Adapter	Date of Test	2023-01-19
Factor	DRH18-E	Temp. / Humidity	20°C /62%
Polarity	Horizontal	Site / Test Engineer	AC2 / Ares
Test Mode	802.11ac-40MHz_TX_Band2_CH 62_ANT 1+2	Test Voltage	By Notebook PC

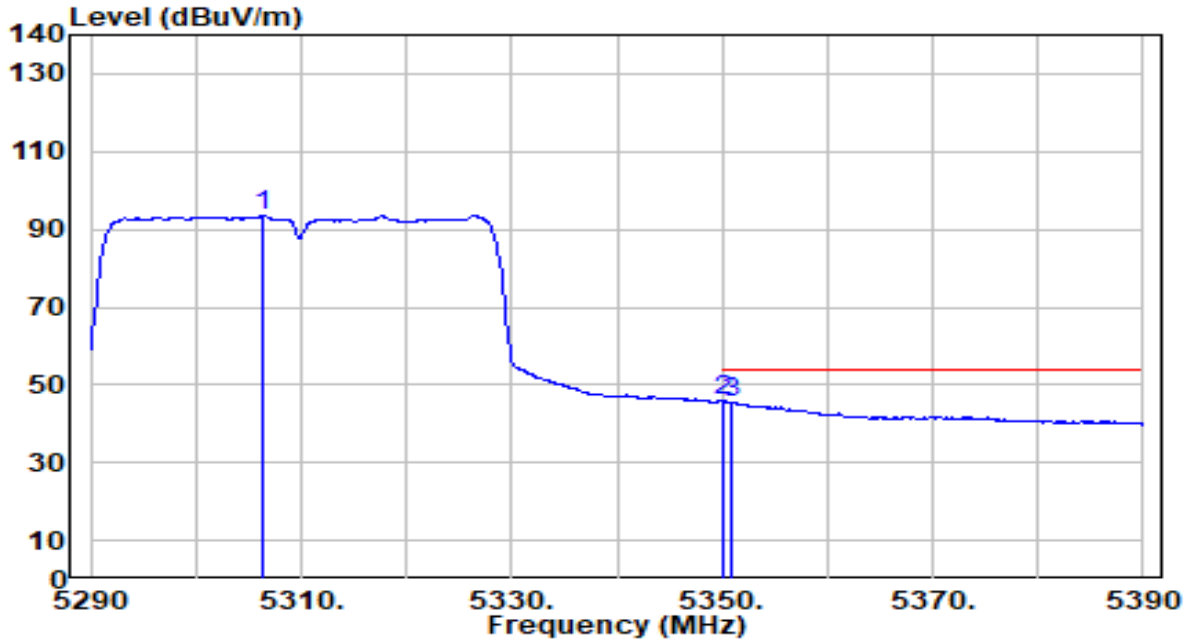

No	Frequency (MHz)	Reading (dBuV)	C.F (dB/m)	Measurement (dBuV/m)	Margin (dB)	Limit (dBuV/m)	Height (cm)	Angle (deg)	Remark (QP/PK/AV)
1	5306.400	94.46	-0.90	93.56	N/A	N/A	250	183	Average
2	* 5350.000	46.99	-0.98	46.00	-8.00	54.00	250	183	Average
3	5351.000	46.54	-0.99	45.55	-8.45	54.00	250	183	Average

Note:

1. " \*", means this data is the worst emission level.
2. C.F (Correction Factor) = Antenna Factor (dB/m) + Cable Loss (dB) – Preamplifier(dB) + 10dB Attenuation.
3. Measurement (dBuV/m) = Reading(dBuV) + C.F (Correction Factor).
4. The emission levels of other frequencies are very lower than the limit and not show in test report.

EUT	AX3000 High Gain Wireless USB Adapter	Date of Test	2023-01-19
Factor	DRH18-E	Temp. / Humidity	20°C /62%
Polarity	Vertical	Site / Test Engineer	AC2 / Ares
Test Mode	802.11ac-40MHz_TX_Band2_CH 62_ANT 1+2	Test Voltage	By Notebook PC

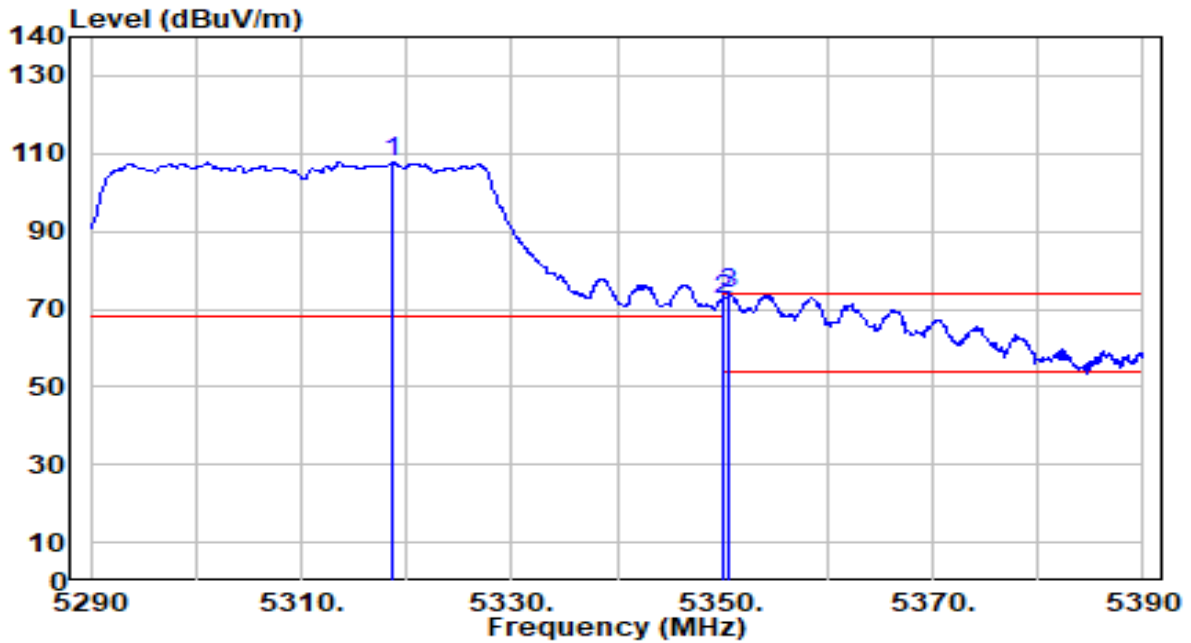

No	Frequency (MHz)	Reading (dBuV)	C.F (dB/m)	Measurement (dBuV/m)	Margin (dB)	Limit (dBuV/m)	Height (cm)	Angle (deg)	Remark (QP/PK/AV)
1	5318.700	108.61	-0.92	107.69	N/A	N/A	302	254	Peak
2	5350.000	73.42	-0.98	72.44	-1.56	74.00	302	254	Peak
3	* 5350.700	74.81	-0.99	73.82	-0.18	74.00	302	254	Peak

Note:

1. " \*", means this data is the worst emission level.
2. C.F (Correction Factor) = Antenna Factor (dB/m) + Cable Loss (dB) – Preamplifier(dB) + 10dB Attenuation.
3. Measurement (dBuV/m) = Reading(dBuV) + C.F (Correction Factor).
4. The emission levels of other frequencies are very lower than the limit and not show in test report.

EUT	AX3000 High Gain Wireless USB Adapter	Date of Test	2023-01-19
Factor	DRH18-E	Temp. / Humidity	20°C /62%
Polarity	Vertical	Site / Test Engineer	AC2 / Ares
Test Mode	802.11ac-40MHz_TX_Band2_CH 62_ANT 1+2	Test Voltage	By Notebook PC

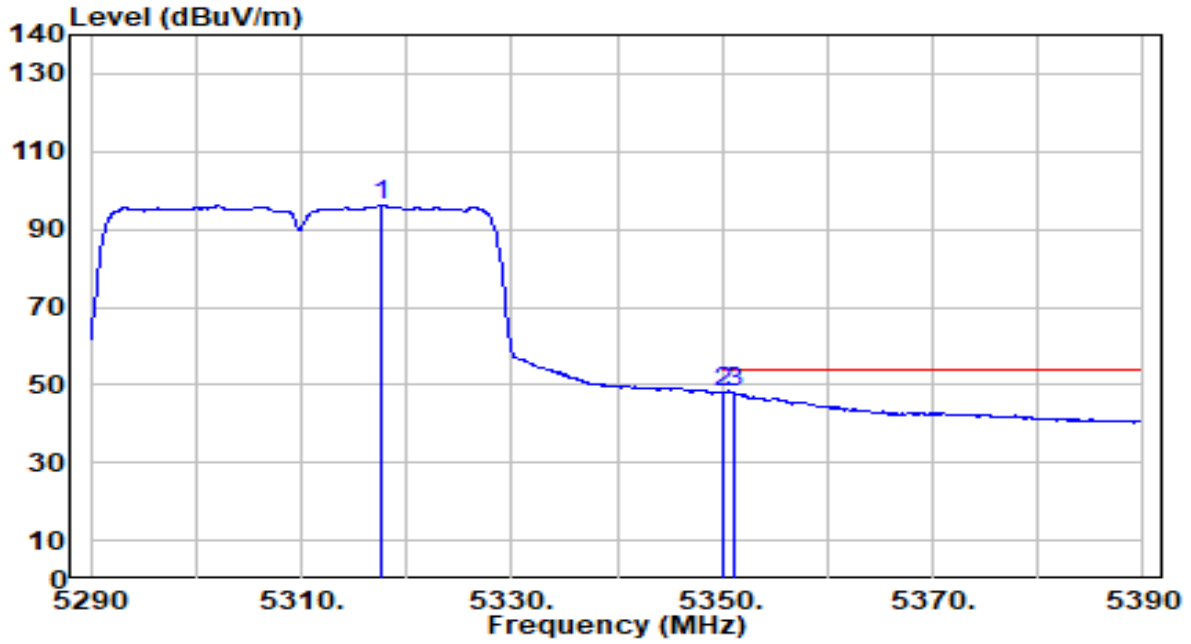

No	Frequency (MHz)	Reading (dBuV)	C.F (dB/m)	Measurement (dBuV/m)	Margin (dB)	Limit (dBuV/m)	Height (cm)	Angle (deg)	Remark (QP/PK/AV)
1	5317.600	97.20	-0.92	96.28	N/A	N/A	302	254	Average
2	* 5350.000	49.14	-0.98	48.16	-5.84	54.00	302	254	Average
3	5351.100	48.98	-0.99	47.99	-6.01	54.00	302	254	Average

Note:

1. " \*", means this data is the worst emission level.
2. C.F (Correction Factor) = Antenna Factor (dB/m) + Cable Loss (dB) – Preamplifier(dB) + 10dB Attenuation.
3. Measurement (dBuV/m) = Reading(dBuV) + C.F (Correction Factor).
4. The emission levels of other frequencies are very lower than the limit and not show in test report.

EUT	AX3000 High Gain Wireless USB Adapter	Date of Test	2023-01-19
Factor	DRH18-E	Temp. / Humidity	20°C /62%
Polarity	Horizontal	Site / Test Engineer	AC2 / Ares
Test Mode	802.11ac-40MHz_TX_Band3_CH 102_ANT 1+2	Test Voltage	By Notebook PC

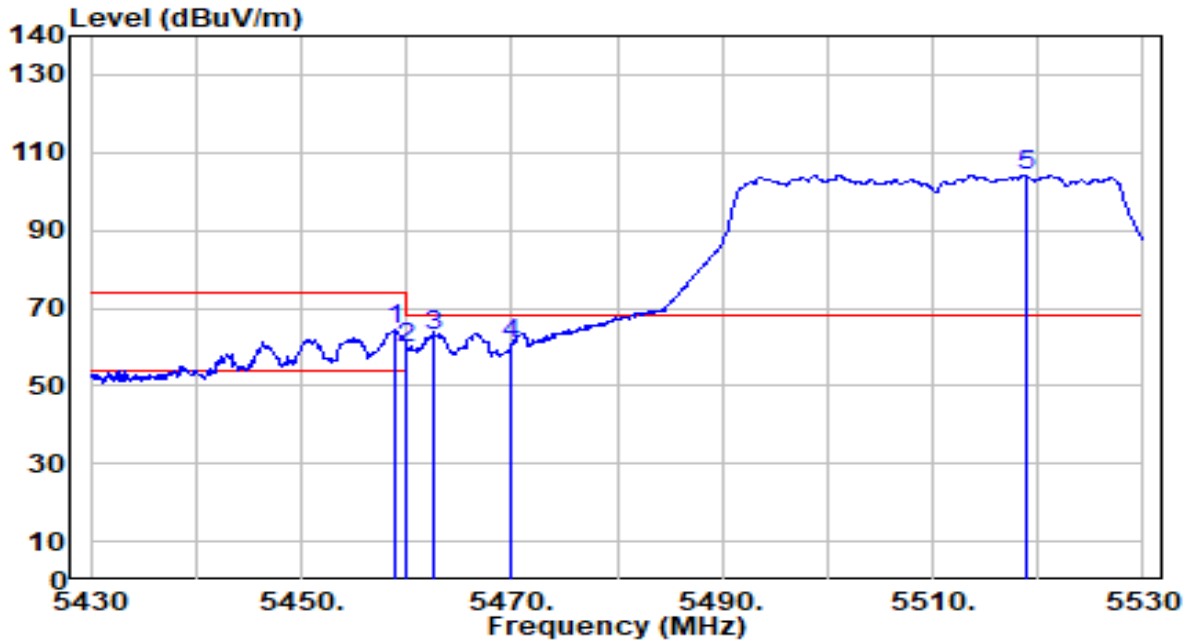

No	Frequency (MHz)	Reading (dBUV)	C.F (dB/m)	Measurement (dBUV/m)	Margin (dB)	Limit (dBUV/m)	Height (cm)	Angle (deg)	Remark (QP/PK/AV)
1	5458.800	65.22	-0.85	64.36	-9.64	74.00	210	178	Peak
2	5460.000	60.38	-0.85	59.54	-14.46	74.00	210	178	Peak
3	* 5462.600	63.63	-0.84	62.79	-5.41	68.20	210	178	Peak
4	5470.000	61.79	-0.81	60.99	-7.21	68.20	210	178	Peak
5	5518.800	104.81	-0.61	104.20	N/A	N/A	210	178	Peak

Note:

1. " \*", means this data is the worst emission level.
2. C.F (Correction Factor) = Antenna Factor (dB/m) + Cable Loss (dB) – Preamplifier(dB) + 10dB Attenuation.
3. Measurement (dBUV/m) = Reading(dBUV) + C.F (Correction Factor).
4. The emission levels of other frequencies are very lower than the limit and not show in test report.

EUT	AX3000 High Gain Wireless USB Adapter	Date of Test	2023-01-19
Factor	DRH18-E	Temp. / Humidity	20°C /62%
Polarity	Horizontal	Site / Test Engineer	AC2 / Ares
Test Mode	802.11ac-40MHz_TX_Band3_CH 102_ANT 1+2	Test Voltage	By Notebook PC

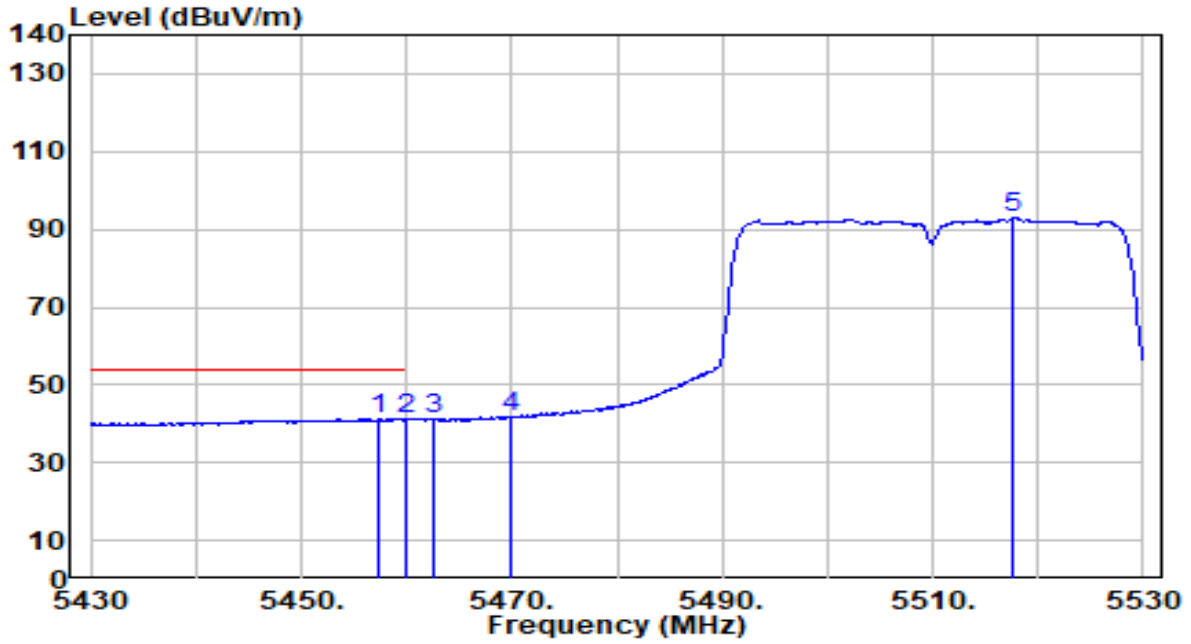

No	Frequency (MHz)	Reading (dBuV)	C.F (dB/m)	Measurement (dBuV/m)	Margin (dB)	Limit (dBuV/m)	Height (cm)	Angle (deg)	Remark (QP/PK/AV)
1	* 5457.400	42.29	-0.86	41.43	-12.57	54.00	210	178	Average
2	5460.000	42.01	-0.85	41.16	-12.84	54.00	210	178	Average
3	5462.600	42.00	-0.84	41.17	N/A	N/A	210	178	Average
4	5470.000	42.62	-0.81	41.82	N/A	N/A	210	178	Average
5	5517.700	93.55	-0.61	92.94	N/A	N/A	210	178	Average

Note:

1. " \*", means this data is the worst emission level.
2. C.F (Correction Factor) = Antenna Factor (dB/m) + Cable Loss (dB) – Preamplifier(dB) + 10dB Attenuation.
3. Measurement (dBuV/m) = Reading(dBuV) + C.F (Correction Factor).
4. The emission levels of other frequencies are very lower than the limit and not show in test report.

EUT	AX3000 High Gain Wireless USB Adapter	Date of Test	2023-01-19
Factor	DRH18-E	Temp. / Humidity	20°C /62%
Polarity	Vertical	Site / Test Engineer	AC2 / Ares
Test Mode	802.11ac-40MHz_TX_Band3_CH 102_ANT 1+2	Test Voltage	By Notebook PC

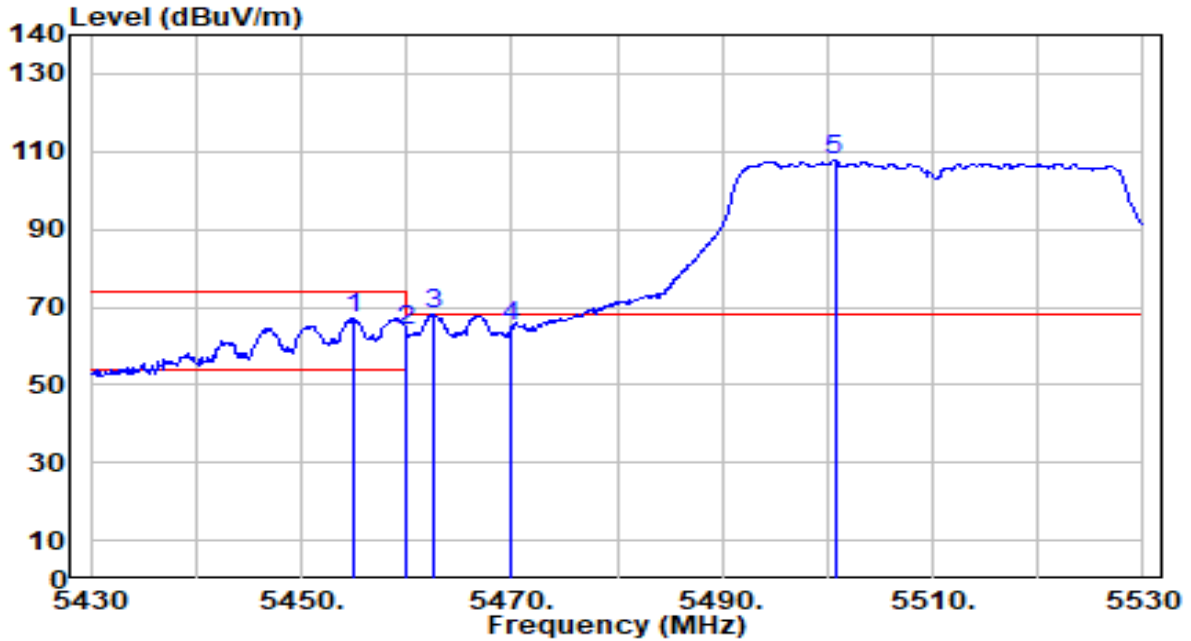

No	Frequency (MHz)	Reading (dBuV)	C.F (dB/m)	Measurement (dBuV/m)	Margin (dB)	Limit (dBuV/m)	Height (cm)	Angle (deg)	Remark (QP/PK/AV)
1	5455.100	68.04	-0.87	67.18	-6.82	74.00	278	252	Peak
2	5460.000	64.73	-0.85	63.88	-10.12	74.00	278	252	Peak
3	* 5462.600	68.99	-0.84	68.15	-0.05	68.20	278	252	Peak
4	5470.000	65.59	-0.81	64.78	-3.42	68.20	278	252	Peak
5	5500.700	108.56	-0.69	107.87	N/A	N/A	278	252	Peak

Note:

1. " \*", means this data is the worst emission level.
2. C.F (Correction Factor) = Antenna Factor (dB/m) + Cable Loss (dB) – Preamplifier(dB) + 10dB Attenuation.
3. Measurement (dBuV/m) = Reading(dBuV) + C.F (Correction Factor).
4. The emission levels of other frequencies are very lower than the limit and not show in test report.



EUT	AX3000 High Gain Wireless USB Adapter	Date of Test	2023-01-19
Factor	DRH18-E	Temp. / Humidity	20°C /62%
Polarity	Vertical	Site / Test Engineer	AC2 / Ares
Test Mode	802.11ac-40MHz_TX_Band3_CH 102_ANT 1+2	Test Voltage	By Notebook PC

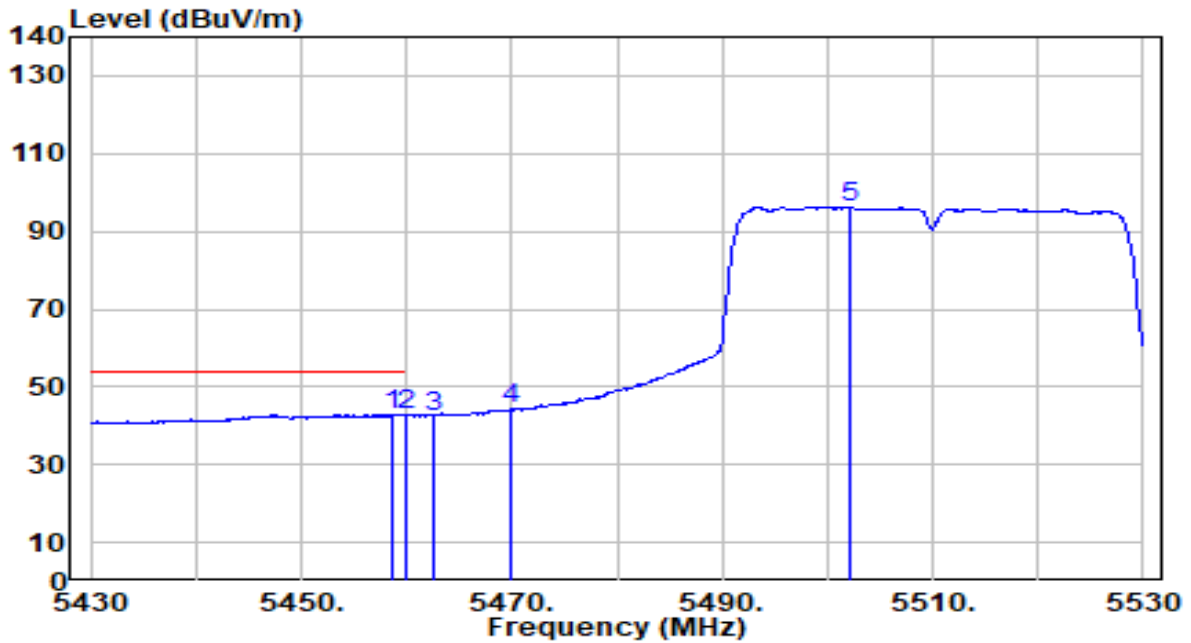

No	Frequency (MHz)	Reading (dBuV)	C.F (dB/m)	Measurement (dBuV/m)	Margin (dB)	Limit (dBuV/m)	Height (cm)	Angle (deg)	Remark (QP/PK/AV)	
1	*	5458.700	43.78	-0.85	42.93	-11.07	54.00	278	252	Average
2		5460.000	43.41	-0.85	42.56	-11.44	54.00	278	252	Average
3		5462.600	43.36	-0.84	42.52	N/A	N/A	278	252	Average
4		5470.000	45.01	-0.81	44.20	N/A	N/A	278	252	Average
5		5502.100	97.07	-0.68	96.39	N/A	N/A	278	252	Average

Note:

1. " \*", means this data is the worst emission level.
2. C.F (Correction Factor) = Antenna Factor (dB/m) + Cable Loss (dB) – Preamplifier(dB) + 10dB Attenuation.
3. Measurement (dBuV/m) = Reading(dBuV) + C.F (Correction Factor).
4. The emission levels of other frequencies are very lower than the limit and not show in test report.

EUT	AX3000 High Gain Wireless USB Adapter	Date of Test	2023-01-19
Factor	DRH18-E	Temp. / Humidity	20°C /62%
Polarity	Horizontal	Site / Test Engineer	AC2 / Ares
Test Mode	802.11ac-40MHz_TX_Band3_CH 134_ANT 1+2	Test Voltage	By Notebook PC

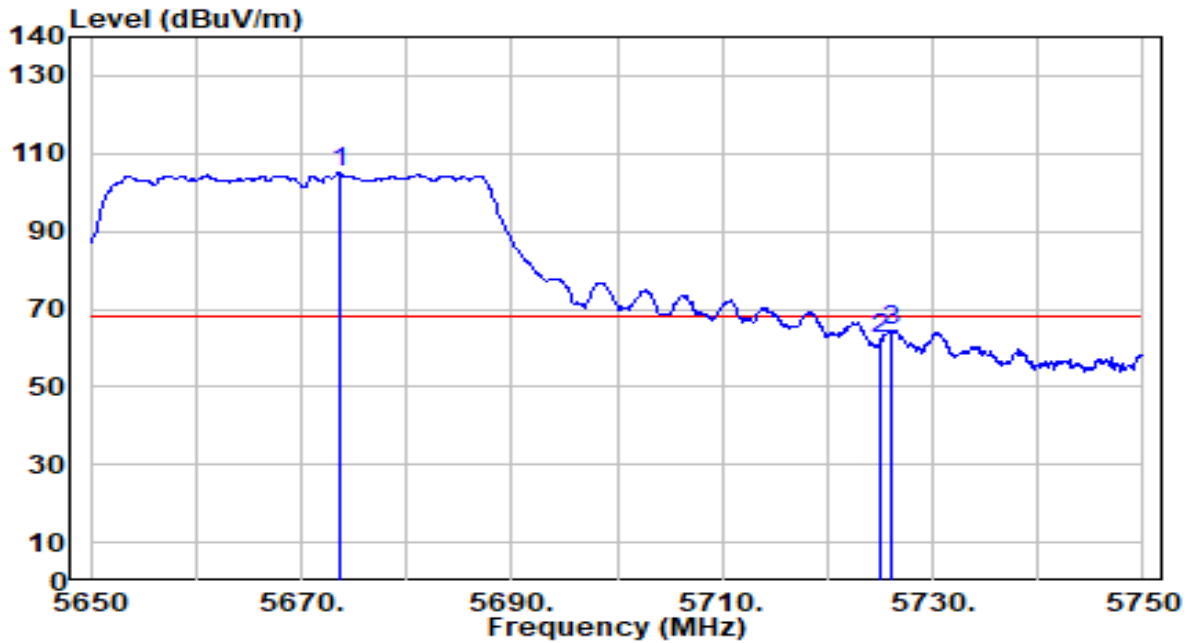

No	Frequency (MHz)	Reading (dBuV)	C.F (dB/m)	Measurement (dBuV/m)	Margin (dB)	Limit (dBuV/m)	Height (cm)	Angle (deg)	Remark (QP/PK/AV)
1	5673.600	104.89	0.01	104.90	N/A	N/A	250	173	Peak
2	5725.000	62.11	0.21	62.31	-5.89	68.20	250	173	Peak
3	* 5726.100	64.38	0.21	64.59	-3.61	68.20	250	173	Peak

Note:

1. " \*", means this data is the worst emission level.
2. C.F (Correction Factor) = Antenna Factor (dB/m) + Cable Loss (dB) – Preamplifier(dB) + 10dB Attenuation.
3. Measurement (dBuV/m) = Reading(dBuV) + C.F (Correction Factor).
4. The emission levels of other frequencies are very lower than the limit and not show in test report.

EUT	AX3000 High Gain Wireless USB Adapter	Date of Test	2023-01-19
Factor	DRH18-E	Temp. / Humidity	20°C /62%
Polarity	Vertical	Site / Test Engineer	AC2 / Ares
Test Mode	802.11ac-40MHz_TX_Band3_CH 134_ANT 1+2	Test Voltage	By Notebook PC

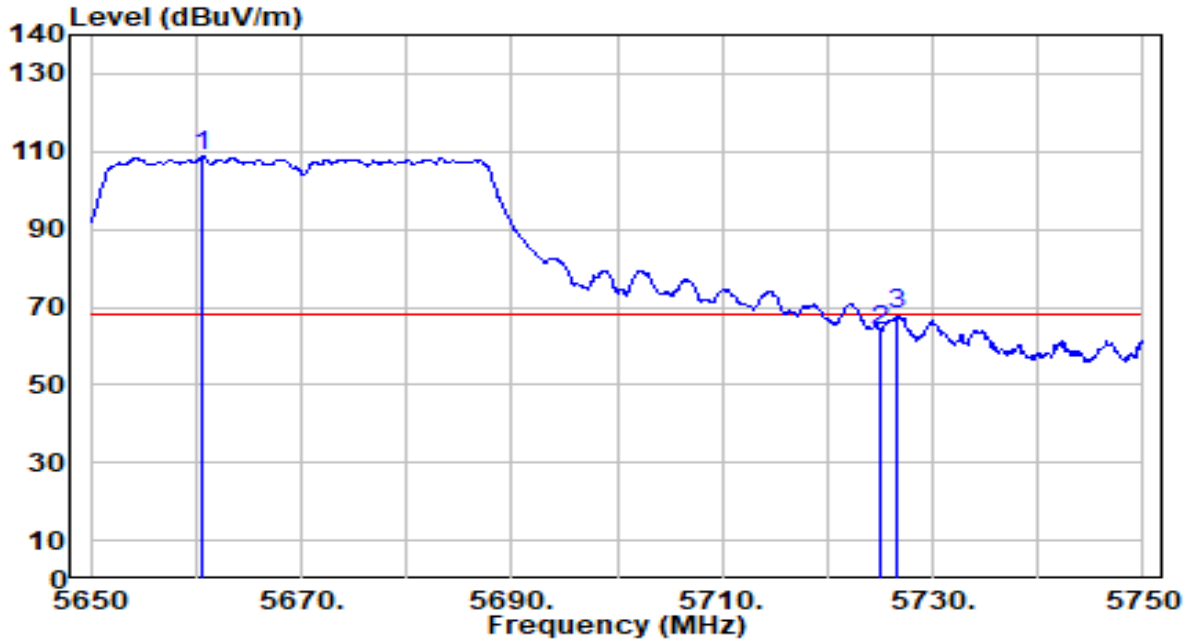

No	Frequency (MHz)	Reading (dBuV)	C.F (dB/m)	Measurement (dBuV/m)	Margin (dB)	Limit (dBuV/m)	Height (cm)	Angle (deg)	Remark (QP/PK/AV)
1	5660.600	108.76	-0.04	108.72	N/A	N/A	267	250	Peak
2	5725.000	63.79	0.21	63.99	-4.21	68.20	267	250	Peak
3	* 5726.500	67.86	0.21	68.07	-0.13	68.20	267	250	Peak

Note:

1. " \*", means this data is the worst emission level.
2. C.F (Correction Factor) = Antenna Factor (dB/m) + Cable Loss (dB) – Pre-amplifier(dB) + 10dB Attenuation.
3. Measurement (dBuV/m) = Reading(dBuV) + C.F (Correction Factor).
4. The emission levels of other frequencies are very lower than the limit and not show in test report.

EUT	AX3000 High Gain Wireless USB Adapter	Date of Test	2023-01-19
Factor	DRH18-E	Temp. / Humidity	20°C /62%
Polarity	Horizontal	Site / Test Engineer	AC2 / Ares
Test Mode	802.11ac-40MHz_TX_Band4_CH 151_ANT 1+2	Test Voltage	By Notebook PC

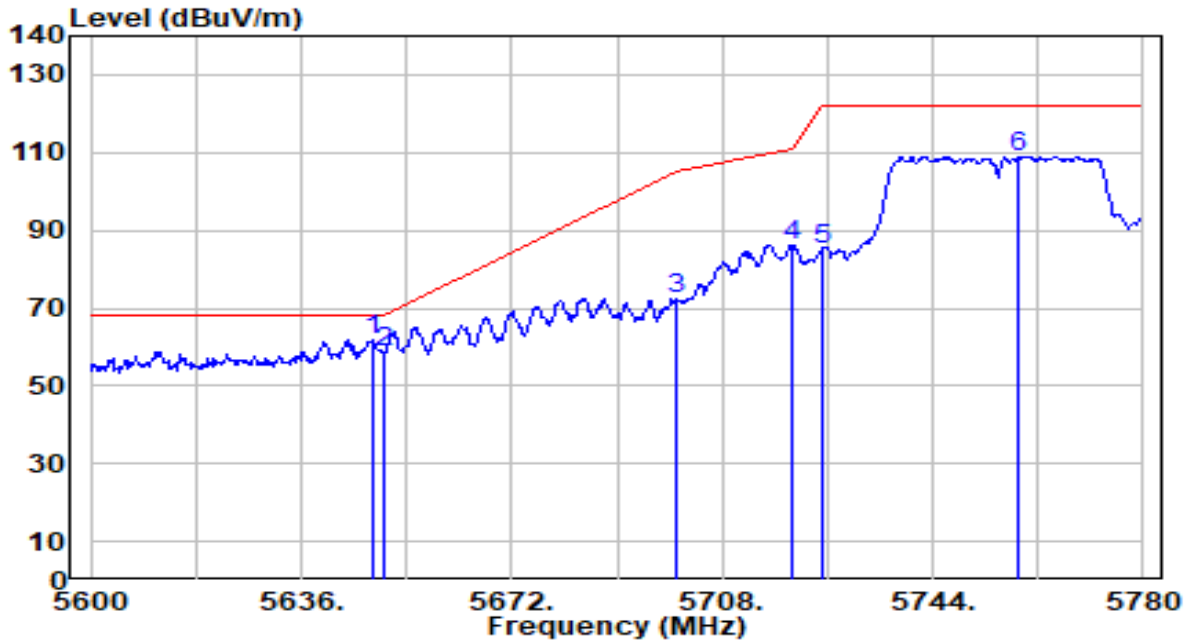

No	Frequency (MHz)	Reading (dBUV)	C.F (dB/m)	Measurement (dBUV/m)	Margin (dB)	Limit (dBUV/m)	Height (cm)	Angle (deg)	Remark (QP/PK/AV)
1	* 5648.060	62.00	-0.08	61.92	-6.28	68.20	266	181	Peak
2	5650.000	58.88	-0.08	58.80	-9.40	68.20	266	181	Peak
3	5700.000	72.06	0.11	72.18	-33.02	105.20	266	181	Peak
4	5720.000	86.06	0.19	86.25	-24.55	110.80	266	181	Peak
5	5725.000	85.01	0.21	85.21	-36.99	122.20	266	181	Peak
6	5758.580	108.72	0.33	109.05	N/A	N/A	266	181	Peak

Note:

1. " \*", means this data is the worst emission level.
2. C.F (Correction Factor) = Antenna Factor (dB/m) + Cable Loss (dB) – Preamplifier(dB) + 10dB Attenuation.
3. Measurement (dBUV/m) = Reading(dBUV) + C.F (Correction Factor).
4. The emission levels of other frequencies are very lower than the limit and not show in test report.

EUT	AX3000 High Gain Wireless USB Adapter	Date of Test	2023-01-19
Factor	DRH18-E	Temp. / Humidity	20°C /62%
Polarity	Vertical	Site / Test Engineer	AC2 / Ares
Test Mode	802.11ac-40MHz_TX_Band4_CH 151_ANT 1+2	Test Voltage	By Notebook PC

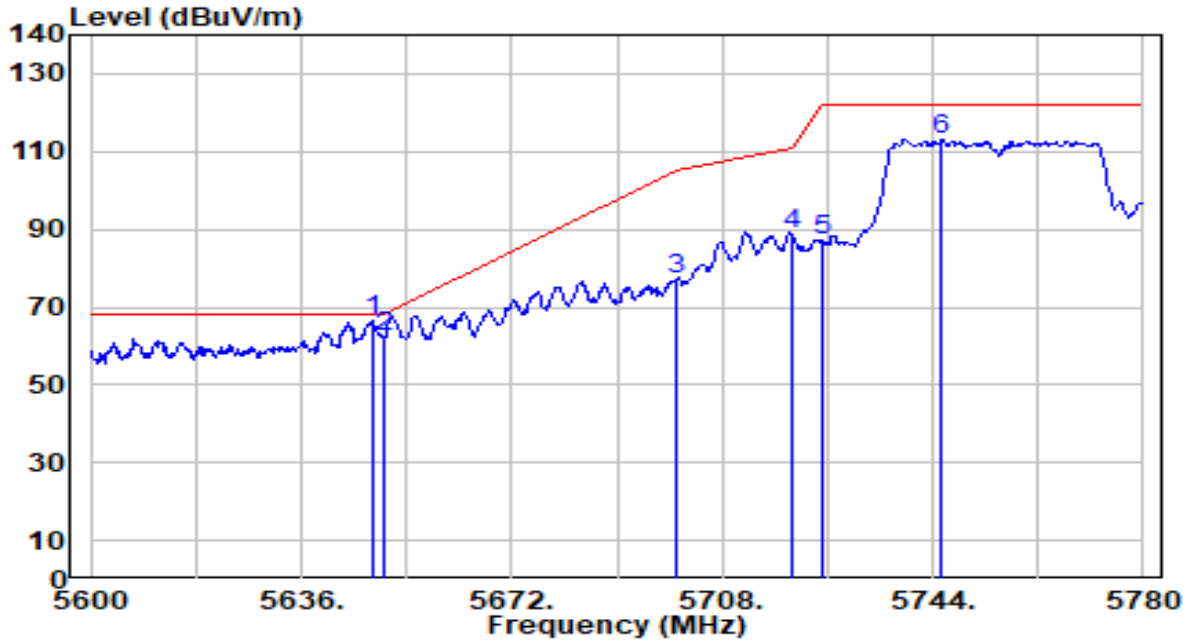

No	Frequency (MHz)	Reading (dBuV)	C.F (dB/m)	Measurement (dBuV/m)	Margin (dB)	Limit (dBuV/m)	Height (cm)	Angle (deg)	Remark (QP/PK/AV)	
1	*	5648.240	66.65	-0.08	66.56	-1.64	68.20	263	250	Peak
2		5650.000	62.61	-0.08	62.54	-5.66	68.20	263	250	Peak
3		5700.000	77.06	0.11	77.17	-28.03	105.20	263	250	Peak
4		5720.000	88.52	0.19	88.71	-22.09	110.80	263	250	Peak
5		5725.000	87.16	0.21	87.37	-34.83	122.20	263	250	Peak
6		5745.620	112.96	0.28	113.24	N/A	N/A	263	250	Peak

Note:

1. " \*", means this data is the worst emission level.
2. C.F (Correction Factor) = Antenna Factor (dB/m) + Cable Loss (dB) – Preamplifier(dB) + 10dB Attenuation.
3. Measurement (dBuV/m) = Reading(dBuV) + C.F (Correction Factor).
4. The emission levels of other frequencies are very lower than the limit and not show in test report.

EUT	AX3000 High Gain Wireless USB Adapter	Date of Test	2023-01-19
Factor	DRH18-E	Temp. / Humidity	20°C /62%
Polarity	Horizontal	Site / Test Engineer	AC2 / Ares
Test Mode	802.11ac-40MHz_TX_Band4_CH 159_ANT 1+2	Test Voltage	By Notebook PC

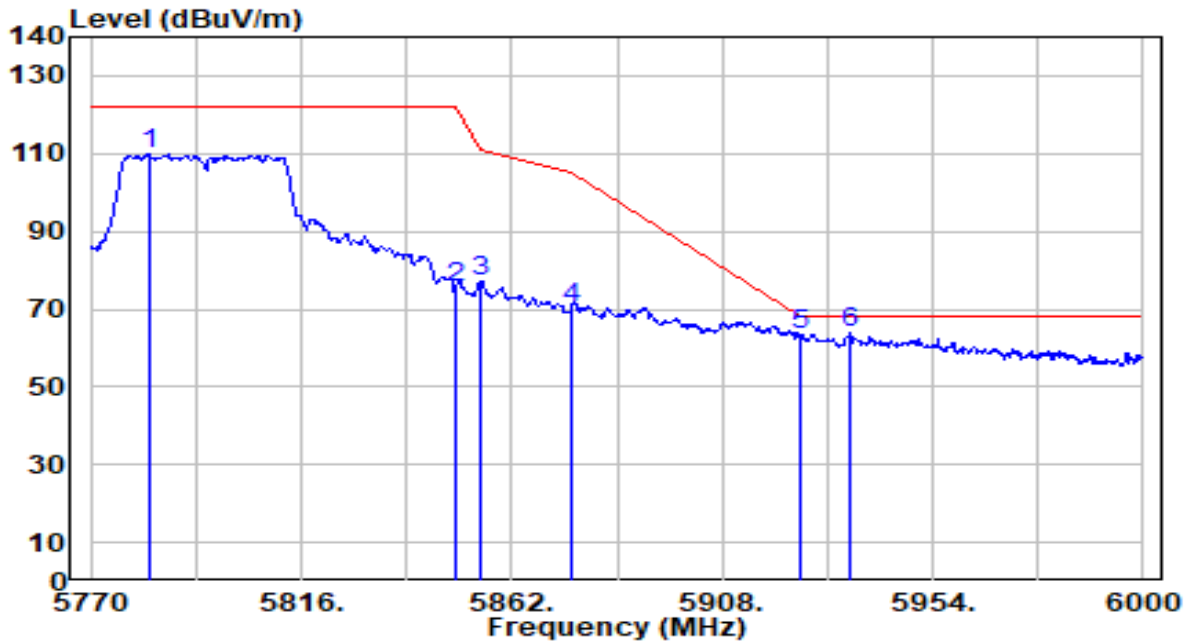

No	Frequency (MHz)	Reading (dBuV)	C.F (dB/m)	Measurement (dBuV/m)	Margin (dB)	Limit (dBuV/m)	Height (cm)	Angle (deg)	Remark (QP/PK/AV)
1	5782.650	109.30	0.42	109.73	N/A	N/A	266	181	Peak
2	5850.000	75.26	0.55	75.81	-46.39	122.20	266	181	Peak
3	5855.000	76.67	0.56	77.23	-33.57	110.80	266	181	Peak
4	5875.000	69.75	0.58	70.33	-34.87	105.20	266	181	Peak
5	5925.000	62.64	0.65	63.28	-4.92	68.20	266	181	Peak
6	* 5936.060	63.22	0.66	63.88	-4.32	68.20	266	181	Peak

Note:

1. " \*", means this data is the worst emission level.
2. C.F (Correction Factor) = Antenna Factor (dB/m) + Cable Loss (dB) – Preamplifier(dB) + 10dB Attenuation.
3. Measurement (dBuV/m) = Reading(dBuV) + C.F (Correction Factor).
4. The emission levels of other frequencies are very lower than the limit and not show in test report.

EUT	AX3000 High Gain Wireless USB Adapter	Date of Test	2023-01-19
Factor	DRH18-E	Temp. / Humidity	20°C /62%
Polarity	Vertical	Site / Test Engineer	AC2 / Ares
Test Mode	802.11ac-40MHz_TX_Band4_CH 159_ANT 1+2	Test Voltage	By Notebook PC

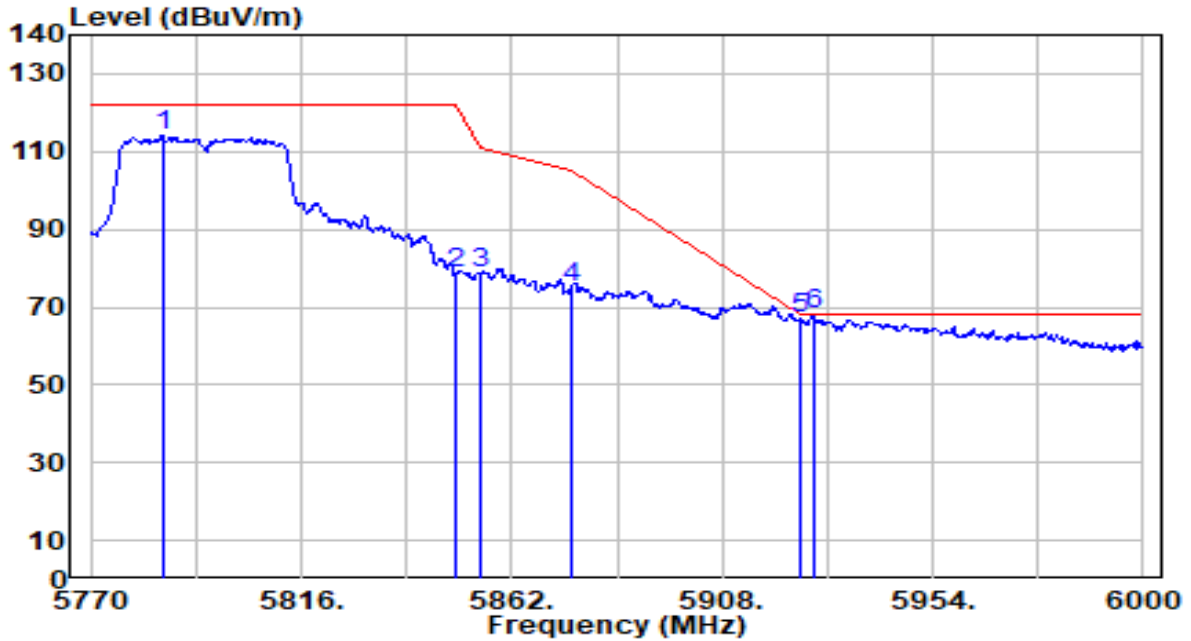

No	Frequency (MHz)	Reading (dBuV)	C.F (dB/m)	Measurement (dBuV/m)	Margin (dB)	Limit (dBuV/m)	Height (cm)	Angle (deg)	Remark (QP/PK/AV)
1	5785.640	113.61	0.43	114.04	N/A	N/A	263	250	Peak
2	5850.000	78.06	0.55	78.61	-43.59	122.20	263	250	Peak
3	5855.000	78.06	0.56	78.61	-32.19	110.80	263	250	Peak
4	5875.000	74.40	0.58	74.98	-30.22	105.20	263	250	Peak
5	5925.000	66.46	0.65	67.11	-1.09	68.20	263	250	Peak
6	* 5928.010	67.42	0.65	68.07	-0.13	68.20	263	250	Peak

Note:

1. " \*", means this data is the worst emission level.
2. C.F (Correction Factor) = Antenna Factor (dB/m) + Cable Loss (dB) – Preamplifier(dB) + 10dB Attenuation.
3. Measurement (dBuV/m) = Reading(dBuV) + C.F (Correction Factor).
4. The emission levels of other frequencies are very lower than the limit and not show in test report.

EUT	AX3000 High Gain Wireless USB Adapter	Date of Test	2023-01-19
-----	---------------------------------------	--------------	------------

Factor	DRH18-E	Temp. / Humidity	20°C /62%
Polarity	Horizontal	Site / Test Engineer	AC2 / Ares
Test Mode	802.11ac-80MHz_TX_Band1_CH 42_ANT 1+2	Test Voltage	By Notebook PC

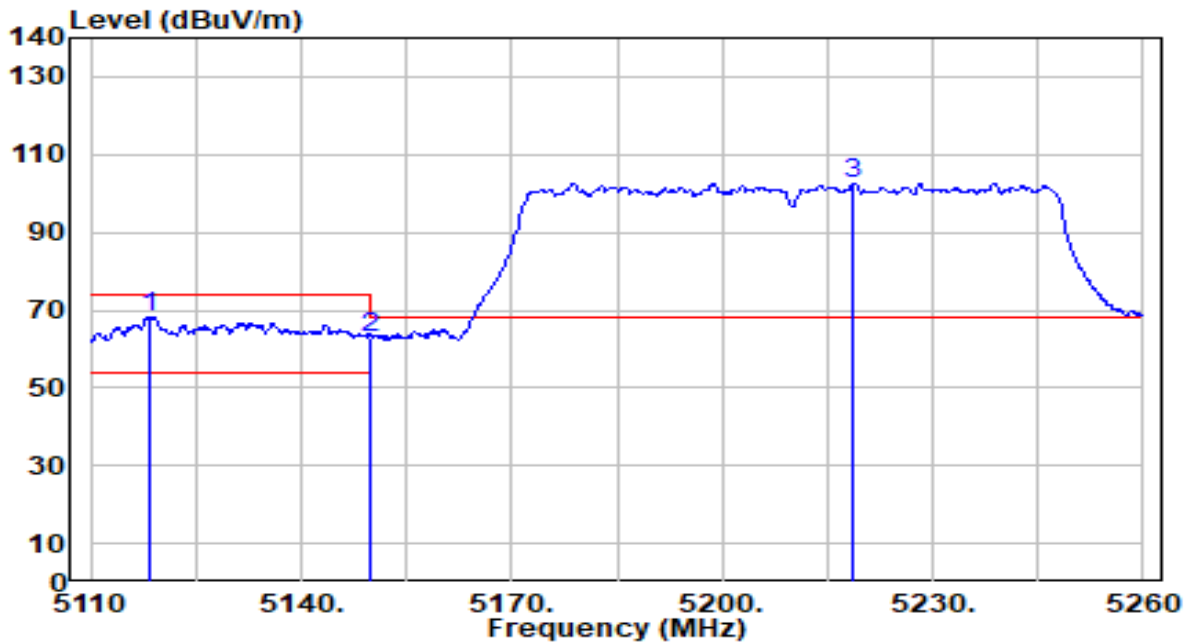

No	Frequency (MHz)	Reading (dBUV)	C.F (dB/m)	Measurement (dBUV/m)	Margin (dB)	Limit (dBUV/m)	Height (cm)	Angle (deg)	Remark (QP/PK/AV)
1	* 5118.550	69.10	-0.76	68.34	-5.66	74.00	227	174	Peak
2	5150.000	63.63	-0.73	62.90	-11.10	74.00	227	174	Peak
3	5218.750	103.36	-0.72	102.64	N/A	N/A	227	174	Peak

Note:

1. " \*", means this data is the worst emission level.
2. C.F (Correction Factor) = Antenna Factor (dB/m) + Cable Loss (dB) – Pre-amplifier(dB) + 10dB Attenuation.
3. Measurement (dBUV/m) = Reading(dBUV) + C.F (Correction Factor).
4. The emission levels of other frequencies are very lower than the limit and not show in test report.



EUT	AX3000 High Gain Wireless USB Adapter	Date of Test	2023-01-19
Factor	DRH18-E	Temp. / Humidity	20°C /62%
Polarity	Horizontal	Site / Test Engineer	AC2 / Ares
Test Mode	802.11ac-80MHz_TX_Band1_CH 42_ANT 1+2	Test Voltage	By Notebook PC

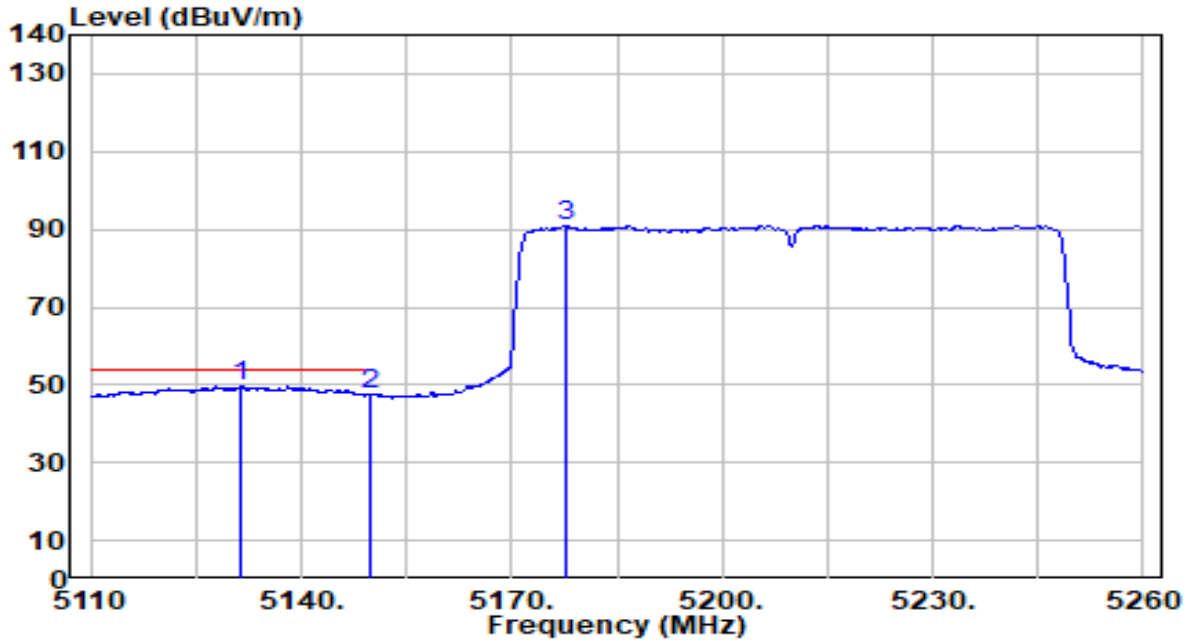

No	Frequency (MHz)	Reading (dBuV)	C.F (dB/m)	Measurement (dBuV/m)	Margin (dB)	Limit (dBuV/m)	Height (cm)	Angle (deg)	Remark (QP/PK/AV)	
1	*	5131.450	50.41	-0.74	49.67	-4.33	54.00	227	174	Average
2		5150.000	48.31	-0.73	47.59	-6.41	54.00	227	174	Average
3		5177.650	91.64	-0.70	90.94	N/A	N/A	227	174	Average

Note:

1. " \*", means this data is the worst emission level.
2. C.F (Correction Factor) = Antenna Factor (dB/m) + Cable Loss (dB) – Preamplifier(dB) + 10dB Attenuation.
3. Measurement (dBuV/m) = Reading(dBuV) + C.F (Correction Factor).
4. The emission levels of other frequencies are very lower than the limit and not show in test report.

EUT	AX3000 High Gain Wireless USB Adapter	Date of Test	2023-01-19
Factor	DRH18-E	Temp. / Humidity	20°C /62%
Polarity	Vertical	Site / Test Engineer	AC2 / Ares
Test Mode	802.11ac-80MHz_TX_Band1_CH 42_ANT 1+2	Test Voltage	By Notebook PC

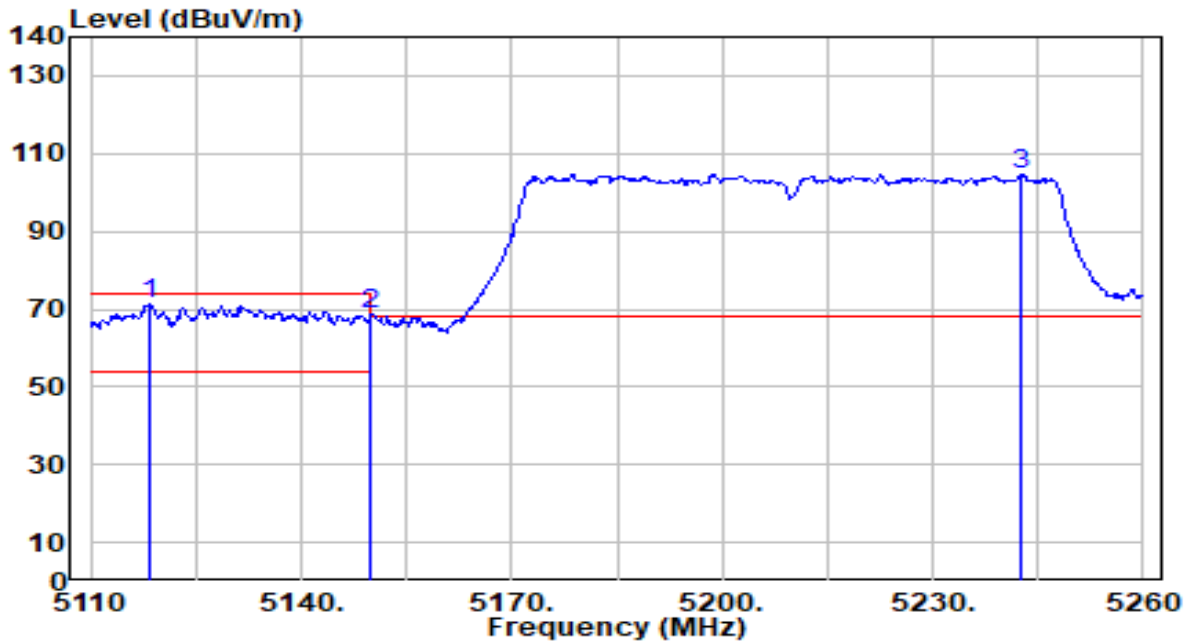

No	Frequency (MHz)	Reading (dBuV)	C.F (dB/m)	Measurement (dBuV/m)	Margin (dB)	Limit (dBuV/m)	Height (cm)	Angle (deg)	Remark (QP/PK/AV)
1	* 5118.400	71.82	-0.76	71.07	-2.93	74.00	122	44	Peak
2	5150.000	69.42	-0.73	68.70	-5.30	74.00	122	44	Peak
3	5242.750	105.47	-0.77	104.71	N/A	N/A	122	44	Peak

Note:

1. " \*", means this data is the worst emission level.
2. C.F (Correction Factor) = Antenna Factor (dB/m) + Cable Loss (dB) – Preamplifier(dB) + 10dB Attenuation.
3. Measurement (dBuV/m) = Reading(dBuV) + C.F (Correction Factor).
4. The emission levels of other frequencies are very lower than the limit and not show in test report.

EUT	AX3000 High Gain Wireless USB Adapter	Date of Test	2023-01-19
Factor	DRH18-E	Temp. / Humidity	20°C /62%
Polarity	Vertical	Site / Test Engineer	AC2 / Ares
Test Mode	802.11ac-80MHz_TX_Band1_CH 42_ANT 1+2	Test Voltage	By Notebook PC

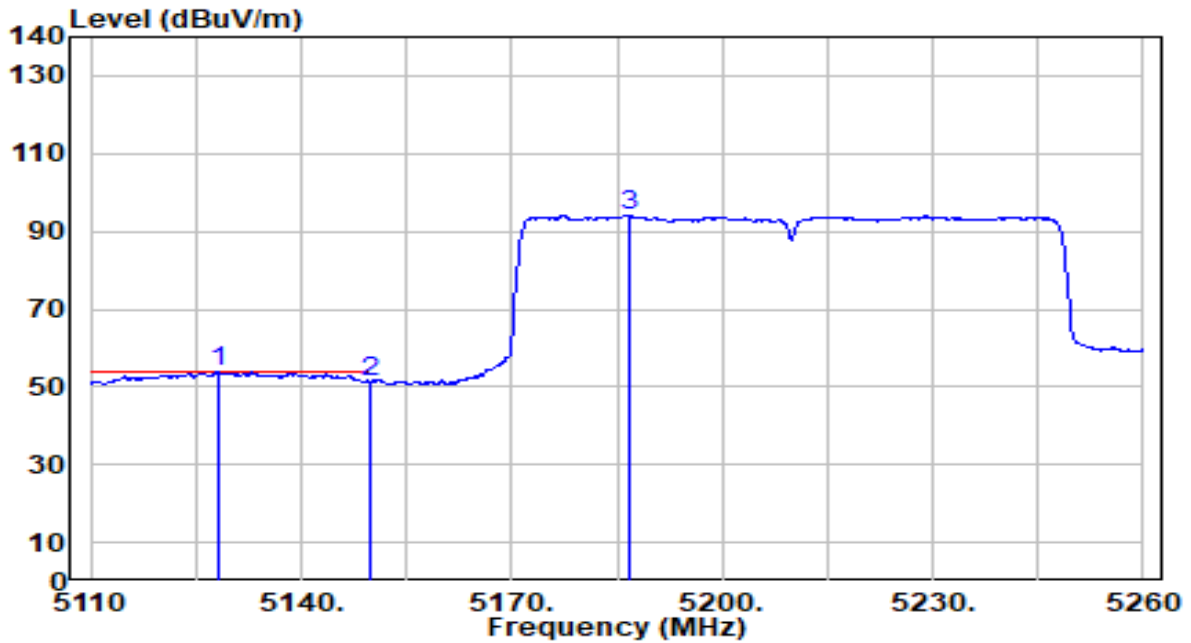

No	Frequency (MHz)	Reading (dBuV)	C.F (dB/m)	Measurement (dBuV/m)	Margin (dB)	Limit (dBuV/m)	Height (cm)	Angle (deg)	Remark (QP/PK/AV)	
1	*	5128.300	54.63	-0.75	53.88	-0.12	54.00	122	44	Average
2		5150.000	52.22	-0.73	51.49	-2.51	54.00	122	44	Average
3		5186.650	94.91	-0.69	94.22	N/A	N/A	122	44	Average

Note:

1. " \*", means this data is the worst emission level.
2. C.F (Correction Factor) = Antenna Factor (dB/m) + Cable Loss (dB) – Preamplifier(dB) + 10dB Attenuation.
3. Measurement (dBuV/m) = Reading(dBuV) + C.F (Correction Factor).
4. The emission levels of other frequencies are very lower than the limit and not show in test report.

EUT	AX3000 High Gain Wireless USB Adapter	Date of Test	2023-01-19
Factor	DRH18-E	Temp. / Humidity	20°C /62%
Polarity	Horizontal	Site / Test Engineer	AC2 / Ares
Test Mode	802.11ac-80MHz_TX_Band2_CH 58_ANT 1+2	Test Voltage	By Notebook PC

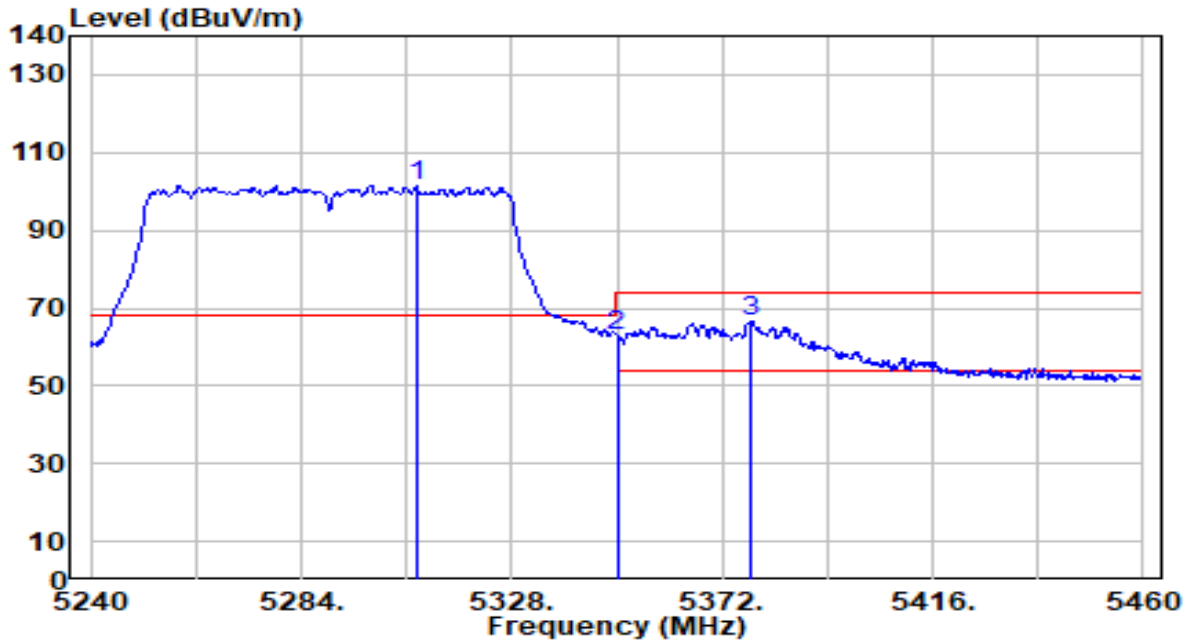

No	Frequency (MHz)	Reading (dBuV)	C.F (dB/m)	Measurement (dBuV/m)	Margin (dB)	Limit (dBuV/m)	Height (cm)	Angle (deg)	Remark (QP/PK/AV)
1	5308.200	102.35	-0.90	101.45	N/A	N/A	250	183	Peak
2	5350.000	63.92	-0.98	62.93	-11.07	74.00	250	183	Peak
3	* 5378.160	67.86	-1.04	66.82	-7.18	74.00	250	183	Peak

Note:

1. " \*", means this data is the worst emission level.
2. C.F (Correction Factor) = Antenna Factor (dB/m) + Cable Loss (dB) – Pre-amplifier(dB) + 10dB Attenuation.
3. Measurement (dBuV/m) = Reading(dBuV) + C.F (Correction Factor).
4. The emission levels of other frequencies are very lower than the limit and not show in test report.

EUT	AX3000 High Gain Wireless USB Adapter	Date of Test	2023-01-19
Factor	DRH18-E	Temp. / Humidity	20°C /62%
Polarity	Horizontal	Site / Test Engineer	AC2 / Ares
Test Mode	802.11ac-80MHz_TX_Band2_CH 58_ANT 1+2	Test Voltage	By Notebook PC

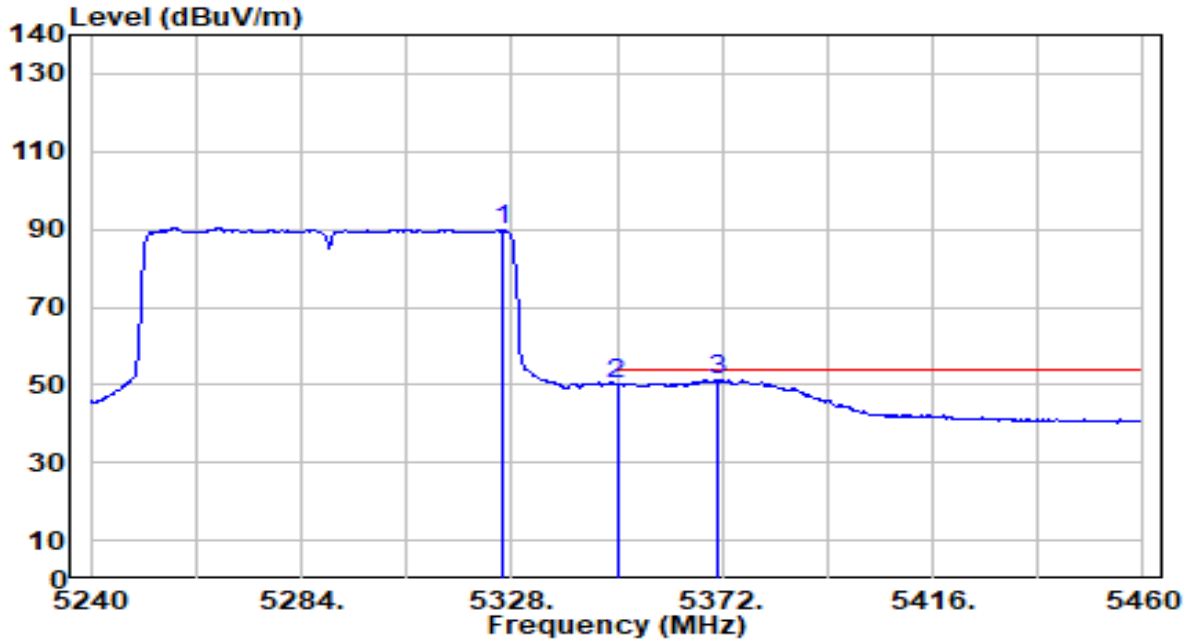

No	Frequency (MHz)	Reading (dBuV)	C.F (dB/m)	Measurement (dBuV/m)	Margin (dB)	Limit (dBuV/m)	Height (cm)	Angle (deg)	Remark (QP/PK/AV)
1	5326.020	90.87	-0.94	89.94	N/A	N/A	250	183	Average
2	5350.000	51.06	-0.98	50.08	-3.92	54.00	250	183	Average
3	* 5371.120	52.31	-1.03	51.28	-2.72	54.00	250	183	Average

Note:

1. " \*", means this data is the worst emission level.
2. C.F (Correction Factor) = Antenna Factor (dB/m) + Cable Loss (dB) – Preamplifier(dB) + 10dB Attenuation.
3. Measurement (dBuV/m) = Reading(dBuV) + C.F (Correction Factor).
4. The emission levels of other frequencies are very lower than the limit and not show in test report.

EUT	AX3000 High Gain Wireless USB Adapter	Date of Test	2023-01-19
Factor	DRH18-E	Temp. / Humidity	20°C /62%
Polarity	Vertical	Site / Test Engineer	AC2 / Ares
Test Mode	802.11ac-80MHz_TX_Band2_CH 58_ANT 1+2	Test Voltage	By Notebook PC

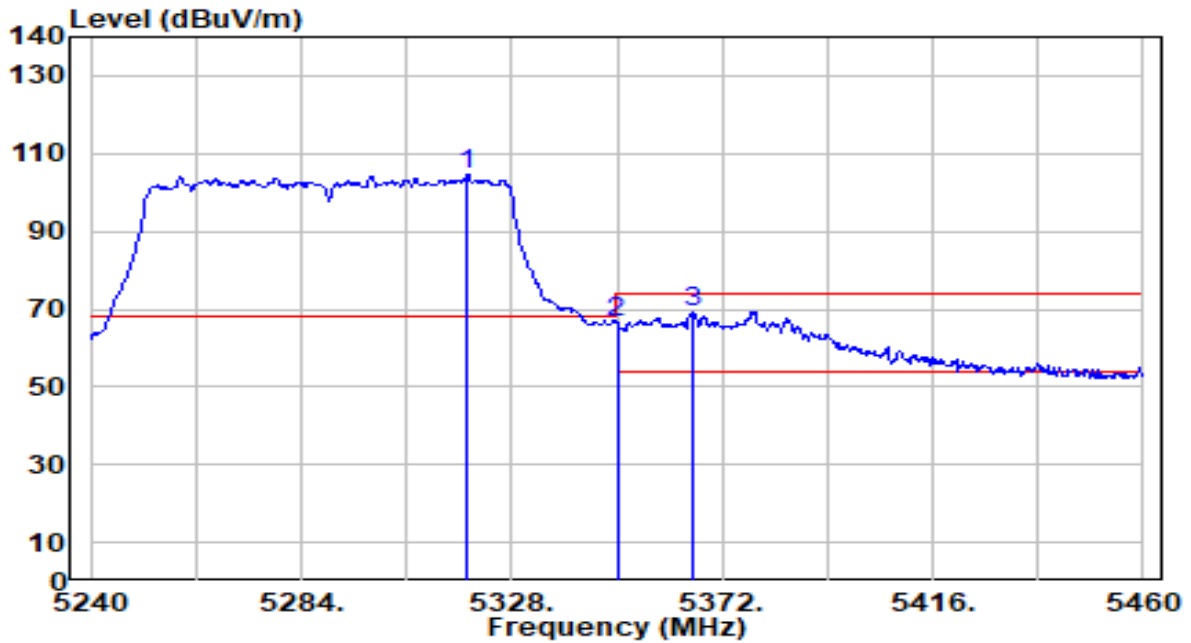

No	Frequency (MHz)	Reading (dBuV)	C.F (dB/m)	Measurement (dBuV/m)	Margin (dB)	Limit (dBuV/m)	Height (cm)	Angle (deg)	Remark (QP/PK/AV)
1	5318.760	105.63	-0.92	104.71	N/A	N/A	302	254	Peak
2	5350.000	67.31	-0.98	66.33	-7.67	74.00	302	254	Peak
3	* 5365.840	70.12	-1.02	69.11	-4.89	74.00	302	254	Peak

Note:

1. " \*", means this data is the worst emission level.
2. C.F (Correction Factor) = Antenna Factor (dB/m) + Cable Loss (dB) – Preamplifier(dB) + 10dB Attenuation.
3. Measurement (dBuV/m) = Reading(dBuV) + C.F (Correction Factor).
4. The emission levels of other frequencies are very lower than the limit and not show in test report.

EUT	AX3000 High Gain Wireless USB Adapter	Date of Test	2023-01-19
Factor	DRH18-E	Temp. / Humidity	20°C /62%
Polarity	Vertical	Site / Test Engineer	AC2 / Ares
Test Mode	802.11ac-80MHz_TX_Band2_CH 58_ANT 1+2	Test Voltage	By Notebook PC

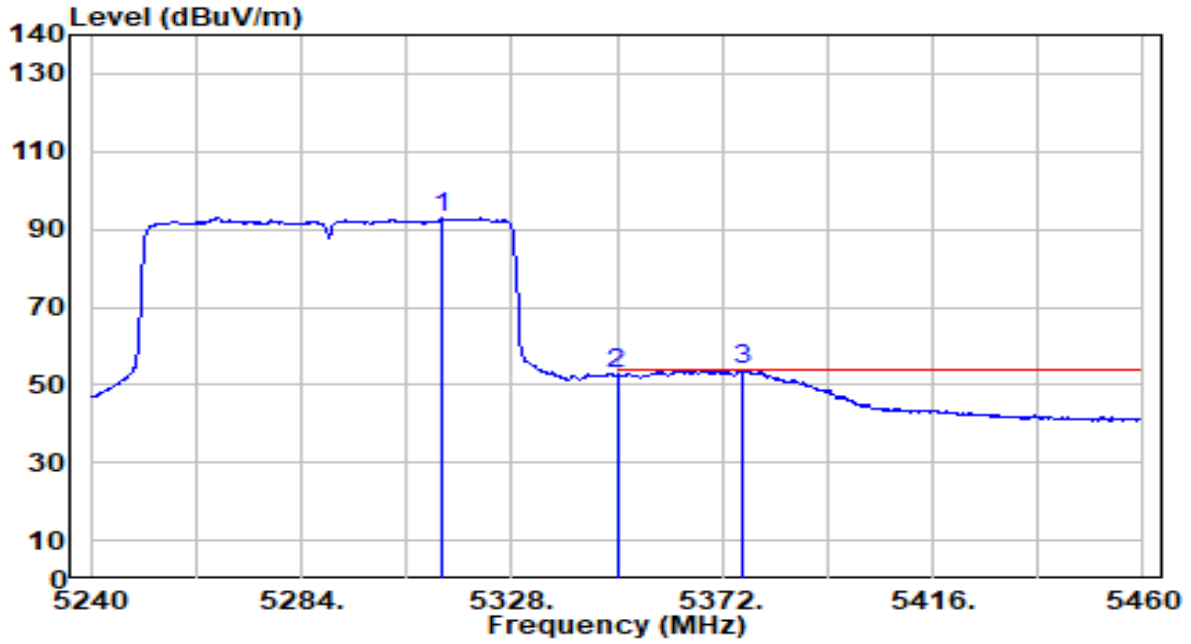

No	Frequency (MHz)	Reading (dBuV)	C.F (dB/m)	Measurement (dBuV/m)	Margin (dB)	Limit (dBuV/m)	Height (cm)	Angle (deg)	Remark (QP/PK/AV)
1	5313.260	93.72	-0.91	92.81	N/A	N/A	302	254	Average
2	5350.000	53.60	-0.98	52.61	-1.39	54.00	302	254	Average
3	* 5376.400	54.86	-1.04	53.82	-0.18	54.00	302	254	Average

Note:

1. " \*", means this data is the worst emission level.
2. C.F (Correction Factor) = Antenna Factor (dB/m) + Cable Loss (dB) – Preamplifier(dB) + 10dB Attenuation.
3. Measurement (dBuV/m) = Reading(dBuV) + C.F (Correction Factor).
4. The emission levels of other frequencies are very lower than the limit and not show in test report.

EUT	AX3000 High Gain Wireless USB Adapter	Date of Test	2023-01-30
Factor	DRH18-E	Temp. / Humidity	20°C /62%
Polarity	Horizontal	Site / Test Engineer	AC2 / Ares
Test Mode	802.11ac-80MHz_TX_Band3_CH 106_ANT 1+2	Test Voltage	By Notebook PC

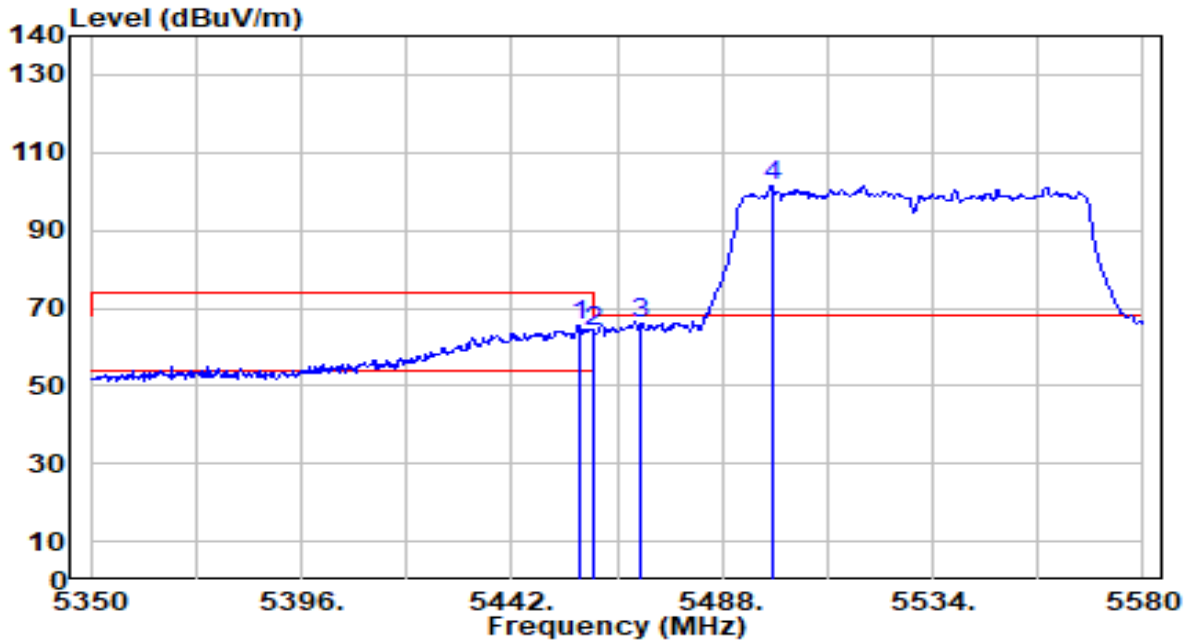

No	Frequency (MHz)	Reading (dBuV)	C.F (dB/m)	Measurement (dBuV/m)	Margin (dB)	Limit (dBuV/m)	Height (cm)	Angle (deg)	Remark (QP/PK/AV)
1	5456.720	66.49	-0.86	65.63	-8.37	74.00	210	178	Peak
2	5460.000	64.70	-0.85	63.85	-10.15	74.00	210	178	Peak
3	* 5470.000	66.74	-0.81	65.94	-2.26	68.20	210	178	Peak
4	5498.810	102.06	-0.69	101.37	N/A	N/A	210	178	Peak

Note:

1. " \*", means this data is the worst emission level.
2. C.F (Correction Factor) = Antenna Factor (dB/m) + Cable Loss (dB) – Preamplifier(dB) + 10dB Attenuation.
3. Measurement (dBuV/m) = Reading(dBuV) + C.F (Correction Factor).
4. The emission levels of other frequencies are very lower than the limit and not show in test report.



EUT	AX3000 High Gain Wireless USB Adapter	Date of Test	2023-01-30
Factor	DRH18-E	Temp. / Humidity	20°C /62%
Polarity	Horizontal	Site / Test Engineer	AC2 / Ares
Test Mode	802.11ac-80MHz_TX_Band3_CH 106_ANT 1+2	Test Voltage	By Notebook PC

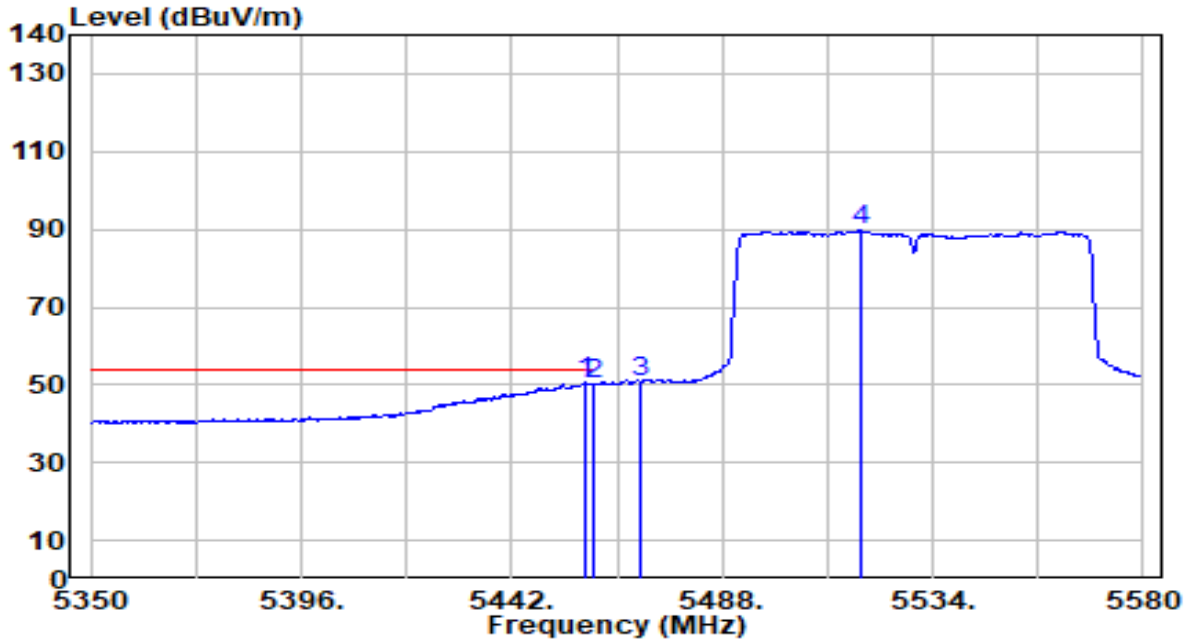

No	Frequency (MHz)	Reading (dBuV)	C.F (dB/m)	Measurement (dBuV/m)	Margin (dB)	Limit (dBuV/m)	Height (cm)	Angle (deg)	Remark (QP/PK/AV)	
1	*	5458.330	51.55	-0.86	50.70	-3.30	54.00	210	178	Average
2		5460.000	50.99	-0.85	50.14	-3.86	54.00	210	178	Average
3		5470.000	51.63	-0.81	50.82	N/A	N/A	210	178	Average
4		5518.130	90.34	-0.61	89.72	N/A	N/A	210	178	Average

Note:

1. " \*", means this data is the worst emission level.
2. C.F (Correction Factor) = Antenna Factor (dB/m) + Cable Loss (dB) – Pre-amplifier(dB) + 10dB Attenuation.
3. Measurement (dBuV/m) = Reading(dBuV) + C.F (Correction Factor).
4. The emission levels of other frequencies are very lower than the limit and not show in test report.

EUT	AX3000 High Gain Wireless USB Adapter	Date of Test	2023-01-30
Factor	DRH18-E	Temp. / Humidity	20°C /62%
Polarity	Vertical	Site / Test Engineer	AC2 / Ares
Test Mode	802.11ac-80MHz_TX_Band3_CH 106_ANT 1+2	Test Voltage	By Notebook PC

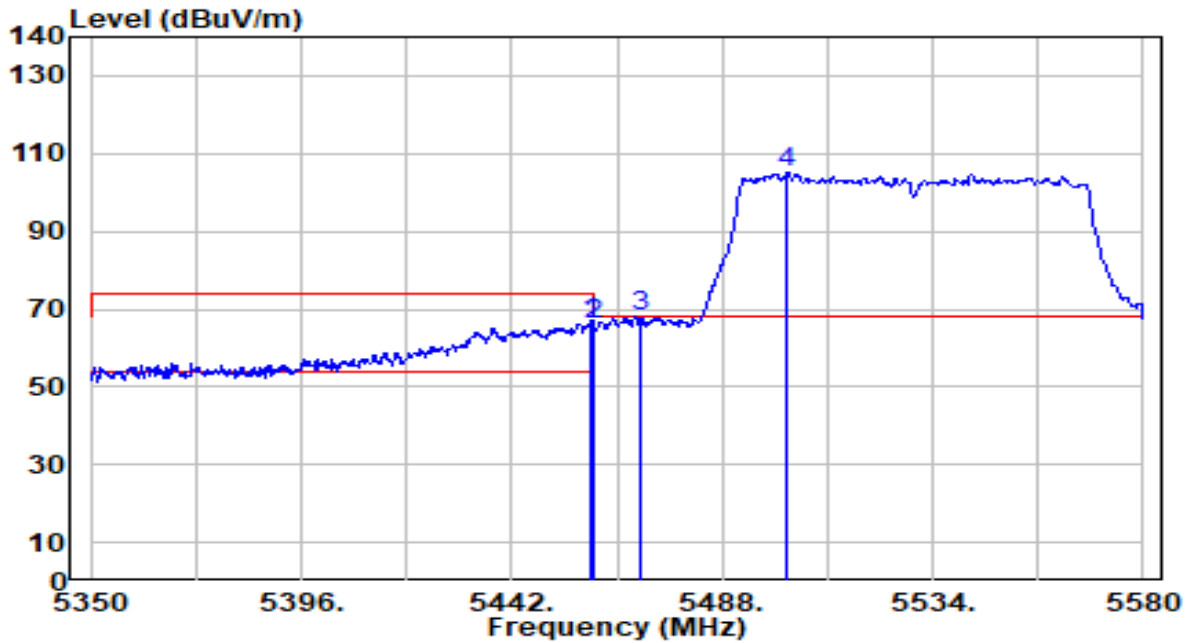

No	Frequency (MHz)	Reading (dBuV)	C.F (dB/m)	Measurement (dBuV/m)	Margin (dB)	Limit (dBuV/m)	Height (cm)	Angle (deg)	Remark (QP/PK/AV)
1	5459.020	67.15	-0.85	66.30	-7.70	74.00	278	252	Peak
2	5460.000	66.90	-0.85	66.06	-7.94	74.00	278	252	Peak
3	* 5470.000	68.84	-0.81	68.03	-0.17	68.20	278	252	Peak
4	5502.260	105.93	-0.68	105.25	N/A	N/A	278	252	Peak

Note:

1. " \*", means this data is the worst emission level.
2. C.F (Correction Factor) = Antenna Factor (dB/m) + Cable Loss (dB) – Pre-amplifier(dB) + 10dB Attenuation.
3. Measurement (dBuV/m) = Reading(dBuV) + C.F (Correction Factor).
4. The emission levels of other frequencies are very lower than the limit and not show in test report.

EUT	AX3000 High Gain Wireless USB Adapter	Date of Test	2023-01-30
Factor	DRH18-E	Temp. / Humidity	20°C /62%
Polarity	Vertical	Site / Test Engineer	AC2 / Ares
Test Mode	802.11ac-80MHz_TX_Band3_CH 106_ANT 1+2	Test Voltage	By Notebook PC

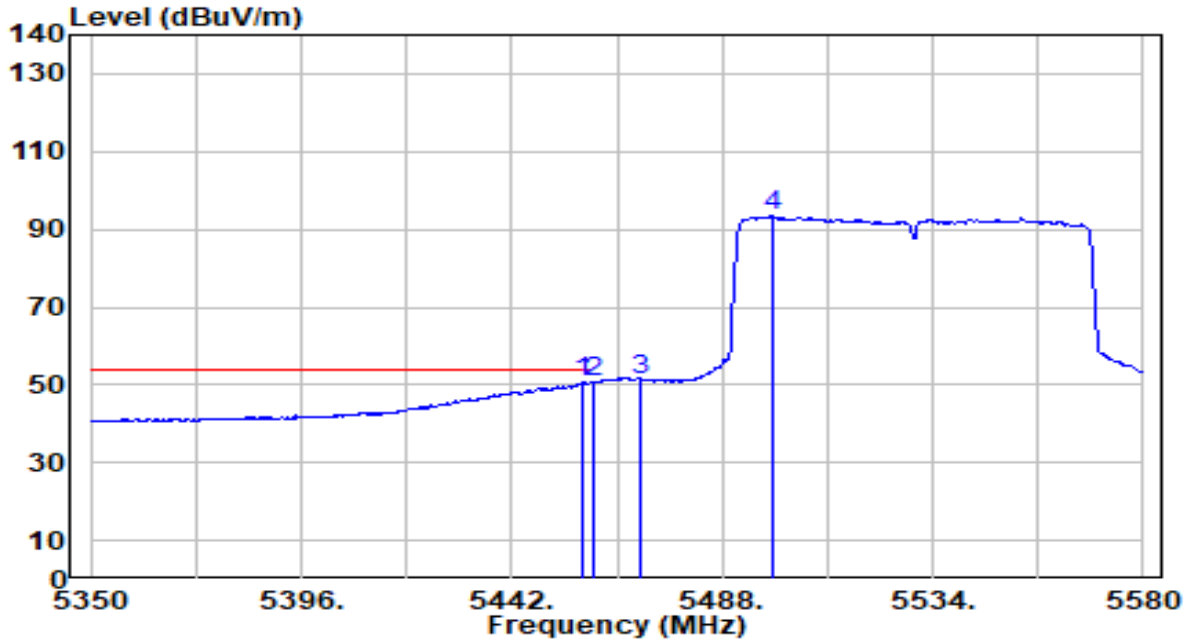

No	Frequency (MHz)	Reading (dBuV)	C.F (dB/m)	Measurement (dBuV/m)	Margin (dB)	Limit (dBuV/m)	Height (cm)	Angle (deg)	Remark (QP/PK/AV)
1	5457.640	51.44	-0.86	50.59	-3.41	54.00	278	252	Average
2	* 5460.000	51.61	-0.85	50.76	-3.24	54.00	278	252	Average
3	5470.000	52.12	-0.81	51.31	N/A	N/A	278	252	Average
4	5498.810	93.97	-0.69	93.28	N/A	N/A	278	252	Average

Note:

1. " \*", means this data is the worst emission level.
2. C.F (Correction Factor) = Antenna Factor (dB/m) + Cable Loss (dB) – Preamplifier(dB) + 10dB Attenuation.
3. Measurement (dBuV/m) = Reading(dBuV) + C.F (Correction Factor).
4. The emission levels of other frequencies are very lower than the limit and not show in test report.

EUT	AX3000 High Gain Wireless USB Adapter	Date of Test	2023-01-19
Factor	DRH18-E	Temp. / Humidity	20°C /62%
Polarity	Horizontal	Site / Test Engineer	AC2 / Ares
Test Mode	802.11ac-80MHz_TX_Band4_CH 155_ANT 1+2	Test Voltage	By Notebook PC

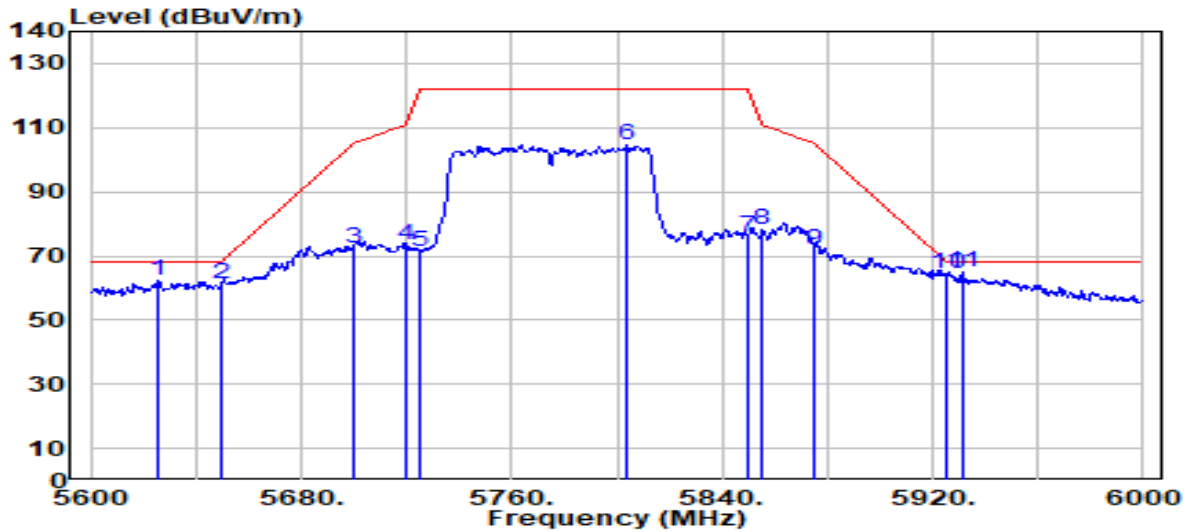

No	Frequency (MHz)	Reading (dBUV)	C.F (dB/m)	Measurement (dBUV/m)	Margin (dB)	Limit (dBUV/m)	Height (cm)	Angle (deg)	Remark (QP/PK/AV)
1	5625.600	62.52	-0.17	62.35	-5.85	68.20	260	181	Peak
2	5650.000	61.47	-0.08	61.39	-6.81	68.20	260	181	Peak
3	5700.000	72.24	0.11	72.35	-32.85	105.20	260	181	Peak
4	5720.000	73.22	0.19	73.41	-37.39	110.80	260	181	Peak
5	5725.000	71.35	0.21	71.56	-50.64	122.20	260	181	Peak
6	5804.000	103.88	0.49	104.38	N/A	N/A	260	181	Peak
7	5850.000	75.47	0.55	76.02	-46.18	122.20	260	181	Peak
8	5855.000	77.72	0.56	78.27	-32.53	110.80	260	181	Peak
9	5875.000	71.21	0.58	71.79	-33.41	105.20	260	181	Peak
10	5925.000	63.55	0.65	64.19	-4.01	68.20	260	181	Peak
11	* 5931.600	64.07	0.65	64.73	-3.47	68.20	260	181	Peak

Note:

1. " \*", means this data is the worst emission level.
2. C.F (Correction Factor) = Antenna Factor (dB/m) + Cable Loss (dB) – Pre-amplifier(dB) + 10dB Attenuation.
3. Measurement (dBUV/m) = Reading(dBUV) + C.F (Correction Factor).
4. The emission levels of other frequencies are very lower than the limit and not show in test report.

EUT	AX3000 High Gain Wireless USB Adapter	Date of Test	2023-01-19
Factor	DRH18-E	Temp. / Humidity	20°C /62%
Polarity	Vertical	Site / Test Engineer	AC2 / Ares
Test Mode	802.11ac-80MHz_TX_Band4_CH 155_ANT 1+2	Test Voltage	By Notebook PC

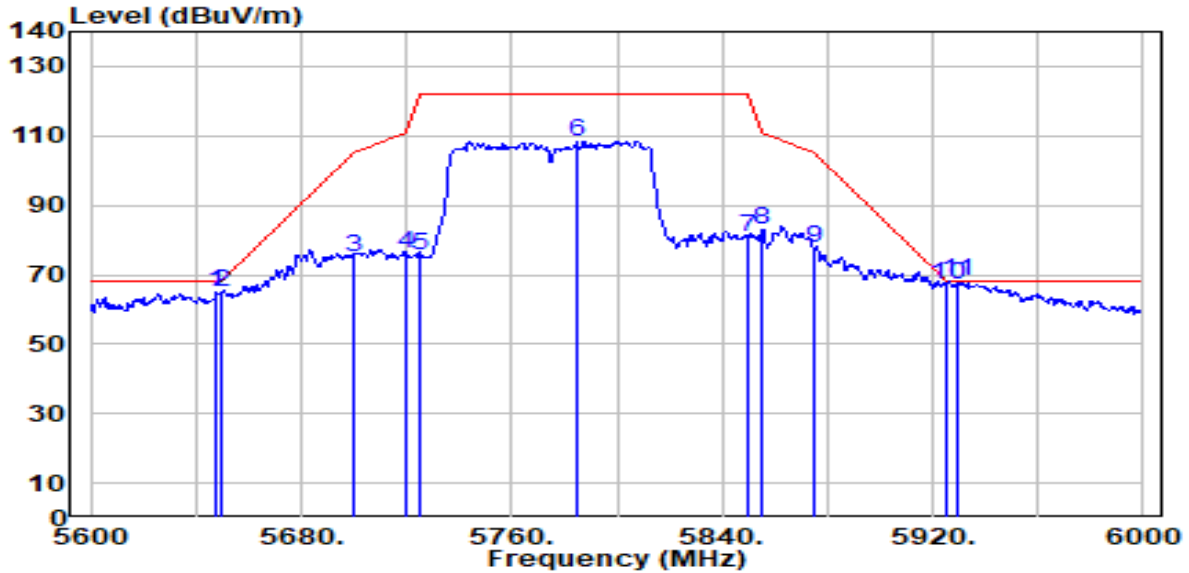

No	Frequency (MHz)	Reading (dBuV)	C.F (dB/m)	Measurement (dBuV/m)	Margin (dB)	Limit (dBuV/m)	Height (cm)	Angle (deg)	Remark (QP/PK/AV)
1	5648.000	65.19	-0.08	65.11	-3.09	68.20	264	252	Peak
2	5650.000	64.87	-0.08	64.79	-3.41	68.20	264	252	Peak
3	5700.000	74.97	0.11	75.08	-30.12	105.20	264	252	Peak
4	5720.000	75.80	0.19	75.99	-34.81	110.80	264	252	Peak
5	5725.000	75.27	0.21	75.47	-46.73	122.20	264	252	Peak
6	5785.200	108.13	0.43	108.56	N/A	N/A	264	252	Peak
7	5850.000	80.46	0.55	81.01	-41.19	122.20	264	252	Peak
8	5855.000	82.28	0.56	82.84	-27.96	110.80	264	252	Peak
9	5875.000	76.91	0.58	77.49	-27.71	105.20	264	252	Peak
10	5925.000	66.59	0.65	67.23	-0.97	68.20	264	252	Peak
11 *	5929.200	67.36	0.65	68.01	-0.19	68.20	264	252	Peak

Note:

1. " \*", means this data is the worst emission level.
2. C.F (Correction Factor) = Antenna Factor (dB/m) + Cable Loss (dB) – Pre-amplifier(dB) + 10dB Attenuation.
3. Measurement (dBuV/m) = Reading(dBuV) + C.F (Correction Factor).
4. The emission levels of other frequencies are very lower than the limit and not show in test report.

EUT	AX3000 High Gain Wireless USB Adapter	Date of Test	2023-01-19
-----	---------------------------------------	--------------	------------

Factor	DRH18-E	Temp. / Humidity	20°C /62%
Polarity	Horizontal	Site / Test Engineer	AC2 / Ares
Test Mode	802.11ac-160MHz_TX_Band1,2_CH 50_ANT 1+2	Test Voltage	By Notebook PC

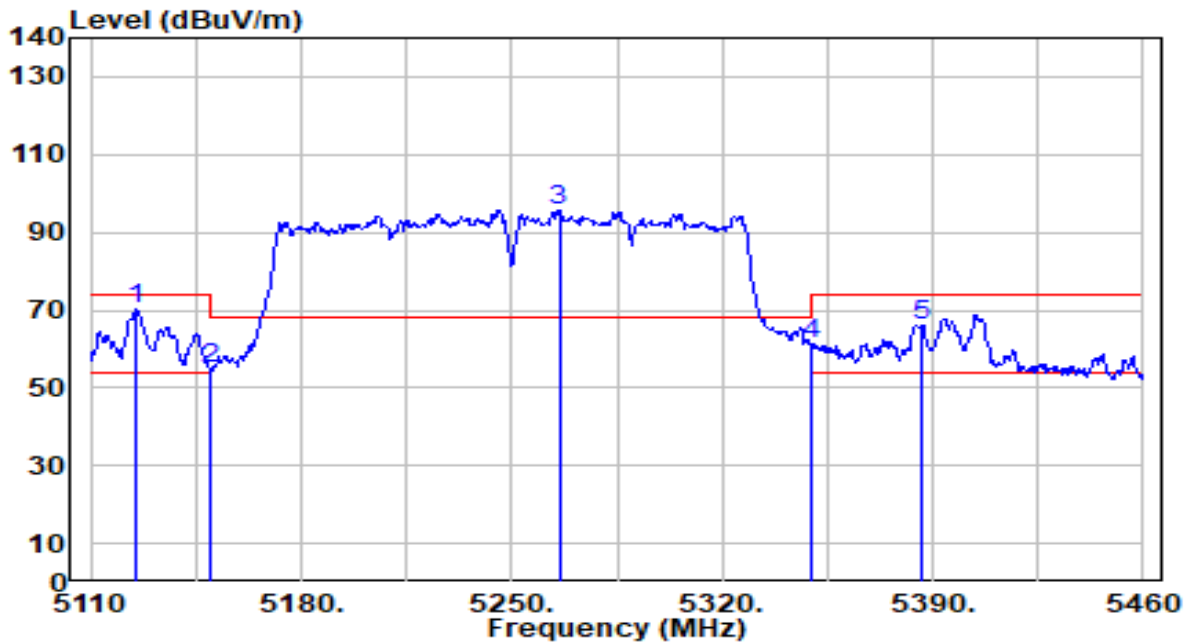

No	Frequency (MHz)	Reading (dBUV)	C.F (dB/m)	Measurement (dBUV/m)	Margin (dB)	Limit (dBUV/m)	Height (cm)	Angle (deg)	Remark (QP/PK/AV)
1	* 5125.400	70.76	-0.75	70.01	-3.99	74.00	250	183	Peak
2	5150.000	55.86	-0.73	55.13	-18.87	74.00	250	183	Peak
3	5265.750	96.59	-0.81	95.78	N/A	N/A	250	183	Peak
4	5350.000	62.20	-0.98	61.22	-12.78	74.00	250	183	Peak
5	5386.500	67.32	-1.06	66.26	-7.74	74.00	250	183	Peak

Note:

1. " \*", means this data is the worst emission level.
2. C.F (Correction Factor) = Antenna Factor (dB/m) + Cable Loss (dB) – Preamplifier(dB) + 10dB Attenuation.
3. Measurement (dBUV/m) = Reading(dBUV) + C.F (Correction Factor).
4. The emission levels of other frequencies are very lower than the limit and not show in test report.

EUT	AX3000 High Gain Wireless USB Adapter	Date of Test	2023-01-19
Factor	DRH18-E	Temp. / Humidity	20°C /62%
Polarity	Horizontal	Site / Test Engineer	AC2 / Ares
Test Mode	802.11ac-160MHz_TX_Band1,2_CH 50_ANT 1+2	Test Voltage	By Notebook PC

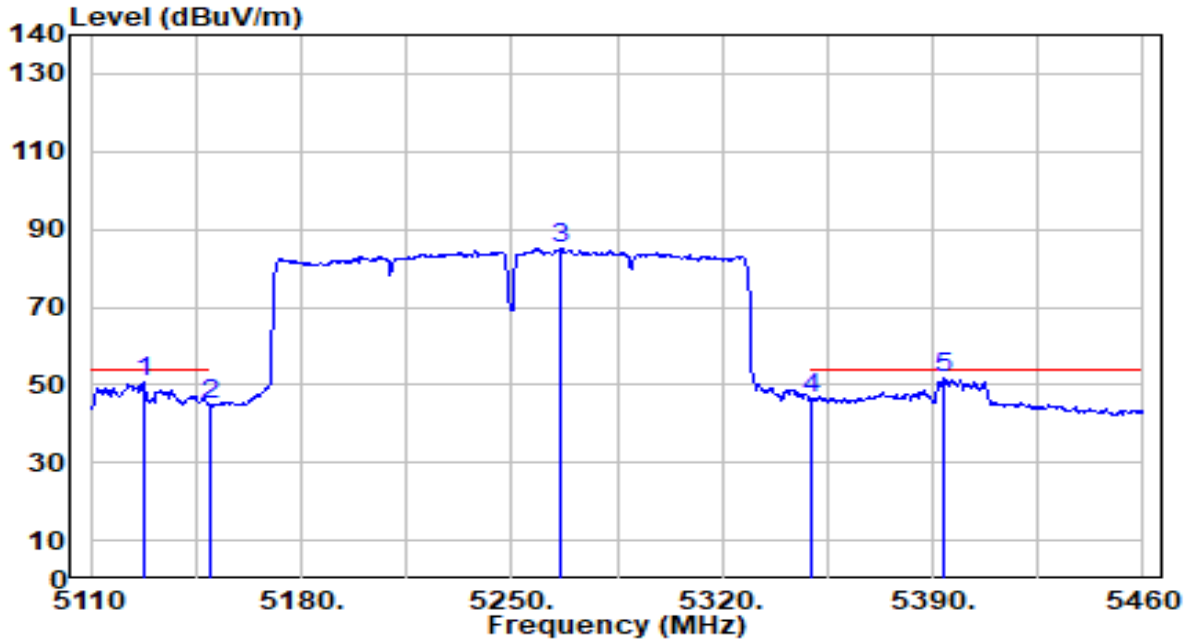

No	Frequency (MHz)	Reading (dBuV)	C.F (dB/m)	Measurement (dBuV/m)	Margin (dB)	Limit (dBuV/m)	Height (cm)	Angle (deg)	Remark (QP/PK/AV)
1	5127.500	51.30	-0.75	50.55	-3.45	54.00	250	183	Average
2	5150.000	45.42	-0.73	44.69	-9.31	54.00	250	183	Average
3	5266.450	85.70	-0.81	84.88	N/A	N/A	250	183	Average
4	5350.000	47.35	-0.98	46.36	-7.64	54.00	250	183	Average
5	* 5393.850	52.76	-1.07	51.68	-2.32	54.00	250	183	Average

Note:

1. " \*", means this data is the worst emission level.
2. C.F (Correction Factor) = Antenna Factor (dB/m) + Cable Loss (dB) – Preamplifier(dB) + 10dB Attenuation.
3. Measurement (dBuV/m) = Reading(dBuV) + C.F (Correction Factor).
4. The emission levels of other frequencies are very lower than the limit and not show in test report.

EUT	AX3000 High Gain Wireless USB Adapter	Date of Test	2023-01-19
Factor	DRH18-E	Temp. / Humidity	20°C /62%
Polarity	Vertical	Site / Test Engineer	AC2 / Ares
Test Mode	802.11ac-160MHz_TX_Band1,2_CH 50_ANT 1+2	Test Voltage	By Notebook PC

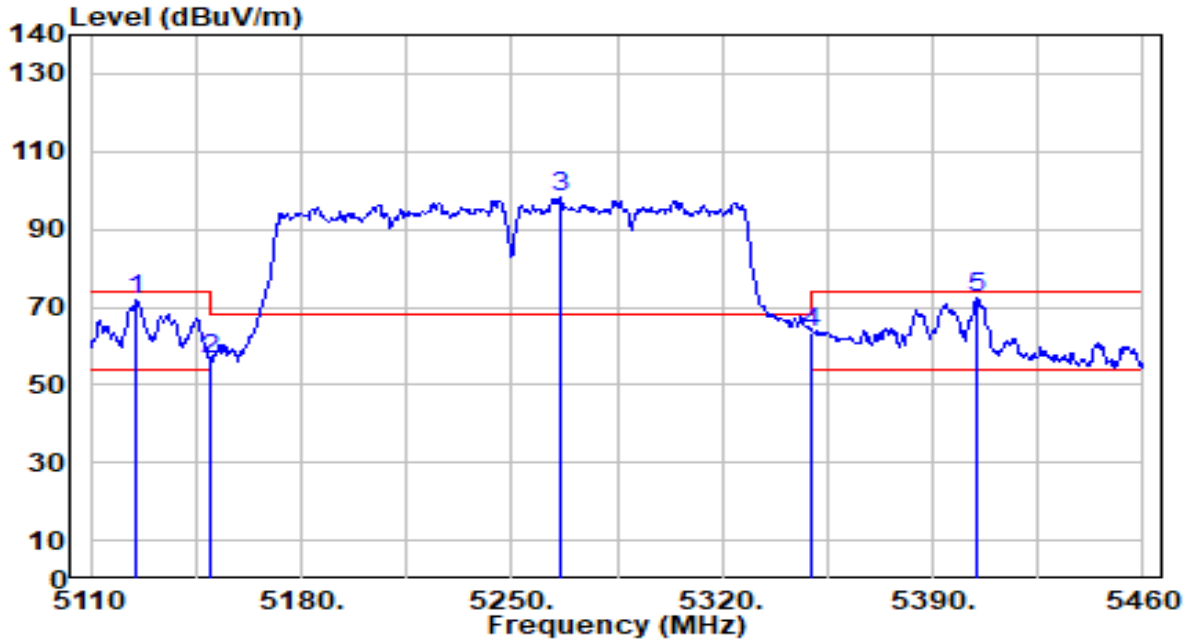

No	Frequency (MHz)	Reading (dBuV)	C.F (dB/m)	Measurement (dBuV/m)	Margin (dB)	Limit (dBuV/m)	Height (cm)	Angle (deg)	Remark (QP/PK/AV)
1	5125.050	72.54	-0.75	71.79	-2.21	74.00	302	254	Peak
2	5150.000	57.05	-0.73	56.32	-17.68	74.00	302	254	Peak
3	5266.100	98.88	-0.81	98.07	N/A	N/A	302	254	Peak
4	5350.000	64.50	-0.98	63.51	-10.49	74.00	302	254	Peak
5	* 5404.700	73.20	-1.07	72.13	-1.87	74.00	302	254	Peak

Note:

1. " \*", means this data is the worst emission level.
2. C.F (Correction Factor) = Antenna Factor (dB/m) + Cable Loss (dB) – Preamplifier(dB) + 10dB Attenuation.
3. Measurement (dBuV/m) = Reading(dBuV) + C.F (Correction Factor).
4. The emission levels of other frequencies are very lower than the limit and not show in test report.



EUT	AX3000 High Gain Wireless USB Adapter	Date of Test	2023-01-19
Factor	DRH18-E	Temp. / Humidity	20°C /62%
Polarity	Vertical	Site / Test Engineer	AC2 / Ares
Test Mode	802.11ac-160MHz_TX_Band1,2_CH 50_ANT 1+2	Test Voltage	By Notebook PC

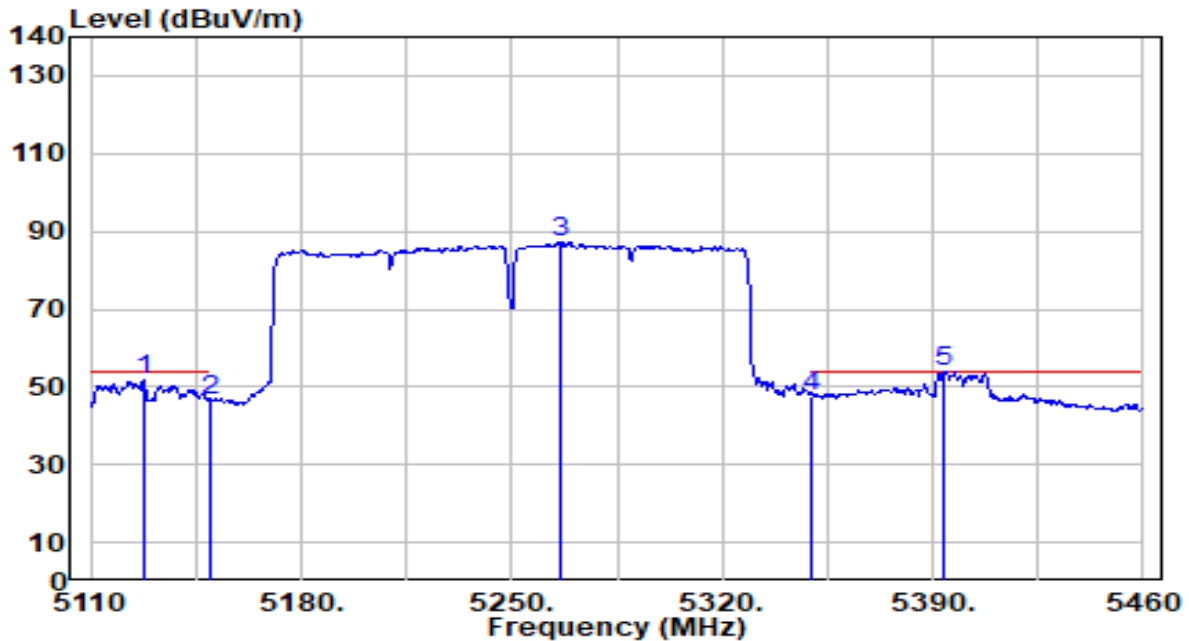

No	Frequency (MHz)	Reading (dBuV)	C.F (dB/m)	Measurement (dBuV/m)	Margin (dB)	Limit (dBuV/m)	Height (cm)	Angle (deg)	Remark (QP/PK/AV)
1	5127.850	52.54	-0.75	51.79	-2.21	54.00	302	254	Average
2	5150.000	47.38	-0.73	46.65	-7.35	54.00	302	254	Average
3	5266.450	88.18	-0.81	87.37	N/A	N/A	302	254	Average
4	5350.000	48.34	-0.98	47.36	-6.64	54.00	302	254	Average
5	* 5393.850	54.97	-1.07	53.90	-0.10	54.00	302	254	Average

Note:

1. " \*", means this data is the worst emission level.
2. C.F (Correction Factor) = Antenna Factor (dB/m) + Cable Loss (dB) – Preamplifier(dB) + 10dB Attenuation.
3. Measurement (dBuV/m) = Reading(dBuV) + C.F (Correction Factor).
4. The emission levels of other frequencies are very lower than the limit and not show in test report.

EUT	AX3000 High Gain Wireless USB Adapter	Date of Test	2023-01-19
Factor	DRH18-E	Temp. / Humidity	20°C /62%

Polarity	Horizontal	Site / Test Engineer	AC2 / Ares
Test Mode	802.11ac-160MHz_TX_Band3_CH 114_ANT 1+2	Test Voltage	By Notebook PC

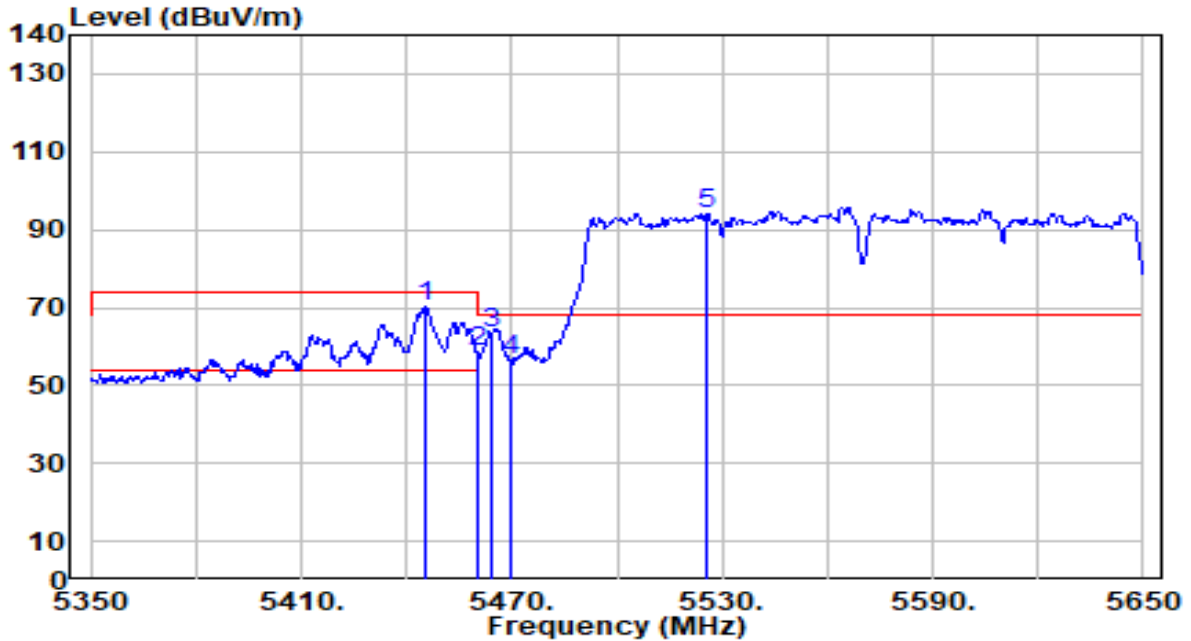

No	Frequency (MHz)	Reading (dBuV)	C.F (dB/m)	Measurement (dBuV/m)	Margin (dB)	Limit (dBuV/m)	Height (cm)	Angle (deg)	Remark (QP/PK/AV)	
1	*	5445.400	71.10	-0.91	70.20	-3.80	74.00	210	178	Peak
2		5460.000	59.39	-0.85	58.55	-15.45	74.00	210	178	Peak
3		5464.300	64.12	-0.83	63.29	-4.91	68.20	210	178	Peak
4		5470.000	57.15	-0.81	56.34	-11.86	68.20	210	178	Peak
5		5525.800	94.75	-0.58	94.17	N/A	N/A	210	178	Peak

Note:

1. " \*", means this data is the worst emission level.
2. C.F (Correction Factor) = Antenna Factor (dB/m) + Cable Loss (dB) – Preamplifier(dB) + 10dB Attenuation.
3. Measurement (dBuV/m) = Reading(dBuV) + C.F (Correction Factor).
4. The emission levels of other frequencies are very lower than the limit and not show in test report.

EUT	AX3000 High Gain Wireless USB Adapter	Date of Test	2023-01-19
Factor	DRH18-E	Temp. / Humidity	20°C /62%
Polarity	Horizontal	Site / Test Engineer	AC2 / Ares
Test Mode	802.11ac-160MHz_TX_Band3_CH 114_ANT 1+2	Test Voltage	By Notebook PC

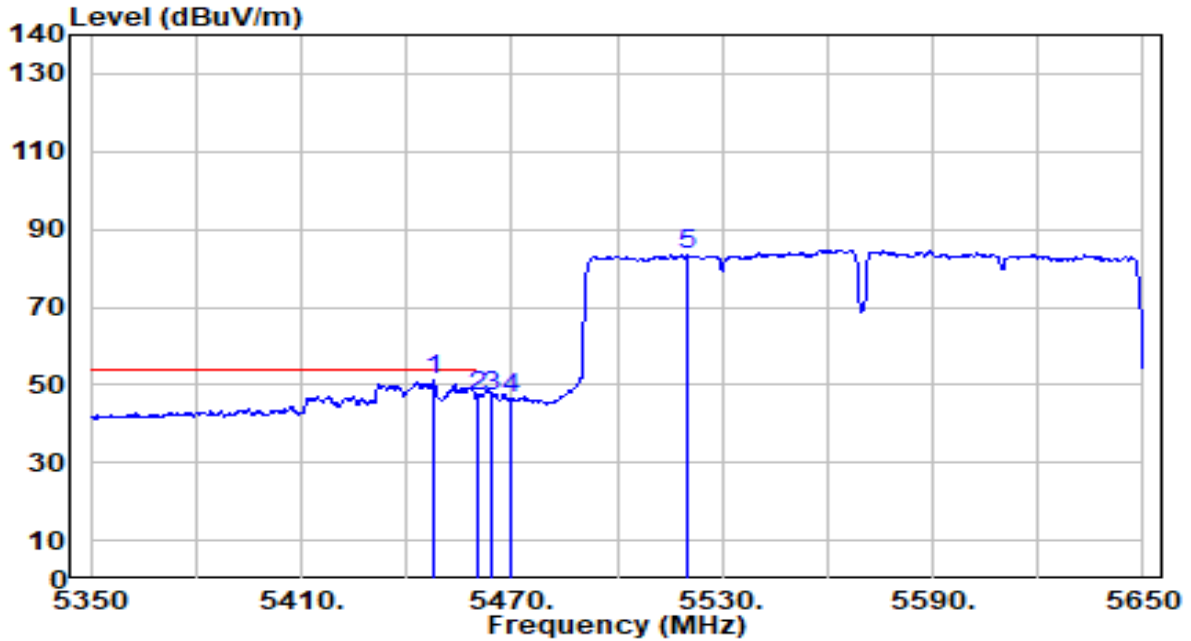

No	Frequency (MHz)	Reading (dBuV)	C.F (dB/m)	Measurement (dBuV/m)	Margin (dB)	Limit (dBuV/m)	Height (cm)	Angle (deg)	Remark (QP/PK/AV)
1	* 5447.800	52.00	-0.90	51.10	-2.90	54.00	210	178	Average
2	5460.000	47.97	-0.85	47.12	-6.88	54.00	210	178	Average
3	5464.300	47.72	-0.83	46.89	N/A	N/A	210	178	Average
4	5470.000	47.21	-0.81	46.40	N/A	N/A	210	178	Average
5	5520.100	84.06	-0.60	83.46	N/A	N/A	210	178	Average

Note:

1. " \*", means this data is the worst emission level.
2. C.F (Correction Factor) = Antenna Factor (dB/m) + Cable Loss (dB) – Preamplifier(dB) + 10dB Attenuation.
3. Measurement (dBuV/m) = Reading(dBuV) + C.F (Correction Factor).
4. The emission levels of other frequencies are very lower than the limit and not show in test report.

EUT	AX3000 High Gain Wireless USB Adapter	Date of Test	2023-01-19
Factor	DRH18-E	Temp. / Humidity	20°C /62%
Polarity	Vertical	Site / Test Engineer	AC2 / Ares
Test Mode	802.11ac-160MHz_TX_Band3_CH 114_ANT 1+2	Test Voltage	By Notebook PC

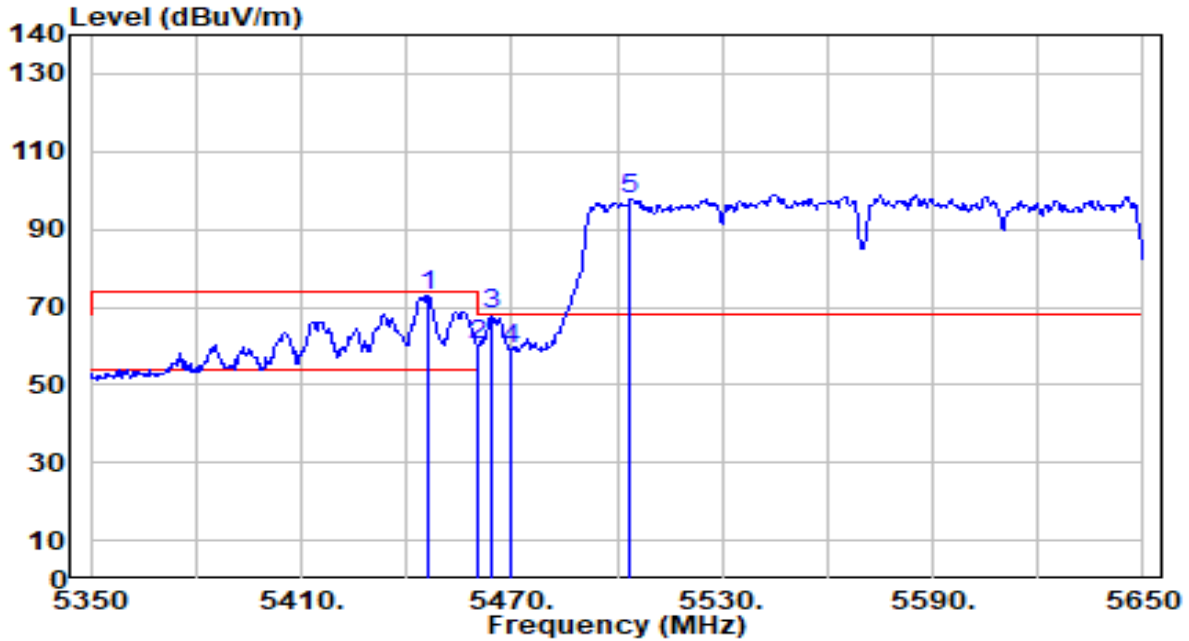

No	Frequency (MHz)	Reading (dBuV)	C.F (dB/m)	Measurement (dBuV/m)	Margin (dB)	Limit (dBuV/m)	Height (cm)	Angle (deg)	Remark (QP/PK/AV)
1	5446.000	73.84	-0.90	72.94	-1.06	74.00	278	252	Peak
2	5460.000	60.86	-0.85	60.01	-13.99	74.00	278	252	Peak
3	* 5464.300	68.90	-0.83	68.07	-0.13	68.20	278	252	Peak
4	5470.000	60.01	-0.81	59.20	-9.00	68.20	278	252	Peak
5	5503.900	98.54	-0.67	97.87	N/A	N/A	278	252	Peak

Note:

1. " \*", means this data is the worst emission level.
2. C.F (Correction Factor) = Antenna Factor (dB/m) + Cable Loss (dB) – Preamplifier(dB) + 10dB Attenuation.
3. Measurement (dBuV/m) = Reading(dBuV) + C.F (Correction Factor).
4. The emission levels of other frequencies are very lower than the limit and not show in test report.

EUT	AX3000 High Gain Wireless USB Adapter	Date of Test	2023-01-19
Factor	DRH18-E	Temp. / Humidity	20°C /62%
Polarity	Vertical	Site / Test Engineer	AC2 / Ares
Test Mode	802.11ac-160MHz_TX_Band3_CH 114_ANT 1+2	Test Voltage	By Notebook PC

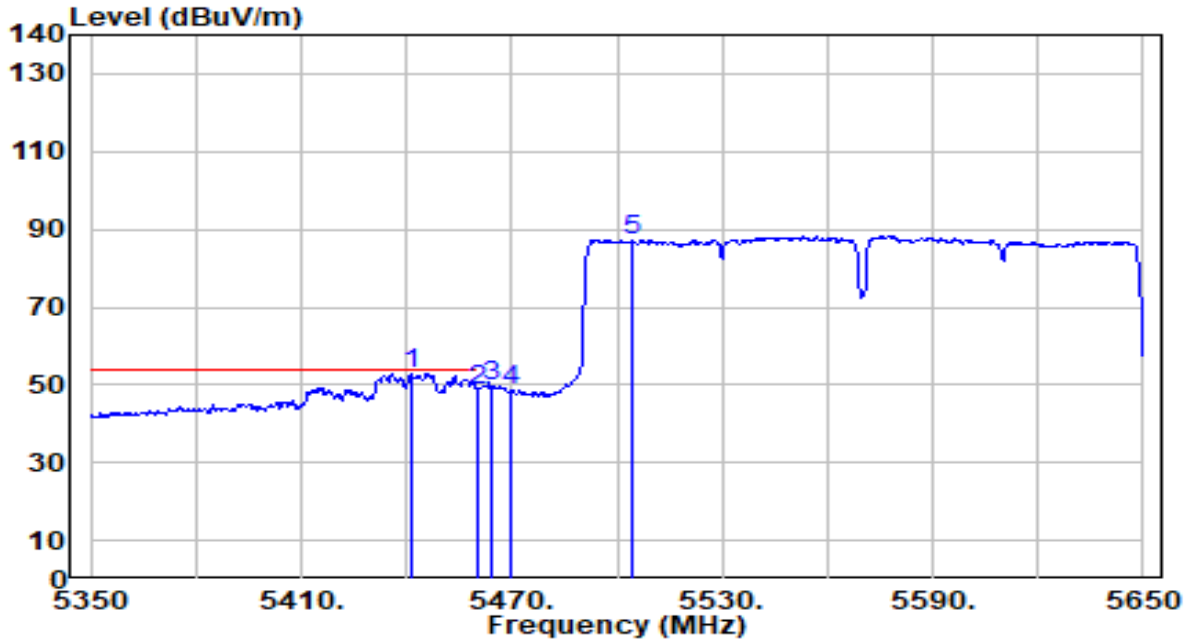

No	Frequency (MHz)	Reading (dBuV)	C.F (dB/m)	Measurement (dBuV/m)	Margin (dB)	Limit (dBuV/m)	Height (cm)	Angle (deg)	Remark (QP/PK/AV)
1	* 5441.500	53.67	-0.92	52.74	-1.26	54.00	278	252	Average
2	5460.000	49.21	-0.85	48.37	-5.63	54.00	278	252	Average
3	5464.300	50.59	-0.83	49.76	N/A	N/A	278	252	Average
4	5470.000	49.52	-0.81	48.71	N/A	N/A	278	252	Average
5	5504.200	88.03	-0.67	87.36	N/A	N/A	278	252	Average

Note:

1. " \*", means this data is the worst emission level.
2. C.F (Correction Factor) = Antenna Factor (dB/m) + Cable Loss (dB) – Preamplifier(dB) + 10dB Attenuation.
3. Measurement (dBuV/m) = Reading(dBuV) + C.F (Correction Factor).
4. The emission levels of other frequencies are very lower than the limit and not show in test report.

EUT	AX3000 High Gain Wireless USB Adapter	Date of Test	2023-01-19
Factor	DRH18-E	Temp. / Humidity	20°C /62%

Polarity	Horizontal	Site / Test Engineer	AC2 / Ares
Test Mode	802.11ax-20MHz_TX_Band1_CH 36_ANT 1+2	Test Voltage	By Notebook PC

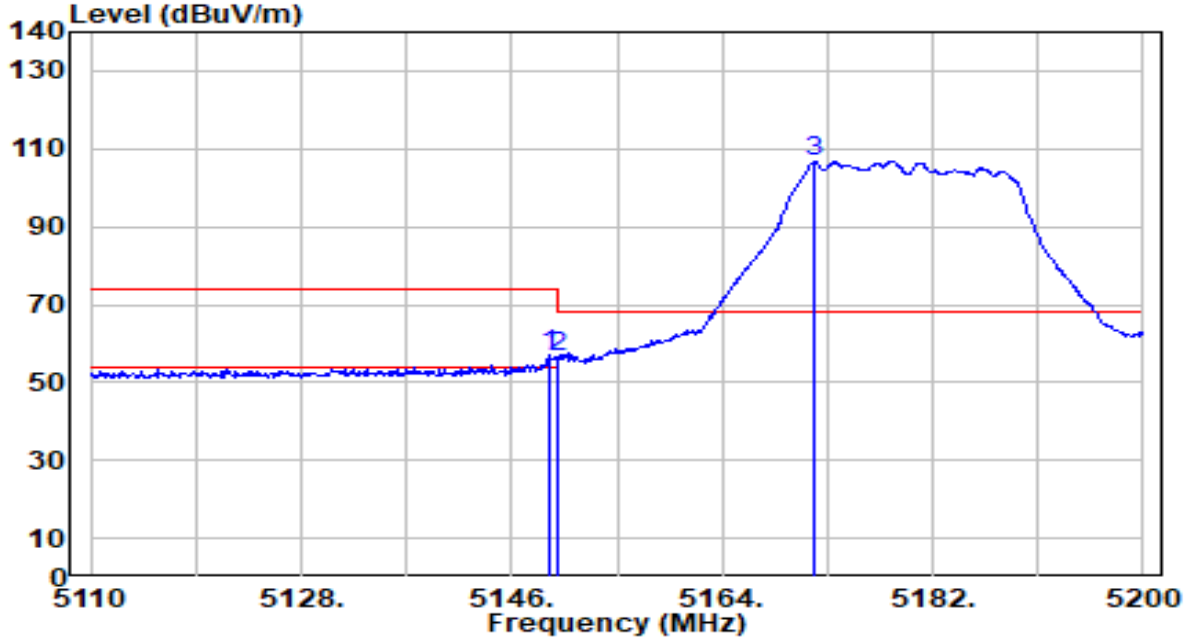

No	Frequency (MHz)	Reading (dBuV)	C.F (dB/m)	Measurement (dBuV/m)	Margin (dB)	Limit (dBuV/m)	Height (cm)	Angle (deg)	Remark (QP/PK/AV)
1	*	57.96	-0.73	57.23	-16.77	74.00	250	183	Peak
2		57.08	-0.73	56.35	-17.65	74.00	250	183	Peak
3		107.45	-0.70	106.75	N/A	N/A	250	183	Peak

Note:

1. " \*", means this data is the worst emission level.
2. C.F (Correction Factor) = Antenna Factor (dB/m) + Cable Loss (dB) – Pre-amplifier(dB) + 10dB Attenuation.
3. Measurement (dBuV/m) = Reading(dBuV) + C.F (Correction Factor).
4. The emission levels of other frequencies are very lower than the limit and not show in test report.

EUT	AX3000 High Gain Wireless USB Adapter	Date of Test	2023-01-19
Factor	DRH18-E	Temp. / Humidity	20°C /62%
Polarity	Horizontal	Site / Test Engineer	AC2 / Ares
Test Mode	802.11ax-20MHz_TX_Band1_CH 36_ANT 1+2	Test Voltage	By Notebook PC

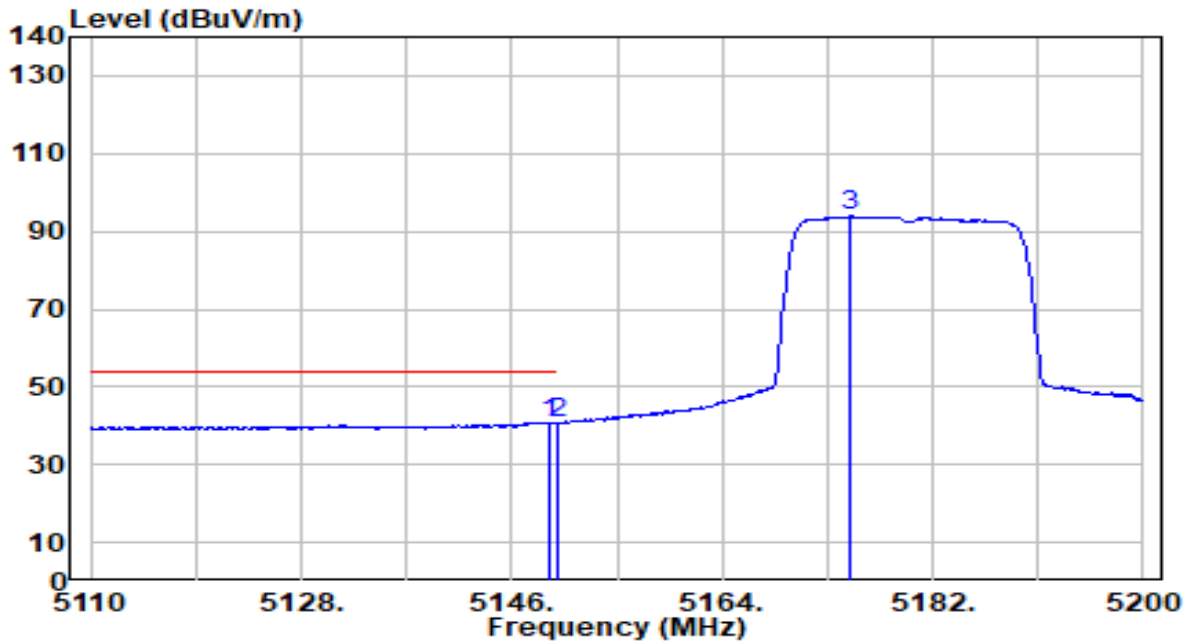

No	Frequency (MHz)	Reading (dBuV)	C.F (dB/m)	Measurement (dBuV/m)	Margin (dB)	Limit (dBuV/m)	Height (cm)	Angle (deg)	Remark (QP/PK/AV)	
1	*	5149.330	41.63	-0.73	40.91	-13.09	54.00	250	183	Average
2		5150.000	41.34	-0.73	40.61	-13.39	54.00	250	183	Average
3		5174.890	94.50	-0.70	93.80	N/A	N/A	250	183	Average

Note:

1. " \*", means this data is the worst emission level.
2. C.F (Correction Factor) = Antenna Factor (dB/m) + Cable Loss (dB) – Preamplifier(dB) + 10dB Attenuation.
3. Measurement (dBuV/m) = Reading(dBuV) + C.F (Correction Factor).
4. The emission levels of other frequencies are very lower than the limit and not show in test report.

EUT	AX3000 High Gain Wireless USB Adapter	Date of Test	2023-01-19
Factor	DRH18-E	Temp. / Humidity	20°C /62%
Polarity	Vertical	Site / Test Engineer	AC2 / Ares
Test Mode	802.11ax-20MHz_TX_Band1_CH 36_ANT 1+2	Test Voltage	By Notebook PC

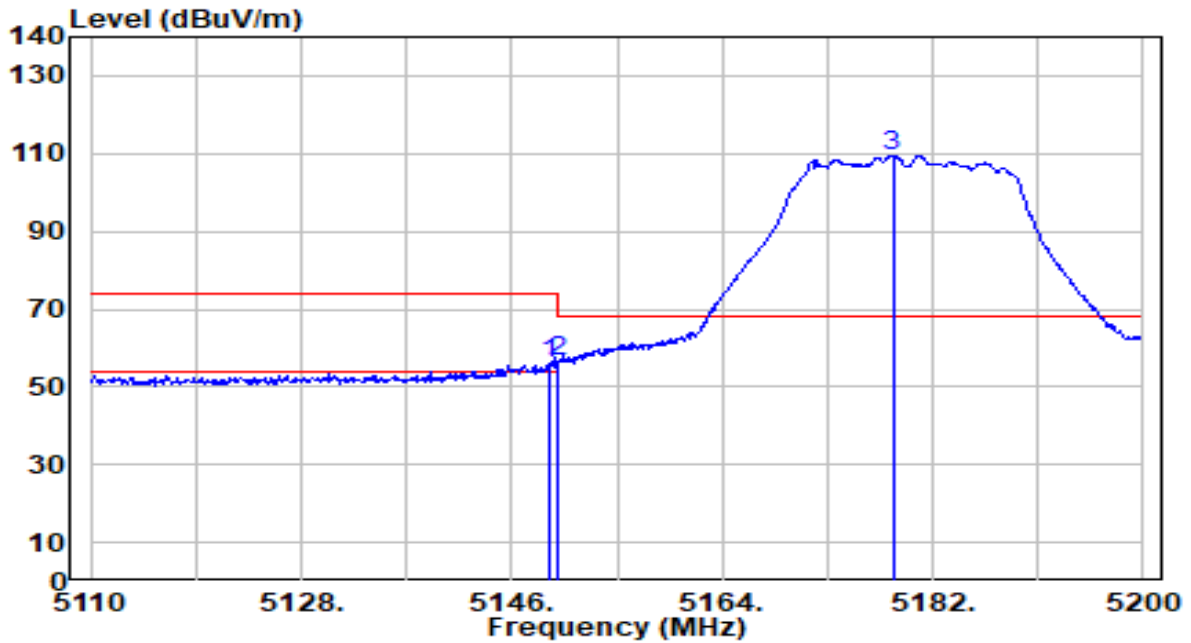

No	Frequency (MHz)	Reading (dBuV)	C.F (dB/m)	Measurement (dBuV/m)	Margin (dB)	Limit (dBuV/m)	Height (cm)	Angle (deg)	Remark (QP/PK/AV)
1	5149.150	56.57	-0.73	55.84	-18.16	74.00	302	260	Peak
2	* 5150.000	57.41	-0.73	56.69	-17.31	74.00	302	260	Peak
3	5178.580	110.21	-0.70	109.51	N/A	N/A	302	260	Peak

Note:

1. " \*", means this data is the worst emission level.
2. C.F (Correction Factor) = Antenna Factor (dB/m) + Cable Loss (dB) – Preamplifier(dB) + 10dB Attenuation.
3. Measurement (dBuV/m) = Reading(dBuV) + C.F (Correction Factor).
4. The emission levels of other frequencies are very lower than the limit and not show in test report.



EUT	AX3000 High Gain Wireless USB Adapter	Date of Test	2023-01-19
Factor	DRH18-E	Temp. / Humidity	20°C /62%
Polarity	Vertical	Site / Test Engineer	AC2 / Ares
Test Mode	802.11ax-20MHz_TX_Band1_CH 36_ANT 1+2	Test Voltage	By Notebook PC

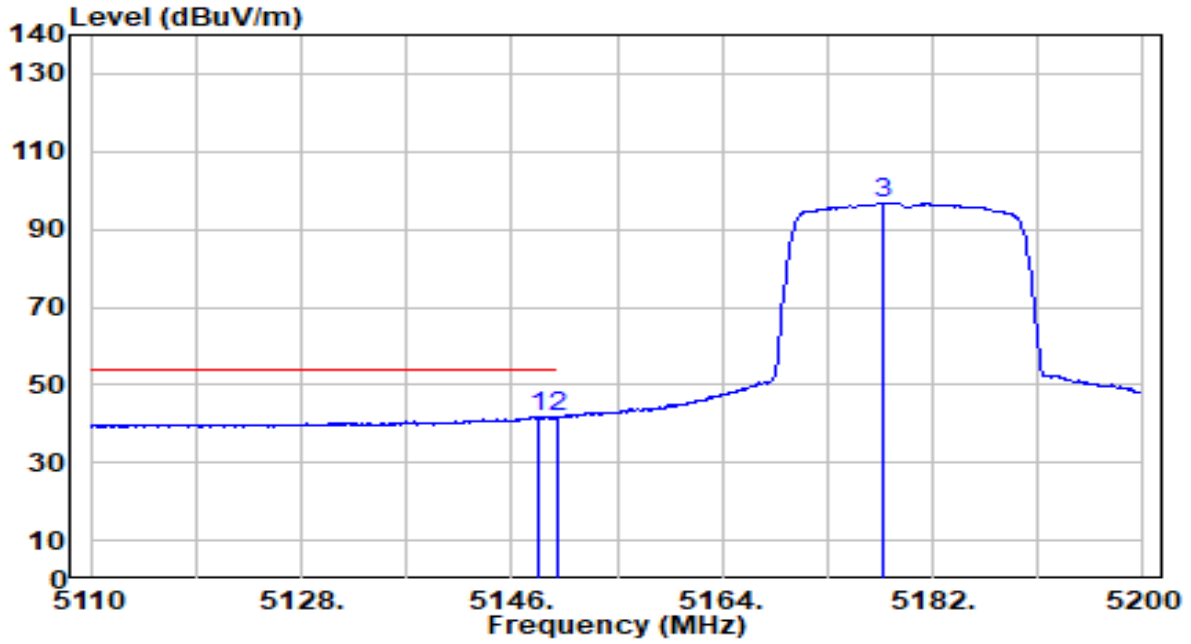

No	Frequency (MHz)	Reading (dBuV)	C.F (dB/m)	Measurement (dBuV/m)	Margin (dB)	Limit (dBuV/m)	Height (cm)	Angle (deg)	Remark (QP/PK/AV)
1	5148.340	42.41	-0.73	41.68	-12.32	54.00	302	260	Average
2	* 5150.000	42.42	-0.73	41.70	-12.30	54.00	302	260	Average
3	5177.680	97.43	-0.70	96.73	N/A	N/A	302	260	Average

Note:

1. " \*", means this data is the worst emission level.
2. C.F (Correction Factor) = Antenna Factor (dB/m) + Cable Loss (dB) – Preamplifier(dB) + 10dB Attenuation.
3. Measurement (dBuV/m) = Reading(dBuV) + C.F (Correction Factor).
4. The emission levels of other frequencies are very lower than the limit and not show in test report.

EUT	AX3000 High Gain Wireless USB Adapter	Date of Test	2023-01-19
Factor	DRH18-E	Temp. / Humidity	20°C /62%
Polarity	Horizontal	Site / Test Engineer	AC2 / Ares
Test Mode	802.11ax-20MHz_TX_Band2_CH 64_ANT 1+2	Test Voltage	By Notebook PC

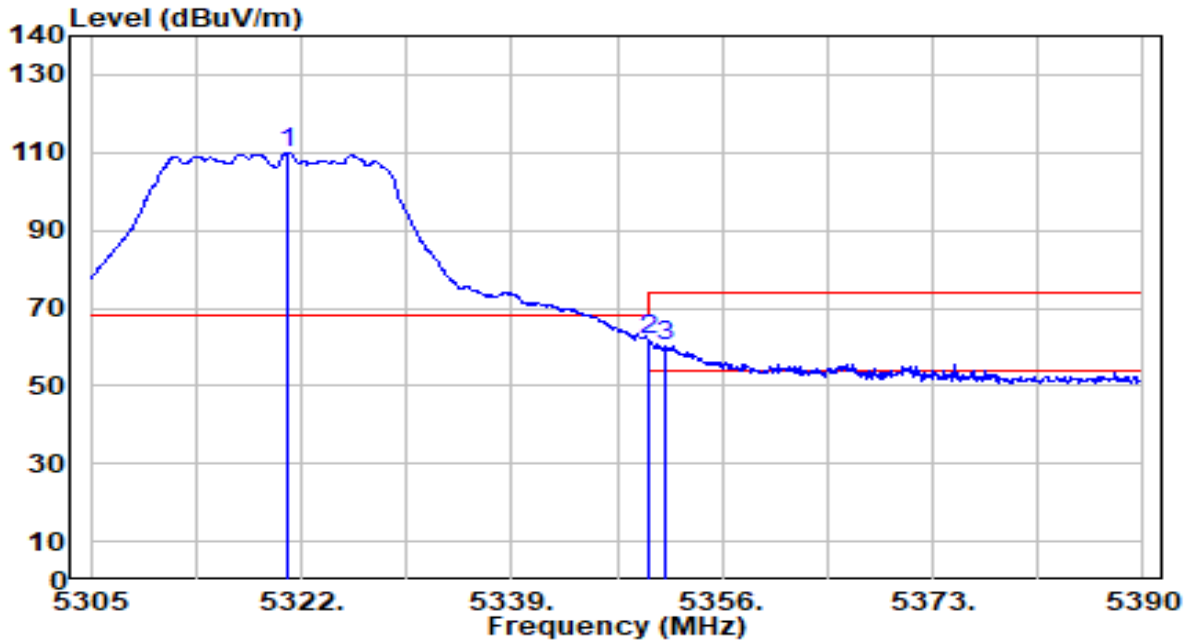

No	Frequency (MHz)	Reading (dBuV)	C.F (dB/m)	Measurement (dBuV/m)	Margin (dB)	Limit (dBuV/m)	Height (cm)	Angle (deg)	Remark (QP/PK/AV)
1	5320.980	110.82	-0.92	109.90	N/A	N/A	250	183	Peak
2	* 5350.000	62.59	-0.98	61.60	-12.40	74.00	250	183	Peak
3	5351.325	61.10	-0.99	60.12	-13.88	74.00	250	183	Peak

Note:

1. " \*", means this data is the worst emission level.
2. C.F (Correction Factor) = Antenna Factor (dB/m) + Cable Loss (dB) – Pre-amplifier(dB) + 10dB Attenuation.
3. Measurement (dBuV/m) = Reading(dBuV) + C.F (Correction Factor).
4. The emission levels of other frequencies are very lower than the limit and not show in test report.

EUT	AX3000 High Gain Wireless USB Adapter	Date of Test	2023-01-19
Factor	DRH18-E	Temp. / Humidity	20°C /62%
Polarity	Horizontal	Site / Test Engineer	AC2 / Ares
Test Mode	802.11ax-20MHz_TX_Band2_CH 64_ANT 1+2	Test Voltage	By Notebook PC

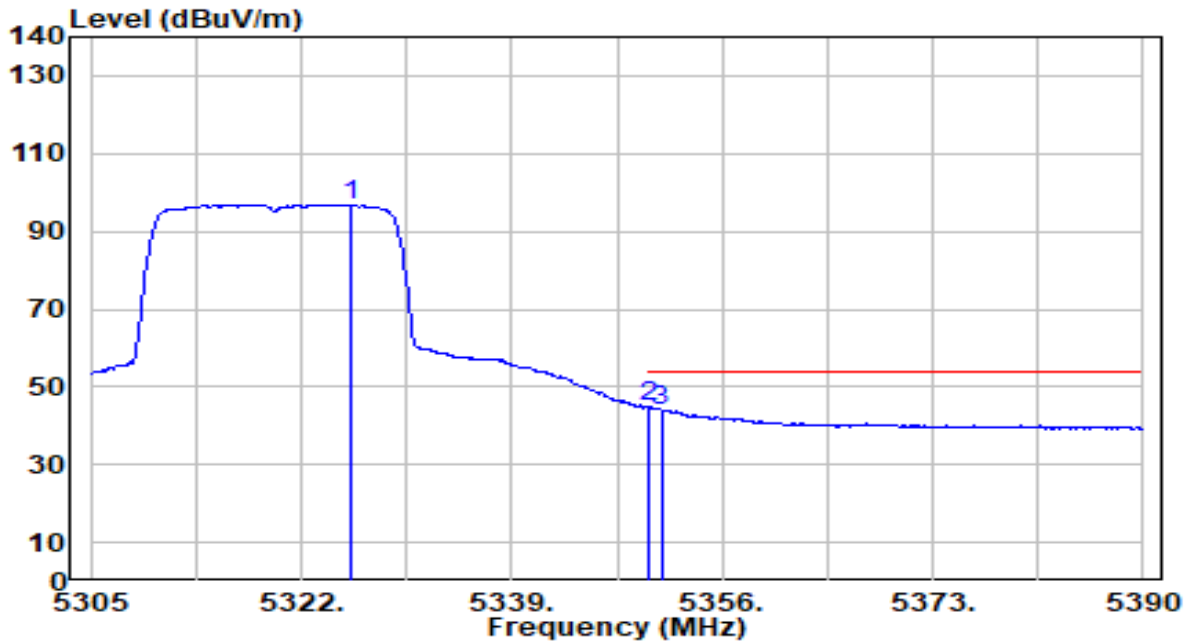

No	Frequency (MHz)	Reading (dBuV)	C.F (dB/m)	Measurement (dBuV/m)	Margin (dB)	Limit (dBuV/m)	Height (cm)	Angle (deg)	Remark (QP/PK/AV)
1	5325.995	97.77	-0.94	96.83	N/A	N/A	250	183	Average
2	* 5350.000	45.95	-0.98	44.96	-9.04	54.00	250	183	Average
3	5351.070	45.00	-0.99	44.02	-9.98	54.00	250	183	Average

Note:

1. " \*", means this data is the worst emission level.
2. C.F (Correction Factor) = Antenna Factor (dB/m) + Cable Loss (dB) – Preamplifier(dB) + 10dB Attenuation.
3. Measurement (dBuV/m) = Reading(dBuV) + C.F (Correction Factor).
4. The emission levels of other frequencies are very lower than the limit and not show in test report.

EUT	AX3000 High Gain Wireless USB Adapter	Date of Test	2023-01-19
Factor	DRH18-E	Temp. / Humidity	20°C /62%
Polarity	Vertical	Site / Test Engineer	AC2 / Ares
Test Mode	802.11ax-20MHz_TX_Band2_CH 64_ANT 1+2	Test Voltage	By Notebook PC

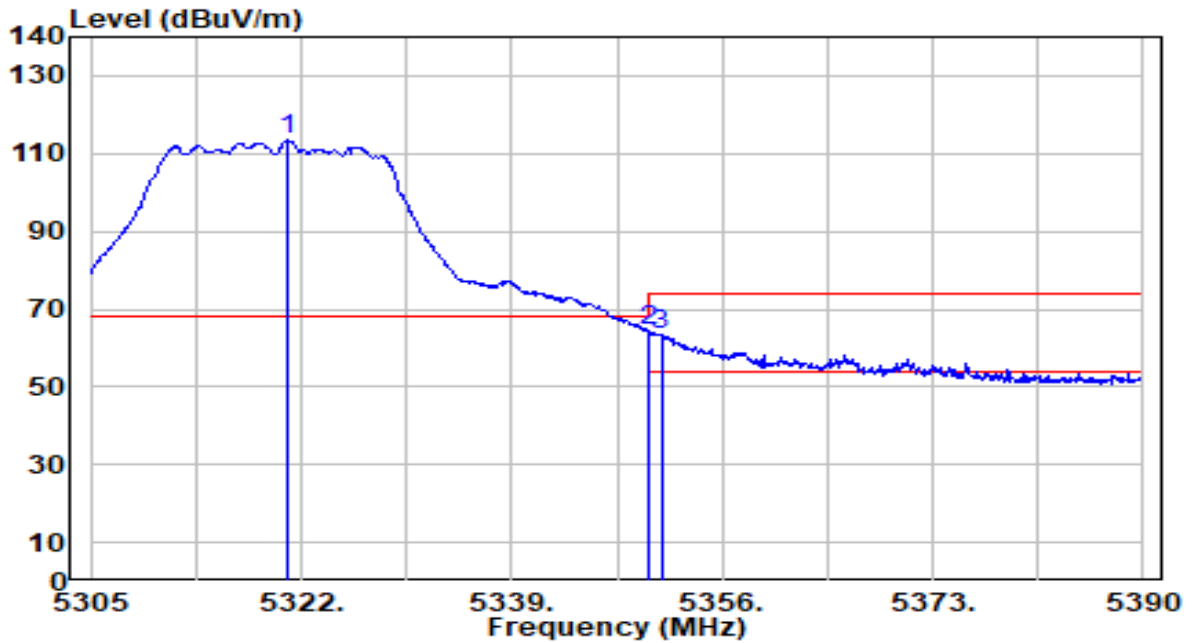

No	Frequency (MHz)	Reading (dBuV)	C.F (dB/m)	Measurement (dBuV/m)	Margin (dB)	Limit (dBuV/m)	Height (cm)	Angle (deg)	Remark (QP/PK/AV)
1	5320.895	114.25	-0.92	113.33	N/A	N/A	302	254	Peak
2	* 5350.000	65.39	-0.98	64.40	-9.60	74.00	302	254	Peak
3	5351.070	64.49	-0.99	63.51	-10.49	74.00	302	254	Peak

Note:

1. " \*", means this data is the worst emission level.
2. C.F (Correction Factor) = Antenna Factor (dB/m) + Cable Loss (dB) – Preamplifier(dB) + 10dB Attenuation.
3. Measurement (dBuV/m) = Reading(dBuV) + C.F (Correction Factor).
4. The emission levels of other frequencies are very lower than the limit and not show in test report.

EUT	AX3000 High Gain Wireless USB Adapter	Date of Test	2023-01-19
Factor	DRH18-E	Temp. / Humidity	20°C /62%
Polarity	Vertical	Site / Test Engineer	AC2 / Ares
Test Mode	802.11ax-20MHz_TX_Band2_CH 64_ANT 1+2	Test Voltage	By Notebook PC

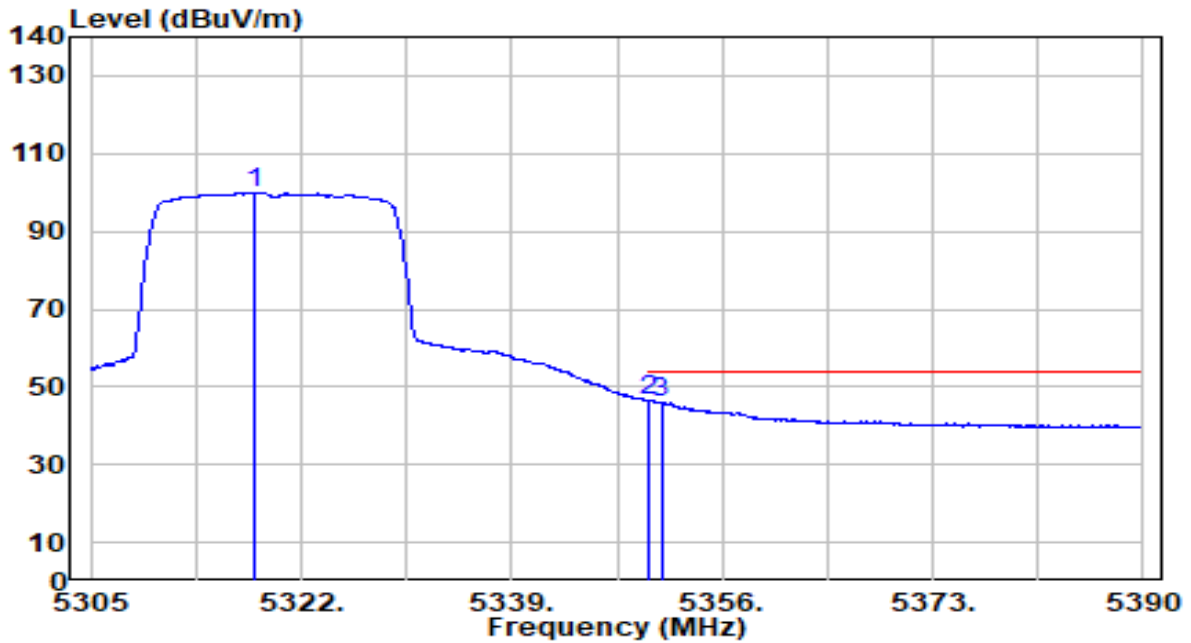

No	Frequency (MHz)	Reading (dBuV)	C.F (dB/m)	Measurement (dBuV/m)	Margin (dB)	Limit (dBuV/m)	Height (cm)	Angle (deg)	Remark (QP/PK/AV)
1	5318.175	100.93	-0.92	100.01	N/A	N/A	302	254	Average
2	* 5350.000	47.61	-0.98	46.63	-7.37	54.00	302	254	Average
3	5351.070	46.88	-0.99	45.90	-8.10	54.00	302	254	Average

Note:

1. " \*", means this data is the worst emission level.
2. C.F (Correction Factor) = Antenna Factor (dB/m) + Cable Loss (dB) – Preamplifier(dB) + 10dB Attenuation.
3. Measurement (dBuV/m) = Reading(dBuV) + C.F (Correction Factor).
4. The emission levels of other frequencies are very lower than the limit and not show in test report.

EUT	AX3000 High Gain Wireless USB Adapter	Date of Test	2023-01-19
Factor	DRH18-E	Temp. / Humidity	20°C /62%
Polarity	Horizontal	Site / Test Engineer	AC2 / Ares
Test Mode	802.11ax-20MHz_TX_Band3_CH 100_ANT 1+2	Test Voltage	By Notebook PC

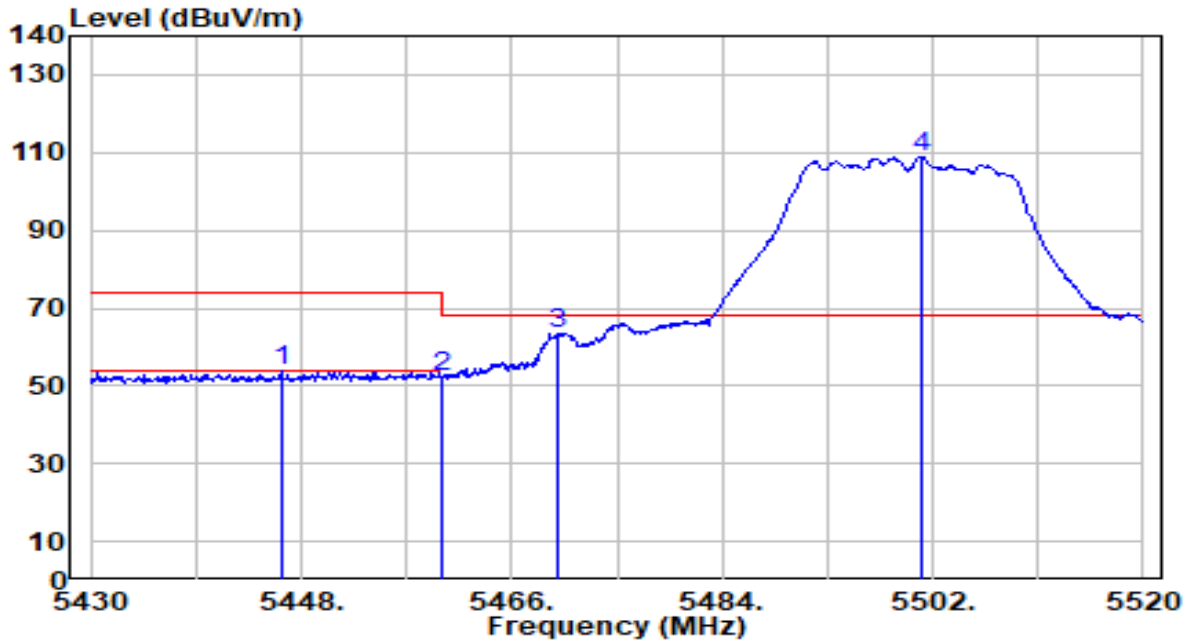

No	Frequency (MHz)	Reading (dBUV)	C.F (dB/m)	Measurement (dBUV/m)	Margin (dB)	Limit (dBUV/m)	Height (cm)	Angle (deg)	Remark (QP/PK/AV)
1	5446.290	54.69	-0.90	53.79	-20.21	74.00	198	178	Peak
2	5460.000	53.18	-0.85	52.33	-21.67	74.00	198	178	Peak
3	* 5470.000	64.10	-0.81	63.29	-4.91	68.20	198	178	Peak
4	5501.100	109.61	-0.69	108.93	N/A	N/A	198	178	Peak

Note:

- "\*" means this data is the worst emission level.
- C.F (Correction Factor) = Antenna Factor (dB/m) + Cable Loss (dB) – Preamplifier(dB) + 10dB Attenuation.
- Measurement (dBUV/m) = Reading(dBUV) + C.F (Correction Factor).
- The emission levels of other frequencies are very lower than the limit and not show in test report.

EUT	AX3000 High Gain Wireless USB Adapter	Date of Test	2023-01-19
Factor	DRH18-E	Temp. / Humidity	20°C /62%
Polarity	Horizontal	Site / Test Engineer	AC2 / Ares
Test Mode	802.11ax-20MHz_TX_Band3_CH 100_ANT 1+2	Test Voltage	By Notebook PC

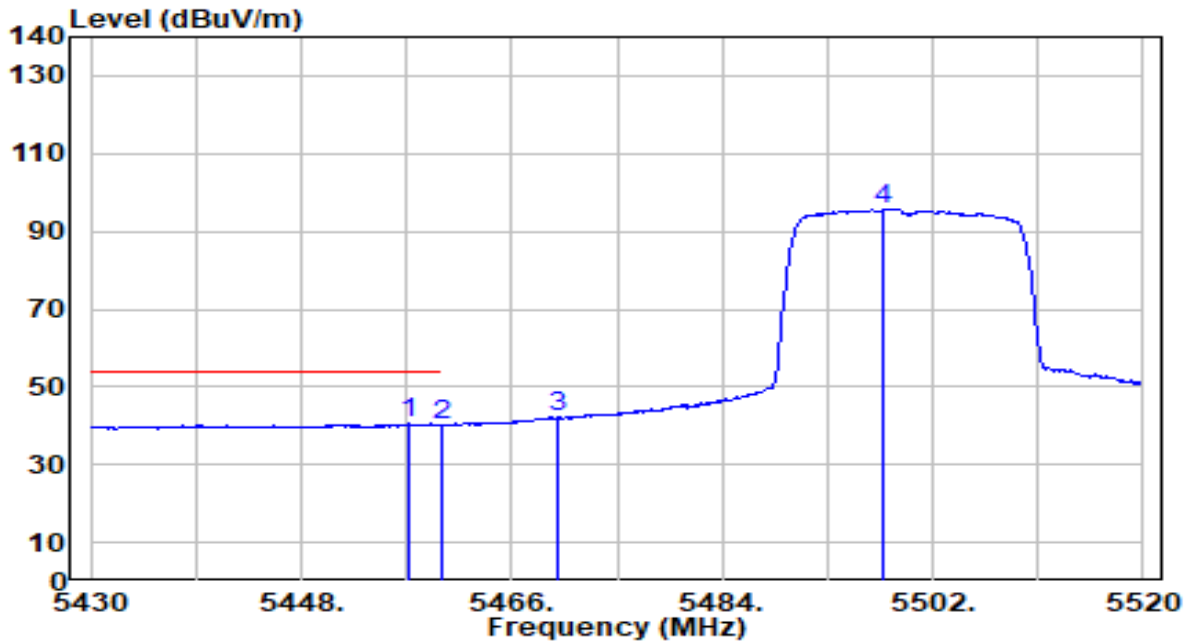

No	Frequency (MHz)	Reading (dBuV)	C.F (dB/m)	Measurement (dBuV/m)	Margin (dB)	Limit (dBuV/m)	Height (cm)	Angle (deg)	Remark (QP/PK/AV)	
1	*	5457.180	41.38	-0.86	40.52	-13.48	54.00	198	178	Average
2		5460.000	41.15	-0.85	40.30	-13.70	54.00	198	178	Average
3		5470.000	43.01	-0.81	42.20	N/A	N/A	198	178	Average
4		5497.860	96.36	-0.70	95.66	N/A	N/A	198	178	Average

Note:

1. " \*", means this data is the worst emission level.
2. C.F (Correction Factor) = Antenna Factor (dB/m) + Cable Loss (dB) – Preamplifier(dB) + 10dB Attenuation.
3. Measurement (dBuV/m) = Reading(dBuV) + C.F (Correction Factor).
4. The emission levels of other frequencies are very lower than the limit and not show in test report.

EUT	AX3000 High Gain Wireless USB Adapter	Date of Test	2023-01-19
Factor	DRH18-E	Temp. / Humidity	20°C /62%
Polarity	Vertical	Site / Test Engineer	AC2 / Ares
Test Mode	802.11ax-20MHz_TX_Band3_CH 100_ANT 1+2	Test Voltage	By Notebook PC

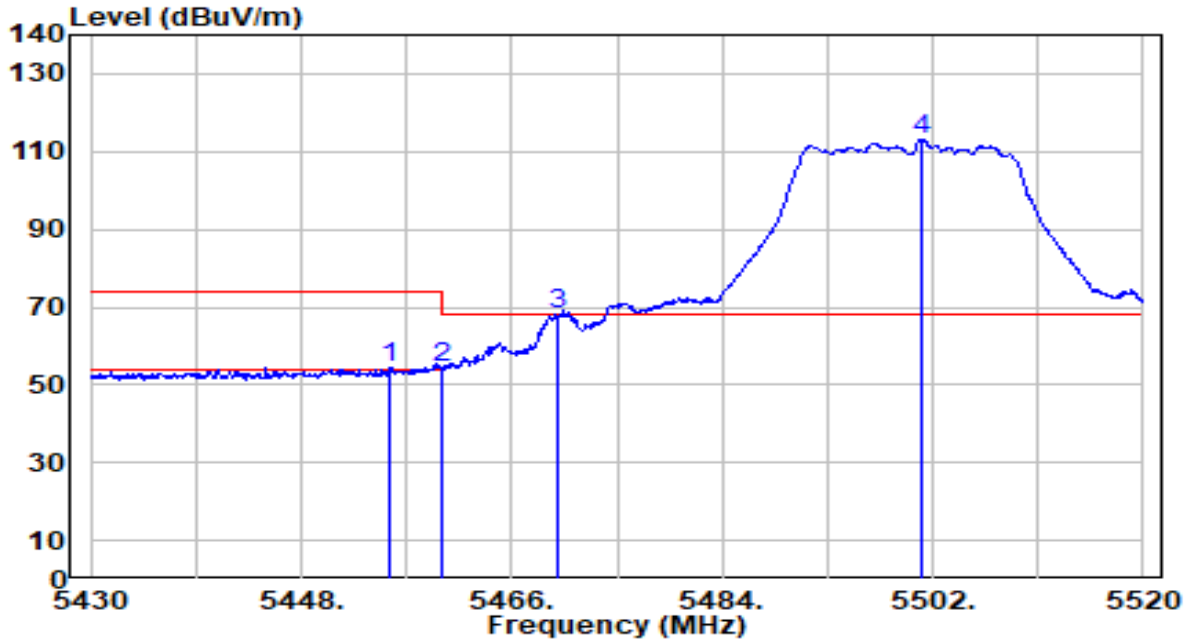

No	Frequency (MHz)	Reading (dBuV)	C.F (dB/m)	Measurement (dBuV/m)	Margin (dB)	Limit (dBuV/m)	Height (cm)	Angle (deg)	Remark (QP/PK/AV)
1	5455.560	55.51	-0.87	54.65	-19.35	74.00	278	252	Peak
2	5460.000	55.19	-0.85	54.34	-19.66	74.00	278	252	Peak
3	* 5470.000	68.98	-0.81	68.17	-0.03	68.20	278	252	Peak
4	5501.100	113.76	-0.69	113.07	N/A	N/A	278	252	Peak

Note:

1. " \*", means this data is the worst emission level.
2. C.F (Correction Factor) = Antenna Factor (dB/m) + Cable Loss (dB) – Pre-amplifier(dB) + 10dB Attenuation.
3. Measurement (dBuV/m) = Reading(dBuV) + C.F (Correction Factor).
4. The emission levels of other frequencies are very lower than the limit and not show in test report.



EUT	AX3000 High Gain Wireless USB Adapter	Date of Test	2023-01-19
Factor	DRH18-E	Temp. / Humidity	20°C /62%
Polarity	Vertical	Site / Test Engineer	AC2 / Ares
Test Mode	802.11ax-20MHz_TX_Band3_CH 100_ANT 1+2	Test Voltage	By Notebook PC

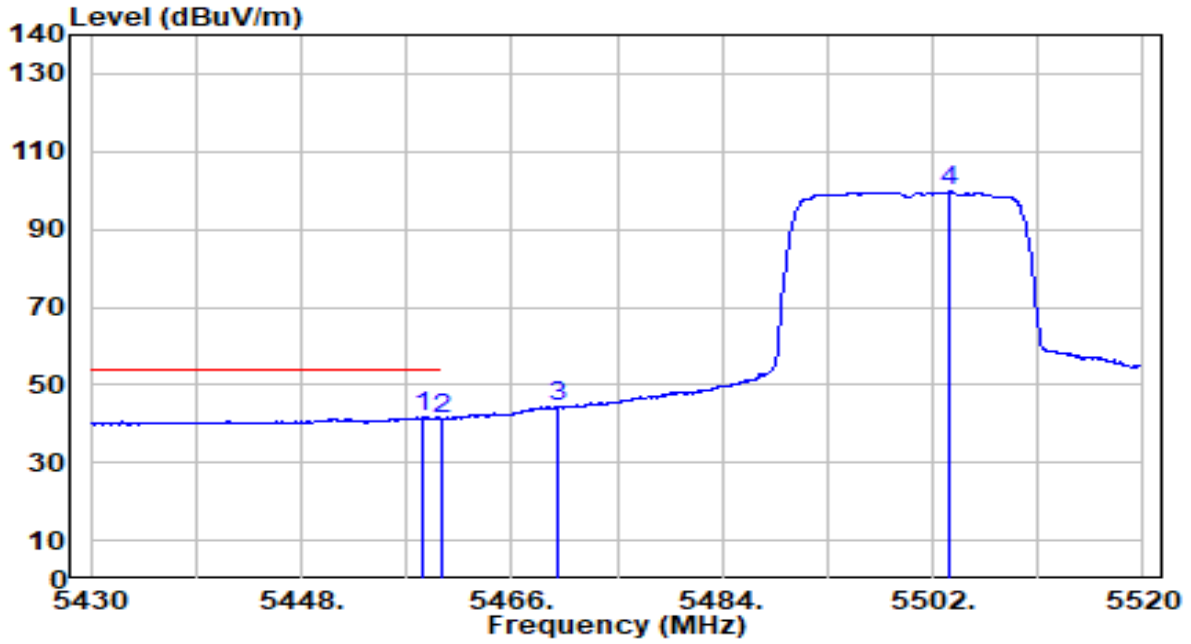

No	Frequency (MHz)	Reading (dBuV)	C.F (dB/m)	Measurement (dBuV/m)	Margin (dB)	Limit (dBuV/m)	Height (cm)	Angle (deg)	Remark (QP/PK/AV)
1	* 5458.440	42.55	-0.85	41.69	-12.31	54.00	278	252	Average
2	5460.000	42.21	-0.85	41.37	-12.63	54.00	278	252	Average
3	5470.000	44.93	-0.81	44.12	N/A	N/A	278	252	Average
4	5503.440	100.32	-0.68	99.64	N/A	N/A	278	252	Average

Note:

1. " \*", means this data is the worst emission level.
2. C.F (Correction Factor) = Antenna Factor (dB/m) + Cable Loss (dB) – Preamplifier(dB) + 10dB Attenuation.
3. Measurement (dBuV/m) = Reading(dBuV) + C.F (Correction Factor).
4. The emission levels of other frequencies are very lower than the limit and not show in test report.

EUT	AX3000 High Gain Wireless USB Adapter	Date of Test	2023-01-19
Factor	DRH18-E	Temp. / Humidity	20°C /62%
Polarity	Horizontal	Site / Test Engineer	AC2 / Ares
Test Mode	802.11ax-20MHz_TX_Band3_CH 140_ANT 1+2	Test Voltage	By Notebook PC

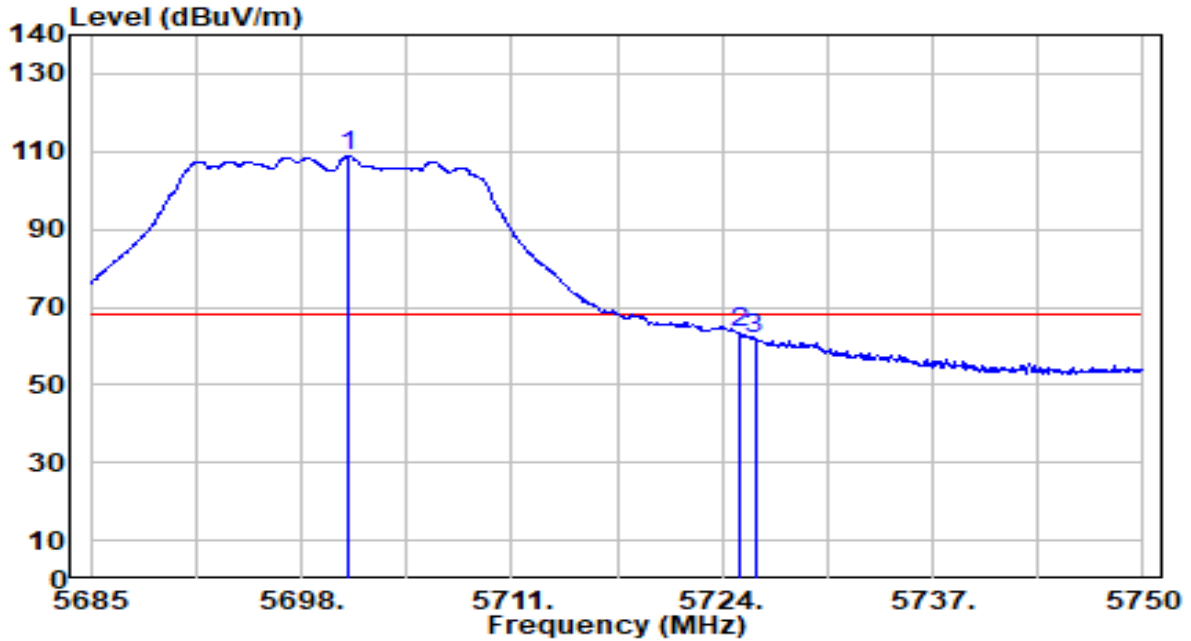

No	Frequency (MHz)	Reading (dBuV)	C.F (dB/m)	Measurement (dBuV/m)	Margin (dB)	Limit (dBuV/m)	Height (cm)	Angle (deg)	Remark (QP/PK/AV)
1	5700.925	108.57	0.12	108.68	N/A	N/A	250	173	Peak
2	* 5725.000	63.18	0.21	63.39	-4.81	68.20	250	173	Peak
3	5726.015	61.39	0.21	61.60	-6.60	68.20	250	173	Peak

Note:

1. " \*", means this data is the worst emission level.
2. C.F (Correction Factor) = Antenna Factor (dB/m) + Cable Loss (dB) – Preamplifier(dB) + 10dB Attenuation.
3. Measurement (dBuV/m) = Reading(dBuV) + C.F (Correction Factor).
4. The emission levels of other frequencies are very lower than the limit and not show in test report.

EUT	AX3000 High Gain Wireless USB Adapter	Date of Test	2023-01-19
Factor	DRH18-E	Temp. / Humidity	20°C /62%
Polarity	Vertical	Site / Test Engineer	AC2 / Ares
Test Mode	802.11ax-20MHz_TX_Band3_CH 140_ANT 1+2	Test Voltage	By Notebook PC

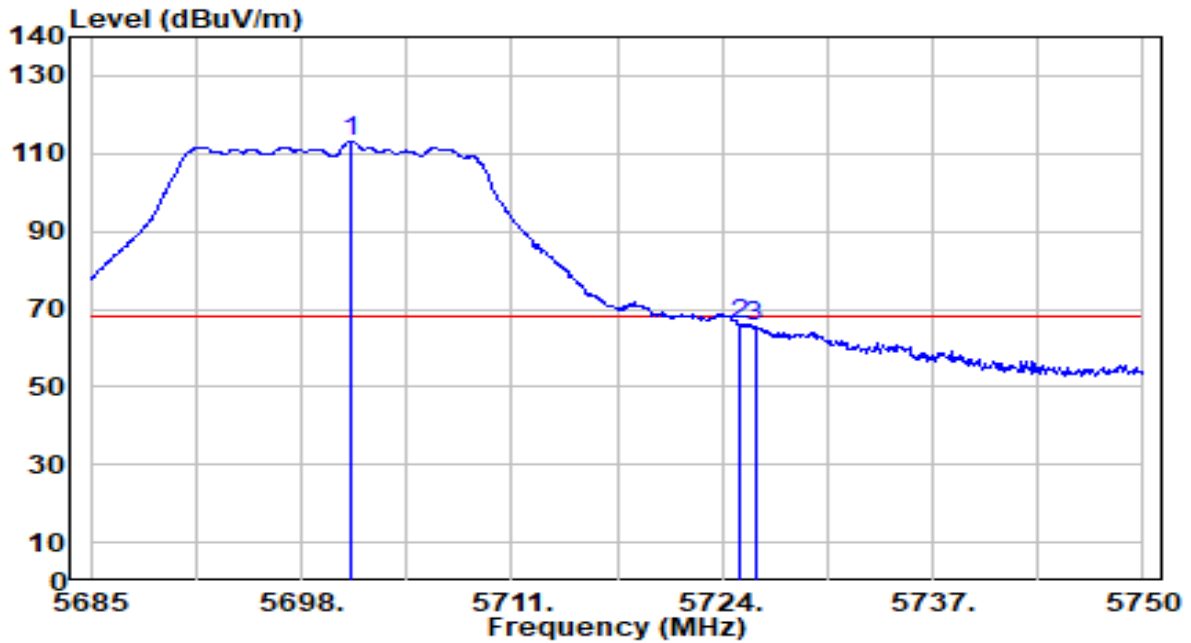

No	Frequency (MHz)	Reading (dBuV)	C.F (dB/m)	Measurement (dBuV/m)	Margin (dB)	Limit (dBuV/m)	Height (cm)	Angle (deg)	Remark (QP/PK/AV)
1	5701.055	113.06	0.12	113.17	N/A	N/A	267	250	Peak
2	* 5725.000	65.92	0.21	66.12	-2.08	68.20	267	250	Peak
3	5726.015	65.38	0.21	65.59	-2.61	68.20	267	250	Peak

Note:

1. " \*", means this data is the worst emission level.
2. C.F (Correction Factor) = Antenna Factor (dB/m) + Cable Loss (dB) – Preamplifier(dB) + 10dB Attenuation.
3. Measurement (dBuV/m) = Reading(dBuV) + C.F (Correction Factor).
4. The emission levels of other frequencies are very lower than the limit and not show in test report.

EUT	AX3000 High Gain Wireless USB Adapter	Date of Test	2023-01-19
Factor	DRH18-E	Temp. / Humidity	20°C /62%
Polarity	Horizontal	Site / Test Engineer	AC2 / Ares
Test Mode	802.11ax-20MHz_TX_Band4_CH 149_ANT 1+2	Test Voltage	By Notebook PC

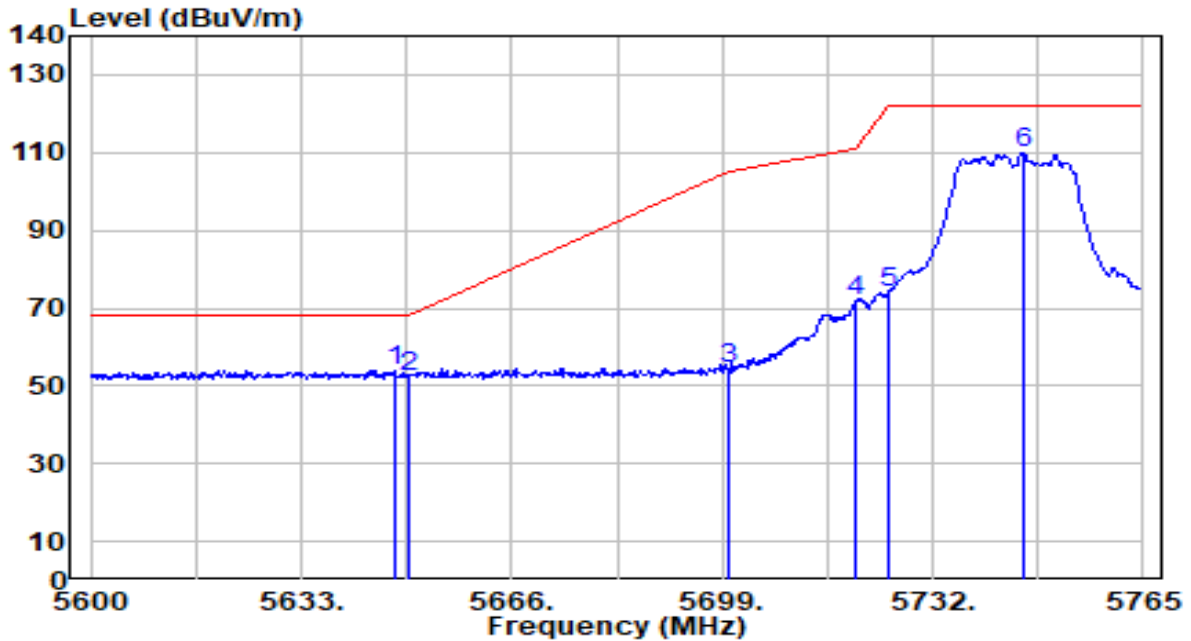

No	Frequency (MHz)	Reading (dBUV)	C.F (dB/m)	Measurement (dBUV/m)	Margin (dB)	Limit (dBUV/m)	Height (cm)	Angle (deg)	Remark (QP/PK/AV)
1	* 5647.685	54.12	-0.08	54.03	-14.17	68.20	266	181	Peak
2	5650.000	52.47	-0.08	52.39	-15.81	68.20	266	181	Peak
3	5700.000	54.44	0.11	54.55	-50.65	105.20	266	181	Peak
4	5720.000	71.54	0.19	71.73	-39.07	110.80	266	181	Peak
5	5725.000	73.61	0.21	73.82	-48.38	122.20	266	181	Peak
6	5746.190	109.71	0.29	110.00	N/A	N/A	266	181	Peak

Note:

1. " \*", means this data is the worst emission level.
2. C.F (Correction Factor) = Antenna Factor (dB/m) + Cable Loss (dB) – Preamplifier(dB) + 10dB Attenuation.
3. Measurement (dBUV/m) = Reading(dBUV) + C.F (Correction Factor).
4. The emission levels of other frequencies are very lower than the limit and not show in test report.

EUT	AX3000 High Gain Wireless USB Adapter	Date of Test	2023-01-19
Factor	DRH18-E	Temp. / Humidity	20°C /62%
Polarity	Vertical	Site / Test Engineer	AC2 / Ares
Test Mode	802.11ax-20MHz_TX_Band4_CH 149_ANT 1+2	Test Voltage	By Notebook PC

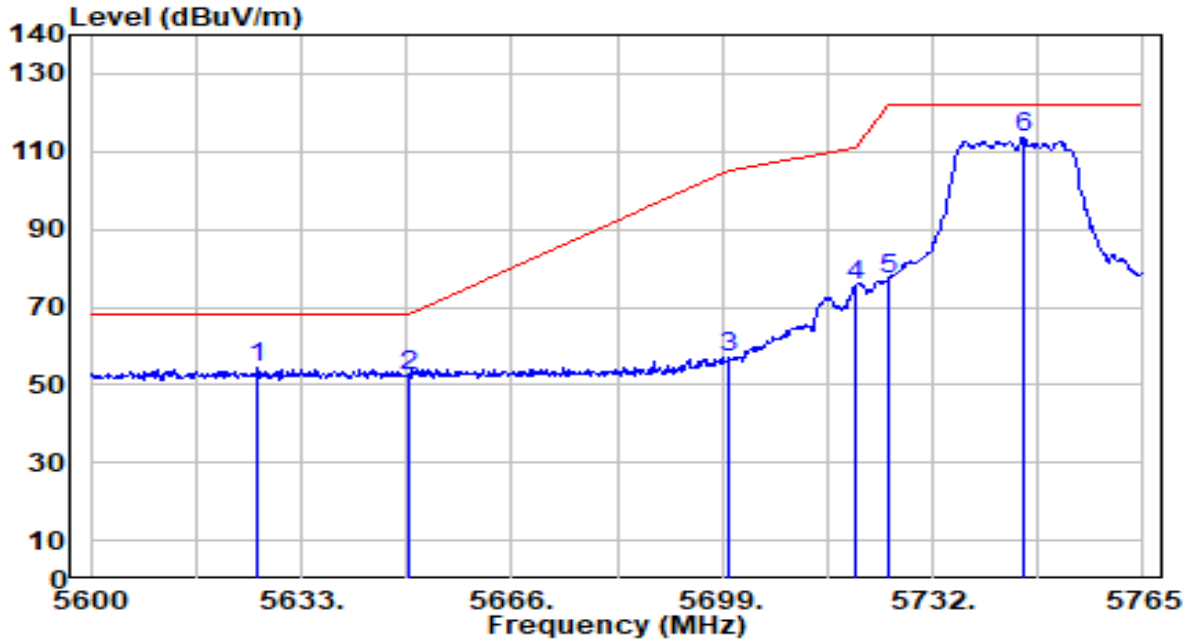

No	Frequency (MHz)	Reading (dBuV)	C.F (dB/m)	Measurement (dBuV/m)	Margin (dB)	Limit (dBuV/m)	Height (cm)	Angle (deg)	Remark (QP/PK/AV)
1	*	54.41	-0.17	54.24	-13.96	68.20	263	250	Peak
2		52.51	-0.08	52.44	-15.76	68.20	263	250	Peak
3		56.86	0.11	56.97	-48.23	105.20	263	250	Peak
4		75.44	0.19	75.63	-35.17	110.80	263	250	Peak
5		77.16	0.21	77.36	-44.84	122.20	263	250	Peak
6		113.30	0.29	113.59	N/A	N/A	263	250	Peak

Note:

1. " \*", means this data is the worst emission level.
2. C.F (Correction Factor) = Antenna Factor (dB/m) + Cable Loss (dB) – Preamplifier(dB) + 10dB Attenuation.
3. Measurement (dBuV/m) = Reading(dBuV) + C.F (Correction Factor).
4. The emission levels of other frequencies are very lower than the limit and not show in test report.

EUT	AX3000 High Gain Wireless USB Adapter	Date of Test	2023-01-19
Factor	DRH18-E	Temp. / Humidity	20°C /62%
Polarity	Horizontal	Site / Test Engineer	AC2 / Ares
Test Mode	802.11ax-20MHz_TX_Band4_CH 165_ANT 1+2	Test Voltage	By Notebook PC

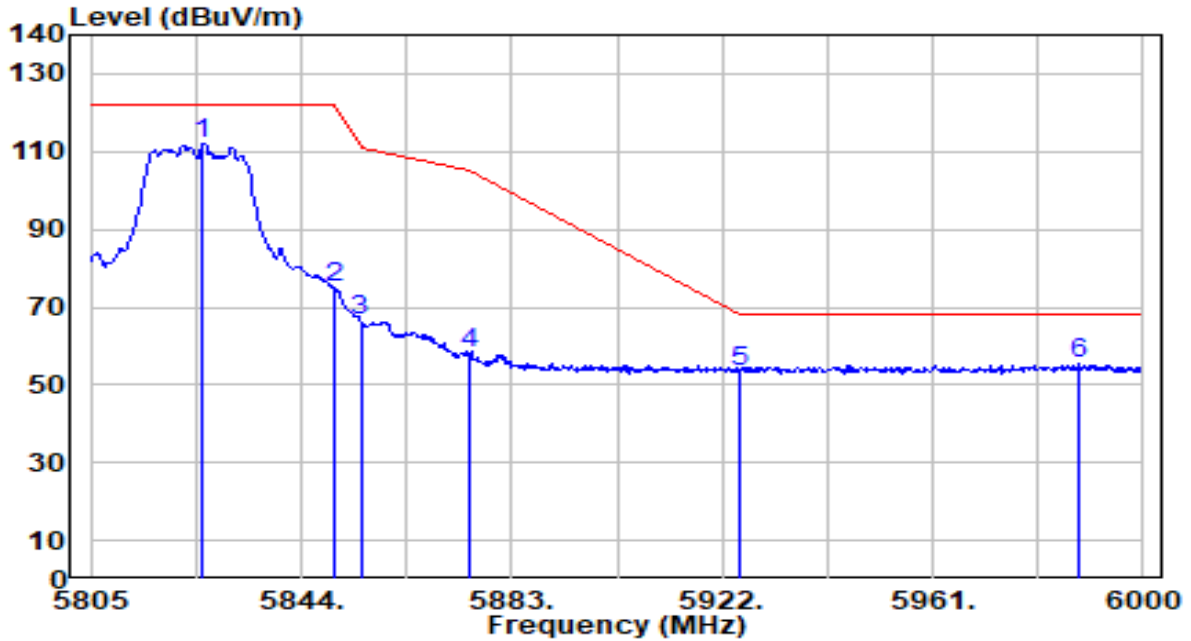

No	Frequency (MHz)	Reading (dBuV)	C.F (dB/m)	Measurement (dBuV/m)	Margin (dB)	Limit (dBuV/m)	Height (cm)	Angle (deg)	Remark (QP/PK/AV)
1	5825.865	111.53	0.52	112.05	N/A	N/A	260	181	Peak
2	5850.000	74.37	0.55	74.92	-47.28	122.20	260	181	Peak
3	5855.000	66.05	0.56	66.61	-44.19	110.80	260	181	Peak
4	5875.000	57.29	0.58	57.87	-47.33	105.20	260	181	Peak
5	5925.000	52.84	0.65	53.48	-14.72	68.20	260	181	Peak
6	* 5987.910	54.60	0.72	55.32	-12.88	68.20	260	181	Peak

Note:

1. " \*", means this data is the worst emission level.
2. C.F (Correction Factor) = Antenna Factor (dB/m) + Cable Loss (dB) – Preamplifier(dB) + 10dB Attenuation.
3. Measurement (dBuV/m) = Reading(dBuV) + C.F (Correction Factor).
4. The emission levels of other frequencies are very lower than the limit and not show in test report.

EUT	AX3000 High Gain Wireless USB Adapter	Date of Test	2023-01-19
Factor	DRH18-E	Temp. / Humidity	20°C /62%
Polarity	Vertical	Site / Test Engineer	AC2 / Ares
Test Mode	802.11ax-20MHz_TX_Band4_CH 165_ANT 1+2	Test Voltage	By Notebook PC

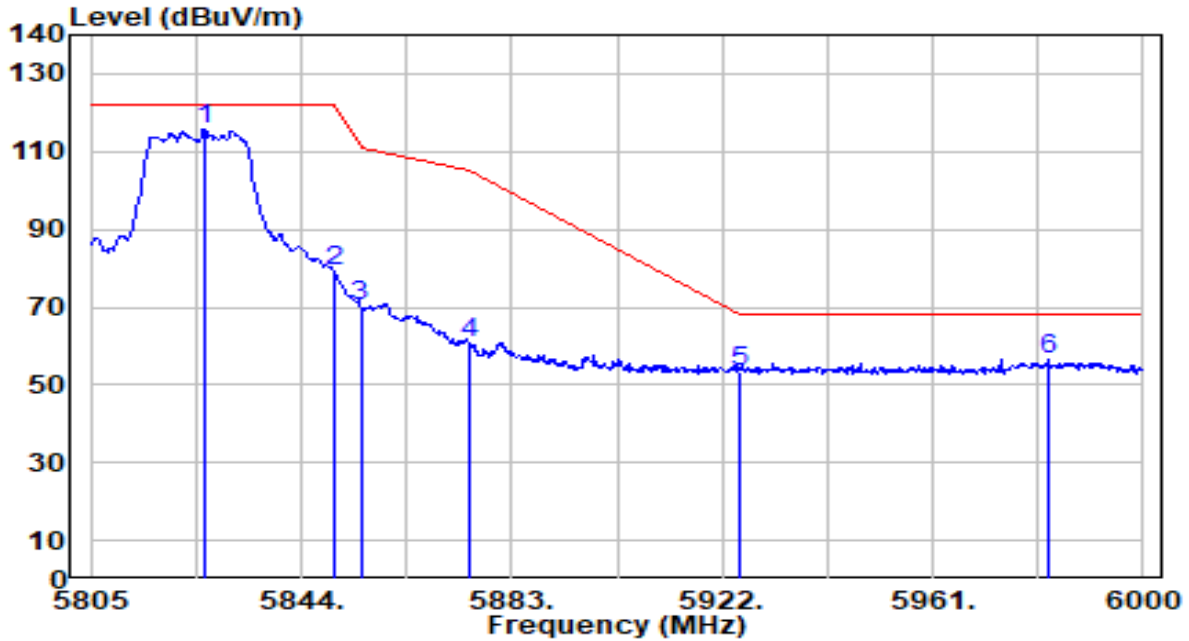

No	Frequency (MHz)	Reading (dBuV)	C.F (dB/m)	Measurement (dBuV/m)	Margin (dB)	Limit (dBuV/m)	Height (cm)	Angle (deg)	Remark (QP/PK/AV)
1	5826.060	115.18	0.52	115.70	N/A	N/A	263	250	Peak
2	5850.000	78.65	0.55	79.20	-43.00	122.20	263	250	Peak
3	5855.000	69.73	0.56	70.29	-40.51	110.80	263	250	Peak
4	5875.000	60.05	0.58	60.63	-44.57	105.20	263	250	Peak
5	5925.000	52.57	0.65	53.21	-14.99	68.20	263	250	Peak
6	* 5982.450	55.66	0.72	56.37	-11.83	68.20	263	250	Peak

Note:

1. " \*", means this data is the worst emission level.
2. C.F (Correction Factor) = Antenna Factor (dB/m) + Cable Loss (dB) – Preamplifier(dB) + 10dB Attenuation.
3. Measurement (dBuV/m) = Reading(dBuV) + C.F (Correction Factor).
4. The emission levels of other frequencies are very lower than the limit and not show in test report.

EUT	AX3000 High Gain Wireless USB Adapter	Date of Test	2023-01-19
-----	---------------------------------------	--------------	------------

Factor	DRH18-E	Temp. / Humidity	20°C /62%
Polarity	Horizontal	Site / Test Engineer	AC2 / Ares
Test Mode	802.11ax-40MHz_TX_Band1_CH 38_ANT 1+2	Test Voltage	By Notebook PC

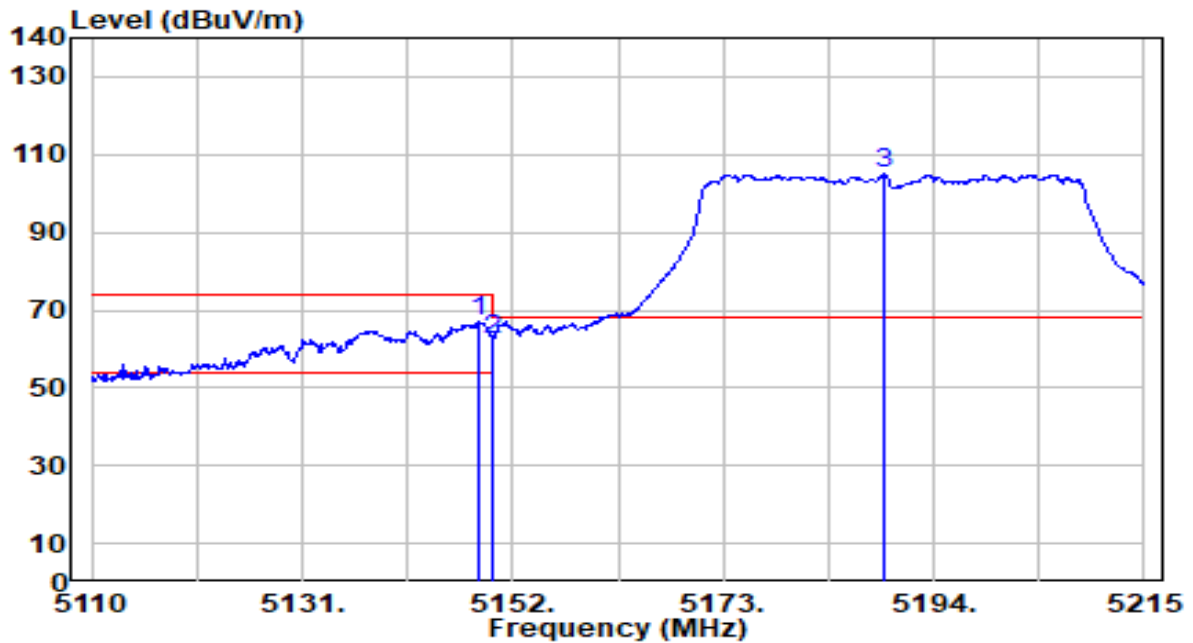

No	Frequency (MHz)	Reading (dBuV)	C.F (dB/m)	Measurement (dBuV/m)	Margin (dB)	Limit (dBuV/m)	Height (cm)	Angle (deg)	Remark (QP/PK/AV)
1	* 5148.745	67.91	-0.73	67.18	-6.82	74.00	227	174	Peak
2	5150.000	63.27	-0.73	62.55	-11.45	74.00	227	174	Peak
3	5189.065	105.61	-0.69	104.92	N/A	N/A	227	174	Peak

Note:

1. " \*", means this data is the worst emission level.
2. C.F (Correction Factor) = Antenna Factor (dB/m) + Cable Loss (dB) – Pre-amplifier(dB) + 10dB Attenuation.
3. Measurement (dBuV/m) = Reading(dBuV) + C.F (Correction Factor).
4. The emission levels of other frequencies are very lower than the limit and not show in test report.



EUT	AX3000 High Gain Wireless USB Adapter	Date of Test	2023-01-19
Factor	DRH18-E	Temp. / Humidity	20°C /62%
Polarity	Horizontal	Site / Test Engineer	AC2 / Ares
Test Mode	802.11ax-40MHz_TX_Band1_CH 38_ANT 1+2	Test Voltage	By Notebook PC

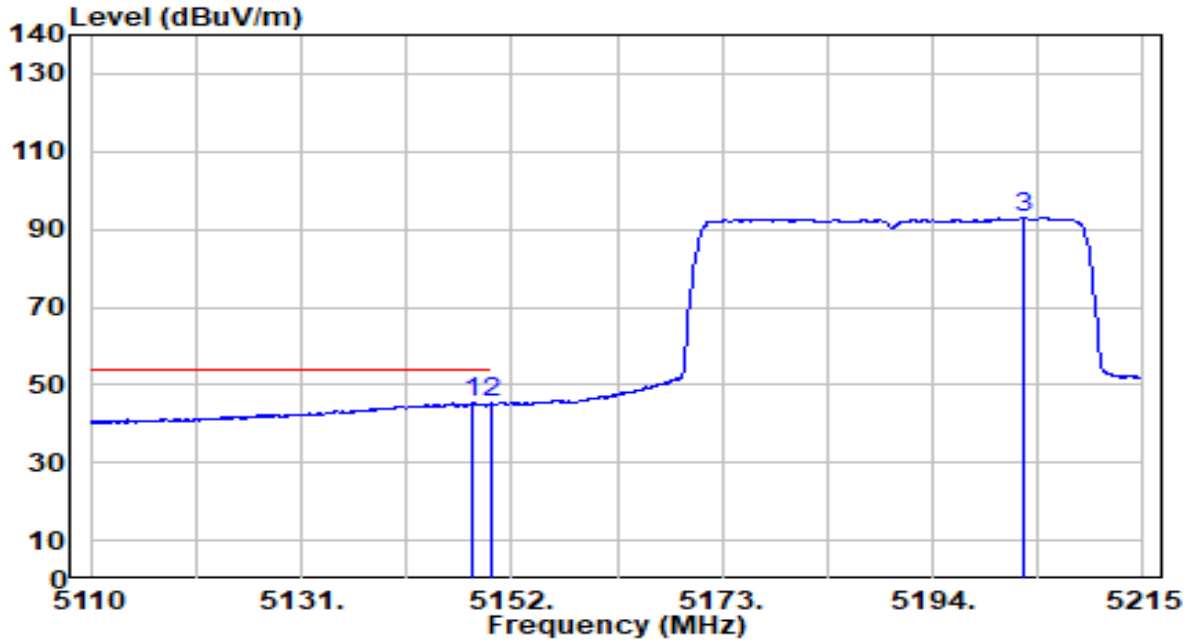

No	Frequency (MHz)	Reading (dBuV)	C.F (dB/m)	Measurement (dBuV/m)	Margin (dB)	Limit (dBuV/m)	Height (cm)	Angle (deg)	Remark (QP/PK/AV)
1	5148.115	45.94	-0.73	45.22	-8.78	54.00	227	174	Average
2	* 5150.000	46.03	-0.73	45.30	-8.70	54.00	227	174	Average
3	5203.135	93.71	-0.68	93.03	N/A	N/A	227	174	Average

Note:

1. " \*", means this data is the worst emission level.
2. C.F (Correction Factor) = Antenna Factor (dB/m) + Cable Loss (dB) – Preamplifier(dB) + 10dB Attenuation.
3. Measurement (dBuV/m) = Reading(dBuV) + C.F (Correction Factor).
4. The emission levels of other frequencies are very lower than the limit and not show in test report.

EUT	AX3000 High Gain Wireless USB Adapter	Date of Test	2023-01-19
Factor	DRH18-E	Temp. / Humidity	20°C /62%
Polarity	Vertical	Site / Test Engineer	AC2 / Ares
Test Mode	802.11ax-40MHz_TX_Band1_CH 38_ANT 1+2	Test Voltage	By Notebook PC

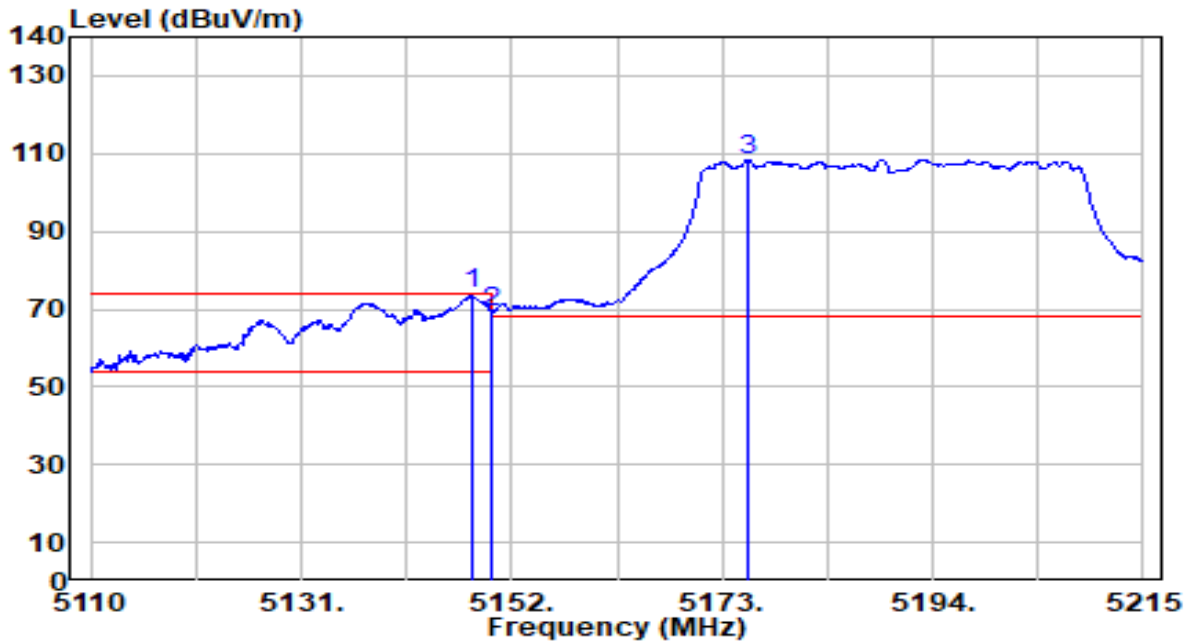

No	Frequency (MHz)	Reading (dBuV)	C.F (dB/m)	Measurement (dBuV/m)	Margin (dB)	Limit (dBuV/m)	Height (cm)	Angle (deg)	Remark (QP/PK/AV)	
1	*	5148.010	74.57	-0.73	73.84	-0.16	74.00	155	63	Peak
2		5150.000	70.14	-0.73	69.41	-4.59	74.00	155	63	Peak
3		5175.625	109.21	-0.70	108.50	N/A	N/A	155	63	Peak

Note:

1. " \*", means this data is the worst emission level.
2. C.F (Correction Factor) = Antenna Factor (dB/m) + Cable Loss (dB) – Preamplifier(dB) + 10dB Attenuation.
3. Measurement (dBuV/m) = Reading(dBuV) + C.F (Correction Factor).
4. The emission levels of other frequencies are very lower than the limit and not show in test report.

EUT	AX3000 High Gain Wireless USB Adapter	Date of Test	2023-01-19
Factor	DRH18-E	Temp. / Humidity	20°C /62%
Polarity	Vertical	Site / Test Engineer	AC2 / Ares
Test Mode	802.11ax-40MHz_TX_Band1_CH 38_ANT 1+2	Test Voltage	By Notebook PC

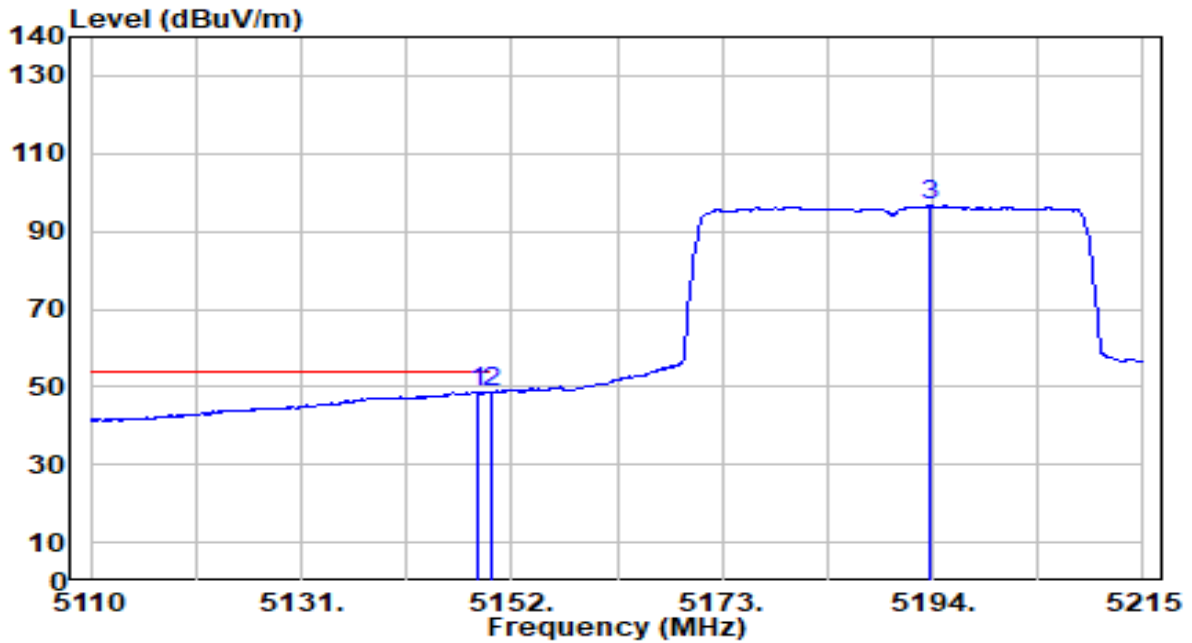

No	Frequency (MHz)	Reading (dBuV)	C.F (dB/m)	Measurement (dBuV/m)	Margin (dB)	Limit (dBuV/m)	Height (cm)	Angle (deg)	Remark (QP/PK/AV)
1	* 5148.535	49.39	-0.73	48.67	-5.33	54.00	155	63	Average
2	5150.000	49.35	-0.73	48.62	-5.38	54.00	155	63	Average
3	5193.685	97.25	-0.68	96.56	N/A	N/A	155	63	Average

Note:

1. " \*", means this data is the worst emission level.
2. C.F (Correction Factor) = Antenna Factor (dB/m) + Cable Loss (dB) – Preamplifier(dB) + 10dB Attenuation.
3. Measurement (dBuV/m) = Reading(dBuV) + C.F (Correction Factor).
4. The emission levels of other frequencies are very lower than the limit and not show in test report.

EUT	AX3000 High Gain Wireless USB Adapter	Date of Test	2023-01-19
Factor	DRH18-E	Temp. / Humidity	20°C /62%
Polarity	Horizontal	Site / Test Engineer	AC2 / Ares
Test Mode	802.11ax-40MHz_TX_Band2_CH 62_ANT 1+2	Test Voltage	By Notebook PC

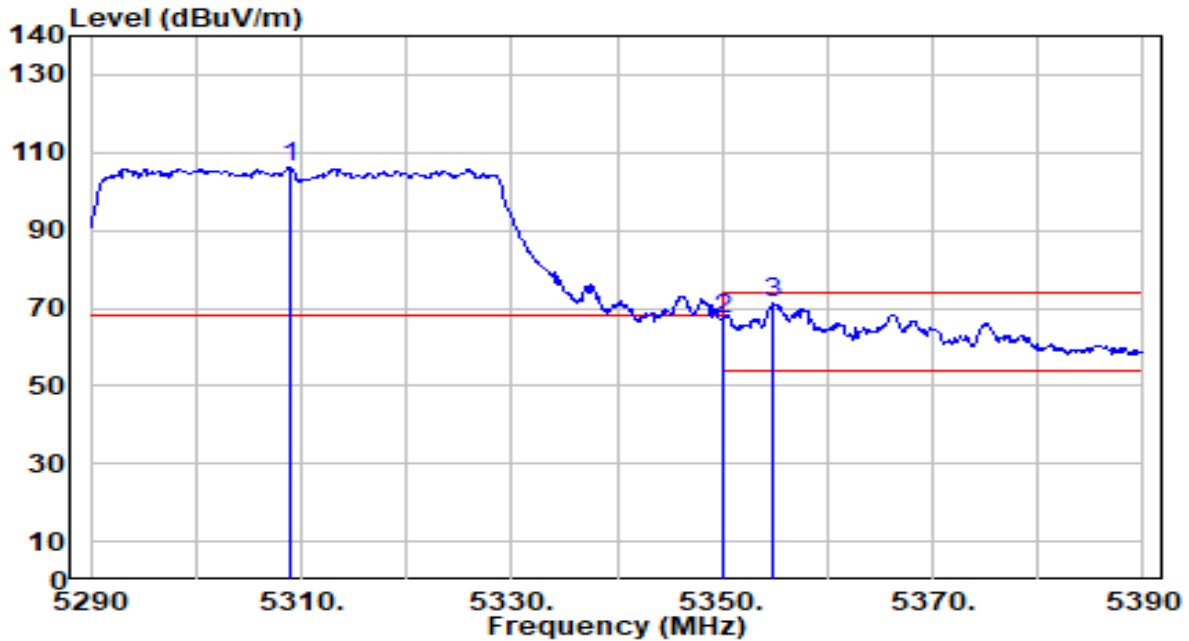

No	Frequency (MHz)	Reading (dBuV)	C.F (dB/m)	Measurement (dBuV/m)	Margin (dB)	Limit (dBuV/m)	Height (cm)	Angle (deg)	Remark (QP/PK/AV)
1	5309.000	106.91	-0.90	106.01	N/A	N/A	250	183	Peak
2	5350.000	68.13	-0.98	67.15	-6.85	74.00	250	183	Peak
3	* 5354.800	72.22	-0.99	71.23	-2.77	74.00	250	183	Peak

Note:

1. " \*", means this data is the worst emission level.
2. C.F (Correction Factor) = Antenna Factor (dB/m) + Cable Loss (dB) – Pre-amplifier(dB) + 10dB Attenuation.
3. Measurement (dBuV/m) = Reading(dBuV) + C.F (Correction Factor).
4. The emission levels of other frequencies are very lower than the limit and not show in test report.

EUT	AX3000 High Gain Wireless USB Adapter	Date of Test	2023-01-19
Factor	DRH18-E	Temp. / Humidity	20°C /62%
Polarity	Horizontal	Site / Test Engineer	AC2 / Ares
Test Mode	802.11ax-40MHz_TX_Band2_CH 62_ANT 1+2	Test Voltage	By Notebook PC

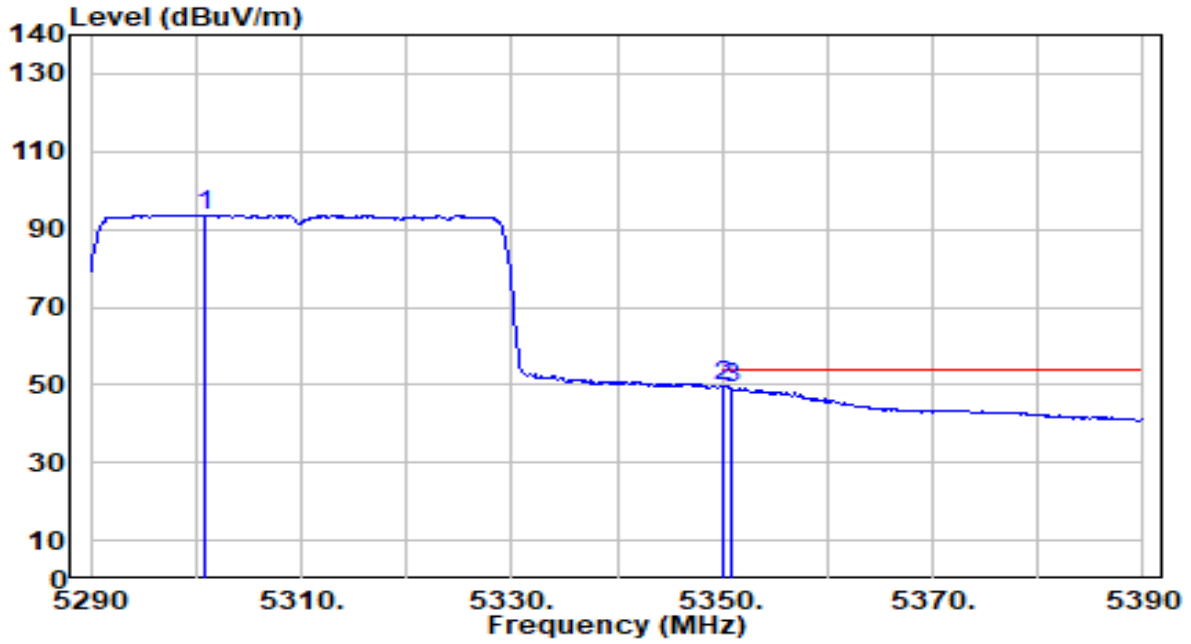

No	Frequency (MHz)	Reading (dBuV)	C.F (dB/m)	Measurement (dBuV/m)	Margin (dB)	Limit (dBuV/m)	Height (cm)	Angle (deg)	Remark (QP/PK/AV)
1	5300.800	94.59	-0.88	93.70	N/A	N/A	250	183	Average
2	* 5350.000	50.67	-0.98	49.69	-4.31	54.00	250	183	Average
3	5351.000	49.98	-0.99	49.00	-5.00	54.00	250	183	Average

Note:

1. " \*", means this data is the worst emission level.
2. C.F (Correction Factor) = Antenna Factor (dB/m) + Cable Loss (dB) – Preamplifier(dB) + 10dB Attenuation.
3. Measurement (dBuV/m) = Reading(dBuV) + C.F (Correction Factor).
4. The emission levels of other frequencies are very lower than the limit and not show in test report.

EUT	AX3000 High Gain Wireless USB Adapter	Date of Test	2023-01-19
Factor	DRH18-E	Temp. / Humidity	20°C /62%
Polarity	Vertical	Site / Test Engineer	AC2 / Ares
Test Mode	802.11ax-40MHz_TX_Band2_CH 62_ANT 1+2	Test Voltage	By Notebook PC

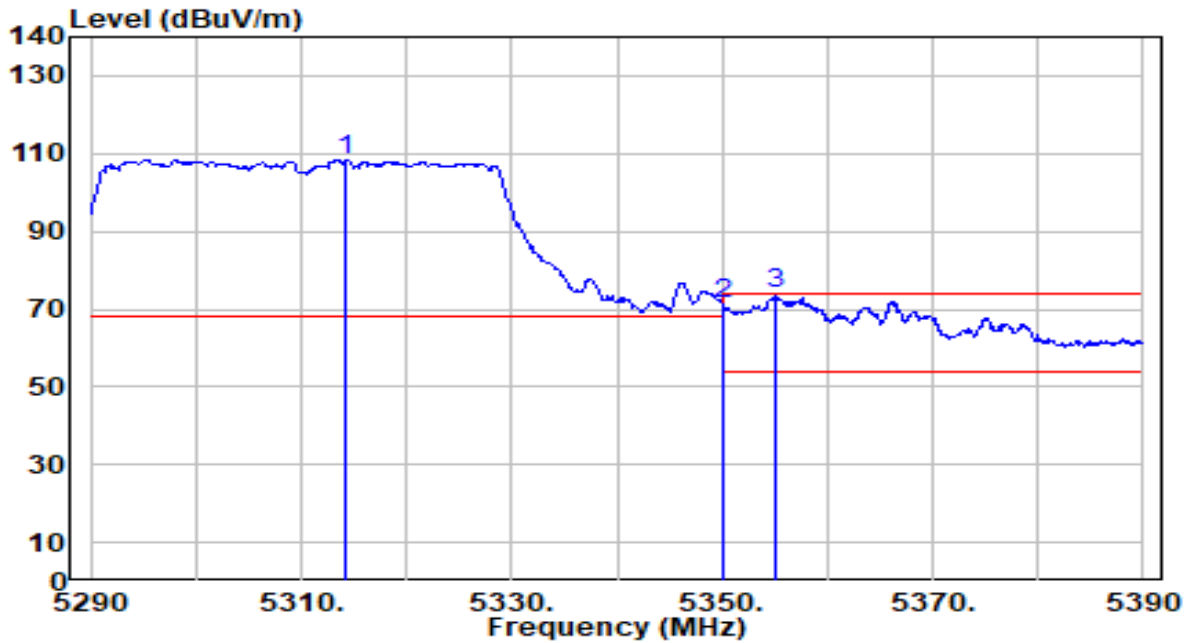

No	Frequency (MHz)	Reading (dBuV)	C.F (dB/m)	Measurement (dBuV/m)	Margin (dB)	Limit (dBuV/m)	Height (cm)	Angle (deg)	Remark (QP/PK/AV)
1	5314.300	109.22	-0.91	108.31	N/A	N/A	302	246	Peak
2	5350.000	72.11	-0.98	71.12	-2.88	74.00	302	246	Peak
3	* 5355.000	74.89	-0.99	73.89	-0.11	74.00	302	246	Peak

Note:

1. " \*", means this data is the worst emission level.
2. C.F (Correction Factor) = Antenna Factor (dB/m) + Cable Loss (dB) – Preamplifier(dB) + 10dB Attenuation.
3. Measurement (dBuV/m) = Reading(dBuV) + C.F (Correction Factor).
4. The emission levels of other frequencies are very lower than the limit and not show in test report.

EUT	AX3000 High Gain Wireless USB Adapter	Date of Test	2023-01-19
Factor	DRH18-E	Temp. / Humidity	20°C /62%
Polarity	Vertical	Site / Test Engineer	AC2 / Ares
Test Mode	802.11ax-40MHz_TX_Band2_CH 62_ANT 1+2	Test Voltage	By Notebook PC

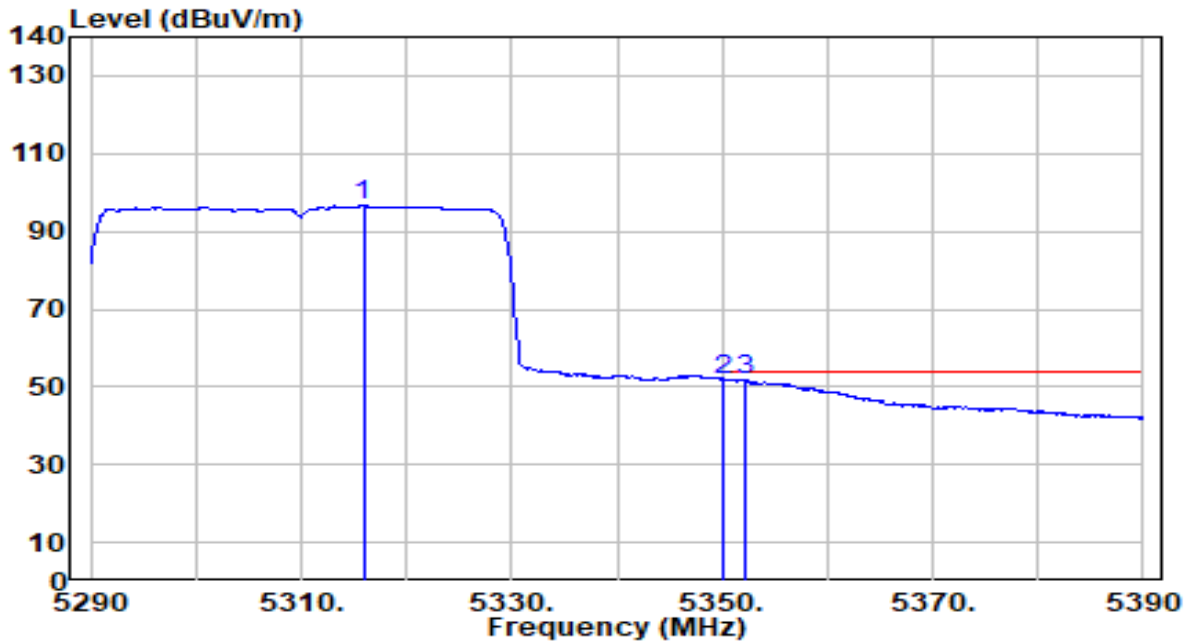

No	Frequency (MHz)	Reading (dBuV)	C.F (dB/m)	Measurement (dBuV/m)	Margin (dB)	Limit (dBuV/m)	Height (cm)	Angle (deg)	Remark (QP/PK/AV)
1	5315.900	97.56	-0.91	96.64	N/A	N/A	302	246	Average
2 *	5350.000	52.89	-0.98	51.91	-2.09	54.00	302	246	Average
3	5352.200	52.75	-0.99	51.76	-2.24	54.00	302	246	Average

Note:

1. " \*", means this data is the worst emission level.
2. C.F (Correction Factor) = Antenna Factor (dB/m) + Cable Loss (dB) – Preamplifier(dB) + 10dB Attenuation.
3. Measurement (dBuV/m) = Reading(dBuV) + C.F (Correction Factor).
4. The emission levels of other frequencies are very lower than the limit and not show in test report.

EUT	AX3000 High Gain Wireless USB Adapter	Date of Test	2023-01-19
Factor	DRH18-E	Temp. / Humidity	20°C /62%
Polarity	Horizontal	Site / Test Engineer	AC2 / Ares
Test Mode	802.11ax-40MHz_TX_Band3_CH 102_ANT 1+2	Test Voltage	By Notebook PC

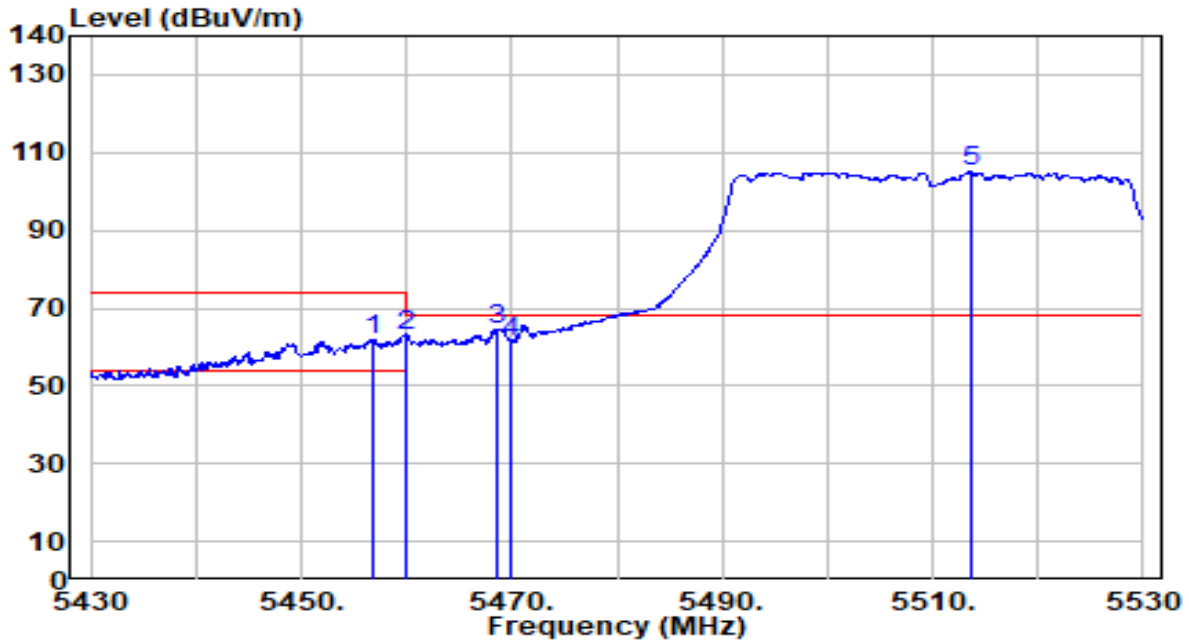

No	Frequency (MHz)	Reading (dBUV)	C.F (dB/m)	Measurement (dBUV/m)	Margin (dB)	Limit (dBUV/m)	Height (cm)	Angle (deg)	Remark (QP/PK/AV)
1	5456.800	62.79	-0.86	61.93	-12.07	74.00	210	178	Peak
2	5460.000	63.75	-0.85	62.90	-11.10	74.00	210	178	Peak
3	* 5468.500	65.01	-0.81	64.20	-4.00	68.20	210	178	Peak
4	5470.000	62.09	-0.81	61.28	-6.92	68.20	210	178	Peak
5	5513.600	105.54	-0.63	104.91	N/A	N/A	210	178	Peak

Note:

1. " \*", means this data is the worst emission level.
2. C.F (Correction Factor) = Antenna Factor (dB/m) + Cable Loss (dB) – Preamplifier(dB) + 10dB Attenuation.
3. Measurement (dBUV/m) = Reading(dBUV) + C.F (Correction Factor).
4. The emission levels of other frequencies are very lower than the limit and not show in test report.



EUT	AX3000 High Gain Wireless USB Adapter	Date of Test	2023-01-19
Factor	DRH18-E	Temp. / Humidity	20°C /62%
Polarity	Horizontal	Site / Test Engineer	AC2 / Ares
Test Mode	802.11ax-40MHz_TX_Band3_CH 102_ANT 1+2	Test Voltage	By Notebook PC

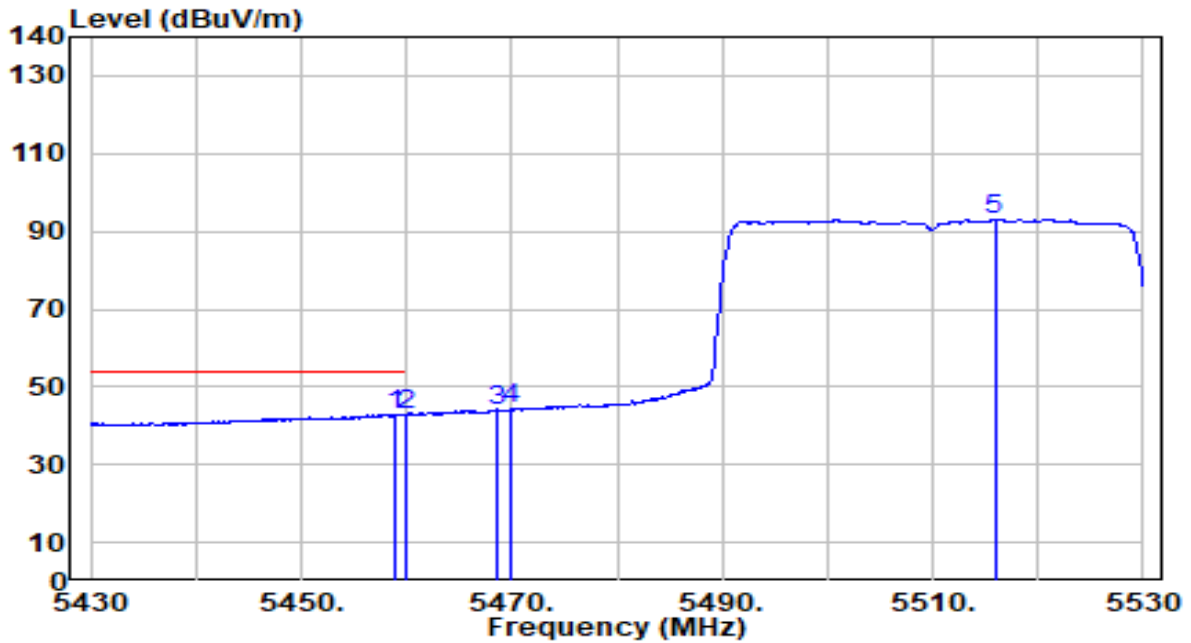

No	Frequency (MHz)	Reading (dBuV)	C.F (dB/m)	Measurement (dBuV/m)	Margin (dB)	Limit (dBuV/m)	Height (cm)	Angle (deg)	Remark (QP/PK/AV)
1	* 5458.800	43.74	-0.85	42.89	-11.11	54.00	210	178	Average
2	5460.000	43.66	-0.85	42.81	-11.19	54.00	210	178	Average
3	5468.500	44.88	-0.81	44.07	N/A	N/A	210	178	Average
4	5470.000	45.00	-0.81	44.19	N/A	N/A	210	178	Average
5	5515.900	93.61	-0.62	92.99	N/A	N/A	210	178	Average

Note:

1. " \*", means this data is the worst emission level.
2. C.F (Correction Factor) = Antenna Factor (dB/m) + Cable Loss (dB) – Preamplifier(dB) + 10dB Attenuation.
3. Measurement (dBuV/m) = Reading(dBuV) + C.F (Correction Factor).
4. The emission levels of other frequencies are very lower than the limit and not show in test report.

EUT	AX3000 High Gain Wireless USB Adapter	Date of Test	2023-01-19
Factor	DRH18-E	Temp. / Humidity	20°C /62%
Polarity	Vertical	Site / Test Engineer	AC2 / Ares
Test Mode	802.11ax-40MHz_TX_Band3_CH 102_ANT 1+2	Test Voltage	By Notebook PC

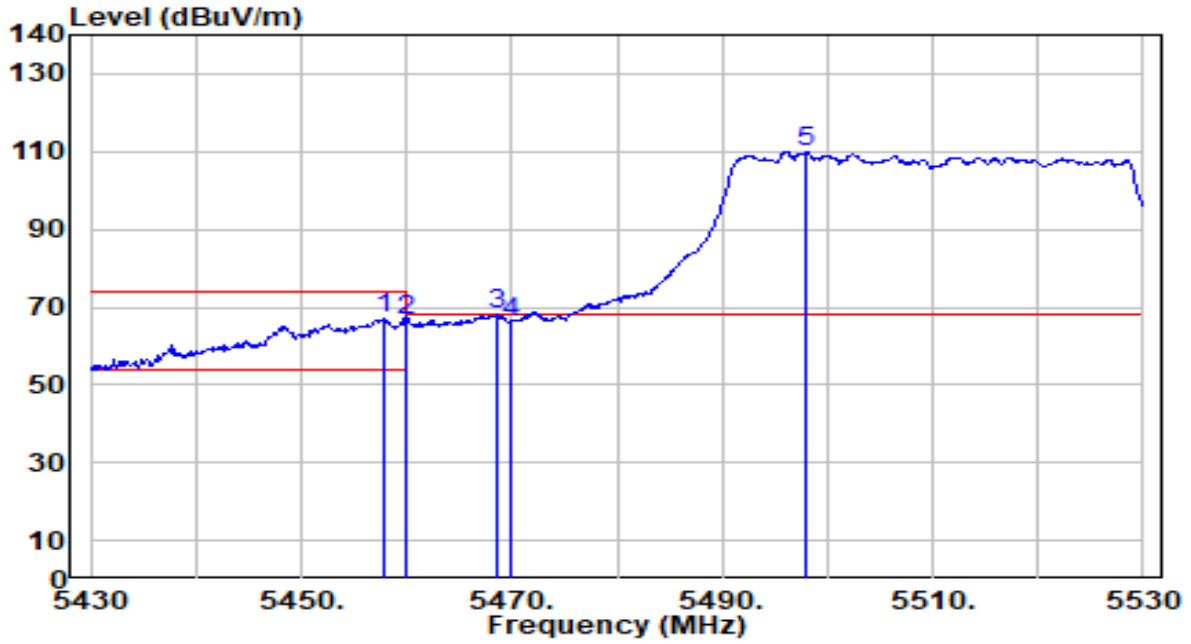

No	Frequency (MHz)	Reading (dBuV)	C.F (dB/m)	Measurement (dBuV/m)	Margin (dB)	Limit (dBuV/m)	Height (cm)	Angle (deg)	Remark (QP/PK/AV)
1	5457.900	67.69	-0.86	66.84	-7.16	74.00	278	252	Peak
2	5460.000	67.38	-0.85	66.54	-7.46	74.00	278	252	Peak
3	* 5468.500	68.88	-0.81	68.06	-0.14	68.20	278	252	Peak
4	5470.000	67.00	-0.81	66.20	-2.00	68.20	278	252	Peak
5	5498.000	110.49	-0.70	109.79	N/A	N/A	278	252	Peak

Note:

1. " \*", means this data is the worst emission level.
2. C.F (Correction Factor) = Antenna Factor (dB/m) + Cable Loss (dB) – Preamplifier(dB) + 10dB Attenuation.
3. Measurement (dBuV/m) = Reading(dBuV) + C.F (Correction Factor).
4. The emission levels of other frequencies are very lower than the limit and not show in test report.

EUT	AX3000 High Gain Wireless USB Adapter	Date of Test	2023-01-19
Factor	DRH18-E	Temp. / Humidity	20°C /62%
Polarity	Vertical	Site / Test Engineer	AC2 / Ares
Test Mode	802.11ax-40MHz_TX_Band3_CH 102_ANT 1+2	Test Voltage	By Notebook PC

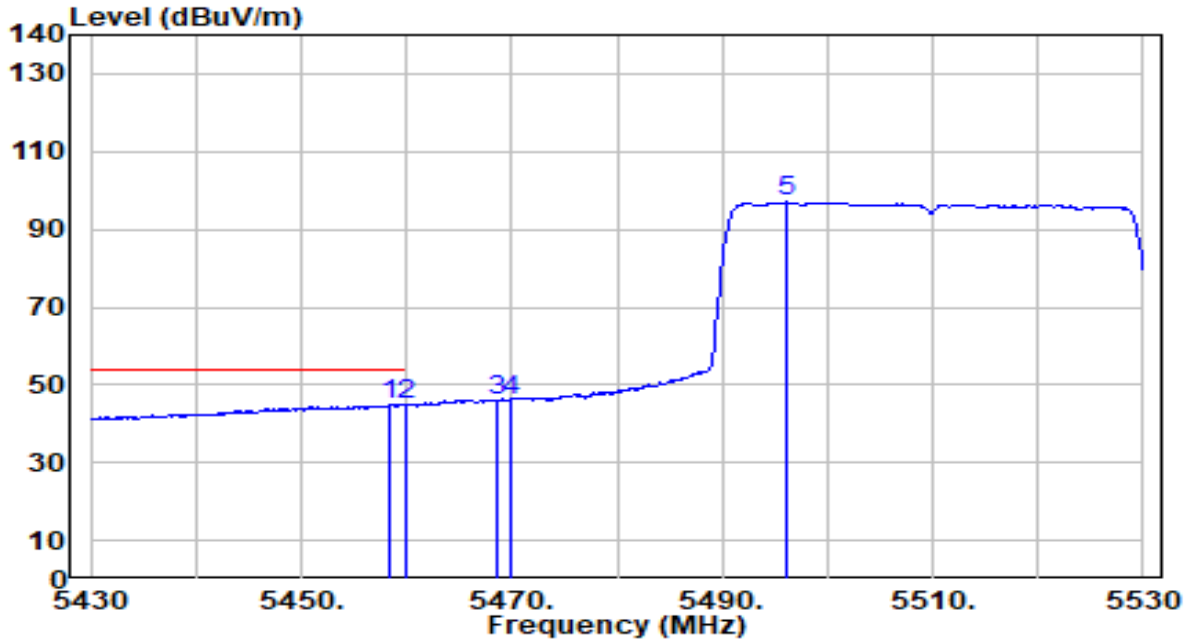

No	Frequency (MHz)	Reading (dBuV)	C.F (dB/m)	Measurement (dBuV/m)	Margin (dB)	Limit (dBuV/m)	Height (cm)	Angle (deg)	Remark (QP/PK/AV)
1	5458.400	45.72	-0.85	44.86	-9.14	54.00	278	252	Average
2	* 5460.000	45.84	-0.85	44.99	-9.01	54.00	278	252	Average
3	5468.500	46.81	-0.81	45.99	N/A	N/A	278	252	Average
4	5470.000	46.98	-0.81	46.17	N/A	N/A	278	252	Average
5	5496.200	97.76	-0.71	97.06	N/A	N/A	278	252	Average

Note:

1. " \*", means this data is the worst emission level.
2. C.F (Correction Factor) = Antenna Factor (dB/m) + Cable Loss (dB) – Preamplifier(dB) + 10dB Attenuation.
3. Measurement (dBuV/m) = Reading(dBuV) + C.F (Correction Factor).
4. The emission levels of other frequencies are very lower than the limit and not show in test report.

EUT	AX3000 High Gain Wireless USB Adapter	Date of Test	2023-01-19
Factor	DRH18-E	Temp. / Humidity	20°C /62%
Polarity	Horizontal	Site / Test Engineer	AC2 / Ares
Test Mode	802.11ax-40MHz_TX_Band3_CH 134_ANT 1+2	Test Voltage	By Notebook PC

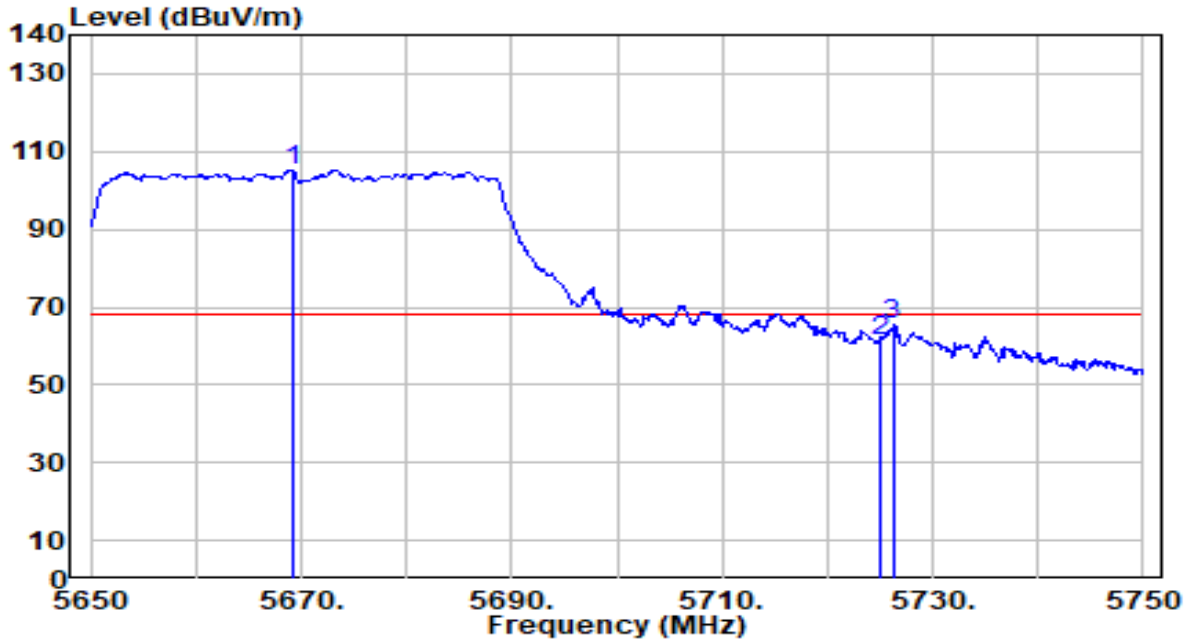

No	Frequency (MHz)	Reading (dBuV)	C.F (dB/m)	Measurement (dBuV/m)	Margin (dB)	Limit (dBuV/m)	Height (cm)	Angle (deg)	Remark (QP/PK/AV)
1	5669.100	105.16	0.00	105.16	N/A	N/A	250	173	Peak
2	5725.000	61.24	0.21	61.45	-6.75	68.20	250	173	Peak
3	* 5726.200	65.44	0.21	65.65	-2.55	68.20	250	173	Peak

Note:

1. " \*", means this data is the worst emission level.
2. C.F (Correction Factor) = Antenna Factor (dB/m) + Cable Loss (dB) – Preamplifier(dB) + 10dB Attenuation.
3. Measurement (dBuV/m) = Reading(dBuV) + C.F (Correction Factor).
4. The emission levels of other frequencies are very lower than the limit and not show in test report.

EUT	AX3000 High Gain Wireless USB Adapter	Date of Test	2023-01-19
Factor	DRH18-E	Temp. / Humidity	20°C /62%
Polarity	Vertical	Site / Test Engineer	AC2 / Ares
Test Mode	802.11ax-40MHz_TX_Band3_CH 134_ANT 1+2	Test Voltage	By Notebook PC

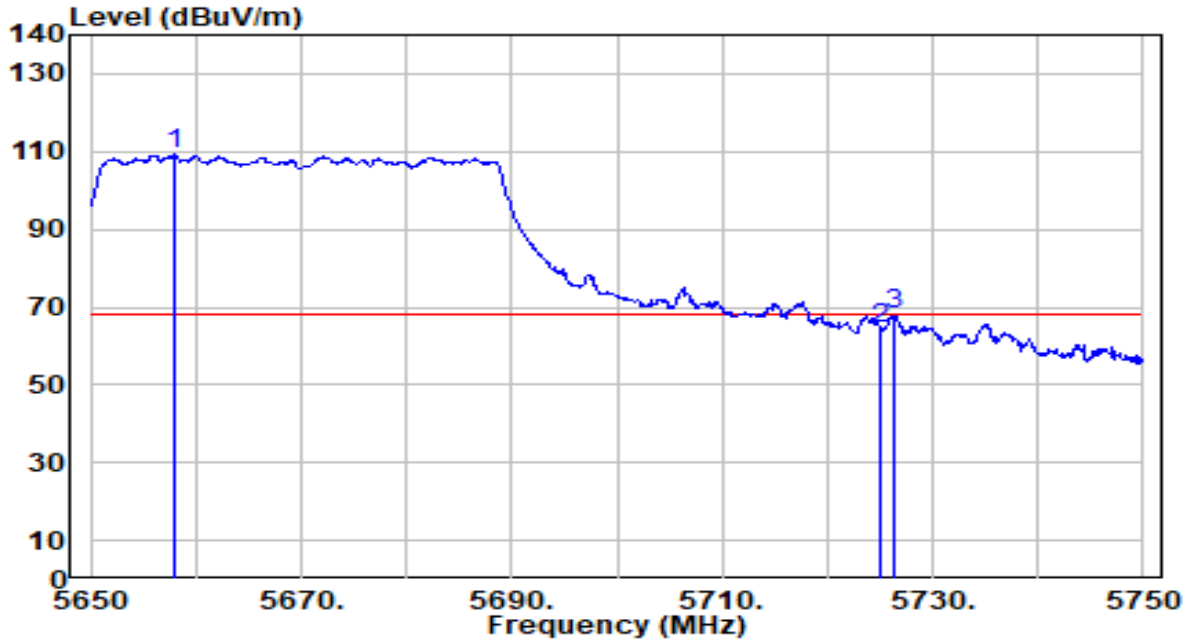

No	Frequency (MHz)	Reading (dBuV)	C.F (dB/m)	Measurement (dBuV/m)	Margin (dB)	Limit (dBuV/m)	Height (cm)	Angle (deg)	Remark (QP/PK/AV)
1	5657.900	109.19	-0.05	109.14	N/A	N/A	267	250	Peak
2	5725.000	64.40	0.21	64.61	-3.59	68.20	267	250	Peak
3	* 5726.300	67.83	0.21	68.04	-0.16	68.20	267	250	Peak

Note:

1. " \*", means this data is the worst emission level.
2. C.F (Correction Factor) = Antenna Factor (dB/m) + Cable Loss (dB) – Preamplifier(dB) + 10dB Attenuation.
3. Measurement (dBuV/m) = Reading(dBuV) + C.F (Correction Factor).
4. The emission levels of other frequencies are very lower than the limit and not show in test report.

## 7.10.AC Conducted Emissions Measurement

### 7.10.1.Test Limit

FCC Part 15.207 Limits		
Frequency (MHz)	QP (dB $\mu$ V)	AV (dB $\mu$ V)
0.15 - 0.50	66 - 56	56 - 46
0.50 - 5.0	56	46
5.0 - 30	60	50

Note 1: The lower limit shall apply at the transition frequencies.

Note 2: The limit decreases linearly with the logarithm of the frequency in the range 0.15MHz to 0.5MHz.

### 7.10.2.Test Setup

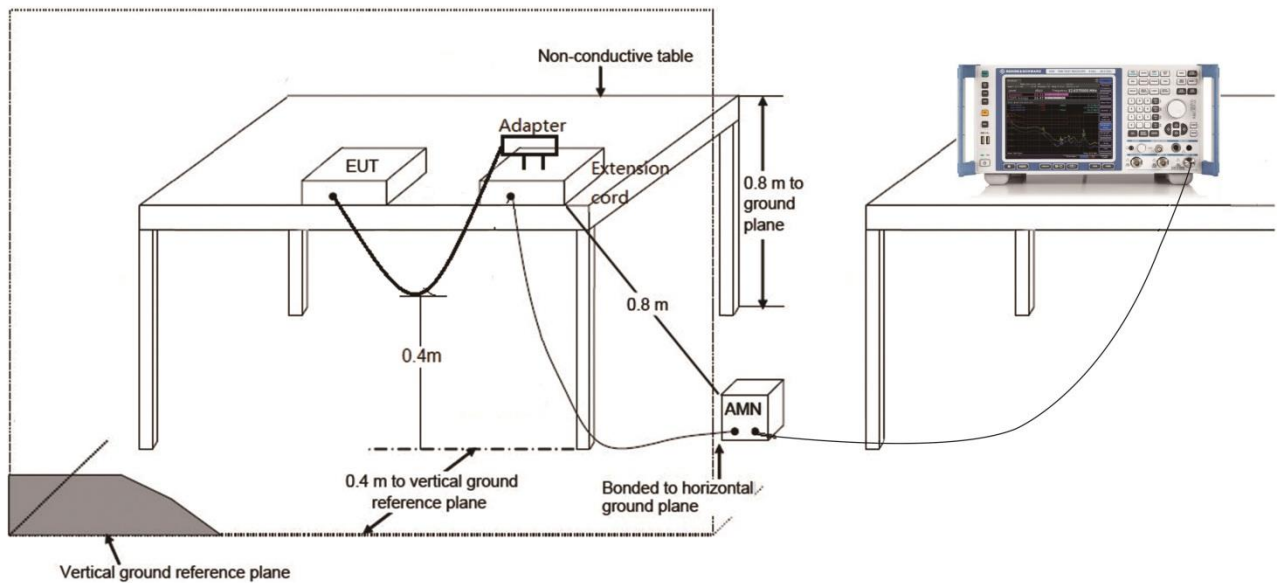

### 7.10.3. Test Result

EUT	AX3000 High Gain Wireless USB Adapter	Date of Test	2023-02-10
Factor	CE_ENV216-L1 (Filter ON)	Temp. / Humidity	23.7°C /67%
Polarity	Line1	Site / Test Engineer	SR2 / Tim
Test Mode	802.11ac-20MHz_TX_Band1_CH 44_ANT 1+2	Test Voltage	AC 120V/60Hz

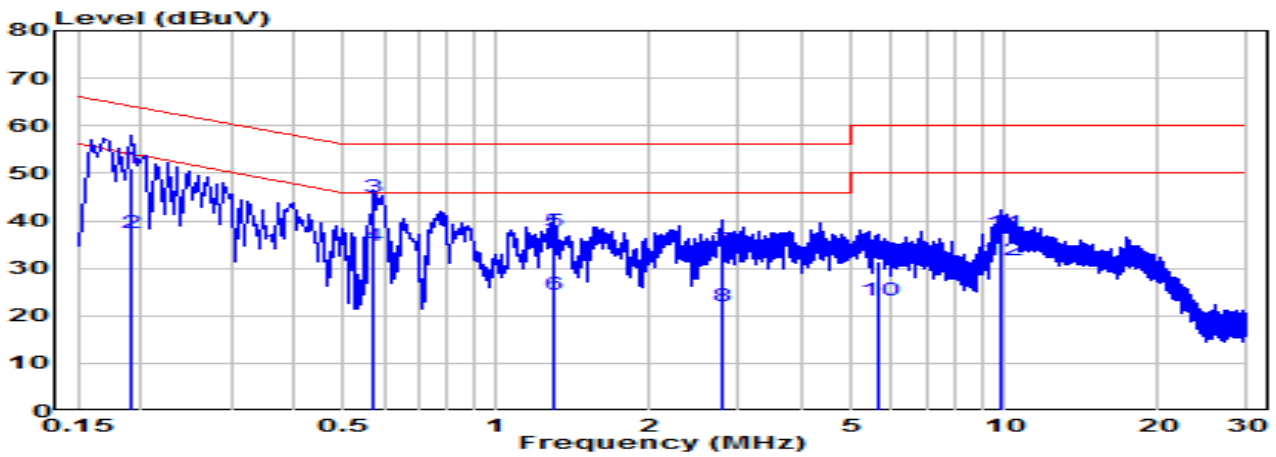

No	Frequency (MHz)	Reading (dBUV)	C.F (dB)	Measurement (dBUV)	Margin (dB)	Limit (dBUV)	Remark (QP/PK/AV)
1	0.190	41.33	9.62	50.95	-13.07	64.01	QP
2	0.190	27.83	9.62	37.45	-16.56	54.01	Average
3	* 0.573	35.39	9.65	45.03	-10.97	56.00	QP
4	* 0.573	25.08	9.65	34.73	-11.27	46.00	Average
5	1.293	27.95	9.68	37.63	-18.37	56.00	QP
6	1.293	14.64	9.68	24.32	-21.68	46.00	Average
7	2.796	24.17	9.71	33.88	-22.12	56.00	QP
8	2.796	12.44	9.71	22.14	-23.86	46.00	Average
9	5.657	21.53	9.76	31.29	-28.71	60.00	QP
10	5.657	13.45	9.76	23.21	-26.79	50.00	Average
11	9.901	27.61	9.86	37.47	-22.53	60.00	QP
12	9.901	21.87	9.86	31.72	-18.28	50.00	Average

Note:

1. " \*", means this data is the worst emission level.
2. C.F (Correction Factor) = LISN Factor (dB)+ Cable Loss (dB).
3. Measurement (dBUV) = Reading(dBUV) + C.F (Correction Factor).

EUT	AX3000 High Gain Wireless USB Adapter	Date of Test	2023-02-10
Factor	CE_ENV216-N (Filter ON)	Temp. / Humidity	23.7°C /67%
Polarity	Neutral	Site / Test Engineer	SR2 / Tim
Test Mode	802.11ac-20MHz_TX_Band1_CH 44_ANT 1+2	Test Voltage	AC 120V/60Hz

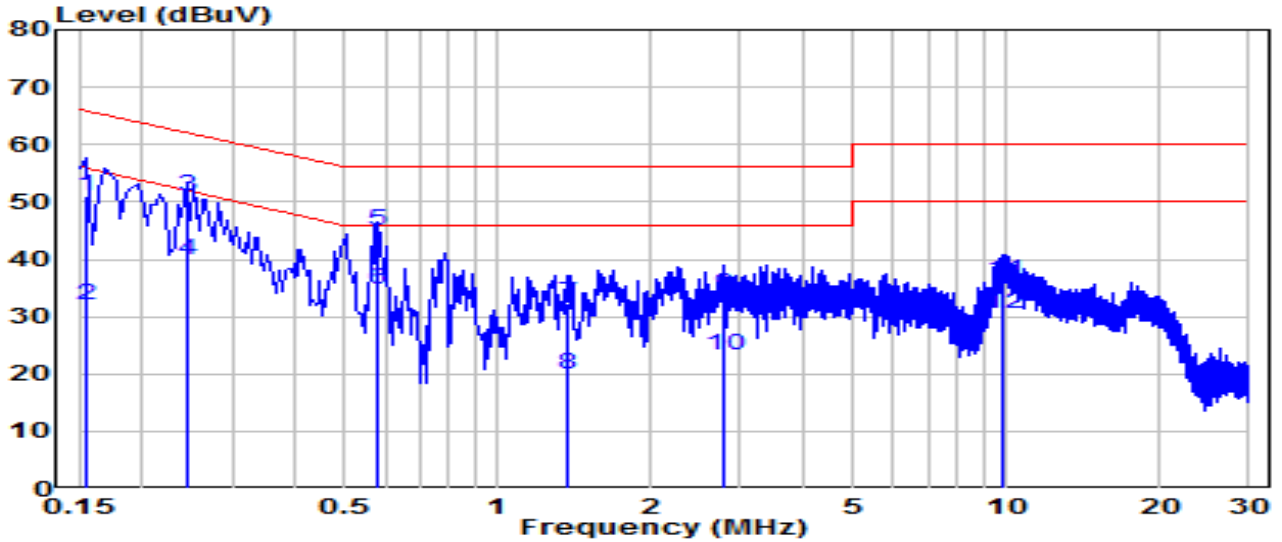

No	Frequency (MHz)	Reading (dBuV)	C.F (dB)	Measurement (dBuV)	Margin (dB)	Limit (dBuV)	Remark (QP/PK/AV)
1	0.154	41.31	9.62	50.93	-14.82	65.75	QP
2	0.154	22.37	9.62	31.99	-23.76	55.75	Average
3	0.244	41.34	9.63	50.97	-10.98	61.94	QP
4	0.244	30.20	9.63	39.83	-12.11	51.94	Average
5	* 0.582	35.39	9.65	45.03	-10.97	56.00	QP
6	* 0.582	24.99	9.65	34.64	-11.36	46.00	Average
7	1.378	22.68	9.68	32.35	-23.65	56.00	QP
8	1.378	10.17	9.68	19.85	-26.15	46.00	Average
9	2.787	23.95	9.71	33.66	-22.34	56.00	QP
10	2.787	13.44	9.71	23.15	-22.85	46.00	Average
11	9.887	26.48	9.87	36.34	-23.66	60.00	QP
12	9.887	20.51	9.87	30.38	-19.62	50.00	Average

Note:

1. " \*", means this data is the worst emission level.
2. C.F (Correction Factor) = LISN Factor (dB)+ Cable Loss (dB).
3. Measurement (dBuV) = Reading(dBuV) + C.F (Correction Factor).



EUT	AX3000 High Gain Wireless USB Adapter	Date of Test	2023-02-10
Factor	CE_ENV216-L1 (Filter ON)	Temp. / Humidity	23.7°C /67%
Polarity	Line1	Site / Test Engineer	SR2 / Tim
Test Mode	802.11ac-20MHz_TX_Band1_CH 44_ANT 1+2	Test Voltage	AC 240V/60Hz

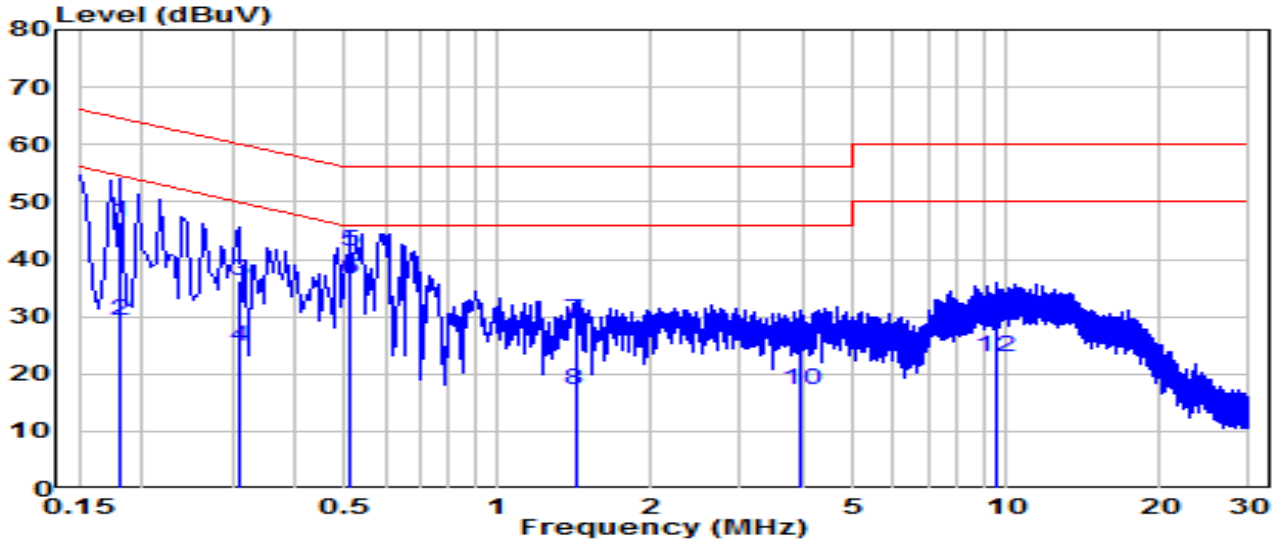

No	Frequency (MHz)	Reading (dBUV)	C.F (dB)	Measurement (dBUV)	Margin (dB)	Limit (dBUV)	Remark (QP/PK/AV)
1	0.181	36.80	9.62	46.42	-18.00	64.42	QP
2	0.181	19.56	9.62	29.18	-25.24	54.42	Average
3	0.312	26.70	9.63	36.33	-23.59	59.92	QP
4	0.312	15.21	9.63	24.84	-25.08	49.92	Average
5	*	0.514	9.64	41.22	-14.78	56.00	QP
6	*	0.514	9.64	36.64	-9.36	46.00	Average
7	1.419	19.68	9.68	29.36	-26.64	56.00	QP
8	1.419	7.39	9.68	17.07	-28.93	46.00	Average
9	3.948	15.45	9.73	25.18	-30.82	56.00	QP
10	3.948	7.61	9.73	17.34	-28.66	46.00	Average
11	9.509	19.74	9.85	29.59	-30.41	60.00	QP
12	9.509	13.14	9.85	22.99	-27.01	50.00	Average

Note:

1. " \*", means this data is the worst emission level.
2. C.F (Correction Factor) = LISN Factor (dB)+ Cable Loss (dB).
3. Measurement (dBUV) = Reading(dBUV) + C.F (Correction Factor).

EUT	AX3000 High Gain Wireless USB Adapter	Date of Test	2023-02-10
Factor	CE_ENV216-N (Filter ON)	Temp. / Humidity	23.7°C /67%
Polarity	Neutral	Site / Test Engineer	SR2 / Tim
Test Mode	802.11ac-20MHz_TX_Band1_CH 44_ANT 1+2	Test Voltage	AC 240V/60Hz

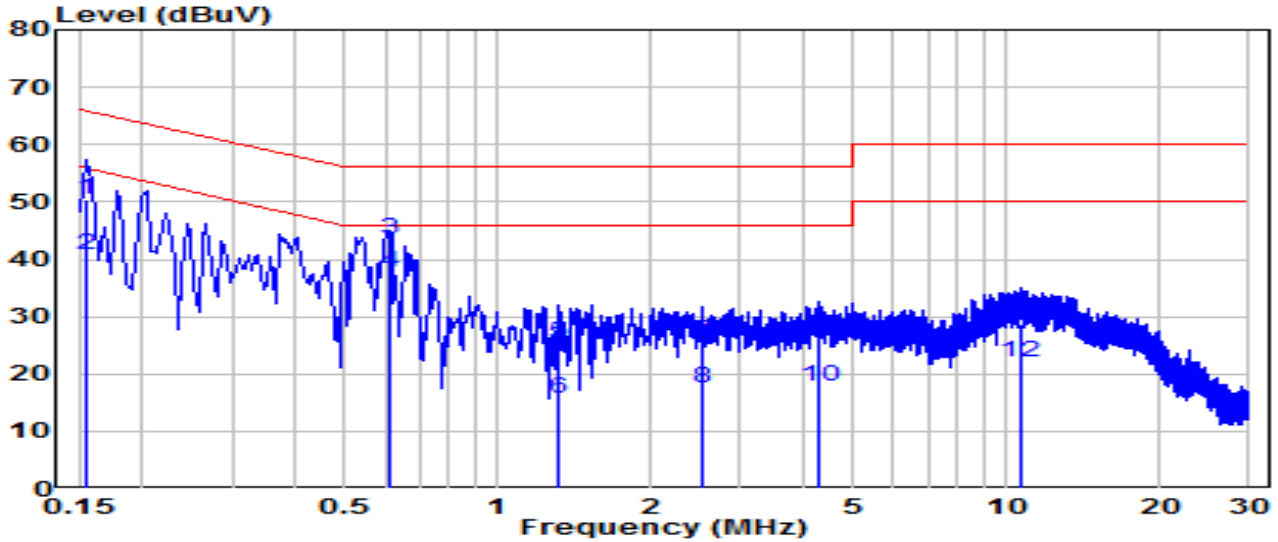

No	Frequency (MHz)	Reading (dBUV)	C.F (dB)	Measurement (dBUV)	Margin (dB)	Limit (dBUV)	Remark (QP/PK/AV)
1	0.154	40.69	9.62	50.31	-15.45	65.75	QP
2	0.154	31.24	9.62	40.86	-14.90	55.75	Average
3	*	0.609	33.87	43.52	-12.48	56.00	QP
4	*	0.609	28.12	37.77	-8.23	46.00	Average
5	1.315	15.66	9.68	25.34	-30.66	56.00	QP
6	1.315	6.00	9.68	15.68	-30.32	46.00	Average
7	2.512	15.91	9.70	25.61	-30.39	56.00	QP
8	2.512	7.79	9.70	17.49	-28.51	46.00	Average
9	4.299	16.57	9.73	26.31	-29.69	56.00	QP
10	4.299	8.05	9.73	17.79	-28.21	46.00	Average
11	10.625	18.92	9.88	28.80	-31.20	60.00	QP
12	10.625	12.27	9.88	22.15	-27.85	50.00	Average

Note:

1. " \*", means this data is the worst emission level.
2. C.F (Correction Factor) = LISN Factor (dB)+ Cable Loss (dB).
3. Measurement (dBUV) = Reading(dBUV) + C.F (Correction Factor).

## 8. CONCLUSION

The data collected relate only the item(s) tested and show that the device is in compliance with Part 15E of the FCC Rules.

## **Appendix A : Test Setup Photograph**

Refer to “2308TW0101-UT” file.

## **Appendix B : External Photograph**

Refer to “2308TW0101-UE” file.

## **Appendix C : Internal Photograph**

Refer to “2308TW0101-UI” file.

————— The End —————