

802.11 n40 CH06 (2437MHz)

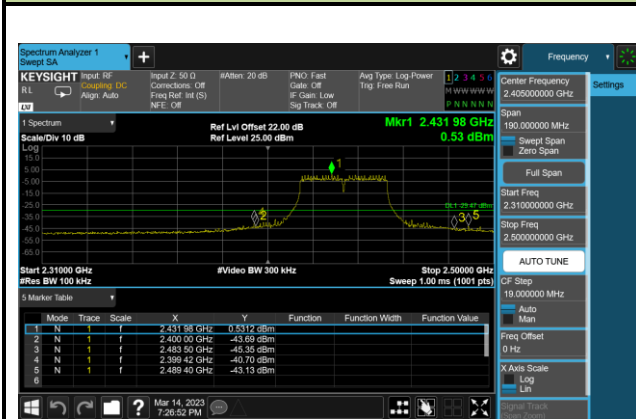

802.11 n40 CH06 (2437MHz)

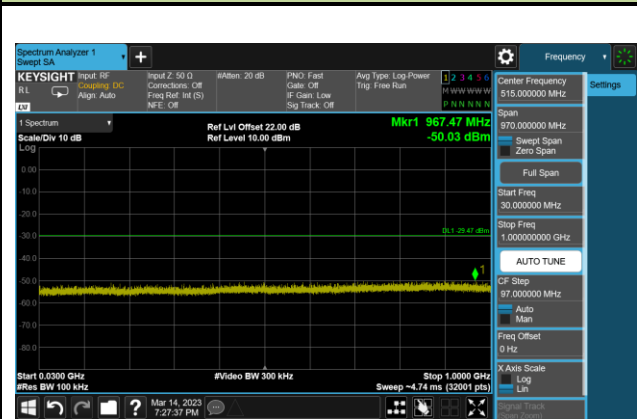

802.11 n40 CH06 (2437MHz)

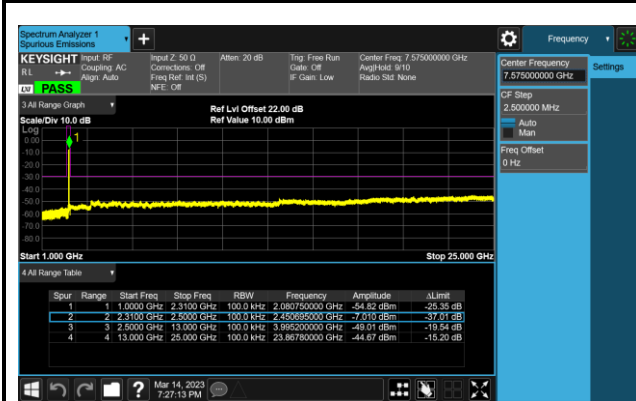

802.11 n40 CH09 (2452MHz)

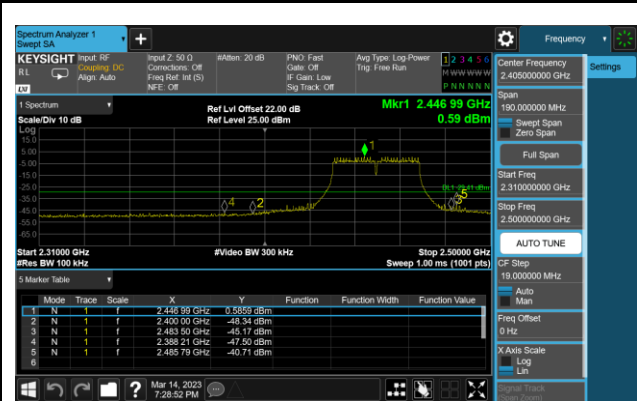

802.11 n40 CH09 (2452MHz)



802.11 n40 CH09 (2452MHz)

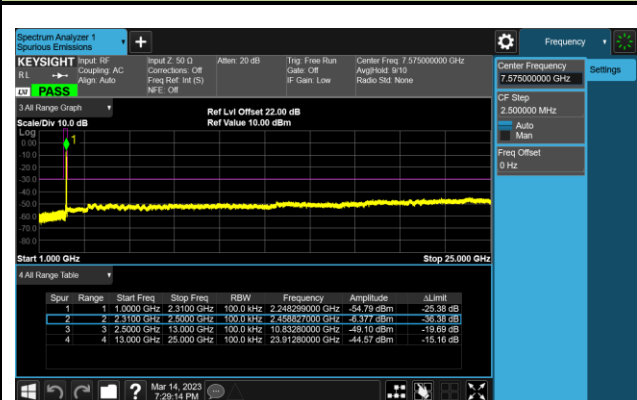

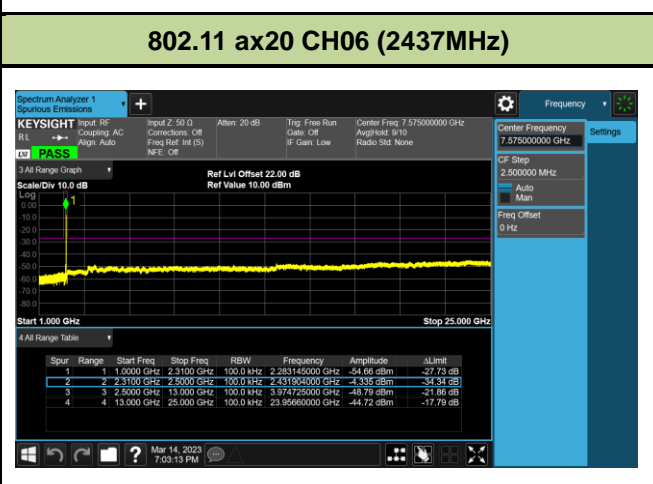
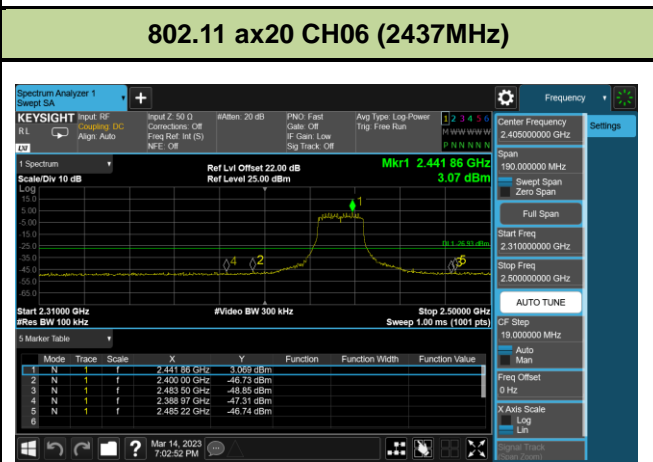
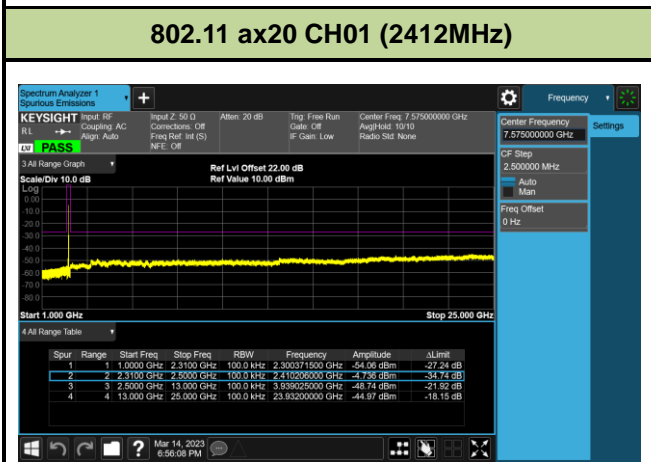
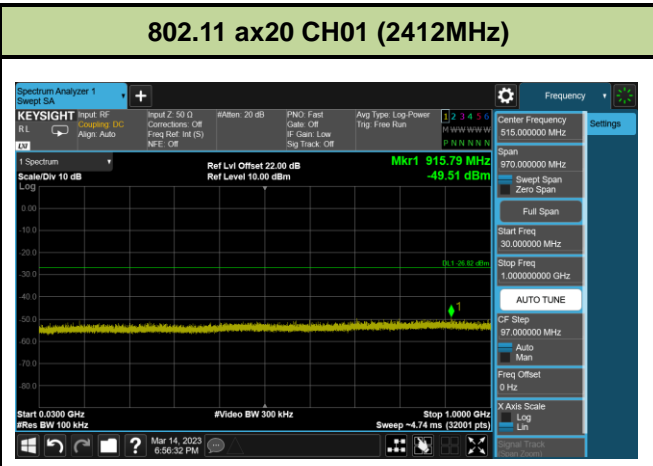

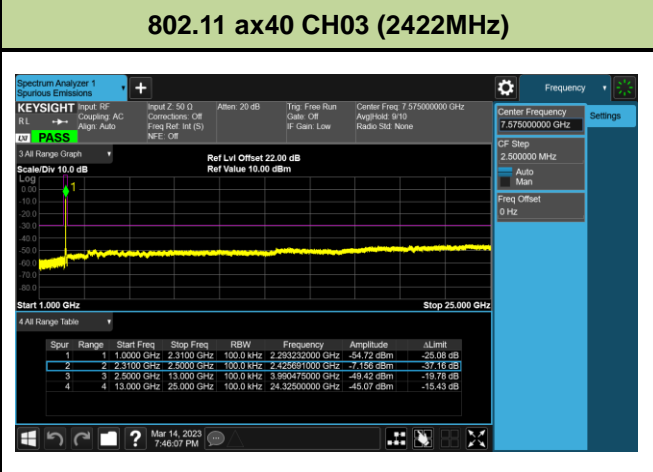
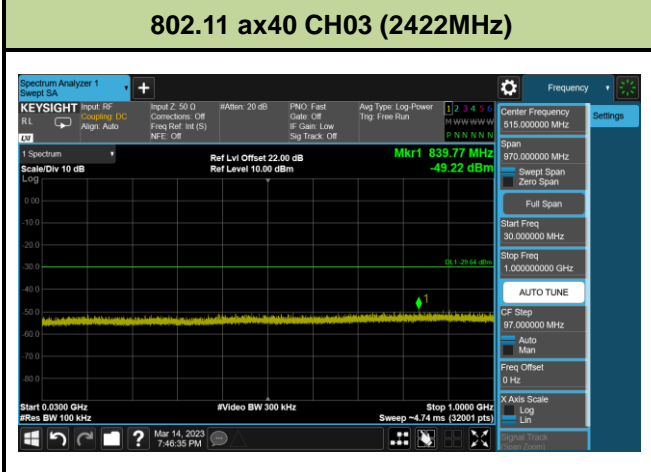
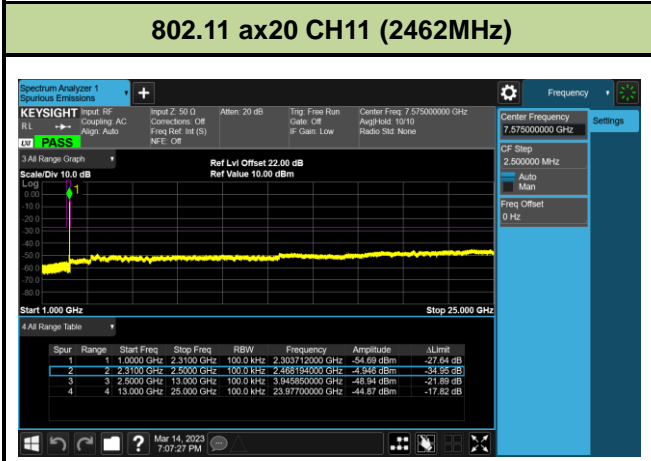
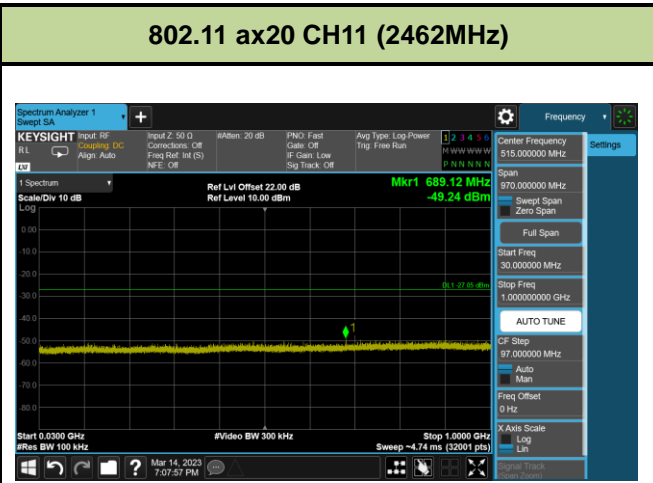
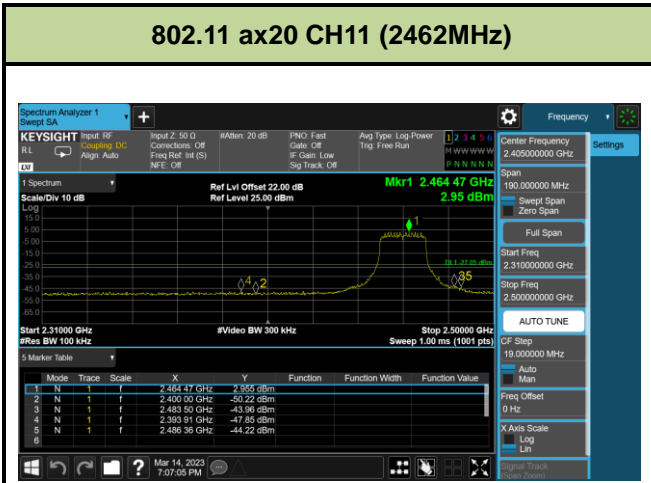

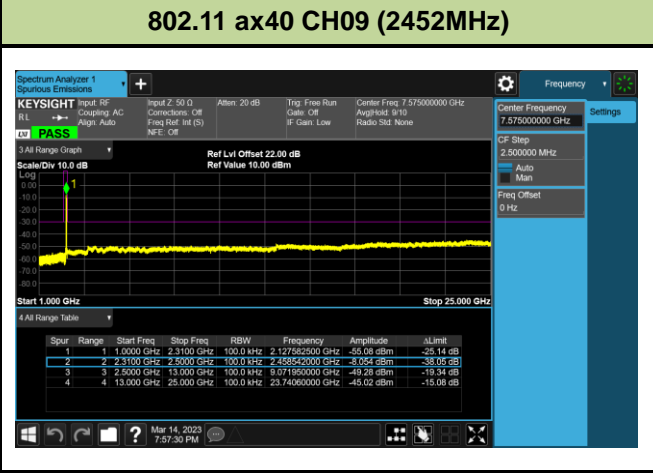
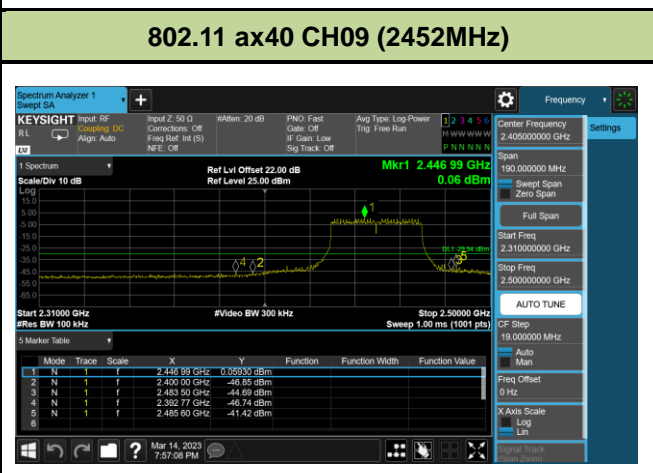
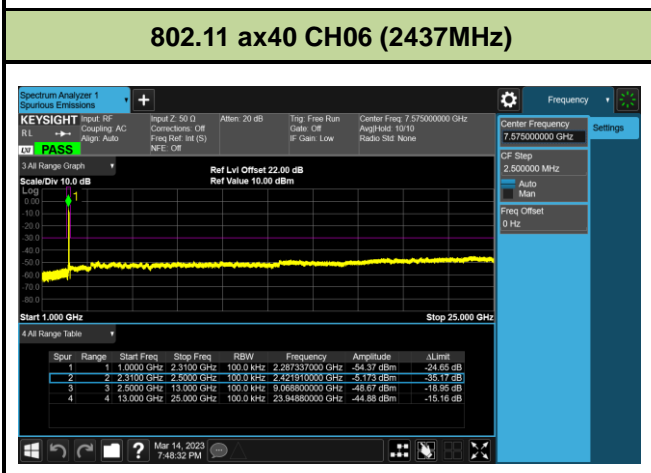
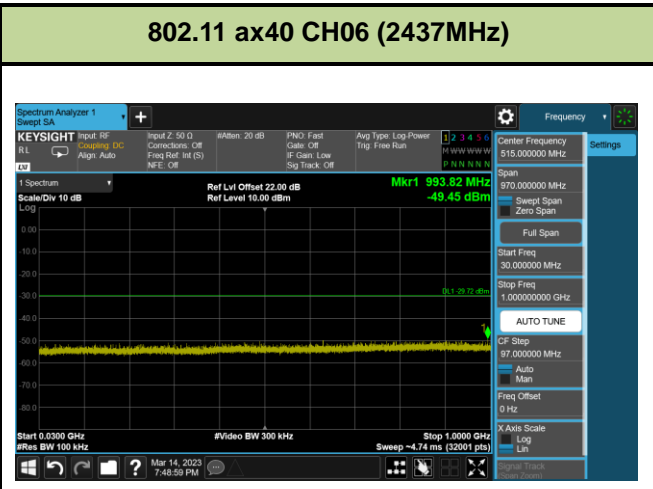
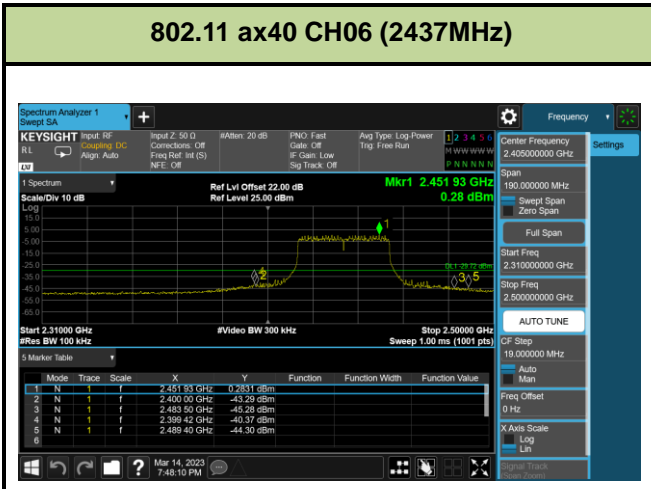

7.6. Radiated Spurious Emission Measurement

7.6.1. Test Limit

All out of band emissions appearing in a restricted band as specified in Section 15.205 of the Title 47CFR must not exceed the limits shown in Table per Section 15.209.

FCC Part 15 Subpart C Paragraph 15.209		
Frequency [MHz]	Field Strength [Uv/m]	Measured Distance [Meters]
0.009 - 0.490	2400/F (kHz)	300
0.490 - 1.705	24000/F (kHz)	30
1.705 - 30	30	30
30 - 88	100	3
88 - 216	150	3
216 - 960	200	3
Above 960	500	3

7.6.2. Test Procedure Used

ANSI C63.10 - 2013 Section 6.3 (General Requirements)

ANSI C63.10 - 2013 Section 6.4 (Standard test method below 30MHz)

ANSI C63.10 - 2013 Section 6.5 (Standard test method above 30MHz to 1GHz)

ANSI C63.10 - 2013 Section 6.6 (Standard test method above 1GHz)

7.6.3. Test Setting

Table 1 - RBW as a function of frequency

Frequency	RBW
9 ~ 150 kHz	200 ~ 300 Hz
0.15 ~ 30 MHz	9 ~ 10 kHz
30 ~ 1000 MHz	100 ~ 120 kHz
> 1000MHz	1MHz

Quasi-Peak Measurements below 1GHz

1. Analyzer center frequency was set to the frequency of the radiated spurious emission of interest
2. Span was set greater than 1MHz
3. RBW = as specified in Table 1
4. Detector = CISPR quasi-peak
5. Sweep time = auto couple
6. Trace was allowed to stabilize

Peak Measurements above 1GHz

1. Analyzer center frequency was set to the frequency of the radiated spurious emission of interest
2. RBW = 1MHz
3. VBW = 3MHz
4. Detector = peak
5. Sweep time = auto couple
6. Trace mode = max hold
7. Trace was allowed to stabilize

Average Measurements above 1GHz (Method VB)

1. Analyzer center frequency was set to the frequency of the radiated spurious emission of interest
2. RBW = 1MHz
3. VBW; If the EUT is configured to transmit with duty cycle $\geq 98\%$, set VBW = 10 Hz.
If the EUT duty cycle is $< 98\%$, set VBW $\geq 1/T$. T is the minimum transmission duration.
4. Detector = Peak
5. Sweep time = auto
6. Trace mode = max hold
7. Trace was allowed to stabilize

7.6.4. Test Setup

Below 1GHz Test Setup:

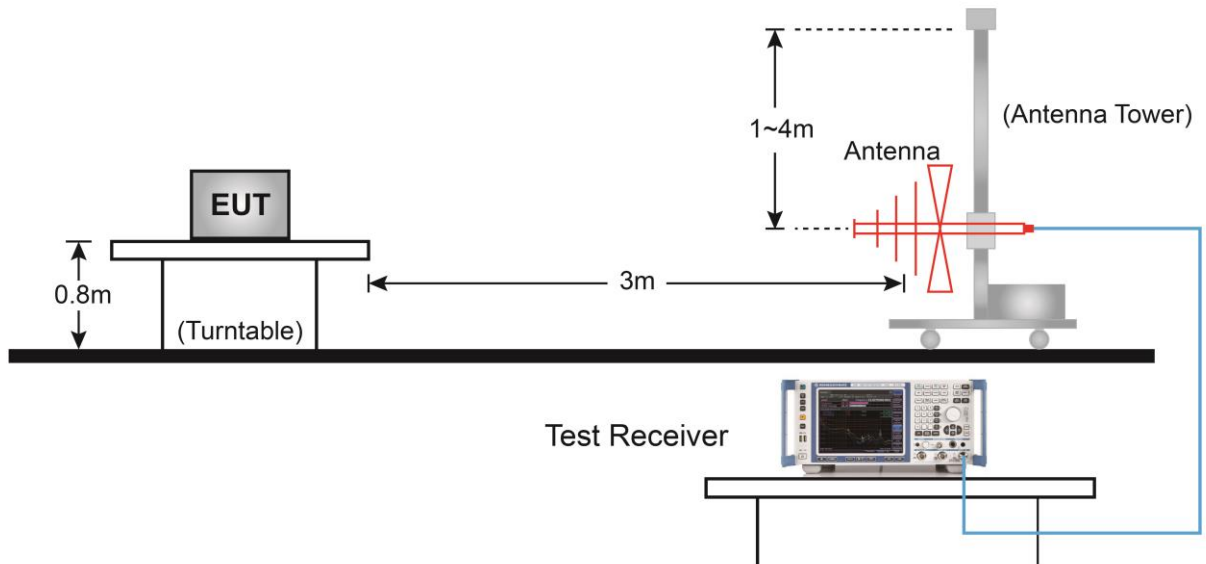

Above 1GHz Test Setup:

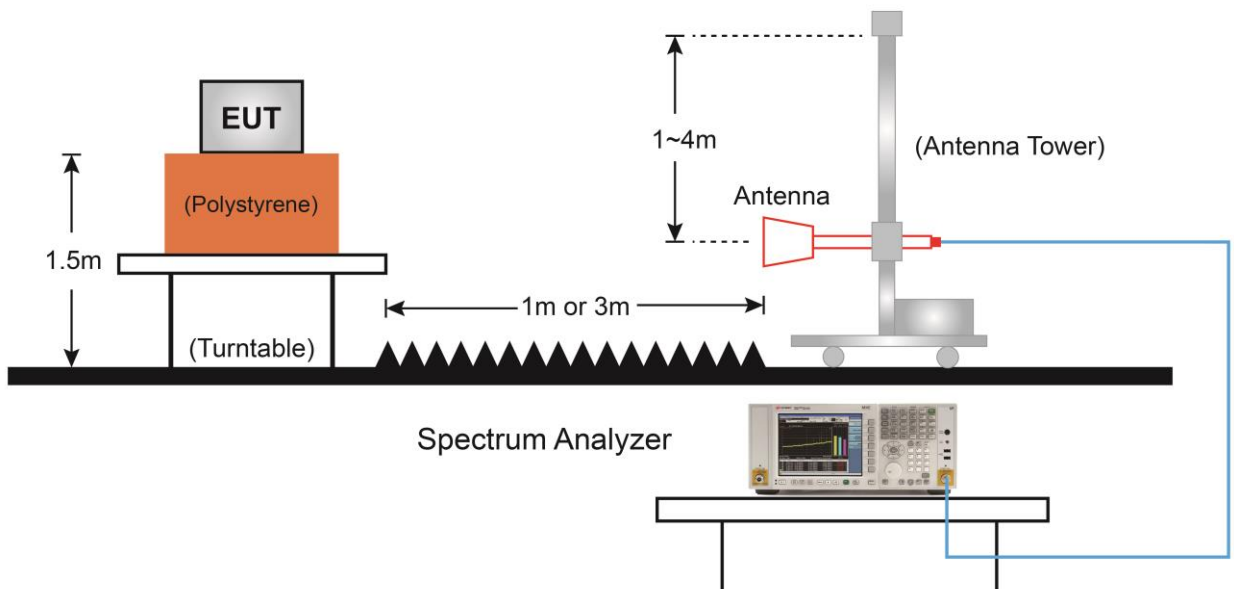

7.6.5. Test Result

EUT	AX3000 High Gain Wireless USB Adapter	Date of Test	2023-01-16
Factor	VULB 9162	Temp. / Humidity	20°C /62%
Polarity	Horizontal	Site / Test Engineer	AC2 / Xuan
Test Mode	802.11n-20MHz_TX_CH 6_ANT 1+2	Test Voltage	By Notebook PC

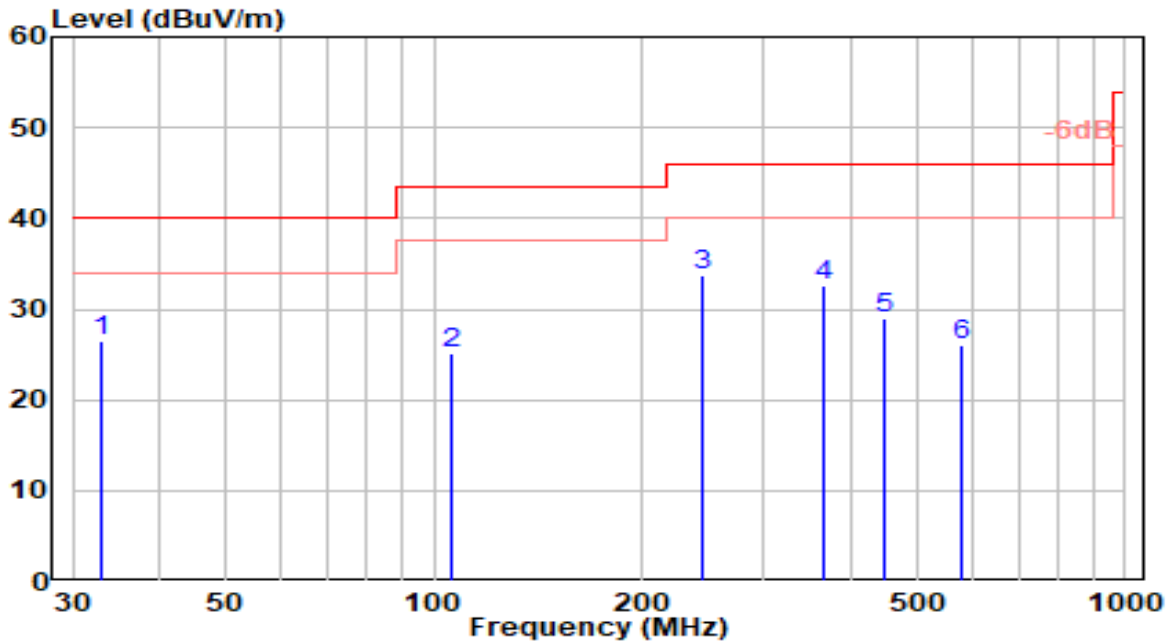

No	Frequency (MHz)	Reading (dBUV)	C.F (dB/m)	Measurement (dBUV/m)	Margin (dB)	Limit (dBUV/m)	Height (cm)	Angle (deg)	Remark (QP/PK/AV)
1	32.910	9.48	17.10	26.58	-13.42	40.00	200	225	QP
2	105.660	6.93	18.22	25.15	-18.35	43.50	200	271	QP
3	* 244.370	14.18	19.64	33.81	-12.19	46.00	100	308	QP
4	367.560	10.11	22.59	32.71	-13.29	46.00	100	47	QP
5	449.040	5.36	23.54	28.90	-17.10	46.00	100	161	QP
6	579.990	-0.35	26.35	26.00	-20.00	46.00	150	226	QP

Note:

- "*" means this data is the worst emission level.
- C.F (Correction Factor) = Antenna Factor (dB/m) + Cable Loss (dB).
- Measurement (dBUV/m) = Reading(dBUV) + C.F (Correction Factor).
- The emission levels of other frequencies are very lower than the limit and not show in test report.

EUT	AX3000 High Gain Wireless USB Adapter	Date of Test	2023-01-16
Factor	VULB 9162	Temp. / Humidity	20°C /62%
Polarity	Vertical	Site / Test Engineer	AC2 / Xuan
Test Mode	802.11n-20MHz_TX_CH 6_ANT 1+2	Test Voltage	By Notebook PC

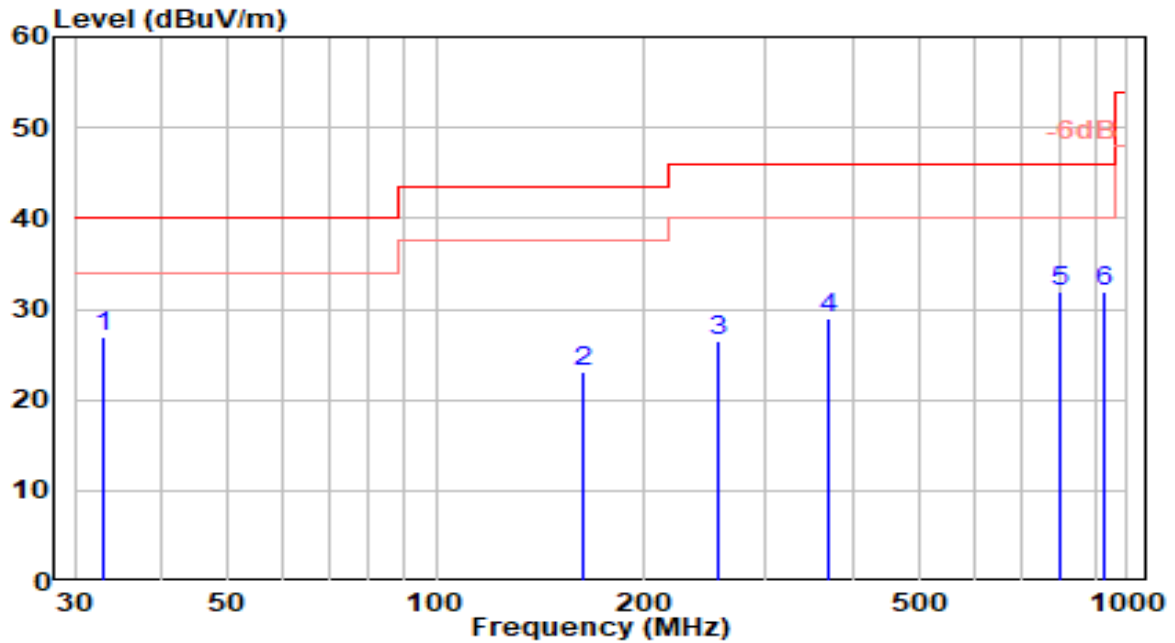

No	Frequency (MHz)	Reading (dBuV)	C.F (dB/m)	Measurement (dBuV/m)	Margin (dB)	Limit (dBuV/m)	Height (cm)	Angle (deg)	Remark (QP/PK/AV)	
1	*	32.910	9.73	17.10	26.83	-13.17	40.00	100	185	QP
2		163.860	7.58	15.58	23.16	-20.34	43.50	200	360	QP
3		256.010	6.45	19.94	26.39	-19.61	46.00	150	299	QP
4		368.530	6.26	22.61	28.87	-17.13	46.00	100	333	QP
5		800.180	2.60	29.28	31.88	-14.12	46.00	150	203	QP
6		924.340	0.99	30.99	31.98	-14.02	46.00	150	30	QP

Note:

1. " *", means this data is the worst emission level.
2. C.F (Correction Factor) = Antenna Factor (dB/m) + Cable Loss (dB).
3. Measurement (dBuV/m) = Reading(dBuV) + C.F (Correction Factor).
4. The emission levels of other frequencies are very lower than the limit and not show in test report.

EUT	AX3000 High Gain Wireless USB Adapter	Date of Test	2023-01-17
Factor	DRH18-E	Temp. / Humidity	20°C /62%
Polarity	Horizontal	Site / Test Engineer	AC2 / Ares
Test Mode	802.11b_TX_CH 1_ANT 1+2	Test Voltage	By Notebook PC

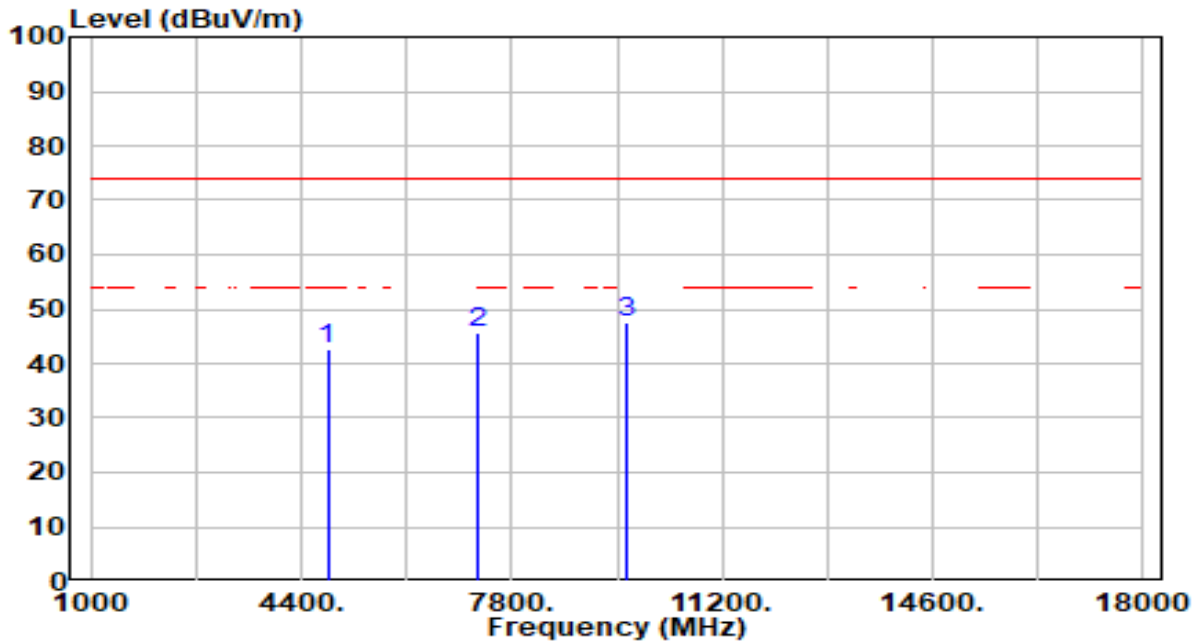

No	Frequency (MHz)	Reading (dBuV)	C.F (dB/m)	Measurement (dBuV/m)	Margin (dB)	Limit (dBuV/m)	Height (cm)	Angle (deg)	Remark (QP/PK/AV)
1	4824.000	43.73	-1.23	42.50	-31.50	74.00	300	204	Peak
2	7236.000	41.47	4.16	45.63	-28.37	74.00	300	91	Peak
3	* 9648.000	44.11	3.29	47.40	-26.60	74.00	200	360	Peak

Note:

1. " *", means this data is the worst emission level.
2. C.F (Correction Factor) = Antenna Factor (dB/m) + Cable Loss (dB) – Preamplifier(dB).
3. Measurement (dBuV/m) = Reading(dBuV) + C.F (Correction Factor).
4. The emission levels of other frequencies are very lower than the limit and not show in test report.

EUT	AX3000 High Gain Wireless USB Adapter	Date of Test	2023-01-17
Factor	DRH18-E	Temp. / Humidity	20°C /62%
Polarity	Vertical	Site / Test Engineer	AC2 / Ares
Test Mode	802.11b_TX_CH 1_ANT 1+2	Test Voltage	By Notebook PC

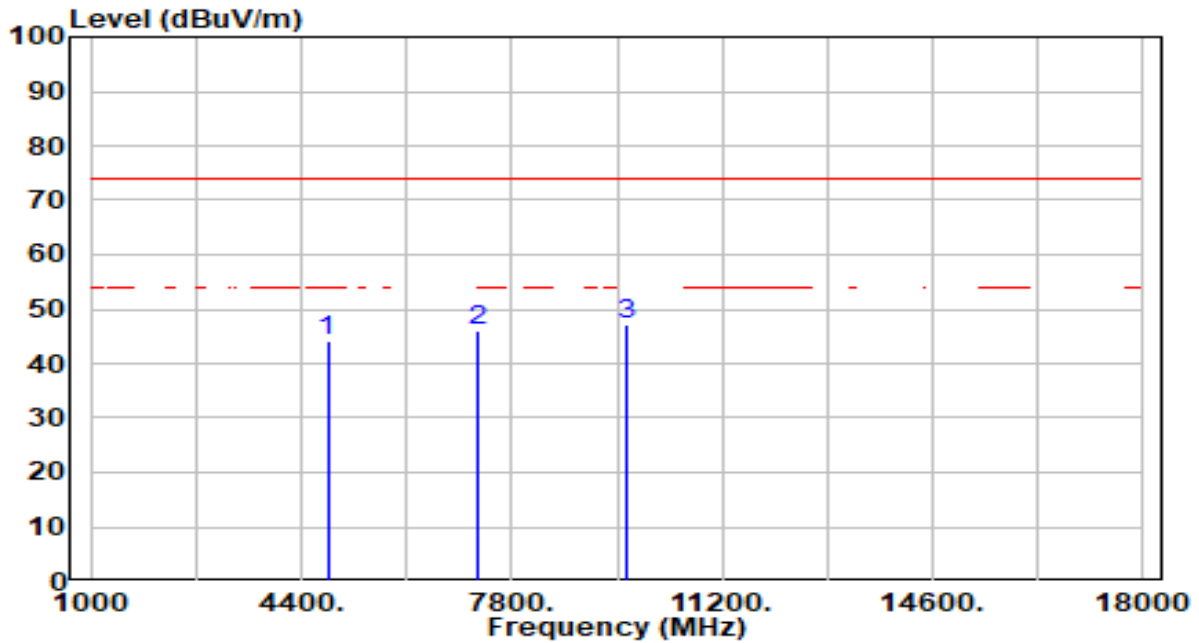

No	Frequency (MHz)	Reading (dBuV)	C.F (dB/m)	Measurement (dBuV/m)	Margin (dB)	Limit (dBuV/m)	Height (cm)	Angle (deg)	Remark (QP/PK/AV)
1	4824.000	45.52	-1.23	44.29	-29.71	74.00	100	93	Peak
2	7236.000	41.76	4.16	45.92	-28.08	74.00	200	109	Peak
3	* 9648.000	43.97	3.29	47.26	-26.74	74.00	300	280	Peak

Note:

1. " *", means this data is the worst emission level.
2. C.F (Correction Factor) = Antenna Factor (dB/m) + Cable Loss (dB) – Preamplifier(dB).
3. Measurement (dBuV/m) = Reading(dBuV) + C.F (Correction Factor).
4. The emission levels of other frequencies are very lower than the limit and not show in test report.

EUT	AX3000 High Gain Wireless USB Adapter	Date of Test	2023-01-17
Factor	DRH18-E	Temp. / Humidity	20°C /62%
Polarity	Horizontal	Site / Test Engineer	AC2 / Ares
Test Mode	802.11b_TX_CH 6_ANT 1+2	Test Voltage	By Notebook PC

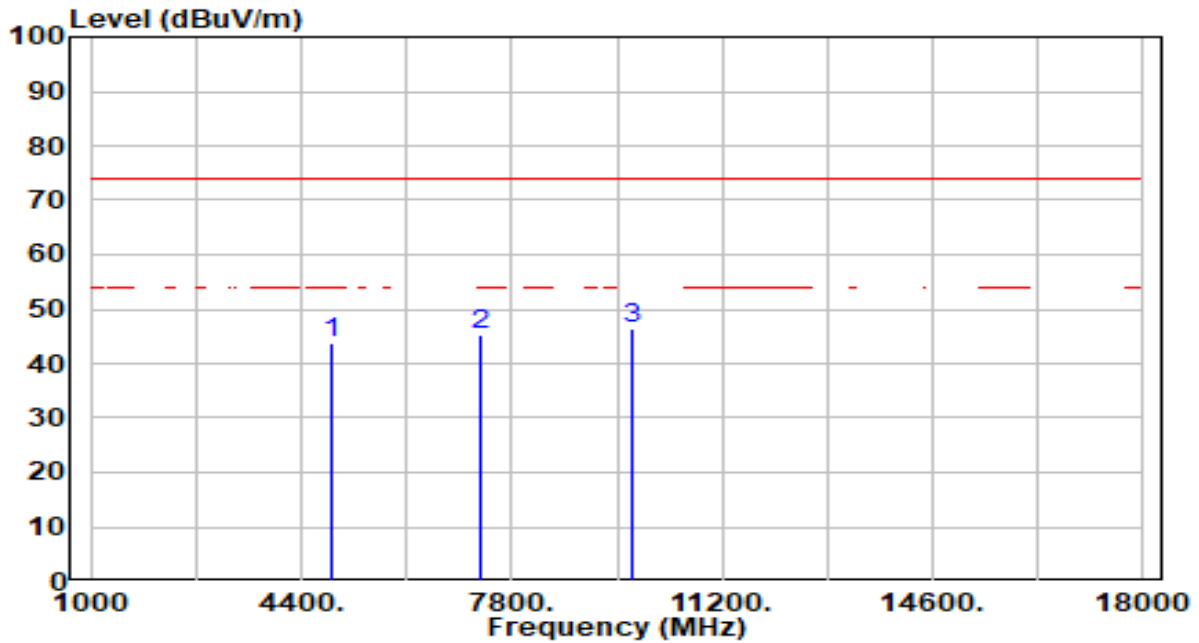

No	Frequency (MHz)	Reading (dBuV)	C.F (dB/m)	Measurement (dBuV/m)	Margin (dB)	Limit (dBuV/m)	Height (cm)	Angle (deg)	Remark (QP/PK/AV)
1	4874.000	44.90	-1.13	43.77	-30.23	74.00	100	27	Peak
2	7311.000	41.20	4.14	45.33	-28.67	74.00	100	115	Peak
3	* 9748.000	43.17	3.33	46.50	-27.50	74.00	100	360	Peak

Note:

1. " *", means this data is the worst emission level.
2. C.F (Correction Factor) = Antenna Factor (dB/m) + Cable Loss (dB) – Preamplifier(dB).
3. Measurement (dBuV/m) = Reading(dBuV) + C.F (Correction Factor).
4. The emission levels of other frequencies are very lower than the limit and not show in test report.

EUT	AX3000 High Gain Wireless USB Adapter	Date of Test	2023-01-17
Factor	DRH18-E	Temp. / Humidity	20°C /62%
Polarity	Vertical	Site / Test Engineer	AC2 / Ares
Test Mode	802.11b_TX_CH 6_ANT 1+2	Test Voltage	By Notebook PC

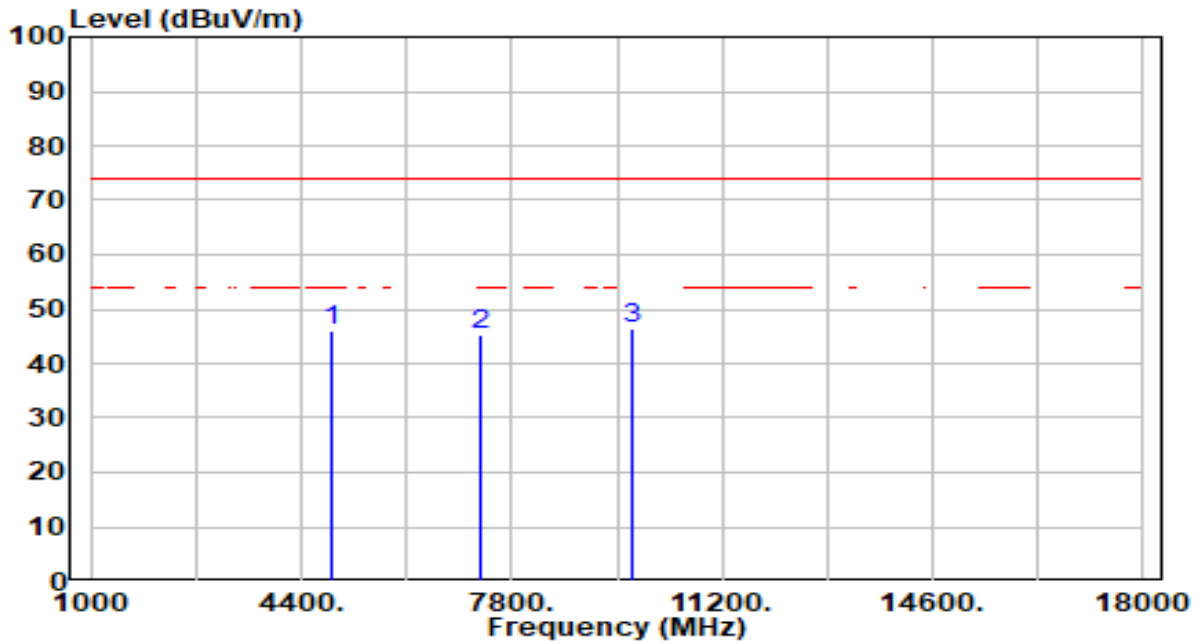

No	Frequency (MHz)	Reading (dBuV)	C.F (dB/m)	Measurement (dBuV/m)	Margin (dB)	Limit (dBuV/m)	Height (cm)	Angle (deg)	Remark (QP/PK/AV)
1	4874.000	47.15	-1.13	46.02	-27.98	74.00	100	277	Peak
2	7311.000	41.09	4.14	45.23	-28.77	74.00	100	68	Peak
3	* 9748.000	43.02	3.33	46.35	-27.65	74.00	100	0	Peak

Note:

1. " *", means this data is the worst emission level.
2. C.F (Correction Factor) = Antenna Factor (dB/m) + Cable Loss (dB) – Preamplifier(dB).
3. Measurement (dBuV/m) = Reading(dBuV) + C.F (Correction Factor).
4. The emission levels of other frequencies are very lower than the limit and not show in test report.

EUT	AX3000 High Gain Wireless USB Adapter	Date of Test	2023-01-17
Factor	DRH18-E	Temp. / Humidity	20°C /62%
Polarity	Horizontal	Site / Test Engineer	AC2 / Ares
Test Mode	802.11b_TX_CH 11_ANT 1+2	Test Voltage	By Notebook PC

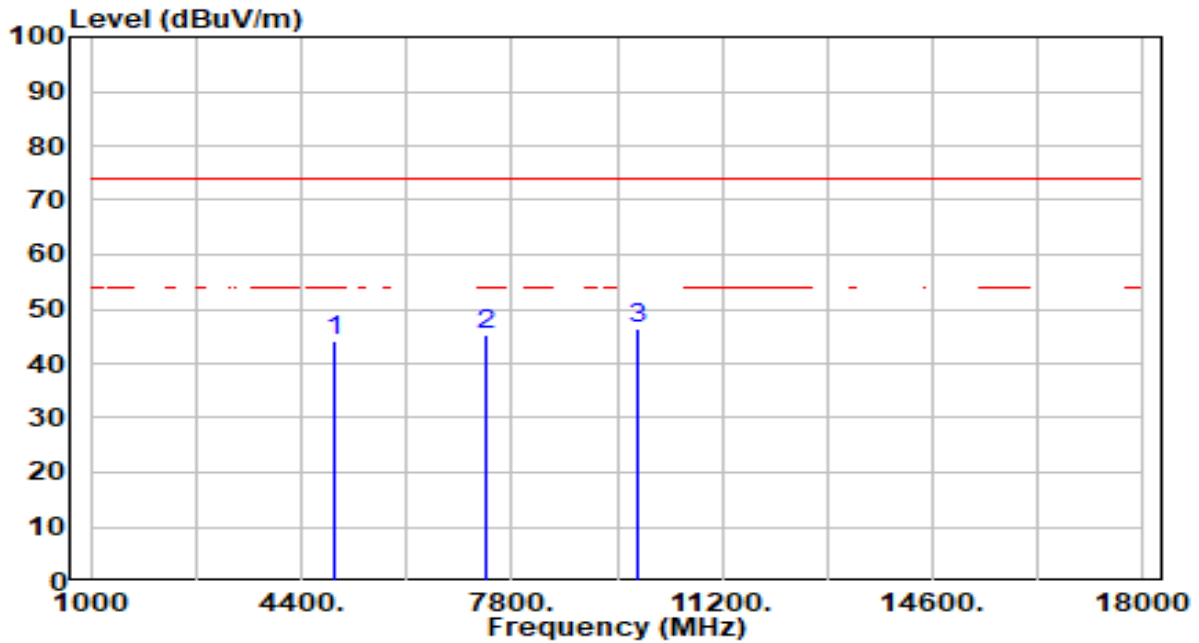

No	Frequency (MHz)	Reading (dBuV)	C.F (dB/m)	Measurement (dBuV/m)	Margin (dB)	Limit (dBuV/m)	Height (cm)	Angle (deg)	Remark (QP/PK/AV)
1	4924.000	45.21	-1.03	44.19	-29.81	74.00	100	15	Peak
2	7386.000	41.11	4.11	45.22	-28.78	74.00	100	0	Peak
3	* 9848.000	43.16	3.39	46.55	-27.45	74.00	100	308	Peak

Note:

1. " *", means this data is the worst emission level.
2. C.F (Correction Factor) = Antenna Factor (dB/m) + Cable Loss (dB) – Preamplifier(dB).
3. Measurement (dBuV/m) = Reading(dBuV) + C.F (Correction Factor).
4. The emission levels of other frequencies are very lower than the limit and not show in test report.

EUT	AX3000 High Gain Wireless USB Adapter	Date of Test	2023-01-17
Factor	DRH18-E	Temp. / Humidity	20°C /62%
Polarity	Vertical	Site / Test Engineer	AC2 / Ares
Test Mode	802.11b_TX_CH 11_ANT 1+2	Test Voltage	By Notebook PC

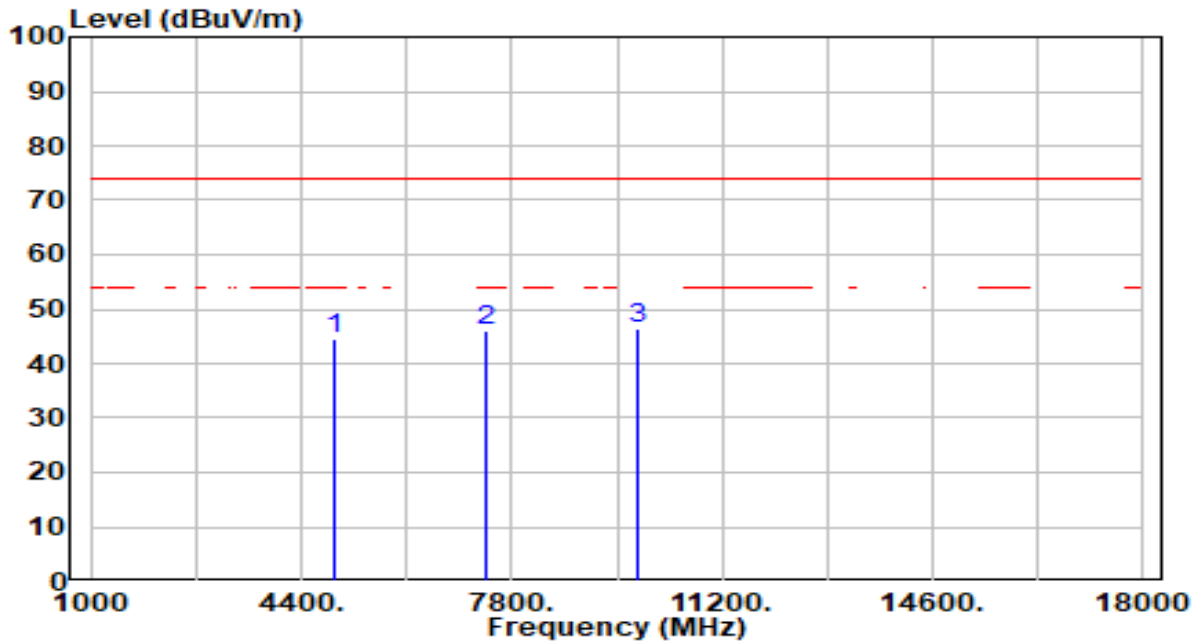

No	Frequency (MHz)	Reading (dBuV)	C.F (dB/m)	Measurement (dBuV/m)	Margin (dB)	Limit (dBuV/m)	Height (cm)	Angle (deg)	Remark (QP/PK/AV)
1	4924.000	45.55	-1.03	44.53	-29.47	74.00	100	245	Peak
2	7386.000	41.74	4.11	45.86	-28.14	74.00	100	103	Peak
3	* 9848.000	42.86	3.39	46.24	-27.76	74.00	100	154	Peak

Note:

1. " *", means this data is the worst emission level.
2. C.F (Correction Factor) = Antenna Factor (dB/m) + Cable Loss (dB) – Preamplifier(dB).
3. Measurement (dBuV/m) = Reading(dBuV) + C.F (Correction Factor).
4. The emission levels of other frequencies are very lower than the limit and not show in test report.

EUT	AX3000 High Gain Wireless USB Adapter	Date of Test	2023-01-17
Factor	DRH18-E	Temp. / Humidity	20°C /62%
Polarity	Horizontal	Site / Test Engineer	AC2 / Ares
Test Mode	802.11g_TX_CH 1_ANT 1+2	Test Voltage	By Notebook PC

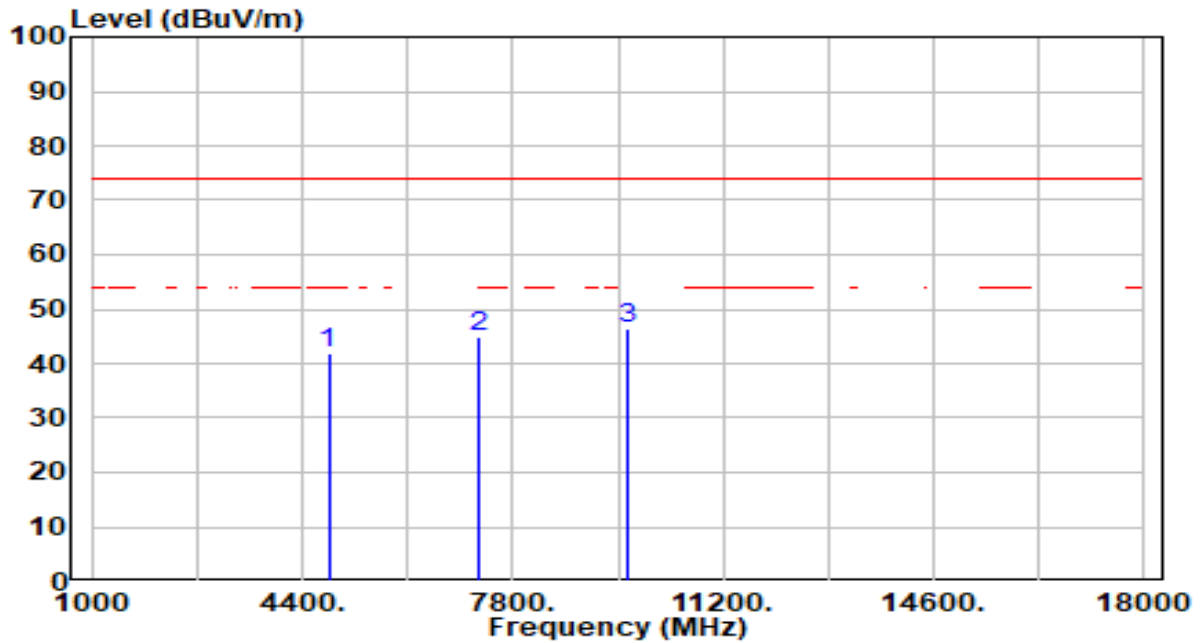

No	Frequency (MHz)	Reading (dBuV)	C.F (dB/m)	Measurement (dBuV/m)	Margin (dB)	Limit (dBuV/m)	Height (cm)	Angle (deg)	Remark (QP/PK/AV)
1	4824.000	43.08	-1.23	41.85	-32.15	74.00	100	356	Peak
2	7236.000	40.88	4.16	45.04	-28.96	74.00	100	186	Peak
3	* 9648.000	43.04	3.29	46.33	-27.67	74.00	100	326	Peak

Note:

1. " *", means this data is the worst emission level.
2. C.F (Correction Factor) = Antenna Factor (dB/m) + Cable Loss (dB) – Preamplifier(dB).
3. Measurement (dBuV/m) = Reading(dBuV) + C.F (Correction Factor).
4. The emission levels of other frequencies are very lower than the limit and not show in test report.

EUT	AX3000 High Gain Wireless USB Adapter	Date of Test	2023-01-17
Factor	DRH18-E	Temp. / Humidity	20°C /62%
Polarity	Vertical	Site / Test Engineer	AC2 / Ares
Test Mode	802.11g_TX_CH 1_ANT 1+2	Test Voltage	By Notebook PC

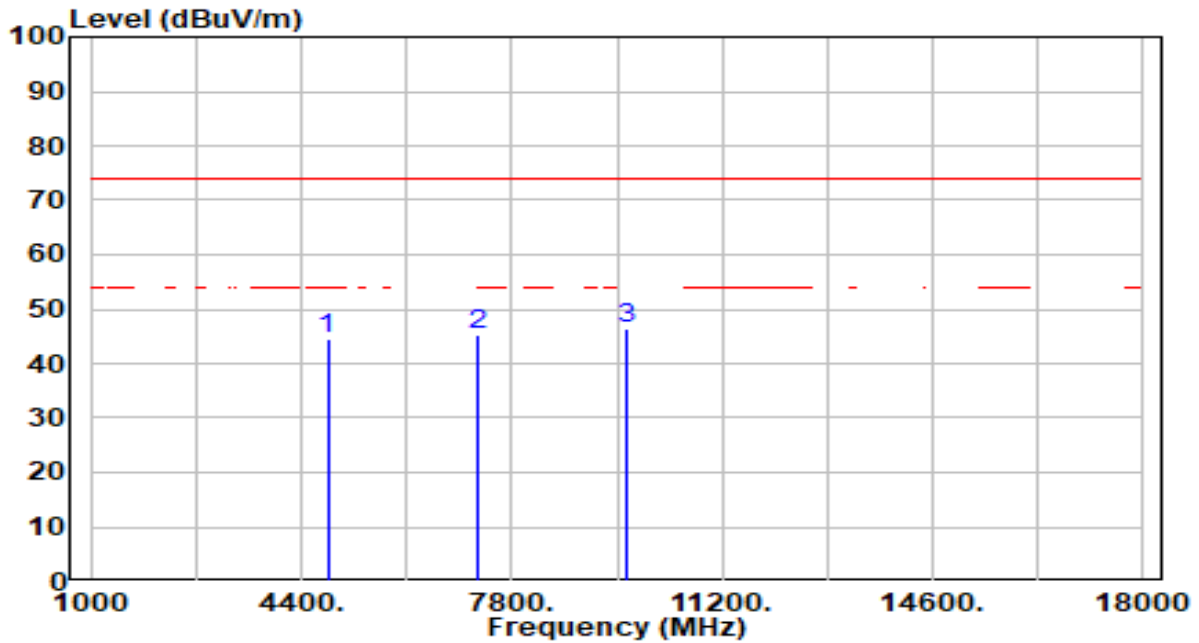

No	Frequency (MHz)	Reading (dBuV)	C.F (dB/m)	Measurement (dBuV/m)	Margin (dB)	Limit (dBuV/m)	Height (cm)	Angle (deg)	Remark (QP/PK/AV)
1	4824.000	45.84	-1.23	44.61	-29.39	74.00	100	289	Peak
2	7236.000	40.95	4.16	45.11	-28.89	74.00	100	1	Peak
3	* 9648.000	43.27	3.29	46.56	-27.44	74.00	100	16	Peak

Note:

1. " *", means this data is the worst emission level.
2. C.F (Correction Factor) = Antenna Factor (dB/m) + Cable Loss (dB) – Preamplifier(dB).
3. Measurement (dBuV/m) = Reading(dBuV) + C.F (Correction Factor).
4. The emission levels of other frequencies are very lower than the limit and not show in test report.

EUT	AX3000 High Gain Wireless USB Adapter	Date of Test	2023-01-17
Factor	DRH18-E	Temp. / Humidity	20°C /62%
Polarity	Horizontal	Site / Test Engineer	AC2 / Ares
Test Mode	802.11g_TX_CH 6_ANT 1+2	Test Voltage	By Notebook PC

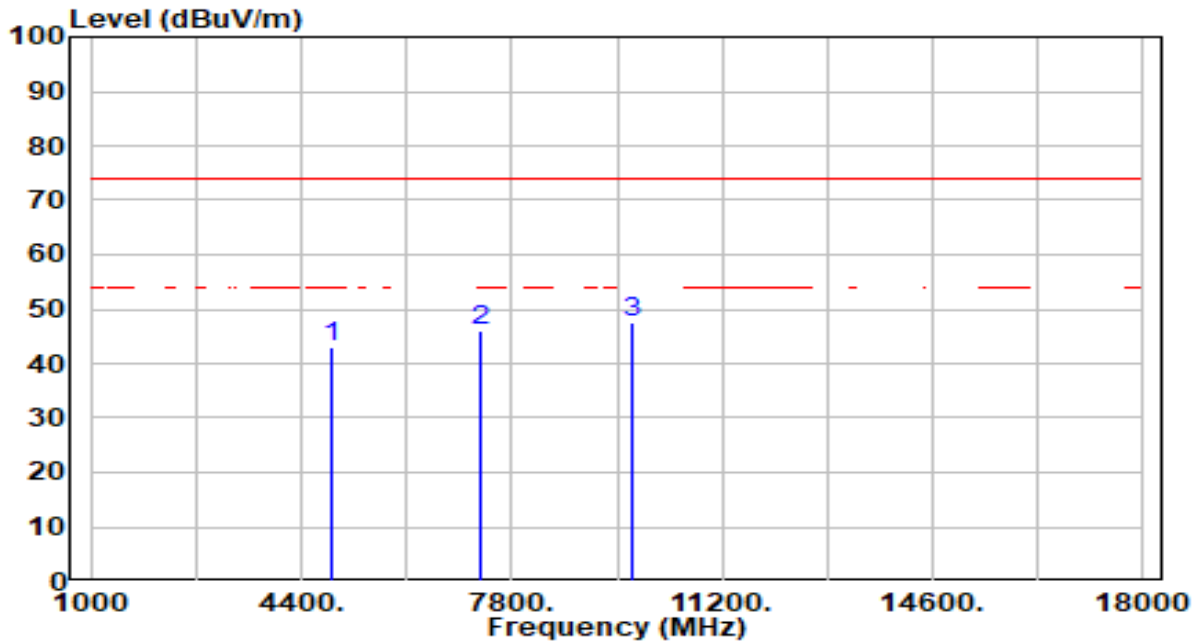

No	Frequency (MHz)	Reading (dBuV)	C.F (dB/m)	Measurement (dBuV/m)	Margin (dB)	Limit (dBuV/m)	Height (cm)	Angle (deg)	Remark (QP/PK/AV)
1	4874.000	44.31	-1.13	43.19	-30.81	74.00	100	26	Peak
2	7311.000	41.72	4.14	45.85	-28.15	74.00	100	112	Peak
3	* 9748.000	44.26	3.33	47.59	-26.41	74.00	100	342	Peak

Note:

1. " *", means this data is the worst emission level.
2. C.F (Correction Factor) = Antenna Factor (dB/m) + Cable Loss (dB) – Preamplifier(dB).
3. Measurement (dBuV/m) = Reading(dBuV) + C.F (Correction Factor).
4. The emission levels of other frequencies are very lower than the limit and not show in test report.

EUT	AX3000 High Gain Wireless USB Adapter	Date of Test	2023-01-17
Factor	DRH18-E	Temp. / Humidity	20°C /62%
Polarity	Vertical	Site / Test Engineer	AC2 / Ares
Test Mode	802.11g_TX_CH 6_ANT 1+2	Test Voltage	By Notebook PC

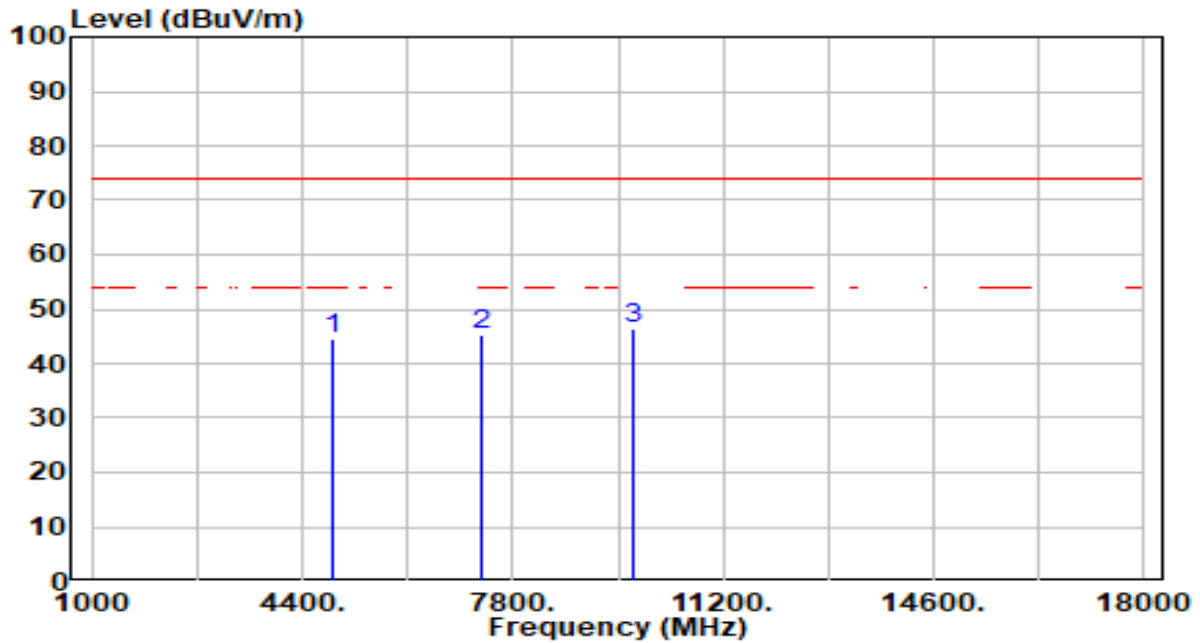

No	Frequency (MHz)	Reading (dBuV)	C.F (dB/m)	Measurement (dBuV/m)	Margin (dB)	Limit (dBuV/m)	Height (cm)	Angle (deg)	Remark (QP/PK/AV)
1	4874.000	45.69	-1.13	44.56	-29.44	74.00	100	294	Peak
2	7311.000	41.00	4.14	45.14	-28.86	74.00	100	54	Peak
3	* 9748.000	43.19	3.33	46.51	-27.49	74.00	100	86	Peak

Note:

1. " *", means this data is the worst emission level.
2. C.F (Correction Factor) = Antenna Factor (dB/m) + Cable Loss (dB) – Preamplifier(dB).
3. Measurement (dBuV/m) = Reading(dBuV) + C.F (Correction Factor).
4. The emission levels of other frequencies are very lower than the limit and not show in test report.

EUT	AX3000 High Gain Wireless USB Adapter	Date of Test	2023-01-17
Factor	DRH18-E	Temp. / Humidity	20°C /62%
Polarity	Horizontal	Site / Test Engineer	AC2 / Ares
Test Mode	802.11g_TX_CH 11_ANT 1+2	Test Voltage	By Notebook PC

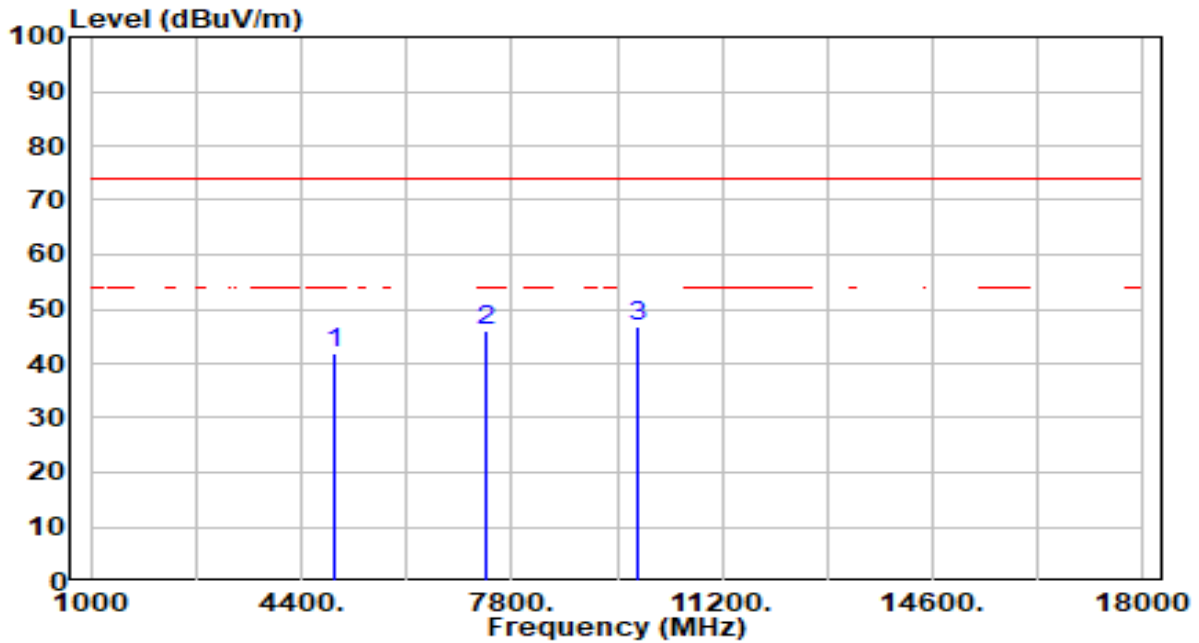

No	Frequency (MHz)	Reading (dBuV)	C.F (dB/m)	Measurement (dBuV/m)	Margin (dB)	Limit (dBuV/m)	Height (cm)	Angle (deg)	Remark (QP/PK/AV)
1	4924.000	43.07	-1.03	42.04	-31.96	74.00	100	26	Peak
2	7386.000	41.93	4.11	46.04	-27.96	74.00	100	310	Peak
3	* 9848.000	43.22	3.39	46.61	-27.39	74.00	100	163	Peak

Note:

1. " *", means this data is the worst emission level.
2. C.F (Correction Factor) = Antenna Factor (dB/m) + Cable Loss (dB) – Preamplifier(dB).
3. Measurement (dBuV/m) = Reading(dBuV) + C.F (Correction Factor).
4. The emission levels of other frequencies are very lower than the limit and not show in test report.

EUT	AX3000 High Gain Wireless USB Adapter	Date of Test	2023-01-17
Factor	DRH18-E	Temp. / Humidity	20°C /62%
Polarity	Vertical	Site / Test Engineer	AC2 / Ares
Test Mode	802.11g_TX_CH 11_ANT 1+2	Test Voltage	By Notebook PC

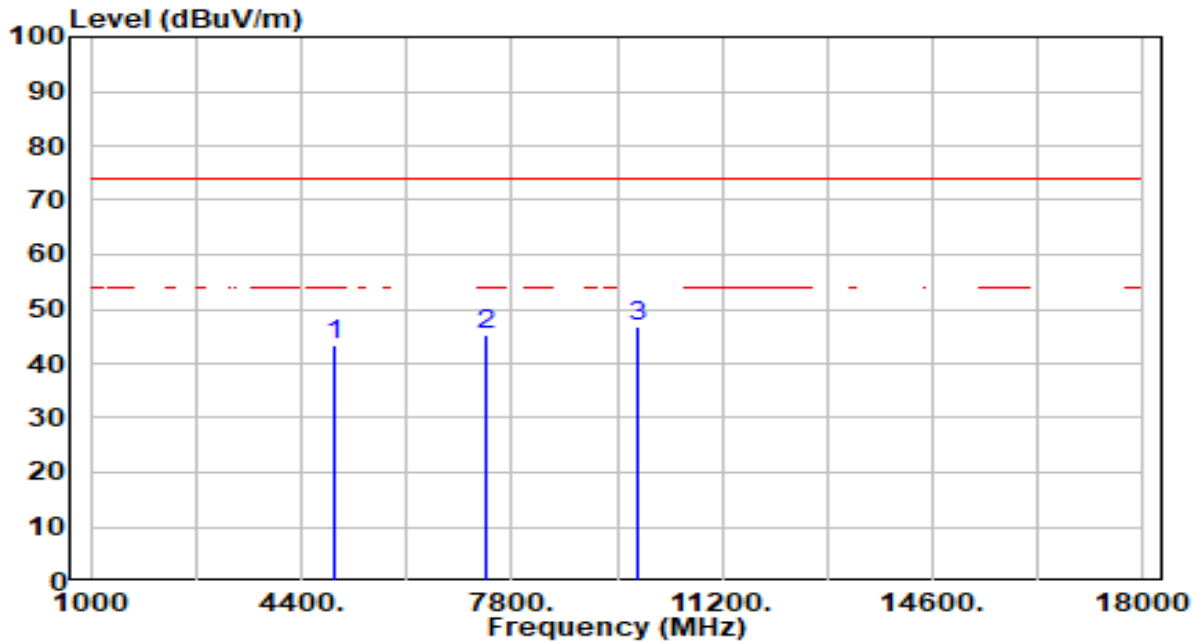

No	Frequency (MHz)	Reading (dBuV)	C.F (dB/m)	Measurement (dBuV/m)	Margin (dB)	Limit (dBuV/m)	Height (cm)	Angle (deg)	Remark (QP/PK/AV)
1	4924.000	44.36	-1.03	43.33	-30.67	74.00	100	300	Peak
2	7386.000	41.21	4.11	45.32	-28.68	74.00	100	360	Peak
3	* 9848.000	43.22	3.39	46.60	-27.40	74.00	100	246	Peak

Note:

1. " *", means this data is the worst emission level.
2. C.F (Correction Factor) = Antenna Factor (dB/m) + Cable Loss (dB) – Preamplifier(dB).
3. Measurement (dBuV/m) = Reading(dBuV) + C.F (Correction Factor).
4. The emission levels of other frequencies are very lower than the limit and not show in test report.

EUT	AX3000 High Gain Wireless USB Adapter	Date of Test	2023-01-17
Factor	DRH18-E	Temp. / Humidity	20°C /62%
Polarity	Horizontal	Site / Test Engineer	AC2 / Ares
Test Mode	802.11n-20MHz_TX_CH 1_ANT 1+2	Test Voltage	By Notebook PC

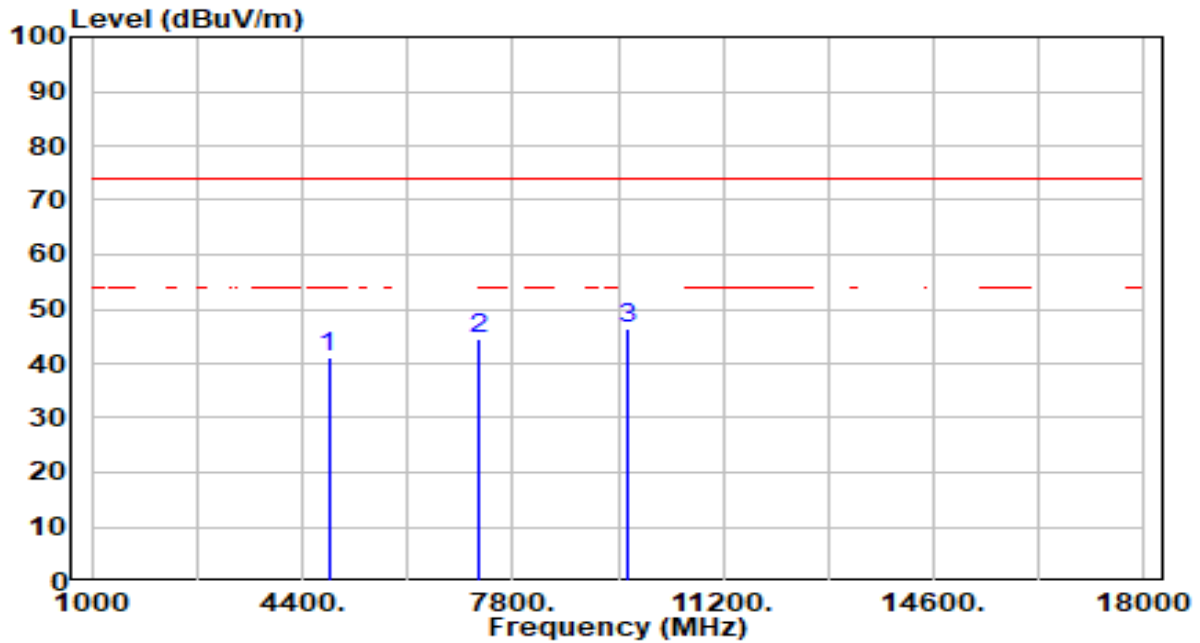

No	Frequency (MHz)	Reading (dBuV)	C.F (dB/m)	Measurement (dBuV/m)	Margin (dB)	Limit (dBuV/m)	Height (cm)	Angle (deg)	Remark (QP/PK/AV)
1	4824.000	42.41	-1.23	41.19	-32.81	74.00	100	352	Peak
2	7236.000	40.51	4.16	44.67	-29.33	74.00	100	234	Peak
3	* 9648.000	42.95	3.29	46.24	-27.76	74.00	100	352	Peak

Note:

1. " *", means this data is the worst emission level.
2. C.F (Correction Factor) = Antenna Factor (dB/m) + Cable Loss (dB) – Preamplifier(dB).
3. Measurement (dBuV/m) = Reading(dBuV) + C.F (Correction Factor).
4. The emission levels of other frequencies are very lower than the limit and not show in test report.

EUT	AX3000 High Gain Wireless USB Adapter	Date of Test	2023-01-17
Factor	DRH18-E	Temp. / Humidity	20°C /62%
Polarity	Vertical	Site / Test Engineer	AC2 / Ares
Test Mode	802.11n-20MHz_TX_CH 1_ANT 1+2	Test Voltage	By Notebook PC

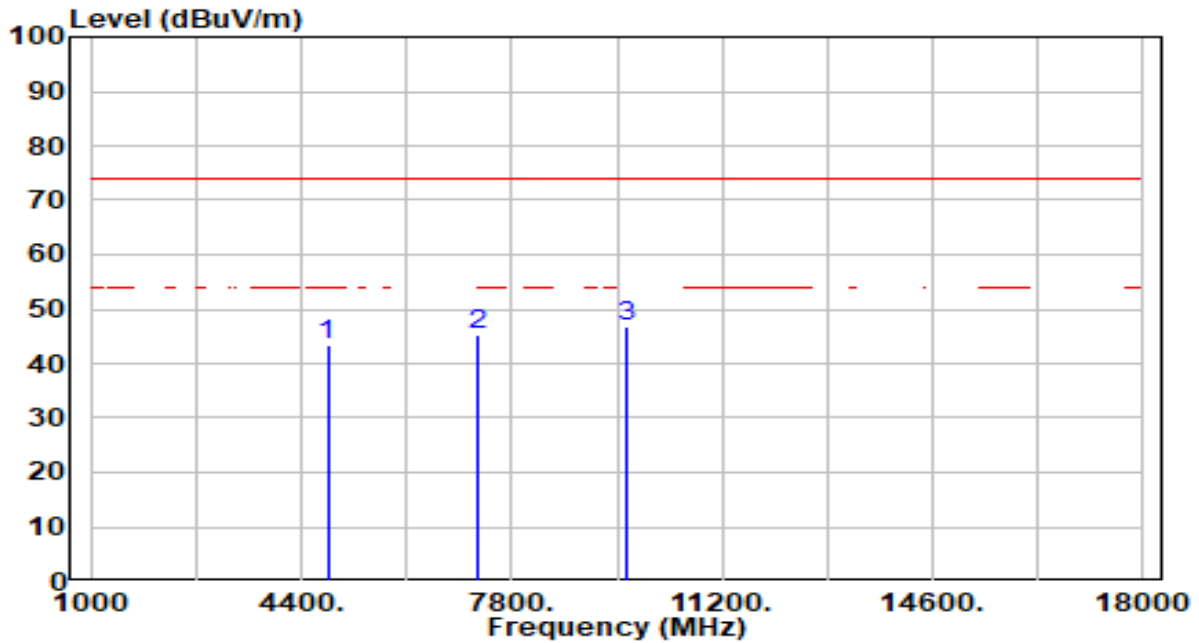

No	Frequency (MHz)	Reading (dBuV)	C.F (dB/m)	Measurement (dBuV/m)	Margin (dB)	Limit (dBuV/m)	Height (cm)	Angle (deg)	Remark (QP/PK/AV)
1	4824.000	44.48	-1.23	43.25	-30.75	74.00	100	314	Peak
2	7236.000	41.30	4.16	45.46	-28.54	74.00	100	349	Peak
3	* 9648.000	43.45	3.29	46.74	-27.26	74.00	100	180	Peak

Note:

1. " *", means this data is the worst emission level.
2. C.F (Correction Factor) = Antenna Factor (dB/m) + Cable Loss (dB) – Preamplifier(dB).
3. Measurement (dBuV/m) = Reading(dBuV) + C.F (Correction Factor).
4. The emission levels of other frequencies are very lower than the limit and not show in test report.

EUT	AX3000 High Gain Wireless USB Adapter	Date of Test	2023-01-17
Factor	DRH18-E	Temp. / Humidity	20°C /62%
Polarity	Horizontal	Site / Test Engineer	AC2 / Ares
Test Mode	802.11n-20MHz_TX_CH 6_ANT 1+2	Test Voltage	By Notebook PC

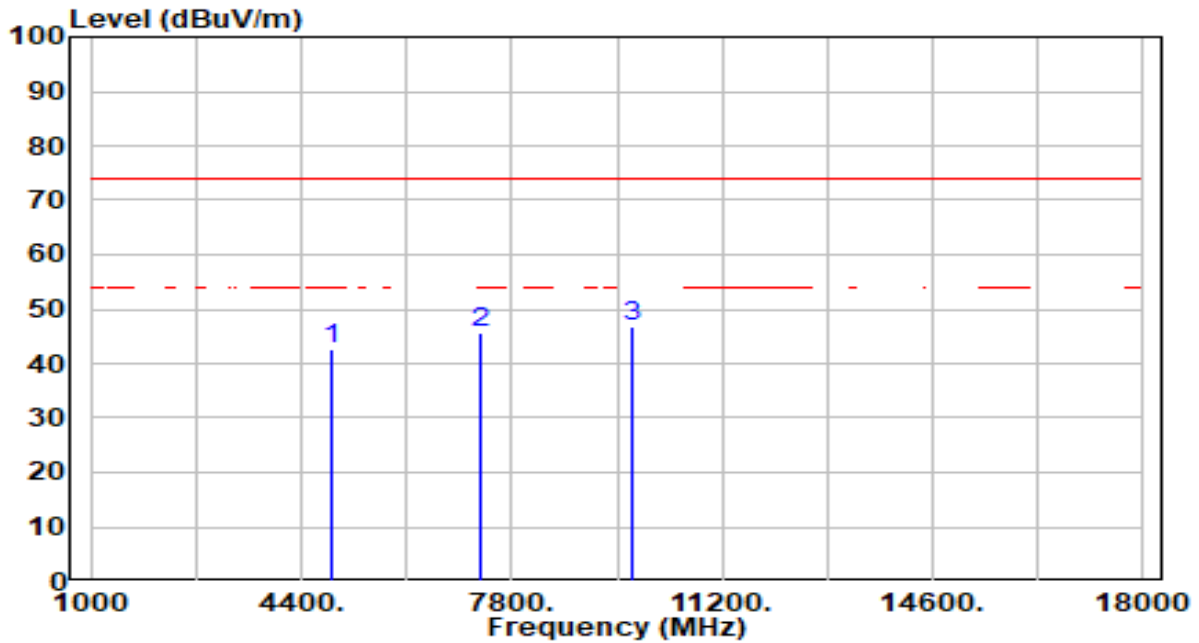

No	Frequency (MHz)	Reading (dBuV)	C.F (dB/m)	Measurement (dBuV/m)	Margin (dB)	Limit (dBuV/m)	Height (cm)	Angle (deg)	Remark (QP/PK/AV)
1	4874.000	43.86	-1.13	42.73	-31.27	74.00	100	0	Peak
2	7311.000	41.69	4.14	45.82	-28.18	74.00	100	106	Peak
3	* 9748.000	43.28	3.33	46.61	-27.39	74.00	100	201	Peak

Note:

1. " *", means this data is the worst emission level.
2. C.F (Correction Factor) = Antenna Factor (dB/m) + Cable Loss (dB) – Preamplifier(dB).
3. Measurement (dBuV/m) = Reading(dBuV) + C.F (Correction Factor).
4. The emission levels of other frequencies are very lower than the limit and not show in test report.

EUT	AX3000 High Gain Wireless USB Adapter	Date of Test	2023-01-17
Factor	DRH18-E	Temp. / Humidity	20°C /62%
Polarity	Vertical	Site / Test Engineer	AC2 / Ares
Test Mode	802.11n-20MHz_TX_CH 6_ANT 1+2	Test Voltage	By Notebook PC

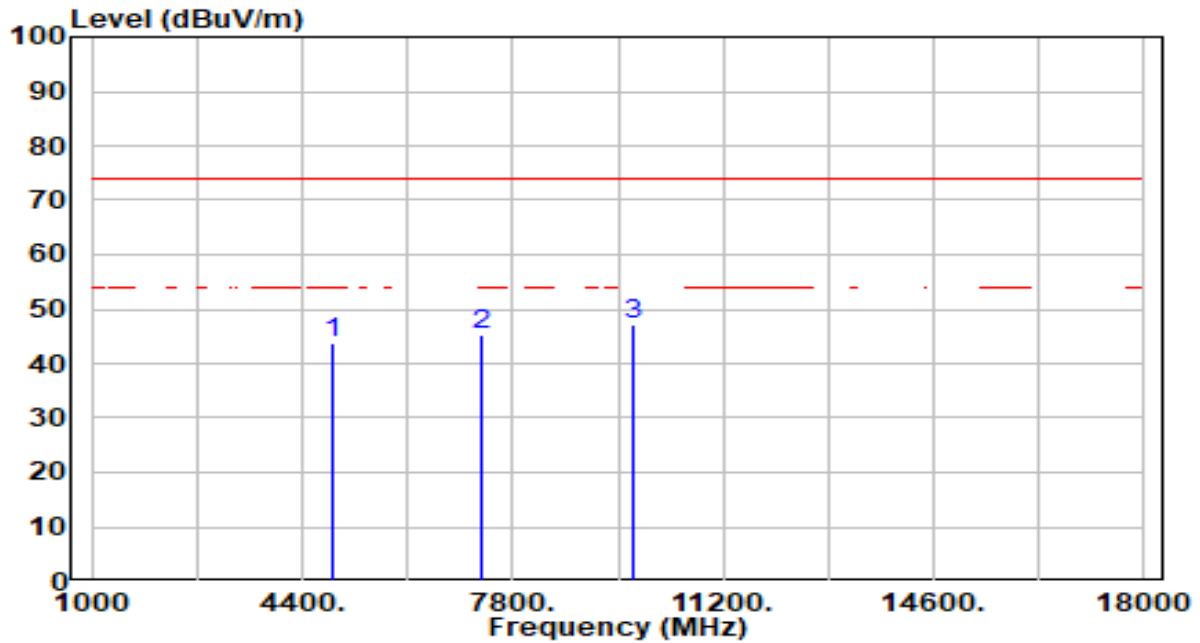

No	Frequency (MHz)	Reading (dBuV)	C.F (dB/m)	Measurement (dBuV/m)	Margin (dB)	Limit (dBuV/m)	Height (cm)	Angle (deg)	Remark (QP/PK/AV)
1	4874.000	44.88	-1.13	43.76	-30.24	74.00	100	111	Peak
2	7311.000	41.18	4.14	45.32	-28.68	74.00	100	179	Peak
3	* 9748.000	43.97	3.33	47.30	-26.70	74.00	100	36	Peak

Note:

1. " *", means this data is the worst emission level.
2. C.F (Correction Factor) = Antenna Factor (dB/m) + Cable Loss (dB) – Preamplifier(dB).
3. Measurement (dBuV/m) = Reading(dBuV) + C.F (Correction Factor).
4. The emission levels of other frequencies are very lower than the limit and not show in test report.

EUT	AX3000 High Gain Wireless USB Adapter	Date of Test	2023-01-17
Factor	DRH18-E	Temp. / Humidity	20°C /62%
Polarity	Horizontal	Site / Test Engineer	AC2 / Ares
Test Mode	802.11n-20MHz_TX_CH 11_ANT 1+2	Test Voltage	By Notebook PC

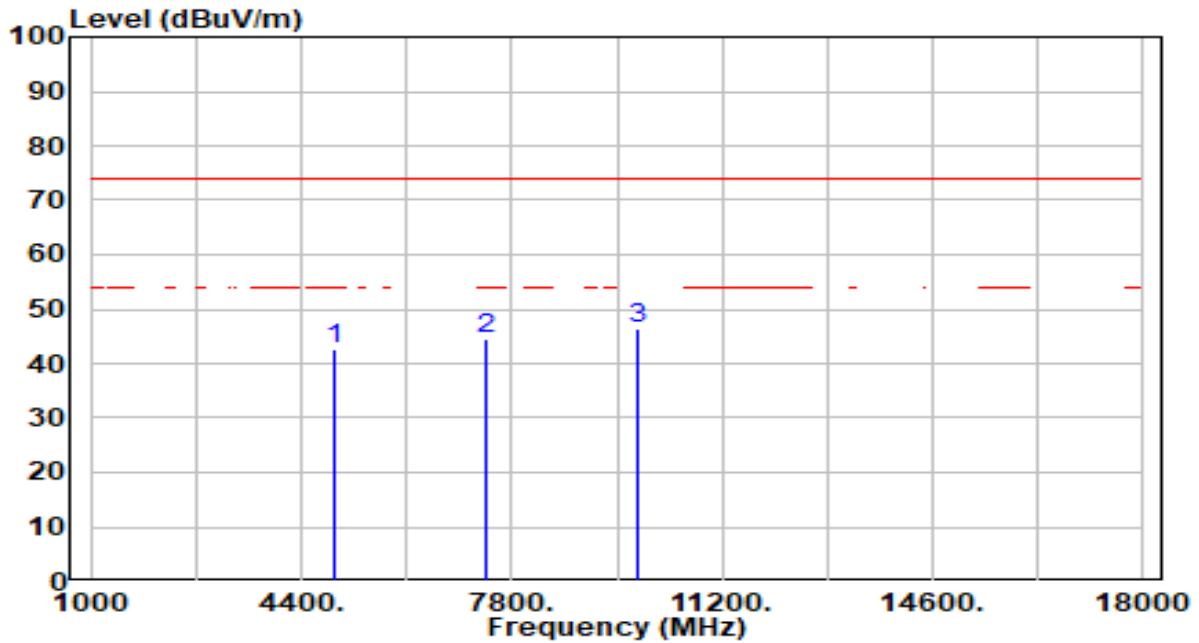

No	Frequency (MHz)	Reading (dBuV)	C.F (dB/m)	Measurement (dBuV/m)	Margin (dB)	Limit (dBuV/m)	Height (cm)	Angle (deg)	Remark (QP/PK/AV)
1	4924.000	43.78	-1.03	42.76	-31.24	74.00	100	0	Peak
2	7386.000	40.34	4.11	44.45	-29.55	74.00	100	115	Peak
3	* 9848.000	43.18	3.39	46.56	-27.44	74.00	100	235	Peak

Note:

1. " *", means this data is the worst emission level.
2. C.F (Correction Factor) = Antenna Factor (dB/m) + Cable Loss (dB) – Preamplifier(dB).
3. Measurement (dBuV/m) = Reading(dBuV) + C.F (Correction Factor).
4. The emission levels of other frequencies are very lower than the limit and not show in test report.

EUT	AX3000 High Gain Wireless USB Adapter	Date of Test	2023-01-17
Factor	DRH18-E	Temp. / Humidity	20°C /62%
Polarity	Vertical	Site / Test Engineer	AC2 / Ares
Test Mode	802.11n-20MHz_TX_CH 11_ANT 1+2	Test Voltage	By Notebook PC

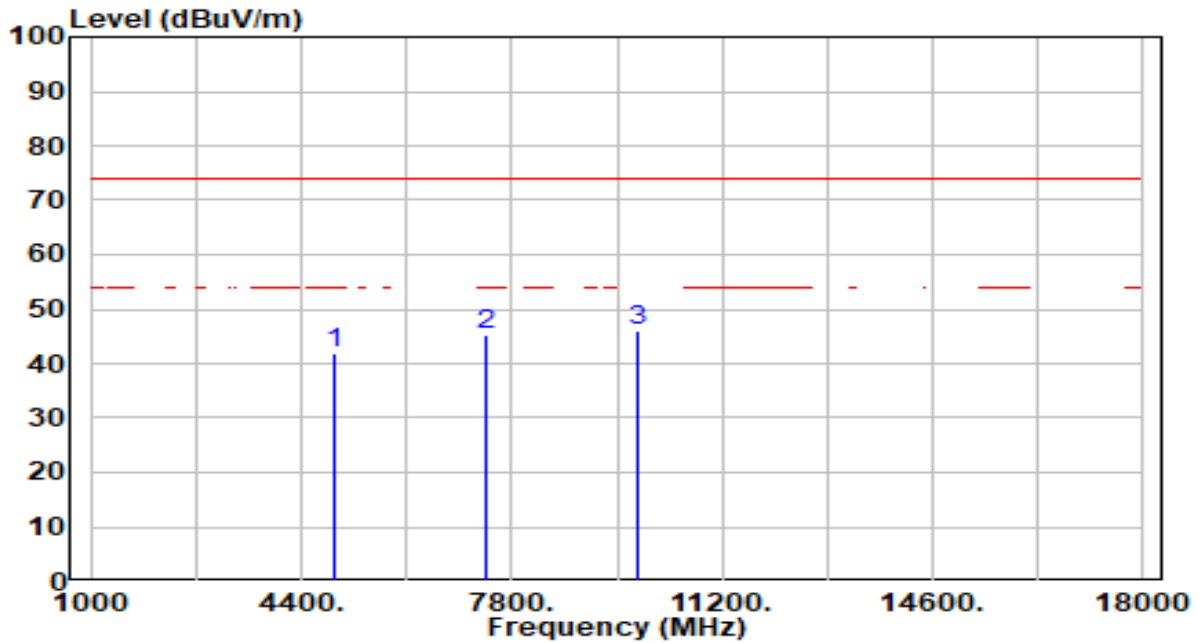

No	Frequency (MHz)	Reading (dBuV)	C.F (dB/m)	Measurement (dBuV/m)	Margin (dB)	Limit (dBuV/m)	Height (cm)	Angle (deg)	Remark (QP/PK/AV)
1	4924.000	42.86	-1.03	41.84	-32.16	74.00	100	95	Peak
2	7386.000	41.35	4.11	45.47	-28.53	74.00	100	63	Peak
3	* 9848.000	42.60	3.39	45.99	-28.01	74.00	100	195	Peak

Note:

1. " *", means this data is the worst emission level.
2. C.F (Correction Factor) = Antenna Factor (dB/m) + Cable Loss (dB) – Preamplifier(dB).
3. Measurement (dBuV/m) = Reading(dBuV) + C.F (Correction Factor).
4. The emission levels of other frequencies are very lower than the limit and not show in test report.

EUT	AX3000 High Gain Wireless USB Adapter	Date of Test	2023-01-17
Factor	DRH18-E	Temp. / Humidity	20°C /62%
Polarity	Horizontal	Site / Test Engineer	AC2 / Ares
Test Mode	802.11n-40MHz_TX_CH 3_ANT 1+2	Test Voltage	By Notebook PC

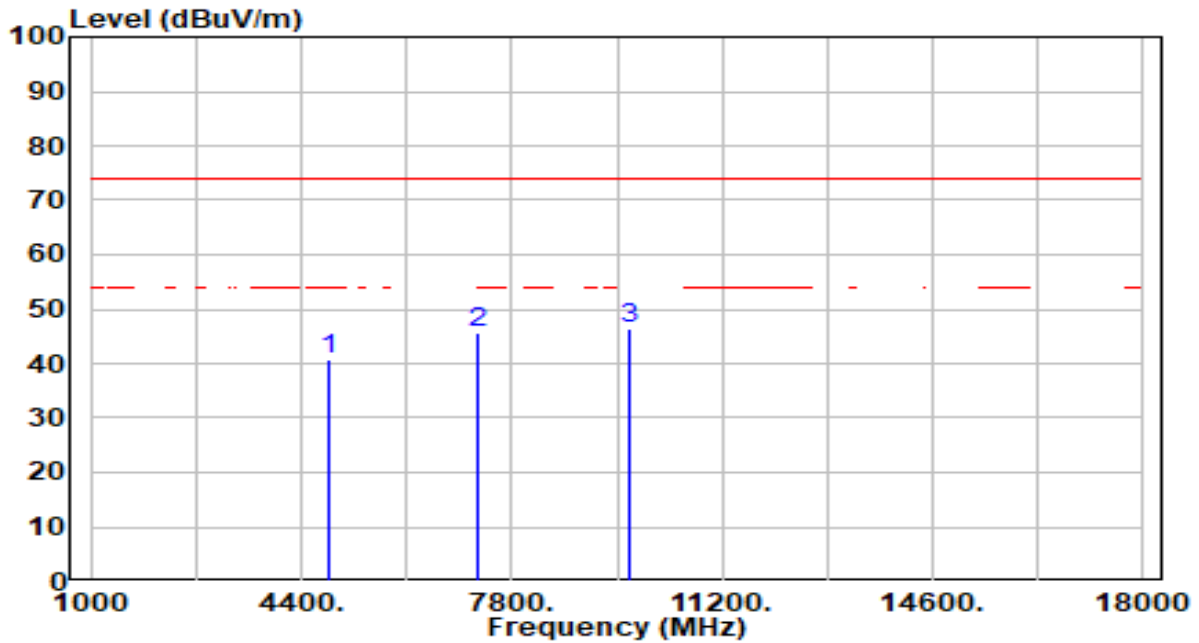

No	Frequency (MHz)	Reading (dBuV)	C.F (dB/m)	Measurement (dBuV/m)	Margin (dB)	Limit (dBuV/m)	Height (cm)	Angle (deg)	Remark (QP/PK/AV)
1	4844.000	41.83	-1.19	40.64	-33.36	74.00	100	360	Peak
2	7266.000	41.38	4.15	45.54	-28.46	74.00	100	138	Peak
3	* 9688.000	42.97	3.30	46.27	-27.73	74.00	100	0	Peak

Note:

1. " *", means this data is the worst emission level.
2. C.F (Correction Factor) = Antenna Factor (dB/m) + Cable Loss (dB) – Preamplifier(dB).
3. Measurement (dBuV/m) = Reading(dBuV) + C.F (Correction Factor).
4. The emission levels of other frequencies are very lower than the limit and not show in test report.

EUT	AX3000 High Gain Wireless USB Adapter	Date of Test	2023-01-17
Factor	DRH18-E	Temp. / Humidity	20°C /62%
Polarity	Vertical	Site / Test Engineer	AC2 / Ares
Test Mode	802.11n-40MHz_TX_CH 3_ANT 1+2	Test Voltage	By Notebook PC

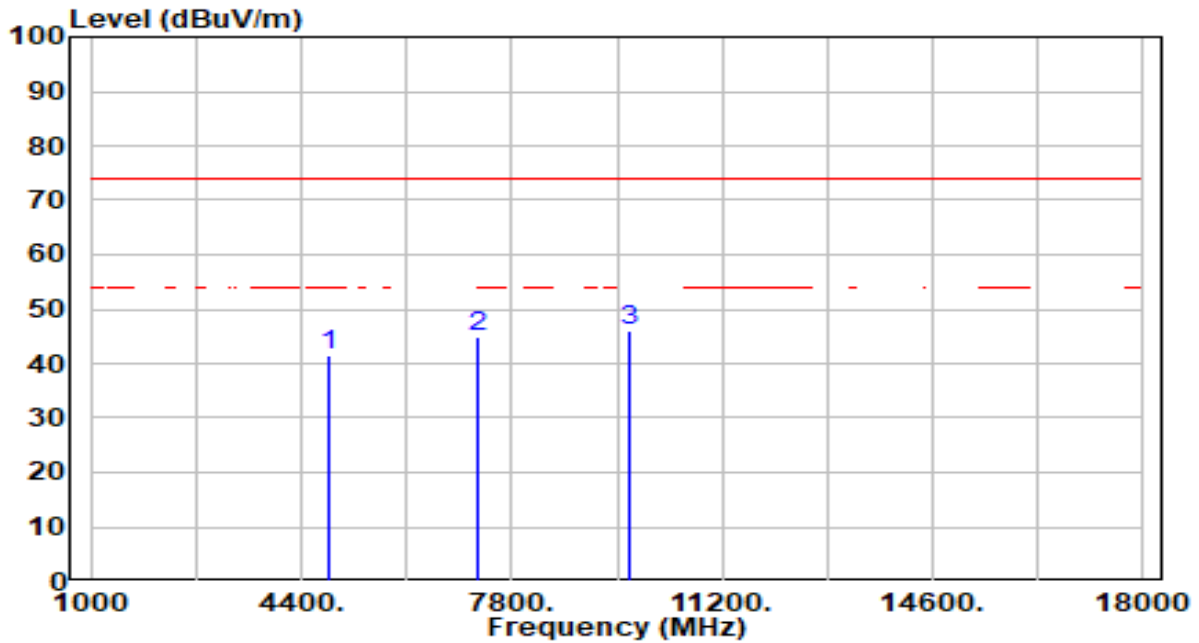

No	Frequency (MHz)	Reading (dBuV)	C.F (dB/m)	Measurement (dBuV/m)	Margin (dB)	Limit (dBuV/m)	Height (cm)	Angle (deg)	Remark (QP/PK/AV)
1	4844.000	42.59	-1.19	41.41	-32.59	74.00	100	108	Peak
2	7266.000	40.91	4.15	45.06	-28.94	74.00	100	108	Peak
3	* 9688.000	42.91	3.30	46.22	-27.78	74.00	100	221	Peak

Note:

1. " *", means this data is the worst emission level.
2. C.F (Correction Factor) = Antenna Factor (dB/m) + Cable Loss (dB) – Preamplifier(dB).
3. Measurement (dBuV/m) = Reading(dBuV) + C.F (Correction Factor).
4. The emission levels of other frequencies are very lower than the limit and not show in test report.

EUT	AX3000 High Gain Wireless USB Adapter	Date of Test	2023-01-17
Factor	DRH18-E	Temp. / Humidity	20°C /62%
Polarity	Horizontal	Site / Test Engineer	AC2 / Ares
Test Mode	802.11n-40MHz_TX_CH 6_ANT 1+2	Test Voltage	By Notebook PC

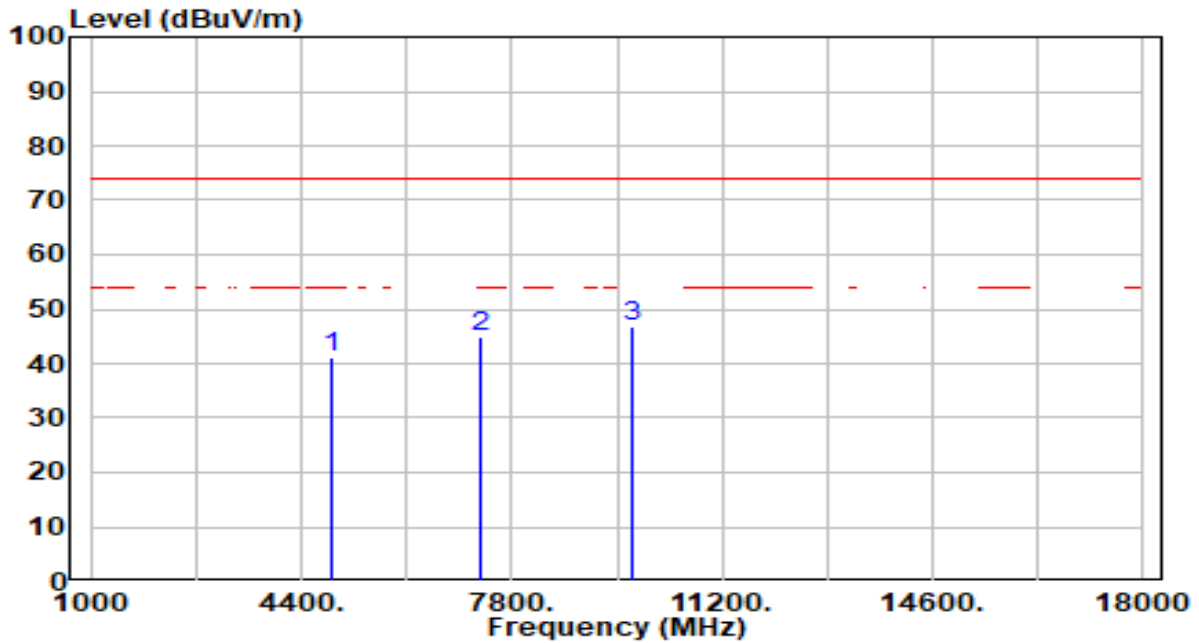

No	Frequency (MHz)	Reading (dBuV)	C.F (dB/m)	Measurement (dBuV/m)	Margin (dB)	Limit (dBuV/m)	Height (cm)	Angle (deg)	Remark (QP/PK/AV)
1	4874.000	42.22	-1.13	41.10	-32.90	74.00	100	23	Peak
2	7311.000	40.86	4.14	45.00	-29.00	74.00	100	203	Peak
3	* 9748.000	43.34	3.33	46.67	-27.33	74.00	100	132	Peak

Note:

1. " *", means this data is the worst emission level.
2. C.F (Correction Factor) = Antenna Factor (dB/m) + Cable Loss (dB) – Preamplifier(dB).
3. Measurement (dBuV/m) = Reading(dBuV) + C.F (Correction Factor).
4. The emission levels of other frequencies are very lower than the limit and not show in test report.

EUT	AX3000 High Gain Wireless USB Adapter	Date of Test	2023-01-17
Factor	DRH18-E	Temp. / Humidity	20°C /62%
Polarity	Vertical	Site / Test Engineer	AC2 / Ares
Test Mode	802.11n-40MHz_TX_CH 6_ANT 1+2	Test Voltage	By Notebook PC

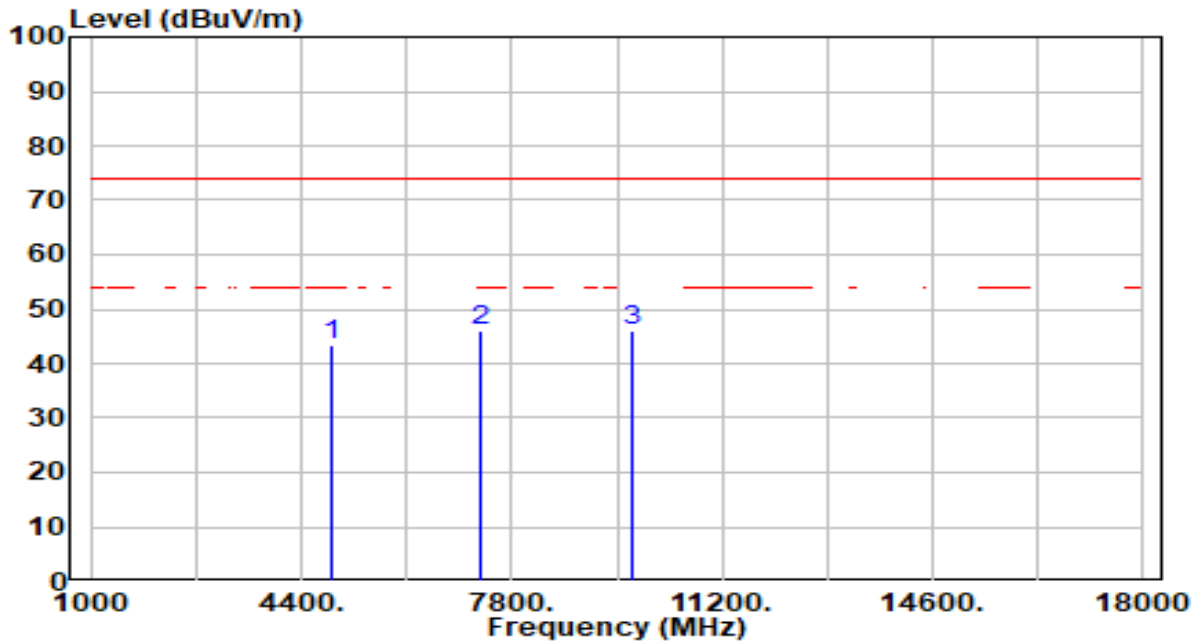

No	Frequency (MHz)	Reading (dBuV)	C.F (dB/m)	Measurement (dBuV/m)	Margin (dB)	Limit (dBuV/m)	Height (cm)	Angle (deg)	Remark (QP/PK/AV)
1	4874.000	44.58	-1.13	43.46	-30.54	74.00	100	279	Peak
2	* 7311.000	41.98	4.14	46.11	-27.89	74.00	100	360	Peak
3	9748.000	42.63	3.33	45.96	-28.04	74.00	100	256	Peak

Note:

1. " *", means this data is the worst emission level.
2. C.F (Correction Factor) = Antenna Factor (dB/m) + Cable Loss (dB) – Preamplifier(dB).
3. Measurement (dBuV/m) = Reading(dBuV) + C.F (Correction Factor).
4. The emission levels of other frequencies are very lower than the limit and not show in test report.

EUT	AX3000 High Gain Wireless USB Adapter	Date of Test	2023-01-17
Factor	DRH18-E	Temp. / Humidity	20°C /62%
Polarity	Horizontal	Site / Test Engineer	AC2 / Ares
Test Mode	802.11n-40MHz_TX_CH 9_ANT 1+2	Test Voltage	By Notebook PC

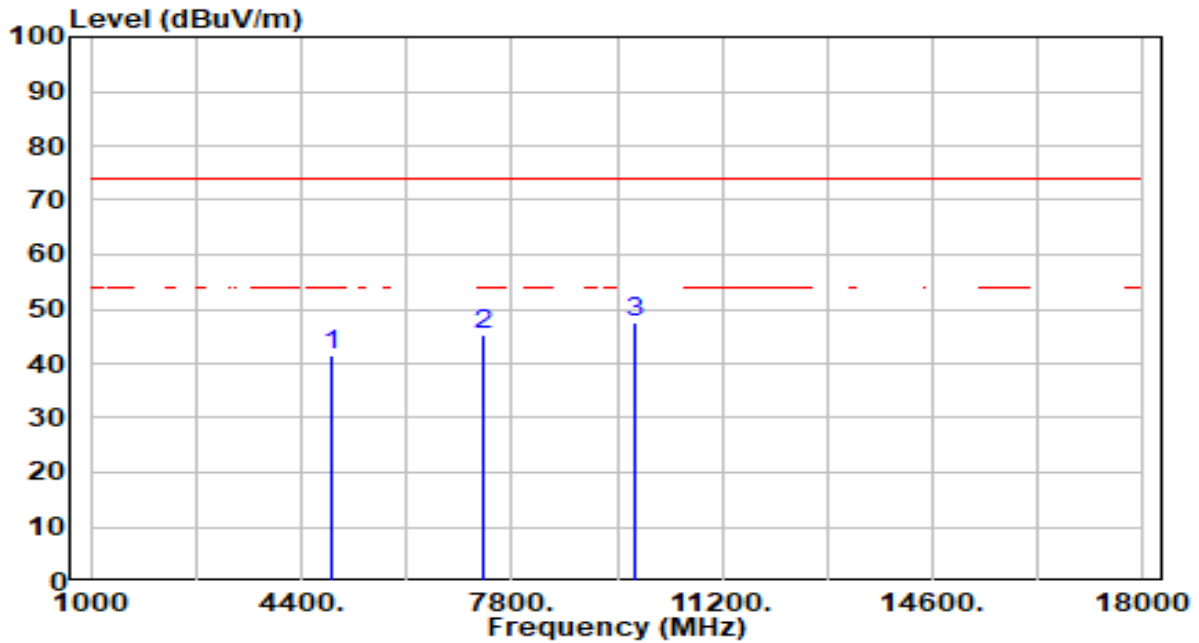

No	Frequency (MHz)	Reading (dBuV)	C.F (dB/m)	Measurement (dBuV/m)	Margin (dB)	Limit (dBuV/m)	Height (cm)	Angle (deg)	Remark (QP/PK/AV)
1	4904.000	42.69	-1.07	41.62	-32.38	74.00	100	17	Peak
2	7356.000	41.10	4.12	45.22	-28.78	74.00	100	358	Peak
3	* 9808.000	44.12	3.35	47.47	-26.53	74.00	100	200	Peak

Note:

1. " *", means this data is the worst emission level.
2. C.F (Correction Factor) = Antenna Factor (dB/m) + Cable Loss (dB) – Preamplifier(dB).
3. Measurement (dBuV/m) = Reading(dBuV) + C.F (Correction Factor).
4. The emission levels of other frequencies are very lower than the limit and not show in test report.

EUT	AX3000 High Gain Wireless USB Adapter	Date of Test	2023-01-17
Factor	DRH18-E	Temp. / Humidity	20°C /62%
Polarity	Vertical	Site / Test Engineer	AC2 / Ares
Test Mode	802.11n-40MHz_TX_CH 9_ANT 1+2	Test Voltage	By Notebook PC

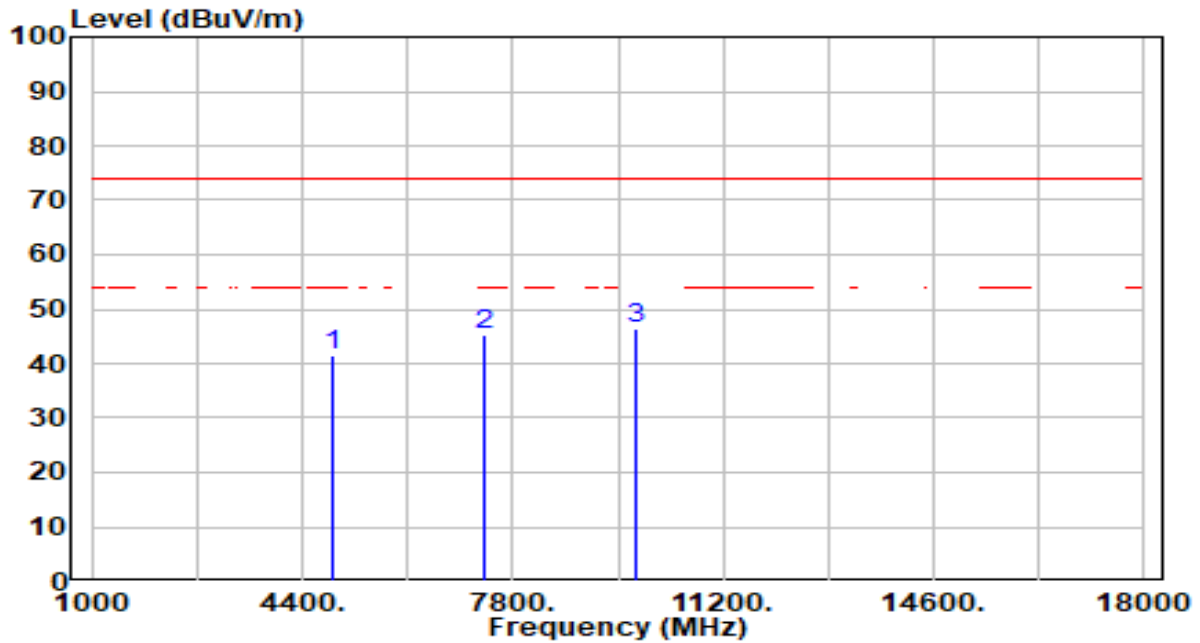

No	Frequency (MHz)	Reading (dBuV)	C.F (dB/m)	Measurement (dBuV/m)	Margin (dB)	Limit (dBuV/m)	Height (cm)	Angle (deg)	Remark (QP/PK/AV)
1	4904.000	42.41	-1.07	41.34	-32.66	74.00	100	254	Peak
2	7356.000	41.16	4.12	45.28	-28.72	74.00	100	223	Peak
3	* 9808.000	42.93	3.35	46.28	-27.72	74.00	100	360	Peak

Note:

1. " *", means this data is the worst emission level.
2. C.F (Correction Factor) = Antenna Factor (dB/m) + Cable Loss (dB) – Preamplifier(dB).
3. Measurement (dBuV/m) = Reading(dBuV) + C.F (Correction Factor).
4. The emission levels of other frequencies are very lower than the limit and not show in test report.

EUT	AX3000 High Gain Wireless USB Adapter	Date of Test	2023-01-17
Factor	DRH18-E	Temp. / Humidity	20°C /62%
Polarity	Horizontal	Site / Test Engineer	AC2 / Ares
Test Mode	802.11ax-20MHz_TX_CH 1_ANT 1+2	Test Voltage	By Notebook PC

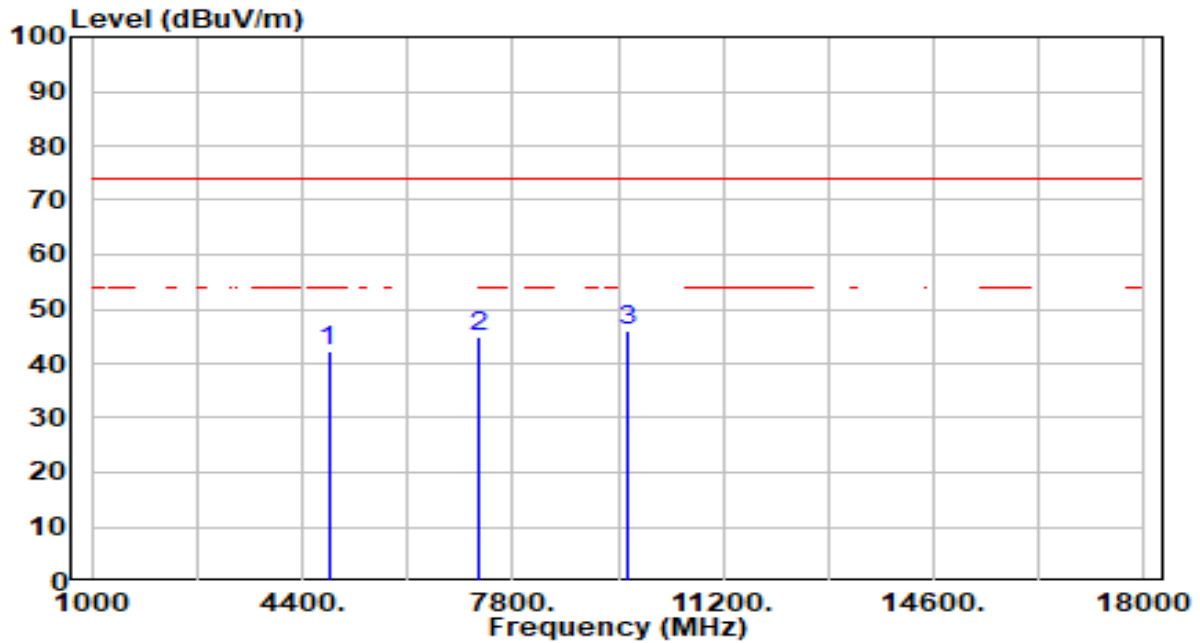

No	Frequency (MHz)	Reading (dBuV)	C.F (dB/m)	Measurement (dBuV/m)	Margin (dB)	Limit (dBuV/m)	Height (cm)	Angle (deg)	Remark (QP/PK/AV)
1	4824.000	43.56	-1.23	42.33	-31.67	74.00	100	37	Peak
2	7236.000	40.69	4.16	44.85	-29.15	74.00	100	355	Peak
3	* 9648.000	42.72	3.29	46.01	-27.99	74.00	100	51	Peak

Note:

1. " *", means this data is the worst emission level.
2. C.F (Correction Factor) = Antenna Factor (dB/m) + Cable Loss (dB) – Preamplifier(dB).
3. Measurement (dBuV/m) = Reading(dBuV) + C.F (Correction Factor).
4. The emission levels of other frequencies are very lower than the limit and not show in test report.

EUT	AX3000 High Gain Wireless USB Adapter	Date of Test	2023-01-17
Factor	DRH18-E	Temp. / Humidity	20°C /62%
Polarity	Vertical	Site / Test Engineer	AC2 / Ares
Test Mode	802.11ax-20MHz_TX_CH 1_ANT 1+2	Test Voltage	By Notebook PC

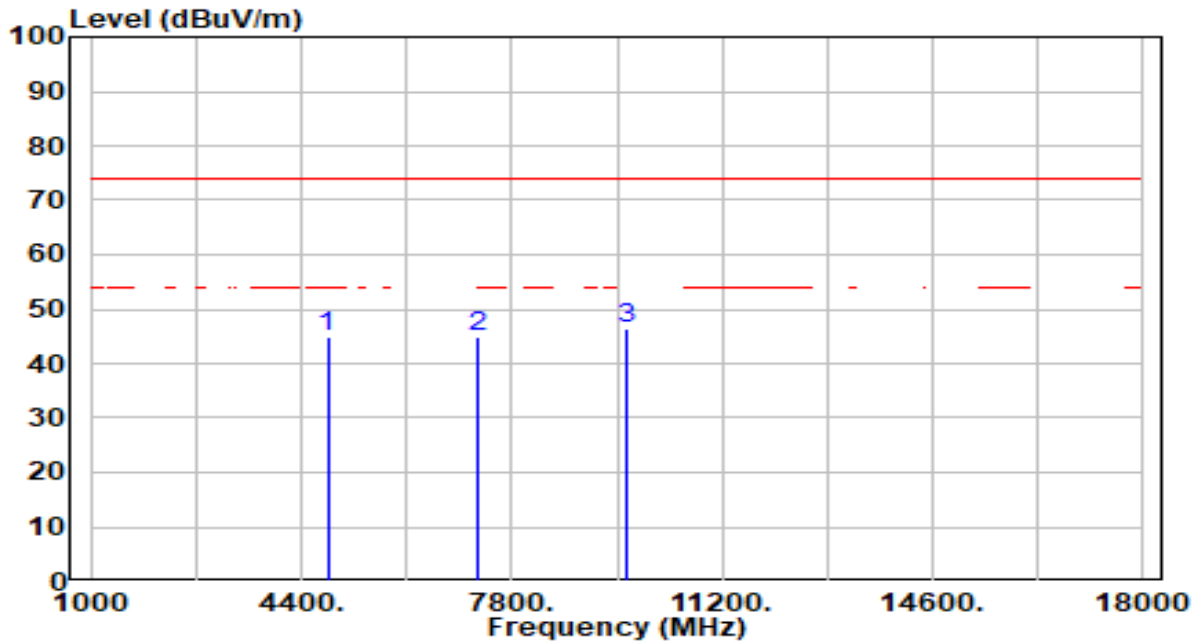

No	Frequency (MHz)	Reading (dBuV)	C.F (dB/m)	Measurement (dBuV/m)	Margin (dB)	Limit (dBuV/m)	Height (cm)	Angle (deg)	Remark (QP/PK/AV)
1	4824.000	46.19	-1.23	44.96	-29.04	74.00	100	277	Peak
2	7236.000	40.58	4.16	44.74	-29.26	74.00	100	360	Peak
3	* 9648.000	43.17	3.29	46.46	-27.54	74.00	100	248	Peak

Note:

1. " *", means this data is the worst emission level.
2. C.F (Correction Factor) = Antenna Factor (dB/m) + Cable Loss (dB) – Preamplifier(dB).
3. Measurement (dBuV/m) = Reading(dBuV) + C.F (Correction Factor).
4. The emission levels of other frequencies are very lower than the limit and not show in test report.

EUT	AX3000 High Gain Wireless USB Adapter	Date of Test	2023-01-17
Factor	DRH18-E	Temp. / Humidity	20°C /62%
Polarity	Horizontal	Site / Test Engineer	AC2 / Ares
Test Mode	802.11ax-20MHz_TX_CH 6_ANT 1+2	Test Voltage	By Notebook PC

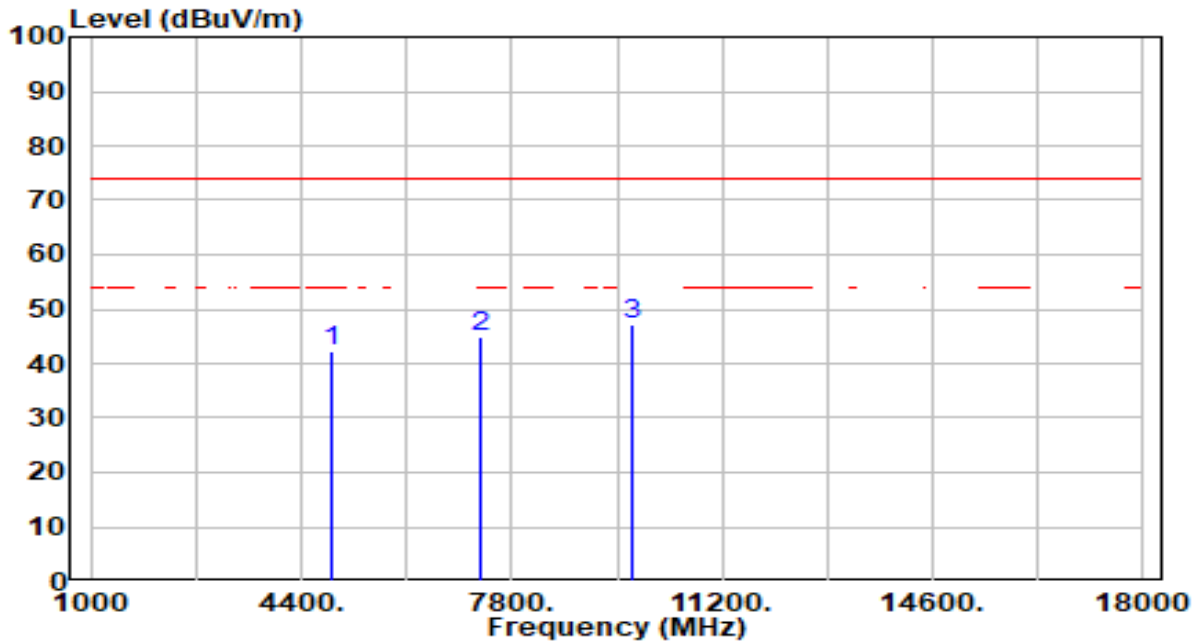

No	Frequency (MHz)	Reading (dBuV)	C.F (dB/m)	Measurement (dBuV/m)	Margin (dB)	Limit (dBuV/m)	Height (cm)	Angle (deg)	Remark (QP/PK/AV)
1	4874.000	43.30	-1.13	42.18	-31.82	74.00	100	355	Peak
2	7311.000	40.88	4.14	45.02	-28.98	74.00	100	232	Peak
3	* 9748.000	43.70	3.33	47.03	-26.97	74.00	100	358	Peak

Note:

1. " *", means this data is the worst emission level.
2. C.F (Correction Factor) = Antenna Factor (dB/m) + Cable Loss (dB) – Preamplifier(dB).
3. Measurement (dBuV/m) = Reading(dBuV) + C.F (Correction Factor).
4. The emission levels of other frequencies are very lower than the limit and not show in test report.

EUT	AX3000 High Gain Wireless USB Adapter	Date of Test	2023-01-17
Factor	DRH18-E	Temp. / Humidity	20°C /62%
Polarity	Vertical	Site / Test Engineer	AC2 / Ares
Test Mode	802.11ax-20MHz_TX_CH 6_ANT 1+2	Test Voltage	By Notebook PC

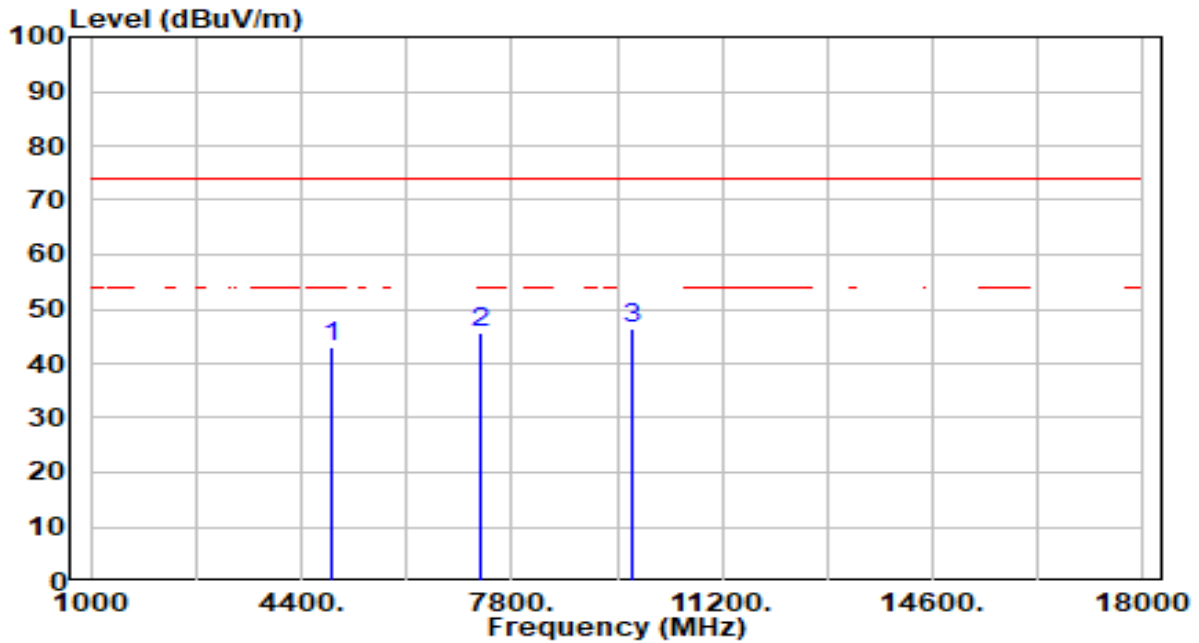

No	Frequency (MHz)	Reading (dBUV)	C.F (dB/m)	Measurement (dBUV/m)	Margin (dB)	Limit (dBUV/m)	Height (cm)	Angle (deg)	Remark (QP/PK/AV)
1	4874.000	44.23	-1.13	43.10	-30.90	74.00	100	114	Peak
2	7311.000	41.39	4.14	45.53	-28.47	74.00	100	315	Peak
3	* 9748.000	42.92	3.33	46.24	-27.76	74.00	100	218	Peak

Note:

1. " *", means this data is the worst emission level.
2. C.F (Correction Factor) = Antenna Factor (dB/m) + Cable Loss (dB) – Preamplifier(dB).
3. Measurement (dBUV/m) = Reading(dBUV) + C.F (Correction Factor).
4. The emission levels of other frequencies are very lower than the limit and not show in test report.

EUT	AX3000 High Gain Wireless USB Adapter	Date of Test	2023-01-17
Factor	DRH18-E	Temp. / Humidity	20°C /62%
Polarity	Horizontal	Site / Test Engineer	AC2 / Ares
Test Mode	802.11ax-20MHz_TX_CH 11_ANT 1+2	Test Voltage	By Notebook PC

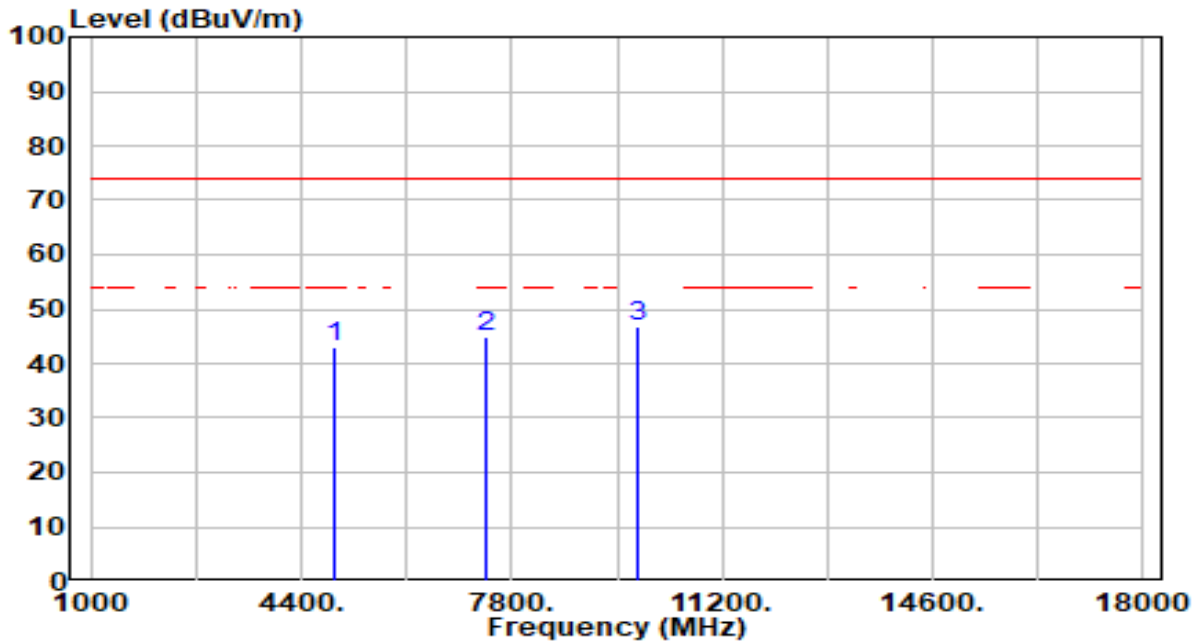

No	Frequency (MHz)	Reading (dBuV)	C.F (dB/m)	Measurement (dBuV/m)	Margin (dB)	Limit (dBuV/m)	Height (cm)	Angle (deg)	Remark (QP/PK/AV)
1	4924.000	44.08	-1.03	43.06	-30.94	74.00	100	359	Peak
2	7386.000	40.65	4.11	44.76	-29.24	74.00	100	3	Peak
3	* 9848.000	43.22	3.39	46.60	-27.40	74.00	100	48	Peak

Note:

1. " *", means this data is the worst emission level.
2. C.F (Correction Factor) = Antenna Factor (dB/m) + Cable Loss (dB) – Preamplifier(dB).
3. Measurement (dBuV/m) = Reading(dBuV) + C.F (Correction Factor).
4. The emission levels of other frequencies are very lower than the limit and not show in test report.

EUT	AX3000 High Gain Wireless USB Adapter	Date of Test	2023-01-17
Factor	DRH18-E	Temp. / Humidity	20°C /62%
Polarity	Vertical	Site / Test Engineer	AC2 / Ares
Test Mode	802.11ax-20MHz_TX_CH 11_ANT 1+2	Test Voltage	By Notebook PC

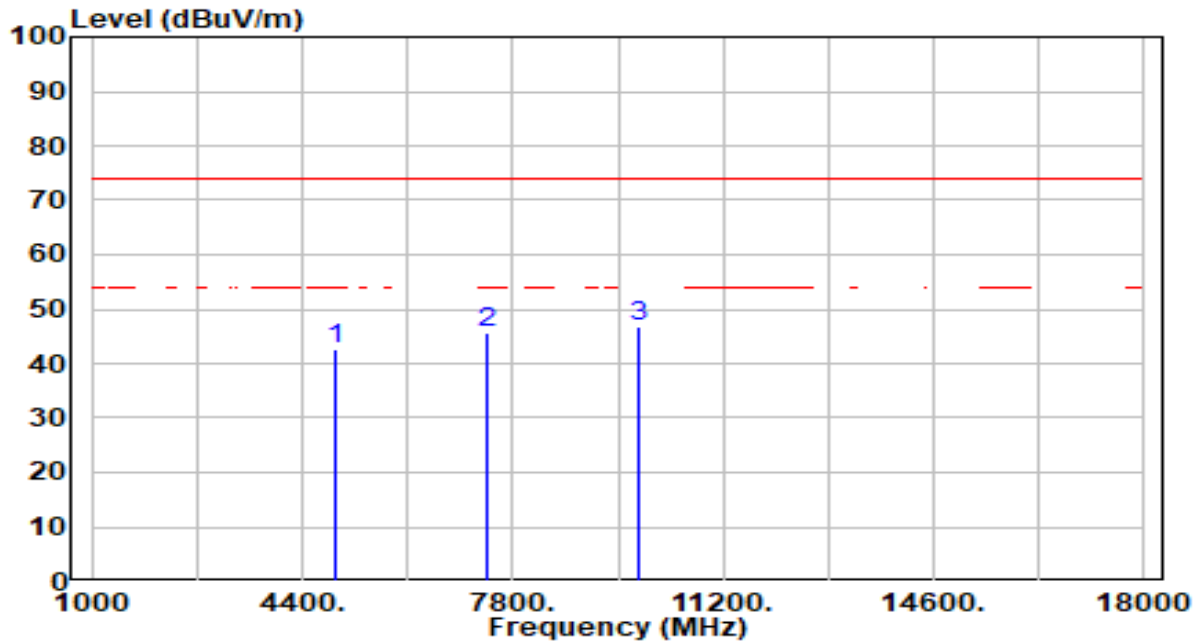

No	Frequency (MHz)	Reading (dBuV)	C.F (dB/m)	Measurement (dBuV/m)	Margin (dB)	Limit (dBuV/m)	Height (cm)	Angle (deg)	Remark (QP/PK/AV)
1	4924.000	43.60	-1.03	42.58	-31.42	74.00	100	361	Peak
2	7386.000	41.45	4.11	45.56	-28.44	74.00	100	189	Peak
3	* 9848.000	43.34	3.39	46.73	-27.27	74.00	100	195	Peak

Note:

1. " *", means this data is the worst emission level.
2. C.F (Correction Factor) = Antenna Factor (dB/m) + Cable Loss (dB) – Preamplifier(dB).
3. Measurement (dBuV/m) = Reading(dBuV) + C.F (Correction Factor).
4. The emission levels of other frequencies are very lower than the limit and not show in test report.

EUT	AX3000 High Gain Wireless USB Adapter	Date of Test	2023-01-17
Factor	DRH18-E	Temp. / Humidity	20°C /62%
Polarity	Horizontal	Site / Test Engineer	AC2 / Ares
Test Mode	802.11ax-40MHz_TX_CH 3_ANT 1+2	Test Voltage	By Notebook PC

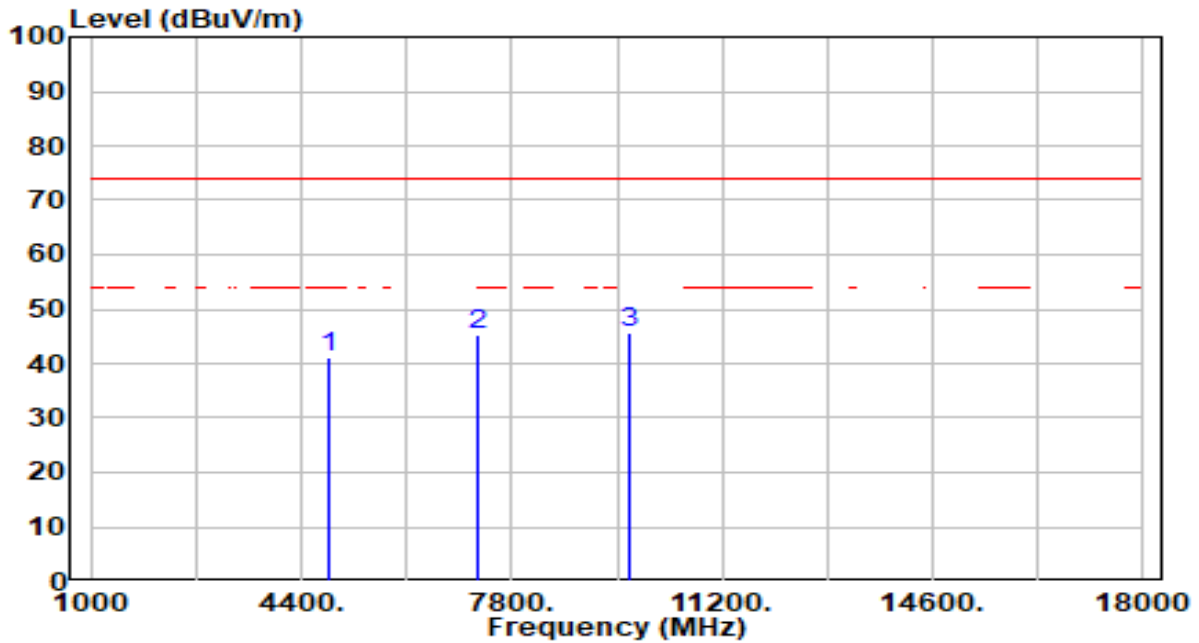

No	Frequency (MHz)	Reading (dBUV)	C.F (dB/m)	Measurement (dBUV/m)	Margin (dB)	Limit (dBUV/m)	Height (cm)	Angle (deg)	Remark (QP/PK/AV)
1	4844.000	42.20	-1.19	41.02	-32.98	74.00	100	63	Peak
2	7266.000	41.06	4.15	45.21	-28.79	74.00	100	183	Peak
3	* 9688.000	42.38	3.30	45.69	-28.31	74.00	100	54	Peak

Note:

1. " *", means this data is the worst emission level.
2. C.F (Correction Factor) = Antenna Factor (dB/m) + Cable Loss (dB) – Preamplifier(dB).
3. Measurement (dBUV/m) = Reading(dBUV) + C.F (Correction Factor).
4. The emission levels of other frequencies are very lower than the limit and not show in test report.

EUT	AX3000 High Gain Wireless USB Adapter	Date of Test	2023-01-17
Factor	DRH18-E	Temp. / Humidity	20°C /62%
Polarity	Vertical	Site / Test Engineer	AC2 / Ares
Test Mode	802.11ax-40MHz_TX_CH 3_ANT 1+2	Test Voltage	By Notebook PC

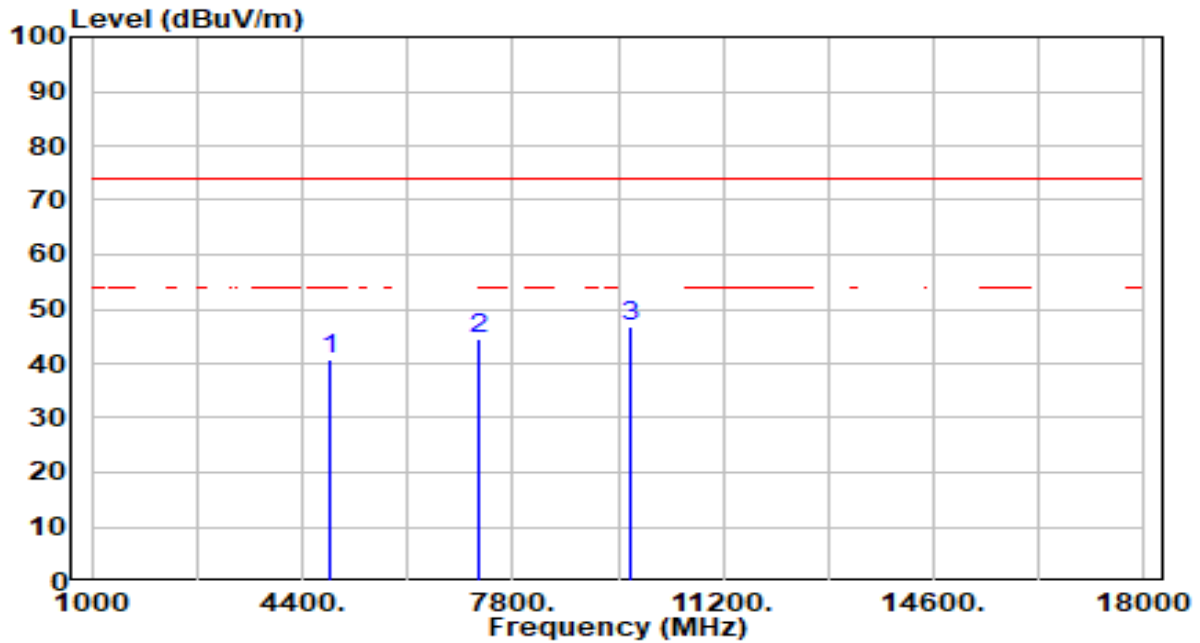

No	Frequency (MHz)	Reading (dBuV)	C.F (dB/m)	Measurement (dBuV/m)	Margin (dB)	Limit (dBuV/m)	Height (cm)	Angle (deg)	Remark (QP/PK/AV)
1	4844.000	41.97	-1.19	40.78	-33.22	74.00	100	98	Peak
2	7266.000	40.39	4.15	44.54	-29.46	74.00	100	211	Peak
3	* 9688.000	43.31	3.30	46.61	-27.39	74.00	100	1	Peak

Note:

1. " *", means this data is the worst emission level.
2. C.F (Correction Factor) = Antenna Factor (dB/m) + Cable Loss (dB) – Preamplifier(dB).
3. Measurement (dBuV/m) = Reading(dBuV) + C.F (Correction Factor).
4. The emission levels of other frequencies are very lower than the limit and not show in test report.

EUT	AX3000 High Gain Wireless USB Adapter	Date of Test	2023-01-17
Factor	DRH18-E	Temp. / Humidity	20°C /62%
Polarity	Horizontal	Site / Test Engineer	AC2 / Ares
Test Mode	802.11ax-40MHz_TX_CH 6_ANT 1+2	Test Voltage	By Notebook PC

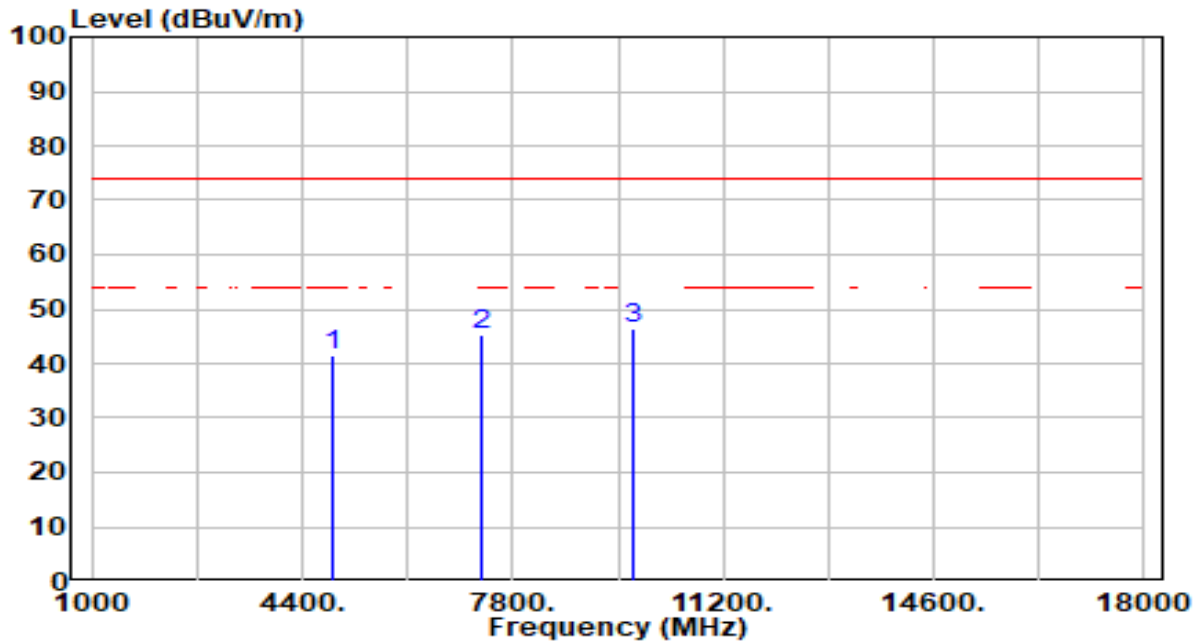

No	Frequency (MHz)	Reading (dBuV)	C.F (dB/m)	Measurement (dBuV/m)	Margin (dB)	Limit (dBuV/m)	Height (cm)	Angle (deg)	Remark (QP/PK/AV)
1	4874.000	42.51	-1.13	41.38	-32.62	74.00	100	0	Peak
2	7311.000	41.04	4.14	45.18	-28.82	74.00	100	59	Peak
3	* 9748.000	43.15	3.33	46.47	-27.53	74.00	100	164	Peak

Note:

1. " *", means this data is the worst emission level.
2. C.F (Correction Factor) = Antenna Factor (dB/m) + Cable Loss (dB) – Preamplifier(dB).
3. Measurement (dBuV/m) = Reading(dBuV) + C.F (Correction Factor).
4. The emission levels of other frequencies are very lower than the limit and not show in test report.

EUT	AX3000 High Gain Wireless USB Adapter	Date of Test	2023-01-17
Factor	DRH18-E	Temp. / Humidity	20°C /62%
Polarity	Vertical	Site / Test Engineer	AC2 / Ares
Test Mode	802.11ax-40MHz_TX_CH 6_ANT 1+2	Test Voltage	By Notebook PC

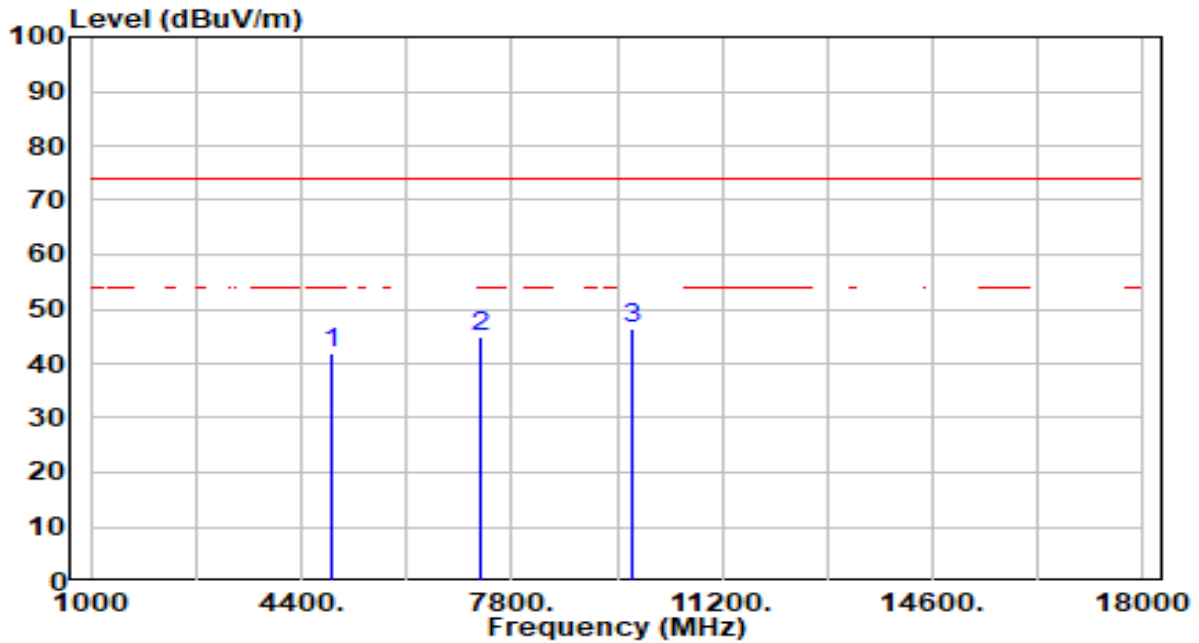

No	Frequency (MHz)	Reading (dBuV)	C.F (dB/m)	Measurement (dBuV/m)	Margin (dB)	Limit (dBuV/m)	Height (cm)	Angle (deg)	Remark (QP/PK/AV)
1	4874.000	42.88	-1.13	41.75	-32.25	74.00	100	214	Peak
2	7311.000	40.94	4.14	45.08	-28.92	74.00	100	169	Peak
3	* 9748.000	43.01	3.33	46.34	-27.66	74.00	100	142	Peak

Note:

1. " *", means this data is the worst emission level.
2. C.F (Correction Factor) = Antenna Factor (dB/m) + Cable Loss (dB) – Preamplifier(dB).
3. Measurement (dBuV/m) = Reading(dBuV) + C.F (Correction Factor).
4. The emission levels of other frequencies are very lower than the limit and not show in test report.

EUT	AX3000 High Gain Wireless USB Adapter	Date of Test	2023-01-17
Factor	DRH18-E	Temp. / Humidity	20°C /62%
Polarity	Horizontal	Site / Test Engineer	AC2 / Ares
Test Mode	802.11ax-40MHz_TX_CH 9_ANT 1+2	Test Voltage	By Notebook PC

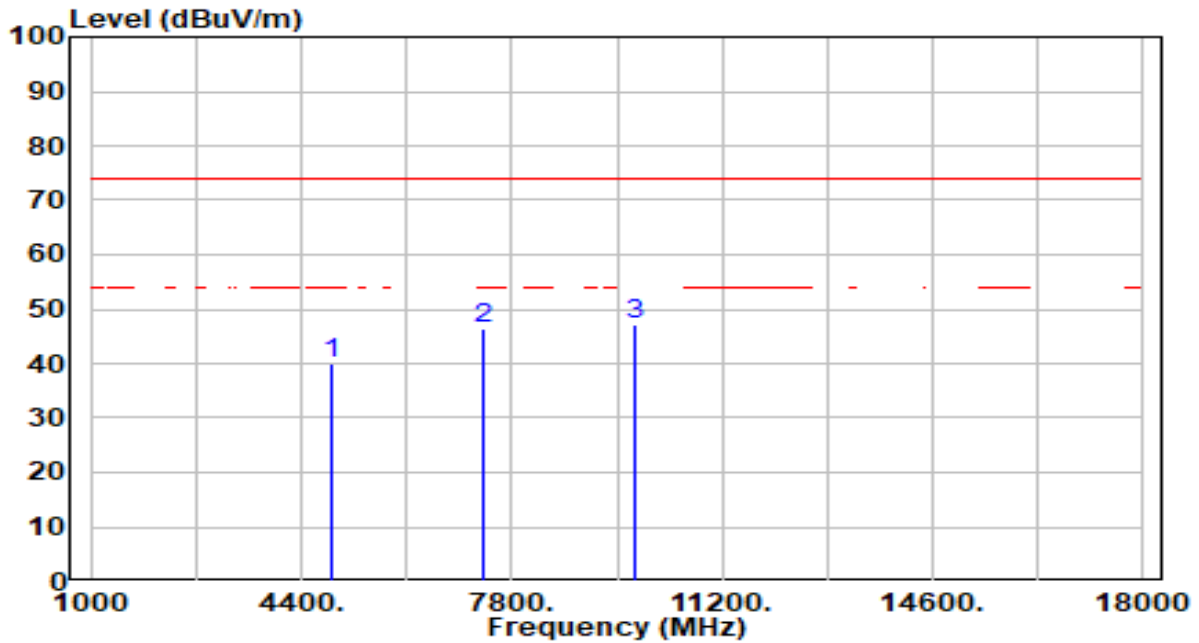

No	Frequency (MHz)	Reading (dBuV)	C.F (dB/m)	Measurement (dBuV/m)	Margin (dB)	Limit (dBuV/m)	Height (cm)	Angle (deg)	Remark (QP/PK/AV)
1	4904.000	41.14	-1.07	40.07	-33.93	74.00	100	36	Peak
2	7356.000	42.24	4.12	46.36	-27.64	74.00	100	81	Peak
3	* 9808.000	43.79	3.35	47.14	-26.86	74.00	100	360	Peak

Note:

1. " *", means this data is the worst emission level.
2. C.F (Correction Factor) = Antenna Factor (dB/m) + Cable Loss (dB) – Preamplifier(dB).
3. Measurement (dBuV/m) = Reading(dBuV) + C.F (Correction Factor).
4. The emission levels of other frequencies are very lower than the limit and not show in test report.

EUT	AX3000 High Gain Wireless USB Adapter	Date of Test	2023-01-17
Factor	DRH18-E	Temp. / Humidity	20°C /62%
Polarity	Vertical	Site / Test Engineer	AC2 / Ares
Test Mode	802.11ax-40MHz_TX_CH 9_ANT 1+2	Test Voltage	By Notebook PC

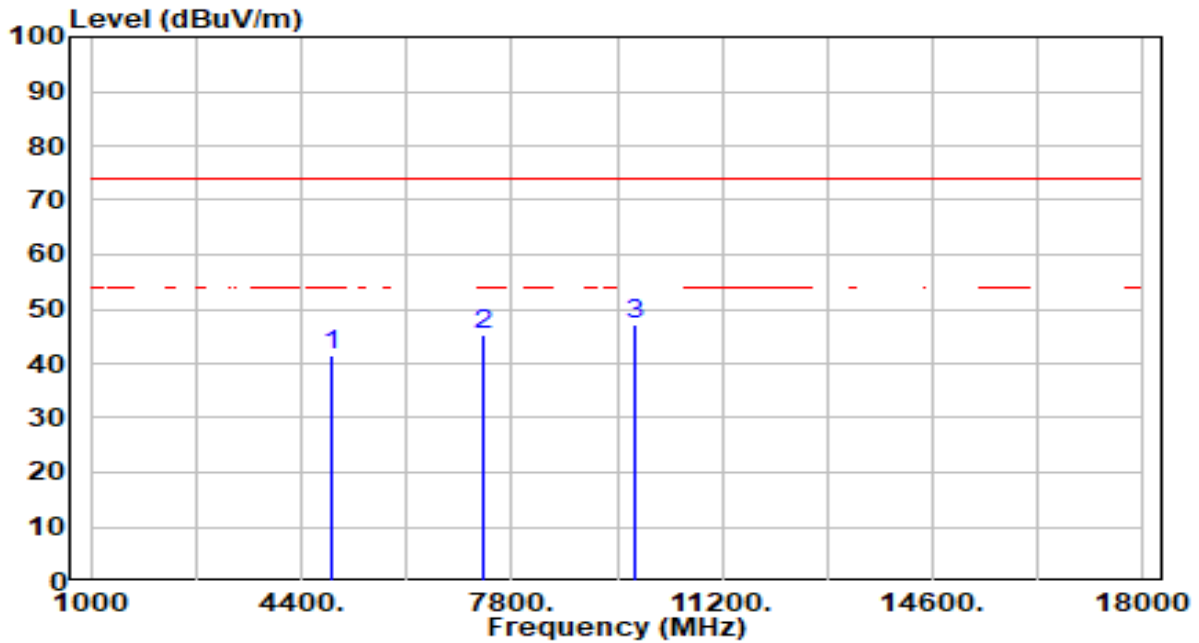

No	Frequency (MHz)	Reading (dBuV)	C.F (dB/m)	Measurement (dBuV/m)	Margin (dB)	Limit (dBuV/m)	Height (cm)	Angle (deg)	Remark (QP/PK/AV)
1	4904.000	42.68	-1.07	41.61	-32.39	74.00	100	101	Peak
2	7356.000	41.13	4.12	45.25	-28.75	74.00	100	83	Peak
3	* 9808.000	43.72	3.35	47.07	-26.93	74.00	100	173	Peak

Note:

1. " *", means this data is the worst emission level.
2. C.F (Correction Factor) = Antenna Factor (dB/m) + Cable Loss (dB) – Preamplifier(dB).
3. Measurement (dBuV/m) = Reading(dBuV) + C.F (Correction Factor).
4. The emission levels of other frequencies are very lower than the limit and not show in test report.

7.7. Radiated Restricted Band Edge Measurement

7.7.1. Test Limit

For 15.205 requirement:

Radiated emissions which fall in the restricted bands, as defined in Section 15.205(a) of FCC part 15, must also comply with the radiated emission limits specified in Section 15.209(a).

Frequency (MHz)	Frequency (MHz)	Frequency (MHz)	Frequency (GHz)
0.090 - 0.110	16.42 - 16.423	399.9 - 410	4.5 - 5.15
¹ 0.495 - 0.505	16.69475 - 16.69525	608 - 614	5.35 - 5.46
2.1735 - 2.1905	16.80425 - 16.80475	960 - 1240	7.25 - 7.75
4.125 - 4.128	25.5 - 25.67	1300 - 1427	8.025 - 8.5
4.17725 - 4.17775	37.5 - 38.25	1435 - 1626.5	9.0 - 9.2
4.20725 - 4.20775	73 - 74.6	1645.5 - 1646.5	9.3 - 9.5
6.215 - 6.218	74.8 - 75.2	1660 - 1710	10.6 - 12.7
6.26775 - 6.26825	108 - 121.94	1718.8 - 1722.2	13.25 - 13.4
6.31175 - 6.31225	123 - 138	2200 - 2300	14.47 - 14.5
8.291 - 8.294	149.9 - 150.05	2310 - 2390	15.35 - 16.2
8.362 - 8.366	156.52475 - 156.52525	2483.5 - 2500	17.7 - 21.4
8.37625 - 8.38675	156.7 - 156.9	2690 - 2900	22.01 - 23.12
8.41425 - 8.41475	162.0125 - 167.17	3260 - 3267	23.6 - 24.0
12.29 - 12.293	167.72 - 173.2	3332 - 3339	31.2 - 31.8
12.51975 - 12.52025	240 - 285	3345.8 - 3358	36.43 - 36.5
12.57675 - 12.57725	322 - 335.4	3600 - 4400	(²)
13.36 - 13.41	--	--	--

All out of band emissions appearing in a restricted band as specified in Section 15.205 of the Title 47CFR must not exceed the limits shown in Table per Section 15.209.

FCC Part 15 Subpart C Paragraph 15.209 Limits		
Frequency [MHz]	Field Strength [uV/m]	Measured Distance [Meters]
0.009 - 0.490	2400/F (kHz)	300
0.490 - 1.705	24000/F (kHz)	30
1.705 - 30	30	30
30 - 88	100	3
88 - 216	150	3
216 - 960	200	3
Above 960	500	3

7.7.2. Test Procedure Used

ANSI C63.10 - 2013 Section 6.3 (General Requirements)

ANSI C63.10 - 2013 Section 6.6 (Standard test method above 1GHz)

7.7.3. Test Setting

Peak Field Strength Measurements

1. Analyzer center frequency was set to the frequency of the radiated spurious emission of interest
2. RBW = 1MHz
3. VBW = 3MHz
4. Detector = peak
5. Sweep time = auto couple
6. Trace mode = max hold
7. Trace was allowed to stabilize

Average Measurements above 1GHz (Method VB)

1. Analyzer center frequency was set to the frequency of the radiated spurious emission of interest
2. RBW = 1MHz
3. VBW; If the EUT is configured to transmit with duty cycle $\geq 98\%$, set VBW = 10 Hz.

If the EUT duty cycle is $< 98\%$, set $VBW \geq 1/T$. T is the minimum transmission duration.

4. Detector = Peak
5. Sweep time = auto
6. Trace mode = max hold
7. Trace was allowed to stabilize

7.7.4. Test Setup

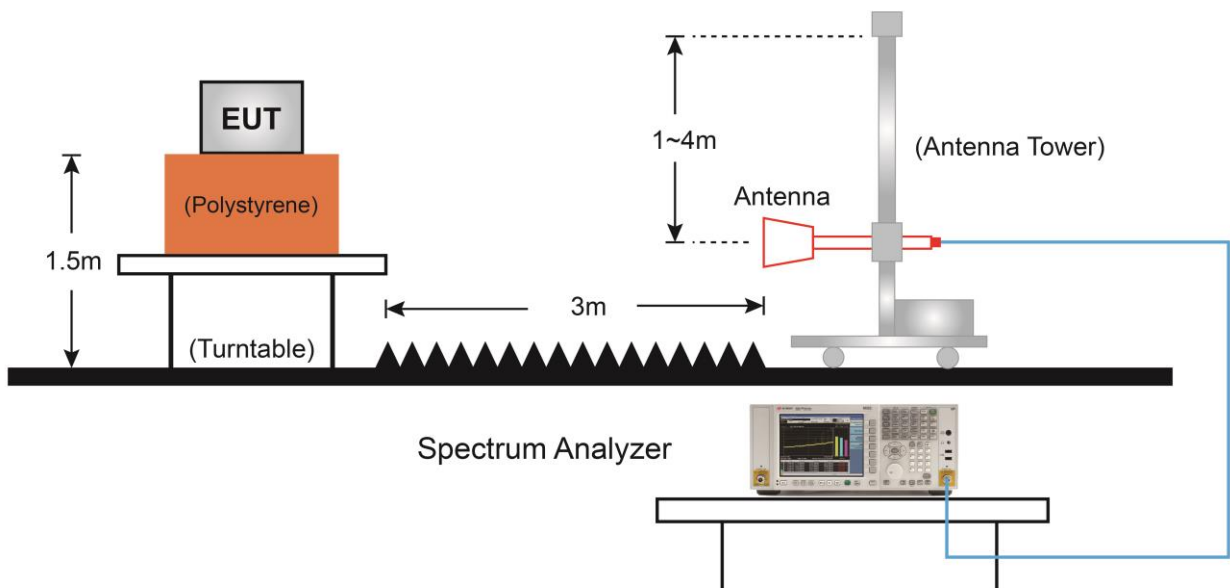

7.7.5. Test Result

EUT	AX3000 High Gain Wireless USB Adapter	Date of Test	2023-01-17
Factor	DRH18-E	Temp. / Humidity	20°C /62%
Polarity	Horizontal	Site / Test Engineer	AC2 / Ares
Test Mode	802.11b_TX_CH 1_ANT 1+2	Test Voltage	By Notebook PC

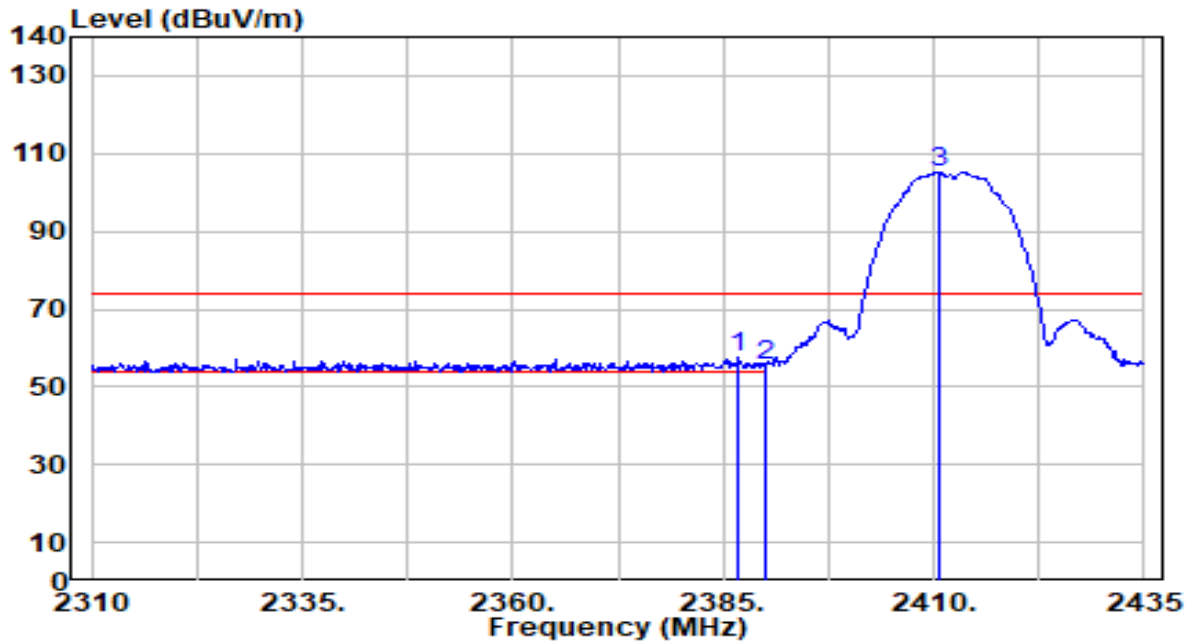

No	Frequency (MHz)	Reading (dBUV)	C.F (dB/m)	Measurement (dBUV/m)	Margin (dB)	Limit (dBUV/m)	Height (cm)	Angle (deg)	Remark (QP/PK/AV)
1	* 2386.750	27.63	29.99	57.62	-16.38	74.00	105	38	Peak
2	2390.000	25.31	29.99	55.31	-18.69	74.00	105	38	Peak
3	2410.625	75.17	30.04	105.22	N/A	N/A	105	38	Peak

Note:

1. " *", means this data is the worst emission level.
2. C.F (Correction Factor) = Antenna Factor (dB/m) + Cable Loss (dB).
3. Measurement (dBUV/m) = Reading(dBUV) + C.F (Correction Factor).
4. The emission levels of other frequencies are very lower than the limit and not show in test report.

EUT	AX3000 High Gain Wireless USB Adapter	Date of Test	2023-01-17
Factor	DRH18-E	Temp. / Humidity	20°C /62%
Polarity	Horizontal	Site / Test Engineer	AC2 / Ares
Test Mode	802.11b_TX_CH 1_ANT 1+2	Test Voltage	By Notebook PC

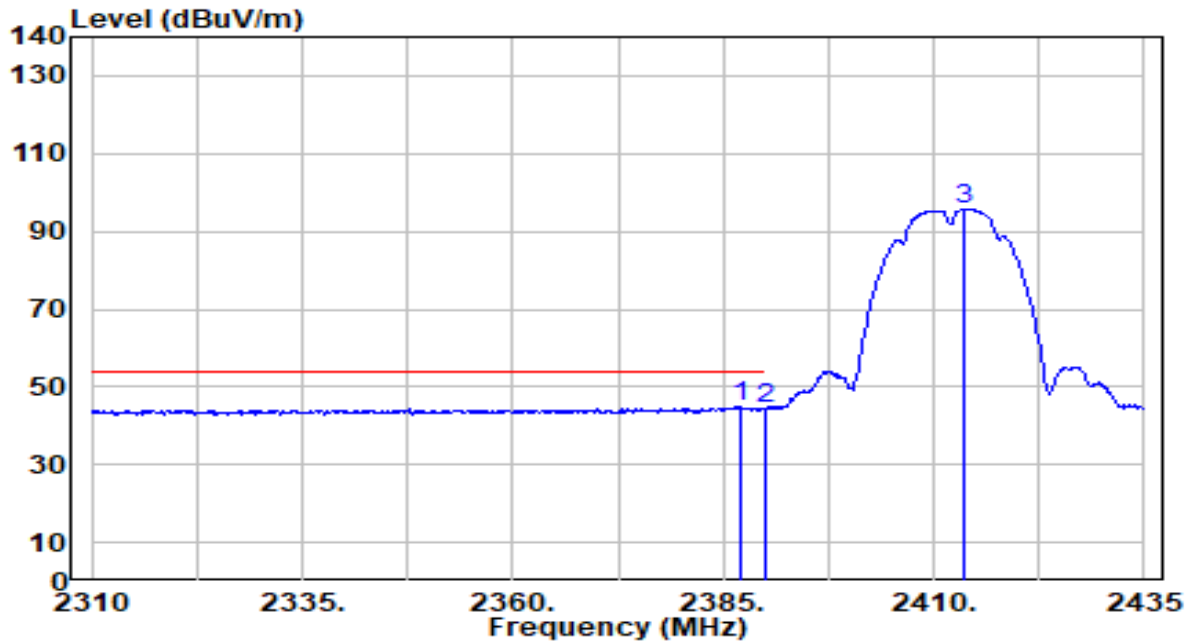

No	Frequency (MHz)	Reading (dBuV)	C.F (dB/m)	Measurement (dBuV/m)	Margin (dB)	Limit (dBuV/m)	Height (cm)	Angle (deg)	Remark (QP/PK/AV)	
1	*	2387.000	14.75	29.99	44.74	-9.26	54.00	105	38	Average
2		2390.000	14.55	29.99	44.55	-9.45	54.00	105	38	Average
3		2413.750	65.56	30.05	95.61	N/A	N/A	105	38	Average

Note:

1. " *", means this data is the worst emission level.
2. C.F (Correction Factor) = Antenna Factor (dB/m) + Cable Loss (dB).
3. Measurement (dBuV/m) = Reading(dBuV) + C.F (Correction Factor).
4. The emission levels of other frequencies are very lower than the limit and not show in test report.

EUT	AX3000 High Gain Wireless USB Adapter	Date of Test	2023-01-17
Factor	DRH18-E	Temp. / Humidity	20°C /62%
Polarity	Vertical	Site / Test Engineer	AC2 / Ares
Test Mode	802.11b_TX_CH 1_ANT 1+2	Test Voltage	By Notebook PC

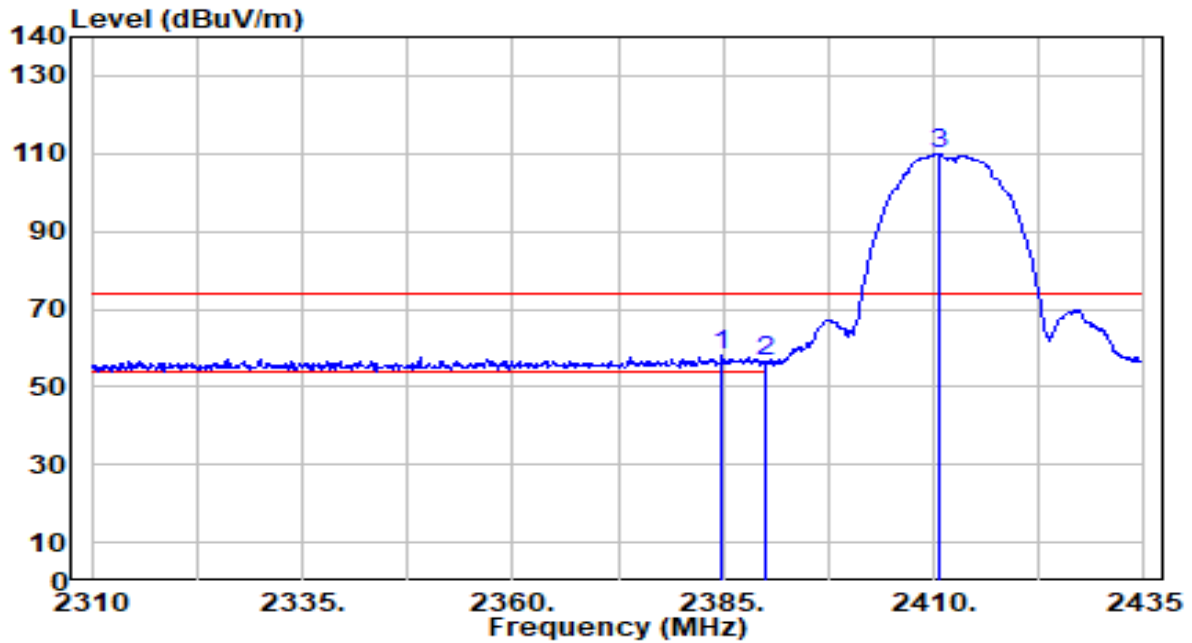

No	Frequency (MHz)	Reading (dBUV)	C.F (dB/m)	Measurement (dBUV/m)	Margin (dB)	Limit (dBUV/m)	Height (cm)	Angle (deg)	Remark (QP/PK/AV)
1	*	28.15	29.99	58.14	-15.86	74.00	200	357	Peak
2		26.44	29.99	56.43	-17.57	74.00	200	357	Peak
3		79.88	30.04	109.93	N/A	N/A	200	357	Peak

Note:

1. "*" , means this data is the worst emission level.
2. C.F (Correction Factor) = Antenna Factor (dB/m) + Cable Loss (dB).
3. Measurement (dBUV/m) = Reading(dBUV) + C.F (Correction Factor).
4. The emission levels of other frequencies are very lower than the limit and not show in test report.

EUT	AX3000 High Gain Wireless USB Adapter	Date of Test	2023-01-17
Factor	DRH18-E	Temp. / Humidity	20°C /62%
Polarity	Vertical	Site / Test Engineer	AC2 / Ares
Test Mode	802.11b_TX_CH 1_ANT 1+2	Test Voltage	By Notebook PC

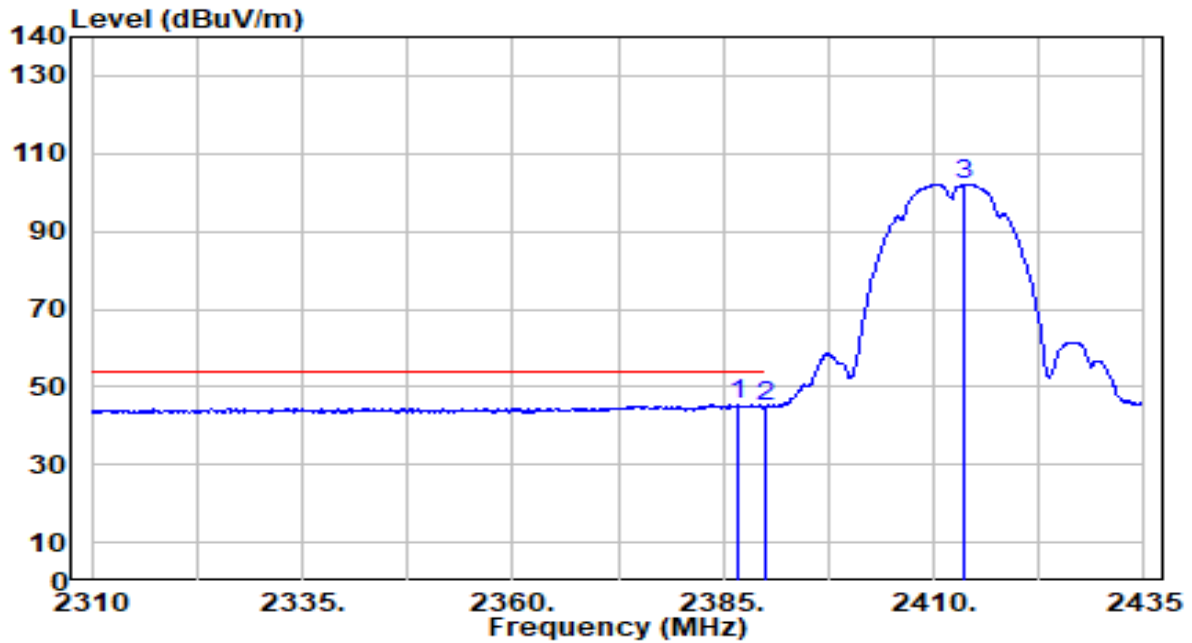

No	Frequency (MHz)	Reading (dBuV)	C.F (dB/m)	Measurement (dBuV/m)	Margin (dB)	Limit (dBuV/m)	Height (cm)	Angle (deg)	Remark (QP/PK/AV)	
1	*	2386.875	15.44	29.99	45.43	-8.57	54.00	200	357	Average
2		2390.000	14.80	29.99	44.79	-9.21	54.00	200	357	Average
3		2413.750	72.04	30.05	102.09	N/A	N/A	200	357	Average

Note:

1. " *", means this data is the worst emission level.
2. C.F (Correction Factor) = Antenna Factor (dB/m) + Cable Loss (dB).
3. Measurement (dBuV/m) = Reading(dBuV) + C.F (Correction Factor).
4. The emission levels of other frequencies are very lower than the limit and not show in test report.

EUT	AX3000 High Gain Wireless USB Adapter	Date of Test	2023-01-17
Factor	DRH18-E	Temp. / Humidity	20°C /62%
Polarity	Horizontal	Site / Test Engineer	AC2 / Ares
Test Mode	802.11b_TX_CH 6_ANT 1+2	Test Voltage	By Notebook PC

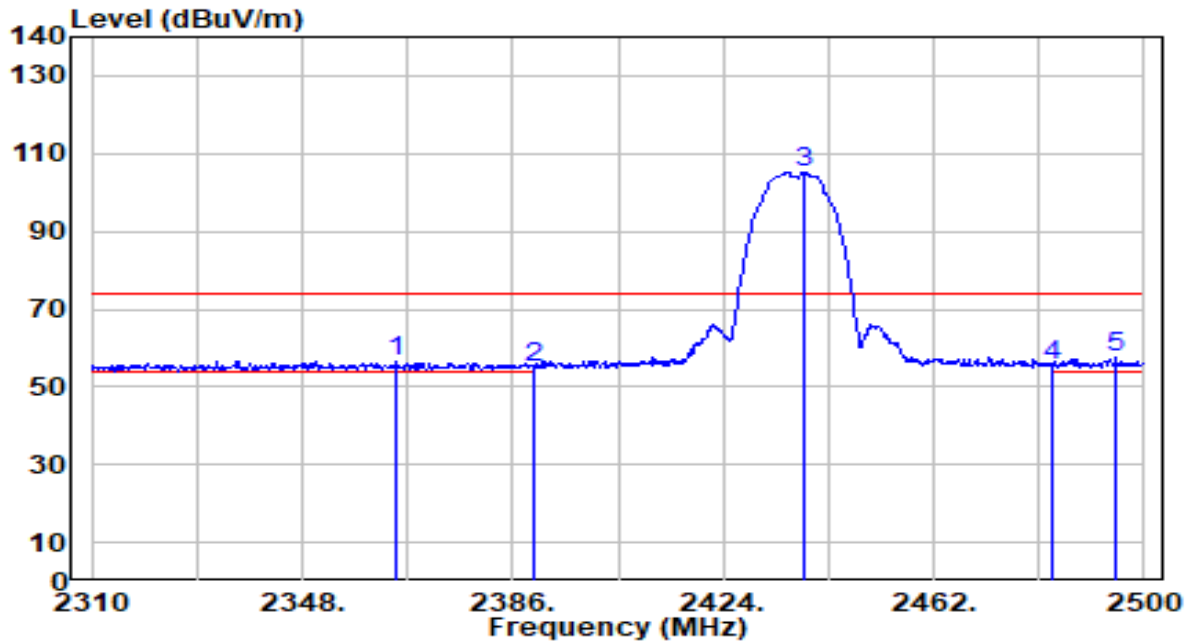

No	Frequency (MHz)	Reading (dBuV)	C.F (dB/m)	Measurement (dBuV/m)	Margin (dB)	Limit (dBuV/m)	Height (cm)	Angle (deg)	Remark (QP/PK/AV)
1	* 2365.100	26.42	29.96	56.38	-17.62	74.00	105	36	Peak
2	2390.000	24.95	29.99	54.94	-19.06	74.00	105	36	Peak
3	2438.630	75.07	30.14	105.21	N/A	N/A	105	36	Peak
4	2483.500	25.22	30.29	55.51	-18.49	74.00	105	36	Peak
5	2494.870	27.08	30.32	57.41	-16.59	74.00	105	36	Peak

Note:

1. " *", means this data is the worst emission level.
2. C.F (Correction Factor) = Antenna Factor (dB/m) + Cable Loss (dB).
3. Measurement (dBuV/m) = Reading(dBuV) + C.F (Correction Factor).
4. The emission levels of other frequencies are very lower than the limit and not show in test report.

EUT	AX3000 High Gain Wireless USB Adapter	Date of Test	2023-01-17
Factor	DRH18-E	Temp. / Humidity	20°C /62%
Polarity	Horizontal	Site / Test Engineer	AC2 / Ares
Test Mode	802.11b_TX_CH 6_ANT 1+2	Test Voltage	By Notebook PC

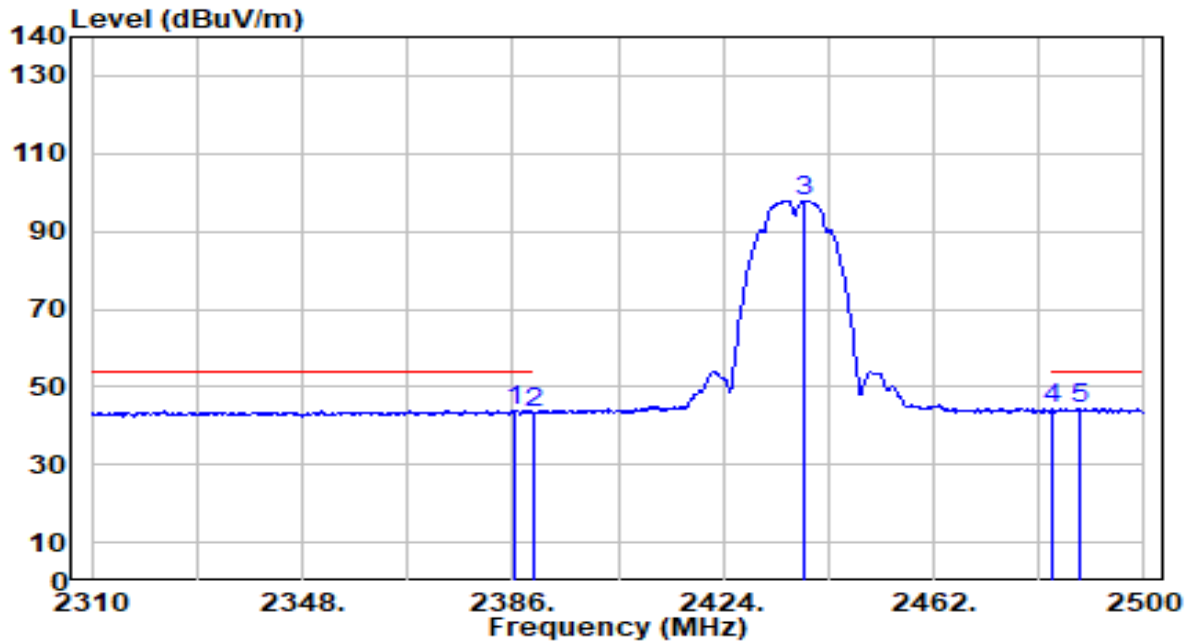

No	Frequency (MHz)	Reading (dBuV)	C.F (dB/m)	Measurement (dBuV/m)	Margin (dB)	Limit (dBuV/m)	Height (cm)	Angle (deg)	Remark (QP/PK/AV)
1	2386.570	13.94	29.99	43.93	-10.07	54.00	105	36	Average
2	2390.000	13.25	29.99	43.25	-10.75	54.00	105	36	Average
3	2438.820	67.66	30.14	97.80	N/A	N/A	105	36	Average
4	2483.500	14.05	30.29	44.33	-9.67	54.00	105	36	Average
5	* 2488.600	14.09	30.30	44.39	-9.61	54.00	105	36	Average

Note:

1. " *", means this data is the worst emission level.
2. C.F (Correction Factor) = Antenna Factor (dB/m) + Cable Loss (dB).
3. Measurement (dBuV/m) = Reading(dBuV) + C.F (Correction Factor).
4. The emission levels of other frequencies are very lower than the limit and not show in test report.

EUT	AX3000 High Gain Wireless USB Adapter	Date of Test	2023-01-17
Factor	DRH18-E	Temp. / Humidity	20°C /62%
Polarity	Vertical	Site / Test Engineer	AC2 / Ares
Test Mode	802.11b_TX_CH 6_ANT 1+2	Test Voltage	By Notebook PC

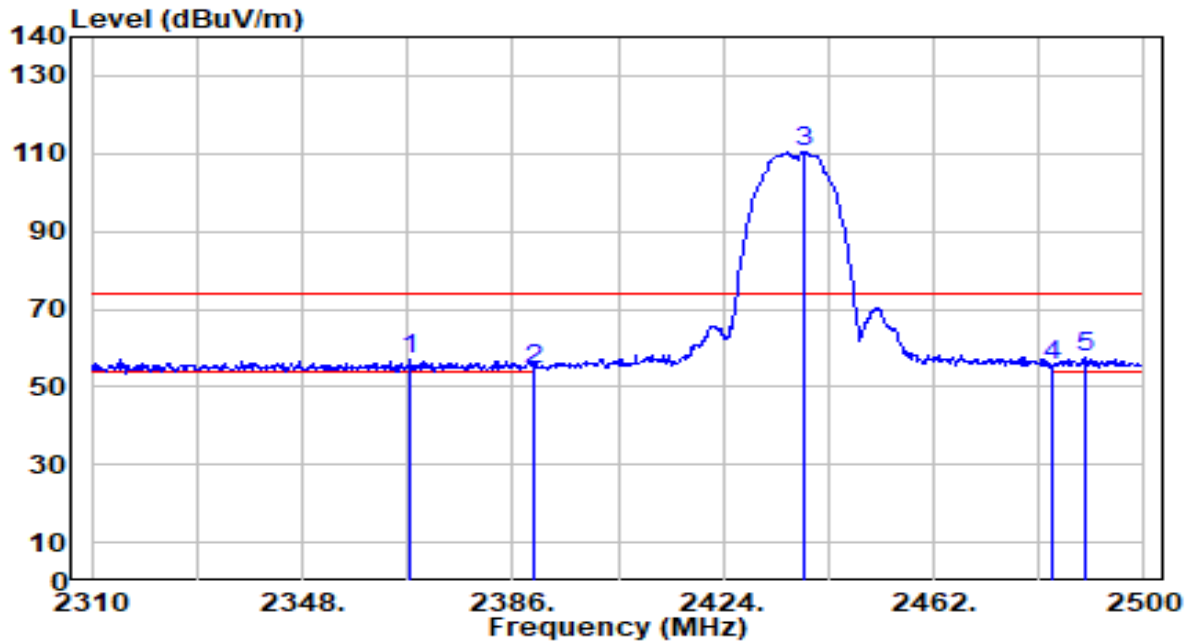

No	Frequency (MHz)	Reading (dBuV)	C.F (dB/m)	Measurement (dBuV/m)	Margin (dB)	Limit (dBuV/m)	Height (cm)	Angle (deg)	Remark (QP/PK/AV)
1	2367.380	27.27	29.96	57.24	-16.76	74.00	200	23	Peak
2	2390.000	24.52	29.99	54.52	-19.48	74.00	200	23	Peak
3	2438.440	80.30	30.14	110.44	N/A	N/A	200	23	Peak
4	2483.500	25.26	30.29	55.55	-18.45	74.00	200	23	Peak
5	* 2489.550	27.51	30.31	57.81	-16.19	74.00	200	23	Peak

Note:

1. " *", means this data is the worst emission level.
2. C.F (Correction Factor) = Antenna Factor (dB/m) + Cable Loss (dB).
3. Measurement (dBuV/m) = Reading(dBuV) + C.F (Correction Factor).
4. The emission levels of other frequencies are very lower than the limit and not show in test report.

EUT	AX3000 High Gain Wireless USB Adapter	Date of Test	2023-01-17
Factor	DRH18-E	Temp. / Humidity	20°C /62%
Polarity	Vertical	Site / Test Engineer	AC2 / Ares
Test Mode	802.11b_TX_CH 6_ANT 1+2	Test Voltage	By Notebook PC

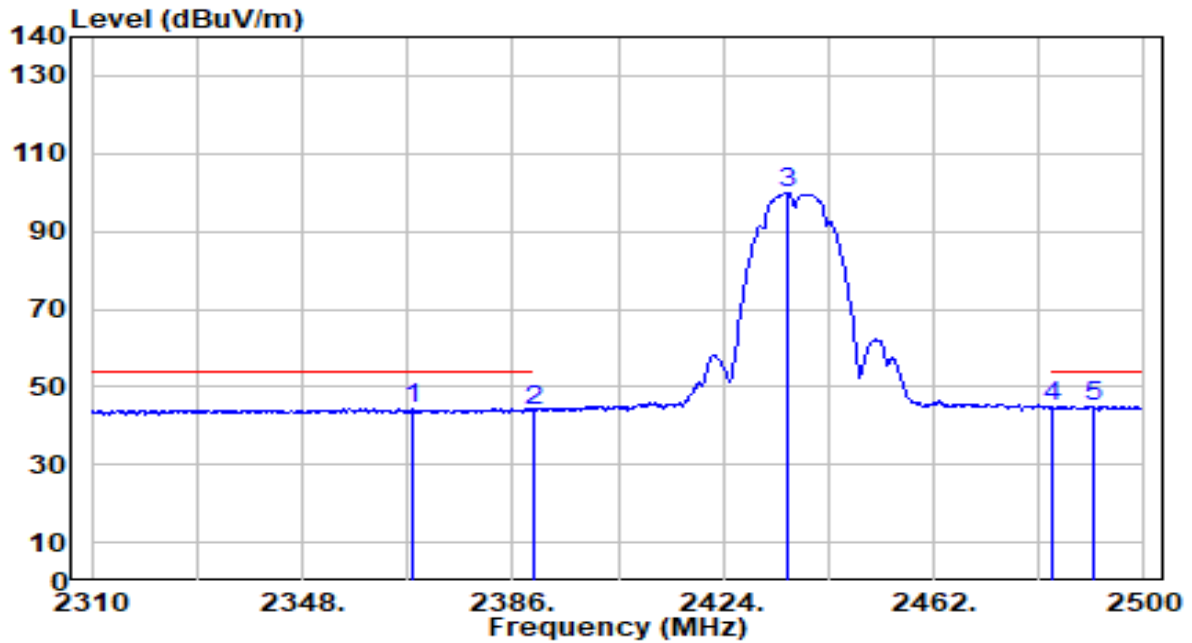

No	Frequency (MHz)	Reading (dBuV)	C.F (dB/m)	Measurement (dBuV/m)	Margin (dB)	Limit (dBuV/m)	Height (cm)	Angle (deg)	Remark (QP/PK/AV)
1	2367.760	14.41	29.97	44.37	-9.63	54.00	200	23	Average
2	2390.000	13.92	29.99	43.92	-10.08	54.00	200	23	Average
3	2435.780	69.65	30.13	99.78	N/A	N/A	200	23	Average
4	2483.500	14.52	30.29	44.81	-9.19	54.00	200	23	Average
5	* 2491.070	14.76	30.31	45.07	-8.93	54.00	200	23	Average

Note:

- " *", means this data is the worst emission level.
- C.F (Correction Factor) = Antenna Factor (dB/m) + Cable Loss (dB).
- Measurement (dBuV/m) = Reading(dBuV) + C.F (Correction Factor).
- The emission levels of other frequencies are very lower than the limit and not show in test report.

EUT	AX3000 High Gain Wireless USB Adapter	Date of Test	2023-01-17
Factor	DRH18-E	Temp. / Humidity	20°C /62%
Polarity	Horizontal	Site / Test Engineer	AC2 / Ares
Test Mode	802.11b_TX_CH 11_ANT 1+2	Test Voltage	By Notebook PC

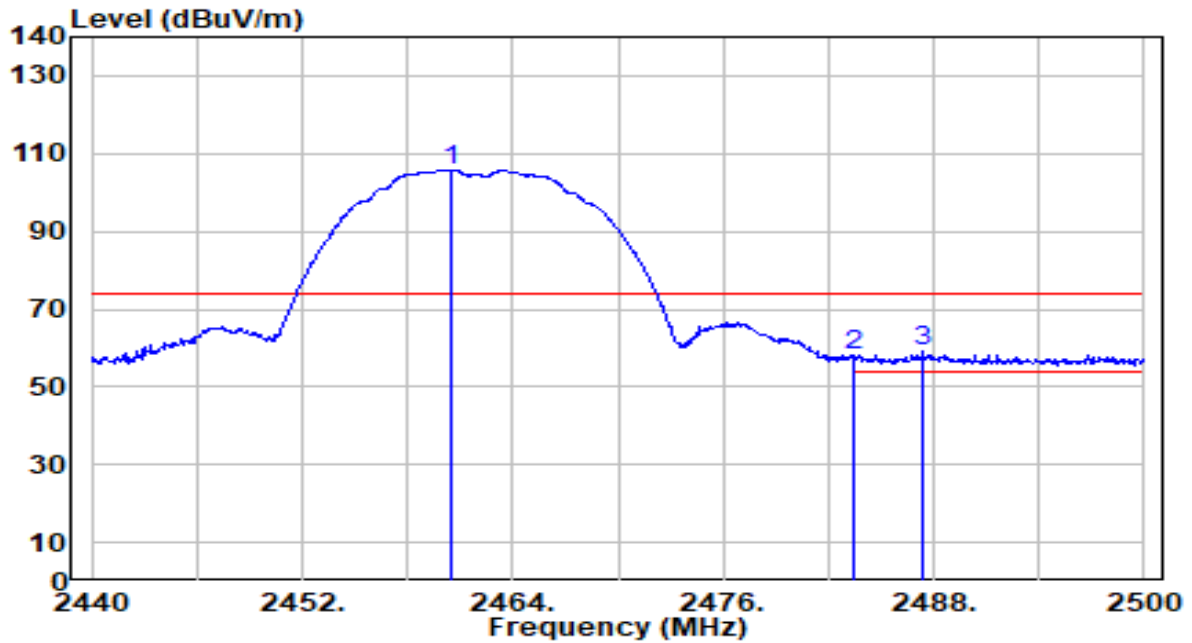

No	Frequency (MHz)	Reading (dBUV)	C.F (dB/m)	Measurement (dBUV/m)	Margin (dB)	Limit (dBUV/m)	Height (cm)	Angle (deg)	Remark (QP/PK/AV)
1	2460.460	75.57	30.21	105.78	N/A	N/A	140	30	Peak
2	2483.500	27.64	30.29	57.93	-16.07	74.00	140	30	Peak
3	* 2487.400	28.70	30.30	59.00	-15.00	74.00	140	30	Peak

Note:

1. " *", means this data is the worst emission level.
2. C.F (Correction Factor) = Antenna Factor (dB/m) + Cable Loss (dB).
3. Measurement (dBUV/m) = Reading(dBUV) + C.F (Correction Factor).
4. The emission levels of other frequencies are very lower than the limit and not show in test report.

EUT	AX3000 High Gain Wireless USB Adapter	Date of Test	2023-01-17
Factor	DRH18-E	Temp. / Humidity	20°C /62%
Polarity	Horizontal	Site / Test Engineer	AC2 / Ares
Test Mode	802.11b_TX_CH 11_ANT 1+2	Test Voltage	By Notebook PC

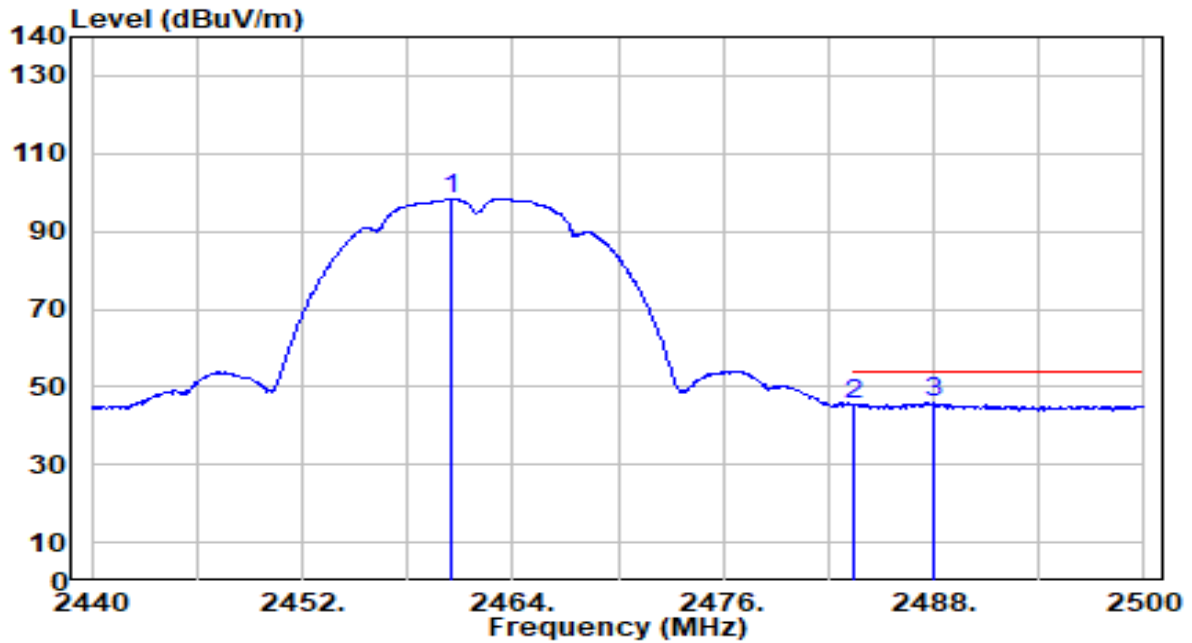

No	Frequency (MHz)	Reading (dBUV)	C.F (dB/m)	Measurement (dBUV/m)	Margin (dB)	Limit (dBUV/m)	Height (cm)	Angle (deg)	Remark (QP/PK/AV)
1	2460.460	67.99	30.21	98.20	N/A	N/A	140	30	Average
2	2483.500	15.20	30.29	45.49	-8.51	54.00	140	30	Average
3	* 2488.000	15.69	30.30	45.99	-8.01	54.00	140	30	Average

Note:

1. " *", means this data is the worst emission level.
2. C.F (Correction Factor) = Antenna Factor (dB/m) + Cable Loss (dB).
3. Measurement (dBUV/m) = Reading(dBUV) + C.F (Correction Factor).
4. The emission levels of other frequencies are very lower than the limit and not show in test report.

EUT	AX3000 High Gain Wireless USB Adapter	Date of Test	2023-01-17
Factor	DRH18-E	Temp. / Humidity	20°C /62%
Polarity	Vertical	Site / Test Engineer	AC2 / Ares
Test Mode	802.11b_TX_CH 11_ANT 1+2	Test Voltage	By Notebook PC

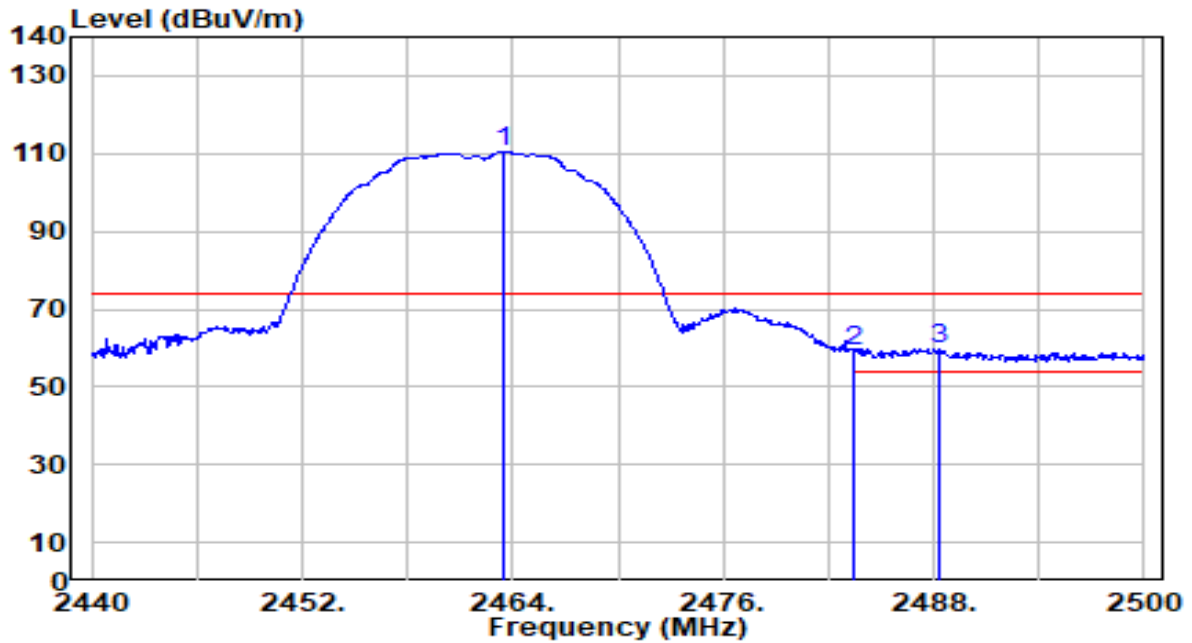

No	Frequency (MHz)	Reading (dBUV)	C.F (dB/m)	Measurement (dBUV/m)	Margin (dB)	Limit (dBUV/m)	Height (cm)	Angle (deg)	Remark (QP/PK/AV)
1	2463.520	80.18	30.22	110.40	N/A	N/A	200	23	Peak
2	2483.500	29.12	30.29	59.41	-14.59	74.00	200	23	Peak
3	* 2488.300	29.58	30.30	59.88	-14.12	74.00	200	23	Peak

Note:

1. " *", means this data is the worst emission level.
2. C.F (Correction Factor) = Antenna Factor (dB/m) + Cable Loss (dB).
3. Measurement (dBUV/m) = Reading(dBUV) + C.F (Correction Factor).
4. The emission levels of other frequencies are very lower than the limit and not show in test report.

EUT	AX3000 High Gain Wireless USB Adapter	Date of Test	2023-01-17
Factor	DRH18-E	Temp. / Humidity	20°C /62%
Polarity	Vertical	Site / Test Engineer	AC2 / Ares
Test Mode	802.11b_TX_CH 11_ANT 1+2	Test Voltage	By Notebook PC

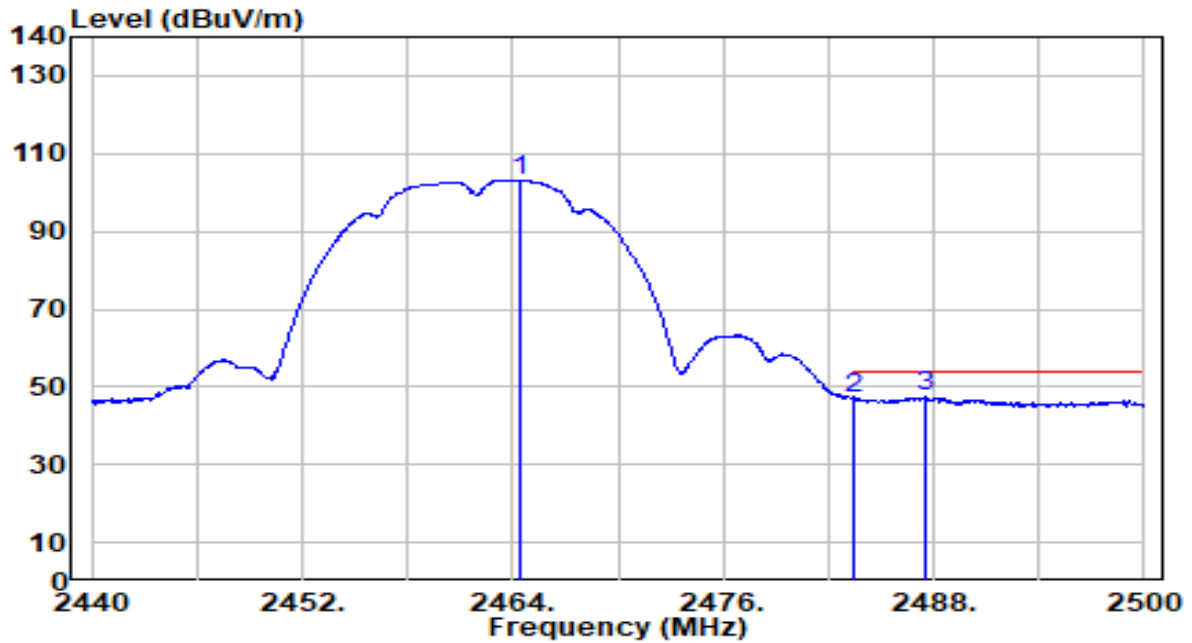

No	Frequency (MHz)	Reading (dBUV)	C.F (dB/m)	Measurement (dBUV/m)	Margin (dB)	Limit (dBUV/m)	Height (cm)	Angle (deg)	Remark (QP/PK/AV)
1	2464.480	72.93	30.22	103.15	N/A	N/A	200	23	Average
2	2483.500	16.83	30.29	47.11	-6.89	54.00	200	23	Average
3	* 2487.460	17.20	30.30	47.50	-6.50	54.00	200	23	Average

Note:

1. " *", means this data is the worst emission level.
2. C.F (Correction Factor) = Antenna Factor (dB/m) + Cable Loss (dB).
3. Measurement (dBUV/m) = Reading(dBUV) + C.F (Correction Factor).
4. The emission levels of other frequencies are very lower than the limit and not show in test report.

EUT	AX3000 High Gain Wireless USB Adapter	Date of Test	2023-01-17
Factor	DRH18-E	Temp. / Humidity	20°C /62%
Polarity	Horizontal	Site / Test Engineer	AC2 / Ares
Test Mode	802.11g_TX_CH 1_ANT 1+2	Test Voltage	By Notebook PC

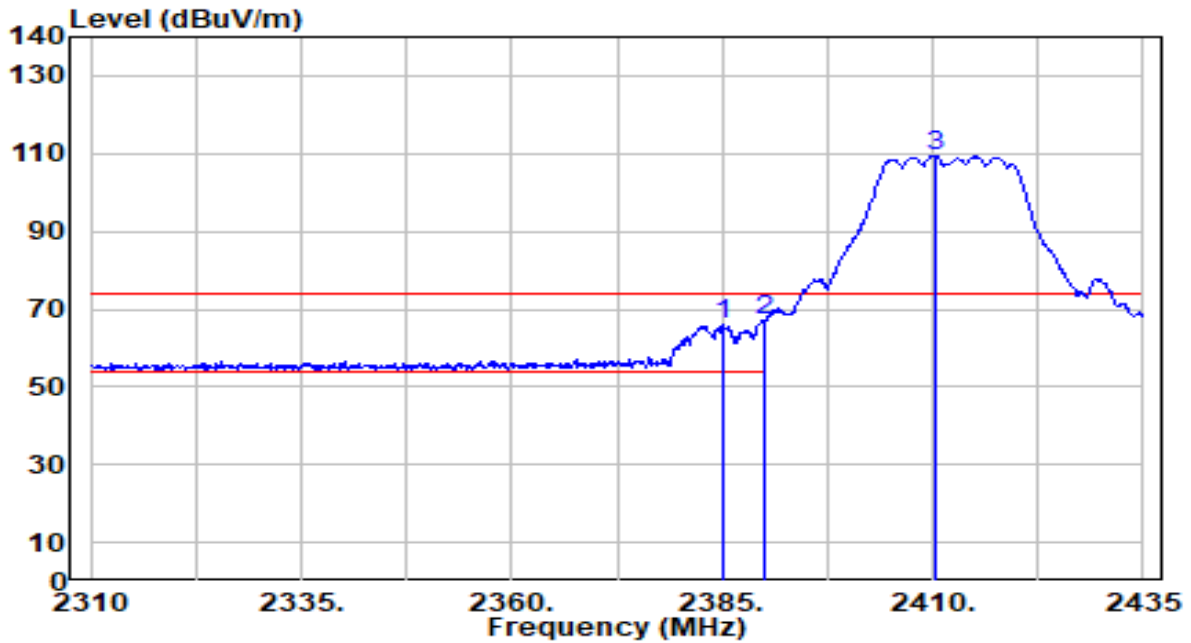

No	Frequency (MHz)	Reading (dBUV)	C.F (dB/m)	Measurement (dBUV/m)	Margin (dB)	Limit (dBUV/m)	Height (cm)	Angle (deg)	Remark (QP/PK/AV)
1	2385.000	35.96	29.99	65.95	-8.05	74.00	214	227	Peak
2	* 2390.000	37.20	29.99	67.19	-6.81	74.00	214	227	Peak
3	2410.250	79.26	30.04	109.30	N/A	N/A	214	227	Peak

Note:

1. " *", means this data is the worst emission level.
2. C.F (Correction Factor) = Antenna Factor (dB/m) + Cable Loss (dB).
3. Measurement (dBUV/m) = Reading(dBUV) + C.F (Correction Factor).
4. The emission levels of other frequencies are very lower than the limit and not show in test report.

EUT	AX3000 High Gain Wireless USB Adapter	Date of Test	2023-01-17
Factor	DRH18-E	Temp. / Humidity	20°C /62%
Polarity	Horizontal	Site / Test Engineer	AC2 / Ares
Test Mode	802.11g_TX_CH 1_ANT 1+2	Test Voltage	By Notebook PC

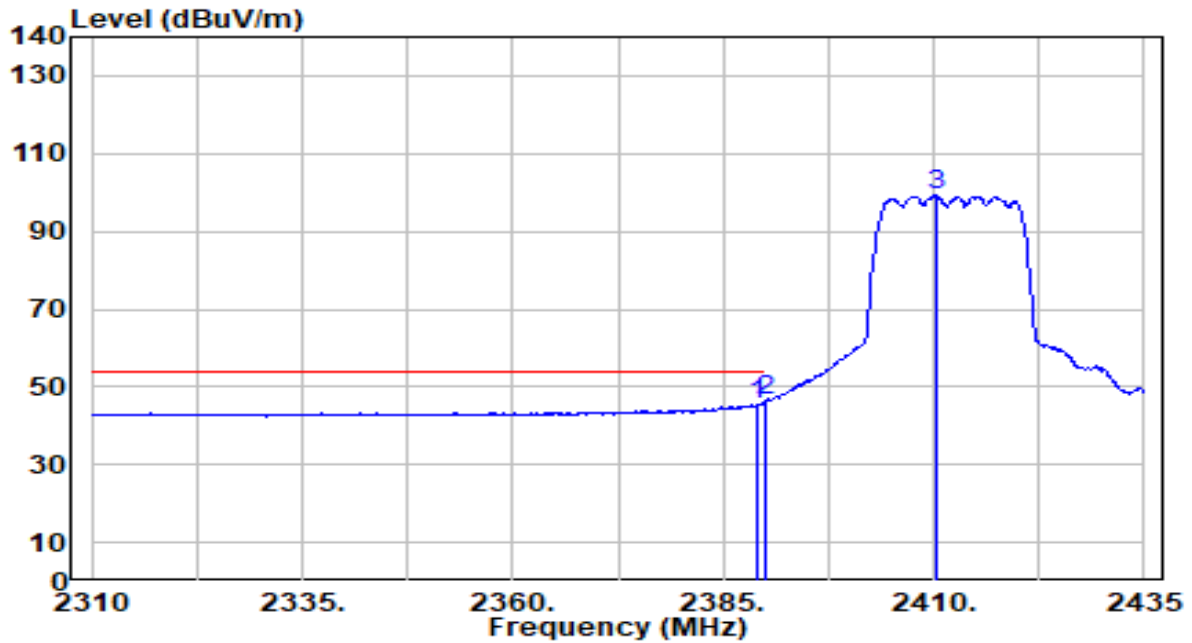

No	Frequency (MHz)	Reading (dBUV)	C.F (dB/m)	Measurement (dBUV/m)	Margin (dB)	Limit (dBUV/m)	Height (cm)	Angle (deg)	Remark (QP/PK/AV)
1	2389.000	15.24	29.99	45.23	-8.77	54.00	214	227	Average
2	* 2390.000	16.33	29.99	46.32	-7.68	54.00	214	227	Average
3	2410.250	69.25	30.04	99.30	N/A	N/A	214	227	Average

Note:

1. " *", means this data is the worst emission level.
2. C.F (Correction Factor) = Antenna Factor (dB/m) + Cable Loss (dB).
3. Measurement (dBUV/m) = Reading(dBUV) + C.F (Correction Factor).
4. The emission levels of other frequencies are very lower than the limit and not show in test report.

EUT	AX3000 High Gain Wireless USB Adapter	Date of Test	2023-01-17
Factor	DRH18-E	Temp. / Humidity	20°C /62%
Polarity	Vertical	Site / Test Engineer	AC2 / Ares
Test Mode	802.11g_TX_CH 1_ANT 1+2	Test Voltage	By Notebook PC

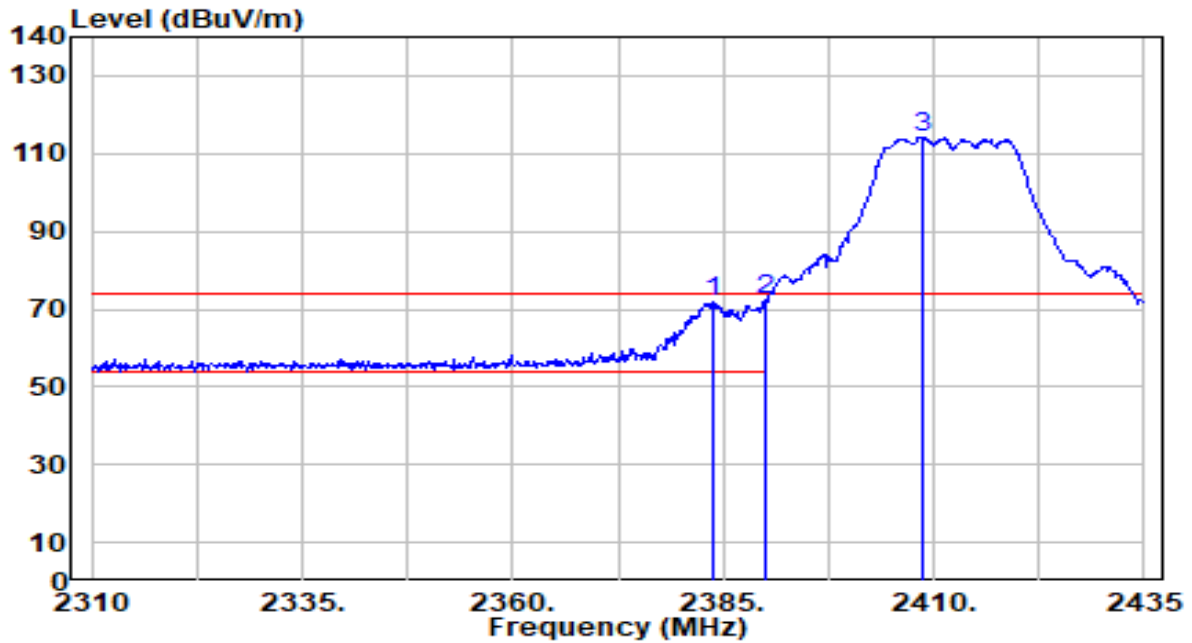

No	Frequency (MHz)	Reading (dBUV)	C.F (dB/m)	Measurement (dBUV/m)	Margin (dB)	Limit (dBUV/m)	Height (cm)	Angle (deg)	Remark (QP/PK/AV)
1	2383.875	41.93	29.99	71.92	-2.08	74.00	243	237	Peak
2	* 2390.000	42.16	29.99	72.15	-1.85	74.00	243	237	Peak
3	2408.750	84.01	30.04	114.05	N/A	N/A	243	237	Peak

Note:

1. " *", means this data is the worst emission level.
2. C.F (Correction Factor) = Antenna Factor (dB/m) + Cable Loss (dB).
3. Measurement (dBUV/m) = Reading(dBUV) + C.F (Correction Factor).
4. The emission levels of other frequencies are very lower than the limit and not show in test report.

EUT	AX3000 High Gain Wireless USB Adapter	Date of Test	2023-01-17
Factor	DRH18-E	Temp. / Humidity	20°C /62%
Polarity	Vertical	Site / Test Engineer	AC2 / Ares
Test Mode	802.11g_TX_CH 1_ANT 1+2	Test Voltage	By Notebook PC

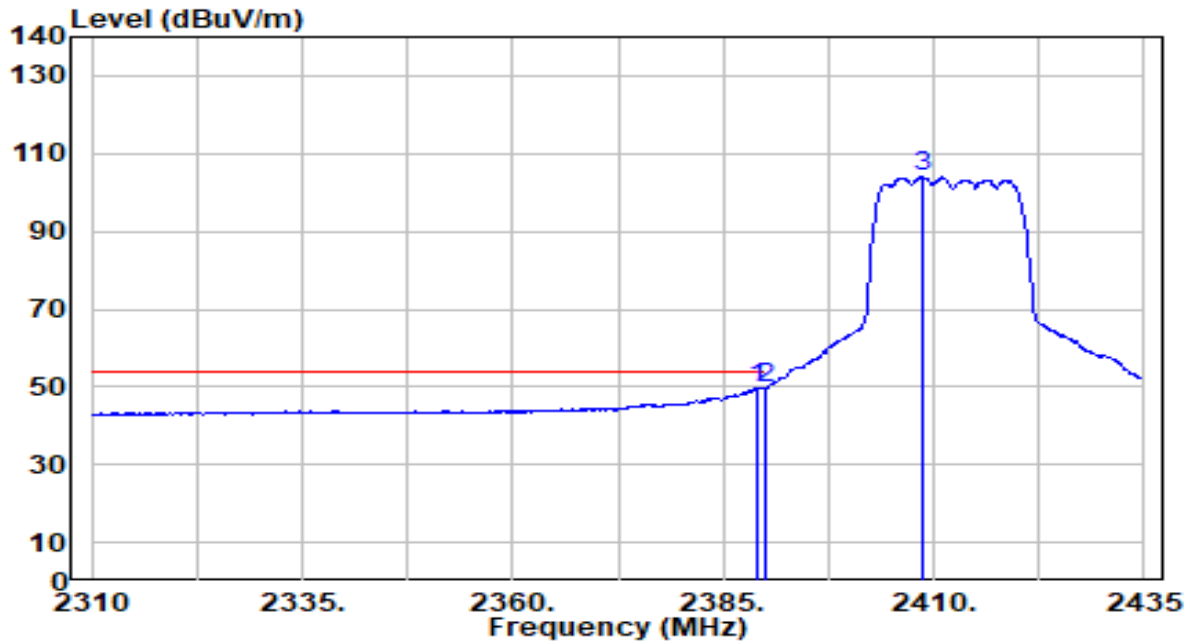

No	Frequency (MHz)	Reading (dBUV)	C.F (dB/m)	Measurement (dBUV/m)	Margin (dB)	Limit (dBUV/m)	Height (cm)	Angle (deg)	Remark (QP/PK/AV)
1	2389.000	19.63	29.99	49.62	-4.38	54.00	243	237	Average
2	* 2390.000	19.90	29.99	49.89	-4.11	54.00	243	237	Average
3	2408.750	73.90	30.04	103.94	N/A	N/A	243	237	Average

Note:

1. " *", means this data is the worst emission level.
2. C.F (Correction Factor) = Antenna Factor (dB/m) + Cable Loss (dB).
3. Measurement (dBUV/m) = Reading(dBUV) + C.F (Correction Factor).
4. The emission levels of other frequencies are very lower than the limit and not show in test report.

EUT	AX3000 High Gain Wireless USB Adapter	Date of Test	2023-01-17
Factor	DRH18-E	Temp. / Humidity	20°C /62%
Polarity	Horizontal	Site / Test Engineer	AC2 / Ares
Test Mode	802.11g_TX_CH 6_ANT 1+2	Test Voltage	By Notebook PC

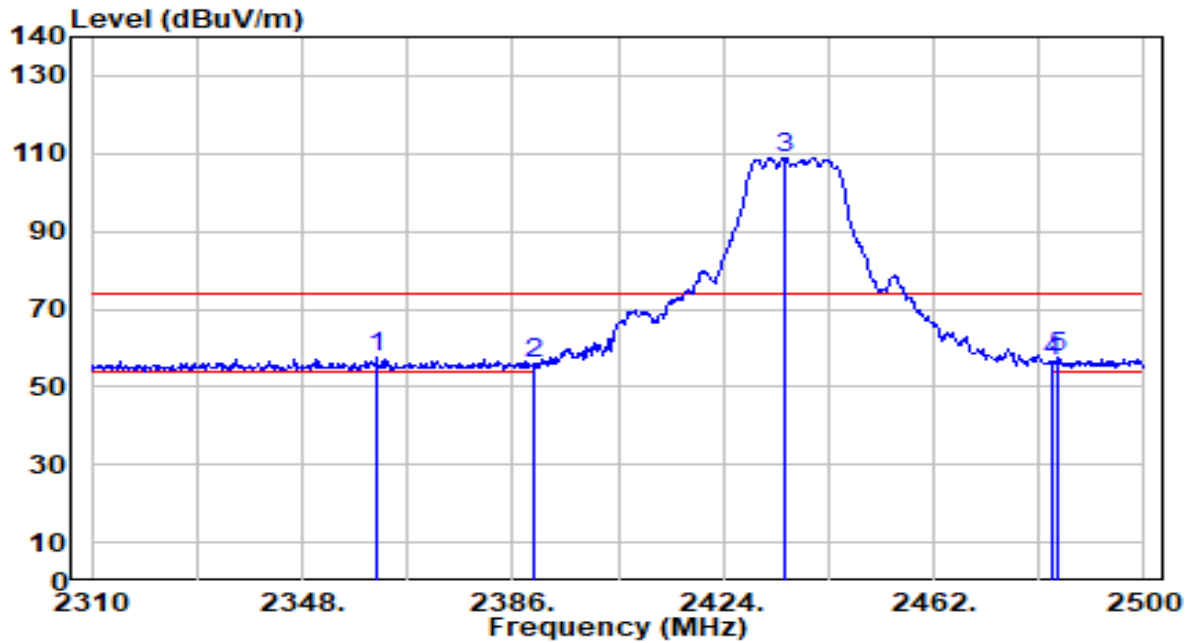

No	Frequency (MHz)	Reading (dBuV)	C.F (dB/m)	Measurement (dBuV/m)	Margin (dB)	Limit (dBuV/m)	Height (cm)	Angle (deg)	Remark (QP/PK/AV)
1	2361.490	27.39	29.96	57.35	-16.65	74.00	214	227	Peak
2	2390.000	25.75	29.99	55.74	-18.26	74.00	214	227	Peak
3	2435.020	78.62	30.12	108.75	N/A	N/A	214	227	Peak
4	2483.500	26.44	30.29	56.72	-17.28	74.00	214	227	Peak
5	* 2484.610	27.16	30.29	57.45	-16.55	74.00	214	227	Peak

Note:

1. " *", means this data is the worst emission level.
2. C.F (Correction Factor) = Antenna Factor (dB/m) + Cable Loss (dB).
3. Measurement (dBuV/m) = Reading(dBuV) + C.F (Correction Factor).
4. The emission levels of other frequencies are very lower than the limit and not show in test report.

EUT	AX3000 High Gain Wireless USB Adapter	Date of Test	2023-01-17
Factor	DRH18-E	Temp. / Humidity	20°C /62%
Polarity	Horizontal	Site / Test Engineer	AC2 / Ares
Test Mode	802.11g_TX_CH 6_ANT 1+2	Test Voltage	By Notebook PC

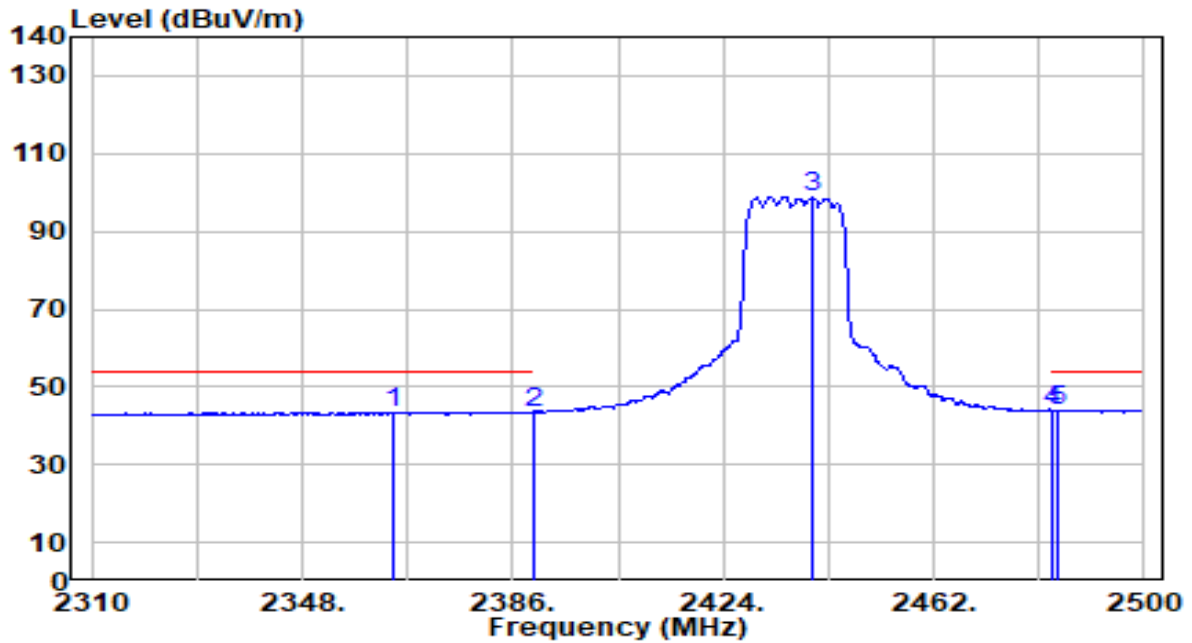

No	Frequency (MHz)	Reading (dBuV)	C.F (dB/m)	Measurement (dBuV/m)	Margin (dB)	Limit (dBuV/m)	Height (cm)	Angle (deg)	Remark (QP/PK/AV)
1	2364.340	13.61	29.96	43.57	-10.43	54.00	214	227	Average
2	2390.000	13.21	29.99	43.21	-10.79	54.00	214	227	Average
3	2439.960	68.58	30.14	98.72	N/A	N/A	214	227	Average
4	2483.500	13.41	30.29	43.69	-10.31	54.00	214	227	Average
5	* 2484.420	13.77	30.29	44.06	-9.94	54.00	214	227	Average

Note:

1. " *", means this data is the worst emission level.
2. C.F (Correction Factor) = Antenna Factor (dB/m) + Cable Loss (dB).
3. Measurement (dBuV/m) = Reading(dBuV) + C.F (Correction Factor).
4. The emission levels of other frequencies are very lower than the limit and not show in test report.

EUT	AX3000 High Gain Wireless USB Adapter	Date of Test	2023-01-17
Factor	DRH18-E	Temp. / Humidity	20°C /62%
Polarity	Vertical	Site / Test Engineer	AC2 / Ares
Test Mode	802.11g_TX_CH 6_ANT 1+2	Test Voltage	By Notebook PC

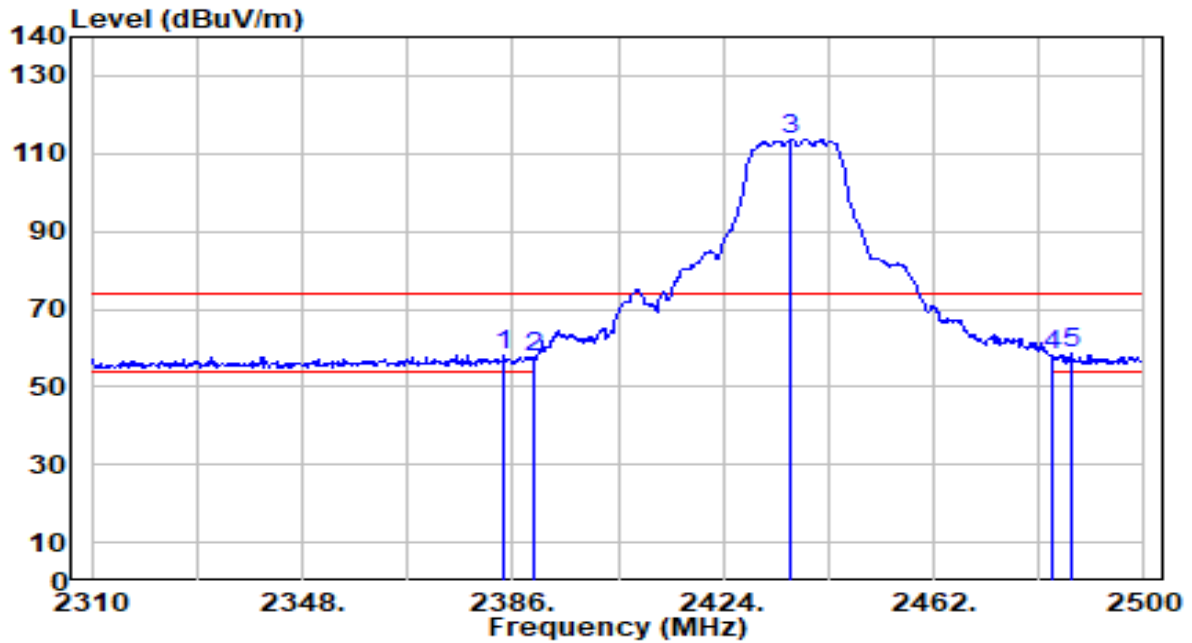

No	Frequency (MHz)	Reading (dBuV)	C.F (dB/m)	Measurement (dBuV/m)	Margin (dB)	Limit (dBuV/m)	Height (cm)	Angle (deg)	Remark (QP/PK/AV)
1	2384.480	28.14	29.99	58.12	-15.88	74.00	243	237	Peak
2	2390.000	27.65	29.99	57.65	-16.35	74.00	243	237	Peak
3	2436.350	83.68	30.13	113.81	N/A	N/A	243	237	Peak
4	2483.500	27.94	30.29	58.23	-15.77	74.00	243	237	Peak
5	* 2487.080	28.24	30.30	58.54	-15.46	74.00	243	237	Peak

Note:

1. " *", means this data is the worst emission level.
2. C.F (Correction Factor) = Antenna Factor (dB/m) + Cable Loss (dB).
3. Measurement (dBuV/m) = Reading(dBuV) + C.F (Correction Factor).
4. The emission levels of other frequencies are very lower than the limit and not show in test report.

EUT	AX3000 High Gain Wireless USB Adapter	Date of Test	2023-01-17
Factor	DRH18-E	Temp. / Humidity	20°C /62%
Polarity	Vertical	Site / Test Engineer	AC2 / Ares
Test Mode	802.11g_TX_CH 6_ANT 1+2	Test Voltage	By Notebook PC

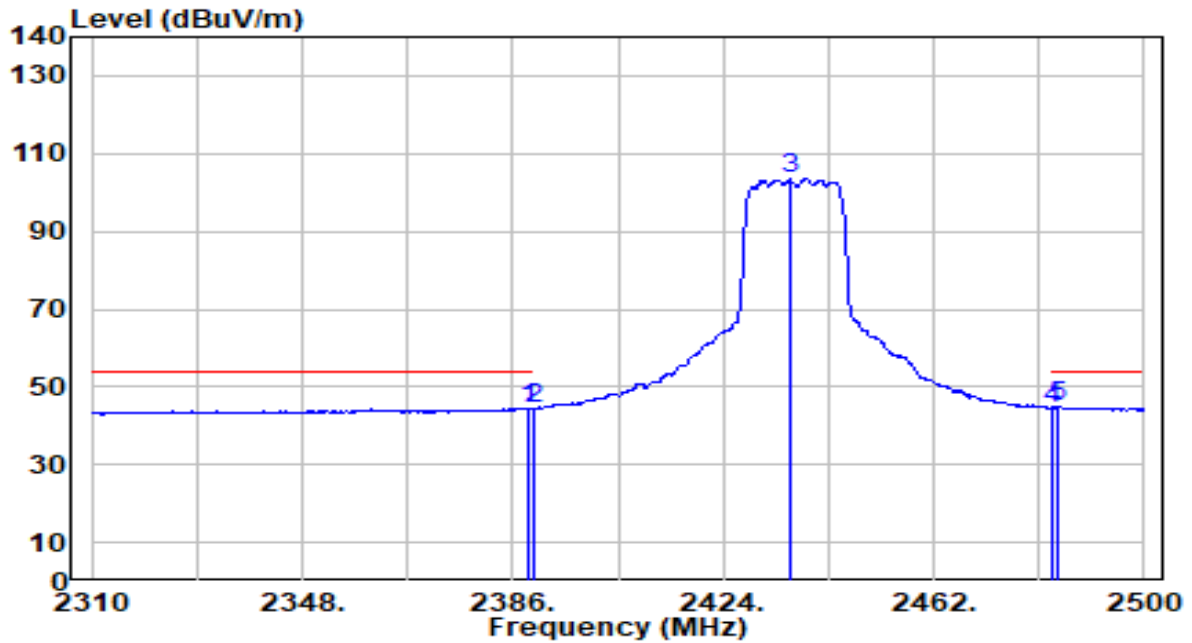

No	Frequency (MHz)	Reading (dBuV)	C.F (dB/m)	Measurement (dBuV/m)	Margin (dB)	Limit (dBuV/m)	Height (cm)	Angle (deg)	Remark (QP/PK/AV)
1	2389.040	14.54	29.99	44.54	-9.46	54.00	243	237	Average
2	2390.000	14.46	29.99	44.46	-9.54	54.00	243	237	Average
3	2435.970	73.31	30.13	103.44	N/A	N/A	243	237	Average
4	2483.500	14.27	30.29	44.55	-9.45	54.00	243	237	Average
5	* 2484.610	14.59	30.29	44.88	-9.12	54.00	243	237	Average

Note:

- "*" means this data is the worst emission level.
- C.F (Correction Factor) = Antenna Factor (dB/m) + Cable Loss (dB).
- Measurement (dBuV/m) = Reading(dBuV) + C.F (Correction Factor).
- The emission levels of other frequencies are very lower than the limit and not show in test report.

EUT	AX3000 High Gain Wireless USB Adapter	Date of Test	2023-01-17
Factor	DRH18-E	Temp. / Humidity	20°C /62%
Polarity	Horizontal	Site / Test Engineer	AC2 / Ares
Test Mode	802.11g_TX_CH 11_ANT 1+2	Test Voltage	By Notebook PC

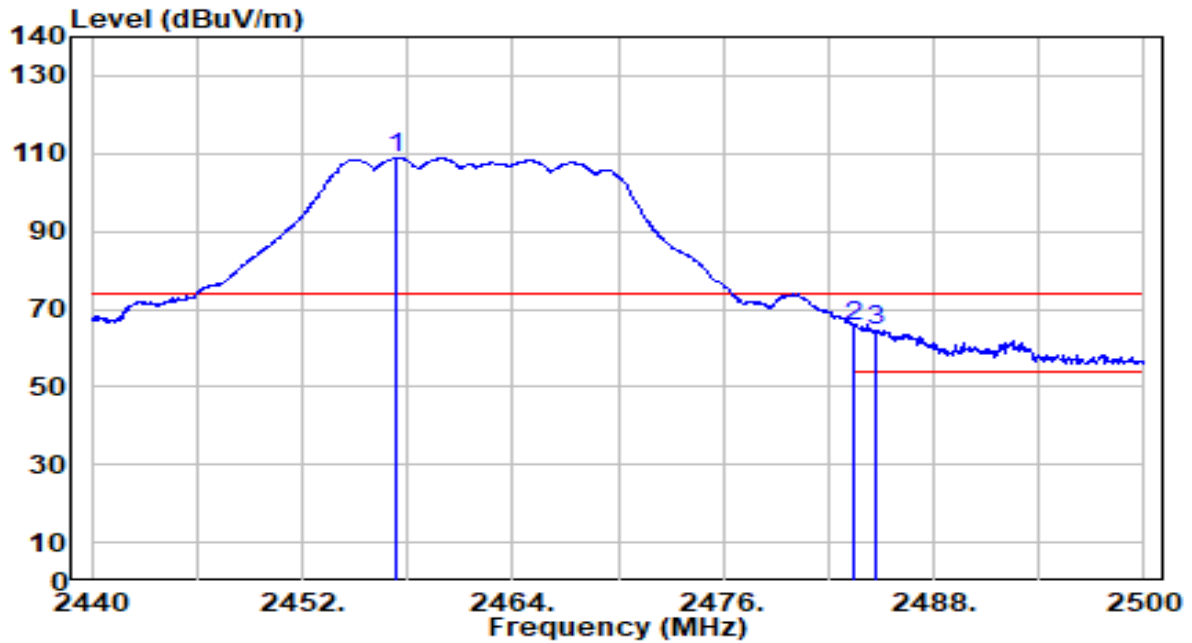

No	Frequency (MHz)	Reading (dBUV)	C.F (dB/m)	Measurement (dBUV/m)	Margin (dB)	Limit (dBUV/m)	Height (cm)	Angle (deg)	Remark (QP/PK/AV)
1	2457.340	78.56	30.20	108.76	N/A	N/A	210	228	Peak
2	* 2483.500	35.33	30.29	65.61	-8.39	74.00	210	228	Peak
3	2484.760	34.14	30.29	64.43	-9.57	74.00	210	228	Peak

Note:

1. " *", means this data is the worst emission level.
2. C.F (Correction Factor) = Antenna Factor (dB/m) + Cable Loss (dB).
3. Measurement (dBUV/m) = Reading(dBUV) + C.F (Correction Factor).
4. The emission levels of other frequencies are very lower than the limit and not show in test report.

EUT	AX3000 High Gain Wireless USB Adapter	Date of Test	2023-01-17
Factor	DRH18-E	Temp. / Humidity	20°C /62%
Polarity	Horizontal	Site / Test Engineer	AC2 / Ares
Test Mode	802.11g_TX_CH 11_ANT 1+2	Test Voltage	By Notebook PC

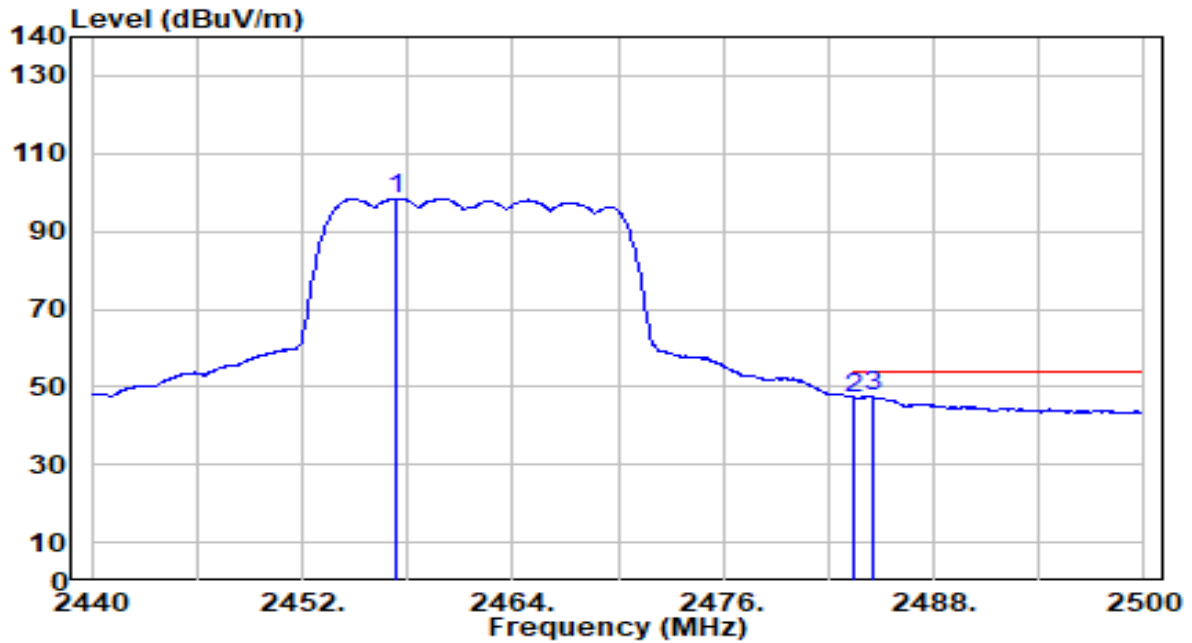

No	Frequency (MHz)	Reading (dBUV)	C.F (dB/m)	Measurement (dBUV/m)	Margin (dB)	Limit (dBUV/m)	Height (cm)	Angle (deg)	Remark (QP/PK/AV)
1	2457.340	68.25	30.20	98.45	N/A	N/A	210	228	Average
2	2483.500	16.88	30.29	47.17	-6.83	54.00	210	228	Average
3	* 2484.580	17.08	30.29	47.37	-6.63	54.00	210	228	Average

Note:

1. " *", means this data is the worst emission level.
2. C.F (Correction Factor) = Antenna Factor (dB/m) + Cable Loss (dB).
3. Measurement (dBUV/m) = Reading(dBUV) + C.F (Correction Factor).
4. The emission levels of other frequencies are very lower than the limit and not show in test report.

EUT	AX3000 High Gain Wireless USB Adapter	Date of Test	2023-01-17
Factor	DRH18-E	Temp. / Humidity	20°C /62%
Polarity	Vertical	Site / Test Engineer	AC2 / Ares
Test Mode	802.11g_TX_CH 11_ANT 1+2	Test Voltage	By Notebook PC

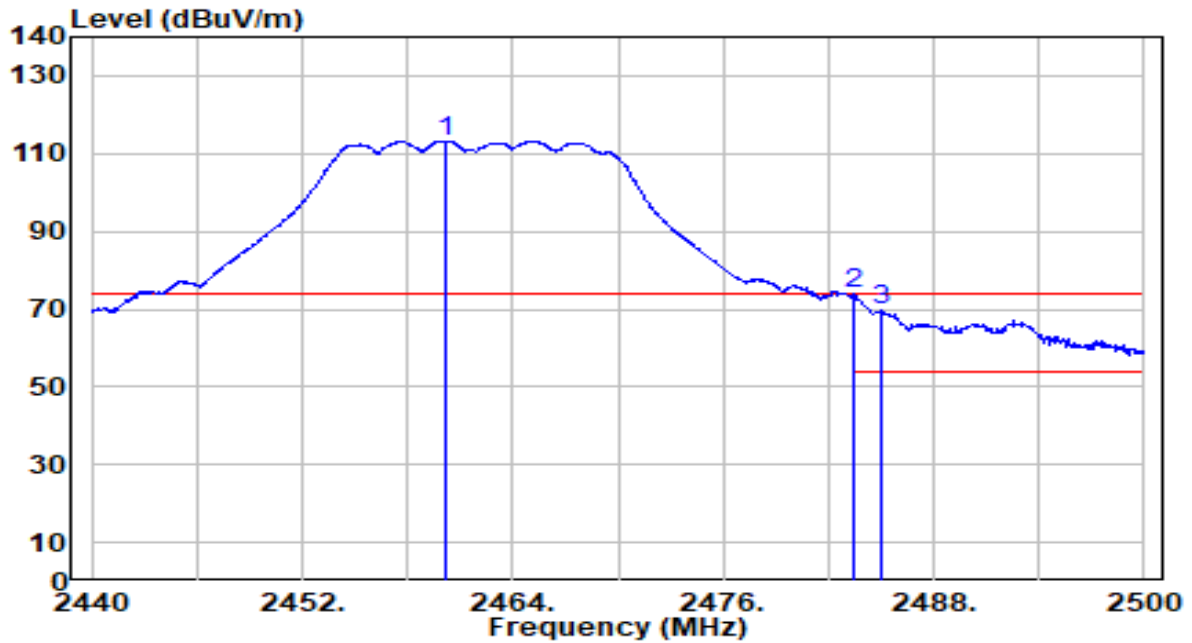

No	Frequency (MHz)	Reading (dBUV)	C.F (dB/m)	Measurement (dBUV/m)	Margin (dB)	Limit (dBUV/m)	Height (cm)	Angle (deg)	Remark (QP/PK/AV)
1	2460.160	83.10	30.21	113.31	N/A	N/A	228	352	Peak
2	* 2483.500	43.61	30.29	73.89	-0.11	74.00	228	352	Peak
3	2485.060	39.25	30.29	69.54	-4.46	74.00	228	352	Peak

Note:

1. " *", means this data is the worst emission level.
2. C.F (Correction Factor) = Antenna Factor (dB/m) + Cable Loss (dB).
3. Measurement (dBUV/m) = Reading(dBUV) + C.F (Correction Factor).
4. The emission levels of other frequencies are very lower than the limit and not show in test report.

EUT	AX3000 High Gain Wireless USB Adapter	Date of Test	2023-01-17
Factor	DRH18-E	Temp. / Humidity	20°C /62%
Polarity	Vertical	Site / Test Engineer	AC2 / Ares
Test Mode	802.11g_TX_CH 11_ANT 1+2	Test Voltage	By Notebook PC

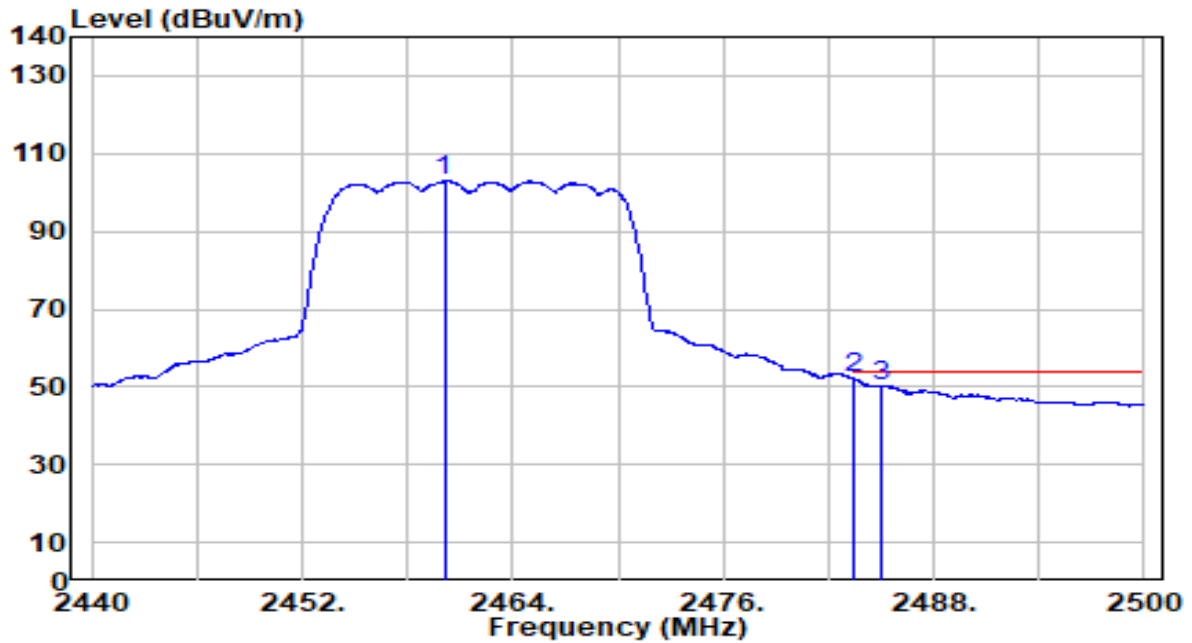

No	Frequency (MHz)	Reading (dBUV)	C.F (dB/m)	Measurement (dBUV/m)	Margin (dB)	Limit (dBUV/m)	Height (cm)	Angle (deg)	Remark (QP/PK/AV)
1	2460.100	72.70	30.21	102.91	N/A	N/A	228	352	Average
2	* 2483.500	21.76	30.29	52.05	-1.95	54.00	228	352	Average
3	2484.940	20.01	30.29	50.30	-3.70	54.00	228	352	Average

Note:

1. " *", means this data is the worst emission level.
2. C.F (Correction Factor) = Antenna Factor (dB/m) + Cable Loss (dB).
3. Measurement (dBUV/m) = Reading(dBUV) + C.F (Correction Factor).
4. The emission levels of other frequencies are very lower than the limit and not show in test report.

EUT	AX3000 High Gain Wireless USB Adapter	Date of Test	2023-01-17
Factor	DRH18-E	Temp. / Humidity	20°C /62%
Polarity	Horizontal	Site / Test Engineer	AC2 / Ares
Test Mode	802.11n-20MHz_TX_CH 1_ANT 1+2	Test Voltage	By Notebook PC

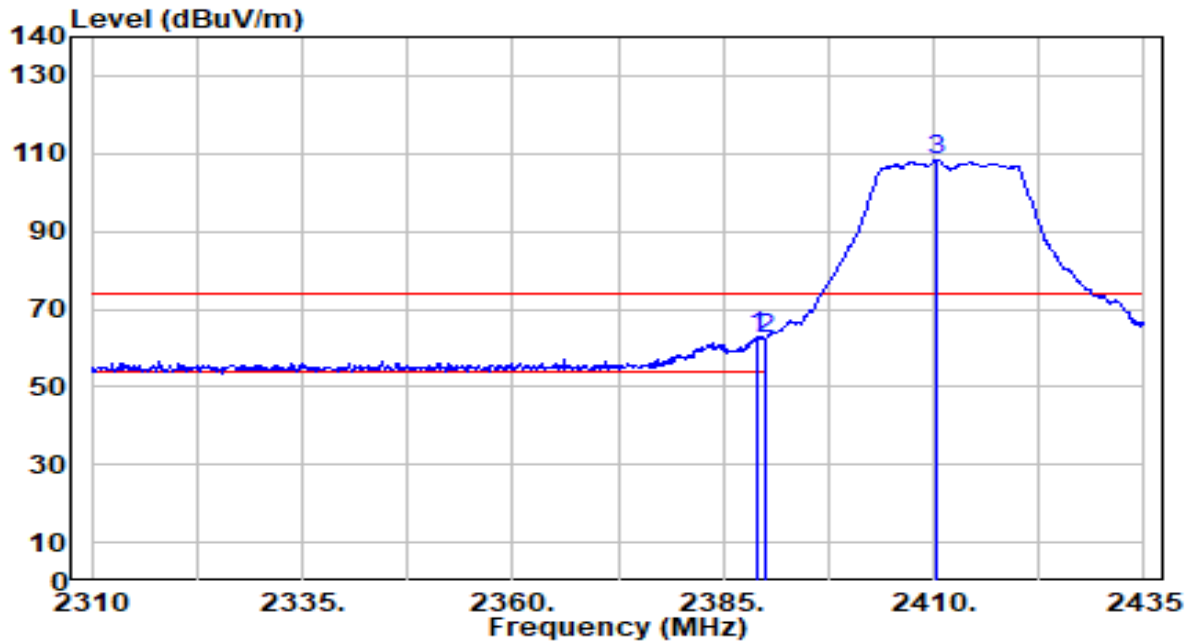

No	Frequency (MHz)	Reading (dBuV)	C.F (dB/m)	Measurement (dBuV/m)	Margin (dB)	Limit (dBuV/m)	Height (cm)	Angle (deg)	Remark (QP/PK/AV)
1	*	32.93	29.99	62.93	-11.07	74.00	214	227	Peak
2		32.14	29.99	62.14	-11.86	74.00	214	227	Peak
3		78.25	30.04	108.29	N/A	N/A	214	227	Peak

Note:

1. " *", means this data is the worst emission level.
2. C.F (Correction Factor) = Antenna Factor (dB/m) + Cable Loss (dB).
3. Measurement (dBuV/m) = Reading(dBuV) + C.F (Correction Factor).
4. The emission levels of other frequencies are very lower than the limit and not show in test report.

EUT	AX3000 High Gain Wireless USB Adapter	Date of Test	2023-01-17
Factor	DRH18-E	Temp. / Humidity	20°C /62%
Polarity	Horizontal	Site / Test Engineer	AC2 / Ares
Test Mode	802.11n-20MHz_TX_CH 1_ANT 1+2	Test Voltage	By Notebook PC

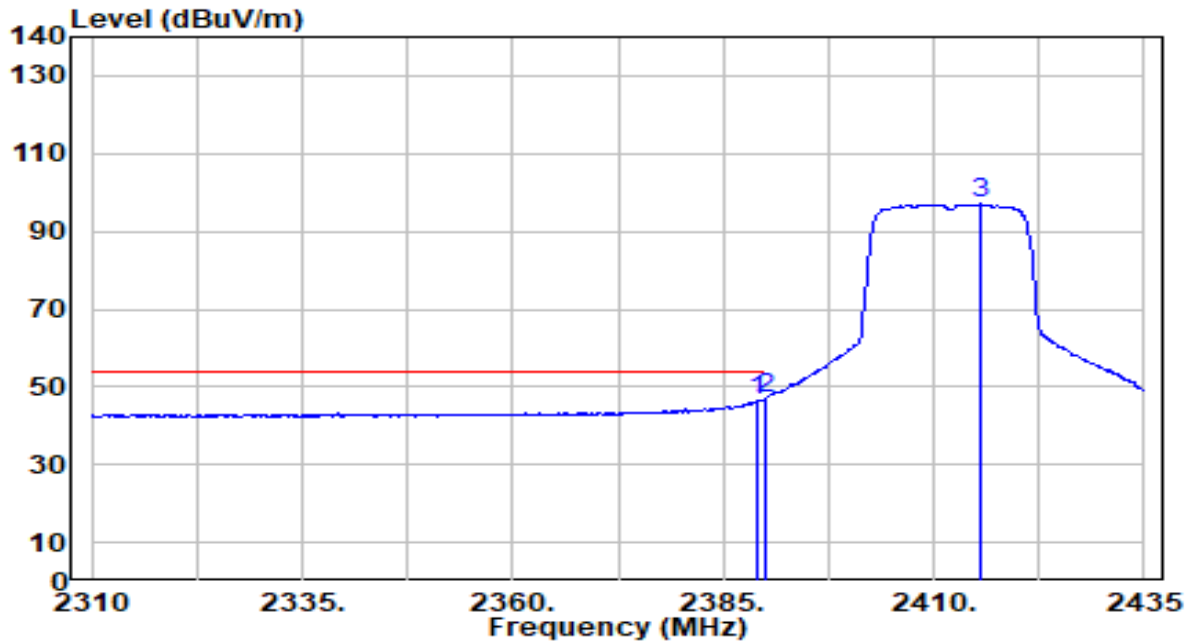

No	Frequency (MHz)	Reading (dBuV)	C.F (dB/m)	Measurement (dBuV/m)	Margin (dB)	Limit (dBuV/m)	Height (cm)	Angle (deg)	Remark (QP/PK/AV)
1	2389.000	16.26	29.99	46.25	-7.75	54.00	214	227	Average
2	* 2390.000	17.20	29.99	47.19	-6.81	54.00	214	227	Average
3	2415.500	67.00	30.06	97.06	N/A	N/A	214	227	Average

Note:

1. " *", means this data is the worst emission level.
2. C.F (Correction Factor) = Antenna Factor (dB/m) + Cable Loss (dB).
3. Measurement (dBuV/m) = Reading(dBuV) + C.F (Correction Factor).
4. The emission levels of other frequencies are very lower than the limit and not show in test report.

EUT	AX3000 High Gain Wireless USB Adapter	Date of Test	2023-01-17
Factor	DRH18-E	Temp. / Humidity	20°C /62%
Polarity	Vertical	Site / Test Engineer	AC2 / Ares
Test Mode	802.11n-20MHz_TX_CH 1_ANT 1+2	Test Voltage	By Notebook PC

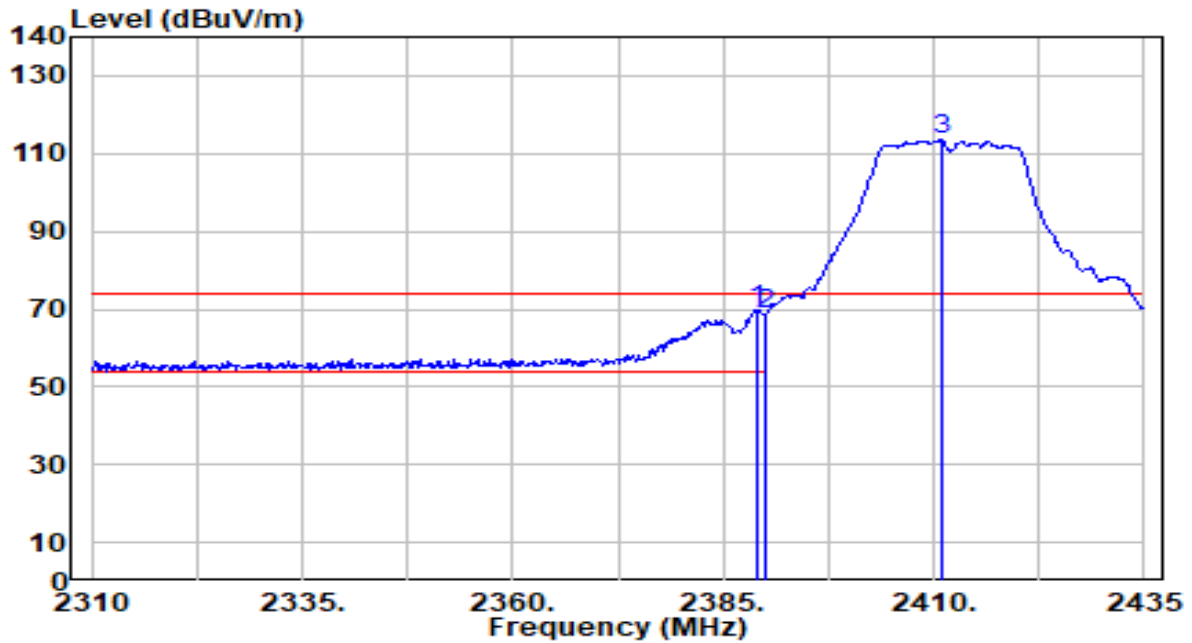

No	Frequency (MHz)	Reading (dBuV)	C.F (dB/m)	Measurement (dBuV/m)	Margin (dB)	Limit (dBuV/m)	Height (cm)	Angle (deg)	Remark (QP/PK/AV)	
1	*	2389.000	39.85	29.99	69.85	-4.15	74.00	244	236	Peak
2		2390.000	38.61	29.99	68.61	-5.39	74.00	244	236	Peak
3		2410.875	83.45	30.04	113.49	N/A	N/A	244	236	Peak

Note:

1. " *", means this data is the worst emission level.
2. C.F (Correction Factor) = Antenna Factor (dB/m) + Cable Loss (dB).
3. Measurement (dBuV/m) = Reading(dBuV) + C.F (Correction Factor).
4. The emission levels of other frequencies are very lower than the limit and not show in test report.

EUT	AX3000 High Gain Wireless USB Adapter	Date of Test	2023-01-17
Factor	DRH18-E	Temp. / Humidity	20°C /62%
Polarity	Vertical	Site / Test Engineer	AC2 / Ares
Test Mode	802.11n-20MHz_TX_CH 1_ANT 1+2	Test Voltage	By Notebook PC

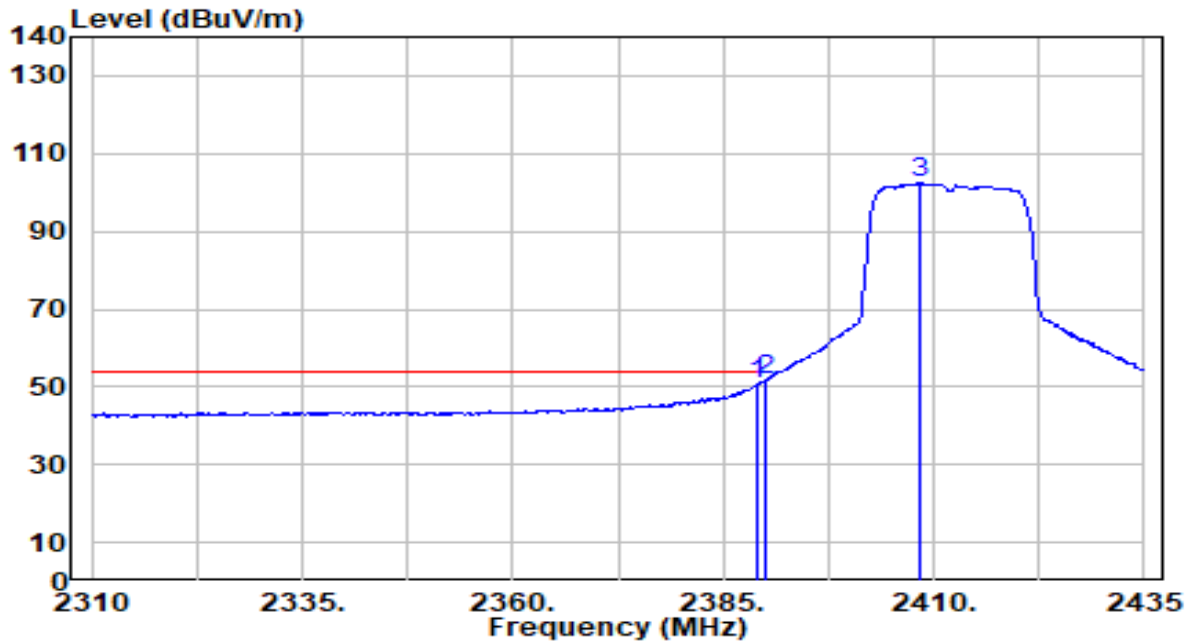

No	Frequency (MHz)	Reading (dBuV)	C.F (dB/m)	Measurement (dBuV/m)	Margin (dB)	Limit (dBuV/m)	Height (cm)	Angle (deg)	Remark (QP/PK/AV)
1	2389.000	20.63	29.99	50.63	-3.37	54.00	244	236	Average
2	* 2390.000	21.66	29.99	51.65	-2.35	54.00	244	236	Average
3	2408.500	72.43	30.04	102.46	N/A	N/A	244	236	Average

Note:

1. " *", means this data is the worst emission level.
2. C.F (Correction Factor) = Antenna Factor (dB/m) + Cable Loss (dB).
3. Measurement (dBuV/m) = Reading(dBuV) + C.F (Correction Factor).
4. The emission levels of other frequencies are very lower than the limit and not show in test report.

EUT	AX3000 High Gain Wireless USB Adapter	Date of Test	2023-01-17
Factor	DRH18-E	Temp. / Humidity	20°C /62%
Polarity	Horizontal	Site / Test Engineer	AC2 / Ares
Test Mode	802.11n-20MHz_TX_CH 6_ANT 1+2	Test Voltage	By Notebook PC

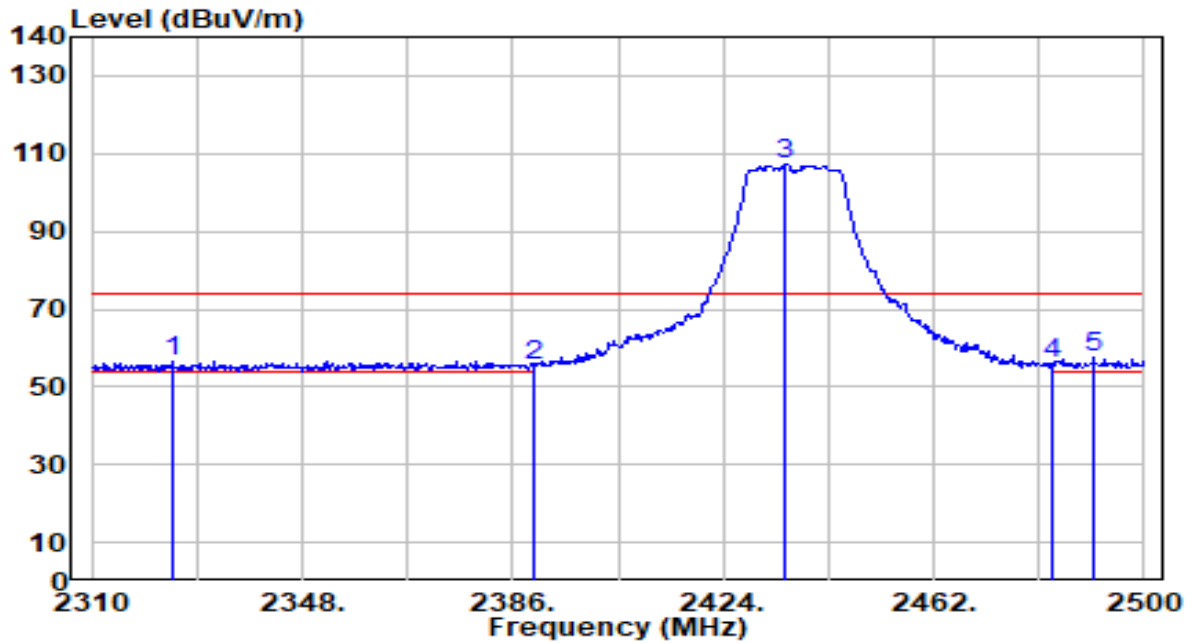

No	Frequency (MHz)	Reading (dBuV)	C.F (dB/m)	Measurement (dBuV/m)	Margin (dB)	Limit (dBuV/m)	Height (cm)	Angle (deg)	Remark (QP/PK/AV)
1	2324.440	26.79	29.91	56.70	-17.30	74.00	214	227	Peak
2	2390.000	25.58	29.99	55.57	-18.43	74.00	214	227	Peak
3	2435.210	77.38	30.12	107.51	N/A	N/A	214	227	Peak
4	2483.500	25.69	30.29	55.97	-18.03	74.00	214	227	Peak
5	* 2490.880	27.09	30.31	57.40	-16.60	74.00	214	227	Peak

Note:

1. " *", means this data is the worst emission level.
2. C.F (Correction Factor) = Antenna Factor (dB/m) + Cable Loss (dB).
3. Measurement (dBuV/m) = Reading(dBuV) + C.F (Correction Factor).
4. The emission levels of other frequencies are very lower than the limit and not show in test report.

EUT	AX3000 High Gain Wireless USB Adapter	Date of Test	2023-01-17
Factor	DRH18-E	Temp. / Humidity	20°C /62%
Polarity	Horizontal	Site / Test Engineer	AC2 / Ares
Test Mode	802.11n-20MHz_TX_CH 6_ANT 1+2	Test Voltage	By Notebook PC

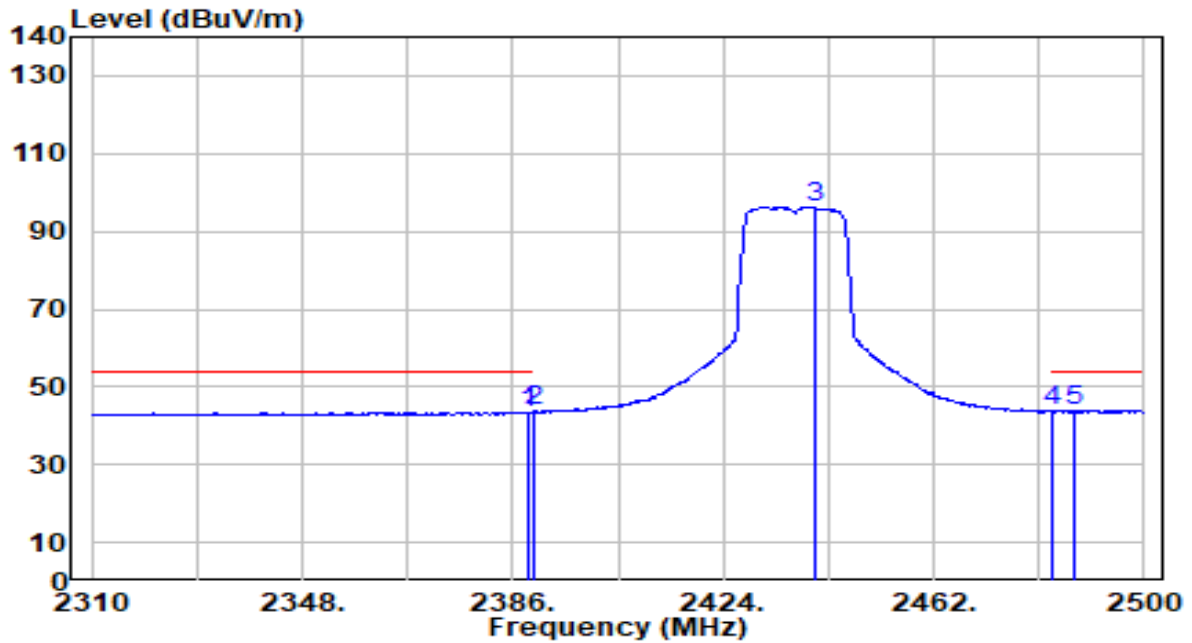

No	Frequency (MHz)	Reading (dBuV)	C.F (dB/m)	Measurement (dBuV/m)	Margin (dB)	Limit (dBuV/m)	Height (cm)	Angle (deg)	Remark (QP/PK/AV)
1	2388.660	13.49	29.99	43.49	-10.51	54.00	214	227	Average
2	2390.000	13.62	29.99	43.61	-10.39	54.00	214	227	Average
3	2440.530	66.10	30.14	96.24	N/A	N/A	214	227	Average
4	2483.500	13.35	30.29	43.64	-10.36	54.00	214	227	Average
5	* 2487.460	13.65	30.30	43.95	-10.05	54.00	214	227	Average

Note:

1. " *", means this data is the worst emission level.
2. C.F (Correction Factor) = Antenna Factor (dB/m) + Cable Loss (dB).
3. Measurement (dBuV/m) = Reading(dBuV) + C.F (Correction Factor).
4. The emission levels of other frequencies are very lower than the limit and not show in test report.

EUT	AX3000 High Gain Wireless USB Adapter	Date of Test	2023-01-17
Factor	DRH18-E	Temp. / Humidity	20°C /62%
Polarity	Vertical	Site / Test Engineer	AC2 / Ares
Test Mode	802.11n-20MHz_TX_CH 6_ANT 1+2	Test Voltage	By Notebook PC

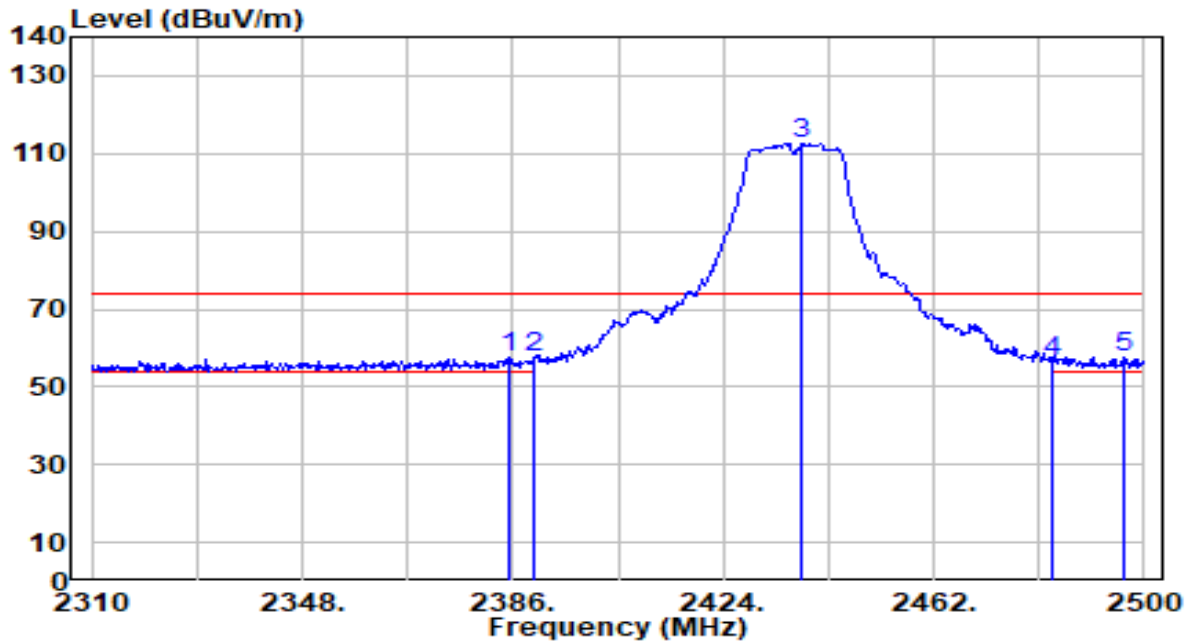

No	Frequency (MHz)	Reading (dBuV)	C.F (dB/m)	Measurement (dBuV/m)	Margin (dB)	Limit (dBuV/m)	Height (cm)	Angle (deg)	Remark (QP/PK/AV)
1	2385.240	27.71	29.99	57.70	-16.30	74.00	243	237	Peak
2	2390.000	27.71	29.99	57.70	-16.30	74.00	243	237	Peak
3	2438.250	82.60	30.13	112.73	N/A	N/A	243	237	Peak
4	2483.500	26.20	30.29	56.48	-17.52	74.00	243	237	Peak
5	* 2496.200	27.46	30.33	57.78	-16.22	74.00	243	237	Peak

Note:

1. " *", means this data is the worst emission level.
2. C.F (Correction Factor) = Antenna Factor (dB/m) + Cable Loss (dB).
3. Measurement (dBuV/m) = Reading(dBuV) + C.F (Correction Factor).
4. The emission levels of other frequencies are very lower than the limit and not show in test report.

EUT	AX3000 High Gain Wireless USB Adapter	Date of Test	2023-01-17
Factor	DRH18-E	Temp. / Humidity	20°C /62%
Polarity	Vertical	Site / Test Engineer	AC2 / Ares
Test Mode	802.11n-20MHz_TX_CH 6_ANT 1+2	Test Voltage	By Notebook PC

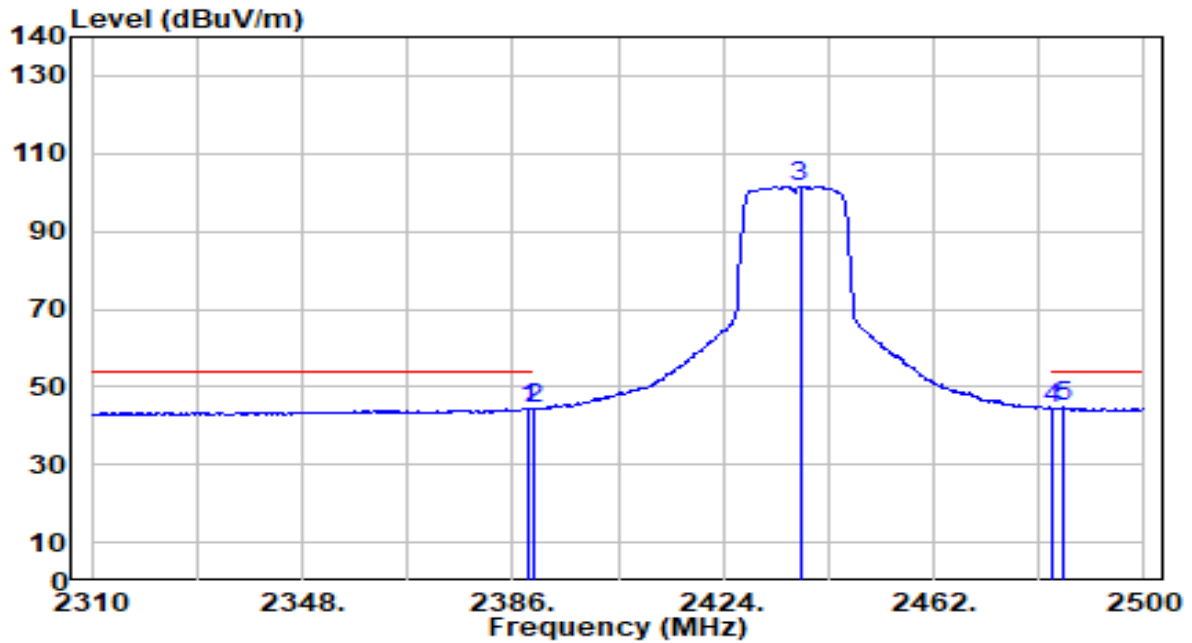

No	Frequency (MHz)	Reading (dBuV)	C.F (dB/m)	Measurement (dBuV/m)	Margin (dB)	Limit (dBuV/m)	Height (cm)	Angle (deg)	Remark (QP/PK/AV)
1	2388.660	14.43	29.99	44.43	-9.57	54.00	243	237	Average
2	2390.000	14.31	29.99	44.30	-9.70	54.00	243	237	Average
3	2437.870	71.50	30.13	101.64	N/A	N/A	243	237	Average
4	2483.500	14.20	30.29	44.48	-9.52	54.00	243	237	Average
5	* 2485.370	14.39	30.29	44.68	-9.32	54.00	243	237	Average

Note:

1. " *", means this data is the worst emission level.
2. C.F (Correction Factor) = Antenna Factor (dB/m) + Cable Loss (dB).
3. Measurement (dBuV/m) = Reading(dBuV) + C.F (Correction Factor).
4. The emission levels of other frequencies are very lower than the limit and not show in test report.

EUT	AX3000 High Gain Wireless USB Adapter	Date of Test	2023-01-17
Factor	DRH18-E	Temp. / Humidity	20°C /62%
Polarity	Horizontal	Site / Test Engineer	AC2 / Ares
Test Mode	802.11n-20MHz_TX_CH 11_ANT 1+2	Test Voltage	By Notebook PC

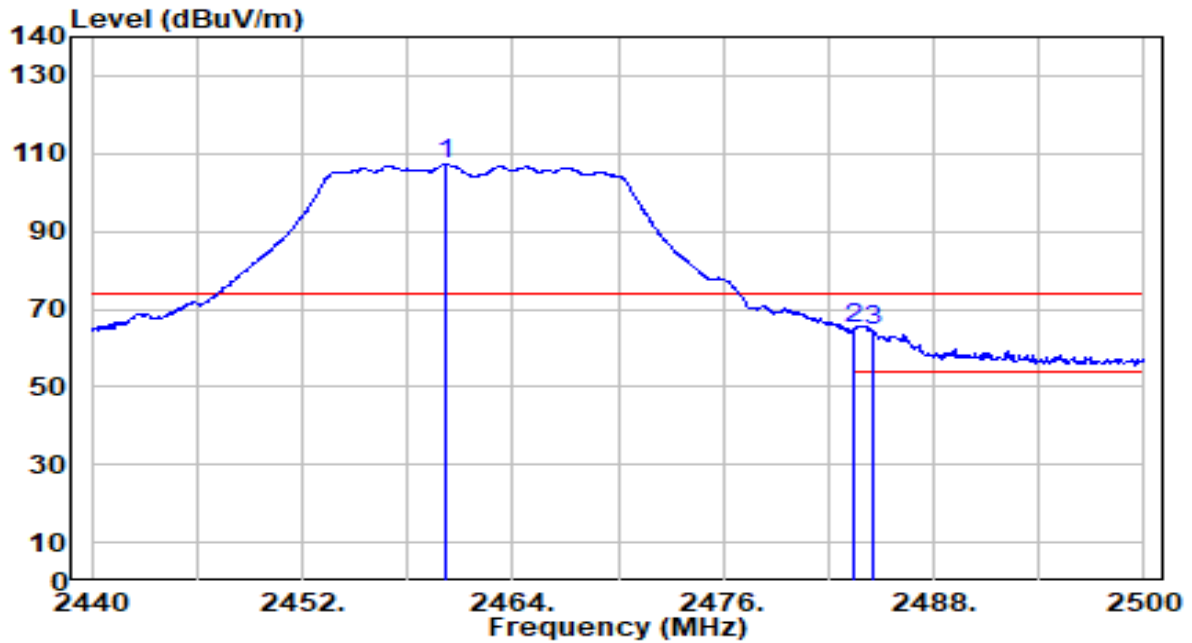

No	Frequency (MHz)	Reading (dBUV)	C.F (dB/m)	Measurement (dBUV/m)	Margin (dB)	Limit (dBUV/m)	Height (cm)	Angle (deg)	Remark (QP/PK/AV)
1	2460.160	77.01	30.21	107.22	N/A	N/A	260	192	Peak
2	* 2483.500	34.69	30.29	64.98	-9.02	74.00	260	192	Peak
3	2484.520	34.16	30.29	64.45	-9.55	74.00	260	192	Peak

Note:

1. " *", means this data is the worst emission level.
2. C.F (Correction Factor) = Antenna Factor (dB/m) + Cable Loss (dB).
3. Measurement (dBUV/m) = Reading(dBUV) + C.F (Correction Factor).
4. The emission levels of other frequencies are very lower than the limit and not show in test report.

EUT	AX3000 High Gain Wireless USB Adapter	Date of Test	2023-01-17
Factor	DRH18-E	Temp. / Humidity	20°C /62%
Polarity	Horizontal	Site / Test Engineer	AC2 / Ares
Test Mode	802.11n-20MHz_TX_CH 11_ANT 1+2	Test Voltage	By Notebook PC

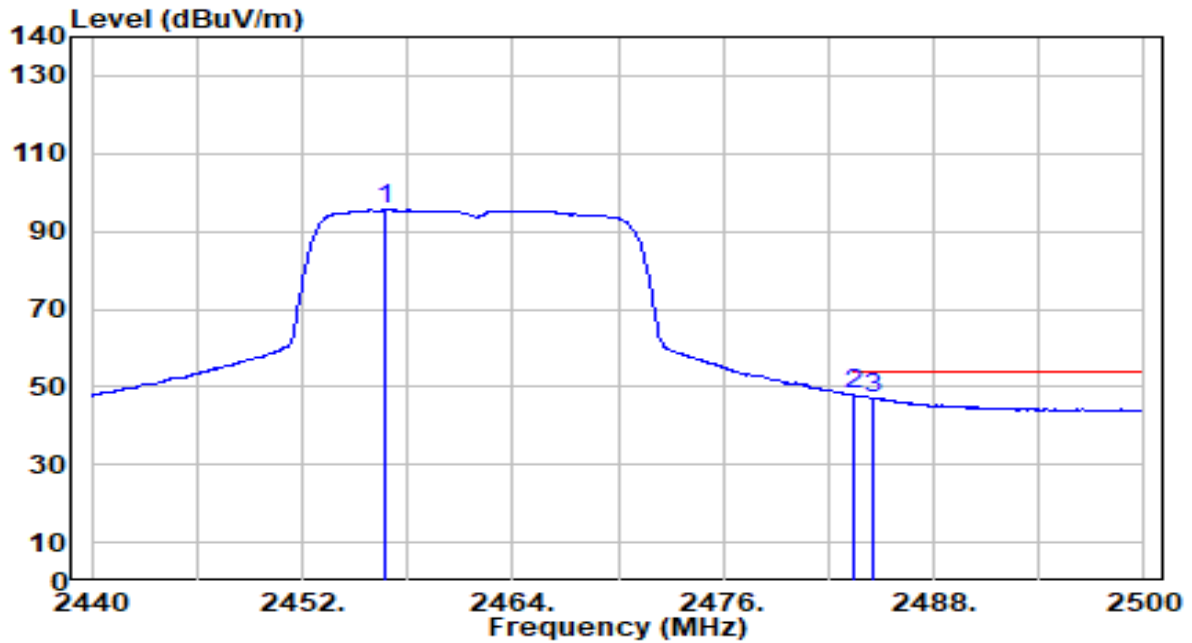

No	Frequency (MHz)	Reading (dBuV)	C.F (dB/m)	Measurement (dBuV/m)	Margin (dB)	Limit (dBuV/m)	Height (cm)	Angle (deg)	Remark (QP/PK/AV)
1	2456.740	65.30	30.20	95.49	N/A	N/A	260	192	Average
2	* 2483.500	17.62	30.29	47.90	-6.10	54.00	260	192	Average
3	2484.580	16.84	30.29	47.13	-6.87	54.00	260	192	Average

Note:

1. " *", means this data is the worst emission level.
2. C.F (Correction Factor) = Antenna Factor (dB/m) + Cable Loss (dB).
3. Measurement (dBuV/m) = Reading(dBuV) + C.F (Correction Factor).
4. The emission levels of other frequencies are very lower than the limit and not show in test report.

EUT	AX3000 High Gain Wireless USB Adapter	Date of Test	2023-01-17
Factor	DRH18-E	Temp. / Humidity	20°C /62%
Polarity	Vertical	Site / Test Engineer	AC2 / Ares
Test Mode	802.11n-20MHz_TX_CH 11_ANT 1+2	Test Voltage	By Notebook PC

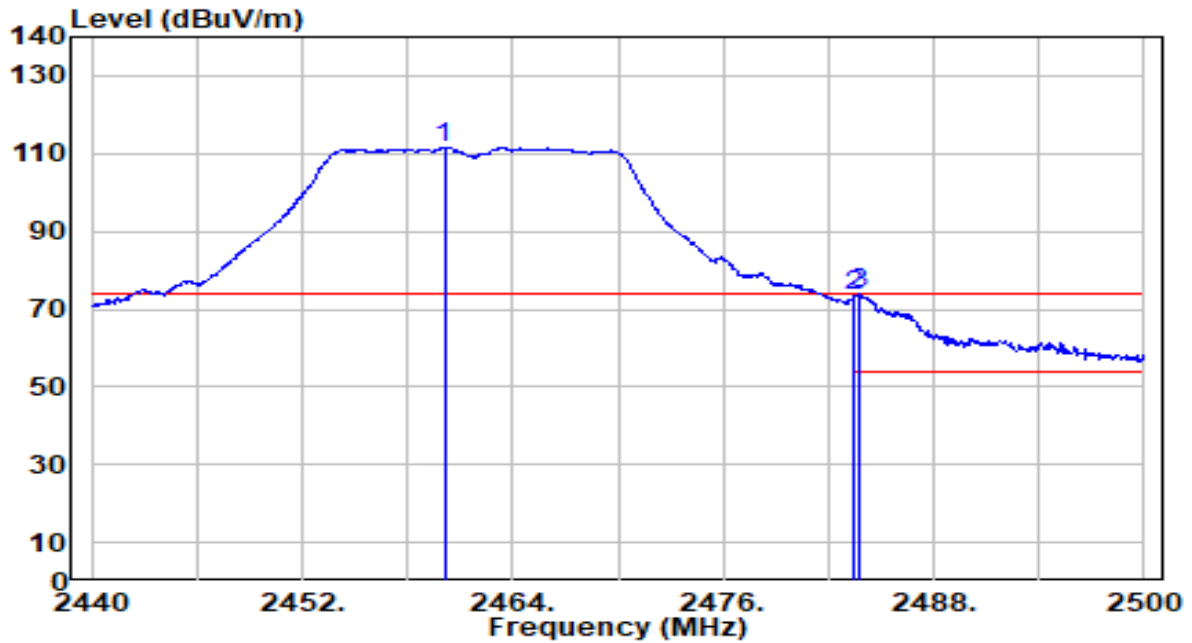

No	Frequency (MHz)	Reading (dBUV)	C.F (dB/m)	Measurement (dBUV/m)	Margin (dB)	Limit (dBUV/m)	Height (cm)	Angle (deg)	Remark (QP/PK/AV)
1	2460.100	81.44	30.21	111.65	N/A	N/A	254	252	Peak
2	2483.500	43.14	30.29	73.42	-0.58	74.00	254	252	Peak
3	* 2483.800	43.60	30.29	73.88	-0.12	74.00	254	252	Peak

Note:

1. " *", means this data is the worst emission level.
2. C.F (Correction Factor) = Antenna Factor (dB/m) + Cable Loss (dB).
3. Measurement (dBUV/m) = Reading(dBUV) + C.F (Correction Factor).
4. The emission levels of other frequencies are very lower than the limit and not show in test report.

EUT	AX3000 High Gain Wireless USB Adapter	Date of Test	2023-01-17
Factor	DRH18-E	Temp. / Humidity	20°C /62%
Polarity	Vertical	Site / Test Engineer	AC2 / Ares
Test Mode	802.11n-20MHz_TX_CH 11_ANT 1+2	Test Voltage	By Notebook PC

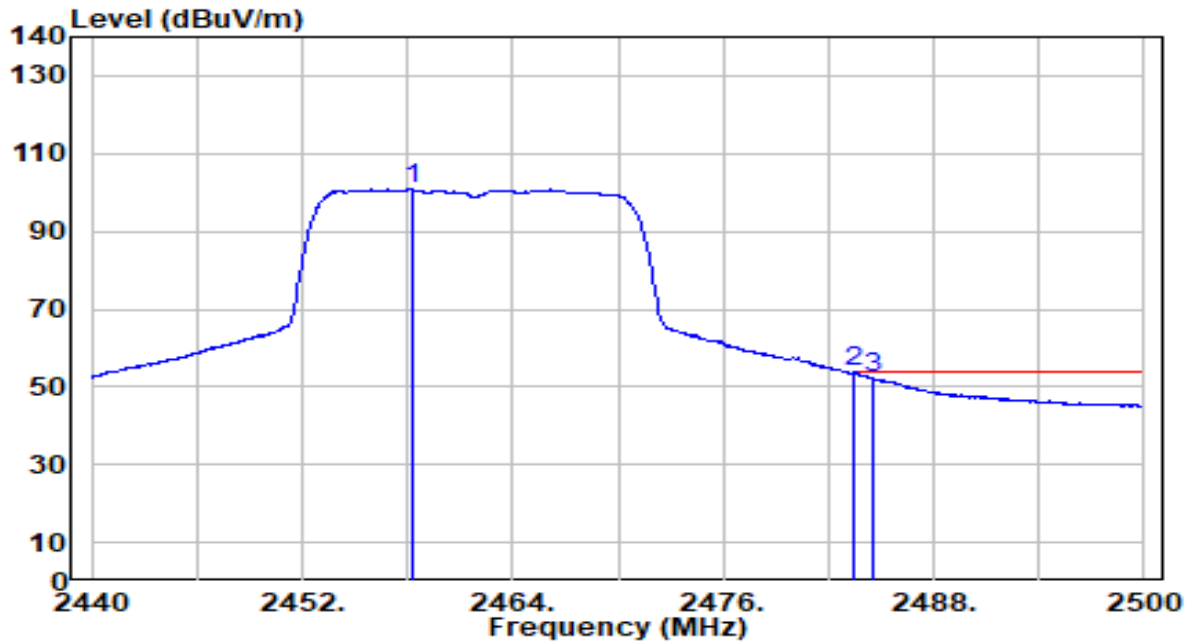

No	Frequency (MHz)	Reading (dBUV)	C.F (dB/m)	Measurement (dBUV/m)	Margin (dB)	Limit (dBUV/m)	Height (cm)	Angle (deg)	Remark (QP/PK/AV)
1	2458.240	70.59	30.20	100.79	N/A	N/A	254	252	Average
2	* 2483.500	23.45	30.29	53.73	-0.27	54.00	254	252	Average
3	2484.580	21.79	30.29	52.08	-1.92	54.00	254	252	Average

Note:

1. " *", means this data is the worst emission level.
2. C.F (Correction Factor) = Antenna Factor (dB/m) + Cable Loss (dB).
3. Measurement (dBUV/m) = Reading(dBUV) + C.F (Correction Factor).
4. The emission levels of other frequencies are very lower than the limit and not show in test report.

EUT	AX3000 High Gain Wireless USB Adapter	Date of Test	2023-01-17
Factor	DRH18-E	Temp. / Humidity	20°C /62%
Polarity	Horizontal	Site / Test Engineer	AC2 / Ares
Test Mode	802.11n-40MHz_TX_CH 3_ANT 1+2	Test Voltage	By Notebook PC

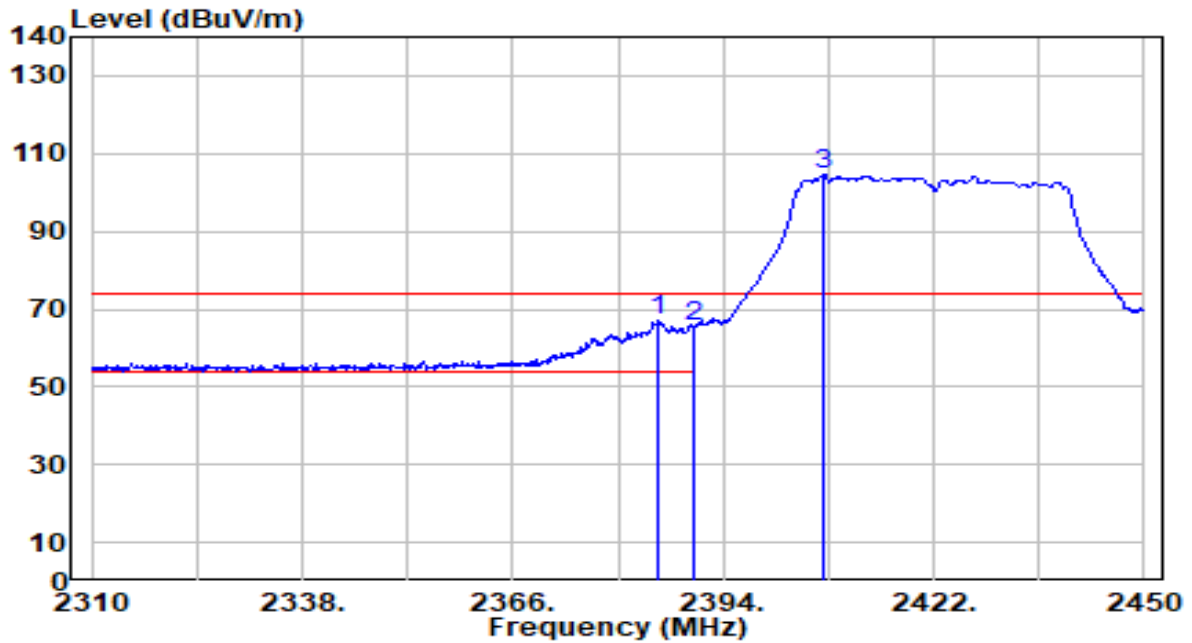

No	Frequency (MHz)	Reading (dBuV)	C.F (dB/m)	Measurement (dBuV/m)	Margin (dB)	Limit (dBuV/m)	Height (cm)	Angle (deg)	Remark (QP/PK/AV)
1	*	37.07	29.99	67.06	-6.94	74.00	214	227	Peak
2		35.54	29.99	65.53	-8.47	74.00	214	227	Peak
3		74.64	30.03	104.67	N/A	N/A	214	227	Peak

Note:

1. "*" , means this data is the worst emission level.
2. C.F (Correction Factor) = Antenna Factor (dB/m) + Cable Loss (dB).
3. Measurement (dBuV/m) = Reading(dBuV) + C.F (Correction Factor).
4. The emission levels of other frequencies are very lower than the limit and not show in test report.

EUT	AX3000 High Gain Wireless USB Adapter	Date of Test	2023-01-17
Factor	DRH18-E	Temp. / Humidity	20°C /62%
Polarity	Horizontal	Site / Test Engineer	AC2 / Ares
Test Mode	802.11n-40MHz_TX_CH 3_ANT 1+2	Test Voltage	By Notebook PC

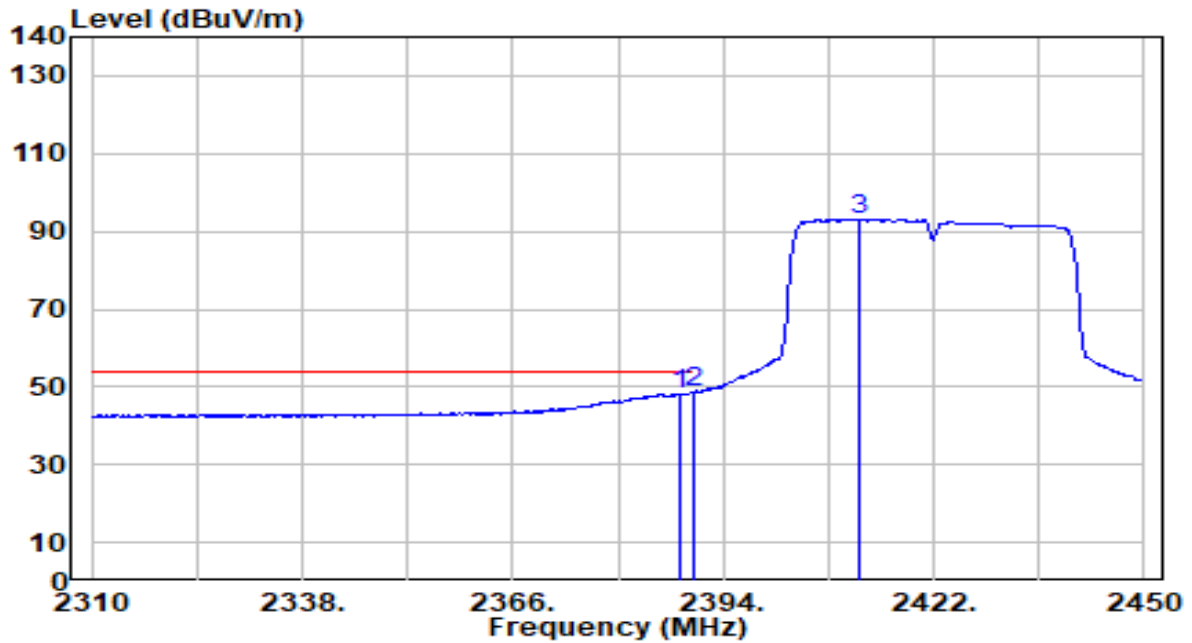

No	Frequency (MHz)	Reading (dBuV)	C.F (dB/m)	Measurement (dBuV/m)	Margin (dB)	Limit (dBuV/m)	Height (cm)	Angle (deg)	Remark (QP/PK/AV)
1	2388.120	18.29	29.99	48.28	-5.72	54.00	214	227	Average
2	* 2390.000	18.53	29.99	48.52	-5.48	54.00	214	227	Average
3	2412.060	63.19	30.05	93.24	N/A	N/A	214	227	Average

Note:

1. " *", means this data is the worst emission level.
2. C.F (Correction Factor) = Antenna Factor (dB/m) + Cable Loss (dB).
3. Measurement (dBuV/m) = Reading(dBuV) + C.F (Correction Factor).
4. The emission levels of other frequencies are very lower than the limit and not show in test report.

EUT	AX3000 High Gain Wireless USB Adapter	Date of Test	2023-01-17
Factor	DRH18-E	Temp. / Humidity	20°C /62%
Polarity	Vertical	Site / Test Engineer	AC2 / Ares
Test Mode	802.11n-40MHz_TX_CH 3_ANT 1+2	Test Voltage	By Notebook PC

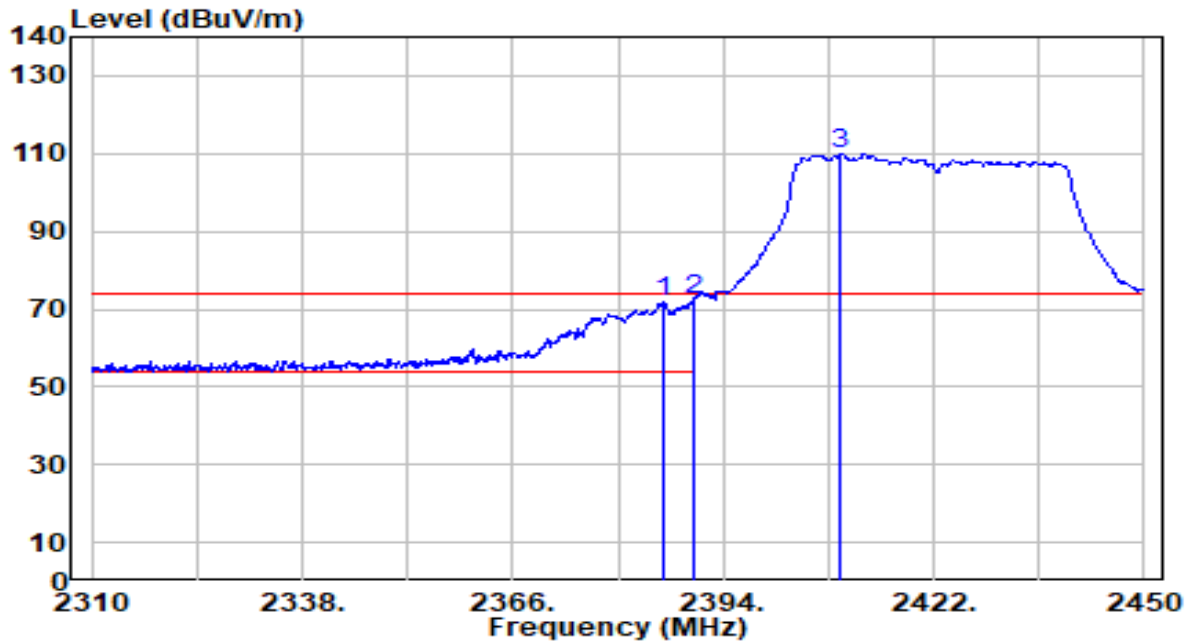

No	Frequency (MHz)	Reading (dBuV)	C.F (dB/m)	Measurement (dBuV/m)	Margin (dB)	Limit (dBuV/m)	Height (cm)	Angle (deg)	Remark (QP/PK/AV)
1	2386.020	41.78	29.99	71.77	-2.23	74.00	244	236	Peak
2	* 2390.000	42.45	29.99	72.44	-1.56	74.00	244	236	Peak
3	2409.680	80.10	30.04	110.14	N/A	N/A	244	236	Peak

Note:

1. " *", means this data is the worst emission level.
2. C.F (Correction Factor) = Antenna Factor (dB/m) + Cable Loss (dB).
3. Measurement (dBuV/m) = Reading(dBuV) + C.F (Correction Factor).
4. The emission levels of other frequencies are very lower than the limit and not show in test report.

EUT	AX3000 High Gain Wireless USB Adapter	Date of Test	2023-01-17
Factor	DRH18-E	Temp. / Humidity	20°C /62%
Polarity	Vertical	Site / Test Engineer	AC2 / Ares
Test Mode	802.11n-40MHz_TX_CH 3_ANT 1+2	Test Voltage	By Notebook PC

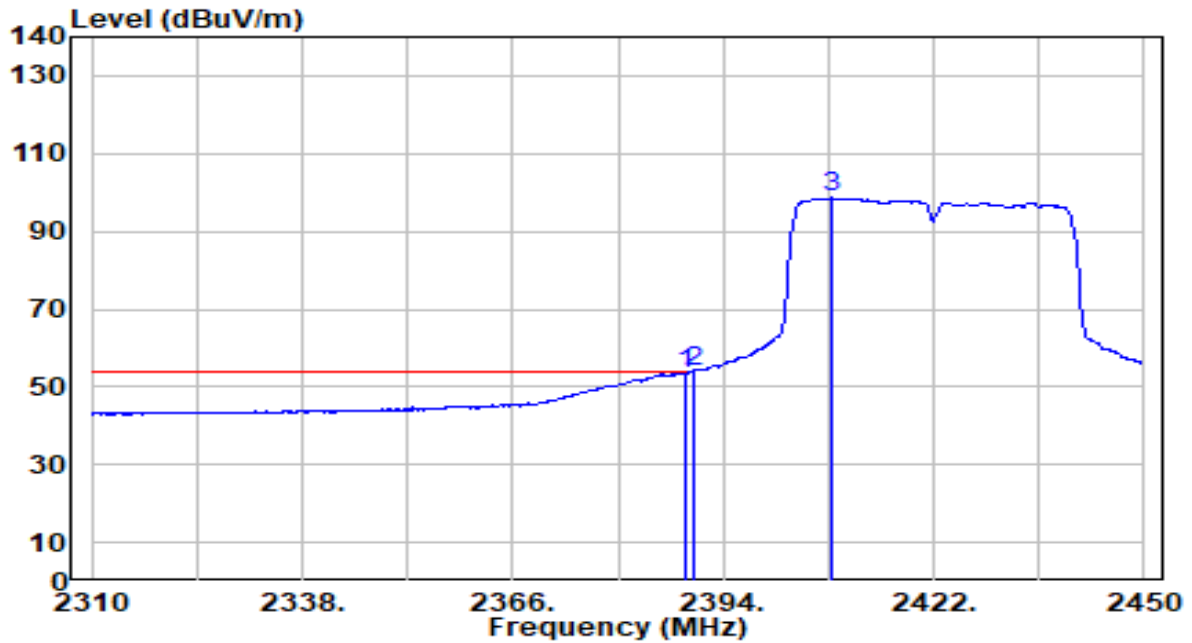

No	Frequency (MHz)	Reading (dBuV)	C.F (dB/m)	Measurement (dBuV/m)	Margin (dB)	Limit (dBuV/m)	Height (cm)	Angle (deg)	Remark (QP/PK/AV)
1	2388.960	23.40	29.99	53.39	-0.61	54.00	244	236	Average
2	* 2390.000	23.87	29.99	53.86	-0.14	54.00	244	236	Average
3	2408.420	68.55	30.04	98.58	N/A	N/A	244	236	Average

Note:

1. " *", means this data is the worst emission level.
2. C.F (Correction Factor) = Antenna Factor (dB/m) + Cable Loss (dB).
3. Measurement (dBuV/m) = Reading(dBuV) + C.F (Correction Factor).
4. The emission levels of other frequencies are very lower than the limit and not show in test report.

EUT	AX3000 High Gain Wireless USB Adapter	Date of Test	2023-01-17
Factor	DRH18-E	Temp. / Humidity	20°C /62%
Polarity	Horizontal	Site / Test Engineer	AC2 / Ares
Test Mode	802.11n-40MHz_TX_CH 6_ANT 1+2	Test Voltage	By Notebook PC

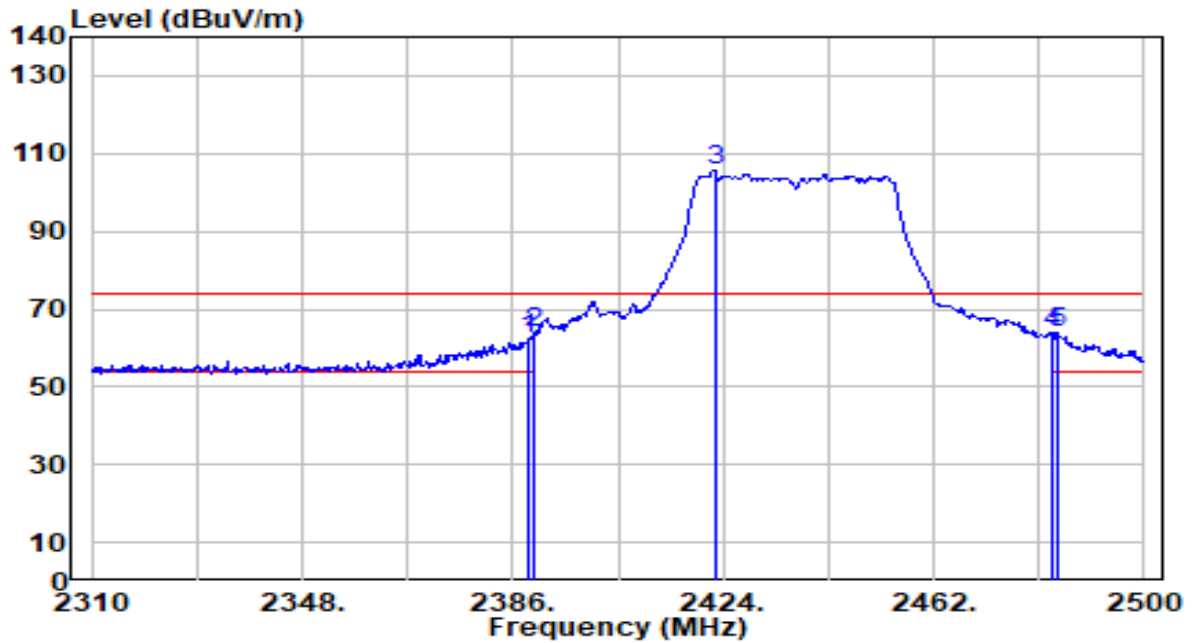

No	Frequency (MHz)	Reading (dBuV)	C.F (dB/m)	Measurement (dBuV/m)	Margin (dB)	Limit (dBuV/m)	Height (cm)	Angle (deg)	Remark (QP/PK/AV)
1	2388.850	32.38	29.99	62.38	-11.62	74.00	214	227	Peak
2	2390.000	33.78	29.99	63.77	-10.23	74.00	214	227	Peak
3	2422.480	75.59	30.08	105.67	N/A	N/A	214	227	Peak
4	* 2483.500	33.83	30.29	64.12	-9.88	74.00	214	227	Peak
5	2484.420	33.56	30.29	63.85	-10.15	74.00	214	227	Peak

Note:

- "*" , means this data is the worst emission level.
- C.F (Correction Factor) = Antenna Factor (dB/m) + Cable Loss (dB).
- Measurement (dBuV/m) = Reading(dBuV) + C.F (Correction Factor).
- The emission levels of other frequencies are very lower than the limit and not show in test report.

EUT	AX3000 High Gain Wireless USB Adapter	Date of Test	2023-01-17
Factor	DRH18-E	Temp. / Humidity	20°C /62%
Polarity	Horizontal	Site / Test Engineer	AC2 / Ares
Test Mode	802.11n-40MHz_TX_CH 6_ANT 1+2	Test Voltage	By Notebook PC

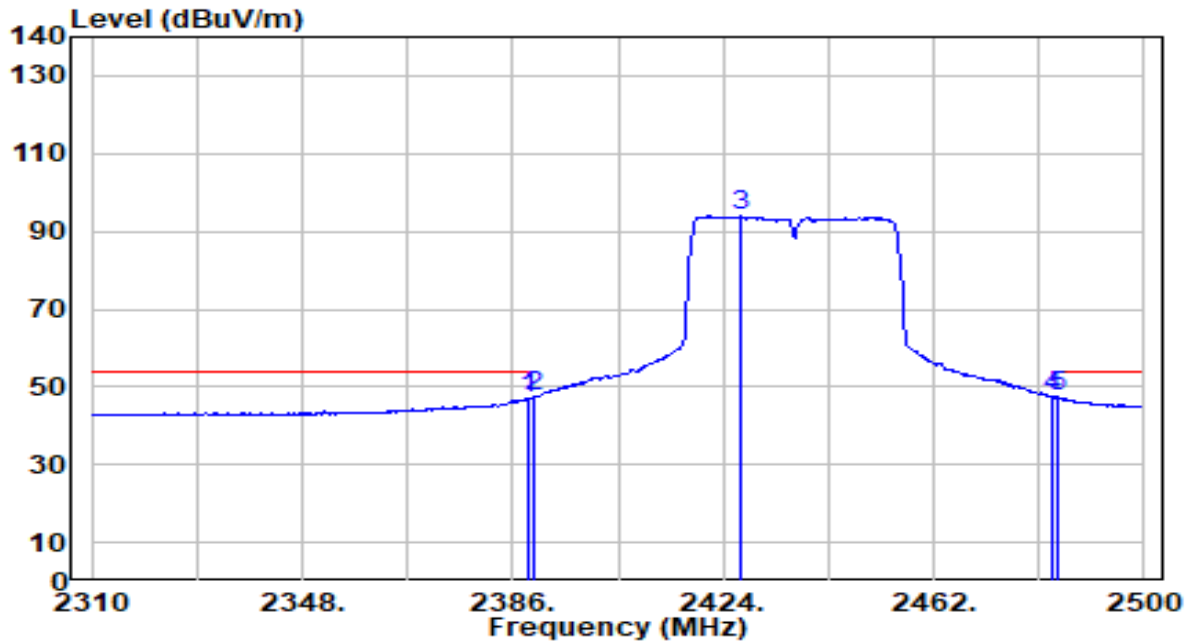

No	Frequency (MHz)	Reading (dBuV)	C.F (dB/m)	Measurement (dBuV/m)	Margin (dB)	Limit (dBuV/m)	Height (cm)	Angle (deg)	Remark (QP/PK/AV)
1	2389.040	17.24	29.99	47.24	-6.76	54.00	214	227	Average
2	2390.000	17.39	29.99	47.38	-6.62	54.00	214	227	Average
3	2427.230	63.77	30.10	93.86	N/A	N/A	214	227	Average
4	2483.500	17.20	30.29	47.49	-6.51	54.00	214	227	Average
5	* 2484.230	17.24	30.29	47.52	-6.48	54.00	214	227	Average

Note:

1. " *", means this data is the worst emission level.
2. C.F (Correction Factor) = Antenna Factor (dB/m) + Cable Loss (dB).
3. Measurement (dBuV/m) = Reading(dBuV) + C.F (Correction Factor).
4. The emission levels of other frequencies are very lower than the limit and not show in test report.

EUT	AX3000 High Gain Wireless USB Adapter	Date of Test	2023-01-17
Factor	DRH18-E	Temp. / Humidity	20°C /62%
Polarity	Vertical	Site / Test Engineer	AC2 / Ares
Test Mode	802.11n-40MHz_TX_CH 6_ANT 1+2	Test Voltage	By Notebook PC

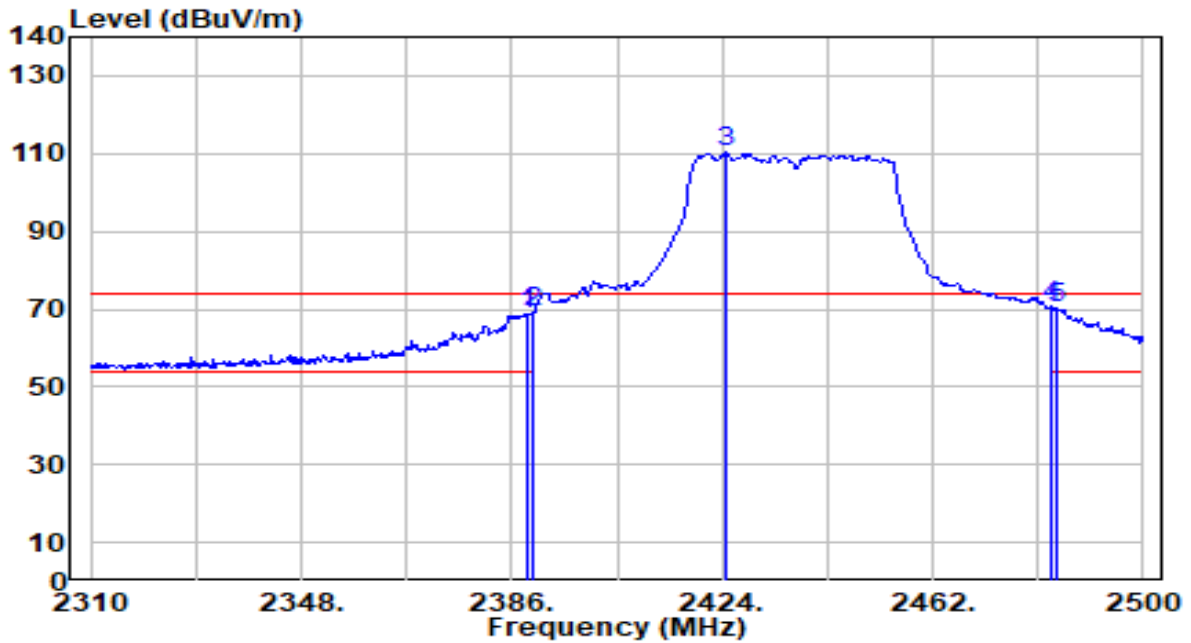

No	Frequency (MHz)	Reading (dBuV)	C.F (dB/m)	Measurement (dBuV/m)	Margin (dB)	Limit (dBuV/m)	Height (cm)	Angle (deg)	Remark (QP/PK/AV)
1	2389.040	38.74	29.99	68.74	-5.26	74.00	243	237	Peak
2	2390.000	39.09	29.99	69.09	-4.91	74.00	243	237	Peak
3	2424.570	80.08	30.09	110.17	N/A	N/A	243	237	Peak
4	* 2483.500	40.30	30.29	70.59	-3.41	74.00	243	237	Peak
5	2484.420	39.94	30.29	70.23	-3.77	74.00	243	237	Peak

Note:

- "*" means this data is the worst emission level.
- C.F (Correction Factor) = Antenna Factor (dB/m) + Cable Loss (dB).
- Measurement (dBuV/m) = Reading(dBuV) + C.F (Correction Factor).
- The emission levels of other frequencies are very lower than the limit and not show in test report.

EUT	AX3000 High Gain Wireless USB Adapter	Date of Test	2023-01-17
Factor	DRH18-E	Temp. / Humidity	20°C /62%
Polarity	Vertical	Site / Test Engineer	AC2 / Ares
Test Mode	802.11n-40MHz_TX_CH 6_ANT 1+2	Test Voltage	By Notebook PC

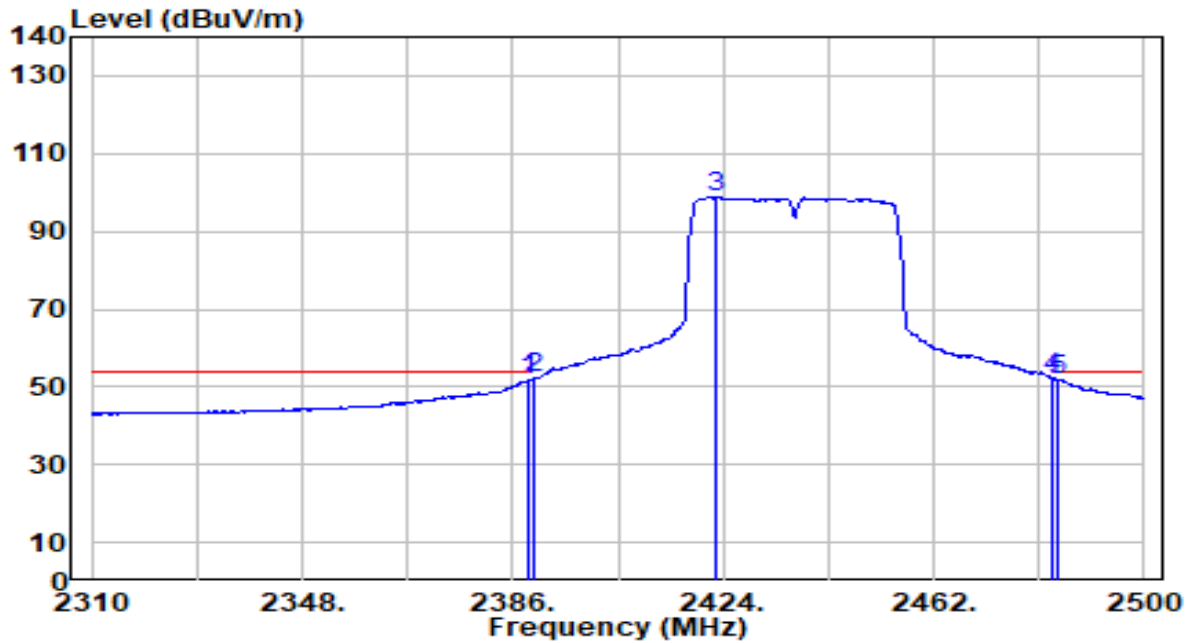

No	Frequency (MHz)	Reading (dBuV)	C.F (dB/m)	Measurement (dBuV/m)	Margin (dB)	Limit (dBuV/m)	Height (cm)	Angle (deg)	Remark (QP/PK/AV)
1	2389.040	21.67	29.99	51.66	-2.34	54.00	243	237	Average
2	* 2390.000	22.39	29.99	52.38	-1.62	54.00	243	237	Average
3	2422.480	68.68	30.08	98.76	N/A	N/A	243	237	Average
4	2483.500	21.81	30.29	52.10	-1.90	54.00	243	237	Average
5	2484.610	21.66	30.29	51.94	-2.06	54.00	243	237	Average

Note:

1. " *", means this data is the worst emission level.
2. C.F (Correction Factor) = Antenna Factor (dB/m) + Cable Loss (dB).
3. Measurement (dBuV/m) = Reading(dBuV) + C.F (Correction Factor).
4. The emission levels of other frequencies are very lower than the limit and not show in test report.

EUT	AX3000 High Gain Wireless USB Adapter	Date of Test	2023-01-17
Factor	DRH18-E	Temp. / Humidity	20°C /62%
Polarity	Horizontal	Site / Test Engineer	AC2 / Ares
Test Mode	802.11n-40MHz_TX_CH 9_ANT 1+2	Test Voltage	By Notebook PC

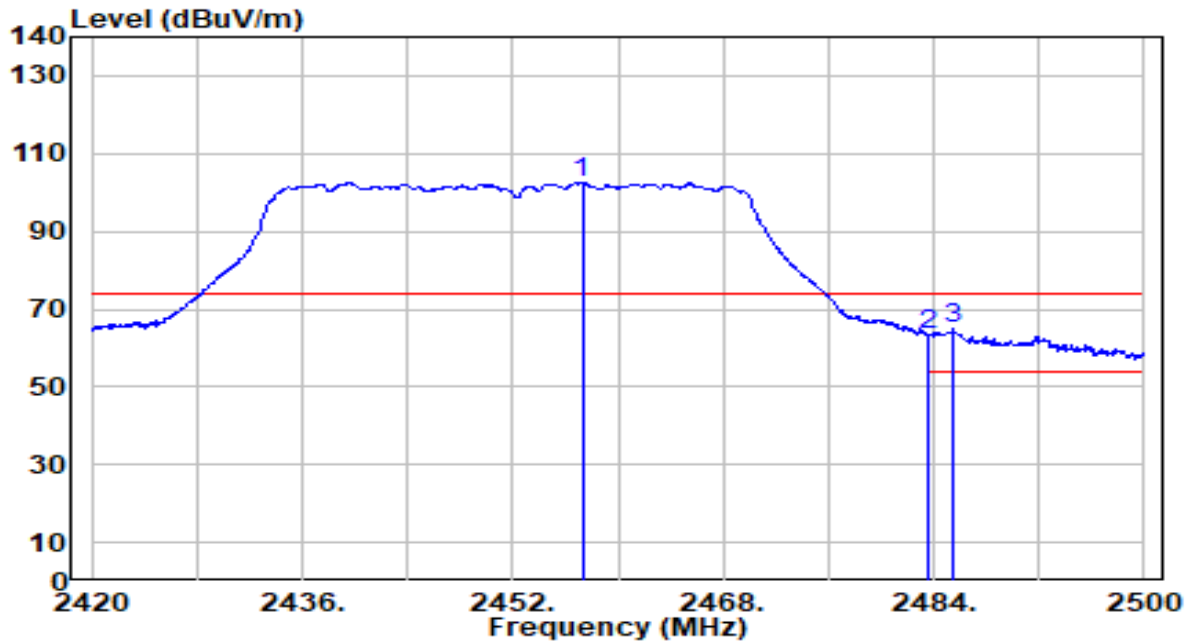

No	Frequency (MHz)	Reading (dBuV)	C.F (dB/m)	Measurement (dBuV/m)	Margin (dB)	Limit (dBuV/m)	Height (cm)	Angle (deg)	Remark (QP/PK/AV)
1	2457.280	72.37	30.20	102.57	N/A	N/A	260	192	Peak
2	2483.500	32.85	30.29	63.14	-10.86	74.00	260	192	Peak
3	* 2485.440	34.73	30.29	65.02	-8.98	74.00	260	192	Peak

Note:

1. " *", means this data is the worst emission level.
2. C.F (Correction Factor) = Antenna Factor (dB/m) + Cable Loss (dB).
3. Measurement (dBuV/m) = Reading(dBuV) + C.F (Correction Factor).
4. The emission levels of other frequencies are very lower than the limit and not show in test report.

EUT	AX3000 High Gain Wireless USB Adapter	Date of Test	2023-01-17
Factor	DRH18-E	Temp. / Humidity	20°C /62%
Polarity	Horizontal	Site / Test Engineer	AC2 / Ares
Test Mode	802.11n-40MHz_TX_CH 9_ANT 1+2	Test Voltage	By Notebook PC

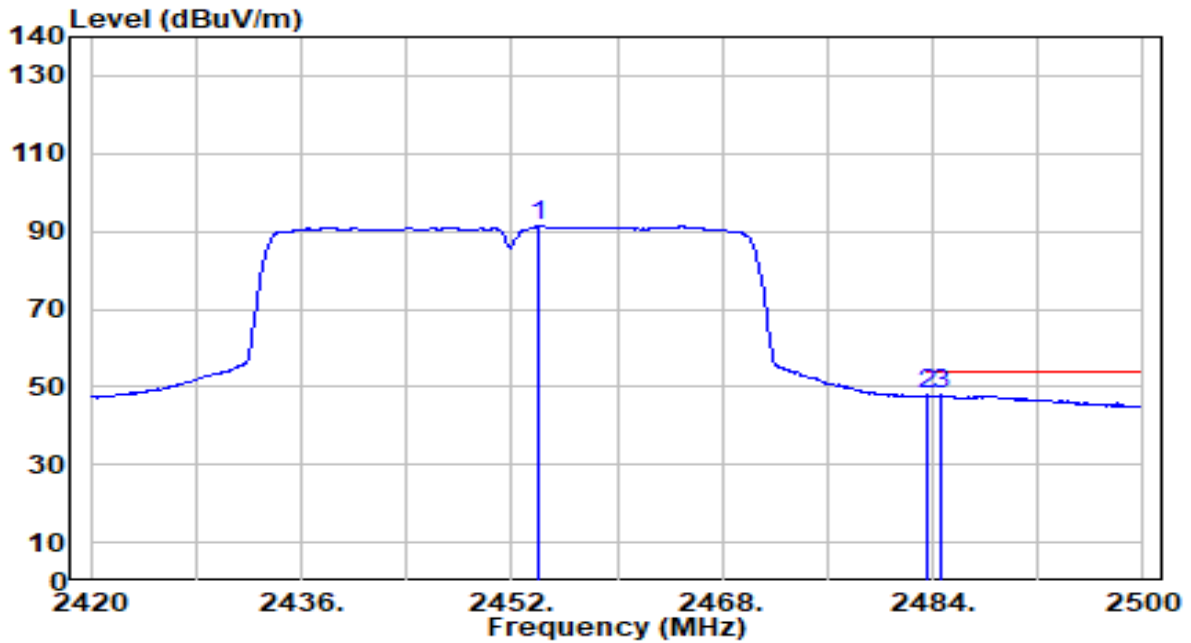

No	Frequency (MHz)	Reading (dBuV)	C.F (dB/m)	Measurement (dBuV/m)	Margin (dB)	Limit (dBuV/m)	Height (cm)	Angle (deg)	Remark (QP/PK/AV)
1	2454.080	61.17	30.19	91.35	N/A	N/A	260	192	Average
2	2483.500	17.55	30.29	47.84	-6.16	54.00	260	192	Average
3	* 2484.640	17.58	30.29	47.87	-6.13	54.00	260	192	Average

Note:

1. " *", means this data is the worst emission level.
2. C.F (Correction Factor) = Antenna Factor (dB/m) + Cable Loss (dB).
3. Measurement (dBuV/m) = Reading(dBuV) + C.F (Correction Factor).
4. The emission levels of other frequencies are very lower than the limit and not show in test report.

EUT	AX3000 High Gain Wireless USB Adapter	Date of Test	2023-01-17
Factor	DRH18-E	Temp. / Humidity	20°C /62%
Polarity	Vertical	Site / Test Engineer	AC2 / Ares
Test Mode	802.11n-40MHz_TX_CH 9_ANT 1+2	Test Voltage	By Notebook PC

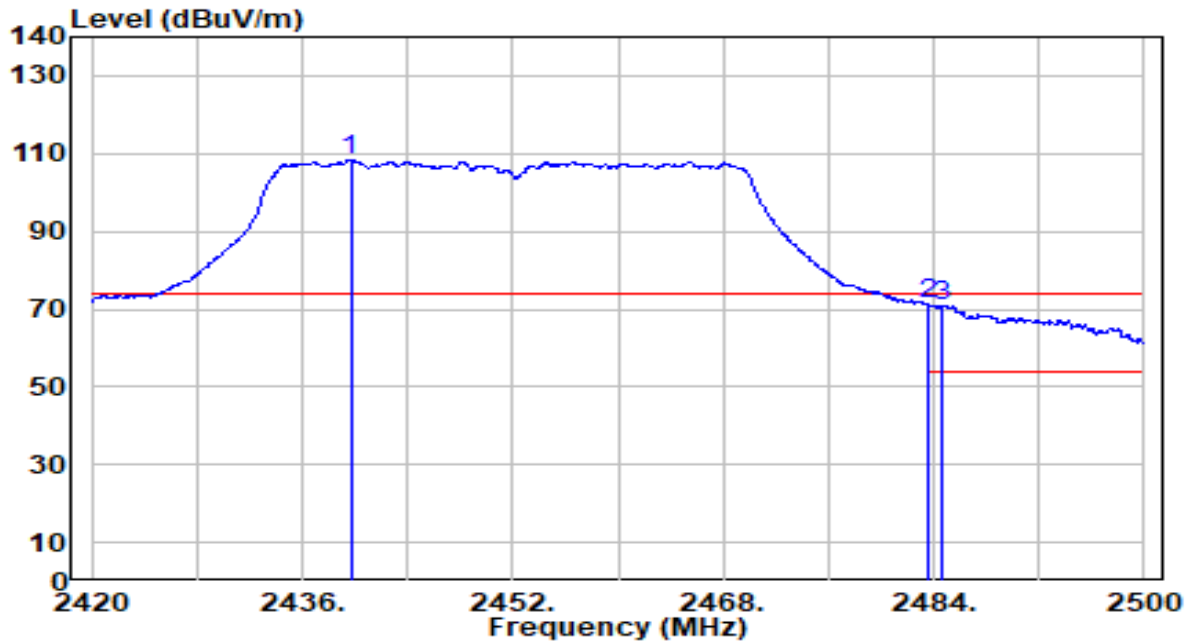

No	Frequency (MHz)	Reading (dBuV)	C.F (dB/m)	Measurement (dBuV/m)	Margin (dB)	Limit (dBuV/m)	Height (cm)	Angle (deg)	Remark (QP/PK/AV)
1	2439.680	78.20	30.14	108.34	N/A	N/A	254	252	Peak
2	* 2483.500	41.15	30.29	71.44	-2.56	74.00	254	252	Peak
3	2484.720	40.65	30.29	70.94	-3.06	74.00	254	252	Peak

Note:

1. " *", means this data is the worst emission level.
2. C.F (Correction Factor) = Antenna Factor (dB/m) + Cable Loss (dB).
3. Measurement (dBuV/m) = Reading(dBuV) + C.F (Correction Factor).
4. The emission levels of other frequencies are very lower than the limit and not show in test report.

EUT	AX3000 High Gain Wireless USB Adapter	Date of Test	2023-01-17
Factor	DRH18-E	Temp. / Humidity	20°C /62%
Polarity	Vertical	Site / Test Engineer	AC2 / Ares
Test Mode	802.11n-40MHz_TX_CH 9_ANT 1+2	Test Voltage	By Notebook PC

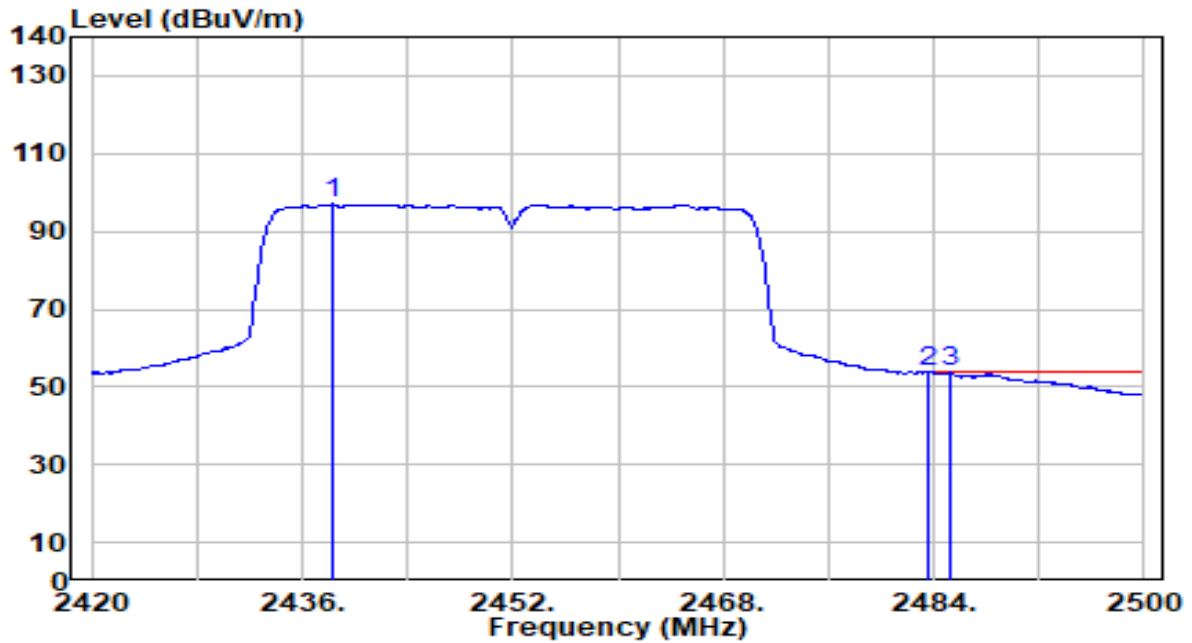

No	Frequency (MHz)	Reading (dBuV)	C.F (dB/m)	Measurement (dBuV/m)	Margin (dB)	Limit (dBuV/m)	Height (cm)	Angle (deg)	Remark (QP/PK/AV)
1	2438.320	66.83	30.14	96.97	N/A	N/A	254	252	Average
2	* 2483.500	23.52	30.29	53.81	-0.19	54.00	254	252	Average
3	2485.280	23.35	30.29	53.64	-0.36	54.00	254	252	Average

Note:

1. " *", means this data is the worst emission level.
2. C.F (Correction Factor) = Antenna Factor (dB/m) + Cable Loss (dB).
3. Measurement (dBuV/m) = Reading(dBuV) + C.F (Correction Factor).
4. The emission levels of other frequencies are very lower than the limit and not show in test report.

EUT	AX3000 High Gain Wireless USB Adapter	Date of Test	2023-01-17
Factor	DRH18-E	Temp. / Humidity	20°C /62%
Polarity	Horizontal	Site / Test Engineer	AC2 / Ares
Test Mode	802.11ax-20MHz_TX_CH 1_ANT 1+2	Test Voltage	By Notebook PC

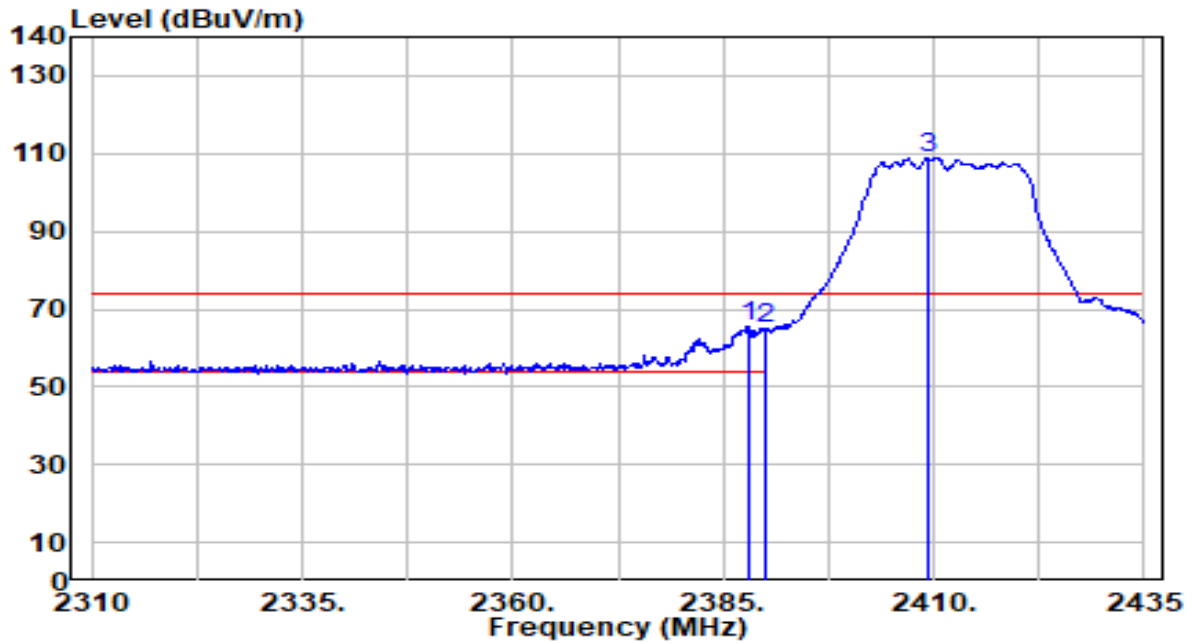

No	Frequency (MHz)	Reading (dBuV)	C.F (dB/m)	Measurement (dBuV/m)	Margin (dB)	Limit (dBuV/m)	Height (cm)	Angle (deg)	Remark (QP/PK/AV)	
1	*	2388.000	35.41	29.99	65.41	-8.59	74.00	214	227	Peak
2		2390.000	34.89	29.99	64.89	-9.11	74.00	214	227	Peak
3		2409.375	79.02	30.04	109.06	N/A	N/A	214	227	Peak

Note:

1. " *", means this data is the worst emission level.
2. C.F (Correction Factor) = Antenna Factor (dB/m) + Cable Loss (dB).
3. Measurement (dBuV/m) = Reading(dBuV) + C.F (Correction Factor).
4. The emission levels of other frequencies are very lower than the limit and not show in test report.

EUT	AX3000 High Gain Wireless USB Adapter	Date of Test	2023-01-17
Factor	DRH18-E	Temp. / Humidity	20°C /62%
Polarity	Horizontal	Site / Test Engineer	AC2 / Ares
Test Mode	802.11ax-20MHz_TX_CH 1_ANT 1+2	Test Voltage	By Notebook PC

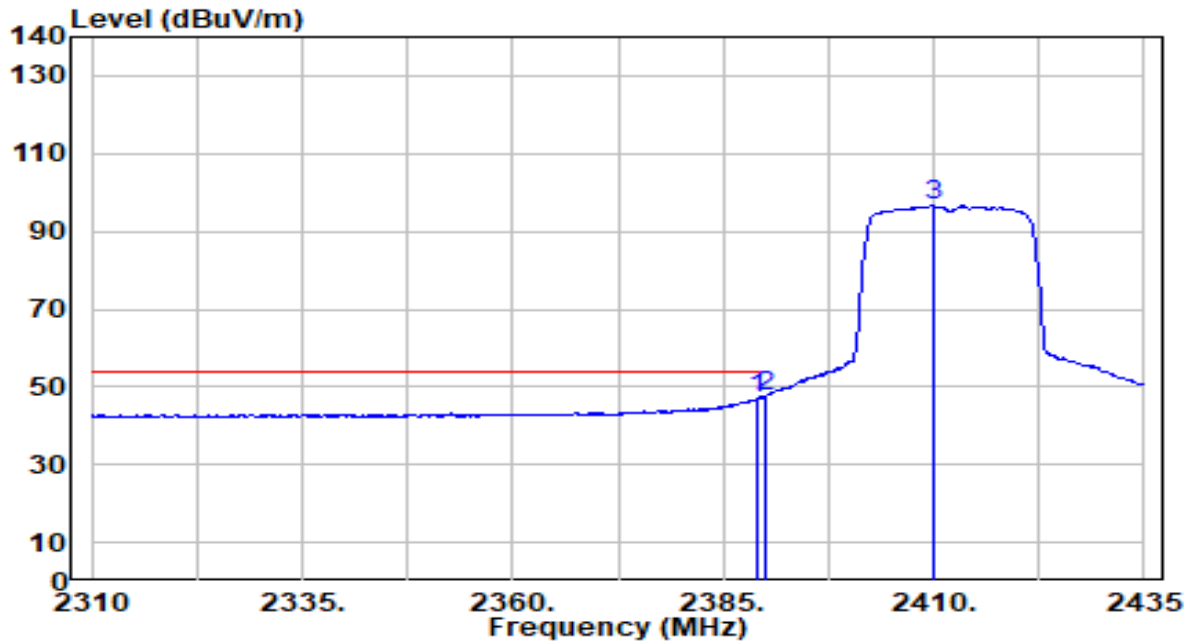

No	Frequency (MHz)	Reading (dBuV)	C.F (dB/m)	Measurement (dBuV/m)	Margin (dB)	Limit (dBuV/m)	Height (cm)	Angle (deg)	Remark (QP/PK/AV)
1	2389.000	17.02	29.99	47.01	-6.99	54.00	214	227	Average
2	* 2390.000	17.47	29.99	47.47	-6.53	54.00	214	227	Average
3	2409.875	66.45	30.04	96.49	N/A	N/A	214	227	Average

Note:

1. " *", means this data is the worst emission level.
2. C.F (Correction Factor) = Antenna Factor (dB/m) + Cable Loss (dB).
3. Measurement (dBuV/m) = Reading(dBuV) + C.F (Correction Factor).
4. The emission levels of other frequencies are very lower than the limit and not show in test report.

EUT	AX3000 High Gain Wireless USB Adapter	Date of Test	2023-01-17
Factor	DRH18-E	Temp. / Humidity	20°C /62%
Polarity	Vertical	Site / Test Engineer	AC2 / Ares
Test Mode	802.11ax-20MHz_TX_CH 1_ANT 1+2	Test Voltage	By Notebook PC

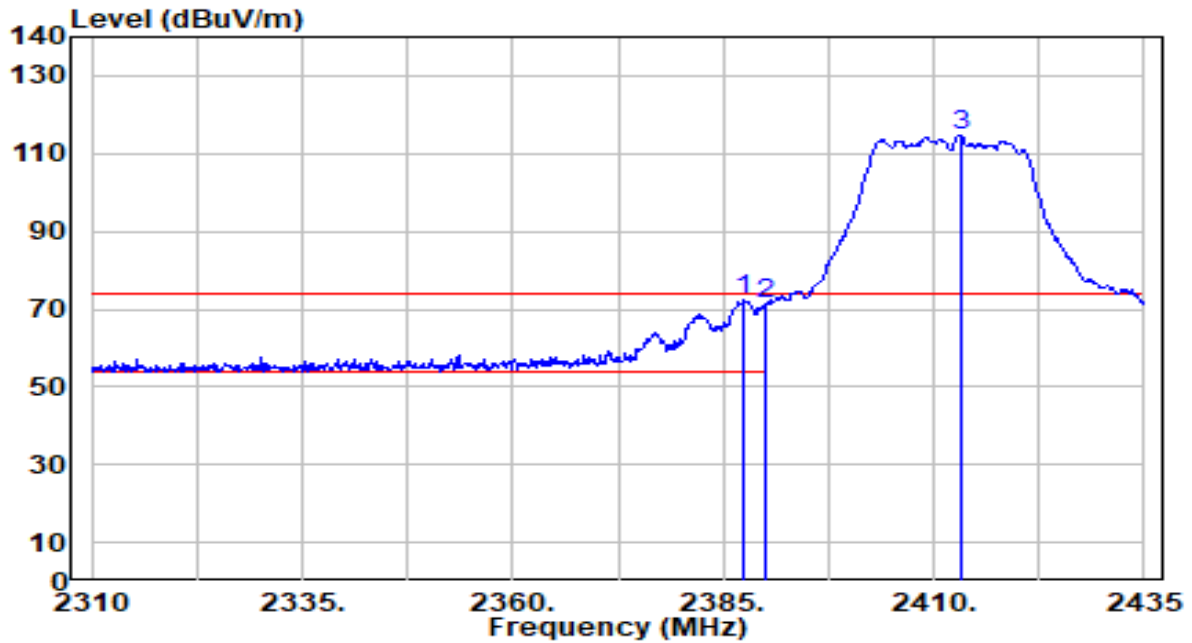

No	Frequency (MHz)	Reading (dBuV)	C.F (dB/m)	Measurement (dBuV/m)	Margin (dB)	Limit (dBuV/m)	Height (cm)	Angle (deg)	Remark (QP/PK/AV)	
1	*	2387.500	42.22	29.99	72.21	-1.79	74.00	244	236	Peak
2		2390.000	41.10	29.99	71.10	-2.90	74.00	244	236	Peak
3		2413.125	84.74	30.05	114.79	N/A	N/A	244	236	Peak

Note:

1. " *", means this data is the worst emission level.
2. C.F (Correction Factor) = Antenna Factor (dB/m) + Cable Loss (dB).
3. Measurement (dBuV/m) = Reading(dBuV) + C.F (Correction Factor).
4. The emission levels of other frequencies are very lower than the limit and not show in test report.

EUT	AX3000 High Gain Wireless USB Adapter	Date of Test	2023-01-17
Factor	DRH18-E	Temp. / Humidity	20°C /62%
Polarity	Vertical	Site / Test Engineer	AC2 / Ares
Test Mode	802.11ax-20MHz_TX_CH 1_ANT 1+2	Test Voltage	By Notebook PC

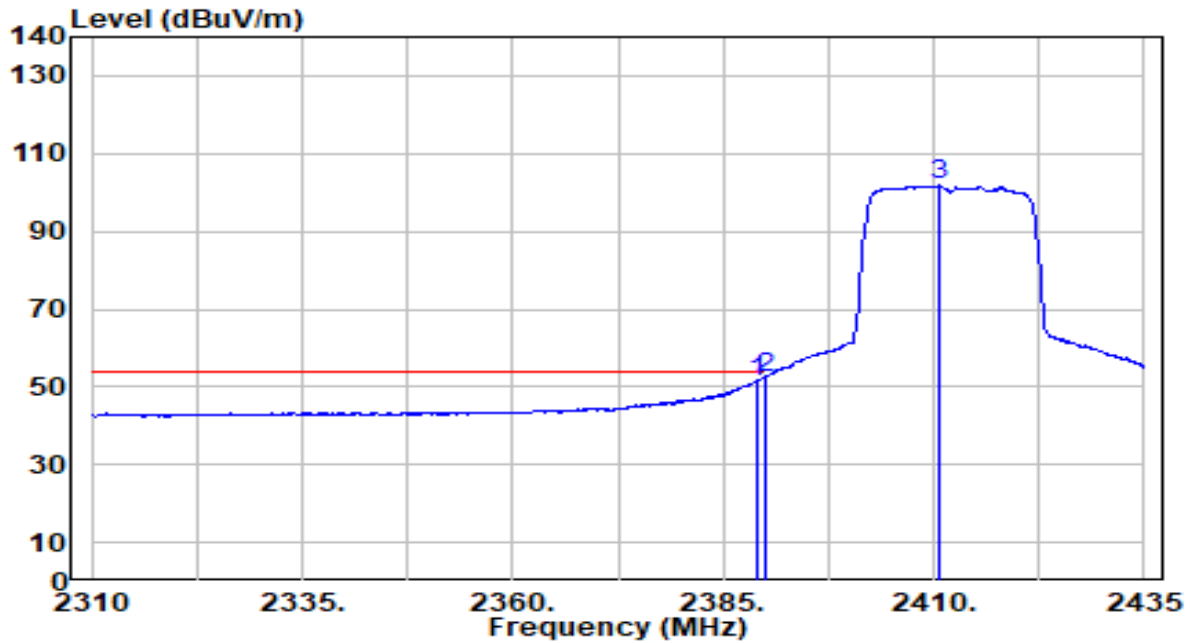

No	Frequency (MHz)	Reading (dBuV)	C.F (dB/m)	Measurement (dBuV/m)	Margin (dB)	Limit (dBuV/m)	Height (cm)	Angle (deg)	Remark (QP/PK/AV)
1	2389.000	21.47	29.99	51.46	-2.54	54.00	244	236	Average
2	* 2390.000	22.39	29.99	52.39	-1.61	54.00	244	236	Average
3	2410.500	71.68	30.04	101.72	N/A	N/A	244	236	Average

Note:

1. " *", means this data is the worst emission level.
2. C.F (Correction Factor) = Antenna Factor (dB/m) + Cable Loss (dB).
3. Measurement (dBuV/m) = Reading(dBuV) + C.F (Correction Factor).
4. The emission levels of other frequencies are very lower than the limit and not show in test report.

EUT	AX3000 High Gain Wireless USB Adapter	Date of Test	2023-01-17
Factor	DRH18-E	Temp. / Humidity	20°C /62%
Polarity	Horizontal	Site / Test Engineer	AC2 / Ares
Test Mode	802.11ax-20MHz_TX_CH 6_ANT 1+2	Test Voltage	By Notebook PC

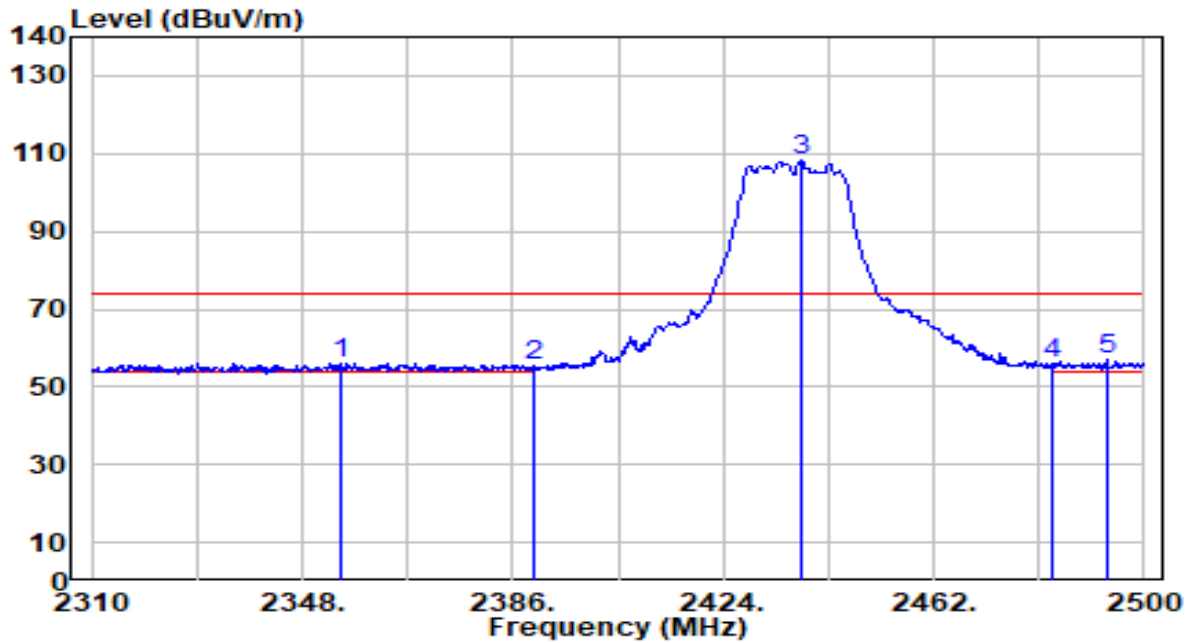

No	Frequency (MHz)	Reading (dBuV)	C.F (dB/m)	Measurement (dBuV/m)	Margin (dB)	Limit (dBuV/m)	Height (cm)	Angle (deg)	Remark (QP/PK/AV)
1	2354.840	26.23	29.95	56.17	-17.83	74.00	260	192	Peak
2	2390.000	25.35	29.99	55.35	-18.65	74.00	260	192	Peak
3	2438.060	78.25	30.13	108.39	N/A	N/A	260	192	Peak
4	2483.500	25.61	30.29	55.89	-18.11	74.00	260	192	Peak
5	* 2493.160	26.64	30.32	56.95	-17.05	74.00	260	192	Peak

Note:

1. " *", means this data is the worst emission level.
2. C.F (Correction Factor) = Antenna Factor (dB/m) + Cable Loss (dB).
3. Measurement (dBuV/m) = Reading(dBuV) + C.F (Correction Factor).
4. The emission levels of other frequencies are very lower than the limit and not show in test report.

EUT	AX3000 High Gain Wireless USB Adapter	Date of Test	2023-01-17
Factor	DRH18-E	Temp. / Humidity	20°C /62%
Polarity	Horizontal	Site / Test Engineer	AC2 / Ares
Test Mode	802.11ax-20MHz_TX_CH 6_ANT 1+2	Test Voltage	By Notebook PC

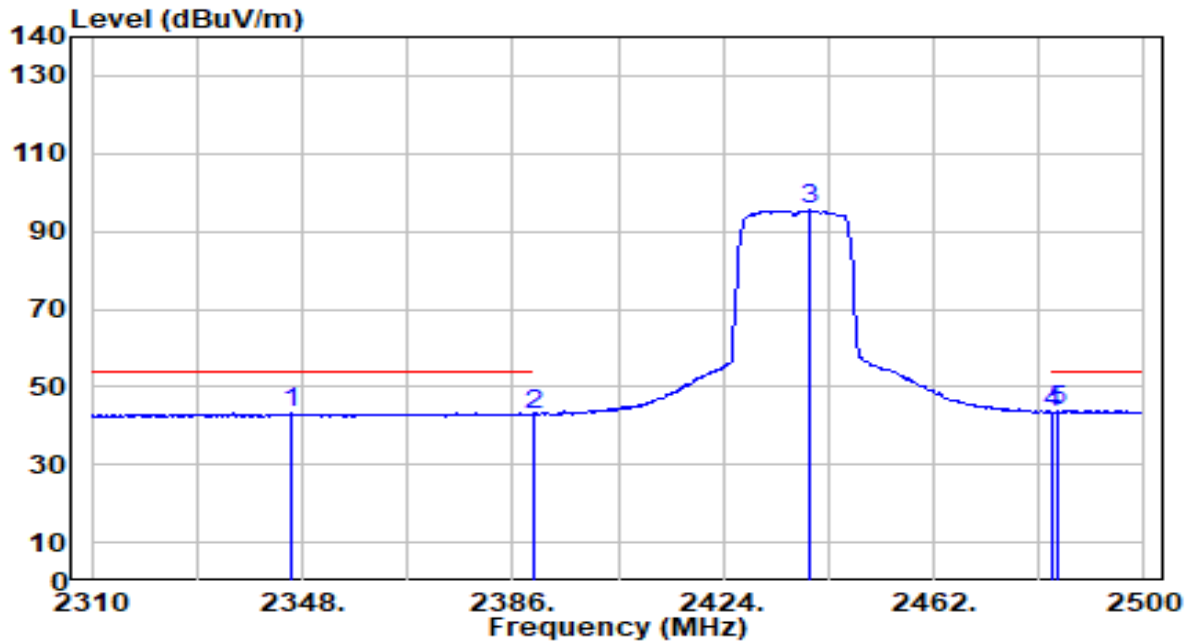

No	Frequency (MHz)	Reading (dBuV)	C.F (dB/m)	Measurement (dBuV/m)	Margin (dB)	Limit (dBuV/m)	Height (cm)	Angle (deg)	Remark (QP/PK/AV)
1	2346.100	13.27	29.94	43.21	-10.79	54.00	260	192	Average
2	2390.000	12.95	29.99	42.95	-11.05	54.00	260	192	Average
3	2439.770	65.27	30.14	95.41	N/A	N/A	260	192	Average
4	2483.500	13.18	30.29	43.47	-10.53	54.00	260	192	Average
5	* 2484.420	13.47	30.29	43.75	-10.25	54.00	260	192	Average

Note:

- " *", means this data is the worst emission level.
- C.F (Correction Factor) = Antenna Factor (dB/m) + Cable Loss (dB).
- Measurement (dBuV/m) = Reading(dBuV) + C.F (Correction Factor).
- The emission levels of other frequencies are very lower than the limit and not show in test report.

EUT	AX3000 High Gain Wireless USB Adapter	Date of Test	2023-01-17
Factor	DRH18-E	Temp. / Humidity	20°C /62%
Polarity	Vertical	Site / Test Engineer	AC2 / Ares
Test Mode	802.11ax-20MHz_TX_CH 6_ANT 1+2	Test Voltage	By Notebook PC

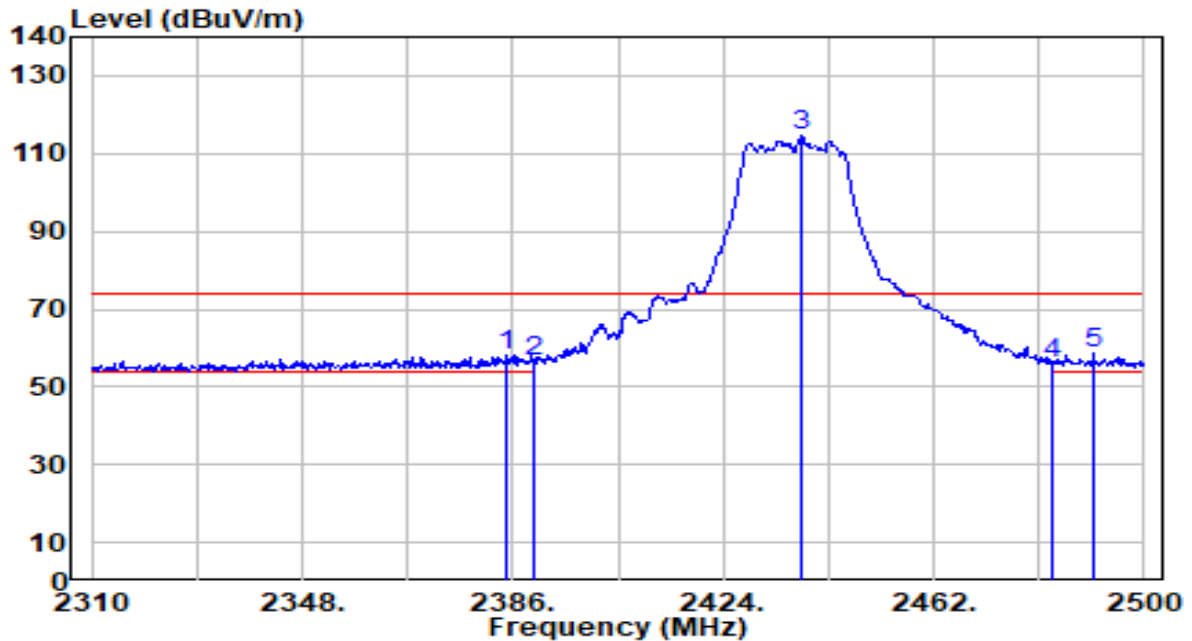

No	Frequency (MHz)	Reading (dBuV)	C.F (dB/m)	Measurement (dBuV/m)	Margin (dB)	Limit (dBuV/m)	Height (cm)	Angle (deg)	Remark (QP/PK/AV)
1	2385.050	28.31	29.99	58.30	-15.70	74.00	243	237	Peak
2	2390.000	26.70	29.99	56.70	-17.30	74.00	243	237	Peak
3	2438.060	84.37	30.13	114.50	N/A	N/A	243	237	Peak
4	2483.500	25.70	30.29	55.99	-18.01	74.00	243	237	Peak
5	* 2490.880	28.16	30.31	58.47	-15.53	74.00	243	237	Peak

Note:

1. " *", means this data is the worst emission level.
2. C.F (Correction Factor) = Antenna Factor (dB/m) + Cable Loss (dB).
3. Measurement (dBuV/m) = Reading(dBuV) + C.F (Correction Factor).
4. The emission levels of other frequencies are very lower than the limit and not show in test report.

EUT	AX3000 High Gain Wireless USB Adapter	Date of Test	2023-01-17
Factor	DRH18-E	Temp. / Humidity	20°C /62%
Polarity	Vertical	Site / Test Engineer	AC2 / Ares
Test Mode	802.11ax-20MHz_TX_CH 6_ANT 1+2	Test Voltage	By Notebook PC

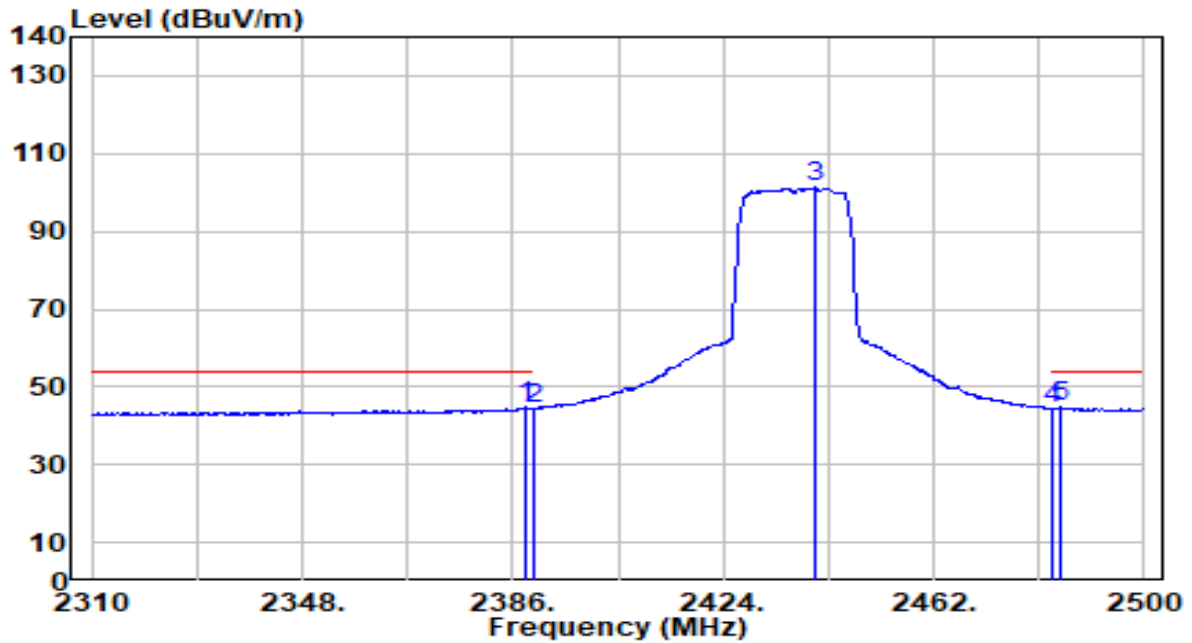

No	Frequency (MHz)	Reading (dBuV)	C.F (dB/m)	Measurement (dBuV/m)	Margin (dB)	Limit (dBuV/m)	Height (cm)	Angle (deg)	Remark (QP/PK/AV)
1	2388.470	14.69	29.99	44.68	-9.32	54.00	243	237	Average
2	2390.000	14.38	29.99	44.38	-9.62	54.00	243	237	Average
3	2440.530	71.06	30.14	101.21	N/A	N/A	243	237	Average
4	2483.500	14.12	30.29	44.41	-9.59	54.00	243	237	Average
5	* 2484.990	14.46	30.29	44.75	-9.25	54.00	243	237	Average

Note:

1. " *", means this data is the worst emission level.
2. C.F (Correction Factor) = Antenna Factor (dB/m) + Cable Loss (dB).
3. Measurement (dBuV/m) = Reading(dBuV) + C.F (Correction Factor).
4. The emission levels of other frequencies are very lower than the limit and not show in test report.

EUT	AX3000 High Gain Wireless USB Adapter	Date of Test	2023-01-17
Factor	DRH18-E	Temp. / Humidity	20°C /62%
Polarity	Horizontal	Site / Test Engineer	AC2 / Ares
Test Mode	802.11ax-20MHz_TX_CH 11_ANT 1+2	Test Voltage	By Notebook PC

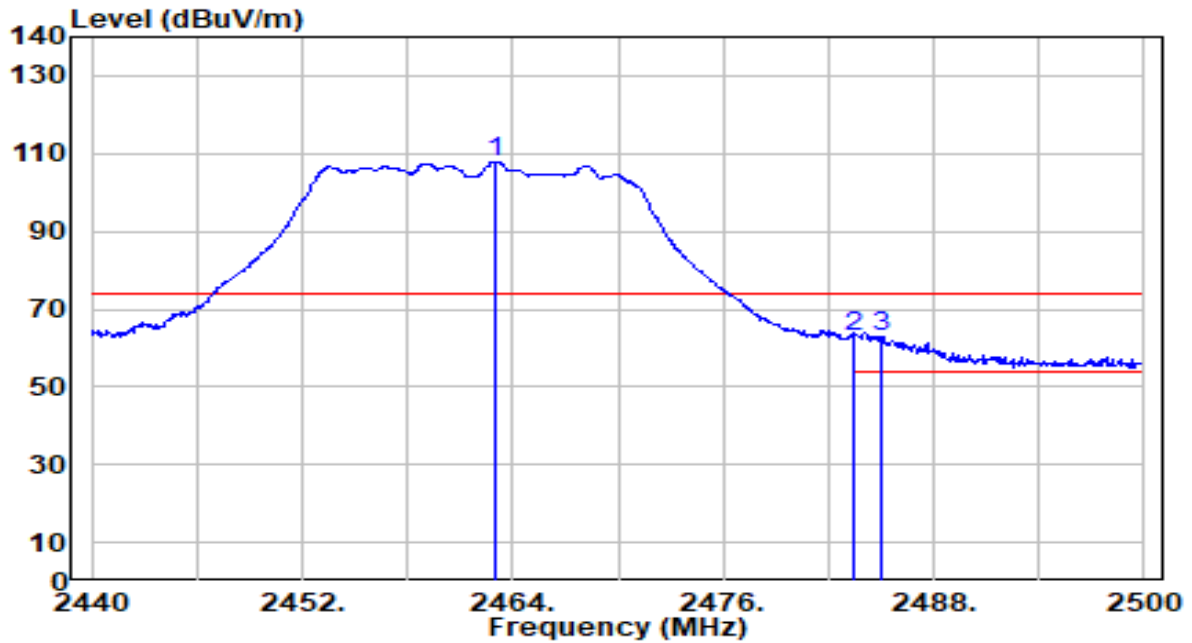

No	Frequency (MHz)	Reading (dBuV)	C.F (dB/m)	Measurement (dBuV/m)	Margin (dB)	Limit (dBuV/m)	Height (cm)	Angle (deg)	Remark (QP/PK/AV)
1	2462.980	77.67	30.22	107.89	N/A	N/A	260	192	Peak
2	* 2483.500	32.54	30.29	62.83	-11.17	74.00	260	192	Peak
3	2485.000	32.52	30.29	62.81	-11.19	74.00	260	192	Peak

Note:

1. " *", means this data is the worst emission level.
2. C.F (Correction Factor) = Antenna Factor (dB/m) + Cable Loss (dB).
3. Measurement (dBuV/m) = Reading(dBuV) + C.F (Correction Factor).
4. The emission levels of other frequencies are very lower than the limit and not show in test report.

EUT	AX3000 High Gain Wireless USB Adapter	Date of Test	2023-01-17
Factor	DRH18-E	Temp. / Humidity	20°C /62%
Polarity	Horizontal	Site / Test Engineer	AC2 / Ares
Test Mode	802.11ax-20MHz_TX_CH 11_ANT 1+2	Test Voltage	By Notebook PC

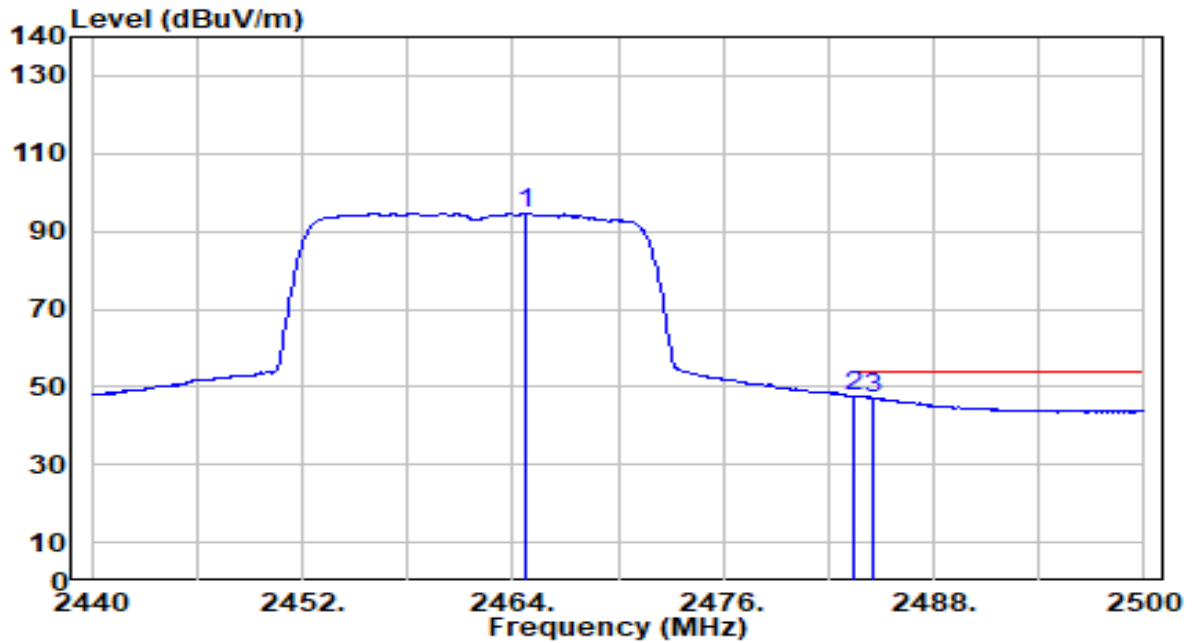

No	Frequency (MHz)	Reading (dBuV)	C.F (dB/m)	Measurement (dBuV/m)	Margin (dB)	Limit (dBuV/m)	Height (cm)	Angle (deg)	Remark (QP/PK/AV)
1	2464.720	64.32	30.22	94.54	N/A	N/A	260	192	Average
2	* 2483.500	17.32	30.29	47.61	-6.39	54.00	260	192	Average
3	2484.580	16.93	30.29	47.22	-6.78	54.00	260	192	Average

Note:

1. " *", means this data is the worst emission level.
2. C.F (Correction Factor) = Antenna Factor (dB/m) + Cable Loss (dB).
3. Measurement (dBuV/m) = Reading(dBuV) + C.F (Correction Factor).
4. The emission levels of other frequencies are very lower than the limit and not show in test report.

EUT	AX3000 High Gain Wireless USB Adapter	Date of Test	2023-01-17
Factor	DRH18-E	Temp. / Humidity	20°C /62%
Polarity	Vertical	Site / Test Engineer	AC2 / Ares
Test Mode	802.11ax-20MHz_TX_CH 11_ANT 1+2	Test Voltage	By Notebook PC

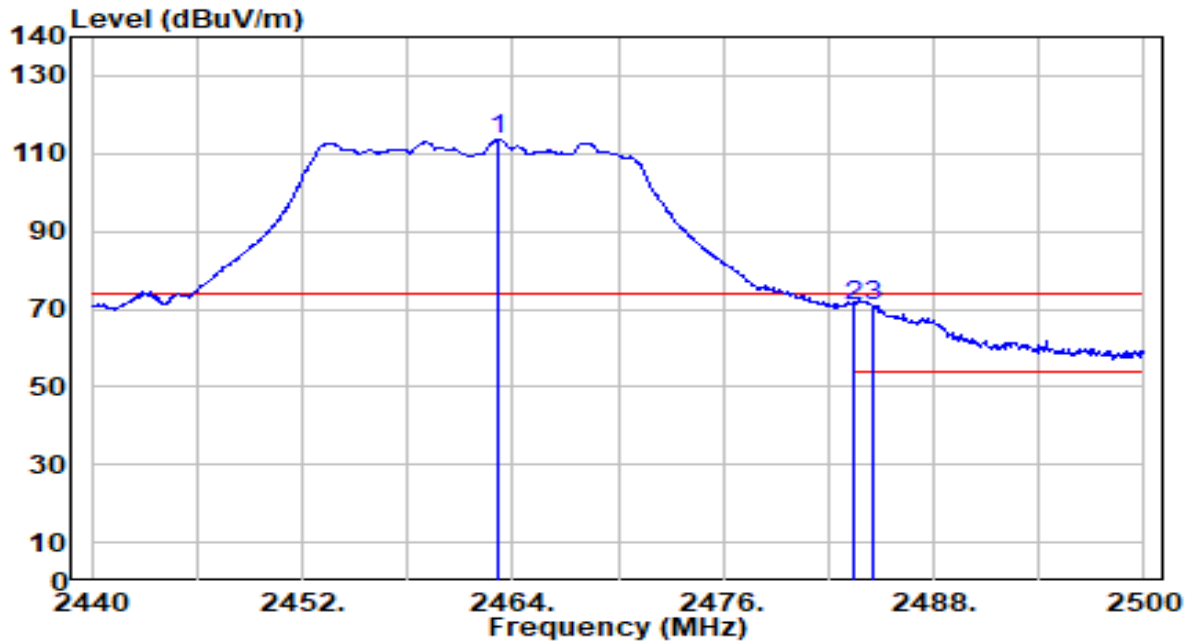

No	Frequency (MHz)	Reading (dBuV)	C.F (dB/m)	Measurement (dBuV/m)	Margin (dB)	Limit (dBuV/m)	Height (cm)	Angle (deg)	Remark (QP/PK/AV)
1	2463.160	83.33	30.22	113.55	N/A	N/A	254	252	Peak
2	* 2483.500	40.65	30.29	70.93	-3.07	74.00	254	252	Peak
3	2484.580	40.57	30.29	70.86	-3.14	74.00	254	252	Peak

Note:

1. " *", means this data is the worst emission level.
2. C.F (Correction Factor) = Antenna Factor (dB/m) + Cable Loss (dB).
3. Measurement (dBuV/m) = Reading(dBuV) + C.F (Correction Factor).
4. The emission levels of other frequencies are very lower than the limit and not show in test report.

EUT	AX3000 High Gain Wireless USB Adapter	Date of Test	2023-01-17
Factor	DRH18-E	Temp. / Humidity	20°C /62%
Polarity	Vertical	Site / Test Engineer	AC2 / Ares
Test Mode	802.11ax-20MHz_TX_CH 11_ANT 1+2	Test Voltage	By Notebook PC

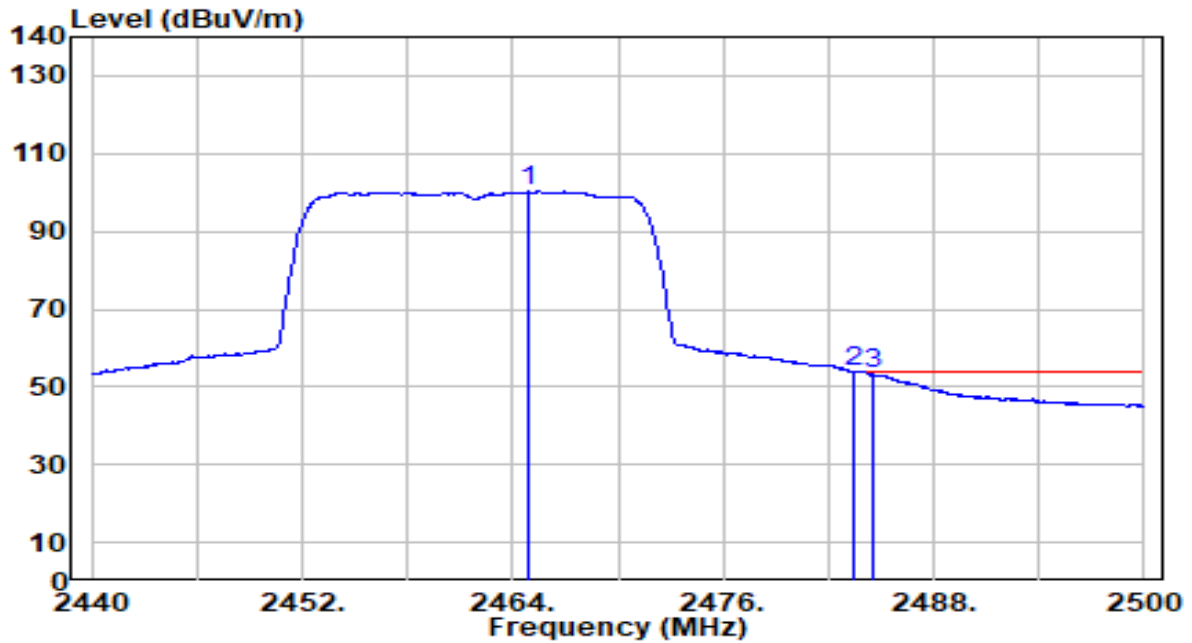

No	Frequency (MHz)	Reading (dBuV)	C.F (dB/m)	Measurement (dBuV/m)	Margin (dB)	Limit (dBuV/m)	Height (cm)	Angle (deg)	Remark (QP/PK/AV)
1	2464.840	69.97	30.22	100.20	N/A	N/A	254	252	Average
2	* 2483.500	23.70	30.29	53.98	-0.02	54.00	254	252	Average
3	2484.520	22.90	30.29	53.19	-0.81	54.00	254	252	Average

Note:

1. " *", means this data is the worst emission level.
2. C.F (Correction Factor) = Antenna Factor (dB/m) + Cable Loss (dB).
3. Measurement (dBuV/m) = Reading(dBuV) + C.F (Correction Factor).
4. The emission levels of other frequencies are very lower than the limit and not show in test report.

EUT	AX3000 High Gain Wireless USB Adapter	Date of Test	2023-01-17
Factor	DRH18-E	Temp. / Humidity	20°C /62%
Polarity	Horizontal	Site / Test Engineer	AC2 / Ares
Test Mode	802.11ax-40MHz_TX_CH 3_ANT 1+2	Test Voltage	By Notebook PC

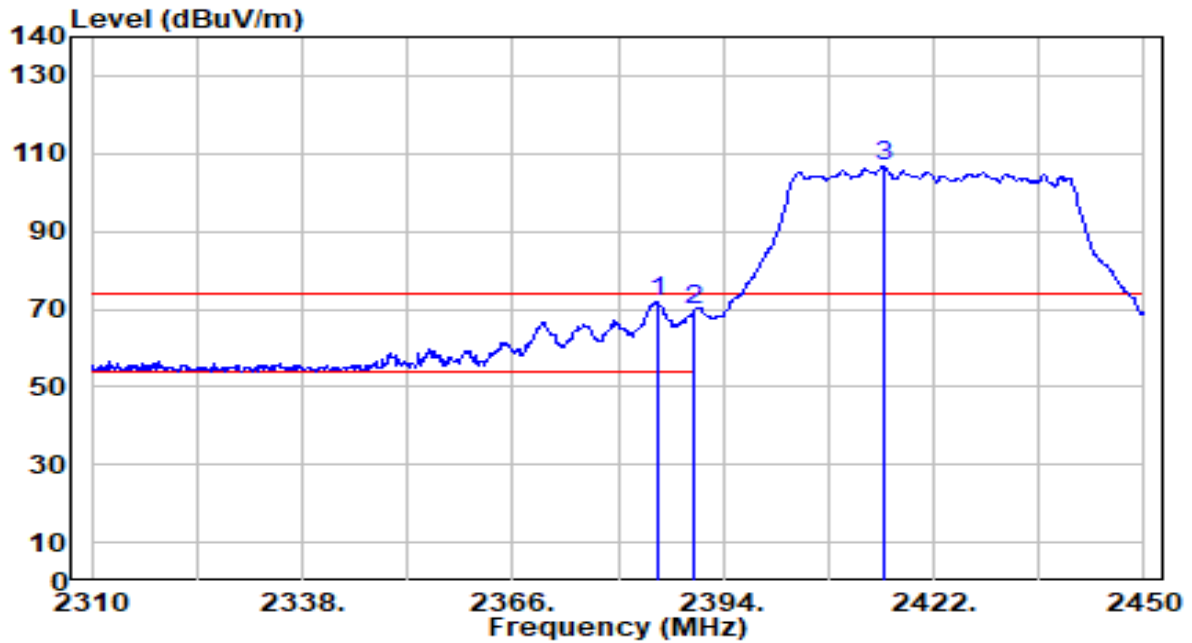

No	Frequency (MHz)	Reading (dBUV)	C.F (dB/m)	Measurement (dBUV/m)	Margin (dB)	Limit (dBUV/m)	Height (cm)	Angle (deg)	Remark (QP/PK/AV)	
1	*	2385.320	41.89	29.99	71.87	-2.13	74.00	214	227	Peak
2		2390.000	39.60	29.99	69.59	-4.41	74.00	214	227	Peak
3		2415.280	76.63	30.06	106.69	N/A	N/A	214	227	Peak

Note:

1. " *", means this data is the worst emission level.
2. C.F (Correction Factor) = Antenna Factor (dB/m) + Cable Loss (dB).
3. Measurement (dBUV/m) = Reading(dBUV) + C.F (Correction Factor).
4. The emission levels of other frequencies are very lower than the limit and not show in test report.

EUT	AX3000 High Gain Wireless USB Adapter	Date of Test	2023-01-17
Factor	DRH18-E	Temp. / Humidity	20°C /62%
Polarity	Horizontal	Site / Test Engineer	AC2 / Ares
Test Mode	802.11ax-40MHz_TX_CH 3_ANT 1+2	Test Voltage	By Notebook PC

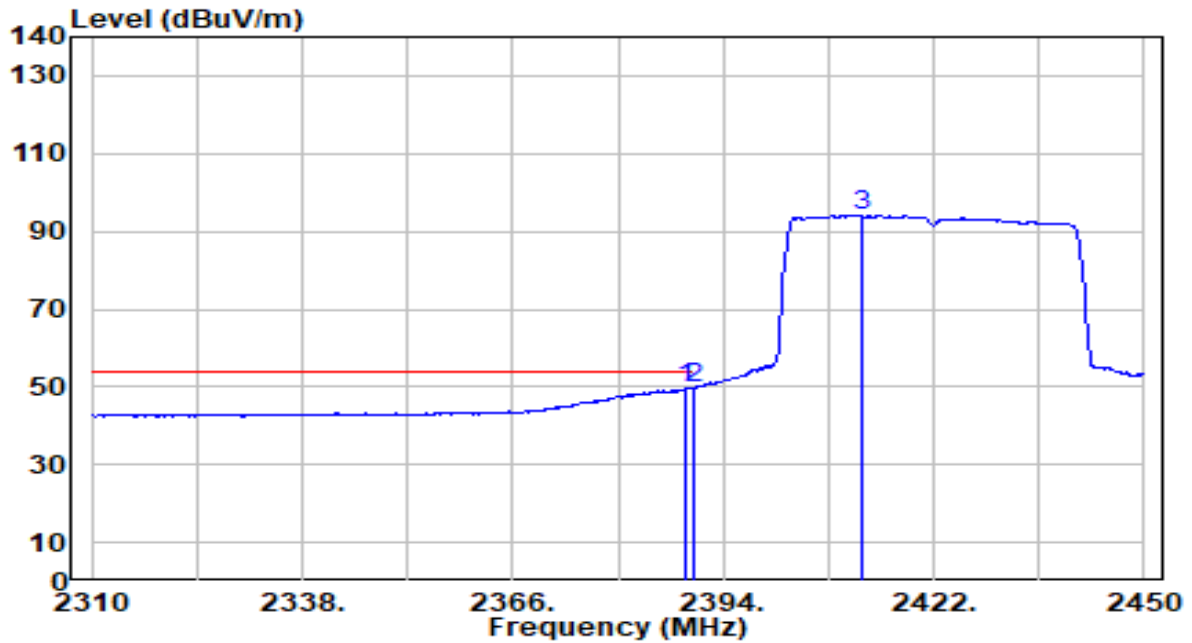

No	Frequency (MHz)	Reading (dBUV)	C.F (dB/m)	Measurement (dBUV/m)	Margin (dB)	Limit (dBUV/m)	Height (cm)	Angle (deg)	Remark (QP/PK/AV)
1	2388.820	19.45	29.99	49.44	-4.56	54.00	214	227	Average
2	* 2390.000	19.84	29.99	49.84	-4.16	54.00	214	227	Average
3	2412.340	64.06	30.05	94.11	N/A	N/A	214	227	Average

Note:

1. " *", means this data is the worst emission level.
2. C.F (Correction Factor) = Antenna Factor (dB/m) + Cable Loss (dB).
3. Measurement (dBUV/m) = Reading(dBUV) + C.F (Correction Factor).
4. The emission levels of other frequencies are very lower than the limit and not show in test report.

EUT	AX3000 High Gain Wireless USB Adapter	Date of Test	2023-01-17
Factor	DRH18-E	Temp. / Humidity	20°C /62%
Polarity	Vertical	Site / Test Engineer	AC2 / Ares
Test Mode	802.11ax-40MHz_TX_CH 3_ANT 1+2	Test Voltage	By Notebook PC

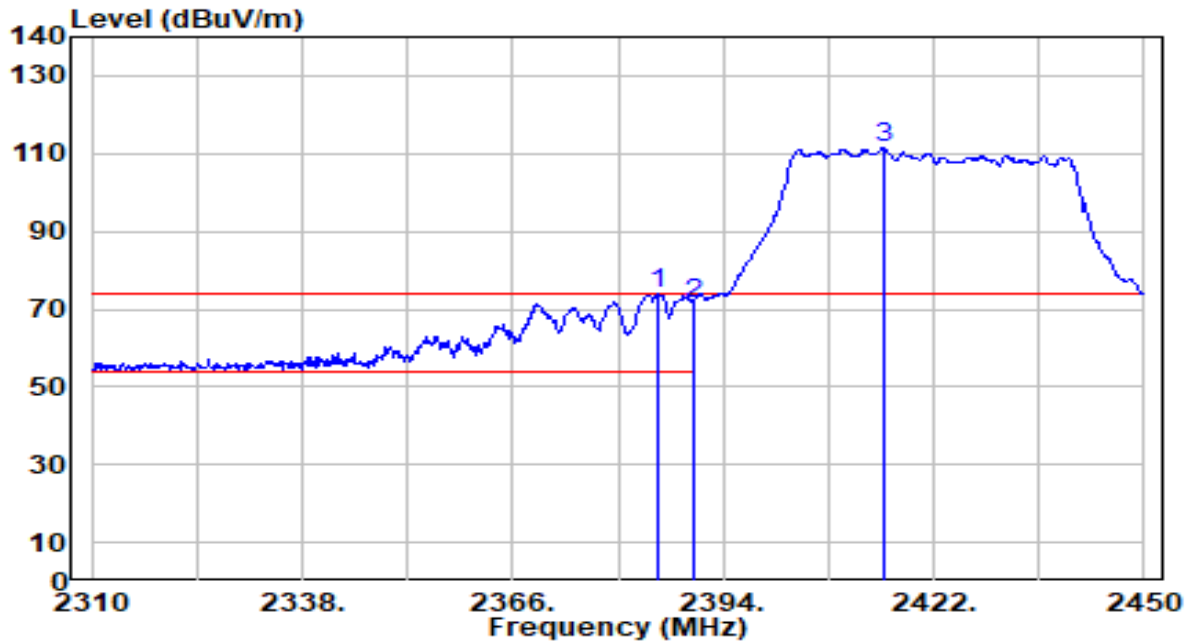

No	Frequency (MHz)	Reading (dBUV)	C.F (dB/m)	Measurement (dBUV/m)	Margin (dB)	Limit (dBUV/m)	Height (cm)	Angle (deg)	Remark (QP/PK/AV)	
1	*	2385.460	43.99	29.99	73.98	-0.02	74.00	244	236	Peak
2		2390.000	41.37	29.99	71.37	-2.63	74.00	244	236	Peak
3		2415.280	81.49	30.06	111.55	N/A	N/A	244	236	Peak

Note:

1. " *", means this data is the worst emission level.
2. C.F (Correction Factor) = Antenna Factor (dB/m) + Cable Loss (dB).
3. Measurement (dBUV/m) = Reading(dBUV) + C.F (Correction Factor).
4. The emission levels of other frequencies are very lower than the limit and not show in test report.

EUT	AX3000 High Gain Wireless USB Adapter	Date of Test	2023-01-17
Factor	DRH18-E	Temp. / Humidity	20°C /62%
Polarity	Vertical	Site / Test Engineer	AC2 / Ares
Test Mode	802.11ax-40MHz_TX_CH 3_ANT 1+2	Test Voltage	By Notebook PC

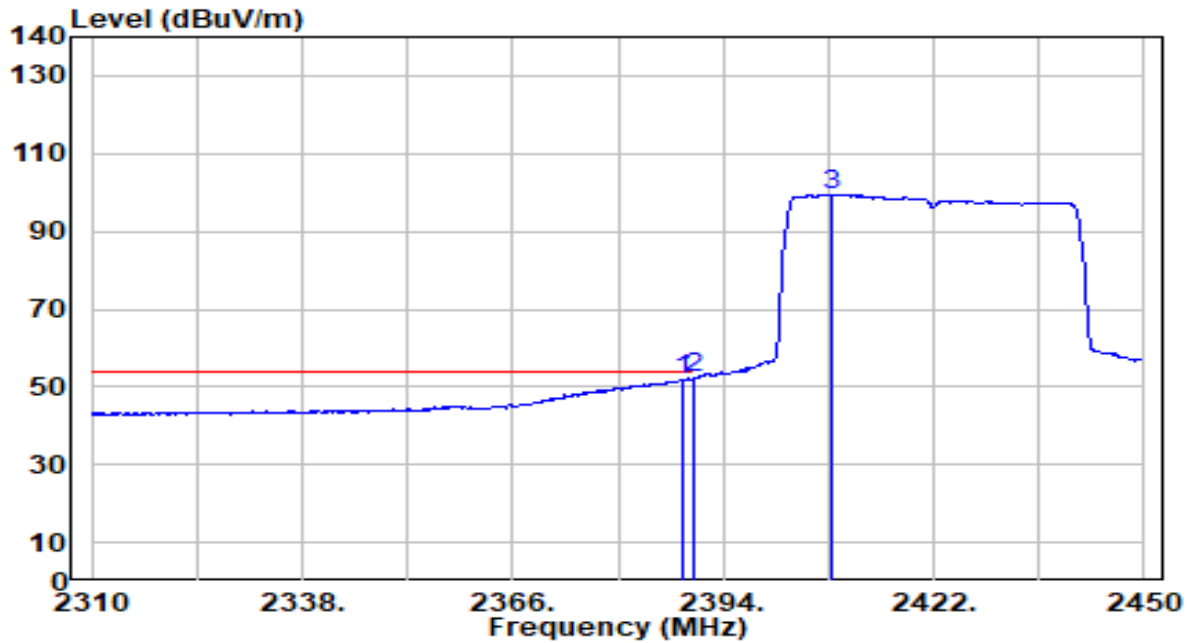

No	Frequency (MHz)	Reading (dBUV)	C.F (dB/m)	Measurement (dBUV/m)	Margin (dB)	Limit (dBUV/m)	Height (cm)	Angle (deg)	Remark (QP/PK/AV)
1	2388.680	21.94	29.99	51.93	-2.07	54.00	244	236	Average
2	* 2390.000	22.29	29.99	52.28	-1.72	54.00	244	236	Average
3	2408.280	69.45	30.04	99.48	N/A	N/A	244	236	Average

Note:

1. " *", means this data is the worst emission level.
2. C.F (Correction Factor) = Antenna Factor (dB/m) + Cable Loss (dB).
3. Measurement (dBUV/m) = Reading(dBUV) + C.F (Correction Factor).
4. The emission levels of other frequencies are very lower than the limit and not show in test report.

EUT	AX3000 High Gain Wireless USB Adapter	Date of Test	2023-01-17
Factor	DRH18-E	Temp. / Humidity	20°C /62%
Polarity	Horizontal	Site / Test Engineer	AC2 / Ares
Test Mode	802.11ax-40MHz_TX_CH 6_ANT 1+2	Test Voltage	By Notebook PC

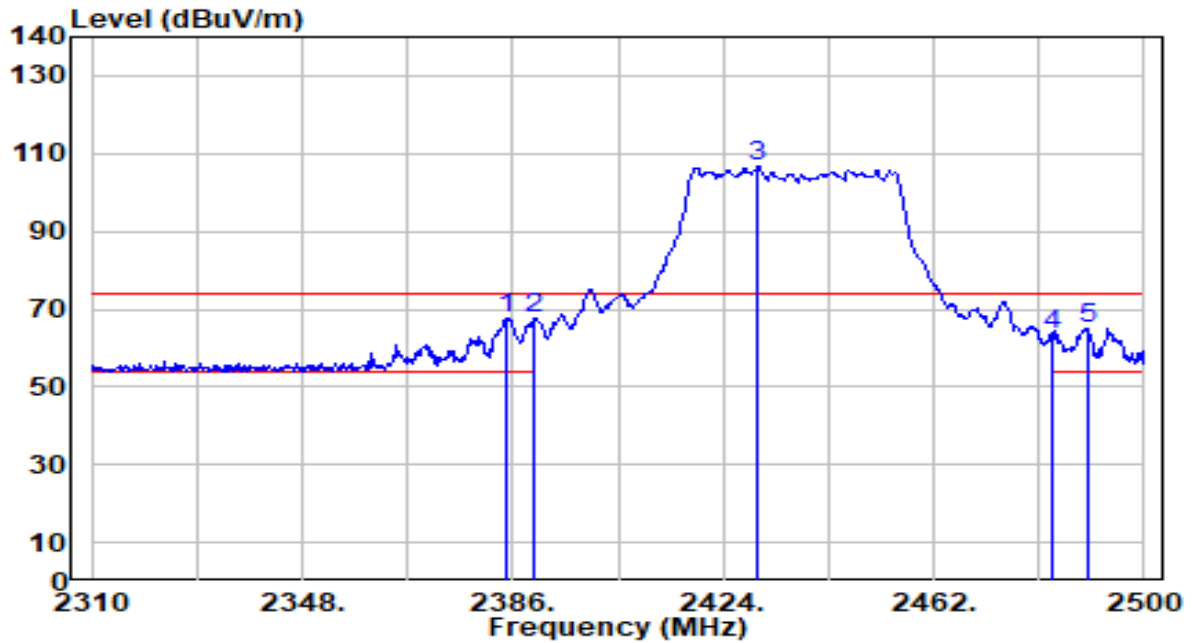

No	Frequency (MHz)	Reading (dBuV)	C.F (dB/m)	Measurement (dBuV/m)	Margin (dB)	Limit (dBuV/m)	Height (cm)	Angle (deg)	Remark (QP/PK/AV)
1	2384.860	37.90	29.99	67.88	-6.12	74.00	214	227	Peak
2	* 2390.000	37.89	29.99	67.89	-6.11	74.00	214	227	Peak
3	2430.270	76.62	30.11	106.72	N/A	N/A	214	227	Peak
4	2483.500	33.19	30.29	63.47	-10.53	74.00	214	227	Peak
5	2489.740	34.64	30.31	64.95	-9.05	74.00	214	227	Peak

Note:

1. " *", means this data is the worst emission level.
2. C.F (Correction Factor) = Antenna Factor (dB/m) + Cable Loss (dB).
3. Measurement (dBuV/m) = Reading(dBuV) + C.F (Correction Factor).
4. The emission levels of other frequencies are very lower than the limit and not show in test report.

EUT	AX3000 High Gain Wireless USB Adapter	Date of Test	2023-01-17
Factor	DRH18-E	Temp. / Humidity	20°C /62%
Polarity	Horizontal	Site / Test Engineer	AC2 / Ares
Test Mode	802.11ax-40MHz_TX_CH 6_ANT 1+2	Test Voltage	By Notebook PC

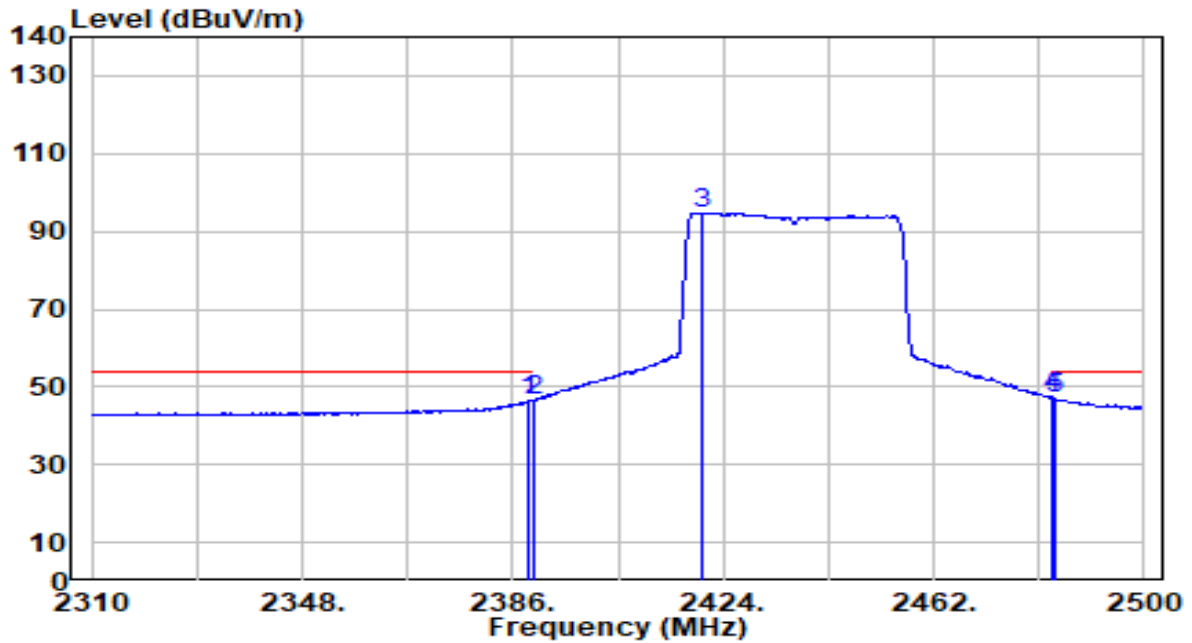

No	Frequency (MHz)	Reading (dBuV)	C.F (dB/m)	Measurement (dBuV/m)	Margin (dB)	Limit (dBuV/m)	Height (cm)	Angle (deg)	Remark (QP/PK/AV)
1	2389.040	16.25	29.99	46.24	-7.76	54.00	214	227	Average
2	2390.000	16.42	29.99	46.42	-7.58	54.00	214	227	Average
3	2420.390	64.71	30.08	94.78	N/A	N/A	214	227	Average
4	* 2483.500	17.21	30.29	47.49	-6.51	54.00	214	227	Average
5	2484.040	16.72	30.29	47.01	-6.99	54.00	214	227	Average

Note:

1. " *", means this data is the worst emission level.
2. C.F (Correction Factor) = Antenna Factor (dB/m) + Cable Loss (dB).
3. Measurement (dBuV/m) = Reading(dBuV) + C.F (Correction Factor).
4. The emission levels of other frequencies are very lower than the limit and not show in test report.

EUT	AX3000 High Gain Wireless USB Adapter	Date of Test	2023-01-17
Factor	DRH18-E	Temp. / Humidity	20°C /62%
Polarity	Vertical	Site / Test Engineer	AC2 / Ares
Test Mode	802.11ax-40MHz_TX_CH 6_ANT 1+2	Test Voltage	By Notebook PC

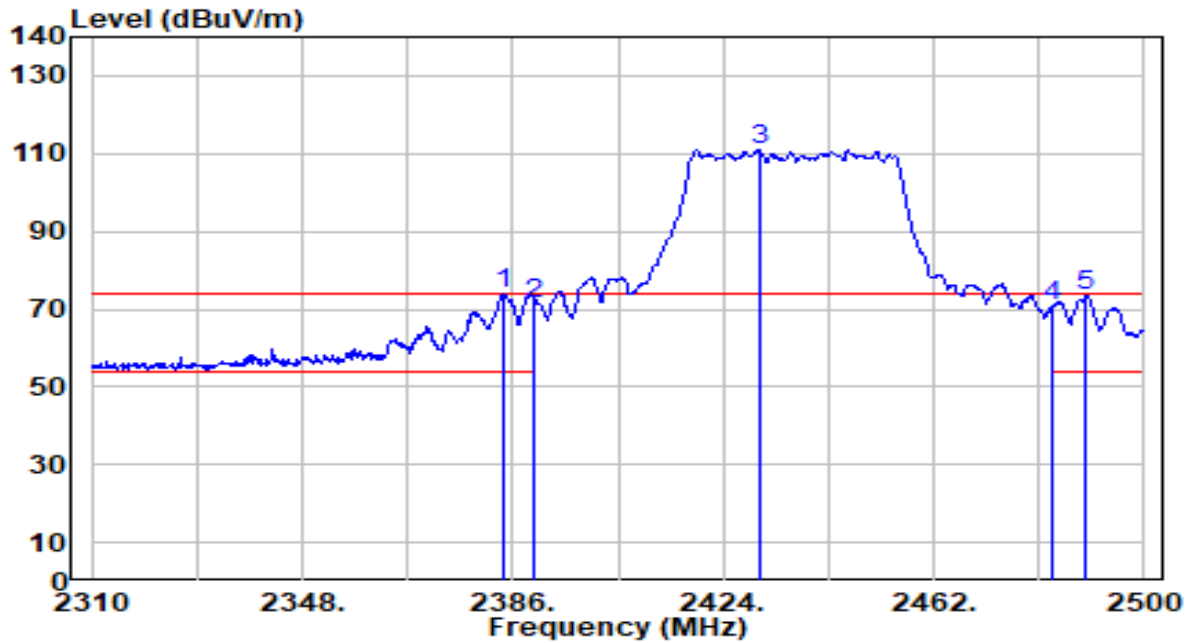

No	Frequency (MHz)	Reading (dBuV)	C.F (dB/m)	Measurement (dBuV/m)	Margin (dB)	Limit (dBuV/m)	Height (cm)	Angle (deg)	Remark (QP/PK/AV)
1	* 2384.290	43.84	29.99	73.83	-0.17	74.00	243	237	Peak
2	2390.000	41.50	29.99	71.50	-2.50	74.00	243	237	Peak
3	2430.460	81.01	30.11	111.12	N/A	N/A	243	237	Peak
4	2483.500	40.58	30.29	70.86	-3.14	74.00	243	237	Peak
5	2489.360	43.28	30.30	73.58	-0.42	74.00	243	237	Peak

Note:

- "*", means this data is the worst emission level.
- C.F (Correction Factor) = Antenna Factor (dB/m) + Cable Loss (dB).
- Measurement (dBuV/m) = Reading(dBuV) + C.F (Correction Factor).
- The emission levels of other frequencies are very lower than the limit and not show in test report.

EUT	AX3000 High Gain Wireless USB Adapter	Date of Test	2023-01-17
Factor	DRH18-E	Temp. / Humidity	20°C /62%
Polarity	Vertical	Site / Test Engineer	AC2 / Ares
Test Mode	802.11ax-40MHz_TX_CH 6_ANT 1+2	Test Voltage	By Notebook PC

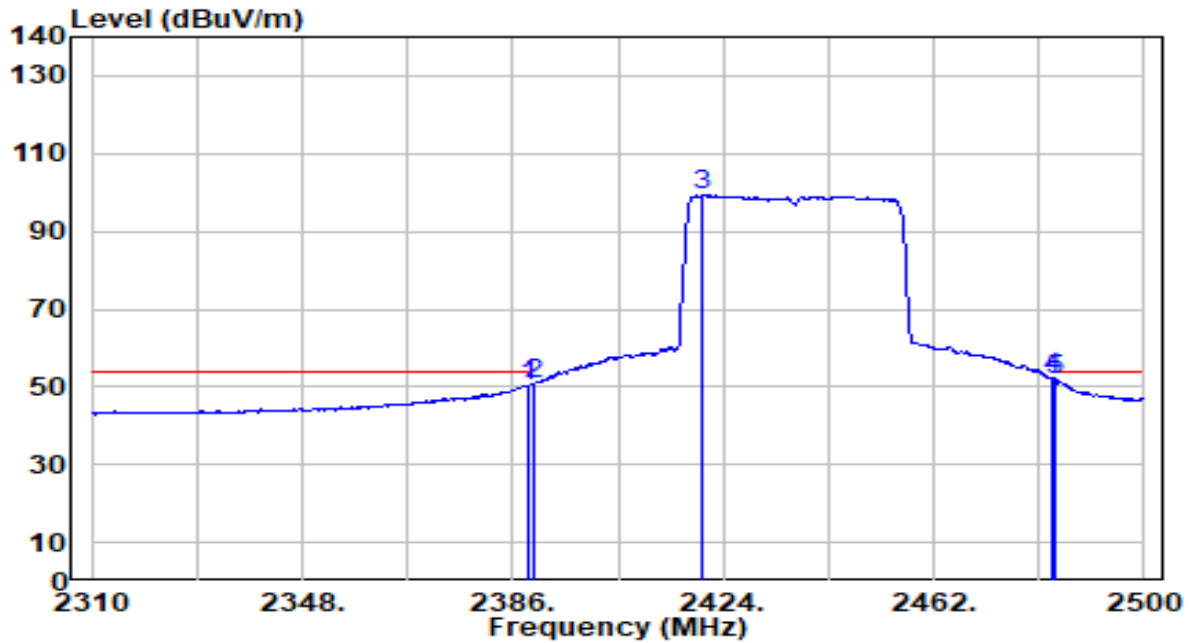

No	Frequency (MHz)	Reading (dBuV)	C.F (dB/m)	Measurement (dBuV/m)	Margin (dB)	Limit (dBuV/m)	Height (cm)	Angle (deg)	Remark (QP/PK/AV)
1	2389.040	20.44	29.99	50.44	-3.56	54.00	243	237	Average
2	2390.000	20.75	29.99	50.74	-3.26	54.00	243	237	Average
3	2420.390	69.13	30.08	99.21	N/A	N/A	243	237	Average
4	* 2483.500	22.02	30.29	52.31	-1.69	54.00	243	237	Average
5	2484.040	21.60	30.29	51.89	-2.11	54.00	243	237	Average

Note:

1. " *", means this data is the worst emission level.
2. C.F (Correction Factor) = Antenna Factor (dB/m) + Cable Loss (dB).
3. Measurement (dBuV/m) = Reading(dBuV) + C.F (Correction Factor).
4. The emission levels of other frequencies are very lower than the limit and not show in test report.

EUT	AX3000 High Gain Wireless USB Adapter	Date of Test	2023-01-17
Factor	DRH18-E	Temp. / Humidity	20°C /62%
Polarity	Horizontal	Site / Test Engineer	AC2 / Ares
Test Mode	802.11ax-40MHz_TX_CH 9_ANT 1+2	Test Voltage	By Notebook PC

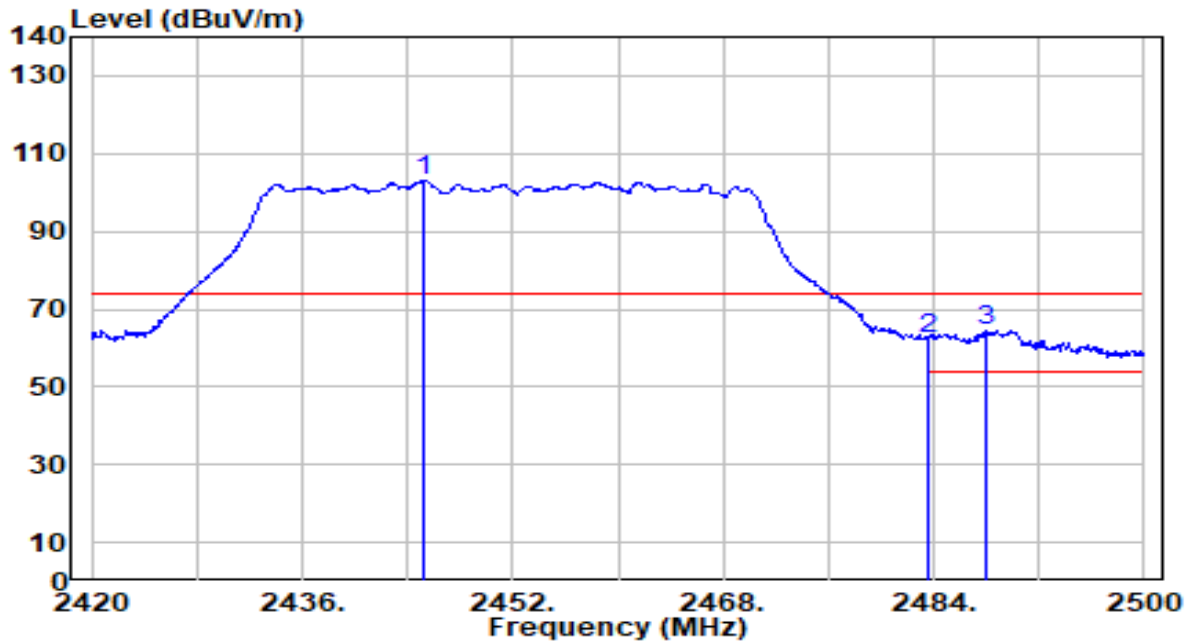

No	Frequency (MHz)	Reading (dBuV)	C.F (dB/m)	Measurement (dBuV/m)	Margin (dB)	Limit (dBuV/m)	Height (cm)	Angle (deg)	Remark (QP/PK/AV)
1	2445.280	73.04	30.16	103.19	N/A	N/A	260	192	Peak
2	2483.500	31.86	30.29	62.15	-11.85	74.00	260	192	Peak
3	* 2488.080	34.23	30.30	64.53	-9.47	74.00	260	192	Peak

Note:

1. " *", means this data is the worst emission level.
2. C.F (Correction Factor) = Antenna Factor (dB/m) + Cable Loss (dB).
3. Measurement (dBuV/m) = Reading(dBuV) + C.F (Correction Factor).
4. The emission levels of other frequencies are very lower than the limit and not show in test report.

EUT	AX3000 High Gain Wireless USB Adapter	Date of Test	2023-01-17
Factor	DRH18-E	Temp. / Humidity	20°C /62%
Polarity	Horizontal	Site / Test Engineer	AC2 / Ares
Test Mode	802.11ax-40MHz_TX_CH 9_ANT 1+2	Test Voltage	By Notebook PC

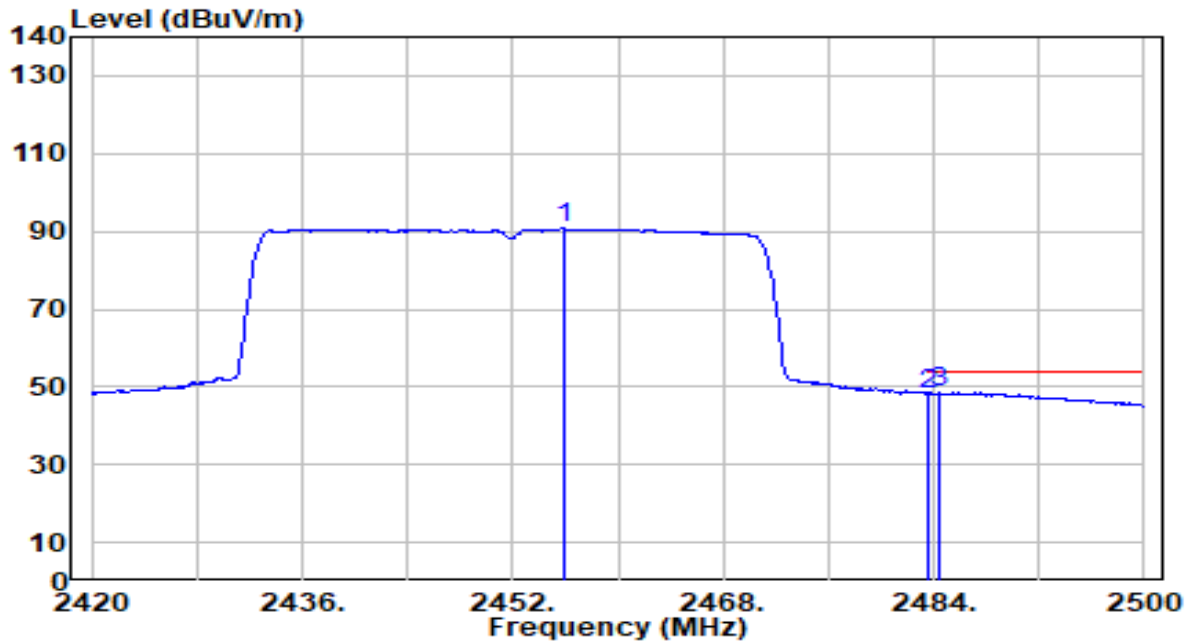

No	Frequency (MHz)	Reading (dBuV)	C.F (dB/m)	Measurement (dBuV/m)	Margin (dB)	Limit (dBuV/m)	Height (cm)	Angle (deg)	Remark (QP/PK/AV)
1	2455.840	60.57	30.19	90.76	N/A	N/A	260	192	Average
2	2483.500	17.92	30.29	48.21	-5.79	54.00	260	192	Average
3	* 2484.480	18.19	30.29	48.48	-5.52	54.00	260	192	Average

Note:

1. " *", means this data is the worst emission level.
2. C.F (Correction Factor) = Antenna Factor (dB/m) + Cable Loss (dB).
3. Measurement (dBuV/m) = Reading(dBuV) + C.F (Correction Factor).
4. The emission levels of other frequencies are very lower than the limit and not show in test report.

EUT	AX3000 High Gain Wireless USB Adapter	Date of Test	2023-01-17
Factor	DRH18-E	Temp. / Humidity	20°C /62%
Polarity	Vertical	Site / Test Engineer	AC2 / Ares
Test Mode	802.11ax-40MHz_TX_CH 9_ANT 1+2	Test Voltage	By Notebook PC

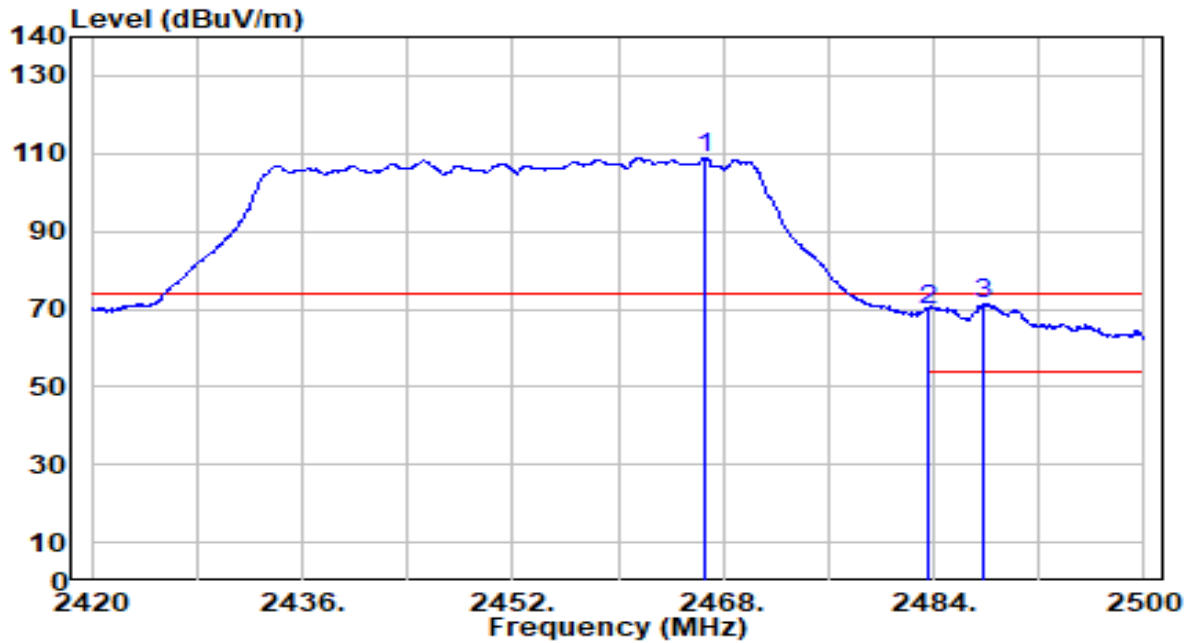

No	Frequency (MHz)	Reading (dBuV)	C.F (dB/m)	Measurement (dBuV/m)	Margin (dB)	Limit (dBuV/m)	Height (cm)	Angle (deg)	Remark (QP/PK/AV)
1	2466.640	78.73	30.23	108.96	N/A	N/A	214	227	Peak
2	2483.500	39.63	30.29	69.92	-4.08	74.00	214	227	Peak
3	* 2487.840	41.18	30.30	71.48	-2.52	74.00	214	227	Peak

Note:

1. " *", means this data is the worst emission level.
2. C.F (Correction Factor) = Antenna Factor (dB/m) + Cable Loss (dB).
3. Measurement (dBuV/m) = Reading(dBuV) + C.F (Correction Factor).
4. The emission levels of other frequencies are very lower than the limit and not show in test report.

EUT	AX3000 High Gain Wireless USB Adapter	Date of Test	2023-01-17
Factor	DRH18-E	Temp. / Humidity	20°C /62%
Polarity	Vertical	Site / Test Engineer	AC2 / Ares
Test Mode	802.11ax-40MHz_TX_CH 9_ANT 1+2	Test Voltage	By Notebook PC

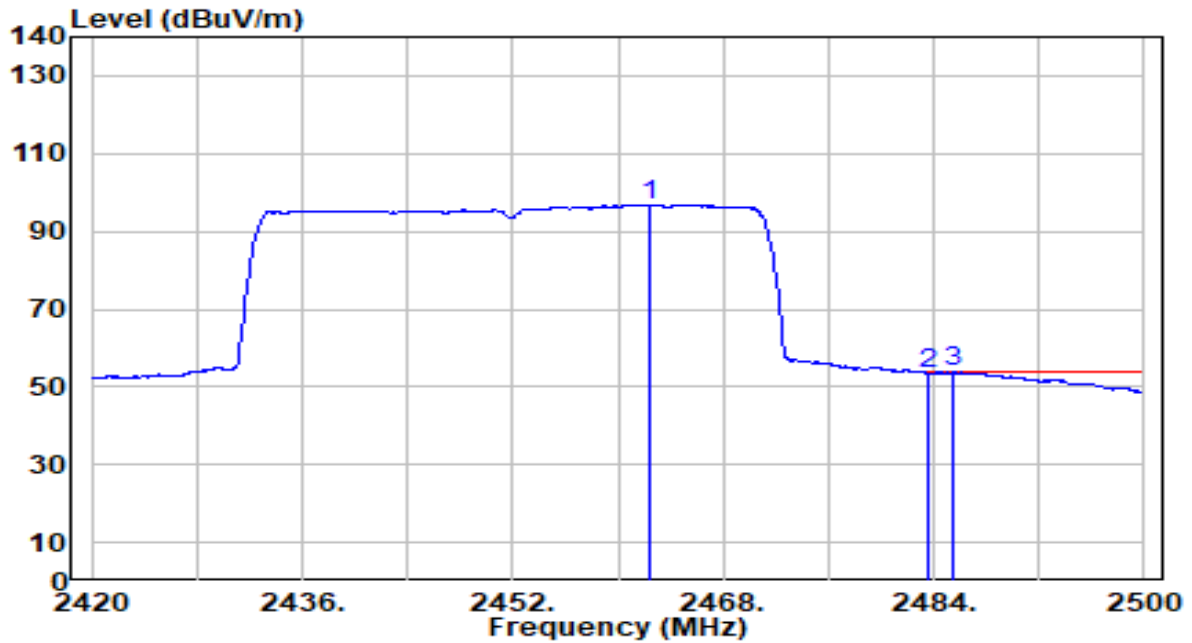

No	Frequency (MHz)	Reading (dBuV)	C.F (dB/m)	Measurement (dBuV/m)	Margin (dB)	Limit (dBuV/m)	Height (cm)	Angle (deg)	Remark (QP/PK/AV)
1	2462.320	66.69	30.21	96.90	N/A	N/A	214	227	Average
2	2483.500	23.22	30.29	53.50	-0.50	54.00	214	227	Average
3	* 2485.440	23.57	30.29	53.86	-0.14	54.00	214	227	Average

Note:

1. " *", means this data is the worst emission level.
2. C.F (Correction Factor) = Antenna Factor (dB/m) + Cable Loss (dB).
3. Measurement (dBuV/m) = Reading(dBuV) + C.F (Correction Factor).
4. The emission levels of other frequencies are very lower than the limit and not show in test report.

7.8. AC Conducted Emissions Measurement

7.8.1. Test Limit

FCC Part 15 Subpart C Paragraph 15.207 Limits		
Frequency (MHz)	QP (dBuV)	AV (dBuV)
0.15 - 0.50	66 - 56	56 - 46
0.50 - 5.0	56	46
5.0 - 30	60	50

Note 1: The lower limit shall apply at the transition frequencies.

Note 2: The limit decreases linearly with the logarithm of the frequency in the range 0.15MHz to 0.5MHz.

7.8.2. Test Setup

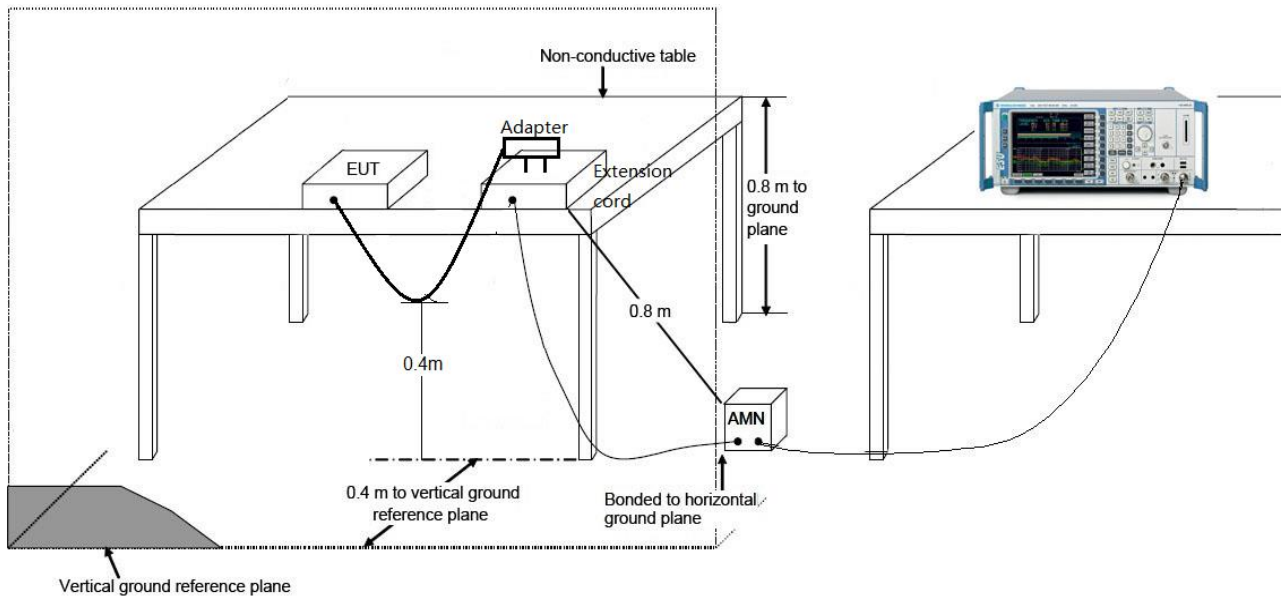

7.8.3. Test Result

EUT	AX3000 High Gain Wireless USB Adapter	Date of Test	2023-02-10
Factor	CE_ENV216-L1 (Filter ON)	Temp. / Humidity	23.7°C /67%
Polarity	Line1	Site / Test Engineer	SR2 / Tim
Test Mode	802.11n-20_TX_CH 6_ANT 1+2	Test Voltage	AC 120V/60Hz

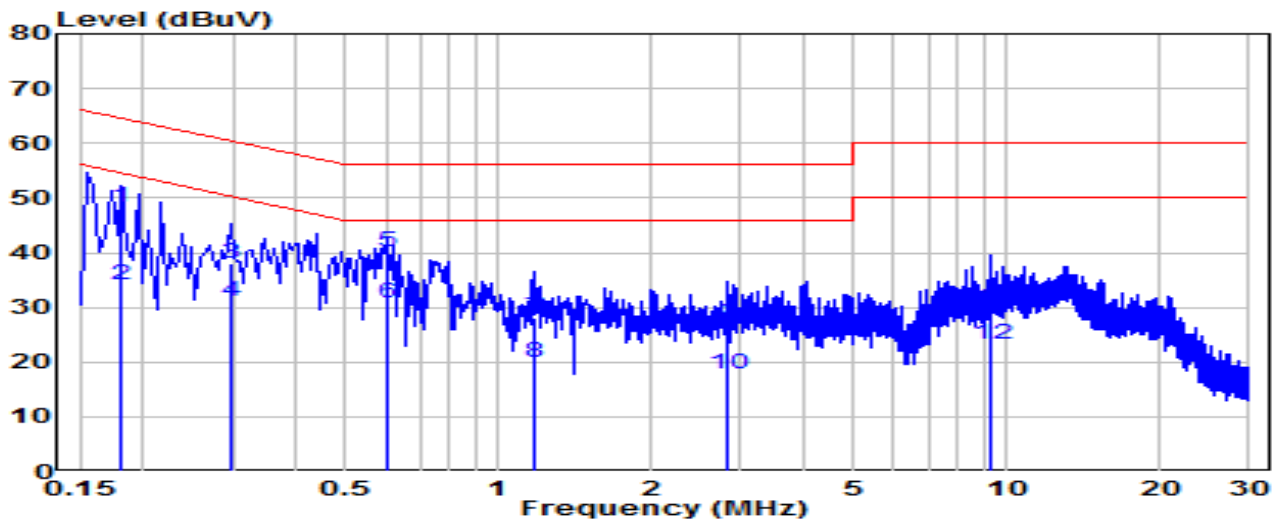

No	Frequency (MHz)	Reading (dBUV)	C.F (dB)	Measurement (dBUV)	Margin (dB)	Limit (dBUV)	Remark (QP/PK/AV)
1	0.181	38.77	9.62	48.39	-16.03	64.42	QP
2	0.181	24.42	9.62	34.04	-20.37	54.42	Average
3	0.298	28.45	9.63	38.08	-22.20	60.28	QP
4	0.298	21.45	9.63	31.08	-19.20	50.28	Average
5	* 0.604	30.50	9.65	40.15	-15.85	56.00	QP
6	* 0.604	21.18	9.65	30.83	-15.17	46.00	Average
7	1.171	18.29	9.67	27.96	-28.04	56.00	QP
8	1.171	10.34	9.67	20.01	-25.99	46.00	Average
9	2.809	17.23	9.71	26.93	-29.07	56.00	QP
10	2.809	7.96	9.71	17.67	-28.33	46.00	Average
11	9.280	19.82	9.84	29.66	-30.34	60.00	QP
12	9.280	13.35	9.84	23.20	-26.80	50.00	Average

Note:

1. " *", means this data is the worst emission level.
2. C.F (Correction Factor) = LISN Factor (dB)+ Cable Loss (dB).
3. Measurement (dBUV) = Reading(dBUV) + C.F (Correction Factor).

EUT	AX3000 High Gain Wireless USB Adapter	Date of Test	2023-02-10
Factor	CE_ENV216-N (Filter ON)	Temp. / Humidity	23.7°C /67%
Polarity	Neutral	Site / Test Engineer	SR2 / Tim
Test Mode	802.11n-20_TX_CH 6_ANT 1+2	Test Voltage	AC 120V/60Hz

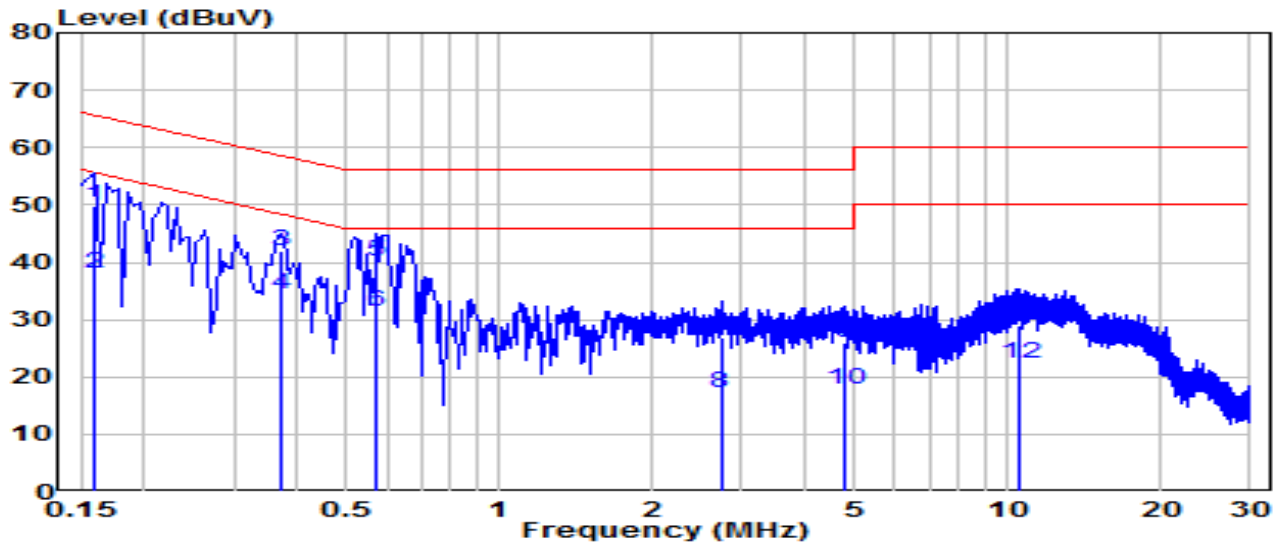

No	Frequency (MHz)	Reading (dBUV)	C.F (dB)	Measurement (dBUV)	Margin (dB)	Limit (dBUV)	Remark (QP/PK/AV)
1	0.159	40.17	9.62	49.80	-15.72	65.52	QP
2	0.159	28.28	9.62	37.90	-17.61	55.52	Average
3	* 0.370	32.44	9.63	42.07	-16.42	58.49	QP
4	* 0.370	24.86	9.63	34.49	-14.00	48.49	Average
5	0.573	30.41	9.65	40.06	-15.94	56.00	QP
6	0.573	21.88	9.65	31.52	-14.48	46.00	Average
7	2.724	17.26	9.70	26.96	-29.04	56.00	QP
8	2.724	7.45	9.70	17.16	-28.84	46.00	Average
9	4.789	16.24	9.74	25.99	-30.01	56.00	QP
10	4.789	8.15	9.74	17.89	-28.11	46.00	Average
11	10.584	18.99	9.88	28.86	-31.14	60.00	QP
12	10.584	12.38	9.88	22.26	-27.74	50.00	Average

Note:

1. " *", means this data is the worst emission level.
2. C.F (Correction Factor) = LISN Factor (dB)+ Cable Loss (dB).
3. Measurement (dBUV) = Reading(dBUV) + C.F (Correction Factor).

EUT	AX3000 High Gain Wireless USB Adapter	Date of Test	2023-02-10
Factor	CE_ENV216-L1 (Filter ON)	Temp. / Humidity	23.7°C /67%
Polarity	Line1	Site / Test Engineer	SR2 / Tim
Test Mode	802.11n-20_TX_CH 6_ANT 1+2	Test Voltage	AC 240V/60Hz

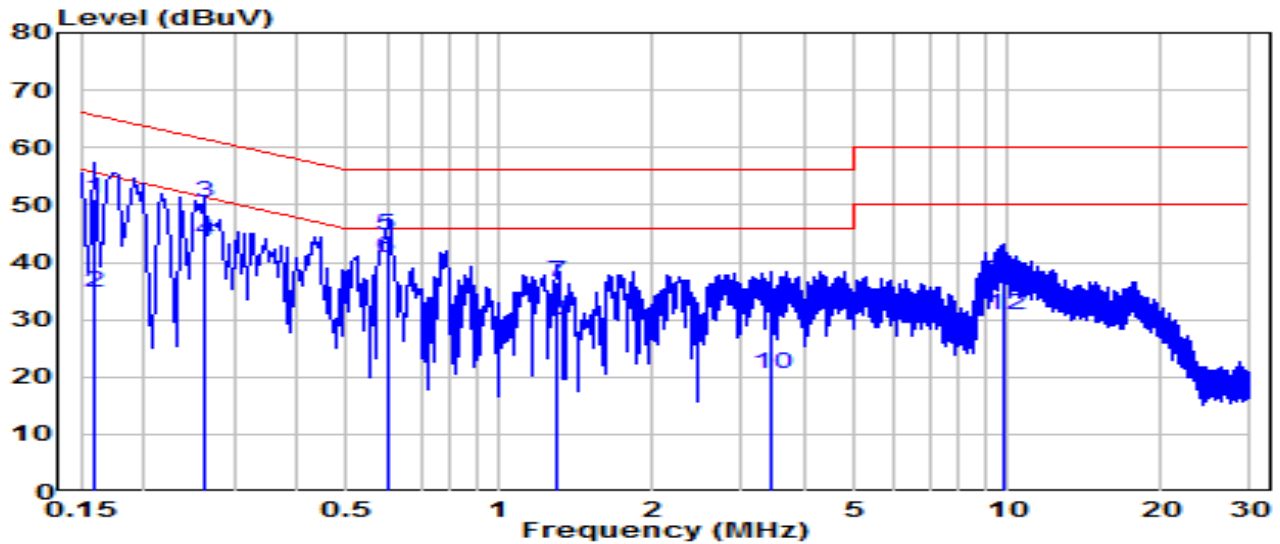

No	Frequency (MHz)	Reading (dBUV)	C.F (dB)	Measurement (dBUV)	Margin (dB)	Limit (dBUV)	Remark (QP/PK/AV)
1	0.159	41.47	9.62	51.09	-14.43	65.52	QP
2	0.159	24.98	9.62	34.60	-20.91	55.52	Average
3	0.262	40.90	9.63	50.53	-10.82	61.35	QP
4	0.262	34.23	9.63	43.86	-7.49	51.35	Average
5	*	0.600	9.65	44.82	-11.18	56.00	QP
6	*	0.600	9.65	40.84	-5.16	46.00	Average
7	1.293	26.75	9.68	36.43	-19.57	56.00	QP
8	1.293	20.08	9.68	29.75	-16.25	46.00	Average
9	3.426	21.71	9.72	31.43	-24.57	56.00	QP
10	3.426	10.89	9.72	20.61	-25.39	46.00	Average
11	9.833	27.15	9.86	37.01	-22.99	60.00	QP
12	9.833	20.84	9.86	30.69	-19.31	50.00	Average

Note:

- "*", means this data is the worst emission level.
- C.F (Correction Factor) = LISN Factor (dB)+ Cable Loss (dB).
- Measurement (dBUV) = Reading(dBUV) + C.F (Correction Factor).

EUT	AX3000 High Gain Wireless USB Adapter	Date of Test	2023-02-10
Factor	CE_ENV216-N (Filter ON)	Temp. / Humidity	23.7°C /67%
Polarity	Neutral	Site / Test Engineer	SR2 / Tim
Test Mode	802.11n-20_TX_CH 6_ANT 1+2	Test Voltage	AC 240V/60Hz

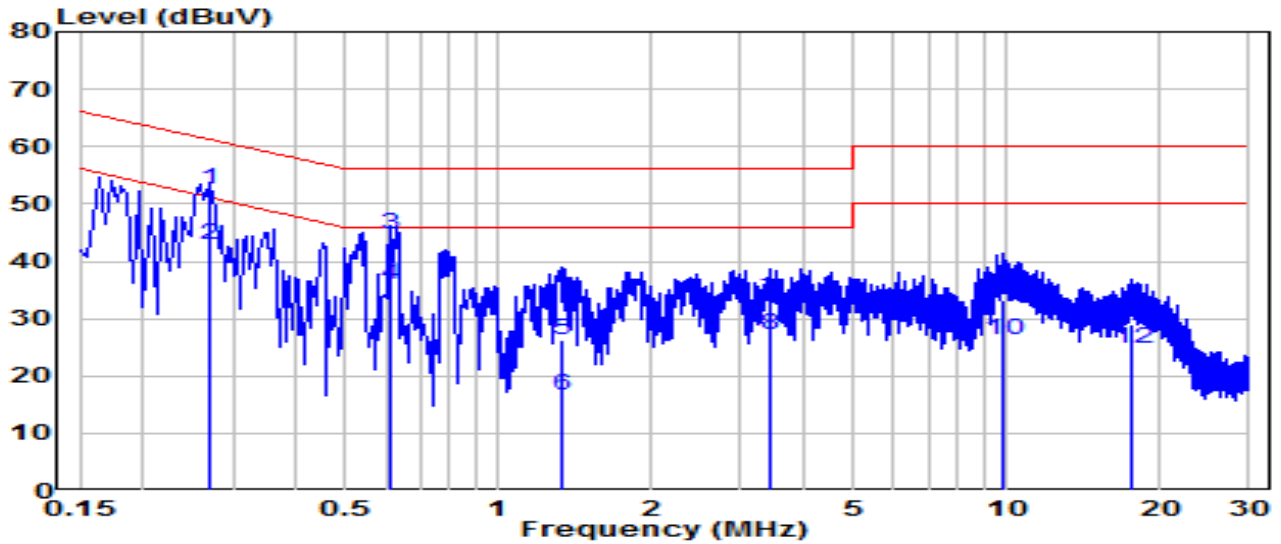

No	Frequency (MHz)	Reading (dBuV)	C.F (dB)	Measurement (dBuV)	Margin (dB)	Limit (dBuV)	Remark (QP/PK/AV)
1	*	42.81	9.63	52.44	-8.64	61.07	QP
2	*	33.31	9.63	42.94	-8.13	51.07	Average
3		34.98	9.65	44.63	-11.37	56.00	QP
4		26.23	9.65	35.88	-10.12	46.00	Average
5		16.67	9.68	26.34	-29.66	56.00	QP
6		6.89	9.68	16.57	-29.43	46.00	Average
7		23.55	9.72	33.27	-22.73	56.00	QP
8		17.48	9.72	27.20	-18.80	46.00	Average
9		23.41	9.87	33.27	-26.73	60.00	QP
10		16.52	9.87	26.39	-23.61	50.00	Average
11		19.08	9.97	29.04	-30.96	60.00	QP
12		14.64	9.97	24.60	-25.40	50.00	Average

Note:

1. " *", means this data is the worst emission level.
2. C.F (Correction Factor) = LISN Factor (dB)+ Cable Loss (dB).
3. Measurement (dBuV) = Reading(dBuV) + C.F (Correction Factor).

8. CONCLUSION

The data collected relate only the item(s) tested and show that the device is compliance with Part 15C of the FCC Rules.

Appendix A : Test Setup Photograph

Refer to “2308TW0101-UT” file.

Appendix B : External Photograph

Refer to “2308TW0101-UE” file.

Appendix C : Internal Photograph

Refer to “2308TW0101-UI” file.

————— The End —————