



## RF MEASUREMENT REPORT

---

**FCC ID** : 2AXJ4S135B  
**APPLICANT** : TP-Link Corporation Limited  
**Application Type** : Certification  
**Product** : Dimmer Control  
**Model No.** : Tapo S135B  
**Brand Name** : tp-link  
**FCC Classification** : Digital Transmission System (DTS)  
**FCC Rule Part(s)** : Part 15.247  
**Test Procedure(s)** : ANSI C63.10-2013  
**Received Date** : October 6 ,2022  
**Test Date** : October 8~14 ,2022

**Tested By** : Owen Tsai  
(Owen Tsai)  
**Reviewed By** : Paddy Chen  
(Paddy Chen)  
**Approved By** : Chenz Ker  
(Chenz Ker)



The test results only relate to the tested sample.

This equipment has been shown to be capable of compliance with the applicable technical standards as indicated in the measurement report and was tested in accordance with the measurement procedures specified in ANSI C63.10. Test results reported herein relate only to the item(s) tested.

The test report shall not be reproduced except in full without the written approval of MRT Technology (Taiwan) Co., Ltd.

---

## Revision History

Report No.	Version	Description	Issue Date	Note
2210TW0106-U1	1.0	Original Report	2023-01-04	Valid

# CONTENTS

Description	Page
<b>§2.1033 General Information .....</b>	<b>5</b>
<b>1. INTRODUCTION .....</b>	<b>6</b>
1.1. Scope.....	6
1.2. MRT Test Location.....	6
<b>2. PRODUCT INFORMATION .....</b>	<b>7</b>
2.1. Equipment Description .....	7
2.2. Product Specification Subjective to this Standard.....	7
2.3. Test Mode.....	7
2.4. Operation Frequency / Channel List.....	8
2.5. Test Configuration.....	9
2.6. Test System Details .....	9
2.7. Test Software.....	9
2.8. EMI Suppression Device(s)/Modifications .....	10
2.9. Labeling Requirements .....	10
<b>3. DESCRIPTION of TEST .....</b>	<b>11</b>
3.1. Evaluation Procedure.....	11
3.2. AC Line Conducted Emissions .....	11
3.3. Radiated Emissions .....	12
<b>4. ANTENNA REQUIREMENTS.....</b>	<b>13</b>
<b>5. TEST EQUIPMENT CALIBRATION DATE.....</b>	<b>14</b>
<b>6. MEASUREMENT UNCERTAINTY.....</b>	<b>15</b>
<b>7. TEST RESULT .....</b>	<b>16</b>
7.1. Summary.....	16
7.2. 6dB Bandwidth Measurement .....	17
7.2.1. Test Limit.....	17
7.2.2. Test Procedure used .....	17
7.2.3. Test Setting .....	17
7.2.4. Test Setup .....	17
7.2.5. Test Result .....	18
7.3. Output Power Measurement.....	19
7.3.1. Test Limit.....	19
7.3.2. Test Procedure Used.....	19
7.3.3. Test Setting .....	19
7.3.4. Test Setup .....	19
7.3.5. Test Result .....	20
7.4. Power Spectral Density Measurement .....	21
7.4.1. Test Limit.....	21
7.4.2. Test Procedure Used.....	21
7.4.3. Test Setting .....	21
7.4.4. Test Setup .....	22

---

7.4.5.	Test Result .....	23
7.5.	Out-of-Band Spurious Emissions Emissions Measurement .....	24
7.5.1.	Test Limit .....	24
7.5.2.	Test Procedure Used .....	24
7.5.3.	Test Setting .....	24
7.5.4.	Test Setup .....	25
7.5.5.	Test Result .....	26
7.6.	Radiated Spurious Emission Measurement .....	29
7.6.1.	Test Limit .....	29
7.6.2.	Test Procedure Used .....	29
7.6.3.	Test Setting .....	29
7.6.4.	Test Setup .....	31
7.6.5.	Test Result .....	32
7.7.	Radiated Restricted Band Edge Measurement .....	40
7.7.1.	Test Limit .....	40
7.7.2.	Test Procedure Used .....	41
7.7.3.	Test Setting .....	41
7.7.4.	Test Setup .....	42
7.7.5.	Test Result .....	43
7.8.	AC Conducted Emissions Measurement .....	47
7.8.1.	Test Limit .....	47
7.8.2.	Test Setup .....	47
7.8.3.	Test Result .....	47
<b>8.</b>	<b>CONCLUSION .....</b>	<b>48</b>
	<b>Appendix A : Test Photograph .....</b>	<b>49</b>
	<b>Appendix B : External Photograph .....</b>	<b>50</b>
	<b>Appendix C : Internal Photograph .....</b>	<b>51</b>

## §2.1033 General Information

<b>Applicant</b>	TP-Link Corporation Limited
<b>Applicant Address</b>	Room 901, 9/F. , New East Ocean Centre, 9 Science Museum Road, Tsim Sha Tsui, Kowloon, Hongkong
<b>Manufacturer</b>	TP-Link Corporation Limited
<b>Manufacturer Address</b>	Room 901, 9/F. , New East Ocean Centre, 9 Science Museum Road, Tsim Sha Tsui, Kowloon, Hongkong
<b>Test Site</b>	MRT Technology (Taiwan) Co., Ltd
<b>Test Site Address</b>	No. 38, Fuxing Second Rd., Guishan Dist., Taoyuan City 333, Taiwan (R.O.C)
<b>MRT FCC Registration No.</b>	291082
<b>FCC Rule Part(s)</b>	Part 15.247

### Test Facility / Accreditations

1. MRT facility is a FCC registered (Reg. No. 291082) test facility with the site description report on file and is designated by the FCC as an Accredited Test Firm.
2. MRT facility is an IC registered (MRT Reg. No. 21723) test laboratory with the site description on file at Industry Canada.
3. MRT Lab is accredited to ISO 17025 by the Taiwan Accreditation Foundation (TAF Cert. No. 3261) in EMC, Telecommunications and Radio testing for FCC (Designation Number: TW3261), Industry Taiwan, EU and TELEC Rules.

# 1. INTRODUCTION

## 1.1. Scope

Measurement and determination of electromagnetic emissions (EMC) of radio frequency devices including intentional and/or unintentional radiators for compliance with the technical rules and regulations of the Federal Communications Commission and the Industry Canada Certification and Engineering Bureau.

## 1.2. MRT Test Location

The map below shows the location of the MRT LABORATORY, its proximity to the Taoyuan City. These measurement tests were conducted at the MRT Technology (Taiwan) Co., Ltd. Facility located at No.38, Fuxing 2nd Rd., Guishan Dist., Taoyuan City 33377, Taiwan (R.O.C).

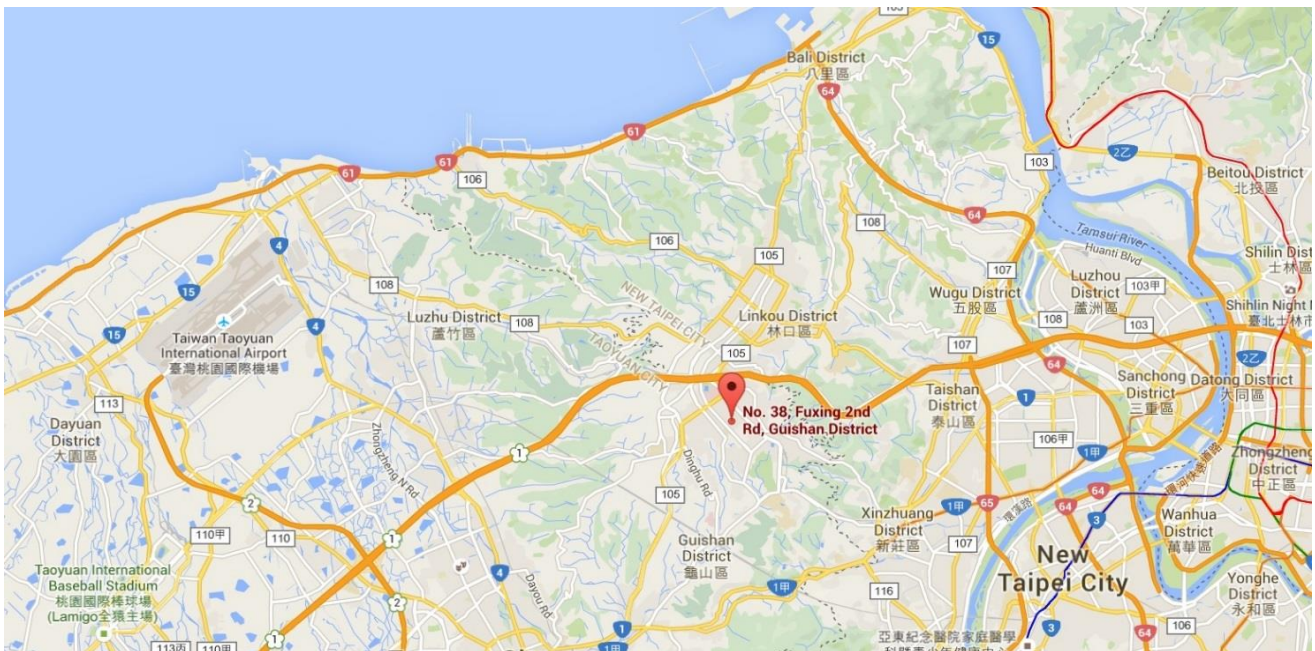

## 2. PRODUCT INFORMATION

### 2.1. Equipment Description

Product Name	Dimmer Control
Model No.	Tapo S135B
Brand Name	tp-link
Bluetooth Specification	Bluetooth Mode: V5.0 (LE mode only)
EUT Identification No.	20221006Sample#1 (Conducted) 20221006Sample#2 (Radiated)
Working Voltage	DC 3.0V (Battery Model: CR2032)

### 2.2. Product Specification Subjective to this Standard

Operating Frequency	2402~2480MHz
Type of modulation	GFSK
Data Rate	1Mbps
Antenna Type	IFA Antenna
Antenna Gain	1.49dBi

### 2.3. Test Mode

Test Mode	Mode 1: Transmit - LE (GFSK)
-----------	------------------------------

## 2.4. Operation Frequency / Channel List

Channel	Frequency	Channel	Frequency	Channel	Frequency
00	2402 MHz	01	2404 MHz	02	2406 MHz
03	2408 MHz	04	2410 MHz	05	2412 MHz
06	2414 MHz	07	2416 MHz	08	2418 MHz
09	2420 MHz	10	2422 MHz	11	2424 MHz
12	2426 MHz	13	2428 MHz	14	2430 MHz
15	2432 MHz	16	2434 MHz	17	2436 MHz
18	2438 MHz	19	2440 MHz	20	2442 MHz
21	2444 MHz	22	2446 MHz	23	2448 MHz
24	2450 MHz	25	2452 MHz	26	2454 MHz
27	2456 MHz	28	2458 MHz	29	2460 MHz
30	2462 MHz	31	2464 MHz	32	2466 MHz
33	2468 MHz	34	2470 MHz	35	2472 MHz
36	2474 MHz	37	2476 MHz	38	2478 MHz
39	2480 MHz	N/A	N/A	N/A	N/A



## 2.5. Test Configuration

This device was tested per the guidance of ANSI C63.10-2013. ANSI C63.10-2013 was used to reference the appropriate EUT setup for radiated spurious emissions testing and AC line conducted testing.

Connection Diagram

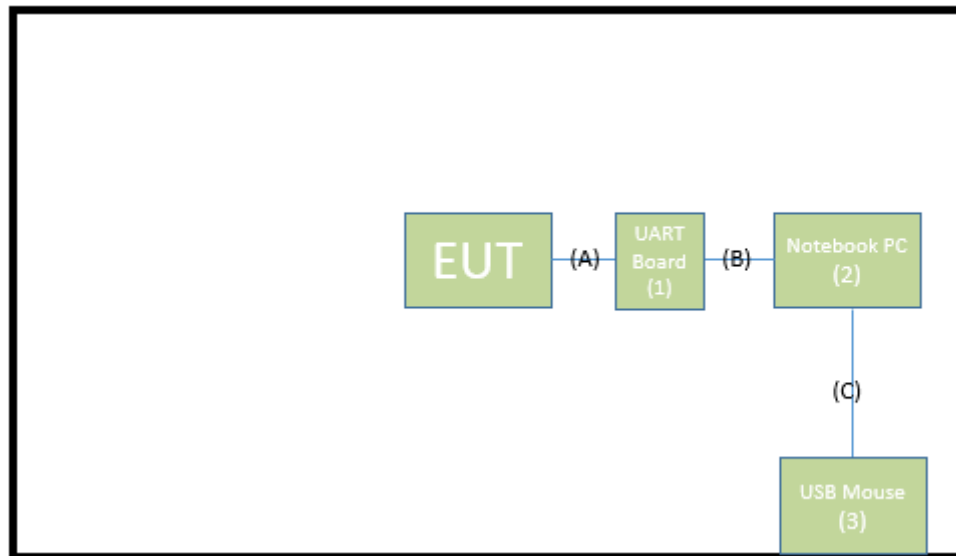

Signal Cable Type		Signal Cable Description
A	Signal Cable	Non-Shielded, 0.1m
B	USB Cable	Shielded, 0.5m
C	USB Mouse Cable	Shielded, 1.8m

## 2.6. Test System Details

The types for all equipments, plus descriptions of all cables used in the tested system (including inserted cards) are:

No.	Product	Manufacturer	Model No.	Serial No.	Power Cord
1	UART Board	Telink	TLSRGSOCBK56B	N/A	N/A
2	Notebook PC	Lenovo	T450	N/A	Non-shielded, 0.8m
3	USB Mouse	Logitech	M90	N/A	N/A

## 2.7. Test Software

The test utility software used during testing was "EMI\_TEST\_v2.0".

## **2.8. EMI Suppression Device(s)/Modifications**

No EMI suppression device(s) were added and/or no modifications were made during testing.

## **2.9. Labeling Requirements**

Per 2.1074 & 15.19; Docket 95-19

The label shall be permanently affixed at a conspicuous location on the device; instruction manual or pamphlet supplied to the user and be readily visible to the purchaser at the time of purchase.

However, when the device is so small wherein placement of the label with specified statement is not practical, only the FCC ID must be displayed on the device per Section 15.19(a)(5). Please see attachment for FCC ID label and label location.

### 3. DESCRIPTION of TEST

#### 3.1. Evaluation Procedure

The measurement procedures described in the American National Standard for Testing Unlicensed Wireless Devices (ANSI C63.10-2013) and were used in the measurement of the DEVICE.

**Deviation from measurement procedure.....None**

#### 3.2. AC Line Conducted Emissions

The line-conducted facility is located inside an 9'x4'x3' shielded enclosure. A 1m x 2m wooden table 80cm high is placed 40cm away from the vertical wall and 80cm away from the sidewall of the shielded room. Two 10kHz-30MHz, 50Ω/50uH Line-Impedance Stabilization Networks (LISNs) are bonded to the shielded room floor. Power to the LISNs is filtered by external high-current high-insertion loss power line filters. These filters attenuate ambient signal noise from entering the measurement lines. These filters are also bonded to the shielded enclosure.

The EUT is powered from one LISN and the support equipment is powered from the second LISN. All interconnecting cables more than 1 meter were shortened to a 1 meter length by non-inductive bundling (serpentine fashion) and draped over the back edge of the test table. All cables were at least 40cm above the horizontal reference ground-plane. Power cables for support equipment were routed down to the second LISN while ensuring that that cables were not draped over the second LISN.

Sufficient time for the EUT, support equipment, and test equipment was allowed in order for them to warm up to their normal operating condition. The RF output of the LISN was connected to the receiver and exploratory measurements were made to determine the frequencies producing the maximum emission from the EUT. The receiver was scanned from 150kHz to 30MHz. The detector function was set to peak mode for exploratory measurements while the bandwidth of the analyzer was set to 9kHz. The EUT, support equipment, and interconnecting cables were arranged and manipulated to maximize each emission. Each emission was also maximized by varying: power lines, the mode of operation or data exchange speed, or support equipment which determined the worst-case emission. Once the worst case emissions have been identified, the one EUT cable configuration/arrangement and mode of operation that produced these emissions are used for final measurements on the same test site. The analyzer is set to CISPR quasi-peak and average detectors with a 9kHz resolution bandwidth for final measurements.

An extension cord was used to connect to a single LISN which powered by EUT. The extension cord was calibrated with LISN, the impedance and insertion loss are compliance with the requirements as stated in ANSI C63.10-2013.

### 3.3. Radiated Emissions

The radiated test facilities consisted of an indoor 3 meter semi-anechoic chamber used for final measurements and exploratory measurements, when necessary. The measurement area is contained within the semi-anechoic chamber which is shielded from any ambient interference. For measurements above 1GHz absorbers are arranged on the floor between the turn table and the antenna mast in such a way so as to maximize the reduction of reflections. For measurements below 1GHz, the absorbers are removed. A MF Model 210SS turntable is used for radiated measurement. It is a continuously rotatable, remote controlled, metallic turntable and 2 meters (6.56 ft.) in diameter. The turn table is flush with the raised floor of the chamber in order to maintain its function as a ground plane. An 80cm high PVC support structure is placed on top of the turntable.

For all measurements, the spectrum was scanned through all EUT azimuths and from 1 to 4 meter receive antenna height using a broadband antenna from 30MHz up to the upper frequency shown in 15.33(b)(1) depending on the highest frequency generated or used in the device or on which the device operates or tunes. For frequencies above 1GHz, linearly polarized double ridge horn antennas were used. For frequencies below 30MHz, a calibrated loop antenna was used. When exploratory measurements were necessary, they were performed at 1 meter test distance inside the semi-anechoic chamber using broadband antennas, broadband amplifiers, and spectrum analyzers to determine the frequencies and modes producing the maximum emissions. Sufficient time for the EUT, support equipment, and test equipment was allowed in order for them to warm up to their normal operating condition. The test set-up for frequencies below 1GHz was placed on top of the 0.8 meter high, 1 x 1.5 meter table; and test set-up for frequencies 1-40GHz was placed on top of the 1.5 meter high, 1 x 1.5 meter table. The EUT, support equipment, and interconnecting cables were arranged and manipulated to maximize each emission. Appropriate precaution was taken to ensure that all emissions from the EUT were maximized and investigated. The system configuration, clock speed, mode of operation or video resolution, if applicable, turntable azimuth, and receive antenna height was noted for each frequency found.

Final measurements were made in the semi-anechoic chamber using calibrated, linearly polarized broadband and horn antennas. The test setup was configured to the setup that produced the worst case emissions. The spectrum analyzer was set to investigate all frequencies required for testing to compare the highest radiated disturbances with respect to the specified limits. The turntable containing the EUT was rotated through 360 degrees and the height of the receive antenna was varied 1 to 4 meters and stopped at the azimuth and height producing the maximum emission. Each emission was maximized by changing the orientation of the EUT through three orthogonal planes and changing the polarity of the receive antenna, which produced the worst-case emissions. According to 3dB Beam-Width of horn antenna, the horn antenna should be always directed to the EUT when rising height.

## 4. ANTENNA REQUIREMENTS

### Excerpt from §15.203 of the FCC Rules/Regulations:

“An intentional radiator antenna shall be designed to ensure that no antenna other than that furnished by the responsible party can be used with the device. The use of a permanently attached antenna or of an antenna that uses a unique coupling to the intentional radiator shall be considered sufficient to comply with the provisions of this section.”

- The antenna of the **Dimmer Control** is permanently attached.
- There are no provisions for connection to an external antenna.

### **Conclusion:**

The EUT unit complies with the requirement of §15.203.

## 5. TEST EQUIPMENT CALIBRATION DATE

### Conducted Emissions – SR2

Instrument	Manufacturer	Type No.	Asset No.	Cali. Interval	Cali. Due Date
Two-Line V-Network	R&S	ENV216	MRTTWA00020	1 year	2023/4/20
Cable	Rosnol	N1C50-RG400-B 1C50-500CM	MRTTWE00013	1 year	2023/6/19
EMI Test Receiver	R&S	ESR3	MRTTWA00009	1 year	2023/3/9

### Radiated Emissions – AC2

Instrument	Manufacturer	Type No.	Asset No.	Cali. Interval	Cali. Due Date
Broadband TRILOG Antenna	SCHWARZBECK	VULB 9162	MRTTWA00001	1 year	2022/11/4
EMI Test Receiver	R&S	ESR3	MRTTWA00009	1 year	2023/3/9
Signal Analyzer	R&S	FSVA3044	MRTTWA00092	1 year	2023/6/23
Active Loop Antenna	Schwarzbeck	FMZB 1519B	MRTTWA00002	1 year	2023/5/24
Broadband Hornantenna	RFSPIN	DRH18-E	MRTTWA00087	1 year	2023/5/10
Breitband Hornantenna	Schwarzbeck	BBHA 9170	MRTTWA00004	1 year	2023/3/29
Broadband Preamplifier	EMC Instruments corporation	EMC118A45SE	MRTTWA00088	1 year	2023/5/9
Broadband Preamplifier	SCHWARZBECK	BBV 9718	MRTTWA00005	1 year	2023/3/30
Cable	HUBERSUHNER	SF106	MRTTWE00034	1 year	2023/6/27

### Conducted Test Equipment – SR5

Instrument	Manufacturer	Type No.	Asset No.	Cali. Interval	Cali. Due Date
EXA Signal Analyzer	KEYSIGHT	N9010A	MRTTWA00012	1 year	2023/10/5
EXA Signal Analyzer	KEYSIGHT	N9010B	MRTTWA00074	1 year	2023/7/19
USB Wideband Power Sensor	KEYSIGHT	U2021XA	MRTTWA00015	1 year	2023/3/16

### Test Software

Software	Version	Function
e3	9.160520a	EMI Test Software
EMI	V3	EMI Test Software

## 6. MEASUREMENT UNCERTAINTY

Where relevant, the following test uncertainty levels have been estimated for tests performed on the EUT as specified in CISPR 16-4-2. This uncertainty represents an expanded uncertainty expressed at approximately the 95% confidence level using a coverage factor of  $k = 2$ .

<b>Conducted Emission- Power Line</b>
Measuring Uncertainty for a Level of Confidence of 95% ( $U=2Uc(y)$ ): 0.15MHz~30MHz: $\pm 2.53\text{dB}$
<b>Radiated Spurious Emission</b>
Measuring Uncertainty for a Level of Confidence of 95% ( $U=2Uc(y)$ ): 9kHz~30MHz: $\pm 3.92\text{dB}$ 30MHz~1GHz: $\pm 4.25\text{dB}$ 1GHz~18GHz: $\pm 4.40\text{dB}$ 18GHz~40GHz: $\pm 4.45\text{dB}$
<b>Frequency Error</b>
Measuring Uncertainty for a Level of Confidence of 95% ( $U=2Uc(y)$ ): $\pm 78.4\text{Hz}$
<b>Conducted Power</b>
Measuring Uncertainty for a Level of Confidence of 95% ( $U=2Uc(y)$ ): $\pm 0.84\text{dB}$
<b>Conducted Spurious Emission</b>
Measuring Uncertainty for a Level of Confidence of 95% ( $U=2Uc(y)$ ): $\pm 2.65\text{ dB}$
<b>Occupied Bandwidth</b>
Measuring Uncertainty for a Level of Confidence of 95% ( $U=2Uc(y)$ ): $\pm 3.3\%$
<b>Temp. / Humidity</b>
Measuring Uncertainty for a Level of Confidence of 95% ( $U=2Uc(y)$ ): $\pm 0.82^\circ\text{C}/ \pm 3\%$
<b>DC Voltage</b>
Measuring Uncertainty for a Level of Confidence of 95% ( $U=2Uc(y)$ ): $\pm 0.3\%$

## 7. TEST RESULT

### 7.1. Summary

**Product Name:** Dimmer Control

**FCC Classification:** (DTS) Digital Transmission System

FCC Part Section(s)	Test Description	Test Limit	Test Condition	Test Result	Reference
15.247(a)(2)	6dB Bandwidth	$\geq 500\text{kHz}$	Conducted	Pass	Section 7.2
15.247(b)(3)	Output Power	$\leq 30.00\text{dBm}$		Pass	Section 7.3
15.247(e)	Power Spectral Density	$\leq 8.00\text{dBm}/3\text{kHz}$		Pass	Section 7.4
15.247(d)	Out-of-Band Emissions	Conducted $\geq 30\text{dBc}$		Pass	Section 7.5
15.205 15.209	Spurious Emission	< FCC 15.209 limits	Radiated	Pass	Section 7.6
15.205 15.209	Band Edge Measurement	$\cong 74\text{dBuV/m(Peak)}$ $\cong 54\text{dBuV/m(Average)}$		Pass	Section 7.7
15.207	AC Conducted Emissions 150kHz - 30MHz	< FCC 15.207 limits	Line Conducted	N/A	Section 7.8

#### Notes:

- 1) Determining compliance is based on the test results met the regulation limits or requirements declared by clients, and the test results don't take into account the value of measurement uncertainty.
- 2) For radiated emission test, every axis (X, Y, Z) was also verified when applicable. The test results shown in the following sections represent the worst-case emissions.
- 3) The analyzer plots shown in this section were all taken with a correction table loaded into the analyzer. The correction table was used to account for the losses of the cables and attenuators used as part of the system to connect the EUT to the analyzer at all frequencies of interest.



## 7.2. 6dB Bandwidth Measurement

### 7.2.1. Test Limit

The minimum 6dB bandwidth shall be at least 500 kHz.

### 7.2.2. Test Procedure used

ANSI C63.10 – 2013 Section 11.8

### 7.2.3. Test Setting

1. The Spectrum's automatic bandwidth measurement capability was used to perform the 6dB bandwidth measurement. The "X" dB bandwidth parameter was set to  $X = 6$ . The bandwidth measurement was not influenced by any intermediate power nulls in the fundamental emission.
2. Set RBW = 100 kHz
3.  $VBW \geq 3 \times RBW$
4. Detector = Peak
5. Trace mode = max hold
6. Sweep = auto couple
7. Allow the trace was allowed to stabilize

### 7.2.4. Test Setup

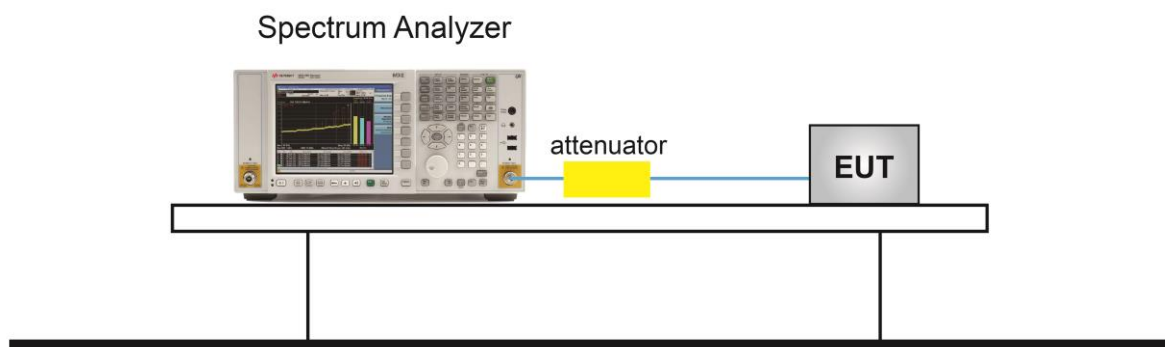

### 7.2.5. Test Result

Product	Dimmer Control	Temperature	23°C
Test Engineer	Jay	Relative Humidity	55%
Test Site	SR5	Test Date	2022/10/11

Test Mode	Channel No.	Frequency (MHz)	6dB Bandwidth (MHz)	Limit (MHz)	Result
LE (1Mbps)	00	2402	0.6928	≥ 0.5	Pass
LE (1Mbps)	19	2440	0.6887	≥ 0.5	Pass
LE (1Mbps)	39	2480	0.6711	≥ 0.5	Pass

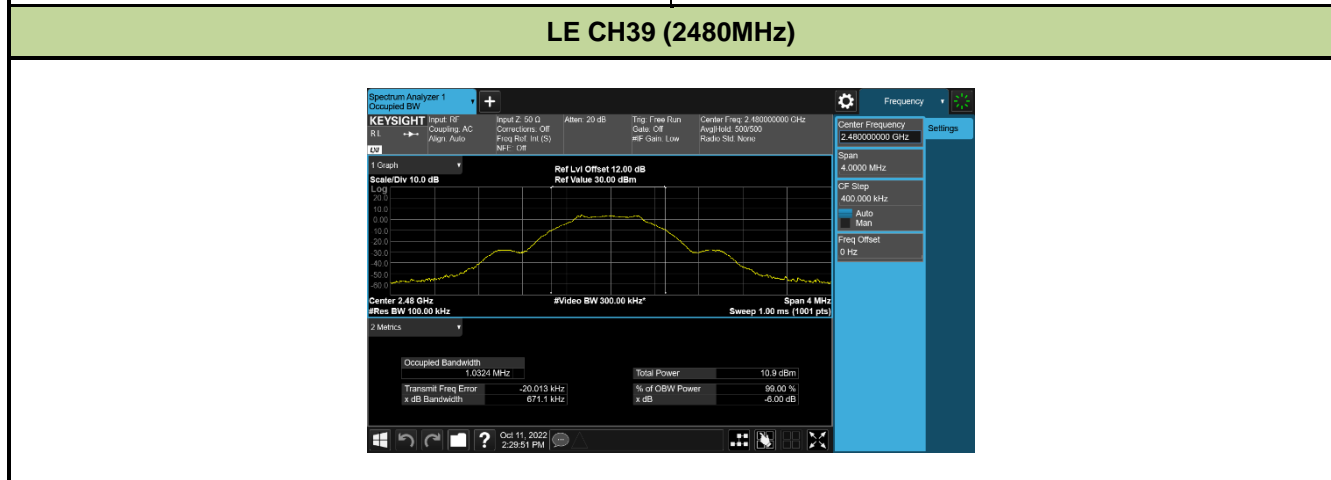
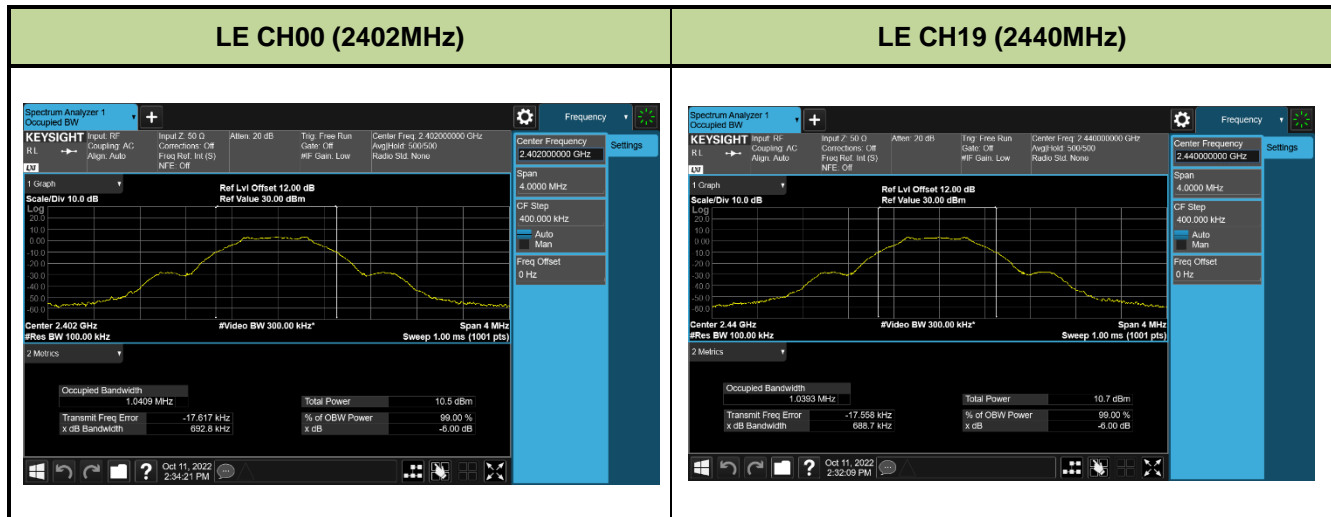

## 7.3. Output Power Measurement

### 7.3.1. Test Limit

The maximum out power shall be less 1 Watt (30dBm).

### 7.3.2. Test Procedure Used

ANSI C63.10 – 2013 Section 11.9.2.3.2

### 7.3.3. Test Setting

#### Peak Power Measurement

The maximum peak conducted output power may be measured using a broadband peak RF power meter. The power meter shall have a video bandwidth that is greater than or equal to the DTS bandwidth and shall utilize a fast-responding diode detector.

#### Average Power Measurement

Average power measurements were performed only when the EUT was transmitting at its maximum power control level using a broadband power meter with a pulse sensor. The power meter implemented triggering and gating capabilities which were set up such that power measurements were recorded only during the ON time of the transmitter. The trace was averaged over 100 traces to obtain the final measured average power.

### 7.3.4. Test Setup

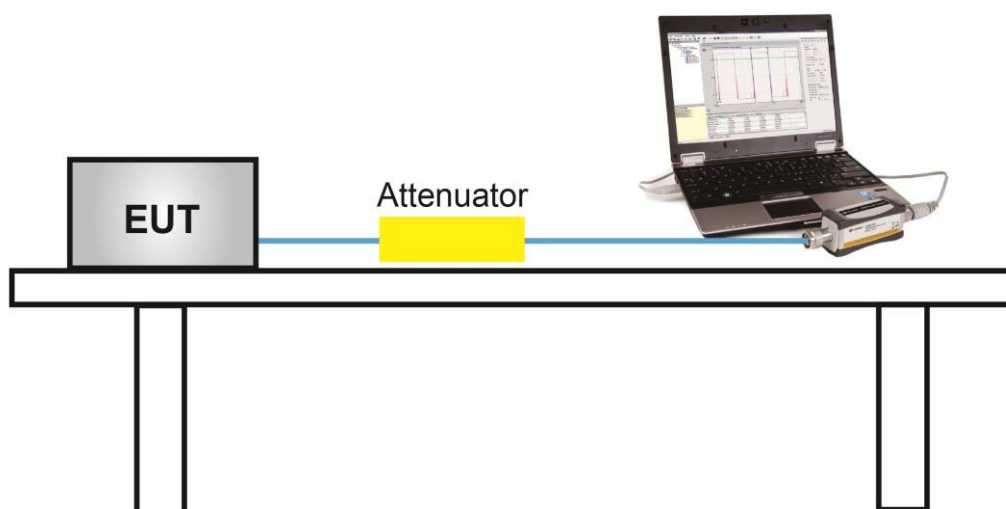

### 7.3.5. Test Result

Product	Dimmer Control	Temperature	23°C
Test Engineer	Jay	Relative Humidity	55%
Test Site	SR5	Test Date	2022/10/11

Test Mode	Channel No.	Frequency (MHz)	Average Power (dBm)	Limit (dBm)
LE(1Mbps)	00	2402	4.02	< 30
LE(1Mbps)	19	2440	4.09	< 30
LE(1Mbps)	39	2480	4.27	< 30

Note: Output power = Reading value on power meter + cable loss.

## **7.4. Power Spectral Density Measurement**

### **7.4.1. Test Limit**

The maximum permissible power spectral density is 8dBm in any 3 kHz band.

### **7.4.2. Test Procedure Used**

ANSI C63.10 - 2013 Section 11.10.5

### **7.4.3. Test Setting**

1. Measure the duty cycle (x) of the transmitter output signal.
2. Set instrument center frequency to DTS channel center frequency.
3. Set span to at least 1.5 times the OBW.
4. RBW = 10 kHz.
5. VBW = 30 kHz.
6. Detector = RMS.
7. Ensure that the number of measurement points in the sweep  $\geq 2 \times \text{span}/\text{RBW}$ .
8. Sweep time = auto couple.
9. Don't use sweep triggering. Allow sweep to "free run".
10. Employ trace averaging (RMS) mode over a minimum of 100 traces.
11. Use the peak marker function to determine the maximum amplitude level.
12. Add  $10 \log (1/x)$ , where x is the duty cycle measured in step (a), to the measured PSD to compute the average PSD during the actual transmission time.

### 7.4.4. Test Setup

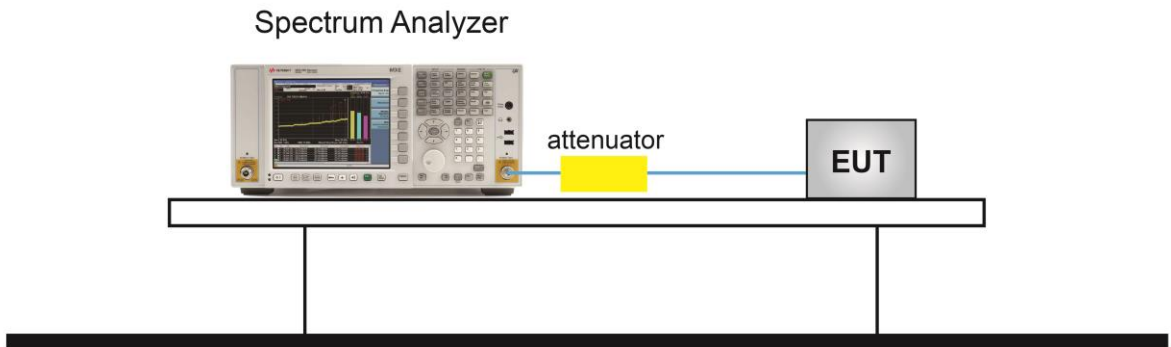

### 7.4.5. Test Result

Product	Dimmer Control	Temperature	23°C
Test Engineer	Jay	Relative Humidity	55%
Test Site	SR5	Test Date	2022/10/11

Test Mode	Channel No.	Frequency (MHz)	PSD (dBm/10kHz)	Duty Cycle (%)	Final PSD (dBm/10kHz)	Limit (dBm/3kHz)	Result
LE (1Mbps)	00	2402	-12.311	100.00	-12.311	≤ 8	Pass
LE (1Mbps)	19	2440	-12.222	100.00	-12.222	≤ 8	Pass
LE (1Mbps)	39	2480	-11.834	100.00	-11.834	≤ 8	Pass

Note: When Duty cycle ≥ 98%, final PSD (dBm/10kHz) = PSD (dBm/10kHz) + 10log (1/Duty cycle)

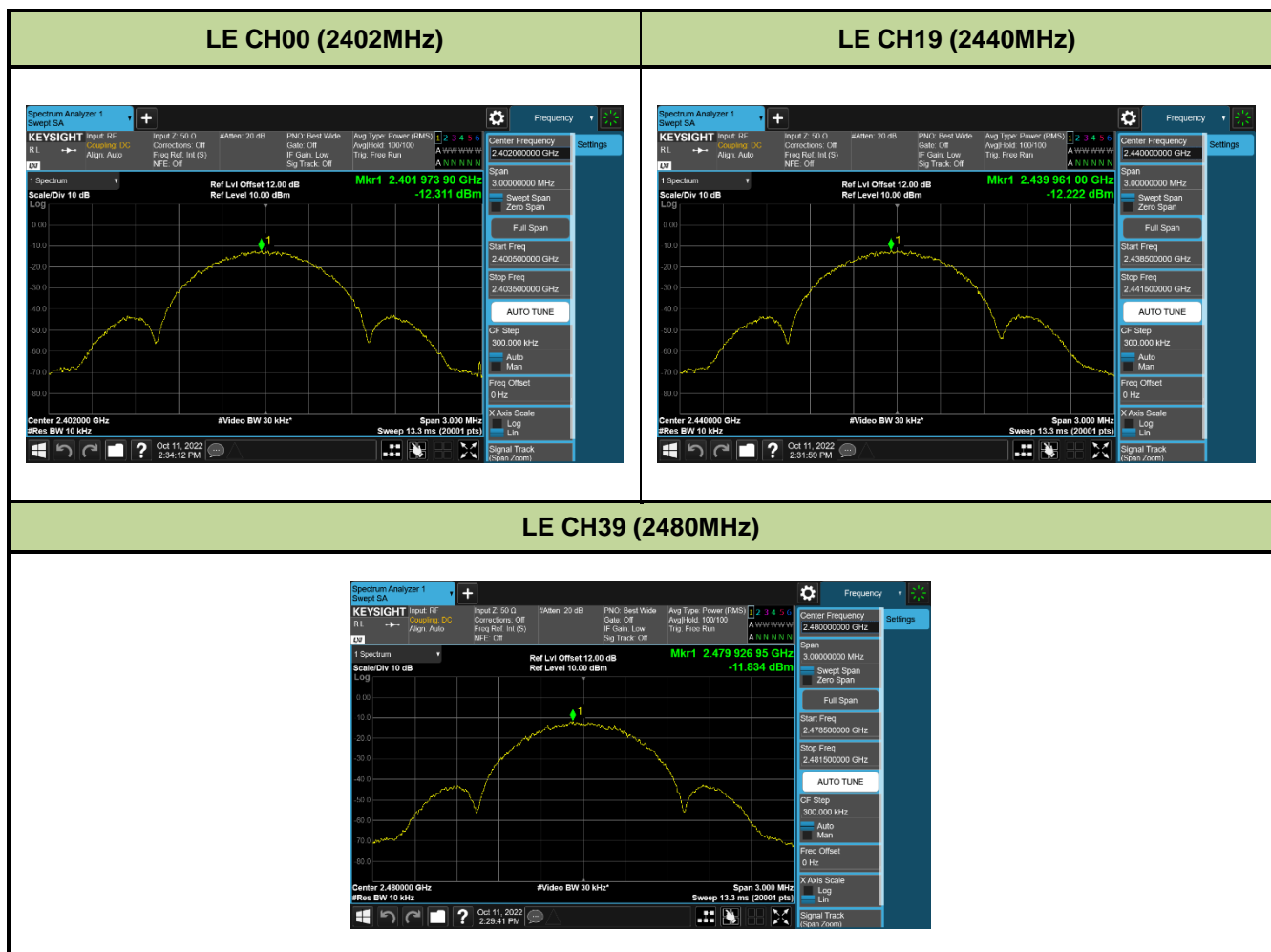

## **7.5. Out-of-Band Spurious Emissions Emissions Measurement**

### **7.5.1. Test Limit**

The limit for out-of-band spurious emissions at the band edge is 30dB below the fundamental emission level, as determined from the in-band power measurement of the DTS channel performed in a 100 kHz bandwidth per the PSD procedure.

### **7.5.2. Test Procedure Used**

ANSI C63.10 – 2013 Section 11.11

### **7.5.3. Test Setting**

#### **Reference level measurement**

1. Set instrument center frequency to DTS channel center frequency
2. Set the span to  $\geq 1.5$  times the DTS bandwidth
3. Set the RBW = 100 kHz
4. Set the VBW  $\geq 3 \times$  RBW
5. Detector = peak
6. Sweep time = auto couple
7. Trace mode = max hold
8. Allow trace to fully stabilize

#### **Emission level measurement**

1. Set the center frequency and span to encompass frequency range to be measured
2. RBW = 100kHz
3. VBW = 300kHz
4. Detector = Peak
5. Trace mode = max hold
6. Sweep time = auto couple
7. The trace was allowed to stabilize



### 7.5.4. Test Setup

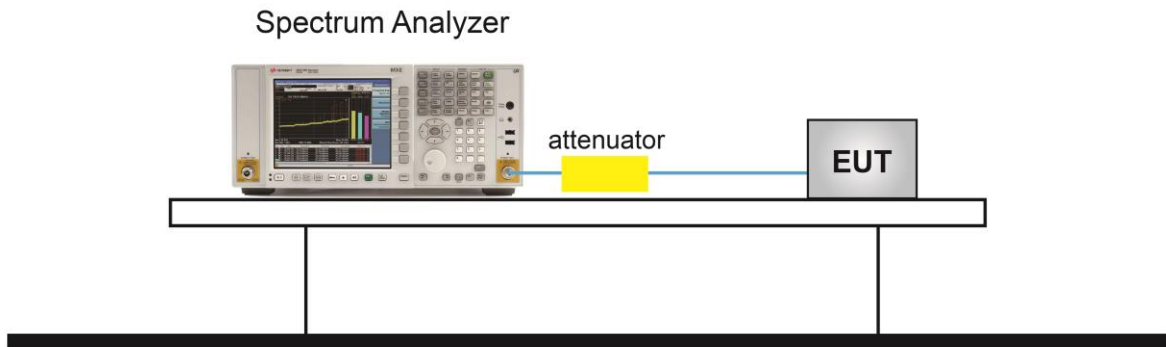

### 7.5.5. Test Result

Product	Dimmer Control	Temperature	23°C
Test Engineer	Jay	Relative Humidity	55%
Test Site	SR5	Test Date	2022/10/11

Test Mode	Channel No.	Frequency (MHz)	Limit	Result
LE	00	2402	30dBc	Pass
LE	19	2440	30dBc	Pass
LE	39	2480	30dBc	Pass



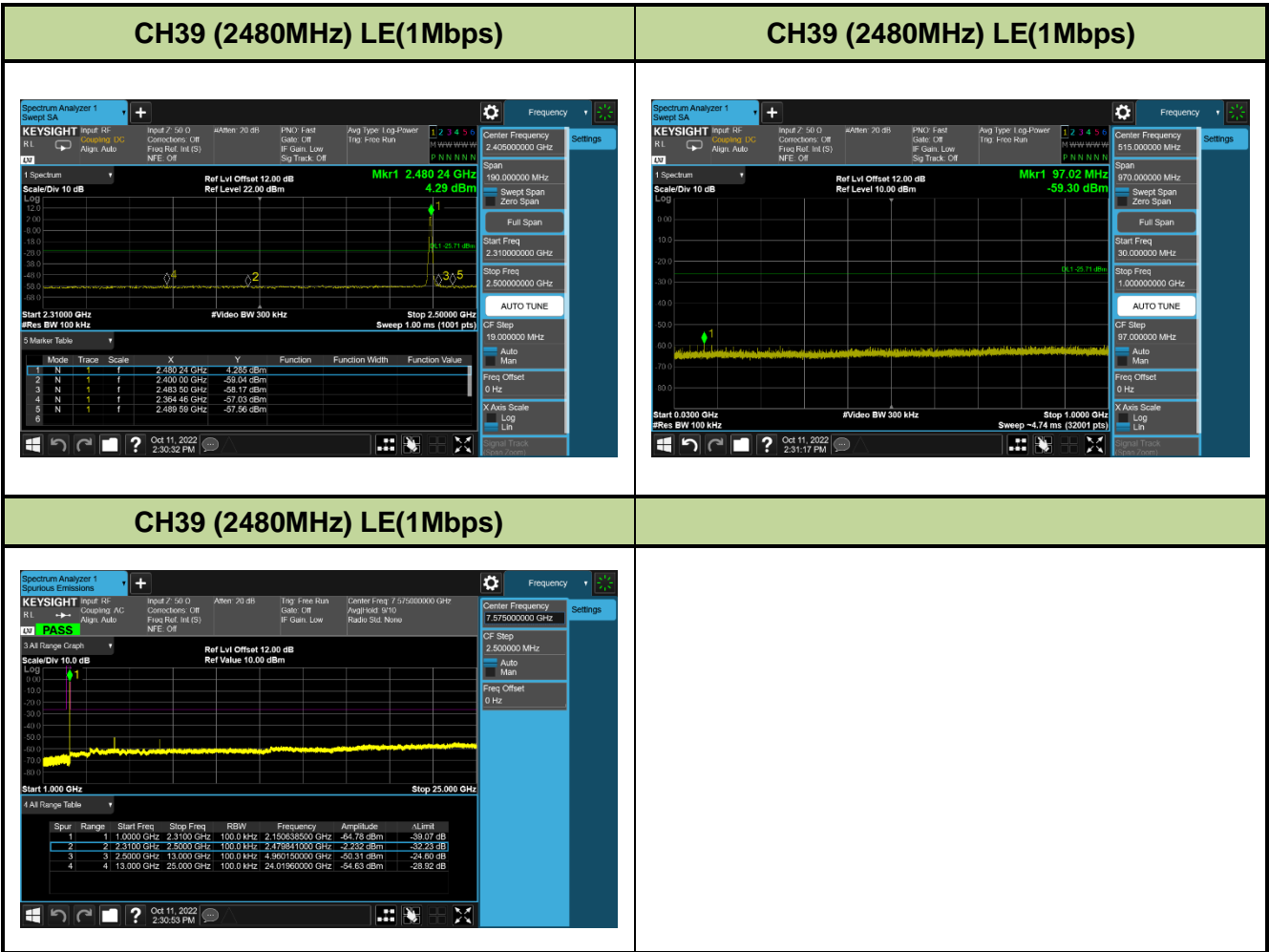

## 7.6. Radiated Spurious Emission Measurement

### 7.6.1. Test Limit

All out of band emissions appearing in a restricted band as specified in Section 15.205 of the Title 47CFR must not exceed the limits shown in Table per Section 15.209.

FCC Part 15 Subpart C Paragraph 15.209		
Frequency [MHz]	Field Strength [Uv/m]	Measured Distance [Meters]
0.009 - 0.490	2400/F (kHz)	300
0.490 - 1.705	24000/F (kHz)	30
1.705 - 30	30	30
30 - 88	100	3
88 - 216	150	3
216 - 960	200	3
Above 960	500	3

### 7.6.2. Test Procedure Used

ANSI C63.10 - 2013 Section 11.11 & 11.12

ANSI C63.10 - 2013 Section 6.3 (General Requirements)

ANSI C63.10 - 2013 Section 6.4 (Standard test method below 30MHz)

ANSI C63.10 - 2013 Section 6.5 (Standard test method above 30MHz to 1GHz)

ANSI C63.10 - 2013 Section 6.6 (Standard test method above 1GHz)

### 7.6.3. Test Setting

**Table 1 - RBW as a function of frequency**

Frequency	RBW
9 ~ 150 kHz	200 ~ 300 Hz
0.15 ~ 30 MHz	9 ~ 10 kHz
30 ~ 1000 MHz	100 ~ 120 kHz
> 1000MHz	1MHz

**Quasi-Peak Measurements below 1GHz**

1. Analyzer center frequency was set to the frequency of the radiated spurious emission of interest
2. Span was set greater than 1MHz
3. RBW = as specified in Table 1
4. Detector = CISPR quasi-peak
5. Sweep time = auto couple
6. Trace was allowed to stabilize

**Peak Measurements above 1GHz**

1. Analyzer center frequency was set to the frequency of the radiated spurious emission of interest
2. RBW = 1MHz
3. VBW = 3MHz
4. Detector = peak
5. Sweep time = auto couple
6. Trace mode = max hold
7. Trace was allowed to stabilize

**Average Measurements above 1GHz (Method VB)**

1. Analyzer center frequency was set to the frequency of the radiated spurious emission of interest
2. RBW = 1MHz
3. VBW; If the EUT is configured to transmit with duty cycle  $\geq 98\%$ , set VBW = 10 Hz.  
If the EUT duty cycle is  $< 98\%$ , set VBW  $\geq 1/T$ . T is the minimum transmission duration.
4. Detector = Peak
5. Sweep time = auto
6. Trace mode = max hold
7. Trace was allowed to stabilize

### 7.6.4. Test Setup

#### Below 1GHz Test Setup:

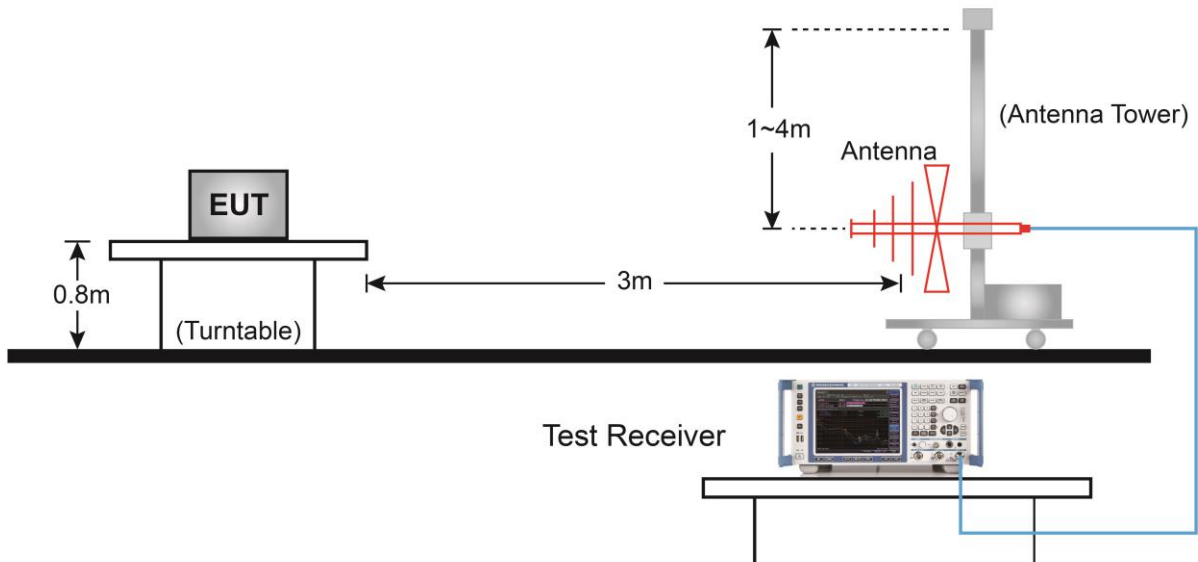

#### Above 1GHz Test Setup:

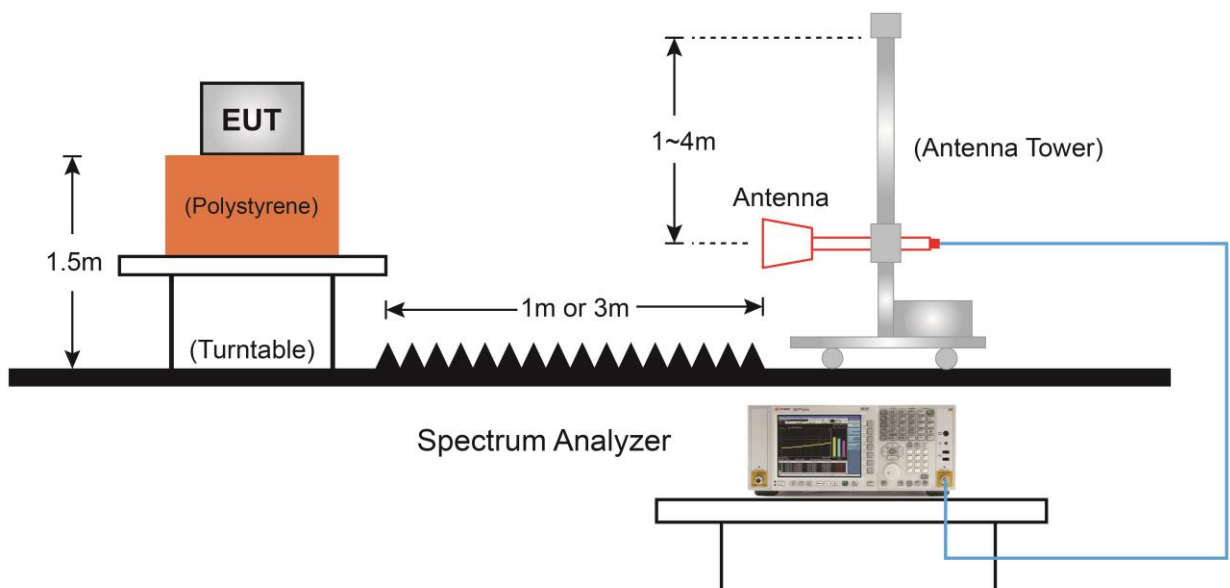

### 7.6.5. Test Result

EUT	Dimmer Control	Date of Test	2022-10-14
Factor	VULB 9162	Temp. / Humidity	24°C /56%
Polarity	Horizontal	Site / Test Engineer	AC2 / Jay
Test Mode	BLE_TX_1Mbps_CH 19	Test Voltage	By Notebook PC

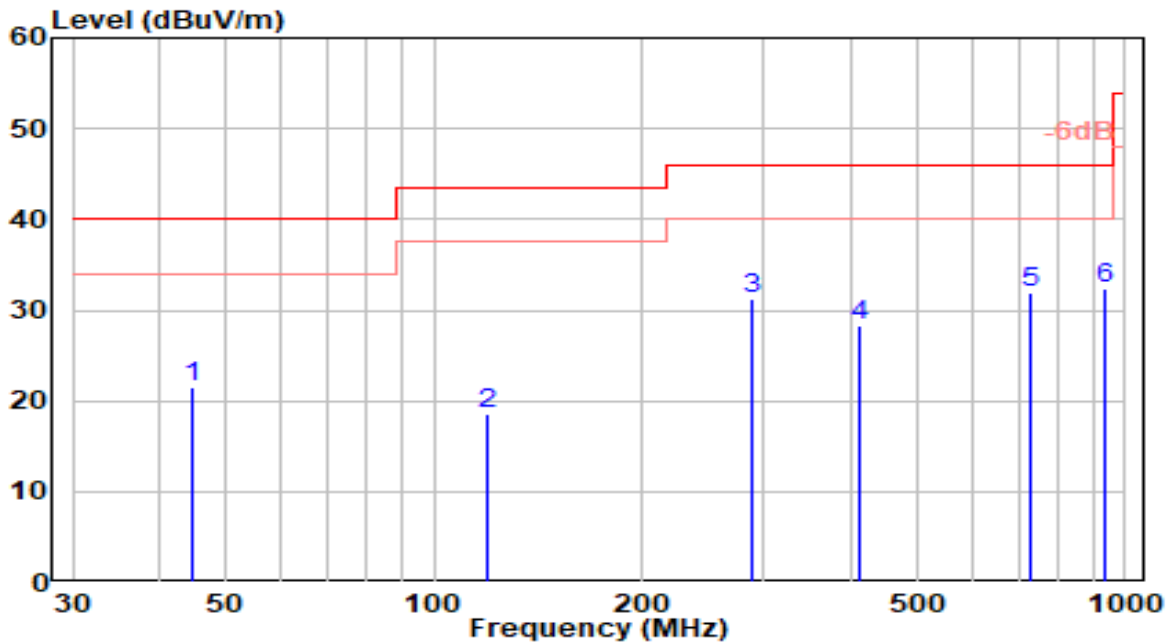

No	Frequency (MHz)	Reading (dBuV)	C.F (dB/m)	Measurement (dBuV/m)	Margin (dB)	Limit (dBuV/m)	Height (cm)	Angle (deg)	Remark (QP/PK/AV)
1	44.550	0.19	21.38	21.57	-18.43	40.00	110	125	QP
2	119.240	0.85	17.68	18.53	-24.97	43.50	100	210	QP
3	288.990	10.15	21.10	31.25	-14.75	46.00	110	55	QP
4	413.150	4.10	24.14	28.24	-17.76	46.00	100	270	QP
5	728.400	2.55	29.31	31.85	-14.15	46.00	110	180	QP
6	* 934.040	0.69	31.63	32.32	-13.68	46.00	110	275	QP

Note:

1. " \*", means this data is the worst emission level.
2. C.F (Correction Factor) = Antenna Factor (dB)+ Cable Loss (dB).
3. Measurement (dBuV/m) = Reading(dBuV) + C.F (Correction Factor).
4. The emission levels of other frequencies are very lower than the limit and not show in test report.



EUT	Dimmer Control	Date of Test	2022-10-14
Factor	VULB 9162	Temp. / Humidity	24°C /56%
Polarity	Vertical	Site / Test Engineer	AC2 / Jay
Test Mode	BLE_TX_1Mbps_CH 19	Test Voltage	By Notebook PC

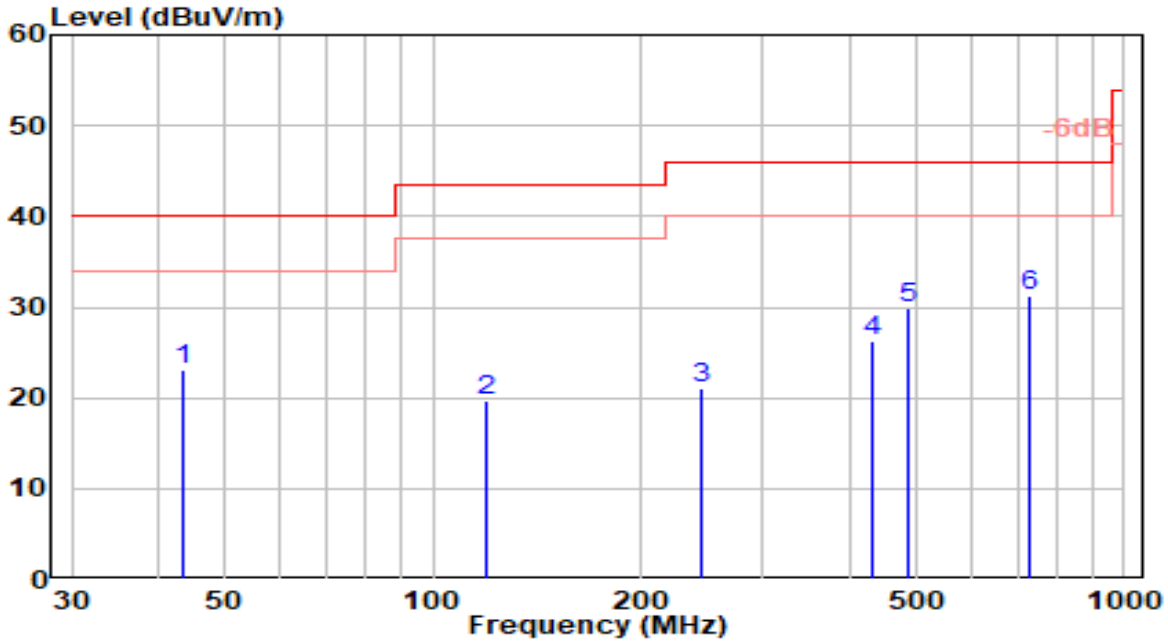

No	Frequency (MHz)	Reading (dBuV)	C.F (dB/m)	Measurement (dBuV/m)	Margin (dB)	Limit (dBuV/m)	Height (cm)	Angle (deg)	Remark (QP/PK/AV)
1	43.580	2.01	21.18	23.19	-16.81	40.00	120	30	QP
2	119.240	1.96	17.68	19.64	-23.86	43.50	100	230	QP
3	244.370	0.56	20.53	21.10	-24.90	46.00	100	255	QP
4	430.610	1.98	24.28	26.26	-19.74	46.00	100	100	QP
5	484.930	4.59	25.33	29.92	-16.08	46.00	100	245	QP
6	* 729.370	1.84	29.32	31.16	-14.84	46.00	100	185	QP

Note:

1. " \*", means this data is the worst emission level.
2. C.F (Correction Factor) = Antenna Factor (dB)+ Cable Loss (dB).
3. Measurement (dBuV/m) = Reading(dBuV) + C.F (Correction Factor).
4. The emission levels of other frequencies are very lower than the limit and not show in test report.

EUT	Dimmer Control	Date of Test	2022-10-11
Factor	DRH18-E	Temp. / Humidity	24°C /56%
Polarity	Horizontal	Site / Test Engineer	AC2 / Jay
Test Mode	BLE_TX_1Mbps_CH 0	Test Voltage	By Notebook PC

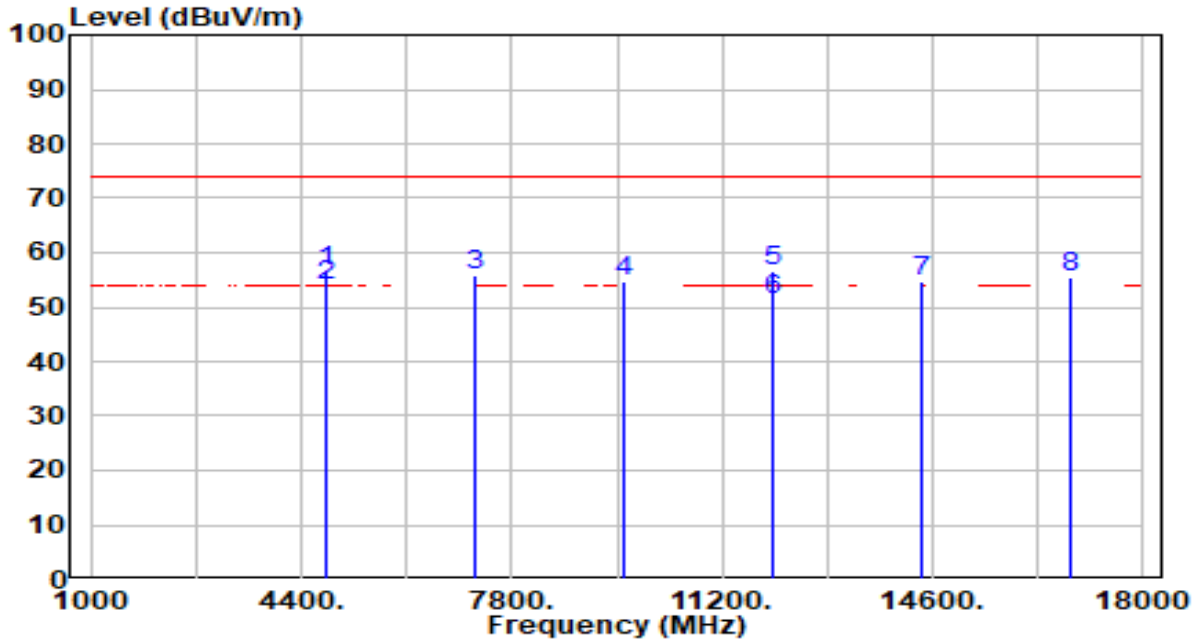

No	Frequency (MHz)	Reading (dBuV)	C.F (dB/m)	Measurement (dBuV/m)	Margin (dB)	Limit (dBuV/m)	Height (cm)	Angle (deg)	Remark (QP/PK/AV)
1	* 4808.000	56.29	0.22	56.51	-17.49	74.00	100	310	Peak
2	* 4808.000	53.60	0.22	53.82	-0.18	54.00	100	310	Average
3	7206.000	49.99	5.82	55.81	-18.19	74.00	100	360	Peak
4	9608.000	49.56	5.32	54.88	-19.12	74.00	100	360	Peak
5	12010.000	50.57	5.95	56.52	-17.48	74.00	100	240	Peak
6	12010.000	45.51	5.95	51.46	-2.54	54.00	100	240	Average
7	14412.000	47.96	6.72	54.68	-19.32	74.00	100	360	Peak
8	16814.000	48.16	7.41	55.57	-18.43	74.00	100	360	Peak

Note:

1. " \*", means this data is the worst emission level.
2. C.F (Correction Factor) = Antenna Factor (dB)+ Cable Loss (dB) – Preamplifier(dB).
3. Measurement (dBuV/m) = Reading(dBuV) + C.F (Correction Factor).
4. The emission levels of other frequencies are very lower than the limit and not show in test report.

EUT	Dimmer Control	Date of Test	2022-10-11
Factor	DRH18-E	Temp. / Humidity	24°C /56%
Polarity	Vertical	Site / Test Engineer	AC2 / Jay
Test Mode	BLE_TX_1Mbps_CH 0	Test Voltage	By Notebook PC

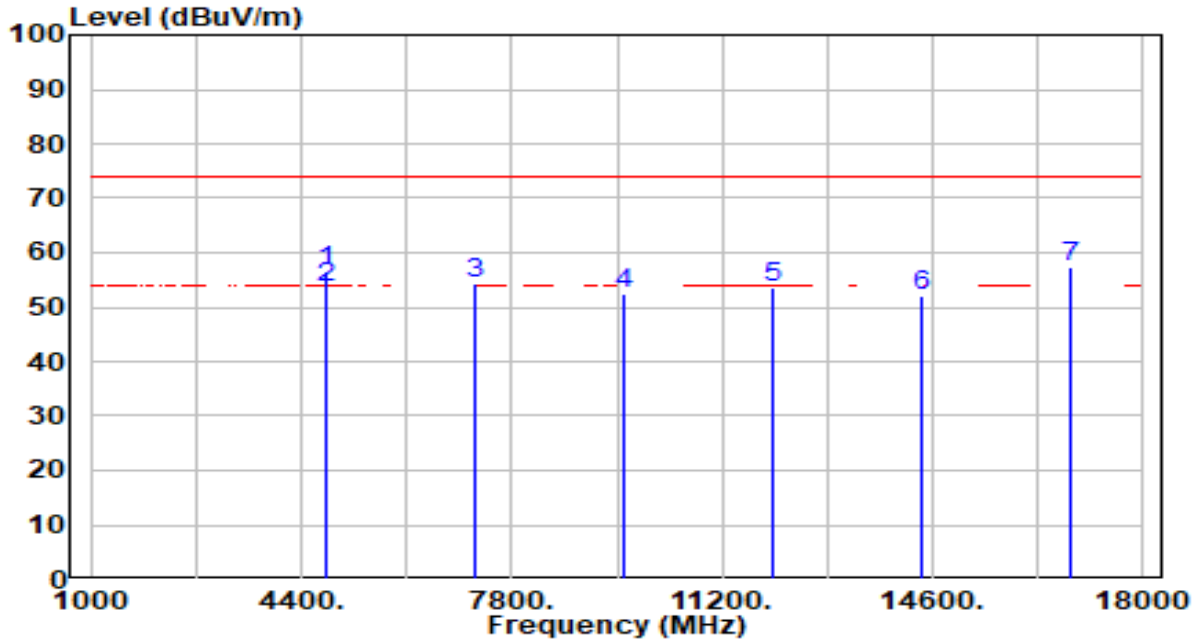

No	Frequency (MHz)	Reading (dBuV)	C.F (dB/m)	Measurement (dBuV/m)	Margin (dB)	Limit (dBuV/m)	Height (cm)	Angle (deg)	Remark (QP/PK/AV)
1	* 4804.000	56.42	0.21	56.63	-17.37	74.00	100	290	Peak
2	* 4804.000	53.46	0.21	53.67	-0.33	54.00	100	290	Average
3	7206.000	48.55	5.82	54.37	-19.63	74.00	100	360	Peak
4	9608.000	47.15	5.32	52.47	-21.53	74.00	100	360	Peak
5	12010.000	47.74	5.95	53.69	-20.31	74.00	100	360	Peak
6	14412.000	45.32	6.72	52.04	-21.96	74.00	100	360	Peak
7	16814.000	49.96	7.41	57.36	-16.64	74.00	100	360	Peak

Note:

1. " \*", means this data is the worst emission level.
2. C.F (Correction Factor) = Antenna Factor (dB)+ Cable Loss (dB) – Preamplifier(dB).
3. Measurement (dBuV/m) = Reading(dBuV) + C.F (Correction Factor).
4. The emission levels of other frequencies are very lower than the limit and not show in test report.

EUT	Dimmer Control	Date of Test	2022-10-11
Factor	DRH18-E	Temp. / Humidity	24°C /56%
Polarity	Horizontal	Site / Test Engineer	AC2 / Jay
Test Mode	BLE_TX_1Mbps_CH 19	Test Voltage	By Notebook PC

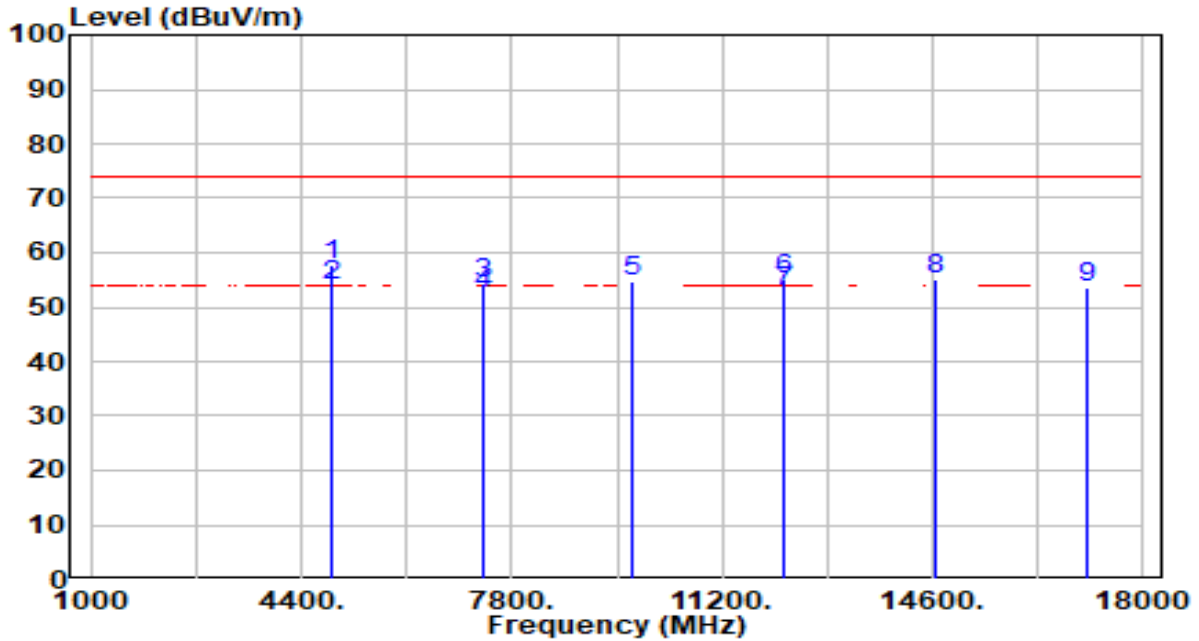

No	Frequency (MHz)	Reading (dBuV)	C.F (dB/m)	Measurement (dBuV/m)	Margin (dB)	Limit (dBuV/m)	Height (cm)	Angle (deg)	Remark (QP/PK/AV)
1	* 4880.000	57.23	0.37	57.60	-16.40	74.00	100	290	Peak
2	* 4880.000	53.53	0.37	53.90	-0.10	54.00	100	290	Average
3	7320.000	48.67	5.79	54.46	-19.54	74.00	100	350	Peak
4	7320.000	46.65	5.79	52.44	-1.56	54.00	100	350	Average
5	9760.000	49.29	5.34	54.63	-19.37	74.00	100	360	Peak
6	12200.000	48.91	6.09	55.00	-19.00	74.00	100	245	Peak
7	12200.000	46.62	6.09	52.71	-1.29	54.00	100	245	Average
8	14640.000	48.52	6.67	55.19	-18.81	74.00	100	360	Peak
9	17080.000	47.51	6.22	53.73	-20.27	74.00	100	360	Peak

Note:

- " \*", means this data is the worst emission level.
- C.F (Correction Factor) = Antenna Factor (dB)+ Cable Loss (dB) – Preamplifier(dB).
- Measurement (dBuV/m) = Reading(dBuV) + C.F (Correction Factor).
- The emission levels of other frequencies are very lower than the limit and not show in test report.

EUT	Dimmer Control	Date of Test	2022-10-11
Factor	DRH18-E	Temp. / Humidity	24°C /56%
Polarity	Vertical	Site / Test Engineer	AC2 / Jay
Test Mode	BLE_TX_1Mbps_CH 19	Test Voltage	By Notebook PC

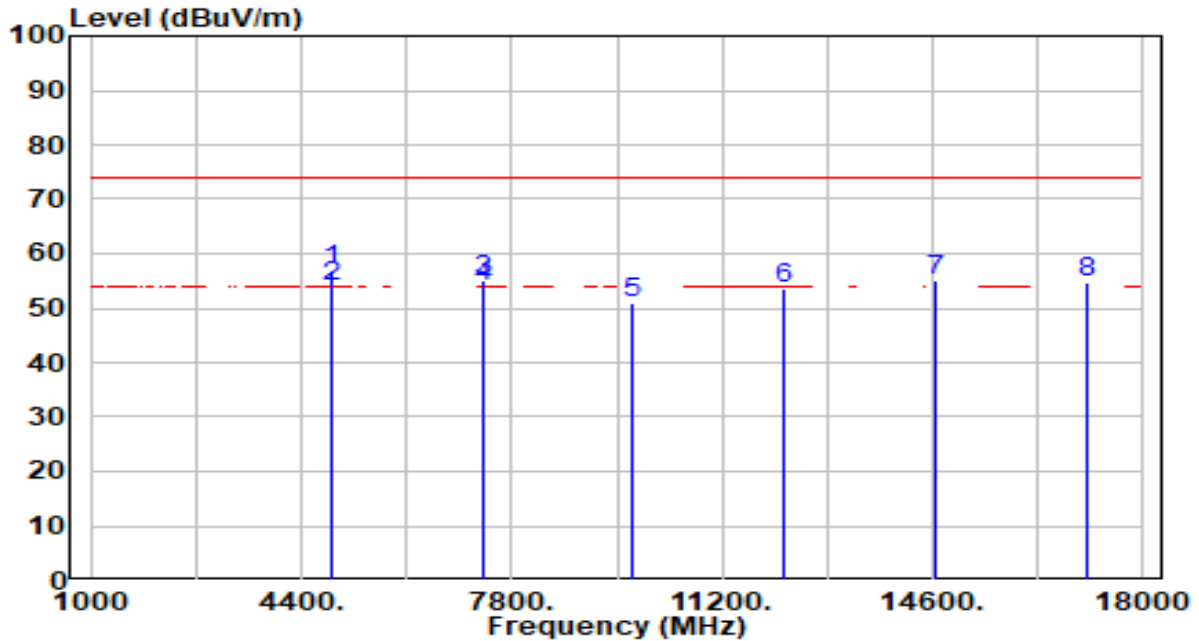

No	Frequency (MHz)	Reading (dBuV)	C.F (dB/m)	Measurement (dBuV/m)	Margin (dB)	Limit (dBuV/m)	Height (cm)	Angle (deg)	Remark (QP/PK/AV)
1	* 4880.000	56.66	0.37	57.02	-16.98	74.00	100	285	Peak
2	* 4880.000	53.52	0.37	53.89	-0.11	54.00	100	285	Average
3	7320.000	49.20	5.79	54.99	-19.01	74.00	100	125	Peak
4	7320.000	47.99	5.79	53.78	-0.22	54.00	100	125	Average
5	9760.000	45.67	5.34	51.01	-22.99	74.00	100	360	Peak
6	12200.000	47.31	6.09	53.40	-20.60	74.00	100	360	Peak
7	14640.000	48.40	6.67	55.07	-18.93	74.00	100	360	Peak
8	17080.000	48.61	6.22	54.83	-19.17	74.00	100	360	Peak

Note:

- "\*" means this data is the worst emission level.
- C.F (Correction Factor) = Antenna Factor (dB)+ Cable Loss (dB) – Preamplifier(dB).
- Measurement (dBuV/m) = Reading(dBuV) + C.F (Correction Factor).
- The emission levels of other frequencies are very lower than the limit and not show in test report.

EUT	Dimmer Control	Date of Test	2022-10-11
Factor	DRH18-E	Temp. / Humidity	24°C /56%
Polarity	Horizontal	Site / Test Engineer	AC2 / Jay
Test Mode	BLE_TX_1Mbps_CH 39	Test Voltage	By Notebook PC

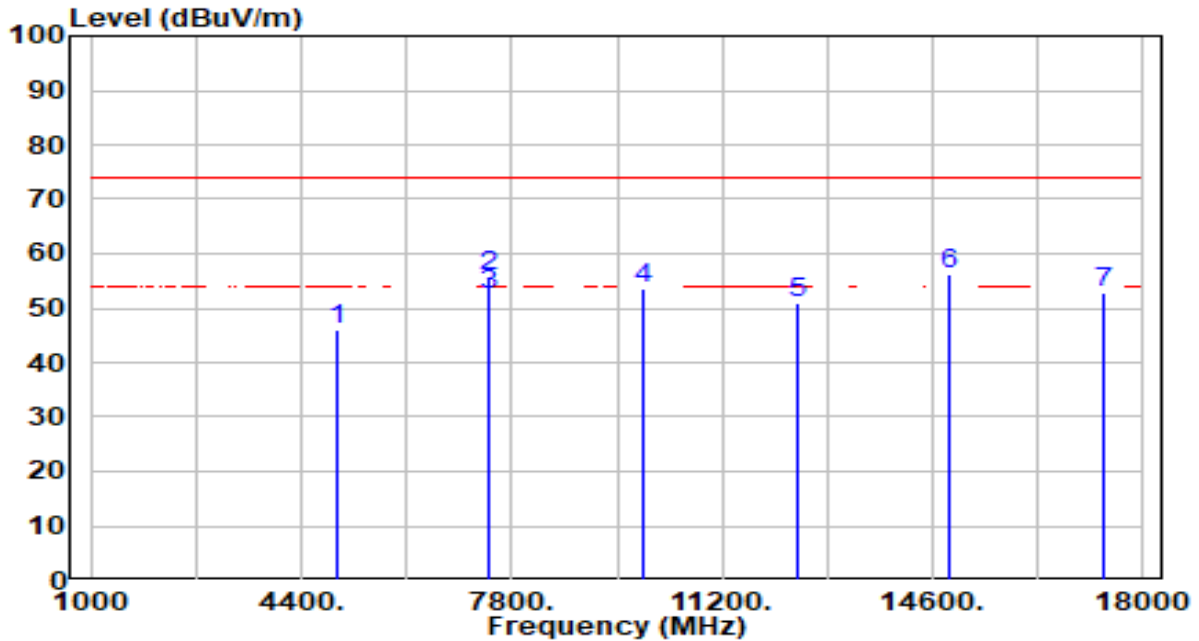

No	Frequency (MHz)	Reading (dBuV)	C.F (dB/m)	Measurement (dBuV/m)	Margin (dB)	Limit (dBuV/m)	Height (cm)	Angle (deg)	Remark (QP/PK/AV)
1	4960.000	45.51	0.53	46.04	-27.96	74.00	100	360	Peak
2	* 7440.000	50.19	5.74	55.93	-18.07	74.00	100	60	Peak
3	* 7440.000	46.87	5.74	52.61	-1.39	54.00	100	60	Average
4	9920.000	48.09	5.43	53.51	-20.49	74.00	100	360	Peak
5	12400.000	44.59	6.34	50.93	-23.07	74.00	100	360	Peak
6	14880.000	49.71	6.39	56.10	-17.90	74.00	100	360	Peak
7	17360.000	47.28	5.52	52.80	-21.20	74.00	100	360	Peak

Note:

- "\*", means this data is the worst emission level.
- C.F (Correction Factor) = Antenna Factor (dB)+ Cable Loss (dB) – Preamplifier(dB).
- Measurement (dBuV/m) = Reading(dBuV) + C.F (Correction Factor).
- The emission levels of other frequencies are very lower than the limit and not show in test report.

EUT	Dimmer Control	Date of Test	2022-10-11
Factor	DRH18-E	Temp. / Humidity	24°C /56%
Polarity	Vertical	Site / Test Engineer	AC2 / Jay
Test Mode	BLE_TX_1Mbps_CH 39	Test Voltage	By Notebook PC

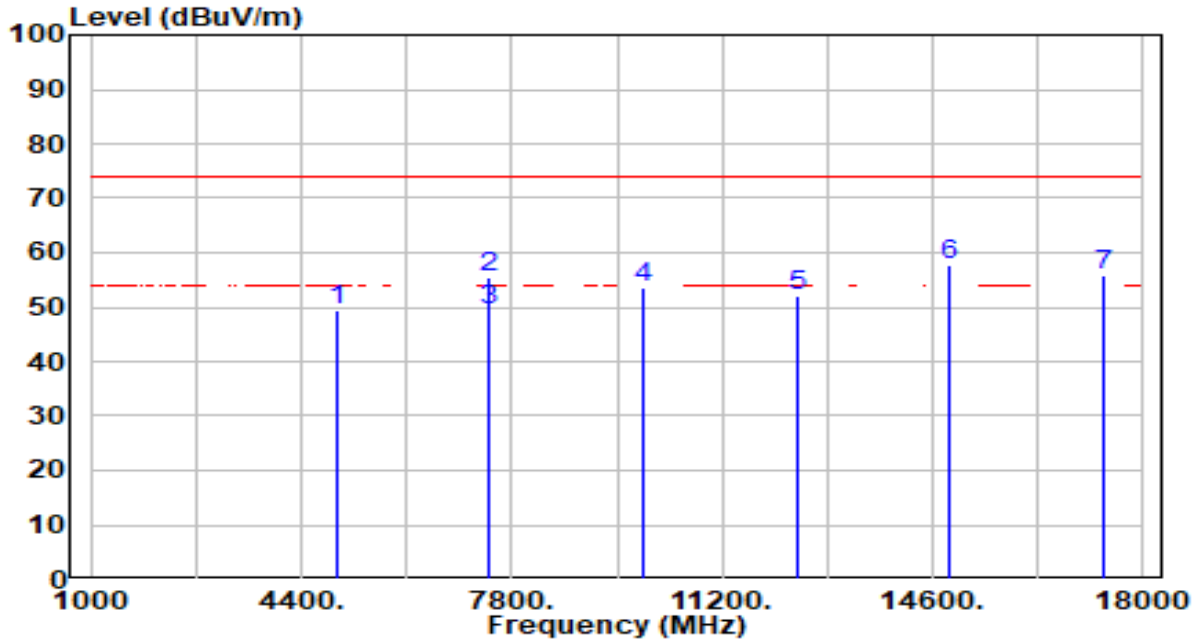

No	Frequency (MHz)	Reading (dBuV)	C.F (dB/m)	Measurement (dBuV/m)	Margin (dB)	Limit (dBuV/m)	Height (cm)	Angle (deg)	Remark (QP/PK/AV)
1	4960.000	48.73	0.53	49.25	-24.75	74.00	100	360	Peak
2	* 7440.000	49.89	5.74	55.62	-18.38	74.00	100	35	Peak
3	* 7440.000	43.87	5.74	49.61	-4.39	54.00	100	35	Average
4	9920.000	48.14	5.43	53.56	-20.44	74.00	100	360	Peak
5	12400.000	45.87	6.34	52.21	-21.79	74.00	100	360	Peak
6	14880.000	51.29	6.39	57.68	-16.32	74.00	100	360	Peak
7	17360.000	50.45	5.52	55.98	-18.02	74.00	100	360	Peak

Note:

- "\*", means this data is the worst emission level.
- C.F (Correction Factor) = Antenna Factor (dB)+ Cable Loss (dB) – Preamplifier(dB).
- Measurement (dBuV/m) = Reading(dBuV) + C.F (Correction Factor).
- The emission levels of other frequencies are very lower than the limit and not show in test report.

## 7.7. Radiated Restricted Band Edge Measurement

### 7.7.1. Test Limit

**For 15.205 requirement:**

Radiated emissions which fall in the restricted bands, as defined in Section 15.205(a) of FCC part 15, must also comply with the radiated emission limits specified in Section 15.209(a).

Frequency (MHz)	Frequency (MHz)	Frequency (MHz)	Frequency (GHz)
0.090 - 0.110	16.42 - 16.423	399.9 - 410	4.5 - 5.15
<sup>1</sup> 0.495 - 0.505	16.69475 - 16.69525	608 - 614	5.35 - 5.46
2.1735 - 2.1905	16.80425 - 16.80475	960 - 1240	7.25 - 7.75
4.125 - 4.128	25.5 - 25.67	1300 - 1427	8.025 - 8.5
4.17725 - 4.17775	37.5 - 38.25	1435 - 1626.5	9.0 - 9.2
4.20725 - 4.20775	73 - 74.6	1645.5 - 1646.5	9.3 - 9.5
6.215 - 6.218	74.8 - 75.2	1660 - 1710	10.6 - 12.7
6.26775 - 6.26825	108 - 121.94	1718.8 - 1722.2	13.25 - 13.4
6.31175 - 6.31225	123 - 138	2200 - 2300	14.47 - 14.5
8.291 - 8.294	149.9 - 150.05	2310 - 2390	15.35 - 16.2
8.362 - 8.366	156.52475 - 156.52525	2483.5 - 2500	17.7 - 21.4
8.37625 - 8.38675	156.7 - 156.9	2690 - 2900	22.01 - 23.12
8.41425 - 8.41475	162.0125 - 167.17	3260 - 3267	23.6 - 24.0
12.29 - 12.293	167.72 - 173.2	3332 - 3339	31.2 - 31.8
12.51975 - 12.52025	240 - 285	3345.8 - 3358	36.43 - 36.5
12.57675 - 12.57725	322 - 335.4	3600 - 4400	( <sup>2</sup> )
13.36 - 13.41	--	--	--



All out of band emissions appearing in a restricted band as specified in Section 15.205 of the Title 47CFR must not exceed the limits shown in Table per Section 15.209.

<b>FCC Part 15 Subpart C Paragraph 15.209 Limits</b>		
Frequency [MHz]	Field Strength [uV/m]	Measured Distance [Meters]
0.009 - 0.490	2400/F (kHz)	300
0.490 - 1.705	24000/F (kHz)	30
1.705 - 30	30	30
30 - 88	100	3
88 - 216	150	3
216 - 960	200	3
Above 960	500	3

### **7.7.2. Test Procedure Used**

ANSI C63.10 - 2013 Section 6.3 (General Requirements)

ANSI C63.10 - 2013 Section 6.6 (Standard test method above 1GHz)

### **7.7.3. Test Setting**

#### **Peak Field Strength Measurements**

1. Analyzer center frequency was set to the frequency of the radiated spurious emission of interest
2. RBW = 1MHz
3. VBW = 3MHz
4. Detector = peak
5. Sweep time = auto couple
6. Trace mode = max hold
7. Trace was allowed to stabilize

### Average Measurements above 1GHz (Method VB)

1. Analyzer center frequency was set to the frequency of the radiated spurious emission of interest
2. RBW = 1MHz
3. VBW; If the EUT is configured to transmit with duty cycle  $\geq 98\%$ , set VBW = 10 Hz.

If the EUT duty cycle is  $< 98\%$ , set  $VBW \geq 1/T$ . T is the minimum transmission duration.

4. Detector = Peak
5. Sweep time = auto
6. Trace mode = max hold
7. Trace was allowed to stabilize

#### 7.7.4. Test Setup

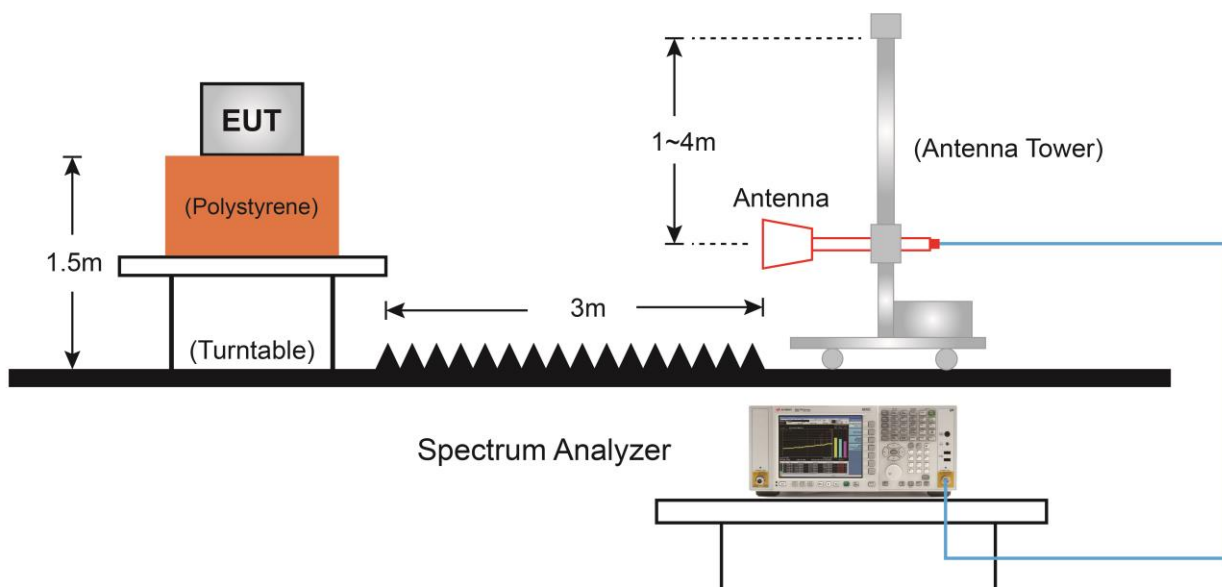

### 7.7.5. Test Result

EUT	Dimmer Control	Date of Test	2022-10-08
Factor	DRH18-E	Temp. / Humidity	24°C /56%
Polarity	Horizontal	Site / Test Engineer	AC2 / Jay
Test Mode	BLE_TX_1Mbps_CH 0	Test Voltage	By Notebook PC

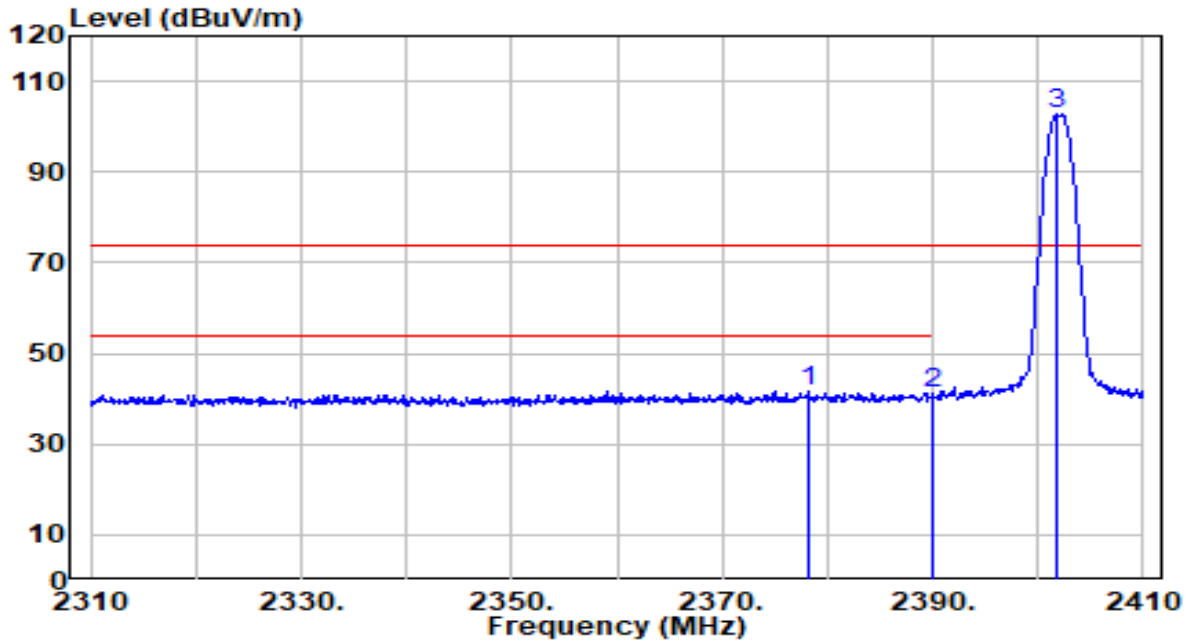

No	Frequency (MHz)	Reading (dBuV)	C.F (dB/m)	Measurement (dBuV/m)	Margin (dB)	Limit (dBuV/m)	Height (cm)	Angle (deg)	Remark (QP/PK/AV)
1	* 2378.200	46.88	-5.00	41.88	-32.12	74.00	150	265	Peak
2	2390.000	46.04	-5.00	41.04	-32.96	74.00	150	265	Peak
3	2401.800	107.59	-4.99	102.60	N/A	N/A	150	265	Peak

Note:

1. " \*", means this data is the worst emission level.
2. C.F (Correction Factor) = Antenna Factor (dB)+ Cable Loss (dB) – Preamplifier(dB).
3. Measurement (dBuV/m) = Reading(dBuV) + C.F (Correction Factor).
4. The emission levels of other frequencies are very lower than the limit and not show in test report.

EUT	Dimmer Control	Date of Test	2022-10-08
Factor	DRH18-E	Temp. / Humidity	24°C /56%
Polarity	Vertical	Site / Test Engineer	AC2 / Jay
Test Mode	BLE_TX_1Mbps_CH 0	Test Voltage	By Notebook PC

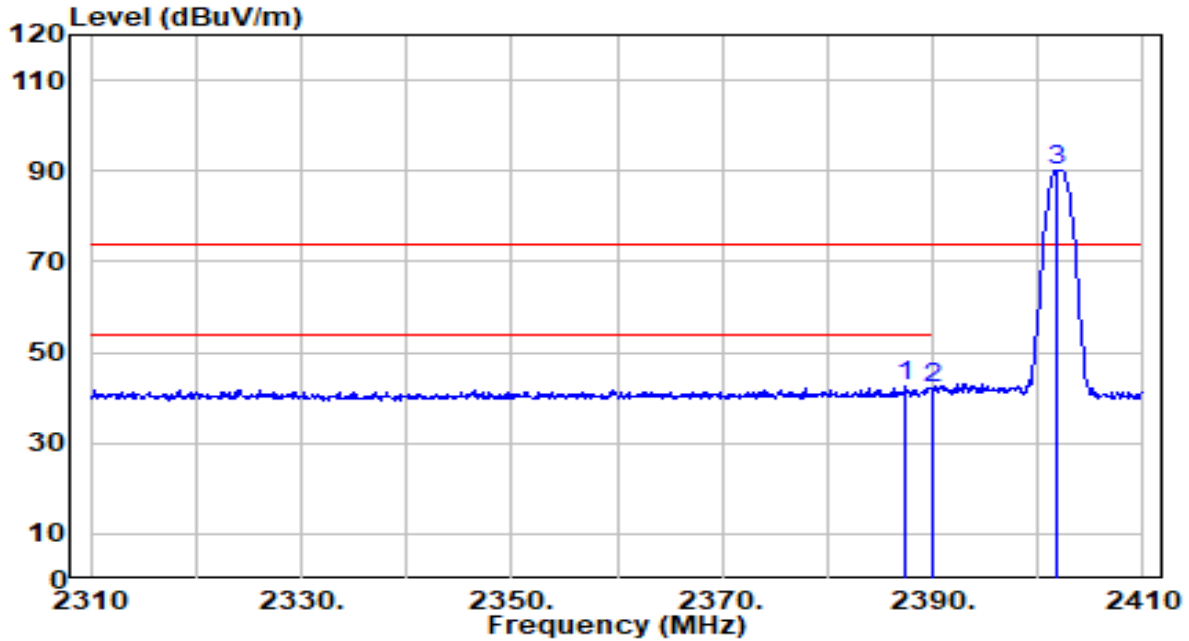

No	Frequency (MHz)	Reading (dBuV)	C.F (dB/m)	Measurement (dBuV/m)	Margin (dB)	Limit (dBuV/m)	Height (cm)	Angle (deg)	Remark (QP/PK/AV)
1	* 2387.500	47.48	-5.00	42.48	-31.52	74.00	125	150	Peak
2	2390.000	47.15	-5.00	42.16	-31.84	74.00	125	150	Peak
3	2401.800	95.21	-4.99	90.22	N/A	N/A	125	150	Peak

Note:

1. " \*", means this data is the worst emission level.
2. C.F (Correction Factor) = Antenna Factor (dB)+ Cable Loss (dB) – Preamplifier(dB).
3. Measurement (dBuV/m) = Reading(dBuV) + C.F (Correction Factor).
4. The emission levels of other frequencies are very lower than the limit and not show in test report.

EUT	Dimmer Control	Date of Test	2022-10-08
Factor	DRH18-E	Temp. / Humidity	24°C /56%
Polarity	Horizontal	Site / Test Engineer	AC2 / Jay
Test Mode	BLE_TX_1Mbps_CH 39	Test Voltage	By Notebook PC

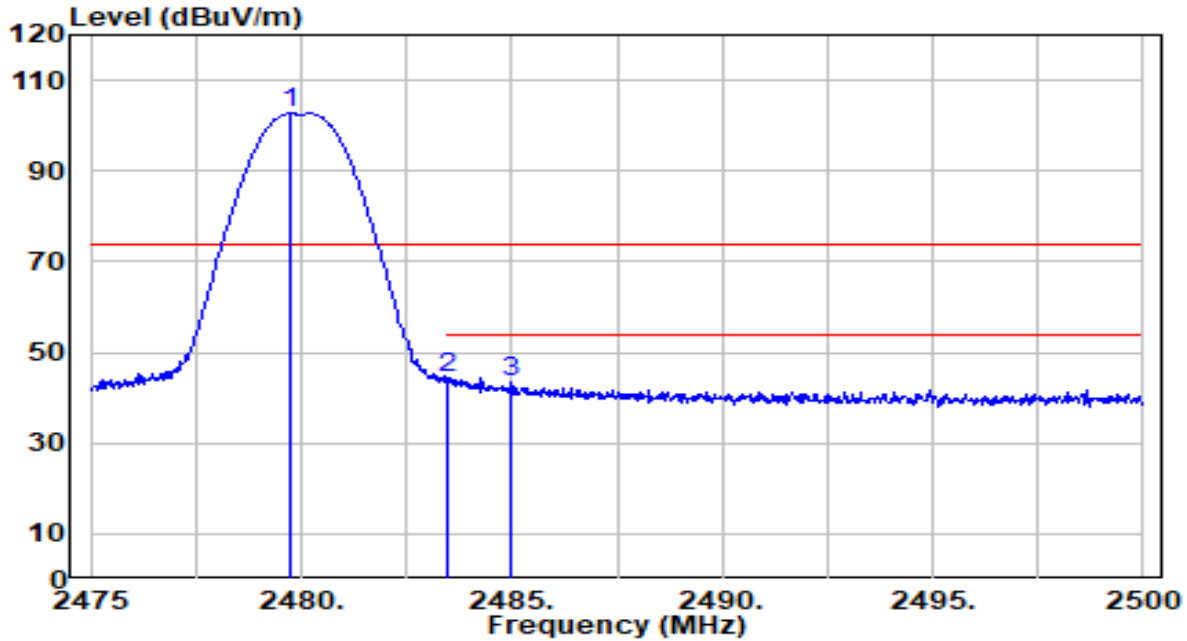

No	Frequency (MHz)	Reading (dBuV)	C.F (dB/m)	Measurement (dBuV/m)	Margin (dB)	Limit (dBuV/m)	Height (cm)	Angle (deg)	Remark (QP/PK/AV)
1	2479.725	107.43	-4.80	102.63	N/A	N/A	170	250	Peak
2	* 2483.500	48.99	-4.79	44.20	-29.80	74.00	170	250	Peak
3	2484.975	48.24	-4.79	43.45	-30.55	74.00	170	250	Peak

Note:

1. " \*", means this data is the worst emission level.
2. C.F (Correction Factor) = Antenna Factor (dB)+ Cable Loss (dB) – Preamplifier(dB).
3. Measurement (dBuV/m) = Reading(dBuV) + C.F (Correction Factor).
4. The emission levels of other frequencies are very lower than the limit and not show in test report.

EUT	Dimmer Control	Date of Test	2022-10-08
Factor	DRH18-E	Temp. / Humidity	24°C /56%
Polarity	Vertical	Site / Test Engineer	AC2 / Jay
Test Mode	BLE_TX_1Mbps_CH 39	Test Voltage	By Notebook PC

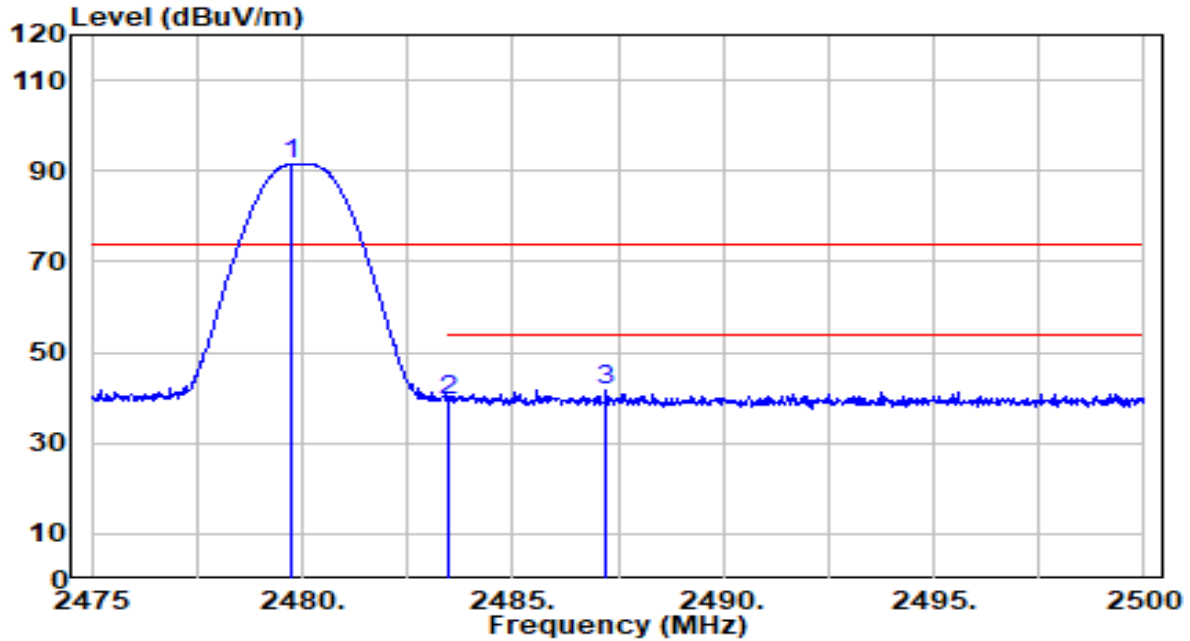

No	Frequency (MHz)	Reading (dBuV)	C.F (dB/m)	Measurement (dBuV/m)	Margin (dB)	Limit (dBuV/m)	Height (cm)	Angle (deg)	Remark (QP/PK/AV)
1	2479.725	96.19	-4.80	91.40	N/A	N/A	230	225	Peak
2	2483.500	44.05	-4.79	39.26	-34.74	74.00	230	225	Peak
3	* 2487.225	46.26	-4.78	41.48	-32.52	74.00	230	225	Peak

Note:

1. " \*", means this data is the worst emission level.
2. C.F (Correction Factor) = Antenna Factor (dB)+ Cable Loss (dB) – Preamplifier(dB).
3. Measurement (dBuV/m) = Reading(dBuV) + C.F (Correction Factor).
4. The emission levels of other frequencies are very lower than the limit and not show in test report.

## 7.8. AC Conducted Emissions Measurement

### 7.8.1. Test Limit

FCC Part 15 Subpart C Paragraph 15.207 / RSS-Gen Limits		
Frequency (MHz)	QP (dB $\mu$ V)	Average (dB $\mu$ V)
0.15 - 0.50	66 - 56	56 - 46
0.50 - 5.0	56	46
5.0 - 30	60	50

Note 1: The lower limit shall apply at the transition frequencies.

Note 2: The limit decreases linearly with the logarithm of the frequency in the range 0.15MHz to 0.5MHz.

### 7.8.2. Test Setup

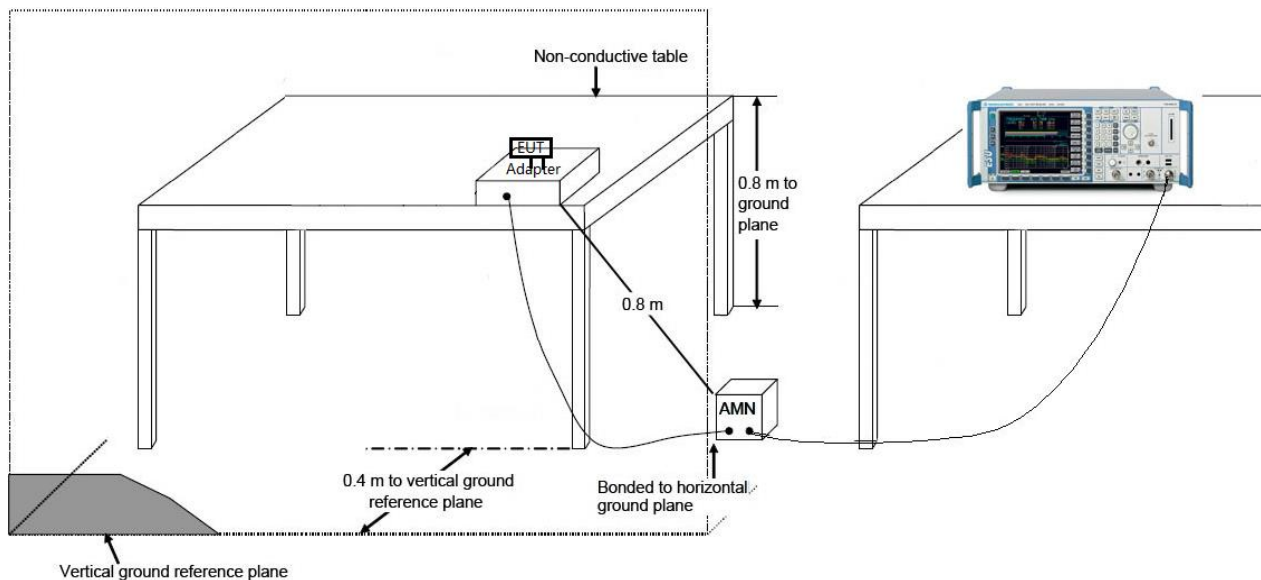

### 7.8.3. Test Result

The EUT Power by Battery, so do not need to test Conducted Emissions.

## 8. CONCLUSION

The data collected relate only the item(s) tested and show that the device is in compliance with Part 15C of the FCC Rules.

\_\_\_\_\_ The End \_\_\_\_\_



## **Appendix A : Test Photograph**

Refer to “2210TW0106-Setup Photo” file.

## **Appendix B : External Photograph**

Refer to “2210TW0106-External Photo” file.

## **Appendix C : Internal Photograph**

Refer to “2210TW0106-Internal Photo” file.