

FCC Radio Test Report

FCC ID: 2AXJ4RE815XE

This report concerns: **Original Grant**

Project No. : 2205C155
Equipment : AXE5400 Tri-Band Wi-Fi 6E Range Extender
Brand Name : tp-link
Test Model : RE815XE
Series Model : N/A
Applicant : TP-Link Corporation Limited
Address : Room 901, 9/F. , New East Ocean Centre, 9 Science Museum Road, Tsim Sha Tsui, Kowloon, Hong Kong
Manufacturer : TP-Link Corporation Limited
Address : Room 901, 9/F. , New East Ocean Centre, 9 Science Museum Road, Tsim Sha Tsui, Kowloon, Hong Kong
Date of Receipt : May 27, 2022
Date of Test : May 31, 2022 ~ Aug. 24, 2022
Issued Date : Sep. 08, 2022
Report Version : R00
Test Sample : Engineering Sample No.: DG20220530510 for power, DG20220530511 for conducted and radiated emissions below 30MHz, DG20220530509 for others.
Standard(s) : FCC CFR Title 47, Part 15, Subpart E
FCC KDB 789033 D02 General UNII Test Procedures New Rules v02r01
FCC KDB 662911 D01 Multiple Transmitter Output v02r01
ANSI C63.10-2013

The above equipment has been tested and found compliance with the requirement of the relative standards by BTL Inc.



Prepared by : Chella Zheng



Approved by : Chay Cai



TESTING CERT #5123.02

BTL Inc.

No. 3 Jinshagang 1st Rd. Shixia, Dalang Town Dongguan City, Guangdong 523792 People's Republic of China.

Tel: +86-769-8318-3000 Web: www.newbtl.com Service mail: btl_qa@newbtl.com

Declaration

BTL represents to the client that testing is done in accordance with standard procedures as applicable and that test instruments used has been calibrated with standards traceable to international standard(s) and/or national standard(s).

BTL's reports apply only to the specific samples tested under conditions. It is manufacture's responsibility to ensure that additional production units of this model are manufactured with the identical electrical and mechanical components. **BTL** shall have no liability for any declarations, inferences or generalizations drawn by the client or others from **BTL** issued reports.

The report must not be used by the client to claim product certification, approval, or endorsement by NVLAP, NIST, A2LA, or any agency of the U.S. Government.

This report is the confidential property of the client. As a mutual protection to the clients, the public and ourselves, the test report shall not be reproduced, except in full, without our written approval.

BTL's laboratory quality assurance procedures are in compliance with the **ISO/IEC 17025** requirements, and accredited by the conformity assessment authorities listed in this test report.

BTL is not responsible for the sampling stage, so the results only apply to the sample as received.

The information, data and test plan are provided by manufacturer which may affect the validity of results, so it is manufacturer's responsibility to ensure that the apparatus meets the essential requirements of applied standards and in all the possible configurations as representative of its intended use.

Limitation

For the use of the authority's logo is limited unless the Test Standard(s)/Scope(s)/Item(s) mentioned in this test report is (are) included in the conformity assessment authorities acceptance respective.

Please note that the measurement uncertainty is provided for informational purpose only and are not use in determining the Pass/Fail results.

Table of Contents	Page
REPORT ISSUED HISTORY	5
1 . SUMMARY OF TEST RESULTS	6
1.1 TEST FACILITY	7
1.2 MEASUREMENT UNCERTAINTY	7
1.3 TEST ENVIRONMENT CONDITIONS	8
2 . GENERAL INFORMATION	9
2.1 GENERAL DESCRIPTION OF EUT	9
2.2 TEST MODES	13
2.3 PARAMETERS OF TEST SOFTWARE	18
2.4 DUTY CYCLE	22
2.5 BLOCK DIAGRAM SHOWING THE CONFIGURATION OF SYSTEM TESTED	25
2.6 SUPPORT UNITS	25
3 . AC POWER LINE CONDUCTED EMISSIONS	26
3.1 LIMIT	26
3.2 TEST PROCEDURE	26
3.3 DEVIATION FROM TEST STANDARD	26
3.4 TEST SETUP	27
3.5 EUT OPERATION CONDITIONS	27
3.6 TEST RESULTS	27
4 . RADIATED EMISSIONS	28
4.1 LIMIT	28
4.2 TEST PROCEDURE	29
4.3 DEVIATION FROM TEST STANDARD	30
4.4 TEST SETUP	30
4.5 EUT OPERATION CONDITIONS	31
4.6 TEST RESULTS - 9 KHZ TO 30 MHZ	31
4.7 TEST RESULTS - 30 MHZ TO 1000 MHZ	31
4.8 TEST RESULTS - ABOVE 1000 MHZ	31
5 . BANDWIDTH	32
5.1 LIMIT	32
5.2 TEST PROCEDURE	32
5.3 DEVIATION FROM STANDARD	32
5.4 TEST SETUP	33

Table of Contents	Page
5.5 EUT OPERATION CONDITIONS	33
5.6 TEST RESULTS	33
6 . MAXIMUM OUTPUT POWER	34
6.1 LIMIT	34
6.2 TEST PROCEDURE	34
6.3 DEVIATION FROM STANDARD	35
6.4 TEST SETUP	35
6.5 EUT OPERATION CONDITIONS	35
6.6 TEST RESULTS	35
7 . POWER SPECTRAL DENSITY	36
7.1 LIMIT	36
7.2 TEST PROCEDURE	36
7.3 DEVIATION FROM STANDARD	36
7.4 TEST SETUP	37
7.5 EUT OPERATION CONDITIONS	37
7.6 TEST RESULTS	37
8 . MEASUREMENT INSTRUMENTS LIST	38
9 . EUT TEST PHOTOS	40
APPENDIX A - AC POWER LINE CONDUCTED EMISSIONS	45
APPENDIX B - RADIATED EMISSION - 9 KHZ TO 30 MHZ	48
APPENDIX C - RADIATED EMISSION - 30 MHZ TO 1000 MHZ	53
APPENDIX D - RADIATED EMISSION - ABOVE 1000 MHZ	56
APPENDIX E - BANDWIDTH	193
APPENDIX F - MAXIMUM OUTPUT POWER	226
APPENDIX G - POWER SPECTRAL DENSITY	287

REPORT ISSUED HISTORY

Report No.	Version	Description	Issued Date	Note
BTL-FCCP-2-2205C155	R00	Original Report.	Sep. 08, 2022	Valid

1. SUMMARY OF TEST RESULTS

Test procedures according to the technical standard(s):

FCC CFR Title 47, Part 15, Subpart E				
Standard(s) Section	Test Item	Test Result	Judgment	Remark
15.207 15.407(b)	AC Power Line Conducted Emissions	APPENDIX A	PASS	-----
15.407(b) 15.205(a) 15.209(a)	Radiated Emissions	APPENDIX B APPENDIX C APPENDIX D	PASS	-----
15.407(a) 15.407(e)	Bandwidth	APPENDIX E	PASS	-----
15.407(a)	Maximum Output Power	APPENDIX F	PASS	-----
15.407(a)	Power Spectral Density	APPENDIX G	PASS	-----
15.407(g)	Frequency Stability	-----	PASS	NOTE (2)
15.203	Antenna Requirements	-----	PASS	NOTE (3)
15.407(c)	Automatically Discontinue Transmission	-----	PASS	NOTE (4)

Note:

- (1) "N/A" denotes test is not applicable in this test report.
- (2) The item is declared by the manufacturer.
- (3) The device what use a permanently attached antenna were considered sufficient to comply with the provisions of 15.203.
- (4) During no any information transmission, the EUT can automatically discontinue transmission and become standby mode for power saving. the EUT can detect the controlling signal of ACK message transmitting from remote device and verify whether it shall resend or discontinue transmission.
- (5) For UNII-1 this device was functioned as a
 - Outdoor access point device
 - Indoor access point device
 - Fixed point-to-point access points device
 - Client device

1.1 TEST FACILITY

The test facilities used to collect the test data in this report is at the location of No. 3 Jinshagang 1st Rd. Shixia, Dalang Town Dongguan City, Guangdong 523792 People's Republic of China.

BTL's Registration Number for FCC: 357015

BTL's Designation Number for FCC: CN1240

1.2 MEASUREMENT UNCERTAINTY

ISO/IEC 17025 requires that an estimate of the measurement uncertainties associated with the emissions test results be included in the report. The measurement uncertainties given below are based on a 95% confidence level (based on a coverage factor (k=2))

The BTL measurement uncertainty as below table:

A. AC power line conducted emissions test:

Test Site	Method	Measurement Frequency Range	U,(dB)
DG-C02	CISPR	150kHz ~ 30MHz	2.60

B. Radiated emissions test:

Test Site	Method	Measurement Frequency Range	U,(dB)
DG-CB01	CISPR	9kHz ~ 30MHz	2.36

Test Site	Method	Measurement Frequency Range	Ant. H / V	U,(dB)
DG-CB03 (3m)	CISPR	30MHz ~ 200MHz	V	4.36
		30MHz ~ 200MHz	H	3.32
		200MHz ~ 1,000MHz	V	4.08
		200MHz ~ 1,000MHz	H	3.96

Test Site	Method	Measurement Frequency Range	U,(dB)
DG-CB03 (3m)	CISPR	1GHz ~ 6GHz	3.80
		6GHz ~ 18GHz	4.82

Test Site	Method	Measurement Frequency Range	U,(dB)
DG-CB03 (1m)	CISPR	18 ~ 26.5 GHz	3.62
		26.5 ~ 40 GHz	4.00

C. Other Measurement test:

Test Item	Uncertainty
Bandwidth	±3.8 %
Maximum Output Power	±0.95 dB
Power Spectral Density	±0.86 dB
Frequency Stability	±0.16 dB
Temperature	±0.08 °C
Humidity	±1.5%

Note: Unless specifically mentioned, the uncertainty of measurement has not been taken into account to declare the compliance or non-compliance to the specification.

1.3 TEST ENVIRONMENT CONDITIONS

Test Item	Temperature	Humidity	Test Voltage	Tested By
AC Power Line Conducted Emissions	26°C	58%	AC 120V/60Hz	Jeter Wang
Radiated Emissions-9kHz to 30 MHz	25°C	55%	AC 120V/60Hz	Bob Cao
Radiated Emissions-30MHz to 1000MHz	25°C	55%	AC 120V/60Hz	Meers Zhang
Radiated Emissions-Above 1000 MHz	22°C	58%	AC 120V/60Hz	Meers Zhang
Bandwidth	24-25°C	57-64%	AC 120V/60Hz	Nicole Chen
Maximum Output Power	23.5-24.5°C	56.7-66.8%	AC 120V/60Hz	Complex Qin
Power Spectral Density	24-25°C	57-64%	AC 120V/60Hz	Nicole Chen

2. GENERAL INFORMATION

2.1 GENERAL DESCRIPTION OF EUT

Equipment	AXE5400 Tri-Band Wi-Fi 6E Range Extender
Brand Name	tp-link
Test Model	RE815XE
Series Model	N/A
Model Difference(s)	N/A
Power Source	AC Mains.
Power Rating	100-240V~ 50/60Hz 0.5A
Operation Frequency Band(s)	UNII-1: 5150 MHz ~ 5250 MHz UNII-2A: 5250 MHz ~ 5350 MHz UNII-2C: 5470 MHz ~ 5725 MHz UNII-3: 5725 MHz ~ 5850 MHz
Modulation Type	IEEE 802.11a/n/ac: OFDM IEEE 802.11ax: OFDMA
Bit Rate of Transmitter	IEEE 802.11a: 54/48/36/24/18/12/9/6 Mbps IEEE 802.11n: up to 300 Mbps IEEE 802.11ac: up to 1733.4 Mbps IEEE 802.11ax: up to 2402 Mbps
Maximum Output Power UNII-1 Non Beamforming	IEEE 802.11a: 27.35 dBm (0.5433 W)
Maximum Output Power UNII-2A Non Beamforming	IEEE 802.11a: 23.89 dBm (0.2449 W)
Maximum Output Power UNII-2C Non Beamforming	IEEE 802.11ac(VHT80): 23.96 dBm (0.2489 W)
Maximum Output Power UNII-3 Non Beamforming	IEEE 802.11ax(HE20): 27.39 dBm (0.5483 W)
Maximum Output Power UNII-1 Beamforming	IEEE 802.11ax(HE20): 26.90 dBm (0.4898 W)
Maximum Output Power UNII-2A Beamforming	IEEE 802.11ax(HE20): 23.27 dBm (0.2123 W)
Maximum Output Power UNII-2C Beamforming	IEEE 802.11ac(VHT20): 23.87 dBm (0.2438 W)
Maximum Output Power UNII-3 Beamforming	IEEE 802.11ac(VHT20): 26.84 dBm (0.4831 W)

Note:

- For a more detailed features description, please refer to the manufacturer's specifications or the user's manual.

2. Channel List:

IEEE 802.11a IEEE 802.11n(HT20) IEEE 802.11ac(VHT20) IEEE 802.11ax(HE20)		IEEE 802.11n(HT40) IEEE 802.11ac(VHT40) IEEE 802.11ax(HE40)		IEEE 802.11ac(VHT80) IEEE 802.11ax(HE80)	
UNII-1		UNII-1		UNII-1	
Channel	Frequency (MHz)	Channel	Frequency (MHz)	Channel	Frequency (MHz)
36	5180	38	5190	42	5210
40	5200	46	5230		
44	5220				
48	5240				

IEEE 802.11a IEEE 802.11n(HT20) IEEE 802.11ac(VHT20) IEEE 802.11ax(HE20)		IEEE 802.11n(HT40) IEEE 802.11ac(VHT40) IEEE 802.11ax(HE40)		IEEE 802.11ac(VHT80) IEEE 802.11ax(HE80)	
UNII-2A		UNII-2A		UNII-2A	
Channel	Frequency (MHz)	Channel	Frequency (MHz)	Channel	Frequency (MHz)
52	5260	54	5270	58	5290
56	5280	62	5310		
60	5300				
64	5320				

IEEE 802.11a IEEE 802.11n(HT20) IEEE 802.11ac(VHT20) IEEE 802.11ax(HE20)		IEEE 802.11n(HT40) IEEE 802.11ac(VHT40) IEEE 802.11ax(HE40)		IEEE 802.11ac(VHT80) IEEE 802.11ax(HE80)	
UNII-2C		UNII-2C		UNII-2C	
Channel	Frequency (MHz)	Channel	Frequency (MHz)	Channel	Frequency (MHz)
100	5500	102	5510	106	5530
104	5520	110	5550	122	5610
108	5540	118	5590	138	5690
112	5560	126	5630		
116	5580	134	5670		
120	5600	142	5710		
124	5620				
128	5640				
132	5660				
136	5680				
140	5700				
144	5720				

IEEE 802.11a IEEE 802.11n(HT20) IEEE 802.11ac(VHT20) IEEE 802.11ax(HE20)		IEEE 802.11n(HT40) IEEE 802.11ac(VHT40) IEEE 802.11ax(HE40)		IEEE 802.11ac(VHT80) IEEE 802.11ax(HE80)	
UNII-3		UNII-3		UNII-3	
Channel	Frequency (MHz)	Channel	Frequency (MHz)	Channel	Frequency (MHz)
149	5745	151	5755	155	5775
153	5765	159	5795		
157	5785				
161	5805				
165	5825				

IEEE 802.11ac(VHT160) IEEE 802.11ax(HE160)	
Channel	Frequency (MHz)
50	5250
114	5570

3. Antenna Specification:

Ant.	Brand	Model Name	Antenna Type	Connector	Gain (dBi)
1	tp-link	N/A	Dipole	N/A	2.69
2	tp-link	N/A	Dipole	N/A	3.00

Note:

- 1) This EUT supports CDD and all antenna gains are not equal, Directional gain= G_{ANT} +Array Gain.
 For power measurements, Array Gain=0dB ($N_{ANT} \leq 4$), so the Directional gain=3.00.
 For power spectral density measurements, $N_{ANT}=2$, $N_{SS}=1$.
 Then the Directional gain= G_{ANT} +Array Gain= $G_{ANT}+10\log(N_{ANT}/N_{SS})$ dBi=3+10log(2/1)dBi=6.01. So the UNII-1 power spectral density limit is 17-(6.01-6)=16.99, the UNII-2A and UNII-2C power spectral density limit is 11-(6.01-6)=10.99, the UNII-3 power spectral density limit is 30-(6.01-6)=29.99.
- 2) Beamforming Gain: 3dB. Then the Directional gain=3+3=6.
- 3) The antenna gain and beamforming gain are provided by the manufacturer.

4. Table for Antenna Configuration:

For Non Beamforming:

Operating Mode	TX Mode	2TX
IEEE 802.11a		V (Ant. 1 + Ant. 2)
IEEE 802.11n(HT20)		V (Ant. 1 + Ant. 2)
IEEE 802.11n(HT40)		V (Ant. 1 + Ant. 2)
IEEE 802.11ac(VHT20)		V (Ant. 1 + Ant. 2)
IEEE 802.11ac(VHT40)		V (Ant. 1 + Ant. 2)
IEEE 802.11ac(VHT80)		V (Ant. 1 + Ant. 2)
IEEE 802.11ac(VHT160)		V (Ant. 1 + Ant. 2)
IEEE 802.11ax(HE20)		V (Ant. 1 + Ant. 2)
IEEE 802.11ax(HE40)		V (Ant. 1 + Ant. 2)
IEEE 802.11ax(HE80)		V (Ant. 1 + Ant. 2)
IEEE 802.11ax(HE160)		V (Ant. 1 + Ant. 2)

For Beamforming:

Operating Mode	TX Mode	2TX
IEEE 802.11n(HT20)		V (Ant. 1 + Ant. 2)
IEEE 802.11n(HT40)		V (Ant. 1 + Ant. 2)
IEEE 802.11ac(VHT20)		V (Ant. 1 + Ant. 2)
IEEE 802.11ac(VHT40)		V (Ant. 1 + Ant. 2)
IEEE 802.11ac(VHT80)		V (Ant. 1 + Ant. 2)
IEEE 802.11ac(VHT160)		V (Ant. 1 + Ant. 2)
IEEE 802.11ax(HE20)		V (Ant. 1 + Ant. 2)
IEEE 802.11ax(HE40)		V (Ant. 1 + Ant. 2)
IEEE 802.11ax(HE80)		V (Ant. 1 + Ant. 2)
IEEE 802.11ax(HE160)		V (Ant. 1 + Ant. 2)

2.2 TEST MODES

The test system was pre-tested based on the consideration of all possible combinations of EUT operation mode.

Pretest Mode	Description
Mode 1	TX A Mode Channel 36/40/48 (UNII-1)
Mode 2	TX AC(VHT20) Mode Channel 36/40/48 (UNII-1)
Mode 3	TX AC(VHT40) Mode Channel 38/46 (UNII-1)
Mode 4	TX AC(VHT80) Mode Channel 42 (UNII-1)
Mode 5	TX AX(HE20) Mode Channel 36/40/48 (UNII-1)
Mode 6	TX AX(HE40) Mode Channel 38/46 (UNII-1)
Mode 7	TX AX(HE80) Mode Channel 42 (UNII-1)
Mode 8	TX A Mode Channel 52/60/64 (UNII-2A)
Mode 9	TX AC(VHT20) Mode Channel 52/60/64 (UNII-2A)
Mode 10	TX AC(VHT40) Mode Channel 54/62 (UNII-2A)
Mode 11	TX AC(VHT80) Mode Channel 58 (UNII-2A)
Mode 12	TX AX(HE20) Mode Channel 52/60/64 (UNII-2A)
Mode 13	TX AX(HE40) Mode Channel 54/62 (UNII-2A)
Mode 14	TX AX(HE80) Mode Channel 58 (UNII-2A)
Mode 15	TX AC(VHT160) Mode Channel 50 (UNII-1+UNII-2A)
Mode 16	TX AX(HE160) Mode Channel 50 (UNII-1+UNII-2A)
Mode 17	TX A Mode Channel 100/116/140/144 (UNII-2C)
Mode 18	TX AC(VHT20) Mode Channel 100/116/140/144 (UNII-2C)
Mode 19	TX AC(VHT40) Mode Channel 102/110/134/142 (UNII-2C)
Mode 20	TX AC(VHT80) Mode Channel 106/122/138 (UNII-2C)
Mode 21	TX AC(VHT160) Mode Channel 114 (UNII-2C)
Mode 22	TX AX(HE20) Mode Channel 100/116/140/144 (UNII-2C)
Mode 23	TX AX(HE40) Mode Channel 102/110/134/142 (UNII-2C)
Mode 24	TX AX(HE80) Mode Channel 106/122/138 (UNII-2C)
Mode 25	TX AX(HE160) Mode Channel 114 (UNII-2C)
Mode 26	TX A Mode Channel 149/157/165 (UNII-3)
Mode 27	TX AC(VHT20) Mode Channel 149/157/165 (UNII-3)
Mode 28	TX AC(VHT40) Mode Channel 151/159 (UNII-3)
Mode 29	TX AC(VHT80) Mode Channel 155 (UNII-3)
Mode 30	TX AX(HE20) Mode Channel 149/157/165 (UNII-3)
Mode 31	TX AX(HE40) Mode Channel 151/159 (UNII-3)
Mode 32	TX AX(HE80) Mode Channel 155 (UNII-3)
Mode 33	TX AX(HE20) Mode Channel 149 (UNII-3)

Following mode(s) was (were) found to be the worst case(s) and selected for the final test.

AC power line conducted emissions test	
Final Test Mode	Description
Mode 33	TX AX(HE20) Mode Channel 149 (UNII-3)

Radiated Emissions Test - Below 1GHz	
Final Test Mode	Description
Mode 33	TX AX(HE20) Mode Channel 149 (UNII-3)

Radiated Emissions Test - Above 1GHz_Non Beamforming	
Final Test Mode	Description
Mode 1	TX A Mode Channel 36/40/48 (UNII-1)
Mode 2	TX AC(VHT20) Mode Channel 36/40/48 (UNII-1)
Mode 3	TX AC(VHT40) Mode Channel 38/46 (UNII-1)
Mode 4	TX AC(VHT80) Mode Channel 42 (UNII-1)
Mode 5	TX AX(HE20) Mode Channel 36/40/48 (UNII-1)
Mode 6	TX AX(HE40) Mode Channel 38/46 (UNII-1)
Mode 7	TX AX(HE80) Mode Channel 42 (UNII-1)
Mode 8	TX A Mode Channel 52/60/64 (UNII-2A)
Mode 9	TX AC(VHT20) Mode Channel 52/60/64 (UNII-2A)
Mode 10	TX AC(VHT40) Mode Channel 54/62 (UNII-2A)
Mode 11	TX AC(VHT80) Mode Channel 58 (UNII-2A)
Mode 12	TX AX(HE20) Mode Channel 52/60/64 (UNII-2A)
Mode 13	TX AX(HE40) Mode Channel 54/62 (UNII-2A)
Mode 14	TX AX(HE80) Mode Channel 58 (UNII-2A)
Mode 15	TX AC(VHT160) Mode Channel 50 (UNII-1+UNII-2A)
Mode 16	TX AX(HE160) Mode Channel 50 (UNII-1+UNII-2A)
Mode 17	TX A Mode Channel 100/116/140/144 (UNII-2C)
Mode 18	TX AC(VHT20) Mode Channel 100/116/140/144 (UNII-2C)
Mode 19	TX AC(VHT40) Mode Channel 102/110/134/142 (UNII-2C)
Mode 20	TX AC(VHT80) Mode Channel 106/122/138 (UNII-2C)
Mode 21	TX AC(VHT160) Mode Channel 114 (UNII-2C)
Mode 22	TX AX(HE20) Mode Channel 100/116/140/144 (UNII-2C)
Mode 23	TX AX(HE40) Mode Channel 102/110/134/142 (UNII-2C)
Mode 24	TX AX(HE80) Mode Channel 106/122/138 (UNII-2C)
Mode 25	TX AX(HE160) Mode Channel 114 (UNII-2C)

Radiated Emissions Test - Above 1GHz_Non Beamforming	
Final Test Mode	Description
Mode 26	TX A Mode Channel 149/157/165 (UNII-3)
Mode 27	TX AC(VHT20) Mode Channel 149/157/165 (UNII-3)
Mode 28	TX AC(VHT40) Mode Channel 151/159 (UNII-3)
Mode 29	TX AC(VHT80) Mode Channel 155 (UNII-3)
Mode 30	TX AX(HE20) Mode Channel 149/157/165 (UNII-3)
Mode 31	TX AX(HE40) Mode Channel 151/159 (UNII-3)
Mode 32	TX AX(HE80) Mode Channel 155 (UNII-3)

Maximum Output Power Test_Non Beamforming	
Final Test Mode	Description
Mode 1	TX A Mode Channel 36/40/48 (UNII-1)
Mode 2	TX AC(VHT20) Mode Channel 36/40/48 (UNII-1)
Mode 3	TX AC(VHT40) Mode Channel 38/46 (UNII-1)
Mode 4	TX AC(VHT80) Mode Channel 42 (UNII-1)
Mode 5	TX AX(HE20) Mode Channel 36/40/48 (UNII-1)
Mode 6	TX AX(HE40) Mode Channel 38/46 (UNII-1)
Mode 7	TX AX(HE80) Mode Channel 42 (UNII-1)
Mode 8	TX A Mode Channel 52/60/64 (UNII-2A)
Mode 9	TX AC(VHT20) Mode Channel 52/60/64 (UNII-2A)
Mode 10	TX AC(VHT40) Mode Channel 54/62 (UNII-2A)
Mode 11	TX AC(VHT80) Mode Channel 58 (UNII-2A)
Mode 12	TX AX(HE20) Mode Channel 52/60/64 (UNII-2A)
Mode 13	TX AX(HE40) Mode Channel 54/62 (UNII-2A)
Mode 14	TX AX(HE80) Mode Channel 58 (UNII-2A)
Mode 15	TX AC(VHT160) Mode Channel 50 (UNII-1+UNII-2A)
Mode 16	TX AX(HE160) Mode Channel 50 (UNII-1+UNII-2A)
Mode 17	TX A Mode Channel 100/116/140/144 (UNII-2C)
Mode 18	TX AC(VHT20) Mode Channel 100/116/140/144 (UNII-2C)
Mode 19	TX AC(VHT40) Mode Channel 102/110/134/142 (UNII-2C)
Mode 20	TX AC(VHT80) Mode Channel 106/122/138 (UNII-2C)
Mode 21	TX AC(VHT160) Mode Channel 114 (UNII-2C)
Mode 22	TX AX(HE20) Mode Channel 100/116/140/144 (UNII-2C)
Mode 23	TX AX(HE40) Mode Channel 102/110/134/142 (UNII-2C)
Mode 24	TX AX(HE80) Mode Channel 106/122/138 (UNII-2C)
Mode 25	TX AX(HE160) Mode Channel 114 (UNII-2C)

Maximum Output Power Test_Non Beamforming	
Final Test Mode	Description
Mode 26	TX A Mode Channel 149/157/165 (UNII-3)
Mode 27	TX AC(VHT20) Mode Channel 149/157/165 (UNII-3)
Mode 28	TX AC(VHT40) Mode Channel 151/159 (UNII-3)
Mode 29	TX AC(VHT80) Mode Channel 155 (UNII-3)
Mode 30	TX AX(HE20) Mode Channel 149/157/165 (UNII-3)
Mode 31	TX AX(HE40) Mode Channel 151/159 (UNII-3)
Mode 32	TX AX(HE80) Mode Channel 155 (UNII-3)

Maximum Output Power Test_Beamforming	
Final Test Mode	Description
Mode 2	TX AC(VHT20) Mode Channel 36/40/48 (UNII-1)
Mode 3	TX AC(VHT40) Mode Channel 38/46 (UNII-1)
Mode 4	TX AC(VHT80) Mode Channel 42 (UNII-1)
Mode 5	TX AX(HE20) Mode Channel 36/40/48 (UNII-1)
Mode 6	TX AX(HE40) Mode Channel 38/46 (UNII-1)
Mode 7	TX AX(HE80) Mode Channel 42 (UNII-1)
Mode 9	TX AC(VHT20) Mode Channel 52/60/64 (UNII-2A)
Mode 10	TX AC(VHT40) Mode Channel 54/62 (UNII-2A)
Mode 11	TX AC(VHT80) Mode Channel 58 (UNII-2A)
Mode 12	TX AX(HE20) Mode Channel 52/60/64 (UNII-2A)
Mode 13	TX AX(HE40) Mode Channel 54/62 (UNII-2A)
Mode 14	TX AX(HE80) Mode Channel 58 (UNII-2A)
Mode 15	TX AC(VHT160) Mode Channel 50 (UNII-1+UNII-2A)
Mode 16	TX AX(HE160) Mode Channel 50 (UNII-1+UNII-2A)
Mode 18	TX AC(VHT20) Mode Channel 100/116/140/144 (UNII-2C)
Mode 19	TX AC(VHT40) Mode Channel 102/110/134/142 (UNII-2C)
Mode 20	TX AC(VHT80) Mode Channel 106/122/138 (UNII-2C)
Mode 21	TX AC(VHT160) Mode Channel 114 (UNII-2C)
Mode 22	TX AX(HE20) Mode Channel 100/116/140/144 (UNII-2C)
Mode 23	TX AX(HE40) Mode Channel 102/110/134/142 (UNII-2C)
Mode 24	TX AX(HE80) Mode Channel 106/122/138 (UNII-2C)
Mode 25	TX AX(HE160) Mode Channel 114 (UNII-2C)
Mode 27	TX AC(VHT20) Mode Channel 149/157/165 (UNII-3)
Mode 28	TX AC(VHT40) Mode Channel 151/159 (UNII-3)
Mode 29	TX AC(VHT80) Mode Channel 155 (UNII-3)
Mode 30	TX AX(HE20) Mode Channel 149/157/165 (UNII-3)
Mode 31	TX AX(HE40) Mode Channel 151/159 (UNII-3)
Mode 32	TX AX(HE80) Mode Channel 155 (UNII-3)

Other Conducted Test_Non Beamforming	
Final Test Mode	Description
Mode 1	TX A Mode Channel 36/40/48 (UNII-1)
Mode 2	TX AC(VHT20) Mode Channel 36/40/48 (UNII-1)
Mode 3	TX AC(VHT40) Mode Channel 38/46 (UNII-1)
Mode 4	TX AC(VHT80) Mode Channel 42 (UNII-1)
Mode 5	TX AX(HE20) Mode Channel 36/40/48 (UNII-1)
Mode 6	TX AX(HE40) Mode Channel 38/46 (UNII-1)
Mode 7	TX AX(HE80) Mode Channel 42 (UNII-1)
Mode 8	TX A Mode Channel 52/60/64 (UNII-2A)
Mode 9	TX AC(VHT20) Mode Channel 52/60/64 (UNII-2A)
Mode 10	TX AC(VHT40) Mode Channel 54/62 (UNII-2A)
Mode 11	TX AC(VHT80) Mode Channel 58 (UNII-2A)
Mode 12	TX AX(HE20) Mode Channel 52/60/64 (UNII-2A)
Mode 13	TX AX(HE40) Mode Channel 54/62 (UNII-2A)
Mode 14	TX AX(HE80) Mode Channel 58 (UNII-2A)
Mode 15	TX AC(VHT160) Mode Channel 50 (UNII-1+UNII-2A)
Mode 16	TX AX(HE160) Mode Channel 50 (UNII-1+UNII-2A)
Mode 17	TX A Mode Channel 100/116/140/144 (UNII-2C)
Mode 18	TX AC(VHT20) Mode Channel 100/116/140/144 (UNII-2C)
Mode 19	TX AC(VHT40) Mode Channel 102/110/134/142 (UNII-2C)
Mode 20	TX AC(VHT80) Mode Channel 106/122/138 (UNII-2C)
Mode 21	TX AC(VHT160) Mode Channel 114 (UNII-2C)
Mode 22	TX AX(HE20) Mode Channel 100/116/140/144 (UNII-2C)
Mode 23	TX AX(HE40) Mode Channel 102/110/134/142 (UNII-2C)
Mode 24	TX AX(HE80) Mode Channel 106/122/138 (UNII-2C)
Mode 25	TX AX(HE160) Mode Channel 114 (UNII-2C)
Mode 26	TX A Mode Channel 149/157/165 (UNII-3)
Mode 27	TX AC(VHT20) Mode Channel 149/157/165 (UNII-3)
Mode 28	TX AC(VHT40) Mode Channel 151/159 (UNII-3)
Mode 29	TX AC(VHT80) Mode Channel 155 (UNII-3)
Mode 30	TX AX(HE20) Mode Channel 149/157/165 (UNII-3)
Mode 31	TX AX(HE40) Mode Channel 151/159 (UNII-3)
Mode 32	TX AX(HE80) Mode Channel 155 (UNII-3)

Note:

- (1) For AC power line conducted emissions and radiated emission below 1 GHz test, the TX AX(HE20) Mode Channel 149 (UNII-3) is found to be the worst case and recorded.
- (2) For radiated emission above 1 GHz test, the spurious points of 1GHz~26.5GHz and 26.5GHz~40GHz have been pre-tested and in this report only recorded the worst case. The remaining spurious points are all below the limit value of 20dB.
- (3) All the bit rate of transmitter have been tested and found the lowest rate is found to be the worst case and recorded.
- (4) VHT20/VHT40 covers HT20/HT40, due to same modulation. The power setting for 802.11n HT20 and HT40 are the same or lower than 802.11ac VHT20 and VHT40.
- (5) The measurements for Output Power are tested, the Non Beamforming and Beamforming are recorded in the report. The worst case is Non Beamforming and only the worst case is documented for other test items.
- (6) IEEE 802.11ax mode only supports full RU, so only the full RU is evaluated and measured inside report.
- (7) For radiated emission above 1 GHz test, the polarization of Vertical and Horizontal are evaluated, the worst case is Vertical and recorded.

2.3 PARAMETERS OF TEST SOFTWARE
Non Beamforming

UNII-1			
Test Software Version	accessMTool_REL_3_2_1_2		
Frequency (MHz)	5180	5200	5240
IEEE 802.11a	97	100	96
IEEE 802.11ac(VHT20)	102	100	96
IEEE 802.11ax(HE20)	95	99	97
Frequency (MHz)	5190	5230	
IEEE 802.11ac(VHT40)	85	96	
IEEE 802.11ax(HE40)	86	94	
Frequency (MHz)	5210		
IEEE 802.11ac(VHT80)	82		
IEEE 802.11ax(HE80)	80		

UNII-2A			
Test Software Version	accessMTool_REL_3_2_1_2		
Frequency (MHz)	5260	5300	5320
IEEE 802.11a	84	84	85
IEEE 802.11ac(VHT20)	83	84	84
IEEE 802.11ax(HE20)	83	83	84
Frequency (MHz)	5270	5310	
IEEE 802.11ac(VHT40)	84	78	
IEEE 802.11ax(HE40)	82	76	
Frequency (MHz)	5290		
IEEE 802.11ac(VHT80)	84		
IEEE 802.11ax(HE80)	76		

UNII-1+UNII-2A	
Test Software Version	accessMTool_REL_3_2_1_2
Frequency (MHz)	5250
IEEE 802.11ac(VHT160)	75
IEEE 802.11ax(HE160)	75

UNII-2C			
Test Software Version	accessMTool_REL_3_2_1_2		
Frequency (MHz)	5500	5580	5700
IEEE 802.11a	84	84	84
IEEE 802.11ac(VHT20)	84	84	84
IEEE 802.11ax(HE20)	82	82	82
Frequency (MHz)	5510	5550	5670
IEEE 802.11ac(VHT40)	84	84	84
IEEE 802.11ax(HE40)	78	83	82
Frequency (MHz)	5530	5610	
IEEE 802.11ac(VHT80)	83	84	
IEEE 802.11ax(HE80)	77	84	
Frequency (MHz)	5570		
IEEE 802.11ac(VHT160)	75		
IEEE 802.11ax(HE160)	71		

UNII-3			
Test Software Version	accessMTool_REL_3_2_1_2		
Frequency (MHz)	5745	5785	5825
IEEE 802.11a	98	99	103
IEEE 802.11ac(VHT20)	98	99	103
IEEE 802.11ax(HE20)	96	96	102
Frequency (MHz)	5755	5795	
IEEE 802.11ac(VHT40)	95	97	
IEEE 802.11ax(HE40)	94	96	
Frequency (MHz)	5775		
IEEE 802.11ac(VHT80)	84		
IEEE 802.11ax(HE80)	82		

Beamforming

UNII-1			
Test Software Version	accessMTool_REL_3_2_1_2		
Frequency (MHz)	5180	5200	5240
IEEE 802.11ac(VHT20)	100	98	94
IEEE 802.11ax(HE20)	94	97	95
Frequency (MHz)	5190	5230	
IEEE 802.11ac(VHT40)	84	94	
IEEE 802.11ax(HE40)	84	92	
Frequency (MHz)	5210		
IEEE 802.11ac(VHT80)	80		
IEEE 802.11ax(HE80)	78		

UNII-2A			
Test Software Version	accessMTool_REL_3_2_1_2		
Frequency (MHz)	5260	5300	5320
IEEE 802.11ac(VHT20)	81	82	82
IEEE 802.11ax(HE20)	81	81	82
Frequency (MHz)	5270	5310	
IEEE 802.11ac(VHT40)	82	77	
IEEE 802.11ax(HE40)	80	74	
Frequency (MHz)	5290		
IEEE 802.11ac(VHT80)	82		
IEEE 802.11ax(HE80)	74		

UNII-1+UNII-2A	
Test Software Version	accessMTool_REL_3_2_1_2
Frequency (MHz)	5250
IEEE 802.11ac(VHT160)	74
IEEE 802.11ax(HE160)	73

UNII-2C			
Test Software Version	accessMTool_REL_3_2_1_2		
Frequency (MHz)	5500	5580	5700
IEEE 802.11ac(VHT20)	82	82	82
IEEE 802.11ax(HE20)	80	80	80
Frequency (MHz)	5510	5550	5670
IEEE 802.11ac(VHT40)	82	82	82
IEEE 802.11ax(HE40)	76	81	80
Frequency (MHz)	5530	5610	
IEEE 802.11ac(VHT80)	81	82	
IEEE 802.11ax(HE80)	75	82	
Frequency (MHz)	5570		
IEEE 802.11ac(VHT160)	74		
IEEE 802.11ax(HE160)	69		

UNII-3			
Test Software Version	accessMTool_REL_3_2_1_2		
Frequency (MHz)	5745	5785	5825
IEEE 802.11ac(VHT20)	96	97	101
IEEE 802.11ax(HE20)	94	94	100
Frequency (MHz)	5755	5795	
IEEE 802.11ac(VHT40)	93	95	
IEEE 802.11ax(HE40)	92	94	
Frequency (MHz)	5775		
IEEE 802.11ac(VHT80)	82		
IEEE 802.11ax(HE80)	80		

2.4 DUTY CYCLE

If duty cycle is $\geq 98\%$, duty factor is not required.
 If duty cycle is $< 98\%$, duty factor shall be considered.
 The output power = measured power + duty factor.
 The power spectral density = measured power spectral density + duty factor.

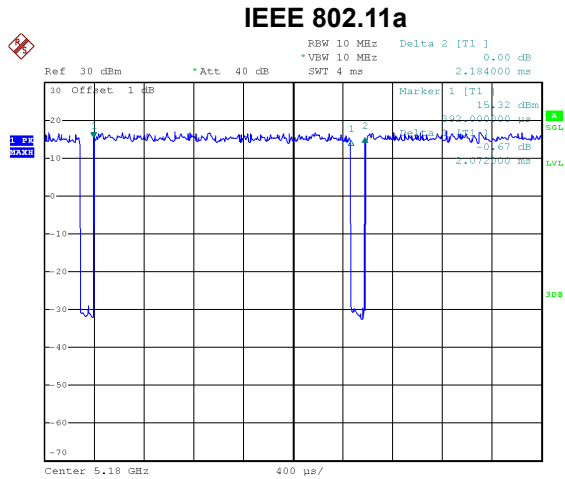

Date: 24.JUN.2022 16:06:34

Duty cycle = $2.072 \text{ ms} / 2.184 \text{ ms} = 94.87\%$
 Duty Factor = $10 \log(1 / \text{Duty cycle}) = 0.23$

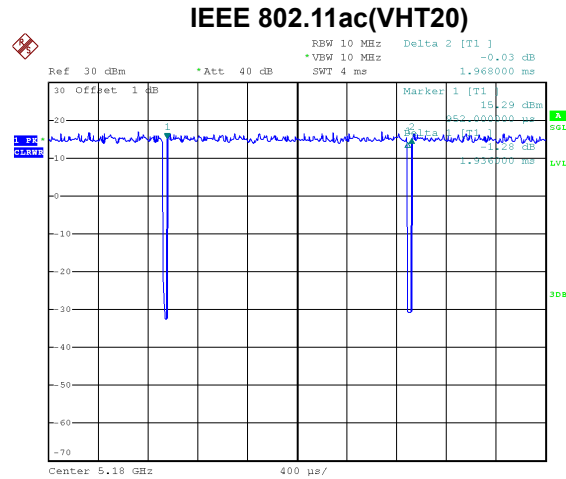

Date: 24.JUN.2022 16:07:09

Duty cycle = $1.936 \text{ ms} / 1.968 \text{ ms} = 98.37\%$
 Duty Factor = $10 \log(1 / \text{Duty cycle}) = 0.00$

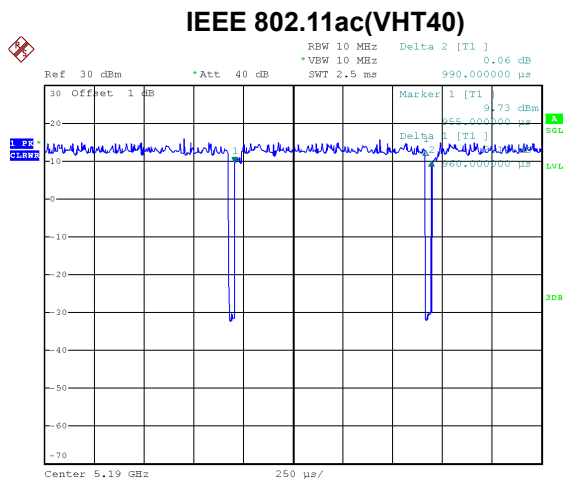

Date: 24.JUN.2022 16:08:30

Duty cycle = $0.960 \text{ ms} / 0.990 \text{ ms} = 96.97\%$
 Duty Factor = $10 \log(1 / \text{Duty cycle}) = 0.13$

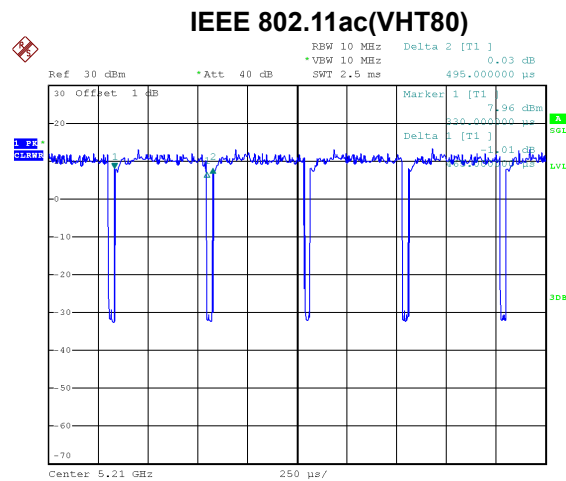

Date: 24.JUN.2022 16:09:42

Duty cycle = $0.465 \text{ ms} / 0.495 \text{ ms} = 93.94\%$
 Duty Factor = $10 \log(1 / \text{Duty cycle}) = 0.27$

IEEE 802.11ac(VHT160)

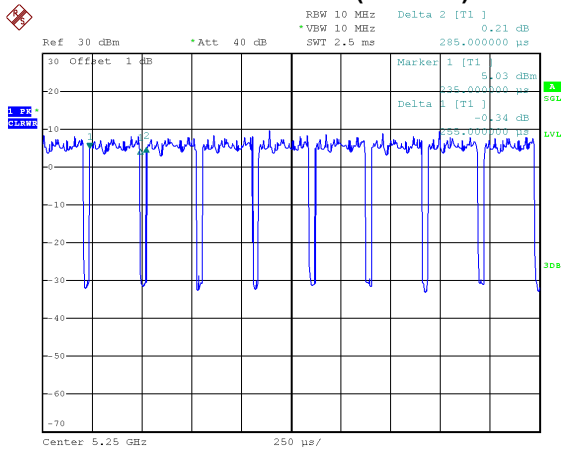

Date: 24.JUN.2022 16:09:59

Duty cycle = 0.255 ms / 0.285 ms = 89.47%
 Duty Factor = 10 log(1 / Duty cycle) = 0.48

IEEE 802.11ax(HE20)

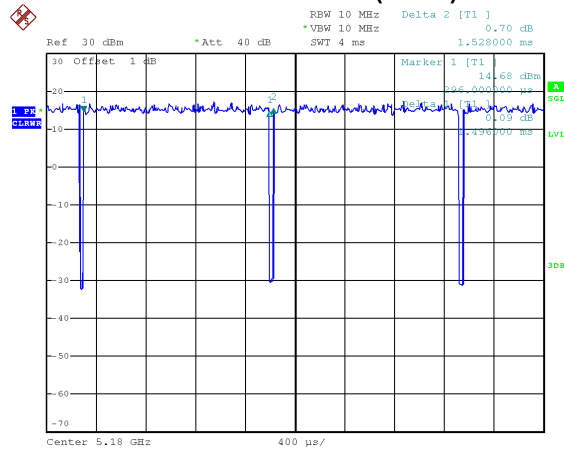

Date: 24.JUN.2022 16:10:28

Duty cycle = 1.496 ms / 1.528 ms = 97.91%
 Duty Factor = 10 log(1 / Duty cycle) = 0.09

IEEE 802.11ax(HE40)

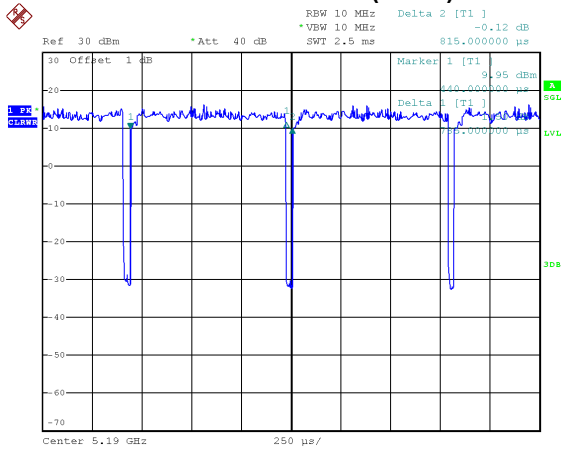

Date: 24.JUN.2022 16:10:41

Duty cycle = 0.785 ms / 0.815 ms = 96.32%
 Duty Factor = 10 log(1 / Duty cycle) = 0.16

IEEE 802.11ax(HE80)

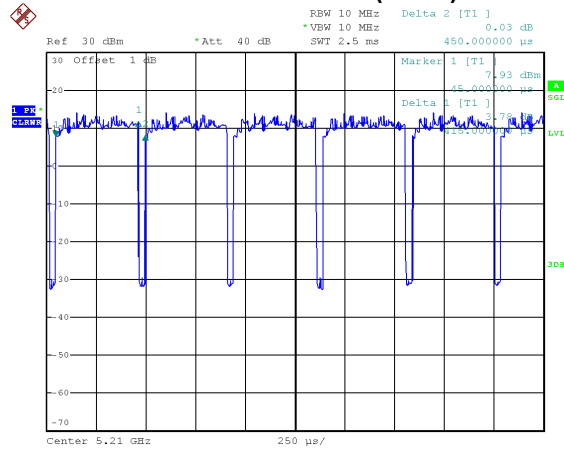

Date: 24.JUN.2022 16:10:54

Duty cycle = 0.415 ms / 0.450 ms = 92.22%
 Duty Factor = 10 log(1 / Duty cycle) = 0.35

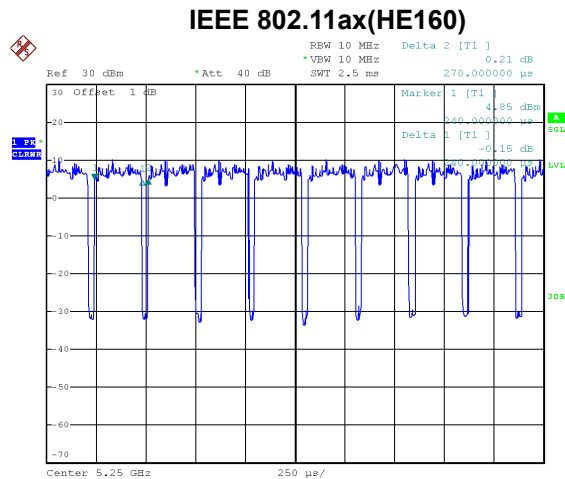

Date: 24.JUN.2022 16:11:14

Duty cycle = 0.240 ms / 0.270 ms = 88.89%
 Duty Factor = 10 log(1 / Duty cycle) = 0.51

NOTE:

For IEEE 802.11a:

For radiated emissions frequency above 1 GHz, the resolution bandwidth of test receiver/spectrum analyzer is 1 MHz and the video bandwidth is 483 Hz (Duty cycle < 98%).

For IEEE 802.11ac(VHT20):

For radiated emissions frequency above 1 GHz, the resolution bandwidth of test receiver/spectrum analyzer is 1 MHz and the video bandwidth is 1 kHz (Duty cycle ≥ 98%).

For IEEE 802.11ac(VHT40):

For radiated emissions frequency above 1 GHz, the resolution bandwidth of test receiver/spectrum analyzer is 1 MHz and the video bandwidth is 1042 Hz (Duty cycle < 98%).

For IEEE 802.11ac(VHT80):

For radiated emissions frequency above 1 GHz, the resolution bandwidth of test receiver/spectrum analyzer is 1 MHz and the video bandwidth is 2151 Hz (Duty cycle < 98%).

For IEEE 802.11ac(VHT160):

For radiated emissions frequency above 1 GHz, the resolution bandwidth of test receiver/spectrum analyzer is 1 MHz and the video bandwidth is 3922 Hz (Duty cycle < 98%).

For IEEE 802.11ax(HE20):

For radiated emissions frequency above 1 GHz, the resolution bandwidth of test receiver/spectrum analyzer is 1 MHz and the video bandwidth is 668 Hz (Duty cycle < 98%).

For IEEE 802.11ax(HE40):

For radiated emissions frequency above 1 GHz, the resolution bandwidth of test receiver/spectrum analyzer is 1 MHz and the video bandwidth is 1274 Hz (Duty cycle < 98%).

For IEEE 802.11ax(HE80):

For radiated emissions frequency above 1 GHz, the resolution bandwidth of test receiver/spectrum analyzer is 1 MHz and the video bandwidth is 2410 Hz (Duty cycle < 98%).

For IEEE 802.11ax(HE160):

For radiated emissions frequency above 1 GHz, the resolution bandwidth of test receiver/spectrum analyzer is 1 MHz and the video bandwidth is 4167 Hz (Duty cycle < 98%).

(Remark: The video bandwidth of the spectrum analyzer was set to 5kHz during the test.)

2.5 BLOCK DIAGRAM SHOWING THE CONFIGURATION OF SYSTEM TESTED

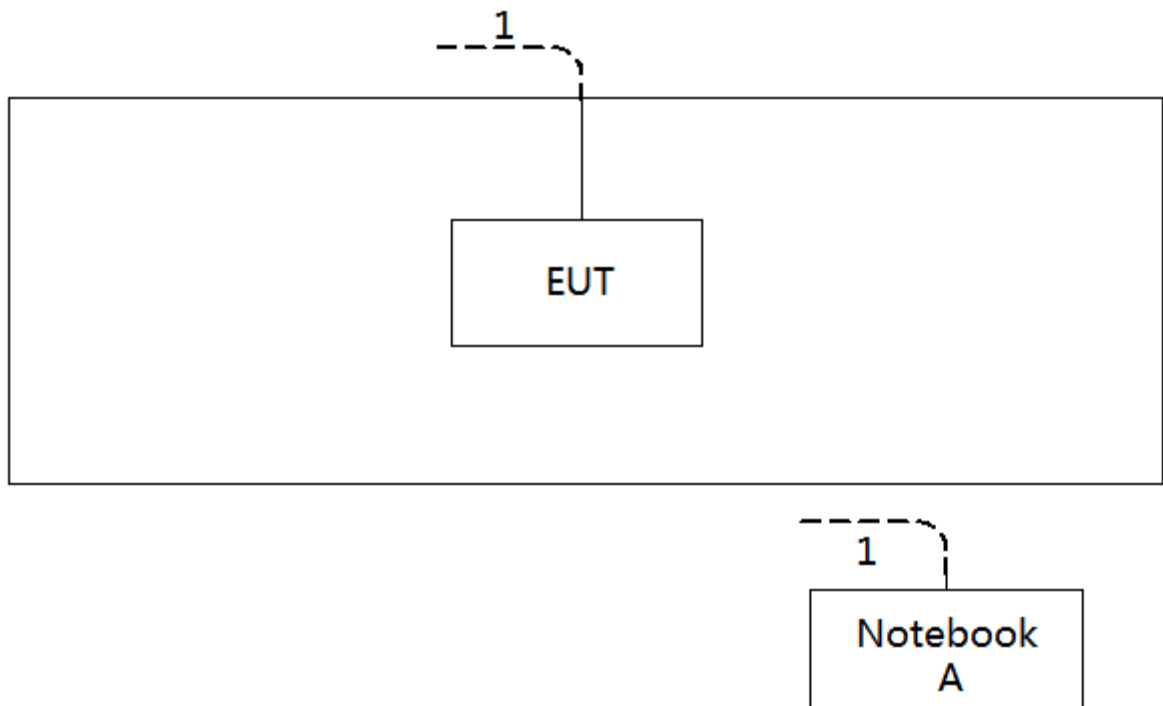

2.6 SUPPORT UNITS

Item	Equipment	Brand	Model No.	Series No.
A	Notebook	Dell	Inspiron 15-7559	N/A

Item	Cable Type	Shielded Type	Ferrite Core	Length
1	RJ45 Cable	NO	NO	10m

3. AC POWER LINE CONDUCTED EMISSIONS

3.1 LIMIT

Frequency (MHz)	Limit (dB μ V)	
	Quasi-peak	Average
0.15 - 0.5	66 to 56*	56 to 46*
0.5 - 5.0	56	46
5.0 - 30.0	60	50

NOTE:

- (1) The tighter limit applies at the band edges.
- (2) The limit of " * " marked band means the limitation decreases linearly with the logarithm of the frequency in the range.

3.2 TEST PROCEDURE

- a. The EUT was placed 0.8 meters from the horizontal ground plane with EUT being connected to the power mains through a line impedance stabilization network (LISN). All other support equipment powered from additional LISN(s). The LISN provide 50 Ohm/ 50uH of coupling impedance for the measuring instrument.
- b. Interconnecting cables that hang closer than 40 cm to the ground plane shall be folded back and forth in the center forming a bundle 30 to 40 cm long.
- c. I/O cables that are not connected to a peripheral shall be bundled in the center. The end of the cable may be terminated, if required, using the correct terminating impedance. The overall length shall not exceed 1 m.
- d. LISN at least 80 cm from nearest part of EUT chassis.
- e. For the actual test configuration, please refer to the related Item -EUT Test Photos.

The following table is the setting of the receiver:

Receiver Parameter	Setting
Start Frequency	0.15 MHz
Stop Frequency	30 MHz
IF Bandwidth	9 kHz

3.3 DEVIATION FROM TEST STANDARD

No deviation

3.4 TEST SETUP

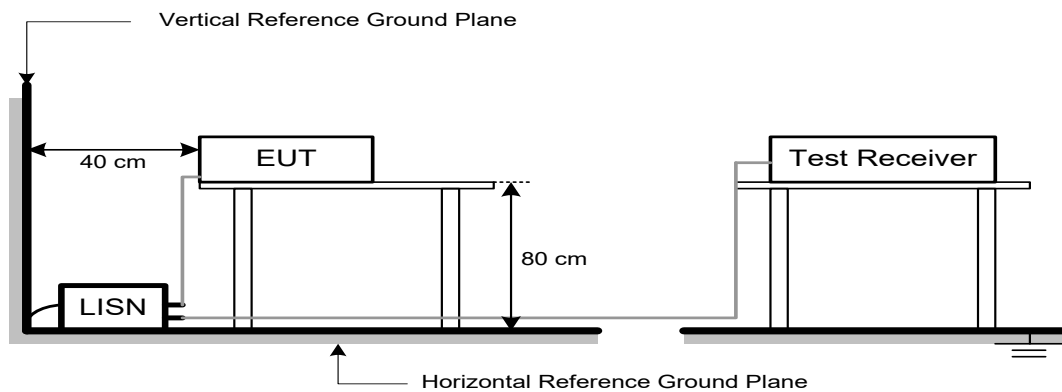

3.5 EUT OPERATION CONDITIONS

The EUT was configured for testing in a typical fashion (as a customer would normally use it). The EUT has been programmed to continuously transmit during test. This operating condition was tested and used to collect the included data.

The EUT was programmed to be in continuously transmitting/TX mode.

3.6 TEST RESULTS

Please refer to the APPENDIX A.

4. RADIATED EMISSIONS

4.1 LIMIT

In case the emission fall within the restricted band specified on 15.205(a), then the 15.209(a) limit in the table below has to be followed.

LIMITS OF RADIATED EMISSIONS MEASUREMENT (9 kHz to 1000 MHz)

Frequency (MHz)	Field Strength (microvolts/meter)	Measurement Distance (meters)
0.009-0.490	2400/F(kHz)	300
0.490-1.705	24000/F(kHz)	30
1.705-30.0	30	30
30-88	100	3
88-216	150	3
216-960	200	3
Above 960	500	3

LIMITS OF UNWANTED EMISSION OUT OF THE RESTRICTED BANDS (Above 1000 MHz)

Frequency (MHz)	EIRP Limit (dBm/MHz)	Equivalent Field Strength at 3m (dBμV/m)
5150-5250	-27	68.2
5250-5350	-27	68.2
5470-5725	-27	68.2
5725-5850 NOTE (2)	-27	68.2
	10	105.2
	15.6	110.8
	27	122.2

NOTE:

(1) The following formula is used to convert the equipment isotropic radiated power (eirp) to field strength:

$$E = \frac{1000000\sqrt{30P}}{3} \mu\text{V/m, where P is the eirp (Watts)}$$

(2) According to 15.407(b)(4)(i), all emissions shall be limited to a level of -27 dBm/MHz at 75 MHz or more above or below the band edge increasing linearly to 10 dBm/MHz at 25 MHz above or below the band edge, and from 25 MHz above or below the band edge increasing linearly to a level of 15.6 dBm/MHz at 5 MHz above or below the band edge, and from 5 MHz above or below the band edge increasing linearly to a level of 27 dBm/MHz at the band edge.

4.2 TEST PROCEDURE

- a. The measuring distance of 3 m shall be used for measurements. The EUT was placed on the top of a rotating table 0.8 meter above the ground at a 3 meter semi-anechoic chamber. The table was rotated 360 degrees to determine the position of the highest radiation.(below 1GHz)
- b. The measuring distance of 3 m shall be used for measurements. The EUT was placed on the top of a rotating table 1.5 meter above the ground at a 3 meter semi-anechoic chamber. The table was rotated 360 degrees to determine the position of the highest radiation.(above 1GHz)
- c. The height of the equipment or of the substitution antenna shall be 0.8m or 1.5m; the height of the test antenna shall vary between 1 m to 4 m. Both horizontal and vertical polarizations of the antenna are set to make the measurement.
- d. For each suspected emission, the EUT was arranged to its worst case and then the antenna was tuned to heights find the maximum reading (used Bore sight function).
- e. The receiver system was set to peak and average detect function and specified bandwidth with maximum hold mode when the test frequency is above 1 GHz.
- f. The initial step in collecting radiated emission data is a receiver peak detector mode pre-scanning the measurement frequency range. Significant peaks are then marked and then Quasi Peak detector mode re-measured.
- g. All readings are Peak unless otherwise stated QP in column of Note. Peak denotes that the Peak reading compliance with the QP Limits and then QP Mode measurement didn't perform.
(below 1 GHz)
- h. All readings are Peak Mode value unless otherwise stated AVG in column of Note. If the Peak Mode Measured value compliance with the Peak Limits and lower than AVG Limits, the EUT shall be deemed to meet both Peak & AVG Limits and then only Peak Mode was measured, but AVG Mode didn't perform. (above 1 GHz)
- i. For the actual test configuration, please refer to the related Item –EUT Test Photos.

The following table is the setting of the receiver:

Spectrum Parameters	Setting
Start ~ Stop Frequency	9 kHz~150 kHz for RBW 200 Hz
Start ~ Stop Frequency	0.15 MHz~30 MHz for RBW 9 kHz
Start ~ Stop Frequency	30 MHz~1000 MHz for RBW 100 kHz

Spectrum Parameters	Setting
Start Frequency	1000 MHz
Stop Frequency	10th carrier harmonic or 40 GHz, whichever is lower
RBW / VBW (Emission in restricted band)	1 MHz / 3 MHz for PK value 1 MHz / 1/T Hz for AVG value

Receiver Parameters	Setting
Start ~ Stop Frequency	9 kHz~90 kHz for PK/AVG detector
Start ~ Stop Frequency	90 kHz~110 kHz for QP detector
Start ~ Stop Frequency	110 kHz~490 kHz for PK/AVG detector
Start ~ Stop Frequency	490 kHz~30 MHz for QP detector
Start ~ Stop Frequency	30 MHz~1000 MHz for QP detector
Start ~ Stop Frequency	1 GHz~40 GHz for PK/AVG detector

4.3 DEVIATION FROM TEST STANDARD

No deviation.

4.4 TEST SETUP

9 kHz to 30 MHz

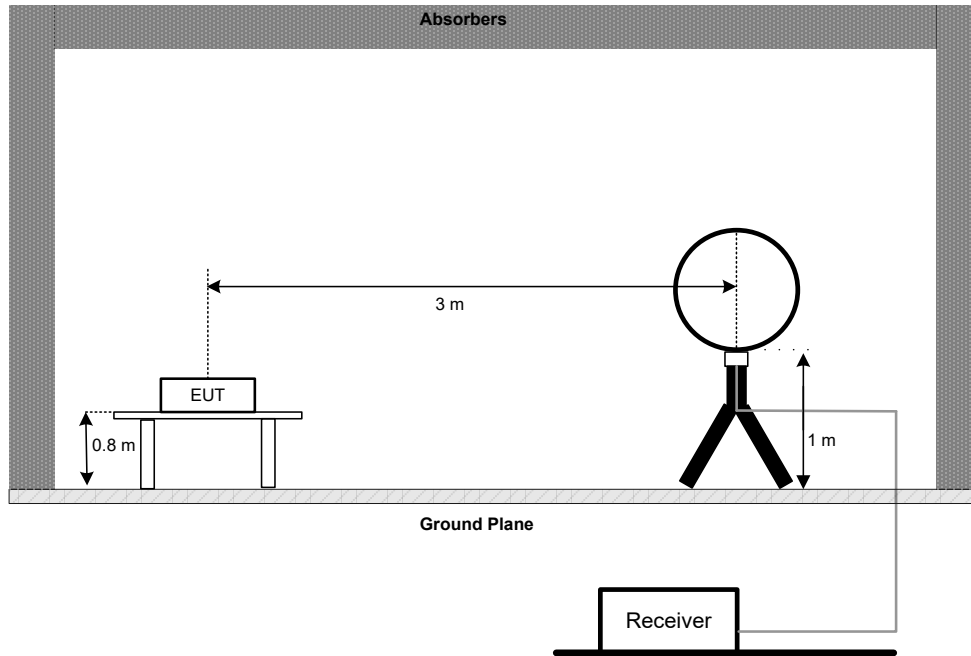

30 MHz to 1 GHz

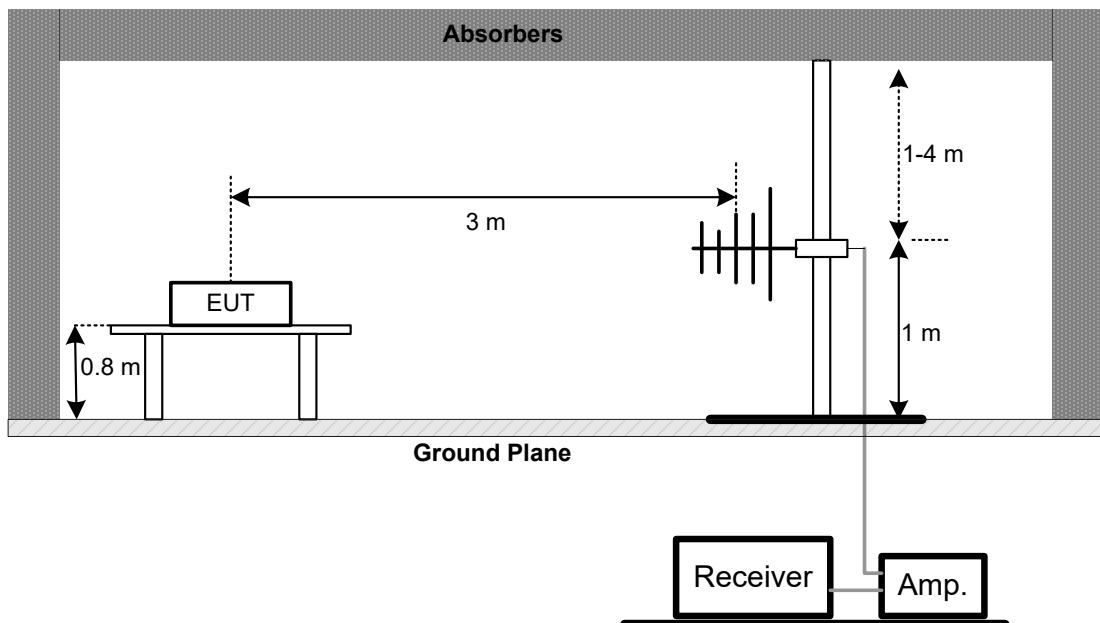

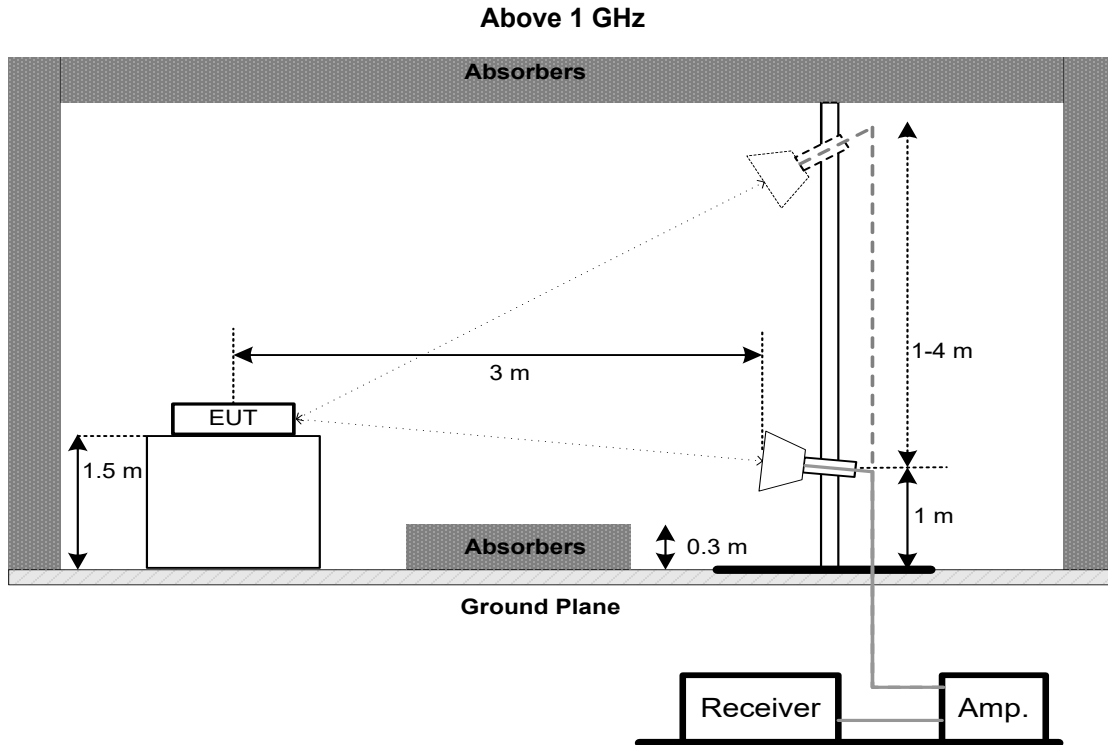

4.5 EUT OPERATION CONDITIONS

The EUT tested system was configured as the statements of 3.5 unless otherwise a special operating condition is specified in the follows during the testing.

4.6 TEST RESULTS - 9 KHZ TO 30 MHZ

Please refer to the APPENDIX B.

Remark:

- (1) Distance extrapolation factor = $40 \log (\text{specific distance} / \text{test distance})$ (dB).
- (2) Limit line = specific limits (dBuV) + distance extrapolation factor.

4.7 TEST RESULTS - 30 MHZ TO 1000 MHZ

Please refer to the APPENDIX C.

4.8 TEST RESULTS - ABOVE 1000 MHZ

Please refer to the APPENDIX D.

Remark:

- (1) No limit: This is fundamental signal, the judgment is not applicable.
For fundamental signal judgment was referred to Peak output test.

5. BANDWIDTH

5.1 LIMIT

Section	Test Item	Limit	Frequency Range (MHz)
FCC 15.407(a) FCC 15.407(e)	26 dB Bandwidth	-	5150-5250
	26 dB Bandwidth	-	5250-5350
	26 dB Bandwidth	-	5470-5725
	6 dB Bandwidth	Minimum 500 kHz	5725-5850

5.2 TEST PROCEDURE

- a. The EUT was directly connected to the spectrum analyzer and antenna output port as show in the block diagram below
- b. Spectrum Setting:
For UNII-1, UNII-2A, UNII-2C:

Spectrum Parameter	Setting
Span Frequency	> 26 dB Bandwidth
RBW	Appromoximately 1% of the emission bandwidth
VBW	> RBW
Detector	Peak
Trace	Max Hold
Sweep Time	Auto

For UNII-3:

Spectrum Parameter	Setting
Span Frequency	> 6 dB Bandwidth
RBW	100 kHz
VBW	300 kHz
Detector	Peak
Trace	Max Hold
Sweep Time	Auto

For 99% Occupied Bandwidth:

Spectrum Parameter	Setting
Span Frequency	1.5 times to 5 times the OBW
RBW	1% to 5% of the OBW
VBW	$\geq 3 \times \text{RBW}$
Detector	Peak
Trace	Max Hold
Sweep Time	Auto

- c. Measured the spectrum width with power higher than 26 dB / 6 dB below carrier.

5.3 DEVIATION FROM STANDARD

No deviation.

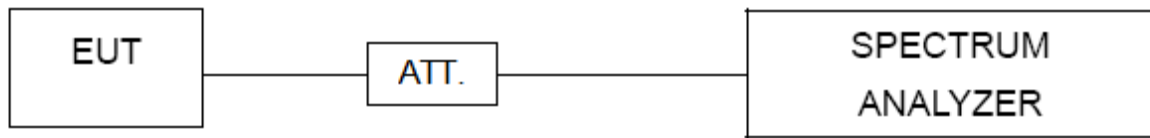
5.4 TEST SETUP**5.5 EUT OPERATION CONDITIONS**

The EUT was programmed to be in continuously transmitting mode.

5.6 TEST RESULTS

Please refer to the APPENDIX E.

6. MAXIMUM OUTPUT POWER

6.1 LIMIT

Section	Test Item	Limit	Frequency Range (MHz)
FCC 15.407(a)	Maximum Output Power	AP device: 1 Watt (30 dBm) Client device: 250 mW (23.98 dBm)	5150-5250
		250 mW (23.98 dBm)	5250-5350
		250 mW (23.98 dBm)	5470-5725
		1 Watt (30dBm)	5725-5850

Note:

- a. For an indoor access point operating in the band 5.15-5.25 GHz, the maximum conducted output power over the frequency band of operation shall not exceed 1 W provided the maximum antenna gain does not exceed 6 dBi. In addition, the maximum power spectral density shall not exceed 17 dBm in any 1 megahertz band. If transmitting antennas of directional gain greater than 6 dBi are used, both the maximum conducted output power and the maximum power spectral density shall be reduced by the amount in dB that the directional gain of the antenna exceeds 6 dBi.
- b. For client devices in the 5.15-5.25 GHz band, the maximum conducted output power over the frequency band of operation shall not exceed 250 mW provided the maximum antenna gain does not exceed 6 dBi. In addition, the maximum power spectral density shall not exceed 11 dBm in any 1 megahertz band. If transmitting antennas of directional gain greater than 6 dBi are used, both the maximum conducted output power and the maximum power spectral density shall be reduced by the amount in dB that the directional gain of the antenna exceeds 6 dBi.
- c. For the 5.25-5.35 GHz and 5.47-5.725 GHz bands, the maximum conducted output power over the frequency bands of operation shall not exceed the lesser of 250 mW or $11 \text{ dBm} + 10 \log B$, where B is the 26dB Bandwidth in megahertz.

6.2 TEST PROCEDURE

- a. The EUT was directly connected to the peak power analyzer and antenna output port as show in the block diagram below.
- b. The test was performed in accordance with method of FCC KDB 789033 D02 General UNII Test Procedures New Rules v02r01.

6.3 DEVIATION FROM STANDARD

No deviation.

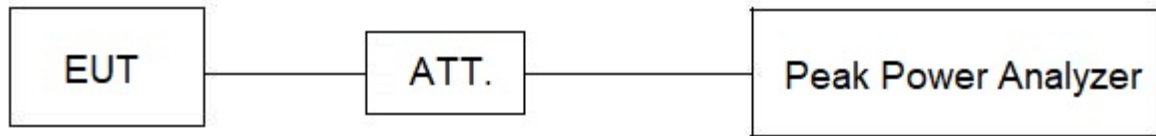
6.4 TEST SETUP**6.5 EUT OPERATION CONDITIONS**

The EUT was programmed to be in continuously transmitting mode.

6.6 TEST RESULTS

Please refer to the APPENDIX F.

7. POWER SPECTRAL DENSITY

7.1 LIMIT

Section	Test Item	Limit	Frequency Range (MHz)
FCC 15.407(a)	Power Spectral Density	AP device: 17 dBm/MHz Client device: 11 dBm/MHz	5150-5250
		11 dBm/MHz	5250-5350
		11 dBm/MHz	5470-5725
		30 dBm/500 kHz	5725-5850

7.2 TEST PROCEDURE

- The EUT was directly connected to the spectrum analyzer and antenna output port as show in the block diagram below.
- Spectrum Setting:

For UNII-1, UNII-2A, UNII-2C:

Spectrum Parameter	Setting
Span Frequency	Encompass the entire emissions bandwidth (EBW) of the signal
RBW	1 MHz.
VBW	3 MHz.
Detector	RMS
Trace average	100 trace
Sweep Time	Auto

For UNII-3:

Spectrum Parameter	Setting
Span Frequency	Encompass the entire emissions bandwidth (EBW) of the signal
RBW	100 kHz.
VBW	300 kHz.
Detector	RMS
Trace average	100 trace
Sweep Time	Auto

Note:

- For UNII-3, according to KDB publication 789033 D02 General UNII Test Procedures New Rules v02r01, section II.F.5., it is acceptable to set RBW at 100kHz and VBW at 300kHz if the spectrum analyzer does not have 500 kHz RBW. Then, add $10 \log(500 \text{ kHz}/100 \text{ kHz})$ to the measured result, i.e. 7 dB.
- During the test of U-NII 3 PSD, the measurement result with RBW=100kHz has been added 7 dB by compensating offset. For example, the cable loss is 13 dB, and the final offset is $13 + 7 = 20$ dB when RBW=100kHz is used.

7.3 DEVIATION FROM STANDARD

No deviation.

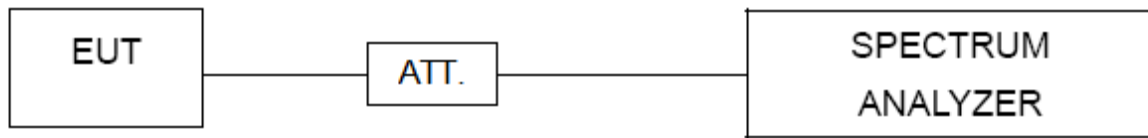
7.4 TEST SETUP**7.5 EUT OPERATION CONDITIONS**

The EUT was programmed to be in continuously transmitting mode.

7.6 TEST RESULTS

Please refer to the APPENDIX G.

8. MEASUREMENT INSTRUMENTS LIST

AC Power Line Conducted Emissions					
Item	Kind of Equipment	Manufacturer	Type No.	Serial No.	Calibrated until
1	EMI Test Receiver	R&S	ESCI	100382	Jan. 22, 2023
2	LISN	EMCO	3816/2	52765	Jan. 23, 2023
3	TWO-LINE V-NETWORK	R&S	ENV216	101447	Jan. 23, 2023
4	50Ω Terminator	SHX	TF5-3	15041304	Jan. 22, 2023
5	Measurement Software	Farad	EZ-EMC Ver.NB-03A1-01	N/A	N/A
6	Cable	N/A	RG223	12m	Mar. 08, 2023
7	643 Shield Room	ETS	6*4*3	N/A	N/A

Radiated Emissions - 9 kHz to 30 MHz					
Item	Kind of Equipment	Manufacturer	Type No.	Serial No.	Calibrated until
1	MXE EMI Receiver	Keysight	N9038A	MY56400091	Jan. 22, 2023
2*	Active Loop Antenna	R&S	HFH2-Z2	830749/020	Aug. 23, 2024
3	Cable	N/A	RG 213/U(9kHz~1GHz)	N/A	Jun. 17, 2022 Jun. 17, 2023
4	Measurement Software	Farad	EZ-EMC Ver.NB-03A1-01	N/A	N/A
5	966 Chamber Room	ETS	9*6*6	N/A	Jul. 14, 2022 Jul. 14, 2023

Radiated Emissions - 30 MHz to 1 GHz					
Item	Kind of Equipment	Manufacturer	Type No.	Serial No.	Calibrated until
1	Antenna	Schwarzbeck	VULB9160	9160-3232	Mar. 03, 2023
2	Amplifier	HP	8447D	2944A08742	Jan. 22, 2023
3	Cable	emci	LMR-400	N/A	Nov. 30, 2022
4	Controller	CT	SC100	N/A	N/A
5	Controller	MF	MF-7802	MF780208416	N/A
6	Receiver	Agilent	N9038A	MY52130039	Jan. 22, 2023
7	Measurement Software	Farad	EZ-EMC Ver.NB-03A1-01	N/A	N/A
8	966 Chamber Room	RM	9*6*6	N/A	Jul. 15, 2022 Jul. 15, 2023

Radiated Emissions - Above 1 GHz					
Item	Kind of Equipment	Manufacturer	Type No.	Serial No.	Calibrated until
1	Double Ridged Horn Antenna	ARA	DRG-118A	16554	Apr. 18, 2023
2	Broad-Band Horn Antenna	Schwarzbeck	BBHA 9170	9170319	May 27, 2023
3	Amplifier	Agilent	8449B	3008A02584	Jul. 03, 2022 Jul. 03, 2023
4	Controller	CT	SC100	N/A	N/A
5	Controller	MF	MF-7802	MF780208416	N/A
6	Receiver	Agilent	N9038A	MY52130039	Jan. 22, 2023
7	EXA Spectrum Analyzer	Keysight	N9010A	MY56480488	Jan. 22, 2023
8*	Low Noise Amplifier	CONNPHY	CLN-18G40G-4330-K	619413	Jul. 05, 2022 Jul. 05, 2025
9	Cable	Talent microwave	A81-SMAMSMAM-12.5M	N/A	Oct. 15, 2022
10	Cable	Talent microwave	A40-2.92M2.92M-2.5M	N/A	Nov. 30, 2022
11*	Band Reject Filter	Micro-Tronics	BRC50704-01	8	Feb. 27, 2024
12*	Band Reject Filter	Micro-Tronics	BRC50703-01	7	Feb. 27, 2024
13*	Band Reject Filter	Micro-Tronics	BRC50705-01	10	Feb. 27, 2024
14	Measurement Software	Farad	EZ-EMC Ver.NB-03A1-01	N/A	N/A
15	966 Chamber Room	RM	9*6*6	N/A	Jul. 15, 2022 Jul. 15, 2023

Bandwidth					
Item	Kind of Equipment	Manufacturer	Type No.	Serial No.	Calibrated until
1	Spectrum Analyzer	R&S	FSP40	100185	Jul. 03, 2022 Jul. 03, 2023
2	Attenuator	WOKEN	6SM3502	VAS1214NL	N/A
3	RF Cable	Tongkaichuan	N/A	N/A	N/A
4	DC Block	Mini	N/A	N/A	N/A

Power Spectral Density					
Item	Kind of Equipment	Manufacturer	Type No.	Serial No.	Calibrated until
1	EXA Spectrum Analyzer	Agilent	N9010A	MY50520044	Jan. 22, 2023
2	Attenuator	WOKEN	6SM3502	VAS1214NL	N/A
3	RF Cable	Tongkaichuan	N/A	N/A	N/A
4	DC Block	Mini	N/A	N/A	N/A

Maximum Output Power					
Item	Kind of Equipment	Manufacturer	Type No.	Serial No.	Calibrated until
1	Peak Power Analyzer	Keysight	8990B	MY51000506	Jul. 03, 2022 Jul. 03, 2023
2	Wideband power sensor	Keysight	N1923A	MY58310004	Jul. 03, 2022 Jul. 03, 2023
3	Attenuator	WOKEN	6SM3502	VAS1214NL	N/A
4	RF Cable	Tongkaichuan	N/A	N/A	N/A

Remark: "N/A" denotes no model name, serial no. or calibration specified.

"*" calibration period of equipment list is three year.

Except * item, all calibration period of equipment list is one year.

9. EUT TEST PHOTOS**AC Power Line Conducted Emissions Test Photos**

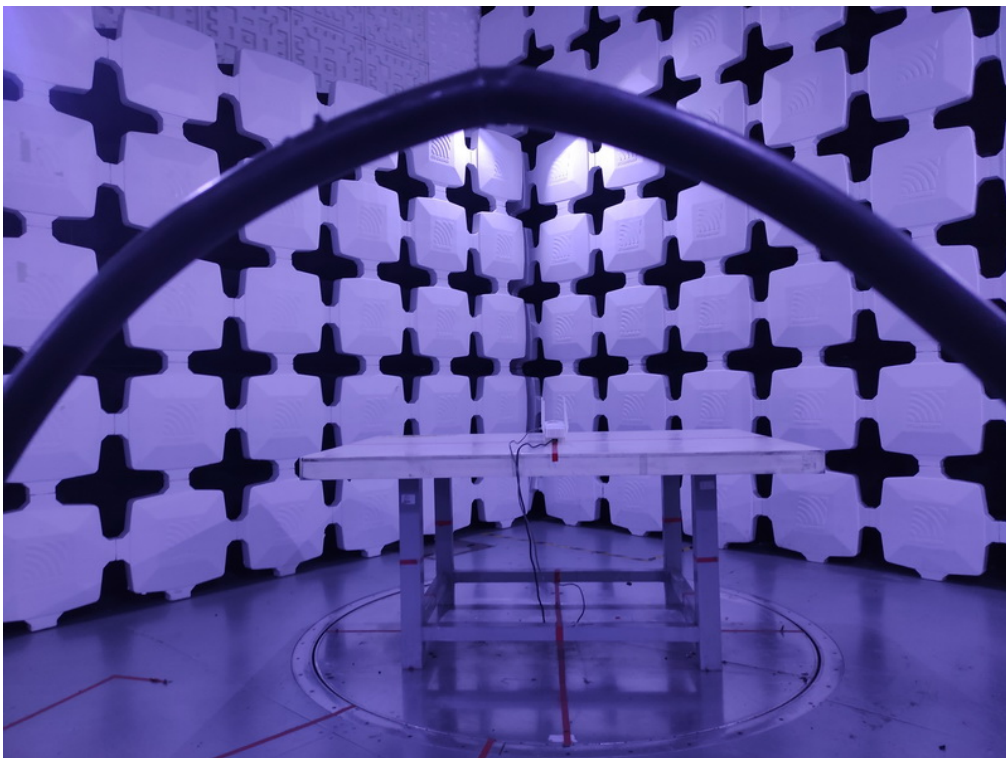
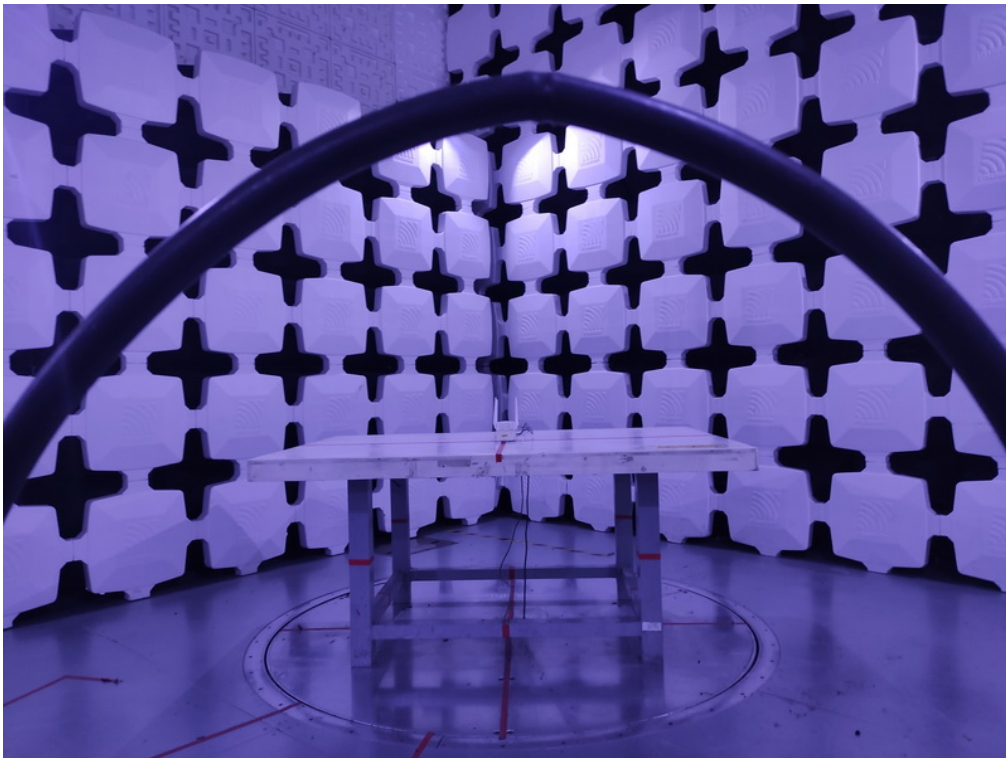
Radiated Emissions Test Photos**9 kHz to 30 MHz**

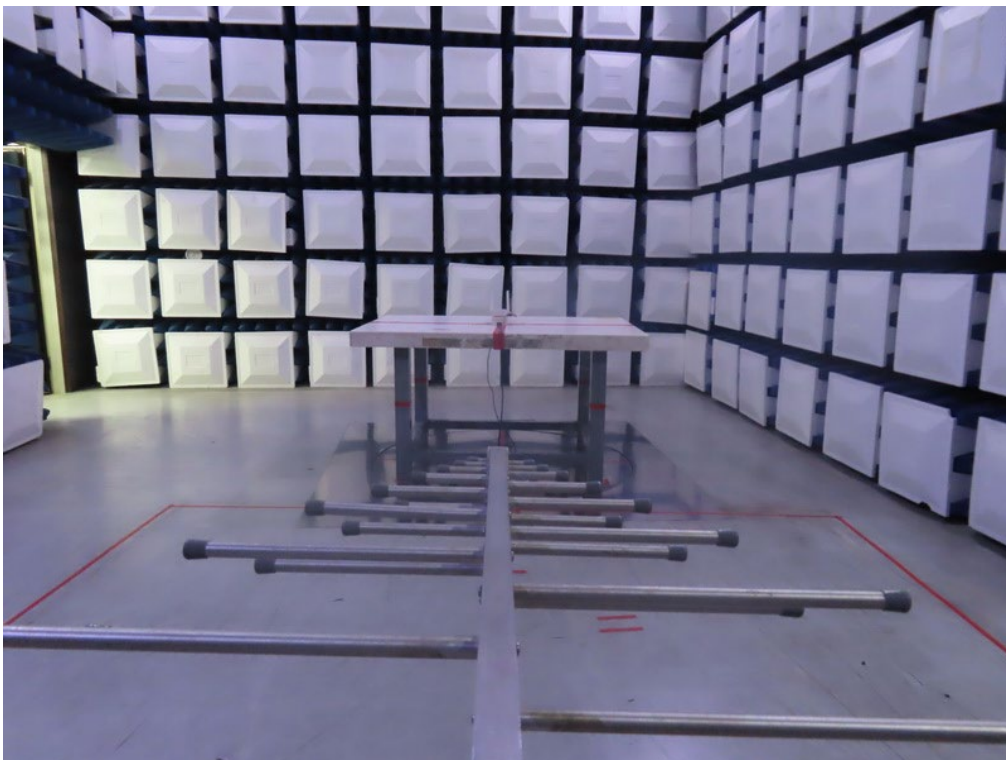
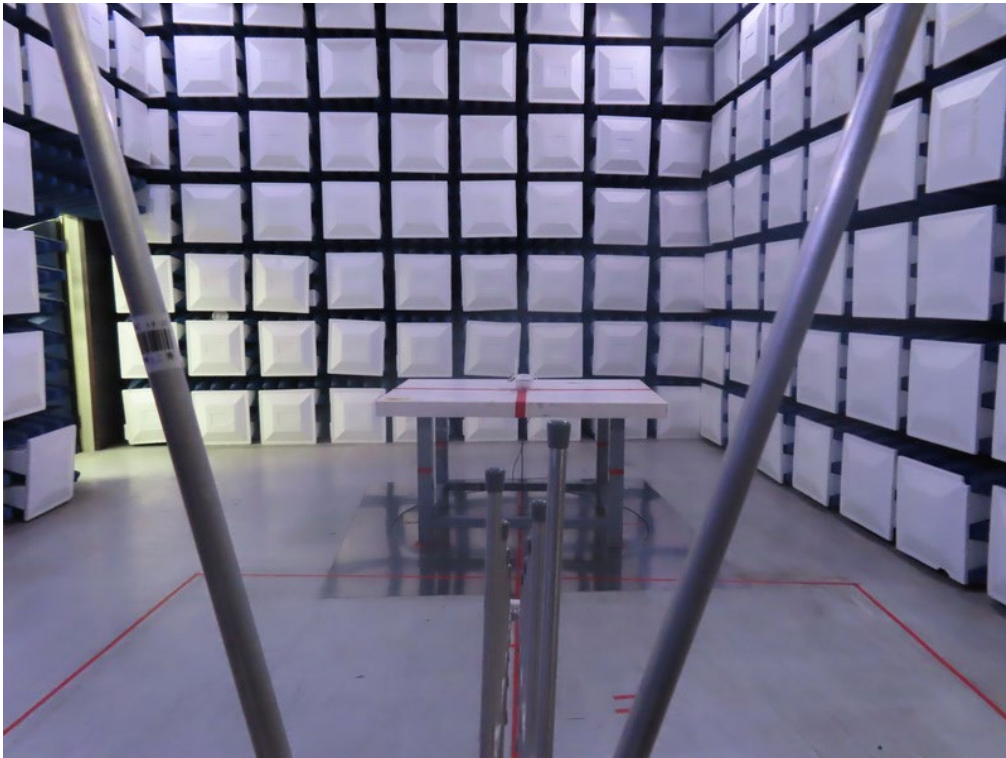
Radiated Emissions Test Photos**30 MHz to 1 GHz**

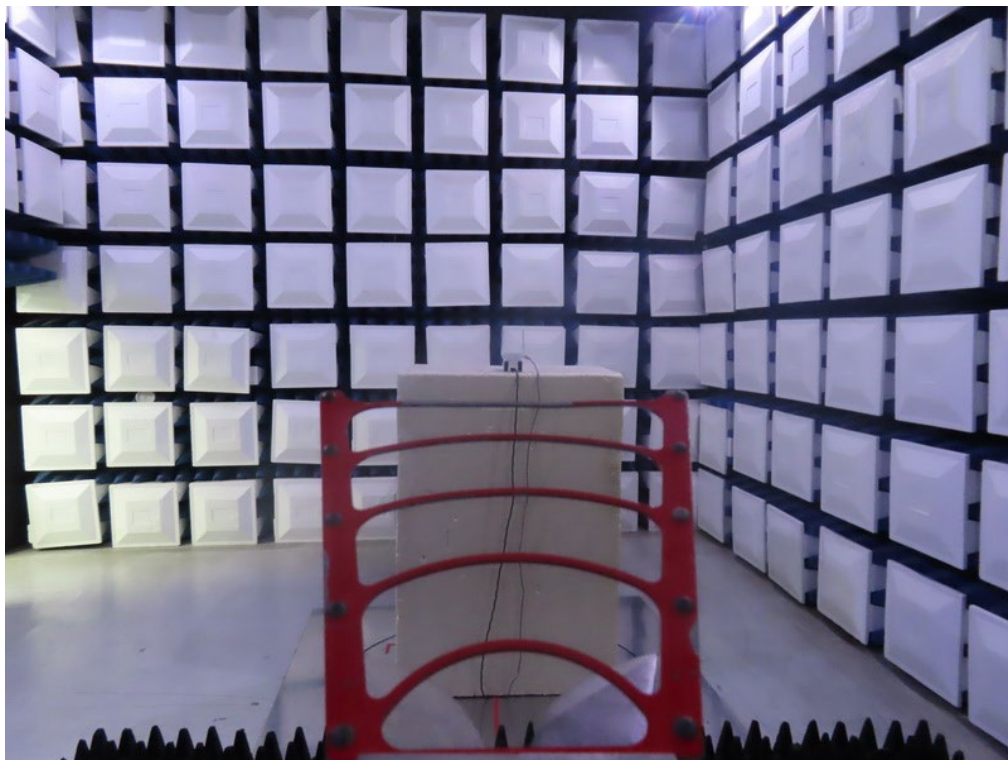
Radiated Emissions Test Photos**Above 1 GHz**

Conducted Test Photos

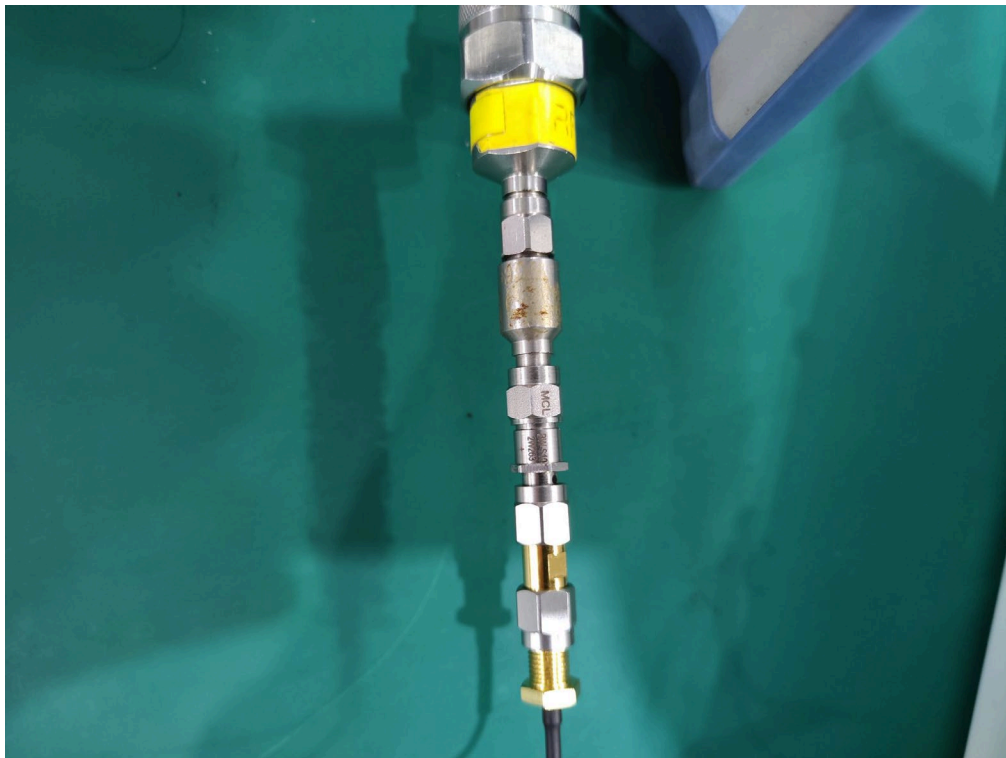
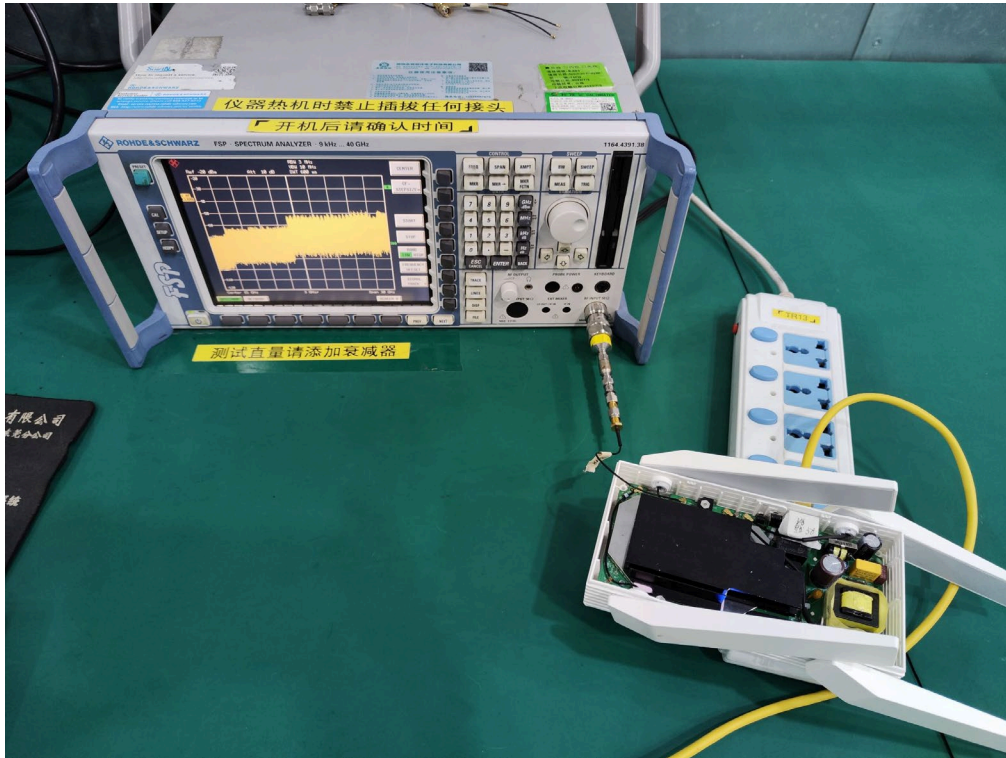

APPENDIX A - AC POWER LINE CONDUCTED EMISSIONS

Test Mode	TX AX(HE20) Mode Channel 149 (UNII-3)	Phase	Line
-----------	---------------------------------------	-------	------

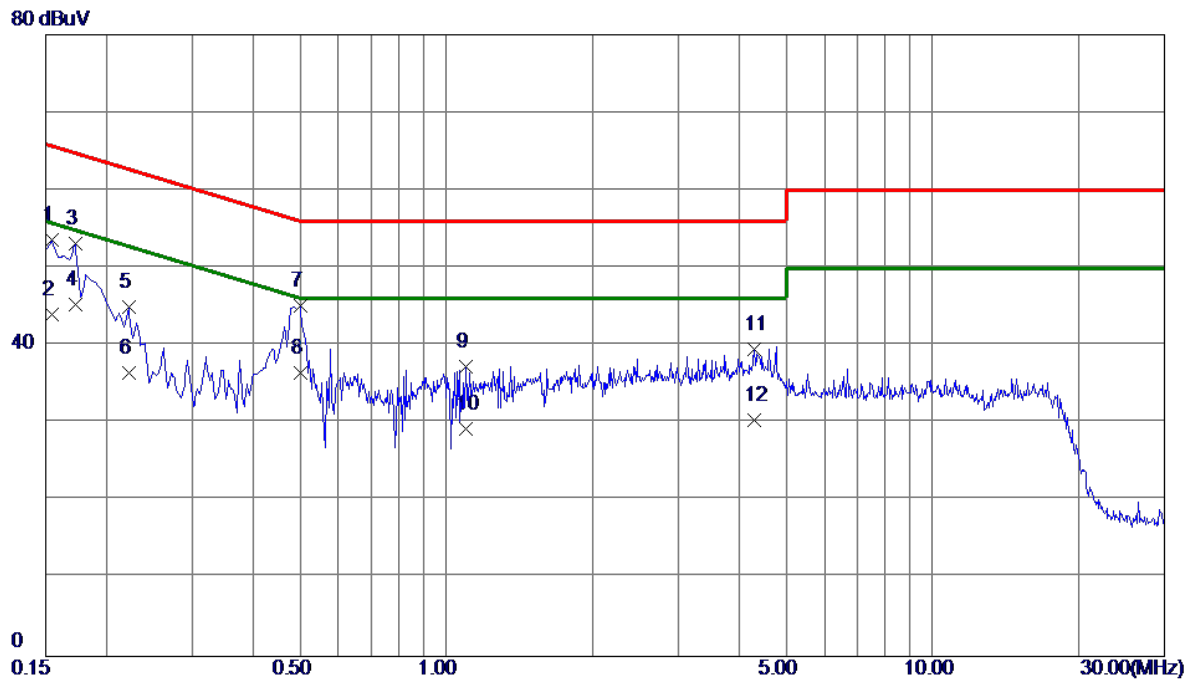

No.	Freq. MHz	Reading Level dBuV	Correct Factor dB	Measure ment dBuV	Limit dBuV	Margin dB	Detector	Comment
1	0.1545	43.98	9.66	53.64	65.75	-12.11	QP	
2	0.1545	34.30	9.66	43.96	55.75	-11.79	AVG	
3	0.1725	43.49	9.67	53.16	64.84	-11.68	QP	
4	0.1725	35.60	9.67	45.27	54.84	-9.57	AVG	
5	0.2220	35.33	9.70	45.03	62.74	-17.71	QP	
6	0.2220	26.79	9.70	36.49	52.74	-16.25	AVG	
7	0.5010	35.33	9.76	45.09	56.00	-10.91	QP	
8 *	0.5010	26.70	9.76	36.46	46.00	-9.54	AVG	
9	1.0950	27.50	9.84	37.34	56.00	-18.66	QP	
10	1.0950	19.50	9.84	29.34	46.00	-16.66	AVG	
11	4.3080	29.44	10.07	39.51	56.00	-16.49	QP	
12	4.3080	20.40	10.07	30.47	46.00	-15.53	AVG	

REMARKS:

- (1) Measurement Value = Reading Level + Correct Factor.
- (2) Margin Level = Measurement Value - Limit Value.
- (3) The test result has included the cable loss.

Test Mode	TX AX(HE20) Mode Channel 149 (UNII-3)	Phase	Neutral
-----------	---------------------------------------	-------	---------

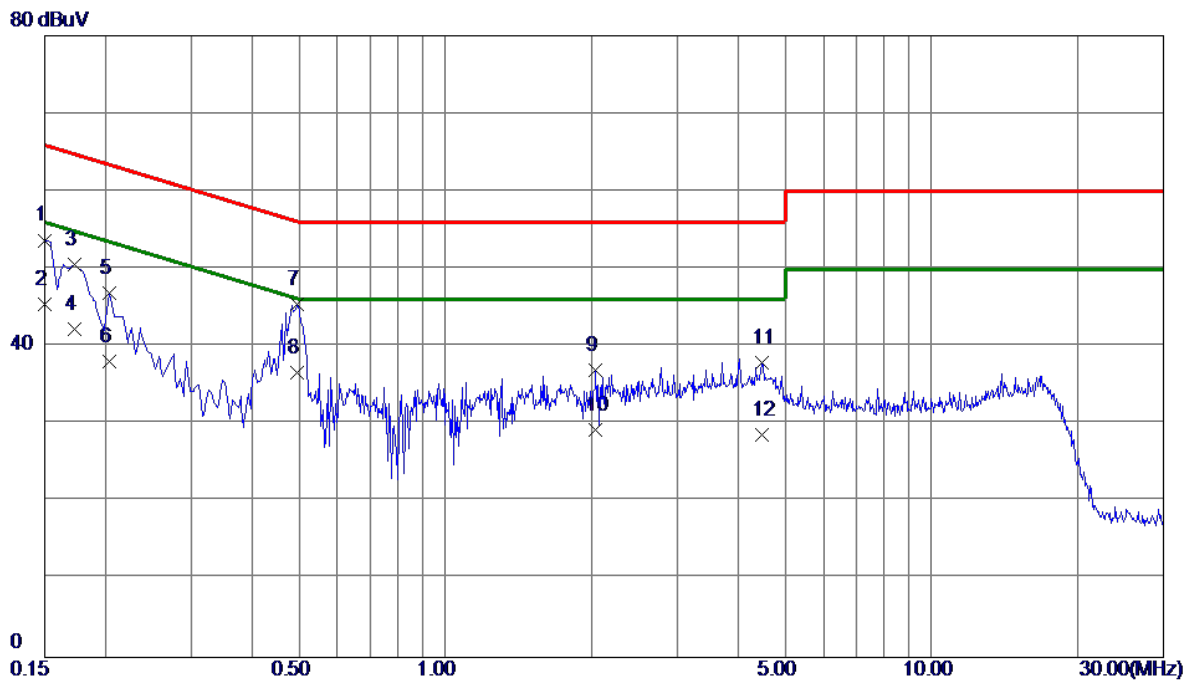

No.	Freq. MHz	Reading Level dBuV	Correct Factor dB	Measurement dBuV	Limit dBuV	Margin dB	Detector	Comment
1	0.1500	43.98	9.70	53.68	66.00	-12.32	QP	
2	0.1500	35.71	9.70	45.41	56.00	-10.59	AVG	
3	0.1725	40.87	9.71	50.58	64.84	-14.26	QP	
4	0.1725	32.60	9.71	42.31	54.84	-12.53	AVG	
5	0.2040	37.14	9.73	46.87	63.45	-16.58	QP	
6	0.2040	28.40	9.73	38.13	53.45	-15.32	AVG	
7	0.4965	35.69	9.79	45.48	56.06	-10.58	QP	
8 *	0.4965	26.80	9.79	36.59	46.06	-9.47	AVG	
9	2.0400	27.00	9.92	36.92	56.00	-19.08	QP	
10	2.0400	19.30	9.92	29.22	46.00	-16.78	AVG	
11	4.4790	27.81	10.11	37.92	56.00	-18.08	QP	
12	4.4790	18.50	10.11	28.61	46.00	-17.39	AVG	

REMARKS:

- (1) Measurement Value = Reading Level + Correct Factor.
- (2) Margin Level = Measurement Value - Limit Value.
- (3) The test result has included the cable loss.

APPENDIX B - RADIATED EMISSION - 9 KHZ TO 30 MHZ

Test Mode	TX AX(HE20) Mode Channel 149 (UNII-3)	Polarization	0°
-----------	---------------------------------------	--------------	----

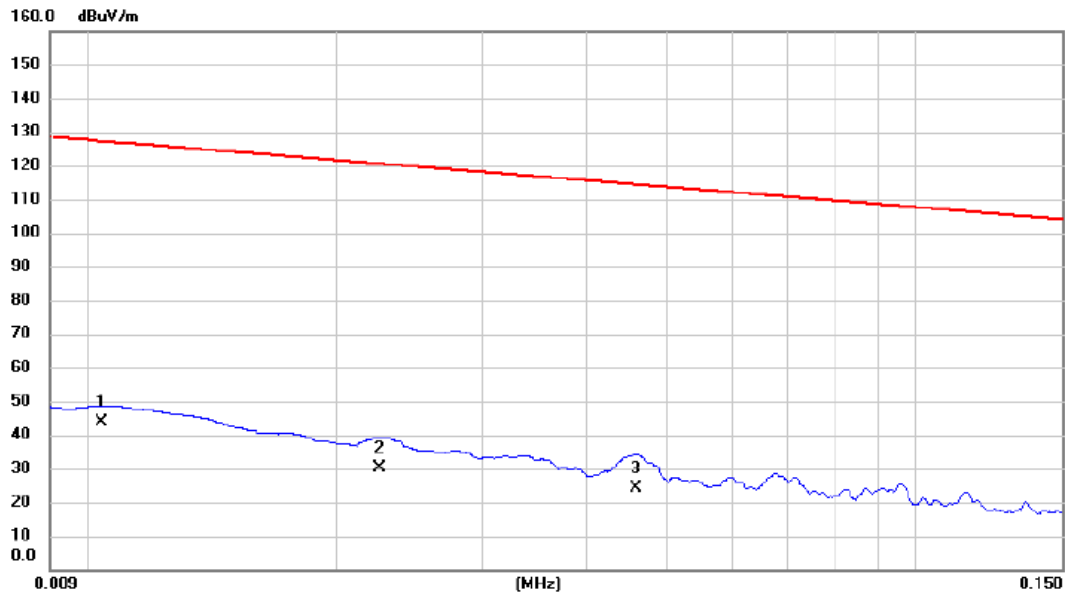

No.	Mk.	Freq. MHz	Reading Level dBuV	Correct Factor dB	Measure- ment dBuV/m	Limit dBuV/m	Margin dB	Detector	Comment
1	*	0.0104	78.12	-34.20	43.92	127.26	-83.34	AVG	
2		0.0225	67.32	-37.28	30.04	120.56	-90.52	AVG	
3		0.0460	62.03	-37.81	24.22	114.35	-90.13	AVG	

REMARKS:

- (1) Measurement Value = Reading Level + Correct Factor.
- (2) Margin Level = Measurement Value - Limit Value.

Test Mode	TX AX(HE20) Mode Channel 149 (UNII-3)	Polarization	0°
-----------	---------------------------------------	--------------	----

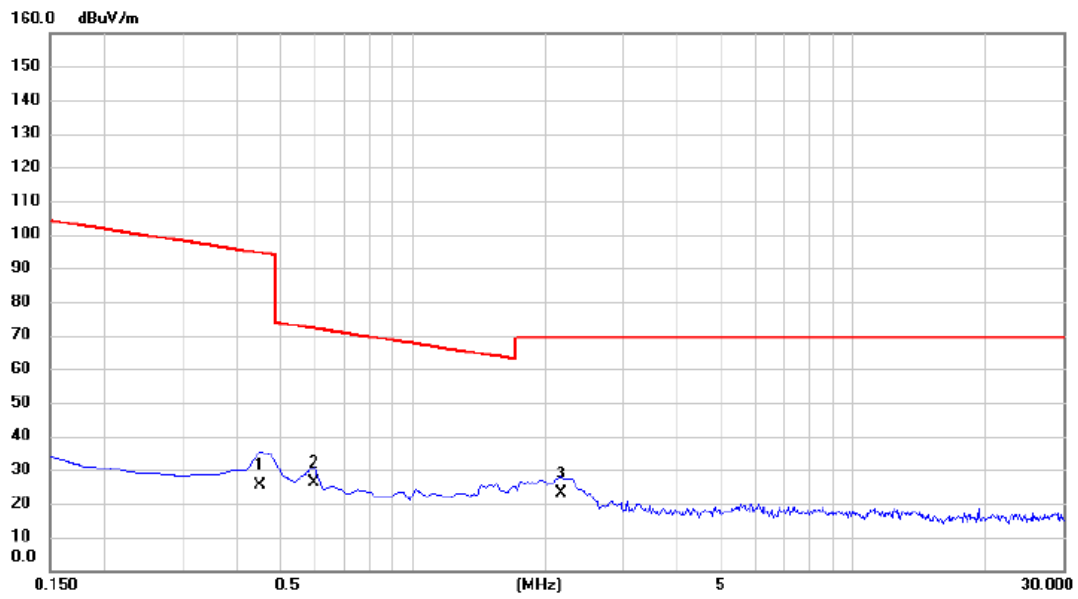

No.	Mk.	Freq. MHz	Reading Level dBuV	Correct Factor dB	Measure- ment dBuV/m	Limit dBuV/m	Margin dB	Detector	Comment
1		0.4485	63.68	-38.15	25.53	94.57	-69.04	AVG	
2	*	0.5978	64.48	-38.32	26.16	72.07	-45.91	QP	
3		2.1798	62.75	-39.64	23.11	69.54	-46.43	QP	

REMARKS:

- (1) Measurement Value = Reading Level + Correct Factor.
- (2) Margin Level = Measurement Value - Limit Value.

Test Mode	TX AX(HE20) Mode Channel 149 (UNII-3)	Polarization	90°
-----------	---------------------------------------	--------------	-----

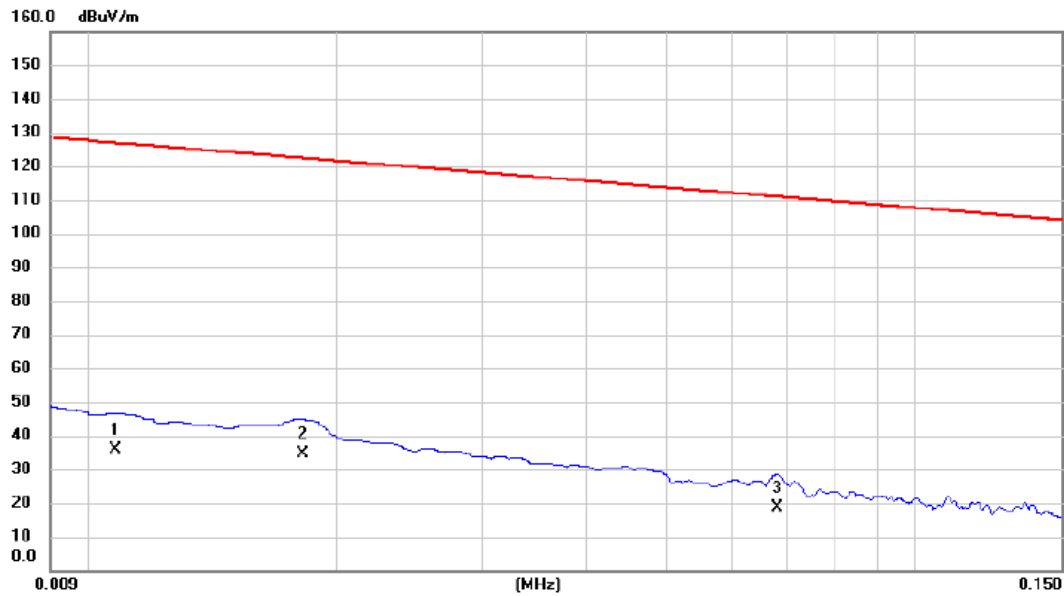

No.	Mk.	Freq. MHz	Reading Level dBuV	Correct Factor dB	Measure- ment dBuV/m	Limit dBuV/m	Margin dB	Detector	Comment
1		0.0108	70.06	-34.33	35.73	126.94	-91.21	AVG	
2	*	0.0182	71.08	-36.65	34.43	122.40	-87.97	AVG	
3		0.0680	56.68	-37.89	18.79	110.95	-92.16	AVG	

REMARKS:

- (1) Measurement Value = Reading Level + Correct Factor.
- (2) Margin Level = Measurement Value - Limit Value.

Test Mode	TX AX(HE20) Mode Channel 149 (UNII-3)	Polarization	90°
-----------	---------------------------------------	--------------	-----

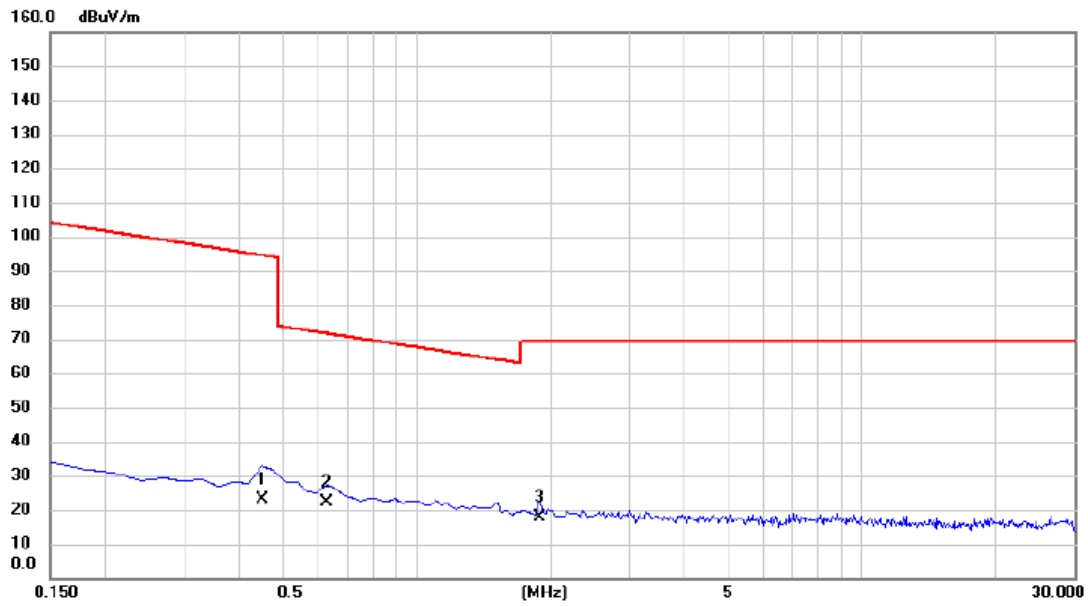

No.	Mk.	Freq. MHz	Reading Level dBuV	Correct Factor dB	Measure- ment dBuV/m	Limit dBuV/m	Margin dB	Detector	Comment
1		0.4485	61.28	-38.15	23.13	94.57	-71.44	AVG	
2	*	0.6276	60.53	-38.35	22.18	71.65	-49.47	QP	
3		1.8813	57.12	-39.48	17.64	69.54	-51.90	QP	

REMARKS:

- (1) Measurement Value = Reading Level + Correct Factor.
- (2) Margin Level = Measurement Value - Limit Value.

APPENDIX C - RADIATED EMISSION - 30 MHZ TO 1000 MHZ

Test Mode	TX AX(HE20) Mode Channel 149 (UNII-3)	Polarization	Vertical
-----------	---------------------------------------	--------------	----------

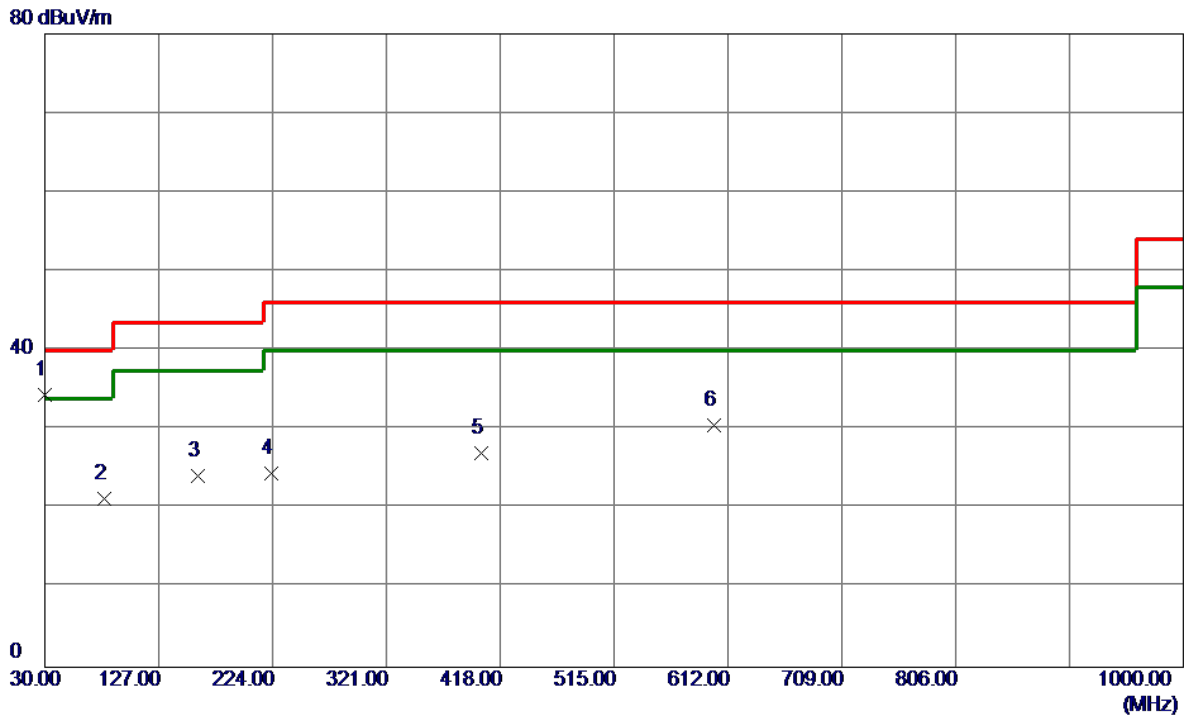

No.	Freq. MHz	Reading Level dBuV/m	Correct Factor dB	Measure ment dBuV/m	Limit dBuV/m	Margin dB	Detector	Comment
1 *	30.0000	50.43	-16.07	34.36	40.00	-5.64	Peak	
2	80.4400	39.74	-18.46	21.28	40.00	-18.72	Peak	
3	159.9800	36.89	-12.72	24.17	43.50	-19.33	Peak	
4	223.0300	39.39	-14.89	24.50	46.00	-21.50	Peak	
5	401.5100	36.01	-8.91	27.10	46.00	-18.90	Peak	
6	600.3600	35.28	-4.78	30.50	46.00	-15.50	Peak	

REMARKS:

- (1) Measurement Value = Reading Level + Correct Factor.
- (2) Margin Level = Measurement Value - Limit Value.

Test Mode	TX AX(HE20) Mode Channel 149 (UNII-3)	Polarization	Horizontal
-----------	---------------------------------------	--------------	------------

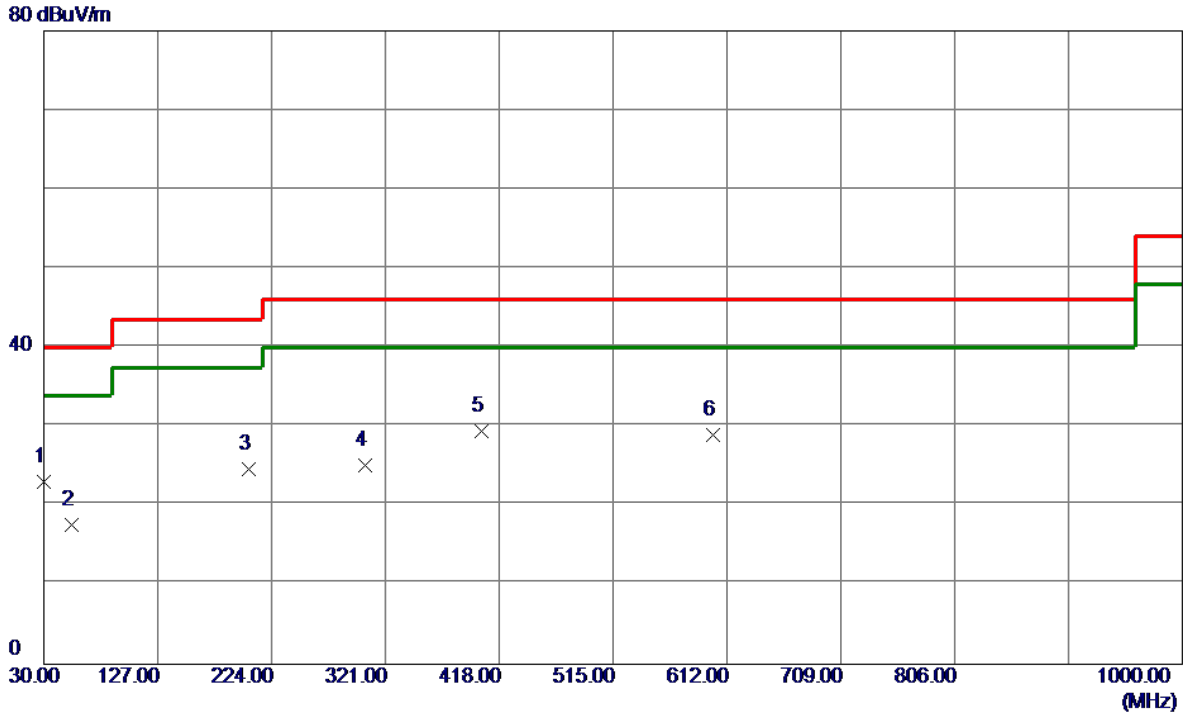

No.	Freq. MHz	Reading Level dBuV/m	Correct Factor dB	Measure ment dBuV/m	Limit dBuV/m	Margin dB	Detector	Comment
1	30.0000	39.17	-16.07	23.10	40.00	-16.90	Peak	
2	53.2800	31.91	-14.31	17.60	40.00	-22.40	Peak	
3	204.6000	40.30	-15.59	24.71	43.50	-18.79	Peak	
4	303.5400	36.28	-11.19	25.09	46.00	-20.91	Peak	
5 *	402.4800	38.35	-8.88	29.47	46.00	-16.53	Peak	
6	600.3600	33.80	-4.78	29.02	46.00	-16.98	Peak	

REMARKS:

- (1) Measurement Value = Reading Level + Correct Factor.
- (2) Margin Level = Measurement Value - Limit Value.

APPENDIX D - RADIATED EMISSION - ABOVE 1000 MHZ

Test Mode	UNII-1_TX A Mode 5180 MHz	Polarization	Vertical
-----------	---------------------------	--------------	----------

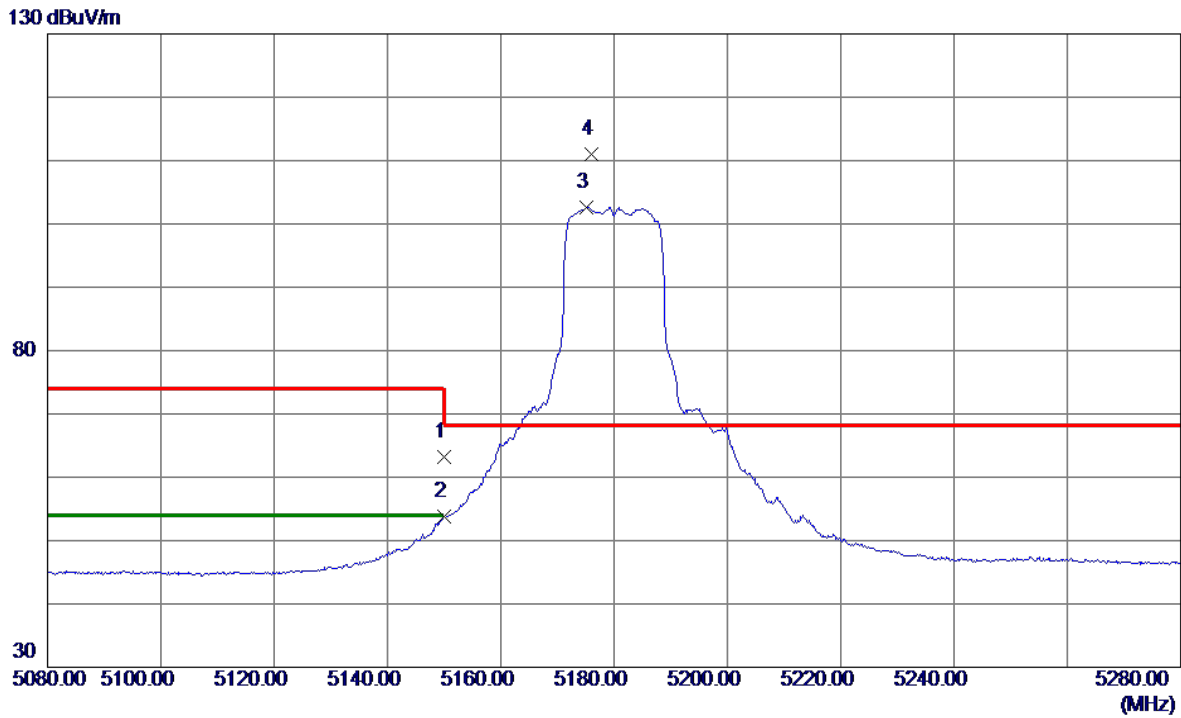

No.	Freq. MHz	Reading Level dBuV/m	Correct Factor dB	Measure ment dBuV/m	Limit dBuV/m	Margin dB	Detector	Comment
1	5150.0000	47.59	15.54	63.13	74.00	-10.87	Peak	
2	5150.0000	38.27	15.54	53.81	54.00	-0.19	AVG	
3	5175.2000	87.08	15.58	102.66	999.00	-896.34	AVG	No Limit
4 *	5176.0000	95.47	15.58	111.05	68.20	42.85	Peak	No Limit

REMARKS:

- (1) Measurement Value = Reading Level + Correct Factor.
- (2) Margin Level = Measurement Value - Limit Value.

Test Mode	UNII-1_TX A Mode 5180 MHz	Polarization	Vertical
-----------	---------------------------	--------------	----------

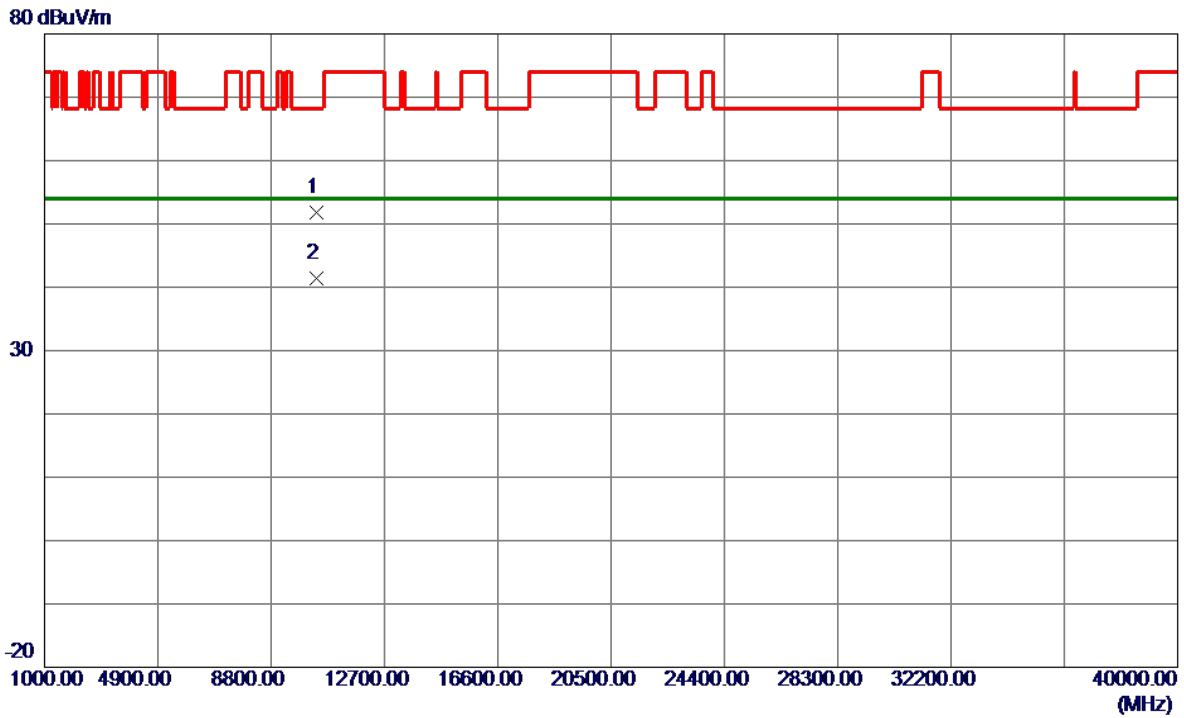

No.	Freq. MHz	Reading Level dBuV/m	Correct Factor dB	Measure ment dBuV/m	Limit dBuV/m	Margin dB	Detector	Comment
1	10356.5400	39.73	12.13	51.86	68.20	-16.34	Peak	
2 *	10361.6400	29.26	12.13	41.39	54.00	-12.61	AVG	

REMARKS:

- (1) Measurement Value = Reading Level + Correct Factor.
- (2) Margin Level = Measurement Value - Limit Value.

Test Mode	UNII-1_TX A Mode 5200 MHz	Polarization	Vertical
-----------	---------------------------	--------------	----------

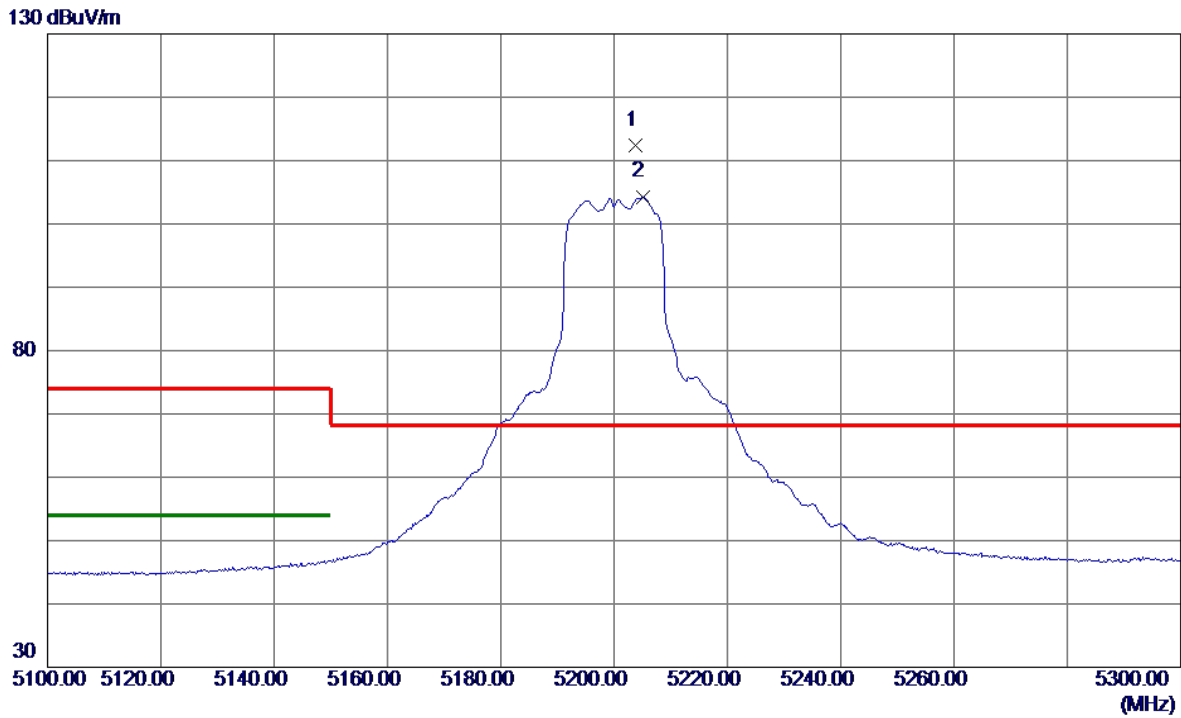

No.	Freq. MHz	Reading Level dBuV/m	Correct Factor dB	Measure ment dBuV/m	Limit dBuV/m	Margin dB	Detector	Comment
1 *	5203.8000	96.74	15.63	112.37	68.20	44.17	Peak	No Limit
2	5205.0000	88.67	15.63	104.30	999.00	-894.70	AVG	No Limit

REMARKS:

- (1) Measurement Value = Reading Level + Correct Factor.
- (2) Margin Level = Measurement Value - Limit Value.

Test Mode	UNII-1_TX A Mode 5200 MHz	Polarization	Vertical
-----------	---------------------------	--------------	----------

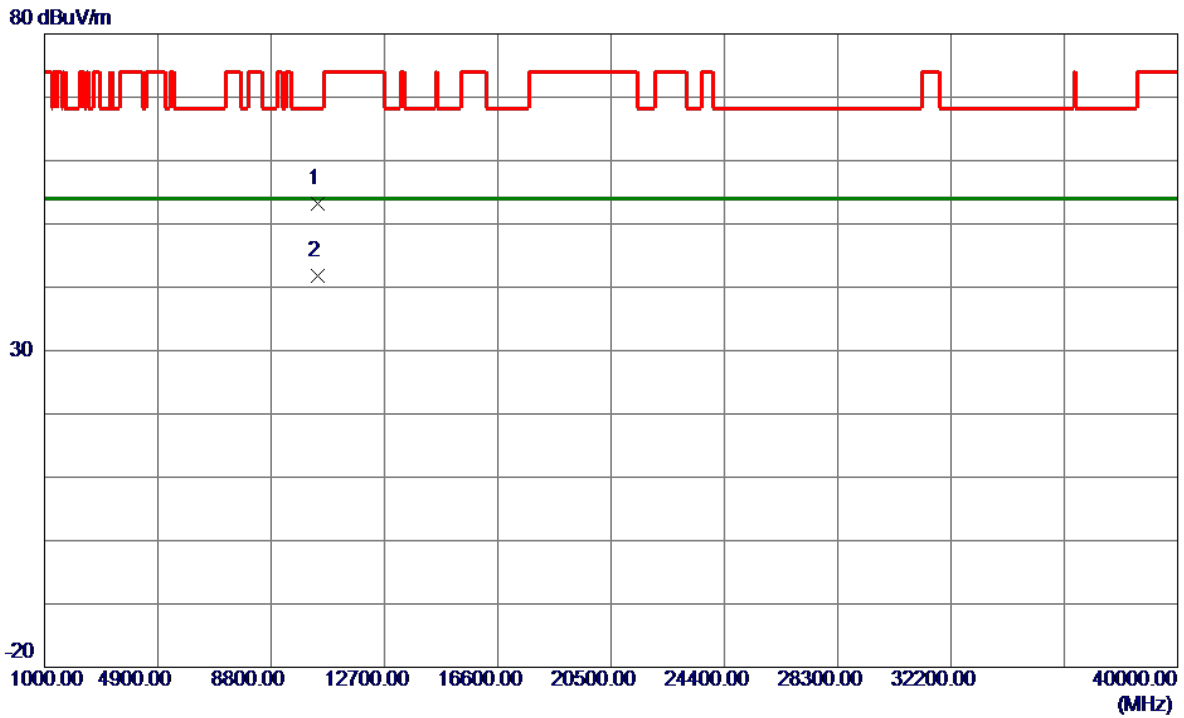

No.	Freq. MHz	Reading Level dBuV/m	Correct Factor dB	Measure ment dBuV/m	Limit dBuV/m	Margin dB	Detector	Comment
1	10401.1300	40.95	12.17	53.12	68.20	-15.08	Peak	
2 *	10401.6200	29.62	12.17	41.79	54.00	-12.21	AVG	

REMARKS:

- (1) Measurement Value = Reading Level + Correct Factor.
- (2) Margin Level = Measurement Value - Limit Value.

Test Mode	UNII-1_TX A Mode 5240 MHz	Polarization	Vertical
-----------	---------------------------	--------------	----------

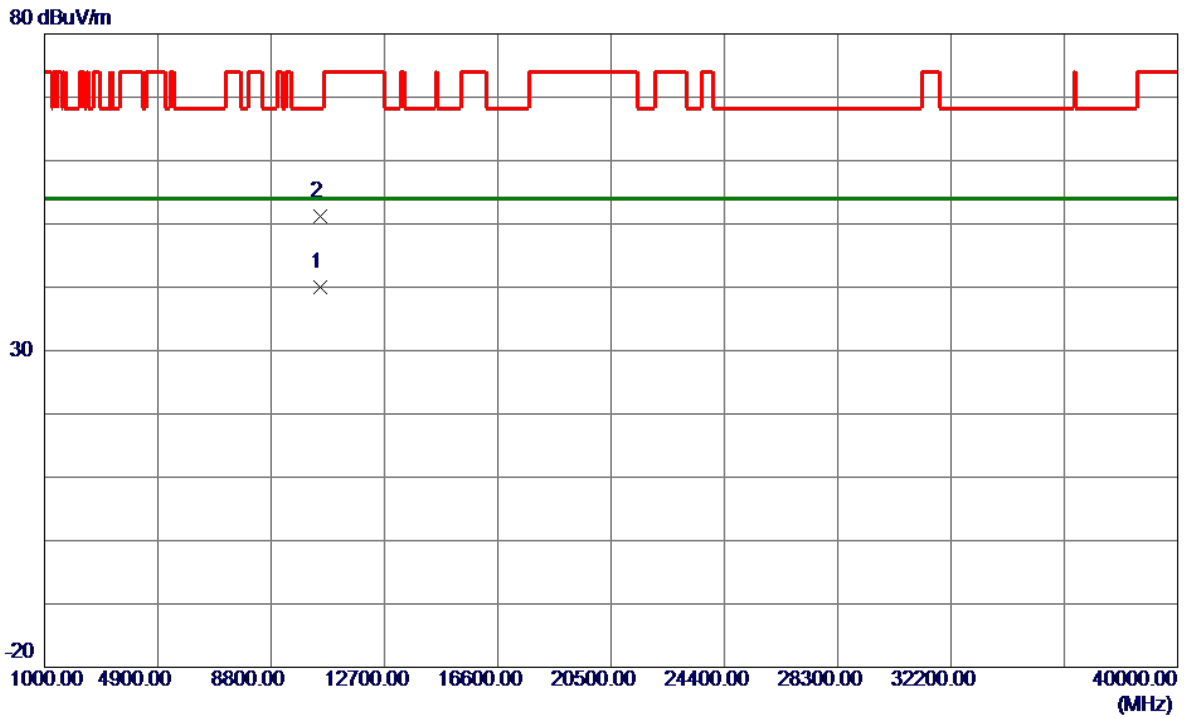

No.	Freq. MHz	Reading Level dBuV/m	Correct Factor dB	Measure ment dBuV/m	Limit dBuV/m	Margin dB	Detector	Comment
1 *	10482.0599	27.81	12.26	40.07	54.00	-13.93	AVG	
2	10483.0400	38.95	12.26	51.21	68.20	-16.99	Peak	

REMARKS:

- (1) Measurement Value = Reading Level + Correct Factor.
- (2) Margin Level = Measurement Value - Limit Value.

Test Mode	UNII-1_TX AC(VHT20) Mode 5180 MHz	Polarization	Vertical
-----------	-----------------------------------	--------------	----------

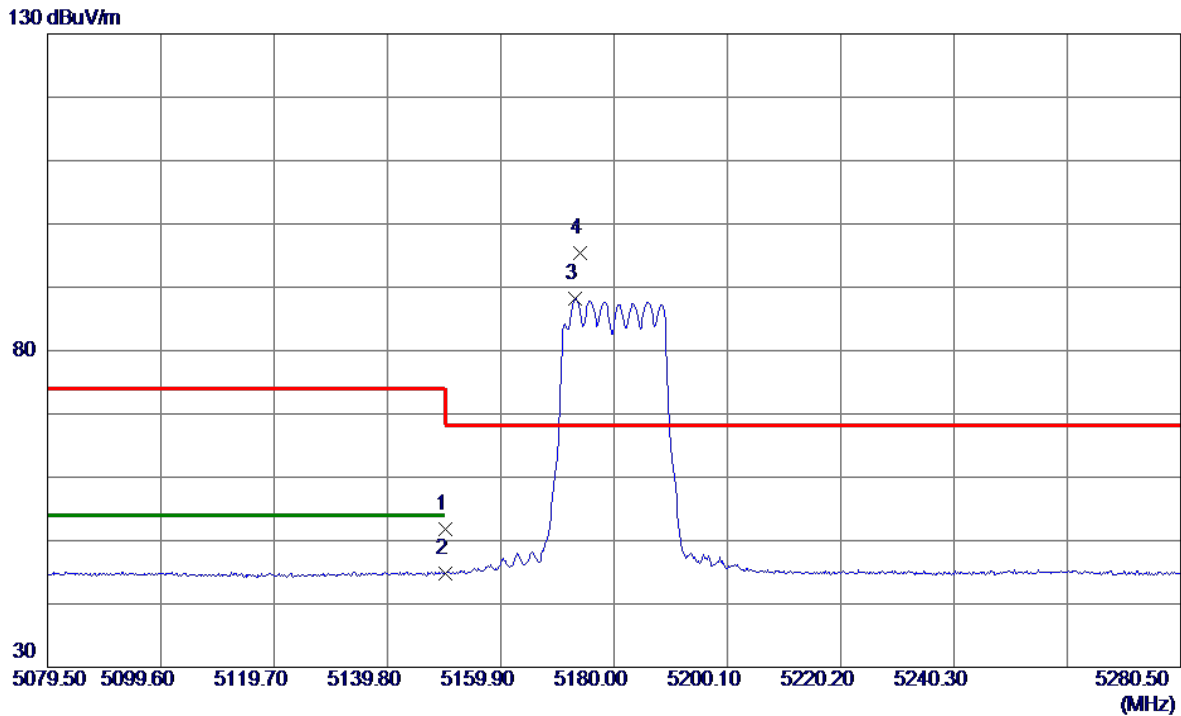

No.	Freq. MHz	Reading Level dBuV/m	Correct Factor dB	Measure ment dBuV/m	Limit dBuV/m	Margin dB	Detector	Comment
1	5150.0000	36.25	15.54	51.79	74.00	-22.21	Peak	
2	5150.0000	29.18	15.54	44.72	54.00	-9.28	AVG	
3	5173.1660	72.66	15.58	88.24	999.00	-910.76	AVG	No Limit
4 *	5173.9700	79.76	15.58	95.34	68.20	27.14	Peak	No Limit

REMARKS:

- (1) Measurement Value = Reading Level + Correct Factor.
- (2) Margin Level = Measurement Value - Limit Value.

Test Mode	UNII-1_TX AC(VHT20) Mode 5180 MHz	Polarization	Vertical
-----------	-----------------------------------	--------------	----------

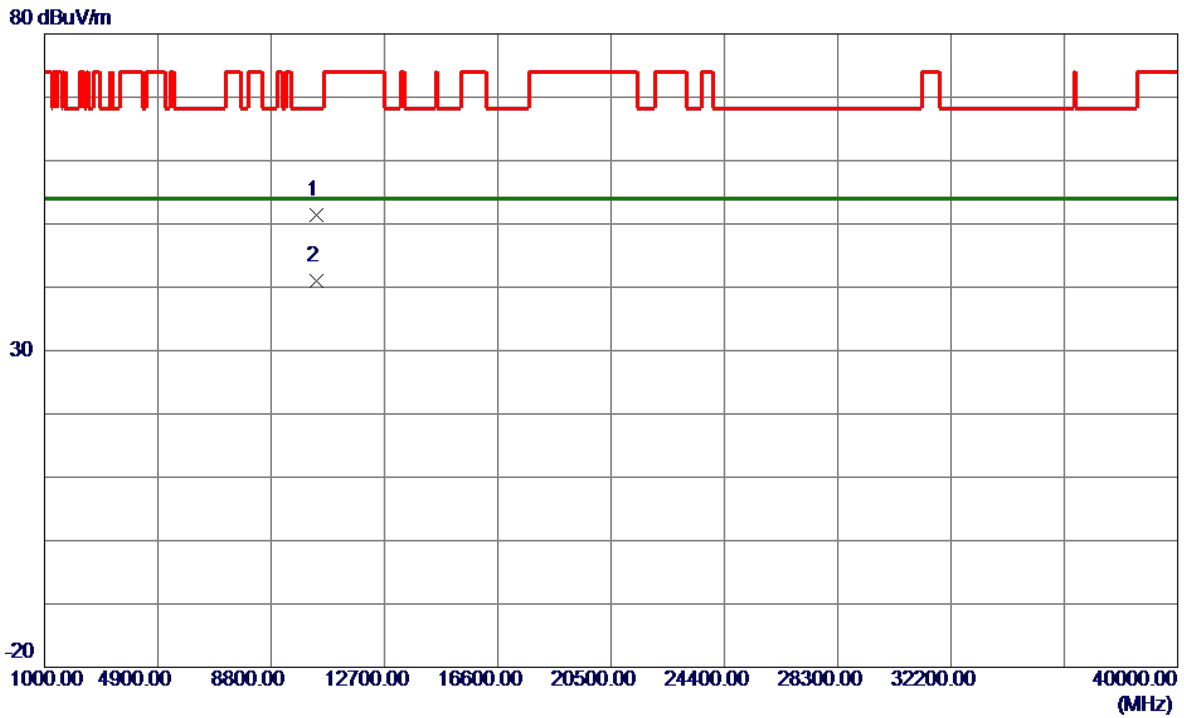

No.	Freq. MHz	Reading Level dBuV/m	Correct Factor dB	Measure ment dBuV/m	Limit dBuV/m	Margin dB	Detector	Comment
1	10360.1200	39.32	12.13	51.45	68.20	-16.75	Peak	
2 *	10360.4500	28.94	12.13	41.07	54.00	-12.93	AVG	

REMARKS:

- (1) Measurement Value = Reading Level + Correct Factor.
- (2) Margin Level = Measurement Value - Limit Value.

Test Mode	UNII-1_TX AC(VHT20) Mode 5200 MHz	Polarization	Vertical
-----------	-----------------------------------	--------------	----------

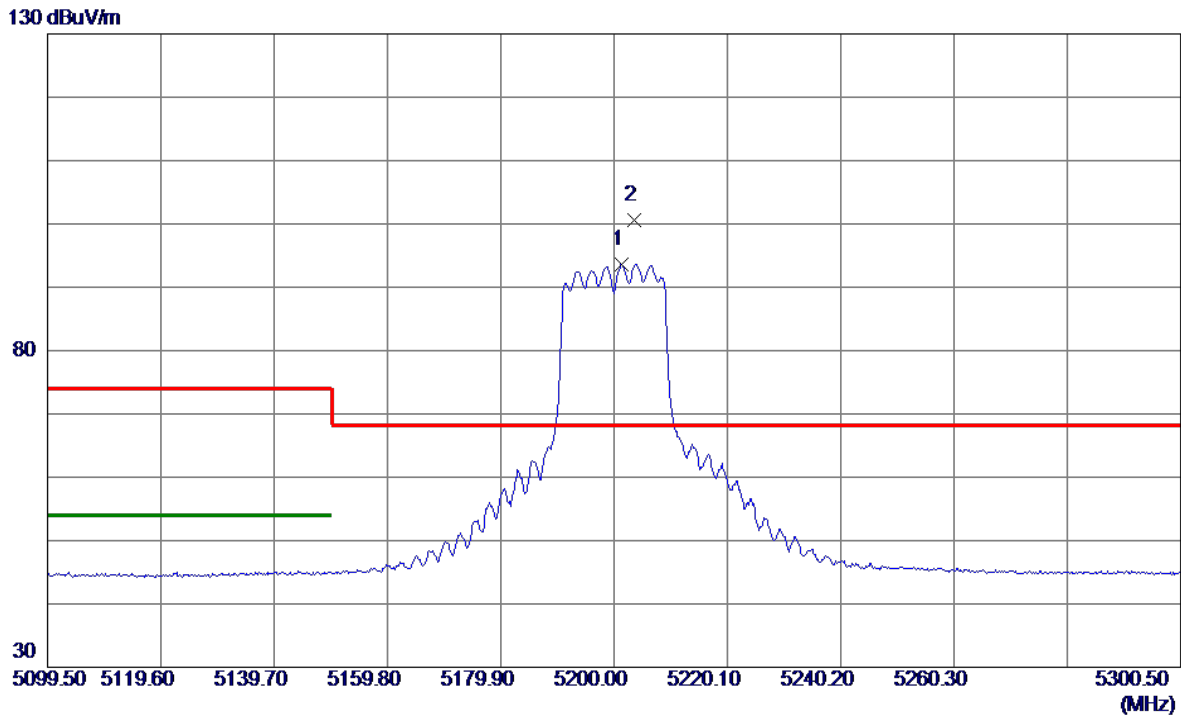

No.	Freq. MHz	Reading Level dBuV/m	Correct Factor dB	Measure ment dBuV/m	Limit dBuV/m	Margin dB	Detector	Comment
1	5201.4070	77.97	15.62	93.59	999.00	-905.41	AVG	No Limit
2 *	5203.6180	85.06	15.63	100.69	68.20	32.49	Peak	No Limit

REMARKS:

- (1) Measurement Value = Reading Level + Correct Factor.
- (2) Margin Level = Measurement Value - Limit Value.

Test Mode	UNII-1_TX AC(VHT20) Mode 5200 MHz	Polarization	Vertical
-----------	-----------------------------------	--------------	----------

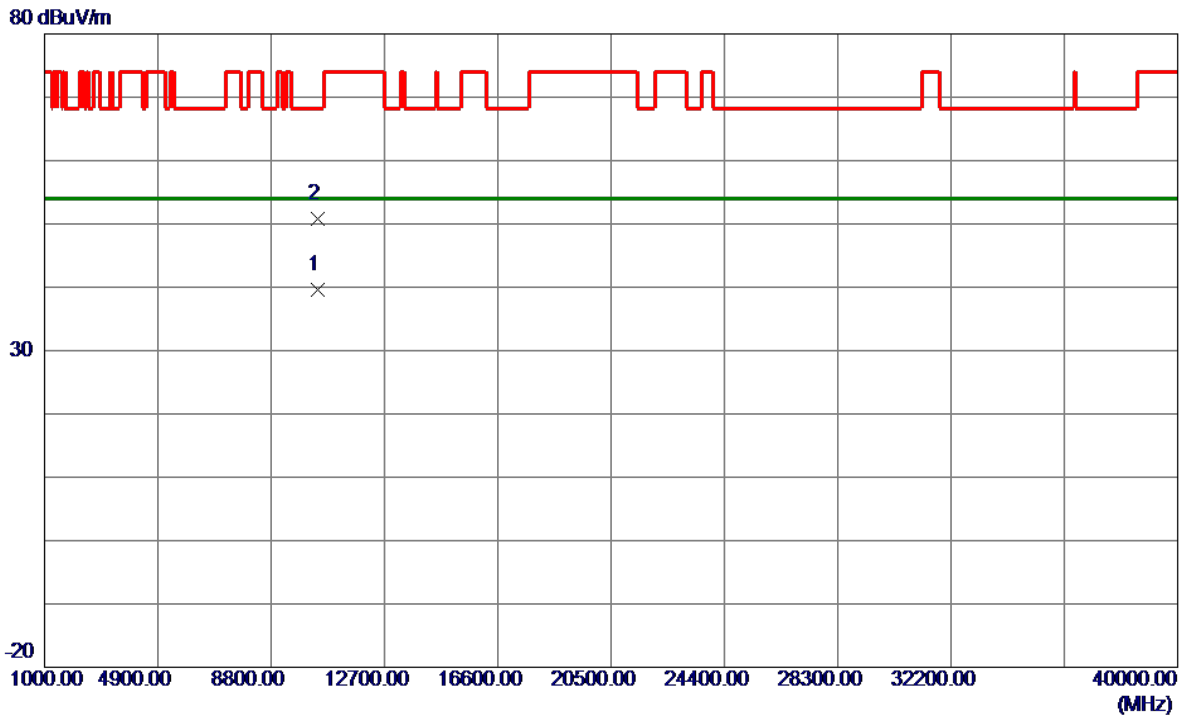

No.	Freq. MHz	Reading Level dBuV/m	Correct Factor dB	Measure ment dBuV/m	Limit dBuV/m	Margin dB	Detector	Comment
1 *	10395.1700	27.42	12.17	39.59	54.00	-14.41	AVG	
2	10402.5100	38.61	12.17	50.78	68.20	-17.42	Peak	

REMARKS:

- (1) Measurement Value = Reading Level + Correct Factor.
- (2) Margin Level = Measurement Value - Limit Value.

Test Mode	UNII-1_TX AC(VHT20) Mode 5240 MHz	Polarization	Vertical
-----------	-----------------------------------	--------------	----------

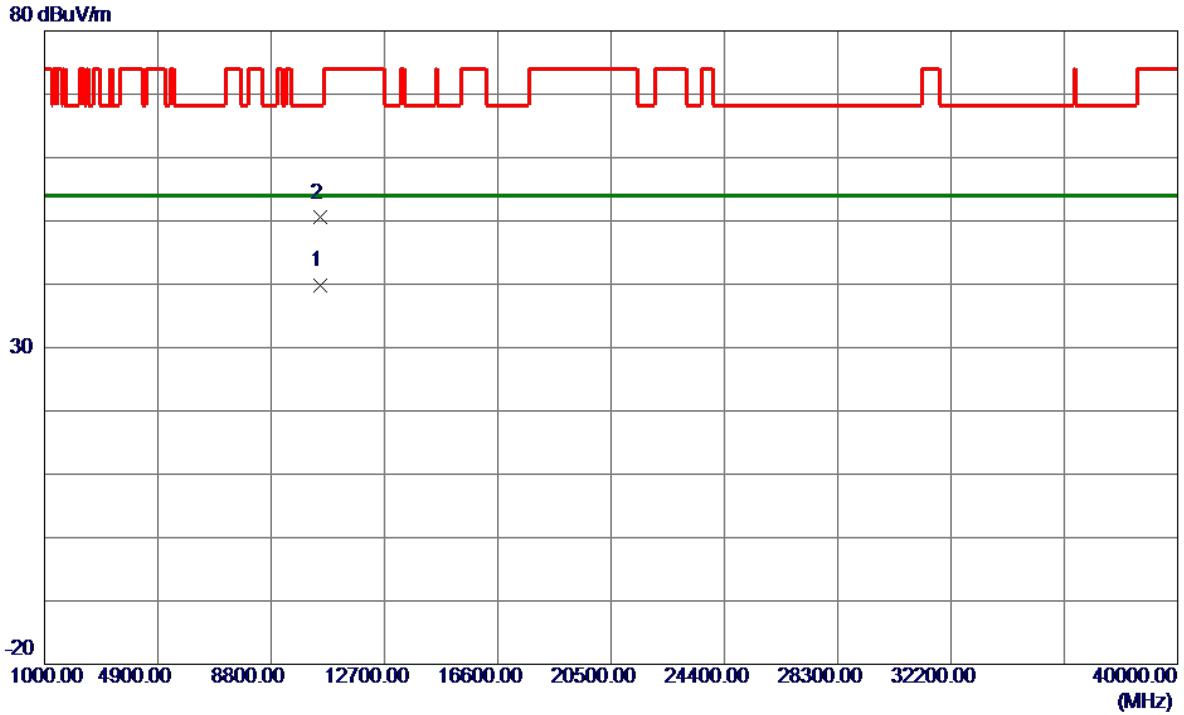

No.	Freq. MHz	Reading Level dBuV/m	Correct Factor dB	Measure ment dBuV/m	Limit dBuV/m	Margin dB	Detector	Comment
1 *	10475.4100	27.54	12.25	39.79	54.00	-14.21	AVG	
2	10482.0300	38.24	12.26	50.50	68.20	-17.70	Peak	

REMARKS:

- (1) Measurement Value = Reading Level + Correct Factor.
- (2) Margin Level = Measurement Value - Limit Value.

Test Mode	UNII-1_TX AC(VHT40) Mode 5190 MHz	Polarization	Vertical
-----------	-----------------------------------	--------------	----------

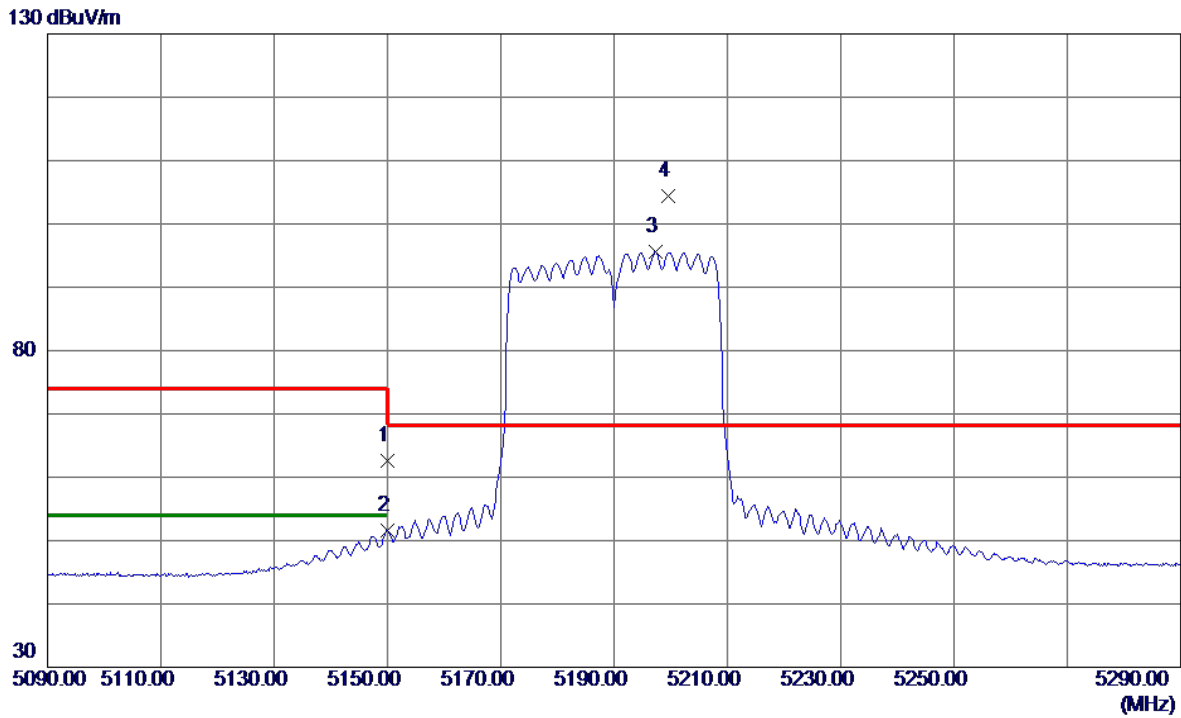

No.	Freq. MHz	Reading Level dBuV/m	Correct Factor dB	Measure ment dBuV/m	Limit dBuV/m	Margin dB	Detector	Comment
1	5150.0000	47.08	15.54	62.62	74.00	-11.38	Peak	
2	5150.0000	35.99	15.54	51.53	54.00	-2.47	AVG	
3	5197.4000	80.00	15.62	95.62	999.00	-903.38	AVG	No Limit
4 *	5199.6000	88.72	15.62	104.34	68.20	36.14	Peak	No Limit

REMARKS:

- (1) Measurement Value = Reading Level + Correct Factor.
- (2) Margin Level = Measurement Value - Limit Value.

Test Mode	UNII-1_TX AC(VHT40) Mode 5190 MHz	Polarization	Vertical
-----------	-----------------------------------	--------------	----------

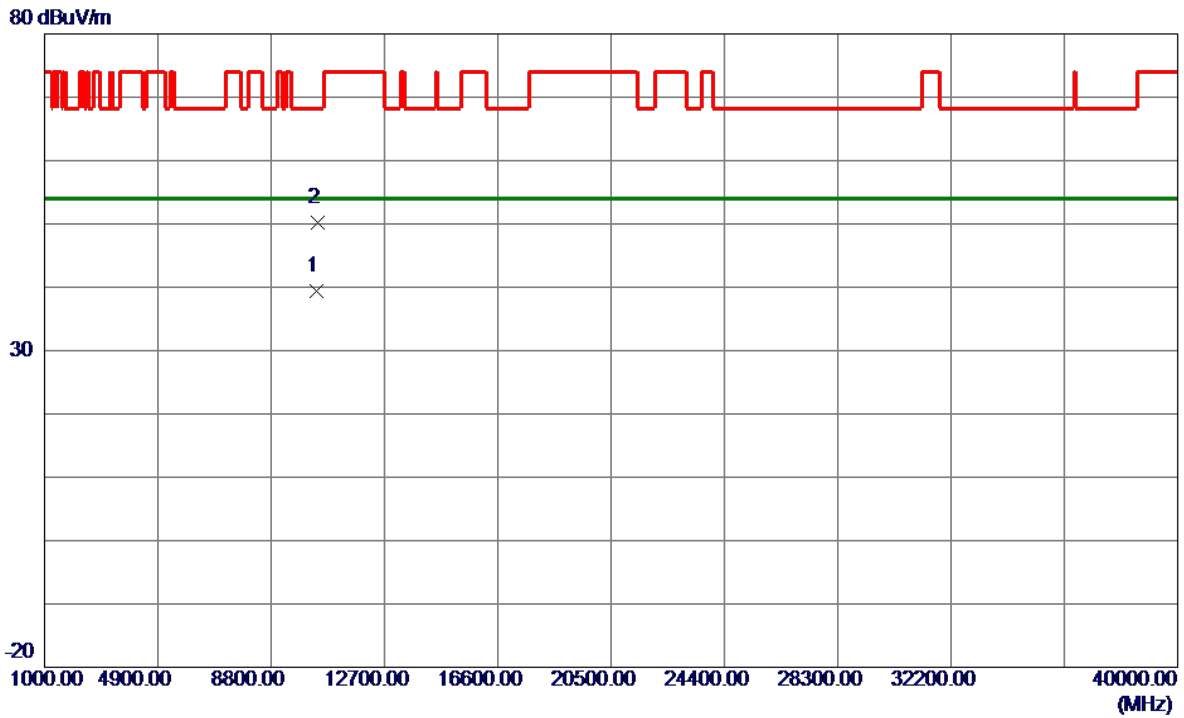

No.	Freq. MHz	Reading Level dBuV/m	Correct Factor dB	Measure ment dBuV/m	Limit dBuV/m	Margin dB	Detector	Comment
1 *	10381.3600	27.25	12.15	39.40	54.00	-14.60	AVG	
2	10382.7800	37.99	12.15	50.14	68.20	-18.06	Peak	

REMARKS:

- (1) Measurement Value = Reading Level + Correct Factor.
- (2) Margin Level = Measurement Value - Limit Value.

Test Mode	UNII-1_TX AC(VHT40) Mode 5230 MHz	Polarization	Vertical
-----------	-----------------------------------	--------------	----------

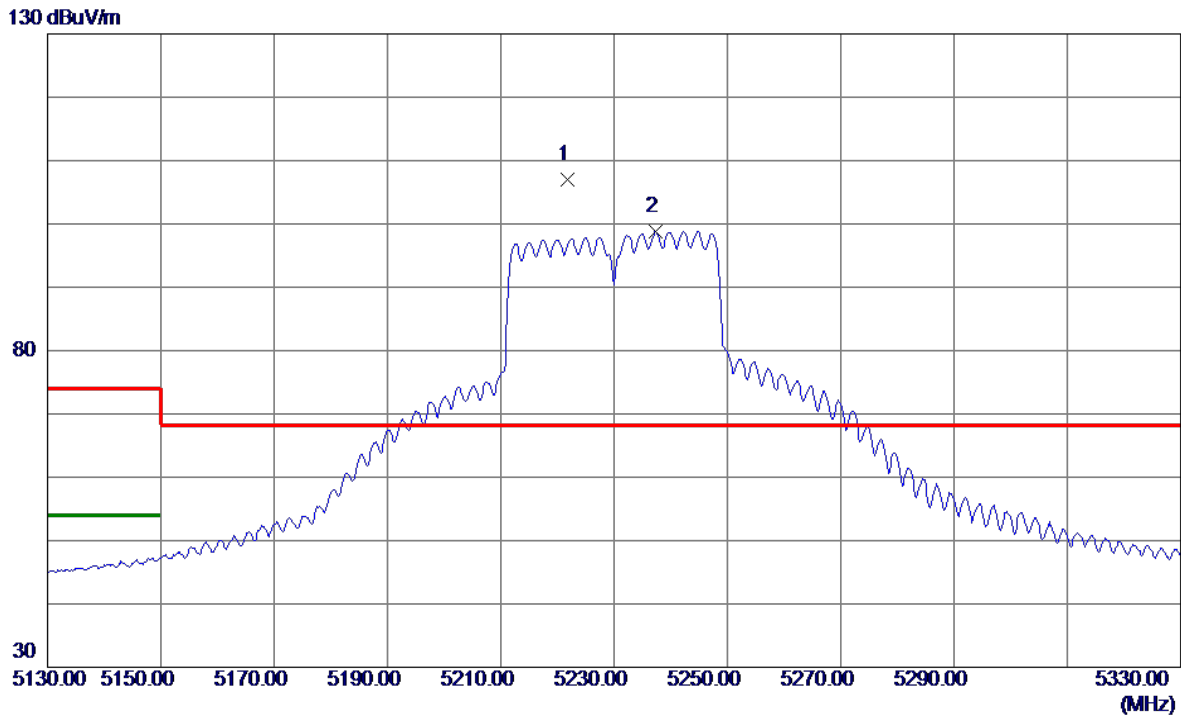

No.	Freq. MHz	Reading Level dBuV/m	Correct Factor dB	Measure ment dBuV/m	Limit dBuV/m	Margin dB	Detector	Comment
1 *	5221.8000	91.33	15.66	106.99	68.20	38.79	Peak	No Limit
2	5237.4000	83.09	15.68	98.77	999.00	-900.23	AVG	No Limit

REMARKS:

- (1) Measurement Value = Reading Level + Correct Factor.
- (2) Margin Level = Measurement Value - Limit Value.

Test Mode	UNII-1_TX AC(VHT40) Mode 5230 MHz	Polarization	Vertical
-----------	-----------------------------------	--------------	----------

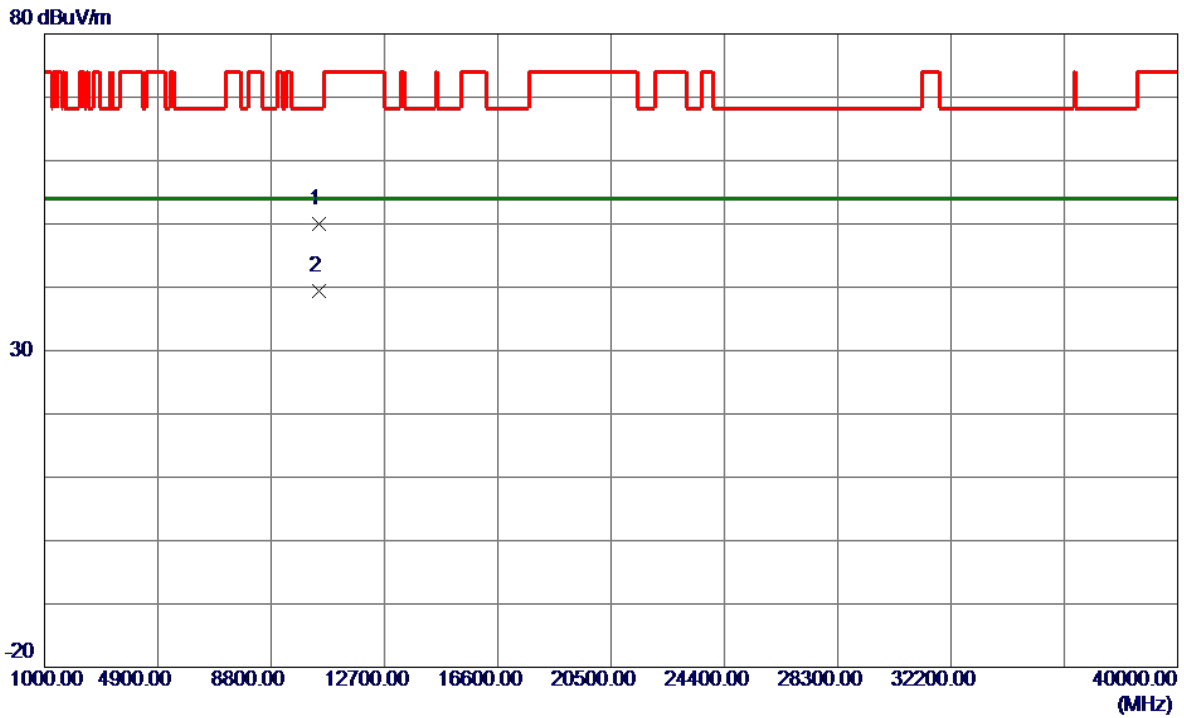

No.	Freq. MHz	Reading Level dBuV/m	Correct Factor dB	Measure ment dBuV/m	Limit dBuV/m	Margin dB	Detector	Comment
1	10462.4400	37.69	12.24	49.93	68.20	-18.27	Peak	
2 *	10463.5599	27.23	12.24	39.47	54.00	-14.53	AVG	

REMARKS:

- (1) Measurement Value = Reading Level + Correct Factor.
- (2) Margin Level = Measurement Value - Limit Value.

Test Mode	UNII-1_TX AC(VHT80) Mode 5210 MHz	Polarization	Vertical
-----------	-----------------------------------	--------------	----------

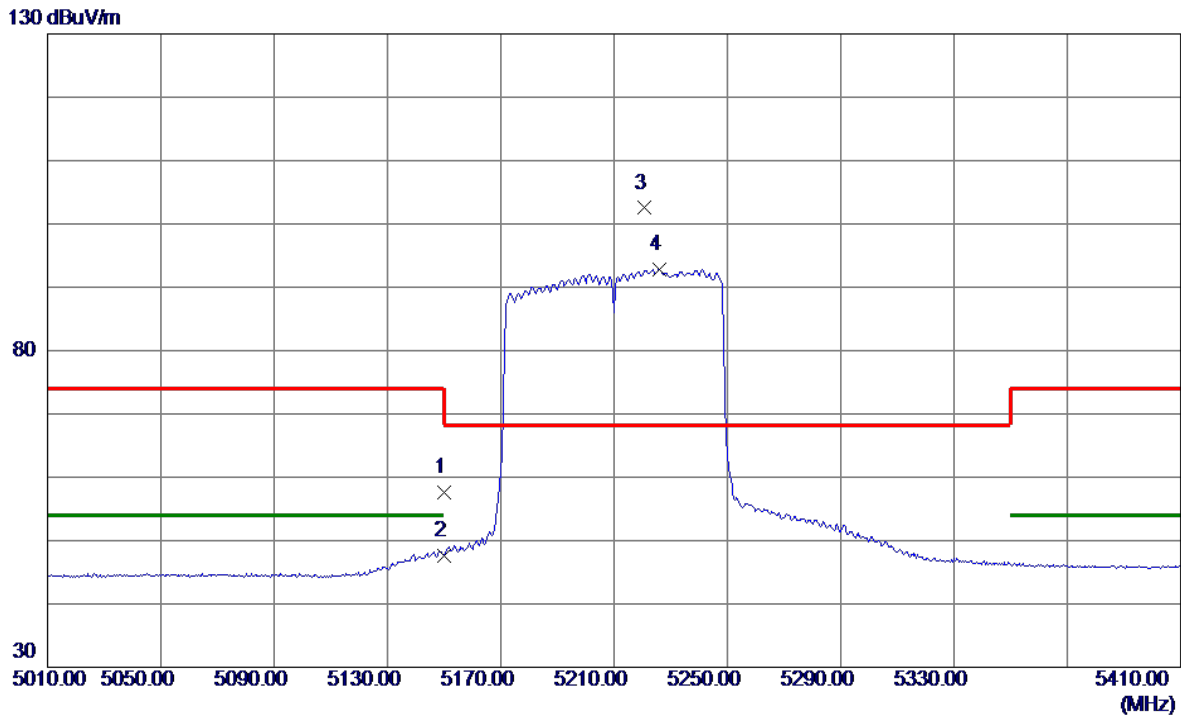

No.	Freq. MHz	Reading Level dBuV/m	Correct Factor dB	Measure ment dBuV/m	Limit dBuV/m	Margin dB	Detector	Comment
1	5150.0000	42.61	15.05	57.66	74.00	-16.34	Peak	
2	5150.0000	32.51	15.05	47.56	54.00	-6.44	AVG	
3 *	5220.8000	87.30	15.20	102.50	68.20	34.30	Peak	No Limit
4	5226.0000	77.57	15.21	92.78	999.00	-906.22	AVG	No Limit

REMARKS:

- (1) Measurement Value = Reading Level + Correct Factor.
- (2) Margin Level = Measurement Value - Limit Value.

Test Mode	UNII-1_TX AC(VHT80) Mode 5210 MHz	Polarization	Vertical
-----------	-----------------------------------	--------------	----------

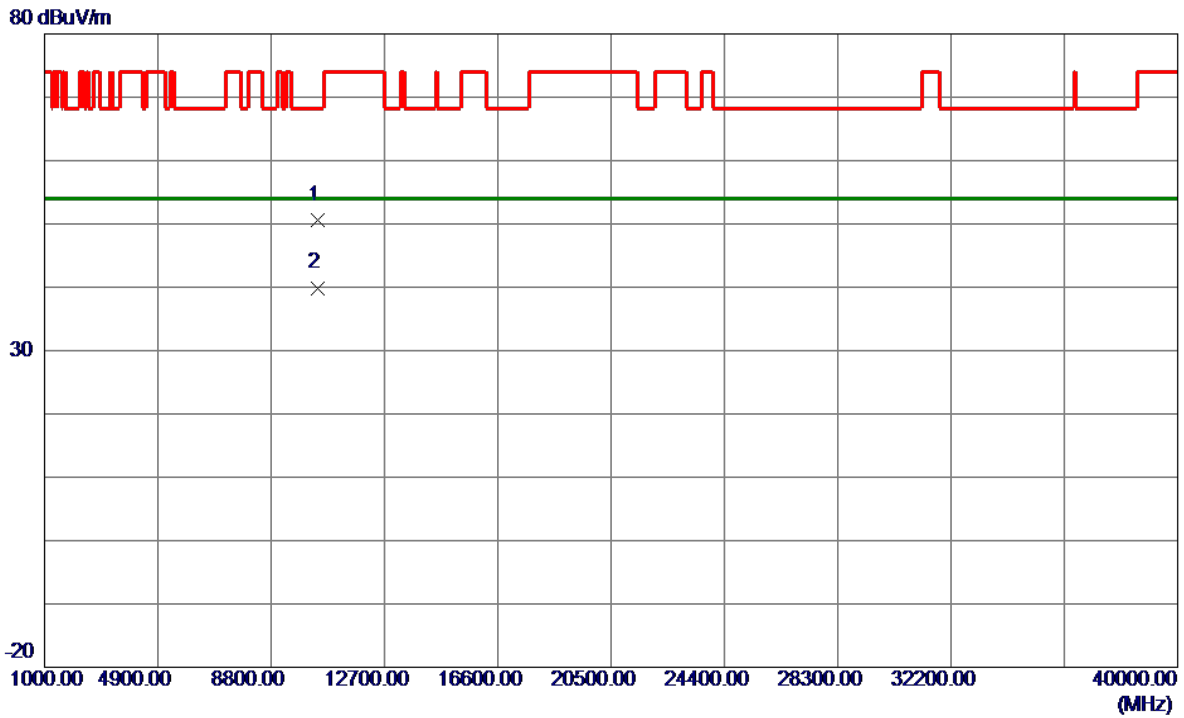

No.	Freq. MHz	Reading Level dBuV/m	Correct Factor dB	Measure ment dBuV/m	Limit dBuV/m	Margin dB	Detector	Comment
1	10420.5199	38.34	12.19	50.53	68.20	-17.67	Peak	
2 *	10420.9200	27.71	12.19	39.90	54.00	-14.10	AVG	

REMARKS:

- (1) Measurement Value = Reading Level + Correct Factor.
- (2) Margin Level = Measurement Value - Limit Value.

Test Mode	UNII-1_TX AX(HE20) Mode 5180 MHz	Polarization	Vertical
-----------	----------------------------------	--------------	----------

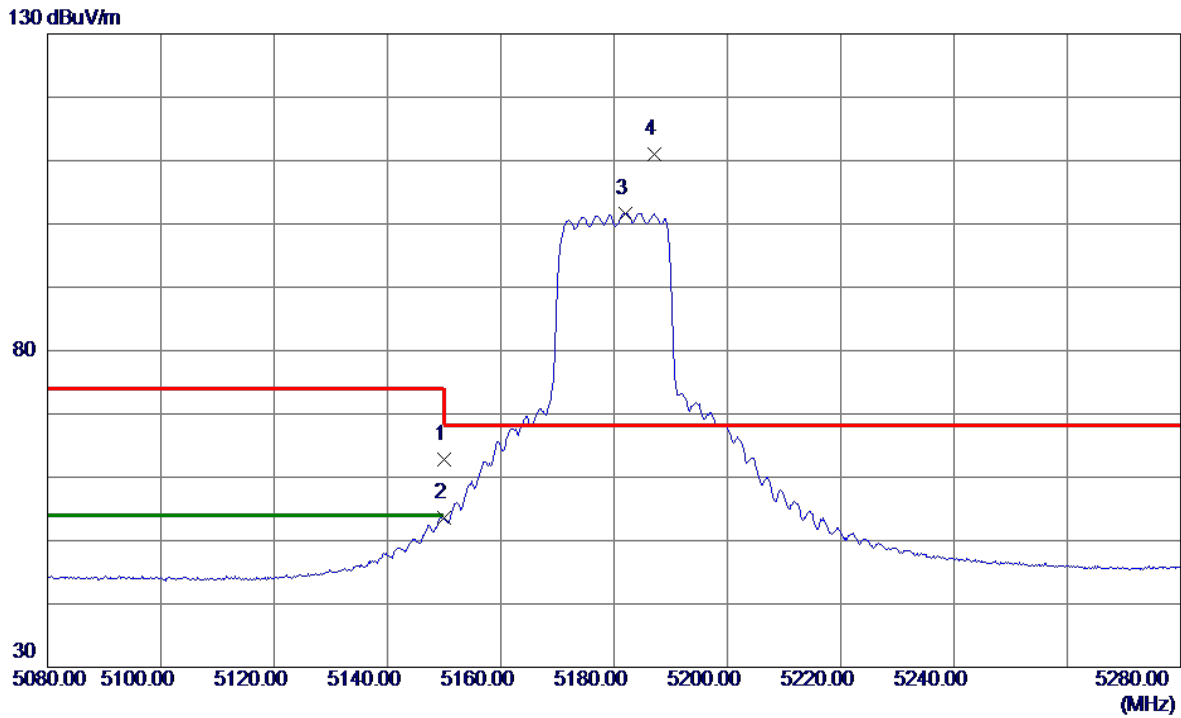

No.	Freq. MHz	Reading Level dBuV/m	Correct Factor dB	Measure ment dBuV/m	Limit dBuV/m	Margin dB	Detector	Comment
1	5150.0000	47.80	15.05	62.85	74.00	-11.15	Peak	
2	5150.0000	38.48	15.05	53.53	54.00	-0.47	AVG	
3	5182.0000	86.57	15.12	101.69	999.00	-897.31	AVG	No Limit
4 *	5187.2000	95.77	15.13	110.90	68.20	42.70	Peak	No Limit

REMARKS:

- (1) Measurement Value = Reading Level + Correct Factor.
- (2) Margin Level = Measurement Value - Limit Value.

Test Mode	UNII-1_TX AX(HE20) Mode 5180 MHz	Polarization	Vertical
-----------	----------------------------------	--------------	----------

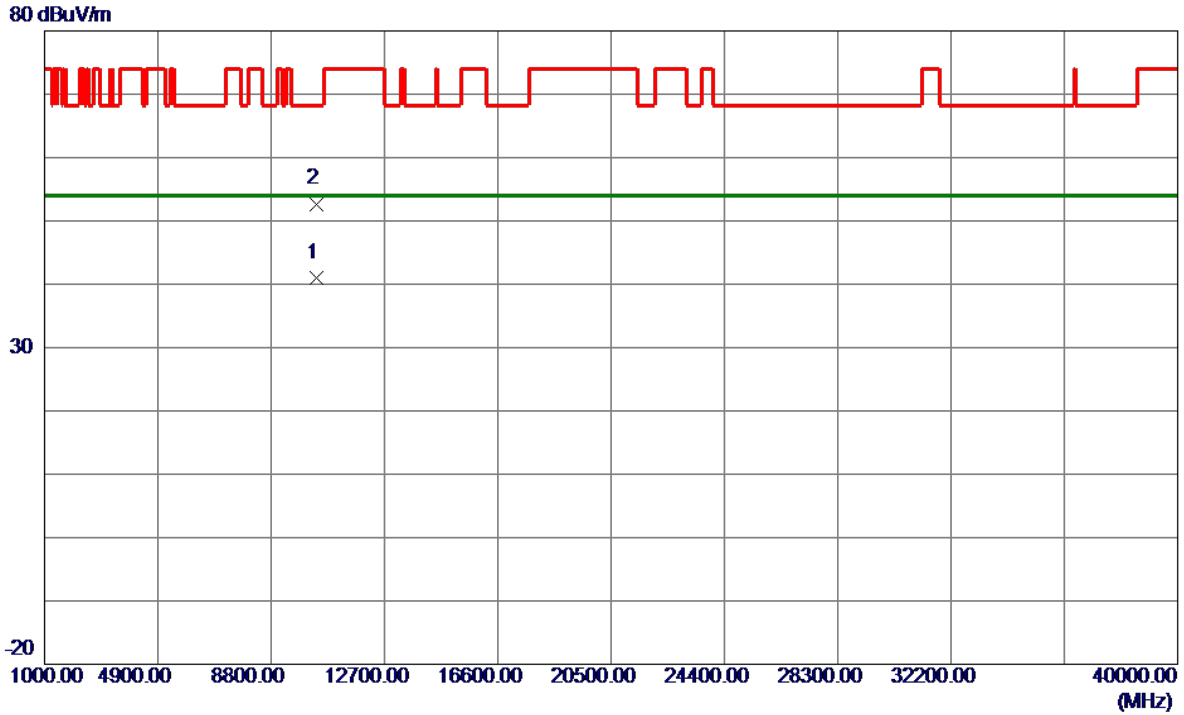

No.	Freq. MHz	Reading Level dBuV/m	Correct Factor dB	Measure ment dBuV/m	Limit dBuV/m	Margin dB	Detector	Comment
1 *	10360.5400	28.90	12.13	41.03	54.00	-12.97	AVG	
2	10361.2500	40.57	12.13	52.70	68.20	-15.50	Peak	

REMARKS:

- (1) Measurement Value = Reading Level + Correct Factor.
- (2) Margin Level = Measurement Value - Limit Value.

Test Mode	UNII-1_TX AX(HE20) Mode 5200 MHz	Polarization	Vertical
-----------	----------------------------------	--------------	----------

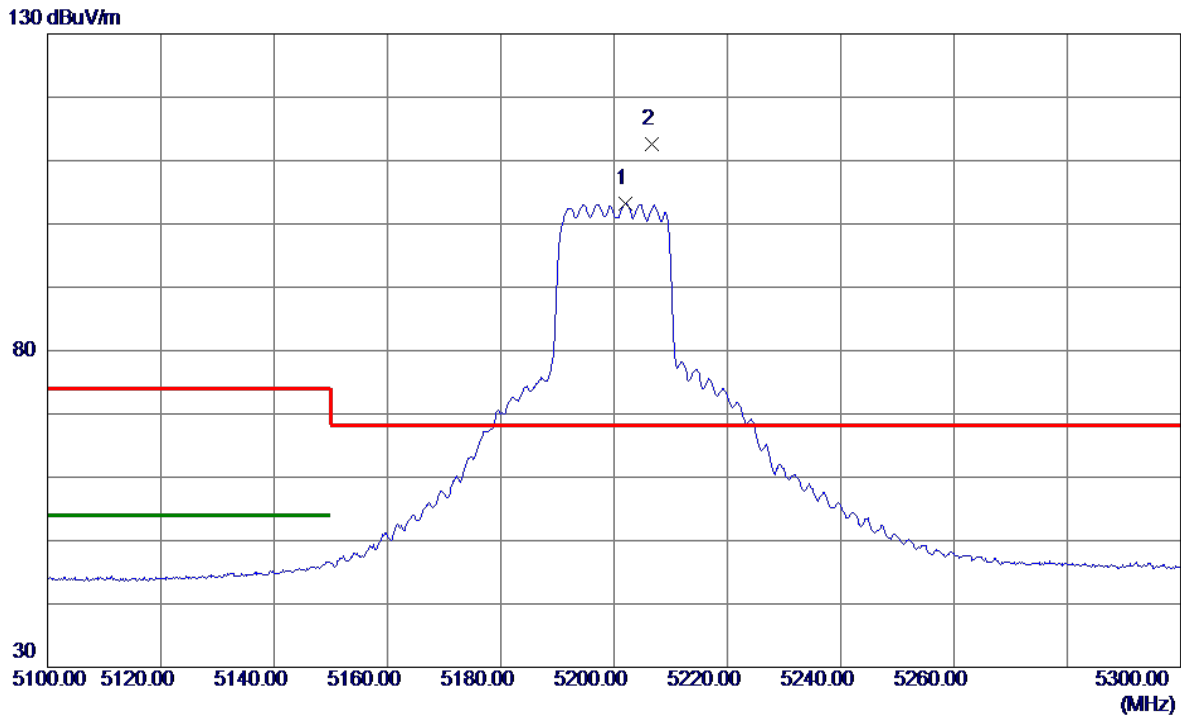

No.	Freq. MHz	Reading Level dBuV/m	Correct Factor dB	Measure ment dBuV/m	Limit dBuV/m	Margin dB	Detector	Comment
1	5202.0000	88.01	15.16	103.17	999.00	-895.83	AVG	No Limit
2 *	5206.6000	97.40	15.17	112.57	68.20	44.37	Peak	No Limit

REMARKS:

- (1) Measurement Value = Reading Level + Correct Factor.
- (2) Margin Level = Measurement Value - Limit Value.

Test Mode	UNII-1_TX AX(HE20) Mode 5200 MHz	Polarization	Vertical
-----------	----------------------------------	--------------	----------

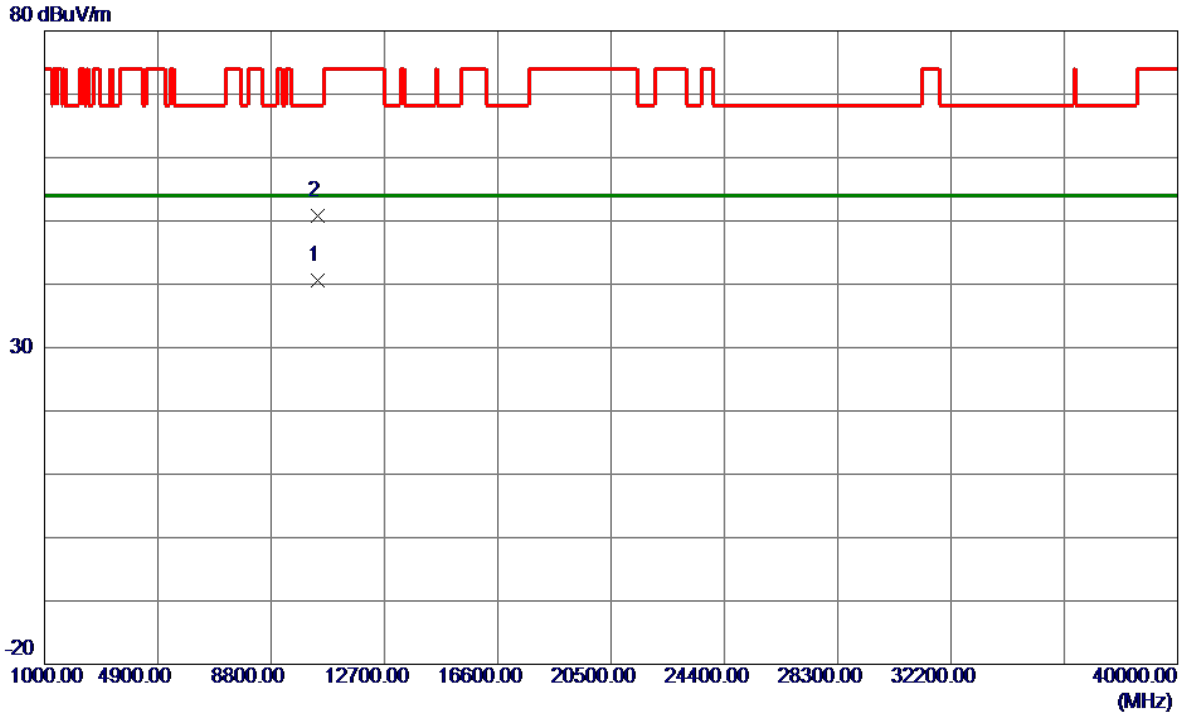

No.	Freq. MHz	Reading Level dBuV/m	Correct Factor dB	Measure ment dBuV/m	Limit dBuV/m	Margin dB	Detector	Comment
1 *	10397.4500	28.43	12.17	40.60	54.00	-13.40	AVG	
2	10398.3600	38.68	12.17	50.85	68.20	-17.35	Peak	

REMARKS:

- (1) Measurement Value = Reading Level + Correct Factor.
- (2) Margin Level = Measurement Value - Limit Value.

Test Mode	UNII-1_TX AX(HE20) Mode 5240 MHz	Polarization	Vertical
-----------	----------------------------------	--------------	----------

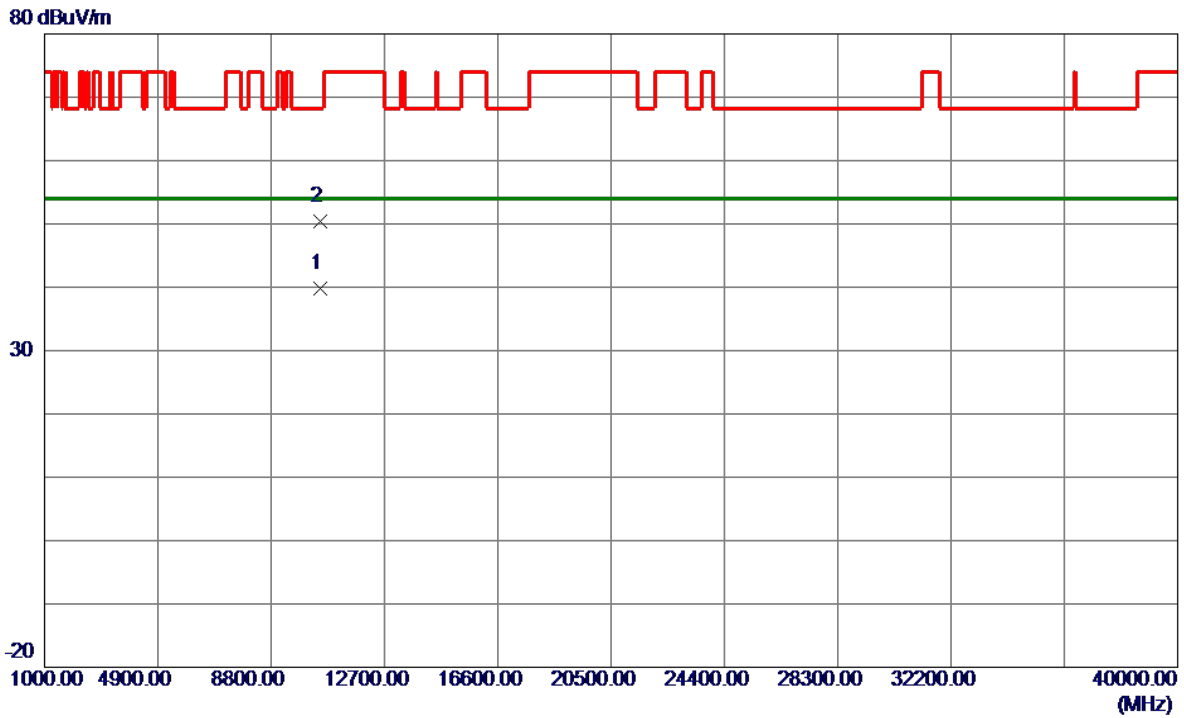

No.	Freq. MHz	Reading Level dBuV/m	Correct Factor dB	Measure ment dBuV/m	Limit dBuV/m	Margin dB	Detector	Comment
1 *	10475.4200	27.48	12.25	39.73	54.00	-14.27	AVG	
2	10477.8200	38.19	12.25	50.44	68.20	-17.76	Peak	

REMARKS:

- (1) Measurement Value = Reading Level + Correct Factor.
- (2) Margin Level = Measurement Value - Limit Value.

Test Mode	UNII-1_TX AX(HE40) Mode 5190 MHz	Polarization	Vertical
-----------	----------------------------------	--------------	----------

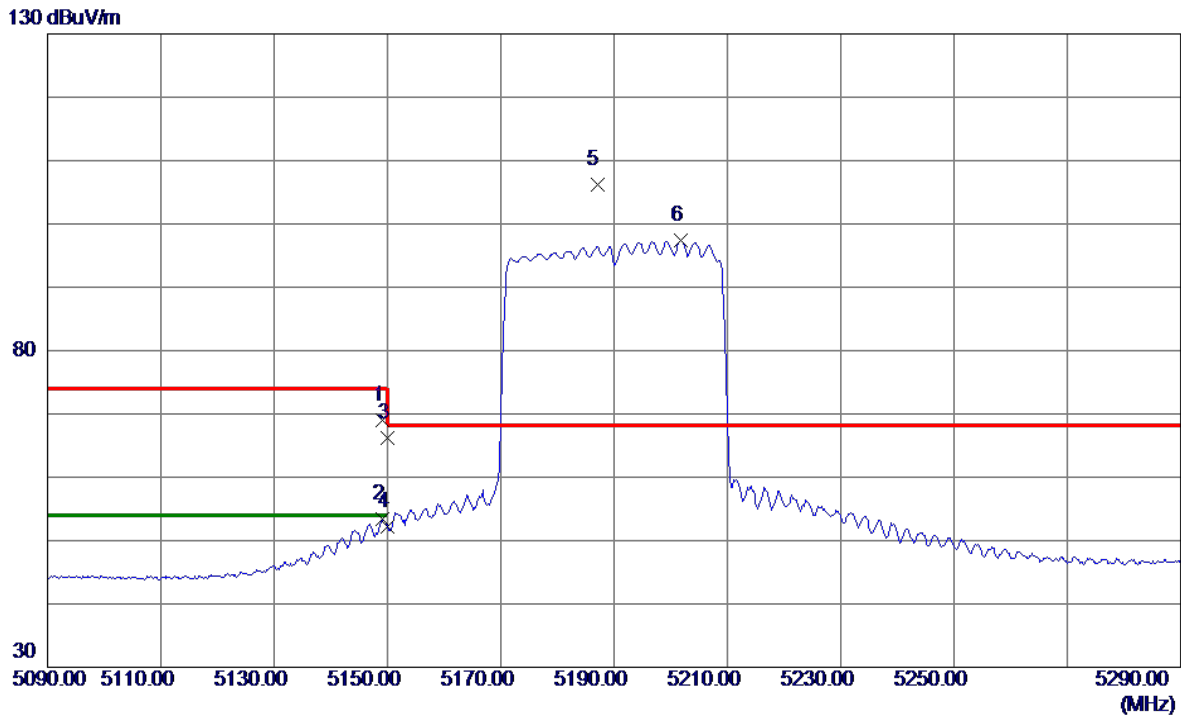

No.	Freq. MHz	Reading Level dBuV/m	Correct Factor dB	Measure ment dBuV/m	Limit dBuV/m	Margin dB	Detector	Comment
1	5149.2000	53.85	15.08	68.93	74.00	-5.07	Peak	
2	5149.2000	38.23	15.08	53.31	54.00	-0.69	AVG	
3	5150.0000	51.21	15.08	66.29	74.00	-7.71	Peak	
4	5150.0000	37.13	15.08	52.21	54.00	-1.79	AVG	
5 *	5187.0000	91.09	15.20	106.29	68.20	38.09	Peak	No Limit
6	5201.8000	82.08	15.24	97.32	999.00	-901.68	AVG	No Limit

REMARKS:

- (1) Measurement Value = Reading Level + Correct Factor.
- (2) Margin Level = Measurement Value - Limit Value.

Test Mode	UNII-1_TX AX(HE40) Mode 5190 MHz	Polarization	Vertical
-----------	----------------------------------	--------------	----------

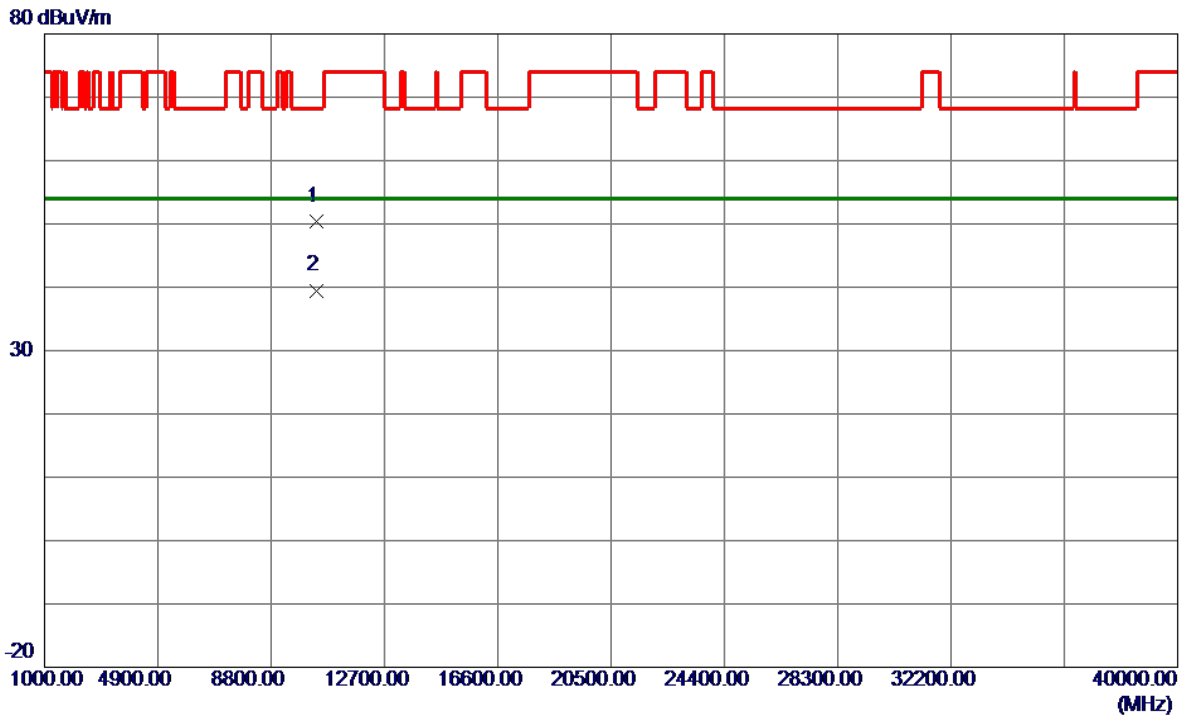

No.	Freq. MHz	Reading Level dBuV/m	Correct Factor dB	Measure ment dBuV/m	Limit dBuV/m	Margin dB	Detector	Comment
1	10375.5800	38.16	12.15	50.31	68.20	-17.89	Peak	
2 *	10376.0900	27.35	12.15	39.50	54.00	-14.50	AVG	

REMARKS:

- (1) Measurement Value = Reading Level + Correct Factor.
- (2) Margin Level = Measurement Value - Limit Value.

Test Mode	UNII-1_TX AX(HE40) Mode 5230 MHz	Polarization	Vertical
-----------	----------------------------------	--------------	----------

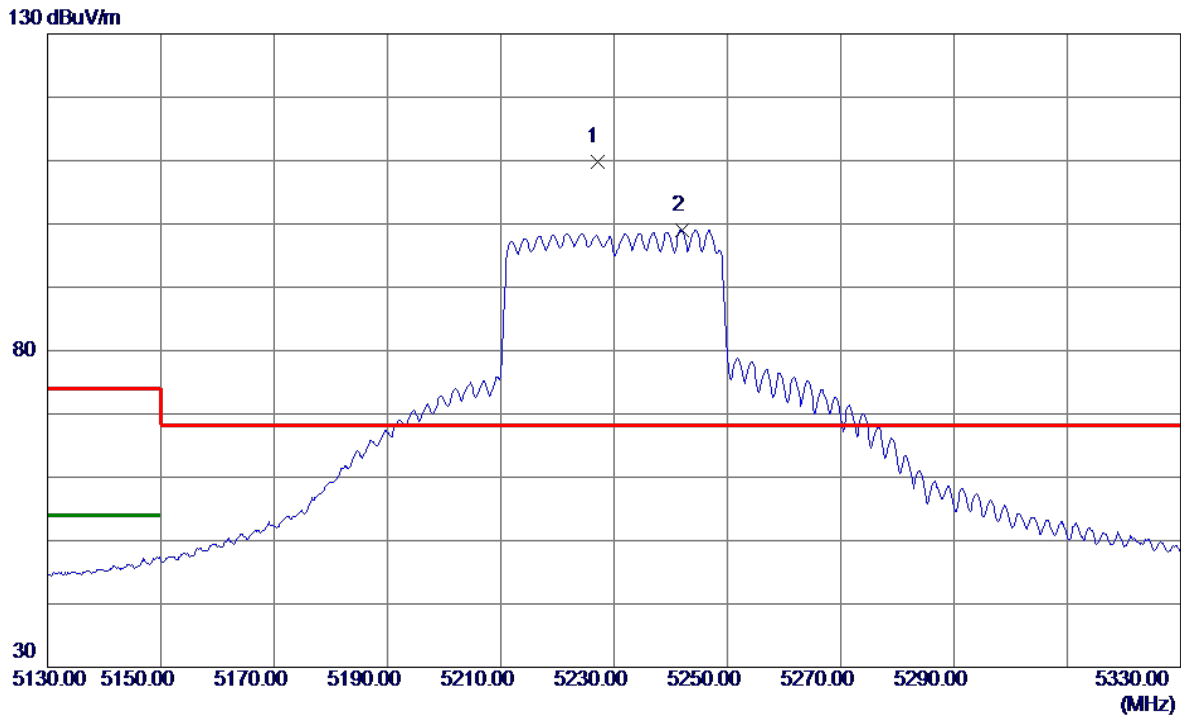

No.	Freq. MHz	Reading Level dBuV/m	Correct Factor dB	Measure ment dBuV/m	Limit dBuV/m	Margin dB	Detector	Comment
1 *	5227.0000	94.52	15.32	109.84	68.20	41.64	Peak	No Limit
2	5242.0000	83.70	15.37	99.07	999.00	-899.93	AVG	No Limit

REMARKS:

- (1) Measurement Value = Reading Level + Correct Factor.
- (2) Margin Level = Measurement Value - Limit Value.

Test Mode	UNII-1_TX AX(HE40) Mode 5230 MHz	Polarization	Vertical
-----------	----------------------------------	--------------	----------

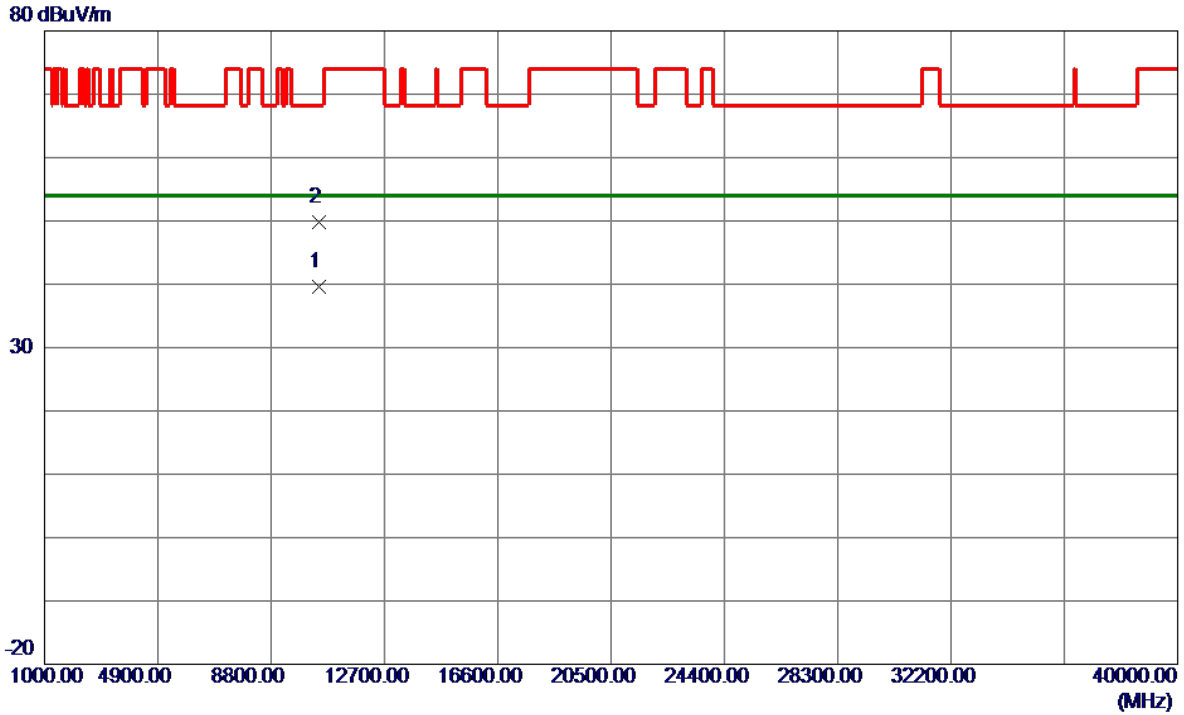

No.	Freq. MHz	Reading Level dBuV/m	Correct Factor dB	Measure ment dBuV/m	Limit dBuV/m	Margin dB	Detector	Comment
1 *	10458.7200	27.32	12.23	39.55	54.00	-14.45	AVG	
2	10458.7699	37.65	12.23	49.88	68.20	-18.32	Peak	

REMARKS:
 (1) Measurement Value = Reading Level + Correct Factor.
 (2) Margin Level = Measurement Value - Limit Value.

Test Mode	UNII-1_TX AX(HE80) Mode 5210 MHz	Polarization	Vertical
-----------	----------------------------------	--------------	----------

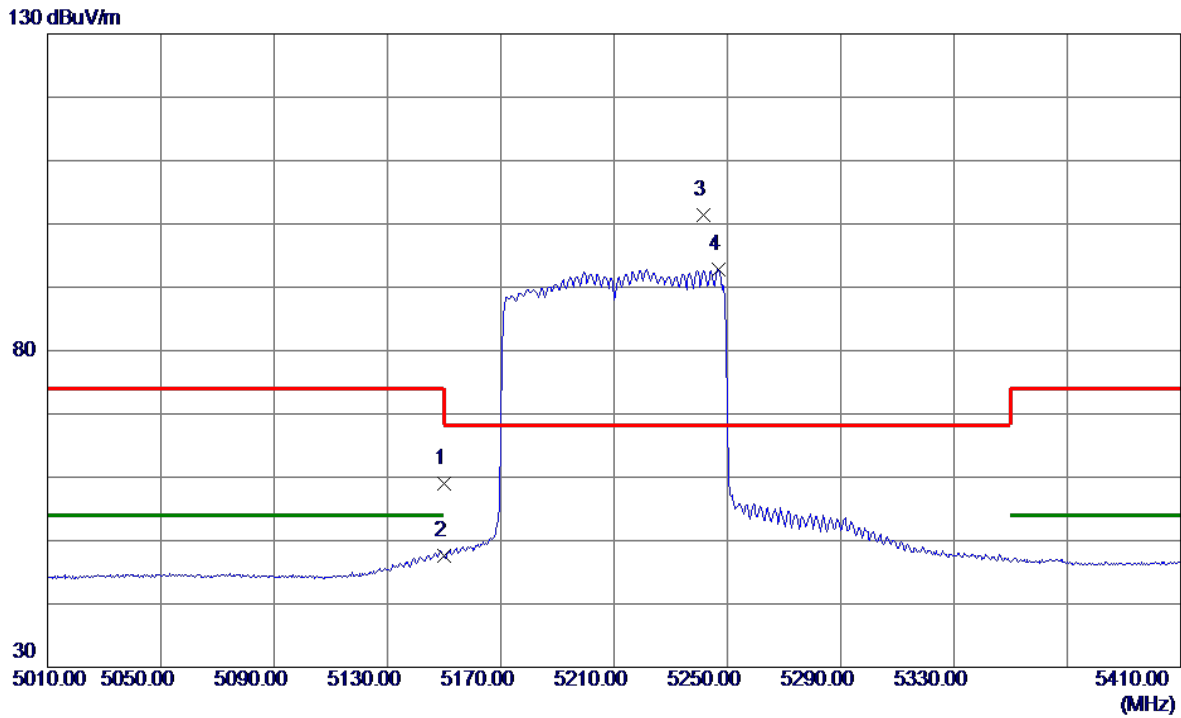

No.	Freq. MHz	Reading Level dBuV/m	Correct Factor dB	Measure ment dBuV/m	Limit dBuV/m	Margin dB	Detector	Comment
1	5150.0000	43.99	15.08	59.07	74.00	-14.93	Peak	
2	5150.0000	32.61	15.08	47.69	54.00	-6.31	AVG	
3 *	5241.6000	86.12	15.37	101.49	68.20	33.29	Peak	No Limit
4	5246.8000	77.42	15.38	92.80	999.00	-906.20	AVG	No Limit

REMARKS:

- (1) Measurement Value = Reading Level + Correct Factor.
- (2) Margin Level = Measurement Value - Limit Value.

Test Mode	UNII-1_TX AX(HE80) Mode 5210 MHz	Polarization	Vertical
-----------	----------------------------------	--------------	----------

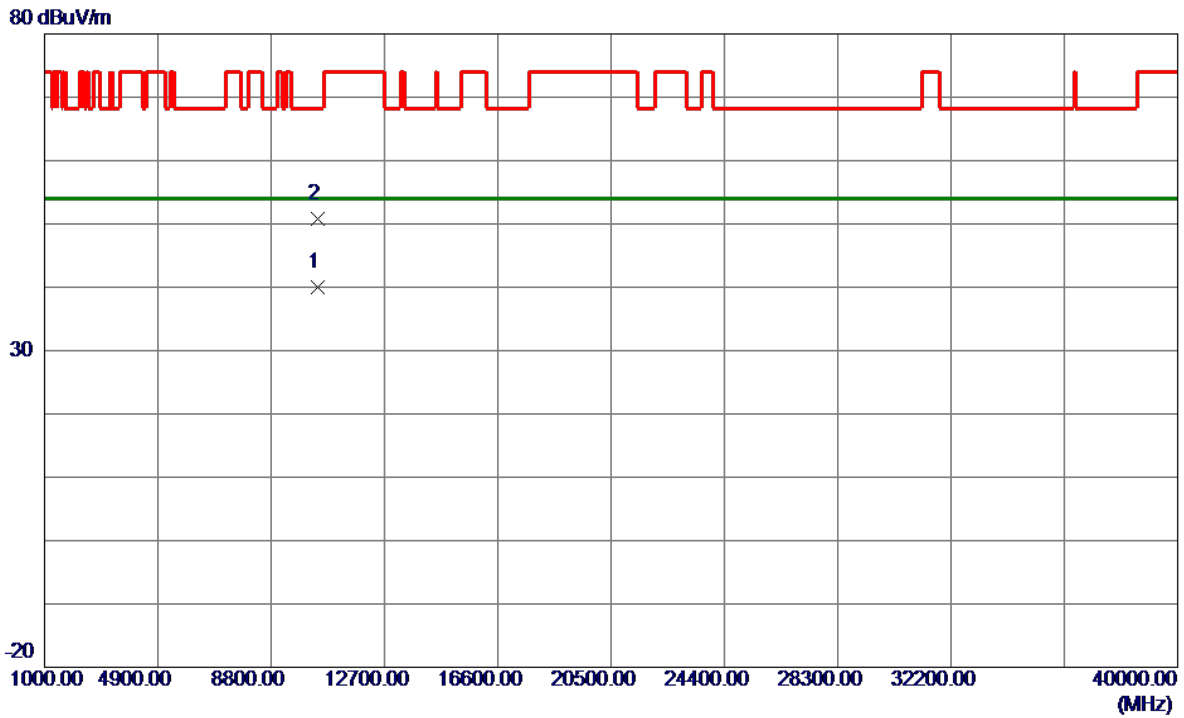

No.	Freq. MHz	Reading Level dBuV/m	Correct Factor dB	Measure ment dBuV/m	Limit dBuV/m	Margin dB	Detector	Comment
1 *	10423.5300	27.74	12.20	39.94	54.00	-14.06	AVG	
2	10424.0599	38.57	12.20	50.77	68.20	-17.43	Peak	

REMARKS:

- (1) Measurement Value = Reading Level + Correct Factor.
- (2) Margin Level = Measurement Value - Limit Value.

Test Mode	UNII-2A_TX A Mode 5260 MHz	Polarization	Vertical
-----------	----------------------------	--------------	----------

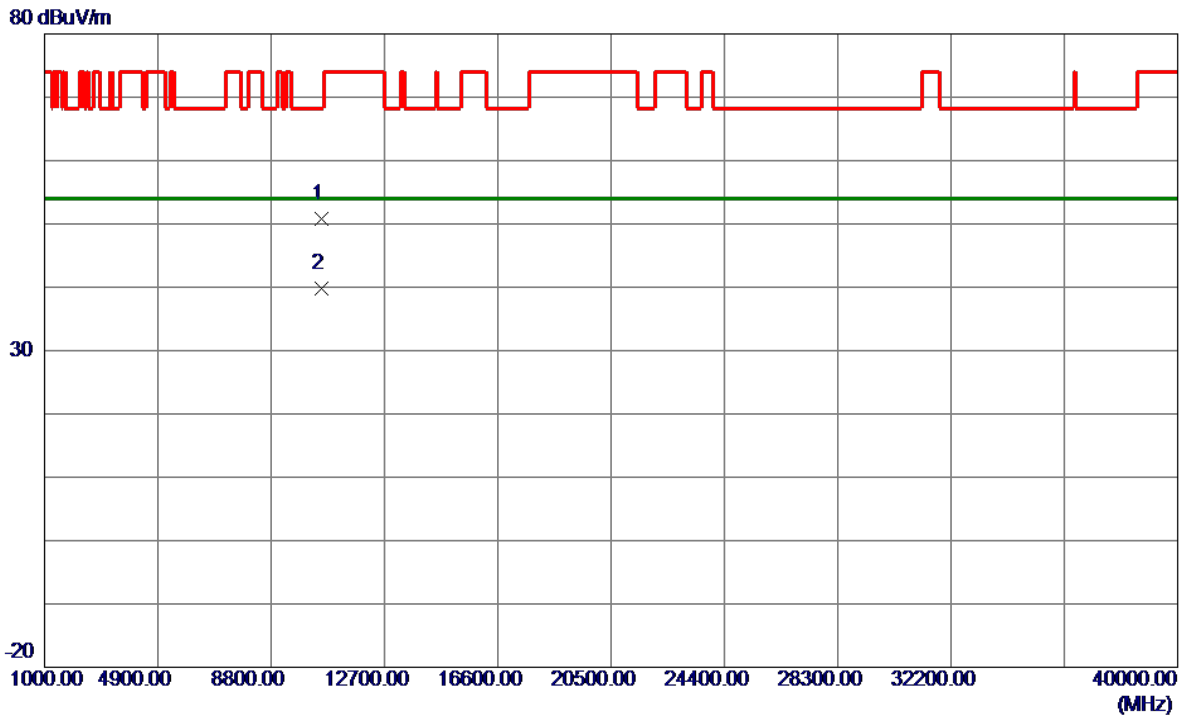

No.	Freq. MHz	Reading Level dBuV/m	Correct Factor dB	Measure ment dBuV/m	Limit dBuV/m	Margin dB	Detector	Comment
1	10516.0400	38.43	12.29	50.72	68.20	-17.48	Peak	
2 *	10516.7000	27.58	12.29	39.87	54.00	-14.13	AVG	

REMARKS:

- (1) Measurement Value = Reading Level + Correct Factor.
- (2) Margin Level = Measurement Value - Limit Value.

Test Mode	UNII-2A_TX A Mode 5300 MHz	Polarization	Vertical
-----------	----------------------------	--------------	----------

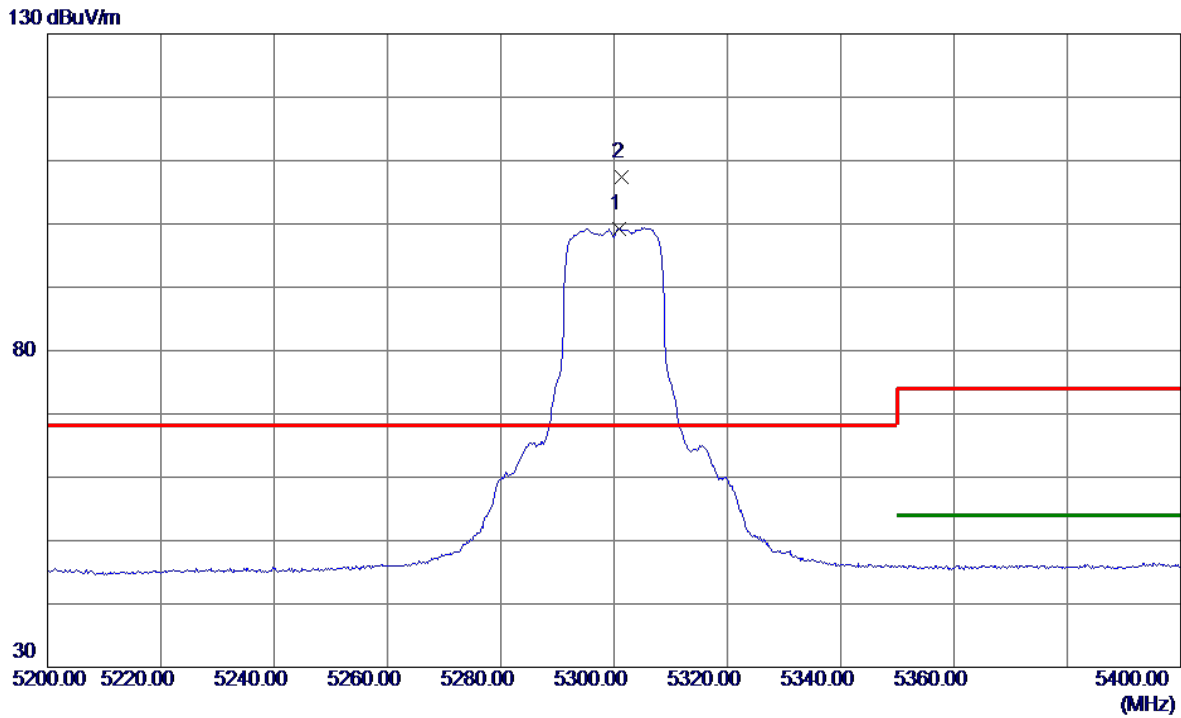

No.	Freq. MHz	Reading Level dBuV/m	Correct Factor dB	Measurement dBuV/m	Limit dBuV/m	Margin dB	Detector	Comment
1	5300.8000	83.50	15.79	99.29	999.00	-899.71	AVG	No Limit
2 *	5301.4000	91.55	15.79	107.34	68.20	39.14	Peak	No Limit

REMARKS:

- (1) Measurement Value = Reading Level + Correct Factor.
- (2) Margin Level = Measurement Value - Limit Value.

Test Mode	UNII-2A_TX A Mode 5300 MHz	Polarization	Vertical
-----------	----------------------------	--------------	----------

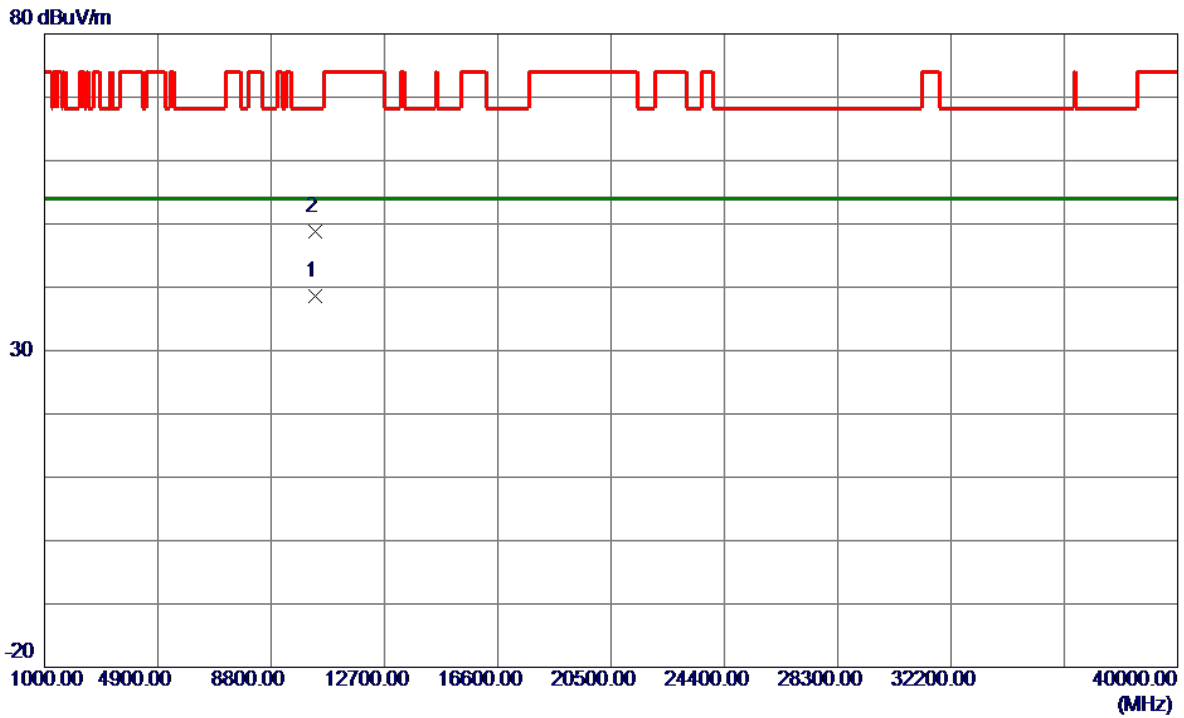

No.	Freq. MHz	Reading Level dBuV/m	Correct Factor dB	Measure ment dBuV/m	Limit dBuV/m	Margin dB	Detector	Comment
1 *	10295.2699	26.56	12.06	38.62	54.00	-15.38	AVG	
2	10299.3600	36.73	12.07	48.80	68.20	-19.40	Peak	

REMARKS:

- (1) Measurement Value = Reading Level + Correct Factor.
- (2) Margin Level = Measurement Value - Limit Value.

Test Mode	UNII-2A_TX A Mode 5320 MHz	Polarization	Vertical
-----------	----------------------------	--------------	----------

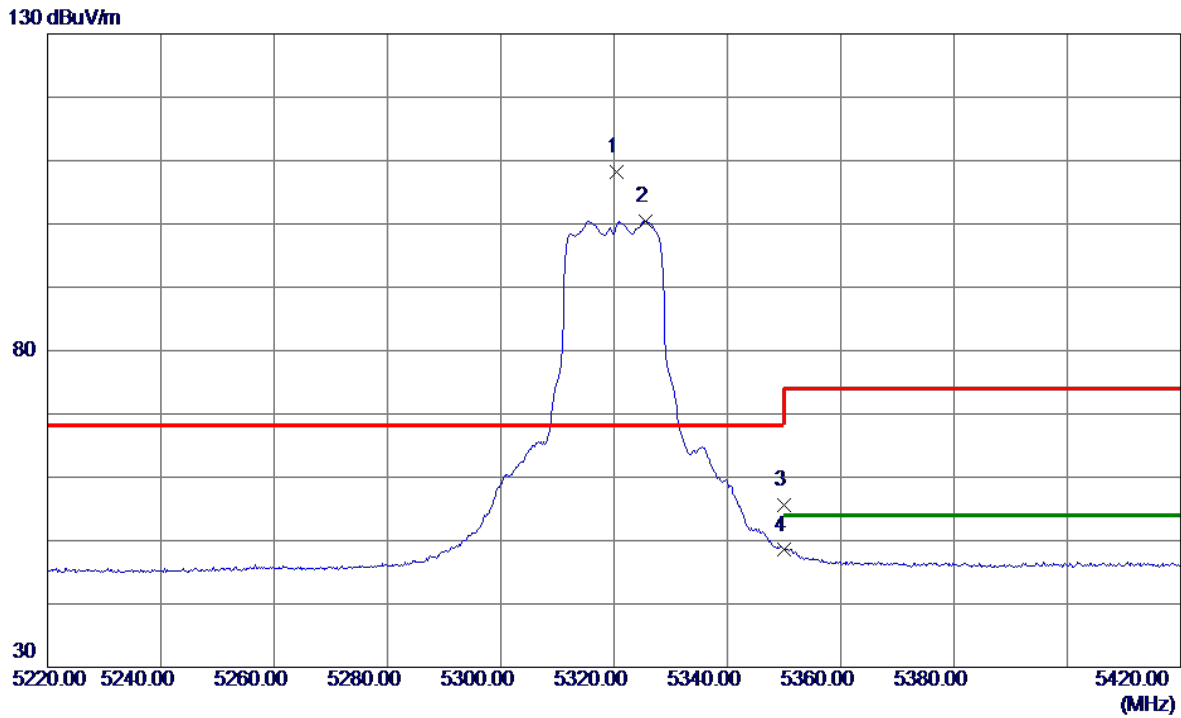

No.	Freq. MHz	Reading Level dBuV/m	Correct Factor dB	Measure ment dBuV/m	Limit dBuV/m	Margin dB	Detector	Comment
1 *	5320.4000	92.31	15.82	108.13	68.20	39.93	Peak	No Limit
2	5325.6000	84.63	15.83	100.46	999.00	-898.54	AVG	No Limit
3	5350.0000	39.67	15.87	55.54	74.00	-18.46	Peak	
4	5350.0000	32.63	15.87	48.50	54.00	-5.50	AVG	

REMARKS:

- (1) Measurement Value = Reading Level + Correct Factor.
- (2) Margin Level = Measurement Value - Limit Value.

Test Mode	UNII-2A_TX A Mode 5320 MHz	Polarization	Vertical
-----------	----------------------------	--------------	----------

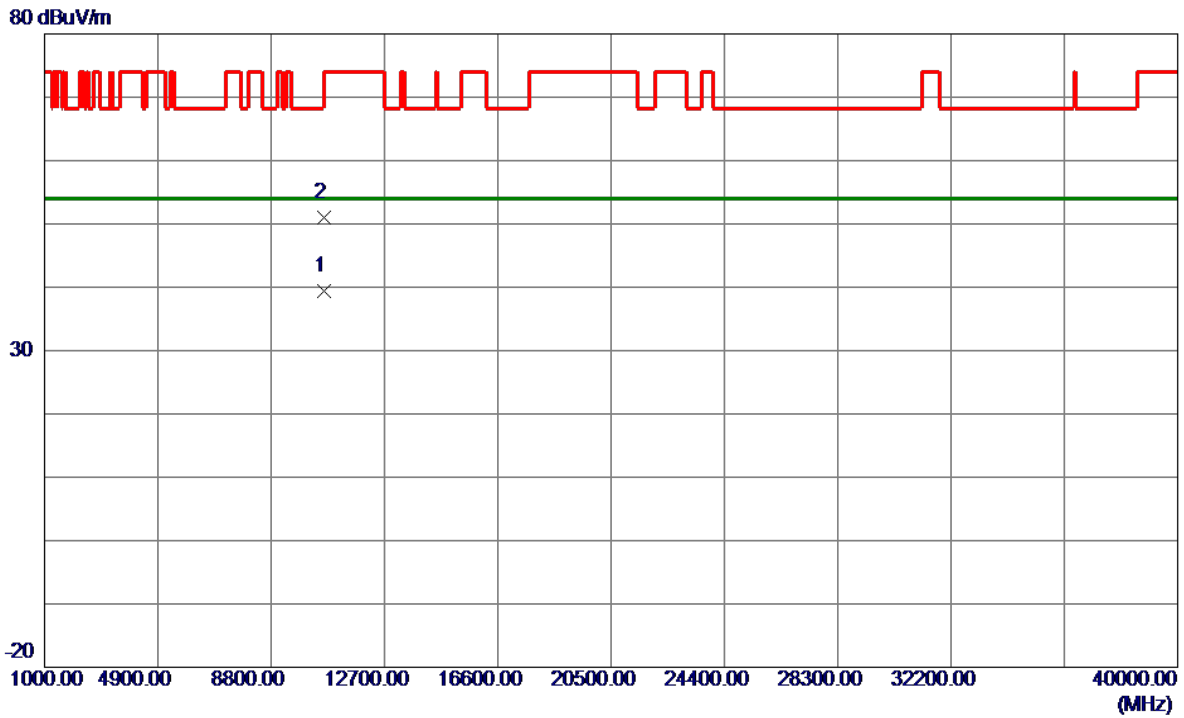

No.	Freq. MHz	Reading Level dBuV/m	Correct Factor dB	Measure ment dBuV/m	Limit dBuV/m	Margin dB	Detector	Comment
1 *	10636.0500	27.08	12.41	39.49	54.00	-14.51	AVG	
2	10641.2600	38.60	12.42	51.02	74.00	-22.98	Peak	

REMARKS:

- (1) Measurement Value = Reading Level + Correct Factor.
- (2) Margin Level = Measurement Value - Limit Value.

Test Mode	UNII-2A_TX AC(VHT20) Mode 5260 MHz	Polarization	Vertical
-----------	------------------------------------	--------------	----------

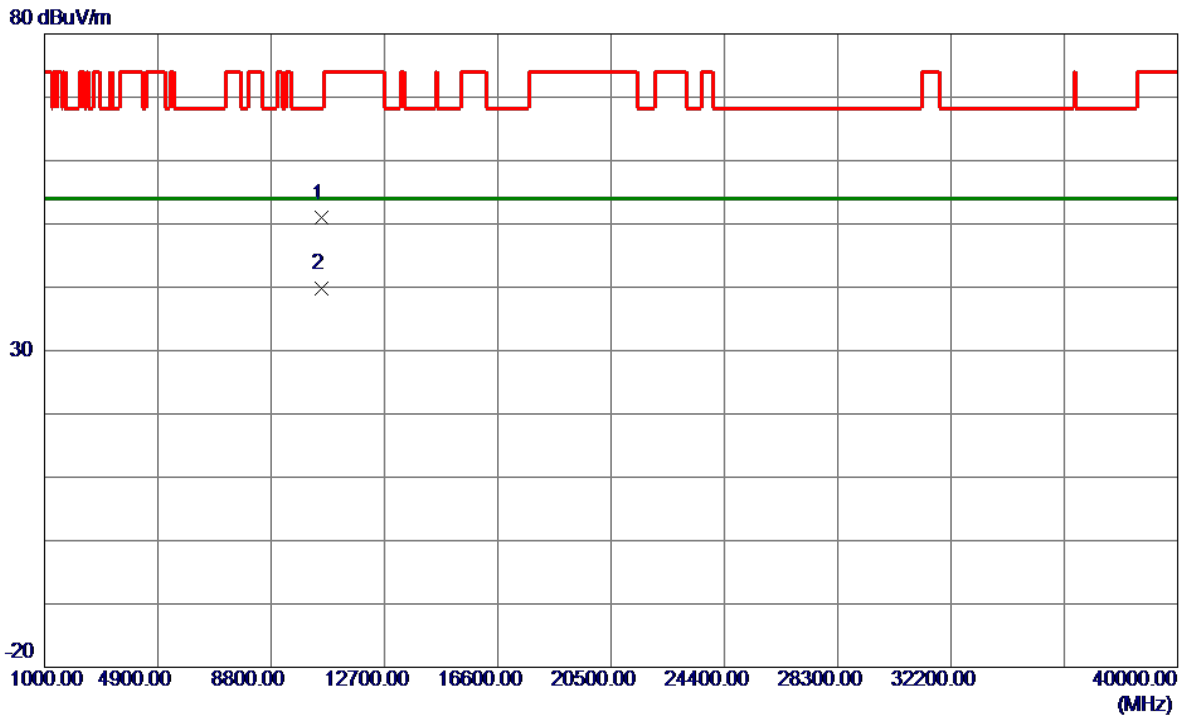

No.	Freq. MHz	Reading Level dBuV/m	Correct Factor dB	Measure ment dBuV/m	Limit dBuV/m	Margin dB	Detector	Comment
1	10521.8900	38.60	12.30	50.90	68.20	-17.30	Peak	
2 *	10524.6300	27.59	12.30	39.89	54.00	-14.11	AVG	

REMARKS:

- (1) Measurement Value = Reading Level + Correct Factor.
- (2) Margin Level = Measurement Value - Limit Value.

Test Mode	UNII-2A_TX AC(VHT20) Mode 5300 MHz	Polarization	Vertical
-----------	------------------------------------	--------------	----------

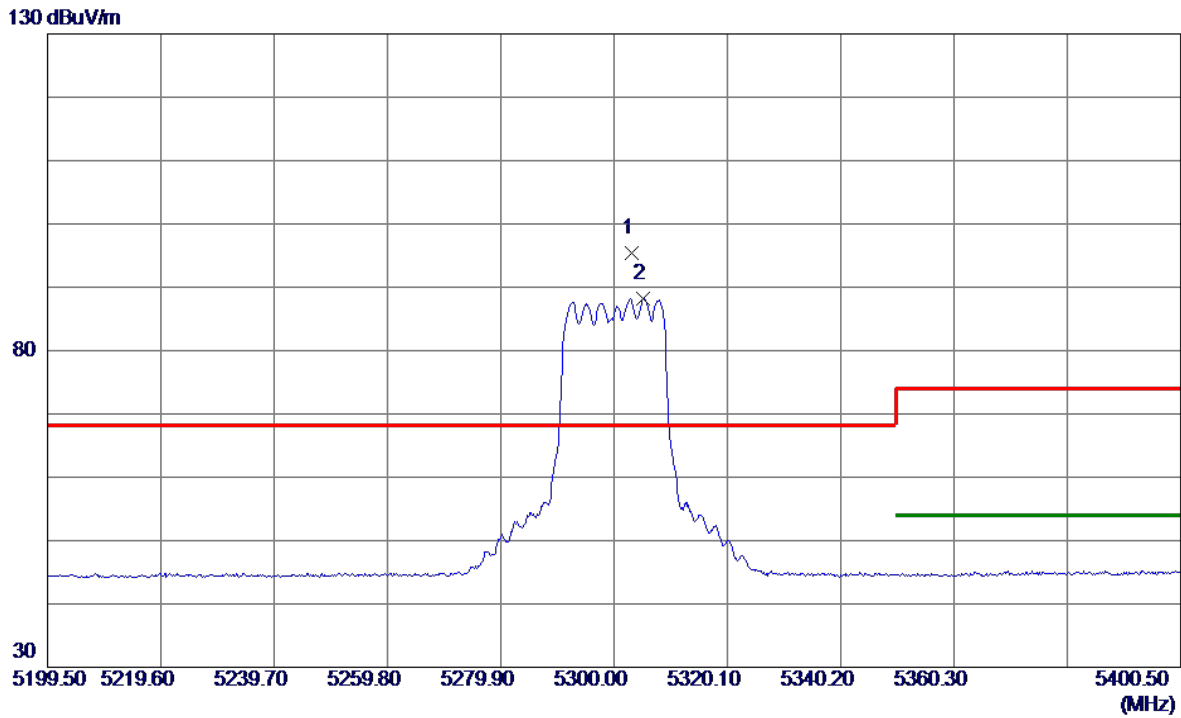

No.	Freq. MHz	Reading Level dBuV/m	Correct Factor dB	Measure ment dBuV/m	Limit dBuV/m	Margin dB	Detector	Comment
1 *	5303.0150	79.59	15.79	95.38	68.20	27.18	Peak	No Limit
2	5305.2260	72.34	15.79	88.13	999.00	-910.87	AVG	No Limit

REMARKS:

- (1) Measurement Value = Reading Level + Correct Factor.
- (2) Margin Level = Measurement Value - Limit Value.

Test Mode	UNII-2A_TX AC(VHT20) Mode 5300 MHz	Polarization	Vertical
-----------	------------------------------------	--------------	----------

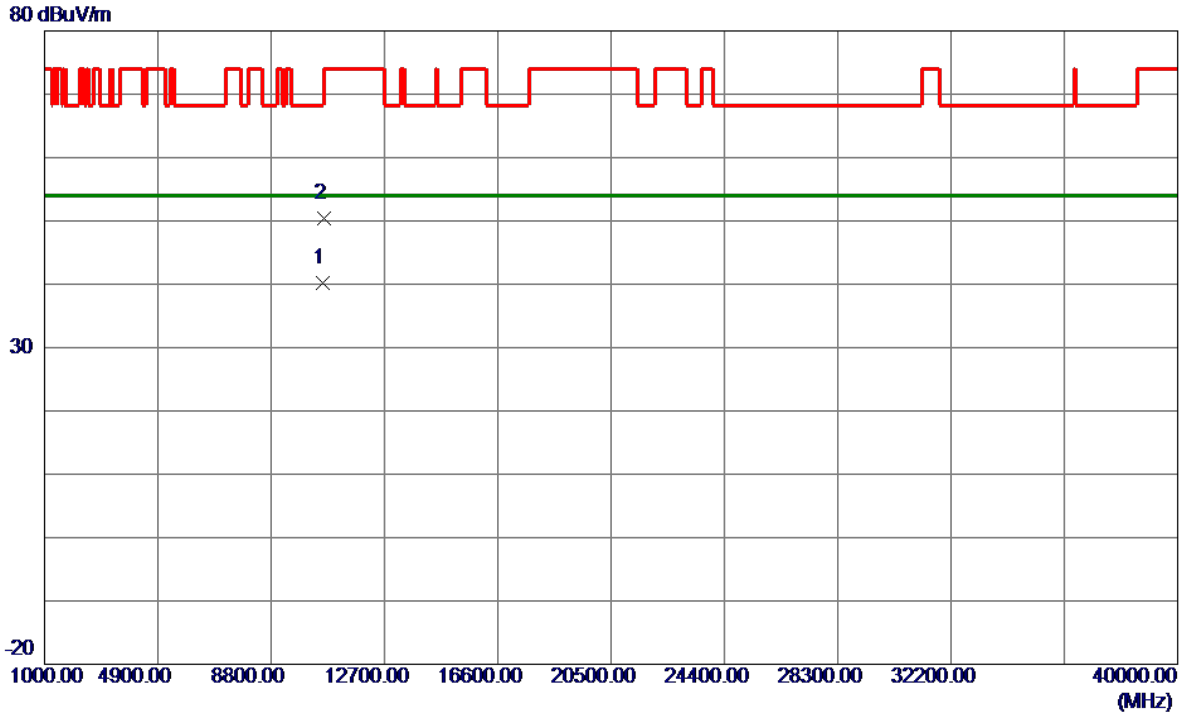

No.	Freq. MHz	Reading Level dBuV/m	Correct Factor dB	Measure ment dBuV/m	Limit dBuV/m	Margin dB	Detector	Comment
1 *	10597.7300	27.82	12.37	40.19	54.00	-13.81	AVG	
2	10600.1700	38.02	12.38	50.40	74.00	-23.60	Peak	

REMARKS:

- (1) Measurement Value = Reading Level + Correct Factor.
- (2) Margin Level = Measurement Value - Limit Value.

Test Mode	UNII-2A_TX AC(VHT20) Mode 5320 MHz	Polarization	Vertical
-----------	------------------------------------	--------------	----------

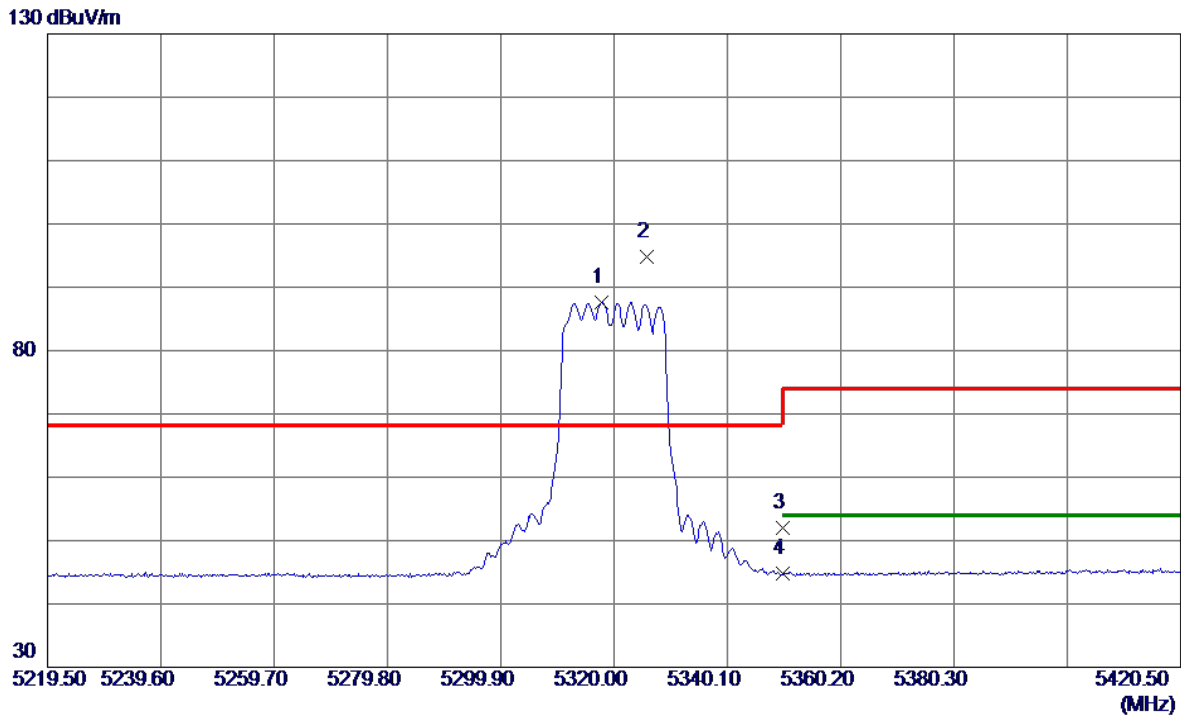

No.	Freq. MHz	Reading Level dBuV/m	Correct Factor dB	Measure ment dBuV/m	Limit dBuV/m	Margin dB	Detector	Comment
1	5317.7890	71.88	15.81	87.69	999.00	-911.31	AVG	No Limit
2 *	5325.8290	79.05	15.83	94.88	68.20	26.68	Peak	No Limit
3	5350.0000	36.10	15.87	51.97	74.00	-22.03	Peak	
4	5350.0000	28.85	15.87	44.72	54.00	-9.28	AVG	

REMARKS:

- (1) Measurement Value = Reading Level + Correct Factor.
- (2) Margin Level = Measurement Value - Limit Value.

Test Mode	UNII-2A_TX AC(VHT20) Mode 5320 MHz	Polarization	Vertical
-----------	------------------------------------	--------------	----------

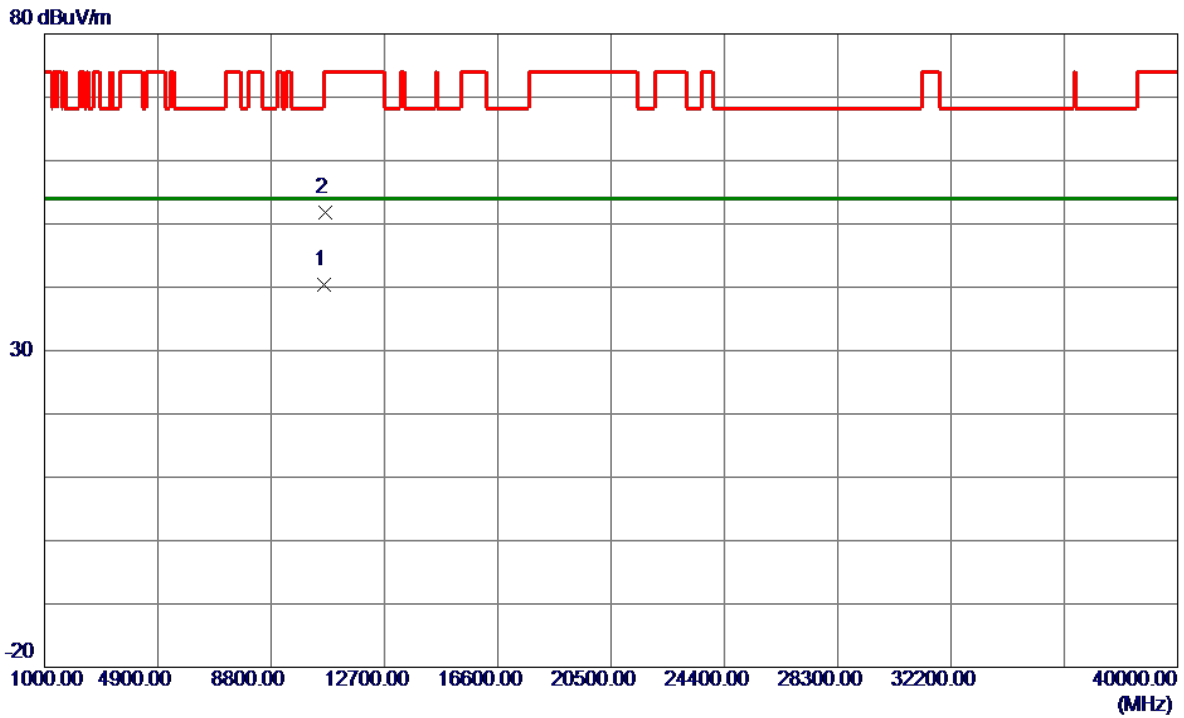

No.	Freq. MHz	Reading Level dBuV/m	Correct Factor dB	Measure ment dBuV/m	Limit dBuV/m	Margin dB	Detector	Comment
1 *	10641.2000	27.93	12.42	40.35	54.00	-13.65	AVG	
2	10644.4200	39.36	12.42	51.78	74.00	-22.22	Peak	

REMARKS:

- (1) Measurement Value = Reading Level + Correct Factor.
- (2) Margin Level = Measurement Value - Limit Value.

Test Mode	UNII-2A_TX AC(VHT40) Mode 5270 MHz	Polarization	Vertical
-----------	------------------------------------	--------------	----------

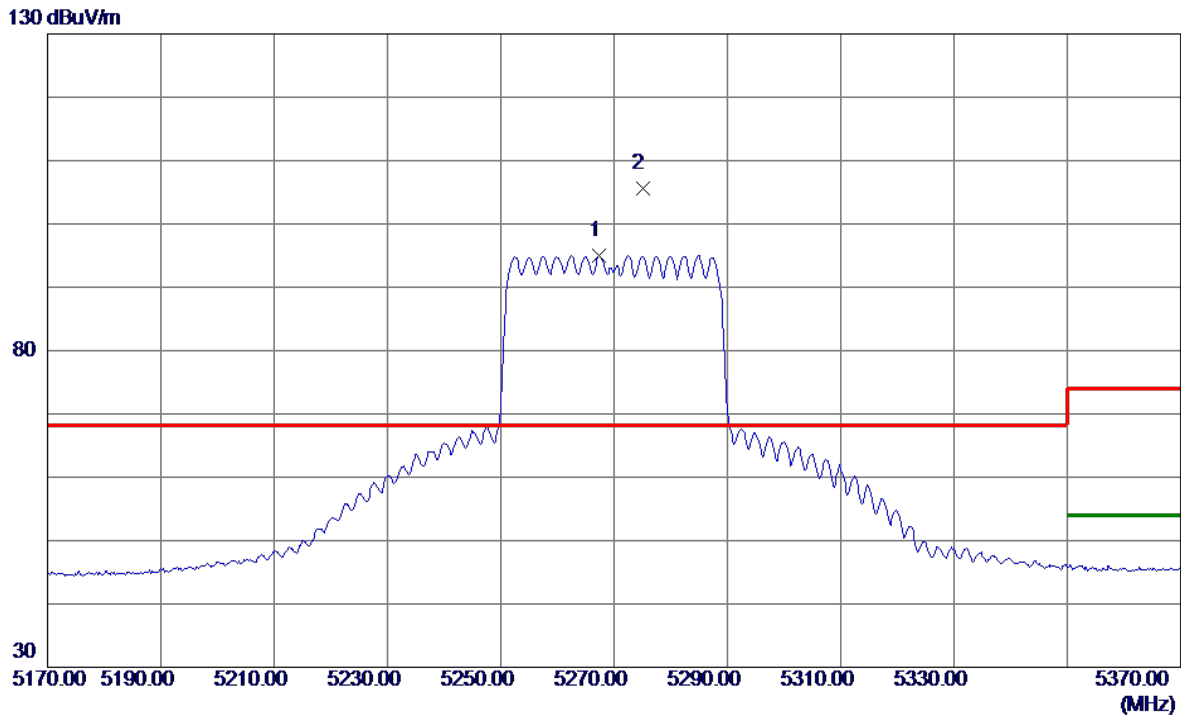

No.	Freq. MHz	Reading Level dBuV/m	Correct Factor dB	Measure ment dBuV/m	Limit dBuV/m	Margin dB	Detector	Comment
1	5267.4000	79.21	15.73	94.94	999.00	-904.06	AVG	No Limit
2 *	5275.0000	89.86	15.74	105.60	68.20	37.40	Peak	No Limit

REMARKS:

- (1) Measurement Value = Reading Level + Correct Factor.
- (2) Margin Level = Measurement Value - Limit Value.

Test Mode	UNII-2A_TX AC(VHT40) Mode 5270 MHz	Polarization	Vertical
-----------	------------------------------------	--------------	----------

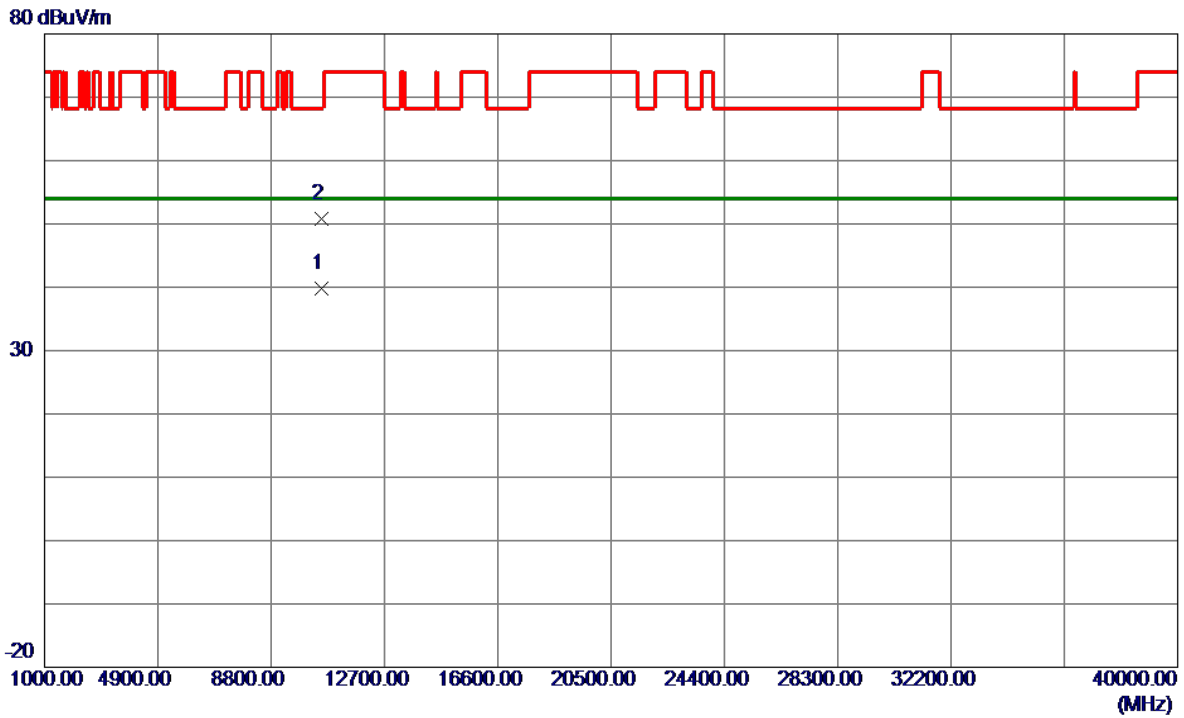

No.	Freq. MHz	Reading Level dBuV/m	Correct Factor dB	Measure ment dBuV/m	Limit dBuV/m	Margin dB	Detector	Comment
1 *	10541.8800	27.41	12.32	39.73	54.00	-14.27	AVG	
2	10544.9100	38.54	12.32	50.86	68.20	-17.34	Peak	

REMARKS:

- (1) Measurement Value = Reading Level + Correct Factor.
- (2) Margin Level = Measurement Value - Limit Value.

Test Mode	UNII-2A_TX AC(VHT40) Mode 5310 MHz	Polarization	Vertical
-----------	------------------------------------	--------------	----------

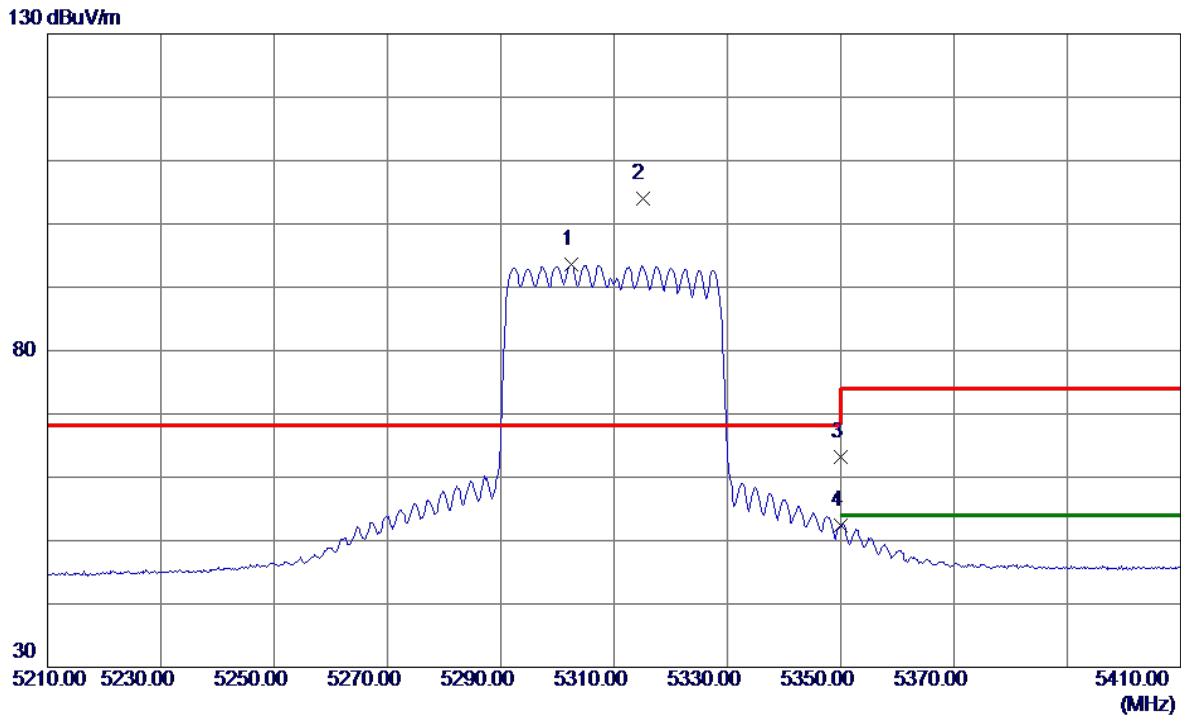

No.	Freq. MHz	Reading Level dBuV/m	Correct Factor dB	Measure ment dBuV/m	Limit dBuV/m	Margin dB	Detector	Comment
1	5302.4000	77.76	15.79	93.55	999.00	-905.45	AVG	No Limit
2 *	5315.0000	88.13	15.81	103.94	68.20	35.74	Peak	No Limit
3	5350.0000	47.24	15.87	63.11	74.00	-10.89	Peak	
4	5350.0000	36.54	15.87	52.41	54.00	-1.59	AVG	

REMARKS:

- (1) Measurement Value = Reading Level + Correct Factor.
- (2) Margin Level = Measurement Value - Limit Value.

Test Mode	UNII-2A_TX AC(VHT40) Mode 5310 MHz	Polarization	Vertical
-----------	------------------------------------	--------------	----------

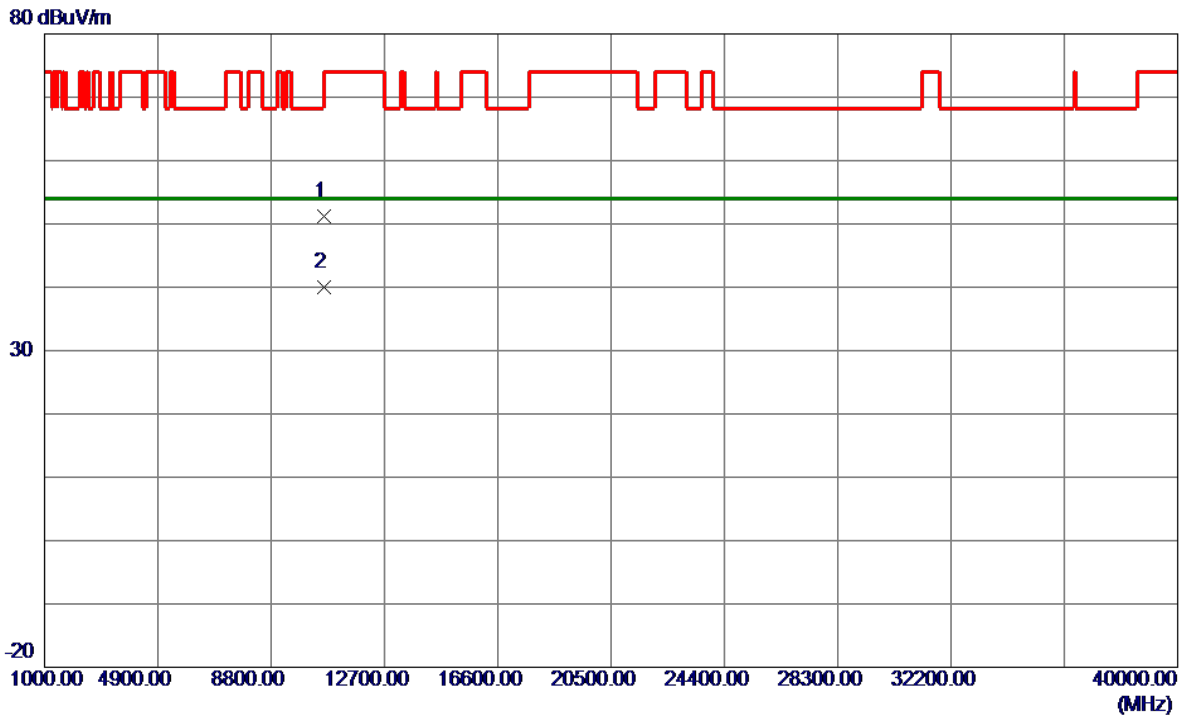

No.	Freq. MHz	Reading Level dBuV/m	Correct Factor dB	Measure ment dBuV/m	Limit dBuV/m	Margin dB	Detector	Comment
1	10616.1200	38.73	12.39	51.12	74.00	-22.88	Peak	
2 *	10624.0100	27.66	12.40	40.06	54.00	-13.94	AVG	

REMARKS:

- (1) Measurement Value = Reading Level + Correct Factor.
- (2) Margin Level = Measurement Value - Limit Value.

Test Mode	UNII-2A_TX AC(VHT80) Mode 5290 MHz	Polarization	Vertical
-----------	------------------------------------	--------------	----------

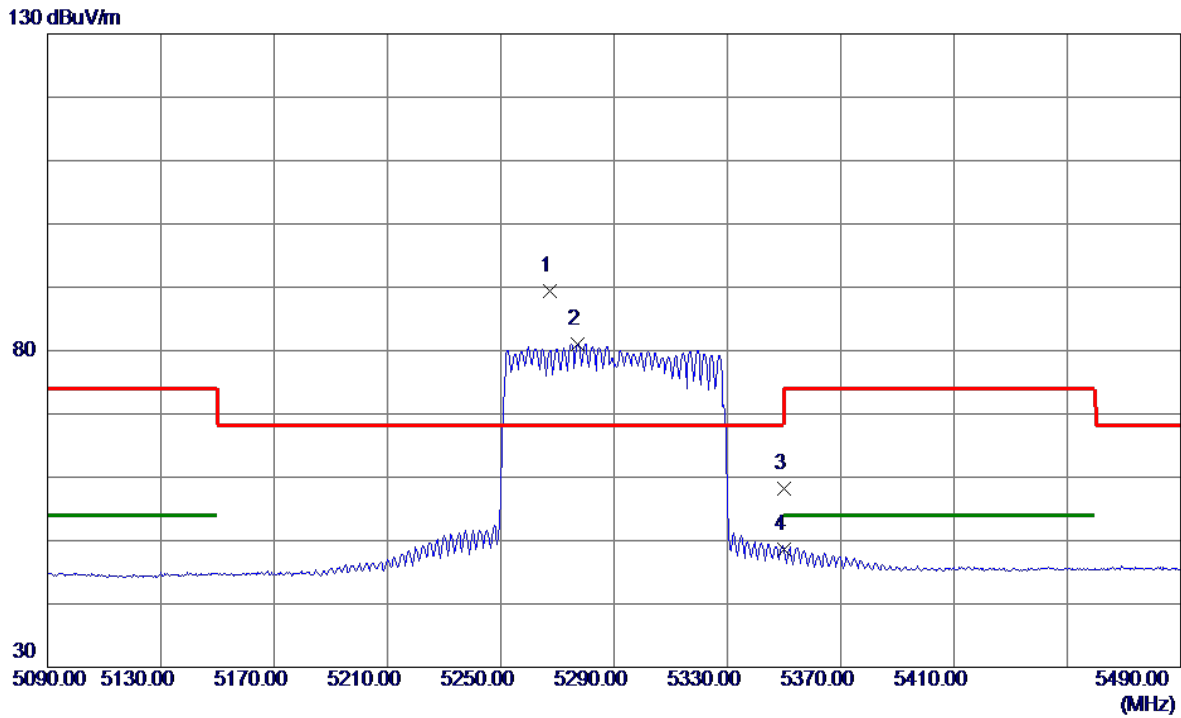

No.	Freq. MHz	Reading Level dBuV/m	Correct Factor dB	Measure ment dBuV/m	Limit dBuV/m	Margin dB	Detector	Comment
1 *	5267.2000	73.75	15.73	89.48	68.20	21.28	Peak	No Limit
2	5277.2000	65.27	15.75	81.02	999.00	-917.98	AVG	No Limit
3	5350.0000	42.38	15.87	58.25	74.00	-15.75	Peak	
4	5350.0000	32.72	15.87	48.59	54.00	-5.41	AVG	

REMARKS:

- (1) Measurement Value = Reading Level + Correct Factor.
- (2) Margin Level = Measurement Value - Limit Value.

Test Mode	UNII-2A_TX AC(VHT80) Mode 5290 MHz	Polarization	Vertical
-----------	------------------------------------	--------------	----------

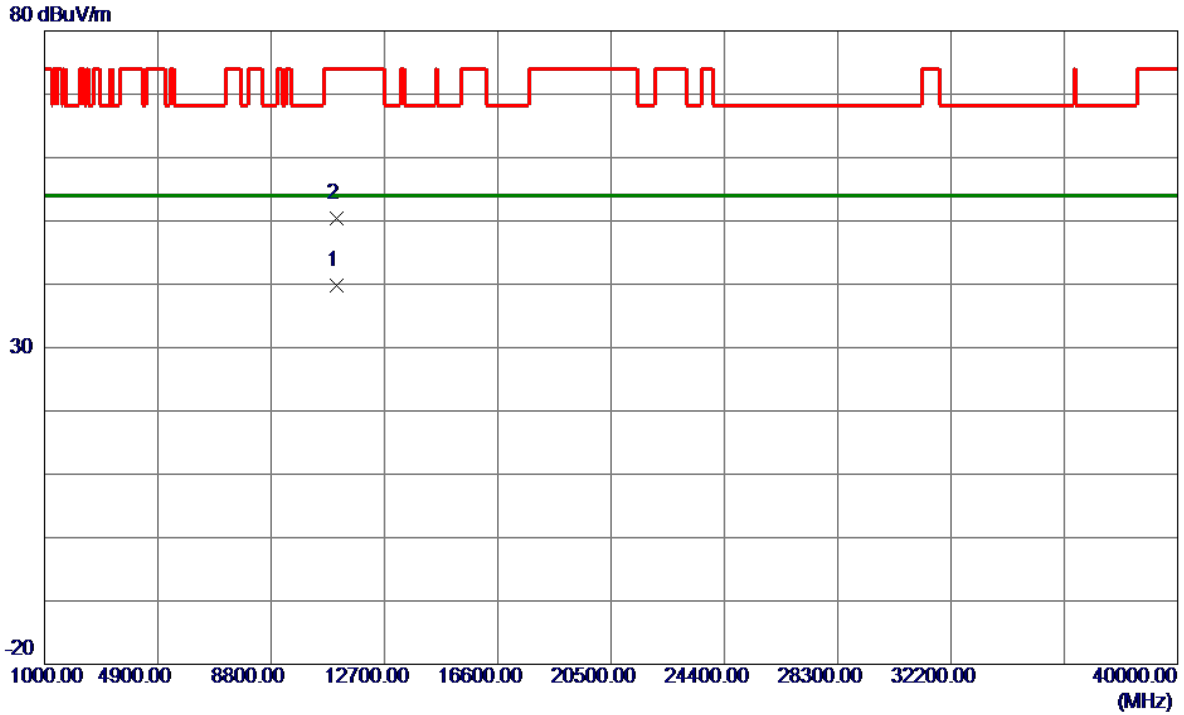

No.	Freq. MHz	Reading Level dBuV/m	Correct Factor dB	Measure ment dBuV/m	Limit dBuV/m	Margin dB	Detector	Comment
1 *	11057.1300	27.01	12.85	39.86	54.00	-14.14	AVG	
2	11058.8400	37.64	12.85	50.49	74.00	-23.51	Peak	

REMARKS:

- (1) Measurement Value = Reading Level + Correct Factor.
- (2) Margin Level = Measurement Value - Limit Value.

Test Mode	UNII-2A_TX AX(HE20) Mode 5260 MHz	Polarization	Vertical
-----------	-----------------------------------	--------------	----------

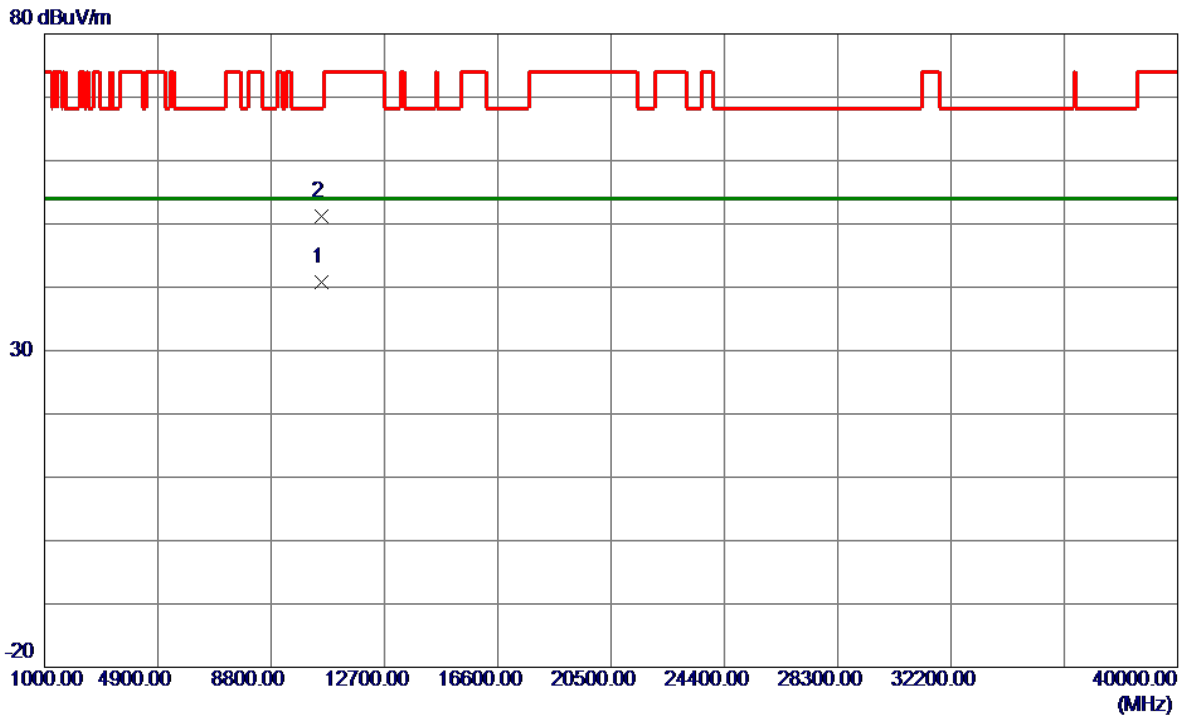

No.	Freq. MHz	Reading Level dBuV/m	Correct Factor dB	Measure ment dBuV/m	Limit dBuV/m	Margin dB	Detector	Comment
1 *	10518.6600	28.45	12.29	40.74	54.00	-13.26	AVG	
2	10524.9600	38.95	12.30	51.25	68.20	-16.95	Peak	

REMARKS:

- (1) Measurement Value = Reading Level + Correct Factor.
- (2) Margin Level = Measurement Value - Limit Value.

Test Mode	UNII-2A_TX AX(HE20) Mode 5300 MHz	Polarization	Vertical
-----------	-----------------------------------	--------------	----------

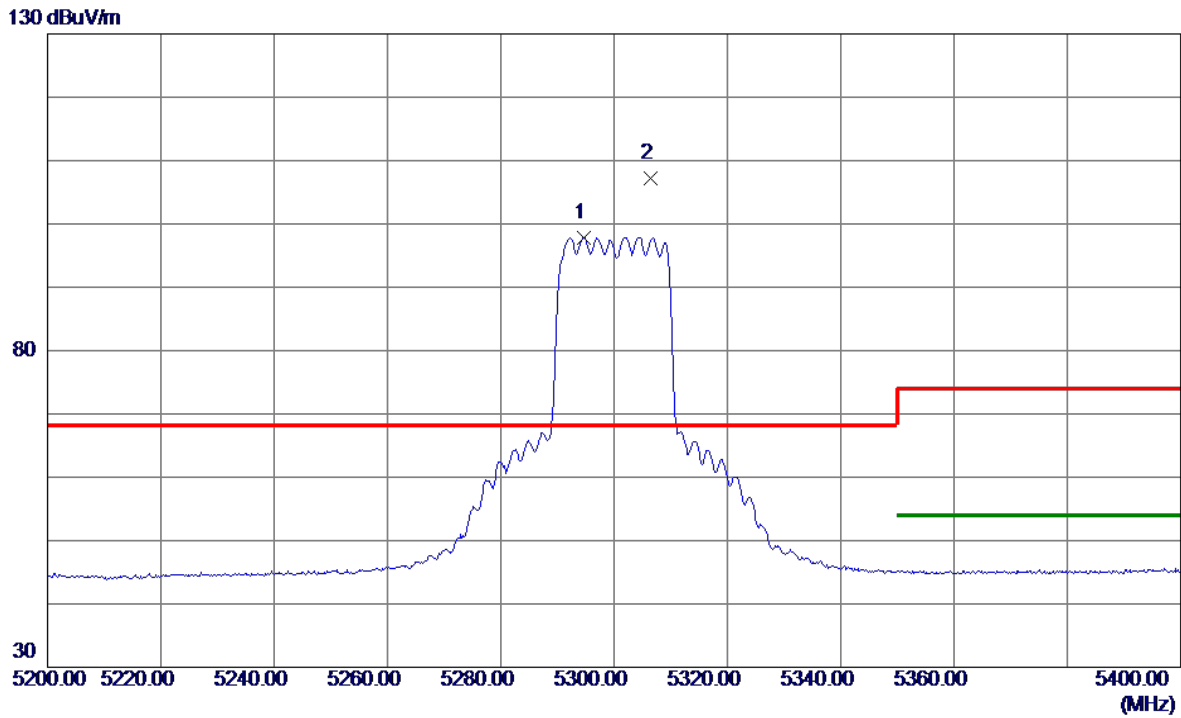

No.	Freq. MHz	Reading Level dBuV/m	Correct Factor dB	Measure ment dBuV/m	Limit dBuV/m	Margin dB	Detector	Comment
1	5294.6000	82.54	15.35	97.89	999.00	-901.11	AVG	No Limit
2 *	5306.4000	91.74	15.37	107.11	68.20	38.91	Peak	No Limit

REMARKS:

- (1) Measurement Value = Reading Level + Correct Factor.
- (2) Margin Level = Measurement Value - Limit Value.

Test Mode	UNII-2A_TX AX(HE20) Mode 5300 MHz	Polarization	Vertical
-----------	-----------------------------------	--------------	----------

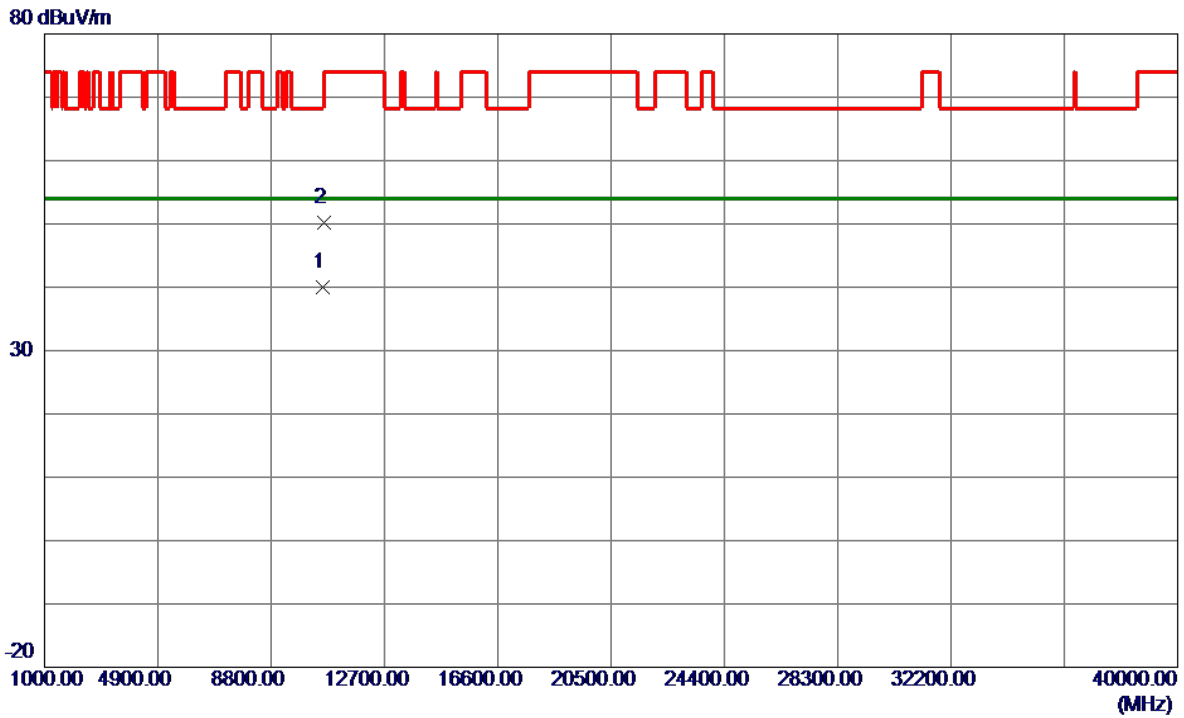

No.	Freq. MHz	Reading Level dBuV/m	Correct Factor dB	Measure ment dBuV/m	Limit dBuV/m	Margin dB	Detector	Comment
1 *	10595.8600	27.63	12.37	40.00	54.00	-14.00	AVG	
2	10604.5700	37.85	12.38	50.23	74.00	-23.77	Peak	

REMARKS:

- (1) Measurement Value = Reading Level + Correct Factor.
- (2) Margin Level = Measurement Value - Limit Value.

Test Mode	UNII-2A_TX AX(HE20) Mode 5320 MHz	Polarization	Vertical
-----------	-----------------------------------	--------------	----------

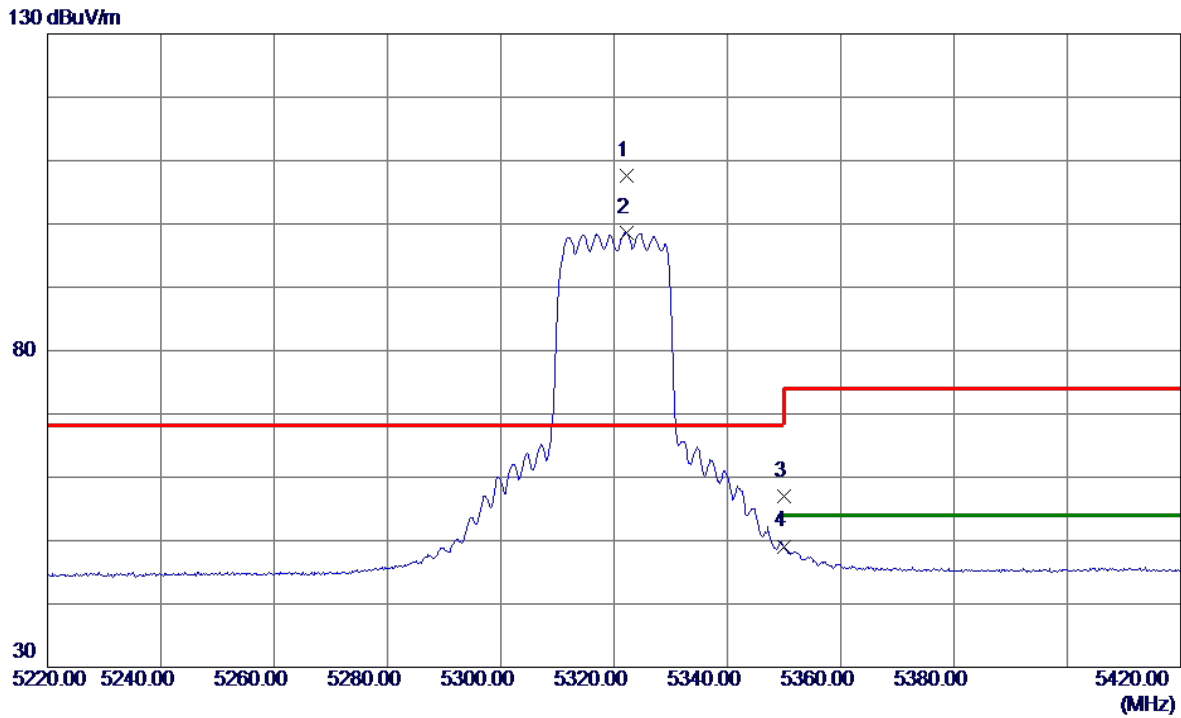

No.	Freq. MHz	Reading Level dBuV/m	Correct Factor dB	Measure ment dBuV/m	Limit dBuV/m	Margin dB	Detector	Comment
1 *	5322.2000	92.16	15.40	107.56	68.20	39.36	Peak	No Limit
2	5322.2000	83.16	15.40	98.56	999.00	-900.44	AVG	No Limit
3	5350.0000	41.61	15.46	57.07	74.00	-16.93	Peak	
4	5350.0000	33.64	15.46	49.10	54.00	-4.90	AVG	

REMARKS:

- (1) Measurement Value = Reading Level + Correct Factor.
- (2) Margin Level = Measurement Value - Limit Value.

Test Mode	UNII-2A_TX AX(HE20) Mode 5320 MHz	Polarization	Vertical
-----------	-----------------------------------	--------------	----------

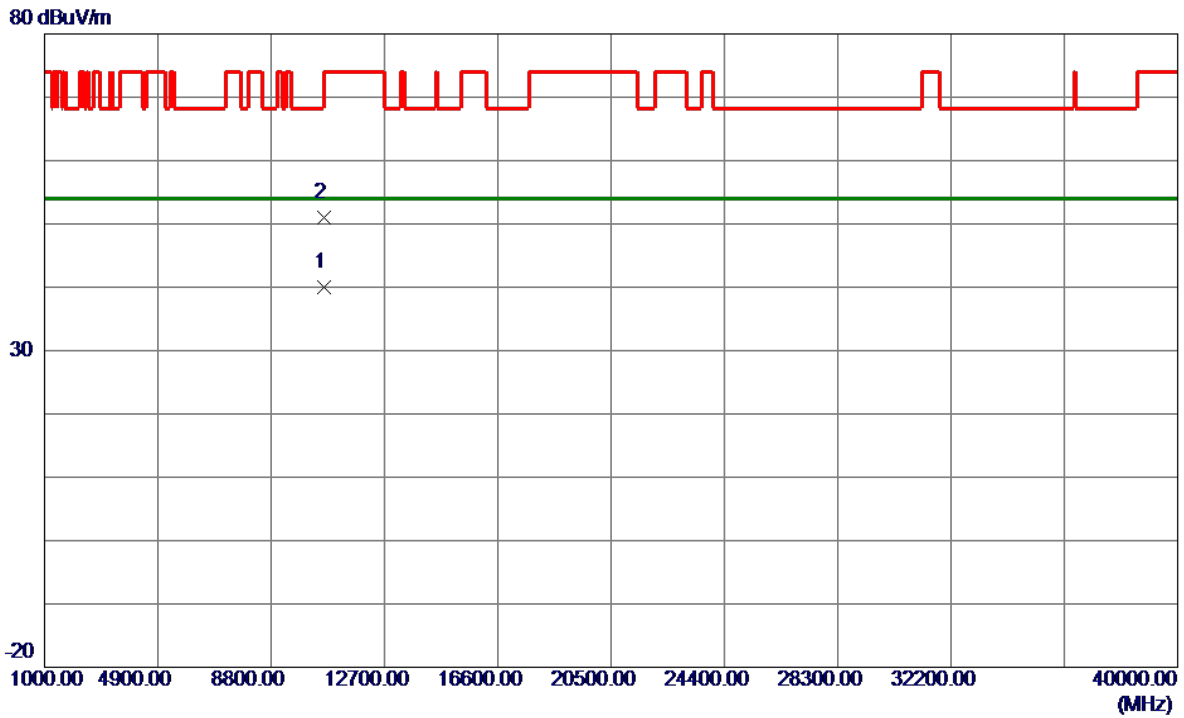

No.	Freq. MHz	Reading Level dBuV/m	Correct Factor dB	Measure ment dBuV/m	Limit dBuV/m	Margin dB	Detector	Comment
1 *	10635.0199	27.58	12.41	39.99	54.00	-14.01	AVG	
2	10635.2100	38.51	12.41	50.92	74.00	-23.08	Peak	

REMARKS:

- (1) Measurement Value = Reading Level + Correct Factor.
- (2) Margin Level = Measurement Value - Limit Value.

Test Mode	UNII-2A_TX AX(HE40) Mode 5270 MHz	Polarization	Vertical
-----------	-----------------------------------	--------------	----------

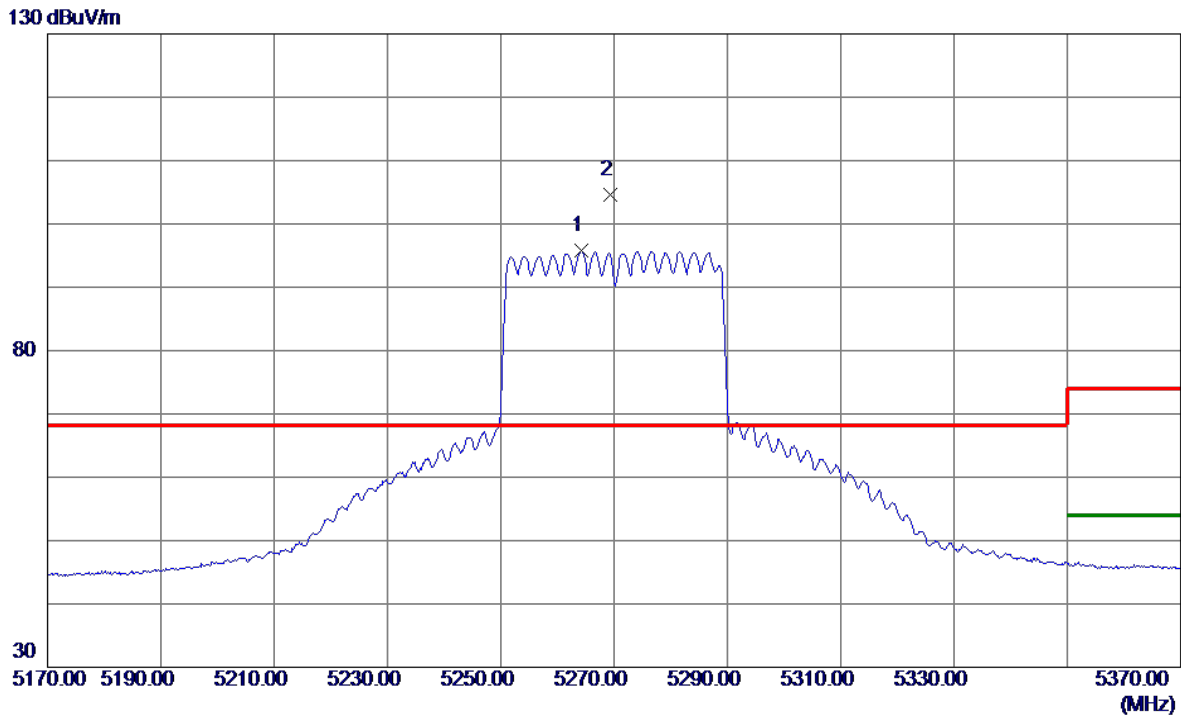

No.	Freq. MHz	Reading Level dBuV/m	Correct Factor dB	Measure ment dBuV/m	Limit dBuV/m	Margin dB	Detector	Comment
1	5264.2000	80.27	15.44	95.71	999.00	-903.29	AVG	No Limit
2 *	5269.4000	89.12	15.45	104.57	68.20	36.37	Peak	No Limit

REMARKS:

- (1) Measurement Value = Reading Level + Correct Factor.
- (2) Margin Level = Measurement Value - Limit Value.

Test Mode	UNII-2A_TX AX(HE40) Mode 5270 MHz	Polarization	Vertical
-----------	-----------------------------------	--------------	----------

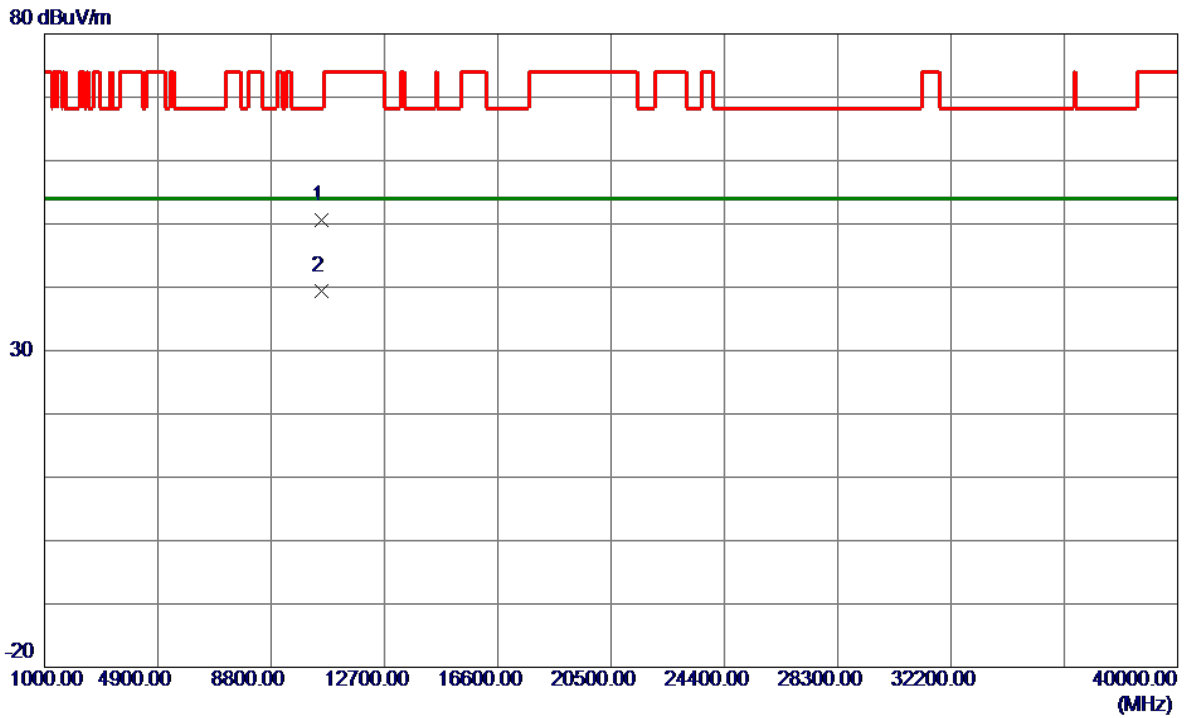

No.	Freq. MHz	Reading Level dBuV/m	Correct Factor dB	Measure ment dBuV/m	Limit dBuV/m	Margin dB	Detector	Comment
1	10542.4700	38.20	12.32	50.52	68.20	-17.68	Peak	
2 *	10543.1100	27.17	12.32	39.49	54.00	-14.51	AVG	

REMARKS:

- (1) Measurement Value = Reading Level + Correct Factor.
- (2) Margin Level = Measurement Value - Limit Value.

Test Mode	UNII-2A_TX AX(HE40) Mode 5310 MHz	Polarization	Vertical
-----------	-----------------------------------	--------------	----------

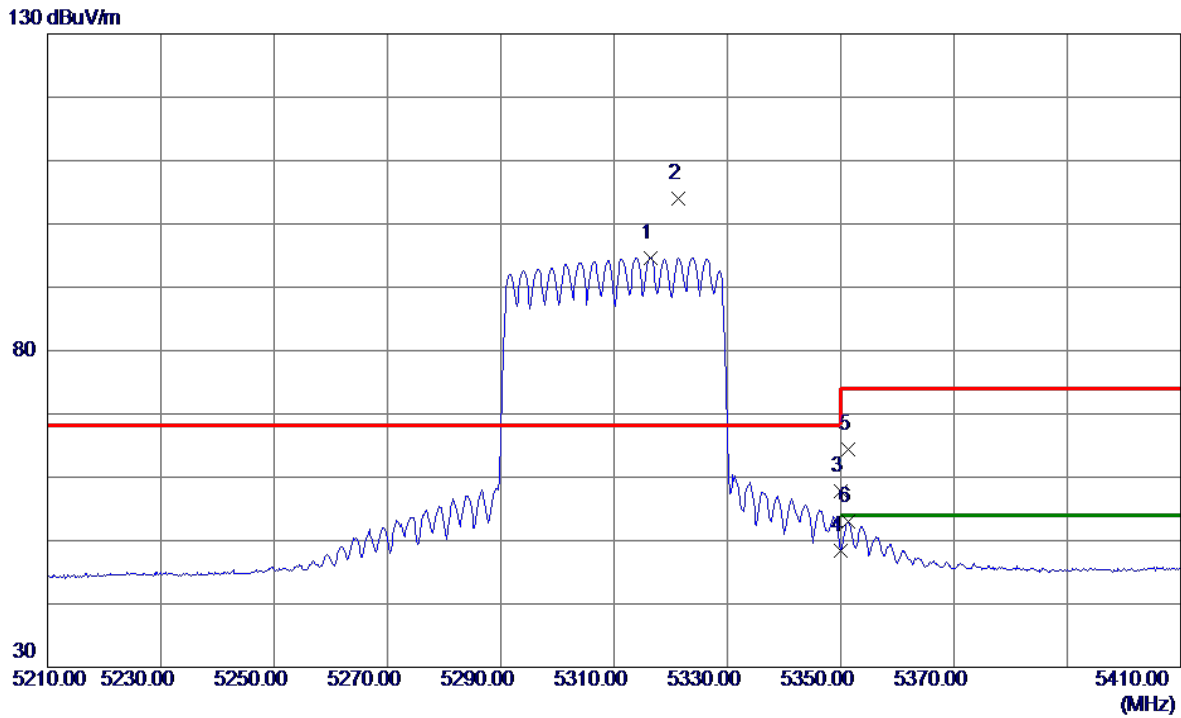

No.	Freq. MHz	Reading Level dBuV/m	Correct Factor dB	Measure ment dBuV/m	Limit dBuV/m	Margin dB	Detector	Comment
1	5316.4000	79.03	15.60	94.63	999.00	-904.37	AVG	No Limit
2 *	5321.4000	88.36	15.61	103.97	68.20	35.77	Peak	No Limit
3	5350.0000	42.11	15.70	57.81	74.00	-16.19	Peak	
4	5350.0000	32.74	15.70	48.44	54.00	-5.56	AVG	
5	5351.4000	48.69	15.71	64.40	74.00	-9.60	Peak	
6	5351.4000	37.31	15.71	53.02	54.00	-0.98	AVG	

REMARKS:

- (1) Measurement Value = Reading Level + Correct Factor.
- (2) Margin Level = Measurement Value - Limit Value.

Test Mode	UNII-2A_TX AX(HE40) Mode 5310 MHz	Polarization	Vertical
-----------	-----------------------------------	--------------	----------

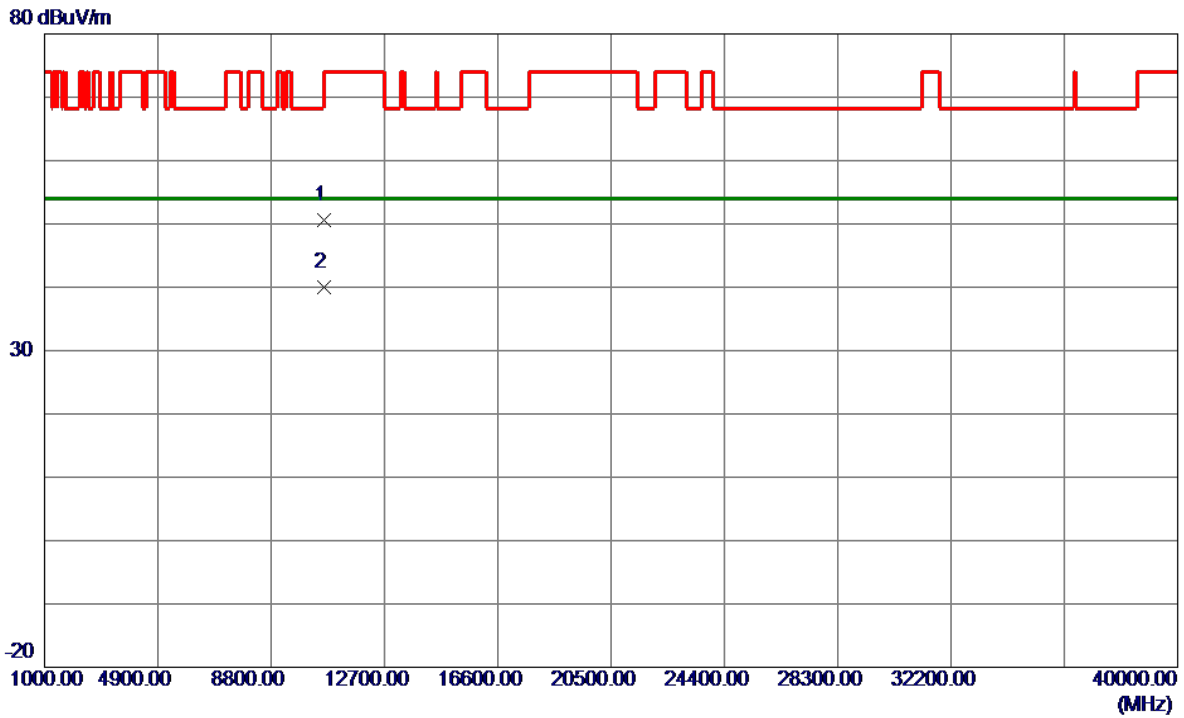

No.	Freq. MHz	Reading Level dBuV/m	Correct Factor dB	Measure ment dBuV/m	Limit dBuV/m	Margin dB	Detector	Comment
1	10617.1700	38.30	12.39	50.69	74.00	-23.31	Peak	
2 *	10624.6600	27.62	12.40	40.02	54.00	-13.98	AVG	

REMARKS:

- (1) Measurement Value = Reading Level + Correct Factor.
- (2) Margin Level = Measurement Value - Limit Value.

Test Mode	UNII-2A_TX AX(HE80) Mode 5290 MHz	Polarization	Vertical
-----------	-----------------------------------	--------------	----------

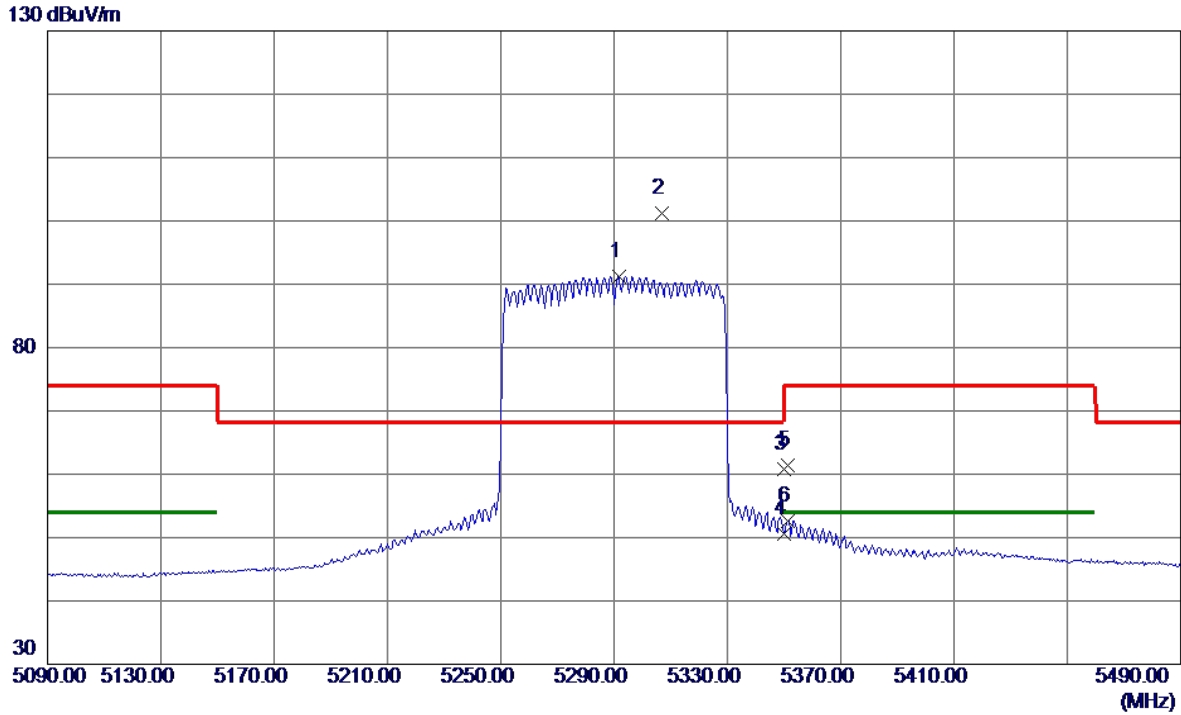

No.	Freq. MHz	Reading Level dBuV/m	Correct Factor dB	Measure ment dBuV/m	Limit dBuV/m	Margin dB	Detector	Comment
1	5291.6000	75.73	15.52	91.25	999.00	-907.75	AVG	No Limit
2 *	5306.8000	85.54	15.57	101.11	68.20	32.91	Peak	No Limit
3	5350.0000	45.10	15.70	60.80	74.00	-13.20	Peak	
4	5350.0000	34.86	15.70	50.56	54.00	-3.44	AVG	
5	5351.2000	45.60	15.71	61.31	74.00	-12.69	Peak	
6	5351.2000	36.95	15.71	52.66	54.00	-1.34	AVG	

REMARKS:

- (1) Measurement Value = Reading Level + Correct Factor.
- (2) Margin Level = Measurement Value - Limit Value.

Test Mode	UNII-2A_TX AX(HE80) Mode 5290 MHz	Polarization	Vertical
-----------	-----------------------------------	--------------	----------

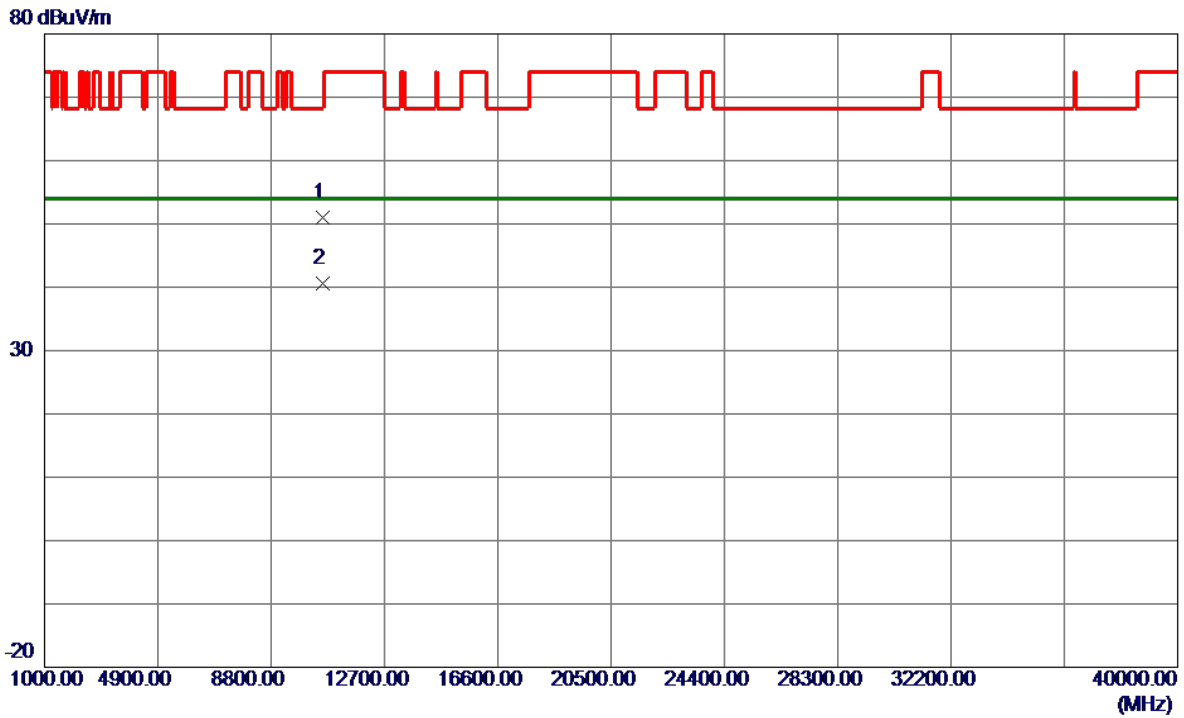

No.	Freq. MHz	Reading Level dBuV/m	Correct Factor dB	Measure ment dBuV/m	Limit dBuV/m	Margin dB	Detector	Comment
1	10577.3500	38.63	12.35	50.98	68.20	-17.22	Peak	
2 *	10579.7100	28.23	12.36	40.59	54.00	-13.41	AVG	

REMARKS:

- (1) Measurement Value = Reading Level + Correct Factor.
- (2) Margin Level = Measurement Value - Limit Value.

Test Mode	UNII-1+UNII-2A_TX AC(VHT160) Mode 5250 MHz	Polarization	Vertical
-----------	--	--------------	----------

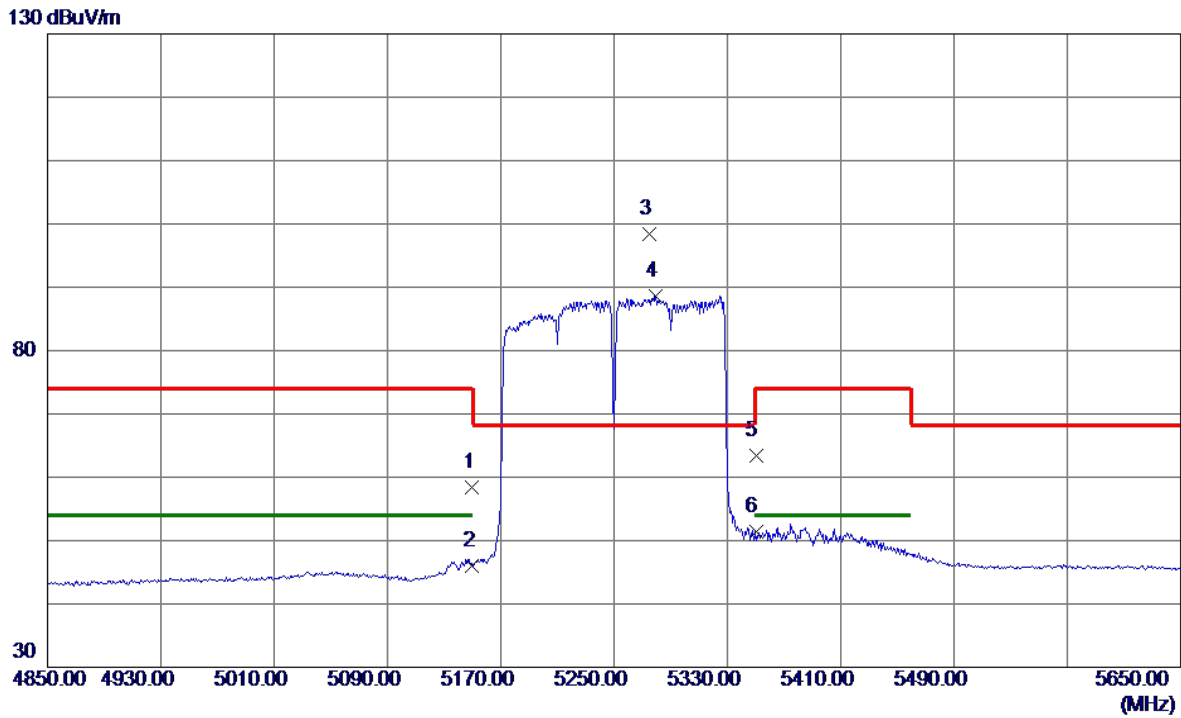

No.	Freq. MHz	Reading Level dBuV/m	Correct Factor dB	Measure ment dBuV/m	Limit dBuV/m	Margin dB	Detector	Comment
1	5150.0000	43.43	15.05	58.48	74.00	-15.52	Peak	
2	5150.0000	30.99	15.05	46.04	54.00	-7.96	AVG	
3 *	5274.8000	83.06	15.31	98.37	68.20	30.17	Peak	No Limit
4	5279.6000	73.24	15.32	88.56	999.00	-910.44	AVG	No Limit
5	5350.0000	47.96	15.46	63.42	74.00	-10.58	Peak	
6	5350.0000	35.88	15.46	51.34	54.00	-2.66	AVG	

REMARKS:

- (1) Measurement Value = Reading Level + Correct Factor.
- (2) Margin Level = Measurement Value - Limit Value.

Test Mode	UNII-1+UNII-2A_TX AC(VHT160) Mode 5250 MHz	Polarization	Vertical
-----------	--	--------------	----------

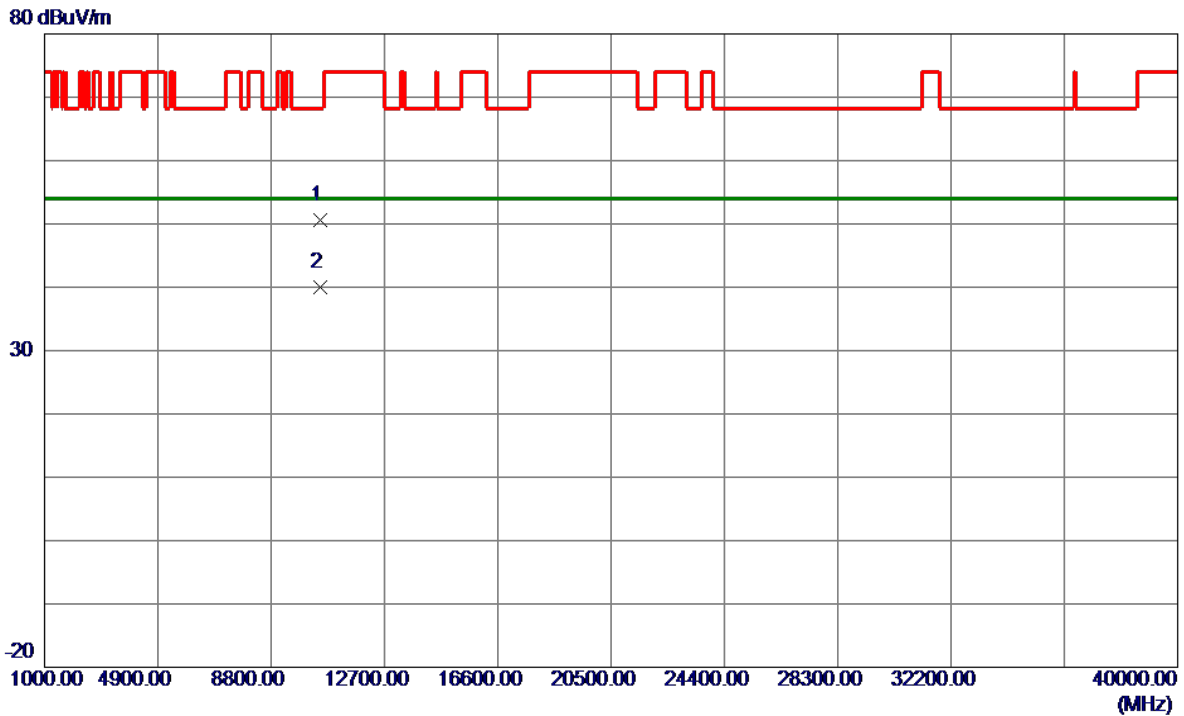

No.	Freq. MHz	Reading Level dBuV/m	Correct Factor dB	Measure ment dBuV/m	Limit dBuV/m	Margin dB	Detector	Comment
1	10502.8800	38.41	12.28	50.69	68.20	-17.51	Peak	
2 *	10504.7699	27.64	12.28	39.92	54.00	-14.08	AVG	

REMARKS:

- (1) Measurement Value = Reading Level + Correct Factor.
- (2) Margin Level = Measurement Value - Limit Value.

Test Mode	UNII-1+UNII-2A_TX AX(HE160) Mode 5250 MHz	Polarization	Vertical
-----------	---	--------------	----------

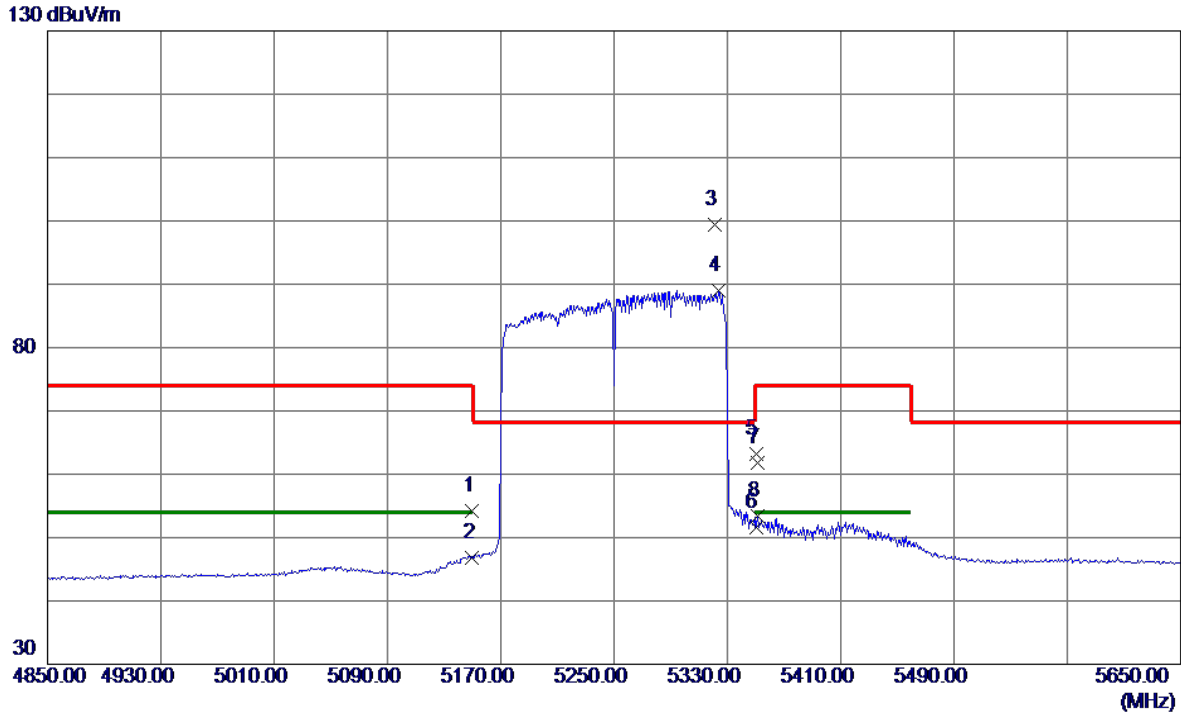

No.	Freq. MHz	Reading Level dBuV/m	Correct Factor dB	Measure ment dBuV/m	Limit dBuV/m	Margin dB	Detector	Comment
1	5150.0000	39.06	15.08	54.14	74.00	-19.86	Peak	
2	5150.0000	31.76	15.08	46.84	54.00	-7.16	AVG	
3 *	5321.2000	83.76	15.61	99.37	68.20	31.17	Peak	No Limit
4	5323.6000	73.40	15.62	89.02	999.00	-909.98	AVG	No Limit
5	5350.0000	47.45	15.70	63.15	74.00	-10.85	Peak	
6	5350.0000	35.84	15.70	51.54	54.00	-2.46	AVG	
7	5351.6000	46.11	15.71	61.82	74.00	-12.18	Peak	
8	5351.6000	37.64	15.71	53.35	54.00	-0.65	AVG	

REMARKS:

- (1) Measurement Value = Reading Level + Correct Factor.
- (2) Margin Level = Measurement Value - Limit Value.

Test Mode	UNII-1+UNII-2A_TX AX(HE160) Mode 5250 MHz	Polarization	Vertical
-----------	---	--------------	----------

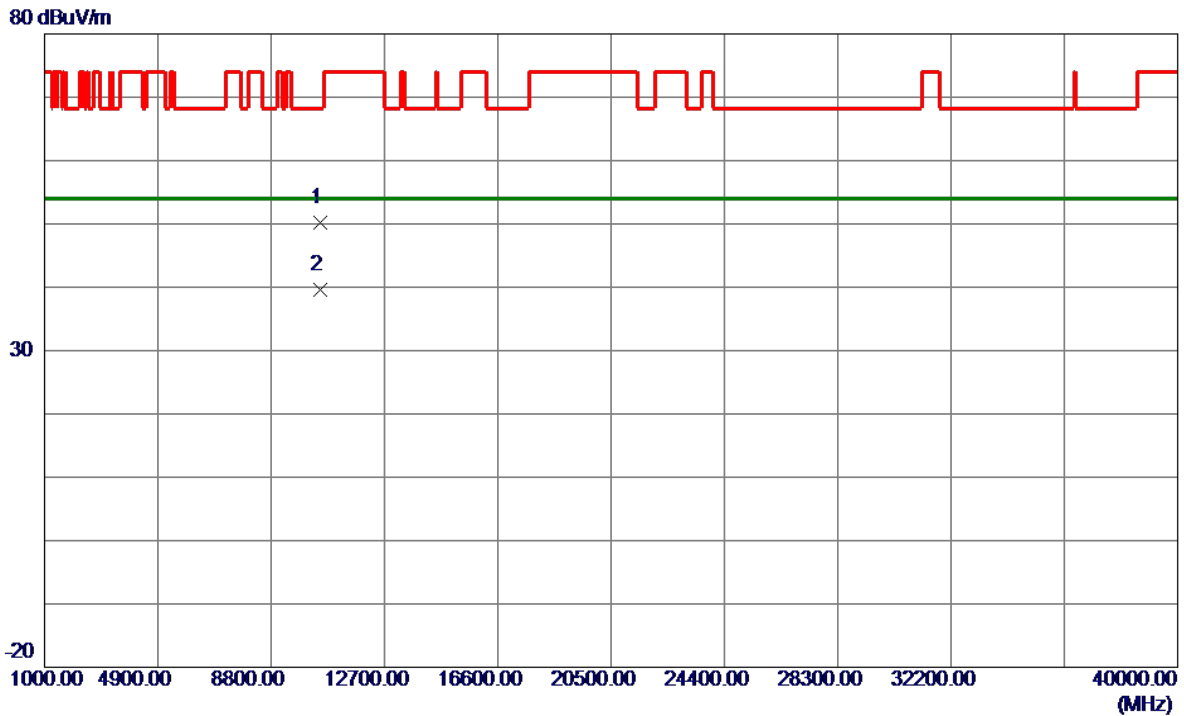

No.	Freq. MHz	Reading Level dBuV/m	Correct Factor dB	Measure ment dBuV/m	Limit dBuV/m	Margin dB	Detector	Comment
1	10496.9800	37.88	12.27	50.15	68.20	-18.05	Peak	
2 *	10502.1200	27.39	12.28	39.67	54.00	-14.33	AVG	

REMARKS:

- (1) Measurement Value = Reading Level + Correct Factor.
- (2) Margin Level = Measurement Value - Limit Value.

Test Mode	UNII-2C_TX A Mode 5500 MHz	Polarization	Vertical
-----------	----------------------------	--------------	----------

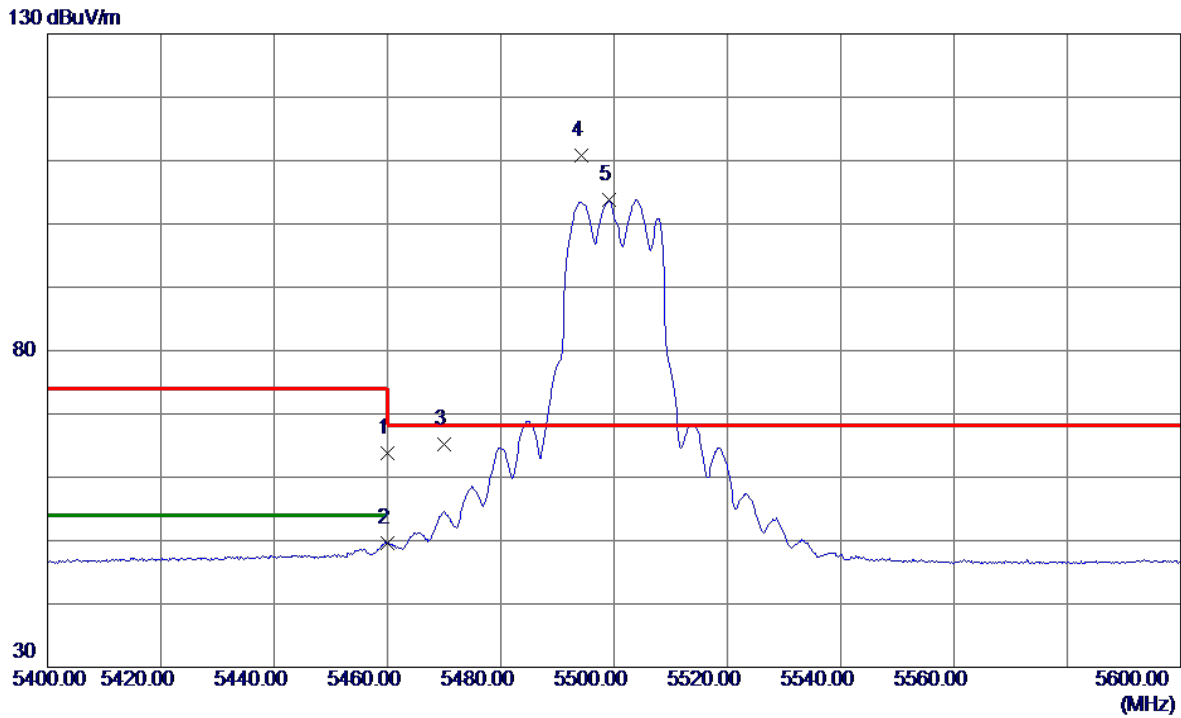

No.	Freq. MHz	Reading Level dBuV/m	Correct Factor dB	Measure ment dBuV/m	Limit dBuV/m	Margin dB	Detector	Comment
1	5460.0000	47.75	16.05	63.80	74.00	-10.20	Peak	
2	5460.0000	33.62	16.05	49.67	54.00	-4.33	AVG	
3	5470.0000	49.20	16.07	65.27	68.20	-2.93	Peak	
4 *	5494.2000	94.71	16.11	110.82	68.20	42.62	Peak	No Limit
5	5499.2000	87.64	16.11	103.75	999.00	-895.25	AVG	No Limit

REMARKS:

- (1) Measurement Value = Reading Level + Correct Factor.
- (2) Margin Level = Measurement Value - Limit Value.

Test Mode	UNII-2C_TX A Mode 5500 MHz	Polarization	Vertical
-----------	----------------------------	--------------	----------

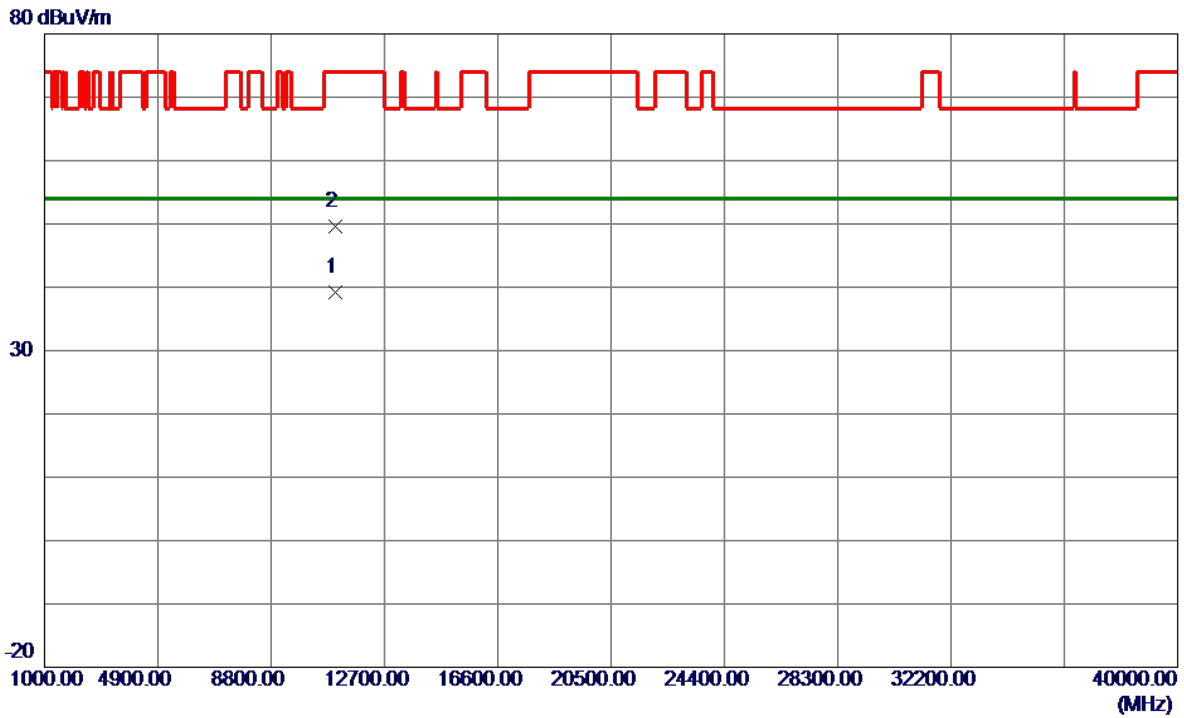

No.	Freq. MHz	Reading Level dBuV/m	Correct Factor dB	Measure ment dBuV/m	Limit dBuV/m	Margin dB	Detector	Comment
1 *	11000.6500	26.36	12.78	39.14	54.00	-14.86	AVG	
2	11004.7500	36.80	12.79	49.59	74.00	-24.41	Peak	

REMARKS:

- (1) Measurement Value = Reading Level + Correct Factor.
- (2) Margin Level = Measurement Value - Limit Value.

Test Mode	UNII-2C_TX A Mode 5580 MHz	Polarization	Vertical
-----------	----------------------------	--------------	----------

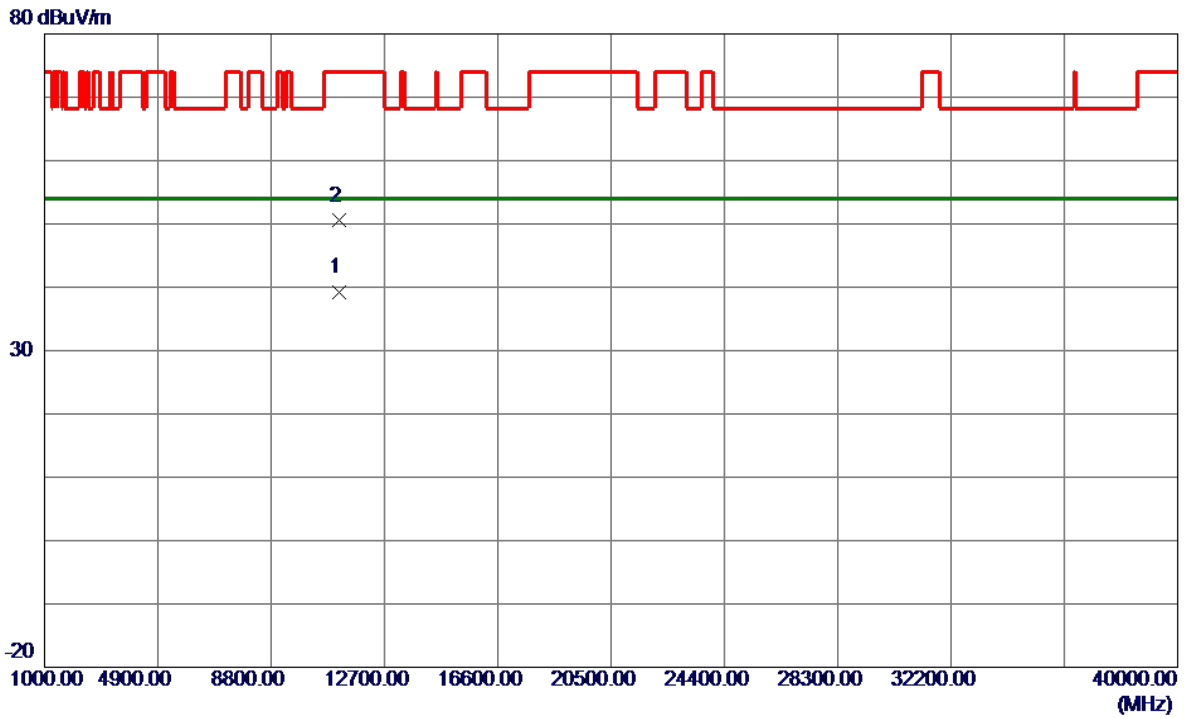

No.	Freq. MHz	Reading Level dBuV/m	Correct Factor dB	Measure ment dBuV/m	Limit dBuV/m	Margin dB	Detector	Comment
1 *	11155.0199	26.18	12.96	39.14	54.00	-14.86	AVG	
2	11161.1600	37.53	12.97	50.50	74.00	-23.50	Peak	

REMARKS:

- (1) Measurement Value = Reading Level + Correct Factor.
- (2) Margin Level = Measurement Value - Limit Value.

Test Mode	UNII-2C_TX A Mode 5700 MHz	Polarization	Vertical
-----------	----------------------------	--------------	----------

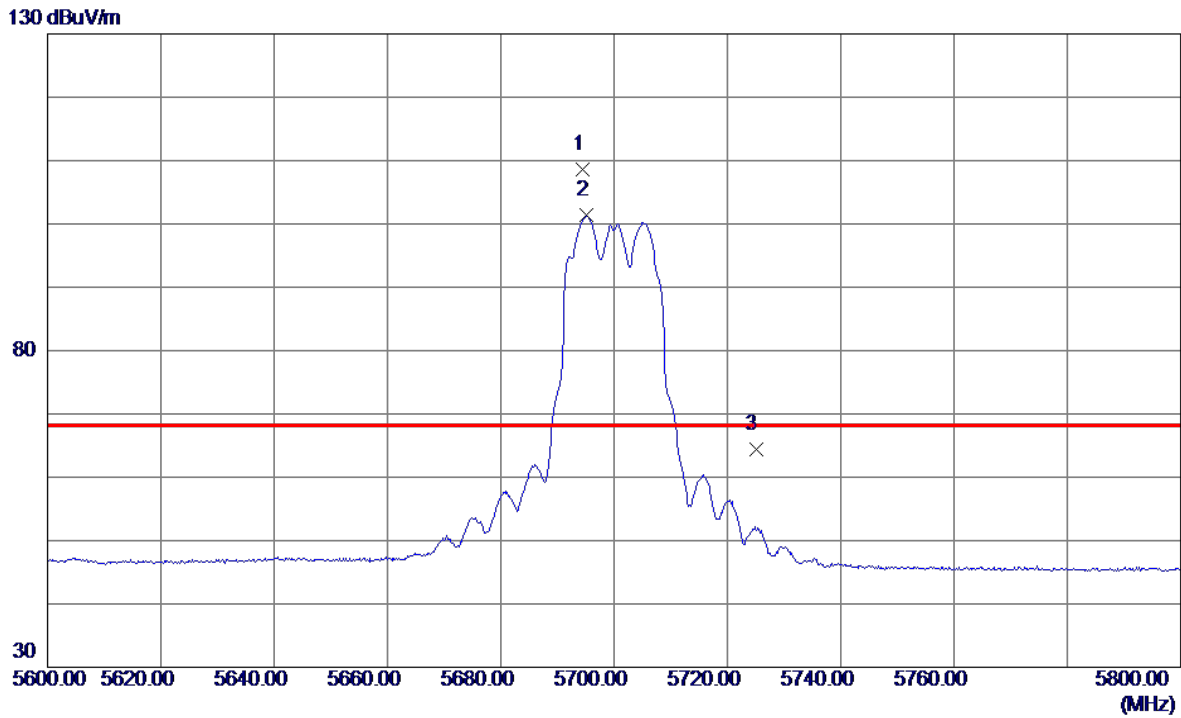

No.	Freq. MHz	Reading Level dBuV/m	Correct Factor dB	Measure ment dBuV/m	Limit dBuV/m	Margin dB	Detector	Comment
1 *	5694.4000	92.42	16.26	108.68	68.20	40.48	Peak	No Limit
2	5695.2000	85.06	16.27	101.33	999.00	-897.67	AVG	No Limit
3	5725.0000	48.19	16.29	64.48	68.20	-3.72	Peak	

REMARKS:

- (1) Measurement Value = Reading Level + Correct Factor.
- (2) Margin Level = Measurement Value - Limit Value.

Test Mode	UNII-2C_TX A Mode 5700 MHz	Polarization	Vertical
-----------	----------------------------	--------------	----------

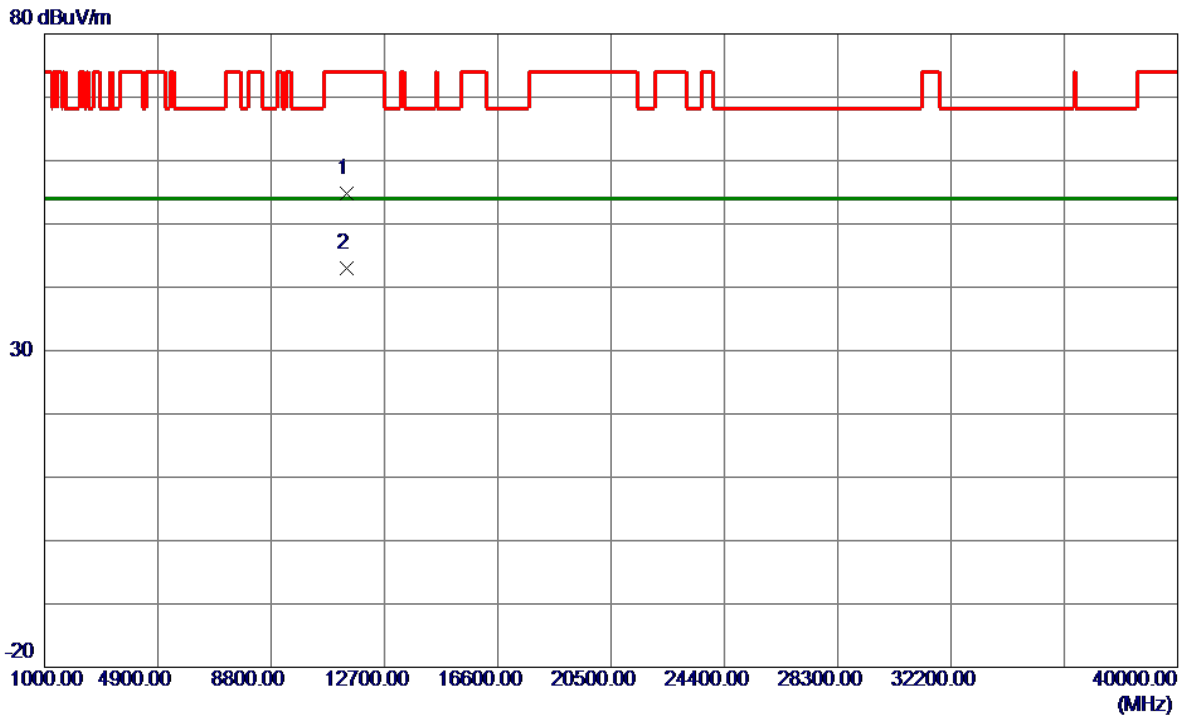

No.	Freq. MHz	Reading Level dBuV/m	Correct Factor dB	Measure ment dBuV/m	Limit dBuV/m	Margin dB	Detector	Comment
1	11397.9100	41.56	13.24	54.80	74.00	-19.20	Peak	
2 *	11398.4200	29.72	13.24	42.96	54.00	-11.04	AVG	

REMARKS:

- (1) Measurement Value = Reading Level + Correct Factor.
- (2) Margin Level = Measurement Value - Limit Value.

Test Mode	UNII-2C_TX AC(VHT20) Mode 5500 MHz	Polarization	Vertical
-----------	------------------------------------	--------------	----------

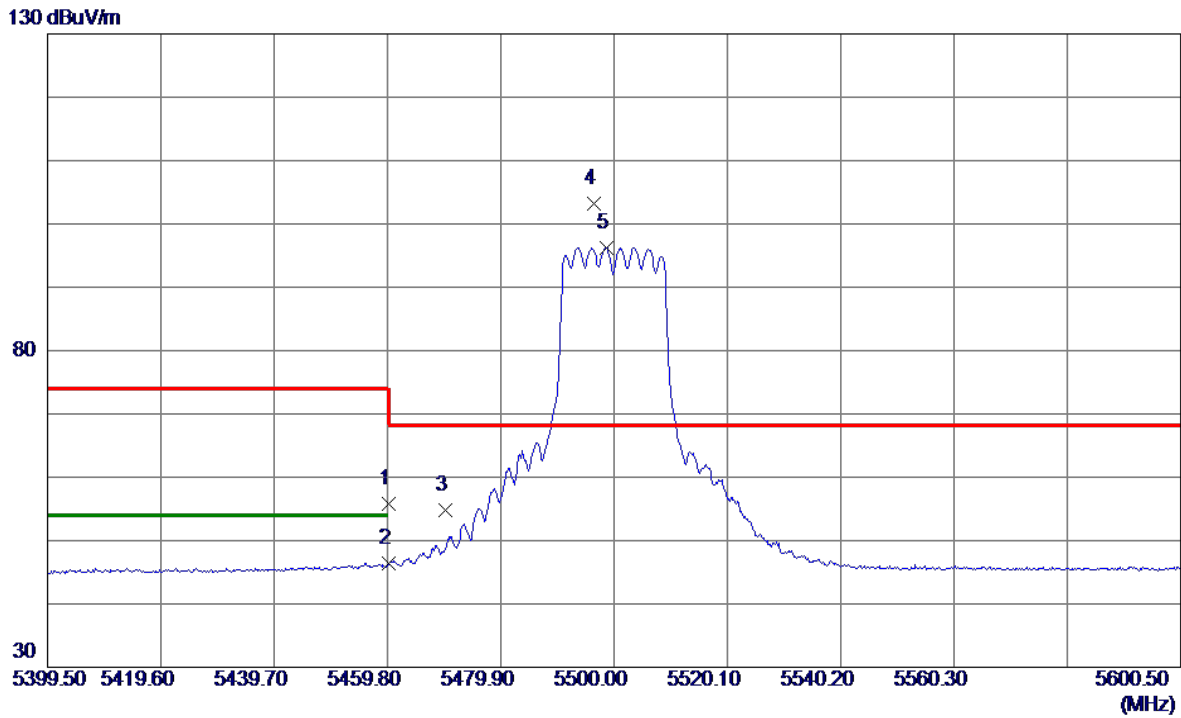

No.	Freq. MHz	Reading Level dBuV/m	Correct Factor dB	Measure ment dBuV/m	Limit dBuV/m	Margin dB	Detector	Comment
1	5460.0000	39.69	16.05	55.74	74.00	-18.26	Peak	
2	5460.0000	30.35	16.05	46.40	54.00	-7.60	AVG	
3	5470.0000	38.74	16.07	54.81	68.20	-13.39	Peak	
4 *	5496.3820	87.00	16.11	103.11	68.20	34.91	Peak	No Limit
5	5498.5930	80.16	16.11	96.27	999.00	-902.73	AVG	No Limit

REMARKS:

- (1) Measurement Value = Reading Level + Correct Factor.
- (2) Margin Level = Measurement Value - Limit Value.

Test Mode	UNII-2C_TX AC(VHT20) Mode 5500 MHz	Polarization	Vertical
-----------	------------------------------------	--------------	----------

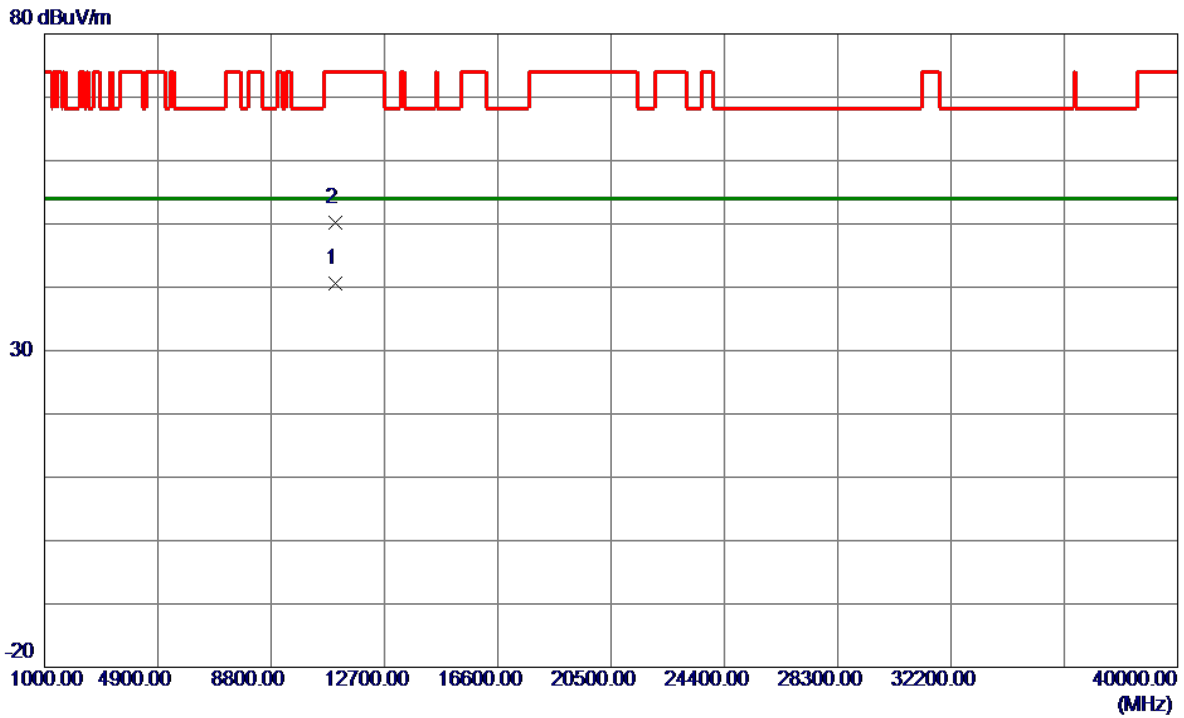

No.	Freq. MHz	Reading Level dBuV/m	Correct Factor dB	Measure ment dBuV/m	Limit dBuV/m	Margin dB	Detector	Comment
1 *	10995.7400	27.87	12.78	40.65	54.00	-13.35	AVG	
2	10996.0599	37.49	12.78	50.27	74.00	-23.73	Peak	

REMARKS:

- (1) Measurement Value = Reading Level + Correct Factor.
- (2) Margin Level = Measurement Value - Limit Value.

Test Mode	UNII-2C_TX AC(VHT20) Mode 5580 MHz	Polarization	Vertical
-----------	------------------------------------	--------------	----------

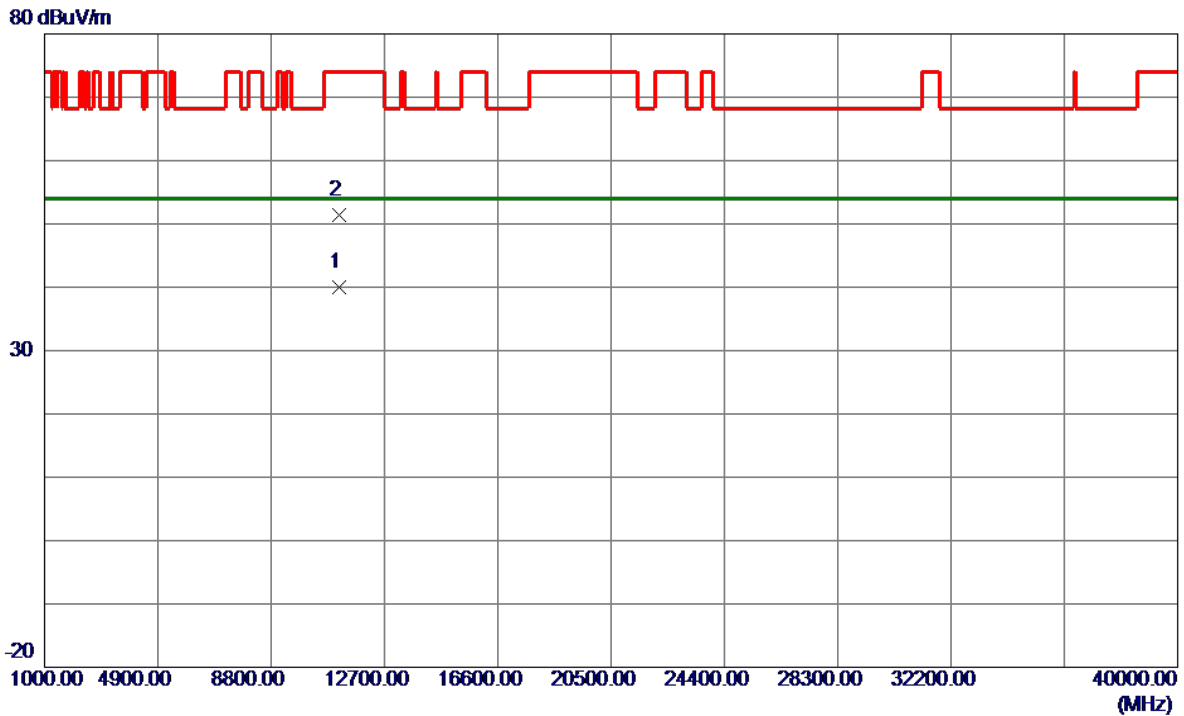

No.	Freq. MHz	Reading Level dBuV/m	Correct Factor dB	Measure ment dBuV/m	Limit dBuV/m	Margin dB	Detector	Comment
1 *	11151.3200	27.09	12.95	40.04	54.00	-13.96	AVG	
2	11155.6400	38.51	12.96	51.47	74.00	-22.53	Peak	

REMARKS:

- (1) Measurement Value = Reading Level + Correct Factor.
- (2) Margin Level = Measurement Value - Limit Value.

Test Mode	UNII-2C_TX AC(VHT20) Mode 5700 MHz	Polarization	Vertical
-----------	------------------------------------	--------------	----------

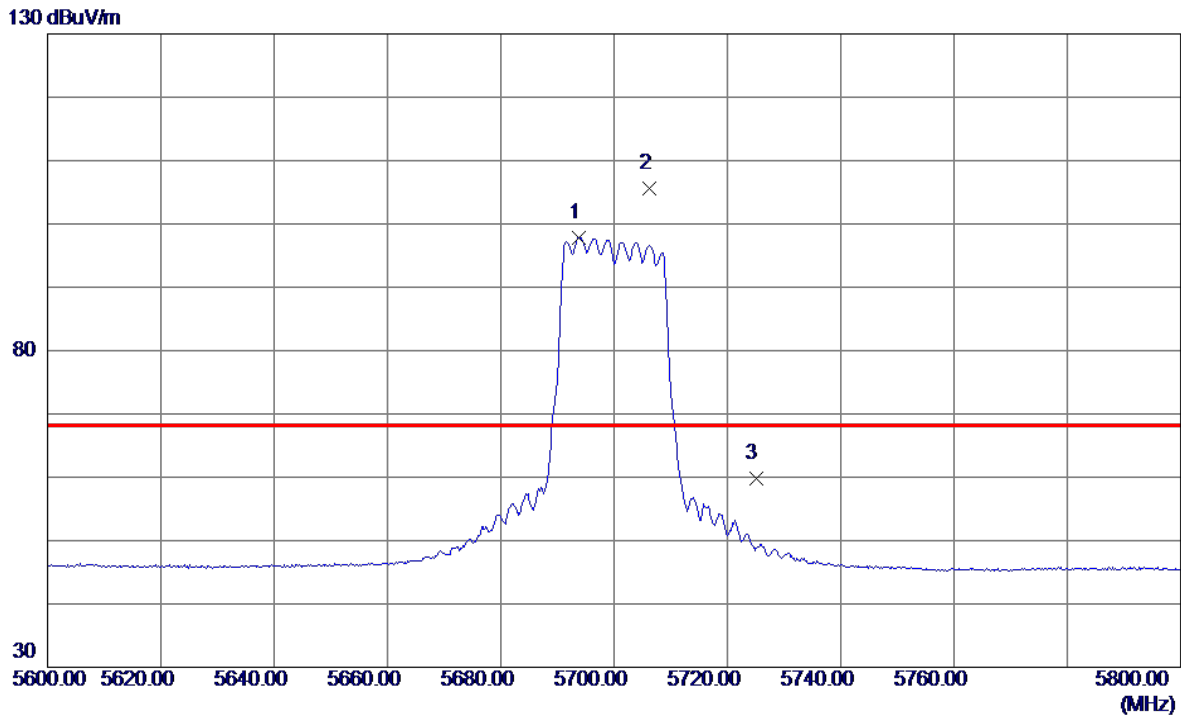

No.	Freq. MHz	Reading Level dBuV/m	Correct Factor dB	Measure ment dBuV/m	Limit dBuV/m	Margin dB	Detector	Comment
1	5693.8000	81.62	16.18	97.80	999.00	-901.20	AVG	No Limit
2 *	5706.2000	89.39	16.21	105.60	68.20	37.40	Peak	No Limit
3	5725.0000	43.58	16.25	59.83	68.20	-8.37	Peak	

REMARKS:

- (1) Measurement Value = Reading Level + Correct Factor.
- (2) Margin Level = Measurement Value - Limit Value.

Test Mode	UNII-2C_TX AC(VHT20) Mode 5700 MHz	Polarization	Vertical
-----------	------------------------------------	--------------	----------

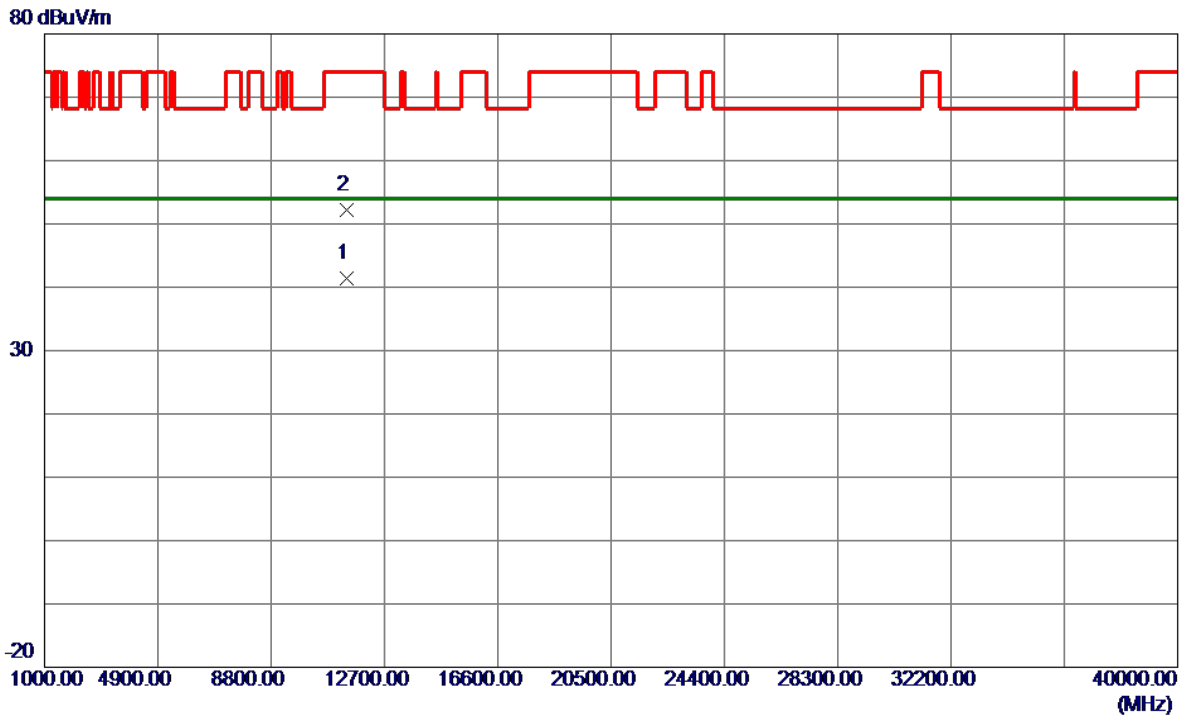

No.	Freq. MHz	Reading Level dBuV/m	Correct Factor dB	Measure ment dBuV/m	Limit dBuV/m	Margin dB	Detector	Comment
1 *	11393.0199	28.24	13.23	41.47	54.00	-12.53	AVG	
2	11405.9200	38.87	13.25	52.12	74.00	-21.88	Peak	

REMARKS:

- (1) Measurement Value = Reading Level + Correct Factor.
- (2) Margin Level = Measurement Value - Limit Value.

Test Mode	UNII-2C_TX AC(VHT40) Mode 5510 MHz	Polarization	Vertical
-----------	------------------------------------	--------------	----------

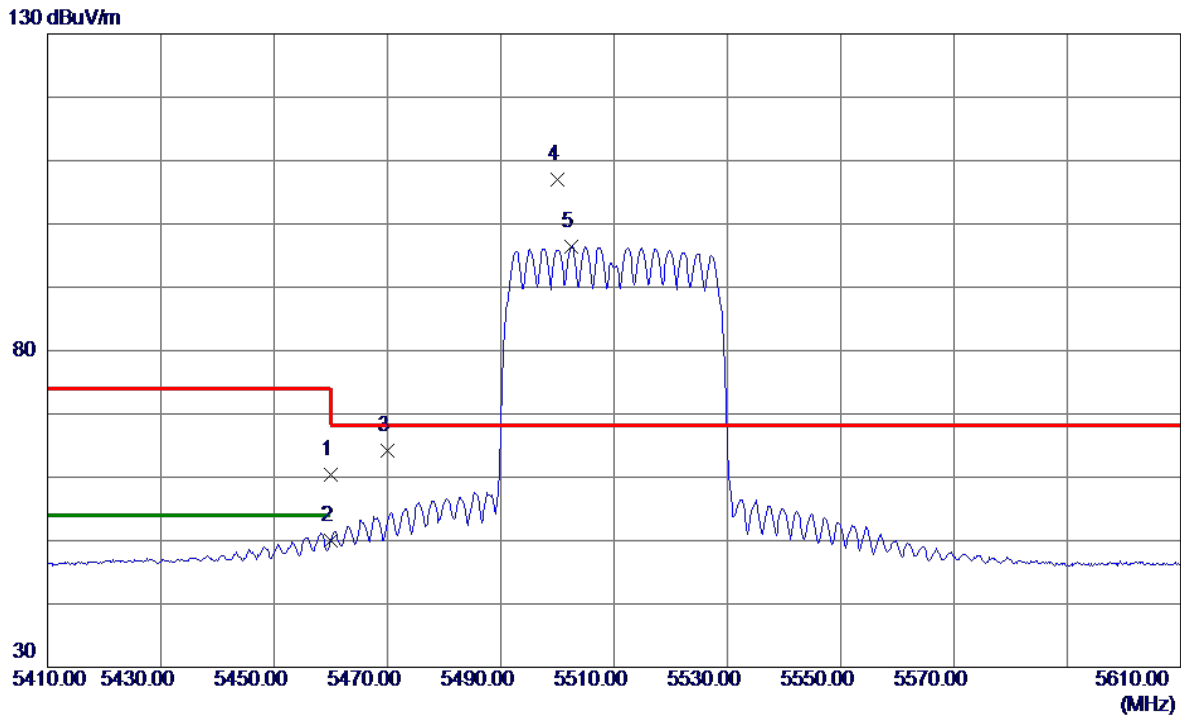

No.	Freq. MHz	Reading Level dBuV/m	Correct Factor dB	Measure ment dBuV/m	Limit dBuV/m	Margin dB	Detector	Comment
1	5460.0000	44.35	16.05	60.40	74.00	-13.60	Peak	
2	5460.0000	34.00	16.05	50.05	54.00	-3.95	AVG	
3	5470.0000	48.16	16.07	64.23	68.20	-3.97	Peak	
4 *	5500.0000	90.86	16.11	106.97	68.20	38.77	Peak	No Limit
5	5502.4000	80.24	16.12	96.36	999.00	-902.64	AVG	No Limit

REMARKS:

- (1) Measurement Value = Reading Level + Correct Factor.
- (2) Margin Level = Measurement Value - Limit Value.

Test Mode	UNII-2C_TX AC(VHT40) Mode 5510 MHz	Polarization	Vertical
-----------	------------------------------------	--------------	----------

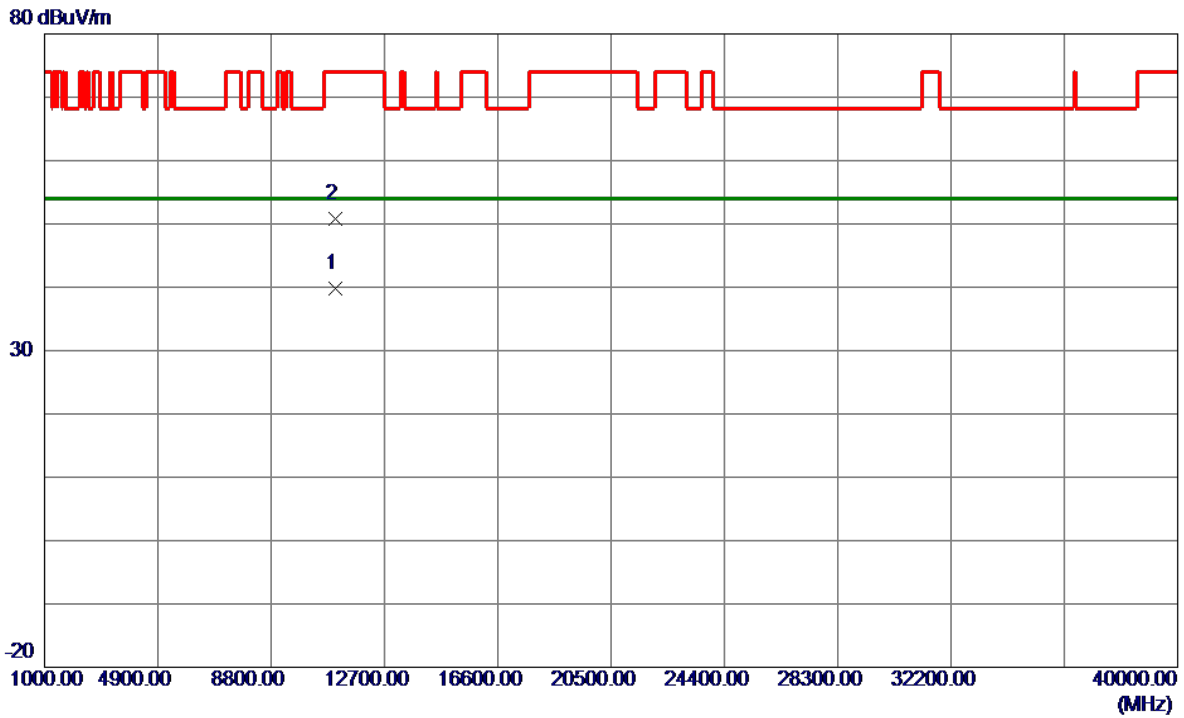

No.	Freq. MHz	Reading Level dBuV/m	Correct Factor dB	Measure ment dBuV/m	Limit dBuV/m	Margin dB	Detector	Comment
1 *	11016.1300	27.06	12.80	39.86	54.00	-14.14	AVG	
2	11020.4100	37.99	12.80	50.79	74.00	-23.21	Peak	

REMARKS:

- (1) Measurement Value = Reading Level + Correct Factor.
- (2) Margin Level = Measurement Value - Limit Value.

Test Mode	UNII-2C_TX AC(VHT40) Mode 5550 MHz	Polarization	Vertical
-----------	------------------------------------	--------------	----------

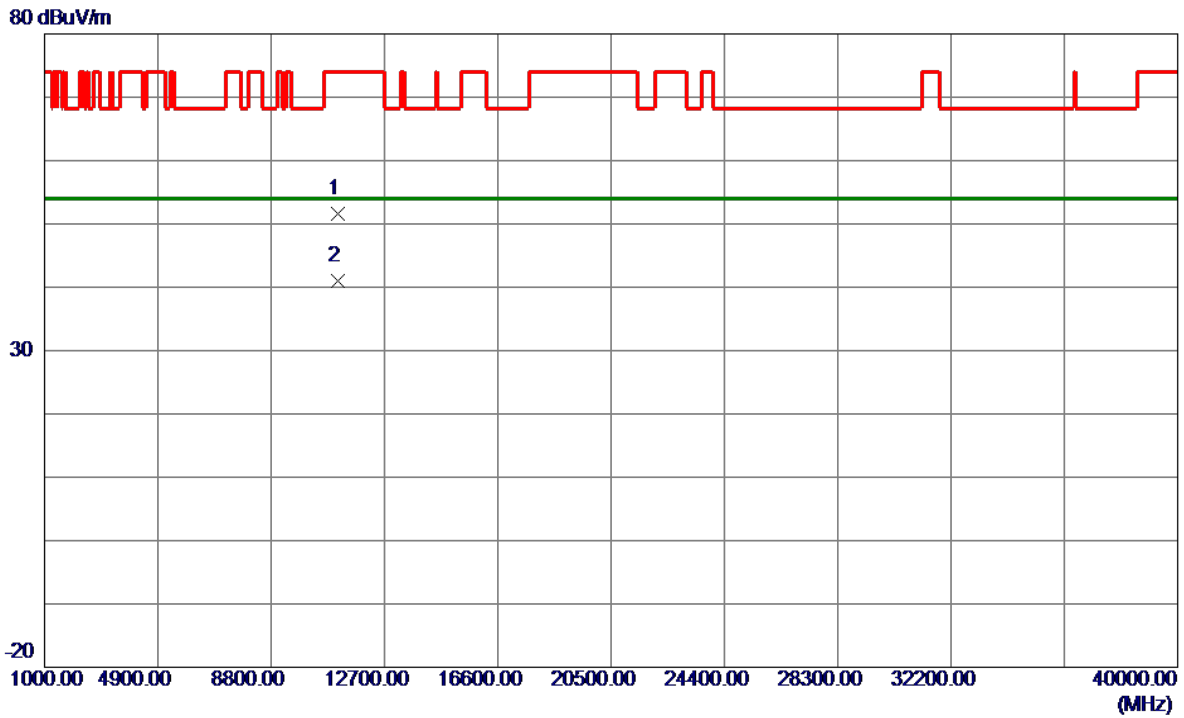

No.	Freq. MHz	Reading Level dBuV/m	Correct Factor dB	Measure ment dBuV/m	Limit dBuV/m	Margin dB	Detector	Comment
1	11096.4200	38.69	12.89	51.58	74.00	-22.42	Peak	
2 *	11104.5100	28.13	12.90	41.03	54.00	-12.97	AVG	

REMARKS:

- (1) Measurement Value = Reading Level + Correct Factor.
- (2) Margin Level = Measurement Value - Limit Value.

Test Mode	UNII-2C_TX AC(VHT40) Mode 5670 MHz	Polarization	Vertical
-----------	------------------------------------	--------------	----------

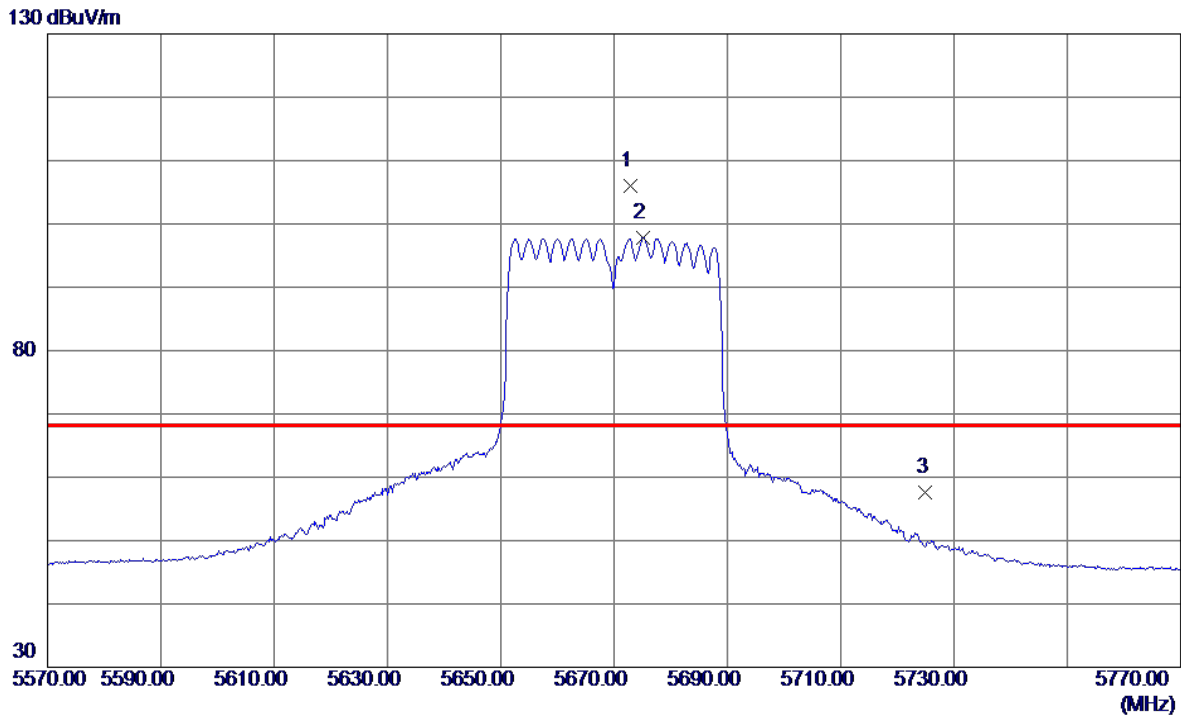

No.	Freq. MHz	Reading Level dBuV/m	Correct Factor dB	Measure ment dBuV/m	Limit dBuV/m	Margin dB	Detector	Comment
1 *	5672.8000	89.81	16.14	105.95	68.20	37.75	Peak	No Limit
2	5675.2000	81.70	16.14	97.84	999.00	-901.16	AVG	No Limit
3	5725.0000	41.27	16.25	57.52	68.20	-10.68	Peak	

REMARKS:

- (1) Measurement Value = Reading Level + Correct Factor.
- (2) Margin Level = Measurement Value - Limit Value.

Test Mode	UNII-2C_TX AC(VHT40) Mode 5670 MHz	Polarization	Vertical
-----------	------------------------------------	--------------	----------

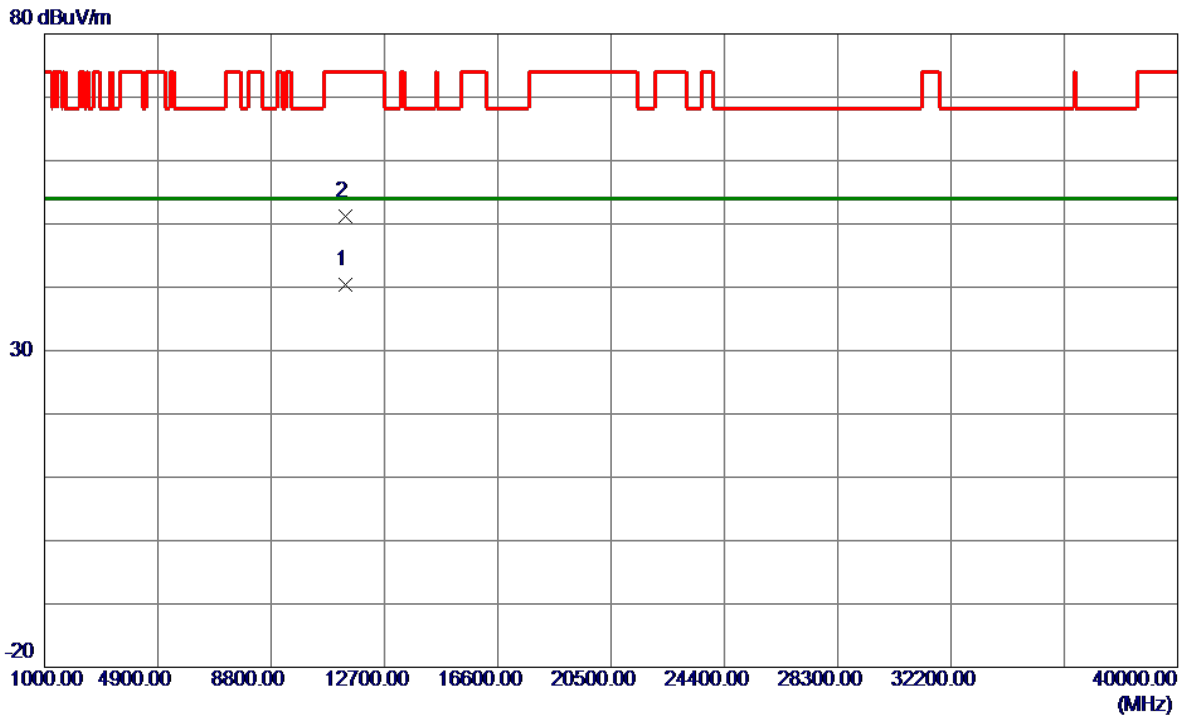

No.	Freq. MHz	Reading Level dBuV/m	Correct Factor dB	Measure ment dBuV/m	Limit dBuV/m	Margin dB	Detector	Comment
1 *	11339.7600	27.26	13.17	40.43	54.00	-13.57	AVG	
2	11341.2100	37.98	13.17	51.15	74.00	-22.85	Peak	

REMARKS:

- (1) Measurement Value = Reading Level + Correct Factor.
- (2) Margin Level = Measurement Value - Limit Value.

Test Mode	UNII-2C_TX AC(VHT80) Mode 5530 MHz	Polarization	Vertical
-----------	------------------------------------	--------------	----------

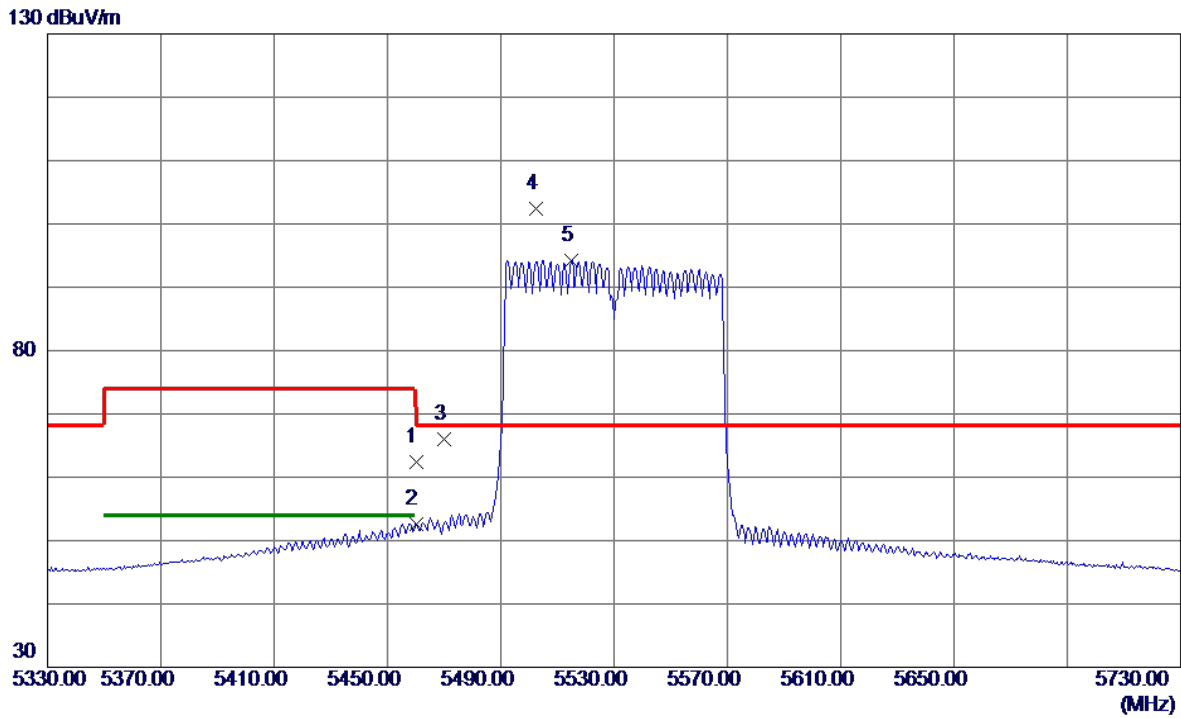

No.	Freq. MHz	Reading Level dBuV/m	Correct Factor dB	Measure ment dBuV/m	Limit dBuV/m	Margin dB	Detector	Comment
1	5460.0000	46.63	15.68	62.31	74.00	-11.69	Peak	
2	5460.0000	36.95	15.68	52.63	54.00	-1.37	AVG	
3	5470.0000	50.24	15.70	65.94	68.20	-2.26	Peak	
4 *	5502.4000	86.55	15.77	102.32	68.20	34.12	Peak	No Limit
5	5514.8000	78.46	15.80	94.26	999.00	-904.74	AVG	No Limit

REMARKS:

- (1) Measurement Value = Reading Level + Correct Factor.
- (2) Margin Level = Measurement Value - Limit Value.

Test Mode	UNII-2C_TX AC(VHT80) Mode 5530 MHz	Polarization	Vertical
-----------	------------------------------------	--------------	----------

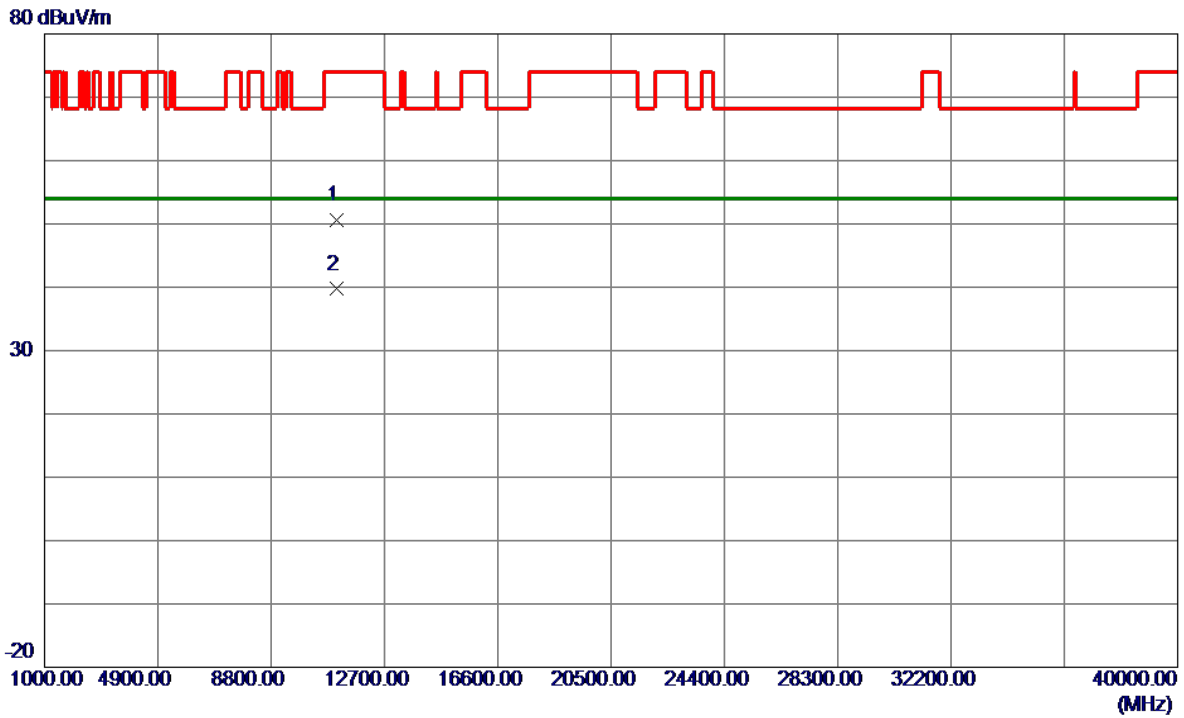

No.	Freq. MHz	Reading Level dBuV/m	Correct Factor dB	Measure ment dBuV/m	Limit dBuV/m	Margin dB	Detector	Comment
1	11057.2000	37.78	12.85	50.63	74.00	-23.37	Peak	
2 *	11058.6500	26.85	12.85	39.70	54.00	-14.30	AVG	

REMARKS:

- (1) Measurement Value = Reading Level + Correct Factor.
- (2) Margin Level = Measurement Value - Limit Value.

Test Mode	UNII-2C_TX AC(VHT80) Mode 5610 MHz	Polarization	Vertical
-----------	------------------------------------	--------------	----------

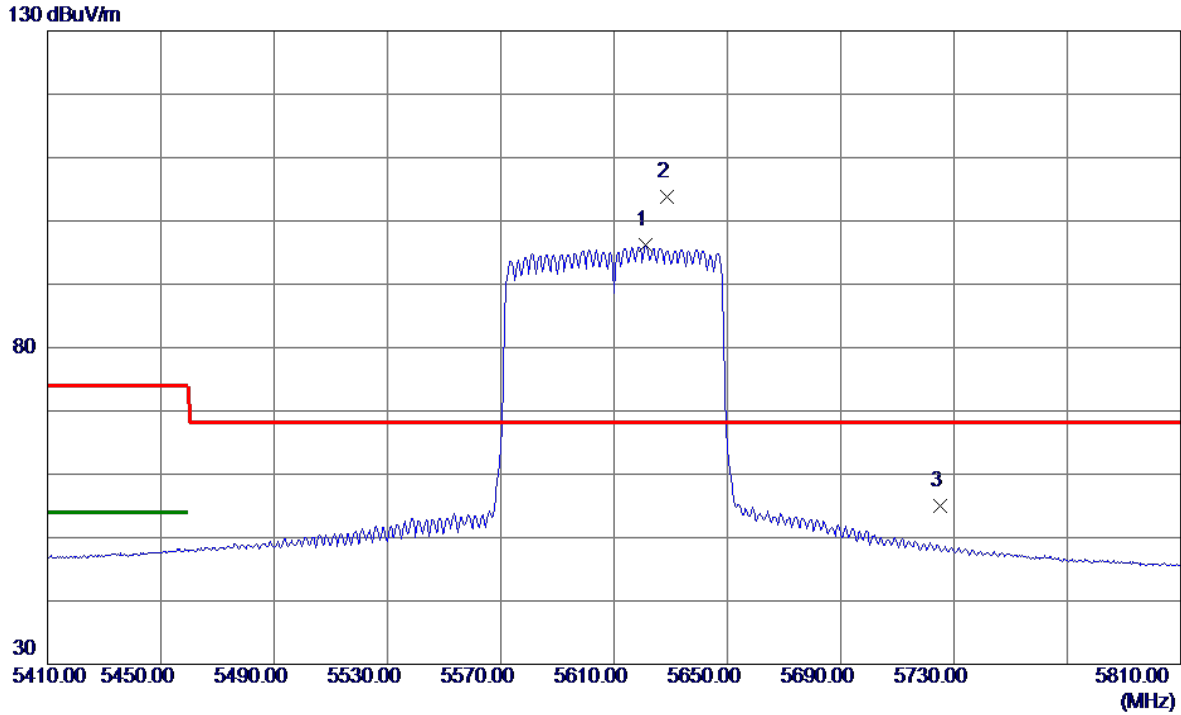

No.	Freq. MHz	Reading Level dBuV/m	Correct Factor dB	Measurement dBuV/m	Limit dBuV/m	Margin dB	Detector	Comment
1	5621.2000	80.10	16.03	96.13	999.00	-902.87	AVG	No Limit
2 *	5628.8000	87.75	16.04	103.79	68.20	35.59	Peak	No Limit
3	5725.0000	38.69	16.25	54.94	68.20	-13.26	Peak	

REMARKS:

- (1) Measurement Value = Reading Level + Correct Factor.
- (2) Margin Level = Measurement Value - Limit Value.

Test Mode	UNII-2C_TX AC(VHT80) Mode 5610 MHz	Polarization	Vertical
-----------	------------------------------------	--------------	----------

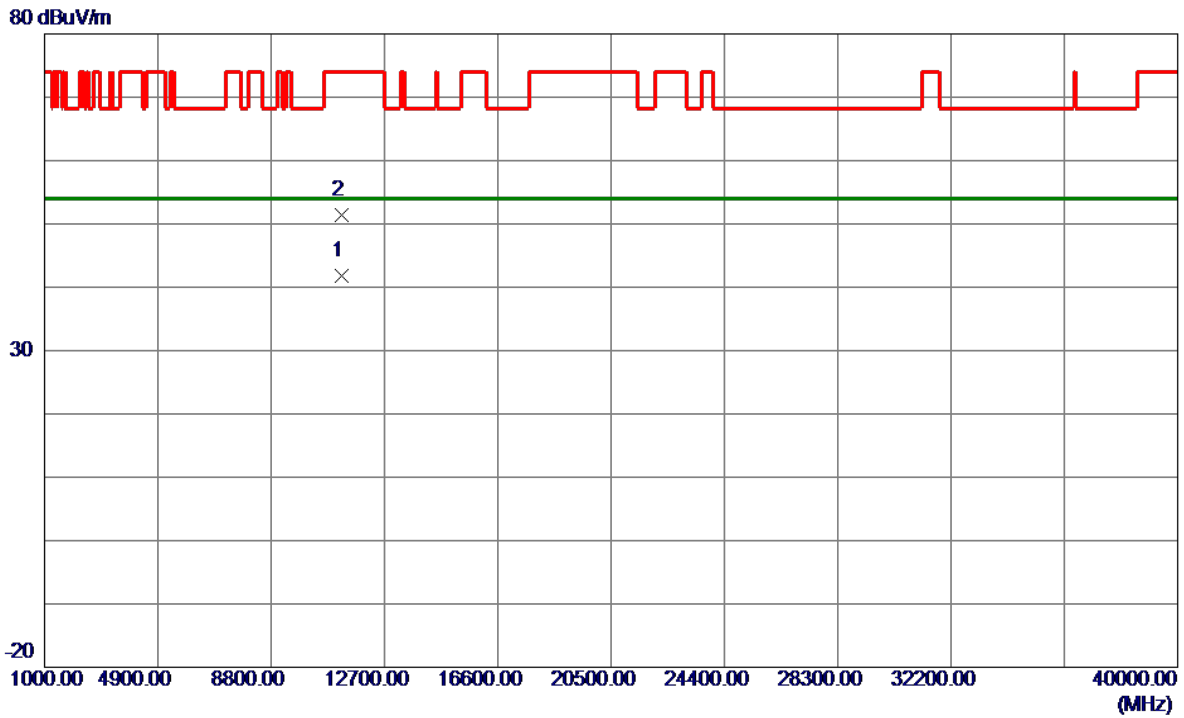

No.	Freq. MHz	Reading Level dBuV/m	Correct Factor dB	Measure ment dBuV/m	Limit dBuV/m	Margin dB	Detector	Comment
1 *	11215.2699	28.80	13.03	41.83	54.00	-12.17	AVG	
2	11220.3600	38.33	13.03	51.36	74.00	-22.64	Peak	

REMARKS:

- (1) Measurement Value = Reading Level + Correct Factor.
- (2) Margin Level = Measurement Value - Limit Value.

Test Mode	UNII-2C_TX AC(VHT160) Mode 5570 MHz	Polarization	Vertical
-----------	-------------------------------------	--------------	----------

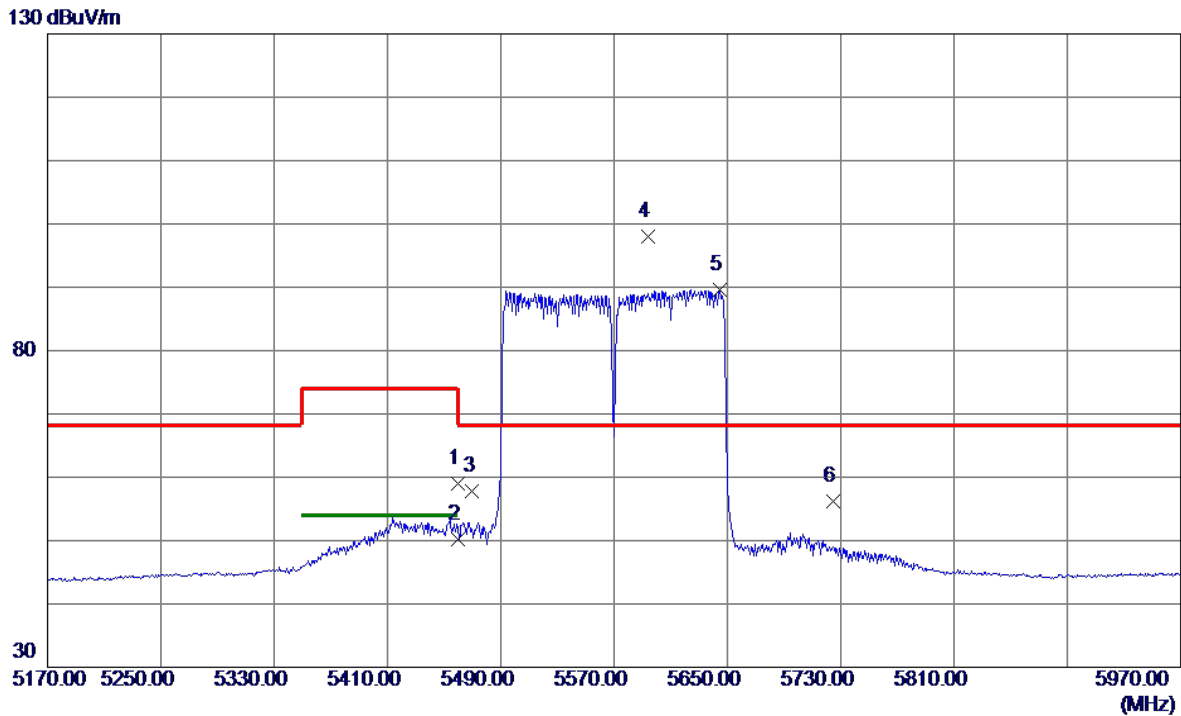

No.	Freq. MHz	Reading Level dBuV/m	Correct Factor dB	Measure ment dBuV/m	Limit dBuV/m	Margin dB	Detector	Comment
1	5460.0000	43.37	15.68	59.05	74.00	-14.95	Peak	
2	5460.0000	34.61	15.68	50.29	54.00	-3.71	AVG	
3	5470.0000	42.17	15.70	57.87	68.20	-10.33	Peak	
4 *	5594.0000	81.95	15.97	97.92	68.20	29.72	Peak	No Limit
5	5644.4000	73.49	16.08	89.57	999.00	-909.43	AVG	No Limit
6	5725.0000	39.90	16.25	56.15	68.20	-12.05	Peak	

REMARKS:

- (1) Measurement Value = Reading Level + Correct Factor.
- (2) Margin Level = Measurement Value - Limit Value.

Test Mode	UNII-2C_TX AC(VHT160) Mode 5570 MHz	Polarization	Vertical
-----------	-------------------------------------	--------------	----------

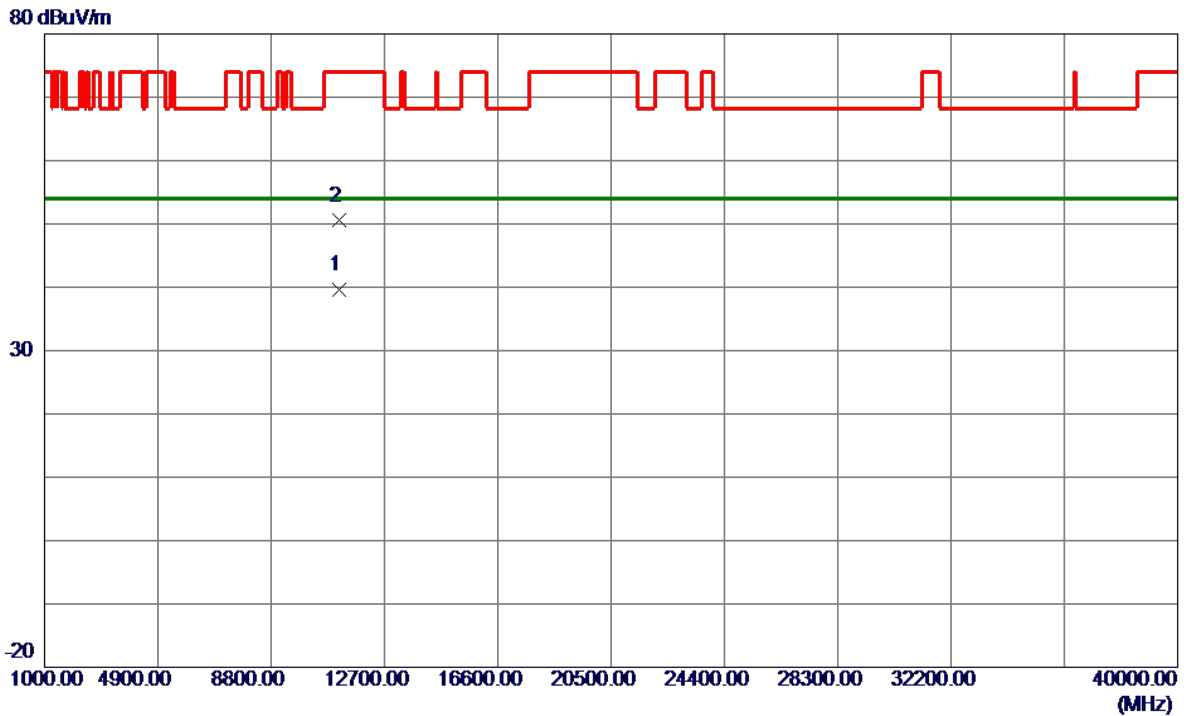

No.	Freq. MHz	Reading Level dBuV/m	Correct Factor dB	Measure ment dBuV/m	Limit dBuV/m	Margin dB	Detector	Comment
1 *	11142.1900	26.67	12.94	39.61	54.00	-14.39	AVG	
2	11145.1600	37.55	12.95	50.50	74.00	-23.50	Peak	

REMARKS:

- (1) Measurement Value = Reading Level + Correct Factor.
- (2) Margin Level = Measurement Value - Limit Value.

Test Mode	UNII-2C_TX AX(HE20) Mode 5500 MHz	Polarization	Vertical
-----------	-----------------------------------	--------------	----------

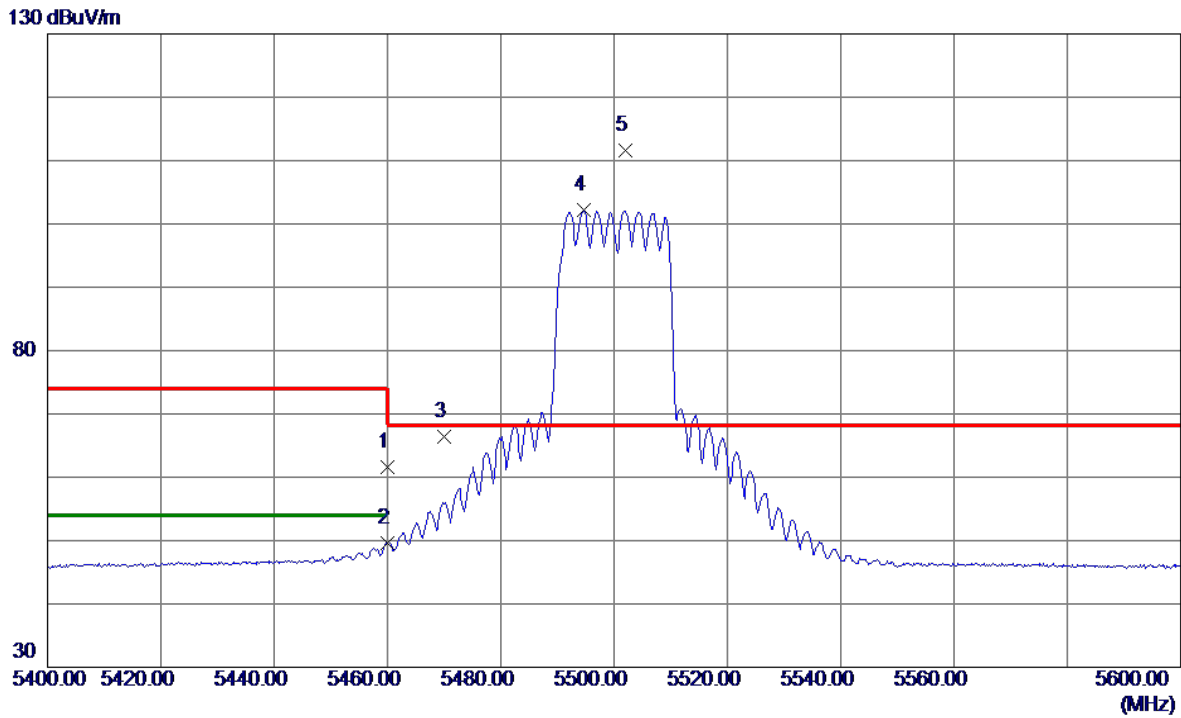

No.	Freq. MHz	Reading Level dBuV/m	Correct Factor dB	Measure ment dBuV/m	Limit dBuV/m	Margin dB	Detector	Comment
1	5460.0000	45.98	15.68	61.66	74.00	-12.34	Peak	
2	5460.0000	34.01	15.68	49.69	54.00	-4.31	AVG	
3	5470.0000	50.64	15.70	66.34	68.20	-1.86	Peak	
4	5494.6000	86.37	15.75	102.12	999.00	-896.88	AVG	No Limit
5 *	5502.0000	95.87	15.77	111.64	68.20	43.44	Peak	No Limit

REMARKS:

- (1) Measurement Value = Reading Level + Correct Factor.
- (2) Margin Level = Measurement Value - Limit Value.

Test Mode	UNII-2C_TX AX(HE20) Mode 5500 MHz	Polarization	Vertical
-----------	-----------------------------------	--------------	----------

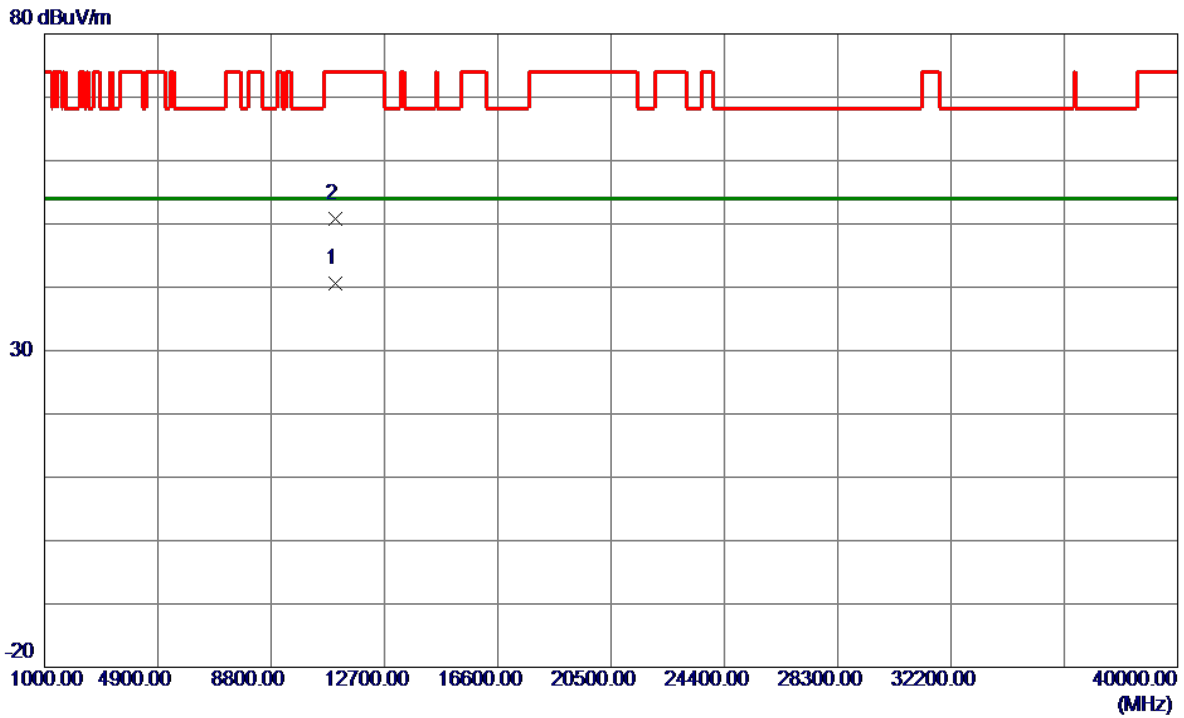

No.	Freq. MHz	Reading Level dBuV/m	Correct Factor dB	Measure ment dBuV/m	Limit dBuV/m	Margin dB	Detector	Comment
1 *	10995.2600	27.75	12.78	40.53	54.00	-13.47	AVG	
2	11003.6400	38.01	12.78	50.79	74.00	-23.21	Peak	

REMARKS:

- (1) Measurement Value = Reading Level + Correct Factor.
- (2) Margin Level = Measurement Value - Limit Value.

Test Mode	UNII-2C_TX AX(HE20) Mode 5580 MHz	Polarization	Vertical
-----------	-----------------------------------	--------------	----------

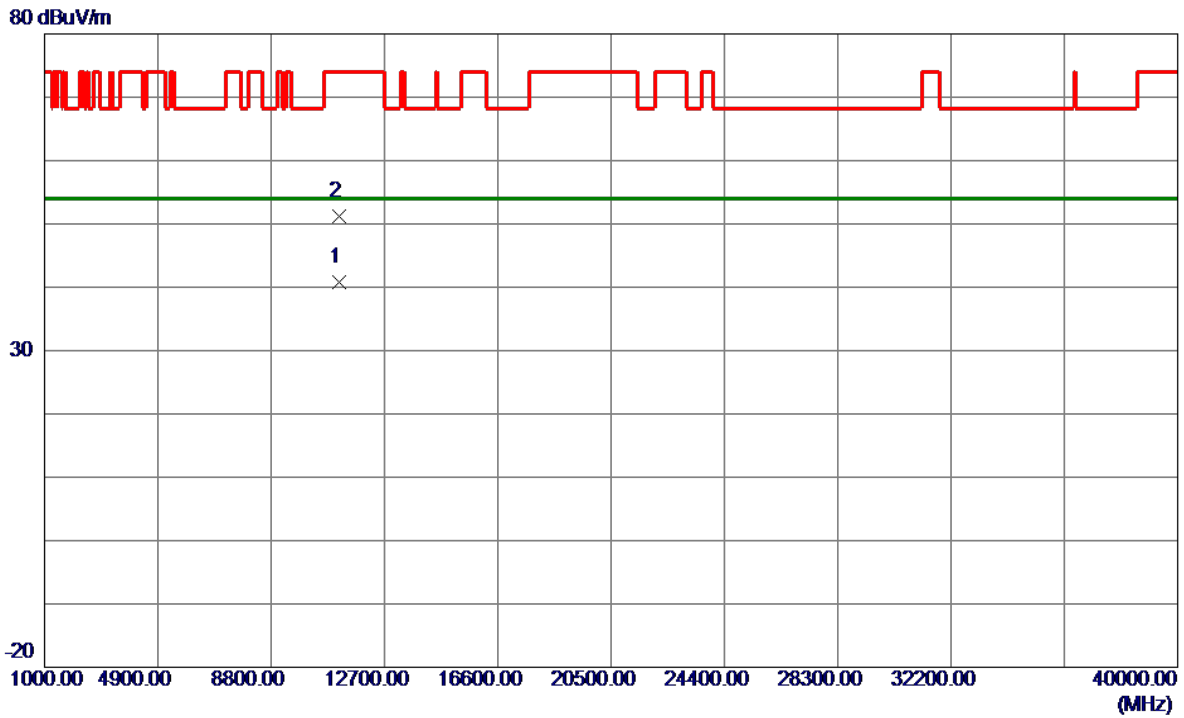

No.	Freq. MHz	Reading Level dBuV/m	Correct Factor dB	Measure ment dBuV/m	Limit dBuV/m	Margin dB	Detector	Comment
1 *	11158.9100	27.81	12.96	40.77	54.00	-13.23	AVG	
2	11161.1500	38.16	12.97	51.13	74.00	-22.87	Peak	

REMARKS:

- (1) Measurement Value = Reading Level + Correct Factor.
- (2) Margin Level = Measurement Value - Limit Value.

Test Mode	UNII-2C_TX AX(HE20) Mode 5700 MHz	Polarization	Vertical
-----------	-----------------------------------	--------------	----------

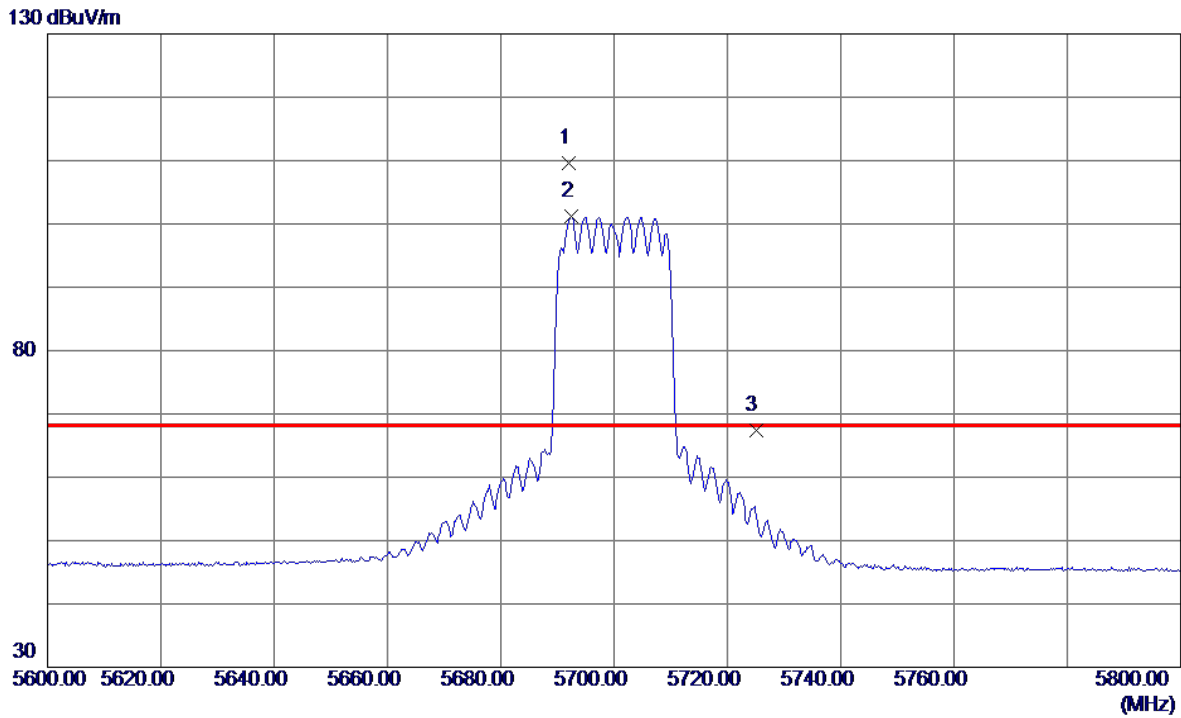

No.	Freq. MHz	Reading Level dBuV/m	Correct Factor dB	Measure ment dBuV/m	Limit dBuV/m	Margin dB	Detector	Comment
1 *	5692.0000	93.44	16.18	109.62	68.20	41.42	Peak	No Limit
2	5692.4000	84.99	16.18	101.17	999.00	-897.83	AVG	No Limit
3	5725.0000	51.07	16.25	67.32	68.20	-0.88	Peak	

REMARKS:

- (1) Measurement Value = Reading Level + Correct Factor.
- (2) Margin Level = Measurement Value - Limit Value.

Test Mode	UNII-2C_TX AX(HE20) Mode 5700 MHz	Polarization	Vertical
-----------	-----------------------------------	--------------	----------

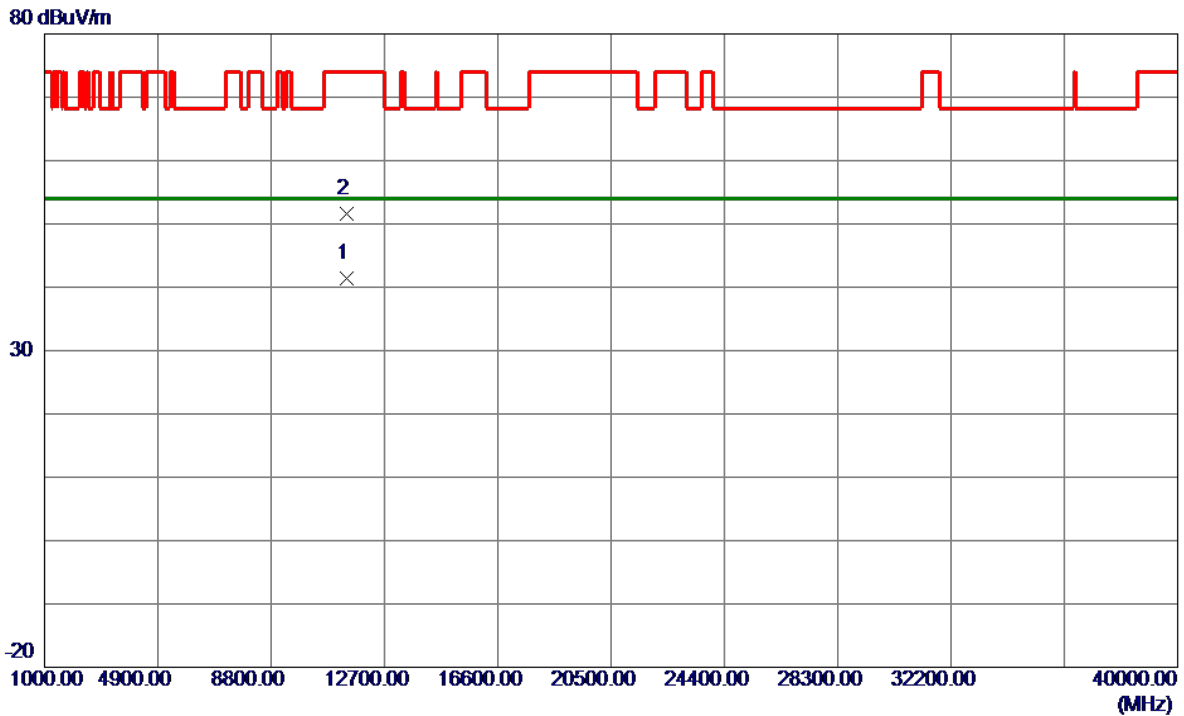

No.	Freq. MHz	Reading Level dBuV/m	Correct Factor dB	Measure ment dBuV/m	Limit dBuV/m	Margin dB	Detector	Comment
1 *	11397.4400	28.07	13.24	41.31	54.00	-12.69	AVG	
2	11398.3400	38.30	13.24	51.54	74.00	-22.46	Peak	

REMARKS:

- (1) Measurement Value = Reading Level + Correct Factor.
- (2) Margin Level = Measurement Value - Limit Value.

Test Mode	UNII-2C_TX AX(HE40) Mode 5510 MHz	Polarization	Vertical
-----------	-----------------------------------	--------------	----------

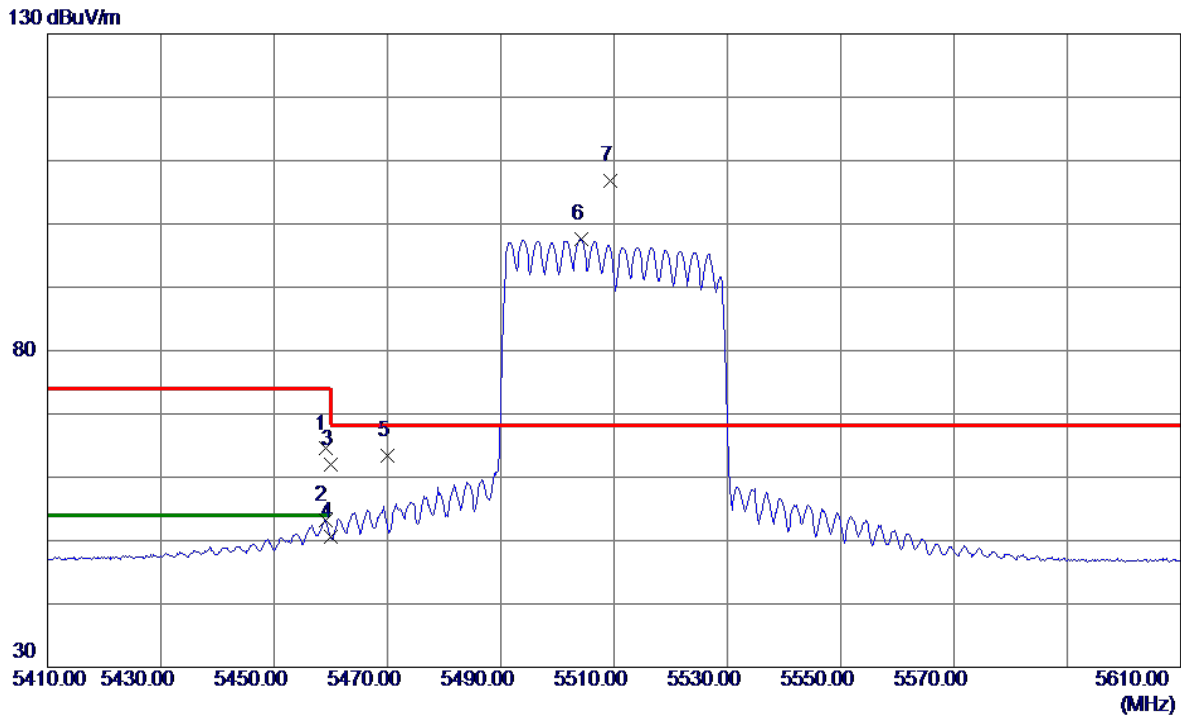

No.	Freq. MHz	Reading Level dBuV/m	Correct Factor dB	Measure ment dBuV/m	Limit dBuV/m	Margin dB	Detector	Comment
1	5459.0000	48.46	16.04	64.50	74.00	-9.50	Peak	
2	5459.0000	37.11	16.04	53.15	54.00	-0.85	AVG	
3	5460.0000	45.98	16.04	62.02	74.00	-11.98	Peak	
4	5460.0000	34.49	16.04	50.53	54.00	-3.47	AVG	
5	5470.0000	47.30	16.07	63.37	68.20	-4.83	Peak	
6	5504.2000	81.35	16.17	97.52	999.00	-901.48	AVG	No Limit
7 *	5509.4000	90.68	16.18	106.86	68.20	38.66	Peak	No Limit

REMARKS:

- (1) Measurement Value = Reading Level + Correct Factor.
- (2) Margin Level = Measurement Value - Limit Value.

Test Mode	UNII-2C_TX AX(HE40) Mode 5510 MHz	Polarization	Vertical
-----------	-----------------------------------	--------------	----------

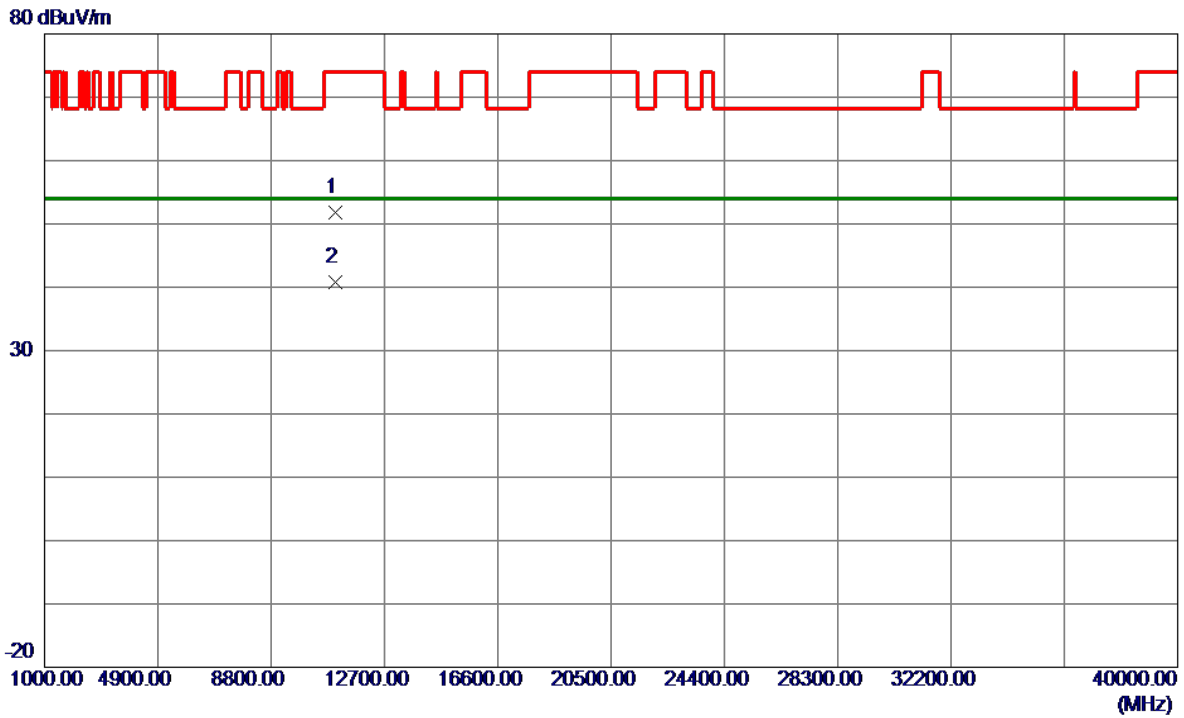

No.	Freq. MHz	Reading Level dBuV/m	Correct Factor dB	Measure ment dBuV/m	Limit dBuV/m	Margin dB	Detector	Comment
1	11017.6400	38.97	12.80	51.77	74.00	-22.23	Peak	
2 *	11024.5000	27.92	12.81	40.73	54.00	-13.27	AVG	

REMARKS:

- (1) Measurement Value = Reading Level + Correct Factor.
- (2) Margin Level = Measurement Value - Limit Value.

Test Mode	UNII-2C_TX AX(HE40) Mode 5550 MHz	Polarization	Vertical
-----------	-----------------------------------	--------------	----------

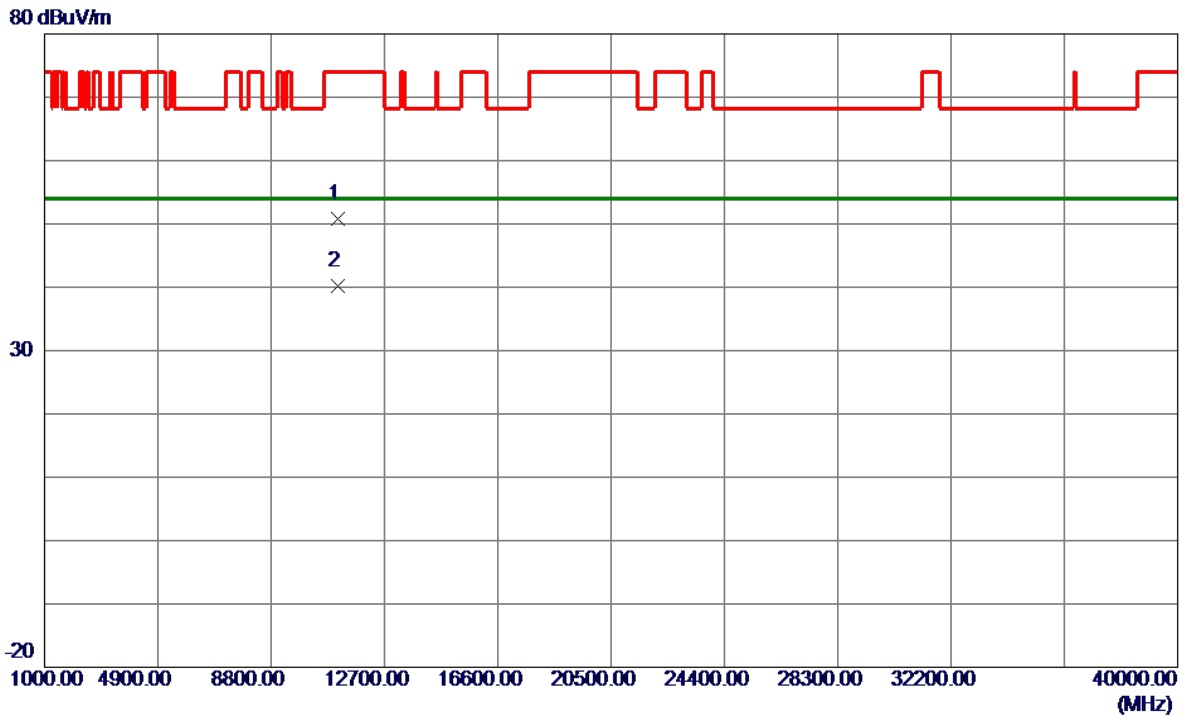

No.	Freq. MHz	Reading Level dBuV/m	Correct Factor dB	Measure ment dBuV/m	Limit dBuV/m	Margin dB	Detector	Comment
1	11101.6900	37.88	12.90	50.78	74.00	-23.22	Peak	
2 *	11104.1600	27.31	12.90	40.21	54.00	-13.79	AVG	

REMARKS:

- (1) Measurement Value = Reading Level + Correct Factor.
- (2) Margin Level = Measurement Value - Limit Value.

Test Mode	UNII-2C_TX AX(HE40) Mode 5670 MHz	Polarization	Vertical
-----------	-----------------------------------	--------------	----------

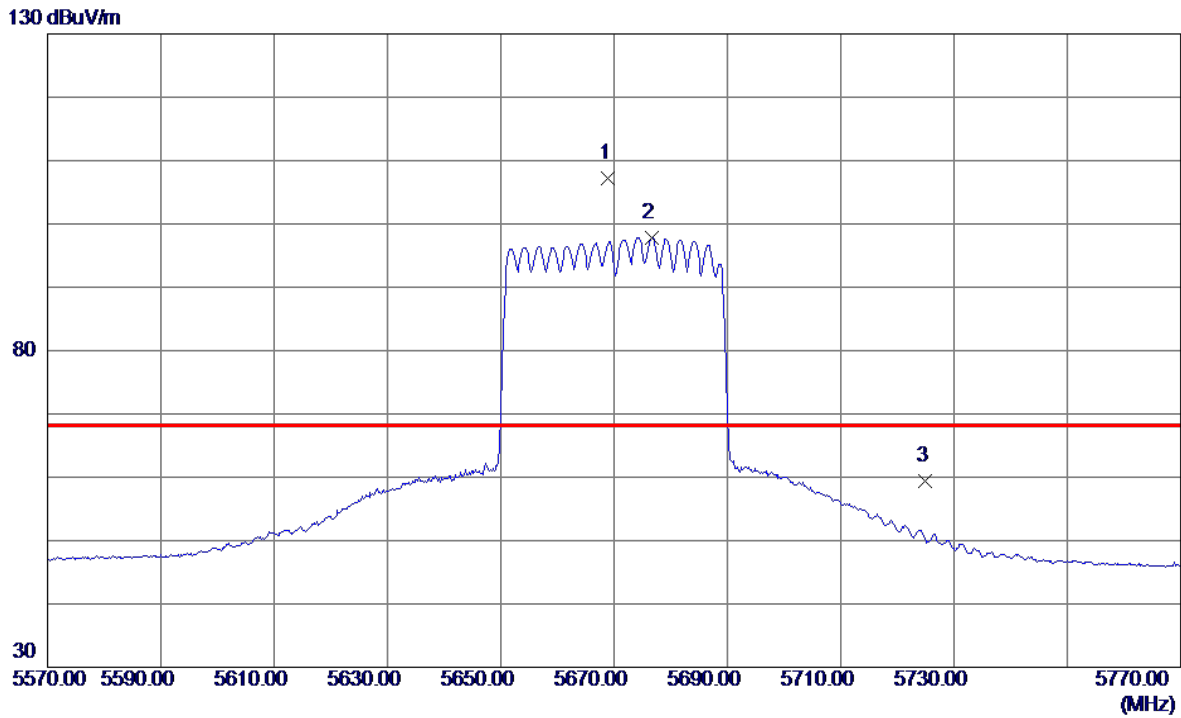

No.	Freq. MHz	Reading Level dBuV/m	Correct Factor dB	Measure ment dBuV/m	Limit dBuV/m	Margin dB	Detector	Comment
1 *	5669.0000	90.69	16.47	107.16	68.20	38.96	Peak	No Limit
2	5676.6000	81.36	16.48	97.84	999.00	-901.16	AVG	No Limit
3	5725.0000	42.79	16.57	59.36	68.20	-8.84	Peak	

REMARKS:

- (1) Measurement Value = Reading Level + Correct Factor.
- (2) Margin Level = Measurement Value - Limit Value.

Test Mode	UNII-2C_TX AX(HE40) Mode 5670 MHz	Polarization	Vertical
-----------	-----------------------------------	--------------	----------

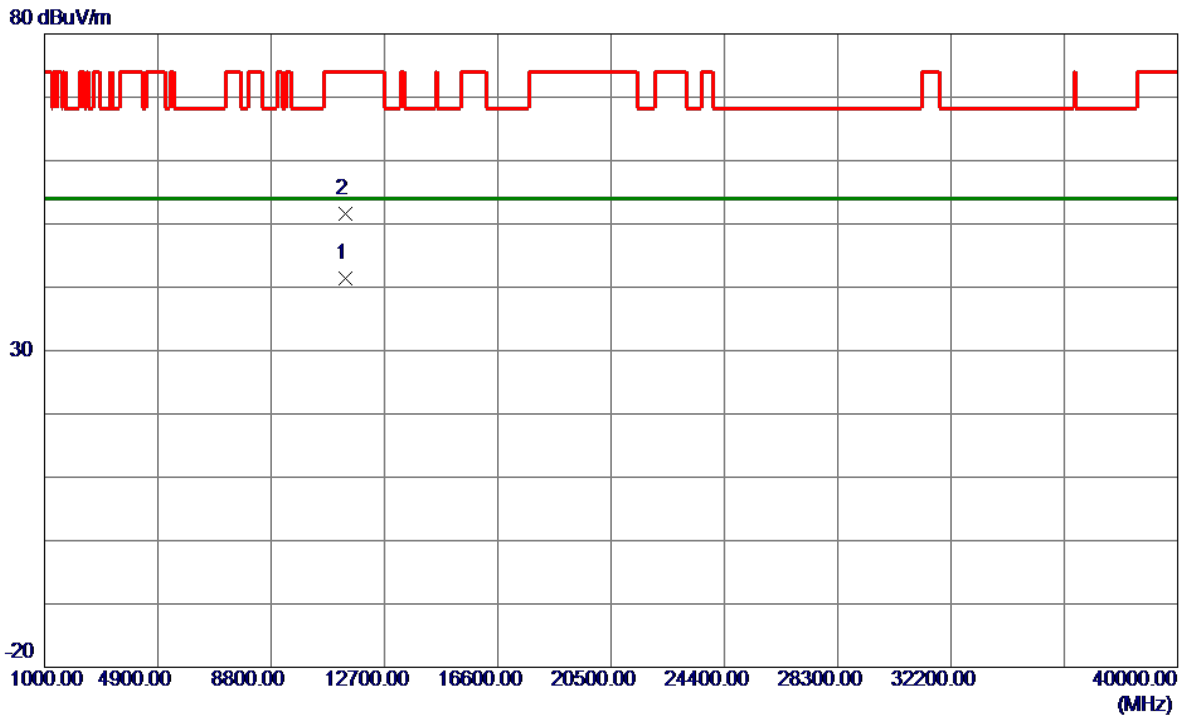

No.	Freq. MHz	Reading Level dBuV/m	Correct Factor dB	Measure ment dBuV/m	Limit dBuV/m	Margin dB	Detector	Comment
1 *	11341.4000	28.18	13.17	41.35	54.00	-12.65	AVG	
2	11344.6100	38.45	13.18	51.63	74.00	-22.37	Peak	

REMARKS:

- (1) Measurement Value = Reading Level + Correct Factor.
- (2) Margin Level = Measurement Value - Limit Value.

Test Mode	UNII-2C_TX AX(HE80) Mode 5530 MHz	Polarization	Vertical
-----------	-----------------------------------	--------------	----------

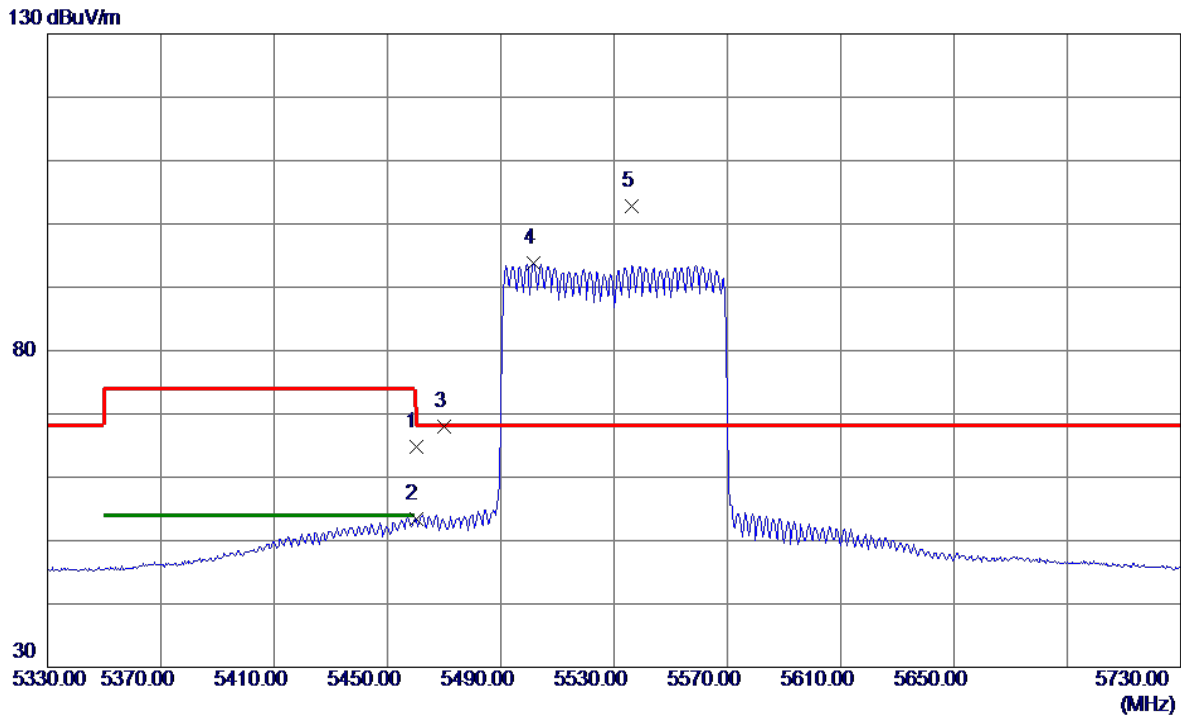

No.	Freq. MHz	Reading Level dBuV/m	Correct Factor dB	Measure ment dBuV/m	Limit dBuV/m	Margin dB	Detector	Comment
1	5460.0000	48.79	16.04	64.83	74.00	-9.17	Peak	
2	5460.0000	37.42	16.04	53.46	54.00	-0.54	AVG	
3	5470.0000	51.88	16.07	67.95	68.20	-0.25	Peak	
4	5501.6000	77.55	16.17	93.72	999.00	-905.28	AVG	No Limit
5 *	5536.4000	86.60	16.23	102.83	68.20	34.63	Peak	No Limit

REMARKS:

- (1) Measurement Value = Reading Level + Correct Factor.
- (2) Margin Level = Measurement Value - Limit Value.

Test Mode	UNII-2C_TX AX(HE80) Mode 5530 MHz	Polarization	Vertical
-----------	-----------------------------------	--------------	----------

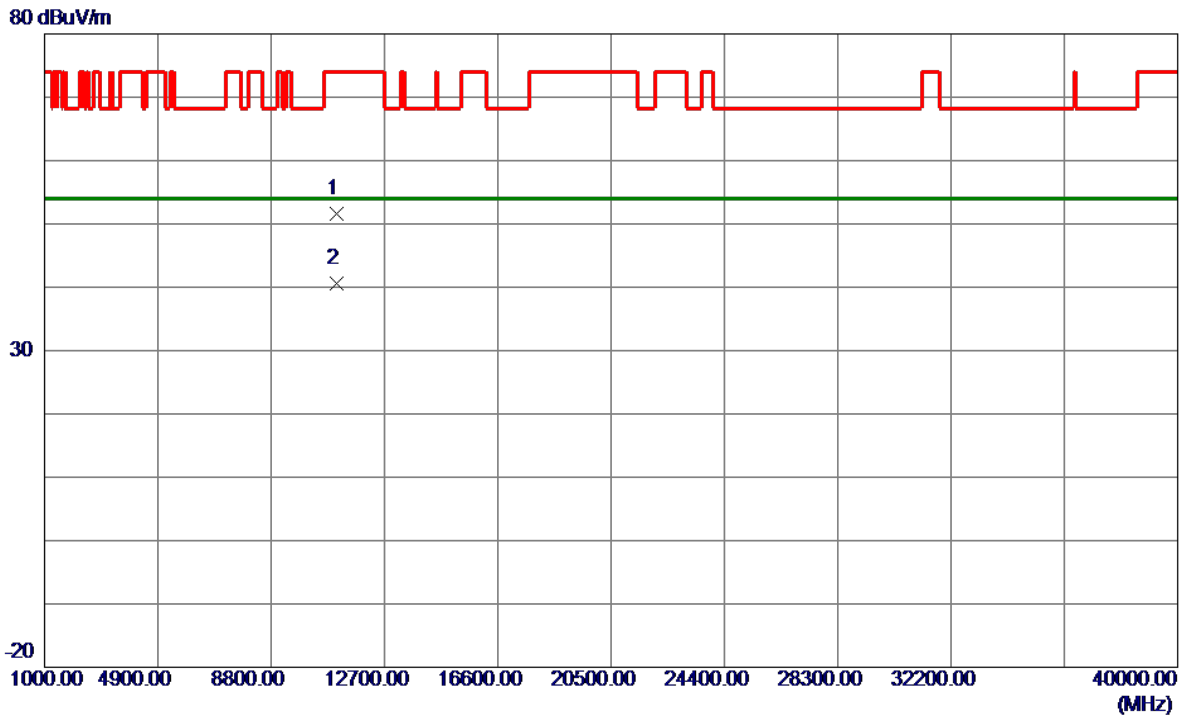

No.	Freq. MHz	Reading Level dBuV/m	Correct Factor dB	Measure ment dBuV/m	Limit dBuV/m	Margin dB	Detector	Comment
1	11056.0100	38.74	12.84	51.58	74.00	-22.42	Peak	
2 *	11061.5900	27.84	12.85	40.69	54.00	-13.31	AVG	

REMARKS:

- (1) Measurement Value = Reading Level + Correct Factor.
- (2) Margin Level = Measurement Value - Limit Value.

Test Mode	UNII-2C_TX AX(HE80) Mode 5610 MHz	Polarization	Vertical
-----------	-----------------------------------	--------------	----------

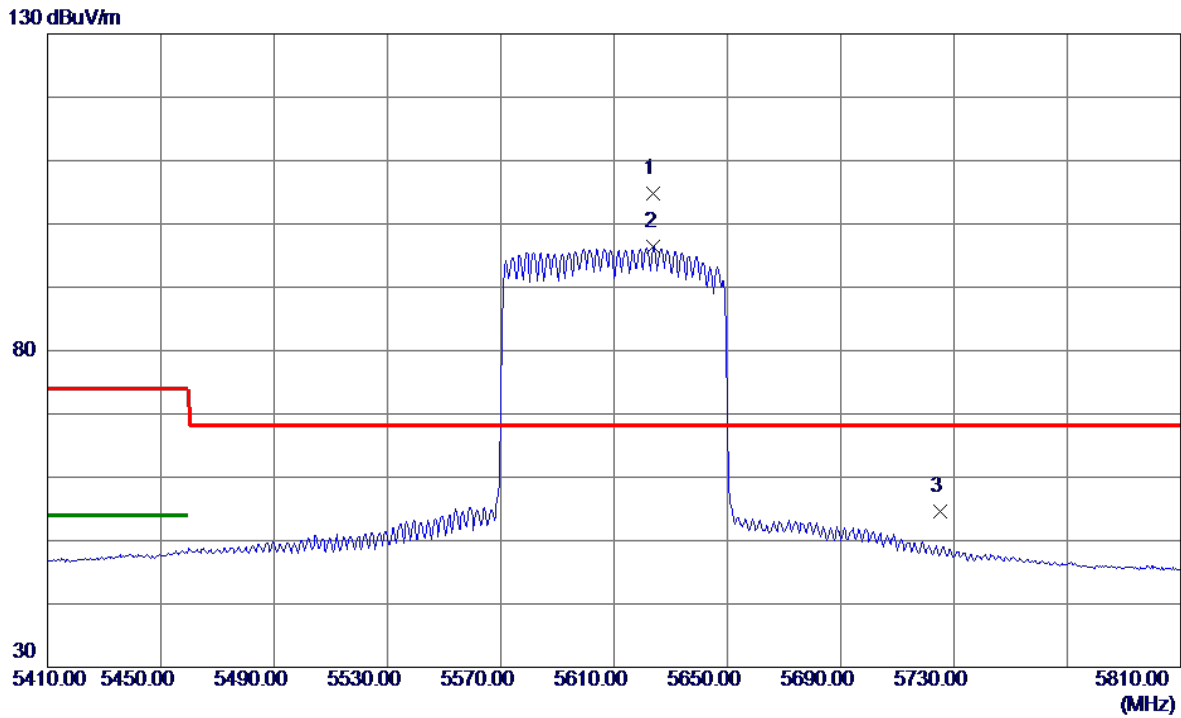

No.	Freq. MHz	Reading Level dBuV/m	Correct Factor dB	Measure ment dBuV/m	Limit dBuV/m	Margin dB	Detector	Comment
1 *	5623.6000	88.36	16.39	104.75	68.20	36.55	Peak	No Limit
2	5624.0000	80.02	16.39	96.41	999.00	-902.59	AVG	No Limit
3	5725.0000	38.04	16.57	54.61	68.20	-13.59	Peak	

REMARKS:

- (1) Measurement Value = Reading Level + Correct Factor.
- (2) Margin Level = Measurement Value - Limit Value.

Test Mode	UNII-2C_TX AX(HE80) Mode 5610 MHz	Polarization	Vertical
-----------	-----------------------------------	--------------	----------

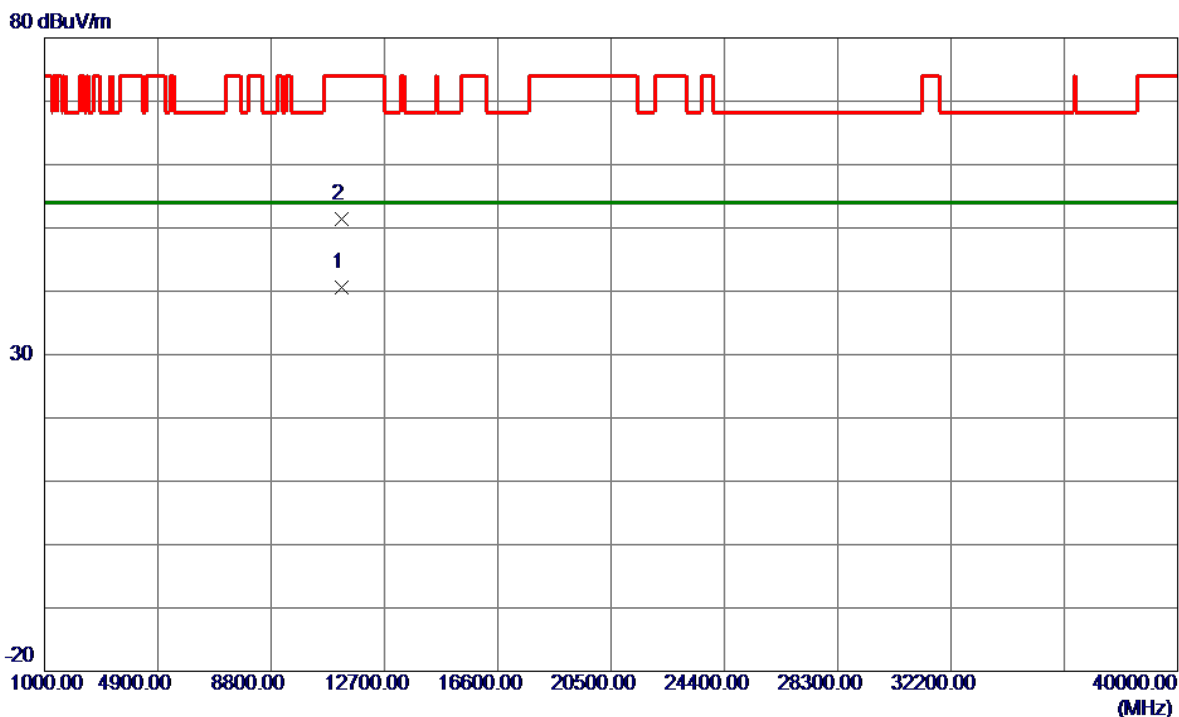

No.	Freq. MHz	Reading Level dBuV/m	Correct Factor dB	Measure ment dBuV/m	Limit dBuV/m	Margin dB	Detector	Comment
1 *	11218.4100	27.61	13.03	40.64	54.00	-13.36	AVG	
2	11219.5400	38.36	13.03	51.39	74.00	-22.61	Peak	

REMARKS:

- (1) Measurement Value = Reading Level + Correct Factor.
- (2) Margin Level = Measurement Value - Limit Value.

Test Mode	UNII-2C_TX AX(HE160) Mode 5570 MHz	Polarization	Vertical
-----------	------------------------------------	--------------	----------

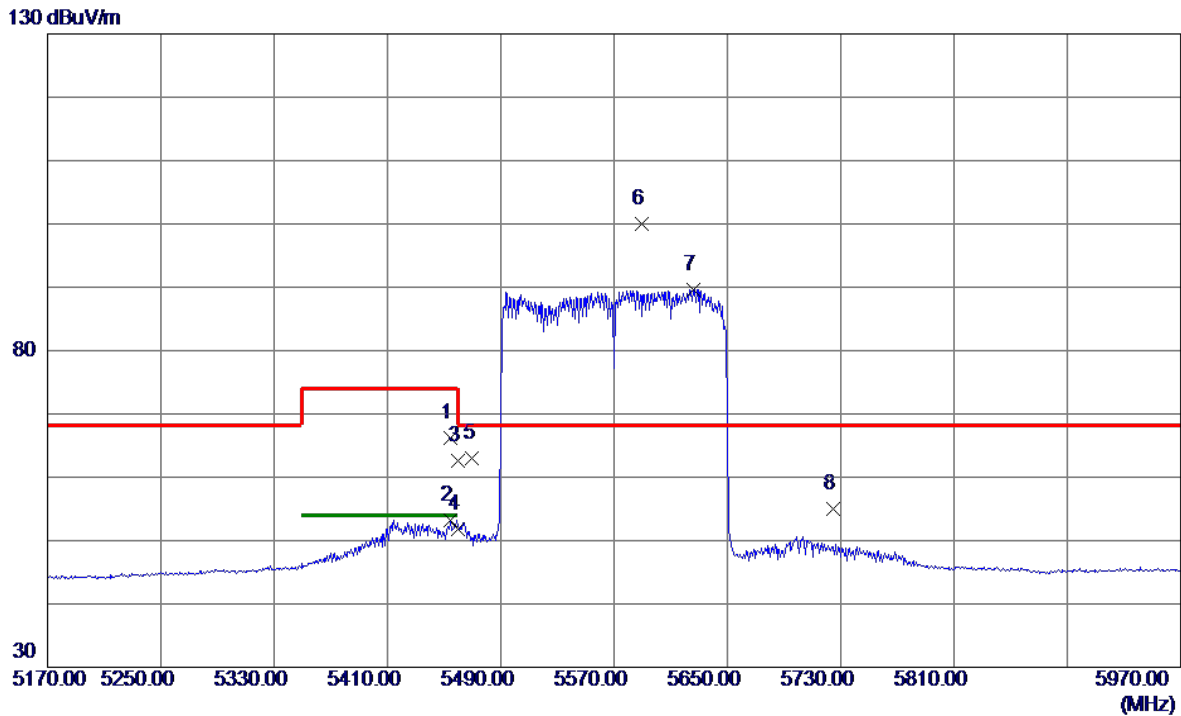

No.	Freq. MHz	Reading Level dBuV/m	Correct Factor dB	Measure ment dBuV/m	Limit dBuV/m	Margin dB	Detector	Comment
1	5454.8000	50.14	16.03	66.17	74.00	-7.83	Peak	
2	5454.8000	37.13	16.03	53.16	54.00	-0.84	AVG	
3	5460.0000	46.48	16.04	62.52	74.00	-11.48	Peak	
4	5460.0000	35.71	16.04	51.75	54.00	-2.25	AVG	
5	5470.0000	46.85	16.07	62.92	68.20	-5.28	Peak	
6 *	5589.2000	83.64	16.32	99.96	68.20	31.76	Peak	No Limit
7	5626.0000	73.29	16.39	89.68	999.00	-909.32	AVG	No Limit
8	5725.0000	38.40	16.57	54.97	68.20	-13.23	Peak	

REMARKS:

- (1) Measurement Value = Reading Level + Correct Factor.
- (2) Margin Level = Measurement Value - Limit Value.

Test Mode	UNII-2C_TX AX(HE160) Mode 5570 MHz	Polarization	Vertical
-----------	------------------------------------	--------------	----------

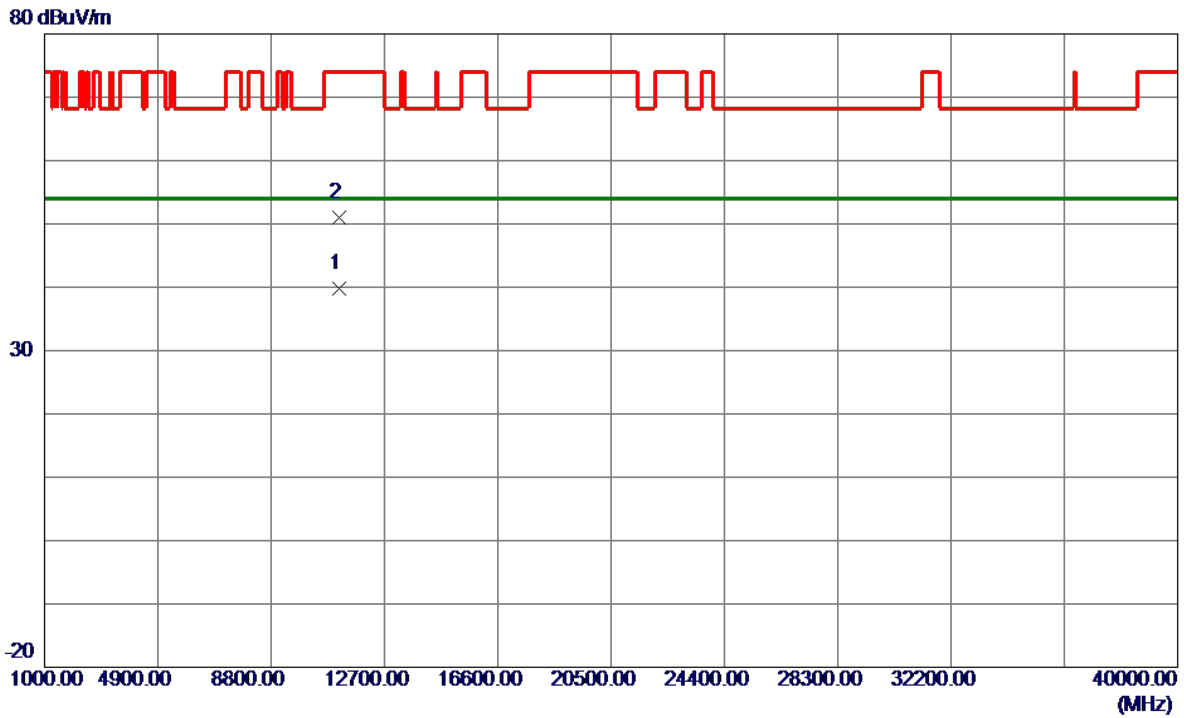

No.	Freq. MHz	Reading Level dBuV/m	Correct Factor dB	Measure ment dBuV/m	Limit dBuV/m	Margin dB	Detector	Comment
1 *	11141.0599	26.89	12.94	39.83	54.00	-14.17	AVG	
2	11145.6700	38.06	12.95	51.01	74.00	-22.99	Peak	

REMARKS:

- (1) Measurement Value = Reading Level + Correct Factor.
- (2) Margin Level = Measurement Value - Limit Value.

Test Mode	UNII-3_TX A Mode 5745 MHz	Polarization	Vertical
-----------	---------------------------	--------------	----------

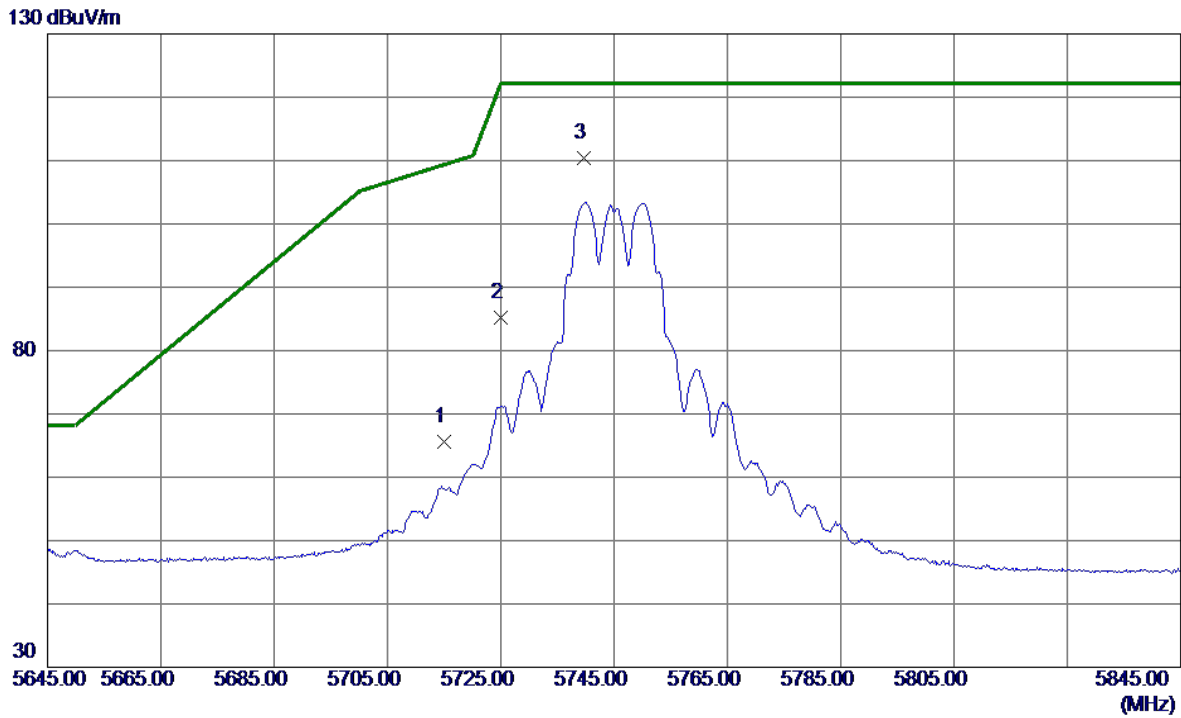

No.	Freq. MHz	Reading Level dBuV/m	Correct Factor dB	Measure ment dBuV/m	Limit dBuV/m	Margin dB	Detector	Comment
1	5715.0000	49.32	16.28	65.60	109.40	-43.80	Peak	
2	5725.0000	68.98	16.29	85.27	122.20	-36.93	Peak	
3 *	5739.6000	94.04	16.30	110.34	122.20	-11.86	Peak	No Limit

REMARKS:

- (1) Measurement Value = Reading Level + Correct Factor.
- (2) Margin Level = Measurement Value - Limit Value.

Test Mode	UNII-3_TX A Mode 5745 MHz	Polarization	Vertical
-----------	---------------------------	--------------	----------

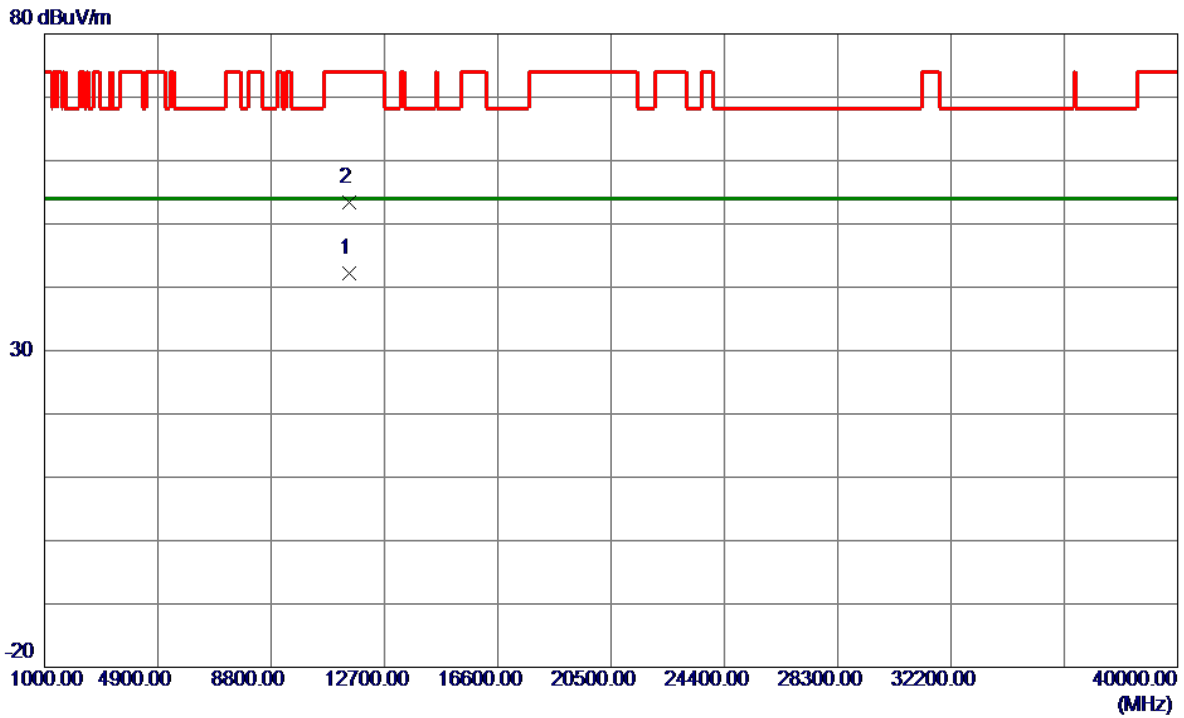

No.	Freq. MHz	Reading Level dBuV/m	Correct Factor dB	Measure ment dBuV/m	Limit dBuV/m	Margin dB	Detector	Comment
1 *	11488.2800	28.87	13.34	42.21	54.00	-11.79	AVG	
2	11491.0500	40.14	13.34	53.48	74.00	-20.52	Peak	

REMARKS:

- (1) Measurement Value = Reading Level + Correct Factor.
- (2) Margin Level = Measurement Value - Limit Value.

Test Mode	UNII-3_TX A Mode 5785 MHz	Polarization	Vertical
-----------	---------------------------	--------------	----------

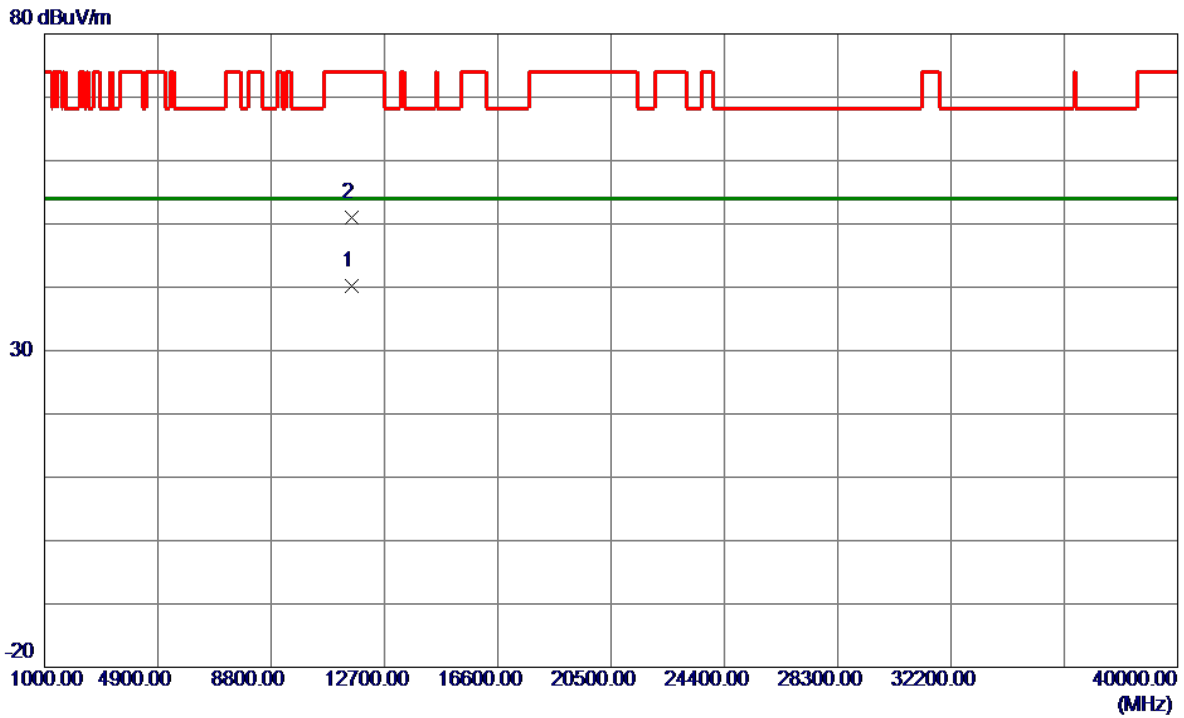

No.	Freq. MHz	Reading Level dBuV/m	Correct Factor dB	Measure ment dBuV/m	Limit dBuV/m	Margin dB	Detector	Comment
1 *	11568.4000	26.76	13.37	40.13	54.00	-13.87	AVG	
2	11569.3400	37.58	13.37	50.95	74.00	-23.05	Peak	

REMARKS:

- (1) Measurement Value = Reading Level + Correct Factor.
- (2) Margin Level = Measurement Value - Limit Value.

Test Mode	UNII-3_TX A Mode 5825 MHz	Polarization	Vertical
-----------	---------------------------	--------------	----------

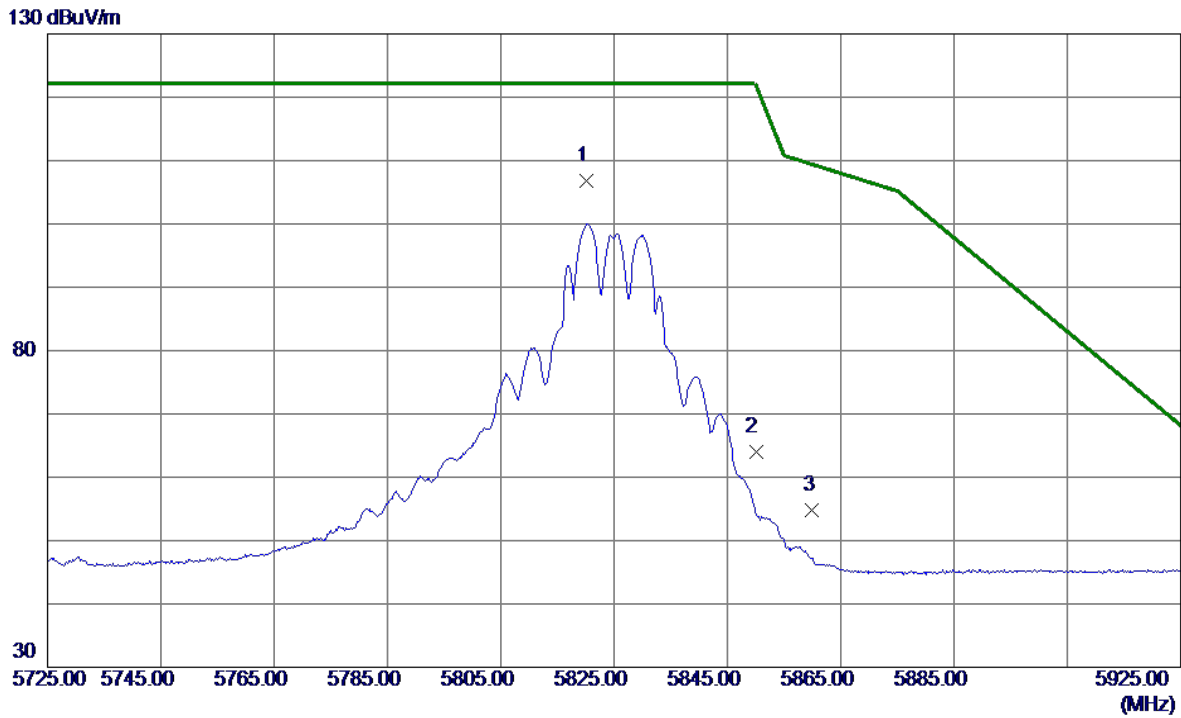

No.	Freq. MHz	Reading Level dBuV/m	Correct Factor dB	Measure ment dBuV/m	Limit dBuV/m	Margin dB	Detector	Comment
1 *	5820.2000	90.38	16.36	106.74	122.20	-15.46	Peak	No Limit
2	5850.0000	47.64	16.38	64.02	122.20	-58.18	Peak	
3	5860.0000	38.36	16.39	54.75	109.40	-54.65	Peak	

REMARKS:

- (1) Measurement Value = Reading Level + Correct Factor.
- (2) Margin Level = Measurement Value - Limit Value.

Test Mode	UNII-3_TX A Mode 5825 MHz	Polarization	Vertical
-----------	---------------------------	--------------	----------

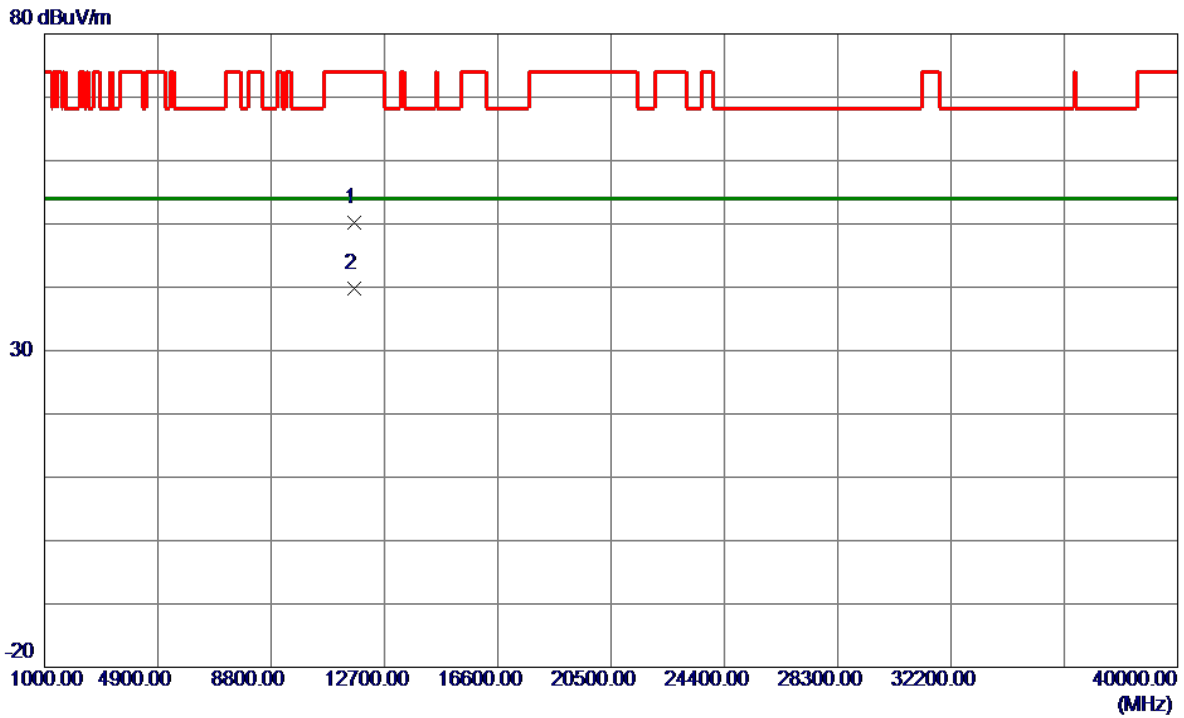

No.	Freq. MHz	Reading Level dBuV/m	Correct Factor dB	Measure ment dBuV/m	Limit dBuV/m	Margin dB	Detector	Comment
1	11648.6900	36.80	13.39	50.19	74.00	-23.81	Peak	
2 *	11654.5300	26.41	13.39	39.80	54.00	-14.20	AVG	

REMARKS:

- (1) Measurement Value = Reading Level + Correct Factor.
- (2) Margin Level = Measurement Value - Limit Value.

Test Mode	UNII-3_TX AC(VHT20) Mode 5745 MHz	Polarization	Vertical
-----------	-----------------------------------	--------------	----------

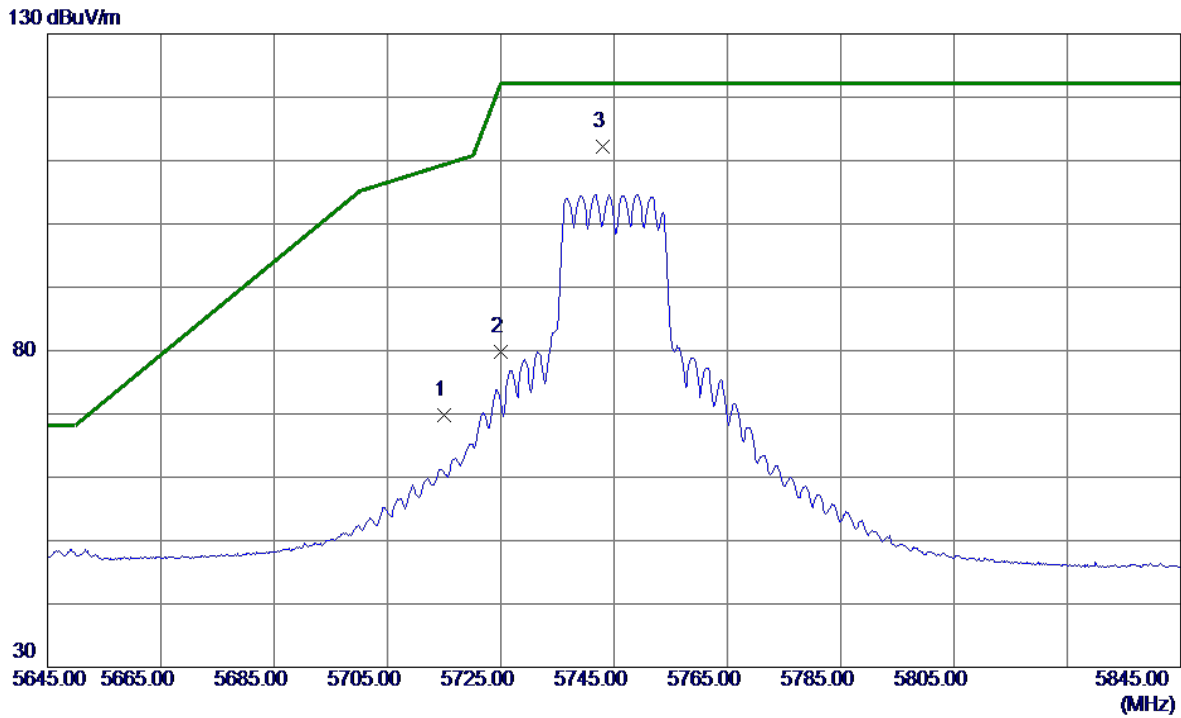

No.	Freq. MHz	Reading Level dBuV/m	Correct Factor dB	Measure ment dBuV/m	Limit dBuV/m	Margin dB	Detector	Comment
1	5715.0000	53.61	16.23	69.84	109.40	-39.56	Peak	
2	5725.0000	63.57	16.25	79.82	122.20	-42.38	Peak	
3 *	5743.0000	95.85	16.29	112.14	122.20	-10.06	Peak	No Limit

REMARKS:

- (1) Measurement Value = Reading Level + Correct Factor.
- (2) Margin Level = Measurement Value - Limit Value.

Test Mode	UNII-3_TX AC(VHT20) Mode 5745 MHz	Polarization	Vertical
-----------	-----------------------------------	--------------	----------

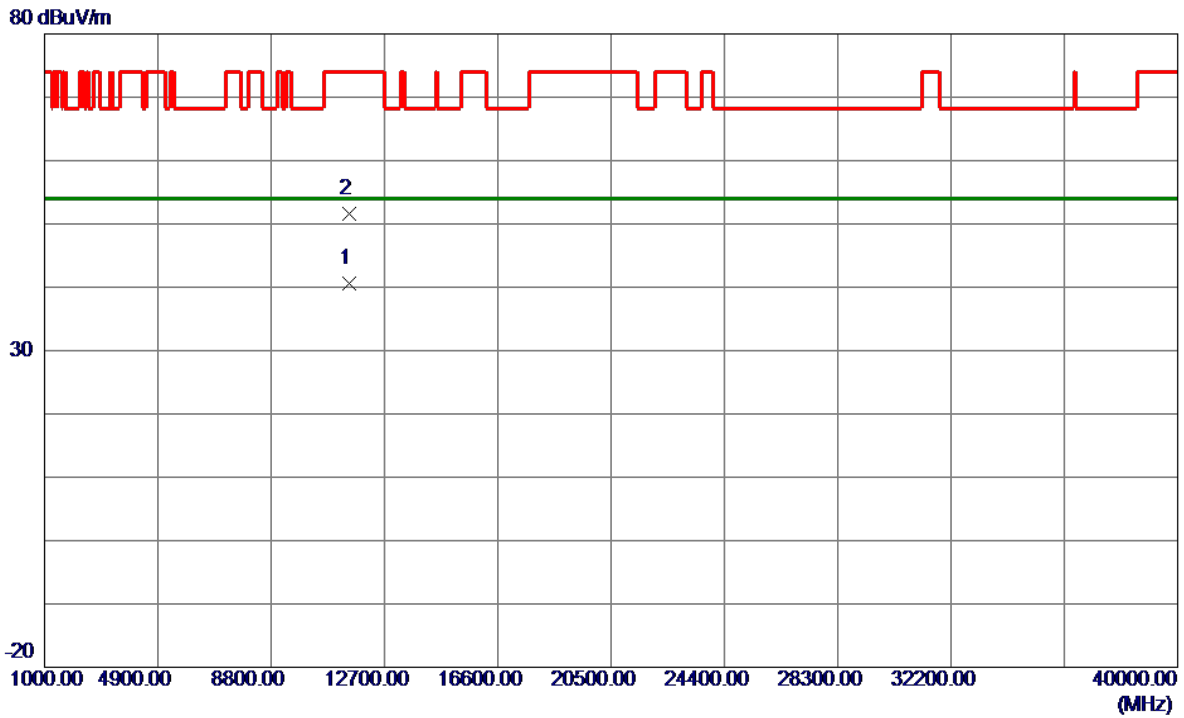

No.	Freq. MHz	Reading Level dBuV/m	Correct Factor dB	Measure ment dBuV/m	Limit dBuV/m	Margin dB	Detector	Comment
1 *	11483.9800	27.33	13.34	40.67	54.00	-13.33	AVG	
2	11494.5000	38.22	13.35	51.57	74.00	-22.43	Peak	

REMARKS:

- (1) Measurement Value = Reading Level + Correct Factor.
- (2) Margin Level = Measurement Value - Limit Value.

Test Mode	UNII-3_TX AC(VHT20) Mode 5785 MHz	Polarization	Vertical
-----------	-----------------------------------	--------------	----------

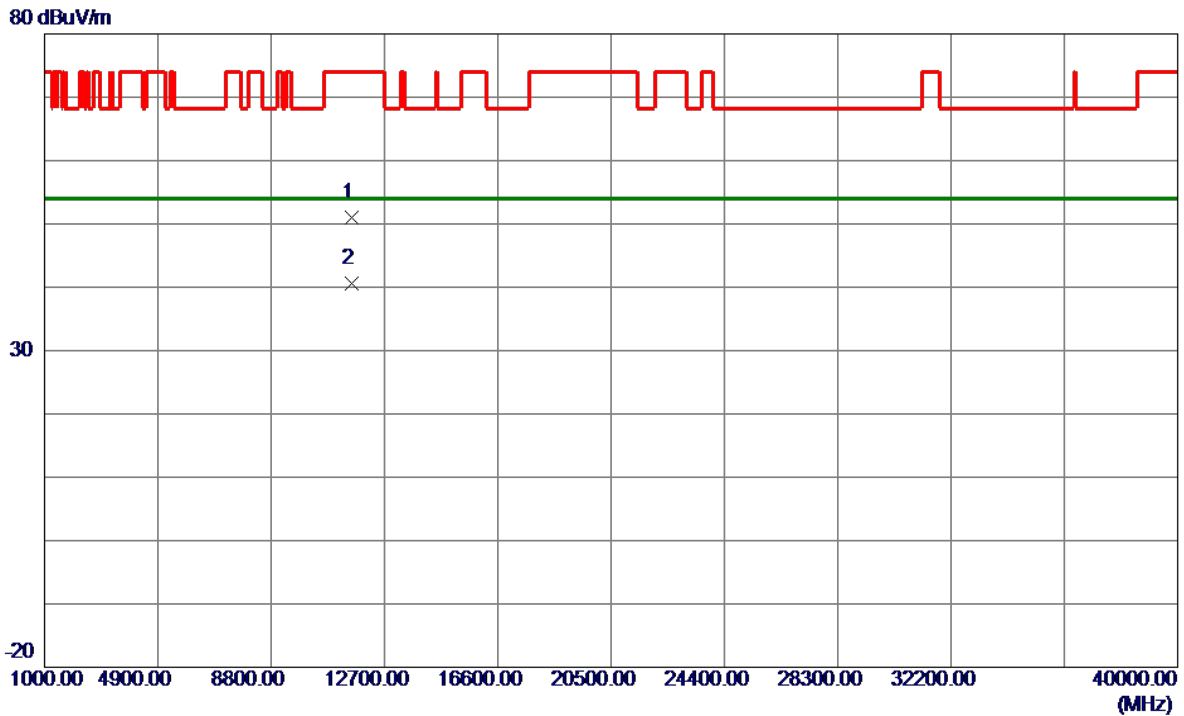

No.	Freq. MHz	Reading Level dBuV/m	Correct Factor dB	Measure ment dBuV/m	Limit dBuV/m	Margin dB	Detector	Comment
1	11571.5199	37.56	13.37	50.93	74.00	-23.07	Peak	
2 *	11571.7000	27.29	13.37	40.66	54.00	-13.34	AVG	

REMARKS:

- (1) Measurement Value = Reading Level + Correct Factor.
- (2) Margin Level = Measurement Value - Limit Value.

Test Mode	UNII-3_TX AC(VHT20) Mode 5825 MHz	Polarization	Vertical
-----------	-----------------------------------	--------------	----------

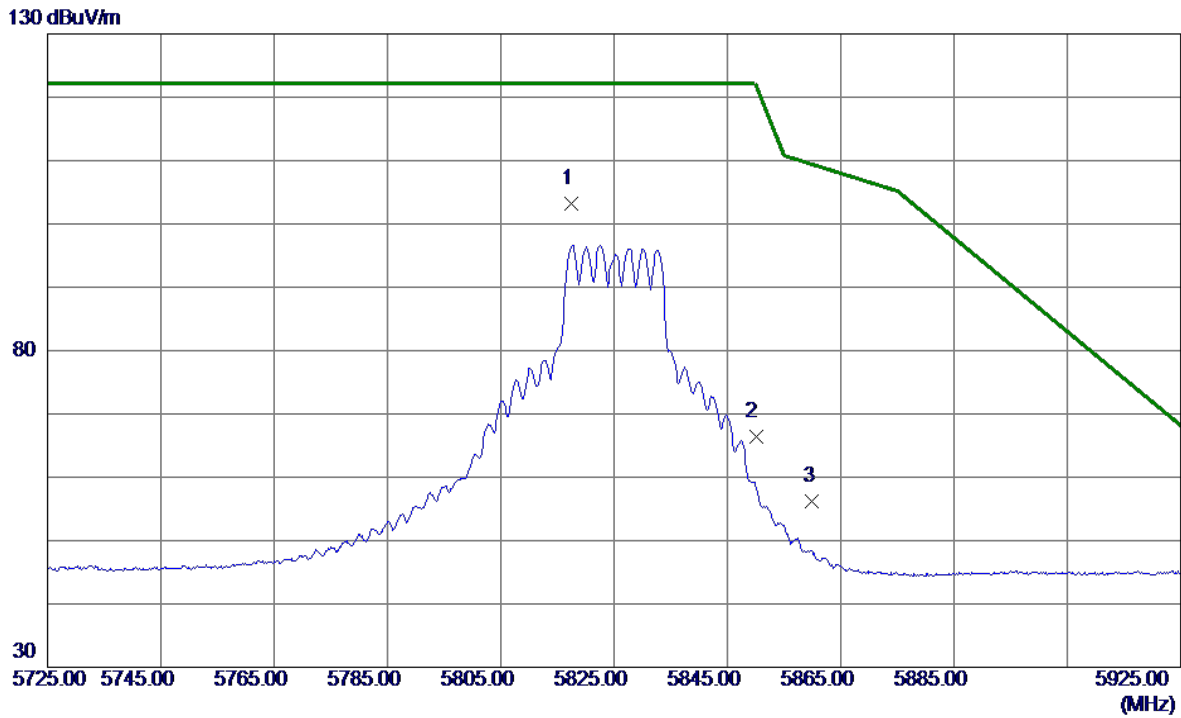

No.	Freq. MHz	Reading Level dBuV/m	Correct Factor dB	Measure ment dBuV/m	Limit dBuV/m	Margin dB	Detector	Comment
1 *	5817.4000	86.93	16.36	103.29	122.20	-18.91	Peak	No Limit
2	5850.0000	50.10	16.38	66.48	122.20	-55.72	Peak	
3	5860.0000	39.77	16.39	56.16	109.40	-53.24	Peak	

REMARKS:

- (1) Measurement Value = Reading Level + Correct Factor.
- (2) Margin Level = Measurement Value - Limit Value.

Test Mode	UNII-3_TX AC(VHT20) Mode 5825 MHz	Polarization	Vertical
-----------	-----------------------------------	--------------	----------

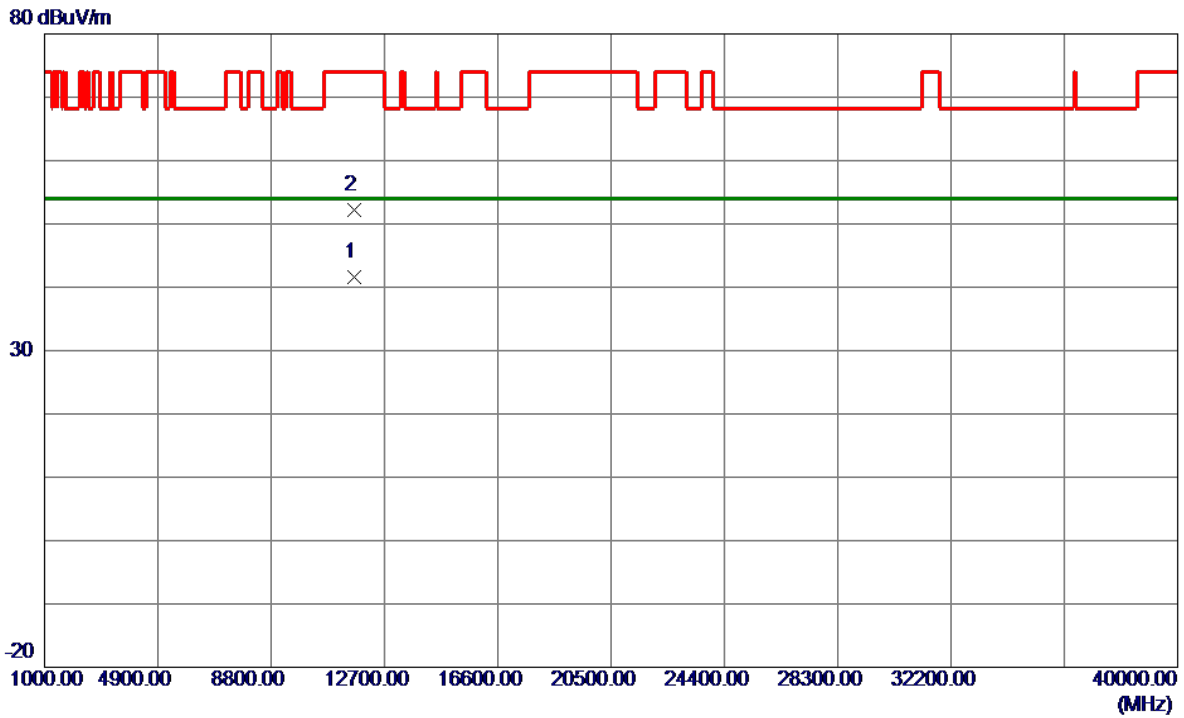

No.	Freq. MHz	Reading Level dBuV/m	Correct Factor dB	Measure ment dBuV/m	Limit dBuV/m	Margin dB	Detector	Comment
1 *	11652.2200	28.15	13.39	41.54	54.00	-12.46	AVG	
2	11655.7000	38.73	13.39	52.12	74.00	-21.88	Peak	

REMARKS:

- (1) Measurement Value = Reading Level + Correct Factor.
- (2) Margin Level = Measurement Value - Limit Value.

Test Mode	UNII-3_TX AC(VHT40) Mode 5755 MHz	Polarization	Vertical
-----------	-----------------------------------	--------------	----------

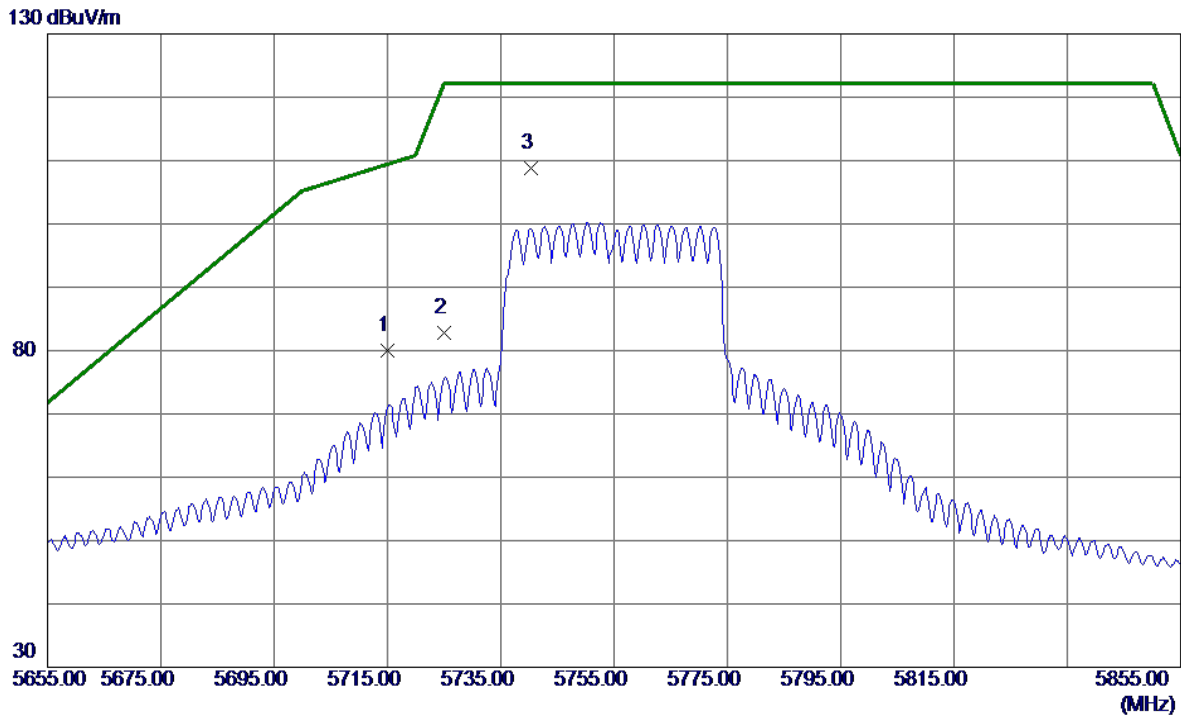

No.	Freq. MHz	Reading Level dBuV/m	Correct Factor dB	Measure ment dBuV/m	Limit dBuV/m	Margin dB	Detector	Comment
1	5715.0000	63.63	16.28	79.91	109.40	-29.49	Peak	
2	5725.0000	66.52	16.29	82.81	122.20	-39.39	Peak	
3 *	5740.4000	92.42	16.30	108.72	122.20	-13.48	Peak	No Limit

REMARKS:

- (1) Measurement Value = Reading Level + Correct Factor.
- (2) Margin Level = Measurement Value - Limit Value.

Test Mode	UNII-3_TX AC(VHT40) Mode 5755 MHz	Polarization	Vertical
-----------	-----------------------------------	--------------	----------

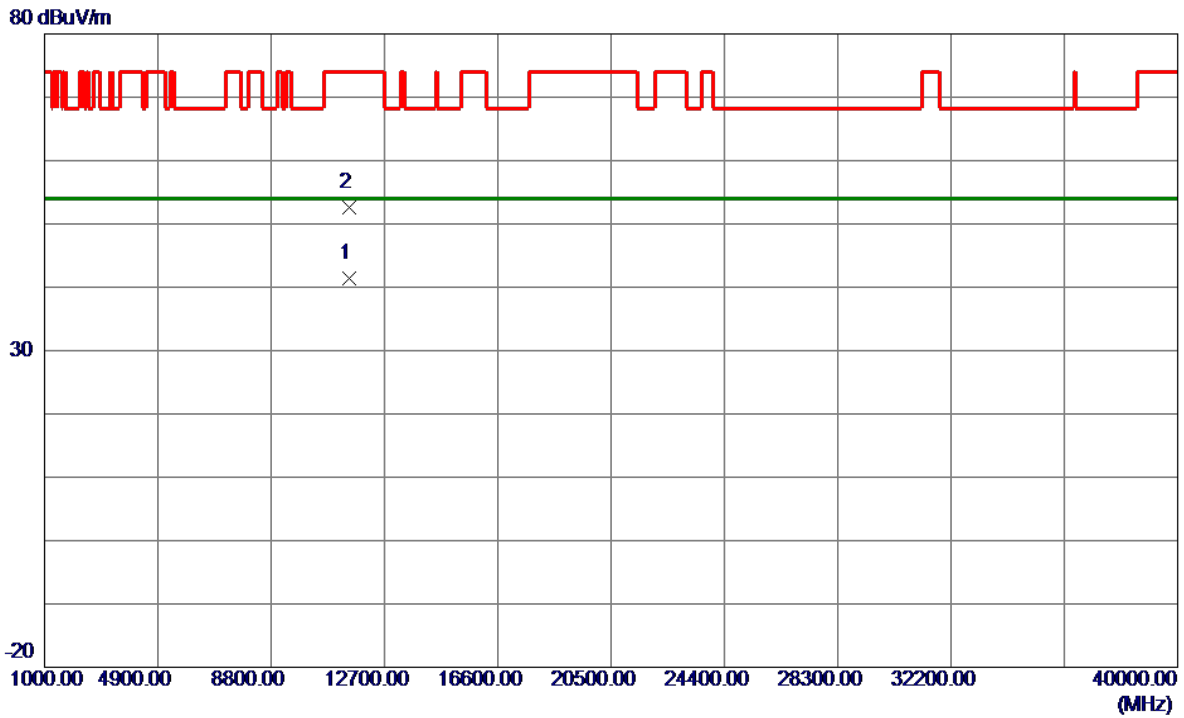

No.	Freq. MHz	Reading Level dBuV/m	Correct Factor dB	Measure ment dBuV/m	Limit dBuV/m	Margin dB	Detector	Comment
1 *	11507.3400	28.07	13.36	41.43	54.00	-12.57	AVG	
2	11507.9600	39.17	13.36	52.53	74.00	-21.47	Peak	

REMARKS:

- (1) Measurement Value = Reading Level + Correct Factor.
- (2) Margin Level = Measurement Value - Limit Value.

Test Mode	UNII-3_TX AC(VHT40) Mode 5795 MHz	Polarization	Vertical
-----------	-----------------------------------	--------------	----------

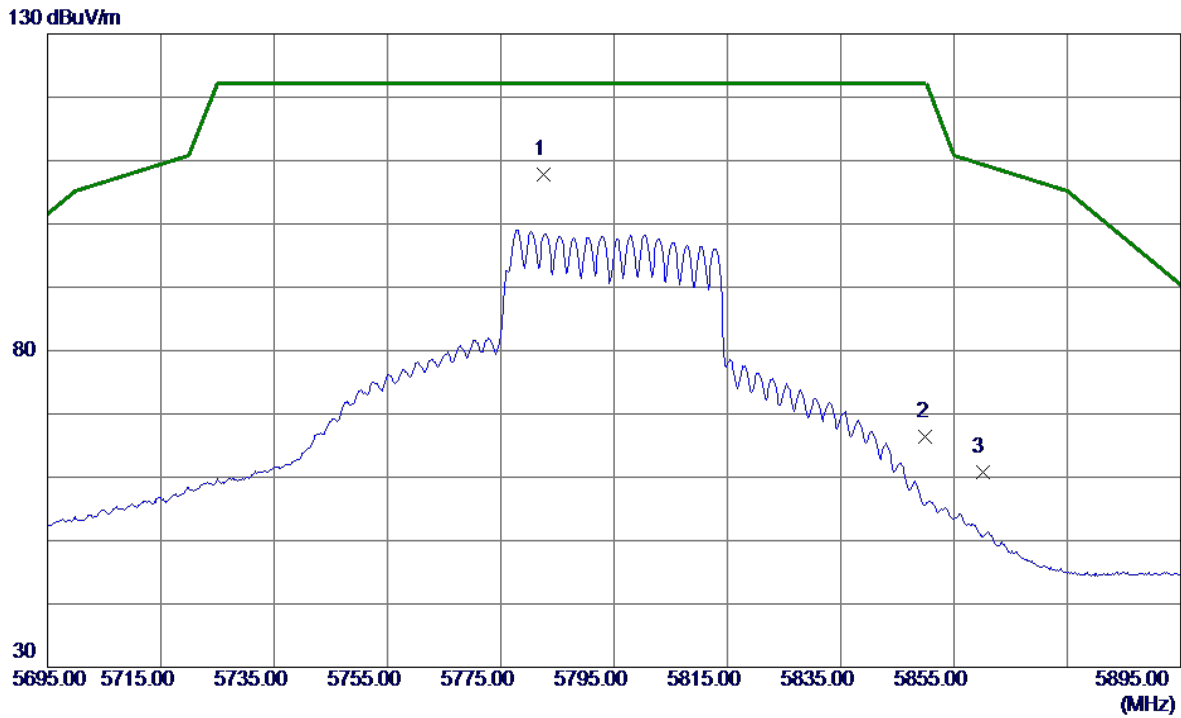

No.	Freq. MHz	Reading Level dBuV/m	Correct Factor dB	Measure ment dBuV/m	Limit dBuV/m	Margin dB	Detector	Comment
1 *	5782.6000	91.48	16.33	107.81	122.20	-14.39	Peak	No Limit
2	5850.0000	50.09	16.38	66.47	122.20	-55.73	Peak	
3	5860.0000	44.45	16.39	60.84	109.40	-48.56	Peak	

REMARKS:

- (1) Measurement Value = Reading Level + Correct Factor.
- (2) Margin Level = Measurement Value - Limit Value.

Test Mode	UNII-3_TX AC(VHT40) Mode 5795 MHz	Polarization	Vertical
-----------	-----------------------------------	--------------	----------

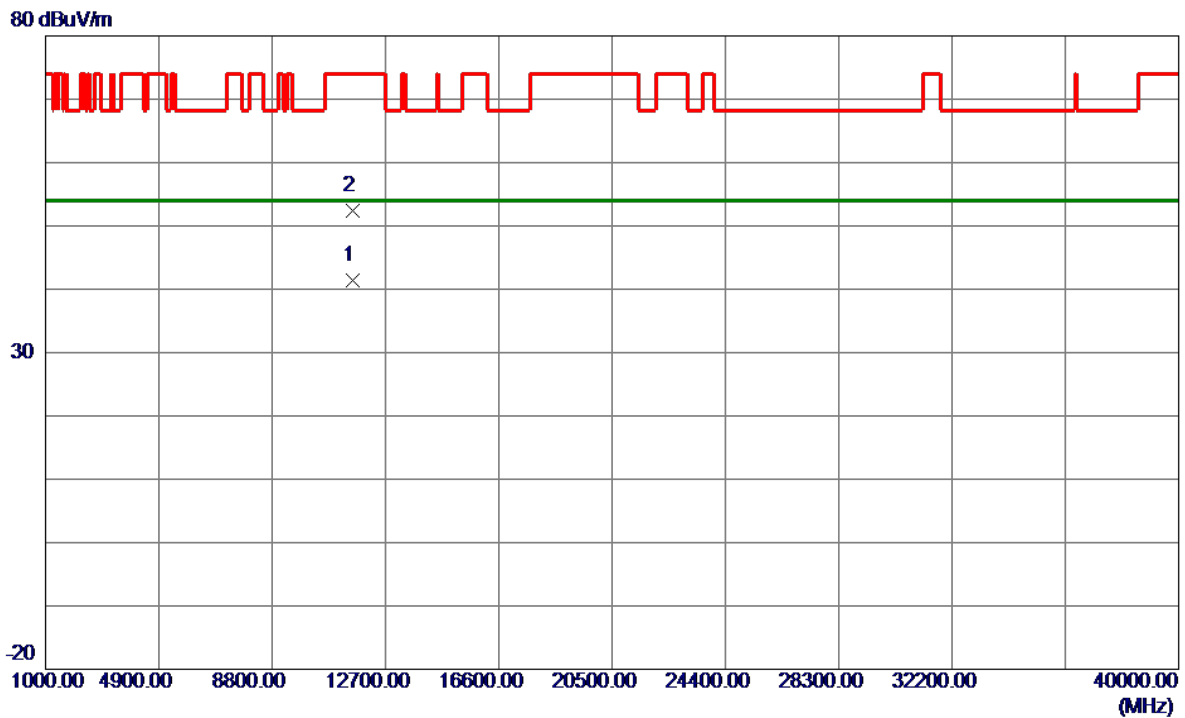

No.	Freq. MHz	Reading Level dBuV/m	Correct Factor dB	Measure ment dBuV/m	Limit dBuV/m	Margin dB	Detector	Comment
1 *	11586.5000	28.01	13.37	41.38	54.00	-12.62	AVG	
2	11594.2500	38.96	13.38	52.34	74.00	-21.66	Peak	

REMARKS:

- (1) Measurement Value = Reading Level + Correct Factor.
- (2) Margin Level = Measurement Value - Limit Value.

Test Mode	UNII-3_TX AC(VHT80) Mode 5775 MHz	Polarization	Vertical
-----------	-----------------------------------	--------------	----------

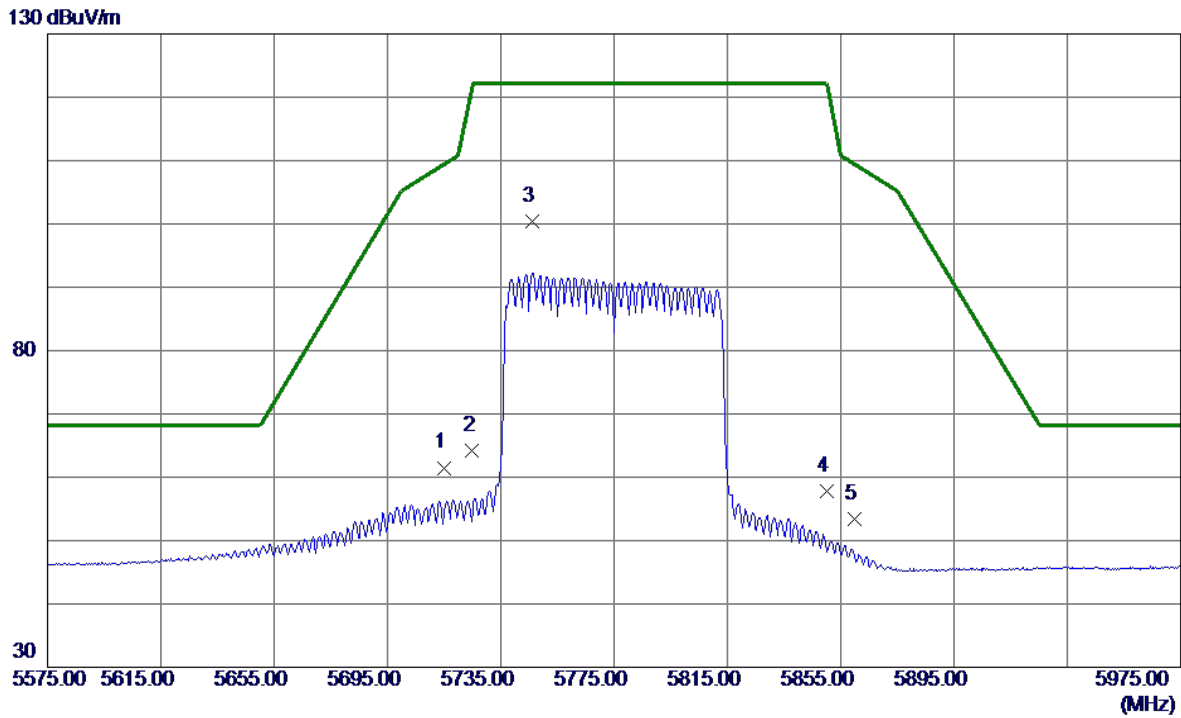

No.	Freq. MHz	Reading Level dBuV/m	Correct Factor dB	Measure ment dBuV/m	Limit dBuV/m	Margin dB	Detector	Comment
1	5715.0000	45.27	16.23	61.50	109.40	-47.90	Peak	
2	5725.0000	47.99	16.25	64.24	122.20	-57.96	Peak	
3 *	5746.2000	84.03	16.29	100.32	122.20	-21.88	Peak	No Limit
4	5850.0000	41.28	16.52	57.80	122.20	-64.40	Peak	
5	5860.0000	36.85	16.54	53.39	109.40	-56.01	Peak	

REMARKS:

- (1) Measurement Value = Reading Level + Correct Factor.
- (2) Margin Level = Measurement Value - Limit Value.

Test Mode	UNII-3_TX AC(VHT80) Mode 5775 MHz	Polarization	Vertical
-----------	-----------------------------------	--------------	----------

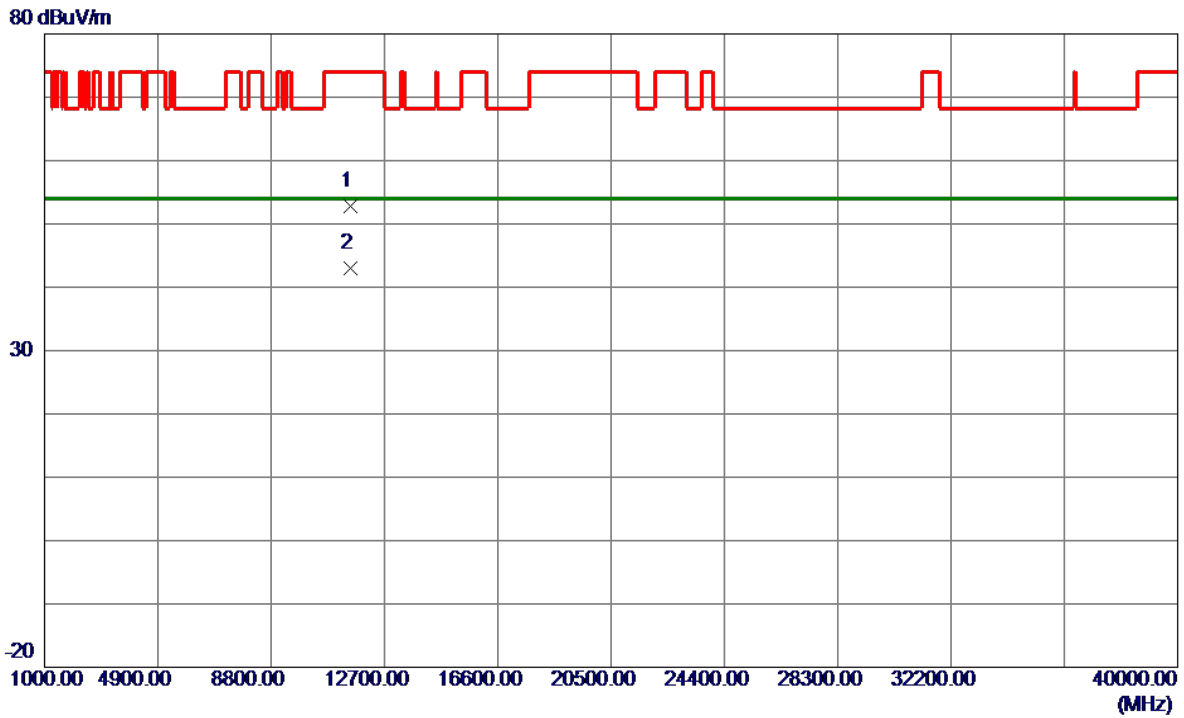

No.	Freq. MHz	Reading Level dBuV/m	Correct Factor dB	Measure ment dBuV/m	Limit dBuV/m	Margin dB	Detector	Comment
1	11550.3099	39.38	13.37	52.75	74.00	-21.25	Peak	
2 *	11550.6400	29.67	13.37	43.04	54.00	-10.96	AVG	

REMARKS:

- (1) Measurement Value = Reading Level + Correct Factor.
- (2) Margin Level = Measurement Value - Limit Value.

Test Mode	UNII-3_TX AX(HE20) Mode 5745 MHz	Polarization	Vertical
-----------	----------------------------------	--------------	----------

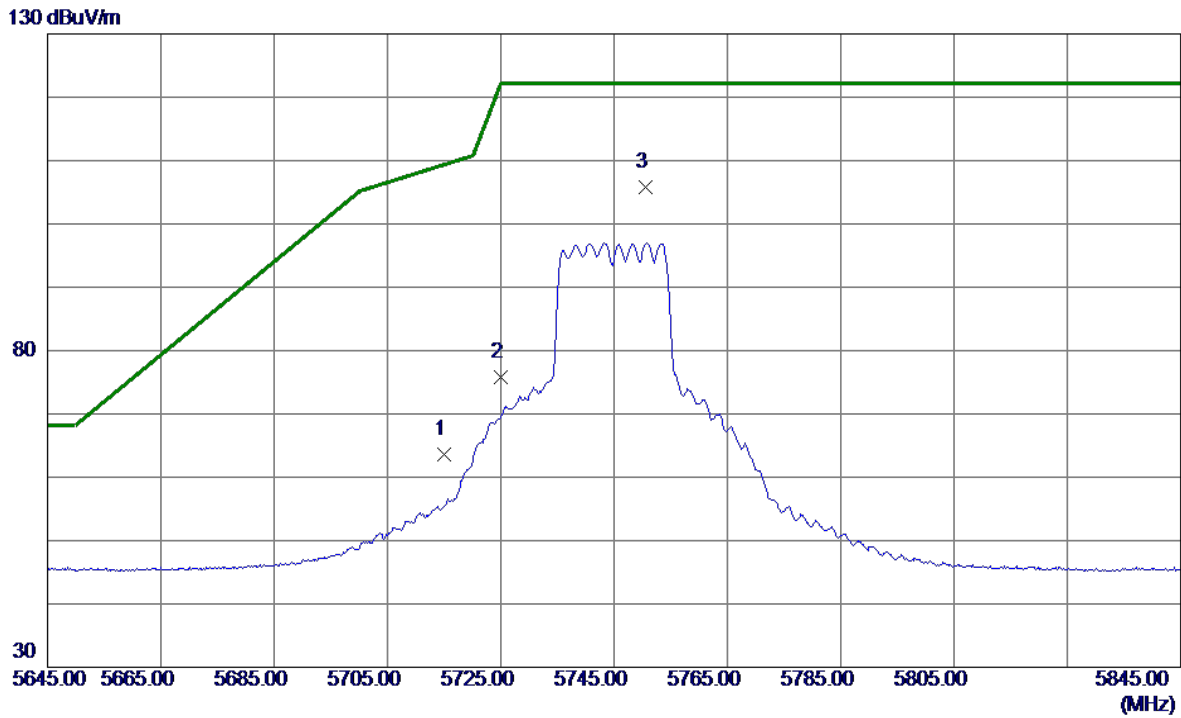

No.	Freq. MHz	Reading Level dBuV/m	Correct Factor dB	Measure ment dBuV/m	Limit dBuV/m	Margin dB	Detector	Comment
1	5715.0000	47.29	16.23	63.52	109.40	-45.88	Peak	
2	5725.0000	59.64	16.25	75.89	122.20	-46.31	Peak	
3 *	5750.6000	89.53	16.30	105.83	122.20	-16.37	Peak	No Limit

REMARKS:

- (1) Measurement Value = Reading Level + Correct Factor.
- (2) Margin Level = Measurement Value - Limit Value.

Test Mode	UNII-3_TX AX(HE20) Mode 5745 MHz	Polarization	Vertical
-----------	----------------------------------	--------------	----------

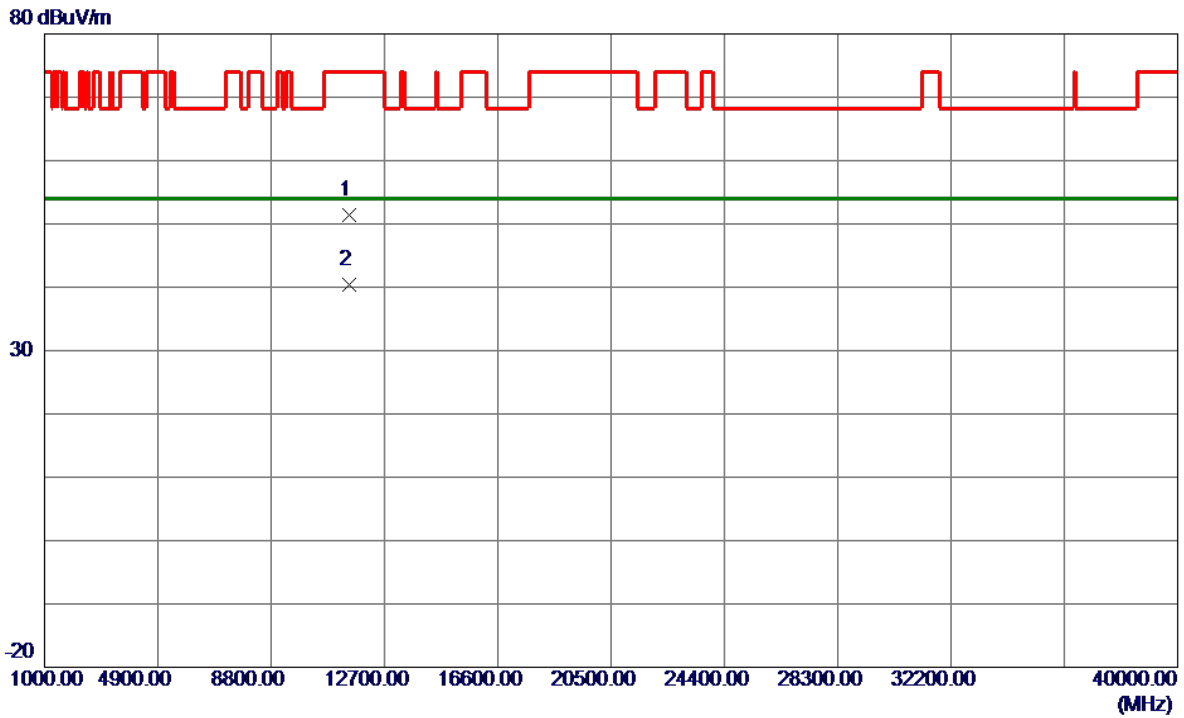

No.	Freq. MHz	Reading Level dBuV/m	Correct Factor dB	Measure ment dBuV/m	Limit dBuV/m	Margin dB	Detector	Comment
1	11485.4500	38.09	13.34	51.43	74.00	-22.57	Peak	
2 *	11494.4600	27.03	13.35	40.38	54.00	-13.62	AVG	

REMARKS:

- (1) Measurement Value = Reading Level + Correct Factor.
- (2) Margin Level = Measurement Value - Limit Value.

Test Mode	UNII-3_TX AX(HE20) Mode 5785 MHz	Polarization	Vertical
-----------	----------------------------------	--------------	----------

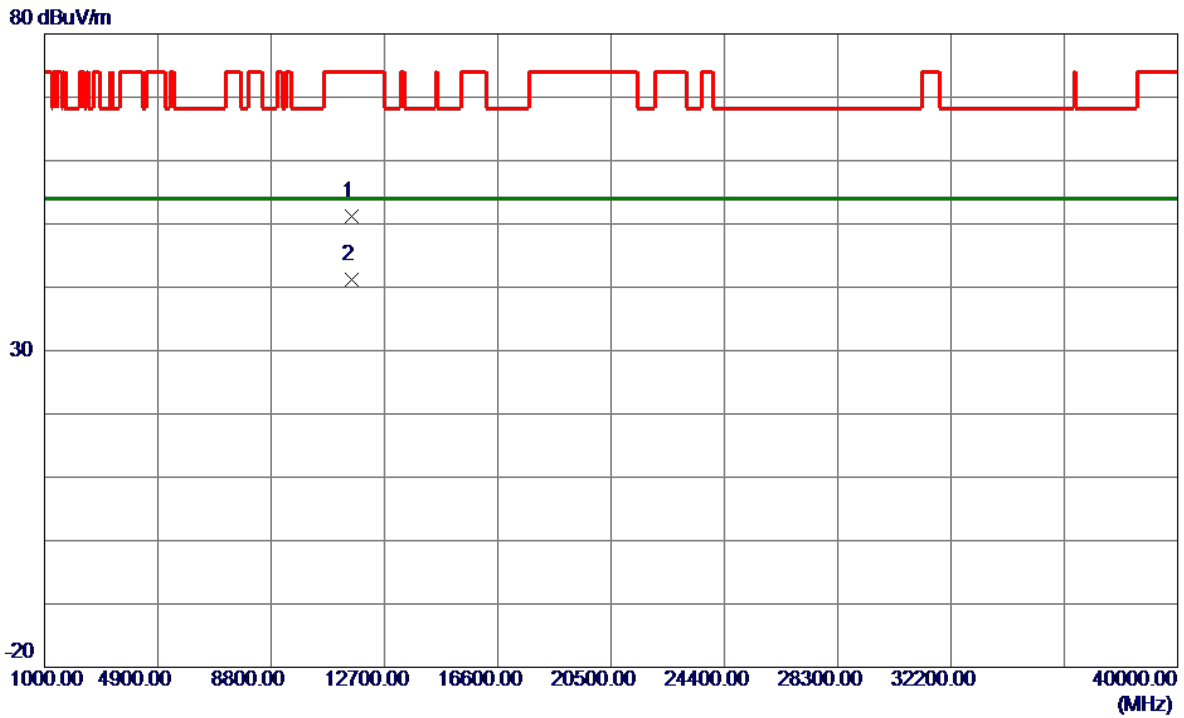

No.	Freq. MHz	Reading Level dBuV/m	Correct Factor dB	Measure ment dBuV/m	Limit dBuV/m	Margin dB	Detector	Comment
1	11570.2200	37.90	13.37	51.27	74.00	-22.73	Peak	
2 *	11574.2600	27.82	13.37	41.19	54.00	-12.81	AVG	

REMARKS:

- (1) Measurement Value = Reading Level + Correct Factor.
- (2) Margin Level = Measurement Value - Limit Value.

Test Mode	UNII-3_TX AX(HE20) Mode 5825 MHz	Polarization	Vertical
-----------	----------------------------------	--------------	----------

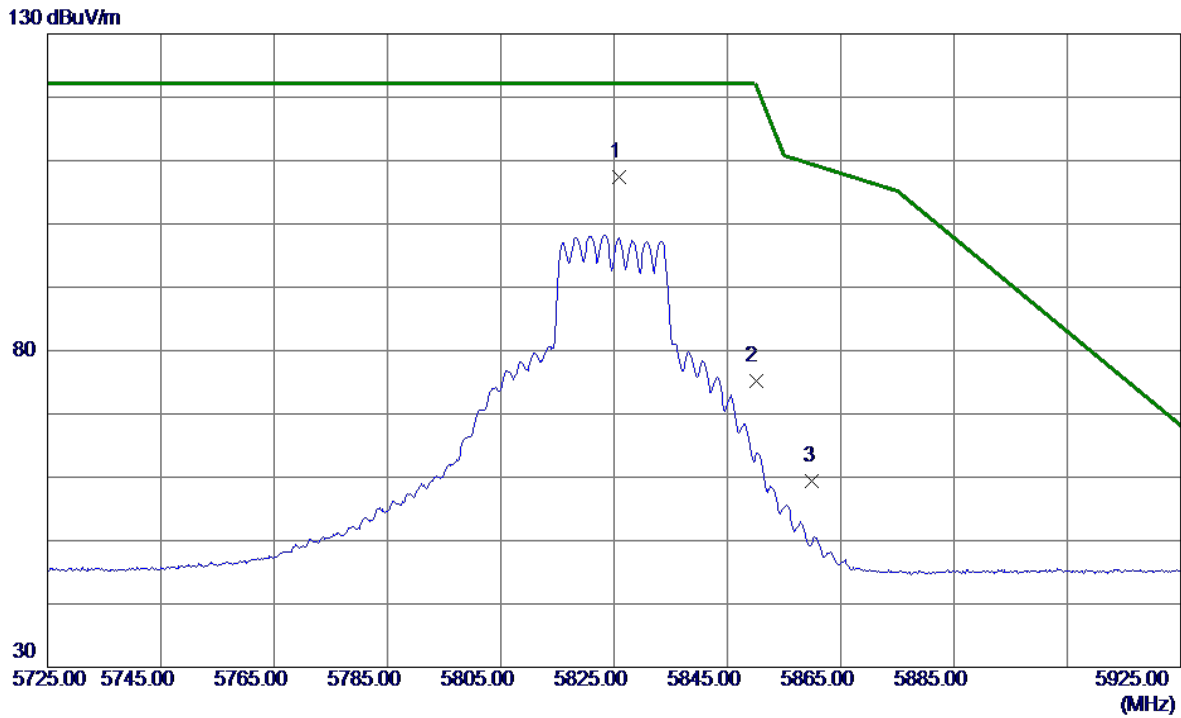

No.	Freq. MHz	Reading Level dBuV/m	Correct Factor dB	Measure ment dBuV/m	Limit dBuV/m	Margin dB	Detector	Comment
1 *	5825.8000	90.95	16.47	107.42	122.20	-14.78	Peak	No Limit
2	5850.0000	58.63	16.52	75.15	122.20	-47.05	Peak	
3	5860.0000	42.95	16.54	59.49	109.40	-49.91	Peak	

REMARKS:

- (1) Measurement Value = Reading Level + Correct Factor.
- (2) Margin Level = Measurement Value - Limit Value.

Test Mode	UNII-3_TX AX(HE20) Mode 5825 MHz	Polarization	Vertical
-----------	----------------------------------	--------------	----------

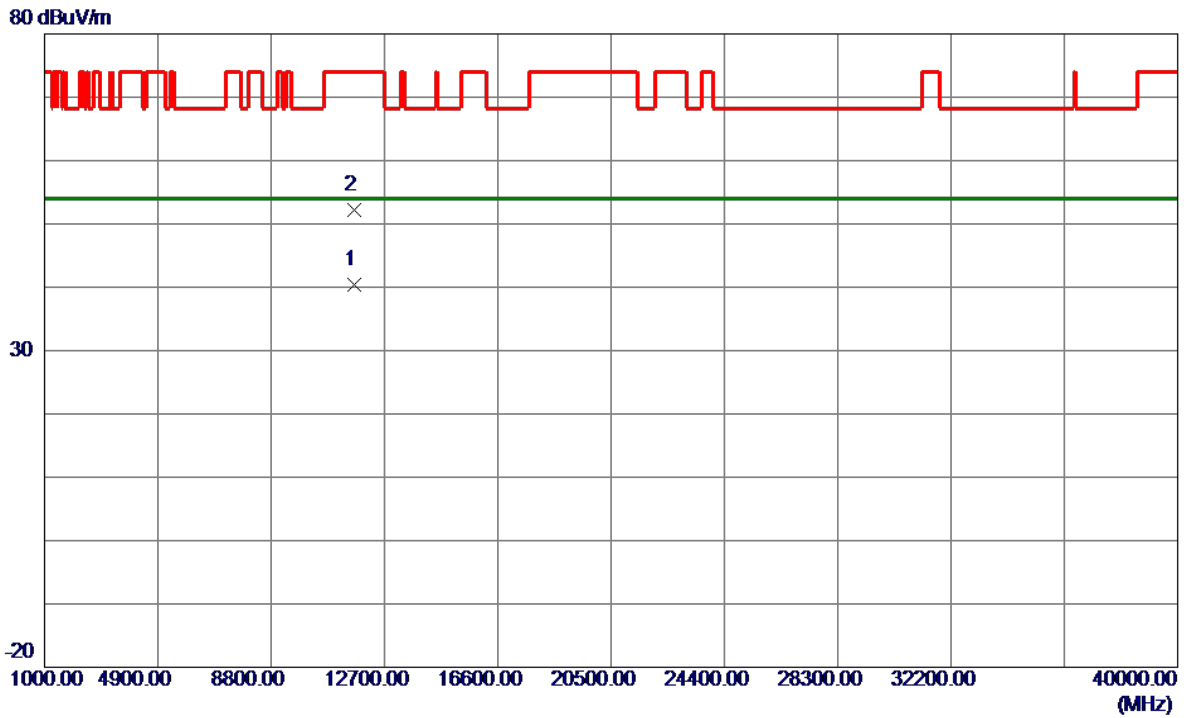

No.	Freq. MHz	Reading Level dBuV/m	Correct Factor dB	Measure ment dBuV/m	Limit dBuV/m	Margin dB	Detector	Comment
1 *	11645.3700	27.00	13.39	40.39	54.00	-13.61	AVG	
2	11653.6100	38.73	13.39	52.12	74.00	-21.88	Peak	

REMARKS:

- (1) Measurement Value = Reading Level + Correct Factor.
- (2) Margin Level = Measurement Value - Limit Value.

Test Mode	UNII-3_TX AX(HE40) Mode 5755 MHz	Polarization	Vertical
-----------	----------------------------------	--------------	----------

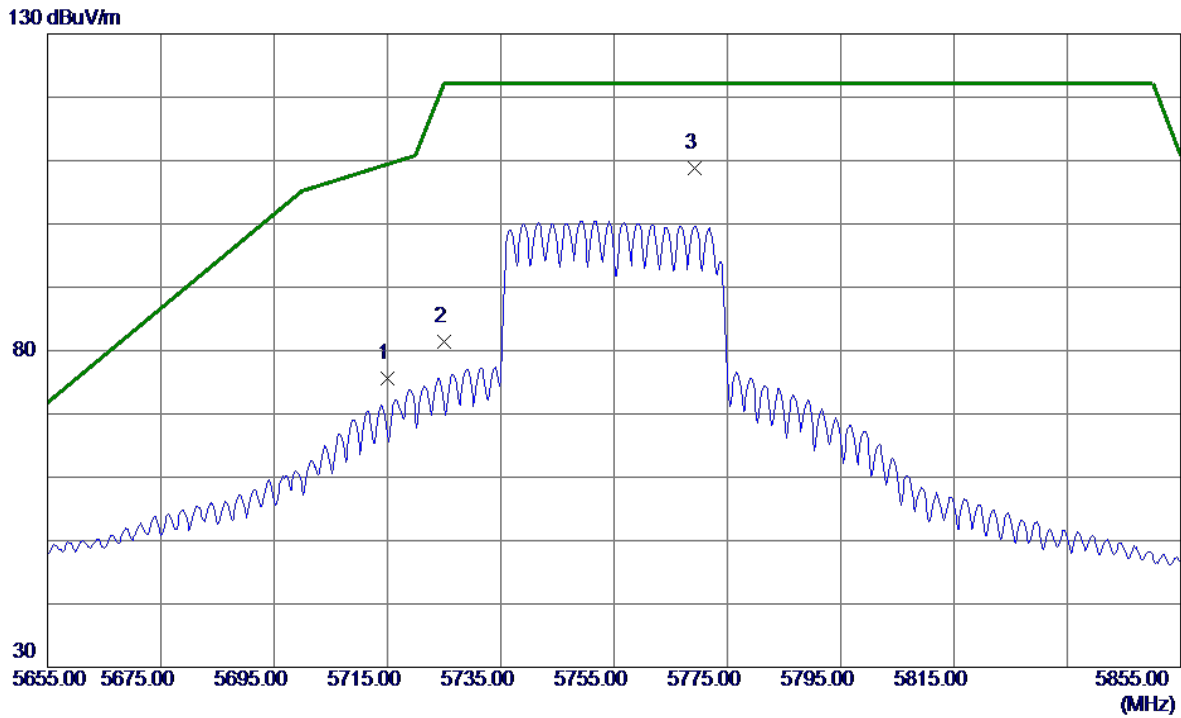

No.	Freq. MHz	Reading Level dBuV/m	Correct Factor dB	Measure ment dBuV/m	Limit dBuV/m	Margin dB	Detector	Comment
1	5715.0000	59.07	16.55	75.62	109.40	-33.78	Peak	
2	5725.0000	64.74	16.57	81.31	122.20	-40.89	Peak	
3 *	5769.2000	92.17	16.65	108.82	122.20	-13.38	Peak	No Limit

REMARKS:

- (1) Measurement Value = Reading Level + Correct Factor.
- (2) Margin Level = Measurement Value - Limit Value.

Test Mode	UNII-3_TX AX(HE40) Mode 5755 MHz	Polarization	Vertical
-----------	----------------------------------	--------------	----------

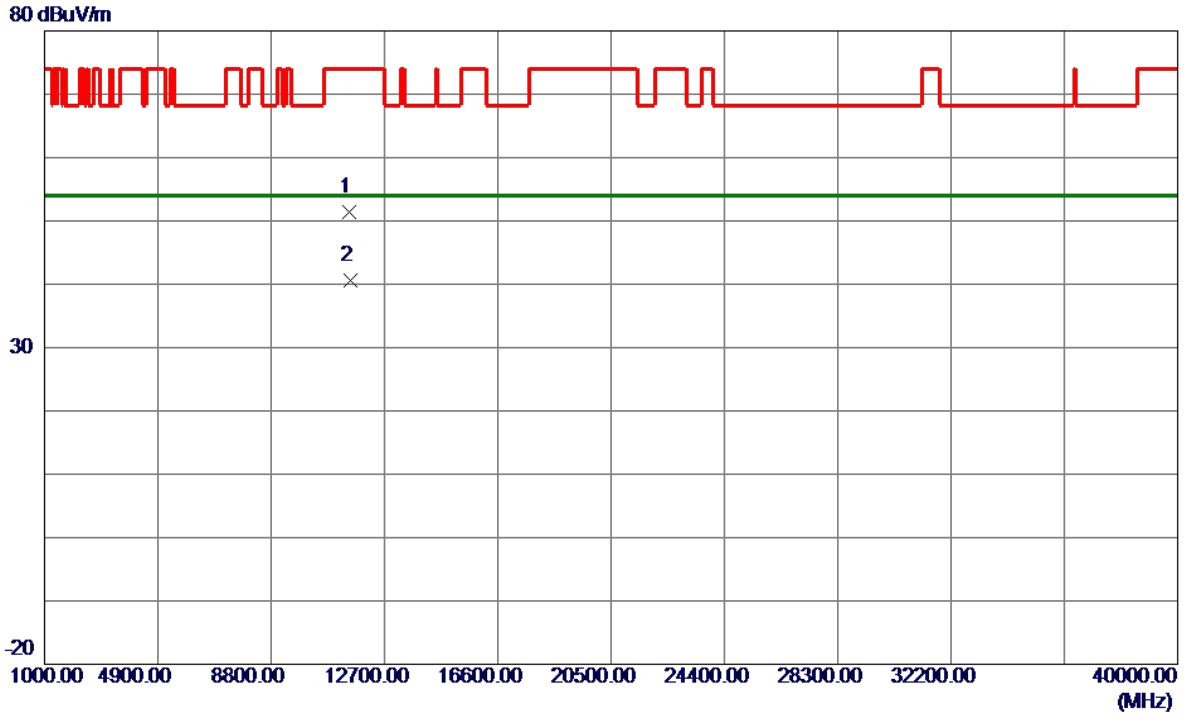

No.	Freq. MHz	Reading Level dBuV/m	Correct Factor dB	Measure ment dBuV/m	Limit dBuV/m	Margin dB	Detector	Comment
1	11505.6400	37.95	13.36	51.31	74.00	-22.69	Peak	
2 *	11510.4000	27.20	13.36	40.56	54.00	-13.44	AVG	

REMARKS:

- (1) Measurement Value = Reading Level + Correct Factor.
- (2) Margin Level = Measurement Value - Limit Value.

Test Mode	UNII-3_TX AX(HE40) Mode 5795 MHz	Polarization	Vertical
-----------	----------------------------------	--------------	----------

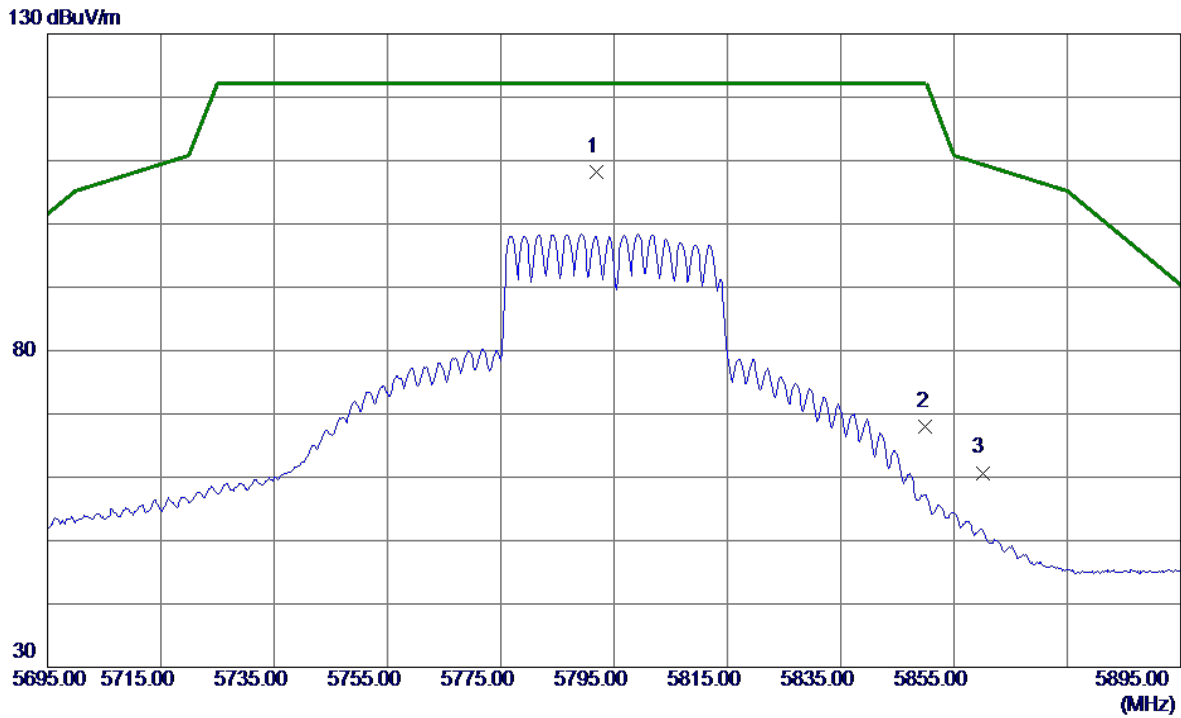

No.	Freq. MHz	Reading Level dBuV/m	Correct Factor dB	Measure ment dBuV/m	Limit dBuV/m	Margin dB	Detector	Comment
1 *	5791.8000	91.48	16.69	108.17	122.20	-14.03	Peak	No Limit
2	5850.0000	51.21	16.79	68.00	122.20	-54.20	Peak	
3	5860.0000	43.89	16.81	60.70	109.40	-48.70	Peak	

REMARKS:

- (1) Measurement Value = Reading Level + Correct Factor.
- (2) Margin Level = Measurement Value - Limit Value.

Test Mode	UNII-3_TX AX(HE40) Mode 5795 MHz	Polarization	Vertical
-----------	----------------------------------	--------------	----------

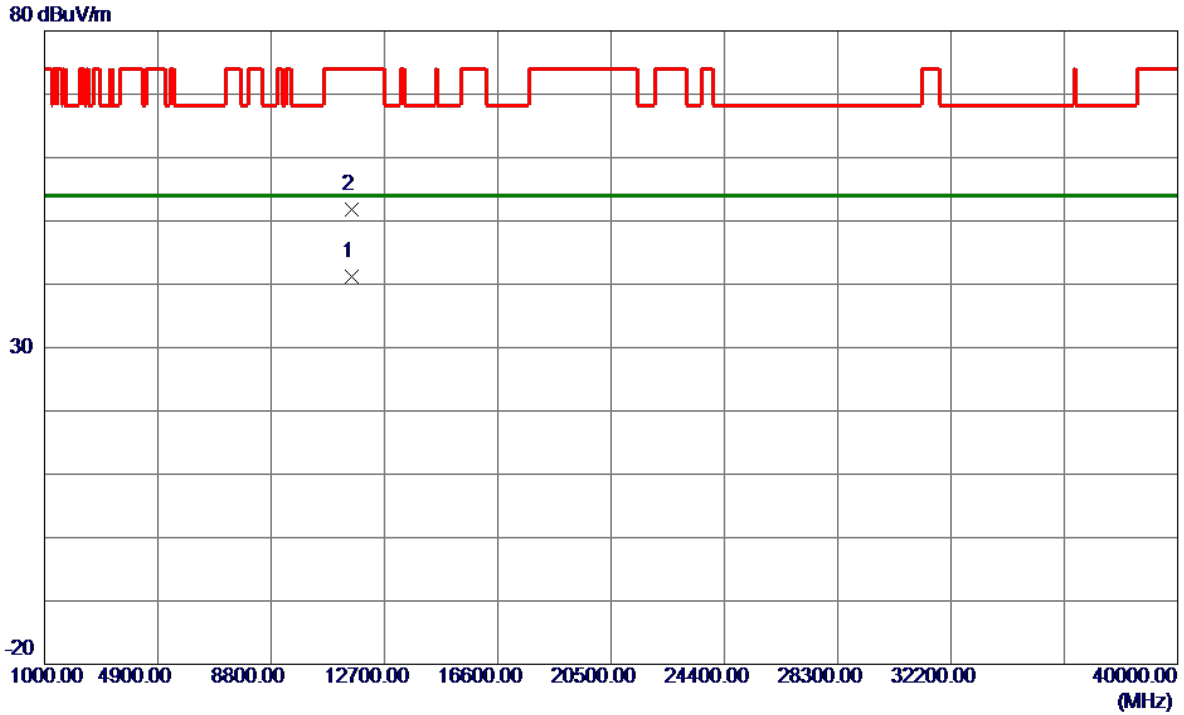

No.	Freq. MHz	Reading Level dBuV/m	Correct Factor dB	Measure ment dBuV/m	Limit dBuV/m	Margin dB	Detector	Comment
1 *	11586.7200	27.90	13.37	41.27	54.00	-12.73	AVG	
2	11590.3800	38.35	13.38	51.73	74.00	-22.27	Peak	

REMARKS:

- (1) Measurement Value = Reading Level + Correct Factor.
- (2) Margin Level = Measurement Value - Limit Value.

Test Mode	UNII-3_TX AX(HE80) Mode 5775 MHz	Polarization	Vertical
-----------	----------------------------------	--------------	----------

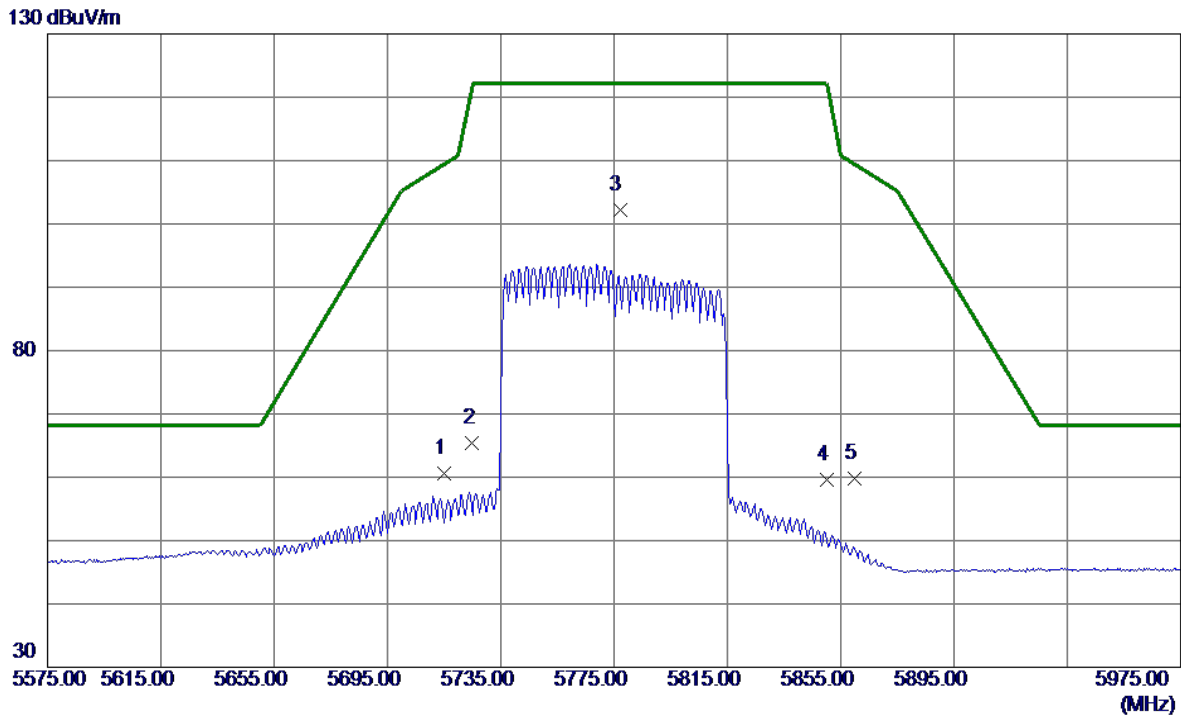

No.	Freq. MHz	Reading Level dBuV/m	Correct Factor dB	Measure ment dBuV/m	Limit dBuV/m	Margin dB	Detector	Comment
1	5715.0000	44.01	16.55	60.56	109.40	-48.84	Peak	
2	5725.0000	48.85	16.57	65.42	122.20	-56.78	Peak	
3 *	5777.0000	85.46	16.66	102.12	122.20	-20.08	Peak	No Limit
4	5850.0000	42.81	16.79	59.60	122.20	-62.60	Peak	
5	5860.0000	43.00	16.81	59.81	109.40	-49.59	Peak	

REMARKS:

- (1) Measurement Value = Reading Level + Correct Factor.
- (2) Margin Level = Measurement Value - Limit Value.

Test Mode	UNII-3_TX AX(HE80) Mode 5775 MHz	Polarization	Vertical
-----------	----------------------------------	--------------	----------

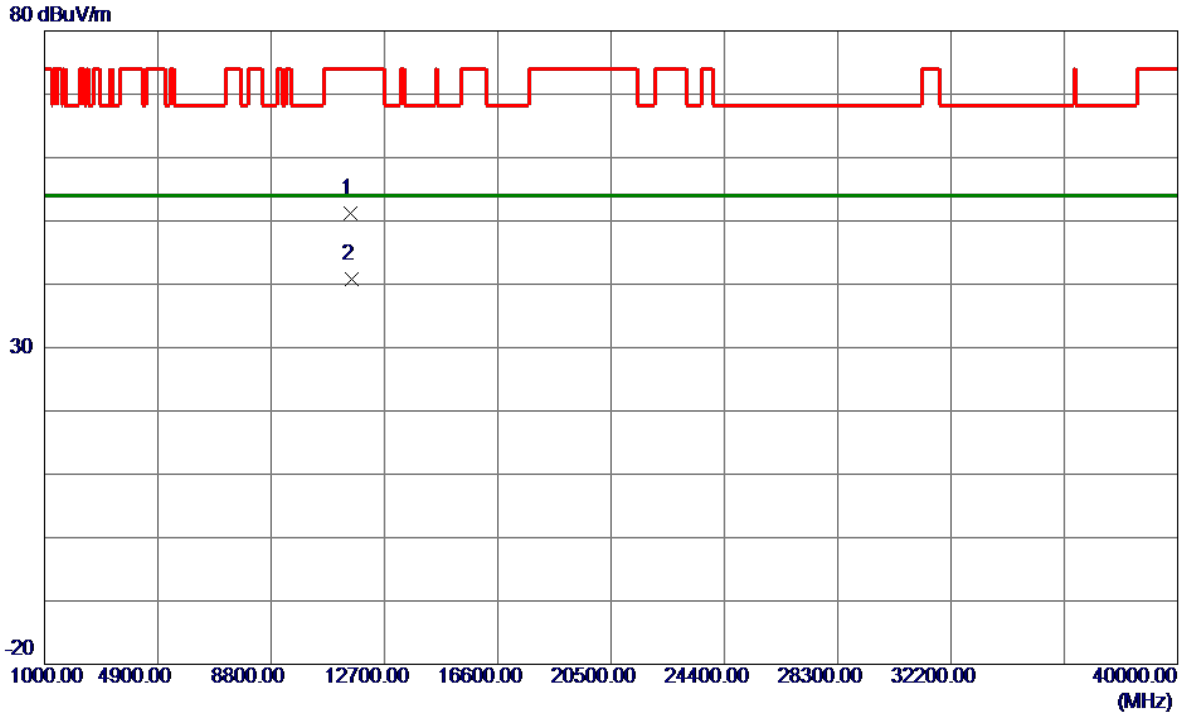

No.	Freq. MHz	Reading Level dBuV/m	Correct Factor dB	Measure ment dBuV/m	Limit dBuV/m	Margin dB	Detector	Comment
1	11545.7600	37.90	13.37	51.27	74.00	-22.73	Peak	
2 *	11553.8700	27.34	13.37	40.71	54.00	-13.29	AVG	

REMARKS:

- (1) Measurement Value = Reading Level + Correct Factor.
- (2) Margin Level = Measurement Value - Limit Value.

Straddle Channel:

Test Mode	UNII-2C_TX A Mode 5720 MHz	Polarization	Vertical
-----------	----------------------------	--------------	----------

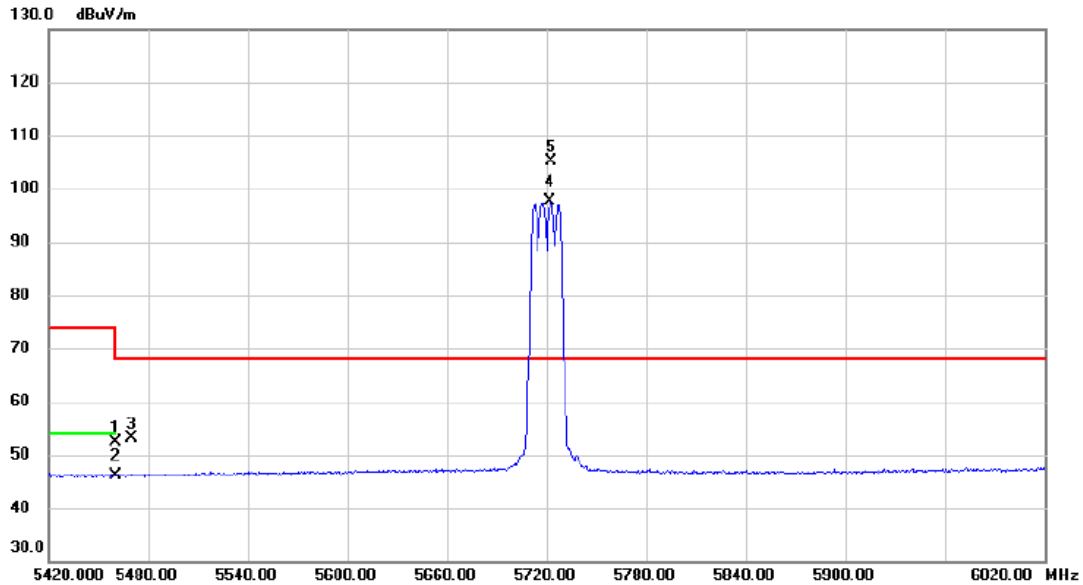

No.	Mk.	Freq. MHz	Reading Level dBuV	Correct Factor dB	Measure- ment dBuV/m	Limit dBuV/m	Margin dB	Detector	Comment
1		5460.000	36.33	16.05	52.38	74.00	-21.62	peak	
2		5460.000	29.99	16.05	46.04	54.00	-7.96	AVG	
3		5470.000	37.17	16.07	53.24	68.20	-14.96	peak	
4	X	5722.400	81.05	16.56	97.61	68.20	29.41	AVG	No Limit
5	*	5723.000	88.56	16.57	105.13	68.20	36.93	peak	No Limit

REMARKS:

- (1) Measurement Value = Reading Level + Correct Factor.
- (2) Margin Level = Measurement Value - Limit Value.
- (3) Straddle channels 138, 142 and 144 are considered to be operating in both U-NII-2C and U-NII-3.
 The worst case out-of-band emission limit, i.e., -27 dBm/MHz peak EIRP, applies at the band edges.
 The band edges are considered to be 5.47 GHz and 5.85 GHz. In addition, the actual limit of the U-NII-3's band edge 5.850GHz is 122.20dBuV/m, so the result of this item should be pass.

Test Mode	UNII-2C_TX AC(VHT20) Mode 5720 MHz	Polarization	Vertical
-----------	------------------------------------	--------------	----------

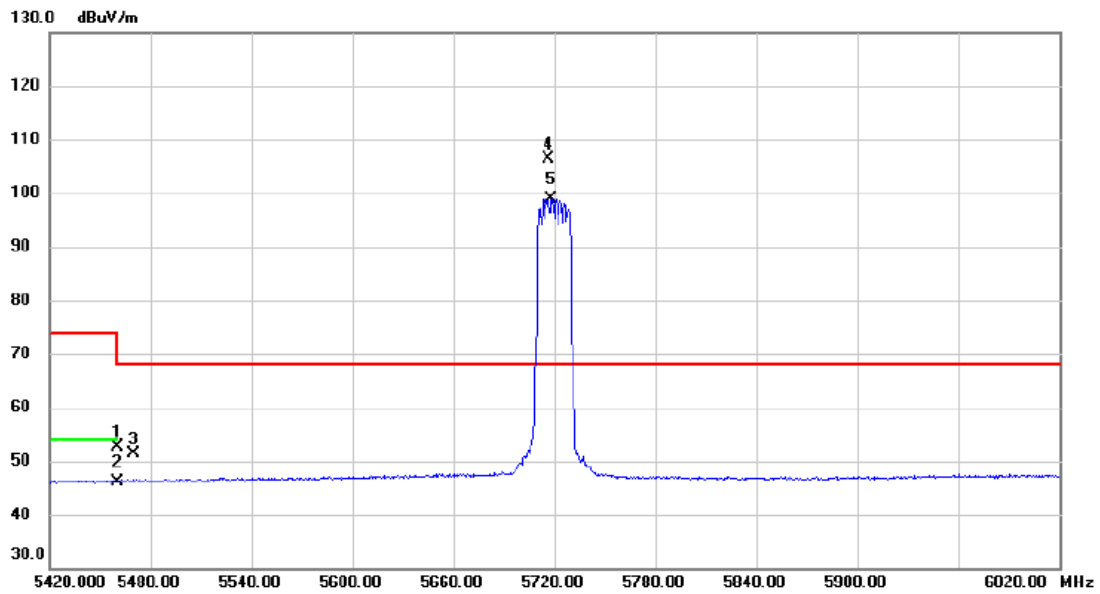

No.	Mk.	Freq. MHz	Reading Level dBuV	Correct Factor dB	Measure- ment dBuV/m	Limit dBuV/m	Margin dB	Detector	Comment
1		5460.000	36.69	16.05	52.74	74.00	-21.26	peak	
2		5460.000	30.05	16.05	46.10	54.00	-7.90	AVG	
3		5470.000	35.22	16.07	51.29	68.20	-16.91	peak	
4	*	5716.400	89.85	16.55	106.40	68.20	38.20	peak	No Limit
5	X	5718.200	82.28	16.55	98.83	68.20	30.63	AVG	No Limit

REMARKS:

- (1) Measurement Value = Reading Level + Correct Factor.
- (2) Margin Level = Measurement Value - Limit Value.
- (3) Straddle channels 138, 142 and 144 are considered to be operating in both U-NII-2C and U-NII-3.
 The worst case out-of-band emission limit, i.e., -27 dBm/MHz peak EIRP, applies at the band edges.
 The band edges are considered to be 5.47 GHz and 5.85 GHz. In addition, the actual limit of the U-NII-3's band edge 5.850GHz is 122.20dBuV/m, so the result of this item should be pass.

Test Mode	UNII-2C_TX AC(VHT40) Mode 5710 MHz	Polarization	Vertical
-----------	------------------------------------	--------------	----------

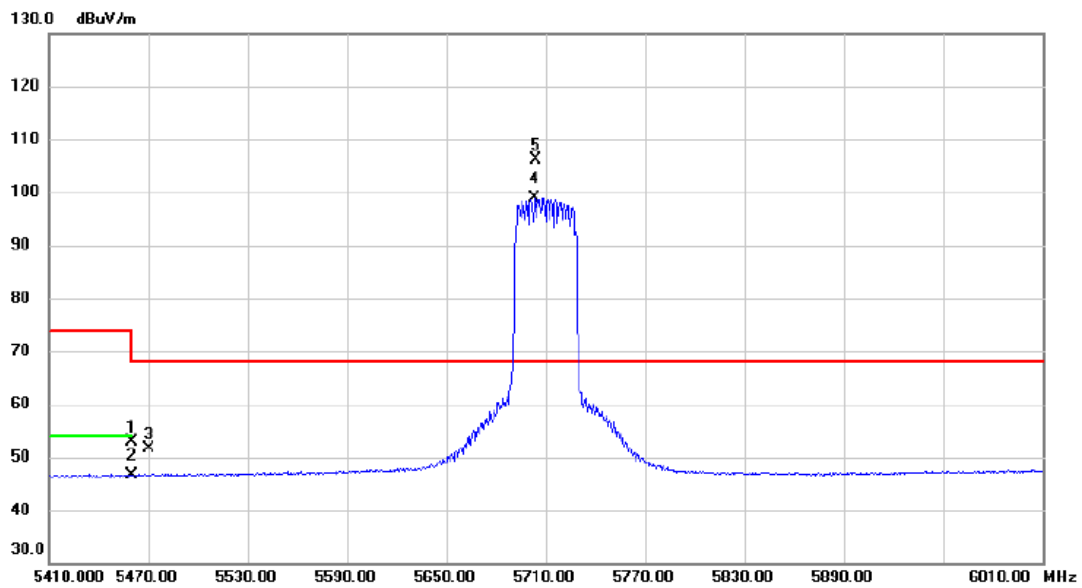

No.	Mk.	Freq. MHz	Reading Level dBuV	Correct Factor dB	Measure- ment dBuV/m	Limit dBuV/m	Margin dB	Detector	Comment
1		5460.000	36.72	16.05	52.77	74.00	-21.23	peak	
2		5460.000	30.55	16.05	46.60	54.00	-7.40	AVG	
3		5470.000	35.53	16.07	51.60	68.20	-16.60	peak	
4	X	5703.400	82.44	16.53	98.97	68.20	30.77	AVG	No Limit
5	*	5704.000	89.67	16.53	106.20	68.20	38.00	peak	No Limit

REMARKS:

- (1) Measurement Value = Reading Level + Correct Factor.
- (2) Margin Level = Measurement Value - Limit Value.
- (3) Straddle channels 138, 142 and 144 are considered to be operating in both U-NII-2C and U-NII-3.
The worst case out-of-band emission limit, i.e., -27 dBm/MHz peak EIRP, applies at the band edges.
The band edges are considered to be 5.47 GHz and 5.85 GHz. In addition, the actual limit of the U-NII-3's band edge 5.850GHz is 122.20dBuV/m, so the result of this item should be pass.

Test Mode	UNII-2C_TX AC(VHT80) Mode 5690 MHz	Polarization	Vertical
-----------	------------------------------------	--------------	----------

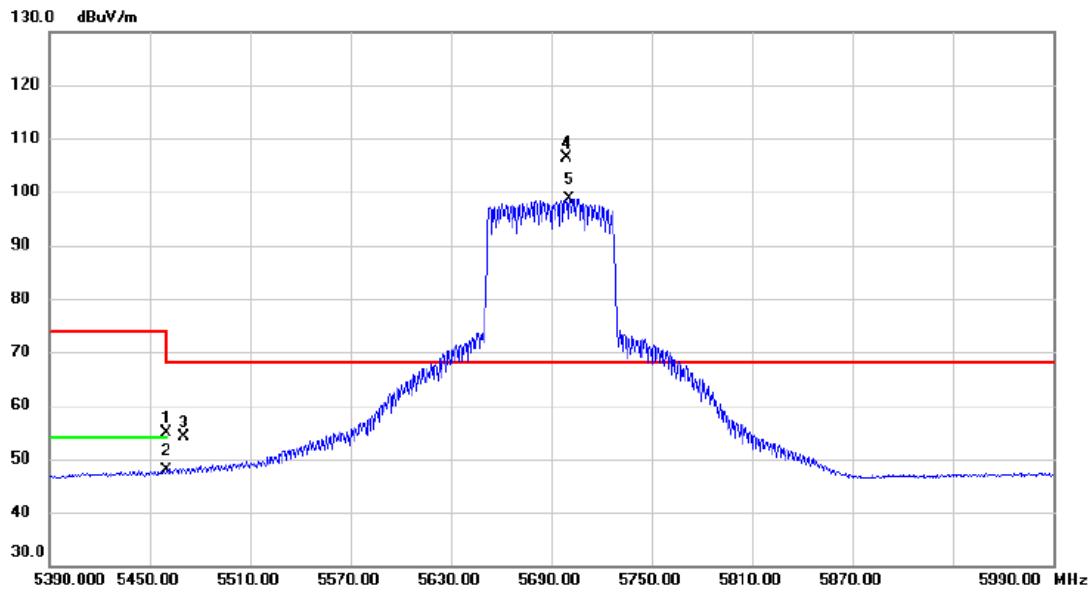

No.	Mk.	Freq. MHz	Reading Level dBuV	Correct Factor dB	Measure- ment dBuV/m	Limit dBuV/m	Margin dB	Detector	Comment
1		5460.000	38.83	16.05	54.88	74.00	-19.12	peak	
2		5460.000	31.73	16.05	47.78	54.00	-6.22	AVG	
3		5470.000	38.12	16.07	54.19	68.20	-14.01	peak	
4	*	5699.000	89.84	16.53	106.37	68.20	38.17	peak	No Limit
5	X	5700.800	82.23	16.52	98.75	68.20	30.55	AVG	No Limit

REMARKS:

- (1) Measurement Value = Reading Level + Correct Factor.
- (2) Margin Level = Measurement Value - Limit Value.
- (3) Straddle channels 138, 142 and 144 are considered to be operating in both U-NII-2C and U-NII-3.
The worst case out-of-band emission limit, i.e., -27 dBm/MHz peak EIRP, applies at the band edges.
The band edges are considered to be 5.47 GHz and 5.85 GHz. In addition, the actual limit of the U-NII-3's band edge 5.85GHz is 122.20dBuV/m, so the result of this item should be pass.

Test Mode	UNII-2C_TX AX(HE20) Mode 5720 MHz	Polarization	Vertical
-----------	-----------------------------------	--------------	----------

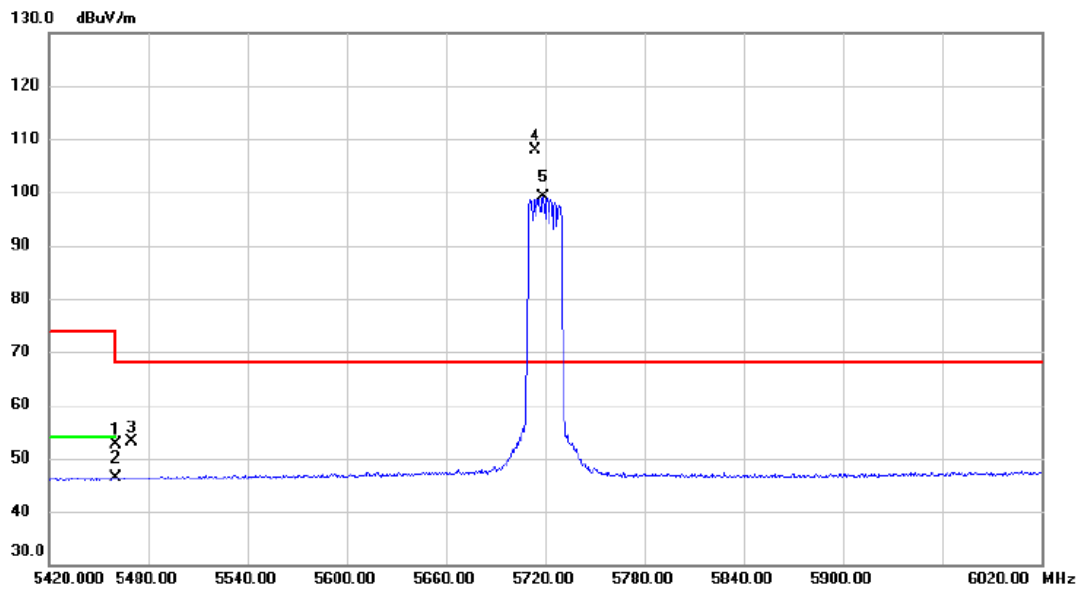

No.	Mk.	Freq. MHz	Reading Level dBuV	Correct Factor dB	Measure- ment dBuV/m	Limit dBuV/m	Margin dB	Detector	Comment
1		5460.000	36.51	16.05	52.56	74.00	-21.44	peak	
2		5460.000	30.44	16.05	46.49	54.00	-7.51	AVG	
3		5470.000	37.09	16.07	53.16	68.20	-15.04	peak	
4	*	5714.000	91.44	16.54	107.98	68.20	39.78	peak	No Limit
5	X	5718.800	82.53	16.56	99.09	68.20	30.89	AVG	No Limit

REMARKS:

- (1) Measurement Value = Reading Level + Correct Factor.
- (2) Margin Level = Measurement Value - Limit Value.
- (3) Straddle channels 138, 142 and 144 are considered to be operating in both U-NII-2C and U-NII-3.
 The worst case out-of-band emission limit, i.e., -27 dBm/MHz peak EIRP, applies at the band edges.
 The band edges are considered to be 5.47 GHz and 5.85 GHz. In addition, the actual limit of the U-NII-3's band edge 5.850GHz is 122.20dBuV/m, so the result of this item should be pass.

Test Mode	UNII-2C_TX AX(HE40) Mode 5710 MHz	Polarization	Vertical
-----------	-----------------------------------	--------------	----------

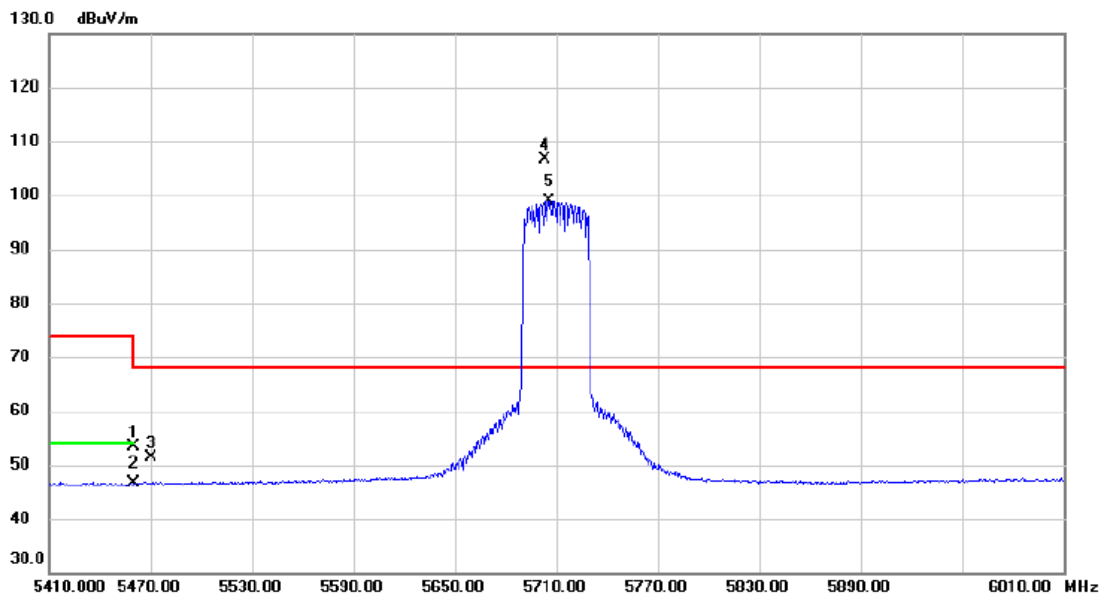

No.	Mk.	Freq. MHz	Reading Level dBuV	Correct Factor dB	Measure- ment dBuV/m	Limit dBuV/m	Margin dB	Detector	Comment
1		5460.000	37.30	16.05	53.35	74.00	-20.65	peak	
2		5460.000	30.52	16.05	46.57	54.00	-7.43	AVG	
3		5470.000	35.39	16.07	51.46	68.20	-16.74	peak	
4	*	5702.800	90.21	16.53	106.74	68.20	38.54	peak	No Limit
5	X	5705.800	82.43	16.52	98.95	68.20	30.75	AVG	No Limit

REMARKS:

- (1) Measurement Value = Reading Level + Correct Factor.
- (2) Margin Level = Measurement Value - Limit Value.
- (3) Straddle channels 138, 142 and 144 are considered to be operating in both U-NII-2C and U-NII-3.
The worst case out-of-band emission limit, i.e., -27 dBm/MHz peak EIRP, applies at the band edges.
The band edges are considered to be 5.47 GHz and 5.85 GHz. In addition, the actual limit of the U-NII-3's band edge 5.850GHz is 122.20dBuV/m, so the result of this item should be pass.

Test Mode	UNII-2C_TX AX(HE80) Mode 5690 MHz	Polarization	Vertical
-----------	-----------------------------------	--------------	----------

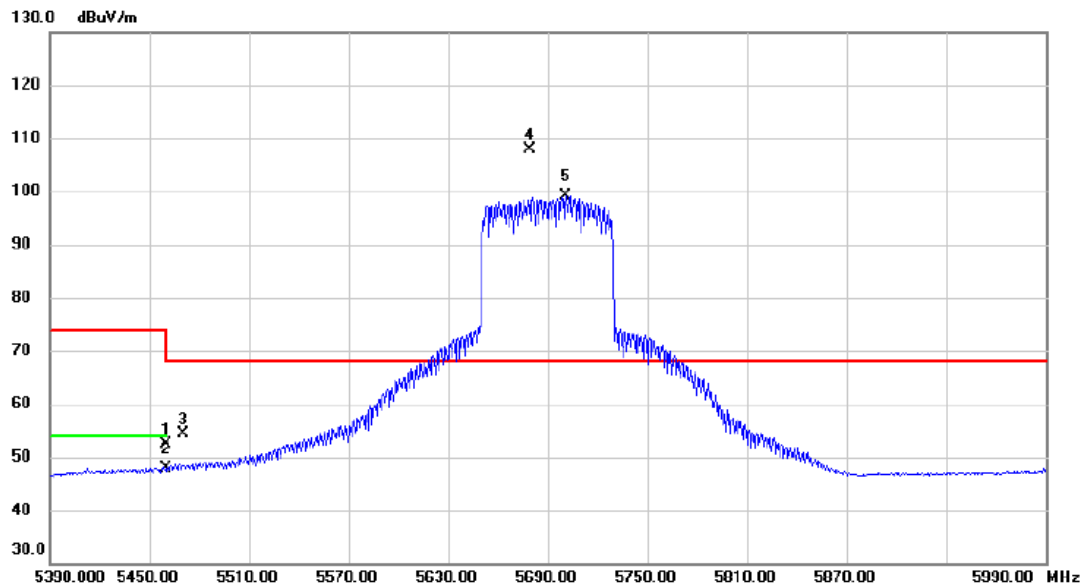

No.	Mk.	Freq. MHz	Reading Level dBuV	Correct Factor dB	Measure- ment dBuV/m	Limit dBuV/m	Margin dB	Detector	Comment
1		5460.000	36.44	16.05	52.49	74.00	-21.51	peak	
2		5460.000	31.74	16.05	47.79	54.00	-6.21	AVG	
3		5470.000	38.23	16.07	54.30	68.20	-13.90	peak	
4	*	5679.200	91.48	16.49	107.97	68.20	39.77	peak	No Limit
5	X	5700.800	82.62	16.52	99.14	68.20	30.94	AVG	No Limit

REMARKS:

- (1) Measurement Value = Reading Level + Correct Factor.
- (2) Margin Level = Measurement Value - Limit Value.
- (3) Straddle channels 138, 142 and 144 are considered to be operating in both U-NII-2C and U-NII-3.
The worst case out-of-band emission limit, i.e., -27 dBm/MHz peak EIRP, applies at the band edges.
The band edges are considered to be 5.47 GHz and 5.85 GHz. In addition, the actual limit of the U-NII-3's band edge 5.850GHz is 122.20dBuV/m, so the result of this item should be pass.

Test Mode	TX A Mode 5720 MHz	Polarization	Vertical
-----------	--------------------	--------------	----------

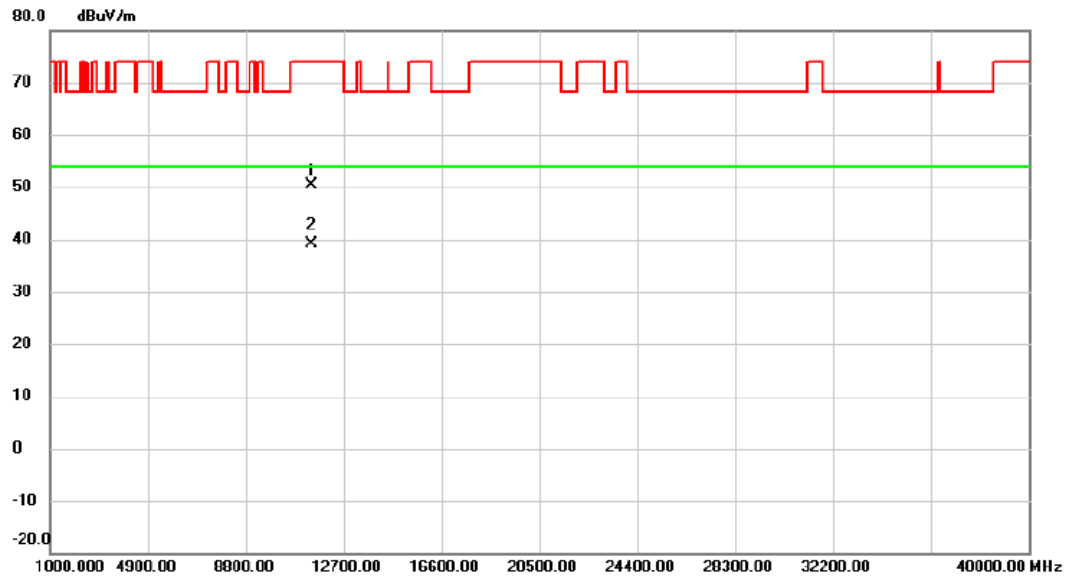

No. Mk.	Freq. MHz	Reading Level dBuV	Correct Factor dB	Measurement dBuV/m	Limit dBuV/m	Margin dB	Detector	Comment
1	11438.18	36.98	13.29	50.27	74.00	-23.73	peak	
2 *	11444.07	25.93	13.29	39.22	54.00	-14.78	AVG	

REMARKS:

- (1) Measurement Value = Reading Level + Correct Factor.
- (2) Margin Level = Measurement Value - Limit Value.

Test Mode	TX AC(VHT20) Mode 5720 MHz	Polarization	Vertical
-----------	----------------------------	--------------	----------

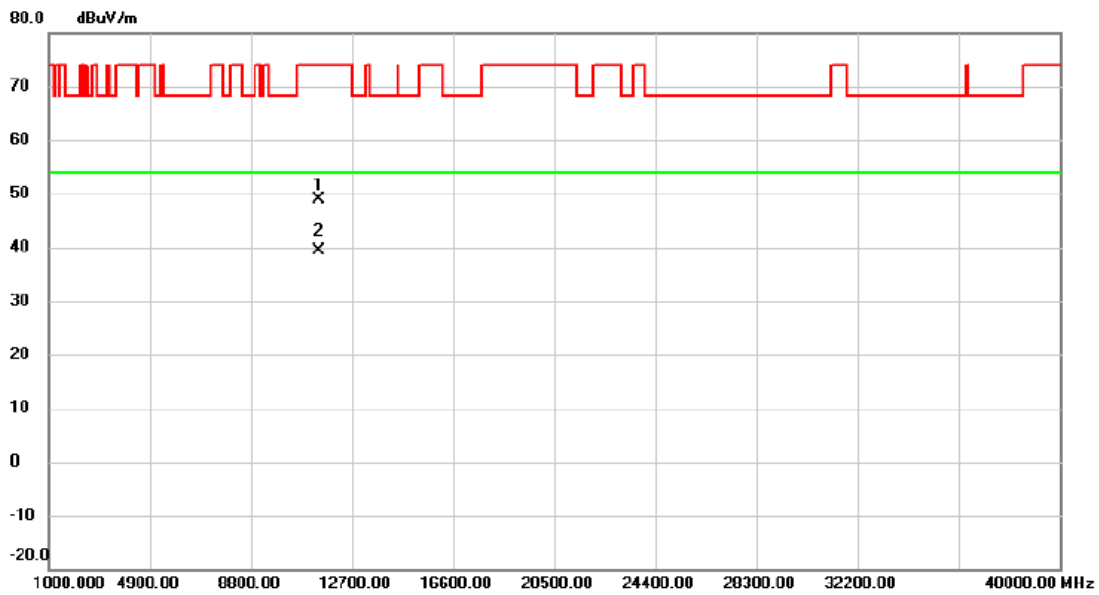

No. Mk.	Freq. MHz	Reading Level dBuV	Correct Factor dB	Measurement dBuV/m	Limit dBuV/m	Margin dB	Detector	Comment
1	11437.69	35.52	13.29	48.81	74.00	-25.19	peak	
2 *	11442.14	25.99	13.29	39.28	54.00	-14.72	AVG	

REMARKS:

- (1) Measurement Value = Reading Level + Correct Factor.
- (2) Margin Level = Measurement Value - Limit Value.