

7.6. Radiated Spurious Emission Measurement

7.6.1. Test Limit

All out of band emissions appearing in a restricted band as specified in Section 15.205 of the Title 47CFR must not exceed the limits shown in Table per Section 15.209.

| FCC Part 15 Subpart C Paragraph 15.209 | | |
|----------------------------------------|--------------------------|-------------------------------|
| Frequency [MHz] | Field Strength [Uv/m] | Measured Distance [Meters] |
| 0.009 - 0.490 | 2400/F (kHz) | 300 |
| 0.490 - 1.705 | 24000/F (kHz) | 30 |
| 1.705 - 30 | 30 | 30 |
| 30 - 88 | 100 | 3 |
| 88 - 216 | 150 | 3 |
| 216 - 960 | 200 | 3 |
| Above 960 | 500 | 3 |

7.6.2. Test Procedure Used

ANSI C63.10 – 2013 Section 11.11 & 11.12

ANSI C63.10 – 2013 Section 6.3 (General Requirements)

ANSI C63.10 – 2013 Section 6.4 (Standard test method below 30MHz)

ANSI C63.10 – 2013 Section 6.5 (Standard test method above 30MHz to 1GHz)

ANSI C63.10 – 2013 Section 6.6 (Standard test method above 1GHz)

7.6.3. Test Setting

Table 1 - RBW as a function of frequency

| Frequency | RBW |
|---------------|---------------|
| 9 ~ 150 kHz | 200 ~ 300 Hz |
| 0.15 ~ 30 MHz | 9 ~ 10 kHz |
| 30 ~ 1000 MHz | 100 ~ 120 kHz |
| > 1000MHz | 1MHz |

Quasi-Peak Measurements below 1GHz

1. Analyzer center frequency was set to the frequency of the radiated spurious emission of interest
2. Span was set greater than 1MHz
3. RBW = as specified in Table 1
4. Detector = CISPR quasi-peak
5. Sweep time = auto couple
6. Trace was allowed to stabilize

Peak Measurements above 1GHz

1. Analyzer center frequency was set to the frequency of the radiated spurious emission of interest
2. RBW = 1MHz
3. VBW = 3MHz
4. Detector = peak
5. Sweep time = auto couple
6. Trace mode = max hold
7. Trace was allowed to stabilize

Average Measurements above 1GHz (Method VB)

1. Analyzer center frequency was set to the frequency of the radiated spurious emission of interest
2. RBW = 1MHz
3. VBW; If the EUT is configured to transmit with duty cycle $\geq 98\%$, set VBW = 10 Hz.
If the EUT duty cycle is $< 98\%$, set VBW $\geq 1/T$. T is the minimum transmission duration.
4. Detector = Peak
5. Sweep time = auto
6. Trace mode = max hold
7. Trace was allowed to stabilize

7.6.4. Test Setup

Below 1GHz Test Setup:

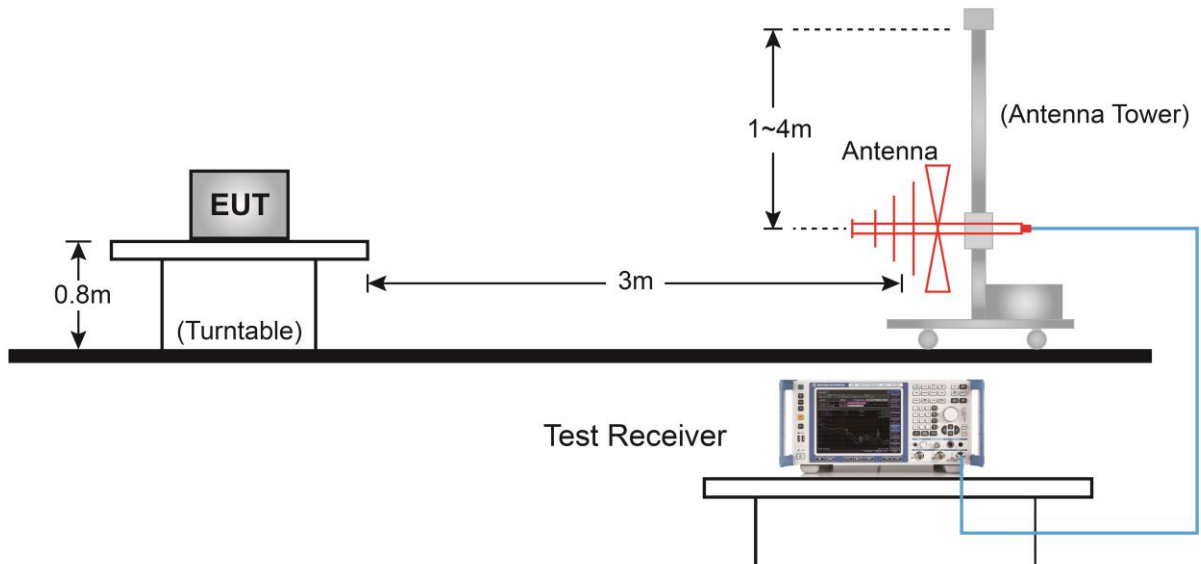

Above 1GHz Test Setup:

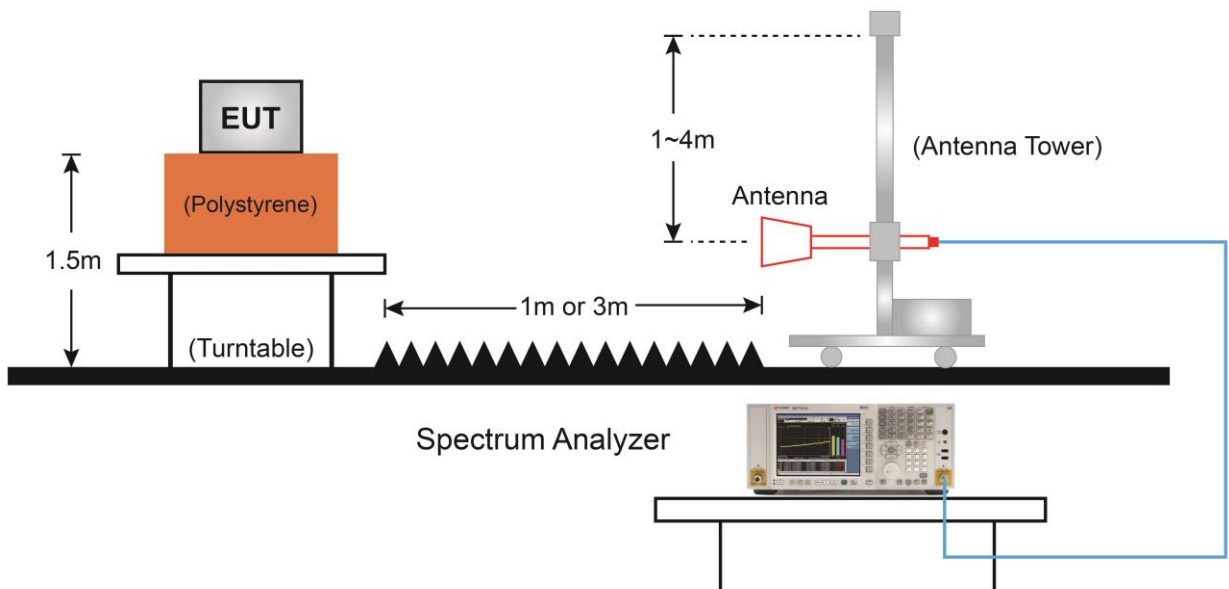

7.6.5. Test Result

| | | | |
|-----------|-------------------------------------------------------|----------------------|--------------|
| EUT | AX3000+G1500 Whole Home Powerline Mesh Wi-Fi 6 System | Date of Test | 2022-09-27 |
| Factor | VULB 9162 | Temp. / Humidity | 23°C /63% |
| Polarity | Horizontal | Site / Test Engineer | AC2 / Jay |
| Test Mode | 802.11n-20MHz_TX_CH 6_ANT 0+1 | Test Voltage | AC 120V/60Hz |

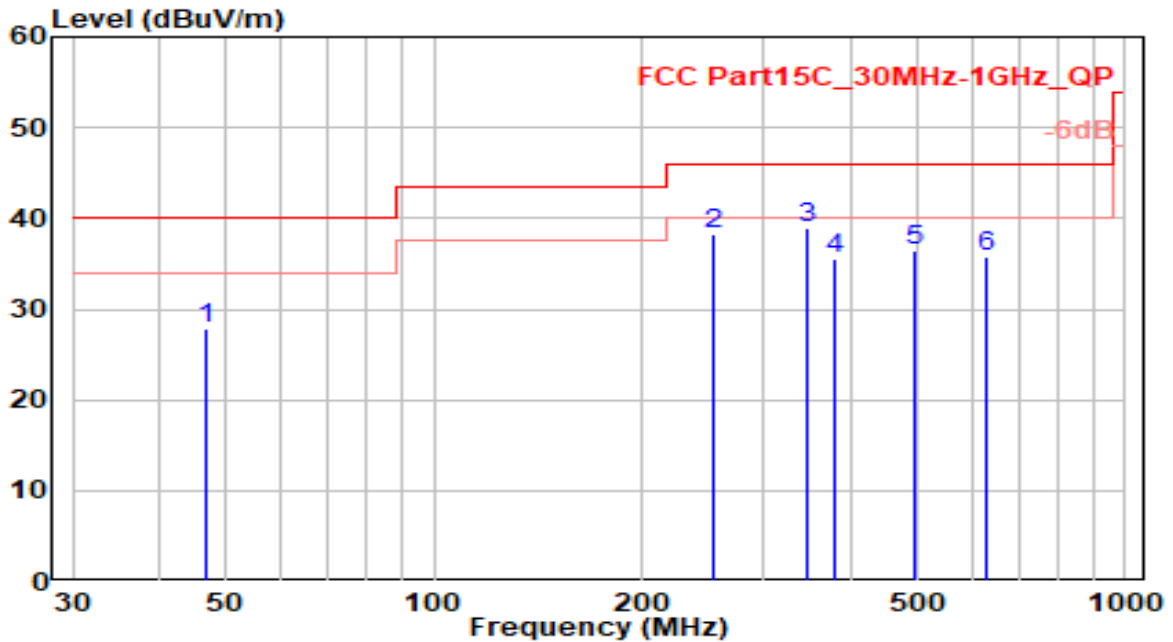

| No | Frequency (MHz) | Reading (dBUV) | C.F (dB/m) | Measurement (dBUV/m) | Margin (dB) | Limit (dBUV/m) | Height (cm) | Angle (deg) | Remark (QP/PK/AV) |
|----|-----------------|----------------|------------|----------------------|-------------|----------------|-------------|-------------|-------------------|
| 1 | 46.860 | 6.27 | 21.52 | 27.79 | -12.21 | 40.00 | 100 | 110 | QP |
| 2 | 253.610 | 17.52 | 20.80 | 38.32 | -7.68 | 46.00 | 100 | 280 | QP |
| 3 | * 346.950 | 15.99 | 22.85 | 38.84 | -7.16 | 46.00 | 100 | 55 | QP |
| 4 | 378.660 | 11.97 | 23.57 | 35.55 | -10.45 | 46.00 | 100 | 85 | QP |
| 5 | 497.430 | 10.74 | 25.65 | 36.39 | -9.61 | 46.00 | 100 | 195 | QP |
| 6 | 629.010 | 7.80 | 27.97 | 35.76 | -10.24 | 46.00 | 100 | 150 | QP |

Note:

1. " *", means this data is the worst emission level.
2. C.F (Correction Factor) = Antenna Factor (dB)+ Cable Loss (dB).
3. Measurement (dBUV/m) = Reading(dBUV) + C.F (Correction Factor).
4. The emission levels of other frequencies are very lower than the limit and not show in test report.

| | | | |
|-----------|-------------------------------------------------------|----------------------|--------------|
| EUT | AX3000+G1500 Whole Home Powerline Mesh Wi-Fi 6 System | Date of Test | 2022-09-27 |
| Factor | VULB 9162 | Temp. / Humidity | 23°C /63% |
| Polarity | Vertical | Site / Test Engineer | AC2 / Jay |
| Test Mode | 802.11n-20MHz_TX_CH 6_ANT 0+1 | Test Voltage | AC 120V/60Hz |

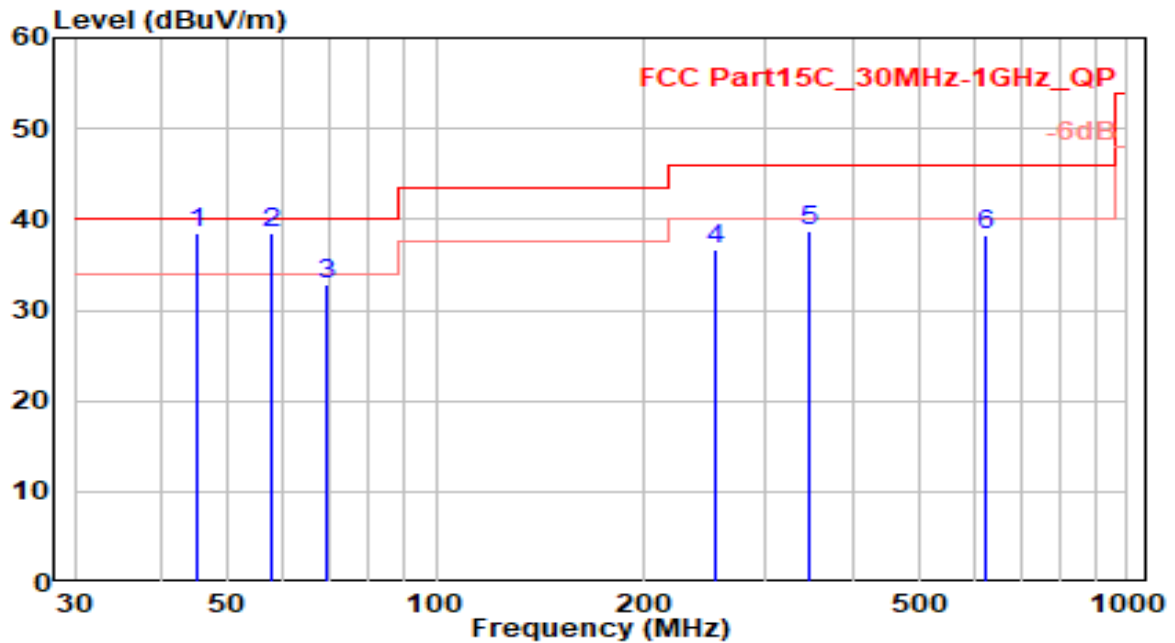

| No | Frequency (MHz) | Reading (dBUV) | C.F (dB/m) | Measurement (dBUV/m) | Margin (dB) | Limit (dBUV/m) | Height (cm) | Angle (deg) | Remark (QP/PK/AV) |
|----|-----------------|----------------|------------|----------------------|-------------|----------------|-------------|-------------|-------------------|
| 1 | 44.920 | 17.00 | 21.46 | 38.45 | -1.55 | 40.00 | 100 | 0 | QP |
| 2 | * 57.730 | 18.14 | 20.40 | 38.54 | -1.46 | 40.00 | 100 | 10 | QP |
| 3 | 69.340 | 16.29 | 16.54 | 32.83 | -7.17 | 40.00 | 100 | 225 | QP |
| 4 | 253.610 | 15.77 | 20.80 | 36.58 | -9.42 | 46.00 | 100 | 30 | QP |
| 5 | 345.890 | 15.85 | 22.82 | 38.67 | -7.33 | 46.00 | 100 | 180 | QP |
| 6 | 622.620 | 10.40 | 27.91 | 38.31 | -7.69 | 46.00 | 100 | 155 | QP |

Note:

1. " *", means this data is the worst emission level.
2. C.F (Correction Factor) = Antenna Factor (dB)+ Cable Loss (dB).
3. Measurement (dBUV/m) = Reading(dBUV) + C.F (Correction Factor).
4. The emission levels of other frequencies are very lower than the limit and not show in test report.

| | | | |
|-----------|-------------------------------------------------------|----------------------|--------------|
| EUT | AX3000+G1500 Whole Home Powerline Mesh Wi-Fi 6 System | Date of Test | 2022-07-06 |
| Factor | DRH18-E | Temp. / Humidity | 23°C /63% |
| Polarity | Horizontal | Site / Test Engineer | AC2 / Ares |
| Test Mode | 802.11b_TX_CH 1_ANT 0+1 | Test Voltage | AC 120V/60Hz |

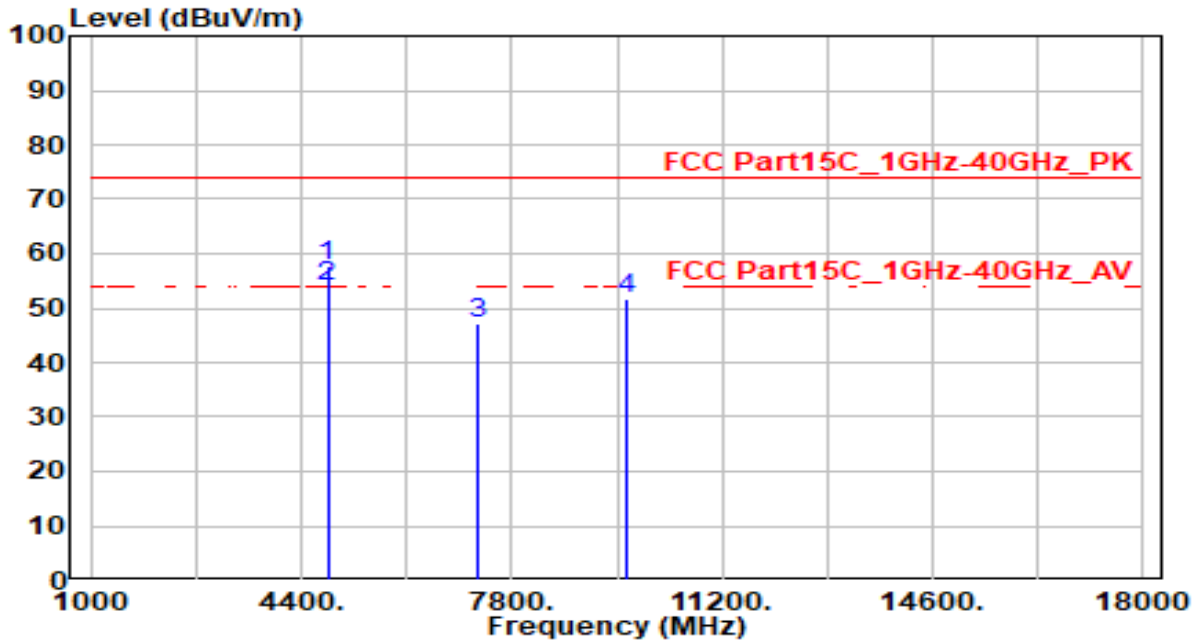

| No | | Frequency (MHz) | Reading (dBuV) | C.F (dB/m) | Measurement (dBuV/m) | Margin (dB) | Limit (dBuV/m) | Height (cm) | Angle (deg) | Remark (QP/PK/AV) |
|----|---|-----------------|----------------|------------|----------------------|-------------|----------------|-------------|-------------|-------------------|
| 1 | * | 4824.000 | 57.36 | 0.25 | 57.61 | -16.39 | 74.00 | 130 | 125 | Peak |
| 2 | * | 4824.000 | 53.61 | 0.25 | 53.86 | -0.14 | 54.00 | 130 | 125 | Average |
| 3 | | 7236.000 | 41.31 | 5.81 | 47.12 | -26.88 | 74.00 | 100 | 110 | Peak |
| 4 | | 9648.000 | 46.44 | 5.32 | 51.76 | -22.24 | 74.00 | 100 | 55 | Peak |

Note:

- "*", means this data is the worst emission level.
- C.F (Correction Factor) = Antenna Factor (dB)+ Cable Loss (dB) – Pre-amplifier(dB).
- Measurement (dBuV/m) = Reading(dBuV) + C.F (Correction Factor).
- The emission levels of other frequencies are very lower than the limit and not show in test report.

| | | | |
|-----------|-------------------------------------------------------|----------------------|--------------|
| EUT | AX3000+G1500 Whole Home Powerline Mesh Wi-Fi 6 System | Date of Test | 2022-07-06 |
| Factor | DRH18-E | Temp. / Humidity | 23°C /63% |
| Polarity | Vertical | Site / Test Engineer | AC2 / Ares |
| Test Mode | 802.11b_TX_CH 1_ANT 0+1 | Test Voltage | AC 120V/60Hz |

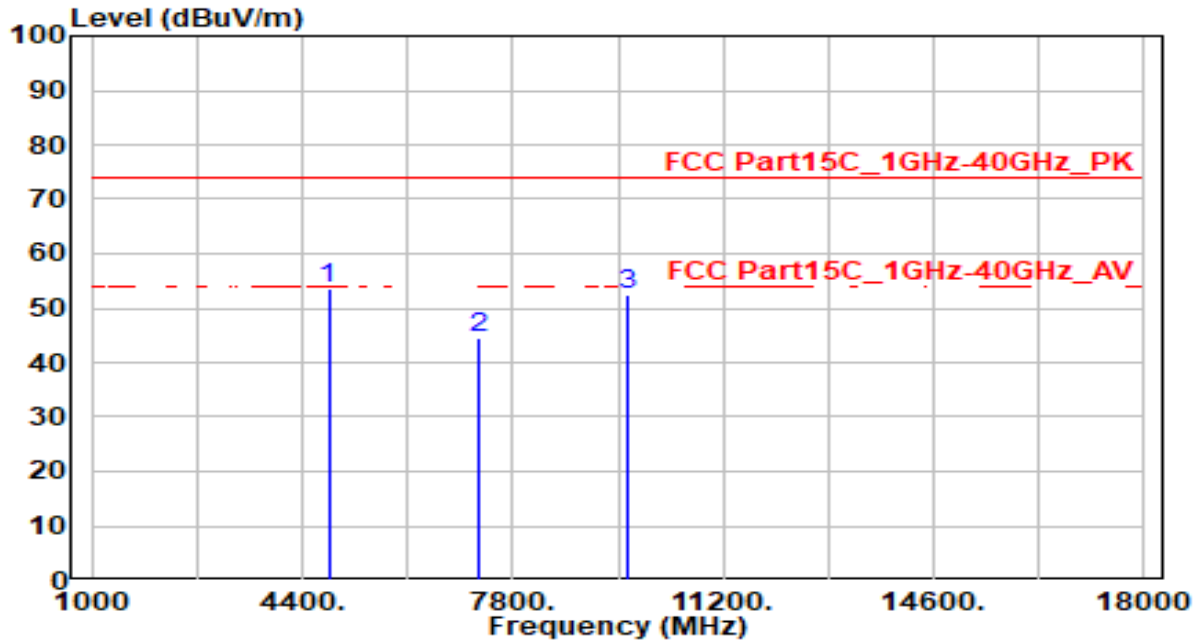

| No | Frequency (MHz) | Reading (dBUV) | C.F (dB/m) | Measurement (dBUV/m) | Margin (dB) | Limit (dBUV/m) | Height (cm) | Angle (deg) | Remark (QP/PK/AV) |
|----|-----------------|----------------|------------|----------------------|-------------|----------------|-------------|-------------|-------------------|
| 1 | * 4824.000 | 53.24 | 0.25 | 53.49 | -20.51 | 74.00 | 100 | 85 | Peak |
| 2 | 7236.000 | 38.58 | 5.81 | 44.40 | -29.60 | 74.00 | 100 | 0 | Peak |
| 3 | 9648.000 | 47.00 | 5.32 | 52.33 | -21.67 | 74.00 | 100 | 190 | Peak |

Note:

1. " *", means this data is the worst emission level.
2. C.F (Correction Factor) = Antenna Factor (dB)+ Cable Loss (dB) – Pre-amplifier(dB).
3. Measurement (dBUV/m) = Reading(dBUV) + C.F (Correction Factor).
4. The emission levels of other frequencies are very lower than the limit and not show in test report.

| | | | |
|-----------|-------------------------------------------------------|----------------------|--------------|
| EUT | AX3000+G1500 Whole Home Powerline Mesh Wi-Fi 6 System | Date of Test | 2022-07-06 |
| Factor | DRH18-E | Temp. / Humidity | 23°C /63% |
| Polarity | Horizontal | Site / Test Engineer | AC2 / Ares |
| Test Mode | 802.11b_TX_CH 6_ANT 0+1 | Test Voltage | AC 120V/60Hz |

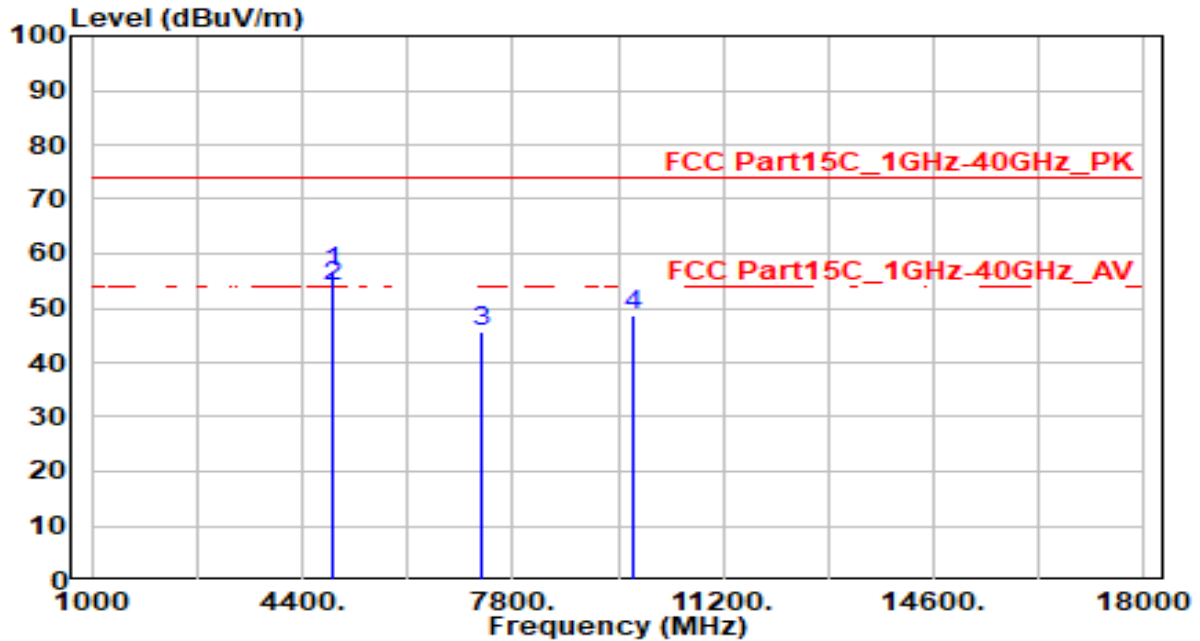

| No | | Frequency (MHz) | Reading (dBuV) | C.F (dB/m) | Measurement (dBuV/m) | Margin (dB) | Limit (dBuV/m) | Height (cm) | Angle (deg) | Remark (QP/PK/AV) |
|----|---|-----------------|----------------|------------|----------------------|-------------|----------------|-------------|-------------|-------------------|
| 1 | * | 4874.000 | 56.16 | 0.35 | 56.51 | -17.49 | 74.00 | 110 | 135 | Peak |
| 2 | * | 4874.000 | 53.50 | 0.35 | 53.85 | -0.15 | 54.00 | 110 | 135 | Average |
| 3 | | 7311.000 | 39.94 | 5.79 | 45.73 | -28.27 | 74.00 | 100 | 360 | Peak |
| 4 | | 9748.000 | 43.47 | 5.34 | 48.81 | -25.19 | 74.00 | 100 | 330 | Peak |

Note:

- "*", means this data is the worst emission level.
- C.F (Correction Factor) = Antenna Factor (dB)+ Cable Loss (dB) – Pre-amplifier(dB).
- Measurement (dBuV/m) = Reading(dBuV) + C.F (Correction Factor).
- The emission levels of other frequencies are very lower than the limit and not show in test report.

| | | | |
|-----------|-------------------------------------------------------|----------------------|--------------|
| EUT | AX3000+G1500 Whole Home Powerline Mesh Wi-Fi 6 System | Date of Test | 2022-07-06 |
| Factor | DRH18-E | Temp. / Humidity | 23°C /63% |
| Polarity | Vertical | Site / Test Engineer | AC2 / Ares |
| Test Mode | 802.11b_TX_CH 6_ANT 0+1 | Test Voltage | AC 120V/60Hz |

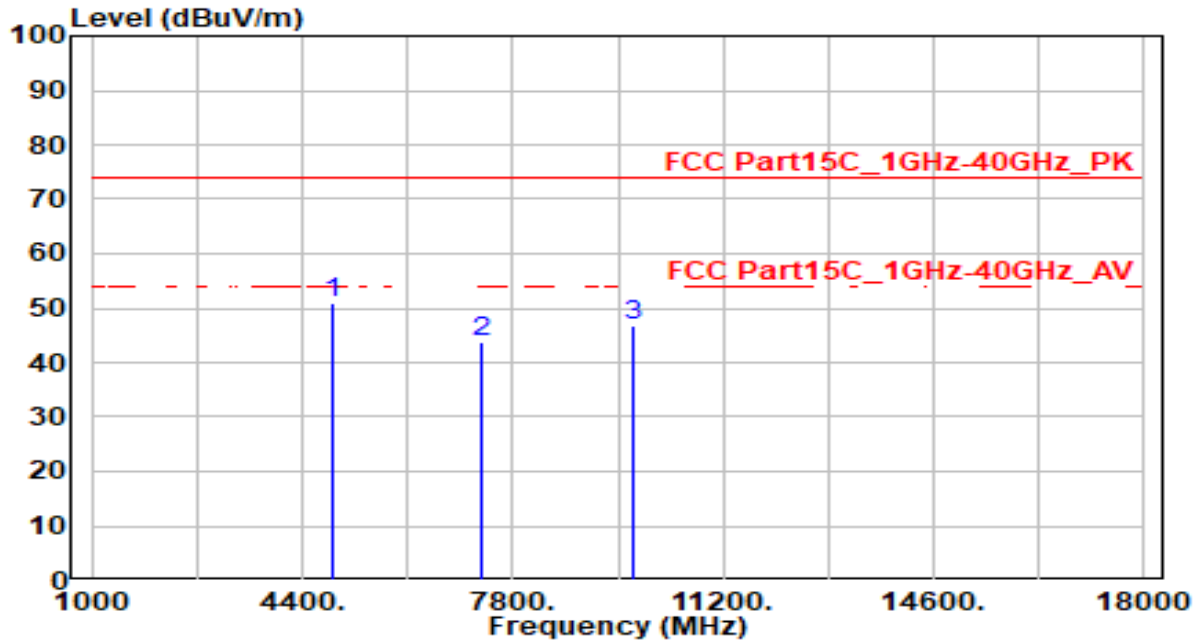

| No | Frequency (MHz) | Reading (dBuV) | C.F (dB/m) | Measurement (dBuV/m) | Margin (dB) | Limit (dBuV/m) | Height (cm) | Angle (deg) | Remark (QP/PK/AV) |
|----|-----------------|----------------|------------|----------------------|-------------|----------------|-------------|-------------|-------------------|
| 1 | * 4874.000 | 50.73 | 0.35 | 51.08 | -22.92 | 74.00 | 100 | 95 | Peak |
| 2 | 7311.000 | 38.13 | 5.79 | 43.92 | -30.08 | 74.00 | 100 | 245 | Peak |
| 3 | 9748.000 | 41.42 | 5.34 | 46.76 | -27.24 | 74.00 | 100 | 150 | Peak |

Note:

1. " *", means this data is the worst emission level.
2. C.F (Correction Factor) = Antenna Factor (dB)+ Cable Loss (dB) – Preamplifier(dB).
3. Measurement (dBuV/m) = Reading(dBuV) + C.F (Correction Factor).
4. The emission levels of other frequencies are very lower than the limit and not show in test report.

| | | | |
|-----------|-------------------------------------------------------|----------------------|--------------|
| EUT | AX3000+G1500 Whole Home Powerline Mesh Wi-Fi 6 System | Date of Test | 2022-07-06 |
| Factor | DRH18-E | Temp. / Humidity | 23°C /63% |
| Polarity | Horizontal | Site / Test Engineer | AC2 / Ares |
| Test Mode | 802.11b_TX_CH 11_ANT 0+1 | Test Voltage | AC 120V/60Hz |

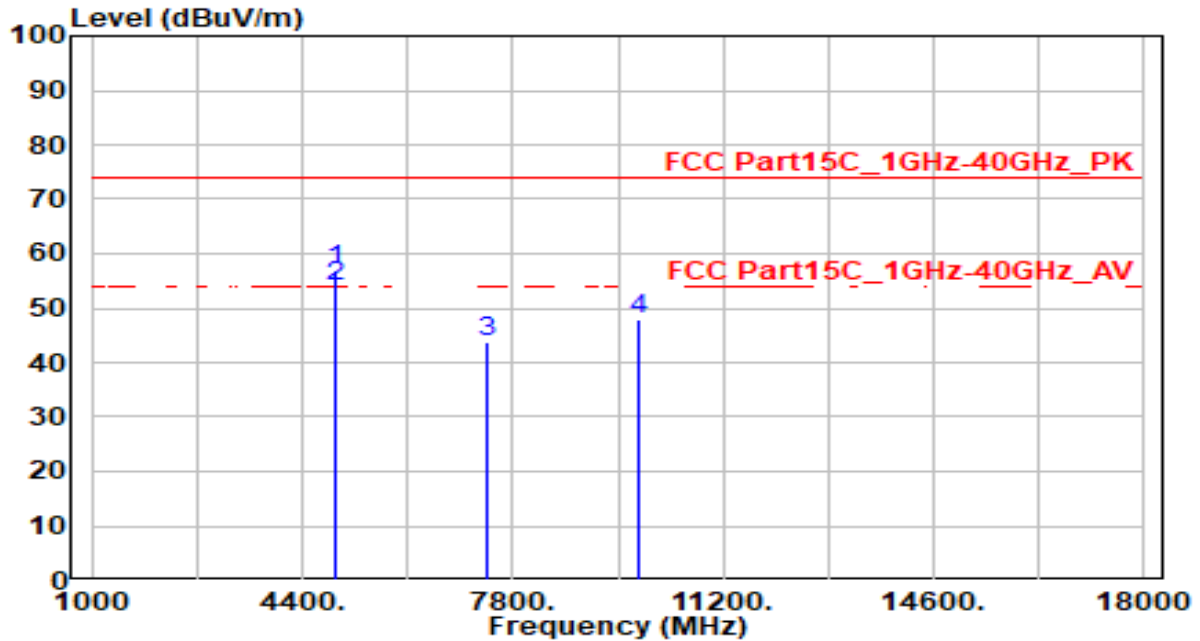

| No | | Frequency (MHz) | Reading (dBuV) | C.F (dB/m) | Measurement (dBuV/m) | Margin (dB) | Limit (dBuV/m) | Height (cm) | Angle (deg) | Remark (QP/PK/AV) |
|----|---|-----------------|----------------|------------|----------------------|-------------|----------------|-------------|-------------|-------------------|
| 1 | * | 4924.000 | 56.44 | 0.45 | 56.89 | -17.11 | 74.00 | 100 | 135 | Peak |
| 2 | * | 4924.000 | 53.36 | 0.45 | 53.81 | -0.19 | 54.00 | 100 | 135 | Average |
| 3 | | 7386.000 | 38.00 | 5.77 | 43.77 | -30.23 | 74.00 | 100 | 150 | Peak |
| 4 | | 9848.000 | 42.39 | 5.38 | 47.77 | -26.23 | 74.00 | 100 | 60 | Peak |

Note:

- "*" means this data is the worst emission level.
- C.F (Correction Factor) = Antenna Factor (dB)+ Cable Loss (dB) – Pre-amplifier(dB).
- Measurement (dBuV/m) = Reading(dBuV) + C.F (Correction Factor).
- The emission levels of other frequencies are very lower than the limit and not show in test report.

| | | | |
|-----------|-------------------------------------------------------|----------------------|--------------|
| EUT | AX3000+G1500 Whole Home Powerline Mesh Wi-Fi 6 System | Date of Test | 2022-07-06 |
| Factor | DRH18-E | Temp. / Humidity | 23°C /63% |
| Polarity | Vertical | Site / Test Engineer | AC2 / Ares |
| Test Mode | 802.11b_TX_CH 11_ANT 0+1 | Test Voltage | AC 120V/60Hz |

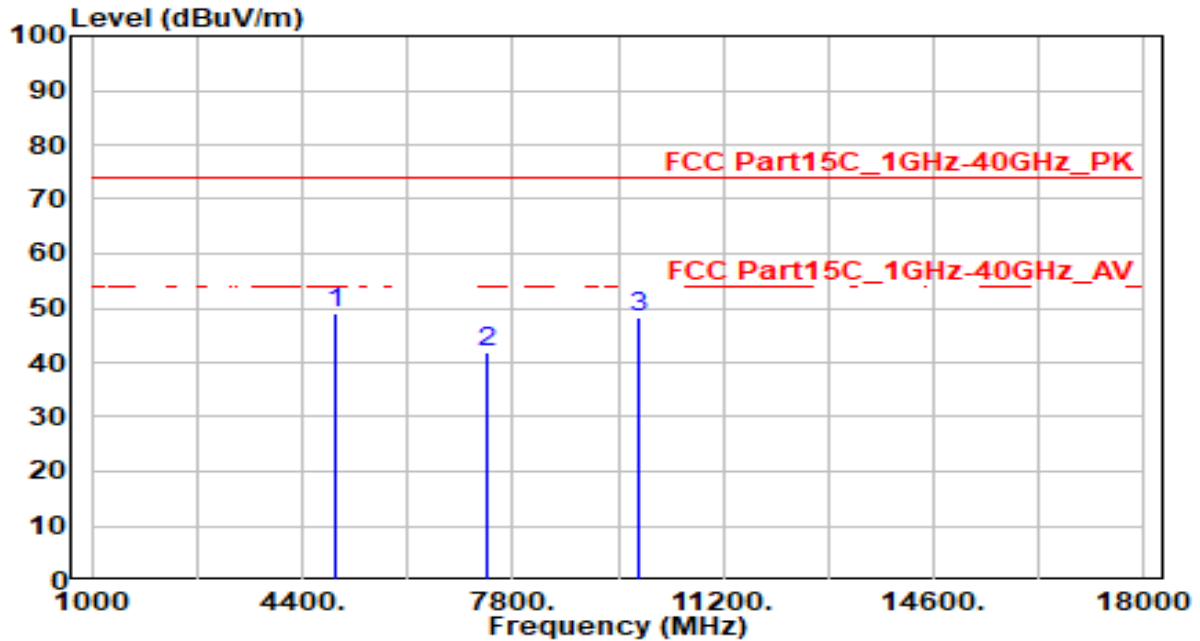

| No | Frequency (MHz) | Reading (dBuV) | C.F (dB/m) | Measurement (dBuV/m) | Margin (dB) | Limit (dBuV/m) | Height (cm) | Angle (deg) | Remark (QP/PK/AV) |
|----|-----------------|----------------|------------|----------------------|-------------|----------------|-------------|-------------|-------------------|
| 1 | * 4924.000 | 48.69 | 0.45 | 49.14 | -24.86 | 74.00 | 100 | 80 | Peak |
| 2 | 7386.000 | 35.98 | 5.77 | 41.75 | -32.25 | 74.00 | 100 | 0 | Peak |
| 3 | 9848.000 | 42.84 | 5.38 | 48.22 | -25.78 | 74.00 | 100 | 230 | Peak |

Note:

- "*" means this data is the worst emission level.
- C.F (Correction Factor) = Antenna Factor (dB)+ Cable Loss (dB) – Pre-amplifier(dB).
- Measurement (dBuV/m) = Reading(dBuV) + C.F (Correction Factor).
- The emission levels of other frequencies are very lower than the limit and not show in test report.

| | | | |
|-----------|-------------------------------------------------------|----------------------|--------------|
| EUT | AX3000+G1500 Whole Home Powerline Mesh Wi-Fi 6 System | Date of Test | 2022-07-06 |
| Factor | DRH18-E | Temp. / Humidity | 23°C /63% |
| Polarity | Horizontal | Site / Test Engineer | AC2 / Ares |
| Test Mode | 802.11g_TX_CH 1_ANT 0+1 | Test Voltage | AC 120V/60Hz |

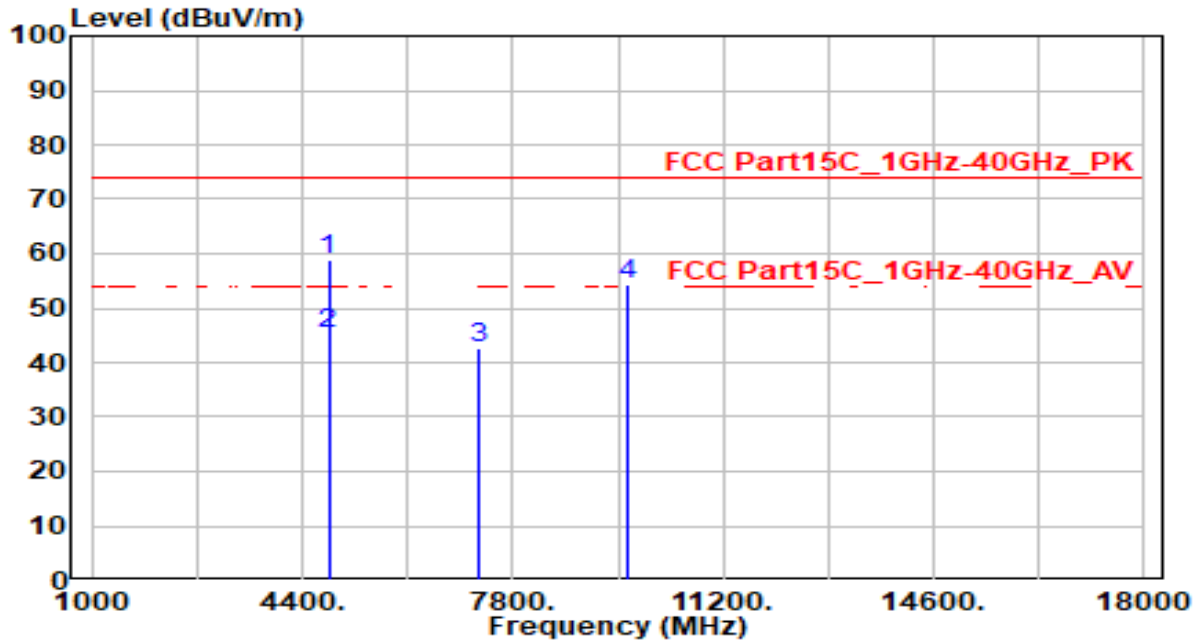

| No | | Frequency (MHz) | Reading (dBUV) | C.F (dB/m) | Measurement (dBUV/m) | Margin (dB) | Limit (dBUV/m) | Height (cm) | Angle (deg) | Remark (QP/PK/AV) |
|----|---|-----------------|----------------|------------|----------------------|-------------|----------------|-------------|-------------|-------------------|
| 1 | * | 4824.000 | 58.79 | 0.25 | 59.04 | -14.96 | 74.00 | 105 | 130 | Peak |
| 2 | * | 4824.000 | 45.03 | 0.25 | 45.28 | -8.72 | 54.00 | 105 | 130 | Average |
| 3 | | 7236.000 | 36.86 | 5.81 | 42.67 | -31.33 | 74.00 | 100 | 195 | Peak |
| 4 | | 9648.000 | 49.00 | 5.32 | 54.32 | -19.68 | 74.00 | 100 | 120 | Peak |

Note:

1. " *", means this data is the worst emission level.
2. C.F (Correction Factor) = Antenna Factor (dB)+ Cable Loss (dB) – Pre-amplifier(dB).
3. Measurement (dBUV/m) = Reading(dBUV) + C.F (Correction Factor).
4. The emission levels of other frequencies are very lower than the limit and not show in test report.

| | | | |
|-----------|-------------------------------------------------------|----------------------|--------------|
| EUT | AX3000+G1500 Whole Home Powerline Mesh Wi-Fi 6 System | Date of Test | 2022-07-06 |
| Factor | DRH18-E | Temp. / Humidity | 23°C /63% |
| Polarity | Vertical | Site / Test Engineer | AC2 / Ares |
| Test Mode | 802.11g_TX_CH 1_ANT 0+1 | Test Voltage | AC 120V/60Hz |

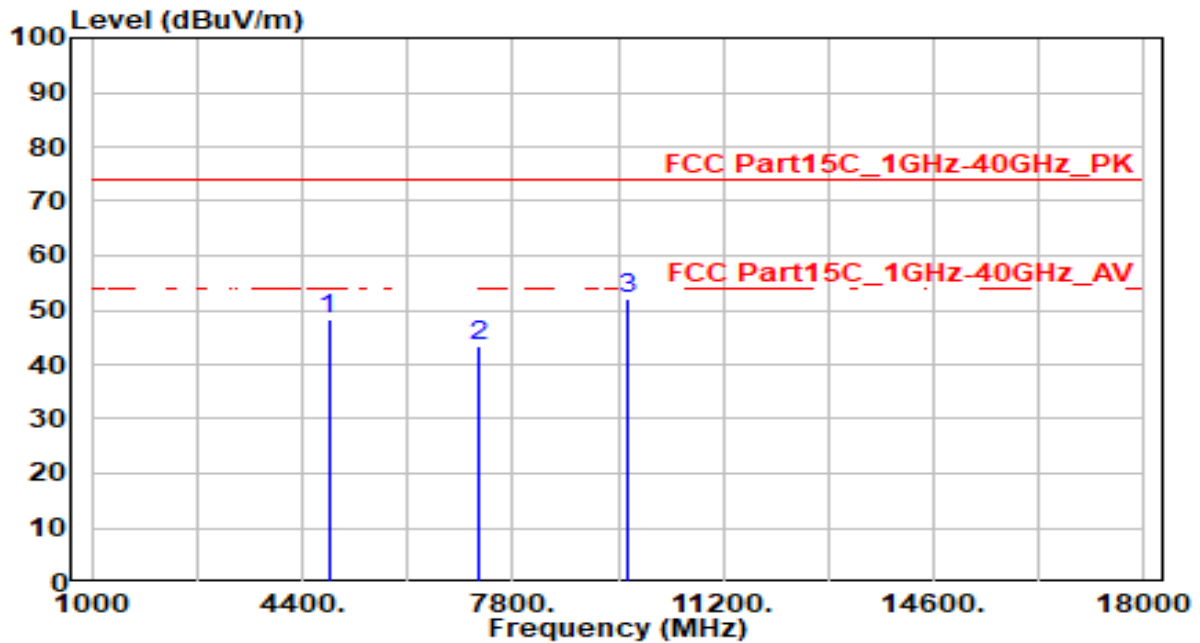

| No | Frequency (MHz) | Reading (dBuV) | C.F (dB/m) | Measurement (dBuV/m) | Margin (dB) | Limit (dBuV/m) | Height (cm) | Angle (deg) | Remark (QP/PK/AV) |
|----|-----------------|----------------|------------|----------------------|-------------|----------------|-------------|-------------|-------------------|
| 1 | 4824.000 | 48.13 | 0.25 | 48.39 | -25.61 | 74.00 | 100 | 95 | Peak |
| 2 | 7236.000 | 37.41 | 5.81 | 43.22 | -30.78 | 74.00 | 100 | 125 | Peak |
| 3 | * 9646.000 | 46.62 | 5.32 | 51.94 | -22.06 | 74.00 | 100 | 90 | Peak |

Note:

1. " *", means this data is the worst emission level.
2. C.F (Correction Factor) = Antenna Factor (dB)+ Cable Loss (dB) – Pre-amplifier(dB).
3. Measurement (dBuV/m) = Reading(dBuV) + C.F (Correction Factor).
4. The emission levels of other frequencies are very lower than the limit and not show in test report.

| | | | |
|-----------|-------------------------------------------------------|----------------------|--------------|
| EUT | AX3000+G1500 Whole Home Powerline Mesh Wi-Fi 6 System | Date of Test | 2022-07-06 |
| Factor | DRH18-E | Temp. / Humidity | 23°C /63% |
| Polarity | Horizontal | Site / Test Engineer | AC2 / Owen |
| Test Mode | 802.11g_TX_CH 6_ANT 0+1 | Test Voltage | AC 120V/60Hz |

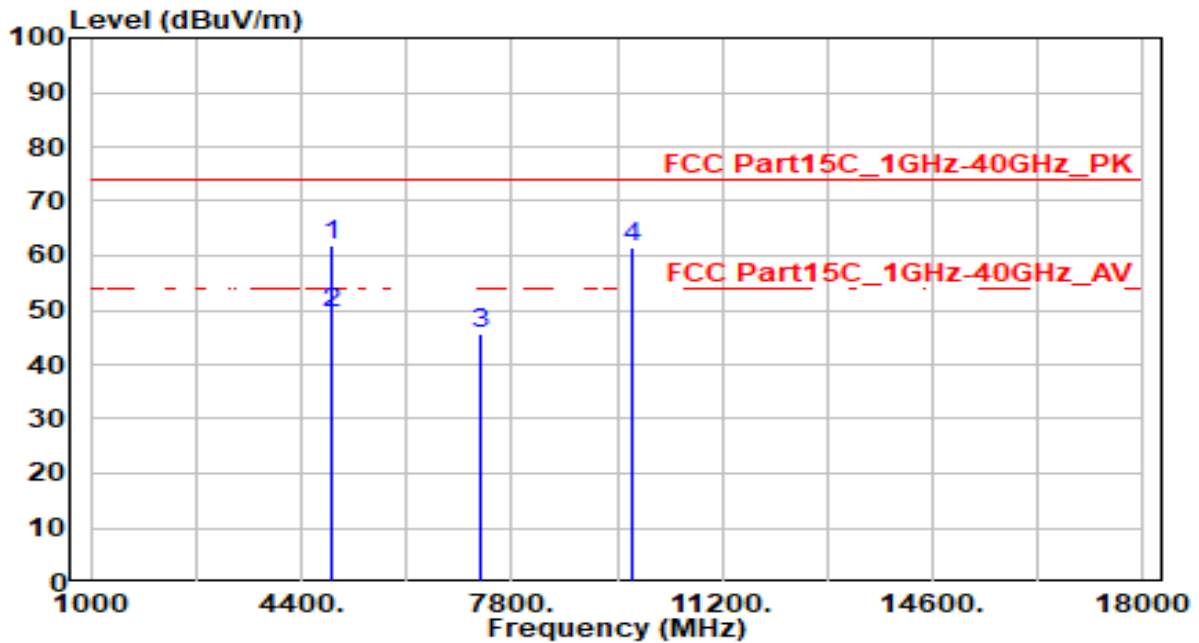

| No | Frequency (MHz) | Reading (dBUV) | C.F (dB/m) | Measurement (dBUV/m) | Margin (dB) | Limit (dBUV/m) | Height (cm) | Angle (deg) | Remark (QP/PK/AV) |
|----|-----------------|----------------|------------|----------------------|-------------|----------------|-------------|-------------|-------------------|
| 1 | * 4874.000 | 61.71 | 0.35 | 62.06 | -11.94 | 74.00 | 100 | 145 | Peak |
| 2 | * 4874.000 | 49.09 | 0.35 | 49.44 | -4.56 | 54.00 | 100 | 145 | Average |
| 3 | 7311.000 | 39.83 | 5.79 | 45.62 | -28.38 | 74.00 | 100 | 90 | Peak |
| 4 | 9748.000 | 56.22 | 5.34 | 61.56 | -12.44 | 74.00 | 200 | 95 | Peak |

Note:

1. " *", means this data is the worst emission level.
2. C.F (Correction Factor) = Antenna Factor (dB)+ Cable Loss (dB) – Pre-amplifier(dB).
3. Measurement (dBUV/m) = Reading(dBUV) + C.F (Correction Factor).
4. The emission levels of other frequencies are very lower than the limit and not show in test report.

| | | | |
|-----------|-------------------------------------------------------|----------------------|--------------|
| EUT | AX3000+G1500 Whole Home Powerline Mesh Wi-Fi 6 System | Date of Test | 2022-07-06 |
| Factor | DRH18-E | Temp. / Humidity | 23°C /63% |
| Polarity | Vertical | Site / Test Engineer | AC2 / Owen |
| Test Mode | 802.11g_TX_CH 6_ANT 0+1 | Test Voltage | AC 120V/60Hz |

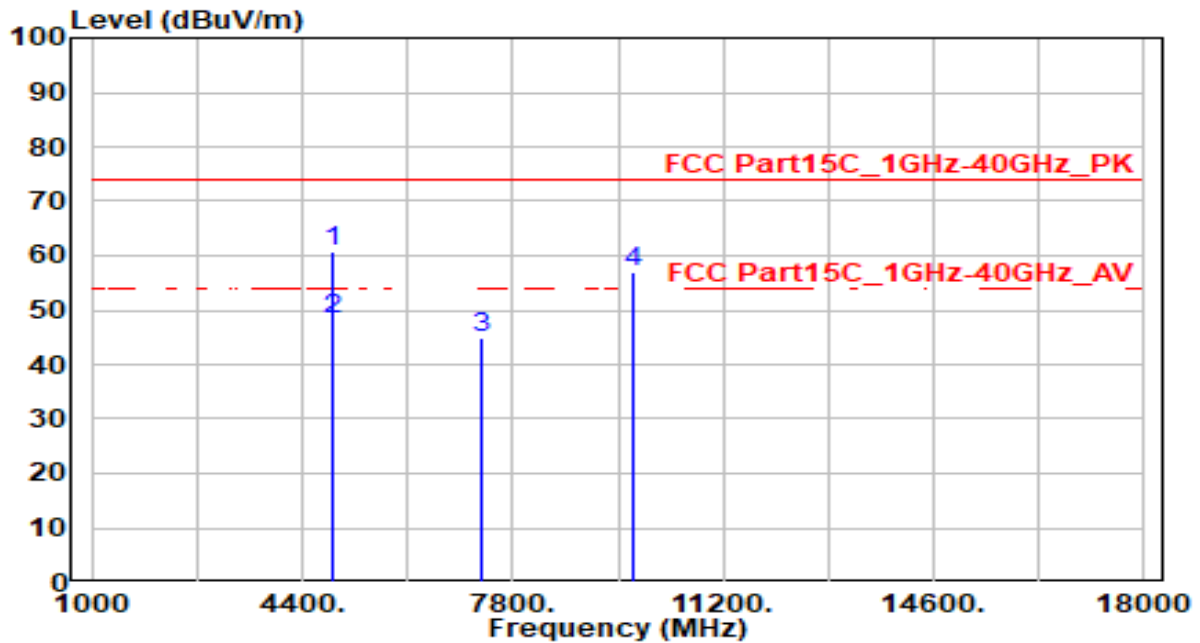

| No | | Frequency (MHz) | Reading (dBuV) | C.F (dB/m) | Measurement (dBuV/m) | Margin (dB) | Limit (dBuV/m) | Height (cm) | Angle (deg) | Remark (QP/PK/AV) |
|----|---|-----------------|----------------|------------|----------------------|-------------|----------------|-------------|-------------|-------------------|
| 1 | * | 4874.000 | 60.38 | 0.35 | 60.73 | -13.27 | 74.00 | 290 | 210 | Peak |
| 2 | * | 4874.000 | 48.00 | 0.35 | 48.35 | -5.65 | 54.00 | 290 | 210 | Average |
| 3 | | 7311.000 | 39.09 | 5.79 | 44.89 | -29.11 | 74.00 | 300 | 135 | Peak |
| 4 | | 9748.000 | 51.63 | 5.34 | 56.97 | -17.03 | 74.00 | 100 | 80 | Peak |

Note:

- "*" means this data is the worst emission level.
- C.F (Correction Factor) = Antenna Factor (dB)+ Cable Loss (dB) – Pre-amplifier(dB).
- Measurement (dBuV/m) = Reading(dBuV) + C.F (Correction Factor).
- The emission levels of other frequencies are very lower than the limit and not show in test report.

| | | | |
|-----------|-------------------------------------------------------|----------------------|--------------|
| EUT | AX3000+G1500 Whole Home Powerline Mesh Wi-Fi 6 System | Date of Test | 2022-07-06 |
| Factor | DRH18-E | Temp. / Humidity | 23°C /63% |
| Polarity | Horizontal | Site / Test Engineer | AC2 / Owen |
| Test Mode | 802.11g_TX_CH 11_ANT 0+1 | Test Voltage | AC 120V/60Hz |

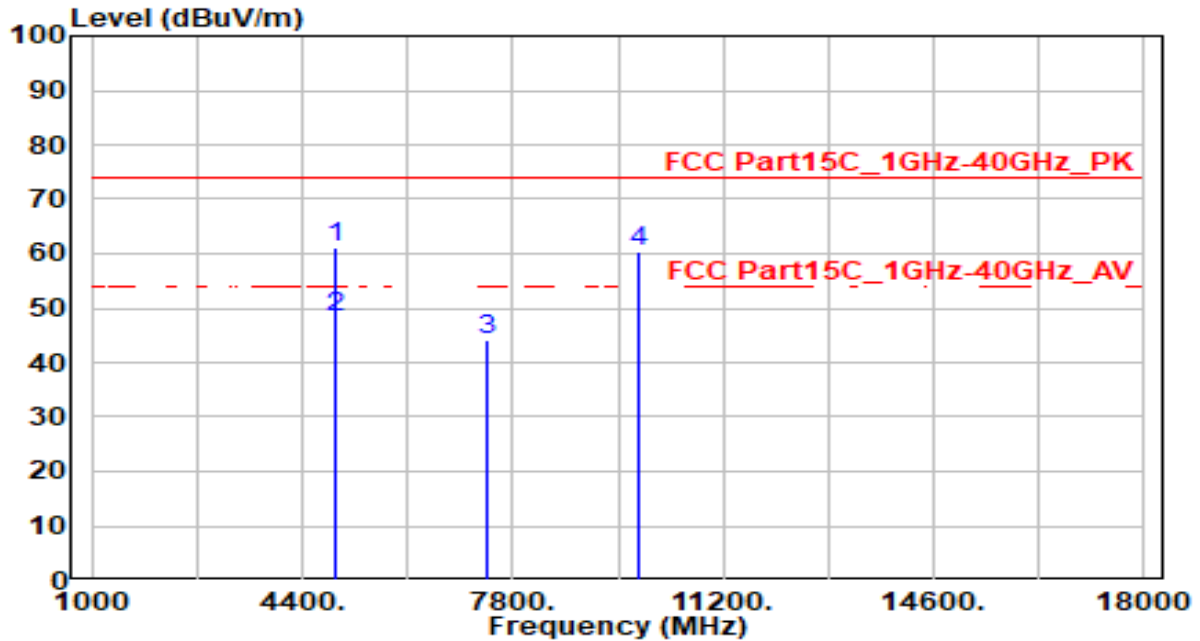

| No | | Frequency (MHz) | Reading (dBuV) | C.F (dB/m) | Measurement (dBuV/m) | Margin (dB) | Limit (dBuV/m) | Height (cm) | Angle (deg) | Remark (QP/PK/AV) |
|----|---|-----------------|----------------|------------|----------------------|-------------|----------------|-------------|-------------|-------------------|
| 1 | * | 4924.000 | 60.52 | 0.45 | 60.97 | -13.03 | 74.00 | 115 | 150 | Peak |
| 2 | * | 4924.000 | 47.69 | 0.45 | 48.14 | -5.86 | 54.00 | 115 | 150 | Average |
| 3 | | 7386.000 | 38.38 | 5.77 | 44.16 | -29.84 | 74.00 | 200 | 0 | Peak |
| 4 | | 9848.000 | 54.98 | 5.38 | 60.35 | -13.65 | 74.00 | 200 | 95 | Peak |

Note:

- "*" means this data is the worst emission level.
- C.F (Correction Factor) = Antenna Factor (dB)+ Cable Loss (dB) – Pre-amplifier(dB).
- Measurement (dBuV/m) = Reading(dBuV) + C.F (Correction Factor).
- The emission levels of other frequencies are very lower than the limit and not show in test report.

| | | | |
|-----------|-------------------------------------------------------|----------------------|--------------|
| EUT | AX3000+G1500 Whole Home Powerline Mesh Wi-Fi 6 System | Date of Test | 2022-07-06 |
| Factor | DRH18-E | Temp. / Humidity | 23°C /63% |
| Polarity | Vertical | Site / Test Engineer | AC2 / Owen |
| Test Mode | 802.11g_TX_CH 11_ANT 0+1 | Test Voltage | AC 120V/60Hz |

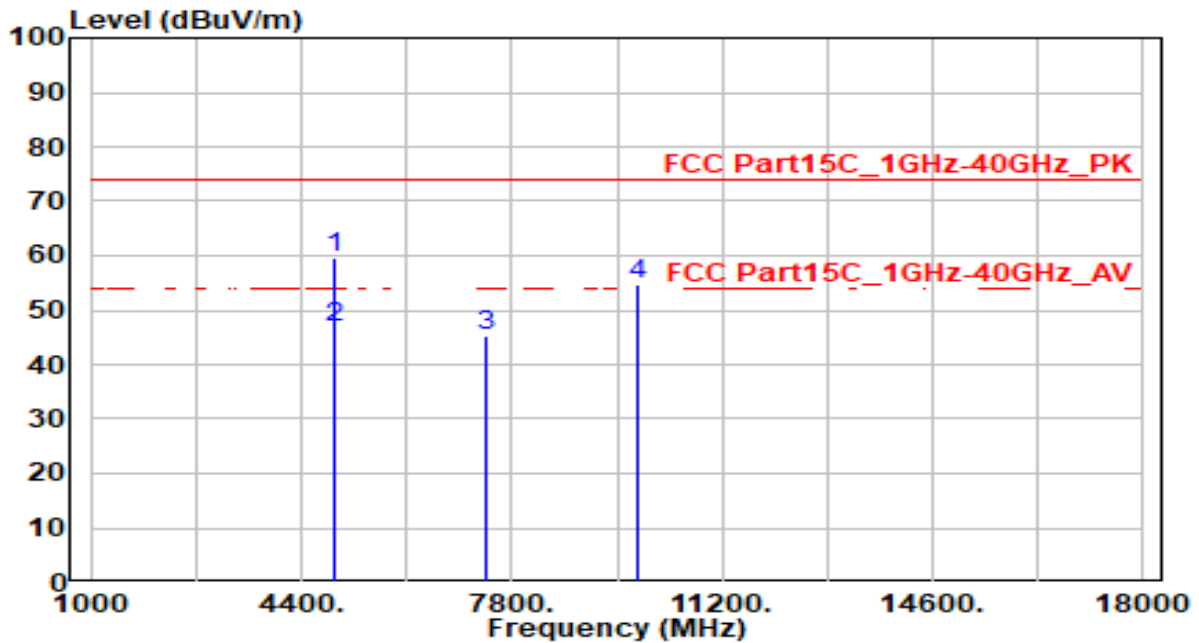

| No | | Frequency (MHz) | Reading (dBUV) | C.F (dB/m) | Measurement (dBUV/m) | Margin (dB) | Limit (dBUV/m) | Height (cm) | Angle (deg) | Remark (QP/PK/AV) |
|----|---|-----------------|----------------|------------|----------------------|-------------|----------------|-------------|-------------|-------------------|
| 1 | * | 4924.000 | 59.21 | 0.45 | 59.66 | -14.34 | 74.00 | 300 | 220 | Peak |
| 2 | * | 4924.000 | 46.20 | 0.45 | 46.65 | -7.35 | 54.00 | 300 | 220 | Average |
| 3 | | 7386.000 | 39.67 | 5.77 | 45.44 | -28.56 | 74.00 | 300 | 130 | Peak |
| 4 | | 9848.000 | 49.34 | 5.38 | 54.72 | -19.28 | 74.00 | 300 | 30 | Peak |

Note:

1. " *", means this data is the worst emission level.
2. C.F (Correction Factor) = Antenna Factor (dB)+ Cable Loss (dB) – Pre-amplifier(dB).
3. Measurement (dBUV/m) = Reading(dBUV) + C.F (Correction Factor).
4. The emission levels of other frequencies are very lower than the limit and not show in test report.

| | | | |
|-----------|-------------------------------------------------------|----------------------|--------------|
| EUT | AX3000+G1500 Whole Home Powerline Mesh Wi-Fi 6 System | Date of Test | 2022-07-06 |
| Factor | DRH18-E | Temp. / Humidity | 23°C /63% |
| Polarity | Horizontal | Site / Test Engineer | AC2 / Owen |
| Test Mode | 802.11n-20MHz_TX_CH 1_ANT 0+1 | Test Voltage | AC 120V/60Hz |

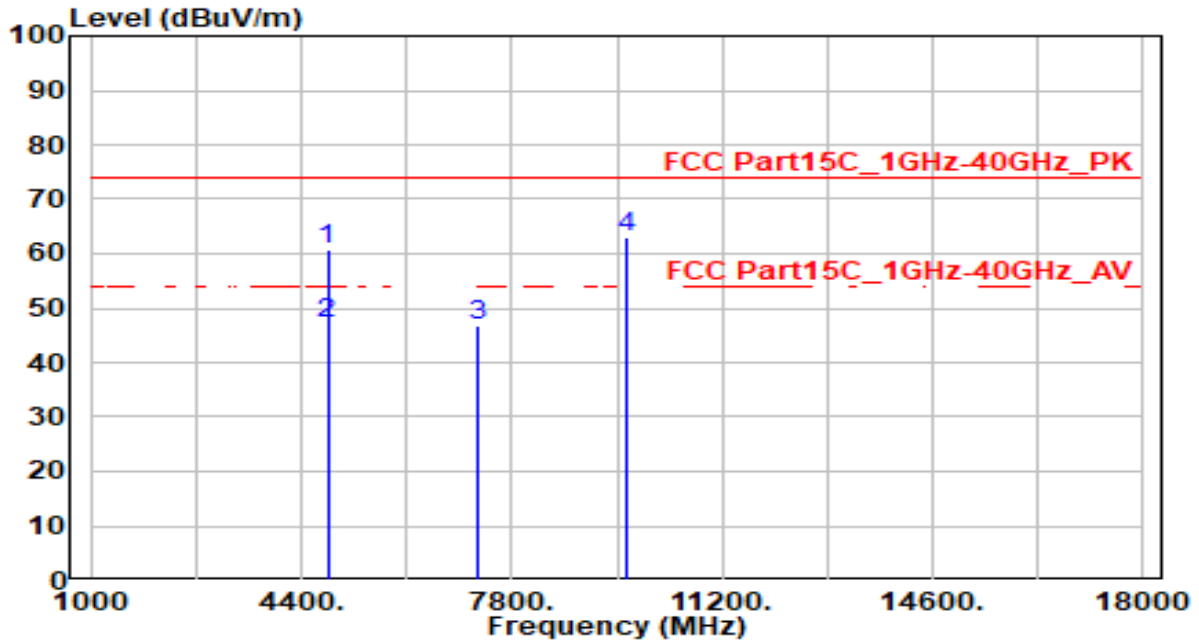

| No | | Frequency (MHz) | Reading (dBuV) | C.F (dB/m) | Measurement (dBuV/m) | Margin (dB) | Limit (dBuV/m) | Height (cm) | Angle (deg) | Remark (QP/PK/AV) |
|----|---|-----------------|----------------|------------|----------------------|-------------|----------------|-------------|-------------|-------------------|
| 1 | * | 4824.000 | 60.44 | 0.25 | 60.69 | -13.31 | 74.00 | 120 | 140 | Peak |
| 2 | * | 4824.000 | 46.90 | 0.25 | 47.15 | -6.85 | 54.00 | 120 | 140 | Average |
| 3 | | 7236.000 | 41.13 | 5.81 | 46.94 | -27.06 | 74.00 | 100 | 230 | Peak |
| 4 | | 9648.000 | 57.70 | 5.32 | 63.03 | -10.97 | 74.00 | 200 | 130 | Peak |

Note:

- "*" means this data is the worst emission level.
- C.F (Correction Factor) = Antenna Factor (dB)+ Cable Loss (dB) – Pre-amplifier(dB).
- Measurement (dBuV/m) = Reading(dBuV) + C.F (Correction Factor).
- The emission levels of other frequencies are very lower than the limit and not show in test report.

| | | | |
|-----------|-------------------------------------------------------|----------------------|--------------|
| EUT | AX3000+G1500 Whole Home Powerline Mesh Wi-Fi 6 System | Date of Test | 2022-07-06 |
| Factor | DRH18-E | Temp. / Humidity | 23°C /63% |
| Polarity | Vertical | Site / Test Engineer | AC2 / Owen |
| Test Mode | 802.11n-20MHz_TX_CH 1_ANT 0+1 | Test Voltage | AC 120V/60Hz |

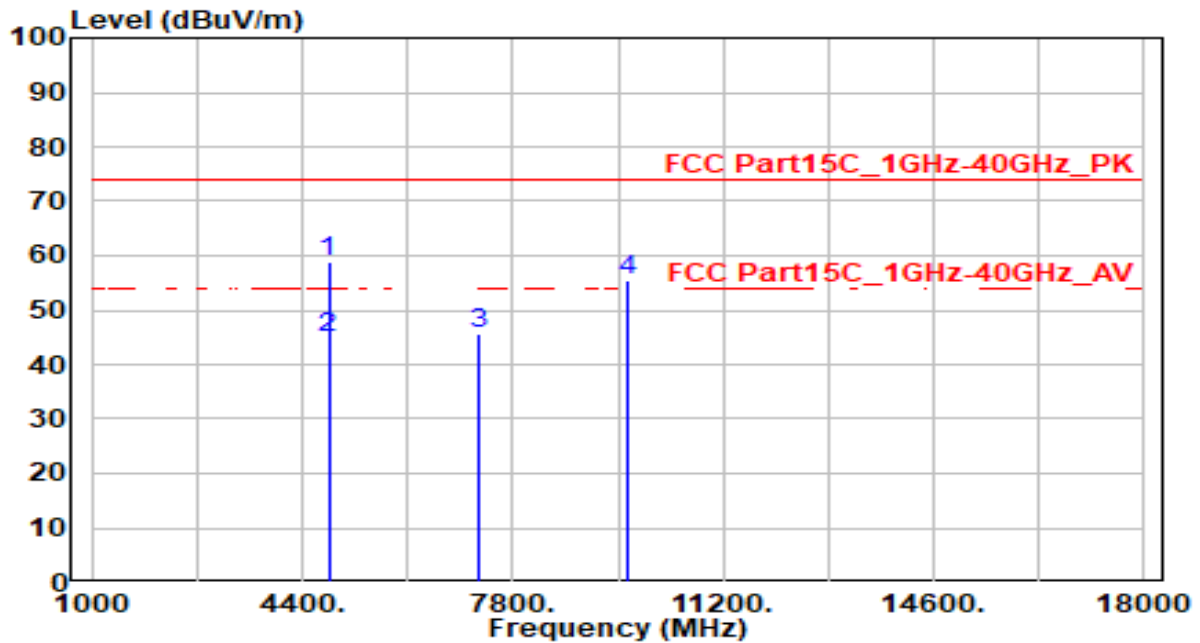

| No | Frequency (MHz) | Reading (dBuV) | C.F (dB/m) | Measurement (dBuV/m) | Margin (dB) | Limit (dBuV/m) | Height (cm) | Angle (deg) | Remark (QP/PK/AV) | |
|----|-----------------|----------------|------------|----------------------|-------------|----------------|-------------|-------------|-------------------|---------|
| 1 | * | 4824.000 | 58.44 | 0.25 | 58.69 | -15.31 | 74.00 | 300 | 25 | Peak |
| 2 | * | 4824.000 | 44.65 | 0.25 | 44.90 | -9.10 | 54.00 | 300 | 25 | Average |
| 3 | | 7236.000 | 39.82 | 5.81 | 45.64 | -28.36 | 74.00 | 100 | 165 | Peak |
| 4 | | 9648.000 | 50.27 | 5.32 | 55.59 | -18.41 | 74.00 | 100 | 80 | Peak |

Note:

1. " *", means this data is the worst emission level.
2. C.F (Correction Factor) = Antenna Factor (dB)+ Cable Loss (dB) – Pre-amplifier(dB).
3. Measurement (dBuV/m) = Reading(dBuV) + C.F (Correction Factor).
4. The emission levels of other frequencies are very lower than the limit and not show in test report.

| | | | |
|-----------|-------------------------------------------------------|----------------------|--------------|
| EUT | AX3000+G1500 Whole Home Powerline Mesh Wi-Fi 6 System | Date of Test | 2022-07-06 |
| Factor | DRH18-E | Temp. / Humidity | 23°C /63% |
| Polarity | Horizontal | Site / Test Engineer | AC2 / Owen |
| Test Mode | 802.11n-20MHz_TX_CH 6_ANT 0+1 | Test Voltage | AC 120V/60Hz |

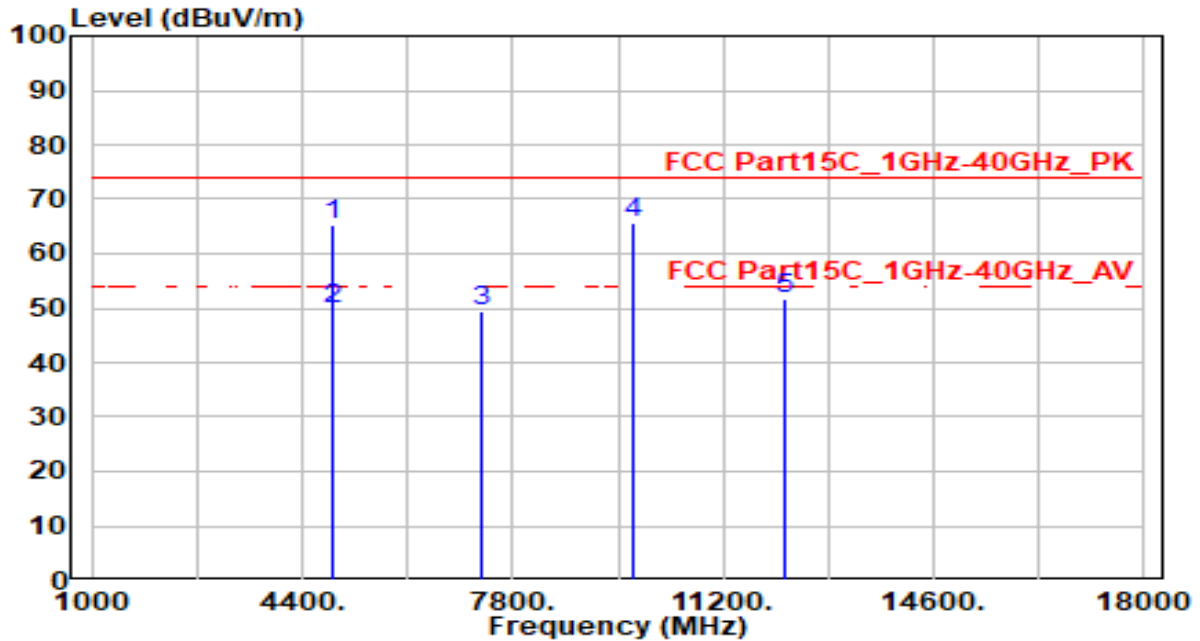

| No | Frequency (MHz) | Reading (dBuV) | C.F (dB/m) | Measurement (dBuV/m) | Margin (dB) | Limit (dBuV/m) | Height (cm) | Angle (deg) | Remark (QP/PK/AV) |
|----|-----------------|----------------|------------|----------------------|-------------|----------------|-------------|-------------|-------------------|
| 1 | * 4874.000 | 64.82 | 0.35 | 65.17 | -8.83 | 74.00 | 200 | 165 | Peak |
| 2 | * 4874.000 | 49.27 | 0.35 | 49.62 | -4.38 | 54.00 | 200 | 165 | Average |
| 3 | 7311.000 | 43.57 | 5.79 | 49.36 | -24.64 | 74.00 | 200 | 90 | Peak |
| 4 | 9748.000 | 60.27 | 5.34 | 65.61 | -8.39 | 74.00 | 200 | 100 | Peak |
| 5 | 12185.000 | 45.80 | 6.08 | 51.88 | -22.12 | 74.00 | 175 | 360 | Peak |

Note:

1. " *", means this data is the worst emission level.
2. C.F (Correction Factor) = Antenna Factor (dB)+ Cable Loss (dB) – Pre-amplifier(dB).
3. Measurement (dBuV/m) = Reading(dBuV) + C.F (Correction Factor).
4. The emission levels of other frequencies are very lower than the limit and not show in test report.

| | | | |
|-----------|-------------------------------------------------------|----------------------|--------------|
| EUT | AX3000+G1500 Whole Home Powerline Mesh Wi-Fi 6 System | Date of Test | 2022-07-06 |
| Factor | DRH18-E | Temp. / Humidity | 23°C /63% |
| Polarity | Vertical | Site / Test Engineer | AC2 / Owen |
| Test Mode | 802.11n-20MHz_TX_CH 6_ANT 0+1 | Test Voltage | AC 120V/60Hz |

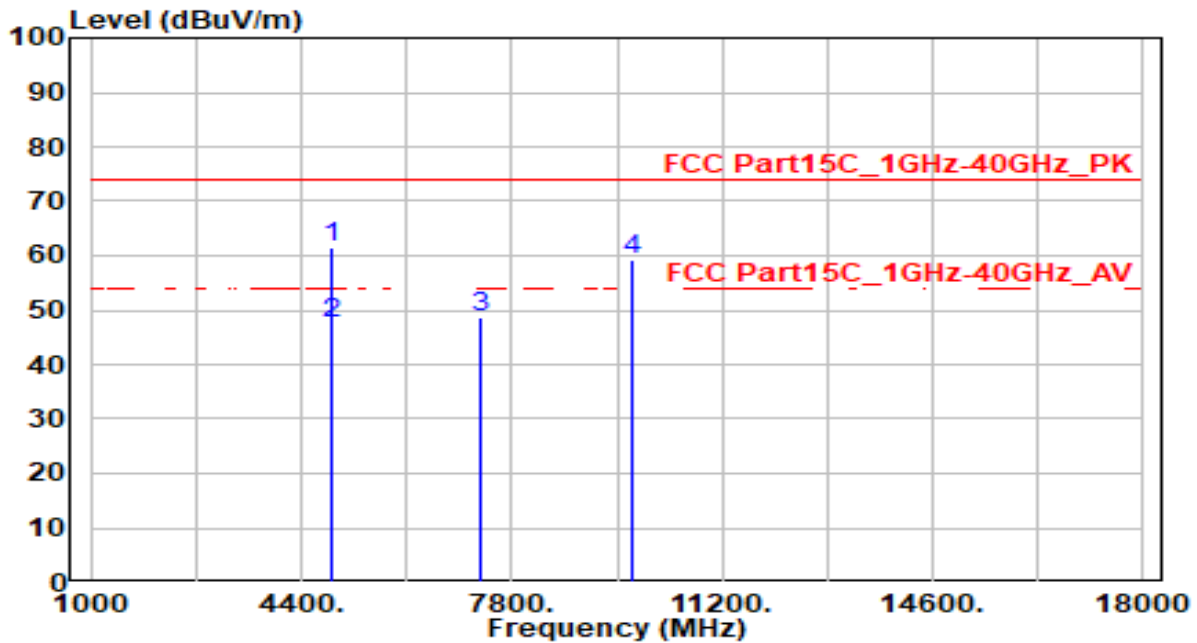

| No | | Frequency (MHz) | Reading (dBuV) | C.F (dB/m) | Measurement (dBuV/m) | Margin (dB) | Limit (dBuV/m) | Height (cm) | Angle (deg) | Remark (QP/PK/AV) |
|----|---|-----------------|----------------|------------|----------------------|-------------|----------------|-------------|-------------|-------------------|
| 1 | * | 4874.000 | 61.05 | 0.35 | 61.40 | -12.60 | 74.00 | 270 | 210 | Peak |
| 2 | * | 4874.000 | 47.34 | 0.35 | 47.69 | -6.31 | 54.00 | 270 | 210 | Average |
| 3 | | 7311.000 | 43.07 | 5.79 | 48.87 | -25.13 | 74.00 | 300 | 145 | Peak |
| 4 | | 9748.000 | 53.94 | 5.34 | 59.28 | -14.72 | 74.00 | 300 | 30 | Peak |

Note:

- "*", means this data is the worst emission level.
- C.F (Correction Factor) = Antenna Factor (dB)+ Cable Loss (dB) – Pre-amplifier(dB).
- Measurement (dBuV/m) = Reading(dBuV) + C.F (Correction Factor).
- The emission levels of other frequencies are very lower than the limit and not show in test report.

| | | | |
|-----------|-------------------------------------------------------|----------------------|--------------|
| EUT | AX3000+G1500 Whole Home Powerline Mesh Wi-Fi 6 System | Date of Test | 2022-07-06 |
| Factor | DRH18-E | Temp. / Humidity | 23°C /63% |
| Polarity | Horizontal | Site / Test Engineer | AC2 / Owen |
| Test Mode | 802.11n-20MHz_TX_CH 11_ANT 0+1 | Test Voltage | AC 120V/60Hz |

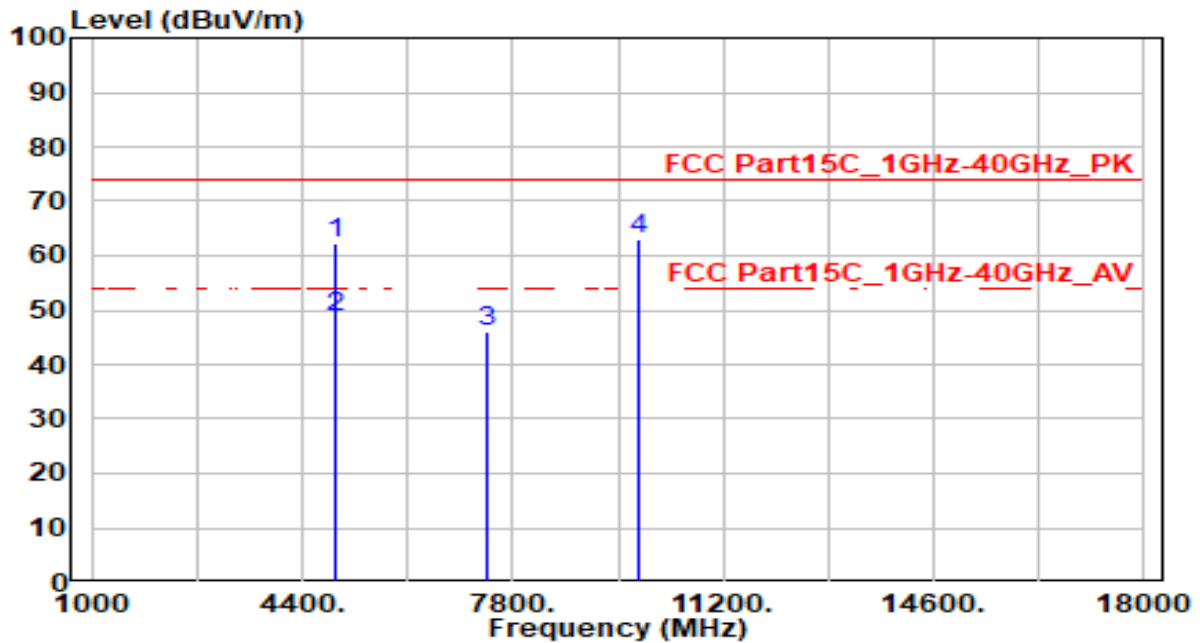

| No | Frequency (MHz) | Reading (dBuV) | C.F (dB/m) | Measurement (dBuV/m) | Margin (dB) | Limit (dBuV/m) | Height (cm) | Angle (deg) | Remark (QP/PK/AV) | |
|----|-----------------|----------------|------------|----------------------|-------------|----------------|-------------|-------------|-------------------|---------|
| 1 | * | 4924.000 | 61.78 | 0.45 | 62.23 | -11.77 | 74.00 | 115 | 150 | Peak |
| 2 | * | 4924.000 | 48.18 | 0.45 | 48.63 | -5.37 | 54.00 | 115 | 150 | Average |
| 3 | | 7386.000 | 40.43 | 5.77 | 46.20 | -27.80 | 74.00 | 100 | 75 | Peak |
| 4 | | 9848.000 | 57.53 | 5.38 | 62.91 | -11.09 | 74.00 | 200 | 140 | Peak |

Note:

- "*" means this data is the worst emission level.
- C.F (Correction Factor) = Antenna Factor (dB)+ Cable Loss (dB) – Pre-amplifier(dB).
- Measurement (dBuV/m) = Reading(dBuV) + C.F (Correction Factor).
- The emission levels of other frequencies are very lower than the limit and not show in test report.

| | | | |
|-----------|-------------------------------------------------------|----------------------|--------------|
| EUT | AX3000+G1500 Whole Home Powerline Mesh Wi-Fi 6 System | Date of Test | 2022-07-06 |
| Factor | DRH18-E | Temp. / Humidity | 23°C /63% |
| Polarity | Vertical | Site / Test Engineer | AC2 / Owen |
| Test Mode | 802.11n-20MHz_TX_CH 11_ANT 0+1 | Test Voltage | AC 120V/60Hz |

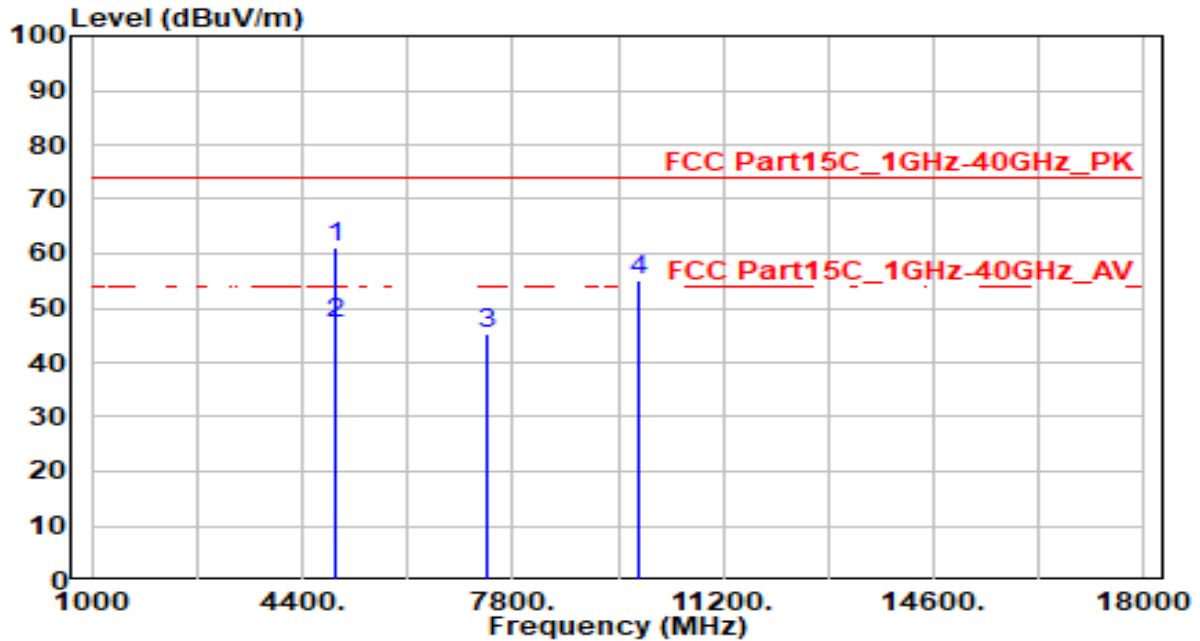

| No | Frequency (MHz) | Reading (dBuV) | C.F (dB/m) | Measurement (dBuV/m) | Margin (dB) | Limit (dBuV/m) | Height (cm) | Angle (deg) | Remark (QP/PK/AV) | |
|----|-----------------|----------------|------------|----------------------|-------------|----------------|-------------|-------------|-------------------|---------|
| 1 | * | 4924.000 | 60.67 | 0.45 | 61.12 | -12.88 | 74.00 | 300 | 220 | Peak |
| 2 | * | 4924.000 | 46.86 | 0.45 | 47.31 | -6.69 | 54.00 | 300 | 220 | Average |
| 3 | | 7386.000 | 39.57 | 5.77 | 45.34 | -28.66 | 74.00 | 100 | 180 | Peak |
| 4 | | 9848.000 | 49.75 | 5.38 | 55.13 | -18.87 | 74.00 | 100 | 240 | Peak |

Note:

- "*" means this data is the worst emission level.
- C.F (Correction Factor) = Antenna Factor (dB)+ Cable Loss (dB) – Pre-amplifier(dB).
- Measurement (dBuV/m) = Reading(dBuV) + C.F (Correction Factor).
- The emission levels of other frequencies are very lower than the limit and not show in test report.

| | | | |
|-----------|-------------------------------------------------------|----------------------|--------------|
| EUT | AX3000+G1500 Whole Home Powerline Mesh Wi-Fi 6 System | Date of Test | 2022-07-06 |
| Factor | DRH18-E | Temp. / Humidity | 23°C /63% |
| Polarity | Horizontal | Site / Test Engineer | AC2 / Owen |
| Test Mode | 802.11n-40MHz_TX_CH 3_ANT 0+1 | Test Voltage | AC 120V/60Hz |

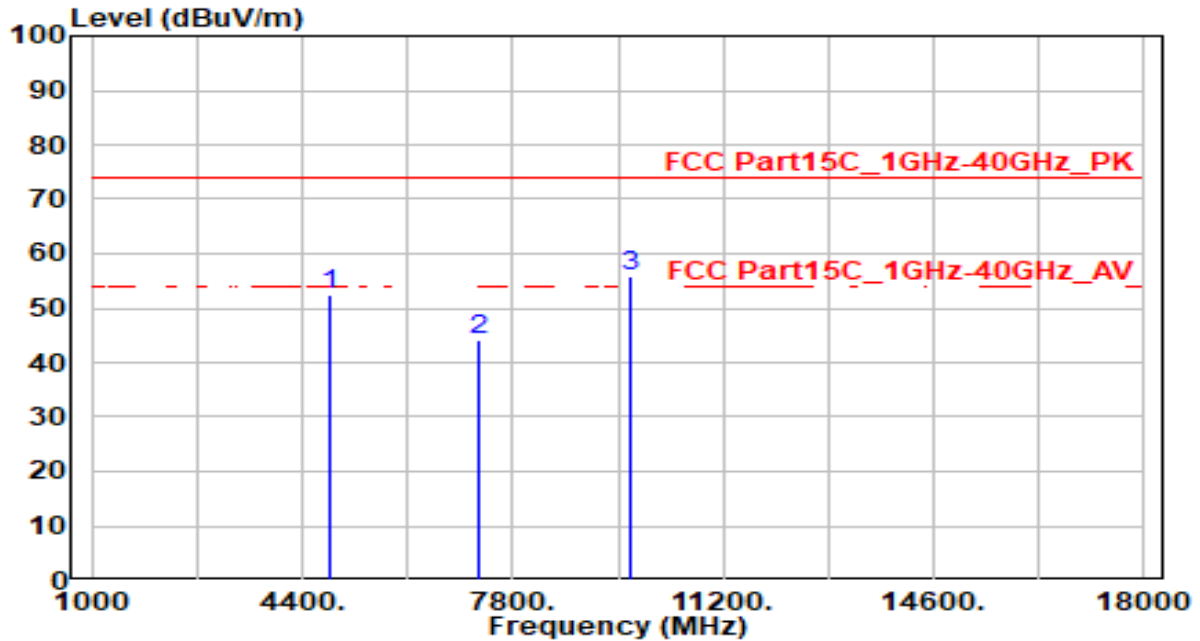

| No | Frequency (MHz) | Reading (dBuV) | C.F (dB/m) | Measurement (dBuV/m) | Margin (dB) | Limit (dBuV/m) | Height (cm) | Angle (deg) | Remark (QP/PK/AV) |
|----|-----------------|----------------|------------|----------------------|-------------|----------------|-------------|-------------|-------------------|
| 1 | 4844.000 | 51.98 | 0.29 | 52.28 | -21.72 | 74.00 | 100 | 150 | Peak |
| 2 | 7266.000 | 38.16 | 5.81 | 43.97 | -30.03 | 74.00 | 200 | 220 | Peak |
| 3 | * 9688.000 | 50.50 | 5.33 | 55.83 | -18.17 | 74.00 | 200 | 105 | Peak |

Note:

1. " *", means this data is the worst emission level.
2. C.F (Correction Factor) = Antenna Factor (dB)+ Cable Loss (dB) – Preamplifier(dB).
3. Measurement (dBuV/m) = Reading(dBuV) + C.F (Correction Factor).
4. The emission levels of other frequencies are very lower than the limit and not show in test report.

| | | | |
|-----------|-------------------------------------------------------|----------------------|--------------|
| EUT | AX3000+G1500 Whole Home Powerline Mesh Wi-Fi 6 System | Date of Test | 2022-07-06 |
| Factor | DRH18-E | Temp. / Humidity | 23°C /63% |
| Polarity | Vertical | Site / Test Engineer | AC2 / Owen |
| Test Mode | 802.11n-40MHz_TX_CH 3_ANT 0+1 | Test Voltage | AC 120V/60Hz |

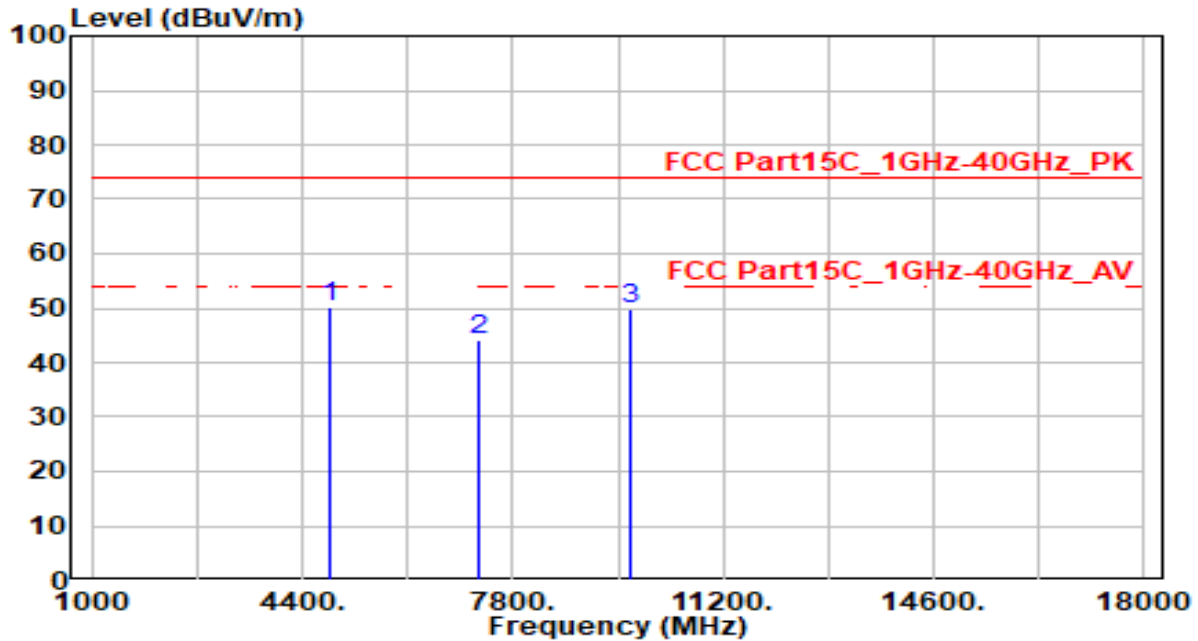

| No | Frequency (MHz) | Reading (dBuV) | C.F (dB/m) | Measurement (dBuV/m) | Margin (dB) | Limit (dBuV/m) | Height (cm) | Angle (deg) | Remark (QP/PK/AV) |
|----|-----------------|----------------|------------|----------------------|-------------|----------------|-------------|-------------|-------------------|
| 1 | * 4844.000 | 49.93 | 0.29 | 50.22 | -23.78 | 74.00 | 300 | 35 | Peak |
| 2 | 7266.000 | 38.30 | 5.81 | 44.10 | -29.90 | 74.00 | 100 | 210 | Peak |
| 3 | 9688.000 | 44.63 | 5.33 | 49.96 | -24.04 | 74.00 | 300 | 35 | Peak |

Note:

1. " *", means this data is the worst emission level.
2. C.F (Correction Factor) = Antenna Factor (dB)+ Cable Loss (dB) – Preamplifier(dB).
3. Measurement (dBuV/m) = Reading(dBuV) + C.F (Correction Factor).
4. The emission levels of other frequencies are very lower than the limit and not show in test report.

| | | | |
|-----------|-------------------------------------------------------|----------------------|--------------|
| EUT | AX3000+G1500 Whole Home Powerline Mesh Wi-Fi 6 System | Date of Test | 2022-07-06 |
| Factor | DRH18-E | Temp. / Humidity | 23°C /63% |
| Polarity | Horizontal | Site / Test Engineer | AC2 / Owen |
| Test Mode | 802.11n-40MHz_TX_CH 6_ANT 0+1 | Test Voltage | AC 120V/60Hz |

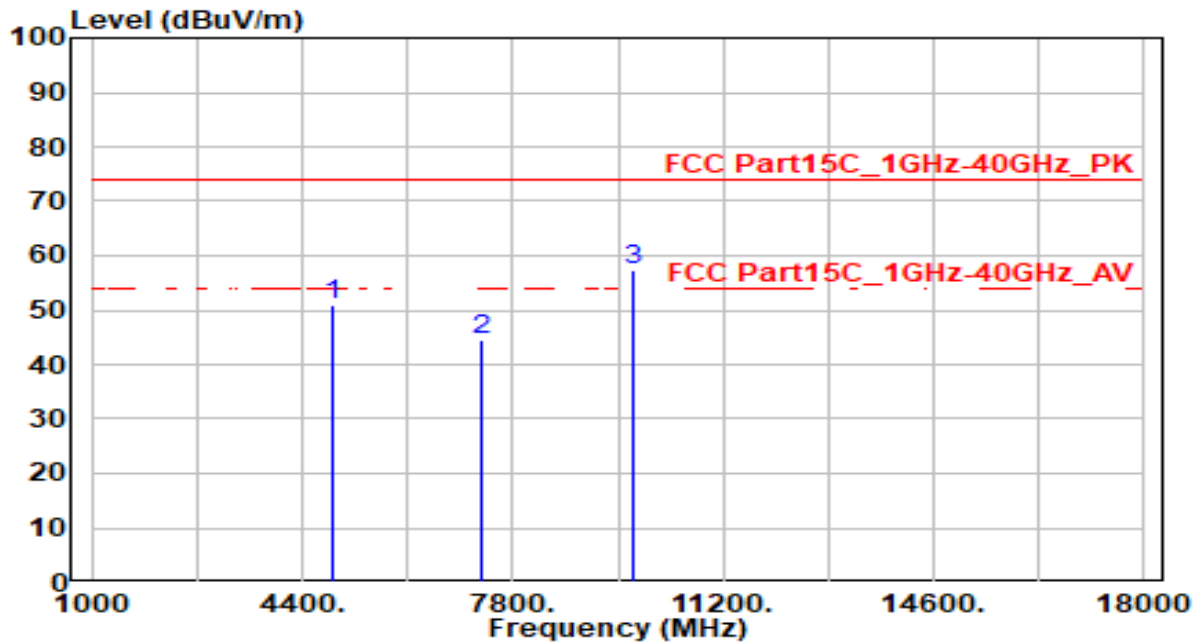

| No | Frequency (MHz) | Reading (dBuV) | C.F (dB/m) | Measurement (dBuV/m) | Margin (dB) | Limit (dBuV/m) | Height (cm) | Angle (deg) | Remark (QP/PK/AV) |
|----|-----------------|----------------|------------|----------------------|-------------|----------------|-------------|-------------|-------------------|
| 1 | 4874.000 | 50.54 | 0.35 | 50.90 | -23.10 | 74.00 | 200 | 125 | Peak |
| 2 | 7311.000 | 38.84 | 5.79 | 44.63 | -29.37 | 74.00 | 100 | 90 | Peak |
| 3 | * 9748.000 | 52.03 | 5.34 | 57.37 | -16.63 | 74.00 | 200 | 85 | Peak |

Note:

1. " *", means this data is the worst emission level.
2. C.F (Correction Factor) = Antenna Factor (dB)+ Cable Loss (dB) – Preamplifier(dB).
3. Measurement (dBuV/m) = Reading(dBuV) + C.F (Correction Factor).
4. The emission levels of other frequencies are very lower than the limit and not show in test report.

| | | | |
|-----------|-------------------------------------------------------|----------------------|--------------|
| EUT | AX3000+G1500 Whole Home Powerline Mesh Wi-Fi 6 System | Date of Test | 2022-07-06 |
| Factor | DRH18-E | Temp. / Humidity | 23°C /63% |
| Polarity | Vertical | Site / Test Engineer | AC2 / Owen |
| Test Mode | 802.11n-40MHz_TX_CH 6_ANT 0+1 | Test Voltage | AC 120V/60Hz |

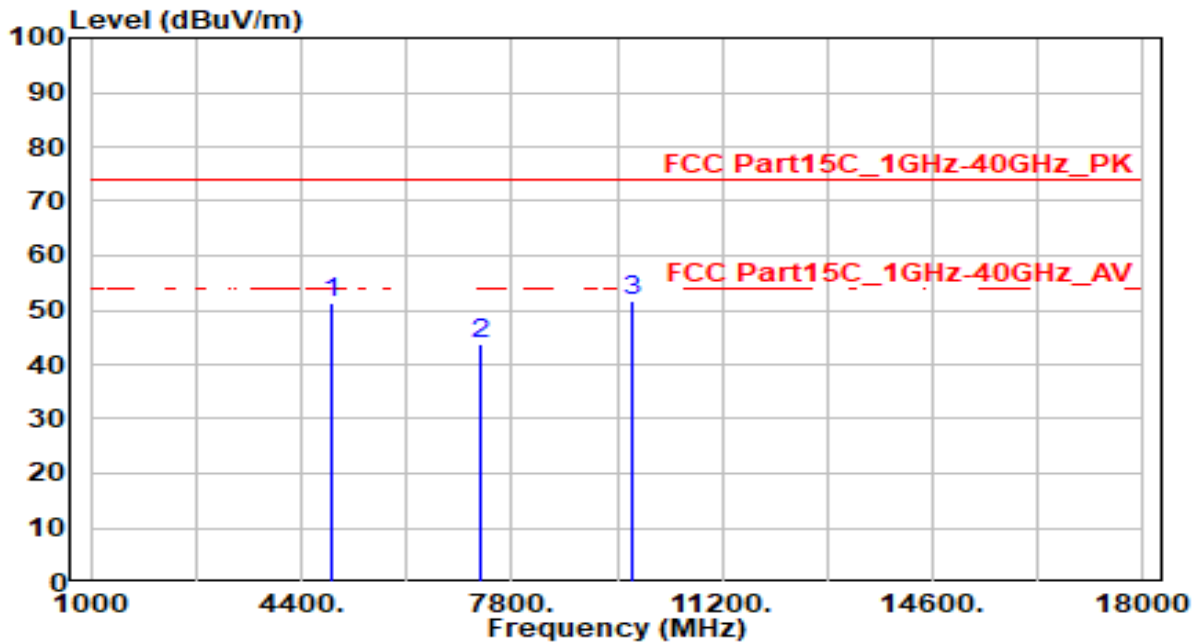

| No | Frequency (MHz) | Reading (dBUV) | C.F (dB/m) | Measurement (dBUV/m) | Margin (dB) | Limit (dBUV/m) | Height (cm) | Angle (deg) | Remark (QP/PK/AV) |
|----|-----------------|----------------|------------|----------------------|-------------|----------------|-------------|-------------|-------------------|
| 1 | 4874.000 | 51.02 | 0.35 | 51.38 | -22.62 | 74.00 | 300 | 30 | Peak |
| 2 | 7311.000 | 37.82 | 5.79 | 43.62 | -30.38 | 74.00 | 110 | 360 | Peak |
| 3 | * 9748.000 | 46.53 | 5.34 | 51.87 | -22.13 | 74.00 | 300 | 30 | Peak |

Note:

1. " *", means this data is the worst emission level.
2. C.F (Correction Factor) = Antenna Factor (dB)+ Cable Loss (dB) – Pre-amplifier(dB).
3. Measurement (dBUV/m) = Reading(dBUV) + C.F (Correction Factor).
4. The emission levels of other frequencies are very lower than the limit and not show in test report.

| | | | |
|-----------|-------------------------------------------------------|----------------------|--------------|
| EUT | AX3000+G1500 Whole Home Powerline Mesh Wi-Fi 6 System | Date of Test | 2022-07-06 |
| Factor | DRH18-E | Temp. / Humidity | 23°C /63% |
| Polarity | Horizontal | Site / Test Engineer | AC2 / Owen |
| Test Mode | 802.11n-40MHz_TX_CH 9_ANT 0+1 | Test Voltage | AC 120V/60Hz |

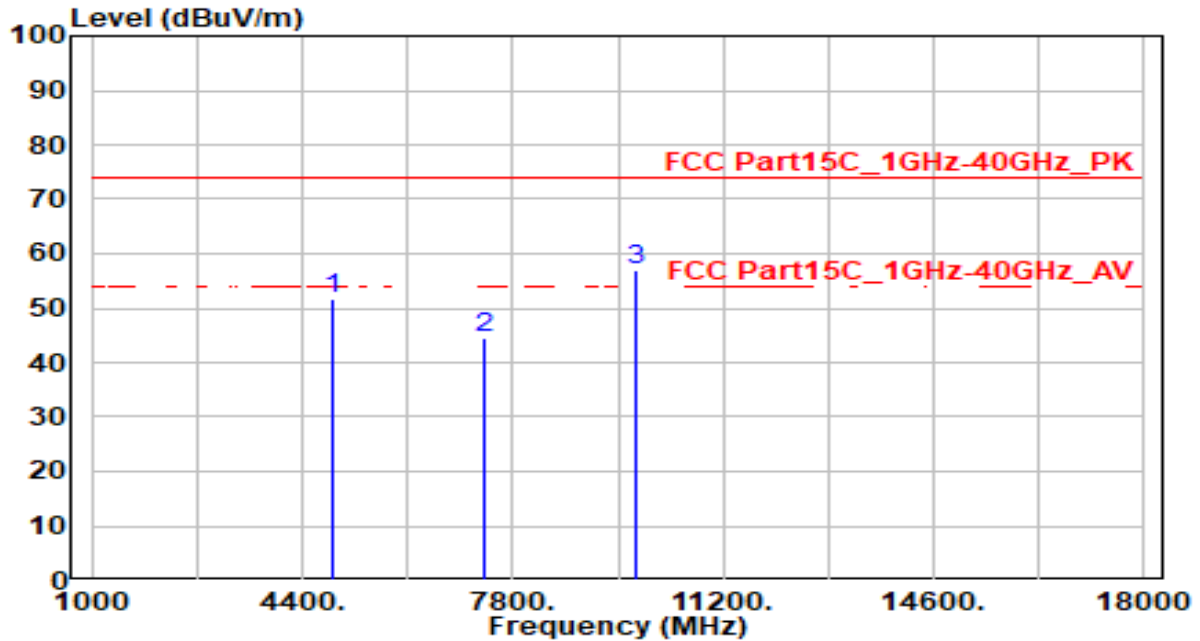

| No | Frequency (MHz) | Reading (dBUV) | C.F (dB/m) | Measurement (dBUV/m) | Margin (dB) | Limit (dBUV/m) | Height (cm) | Angle (deg) | Remark (QP/PK/AV) |
|----|-----------------|----------------|------------|----------------------|-------------|----------------|-------------|-------------|-------------------|
| 1 | 4904.000 | 51.37 | 0.41 | 51.78 | -22.22 | 74.00 | 200 | 130 | Peak |
| 2 | 7356.000 | 38.68 | 5.78 | 44.46 | -29.54 | 74.00 | 100 | 80 | Peak |
| 3 | * 9808.000 | 51.61 | 5.35 | 56.97 | -17.03 | 74.00 | 200 | 120 | Peak |

Note:

1. " *", means this data is the worst emission level.
2. C.F (Correction Factor) = Antenna Factor (dB)+ Cable Loss (dB) – Preamplifier(dB).
3. Measurement (dBUV/m) = Reading(dBUV) + C.F (Correction Factor).
4. The emission levels of other frequencies are very lower than the limit and not show in test report.

| | | | |
|-----------|-------------------------------------------------------|----------------------|--------------|
| EUT | AX3000+G1500 Whole Home Powerline Mesh Wi-Fi 6 System | Date of Test | 2022-07-06 |
| Factor | DRH18-E | Temp. / Humidity | 23°C /63% |
| Polarity | Vertical | Site / Test Engineer | AC2 / Owen |
| Test Mode | 802.11n-40MHz_TX_CH 9_ANT 0+1 | Test Voltage | AC 120V/60Hz |

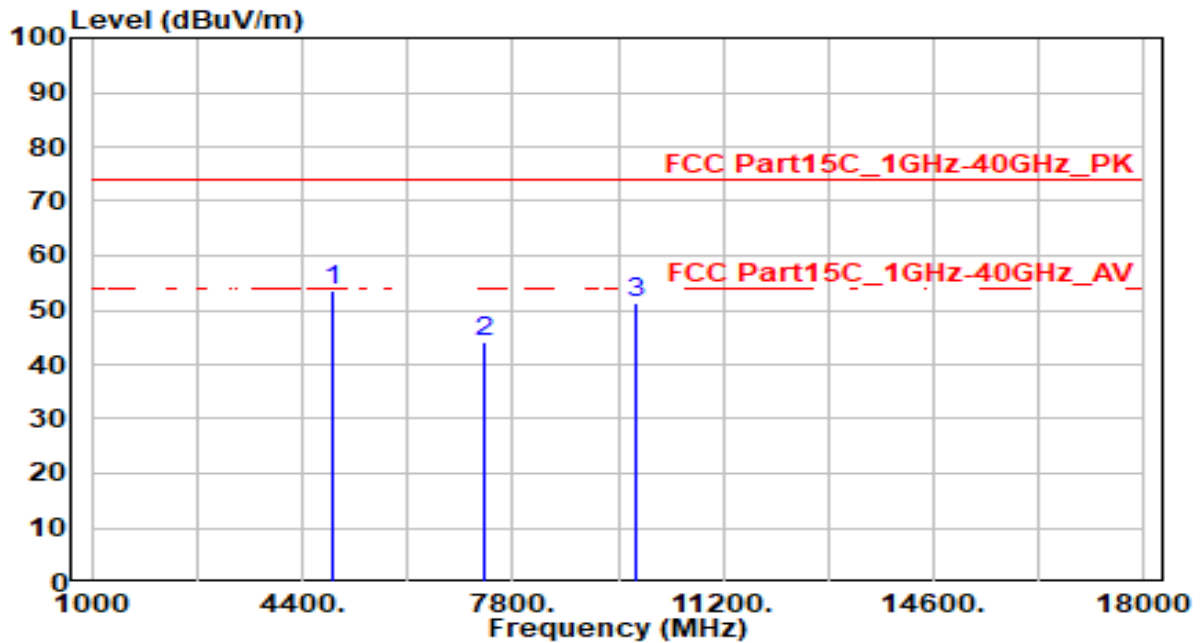

| No | Frequency (MHz) | Reading (dBuV) | C.F (dB/m) | Measurement (dBuV/m) | Margin (dB) | Limit (dBuV/m) | Height (cm) | Angle (deg) | Remark (QP/PK/AV) |
|----|-----------------|----------------|------------|----------------------|-------------|----------------|-------------|-------------|-------------------|
| 1 | * 4904.000 | 52.99 | 0.41 | 53.40 | -20.60 | 74.00 | 300 | 35 | Peak |
| 2 | 7356.000 | 38.22 | 5.78 | 44.00 | -30.00 | 74.00 | 300 | 60 | Peak |
| 3 | 9808.000 | 45.84 | 5.35 | 51.19 | -22.81 | 74.00 | 100 | 200 | Peak |

Note:

1. " *", means this data is the worst emission level.
2. C.F (Correction Factor) = Antenna Factor (dB)+ Cable Loss (dB) – Preamplifier(dB).
3. Measurement (dBuV/m) = Reading(dBuV) + C.F (Correction Factor).
4. The emission levels of other frequencies are very lower than the limit and not show in test report.

| | | | |
|-----------|-------------------------------------------------------|----------------------|--------------|
| EUT | AX3000+G1500 Whole Home Powerline Mesh Wi-Fi 6 System | Date of Test | 2022-07-06 |
| Factor | DRH18-E | Temp. / Humidity | 23°C /63% |
| Polarity | Horizontal | Site / Test Engineer | AC2 / Owen |
| Test Mode | 802.11ax-20MHz_TX_CH 1_ANT 0+1 | Test Voltage | AC 120V/60Hz |

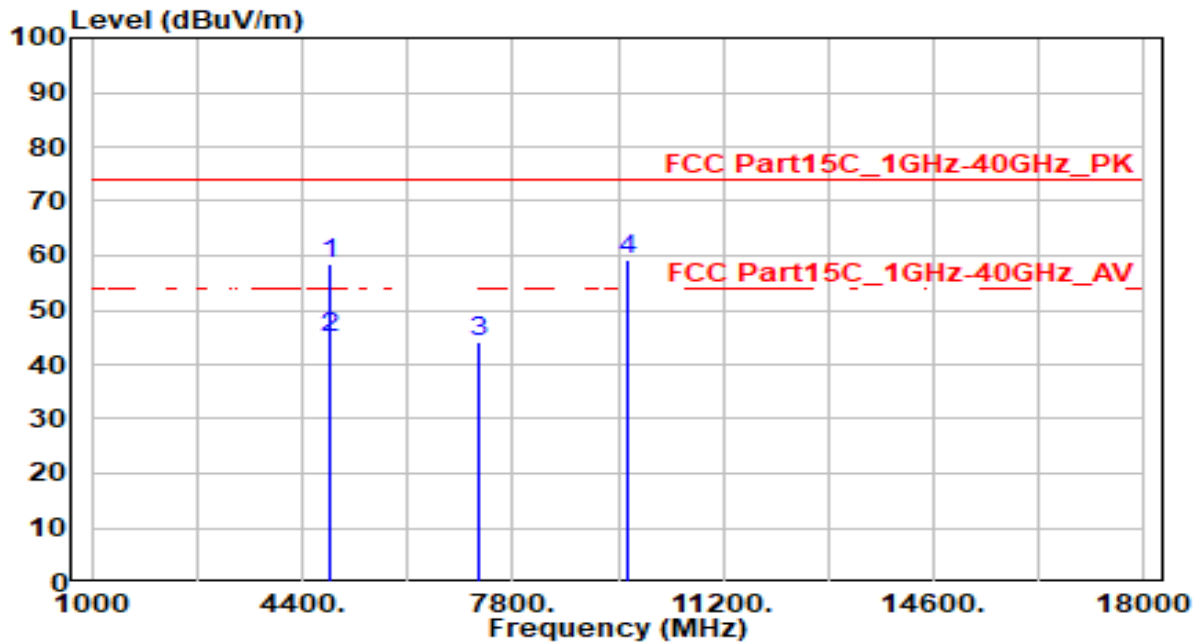

| No | Frequency (MHz) | Reading (dBuV) | C.F (dB/m) | Measurement (dBuV/m) | Margin (dB) | Limit (dBuV/m) | Height (cm) | Angle (deg) | Remark (QP/PK/AV) | |
|----|-----------------|----------------|------------|----------------------|-------------|----------------|-------------|-------------|-------------------|---------|
| 1 | * | 4829.000 | 58.19 | 0.26 | 58.45 | -15.55 | 74.00 | 135 | 135 | Peak |
| 2 | * | 4829.000 | 44.48 | 0.26 | 44.74 | -9.26 | 54.00 | 135 | 135 | Average |
| 3 | | 7236.000 | 38.41 | 5.81 | 44.22 | -29.78 | 74.00 | 100 | 355 | Peak |
| 4 | | 9664.000 | 53.83 | 5.33 | 59.16 | -14.84 | 74.00 | 200 | 125 | Peak |

Note:

- "*" means this data is the worst emission level.
- C.F (Correction Factor) = Antenna Factor (dB)+ Cable Loss (dB) – Pre-amplifier(dB).
- Measurement (dBuV/m) = Reading(dBuV) + C.F (Correction Factor).
- The emission levels of other frequencies are very lower than the limit and not show in test report.

| | | | |
|-----------|-------------------------------------------------------|----------------------|--------------|
| EUT | AX3000+G1500 Whole Home Powerline Mesh Wi-Fi 6 System | Date of Test | 2022-07-06 |
| Factor | DRH18-E | Temp. / Humidity | 23°C /63% |
| Polarity | Vertical | Site / Test Engineer | AC2 / Owen |
| Test Mode | 802.11ax-20MHz_TX_CH 1_ANT 0+1 | Test Voltage | AC 120V/60Hz |

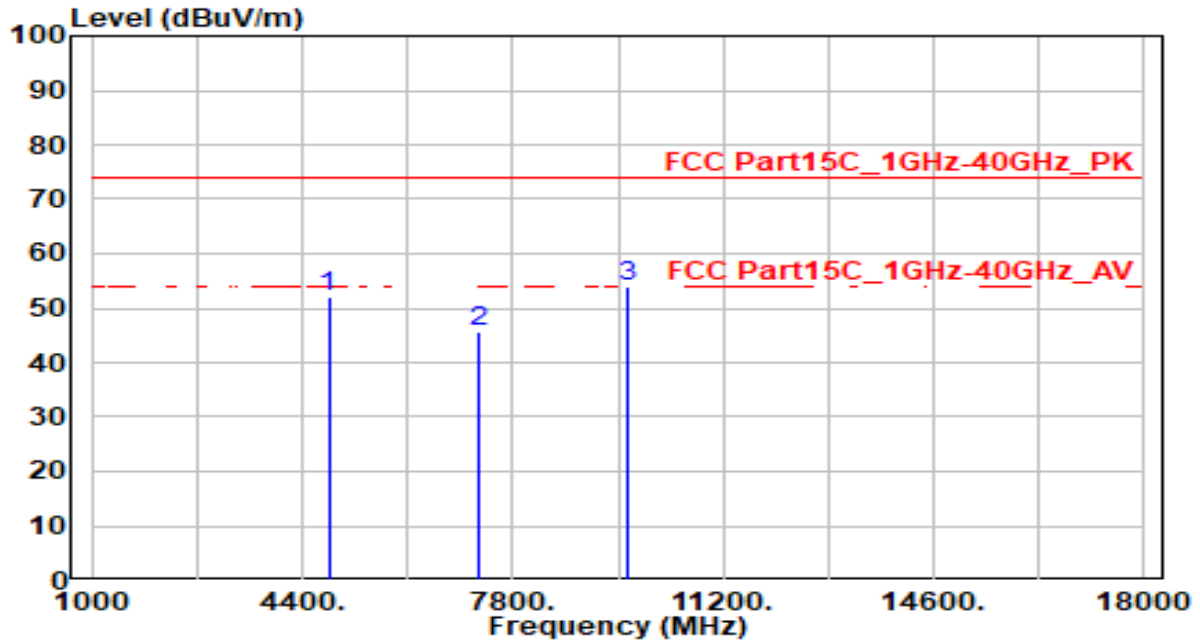

| No | Frequency (MHz) | Reading (dBuV) | C.F (dB/m) | Measurement (dBuV/m) | Margin (dB) | Limit (dBuV/m) | Height (cm) | Angle (deg) | Remark (QP/PK/AV) |
|----|-----------------|----------------|------------|----------------------|-------------|----------------|-------------|-------------|-------------------|
| 1 | 4824.000 | 51.74 | 0.25 | 52.00 | -22.00 | 74.00 | 300 | 30 | Peak |
| 2 | 7236.000 | 39.88 | 5.81 | 45.70 | -28.30 | 74.00 | 300 | 45 | Peak |
| 3 | * 9648.000 | 48.75 | 5.32 | 54.07 | -19.93 | 74.00 | 300 | 30 | Peak |

Note:

1. " *", means this data is the worst emission level.
2. C.F (Correction Factor) = Antenna Factor (dB)+ Cable Loss (dB) – Preamplifier(dB).
3. Measurement (dBuV/m) = Reading(dBuV) + C.F (Correction Factor).
4. The emission levels of other frequencies are very lower than the limit and not show in test report.

| | | | |
|-----------|-------------------------------------------------------|----------------------|--------------|
| EUT | AX3000+G1500 Whole Home Powerline Mesh Wi-Fi 6 System | Date of Test | 2022-07-06 |
| Factor | DRH18-E | Temp. / Humidity | 23°C /63% |
| Polarity | Horizontal | Site / Test Engineer | AC2 / Owen |
| Test Mode | 802.11ax-20MHz_TX_CH 6_ANT 0+1 | Test Voltage | AC 120V/60Hz |

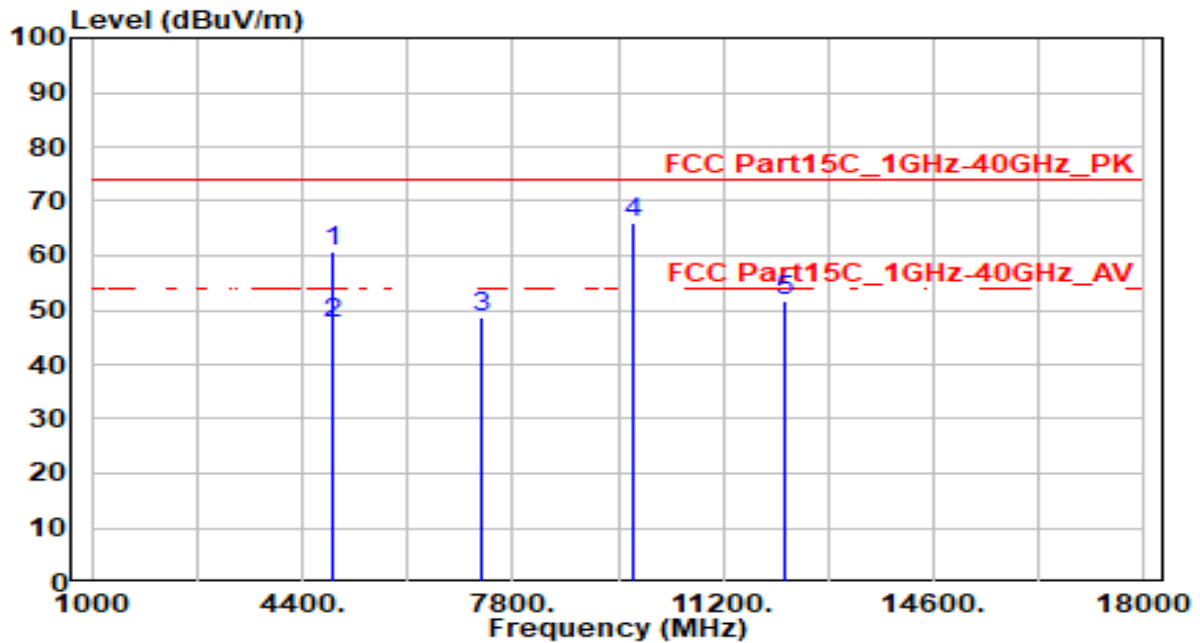

| No | Frequency (MHz) | Reading (dBUV) | C.F (dB/m) | Measurement (dBUV/m) | Margin (dB) | Limit (dBUV/m) | Height (cm) | Angle (deg) | Remark (QP/PK/AV) |
|----|-----------------|----------------|------------|----------------------|-------------|----------------|-------------|-------------|-------------------|
| 1 | * 4874.000 | 60.22 | 0.35 | 60.57 | -13.43 | 74.00 | 100 | 135 | Peak |
| 2 | * 4874.000 | 47.22 | 0.35 | 47.57 | -6.43 | 54.00 | 100 | 135 | Average |
| 3 | 7311.000 | 42.94 | 5.79 | 48.73 | -25.27 | 74.00 | 200 | 250 | Peak |
| 4 | 9748.000 | 60.59 | 5.34 | 65.93 | -8.07 | 74.00 | 200 | 125 | Peak |
| 5 | 12185.000 | 45.56 | 6.08 | 51.64 | -22.36 | 74.00 | 200 | 245 | Peak |

Note:

1. " *", means this data is the worst emission level.
2. C.F (Correction Factor) = Antenna Factor (dB)+ Cable Loss (dB) – Pre-amplifier(dB).
3. Measurement (dBUV/m) = Reading(dBUV) + C.F (Correction Factor).
4. The emission levels of other frequencies are very lower than the limit and not show in test report.

| | | | |
|-----------|-------------------------------------------------------|----------------------|--------------|
| EUT | AX3000+G1500 Whole Home Powerline Mesh Wi-Fi 6 System | Date of Test | 2022-07-06 |
| Factor | DRH18-E | Temp. / Humidity | 23°C /63% |
| Polarity | Vertical | Site / Test Engineer | AC2 / Owen |
| Test Mode | 802.11ax-20MHz_TX_CH 6_ANT 0+1 | Test Voltage | AC 120V/60Hz |

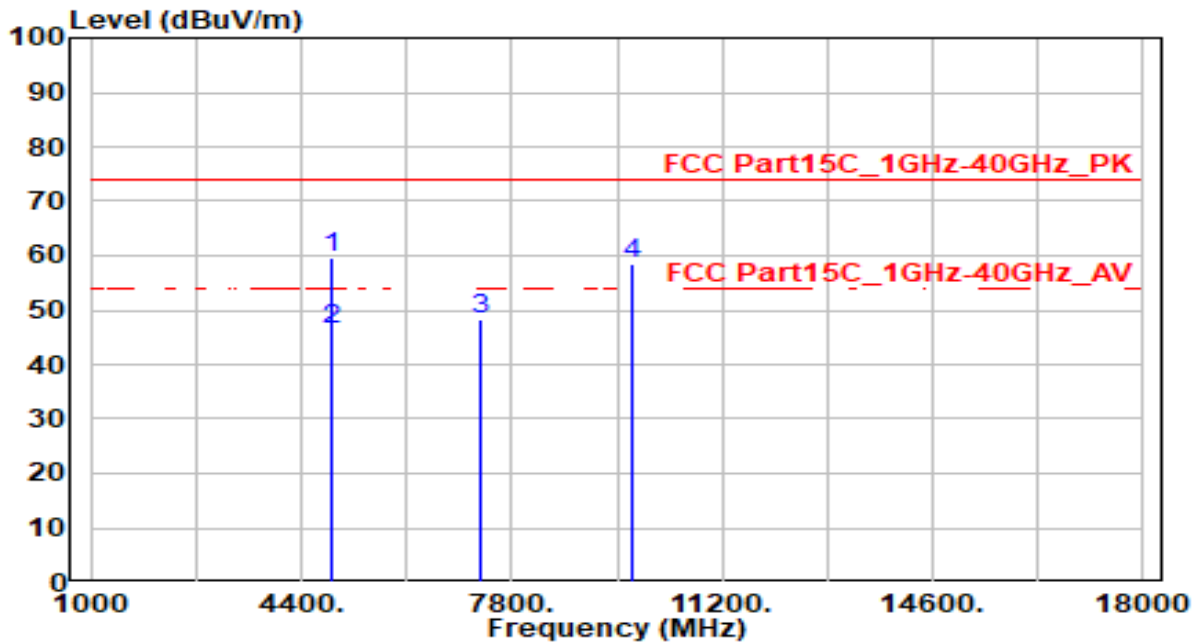

| No | Frequency (MHz) | Reading (dBUV) | C.F (dB/m) | Measurement (dBUV/m) | Margin (dB) | Limit (dBUV/m) | Height (cm) | Angle (deg) | Remark (QP/PK/AV) |
|----|-----------------|----------------|------------|----------------------|-------------|----------------|-------------|-------------|-------------------|
| 1 | * 4874.000 | 59.18 | 0.35 | 59.53 | -14.47 | 74.00 | 300 | 30 | Peak |
| 2 | * 4874.000 | 46.10 | 0.35 | 46.45 | -7.55 | 54.00 | 300 | 30 | Average |
| 3 | 7311.000 | 42.47 | 5.79 | 48.26 | -25.74 | 74.00 | 100 | 250 | Peak |
| 4 | 9748.000 | 53.27 | 5.34 | 58.61 | -15.39 | 74.00 | 100 | 85 | Peak |

Note:

1. " *", means this data is the worst emission level.
2. C.F (Correction Factor) = Antenna Factor (dB)+ Cable Loss (dB) – Preamplifier(dB).
3. Measurement (dBUV/m) = Reading(dBUV) + C.F (Correction Factor).
4. The emission levels of other frequencies are very lower than the limit and not show in test report.

| | | | |
|-----------|-------------------------------------------------------|----------------------|--------------|
| EUT | AX3000+G1500 Whole Home Powerline Mesh Wi-Fi 6 System | Date of Test | 2022-07-06 |
| Factor | DRH18-E | Temp. / Humidity | 23°C /63% |
| Polarity | Horizontal | Site / Test Engineer | AC2 / Owen |
| Test Mode | 802.11ax-20MHz_TX_CH 11_ANT 0+1 | Test Voltage | AC 120V/60Hz |

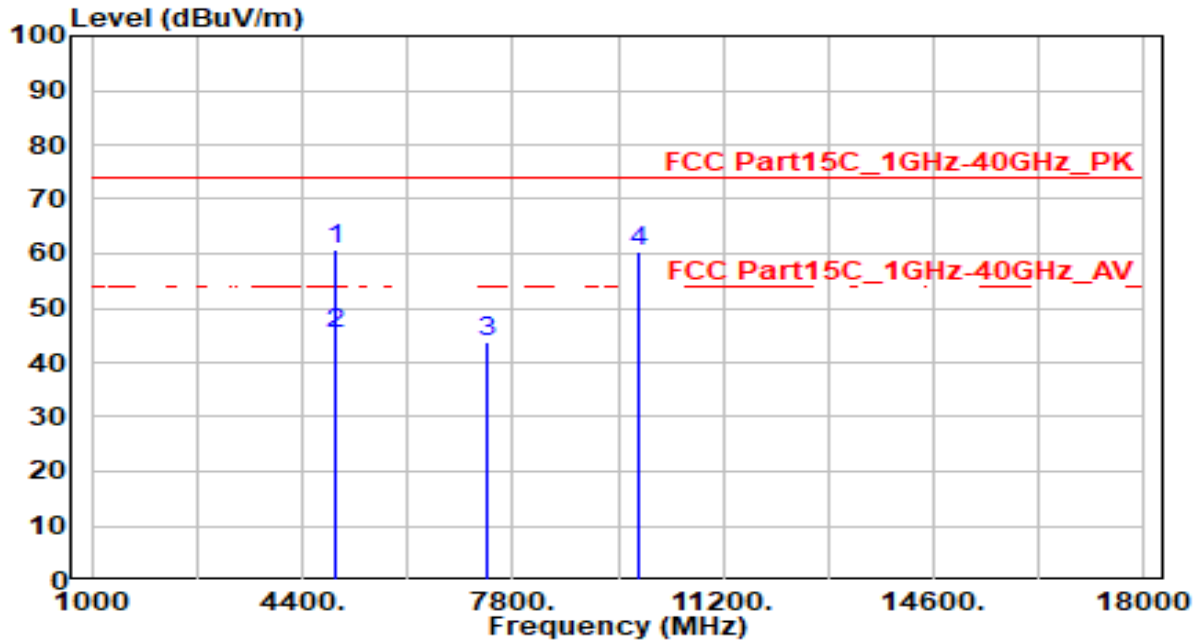

| No | | Frequency (MHz) | Reading (dBuV) | C.F (dB/m) | Measurement (dBuV/m) | Margin (dB) | Limit (dBuV/m) | Height (cm) | Angle (deg) | Remark (QP/PK/AV) |
|----|---|-----------------|----------------|------------|----------------------|-------------|----------------|-------------|-------------|-------------------|
| 1 | * | 4924.000 | 60.14 | 0.45 | 60.59 | -13.41 | 74.00 | 100 | 135 | Peak |
| 2 | * | 4924.000 | 44.66 | 0.45 | 45.11 | -8.89 | 54.00 | 100 | 135 | Average |
| 3 | | 7386.000 | 37.96 | 5.77 | 43.73 | -30.27 | 74.00 | 100 | 215 | Peak |
| 4 | | 9848.000 | 55.05 | 5.38 | 60.43 | -13.57 | 74.00 | 200 | 105 | Peak |

Note:

- "*" means this data is the worst emission level.
- C.F (Correction Factor) = Antenna Factor (dB)+ Cable Loss (dB) – Pre-amplifier(dB).
- Measurement (dBuV/m) = Reading(dBuV) + C.F (Correction Factor).
- The emission levels of other frequencies are very lower than the limit and not show in test report.

| | | | |
|-----------|-------------------------------------------------------|----------------------|--------------|
| EUT | AX3000+G1500 Whole Home Powerline Mesh Wi-Fi 6 System | Date of Test | 2022-07-06 |
| Factor | DRH18-E | Temp. / Humidity | 23°C /63% |
| Polarity | Vertical | Site / Test Engineer | AC2 / Owen |
| Test Mode | 802.11ax-20MHz_TX_CH 11_ANT 0+1 | Test Voltage | AC 120V/60Hz |

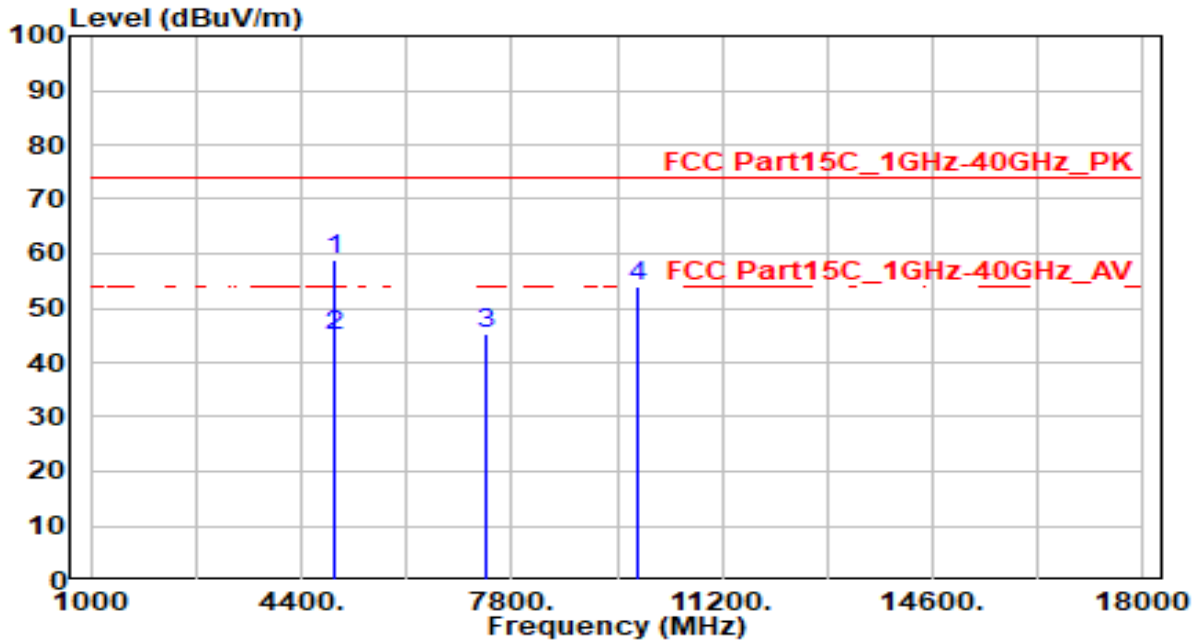

| No | Frequency (MHz) | Reading (dBUV) | C.F (dB/m) | Measurement (dBUV/m) | Margin (dB) | Limit (dBUV/m) | Height (cm) | Angle (deg) | Remark (QP/PK/AV) | |
|----|-----------------|----------------|------------|----------------------|-------------|----------------|-------------|-------------|-------------------|---------|
| 1 | * | 4924.000 | 58.48 | 0.45 | 58.93 | -15.07 | 74.00 | 300 | 220 | Peak |
| 2 | * | 4924.000 | 44.36 | 0.45 | 44.81 | -9.19 | 54.00 | 300 | 220 | Average |
| 3 | | 7386.000 | 39.47 | 5.77 | 45.24 | -28.76 | 74.00 | 200 | 0 | Peak |
| 4 | | 9848.000 | 48.75 | 5.38 | 54.13 | -19.87 | 74.00 | 100 | 105 | Peak |

Note:

1. " *", means this data is the worst emission level.
2. C.F (Correction Factor) = Antenna Factor (dB)+ Cable Loss (dB) – Pre-amplifier(dB).
3. Measurement (dBUV/m) = Reading(dBUV) + C.F (Correction Factor).
4. The emission levels of other frequencies are very lower than the limit and not show in test report.

| | | | |
|-----------|-------------------------------------------------------|----------------------|--------------|
| EUT | AX3000+G1500 Whole Home Powerline Mesh Wi-Fi 6 System | Date of Test | 2022-07-06 |
| Factor | DRH18-E | Temp. / Humidity | 23°C /63% |
| Polarity | Horizontal | Site / Test Engineer | AC2 / Owen |
| Test Mode | 802.11ax-40MHz_TX_CH 3_ANT 0+1 | Test Voltage | AC 120V/60Hz |

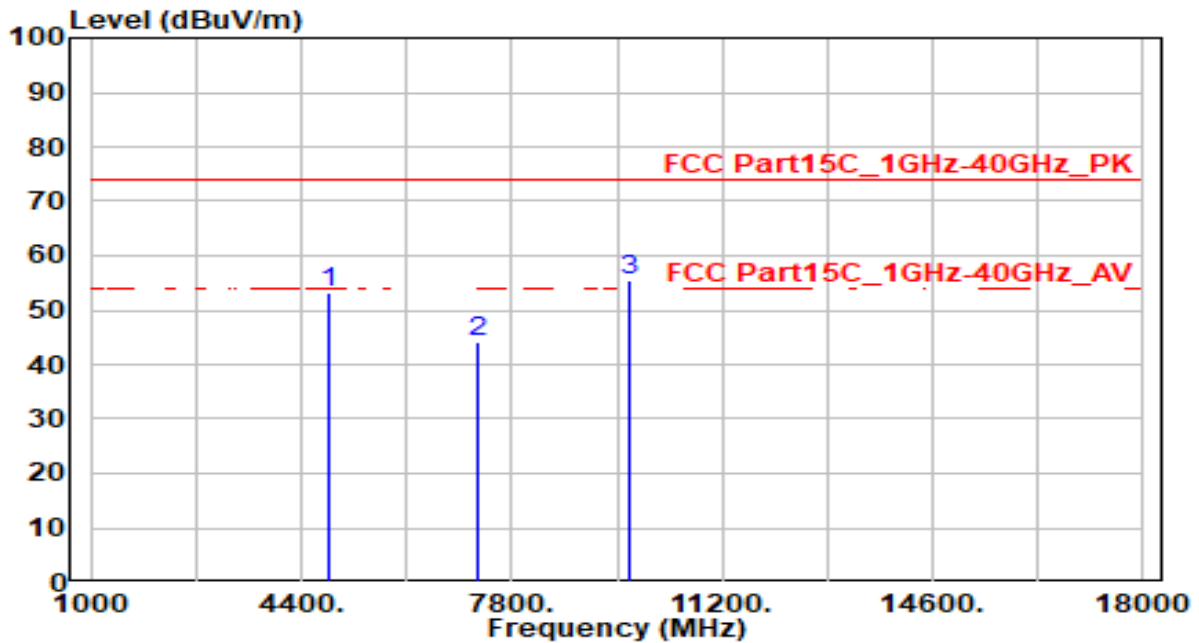

| No | Frequency (MHz) | Reading (dBuV) | C.F (dB/m) | Measurement (dBuV/m) | Margin (dB) | Limit (dBuV/m) | Height (cm) | Angle (deg) | Remark (QP/PK/AV) |
|----|-----------------|----------------|------------|----------------------|-------------|----------------|-------------|-------------|-------------------|
| 1 | 4844.000 | 52.81 | 0.29 | 53.11 | -20.89 | 74.00 | 100 | 140 | Peak |
| 2 | 7266.000 | 38.20 | 5.81 | 44.01 | -29.99 | 74.00 | 140 | 360 | Peak |
| 3 | * 9688.000 | 50.22 | 5.33 | 55.55 | -18.45 | 74.00 | 200 | 100 | Peak |

Note:

1. " *", means this data is the worst emission level.
2. C.F (Correction Factor) = Antenna Factor (dB)+ Cable Loss (dB) – Pre-amplifier(dB).
3. Measurement (dBuV/m) = Reading(dBuV) + C.F (Correction Factor).
4. The emission levels of other frequencies are very lower than the limit and not show in test report.

| | | | |
|-----------|-------------------------------------------------------|----------------------|--------------|
| EUT | AX3000+G1500 Whole Home Powerline Mesh Wi-Fi 6 System | Date of Test | 2022-07-06 |
| Factor | DRH18-E | Temp. / Humidity | 23°C /63% |
| Polarity | Vertical | Site / Test Engineer | AC2 / Owen |
| Test Mode | 802.11ax-40MHz_TX_CH 3_ANT 0+1 | Test Voltage | AC 120V/60Hz |

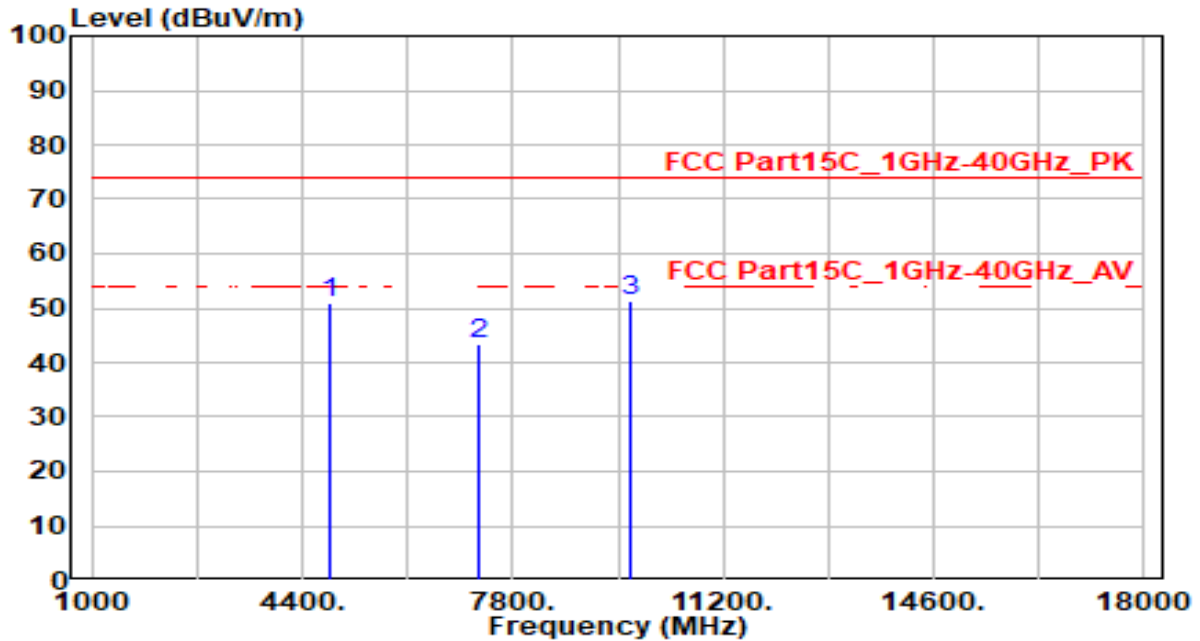

| No | Frequency (MHz) | Reading (dBuV) | C.F (dB/m) | Measurement (dBuV/m) | Margin (dB) | Limit (dBuV/m) | Height (cm) | Angle (deg) | Remark (QP/PK/AV) |
|----|-----------------|----------------|------------|----------------------|-------------|----------------|-------------|-------------|-------------------|
| 1 | 4844.000 | 50.55 | 0.29 | 50.84 | -23.16 | 74.00 | 300 | 30 | Peak |
| 2 | 7266.000 | 37.53 | 5.81 | 43.34 | -30.66 | 74.00 | 300 | 0 | Peak |
| 3 | * 9688.000 | 45.90 | 5.33 | 51.23 | -22.77 | 74.00 | 300 | 20 | Peak |

Note:

1. " *", means this data is the worst emission level.
2. C.F (Correction Factor) = Antenna Factor (dB)+ Cable Loss (dB) – Pre-amplifier(dB).
3. Measurement (dBuV/m) = Reading(dBuV) + C.F (Correction Factor).
4. The emission levels of other frequencies are very lower than the limit and not show in test report.

| | | | |
|-----------|-------------------------------------------------------|----------------------|--------------|
| EUT | AX3000+G1500 Whole Home Powerline Mesh Wi-Fi 6 System | Date of Test | 2022-07-06 |
| Factor | DRH18-E | Temp. / Humidity | 23°C /63% |
| Polarity | Horizontal | Site / Test Engineer | AC2 / Owen |
| Test Mode | 802.11ax-40MHz_TX_CH 6_ANT 0+1 | Test Voltage | AC 120V/60Hz |

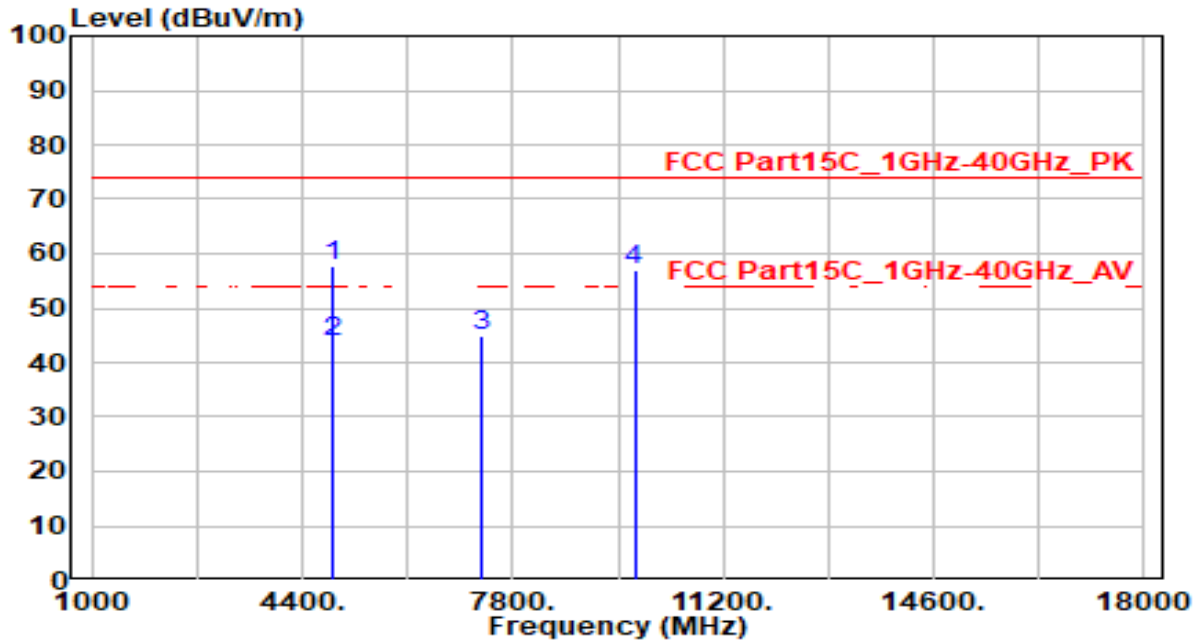

| No | | Frequency (MHz) | Reading (dBuV) | C.F (dB/m) | Measurement (dBuV/m) | Margin (dB) | Limit (dBuV/m) | Height (cm) | Angle (deg) | Remark (QP/PK/AV) |
|----|---|-----------------|----------------|------------|----------------------|-------------|----------------|-------------|-------------|-------------------|
| 1 | * | 4874.000 | 57.56 | 0.35 | 57.91 | -16.09 | 74.00 | 100 | 150 | Peak |
| 2 | * | 4874.000 | 43.58 | 0.35 | 43.93 | -10.07 | 54.00 | 100 | 150 | Average |
| 3 | | 7311.000 | 39.23 | 5.79 | 45.03 | -28.97 | 74.00 | 200 | 360 | Peak |
| 4 | | 9768.000 | 51.54 | 5.34 | 56.88 | -17.12 | 74.00 | 200 | 125 | Peak |

Note:

1. " *", means this data is the worst emission level.
2. C.F (Correction Factor) = Antenna Factor (dB)+ Cable Loss (dB) – Pre-amplifier(dB).
3. Measurement (dBuV/m) = Reading(dBuV) + C.F (Correction Factor).
4. The emission levels of other frequencies are very lower than the limit and not show in test report.

| | | | |
|-----------|-------------------------------------------------------|----------------------|--------------|
| EUT | AX3000+G1500 Whole Home Powerline Mesh Wi-Fi 6 System | Date of Test | 2022-07-06 |
| Factor | DRH18-E | Temp. / Humidity | 23°C /63% |
| Polarity | Vertical | Site / Test Engineer | AC2 / Owen |
| Test Mode | 802.11ax-40MHz_TX_CH 6_ANT 0+1 | Test Voltage | AC 120V/60Hz |

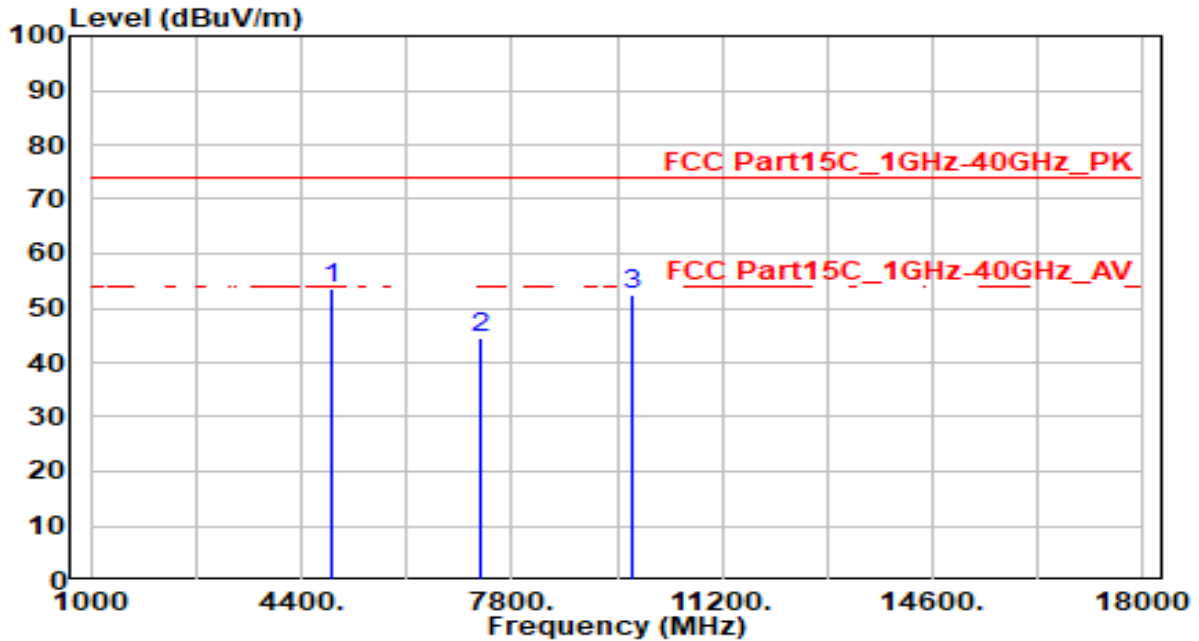

| No | Frequency (MHz) | Reading (dBuV) | C.F (dB/m) | Measurement (dBuV/m) | Margin (dB) | Limit (dBuV/m) | Height (cm) | Angle (deg) | Remark (QP/PK/AV) |
|----|-----------------|----------------|------------|----------------------|-------------|----------------|-------------|-------------|-------------------|
| 1 | * 4874.000 | 53.12 | 0.35 | 53.48 | -20.52 | 74.00 | 300 | 205 | Peak |
| 2 | 7311.000 | 38.55 | 5.79 | 44.34 | -29.66 | 74.00 | 200 | 360 | Peak |
| 3 | 9748.000 | 46.94 | 5.34 | 52.28 | -21.72 | 74.00 | 300 | 20 | Peak |

Note:

1. " *", means this data is the worst emission level.
2. C.F (Correction Factor) = Antenna Factor (dB)+ Cable Loss (dB) – Pre-amplifier(dB).
3. Measurement (dBuV/m) = Reading(dBuV) + C.F (Correction Factor).
4. The emission levels of other frequencies are very lower than the limit and not show in test report.

| | | | |
|-----------|-------------------------------------------------------|----------------------|--------------|
| EUT | AX3000+G1500 Whole Home Powerline Mesh Wi-Fi 6 System | Date of Test | 2022-07-06 |
| Factor | DRH18-E | Temp. / Humidity | 23°C /63% |
| Polarity | Horizontal | Site / Test Engineer | AC2 / Owen |
| Test Mode | 802.11ax-40MHz_TX_CH 9_ANT 0+1 | Test Voltage | AC 120V/60Hz |

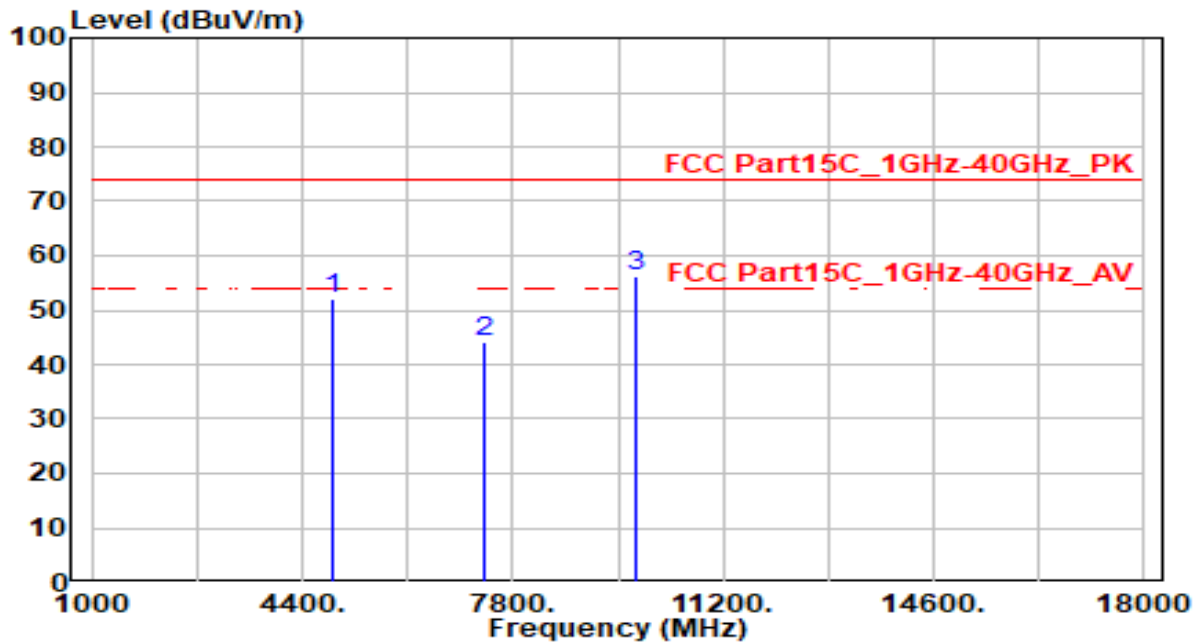

| No | Frequency (MHz) | Reading (dBuV) | C.F (dB/m) | Measurement (dBuV/m) | Margin (dB) | Limit (dBuV/m) | Height (cm) | Angle (deg) | Remark (QP/PK/AV) |
|----|-----------------|----------------|------------|----------------------|-------------|----------------|-------------|-------------|-------------------|
| 1 | 4904.000 | 51.79 | 0.41 | 52.21 | -21.79 | 74.00 | 100 | 160 | Peak |
| 2 | 7356.000 | 38.24 | 5.78 | 44.02 | -29.98 | 74.00 | 200 | 265 | Peak |
| 3 | * 9808.000 | 50.74 | 5.35 | 56.10 | -17.90 | 74.00 | 200 | 95 | Peak |

Note:

1. " *", means this data is the worst emission level.
2. C.F (Correction Factor) = Antenna Factor (dB)+ Cable Loss (dB) – Pre-amplifier(dB).
3. Measurement (dBuV/m) = Reading(dBuV) + C.F (Correction Factor).
4. The emission levels of other frequencies are very lower than the limit and not show in test report.

| | | | |
|-----------|-------------------------------------------------------|----------------------|--------------|
| EUT | AX3000+G1500 Whole Home Powerline Mesh Wi-Fi 6 System | Date of Test | 2022-07-06 |
| Factor | DRH18-E | Temp. / Humidity | 23°C /63% |
| Polarity | Vertical | Site / Test Engineer | AC2 / Owen |
| Test Mode | 802.11ax-40MHz_TX_CH 9_ANT 0+1 | Test Voltage | AC 120V/60Hz |

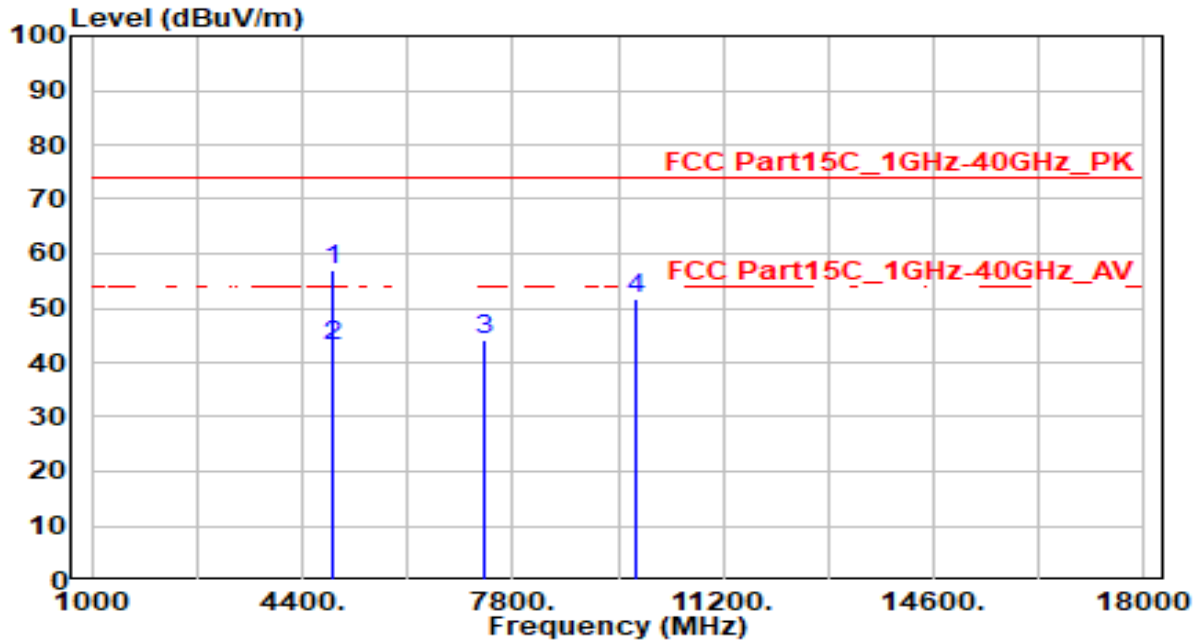

| No | | Frequency (MHz) | Reading (dBUV) | C.F (dB/m) | Measurement (dBUV/m) | Margin (dB) | Limit (dBUV/m) | Height (cm) | Angle (deg) | Remark (QP/PK/AV) |
|----|---|-----------------|----------------|------------|----------------------|-------------|----------------|-------------|-------------|-------------------|
| 1 | * | 4904.000 | 56.47 | 0.41 | 56.88 | -17.12 | 74.00 | 305 | 30 | Peak |
| 2 | * | 4904.000 | 42.47 | 0.41 | 42.88 | -11.12 | 54.00 | 305 | 30 | Average |
| 3 | | 7356.000 | 38.44 | 5.78 | 44.22 | -29.78 | 74.00 | 195 | 360 | Peak |
| 4 | | 9808.000 | 46.51 | 5.35 | 51.87 | -22.13 | 74.00 | 100 | 90 | Peak |

Note:

1. " *", means this data is the worst emission level.
2. C.F (Correction Factor) = Antenna Factor (dB)+ Cable Loss (dB) – Pre-amplifier(dB).
3. Measurement (dBUV/m) = Reading(dBUV) + C.F (Correction Factor).
4. The emission levels of other frequencies are very lower than the limit and not show in test report.

7.7. Radiated Restricted Band Edge Measurement

7.7.1. Test Limit

For 15.205 requirement:

Radiated emissions which fall in the restricted bands, as defined in Section 15.205(a) of FCC part 15, must also comply with the radiated emission limits specified in Section 15.209(a).

| Frequency (MHz) | Frequency (MHz) | Frequency (MHz) | Frequency (GHz) |
|----------------------------|-----------------------|--------------------|--------------------|
| 0.090 - 0.110 | 16.42 - 16.423 | 399.9 - 410 | 4.5 - 5.15 |
| ¹ 0.495 - 0.505 | 16.69475 - 16.69525 | 608 - 614 | 5.35 - 5.46 |
| 2.1735 - 2.1905 | 16.80425 - 16.80475 | 960 - 1240 | 7.25 - 7.75 |
| 4.125 - 4.128 | 25.5 - 25.67 | 1300 - 1427 | 8.025 - 8.5 |
| 4.17725 - 4.17775 | 37.5 - 38.25 | 1435 - 1626.5 | 9.0 - 9.2 |
| 4.20725 - 4.20775 | 73 - 74.6 | 1645.5 - 1646.5 | 9.3 - 9.5 |
| 6.215 - 6.218 | 74.8 - 75.2 | 1660 - 1710 | 10.6 - 12.7 |
| 6.26775 - 6.26825 | 108 - 121.94 | 1718.8 - 1722.2 | 13.25 - 13.4 |
| 6.31175 - 6.31225 | 123 - 138 | 2200 - 2300 | 14.47 - 14.5 |
| 8.291 - 8.294 | 149.9 - 150.05 | 2310 - 2390 | 15.35 - 16.2 |
| 8.362 - 8.366 | 156.52475 - 156.52525 | 2483.5 - 2500 | 17.7 - 21.4 |
| 8.37625 - 8.38675 | 156.7 - 156.9 | 2690 - 2900 | 22.01 - 23.12 |
| 8.41425 - 8.41475 | 162.0125 - 167.17 | 3260 - 3267 | 23.6 - 24.0 |
| 12.29 - 12.293 | 167.72 - 173.2 | 3332 - 3339 | 31.2 - 31.8 |
| 12.51975 - 12.52025 | 240 - 285 | 3345.8 - 3358 | 36.43 - 36.5 |
| 12.57675 - 12.57725 | 322 - 335.4 | 3600 - 4400 | (²) |
| 13.36 - 13.41 | -- | -- | -- |

All out of band emissions appearing in a restricted band as specified in Section 15.205 of the Title 47CFR must not exceed the limits shown in Table per Section 15.209.

| FCC Part 15 Subpart C Paragraph 15.209 Limits | | |
|-----------------------------------------------|--------------------------|-------------------------------|
| Frequency [MHz] | Field Strength [uV/m] | Measured Distance [Meters] |
| 0.009 - 0.490 | 2400/F (kHz) | 300 |
| 0.490 - 1.705 | 24000/F (kHz) | 30 |
| 1.705 - 30 | 30 | 30 |
| 30 - 88 | 100 | 3 |
| 88 - 216 | 150 | 3 |
| 216 - 960 | 200 | 3 |
| Above 960 | 500 | 3 |

7.7.2. Test Procedure Used

ANSI C63.10 – 2013 Section 6.3 (General Requirements)

ANSI C63.10 – 2013 Section 6.6 (Standard test method above 1GHz)

7.7.3. Test Setting

Peak Field Strength Measurements

1. Analyzer center frequency was set to the frequency of the radiated spurious emission of interest
2. RBW = 1MHz
3. VBW = 3MHz
4. Detector = peak
5. Sweep time = auto couple
6. Trace mode = max hold
7. Trace was allowed to stabilize

Average Measurements above 1GHz (Method VB)

1. Analyzer center frequency was set to the frequency of the radiated spurious emission of interest
2. RBW = 1MHz
3. VBW; If the EUT is configured to transmit with duty cycle $\geq 98\%$, set VBW = 10 Hz.
If the EUT duty cycle is $< 98\%$, set VBW $\geq 1/T$. T is the minimum transmission duration.

4. Detector = Peak
5. Sweep time = auto
6. Trace mode = max hold
7. Trace was allowed to stabilize

7.7.4. Test Setup

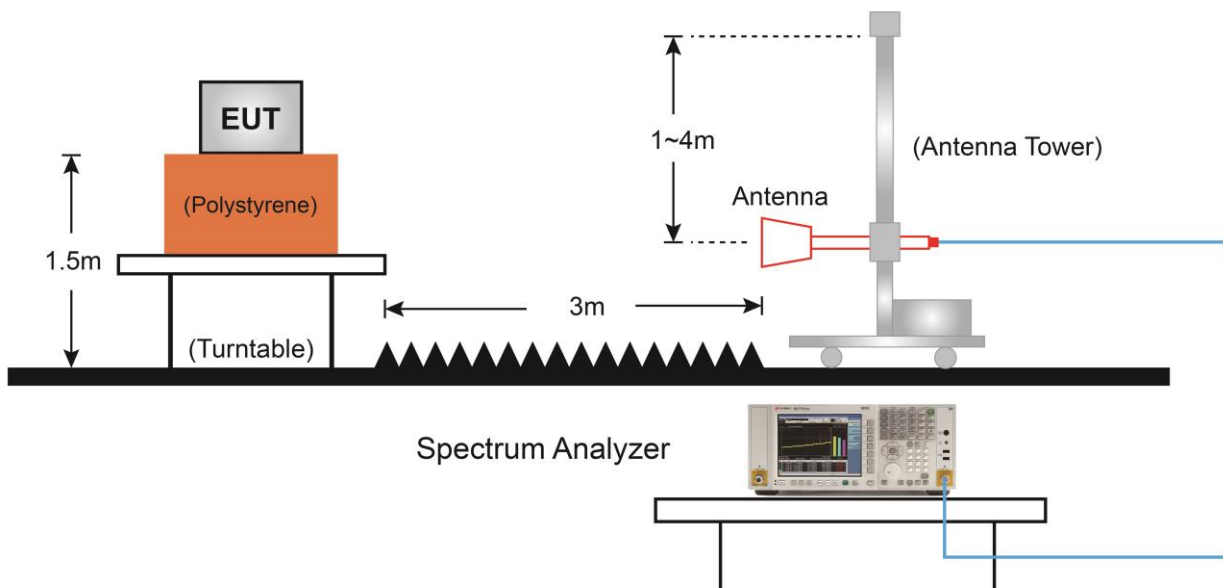

7.7.5. Test Result

| | | | |
|-----------|-------------------------------------------------------|----------------------|--------------|
| EUT | AX3000+G1500 Whole Home Powerline Mesh Wi-Fi 6 System | Date of Test | 2022-07-06 |
| Factor | DRH18-E | Temp. / Humidity | 23°C /63% |
| Polarity | Horizontal | Site / Test Engineer | AC2 / Ares |
| Test Mode | 802.11b_TX_CH 1_ANT 0+1 | Test Voltage | AC 120V/60Hz |

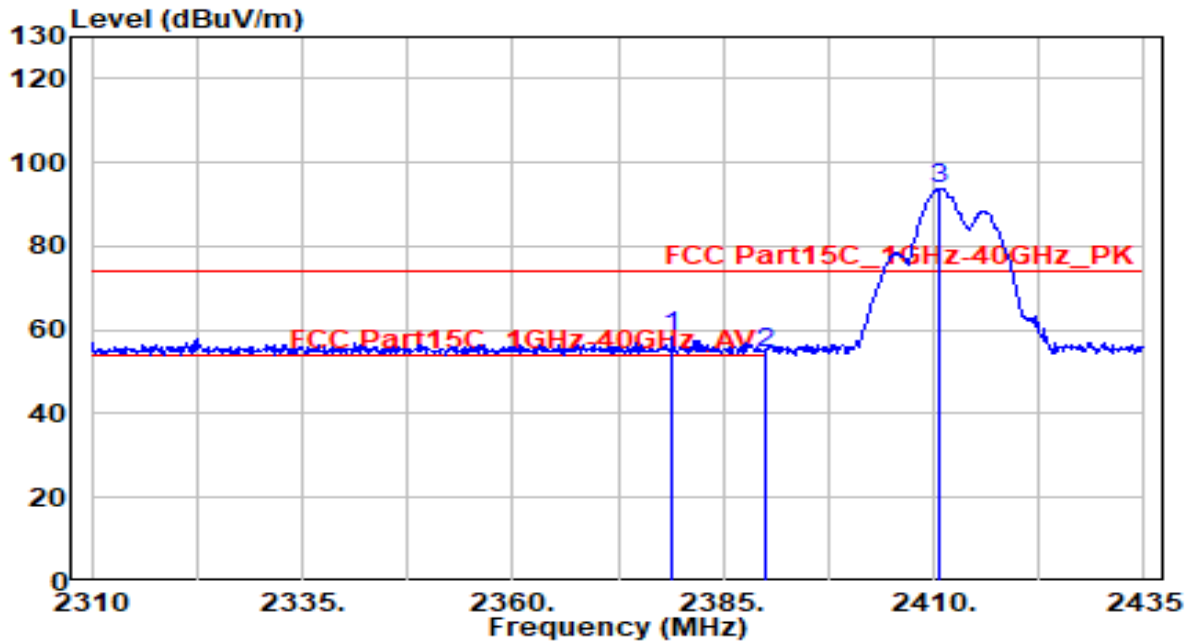

| No | Frequency (MHz) | Reading (dBUV) | C.F (dB/m) | Measurement (dBUV/m) | Margin (dB) | Limit (dBUV/m) | Height (cm) | Angle (deg) | Remark (QP/PK/AV) |
|----|-----------------|----------------|------------|----------------------|-------------|----------------|-------------|-------------|-------------------|
| 1 | * 2378.875 | 27.71 | 30.60 | 58.30 | -15.70 | 74.00 | 100 | 255 | Peak |
| 2 | 2390.000 | 23.95 | 30.61 | 54.56 | -19.44 | 74.00 | 100 | 255 | Peak |
| 3 | 2410.750 | 63.20 | 30.66 | 93.87 | N/A | N/A | 100 | 255 | Peak |

Note:

1. " *", means this data is the worst emission level.
2. C.F (Correction Factor) = Antenna Factor (dB)+ Cable Loss (dB).
3. Measurement (dBUV/m) = Reading(dBUV) + C.F (Correction Factor).
4. The emission levels of other frequencies are very lower than the limit and not show in test report.

| | | | |
|-----------|-------------------------------------------------------|----------------------|--------------|
| EUT | AX3000+G1500 Whole Home Powerline Mesh Wi-Fi 6 System | Date of Test | 2022-07-06 |
| Factor | DRH18-E | Temp. / Humidity | 23°C /63% |
| Polarity | Horizontal | Site / Test Engineer | AC2 / Ares |
| Test Mode | 802.11b_TX_CH 1_ANT 0+1 | Test Voltage | AC 120V/60Hz |

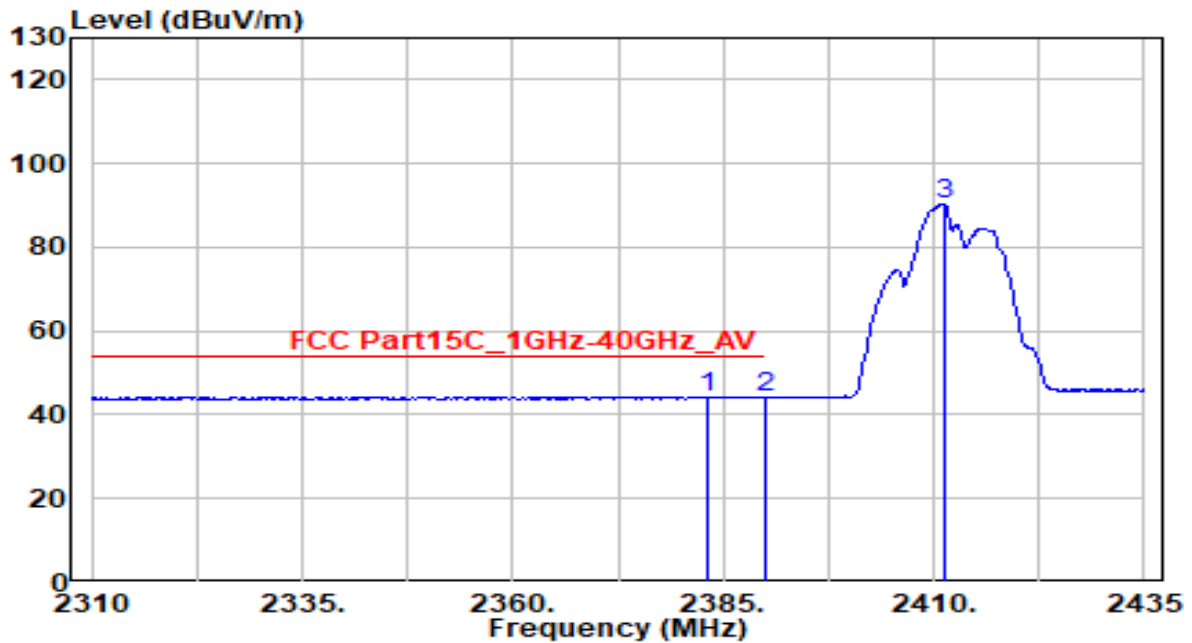

| No | Frequency (MHz) | Reading (dBuV) | C.F (dB/m) | Measurement (dBuV/m) | Margin (dB) | Limit (dBuV/m) | Height (cm) | Angle (deg) | Remark (QP/PK/AV) |
|----|-----------------|----------------|------------|----------------------|-------------|----------------|-------------|-------------|-------------------|
| 1 | * 2383.250 | 13.79 | 30.60 | 44.39 | -9.61 | 54.00 | 100 | 255 | Average |
| 2 | 2390.000 | 13.45 | 30.61 | 44.06 | -9.94 | 54.00 | 100 | 255 | Average |
| 3 | 2411.250 | 59.74 | 30.67 | 90.41 | N/A | N/A | 100 | 255 | Average |

Note:

1. " *", means this data is the worst emission level.
2. C.F (Correction Factor) = Antenna Factor (dB)+ Cable Loss (dB).
3. Measurement (dBuV/m) = Reading(dBuV) + C.F (Correction Factor).
4. The emission levels of other frequencies are very lower than the limit and not show in test report.

| | | | |
|-----------|-------------------------------------------------------|----------------------|--------------|
| EUT | AX3000+G1500 Whole Home Powerline Mesh Wi-Fi 6 System | Date of Test | 2022-07-06 |
| Factor | DRH18-E | Temp. / Humidity | 23°C /63% |
| Polarity | Vertical | Site / Test Engineer | AC2 / Ares |
| Test Mode | 802.11b_TX_CH 1_ANT 0+1 | Test Voltage | AC 120V/60Hz |

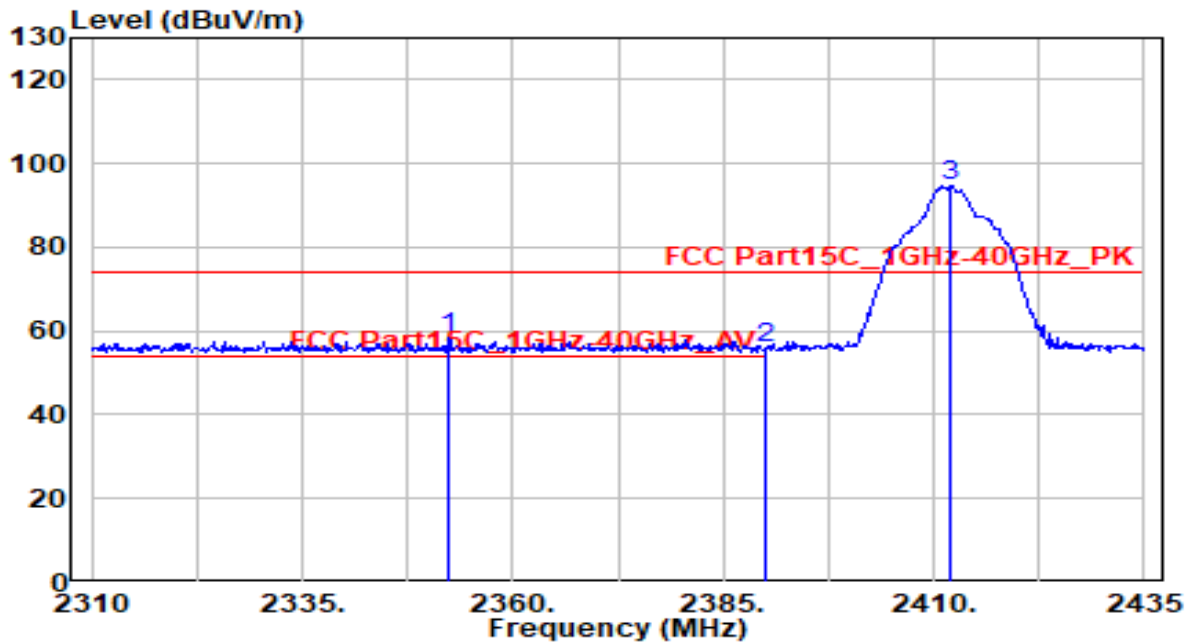

| No | Frequency (MHz) | Reading (dBUV) | C.F (dB/m) | Measurement (dBUV/m) | Margin (dB) | Limit (dBUV/m) | Height (cm) | Angle (deg) | Remark (QP/PK/AV) |
|----|-----------------|----------------|------------|----------------------|-------------|----------------|-------------|-------------|-------------------|
| 1 | * 2352.500 | 27.62 | 30.56 | 58.18 | -15.82 | 74.00 | 110 | 55 | Peak |
| 2 | 2390.000 | 25.23 | 30.61 | 55.85 | -18.15 | 74.00 | 110 | 55 | Peak |
| 3 | 2412.000 | 63.89 | 30.67 | 94.56 | N/A | N/A | 110 | 55 | Peak |

Note:

1. " *", means this data is the worst emission level.
2. C.F (Correction Factor) = Antenna Factor (dB)+ Cable Loss (dB).
3. Measurement (dBUV/m) = Reading(dBUV) + C.F (Correction Factor).
4. The emission levels of other frequencies are very lower than the limit and not show in test report.

| | | | |
|-----------|-------------------------------------------------------|----------------------|--------------|
| EUT | AX3000+G1500 Whole Home Powerline Mesh Wi-Fi 6 System | Date of Test | 2022-07-06 |
| Factor | DRH18-E | Temp. / Humidity | 23°C /63% |
| Polarity | Vertical | Site / Test Engineer | AC2 / Ares |
| Test Mode | 802.11b_TX_CH 1_ANT 0+1 | Test Voltage | AC 120V/60Hz |

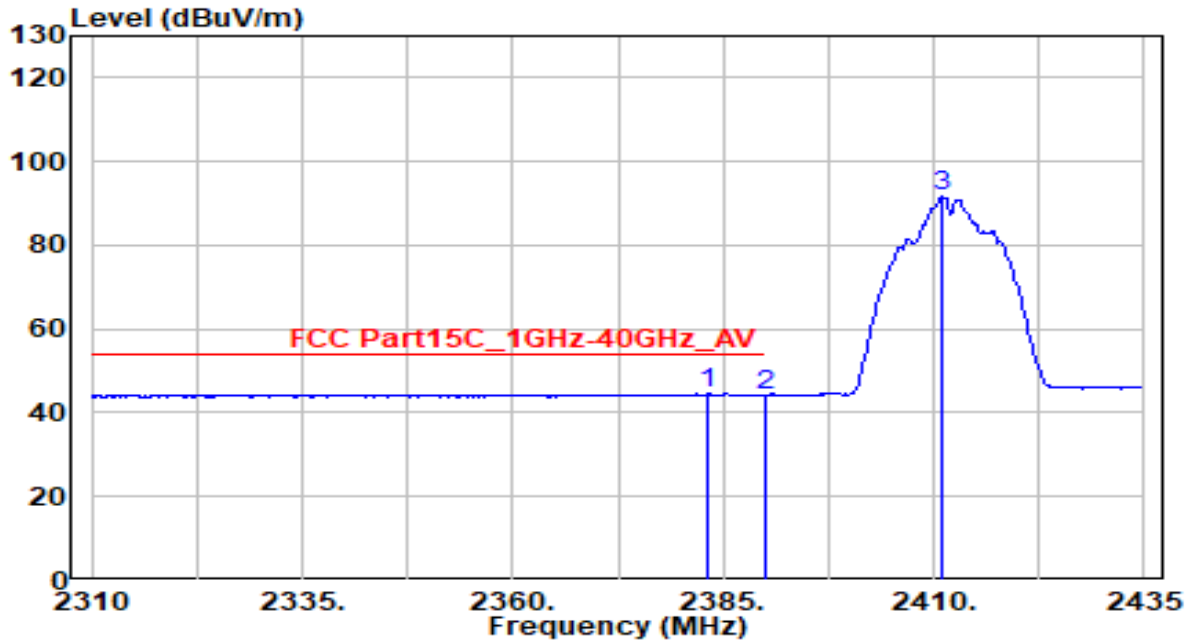

| No | Frequency (MHz) | Reading (dBuV) | C.F (dB/m) | Measurement (dBuV/m) | Margin (dB) | Limit (dBuV/m) | Height (cm) | Angle (deg) | Remark (QP/PK/AV) |
|----|-----------------|----------------|------------|----------------------|-------------|----------------|-------------|-------------|-------------------|
| 1 | * 2383.125 | 13.93 | 30.60 | 44.54 | -9.46 | 54.00 | 110 | 55 | Average |
| 2 | 2390.000 | 13.70 | 30.61 | 44.32 | -9.68 | 54.00 | 110 | 55 | Average |
| 3 | 2411.000 | 60.97 | 30.67 | 91.64 | N/A | N/A | 110 | 55 | Average |

Note:

1. " *", means this data is the worst emission level.
2. C.F (Correction Factor) = Antenna Factor (dB)+ Cable Loss (dB).
3. Measurement (dBuV/m) = Reading(dBuV) + C.F (Correction Factor).
4. The emission levels of other frequencies are very lower than the limit and not show in test report.

| | | | |
|-----------|-------------------------------------------------------|----------------------|--------------|
| EUT | AX3000+G1500 Whole Home Powerline Mesh Wi-Fi 6 System | Date of Test | 2022-07-06 |
| Factor | DRH18-E | Temp. / Humidity | 23°C /63% |
| Polarity | Horizontal | Site / Test Engineer | AC2 / Ares |
| Test Mode | 802.11b_TX_CH 6_ANT 0+1 | Test Voltage | AC 120V/60Hz |

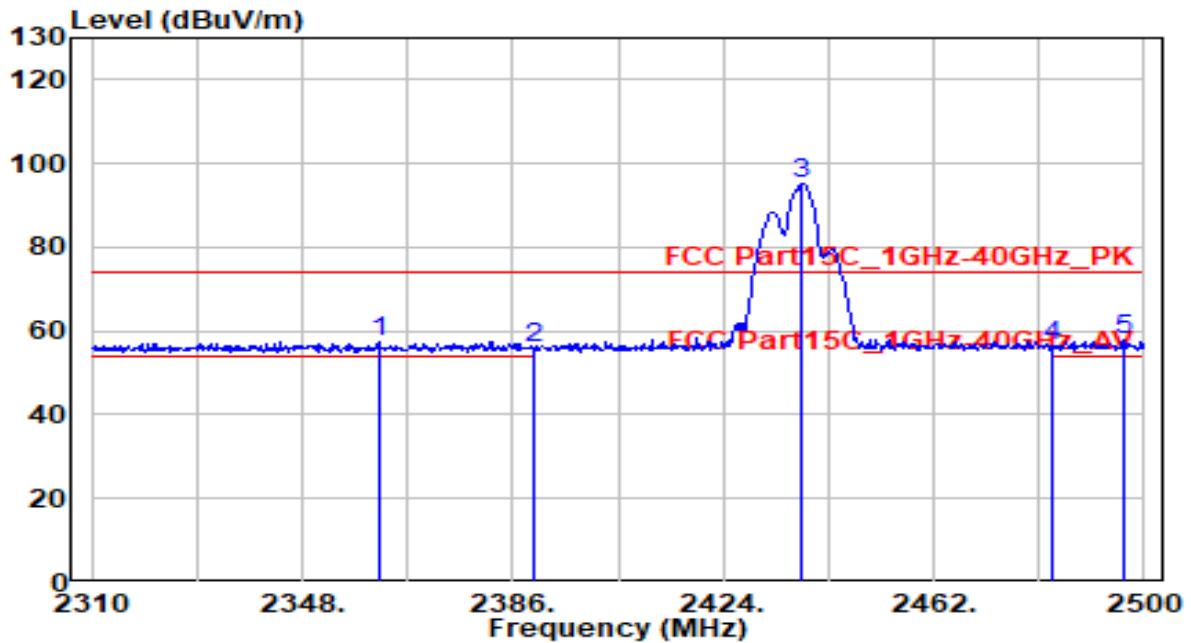

| No | Frequency (MHz) | Reading (dBUV) | C.F (dB/m) | Measurement (dBUV/m) | Margin (dB) | Limit (dBUV/m) | Height (cm) | Angle (deg) | Remark (QP/PK/AV) |
|----|-----------------|----------------|------------|----------------------|-------------|----------------|-------------|-------------|-------------------|
| 1 | 2361.870 | 26.80 | 30.57 | 57.38 | -16.62 | 74.00 | 105 | 210 | Peak |
| 2 | 2390.000 | 25.38 | 30.61 | 55.99 | -18.01 | 74.00 | 105 | 210 | Peak |
| 3 | 2438.250 | 64.63 | 30.76 | 95.39 | N/A | N/A | 105 | 210 | Peak |
| 4 | 2483.500 | 25.60 | 30.91 | 56.52 | -17.48 | 74.00 | 105 | 210 | Peak |
| 5 | * 2496.390 | 26.74 | 30.96 | 57.70 | -16.30 | 74.00 | 105 | 210 | Peak |

Note:

1. " *", means this data is the worst emission level.
2. C.F (Correction Factor) = Antenna Factor (dB)+ Cable Loss (dB).
3. Measurement (dBUV/m) = Reading(dBUV) + C.F (Correction Factor).
4. The emission levels of other frequencies are very lower than the limit and not show in test report.

| | | | |
|-----------|-------------------------------------------------------|----------------------|--------------|
| EUT | AX3000+G1500 Whole Home Powerline Mesh Wi-Fi 6 System | Date of Test | 2022-07-06 |
| Factor | DRH18-E | Temp. / Humidity | 23°C /63% |
| Polarity | Horizontal | Site / Test Engineer | AC2 / Ares |
| Test Mode | 802.11b_TX_CH 6_ANT 0+1 | Test Voltage | AC 120V/60Hz |

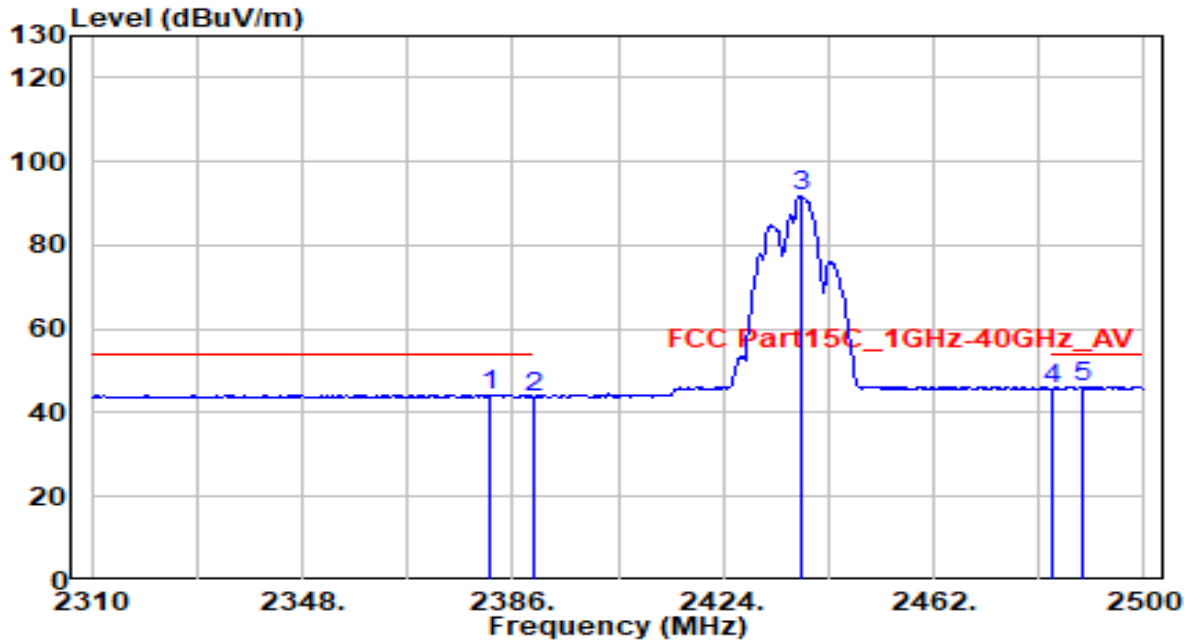

| No | Frequency (MHz) | Reading (dBUV) | C.F (dB/m) | Measurement (dBUV/m) | Margin (dB) | Limit (dBUV/m) | Height (cm) | Angle (deg) | Remark (QP/PK/AV) |
|----|-----------------|----------------|------------|----------------------|-------------|----------------|-------------|-------------|-------------------|
| 1 | 2381.820 | 13.60 | 30.60 | 44.20 | -9.80 | 54.00 | 105 | 210 | Average |
| 2 | 2390.000 | 13.24 | 30.61 | 43.85 | -10.15 | 54.00 | 105 | 210 | Average |
| 3 | 2438.250 | 60.90 | 30.76 | 91.66 | N/A | N/A | 105 | 210 | Average |
| 4 | 2483.500 | 14.83 | 30.91 | 45.75 | -8.25 | 54.00 | 105 | 210 | Average |
| 5 | * 2488.790 | 15.42 | 30.93 | 46.35 | -7.65 | 54.00 | 105 | 210 | Average |

Note:

1. " *", means this data is the worst emission level.
2. C.F (Correction Factor) = Antenna Factor (dB)+ Cable Loss (dB).
3. Measurement (dBUV/m) = Reading(dBUV) + C.F (Correction Factor).
4. The emission levels of other frequencies are very lower than the limit and not show in test report.

| | | | |
|-----------|-------------------------------------------------------|----------------------|--------------|
| EUT | AX3000+G1500 Whole Home Powerline Mesh Wi-Fi 6 System | Date of Test | 2022-07-06 |
| Factor | DRH18-E | Temp. / Humidity | 23°C /63% |
| Polarity | Vertical | Site / Test Engineer | AC2 / Ares |
| Test Mode | 802.11b_TX_CH 6_ANT 0+1 | Test Voltage | AC 120V/60Hz |

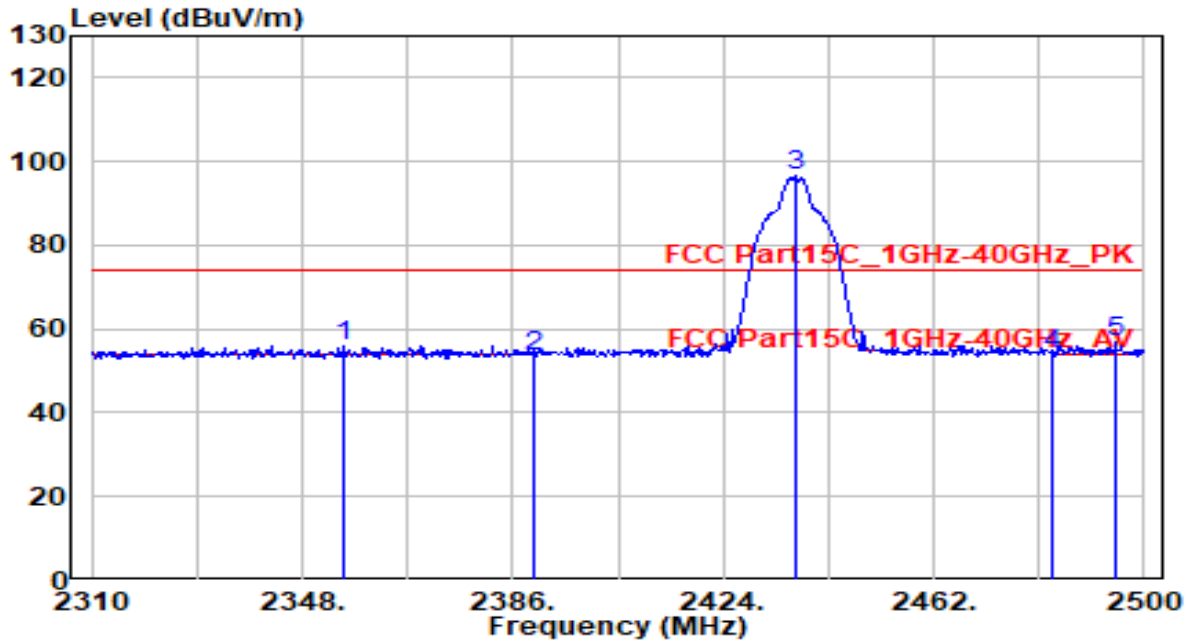

| No | Frequency (MHz) | Reading (dBUV) | C.F (dB/m) | Measurement (dBUV/m) | Margin (dB) | Limit (dBUV/m) | Height (cm) | Angle (deg) | Remark (QP/PK/AV) |
|----|-----------------|----------------|------------|----------------------|-------------|----------------|-------------|-------------|-------------------|
| 1 | 2355.410 | 25.32 | 30.56 | 55.88 | -18.12 | 74.00 | 120 | 45 | Peak |
| 2 | 2390.000 | 22.84 | 30.61 | 53.45 | -20.55 | 74.00 | 120 | 45 | Peak |
| 3 | 2437.110 | 65.78 | 30.75 | 96.54 | N/A | N/A | 120 | 45 | Peak |
| 4 | 2483.500 | 23.06 | 30.91 | 53.97 | -20.03 | 74.00 | 120 | 45 | Peak |
| 5 | * 2494.870 | 25.89 | 30.95 | 56.84 | -17.16 | 74.00 | 120 | 45 | Peak |

Note:

1. " *", means this data is the worst emission level.
2. C.F (Correction Factor) = Antenna Factor (dB)+ Cable Loss (dB).
3. Measurement (dBUV/m) = Reading(dBUV) + C.F (Correction Factor).
4. The emission levels of other frequencies are very lower than the limit and not show in test report.

| | | | |
|-----------|-------------------------------------------------------|----------------------|--------------|
| EUT | AX3000+G1500 Whole Home Powerline Mesh Wi-Fi 6 System | Date of Test | 2022-07-06 |
| Factor | DRH18-E | Temp. / Humidity | 23°C /63% |
| Polarity | Vertical | Site / Test Engineer | AC2 / Ares |
| Test Mode | 802.11b_TX_CH 6_ANT 0+1 | Test Voltage | AC 120V/60Hz |

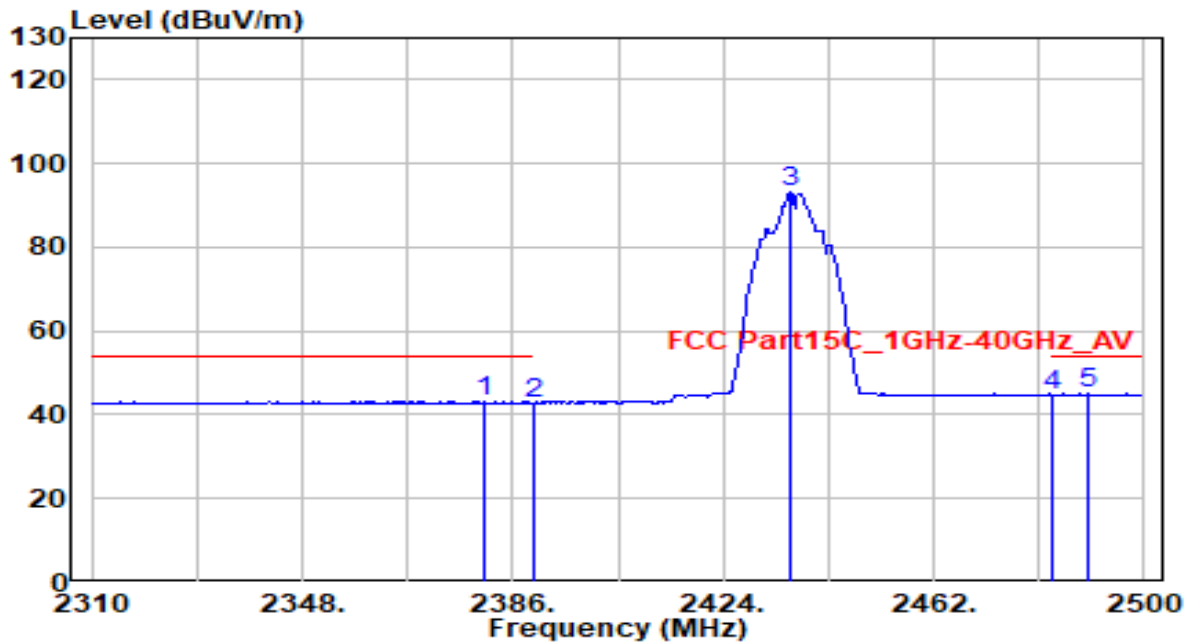

| No | Frequency (MHz) | Reading (dBUV) | C.F (dB/m) | Measurement (dBUV/m) | Margin (dB) | Limit (dBUV/m) | Height (cm) | Angle (deg) | Remark (QP/PK/AV) |
|----|-----------------|----------------|------------|----------------------|-------------|----------------|-------------|-------------|-------------------|
| 1 | 2380.870 | 12.52 | 30.60 | 43.12 | -10.88 | 54.00 | 120 | 55 | Average |
| 2 | 2390.000 | 12.24 | 30.61 | 42.85 | -11.15 | 54.00 | 120 | 55 | Average |
| 3 | 2435.970 | 62.35 | 30.75 | 93.10 | N/A | N/A | 120 | 55 | Average |
| 4 | 2483.500 | 13.65 | 30.91 | 44.56 | -9.44 | 54.00 | 120 | 55 | Average |
| 5 | * 2489.930 | 14.09 | 30.94 | 45.02 | -8.98 | 54.00 | 120 | 55 | Average |

Note:

1. " *", means this data is the worst emission level.
2. C.F (Correction Factor) = Antenna Factor (dB)+ Cable Loss (dB).
3. Measurement (dBUV/m) = Reading(dBUV) + C.F (Correction Factor).
4. The emission levels of other frequencies are very lower than the limit and not show in test report.

| | | | |
|-----------|-------------------------------------------------------|----------------------|--------------|
| EUT | AX3000+G1500 Whole Home Powerline Mesh Wi-Fi 6 System | Date of Test | 2022-07-06 |
| Factor | DRH18-E | Temp. / Humidity | 23°C /63% |
| Polarity | Horizontal | Site / Test Engineer | AC2 / Ares |
| Test Mode | 802.11b_TX_CH 11_ANT 0+1 | Test Voltage | AC 120V/60Hz |

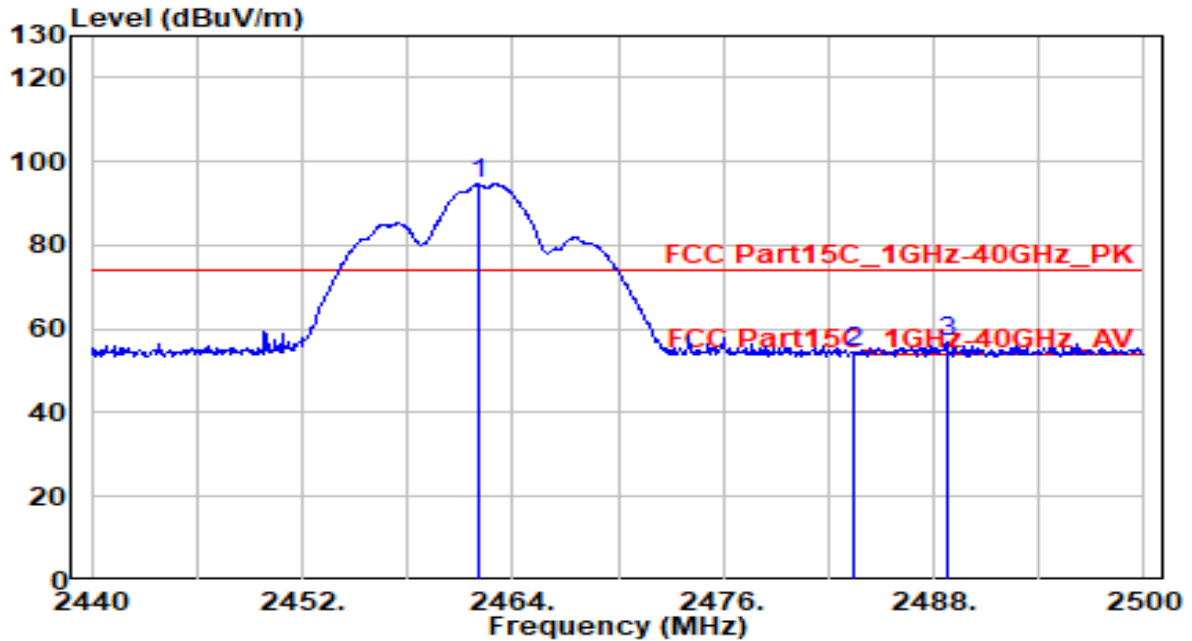

| No | Frequency (MHz) | Reading (dBuV) | C.F (dB/m) | Measurement (dBuV/m) | Margin (dB) | Limit (dBuV/m) | Height (cm) | Angle (deg) | Remark (QP/PK/AV) |
|----|-----------------|----------------|------------|----------------------|-------------|----------------|-------------|-------------|-------------------|
| 1 | 2462.020 | 63.69 | 30.84 | 94.53 | N/A | N/A | 115 | 240 | Peak |
| 2 | 2483.500 | 23.31 | 30.91 | 54.22 | -19.78 | 74.00 | 115 | 240 | Peak |
| 3 | * 2488.720 | 25.86 | 30.93 | 56.80 | -17.20 | 74.00 | 115 | 240 | Peak |

Note:

1. " *", means this data is the worst emission level.
2. C.F (Correction Factor) = Antenna Factor (dB)+ Cable Loss (dB).
3. Measurement (dBuV/m) = Reading(dBuV) + C.F (Correction Factor).
4. The emission levels of other frequencies are very lower than the limit and not show in test report.

| | | | |
|-----------|-------------------------------------------------------|----------------------|--------------|
| EUT | AX3000+G1500 Whole Home Powerline Mesh Wi-Fi 6 System | Date of Test | 2022-07-06 |
| Factor | DRH18-E | Temp. / Humidity | 23°C /63% |
| Polarity | Horizontal | Site / Test Engineer | AC2 / Ares |
| Test Mode | 802.11b_TX_CH 11_ANT 0+1 | Test Voltage | AC 120V/60Hz |

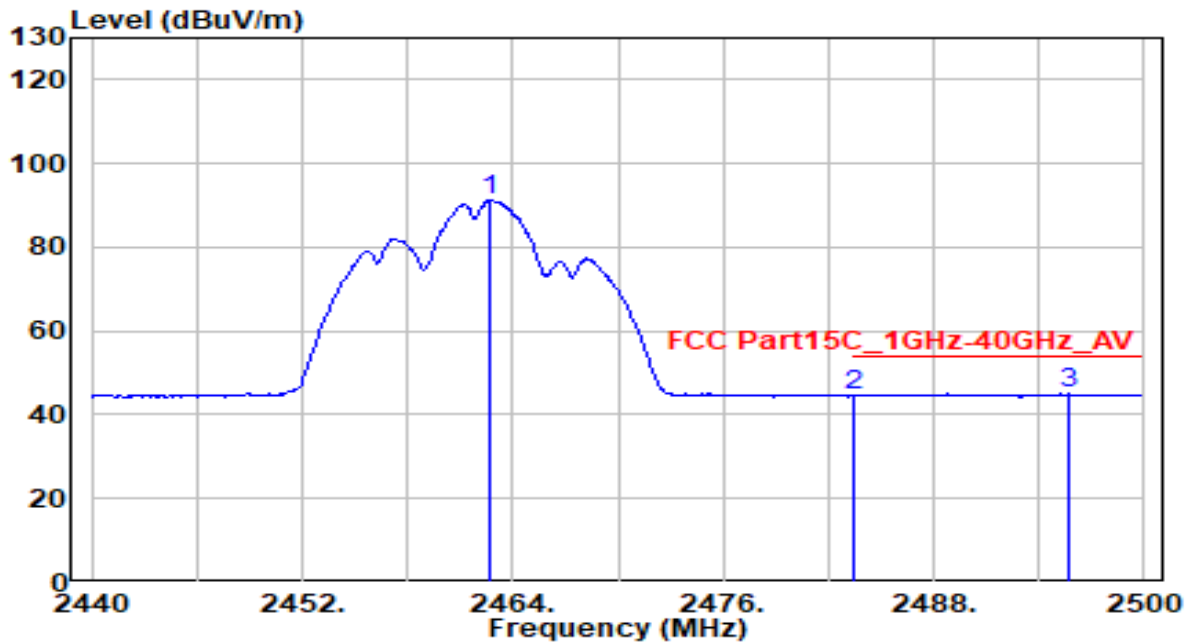

| No | Frequency (MHz) | Reading (dBUV) | C.F (dB/m) | Measurement (dBUV/m) | Margin (dB) | Limit (dBUV/m) | Height (cm) | Angle (deg) | Remark (QP/PK/AV) |
|----|-----------------|----------------|------------|----------------------|-------------|----------------|-------------|-------------|-------------------|
| 1 | 2462.740 | 60.52 | 30.84 | 91.37 | N/A | N/A | 115 | 240 | Average |
| 2 | 2483.500 | 13.76 | 30.91 | 44.67 | -9.33 | 54.00 | 115 | 240 | Average |
| 3 | * 2495.740 | 14.03 | 30.96 | 44.98 | -9.02 | 54.00 | 115 | 240 | Average |

Note:

1. " *", means this data is the worst emission level.
2. C.F (Correction Factor) = Antenna Factor (dB)+ Cable Loss (dB).
3. Measurement (dBUV/m) = Reading(dBUV) + C.F (Correction Factor).
4. The emission levels of other frequencies are very lower than the limit and not show in test report.

| | | | |
|-----------|-------------------------------------------------------|----------------------|--------------|
| EUT | AX3000+G1500 Whole Home Powerline Mesh Wi-Fi 6 System | Date of Test | 2022-07-06 |
| Factor | DRH18-E | Temp. / Humidity | 23°C /63% |
| Polarity | Vertical | Site / Test Engineer | AC2 / Ares |
| Test Mode | 802.11b_TX_CH 11_ANT 0+1 | Test Voltage | AC 120V/60Hz |

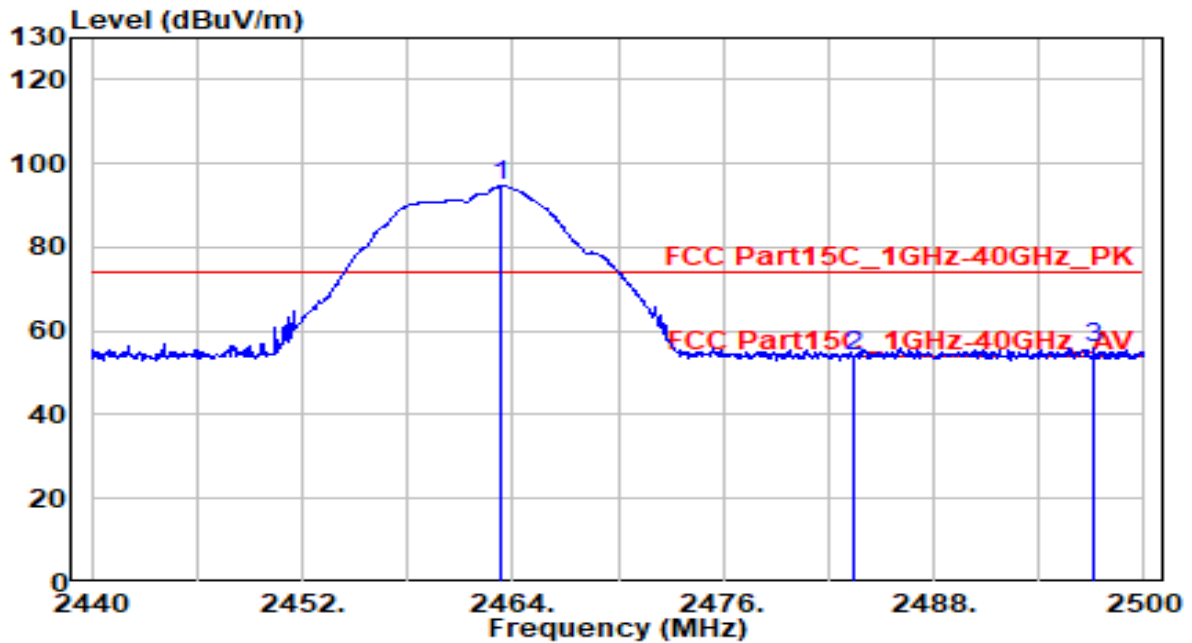

| No | Frequency (MHz) | Reading (dBuV) | C.F (dB/m) | Measurement (dBuV/m) | Margin (dB) | Limit (dBuV/m) | Height (cm) | Angle (deg) | Remark (QP/PK/AV) |
|----|-----------------|----------------|------------|----------------------|-------------|----------------|-------------|-------------|-------------------|
| 1 | 2463.340 | 63.77 | 30.84 | 94.61 | N/A | N/A | 100 | 80 | Peak |
| 2 | 2483.500 | 23.21 | 30.91 | 54.13 | -19.87 | 74.00 | 100 | 80 | Peak |
| 3 | * 2497.180 | 25.02 | 30.96 | 55.99 | -18.01 | 74.00 | 100 | 80 | Peak |

Note:

1. " *", means this data is the worst emission level.
2. C.F (Correction Factor) = Antenna Factor (dB)+ Cable Loss (dB).
3. Measurement (dBuV/m) = Reading(dBuV) + C.F (Correction Factor).
4. The emission levels of other frequencies are very lower than the limit and not show in test report.

| | | | |
|-----------|-------------------------------------------------------|----------------------|--------------|
| EUT | AX3000+G1500 Whole Home Powerline Mesh Wi-Fi 6 System | Date of Test | 2022-07-06 |
| Factor | DRH18-E | Temp. / Humidity | 23°C /63% |
| Polarity | Vertical | Site / Test Engineer | AC2 / Ares |
| Test Mode | 802.11b_TX_CH 11_ANT 0+1 | Test Voltage | AC 120V/60Hz |

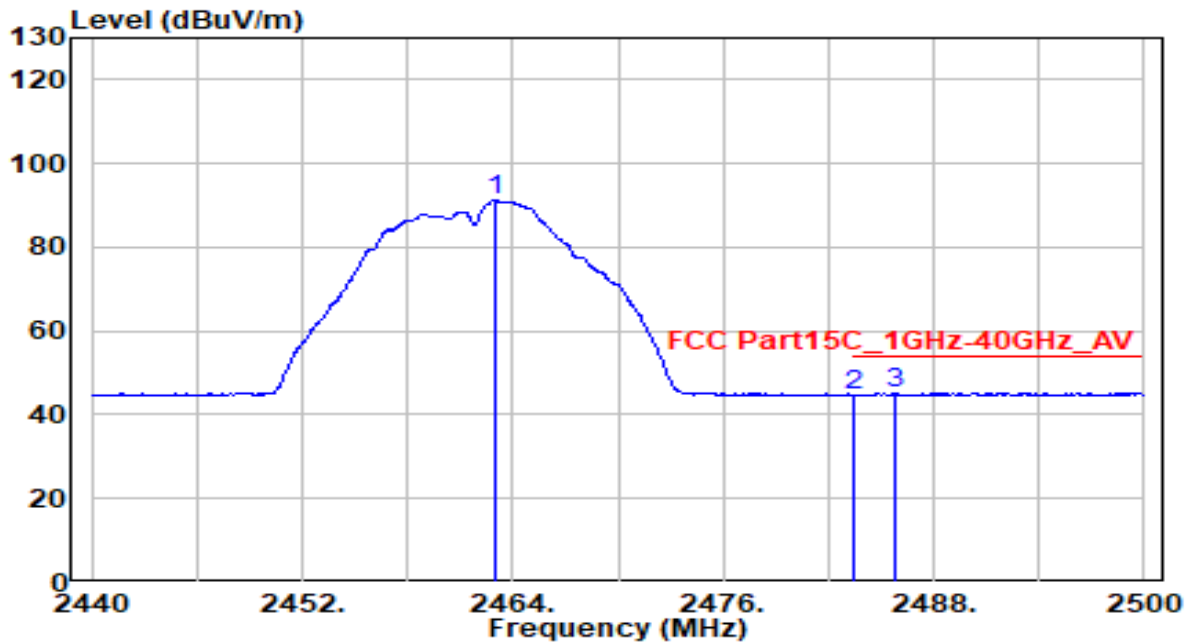

| No | Frequency (MHz) | Reading (dBuV) | C.F (dB/m) | Measurement (dBuV/m) | Margin (dB) | Limit (dBuV/m) | Height (cm) | Angle (deg) | Remark (QP/PK/AV) |
|----|-----------------|----------------|------------|----------------------|-------------|----------------|-------------|-------------|-------------------|
| 1 | 2462.980 | 60.48 | 30.84 | 91.32 | N/A | N/A | 100 | 80 | Average |
| 2 | 2483.500 | 13.92 | 30.91 | 44.83 | -9.17 | 54.00 | 100 | 80 | Average |
| 3 | * 2485.780 | 14.23 | 30.92 | 45.15 | -8.85 | 54.00 | 100 | 80 | Average |

Note:

1. " *", means this data is the worst emission level.
2. C.F (Correction Factor) = Antenna Factor (dB)+ Cable Loss (dB).
3. Measurement (dBuV/m) = Reading(dBuV) + C.F (Correction Factor).
4. The emission levels of other frequencies are very lower than the limit and not show in test report.

| | | | |
|-----------|-------------------------------------------------------|----------------------|--------------|
| EUT | AX3000+G1500 Whole Home Powerline Mesh Wi-Fi 6 System | Date of Test | 2022-07-06 |
| Factor | DRH18-E | Temp. / Humidity | 23°C /63% |
| Polarity | Horizontal | Site / Test Engineer | AC2 / Ares |
| Test Mode | 802.11g_TX_CH 1_ANT 0+1 | Test Voltage | AC 120V/60Hz |

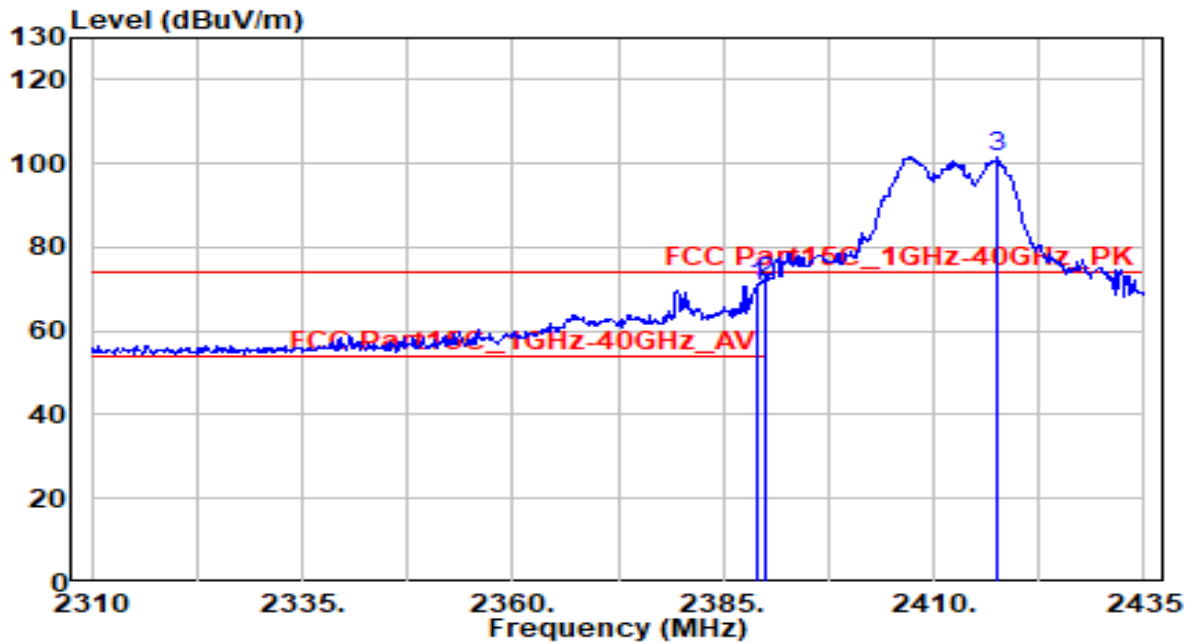

| No | Frequency (MHz) | Reading (dBUV) | C.F (dB/m) | Measurement (dBUV/m) | Margin (dB) | Limit (dBUV/m) | Height (cm) | Angle (deg) | Remark (QP/PK/AV) |
|----|-----------------|----------------|------------|----------------------|-------------|----------------|-------------|-------------|-------------------|
| 1 | 2389.000 | 40.09 | 30.61 | 70.71 | -3.29 | 74.00 | 155 | 235 | Peak |
| 2 | * 2390.000 | 41.14 | 30.61 | 71.75 | -2.25 | 74.00 | 155 | 235 | Peak |
| 3 | 2417.625 | 70.68 | 30.69 | 101.37 | N/A | N/A | 155 | 235 | Peak |

Note:

1. " *", means this data is the worst emission level.
2. C.F (Correction Factor) = Antenna Factor (dB)+ Cable Loss (dB).
3. Measurement (dBUV/m) = Reading(dBUV) + C.F (Correction Factor).
4. The emission levels of other frequencies are very lower than the limit and not show in test report.

| | | | |
|-----------|-------------------------------------------------------|----------------------|--------------|
| EUT | AX3000+G1500 Whole Home Powerline Mesh Wi-Fi 6 System | Date of Test | 2022-07-06 |
| Factor | DRH18-E | Temp. / Humidity | 23°C /63% |
| Polarity | Horizontal | Site / Test Engineer | AC2 / Ares |
| Test Mode | 802.11g_TX_CH 1_ANT 0+1 | Test Voltage | AC 120V/60Hz |

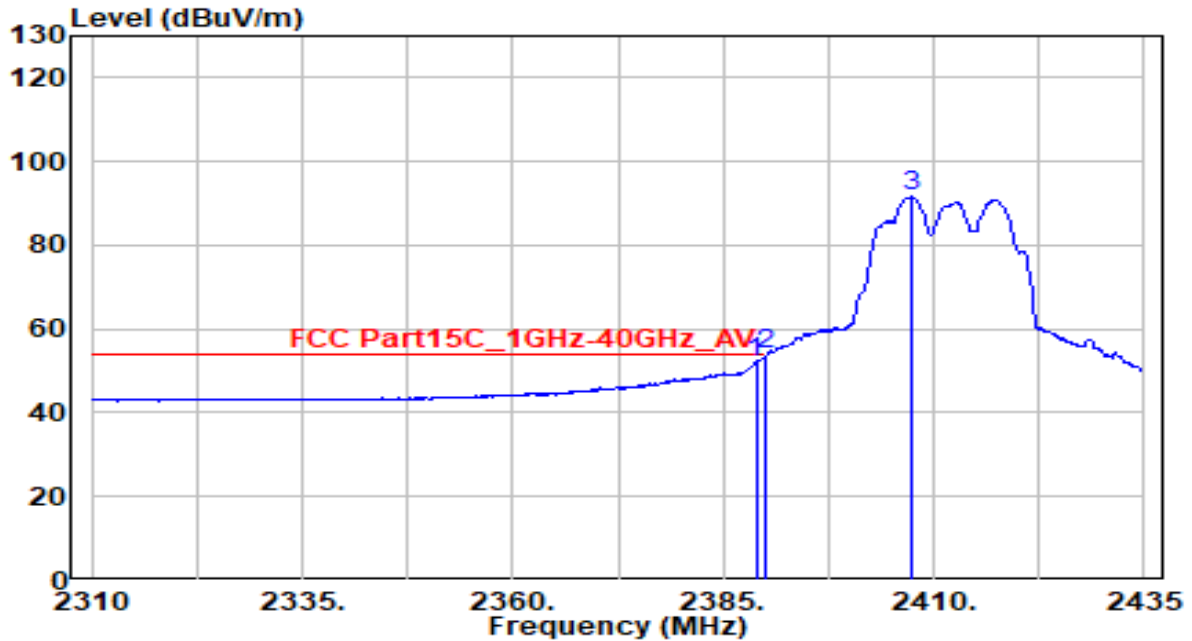

| No | Frequency (MHz) | Reading (dBUV) | C.F (dB/m) | Measurement (dBUV/m) | Margin (dB) | Limit (dBUV/m) | Height (cm) | Angle (deg) | Remark (QP/PK/AV) |
|----|-----------------|----------------|------------|----------------------|-------------|----------------|-------------|-------------|-------------------|
| 1 | 2388.875 | 21.43 | 30.61 | 52.04 | -1.96 | 54.00 | 155 | 235 | Average |
| 2 | * 2390.000 | 23.21 | 30.61 | 53.82 | -0.18 | 54.00 | 155 | 235 | Average |
| 3 | 2407.250 | 60.87 | 30.65 | 91.52 | N/A | N/A | 155 | 235 | Average |

Note:

1. " *", means this data is the worst emission level.
2. C.F (Correction Factor) = Antenna Factor (dB)+ Cable Loss (dB).
3. Measurement (dBUV/m) = Reading(dBUV) + C.F (Correction Factor).
4. The emission levels of other frequencies are very lower than the limit and not show in test report.

| | | | |
|-----------|-------------------------------------------------------|----------------------|--------------|
| EUT | AX3000+G1500 Whole Home Powerline Mesh Wi-Fi 6 System | Date of Test | 2022-07-06 |
| Factor | DRH18-E | Temp. / Humidity | 23°C /63% |
| Polarity | Vertical | Site / Test Engineer | AC2 / Ares |
| Test Mode | 802.11g_TX_CH 1_ANT 0+1 | Test Voltage | AC 120V/60Hz |

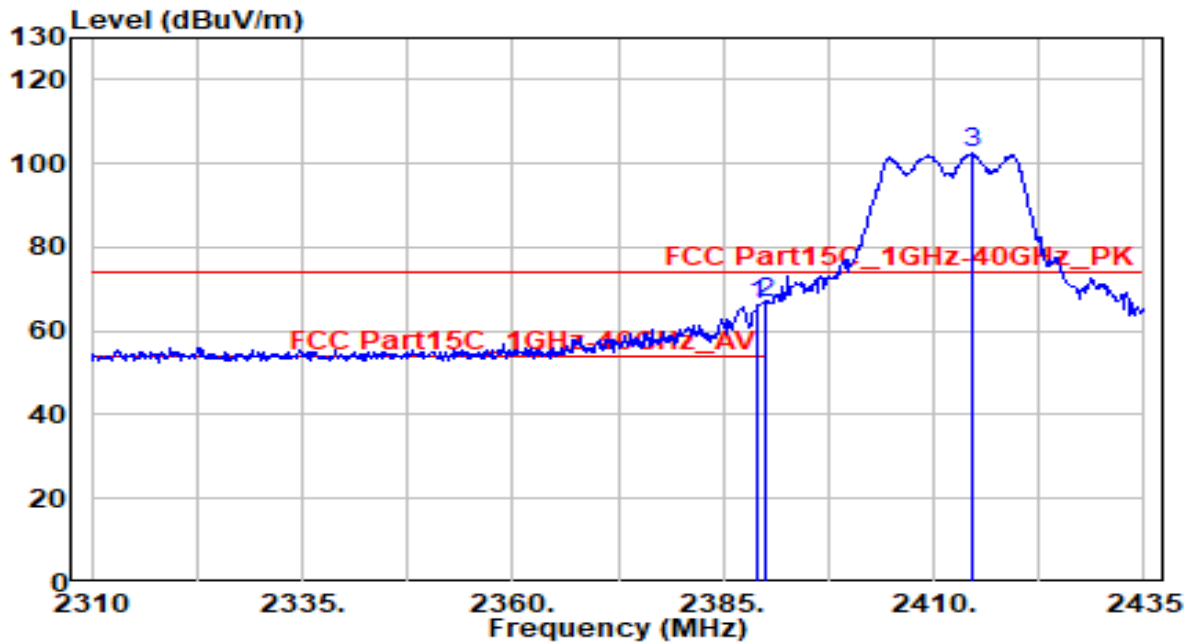

| No | Frequency (MHz) | Reading (dBUV) | C.F (dB/m) | Measurement (dBUV/m) | Margin (dB) | Limit (dBUV/m) | Height (cm) | Angle (deg) | Remark (QP/PK/AV) |
|----|-----------------|----------------|------------|----------------------|-------------|----------------|-------------|-------------|-------------------|
| 1 | 2389.000 | 35.80 | 30.61 | 66.41 | -7.59 | 74.00 | 135 | 40 | Peak |
| 2 | * 2390.000 | 36.04 | 30.61 | 66.65 | -7.35 | 74.00 | 135 | 40 | Peak |
| 3 | 2414.500 | 71.76 | 30.68 | 102.43 | N/A | N/A | 135 | 40 | Peak |

Note:

1. " *", means this data is the worst emission level.
2. C.F (Correction Factor) = Antenna Factor (dB)+ Cable Loss (dB).
3. Measurement (dBUV/m) = Reading(dBUV) + C.F (Correction Factor).
4. The emission levels of other frequencies are very lower than the limit and not show in test report.

| | | | |
|-----------|-------------------------------------------------------|----------------------|--------------|
| EUT | AX3000+G1500 Whole Home Powerline Mesh Wi-Fi 6 System | Date of Test | 2022-07-06 |
| Factor | DRH18-E | Temp. / Humidity | 23°C /63% |
| Polarity | Vertical | Site / Test Engineer | AC2 / Ares |
| Test Mode | 802.11g_TX_CH 1_ANT 0+1 | Test Voltage | AC 120V/60Hz |

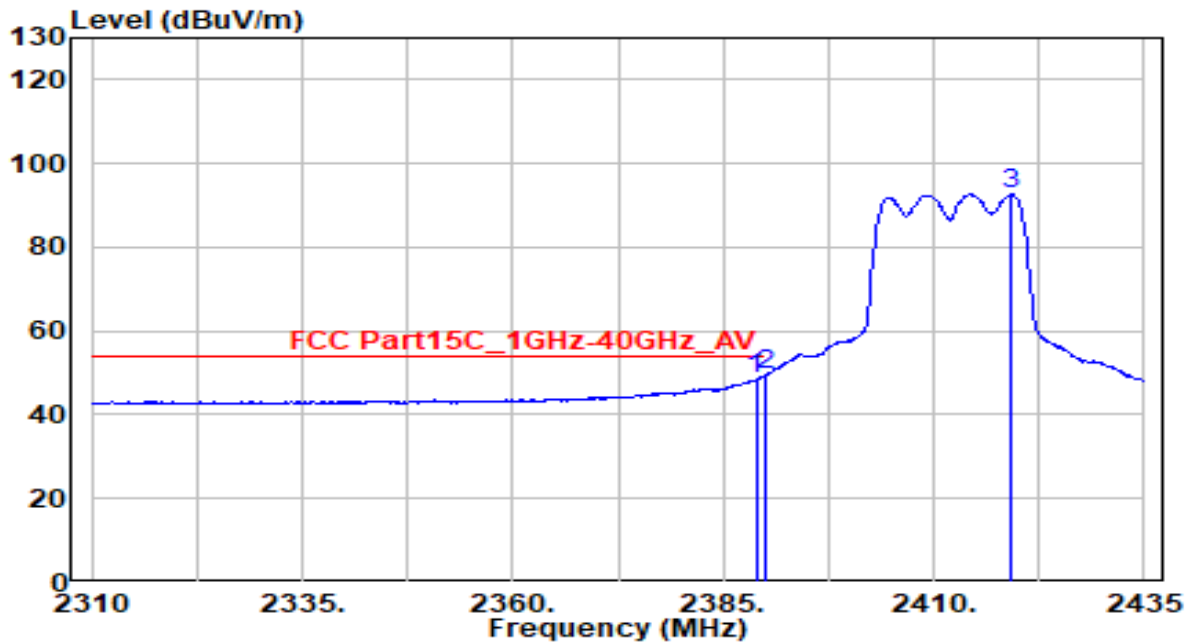

| No | Frequency (MHz) | Reading (dBuV) | C.F (dB/m) | Measurement (dBuV/m) | Margin (dB) | Limit (dBuV/m) | Height (cm) | Angle (deg) | Remark (QP/PK/AV) |
|----|-----------------|----------------|------------|----------------------|-------------|----------------|-------------|-------------|-------------------|
| 1 | 2388.875 | 18.03 | 30.61 | 48.64 | -5.36 | 54.00 | 135 | 40 | Average |
| 2 | * 2390.000 | 18.90 | 30.61 | 49.51 | -4.49 | 54.00 | 135 | 40 | Average |
| 3 | 2419.250 | 61.89 | 30.69 | 92.59 | N/A | N/A | 135 | 40 | Average |

Note:

1. " *", means this data is the worst emission level.
2. C.F (Correction Factor) = Antenna Factor (dB)+ Cable Loss (dB).
3. Measurement (dBuV/m) = Reading(dBuV) + C.F (Correction Factor).
4. The emission levels of other frequencies are very lower than the limit and not show in test report.

| | | | |
|-----------|-------------------------------------------------------|----------------------|--------------|
| EUT | AX3000+G1500 Whole Home Powerline Mesh Wi-Fi 6 System | Date of Test | 2022-07-06 |
| Factor | DRH18-E | Temp. / Humidity | 23°C /63% |
| Polarity | Horizontal | Site / Test Engineer | AC2 / Ares |
| Test Mode | 802.11g_TX_CH 6_ANT 0+1 | Test Voltage | AC 120V/60Hz |

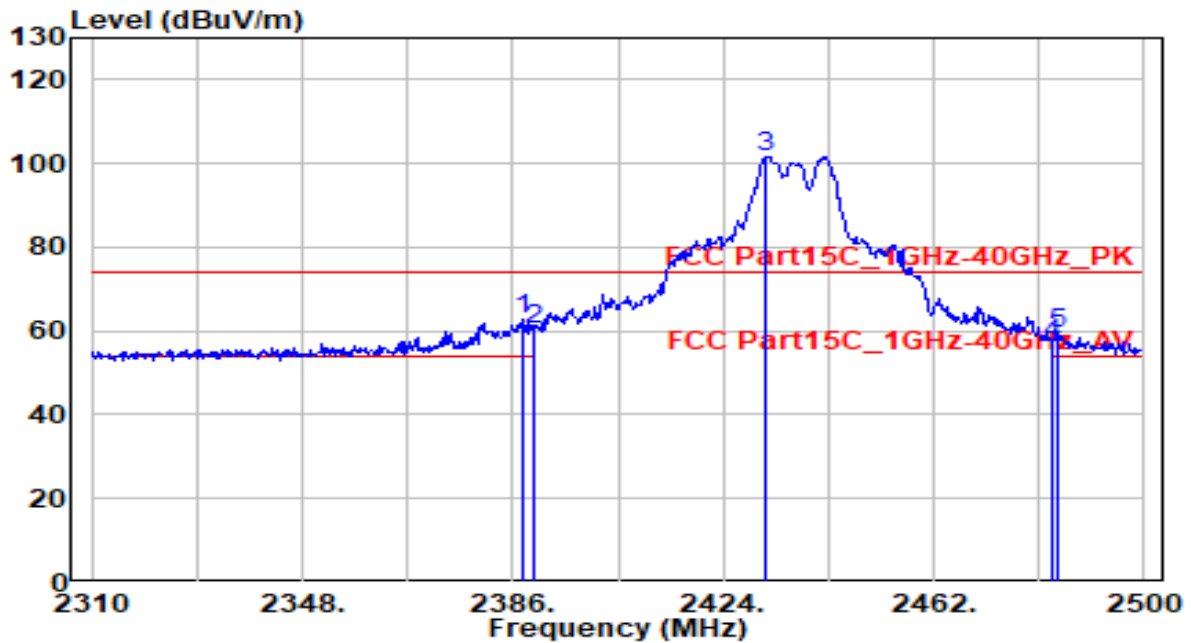

| No | Frequency (MHz) | Reading (dBUV) | C.F (dB/m) | Measurement (dBUV/m) | Margin (dB) | Limit (dBUV/m) | Height (cm) | Angle (deg) | Remark (QP/PK/AV) |
|----|-----------------|----------------|------------|----------------------|-------------|----------------|-------------|-------------|-------------------|
| 1 | * 2387.710 | 32.04 | 30.61 | 62.66 | -11.34 | 74.00 | 105 | 240 | Peak |
| 2 | 2390.000 | 29.59 | 30.61 | 60.20 | -13.80 | 74.00 | 105 | 240 | Peak |
| 3 | 2431.790 | 70.99 | 30.74 | 101.73 | N/A | N/A | 105 | 240 | Peak |
| 4 | 2483.500 | 25.93 | 30.91 | 56.84 | -17.16 | 74.00 | 105 | 240 | Peak |
| 5 | 2484.420 | 28.32 | 30.92 | 59.23 | -14.77 | 74.00 | 105 | 240 | Peak |

Note:

1. " *", means this data is the worst emission level.
2. C.F (Correction Factor) = Antenna Factor (dB)+ Cable Loss (dB).
3. Measurement (dBUV/m) = Reading(dBUV) + C.F (Correction Factor).
4. The emission levels of other frequencies are very lower than the limit and not show in test report.

| | | | |
|-----------|-------------------------------------------------------|----------------------|--------------|
| EUT | AX3000+G1500 Whole Home Powerline Mesh Wi-Fi 6 System | Date of Test | 2022-07-06 |
| Factor | DRH18-E | Temp. / Humidity | 23°C /63% |
| Polarity | Horizontal | Site / Test Engineer | AC2 / Ares |
| Test Mode | 802.11g_TX_CH 6_ANT 0+1 | Test Voltage | AC 120V/60Hz |

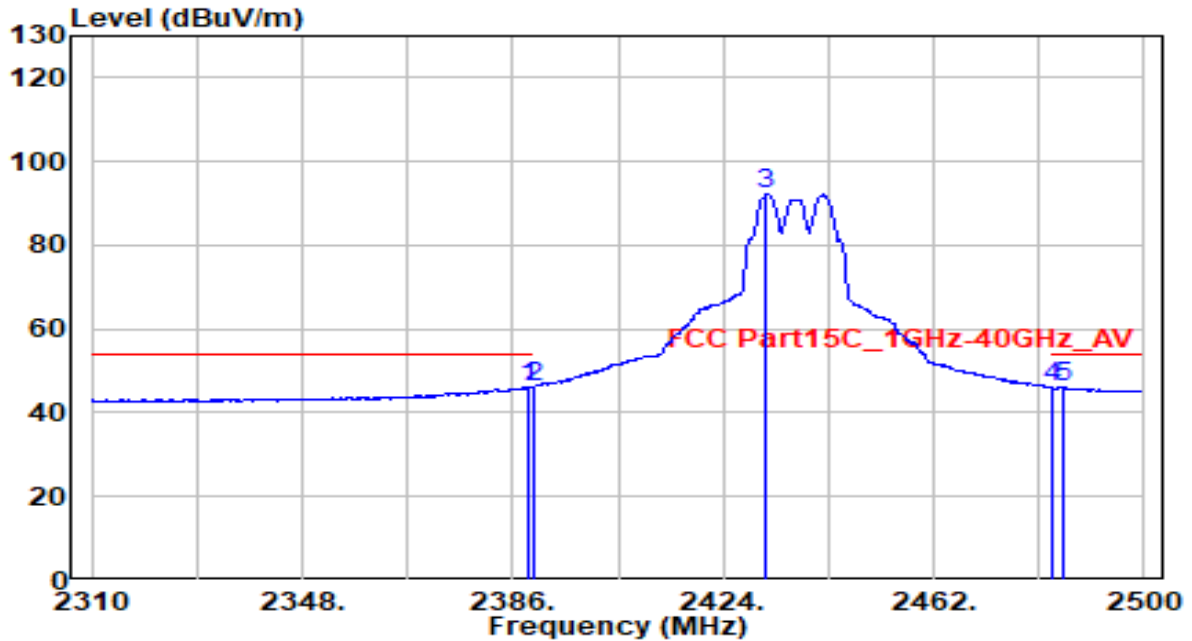

| No | Frequency (MHz) | Reading (dBUV) | C.F (dB/m) | Measurement (dBUV/m) | Margin (dB) | Limit (dBUV/m) | Height (cm) | Angle (deg) | Remark (QP/PK/AV) |
|----|-----------------|----------------|------------|----------------------|-------------|----------------|-------------|-------------|-------------------|
| 1 | 2388.850 | 15.51 | 30.61 | 46.12 | -7.88 | 54.00 | 105 | 240 | Average |
| 2 | * 2390.000 | 15.67 | 30.61 | 46.29 | -7.71 | 54.00 | 105 | 240 | Average |
| 3 | 2431.790 | 61.63 | 30.74 | 92.36 | N/A | N/A | 105 | 240 | Average |
| 4 | 2483.500 | 15.01 | 30.91 | 45.92 | -8.08 | 54.00 | 105 | 240 | Average |
| 5 | 2485.560 | 15.35 | 30.92 | 46.27 | -7.73 | 54.00 | 105 | 240 | Average |

Note:

1. " *", means this data is the worst emission level.
2. C.F (Correction Factor) = Antenna Factor (dB)+ Cable Loss (dB).
3. Measurement (dBUV/m) = Reading(dBUV) + C.F (Correction Factor).
4. The emission levels of other frequencies are very lower than the limit and not show in test report.

| | | | |
|-----------|-------------------------------------------------------|----------------------|--------------|
| EUT | AX3000+G1500 Whole Home Powerline Mesh Wi-Fi 6 System | Date of Test | 2022-07-06 |
| Factor | DRH18-E | Temp. / Humidity | 23°C /63% |
| Polarity | Vertical | Site / Test Engineer | AC2 / Ares |
| Test Mode | 802.11g_TX_CH 6_ANT 0+1 | Test Voltage | AC 120V/60Hz |

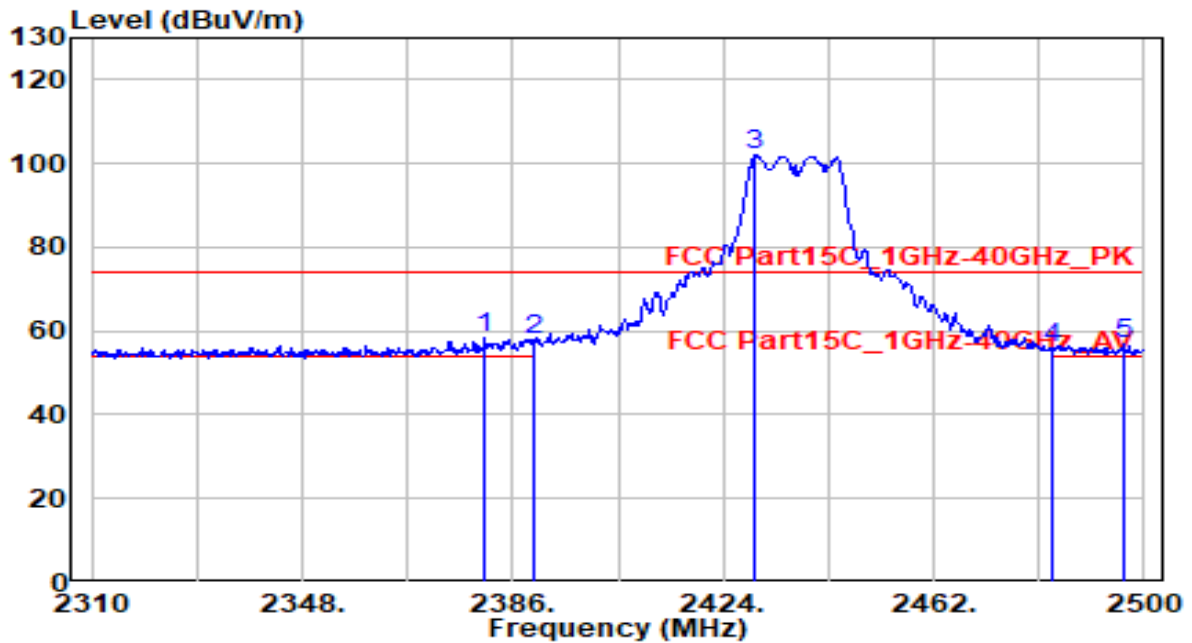

| No | Frequency (MHz) | Reading (dBUV) | C.F (dB/m) | Measurement (dBUV/m) | Margin (dB) | Limit (dBUV/m) | Height (cm) | Angle (deg) | Remark (QP/PK/AV) |
|----|-----------------|----------------|------------|----------------------|-------------|----------------|-------------|-------------|-------------------|
| 1 | * 2381.060 | 27.72 | 30.60 | 58.32 | -15.68 | 74.00 | 115 | 50 | Peak |
| 2 | 2390.000 | 27.04 | 30.61 | 57.65 | -16.35 | 74.00 | 115 | 50 | Peak |
| 3 | 2429.700 | 71.15 | 30.73 | 101.88 | N/A | N/A | 115 | 50 | Peak |
| 4 | 2483.500 | 25.18 | 30.91 | 56.10 | -17.90 | 74.00 | 115 | 50 | Peak |
| 5 | 2496.390 | 26.15 | 30.96 | 57.11 | -16.89 | 74.00 | 115 | 50 | Peak |

Note:

1. " *", means this data is the worst emission level.
2. C.F (Correction Factor) = Antenna Factor (dB)+ Cable Loss (dB).
3. Measurement (dBUV/m) = Reading(dBUV) + C.F (Correction Factor).
4. The emission levels of other frequencies are very lower than the limit and not show in test report.

| | | | |
|-----------|-------------------------------------------------------|----------------------|--------------|
| EUT | AX3000+G1500 Whole Home Powerline Mesh Wi-Fi 6 System | Date of Test | 2022-07-06 |
| Factor | DRH18-E | Temp. / Humidity | 23°C /63% |
| Polarity | Vertical | Site / Test Engineer | AC2 / Ares |
| Test Mode | 802.11g_TX_CH 6_ANT 0+1 | Test Voltage | AC 120V/60Hz |

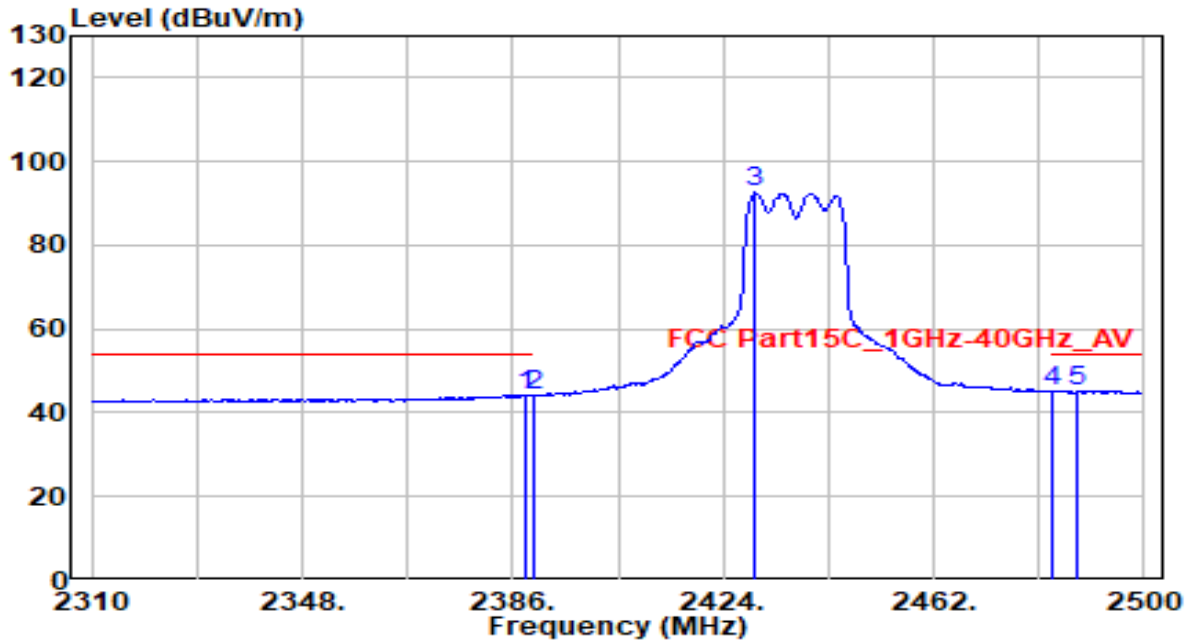

| No | Frequency (MHz) | Reading (dBUV) | C.F (dB/m) | Measurement (dBUV/m) | Margin (dB) | Limit (dBUV/m) | Height (cm) | Angle (deg) | Remark (QP/PK/AV) |
|----|-----------------|----------------|------------|----------------------|-------------|----------------|-------------|-------------|-------------------|
| 1 | 2388.470 | 13.64 | 30.61 | 44.25 | -9.75 | 54.00 | 115 | 50 | Average |
| 2 | 2390.000 | 13.53 | 30.61 | 44.14 | -9.86 | 54.00 | 115 | 50 | Average |
| 3 | 2429.700 | 61.87 | 30.73 | 92.60 | N/A | N/A | 115 | 50 | Average |
| 4 | 2483.500 | 14.26 | 30.91 | 45.18 | -8.82 | 54.00 | 115 | 50 | Average |
| 5 | * 2488.030 | 14.32 | 30.93 | 45.25 | -8.75 | 54.00 | 115 | 50 | Average |

Note:

1. " *", means this data is the worst emission level.
2. C.F (Correction Factor) = Antenna Factor (dB)+ Cable Loss (dB).
3. Measurement (dBUV/m) = Reading(dBUV) + C.F (Correction Factor).
4. The emission levels of other frequencies are very lower than the limit and not show in test report.

| | | | |
|-----------|-------------------------------------------------------|----------------------|--------------|
| EUT | AX3000+G1500 Whole Home Powerline Mesh Wi-Fi 6 System | Date of Test | 2022-07-06 |
| Factor | DRH18-E | Temp. / Humidity | 23°C /63% |
| Polarity | Horizontal | Site / Test Engineer | AC2 / Ares |
| Test Mode | 802.11g_TX_CH 11_ANT 0+1 | Test Voltage | AC 120V/60Hz |

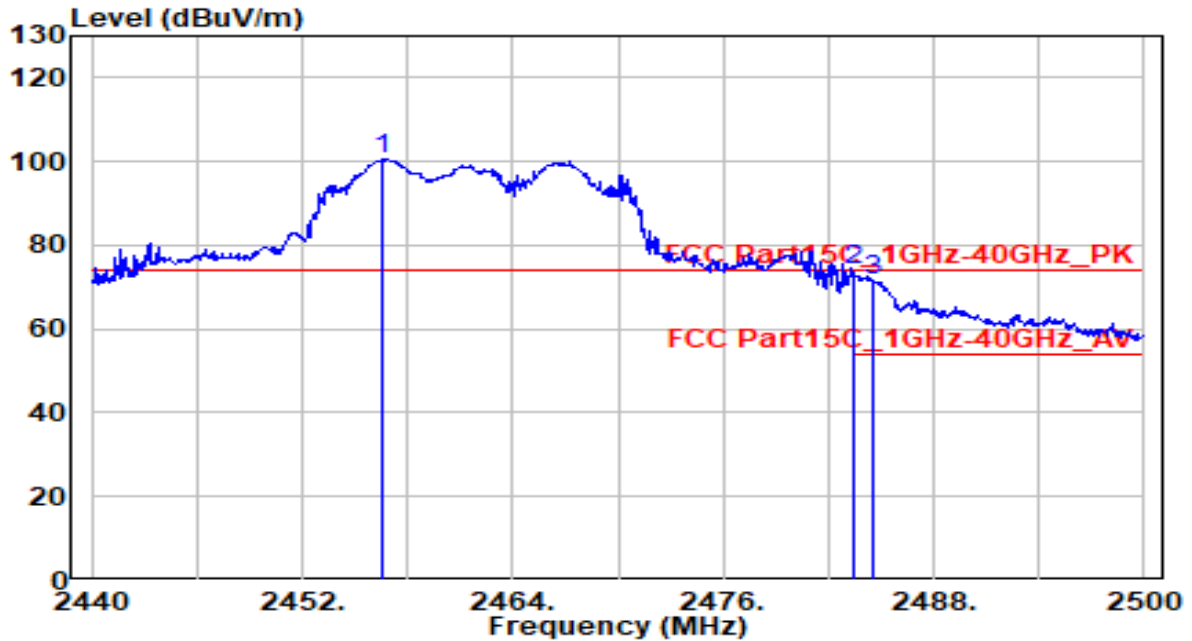

| No | Frequency (MHz) | Reading (dBuV) | C.F (dB/m) | Measurement (dBuV/m) | Margin (dB) | Limit (dBuV/m) | Height (cm) | Angle (deg) | Remark (QP/PK/AV) |
|----|-----------------|----------------|------------|----------------------|-------------|----------------|-------------|-------------|-------------------|
| 1 | 2456.620 | 69.63 | 30.82 | 100.45 | N/A | N/A | 110 | 240 | Peak |
| 2 | * 2483.500 | 42.94 | 30.91 | 73.85 | -0.15 | 74.00 | 110 | 240 | Peak |
| 3 | 2484.520 | 40.79 | 30.92 | 71.71 | -2.29 | 74.00 | 110 | 240 | Peak |

Note:

1. " *", means this data is the worst emission level.
2. C.F (Correction Factor) = Antenna Factor (dB)+ Cable Loss (dB).
3. Measurement (dBuV/m) = Reading(dBuV) + C.F (Correction Factor).
4. The emission levels of other frequencies are very lower than the limit and not show in test report.

| | | | |
|-----------|-------------------------------------------------------|----------------------|--------------|
| EUT | AX3000+G1500 Whole Home Powerline Mesh Wi-Fi 6 System | Date of Test | 2022-07-06 |
| Factor | DRH18-E | Temp. / Humidity | 23°C /63% |
| Polarity | Horizontal | Site / Test Engineer | AC2 / Ares |
| Test Mode | 802.11g_TX_CH 11_ANT 0+1 | Test Voltage | AC 120V/60Hz |

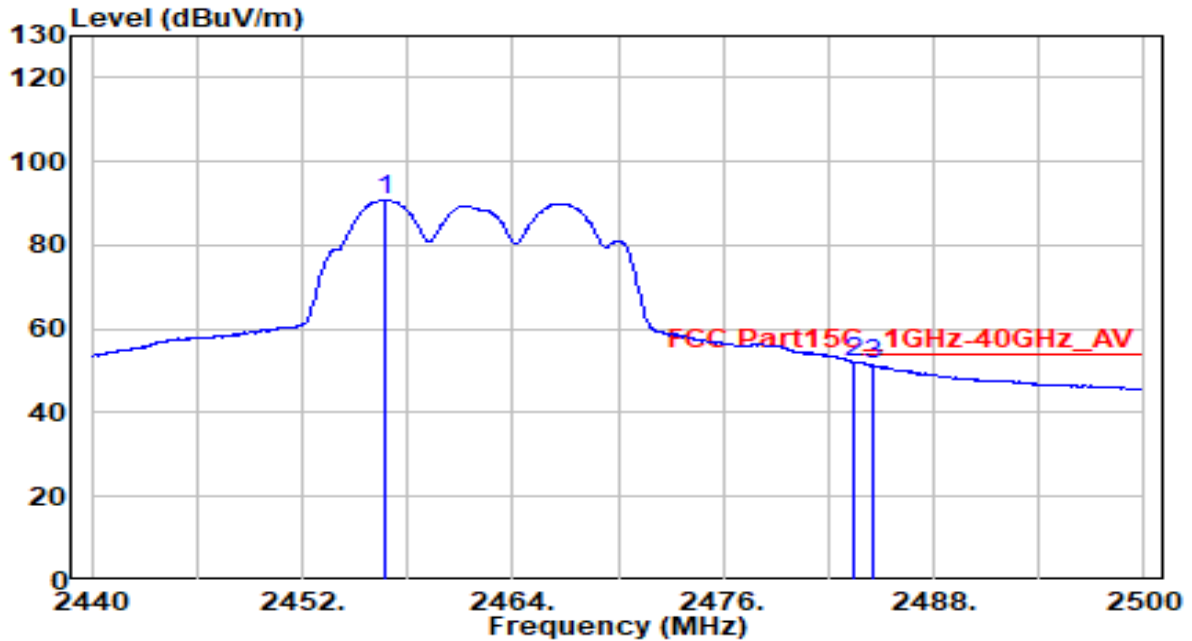

| No | Frequency (MHz) | Reading (dBUV) | C.F (dB/m) | Measurement (dBUV/m) | Margin (dB) | Limit (dBUV/m) | Height (cm) | Angle (deg) | Remark (QP/PK/AV) |
|----|-----------------|----------------|------------|----------------------|-------------|----------------|-------------|-------------|-------------------|
| 1 | 2456.680 | 60.12 | 30.82 | 90.95 | N/A | N/A | 110 | 240 | Average |
| 2 | * 2483.500 | 21.20 | 30.91 | 52.11 | -1.89 | 54.00 | 110 | 240 | Average |
| 3 | 2484.520 | 20.50 | 30.92 | 51.42 | -2.58 | 54.00 | 110 | 240 | Average |

Note:

- "*", means this data is the worst emission level.
- C.F (Correction Factor) = Antenna Factor (dB)+ Cable Loss (dB).
- Measurement (dBUV/m) = Reading(dBUV) + C.F (Correction Factor).
- The emission levels of other frequencies are very lower than the limit and not show in test report.

| | | | |
|-----------|-------------------------------------------------------|----------------------|--------------|
| EUT | AX3000+G1500 Whole Home Powerline Mesh Wi-Fi 6 System | Date of Test | 2022-07-06 |
| Factor | DRH18-E | Temp. / Humidity | 23°C /63% |
| Polarity | Vertical | Site / Test Engineer | AC2 / Ares |
| Test Mode | 802.11g_TX_CH 11_ANT 0+1 | Test Voltage | AC 120V/60Hz |

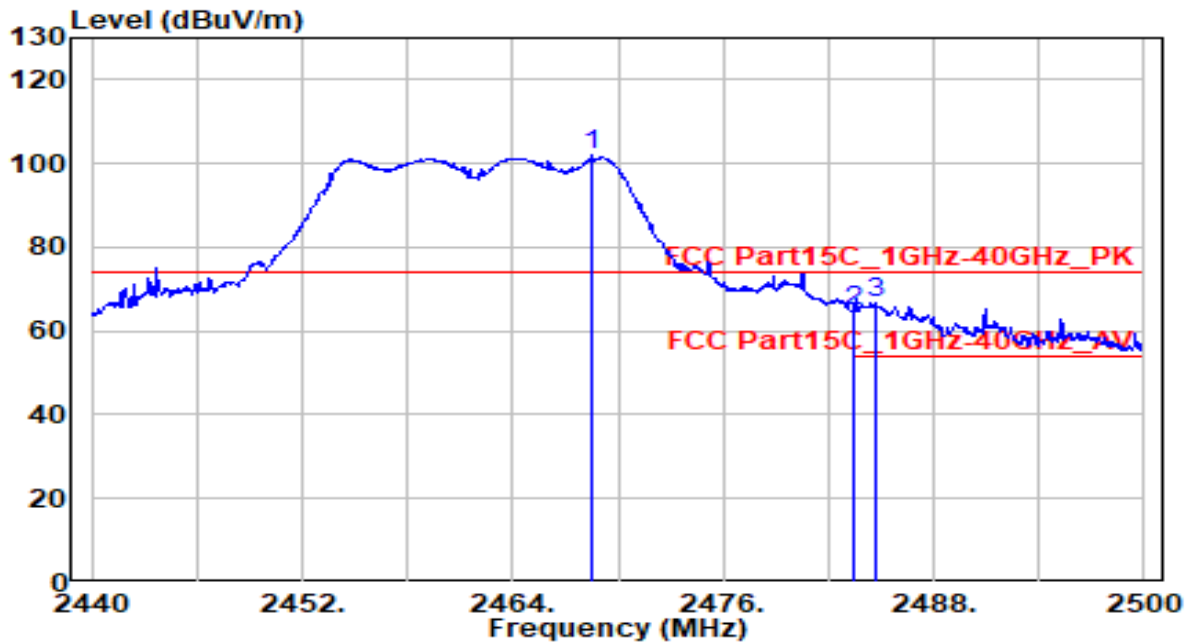

| No | Frequency (MHz) | Reading (dBuV) | C.F (dB/m) | Measurement (dBuV/m) | Margin (dB) | Limit (dBuV/m) | Height (cm) | Angle (deg) | Remark (QP/PK/AV) |
|----|-----------------|----------------|------------|----------------------|-------------|----------------|-------------|-------------|-------------------|
| 1 | 2468.440 | 70.97 | 30.86 | 101.83 | N/A | N/A | 100 | 45 | Peak |
| 2 | 2483.500 | 34.05 | 30.91 | 64.97 | -9.03 | 74.00 | 100 | 45 | Peak |
| 3 | * 2484.700 | 35.61 | 30.92 | 66.53 | -7.47 | 74.00 | 100 | 45 | Peak |

Note:

1. " *", means this data is the worst emission level.
2. C.F (Correction Factor) = Antenna Factor (dB)+ Cable Loss (dB).
3. Measurement (dBuV/m) = Reading(dBuV) + C.F (Correction Factor).
4. The emission levels of other frequencies are very lower than the limit and not show in test report.

| | | | |
|-----------|-------------------------------------------------------|----------------------|--------------|
| EUT | AX3000+G1500 Whole Home Powerline Mesh Wi-Fi 6 System | Date of Test | 2022-07-06 |
| Factor | DRH18-E | Temp. / Humidity | 23°C /63% |
| Polarity | Vertical | Site / Test Engineer | AC2 / Ares |
| Test Mode | 802.11g_TX_CH 11_ANT 0+1 | Test Voltage | AC 120V/60Hz |

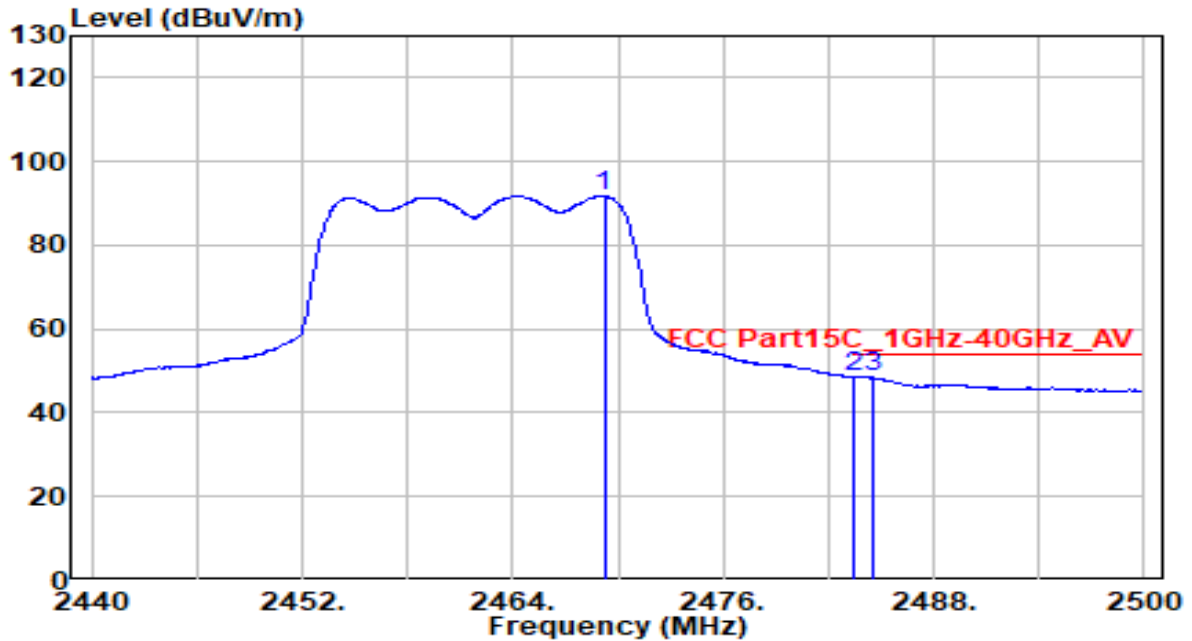

| No | Frequency (MHz) | Reading (dBuV) | C.F (dB/m) | Measurement (dBuV/m) | Margin (dB) | Limit (dBuV/m) | Height (cm) | Angle (deg) | Remark (QP/PK/AV) |
|----|-----------------|----------------|------------|----------------------|-------------|----------------|-------------|-------------|-------------------|
| 1 | 2469.220 | 61.10 | 30.86 | 91.97 | N/A | N/A | 100 | 45 | Average |
| 2 | * 2483.500 | 17.61 | 30.91 | 48.52 | -5.48 | 54.00 | 100 | 45 | Average |
| 3 | 2484.520 | 17.46 | 30.92 | 48.37 | -5.63 | 54.00 | 100 | 45 | Average |

Note:

- " *", means this data is the worst emission level.
- C.F (Correction Factor) = Antenna Factor (dB)+ Cable Loss (dB).
- Measurement (dBuV/m) = Reading(dBuV) + C.F (Correction Factor).
- The emission levels of other frequencies are very lower than the limit and not show in test report.

| | | | |
|-----------|-------------------------------------------------------|----------------------|--------------|
| EUT | AX3000+G1500 Whole Home Powerline Mesh Wi-Fi 6 System | Date of Test | 2022-07-06 |
| Factor | DRH18-E | Temp. / Humidity | 23°C /63% |
| Polarity | Horizontal | Site / Test Engineer | AC2 / Ares |
| Test Mode | 802.11n-20MHz_TX_CH 1_ANT 0+1 | Test Voltage | AC 120V/60Hz |

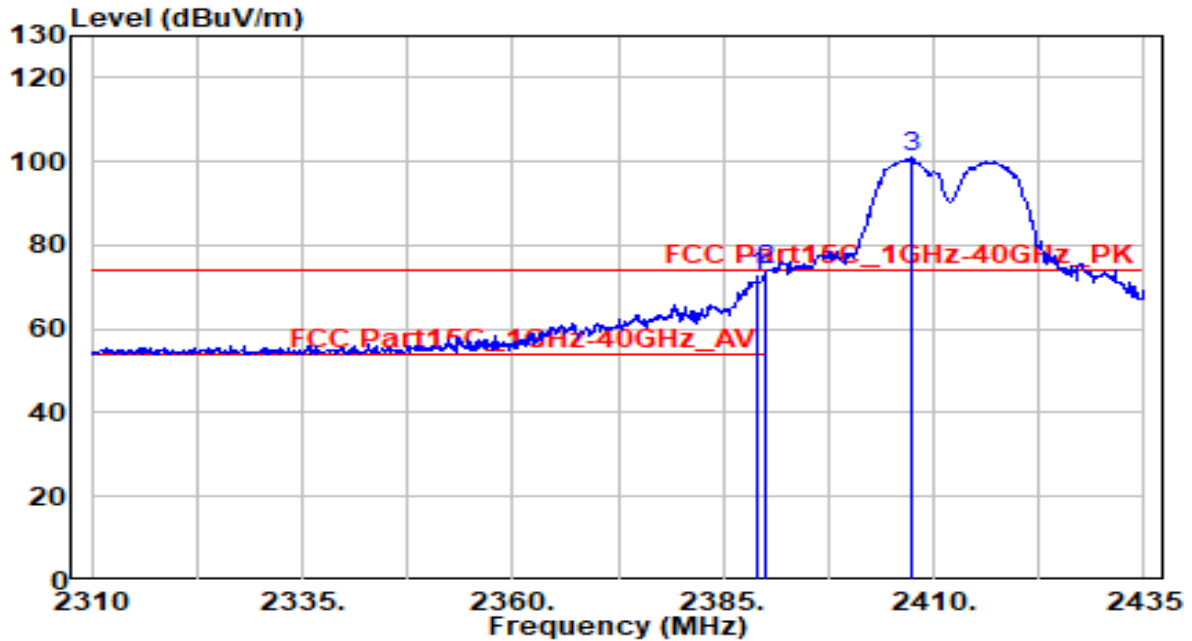

| No | Frequency (MHz) | Reading (dBUV) | C.F (dB/m) | Measurement (dBUV/m) | Margin (dB) | Limit (dBUV/m) | Height (cm) | Angle (deg) | Remark (QP/PK/AV) |
|----|-----------------|----------------|------------|----------------------|-------------|----------------|-------------|-------------|-------------------|
| 1 | 2389.000 | 41.94 | 30.61 | 72.55 | -1.45 | 74.00 | 160 | 235 | Peak |
| 2 | * 2390.000 | 43.26 | 30.61 | 73.87 | -0.13 | 74.00 | 160 | 235 | Peak |
| 3 | 2407.375 | 70.24 | 30.65 | 100.89 | N/A | N/A | 160 | 235 | Peak |

Note:

1. " *", means this data is the worst emission level.
2. C.F (Correction Factor) = Antenna Factor (dB)+ Cable Loss (dB).
3. Measurement (dBUV/m) = Reading(dBUV) + C.F (Correction Factor).
4. The emission levels of other frequencies are very lower than the limit and not show in test report.

| | | | |
|-----------|-------------------------------------------------------|----------------------|--------------|
| EUT | AX3000+G1500 Whole Home Powerline Mesh Wi-Fi 6 System | Date of Test | 2022-07-06 |
| Factor | DRH18-E | Temp. / Humidity | 23°C /63% |
| Polarity | Horizontal | Site / Test Engineer | AC2 / Ares |
| Test Mode | 802.11n-20MHz_TX_CH 1_ANT 0+1 | Test Voltage | AC 120V/60Hz |

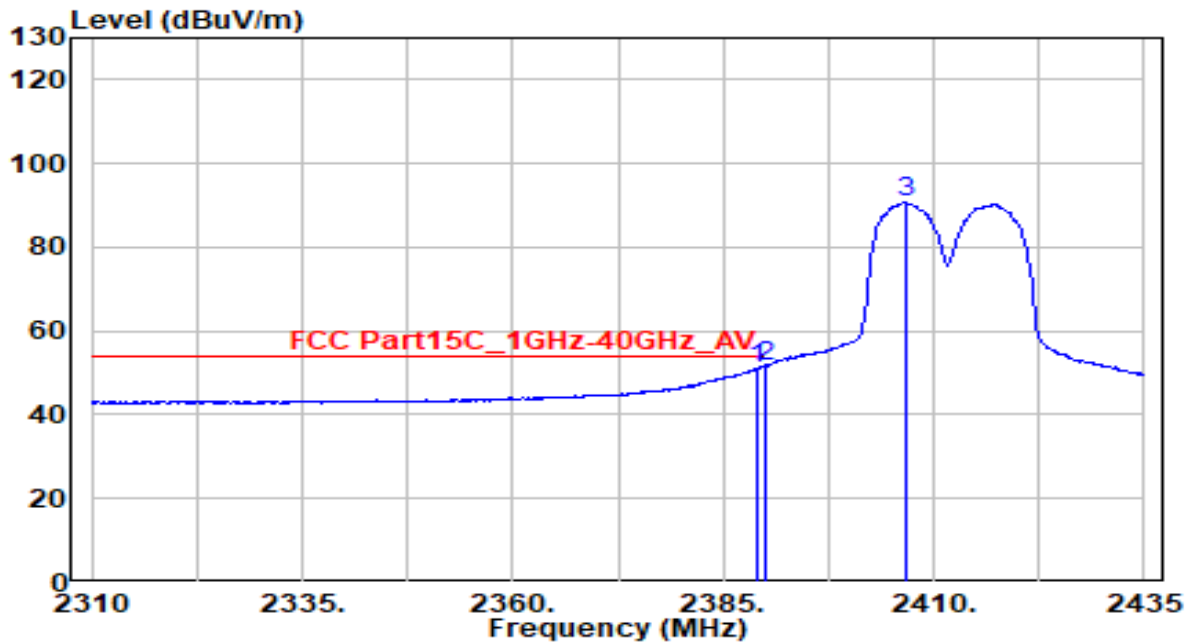

| No | Frequency (MHz) | Reading (dBuV) | C.F (dB/m) | Measurement (dBuV/m) | Margin (dB) | Limit (dBuV/m) | Height (cm) | Angle (deg) | Remark (QP/PK/AV) |
|----|-----------------|----------------|------------|----------------------|-------------|----------------|-------------|-------------|-------------------|
| 1 | 2389.000 | 20.65 | 30.61 | 51.26 | -2.74 | 54.00 | 160 | 235 | Average |
| 2 | * 2390.000 | 21.08 | 30.61 | 51.69 | -2.31 | 54.00 | 160 | 235 | Average |
| 3 | 2406.625 | 60.13 | 30.65 | 90.78 | N/A | N/A | 160 | 235 | Average |

Note:

1. " *", means this data is the worst emission level.
2. C.F (Correction Factor) = Antenna Factor (dB)+ Cable Loss (dB).
3. Measurement (dBuV/m) = Reading(dBuV) + C.F (Correction Factor).
4. The emission levels of other frequencies are very lower than the limit and not show in test report.

| | | | |
|-----------|-------------------------------------------------------|----------------------|--------------|
| EUT | AX3000+G1500 Whole Home Powerline Mesh Wi-Fi 6 System | Date of Test | 2022-07-06 |
| Factor | DRH18-E | Temp. / Humidity | 23°C /63% |
| Polarity | Vertical | Site / Test Engineer | AC2 / Ares |
| Test Mode | 802.11n-20MHz_TX_CH 1_ANT 0+1 | Test Voltage | AC 120V/60Hz |

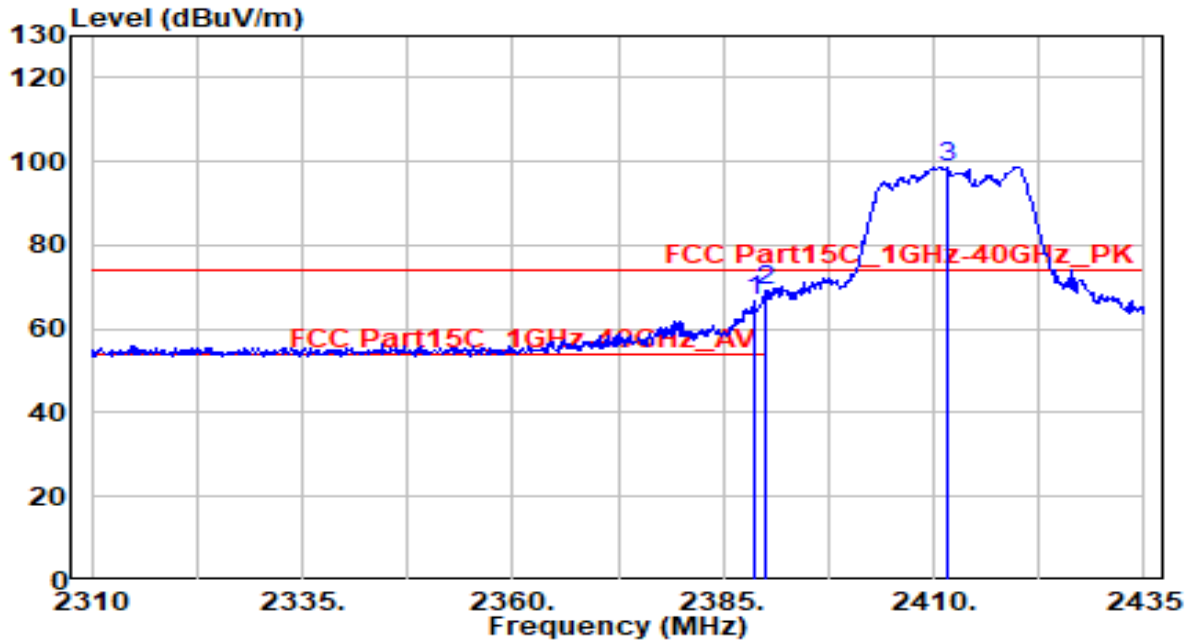

| No | Frequency (MHz) | Reading (dBUV) | C.F (dB/m) | Measurement (dBUV/m) | Margin (dB) | Limit (dBUV/m) | Height (cm) | Angle (deg) | Remark (QP/PK/AV) |
|----|-----------------|----------------|------------|----------------------|-------------|----------------|-------------|-------------|-------------------|
| 1 | 2388.625 | 35.92 | 30.61 | 66.53 | -7.47 | 74.00 | 100 | 40 | Peak |
| 2 | * 2390.000 | 38.73 | 30.61 | 69.34 | -4.66 | 74.00 | 100 | 40 | Peak |
| 3 | 2411.500 | 68.11 | 30.67 | 98.78 | N/A | N/A | 100 | 40 | Peak |

Note:

1. " *", means this data is the worst emission level.
2. C.F (Correction Factor) = Antenna Factor (dB)+ Cable Loss (dB).
3. Measurement (dBUV/m) = Reading(dBUV) + C.F (Correction Factor).
4. The emission levels of other frequencies are very lower than the limit and not show in test report.

| | | | |
|-----------|-------------------------------------------------------|----------------------|--------------|
| EUT | AX3000+G1500 Whole Home Powerline Mesh Wi-Fi 6 System | Date of Test | 2022-07-06 |
| Factor | DRH18-E | Temp. / Humidity | 23°C /63% |
| Polarity | Vertical | Site / Test Engineer | AC2 / Ares |
| Test Mode | 802.11n-20MHz_TX_CH 1_ANT 0+1 | Test Voltage | AC 120V/60Hz |

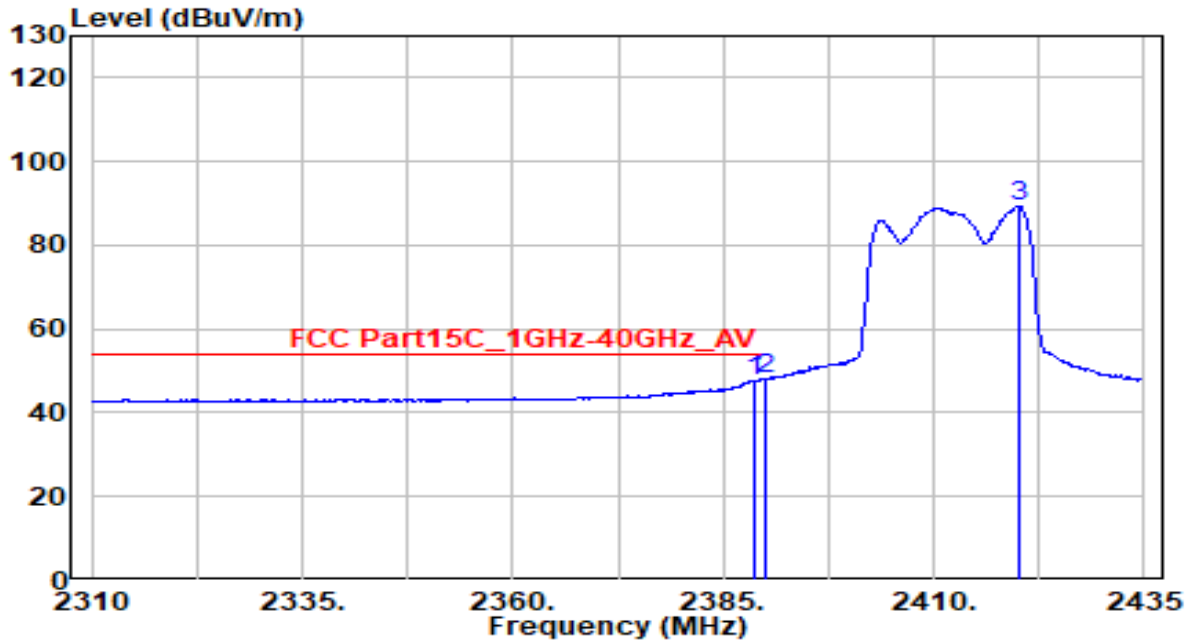

| No | Frequency (MHz) | Reading (dBuV) | C.F (dB/m) | Measurement (dBuV/m) | Margin (dB) | Limit (dBuV/m) | Height (cm) | Angle (deg) | Remark (QP/PK/AV) |
|----|-----------------|----------------|------------|----------------------|-------------|----------------|-------------|-------------|-------------------|
| 1 | 2388.750 | 17.16 | 30.61 | 47.77 | -6.23 | 54.00 | 100 | 40 | Average |
| 2 | * 2390.000 | 17.43 | 30.61 | 48.04 | -5.96 | 54.00 | 100 | 40 | Average |
| 3 | 2420.000 | 58.56 | 30.70 | 89.25 | N/A | N/A | 100 | 40 | Average |

Note:

- "*", means this data is the worst emission level.
- C.F (Correction Factor) = Antenna Factor (dB)+ Cable Loss (dB).
- Measurement (dBuV/m) = Reading(dBuV) + C.F (Correction Factor).
- The emission levels of other frequencies are very lower than the limit and not show in test report.

| | | | |
|-----------|-------------------------------------------------------|----------------------|--------------|
| EUT | AX3000+G1500 Whole Home Powerline Mesh Wi-Fi 6 System | Date of Test | 2022-07-06 |
| Factor | DRH18-E | Temp. / Humidity | 23°C /63% |
| Polarity | Horizontal | Site / Test Engineer | AC2 / Ares |
| Test Mode | 802.11n-20MHz_TX_CH 6_ANT 0+1 | Test Voltage | AC 120V/60Hz |

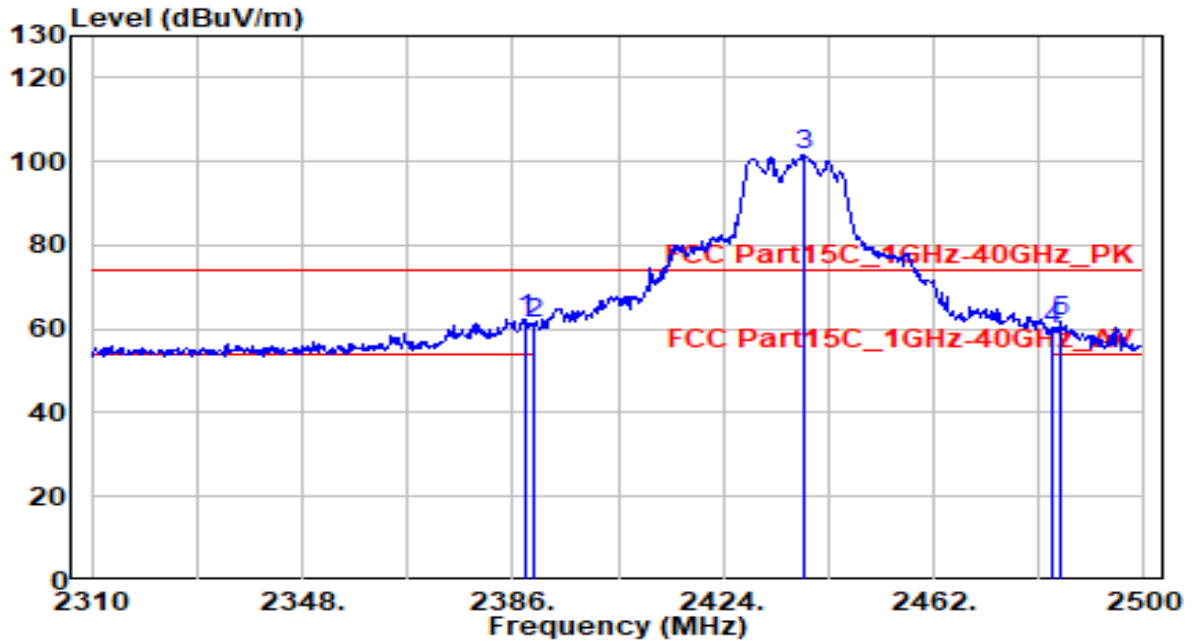

| No | Frequency (MHz) | Reading (dBUV) | C.F (dB/m) | Measurement (dBUV/m) | Margin (dB) | Limit (dBUV/m) | Height (cm) | Angle (deg) | Remark (QP/PK/AV) |
|----|-----------------|----------------|------------|----------------------|-------------|----------------|-------------|-------------|-------------------|
| 1 | * 2388.280 | 31.88 | 30.61 | 62.49 | -11.51 | 74.00 | 105 | 230 | Peak |
| 2 | 2390.000 | 30.91 | 30.61 | 61.52 | -12.48 | 74.00 | 105 | 230 | Peak |
| 3 | 2438.630 | 70.88 | 30.76 | 101.64 | N/A | N/A | 105 | 230 | Peak |
| 4 | 2483.500 | 28.72 | 30.91 | 59.64 | -14.36 | 74.00 | 105 | 230 | Peak |
| 5 | 2484.800 | 30.80 | 30.92 | 61.72 | -12.28 | 74.00 | 105 | 230 | Peak |

Note:

1. " *", means this data is the worst emission level.
2. C.F (Correction Factor) = Antenna Factor (dB)+ Cable Loss (dB).
3. Measurement (dBUV/m) = Reading(dBUV) + C.F (Correction Factor).
4. The emission levels of other frequencies are very lower than the limit and not show in test report.

| | | | |
|-----------|-------------------------------------------------------|----------------------|--------------|
| EUT | AX3000+G1500 Whole Home Powerline Mesh Wi-Fi 6 System | Date of Test | 2022-07-06 |
| Factor | DRH18-E | Temp. / Humidity | 23°C /63% |
| Polarity | Horizontal | Site / Test Engineer | AC2 / Ares |
| Test Mode | 802.11n-20MHz_TX_CH 6_ANT 0+1 | Test Voltage | AC 120V/60Hz |

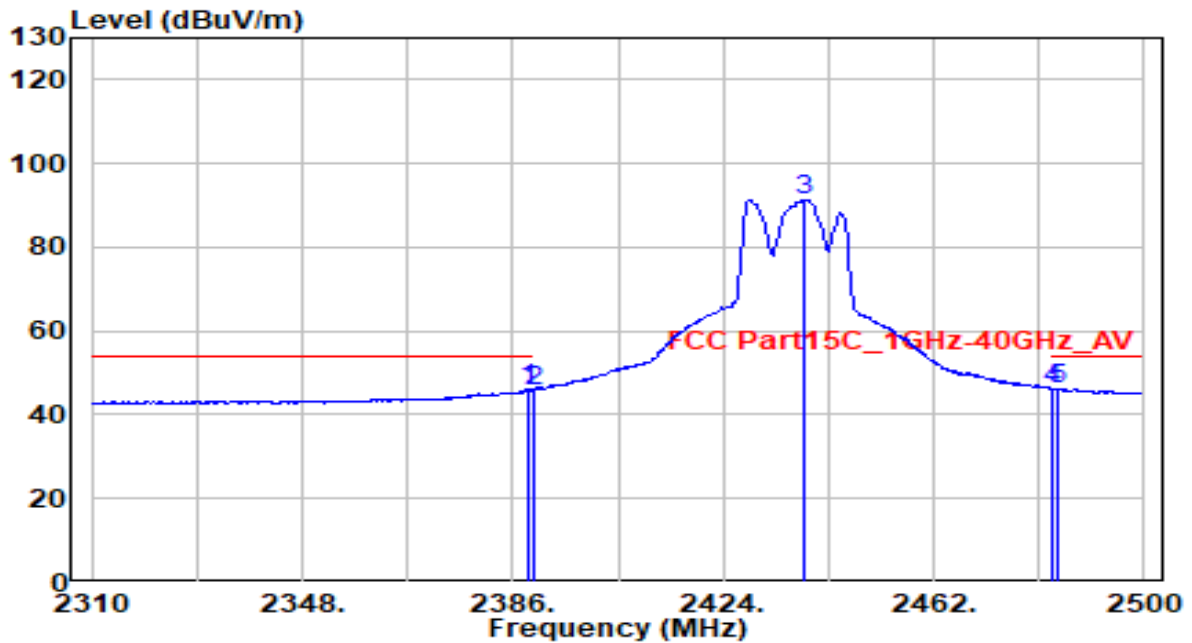

| No | Frequency (MHz) | Reading (dBUV) | C.F (dB/m) | Measurement (dBUV/m) | Margin (dB) | Limit (dBUV/m) | Height (cm) | Angle (deg) | Remark (QP/PK/AV) |
|----|-----------------|----------------|------------|----------------------|-------------|----------------|-------------|-------------|-------------------|
| 1 | * 2388.660 | 15.30 | 30.61 | 45.91 | -8.09 | 54.00 | 105 | 230 | Average |
| 2 | 2390.000 | 15.25 | 30.61 | 45.86 | -8.14 | 54.00 | 105 | 230 | Average |
| 3 | 2438.820 | 60.65 | 30.76 | 91.41 | N/A | N/A | 105 | 230 | Average |
| 4 | 2483.500 | 15.21 | 30.91 | 46.12 | -7.88 | 54.00 | 105 | 230 | Average |
| 5 | 2484.610 | 15.15 | 30.92 | 46.07 | -7.93 | 54.00 | 105 | 230 | Average |

Note:

1. " *", means this data is the worst emission level.
2. C.F (Correction Factor) = Antenna Factor (dB)+ Cable Loss (dB).
3. Measurement (dBUV/m) = Reading(dBUV) + C.F (Correction Factor).
4. The emission levels of other frequencies are very lower than the limit and not show in test report.

| | | | |
|-----------|-------------------------------------------------------|----------------------|--------------|
| EUT | AX3000+G1500 Whole Home Powerline Mesh Wi-Fi 6 System | Date of Test | 2022-07-06 |
| Factor | DRH18-E | Temp. / Humidity | 23°C /63% |
| Polarity | Vertical | Site / Test Engineer | AC2 / Ares |
| Test Mode | 802.11n-20MHz_TX_CH 6_ANT 0+1 | Test Voltage | AC 120V/60Hz |

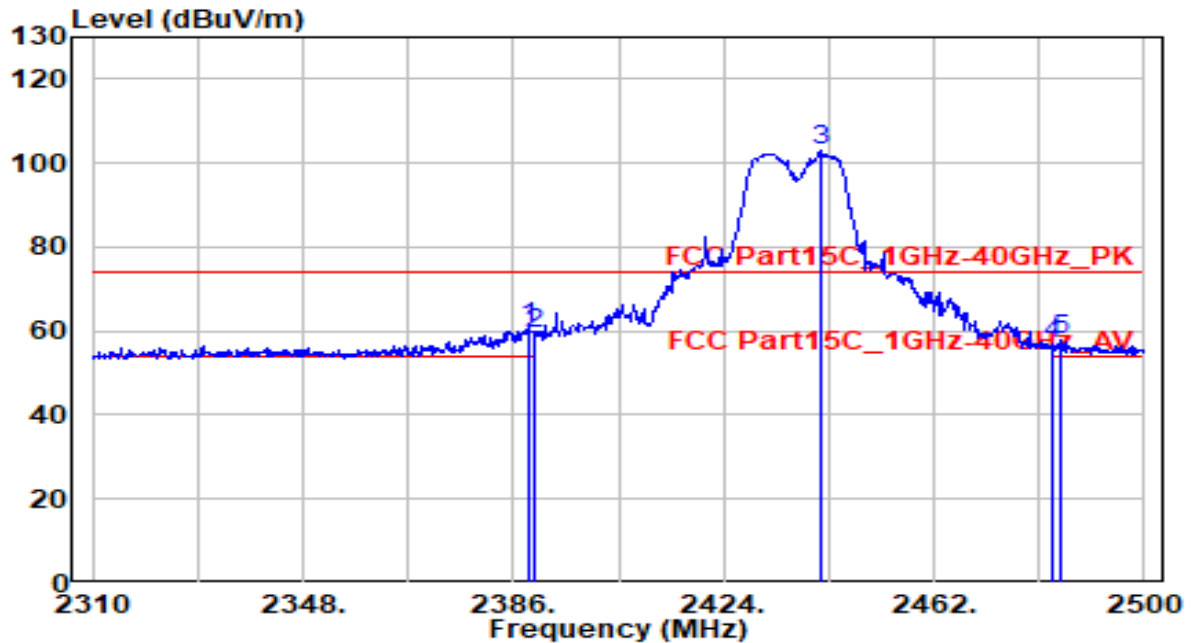

| No | Frequency (MHz) | Reading (dBuV) | C.F (dB/m) | Measurement (dBuV/m) | Margin (dB) | Limit (dBuV/m) | Height (cm) | Angle (deg) | Remark (QP/PK/AV) |
|----|-----------------|----------------|------------|----------------------|-------------|----------------|-------------|-------------|-------------------|
| 1 | * 2389.040 | 30.34 | 30.61 | 60.96 | -13.04 | 74.00 | 110 | 50 | Peak |
| 2 | 2390.000 | 28.67 | 30.61 | 59.28 | -14.72 | 74.00 | 110 | 50 | Peak |
| 3 | 2441.480 | 72.41 | 30.77 | 103.18 | N/A | N/A | 110 | 50 | Peak |
| 4 | 2483.500 | 25.85 | 30.91 | 56.77 | -17.23 | 74.00 | 110 | 50 | Peak |
| 5 | 2484.800 | 26.94 | 30.92 | 57.86 | -16.14 | 74.00 | 110 | 50 | Peak |

Note:

1. " *", means this data is the worst emission level.
2. C.F (Correction Factor) = Antenna Factor (dB)+ Cable Loss (dB).
3. Measurement (dBuV/m) = Reading(dBuV) + C.F (Correction Factor).
4. The emission levels of other frequencies are very lower than the limit and not show in test report.

| | | | |
|-----------|-------------------------------------------------------|----------------------|--------------|
| EUT | AX3000+G1500 Whole Home Powerline Mesh Wi-Fi 6 System | Date of Test | 2022-07-06 |
| Factor | DRH18-E | Temp. / Humidity | 23°C /63% |
| Polarity | Vertical | Site / Test Engineer | AC2 / Ares |
| Test Mode | 802.11n-20MHz_TX_CH 6_ANT 0+1 | Test Voltage | AC 120V/60Hz |

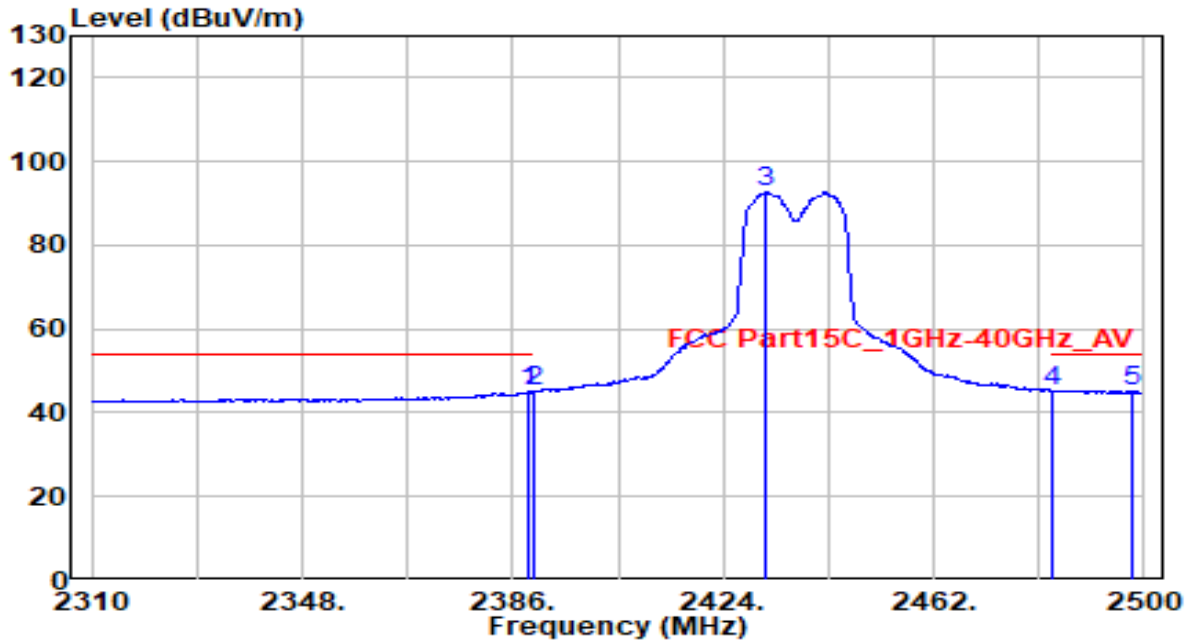

| No | Frequency (MHz) | Reading (dBUV) | C.F (dB/m) | Measurement (dBUV/m) | Margin (dB) | Limit (dBUV/m) | Height (cm) | Angle (deg) | Remark (QP/PK/AV) |
|----|-----------------|----------------|------------|----------------------|-------------|----------------|-------------|-------------|-------------------|
| 1 | 2388.850 | 14.39 | 30.61 | 45.00 | -9.00 | 54.00 | 110 | 50 | Average |
| 2 | 2390.000 | 14.33 | 30.61 | 44.94 | -9.06 | 54.00 | 110 | 50 | Average |
| 3 | 2431.790 | 61.94 | 30.74 | 92.68 | N/A | N/A | 110 | 50 | Average |
| 4 | 2483.500 | 14.19 | 30.91 | 45.10 | -8.90 | 54.00 | 110 | 50 | Average |
| 5 | * 2497.720 | 14.34 | 30.96 | 45.30 | -8.70 | 54.00 | 110 | 50 | Average |

Note:

1. " *", means this data is the worst emission level.
2. C.F (Correction Factor) = Antenna Factor (dB)+ Cable Loss (dB).
3. Measurement (dBUV/m) = Reading(dBUV) + C.F (Correction Factor).
4. The emission levels of other frequencies are very lower than the limit and not show in test report.

| | | | |
|-----------|-------------------------------------------------------|----------------------|--------------|
| EUT | AX3000+G1500 Whole Home Powerline Mesh Wi-Fi 6 System | Date of Test | 2022-07-06 |
| Factor | DRH18-E | Temp. / Humidity | 23°C /63% |
| Polarity | Horizontal | Site / Test Engineer | AC2 / Ares |
| Test Mode | 802.11n-20MHz_TX_CH 11_ANT 0+1 | Test Voltage | AC 120V/60Hz |

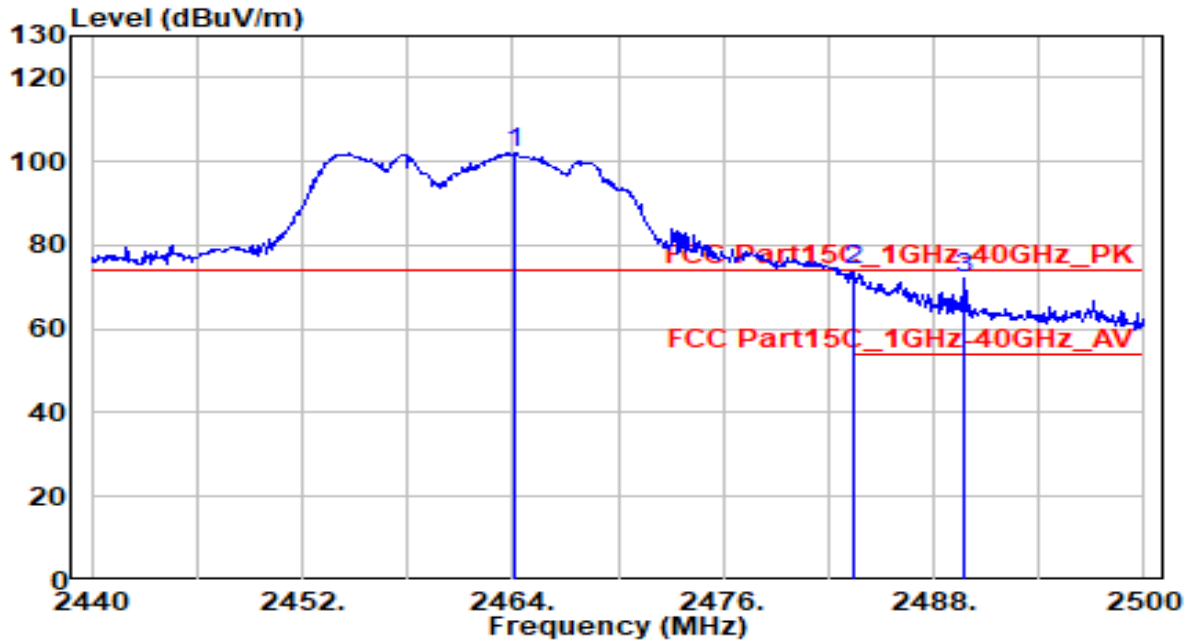

| No | Frequency (MHz) | Reading (dBuV) | C.F (dB/m) | Measurement (dBuV/m) | Margin (dB) | Limit (dBuV/m) | Height (cm) | Angle (deg) | Remark (QP/PK/AV) |
|----|-----------------|----------------|------------|----------------------|-------------|----------------|-------------|-------------|-------------------|
| 1 | 2464.180 | 71.23 | 30.85 | 102.08 | N/A | N/A | 100 | 225 | Peak |
| 2 | * 2483.500 | 42.98 | 30.91 | 73.89 | -0.11 | 74.00 | 100 | 225 | Peak |
| 3 | 2489.740 | 41.02 | 30.93 | 71.95 | -2.05 | 74.00 | 100 | 225 | Peak |

Note:

1. " *", means this data is the worst emission level.
2. C.F (Correction Factor) = Antenna Factor (dB)+ Cable Loss (dB).
3. Measurement (dBuV/m) = Reading(dBuV) + C.F (Correction Factor).
4. The emission levels of other frequencies are very lower than the limit and not show in test report.

| | | | |
|-----------|-------------------------------------------------------|----------------------|--------------|
| EUT | AX3000+G1500 Whole Home Powerline Mesh Wi-Fi 6 System | Date of Test | 2022-07-06 |
| Factor | DRH18-E | Temp. / Humidity | 23°C /63% |
| Polarity | Horizontal | Site / Test Engineer | AC2 / Ares |
| Test Mode | 802.11n-20MHz_TX_CH 11_ANT 0+1 | Test Voltage | AC 120V/60Hz |

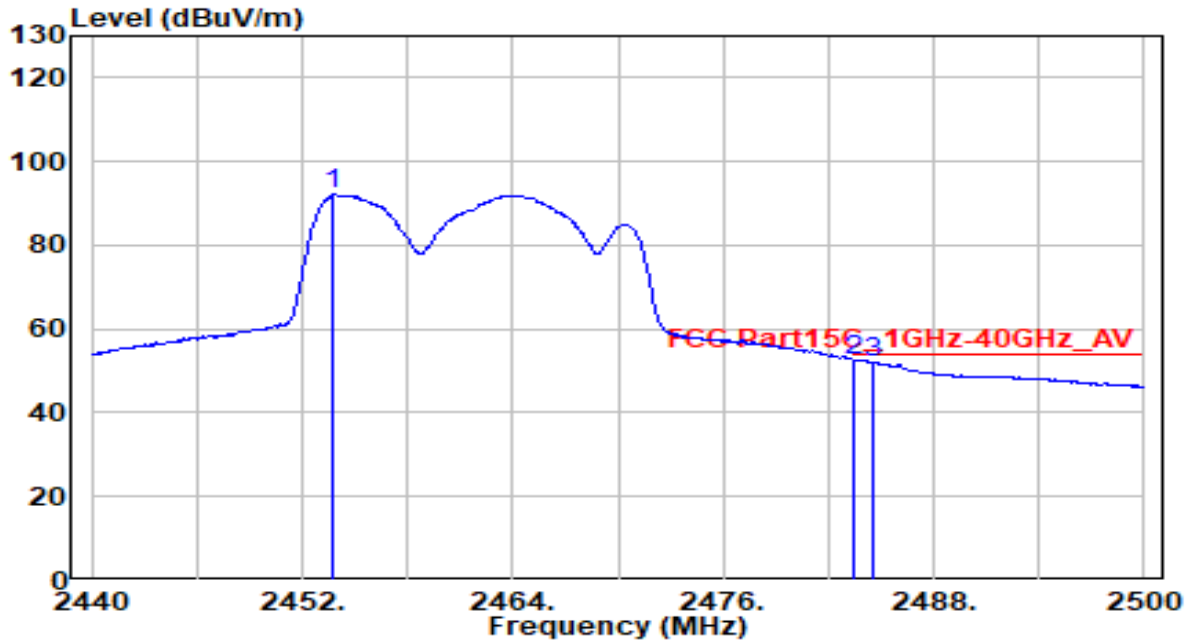

| No | Frequency (MHz) | Reading (dBuV) | C.F (dB/m) | Measurement (dBuV/m) | Margin (dB) | Limit (dBuV/m) | Height (cm) | Angle (deg) | Remark (QP/PK/AV) |
|----|-----------------|----------------|------------|----------------------|-------------|----------------|-------------|-------------|-------------------|
| 1 | 2453.800 | 61.24 | 30.81 | 92.05 | N/A | N/A | 100 | 225 | Average |
| 2 | * 2483.500 | 21.63 | 30.91 | 52.54 | -1.46 | 54.00 | 100 | 225 | Average |
| 3 | 2484.520 | 21.19 | 30.92 | 52.10 | -1.90 | 54.00 | 100 | 225 | Average |

Note:

1. " *", means this data is the worst emission level.
2. C.F (Correction Factor) = Antenna Factor (dB)+ Cable Loss (dB).
3. Measurement (dBuV/m) = Reading(dBuV) + C.F (Correction Factor).
4. The emission levels of other frequencies are very lower than the limit and not show in test report.

| | | | |
|-----------|-------------------------------------------------------|----------------------|--------------|
| EUT | AX3000+G1500 Whole Home Powerline Mesh Wi-Fi 6 System | Date of Test | 2022-07-06 |
| Factor | DRH18-E | Temp. / Humidity | 23°C /63% |
| Polarity | Vertical | Site / Test Engineer | AC2 / Ares |
| Test Mode | 802.11n-20MHz_TX_CH 11_ANT 0+1 | Test Voltage | AC 120V/60Hz |

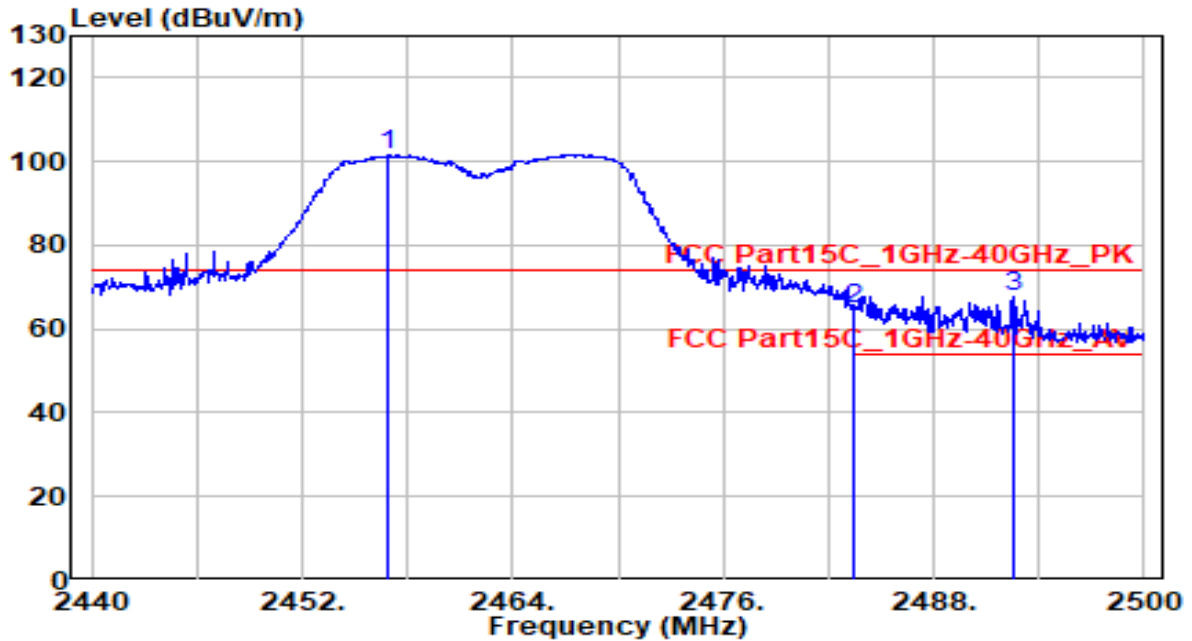

| No | Frequency (MHz) | Reading (dBuV) | C.F (dB/m) | Measurement (dBuV/m) | Margin (dB) | Limit (dBuV/m) | Height (cm) | Angle (deg) | Remark (QP/PK/AV) |
|----|-----------------|----------------|------------|----------------------|-------------|----------------|-------------|-------------|-------------------|
| 1 | 2456.920 | 70.95 | 30.82 | 101.77 | N/A | N/A | 120 | 55 | Peak |
| 2 | 2483.500 | 33.71 | 30.91 | 64.63 | -9.37 | 74.00 | 120 | 55 | Peak |
| 3 | * 2492.620 | 36.96 | 30.94 | 67.91 | -6.09 | 74.00 | 120 | 55 | Peak |

Note:

1. " *", means this data is the worst emission level.
2. C.F (Correction Factor) = Antenna Factor (dB)+ Cable Loss (dB).
3. Measurement (dBuV/m) = Reading(dBuV) + C.F (Correction Factor).
4. The emission levels of other frequencies are very lower than the limit and not show in test report.

| | | | |
|-----------|-------------------------------------------------------|----------------------|--------------|
| EUT | AX3000+G1500 Whole Home Powerline Mesh Wi-Fi 6 System | Date of Test | 2022-07-06 |
| Factor | DRH18-E | Temp. / Humidity | 23°C /63% |
| Polarity | Vertical | Site / Test Engineer | AC2 / Ares |
| Test Mode | 802.11n-20MHz_TX_CH 11_ANT 0+1 | Test Voltage | AC 120V/60Hz |

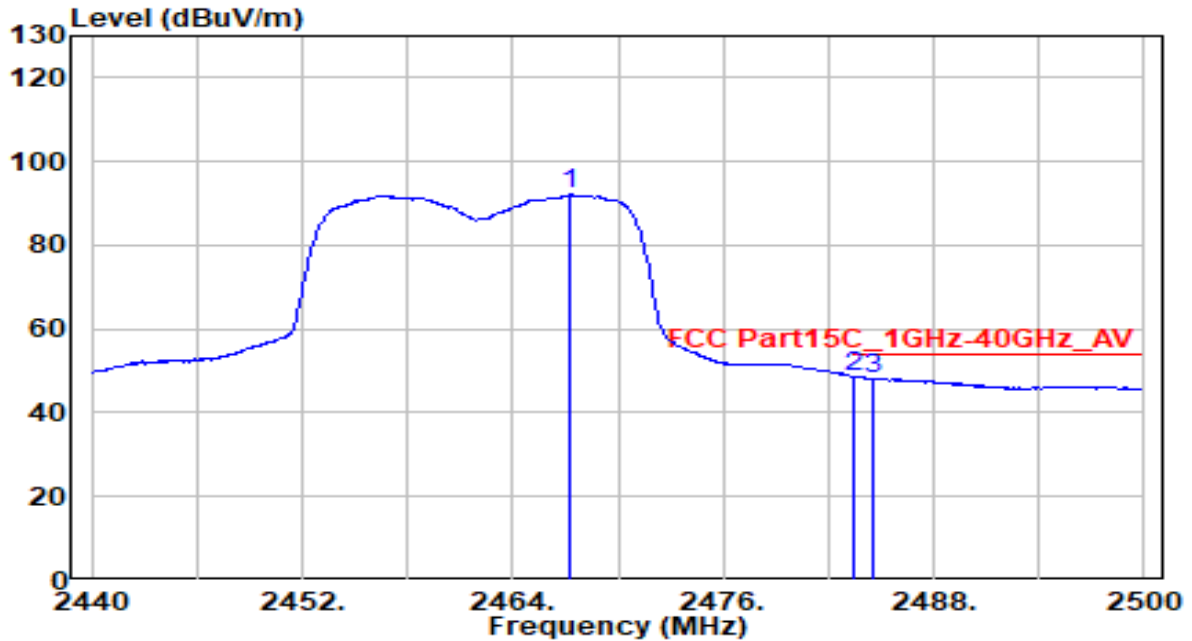

| No | Frequency (MHz) | Reading (dBUV) | C.F (dB/m) | Measurement (dBUV/m) | Margin (dB) | Limit (dBUV/m) | Height (cm) | Angle (deg) | Remark (QP/PK/AV) |
|----|-----------------|----------------|------------|----------------------|-------------|----------------|-------------|-------------|-------------------|
| 1 | 2467.300 | 61.19 | 30.86 | 92.04 | N/A | N/A | 120 | 55 | Average |
| 2 | * 2483.500 | 17.67 | 30.91 | 48.59 | -5.41 | 54.00 | 120 | 55 | Average |
| 3 | 2484.520 | 17.33 | 30.92 | 48.24 | -5.76 | 54.00 | 120 | 55 | Average |

Note:

- "*", means this data is the worst emission level.
- C.F (Correction Factor) = Antenna Factor (dB)+ Cable Loss (dB).
- Measurement (dBUV/m) = Reading(dBUV) + C.F (Correction Factor).
- The emission levels of other frequencies are very lower than the limit and not show in test report.

| | | | |
|-----------|-------------------------------------------------------|----------------------|--------------|
| EUT | AX3000+G1500 Whole Home Powerline Mesh Wi-Fi 6 System | Date of Test | 2022-07-06 |
| Factor | DRH18-E | Temp. / Humidity | 23°C /63% |
| Polarity | Horizontal | Site / Test Engineer | AC2 / Ares |
| Test Mode | 802.11n-40MHz_TX_CH 3_ANT 0+1 | Test Voltage | AC 120V/60Hz |

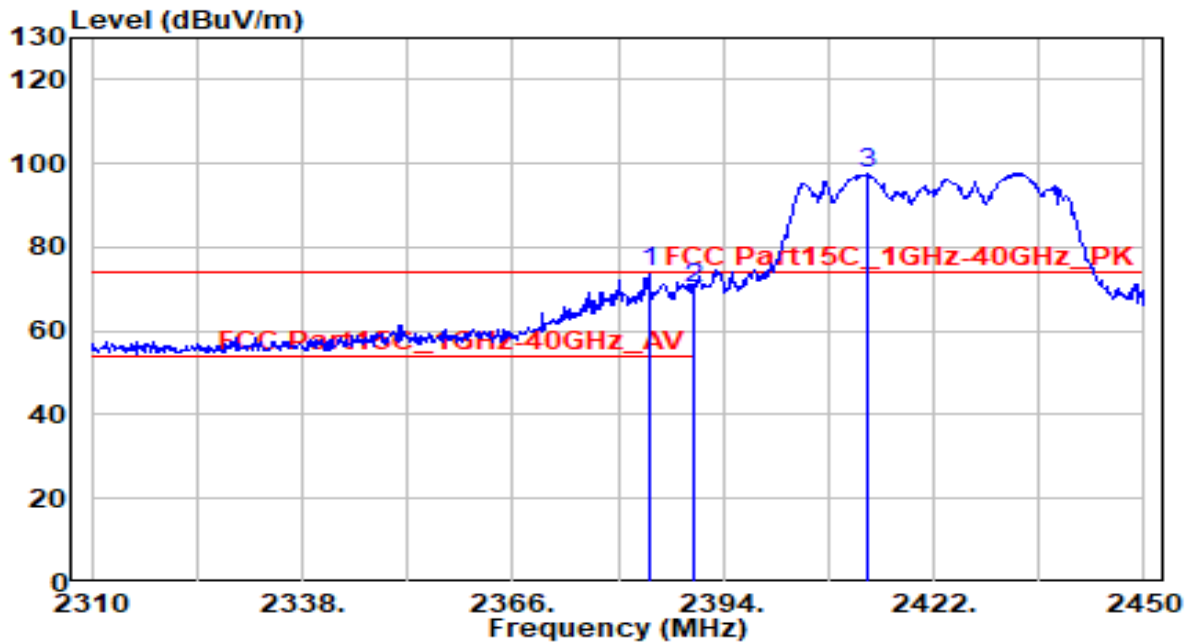

| No | Frequency (MHz) | Reading (dBUV) | C.F (dB/m) | Measurement (dBUV/m) | Margin (dB) | Limit (dBUV/m) | Height (cm) | Angle (deg) | Remark (QP/PK/AV) |
|----|-----------------|----------------|------------|----------------------|-------------|----------------|-------------|-------------|-------------------|
| 1 | * 2384.200 | 43.27 | 30.61 | 73.88 | -0.12 | 74.00 | 105 | 235 | Peak |
| 2 | 2390.000 | 39.45 | 30.61 | 70.06 | -3.94 | 74.00 | 105 | 235 | Peak |
| 3 | 2413.180 | 67.19 | 30.67 | 97.86 | N/A | N/A | 105 | 235 | Peak |

Note:

1. " *", means this data is the worst emission level.
2. C.F (Correction Factor) = Antenna Factor (dB)+ Cable Loss (dB).
3. Measurement (dBUV/m) = Reading(dBUV) + C.F (Correction Factor).
4. The emission levels of other frequencies are very lower than the limit and not show in test report.

| | | | |
|-----------|-------------------------------------------------------|----------------------|--------------|
| EUT | AX3000+G1500 Whole Home Powerline Mesh Wi-Fi 6 System | Date of Test | 2022-07-06 |
| Factor | DRH18-E | Temp. / Humidity | 23°C /63% |
| Polarity | Horizontal | Site / Test Engineer | AC2 / Ares |
| Test Mode | 802.11n-40MHz_TX_CH 3_ANT 0+1 | Test Voltage | AC 120V/60Hz |

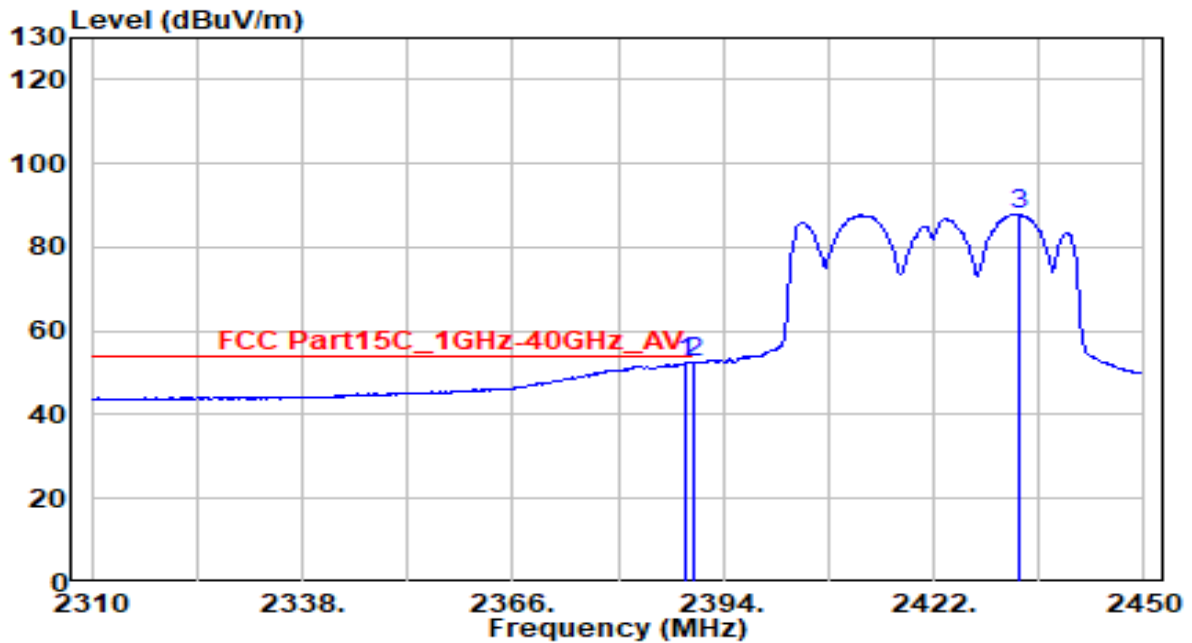

| No | Frequency (MHz) | Reading (dBUV) | C.F (dB/m) | Measurement (dBUV/m) | Margin (dB) | Limit (dBUV/m) | Height (cm) | Angle (deg) | Remark (QP/PK/AV) |
|----|-----------------|----------------|------------|----------------------|-------------|----------------|-------------|-------------|-------------------|
| 1 | 2388.960 | 21.66 | 30.61 | 52.27 | -1.73 | 54.00 | 105 | 235 | Average |
| 2 | * 2390.000 | 21.87 | 30.61 | 52.48 | -1.52 | 54.00 | 105 | 235 | Average |
| 3 | 2433.340 | 57.15 | 30.74 | 87.89 | N/A | N/A | 105 | 235 | Average |

Note:

1. " *", means this data is the worst emission level.
2. C.F (Correction Factor) = Antenna Factor (dB)+ Cable Loss (dB).
3. Measurement (dBUV/m) = Reading(dBUV) + C.F (Correction Factor).
4. The emission levels of other frequencies are very lower than the limit and not show in test report.

| | | | |
|-----------|-------------------------------------------------------|----------------------|--------------|
| EUT | AX3000+G1500 Whole Home Powerline Mesh Wi-Fi 6 System | Date of Test | 2022-07-06 |
| Factor | DRH18-E | Temp. / Humidity | 23°C /63% |
| Polarity | Vertical | Site / Test Engineer | AC2 / Ares |
| Test Mode | 802.11n-40MHz_TX_CH 3_ANT 0+1 | Test Voltage | AC 120V/60Hz |

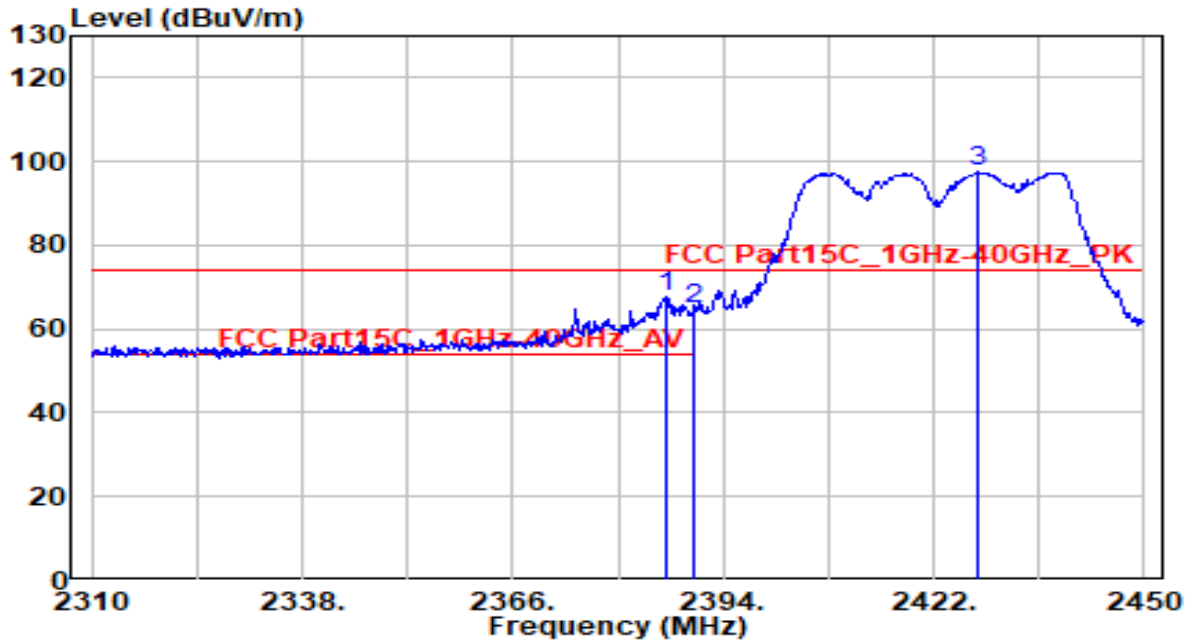

| No | Frequency (MHz) | Reading (dBUV) | C.F (dB/m) | Measurement (dBUV/m) | Margin (dB) | Limit (dBUV/m) | Height (cm) | Angle (deg) | Remark (QP/PK/AV) |
|----|-----------------|----------------|------------|----------------------|-------------|----------------|-------------|-------------|-------------------|
| 1 | * 2386.440 | 37.12 | 30.61 | 67.72 | -6.28 | 74.00 | 110 | 60 | Peak |
| 2 | 2390.000 | 34.37 | 30.61 | 64.98 | -9.02 | 74.00 | 110 | 60 | Peak |
| 3 | 2427.880 | 66.67 | 30.72 | 97.39 | N/A | N/A | 110 | 60 | Peak |

Note:

- "*", means this data is the worst emission level.
- C.F (Correction Factor) = Antenna Factor (dB)+ Cable Loss (dB).
- Measurement (dBUV/m) = Reading(dBUV) + C.F (Correction Factor).
- The emission levels of other frequencies are very lower than the limit and not show in test report.

| | | | |
|-----------|-------------------------------------------------------|----------------------|--------------|
| EUT | AX3000+G1500 Whole Home Powerline Mesh Wi-Fi 6 System | Date of Test | 2022-07-06 |
| Factor | DRH18-E | Temp. / Humidity | 23°C /63% |
| Polarity | Vertical | Site / Test Engineer | AC2 / Ares |
| Test Mode | 802.11n-40MHz_TX_CH 3_ANT 0+1 | Test Voltage | AC 120V/60Hz |

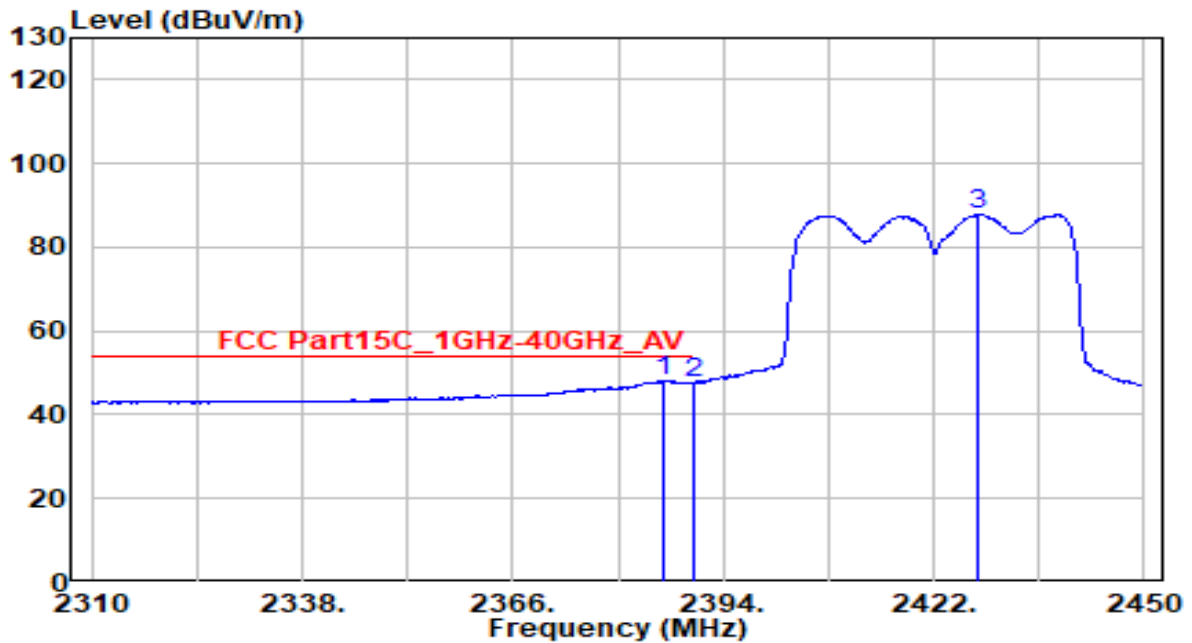

| No | Frequency (MHz) | Reading (dBuV) | C.F (dB/m) | Measurement (dBuV/m) | Margin (dB) | Limit (dBuV/m) | Height (cm) | Angle (deg) | Remark (QP/PK/AV) |
|----|-----------------|----------------|------------|----------------------|-------------|----------------|-------------|-------------|-------------------|
| 1 | * 2386.020 | 17.65 | 30.61 | 48.26 | -5.74 | 54.00 | 110 | 60 | Average |
| 2 | 2390.000 | 16.99 | 30.61 | 47.60 | -6.40 | 54.00 | 110 | 60 | Average |
| 3 | 2428.020 | 57.02 | 30.72 | 87.74 | N/A | N/A | 110 | 60 | Average |

Note:

1. " *", means this data is the worst emission level.
2. C.F (Correction Factor) = Antenna Factor (dB)+ Cable Loss (dB).
3. Measurement (dBuV/m) = Reading(dBuV) + C.F (Correction Factor).
4. The emission levels of other frequencies are very lower than the limit and not show in test report.

| | | | |
|-----------|-------------------------------------------------------|----------------------|--------------|
| EUT | AX3000+G1500 Whole Home Powerline Mesh Wi-Fi 6 System | Date of Test | 2022-07-06 |
| Factor | DRH18-E | Temp. / Humidity | 23°C /63% |
| Polarity | Horizontal | Site / Test Engineer | AC2 / Ares |
| Test Mode | 802.11n-40MHz_TX_CH 6_ANT 0+1 | Test Voltage | AC 120V/60Hz |

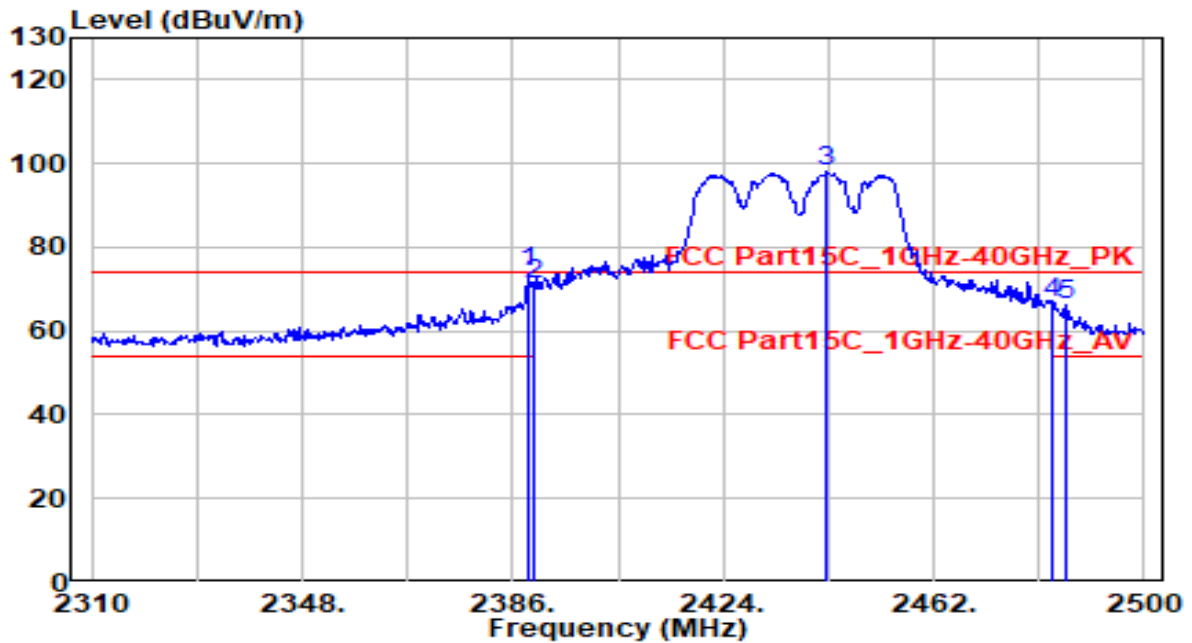

| No | Frequency (MHz) | Reading (dBUV) | C.F (dB/m) | Measurement (dBUV/m) | Margin (dB) | Limit (dBUV/m) | Height (cm) | Angle (deg) | Remark (QP/PK/AV) |
|----|-----------------|----------------|------------|----------------------|-------------|----------------|-------------|-------------|-------------------|
| 1 | * 2388.850 | 43.27 | 30.61 | 73.88 | -0.12 | 74.00 | 105 | 230 | Peak |
| 2 | 2390.000 | 40.63 | 30.61 | 71.24 | -2.76 | 74.00 | 105 | 230 | Peak |
| 3 | 2442.810 | 67.47 | 30.77 | 98.24 | N/A | N/A | 105 | 230 | Peak |
| 4 | 2483.500 | 35.99 | 30.91 | 66.90 | -7.10 | 74.00 | 105 | 230 | Peak |
| 5 | 2486.130 | 35.20 | 30.92 | 66.12 | -7.88 | 74.00 | 105 | 230 | Peak |

Note:

1. " *", means this data is the worst emission level.
2. C.F (Correction Factor) = Antenna Factor (dB)+ Cable Loss (dB).
3. Measurement (dBUV/m) = Reading(dBUV) + C.F (Correction Factor).
4. The emission levels of other frequencies are very lower than the limit and not show in test report.

| | | | |
|-----------|-------------------------------------------------------|----------------------|--------------|
| EUT | AX3000+G1500 Whole Home Powerline Mesh Wi-Fi 6 System | Date of Test | 2022-07-06 |
| Factor | DRH18-E | Temp. / Humidity | 23°C /63% |
| Polarity | Horizontal | Site / Test Engineer | AC2 / Ares |
| Test Mode | 802.11n-40MHz_TX_CH 6_ANT 0+1 | Test Voltage | AC 120V/60Hz |

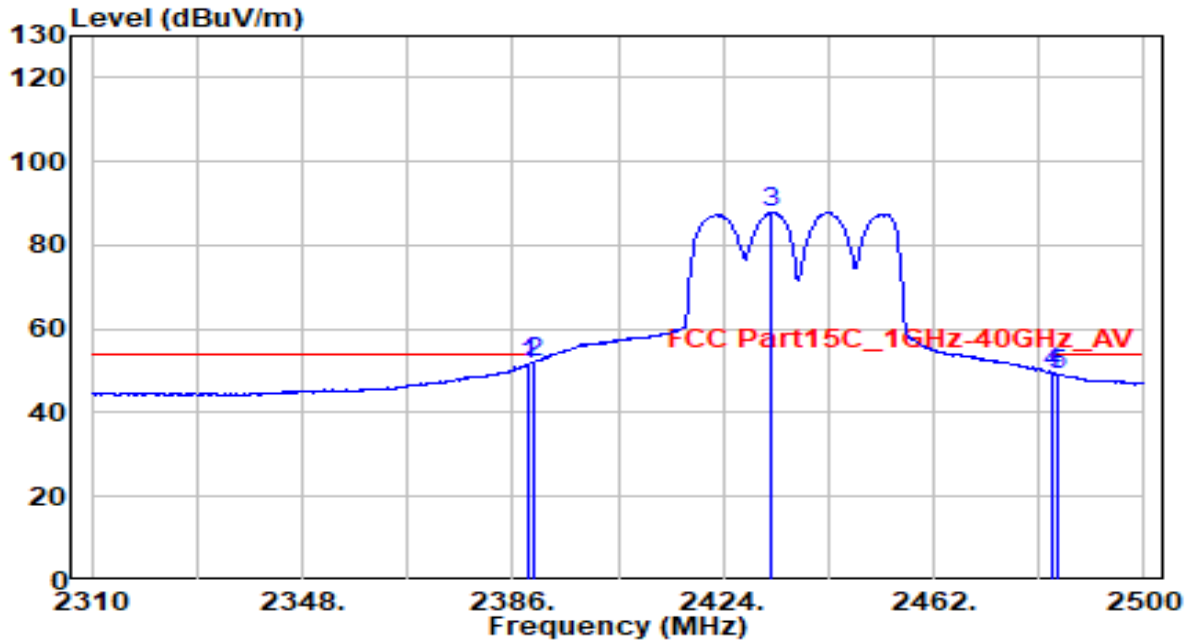

| No | Frequency (MHz) | Reading (dBUV) | C.F (dB/m) | Measurement (dBUV/m) | Margin (dB) | Limit (dBUV/m) | Height (cm) | Angle (deg) | Remark (QP/PK/AV) |
|----|-----------------|----------------|------------|----------------------|-------------|----------------|-------------|-------------|-------------------|
| 1 | 2389.040 | 21.08 | 30.61 | 51.70 | -2.30 | 54.00 | 105 | 235 | Average |
| 2 | * 2390.000 | 21.53 | 30.61 | 52.14 | -1.86 | 54.00 | 105 | 235 | Average |
| 3 | 2432.550 | 57.04 | 30.74 | 87.78 | N/A | N/A | 105 | 235 | Average |
| 4 | 2483.500 | 18.55 | 30.91 | 49.47 | -4.53 | 54.00 | 105 | 235 | Average |
| 5 | 2484.610 | 18.29 | 30.92 | 49.20 | -4.80 | 54.00 | 105 | 235 | Average |

Note:

1. " *", means this data is the worst emission level.
2. C.F (Correction Factor) = Antenna Factor (dB)+ Cable Loss (dB).
3. Measurement (dBUV/m) = Reading(dBUV) + C.F (Correction Factor).
4. The emission levels of other frequencies are very lower than the limit and not show in test report.

| | | | |
|-----------|-------------------------------------------------------|----------------------|--------------|
| EUT | AX3000+G1500 Whole Home Powerline Mesh Wi-Fi 6 System | Date of Test | 2022-07-06 |
| Factor | DRH18-E | Temp. / Humidity | 23°C /63% |
| Polarity | Vertical | Site / Test Engineer | AC2 / Ares |
| Test Mode | 802.11n-40MHz_TX_CH 6_ANT 0+1 | Test Voltage | AC 120V/60Hz |

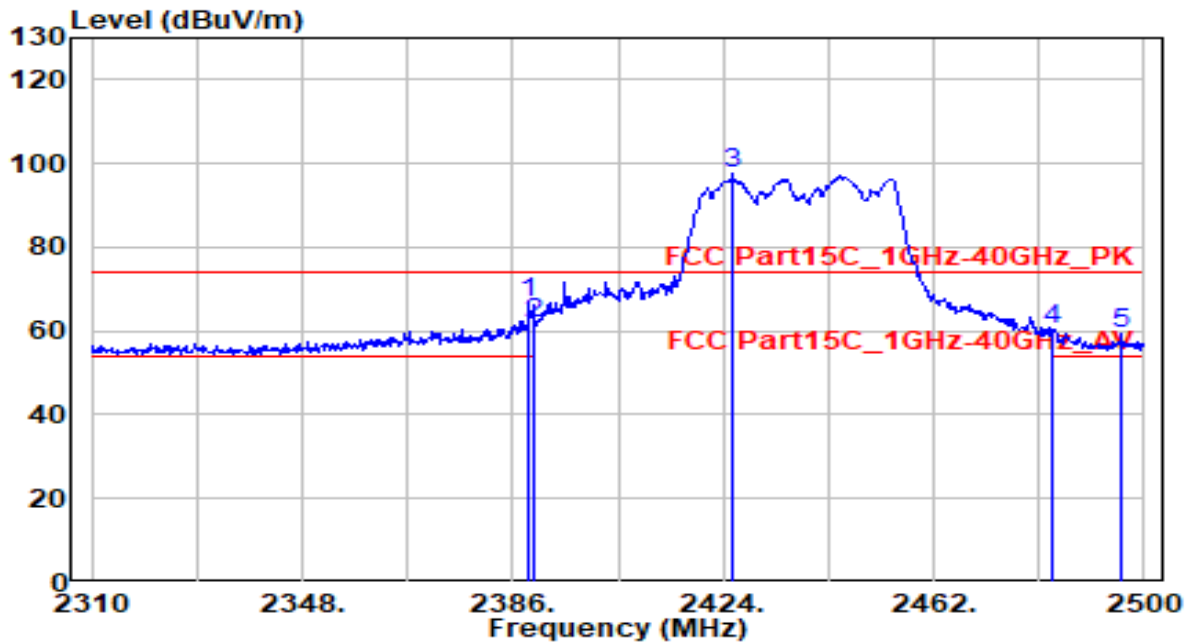

| No | Frequency (MHz) | Reading (dBUV) | C.F (dB/m) | Measurement (dBUV/m) | Margin (dB) | Limit (dBUV/m) | Height (cm) | Angle (deg) | Remark (QP/PK/AV) |
|----|-----------------|----------------|------------|----------------------|-------------|----------------|-------------|-------------|-------------------|
| 1 | * 2388.850 | 36.06 | 30.61 | 66.67 | -7.33 | 74.00 | 100 | 35 | Peak |
| 2 | 2390.000 | 31.43 | 30.61 | 62.04 | -11.96 | 74.00 | 100 | 35 | Peak |
| 3 | 2425.900 | 66.73 | 30.72 | 97.45 | N/A | N/A | 100 | 35 | Peak |
| 4 | 2483.500 | 29.60 | 30.91 | 60.52 | -13.48 | 74.00 | 100 | 35 | Peak |
| 5 | 2496.010 | 28.34 | 30.96 | 59.29 | -14.71 | 74.00 | 100 | 35 | Peak |

Note:

1. " *", means this data is the worst emission level.
2. C.F (Correction Factor) = Antenna Factor (dB)+ Cable Loss (dB).
3. Measurement (dBUV/m) = Reading(dBUV) + C.F (Correction Factor).
4. The emission levels of other frequencies are very lower than the limit and not show in test report.

| | | | |
|-----------|-------------------------------------------------------|----------------------|--------------|
| EUT | AX3000+G1500 Whole Home Powerline Mesh Wi-Fi 6 System | Date of Test | 2022-07-06 |
| Factor | DRH18-E | Temp. / Humidity | 23°C /63% |
| Polarity | Vertical | Site / Test Engineer | AC2 / Ares |
| Test Mode | 802.11n-40MHz_TX_CH 6_ANT 0+1 | Test Voltage | AC 120V/60Hz |

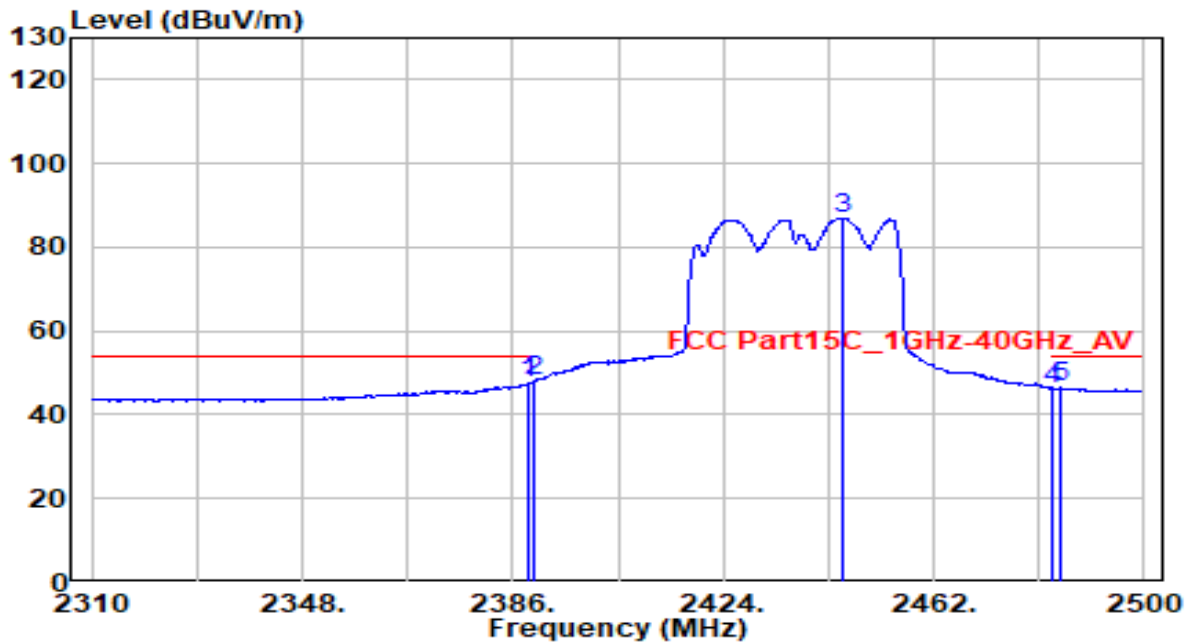

| No | Frequency (MHz) | Reading (dBUV) | C.F (dB/m) | Measurement (dBUV/m) | Margin (dB) | Limit (dBUV/m) | Height (cm) | Angle (deg) | Remark (QP/PK/AV) |
|----|-----------------|----------------|------------|----------------------|-------------|----------------|-------------|-------------|-------------------|
| 1 | 2389.040 | 16.78 | 30.61 | 47.39 | -6.61 | 54.00 | 100 | 35 | Average |
| 2 | * 2390.000 | 17.55 | 30.61 | 48.16 | -5.84 | 54.00 | 100 | 35 | Average |
| 3 | 2445.470 | 56.16 | 30.78 | 86.94 | N/A | N/A | 100 | 35 | Average |
| 4 | 2483.500 | 15.44 | 30.91 | 46.36 | -7.64 | 54.00 | 100 | 35 | Average |
| 5 | 2484.800 | 15.45 | 30.92 | 46.37 | -7.63 | 54.00 | 100 | 35 | Average |

Note:

1. " *", means this data is the worst emission level.
2. C.F (Correction Factor) = Antenna Factor (dB)+ Cable Loss (dB).
3. Measurement (dBUV/m) = Reading(dBUV) + C.F (Correction Factor).
4. The emission levels of other frequencies are very lower than the limit and not show in test report.

| | | | |
|-----------|-------------------------------------------------------|----------------------|--------------|
| EUT | AX3000+G1500 Whole Home Powerline Mesh Wi-Fi 6 System | Date of Test | 2022-07-06 |
| Factor | DRH18-E | Temp. / Humidity | 23°C /63% |
| Polarity | Horizontal | Site / Test Engineer | AC2 / Ares |
| Test Mode | 802.11n-40MHz_TX_CH 9_ANT 0+1 | Test Voltage | AC 120V/60Hz |

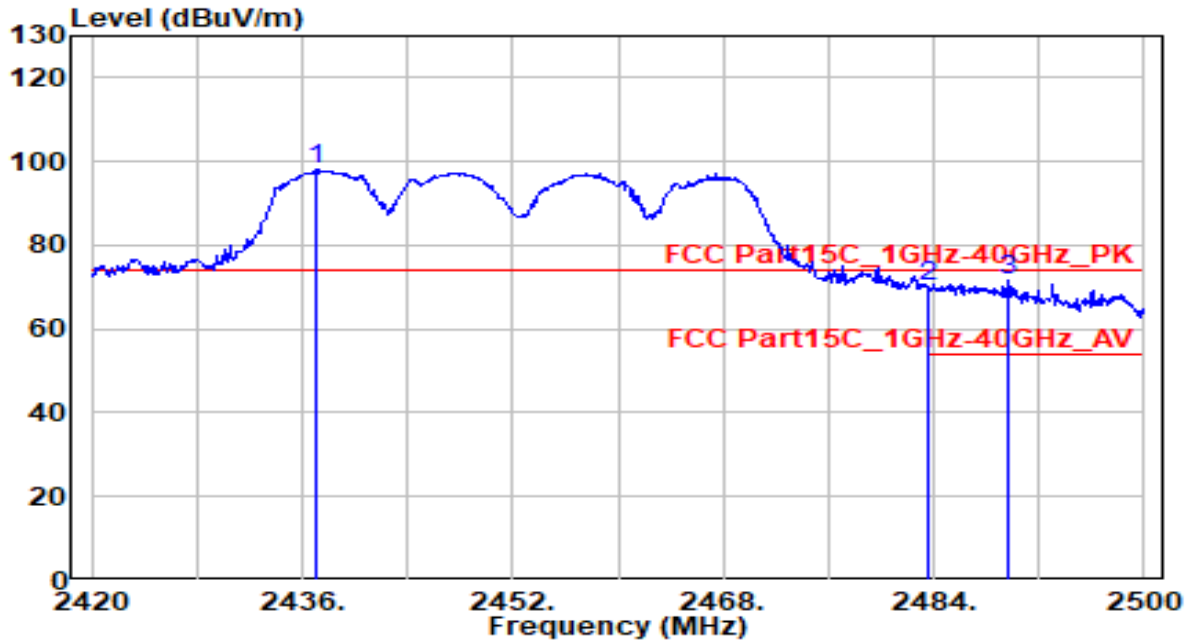

| No | Frequency (MHz) | Reading (dBuV) | C.F (dB/m) | Measurement (dBuV/m) | Margin (dB) | Limit (dBuV/m) | Height (cm) | Angle (deg) | Remark (QP/PK/AV) |
|----|-----------------|----------------|------------|----------------------|-------------|----------------|-------------|-------------|-------------------|
| 1 | 2437.040 | 67.46 | 30.75 | 98.21 | N/A | N/A | 105 | 235 | Peak |
| 2 | 2483.500 | 39.23 | 30.91 | 70.14 | -3.86 | 74.00 | 105 | 235 | Peak |
| 3 | * 2489.600 | 40.47 | 30.93 | 71.41 | -2.59 | 74.00 | 105 | 235 | Peak |

Note:

1. " *", means this data is the worst emission level.
2. C.F (Correction Factor) = Antenna Factor (dB)+ Cable Loss (dB).
3. Measurement (dBuV/m) = Reading(dBuV) + C.F (Correction Factor).
4. The emission levels of other frequencies are very lower than the limit and not show in test report.

| | | | |
|-----------|-------------------------------------------------------|----------------------|--------------|
| EUT | AX3000+G1500 Whole Home Powerline Mesh Wi-Fi 6 System | Date of Test | 2022-07-06 |
| Factor | DRH18-E | Temp. / Humidity | 23°C /63% |
| Polarity | Horizontal | Site / Test Engineer | AC2 / Ares |
| Test Mode | 802.11n-40MHz_TX_CH 9_ANT 0+1 | Test Voltage | AC 120V/60Hz |

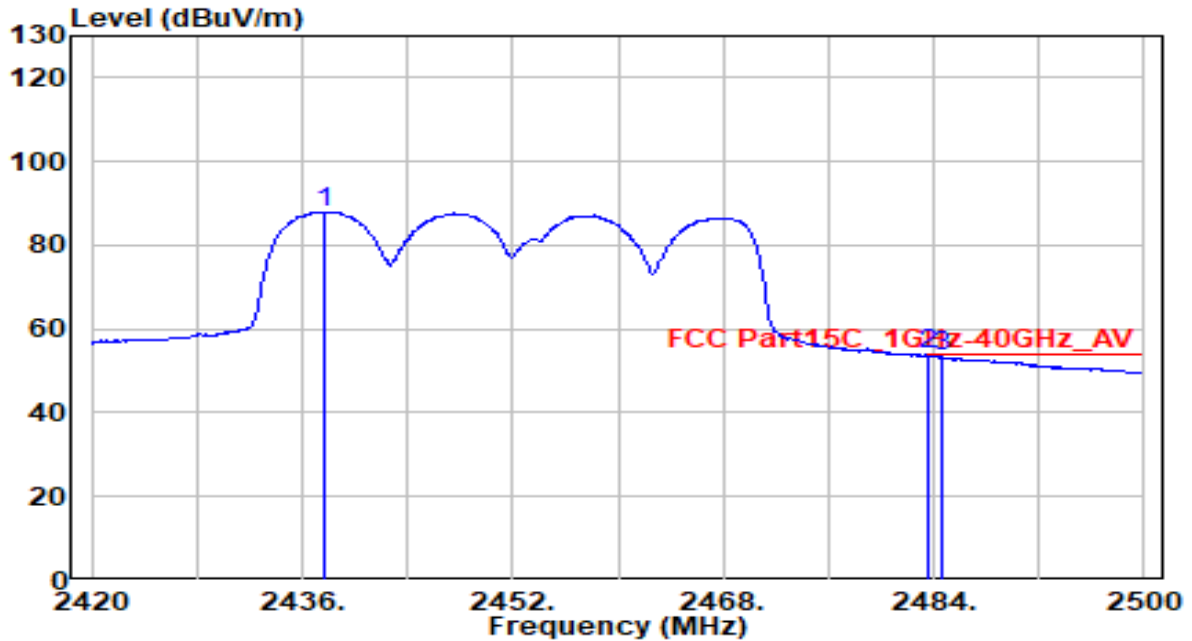

| No | Frequency (MHz) | Reading (dBuV) | C.F (dB/m) | Measurement (dBuV/m) | Margin (dB) | Limit (dBuV/m) | Height (cm) | Angle (deg) | Remark (QP/PK/AV) |
|----|-----------------|----------------|------------|----------------------|-------------|----------------|-------------|-------------|-------------------|
| 1 | 2437.680 | 57.17 | 30.76 | 87.93 | N/A | N/A | 105 | 235 | Average |
| 2 | * 2483.500 | 22.93 | 30.91 | 53.84 | -0.16 | 54.00 | 105 | 235 | Average |
| 3 | 2484.640 | 22.32 | 30.92 | 53.23 | -0.77 | 54.00 | 105 | 235 | Average |

Note:

- "*", means this data is the worst emission level.
- C.F (Correction Factor) = Antenna Factor (dB)+ Cable Loss (dB).
- Measurement (dBuV/m) = Reading(dBuV) + C.F (Correction Factor).
- The emission levels of other frequencies are very lower than the limit and not show in test report.

| | | | |
|-----------|-------------------------------------------------------|----------------------|--------------|
| EUT | AX3000+G1500 Whole Home Powerline Mesh Wi-Fi 6 System | Date of Test | 2022-07-06 |
| Factor | DRH18-E | Temp. / Humidity | 23°C /63% |
| Polarity | Vertical | Site / Test Engineer | AC2 / Ares |
| Test Mode | 802.11n-40MHz_TX_CH 9_ANT 0+1 | Test Voltage | AC 120V/60Hz |

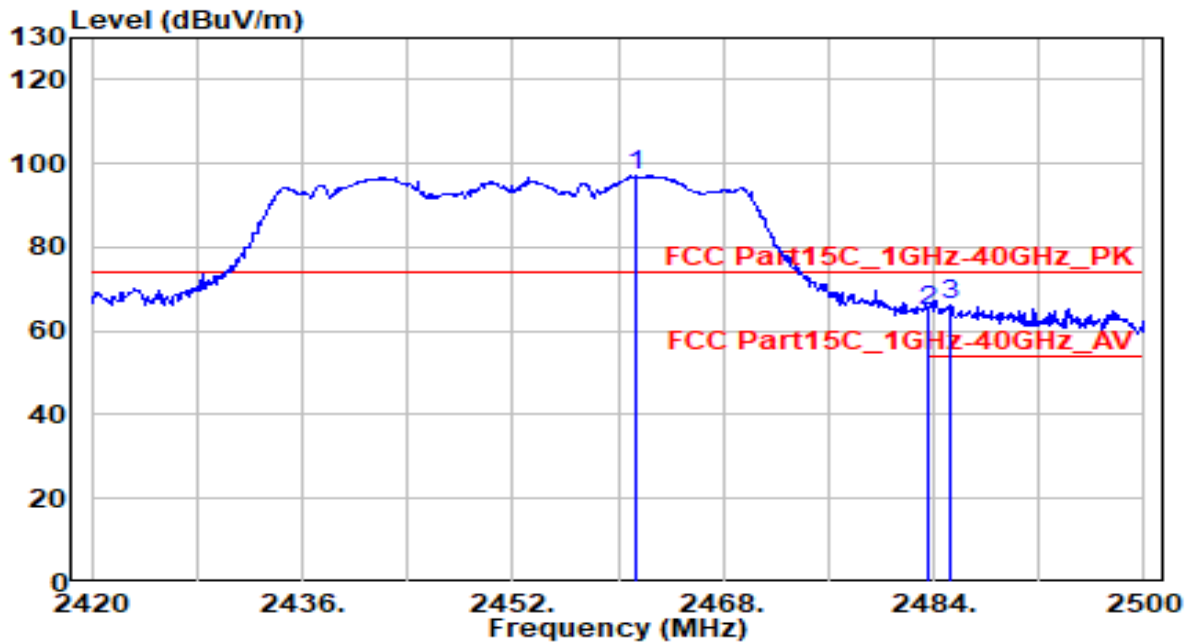

| No | Frequency (MHz) | Reading (dBUV) | C.F (dB/m) | Measurement (dBUV/m) | Margin (dB) | Limit (dBUV/m) | Height (cm) | Angle (deg) | Remark (QP/PK/AV) |
|----|-----------------|----------------|------------|----------------------|-------------|----------------|-------------|-------------|-------------------|
| 1 | 2461.440 | 66.33 | 30.84 | 97.17 | N/A | N/A | 100 | 55 | Peak |
| 2 | 2483.500 | 34.05 | 30.91 | 64.97 | -9.03 | 74.00 | 100 | 55 | Peak |
| 3 | * 2485.200 | 35.11 | 30.92 | 66.03 | -7.97 | 74.00 | 100 | 55 | Peak |

Note:

1. " *", means this data is the worst emission level.
2. C.F (Correction Factor) = Antenna Factor (dB)+ Cable Loss (dB).
3. Measurement (dBUV/m) = Reading(dBUV) + C.F (Correction Factor).
4. The emission levels of other frequencies are very lower than the limit and not show in test report.

| | | | |
|-----------|-------------------------------------------------------|----------------------|--------------|
| EUT | AX3000+G1500 Whole Home Powerline Mesh Wi-Fi 6 System | Date of Test | 2022-07-06 |
| Factor | DRH18-E | Temp. / Humidity | 23°C /63% |
| Polarity | Vertical | Site / Test Engineer | AC2 / Ares |
| Test Mode | 802.11n-40MHz_TX_CH 9_ANT 0+1 | Test Voltage | AC 120V/60Hz |

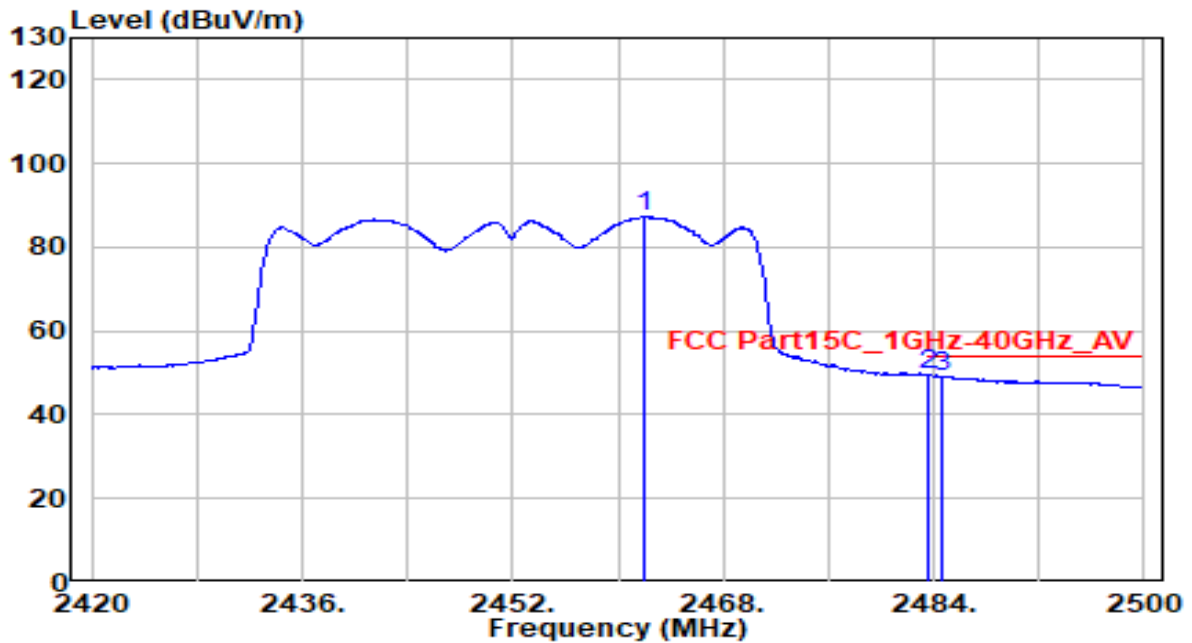

| No | Frequency (MHz) | Reading (dBUV) | C.F (dB/m) | Measurement (dBUV/m) | Margin (dB) | Limit (dBUV/m) | Height (cm) | Angle (deg) | Remark (QP/PK/AV) |
|----|-----------------|----------------|------------|----------------------|-------------|----------------|-------------|-------------|-------------------|
| 1 | 2462.080 | 56.40 | 30.84 | 87.24 | N/A | N/A | 100 | 55 | Average |
| 2 | * 2483.500 | 18.44 | 30.91 | 49.36 | -4.64 | 54.00 | 100 | 55 | Average |
| 3 | 2484.560 | 18.30 | 30.92 | 49.21 | -4.79 | 54.00 | 100 | 55 | Average |

Note:

- "*", means this data is the worst emission level.
- C.F (Correction Factor) = Antenna Factor (dB)+ Cable Loss (dB).
- Measurement (dBUV/m) = Reading(dBUV) + C.F (Correction Factor).
- The emission levels of other frequencies are very lower than the limit and not show in test report.

| | | | |
|-----------|-------------------------------------------------------|----------------------|--------------|
| EUT | AX3000+G1500 Whole Home Powerline Mesh Wi-Fi 6 System | Date of Test | 2022-07-06 |
| Factor | DRH18-E | Temp. / Humidity | 23°C /63% |
| Polarity | Horizontal | Site / Test Engineer | AC2 / Ares |
| Test Mode | 802.11ax-20MHz_TX_CH 1_ANT 0+1 | Test Voltage | AC 120V/60Hz |

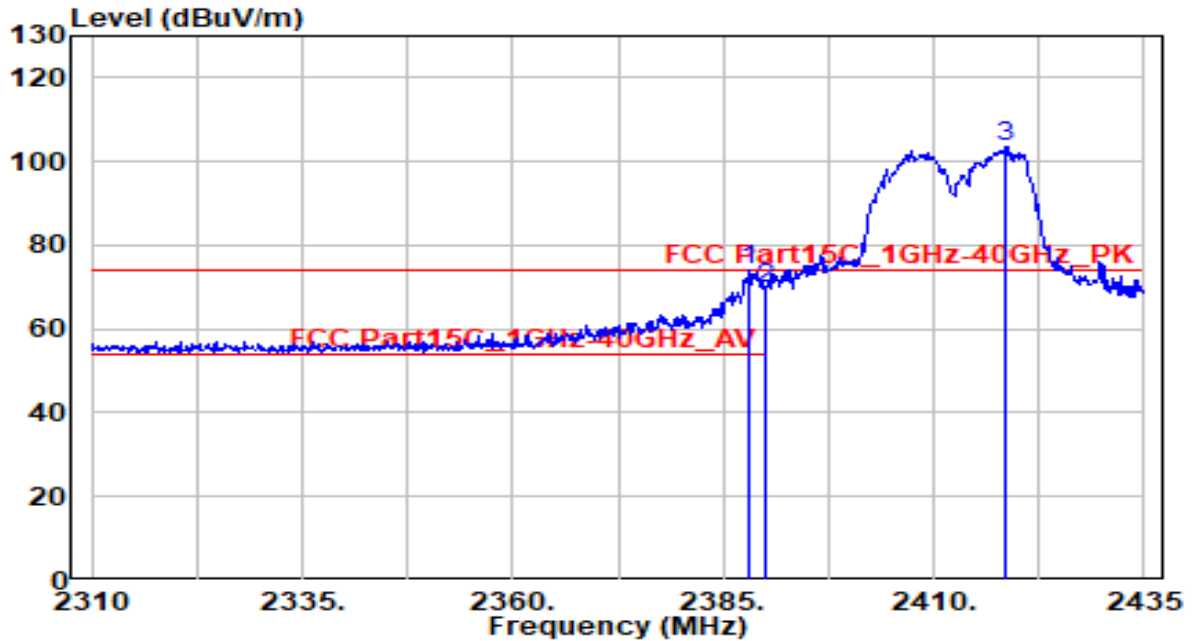

| No | Frequency (MHz) | Reading (dBUV) | C.F (dB/m) | Measurement (dBUV/m) | Margin (dB) | Limit (dBUV/m) | Height (cm) | Angle (deg) | Remark (QP/PK/AV) |
|----|-----------------|----------------|------------|----------------------|-------------|----------------|-------------|-------------|-------------------|
| 1 | * 2388.125 | 43.22 | 30.61 | 73.83 | -0.17 | 74.00 | 145 | 225 | Peak |
| 2 | 2390.000 | 39.20 | 30.61 | 69.81 | -4.19 | 74.00 | 145 | 225 | Peak |
| 3 | 2418.625 | 72.64 | 30.69 | 103.34 | N/A | N/A | 145 | 225 | Peak |

Note:

1. " *", means this data is the worst emission level.
2. C.F (Correction Factor) = Antenna Factor (dB)+ Cable Loss (dB).
3. Measurement (dBUV/m) = Reading(dBUV) + C.F (Correction Factor).
4. The emission levels of other frequencies are very lower than the limit and not show in test report.

| | | | |
|-----------|-------------------------------------------------------|----------------------|--------------|
| EUT | AX3000+G1500 Whole Home Powerline Mesh Wi-Fi 6 System | Date of Test | 2022-07-06 |
| Factor | DRH18-E | Temp. / Humidity | 23°C /63% |
| Polarity | Horizontal | Site / Test Engineer | AC2 / Ares |
| Test Mode | 802.11ax-20MHz_TX_CH 1_ANT 0+1 | Test Voltage | AC 120V/60Hz |

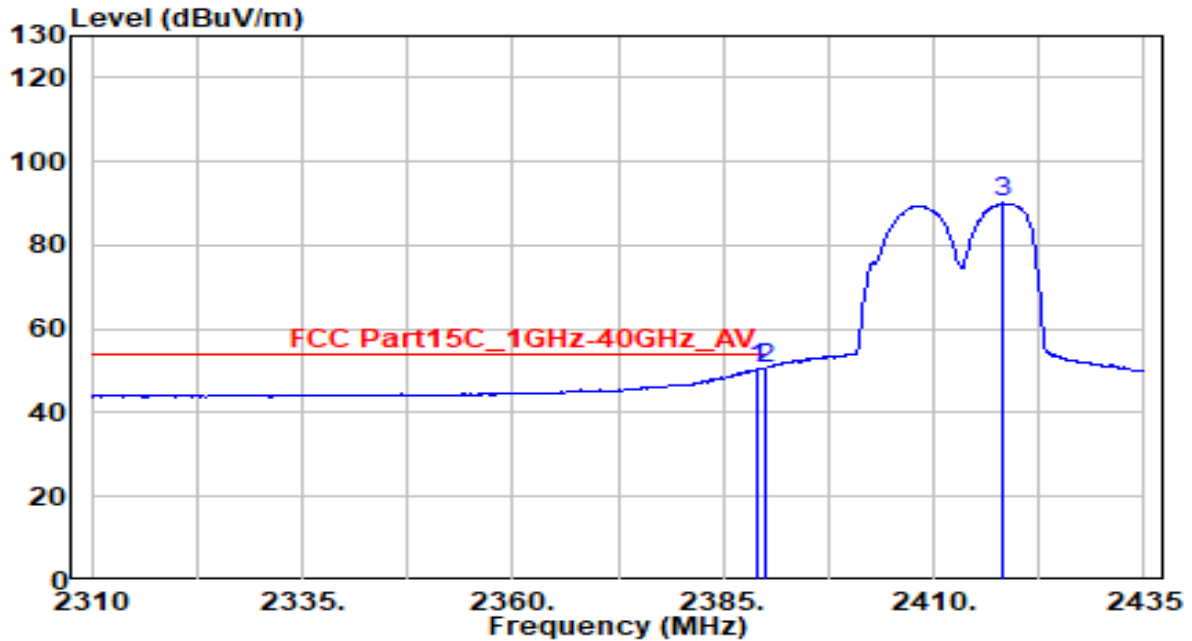

| No | Frequency (MHz) | Reading (dBuV) | C.F (dB/m) | Measurement (dBuV/m) | Margin (dB) | Limit (dBuV/m) | Height (cm) | Angle (deg) | Remark (QP/PK/AV) |
|----|-----------------|----------------|------------|----------------------|-------------|----------------|-------------|-------------|-------------------|
| 1 | 2389.000 | 19.77 | 30.61 | 50.38 | -3.62 | 54.00 | 145 | 225 | Average |
| 2 | * 2390.000 | 20.04 | 30.61 | 50.65 | -3.35 | 54.00 | 145 | 225 | Average |
| 3 | 2418.250 | 59.47 | 30.69 | 90.16 | N/A | N/A | 145 | 225 | Average |

Note:

- "*", means this data is the worst emission level.
- C.F (Correction Factor) = Antenna Factor (dB)+ Cable Loss (dB).
- Measurement (dBuV/m) = Reading(dBuV) + C.F (Correction Factor).
- The emission levels of other frequencies are very lower than the limit and not show in test report.

| | | | |
|-----------|-------------------------------------------------------|----------------------|--------------|
| EUT | AX3000+G1500 Whole Home Powerline Mesh Wi-Fi 6 System | Date of Test | 2022-07-06 |
| Factor | DRH18-E | Temp. / Humidity | 23°C /63% |
| Polarity | Vertical | Site / Test Engineer | AC2 / Ares |
| Test Mode | 802.11ax-20MHz_TX_CH 1_ANT 0+1 | Test Voltage | AC 120V/60Hz |

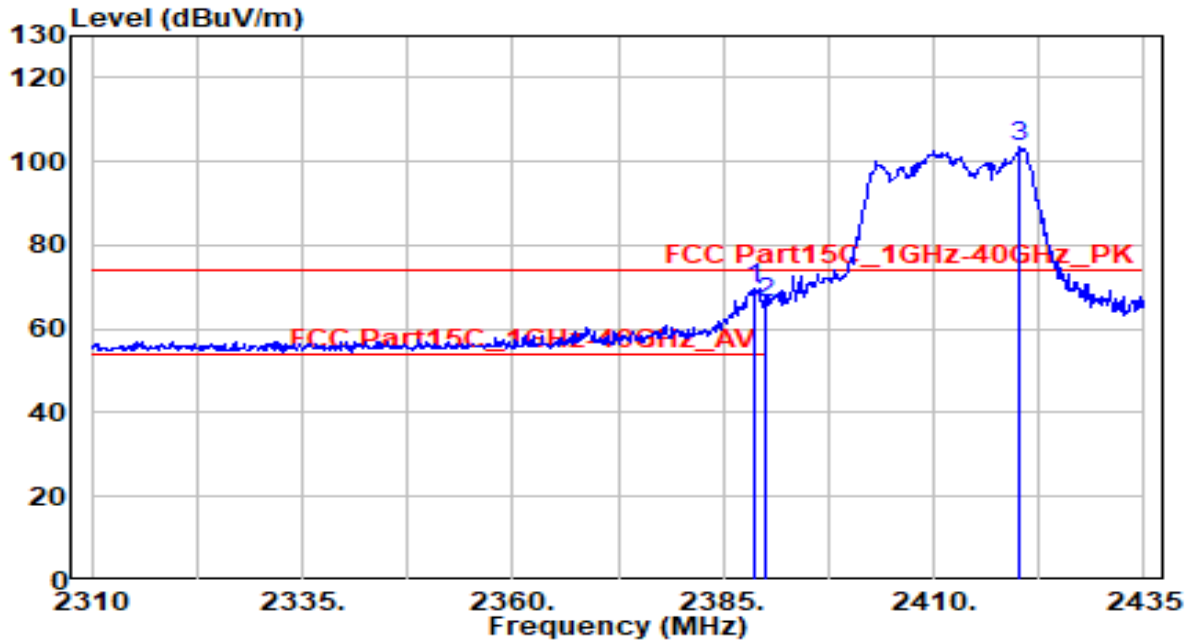

| No | Frequency (MHz) | Reading (dBUV) | C.F (dB/m) | Measurement (dBUV/m) | Margin (dB) | Limit (dBUV/m) | Height (cm) | Angle (deg) | Remark (QP/PK/AV) |
|----|-----------------|----------------|------------|----------------------|-------------|----------------|-------------|-------------|-------------------|
| 1 | * 2388.625 | 38.88 | 30.61 | 69.49 | -4.51 | 74.00 | 100 | 40 | Peak |
| 2 | 2390.000 | 35.57 | 30.61 | 66.18 | -7.82 | 74.00 | 100 | 40 | Peak |
| 3 | 2420.250 | 72.58 | 30.70 | 103.28 | N/A | N/A | 100 | 40 | Peak |

Note:

1. " *", means this data is the worst emission level.
2. C.F (Correction Factor) = Antenna Factor (dB)+ Cable Loss (dB).
3. Measurement (dBUV/m) = Reading(dBUV) + C.F (Correction Factor).
4. The emission levels of other frequencies are very lower than the limit and not show in test report.

| | | | |
|-----------|-------------------------------------------------------|----------------------|--------------|
| EUT | AX3000+G1500 Whole Home Powerline Mesh Wi-Fi 6 System | Date of Test | 2022-07-06 |
| Factor | DRH18-E | Temp. / Humidity | 23°C /63% |
| Polarity | Vertical | Site / Test Engineer | AC2 / Ares |
| Test Mode | 802.11ax-20MHz_TX_CH 1_ANT 0+1 | Test Voltage | AC 120V/60Hz |

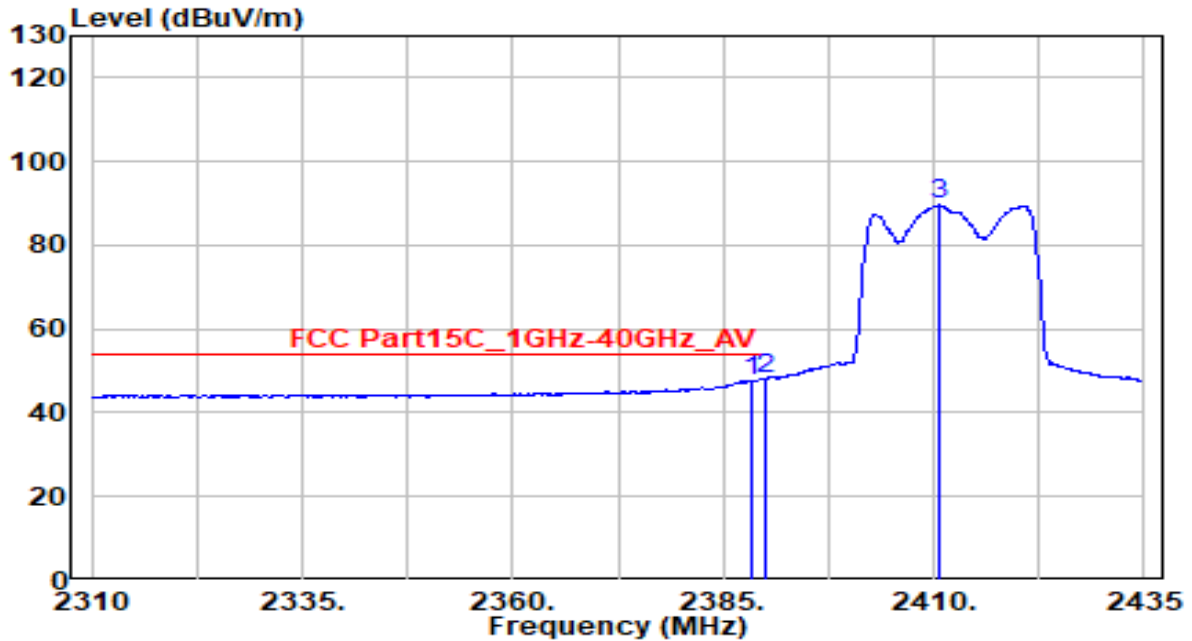

| No | Frequency (MHz) | Reading (dBuV) | C.F (dB/m) | Measurement (dBuV/m) | Margin (dB) | Limit (dBuV/m) | Height (cm) | Angle (deg) | Remark (QP/PK/AV) |
|----|-----------------|----------------|------------|----------------------|-------------|----------------|-------------|-------------|-------------------|
| 1 | 2388.375 | 17.07 | 30.61 | 47.69 | -6.31 | 54.00 | 100 | 40 | Average |
| 2 | * 2390.000 | 17.29 | 30.61 | 47.90 | -6.10 | 54.00 | 100 | 40 | Average |
| 3 | 2410.750 | 58.87 | 30.66 | 89.54 | N/A | N/A | 100 | 40 | Average |

Note:

1. " *", means this data is the worst emission level.
2. C.F (Correction Factor) = Antenna Factor (dB)+ Cable Loss (dB).
3. Measurement (dBuV/m) = Reading(dBuV) + C.F (Correction Factor).
4. The emission levels of other frequencies are very lower than the limit and not show in test report.

| | | | |
|-----------|-------------------------------------------------------|----------------------|--------------|
| EUT | AX3000+G1500 Whole Home Powerline Mesh Wi-Fi 6 System | Date of Test | 2022-07-06 |
| Factor | DRH18-E | Temp. / Humidity | 23°C /63% |
| Polarity | Horizontal | Site / Test Engineer | AC2 / Ares |
| Test Mode | 802.11ax-20MHz_TX_CH 2_ANT 0+1 | Test Voltage | AC 120V/60Hz |

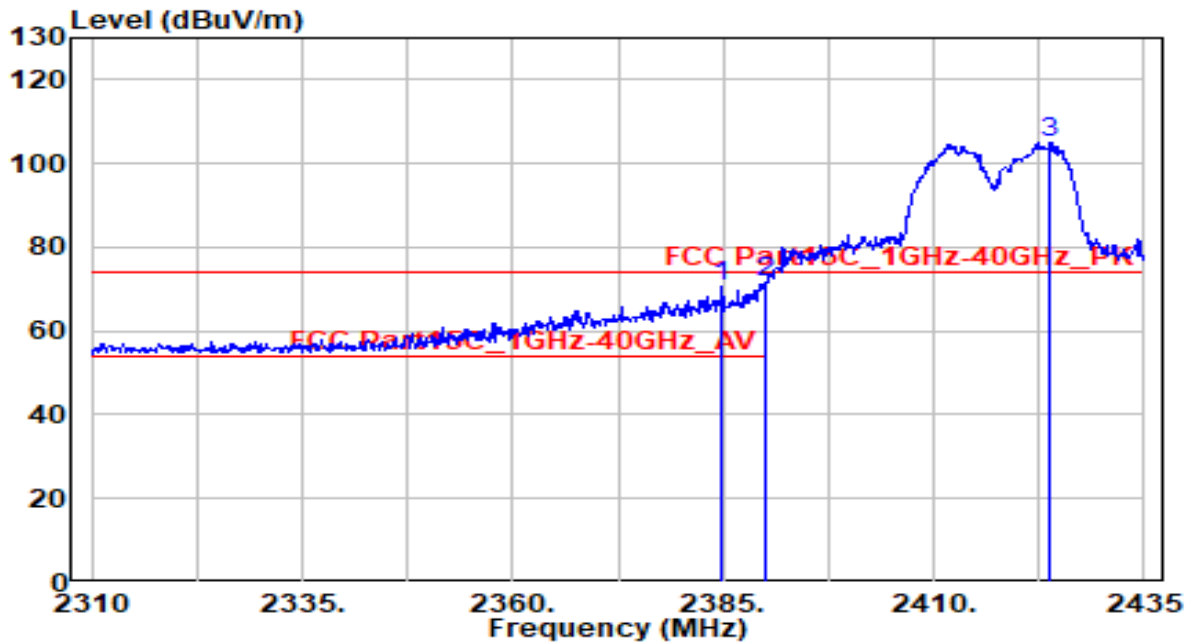

| No | Frequency (MHz) | Reading (dBUV) | C.F (dB/m) | Measurement (dBUV/m) | Margin (dB) | Limit (dBUV/m) | Height (cm) | Angle (deg) | Remark (QP/PK/AV) |
|----|-----------------|----------------|------------|----------------------|-------------|----------------|-------------|-------------|-------------------|
| 1 | 2384.750 | 40.17 | 30.61 | 70.78 | -3.22 | 74.00 | 170 | 230 | Peak |
| 2 | * 2390.000 | 40.96 | 30.61 | 71.57 | -2.43 | 74.00 | 170 | 230 | Peak |
| 3 | 2423.875 | 74.25 | 30.71 | 104.96 | N/A | N/A | 170 | 230 | Peak |

Note:

1. " *", means this data is the worst emission level.
2. C.F (Correction Factor) = Antenna Factor (dB)+ Cable Loss (dB).
3. Measurement (dBUV/m) = Reading(dBUV) + C.F (Correction Factor).
4. The emission levels of other frequencies are very lower than the limit and not show in test report.

| | | | |
|-----------|-------------------------------------------------------|----------------------|--------------|
| EUT | AX3000+G1500 Whole Home Powerline Mesh Wi-Fi 6 System | Date of Test | 2022-07-06 |
| Factor | DRH18-E | Temp. / Humidity | 23°C /63% |
| Polarity | Horizontal | Site / Test Engineer | AC2 / Ares |
| Test Mode | 802.11ax-20MHz_TX_CH 2_ANT 0+1 | Test Voltage | AC 120V/60Hz |

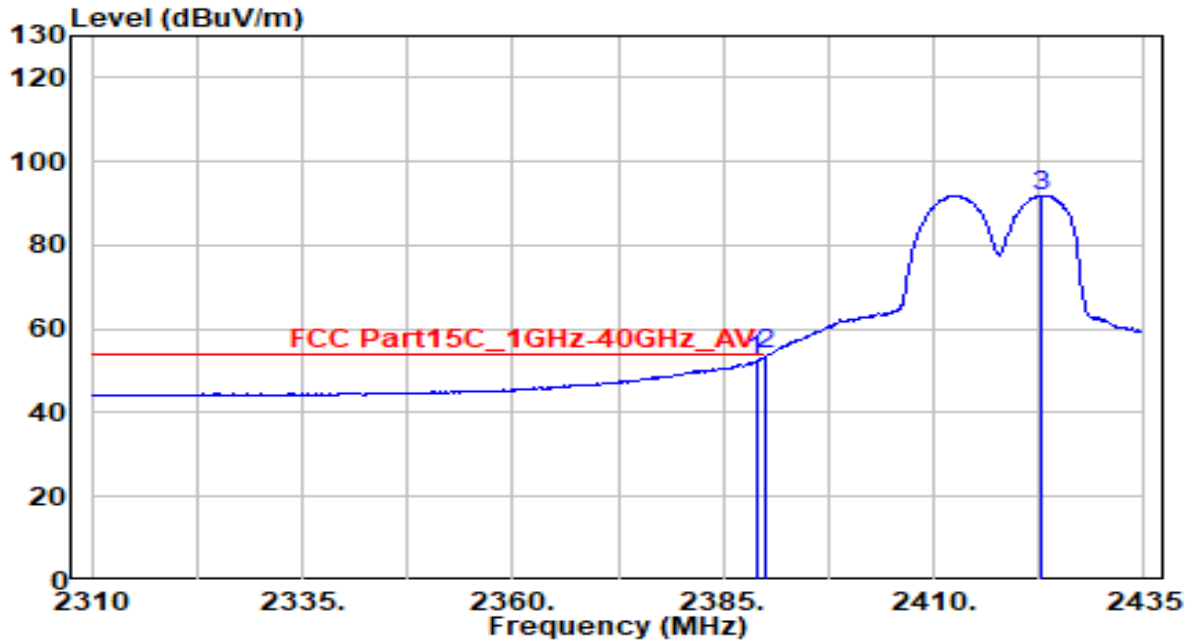

| No | Frequency (MHz) | Reading (dBuV) | C.F (dB/m) | Measurement (dBuV/m) | Margin (dB) | Limit (dBuV/m) | Height (cm) | Angle (deg) | Remark (QP/PK/AV) |
|----|-----------------|----------------|------------|----------------------|-------------|----------------|-------------|-------------|-------------------|
| 1 | 2388.875 | 21.76 | 30.61 | 52.37 | -1.63 | 54.00 | 170 | 230 | Average |
| 2 | * 2390.000 | 23.26 | 30.61 | 53.88 | -0.12 | 54.00 | 170 | 230 | Average |
| 3 | 2422.875 | 61.10 | 30.71 | 91.80 | N/A | N/A | 170 | 230 | Average |

Note:

1. " *", means this data is the worst emission level.
2. C.F (Correction Factor) = Antenna Factor (dB)+ Cable Loss (dB).
3. Measurement (dBuV/m) = Reading(dBuV) + C.F (Correction Factor).
4. The emission levels of other frequencies are very lower than the limit and not show in test report.

| | | | |
|-----------|-------------------------------------------------------|----------------------|--------------|
| EUT | AX3000+G1500 Whole Home Powerline Mesh Wi-Fi 6 System | Date of Test | 2022-07-06 |
| Factor | DRH18-E | Temp. / Humidity | 23°C /63% |
| Polarity | Vertical | Site / Test Engineer | AC2 / Ares |
| Test Mode | 802.11ax-20MHz_TX_CH 2_ANT 0+1 | Test Voltage | AC 120V/60Hz |

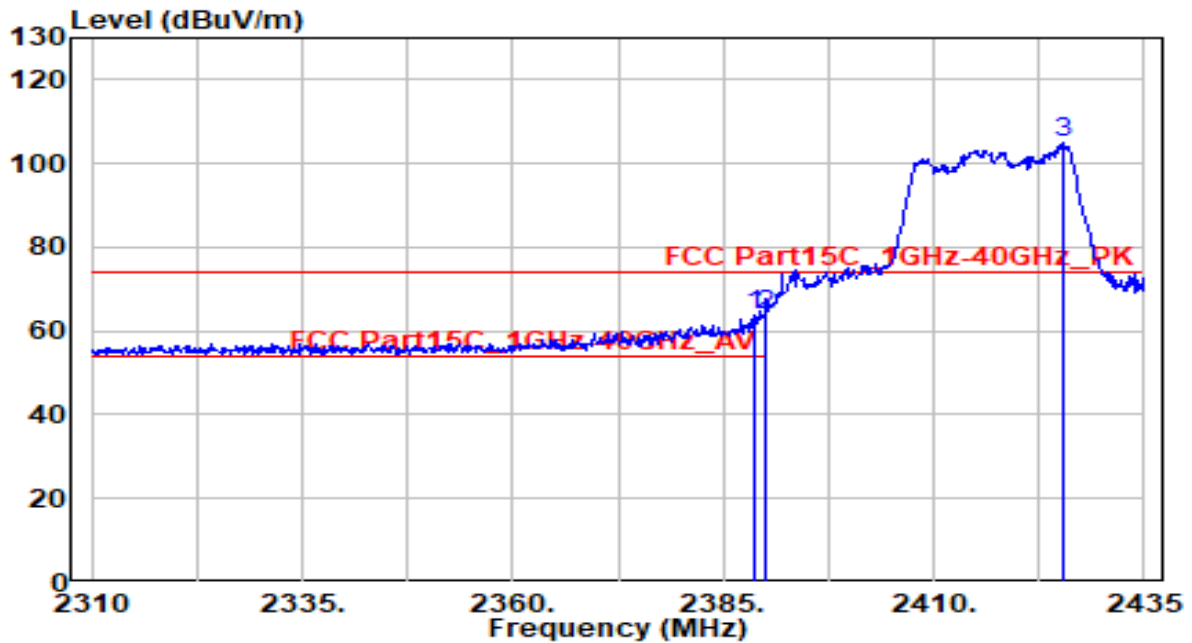

| No | Frequency (MHz) | Reading (dBUV) | C.F (dB/m) | Measurement (dBUV/m) | Margin (dB) | Limit (dBUV/m) | Height (cm) | Angle (deg) | Remark (QP/PK/AV) | |
|----|-----------------|----------------|------------|----------------------|-------------|----------------|-------------|-------------|-------------------|------|
| 1 | * | 2388.625 | 33.33 | 30.61 | 63.95 | -10.05 | 74.00 | 125 | 40 | Peak |
| 2 | | 2390.000 | 33.07 | 30.61 | 63.68 | -10.32 | 74.00 | 125 | 40 | Peak |
| 3 | | 2425.250 | 74.49 | 30.71 | 105.20 | N/A | N/A | 125 | 40 | Peak |

Note:

1. " *", means this data is the worst emission level.
2. C.F (Correction Factor) = Antenna Factor (dB)+ Cable Loss (dB).
3. Measurement (dBUV/m) = Reading(dBUV) + C.F (Correction Factor).
4. The emission levels of other frequencies are very lower than the limit and not show in test report.

| | | | |
|-----------|-------------------------------------------------------|----------------------|--------------|
| EUT | AX3000+G1500 Whole Home Powerline Mesh Wi-Fi 6 System | Date of Test | 2022-07-06 |
| Factor | DRH18-E | Temp. / Humidity | 23°C /63% |
| Polarity | Vertical | Site / Test Engineer | AC2 / Ares |
| Test Mode | 802.11ax-20MHz_TX_CH 2_ANT 0+1 | Test Voltage | AC 120V/60Hz |

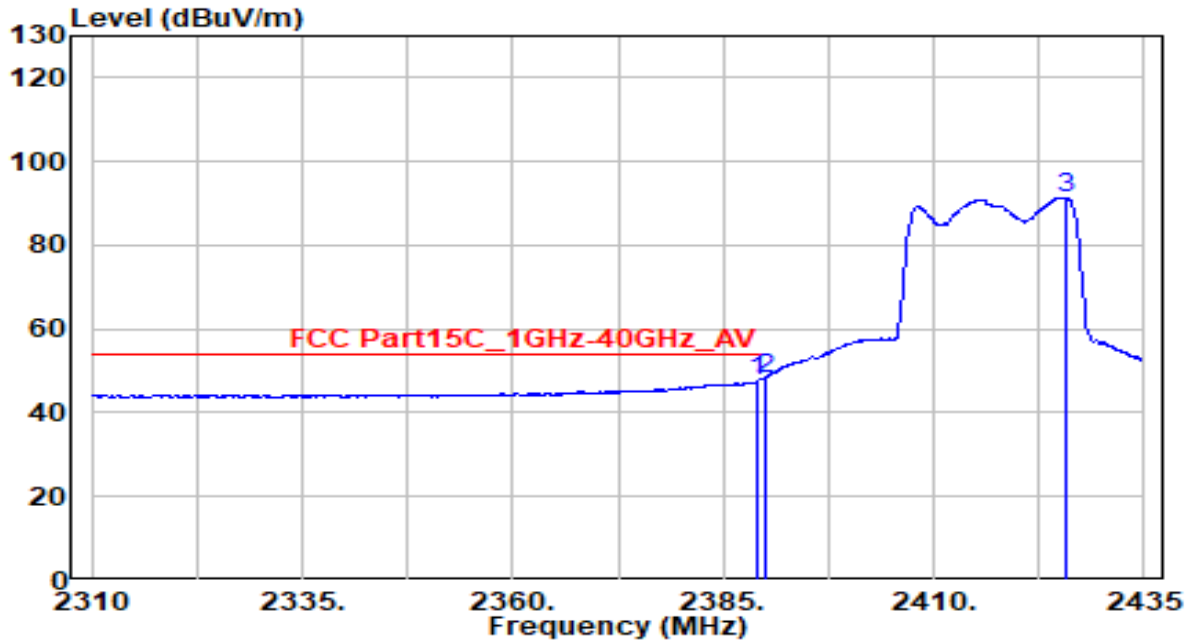

| No | Frequency (MHz) | Reading (dBuV) | C.F (dB/m) | Measurement (dBuV/m) | Margin (dB) | Limit (dBuV/m) | Height (cm) | Angle (deg) | Remark (QP/PK/AV) |
|----|-----------------|----------------|------------|----------------------|-------------|----------------|-------------|-------------|-------------------|
| 1 | 2389.000 | 17.11 | 30.61 | 47.72 | -6.28 | 54.00 | 125 | 40 | Average |
| 2 | * 2390.000 | 17.61 | 30.61 | 48.22 | -5.78 | 54.00 | 125 | 40 | Average |
| 3 | 2425.625 | 60.67 | 30.72 | 91.39 | N/A | N/A | 125 | 40 | Average |

Note:

1. " *", means this data is the worst emission level.
2. C.F (Correction Factor) = Antenna Factor (dB)+ Cable Loss (dB).
3. Measurement (dBuV/m) = Reading(dBuV) + C.F (Correction Factor).
4. The emission levels of other frequencies are very lower than the limit and not show in test report.

| | | | |
|-----------|-------------------------------------------------------|----------------------|--------------|
| EUT | AX3000+G1500 Whole Home Powerline Mesh Wi-Fi 6 System | Date of Test | 2022-07-06 |
| Factor | DRH18-E | Temp. / Humidity | 23°C /63% |
| Polarity | Horizontal | Site / Test Engineer | AC2 / Ares |
| Test Mode | 802.11ax-20MHz_TX_CH 6_ANT 0+1 | Test Voltage | AC 120V/60Hz |

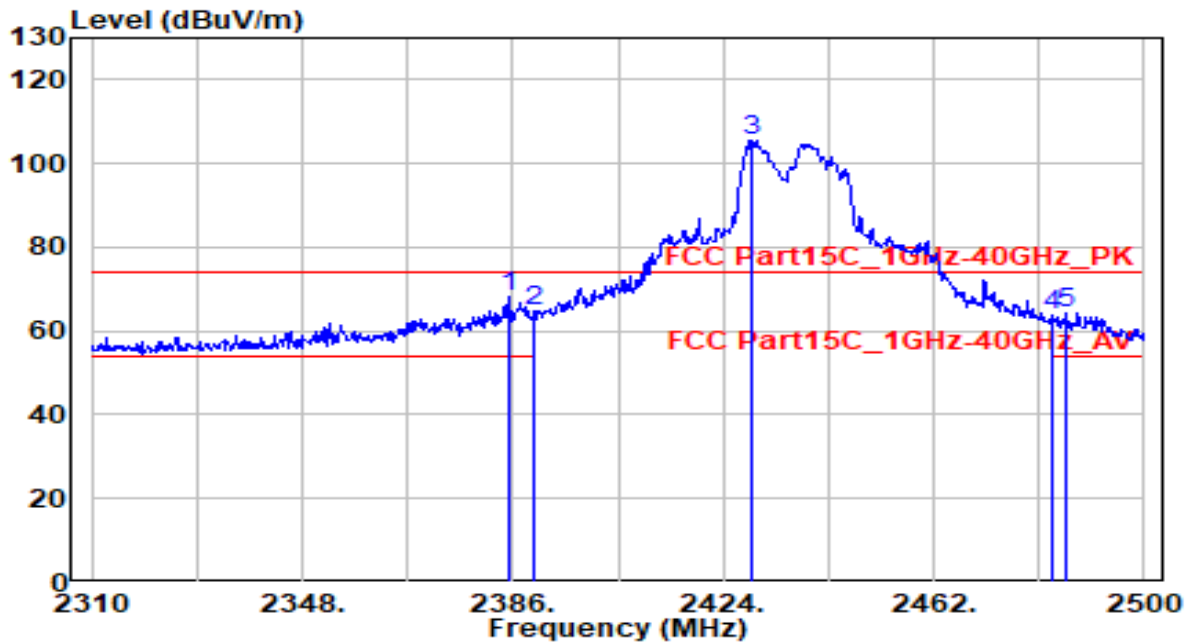

| No | Frequency (MHz) | Reading (dBUV) | C.F (dB/m) | Measurement (dBUV/m) | Margin (dB) | Limit (dBUV/m) | Height (cm) | Angle (deg) | Remark (QP/PK/AV) |
|----|-----------------|----------------|------------|----------------------|-------------|----------------|-------------|-------------|-------------------|
| 1 | * 2385.240 | 37.35 | 30.61 | 67.95 | -6.05 | 74.00 | 100 | 225 | Peak |
| 2 | 2390.000 | 34.34 | 30.61 | 64.95 | -9.05 | 74.00 | 100 | 225 | Peak |
| 3 | 2429.130 | 74.95 | 30.73 | 105.68 | N/A | N/A | 100 | 225 | Peak |
| 4 | 2483.500 | 32.80 | 30.91 | 63.71 | -10.29 | 74.00 | 100 | 225 | Peak |
| 5 | 2485.940 | 33.22 | 30.92 | 64.15 | -9.85 | 74.00 | 100 | 225 | Peak |

Note:

1. " *", means this data is the worst emission level.
2. C.F (Correction Factor) = Antenna Factor (dB)+ Cable Loss (dB).
3. Measurement (dBUV/m) = Reading(dBUV) + C.F (Correction Factor).
4. The emission levels of other frequencies are very lower than the limit and not show in test report.

| | | | |
|-----------|-------------------------------------------------------|----------------------|--------------|
| EUT | AX3000+G1500 Whole Home Powerline Mesh Wi-Fi 6 System | Date of Test | 2022-07-06 |
| Factor | DRH18-E | Temp. / Humidity | 23°C /63% |
| Polarity | Horizontal | Site / Test Engineer | AC2 / Ares |
| Test Mode | 802.11ax-20MHz_TX_CH 6_ANT 0+1 | Test Voltage | AC 120V/60Hz |

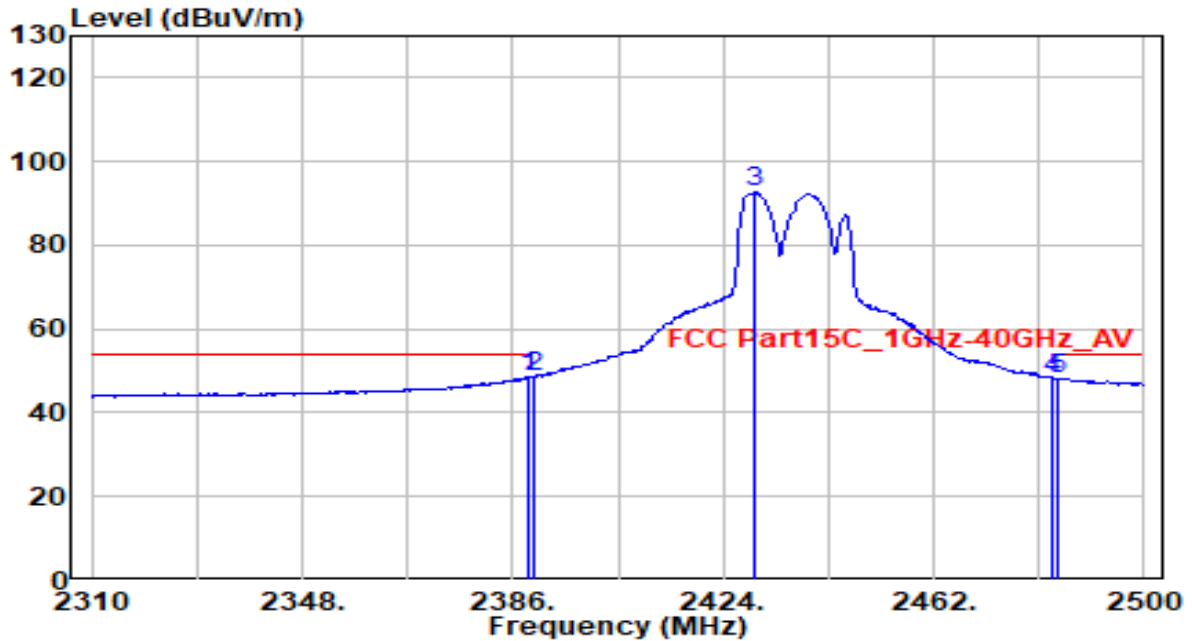

| No | Frequency (MHz) | Reading (dBUV) | C.F (dB/m) | Measurement (dBUV/m) | Margin (dB) | Limit (dBUV/m) | Height (cm) | Angle (deg) | Remark (QP/PK/AV) |
|----|-----------------|----------------|------------|----------------------|-------------|----------------|-------------|-------------|-------------------|
| 1 | 2388.660 | 17.73 | 30.61 | 48.34 | -5.66 | 54.00 | 100 | 225 | Average |
| 2 | * 2390.000 | 18.18 | 30.61 | 48.79 | -5.21 | 54.00 | 100 | 225 | Average |
| 3 | 2429.700 | 61.85 | 30.73 | 92.58 | N/A | N/A | 100 | 225 | Average |
| 4 | 2483.500 | 17.27 | 30.91 | 48.19 | -5.81 | 54.00 | 100 | 225 | Average |
| 5 | 2484.420 | 17.23 | 30.92 | 48.15 | -5.85 | 54.00 | 100 | 225 | Average |

Note:

1. " *", means this data is the worst emission level.
2. C.F (Correction Factor) = Antenna Factor (dB)+ Cable Loss (dB).
3. Measurement (dBUV/m) = Reading(dBUV) + C.F (Correction Factor).
4. The emission levels of other frequencies are very lower than the limit and not show in test report.

| | | | |
|-----------|-------------------------------------------------------|----------------------|--------------|
| EUT | AX3000+G1500 Whole Home Powerline Mesh Wi-Fi 6 System | Date of Test | 2022-07-06 |
| Factor | DRH18-E | Temp. / Humidity | 23°C /63% |
| Polarity | Vertical | Site / Test Engineer | AC2 / Ares |
| Test Mode | 802.11ax-20MHz_TX_CH 6_ANT 0+1 | Test Voltage | AC 120V/60Hz |

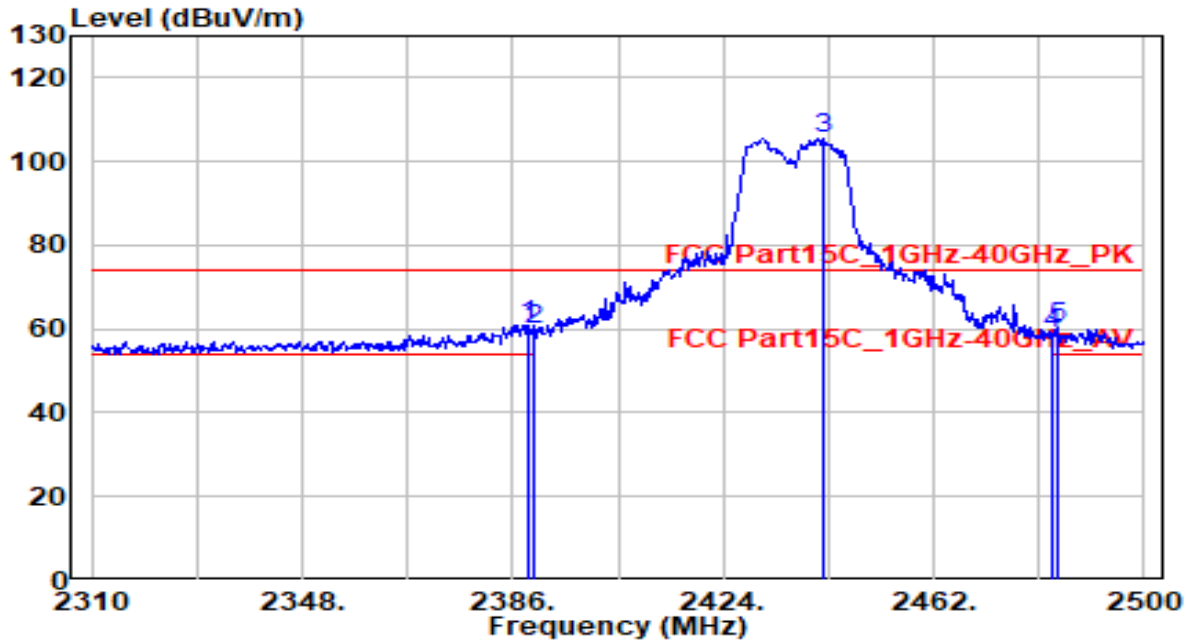

| No | Frequency (MHz) | Reading (dBUV) | C.F (dB/m) | Measurement (dBUV/m) | Margin (dB) | Limit (dBUV/m) | Height (cm) | Angle (deg) | Remark (QP/PK/AV) |
|----|-----------------|----------------|------------|----------------------|-------------|----------------|-------------|-------------|-------------------|
| 1 | * 2388.850 | 30.41 | 30.61 | 61.03 | -12.97 | 74.00 | 120 | 40 | Peak |
| 2 | 2390.000 | 29.08 | 30.61 | 59.69 | -14.31 | 74.00 | 120 | 40 | Peak |
| 3 | 2442.240 | 74.78 | 30.77 | 105.55 | N/A | N/A | 120 | 40 | Peak |
| 4 | 2483.500 | 28.00 | 30.91 | 58.91 | -15.09 | 74.00 | 120 | 40 | Peak |
| 5 | 2484.420 | 29.33 | 30.92 | 60.25 | -13.75 | 74.00 | 120 | 40 | Peak |

Note:

1. " *", means this data is the worst emission level.
2. C.F (Correction Factor) = Antenna Factor (dB)+ Cable Loss (dB).
3. Measurement (dBUV/m) = Reading(dBUV) + C.F (Correction Factor).
4. The emission levels of other frequencies are very lower than the limit and not show in test report.

| | | | |
|-----------|-------------------------------------------------------|----------------------|--------------|
| EUT | AX3000+G1500 Whole Home Powerline Mesh Wi-Fi 6 System | Date of Test | 2022-07-06 |
| Factor | DRH18-E | Temp. / Humidity | 23°C /63% |
| Polarity | Vertical | Site / Test Engineer | AC2 / Ares |
| Test Mode | 802.11ax-20MHz_TX_CH 6_ANT 0+1 | Test Voltage | AC 120V/60Hz |

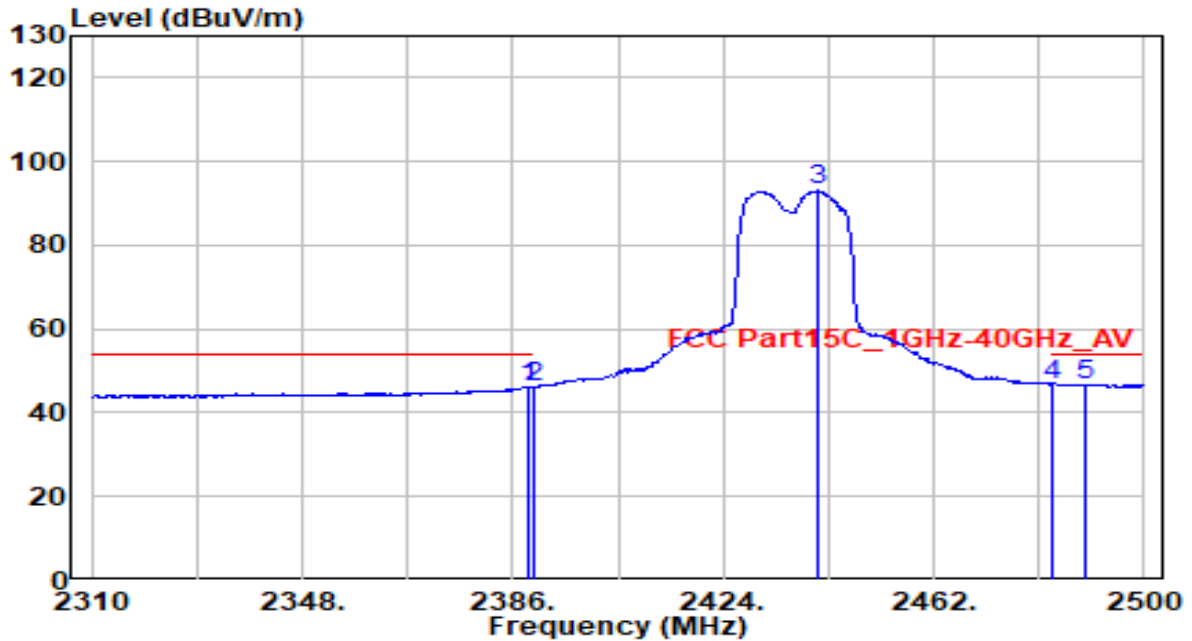

| No | Frequency (MHz) | Reading (dBUV) | C.F (dB/m) | Measurement (dBUV/m) | Margin (dB) | Limit (dBUV/m) | Height (cm) | Angle (deg) | Remark (QP/PK/AV) |
|----|-----------------|----------------|------------|----------------------|-------------|----------------|-------------|-------------|-------------------|
| 1 | 2388.850 | 15.59 | 30.61 | 46.20 | -7.80 | 54.00 | 120 | 40 | Average |
| 2 | 2390.000 | 15.48 | 30.61 | 46.09 | -7.91 | 54.00 | 120 | 40 | Average |
| 3 | 2441.290 | 62.24 | 30.77 | 93.01 | N/A | N/A | 120 | 40 | Average |
| 4 | * 2483.500 | 15.92 | 30.91 | 46.83 | -7.17 | 54.00 | 120 | 40 | Average |
| 5 | 2489.360 | 15.89 | 30.93 | 46.82 | -7.18 | 54.00 | 120 | 40 | Average |

Note:

1. " *", means this data is the worst emission level.
2. C.F (Correction Factor) = Antenna Factor (dB)+ Cable Loss (dB).
3. Measurement (dBUV/m) = Reading(dBUV) + C.F (Correction Factor).
4. The emission levels of other frequencies are very lower than the limit and not show in test report.

| | | | |
|-----------|-------------------------------------------------------|----------------------|--------------|
| EUT | AX3000+G1500 Whole Home Powerline Mesh Wi-Fi 6 System | Date of Test | 2022-07-06 |
| Factor | DRH18-E | Temp. / Humidity | 23°C /63% |
| Polarity | Horizontal | Site / Test Engineer | AC2 / Ares |
| Test Mode | 802.11ax-20MHz_TX_CH 11_ANT 0+1 | Test Voltage | AC 120V/60Hz |

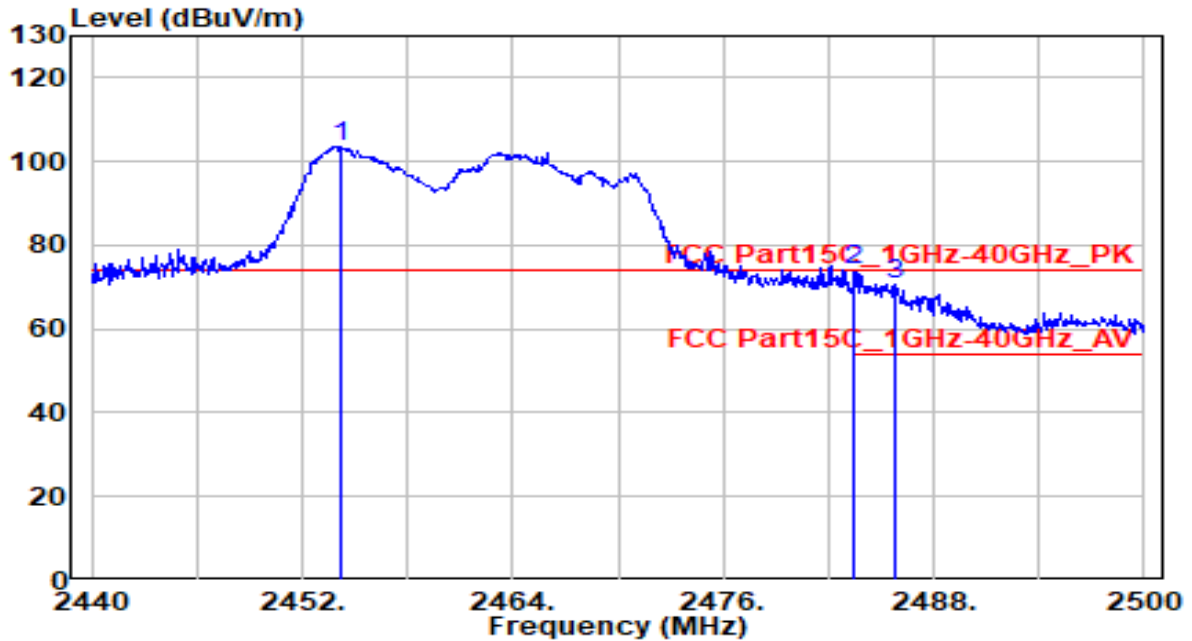

| No | Frequency (MHz) | Reading (dBuV) | C.F (dB/m) | Measurement (dBuV/m) | Margin (dB) | Limit (dBuV/m) | Height (cm) | Angle (deg) | Remark (QP/PK/AV) |
|----|-----------------|----------------|------------|----------------------|-------------|----------------|-------------|-------------|-------------------|
| 1 | 2454.160 | 72.91 | 30.81 | 103.72 | N/A | N/A | 110 | 225 | Peak |
| 2 | * 2483.500 | 42.99 | 30.91 | 73.90 | -0.10 | 74.00 | 110 | 225 | Peak |
| 3 | 2485.780 | 39.54 | 30.92 | 70.46 | -3.54 | 74.00 | 110 | 225 | Peak |

Note:

- "*", means this data is the worst emission level.
- C.F (Correction Factor) = Antenna Factor (dB)+ Cable Loss (dB).
- Measurement (dBuV/m) = Reading(dBuV) + C.F (Correction Factor).
- The emission levels of other frequencies are very lower than the limit and not show in test report.

| | | | |
|-----------|-------------------------------------------------------|----------------------|--------------|
| EUT | AX3000+G1500 Whole Home Powerline Mesh Wi-Fi 6 System | Date of Test | 2022-07-06 |
| Factor | DRH18-E | Temp. / Humidity | 23°C /63% |
| Polarity | Horizontal | Site / Test Engineer | AC2 / Ares |
| Test Mode | 802.11ax-20MHz_TX_CH 11_ANT 0+1 | Test Voltage | AC 120V/60Hz |

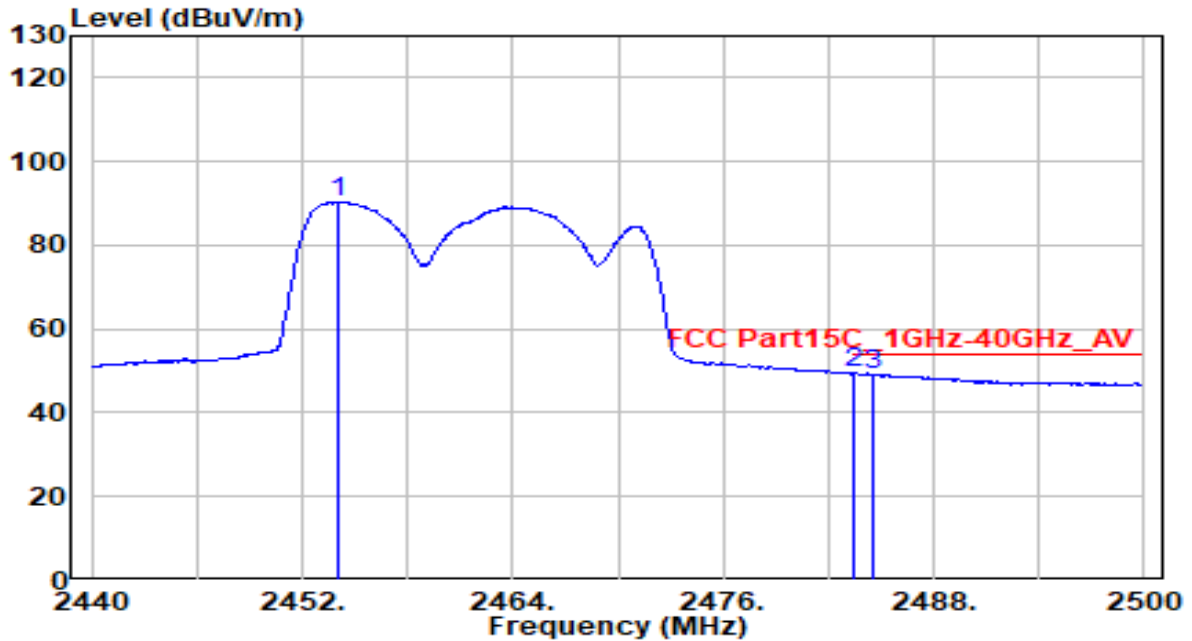

| No | Frequency (MHz) | Reading (dBUV) | C.F (dB/m) | Measurement (dBUV/m) | Margin (dB) | Limit (dBUV/m) | Height (cm) | Angle (deg) | Remark (QP/PK/AV) |
|----|-----------------|----------------|------------|----------------------|-------------|----------------|-------------|-------------|-------------------|
| 1 | 2454.100 | 59.65 | 30.81 | 90.46 | N/A | N/A | 110 | 225 | Average |
| 2 | * 2483.500 | 18.53 | 30.91 | 49.44 | -4.56 | 54.00 | 110 | 225 | Average |
| 3 | 2484.520 | 18.15 | 30.92 | 49.06 | -4.94 | 54.00 | 110 | 225 | Average |

Note:

- " *", means this data is the worst emission level.
- C.F (Correction Factor) = Antenna Factor (dB)+ Cable Loss (dB).
- Measurement (dBUV/m) = Reading(dBUV) + C.F (Correction Factor).
- The emission levels of other frequencies are very lower than the limit and not show in test report.

| | | | |
|-----------|-------------------------------------------------------|----------------------|--------------|
| EUT | AX3000+G1500 Whole Home Powerline Mesh Wi-Fi 6 System | Date of Test | 2022-07-06 |
| Factor | DRH18-E | Temp. / Humidity | 23°C /63% |
| Polarity | Vertical | Site / Test Engineer | AC2 / Ares |
| Test Mode | 802.11ax-20MHz_TX_CH 11_ANT 0+1 | Test Voltage | AC 120V/60Hz |

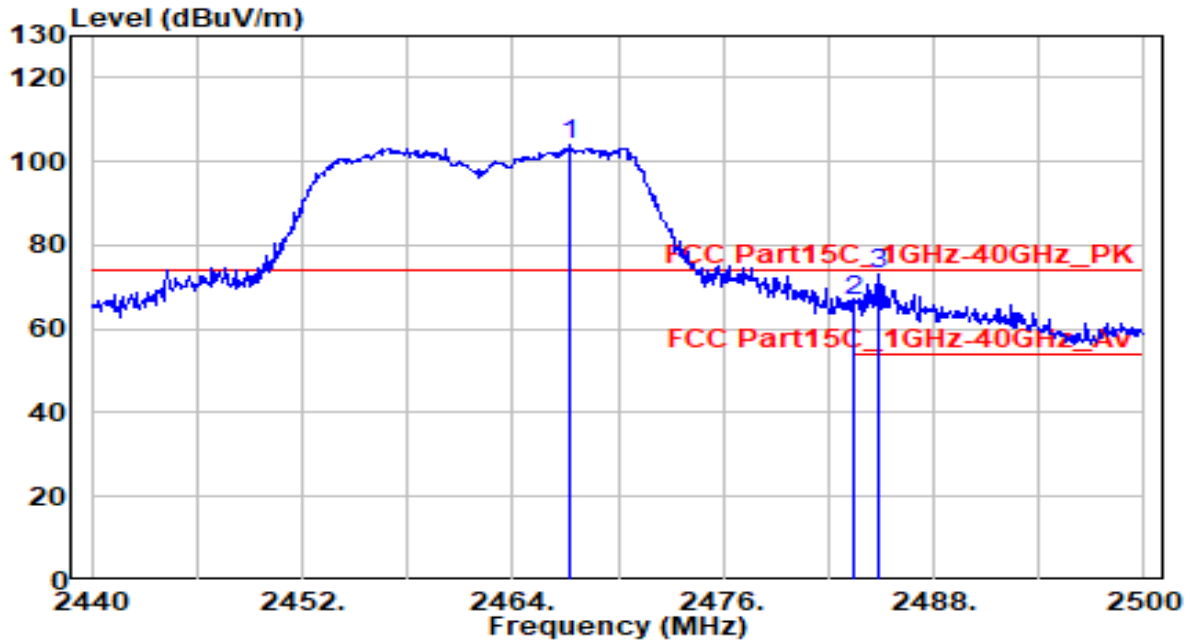

| No | Frequency (MHz) | Reading (dBuV) | C.F (dB/m) | Measurement (dBuV/m) | Margin (dB) | Limit (dBuV/m) | Height (cm) | Angle (deg) | Remark (QP/PK/AV) |
|----|-----------------|----------------|------------|----------------------|-------------|----------------|-------------|-------------|-------------------|
| 1 | 2467.240 | 73.07 | 30.86 | 103.93 | N/A | N/A | 100 | 65 | Peak |
| 2 | 2483.500 | 35.61 | 30.91 | 66.52 | -7.48 | 74.00 | 100 | 65 | Peak |
| 3 | * 2484.820 | 41.99 | 30.92 | 72.90 | -1.10 | 74.00 | 100 | 65 | Peak |

Note:

1. " *", means this data is the worst emission level.
2. C.F (Correction Factor) = Antenna Factor (dB)+ Cable Loss (dB).
3. Measurement (dBuV/m) = Reading(dBuV) + C.F (Correction Factor).
4. The emission levels of other frequencies are very lower than the limit and not show in test report.

| | | | |
|-----------|-------------------------------------------------------|----------------------|--------------|
| EUT | AX3000+G1500 Whole Home Powerline Mesh Wi-Fi 6 System | Date of Test | 2022-07-06 |
| Factor | DRH18-E | Temp. / Humidity | 23°C /63% |
| Polarity | Vertical | Site / Test Engineer | AC2 / Ares |
| Test Mode | 802.11ax-20MHz_TX_CH 11_ANT 0+1 | Test Voltage | AC 120V/60Hz |

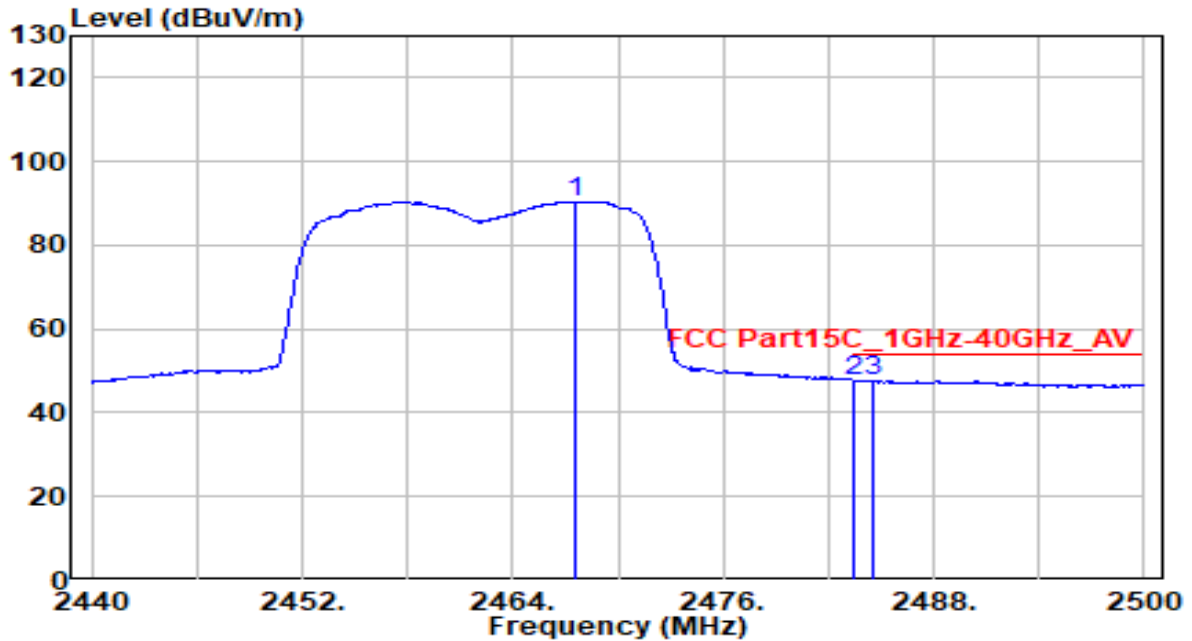

| No | Frequency (MHz) | Reading (dBUV) | C.F (dB/m) | Measurement (dBUV/m) | Margin (dB) | Limit (dBUV/m) | Height (cm) | Angle (deg) | Remark (QP/PK/AV) |
|----|-----------------|----------------|------------|----------------------|-------------|----------------|-------------|-------------|-------------------|
| 1 | 2467.540 | 59.55 | 30.86 | 90.41 | N/A | N/A | 100 | 65 | Average |
| 2 | * 2483.500 | 16.89 | 30.91 | 47.80 | -6.20 | 54.00 | 100 | 65 | Average |
| 3 | 2484.580 | 16.62 | 30.92 | 47.54 | -6.46 | 54.00 | 100 | 65 | Average |

Note:

1. " *", means this data is the worst emission level.
2. C.F (Correction Factor) = Antenna Factor (dB)+ Cable Loss (dB).
3. Measurement (dBUV/m) = Reading(dBUV) + C.F (Correction Factor).
4. The emission levels of other frequencies are very lower than the limit and not show in test report.

| | | | |
|-----------|-------------------------------------------------------|----------------------|--------------|
| EUT | AX3000+G1500 Whole Home Powerline Mesh Wi-Fi 6 System | Date of Test | 2022-07-06 |
| Factor | DRH18-E | Temp. / Humidity | 23°C /63% |
| Polarity | Horizontal | Site / Test Engineer | AC2 / Ares |
| Test Mode | 802.11ax-40MHz_TX_CH 3_ANT 0+1 | Test Voltage | AC 120V/60Hz |

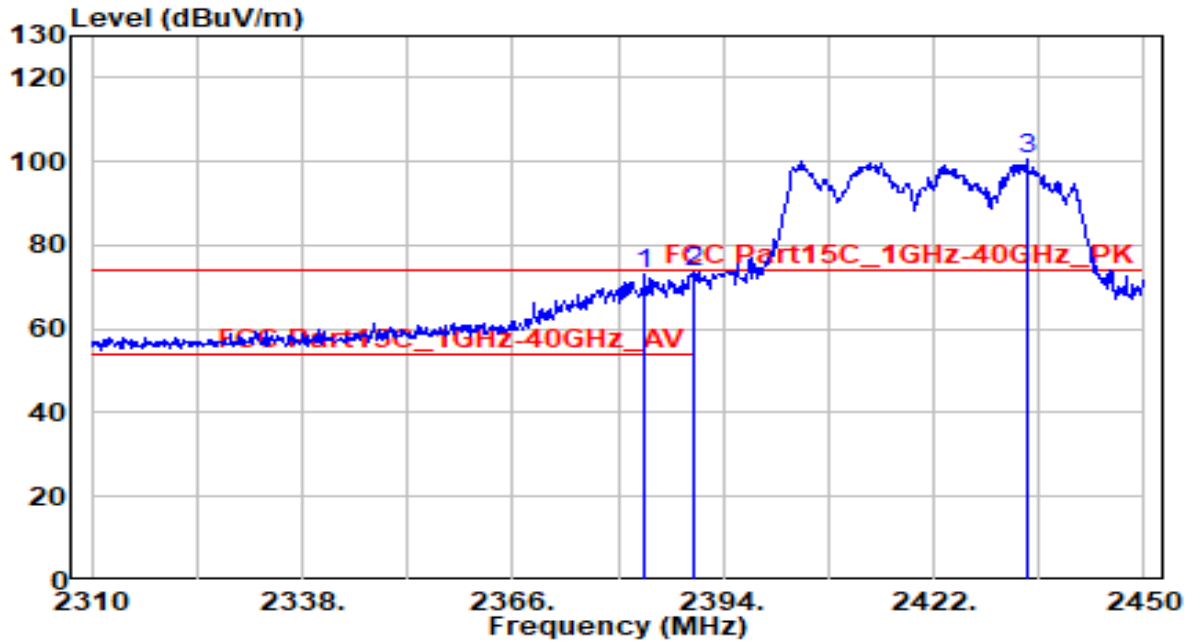

| No | Frequency (MHz) | Reading (dBuV) | C.F (dB/m) | Measurement (dBuV/m) | Margin (dB) | Limit (dBuV/m) | Height (cm) | Angle (deg) | Remark (QP/PK/AV) |
|----|-----------------|----------------|------------|----------------------|-------------|----------------|-------------|-------------|-------------------|
| 1 | 2383.640 | 42.52 | 30.60 | 73.12 | -0.88 | 74.00 | 105 | 225 | Peak |
| 2 | * 2390.000 | 43.22 | 30.61 | 73.83 | -0.17 | 74.00 | 105 | 225 | Peak |
| 3 | 2434.460 | 69.70 | 30.75 | 100.44 | N/A | N/A | 105 | 225 | Peak |

Note:

1. " *", means this data is the worst emission level.
2. C.F (Correction Factor) = Antenna Factor (dB)+ Cable Loss (dB).
3. Measurement (dBuV/m) = Reading(dBuV) + C.F (Correction Factor).
4. The emission levels of other frequencies are very lower than the limit and not show in test report.

| | | | |
|-----------|-------------------------------------------------------|----------------------|--------------|
| EUT | AX3000+G1500 Whole Home Powerline Mesh Wi-Fi 6 System | Date of Test | 2022-07-06 |
| Factor | DRH18-E | Temp. / Humidity | 23°C /63% |
| Polarity | Horizontal | Site / Test Engineer | AC2 / Ares |
| Test Mode | 802.11ax-40MHz_TX_CH 3_ANT 0+1 | Test Voltage | AC 120V/60Hz |

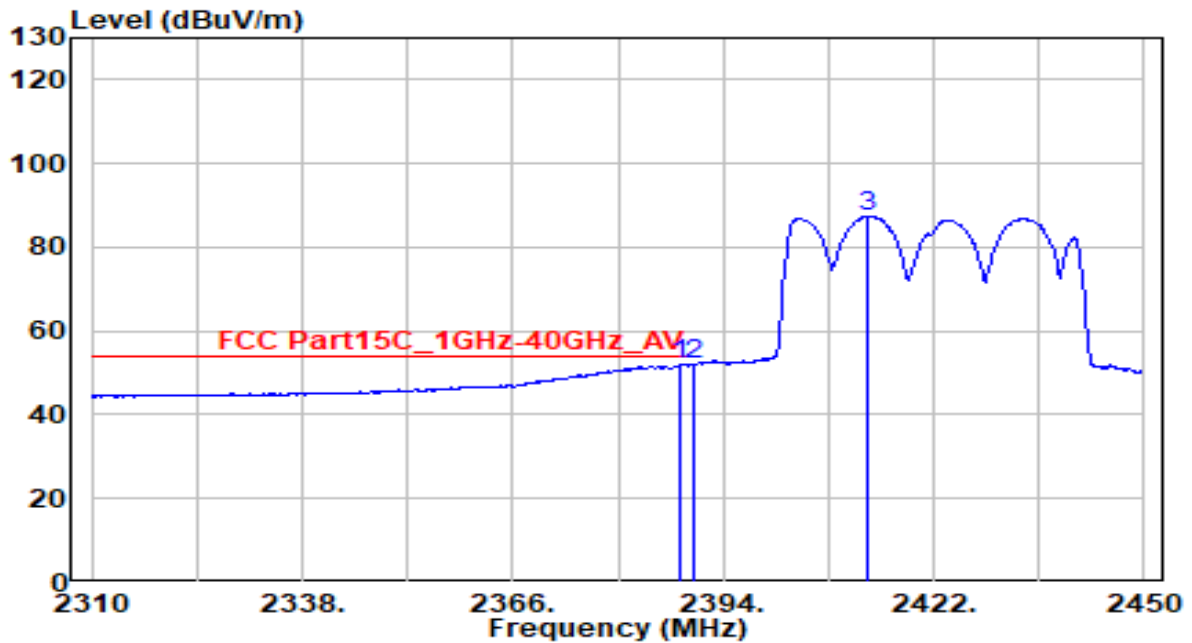

| No | Frequency (MHz) | Reading (dBUV) | C.F (dB/m) | Measurement (dBUV/m) | Margin (dB) | Limit (dBUV/m) | Height (cm) | Angle (deg) | Remark (QP/PK/AV) |
|----|-----------------|----------------|------------|----------------------|-------------|----------------|-------------|-------------|-------------------|
| 1 | * 2388.400 | 21.58 | 30.61 | 52.20 | -1.80 | 54.00 | 105 | 225 | Average |
| 2 | 2390.000 | 21.29 | 30.61 | 51.90 | -2.10 | 54.00 | 105 | 225 | Average |
| 3 | 2413.040 | 56.70 | 30.67 | 87.37 | N/A | N/A | 105 | 225 | Average |

Note:

1. " *", means this data is the worst emission level.
2. C.F (Correction Factor) = Antenna Factor (dB)+ Cable Loss (dB).
3. Measurement (dBUV/m) = Reading(dBUV) + C.F (Correction Factor).
4. The emission levels of other frequencies are very lower than the limit and not show in test report.

| | | | |
|-----------|-------------------------------------------------------|----------------------|--------------|
| EUT | AX3000+G1500 Whole Home Powerline Mesh Wi-Fi 6 System | Date of Test | 2022-07-06 |
| Factor | DRH18-E | Temp. / Humidity | 23°C /63% |
| Polarity | Vertical | Site / Test Engineer | AC2 / Ares |
| Test Mode | 802.11ax-40MHz_TX_CH 3_ANT 0+1 | Test Voltage | AC 120V/60Hz |

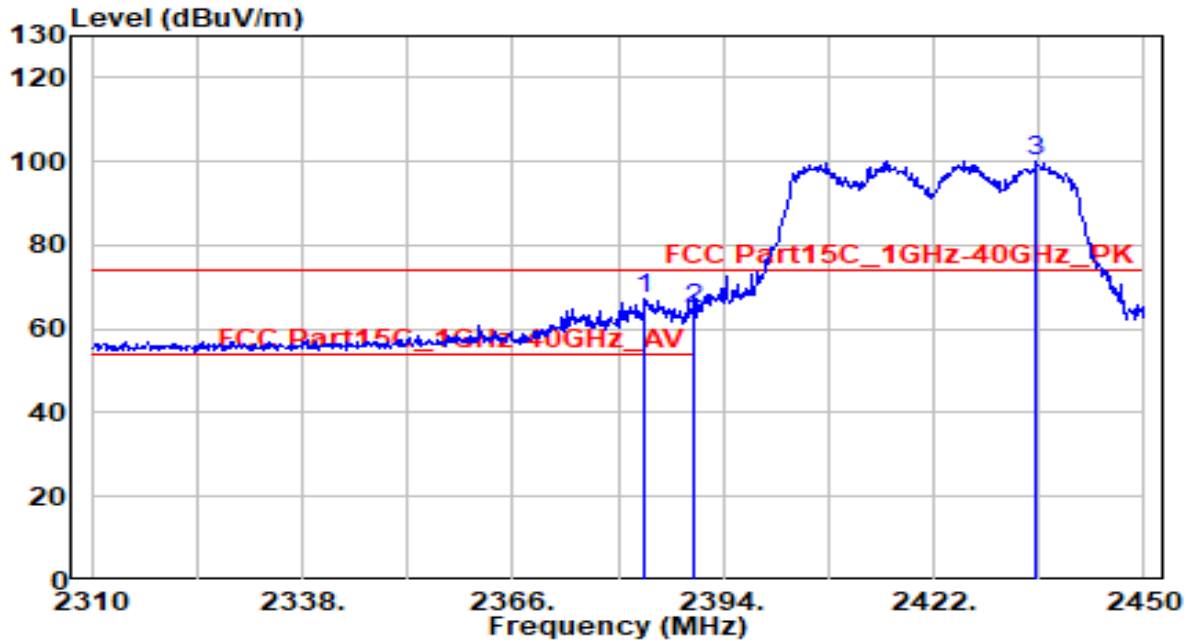

| No | Frequency (MHz) | Reading (dBUV) | C.F (dB/m) | Measurement (dBUV/m) | Margin (dB) | Limit (dBUV/m) | Height (cm) | Angle (deg) | Remark (QP/PK/AV) |
|----|-----------------|----------------|------------|----------------------|-------------|----------------|-------------|-------------|-------------------|
| 1 | * 2383.500 | 36.57 | 30.60 | 67.17 | -6.83 | 74.00 | 100 | 45 | Peak |
| 2 | 2390.000 | 34.13 | 30.61 | 64.74 | -9.26 | 74.00 | 100 | 45 | Peak |
| 3 | 2435.580 | 69.34 | 30.75 | 100.09 | N/A | N/A | 100 | 45 | Peak |

Note:

1. " *", means this data is the worst emission level.
2. C.F (Correction Factor) = Antenna Factor (dB)+ Cable Loss (dB).
3. Measurement (dBUV/m) = Reading(dBUV) + C.F (Correction Factor).
4. The emission levels of other frequencies are very lower than the limit and not show in test report.

| | | | |
|-----------|-------------------------------------------------------|----------------------|--------------|
| EUT | AX3000+G1500 Whole Home Powerline Mesh Wi-Fi 6 System | Date of Test | 2022-07-06 |
| Factor | DRH18-E | Temp. / Humidity | 23°C /63% |
| Polarity | Vertical | Site / Test Engineer | AC2 / Ares |
| Test Mode | 802.11ax-40MHz_TX_CH 3_ANT 0+1 | Test Voltage | AC 120V/60Hz |

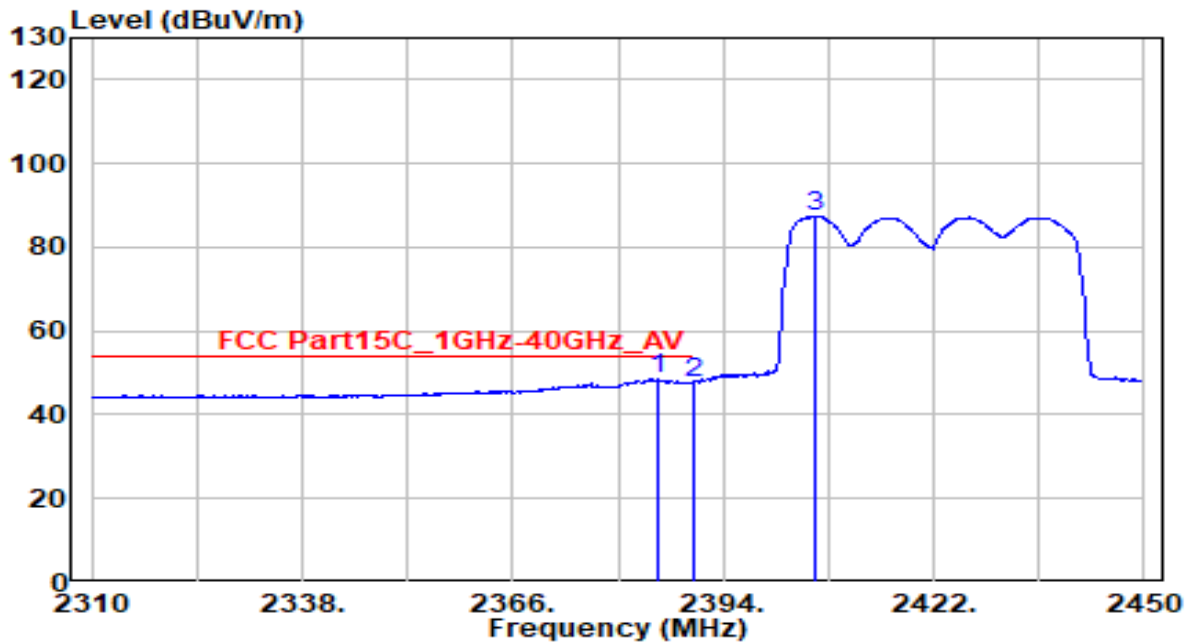

| No | Frequency (MHz) | Reading (dBUV) | C.F (dB/m) | Measurement (dBUV/m) | Margin (dB) | Limit (dBUV/m) | Height (cm) | Angle (deg) | Remark (QP/PK/AV) |
|----|-----------------|----------------|------------|----------------------|-------------|----------------|-------------|-------------|-------------------|
| 1 | * 2385.320 | 17.84 | 30.61 | 48.45 | -5.55 | 54.00 | 100 | 45 | Average |
| 2 | 2390.000 | 17.21 | 30.61 | 47.83 | -6.17 | 54.00 | 100 | 45 | Average |
| 3 | 2406.180 | 56.68 | 30.65 | 87.33 | N/A | N/A | 100 | 45 | Average |

Note:

1. " *", means this data is the worst emission level.
2. C.F (Correction Factor) = Antenna Factor (dB)+ Cable Loss (dB).
3. Measurement (dBUV/m) = Reading(dBUV) + C.F (Correction Factor).
4. The emission levels of other frequencies are very lower than the limit and not show in test report.

| | | | |
|-----------|-------------------------------------------------------|----------------------|--------------|
| EUT | AX3000+G1500 Whole Home Powerline Mesh Wi-Fi 6 System | Date of Test | 2022-07-06 |
| Factor | DRH18-E | Temp. / Humidity | 23°C /63% |
| Polarity | Horizontal | Site / Test Engineer | AC2 / Owen |
| Test Mode | 802.11ax-40MHz_TX_CH 6_ANT 0+1 | Test Voltage | AC 120V/60Hz |

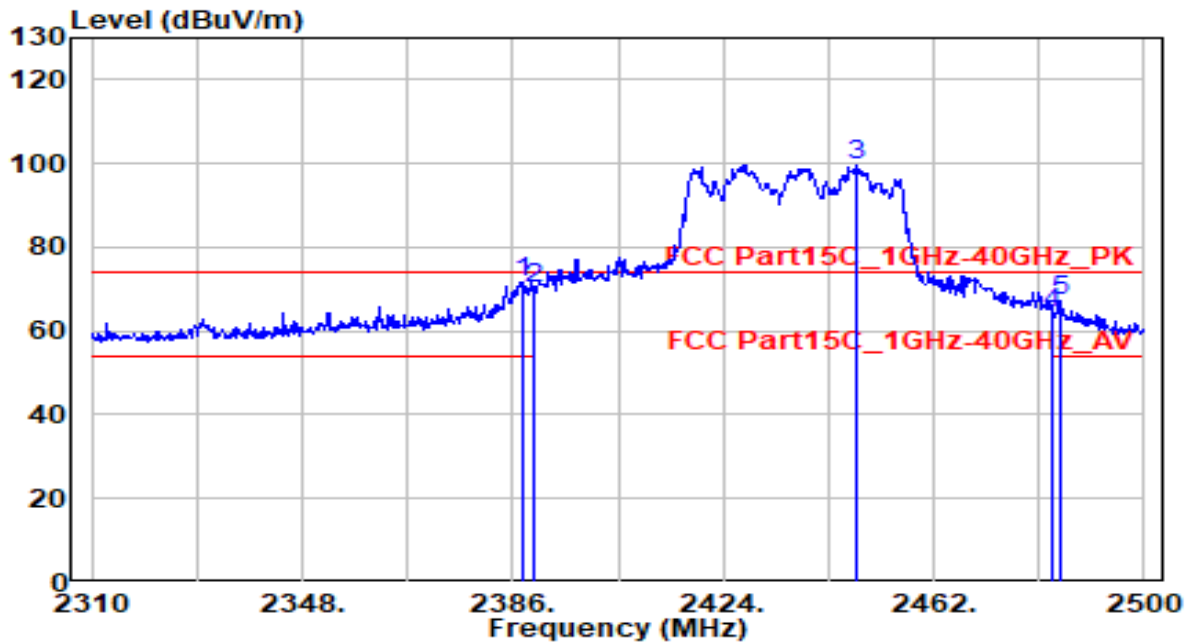

| No | Frequency (MHz) | Reading (dBuV) | C.F (dB/m) | Measurement (dBuV/m) | Margin (dB) | Limit (dBuV/m) | Height (cm) | Angle (deg) | Remark (QP/PK/AV) |
|----|-----------------|----------------|------------|----------------------|-------------|----------------|-------------|-------------|-------------------|
| 1 | * 2387.900 | 41.04 | 30.61 | 71.65 | -2.35 | 74.00 | 105 | 235 | Peak |
| 2 | 2390.000 | 39.65 | 30.61 | 70.27 | -3.73 | 74.00 | 105 | 235 | Peak |
| 3 | 2448.130 | 68.97 | 30.79 | 99.76 | N/A | N/A | 105 | 235 | Peak |
| 4 | 2483.500 | 33.46 | 30.91 | 64.37 | -9.63 | 74.00 | 105 | 235 | Peak |
| 5 | 2484.800 | 36.17 | 30.92 | 67.09 | -6.91 | 74.00 | 105 | 235 | Peak |

Note:

1. " *", means this data is the worst emission level.
2. C.F (Correction Factor) = Antenna Factor (dB)+ Cable Loss (dB).
3. Measurement (dBuV/m) = Reading(dBuV) + C.F (Correction Factor).
4. The emission levels of other frequencies are very lower than the limit and not show in test report.

| | | | |
|-----------|-------------------------------------------------------|----------------------|--------------|
| EUT | AX3000+G1500 Whole Home Powerline Mesh Wi-Fi 6 System | Date of Test | 2022-07-06 |
| Factor | DRH18-E | Temp. / Humidity | 23°C /63% |
| Polarity | Horizontal | Site / Test Engineer | AC2 / Owen |
| Test Mode | 802.11ax-40MHz_TX_CH 6_ANT 0+1 | Test Voltage | AC 120V/60Hz |

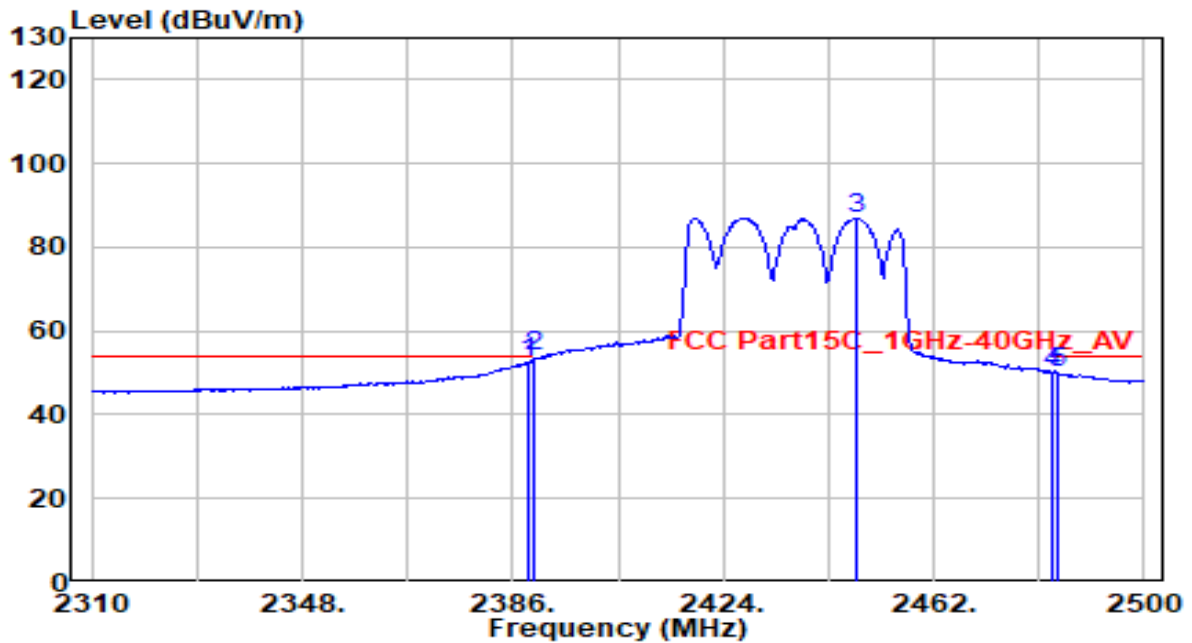

| No | Frequency (MHz) | Reading (dBUV) | C.F (dB/m) | Measurement (dBUV/m) | Margin (dB) | Limit (dBUV/m) | Height (cm) | Angle (deg) | Remark (QP/PK/AV) |
|----|-----------------|----------------|------------|----------------------|-------------|----------------|-------------|-------------|-------------------|
| 1 | 2388.850 | 21.99 | 30.61 | 52.60 | -1.40 | 54.00 | 105 | 235 | Average |
| 2 | * 2390.000 | 23.21 | 30.61 | 53.82 | -0.18 | 54.00 | 105 | 235 | Average |
| 3 | 2447.940 | 56.09 | 30.79 | 86.88 | N/A | N/A | 105 | 235 | Average |
| 4 | 2483.500 | 19.08 | 30.91 | 50.00 | -4.00 | 54.00 | 105 | 235 | Average |
| 5 | 2484.420 | 18.96 | 30.92 | 49.88 | -4.12 | 54.00 | 105 | 235 | Average |

Note:

1. " *", means this data is the worst emission level.
2. C.F (Correction Factor) = Antenna Factor (dB)+ Cable Loss (dB).
3. Measurement (dBUV/m) = Reading(dBUV) + C.F (Correction Factor).
4. The emission levels of other frequencies are very lower than the limit and not show in test report.

| | | | |
|-----------|-------------------------------------------------------|----------------------|--------------|
| EUT | AX3000+G1500 Whole Home Powerline Mesh Wi-Fi 6 System | Date of Test | 2022-07-06 |
| Factor | DRH18-E | Temp. / Humidity | 23°C /63% |
| Polarity | Vertical | Site / Test Engineer | AC2 / Owen |
| Test Mode | 802.11ax-40MHz_TX_CH 6_ANT 0+1 | Test Voltage | AC 120V/60Hz |

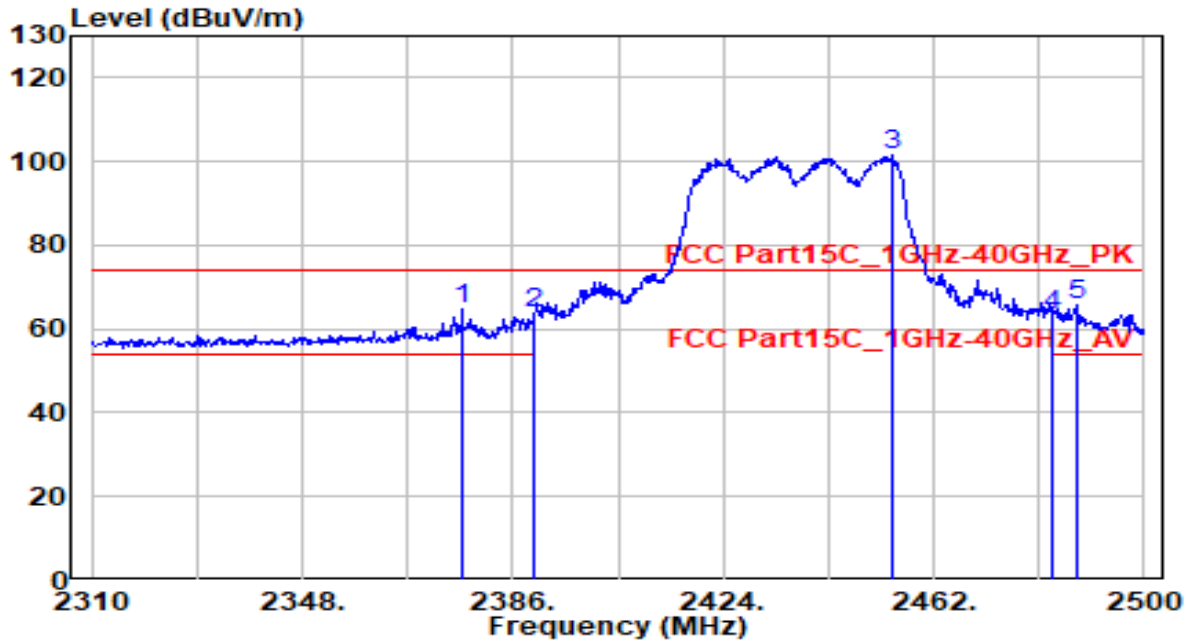

| No | Frequency (MHz) | Reading (dBUV) | C.F (dB/m) | Measurement (dBUV/m) | Margin (dB) | Limit (dBUV/m) | Height (cm) | Angle (deg) | Remark (QP/PK/AV) |
|----|-----------------|----------------|------------|----------------------|-------------|----------------|-------------|-------------|-------------------|
| 1 | 2376.880 | 34.16 | 30.60 | 64.75 | -9.25 | 74.00 | 100 | 70 | Peak |
| 2 | 2390.000 | 33.34 | 30.61 | 63.96 | -10.04 | 74.00 | 100 | 70 | Peak |
| 3 | 2454.400 | 70.50 | 30.81 | 101.32 | N/A | N/A | 100 | 70 | Peak |
| 4 | 2483.500 | 32.16 | 30.91 | 63.08 | -10.92 | 74.00 | 100 | 70 | Peak |
| 5 | * 2487.650 | 34.89 | 30.93 | 65.82 | -8.18 | 74.00 | 100 | 70 | Peak |

Note:

1. " *", means this data is the worst emission level.
2. C.F (Correction Factor) = Antenna Factor (dB)+ Cable Loss (dB).
3. Measurement (dBUV/m) = Reading(dBUV) + C.F (Correction Factor).
4. The emission levels of other frequencies are very lower than the limit and not show in test report.

| | | | |
|-----------|-------------------------------------------------------|----------------------|--------------|
| EUT | AX3000+G1500 Whole Home Powerline Mesh Wi-Fi 6 System | Date of Test | 2022-07-06 |
| Factor | DRH18-E | Temp. / Humidity | 23°C /63% |
| Polarity | Vertical | Site / Test Engineer | AC2 / Owen |
| Test Mode | 802.11ax-40MHz_TX_CH 6_ANT 0+1 | Test Voltage | AC 120V/60Hz |

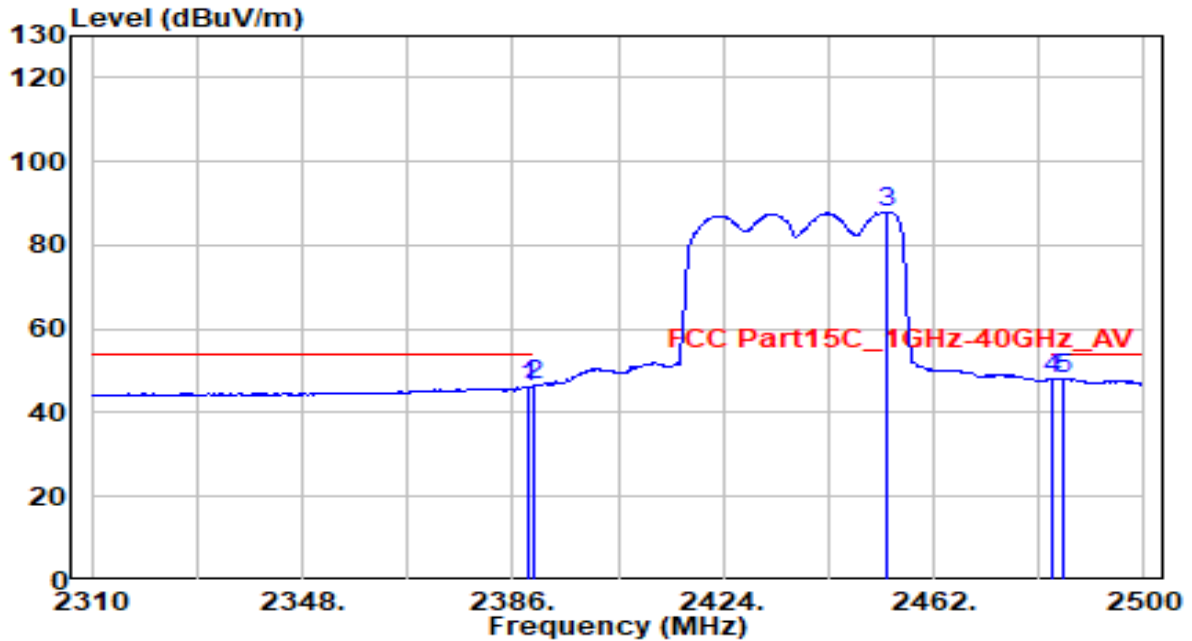

| No | Frequency (MHz) | Reading (dBUV) | C.F (dB/m) | Measurement (dBUV/m) | Margin (dB) | Limit (dBUV/m) | Height (cm) | Angle (deg) | Remark (QP/PK/AV) |
|----|-----------------|----------------|------------|----------------------|-------------|----------------|-------------|-------------|-------------------|
| 1 | 2389.040 | 15.64 | 30.61 | 46.25 | -7.75 | 54.00 | 100 | 70 | Average |
| 2 | 2390.000 | 15.83 | 30.61 | 46.45 | -7.55 | 54.00 | 100 | 70 | Average |
| 3 | 2453.450 | 57.14 | 30.81 | 87.95 | N/A | N/A | 100 | 70 | Average |
| 4 | 2483.500 | 17.23 | 30.91 | 48.14 | -5.86 | 54.00 | 100 | 70 | Average |
| 5 | * 2485.370 | 17.32 | 30.92 | 48.24 | -5.76 | 54.00 | 100 | 70 | Average |

Note:

1. " *", means this data is the worst emission level.
2. C.F (Correction Factor) = Antenna Factor (dB)+ Cable Loss (dB).
3. Measurement (dBUV/m) = Reading(dBUV) + C.F (Correction Factor).
4. The emission levels of other frequencies are very lower than the limit and not show in test report.

| | | | |
|-----------|-------------------------------------------------------|----------------------|--------------|
| EUT | AX3000+G1500 Whole Home Powerline Mesh Wi-Fi 6 System | Date of Test | 2022-07-06 |
| Factor | DRH18-E | Temp. / Humidity | 23°C /63% |
| Polarity | Horizontal | Site / Test Engineer | AC2 / Owen |
| Test Mode | 802.11ax-40MHz_TX_CH 9_ANT 0+1 | Test Voltage | AC 120V/60Hz |

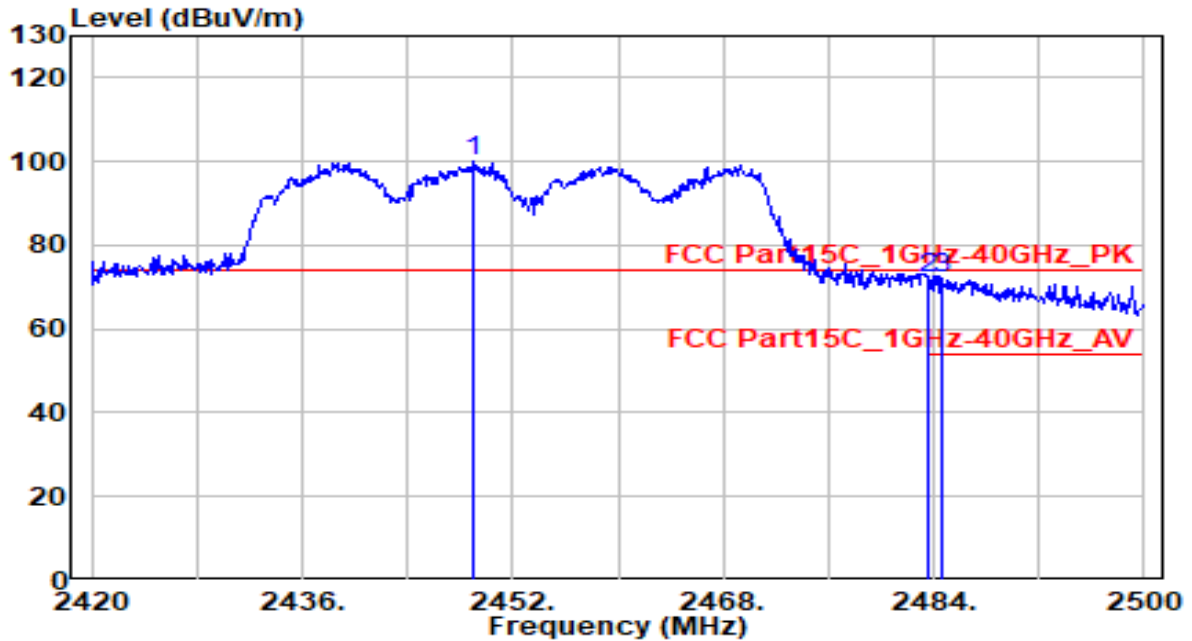

| No | Frequency (MHz) | Reading (dBuV) | C.F (dB/m) | Measurement (dBuV/m) | Margin (dB) | Limit (dBuV/m) | Height (cm) | Angle (deg) | Remark (QP/PK/AV) |
|----|-----------------|----------------|------------|----------------------|-------------|----------------|-------------|-------------|-------------------|
| 1 | 2448.960 | 69.16 | 30.80 | 99.96 | N/A | N/A | 100 | 225 | Peak |
| 2 | * 2483.500 | 41.30 | 30.91 | 72.22 | -1.78 | 74.00 | 100 | 225 | Peak |
| 3 | 2484.640 | 41.28 | 30.92 | 72.20 | -1.80 | 74.00 | 100 | 225 | Peak |

Note:

- "*", means this data is the worst emission level.
- C.F (Correction Factor) = Antenna Factor (dB)+ Cable Loss (dB).
- Measurement (dBuV/m) = Reading(dBuV) + C.F (Correction Factor).
- The emission levels of other frequencies are very lower than the limit and not show in test report.

| | | | |
|-----------|-------------------------------------------------------|----------------------|--------------|
| EUT | AX3000+G1500 Whole Home Powerline Mesh Wi-Fi 6 System | Date of Test | 2022-07-06 |
| Factor | DRH18-E | Temp. / Humidity | 23°C /63% |
| Polarity | Horizontal | Site / Test Engineer | AC2 / Owen |
| Test Mode | 802.11ax-40MHz_TX_CH 9_ANT 0+1 | Test Voltage | AC 120V/60Hz |

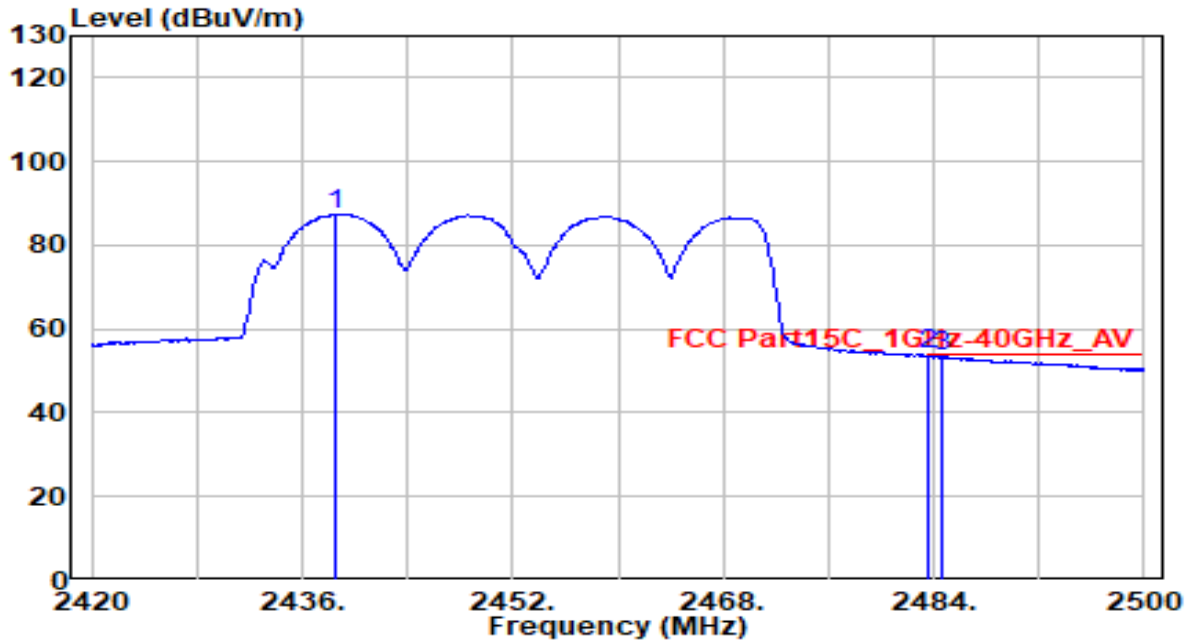

| No | Frequency (MHz) | Reading (dBuV) | C.F (dB/m) | Measurement (dBuV/m) | Margin (dB) | Limit (dBuV/m) | Height (cm) | Angle (deg) | Remark (QP/PK/AV) |
|----|-----------------|----------------|------------|----------------------|-------------|----------------|-------------|-------------|-------------------|
| 1 | 2438.480 | 56.55 | 30.76 | 87.31 | N/A | N/A | 100 | 225 | Average |
| 2 | * 2483.500 | 22.88 | 30.91 | 53.79 | -0.21 | 54.00 | 100 | 225 | Average |
| 3 | 2484.640 | 22.55 | 30.92 | 53.47 | -0.53 | 54.00 | 100 | 225 | Average |

Note:

1. " *", means this data is the worst emission level.
2. C.F (Correction Factor) = Antenna Factor (dB)+ Cable Loss (dB).
3. Measurement (dBuV/m) = Reading(dBuV) + C.F (Correction Factor).
4. The emission levels of other frequencies are very lower than the limit and not show in test report.

| | | | |
|-----------|-------------------------------------------------------|----------------------|--------------|
| EUT | AX3000+G1500 Whole Home Powerline Mesh Wi-Fi 6 System | Date of Test | 2022-07-06 |
| Factor | DRH18-E | Temp. / Humidity | 23°C /63% |
| Polarity | Vertical | Site / Test Engineer | AC2 / Owen |
| Test Mode | 802.11ax-40MHz_TX_CH 9_ANT 0+1 | Test Voltage | AC 120V/60Hz |

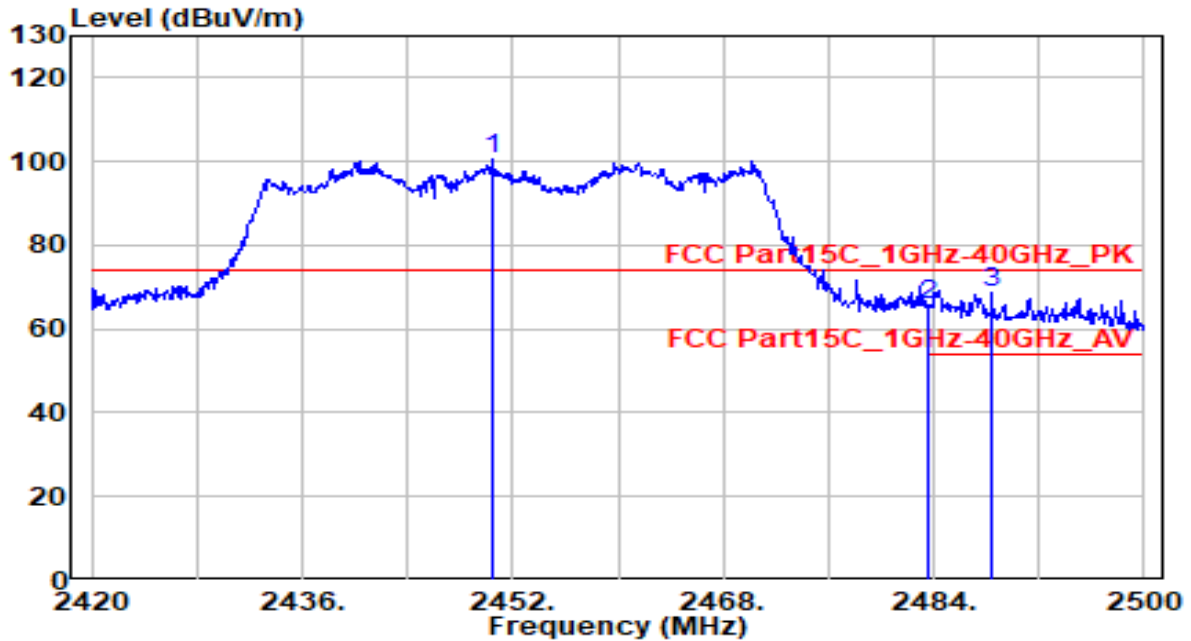

| No | Frequency (MHz) | Reading (dBuV) | C.F (dB/m) | Measurement (dBuV/m) | Margin (dB) | Limit (dBuV/m) | Height (cm) | Angle (deg) | Remark (QP/PK/AV) |
|----|-----------------|----------------|------------|----------------------|-------------|----------------|-------------|-------------|-------------------|
| 1 | 2450.400 | 69.75 | 30.80 | 100.55 | N/A | N/A | 100 | 45 | Peak |
| 2 | 2483.500 | 34.72 | 30.91 | 65.63 | -8.37 | 74.00 | 100 | 45 | Peak |
| 3 | * 2488.400 | 37.70 | 30.93 | 68.63 | -5.37 | 74.00 | 100 | 45 | Peak |

Note:

1. " *", means this data is the worst emission level.
2. C.F (Correction Factor) = Antenna Factor (dB)+ Cable Loss (dB).
3. Measurement (dBuV/m) = Reading(dBuV) + C.F (Correction Factor).
4. The emission levels of other frequencies are very lower than the limit and not show in test report.

| | | | |
|-----------|-------------------------------------------------------|----------------------|--------------|
| EUT | AX3000+G1500 Whole Home Powerline Mesh Wi-Fi 6 System | Date of Test | 2022-07-06 |
| Factor | DRH18-E | Temp. / Humidity | 23°C /63% |
| Polarity | Vertical | Site / Test Engineer | AC2 / Owen |
| Test Mode | 802.11ax-40MHz_TX_CH 9_ANT 0+1 | Test Voltage | AC 120V/60Hz |

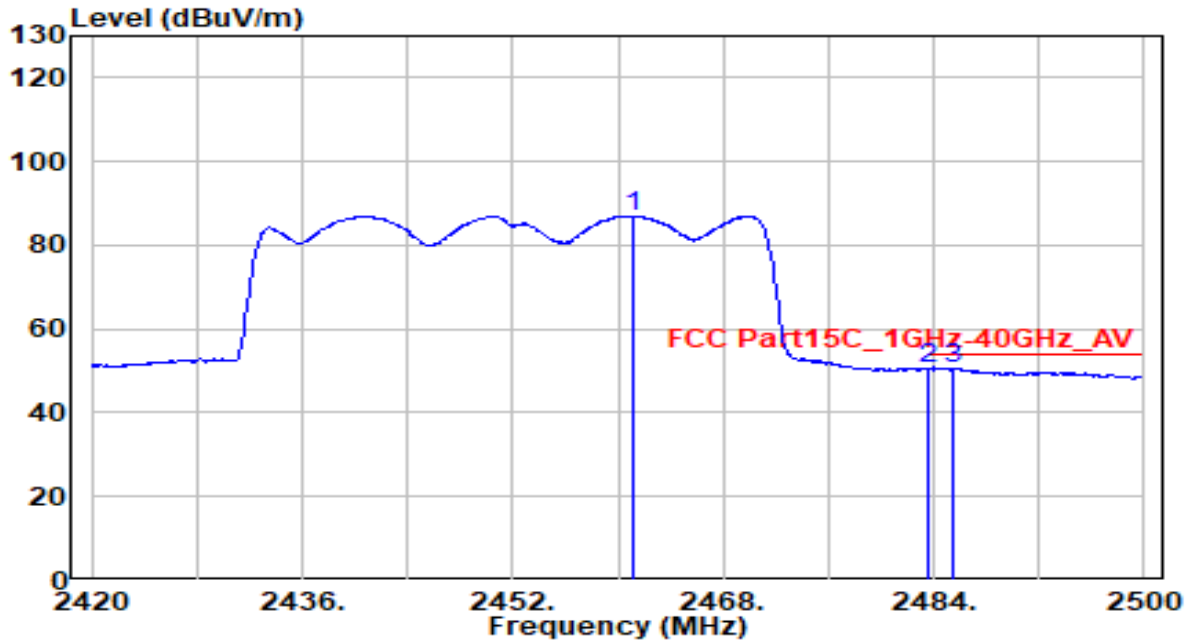

| No | Frequency (MHz) | Reading (dBuV) | C.F (dB/m) | Measurement (dBuV/m) | Margin (dB) | Limit (dBuV/m) | Height (cm) | Angle (deg) | Remark (QP/PK/AV) |
|----|-----------------|----------------|------------|----------------------|-------------|----------------|-------------|-------------|-------------------|
| 1 | 2461.120 | 56.13 | 30.84 | 86.97 | N/A | N/A | 100 | 45 | Average |
| 2 | 2483.500 | 19.44 | 30.91 | 50.35 | -3.65 | 54.00 | 100 | 45 | Average |
| 3 | * 2485.440 | 19.71 | 30.92 | 50.63 | -3.37 | 54.00 | 100 | 45 | Average |

Note:

1. " *", means this data is the worst emission level.
2. C.F (Correction Factor) = Antenna Factor (dB)+ Cable Loss (dB).
3. Measurement (dBuV/m) = Reading(dBuV) + C.F (Correction Factor).
4. The emission levels of other frequencies are very lower than the limit and not show in test report.

7.8. AC Conducted Emissions Measurement

7.8.1. Test Limit

| FCC Part 15 Subpart C Paragraph 15.207 Limits | | |
|-----------------------------------------------|-----------|-----------|
| Frequency (MHz) | QP (dBuV) | AV (dBuV) |
| 0.15 - 0.50 | 66 - 56 | 56 - 46 |
| 0.50 - 5.0 | 56 | 46 |
| 5.0 - 30 | 60 | 50 |

Note 1: The lower limit shall apply at the transition frequencies.

Note 2: The limit decreases linearly with the logarithm of the frequency in the range 0.15MHz to 0.5MHz.

7.8.2. Test Setup

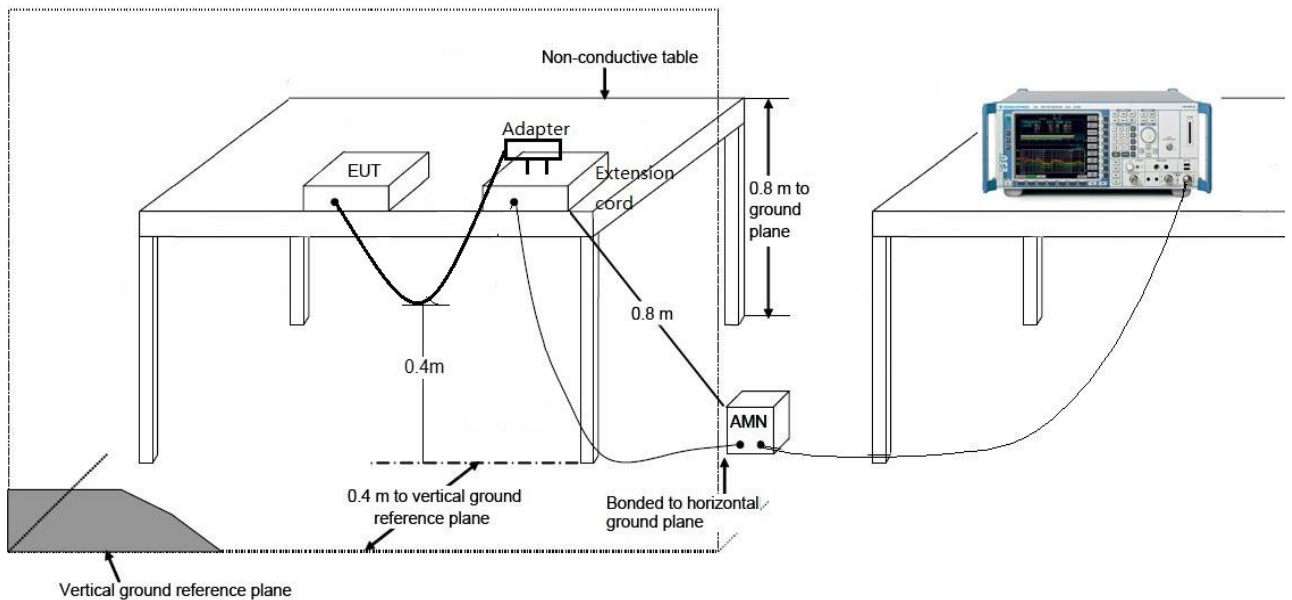

7.8.3. Test Result

| | | | |
|-----------|-------------------------------------------------------|----------------------|---------------|
| EUT | AX3000+G1500 Whole Home Powerline Mesh Wi-Fi 6 System | Date of Test | 2022-09-27 |
| Factor | CE_ENV216-L1 (Filter ON) | Temp. / Humidity | 24.8°C /55% |
| Polarity | Line1 | Site / Test Engineer | SR2 / Jeff |
| Test Mode | 802.11n-20MHz_TX_CH6_Ant 0+1 | Test Voltage | AC 120V/ 60Hz |

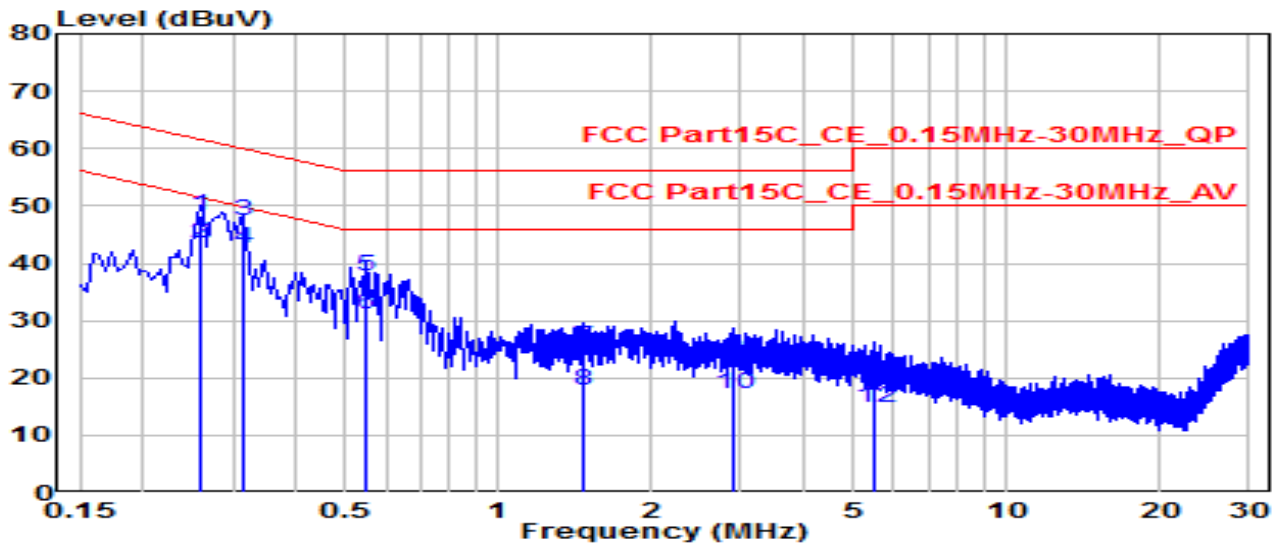

| No | Frequency (MHz) | Reading (dBUV) | C.F (dB) | Measurement (dBUV) | Margin (dB) | Limit (dBUV) | Remark (QP/PK/AV) |
|----|-----------------|----------------|----------|--------------------|-------------|--------------|-------------------|
| 1 | 0.258 | 38.57 | 9.63 | 48.19 | -13.30 | 61.50 | QP |
| 2 | 0.258 | 33.96 | 9.63 | 43.59 | -7.91 | 51.50 | Average |
| 3 | * 0.316 | 37.72 | 9.63 | 47.35 | -12.45 | 59.80 | QP |
| 4 | * 0.316 | 33.03 | 9.63 | 42.66 | -7.14 | 49.80 | Average |
| 5 | 0.550 | 28.02 | 9.64 | 37.67 | -18.33 | 56.00 | QP |
| 6 | 0.550 | 21.60 | 9.64 | 31.24 | -14.76 | 46.00 | Average |
| 7 | 1.473 | 15.59 | 9.68 | 25.27 | -30.73 | 56.00 | QP |
| 8 | 1.473 | 8.23 | 9.68 | 17.91 | -28.09 | 46.00 | Average |
| 9 | 2.895 | 13.43 | 9.71 | 23.14 | -32.86 | 56.00 | QP |
| 10 | 2.895 | 7.37 | 9.71 | 17.08 | -28.92 | 46.00 | Average |
| 11 | 5.500 | 9.45 | 9.76 | 19.21 | -40.79 | 60.00 | QP |
| 12 | 5.500 | 5.15 | 9.76 | 14.91 | -35.09 | 50.00 | Average |

Note:

1. " *", means this data is the worst emission level.
2. C.F (Correction Factor) = Antenna Factor (dB)+ Cable Loss (dB).
3. Measurement (dBUV) = Reading(dBUV) + C.F (Correction Factor).

| | | | |
|-----------|-------------------------------------------------------|----------------------|---------------|
| EUT | AX3000+G1500 Whole Home Powerline Mesh Wi-Fi 6 System | Date of Test | 2022-09-27 |
| Factor | CE_ENV216-N (Filter ON) | Temp. / Humidity | 24.8°C /55% |
| Polarity | Neutral | Site / Test Engineer | SR2 / Jeff |
| Test Mode | 802.11n-20MHz_TX_CH6_Ant 0+1 | Test Voltage | AC 120V/ 60Hz |

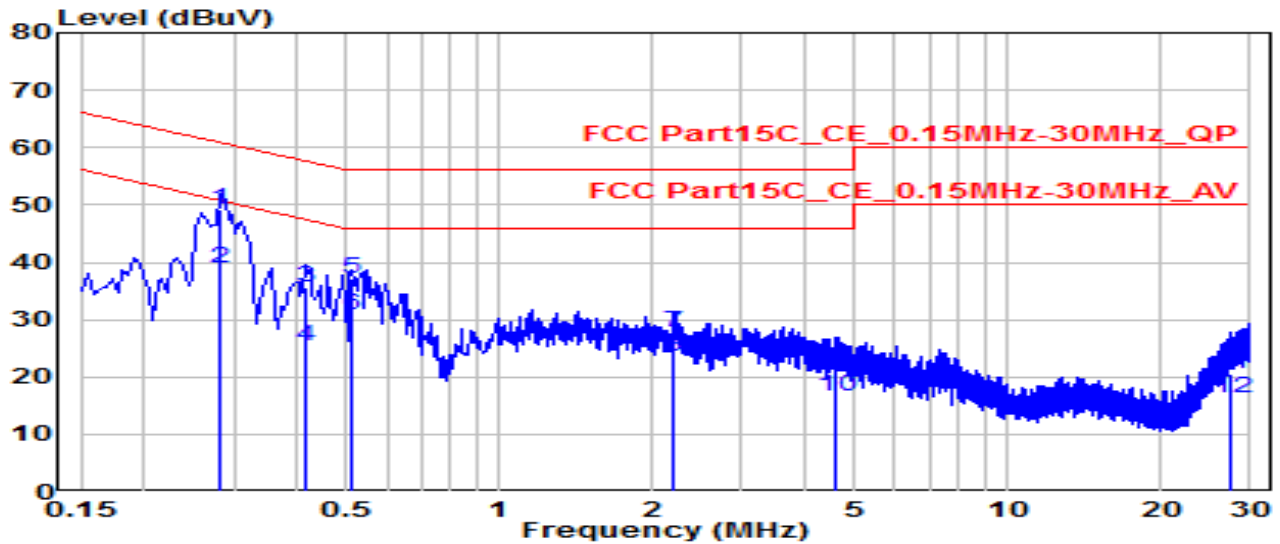

| No | Frequency (MHz) | Reading (dBUV) | C.F (dB) | Measurement (dBUV) | Margin (dB) | Limit (dBUV) | Remark (QP/PK/AV) |
|----|-----------------|----------------|----------|--------------------|-------------|--------------|-------------------|
| 1 | * 0.280 | 39.54 | 9.63 | 49.16 | -11.64 | 60.80 | QP |
| 2 | * 0.280 | 29.30 | 9.63 | 38.92 | -11.88 | 50.80 | Average |
| 3 | 0.415 | 26.08 | 9.64 | 35.71 | -21.82 | 57.54 | QP |
| 4 | 0.415 | 15.58 | 9.64 | 25.22 | -22.32 | 47.54 | Average |
| 5 | 0.514 | 27.57 | 9.64 | 37.22 | -18.78 | 56.00 | QP |
| 6 | 0.514 | 21.09 | 9.64 | 30.73 | -15.27 | 46.00 | Average |
| 7 | 2.211 | 18.23 | 9.69 | 27.92 | -28.08 | 56.00 | QP |
| 8 | 2.211 | 13.79 | 9.69 | 23.48 | -22.52 | 46.00 | Average |
| 9 | 4.591 | 11.66 | 9.74 | 21.40 | -34.60 | 56.00 | QP |
| 10 | 4.591 | 6.99 | 9.74 | 16.73 | -29.27 | 46.00 | Average |
| 11 | 27.381 | 10.56 | 10.04 | 20.60 | -39.40 | 60.00 | QP |
| 12 | 27.381 | 6.22 | 10.04 | 16.25 | -33.75 | 50.00 | Average |

Note:

1. " *", means this data is the worst emission level.
2. C.F (Correction Factor) = Antenna Factor (dB)+ Cable Loss (dB).
3. Measurement (dBUV) = Reading(dBUV) + C.F (Correction Factor).

| | | | |
|-----------|-------------------------------------------------------|----------------------|---------------|
| EUT | AX3000+G1500 Whole Home Powerline Mesh Wi-Fi 6 System | Date of Test | 2022-09-27 |
| Factor | CE_ENV216-L1 (Filter ON) | Temp. / Humidity | 24.8°C /55% |
| Polarity | Line1 | Site / Test Engineer | SR2 / Jeff |
| Test Mode | 802.11n-20MHz_TX_CH6_Ant 0+1 | Test Voltage | AC 240V/ 60Hz |

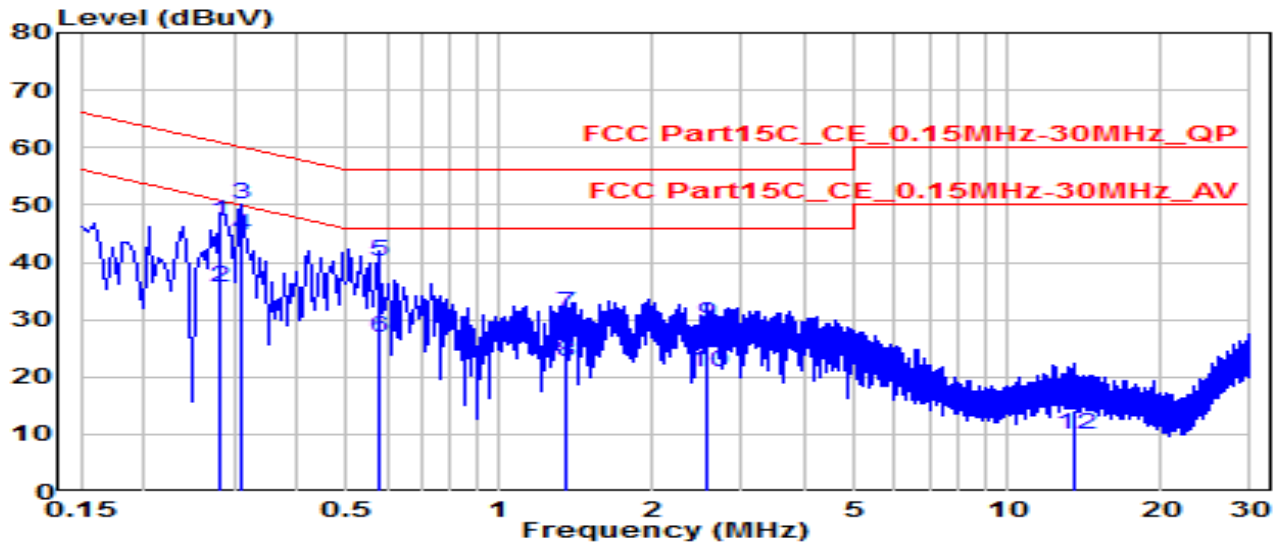

| No | Frequency (MHz) | Reading (dBuV) | C.F (dB) | Measurement (dBuV) | Margin (dB) | Limit (dBuV) | Remark (QP/PK/AV) |
|----|-----------------|----------------|----------|--------------------|-------------|--------------|-------------------|
| 1 | 0.280 | 37.55 | 9.63 | 47.18 | -13.62 | 60.80 | QP |
| 2 | 0.280 | 26.10 | 9.63 | 35.73 | -15.07 | 50.80 | Average |
| 3 | * 0.312 | 40.43 | 9.63 | 50.06 | -9.86 | 59.92 | QP |
| 4 | * 0.312 | 35.18 | 9.63 | 44.81 | -5.10 | 49.92 | Average |
| 5 | 0.582 | 30.58 | 9.65 | 40.23 | -15.77 | 56.00 | QP |
| 6 | 0.582 | 17.29 | 9.65 | 26.94 | -19.06 | 46.00 | Average |
| 7 | 1.360 | 21.48 | 9.68 | 31.16 | -24.84 | 56.00 | QP |
| 8 | 1.360 | 13.10 | 9.68 | 22.78 | -23.22 | 46.00 | Average |
| 9 | 2.566 | 19.50 | 9.70 | 29.20 | -26.80 | 56.00 | QP |
| 10 | 2.566 | 11.28 | 9.70 | 20.98 | -25.02 | 46.00 | Average |
| 11 | 13.455 | 4.27 | 9.88 | 14.15 | -45.85 | 60.00 | QP |
| 12 | 13.455 | 0.09 | 9.88 | 9.97 | -40.03 | 50.00 | Average |

Note:

1. " *", means this data is the worst emission level.
2. C.F (Correction Factor) = Antenna Factor (dB)+ Cable Loss (dB).
3. Measurement (dBuV) = Reading(dBuV) + C.F (Correction Factor).

| | | | |
|-----------|-------------------------------------------------------|----------------------|---------------|
| EUT | AX3000+G1500 Whole Home Powerline Mesh Wi-Fi 6 System | Date of Test | 2022-09-27 |
| Factor | CE_ENV216-N (Filter ON) | Temp. / Humidity | 24.8°C /55% |
| Polarity | Neutral | Site / Test Engineer | SR2 / Jeff |
| Test Mode | 802.11n-20MHz_TX_CH6_Ant 0+1 | Test Voltage | AC 240V/ 60Hz |

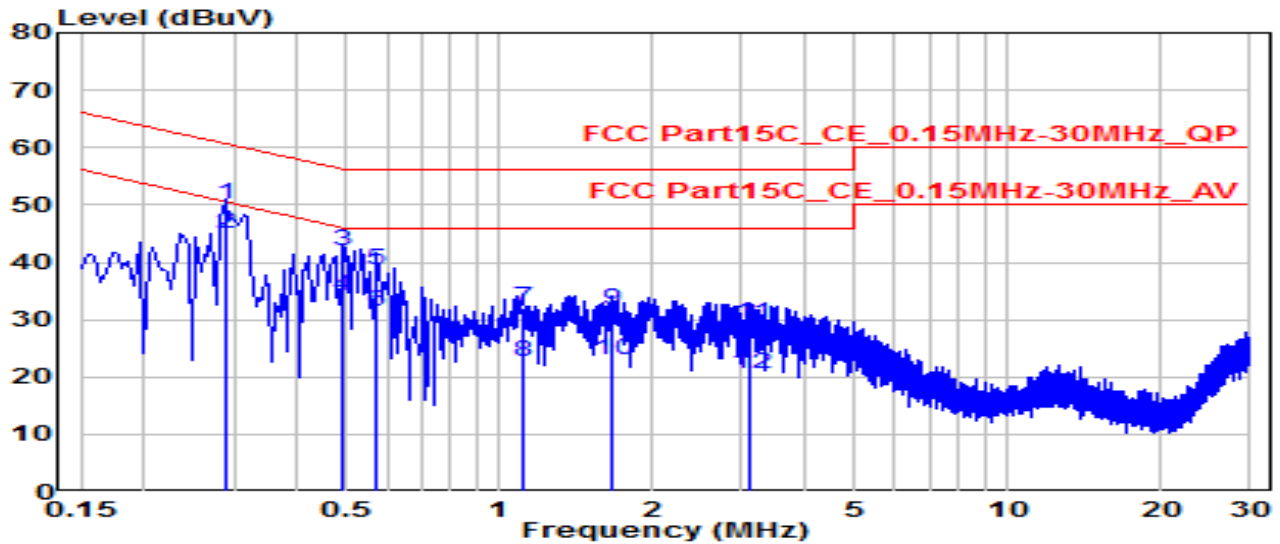

| No | Frequency (MHz) | Reading (dBuV) | C.F (dB) | Measurement (dBuV) | Margin (dB) | Limit (dBuV) | Remark (QP/PK/AV) |
|----|-----------------|----------------|----------|--------------------|-------------|--------------|-------------------|
| 1 | * | 40.40 | 9.63 | 50.03 | -10.51 | 60.54 | QP |
| 2 | * | 35.31 | 9.63 | 44.94 | -5.60 | 50.54 | Average |
| 3 | | 32.23 | 9.64 | 41.87 | -14.27 | 56.13 | QP |
| 4 | | 24.62 | 9.64 | 34.26 | -11.87 | 46.13 | Average |
| 5 | | 29.00 | 9.65 | 38.65 | -17.35 | 56.00 | QP |
| 6 | | 21.88 | 9.65 | 31.53 | -14.47 | 46.00 | Average |
| 7 | | 22.46 | 9.67 | 32.13 | -23.87 | 56.00 | QP |
| 8 | | 13.01 | 9.67 | 22.69 | -23.31 | 46.00 | Average |
| 9 | | 22.06 | 9.68 | 31.74 | -24.26 | 56.00 | QP |
| 10 | | 13.33 | 9.68 | 23.01 | -22.99 | 46.00 | Average |
| 11 | | 19.71 | 9.71 | 29.42 | -26.58 | 56.00 | QP |
| 12 | | 10.96 | 9.71 | 20.68 | -25.32 | 46.00 | Average |

Note:

1. " *", means this data is the worst emission level.
2. C.F (Correction Factor) = Antenna Factor (dB)+ Cable Loss (dB).
3. Measurement (dBuV) = Reading(dBuV) + C.F (Correction Factor).

8. CONCLUSION

The data collected relate only the item(s) tested and show that the device is compliance with Part 15C of the FCC Rules.

————— The End —————

Appendix A : Test Setup Photograph

Refer to “2206TW0106-Setup Photo” file.

Appendix B : External Photograph

Refer to "2206TW0106-External Photo" file.

Appendix C : Internal Photograph

Refer to "2206TW0106-Internal Photo" file.