

Product Name: Kasa Smart Wi-Fi Outdoor Plug	Report No: FCC022022-5387RF6
Product Model: EP40A	Security Classification: Open
Version: V1.0	Total Page:46

TIRT Testing Report



Prepared By:	Checked By:	Approved By:	
Stone Tang	Randy Lv	Daniel Chen	
<i>Stone Tang</i>	<i>Randy Lv</i>	<i>Daniel Chen</i>	

FCC Radio Test Report

FCC ID: 2AXJ4P400

This report concerns: Original Grant

Project No. : 022022-5387
Equipment : Kasa Smart Wi-Fi Outdoor Plug
Brand Name : TP-Link
Test Model : EP40A
Series Model : N/A
Applicant : TP-Link Corporation Limited
Address : Room 901, 9/F. , New East Ocean Centre, 9 Science Museum Road,
Tsim Sha Tsui, Kowloon, Hong Kong
Manufacturer : TP-Link Corporation Limited
Address : Room 901, 9/F. , New East Ocean Centre, 9 Science Museum Road,
Tsim Sha Tsui, Kowloon, Hong Kong
Date of Test : 2022.07.13-2022.10.12
Issued Date : 2022.10.26
Report Version : V1.0
Test Sample : Engineering Sample No.: 20220713018150
Standard(s) : FCC CFR Title 47, Part 15, Subpart C
FCC KDB 558074 D01 15.247 Meas Guidance v05r02
ANSI C63.10-2013

- The test result referred exclusively to the presented test model /sample.
- Without written approval of TIRT Inc. the test report shall not reproduced except in full.

Add: 101,3 # Factory Building, Gongjin Electronics Shatin Community, Kengzi Street,
Pingshan District, Shenzhen, China

TEL: +86-0755-27087573

Table of Contents**Page**

REPORT ISSUED HISTORY	5
1 . SUMMARY OF TEST RESULTS	6
1.1 TEST FACILITY	7
1.2 MEASUREMENT UNCERTAINTY	7
1.3 TEST ENVIRONMENT CONDITIONS	7
2 . GENERAL INFORMATION	8
2.1 GENERAL DESCRIPTION OF EUT	8
2.2 DESCRIPTION OF TEST MODES	9
2.3 PARAMETERS OF TEST SOFTWARE	9
2.4 BLOCK DIAGRAM SHOWING THE CONFIGURATION OF SYSTEM TESTED	10
2.5 SUPPORT UNITS	10
3 . AC POWER LINE CONDUCTED EMISSIONS	11
3.1 LIMIT	11
3.2 TEST PROCEDURE	11
3.3 DEVIATION FROM TEST STANDARD	11
3.4 TEST SETUP	12
3.5 EUT OPERATING CONDITIONS	12
3.6 TEST RESULTS	12
4 . RADIATED EMISSIONS	13
4.1 LIMIT	13
4.2 TEST PROCEDURE	14
4.3 DEVIATION FROM TEST STANDARD	15
4.4 TEST SETUP	15
4.5 EUT OPERATING CONDITIONS	16
4.6 TEST RESULT - 9 KHZ TO 30 MHZ	16
4.7 TEST RESULT - 30 MHZ TO 1000 MHZ	16
4.8 TEST RESULT - ABOVE 1000 MHZ	16
5 . BANDWIDTH	17
5.1 LIMIT	17
5.2 TEST PROCEDURE	17
5.3 DEVIATION FROM STANDARD	17
5.4 TEST SETUP	17
5.5 EUT OPERATION CONDITIONS	17
5.6 TEST RESULTS	17

Table of Contents**Page**

6 . MAXIMUM OUTPUT POWER & E.I.R.P.	18
6.1 LIMIT	18
6.2 TEST PROCEDURE	18
6.3 DEVIATION FROM STANDARD	18
6.4 TEST SETUP	18
6.5 EUT OPERATION CONDITIONS	18
6.6 TEST RESULTS	18
7 . CONDUCTED SPURIOUS EMISSION	19
7.1 LIMIT	19
7.2 TEST PROCEDURE	19
7.3 DEVIATION FROM STANDARD	19
7.4 TEST SETUP	19
7.5 EUT OPERATION CONDITIONS	19
7.6 TEST RESULTS	19
8 . POWER SPECTRAL DENSITY	20
8.1 LIMIT	20
8.2 TEST PROCEDURE	20
8.3 DEVIATION FROM STANDARD	20
8.4 TEST SETUP	20
8.5 EUT OPERATION CONDITIONS	20
8.6 TEST RESULTS	20
9 . MEASUREMENT INSTRUMENTS LIST	21
10 . EUT TEST PHOTO	22
APPENDIX A - AC POWER LINE CONDUCTED EMISSIONS	26
APPENDIX B - RADIATED EMISSION - 9 KHZ TO 30 MHZ	29
APPENDIX C - RADIATED EMISSION - 30 MHZ TO 1000 MHZ	30
APPENDIX D - RADIATED EMISSION - ABOVE 1000 MHZ	33
APPENDIX E - BANDWIDTH	39
APPENDIX F - MAXIMUM AVERAGE OUTPUT POWER	41
APPENDIX G - CONDUCTED SPURIOUS EMISSION	43
APPENDIX H - POWER SPECTRAL DENSITY	45

REPORT ISSUED HISTORY

Report No.	Version	Description	Issued Date	Note
FCC022022-5387RF6	V1.0	Original Report.	2022.10.26	Valid

1. SUMMARY OF TEST RESULTS

Test procedures according to the technical standard(s):

FCC CFR Title 47, Part 15, Subpart C				
Standard(s) Section	Test Item	Test Result	Judgment	Remark
15.207	AC Power Line Conducted Emissions	APPENDIX A	PASS	-----
15.247(d) 15.205(a) 15.209(a)	Radiated Emissions	APPENDIX B APPENDIX C APPENDIX D	PASS	-----
15.247(a)(2)	Bandwidth	APPENDIX E	PASS	-----
15.247(b)(3)	Maximum Output Power	APPENDIX F	PASS	-----
15.247(d)	Conducted Spurious Emission	APPENDIX G	PASS	-----
15.247(e)	Power Spectral Density	APPENDIX H	PASS	-----
15.203	Antenna Requirement	-----	PASS	Note(2)

Note:

- (1) "N/A" denotes test is not applicable to this device.
- (2) The device what use a permanently attached antenna were considered sufficient to comply with the provisions of 15.203.

1.1 TEST FACILITY

Company:	Beijing TIRT Technology Service Co.,Ltd Shenzhen
Address:	101,3 # Factory Building, Gongjin Electronics Shatin Community, Kengzi Street, Pingshan District, Shenzhen, China
CNAS Registration Number:	CNAS L14158
A2LA Registration Number	6049.01
Telephone:	+86-0755-27087573

1.2 MEASUREMENT UNCERTAINTY

ISO/IEC 17025 requires that an estimate of the measurement uncertainties associated with the emissions test results be included in the report. The measurement uncertainties given below are based on a 95% confidence level (based on a coverage factor (k=2))

The TIRT measurement uncertainty as below table:

Parameter	Uncertainty
Occupied Channel Bandwidth	±142.12 KHz
RF power conducted	±0.74 dB
RF power radiated	±3.25dB
Spurious emissions, conducted	±1.78dB
Spurious emissions, radiated (30MHz~1GHz)	±4.6dB
Spurious emissions, radiated (1GHz ~ 18GHz)	±4.9dB
Conduction Emissions(150kHz~30MHz)	±3.1 dB
Humidity	±4.6%
Temperature	±0.7°C
Time	±1.25%

Note: Unless specifically mentioned, the uncertainty of measurement has not been taken into account to declare the compliance or non-compliance to the specification.

1.3 TEST ENVIRONMENT CONDITIONS

Test Item	Temperature	Humidity	Test Voltage	Tested By
AC Power Line Conducted Emissions	24.2°C	56%	AC 120V/60Hz	Stone Tang
Radiated Emissions-9kHz to 30 MHz	24.6°C	55%	AC 120V/60Hz	Stone Tang
Radiated Emissions-30MHz to 1000MHz	24.6°C	55%	AC 120V/60Hz	Stone Tang
Radiated Emissions-Above 1000MHz	24.6°C	55%	AC 120V/60Hz	Stone Tang
Bandwidth	24.2°C	55%	AC 120V/60Hz	Stone Tang
Maximum Output Power	24.2°C	55%	AC 120V/60Hz	Stone Tang
Conducted Spurious Emissions	24.6°C	55%	AC 120V/60Hz	Stone Tang
Power Spectral Density	24.6°C	55%	AC 120V/60Hz	Stone Tang

2. GENERAL INFORMATION

2.1 GENERAL DESCRIPTION OF EUT

Equipment	Kasa Smart Wi-Fi Outdoor Plug
Brand Name	TP-Link
Test Model	EP40A
Series Model	N/A
Model Difference(s)	N/A
Power Source	AC Mains.
Power Rating	125V~ 60Hz 15A Maximum
Operation Frequency	2402 MHz ~ 2480 MHz
Modulation Type	GFSK
Bit Rate of Transmitter	1Mbps
Max. Output Power	1Mbps: 5.10 dBm (0.0032 W)

Note:

- For a more detailed features description, please refer to the manufacturer's specifications or the user's manual.

2. Channel List:

Channel	Frequency (MHz)	Channel	Frequency (MHz)
00	2402	20	2442
01	2404	21	2444
02	2406	22	2446
03	2408	23	2448
04	2410	24	2450
05	2412	25	2452
06	2414	26	2454
07	2416	27	2456
08	2418	28	2458
09	2420	29	2460
10	2422	30	2462
11	2424	31	2464
12	2426	32	2466
13	2428	33	2468
14	2430	34	2470
15	2432	35	2472
16	2434	36	2474
17	2436	37	2476
18	2438	38	2478
19	2440	39	2480

3. Table for Filed Antenna:

Ant.	Brand	Model Name	Antenna Type	Connector	Gain (dBi)
1	TP-link	N/A	IFA	N/A	3.50
2	TP-link	N/A	IFA	N/A	1.32

Note:

- The antenna gain is provided by the manufacturer.
- Only one antenna is actually used for smart antenna switchover.

2.2 DESCRIPTION OF TEST MODES

The test system was pre-tested based on the consideration of all possible combinations of EUT operation mode.

Pretest Mode	Description
Mode 1	TX Mode_1Mbps Channel 00/19/39
Mode 2	TX Mode_1Mbps Channel 19

Following mode(s) was (were) found to be the worst case(s) and selected for the final test.

AC power line conducted emissions test	
Final Test Mode	Description
Mode 2	TX Mode_1Mbps Channel 19

Radiated emissions test - Below 1GHz	
Final Test Mode	Description
Mode 2	TX Mode_1Mbps Channel 19

Radiated emissions test - Above 1GHz	
Final Test Mode	Description
Mode 1	TX Mode_1Mbps Channel 00/19/39

Conducted test	
Final Test Mode	Description
Mode 1	TX Mode_1Mbps Channel 00/19/39

Note:

- (1) For radiated emission above 1 GHz test, the spurious points of 1GHz~26.5GHz have been pre-tested and in this report only recorded the worst case. The remaining spurious points are all below the limit value of 20dB.
- (2) For AC power line conducted emissions and radiated emissions below 1 GHz test, the 1Mbps channel 19 is found to be the worst case and recorded.

2.3 PARAMETERS OF TEST SOFTWARE

During testing channel & power controlling software provided by the customer was used to control the operating channel as well as the output power level.

Test Software Version	RTLBTAPP_V5.2.2.27		
Frequency (MHz)	2402	2440	2480
1Mbps	0X25	0X25	0X25

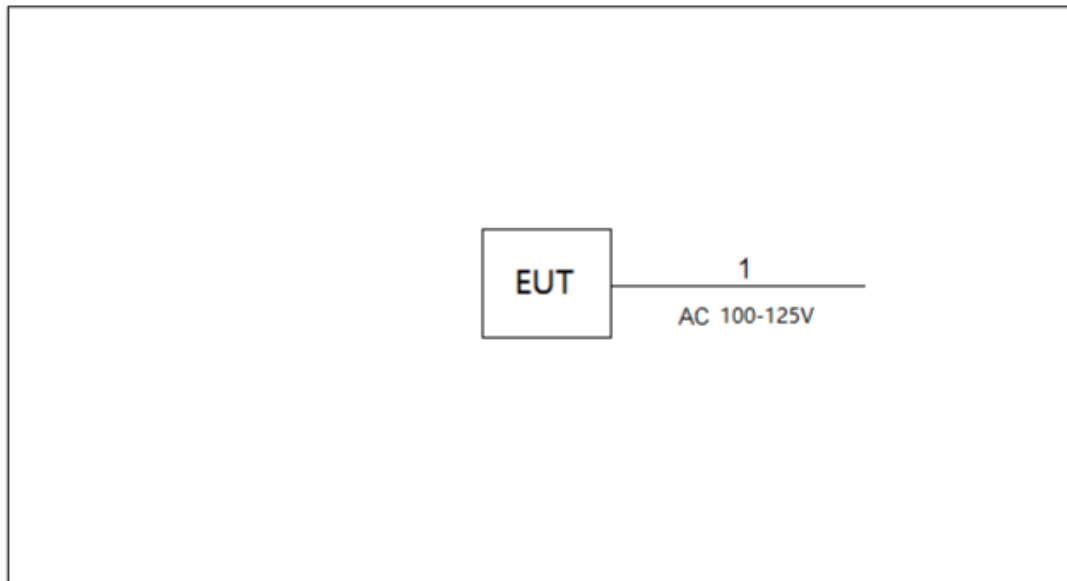
2.4 BLOCK DIAGRAM SHOWING THE CONFIGURATION OF SYSTEM TESTED**2.5 SUPPORT UNITS**

Support Equipment				
No.	Equipment	Brand Name	Model Name	Remarks
1	AC Cable	NO	NO	1.2m

3. AC POWER LINE CONDUCTED EMISSIONS

3.1 LIMIT

Frequency of Emission (MHz)	Limit (dBμV)	
	Quasi-peak	Average
0.15 - 0.5	66 to 56*	56 to 46*
0.5 - 5.0	56	6
5.0 - 30.0	60	50

Note:

- (1) The tighter limit applies at the band edges.
- (2) The limit of " * " marked band means the limitation decreases linearly with the logarithm of the frequency in the range.

3.2 TEST PROCEDURE

- a. The EUT was placed 0.8 meters from the horizontal ground plane with EUT being connected to the power mains through a line impedance stabilization network (LISN). All other support equipment powered from additional LISN(s). The LISN provide 50 Ohm/ 50uH of coupling impedance for the measuring instrument.
- b. Interconnecting cables that hang closer than 40 cm to the ground plane shall be folded back and forth in the center forming a bundle 30 to 40 cm long.
- c. I/O cables that are not connected to a peripheral shall be bundled in the center. The end of the cable may be terminated, if required, using the correct terminating impedance. The overall length shall not exceed 1 m.
- d. LISN at least 80 cm from nearest part of EUT chassis.
- e. For the actual test configuration, please refer to the related Item –EUT Test Photos.

The following table is the setting of the receiver:

Receiver Parameters	Setting
Start Frequency	0.15 MHz
Stop Frequency	30 MHz
IF Bandwidth	9 kHz

3.3 DEVIATION FROM TEST STANDARD

No deviation.

3.4 TEST SETUP

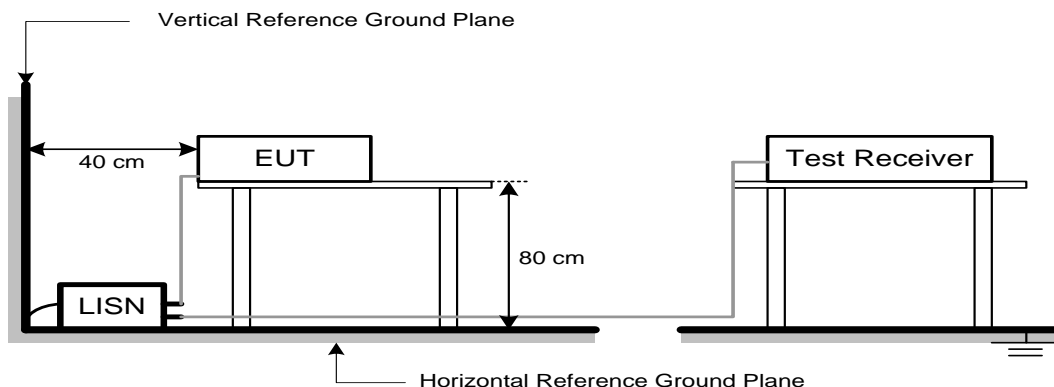

3.5 EUT OPERATING CONDITIONS

The EUT was configured for testing in a typical fashion (as a customer would normally use it). The EUT has been programmed to continuously transmit during test. This operating condition was tested and used to collect the included data.

3.6 TEST RESULTS

Please refer to the APPENDIX A.

Remark:

- (1) All readings are QP Mode value unless otherwise stated AVG in column of 『Note』 . If the QP Mode Measured value compliance with the QP Limits and lower than AVG Limits, the EUT shall be deemed to meet both QP & AVG Limits and then only QP Mode was measured, but AVG Mode didn't perform. In this case, a “ * ” marked in AVG Mode column of Interference Voltage Measured.
- (2) Measuring frequency range from 150 kHz to 30 MHz.

4. RADIATED EMISSIONS

4.1 LIMIT

In case the emission fall within the restricted band specified on 15.205(a), then the 15.209(a) limit in the table below has to be followed.

LIMITS OF RADIATED EMISSION MEASUREMENT (9 kHz-1000 MHz)

Frequency (MHz)	Field Strength (microvolts/meter)	Measurement Distance (meters)
0.009-0.490	2400/F(kHz)	300
0.490-1.705	24000/F(kHz)	30
1.705-30.0	30	30
30-88	100	3
88-216	150	3
216-960	200	3
Above 960	500	3

LIMITS OF RADIATED EMISSION MEASUREMENT (Above 1000 MHz)

Frequency (MHz)	(dBuV/m at 3 m)	
	Peak	Average
Above 1000	74	54

Note:

- (1) The limit for radiated test was performed according to FCC CFR Title 47, Part 15, Subpart C.
- (2) The tighter limit applies at the band edges.
- (3) Emission level (dBuV/m)=20log Emission level (uV/m).

4.2 TEST PROCEDURE

- a. The measuring distance of 3 m shall be used for measurements. The EUT was placed on the top of a rotating table 0.8 meter above the ground at a 3 meter semi-anechoic chamber. The table was rotated 360 degrees to determine the position of the highest radiation.(below 1 GHz)
- b. The measuring distance of 3 m shall be used for measurements. The EUT was placed on the top of a rotating table 1.5 meter above the ground at a 3 meter semi-anechoic chamber. The table was rotated 360 degrees to determine the position of the highest radiation.(above 1 GHz)
- c. The height of the equipment or of the substitution antenna shall be 0.8m or 1.5m; the height of the test antenna shall vary between 1 m to 4 m. Both horizontal and vertical polarizations of the antenna are set to make the measurement.
- d. For each suspected emission, the EUT was arranged to its worst case and then the antenna was tuned to heights find the maximum reading (used Bore sight function).
- e. The receiver system was set to peak and average detect function and specified bandwidth with maximum hold mode when the test frequency is above 1 GHz.
- f. The initial step in collecting radiated emission data is a receiver peak detector mode pre-scanning the measurement frequency range. Significant peaks are then marked and then Quasi Peak detector mode re-measured.
- g. All readings are Peak unless otherwise stated QP in column of Note. Peak denotes that the Peak reading compliance with the QP Limits and then QP Mode measurement didn't perform. (below 1 GHz)
- h. All readings are Peak Mode value unless otherwise stated AVG in column of Note. If the Peak Mode Measured value compliance with the Peak Limits and lower than AVG Limits, the EUT shall be deemed to meet both Peak & AVG Limits and then only Peak Mode was measured, but AVG Mode didn't perform. (above 1 GHz)
- i. For the actual test configuration, please refer to the related Item –EUT Test Photos.

The following table is the setting of the receiver:

Spectrum Parameters	Setting
Start ~ Stop Frequency	9 kHz~150 kHz for RBW 200 Hz
Start ~ Stop Frequency	0.15 MHz~30 MHz for RBW 9 kHz
Start ~ Stop Frequency	30 MHz~1000 MHz for RBW 100 kHz

Spectrum Parameters	Setting
Start Frequency	1000 MHz
Stop Frequency	10th carrier harmonic
RBW / VBW (Emission in restricted band)	1 MHz / 3 MHz for PK value 1 MHz / 1/T Hz for AVG value

Spectrum Parameters	Setting
Start ~ Stop Frequency	9 kHz~90 kHz for PK/AVG detector
Start ~ Stop Frequency	90 kHz~110 kHz for QP detector
Start ~ Stop Frequency	110 kHz~490 kHz for PK/AVG detector
Start ~ Stop Frequency	490 kHz~30 MHz for QP detector
Start ~ Stop Frequency	30 MHz~1000 MHz for QP detector
Start ~ Stop Frequency	1 GHz~26.5 GHz for PK/AVG detector

4.3 DEVIATION FROM TEST STANDARD

No deviation.

4.4 TEST SETUP

9 kHz to 30 MHz

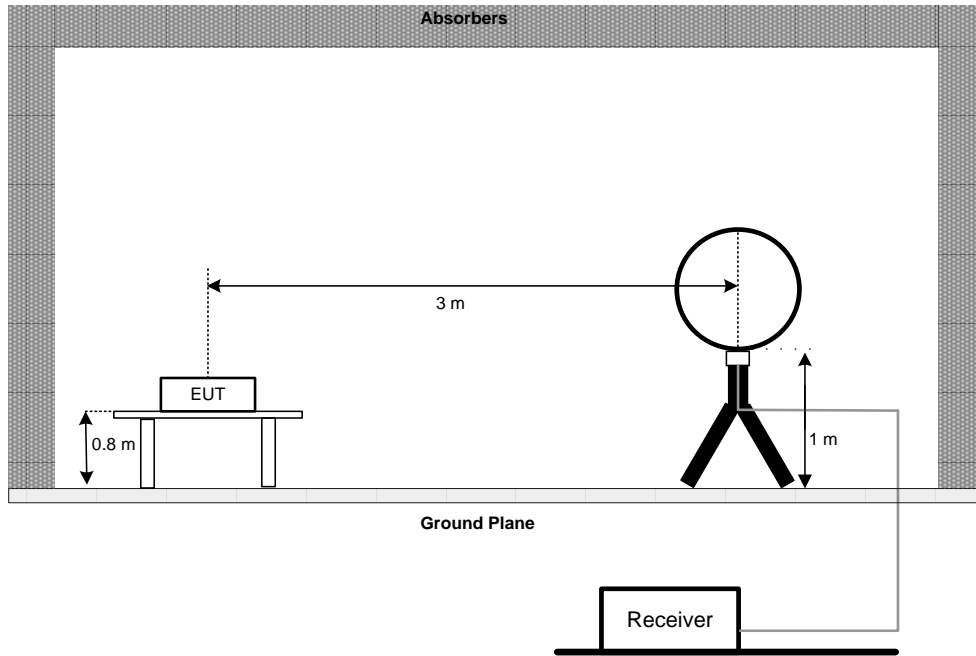

30 MHz to 1 GHz

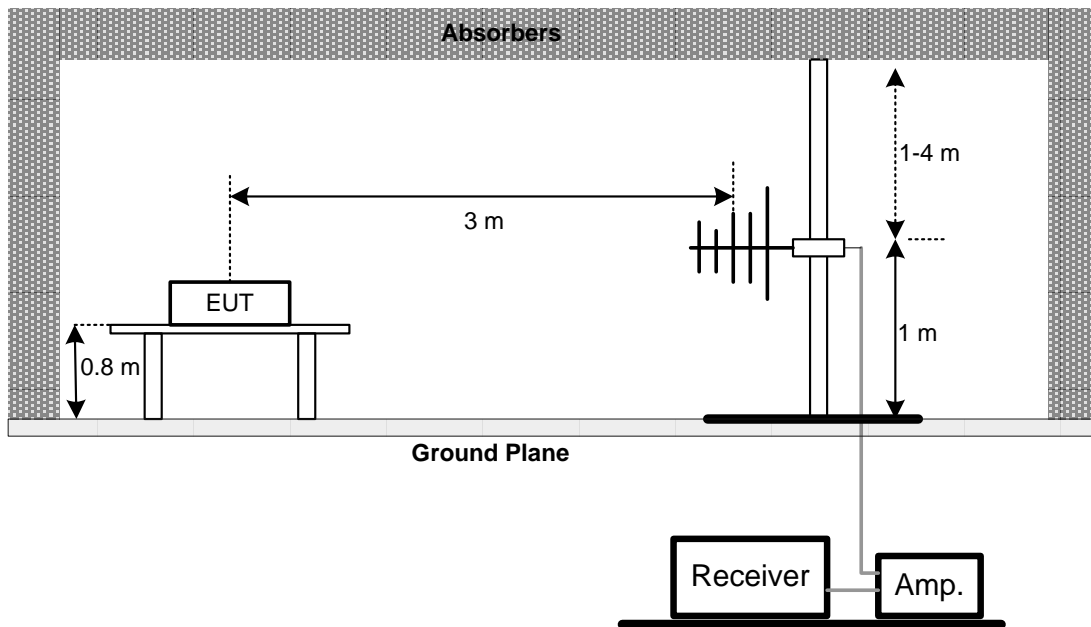

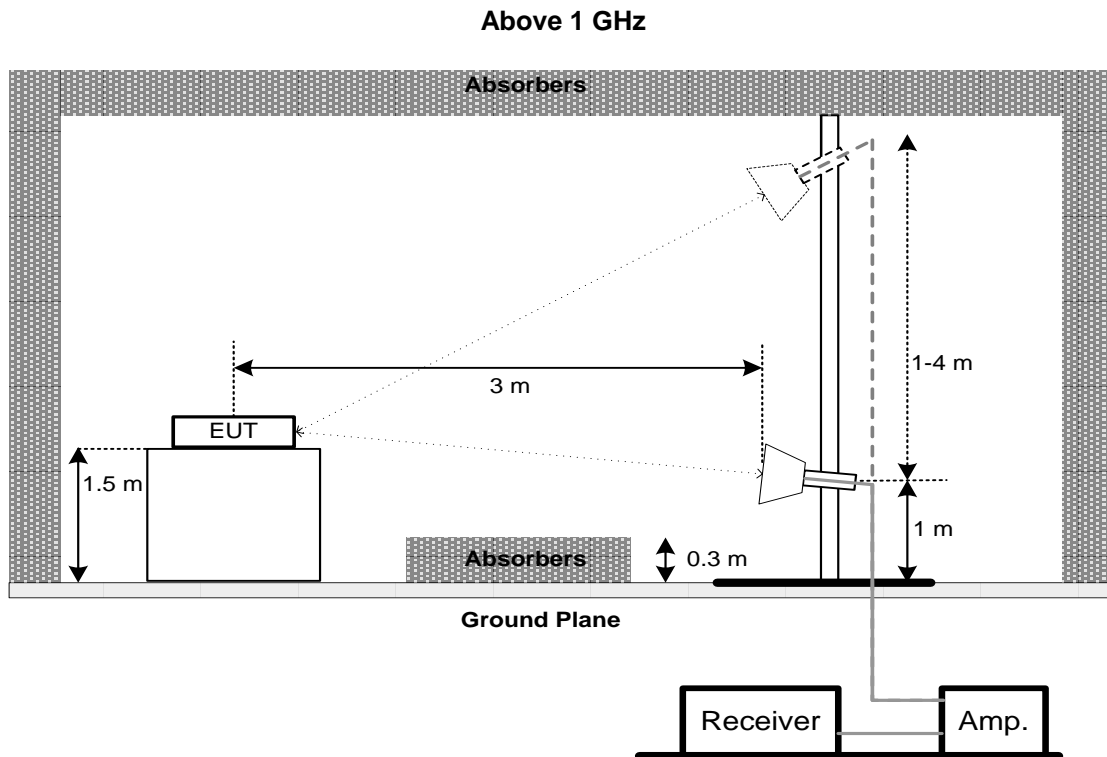

4.5 EUT OPERATING CONDITIONS

The EUT was programmed to be in continuously transmitting mode.

4.6 TEST RESULT - 9 kHz TO 30 MHz

Please refer to the APPENDIX B.

Remark:

- (1) Distance extrapolation factor = $40 \log (\text{specific distance} / \text{test distance})$ (dB).
- (2) Limit line = specific limits (dBuV) + distance extrapolation factor.

4.7 TEST RESULT - 30 MHz TO 1000 MHz

Please refer to the APPENDIX C.

4.8 TEST RESULT - ABOVE 1000 MHz

Please refer to the APPENDIX D.

Remark:

- (1) No limit: This is fundamental signal, the judgment is not applicable. For fundamental signal judgment was referred to Peak output test.

5. BANDWIDTH

5.1 LIMIT

Section	Test Item	Limit
FCC 15.247(a)(2)	6 dB Bandwidth	≥ 500 kHz
	99% Emission Bandwidth	-

5.2 TEST PROCEDURE

- The EUT was directly connected to the spectrum analyzer and antenna output port as show in the block diagram below.
- The following table is the setting of the spectrum analyzer:

For 6 dB Bandwidth:

Spectrum Parameters	Setting
Span Frequency	$>$ Measurement Bandwidth
RBW	100 kHz
VBW	300 kHz
Detector	Peak
Trace	Max Hold
Sweep Time	Auto

For 99% Emission Bandwidth:

Spectrum Parameters	Setting
Span Frequency	Between 1.5 times and 5.0 times the OBW
RBW	30 kHz
VBW	100 kHz
Detector	Peak
Trace	Max Hold
Sweep Time	Auto

5.3 DEVIATION FROM STANDARD

No deviation.

5.4 TEST SETUP



5.5 EUT OPERATION CONDITIONS

The EUT was programmed to be in continuously transmitting mode.

5.6 TEST RESULTS

Please refer to the APPENDIX E.

6. MAXIMUM OUTPUT POWER & E.I.R.P.

6.1 LIMIT

Section	Test Item	Limit
FCC 15.247(b)(3)	Maximum Output Power	1.0000 watt or 30.00 dBm

6.2 TEST PROCEDURE

- The EUT was directly connected to the spectrum analyzer and antenna output port as show in the block diagram below.
- The following table is the setting of the spectrum analyzer:

Spectrum Parameters	Setting
Span Frequency	$\geq 3 \times \text{RBW}$
RBW	3 MHz
VBW	3 MHz
Detector	Peak
Trace	Max Hold
Sweep Time	Auto

Spectrum Parameters	Setting
Span Frequency	At least 1.5 times the OBW
RBW	1% to 5% of the OBW, not to exceed 1 MHz
VBW	$\geq 3 \times \text{RBW}$
Detector	RMS
Trace	Max Hold
Sweep Time	$\leq (\text{number of points in sweep}) \times T$ (Note)

Note: Where T is defined in 11.6 of ANSI C63.10-2013.

6.3 DEVIATION FROM STANDARD

No deviation.

6.4 TEST SETUP



6.5 EUT OPERATION CONDITIONS

The EUT was programmed to be in continuously transmitting mode.

6.6 TEST RESULTS

Please refer to the APPENDIX F.

7. CONDUCTED SPURIOUS EMISSION

7.1 LIMIT

In any 100 kHz bandwidth outside the frequency band in which the spread spectrum or digitally modulated intentional radiator is operating, the radio frequency power that is produced by the intentional radiator shall be at least 20 dB below that in the 100 kHz bandwidth within the band that contains the highest level of the desired power, based on either an RF conducted or a radiated measurement, provided the transmitter demonstrates compliance with the peak Output Power limits. If the transmitter complies with the Output Power limits based on the use of RMS averaging over a time interval, as permitted under paragraph (b)(3) of this section, the attenuation required under this paragraph shall be 30 dB instead of 20 dB. Attenuation below the general limits specified in Section 15.209(a) is not required.

7.2 TEST PROCEDURE

- a. The EUT was directly connected to the spectrum analyzer and antenna output port as show in the block diagram below.
- b. The following table is the setting of the spectrum analyzer:

Spectrum Parameters	Setting
Start Frequency	30 MHz
Stop Frequency	26.5 GHz
RBW	100 kHz
VBW	300 kHz
Detector	Peak
Trace	Max Hold
Sweep Time	Auto

7.3 DEVIATION FROM STANDARD

No deviation.

7.4 TEST SETUP



7.5 EUT OPERATION CONDITIONS

The EUT was programmed to be in continuously transmitting mode.

7.6 TEST RESULTS

Please refer to the APPENDIX G.

8. POWER SPECTRAL DENSITY

8.1 LIMIT

Section	Test Item	Limit
FCC 15.247(e)	Power Spectral Density	8 dBm (in any 3 kHz)

8.2 TEST PROCEDURE

- a. The EUT was directly connected to the spectrum analyzer and antenna output port as show in the block diagram below.
- b. The following table is the setting of the spectrum analyzer:

Spectrum Parameters	Setting
Span Frequency	2 MHz (1 Mbps) / 4 MHz (2 Mbps)
RBW	3 kHz
VBW	10 kHz
Detector	Peak
Trace	Max Hold
Sweep Time	Auto

8.3 DEVIATION FROM STANDARD

No deviation.

8.4 TEST SETUP

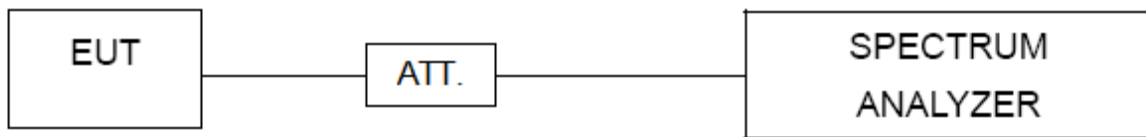

8.5 EUT OPERATION CONDITIONS

The EUT was programmed to be in continuously transmitting mode.

8.6 TEST RESULTS

Please refer to the APPENDIX H.

9. MEASUREMENT INSTRUMENTS LIST

No.	Equipment	Manufacturer	Type No.	Serial No.	Calibrated until
1	EMI Receiver	Rohde&Schwarz	ESCI	1166.5950.03	2022/11/09
2	AMN	Rohde&Schwarz	ENV216	3560.6550.05	2022/11/09
3	AMN	Schwarzbeck	NSLK8127	#829	2022/11/09
4	ECSI RF IN RF Cable	Rohde&Schwarz	RP-X1	N/A	2022/11/09
5	ECSI RF IN RF Cable	Rohde&Schwarz	Sapre sm	N/A	2022/11/09
6	EMI Receiver	Rohde&Schwarz	ESR7	102013	2022/11/09
7	Spectrum analyzer	Rohde&Schwarz	FSV30	103741	2022/11/09
8	Spectrum analyzer	KEYSIGHT	N9010A-44	MY51440158	2022/11/09
9	Integral Antenna	Schwarzbeck	VULB 9163	VULB 9163-361	2022/11/20
10	Integral Antenna	Schwarzbeck	BBHA 9120D	BBHA 9120D 1201	2022/11/20
11	Integral Antenna	Schwarzbeck	BBHA 9170	9170#685	2022/11/20
12	Preamplifier	Schwarzbeck	BBV9745	#78	2022/11/09
13	Preamplifier	Schwarzbeck	BBV9721	9721-019	2022/11/09
14	Preamplifier	RF System/UK	TRLA-0101 80G50B	22062101	2023/07/20
15	ECSI RF IN RF Cable	Rohde&Schwarz	AP-X1	N/A	2022/11/09
16	ECSI RF IN RF Cable	HAOXUN	Z-108	N/A	2022/11/09
17	RF Cable	ZDECL	ZT40-2.92J -2.92J-6M	18124358	2023/07/20
18	Spectrum Analyzer	Agilent	N9010A	MY51440158	2022/11/09
19	Spectrum Analyzer	Agilent	N9010A	MY52221119	2022/11/09
20	EMI Receiver	Rohde&Schwarz	ESU	100184	2023/07/20
21	Temp&Humidity Recorder	Anymetre	JR900	N/A	2022/11/03
22	Temp&Humidity Chamber	ETOMA	NTH1100-3 0A	16080628	2022/11/03
23	Filter	STI	STI15-9845	N/A	N/A
24	Filter	STI	5.1G	N/A	N/A
25	Filter	STI	STI15-9845	N/A	N/A
26	Testing Software	EZ-EMC	TW-03A2	N/A	N/A

Remark: "N/A" denotes no model name, serial no. or calibration specified.

"**" calibration period of equipment list is three year.

Except * item, all calibration period of equipment list is one year.

10. EUT TEST PHOTO

AC Power Line Conducted Emissions Test Photos



Radiated Emissions Test Photos

30 MHz to 1000 MHz



Radiated Emissions Test Photos

Above 1 GHz

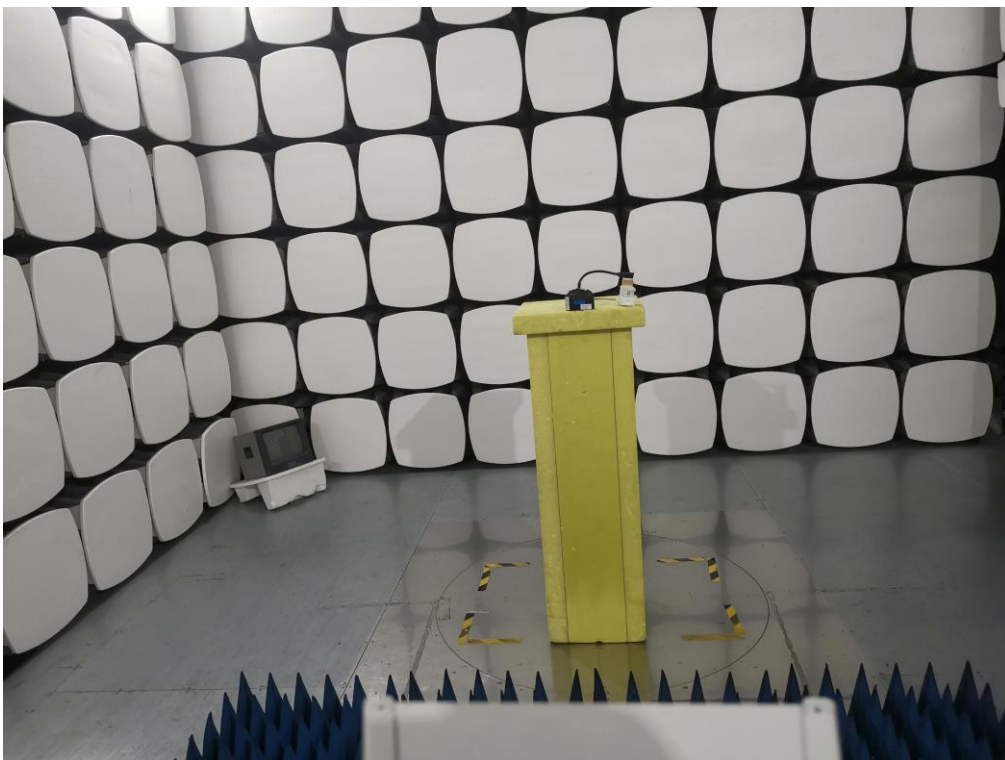
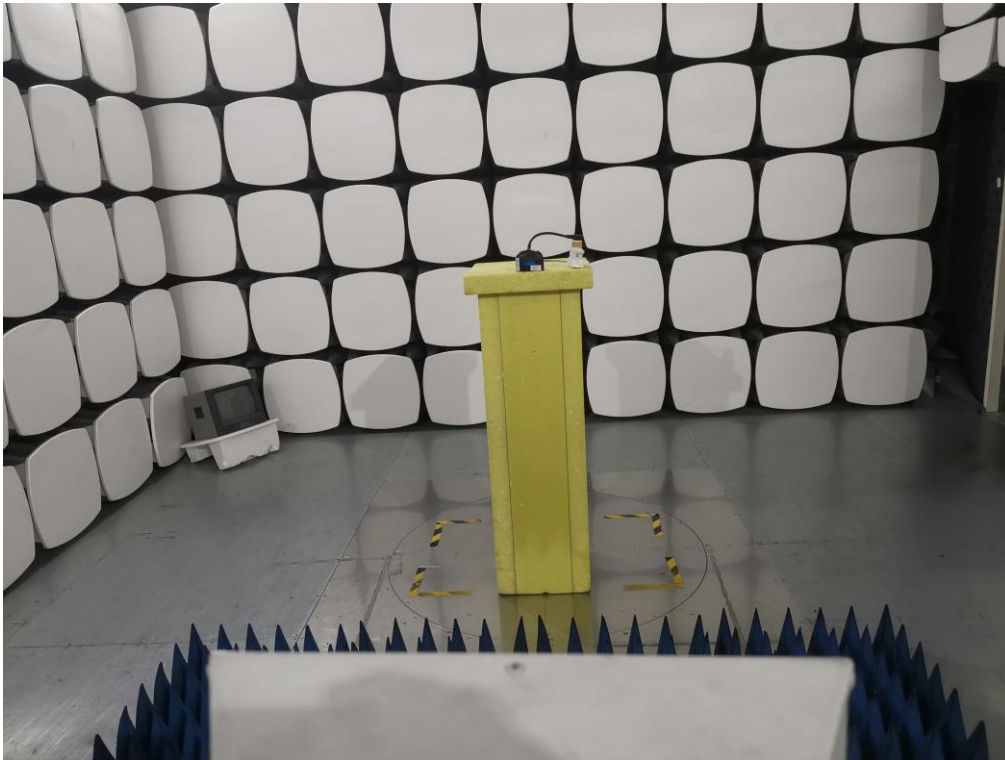

Conducted Test Photos



APPENDIX A - AC POWER LINE CONDUCTED EMISSIONS

Test Mode	TX Mode Channel 19_1Mbps	Phase	Line
-----------	--------------------------	-------	------

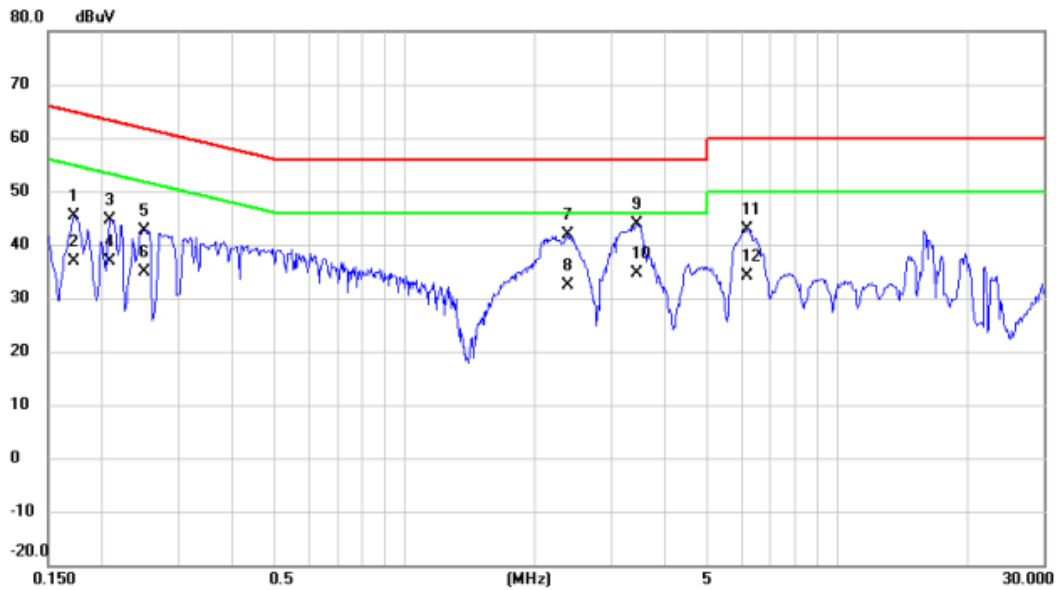

No. Mk.	Freq. MHz	Reading Level dBuV	Correct Factor dB	Measurement dBuV	Limit dBuV	Over dB	Detector	Comment
1	0.1725	25.99	19.31	45.30	64.84	-19.54	QP	
2	0.1725	17.59	19.31	36.90	54.84	-17.94	AVG	
3	0.2085	25.27	19.31	44.58	63.26	-18.68	QP	
4	0.2085	17.59	19.31	36.90	53.26	-16.36	AVG	
5	0.2508	23.27	19.32	42.59	61.73	-19.14	QP	
6	0.2508	15.59	19.32	34.91	51.73	-16.82	AVG	
7	2.3820	20.90	20.90	41.80	56.00	-14.20	QP	
8	2.3820	11.59	20.90	32.49	46.00	-13.51	AVG	
9	3.4440	23.04	20.81	43.85	56.00	-12.15	QP	
10 *	3.4440	13.79	20.81	34.60	46.00	-11.40	AVG	
11	6.1890	22.10	20.76	42.86	60.00	-17.14	QP	
12	6.1890	13.49	20.76	34.25	50.00	-15.75	AVG	

REMARKS:

(1) Measurement Value = Reading Level + Correct Factor.

(2) Margin Level = Measurement Value - Limit Value.

Test Mode	TX Mode Channel 19_1Mbps	Phase	Neutral
-----------	--------------------------	-------	---------

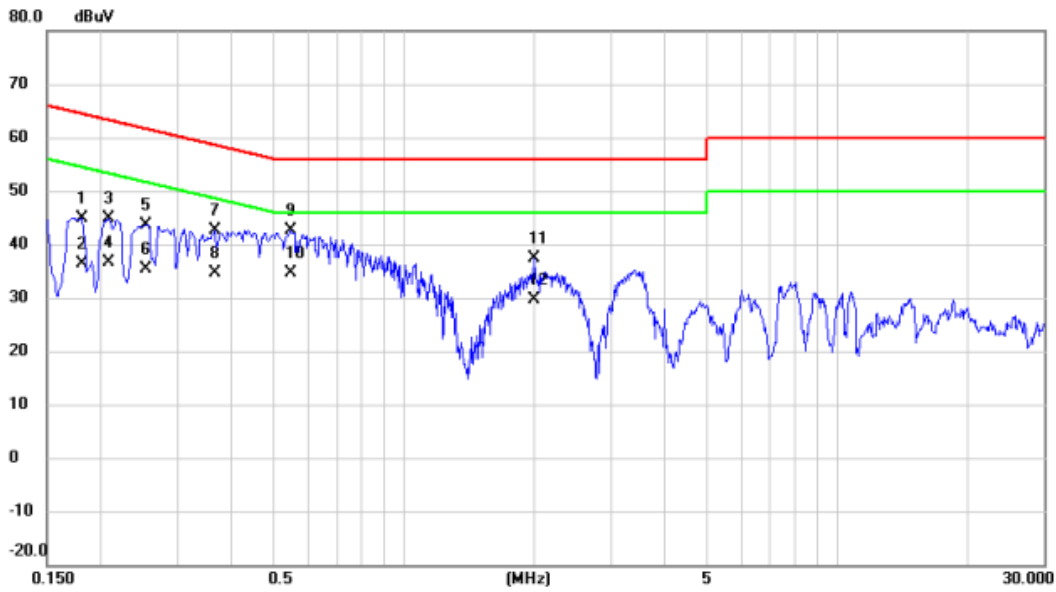

No.	Mk.	Freq. MHz	Reading Level dBuV	Correct Factor dB	Measure- ment dBuV	Limit dBuV	Over dB	Detector	Comment
1		0.1815	25.51	19.48	44.99	64.42	-19.43	QP	
2		0.1815	16.92	19.48	36.40	54.42	-18.02	AVG	
3		0.2085	25.34	19.48	44.82	63.26	-18.44	QP	
4		0.2085	17.12	19.48	36.60	53.26	-16.66	AVG	
5		0.2535	24.24	19.48	43.72	61.64	-17.92	QP	
6		0.2535	15.92	19.48	35.40	51.64	-16.24	AVG	
7		0.3660	23.23	19.50	42.73	58.59	-15.86	QP	
8		0.3660	15.02	19.50	34.52	48.59	-14.07	AVG	
9		0.5503	23.12	19.58	42.70	56.00	-13.30	QP	
10	*	0.5503	15.02	19.58	34.60	46.00	-11.40	AVG	
11		1.9950	16.69	20.66	37.35	56.00	-18.65	QP	
12		1.9950	8.92	20.66	29.58	46.00	-16.42	AVG	

REMARKS:

- (1) Measurement Value = Reading Level + Correct Factor.
- (2) Margin Level = Measurement Value - Limit Value.

APPENDIX B - RADIATED EMISSION - 9 KHZ TO 30 MHZ

Radiated emission: 9KHz-30MHz

The low frequency, which started from 9 kHz to 30MHz, was pre-scanned and the result which was 20dB lower than the limit line was not reported.

There is a comparison data of both open-field test site and semi-Anechoic chamber, and the result came out very similar.

APPENDIX C - RADIATED EMISSION - 30 MHZ TO 1000 MHZ

Test Mode	TX Mode Channel 19 _1Mbps	Polarization	Vertical
-----------	---------------------------	--------------	----------

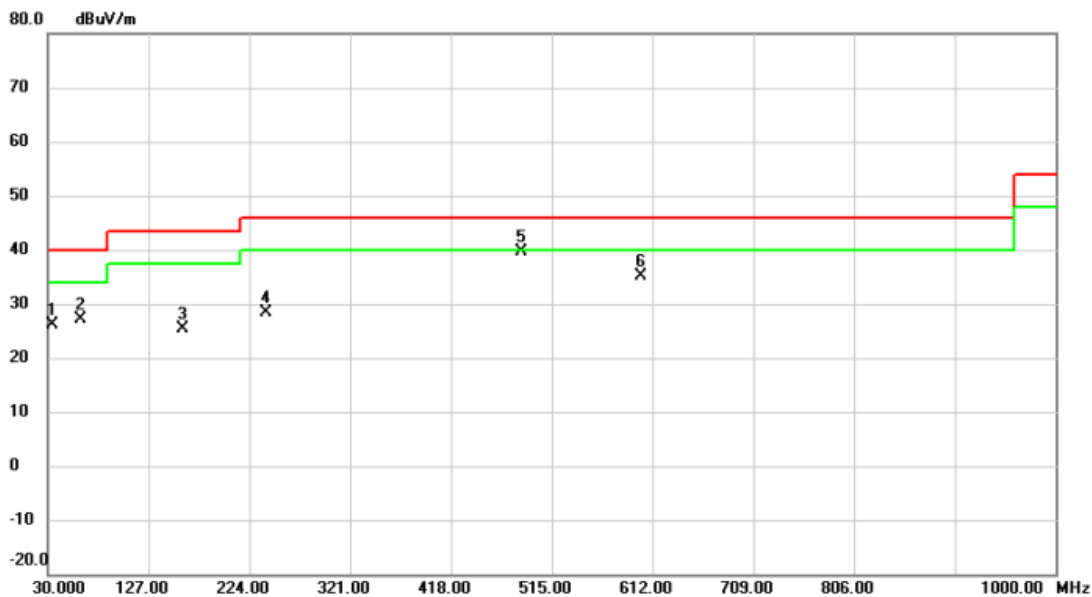

No.	Mk.	Freq. MHz	Reading Level dBuV	Correct Factor dB	Measure- ment dBuV/m	Limit dBuV/m	Margin dB	Detector	Comment
1		33.880	11.89	14.35	26.24	40.00	-13.76	peak	
2		62.010	12.49	14.65	27.14	40.00	-12.86	peak	
3		159.980	10.18	15.23	25.41	43.50	-18.09	peak	
4		240.490	11.89	16.37	28.26	46.00	-17.74	peak	
5	*	485.900	18.54	21.00	39.54	46.00	-6.46	peak	
6		600.360	11.94	23.21	35.15	46.00	-10.85	peak	

REMARKS:

(1) Measurement Value = Reading Level + Correct Factor.

(2) Margin Level = Measurement Value - Limit Value.

Test Mode	TX Mode Channel 19 _1Mbps	Polarization	Horizontal
-----------	---------------------------	--------------	------------

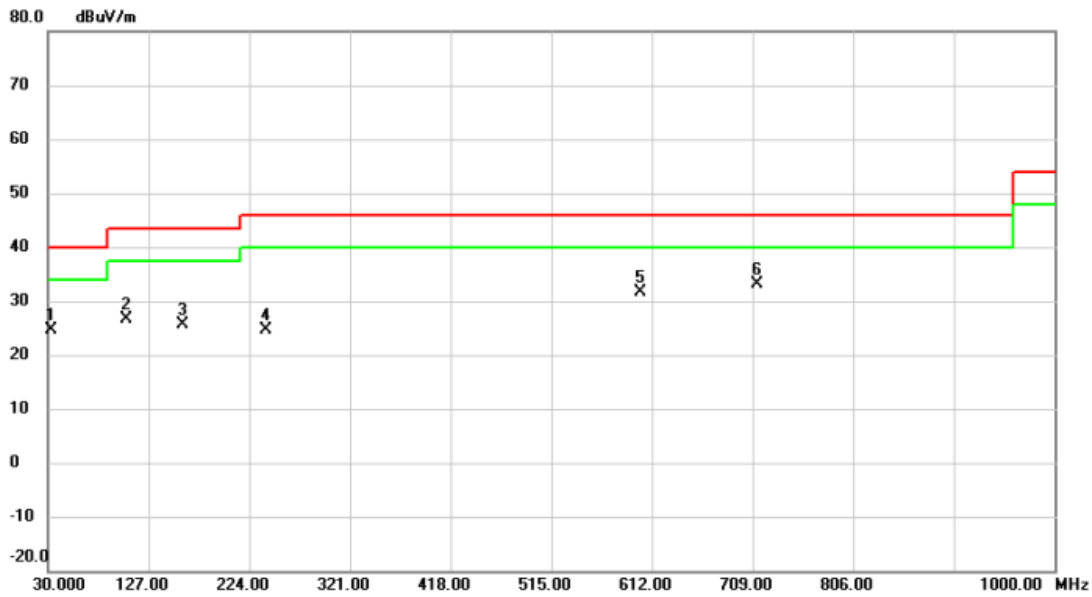

No.	Mk.	Freq. MHz	Reading Level dBuV	Correct Factor dB	Measure- ment dBuV/m	Limit dBuV/m	Margin dB	Detector	Comment
1		32.910	13.24	11.32	24.56	40.00	-15.44	peak	
2		105.660	13.87	12.67	26.54	43.50	-16.96	peak	
3		159.980	12.30	13.37	25.67	43.50	-17.83	peak	
4		240.490	8.28	16.37	24.65	46.00	-21.35	peak	
5		600.360	8.41	23.21	31.62	46.00	-14.38	peak	
6	*	713.850	8.79	24.45	33.24	46.00	-12.76	peak	

REMARKS:

- (1) Measurement Value = Reading Level + Correct Factor.
- (2) Margin Level = Measurement Value - Limit Value.

APPENDIX D - RADIATED EMISSION - ABOVE 1000 MHZ

Test Mode	TX 2402 MHz _CH00_1Mbps	Polarization	Vertical
-----------	-------------------------	--------------	----------

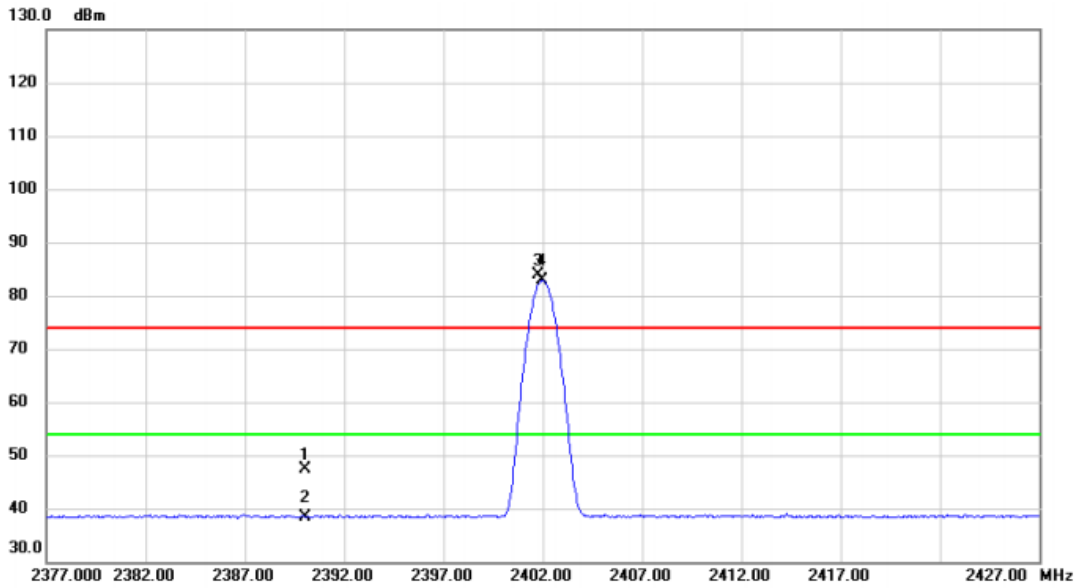

No.	Mk.	Freq. MHz	Reading Level dBm	Correct Factor dB	Measure- ment dBm	Limit dBm	Over dB	Detector	Comment
1		2390.000	14.76	32.63	47.39	74.00	-26.61	peak	
2		2390.000	5.86	32.63	38.49	54.00	-15.51	AVG	
3	X	2401.750	51.13	32.67	83.80	74.00	9.80	peak	No Limit
4	*	2401.950	50.17	32.67	82.84	54.00	28.84	AVG	No Limit

REMARKS:

- (1) Measurement Value = Reading Level + Correct Factor.
 (2) Margin Level = Measurement Value - Limit Value.

Test Mode	TX 2402 MHz _CH00_1Mbps	Polarization	Vertical
-----------	-------------------------	--------------	----------

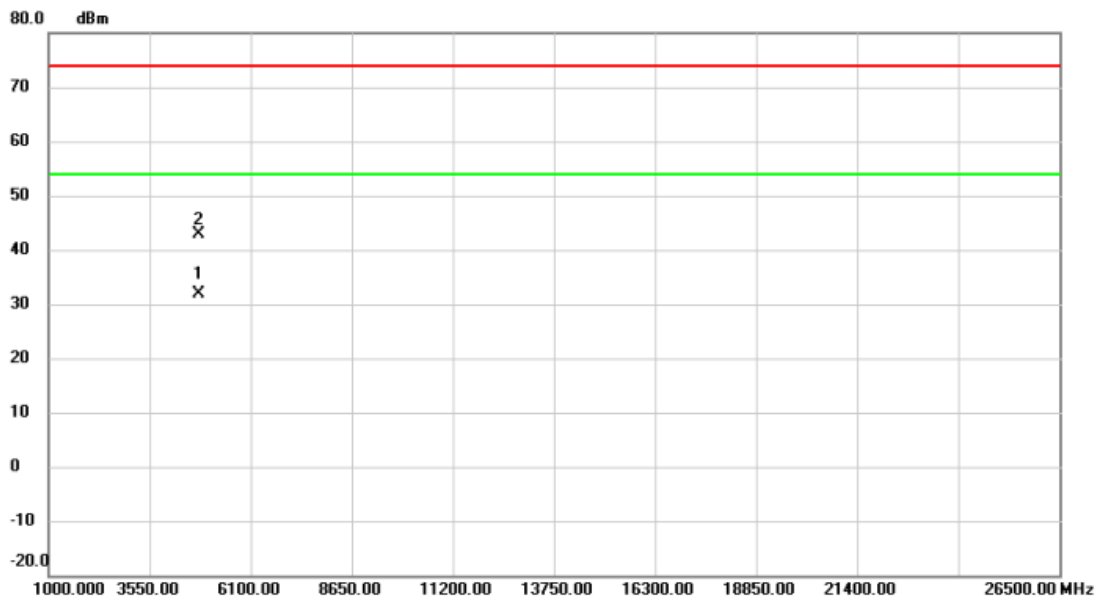

No.	Mk.	Freq.	Reading Level	Correct Factor	Measurement	Limit	Over	Detector	Comment
		MHz	dBm	dB	dBm	dBm	dB		
1	*	4801.890	46.30	-14.50	31.80	54.00	-22.20	AVG	
2		4804.690	57.31	-14.49	42.82	74.00	-31.18	peak	

REMARKS:

- (1) Measurement Value = Reading Level + Correct Factor.
- (2) Margin Level = Measurement Value - Limit Value.

Test Mode	TX 2440 MHz _CH19_1Mbps	Polarization	Vertical
-----------	-------------------------	--------------	----------

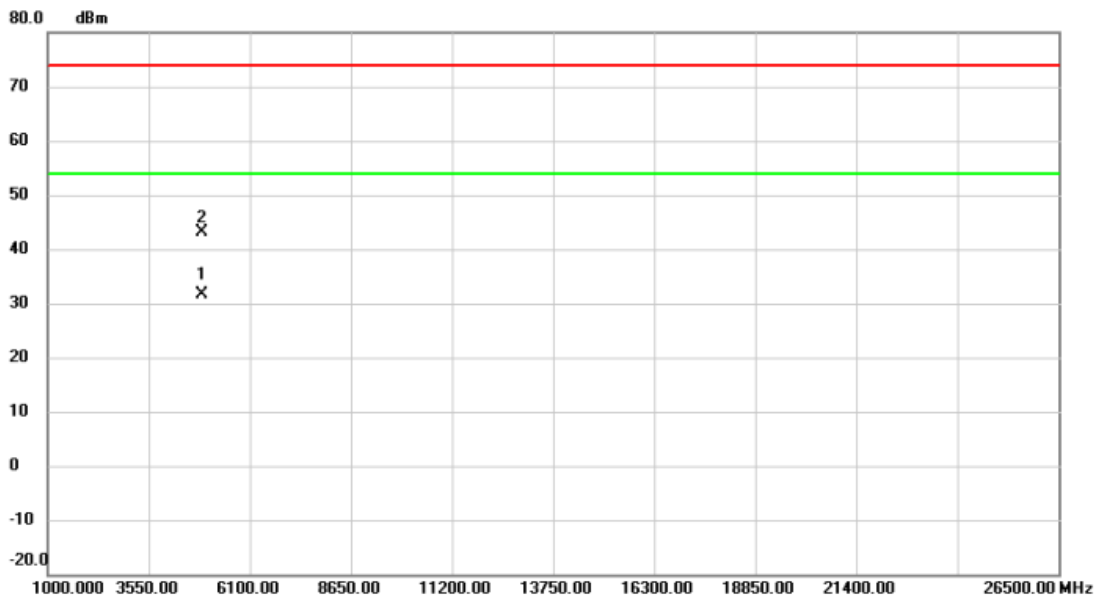

No.	Mk.	Freq.	Reading Level	Correct Factor	Measurement	Limit	Over	Detector	Comment
		MHz	dBm	dB	dBm	dBm	dB		
1	*	4881.135	45.91	-14.22	31.69	54.00	-22.31	AVG	
2		4882.110	57.31	-14.22	43.09	74.00	-30.91	peak	

REMARKS:

- (1) Measurement Value = Reading Level + Correct Factor.
- (2) Margin Level = Measurement Value - Limit Value.

Test Mode	TX 2480 MHz _CH39_1Mbps	Polarization	Vertical
-----------	-------------------------	--------------	----------

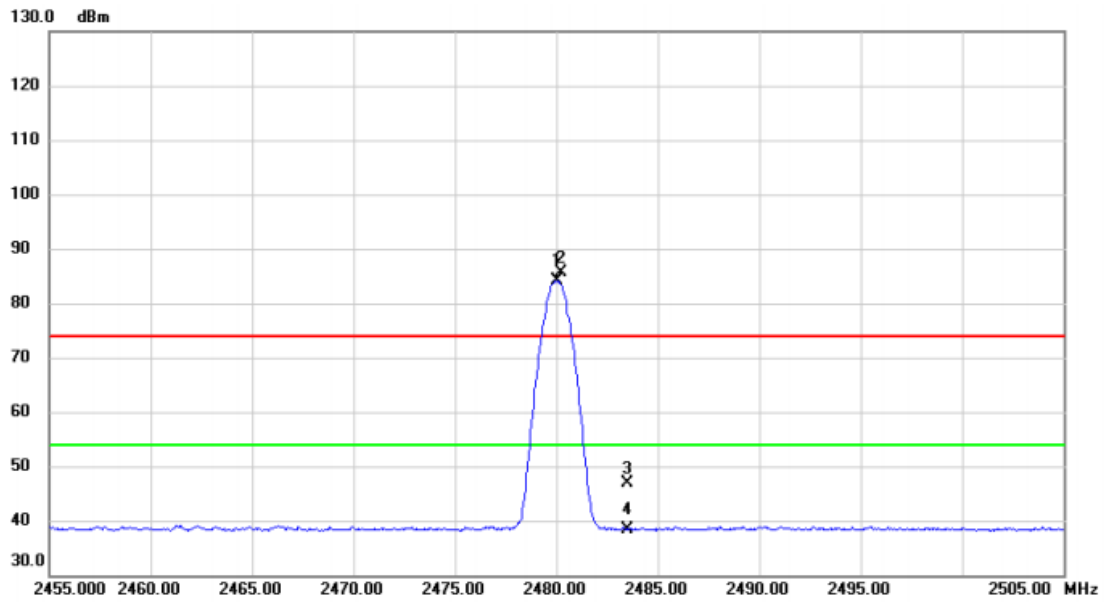

No.	Mk.	Freq.	Reading Level	Correct Factor	Measurement	Limit	Over	Detector	Comment
		MHz	dBm	dB	dBm	dBm	dB		
1	*	2480.050	51.17	32.96	84.13	54.00	30.13	AVG	No Limit
2	X	2480.250	52.61	32.96	85.57	74.00	11.57	peak	No Limit
3		2483.500	13.80	32.97	46.77	74.00	-27.23	peak	
4		2483.500	5.49	32.97	38.46	54.00	-15.54	AVG	

REMARKS:

- (1) Measurement Value = Reading Level + Correct Factor.
- (2) Margin Level = Measurement Value - Limit Value.

Test Mode	TX 2480 MHz _CH39_1Mbps	Polarization	Vertical
-----------	-------------------------	--------------	----------

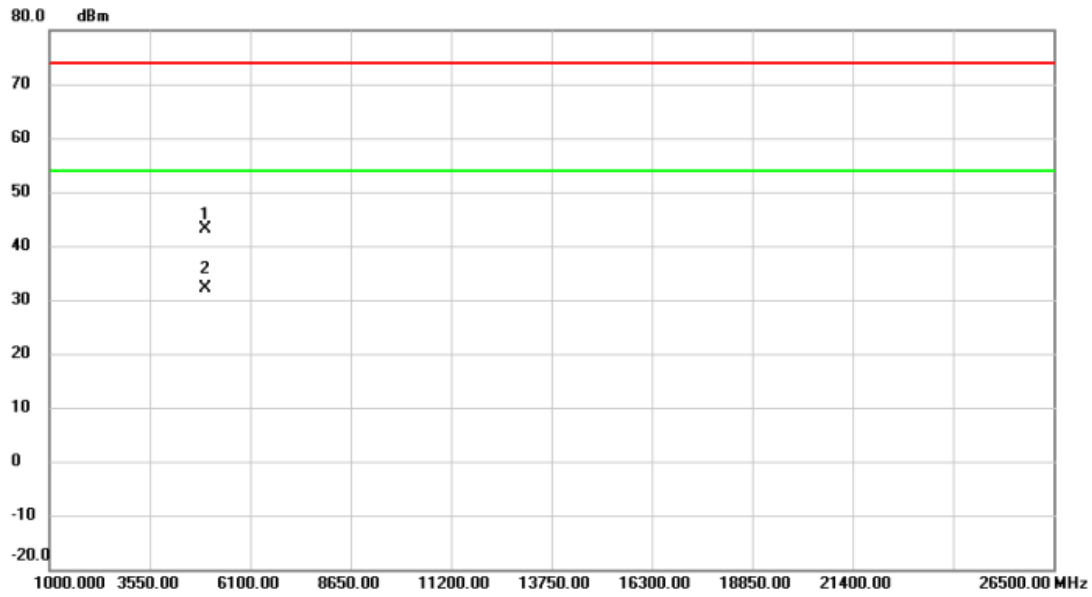

No. Mk.	Freq. MHz	Reading Level dBm	Correct Factor dB	Measurement dBm	Limit dBm	Over dB	Detector	Comment
1	4957.645	56.97	-13.96	43.01	74.00	-30.99	peak	
2 *	4962.255	45.97	-13.95	32.02	54.00	-21.98	AVG	

REMARKS:

- (1) Measurement Value = Reading Level + Correct Factor.
 (2) Margin Level = Measurement Value - Limit Value.

APPENDIX E - BANDWIDTH

Test Mode	TX Mode_1Mbps
-----------	---------------

Channel	Frequency (MHz)	6 dB Bandwidth (MHz)	99 % Occupied Bandwidth (MHz)	6 dB Bandwidth Min. Limit (MHz)	Test Result
00	2402	0.664	1.020	0.5	Pass
19	2440	0.648	1.028	0.5	Pass
39	2480	0.660	1.040	0.5	Pass

CH00

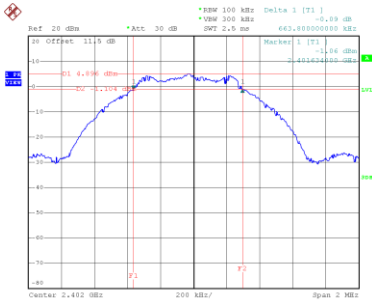

Date: 24.AUG.2022 16:02:12

CH19

6 dB Bandwidth

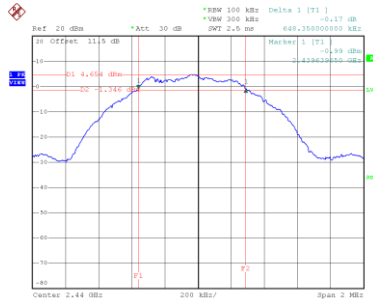

Date: 24.AUG.2022 16:03:42

CH39

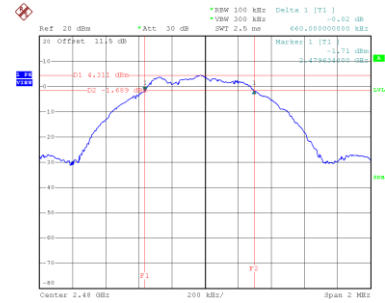

Date: 24.AUG.2022 16:04:59

99 % Occupied Bandwidth

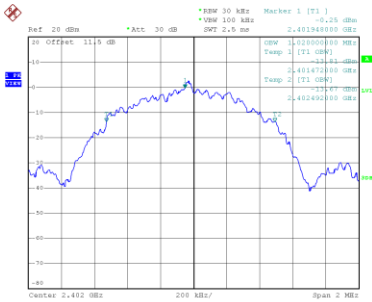

Date: 24.AUG.2022 16:01:23

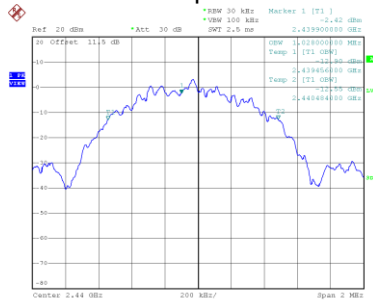

Date: 24.AUG.2022 16:03:49

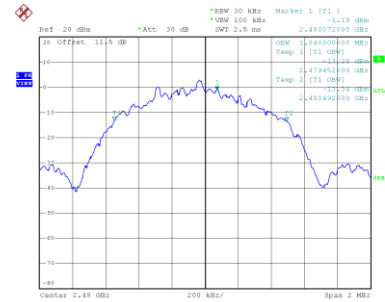

Date: 24.AUG.2022 16:05:06

APPENDIX F - MAXIMUM AVERAGE OUTPUT POWER

Test Mode	TX Mode _1Mbps
-----------	----------------

Frequency (MHz)	Output Power (dBm)	Output Power (W)	Max. Limit (dBm)	Max. Limit (W)	Test Result
2402	4.68	0.0029	30.00	1.0000	Pass
2440	5.10	0.0032	30.00	1.0000	Pass
2480	4.88	0.0031	30.00	1.0000	Pass

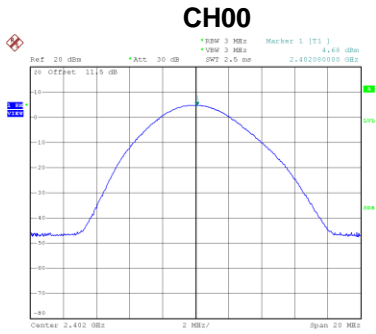

Date: 24.AUG.2022 16:43:00

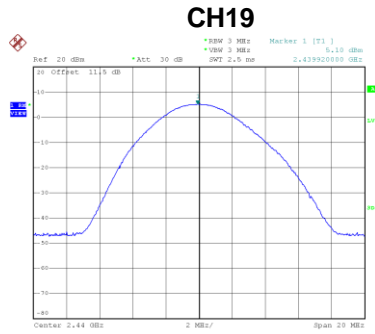

Date: 24.AUG.2022 16:43:19

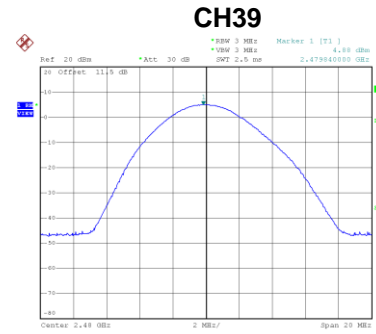

Date: 24.AUG.2022 16:43:41

APPENDIX G - CONDUCTED SPURIOUS EMISSION

Test Mode TX Mode_1Mbps

Bandedge CH00 (Lower)

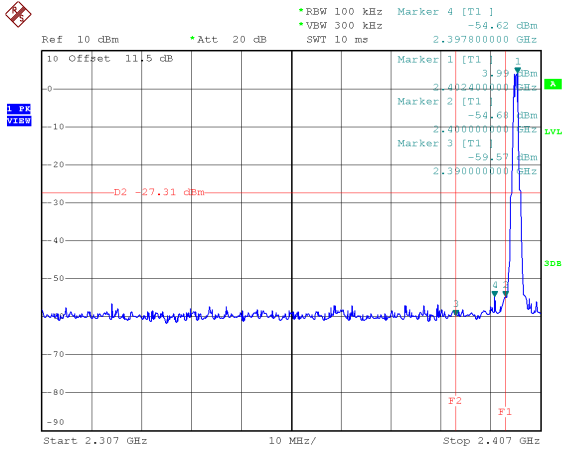

Bandedge CH39 (Upper)

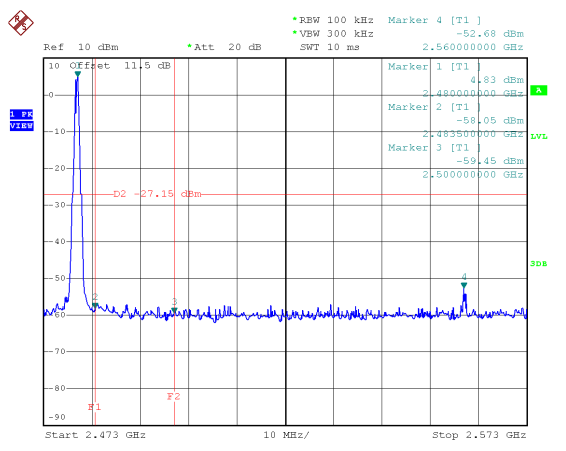

Date: 24.AUG.2022 16:19:50

Date: 24.AUG.2022 16:29:56

CH00 – 10th Harmonic of the fundamental frequency

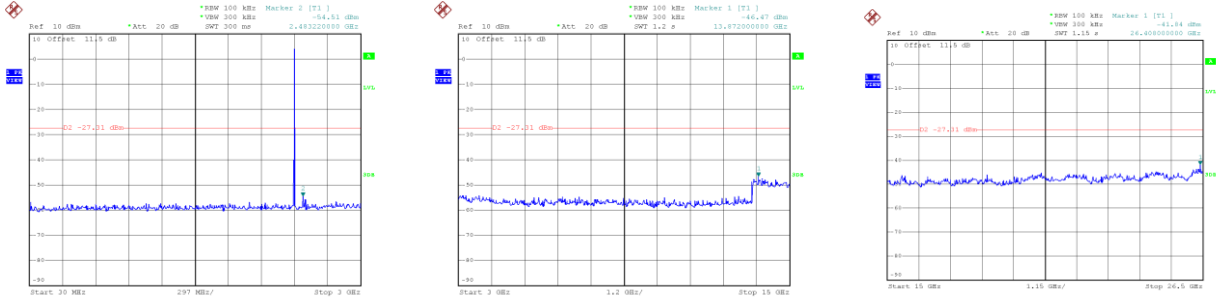

Date: 24.AUG.2022 16:20:13

Date: 24.AUG.2022 16:21:22

Date: 24.AUG.2022 16:21:59

CH19 – 10th Harmonic of the fundamental frequency

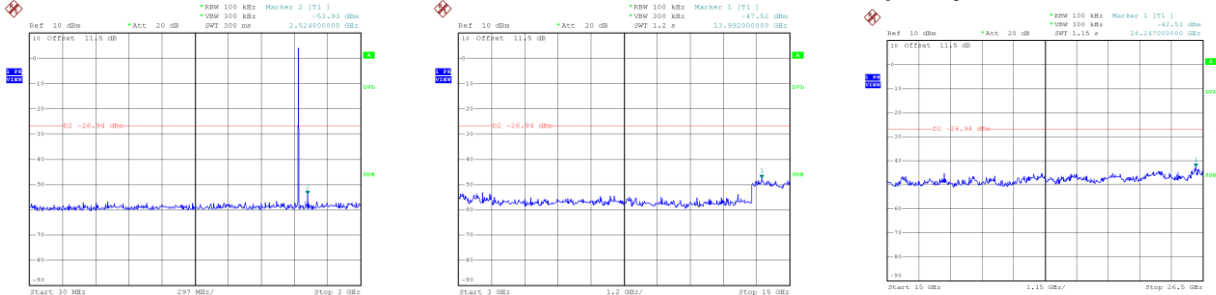

Date: 24.AUG.2022 16:25:53

Date: 24.AUG.2022 16:26:47

Date: 24.AUG.2022 16:27:20

CH39 – 10th Harmonic of the fundamental frequency

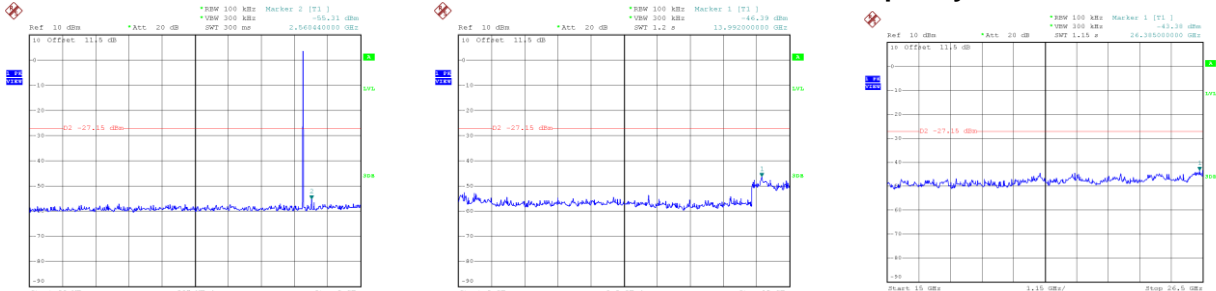

Date: 24.AUG.2022 16:31:34

Date: 24.AUG.2022 16:32:13

Date: 24.AUG.2022 16:32:51

APPENDIX H - POWER SPECTRAL DENSITY

Test Mode	TX Mode _1Mbps
-----------	----------------

Channel	Frequency (MHz)	Power Spectral Density (dBm/3 kHz)	Max. Limit (dBm/3 kHz)	Test Result
00	2402	-11.23	8.00	Pass
19	2440	-8.80	8.00	Pass
39	2480	-9.97	8.00	Pass

CH00

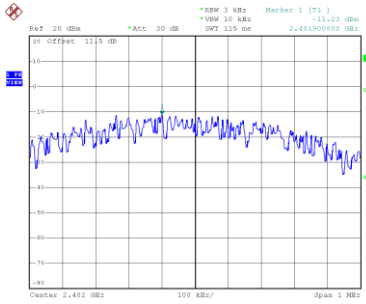

Date: 24.AUG.2022 16:11:29

CH19

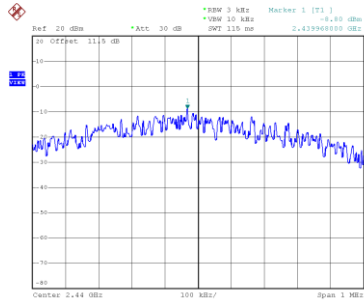

Date: 24.AUG.2022 16:12:05

CH39

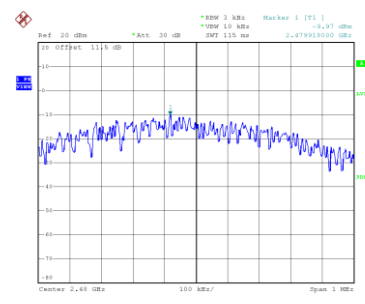

Date: 24.AUG.2022 16:12:37

End of Test Report