

RF MEASUREMENT REPORT

FCC ID : 2AXJ4P306
Applicant : TP-Link Corporation Limited
Application Type : Certification
Product : Smart Wi-Fi Outlet Extender
Model No. : Tapo P306
Brand Name : tp-link
Trademark : 
FCC Classification : Digital Transmission System (DTS)
FCC Rule Part(s) : Part15 Subpart C (Section 15.247)
Received Date : June 2, 2023
Test Date : June 8, 2023~ August 31, 2023

Tested By : Owen Tsai
(Owen Tsai)
Reviewed By : Paddy Chen
(Paddy Chen)
Approved By : Chenz Ker
(Chenz Ker)



The test results relate only to the samples tested.

This equipment has been shown to be capable of compliance with the applicable technical standards as indicated in the measurement report and was tested in accordance with the measurement procedures specified in ANSI C63.10-2013. Test results reported herein relate only to the item(s) tested.

The test report shall not be reproduced except in full without the written approval of MRT Technology (Taiwan) Co., Ltd.

Revision History

Report No.	Version	Description	Issue Date	Note
2306TW0102-U3	1.0	Original Report	2023-11-29	Valid

CONTENTS

Description	Page
1. INTRODUCTION.....	6
1.1. Scope.....	6
1.2. MRT Test Location.....	6
2. PRODUCT INFORMATION.....	7
2.1. Feature of Equipment under Test.....	7
2.2. Product Specification Subjective to this Report.....	7
2.3. Working Frequencies for this report.....	8
2.4. Description of Available Antennas.....	8
2.5. Test Mode.....	8
2.6. Configuration of Test System.....	9
2.7. Test System Details.....	10
2.8. Description of Test Software.....	10
2.9. Applied Standards.....	10
2.10. Duty Cycle.....	11
2.11. Test Configuration.....	12
2.12. EMI Suppression Device(s)/Modifications.....	12
2.13. Labeling Requirements.....	12
3. DESCRIPTION of TEST.....	13
3.1. Evaluation Procedure.....	13
3.2. AC Line Conducted Emissions.....	13
3.3. Radiated Emissions.....	14
4. ANTENNA REQUIREMENTS.....	15
5. TEST EQUIPMENT CALIBRATION DATE.....	16
6. MEASUREMENT UNCERTAINTY.....	18
7. TEST RESULT.....	19
7.1. Summary.....	19
7.2. 6dB Bandwidth Measurement.....	20
7.2.1. Test Limit.....	20
7.2.2. Test Procedure used.....	20
7.2.3. Test Setting.....	20
7.2.4. Test Setup.....	20
7.2.5. Test Result.....	21
7.3. Output Power Measurement.....	24

7.3.1. Test Limit	24
7.3.2. Test Procedure Used	24
7.3.3. Test Setting	24
7.3.4. Test Setup	24
7.3.5. Test Result	25
7.4. Power Spectral Density Measurement.....	26
7.4.1. Test Limit	26
7.4.2. Test Procedure Used	26
7.4.3. Test Setting	26
7.4.4. Test Setup	27
7.4.5. Test Result	28
7.5. Conducted Band Edge and Out-of-Band Emissions	31
7.5.1. Test Limit	31
7.5.2. Test Procedure Used	31
7.5.3. Test Setting	31
7.5.4. Test Setup	32
7.5.5. Test Result	33
7.6. Radiated Spurious Emission Measurement	37
7.6.1. Test Limit	37
7.6.2. Test Procedure Used	37
7.6.3. Test Setting	37
7.6.4. Test Setup	39
7.6.5. Test Result	40
7.7. Radiated Restricted Band Edge Measurement.....	80
7.7.1. Test Limit	80
7.7.2. Test Procedure Used	81
7.7.3. Test Setting	81
7.7.4. Test Setup	82
7.7.5. Test Result	83
7.8. AC Conducted Emissions Measurement	175
7.8.1. Test Limit	175
7.8.2. Test Setup	175
7.8.3. Test Result	176
8. CONCLUSION	180
Appendix A : Test Setup Photograph	181
Appendix B : External Photograph.....	181
Appendix C : Internal Photograph.....	181

General Information

Applicant	TP-Link Corporation Limited
Applicant Address	Room 901, 9/F., New East Ocean Centre, 9 Science Museum Road, Tsim Sha Tsui, Kowloon, Hongkong
Manufacturer	TP-Link Corporation Limited
Manufacturer Address	Room901, 9/F., New East Ocean Centre, 9 Science Museum Road, Tsim Sha Tsui, Kowloon, HongKong
Test Site	MRT Technology (Taiwan) Co., Ltd
Test Site Address	No. 38, Fuxing Second Rd., Guishan Dist., Taoyuan City 333, Taiwan (R.O.C)
MRT FCC Registration No.	291082
FCC Rule Part(s)	Part 15.247

Test Facility / Accreditations

1. MRT facility is a FCC registered (Reg. No. 291082) test facility with the site description report on file and is designated by the FCC as an Accredited Test Firm.
2. MRT facility is an IC registered (MRT Reg. No. 21723) test laboratory with the site description on file at Industry Canada.
3. MRT Lab is accredited to ISO 17025 by the Taiwan Accreditation Foundation (TAF Cert. No. 3261) in EMC, Telecommunications and Radio testing for FCC (Designation Number: TW3261), Industry Canada, EU and TELEC Rules.

1. INTRODUCTION

1.1. Scope

Measurement and determination of electromagnetic emissions (EMC) of radio frequency devices including intentional and/or unintentional radiators for compliance with the technical rules and regulations of the Federal Communications Commission and the Innovation, Science and Economic Development Canada and Certification and Engineering Bureau.

1.2. MRT Test Location

The map below shows the location of the MRT LABORATORY, its proximity to the Taoyuan City. These measurement tests were conducted at the MRT Technology (Taiwan) Co., Ltd. Facility located at No.38, Fuxing 2nd Rd., Guishan Dist., Taoyuan City 33377, Taiwan (R.O.C).

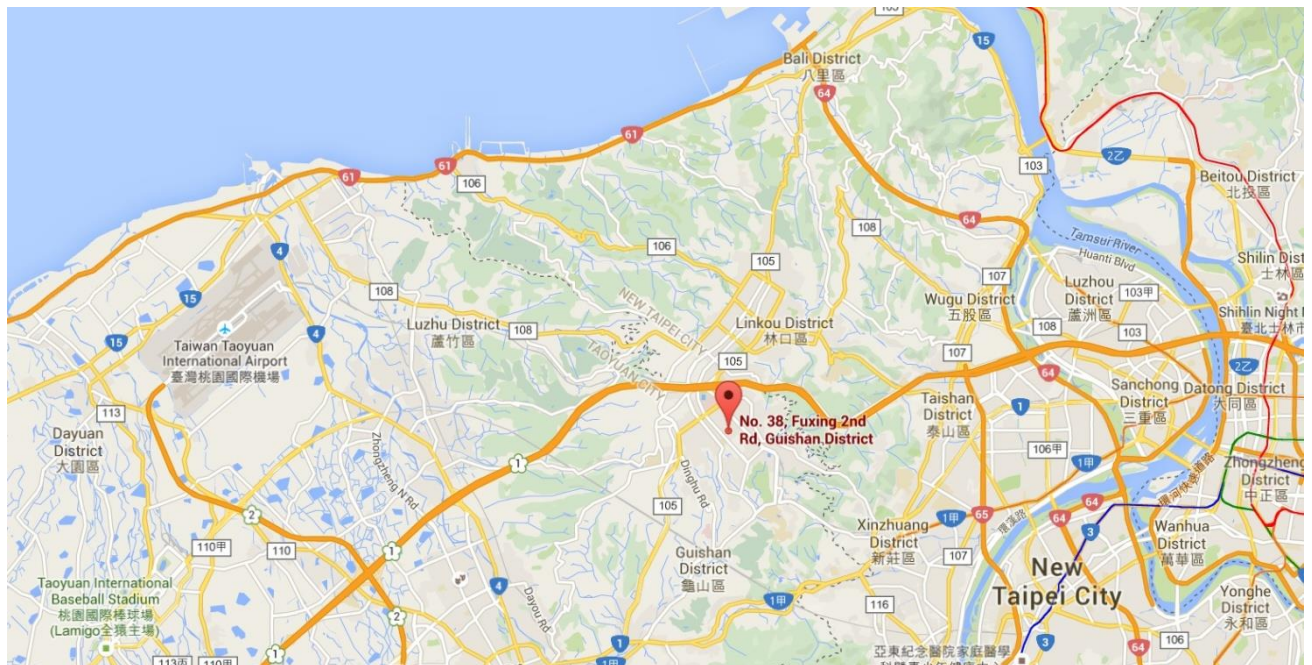

2. PRODUCT INFORMATION

2.1. Feature of Equipment under Test

Product Name:	Smart Wi-Fi Outlet Extender
Model No.:	Tapo P306
Brand Name:	tp-link
Bluetooth Specification	BLE
Wi-Fi Specification:	802.11b/g/n
EUT Identification No.:	#1-1 (Conducted) #1-2 (Radiated)

2.2. Product Specification Subjective to this Report

Frequency Range:	802.11b/g/n-HT20: 2412 ~ 2462MHz
Channel Number:	802.11b/g/n-HT20: 11
Type of Modulation:	802.11b: DSSS 802.11g/n: OFDM
Data Rate:	802.11b: 1/2/5.5/11Mbps 802.11g: 6/9/12/18/24/36/48/54Mbps 802.11n: up to 72.2Mbps

Note: For other features of this EUT, test report will be issued separately.

2.3. Working Frequencies for this report

802.11b/g/n-HT20

Channel	Frequency	Channel	Frequency	Channel	Frequency
01	2412 MHz	02	2417 MHz	03	2422 MHz
04	2427 MHz	05	2432 MHz	06	2437 MHz
07	2442 MHz	08	2447 MHz	09	2452 MHz
10	2457 MHz	11	2462 MHz	--	--

2.4. Description of Available Antennas

Antenna Type	Frequency Band (MHz)	Antenna Gain (dBi)	
		Ant 0	Ant 1
Monopole	2400 ~ 2483.5	2.08	2.37

Notes:

1. The EUT supports SISO only, and which are switched by the Switch IC.
2. All information of antenna were from the AUT report.

2.5. Test Mode

Test Mode	Mode 1: Transmit by 802.11b (1Mbps) with Ant 0
	Mode 2: Transmit by 802.11g (6Mbps) with Ant 0
	Mode 3: Transmit by 802.11n-HT20 (MCS0) with Ant 0
	Mode 4: Transmit by 802.11b (1Mbps) with Ant 1
	Mode 5: Transmit by 802.11g (6Mbps) with Ant 1
	Mode 6: Transmit by 802.11n-HT20 (MCS0) with Ant 1

Note:

1. This product has two Antenna Ports, which are switched only by the Switch IC, so the conducted item is only measured at the feed point of the Switch IC (please refer to the internal photo).

2.6. Configuration of Test System

The device was tested per the guidance ANSI C63.10: 2013 was used to reference the appropriate EUT setup for radiated emissions testing and AC line conducted testing.

Connection Diagram

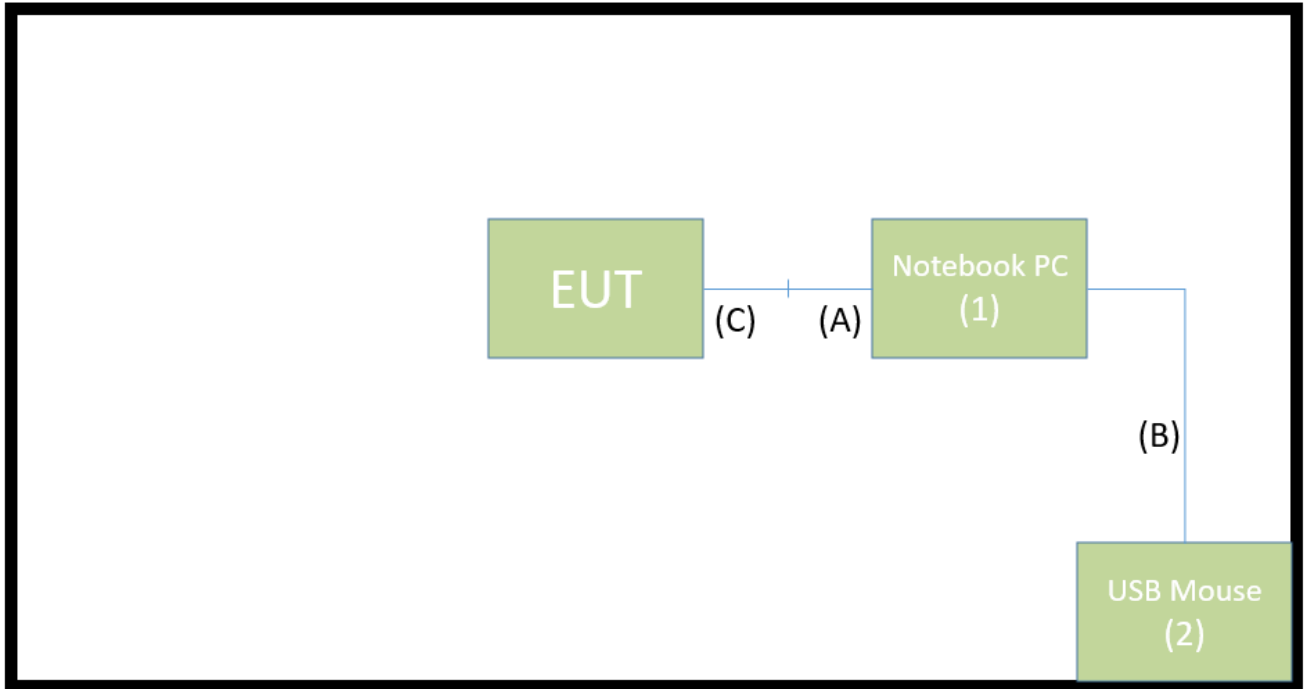

	Cable Type	Cable Description
A	Signal to USB Cable	Non shielded, 1.0m
B	USB Mouse Cable	Shielded, 1.8m
C	Signal Cable	Non shielded, 0.1m

2.7. Test System Details

The types for all equipments, plus descriptions of all cables used in the tested system (including inserted cards) are:

	Product	Manufacturer	Model No.	Serial No.	Power Cord
1	Notebook PC	Dell	P65F	N/A	Non-shielded, 0.8m
2	USB Mouse	Logitech	M90	N/A	N/A

2.8. Description of Test Software

The test utility software used during testing was "AmebaZ2_mptool_1V3".

Note: Final power setting please refer to operational description.

2.9. Applied Standards

According to the specifications of the manufacturer, the EUT must comply with the requirements of the following standards:

- FCC Part 15.247
- KDB 558074 D01v05r02
- ANSI C63.10-2013

2.10. Duty Cycle

2.4GHz WLAN (DTS) operation is possible in 20MHz channel bandwidths. The maximum achievable duty cycles for all modes were determined based on measurements performed on a spectrum analyzer in zero-span mode with RBW = 8MHz, VBW = 50MHz. The RBW and VBW were both greater than 50/T, where T is the minimum transmission duration, and the number of sweep points across T was greater than 100. The duty cycles are as follows:

Test Mode	Duty Cycle
802.11b	98.64%
802.11g	93.89%
802.11n-HT20	93.08%



2.11. Test Configuration

The device was tested per the guidance of ANSI C63.10-2013. ANSI C63.10-2013 was used to reference the appropriate EUT setup for radiated spurious emissions testing and AC line conducted testing.

2.12. EMI Suppression Device(s)/Modifications

No EMI suppression device(s) were added and/or no modifications were made during testing.

2.13. Labeling Requirements

Per 2.1074 & 15.19; Docket 95-19

The label shall be permanently affixed at a conspicuous location on the device; instruction manual or pamphlet supplied to the user and be readily visible to the purchaser at the time of purchase. However, when the device is so small wherein placement of the label with specified statement is not practical, only the FCC ID must be displayed on the device per Section 15.19(a)(5). Please see attachment for FCC ID label and label location.

3. DESCRIPTION of TEST

3.1. Evaluation Procedure

The measurement procedures described in the American National Standard of Procedures for Compliance Testing of Unlicensed Wireless Devices (ANSI C63.10-2013), and the guidance was used in the measurement.

3.2. AC Line Conducted Emissions

The line-conducted facility is located inside an 8'x4'x4' shielded enclosure. A 1m x 2m wooden table 80cm high is placed 40cm away from the vertical wall and 80cm away from the sidewall of the shielded room. Two 10kHz-30MHz, 50Ω/50uH Line-Impedance Stabilization Networks (LISNs) are bonded to the shielded room floor. Power to the LISNs is filtered by external high-current high-insertion loss power line filters. These filters attenuate ambient signal noise from entering the measurement lines. These filters are also bonded to the shielded enclosure.

The EUT is powered from one LISN and the support equipment is powered from the second LISN. All interconnecting cables more than 1 meter were shortened to a 1 meter length by non-inductive bundling (serpentine fashion) and draped over the back edge of the test table. All cables were at least 40cm above the horizontal reference ground-plane. Power cables for support equipment were routed down to the second LISN while ensuring that that cables were not draped over the second LISN.

Sufficient time for the EUT, support equipment, and test equipment was allowed in order for them to warm up to their normal operating condition. The RF output of the LISN was connected to the receiver and exploratory measurements were made to determine the frequencies producing the maximum emission from the EUT. The receiver was scanned from 150kHz to 30MHz. The detector function was set to peak mode for exploratory measurements while the bandwidth of the analyzer was set to 9kHz. The EUT, support equipment, and interconnecting cables were arranged and manipulated to maximize each emission. Each emission was also maximized by varying power lines, the mode of operation or data exchange speed, or support equipment whichever determined the worst-case emission. Once the worst-case emissions have been identified, the one EUT cable configuration/arrangement and mode of operation that produced these emissions are used for final measurements on the same test site. The analyzer is set to CISPR quasi-peak and average detectors with a 9kHz resolution bandwidth for final measurements.

An extension cord was used to connect to a single LISN which powered by EUT. The extension cord was calibrated with LISN, the impedance and insertion loss are compliance with the requirements as stated in ANSI C63.10-2013.

3.3. Radiated Emissions

The radiated test facilities consisted of an indoor 3 meter semi-anechoic chamber used for final measurements and exploratory measurements, when necessary. The measurement area is contained within the semi-anechoic chamber which is shielded from any ambient interference. For measurements above 1GHz absorbers are arranged on the floor between the turn table and the antenna mast in such a way so as to maximize the reduction of reflections. For measurements below 1GHz, the absorbers are removed. A MF Model 210SS turntable is used for radiated measurement. It is a continuously rotatable, remote controlled, metallic turntable and 2 meters (6.56 ft.) in diameter. The turn table is flush with the raised floor of the chamber in order to maintain its function as a ground plane. An 80cm high PVC support structure is placed on top of the turntable.

For all measurements, the spectrum was scanned through all EUT azimuths and from 1 to 4 meter receive antenna height using a broadband antenna from 30MHz up to the upper frequency shown in 15.33(b)(1) depending on the highest frequency generated or used in the device or on which the device operates or tunes. For frequencies above 1GHz, linearly polarized double ridge horn antennas were used. For frequencies below 30MHz, a calibrated loop antenna was used. When exploratory measurements were necessary, they were performed at 1 meter test distance inside the semi-anechoic chamber using broadband antennas, broadband amplifiers, and spectrum analyzers to determine the frequencies and modes producing the maximum emissions. Sufficient time for the EUT, support equipment, and test equipment was allowed in order for them to warm up to their normal operating condition. The test set-up for frequencies below 1GHz was placed on top of the 0.8 meter high, 1 x 1.5 meter table; and test set-up for frequencies 1-40GHz was placed on top of the 1.5 meter high, 1 x 1.5 meter table. The EUT, support equipment, and interconnecting cables were arranged and manipulated to maximize each emission. Appropriate precaution was taken to ensure that all emissions from the EUT were maximized and investigated. The system configuration, clock speed, mode of operation or video resolution, if applicable, turntable azimuth, and receive antenna height was noted for each frequency found.

Final measurements were made in the semi-anechoic chamber using calibrated, linearly polarized broadband and horn antennas. The test setup was configured to the setup that produced the worst case emissions. The spectrum analyzer was set to investigate all frequencies required for testing to compare the highest radiated disturbances with respect to the specified limits. The turntable containing the EUT was rotated through 360 degrees and the height of the receive antenna was varied 1 to 4 meters and stopped at the azimuth and height producing the maximum emission. Each emission was maximized by changing the orientation of the EUT through three orthogonal planes and changing the polarity of the receive antenna, whichever produced the worst-case emissions. According to 3dB Beam-Width of horn antenna, the horn antenna should be always directed to the EUT when rising height.

4. ANTENNA REQUIREMENTS

Excerpt from §15.203 of the FCC Rules/Regulations:

“An intentional radiator antenna shall be designed to ensure that no antenna other than that furnished by the responsible party can be used with the device. The use of a permanently attached antenna or of an antenna that uses a unique coupling to the intentional radiator shall be considered sufficient to comply with the provisions of this section.”

- The antenna of the device is **permanently attached**.
- There are no provisions for connection to an external antenna.

Conclusion:

The unit complies with the requirement of §15.203.

5. TEST EQUIPMENT CALIBRATION DATE

Conducted Emissions

Instrument	Manufacturer	Type No.	Asset No.	Cali. Interval	Cali. Due Date
Two-Line V-Network	R&S	ENV216	MRTTWA00019	1 year	2024/3/7
Two-Line V-Network	R&S	ENV216	MRTTWA00020	1 year	2024/4/17
EMI Test Receiver	R&S	ESR3	MRTTWA00045	1 year	2024/5/10

Radiated Emissions

Instrument	Manufacturer	Type No.	Asset No.	Cali. Interval	Cali. Due Date
Active Loop Antenna	SCHWARZBECK	FMZB 1519B	MRTTWA00002	1 year	2024/5/22
Broadband TRILOG Antenna	SCHWARZBECK	VULB 9162	MRTTWA00001	1 year	2023/12/21
Broadband Hornantenna	RFSPIN	DRH18-E	MRTTWA00087	1 year	2024/5/17
Broadband Preamplifier	EMC Instruments corporation	EMC118A45SE	MRTTWA00088	1 year	2024/5/17
Breitband Hornantenna	SCHWARZBECK	BBHA 9170	MRTTWA00004	1 year	2024/3/20
Broadband Amplifier	SCHWARZBECK	BBV 9721	MRTTWA00006	1 year	2024/3/27
EMI Test Receiver	R&S	ESR3	MRTTWA00009	1 year	2024/3/8
Signal Analyzer	R&S	FSVA3044	MRTTWA00092	1 year	2024/6/29
Antenna Cable	HUBERSUHNER	SF106	MRTTWE00034	1 year	2024/6/26
Cable	HUBERSUHNER	EMC105-NM-NM-3000	MRTTWE00035	1 year	2024/6/26
Temperature/Humidity Meter	TFA	35.1078.10.IT	MRTTWA00032	1 year	2024/6/4

Conducted Test Equipment

Instrument	Manufacturer	Type No.	Asset No.	Cali. Interval	Cali. Due Date
X-Series USB Peak and Average Power Sensor	KEYSIGHT	U2021XA	MRTTWA00014	1 year	2024/4/19
EXA Signal Analyzer	KEYSIGHT	N9010A	MRTTWA00012	1 year	2023/10/5
EXA Signal Analyzer	KEYSIGHT	N9010B	MRTTWA00074	1 year	2024/7/19
Attenuator	WTI	218FS-20	MRTTWE00026	1 year	2023/11/2
Attenuator	WTI	218FS-10	MRTTWE00027	1 year	2024/6/14
Attenuator	WTI	218FS-06	MRTTWE00028	1 year	2024/6/14
Temperature & Humidity Chamber	TEN BILLION	TTH-B3UP	MRTTWA00036	1 year	2024/6/11
DIVA PLUS Funk-Wetterstation	TFA	35.1083	MRTTWA00050	1 year	2024/6/15

Software	Version	Function
e3	9.160520a	EMI Test Software

6. MEASUREMENT UNCERTAINTY

Where relevant, the following test uncertainty levels have been estimated for tests performed on the EUT as specified in CISPR 16-4-2. This uncertainty represents an expanded uncertainty expressed at approximately the 95% confidence level using a coverage factor of $k = 2$.

AC Conducted Emission Measurement
Measuring Uncertainty for a Level of Confidence of 95% ($U=2Uc(y)$): 150kHz~30MHz: $\pm 2.53\text{dB}$
Radiated Emission Measurement
Measuring Uncertainty for a Level of Confidence of 95% ($U=2Uc(y)$): 9kHz ~ 1GHz: $\pm 4.25\text{dB}$ 1GHz ~ 40GHz: $\pm 4.45\text{dB}$
Conducted Power (Carrier Power / Power Density)
Measuring Uncertainty for a Level of Confidence of 95% ($U=2Uc(y)$): $\pm 0.84\text{dB}$
Conducted Spurious Emission
Measuring Uncertainty for a Level of Confidence of 95% ($U=2Uc(y)$): $\pm 2.65\text{ dB}$
Occupied Bandwidth
Measuring Uncertainty for a Level of Confidence of 95% ($U=2Uc(y)$): $\pm 3.3\%$
Temp. / Humidity
Measuring Uncertainty for a Level of Confidence of 95% ($U=2Uc(y)$): $\pm 0.82^\circ\text{C} / \pm 3\%$

7. TEST RESULT

7.1. Summary

FCC Section(s)	Test Description	Test Limit	Test Condition	Test Result	Reference
15.247(a)(2)	6dB Bandwidth	$\geq 500\text{kHz}$	Conducted	Pass	Section 7.2
15.247(b)(3)	Output Power	$\leq 30\text{dBm}$		Pass	Section 7.3
15.247(e)	Power Spectral Density	$\leq 8\text{dBm}/3\text{kHz}$		Pass	Section 7.4
15.247(d)	Band Edge / Out-of-Band Emissions	$\geq 30\text{dBc}$ (Average)		Pass	Section 7.5
15.205 15.209	General Field Strength Limits (Restricted Bands and Radiated Emission Limits)	Emissions in restricted bands must meet the radiated limits detailed in 15.209	Radiated	Pass	Section 7.6 & 7.7
15.207	AC Conducted Emissions 150kHz - 30MHz	< FCC 15.207 limits	Line Conducted	Pass	Section 7.8

Notes:

- 1) Determining compliance is based on the test results met the regulation limits or requirements declared by clients, and the test results don't take into account the value of measurement uncertainty.
- 2) The analyzer plots shown in this section were all taken with a correction table loaded into the analyzer. The correction table was used to account for the losses of the cables and attenuators used as part of the system to connect the EUT to the analyzer at all frequencies of interest.
- 3) For radiated emission test, every axis (X, Y, Z) was also verified. The test results shown in the following sections represent the worst-case emissions.

7.2. 6dB Bandwidth Measurement

7.2.1. Test Limit

The minimum 6dB bandwidth shall be at least 500 kHz.

7.2.2. Test Procedure used

ANSI C63.10-2013 Section 11.8

7.2.3. Test Setting

1. The Spectrum's automatic bandwidth measurement capability was used to perform the 6dB bandwidth measurement. The "X" dB bandwidth parameter was set to $X = 6$. The bandwidth measurement was not influenced by any intermediate power nulls in the fundamental emission.
2. Set RBW = 100 kHz
3. $VBW \geq 3 \times RBW$
4. Detector = Peak
5. Trace mode = max hold
6. Sweep = auto couple
7. Allow the trace was allowed to stabilize

7.2.4. Test Setup

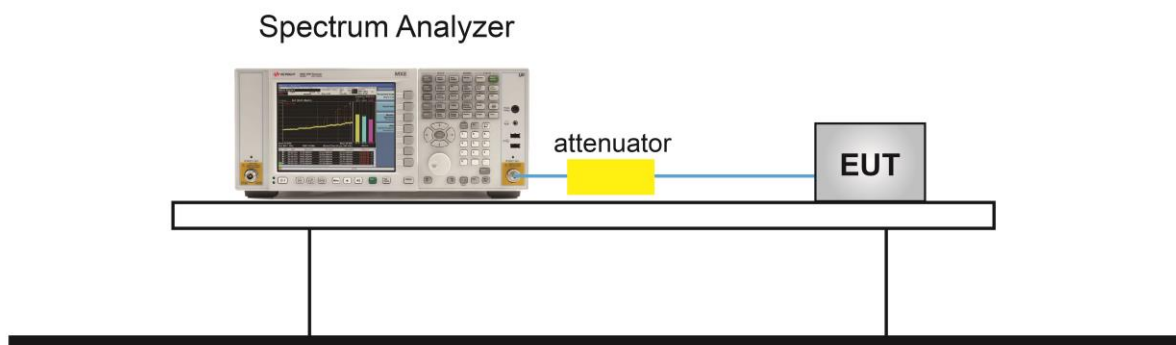

7.2.5. Test Result

Product	Smart Wi-Fi Outlet Extender	Temperature	25°C
Test Engineer	Xuan Yu	Relative Humidity	54%
Test Site	SR6	Test Date	2023/06/13

Test Mode	Data Rate / MCS	Channel No.	Frequency (MHz)	6dB Bandwidth (MHz)	Limit (MHz)	Result
802.11b	1Mbps	01	2412	9.046	≥ 0.5	Pass
802.11b	1Mbps	06	2437	9.067	≥ 0.5	Pass
802.11b	1Mbps	11	2462	8.588	≥ 0.5	Pass
802.11g	6Mbps	01	2412	16.340	≥ 0.5	Pass
802.11g	6Mbps	06	2437	16.340	≥ 0.5	Pass
802.11g	6Mbps	11	2462	16.380	≥ 0.5	Pass
802.11n-HT20	MCS0	01	2412	17.570	≥ 0.5	Pass
802.11n-HT20	MCS0	06	2437	17.540	≥ 0.5	Pass
802.11n-HT20	MCS0	11	2462	17.570	≥ 0.5	Pass

802.11b 6dB Bandwidth

Channel 01 (2412MHz)

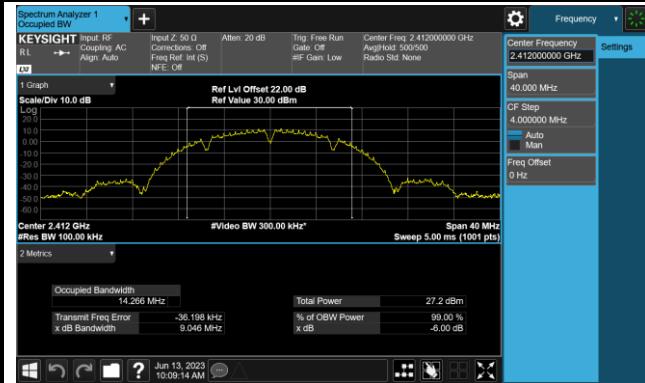

Channel 06 (2437MHz)

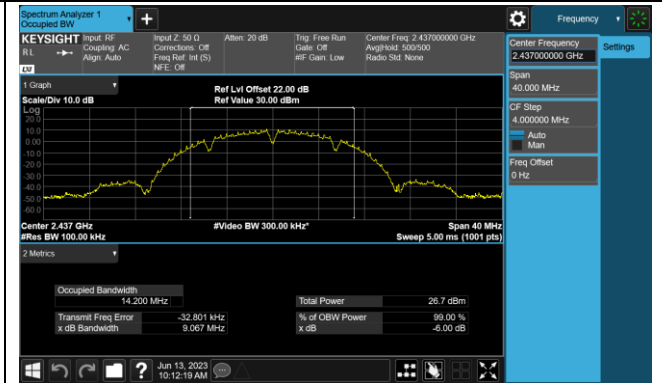

Channel 11 (2462MHz)

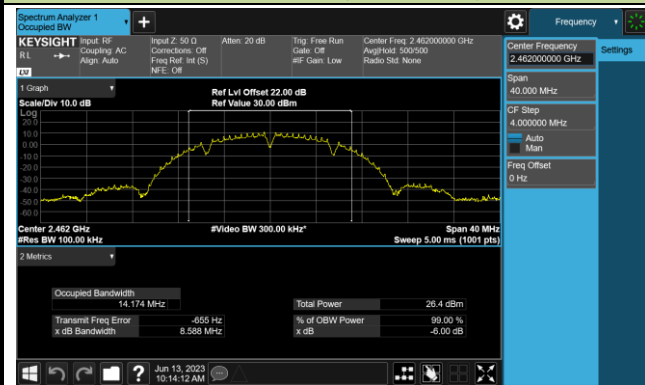

802.11g 6dB Bandwidth

Channel 01 (2412MHz)

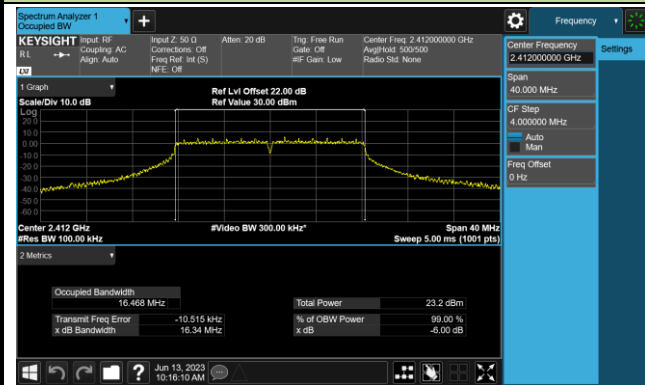

Channel 06 (2437MHz)

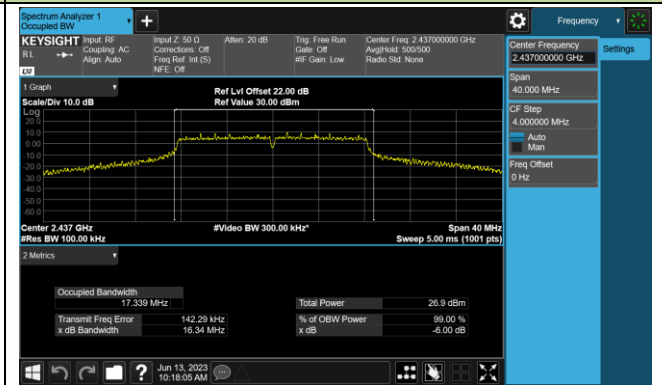

Channel 11 (2462MHz)

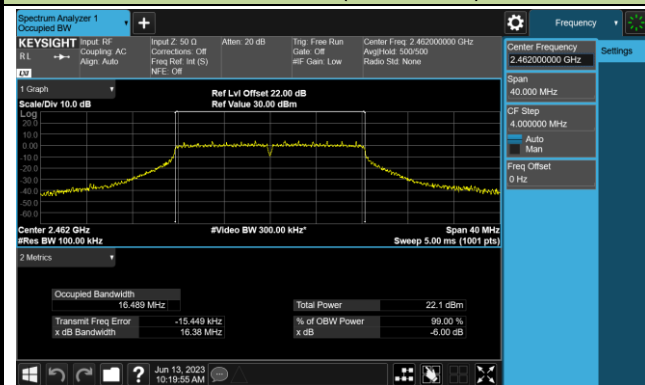

802.11n-HT20 6dB Bandwidth

Channel 01 (2412MHz)

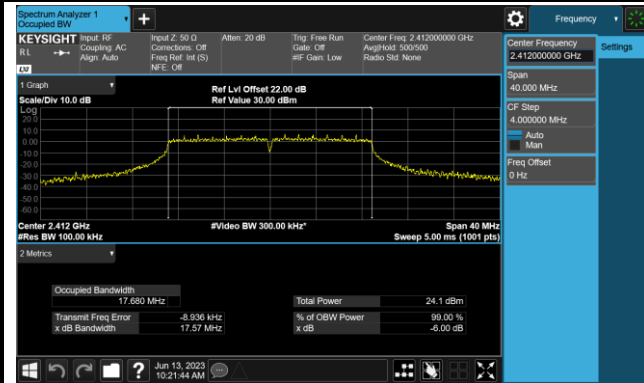

Channel 06 (2437MHz)

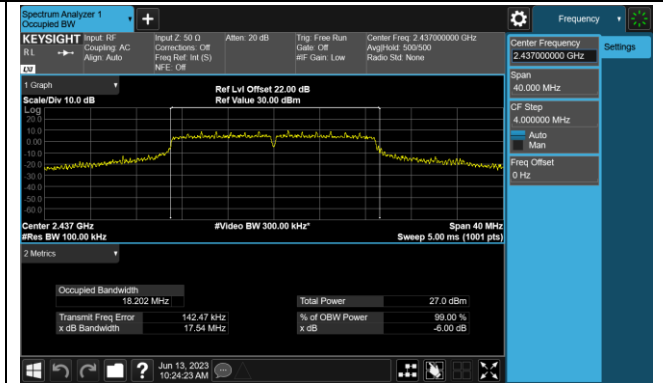

Channel 11 (2462MHz)

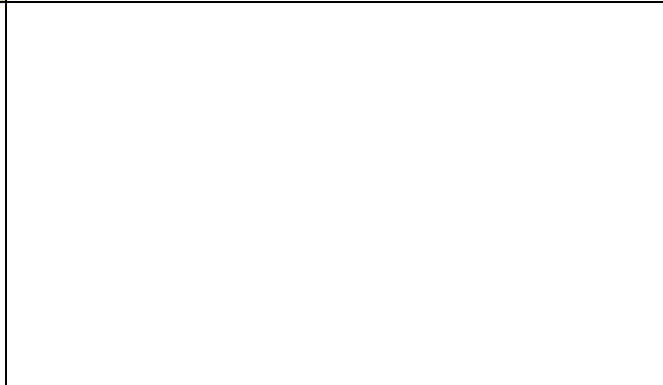
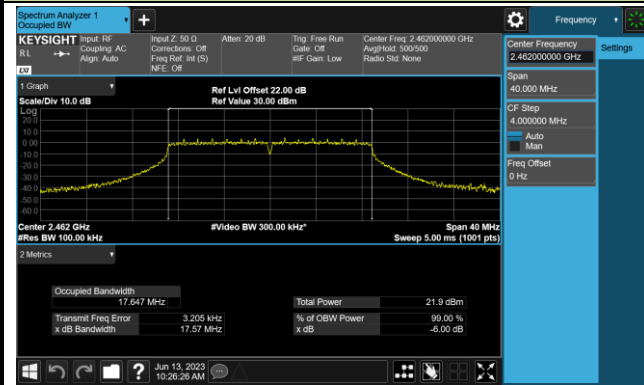

7.3. Output Power Measurement

7.3.1. Test Limit

The maximum output power shall be less 1 Watt (30dBm).

The conducted output power limit specified in paragraph FCC Part 15.247(b) of this section is based on the use of antennas with directional gains that do not exceed 6 dBi. If transmitting antennas of directional gain greater than 6 dBi are used, the conducted output power from the intentional radiator shall be reduced below the stated values in paragraphs FCC Part 15.247(b)(3) of this section, as appropriate, by the amount in dB that the directional gain of the antenna exceeds 6 dBi.

7.3.2. Test Procedure Used

ANSI C63.10-2013 Section 11.9.2.3.2

7.3.3. Test Setting

Average Power Measurement

Average power measurements were performed only when the EUT was transmitting at its maximum power control level using a broadband power meter with a pulse sensor. The power meter implemented triggering and gating capabilities which were set up such that power measurements were recorded only during the ON time of the transmitter.

7.3.4. Test Setup

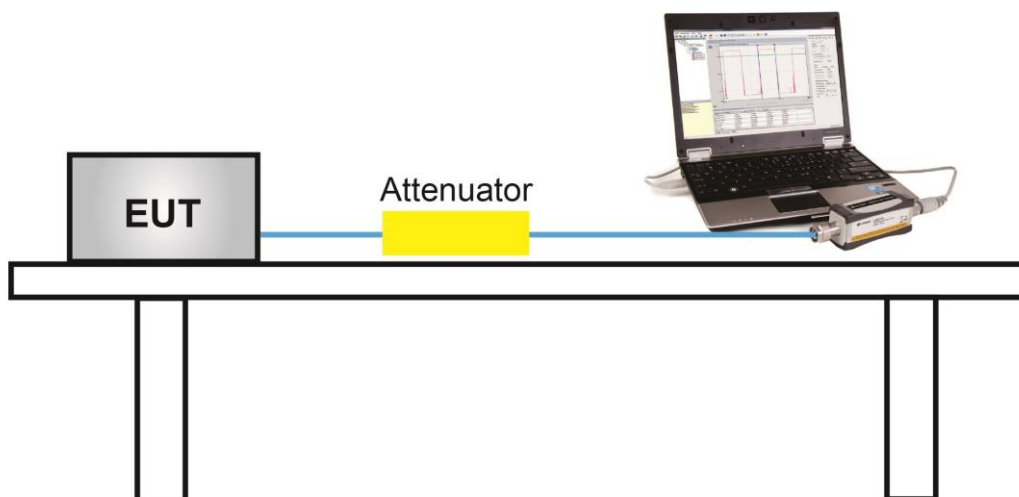

7.3.5. Test Result

Product	Smart Wi-Fi Outlet Extender	Temperature	25°C
Test Engineer	Xuan Yu	Relative Humidity	54%
Test Site	SR6	Test Date	2023/06/14

Test Mode	Data Rate/ MCS	Channel No.	Freq. (MHz)	Average Power (dBm)	Limit (dBm)	Result
802.11b	1Mbps	01	2412	20.21	≤ 30.00	Pass
802.11b	1Mbps	06	2437	19.54	≤ 30.00	Pass
802.11b	1Mbps	11	2462	19.04	≤ 30.00	Pass
802.11g	6Mbps	01	2412	17.00	≤ 30.00	Pass
802.11g	6Mbps	02	2417	20.74	≤ 30.00	Pass
802.11g	6Mbps	06	2437	20.96	≤ 30.00	Pass
802.11g	6Mbps	10	2457	18.21	≤ 30.00	Pass
802.11g	6Mbps	11	2462	16.68	≤ 30.00	Pass
802.11n-HT20	MCS0	01	2412	17.80	≤ 30.00	Pass
802.11n-HT20	MCS0	06	2437	20.97	≤ 30.00	Pass
802.11n-HT20	MCS0	10	2457	19.15	≤ 30.00	Pass
802.11n-HT20	MCS0	11	2462	16.30	≤ 30.00	Pass

7.4. Power Spectral Density Measurement

7.4.1. Test Limit

The maximum permissible power spectral density is 8dBm in any 3 kHz band.

The same method of determining the conducted output power shall be used to determine the power spectral density.

7.4.2. Test Procedure Used

ANSI C63.10-2013 Section 11.10.5

7.4.3. Test Setting

1. Measure the duty cycle (x) of the transmitter output signal.
2. Set instrument center frequency to DTS channel center frequency.
3. Set span to at least 1.5 times the OBW.
4. RBW = 10 kHz.
5. VBW = 30 kHz.
6. Detector = RMS.
7. Ensure that the number of measurement points in the sweep $\geq 2 \times \text{span}/\text{RBW}$.
8. Sweep time = auto couple.
9. Don't use sweep triggering. Allow sweep to "free run".
10. Employ trace averaging (RMS) mode over a minimum of 100 traces.
11. Use the peak marker function to determine the maximum amplitude level.
12. Add $10 \log (1/x)$, where x is the duty cycle measured in step (a), to the measured PSD to compute the average PSD during the actual transmission time.

7.4.4. Test Setup

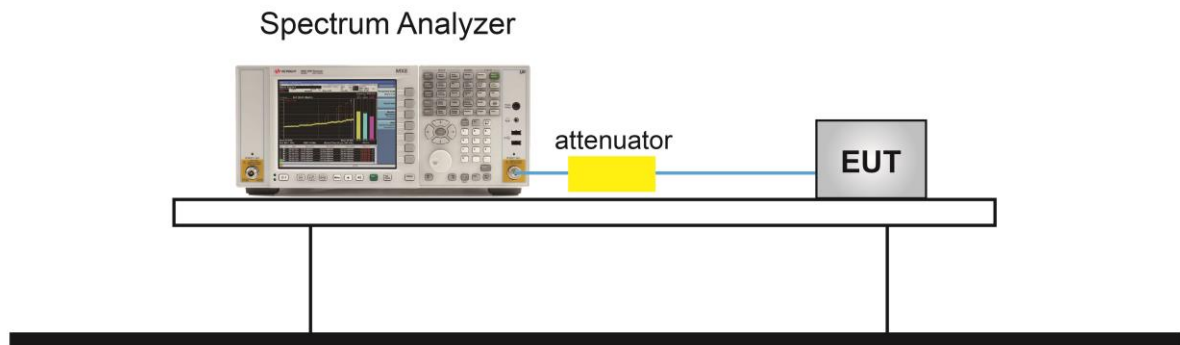

7.4.5. Test Result

Product	Smart Wi-Fi Outlet Extender	Temperature	25°C
Test Engineer	Xuan Yu	Relative Humidity	54%
Test Site	SR6	Test Date	2023/06/13

Test Mode	Data Rate/ MCS	Channel No.	Freq. (MHz)	PSD (dBm/ 10kHz)	Duty Cycle (%)	Total PSD (dBm/ 10kHz)	Limit (dBm/ 3kHz)	Result
802.11b	1Mbps	01	2412	-5.361	98.64%	-5.302	≤ 8.00	Pass
802.11b	1Mbps	06	2437	-5.881	98.64%	-5.822	≤ 8.00	Pass
802.11b	1Mbps	11	2462	-6.035	98.64%	-5.976	≤ 8.00	Pass
802.11g	6Mbps	01	2412	-10.171	93.89%	-9.897	≤ 8.00	Pass
802.11g	6Mbps	06	2437	-7.119	93.89%	-6.845	≤ 8.00	Pass
802.11g	6Mbps	11	2462	-11.327	93.89%	-11.053	≤ 8.00	Pass
802.11n-HT20	MCS0	01	2412	-9.522	93.08%	-9.211	≤ 8.00	Pass
802.11n-HT20	MCS0	06	2437	-6.526	93.08%	-6.215	≤ 8.00	Pass
802.11n-HT20	MCS0	11	2462	-11.951	93.08%	-11.640	≤ 8.00	Pass

Note: Total AVGPDS = AVGPDS + 10*log(1/Duty Cycle).

802.11b AVGPSD

Channel 01 (2412MHz)

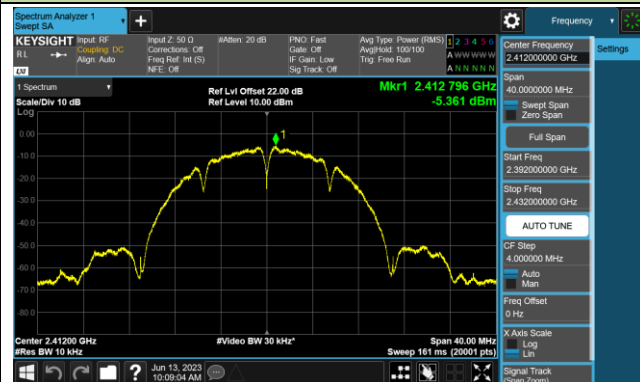

Channel 06 (2437MHz)

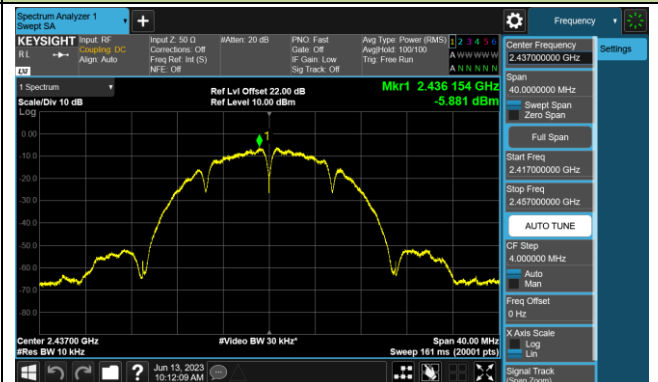

Channel 11 (2462MHz)

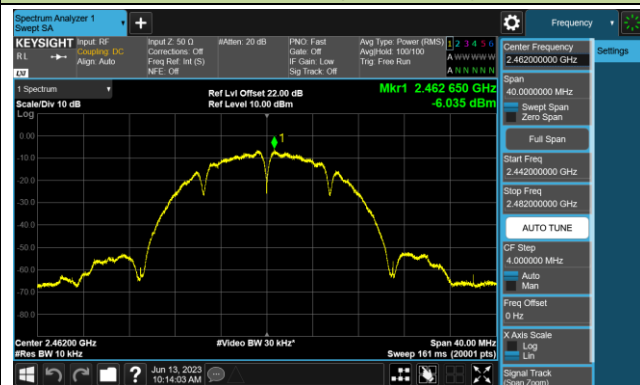

802.11g AVGPSD

Channel 01 (2412MHz)

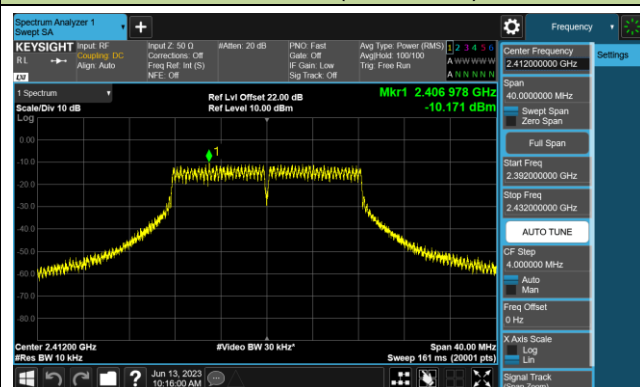

Channel 06 (2437MHz)

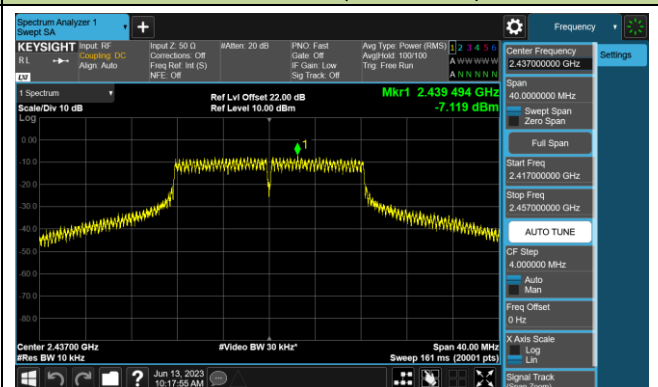

Channel 11 (2462MHz)

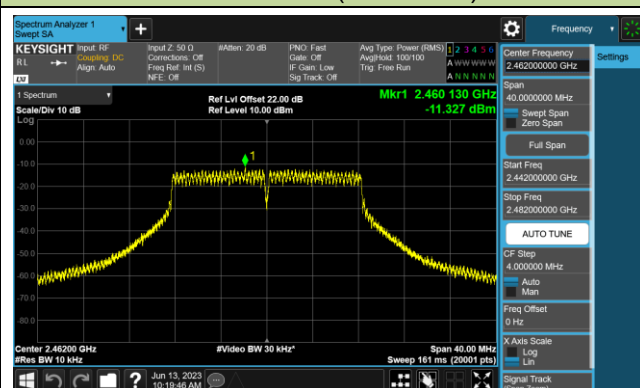

802.11n-HT20 AVGPSPD

Channel 01 (2412MHz)

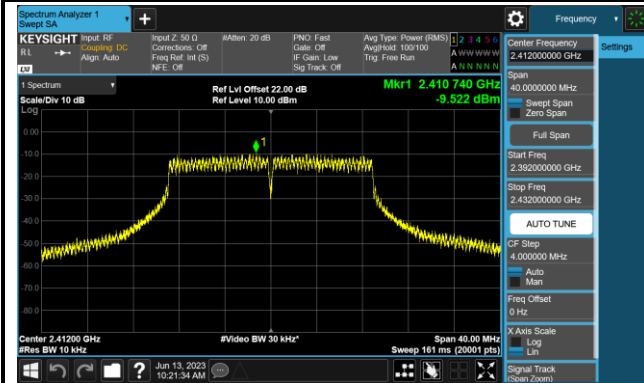

Channel 06 (2437MHz)

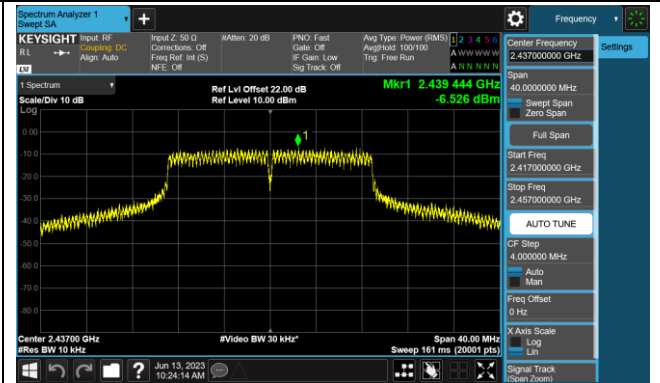

Channel 11 (2462MHz)

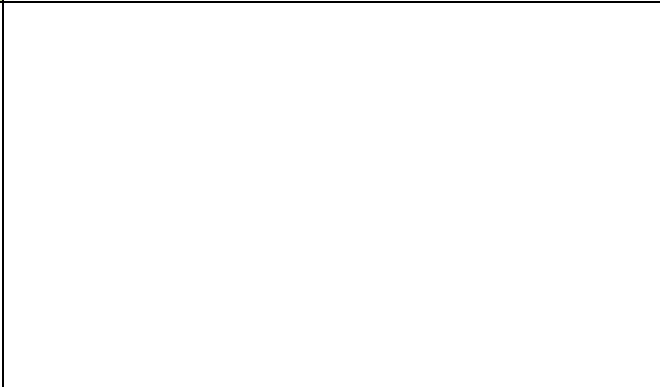
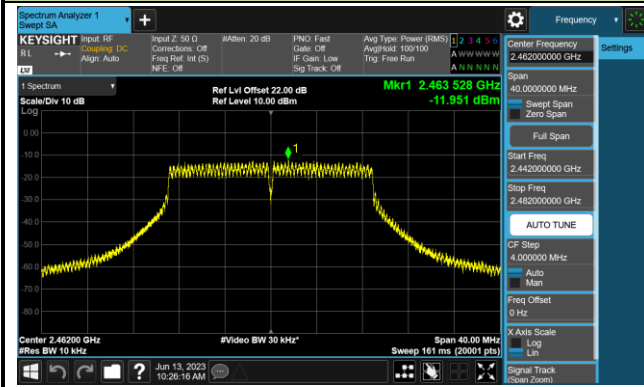

7.5. Conducted Band Edge and Out-of-Band Emissions

7.5.1. Test Limit

The limit for out-of-band spurious emissions at the band edge is 30dB below the fundamental emission level, as determined from the in-band power measurement of the DTS channel performed in a 100 kHz bandwidth per the PSD procedure.

7.5.2. Test Procedure Used

ANSI C63.10-2013 Section 11.11

7.5.3. Test Setting

Reference level measurement

1. Set instrument center frequency to DTS channel center frequency
2. Set the span to ≥ 1.5 times the DTS bandwidth
3. Set the RBW = 100 kHz
4. Set the VBW $\geq 3 \times$ RBW
5. Detector = peak
6. Sweep time = auto couple
7. Trace mode = max hold
8. Allow trace to fully stabilize

Emission level measurement

1. Set the center frequency and span to encompass frequency range to be measured
2. RBW = 100kHz
3. VBW = 300kHz
4. Detector = Peak
5. Trace mode = max hold
6. Sweep time = auto couple
7. The trace was allowed to stabilize

7.5.4. Test Setup

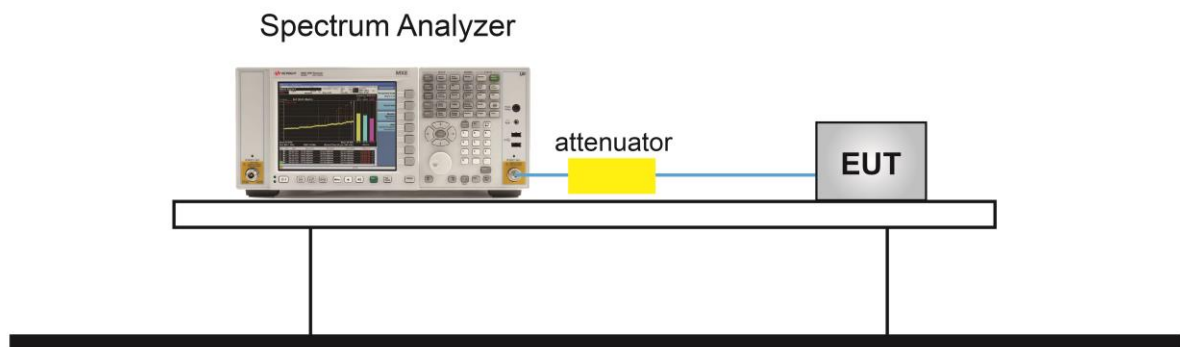

7.5.5. Test Result

Product	Smart Wi-Fi Outlet Extender	Temperature	25°C
Test Engineer	Xuan Yu	Relative Humidity	54%
Test Site	SR6	Test Date	2023/06/13

Test Mode	Data Rate / MCS	Channel No.	Frequency (MHz)	Limit (dBc)	Result
802.11b	1Mbps	01	2412	30	Pass
802.11b	1Mbps	06	2437	30	Pass
802.11b	1Mbps	11	2462	30	Pass
802.11g	6Mbps	01	2412	30	Pass
802.11g	6Mbps	06	2437	30	Pass
802.11g	6Mbps	11	2462	30	Pass
802.11n-HT20	MCS0	01	2412	30	Pass
802.11n-HT20	MCS0	06	2437	30	Pass
802.11n-HT20	MCS0	11	2462	30	Pass

802.11 b CH01 (2412MHz)

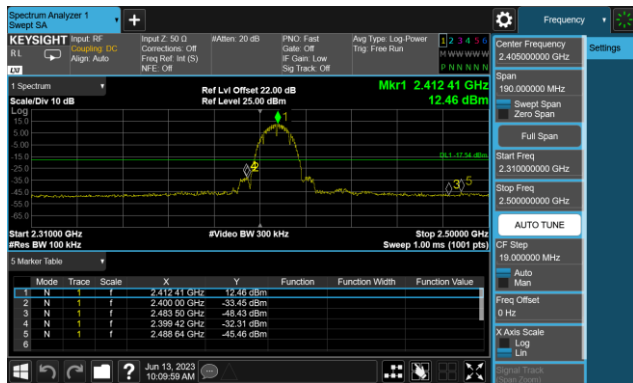

802.11 b CH01 (2412MHz)

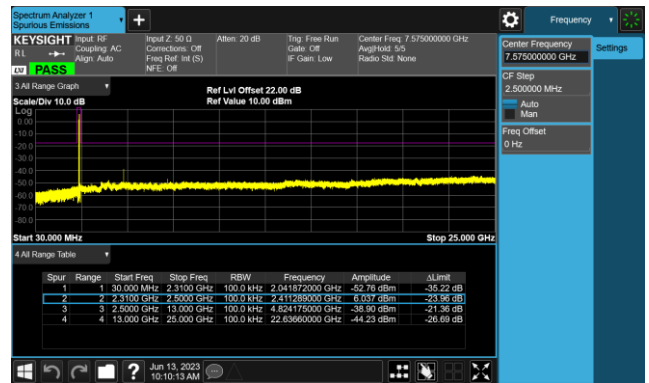

802.11 b CH06 (2437MHz)

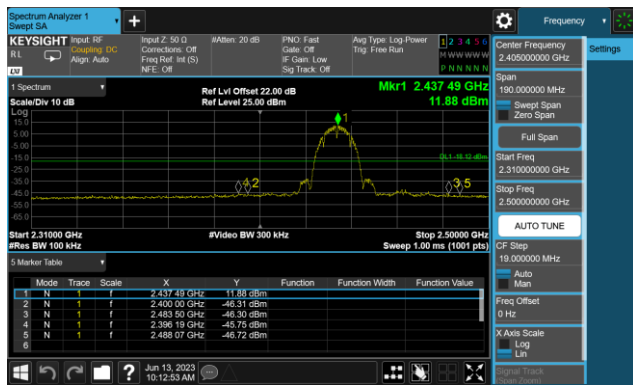

802.11 b CH06 (2437MHz)

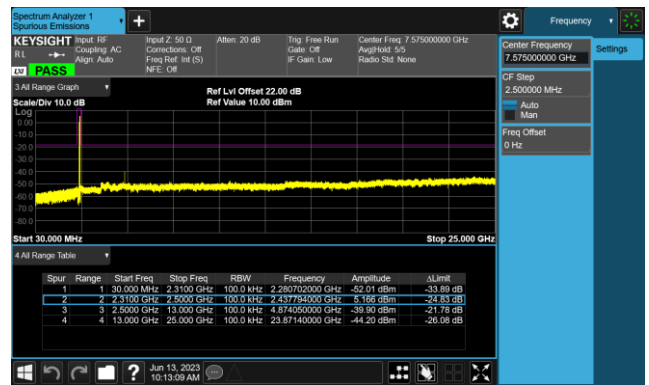

802.11 b CH11 (2462MHz)

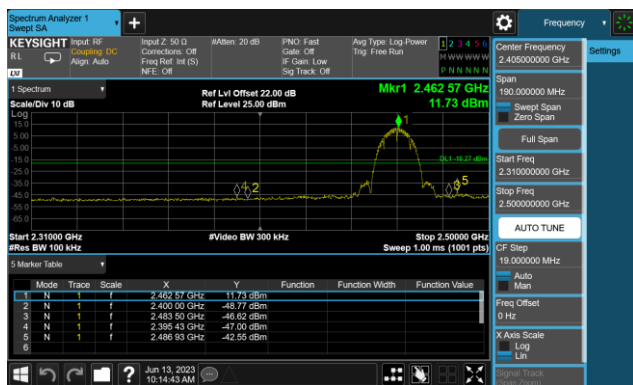

802.11 b CH11 (2462MHz)

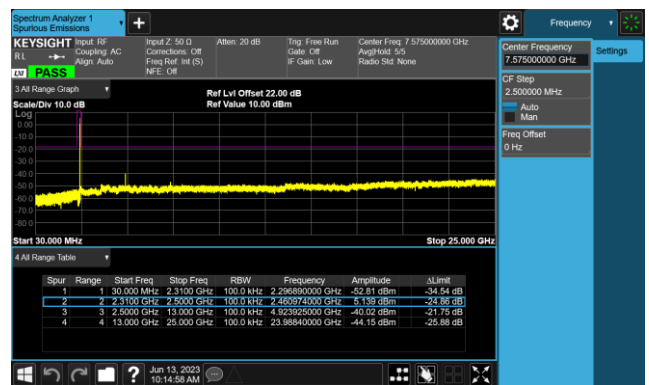

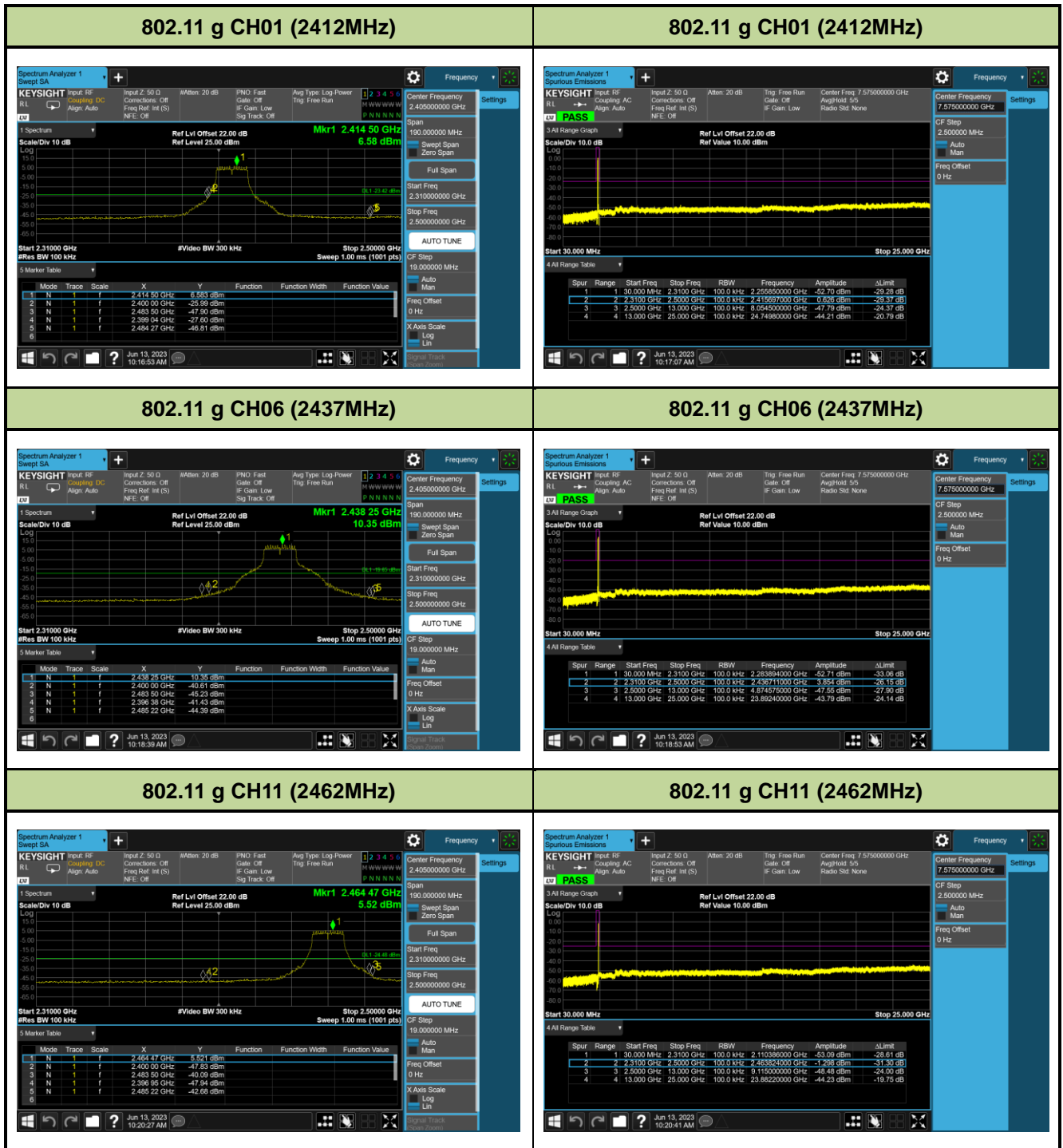

802.11 n20 CH01 (2412MHz)

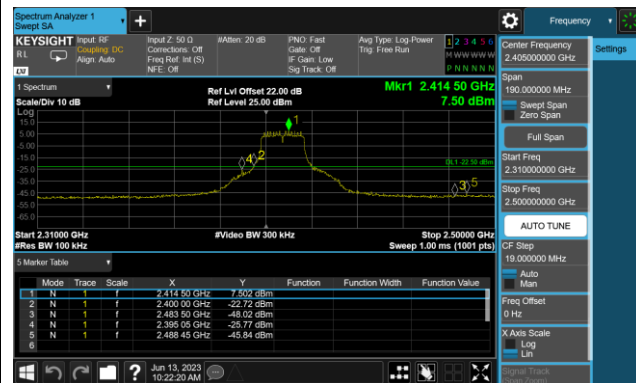

802.11 n20 CH01 (2412MHz)

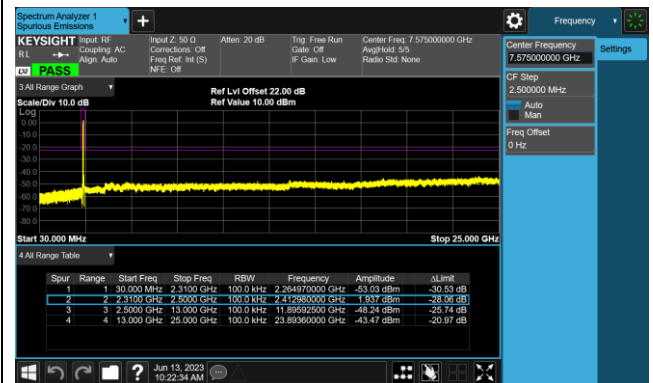

802.11 n20 CH06 (2437MHz)

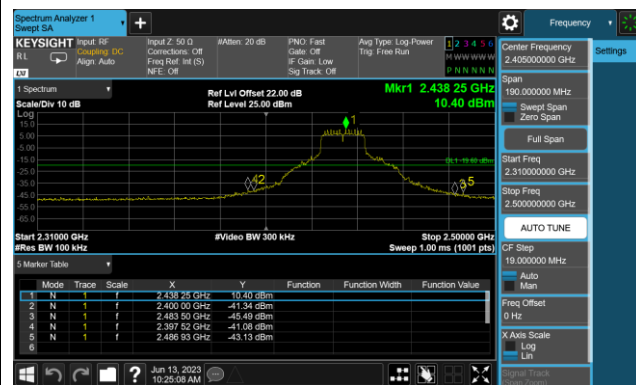

802.11 n20 CH06 (2437MHz)

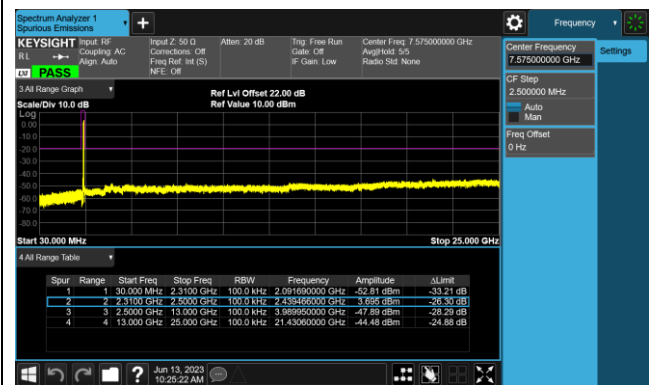

802.11 n20 CH11 (2462MHz)

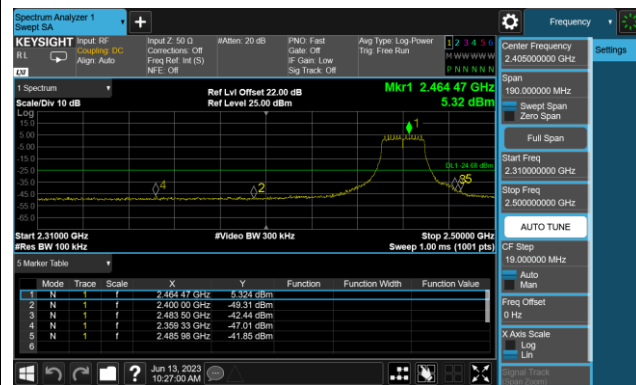

802.11 n20 CH11 (2462MHz)

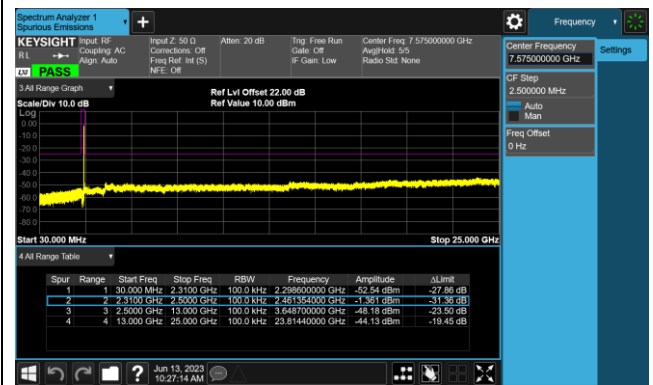

7.6. Radiated Spurious Emission Measurement

7.6.1. Test Limit

All out of band emissions appearing in a restricted band as specified in Section 15.205 of the Title 47CFR must not exceed the limits shown in Table per Section 15.209.

FCC Part 15 Subpart C Paragraph 15.209		
Frequency [MHz]	Field Strength [Uv/m]	Measured Distance [Meters]
0.009 - 0.490	2400/F (kHz)	300
0.490 - 1.705	24000/F (kHz)	30
1.705 - 30	30	30
30 - 88	100	3
88 - 216	150	3
216 - 960	200	3
Above 960	500	3

7.6.2. Test Procedure Used

ANSI C63.10-2013 Section 6.3 (General Requirements)

ANSI C63.10-2013 Section 6.4 (Standard test method below 30MHz)

ANSI C63.10-2013 Section 6.5 (Standard test method above 30MHz to 1GHz)

ANSI C63.10-2013 Section 6.6 (Standard test method above 1GHz)

7.6.3. Test Setting

Table 1 - RBW as a function of frequency

Frequency	RBW
9 ~ 150 kHz	200 ~ 300 Hz
0.15 ~ 30 MHz	9 ~ 10 kHz
30 ~ 1000 MHz	100 ~ 120 kHz
> 1000MHz	1MHz

Quasi-Peak Measurements below 1GHz

1. Analyzer center frequency was set to the frequency of the radiated spurious emission of interest
2. Span was set greater than 1MHz
3. RBW = as specified in Table 1
4. Detector = CISPR quasi-peak
5. Sweep time = auto couple
6. Trace was allowed to stabilize

Peak Measurements above 1GHz

1. Analyzer center frequency was set to the frequency of the radiated spurious emission of interest
2. RBW = 1MHz
3. VBW = 3MHz
4. Detector = peak
5. Sweep time = auto couple
6. Trace mode = max hold
7. Trace was allowed to stabilize

Average Measurements above 1GHz (Method VB)

1. Analyzer center frequency was set to the frequency of the radiated spurious emission of interest
2. RBW = 1MHz
3. VBW; If the EUT is configured to transmit with duty cycle $\geq 98\%$, set VBW = 10 Hz.
If the EUT duty cycle is $< 98\%$, set VBW $\geq 1/T$. T is the minimum transmission duration.
4. Detector = Peak
5. Sweep time = auto
6. Trace mode = max hold
7. Trace was allowed to stabilize

7.6.4. Test Setup

Below 1GHz Test Setup:

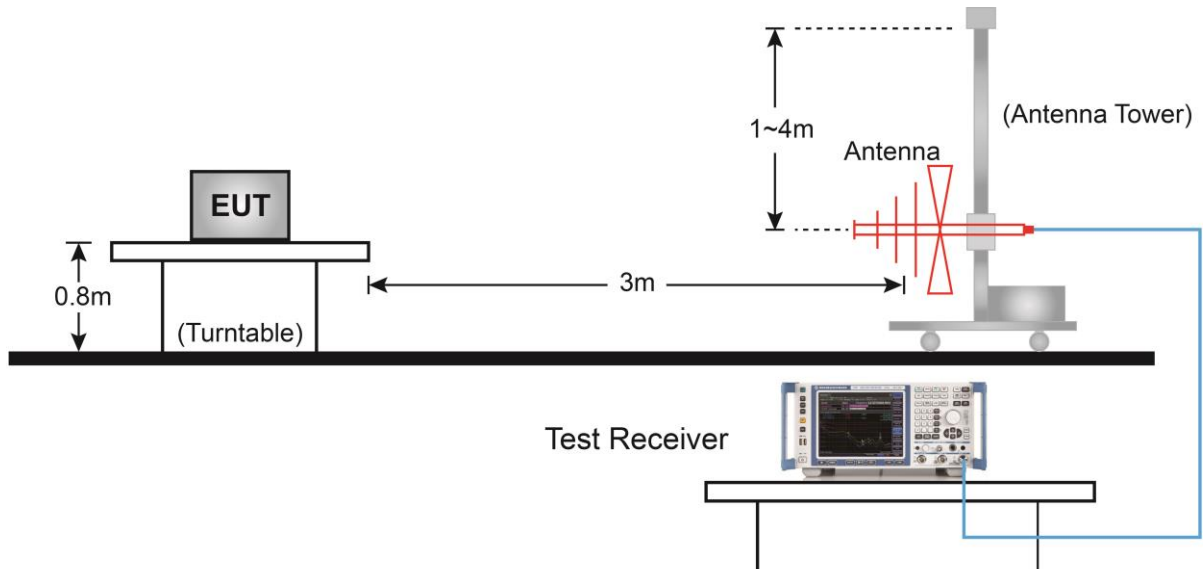

Above 1GHz Test Setup:

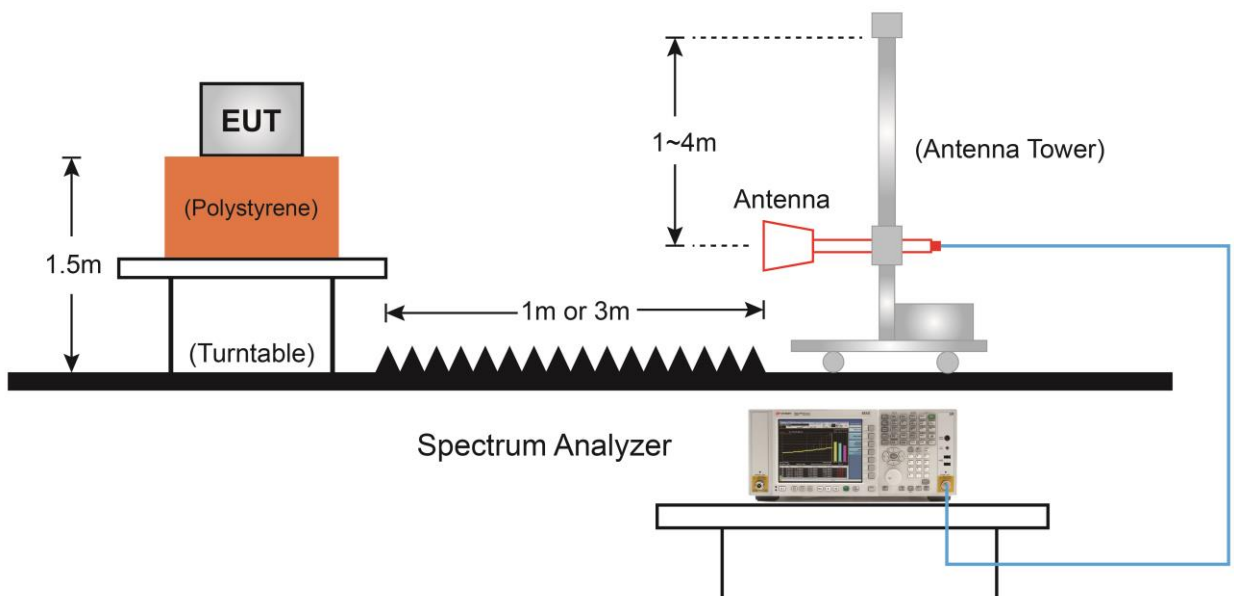

7.6.5. Test Result

EUT	Smart Wi-Fi Outlet Extender	Date of Test	2023-06-08
Factor	VULB 9162	Temp. / Humidity	21°C /61%
Polarity	Horizontal	Site / Test Engineer	AC2 / Stanley
Test Mode	802.11n-20MHz_TX_CH 6_ANT 0	Test Voltage	AC 120V/60Hz

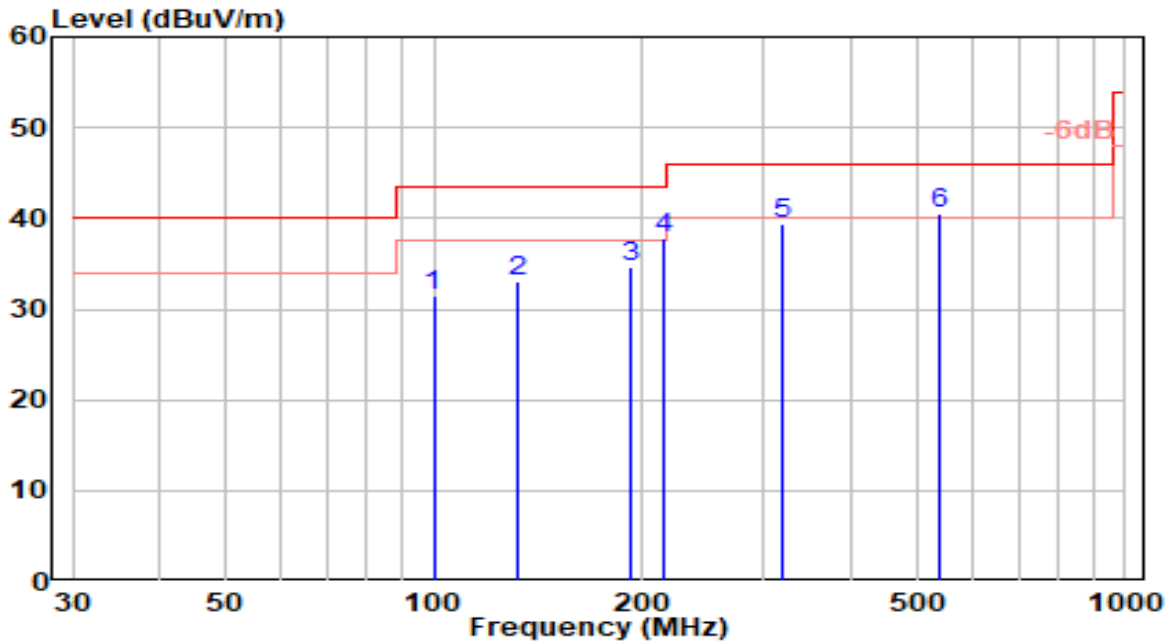

No	Frequency (MHz)	Reading (dBUV)	C.F (dB/m)	Measurement (dBUV/m)	Margin (dB)	Limit (dBUV/m)	Height (cm)	Angle (deg)	Remark (QP/PK/AV)
1	99.840	13.19	18.39	31.58	-11.92	43.50	150	265	QP
2	131.850	17.66	15.31	32.98	-10.52	43.50	200	301	QP
3	191.990	16.96	17.67	34.62	-8.88	43.50	150	360	QP
4	215.270	19.89	18.03	37.92	-5.58	43.50	150	76	QP
5	320.030	18.27	21.22	39.49	-6.51	46.00	100	197	QP
6	* 540.220	15.12	25.42	40.55	-5.45	46.00	200	83	QP

Note:

1. " *", means this data is the worst emission level.
2. C.F (Correction Factor) = Antenna Factor (dB/m) + Cable Loss (dB).
3. Measurement (dBUV/m) = Reading(dBUV) + C.F (Correction Factor).
4. The emission levels of other frequencies are very lower than the limit and not show in test report.

EUT	Smart Wi-Fi Outlet Extender	Date of Test	2023-06-08
Factor	VULB 9162	Temp. / Humidity	21°C /61%
Polarity	Vertical	Site / Test Engineer	AC2 / Stanley
Test Mode	802.11n-20MHz_TX_CH 6_ANT 0	Test Voltage	AC 120V/60Hz

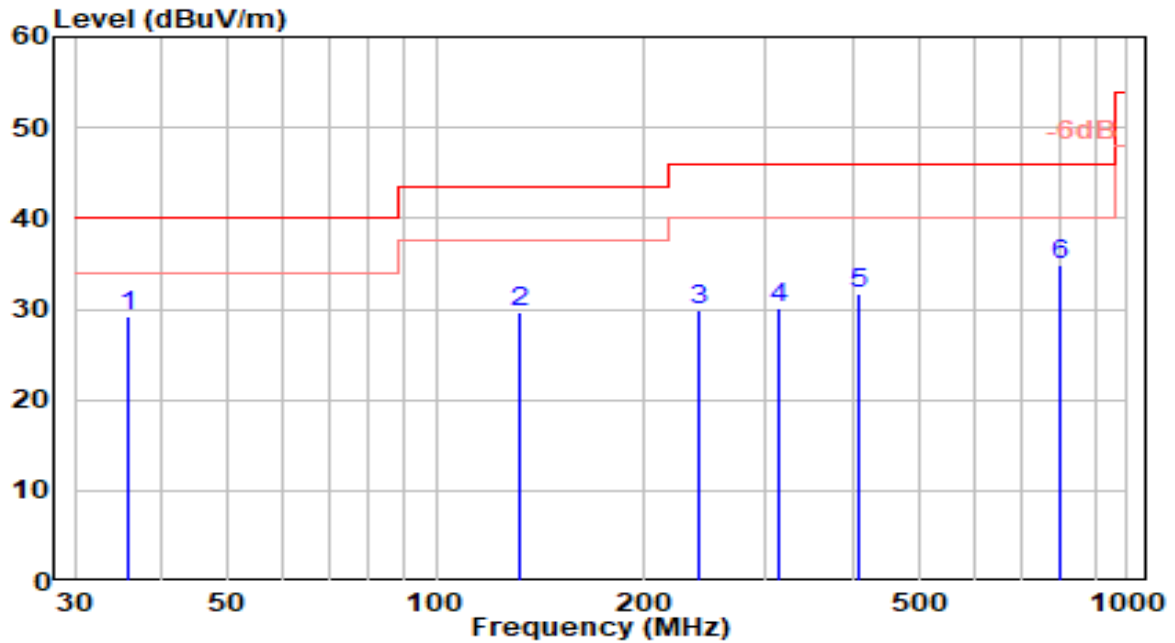

No	Frequency (MHz)	Reading (dBuV)	C.F (dB/m)	Measurement (dBuV/m)	Margin (dB)	Limit (dBuV/m)	Height (cm)	Angle (deg)	Remark (QP/PK/AV)	
1	*	35.820	11.27	17.84	29.11	-10.89	40.00	100	279	QP
2		131.850	14.41	15.31	29.72	-13.78	43.50	100	10	QP
3		239.520	10.57	19.43	30.00	-16.00	46.00	150	59	QP
4		312.270	9.14	20.93	30.08	-15.92	46.00	146	360	QP
5		408.300	8.54	23.16	31.70	-14.30	46.00	200	333	QP
6		800.180	5.53	29.28	34.82	-11.18	46.00	150	0	QP

Note:

1. " *", means this data is the worst emission level.
2. C.F (Correction Factor) = Antenna Factor (dB/m) + Cable Loss (dB).
3. Measurement (dBuV/m) = Reading(dBuV) + C.F (Correction Factor).
4. The emission levels of other frequencies are very lower than the limit and not show in test report.

EUT	Smart Wi-Fi Outlet Extender	Date of Test	2023-06-08
Factor	VULB 9162	Temp. / Humidity	21°C /61%
Polarity	Horizontal	Site / Test Engineer	AC2 / Stanley
Test Mode	802.11n-20MHz_TX_CH 6_ANT 1	Test Voltage	AC 120V/60Hz

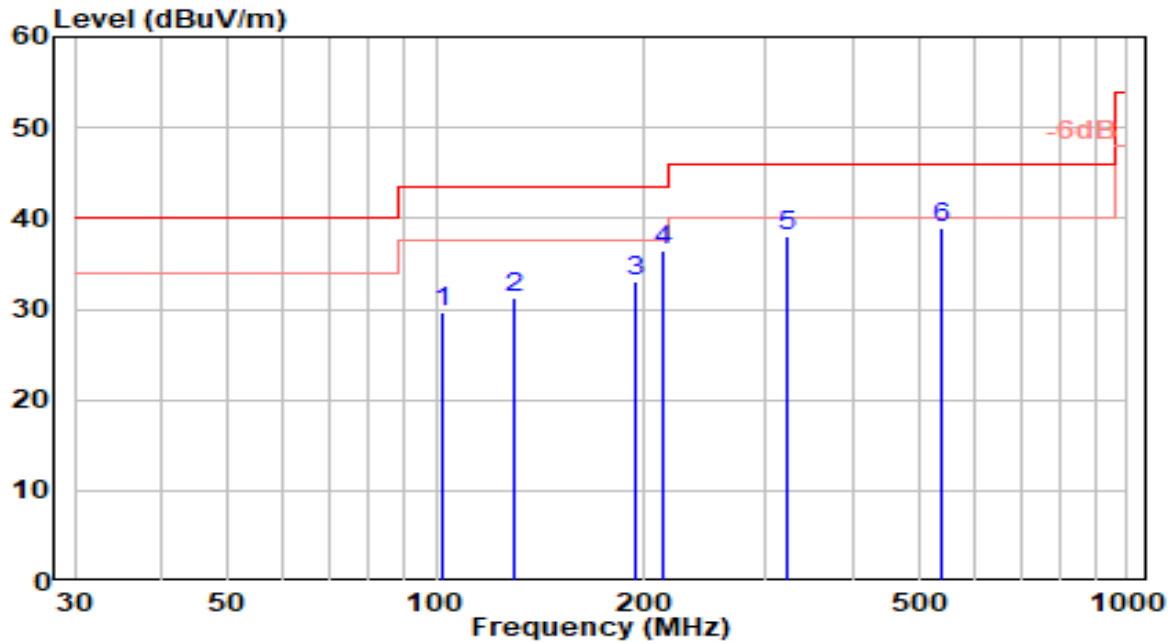

No	Frequency (MHz)	Reading (dBuV)	C.F (dB/m)	Measurement (dBuV/m)	Margin (dB)	Limit (dBuV/m)	Height (cm)	Angle (deg)	Remark (QP/PK/AV)
1	102.500	11.37	18.33	29.70	-13.80	43.50	200	279	QP
2	129.830	15.69	15.49	31.18	-12.32	43.50	200	315	QP
3	195.030	15.29	17.79	33.08	-10.42	43.50	100	14	QP
4	213.310	18.47	17.91	36.38	-7.12	43.50	150	90	QP
5	322.330	16.64	21.31	37.95	-8.05	46.00	100	211	QP
6	* 538.880	13.60	25.41	39.01	-6.99	46.00	150	97	QP

Note:

1. " *", means this data is the worst emission level.
2. C.F (Correction Factor) = Antenna Factor (dB/m) + Cable Loss (dB).
3. Measurement (dBuV/m) = Reading(dBuV) + C.F (Correction Factor).
4. The emission levels of other frequencies are very lower than the limit and not show in test report.

EUT	Smart Wi-Fi Outlet Extender	Date of Test	2023-06-08
Factor	VULB 9162	Temp. / Humidity	21°C /61%
Polarity	Vertical	Site / Test Engineer	AC2 / Stanley
Test Mode	802.11n-20MHz_TX_CH 6_ANT 1	Test Voltage	AC 120V/60Hz

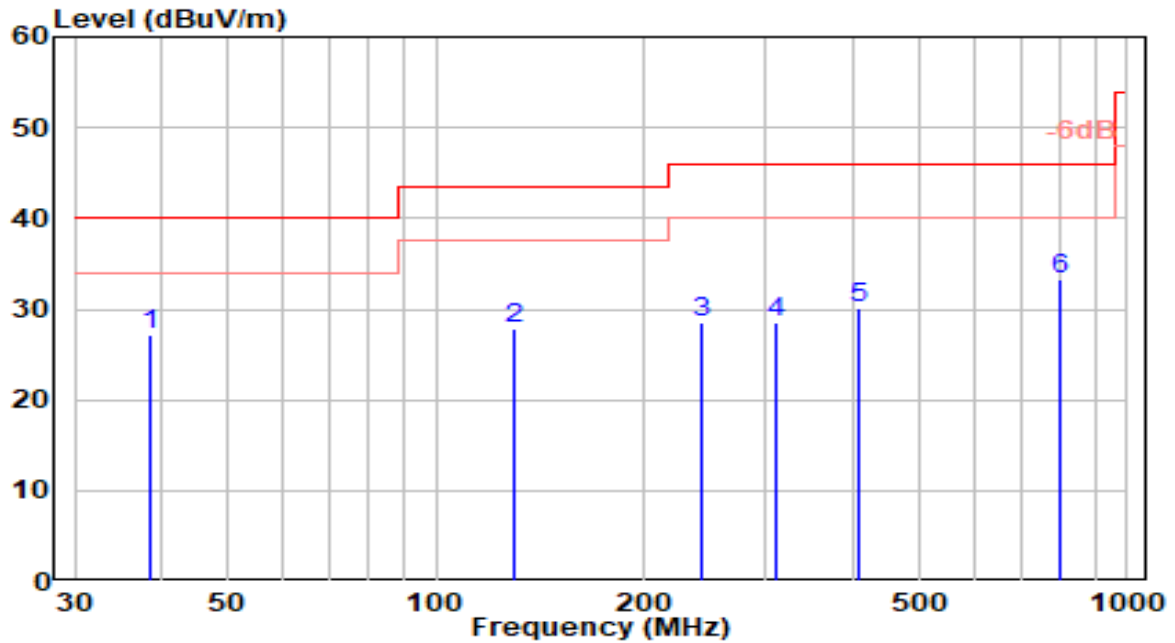

No	Frequency (MHz)	Reading (dBuV)	C.F (dB/m)	Measurement (dBuV/m)	Margin (dB)	Limit (dBuV/m)	Height (cm)	Angle (deg)	Remark (QP/PK/AV)
1	38.480	8.47	18.76	27.23	-12.77	40.00	200	293	QP
2	129.830	12.43	15.49	27.92	-15.58	43.50	100	24	QP
3	242.560	8.90	19.56	28.46	-17.54	46.00	150	73	QP
4	310.310	7.67	20.86	28.54	-17.46	46.00	200	14	QP
5	410.600	6.98	23.18	30.16	-15.84	46.00	200	347	QP
6	* 798.840	4.01	29.27	33.28	-12.72	46.00	150	14	QP

Note:

1. " *", means this data is the worst emission level.
2. C.F (Correction Factor) = Antenna Factor (dB/m) + Cable Loss (dB).
3. Measurement (dBuV/m) = Reading(dBuV) + C.F (Correction Factor).
4. The emission levels of other frequencies are very lower than the limit and not show in test report.

EUT	Smart Wi-Fi Outlet Extender	Date of Test	2023-06-13
Factor	DRH18-E	Temp. / Humidity	21°C /61%
Polarity	Horizontal	Site / Test Engineer	AC2 / Marvin
Test Mode	802.11b_TX_CH 1_ANT 0	Test Voltage	By Notebook PC

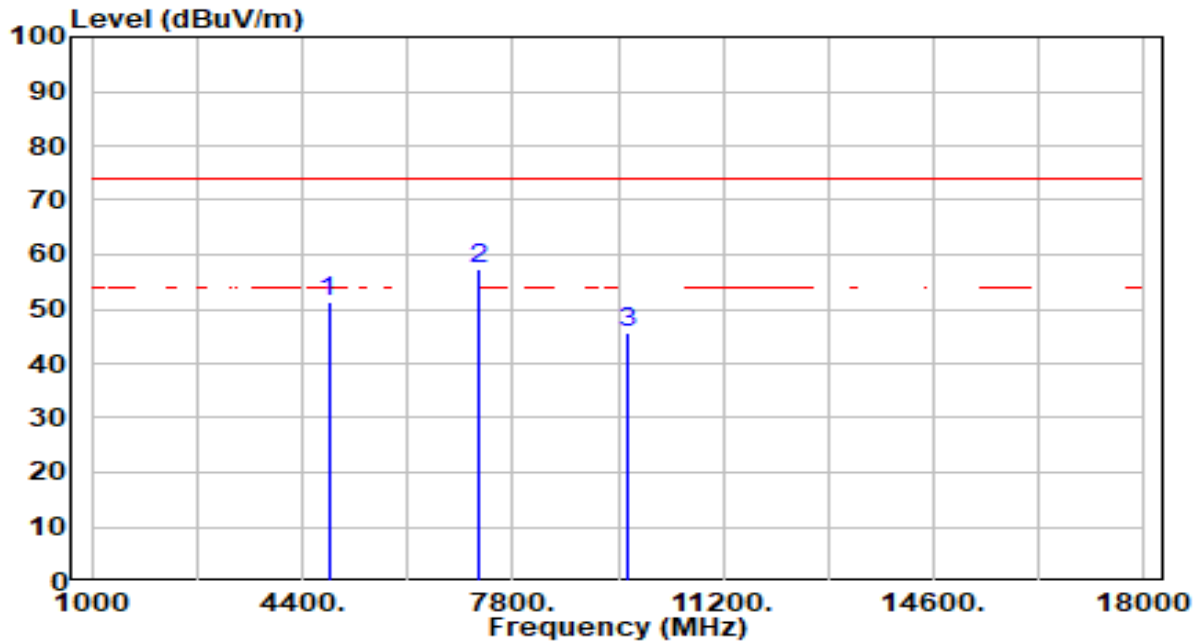

No	Frequency (MHz)	Reading (dBUV)	C.F (dB/m)	Measurement (dBUV/m)	Margin (dB)	Limit (dBUV/m)	Height (cm)	Angle (deg)	Remark (QP/PK/AV)
1	4824.000	52.61	-1.10	51.51	-22.49	74.00	200	110	Peak
2	* 7236.000	53.30	3.90	57.20	-16.80	74.00	200	267	Peak
3	9648.000	42.53	3.21	45.75	-28.25	74.00	300	42	Peak

Note:

1. " *", means this data is the worst emission level.
2. C.F (Correction Factor) = Antenna Factor (dB/m)+ Cable Loss (dB) – Pre-amplifier(dB).
3. Measurement (dBUV/m) = Reading(dBUV) + C.F (Correction Factor).
4. The emission levels of other frequencies are very lower than the limit and not show in test report.

EUT	Smart Wi-Fi Outlet Extender	Date of Test	2023-06-13
Factor	DRH18-E	Temp. / Humidity	21°C /61%
Polarity	Vertical	Site / Test Engineer	AC2 / Marvin
Test Mode	802.11b_TX_CH 1_ANT 0	Test Voltage	By Notebook PC

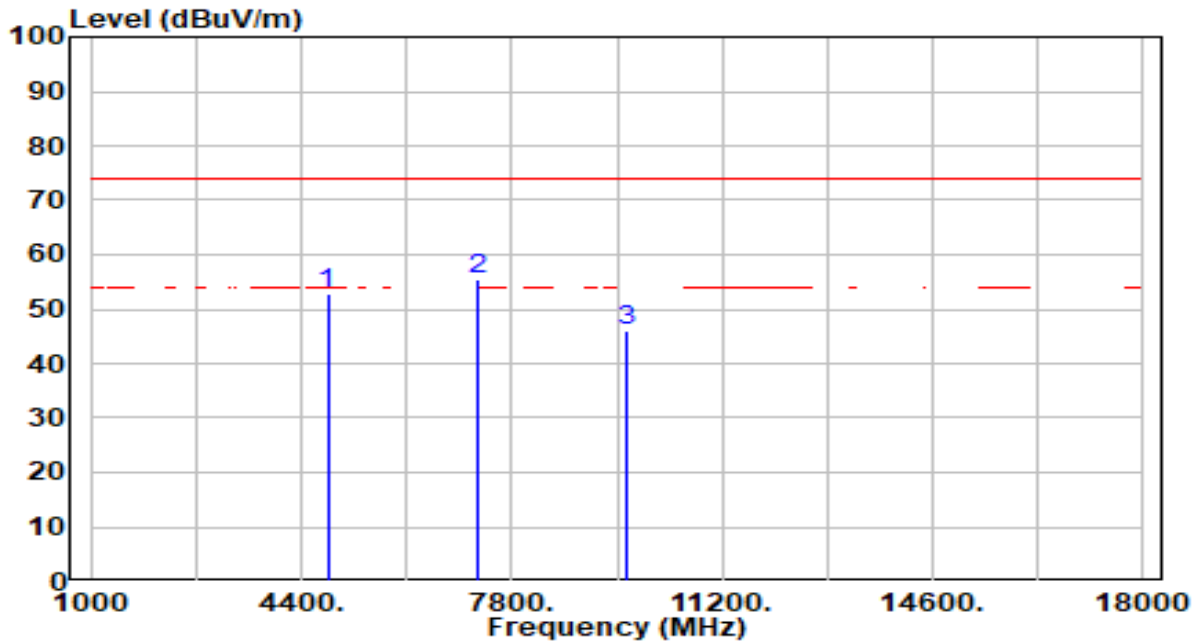

No	Frequency (MHz)	Reading (dBUV)	C.F (dB/m)	Measurement (dBUV/m)	Margin (dB)	Limit (dBUV/m)	Height (cm)	Angle (deg)	Remark (QP/PK/AV)
1	4824.000	53.74	-1.10	52.64	-21.36	74.00	200	115	Peak
2	* 7236.000	51.54	3.90	55.45	-18.55	74.00	238	0	Peak
3	9648.000	42.91	3.21	46.12	-27.88	74.00	300	85	Peak

Note:

1. " *", means this data is the worst emission level.
2. C.F (Correction Factor) = Antenna Factor (dB/m)+ Cable Loss (dB) – Pre-amplifier(dB).
3. Measurement (dBUV/m) = Reading(dBUV) + C.F (Correction Factor).
4. The emission levels of other frequencies are very lower than the limit and not show in test report.

EUT	Smart Wi-Fi Outlet Extender	Date of Test	2023-06-13
Factor	DRH18-E	Temp. / Humidity	21°C /61%
Polarity	Horizontal	Site / Test Engineer	AC2 / Marvin
Test Mode	802.11b_TX_CH 6_ANT 0	Test Voltage	By Notebook PC

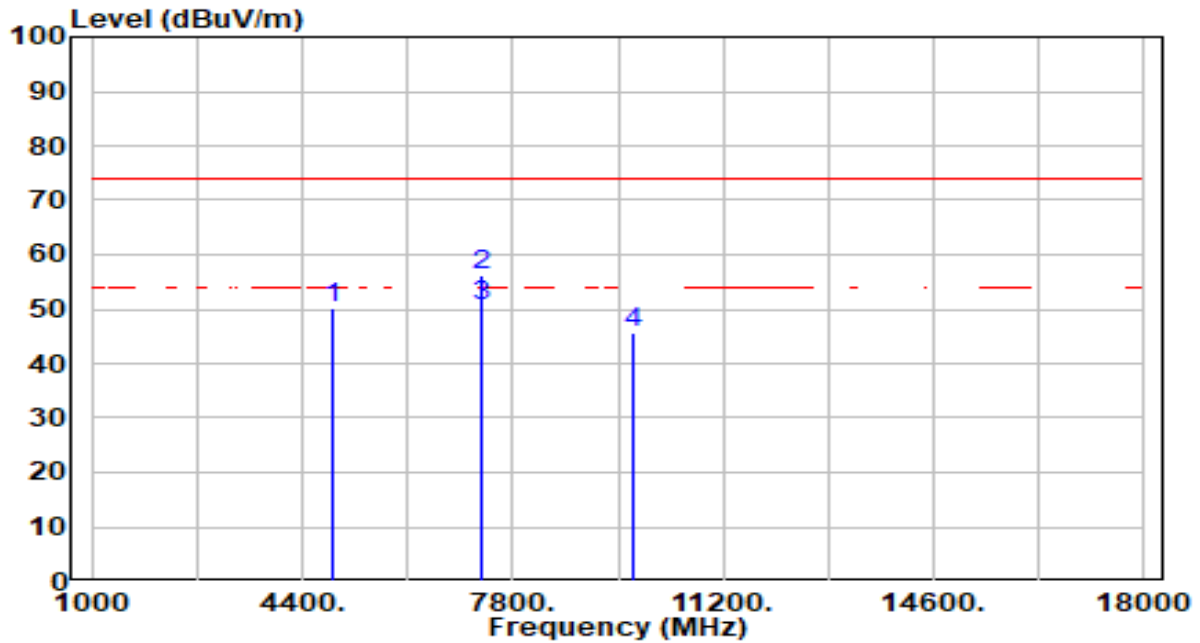

No	Frequency (MHz)	Reading (dBuV)	C.F (dB/m)	Measurement (dBuV/m)	Margin (dB)	Limit (dBuV/m)	Height (cm)	Angle (deg)	Remark (QP/PK/AV)
1	4874.000	51.28	-0.97	50.31	-23.69	74.00	200	124	Peak
2	* 7311.000	52.16	3.92	56.08	-17.92	74.00	198	270	Peak
3	* 7311.000	46.52	3.92	50.44	-3.56	54.00	198	270	Average
4	9748.000	42.37	3.24	45.61	-28.39	74.00	200	135	Peak

Note:

1. " *", means this data is the worst emission level.
2. C.F (Correction Factor) = Antenna Factor (dB/m)+ Cable Loss (dB) – Pre-amplifier(dB).
3. Measurement (dBuV/m) = Reading(dBuV) + C.F (Correction Factor).
4. The emission levels of other frequencies are very lower than the limit and not show in test report.

EUT	Smart Wi-Fi Outlet Extender	Date of Test	2023-06-13
Factor	DRH18-E	Temp. / Humidity	21°C /61%
Polarity	Vertical	Site / Test Engineer	AC2 / Marvin
Test Mode	802.11b_TX_CH 6_ANT 0	Test Voltage	By Notebook PC

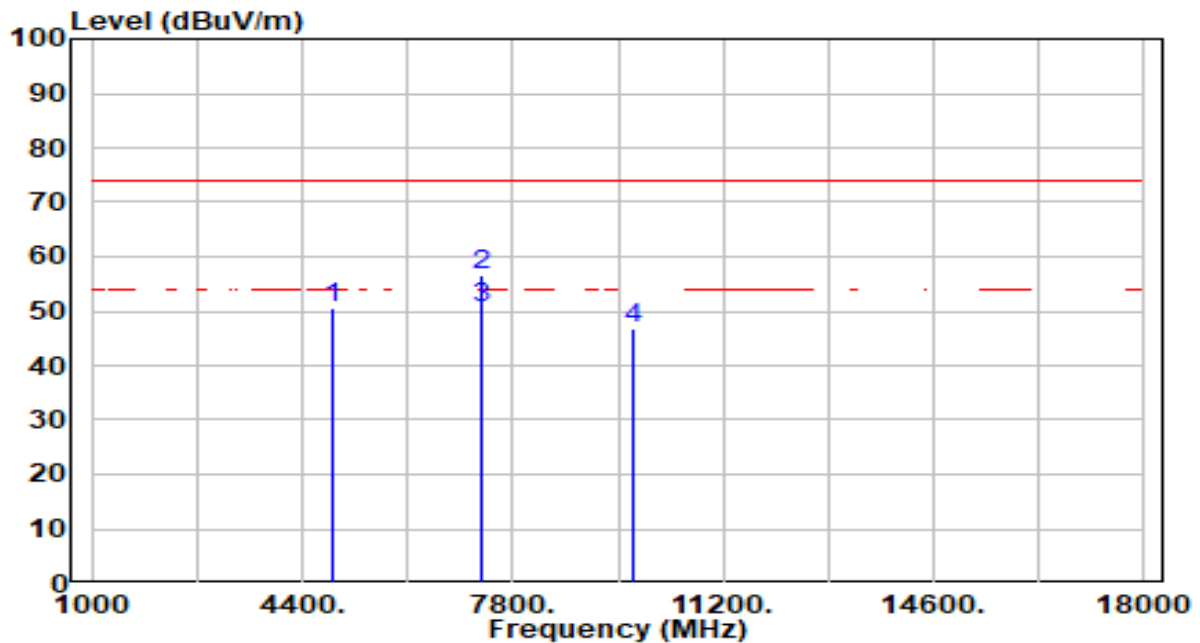

No	Frequency (MHz)	Reading (dBuV)	C.F (dB/m)	Measurement (dBuV/m)	Margin (dB)	Limit (dBuV/m)	Height (cm)	Angle (deg)	Remark (QP/PK/AV)
1	4874.000	51.59	-0.97	50.62	-23.38	74.00	200	253	Peak
2	* 7311.000	52.64	3.92	56.56	-17.44	74.00	234	24	Peak
3	* 7311.000	46.76	3.92	50.68	-23.32	74.00	234	24	Peak
4	9748.000	43.68	3.24	46.93	-27.07	74.00	200	0	Peak

Note:

- "*" means this data is the worst emission level.
- C.F (Correction Factor) = Antenna Factor (dB/m)+ Cable Loss (dB) – Pre-amplifier(dB).
- Measurement (dBuV/m) = Reading(dBuV) + C.F (Correction Factor).
- The emission levels of other frequencies are very lower than the limit and not show in test report.

EUT	Smart Wi-Fi Outlet Extender	Date of Test	2023-06-13
Factor	DRH18-E	Temp. / Humidity	21°C /61%
Polarity	Horizontal	Site / Test Engineer	AC2 / Marvin
Test Mode	802.11b_TX_CH 11_ANT 0	Test Voltage	By Notebook PC

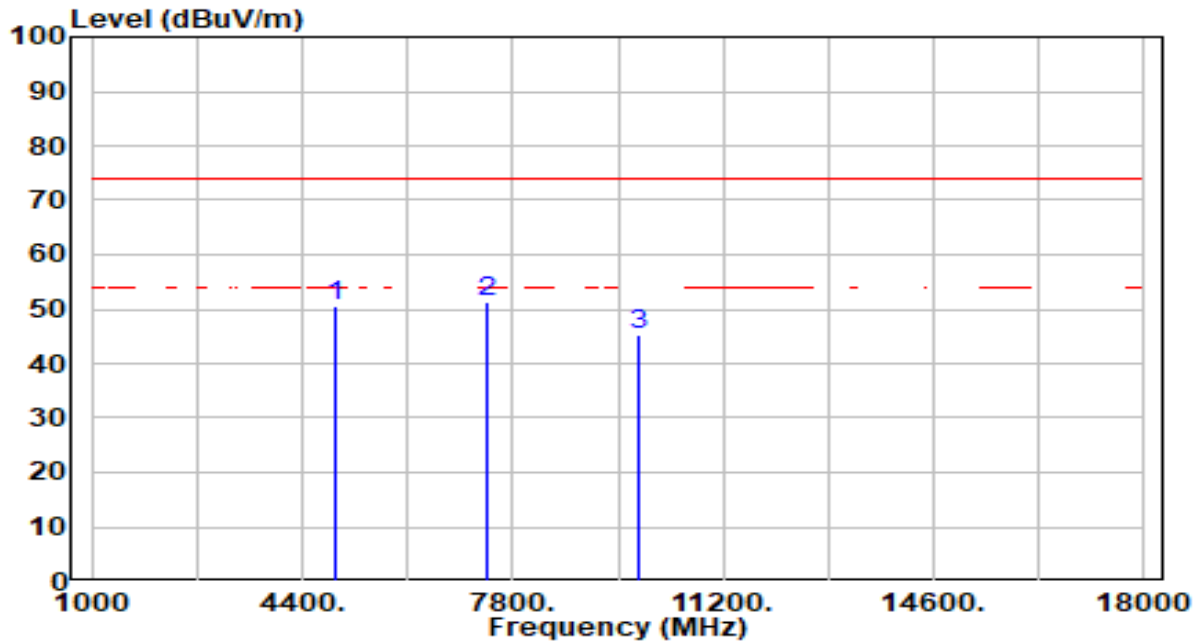

No	Frequency (MHz)	Reading (dBuV)	C.F (dB/m)	Measurement (dBuV/m)	Margin (dB)	Limit (dBuV/m)	Height (cm)	Angle (deg)	Remark (QP/PK/AV)
1	4924.000	51.38	-0.84	50.54	-23.46	74.00	200	189	Peak
2	* 7386.000	47.52	3.93	51.45	-22.55	74.00	200	314	Peak
3	9848.000	42.11	3.27	45.38	-28.62	74.00	200	135	Peak

Note:

1. " *", means this data is the worst emission level.
2. C.F (Correction Factor) = Antenna Factor (dB/m)+ Cable Loss (dB) – Preamplifier(dB).
3. Measurement (dBuV/m) = Reading(dBuV) + C.F (Correction Factor).
4. The emission levels of other frequencies are very lower than the limit and not show in test report.

EUT	Smart Wi-Fi Outlet Extender	Date of Test	2023-06-13
Factor	DRH18-E	Temp. / Humidity	21°C /61%
Polarity	Vertical	Site / Test Engineer	AC2 / Marvin
Test Mode	802.11b_TX_CH 11_ANT 0	Test Voltage	By Notebook PC

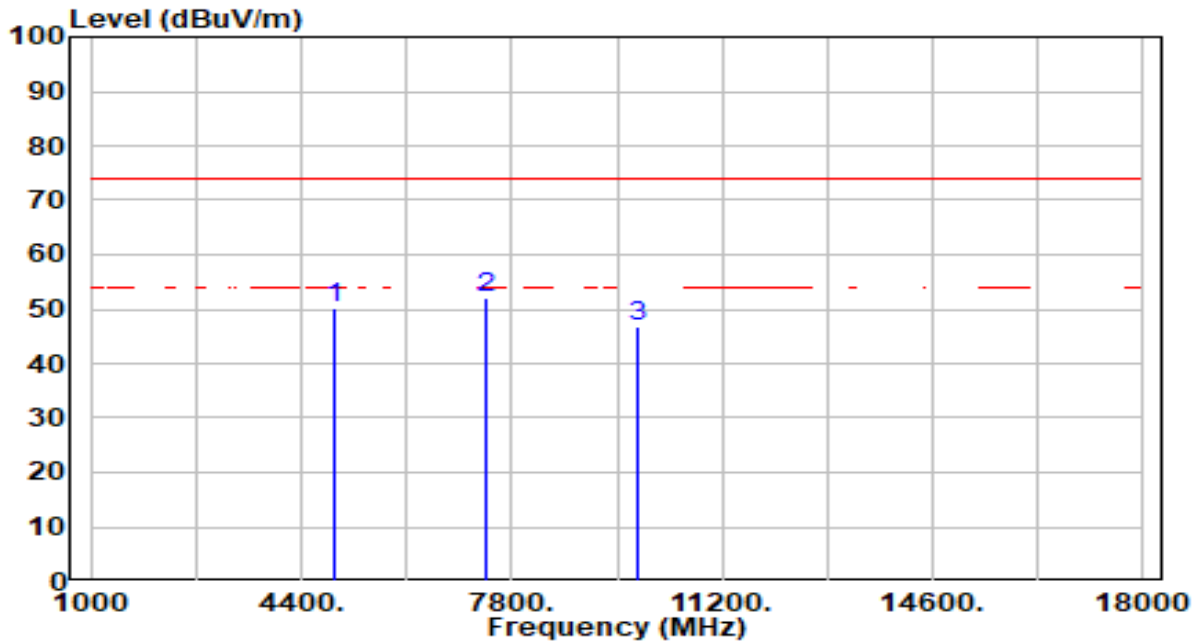

No	Frequency (MHz)	Reading (dBuV)	C.F (dB/m)	Measurement (dBuV/m)	Margin (dB)	Limit (dBuV/m)	Height (cm)	Angle (deg)	Remark (QP/PK/AV)
1	4924.000	50.87	-0.84	50.03	-23.97	74.00	200	249	Peak
2	* 7386.000	48.20	3.93	52.13	-21.87	74.00	200	0	Peak
3	9848.000	43.53	3.27	46.80	-27.20	74.00	200	7	Peak

Note:

1. " *", means this data is the worst emission level.
2. C.F (Correction Factor) = Antenna Factor (dB/m)+ Cable Loss (dB) – Pre-amplifier(dB).
3. Measurement (dBuV/m) = Reading(dBuV) + C.F (Correction Factor).
4. The emission levels of other frequencies are very lower than the limit and not show in test report.

EUT	Smart Wi-Fi Outlet Extender	Date of Test	2023-06-13
Factor	DRH18-E	Temp. / Humidity	21°C /61%
Polarity	Horizontal	Site / Test Engineer	AC2 / Marvin
Test Mode	802.11g_TX_CH 1_ANT 0	Test Voltage	By Notebook PC

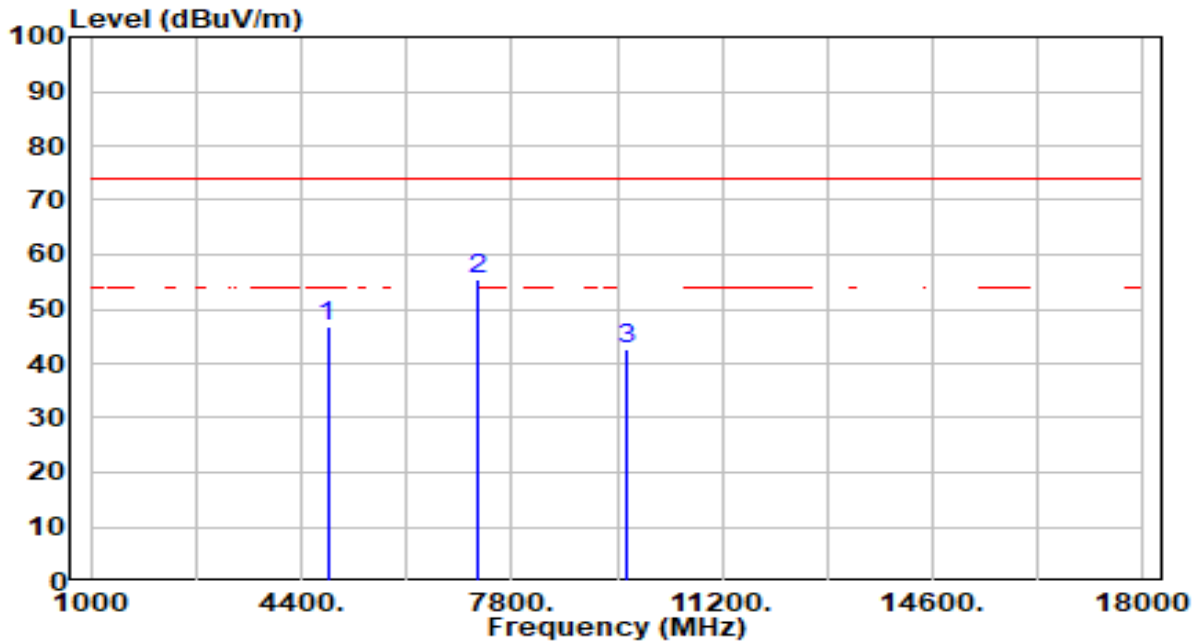

No	Frequency (MHz)	Reading (dBuV)	C.F (dB/m)	Measurement (dBuV/m)	Margin (dB)	Limit (dBuV/m)	Height (cm)	Angle (deg)	Remark (QP/PK/AV)
1	4824.000	47.99	-1.10	46.90	-27.10	74.00	200	114	Peak
2	* 7236.000	51.63	3.90	55.53	-18.47	74.00	200	276	Peak
3	9648.000	39.56	3.21	42.77	-31.23	74.00	200	1	Peak

Note:

1. " *", means this data is the worst emission level.
2. C.F (Correction Factor) = Antenna Factor (dB/m)+ Cable Loss (dB) – Pre-amplifier(dB).
3. Measurement (dBuV/m) = Reading(dBuV) + C.F (Correction Factor).
4. The emission levels of other frequencies are very lower than the limit and not show in test report.

EUT	Smart Wi-Fi Outlet Extender	Date of Test	2023-06-13
Factor	DRH18-E	Temp. / Humidity	21°C /61%
Polarity	Vertical	Site / Test Engineer	AC2 / Marvin
Test Mode	802.11g_TX_CH 1_ANT 0	Test Voltage	By Notebook PC

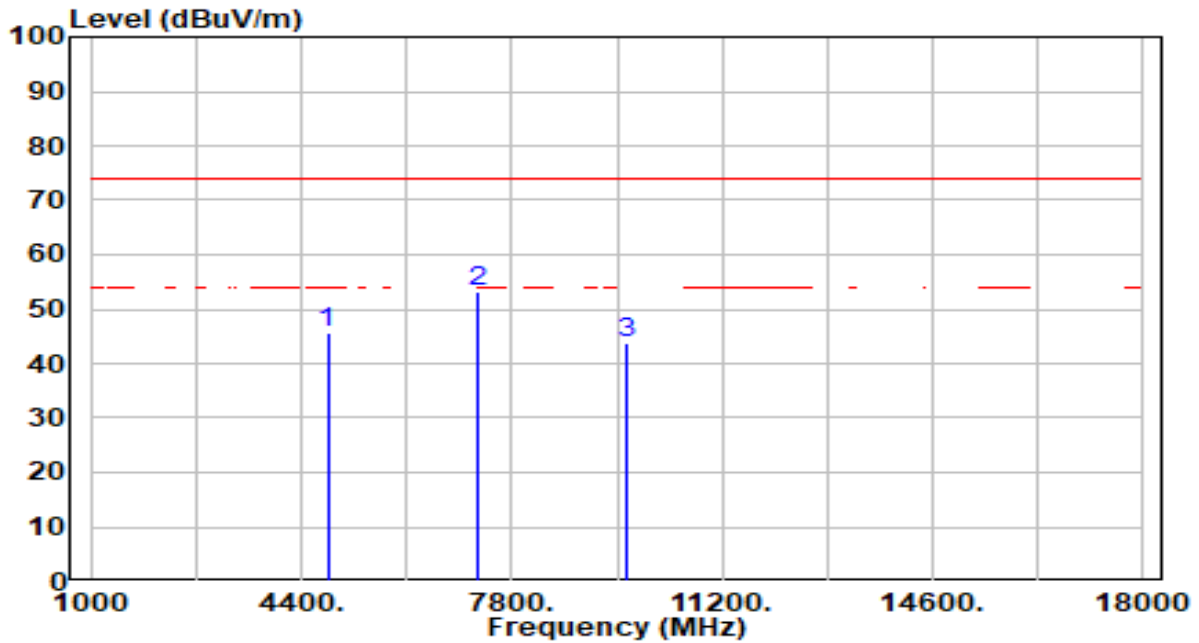

No	Frequency (MHz)	Reading (dBuV)	C.F (dB/m)	Measurement (dBuV/m)	Margin (dB)	Limit (dBuV/m)	Height (cm)	Angle (deg)	Remark (QP/PK/AV)
1	4824.000	46.73	-1.10	45.63	-28.37	74.00	200	175	Peak
2	* 7236.000	49.34	3.90	53.24	-20.76	74.00	200	360	Peak
3	9648.000	40.58	3.21	43.79	-30.21	74.00	200	68	Peak

Note:

1. " *", means this data is the worst emission level.
2. C.F (Correction Factor) = Antenna Factor (dB/m)+ Cable Loss (dB) – Preamplifier(dB).
3. Measurement (dBuV/m) = Reading(dBuV) + C.F (Correction Factor).
4. The emission levels of other frequencies are very lower than the limit and not show in test report.

EUT	Smart Wi-Fi Outlet Extender	Date of Test	2023-06-13
Factor	DRH18-E	Temp. / Humidity	21°C /61%
Polarity	Horizontal	Site / Test Engineer	AC2 / Marvin
Test Mode	802.11g_TX_CH 6_ANT 0	Test Voltage	By Notebook PC

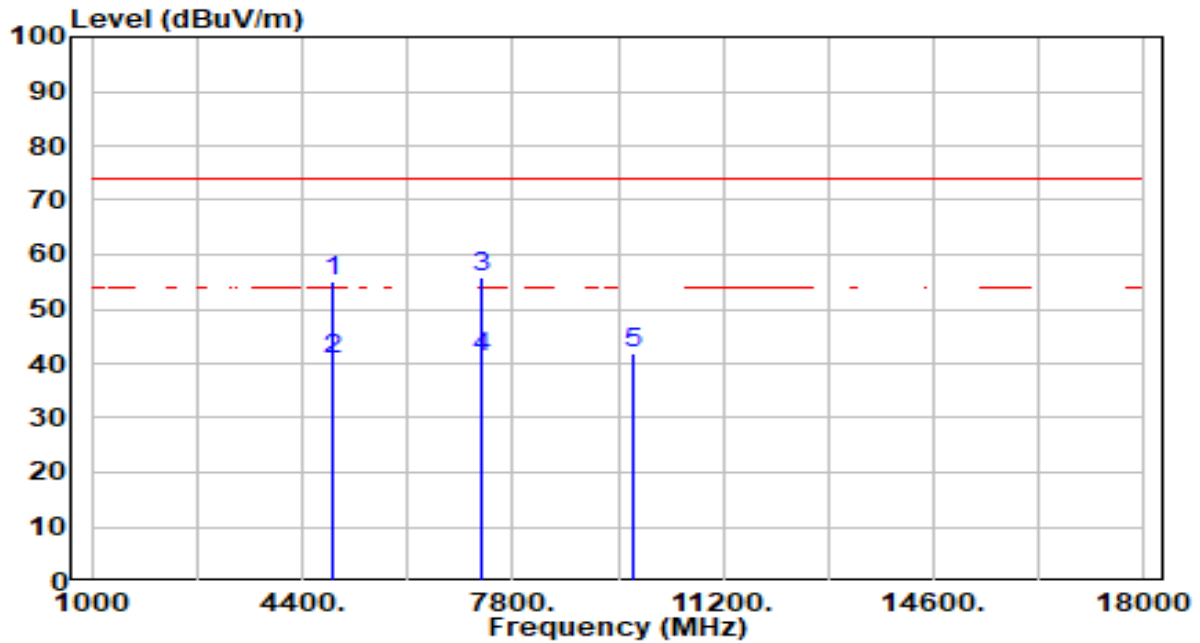

No	Frequency (MHz)	Reading (dBuV)	C.F (dB/m)	Measurement (dBuV/m)	Margin (dB)	Limit (dBuV/m)	Height (cm)	Angle (deg)	Remark (QP/PK/AV)
1	4874.000	56.03	-0.97	55.06	-18.94	74.00	200	54	Peak
2	4874.000	41.88	-0.97	40.91	-13.09	54.00	200	54	Average
3	* 7311.000	51.97	3.92	55.89	-18.11	74.00	200	229	Peak
4	* 7311.000	37.22	3.92	41.14	-12.86	54.00	200	229	Average
5	9748.000	38.79	3.24	42.03	-31.97	74.00	200	308	Peak

Note:

- " *", means this data is the worst emission level.
- C.F (Correction Factor) = Antenna Factor (dB/m)+ Cable Loss (dB) – Pre-amplifier(dB).
- Measurement (dBuV/m) = Reading(dBuV) + C.F (Correction Factor).
- The emission levels of other frequencies are very lower than the limit and not show in test report.

EUT	Smart Wi-Fi Outlet Extender	Date of Test	2023-06-13
Factor	DRH18-E	Temp. / Humidity	21°C /61%
Polarity	Vertical	Site / Test Engineer	AC2 / Marvin
Test Mode	802.11g_TX_CH 6_ANT 0	Test Voltage	By Notebook PC

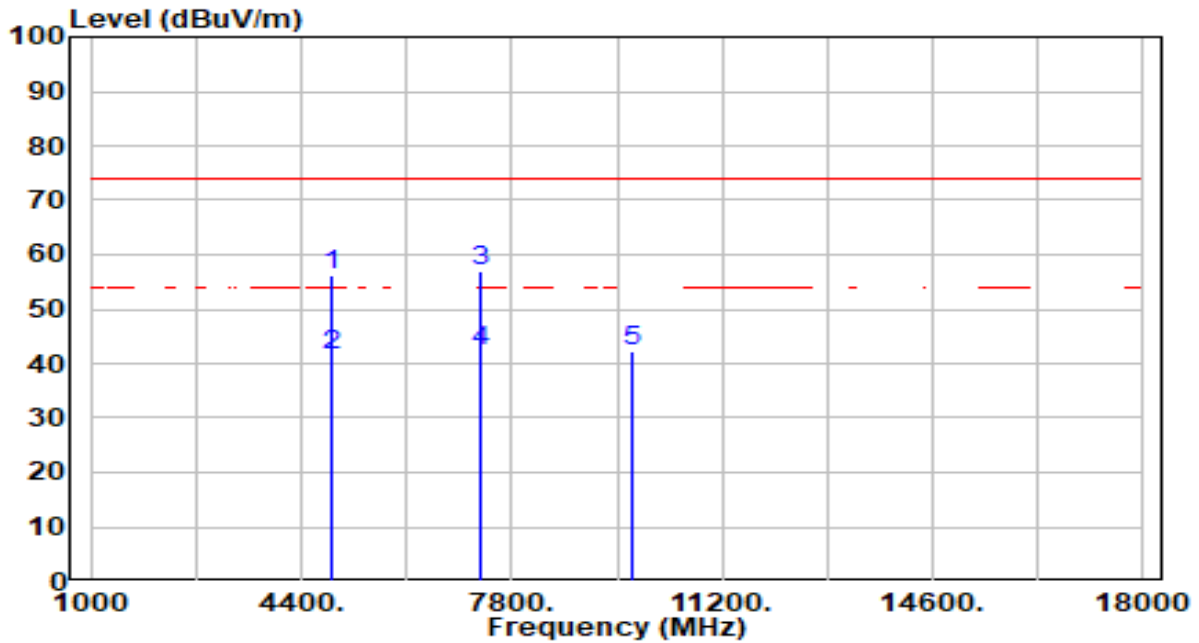

No	Frequency (MHz)	Reading (dBuV)	C.F (dB/m)	Measurement (dBuV/m)	Margin (dB)	Limit (dBuV/m)	Height (cm)	Angle (deg)	Remark (QP/PK/AV)
1	4874.000	57.23	-0.97	56.26	-17.74	74.00	200	123	Peak
2	4874.000	42.49	-0.97	41.52	-12.48	54.00	200	123	Average
3	* 7311.000	53.06	3.92	56.98	-17.02	74.00	200	360	Peak
4	* 7311.000	38.25	3.92	42.17	-11.83	54.00	200	360	Average
5	9748.000	39.15	3.24	42.39	-31.61	74.00	200	158	Peak

Note:

- " *", means this data is the worst emission level.
- C.F (Correction Factor) = Antenna Factor (dB/m)+ Cable Loss (dB) – Preamplifier(dB).
- Measurement (dBuV/m) = Reading(dBuV) + C.F (Correction Factor).
- The emission levels of other frequencies are very lower than the limit and not show in test report.

EUT	Smart Wi-Fi Outlet Extender	Date of Test	2023-06-13
Factor	DRH18-E	Temp. / Humidity	21°C /61%
Polarity	Horizontal	Site / Test Engineer	AC2 / Marvin
Test Mode	802.11g_TX_CH 11_ANT 0	Test Voltage	By Notebook PC

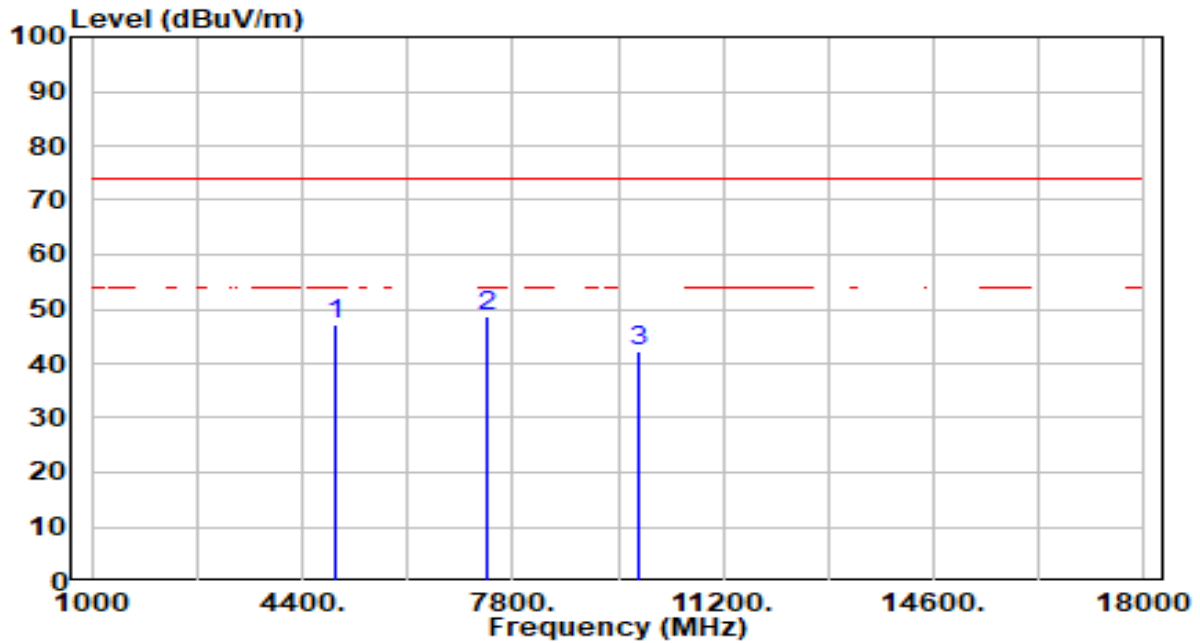

No	Frequency (MHz)	Reading (dBuV)	C.F (dB/m)	Measurement (dBuV/m)	Margin (dB)	Limit (dBuV/m)	Height (cm)	Angle (deg)	Remark (QP/PK/AV)
1	4924.000	48.03	-0.84	47.19	-26.81	74.00	200	30	Peak
2	* 7386.000	44.68	3.93	48.61	-25.39	74.00	200	352	Peak
3	9848.000	39.06	3.27	42.33	-31.67	74.00	200	344	Peak

Note:

1. " *", means this data is the worst emission level.
2. C.F (Correction Factor) = Antenna Factor (dB/m)+ Cable Loss (dB) – Preamplifier(dB).
3. Measurement (dBuV/m) = Reading(dBuV) + C.F (Correction Factor).
4. The emission levels of other frequencies are very lower than the limit and not show in test report.

EUT	Smart Wi-Fi Outlet Extender	Date of Test	2023-06-13
Factor	DRH18-E	Temp. / Humidity	21°C /61%
Polarity	Vertical	Site / Test Engineer	AC2 / Marvin
Test Mode	802.11g_TX_CH 11_ANT 0	Test Voltage	By Notebook PC

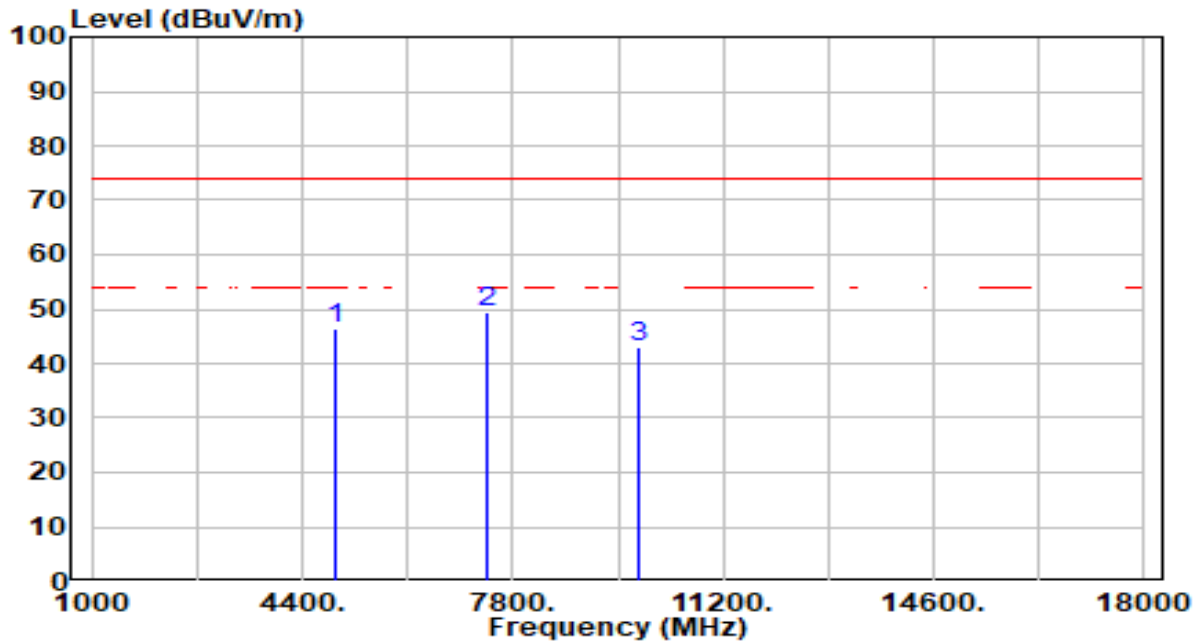

No	Frequency (MHz)	Reading (dBuV)	C.F (dB/m)	Measurement (dBuV/m)	Margin (dB)	Limit (dBuV/m)	Height (cm)	Angle (deg)	Remark (QP/PK/AV)
1	4924.000	47.14	-0.84	46.31	-27.69	74.00	200	123	Peak
2	* 7386.000	45.38	3.93	49.31	-24.69	74.00	200	360	Peak
3	9848.000	39.62	3.27	42.88	-31.12	74.00	200	183	Peak

Note:

1. " *", means this data is the worst emission level.
2. C.F (Correction Factor) = Antenna Factor (dB/m)+ Cable Loss (dB) – Preamplifier(dB).
3. Measurement (dBuV/m) = Reading(dBuV) + C.F (Correction Factor).
4. The emission levels of other frequencies are very lower than the limit and not show in test report.

EUT	Smart Wi-Fi Outlet Extender	Date of Test	2023-06-13
Factor	DRH18-E	Temp. / Humidity	21°C /61%
Polarity	Horizontal	Site / Test Engineer	AC2 / Marvin
Test Mode	802.11n-20MHz_TX_CH 1_ANT 0	Test Voltage	By Notebook PC

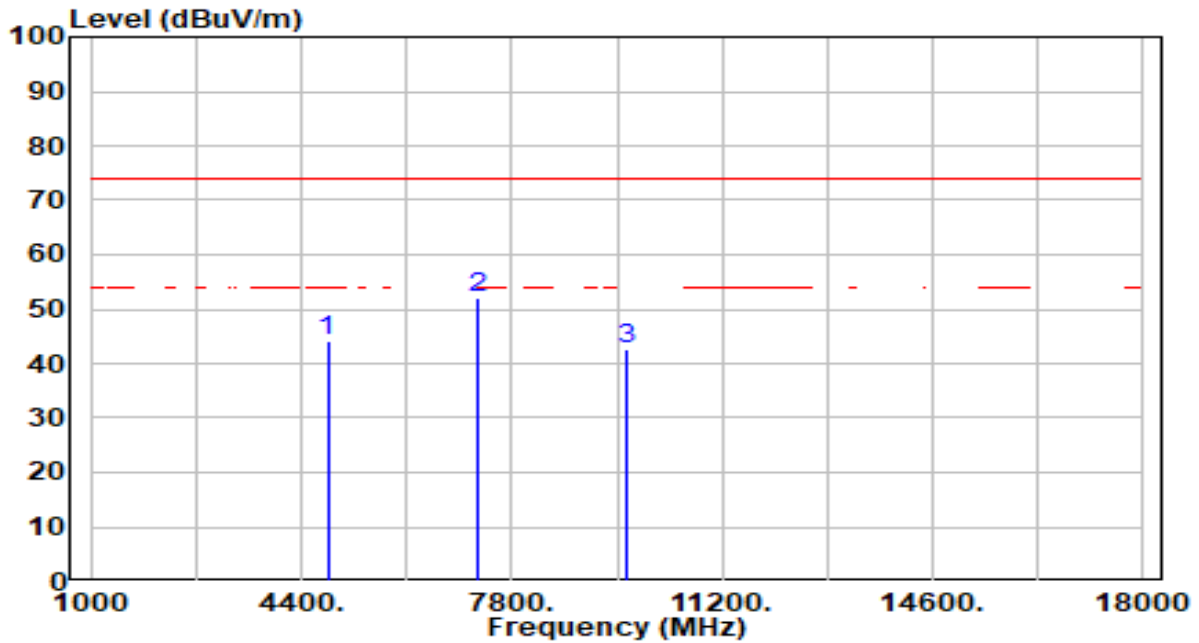

No	Frequency (MHz)	Reading (dBuV)	C.F (dB/m)	Measurement (dBuV/m)	Margin (dB)	Limit (dBuV/m)	Height (cm)	Angle (deg)	Remark (QP/PK/AV)
1	4824.000	45.13	-1.10	44.03	-29.97	74.00	200	90	Peak
2	* 7236.000	48.17	3.90	52.08	-21.92	74.00	200	249	Peak
3	9648.000	39.25	3.21	42.47	-31.53	74.00	200	225	Peak

Note:

1. " *", means this data is the worst emission level.
2. C.F (Correction Factor) = Antenna Factor (dB/m)+ Cable Loss (dB) – Preamplifier(dB).
3. Measurement (dBuV/m) = Reading(dBuV) + C.F (Correction Factor).
4. The emission levels of other frequencies are very lower than the limit and not show in test report.

EUT	Smart Wi-Fi Outlet Extender	Date of Test	2023-06-13
Factor	DRH18-E	Temp. / Humidity	21°C /61%
Polarity	Vertical	Site / Test Engineer	AC2 / Marvin
Test Mode	802.11n-20MHz_TX_CH 1_ANT 0	Test Voltage	By Notebook PC

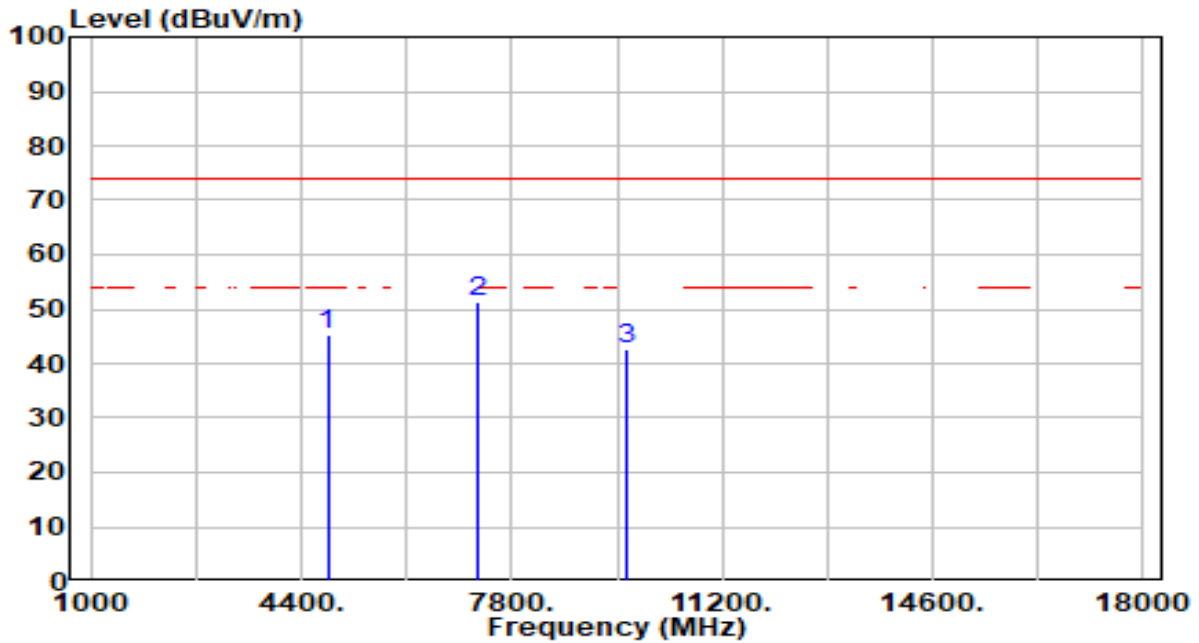

No	Frequency (MHz)	Reading (dBuV)	C.F (dB/m)	Measurement (dBuV/m)	Margin (dB)	Limit (dBuV/m)	Height (cm)	Angle (deg)	Remark (QP/PK/AV)
1	4824.000	46.51	-1.10	45.42	-28.58	74.00	200	112	Peak
2	* 7236.000	47.39	3.90	51.30	-22.70	74.00	200	0	Peak
3	9648.000	39.29	3.21	42.50	-31.50	74.00	200	104	Peak

Note:

1. " *", means this data is the worst emission level.
2. C.F (Correction Factor) = Antenna Factor (dB/m)+ Cable Loss (dB) – Preamplifier(dB).
3. Measurement (dBuV/m) = Reading(dBuV) + C.F (Correction Factor).
4. The emission levels of other frequencies are very lower than the limit and not show in test report.

EUT	Smart Wi-Fi Outlet Extender	Date of Test	2023-06-13
Factor	DRH18-E	Temp. / Humidity	21°C /61%
Polarity	Horizontal	Site / Test Engineer	AC2 / Marvin
Test Mode	802.11n-20MHz_TX_CH 6_ANT 0	Test Voltage	By Notebook PC

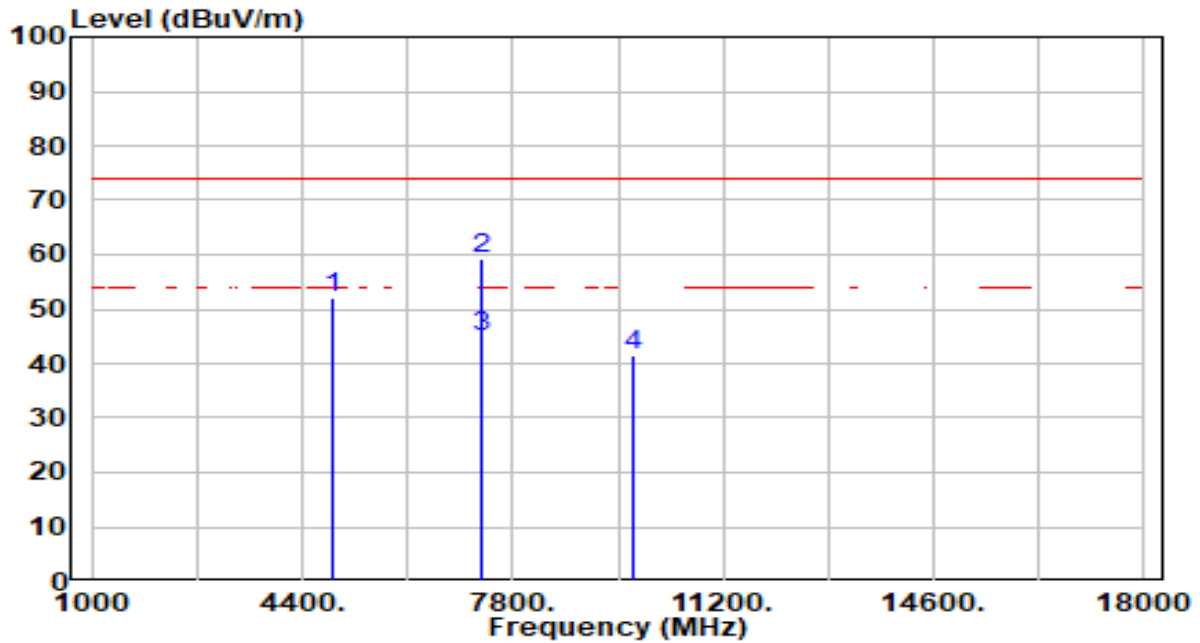

No	Frequency (MHz)	Reading (dBuV)	C.F (dB/m)	Measurement (dBuV/m)	Margin (dB)	Limit (dBuV/m)	Height (cm)	Angle (deg)	Remark (QP/PK/AV)
1	4874.000	52.88	-0.97	51.91	-22.09	74.00	200	178	Peak
2	* 7311.000	55.14	3.92	59.06	-14.94	74.00	200	312	Peak
3	* 7311.000	40.90	3.92	44.82	-9.18	54.00	200	312	Average
4	9748.000	38.42	3.24	41.66	-32.34	74.00	200	110	Peak

Note:

- "*", means this data is the worst emission level.
- C.F (Correction Factor) = Antenna Factor (dB/m)+ Cable Loss (dB) – Pre-amplifier(dB).
- Measurement (dBuV/m) = Reading(dBuV) + C.F (Correction Factor).
- The emission levels of other frequencies are very lower than the limit and not show in test report.

EUT	Smart Wi-Fi Outlet Extender	Date of Test	2023-06-13
Factor	DRH18-E	Temp. / Humidity	21°C /61%
Polarity	Vertical	Site / Test Engineer	AC2 / Marvin
Test Mode	802.11n-20MHz_TX_CH 6_ANT 0	Test Voltage	By Notebook PC

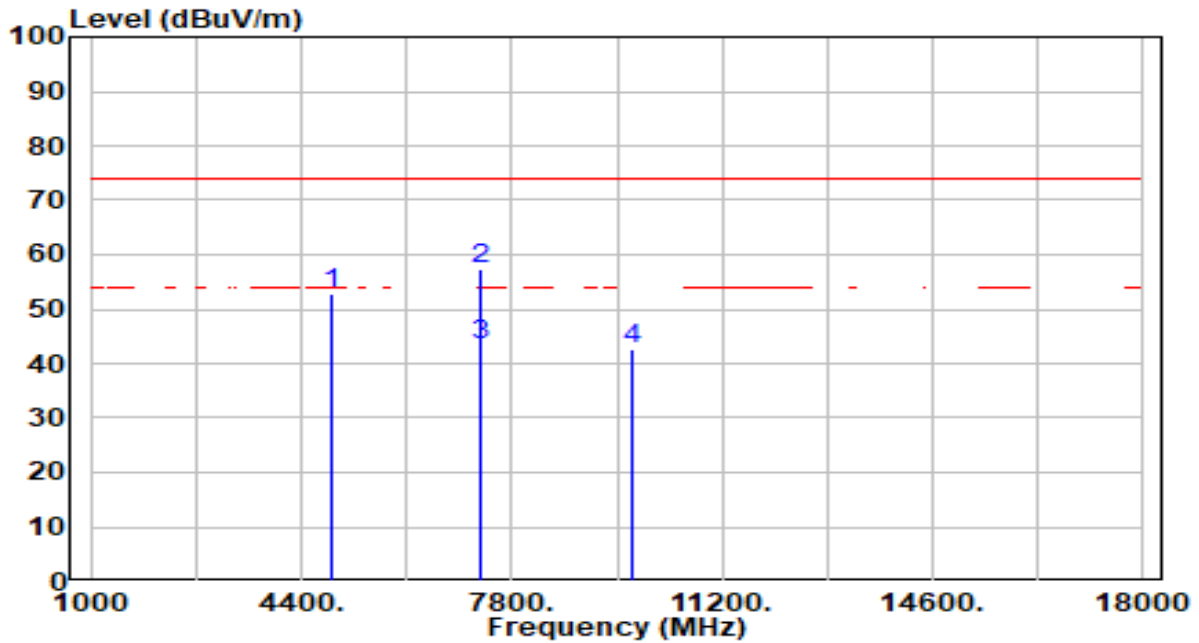

No	Frequency (MHz)	Reading (dBuV)	C.F (dB/m)	Measurement (dBuV/m)	Margin (dB)	Limit (dBuV/m)	Height (cm)	Angle (deg)	Remark (QP/PK/AV)
1	4874.000	53.85	-0.97	52.88	-21.12	74.00	200	123	Peak
2	* 7311.000	53.33	3.92	57.25	-16.75	74.00	200	357	Peak
3	* 7311.000	39.56	3.92	43.48	-10.52	54.00	200	357	Average
4	9748.000	39.23	3.24	42.48	-31.52	74.00	200	360	Peak

Note:

- "*" means this data is the worst emission level.
- C.F (Correction Factor) = Antenna Factor (dB/m)+ Cable Loss (dB) – Pre-amplifier(dB).
- Measurement (dBuV/m) = Reading(dBuV) + C.F (Correction Factor).
- The emission levels of other frequencies are very lower than the limit and not show in test report.

EUT	Smart Wi-Fi Outlet Extender	Date of Test	2023-06-13
Factor	DRH18-E	Temp. / Humidity	21°C /61%
Polarity	Horizontal	Site / Test Engineer	AC2 / Marvin
Test Mode	802.11n-20MHz_TX_CH 11_ANT 0	Test Voltage	By Notebook PC

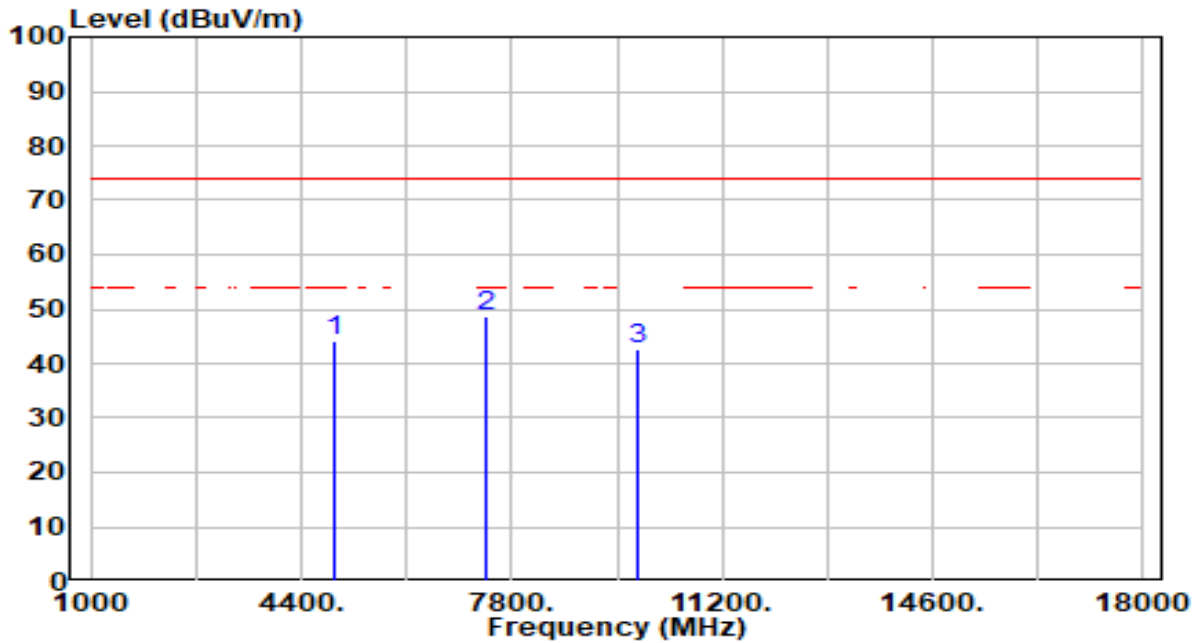

No	Frequency (MHz)	Reading (dBuV)	C.F (dB/m)	Measurement (dBuV/m)	Margin (dB)	Limit (dBuV/m)	Height (cm)	Angle (deg)	Remark (QP/PK/AV)
1	4924.000	44.87	-0.84	44.03	-29.97	74.00	200	22	Peak
2	* 7386.000	44.57	3.93	48.50	-25.50	74.00	200	277	Peak
3	9848.000	39.50	3.27	42.77	-31.23	74.00	200	62	Peak

Note:

1. " *", means this data is the worst emission level.
2. C.F (Correction Factor) = Antenna Factor (dB/m)+ Cable Loss (dB) – Preamplifier(dB).
3. Measurement (dBuV/m) = Reading(dBuV) + C.F (Correction Factor).
4. The emission levels of other frequencies are very lower than the limit and not show in test report.

EUT	Smart Wi-Fi Outlet Extender	Date of Test	2023-06-13
Factor	DRH18-E	Temp. / Humidity	21°C /61%
Polarity	Vertical	Site / Test Engineer	AC2 / Marvin
Test Mode	802.11n-20MHz_TX_CH 11_ANT 0	Test Voltage	By Notebook PC

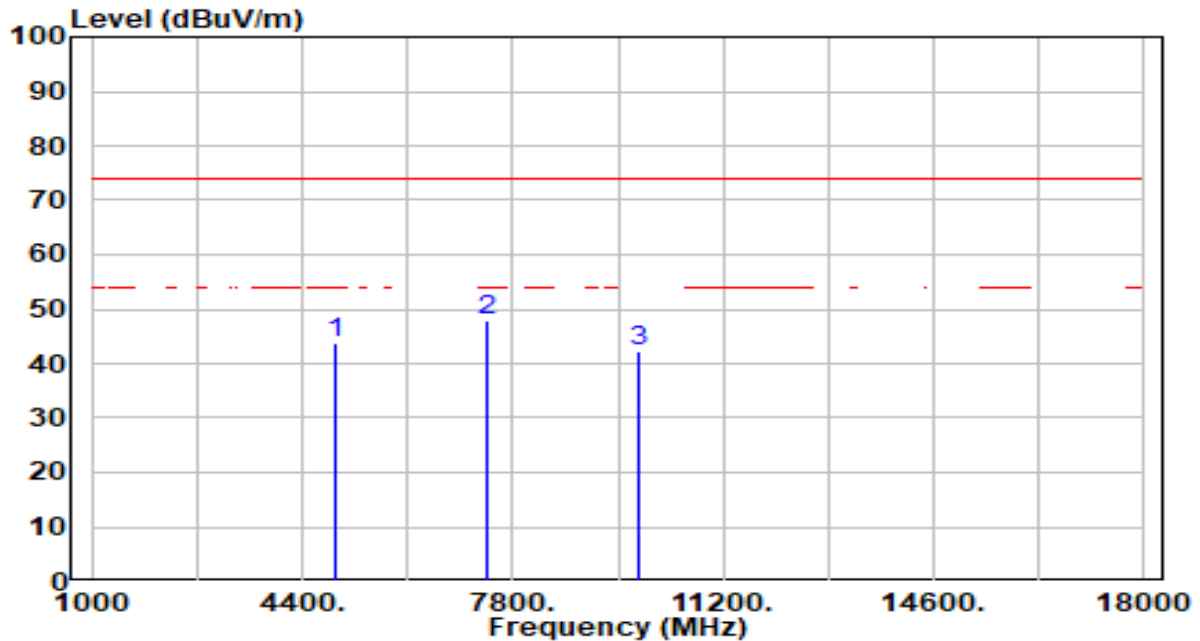

No	Frequency (MHz)	Reading (dBuV)	C.F (dB/m)	Measurement (dBuV/m)	Margin (dB)	Limit (dBuV/m)	Height (cm)	Angle (deg)	Remark (QP/PK/AV)
1	4924.000	44.79	-0.84	43.95	-30.05	74.00	200	123	Peak
2	* 7386.000	43.98	3.93	47.92	-26.08	74.00	200	27	Peak
3	9848.000	38.86	3.27	42.13	-31.87	74.00	200	119	Peak

Note:

1. " *", means this data is the worst emission level.
2. C.F (Correction Factor) = Antenna Factor (dB/m)+ Cable Loss (dB) – Preamplifier(dB).
3. Measurement (dBuV/m) = Reading(dBuV) + C.F (Correction Factor).
4. The emission levels of other frequencies are very lower than the limit and not show in test report.

EUT	Smart Wi-Fi Outlet Extender	Date of Test	2023-06-13
Factor	DRH18-E	Temp. / Humidity	21°C /61%
Polarity	Horizontal	Site / Test Engineer	AC2 / Stanley
Test Mode	802.11b_TX_CH 1_ANT 1	Test Voltage	By Notebook PC

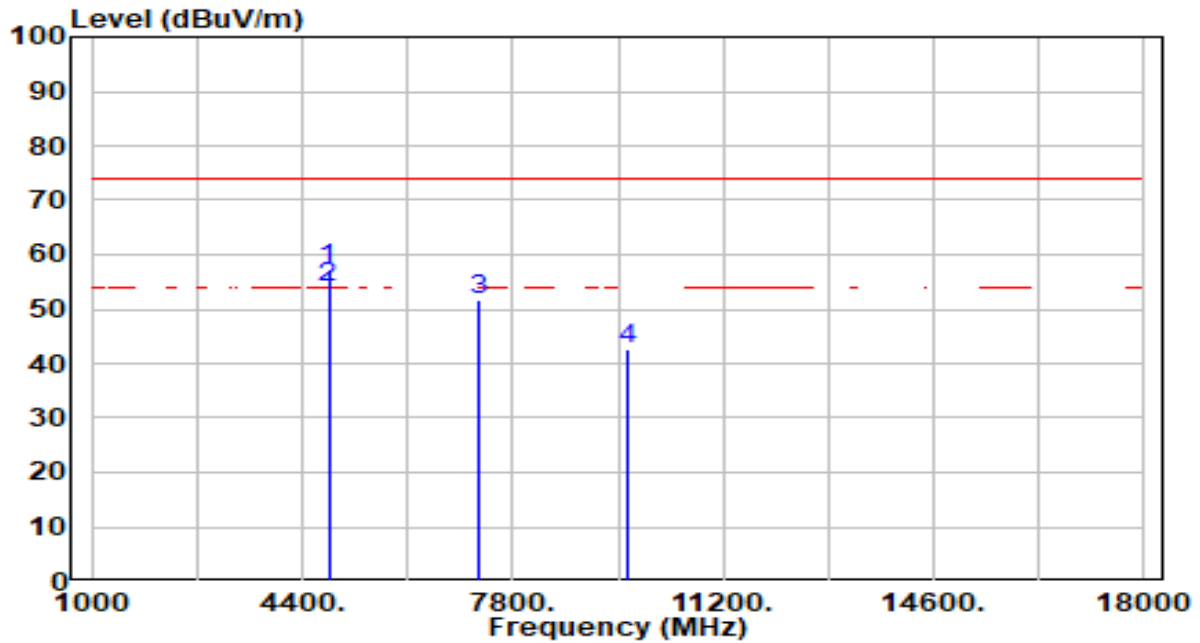

No	Frequency (MHz)	Reading (dBuV)	C.F (dB/m)	Measurement (dBuV/m)	Margin (dB)	Limit (dBuV/m)	Height (cm)	Angle (deg)	Remark (QP/PK/AV)
1	* 4824.000	58.36	-1.10	57.26	-16.74	74.00	200	302	Peak
2	* 4824.000	55.08	-1.10	53.98	-0.02	54.00	200	302	Average
3	7236.000	47.66	3.90	51.56	-22.44	74.00	300	275	Peak
4	9648.000	39.46	3.21	42.68	-31.32	74.00	100	117	Peak

Note:

1. " *", means this data is the worst emission level.
2. C.F (Correction Factor) = Antenna Factor (dB/m) + Cable Loss (dB) – Pre-amplifier(dB).
3. Measurement (dBuV/m) = Reading(dBuV) + C.F (Correction Factor).
4. The emission levels of other frequencies are very lower than the limit and not show in test report.

EUT	Smart Wi-Fi Outlet Extender	Date of Test	2023-06-13
Factor	DRH18-E	Temp. / Humidity	21°C /61%
Polarity	Vertical	Site / Test Engineer	AC2 / Stanley
Test Mode	802.11b_TX_CH 1_ANT 1	Test Voltage	By Notebook PC

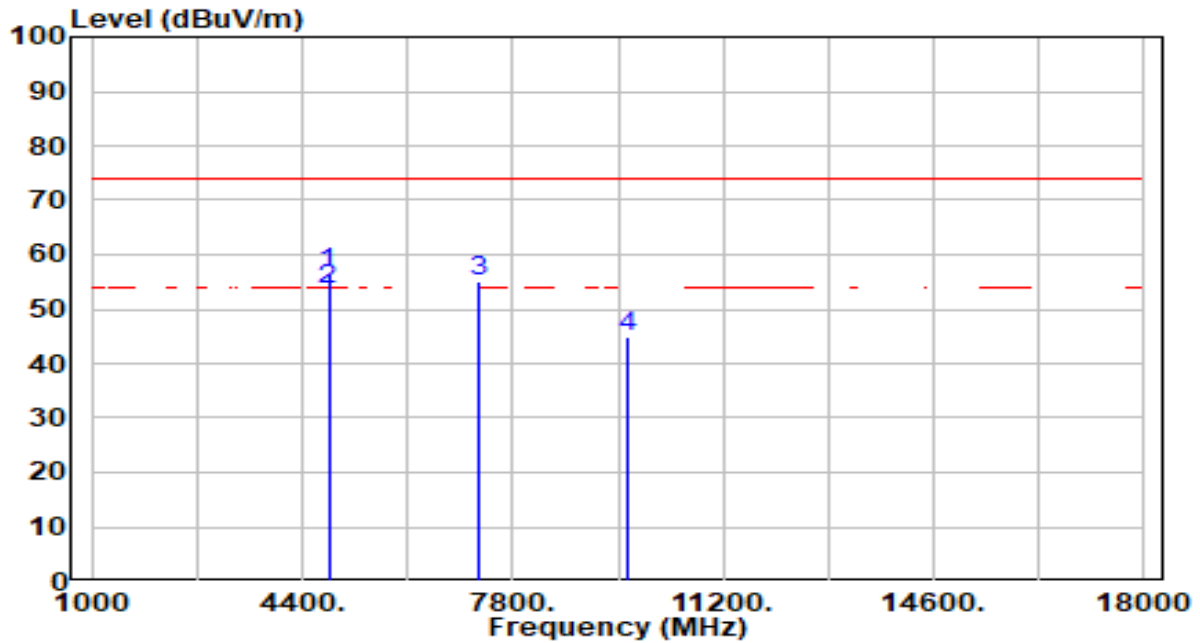

No	Frequency (MHz)	Reading (dBuV)	C.F (dB/m)	Measurement (dBuV/m)	Margin (dB)	Limit (dBuV/m)	Height (cm)	Angle (deg)	Remark (QP/PK/AV)
1	* 4824.000	57.67	-1.10	56.57	-17.43	74.00	306	120	Peak
2	* 4824.000	54.85	-1.10	53.75	-0.25	54.00	306	120	Average
3	7236.000	51.32	3.90	55.22	-18.78	74.00	300	21	Peak
4	9648.000	41.75	3.21	44.97	-29.03	74.00	300	90	Peak

Note:

1. " *", means this data is the worst emission level.
2. C.F (Correction Factor) = Antenna Factor (dB/m) + Cable Loss (dB) – Pre-amplifier(dB).
3. Measurement (dBuV/m) = Reading(dBuV) + C.F (Correction Factor).
4. The emission levels of other frequencies are very lower than the limit and not show in test report.

EUT	Smart Wi-Fi Outlet Extender	Date of Test	2023-06-13
Factor	DRH18-E	Temp. / Humidity	21°C /61%
Polarity	Horizontal	Site / Test Engineer	AC2 / Stanley
Test Mode	802.11b_TX_CH 6_ANT 1	Test Voltage	By Notebook PC

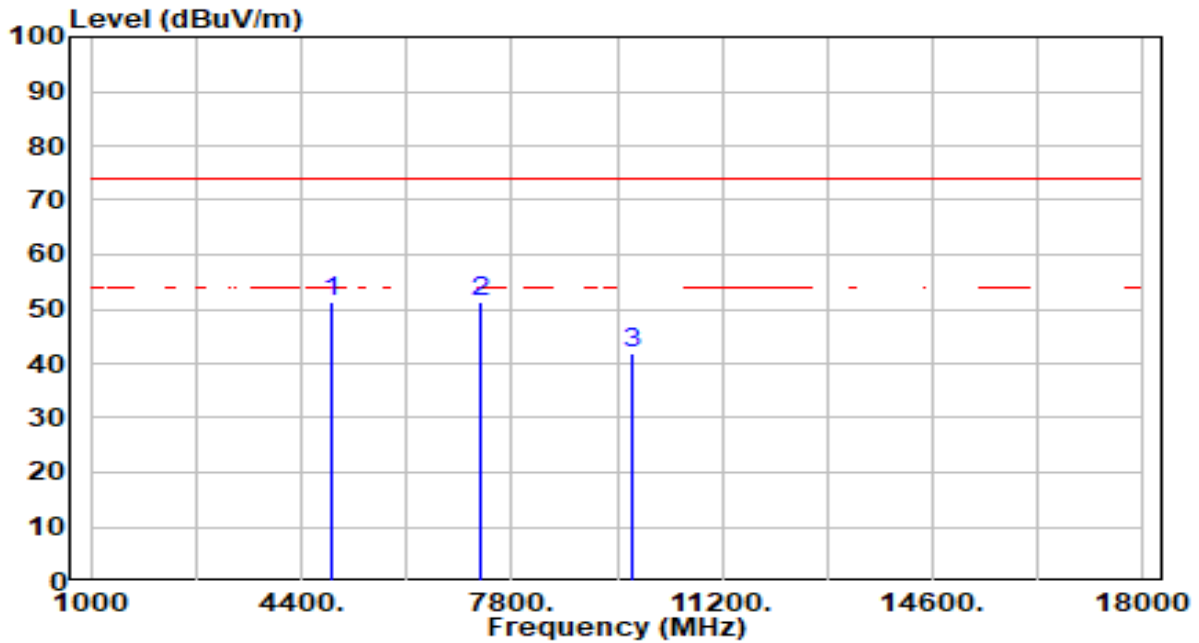

No	Frequency (MHz)	Reading (dBuV)	C.F (dB/m)	Measurement (dBuV/m)	Margin (dB)	Limit (dBuV/m)	Height (cm)	Angle (deg)	Remark (QP/PK/AV)	
1	*	4874.000	52.39	-0.97	51.42	-22.58	74.00	300	214	Peak
2		7311.000	47.44	3.92	51.35	-22.65	74.00	300	297	Peak
3		9748.000	38.68	3.24	41.93	-32.07	74.00	300	42	Peak

Note:

1. " *", means this data is the worst emission level.
2. C.F (Correction Factor) = Antenna Factor (dB/m) + Cable Loss (dB) – Preamplifier(dB).
3. Measurement (dBuV/m) = Reading(dBuV) + C.F (Correction Factor).
4. The emission levels of other frequencies are very lower than the limit and not show in test report.

EUT	Smart Wi-Fi Outlet Extender	Date of Test	2023-06-13
Factor	DRH18-E	Temp. / Humidity	21°C /61%
Polarity	Vertical	Site / Test Engineer	AC2 / Stanley
Test Mode	802.11b_TX_CH 6_ANT 1	Test Voltage	By Notebook PC

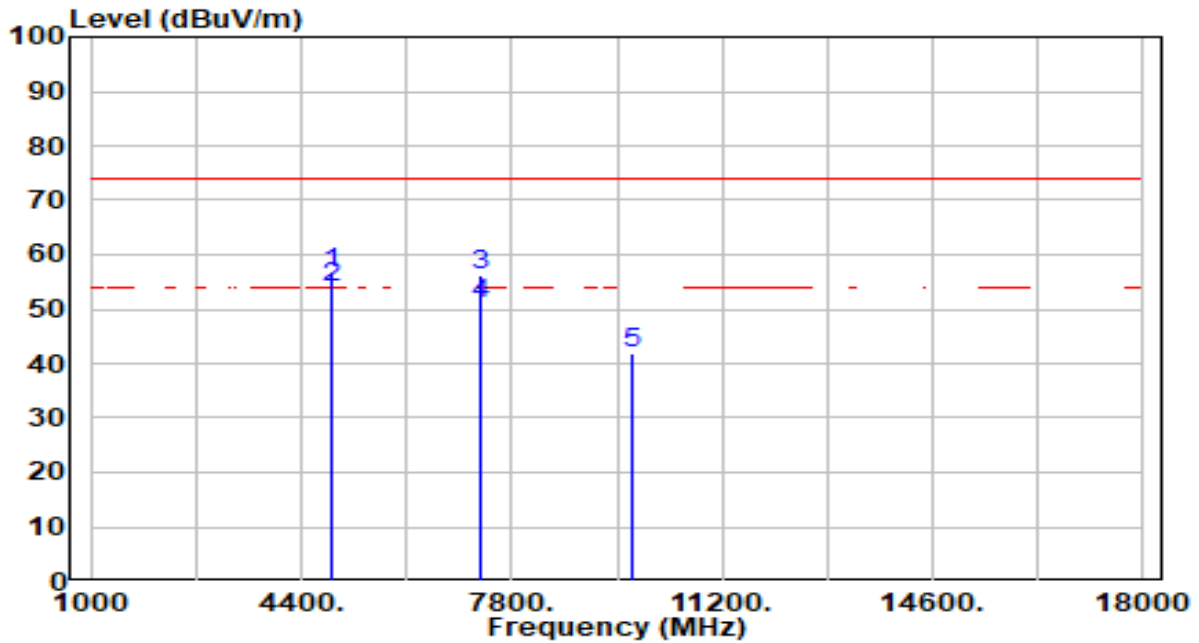

No	Frequency (MHz)	Reading (dBuV)	C.F (dB/m)	Measurement (dBuV/m)	Margin (dB)	Limit (dBuV/m)	Height (cm)	Angle (deg)	Remark (QP/PK/AV)	
1	*	4874.000	57.50	-0.97	56.53	-17.47	74.00	310	120	Peak
2	*	4874.000	54.75	-0.97	53.78	-0.22	54.00	310	120	Average
3		7311.000	52.26	3.92	56.18	-17.82	74.00	300	17	Peak
4		7311.000	46.97	3.92	50.89	-3.11	54.00	300	17	Average
5		9748.000	38.76	3.24	42.00	-32.00	74.00	300	0	Peak

Note:

- "*" means this data is the worst emission level.
- C.F (Correction Factor) = Antenna Factor (dB/m) + Cable Loss (dB) – Preamplifier(dB).
- Measurement (dBuV/m) = Reading(dBuV) + C.F (Correction Factor).
- The emission levels of other frequencies are very lower than the limit and not show in test report.

EUT	Smart Wi-Fi Outlet Extender	Date of Test	2023-06-13
Factor	DRH18-E	Temp. / Humidity	21°C /61%
Polarity	Vertical	Site / Test Engineer	AC2 / Stanley
Test Mode	802.11b_TX_CH 11_ANT 1	Test Voltage	By Notebook PC

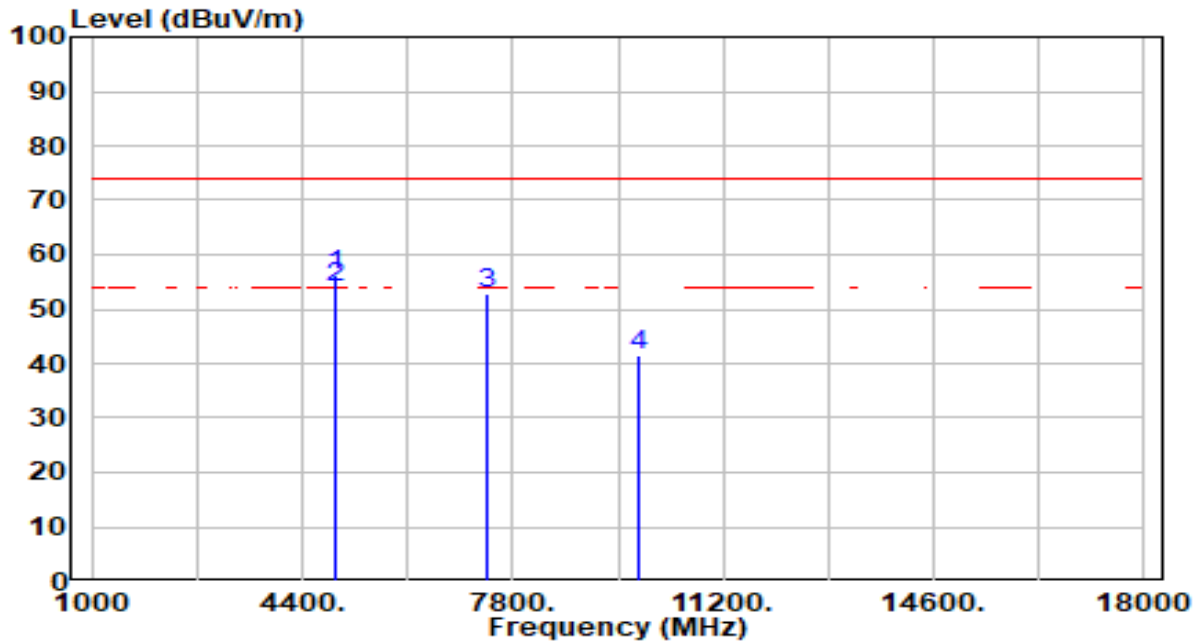

No	Frequency (MHz)	Reading (dBuV)	C.F (dB/m)	Measurement (dBuV/m)	Margin (dB)	Limit (dBuV/m)	Height (cm)	Angle (deg)	Remark (QP/PK/AV)
1	* 4924.000	57.11	-0.84	56.27	-17.73	74.00	300	128	Peak
2	* 4924.000	54.63	-0.84	53.79	-0.21	54.00	300	128	Average
3	7386.000	48.71	3.93	52.65	-21.35	74.00	300	37	Peak
4	9848.000	38.18	3.27	41.44	-32.56	74.00	300	21	Peak

Note:

- "*" means this data is the worst emission level.
- C.F (Correction Factor) = Antenna Factor (dB/m) + Cable Loss (dB) – Pre-amplifier(dB).
- Measurement (dBuV/m) = Reading(dBuV) + C.F (Correction Factor).
- The emission levels of other frequencies are very lower than the limit and not show in test report.

EUT	Smart Wi-Fi Outlet Extender	Date of Test	2023-06-13
Factor	DRH18-E	Temp. / Humidity	21°C /61%
Polarity	Horizontal	Site / Test Engineer	AC2 / Stanley
Test Mode	802.11b_TX_CH 11_ANT 1	Test Voltage	By Notebook PC

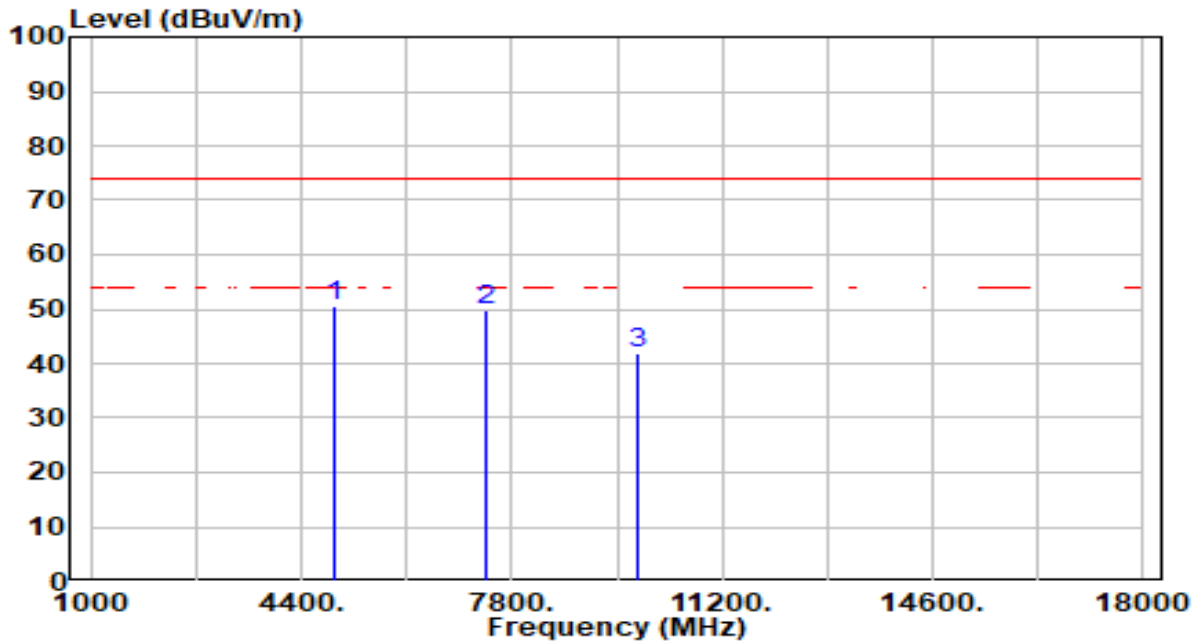

No	Frequency (MHz)	Reading (dBuV)	C.F (dB/m)	Measurement (dBuV/m)	Margin (dB)	Limit (dBuV/m)	Height (cm)	Angle (deg)	Remark (QP/PK/AV)	
1	*	4924.000	51.32	-0.84	50.49	-23.51	74.00	300	288	Peak
2		7386.000	45.69	3.93	49.63	-24.37	74.00	300	272	Peak
3		9848.000	38.53	3.27	41.80	-32.20	74.00	300	316	Peak

Note:

1. " *", means this data is the worst emission level.
2. C.F (Correction Factor) = Antenna Factor (dB/m) + Cable Loss (dB) – Preamplifier(dB).
3. Measurement (dBuV/m) = Reading(dBuV) + C.F (Correction Factor).
4. The emission levels of other frequencies are very lower than the limit and not show in test report.

EUT	Smart Wi-Fi Outlet Extender	Date of Test	2023-06-13
Factor	DRH18-E	Temp. / Humidity	21°C /61%
Polarity	Horizontal	Site / Test Engineer	AC2 / Stanley
Test Mode	802.11g_TX_CH 1_ANT 1	Test Voltage	By Notebook PC

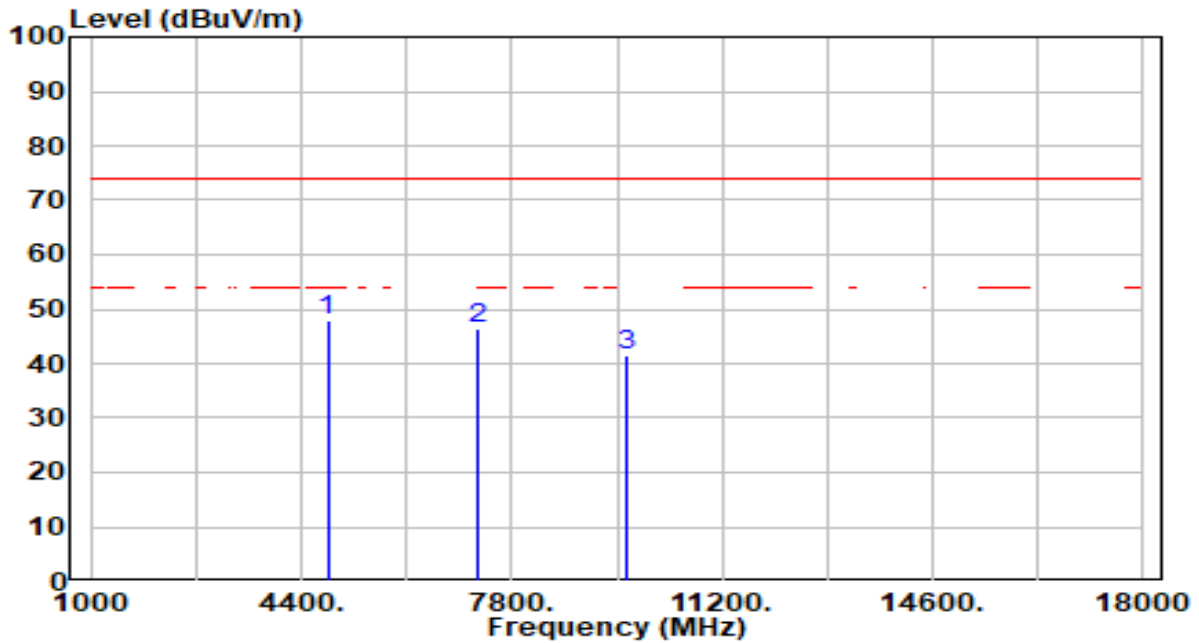

No	Frequency (MHz)	Reading (dBuV)	C.F (dB/m)	Measurement (dBuV/m)	Margin (dB)	Limit (dBuV/m)	Height (cm)	Angle (deg)	Remark (QP/PK/AV)
1	*	48.83	-1.10	47.74	-26.26	74.00	300	217	Peak
2		42.39	3.90	46.30	-27.70	74.00	300	276	Peak
3		38.33	3.21	41.55	-32.45	74.00	300	253	Peak

Note:

1. " *", means this data is the worst emission level.
2. C.F (Correction Factor) = Antenna Factor (dB/m) + Cable Loss (dB) – Preamplifier(dB).
3. Measurement (dBuV/m) = Reading(dBuV) + C.F (Correction Factor).
4. The emission levels of other frequencies are very lower than the limit and not show in test report.

EUT	Smart Wi-Fi Outlet Extender	Date of Test	2023-06-13
Factor	DRH18-E	Temp. / Humidity	21°C /61%
Polarity	Vertical	Site / Test Engineer	AC2 / Stanley
Test Mode	802.11g_TX_CH 1_ANT 1	Test Voltage	By Notebook PC

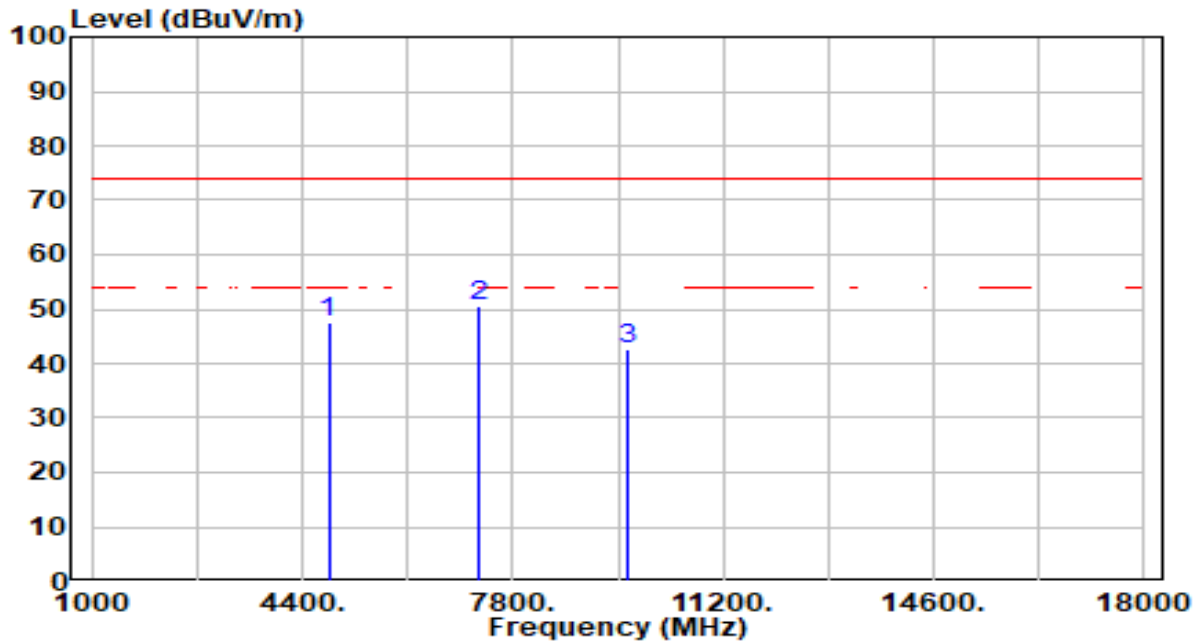

No	Frequency (MHz)	Reading (dBuV)	C.F (dB/m)	Measurement (dBuV/m)	Margin (dB)	Limit (dBuV/m)	Height (cm)	Angle (deg)	Remark (QP/PK/AV)
1	4824.000	48.63	-1.10	47.53	-26.47	74.00	300	111	Peak
2	* 7236.000	46.62	3.90	50.52	-23.48	74.00	300	20	Peak
3	9648.000	39.56	3.21	42.77	-31.23	74.00	300	80	Peak

Note:

1. " *", means this data is the worst emission level.
2. C.F (Correction Factor) = Antenna Factor (dB/m) + Cable Loss (dB) – Preamplifier(dB).
3. Measurement (dBuV/m) = Reading(dBuV) + C.F (Correction Factor).
4. The emission levels of other frequencies are very lower than the limit and not show in test report.

EUT	Smart Wi-Fi Outlet Extender	Date of Test	2023-06-13
Factor	DRH18-E	Temp. / Humidity	21°C /61%
Polarity	Horizontal	Site / Test Engineer	AC2 / Stanley
Test Mode	802.11g_TX_CH 6_ANT 1	Test Voltage	By Notebook PC

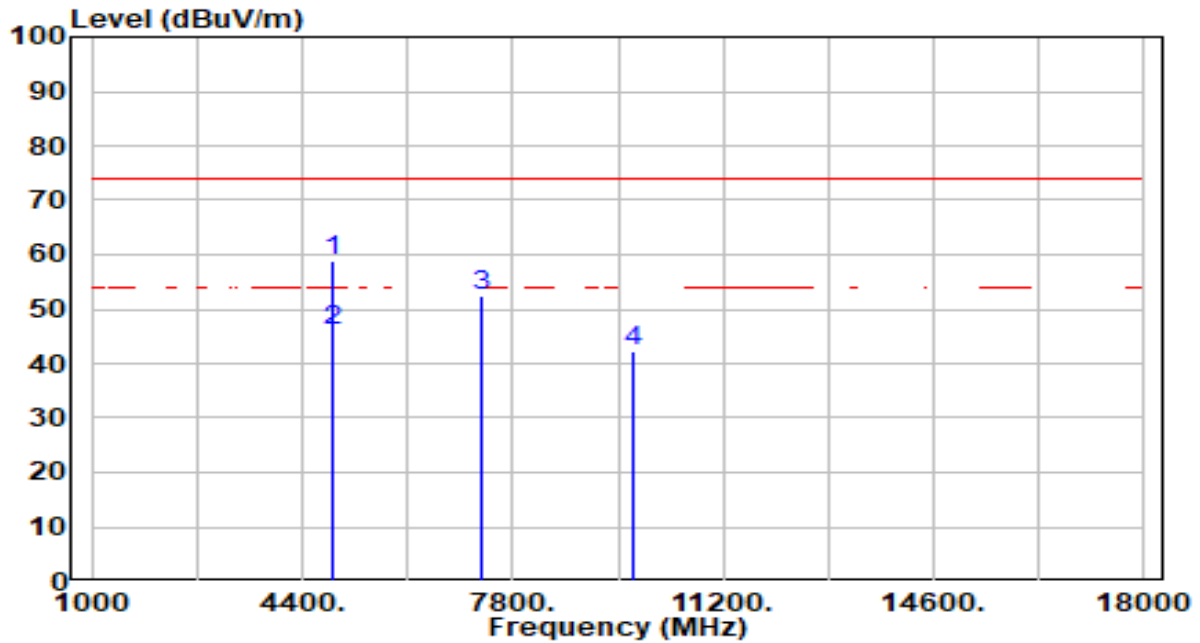

No	Frequency (MHz)	Reading (dBuV)	C.F (dB/m)	Measurement (dBuV/m)	Margin (dB)	Limit (dBuV/m)	Height (cm)	Angle (deg)	Remark (QP/PK/AV)	
1	*	4874.000	60.00	-0.97	59.03	-14.97	74.00	312	48	Peak
2	*	4874.000	46.87	-0.97	45.90	-8.10	54.00	312	48	Average
3		7311.000	48.69	3.92	52.61	-21.39	74.00	300	292	Peak
4		9748.000	39.12	3.24	42.36	-31.64	74.00	300	86	Peak

Note:

1. "*" means this data is the worst emission level.
2. C.F (Correction Factor) = Antenna Factor (dB/m) + Cable Loss (dB) – Pre-amplifier(dB).
3. Measurement (dBuV/m) = Reading(dBuV) + C.F (Correction Factor).
4. The emission levels of other frequencies are very lower than the limit and not show in test report.

EUT	Smart Wi-Fi Outlet Extender	Date of Test	2023-06-13
Factor	DRH18-E	Temp. / Humidity	21°C /61%
Polarity	Vertical	Site / Test Engineer	AC2 / Stanley
Test Mode	802.11g_TX_CH 6_ANT 1	Test Voltage	By Notebook PC

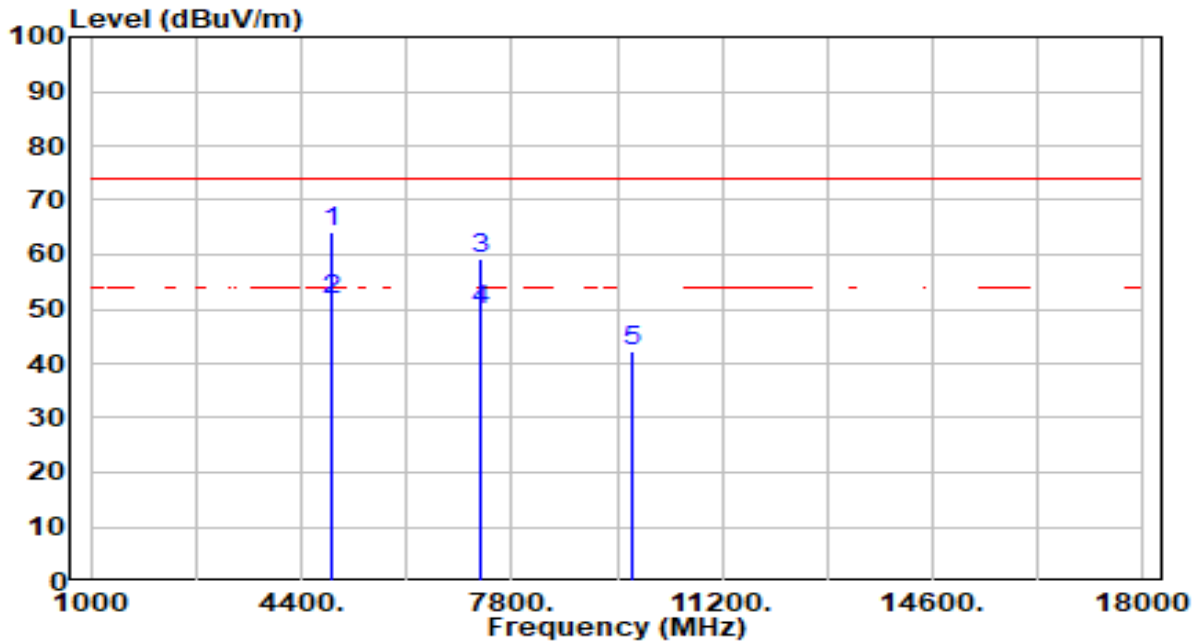

No	Frequency (MHz)	Reading (dBuV)	C.F (dB/m)	Measurement (dBuV/m)	Margin (dB)	Limit (dBuV/m)	Height (cm)	Angle (deg)	Remark (QP/PK/AV)	
1	*	4874.000	65.13	-0.97	64.16	-9.84	74.00	308	122	Peak
2	*	4874.000	52.63	-0.97	51.66	-2.34	54.00	308	122	Average
3		7311.000	55.46	3.92	59.38	-14.62	74.00	300	13	Peak
4		7311.000	46.04	3.92	49.96	-24.04	74.00	300	13	Peak
5		9748.000	39.13	3.24	42.37	-31.63	74.00	300	85	Peak

Note:

- " *", means this data is the worst emission level.
- C.F (Correction Factor) = Antenna Factor (dB/m) + Cable Loss (dB) – Preamplifier(dB).
- Measurement (dBuV/m) = Reading(dBuV) + C.F (Correction Factor).
- The emission levels of other frequencies are very lower than the limit and not show in test report.

EUT	Smart Wi-Fi Outlet Extender	Date of Test	2023-06-13
Factor	DRH18-E	Temp. / Humidity	21°C /61%
Polarity	Horizontal	Site / Test Engineer	AC2 / Stanley
Test Mode	802.11g_TX_CH 11_ANT 1	Test Voltage	By Notebook PC

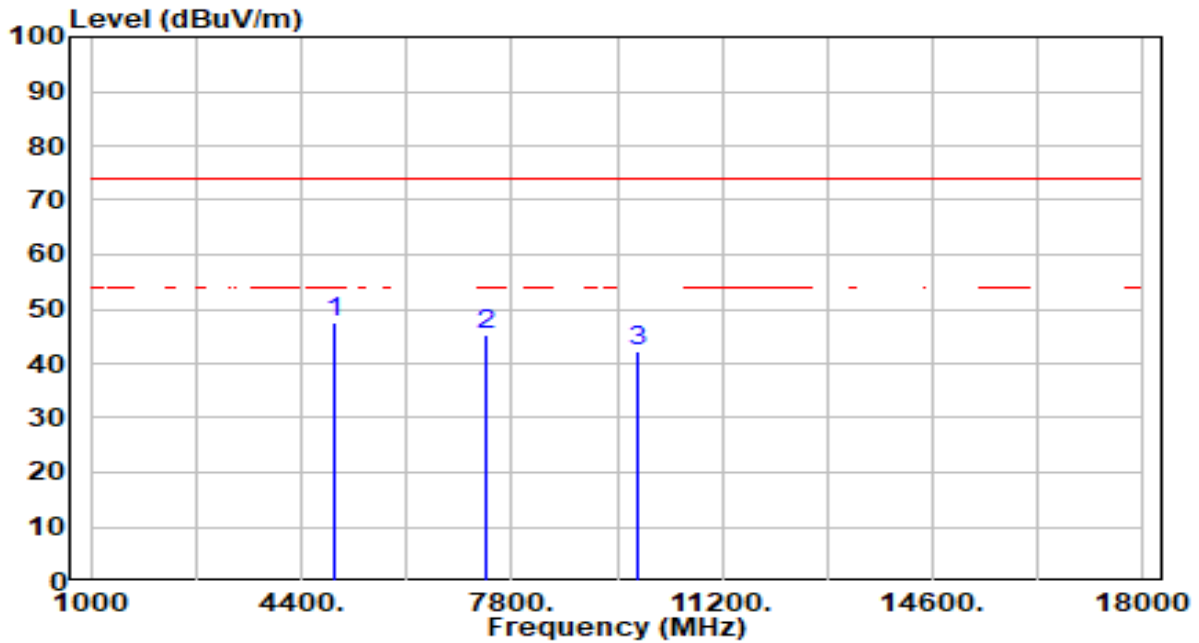

No	Frequency (MHz)	Reading (dBuV)	C.F (dB/m)	Measurement (dBuV/m)	Margin (dB)	Limit (dBuV/m)	Height (cm)	Angle (deg)	Remark (QP/PK/AV)	
1	*	4924.000	48.40	-0.84	47.56	-26.44	74.00	300	209	Peak
2		7386.000	41.32	3.93	45.26	-28.74	74.00	300	296	Peak
3		9848.000	38.84	3.27	42.11	-31.89	74.00	300	6	Peak

Note:

1. " *", means this data is the worst emission level.
2. C.F (Correction Factor) = Antenna Factor (dB/m) + Cable Loss (dB) – Preamplifier(dB).
3. Measurement (dBuV/m) = Reading(dBuV) + C.F (Correction Factor).
4. The emission levels of other frequencies are very lower than the limit and not show in test report.

EUT	Smart Wi-Fi Outlet Extender	Date of Test	2023-06-13
Factor	DRH18-E	Temp. / Humidity	21°C /61%
Polarity	Vertical	Site / Test Engineer	AC2 / Stanley
Test Mode	802.11g_TX_CH 11_ANT 1	Test Voltage	By Notebook PC

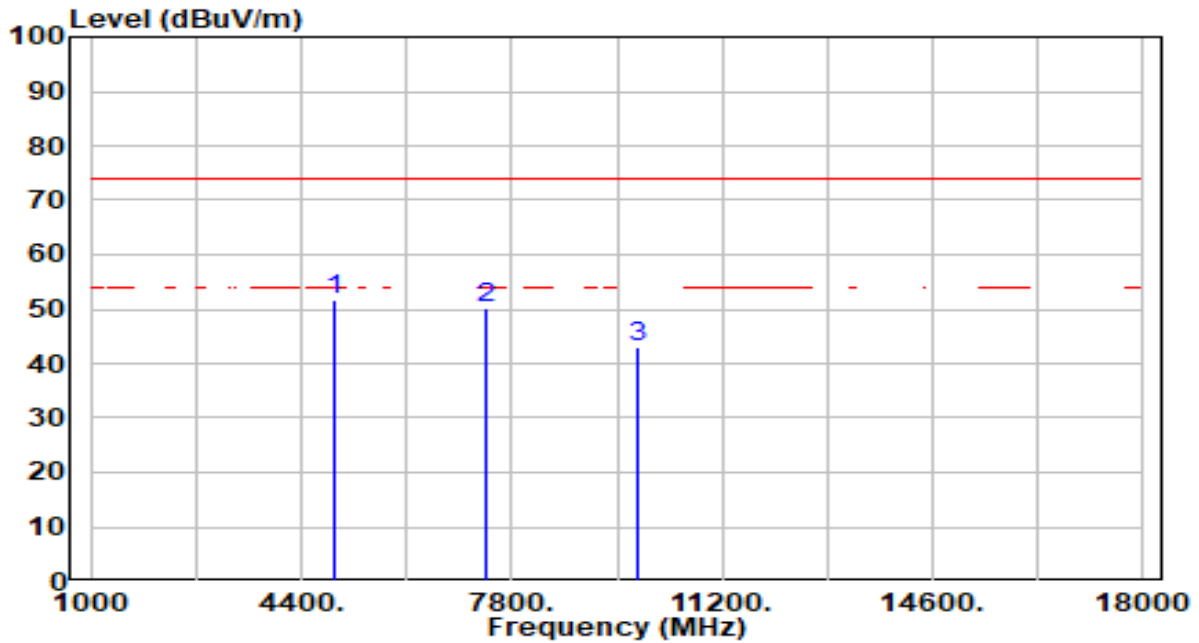

No	Frequency (MHz)	Reading (dBuV)	C.F (dB/m)	Measurement (dBuV/m)	Margin (dB)	Limit (dBuV/m)	Height (cm)	Angle (deg)	Remark (QP/PK/AV)	
1	*	4924.000	52.70	-0.84	51.86	-22.14	74.00	300	119	Peak
2		7386.000	46.22	3.93	50.16	-23.84	74.00	300	52	Peak
3		9848.000	39.73	3.27	43.00	-31.00	74.00	300	83	Peak

Note:

1. " *", means this data is the worst emission level.
2. C.F (Correction Factor) = Antenna Factor (dB/m) + Cable Loss (dB) – Preamplifier(dB).
3. Measurement (dBuV/m) = Reading(dBuV) + C.F (Correction Factor).
4. The emission levels of other frequencies are very lower than the limit and not show in test report.

EUT	Smart Wi-Fi Outlet Extender	Date of Test	2023-06-13
Factor	DRH18-E	Temp. / Humidity	21°C /61%
Polarity	Horizontal	Site / Test Engineer	AC2 / Stanley
Test Mode	802.11n-20MHz_TX_CH 1_ANT 1	Test Voltage	By Notebook PC

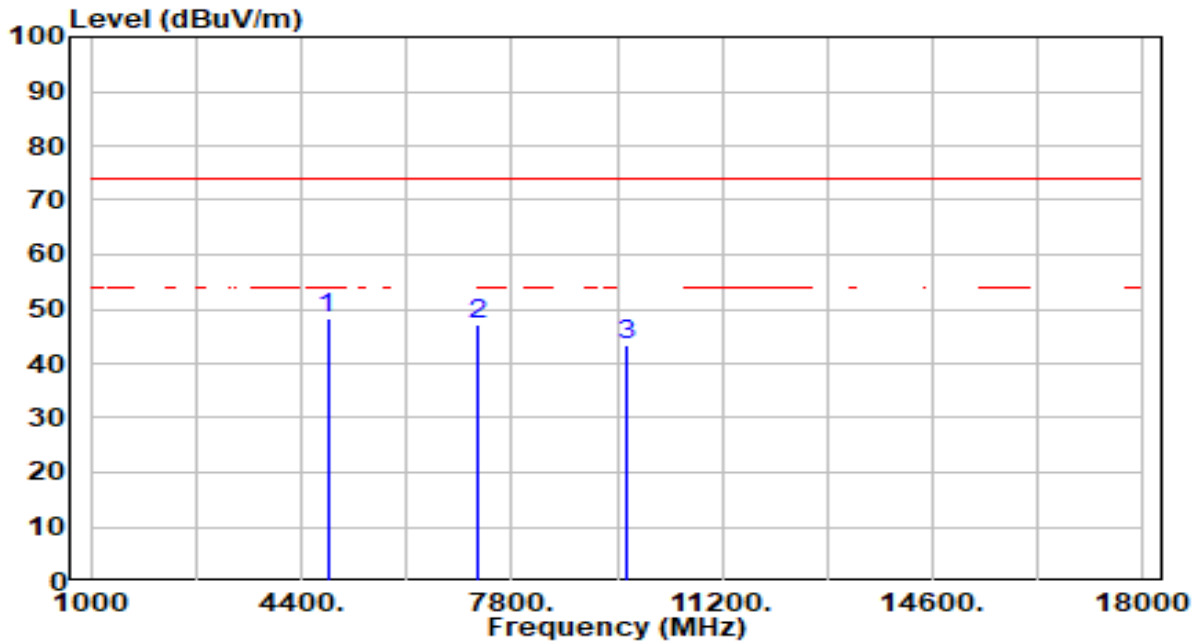

No	Frequency (MHz)	Reading (dBuV)	C.F (dB/m)	Measurement (dBuV/m)	Margin (dB)	Limit (dBuV/m)	Height (cm)	Angle (deg)	Remark (QP/PK/AV)
1	*	49.42	-1.10	48.32	-25.68	74.00	300	328	Peak
2		43.40	3.90	47.30	-26.70	74.00	300	277	Peak
3		40.08	3.21	43.30	-30.70	74.00	300	161	Peak

Note:

1. " *", means this data is the worst emission level.
2. C.F (Correction Factor) = Antenna Factor (dB/m) + Cable Loss (dB) – Preamplifier(dB).
3. Measurement (dBuV/m) = Reading(dBuV) + C.F (Correction Factor).
4. The emission levels of other frequencies are very lower than the limit and not show in test report.

EUT	Smart Wi-Fi Outlet Extender	Date of Test	2023-06-13
Factor	DRH18-E	Temp. / Humidity	21°C /61%
Polarity	Vertical	Site / Test Engineer	AC2 / Stanley
Test Mode	802.11n-20MHz_TX_CH 1_ANT 1	Test Voltage	By Notebook PC

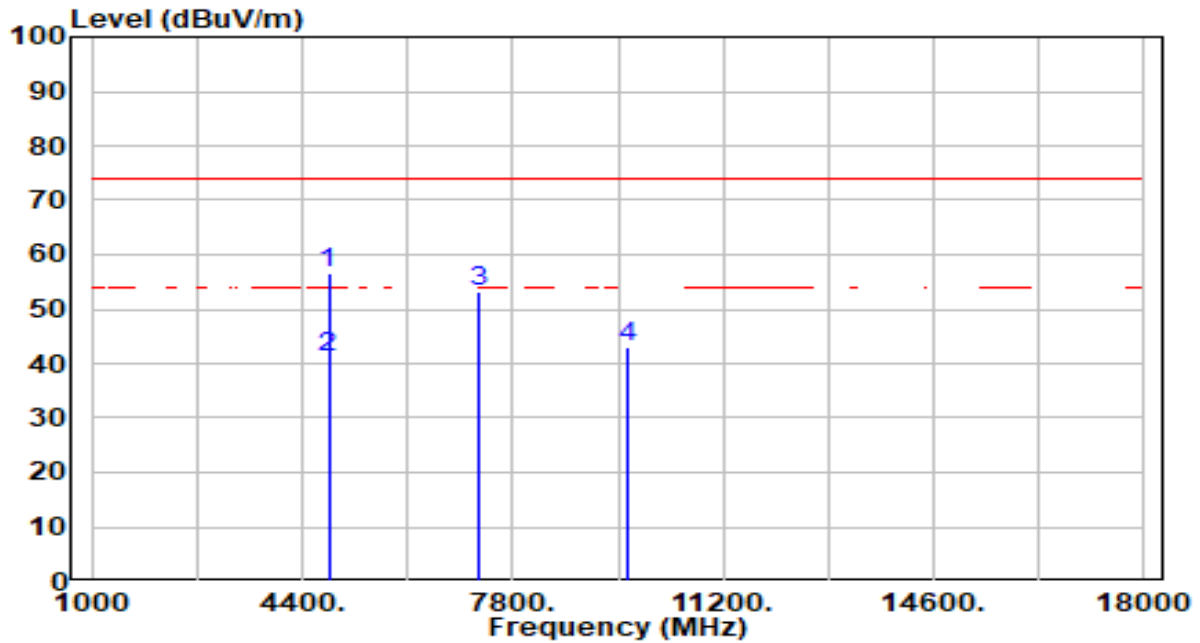

No	Frequency (MHz)	Reading (dBuV)	C.F (dB/m)	Measurement (dBuV/m)	Margin (dB)	Limit (dBuV/m)	Height (cm)	Angle (deg)	Remark (QP/PK/AV)
1	* 4824.000	57.76	-1.10	56.66	-17.34	74.00	312	120	Peak
2	* 4824.000	42.06	-1.10	40.96	-13.04	54.00	312	120	Average
3	7236.000	49.12	3.90	53.02	-20.98	74.00	300	14	Peak
4	9648.000	39.66	3.21	42.88	-31.12	74.00	300	322	Peak

Note:

1. "*" means this data is the worst emission level.
2. C.F (Correction Factor) = Antenna Factor (dB/m) + Cable Loss (dB) – Pre-amplifier(dB).
3. Measurement (dBuV/m) = Reading(dBuV) + C.F (Correction Factor).
4. The emission levels of other frequencies are very lower than the limit and not show in test report.

EUT	Smart Wi-Fi Outlet Extender	Date of Test	2023-06-13
Factor	DRH18-E	Temp. / Humidity	21°C /61%
Polarity	Horizontal	Site / Test Engineer	AC2 / Stanley
Test Mode	802.11n-20MHz_TX_CH 6_ANT 1	Test Voltage	By Notebook PC

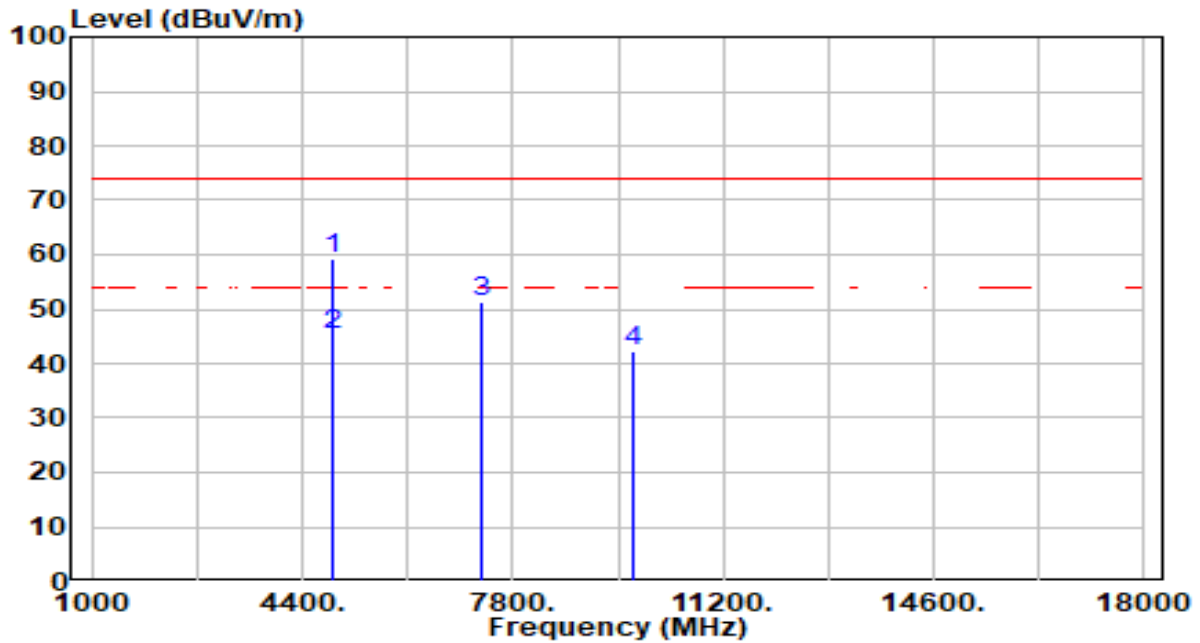

No	Frequency (MHz)	Reading (dBuV)	C.F (dB/m)	Measurement (dBuV/m)	Margin (dB)	Limit (dBuV/m)	Height (cm)	Angle (deg)	Remark (QP/PK/AV)	
1	*	4874.000	60.13	-0.97	59.16	-14.84	74.00	300	50	Peak
2	*	4874.000	46.40	-0.97	45.43	-8.57	54.00	300	50	Average
3		7311.000	47.26	3.92	51.18	-22.82	74.00	300	272	Peak
4		9748.000	38.87	3.24	42.11	-31.89	74.00	300	288	Peak

Note:

1. "*" means this data is the worst emission level.
2. C.F (Correction Factor) = Antenna Factor (dB/m) + Cable Loss (dB) – Pre-amplifier(dB).
3. Measurement (dBuV/m) = Reading(dBuV) + C.F (Correction Factor).
4. The emission levels of other frequencies are very lower than the limit and not show in test report.

EUT	Smart Wi-Fi Outlet Extender	Date of Test	2023-06-13
Factor	DRH18-E	Temp. / Humidity	21°C /61%
Polarity	Vertical	Site / Test Engineer	AC2 / Stanley
Test Mode	802.11n-20MHz_TX_CH 6_ANT 1	Test Voltage	By Notebook PC

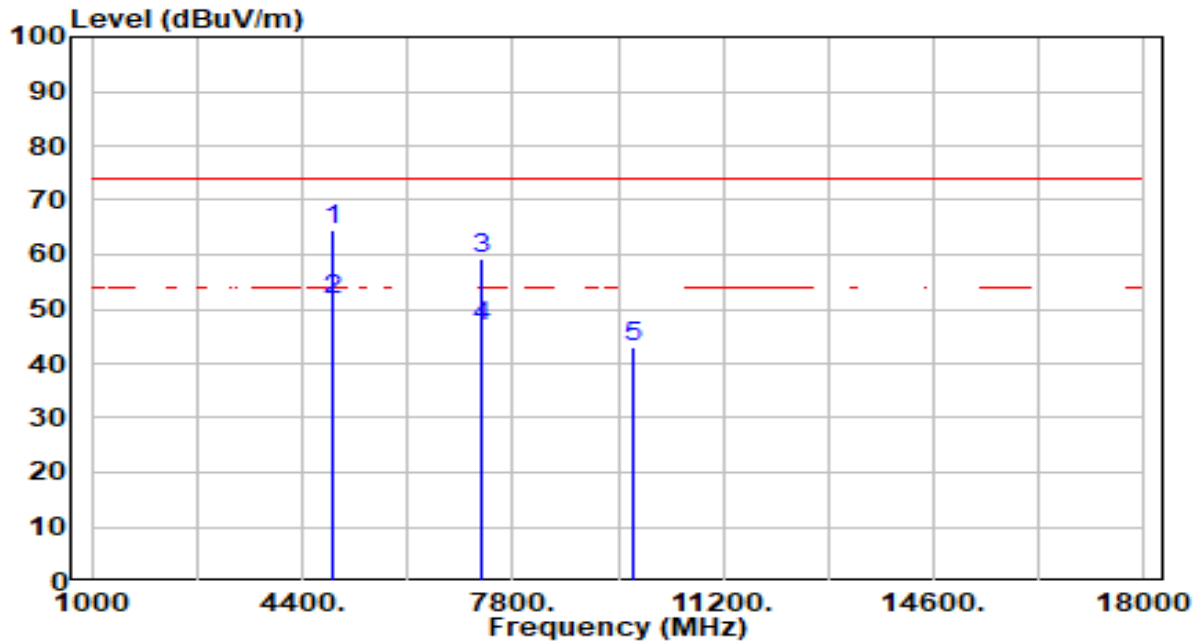

No	Frequency (MHz)	Reading (dBuV)	C.F (dB/m)	Measurement (dBuV/m)	Margin (dB)	Limit (dBuV/m)	Height (cm)	Angle (deg)	Remark (QP/PK/AV)	
1	*	4874.000	65.49	-0.97	64.52	-9.48	74.00	300	128	Peak
2	*	4874.000	52.56	-0.97	51.59	-2.41	54.00	300	128	Average
3		7311.000	55.48	3.92	59.40	-14.60	74.00	300	20	Peak
4		7311.000	43.03	3.92	46.95	-27.05	74.00	300	15	Peak
5		9748.000	39.88	3.24	43.12	-30.88	74.00	300	76	Peak

Note:

1. " *", means this data is the worst emission level.
2. C.F (Correction Factor) = Antenna Factor (dB/m) + Cable Loss (dB) – Preamplifier(dB).
3. Measurement (dBuV/m) = Reading(dBuV) + C.F (Correction Factor).
4. The emission levels of other frequencies are very lower than the limit and not show in test report.

EUT	Smart Wi-Fi Outlet Extender	Date of Test	2023-06-13
Factor	DRH18-E	Temp. / Humidity	21°C /61%
Polarity	Horizontal	Site / Test Engineer	AC2 / Stanley
Test Mode	802.11n-20MHz_TX_CH 11_ANT 1	Test Voltage	By Notebook PC

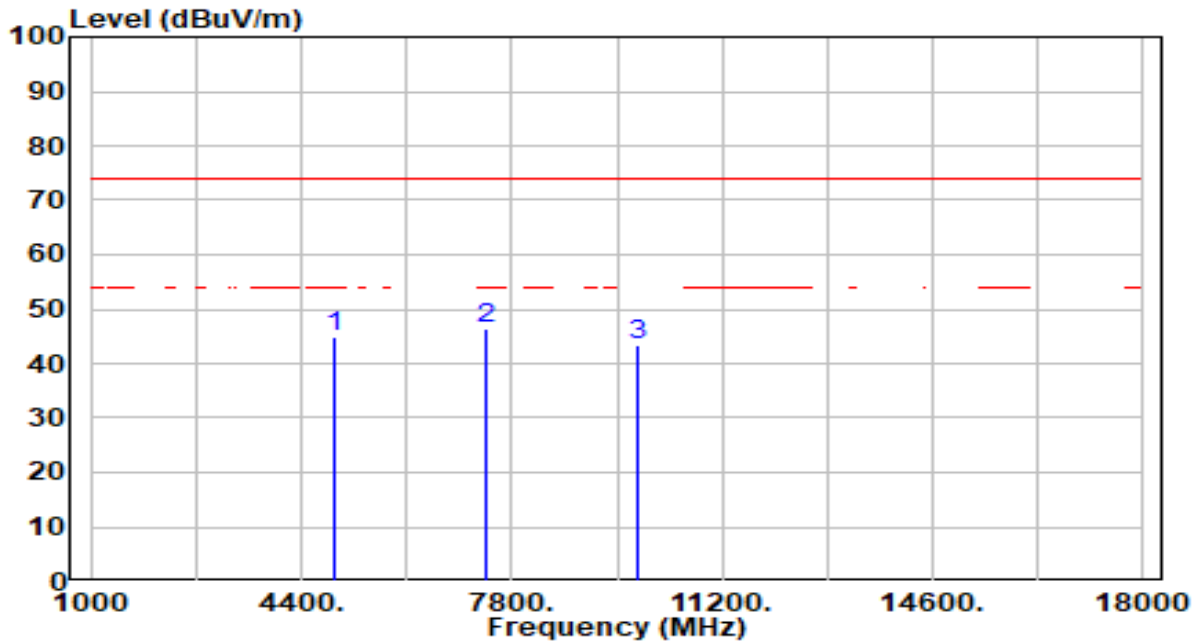

No	Frequency (MHz)	Reading (dBuV)	C.F (dB/m)	Measurement (dBuV/m)	Margin (dB)	Limit (dBuV/m)	Height (cm)	Angle (deg)	Remark (QP/PK/AV)
1	4924.000	45.72	-0.84	44.88	-29.12	74.00	300	200	Peak
2	* 7386.000	42.58	3.93	46.52	-27.48	74.00	300	300	Peak
3	9848.000	40.25	3.27	43.52	-30.48	74.00	300	189	Peak

Note:

1. " *", means this data is the worst emission level.
2. C.F (Correction Factor) = Antenna Factor (dB/m) + Cable Loss (dB) – Preamplifier(dB).
3. Measurement (dBuV/m) = Reading(dBuV) + C.F (Correction Factor).
4. The emission levels of other frequencies are very lower than the limit and not show in test report.

EUT	Smart Wi-Fi Outlet Extender	Date of Test	2023-06-13
Factor	DRH18-E	Temp. / Humidity	21°C /61%
Polarity	Vertical	Site / Test Engineer	AC2 / Stanley
Test Mode	802.11n-20MHz_TX_CH 11_ANT 1	Test Voltage	By Notebook PC

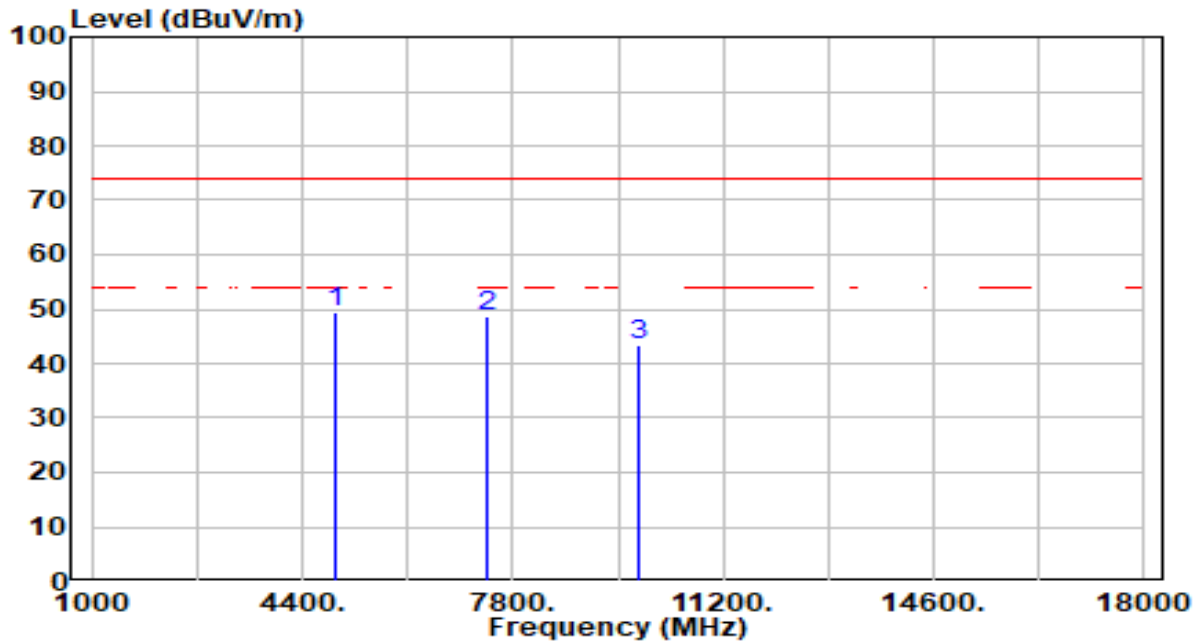

No	Frequency (MHz)	Reading (dBuV)	C.F (dB/m)	Measurement (dBuV/m)	Margin (dB)	Limit (dBuV/m)	Height (cm)	Angle (deg)	Remark (QP/PK/AV)	
1	*	4924.000	50.10	-0.84	49.26	-24.74	74.00	300	120	Peak
2		7386.000	44.82	3.93	48.76	-25.24	74.00	300	68	Peak
3		9848.000	40.05	3.27	43.32	-30.68	74.00	300	68	Peak

Note:

1. " *", means this data is the worst emission level.
2. C.F (Correction Factor) = Antenna Factor (dB/m) + Cable Loss (dB) – Preamplifier(dB).
3. Measurement (dBuV/m) = Reading(dBuV) + C.F (Correction Factor).
4. The emission levels of other frequencies are very lower than the limit and not show in test report.

7.7. Radiated Restricted Band Edge Measurement

7.7.1. Test Limit

For 15.205 requirement:

Radiated emissions which fall in the restricted bands, as defined in Section 15.205(a) of FCC part 15, must also comply with the radiated emission limits specified in Section 15.209(a).

Frequency (MHz)	Frequency (MHz)	Frequency (MHz)	Frequency (GHz)
0.090 - 0.110	16.42 - 16.423	399.9 - 410	4.5 - 5.15
¹ 0.495 - 0.505	16.69475 - 16.69525	608 - 614	5.35 - 5.46
2.1735 - 2.1905	16.80425 - 16.80475	960 - 1240	7.25 - 7.75
4.125 - 4.128	25.5 - 25.67	1300 - 1427	8.025 - 8.5
4.17725 - 4.17775	37.5 - 38.25	1435 - 1626.5	9.0 - 9.2
4.20725 - 4.20775	73 - 74.6	1645.5 - 1646.5	9.3 - 9.5
6.215 - 6.218	74.8 - 75.2	1660 - 1710	10.6 - 12.7
6.26775 - 6.26825	108 - 121.94	1718.8 - 1722.2	13.25 - 13.4
6.31175 - 6.31225	123 - 138	2200 - 2300	14.47 - 14.5
8.291 - 8.294	149.9 - 150.05	2310 - 2390	15.35 - 16.2
8.362 - 8.366	156.52475 - 156.52525	2483.5 - 2500	17.7 - 21.4
8.37625 - 8.38675	156.7 - 156.9	2690 - 2900	22.01 - 23.12
8.41425 - 8.41475	162.0125 - 167.17	3260 - 3267	23.6 - 24.0
12.29 - 12.293	167.72 - 173.2	3332 - 3339	31.2 - 31.8
12.51975 - 12.52025	240 - 285	3345.8 - 3358	36.43 - 36.5
12.57675 - 12.57725	322 - 335.4	3600 - 4400	(²)
13.36 - 13.41	--	--	--

All out of band emissions appearing in a restricted band as specified in Section 15.205 of the Title 47CFR must not exceed the limits shown in Table per Section 15.209.

FCC Part 15 Subpart C Paragraph 15.209 Limits		
Frequency [MHz]	Field Strength [uV/m]	Measured Distance [Meters]
0.009 - 0.490	2400/F (kHz)	300
0.490 - 1.705	24000/F (kHz)	30
1.705 - 30	30	30
30 - 88	100	3
88 - 216	150	3
216 - 960	200	3
Above 960	500	3

7.7.2. Test Procedure Used

ANSI C63.10 Section 6.3 (General Requirements)

ANSI C63.10 Section 6.6 (Standard test method above 1GHz)

7.7.3. Test Setting

Peak Field Strength Measurements

1. Analyzer center frequency was set to the frequency of the radiated spurious emission of interest
2. RBW = 1MHz
3. VBW = 3MHz
4. Detector = peak
5. Sweep time = auto couple
6. Trace mode = max hold
7. Trace was allowed to stabilize

Average Measurements above 1GHz (Method VB)

1. Analyzer center frequency was set to the frequency of the radiated spurious emission of interest
2. RBW = 1MHz
3. VBW; If the EUT is configured to transmit with duty cycle $\geq 98\%$, set VBW = 10 Hz.

If the EUT duty cycle is $< 98\%$, set $VBW \geq 1/T$. T is the minimum transmission duration.

4. Detector = Peak
5. Sweep time = auto
6. Trace mode = max hold
7. Trace was allowed to stabilize

7.7.4. Test Setup

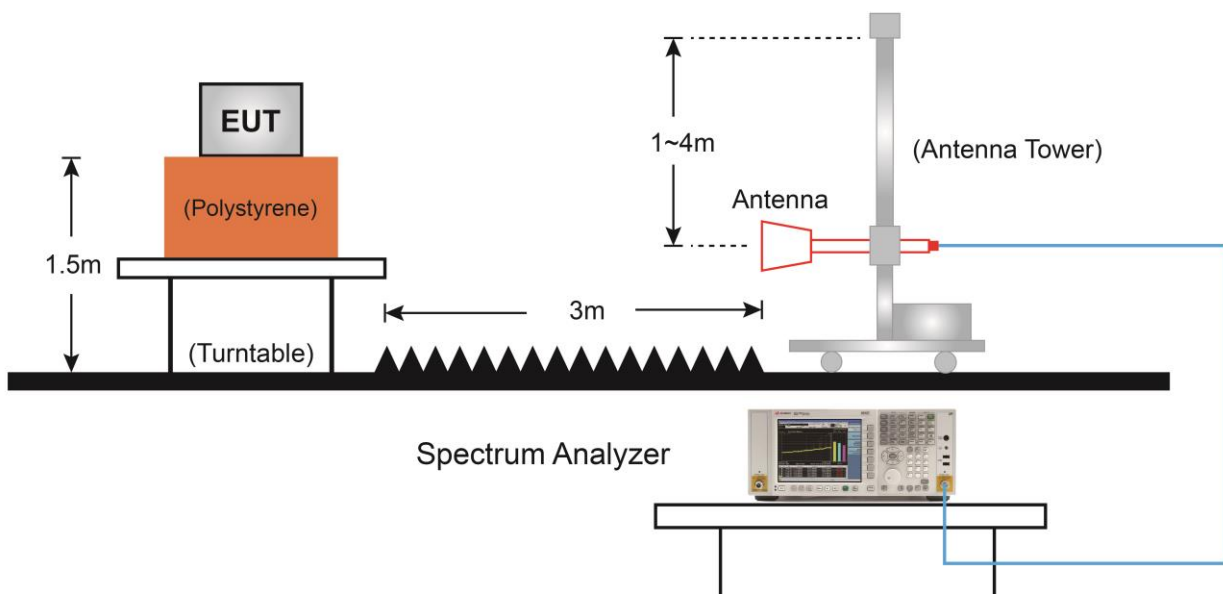

7.7.5. Test Result

EUT	Smart Wi-Fi Outlet Extender	Date of Test	2023-06-13
Factor	DRH18-E	Temp. / Humidity	21°C /61%
Polarity	Horizontal	Site / Test Engineer	AC2 / Marvin
Test Mode	802.11b_TX_CH 1_ANT 0	Test Voltage	By Notebook PC

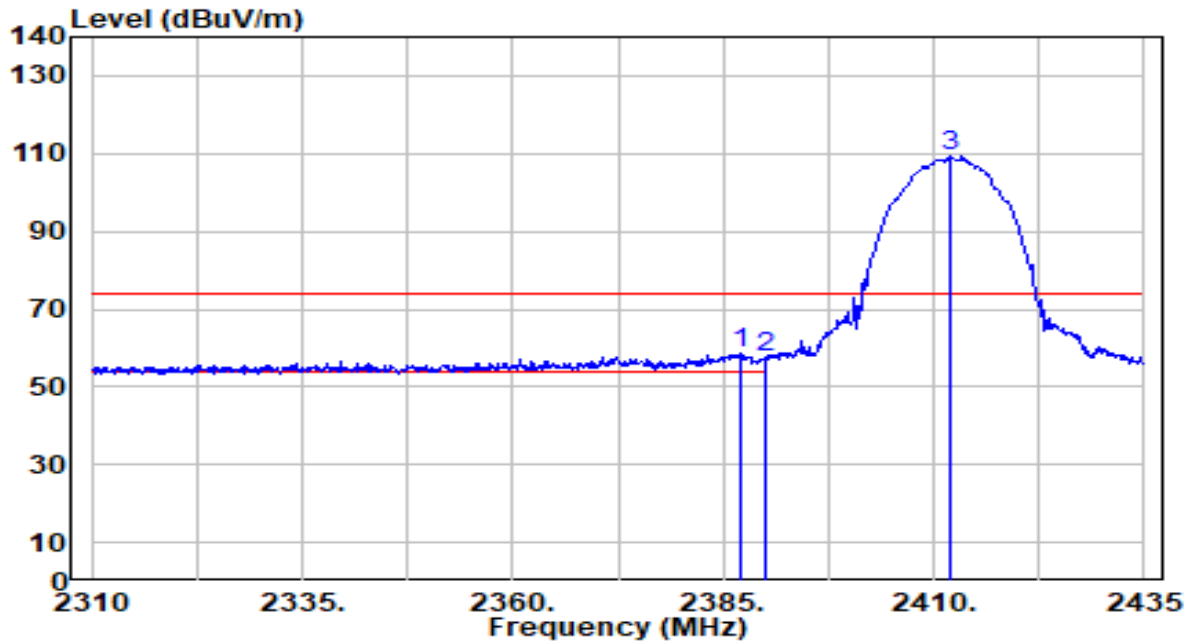

No	Frequency (MHz)	Reading (dBuV)	C.F (dB/m)	Measurement (dBuV/m)	Margin (dB)	Limit (dBuV/m)	Height (cm)	Angle (deg)	Remark (QP/PK/AV)
1	* 2387.000	28.72	30.17	58.89	-15.11	74.00	310	265	Peak
2	2390.000	27.17	30.18	57.35	-16.65	74.00	310	265	Peak
3	2412.000	78.95	30.22	109.17	N/A	N/A	310	265	Peak

Note:

1. " *", means this data is the worst emission level.
2. C.F (Correction Factor) = Antenna Factor (dB/m)+ Cable Loss (dB).
3. Measurement (dBuV/m) = Reading(dBuV) + C.F (Correction Factor).
4. The emission levels of other frequencies are very lower than the limit and not show in test report.

EUT	Smart Wi-Fi Outlet Extender	Date of Test	2023-06-13
Factor	DRH18-E	Temp. / Humidity	21°C /61%
Polarity	Horizontal	Site / Test Engineer	AC2 / Marvin
Test Mode	802.11b_TX_CH 1_ANT 0	Test Voltage	By Notebook PC

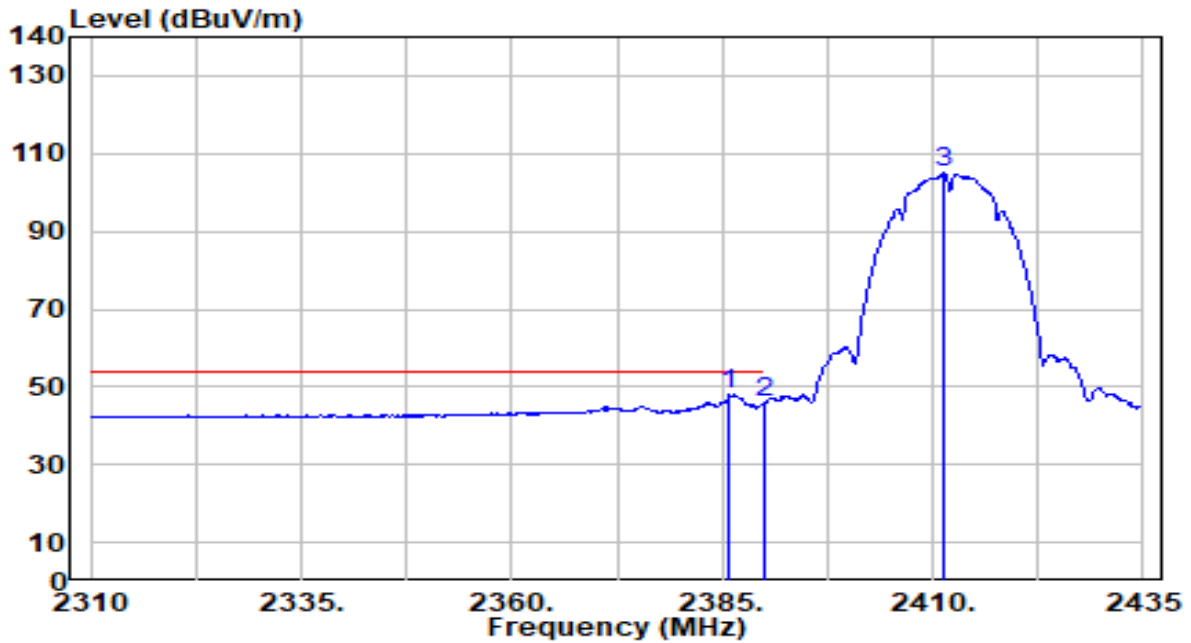

No	Frequency (MHz)	Reading (dBUV)	C.F (dB/m)	Measurement (dBUV/m)	Margin (dB)	Limit (dBUV/m)	Height (cm)	Angle (deg)	Remark (QP/PK/AV)	
1	*	2385.875	17.72	30.17	47.89	-6.11	54.00	310	265	Average
2		2390.000	15.70	30.18	45.88	-8.12	54.00	310	265	Average
3		2411.250	74.71	30.22	104.94	N/A	N/A	310	265	Average

Note:

1. " *", means this data is the worst emission level.
2. C.F (Correction Factor) = Antenna Factor (dB/m)+ Cable Loss (dB).
3. Measurement (dBUV/m) = Reading(dBUV) + C.F (Correction Factor).
4. The emission levels of other frequencies are very lower than the limit and not show in test report.

EUT	Smart Wi-Fi Outlet Extender	Date of Test	2023-06-13
Factor	DRH18-E	Temp. / Humidity	21°C /61%
Polarity	Vertical	Site / Test Engineer	AC2 / Marvin
Test Mode	802.11b_TX_CH 1_ANT 0	Test Voltage	By Notebook PC

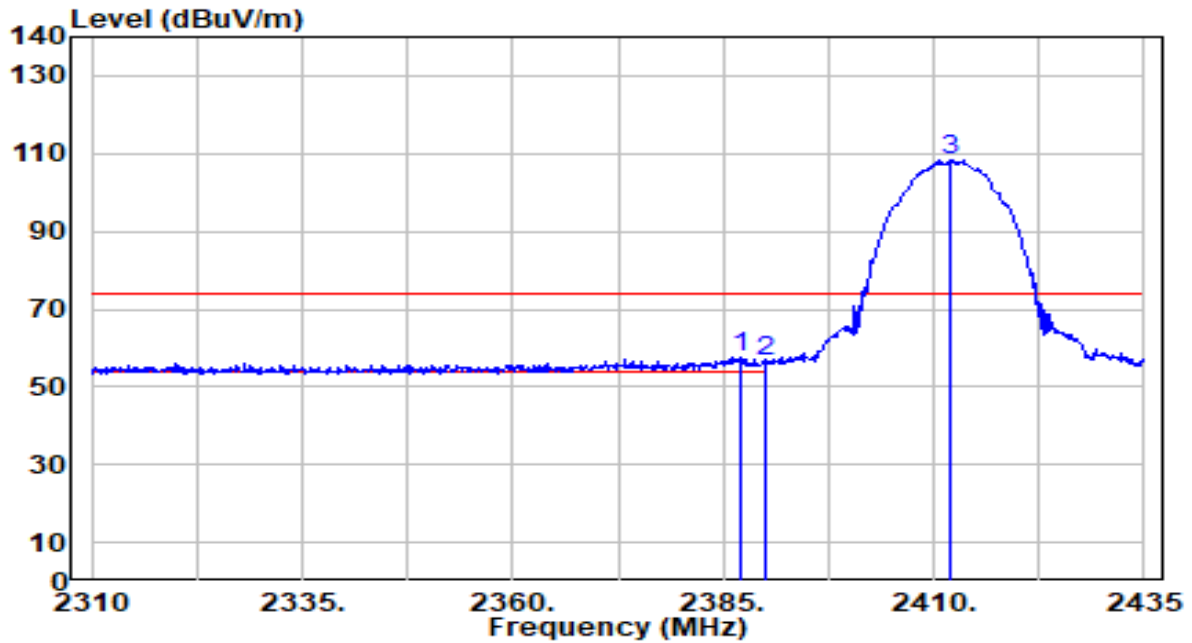

No	Frequency (MHz)	Reading (dBUV)	C.F (dB/m)	Measurement (dBUV/m)	Margin (dB)	Limit (dBUV/m)	Height (cm)	Angle (deg)	Remark (QP/PK/AV)	
1	*	2387.125	27.24	30.17	57.41	-16.59	74.00	316	206	Peak
2		2390.000	26.29	30.18	56.47	-17.53	74.00	316	206	Peak
3		2412.000	78.13	30.22	108.35	N/A	N/A	316	206	Peak

Note:

1. " *", means this data is the worst emission level.
2. C.F (Correction Factor) = Antenna Factor (dB/m)+ Cable Loss (dB).
3. Measurement (dBUV/m) = Reading(dBUV) + C.F (Correction Factor).
4. The emission levels of other frequencies are very lower than the limit and not show in test report.

EUT	Smart Wi-Fi Outlet Extender	Date of Test	2023-06-13
Factor	DRH18-E	Temp. / Humidity	21°C /61%
Polarity	Vertical	Site / Test Engineer	AC2 / Marvin
Test Mode	802.11b_TX_CH 1_ANT 0	Test Voltage	By Notebook PC

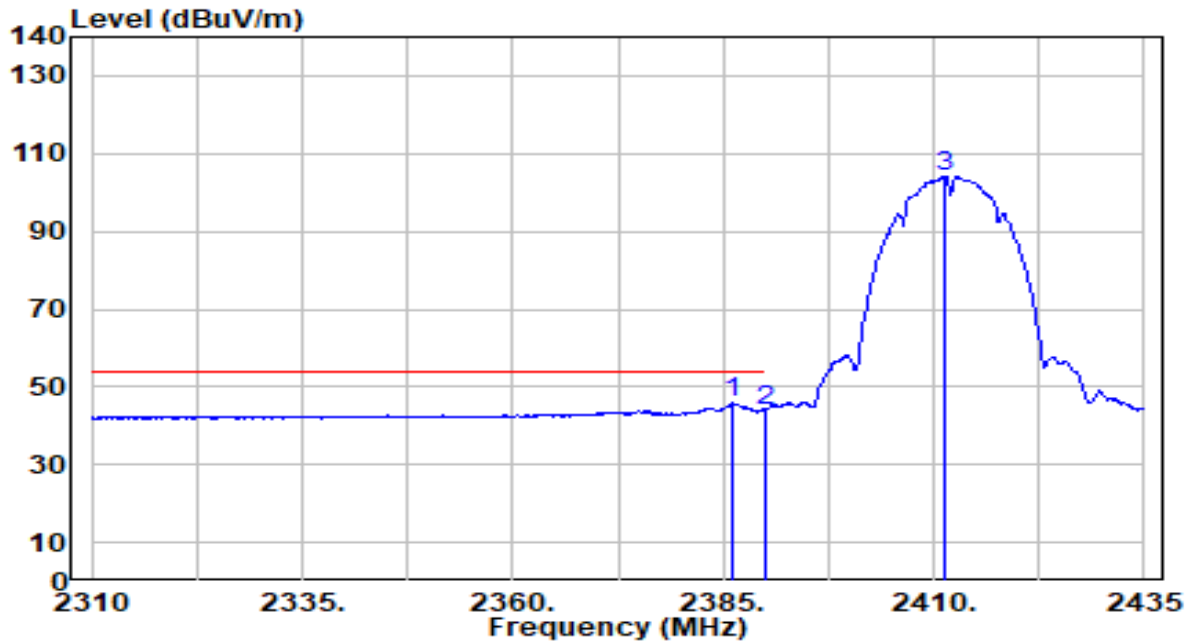

No	Frequency (MHz)	Reading (dBuV)	C.F (dB/m)	Measurement (dBuV/m)	Margin (dB)	Limit (dBuV/m)	Height (cm)	Angle (deg)	Remark (QP/PK/AV)	
1	*	2386.000	15.53	30.17	45.70	-8.30	54.00	316	206	Average
2		2390.000	13.93	30.18	44.11	-9.89	54.00	316	206	Average
3		2411.375	73.91	30.22	104.13	N/A	N/A	316	206	Average

Note:

1. " *", means this data is the worst emission level.
2. C.F (Correction Factor) = Antenna Factor (dB/m)+ Cable Loss (dB).
3. Measurement (dBuV/m) = Reading(dBuV) + C.F (Correction Factor).
4. The emission levels of other frequencies are very lower than the limit and not show in test report.

EUT	Smart Wi-Fi Outlet Extender	Date of Test	2023-06-13
Factor	DRH18-E	Temp. / Humidity	21°C /61%
Polarity	Horizontal	Site / Test Engineer	AC2 / Marvin
Test Mode	802.11b_TX_CH 6_ANT 0	Test Voltage	By Notebook PC

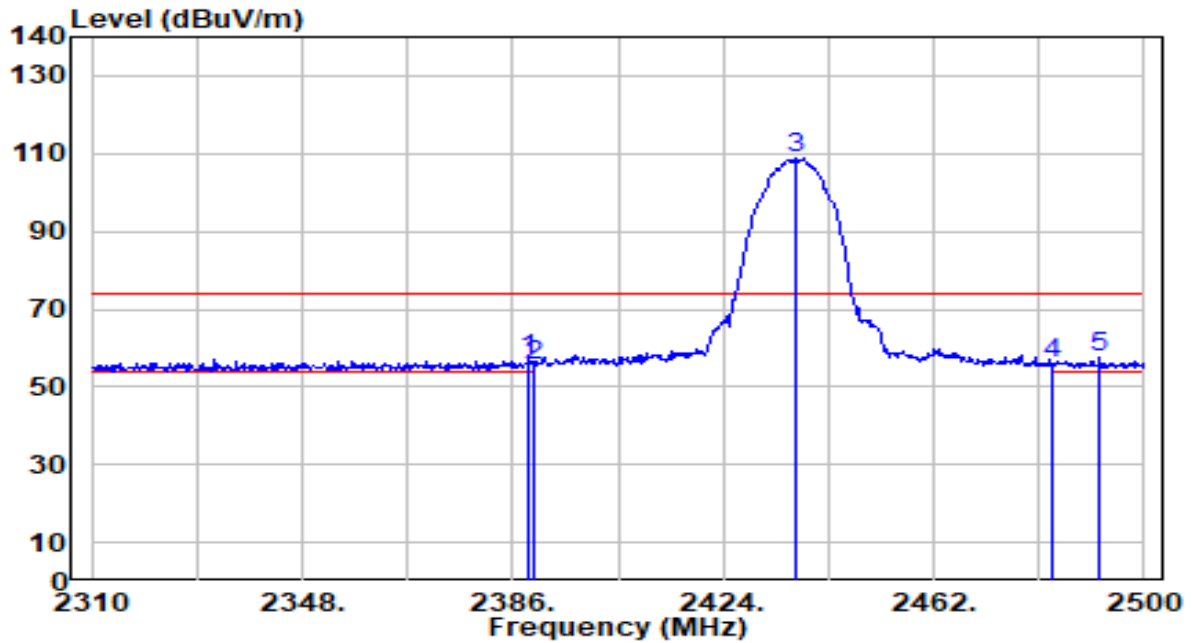

No	Frequency (MHz)	Reading (dBuV)	C.F (dB/m)	Measurement (dBuV/m)	Margin (dB)	Limit (dBuV/m)	Height (cm)	Angle (deg)	Remark (QP/PK/AV)
1	2389.040	26.67	30.18	56.84	-17.16	74.00	303	269	Peak
2	2390.000	25.49	30.18	55.67	-18.33	74.00	303	269	Peak
3	2437.110	78.57	30.26	108.82	N/A	N/A	303	269	Peak
4	2483.500	25.55	30.32	55.86	-18.14	74.00	303	269	Peak
5	* 2491.830	27.05	30.33	57.38	-16.62	74.00	303	269	Peak

Note:

1. " *", means this data is the worst emission level.
2. C.F (Correction Factor) = Antenna Factor (dB/m)+ Cable Loss (dB).
3. Measurement (dBuV/m) = Reading(dBuV) + C.F (Correction Factor).
4. The emission levels of other frequencies are very lower than the limit and not show in test report.

EUT	Smart Wi-Fi Outlet Extender	Date of Test	2023-06-13
Factor	DRH18-E	Temp. / Humidity	21°C /61%
Polarity	Horizontal	Site / Test Engineer	AC2 / Marvin
Test Mode	802.11b_TX_CH 6_ANT 0	Test Voltage	By Notebook PC

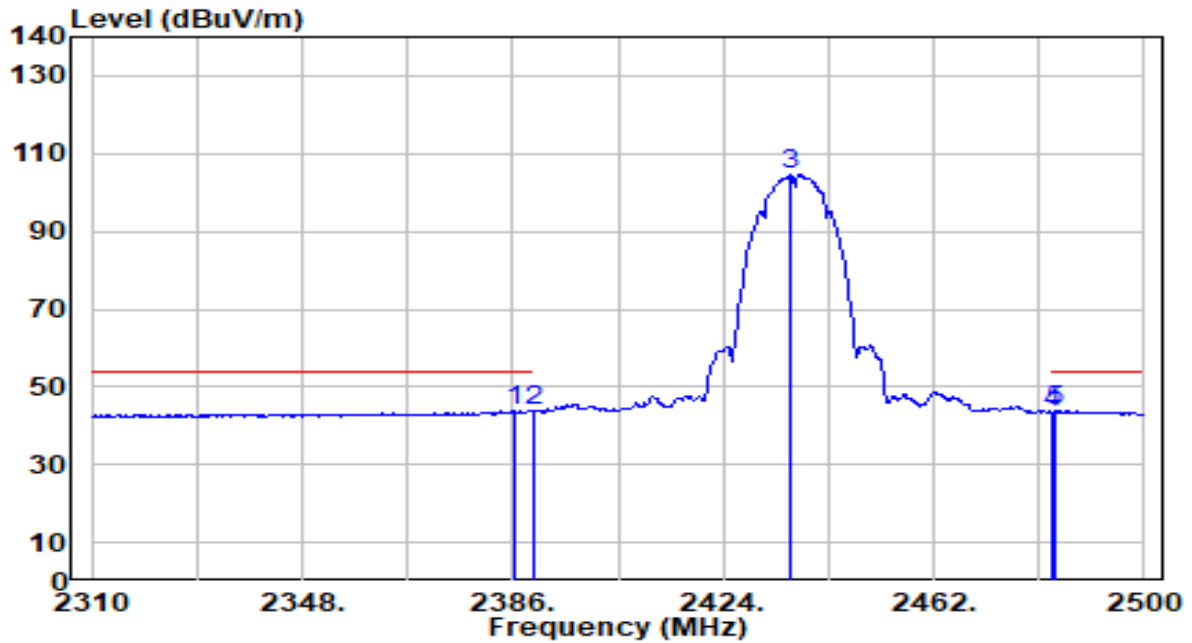

No	Frequency (MHz)	Reading (dBuV)	C.F (dB/m)	Measurement (dBuV/m)	Margin (dB)	Limit (dBuV/m)	Height (cm)	Angle (deg)	Remark (QP/PK/AV)
1	2386.570	13.59	30.17	43.76	-10.24	54.00	303	269	Average
2	2390.000	13.51	30.18	43.69	-10.31	54.00	303	269	Average
3	2436.350	74.42	30.26	104.68	N/A	N/A	303	269	Average
4	2483.500	13.17	30.32	43.49	-10.51	54.00	303	269	Average
5	* 2484.040	13.49	30.32	43.81	-10.19	54.00	303	269	Average

Note:

1. " *", means this data is the worst emission level.
2. C.F (Correction Factor) = Antenna Factor (dB/m)+ Cable Loss (dB).
3. Measurement (dBuV/m) = Reading(dBuV) + C.F (Correction Factor).
4. The emission levels of other frequencies are very lower than the limit and not show in test report.

EUT	Smart Wi-Fi Outlet Extender	Date of Test	2023-06-13
Factor	DRH18-E	Temp. / Humidity	21°C /61%
Polarity	Vertical	Site / Test Engineer	AC2 / Marvin
Test Mode	802.11b_TX_CH 6_ANT 0	Test Voltage	By Notebook PC

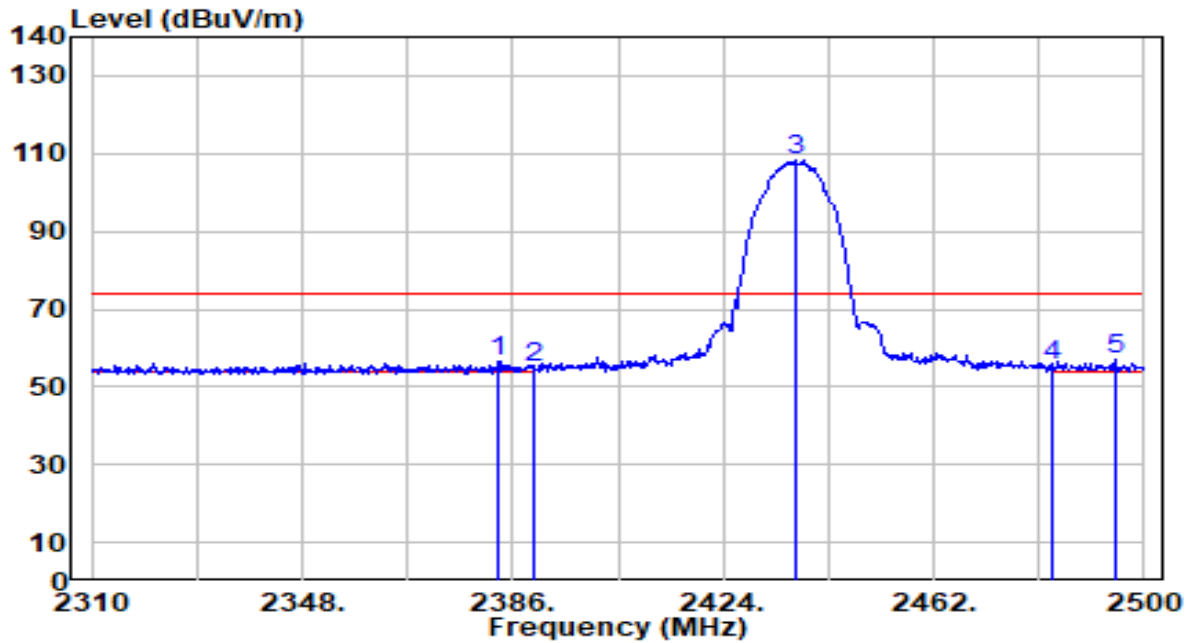

No	Frequency (MHz)	Reading (dBuV)	C.F (dB/m)	Measurement (dBuV/m)	Margin (dB)	Limit (dBuV/m)	Height (cm)	Angle (deg)	Remark (QP/PK/AV)
1	2383.530	26.57	30.16	56.73	-17.27	74.00	309	209	Peak
2	2390.000	24.74	30.18	54.92	-19.08	74.00	309	209	Peak
3	2437.110	77.98	30.26	108.23	N/A	N/A	309	209	Peak
4	2483.500	25.09	30.32	55.40	-18.60	74.00	309	209	Peak
5	* 2495.060	26.59	30.33	56.93	-17.07	74.00	309	209	Peak

Note:

1. " *", means this data is the worst emission level.
2. C.F (Correction Factor) = Antenna Factor (dB/m)+ Cable Loss (dB).
3. Measurement (dBuV/m) = Reading(dBuV) + C.F (Correction Factor).
4. The emission levels of other frequencies are very lower than the limit and not show in test report.

EUT	Smart Wi-Fi Outlet Extender	Date of Test	2023-06-13
Factor	DRH18-E	Temp. / Humidity	21°C /61%
Polarity	Vertical	Site / Test Engineer	AC2 / Marvin
Test Mode	802.11b_TX_CH 6_ANT 0	Test Voltage	By Notebook PC

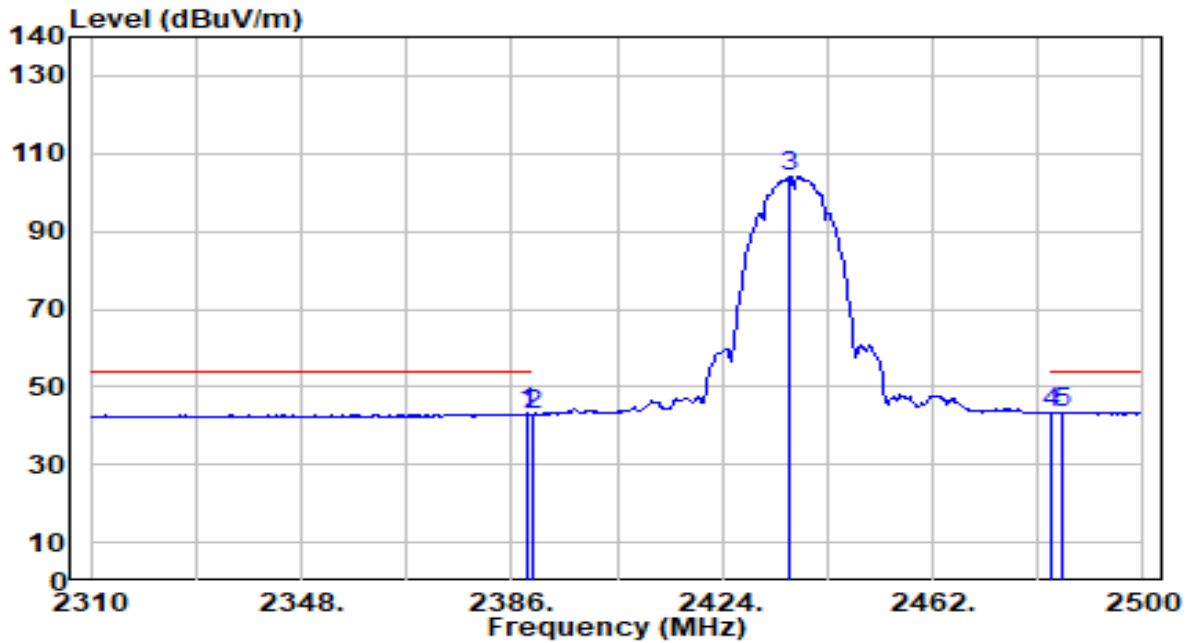

No	Frequency (MHz)	Reading (dBuV)	C.F (dB/m)	Measurement (dBuV/m)	Margin (dB)	Limit (dBuV/m)	Height (cm)	Angle (deg)	Remark (QP/PK/AV)
1	2389.040	13.00	30.18	43.18	-10.82	54.00	309	209	Average
2	2390.000	12.76	30.18	42.94	-11.06	54.00	309	209	Average
3	2436.350	73.95	30.26	104.20	N/A	N/A	309	209	Average
4	* 2483.500	13.18	30.32	43.49	-10.51	54.00	309	209	Average
5	2485.560	13.15	30.32	43.47	-10.53	54.00	309	209	Average

Note:

- " *", means this data is the worst emission level.
- C.F (Correction Factor) = Antenna Factor (dB/m)+ Cable Loss (dB).
- Measurement (dBuV/m) = Reading(dBuV) + C.F (Correction Factor).
- The emission levels of other frequencies are very lower than the limit and not show in test report.

EUT	Smart Wi-Fi Outlet Extender	Date of Test	2023-06-13
Factor	DRH18-E	Temp. / Humidity	21°C /61%
Polarity	Horizontal	Site / Test Engineer	AC2 / Marvin
Test Mode	802.11b_TX_CH 11_ANT 0	Test Voltage	By Notebook PC

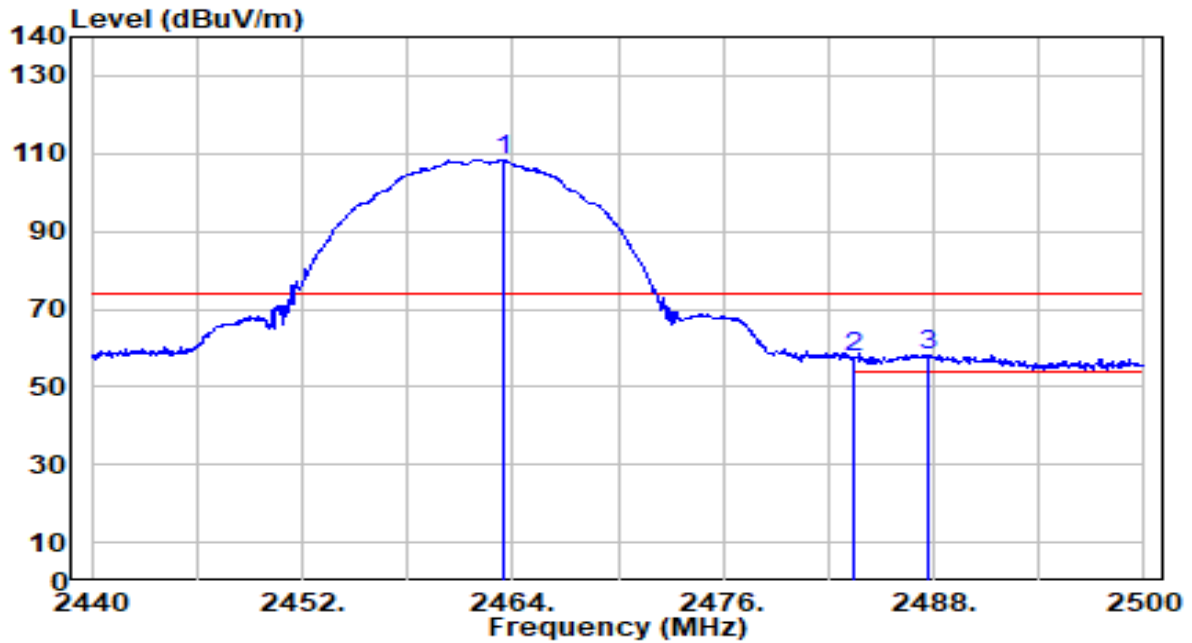

No	Frequency (MHz)	Reading (dBUV)	C.F (dB/m)	Measurement (dBUV/m)	Margin (dB)	Limit (dBUV/m)	Height (cm)	Angle (deg)	Remark (QP/PK/AV)
1	2463.460	78.26	30.29	108.55	N/A	N/A	300	269	Peak
2	2483.500	27.45	30.32	57.77	-16.23	74.00	300	269	Peak
3	* 2487.700	28.05	30.32	58.37	-15.63	74.00	300	269	Peak

Note:

1. " *", means this data is the worst emission level.
2. C.F (Correction Factor) = Antenna Factor (dB/m)+ Cable Loss (dB).
3. Measurement (dBUV/m) = Reading(dBUV) + C.F (Correction Factor).
4. The emission levels of other frequencies are very lower than the limit and not show in test report.

EUT	Smart Wi-Fi Outlet Extender	Date of Test	2023-06-13
Factor	DRH18-E	Temp. / Humidity	21°C /61%
Polarity	Horizontal	Site / Test Engineer	AC2 / Marvin
Test Mode	802.11b_TX_CH 11_ANT 0	Test Voltage	By Notebook PC

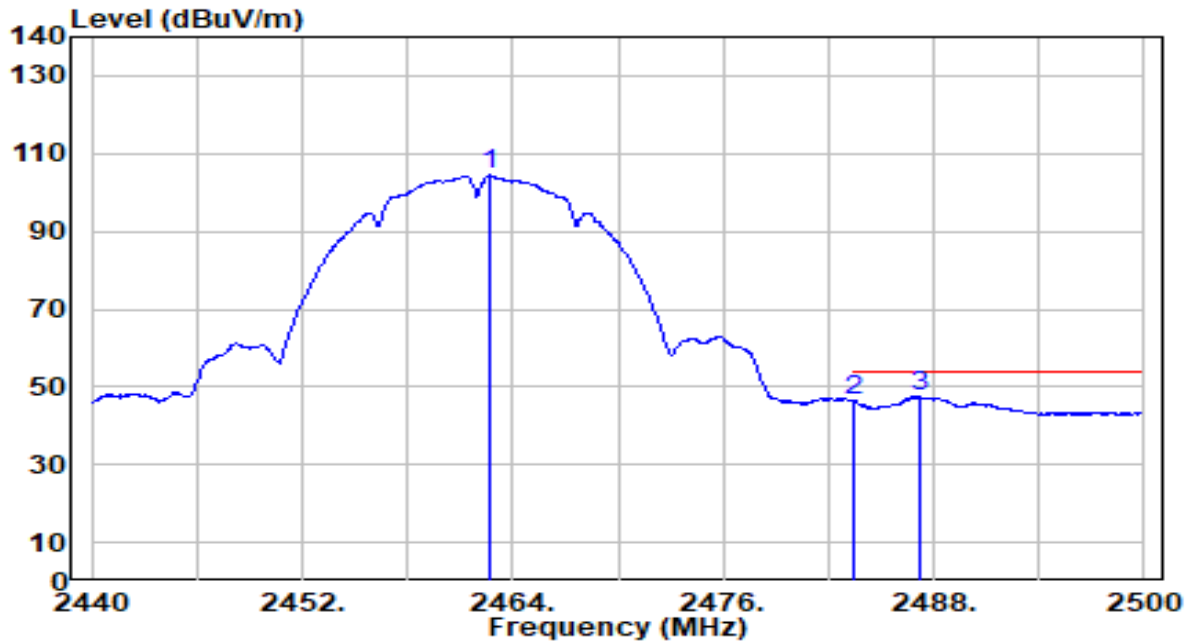

No	Frequency (MHz)	Reading (dBuV)	C.F (dB/m)	Measurement (dBuV/m)	Margin (dB)	Limit (dBuV/m)	Height (cm)	Angle (deg)	Remark (QP/PK/AV)
1	2462.680	74.08	30.29	104.37	N/A	N/A	300	269	Average
2	2483.500	15.91	30.32	46.23	-7.77	54.00	300	269	Average
3	* 2487.160	17.35	30.32	47.68	-6.32	54.00	300	269	Average

Note:

1. " *", means this data is the worst emission level.
2. C.F (Correction Factor) = Antenna Factor (dB/m)+ Cable Loss (dB).
3. Measurement (dBuV/m) = Reading(dBuV) + C.F (Correction Factor).
4. The emission levels of other frequencies are very lower than the limit and not show in test report.

EUT	Smart Wi-Fi Outlet Extender	Date of Test	2023-06-13
Factor	DRH18-E	Temp. / Humidity	21°C /61%
Polarity	Vertical	Site / Test Engineer	AC2 / Marvin
Test Mode	802.11b_TX_CH 11_ANT 0	Test Voltage	By Notebook PC

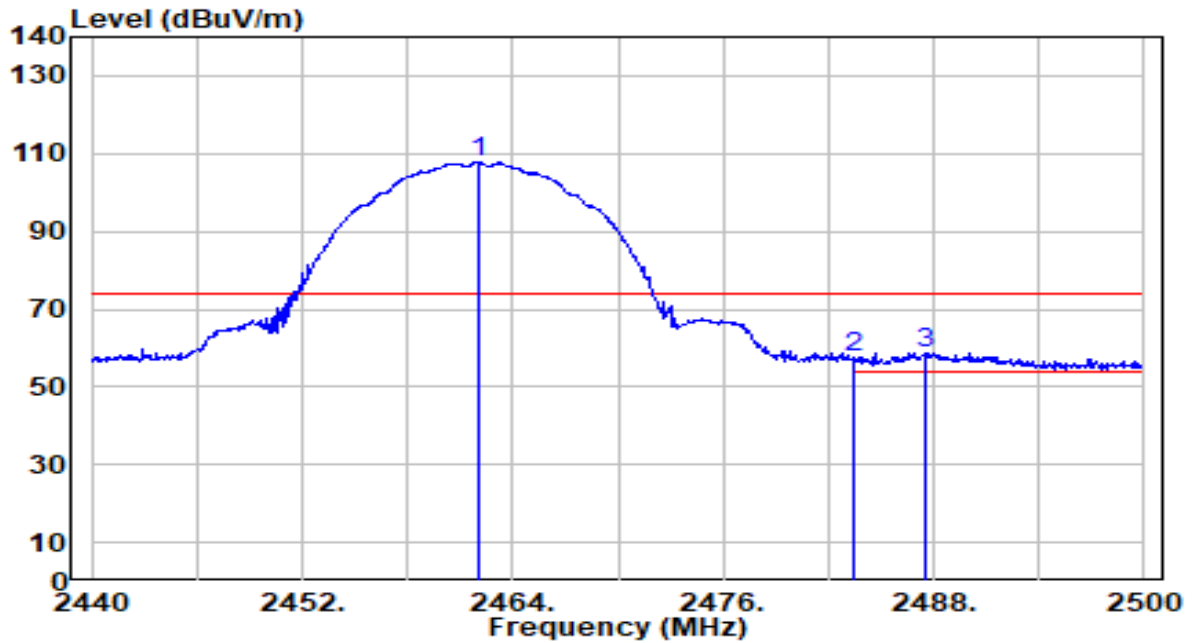

No	Frequency (MHz)	Reading (dBUV)	C.F (dB/m)	Measurement (dBUV/m)	Margin (dB)	Limit (dBUV/m)	Height (cm)	Angle (deg)	Remark (QP/PK/AV)
1	2462.020	77.62	30.29	107.91	N/A	N/A	300	189	Peak
2	2483.500	27.22	30.32	57.54	-16.46	74.00	300	189	Peak
3	* 2487.580	28.38	30.32	58.70	-15.30	74.00	300	189	Peak

Note:

1. " *", means this data is the worst emission level.
2. C.F (Correction Factor) = Antenna Factor (dB/m)+ Cable Loss (dB).
3. Measurement (dBUV/m) = Reading(dBUV) + C.F (Correction Factor).
4. The emission levels of other frequencies are very lower than the limit and not show in test report.

EUT	Smart Wi-Fi Outlet Extender	Date of Test	2023-06-13
Factor	DRH18-E	Temp. / Humidity	21°C /61%
Polarity	Vertical	Site / Test Engineer	AC2 / Marvin
Test Mode	802.11b_TX_CH 11_ANT 0	Test Voltage	By Notebook PC

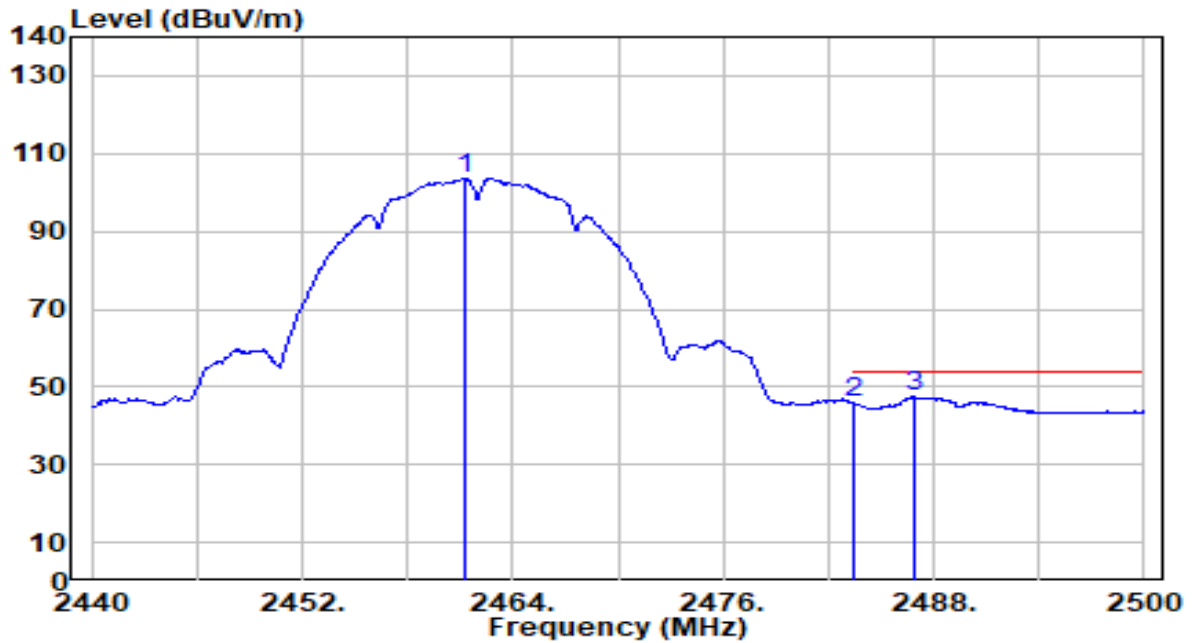

No	Frequency (MHz)	Reading (dBUV)	C.F (dB/m)	Measurement (dBUV/m)	Margin (dB)	Limit (dBUV/m)	Height (cm)	Angle (deg)	Remark (QP/PK/AV)
1	2461.300	73.33	30.29	103.62	N/A	N/A	300	189	Average
2	2483.500	15.47	30.32	45.79	-8.21	54.00	300	189	Average
3	* 2486.860	17.08	30.32	47.40	-6.60	54.00	300	189	Average

Note:

1. " *", means this data is the worst emission level.
2. C.F (Correction Factor) = Antenna Factor (dB/m)+ Cable Loss (dB).
3. Measurement (dBUV/m) = Reading(dBUV) + C.F (Correction Factor).
4. The emission levels of other frequencies are very lower than the limit and not show in test report.

EUT	Smart Wi-Fi Outlet Extender	Date of Test	2023-06-13
Factor	DRH18-E	Temp. / Humidity	21°C /61%
Polarity	Horizontal	Site / Test Engineer	AC2 / Marvin
Test Mode	802.11g_TX_CH 1_ANT 0	Test Voltage	By Notebook PC

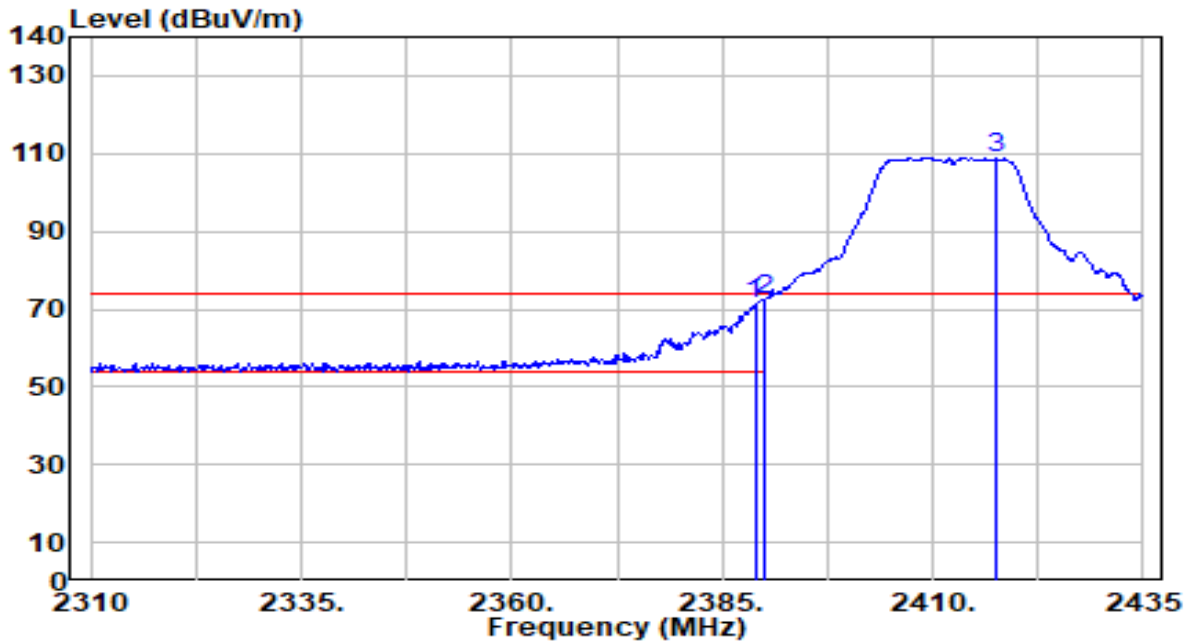

No	Frequency (MHz)	Reading (dBUV)	C.F (dB/m)	Measurement (dBUV/m)	Margin (dB)	Limit (dBUV/m)	Height (cm)	Angle (deg)	Remark (QP/PK/AV)
1	2388.875	41.38	30.18	71.56	-2.44	74.00	310	264	Peak
2	* 2390.000	41.94	30.18	72.12	-1.88	74.00	310	264	Peak
3	2417.625	78.66	30.23	108.89	N/A	N/A	310	264	Peak

Note:

1. " *", means this data is the worst emission level.
2. C.F (Correction Factor) = Antenna Factor (dB/m)+ Cable Loss (dB).
3. Measurement (dBUV/m) = Reading(dBUV) + C.F (Correction Factor).
4. The emission levels of other frequencies are very lower than the limit and not show in test report.

EUT	Smart Wi-Fi Outlet Extender	Date of Test	2023-06-13
Factor	DRH18-E	Temp. / Humidity	21°C /61%
Polarity	Horizontal	Site / Test Engineer	AC2 / Marvin
Test Mode	802.11g_TX_CH 1_ANT 0	Test Voltage	By Notebook PC

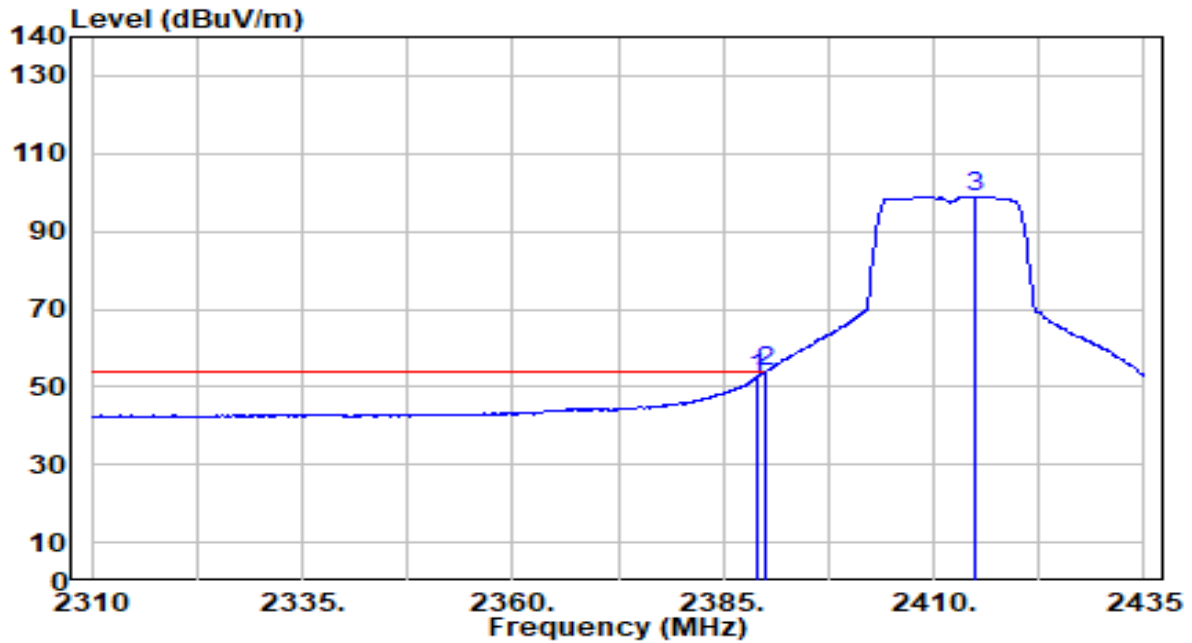

No	Frequency (MHz)	Reading (dBUV)	C.F (dB/m)	Measurement (dBUV/m)	Margin (dB)	Limit (dBUV/m)	Height (cm)	Angle (deg)	Remark (QP/PK/AV)
1	2389.000	22.30	30.18	52.47	-1.53	54.00	310	264	Average
2	* 2390.000	23.69	30.18	53.87	-0.13	54.00	310	264	Average
3	2414.875	68.72	30.23	98.95	N/A	N/A	310	264	Average

Note:

1. " *", means this data is the worst emission level.
2. C.F (Correction Factor) = Antenna Factor (dB/m)+ Cable Loss (dB).
3. Measurement (dBUV/m) = Reading(dBUV) + C.F (Correction Factor).
4. The emission levels of other frequencies are very lower than the limit and not show in test report.

EUT	Smart Wi-Fi Outlet Extender	Date of Test	2023-06-13
Factor	DRH18-E	Temp. / Humidity	21°C /61%
Polarity	Vertical	Site / Test Engineer	AC2 / Marvin
Test Mode	802.11g_TX_CH 1_ANT 0	Test Voltage	By Notebook PC

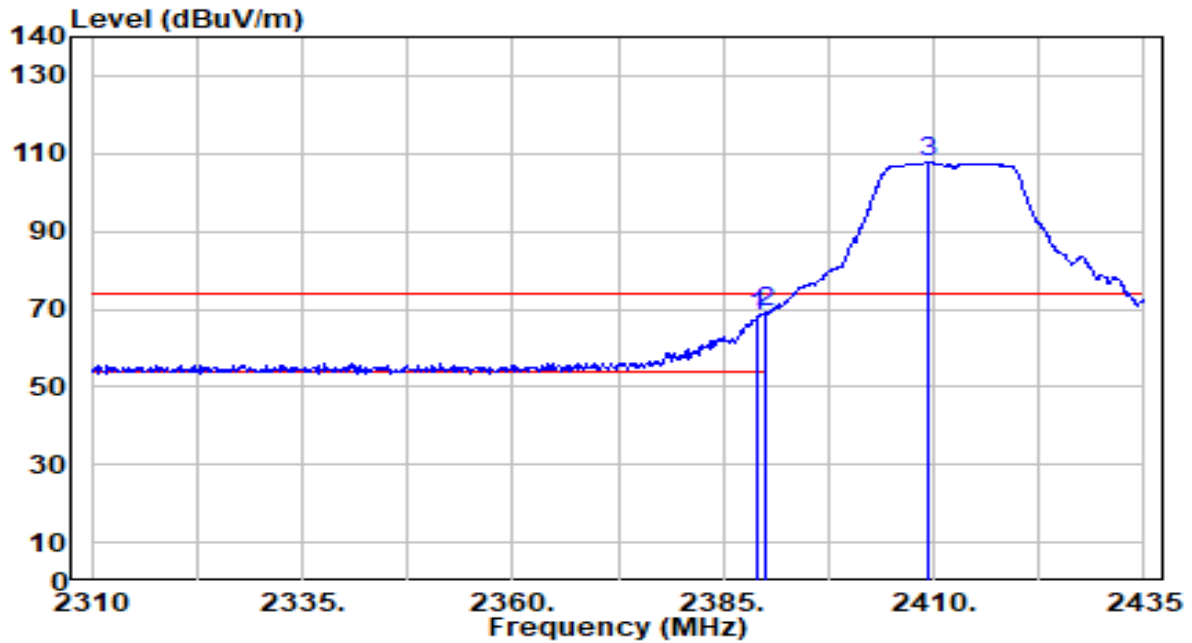

No	Frequency (MHz)	Reading (dBuV)	C.F (dB/m)	Measurement (dBuV/m)	Margin (dB)	Limit (dBuV/m)	Height (cm)	Angle (deg)	Remark (QP/PK/AV)
1	2389.000	37.84	30.18	68.02	-5.98	74.00	315	206	Peak
2	* 2390.000	39.07	30.18	69.25	-4.75	74.00	315	206	Peak
3	2409.375	77.59	30.22	107.82	N/A	N/A	315	206	Peak

Note:

1. " *", means this data is the worst emission level.
2. C.F (Correction Factor) = Antenna Factor (dB/m)+ Cable Loss (dB).
3. Measurement (dBuV/m) = Reading(dBuV) + C.F (Correction Factor).
4. The emission levels of other frequencies are very lower than the limit and not show in test report.

EUT	Smart Wi-Fi Outlet Extender	Date of Test	2023-06-13
Factor	DRH18-E	Temp. / Humidity	21°C /61%
Polarity	Vertical	Site / Test Engineer	AC2 / Marvin
Test Mode	802.11g_TX_CH 1_ANT 0	Test Voltage	By Notebook PC

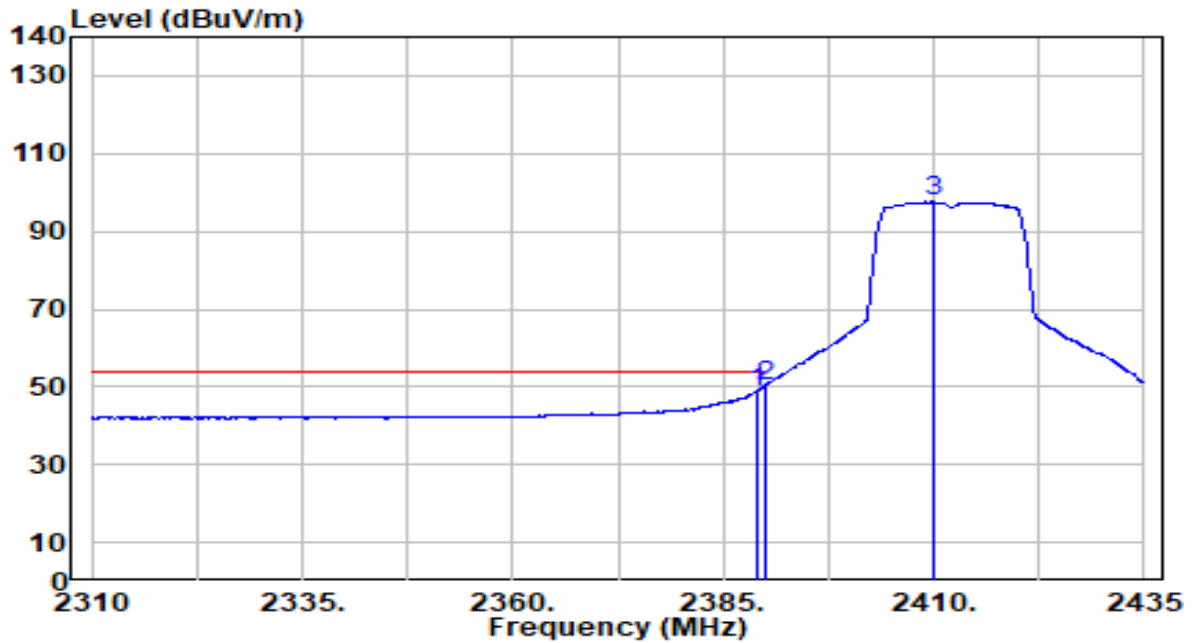

No	Frequency (MHz)	Reading (dBUV)	C.F (dB/m)	Measurement (dBUV/m)	Margin (dB)	Limit (dBUV/m)	Height (cm)	Angle (deg)	Remark (QP/PK/AV)
1	2389.000	18.50	30.18	48.68	-5.32	54.00	314	206	Average
2	* 2390.000	20.17	30.18	50.35	-3.65	54.00	314	206	Average
3	2410.000	67.45	30.22	97.68	N/A	N/A	314	206	Average

Note:

1. " *", means this data is the worst emission level.
2. C.F (Correction Factor) = Antenna Factor (dB/m)+ Cable Loss (dB).
3. Measurement (dBUV/m) = Reading(dBUV) + C.F (Correction Factor).
4. The emission levels of other frequencies are very lower than the limit and not show in test report.

EUT	Smart Wi-Fi Outlet Extender	Date of Test	2023-06-13
Factor	DRH18-E	Temp. / Humidity	21°C /61%
Polarity	Horizontal	Site / Test Engineer	AC2 / Marvin
Test Mode	802.11g_TX_CH 6_ANT 0	Test Voltage	By Notebook PC

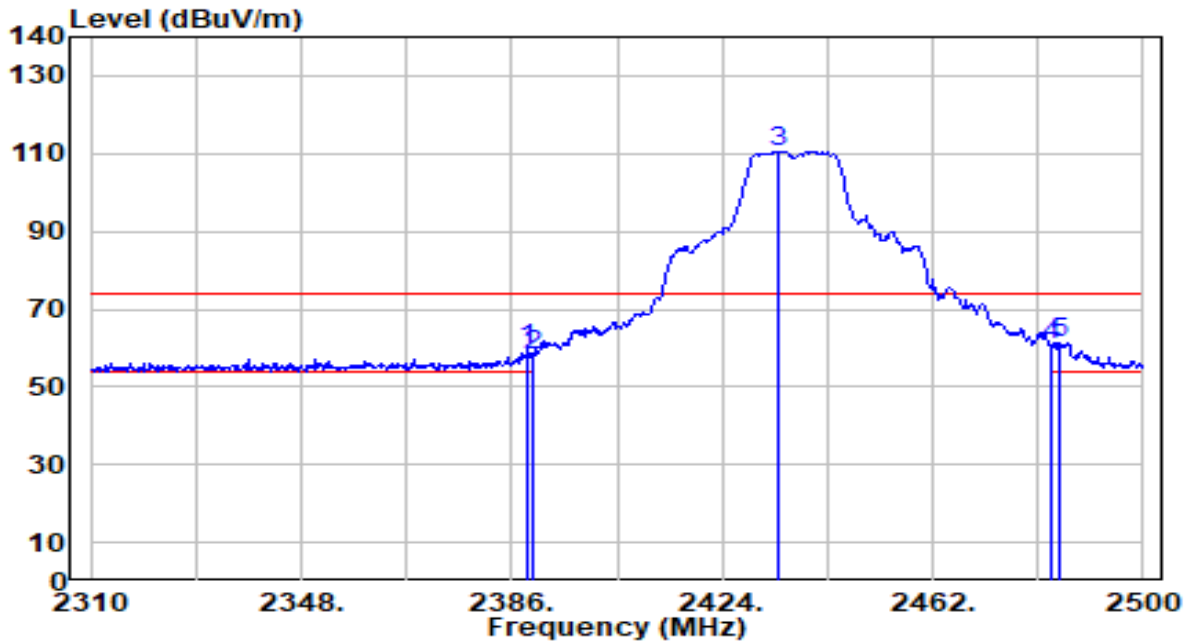

No	Frequency (MHz)	Reading (dBuV)	C.F (dB/m)	Measurement (dBuV/m)	Margin (dB)	Limit (dBuV/m)	Height (cm)	Angle (deg)	Remark (QP/PK/AV)
1	2389.040	29.42	30.18	59.59	-14.41	74.00	301	268	Peak
2	2390.000	28.01	30.18	58.19	-15.81	74.00	301	268	Peak
3	2434.260	80.29	30.25	110.55	N/A	N/A	301	268	Peak
4	2483.500	30.45	30.32	60.77	-13.23	74.00	301	268	Peak
5	* 2484.990	31.14	30.32	61.46	-12.54	74.00	301	268	Peak

Note:

- "*" means this data is the worst emission level.
- C.F (Correction Factor) = Antenna Factor (dB/m)+ Cable Loss (dB).
- Measurement (dBuV/m) = Reading(dBuV) + C.F (Correction Factor).
- The emission levels of other frequencies are very lower than the limit and not show in test report.

EUT	Smart Wi-Fi Outlet Extender	Date of Test	2023-06-13
Factor	DRH18-E	Temp. / Humidity	21°C /61%
Polarity	Horizontal	Site / Test Engineer	AC2 / Marvin
Test Mode	802.11g_TX_CH 6_ANT 0	Test Voltage	By Notebook PC

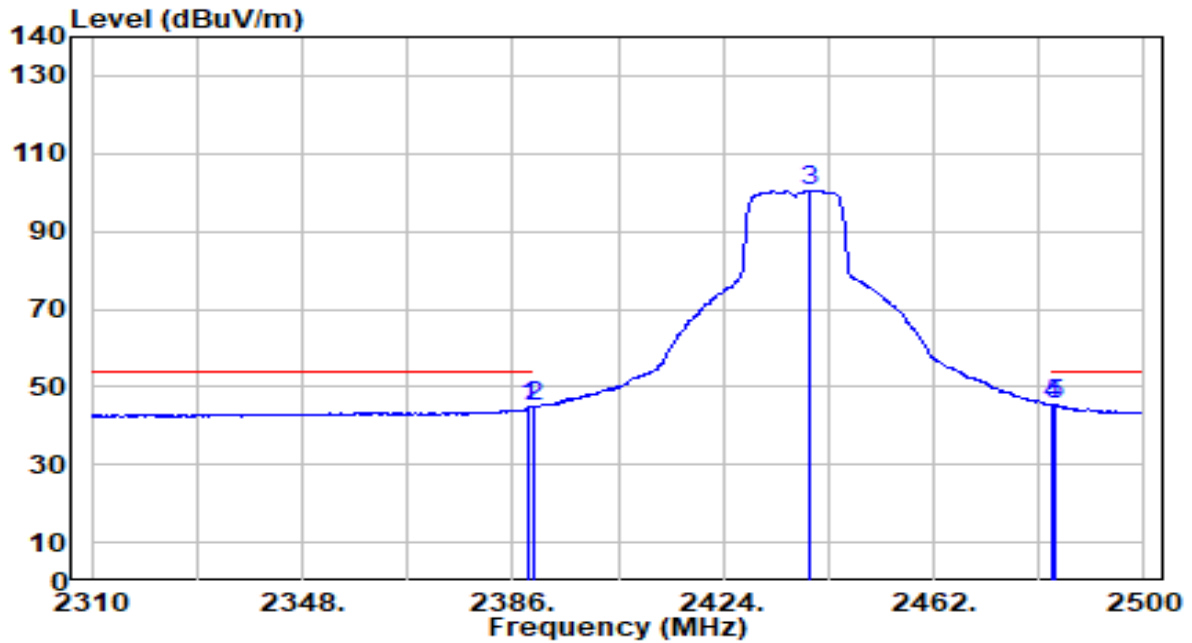

No	Frequency (MHz)	Reading (dBuV)	C.F (dB/m)	Measurement (dBuV/m)	Margin (dB)	Limit (dBuV/m)	Height (cm)	Angle (deg)	Remark (QP/PK/AV)
1	2389.040	14.49	30.18	44.67	-9.33	54.00	301	268	Average
2	2390.000	14.65	30.18	44.83	-9.17	54.00	301	268	Average
3	2439.390	70.13	30.26	100.39	N/A	N/A	301	268	Average
4	2483.500	14.87	30.32	45.19	-8.81	54.00	301	268	Average
5	* 2484.040	14.91	30.32	45.23	-8.77	54.00	301	268	Average

Note:

1. " *", means this data is the worst emission level.
2. C.F (Correction Factor) = Antenna Factor (dB/m)+ Cable Loss (dB).
3. Measurement (dBuV/m) = Reading(dBuV) + C.F (Correction Factor).
4. The emission levels of other frequencies are very lower than the limit and not show in test report.

EUT	Smart Wi-Fi Outlet Extender	Date of Test	2023-06-13
Factor	DRH18-E	Temp. / Humidity	21°C /61%
Polarity	Vertical	Site / Test Engineer	AC2 / Marvin
Test Mode	802.11g_TX_CH 6_ANT 0	Test Voltage	By Notebook PC

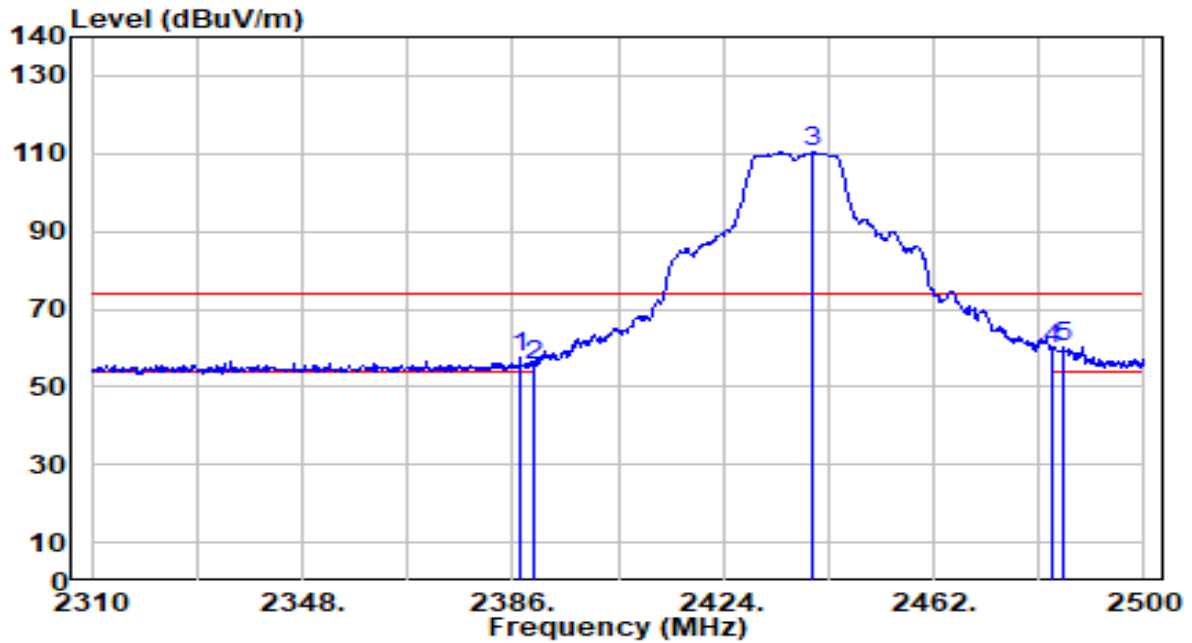

No	Frequency (MHz)	Reading (dBuV)	C.F (dB/m)	Measurement (dBuV/m)	Margin (dB)	Limit (dBuV/m)	Height (cm)	Angle (deg)	Remark (QP/PK/AV)
1	2387.330	27.27	30.17	57.44	-16.56	74.00	305	207	Peak
2	2390.000	25.50	30.18	55.68	-18.32	74.00	305	207	Peak
3	2440.150	79.95	30.26	110.21	N/A	N/A	305	207	Peak
4	2483.500	29.60	30.32	59.92	-14.08	74.00	305	207	Peak
5	* 2485.370	30.09	30.32	60.41	-13.59	74.00	305	207	Peak

Note:

1. " *", means this data is the worst emission level.
2. C.F (Correction Factor) = Antenna Factor (dB/m)+ Cable Loss (dB).
3. Measurement (dBuV/m) = Reading(dBuV) + C.F (Correction Factor).
4. The emission levels of other frequencies are very lower than the limit and not show in test report.

EUT	Smart Wi-Fi Outlet Extender	Date of Test	2023-06-13
Factor	DRH18-E	Temp. / Humidity	21°C /61%
Polarity	Vertical	Site / Test Engineer	AC2 / Marvin
Test Mode	802.11g_TX_CH 6_ANT 0	Test Voltage	By Notebook PC

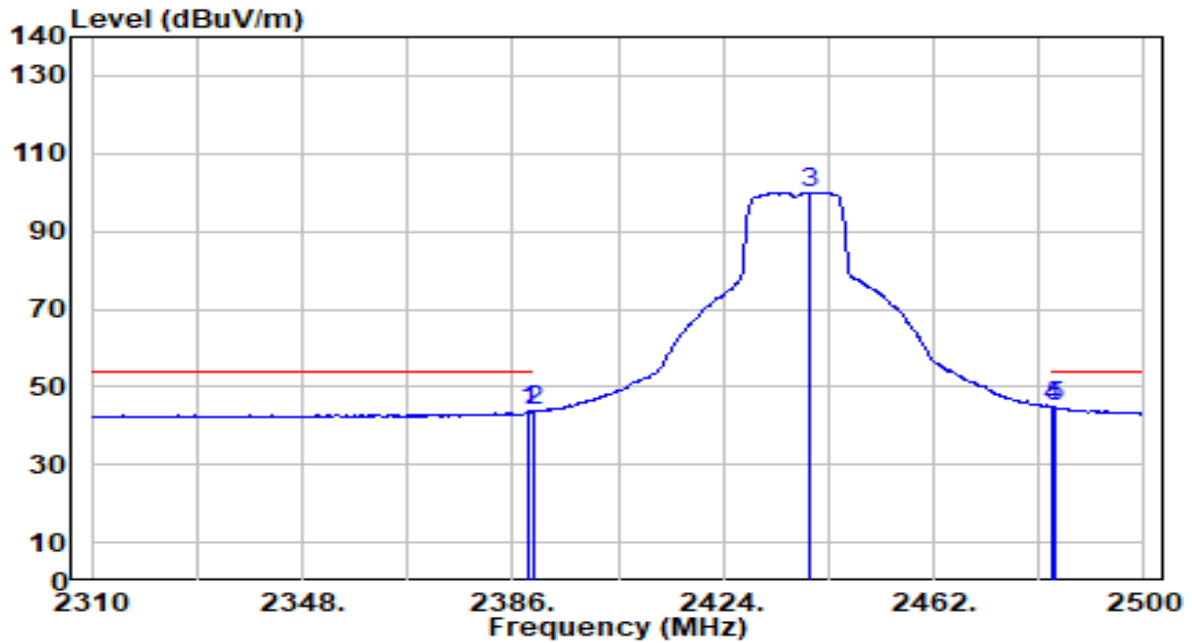

No	Frequency (MHz)	Reading (dBuV)	C.F (dB/m)	Measurement (dBuV/m)	Margin (dB)	Limit (dBuV/m)	Height (cm)	Angle (deg)	Remark (QP/PK/AV)
1	2389.040	13.57	30.18	43.74	-10.26	54.00	305	207	Average
2	2390.000	13.75	30.18	43.93	-10.07	54.00	305	207	Average
3	2439.390	69.84	30.26	100.10	N/A	N/A	305	207	Average
4	* 2483.500	14.55	30.32	44.87	-9.13	54.00	305	207	Average
5	2484.040	14.37	30.32	44.69	-9.31	54.00	305	207	Average

Note:

1. " *", means this data is the worst emission level.
2. C.F (Correction Factor) = Antenna Factor (dB/m)+ Cable Loss (dB).
3. Measurement (dBuV/m) = Reading(dBuV) + C.F (Correction Factor).
4. The emission levels of other frequencies are very lower than the limit and not show in test report.

EUT	Smart Wi-Fi Outlet Extender	Date of Test	2023-06-13
Factor	DRH18-E	Temp. / Humidity	21°C /61%
Polarity	Horizontal	Site / Test Engineer	AC2 / Marvin
Test Mode	802.11g_TX_CH 10_ANT 0	Test Voltage	By Notebook PC

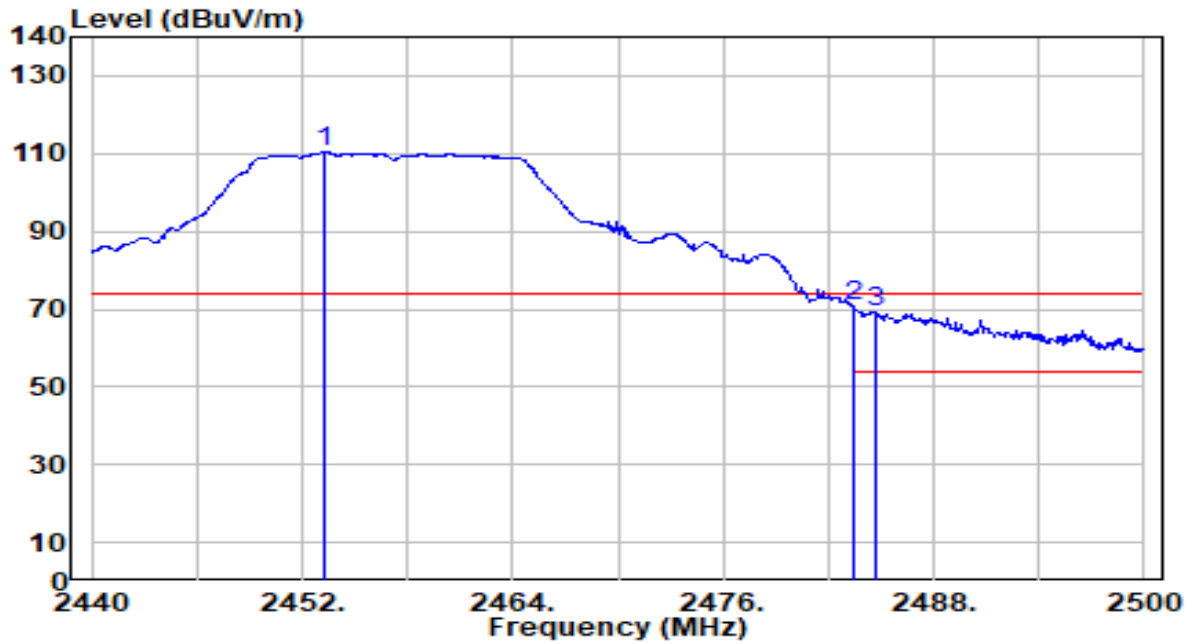

No	Frequency (MHz)	Reading (dBuV)	C.F (dB/m)	Measurement (dBuV/m)	Margin (dB)	Limit (dBuV/m)	Height (cm)	Angle (deg)	Remark (QP/PK/AV)
1	2453.260	79.97	30.28	110.25	N/A	N/A	300	283	Peak
2	* 2483.500	40.39	30.32	70.71	-3.29	74.00	300	283	Peak
3	2484.640	38.85	30.32	69.17	-4.83	74.00	300	283	Peak

Note:

1. " *", means this data is the worst emission level.
2. C.F (Correction Factor) = Antenna Factor (dB/m)+ Cable Loss (dB).
3. Measurement (dBuV/m) = Reading(dBuV) + C.F (Correction Factor).
4. The emission levels of other frequencies are very lower than the limit and not show in test report.

EUT	Smart Wi-Fi Outlet Extender	Date of Test	2023-06-13
Factor	DRH18-E	Temp. / Humidity	21°C /61%
Polarity	Horizontal	Site / Test Engineer	AC2 / Marvin
Test Mode	802.11g_TX_CH 10_ANT 0	Test Voltage	By Notebook PC

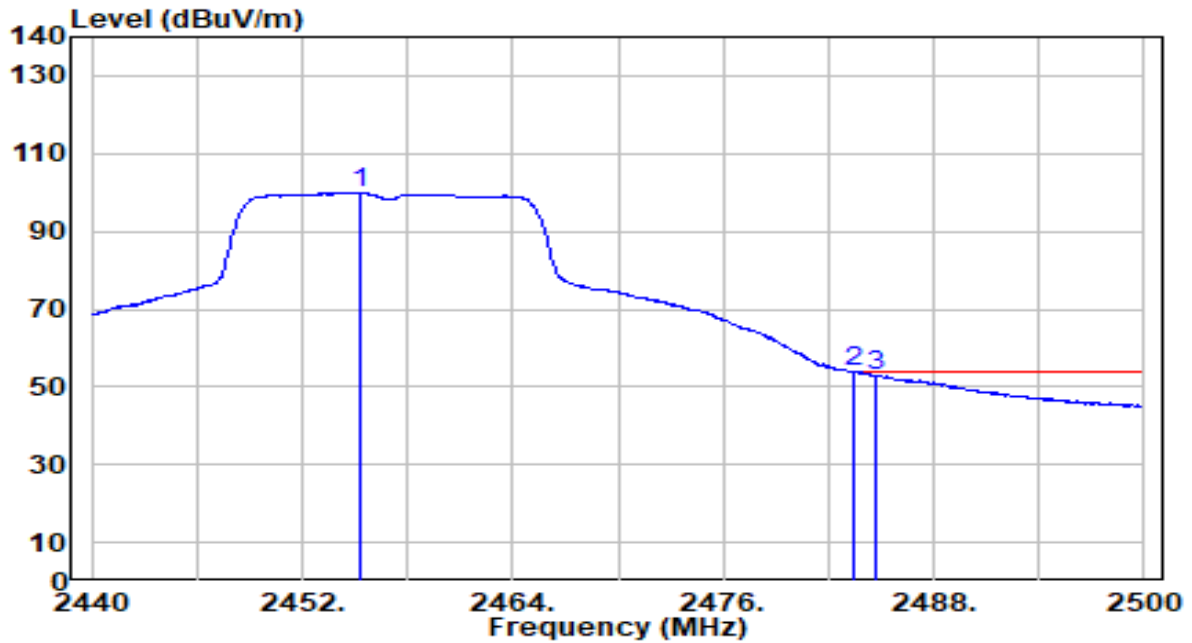

No	Frequency (MHz)	Reading (dBUV)	C.F (dB/m)	Measurement (dBUV/m)	Margin (dB)	Limit (dBUV/m)	Height (cm)	Angle (deg)	Remark (QP/PK/AV)
1	2455.360	69.61	30.28	99.90	N/A	N/A	300	283	Average
2	* 2483.500	23.58	30.32	53.90	-0.10	54.00	300	283	Average
3	2484.700	22.65	30.32	52.97	-1.03	54.00	300	283	Average

Note:

1. " *", means this data is the worst emission level.
2. C.F (Correction Factor) = Antenna Factor (dB/m)+ Cable Loss (dB).
3. Measurement (dBUV/m) = Reading(dBUV) + C.F (Correction Factor).
4. The emission levels of other frequencies are very lower than the limit and not show in test report.

EUT	Smart Wi-Fi Outlet Extender	Date of Test	2023-06-13
Factor	DRH18-E	Temp. / Humidity	21°C /61%
Polarity	Vertical	Site / Test Engineer	AC2 / Marvin
Test Mode	802.11g_TX_CH 10_ANT 0	Test Voltage	By Notebook PC

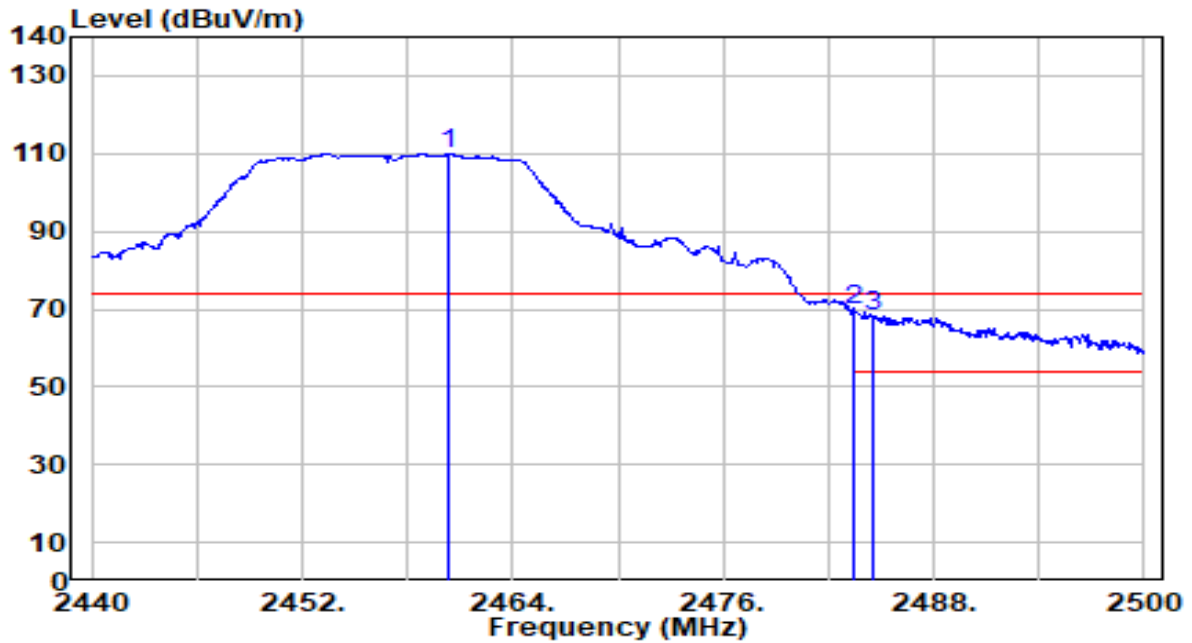

No	Frequency (MHz)	Reading (dBUV)	C.F (dB/m)	Measurement (dBUV/m)	Margin (dB)	Limit (dBUV/m)	Height (cm)	Angle (deg)	Remark (QP/PK/AV)
1	2460.400	79.75	30.29	110.04	N/A	N/A	300	193	Peak
2	* 2483.500	39.57	30.32	69.89	-4.11	74.00	300	193	Peak
3	2484.580	38.01	30.32	68.33	-5.67	74.00	300	193	Peak

Note:

1. " *", means this data is the worst emission level.
2. C.F (Correction Factor) = Antenna Factor (dB/m)+ Cable Loss (dB).
3. Measurement (dBUV/m) = Reading(dBUV) + C.F (Correction Factor).
4. The emission levels of other frequencies are very lower than the limit and not show in test report.

EUT	Smart Wi-Fi Outlet Extender	Date of Test	2023-06-13
Factor	DRH18-E	Temp. / Humidity	21°C /61%
Polarity	Vertical	Site / Test Engineer	AC2 / Marvin
Test Mode	802.11g_TX_CH 10_ANT 0	Test Voltage	By Notebook PC

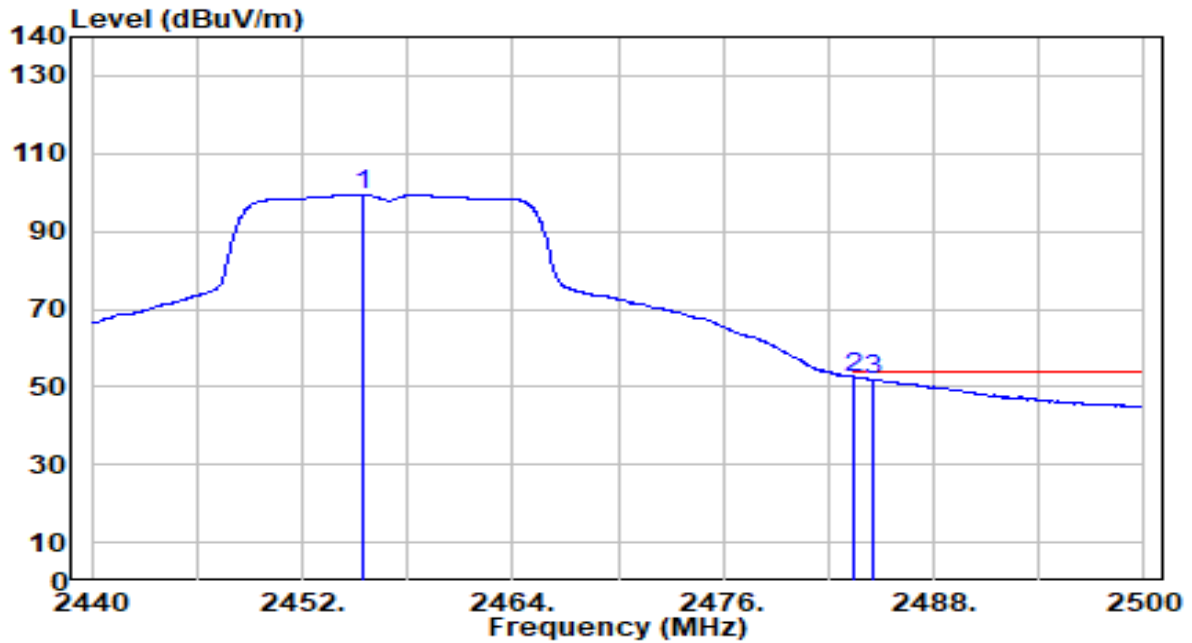

No	Frequency (MHz)	Reading (dBUV)	C.F (dB/m)	Measurement (dBUV/m)	Margin (dB)	Limit (dBUV/m)	Height (cm)	Angle (deg)	Remark (QP/PK/AV)
1	2455.480	69.15	30.28	99.43	N/A	N/A	300	193	Average
2	* 2483.500	22.07	30.32	52.39	-1.61	54.00	300	193	Average
3	2484.520	21.53	30.32	51.85	-2.15	54.00	300	193	Average

Note:

1. " *", means this data is the worst emission level.
2. C.F (Correction Factor) = Antenna Factor (dB/m)+ Cable Loss (dB).
3. Measurement (dBUV/m) = Reading(dBUV) + C.F (Correction Factor).
4. The emission levels of other frequencies are very lower than the limit and not show in test report.

EUT	Smart Wi-Fi Outlet Extender	Date of Test	2023-06-13
Factor	DRH18-E	Temp. / Humidity	21°C /61%
Polarity	Horizontal	Site / Test Engineer	AC2 / Marvin
Test Mode	802.11g_TX_CH 11_ANT 0	Test Voltage	By Notebook PC

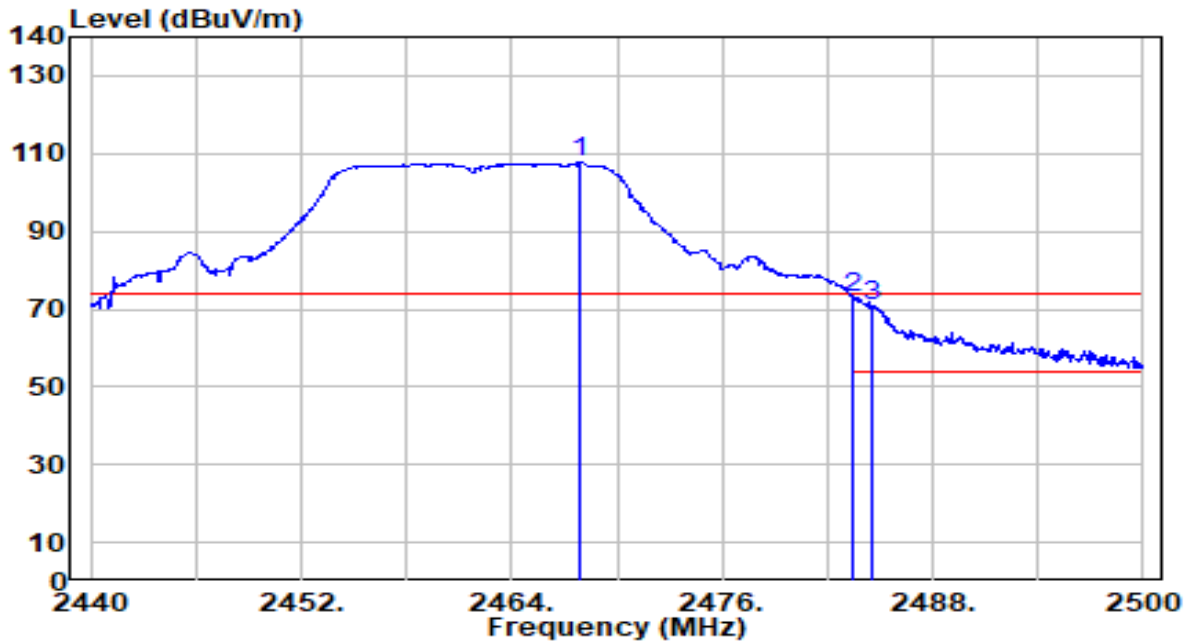

No	Frequency (MHz)	Reading (dBuV)	C.F (dB/m)	Measurement (dBuV/m)	Margin (dB)	Limit (dBuV/m)	Height (cm)	Angle (deg)	Remark (QP/PK/AV)
1	2467.840	77.41	30.30	107.71	N/A	N/A	300	270	Peak
2	* 2483.500	42.75	30.32	73.07	-0.93	74.00	300	270	Peak
3	2484.580	40.40	30.32	70.72	-3.28	74.00	300	270	Peak

Note:

1. " *", means this data is the worst emission level.
2. C.F (Correction Factor) = Antenna Factor (dB/m)+ Cable Loss (dB).
3. Measurement (dBuV/m) = Reading(dBuV) + C.F (Correction Factor).
4. The emission levels of other frequencies are very lower than the limit and not show in test report.

EUT	Smart Wi-Fi Outlet Extender	Date of Test	2023-06-13
Factor	DRH18-E	Temp. / Humidity	21°C /61%
Polarity	Horizontal	Site / Test Engineer	AC2 / Marvin
Test Mode	802.11g_TX_CH 11_ANT 0	Test Voltage	By Notebook PC

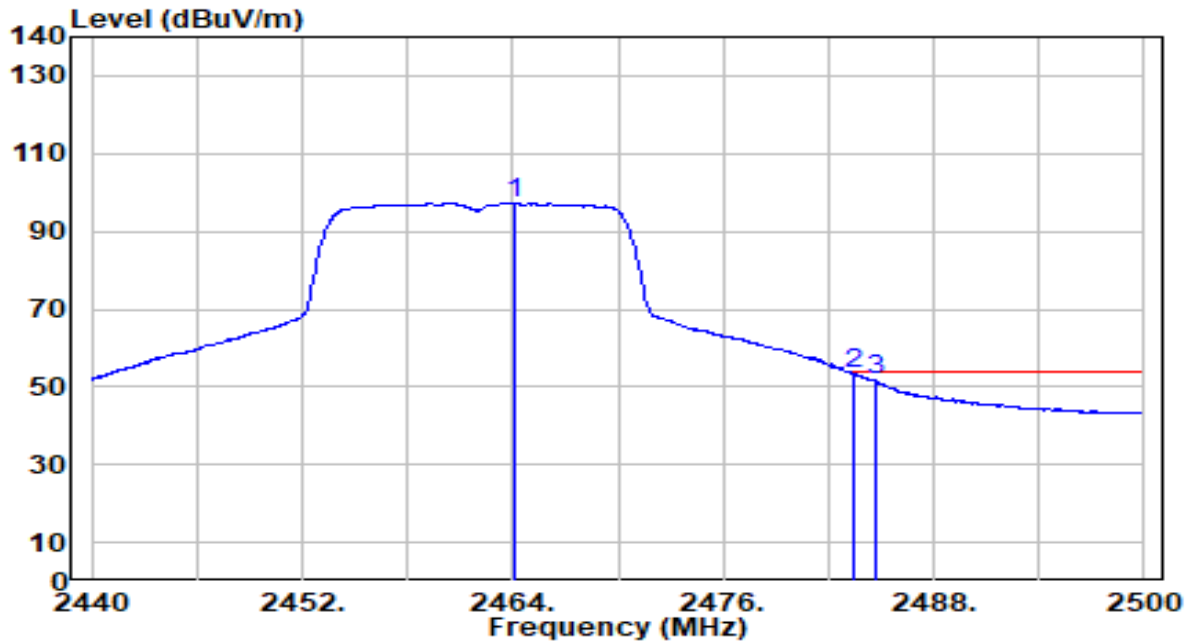

No	Frequency (MHz)	Reading (dBuV)	C.F (dB/m)	Measurement (dBuV/m)	Margin (dB)	Limit (dBuV/m)	Height (cm)	Angle (deg)	Remark (QP/PK/AV)
1	2464.060	66.95	30.29	97.24	N/A	N/A	300	270	Average
2	* 2483.500	22.90	30.32	53.22	-0.78	54.00	300	270	Average
3	2484.640	21.30	30.32	51.62	-2.38	54.00	300	270	Average

Note:

1. " *", means this data is the worst emission level.
2. C.F (Correction Factor) = Antenna Factor (dB/m)+ Cable Loss (dB).
3. Measurement (dBuV/m) = Reading(dBuV) + C.F (Correction Factor).
4. The emission levels of other frequencies are very lower than the limit and not show in test report.

EUT	Smart Wi-Fi Outlet Extender	Date of Test	2023-06-13
Factor	DRH18-E	Temp. / Humidity	21°C /61%
Polarity	Vertical	Site / Test Engineer	AC2 / Marvin
Test Mode	802.11g_TX_CH 11_ANT 0	Test Voltage	By Notebook PC

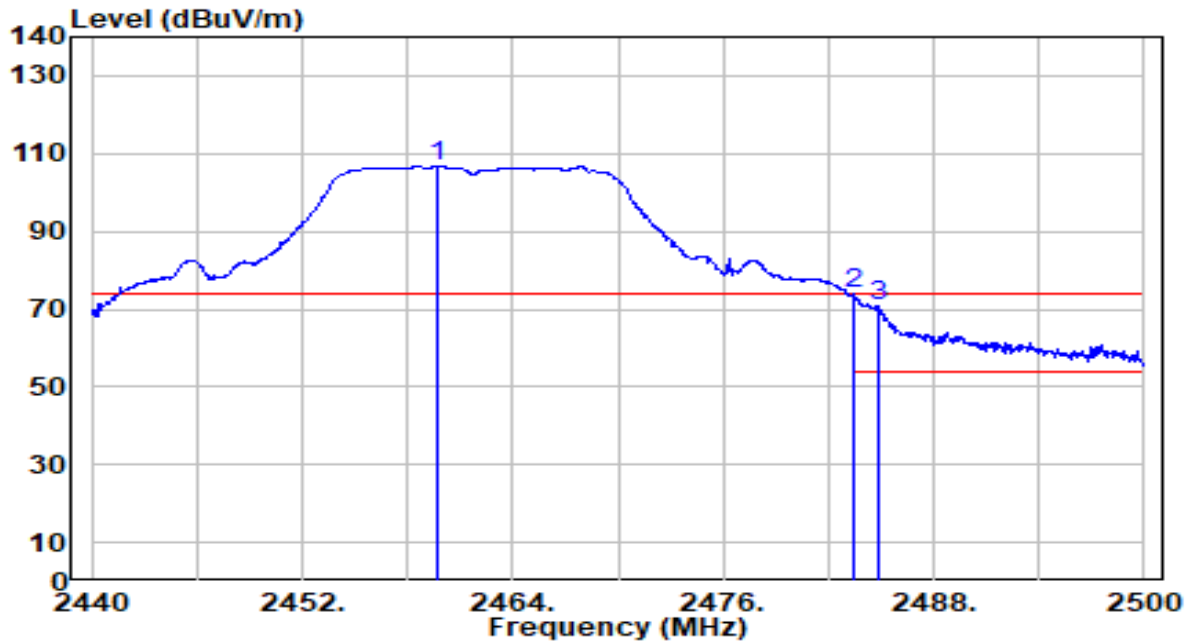

No	Frequency (MHz)	Reading (dBuV)	C.F (dB/m)	Measurement (dBuV/m)	Margin (dB)	Limit (dBuV/m)	Height (cm)	Angle (deg)	Remark (QP/PK/AV)
1	2459.740	76.31	30.29	106.60	N/A	N/A	300	188	Peak
2	* 2483.500	43.42	30.32	73.74	-0.26	74.00	300	188	Peak
3	2484.880	40.42	30.32	70.74	-3.26	74.00	300	188	Peak

Note:

1. " *", means this data is the worst emission level.
2. C.F (Correction Factor) = Antenna Factor (dB/m)+ Cable Loss (dB).
3. Measurement (dBuV/m) = Reading(dBuV) + C.F (Correction Factor).
4. The emission levels of other frequencies are very lower than the limit and not show in test report.

EUT	Smart Wi-Fi Outlet Extender	Date of Test	2023-06-13
Factor	DRH18-E	Temp. / Humidity	21°C /61%
Polarity	Vertical	Site / Test Engineer	AC2 / Marvin
Test Mode	802.11g_TX_CH 11_ANT 0	Test Voltage	By Notebook PC

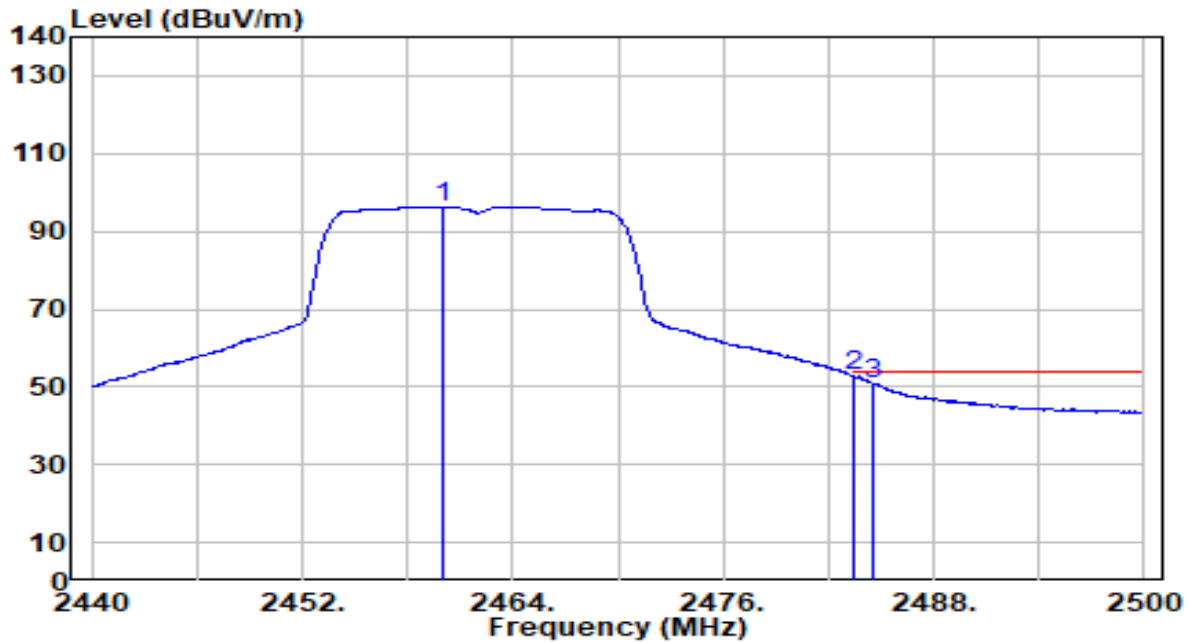

No	Frequency (MHz)	Reading (dBuV)	C.F (dB/m)	Measurement (dBuV/m)	Margin (dB)	Limit (dBuV/m)	Height (cm)	Angle (deg)	Remark (QP/PK/AV)
1	2459.980	66.06	30.29	96.35	N/A	N/A	300	188	Average
2	* 2483.500	22.39	30.32	52.71	-1.29	54.00	300	188	Average
3	2484.520	20.64	30.32	50.96	-3.04	54.00	300	188	Average

Note:

1. " *", means this data is the worst emission level.
2. C.F (Correction Factor) = Antenna Factor (dB/m)+ Cable Loss (dB).
3. Measurement (dBuV/m) = Reading(dBuV) + C.F (Correction Factor).
4. The emission levels of other frequencies are very lower than the limit and not show in test report.

EUT	Smart Wi-Fi Outlet Extender	Date of Test	2023-06-13
Factor	DRH18-E	Temp. / Humidity	21°C /61%
Polarity	Horizontal	Site / Test Engineer	AC2 / Marvin
Test Mode	802.11n-20MHz_TX_CH 1_ANT 0	Test Voltage	By Notebook PC

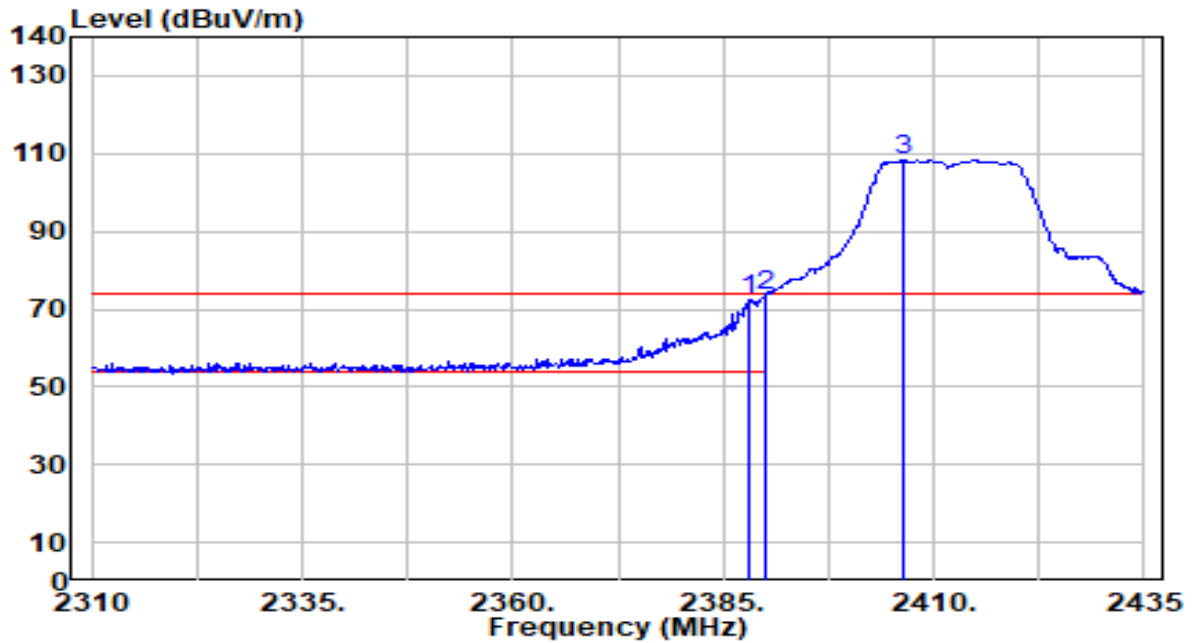

No	Frequency (MHz)	Reading (dBuV)	C.F (dB/m)	Measurement (dBuV/m)	Margin (dB)	Limit (dBuV/m)	Height (cm)	Angle (deg)	Remark (QP/PK/AV)
1	2388.125	42.29	30.17	72.47	-1.53	74.00	311	265	Peak
2	* 2390.000	43.25	30.18	73.43	-0.57	74.00	311	265	Peak
3	2406.250	78.13	30.22	108.35	N/A	N/A	311	265	Peak

Note:

1. " *", means this data is the worst emission level.
2. C.F (Correction Factor) = Antenna Factor (dB/m)+ Cable Loss (dB).
3. Measurement (dBuV/m) = Reading(dBuV) + C.F (Correction Factor).
4. The emission levels of other frequencies are very lower than the limit and not show in test report.

EUT	Smart Wi-Fi Outlet Extender	Date of Test	2023-06-13
Factor	DRH18-E	Temp. / Humidity	21°C /61%
Polarity	Horizontal	Site / Test Engineer	AC2 / Marvin
Test Mode	802.11n-20MHz_TX_CH 1_ANT 0	Test Voltage	By Notebook PC

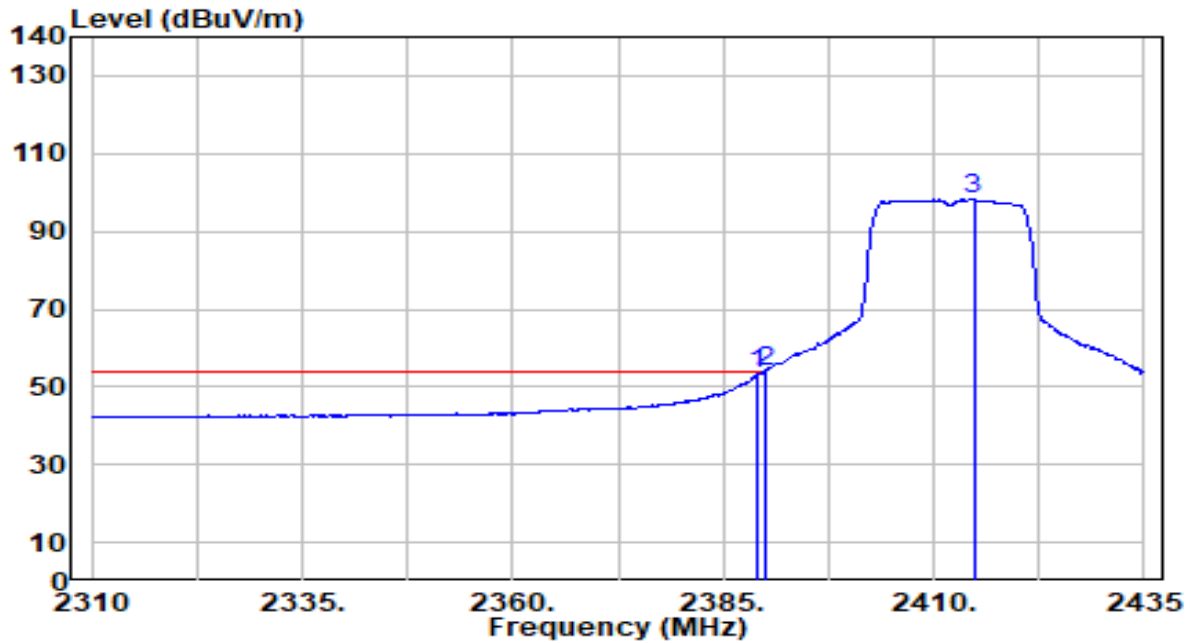

No	Frequency (MHz)	Reading (dBuV)	C.F (dB/m)	Measurement (dBuV/m)	Margin (dB)	Limit (dBuV/m)	Height (cm)	Angle (deg)	Remark (QP/PK/AV)
1	2389.000	23.04	30.18	53.21	-0.79	54.00	311	265	Average
2	* 2390.000	23.69	30.18	53.87	-0.13	54.00	311	265	Average
3	2414.750	67.95	30.23	98.18	N/A	N/A	311	265	Average

Note:

1. " *", means this data is the worst emission level.
2. C.F (Correction Factor) = Antenna Factor (dB/m)+ Cable Loss (dB).
3. Measurement (dBuV/m) = Reading(dBuV) + C.F (Correction Factor).
4. The emission levels of other frequencies are very lower than the limit and not show in test report.

EUT	Smart Wi-Fi Outlet Extender	Date of Test	2023-06-13
Factor	DRH18-E	Temp. / Humidity	21°C /61%
Polarity	Vertical	Site / Test Engineer	AC2 / Marvin
Test Mode	802.11n-20MHz_TX_CH 1_ANT 0	Test Voltage	By Notebook PC

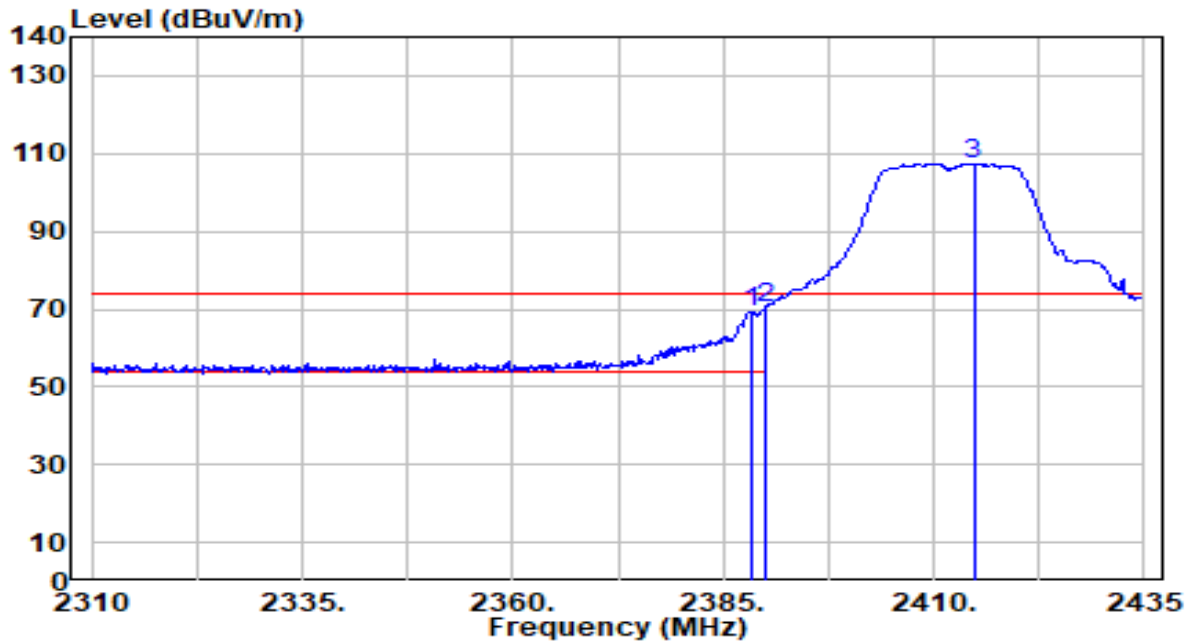

No	Frequency (MHz)	Reading (dBuV)	C.F (dB/m)	Measurement (dBuV/m)	Margin (dB)	Limit (dBuV/m)	Height (cm)	Angle (deg)	Remark (QP/PK/AV)
1	2388.375	39.17	30.18	69.34	-4.66	74.00	317	206	Peak
2	* 2390.000	40.21	30.18	70.39	-3.61	74.00	317	206	Peak
3	2414.750	77.17	30.23	107.40	N/A	N/A	317	206	Peak

Note:

1. " *", means this data is the worst emission level.
2. C.F (Correction Factor) = Antenna Factor (dB/m)+ Cable Loss (dB).
3. Measurement (dBuV/m) = Reading(dBuV) + C.F (Correction Factor).
4. The emission levels of other frequencies are very lower than the limit and not show in test report.

EUT	Smart Wi-Fi Outlet Extender	Date of Test	2023-06-13
Factor	DRH18-E	Temp. / Humidity	21°C /61%
Polarity	Vertical	Site / Test Engineer	AC2 / Marvin
Test Mode	802.11n-20MHz_TX_CH 1_ANT 0	Test Voltage	By Notebook PC

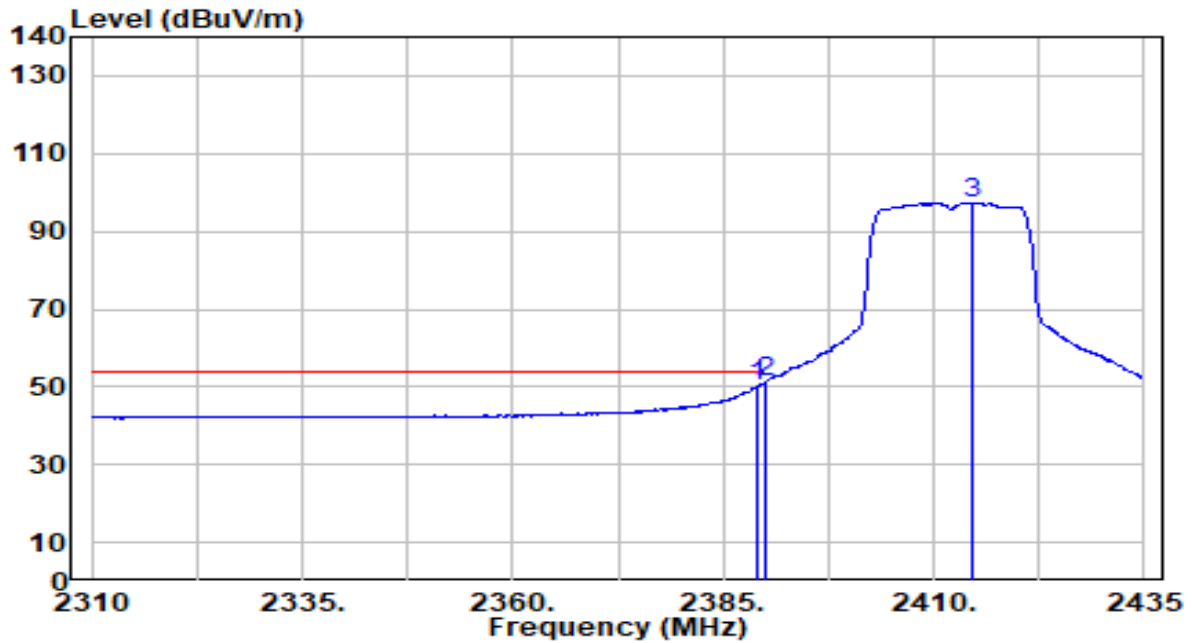

No	Frequency (MHz)	Reading (dBuV)	C.F (dB/m)	Measurement (dBuV/m)	Margin (dB)	Limit (dBuV/m)	Height (cm)	Angle (deg)	Remark (QP/PK/AV)
1	2389.000	19.94	30.18	50.11	-3.89	54.00	317	206	Average
2	* 2390.000	21.07	30.18	51.25	-2.75	54.00	317	206	Average
3	2414.500	67.09	30.23	97.32	N/A	N/A	317	206	Average

Note:

1. " *", means this data is the worst emission level.
2. C.F (Correction Factor) = Antenna Factor (dB/m)+ Cable Loss (dB).
3. Measurement (dBuV/m) = Reading(dBuV) + C.F (Correction Factor).
4. The emission levels of other frequencies are very lower than the limit and not show in test report.

EUT	Smart Wi-Fi Outlet Extender	Date of Test	2023-06-13
Factor	DRH18-E	Temp. / Humidity	21°C /61%
Polarity	Horizontal	Site / Test Engineer	AC2 / Marvin
Test Mode	802.11n-20MHz_TX_CH 6_ANT 0	Test Voltage	By Notebook PC

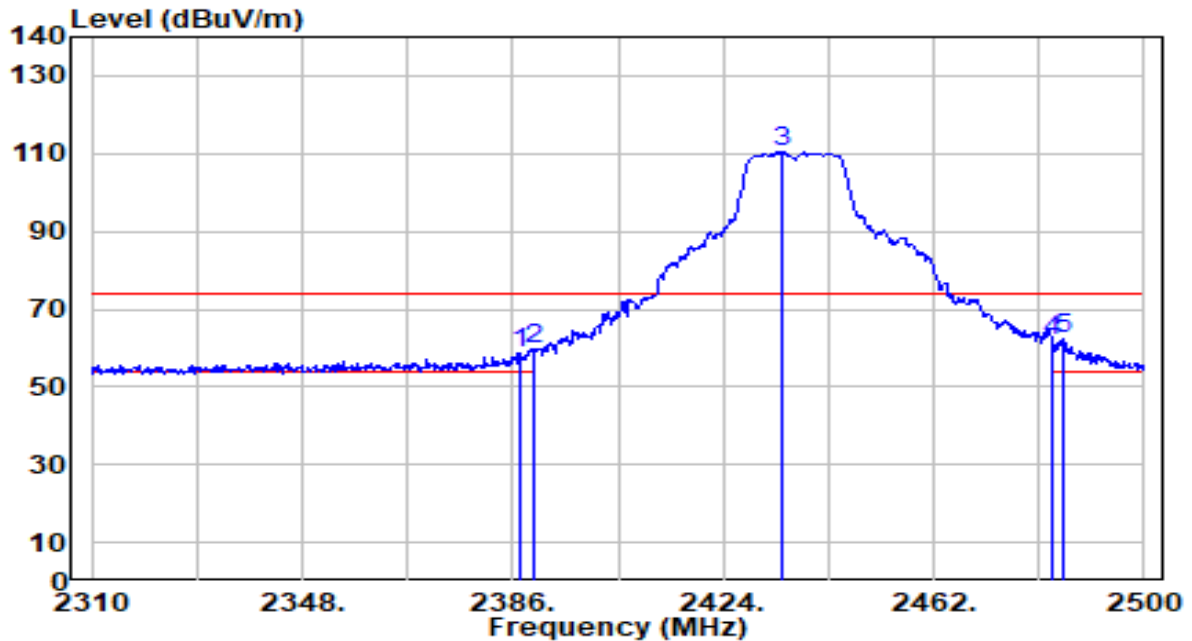

No	Frequency (MHz)	Reading (dBuV)	C.F (dB/m)	Measurement (dBuV/m)	Margin (dB)	Limit (dBuV/m)	Height (cm)	Angle (deg)	Remark (QP/PK/AV)
1	2387.520	28.43	30.17	58.60	-15.40	74.00	300	267	Peak
2	2390.000	29.29	30.18	59.47	-14.53	74.00	300	267	Peak
3	2434.830	80.25	30.25	110.50	N/A	N/A	300	267	Peak
4	2483.500	31.69	30.32	62.01	-11.99	74.00	300	267	Peak
5	* 2485.560	32.03	30.32	62.35	-11.65	74.00	300	267	Peak

Note:

1. " *", means this data is the worst emission level.
2. C.F (Correction Factor) = Antenna Factor (dB/m)+ Cable Loss (dB).
3. Measurement (dBuV/m) = Reading(dBuV) + C.F (Correction Factor).
4. The emission levels of other frequencies are very lower than the limit and not show in test report.

EUT	Smart Wi-Fi Outlet Extender	Date of Test	2023-06-13
Factor	DRH18-E	Temp. / Humidity	21°C /61%
Polarity	Horizontal	Site / Test Engineer	AC2 / Marvin
Test Mode	802.11n-20MHz_TX_CH 6_ANT 0	Test Voltage	By Notebook PC

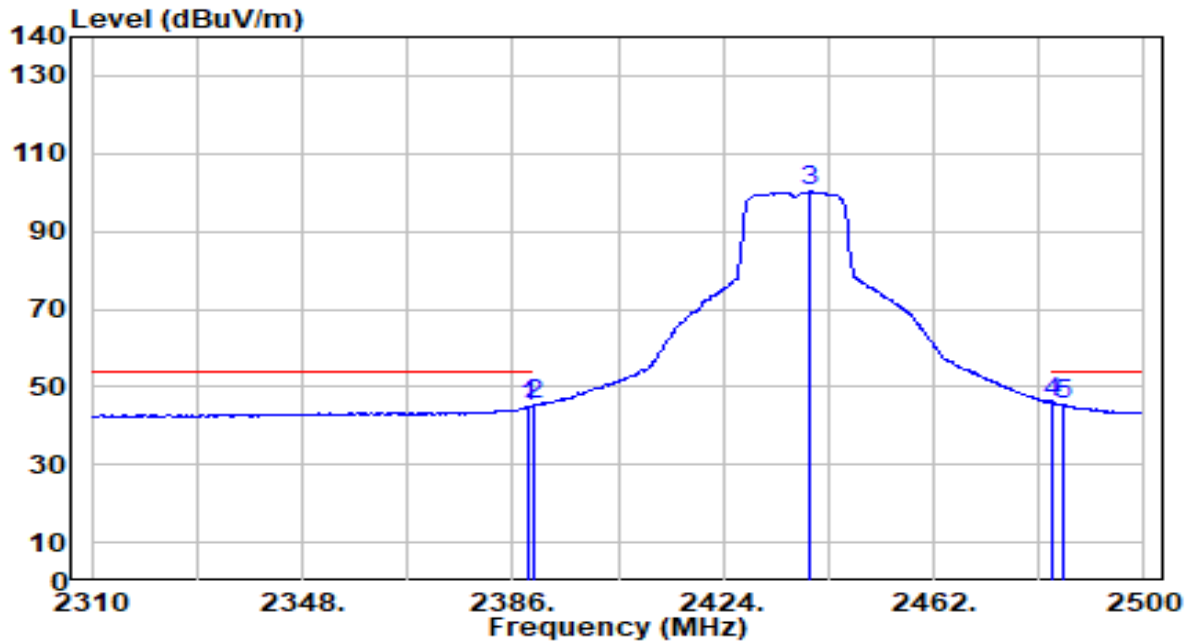

No	Frequency (MHz)	Reading (dBuV)	C.F (dB/m)	Measurement (dBuV/m)	Margin (dB)	Limit (dBuV/m)	Height (cm)	Angle (deg)	Remark (QP/PK/AV)
1	2388.850	14.91	30.18	45.09	-8.91	54.00	300	267	Average
2	2390.000	15.13	30.18	45.31	-8.69	54.00	300	267	Average
3	2439.580	70.02	30.26	100.28	N/A	N/A	300	267	Average
4	* 2483.500	15.67	30.32	45.99	-8.01	54.00	300	267	Average
5	2485.560	15.35	30.32	45.67	-8.33	54.00	300	267	Average

Note:

1. " *", means this data is the worst emission level.
2. C.F (Correction Factor) = Antenna Factor (dB/m)+ Cable Loss (dB).
3. Measurement (dBuV/m) = Reading(dBuV) + C.F (Correction Factor).
4. The emission levels of other frequencies are very lower than the limit and not show in test report.

EUT	Smart Wi-Fi Outlet Extender	Date of Test	2023-06-13
Factor	DRH18-E	Temp. / Humidity	21°C /61%
Polarity	Vertical	Site / Test Engineer	AC2 / Marvin
Test Mode	802.11n-20MHz_TX_CH 6_ANT 0	Test Voltage	By Notebook PC

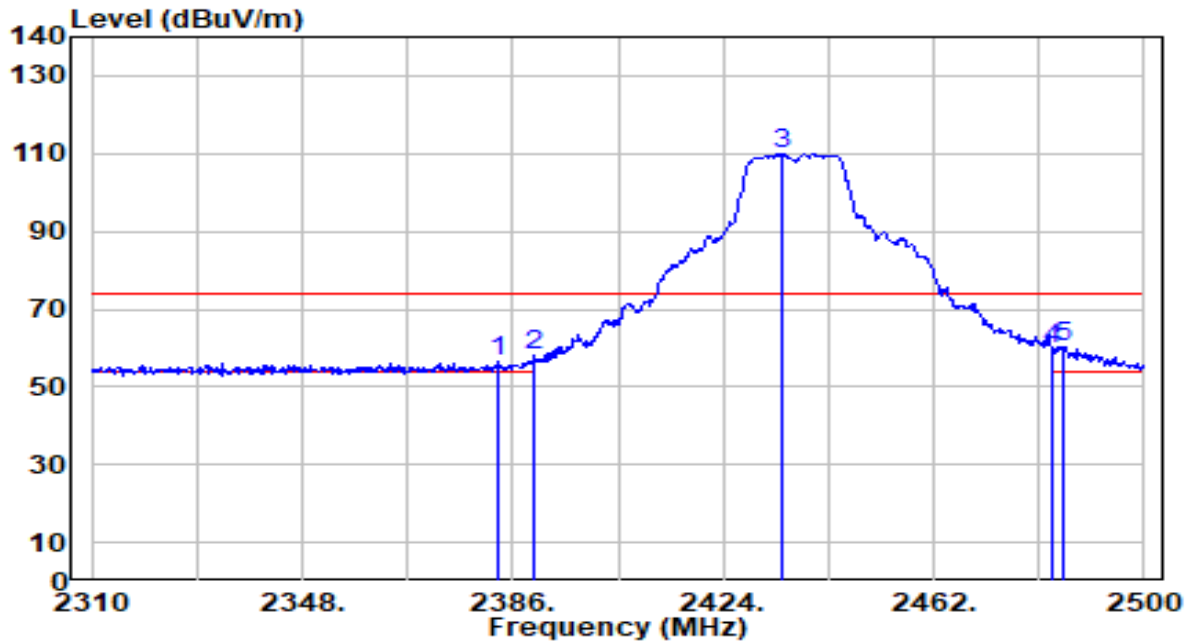

No	Frequency (MHz)	Reading (dBuV)	C.F (dB/m)	Measurement (dBuV/m)	Margin (dB)	Limit (dBuV/m)	Height (cm)	Angle (deg)	Remark (QP/PK/AV)
1	2383.340	26.54	30.16	56.70	-17.30	74.00	305	206	Peak
2	2390.000	28.18	30.18	58.36	-15.64	74.00	305	206	Peak
3	2434.830	79.75	30.25	110.00	N/A	N/A	305	206	Peak
4	2483.500	29.49	30.32	59.81	-14.19	74.00	305	206	Peak
5	* 2485.370	30.16	30.32	60.48	-13.52	74.00	305	206	Peak

Note:

1. " *", means this data is the worst emission level.
2. C.F (Correction Factor) = Antenna Factor (dB/m)+ Cable Loss (dB).
3. Measurement (dBuV/m) = Reading(dBuV) + C.F (Correction Factor).
4. The emission levels of other frequencies are very lower than the limit and not show in test report.

EUT	Smart Wi-Fi Outlet Extender	Date of Test	2023-06-13
Factor	DRH18-E	Temp. / Humidity	21°C /61%
Polarity	Vertical	Site / Test Engineer	AC2 / Marvin
Test Mode	802.11n-20MHz_TX_CH 6_ANT 0	Test Voltage	By Notebook PC

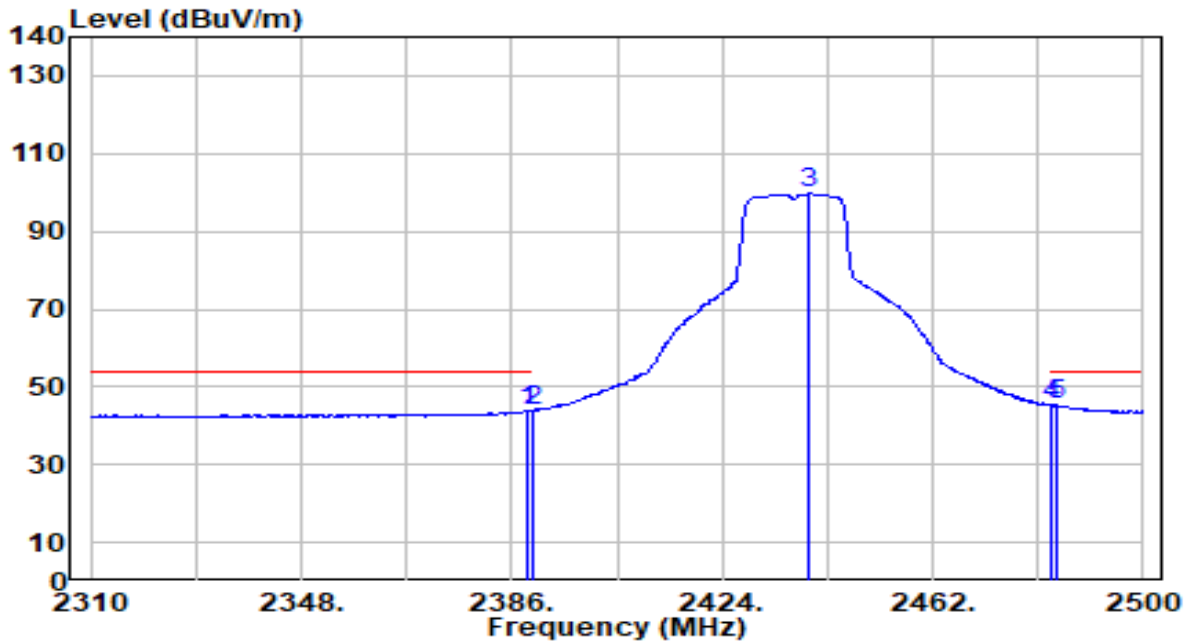

No	Frequency (MHz)	Reading (dBuV)	C.F (dB/m)	Measurement (dBuV/m)	Margin (dB)	Limit (dBuV/m)	Height (cm)	Angle (deg)	Remark (QP/PK/AV)
1	2389.040	13.81	30.18	43.99	-10.01	54.00	305	206	Average
2	2390.000	13.78	30.18	43.96	-10.04	54.00	305	206	Average
3	2439.770	69.60	30.26	99.86	N/A	N/A	305	206	Average
4	* 2483.500	15.31	30.32	45.63	-8.37	54.00	305	206	Average
5	2484.420	14.96	30.32	45.28	-8.72	54.00	305	206	Average

Note:

1. " *", means this data is the worst emission level.
2. C.F (Correction Factor) = Antenna Factor (dB/m)+ Cable Loss (dB).
3. Measurement (dBuV/m) = Reading(dBuV) + C.F (Correction Factor).
4. The emission levels of other frequencies are very lower than the limit and not show in test report.

EUT	Smart Wi-Fi Outlet Extender	Date of Test	2023-06-13
Factor	DRH18-E	Temp. / Humidity	21°C /61%
Polarity	Horizontal	Site / Test Engineer	AC2 / Marvin
Test Mode	802.11n-20MHz_TX_CH 10_ANT 0	Test Voltage	By Notebook PC

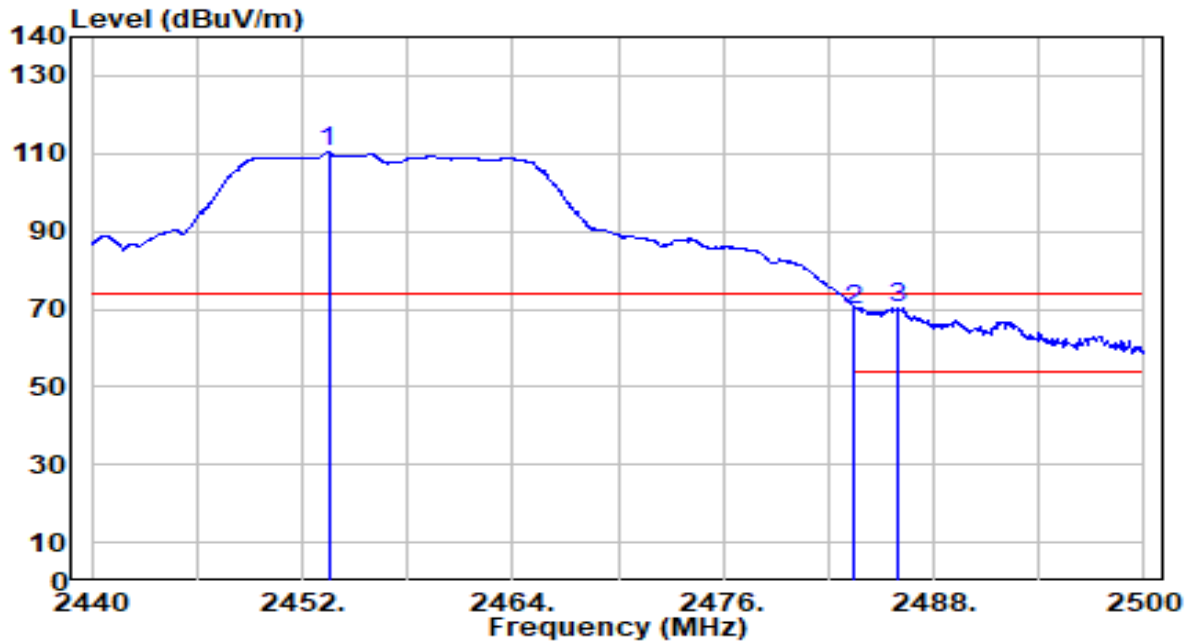

No	Frequency (MHz)	Reading (dBuV)	C.F (dB/m)	Measurement (dBuV/m)	Margin (dB)	Limit (dBuV/m)	Height (cm)	Angle (deg)	Remark (QP/PK/AV)
1	2453.500	79.95	30.28	110.23	N/A	N/A	300	281	Peak
2	2483.500	39.67	30.32	69.99	-4.01	74.00	300	281	Peak
3	* 2485.900	39.96	30.32	70.28	-3.72	74.00	300	281	Peak

Note:

1. " *", means this data is the worst emission level.
2. C.F (Correction Factor) = Antenna Factor (dB/m)+ Cable Loss (dB).
3. Measurement (dBuV/m) = Reading(dBuV) + C.F (Correction Factor).
4. The emission levels of other frequencies are very lower than the limit and not show in test report.

EUT	Smart Wi-Fi Outlet Extender	Date of Test	2023-06-13
Factor	DRH18-E	Temp. / Humidity	21°C /61%
Polarity	Horizontal	Site / Test Engineer	AC2 / Marvin
Test Mode	802.11n-20MHz_TX_CH 10_ANT 0	Test Voltage	By Notebook PC

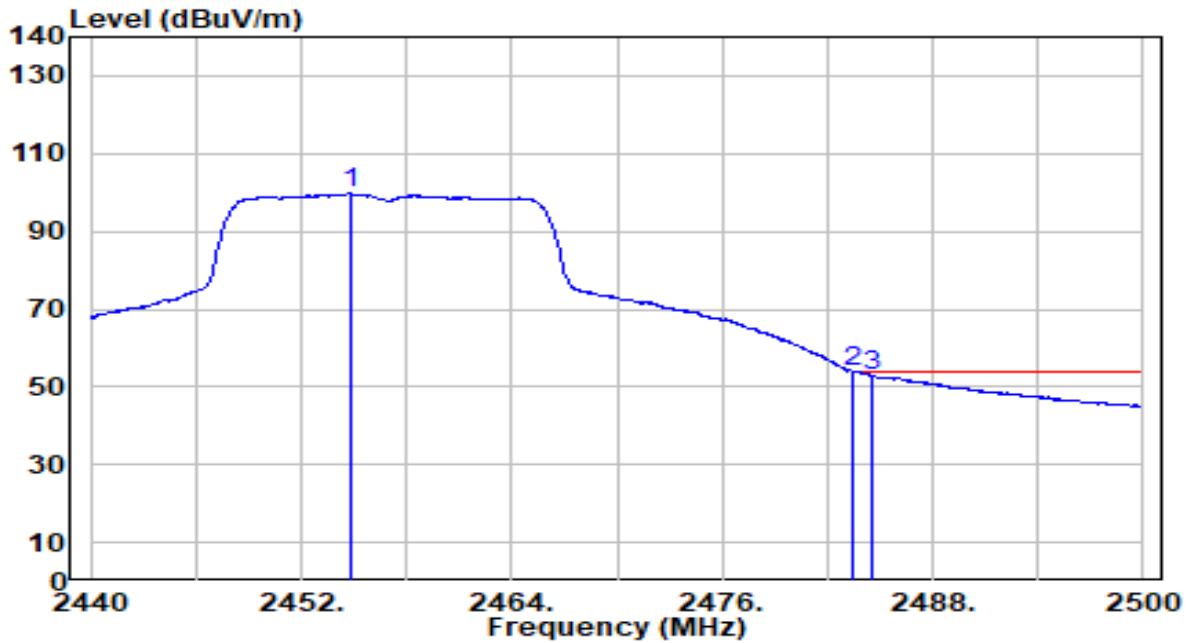

No	Frequency (MHz)	Reading (dBuV)	C.F (dB/m)	Measurement (dBuV/m)	Margin (dB)	Limit (dBuV/m)	Height (cm)	Angle (deg)	Remark (QP/PK/AV)
1	2454.820	69.37	30.28	99.65	N/A	N/A	300	281	Average
2	* 2483.500	23.55	30.32	53.87	-0.13	54.00	300	281	Average
3	2484.520	22.49	30.32	52.80	-1.20	54.00	300	281	Average

Note:

1. " *", means this data is the worst emission level.
2. C.F (Correction Factor) = Antenna Factor (dB/m)+ Cable Loss (dB).
3. Measurement (dBuV/m) = Reading(dBuV) + C.F (Correction Factor).
4. The emission levels of other frequencies are very lower than the limit and not show in test report.

EUT	Smart Wi-Fi Outlet Extender	Date of Test	2023-06-13
Factor	DRH18-E	Temp. / Humidity	21°C /61%
Polarity	Vertical	Site / Test Engineer	AC2 / Marvin
Test Mode	802.11n-20MHz_TX_CH 10_ANT 0	Test Voltage	By Notebook PC

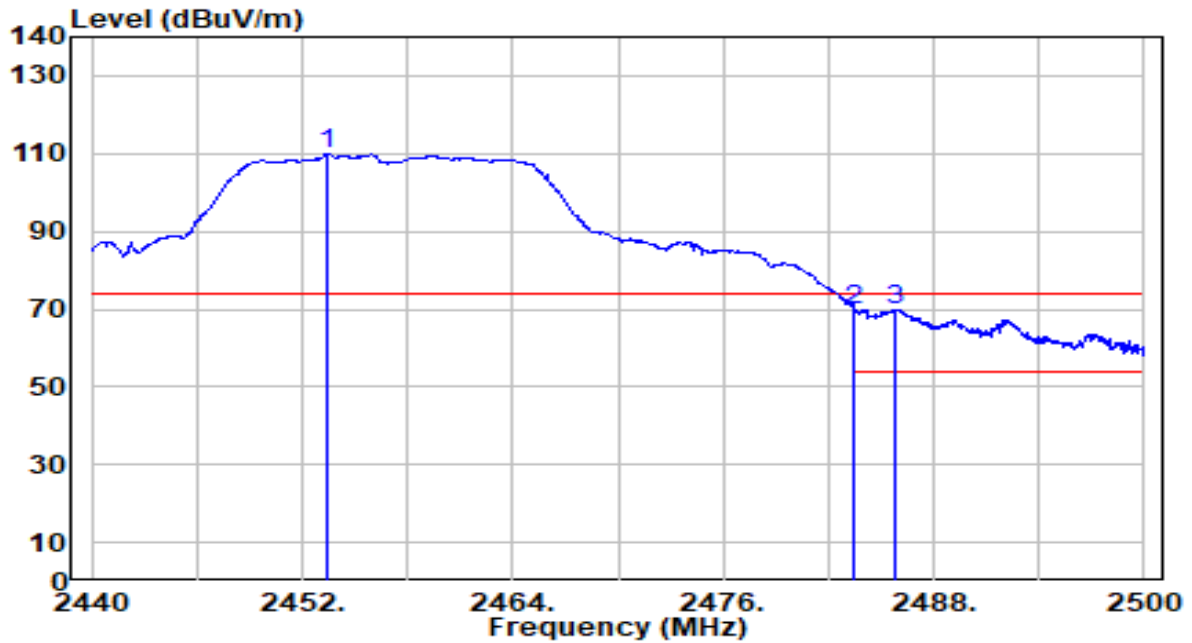

No	Frequency (MHz)	Reading (dBuV)	C.F (dB/m)	Measurement (dBuV/m)	Margin (dB)	Limit (dBuV/m)	Height (cm)	Angle (deg)	Remark (QP/PK/AV)
1	2453.440	79.51	30.28	109.79	N/A	N/A	300	193	Peak
2	2483.500	39.19	30.32	69.51	-4.49	74.00	300	193	Peak
3	* 2485.840	39.61	30.32	69.93	-4.07	74.00	300	193	Peak

Note:

1. " *", means this data is the worst emission level.
2. C.F (Correction Factor) = Antenna Factor (dB/m)+ Cable Loss (dB).
3. Measurement (dBuV/m) = Reading(dBuV) + C.F (Correction Factor).
4. The emission levels of other frequencies are very lower than the limit and not show in test report.

EUT	Smart Wi-Fi Outlet Extender	Date of Test	2023-06-13
Factor	DRH18-E	Temp. / Humidity	21°C /61%
Polarity	Vertical	Site / Test Engineer	AC2 / Marvin
Test Mode	802.11n-20MHz_TX_CH 10_ANT 0	Test Voltage	By Notebook PC

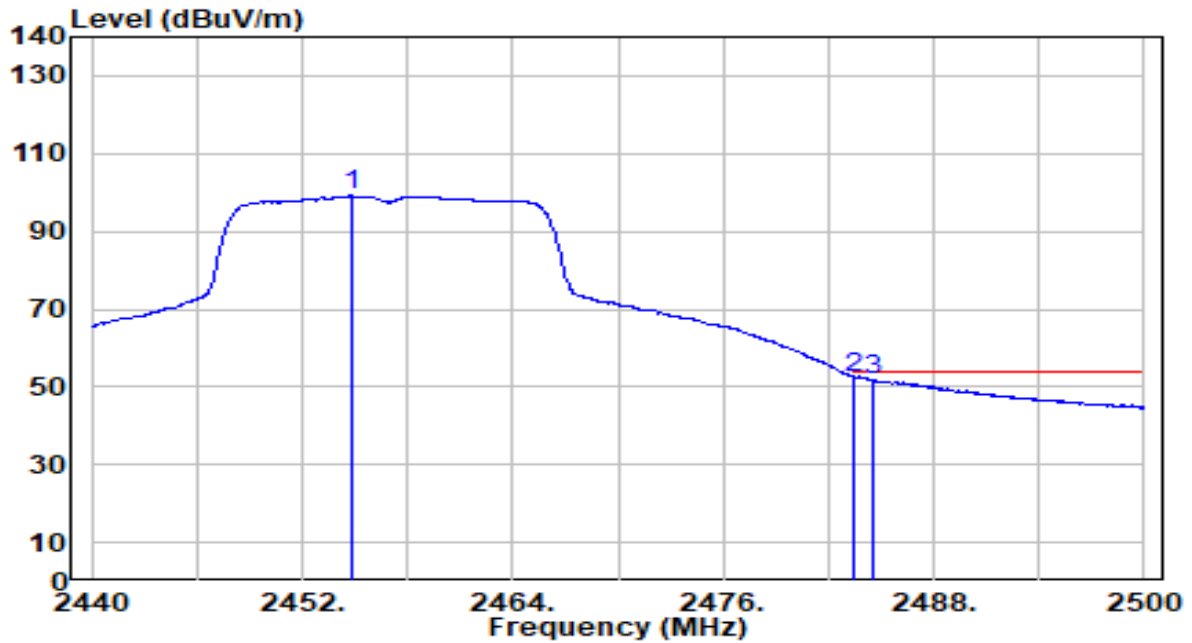

No	Frequency (MHz)	Reading (dBuV)	C.F (dB/m)	Measurement (dBuV/m)	Margin (dB)	Limit (dBuV/m)	Height (cm)	Angle (deg)	Remark (QP/PK/AV)
1	2454.820	68.85	30.28	99.13	N/A	N/A	300	193	Average
2	* 2483.500	22.15	30.32	52.47	-1.53	54.00	300	193	Average
3	2484.520	21.59	30.32	51.91	-2.09	54.00	300	193	Average

Note:

1. " *", means this data is the worst emission level.
2. C.F (Correction Factor) = Antenna Factor (dB/m)+ Cable Loss (dB).
3. Measurement (dBuV/m) = Reading(dBuV) + C.F (Correction Factor).
4. The emission levels of other frequencies are very lower than the limit and not show in test report.

EUT	Smart Wi-Fi Outlet Extender	Date of Test	2023-06-13
Factor	DRH18-E	Temp. / Humidity	21°C /61%
Polarity	Horizontal	Site / Test Engineer	AC2 / Marvin
Test Mode	802.11n-20MHz_TX_CH 11_ANT 0	Test Voltage	By Notebook PC

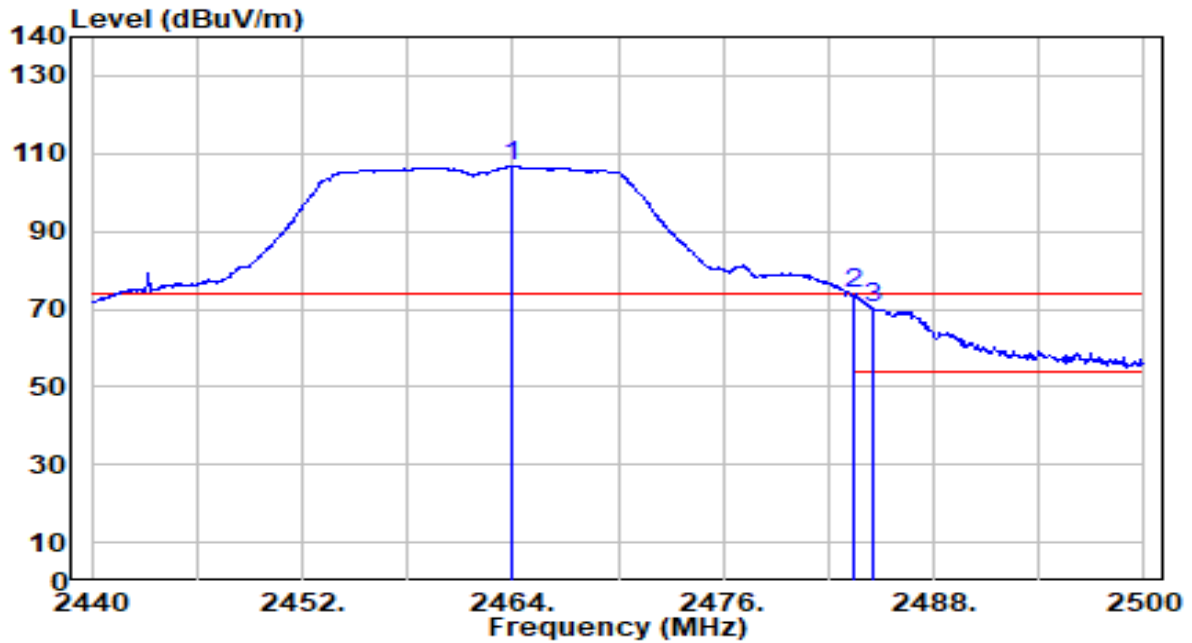

No	Frequency (MHz)	Reading (dBuV)	C.F (dB/m)	Measurement (dBuV/m)	Margin (dB)	Limit (dBuV/m)	Height (cm)	Angle (deg)	Remark (QP/PK/AV)
1	2463.940	76.57	30.29	106.87	N/A	N/A	300	269	Peak
2	* 2483.500	43.50	30.32	73.81	-0.19	74.00	300	269	Peak
3	2484.580	39.69	30.32	70.01	-3.99	74.00	300	269	Peak

Note:

1. " *", means this data is the worst emission level.
2. C.F (Correction Factor) = Antenna Factor (dB/m)+ Cable Loss (dB).
3. Measurement (dBuV/m) = Reading(dBuV) + C.F (Correction Factor).
4. The emission levels of other frequencies are very lower than the limit and not show in test report.

EUT	Smart Wi-Fi Outlet Extender	Date of Test	2023-06-13
Factor	DRH18-E	Temp. / Humidity	21°C /61%
Polarity	Horizontal	Site / Test Engineer	AC2 / Marvin
Test Mode	802.11n-20MHz_TX_CH 11_ANT 0	Test Voltage	By Notebook PC

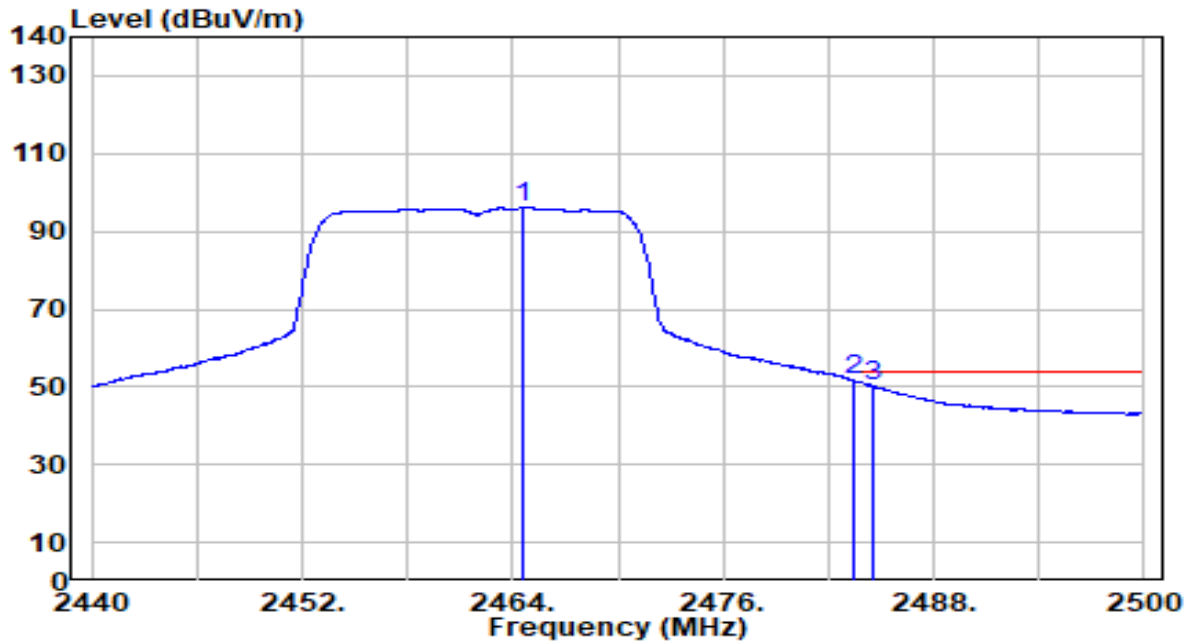

No	Frequency (MHz)	Reading (dBUV)	C.F (dB/m)	Measurement (dBUV/m)	Margin (dB)	Limit (dBUV/m)	Height (cm)	Angle (deg)	Remark (QP/PK/AV)
1	2464.600	65.72	30.29	96.02	N/A	N/A	300	269	Average
2	* 2483.500	21.32	30.32	51.64	-2.36	54.00	300	269	Average
3	2484.580	19.79	30.32	50.11	-3.89	54.00	300	269	Average

Note:

1. " *", means this data is the worst emission level.
2. C.F (Correction Factor) = Antenna Factor (dB/m)+ Cable Loss (dB).
3. Measurement (dBUV/m) = Reading(dBUV) + C.F (Correction Factor).
4. The emission levels of other frequencies are very lower than the limit and not show in test report.

EUT	Smart Wi-Fi Outlet Extender	Date of Test	2023-06-13
Factor	DRH18-E	Temp. / Humidity	21°C /61%
Polarity	Vertical	Site / Test Engineer	AC2 / Marvin
Test Mode	802.11n-20MHz_TX_CH 11_ANT 0	Test Voltage	By Notebook PC

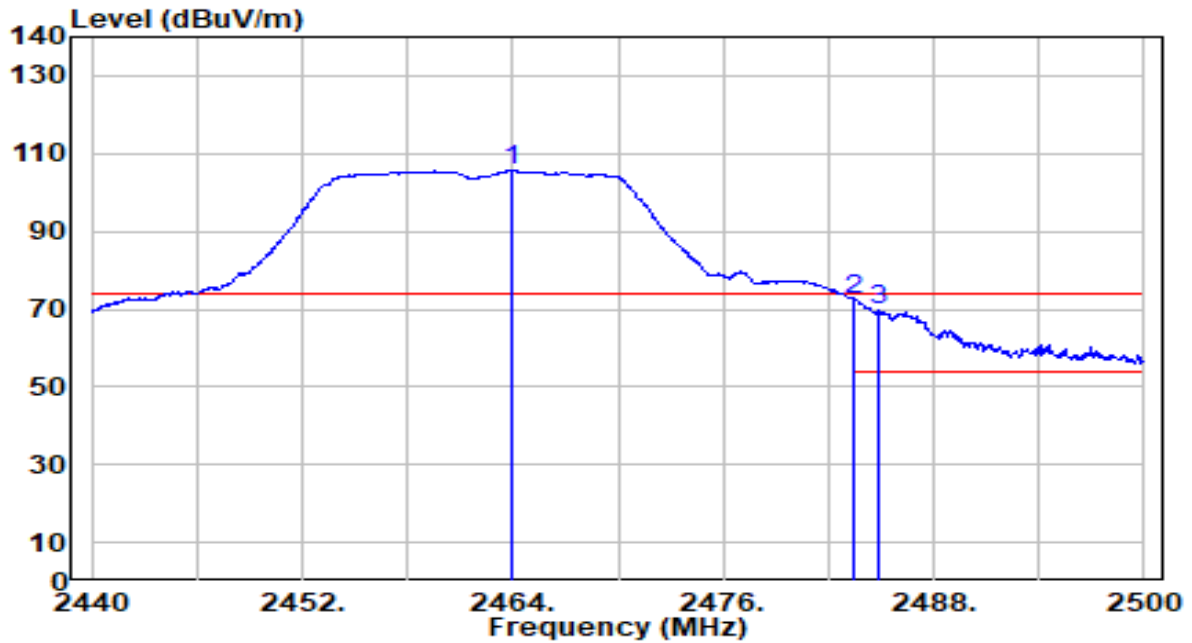

No	Frequency (MHz)	Reading (dBuV)	C.F (dB/m)	Measurement (dBuV/m)	Margin (dB)	Limit (dBuV/m)	Height (cm)	Angle (deg)	Remark (QP/PK/AV)
1	2463.940	75.49	30.29	105.78	N/A	N/A	300	190	Peak
2	* 2483.500	42.11	30.32	72.43	-1.57	74.00	300	190	Peak
3	2484.880	39.16	30.32	69.48	-4.52	74.00	300	190	Peak

Note:

1. " *", means this data is the worst emission level.
2. C.F (Correction Factor) = Antenna Factor (dB/m)+ Cable Loss (dB).
3. Measurement (dBuV/m) = Reading(dBuV) + C.F (Correction Factor).
4. The emission levels of other frequencies are very lower than the limit and not show in test report.

EUT	Smart Wi-Fi Outlet Extender	Date of Test	2023-06-13
Factor	DRH18-E	Temp. / Humidity	21°C /61%
Polarity	Vertical	Site / Test Engineer	AC2 / Marvin
Test Mode	802.11n-20MHz_TX_CH 11_ANT 0	Test Voltage	By Notebook PC

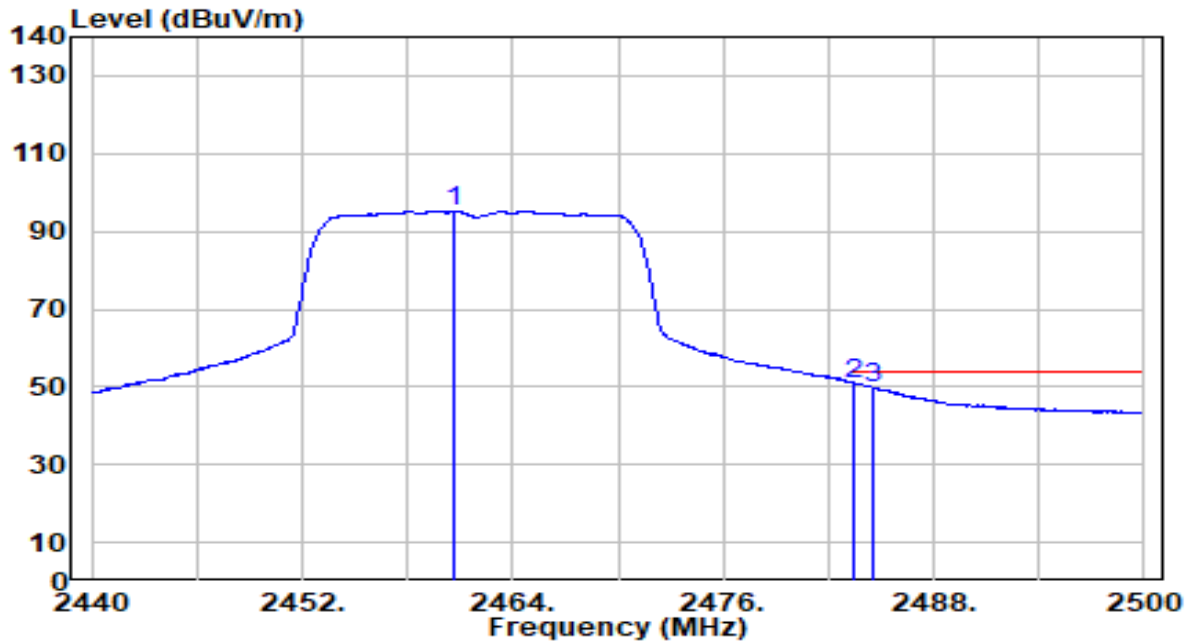

No	Frequency (MHz)	Reading (dBuV)	C.F (dB/m)	Measurement (dBuV/m)	Margin (dB)	Limit (dBuV/m)	Height (cm)	Angle (deg)	Remark (QP/PK/AV)
1	2460.700	64.74	30.29	95.02	N/A	N/A	300	190	Average
2	* 2483.500	20.61	30.32	50.93	-3.07	54.00	300	190	Average
3	2484.580	19.42	30.32	49.74	-4.26	54.00	300	190	Average

Note:

1. " *", means this data is the worst emission level.
2. C.F (Correction Factor) = Antenna Factor (dB/m)+ Cable Loss (dB).
3. Measurement (dBuV/m) = Reading(dBuV) + C.F (Correction Factor).
4. The emission levels of other frequencies are very lower than the limit and not show in test report.

EUT	Smart Wi-Fi Outlet Extender	Date of Test	2023-06-13
Factor	DRH18-E	Temp. / Humidity	21°C /61%
Polarity	Horizontal	Site / Test Engineer	AC2 / Stanley
Test Mode	802.11b_TX_CH 1_ANT 1	Test Voltage	By Notebook PC

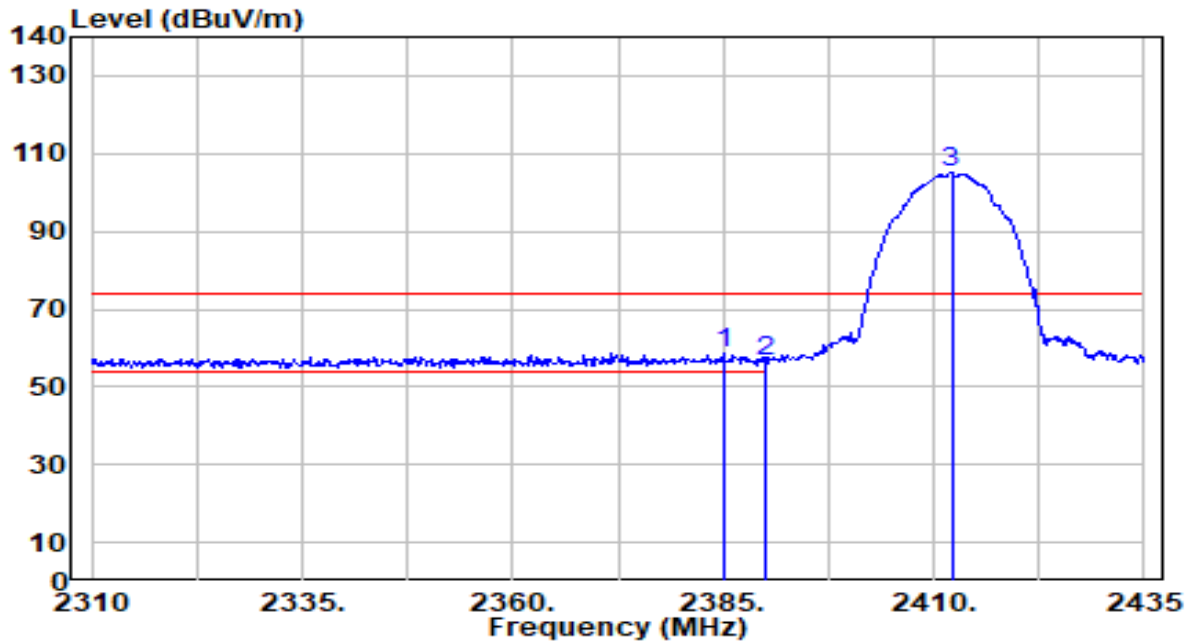

No	Frequency (MHz)	Reading (dBUV)	C.F (dB/m)	Measurement (dBUV/m)	Margin (dB)	Limit (dBUV/m)	Height (cm)	Angle (deg)	Remark (QP/PK/AV)	
1	*	2385.125	28.55	30.17	58.72	-15.28	74.00	311	74	Peak
2		2390.000	26.58	30.18	56.76	-17.24	74.00	311	74	Peak
3		2412.125	74.88	30.22	105.10	N/A	N/A	311	74	Peak

Note:

1. " *", means this data is the worst emission level.
2. C.F (Correction Factor) = Antenna Factor (dB/m) + Cable Loss (dB).
3. Measurement (dBUV/m) = Reading(dBUV) + C.F (Correction Factor).
4. The emission levels of other frequencies are very lower than the limit and not show in test report.

EUT	Smart Wi-Fi Outlet Extender	Date of Test	2023-06-13
Factor	DRH18-E	Temp. / Humidity	21°C /61%
Polarity	Horizontal	Site / Test Engineer	AC2 / Stanley
Test Mode	802.11b_TX_CH 1_ANT 1	Test Voltage	By Notebook PC

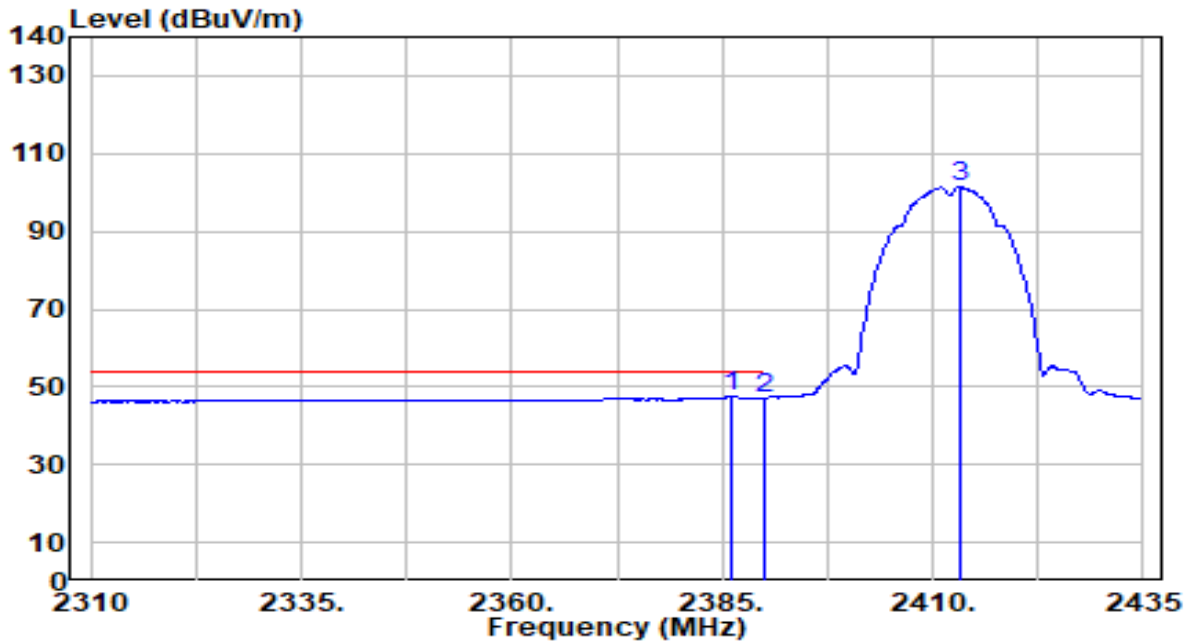

No	Frequency (MHz)	Reading (dBUV)	C.F (dB/m)	Measurement (dBUV/m)	Margin (dB)	Limit (dBUV/m)	Height (cm)	Angle (deg)	Remark (QP/PK/AV)
1	*	17.32	30.17	47.49	-6.51	54.00	311	74	Average
2		16.87	30.18	47.05	-6.95	54.00	311	74	Average
3		71.21	30.23	101.43	N/A	N/A	311	74	Average

Note:

1. " *", means this data is the worst emission level.
2. C.F (Correction Factor) = Antenna Factor (dB/m) + Cable Loss (dB).
3. Measurement (dBUV/m) = Reading(dBUV) + C.F (Correction Factor).
4. The emission levels of other frequencies are very lower than the limit and not show in test report.

EUT	Smart Wi-Fi Outlet Extender	Date of Test	2023-06-13
Factor	DRH18-E	Temp. / Humidity	21°C /61%
Polarity	Vertical	Site / Test Engineer	AC2 / Stanley
Test Mode	802.11b_TX_CH 1_ANT 1	Test Voltage	By Notebook PC

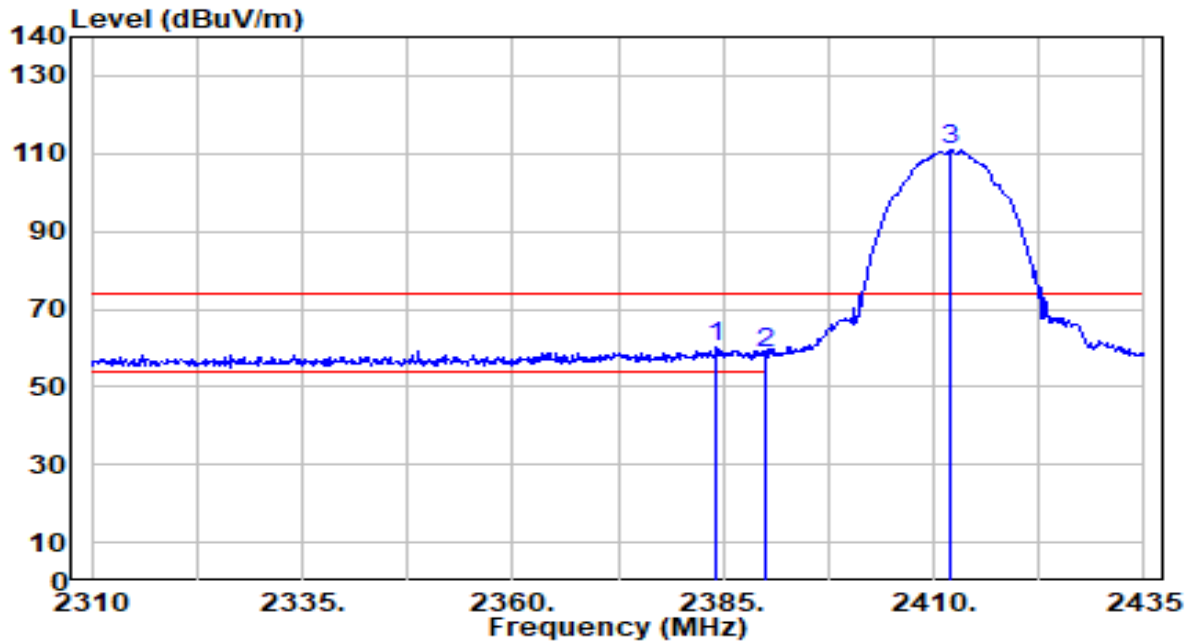

No	Frequency (MHz)	Reading (dBUV)	C.F (dB/m)	Measurement (dBUV/m)	Margin (dB)	Limit (dBUV/m)	Height (cm)	Angle (deg)	Remark (QP/PK/AV)	
1	*	2384.125	29.84	30.16	60.00	-14.00	74.00	198	60	Peak
2		2390.000	28.28	30.18	58.46	-15.54	74.00	198	60	Peak
3		2412.000	80.79	30.22	111.01	N/A	N/A	198	60	Peak

Note:

1. " *", means this data is the worst emission level.
2. C.F (Correction Factor) = Antenna Factor (dB/m) + Cable Loss (dB).
3. Measurement (dBUV/m) = Reading(dBUV) + C.F (Correction Factor).
4. The emission levels of other frequencies are very lower than the limit and not show in test report.

EUT	Smart Wi-Fi Outlet Extender	Date of Test	2023-06-13
Factor	DRH18-E	Temp. / Humidity	21°C /61%
Polarity	Vertical	Site / Test Engineer	AC2 / Stanley
Test Mode	802.11b_TX_CH 1_ANT 1	Test Voltage	By Notebook PC

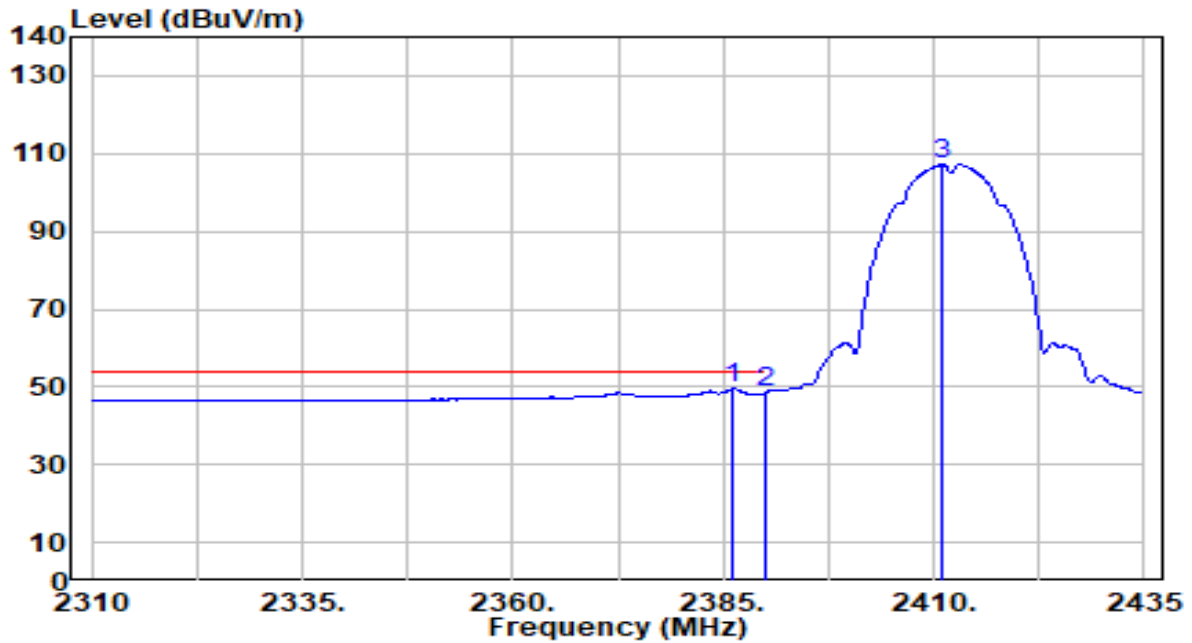

No	Frequency (MHz)	Reading (dBUV)	C.F (dB/m)	Measurement (dBUV/m)	Margin (dB)	Limit (dBUV/m)	Height (cm)	Angle (deg)	Remark (QP/PK/AV)	
1	*	2386.250	19.24	30.17	49.41	-4.59	54.00	198	60	Average
2		2390.000	18.29	30.18	48.47	-5.53	54.00	198	60	Average
3		2411.000	76.95	30.22	107.17	N/A	N/A	198	60	Average

Note:

1. " *", means this data is the worst emission level.
2. C.F (Correction Factor) = Antenna Factor (dB/m) + Cable Loss (dB).
3. Measurement (dBUV/m) = Reading(dBUV) + C.F (Correction Factor).
4. The emission levels of other frequencies are very lower than the limit and not show in test report.

EUT	Smart Wi-Fi Outlet Extender	Date of Test	2023-06-13
Factor	DRH18-E	Temp. / Humidity	21°C /61%
Polarity	Horizontal	Site / Test Engineer	AC2 / Stanley
Test Mode	802.11b_TX_CH 6_ANT 1	Test Voltage	By Notebook PC

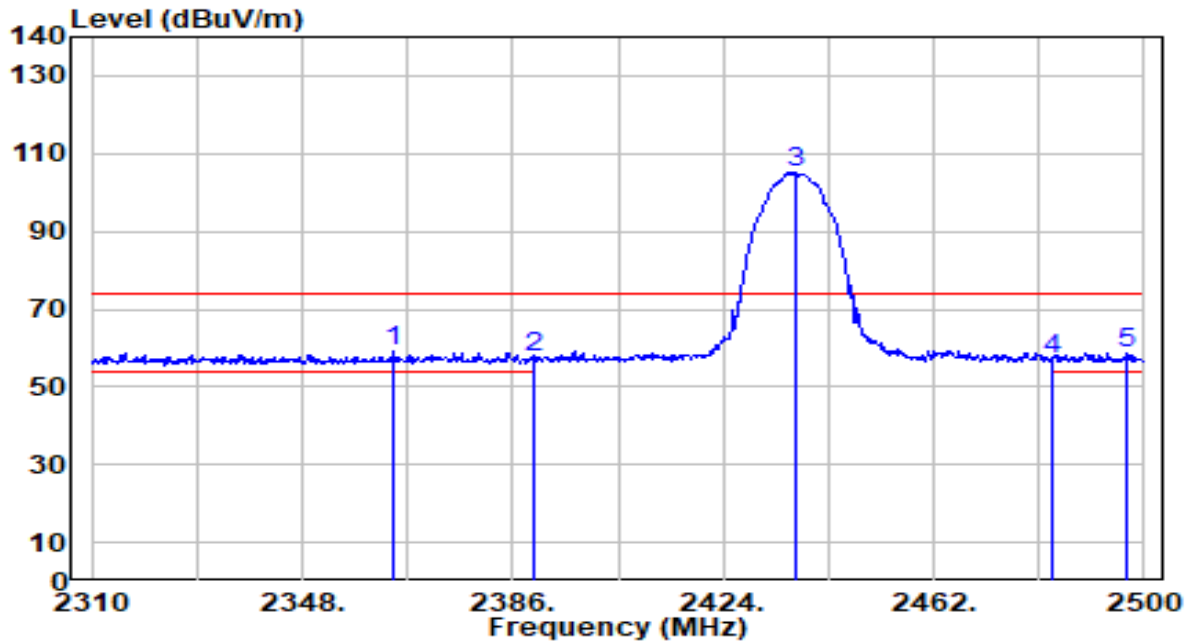

No	Frequency (MHz)	Reading (dBuV)	C.F (dB/m)	Measurement (dBuV/m)	Margin (dB)	Limit (dBuV/m)	Height (cm)	Angle (deg)	Remark (QP/PK/AV)
1	*	28.84	30.11	58.95	-15.05	74.00	307	134	Peak
2		27.26	30.18	57.44	-16.56	74.00	307	134	Peak
3		75.06	30.26	105.32	N/A	N/A	307	134	Peak
4		26.83	30.32	57.15	-16.85	74.00	307	134	Peak
5		28.49	30.34	58.83	-15.17	74.00	307	134	Peak

Note:

1. " *", means this data is the worst emission level.
2. C.F (Correction Factor) = Antenna Factor (dB/m) + Cable Loss (dB).
3. Measurement (dBuV/m) = Reading(dBuV) + C.F (Correction Factor).
4. The emission levels of other frequencies are very lower than the limit and not show in test report.

EUT	Smart Wi-Fi Outlet Extender	Date of Test	2023-06-13
Factor	DRH18-E	Temp. / Humidity	21°C /61%
Polarity	Horizontal	Site / Test Engineer	AC2 / Stanley
Test Mode	802.11b_TX_CH 6_ANT 1	Test Voltage	By Notebook PC

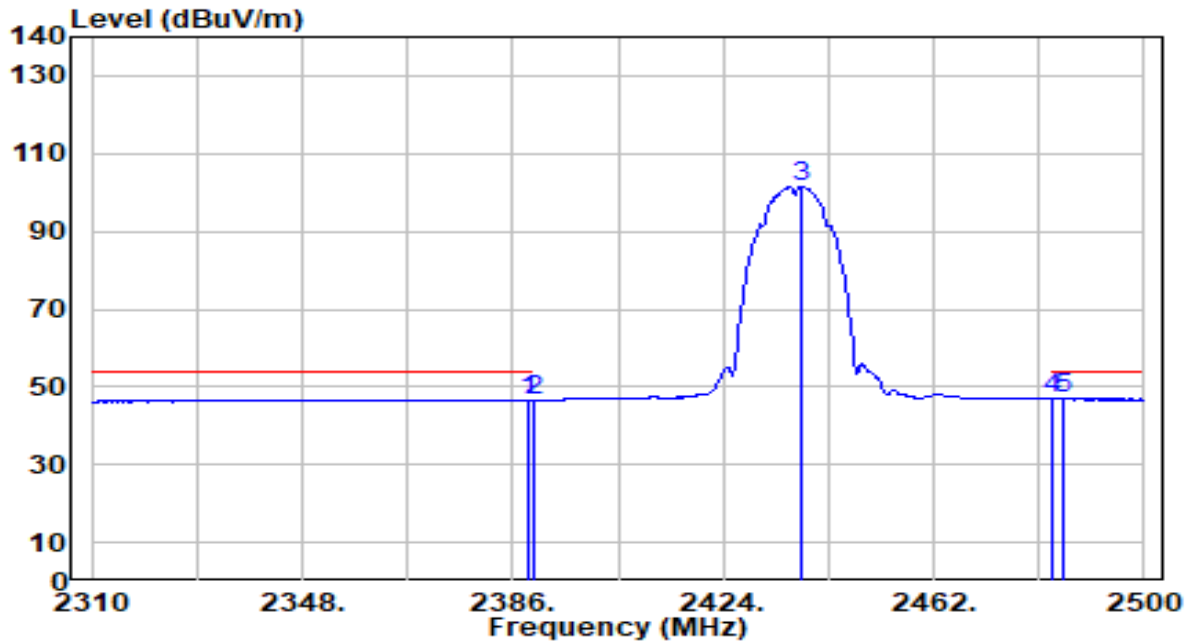

No	Frequency (MHz)	Reading (dBuV)	C.F (dB/m)	Measurement (dBuV/m)	Margin (dB)	Limit (dBuV/m)	Height (cm)	Angle (deg)	Remark (QP/PK/AV)
1	2389.040	16.48	30.18	46.65	-7.35	54.00	307	134	Average
2	2390.000	16.50	30.18	46.68	-7.32	54.00	307	134	Average
3	2438.060	71.36	30.26	101.61	N/A	N/A	307	134	Average
4	2483.500	16.45	30.32	46.77	-7.23	54.00	307	134	Average
5	* 2485.180	16.53	30.32	46.85	-7.15	54.00	307	134	Average

Note:

1. " *", means this data is the worst emission level.
2. C.F (Correction Factor) = Antenna Factor (dB/m) + Cable Loss (dB).
3. Measurement (dBuV/m) = Reading(dBuV) + C.F (Correction Factor).
4. The emission levels of other frequencies are very lower than the limit and not show in test report.

EUT	Smart Wi-Fi Outlet Extender	Date of Test	2023-06-13
Factor	DRH18-E	Temp. / Humidity	21°C /61%
Polarity	Vertical	Site / Test Engineer	AC2 / Stanley
Test Mode	802.11b_TX_CH 6_ANT 1	Test Voltage	By Notebook PC

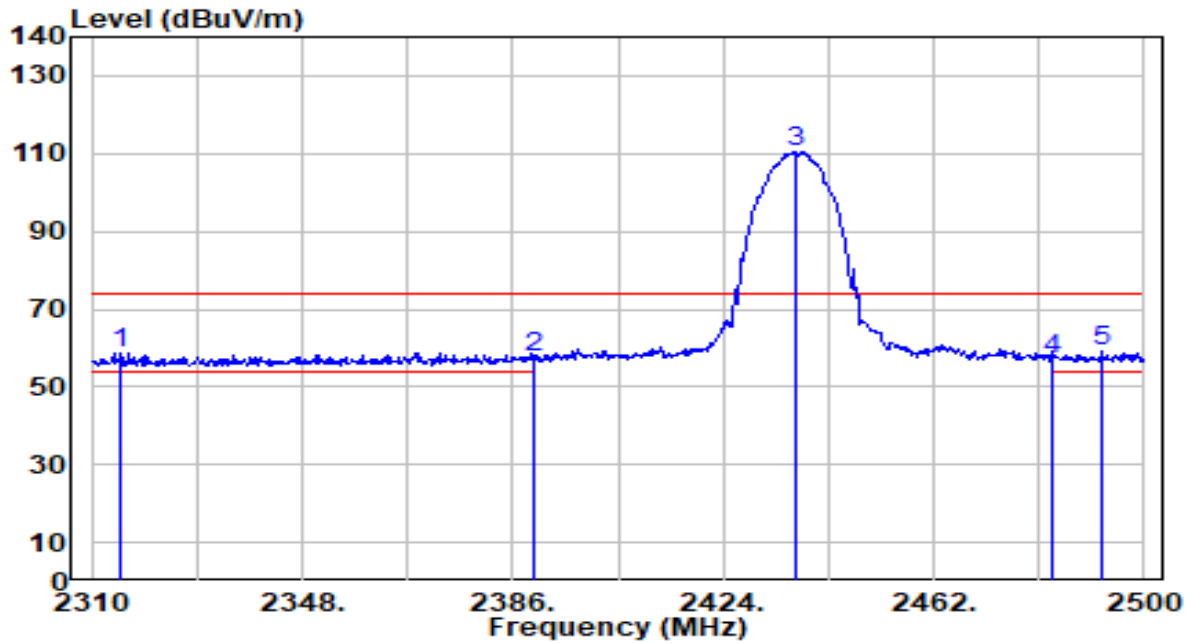

No	Frequency (MHz)	Reading (dBuV)	C.F (dB/m)	Measurement (dBuV/m)	Margin (dB)	Limit (dBuV/m)	Height (cm)	Angle (deg)	Remark (QP/PK/AV)
1	2315.320	28.60	29.97	58.57	-15.43	74.00	200	56	Peak
2	2390.000	27.26	30.18	57.44	-16.56	74.00	200	56	Peak
3	2437.110	80.32	30.26	110.58	N/A	N/A	200	56	Peak
4	2483.500	26.98	30.32	57.30	-16.70	74.00	200	56	Peak
5	* 2492.210	28.58	30.33	58.91	-15.09	74.00	200	56	Peak

Note:

- " *", means this data is the worst emission level.
- C.F (Correction Factor) = Antenna Factor (dB/m) + Cable Loss (dB).
- Measurement (dBuV/m) = Reading(dBuV) + C.F (Correction Factor).
- The emission levels of other frequencies are very lower than the limit and not show in test report.

EUT	Smart Wi-Fi Outlet Extender	Date of Test	2023-06-13
Factor	DRH18-E	Temp. / Humidity	21°C /61%
Polarity	Vertical	Site / Test Engineer	AC2 / Stanley
Test Mode	802.11b_TX_CH 6_ANT 1	Test Voltage	By Notebook PC

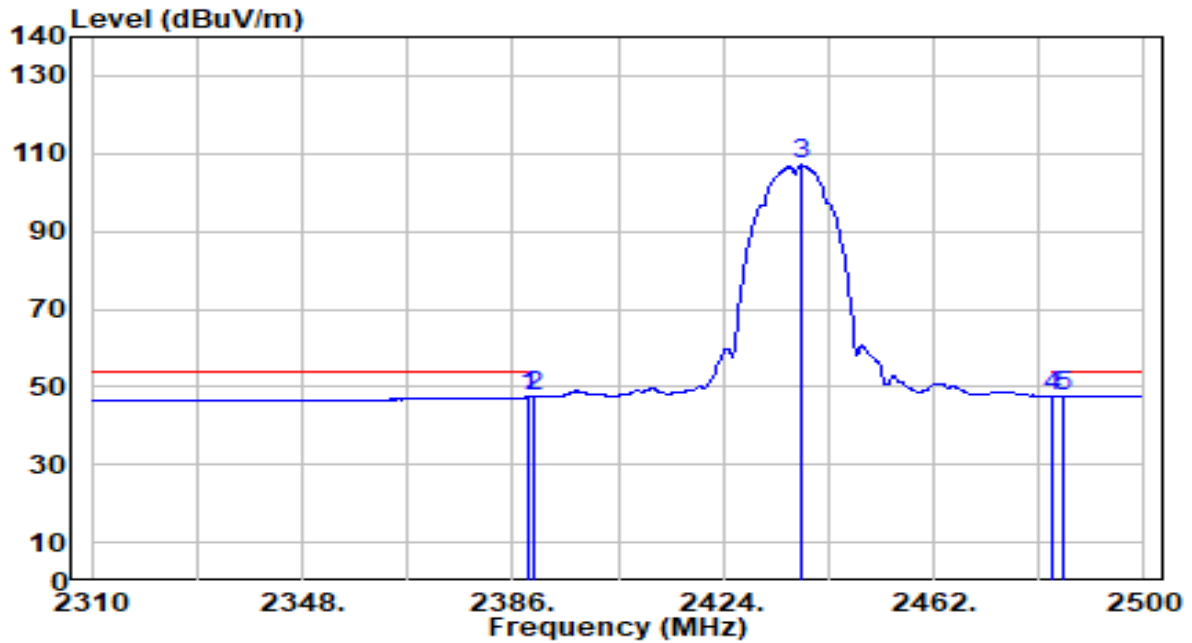

No	Frequency (MHz)	Reading (dBuV)	C.F (dB/m)	Measurement (dBuV/m)	Margin (dB)	Limit (dBuV/m)	Height (cm)	Angle (deg)	Remark (QP/PK/AV)
1	2389.040	17.18	30.18	47.36	-6.64	54.00	200	56	Average
2	2390.000	17.26	30.18	47.44	-6.56	54.00	200	56	Average
3	2438.250	76.79	30.26	107.05	N/A	N/A	200	56	Average
4	2483.500	17.25	30.32	47.57	-6.43	54.00	200	56	Average
5	* 2485.180	17.40	30.32	47.72	-6.28	54.00	200	56	Average

Note:

- "*" means this data is the worst emission level.
- C.F (Correction Factor) = Antenna Factor (dB/m) + Cable Loss (dB).
- Measurement (dBuV/m) = Reading(dBuV) + C.F (Correction Factor).
- The emission levels of other frequencies are very lower than the limit and not show in test report.

EUT	Smart Wi-Fi Outlet Extender	Date of Test	2023-06-13
Factor	DRH18-E	Temp. / Humidity	21°C /61%
Polarity	Horizontal	Site / Test Engineer	AC2 / Stanley
Test Mode	802.11b_TX_CH 11_ANT 1	Test Voltage	By Notebook PC

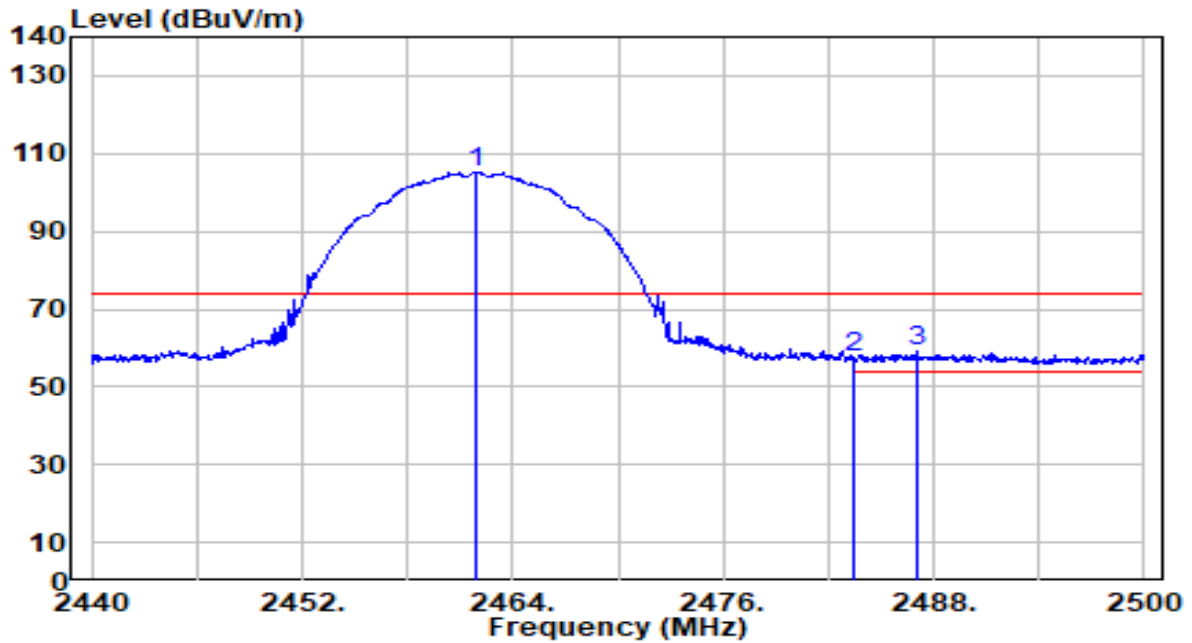

No	Frequency (MHz)	Reading (dBUV)	C.F (dB/m)	Measurement (dBUV/m)	Margin (dB)	Limit (dBUV/m)	Height (cm)	Angle (deg)	Remark (QP/PK/AV)
1	2461.840	74.93	30.29	105.22	N/A	N/A	341	135	Peak
2	2483.500	27.15	30.32	57.46	-16.54	74.00	341	135	Peak
3	* 2487.040	28.77	30.32	59.09	-14.91	74.00	341	135	Peak

Note:

1. " *", means this data is the worst emission level.
2. C.F (Correction Factor) = Antenna Factor (dB/m) + Cable Loss (dB).
3. Measurement (dBUV/m) = Reading(dBUV) + C.F (Correction Factor).
4. The emission levels of other frequencies are very lower than the limit and not show in test report.

EUT	Smart Wi-Fi Outlet Extender	Date of Test	2023-06-13
Factor	DRH18-E	Temp. / Humidity	21°C /61%
Polarity	Horizontal	Site / Test Engineer	AC2 / Stanley
Test Mode	802.11b_TX_CH 11_ANT 1	Test Voltage	By Notebook PC

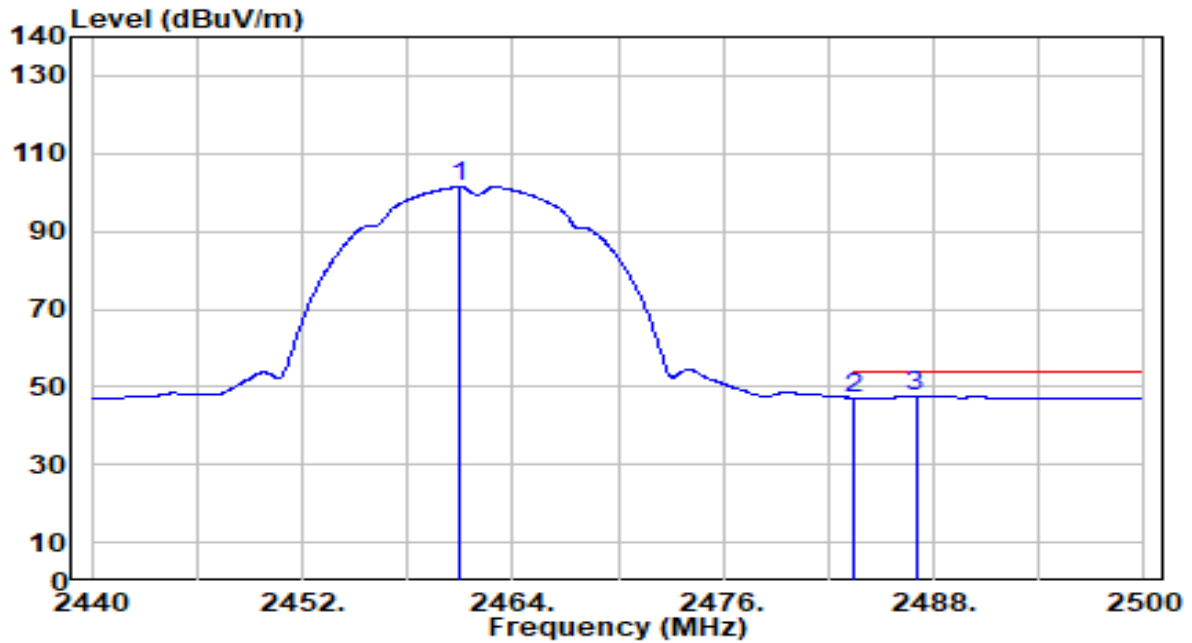

No	Frequency (MHz)	Reading (dBUV)	C.F (dB/m)	Measurement (dBUV/m)	Margin (dB)	Limit (dBUV/m)	Height (cm)	Angle (deg)	Remark (QP/PK/AV)
1	2461.000	71.10	30.29	101.39	N/A	N/A	341	135	Average
2	2483.500	16.86	30.32	47.18	-6.82	54.00	341	135	Average
3	* 2486.980	17.38	30.32	47.71	-6.29	54.00	341	135	Average

Note:

1. " *", means this data is the worst emission level.
2. C.F (Correction Factor) = Antenna Factor (dB/m) + Cable Loss (dB).
3. Measurement (dBUV/m) = Reading(dBUV) + C.F (Correction Factor).
4. The emission levels of other frequencies are very lower than the limit and not show in test report.

EUT	Smart Wi-Fi Outlet Extender	Date of Test	2023-06-13
Factor	DRH18-E	Temp. / Humidity	21°C /61%
Polarity	Vertical	Site / Test Engineer	AC2 / Stanley
Test Mode	802.11b_TX_CH 11_ANT 1	Test Voltage	By Notebook PC

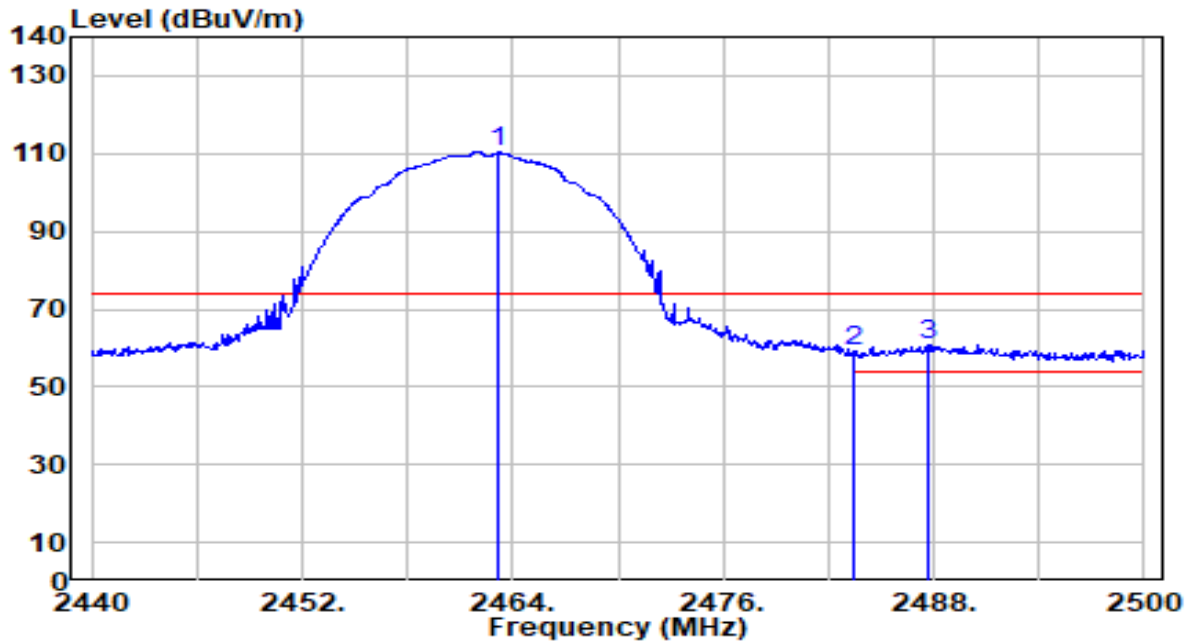

No	Frequency (MHz)	Reading (dBUV)	C.F (dB/m)	Measurement (dBUV/m)	Margin (dB)	Limit (dBUV/m)	Height (cm)	Angle (deg)	Remark (QP/PK/AV)
1	2463.220	80.16	30.29	110.45	N/A	N/A	194	58	Peak
2	2483.500	28.86	30.32	59.18	-14.82	74.00	194	58	Peak
3	* 2487.760	30.24	30.32	60.57	-13.43	74.00	194	58	Peak

Note:

1. " *", means this data is the worst emission level.
2. C.F (Correction Factor) = Antenna Factor (dB/m) + Cable Loss (dB).
3. Measurement (dBUV/m) = Reading(dBUV) + C.F (Correction Factor).
4. The emission levels of other frequencies are very lower than the limit and not show in test report.

EUT	Smart Wi-Fi Outlet Extender	Date of Test	2023-06-13
Factor	DRH18-E	Temp. / Humidity	21°C /61%
Polarity	Vertical	Site / Test Engineer	AC2 / Stanley
Test Mode	802.11b_TX_CH 11_ANT 1	Test Voltage	By Notebook PC

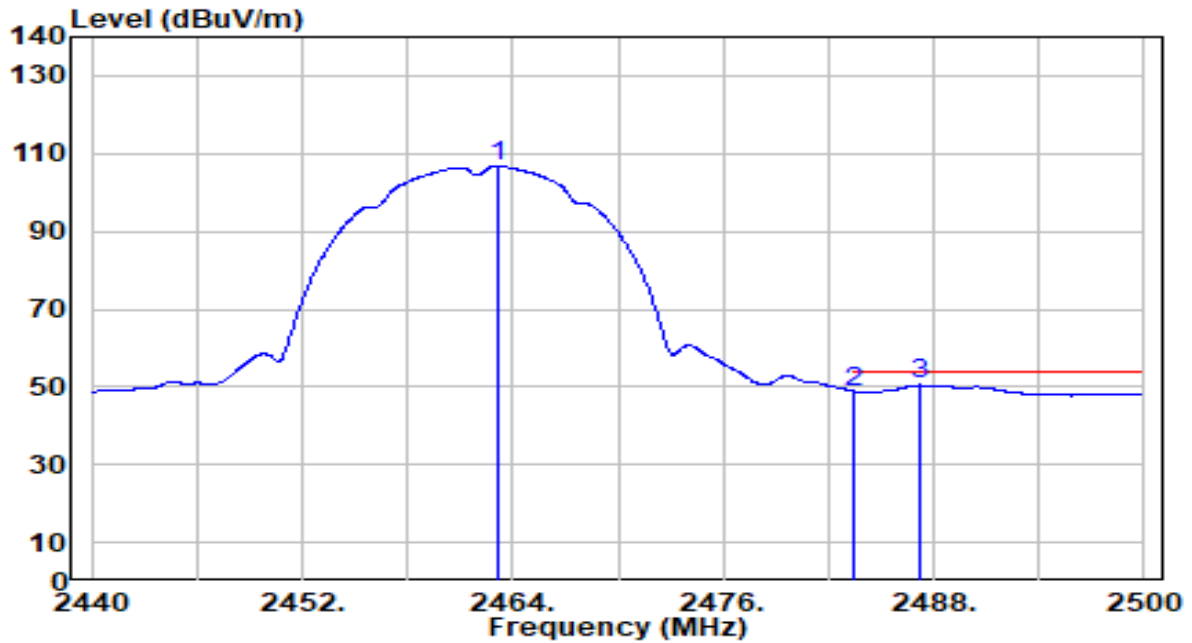

No	Frequency (MHz)	Reading (dBuV)	C.F (dB/m)	Measurement (dBuV/m)	Margin (dB)	Limit (dBuV/m)	Height (cm)	Angle (deg)	Remark (QP/PK/AV)
1	2463.100	76.46	30.29	106.75	N/A	N/A	194	58	Average
2	2483.500	18.48	30.32	48.80	-5.20	54.00	194	58	Average
3	* 2487.280	20.15	30.32	50.47	-3.53	54.00	194	58	Average

Note:

1. " *", means this data is the worst emission level.
2. C.F (Correction Factor) = Antenna Factor (dB/m) + Cable Loss (dB).
3. Measurement (dBuV/m) = Reading(dBuV) + C.F (Correction Factor).
4. The emission levels of other frequencies are very lower than the limit and not show in test report.

EUT	Smart Wi-Fi Outlet Extender	Date of Test	2023-06-13
Factor	DRH18-E	Temp. / Humidity	21°C /61%
Polarity	Horizontal	Site / Test Engineer	AC2 / Stanley
Test Mode	802.11g_TX_CH 1_ANT 1	Test Voltage	By Notebook PC

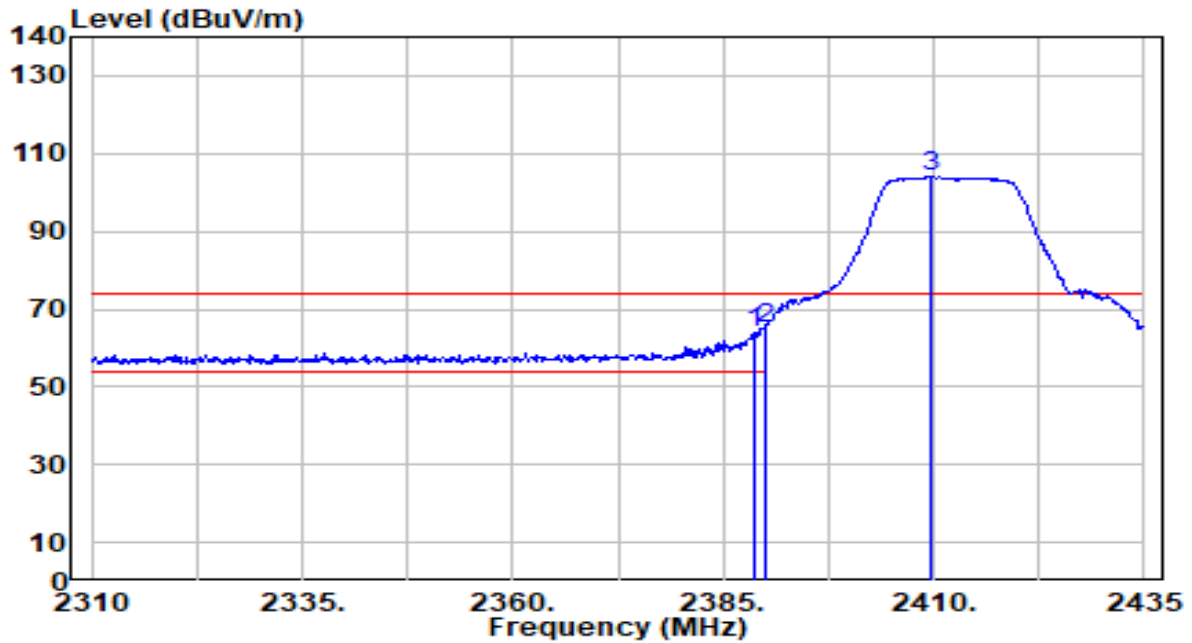

No	Frequency (MHz)	Reading (dBUV)	C.F (dB/m)	Measurement (dBUV/m)	Margin (dB)	Limit (dBUV/m)	Height (cm)	Angle (deg)	Remark (QP/PK/AV)
1	2388.625	33.67	30.18	63.84	-10.16	74.00	280	65	Peak
2	* 2390.000	34.97	30.18	65.15	-8.85	74.00	280	65	Peak
3	2409.750	73.70	30.22	103.92	N/A	N/A	280	65	Peak

Note:

1. " *", means this data is the worst emission level.
2. C.F (Correction Factor) = Antenna Factor (dB/m) + Cable Loss (dB).
3. Measurement (dBUV/m) = Reading(dBUV) + C.F (Correction Factor).
4. The emission levels of other frequencies are very lower than the limit and not show in test report.

EUT	Smart Wi-Fi Outlet Extender	Date of Test	2023-06-13
Factor	DRH18-E	Temp. / Humidity	21°C /61%
Polarity	Horizontal	Site / Test Engineer	AC2 / Stanley
Test Mode	802.11g_TX_CH 1_ANT 1	Test Voltage	By Notebook PC

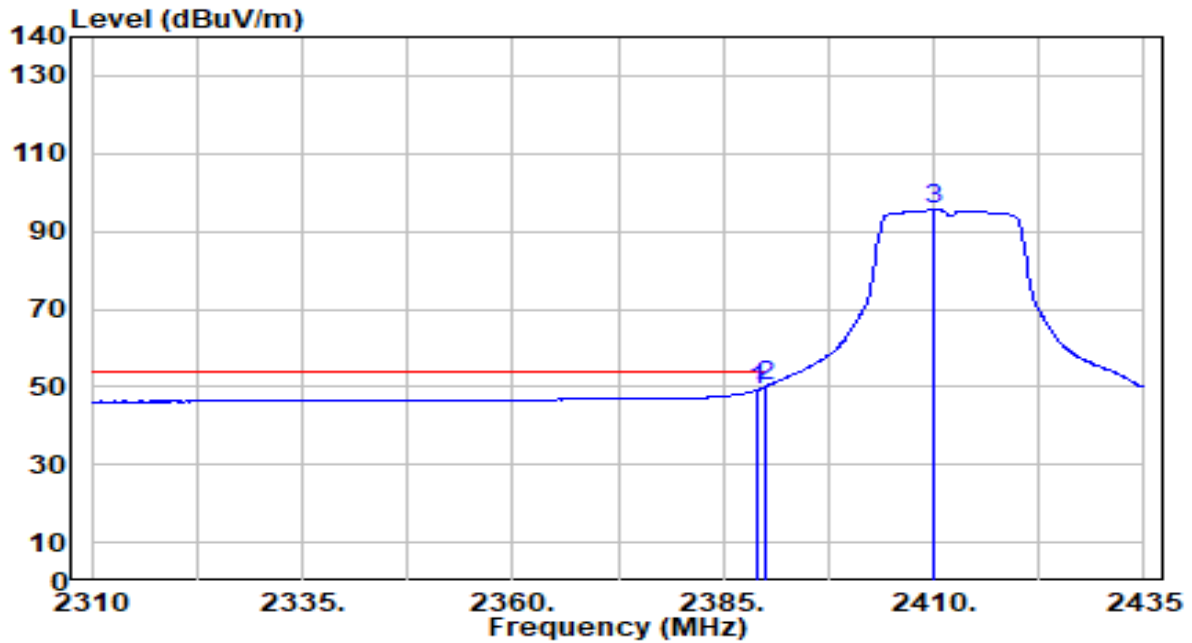

No	Frequency (MHz)	Reading (dBuV)	C.F (dB/m)	Measurement (dBuV/m)	Margin (dB)	Limit (dBuV/m)	Height (cm)	Angle (deg)	Remark (QP/PK/AV)
1	2389.000	19.05	30.18	49.22	-4.78	54.00	280	65	Average
2	* 2390.000	19.76	30.18	49.94	-4.06	54.00	280	65	Average
3	2410.000	65.23	30.22	95.45	N/A	N/A	280	65	Average

Note:

1. " *", means this data is the worst emission level.
2. C.F (Correction Factor) = Antenna Factor (dB/m) + Cable Loss (dB).
3. Measurement (dBuV/m) = Reading(dBuV) + C.F (Correction Factor).
4. The emission levels of other frequencies are very lower than the limit and not show in test report.

EUT	Smart Wi-Fi Outlet Extender	Date of Test	2023-06-13
Factor	DRH18-E	Temp. / Humidity	21°C /61%
Polarity	Vertical	Site / Test Engineer	AC2 / Stanley
Test Mode	802.11g_TX_CH 1_ANT 1	Test Voltage	By Notebook PC

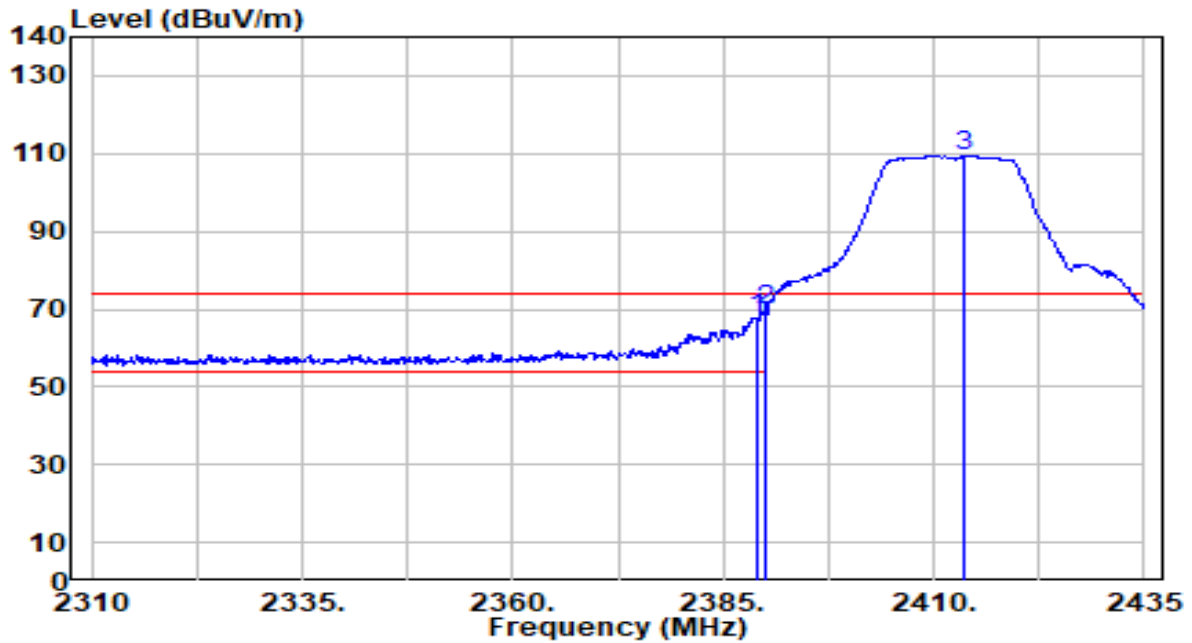

No	Frequency (MHz)	Reading (dBUV)	C.F (dB/m)	Measurement (dBUV/m)	Margin (dB)	Limit (dBUV/m)	Height (cm)	Angle (deg)	Remark (QP/PK/AV)
1	2389.000	37.56	30.18	67.74	-6.26	74.00	202	60	Peak
2	* 2390.000	39.40	30.18	69.58	-4.42	74.00	202	60	Peak
3	2413.750	79.10	30.23	109.32	N/A	N/A	202	60	Peak

Note:

1. " *", means this data is the worst emission level.
2. C.F (Correction Factor) = Antenna Factor (dB/m) + Cable Loss (dB).
3. Measurement (dBUV/m) = Reading(dBUV) + C.F (Correction Factor).
4. The emission levels of other frequencies are very lower than the limit and not show in test report.

EUT	Smart Wi-Fi Outlet Extender	Date of Test	2023-06-13
Factor	DRH18-E	Temp. / Humidity	21°C /61%
Polarity	Vertical	Site / Test Engineer	AC2 / Stanley
Test Mode	802.11g_TX_CH 1_ANT 1	Test Voltage	By Notebook PC

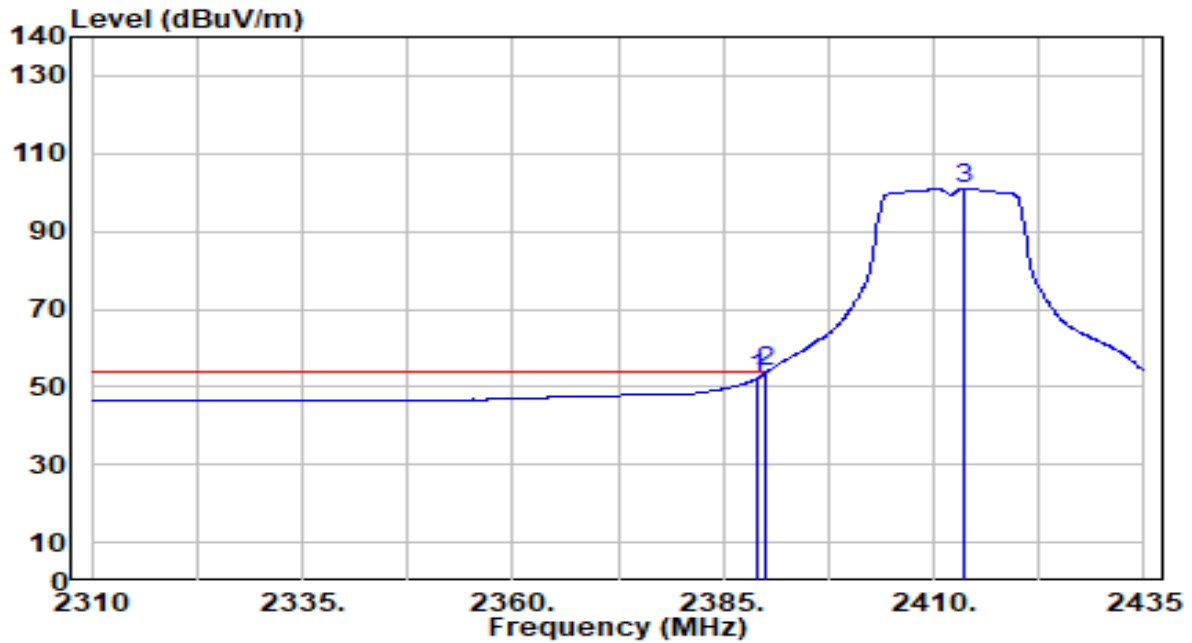

No	Frequency (MHz)	Reading (dBuV)	C.F (dB/m)	Measurement (dBuV/m)	Margin (dB)	Limit (dBuV/m)	Height (cm)	Angle (deg)	Remark (QP/PK/AV)
1	2389.000	22.11	30.18	52.29	-1.71	54.00	202	60	Average
2	* 2390.000	23.56	30.18	53.74	-0.26	54.00	202	60	Average
3	2413.625	70.60	30.23	100.83	N/A	N/A	202	60	Average

Note:

1. " *", means this data is the worst emission level.
2. C.F (Correction Factor) = Antenna Factor (dB/m) + Cable Loss (dB).
3. Measurement (dBuV/m) = Reading(dBuV) + C.F (Correction Factor).
4. The emission levels of other frequencies are very lower than the limit and not show in test report.

EUT	Smart Wi-Fi Outlet Extender	Date of Test	2023-06-13
Factor	DRH18-E	Temp. / Humidity	21°C /61%
Polarity	Horizontal	Site / Test Engineer	AC2 / Marvin
Test Mode	802.11g_TX_CH 2_ANT 1	Test Voltage	By Notebook PC

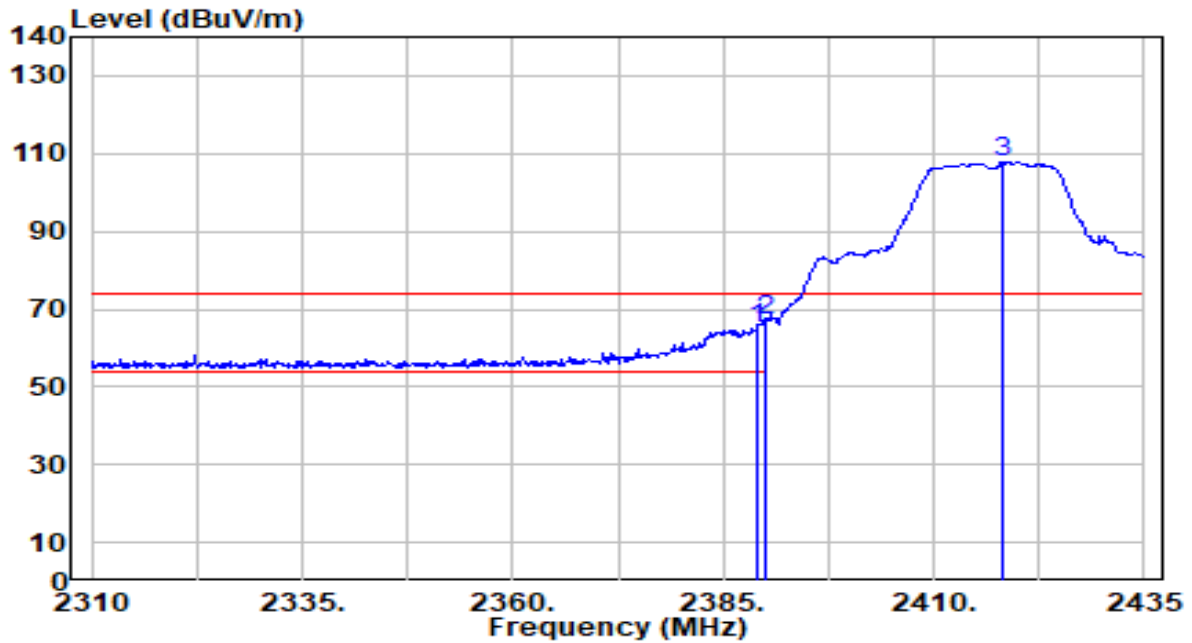

No	Frequency (MHz)	Reading (dBUV)	C.F (dB/m)	Measurement (dBUV/m)	Margin (dB)	Limit (dBUV/m)	Height (cm)	Angle (deg)	Remark (QP/PK/AV)
1	2389.000	34.94	30.18	65.12	-8.88	74.00	312	81	Peak
2	* 2390.000	36.97	30.18	67.15	-6.85	74.00	312	81	Peak
3	2418.250	77.48	30.23	107.71	N/A	N/A	312	81	Peak

Note:

1. " *", means this data is the worst emission level.
2. C.F (Correction Factor) = Antenna Factor (dB/m)+ Cable Loss (dB).
3. Measurement (dBUV/m) = Reading(dBUV) + C.F (Correction Factor).
4. The emission levels of other frequencies are very lower than the limit and not show in test report.

EUT	Smart Wi-Fi Outlet Extender	Date of Test	2023-06-13
Factor	DRH18-E	Temp. / Humidity	21°C /61%
Polarity	Horizontal	Site / Test Engineer	AC2 / Marvin
Test Mode	802.11g_TX_CH 2_ANT 1	Test Voltage	By Notebook PC

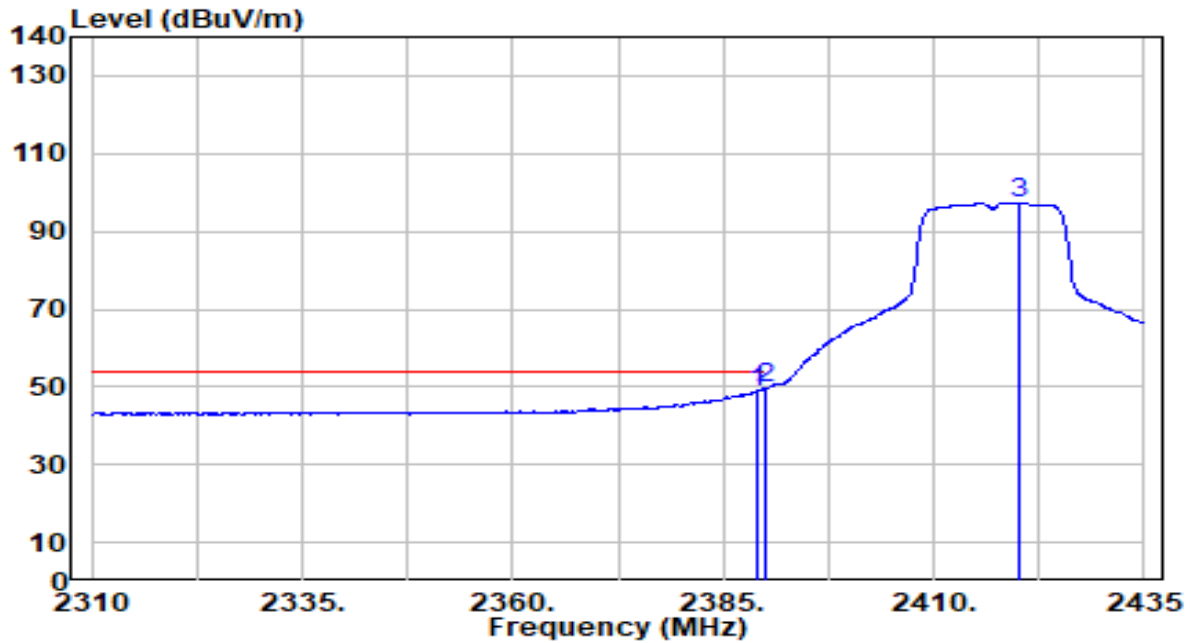

No	Frequency (MHz)	Reading (dBUV)	C.F (dB/m)	Measurement (dBUV/m)	Margin (dB)	Limit (dBUV/m)	Height (cm)	Angle (deg)	Remark (QP/PK/AV)
1	2389.000	18.59	30.18	48.77	-5.23	54.00	312	81	Average
2	* 2390.000	19.45	30.18	49.63	-4.37	54.00	312	81	Average
3	2420.000	66.96	30.23	97.20	N/A	N/A	312	81	Average

Note:

1. " *", means this data is the worst emission level.
2. C.F (Correction Factor) = Antenna Factor (dB/m)+ Cable Loss (dB).
3. Measurement (dBUV/m) = Reading(dBUV) + C.F (Correction Factor).
4. The emission levels of other frequencies are very lower than the limit and not show in test report.

EUT	Smart Wi-Fi Outlet Extender	Date of Test	2023-06-13
Factor	DRH18-E	Temp. / Humidity	21°C /61%
Polarity	Vertical	Site / Test Engineer	AC2 / Marvin
Test Mode	802.11g_TX_CH 2_ANT 1	Test Voltage	By Notebook PC

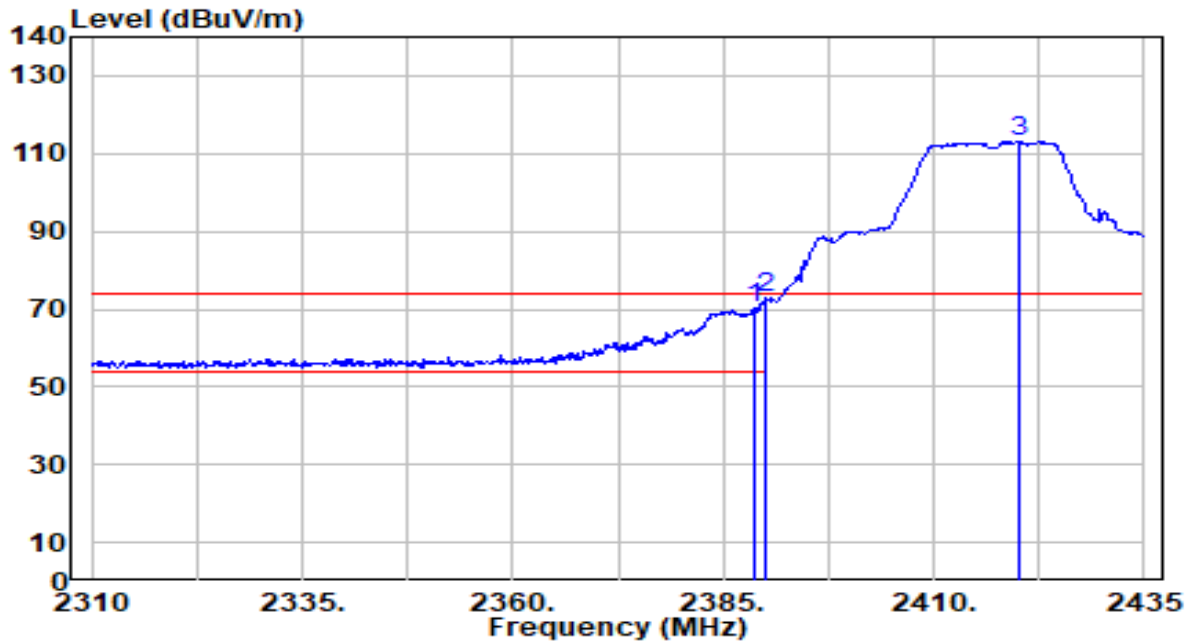

No	Frequency (MHz)	Reading (dBUV)	C.F (dB/m)	Measurement (dBUV/m)	Margin (dB)	Limit (dBUV/m)	Height (cm)	Angle (deg)	Remark (QP/PK/AV)
1	2388.625	40.21	30.18	70.39	-3.61	74.00	253	48	Peak
2	* 2390.000	42.60	30.18	72.78	-1.22	74.00	253	48	Peak
3	2420.000	82.76	30.23	113.00	N/A	N/A	253	48	Peak

Note:

1. " *", means this data is the worst emission level.
2. C.F (Correction Factor) = Antenna Factor (dB/m)+ Cable Loss (dB).
3. Measurement (dBUV/m) = Reading(dBUV) + C.F (Correction Factor).
4. The emission levels of other frequencies are very lower than the limit and not show in test report.

EUT	Smart Wi-Fi Outlet Extender	Date of Test	2023-06-13
Factor	DRH18-E	Temp. / Humidity	21°C /61%
Polarity	Vertical	Site / Test Engineer	AC2 / Marvin
Test Mode	802.11g_TX_CH 2_ANT 1	Test Voltage	By Notebook PC

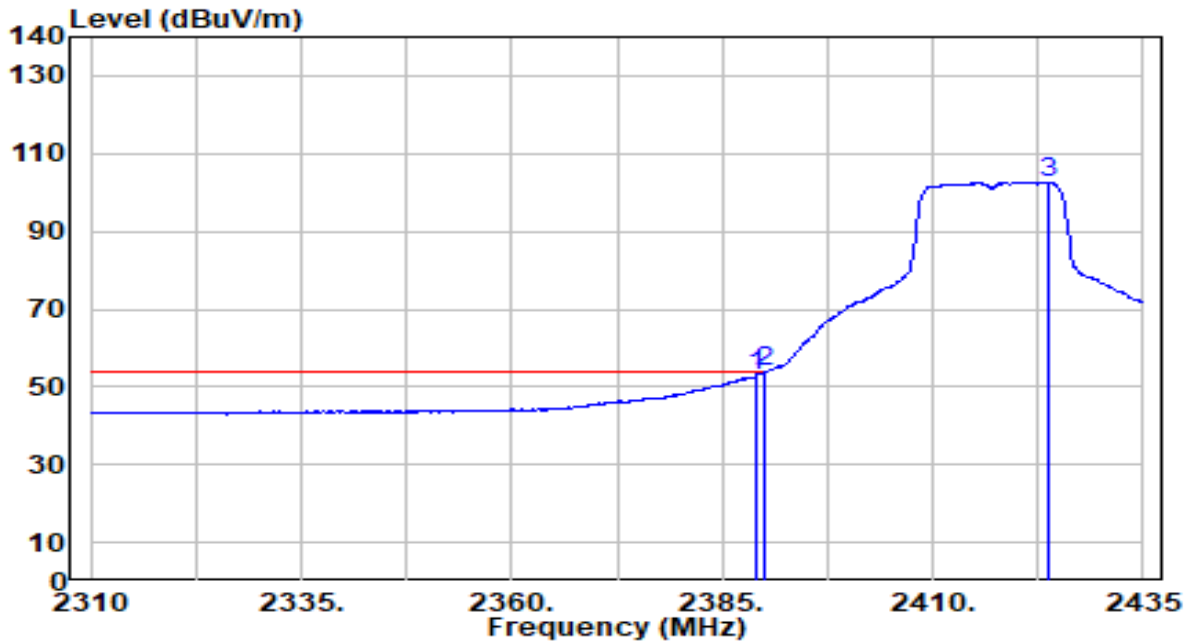

No	Frequency (MHz)	Reading (dBUV)	C.F (dB/m)	Measurement (dBUV/m)	Margin (dB)	Limit (dBUV/m)	Height (cm)	Angle (deg)	Remark (QP/PK/AV)
1	2389.000	22.73	30.18	52.90	-1.10	54.00	253	48	Average
2	* 2390.000	23.67	30.18	53.85	-0.15	54.00	253	48	Average
3	2423.875	72.31	30.24	102.55	N/A	N/A	253	48	Average

Note:

1. " *", means this data is the worst emission level.
2. C.F (Correction Factor) = Antenna Factor (dB/m)+ Cable Loss (dB).
3. Measurement (dBUV/m) = Reading(dBUV) + C.F (Correction Factor).
4. The emission levels of other frequencies are very lower than the limit and not show in test report.

EUT	Smart Wi-Fi Outlet Extender	Date of Test	2023-06-13
Factor	DRH18-E	Temp. / Humidity	21°C /61%
Polarity	Horizontal	Site / Test Engineer	AC2 / Stanley
Test Mode	802.11g_TX_CH 6_ANT 1	Test Voltage	By Notebook PC

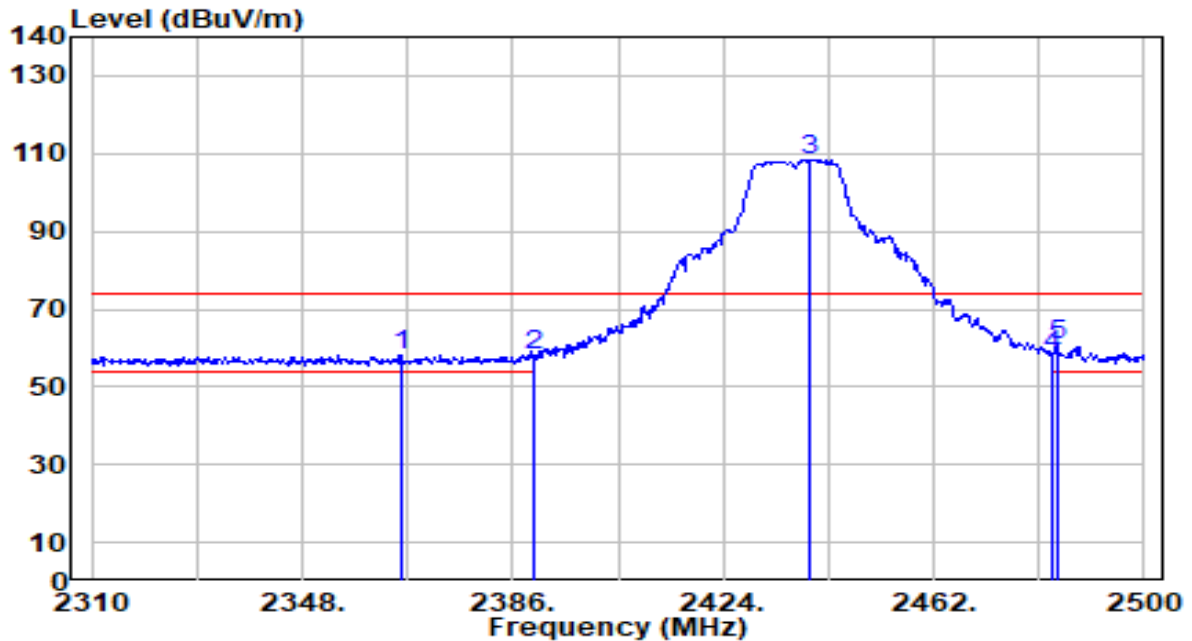

No	Frequency (MHz)	Reading (dBuV)	C.F (dB/m)	Measurement (dBuV/m)	Margin (dB)	Limit (dBuV/m)	Height (cm)	Angle (deg)	Remark (QP/PK/AV)
1	2365.860	28.10	30.11	58.21	-15.79	74.00	313	133	Peak
2	2390.000	27.92	30.18	58.10	-15.90	74.00	313	133	Peak
3	2439.770	78.20	30.26	108.46	N/A	N/A	313	133	Peak
4	2483.500	27.81	30.32	58.13	-15.87	74.00	313	133	Peak
5	* 2484.420	30.20	30.32	60.52	-13.48	74.00	313	133	Peak

Note:

1. " *", means this data is the worst emission level.
2. C.F (Correction Factor) = Antenna Factor (dB/m) + Cable Loss (dB).
3. Measurement (dBuV/m) = Reading(dBuV) + C.F (Correction Factor).
4. The emission levels of other frequencies are very lower than the limit and not show in test report.

EUT	Smart Wi-Fi Outlet Extender	Date of Test	2023-06-13
Factor	DRH18-E	Temp. / Humidity	21°C /61%
Polarity	Horizontal	Site / Test Engineer	AC2 / Stanley
Test Mode	802.11g_TX_CH 6_ANT 1	Test Voltage	By Notebook PC

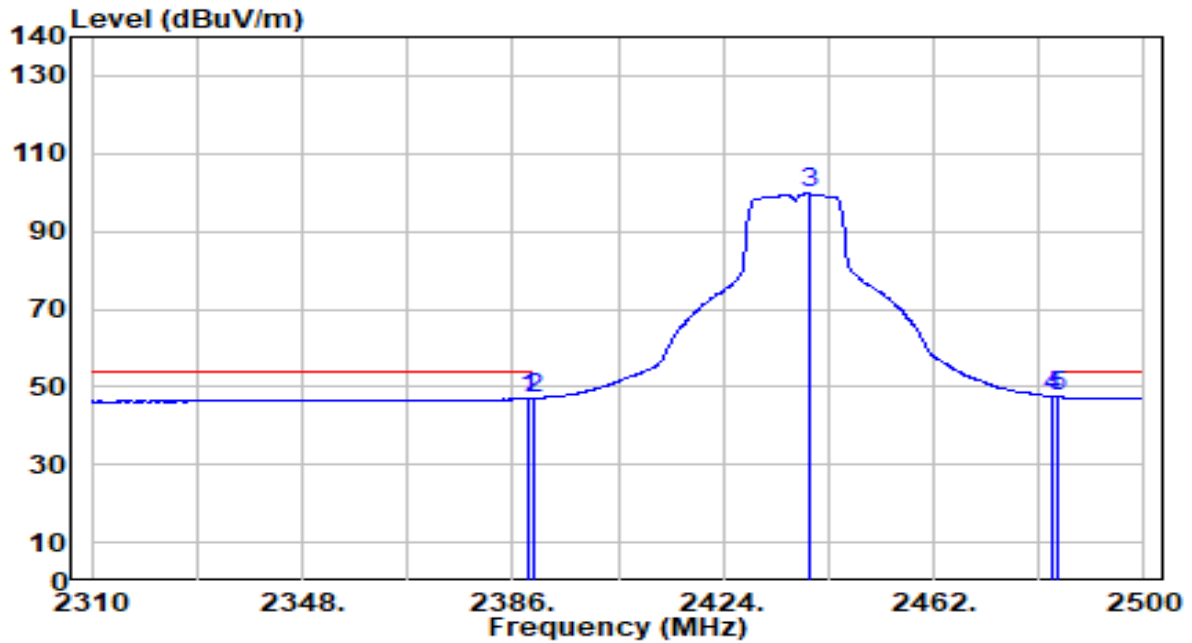

No	Frequency (MHz)	Reading (dBuV)	C.F (dB/m)	Measurement (dBuV/m)	Margin (dB)	Limit (dBuV/m)	Height (cm)	Angle (deg)	Remark (QP/PK/AV)
1	2388.850	16.81	30.18	46.99	-7.01	54.00	313	133	Average
2	2390.000	16.92	30.18	47.10	-6.90	54.00	313	133	Average
3	2439.390	69.39	30.26	99.65	N/A	N/A	313	133	Average
4	* 2483.500	17.25	30.32	47.57	-6.43	54.00	313	133	Average
5	2484.230	17.13	30.32	47.45	-6.55	54.00	313	133	Average

Note:

- "*" means this data is the worst emission level.
- C.F (Correction Factor) = Antenna Factor (dB/m) + Cable Loss (dB).
- Measurement (dBuV/m) = Reading(dBuV) + C.F (Correction Factor).
- The emission levels of other frequencies are very lower than the limit and not show in test report.

EUT	Smart Wi-Fi Outlet Extender	Date of Test	2023-06-13
Factor	DRH18-E	Temp. / Humidity	21°C /61%
Polarity	Vertical	Site / Test Engineer	AC2 / Stanley
Test Mode	802.11g_TX_CH 6_ANT 1	Test Voltage	By Notebook PC

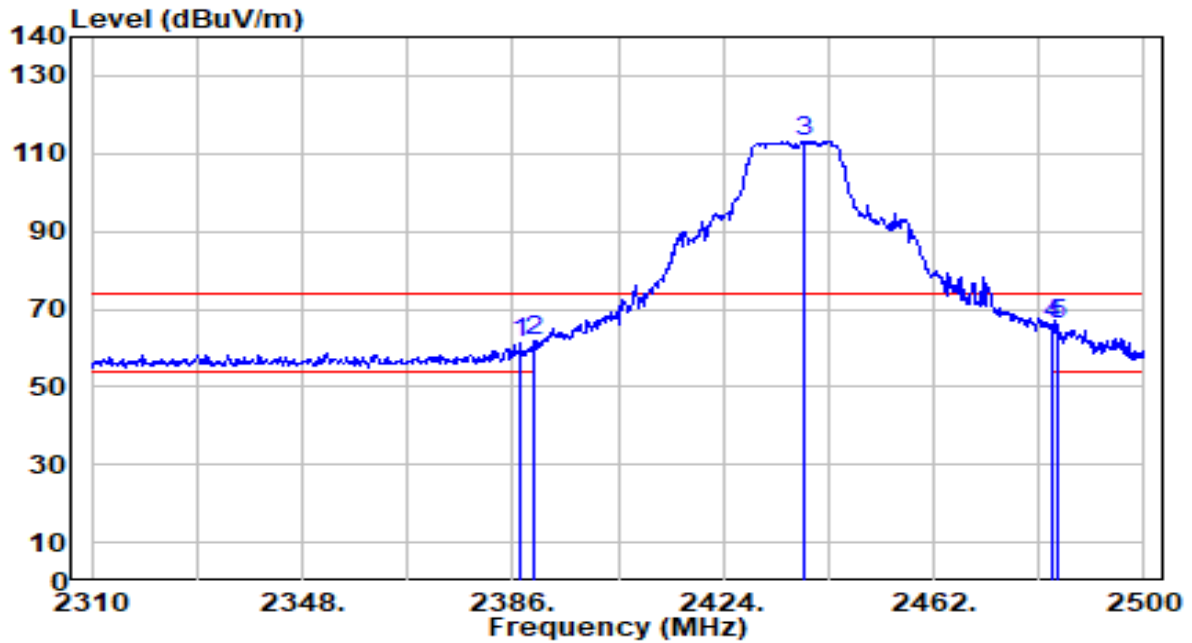

No	Frequency (MHz)	Reading (dBuV)	C.F (dB/m)	Measurement (dBuV/m)	Margin (dB)	Limit (dBuV/m)	Height (cm)	Angle (deg)	Remark (QP/PK/AV)
1	2387.520	30.86	30.17	61.04	-12.96	74.00	200	51	Peak
2	2390.000	31.61	30.18	61.79	-12.21	74.00	200	51	Peak
3	2438.820	82.87	30.26	113.13	N/A	N/A	200	51	Peak
4	2483.500	35.58	30.32	65.89	-8.11	74.00	200	51	Peak
5	* 2484.230	35.87	30.32	66.19	-7.81	74.00	200	51	Peak

Note:

1. " *", means this data is the worst emission level.
2. C.F (Correction Factor) = Antenna Factor (dB/m) + Cable Loss (dB).
3. Measurement (dBuV/m) = Reading(dBuV) + C.F (Correction Factor).
4. The emission levels of other frequencies are very lower than the limit and not show in test report.

EUT	Smart Wi-Fi Outlet Extender	Date of Test	2023-06-13
Factor	DRH18-E	Temp. / Humidity	21°C /61%
Polarity	Vertical	Site / Test Engineer	AC2 / Stanley
Test Mode	802.11g_TX_CH 6_ANT 1	Test Voltage	By Notebook PC

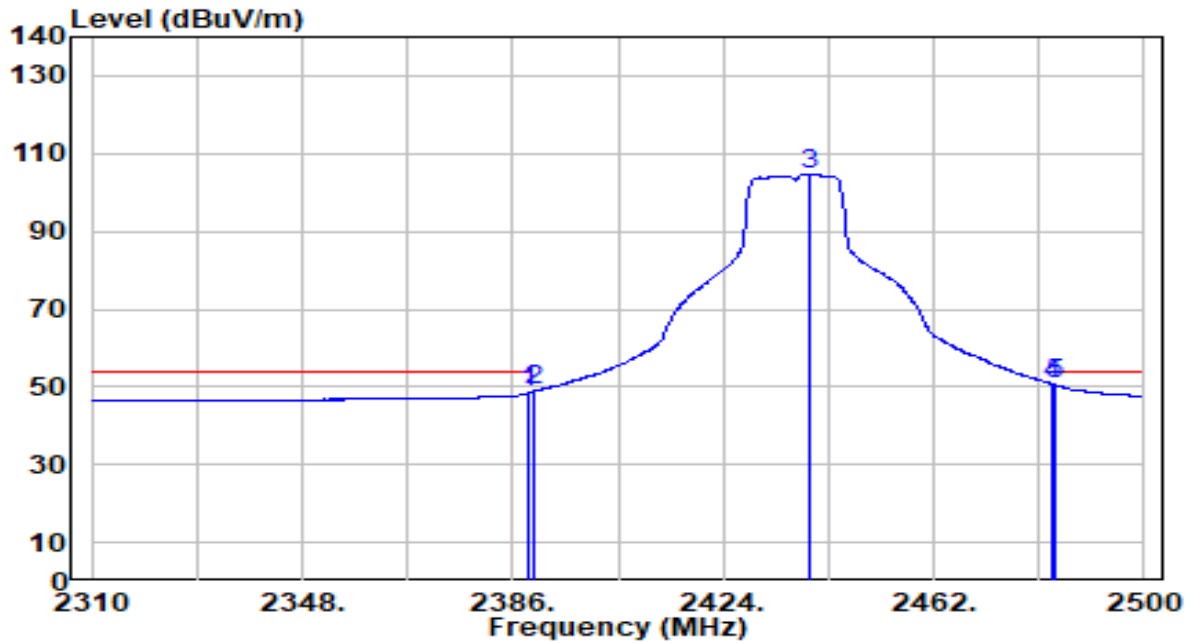

No	Frequency (MHz)	Reading (dBuV)	C.F (dB/m)	Measurement (dBuV/m)	Margin (dB)	Limit (dBuV/m)	Height (cm)	Angle (deg)	Remark (QP/PK/AV)
1	2389.040	18.44	30.18	48.62	-5.38	54.00	200	51	Average
2	2390.000	18.84	30.18	49.02	-4.98	54.00	200	51	Average
3	2439.580	74.40	30.26	104.66	N/A	N/A	200	51	Average
4	* 2483.500	20.38	30.32	50.70	-3.30	54.00	200	51	Average
5	2484.040	20.15	30.32	50.47	-3.53	54.00	200	51	Average

Note:

1. " *", means this data is the worst emission level.
2. C.F (Correction Factor) = Antenna Factor (dB/m) + Cable Loss (dB).
3. Measurement (dBuV/m) = Reading(dBuV) + C.F (Correction Factor).
4. The emission levels of other frequencies are very lower than the limit and not show in test report.

EUT	Smart Wi-Fi Outlet Extender	Date of Test	2023-06-13
Factor	DRH18-E	Temp. / Humidity	21°C /61%
Polarity	Horizontal	Site / Test Engineer	AC2 / Stanley
Test Mode	802.11g_TX_CH 10_ANT 1	Test Voltage	By Notebook PC

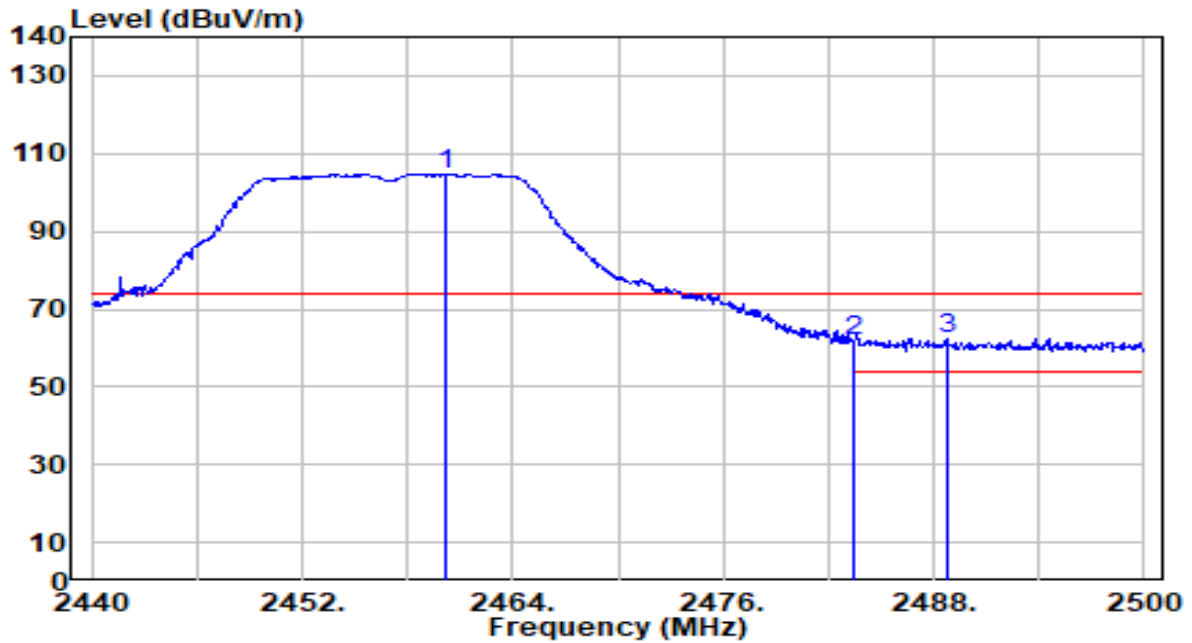

No	Frequency (MHz)	Reading (dBUV)	C.F (dB/m)	Measurement (dBUV/m)	Margin (dB)	Limit (dBUV/m)	Height (cm)	Angle (deg)	Remark (QP/PK/AV)
1	2460.220	74.44	30.29	104.72	N/A	N/A	216	122	Peak
2	2483.500	31.49	30.32	61.81	-12.19	74.00	216	122	Peak
3	* 2488.780	32.19	30.33	62.52	-11.48	74.00	216	122	Peak

Note:

1. " *", means this data is the worst emission level.
2. C.F (Correction Factor) = Antenna Factor (dB/m) + Cable Loss (dB).
3. Measurement (dBUV/m) = Reading(dBUV) + C.F (Correction Factor).
4. The emission levels of other frequencies are very lower than the limit and not show in test report.

EUT	Smart Wi-Fi Outlet Extender	Date of Test	2023-06-13
Factor	DRH18-E	Temp. / Humidity	21°C /61%
Polarity	Horizontal	Site / Test Engineer	AC2 / Stanley
Test Mode	802.11g_TX_CH 10_ANT 1	Test Voltage	By Notebook PC

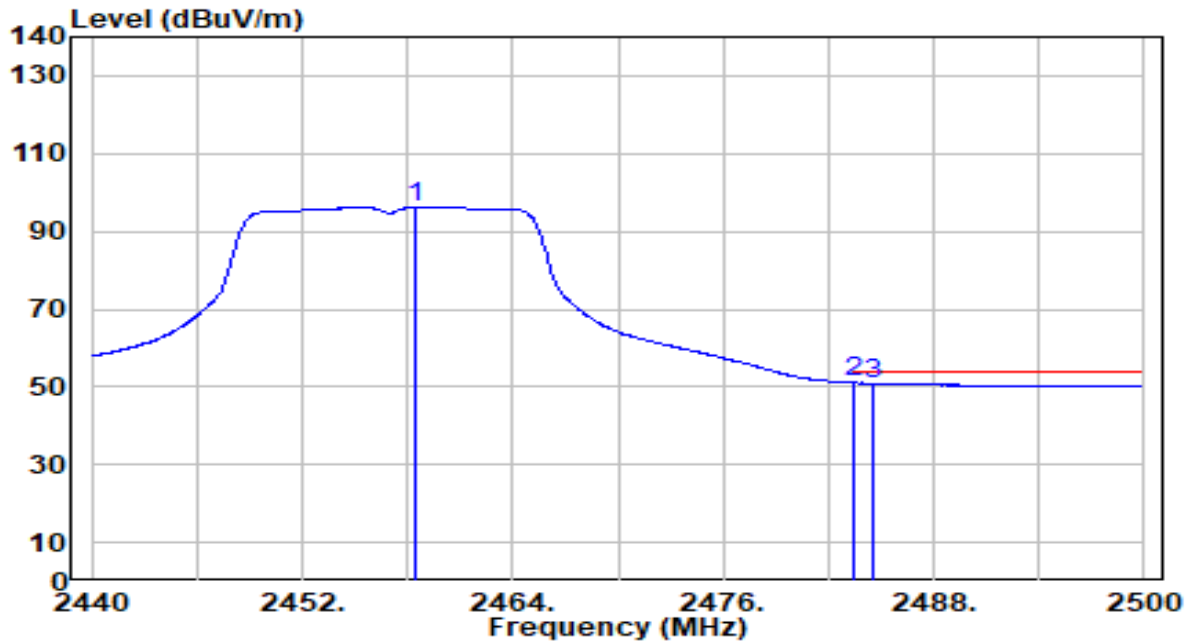

No	Frequency (MHz)	Reading (dBuV)	C.F (dB/m)	Measurement (dBuV/m)	Margin (dB)	Limit (dBuV/m)	Height (cm)	Angle (deg)	Remark (QP/PK/AV)
1	2458.480	65.81	30.29	96.10	N/A	N/A	216	122	Average
2	* 2483.500	20.69	30.32	51.00	-3.00	54.00	216	122	Average
3	2484.580	20.56	30.32	50.87	-3.13	54.00	216	122	Average

Note:

1. " *", means this data is the worst emission level.
2. C.F (Correction Factor) = Antenna Factor (dB/m) + Cable Loss (dB).
3. Measurement (dBuV/m) = Reading(dBuV) + C.F (Correction Factor).
4. The emission levels of other frequencies are very lower than the limit and not show in test report.

EUT	Smart Wi-Fi Outlet Extender	Date of Test	2023-06-13
Factor	DRH18-E	Temp. / Humidity	21°C /61%
Polarity	Vertical	Site / Test Engineer	AC2 / Stanley
Test Mode	802.11g_TX_CH 10_ANT 1	Test Voltage	By Notebook PC

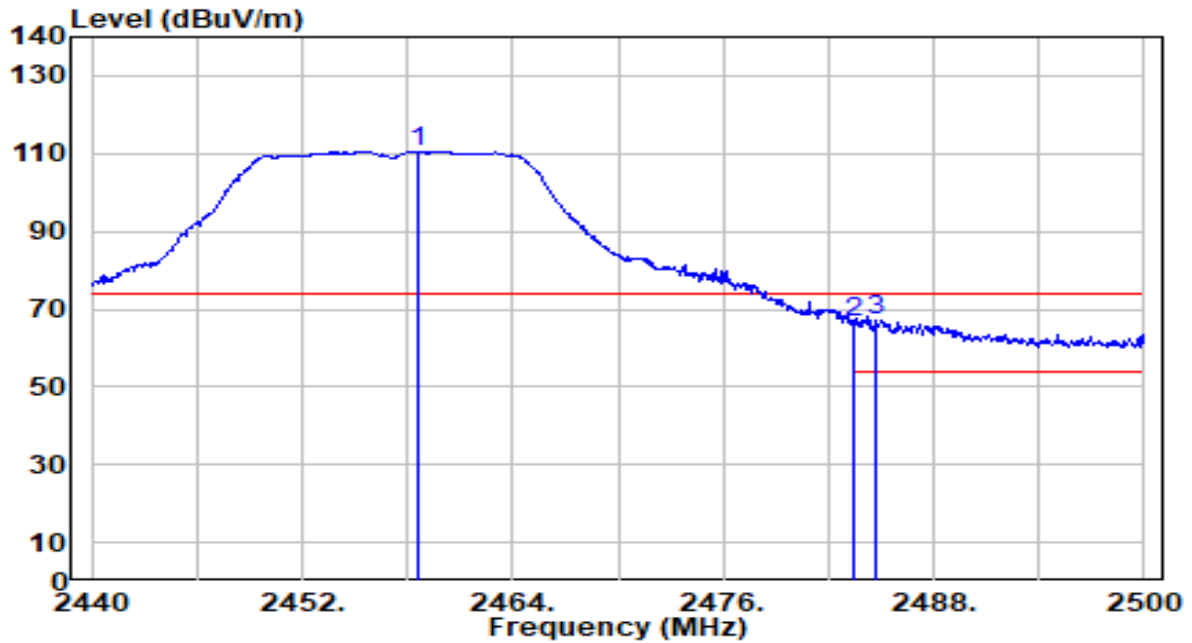

No	Frequency (MHz)	Reading (dBUV)	C.F (dB/m)	Measurement (dBUV/m)	Margin (dB)	Limit (dBUV/m)	Height (cm)	Angle (deg)	Remark (QP/PK/AV)
1	2458.540	80.24	30.29	110.52	N/A	N/A	300	49	Peak
2	2483.500	36.07	30.32	66.39	-7.61	74.00	300	49	Peak
3	* 2484.700	37.03	30.32	67.35	-6.65	74.00	300	49	Peak

Note:

1. " *", means this data is the worst emission level.
2. C.F (Correction Factor) = Antenna Factor (dB/m) + Cable Loss (dB).
3. Measurement (dBUV/m) = Reading(dBUV) + C.F (Correction Factor).
4. The emission levels of other frequencies are very lower than the limit and not show in test report.

EUT	Smart Wi-Fi Outlet Extender	Date of Test	2023-06-13
Factor	DRH18-E	Temp. / Humidity	21°C /61%
Polarity	Vertical	Site / Test Engineer	AC2 / Stanley
Test Mode	802.11g_TX_CH 10_ANT 1	Test Voltage	By Notebook PC

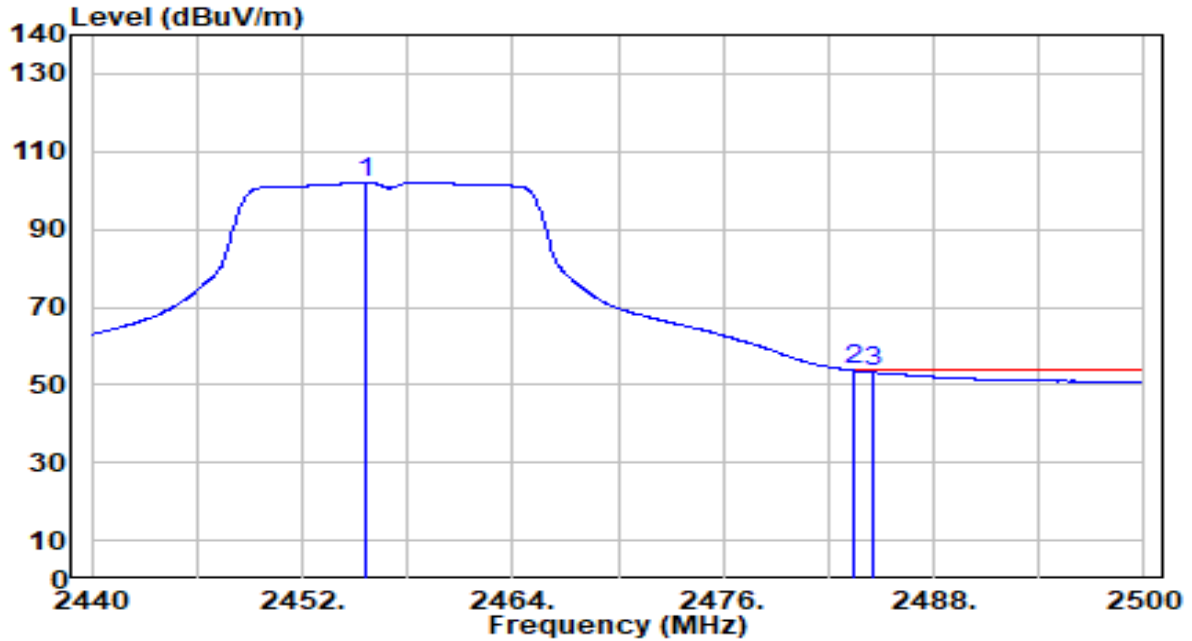

No	Frequency (MHz)	Reading (dBUV)	C.F (dB/m)	Measurement (dBUV/m)	Margin (dB)	Limit (dBUV/m)	Height (cm)	Angle (deg)	Remark (QP/PK/AV)
1	2455.660	71.69	30.28	101.97	N/A	N/A	300	49	Average
2	* 2483.500	23.45	30.32	53.67	-0.23	54.00	300	49	Average
3	2484.520	22.91	30.32	53.23	-0.77	54.00	300	49	Average

Note:

1. " *", means this data is the worst emission level.
2. C.F (Correction Factor) = Antenna Factor (dB/m) + Cable Loss (dB).
3. Measurement (dBUV/m) = Reading(dBUV) + C.F (Correction Factor).
4. The emission levels of other frequencies are very lower than the limit and not show in test report.

EUT	Smart Wi-Fi Outlet Extender	Date of Test	2023-06-13
Factor	DRH18-E	Temp. / Humidity	21°C /61%
Polarity	Horizontal	Site / Test Engineer	AC2 / Stanley
Test Mode	802.11g_TX_CH 11_ANT 1	Test Voltage	By Notebook PC

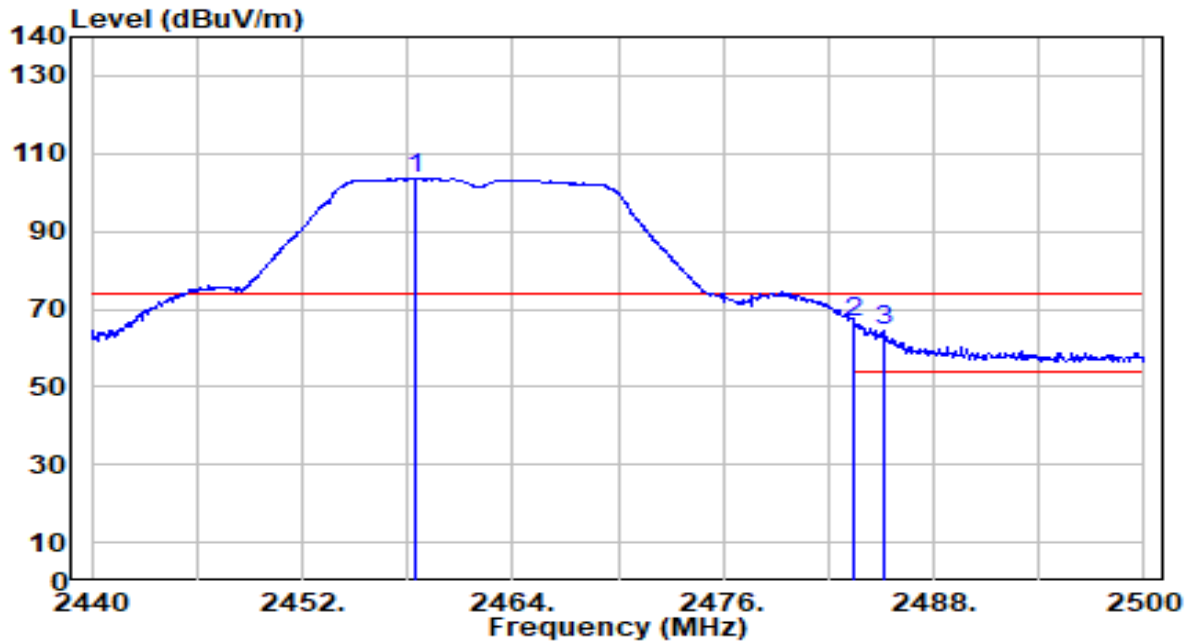

No	Frequency (MHz)	Reading (dBUV)	C.F (dB/m)	Measurement (dBUV/m)	Margin (dB)	Limit (dBUV/m)	Height (cm)	Angle (deg)	Remark (QP/PK/AV)
1	2458.420	73.38	30.29	103.67	N/A	N/A	342	134	Peak
2	* 2483.500	36.39	30.32	66.71	-7.29	74.00	342	134	Peak
3	2485.120	34.15	30.32	64.47	-9.53	74.00	342	134	Peak

Note:

1. " *", means this data is the worst emission level.
2. C.F (Correction Factor) = Antenna Factor (dB/m) + Cable Loss (dB).
3. Measurement (dBUV/m) = Reading(dBUV) + C.F (Correction Factor).
4. The emission levels of other frequencies are very lower than the limit and not show in test report.

EUT	Smart Wi-Fi Outlet Extender	Date of Test	2023-06-13
Factor	DRH18-E	Temp. / Humidity	21°C /61%
Polarity	Horizontal	Site / Test Engineer	AC2 / Stanley
Test Mode	802.11g_TX_CH 11_ANT 1	Test Voltage	By Notebook PC

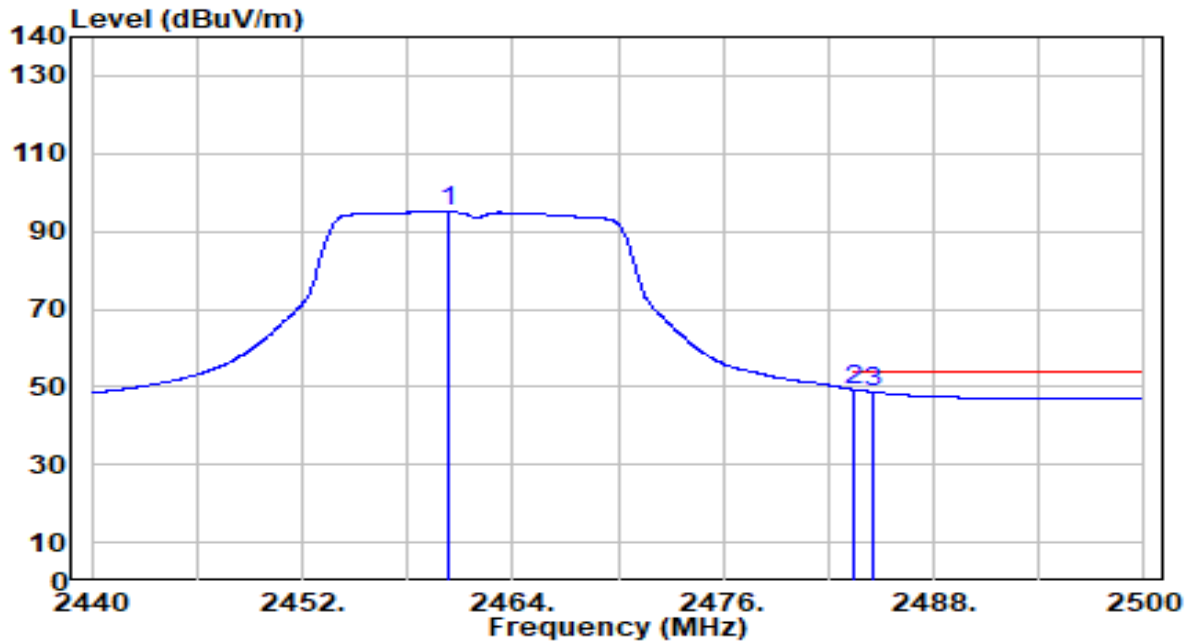

No	Frequency (MHz)	Reading (dBuV)	C.F (dB/m)	Measurement (dBuV/m)	Margin (dB)	Limit (dBuV/m)	Height (cm)	Angle (deg)	Remark (QP/PK/AV)
1	2460.340	64.64	30.29	94.93	N/A	N/A	342	134	Average
2	* 2483.500	18.95	30.32	49.27	-4.73	54.00	342	134	Average
3	2484.520	18.43	30.32	48.75	-5.25	54.00	342	134	Average

Note:

1. " *", means this data is the worst emission level.
2. C.F (Correction Factor) = Antenna Factor (dB/m) + Cable Loss (dB).
3. Measurement (dBuV/m) = Reading(dBuV) + C.F (Correction Factor).
4. The emission levels of other frequencies are very lower than the limit and not show in test report.

EUT	Smart Wi-Fi Outlet Extender	Date of Test	2023-06-13
Factor	DRH18-E	Temp. / Humidity	21°C /61%
Polarity	Vertical	Site / Test Engineer	AC2 / Stanley
Test Mode	802.11g_TX_CH 11_ANT 1	Test Voltage	By Notebook PC

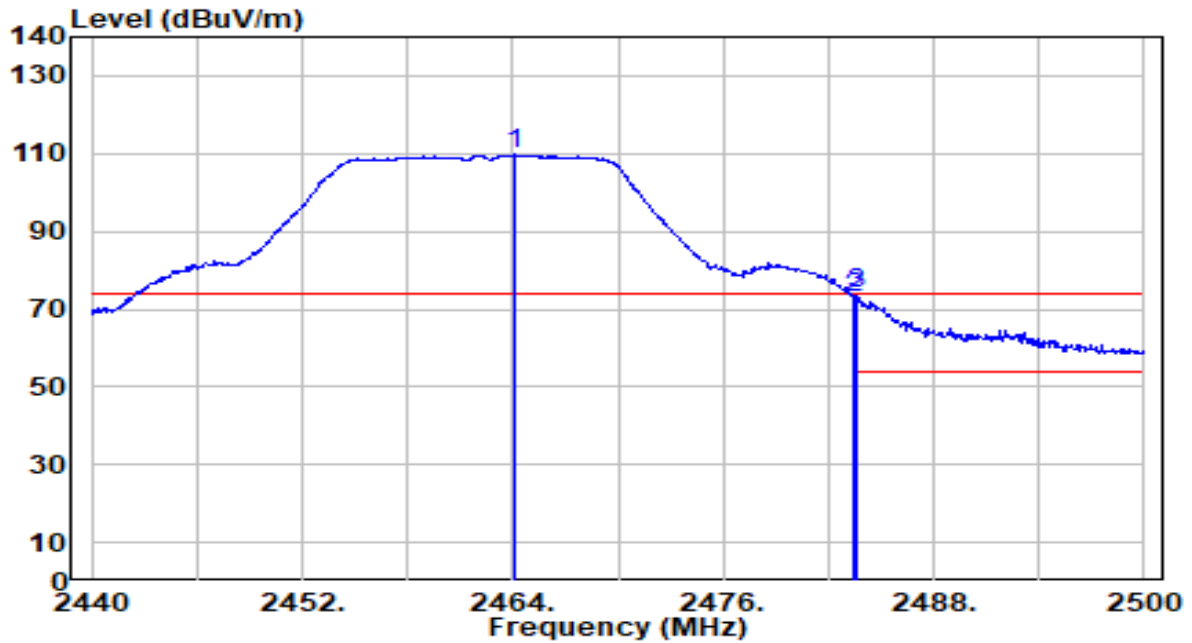

No	Frequency (MHz)	Reading (dBuV)	C.F (dB/m)	Measurement (dBuV/m)	Margin (dB)	Limit (dBuV/m)	Height (cm)	Angle (deg)	Remark (QP/PK/AV)
1	2464.060	79.36	30.29	109.65	N/A	N/A	191	46	Peak
2	2483.500	42.63	30.32	72.95	-1.05	74.00	191	46	Peak
3	* 2483.560	43.47	30.32	73.79	-0.21	74.00	191	46	Peak

Note:

1. " *", means this data is the worst emission level.
2. C.F (Correction Factor) = Antenna Factor (dB/m) + Cable Loss (dB).
3. Measurement (dBuV/m) = Reading(dBuV) + C.F (Correction Factor).
4. The emission levels of other frequencies are very lower than the limit and not show in test report.

EUT	Smart Wi-Fi Outlet Extender	Date of Test	2023-06-13
Factor	DRH18-E	Temp. / Humidity	21°C /61%
Polarity	Vertical	Site / Test Engineer	AC2 / Stanley
Test Mode	802.11g_TX_CH 11_ANT 1	Test Voltage	By Notebook PC

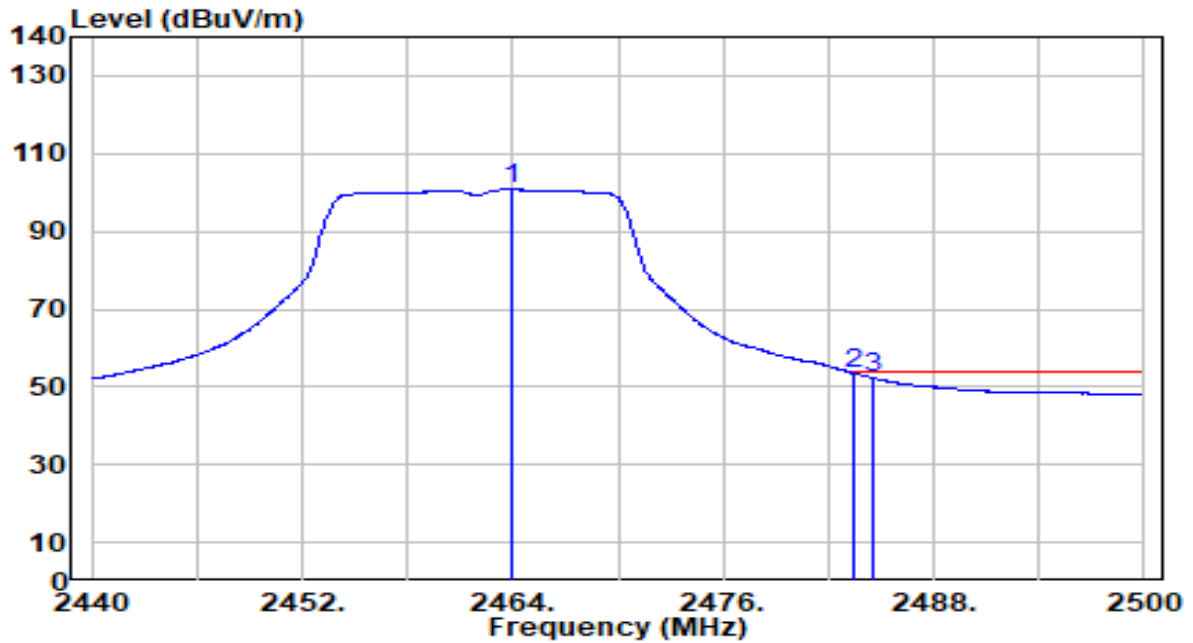

No	Frequency (MHz)	Reading (dBUV)	C.F (dB/m)	Measurement (dBUV/m)	Margin (dB)	Limit (dBUV/m)	Height (cm)	Angle (deg)	Remark (QP/PK/AV)
1	2463.880	70.40	30.29	100.69	N/A	N/A	191	46	Average
2	* 2483.500	23.08	30.32	53.40	-0.60	54.00	191	46	Average
3	2484.520	22.06	30.32	52.38	-1.62	54.00	191	46	Average

Note:

1. " *", means this data is the worst emission level.
2. C.F (Correction Factor) = Antenna Factor (dB/m) + Cable Loss (dB).
3. Measurement (dBUV/m) = Reading(dBUV) + C.F (Correction Factor).
4. The emission levels of other frequencies are very lower than the limit and not show in test report.

EUT	Smart Wi-Fi Outlet Extender	Date of Test	2023-06-13
Factor	DRH18-E	Temp. / Humidity	21°C /61%
Polarity	Horizontal	Site / Test Engineer	AC2 / Stanley
Test Mode	802.11n-20MHz_TX_CH 1_ANT 1	Test Voltage	By Notebook PC

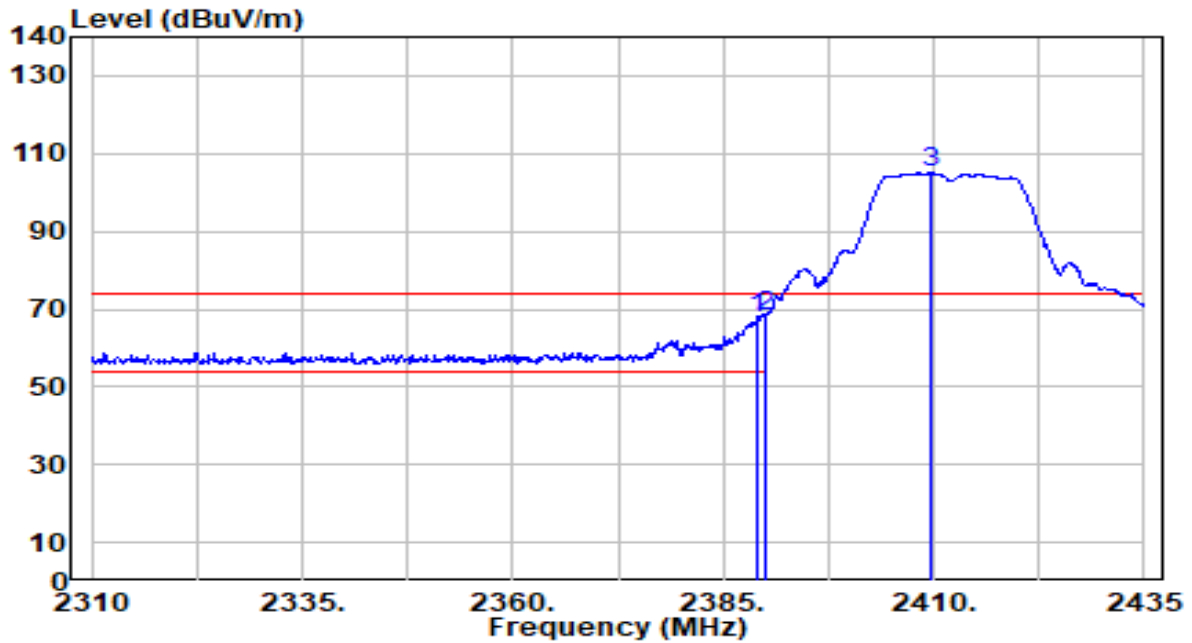

No	Frequency (MHz)	Reading (dBuV)	C.F (dB/m)	Measurement (dBuV/m)	Margin (dB)	Limit (dBuV/m)	Height (cm)	Angle (deg)	Remark (QP/PK/AV)
1	2389.000	37.63	30.18	67.81	-6.19	74.00	278	79	Peak
2	* 2390.000	38.10	30.18	68.28	-5.72	74.00	278	79	Peak
3	2409.625	74.82	30.22	105.04	N/A	N/A	278	79	Peak

Note:

1. " *", means this data is the worst emission level.
2. C.F (Correction Factor) = Antenna Factor (dB/m) + Cable Loss (dB).
3. Measurement (dBuV/m) = Reading(dBuV) + C.F (Correction Factor).
4. The emission levels of other frequencies are very lower than the limit and not show in test report.

EUT	Smart Wi-Fi Outlet Extender	Date of Test	2023-06-13
Factor	DRH18-E	Temp. / Humidity	21°C /61%
Polarity	Horizontal	Site / Test Engineer	AC2 / Stanley
Test Mode	802.11n-20MHz_TX_CH 1_ANT 1	Test Voltage	By Notebook PC

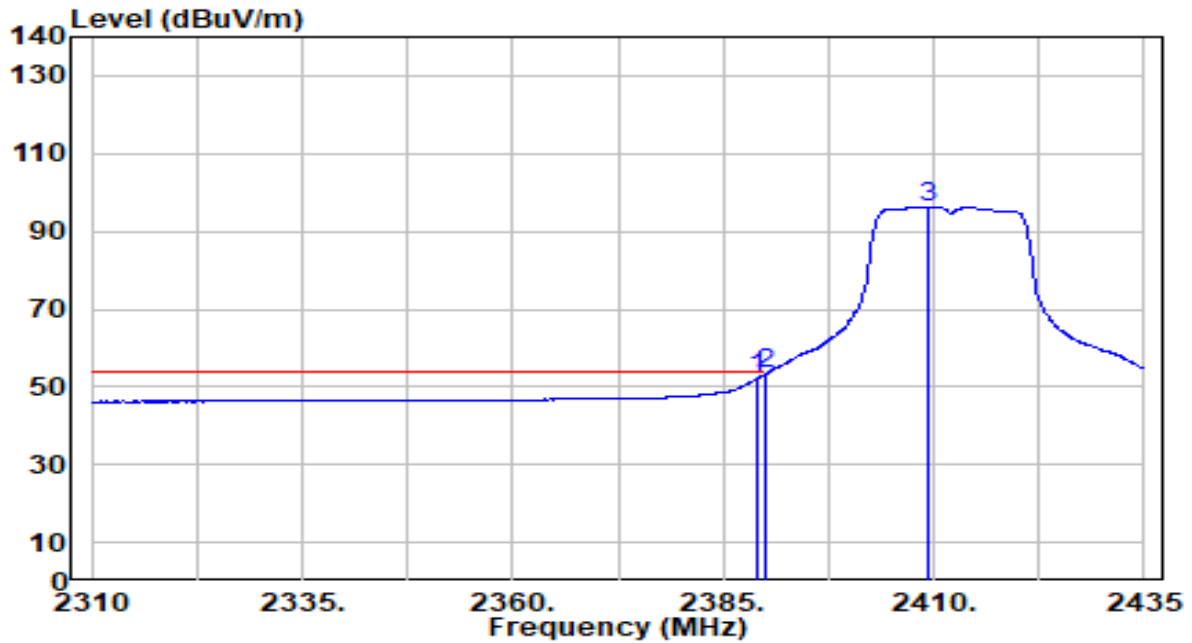

No	Frequency (MHz)	Reading (dBuV)	C.F (dB/m)	Measurement (dBuV/m)	Margin (dB)	Limit (dBuV/m)	Height (cm)	Angle (deg)	Remark (QP/PK/AV)
1	2389.000	21.90	30.18	52.08	-1.92	54.00	278	79	Average
2	* 2390.000	23.01	30.18	53.19	-0.81	54.00	278	79	Average
3	2409.375	66.04	30.22	96.26	N/A	N/A	278	79	Average

Note:

1. " *", means this data is the worst emission level.
2. C.F (Correction Factor) = Antenna Factor (dB/m) + Cable Loss (dB).
3. Measurement (dBuV/m) = Reading(dBuV) + C.F (Correction Factor).
4. The emission levels of other frequencies are very lower than the limit and not show in test report.

EUT	Smart Wi-Fi Outlet Extender	Date of Test	2023-06-13
Factor	DRH18-E	Temp. / Humidity	21°C /61%
Polarity	Vertical	Site / Test Engineer	AC2 / Stanley
Test Mode	802.11n-20MHz_TX_CH 1_ANT 1	Test Voltage	By Notebook PC

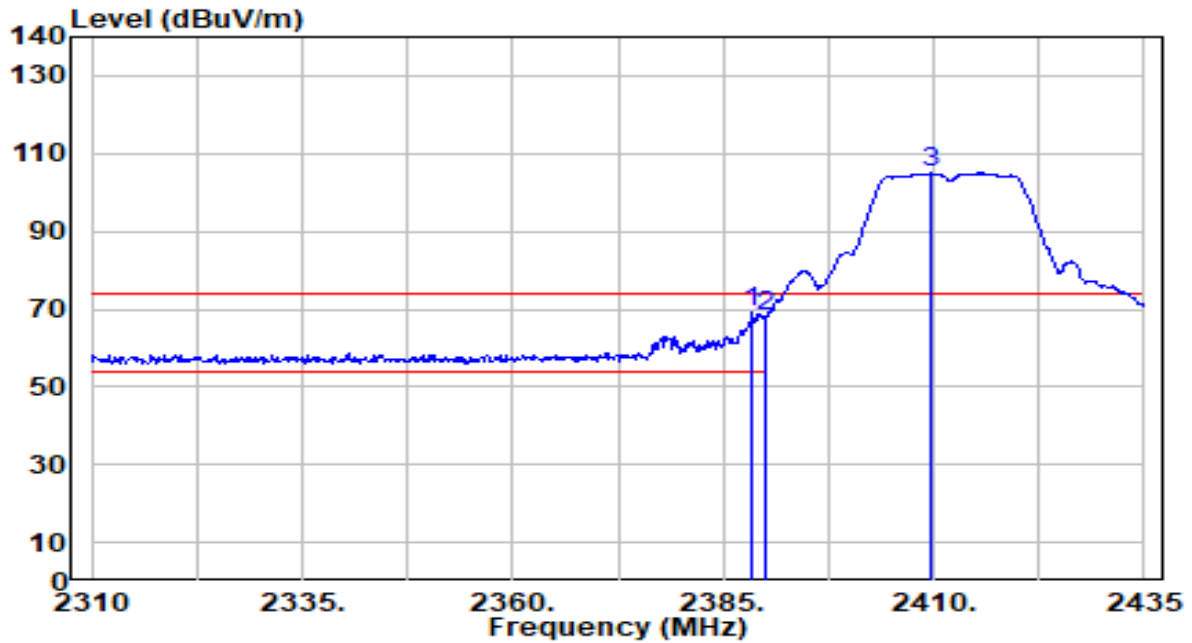

No	Frequency (MHz)	Reading (dBuV)	C.F (dB/m)	Measurement (dBuV/m)	Margin (dB)	Limit (dBuV/m)	Height (cm)	Angle (deg)	Remark (QP/PK/AV)	
1	*	2388.500	38.81	30.18	68.99	-5.01	74.00	249	68	Peak
2		2390.000	38.12	30.18	68.30	-5.70	74.00	249	68	Peak
3		2409.750	74.69	30.22	104.91	N/A	N/A	249	68	Peak

Note:

1. " *", means this data is the worst emission level.
2. C.F (Correction Factor) = Antenna Factor (dB/m) + Cable Loss (dB).
3. Measurement (dBuV/m) = Reading(dBuV) + C.F (Correction Factor).
4. The emission levels of other frequencies are very lower than the limit and not show in test report.

EUT	Smart Wi-Fi Outlet Extender	Date of Test	2023-06-13
Factor	DRH18-E	Temp. / Humidity	21°C /61%
Polarity	Vertical	Site / Test Engineer	AC2 / Stanley
Test Mode	802.11n-20MHz_TX_CH 1_ANT 1	Test Voltage	By Notebook PC

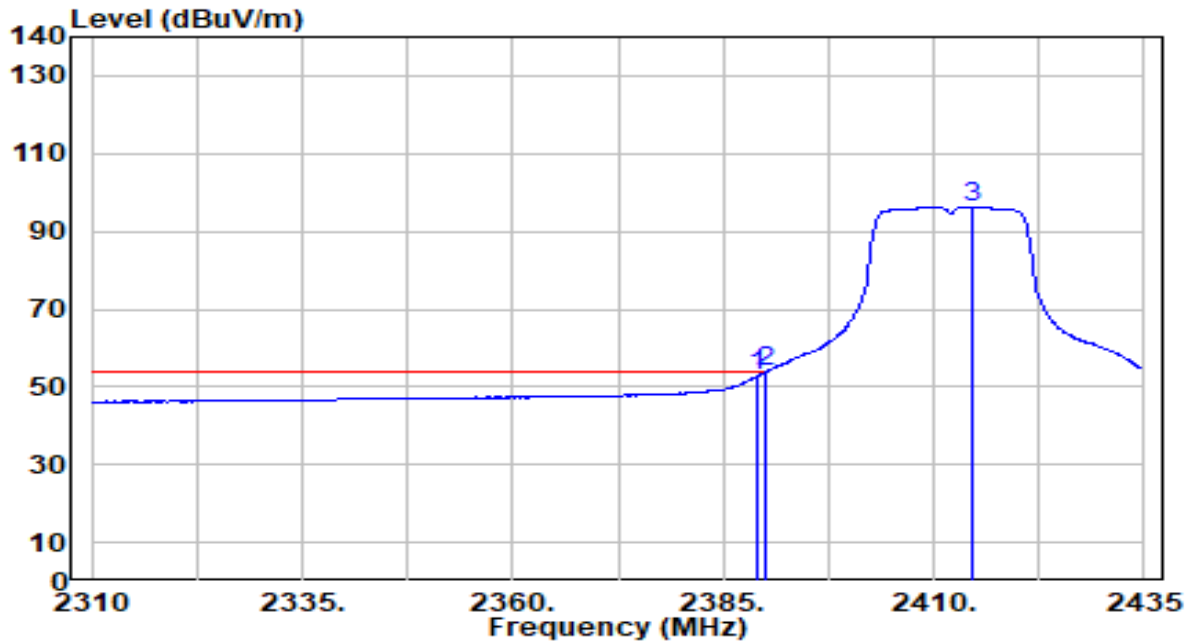

No	Frequency (MHz)	Reading (dBuV)	C.F (dB/m)	Measurement (dBuV/m)	Margin (dB)	Limit (dBuV/m)	Height (cm)	Angle (deg)	Remark (QP/PK/AV)
1	2389.000	22.64	30.18	52.82	-1.18	54.00	249	68	Average
2	* 2390.000	23.71	30.18	53.89	-0.11	54.00	249	68	Average
3	2414.625	66.05	30.23	96.28	N/A	N/A	249	68	Average

Note:

1. " *", means this data is the worst emission level.
2. C.F (Correction Factor) = Antenna Factor (dB/m) + Cable Loss (dB).
3. Measurement (dBuV/m) = Reading(dBuV) + C.F (Correction Factor).
4. The emission levels of other frequencies are very lower than the limit and not show in test report.

EUT	Smart Wi-Fi Outlet Extender	Date of Test	2023-06-13
Factor	DRH18-E	Temp. / Humidity	21°C /61%
Polarity	Horizontal	Site / Test Engineer	AC2 / Stanley
Test Mode	802.11n-20MHz_TX_CH 6_ANT 1	Test Voltage	By Notebook PC

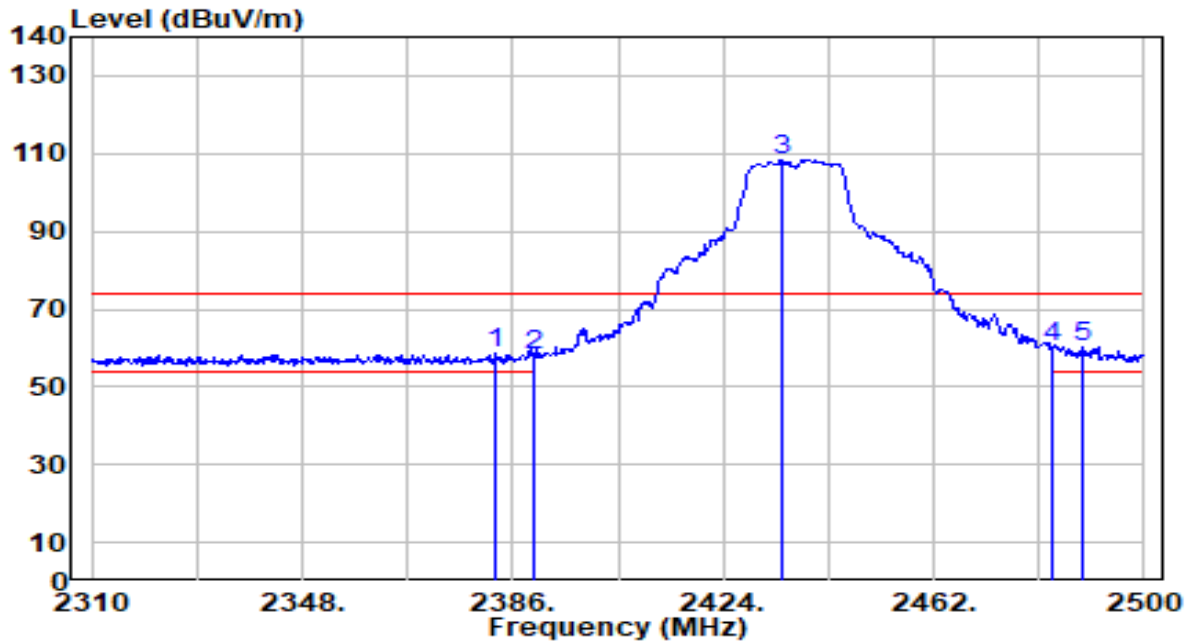

No	Frequency (MHz)	Reading (dBuV)	C.F (dB/m)	Measurement (dBuV/m)	Margin (dB)	Limit (dBuV/m)	Height (cm)	Angle (deg)	Remark (QP/PK/AV)
1	2382.960	28.28	30.16	58.44	-15.56	74.00	308	133	Peak
2	2390.000	27.80	30.18	57.98	-16.02	74.00	308	133	Peak
3	2434.450	78.19	30.25	108.44	N/A	N/A	308	133	Peak
4	2483.500	29.95	30.32	60.27	-13.73	74.00	308	133	Peak
5	* 2488.980	30.16	30.33	60.48	-13.52	74.00	308	133	Peak

Note:

1. " *", means this data is the worst emission level.
2. C.F (Correction Factor) = Antenna Factor (dB/m) + Cable Loss (dB).
3. Measurement (dBuV/m) = Reading(dBuV) + C.F (Correction Factor).
4. The emission levels of other frequencies are very lower than the limit and not show in test report.

EUT	Smart Wi-Fi Outlet Extender	Date of Test	2023-06-13
Factor	DRH18-E	Temp. / Humidity	21°C /61%
Polarity	Horizontal	Site / Test Engineer	AC2 / Stanley
Test Mode	802.11n-20MHz_TX_CH 6_ANT 1	Test Voltage	By Notebook PC

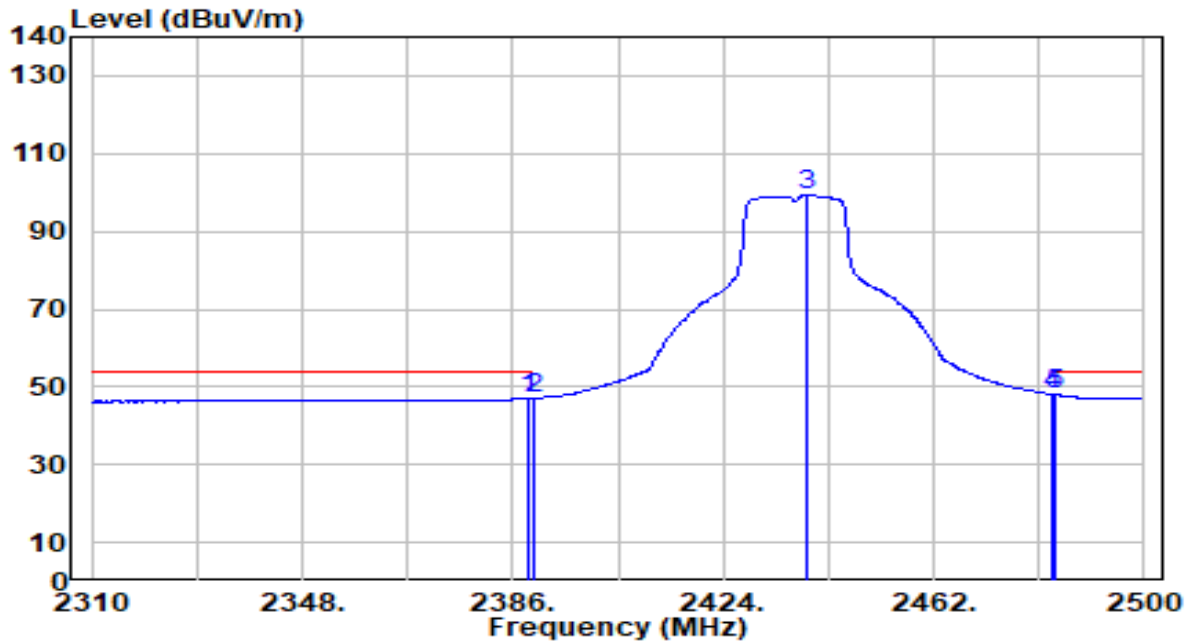

No	Frequency (MHz)	Reading (dBuV)	C.F (dB/m)	Measurement (dBuV/m)	Margin (dB)	Limit (dBuV/m)	Height (cm)	Angle (deg)	Remark (QP/PK/AV)
1	2389.040	16.88	30.18	47.06	-6.94	54.00	308	133	Average
2	2390.000	16.96	30.18	47.14	-6.86	54.00	308	133	Average
3	2439.010	68.96	30.26	99.22	N/A	N/A	308	133	Average
4	* 2483.500	17.74	30.32	48.06	-5.94	54.00	308	133	Average
5	2484.040	17.63	30.32	47.95	-6.05	54.00	308	133	Average

Note:

- "*" means this data is the worst emission level.
- C.F (Correction Factor) = Antenna Factor (dB/m) + Cable Loss (dB).
- Measurement (dBuV/m) = Reading(dBuV) + C.F (Correction Factor).
- The emission levels of other frequencies are very lower than the limit and not show in test report.

EUT	Smart Wi-Fi Outlet Extender	Date of Test	2023-06-13
Factor	DRH18-E	Temp. / Humidity	21°C /61%
Polarity	Vertical	Site / Test Engineer	AC2 / Stanley
Test Mode	802.11n-20MHz_TX_CH 6_ANT 1	Test Voltage	By Notebook PC

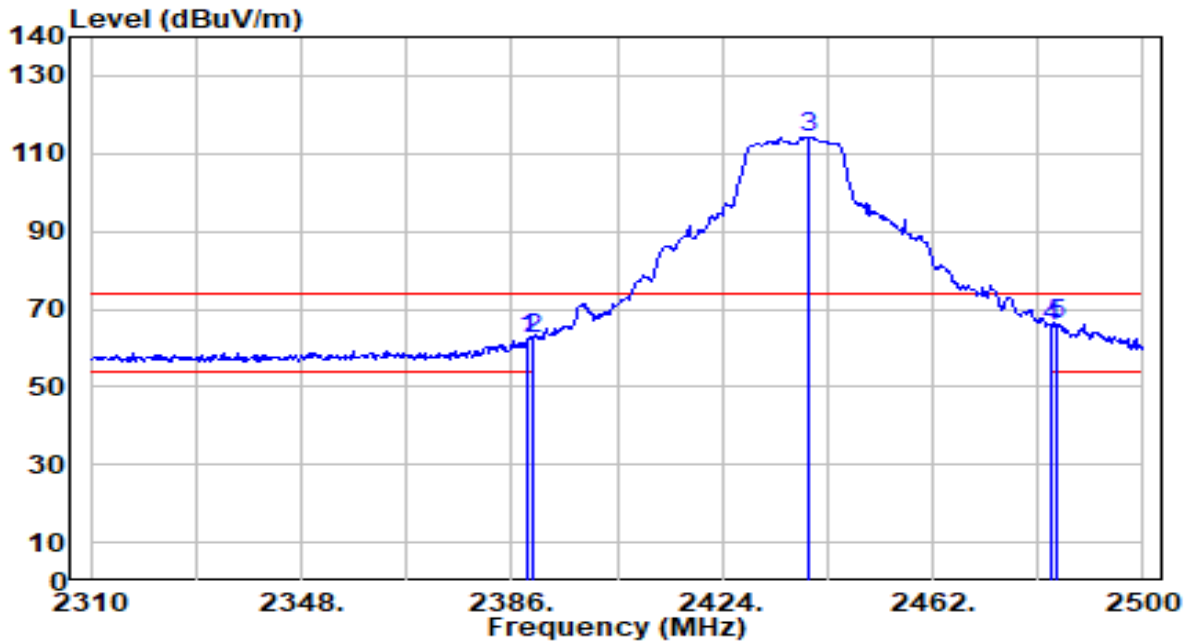

No	Frequency (MHz)	Reading (dBuV)	C.F (dB/m)	Measurement (dBuV/m)	Margin (dB)	Limit (dBuV/m)	Height (cm)	Angle (deg)	Remark (QP/PK/AV)
1	2389.040	31.94	30.18	62.11	-11.89	74.00	173	59	Peak
2	2390.000	32.12	30.18	62.30	-11.70	74.00	173	59	Peak
3	2439.390	83.82	30.26	114.08	N/A	N/A	173	59	Peak
4	2483.500	35.35	30.32	65.67	-8.33	74.00	173	59	Peak
5	* 2484.230	35.96	30.32	66.28	-7.72	74.00	173	59	Peak

Note:

- "*" , means this data is the worst emission level.
- C.F (Correction Factor) = Antenna Factor (dB/m) + Cable Loss (dB).
- Measurement (dBuV/m) = Reading(dBuV) + C.F (Correction Factor).
- The emission levels of other frequencies are very lower than the limit and not show in test report.

EUT	Smart Wi-Fi Outlet Extender	Date of Test	2023-06-13
Factor	DRH18-E	Temp. / Humidity	21°C /61%
Polarity	Vertical	Site / Test Engineer	AC2 / Stanley
Test Mode	802.11n-20MHz_TX_CH 6_ANT 1	Test Voltage	By Notebook PC

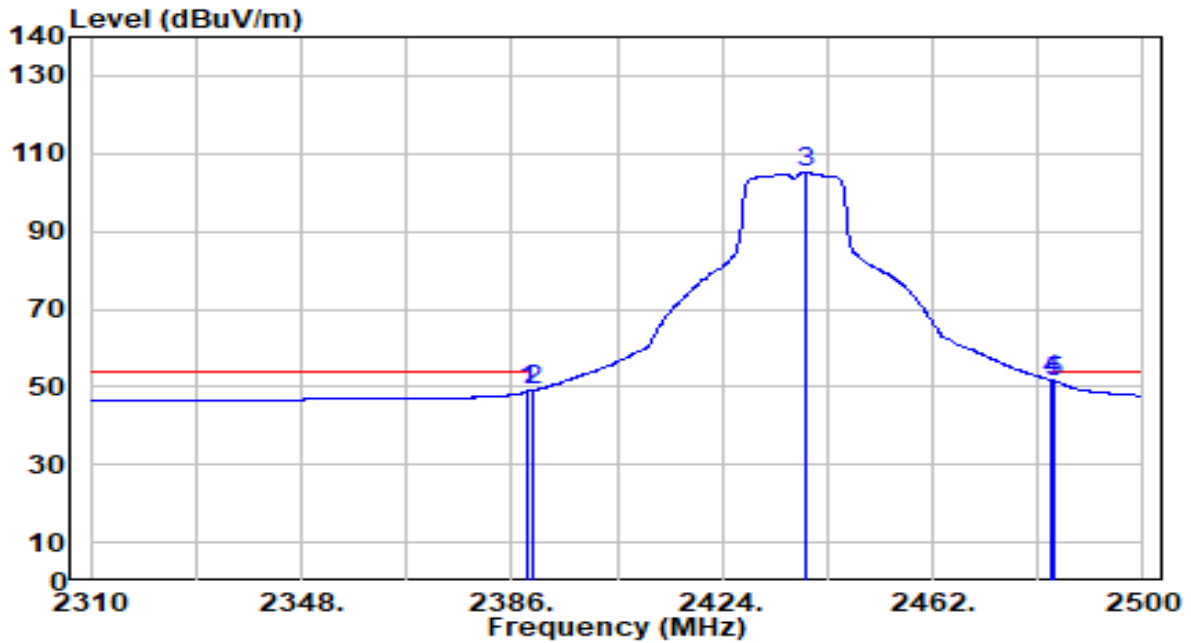

No	Frequency (MHz)	Reading (dBuV)	C.F (dB/m)	Measurement (dBuV/m)	Margin (dB)	Limit (dBuV/m)	Height (cm)	Angle (deg)	Remark (QP/PK/AV)
1	2389.040	18.70	30.18	48.88	-5.12	54.00	173	59	Average
2	2390.000	18.98	30.18	49.16	-4.84	54.00	173	59	Average
3	2439.200	74.73	30.26	104.99	N/A	N/A	173	59	Average
4	* 2483.500	21.29	30.32	51.61	-2.39	54.00	173	59	Average
5	2484.040	21.11	30.32	51.43	-2.57	54.00	173	59	Average

Note:

1. " *", means this data is the worst emission level.
2. C.F (Correction Factor) = Antenna Factor (dB/m) + Cable Loss (dB).
3. Measurement (dBuV/m) = Reading(dBuV) + C.F (Correction Factor).
4. The emission levels of other frequencies are very lower than the limit and not show in test report.

EUT	Smart Wi-Fi Outlet Extender	Date of Test	2023-06-13
Factor	DRH18-E	Temp. / Humidity	21°C /61%
Polarity	Horizontal	Site / Test Engineer	AC2 / Marvin
Test Mode	802.11n-20MHz_TX_CH 10_ANT 1	Test Voltage	By Notebook PC

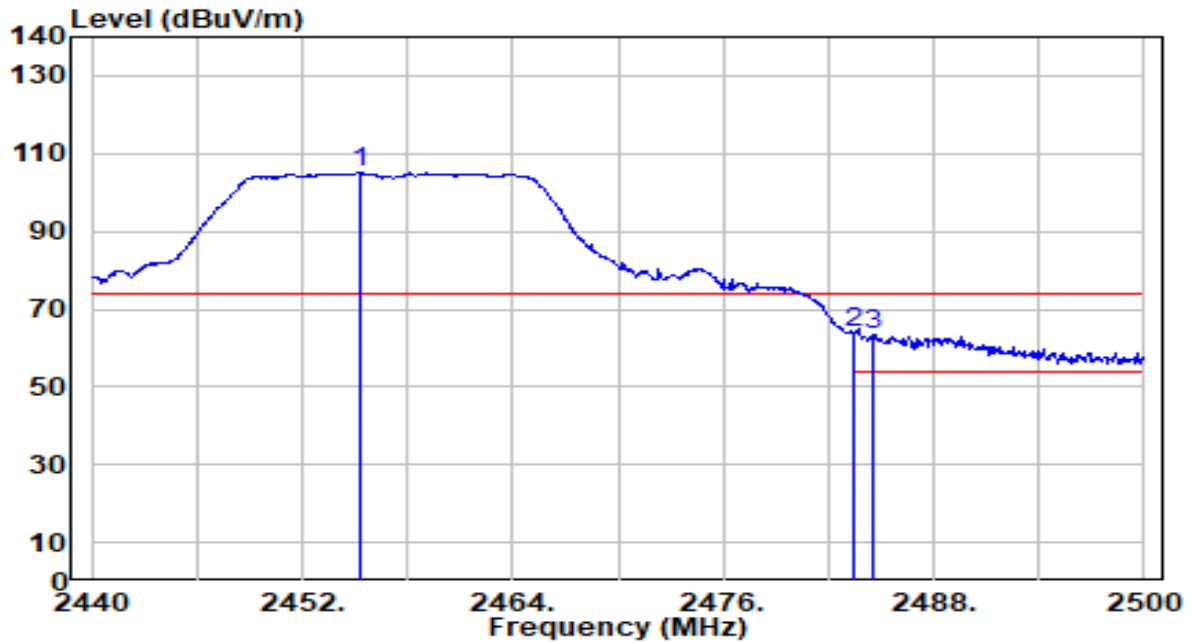

No	Frequency (MHz)	Reading (dBUV)	C.F (dB/m)	Measurement (dBUV/m)	Margin (dB)	Limit (dBUV/m)	Height (cm)	Angle (deg)	Remark (QP/PK/AV)
1	2455.360	74.64	30.28	104.92	N/A	N/A	300	78	Peak
2	* 2483.500	33.66	30.32	63.97	-10.03	74.00	300	78	Peak
3	2484.520	32.92	30.32	63.24	-10.76	74.00	300	78	Peak

Note:

1. " *", means this data is the worst emission level.
2. C.F (Correction Factor) = Antenna Factor (dB/m)+ Cable Loss (dB).
3. Measurement (dBUV/m) = Reading(dBUV) + C.F (Correction Factor).
4. The emission levels of other frequencies are very lower than the limit and not show in test report.

EUT	Smart Wi-Fi Outlet Extender	Date of Test	2023-06-13
Factor	DRH18-E	Temp. / Humidity	21°C /61%
Polarity	Horizontal	Site / Test Engineer	AC2 / Marvin
Test Mode	802.11n-20MHz_TX_CH 10_ANT 1	Test Voltage	By Notebook PC

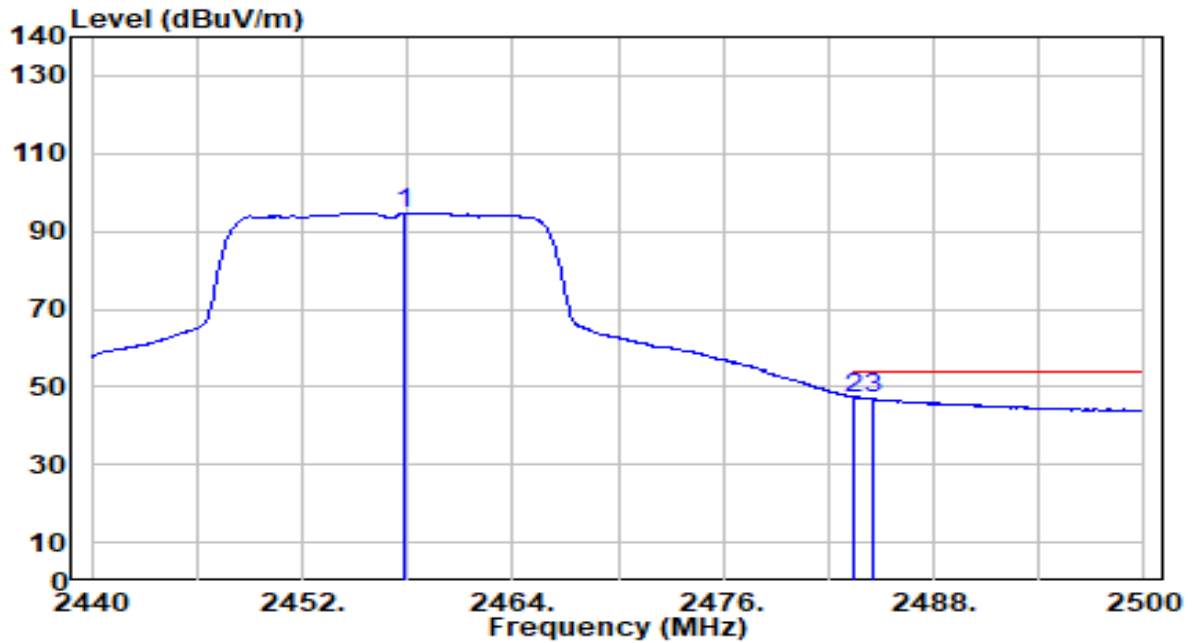

No	Frequency (MHz)	Reading (dBuV)	C.F (dB/m)	Measurement (dBuV/m)	Margin (dB)	Limit (dBuV/m)	Height (cm)	Angle (deg)	Remark (QP/PK/AV)
1	2457.880	64.49	30.28	94.77	N/A	N/A	300	78	Average
2	* 2483.500	16.94	30.32	47.26	-6.74	54.00	300	78	Average
3	2484.580	16.53	30.32	46.85	-7.15	54.00	300	78	Average

Note:

1. " *", means this data is the worst emission level.
2. C.F (Correction Factor) = Antenna Factor (dB/m)+ Cable Loss (dB).
3. Measurement (dBuV/m) = Reading(dBuV) + C.F (Correction Factor).
4. The emission levels of other frequencies are very lower than the limit and not show in test report.

EUT	Smart Wi-Fi Outlet Extender	Date of Test	2023-06-13
Factor	DRH18-E	Temp. / Humidity	21°C /61%
Polarity	Vertical	Site / Test Engineer	AC2 / Marvin
Test Mode	802.11n-20MHz_TX_CH 10_ANT 1	Test Voltage	By Notebook PC

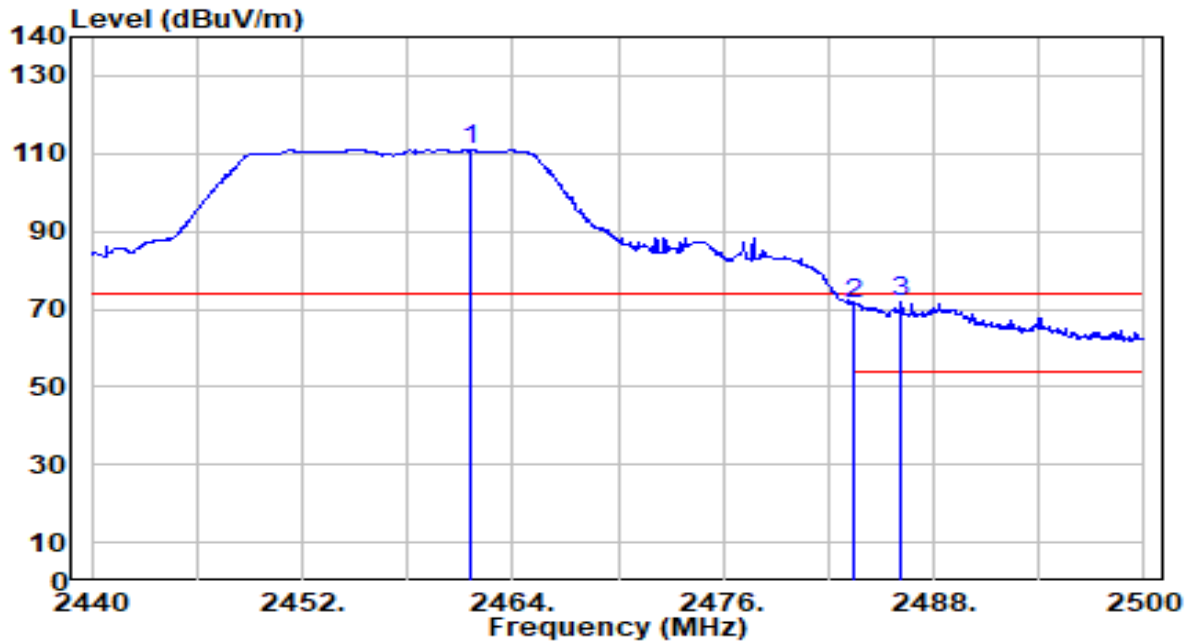

No	Frequency (MHz)	Reading (dBuV)	C.F (dB/m)	Measurement (dBuV/m)	Margin (dB)	Limit (dBuV/m)	Height (cm)	Angle (deg)	Remark (QP/PK/AV)
1	2461.600	80.65	30.29	110.94	N/A	N/A	200	48	Peak
2	2483.500	41.11	30.32	71.42	-2.58	74.00	200	48	Peak
3	* 2486.140	41.62	30.32	71.94	-2.06	74.00	200	48	Peak

Note:

1. " *", means this data is the worst emission level.
2. C.F (Correction Factor) = Antenna Factor (dB/m)+ Cable Loss (dB).
3. Measurement (dBuV/m) = Reading(dBuV) + C.F (Correction Factor).
4. The emission levels of other frequencies are very lower than the limit and not show in test report.

EUT	Smart Wi-Fi Outlet Extender	Date of Test	2023-06-13
Factor	DRH18-E	Temp. / Humidity	21°C /61%
Polarity	Vertical	Site / Test Engineer	AC2 / Marvin
Test Mode	802.11n-20MHz_TX_CH 10_ANT 1	Test Voltage	By Notebook PC

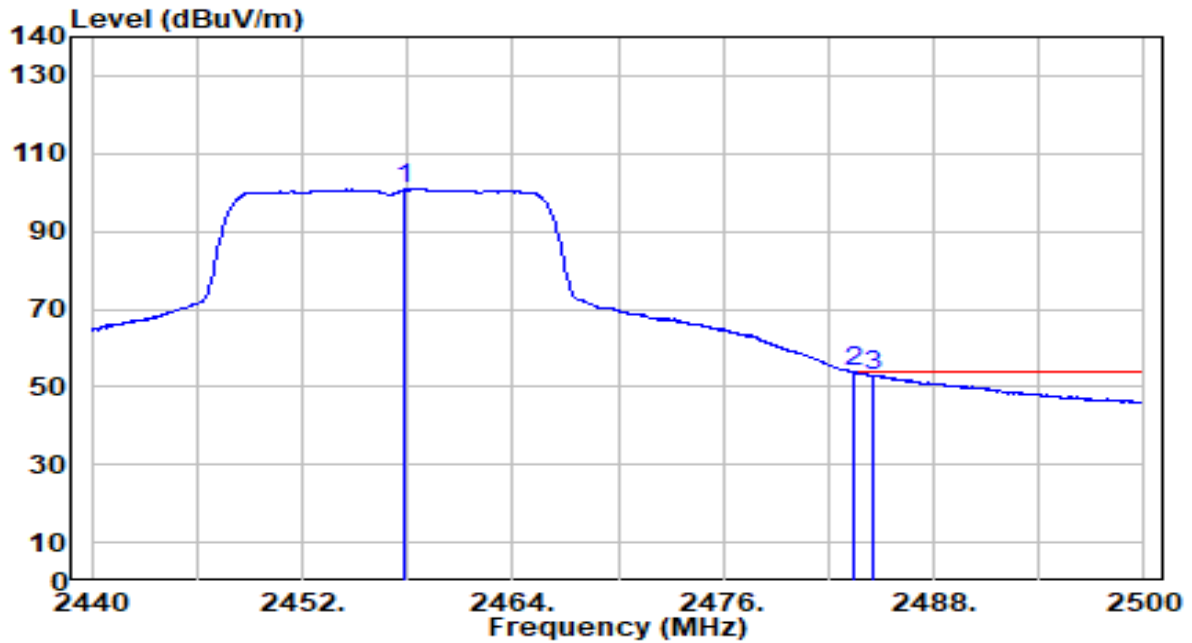

No	Frequency (MHz)	Reading (dBuV)	C.F (dB/m)	Measurement (dBuV/m)	Margin (dB)	Limit (dBuV/m)	Height (cm)	Angle (deg)	Remark (QP/PK/AV)
1	2457.880	70.49	30.28	100.77	N/A	N/A	200	48	Average
2	* 2483.500	23.50	30.32	53.81	-0.19	54.00	200	48	Average
3	2484.580	22.61	30.32	52.93	-1.07	54.00	200	48	Average

Note:

1. " *", means this data is the worst emission level.
2. C.F (Correction Factor) = Antenna Factor (dB/m)+ Cable Loss (dB).
3. Measurement (dBuV/m) = Reading(dBuV) + C.F (Correction Factor).
4. The emission levels of other frequencies are very lower than the limit and not show in test report.

EUT	Smart Wi-Fi Outlet Extender	Date of Test	2023-06-13
Factor	DRH18-E	Temp. / Humidity	21°C /61%
Polarity	Horizontal	Site / Test Engineer	AC2 / Stanley
Test Mode	802.11n-20MHz_TX_CH 11_ANT 1	Test Voltage	By Notebook PC

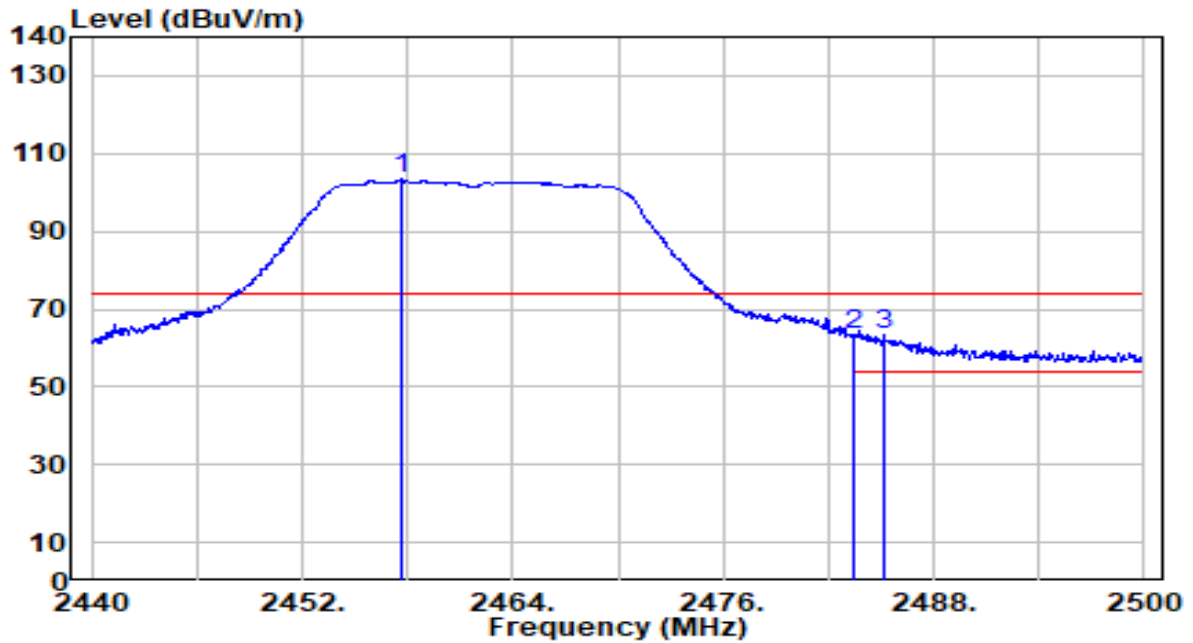

No	Frequency (MHz)	Reading (dBuV)	C.F (dB/m)	Measurement (dBuV/m)	Margin (dB)	Limit (dBuV/m)	Height (cm)	Angle (deg)	Remark (QP/PK/AV)
1	2457.640	73.03	30.28	103.31	N/A	N/A	340	135	Peak
2	* 2483.500	32.94	30.32	63.25	-10.75	74.00	340	135	Peak
3	2485.120	32.82	30.32	63.14	-10.86	74.00	340	135	Peak

Note:

1. " *", means this data is the worst emission level.
2. C.F (Correction Factor) = Antenna Factor (dB/m) + Cable Loss (dB).
3. Measurement (dBuV/m) = Reading(dBuV) + C.F (Correction Factor).
4. The emission levels of other frequencies are very lower than the limit and not show in test report.

EUT	Smart Wi-Fi Outlet Extender	Date of Test	2023-06-13
Factor	DRH18-E	Temp. / Humidity	21°C /61%
Polarity	Horizontal	Site / Test Engineer	AC2 / Stanley
Test Mode	802.11n-20MHz_TX_CH 11_ANT 1	Test Voltage	By Notebook PC

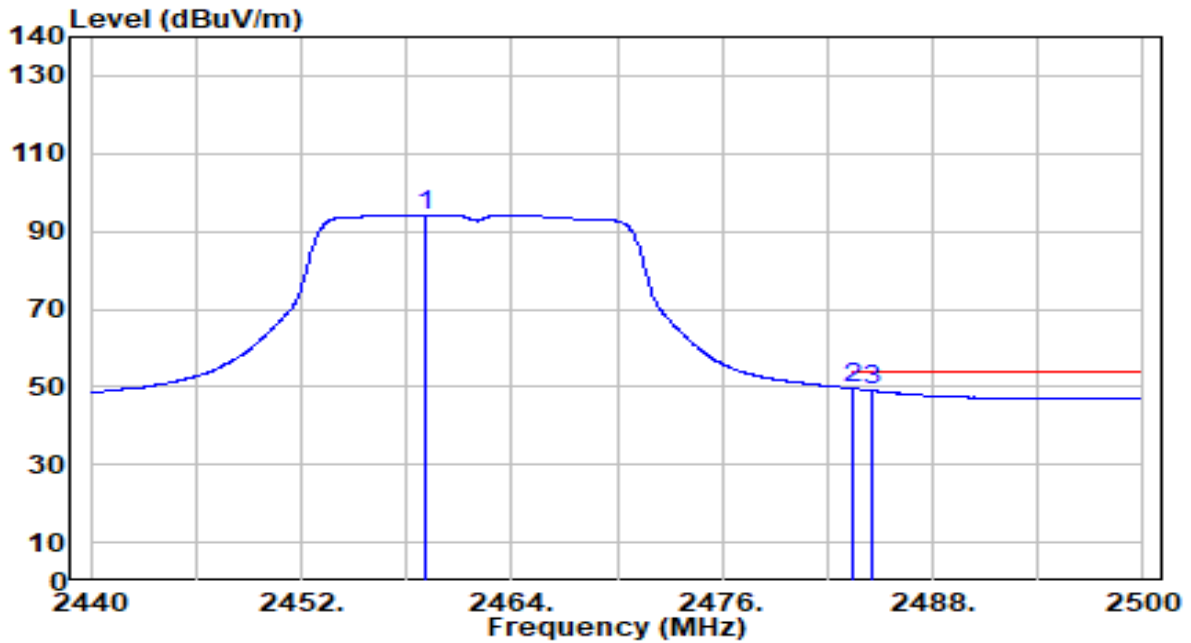

No	Frequency (MHz)	Reading (dBuV)	C.F (dB/m)	Measurement (dBuV/m)	Margin (dB)	Limit (dBuV/m)	Height (cm)	Angle (deg)	Remark (QP/PK/AV)
1	2459.140	63.86	30.29	94.15	N/A	N/A	340	135	Average
2	* 2483.500	19.22	30.32	49.54	-4.46	54.00	340	135	Average
3	2484.520	18.69	30.32	49.01	-4.99	54.00	340	135	Average

Note:

1. " *", means this data is the worst emission level.
2. C.F (Correction Factor) = Antenna Factor (dB/m) + Cable Loss (dB).
3. Measurement (dBuV/m) = Reading(dBuV) + C.F (Correction Factor).
4. The emission levels of other frequencies are very lower than the limit and not show in test report.

EUT	Smart Wi-Fi Outlet Extender	Date of Test	2023-06-13
Factor	DRH18-E	Temp. / Humidity	21°C /61%
Polarity	Vertical	Site / Test Engineer	AC2 / Stanley
Test Mode	802.11n-20MHz_TX_CH 11_ANT 1	Test Voltage	By Notebook PC

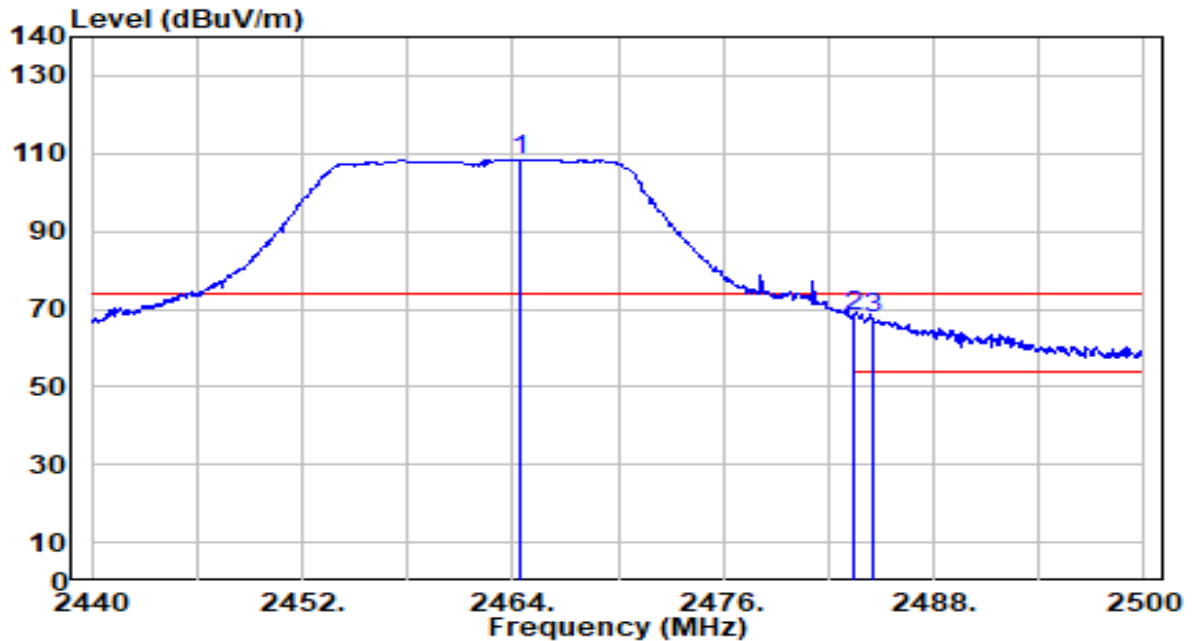

No	Frequency (MHz)	Reading (dBUV)	C.F (dB/m)	Measurement (dBUV/m)	Margin (dB)	Limit (dBUV/m)	Height (cm)	Angle (deg)	Remark (QP/PK/AV)
1	2464.360	78.23	30.29	108.53	N/A	N/A	191	47	Peak
2	* 2483.500	37.84	30.32	68.16	-5.84	74.00	191	47	Peak
3	2484.520	37.22	30.32	67.54	-6.46	74.00	191	47	Peak

Note:

1. " *", means this data is the worst emission level.
2. C.F (Correction Factor) = Antenna Factor (dB/m) + Cable Loss (dB).
3. Measurement (dBUV/m) = Reading(dBUV) + C.F (Correction Factor).
4. The emission levels of other frequencies are very lower than the limit and not show in test report.

EUT	Smart Wi-Fi Outlet Extender	Date of Test	2023-06-13
Factor	DRH18-E	Temp. / Humidity	21°C /61%
Polarity	Vertical	Site / Test Engineer	AC2 / Stanley
Test Mode	802.11n-20MHz_TX_CH 11_ANT 1	Test Voltage	By Notebook PC

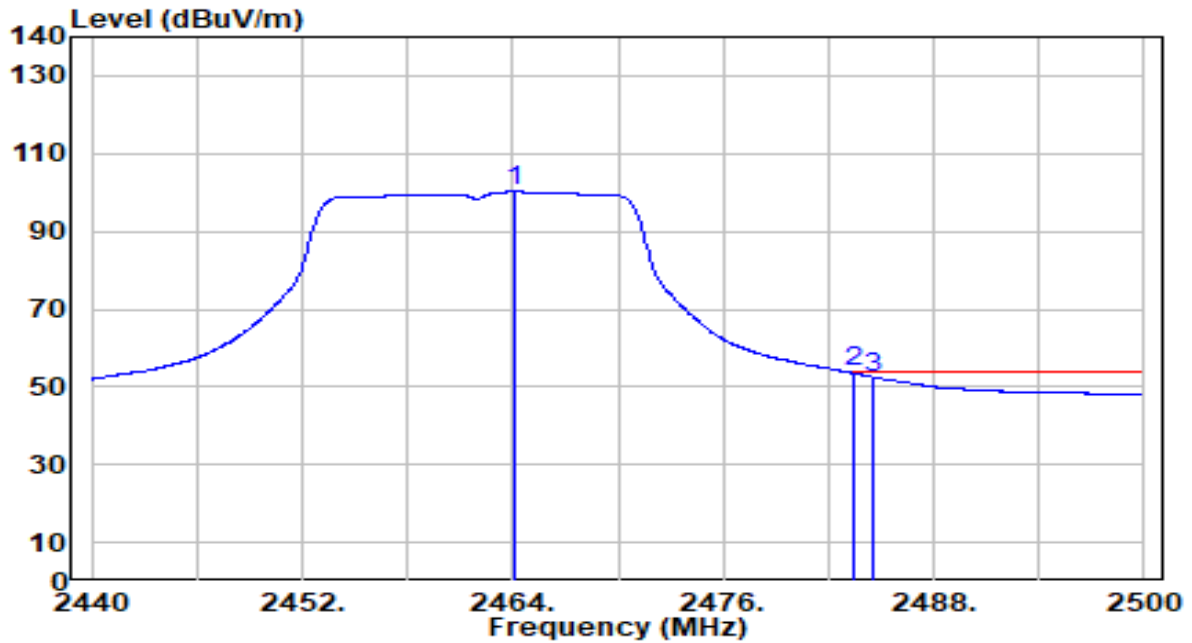

No	Frequency (MHz)	Reading (dBuV)	C.F (dB/m)	Measurement (dBuV/m)	Margin (dB)	Limit (dBuV/m)	Height (cm)	Angle (deg)	Remark (QP/PK/AV)
1	2464.120	69.86	30.29	100.16	N/A	N/A	191	47	Average
2	* 2483.500	23.45	30.32	53.76	-0.24	54.00	191	47	Average
3	2484.520	22.22	30.32	52.54	-1.46	54.00	191	47	Average

Note:

1. " *", means this data is the worst emission level.
2. C.F (Correction Factor) = Antenna Factor (dB/m) + Cable Loss (dB).
3. Measurement (dBuV/m) = Reading(dBuV) + C.F (Correction Factor).
4. The emission levels of other frequencies are very lower than the limit and not show in test report.

7.8. AC Conducted Emissions Measurement

7.8.1. Test Limit

FCC Part 15 Subpart C Paragraph 15.207 Limits		
Frequency (MHz)	QP (dBuV)	AV (dBuV)
0.15 - 0.50	66 - 56	56 - 46
0.50 - 5.0	56	46
5.0 - 30	60	50

Note 1: The lower limit shall apply at the transition frequencies.

Note 2: The limit decreases linearly with the logarithm of the frequency in the range 0.15MHz to 0.5MHz.

7.8.2. Test Setup

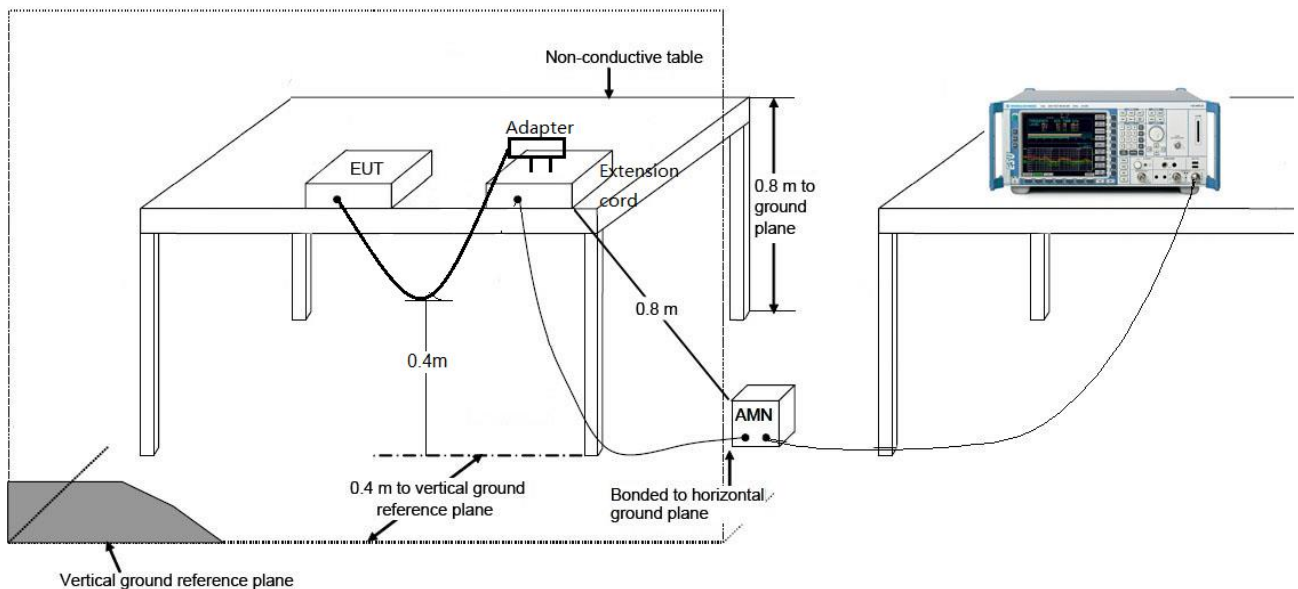

7.8.3. Test Result

EUT	Smart Wi-Fi Outlet Extender	Date of Test	2023-08-31
Factor	CE_ENV216-L1 (Filter ON)	Temp. / Humidity	25.4°C /49%
Polarity	Line1	Site / Test Engineer	SR2 / Bob
Test Mode	802.11n-20MHz_TX_CH 6_ANT 1	Test Voltage	AC 120V/60Hz

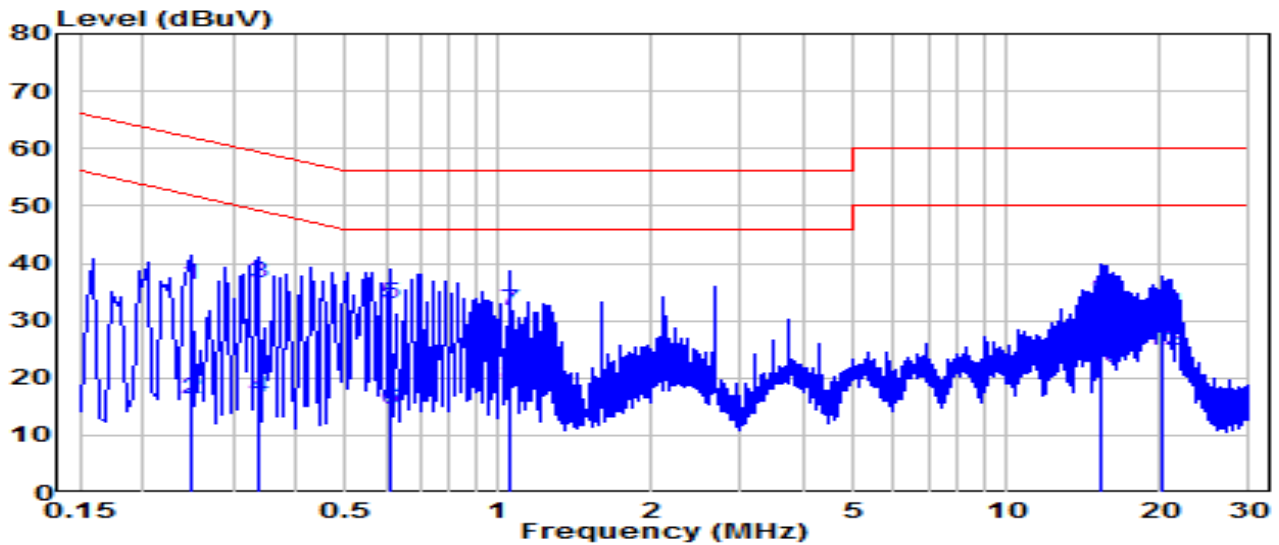

No	Frequency (MHz)	Reading (dBuV)	C.F (dB)	Measurement (dBuV)	Margin (dB)	Limit (dBuV)	Remark (QP/PK/AV)
1	0.249	26.53	9.63	36.15	-25.64	61.79	QP
2	0.249	6.62	9.63	16.25	-35.54	51.79	Average
3	* 0.339	26.96	9.63	36.59	-22.64	59.23	QP
4	* 0.339	7.11	9.63	16.74	-32.49	49.23	Average
5	0.609	23.34	9.65	32.99	-23.01	56.00	QP
6	0.609	4.74	9.65	14.39	-31.61	46.00	Average
7	1.059	22.07	9.67	31.74	-24.26	56.00	QP
8	1.059	8.92	9.67	18.59	-27.41	46.00	Average
9	15.408	23.55	9.89	33.44	-26.56	60.00	QP
10	15.408	11.93	9.89	21.82	-28.18	50.00	Average
11	20.308	21.20	9.93	31.13	-28.87	60.00	QP
12	20.308	14.69	9.93	24.62	-25.38	50.00	Average

Note:

1. " *", means this data is the worst emission level.
2. C.F (Correction Factor) = LISN Factor (dB)+ Cable Loss (dB).
3. Measurement (dBuV) = Reading(dBuV) + C.F (Correction Factor).

EUT	Smart Wi-Fi Outlet Extender	Date of Test	2023-08-31
Factor	CE_ENV216-N (Filter ON)	Temp. / Humidity	25.4°C /49%
Polarity	Neutral	Site / Test Engineer	SR2 / Bob
Test Mode	802.11n-20MHz_TX_CH 6_ANT 1	Test Voltage	AC 120V/60Hz

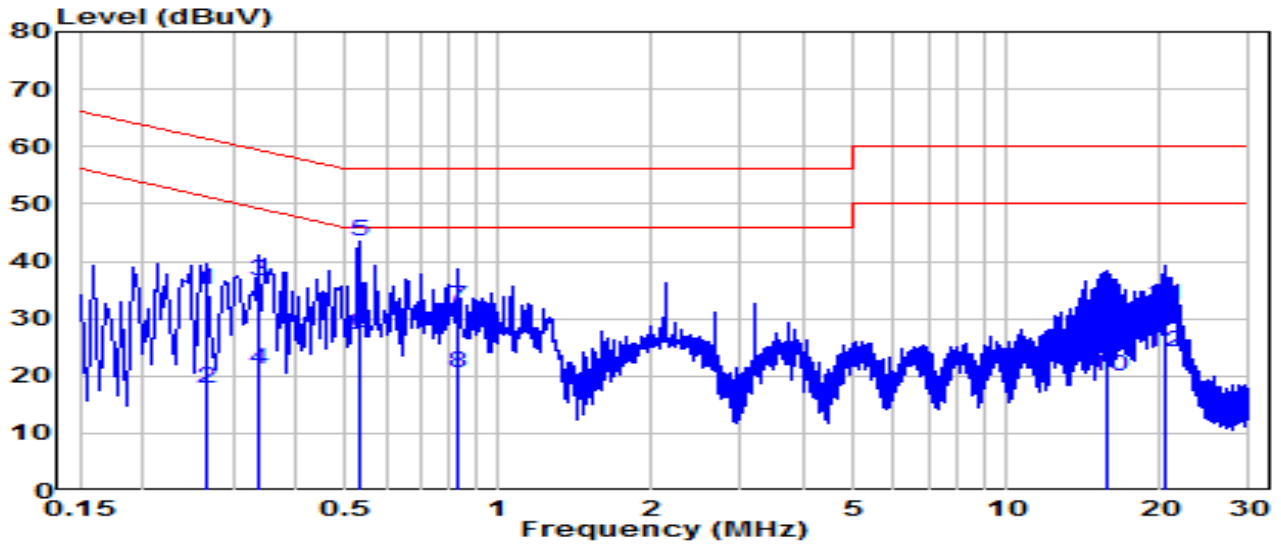

No	Frequency (MHz)	Reading (dBuV)	C.F (dB)	Measurement (dBuV)	Margin (dB)	Limit (dBuV)	Remark (QP/PK/AV)
1	0.267	25.26	9.63	34.89	-26.32	61.21	QP
2	0.267	8.24	9.63	17.87	-33.34	51.21	Average
3	0.339	27.01	9.63	36.64	-22.59	59.23	QP
4	0.339	11.61	9.63	21.24	-27.99	49.23	Average
5	* 0.532	33.90	9.64	43.54	-12.46	56.00	QP
6	* 0.532	17.87	9.64	27.52	-18.48	46.00	Average
7	0.834	22.41	9.66	32.07	-23.93	56.00	QP
8	0.834	10.89	9.66	20.55	-25.45	46.00	Average
9	15.858	22.25	9.94	32.19	-27.81	60.00	QP
10	15.858	9.88	9.94	19.82	-30.18	50.00	Average
11	20.393	22.18	10.00	32.18	-27.82	60.00	QP
12	20.393	14.03	10.00	24.04	-25.96	50.00	Average

Note:

1. " *", means this data is the worst emission level.
2. C.F (Correction Factor) = LISN Factor (dB)+ Cable Loss (dB).
3. Measurement (dBuV) = Reading(dBuV) + C.F (Correction Factor).

EUT	Smart Wi-Fi Outlet Extender	Date of Test	2023-08-31
Factor	CE_ENV216-L1 (Filter ON)	Temp. / Humidity	25.4°C /49%
Polarity	Line1	Site / Test Engineer	SR2 / Bob
Test Mode	802.11n-20MHz_TX_CH 6_ANT 1	Test Voltage	AC 240V/60Hz

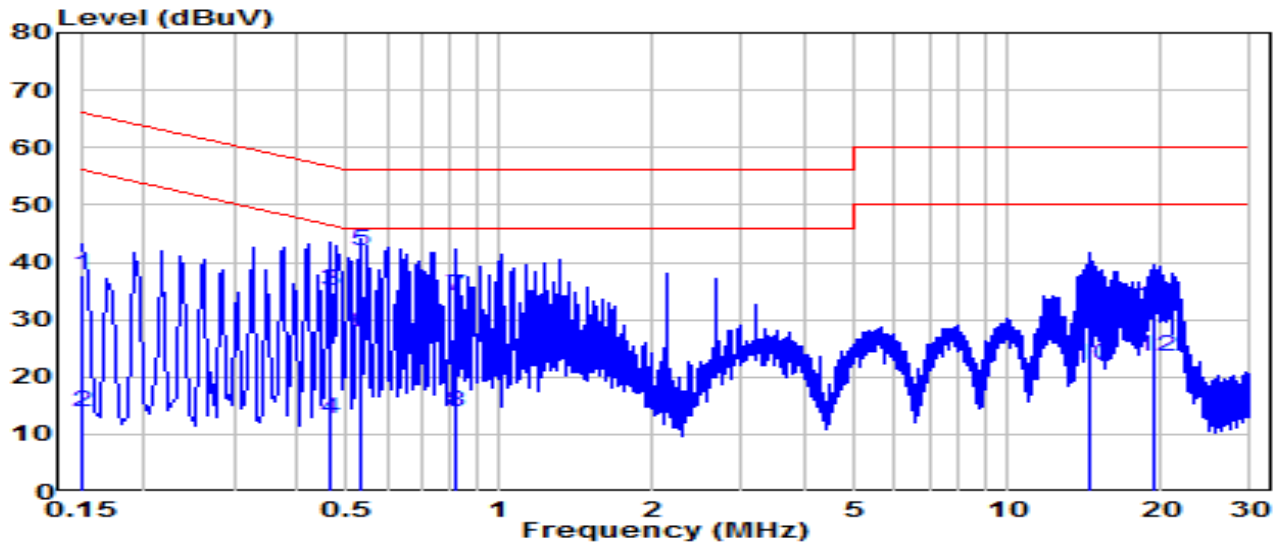

No	Frequency (MHz)	Reading (dBuV)	C.F (dB)	Measurement (dBuV)	Margin (dB)	Limit (dBuV)	Remark (QP/PK/AV)
1	0.150	28.20	9.62	37.82	-28.18	66.00	QP
2	0.150	4.28	9.62	13.90	-42.10	56.00	Average
3	0.465	25.34	9.64	34.98	-21.62	56.60	QP
4	0.465	3.00	9.64	12.64	-33.97	46.60	Average
5	* 0.532	32.44	9.64	42.08	-13.92	56.00	QP
6	* 0.532	18.00	9.64	27.64	-18.36	46.00	Average
7	0.825	24.49	9.66	34.15	-21.85	56.00	QP
8	0.825	4.33	9.66	13.99	-32.01	46.00	Average
9	14.450	23.98	9.89	33.87	-26.13	60.00	QP
10	14.450	12.02	9.89	21.91	-28.09	50.00	Average
11	19.444	22.29	9.93	32.22	-27.78	60.00	QP
12	19.444	13.76	9.93	23.69	-26.31	50.00	Average

Note:

- "*" means this data is the worst emission level.
- C.F (Correction Factor) = LISN Factor (dB)+ Cable Loss (dB).
- Measurement (dBuV) = Reading(dBuV) + C.F (Correction Factor).

EUT	Smart Wi-Fi Outlet Extender	Date of Test	2023-08-31
Factor	CE_ENV216-N (Filter ON)	Temp. / Humidity	25.4°C /49%
Polarity	Neutral	Site / Test Engineer	SR2 / Bob
Test Mode	802.11n-20MHz_TX_CH 6_ANT 1	Test Voltage	AC 240V/60Hz

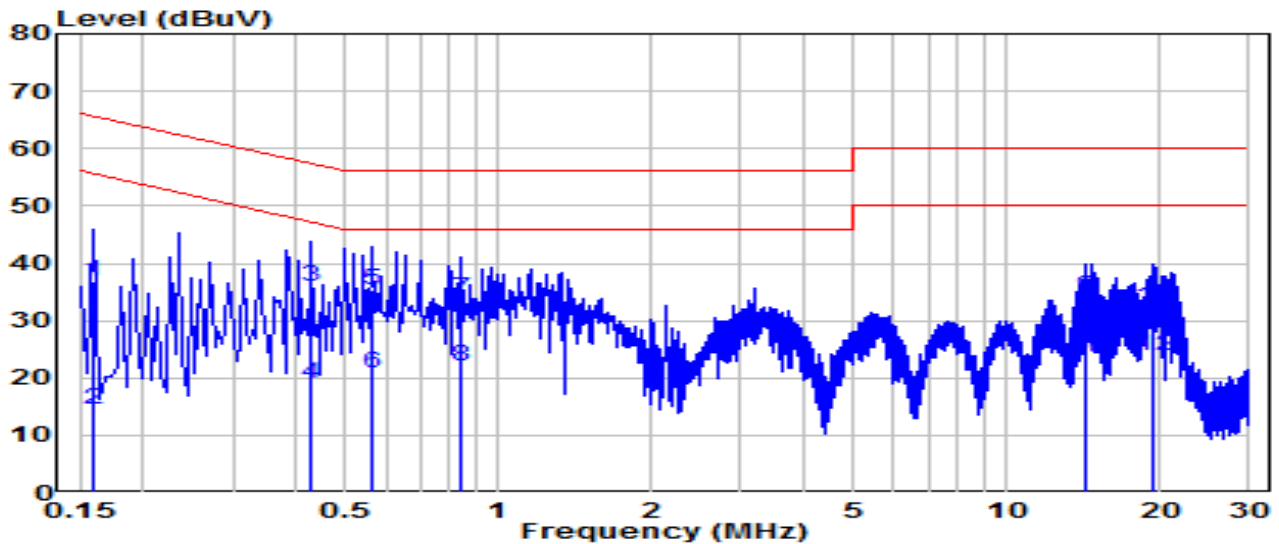

No	Frequency (MHz)	Reading (dBuV)	C.F (dB)	Measurement (dBuV)	Margin (dB)	Limit (dBuV)	Remark (QP/PK/AV)
1	0.159	27.12	9.62	36.74	-28.78	65.52	QP
2	0.159	4.78	9.62	14.40	-41.12	55.52	Average
3	0.429	26.25	9.64	35.89	-21.38	57.27	QP
4	0.429	9.40	9.64	19.04	-28.24	47.27	Average
5	* 0.564	25.63	9.65	35.28	-20.72	56.00	QP
6	* 0.564	11.14	9.65	20.79	-25.21	46.00	Average
7	0.847	24.17	9.66	33.83	-22.17	56.00	QP
8	0.847	12.40	9.66	22.06	-23.94	46.00	Average
9	14.387	24.28	9.92	34.21	-25.79	60.00	QP
10	14.387	13.19	9.92	23.11	-26.89	50.00	Average
11	19.386	22.26	9.99	32.25	-27.75	60.00	QP
12	19.386	13.75	9.99	23.74	-26.26	50.00	Average

Note:

1. " *", means this data is the worst emission level.
2. C.F (Correction Factor) = LISN Factor (dB)+ Cable Loss (dB).
3. Measurement (dBuV) = Reading(dBuV) + C.F (Correction Factor).

8. CONCLUSION

The data collected relate only the item(s) tested and show that the device is compliance with Part 15C of the FCC Rules.

Appendix A : Test Setup Photograph

Refer to “2306TW0102-UT” file.

Appendix B : External Photograph

Refer to “2306TW0102-UE” file.

Appendix C : Internal Photograph

Refer to “2306TW0102-UI” file.

————— The End —————