

**CFR 47 FCC PART 15 SUBPART C**

**TEST REPORT**

*For*

**Tapo Smart Wi-Fi Light Bulb, Dimmable**

**MODEL NUMBER: Tapo L510E**

**REPORT NUMBER: 4790874478-1-RF-1**

**ISSUE DATE: July 14, 2023**

**FCC ID: 2AXJ4L510**

*Prepared for*

**TP-Link Corporation Limited  
Room 901, 9/F. , New East Ocean Centre, 9 Science Museum Road, Tsim Sha Tsui,  
Kowloon, Hong Kong**

*Prepared by*

**UL Verification Services (Guangzhou) Co., Ltd, Song Shan Lake Branch**

**Building 10, Innovation Technology Park, No. 1, Li Bin Road, Song Shan Lake Hi-Tech Development Zone Dongguan, 523808, People's Republic of China**

**Tel: +86 769 22038881**

**Fax: +86 769 33244054**

**Website: [www.ul.com](http://www.ul.com)**

## Revision History

Rev.	Issue Date	Revisions	Revised By
V0	July 14, 2023	Initial Issue	

### Summary of Test Results

Test Item	Clause	Limit/Requirement	Result
Antenna Requirement	N/A	FCC Part 15.203/15.247 (c)	Pass
AC Power Line Conducted Emission	ANSI C63.10-2013, Clause 6.2	FCC Part 15.207	Pass
Conducted Output Power	ANSI C63.10-2013, Clause 11.9.1.3	FCC Part 15.247 (b)(3)	Pass
6dB Bandwidth and 99% Occupied Bandwidth	ANSI C63.10-2013, Clause 11.8.1	FCC Part 15.247 (a)(2)	Pass
Power Spectral Density	ANSI C63.10-2013, Clause 11.10.2	FCC Part 15.247 (e)	Pass
Conducted Band edge and spurious emission	ANSI C63.10-2013, Clause 11.11	FCC Part 15.247(d)	Pass
Radiated Band edge and Spurious Emission	ANSI C63.10-2013, Clause 11.12 & Clause 11.13	FCC Part 15.247 (d) FCC Part 15.205/15.209	Pass
Duty Cycle	ANSI C63.10-2013, Clause 11.6	None; for reporting purposes only.	Pass

\*This test report is only published to and used by the applicant, and it is not for evidence purpose in China.

\*The measurement result for the sample received is <Pass> according to <CFR 47 FCC PART 15 SUBPART C> when <Accuracy Method> decision rule is applied.

## CONTENTS

<b>1. ATTESTATION OF TEST RESULTS</b> .....	<b>6</b>
<b>2. TEST METHODOLOGY</b> .....	<b>7</b>
<b>3. FACILITIES AND ACCREDITATION</b> .....	<b>7</b>
<b>4. CALIBRATION AND UNCERTAINTY</b> .....	<b>8</b>
4.1. <i>MEASURING INSTRUMENT CALIBRATION</i> .....	8
4.2. <i>MEASUREMENT UNCERTAINTY</i> .....	8
<b>5. EQUIPMENT UNDER TEST</b> .....	<b>9</b>
5.1. <i>DESCRIPTION OF EUT</i> .....	9
5.2. <i>CHANNEL LIST</i> .....	9
5.3. <i>MAXIMUM EIRP</i> .....	9
5.4. <i>TEST CHANNEL CONFIGURATION</i> .....	9
5.5. <i>THE WORSE CASE POWER SETTING PARAMETER</i> .....	10
5.6. <i>WORST-CASE CONFIGURATIONS</i> .....	11
5.7. <i>DESCRIPTION OF AVAILABLE ANTENNAS</i> .....	12
5.8. <i>SUPPORT UNITS FOR SYSTEM TEST</i> .....	13
<b>6. MEASURING EQUIPMENT AND SOFTWARE USED</b> .....	<b>14</b>
<b>7. ANTENNA PORT TEST RESULTS</b> .....	<b>17</b>
7.1. <i>CONDUCTED OUTPUT POWER</i> .....	17
7.2. <i>6DB BANDWIDTH AND 99% OCCUPIED BANDWIDTH</i> .....	18
7.3. <i>POWER SPECTRAL DENSITY</i> .....	20
7.4. <i>CONDUCTED BAND EDGE AND SPURIOUS EMISSION</i> .....	22
7.5. <i>DUTY CYCLE</i> .....	24
<b>8. RADIATED TEST RESULTS</b> .....	<b>25</b>
8.1. <i>RESTRICTED BANDEDGE</i> .....	33
8.2. <i>SPURIOUS EMISSIONS(1 GHZ~3 GHZ)</i> .....	52
8.3. <i>SPURIOUS EMISSIONS(3 GHZ~18 GHZ)</i> .....	58
8.4. <i>SPURIOUS EMISSIONS(9 KHZ~30 MHZ)</i> .....	84
8.5. <i>SPURIOUS EMISSIONS(18 GHZ~26 GHZ)</i> .....	87
8.6. <i>SPURIOUS EMISSIONS(30 MHZ~1 GHZ)</i> .....	89
<b>9. ANTENNA REQUIREMENT</b> .....	<b>91</b>
<b>10. AC POWER LINE CONDUCTED EMISSION</b> .....	<b>92</b>

<b>11.</b>	<b>TEST DATA .....</b>	<b>96</b>
11.1.	<i>APPENDIX A: DTS BANDWIDTH .....</i>	<i>96</i>
11.1.1.	Test Result .....	96
11.1.2.	Test Graphs .....	97
11.2.	<i>APPENDIX B: OCCUPIED CHANNEL BANDWIDTH .....</i>	<i>102</i>
11.2.1.	Test Result .....	102
11.2.2.	Test Graphs .....	103
11.3.	<i>APPENDIX C: MAXIMUM CONDUCTED OUTPUT POWER .....</i>	<i>108</i>
11.3.1.	Test Result .....	108
11.4.	<i>APPENDIX D: MAXIMUM POWER SPECTRAL DENSITY .....</i>	<i>109</i>
11.4.1.	Test Result .....	109
11.4.2.	Test Graphs .....	110
11.5.	<i>APPENDIX E: BAND EDGE MEASUREMENTS .....</i>	<i>115</i>
11.5.1.	Test Result .....	115
11.5.2.	Test Graphs .....	116
11.6.	<i>APPENDIX F: CONDUCTED SPURIOUS EMISSION .....</i>	<i>120</i>
11.6.1.	Test Result .....	120
11.6.2.	Test Graphs .....	121
11.7.	<i>APPENDIX G: DUTY CYCLE .....</i>	<i>136</i>
11.7.1.	Test Result .....	136
11.7.2.	Test Graphs .....	137

## 1. ATTESTATION OF TEST RESULTS

### Applicant Information

Company Name: TP-Link Corporation Limited  
Address: Room 901, 9/F. , New East Ocean Centre, 9 Science Museum Road, Tsim Sha Tsui, Kowloon, Hong Kong

### Manufacturer Information

Company Name: TP-Link Corporation Limited  
Address: Room 901, 9/F. , New East Ocean Centre, 9 Science Museum Road, Tsim Sha Tsui, Kowloon, Hong Kong

### EUT Information

EUT Name: Tapo Smart Wi-Fi Light Bulb, Dimmable  
Model: Tapo L510E  
Brand: tp-link  
Sample Received Date: June 6, 2023  
Sample Status: Normal  
Sample ID: 6155166  
Date of Tested: June 16, 2023 to July 14, 2023

APPLICABLE STANDARDS	
STANDARD	TEST RESULTS
CFR 47 FCC PART 15 SUBPART C	Pass

Prepared By:



Fanny Huang

Engineer Project Associate

Checked By:

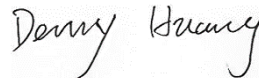

Denny Huang

Senior Project Engineer

Approved By:



Stephen Guo

Operations Manager

## 2. TEST METHODOLOGY

All tests were performed in accordance with the standard CFR 47 FCC PART 15 SUBPART C , KDB 558074 D01 15.247 Meas Guidance v05r02, KDB 414788 D01 Radiated Test Site v01r01, KDB 662911 D01 Multiple Transmitter Output v02r01, CFR 47 FCC Part 2, ANSI C63.10-2013.

## 3. FACILITIES AND ACCREDITATION

Accreditation Certificate	<p><b>A2LA (Certificate No.: 4102.01)</b>                  UL Verification Services (Guangzhou) Co., Ltd. Song Shan Lake Branch. has been assessed and proved to be in compliance with A2LA.</p> <p><b>FCC (FCC Designation No.: CN1187)</b>                  UL Verification Services (Guangzhou) Co., Ltd. Song Shan Lake Branch. Has been recognized to perform compliance testing on equipment subject to the Commission's Declaration of Conformity (DoC) and Certification rules</p> <p><b>ISED (Company No.: 21320)</b>                  UL Verification Services (Guangzhou) Co., Ltd. Song Shan Lake Branch. has been registered and fully described in a report filed with ISED. The Company Number is 21320 and the test lab Conformity Assessment Body Identifier (CABID) is CN0046.</p> <p><b>VCCI (Registration No.: G-20019, R-20004, C-20012 and T-20011)</b>                  UL Verification Services (Guangzhou) Co., Ltd. Song Shan Lake Branch. has been assessed and proved to be in compliance with VCCI, the Membership No. is 3793.                  Facility Name:                  Chamber D, the VCCI registration No. is G-20019 and R-20004                  Shielding Room B , the VCCI registration No. is C-20012 and T-20011</p>
---------------------------	--

**Note 1:**

All tests measurement facilities use to collect the measurement data are located at Building 10, Innovation Technology Park, No. 1, Li Bin Road, Song Shan Lake Hi-Tech Development Zone Dongguan, 523808, People's Republic of China.

**Note 2:**

The test anechoic chamber in UL Verification Services (Guangzhou) Co., Ltd. Song Shan Lake Branch had been calibrated and compared to the open field sites and the test anechoic chamber is shown to be equivalent to or worst case from the open field site.

**Note 3:**

For below 30 MHz, lab had performed measurements at test anechoic chamber and comparing to measurements obtained on an open field site. And these measurements below 30 MHz had been correlated to measurements performed on an OFS.

## 4. CALIBRATION AND UNCERTAINTY

### 4.1. MEASURING INSTRUMENT CALIBRATION

The measuring equipment utilized to perform the tests documented in this report has been calibrated in accordance with the manufacturer's recommendations and is traceable to recognized national standards.

### 4.2. MEASUREMENT UNCERTAINTY

Where relevant, the following measurement uncertainty levels have been estimated for tests performed on the apparatus:

Test Item	Uncertainty
Conduction emission	3.62 dB
Radiated Emission (Included Fundamental Emission) (9 kHz ~ 30 MHz)	2.2 dB
Radiated Emission (Included Fundamental Emission) (30 MHz ~ 1 GHz)	4.00 dB
Radiated Emission (Included Fundamental Emission) (1 GHz to 26 GHz)	5.78 dB (1 GHz ~ 18 GHz)
	5.23 dB (18 GHz ~ 26 GHz)
Duty Cycle	±0.028%
DTS and 99% Occupied Bandwidth	±0.0196%
Maximum Conducted Output Power	±0.686 dB
Maximum Power Spectral Density Level	±0.743 dB
Conducted Band-edge Compliance	±1.328 dB
Conducted Unwanted Emissions In Non-restricted Frequency Bands	±0.746 dB (9 kHz ~ 1 GHz)
	±1.328dB (1 GHz ~ 26 GHz)
Note: This uncertainty represents an expanded uncertainty expressed at approximately the 95% confidence level using a coverage factor of k=2.	



## 5. EQUIPMENT UNDER TEST

### 5.1. DESCRIPTION OF EUT

EUT Name	Tapo Smart Wi-Fi Light Bulb, Dimmable
Model	Tapo L510E
Frequency Range:	2412 MHz to 2462 MHz
Radio Technology:	IEEE802.11b/g/n HT20
Type of Modulation:	IEEE 802.11b: DSSS(CCK, DQPSK, DBPSK) IEEE 802.11g/n: OFDM(64-QAM, 16-QAM, QPSK, BPSK)
Normal Test Voltage:	AC 120 V, 60 Hz

### 5.2. CHANNEL LIST

Channel List for 802.11b/g/n (20 MHz)							
Channel	Frequency (MHz)	Channel	Frequency (MHz)	Channel	Frequency (MHz)	Channel	Frequency (MHz)
1	2412	4	2427	7	2442	10	2457
2	2417	5	2432	8	2447	11	2462
3	2422	6	2437	9	2452	/	/

### 5.3. MAXIMUM EIRP

IEEE Std. 802.11	Frequency (MHz)	Channel Number	Maximum Conducted AVG Output Power (dBm)
b	2412 ~ 2462	1-11[11]	22.47
g	2412 ~ 2462	1-11[11]	21.80
n HT20	2412 ~ 2462	1-11[11]	20.88

### 5.4. TEST CHANNEL CONFIGURATION

Test Mode	Test Channel	Frequency(MHz)
802.11b	CH 1, CH2 CH 6,CH10, CH 11	2412, 2417, 2437, 2457, 2462
802.11g	CH 1, CH2 CH 6,CH10, CH 11	2412, 2417, 2437, 2457, 2462
802.11n HT20	CH 1, CH2 CH 6,CH10, CH 11	2412, 2417, 2437, 2457, 2462

### 5.5. THE WORSE CASE POWER SETTING PARAMETER

The Worse Case Power Setting Parameter under 2400 ~ 2483.5MHz Band											
Test Software		EspRFTestTool									
Modulation Mode	Transmit Antenna Number	Test Software Setting Value									
		NCB: 20MHz					NCB: 40MHz				
		CH1	CH2	CH6	CH10	CH11	CH3	CH4	CH6	CH8	CH9
802.11b	1	0	0	0	0	0	NA				
802.11g	1	10	4	0	4	12					
802.11n HT20	1	2	0	0	0	6					

## 5.6. WORST-CASE CONFIGURATIONS

The EUT was tested in the following configuration(s):

Controlled in test mode using a software application on the EUT supplied by customer. The application was used to enable a continuous transmission and to select the mode, test channels, bandwidth, data rates as required.

Test channels referring to section 5.4.

Maximum power setting referring to section 5.5.

Worst-case data rates as provided by the client were:

802.11b mode: 1 Mbps  
802.11g mode: 6 Mbps  
802.11n HT20 mode: MCS0

The measured additional path loss was included in any path loss calculations for all RF cable used during tested.

## 5.7. DESCRIPTION OF AVAILABLE ANTENNAS

Antenna	Frequency (MHz)	Antenna Type	MAX Antenna Gain (dBi)
1	2412-2462	Monopole Antenna	-1.56

Test Mode	Transmit and Receive Mode	Description
IEEE 802.11b	<input checked="" type="checkbox"/> 1TX, 1RX	ANT 1 can be used as transmitting/receiving antenna.
IEEE 802.11g	<input checked="" type="checkbox"/> 1TX, 1RX	ANT 1 can be used as transmitting/receiving antenna.
IEEE 802.11n HT20	<input checked="" type="checkbox"/> 1TX, 1RX	ANT 1 can be used as transmitting/receiving antenna.

Note: The value of the antenna gain was declared by customer.

## 5.8. SUPPORT UNITS FOR SYSTEM TEST

### SUPPORT EQUIPMENT

Item	Equipment	Brand Name	Model Name	P/N
1	PC	Lenovo	E42-80	/
2	UART	/	/	/

### I/O CABLES

Cable No	Port	Connector Type	Cable Type	Cable Length(m)	Remarks
1	USB	/	/	1.0	/

### ACCESSORIES

Item	Accessory	Brand Name	Model Name	Description
/	/	/	/	/

### TEST SETUP

The EUT can work in engineering mode with a software through a Laptop.

### SETUP DIAGRAM FOR TESTS

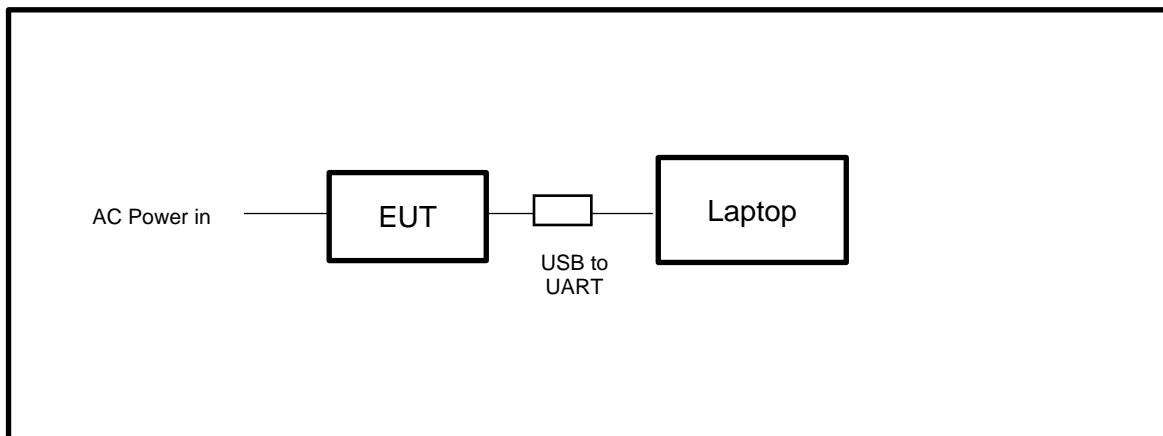

## 6. MEASURING EQUIPMENT AND SOFTWARE USED

R&S TS 8997 Test System					
Equipment	Manufacturer	Model No.	Serial No.	Last Cal.	Due. Date
Power sensor, Power Meter	R&S	OSP120	100921	Mar.31,2023	Mar.30,2024
Vector Signal Generator	R&S	SMBV100A	261637	Oct.17, 2022	Oct.16, 2023
Signal Generator	R&S	SMB100A	178553	Oct.17, 2022	Oct.16, 2023
Signal Analyzer	R&S	FSV40	101118	Oct.17, 2022	Oct.16, 2023
Software					
Description	Manufacturer	Name		Version	
For R&S TS 8997 Test System	Rohde & Schwarz	EMC 32		10.60.10	
Tonsend RF Test System					
Equipment	Manufacturer	Model No.	Serial No.	Last Cal.	Due. Date
Wideband Radio Communication Tester	R&S	CMW500	155523	Oct.17, 2022	Oct.16, 2023
Wireless Connectivity Tester	R&S	CMW270	1201.0002N75-102	Sep.28, 2022	Sep.27, 2023
PXA Signal Analyzer	Keysight	N9030A	MY55410512	Oct.17, 2022	Oct.16, 2023
MXG Vector Signal Generator	Keysight	N5182B	MY56200284	Oct.17, 2022	Oct.16, 2023
MXG Vector Signal Generator	Keysight	N5172B	MY56200301	Oct.17, 2022	Oct.16, 2023
DC power supply	Keysight	E3642A	MY55159130	Oct.17, 2022	Oct.16, 2023
Temperature & Humidity Chamber	SANMOOD	SG-80-CC-2	2088	Oct.17, 2022	Oct.16, 2023
Attenuator	Aglient	8495B	2814a12853	Oct.18, 2022	Oct.17, 2023
RF Control Unit	Tonscend	JS0806-2	23B80620666	April 18,2023	April 17,2024
Software					
Description	Manufacturer	Name		Version	
Tonsend SRD Test System	Tonsend	JS1120-3 RF Test System		V3.2.22	

Conducted Emissions					
Equipment	Manufacturer	Model No.	Serial No.	Last Cal.	Due Date
EMI Test Receiver	R&S	ESR3	101961	Oct.17, 2022	Oct.16, 2023
Two-Line V-Network	R&S	ENV216	101983	Oct.17, 2022	Oct.16, 2023
Artificial Mains Networks	Schwarzbeck	NSLK 8126	8126465	Oct.17, 2022	Oct.16, 2023
Software					
Description			Manufacturer	Name	Version
Test Software for Conducted Emissions			Farad	EZ-EMC	Ver. UL-3A1

Radiated Emissions					
Equipment	Manufacturer	Model No.	Serial No.	Last Cal.	Due Date
MXE EMI Receiver	KESIGHT	N9038A	MY56400036	Oct.17, 2022	Oct.16, 2023
Hybrid Log Periodic Antenna	TDK	HLP-3003C	130959	Aug.02, 2021	Aug.01, 2024
Preamplifier	HP	8447D	2944A09099	Oct.17, 2022	Oct.16, 2023
EMI Measurement Receiver	R&S	ESR26	101377	Oct.17, 2022	Oct.16, 2023
Horn Antenna	TDK	HRN-0118	130940	July 20, 2021	July 19, 2024
Preamplifier	TDK	PA-02-0118	TRS-305-00067	Oct.17, 2022	Oct.16, 2023
Horn Antenna	Schwarzbeck	BBHA9170	697	July 20, 2021	July 19, 2024
Preamplifier	TDK	PA-02-2	TRS-307-00003	Oct.17, 2022	Oct.16, 2023
Preamplifier	TDK	PA-02-3	TRS-308-00002	Oct.17, 2022	Oct.16, 2023
Loop antenna	Schwarzbeck	1519B	00008	Dec.14, 2021	Dec.13, 2024
Preamplifier	TDK	PA-02-001-3000	TRS-302-00050	Oct.17, 2022	Oct.16, 2023
Preamplifier	Mini-Circuits	ZX60-83LN-S+	SUP01202035	Oct.17, 2022	Oct.16, 2023
High Pass Filter	Wi	WHKX10-2700-3000-18000-40SS	23	/	/
Highpass Filter	Wainwright	WHKX10-5850-6500-1800-40SS	4	/	/
Band Reject Filter	Wainwright	WRCJV12-5695-5725-5850-5880-40SS	4	/	/

Band Reject Filter	Wainwright	WRCJV20-5120-5150-5350-5380-60SS	2	/	/
Band Reject Filter	Wainwright	WRCJV20-5440-5470-5725-5755-60SS	1	/	/
Band Reject Filter	Wainwright	WRCJV8-2350-2400-2483.5-2533.5-40SS	4	/	/
Band Reject Filter	Wainwright	WRCD5-1879-1879.85-1880.15-1881-40SS	1	/	/
Notch Filter	Wainwright	WHJ10-882-980-7000-40SS	1	/	/
Software					
Description			Manufacturer	Name	Version
Test Software for Radiated Emissions			Farad	EZ-EMC	Ver. UL-3A1

Other Instrument					
Equipment	Manufacturer	Model No.	Serial No.	Last Cal.	Due Date
Temperature humidity probe	OMEGA	ITHX-SD-5	18470007	Oct.22, 2022	Oct.21, 2023
Barometer	Yiyi	Baro	N/A	Oct.24, 2022	Oct.23, 2023
Attenuator	Agilent	8495B	2814a12853	Oct.18, 2022	Oct.17, 2023



## 7. ANTENNA PORT TEST RESULTS

### 7.1. CONDUCTED OUTPUT POWER

#### LIMITS

CFR 47 FCC Part15 (15.247) Subpart C			
Section	Test Item	Limit	Frequency Range (MHz)
CFR 47 FCC 15.247(b)(3)	AVG Output Power	1 watt or 30 dBm	2400-2483.5

#### TEST PROCEDURE

Refer to ANSI C63.10-2013 clause 11.9.2.3.1.

Connect the EUT to a low loss RF cable from the antenna port to the power sensor (video bandwidth is greater than the occupied bandwidth).

Measure peak emission level, the indicated level is the average output power, after any corrections for external attenuators and cables.

The test result in dBm by adding  $[10 \log (1 / D)]$ , where D is the duty cycle.

#### TEST SETUP

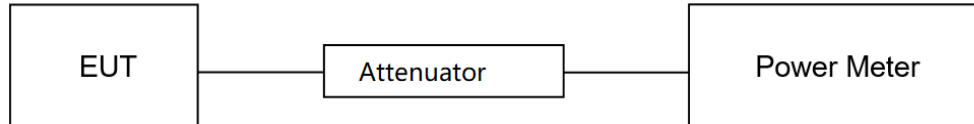

#### TEST ENVIRONMENT

Temperature	26.6°C	Relative Humidity	60.7%
Atmosphere Pressure	101kPa	Test Voltage	AC 120V, 60Hz

#### TEST DATE / ENGINEER

Test Date	June 28, 2023	Test By	Kebo Zhang
-----------	---------------	---------	------------

#### TEST RESULTS

Please refer to section "Test Data" - Appendix C

## 7.2. 6DB BANDWIDTH AND 99% OCCUPIED BANDWIDTH

### LIMITS

CFR 47 FCC Part15 (15.247) Subpart C			
Section	Test Item	Limit	Frequency Range (MHz)
CFR 47 FCC 15.247(a)(2)	6 dB Bandwidth	≥ 500 kHz	2400-2483.5
ISED RSS-Gen Clause 6.7	99 % Occupied Bandwidth	For reporting purposes only.	2400-2483.5

### TEST PROCEDURE

Refer to ANSI C63.10-2013 clause 11.8 for DTS bandwidth and clause 6.9 for Occupied Bandwidth.

Connect the EUT to the spectrum analyser and use the following settings:

Center Frequency	The center frequency of the channel under test
Frequency Span	For 6 dB Bandwidth: Enough to capture all products of the modulation carrier emission For 99 % Occupied Bandwidth: Between 1.5 times and 5.0 times the OBW
Detector	Peak
RBW	For 6 dB Bandwidth: 100 kHz For 99 % Occupied Bandwidth: 1 % to 5 % of the occupied bandwidth
VBW	For 6 dB Bandwidth: ≥3 × RBW For 99 % Occupied Bandwidth: ≥3 × RBW
Trace	Max hold
Sweep	Auto couple

a) Use the 99 % power bandwidth function of the instrument, allow the trace to stabilize and report the measured bandwidth.

b) Allow the trace to stabilize and measure the maximum width of the emission that is constrained by the frequencies associated with the two outermost amplitude points (upper and lower frequencies) that are attenuated by 6 dB relative to the maximum level measured in the fundamental emission.

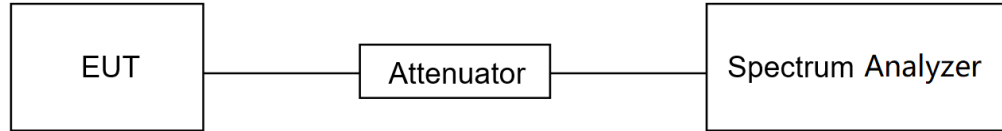
**TEST SETUP****TEST ENVIRONMENT**

Temperature	26.6°C	Relative Humidity	60.7%
Atmosphere Pressure	101kPa	Test Voltage	AC 120V, 60Hz

**TEST DATE / ENGINEER**

Test Date	June 28, 2023	Test By	Kebo Zhang
-----------	---------------	---------	------------

**TEST RESULTS**

Please refer to section "Test Data" - Appendix A&B

### 7.3. POWER SPECTRAL DENSITY

#### LIMITS

CFR 47 FCC Part15 (15.247) Subpart C			
Section	Test Item	Limit	Frequency Range (MHz)
CFR 47 FCC §15.247 (e)	Power Spectral Density	8 dBm in any 3 kHz band	2400-2483.5

#### TEST PROCEDURE

Refer to ANSI C63.10-2013 clause 11.10.5.

Connect the EUT to the spectrum analyser and use the following settings:

Center Frequency	The center frequency of the channel under test
Detector	power averaging (rms)
RBW	$3 \text{ kHz} \leq \text{RBW} \leq 100 \text{ kHz}$
VBW	$\geq 3 \times \text{RBW}$
Span	1.5 x OBW bandwidth
Trace	Average
Sweep time	Auto couple

Allow trace to fully stabilize and use the peak marker function to determine the maximum amplitude level within the RBW.

If measured value exceeds limit, reduce RBW (no less than 3 kHz) and repeat.

#### TEST SETUP

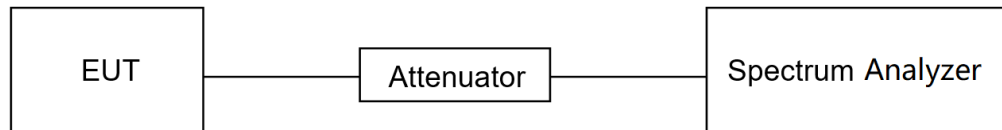

#### TEST ENVIRONMENT

Temperature	26.6°C	Relative Humidity	60.7%
Atmosphere Pressure	101kPa	Test Voltage	AC 120V, 60Hz

#### TEST DATE / ENGINEER

Test Date	June 28, 2023	Test By	Kebo Zhang
-----------	---------------	---------	------------

**TEST RESULTS**

Please refer to section "Test Data" - Appendix D

## 7.4. CONDUCTED BAND EDGE AND SPURIOUS EMISSION

### LIMITS

CFR 47 FCC Part15 (15.247) Subpart C		
Section	Test Item	Limit
CFR 47 FCC §15.247 (d)	Conducted Bandedge and Spurious Emissions	at least 30 dB below that in the 100 kHz bandwidth within the band that contains the highest level of the desired power

### TEST PROCEDURE

Refer to ANSI C63.10-2013 clause 11.11 and 11.13.

Connect the EUT to the spectrum analyser and use the following settings for reference level measurement:

Center Frequency	The center frequency of the channel under test
Detector	Peak
RBW	100 kHz
VBW	$\geq 3 \times \text{RBW}$
Span	1.5 x DTS bandwidth
Trace	Max hold
Sweep time	Auto couple.

Allow trace to fully stabilize and use the peak marker function to determine the maximum PSD level.

Change the settings for emission level measurement:

Span	Set the center frequency and span to encompass frequency range to be measured
Detector	Peak
RBW	100 kHz
VBW	$\geq 3 \times \text{RBW}$
measurement points	$\geq \text{span}/\text{RBW}$
Trace	Max hold
Sweep time	Auto couple.

Allow trace to fully stabilize and use the peak marker function to determine the maximum PSD level. Ensure that the amplitude of all unwanted emissions outside of the authorized frequency band (excluding restricted frequency bands) is attenuated by at least the minimum requirements specified in 11.11.

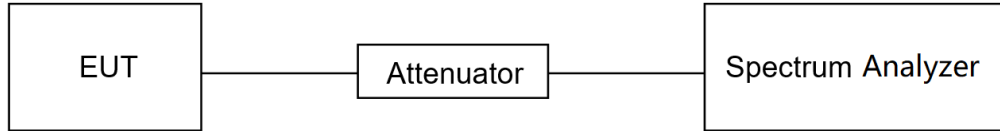
**TEST SETUP****TEST ENVIRONMENT**

Temperature	26.6°C	Relative Humidity	60.7%
Atmosphere Pressure	101kPa	Test Voltage	AC 120V, 60Hz

**TEST DATE / ENGINEER**

Test Date	June 28, 2023	Test By	Kebo Zhang
-----------	---------------	---------	------------

**TEST RESULTS**

Please refer to section "Test Data" - Appendix E&F

## 7.5. DUTY CYCLE

### LIMITS

None; for reporting purposes only.

### TEST PROCEDURE

Refer to ANSI C63.10-2013 clause 11.6 Zero – Span Spectrum Analyzer method.

### TEST SETUP

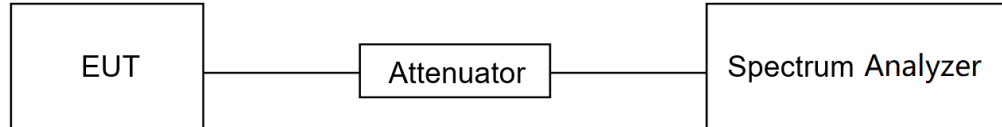

### TEST ENVIRONMENT

Temperature	26.6°C	Relative Humidity	60.7%
Atmosphere Pressure	101kPa	Test Voltage	AC 120V, 60Hz

### TEST DATE / ENGINEER

Test Date	June 28, 2023	Test By	Kebo Zhang
-----------	---------------	---------	------------

### TEST RESULTS

Please refer to section "Test Data" - Appendix G



## 8. RADIATED TEST RESULTS

### LIMITS

Please refer to CFR 47 FCC §15.205 and §15.209.

Radiation Disturbance Test Limit for FCC (Class B) (9 kHz ~ 1 GHz)

Emissions radiated outside of the specified frequency bands above 30 MHz			
Frequency Range (MHz)	Field Strength Limit (uV/m) at 3 m	Field Strength Limit (dBuV/m) at 3 m	
		Quasi-Peak	
30 - 88	100	40	
88 - 216	150	43.5	
216 - 960	200	46	
Above 960	500	54	
Above 1000	500	Peak	Average
		74	54

FCC Emissions radiated outside of the specified frequency bands below 30 MHz		
Frequency (MHz)	Field strength (microvolts/meter)	Measurement distance (meters)
0.009-0.490	2400/F(kHz)	300
0.490-1.705	24000/F(kHz)	30
1.705-30.0	30	30

FCC Restricted bands of operation refer to FCC §15.205 (a):

MHz	MHz	MHz	GHz
0.090-0.110	16.42-16.423	399.9-410	4.5-5.15
<sup>1</sup> 0.495-0.505	16.69475-16.69525	608-614	5.35-5.46
2.1735-2.1905	16.80425-16.80475	960-1240	7.25-7.75
4.125-4.128	25.5-25.67	1300-1427	8.025-8.5
4.17725-4.17775	37.5-38.25	1435-1626.5	9.0-9.2
4.20725-4.20775	73-74.6	1645.5-1646.5	9.3-9.5
6.215-6.218	74.8-75.2	1660-1710	10.6-12.7
6.26775-6.26825	108-121.94	1718.8-1722.2	13.25-13.4
6.31175-6.31225	123-138	2200-2300	14.47-14.5
8.291-8.294	149.9-150.05	2310-2390	15.35-16.2
8.362-8.366	156.52475-156.52525	2483.5-2500	17.7-21.4
8.37625-8.38675	156.7-156.9	2690-2900	22.01-23.12
8.41425-8.41475	162.0125-167.17	3260-3267	23.6-24.0
12.29-12.293	167.72-173.2	3332-3339	31.2-31.8
12.51975-12.52025	240-285	3345.8-3358	36.43-36.5
12.57675-12.57725	322-335.4	3600-4400	( <sup>2</sup> )
13.36-13.41			

Note: <sup>1</sup>Until February 1, 1999, this restricted band shall be 0.490-0.510 MHz.

<sup>2</sup>Above 38.6c

### **TEST PROCEDURE**

Below 30 MHz

The setting of the spectrum analyser

RBW	200 Hz (From 9 kHz to 0.15 MHz)/ 9 kHz (From 0.15 MHz to 30 MHz)
VBW	200 Hz (From 9 kHz to 0.15 MHz)/ 9 kHz (From 0.15 MHz to 30 MHz)
Sweep	Auto

1. The testing follows the guidelines in ANSI C63.10-2013 clause 6.4.
2. The EUT was arranged to its worst case and then turntable (from 0 degree to 360 degrees) to find the maximum reading. A pre-amp and a high pass filter are used for the test in order to get better signal level. Both Horizontal, Face-on and Face-off polarizations of the antenna are set to make the measurement.
3. The EUT was placed on a turntable with 80 cm above ground.
4. The EUT was set 3 meters from the interference receiving antenna, which was mounted on the top of a 1 m height antenna tower.
5. The radiated emission limits are based on measurements employing a CISPR quasi-peak detector except for the frequency bands 9-90 kHz, 110-490 kHz and above 1000 MHz Radiated emission limits in these three bands are based on measurements employing an average detector.
6. For measurement below 1 GHz, the initial step in collecting conducted emission data is a spectrum analyzer peak detector mode pre-scanning the measurement frequency range. Significant peaks are then marked and then Quasi Peak and average detector mode re-measured. If the emission level of the EUT measured by the peak detector is 3 dB lower than the applicable limit, the peak emission level will be reported. Otherwise, the emission measurement will be repeated using the quasi-peak and average detector and reported.

7. Although these tests were performed other than open field site, adequate comparison measurements were confirmed against 30m open field site. Therefore sufficient tests were made to demonstrate that the alternative site produces results that correlate with the ones of tests made in an open field site based on KDB 414788.

8. The limits in CFR 47, Part 15, Subpart C, paragraph 15.209 (a), are identical to those in RSS-GEN Section 8.9, Table 6, since the measurements are performed in terms of magnetic field strength and converted to electric field strength levels (as reported in the table) using the free space impedance of  $377\Omega$ . For example, the measurement frequency X KHz resulted in a level of Y dBuV/m, which is equivalent to  $Y-51.5 = Z$  dBuA/m, which has the same margin, W dB, to the corresponding RSS-GEN Table 6 limit as it has to be 15.209(a) limit.

Below 1 GHz and above 30 MHz

The setting of the spectrum analyser

RBW	120 kHz
VBW	300 kHz
Sweep	Auto
Detector	Peak/QP
Trace	Max hold

1. The testing follows the guidelines in ANSI C63.10-2013 clause 6.5.
2. The EUT was arranged to its worst case and then tune the antenna tower (from 1 m to 4 m) and turntable (from 0 degree to 360 degrees) to find the maximum reading. A pre-amp and a high pass filter are used for the test in order to get better signal level. Both horizontal and vertical polarizations of the antenna are set to make the measurement.
3. The EUT was placed on a turntable with 80 cm above ground.
4. The EUT was set 3 meters from the interference receiving antenna, which was mounted on the top of a variable height antenna tower.
5. For measurement below 1 GHz, the initial step in collecting conducted emission data is a spectrum analyzer peak detector mode pre-scanning the measurement frequency range. Significant peaks are then marked and then Quasi Peak detector mode re-measured. If the emission level of the EUT measured by the peak detector is 3 dB lower than the applicable limit, the peak emission level will be reported. Otherwise, the emission measurement will be repeated using the quasi-peak detector and reported.

Above 1G

The setting of the spectrum analyser

RBW	1 MHz
VBW	PEAK: 3 MHz AVG: see note 6
Sweep	Auto
Detector	Peak
Trace	Max hold

1. The testing follows the guidelines in ANSI C63.10-2013 clause 6.6.
2. The EUT was arranged to its worst case and then tune the antenna tower (from 1 m to 4 m) and turntable (from 0 degree to 360 degrees) to find the maximum reading. A pre-amp and a high pass filter are used for the test in order to get better signal level. Both horizontal and vertical polarizations of the antenna are set to make the measurement.
3. The EUT was placed on a turntable with 1.5 m above ground.
4. The EUT was set 3 meters from the interference receiving antenna, which was mounted on the top of a variable height antenna tower.
5. For measurement above 1 GHz, the emission measurement will be measured by the peak detector. This peak level, once corrected, must comply with the limit specified in Section 15.209.
6. For measurements above 1 GHz the resolution bandwidth is set to 1 MHz, then the video bandwidth is set to 3 MHz for peak measurements and 1 MHz resolution bandwidth with 1/T video bandwidth with peak detector for average measurements. For the Duty Cycle please refer to clause 7.5.ON TIME AND DUTY CYCLE.

X axis, Y axis, Z axis positions:

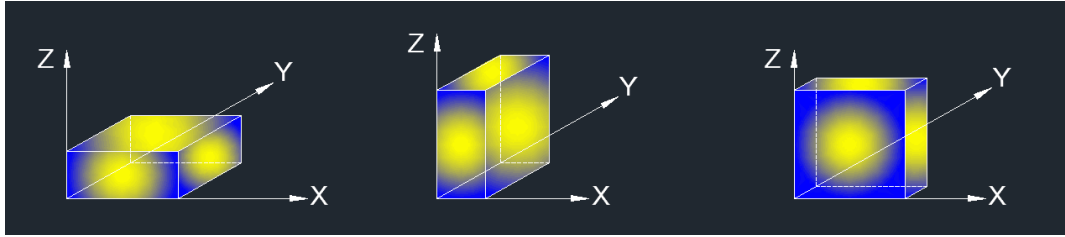

Note 1: For all radiated test, EUT in each of three orthogonal axis emissions had been tested, but only the worst case (X axis) data recorded in the report.

For Band edge:

Note:

1. Measurement = Reading Level + Correct Factor.
2. If the peak values are less than the average limit of 54 dBuV/m, the average result is deemed to comply with average limit.
3. Peak: Peak detector.
4. AVG:  $VBW=1/Ton$ , where: Ton is the transmitting duration.
5. For the transmitting duration, please refer to clause 7.5.
6. Only the worst data was recorded, if it complies with the limit, the other emissions deemed to comply with the limit.
7. Horizontal and Vertical have been tested, only the worst data was recorded in the report.
8. All modes and channels have been tested, only the worst data was recorded in the report.

For Radiate Spurious emission 1GHz-3GHz:

Note:

1. Measurement = Reading Level + Correct Factor.
2. If the Peak values are less than the Average limit of 54 dBuV/m, the Average result is deemed to comply with Average limit.
3. Peak: Peak detector.
4. AVG:  $VBW=1/Ton$ , where: Ton is the transmitting duration.
5. For the transmitting duration, please refer to clause 7.5.
6. Filter losses were only considered in the spurious frequency bands and the authorized band was not corrected for Band reject filter losses.
7. Proper operation of the transmitter prior to adding the filter to the measurement chain.
8. All modes and channels have been tested, only the worst data was recorded in the report.

For Radiate Spurious emission 3GHz-18GHz:

Note:

1. Peak Result = Reading Level + Correct Factor.
2. If the Peak values are less than the Average limit of 54 dBuV/m, the Average result is deemed to comply with Average limit.
3. Peak: Peak detector.
4. AVG:  $VBW=1/Ton$ , where: Ton is the transmitting duration.
5. For the transmitting duration, please refer to clause 7.5.
6. Filter losses were only considered in the spurious frequency bands and the authorized band was not corrected for High Pass Filter losses.
7. Proper operation of the transmitter prior to adding the filter to the measurement chain.
8. All modes and channels have been tested, only the worst data was recorded in the report.

For Radiate Spurious emission 9kHz-30MHz:

Note:

1. Measurement = Reading Level + Correct Factor.  
( $dBuA/m = dBuV/m - 20\log_{10}[120\pi] = dBuV/m - 51.5$ ).
2. If the Peak values are less than the QP limit, the QP result is deemed to comply with QP limit.
3. All 3 polarizations (Horizontal, Face-on and Face-off) of the loop antenna had been tested, but only the worst data recorded in the report.
4. All modes and channels have been tested, only the worst data was recorded in the report.

For Radiate Spurious emission 18GHz-26GHz:

Note:

1. Measurement = Reading Level + Correct Factor.
2. If the Peak values are less than the Average limit of 54 dBuV/m, the Average result is deemed to comply with Average limit.
3. Peak: Peak detector.
4. All modes and channels have been tested, only the worst data was recorded in the report.

For Radiate Spurious emission 30MHz-1GHz:

Note:

1. Result Level = Read Level + Correct Factor.
2. If the Peak values are less than the QP limit, the QP result is deemed to comply with QP limit.
3. Test setup: RBW: 120 kHz, VBW: 300 kHz, Sweep time: auto.
4. All modes and channels have been tested, only the worst data was recorded in the report.

**TEST SETUP**

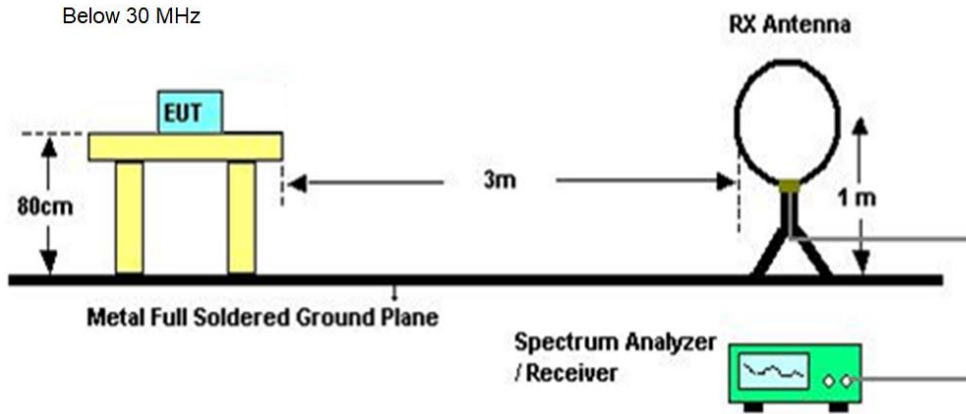

Below 1 GHz and above 30 MHz

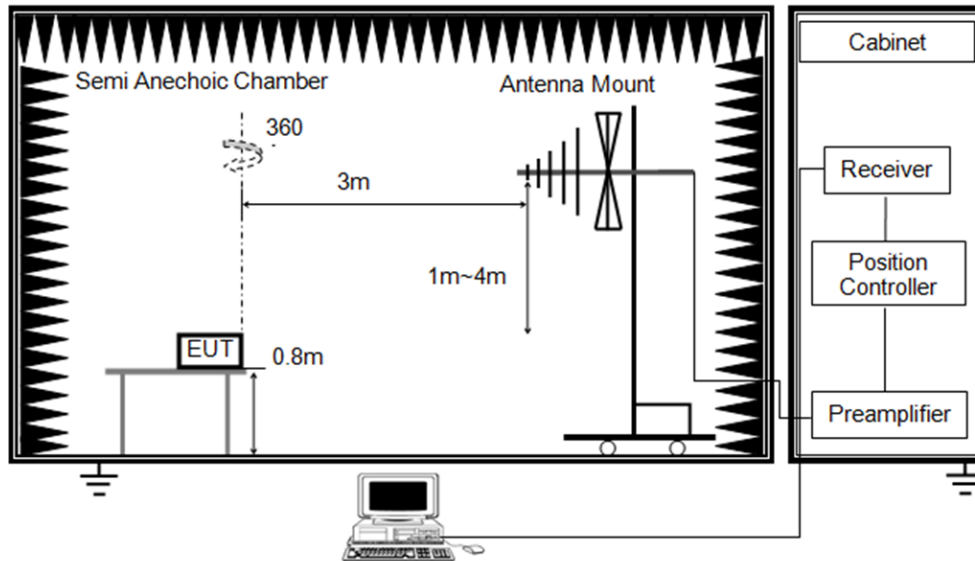

Above 1 GHz

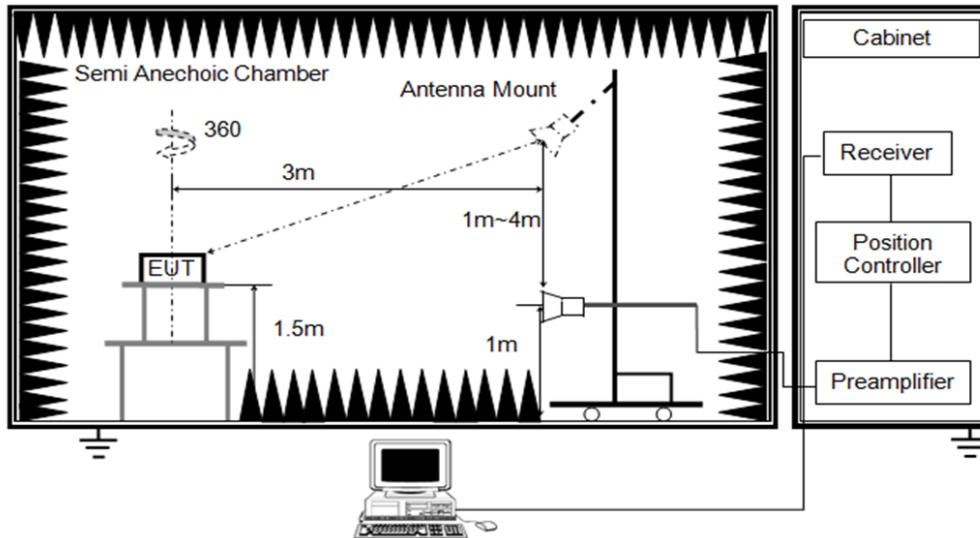

**TEST ENVIRONMENT**

Temperature	25.1 °C	Relative Humidity	63%
Atmosphere Pressure	101kPa	Test Voltage	AC 120V, 60Hz

**TEST DATE / ENGINEER**

Test Date	July 14, 2023	Test By	Rex Huang
-----------	---------------	---------	-----------

**TEST RESULTS**



## 8.1. RESTRICTED BANDEDGE

Test Mode:	802.11b PK	Channel:	2412
Polarity:	Horizontal	Test Voltage:	AC 120V_60Hz

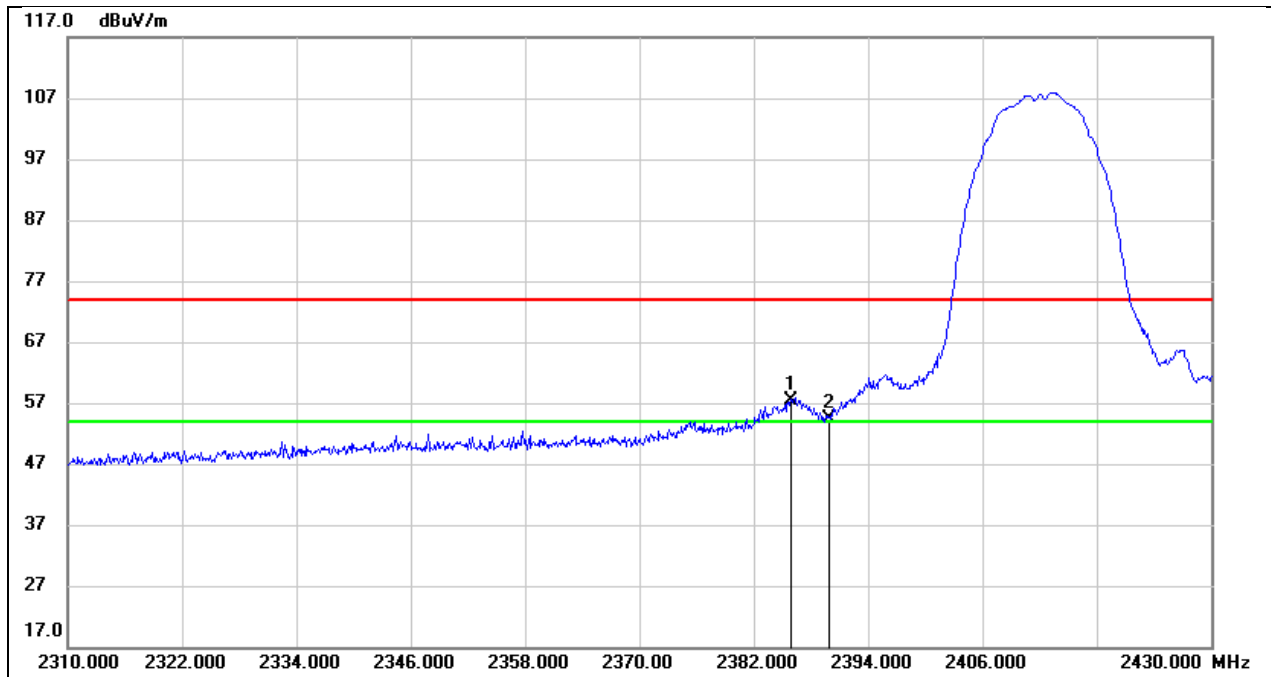

No.	Frequency (MHz)	Reading (dBuV)	Correct (dB/m)	Result (dBuV/m)	Limit (dBuV/m)	Margin (dB)	Remark
1	2385.960	25.34	32.14	57.48	74.00	-16.52	peak
2	2390.000	22.14	32.16	54.30	74.00	-19.70	peak

Test Mode:	802.11b AV	Channel:	2412
Polarity:	Horizontal	Test Voltage:	AC 120V_60Hz

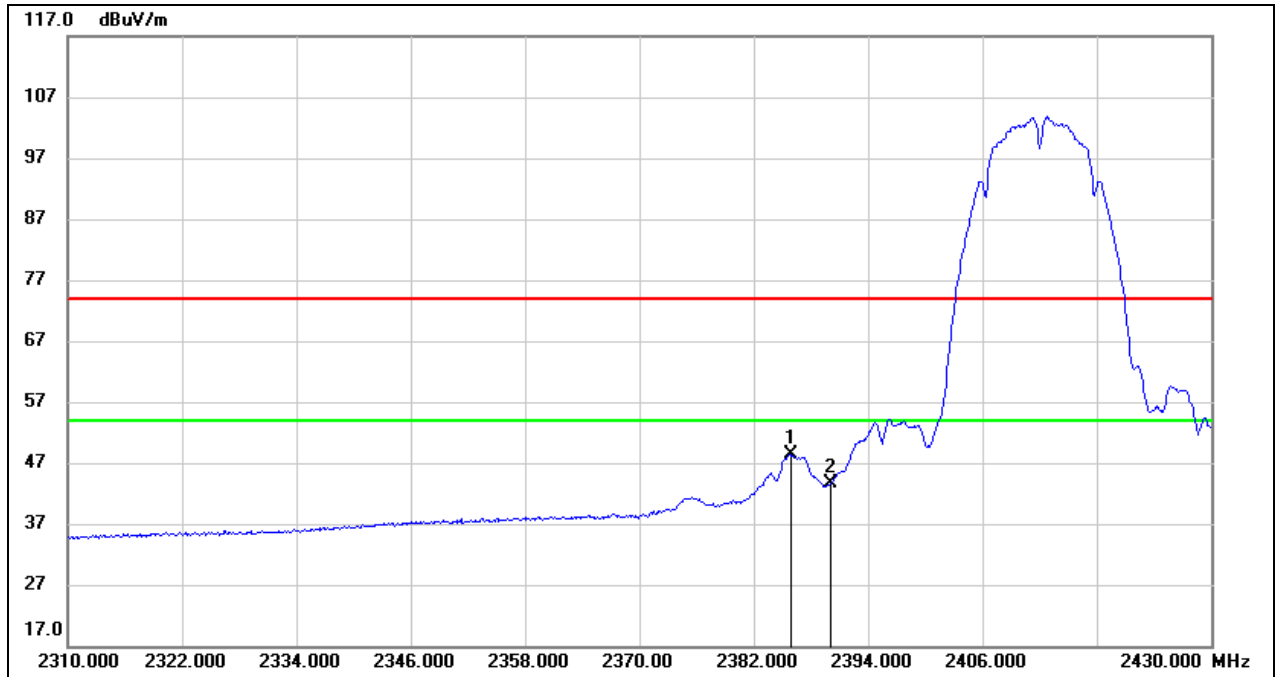

No.	Frequency (MHz)	Reading (dBuV)	Correct (dB/m)	Result (dBuV/m)	Limit (dBuV/m)	Margin (dB)	Remark
1	2385.960	16.33	32.14	48.47	54.00	-5.53	AVG
2	2390.000	11.47	32.16	43.63	54.00	-10.37	AVG

Test Mode:	802.11b PK	Channel:	2412
Polarity:	Vertical	Test Voltage:	AC 120V_60Hz

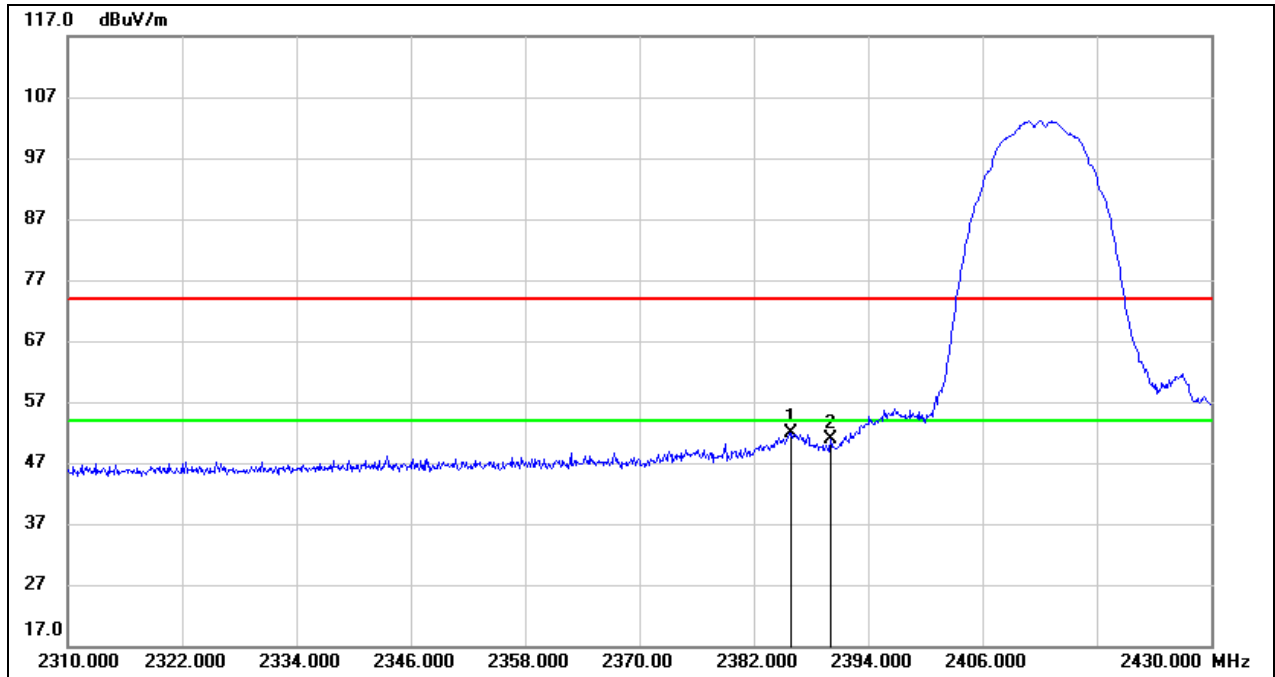

No.	Frequency (MHz)	Reading (dBuV)	Correct (dB/m)	Result (dBuV/m)	Limit (dBuV/m)	Margin (dB)	Remark
1	2385.840	19.86	32.14	52.00	74.00	-22.00	peak
2	2390.000	18.62	32.16	50.78	74.00	-23.22	peak

Test Mode:	802.11b PK	Channel:	2462
Polarity:	Horizontal	Test Voltage:	AC 120V_60Hz

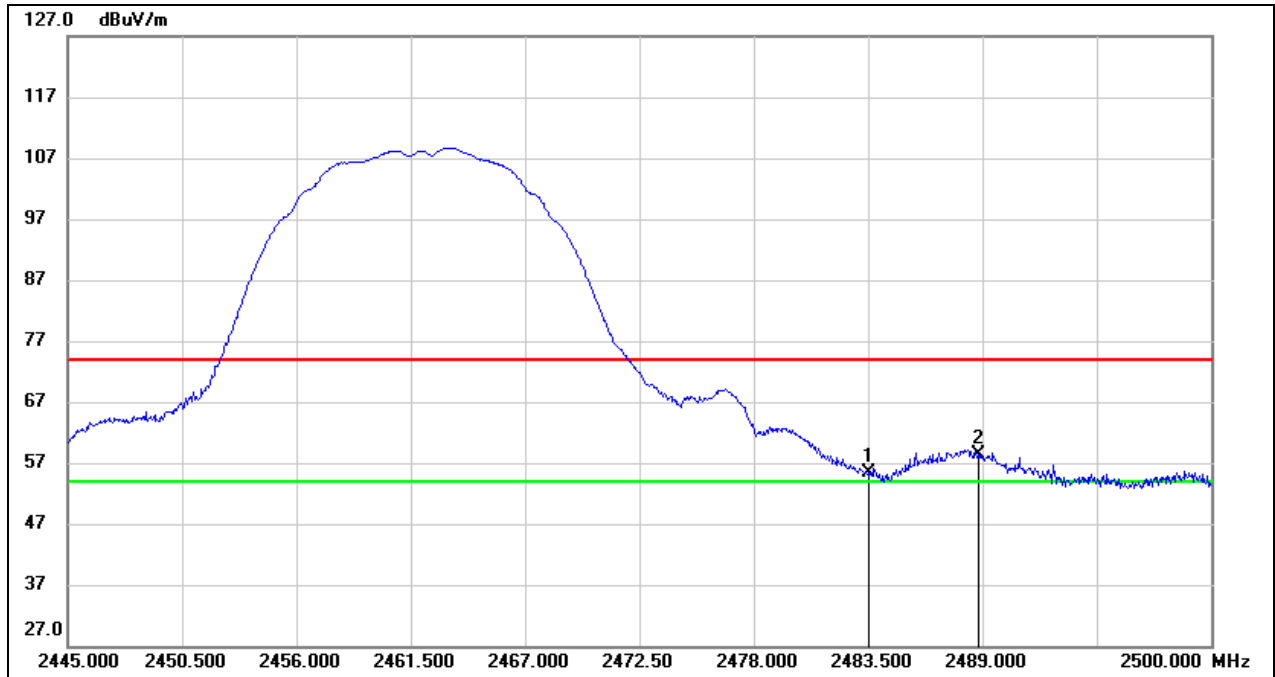

No.	Frequency (MHz)	Reading (dBuV)	Correct (dB/m)	Result (dBuV/m)	Limit (dBuV/m)	Margin (dB)	Remark
1	2483.500	23.02	32.44	55.46	74.00	-18.54	peak
2	2488.780	25.96	32.46	58.42	74.00	-15.58	peak

Test Mode:	802.11b AV	Channel:	2462
Polarity:	Horizontal	Test Voltage:	AC 120V_60Hz

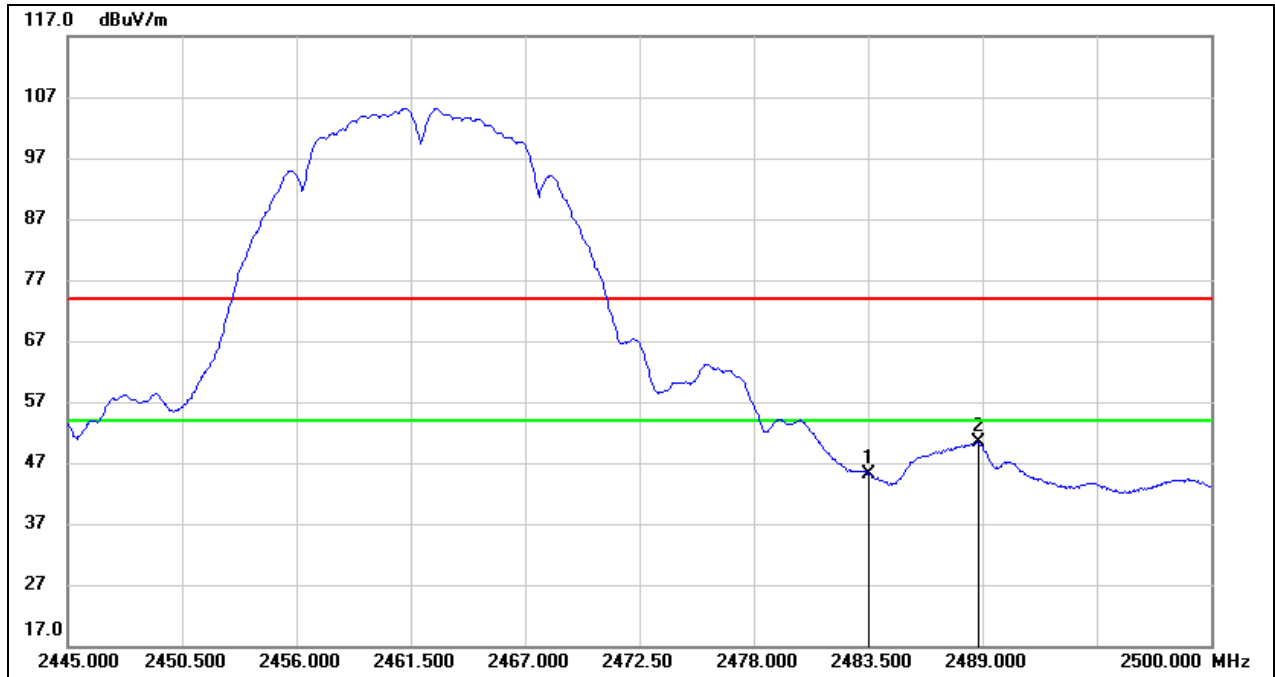

No.	Frequency (MHz)	Reading (dBuV)	Correct (dB/m)	Result (dBuV/m)	Limit (dBuV/m)	Margin (dB)	Remark
1	2483.500	12.69	32.44	45.13	54.00	-8.87	AVG
2	2488.780	17.90	32.46	50.36	54.00	-3.64	AVG

Test Mode:	802.11g PK	Channel:	2412
Polarity:	Horizontal	Test Voltage:	AC 120V_60Hz

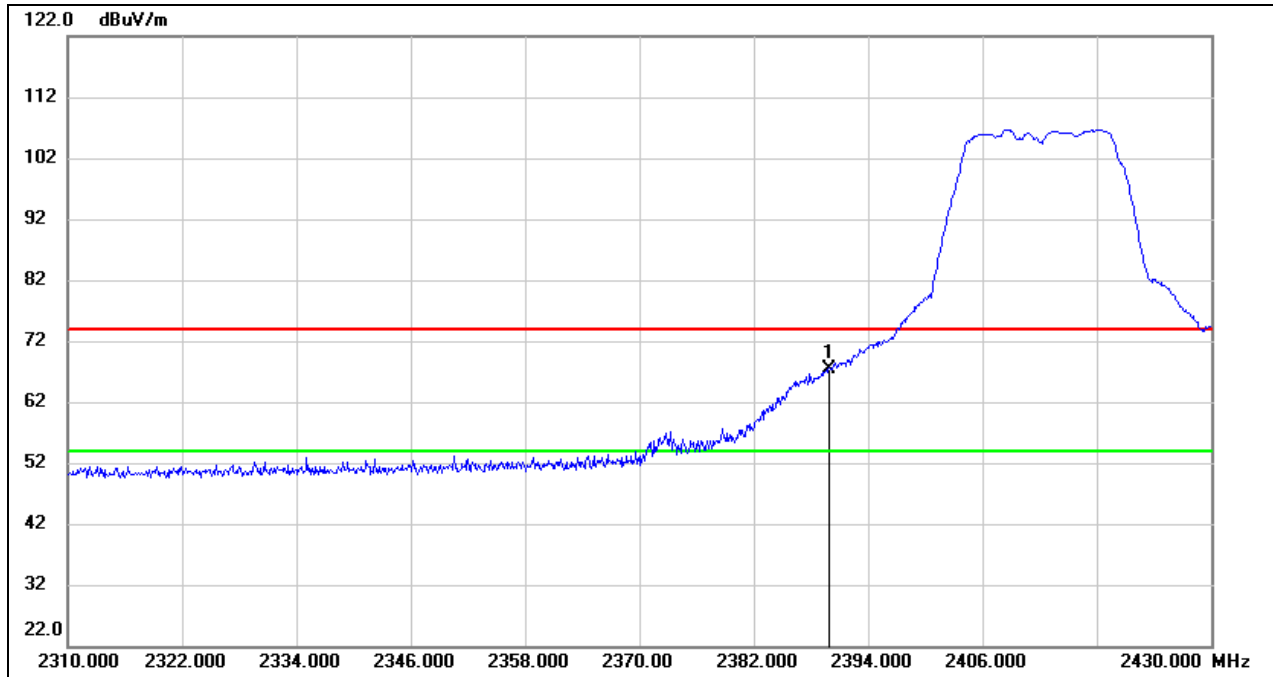

No.	Frequency (MHz)	Reading (dBuV)	Correct (dB/m)	Result (dBuV/m)	Limit (dBuV/m)	Margin (dB)	Remark
1	2390.000	35.14	32.16	67.30	74.00	-6.70	peak

Test Mode:	802.11g AV	Channel:	2412
Polarity:	Horizontal	Test Voltage:	AC 120V_60Hz

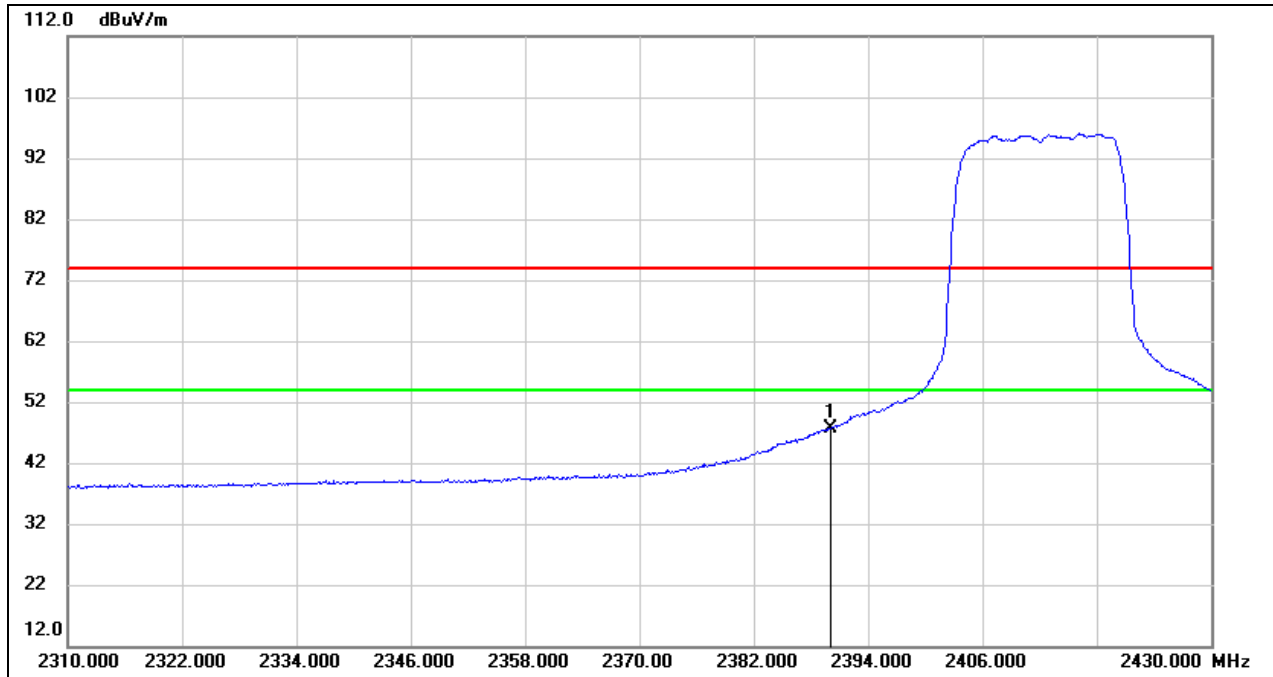

No.	Frequency (MHz)	Reading (dBuV)	Correct (dB/m)	Result (dBuV/m)	Limit (dBuV/m)	Margin (dB)	Remark
1	2390.000	15.52	32.16	47.68	54.00	-6.32	AVG

Test Mode:	802.11g PK	Channel:	2437
Polarity:	Horizontal	Test Voltage:	AC 120V_60Hz

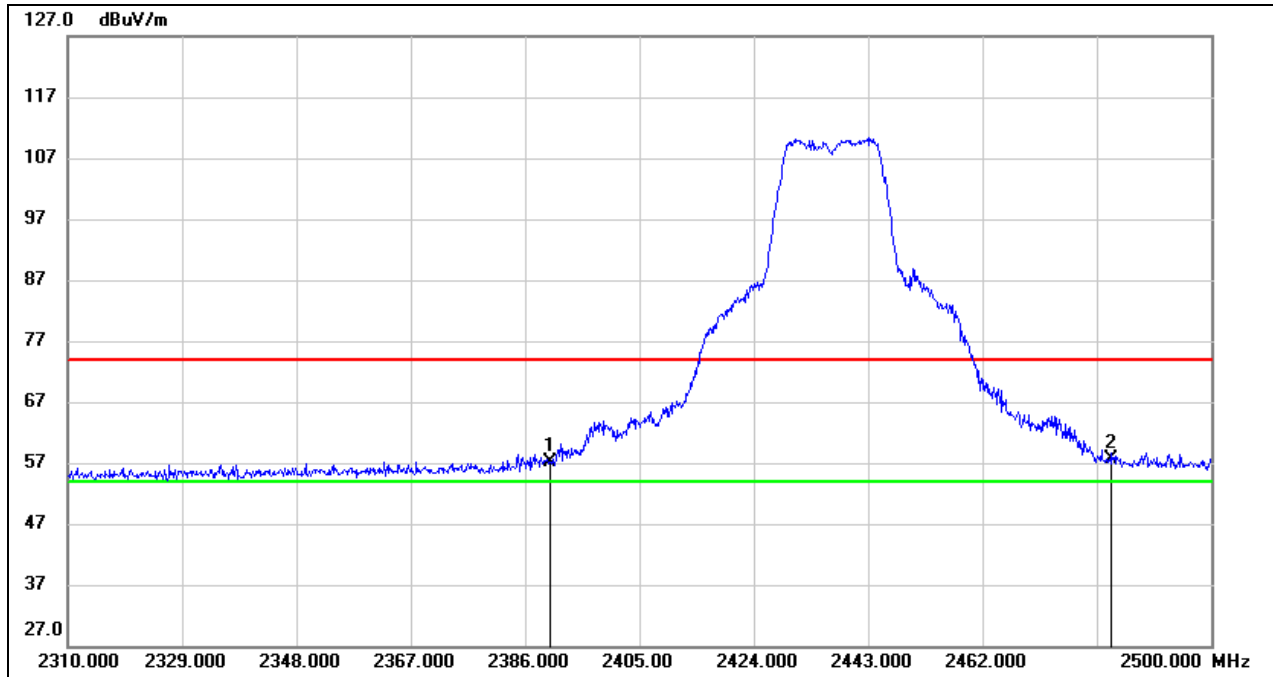

No.	Frequency (MHz)	Reading (dBuV)	Correct (dB/m)	Result (dBuV/m)	Limit (dBuV/m)	Margin (dB)	Remark
1	2390.000	24.94	32.16	57.10	74.00	-16.90	peak
2	2483.500	25.21	32.44	57.65	74.00	-16.35	peak



Test Mode:	802.11g AV	Channel:	2437
Polarity:	Horizontal	Test Voltage:	AC 120V_60Hz

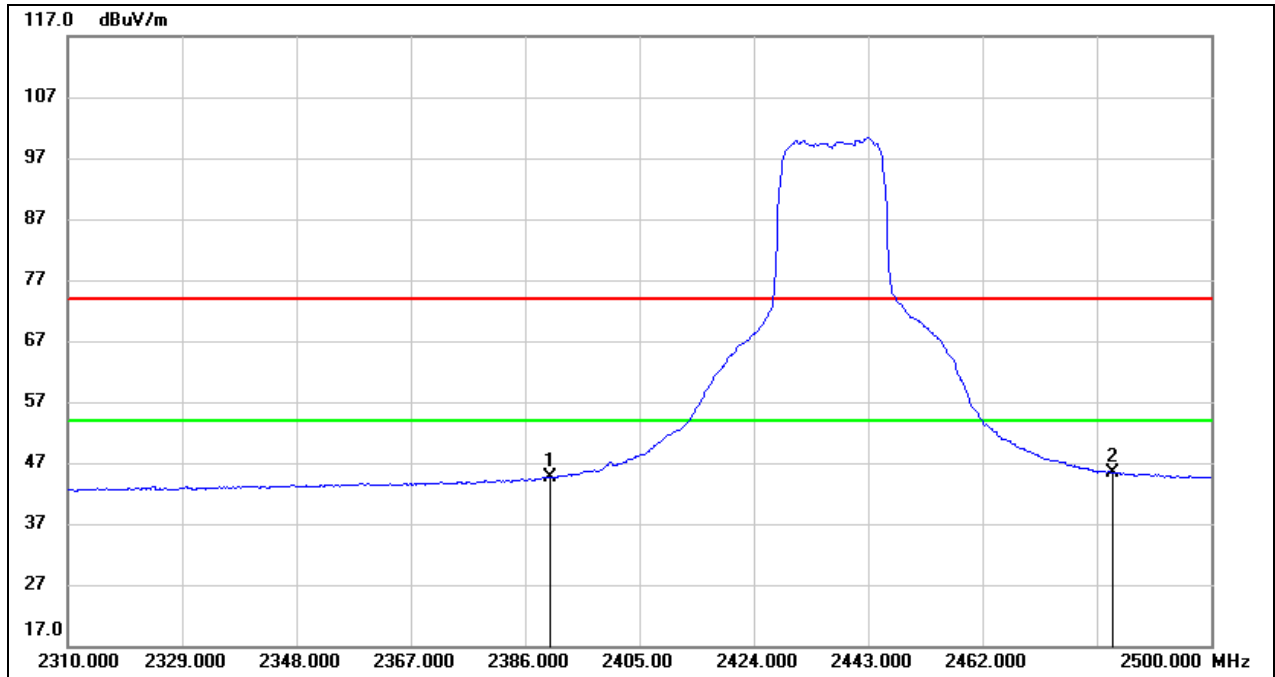

No.	Frequency (MHz)	Reading (dBuV)	Correct (dB/m)	Result (dBuV/m)	Limit (dBuV/m)	Margin (dB)	Remark
1	2390.000	12.44	32.16	44.60	54.00	-9.40	AVG
2	2483.500	12.93	32.44	45.37	54.00	-8.63	AVG

Test Mode:	802.11g PK	Channel:	2457
Polarity:	Horizontal	Test Voltage:	AC 120V_60Hz

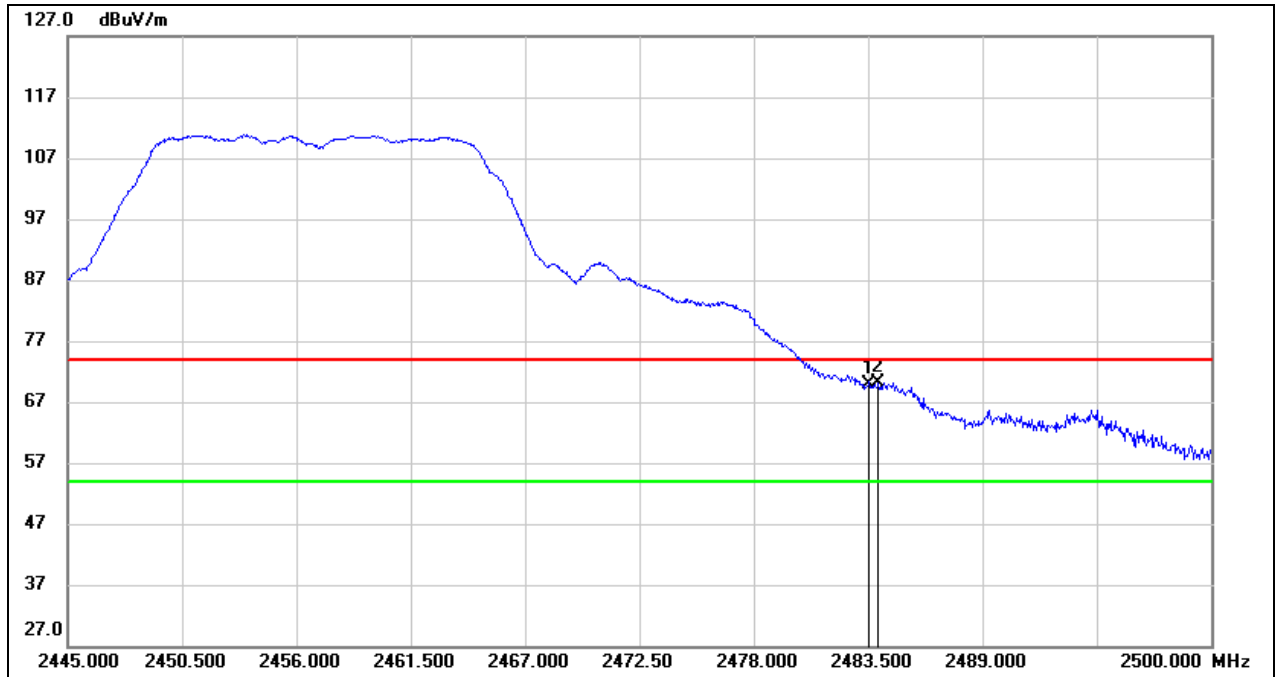

No.	Frequency (MHz)	Reading (dBuV)	Correct (dB/m)	Result (dBuV/m)	Limit (dBuV/m)	Margin (dB)	Remark
1	2483.500	37.33	32.44	69.77	74.00	-4.23	peak
2	2483.995	37.80	32.44	70.24	74.00	-3.76	peak

Test Mode:	802.11g AV	Channel:	2457
Polarity:	Horizontal	Test Voltage:	AC 120V_60Hz

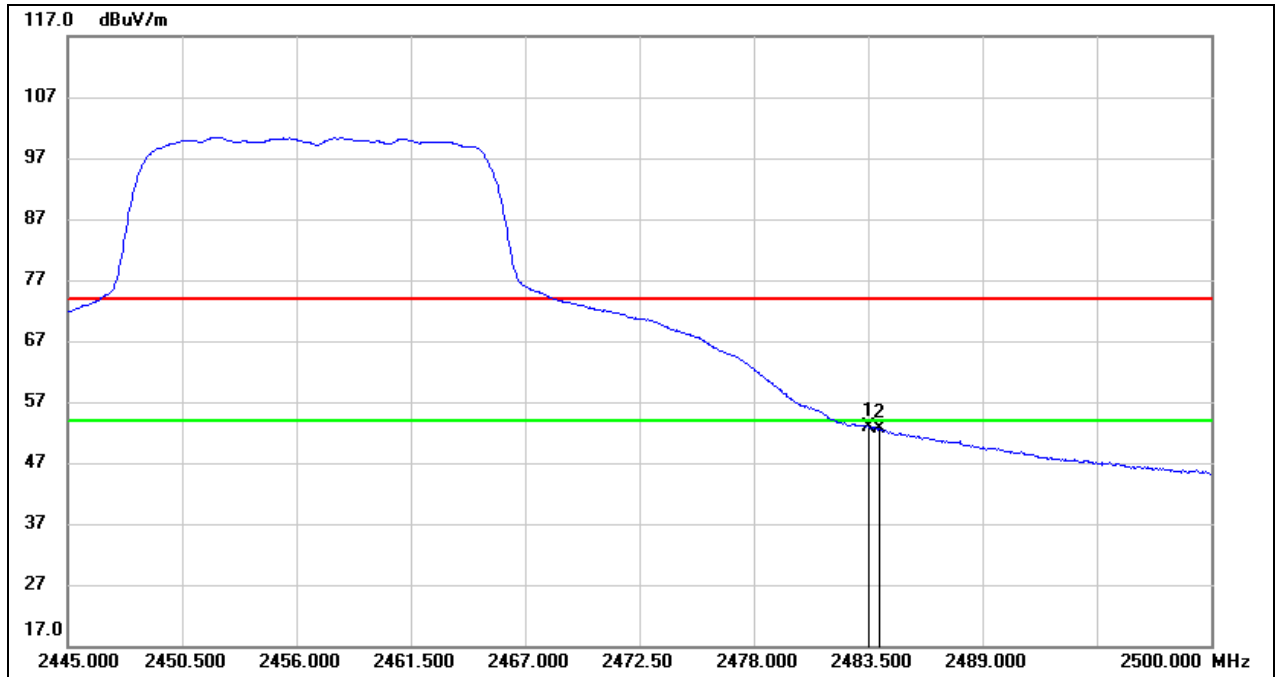

No.	Frequency (MHz)	Reading (dBuV)	Correct (dB/m)	Result (dBuV/m)	Limit (dBuV/m)	Margin (dB)	Remark
1	2483.500	20.45	32.44	52.89	54.00	-1.11	AVG
2	2483.995	20.25	32.44	52.69	54.00	-1.31	AVG

Test Mode:	802.11g PK	Channel:	2462
Polarity:	Horizontal	Test Voltage:	AC 120V_60Hz

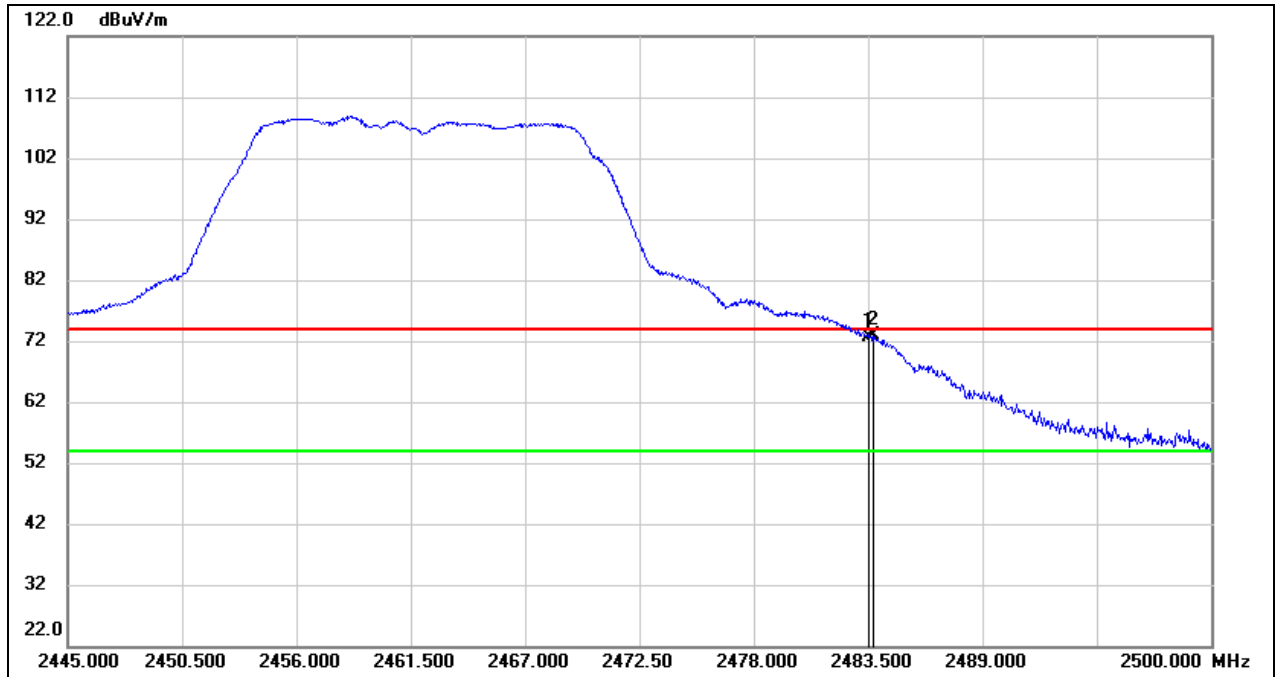

No.	Frequency (MHz)	Reading (dBuV)	Correct (dB/m)	Result (dBuV/m)	Limit (dBuV/m)	Margin (dB)	Remark
1	2483.500	40.28	32.44	72.72	74.00	-1.28	peak
2	2483.720	40.56	32.44	73.00	74.00	-1.00	peak

Test Mode:	802.11g AV	Channel:	2462
Polarity:	Horizontal	Test Voltage:	AC 120V_60Hz

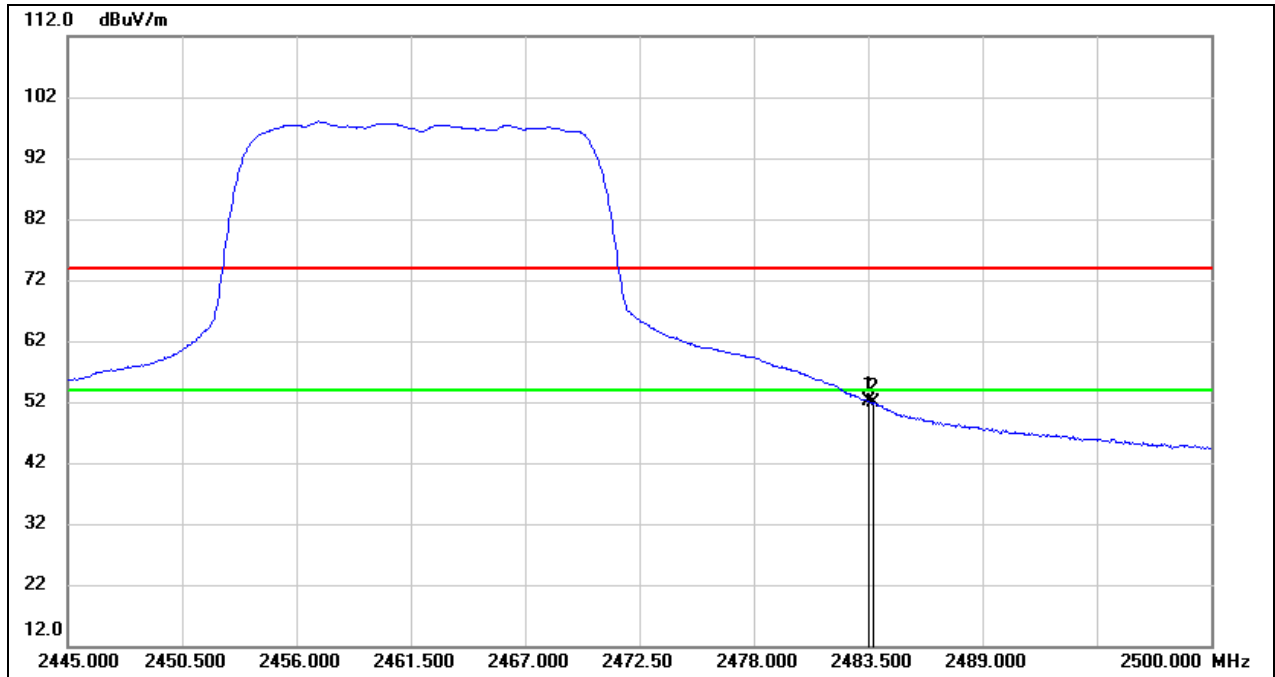

No.	Frequency (MHz)	Reading (dBuV)	Correct (dB/m)	Result (dBuV/m)	Limit (dBuV/m)	Margin (dB)	Remark
1	2483.500	19.75	32.44	52.19	54.00	-1.81	AVG
2	2483.720	19.34	32.44	51.78	54.00	-2.22	AVG

Test Mode:	802.11n HT20 PK	Channel:	2412
Polarity:	Horizontal	Test Voltage:	AC 120V_60Hz

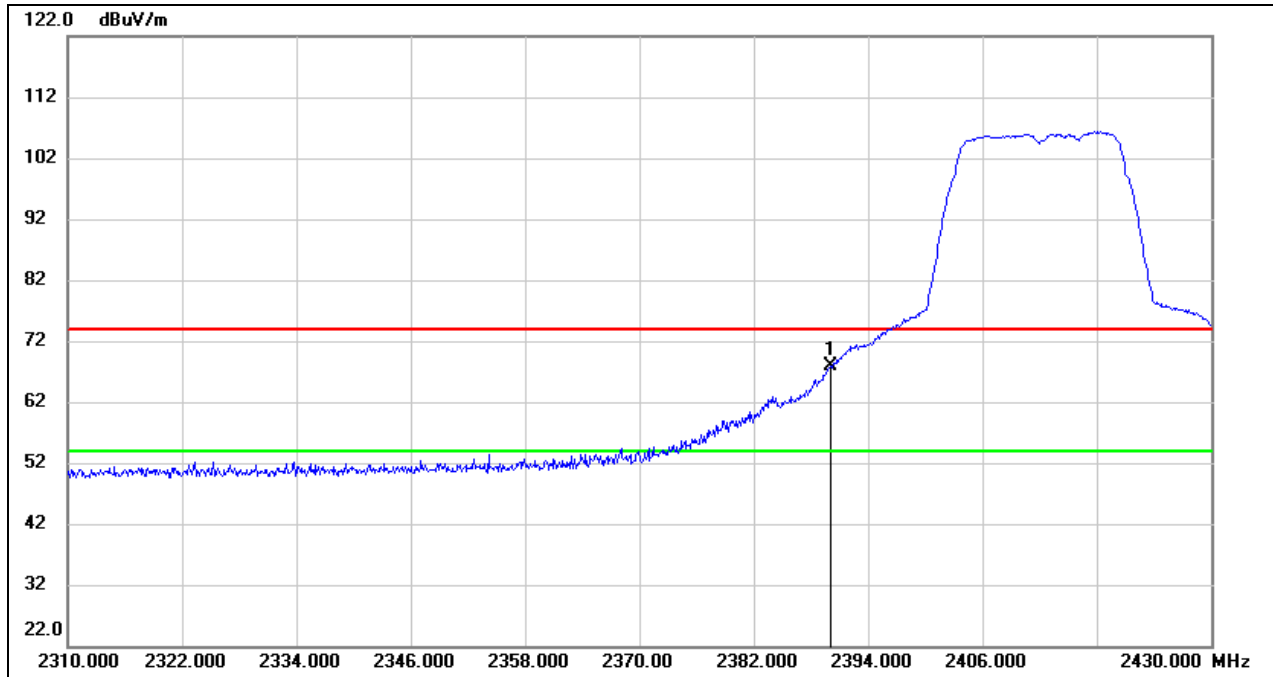

No.	Frequency (MHz)	Reading (dBuV)	Correct (dB/m)	Result (dBuV/m)	Limit (dBuV/m)	Margin (dB)	Remark
1	2390.000	35.82	32.16	67.98	74.00	-6.02	peak

Test Mode:	802.11n HT20 AV	Channel:	2412
Polarity:	Horizontal	Test Voltage:	AC 120V_60Hz

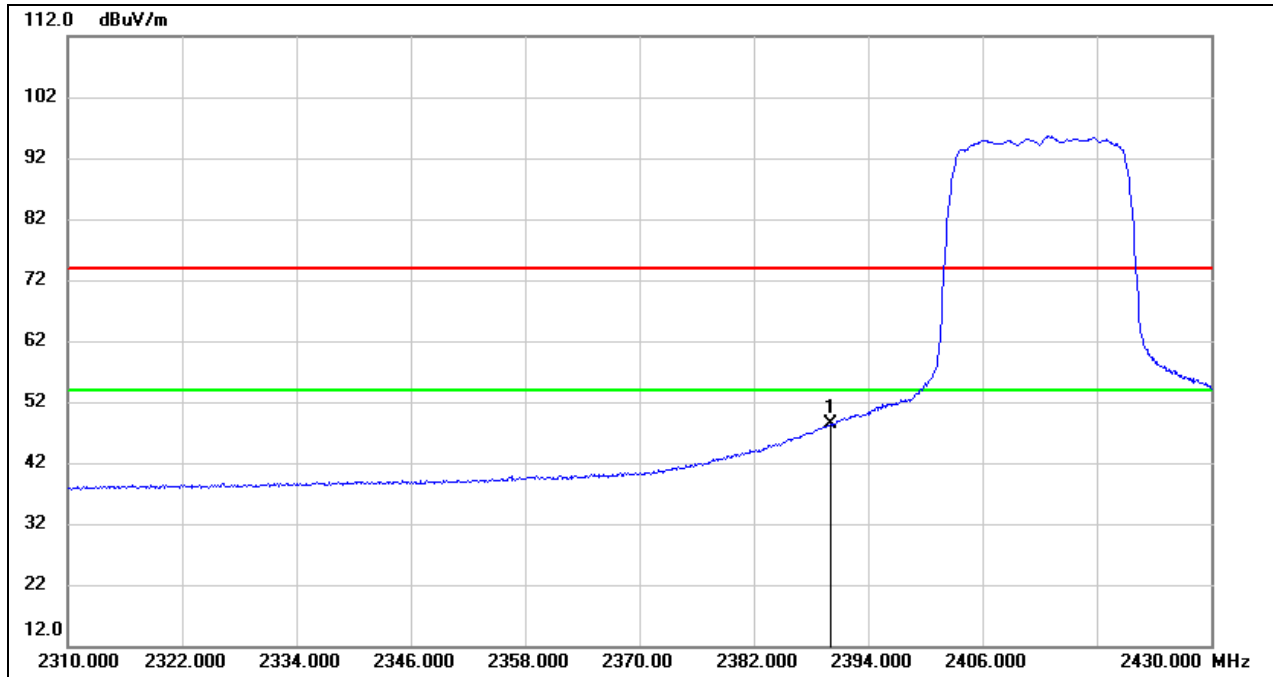

No.	Frequency (MHz)	Reading (dBuV)	Correct (dB/m)	Result (dBuV/m)	Limit (dBuV/m)	Margin (dB)	Remark
1	2390.000	16.12	32.16	48.28	54.00	-5.72	AVG

Test Mode:	802.11n HT20 PK	Channel:	2457
Polarity:	Horizontal	Test Voltage:	AC 120V_60Hz

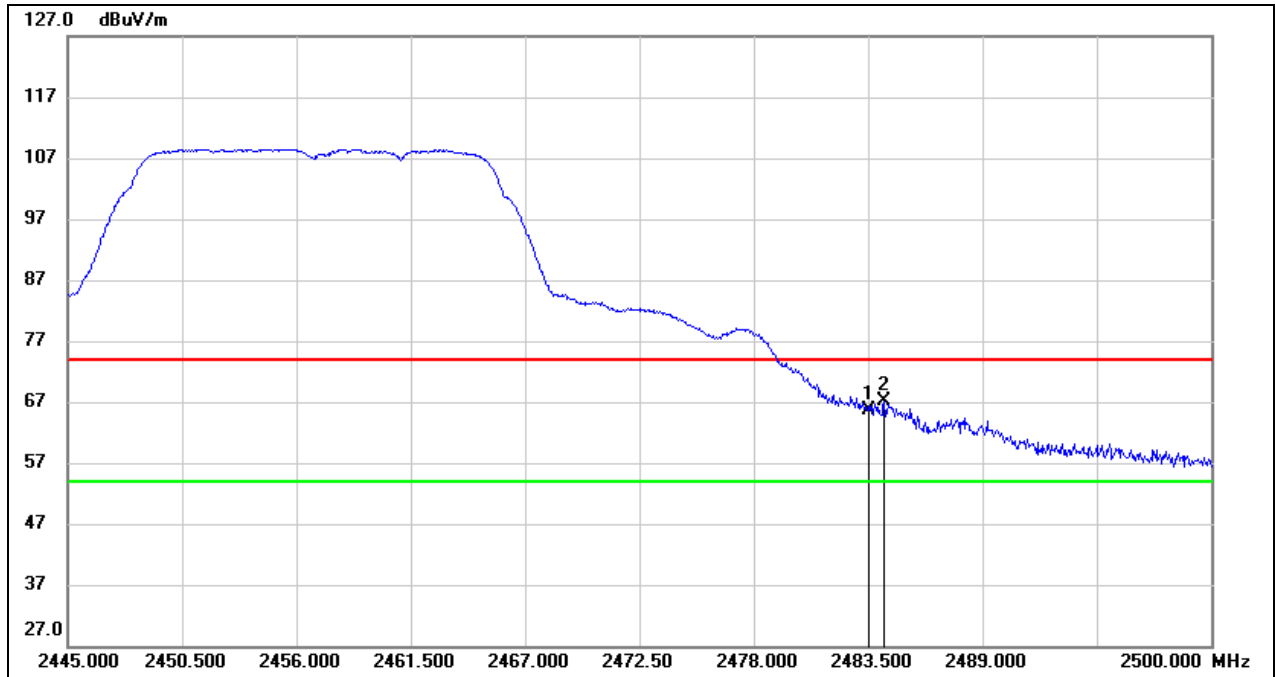

No.	Frequency (MHz)	Reading (dBuV)	Correct (dB/m)	Result (dBuV/m)	Limit (dBuV/m)	Margin (dB)	Remark
1	2483.500	33.19	32.44	65.63	74.00	-8.37	peak
2	2484.270	34.67	32.44	67.11	74.00	-6.89	peak



Test Mode:	802.11n HT20 AV	Channel:	2457
Polarity:	Horizontal	Test Voltage:	AC 120V_60Hz

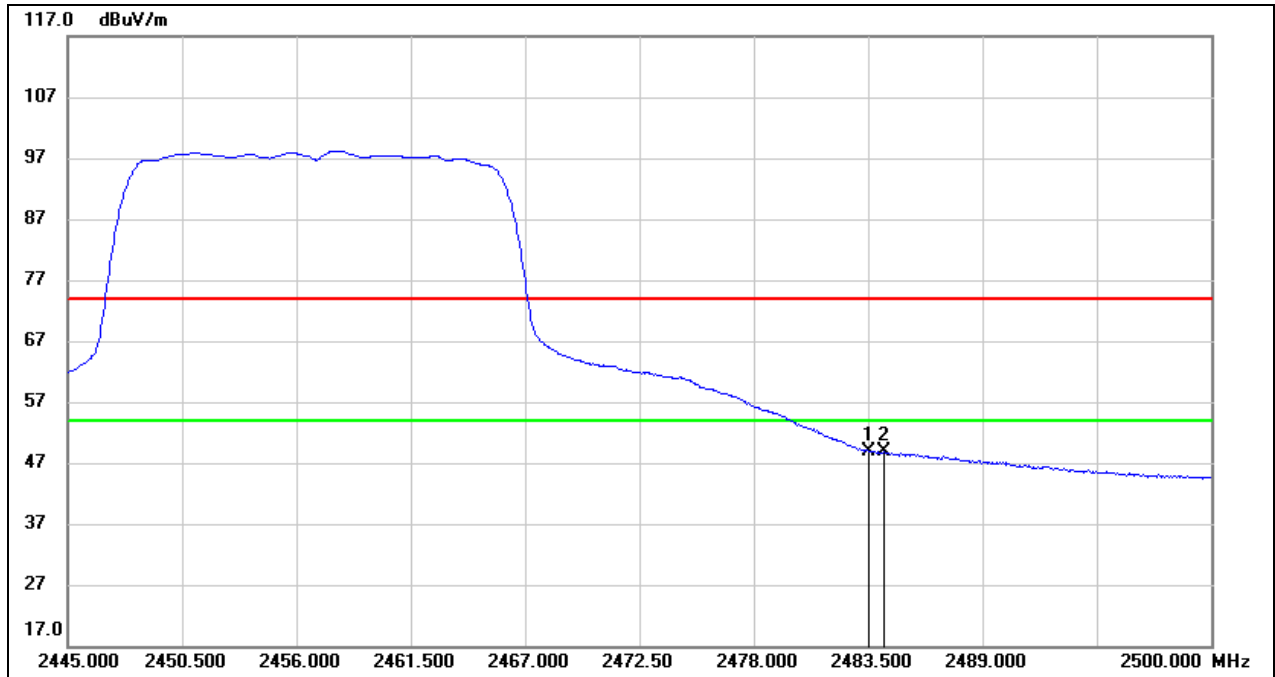

No.	Frequency (MHz)	Reading (dBuV)	Correct (dB/m)	Result (dBuV/m)	Limit (dBuV/m)	Margin (dB)	Remark
1	2483.500	16.40	32.44	48.84	54.00	-5.16	AVG
2	2484.270	16.38	32.44	48.82	54.00	-5.18	AVG

Test Mode:	802.11n HT20 PK	Channel:	2462
Polarity:	Horizontal	Test Voltage:	AC 120V_60Hz

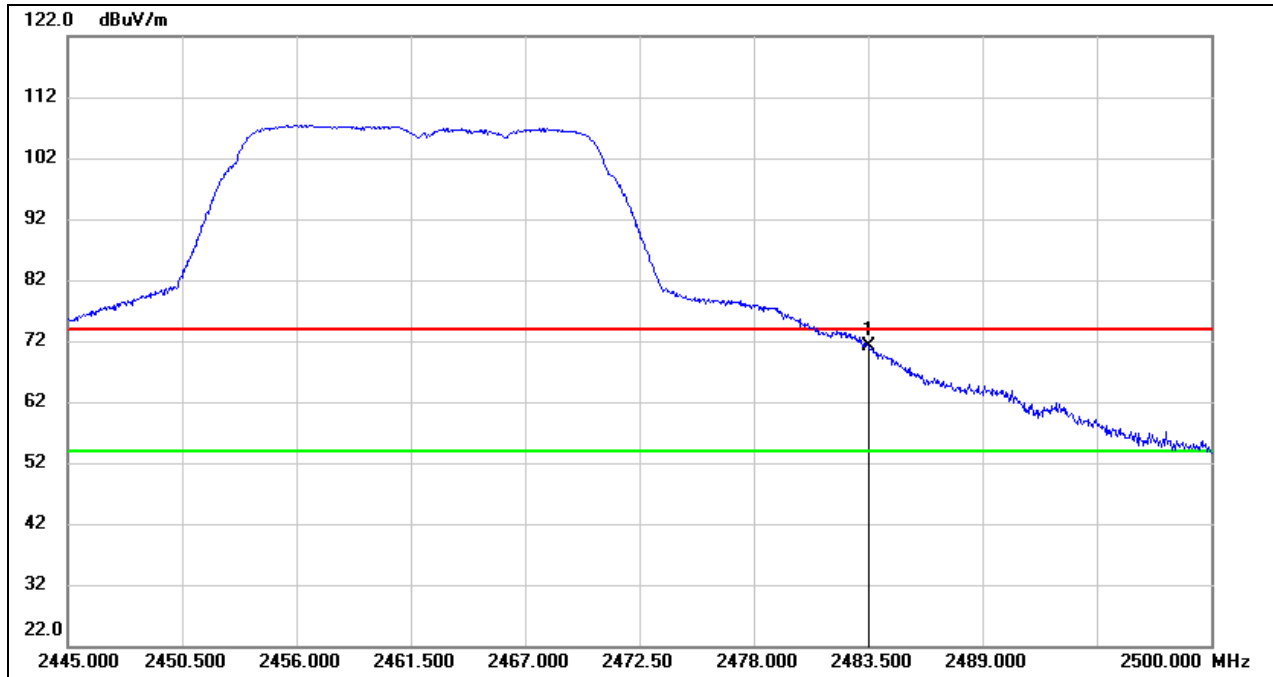

No.	Frequency (MHz)	Reading (dBuV)	Correct (dB/m)	Result (dBuV/m)	Limit (dBuV/m)	Margin (dB)	Remark
1	2483.500	38.77	32.44	71.21	74.00	-2.79	peak

Test Mode:	802.11n HT20 AV	Channel:	2462
Polarity:	Horizontal	Test Voltage:	AC 120V_60Hz

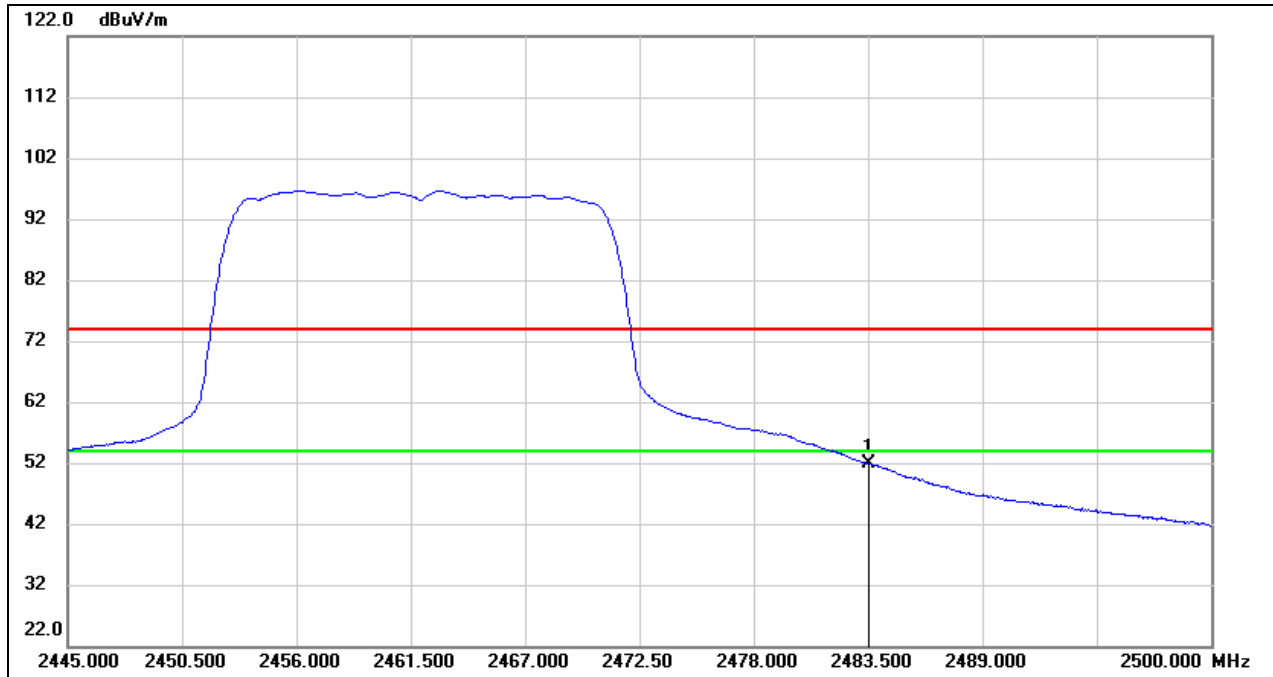

No.	Frequency (MHz)	Reading (dBuV)	Correct (dB/m)	Result (dBuV/m)	Limit (dBuV/m)	Margin (dB)	Remark
1	2483.500	19.49	32.44	51.93	54.00	-2.07	AVG

## 8.2. SPURIOUS EMISSIONS(1 GHZ~3 GHZ)

Test Mode:	802.11b	Channel:	2412
Polarity:	Horizontal	Test Voltage:	AC 120V_60Hz

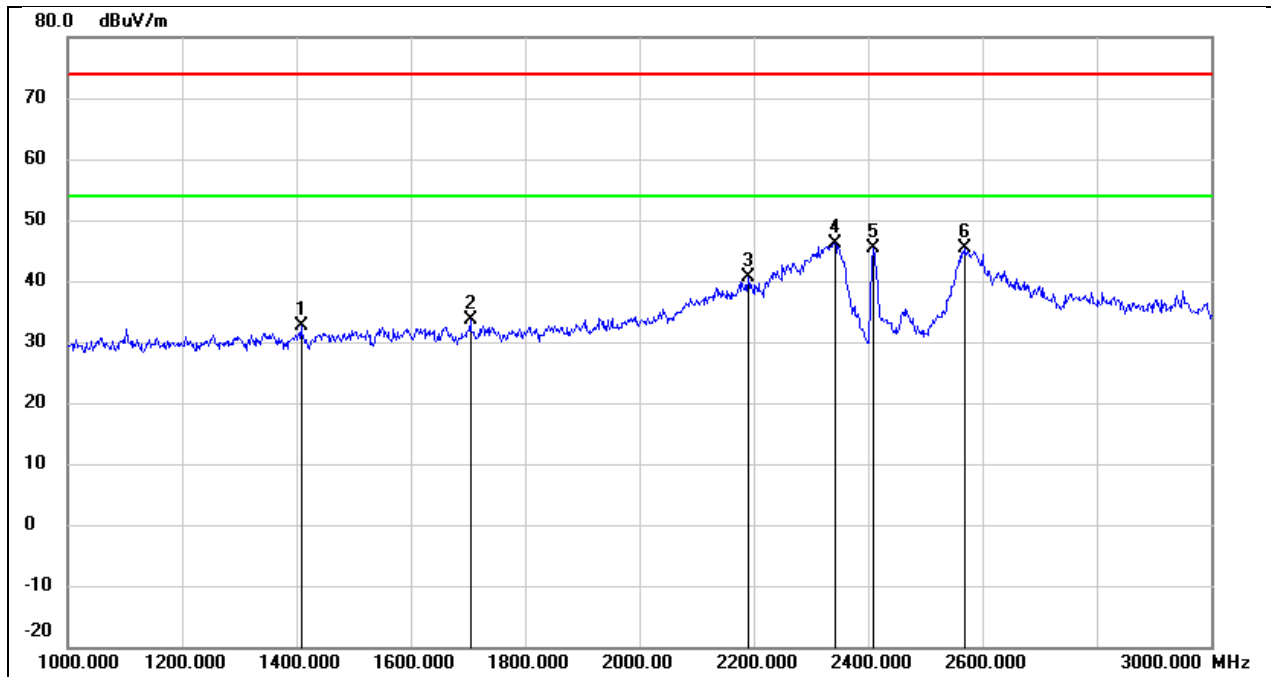

No.	Frequency (MHz)	Reading (dBuV)	Correct (dB/m)	Result (dBuV/m)	Limit (dBuV/m)	Margin (dB)	Remark
1	1408.000	45.87	-13.13	32.74	74.00	-41.26	peak
2	1704.000	45.60	-12.04	33.56	74.00	-40.44	peak
3	2190.000	50.63	-10.09	40.54	74.00	-33.46	peak
4	2342.000	55.41	-9.30	46.11	74.00	-27.89	peak
5	2410.000	54.41	-8.95	45.46	74.00	-28.54	peak
6	2570.000	53.62	-8.27	45.35	74.00	-28.65	peak

Test Mode:	802.11b	Channel:	2412
Polarity:	Vertical	Test Voltage:	AC 120V_60Hz

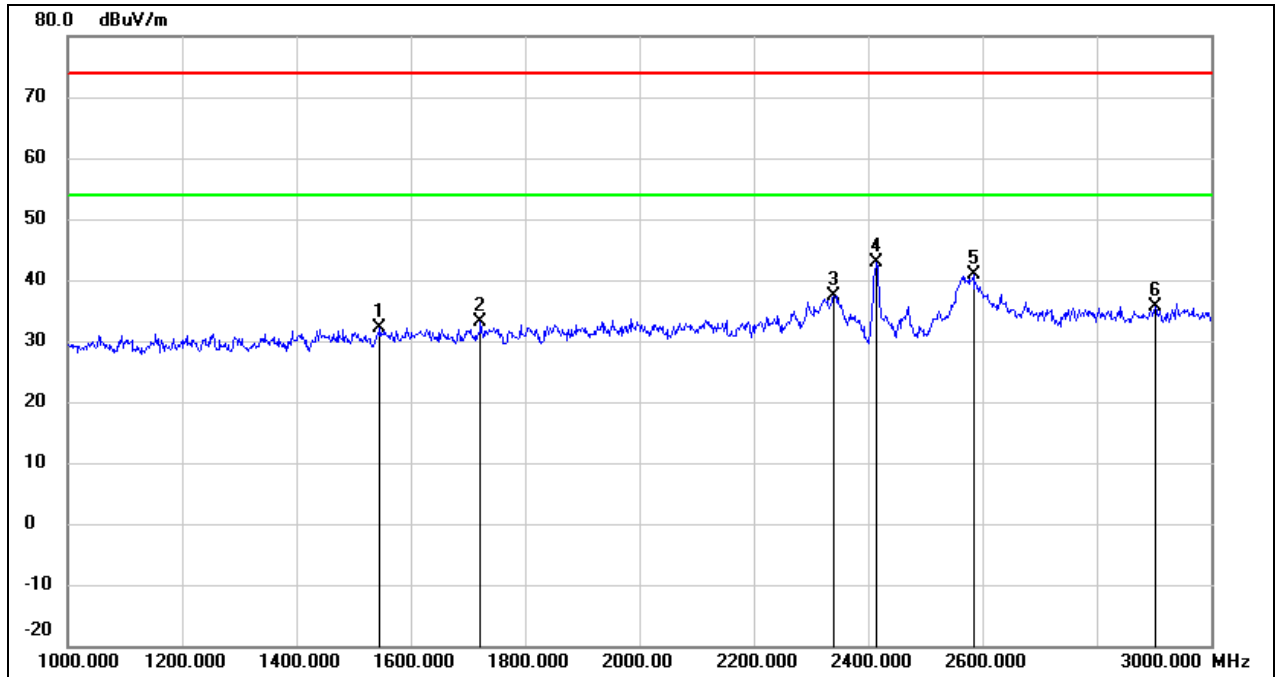

No.	Frequency (MHz)	Reading (dBuV)	Correct (dB/m)	Result (dBuV/m)	Limit (dBuV/m)	Margin (dB)	Remark
1	1546.000	44.62	-12.56	32.06	74.00	-41.94	peak
2	1722.000	45.15	-11.98	33.17	74.00	-40.83	peak
3	2340.000	46.79	-9.31	37.48	74.00	-36.52	peak
4	2414.000	51.77	-8.93	42.84	74.00	-31.16	peak
5	2584.000	49.21	-8.24	40.97	74.00	-33.03	peak
6	2902.000	43.01	-7.28	35.73	74.00	-38.27	peak

Test Mode:	802.11b	Channel:	2437
Polarity:	Horizontal	Test Voltage:	AC 120V_60Hz

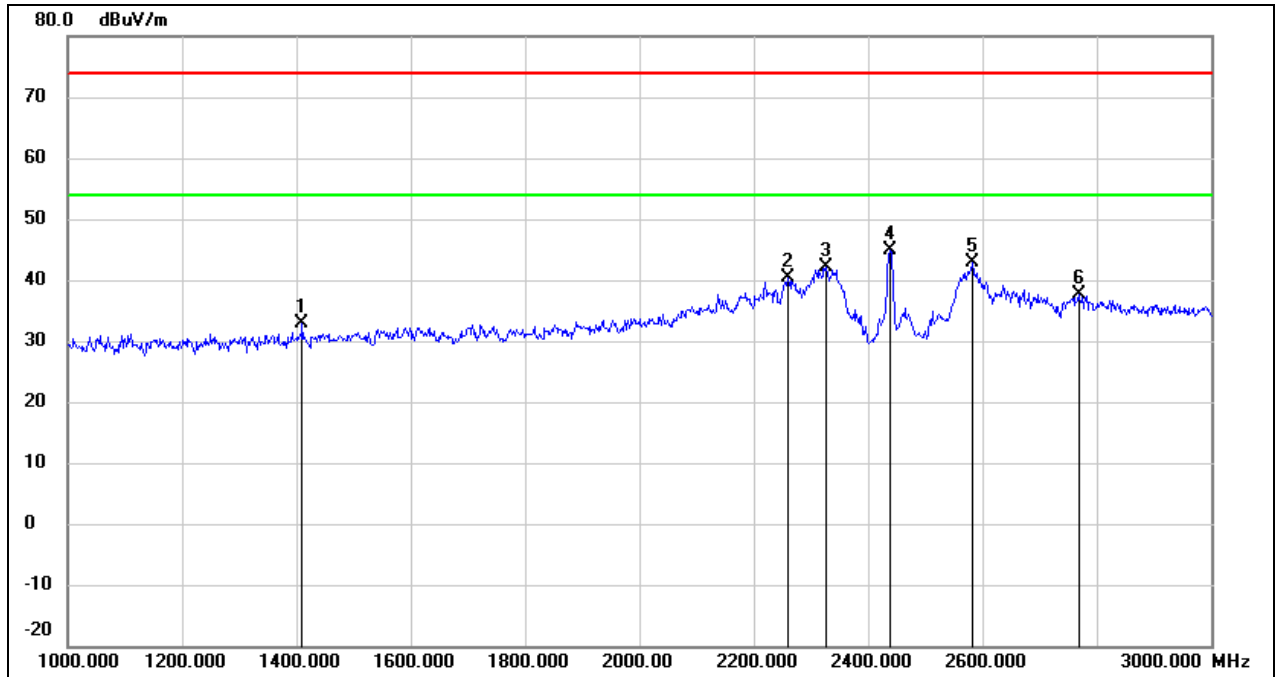

No.	Frequency (MHz)	Reading (dBuV)	Correct (dB/m)	Result (dBuV/m)	Limit (dBuV/m)	Margin (dB)	Remark
1	1410.000	45.93	-13.13	32.80	74.00	-41.20	peak
2	2260.000	49.99	-9.72	40.27	74.00	-33.73	peak
3	2326.000	51.46	-9.38	42.08	74.00	-31.92	peak
4	2438.000	53.60	-8.80	44.80	74.00	-29.20	peak
5	2582.000	51.02	-8.24	42.78	74.00	-31.22	peak
6	2768.000	45.19	-7.68	37.51	74.00	-36.49	peak

Test Mode:	802.11b	Channel:	2437
Polarity:	Vertical	Test Voltage:	AC 120V_60Hz

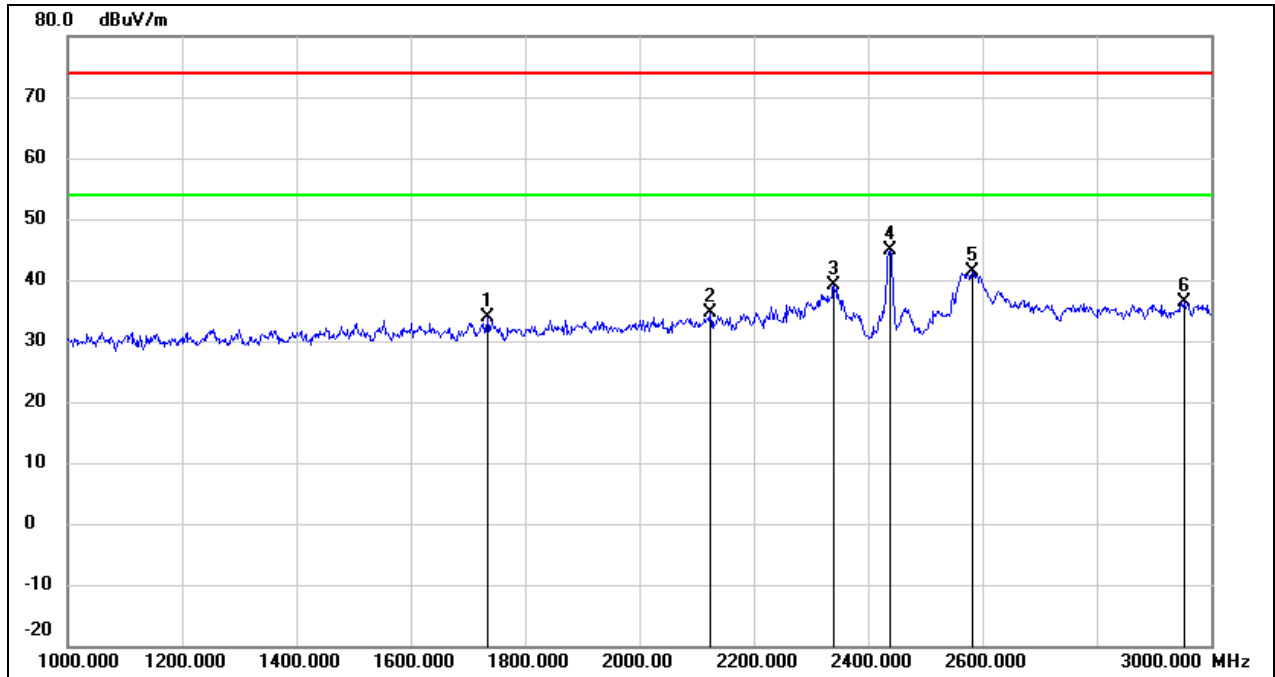

No.	Frequency (MHz)	Reading (dBuV)	Correct (dB/m)	Result (dBuV/m)	Limit (dBuV/m)	Margin (dB)	Remark
1	1734.000	45.79	-11.94	33.85	74.00	-40.15	peak
2	2124.000	45.17	-10.42	34.75	74.00	-39.25	peak
3	2340.000	48.56	-9.31	39.25	74.00	-34.75	peak
4	2438.000	53.74	-8.80	44.94	74.00	-29.06	peak
5	2582.000	49.50	-8.24	41.26	74.00	-32.74	peak
6	2954.000	43.43	-7.11	36.32	74.00	-37.68	peak

Test Mode:	802.11b	Channel:	2462
Polarity:	Horizontal	Test Voltage:	AC 120V_60Hz

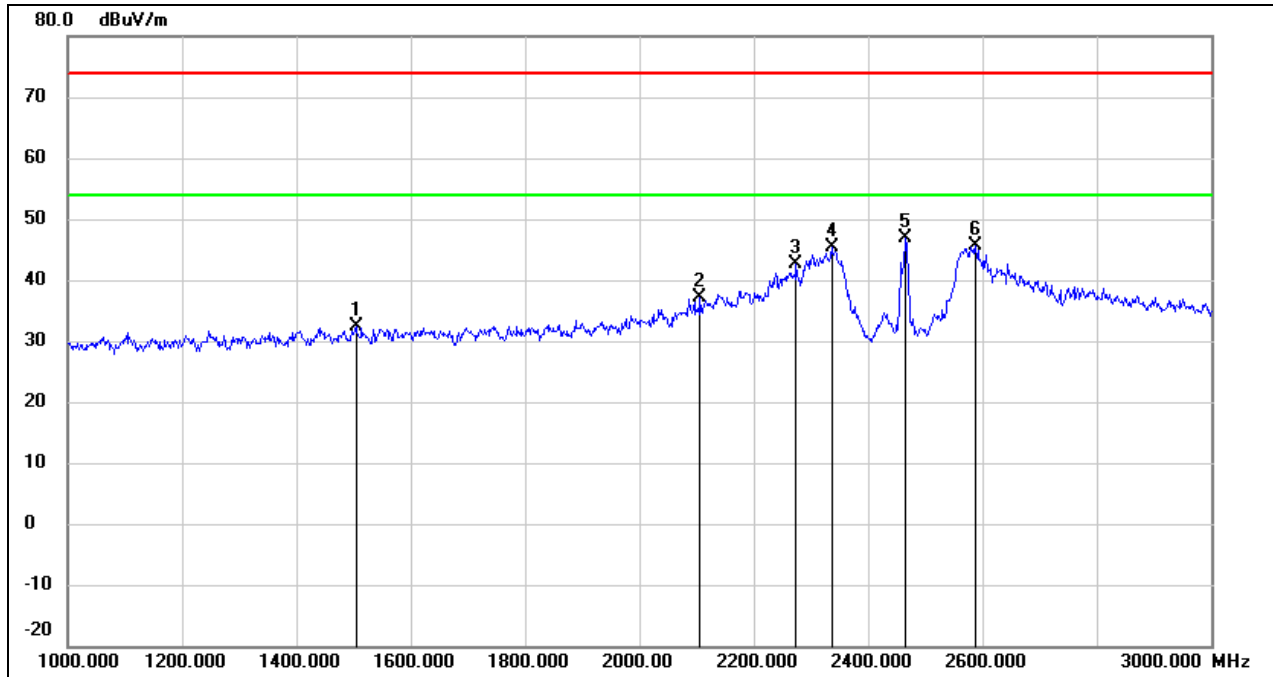

No.	Frequency (MHz)	Reading (dBuV)	Correct (dB/m)	Result (dBuV/m)	Limit (dBuV/m)	Margin (dB)	Remark
1	1504.000	45.04	-12.70	32.34	74.00	-41.66	peak
2	2106.000	47.58	-10.51	37.07	74.00	-36.93	peak
3	2274.000	52.28	-9.66	42.62	74.00	-31.38	peak
4	2336.000	54.61	-9.33	45.28	74.00	-28.72	peak
5	2466.000	55.61	-8.66	46.95	74.00	-27.05	peak
6	2588.000	53.78	-8.22	45.56	74.00	-28.44	peak



Test Mode:	802.11b	Channel:	2462
Polarity:	Vertical	Test Voltage:	AC 120V_60Hz

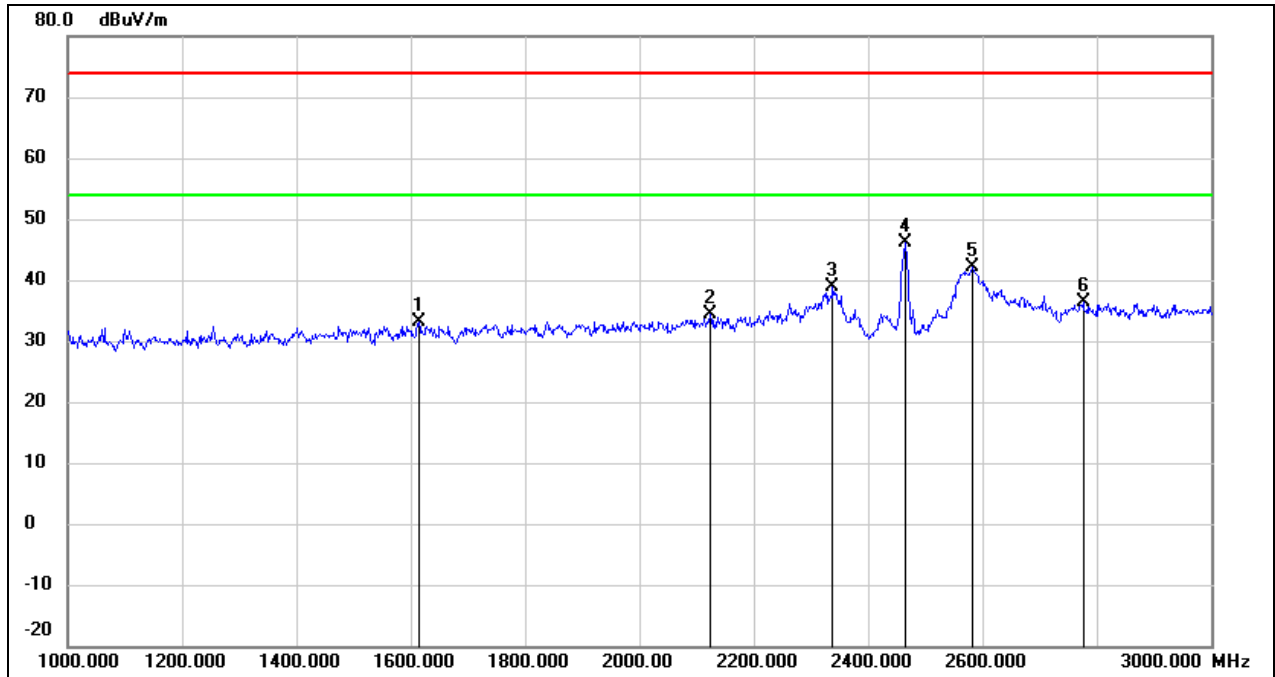

No.	Frequency (MHz)	Reading (dBuV)	Correct (dB/m)	Result (dBuV/m)	Limit (dBuV/m)	Margin (dB)	Remark
1	1614.000	45.35	-12.34	33.01	74.00	-40.99	peak
2	2124.000	44.78	-10.42	34.36	74.00	-39.64	peak
3	2338.000	48.28	-9.32	38.96	74.00	-35.04	peak
4	2464.000	54.87	-8.68	46.19	74.00	-27.81	peak
5	2582.000	50.26	-8.24	42.02	74.00	-31.98	peak
6	2776.000	43.93	-7.66	36.27	74.00	-37.73	peak

### 8.3. SPURIOUS EMISSIONS(3 GHZ~18 GHZ)

Test Mode:	802.11b	Channel:	2412
Polarity:	Horizontal	Test Voltage:	AC 120V_60Hz

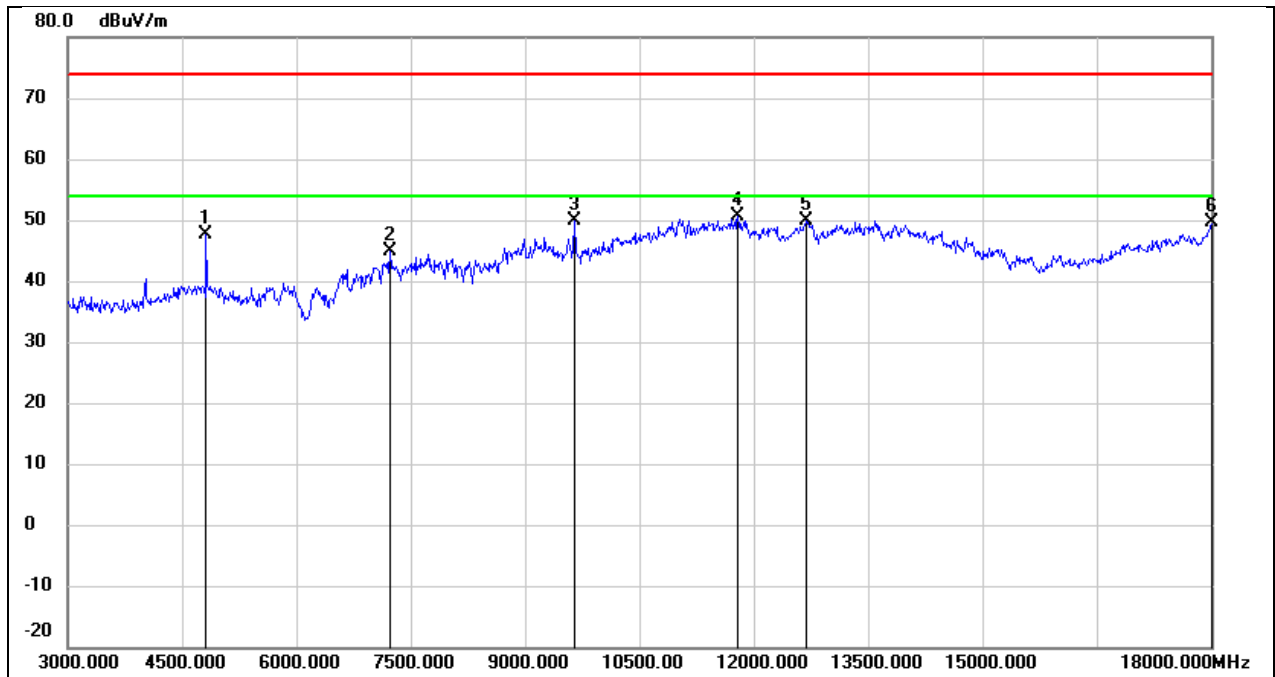

No.	Frequency (MHz)	Reading (dBuV)	Correct (dB/m)	Result (dBuV/m)	Limit (dBuV/m)	Margin (dB)	Remark
1	4815.000	47.92	-0.26	47.66	74.00	-26.34	peak
2	7230.000	38.27	6.53	44.80	74.00	-29.20	peak
3	9645.000	38.76	11.08	49.84	74.00	-24.16	peak
4	11790.000	33.25	17.38	50.63	74.00	-23.37	peak
5	12690.000	31.86	18.02	49.88	74.00	-24.12	peak
6	18000.000	23.99	25.69	49.68	74.00	-24.32	peak

Test Mode:	802.11b	Channel:	2412
Polarity:	Vertical	Test Voltage:	AC 120V_60Hz

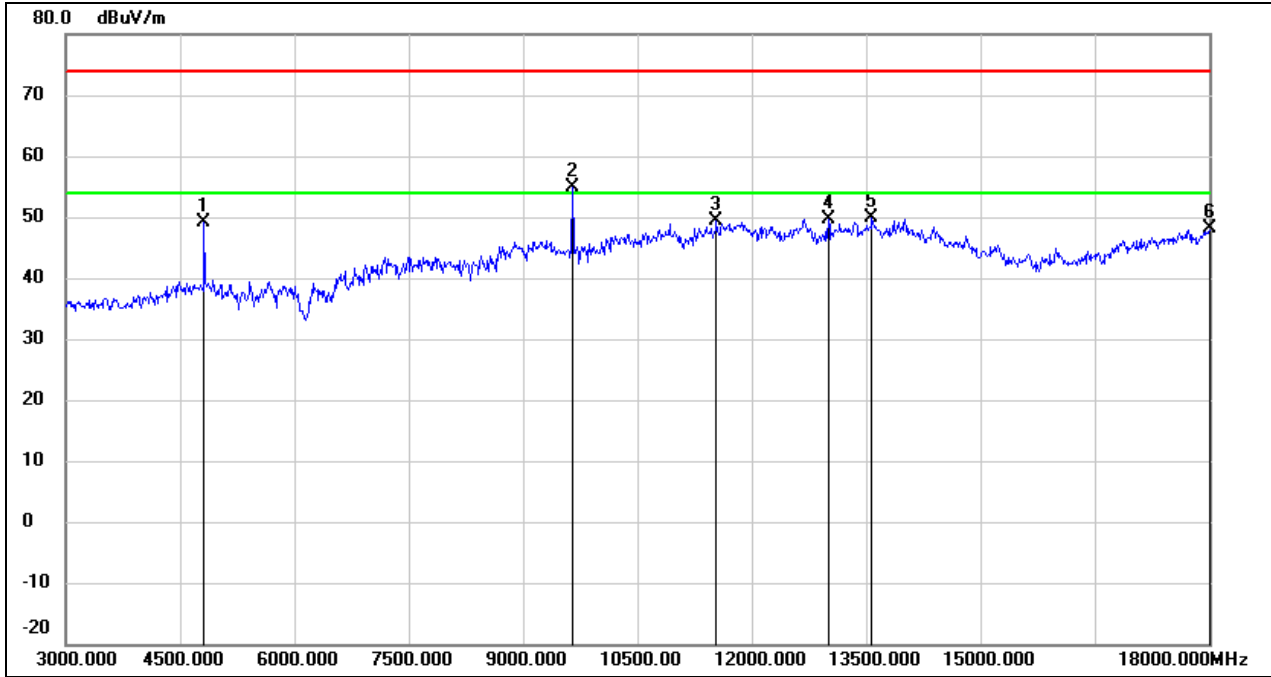

No.	Frequency (MHz)	Reading (dBuV)	Correct (dB/m)	Result (dBuV/m)	Limit (dBuV/m)	Margin (dB)	Remark
1	4815.000	49.27	-0.26	49.01	74.00	-24.99	peak
2	9645.000	43.87	11.08	54.95	74.00	-19.05	peak
3	11535.000	32.68	16.70	49.38	74.00	-24.62	peak
4	13005.000	30.92	18.74	49.66	74.00	-24.34	peak
5	13575.000	28.79	21.06	49.85	74.00	-24.15	peak
6	18000.000	22.39	25.69	48.08	74.00	-25.92	peak

Test Mode:	802.11b	Channel:	2437
Polarity:	Horizontal	Test Voltage:	AC 120V_60Hz

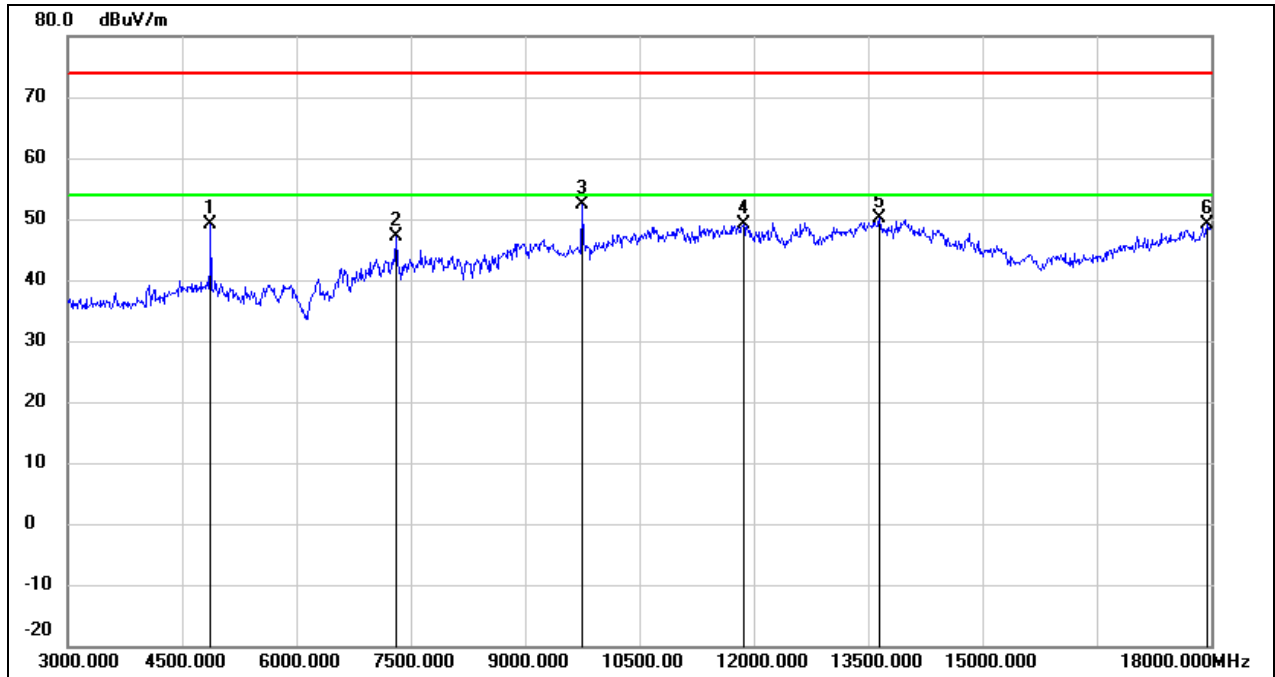

No.	Frequency (MHz)	Reading (dBuV)	Correct (dB/m)	Result (dBuV/m)	Limit (dBuV/m)	Margin (dB)	Remark
1	4875.000	49.25	-0.03	49.22	74.00	-24.78	peak
2	7305.000	40.69	6.47	47.16	74.00	-26.84	peak
3	9750.000	41.04	11.35	52.39	74.00	-21.61	peak
4	11865.000	31.49	17.59	49.08	74.00	-24.92	peak
5	13650.000	28.93	21.21	50.14	74.00	-23.86	peak
6	17955.000	23.76	25.42	49.18	74.00	-24.82	peak

Test Mode:	802.11b	Channel:	2437
Polarity:	Vertical	Test Voltage:	AC 120V_60Hz

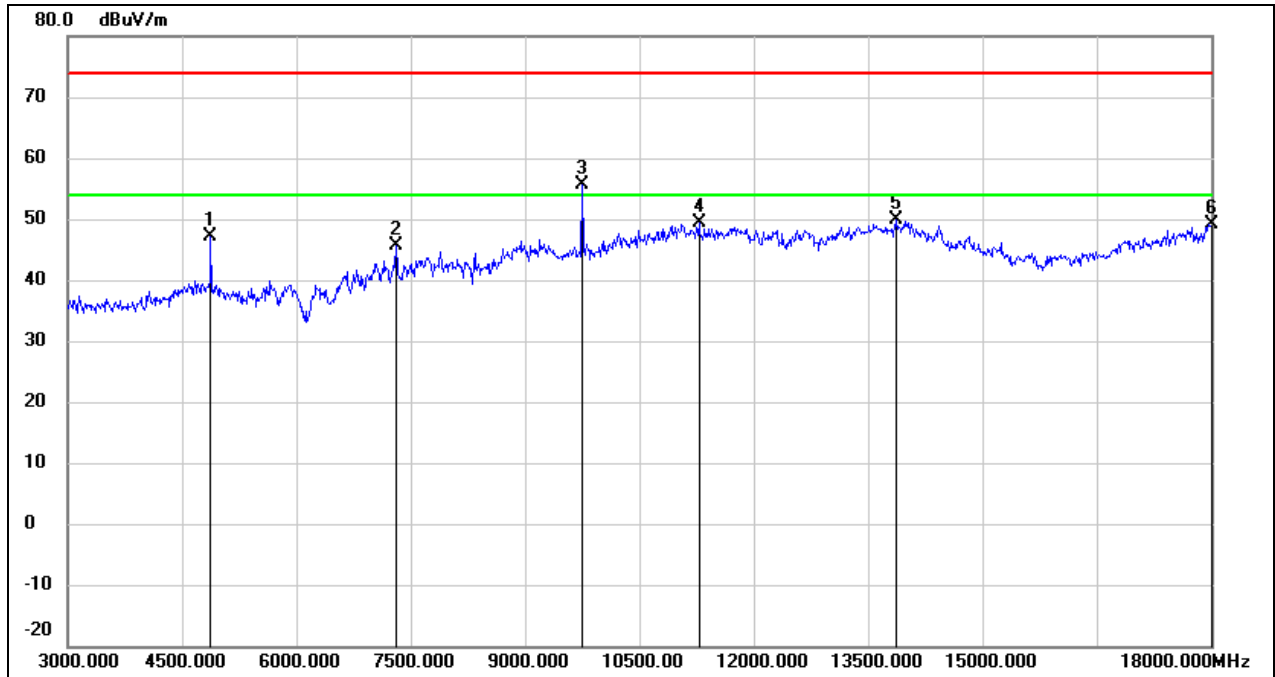

No.	Frequency (MHz)	Reading (dBuV)	Correct (dB/m)	Result (dBuV/m)	Limit (dBuV/m)	Margin (dB)	Remark
1	4875.000	47.24	-0.03	47.21	74.00	-26.79	peak
2	7305.000	39.10	6.47	45.57	74.00	-28.43	peak
3	9750.000	44.25	11.35	55.60	74.00	-18.40	peak
4	11280.000	33.46	15.80	49.26	74.00	-24.74	peak
5	13875.000	28.08	21.70	49.78	74.00	-24.22	peak
6	18000.000	23.54	25.69	49.23	74.00	-24.77	peak

Test Mode:	802.11b	Channel:	2462
Polarity:	Horizontal	Test Voltage:	AC 120V_60Hz

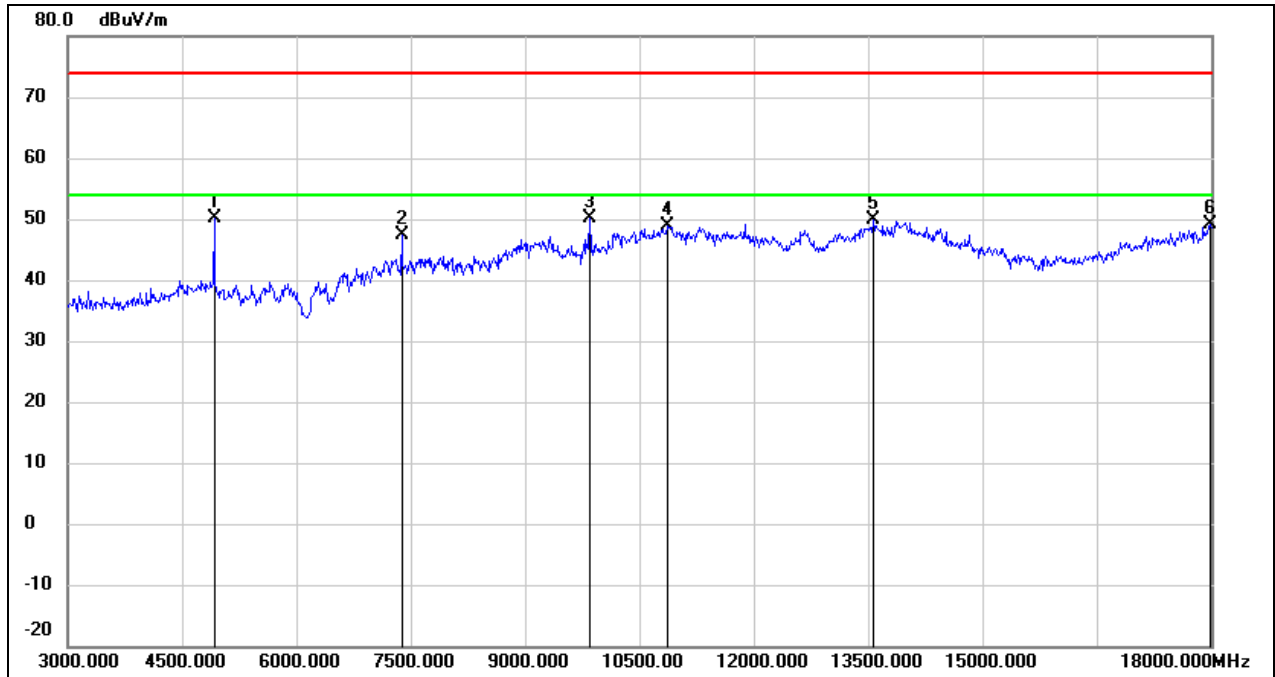

No.	Frequency (MHz)	Reading (dBuV)	Correct (dB/m)	Result (dBuV/m)	Limit (dBuV/m)	Margin (dB)	Remark
1	4920.000	49.97	0.14	50.11	74.00	-23.89	peak
2	7380.000	41.00	6.42	47.42	74.00	-26.58	peak
3	9840.000	38.64	11.59	50.23	74.00	-23.77	peak
4	10860.000	34.55	14.27	48.82	74.00	-25.18	peak
5	13575.000	28.77	21.06	49.83	74.00	-24.17	peak
6	17985.000	23.57	25.60	49.17	74.00	-24.83	peak

Test Mode:	802.11b	Channel:	2462
Polarity:	Vertical	Test Voltage:	AC 120V_60Hz

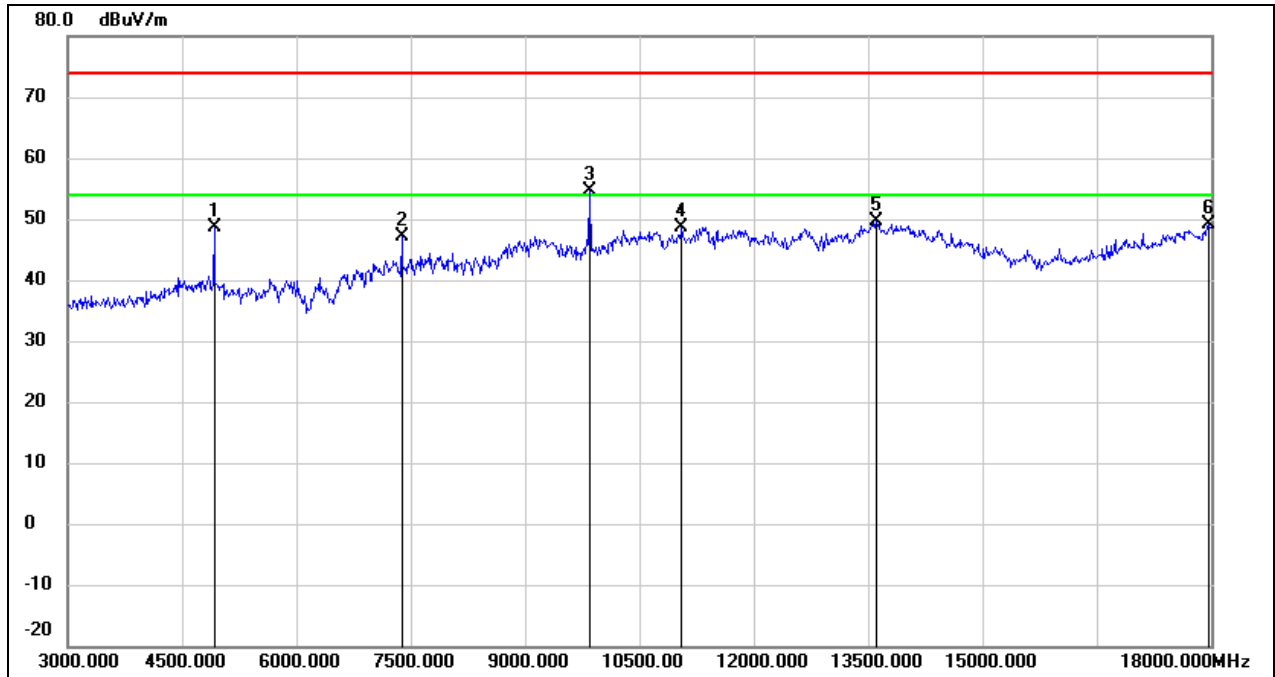

No.	Frequency (MHz)	Reading (dBuV)	Correct (dB/m)	Result (dBuV/m)	Limit (dBuV/m)	Margin (dB)	Remark
1	4920.000	48.60	0.14	48.74	74.00	-25.26	peak
2	7380.000	40.82	6.42	47.24	74.00	-26.76	peak
3	9840.000	43.02	11.59	54.61	74.00	-19.39	peak
4	11055.000	33.77	14.96	48.73	74.00	-25.27	peak
5	13605.000	28.59	21.12	49.71	74.00	-24.29	peak
6	17970.000	23.68	25.51	49.19	74.00	-24.81	peak

Test Mode:	802.11g	Channel:	2412
Polarity:	Horizontal	Test Voltage:	AC 120V_60Hz

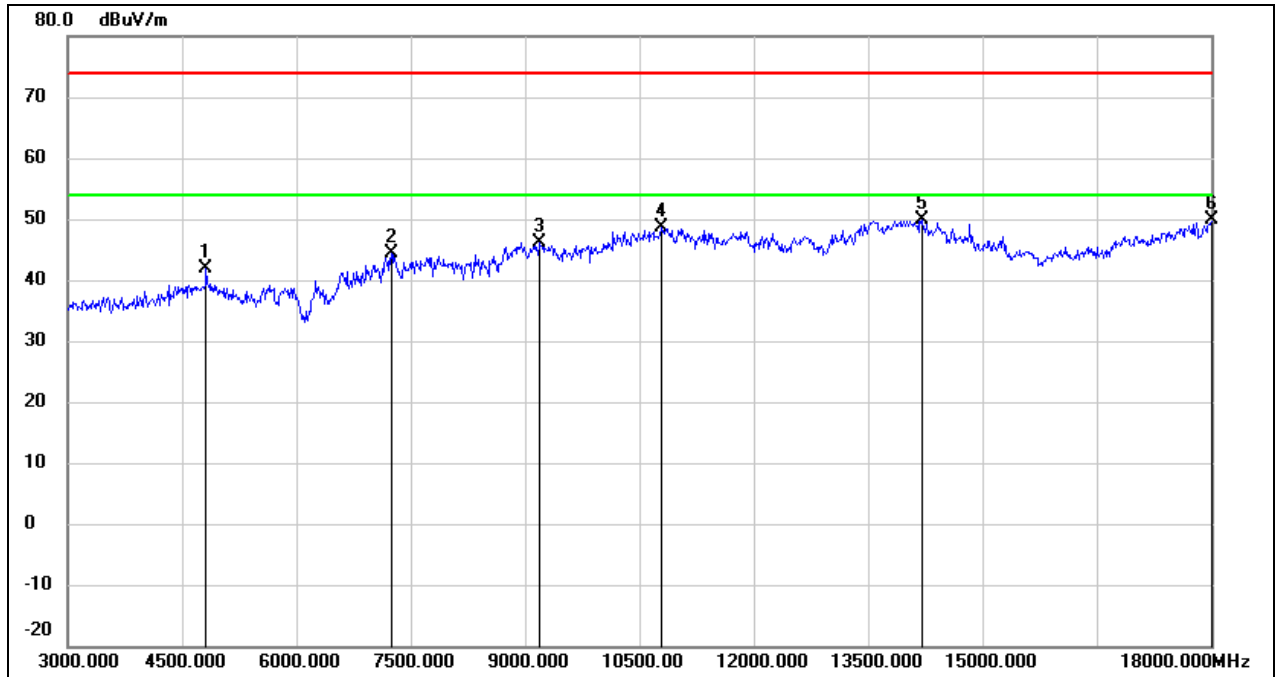

No.	Frequency (MHz)	Reading (dBuV)	Correct (dB/m)	Result (dBuV/m)	Limit (dBuV/m)	Margin (dB)	Remark
1	4815.000	42.02	-0.26	41.76	74.00	-32.24	peak
2	7245.000	37.77	6.51	44.28	74.00	-29.72	peak
3	9195.000	35.68	10.56	46.24	74.00	-27.76	peak
4	10785.000	34.70	14.01	48.71	74.00	-25.29	peak
5	14205.000	28.74	21.11	49.85	74.00	-24.15	peak
6	18000.000	24.25	25.69	49.94	74.00	-24.06	peak



Test Mode:	802.11g	Channel:	2412
Polarity:	Vertical	Test Voltage:	AC 120V_60Hz

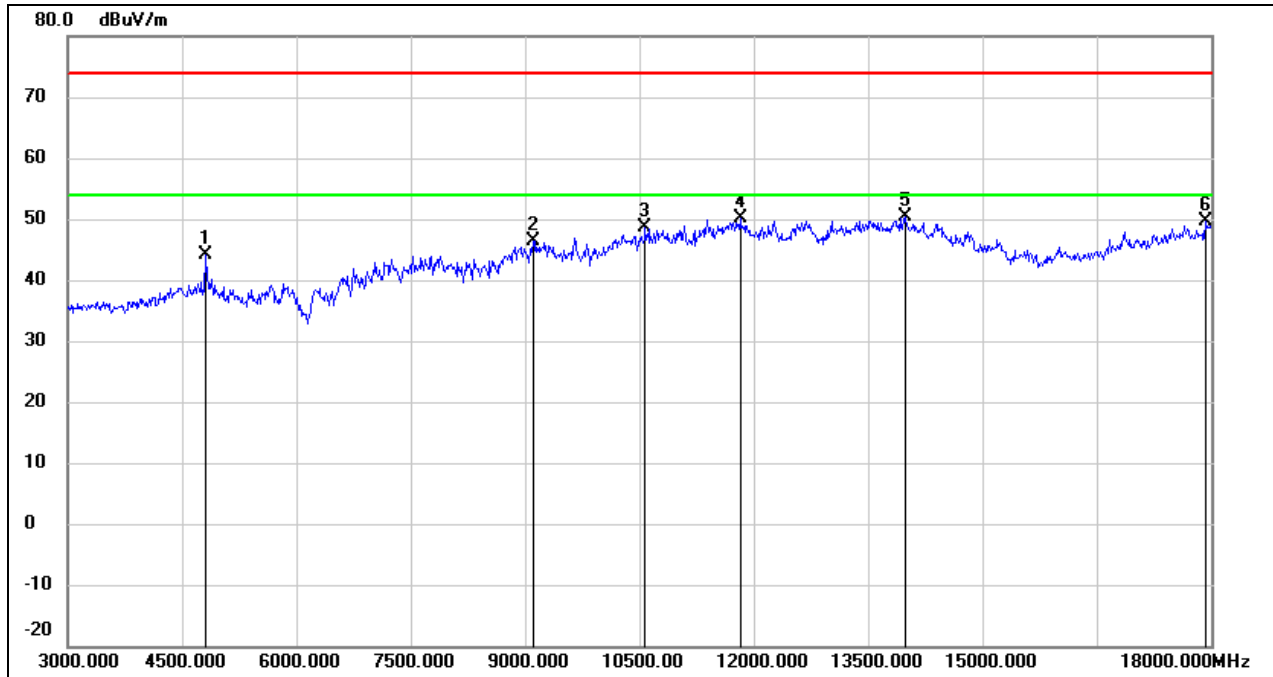

No.	Frequency (MHz)	Reading (dBuV)	Correct (dB/m)	Result (dBuV/m)	Limit (dBuV/m)	Margin (dB)	Remark
1	4800.000	44.42	-0.31	44.11	74.00	-29.89	peak
2	9105.000	35.78	10.53	46.31	74.00	-27.69	peak
3	10575.000	35.33	13.25	48.58	74.00	-25.42	peak
4	11820.000	32.56	17.47	50.03	74.00	-23.97	peak
5	13980.000	28.34	21.92	50.26	74.00	-23.74	peak
6	17925.000	24.48	25.25	49.73	74.00	-24.27	peak

Test Mode:	802.11g	Channel:	2417
Polarity:	Horizontal	Test Voltage:	AC 120V_60Hz

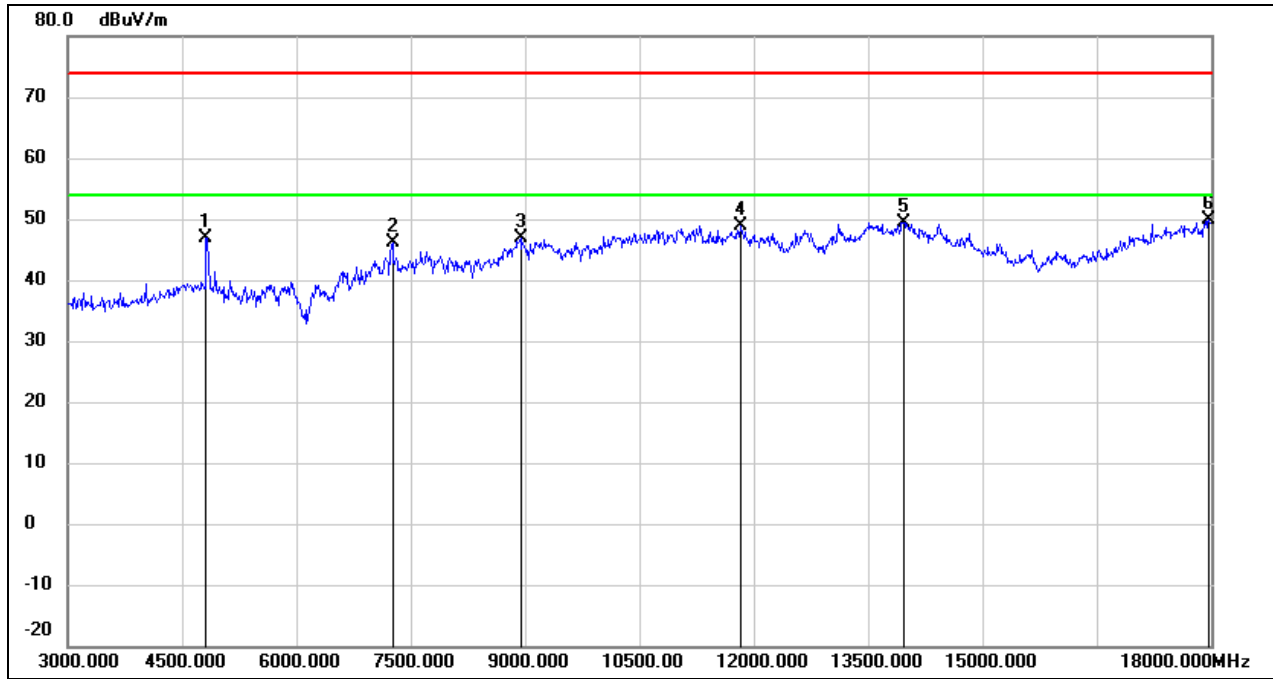

No.	Frequency (MHz)	Reading (dBuV)	Correct (dB/m)	Result (dBuV/m)	Limit (dBuV/m)	Margin (dB)	Remark
1	4815.000	47.15	-0.26	46.89	74.00	-27.11	peak
2	7260.000	39.61	6.50	46.11	74.00	-27.89	peak
3	8940.000	36.77	10.04	46.81	74.00	-27.19	peak
4	11820.000	31.52	17.47	48.99	74.00	-25.01	peak
5	13965.000	27.59	21.89	49.48	74.00	-24.52	peak
6	17970.000	24.32	25.51	49.83	74.00	-24.17	peak

Test Mode:	802.11g	Channel:	2417
Polarity:	Vertical	Test Voltage:	AC 120V_60Hz

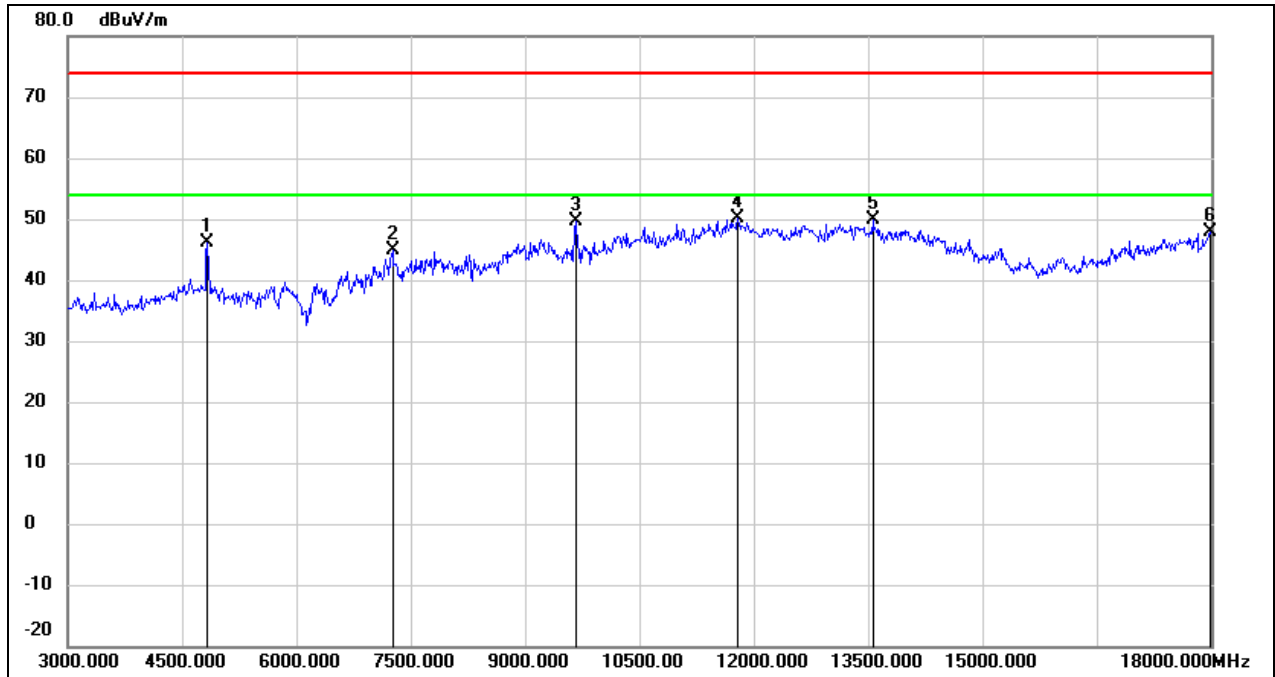

No.	Frequency (MHz)	Reading (dBuV)	Correct (dB/m)	Result (dBuV/m)	Limit (dBuV/m)	Margin (dB)	Remark
1	4830.000	46.41	-0.20	46.21	74.00	-27.79	peak
2	7260.000	38.30	6.50	44.80	74.00	-29.20	peak
3	9660.000	38.59	11.11	49.70	74.00	-24.30	peak
4	11790.000	32.69	17.38	50.07	74.00	-23.93	peak
5	13560.000	28.75	21.04	49.79	74.00	-24.21	peak
6	17985.000	22.16	25.60	47.76	74.00	-26.24	peak

Test Mode:	802.11g	Channel:	2437
Polarity:	Horizontal	Test Voltage:	AC 120V_60Hz

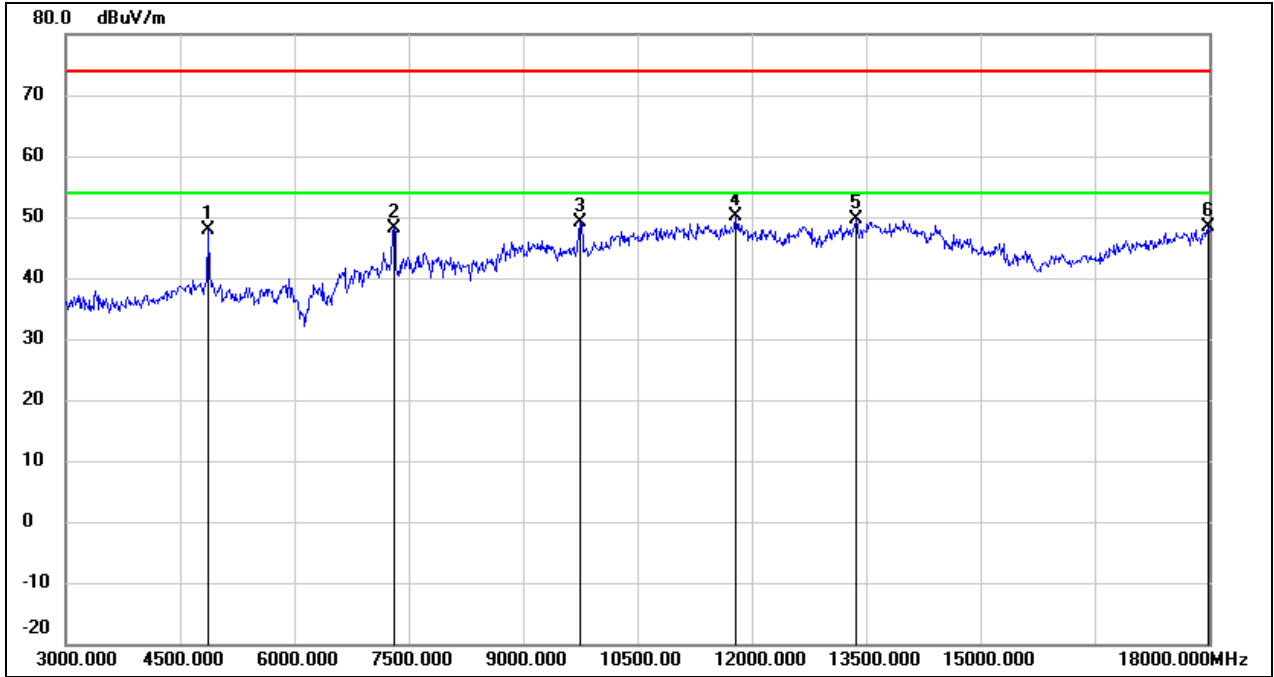

No.	Frequency (MHz)	Reading (dBuV)	Correct (dB/m)	Result (dBuV/m)	Limit (dBuV/m)	Margin (dB)	Remark
1	4875.000	47.80	-0.03	47.77	74.00	-26.23	peak
2	7305.000	41.67	6.47	48.14	74.00	-25.86	peak
3	9750.000	37.78	11.35	49.13	74.00	-24.87	peak
4	11790.000	32.87	17.38	50.25	74.00	-23.75	peak
5	13365.000	29.28	20.31	49.59	74.00	-24.41	peak
6	17985.000	22.80	25.60	48.40	74.00	-25.60	peak

Test Mode:	802.11g	Channel:	2437
Polarity:	Vertical	Test Voltage:	AC 120V_60Hz

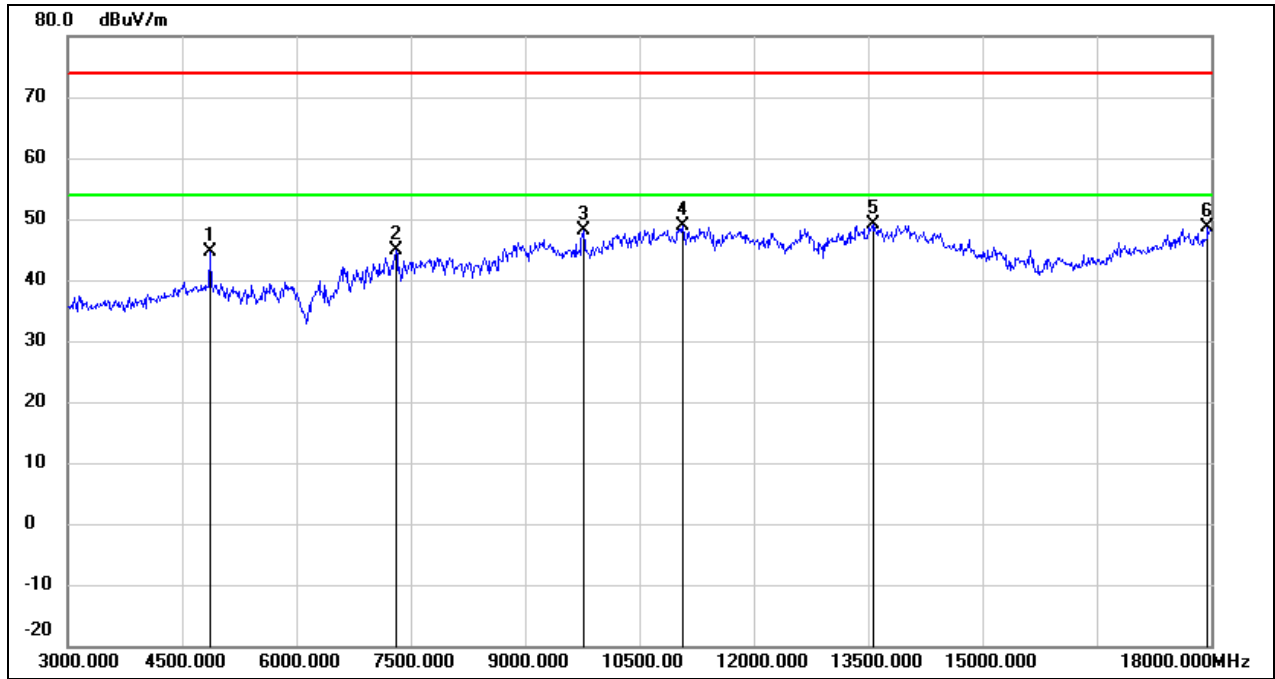

No.	Frequency (MHz)	Reading (dBuV)	Correct (dB/m)	Result (dBuV/m)	Limit (dBuV/m)	Margin (dB)	Remark
1	4860.000	44.63	-0.09	44.54	74.00	-29.46	peak
2	7305.000	38.46	6.47	44.93	74.00	-29.07	peak
3	9765.000	36.68	11.40	48.08	74.00	-25.92	peak
4	11070.000	33.78	15.03	48.81	74.00	-25.19	peak
5	13560.000	28.21	21.04	49.25	74.00	-24.75	peak
6	17955.000	23.29	25.42	48.71	74.00	-25.29	peak

Test Mode:	802.11g	Channel:	2457
Polarity:	Horizontal	Test Voltage:	AC 120V_60Hz

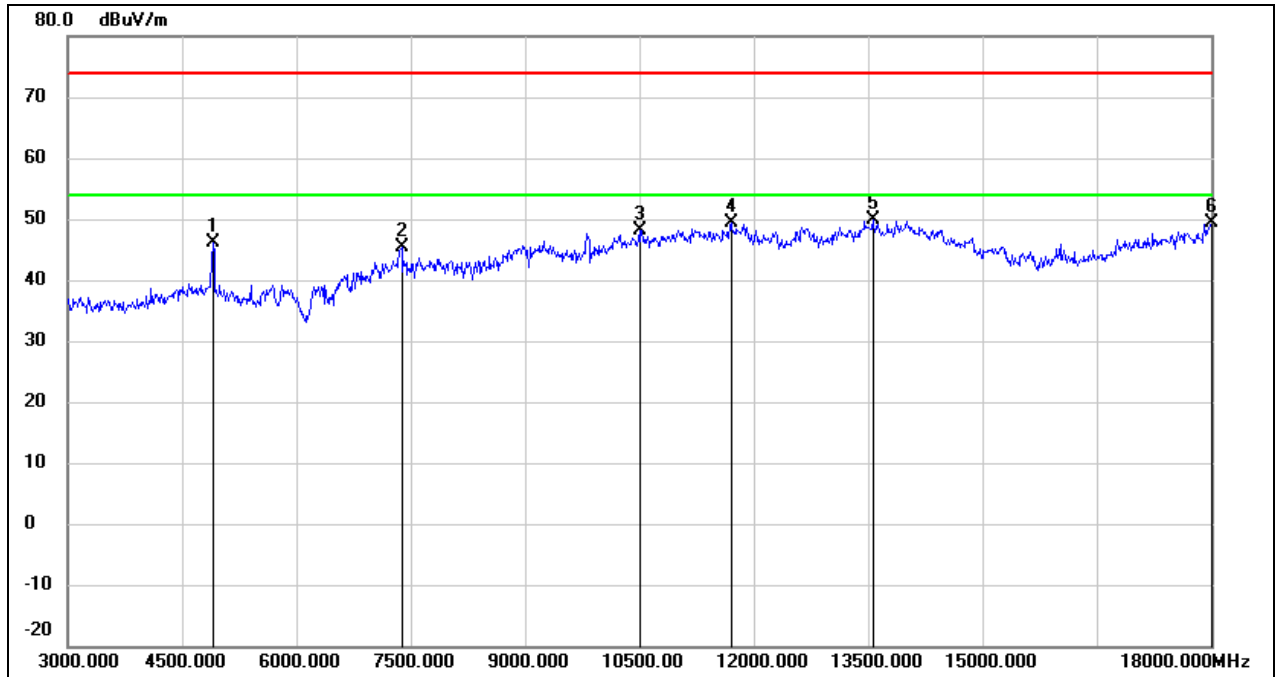

No.	Frequency (MHz)	Reading (dBuV)	Correct (dB/m)	Result (dBuV/m)	Limit (dBuV/m)	Margin (dB)	Remark
1	4905.000	45.96	0.09	46.05	74.00	-27.95	peak
2	7380.000	38.90	6.42	45.32	74.00	-28.68	peak
3	10500.000	35.13	12.99	48.12	74.00	-25.88	peak
4	11700.000	32.27	17.14	49.41	74.00	-24.59	peak
5	13560.000	28.74	21.04	49.78	74.00	-24.22	peak
6	18000.000	23.62	25.69	49.31	74.00	-24.69	peak

Test Mode:	802.11g	Channel:	2457
Polarity:	Vertical	Test Voltage:	AC 120V_60Hz

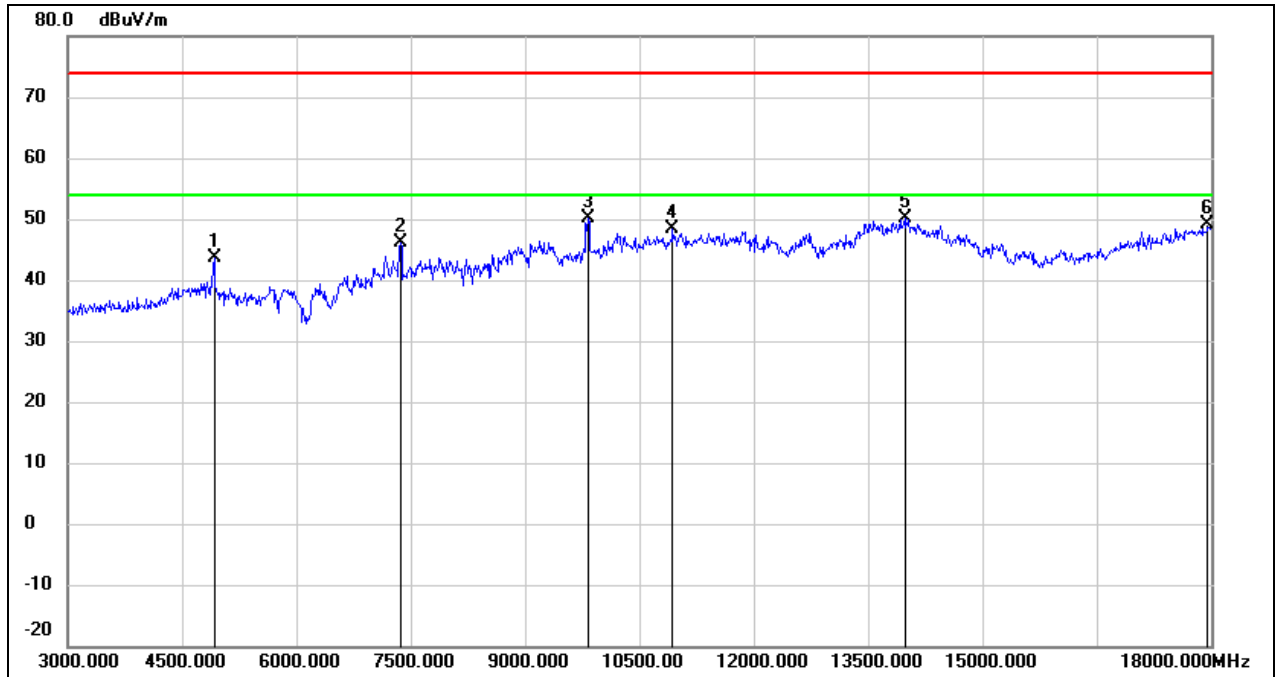

No.	Frequency (MHz)	Reading (dBuV)	Correct (dB/m)	Result (dBuV/m)	Limit (dBuV/m)	Margin (dB)	Remark
1	4920.000	43.45	0.14	43.59	74.00	-30.41	peak
2	7365.000	39.73	6.43	46.16	74.00	-27.84	peak
3	9825.000	38.58	11.56	50.14	74.00	-23.86	peak
4	10935.000	33.83	14.54	48.37	74.00	-25.63	peak
5	13980.000	28.13	21.92	50.05	74.00	-23.95	peak
6	17955.000	23.71	25.42	49.13	74.00	-24.87	peak

Test Mode:	802.11g	Channel:	2462
Polarity:	Horizontal	Test Voltage:	AC 120V_60Hz

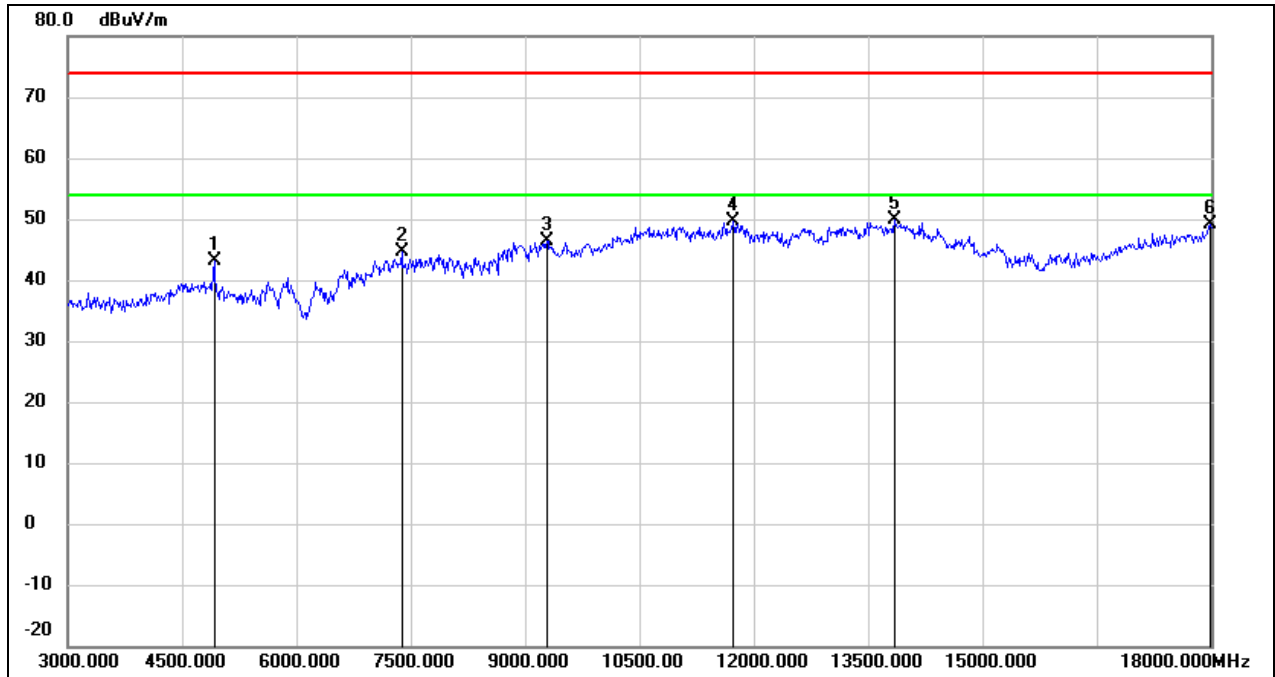

No.	Frequency (MHz)	Reading (dBuV)	Correct (dB/m)	Result (dBuV/m)	Limit (dBuV/m)	Margin (dB)	Remark
1	4920.000	43.06	0.14	43.20	74.00	-30.80	peak
2	7380.000	38.31	6.42	44.73	74.00	-29.27	peak
3	9285.000	35.88	10.61	46.49	74.00	-27.51	peak
4	11730.000	32.40	17.22	49.62	74.00	-24.38	peak
5	13845.000	28.24	21.62	49.86	74.00	-24.14	peak
6	17985.000	23.43	25.60	49.03	74.00	-24.97	peak



Test Mode:	802.11g	Channel:	2462
Polarity:	Vertical	Test Voltage:	AC 120V_60Hz

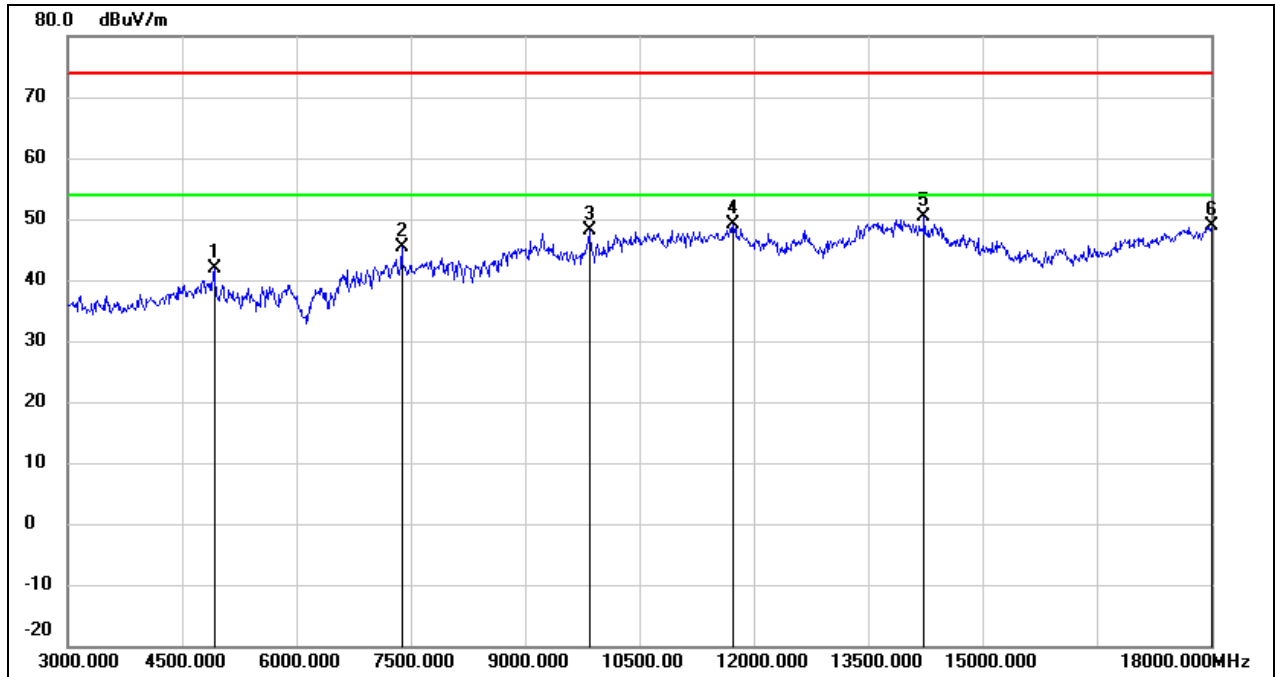

No.	Frequency (MHz)	Reading (dBuV)	Correct (dB/m)	Result (dBuV/m)	Limit (dBuV/m)	Margin (dB)	Remark
1	4920.000	41.73	0.14	41.87	74.00	-32.13	peak
2	7380.000	39.05	6.42	45.47	74.00	-28.53	peak
3	9840.000	36.63	11.59	48.22	74.00	-25.78	peak
4	11730.000	31.79	17.22	49.01	74.00	-24.99	peak
5	14235.000	29.35	20.99	50.34	74.00	-23.66	peak
6	18000.000	23.17	25.69	48.86	74.00	-25.14	peak

Test Mode:	802.11n HT20	Channel:	2412
Polarity:	Horizontal	Test Voltage:	AC 120V_60Hz

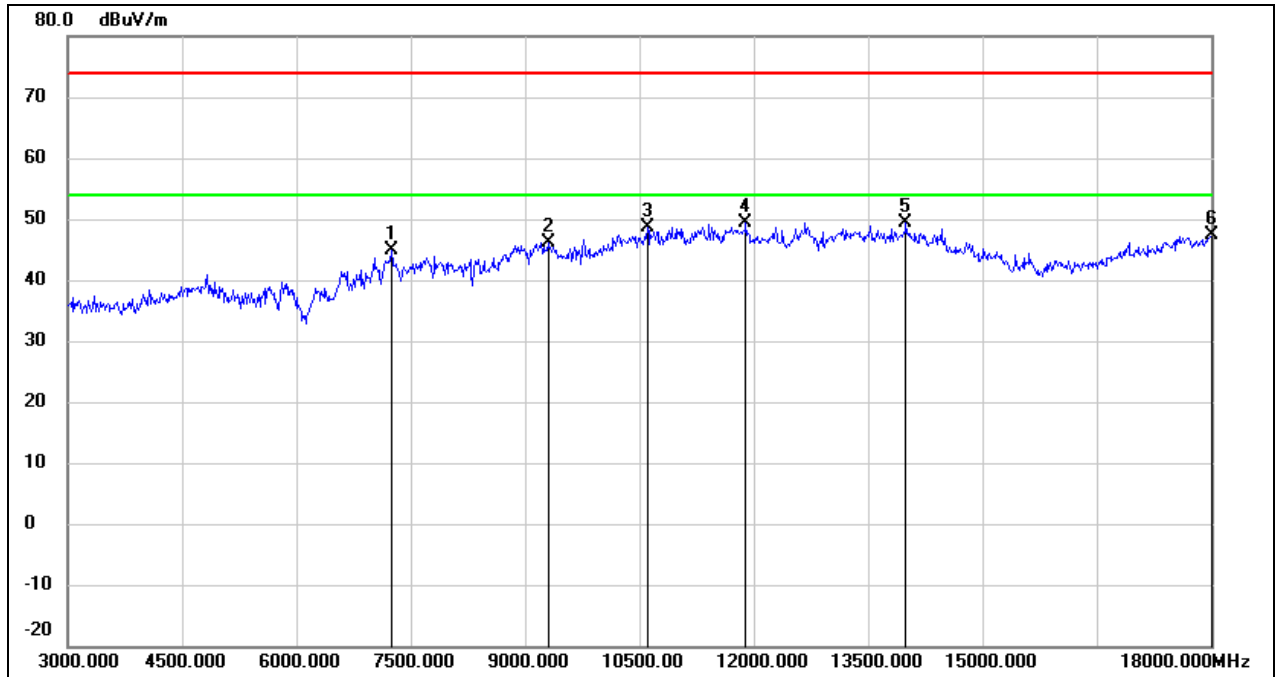

No.	Frequency (MHz)	Reading (dBuV)	Correct (dB/m)	Result (dBuV/m)	Limit (dBuV/m)	Margin (dB)	Remark
1	7245.000	38.25	6.51	44.76	74.00	-29.24	peak
2	9300.000	35.55	10.61	46.16	74.00	-27.84	peak
3	10605.000	35.21	13.37	48.58	74.00	-25.42	peak
4	11895.000	31.70	17.68	49.38	74.00	-24.62	peak
5	13995.000	27.32	21.95	49.27	74.00	-24.73	peak
6	18000.000	21.64	25.69	47.33	74.00	-26.67	peak

Test Mode:	802.11n HT20	Channel:	2412
Polarity:	Vertical	Test Voltage:	AC 120V_60Hz

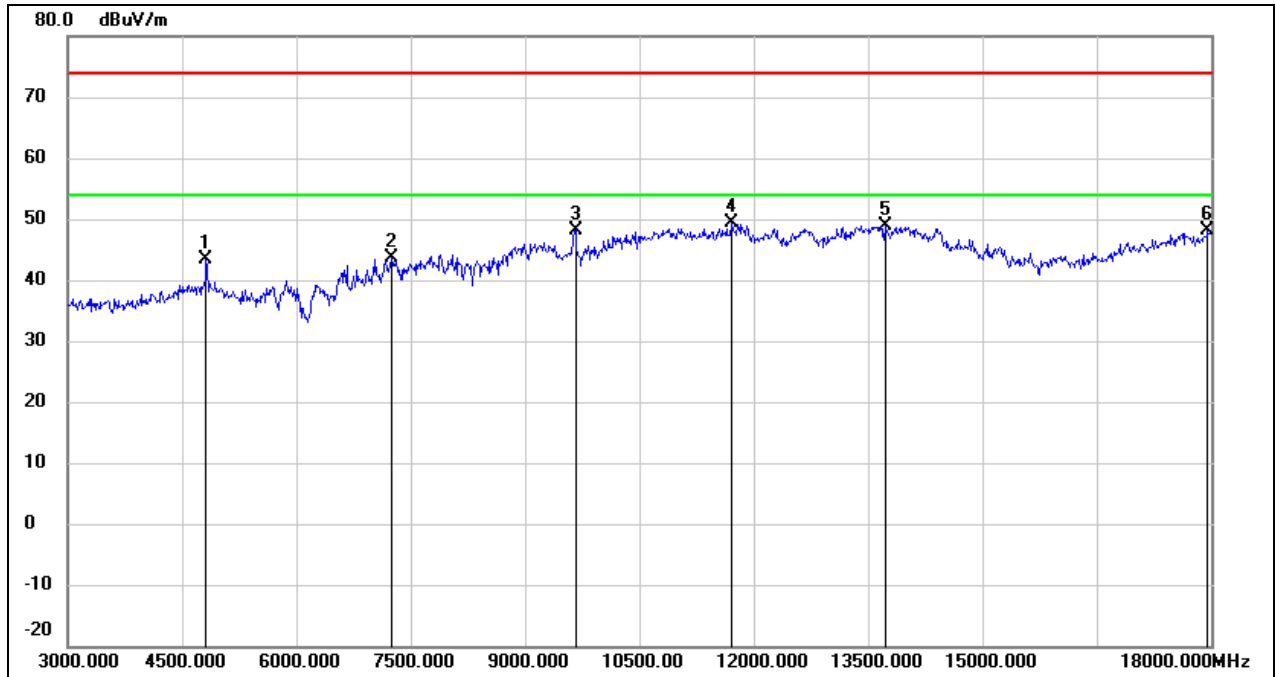

No.	Frequency (MHz)	Reading (dBuV)	Correct (dB/m)	Result (dBuV/m)	Limit (dBuV/m)	Margin (dB)	Remark
1	4815.000	43.63	-0.26	43.37	74.00	-30.63	peak
2	7245.000	37.12	6.51	43.63	74.00	-30.37	peak
3	9660.000	37.12	11.11	48.23	74.00	-25.77	peak
4	11715.000	32.13	17.19	49.32	74.00	-24.68	peak
5	13725.000	27.49	21.37	48.86	74.00	-25.14	peak
6	17955.000	22.63	25.42	48.05	74.00	-25.95	peak

Test Mode:	802.11n HT20	Channel:	2417
Polarity:	Horizontal	Test Voltage:	AC 120V_60Hz

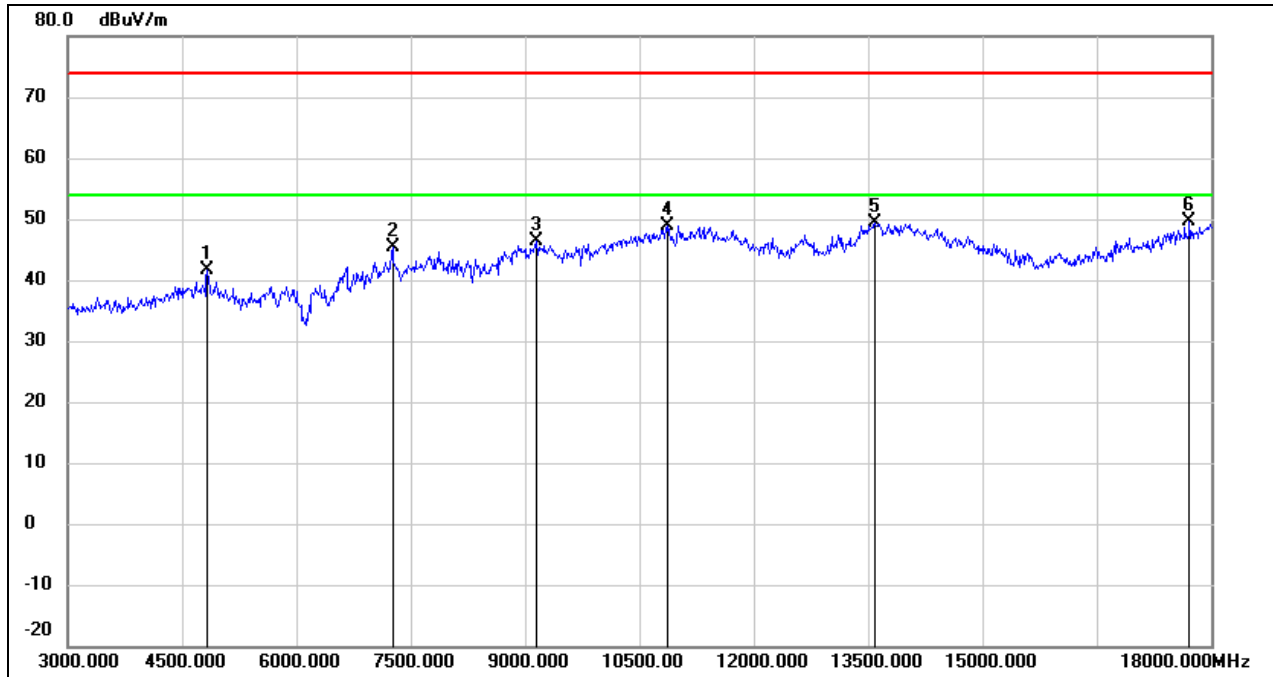

No.	Frequency (MHz)	Reading (dBuV)	Correct (dB/m)	Result (dBuV/m)	Limit (dBuV/m)	Margin (dB)	Remark
1	4830.000	41.93	-0.20	41.73	74.00	-32.27	peak
2	7260.000	38.80	6.50	45.30	74.00	-28.70	peak
3	9150.000	35.75	10.54	46.29	74.00	-27.71	peak
4	10875.000	34.45	14.32	48.77	74.00	-25.23	peak
5	13590.000	28.27	21.09	49.36	74.00	-24.64	peak
6	17715.000	25.71	24.00	49.71	74.00	-24.29	peak

Test Mode:	802.11n HT20	Channel:	2417
Polarity:	Vertical	Test Voltage:	AC 120V_60Hz

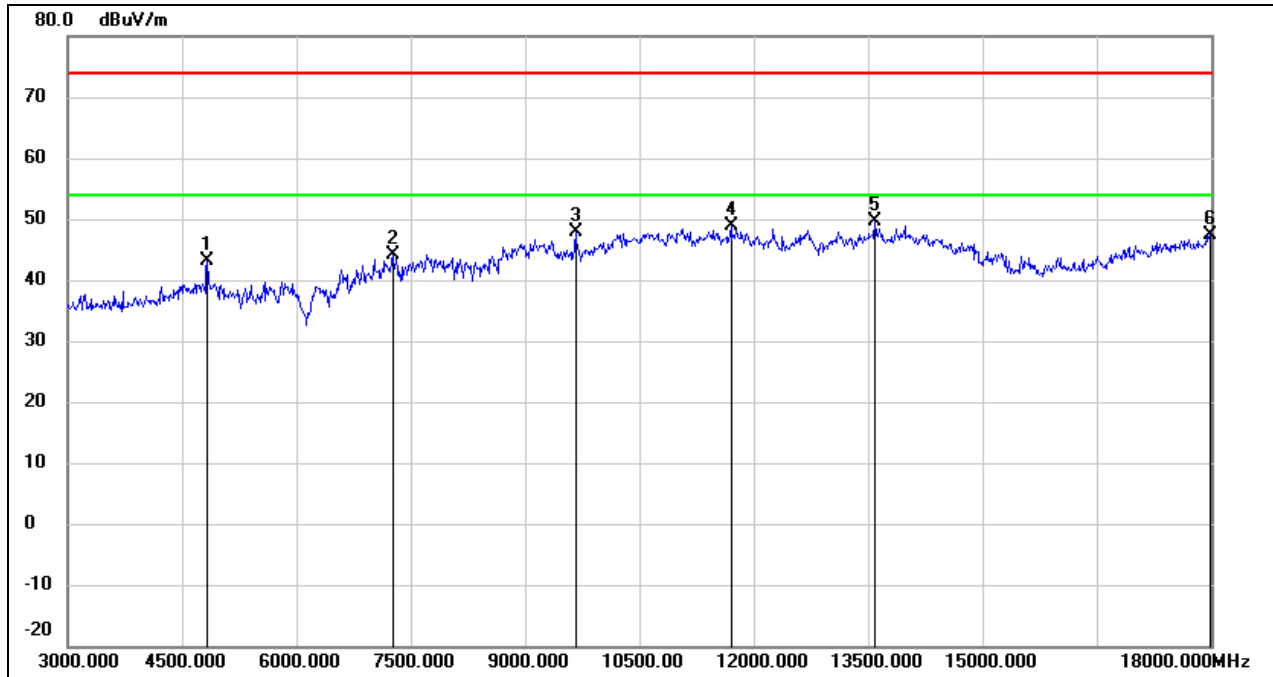

No.	Frequency (MHz)	Reading (dBuV)	Correct (dB/m)	Result (dBuV/m)	Limit (dBuV/m)	Margin (dB)	Remark
1	4830.000	43.24	-0.20	43.04	74.00	-30.96	peak
2	7260.000	37.67	6.50	44.17	74.00	-29.83	peak
3	9660.000	36.81	11.11	47.92	74.00	-26.08	peak
4	11700.000	31.68	17.14	48.82	74.00	-25.18	peak
5	13590.000	28.47	21.09	49.56	74.00	-24.44	peak
6	17985.000	21.81	25.60	47.41	74.00	-26.59	peak

Test Mode:	802.11n HT20	Channel:	2437
Polarity:	Horizontal	Test Voltage:	AC 120V_60Hz

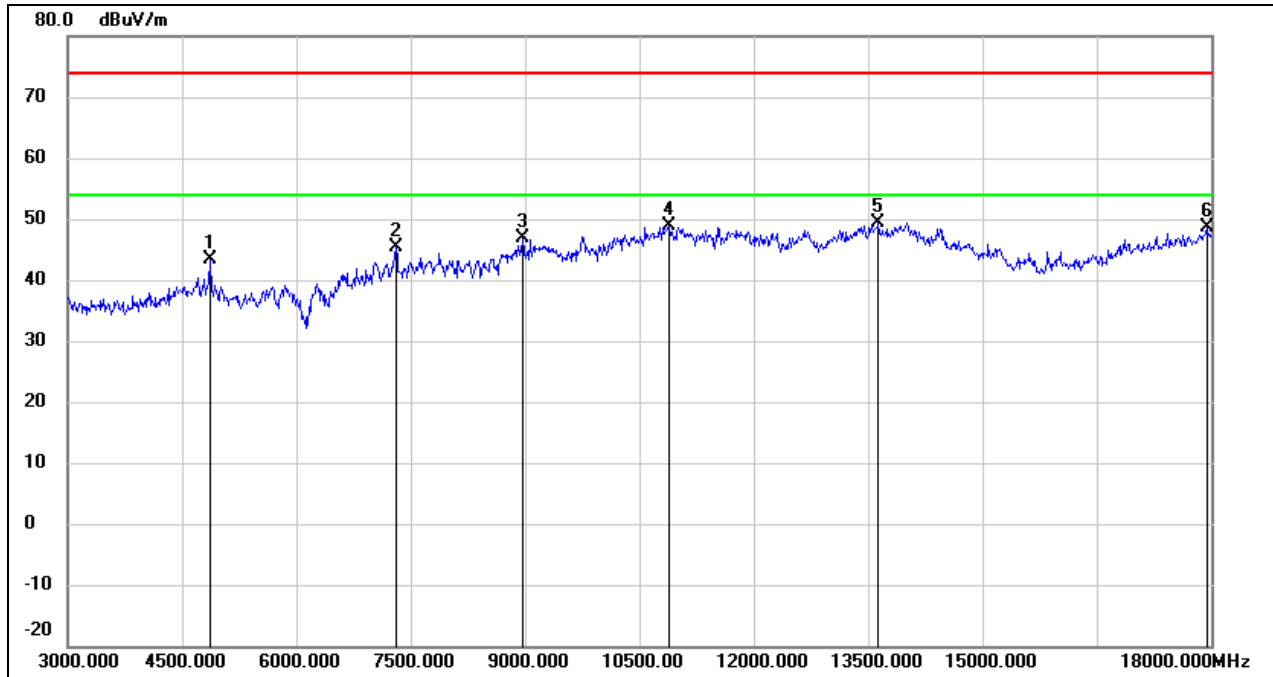

No.	Frequency (MHz)	Reading (dBuV)	Correct (dB/m)	Result (dBuV/m)	Limit (dBuV/m)	Margin (dB)	Remark
1	4860.000	43.46	-0.09	43.37	74.00	-30.63	peak
2	7305.000	39.01	6.47	45.48	74.00	-28.52	peak
3	8970.000	36.51	10.26	46.77	74.00	-27.23	peak
4	10890.000	34.54	14.39	48.93	74.00	-25.07	peak
5	13635.000	28.14	21.19	49.33	74.00	-24.67	peak
6	17940.000	23.17	25.34	48.51	74.00	-25.49	peak

Test Mode:	802.11n HT20	Channel:	2437
Polarity:	Vertical	Test Voltage:	AC 120V_60Hz

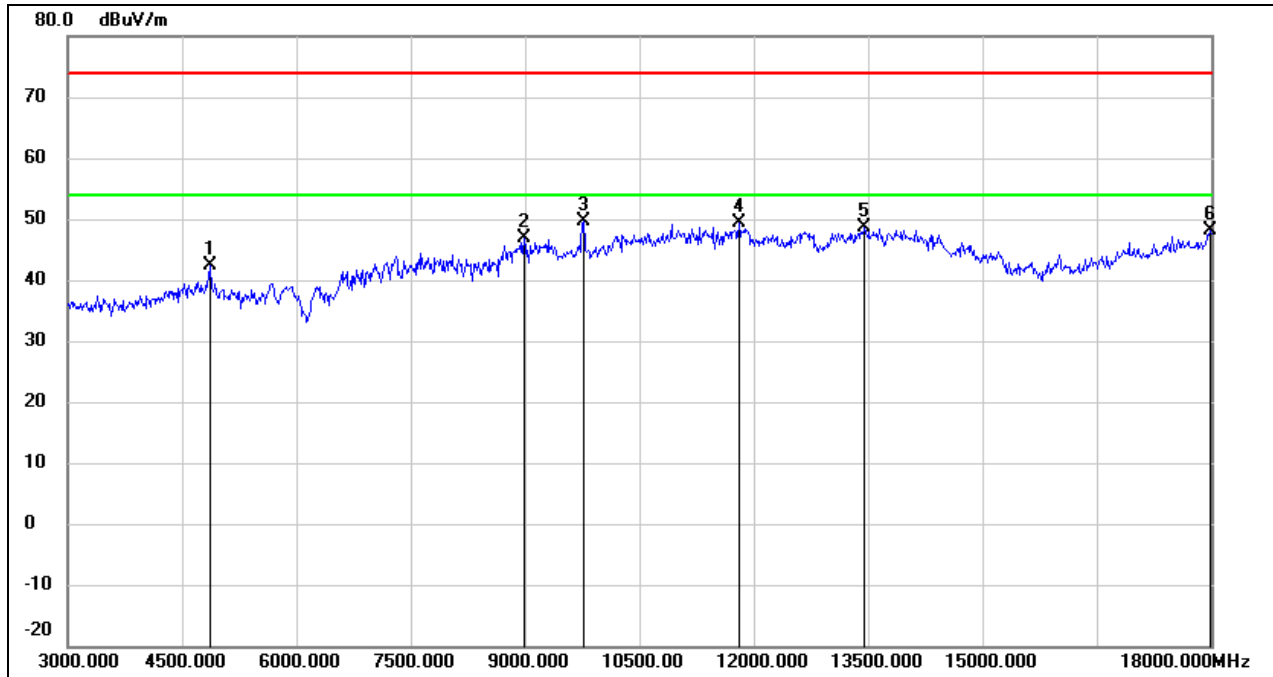

No.	Frequency (MHz)	Reading (dBuV)	Correct (dB/m)	Result (dBuV/m)	Limit (dBuV/m)	Margin (dB)	Remark
1	4875.000	42.42	-0.03	42.39	74.00	-31.61	peak
2	8985.000	36.59	10.37	46.96	74.00	-27.04	peak
3	9765.000	38.20	11.40	49.60	74.00	-24.40	peak
4	11805.000	31.94	17.43	49.37	74.00	-24.63	peak
5	13455.000	28.03	20.71	48.74	74.00	-25.26	peak
6	17985.000	22.62	25.60	48.22	74.00	-25.78	peak

Test Mode:	802.11n HT20	Channel:	2457
Polarity:	Horizontal	Test Voltage:	AC 120V_60Hz

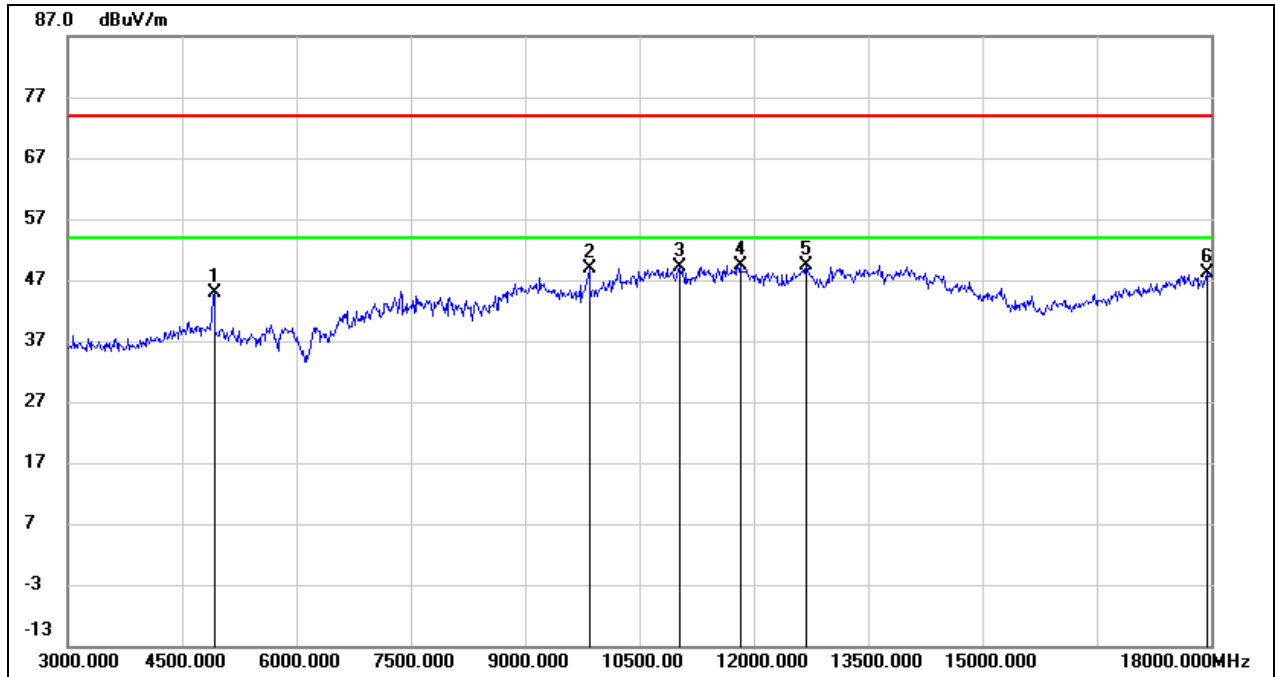

No.	Frequency (MHz)	Reading (dBuV)	Correct (dB/m)	Result (dBuV/m)	Limit (dBuV/m)	Margin (dB)	Remark
1	4920.000	44.62	0.14	44.76	74.00	-29.24	peak
2	9840.000	37.18	11.59	48.77	74.00	-25.23	peak
3	11025.000	34.17	14.85	49.02	74.00	-24.98	peak
4	11820.000	31.88	17.47	49.35	74.00	-24.65	peak
5	12690.000	31.30	18.02	49.32	74.00	-24.68	peak
6	17940.000	22.77	25.34	48.11	74.00	-25.89	peak



Test Mode:	802.11n HT20	Channel:	2457
Polarity:	Vertical	Test Voltage:	AC 120V_60Hz

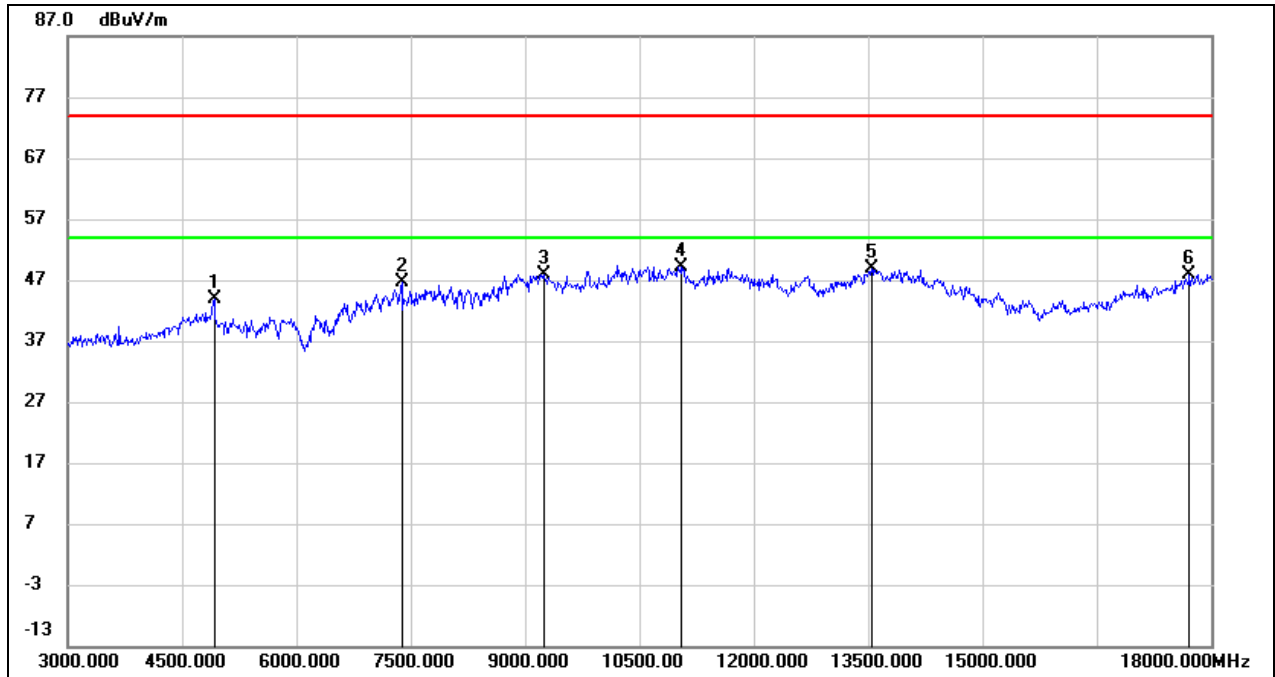

No.	Frequency (MHz)	Reading (dBuV)	Correct (dB/m)	Result (dBuV/m)	Limit (dBuV/m)	Margin (dB)	Remark
1	4920.000	43.71	0.14	43.85	74.00	-30.15	peak
2	7380.000	40.13	6.42	46.55	74.00	-27.45	peak
3	9240.000	37.35	10.58	47.93	74.00	-26.07	peak
4	11040.000	34.28	14.91	49.19	74.00	-24.81	peak
5	13545.000	27.82	20.99	48.81	74.00	-25.19	peak
6	17715.000	23.96	24.00	47.96	74.00	-26.04	peak

Test Mode:	802.11n HT20	Channel:	2462
Polarity:	Horizontal	Test Voltage:	AC 120V_60Hz

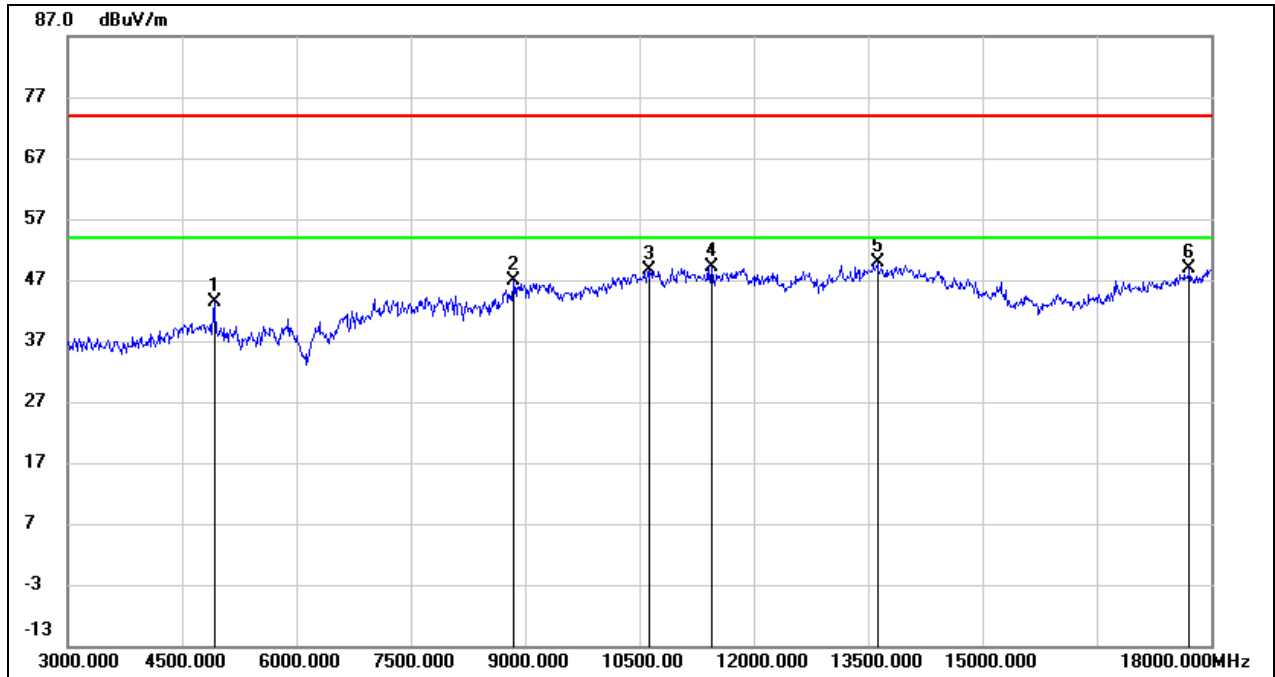

No.	Frequency (MHz)	Reading (dBuV)	Correct (dB/m)	Result (dBuV/m)	Limit (dBuV/m)	Margin (dB)	Remark
1	4920.000	43.27	0.14	43.41	74.00	-30.59	peak
2	8850.000	37.37	9.39	46.76	74.00	-27.24	peak
3	10635.000	35.08	13.47	48.55	74.00	-25.45	peak
4	11445.000	32.82	16.41	49.23	74.00	-24.77	peak
5	13620.000	28.61	21.15	49.76	74.00	-24.24	peak
6	17715.000	24.99	24.00	48.99	74.00	-25.01	peak

Test Mode:	802.11n HT20	Channel:	2462
Polarity:	Vertical	Test Voltage:	AC 120V_60Hz

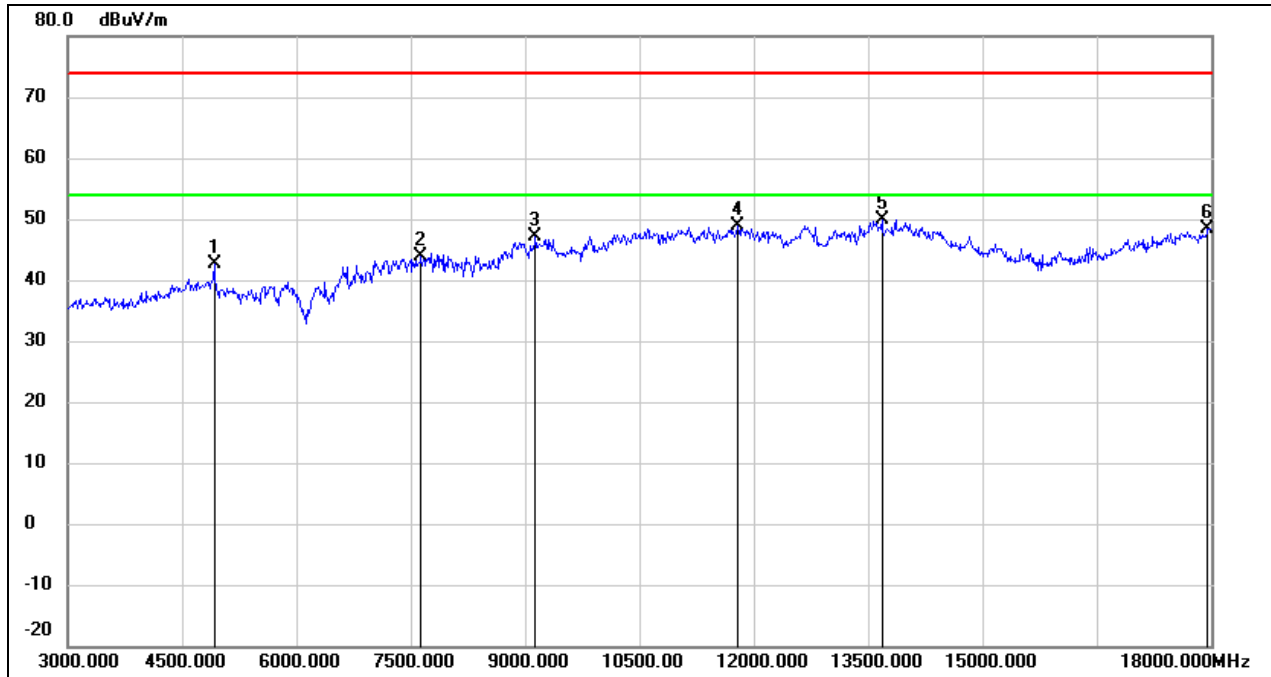

No.	Frequency (MHz)	Reading (dBuV)	Correct (dB/m)	Result (dBuV/m)	Limit (dBuV/m)	Margin (dB)	Remark
1	4920.000	42.42	0.14	42.56	74.00	-31.44	peak
2	7635.000	37.60	6.33	43.93	74.00	-30.07	peak
3	9135.000	36.57	10.55	47.12	74.00	-26.88	peak
4	11790.000	31.51	17.38	48.89	74.00	-25.11	peak
5	13680.000	28.66	21.29	49.95	74.00	-24.05	peak
6	17955.000	23.04	25.42	48.46	74.00	-25.54	peak

### 8.4. SPURIOUS EMISSIONS(9 KHZ~30 MHZ)

Test Mode:	802.11b	Channel:	2412
Polarity:	Horizontal	Test Voltage	AC 120V, 60Hz

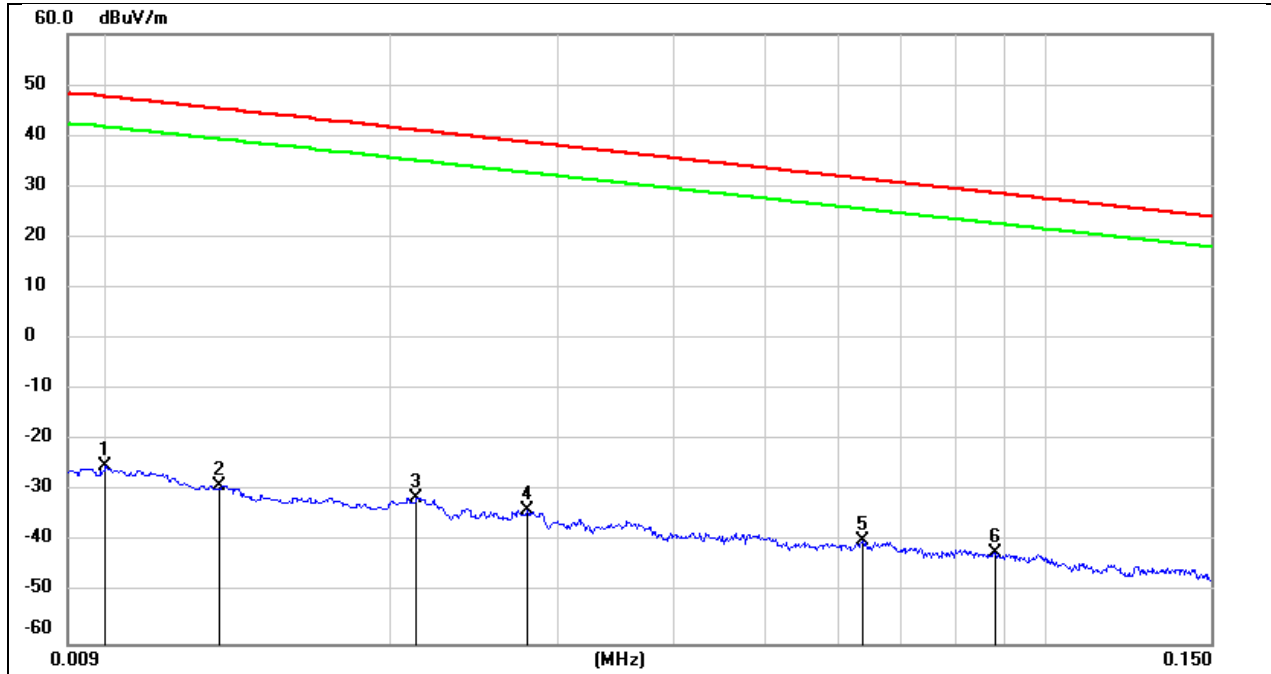

No.	Frequency (MHz)	Reading (dBuV)	Correct (dB/m)	Result (dBuV/m)	Limit (dBuV/m)	Margin (dB)	Remark
1	0.0100	76.22	-101.40	-25.18	47.60	-72.78	peak
2	0.0131	72.47	-101.38	-28.91	45.25	-74.16	peak
3	0.0212	70.04	-101.35	-31.31	41.07	-72.38	peak
4	0.0279	67.67	-101.38	-33.71	38.69	-72.40	peak
5	0.0636	61.81	-101.54	-39.73	31.53	-71.26	peak
6	0.0882	59.59	-101.70	-42.11	28.69	-70.80	peak

Test Mode:	802.11b	Channel:	2412
Polarity:	Horizontal	Test Voltage:	AC 120V, 60Hz

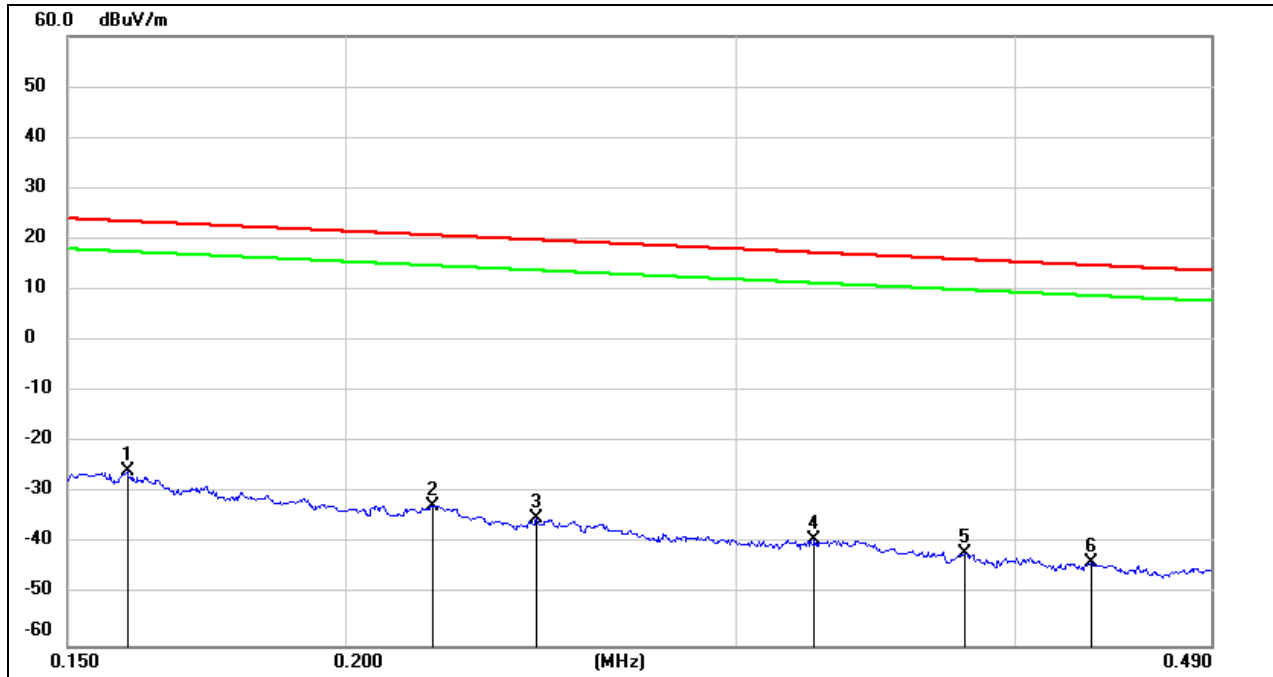

No.	Frequency (MHz)	Reading (dBuV)	Correct (dB/m)	Result (dBuV/m)	Limit (dBuV/m)	Margin (dB)	Remark
1	0.1595	75.86	-101.65	-25.79	23.55	-49.34	peak
2	0.2190	69.27	-101.75	-32.48	20.79	-53.27	peak
3	0.2436	66.96	-101.79	-34.83	19.87	-54.70	peak
4	0.3251	62.71	-101.88	-39.17	17.36	-56.53	peak
5	0.3800	60.02	-101.94	-41.92	16.01	-57.93	peak
6	0.4329	58.23	-101.99	-43.76	14.87	-58.63	peak

Test Mode:	802.11b	Channel:	2412
Polarity:	Horizontal	Test Voltage:	AC 120V, 60HZ

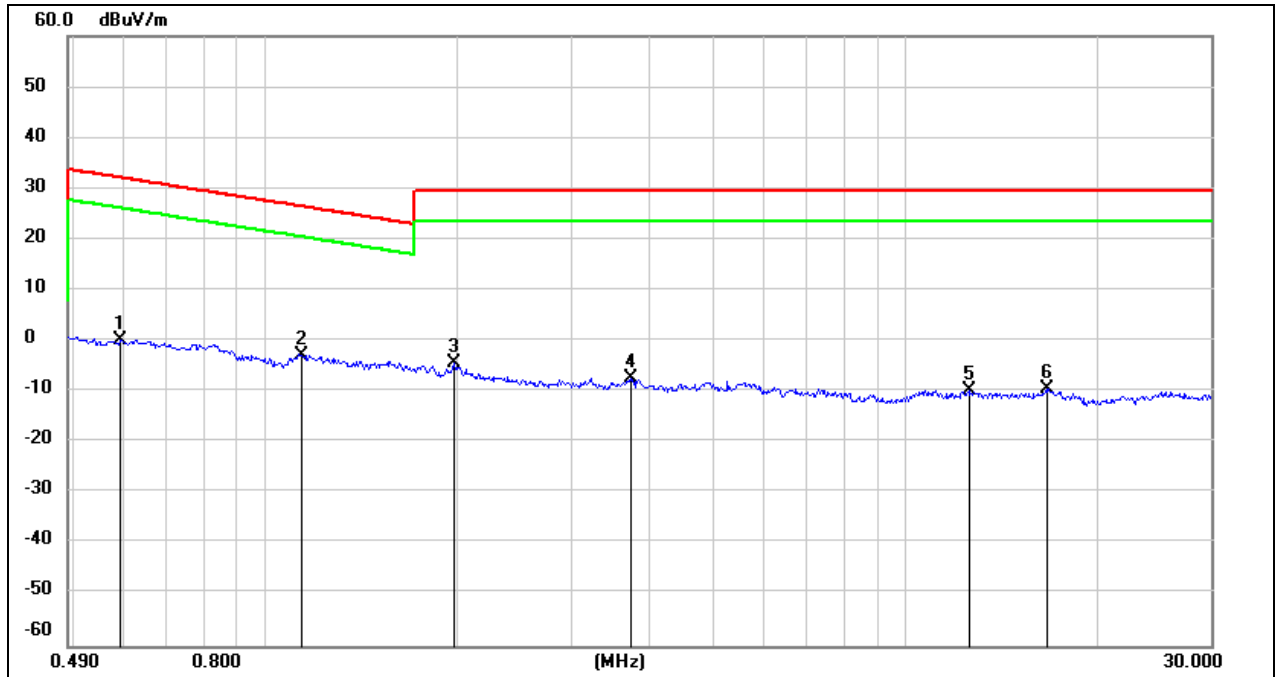

No.	Frequency (MHz)	Reading (dBuV)	Correct (dB/m)	Result (dBuV/m)	Limit (dBuV/m)	Margin (dB)	Remark
1	0.5917	62.24	-62.08	0.16	32.16	-32.00	peak
2	1.1391	59.34	-62.21	-2.87	26.47	-29.34	peak
3	1.9677	57.50	-61.83	-4.33	29.54	-33.87	peak
4	3.7100	54.20	-61.41	-7.21	29.54	-36.75	peak
5	12.5891	51.08	-60.91	-9.83	29.54	-39.37	peak
6	16.6021	51.52	-60.96	-9.44	29.54	-38.98	peak

### 8.5. SPURIOUS EMISSIONS(18 GHZ~26 GHZ)

Test Mode:	802.11b	Channel:	2412
Polarity:	Horizontal	Test Voltage	AC 120V, 60Hz

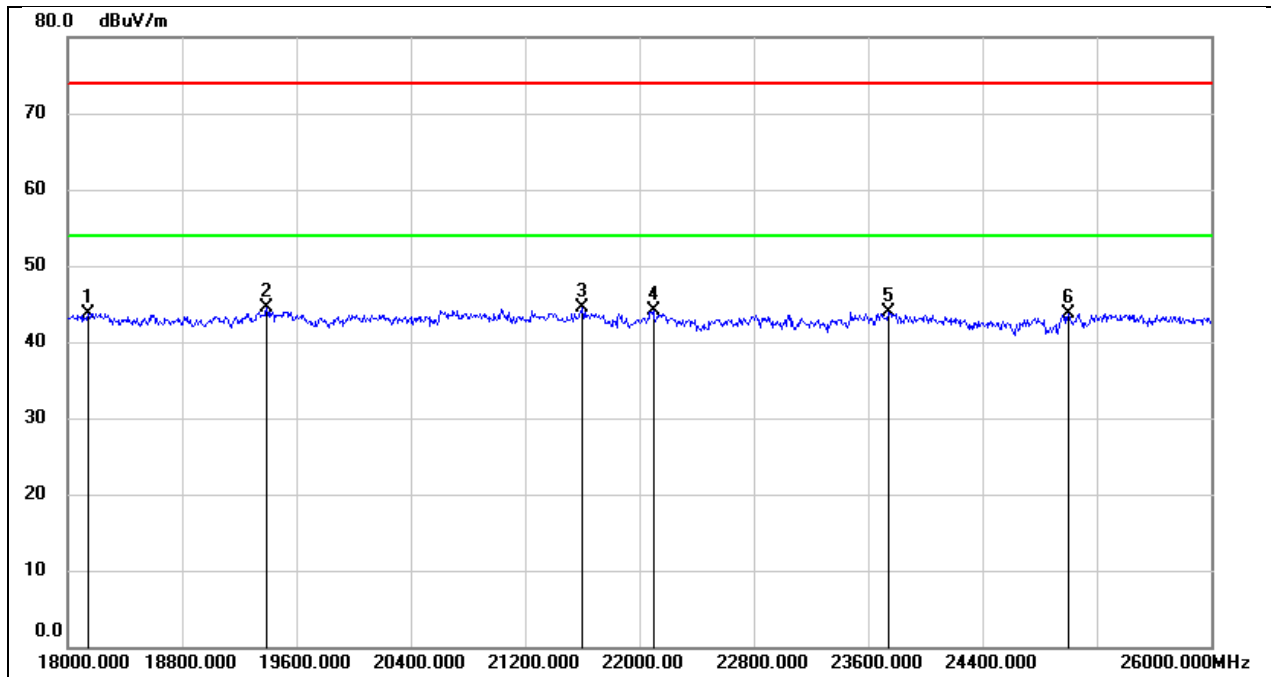

No.	Frequency (MHz)	Reading (dBuV)	Correct (dB/m)	Result (dBuV/m)	Limit (dBuV/m)	Margin (dB)	Remark
1	18144.000	49.27	-5.48	43.79	74.00	-30.21	peak
2	19392.000	50.12	-5.57	44.55	74.00	-29.45	peak
3	21600.000	49.02	-4.54	44.48	74.00	-29.52	peak
4	22096.000	48.54	-4.38	44.16	74.00	-29.84	peak
5	23744.000	47.15	-3.20	43.95	74.00	-30.05	peak
6	25000.000	45.86	-2.10	43.76	74.00	-30.24	peak

Test Mode:	802.11b	Channel:	2412
Polarity:	Vertical	Test Voltage:	AC 120V, 60HZ

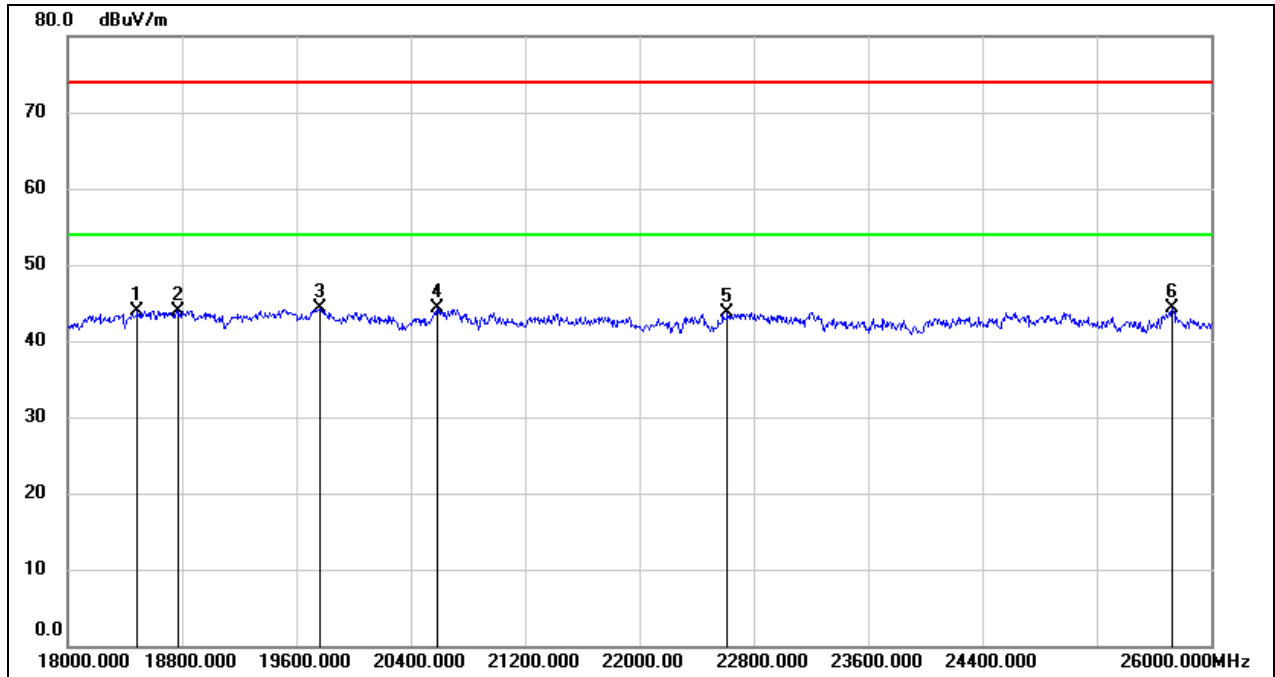

No.	Frequency (MHz)	Reading (dBuV)	Correct (dB/m)	Result (dBuV/m)	Limit (dBuV/m)	Margin (dB)	Remark
1	18488.000	49.08	-5.26	43.82	74.00	-30.18	peak
2	18768.000	49.31	-5.41	43.90	74.00	-30.10	peak
3	19768.000	49.53	-5.26	44.27	74.00	-29.73	peak
4	20584.000	49.50	-5.27	44.23	74.00	-29.77	peak
5	22616.000	47.59	-3.80	43.79	74.00	-30.21	peak
6	25728.000	45.11	-0.72	44.39	74.00	-29.61	peak



### 8.6. SPURIOUS EMISSIONS(30 MHZ~1 GHZ)

Test Mode:	802.11b	Channel:	2412
Polarity:	Horizontal	Test Voltage	AC 120V, 60Hz

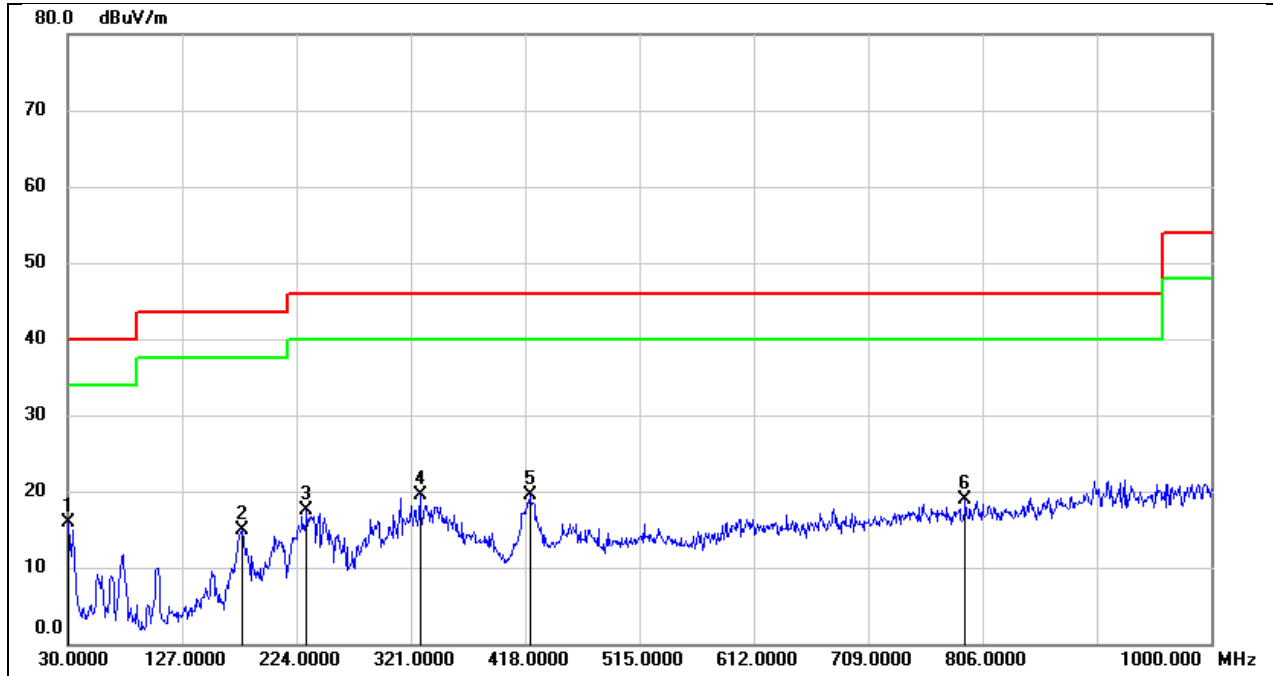

No.	Frequency (MHz)	Reading (dBuV)	Correct (dB/m)	Result (dBuV/m)	Limit (dBuV/m)	Margin (dB)	Remark
1	30.9700	34.27	-18.39	15.88	40.00	-24.12	QP
2	178.4100	31.51	-16.51	15.00	43.50	-28.50	QP
3	232.7300	35.50	-18.06	17.44	46.00	-28.56	QP
4	328.7600	33.34	-13.91	19.43	46.00	-26.57	QP
5	421.8800	31.95	-12.43	19.52	46.00	-26.48	QP
6	791.4500	25.51	-6.66	18.85	46.00	-27.15	QP

Test Mode:	802.11b	Channel:	2412
Polarity:	Vertical	Test Voltage:	AC 120V, 60HZ

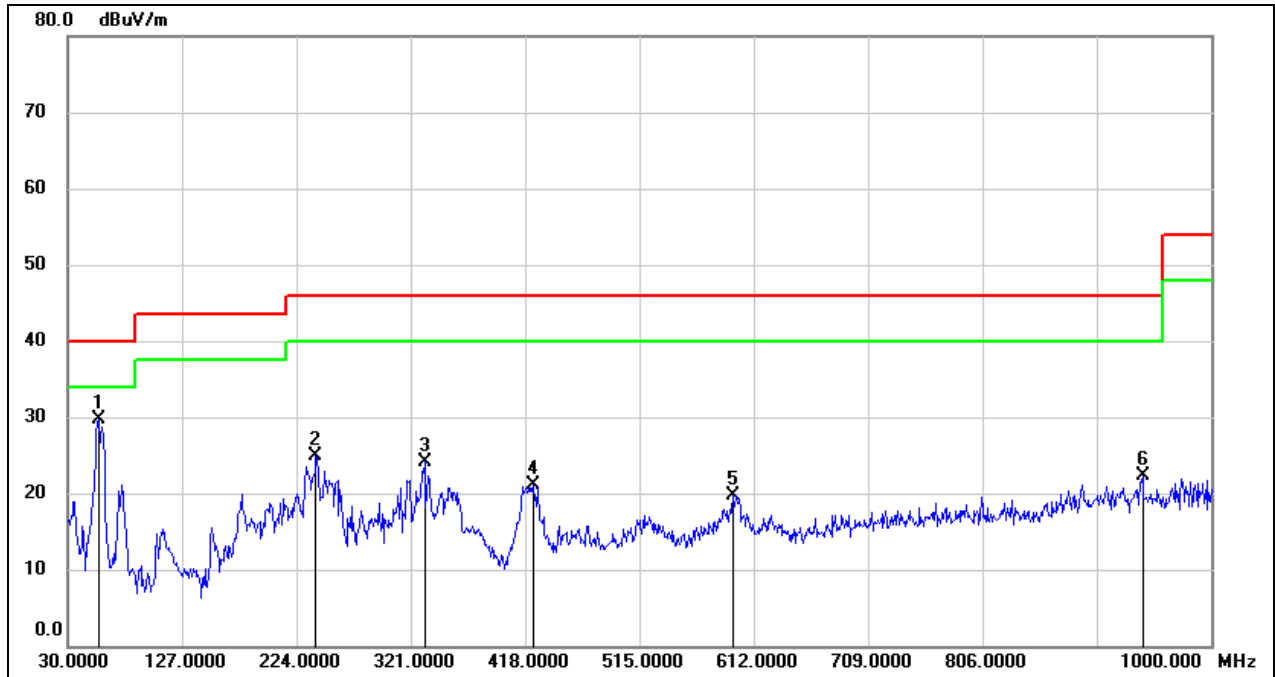

No.	Frequency (MHz)	Reading (dBuV)	Correct (dB/m)	Result (dBuV/m)	Limit (dBuV/m)	Margin (dB)	Remark
1	56.1900	50.08	-20.41	29.67	40.00	-10.33	QP
2	240.4900	43.30	-18.45	24.85	46.00	-21.15	QP
3	332.6400	37.88	-13.74	24.14	46.00	-21.86	QP
4	424.7900	33.38	-12.34	21.04	46.00	-24.96	QP
5	594.5400	29.14	-9.43	19.71	46.00	-26.29	QP
6	941.8000	26.99	-4.61	22.38	46.00	-23.62	QP

## 9. ANTENNA REQUIREMENT

### REQUIREMENT

Please refer to FCC part 15.203

An intentional radiator shall be designed to ensure that no antenna other than that furnished by the responsible party shall be used with the device. The use of a permanently attached antenna or of an antenna that uses a unique coupling to the intentional radiator shall be considered sufficient to comply with the provisions of this section. The manufacturer may design the unit so that a broken antenna can be replaced by the user, but the use of a standard antenna jack or electrical connector is prohibited.

Please refer to FCC part 15.247(b)(4)

The conducted output power limit specified in paragraph (b) of this section is based on the use of antennas with directional gains that do not exceed 6 dBi. Except as shown in paragraph (c) of this section, if transmitting antennas of directional gain greater than 6 dBi are used, the conducted output power from the intentional radiator shall be reduced below the stated values in paragraphs (b)(1), (b)(2), and (b)(3) of this section, as appropriate, by the amount in dB that the directional gain of the antenna exceeds 6 dBi.

### DESCRIPTION

Pass

## 10. AC POWER LINE CONDUCTED EMISSION

### LIMITS

Please refer to CFR 47 FCC §15.207 (a).

FREQUENCY (MHz)	Quasi-peak	Average
0.15 -0.5	66 - 56 *	56 - 46 *
0.50 -5.0	56.00	46.00
5.0 -30.0	60.00	50.00

### TEST PROCEDURE

The EUT is put on a table of non-conducting material that is 80 cm high. The vertical conducting wall of shielding is located 40 cm to the rear of the EUT. The power line of the EUT is connected to the AC mains through a Artificial Mains Network (A.M.N.). A EMI Measurement Receiver (R&S Test Receiver ESR3) is used to test the emissions from both sides of AC line. According to the requirements in Section 6.2 of ANSI C63.10-2013. Conducted emissions from the EUT measured in the frequency range between 0.15 MHz and 30 MHz using CISPR Quasi-Peak and average detector mode. The bandwidth of EMI test receiver is set at 9 kHz.

The arrangement of the equipment is installed to meet the standards and operating in a manner, which tends to maximize its emission characteristics in a normal application.

### TEST SETUP

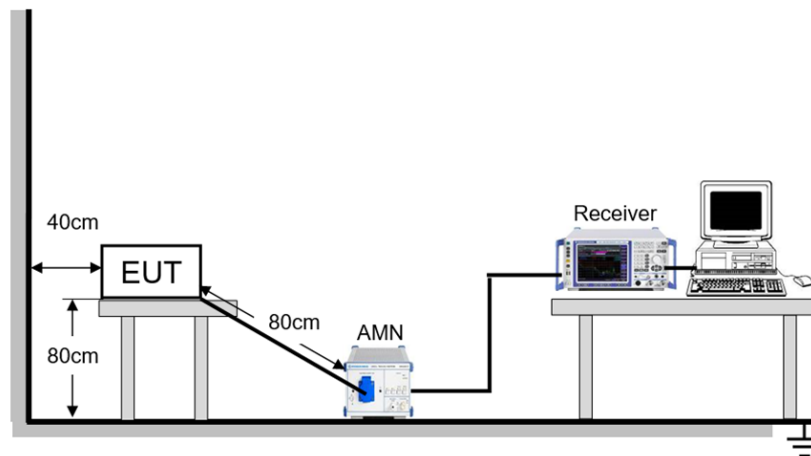

**TEST ENVIRONMENT**

Temperature	27.1 °C	Relative Humidity	50%
Atmosphere Pressure	101kPa	Test Voltage	AC 120 V, 60 Hz

**TEST DATE / ENGINEER**

Test Date	July 14, 2023	Test By	Wite Chen
-----------	---------------	---------	-----------

**TEST RESULTS**

Test Mode:	802.11b	Channel:	2412
Line:	Line	Test Voltage:	AC 120 V, 60 Hz

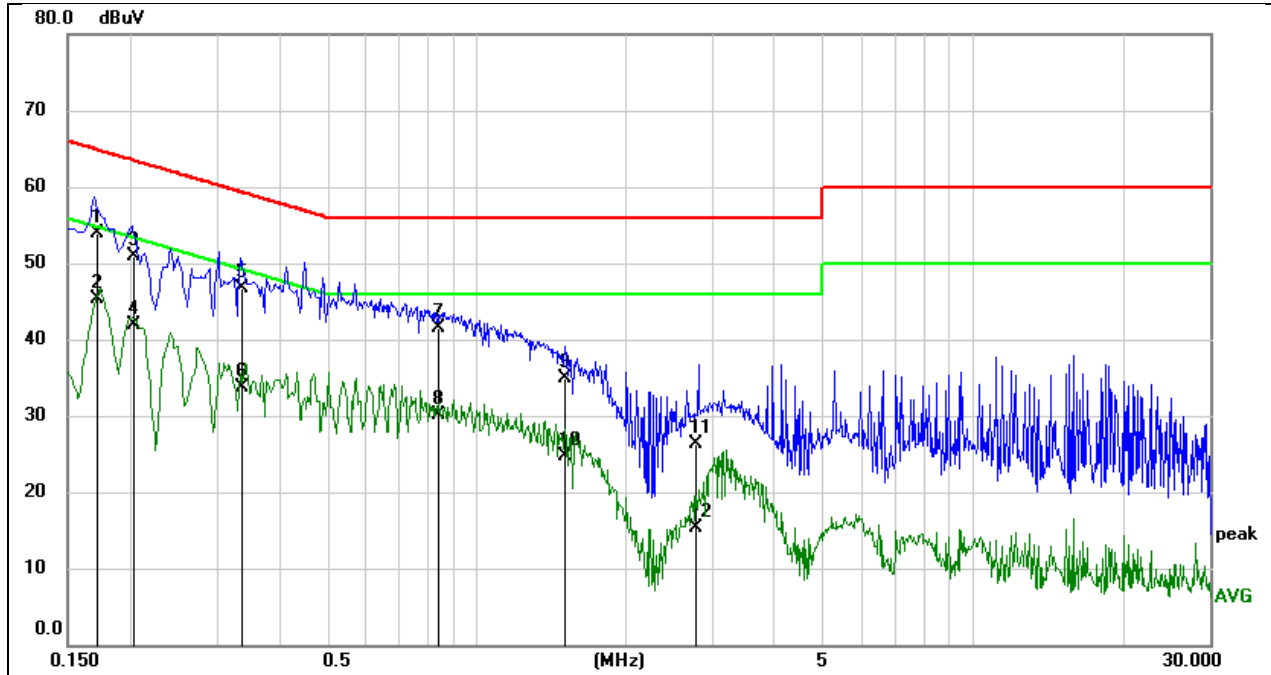

No.	Frequency (MHz)	Reading (dBuV)	Correct (dB)	Result (dBuV)	Limit (dBuV)	Margin (dB)	Remark
1	0.1723	44.38	9.59	53.97	64.85	-10.88	QP
2	0.1723	35.68	9.59	45.27	54.85	-9.58	AVG
3	0.2059	41.32	9.59	50.91	63.37	-12.46	QP
4	0.2059	32.28	9.59	41.87	53.37	-11.50	AVG
5	0.3373	37.05	9.59	46.64	59.27	-12.63	QP
6	0.3373	24.12	9.59	33.71	49.27	-15.56	AVG
7	0.8455	31.89	9.60	41.49	56.00	-14.51	QP
8	0.8455	20.41	9.60	30.01	46.00	-15.99	AVG
9	1.5091	25.23	9.62	34.85	56.00	-21.15	QP
10	1.5091	15.14	9.62	24.76	46.00	-21.24	AVG
11	2.7640	16.56	9.66	26.22	56.00	-29.78	QP
12	2.7640	5.55	9.66	15.21	46.00	-30.79	AVG

**Note:**

1. Result = Reading + Correct Factor.
2. If QP Result complies with AV limit, AV Result is deemed to comply with AV limit.
3. Test setup: RBW: 200 Hz (9 kHz ~ 150 kHz), 9 kHz (150 kHz ~ 30 MHz).
4. Step size: 80 Hz (0.009 MHz ~ 0.15 MHz), 4 kHz (0.15 MHz ~ 30 MHz), Scan time: auto.

Note: All the modes have been tested, only the worst data was recorded in the report.

Test Mode:	802.11b	Channel:	2412
Line:	Neutral	Test Voltage:	AC 120 V, 60 Hz

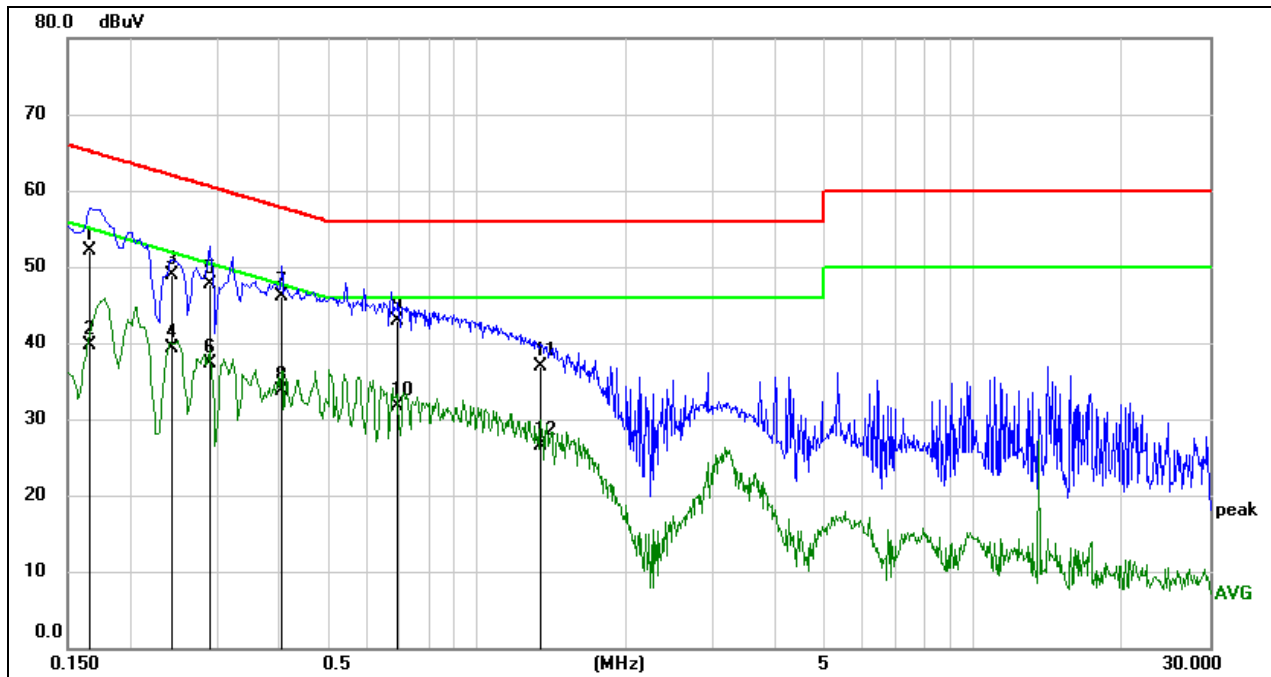

No.	Frequency (MHz)	Reading (dBuV)	Correct (dB)	Result (dBuV)	Limit (dBuV)	Margin (dB)	Remark
1	0.1662	42.49	9.59	52.08	65.15	-13.07	QP
2	0.1662	30.12	9.59	39.71	55.15	-15.44	AVG
3	0.2431	39.39	9.59	48.98	61.99	-13.01	QP
4	0.2431	29.67	9.59	39.26	51.99	-12.73	AVG
5	0.2880	38.19	9.59	47.78	60.58	-12.80	QP
6	0.2880	27.81	9.59	37.40	50.58	-13.18	AVG
7	0.4029	36.45	9.60	46.05	57.79	-11.74	QP
8	0.4029	24.01	9.60	33.61	47.79	-14.18	AVG
9	0.6961	33.30	9.60	42.90	56.00	-13.10	QP
10	0.6961	22.13	9.60	31.73	46.00	-14.27	AVG
11	1.3467	27.20	9.61	36.81	56.00	-19.19	QP
12	1.3467	16.98	9.61	26.59	46.00	-19.41	AVG

Note:

1. Result = Reading + Correct Factor.
2. If QP Result complies with AV limit, AV Result is deemed to comply with AV limit.
3. Test setup: RBW: 200 Hz (9 kHz ~ 150 kHz), 9 kHz (150 kHz ~ 30 MHz).
4. Step size: 80 Hz (0.009 MHz ~ 0.15 MHz), 4 kHz (0.15 MHz ~ 30 MHz), Scan time: auto.

Note: All the modes have been tested, only the worst data was recorded in the report.

## 11. TEST DATA

### 11.1. APPENDIX A: DTS BANDWIDTH

#### 11.1.1. Test Result

Test Mode	Antenna	Frequency[MHz]	DTS BW [MHz]	FL[MHz]	FH[MHz]	Limit[MHz]	Verdict
11B	Ant1	2412	9.600	2407.440	2417.040	$\geq 0.5$	PASS
		2417	9.600	2411.960	2421.560	$\geq 0.5$	PASS
		2437	9.080	2432.440	2441.520	$\geq 0.5$	PASS
		2457	10.040	2451.960	2462.000	$\geq 0.5$	PASS
		2462	9.000	2457.480	2466.480	$\geq 0.5$	PASS
11G	Ant1	2412	16.280	2403.840	2420.120	$\geq 0.5$	PASS
		2417	16.280	2408.840	2425.120	$\geq 0.5$	PASS
		2437	16.320	2428.840	2445.160	$\geq 0.5$	PASS
		2457	16.080	2449.080	2465.160	$\geq 0.5$	PASS
		2462	16.320	2453.840	2470.160	$\geq 0.5$	PASS
11N20SISO	Ant1	2412	17.520	2403.240	2420.760	$\geq 0.5$	PASS
		2417	17.040	2408.720	2425.760	$\geq 0.5$	PASS
		2437	17.320	2428.200	2445.520	$\geq 0.5$	PASS
		2457	16.520	2448.600	2465.120	$\geq 0.5$	PASS
		2462	16.920	2453.840	2470.760	$\geq 0.5$	PASS



### 11.1.2. Test Graphs





11B\_Ant1\_2457



11B\_Ant1\_2462

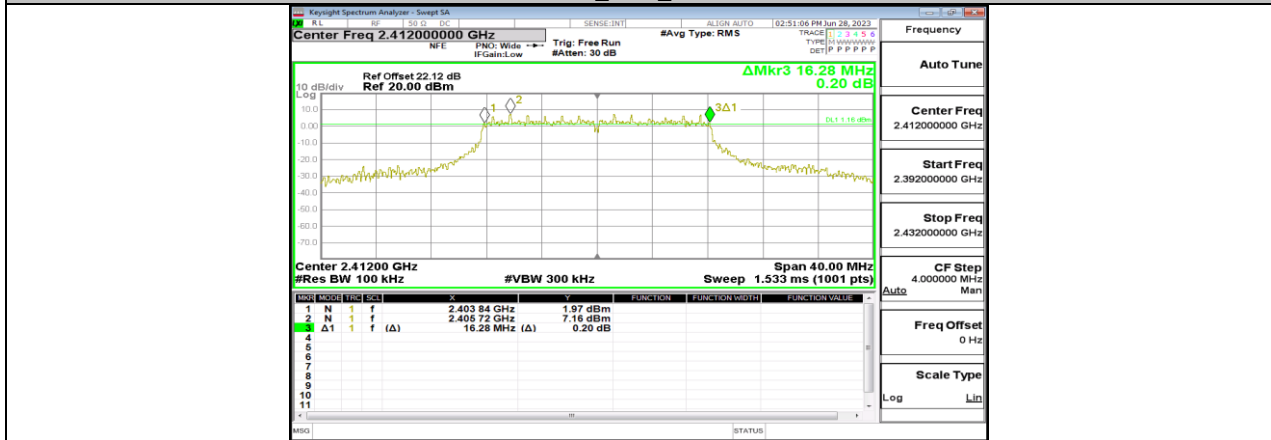

11G\_Ant1\_2412

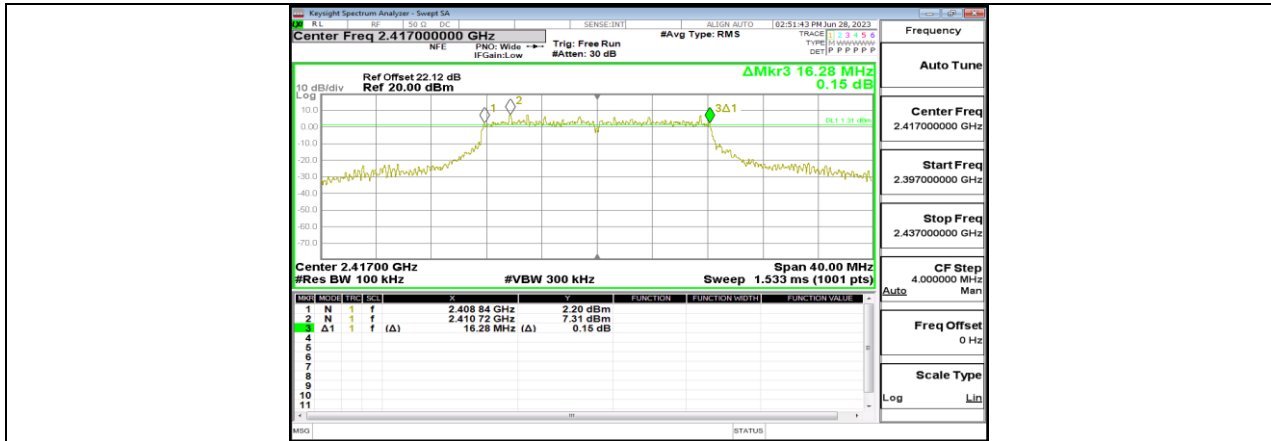

11G\_Ant1\_2417

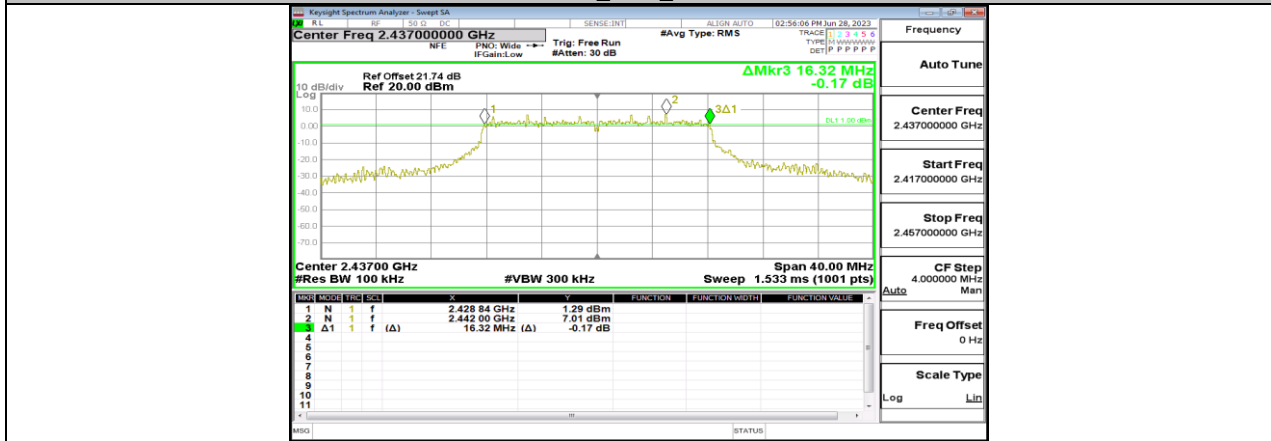

11G\_Ant1\_2437



11G\_Ant1\_2457

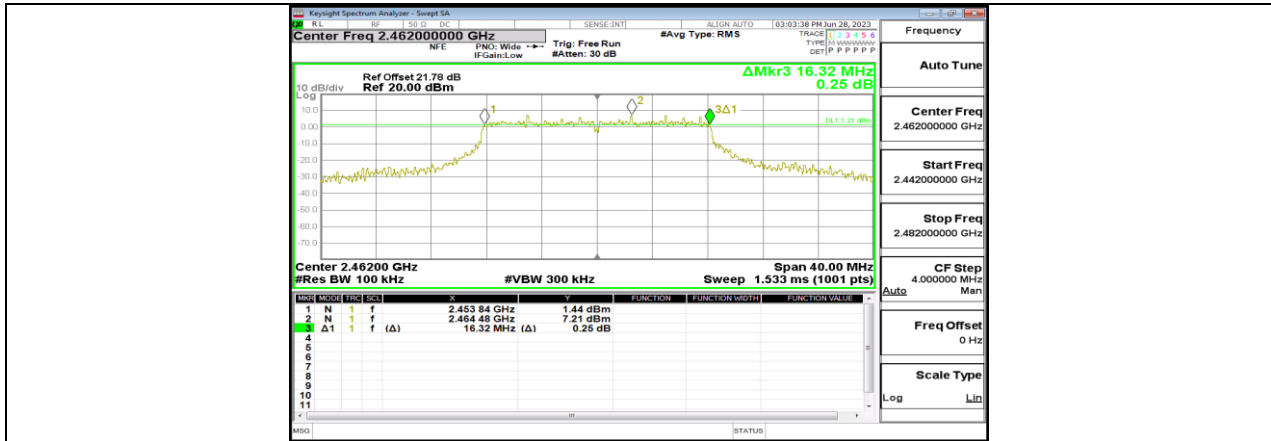

11G\_Ant1\_2462

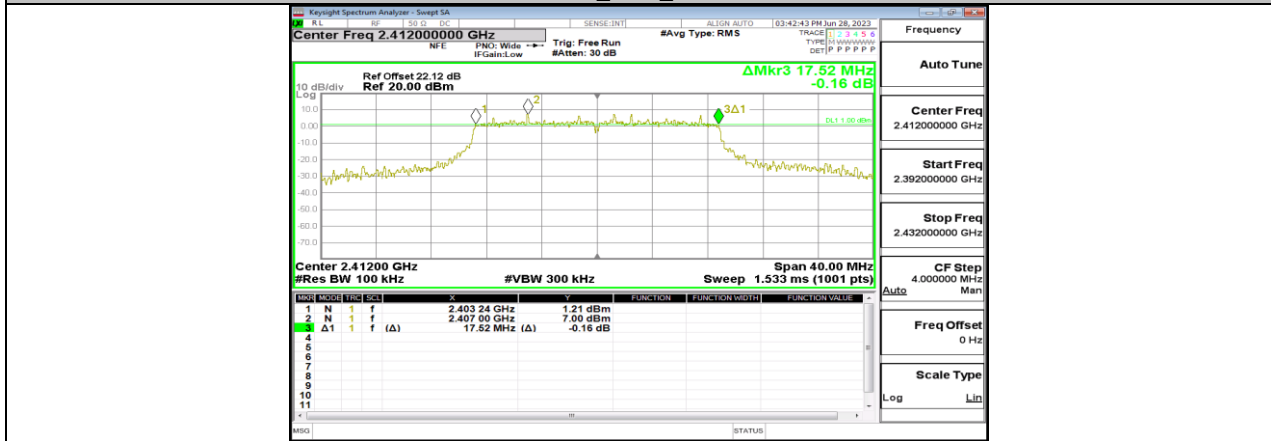

11N20SISO\_Ant1\_2412

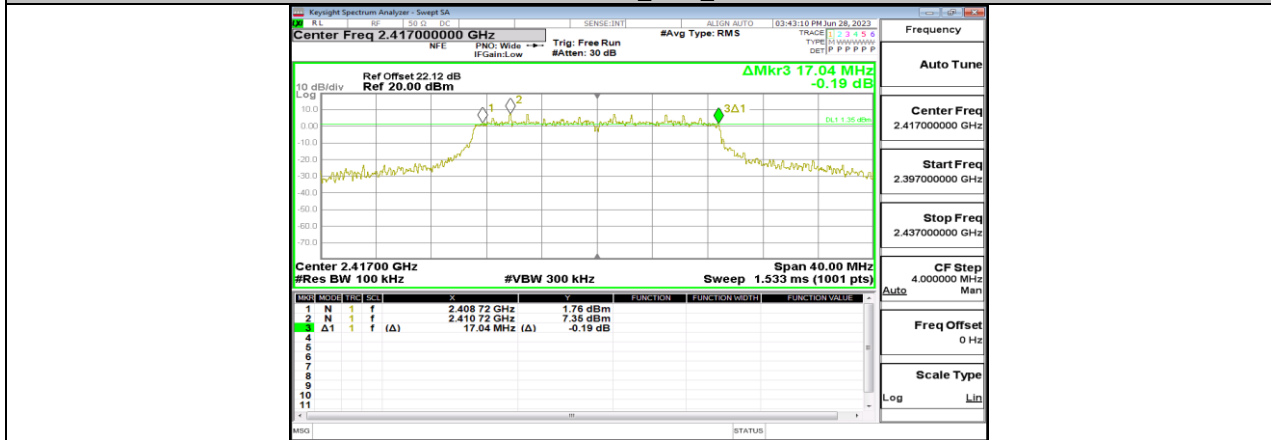

11N20SISO\_Ant1\_2417

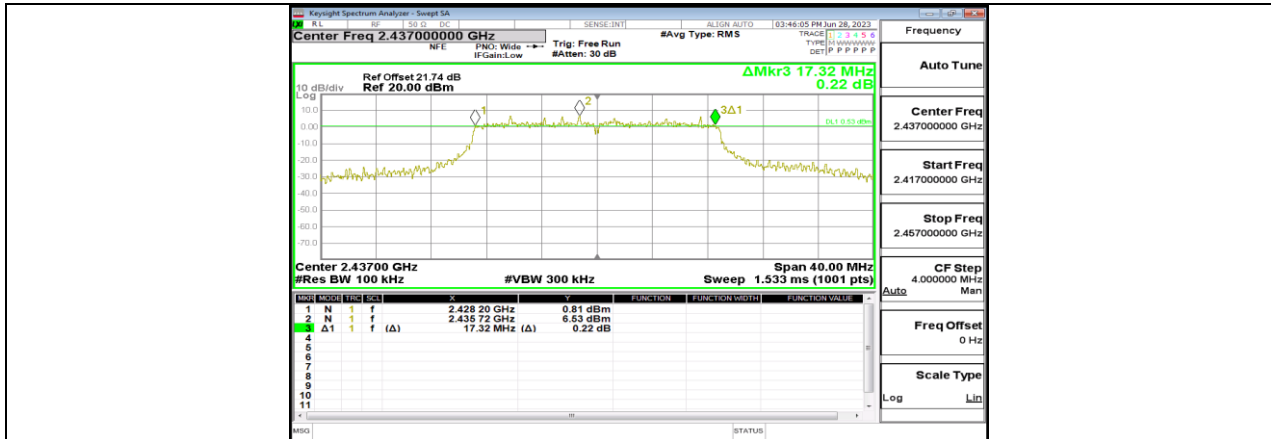

11N20SISO\_Ant1\_2437

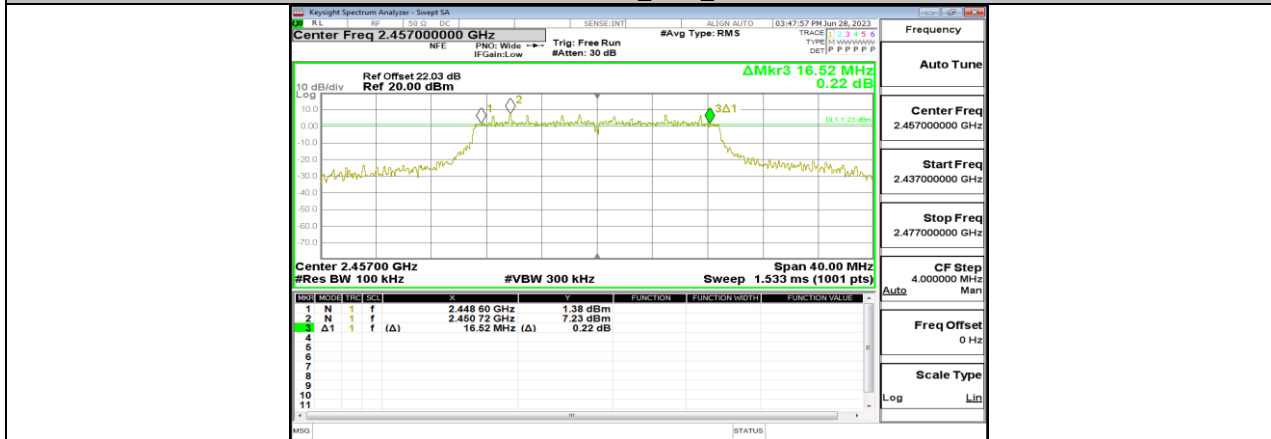

11N20SISO\_Ant1\_2457

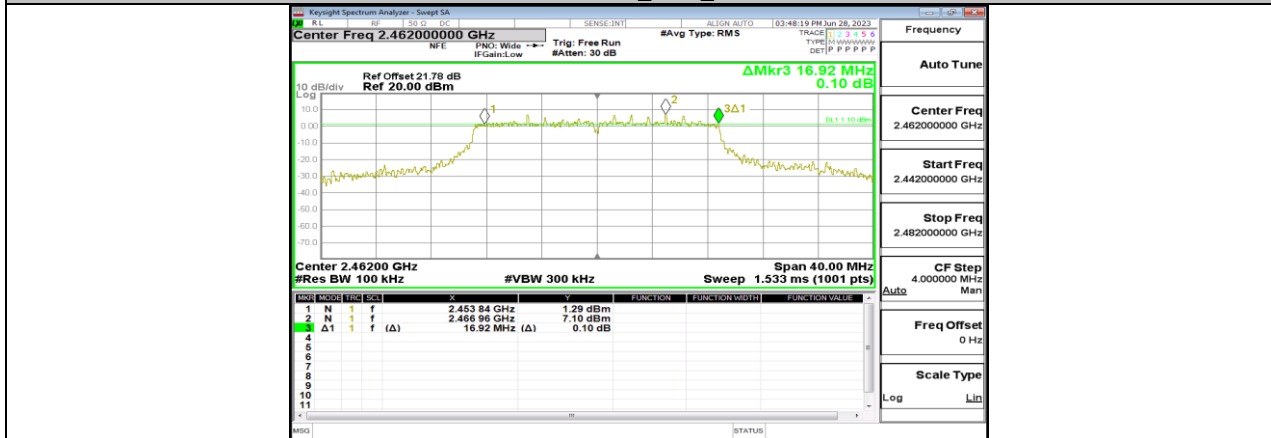

11N20SISO\_Ant1\_2462

## 11.2. APPENDIX B: OCCUPIED CHANNEL BANDWIDTH

### 11.2.1. Test Result

Test Mode	Antenna	Frequency[MHz]	OCB [MHz]	FL[MHz]	FH[MHz]	Verdict
11B	Ant1	2412	14.110	2404.9098	2419.0198	PASS
		2417	14.056	2409.9142	2423.9702	PASS
		2437	13.889	2429.9949	2443.8839	PASS
		2457	13.992	2449.9517	2463.9437	PASS
		2462	13.968	2454.9715	2468.9395	PASS
11G	Ant1	2412	17.489	2403.3412	2420.8302	PASS
		2417	17.537	2408.2842	2425.8212	PASS
		2437	17.442	2428.3237	2445.7657	PASS
		2457	17.560	2448.2883	2465.8483	PASS
		2462	17.502	2453.3223	2470.8243	PASS
11N20SISO	Ant1	2412	18.444	2402.8005	2421.2445	PASS
		2417	18.423	2407.8103	2426.2333	PASS
		2437	18.373	2427.7972	2446.1702	PASS
		2457	18.485	2447.7570	2466.2420	PASS
		2462	18.442	2452.7816	2471.2236	PASS

### 11.2.2. Test Graphs



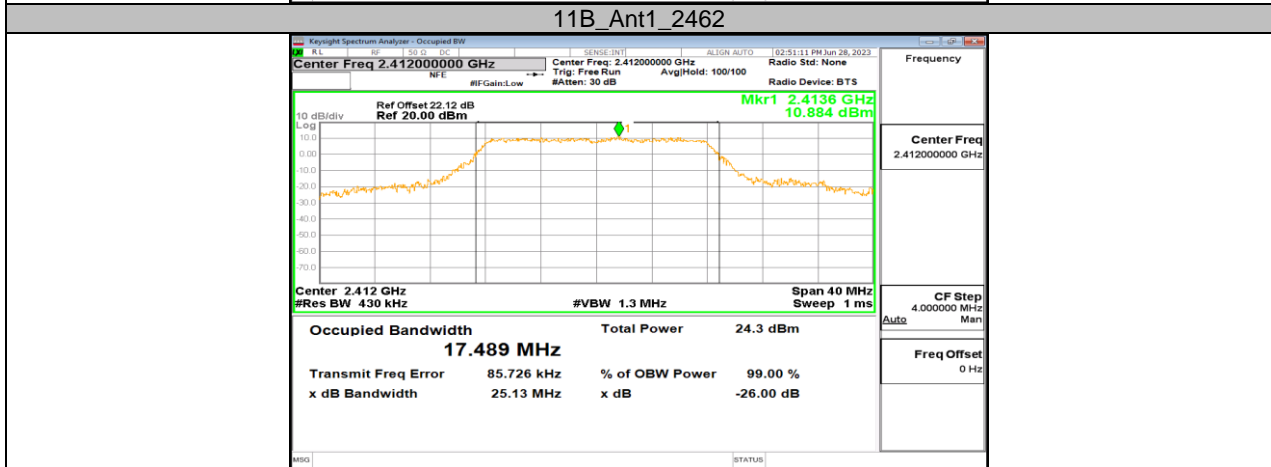
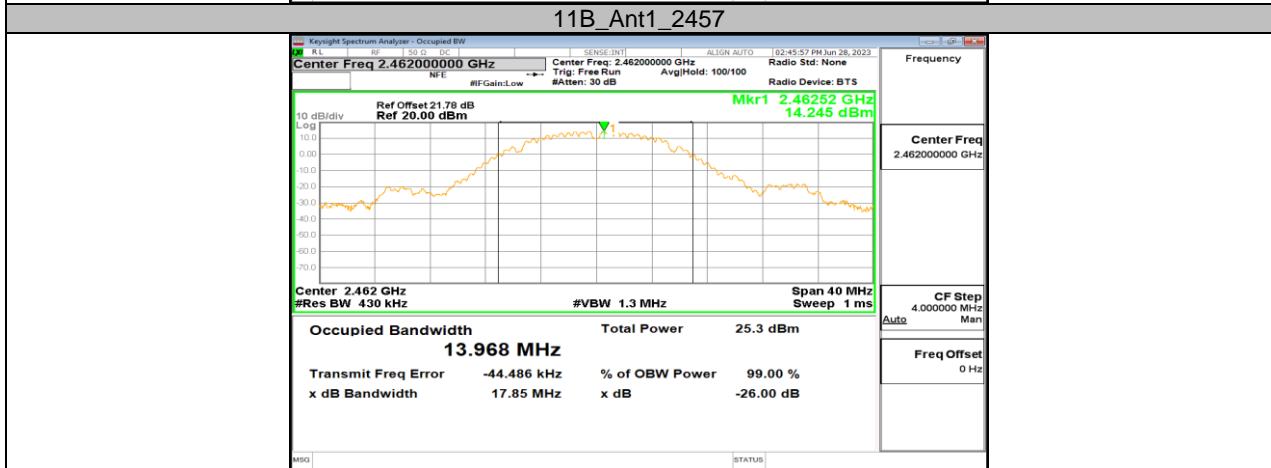
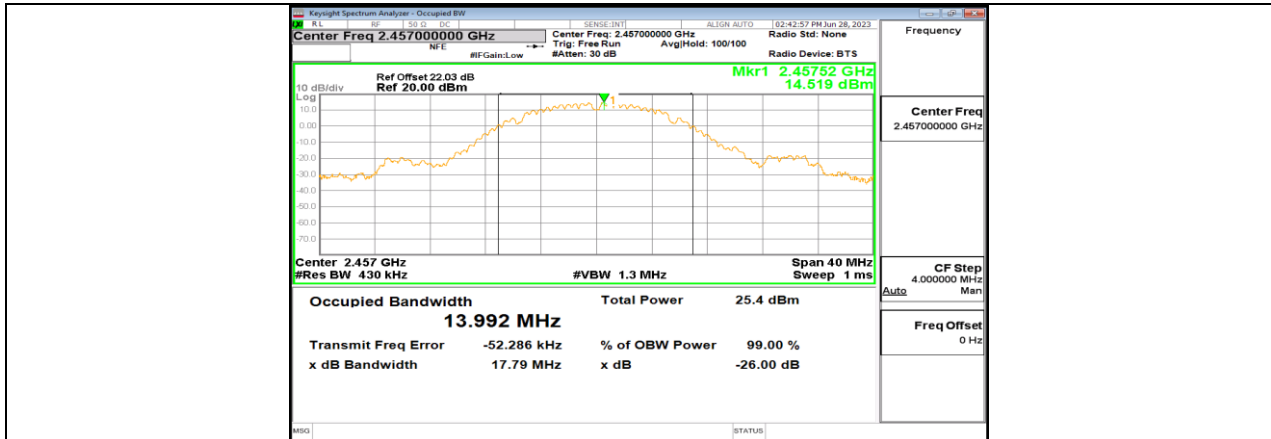



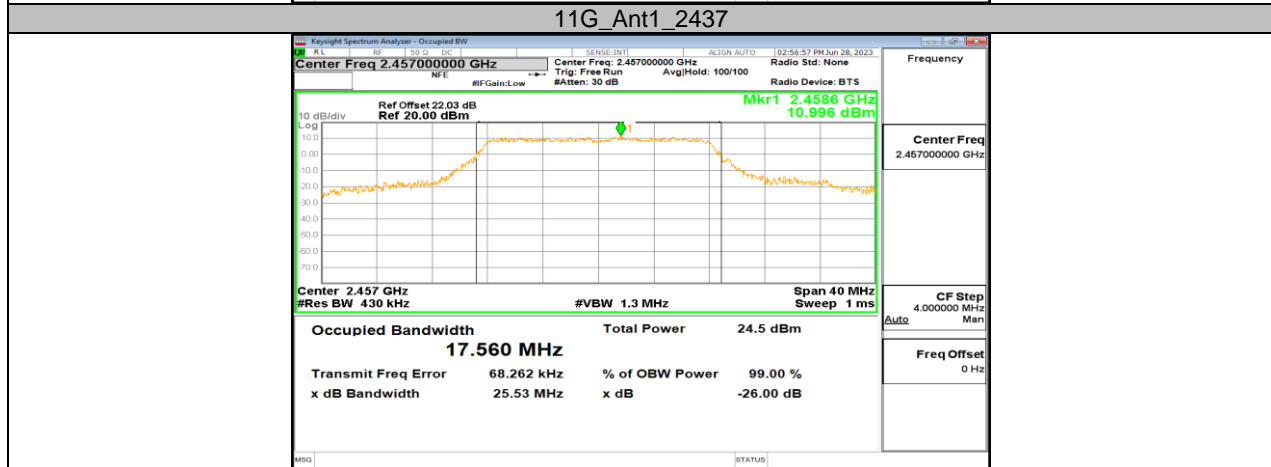
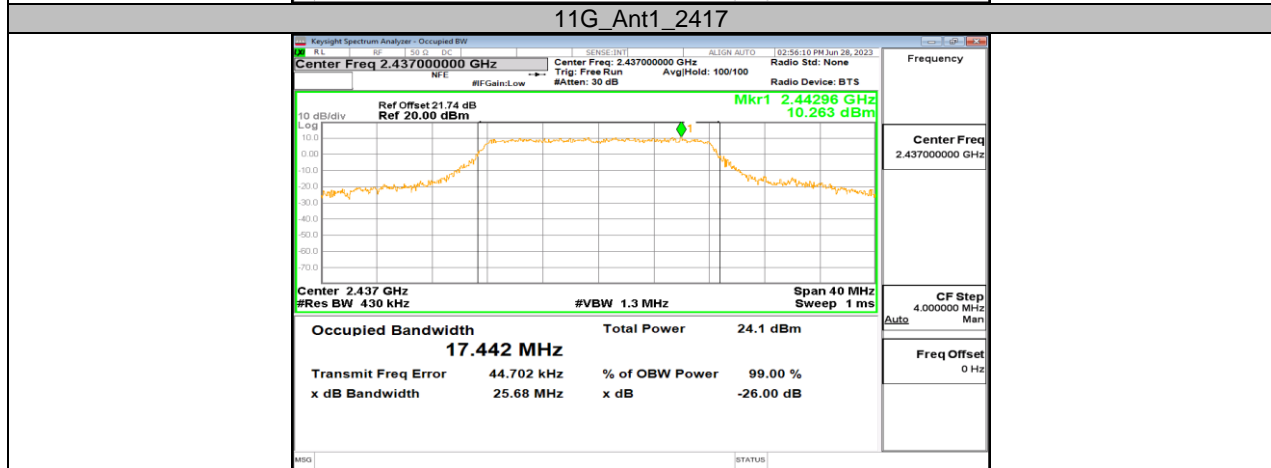
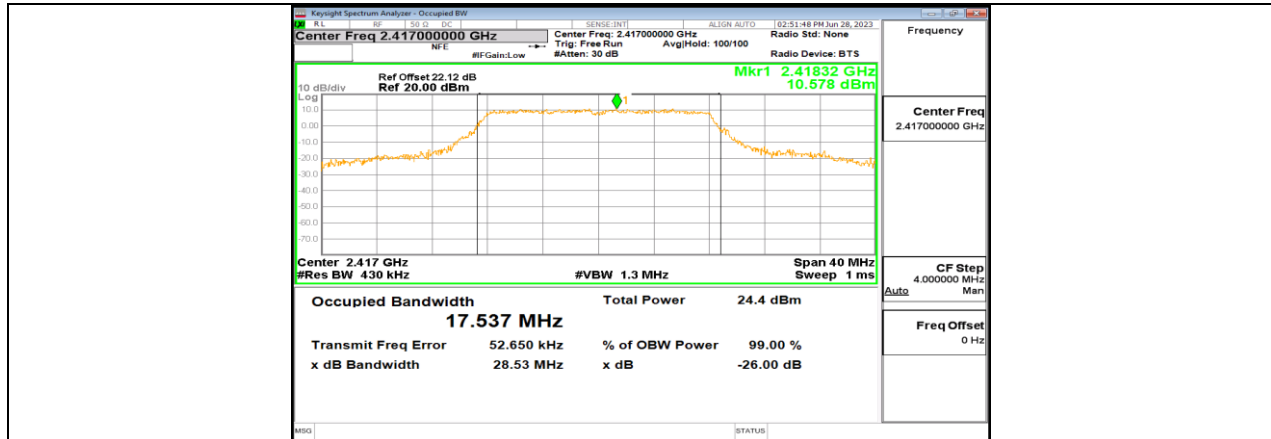

**11G\_Ant1\_2457**

