

FCC Radio Test Report

FCC ID: 2AXJ4KS200

This report concerns: **Original Grant**

Project No. : 2205C096
Equipment : Kasa Smart Wi-Fi Light Switch, Single Pole
Brand Name : tp-link
Test Model : KS200
Series Model : N/A
Applicant : TP-Link Corporation Limited
Address : Room 901, 9/F. , New East Ocean Centre, 9 Science Museum Road,
Tsim Sha Tsui, Kowloon, Hong Kong
Manufacturer : TP-Link Corporation Limited
Address : Room 901, 9/F. , New East Ocean Centre, 9 Science Museum Road,
Tsim Sha Tsui, Kowloon, Hong Kong
Date of Receipt : May 20, 2022
Date of Test : May 23, 2022 ~ Jun. 16, 2022
Issued Date : Jul. 15, 2022
Report Version : R00
Test Sample : Engineering Sample No.: DG2022052066 for conducted,
DG2022052065 for radiated.
Standard(s) : FCC CFR Title 47, Part 15, Subpart C
FCC KDB 558074 D01 15.247 Meas Guidance v05r02
ANSI C63.10-2013

The above equipment has been tested and found compliance with the requirement of the relative standards by BTL Inc.

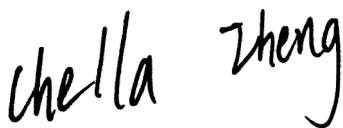

Prepared by : Chella Zheng

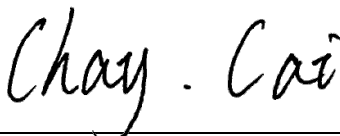

Approved by : Chay Cai



TESTING CERT #5123.02

BTL Inc.

No. 3 Jinshagang 1st Rd. Shixia, Dalang Town Dongguan City, Guangdong 523792 People's Republic of China.

Tel: +86-769-8318-3000

Web: www.newbtl.com

Service mail: btl_qa@newbtl.com

Declaration

BTL represents to the client that testing is done in accordance with standard procedures as applicable and that test instruments used has been calibrated with standards traceable to international standard(s) and/or national standard(s).

BTL's reports apply only to the specific samples tested under conditions. It is manufacture's responsibility to ensure that additional production units of this model are manufactured with the identical electrical and mechanical components. **BTL** shall have no liability for any declarations, inferences or generalizations drawn by the client or others from **BTL** issued reports.

The report must not be used by the client to claim product certification, approval, or endorsement by NVLAP, NIST, A2LA, or any agency of the U.S. Government.

This report is the confidential property of the client. As a mutual protection to the clients, the public and ourselves, the test report shall not be reproduced, except in full, without our written approval.

BTL's laboratory quality assurance procedures are in compliance with the **ISO/IEC 17025** requirements, and accredited by the conformity assessment authorities listed in this test report.

BTL is not responsible for the sampling stage, so the results only apply to the sample as received.

The information, data and test plan are provided by manufacturer which may affect the validity of results, so it is manufacturer's responsibility to ensure that the apparatus meets the essential requirements of applied standards and in all the possible configurations as representative of its intended use.

Limitation

For the use of the authority's logo is limited unless the Test Standard(s)/Scope(s)/Item(s) mentioned in this test report is (are) included in the conformity assessment authorities acceptance respective.

Please note that the measurement uncertainty is provided for informational purpose only and are not use in determining the Pass/Fail results.

| Table of Contents | Page |
|--|-------------|
| REPORT ISSUED HISTORY | 6 |
| 1 . SUMMARY OF TEST RESULTS | 7 |
| 1.1 TEST FACILITY | 8 |
| 1.2 MEASUREMENT UNCERTAINTY | 8 |
| 1.3 TEST ENVIRONMENT CONDITIONS | 9 |
| 2 . GENERAL INFORMATION | 10 |
| 2.1 GENERAL DESCRIPTION OF EUT | 10 |
| 2.2 DESCRIPTION OF TEST MODES | 11 |
| 2.3 PARAMETERS OF TEST SOFTWARE | 12 |
| 2.4 DUTY CYCLE | 13 |
| 2.5 BLOCK DIAGRAM SHOWING THE CONFIGURATION OF SYSTEM TESTED | 15 |
| 2.6 SUPPORT UNITS | 15 |
| 3 . AC POWER LINE CONDUCTED EMISSIONS | 16 |
| 3.1 LIMIT | 16 |
| 3.2 TEST PROCEDURE | 16 |
| 3.3 DEVIATION FROM TEST STANDARD | 16 |
| 3.4 TEST SETUP | 17 |
| 3.5 EUT OPERATION CONDITIONS | 17 |
| 3.6 TEST RESULTS | 17 |
| 4 . RADIATED EMISSIONS | 18 |
| 4.1 LIMIT | 18 |
| 4.2 TEST PROCEDURE | 19 |
| 4.3 DEVIATION FROM TEST STANDARD | 20 |
| 4.4 TEST SETUP | 20 |
| 4.5 EUT OPERATION CONDITIONS | 21 |
| 4.6 TEST RESULTS - 9 KHZ TO 30 MHZ | 21 |
| 4.7 TEST RESULTS - 30 MHZ TO 1000 MHZ | 21 |
| 4.8 TEST RESULTS - ABOVE 1000 MHZ | 21 |
| 5 . BANDWIDTH | 22 |
| 5.1 LIMIT | 22 |
| 5.2 TEST PROCEDURE | 22 |
| 5.3 DEVIATION FROM STANDARD | 22 |
| 5.4 TEST SETUP | 22 |

| Table of Contents | Page |
|--|-------------|
| 5.5 EUT OPERATION CONDITIONS | 22 |
| 5.6 TEST RESULTS | 22 |
| 6 . MAXIMUM AVERAGE OUTPUT POWER | 23 |
| 6.1 LIMIT | 23 |
| 6.2 TEST PROCEDURE | 23 |
| 6.3 DEVIATION FROM STANDARD | 23 |
| 6.4 TEST SETUP | 23 |
| 6.5 EUT OPERATION CONDITIONS | 23 |
| 6.6 TEST RESULTS | 23 |
| 7 . CONDUCTED SPURIOUS EMISSIONS | 24 |
| 7.1 LIMIT | 24 |
| 7.2 TEST PROCEDURE | 24 |
| 7.3 DEVIATION FROM STANDARD | 24 |
| 7.4 TEST SETUP | 24 |
| 7.5 EUT OPERATION CONDITIONS | 24 |
| 7.6 TEST RESULTS | 24 |
| 8 . POWER SPECTRAL DENSITY | 25 |
| 8.1 LIMIT | 25 |
| 8.2 TEST PROCEDURE | 25 |
| 8.3 DEVIATION FROM STANDARD | 25 |
| 8.4 TEST SETUP | 25 |
| 8.5 EUT OPERATION CONDITIONS | 25 |
| 8.6 TEST RESULTS | 25 |
| 9 . MEASUREMENT INSTRUMENTS LIST | 26 |
| 10 . EUT TEST PHOTO | 28 |
| APPENDIX A - AC POWER LINE CONDUCTED EMISSIONS | 33 |
| APPENDIX B - RADIATED EMISSION - 9 KHZ TO 30 MHZ | 36 |
| APPENDIX C - RADIATED EMISSION - 30 MHZ TO 1000 MHZ | 41 |
| APPENDIX D - RADIATED EMISSION- ABOVE 1000 MHZ | 44 |
| APPENDIX E - BANDWIDTH | 75 |
| APPENDIX F - MAXIMUM AVERAGE OUTPUT POWER | 79 |
| APPENDIX G - CONDUCTED SPURIOUS EMISSIONS | 81 |

Table of Contents

Page

APPENDIX H - POWER SPECTRAL DENSITY

88

REPORT ISSUED HISTORY

| Report No. | Version | Description | Issued Date | Note |
|---------------------|---------|-----------------|---------------|-------|
| BTL-FCCP-2-2205C096 | R00 | Original Report | Jul. 15, 2022 | Valid |

1. SUMMARY OF TEST RESULTS

Test procedures according to the technical standard(s):

| FCC CFR Title 47, Part 15, Subpart C | | | | |
|--------------------------------------|-----------------------------------|--|----------|---------|
| Standard(s) Section | Test Item | Test Result | Judgment | Remark |
| 15.207 | AC Power Line Conducted Emissions | APPENDIX A | PASS | ----- |
| 15.247(d) 15.205(a) 15.209(a) | Radiated Emissions | APPENDIX B APPENDIX C APPENDIX D | PASS | ----- |
| 15.247(a)(2) | Bandwidth | APPENDIX E | PASS | ----- |
| 15.247(b)(3) | Maximum Average Output Power | APPENDIX F | PASS | ----- |
| 15.247(d) | Conducted Spurious Emissions | APPENDIX G | PASS | ----- |
| 15.247(e) | Power Spectral Density | APPENDIX H | PASS | ----- |
| 15.203 | Antenna Requirement | ----- | PASS | Note(2) |

Note:

- (1) "N/A" denotes test is not applicable in this test report.
- (2) The device what use a permanently attached antenna were considered sufficient to comply with the provisions of 15.203.

1.1 TEST FACILITY

The test facilities used to collect the test data in this report is at the location of No. 3 Jinshagang 1st Rd. Shixia, Dalang Town Dongguan City, Guangdong 523792 People's Republic of China.

BTL's Registration Number for FCC: 357015

BTL's Designation Number for FCC: CN1240

1.2 MEASUREMENT UNCERTAINTY

ISO/IEC 17025 requires that an estimate of the measurement uncertainties associated with the emissions test results be included in the report. The measurement uncertainties given below are based on a 95% confidence level (based on a coverage factor (k=2))

The BTL measurement uncertainty as below table:

A. AC power line conducted emissions test:

| Test Site | Method | Measurement Frequency Range | U,(dB) |
|-----------|--------|-----------------------------|--------|
| DG-C02 | CISPR | 150kHz ~ 30MHz | 2.60 |

B. Radiated emissions test:

| Test Site | Method | Measurement Frequency Range | U,(dB) |
|-----------|--------|-----------------------------|--------|
| DG-CB01 | CISPR | 9kHz ~ 30MHz | 2.36 |

| Test Site | Method | Measurement Frequency Range | Ant. H / V | U,(dB) |
|-----------------|--------|-----------------------------|---------------|--------|
| DG-CB03 (3m) | CISPR | 30MHz ~ 200MHz | V | 4.36 |
| | | 30MHz ~ 200MHz | H | 3.32 |
| | | 200MHz ~ 1,000MHz | V | 4.08 |
| | | 200MHz ~ 1,000MHz | H | 3.96 |

| Test Site | Method | Measurement Frequency Range | U,(dB) |
|-----------------|--------|-----------------------------|--------|
| DG-CB03 (3m) | CISPR | 1GHz ~ 6GHz | 3.80 |
| | | 6GHz ~ 18GHz | 4.82 |

| Test Site | Method | Measurement Frequency Range | U,(dB) |
|-----------------|--------|-----------------------------|--------|
| DG-CB03 (1m) | CISPR | 18 ~ 26.5 GHz | 3.62 |
| | | 26.5 ~ 40 GHz | 4.00 |

C. Other Measurement:

| Test Item | Uncertainty |
|-----------------------------|-------------|
| Bandwidth | ±3.8 % |
| Maximum Output Power | ±0.95 dB |
| Conducted Spurious Emission | ±2.71 dB |
| Power Spectral Density | ±0.86 dB |
| Temperature | ±0.08 °C |
| Humidity | ±1.5% |

Note: Unless specifically mentioned, the uncertainty of measurement has not been taken into account to declare the compliance or non-compliance to the specification.

1.3 TEST ENVIRONMENT CONDITIONS

| Test Item | Temperature | Humidity | Test Voltage | Tested By |
|-------------------------------------|-------------|------------|--------------|---------------------|
| AC Power Line Conducted Emissions | 26°C | 58% | AC 120V/60Hz | Jeter Wang |
| Radiated Emissions-9kHz to 30 MHz | 24°C | 58% | AC 120V/60Hz | Rod Tang |
| Radiated Emissions-30MHz to 1000MHz | 24°C | 60% | AC 120V/60Hz | Chen Mo |
| Radiated Emissions-Above 1000MHz | 26°C | 56% | AC 120V/60Hz | Chen Mo |
| Bandwidth | 24-25°C | 60-63% | AC 120V/60Hz | Ansel Yang Kwok Guo |
| Maximum Average Output Power | 22.8-24.1°C | 56.8-68.6% | AC 120V/60Hz | Complex Qin |
| Conducted Spurious Emissions | 24-25°C | 60-63% | AC 120V/60Hz | Ansel Yang Kwok Guo |
| Power Spectral Density | 24-25°C | 60-63% | AC 120V/60Hz | Ansel Yang Kwok Guo |

2. GENERAL INFORMATION

2.1 GENERAL DESCRIPTION OF EUT

| | |
|------------------------------|--|
| Equipment | Kasa Smart Wi-Fi Light Switch, Single Pole |
| Brand Name | tp-link |
| Test Model | KS200 |
| Series Model | N/A |
| Model Difference(s) | N/A |
| Power Source | AC Mains. |
| Power Rating | 120V~ 60Hz 15A General Use 600 W Incandescent |
| Operation Frequency | 2412 MHz ~ 2462 MHz |
| Modulation Type | IEEE 802.11b: DSSS IEEE 802.11g: OFDM IEEE 802.11n: OFDM |
| Bit Rate of Transmitter | IEEE 802.11b: 11/5.5/2/1 Mbps IEEE 802.11g: 54/48/36/24/18/12/9/6 Mbps IEEE 802.11n: up to 72.2 Mbps |
| Maximum Average Output Power | IEEE 802.11b: 22.97 dBm (0.1982 W) |

Note:

- For a more detailed features description, please refer to the manufacturer's specifications or the user's manual.

2. Channel List:

| CH01 - CH11 for IEEE 802.11b, IEEE 802.11g, IEEE 802.11n(HT20) | | | | | | | |
|--|-----------------|---------|-----------------|---------|-----------------|---------|-----------------|
| Channel | Frequency (MHz) | Channel | Frequency (MHz) | Channel | Frequency (MHz) | Channel | Frequency (MHz) |
| 01 | 2412 | 04 | 2427 | 07 | 2442 | 10 | 2457 |
| 02 | 2417 | 05 | 2432 | 08 | 2447 | 11 | 2462 |
| 03 | 2422 | 06 | 2437 | 09 | 2452 | | |

3. Antenna Specification:

| Ant. | Brand | P/N | Antenna Type | Connector | Gain (dBi) |
|------|---------|------------|--------------|-----------|------------|
| 1 | tp-link | 6035500079 | Internal | N/A | 2.98 |

Note: The antenna gain is provided by the manufacturer.

2.2 DESCRIPTION OF TEST MODES

The test system was pre-tested based on the consideration of all possible combinations of EUT operation mode.

| Pretest Mode | Description |
|--------------|--|
| Mode 1 | TX B Mode Channel 01/06/11 |
| Mode 2 | TX G Mode Channel 01/06/11 |
| Mode 3 | TX N(HT20) Mode Channel 01/06/11 |
| Mode 4 | TX B Mode Channel 01 |
| Mode 5 | TX B Mode Channel 01/02/06/10/11 |
| Mode 6 | TX G Mode Channel 01/02/06/10/11 |
| Mode 7 | TX N(HT20) Mode Channel 01/02/06/10/11 |

Following mode(s) was (were) found to be the worst case(s) and selected for the final test.

| AC power line conducted emissions test | |
|---|----------------------|
| Final Test Mode | Description |
| Mode 4 | TX B Mode Channel 01 |

| Radiated emissions test - Below 1GHz | |
|---|----------------------|
| Final Test Mode | Description |
| Mode 4 | TX B Mode Channel 01 |

| Radiated emissions test- Above 1GHz | |
|--|--|
| Final Test Mode | Description |
| Mode 5 | TX B Mode Channel 01/02/06/10/11 |
| Mode 6 | TX G Mode Channel 01/02/06/10/11 |
| Mode 7 | TX N(HT20) Mode Channel 01/02/06/10/11 |

| Conducted test | |
|-----------------|----------------------------------|
| Final Test Mode | Description |
| Mode 1 | TX B Mode Channel 01/06/11 |
| Mode 2 | TX G Mode Channel 01/06/11 |
| Mode 3 | TX N(HT20) Mode Channel 01/06/11 |

NOTE:

- (1) All the bit rate of transmitter have been tested and found the lowest rate is found to be the worst case and recorded.
- (2) For AC power line conducted emissions and radiated emission below 1 GHz test, the TX B Mode Channel 01 is found to be the worst case and recorded.
- (3) For radiated emission above 1 GHz test, the spurious points of 1GHz~26.5GHz have been pre-tested and in this report only recorded the worst case. The remaining spurious points are all below the limit value of 20dB.
- (4) For radiated emission above 1 GHz test, the polarization of Vertical and Horizontal are evaluated, the worst case is Vertical for Band edge, Horizontal for Harmonic. In this report only recorded the worst case.

2.3 PARAMETERS OF TEST SOFTWARE

| Test Software Version | UI_mptool V1.0.0.1 | | |
|-----------------------|--------------------|------|------|
| Frequency (MHz) | 2412 | 2437 | 2462 |
| IEEE 802.11b | 118 | 118 | 117 |
| IEEE 802.11g | 111 | 127 | 109 |
| IEEE 802.11n(HT20) | 110 | 127 | 105 |

2.4 DUTY CYCLE

If duty cycle is $\geq 98\%$, duty factor is not required.
 If duty cycle is $< 98\%$, duty factor shall be considered.
 The output power = measured power + duty factor.

IEEE 802.11b

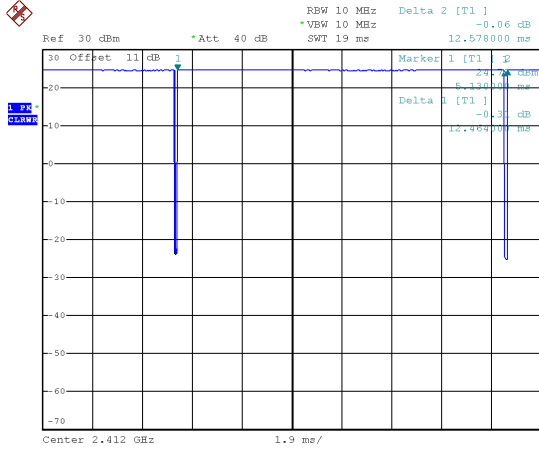

Date: 28.MAY.2022 12:26:56

Duty cycle = $12.464 \text{ ms} / 12.578 \text{ ms} = 99.09\%$
 Duty Factor = $10 \log(1/\text{Duty cycle}) = 0.00$

IEEE 802.11g

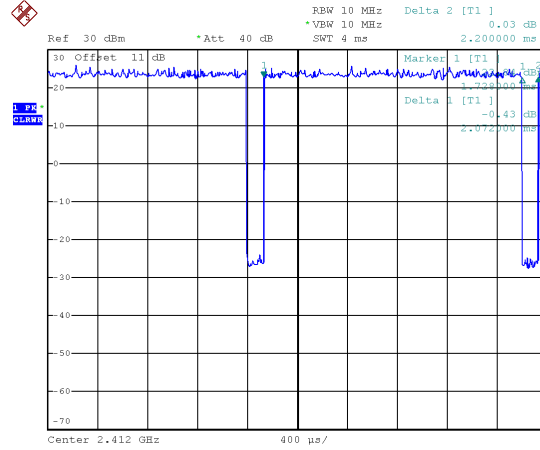

Date: 28.MAY.2022 12:26:30

Duty cycle = $2.072 \text{ ms} / 2.200 \text{ ms} = 94.18\%$
 Duty Factor = $10 \log(1/\text{Duty cycle}) = 0.26$

IEEE 802.11n(HT20)

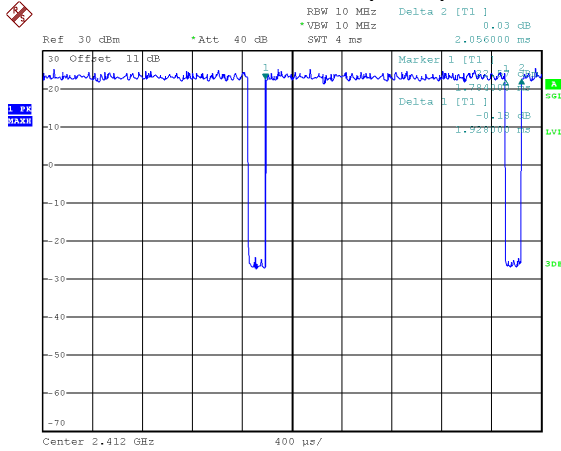

Date: 28.MAY.2022 12:26:06

Duty cycle = $1.928 \text{ ms} / 2.056 \text{ ms} = 93.77\%$
 Duty Factor = $10 \log(1/\text{Duty cycle}) = 0.28$

NOTE:

For IEEE 802.11b:

For radiated emissions frequency above 1 GHz, the resolution bandwidth of test receiver/spectrum analyzer is 1 MHz and the video bandwidth is 1 kHz.

For IEEE 802.11g:

For radiated emissions frequency above 1 GHz, the resolution bandwidth of test receiver/spectrum analyzer is 1 MHz and the video bandwidth is 483 Hz.

For IEEE 802.11n(HT20):

For radiated emissions frequency above 1 GHz, the resolution bandwidth of test receiver/spectrum analyzer is 1 MHz and the video bandwidth is 519 Hz.

(Remark: The video bandwidth of the spectrum analyzer was set to 1kHz during the test.)

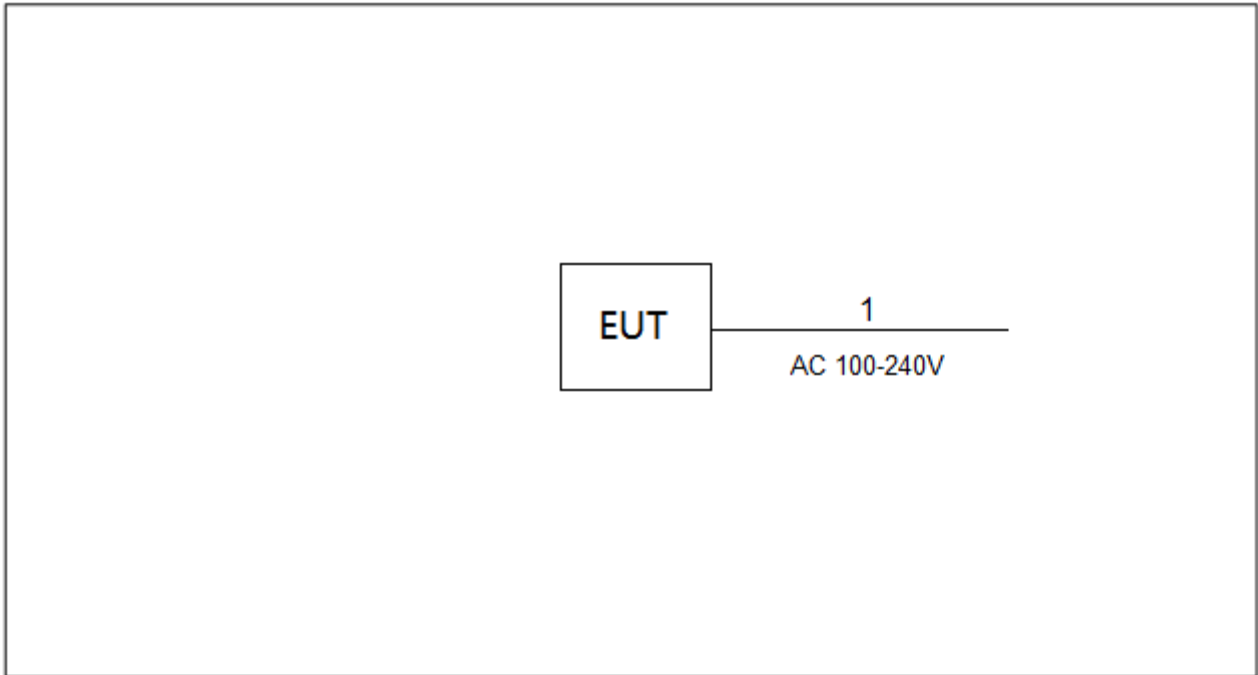
2.5 BLOCK DIAGRAM SHOWING THE CONFIGURATION OF SYSTEM TESTED**2.6 SUPPORT UNITS**

| Item | Equipment | Brand | Model No. | Series No. |
|------|-----------|-------|-----------|------------|
| - | - | - | - | - |

| Item | Cable Type | Shielded Type | Ferrite Core | Length |
|------|------------|---------------|--------------|--------|
| 1 | AC Cable | NO | NO | 1.2m |

3. AC POWER LINE CONDUCTED EMISSIONS

3.1 LIMIT

| Frequency of Emission (MHz) | Limit (dB μ V) | |
|-----------------------------|--------------------|-----------|
| | Quasi-peak | Average |
| 0.15 - 0.5 | 66 to 56* | 56 to 46* |
| 0.5 - 5.0 | 56 | 46 |
| 5.0 - 30.0 | 60 | 50 |

NOTE:

- (1) The tighter limit applies at the band edges.
- (2) The limit of "*" marked band means the limitation decreases linearly with the logarithm of the frequency in the range.

3.2 TEST PROCEDURE

- a. The EUT was placed 0.8 meters from the horizontal ground plane with EUT being connected to the power mains through a line impedance stabilization network (LISN). All other support equipment powered from additional LISN(s). The LISN provide 50 Ohm/ 50uH of coupling impedance for the measuring instrument.
- b. Interconnecting cables that hang closer than 40 cm to the ground plane shall be folded back and forth in the center forming a bundle 30 to 40 cm long.
- c. I/O cables that are not connected to a peripheral shall be bundled in the center. The end of the cable may be terminated, if required, using the correct terminating impedance. The overall length shall not exceed 1 m.
- d. LISN at least 80 cm from nearest part of EUT chassis.
- e. For the actual test configuration, please refer to the related Item -EUT Test Photos.

The following table is the setting of the receiver:

| Receiver Parameters | Setting |
|---------------------|----------|
| Start Frequency | 0.15 MHz |
| Stop Frequency | 30 MHz |
| IF Bandwidth | 9 kHz |

3.3 DEVIATION FROM TEST STANDARD

No deviation.

3.4 TEST SETUP

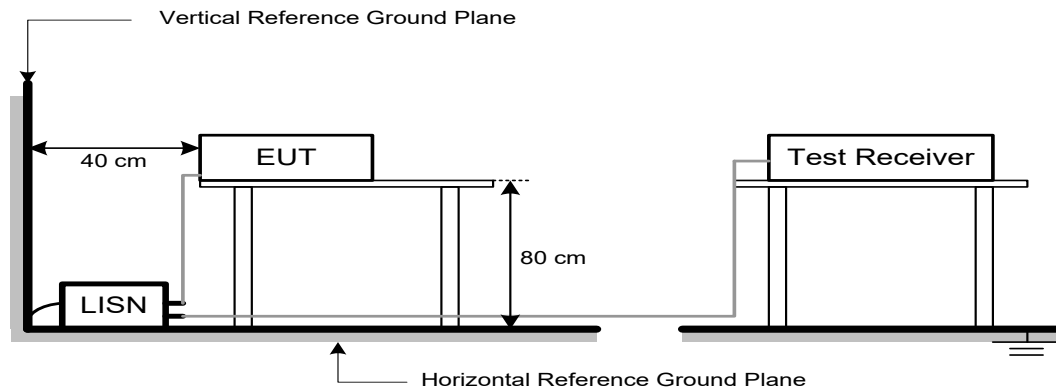

3.5 EUT OPERATION CONDITIONS

EUT was programmed to be in continuously transmitting mode.

3.6 TEST RESULTS

Please refer to the APPENDIX A.

4. RADIATED EMISSIONS

4.1 LIMIT

In case the emission fall within the restricted band specified on 15.205(a), then the 15.209(a) limit in the table below has to be followed.

LIMITS OF RADIATED EMISSION MEASUREMENT (9 kHz-1000 MHz)

| Frequency (MHz) | Field Strength (microvolts/meter) | Measurement Distance (meters) |
|-----------------|-----------------------------------|-------------------------------|
| 0.009-0.490 | 2400/F(kHz) | 300 |
| 0.490-1.705 | 24000/F(kHz) | 30 |
| 1.705-30.0 | 30 | 30 |
| 30-88 | 100 | 3 |
| 88-216 | 150 | 3 |
| 216-960 | 200 | 3 |
| Above 960 | 500 | 3 |

LIMITS OF RADIATED EMISSION MEASUREMENT (Above 1000 MHz)

| Frequency (MHz) | (dBuV/m at 3 m) | |
|-----------------|-----------------|---------|
| | Peak | Average |
| Above 1000 | 74 | 54 |

NOTE:

- (1) The limit for radiated test was performed according to FCC CFR Title 47, Part 15, Subpart C.
- (2) The tighter limit applies at the band edges.
- (3) Emission level (dBuV/m)=20log Emission level (uV/m).

4.2 TEST PROCEDURE

- a. The measuring distance of 3 m shall be used for measurements. The EUT was placed on the top of a rotating table 0.8 meter above the ground at a 3 meter semi-anechoic chamber. The table was rotated 360 degrees to determine the position of the highest radiation.(below 1 GHz)
- b. The measuring distance of 3 m shall be used for measurements. The EUT was placed on the top of a rotating table 1.5 meter above the ground at a 3 meter semi-anechoic chamber. The table was rotated 360 degrees to determine the position of the highest radiation.(above 1 GHz)
- c. The height of the equipment or of the substitution antenna shall be 0.8m or 1.5m; the height of the test antenna shall vary between 1 m to 4 m. Both horizontal and vertical polarizations of the antenna are set to make the measurement.
- d. For each suspected emission, the EUT was arranged to its worst case and then the antenna was tuned to heights find the maximum reading (used Bore sight function).
- e. The receiver system was set to peak and average detect function and specified bandwidth with maximum hold mode when the test frequency is above 1 GHz.
- f. The initial step in collecting radiated emission data is a receiver peak detector mode pre-scanning the measurement frequency range. Significant peaks are then marked and then Quasi Peak detector mode re-measured.
- g. All readings are Peak unless otherwise stated QP in column of Note. Peak denotes that the Peak reading compliance with the QP Limits and then QP Mode measurement didn't perform.
(below 1 GHz)
- h. All readings are Peak Mode value unless otherwise stated AVG in column of Note. If the Peak Mode Measured value compliance with the Peak Limits and lower than AVG Limits, the EUT shall be deemed to meet both Peak & AVG Limits and then only Peak Mode was measured, but AVG Mode didn't perform. (above 1 GHz)
- i. For the actual test configuration, please refer to the related Item -EUT Test Photos.

The following table is the setting of the receiver:

| Spectrum Parameters | Setting |
|------------------------|---------------------------------|
| Start ~ Stop Frequency | 9 kHz~150 kHz for RBW 200 Hz |
| Start ~ Stop Frequency | 0.15 MHz~30 MHz for RBW 9 kHz |
| Start ~ Stop Frequency | 30 MHz~1000 MHz for RBW 100 kHz |

| Spectrum Parameters | Setting |
|--|--|
| Start Frequency | 1000 MHz |
| Stop Frequency | 10th carrier harmonic |
| RBW / VBW (Emission in restricted band) | 1 MHz / 3 MHz for PK value 1 MHz / 1/T Hz for AVG value |

| Receiver Parameters | Setting |
|------------------------|-------------------------------------|
| Start ~ Stop Frequency | 9 kHz~90 kHz for PK/AVG detector |
| Start ~ Stop Frequency | 90 kHz~110 kHz for QP detector |
| Start ~ Stop Frequency | 110 kHz~490 kHz for PK/AVG detector |
| Start ~ Stop Frequency | 490 kHz~30 MHz for QP detector |
| Start ~ Stop Frequency | 30 MHz~1000 MHz for QP detector |
| Start ~ Stop Frequency | 1 GHz~26.5 GHz for PK/AVG detector |

4.3 DEVIATION FROM TEST STANDARD

No deviation.

4.4 TEST SETUP

9 kHz to 30 MHz

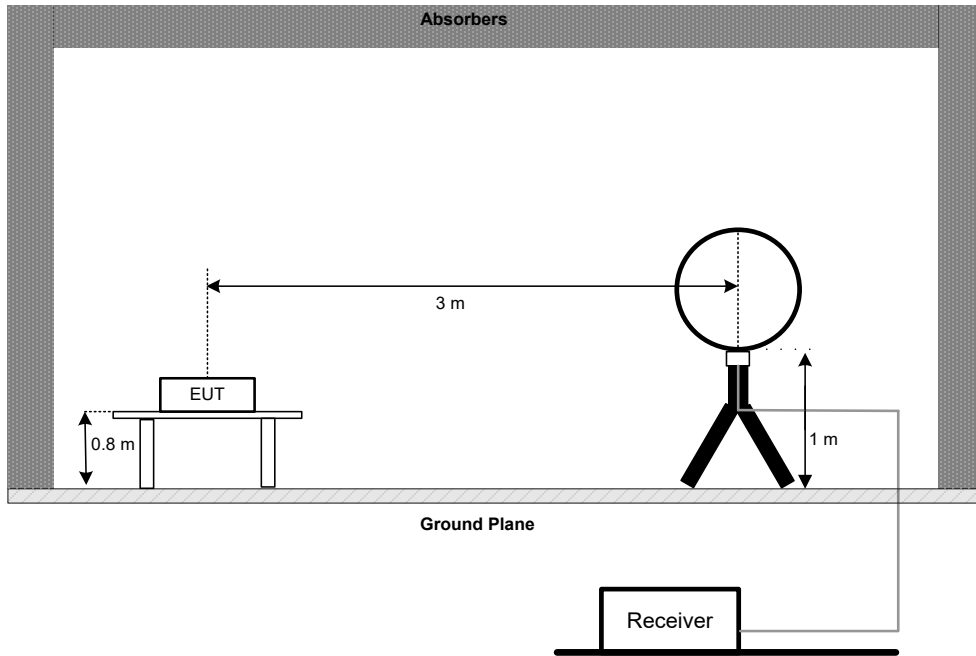

30 MHz to 1 GHz

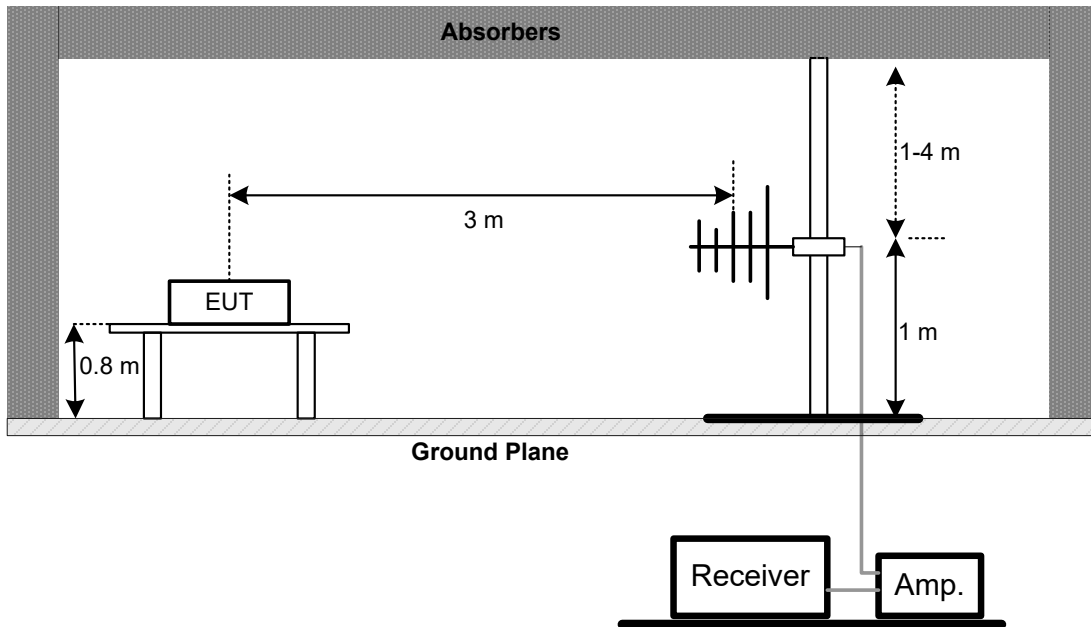

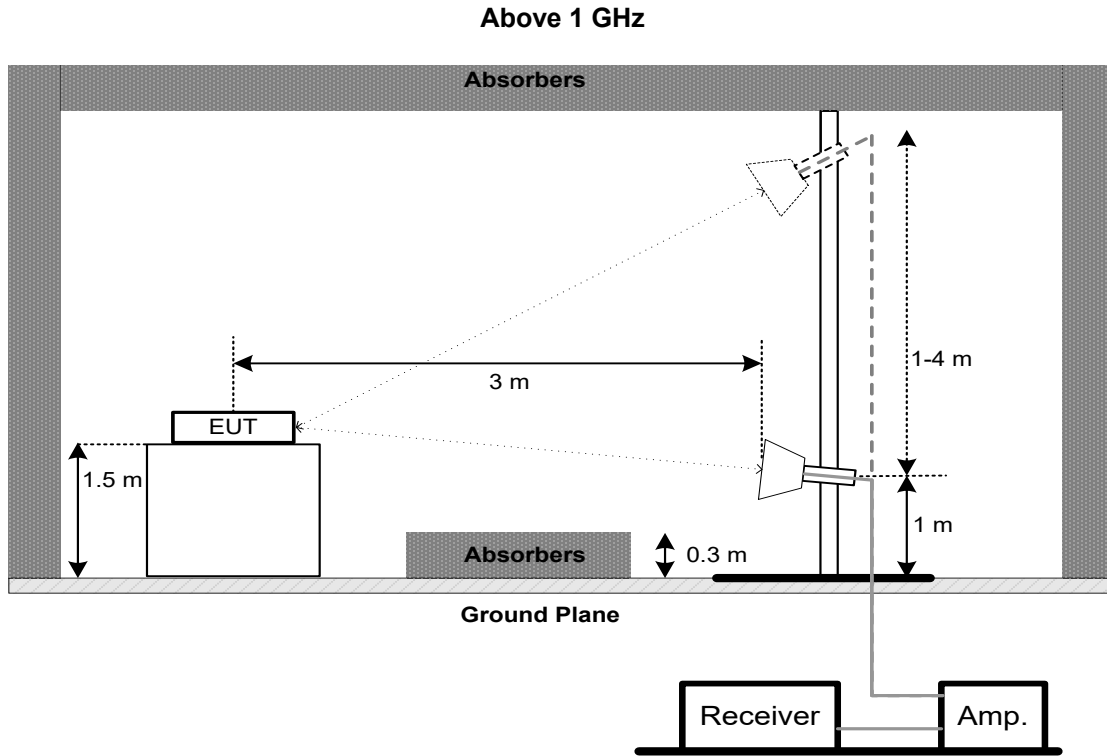

4.5 EUT OPERATION CONDITIONS

The EUT was programmed to be in continuously transmitting mode.

4.6 TEST RESULTS - 9 KHZ TO 30 MHZ

Please refer to the APPENDIX B.

Remark:

- (1) Distance extrapolation factor = $40 \log (\text{specific distance} / \text{test distance})$ (dB).
- (2) Limit line = specific limits (dBuV) + distance extrapolation factor.

4.7 TEST RESULTS - 30 MHZ TO 1000 MHZ

Please refer to the APPENDIX C.

4.8 TEST RESULTS - ABOVE 1000 MHZ

Please refer to the APPENDIX D.

Remark:

- (1) No limit: This is fundamental signal, the judgment is not applicable.
For fundamental signal judgment was referred to Peak output test.

5. BANDWIDTH

5.1 LIMIT

| Section | Test Item | Limit |
|------------------|------------------------|-----------------|
| FCC 15.247(a)(2) | 6 dB Bandwidth | Minimum 500 kHz |
| | 99% Emission Bandwidth | - |

5.2 TEST PROCEDURE

- The EUT was directly connected to the spectrum analyzer and antenna output port as show in the block diagram below.
- The following table is the setting of the spectrum analyzer:

For 6 dB Bandwidth:

| Spectrum Parameters | Setting |
|---------------------|-------------------------|
| Span Frequency | > Measurement Bandwidth |
| RBW | 100 kHz |
| VBW | 300 kHz |
| Detector | Peak |
| Trace | Max Hold |
| Sweep Time | Auto |

For 99% Emission Bandwidth:

| Spectrum Parameters | Setting |
|---------------------|---|
| Span Frequency | Between 1.5 times and 5.0 times the OBW |
| RBW | 300 kHz |
| VBW | 1 MHz |
| Detector | Peak |
| Trace | Max Hold |
| Sweep Time | Auto |

5.3 DEVIATION FROM STANDARD

No deviation.

5.4 TEST SETUP



5.5 EUT OPERATION CONDITIONS

The EUT was programmed to be in continuously transmitting mode.

5.6 TEST RESULTS

Please refer to the APPENDIX E.

6. MAXIMUM AVERAGE OUTPUT POWER

6.1 LIMIT

| Section | Test Item | Limit |
|------------------|------------------------------|--------------------------|
| FCC 15.247(b)(3) | Maximum Average Output Power | 1.0000 Watt or 30.00 dBm |

6.2 TEST PROCEDURE

- The EUT was directly connected to the peak power analyzer and antenna output port as show in the block diagram below.
- The maximum conducted output power was performed in accordance with method 11.9.2.3.1 of ANSI C63.10-2013.

6.3 DEVIATION FROM STANDARD

No deviation.

6.4 TEST SETUP

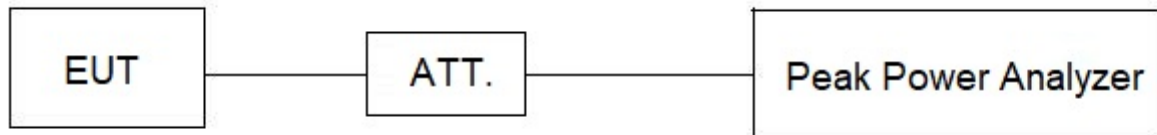

6.5 EUT OPERATION CONDITIONS

The EUT was programmed to be in continuously transmitting mode.

6.6 TEST RESULTS

Please refer to the APPENDIX F.

7. CONDUCTED SPURIOUS EMISSIONS

7.1 LIMIT

In any 100 kHz bandwidth outside the frequency band in which the spread spectrum or digitally modulated intentional radiator is operating, the radio frequency power that is produced by the intentional radiator shall be at least 20 dB below that in the 100 kHz bandwidth within the band that contains the highest level of the desired power, based on either an RF conducted or a radiated measurement, provided the transmitter demonstrates compliance with the peak Output Power limits. If the transmitter complies with the Output Power limits based on the use of RMS averaging over a time interval, as permitted under paragraph (b)(3) of this section, the attenuation required under this paragraph shall be 30 dB instead of 20 dB. Attenuation below the general limits specified in Section 15.209(a) is not required.

7.2 TEST PROCEDURE

- a. The EUT was directly connected to the spectrum analyzer and antenna output port as show in the block diagram below.
- b. The following table is the setting of the spectrum analyzer:

For Reference Level:

| Spectrum Parameters | Setting |
|---------------------|---------------------------------|
| Span Frequency | ≥ 1.5 times the bandwidth. |
| RBW | 100 kHz |
| VBW | 300 kHz |
| Detector | Peak |
| Trace | Max Hold |
| Sweep Time | Auto |

For Emission Level:

| Spectrum Parameters | Setting |
|---------------------|----------|
| Start Frequency | 30 MHz |
| Stop Frequency | 26.5 GHz |
| RBW | 100 kHz |
| VBW | 300 kHz |
| Detector | Peak |
| Trace | Max Hold |
| Sweep Time | Auto |

7.3 DEVIATION FROM STANDARD

No deviation.

7.4 TEST SETUP



7.5 EUT OPERATION CONDITIONS

The EUT was programmed to be in continuously transmitting mode.

7.6 TEST RESULTS

Please refer to the APPENDIX G.

8. POWER SPECTRAL DENSITY

8.1 LIMIT

| Section | Test Item | Limit |
|---------------|------------------------|-------------------------|
| FCC 15.247(e) | Power Spectral Density | 8 dBm (in any 3 kHz) |

8.2 TEST PROCEDURE

- a. The EUT was directly connected to the spectrum analyzer and antenna output port as show in the block diagram below.
- b. The following table is the setting of the spectrum analyzer:

| Spectrum Parameters | Setting |
|---------------------|-----------------------------|
| Span Frequency | 1.5 times the DTS bandwidth |
| RBW | 3 kHz |
| VBW | 10 kHz |
| Detector | Peak |
| Trace | Max Hold |
| Sweep Time | Auto |

8.3 DEVIATION FROM STANDARD

No deviation.

8.4 TEST SETUP

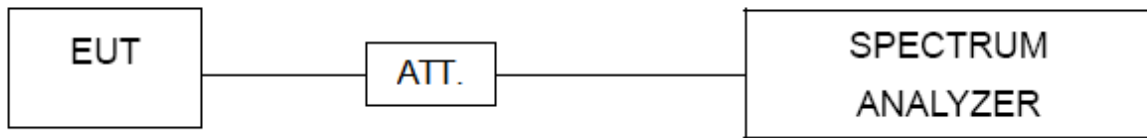

8.5 EUT OPERATION CONDITIONS

The EUT was programmed to be in continuously transmitting mode.

8.6 TEST RESULTS

Please refer to the APPENDIX H.

9. MEASUREMENT INSTRUMENTS LIST

| AC Power Line Conducted Emissions | | | | | |
|-----------------------------------|----------------------|--------------|-----------------------|------------|------------------|
| Item | Kind of Equipment | Manufacturer | Type No. | Serial No. | Calibrated until |
| 1 | EMI Test Receiver | R&S | ESCI | 100382 | Jan. 22, 2023 |
| 2 | LISN | EMCO | 3816/2 | 52765 | Jan. 23, 2023 |
| 3 | TWO-LINE V-NETWORK | R&S | ENV216 | 101447 | Jan. 23, 2023 |
| 4 | 50Ω Terminator | SHX | TF5-3 | 15041305 | N/A |
| 5 | Measurement Software | Farad | EZ-EMC Ver.NB-03A1-01 | N/A | N/A |
| 6 | Cable | N/A | RG223 | 12m | Mar. 08, 2023 |
| 7 | 643 Shield Room | ETS | 6*4*3 | N/A | N/A |

| Radiated Emissions - 9 kHz to 30 MHz | | | | | |
|--------------------------------------|----------------------|--------------|-----------------------|------------|------------------|
| Item | Kind of Equipment | Manufacturer | Type No. | Serial No. | Calibrated until |
| 1 | MXE EMI Receiver | Keysight | N9038A | MY56400091 | Jan. 22, 2023 |
| 2* | Active Loop Antenna | R&S | HFH2-Z2 | 830749/020 | Aug. 23, 2024 |
| 3 | Cable | N/A | RG 213/U(9kHz~1GHz) | N/A | Jul. 09, 2022 |
| 4 | Measurement Software | Farad | EZ-EMC Ver.NB-03A1-01 | N/A | N/A |
| 5 | 966 Chamber Room | ETS | 9*6*6 | N/A | Jul. 17, 2022 |

| Radiated Emissions - 30 MHz to 1 GHz | | | | | |
|--------------------------------------|----------------------|--------------|-----------------------|-------------|------------------|
| Item | Kind of Equipment | Manufacturer | Type No. | Serial No. | Calibrated until |
| 1 | Antenna | Schwarzbeck | VULB9160 | 9160-3232 | Mar. 03, 2023 |
| 2 | Amplifier | HP | 8447D | 2944A08742 | Jan. 22, 2023 |
| 3 | Cable | emci | LMR-400 | N/A | Nov. 30, 2022 |
| 4 | Controller | CT | SC100 | N/A | N/A |
| 5 | Controller | MF | MF-7802 | MF780208416 | N/A |
| 6 | Receiver | Agilent | N9038A | MY52130039 | Jan. 22, 2023 |
| 7 | Measurement Software | Farad | EZ-EMC Ver.NB-03A1-01 | N/A | N/A |
| 8 | 966 Chamber Room | RM | 9*6*6 | N/A | Jul. 24, 2022 |

| Radiated Emissions - Above 1 GHz | | | | | |
|----------------------------------|----------------------------|------------------|-----------------------|-------------|------------------|
| Item | Kind of Equipment | Manufacturer | Type No. | Serial No. | Calibrated until |
| 1 | Double Ridged Horn Antenna | ARA | DRG-118A | 16554 | Apr. 18, 2023 |
| 2 | Broad-Band Horn Antenna | Schwarzbeck | BBHA 9170 | 9170319 | Jun. 30, 2022 |
| 3 | Amplifier | Agilent | 8449B | 3008A02584 | Jul. 10, 2022 |
| 4 | Controller | CT | SC100 | N/A | N/A |
| 5 | Controller | MF | MF-7802 | MF780208416 | N/A |
| 6 | Receiver | Agilent | N9038A | MY52130039 | Jan. 22, 2023 |
| 7 | EXA Spectrum Analyzer | Keysight | N9010A | MY56480488 | Jan. 22, 2023 |
| 8 | Low Noise Amplifier | CONNPHY | CLN-18G40G-4330-K | 619413 | Jul. 16, 2022 |
| 9 | Cable | Talent microwave | A81-SMAMSMAM-12.5M | N/A | Oct. 15, 2022 |
| 10 | Cable | Talent microwave | A40-2.92M2.92M-2.5M | N/A | Nov. 30, 2022 |
| 11 | Filter | STI | STI15-9912 | N/A | Jul. 10, 2022 |
| 12 | Measurement Software | Farad | EZ-EMC Ver.NB-03A1-01 | N/A | N/A |
| 13 | 966 Chamber Room | RM | 9*6*6 | N/A | Jul. 24, 2022 |

| Bandwidth & Conducted Spurious Emissions & Power Spectral Density | | | | | |
|---|-------------------|--------------|----------|------------|------------------|
| Item | Kind of Equipment | Manufacturer | Type No. | Serial No. | Calibrated until |
| 1 | Spectrum Analyzer | R&S | FSP40 | 100185 | Jul. 10, 2022 |
| 2 | Attenuator | WOKEN | 6SM3502 | VAS1214NL | N/A |
| 3 | RF Cable | Tongkaichuan | N/A | N/A | N/A |
| 4 | DC Block | Mini | N/A | N/A | N/A |

| Maximum Average Output Power | | | | | |
|------------------------------|-----------------------|--------------|----------|------------|------------------|
| Item | Kind of Equipment | Manufacturer | Type No. | Serial No. | Calibrated until |
| 1 | Peak Power Analyzer | Keysight | 8990B | MY51000506 | Jul. 10, 2022 |
| 2 | Wideband power sensor | Keysight | N1923A | MY58310004 | Jul. 10, 2022 |
| 3 | Attenuator | WOKEN | 6SM3502 | VAS1214NL | N/A |
| 4 | RF Cable | Tongkaichuan | N/A | N/A | N/A |

Remark: "N/A" denotes no model name, serial no. or calibration specified.

"**" calibration period of equipment list is three year.

Except * item, all calibration period of equipment list is one year.

10. EUT TEST PHOTO**AC Power Line Conducted Emissions Test Photos**

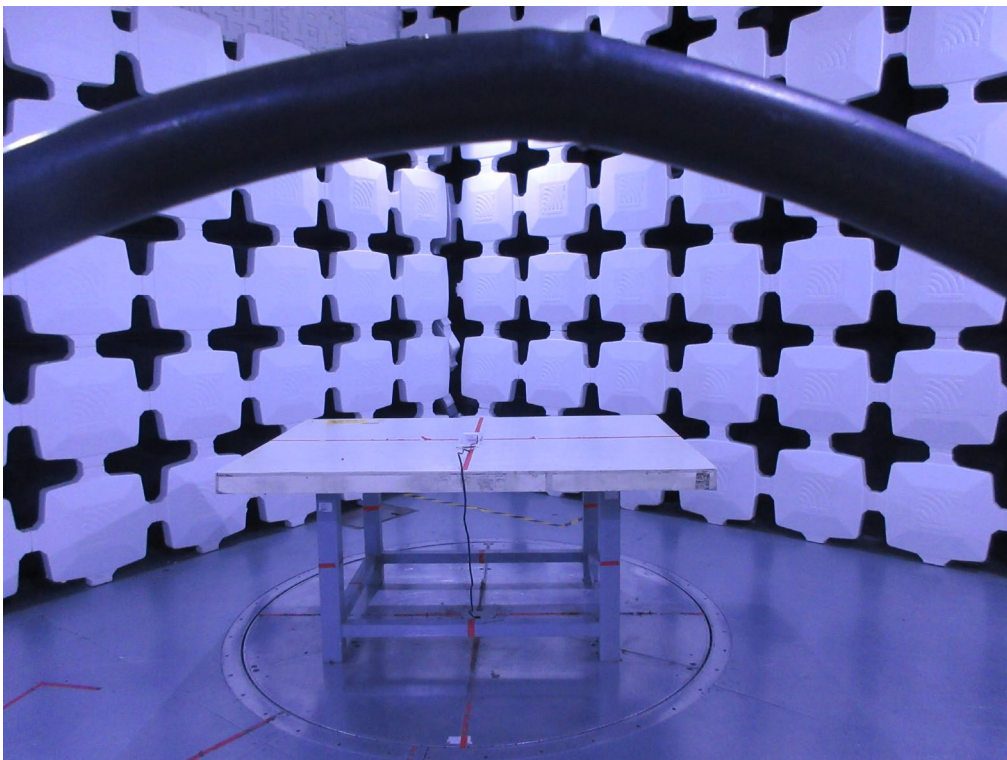
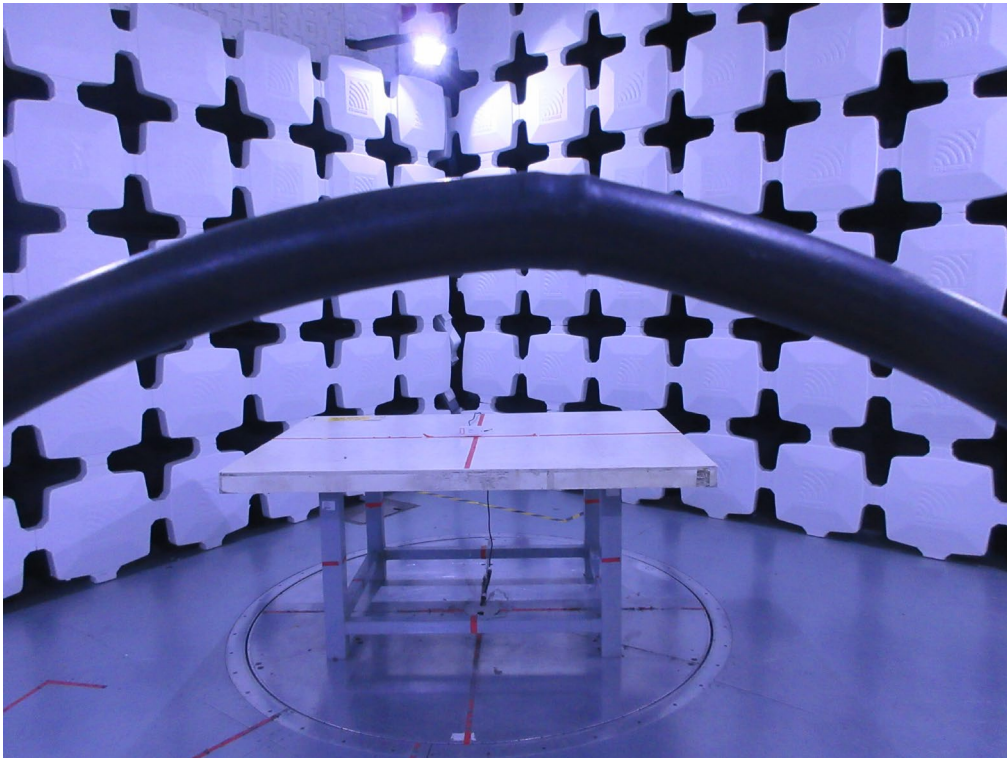
Radiated Emissions Test Photos**9 kHz to 30 MHz**

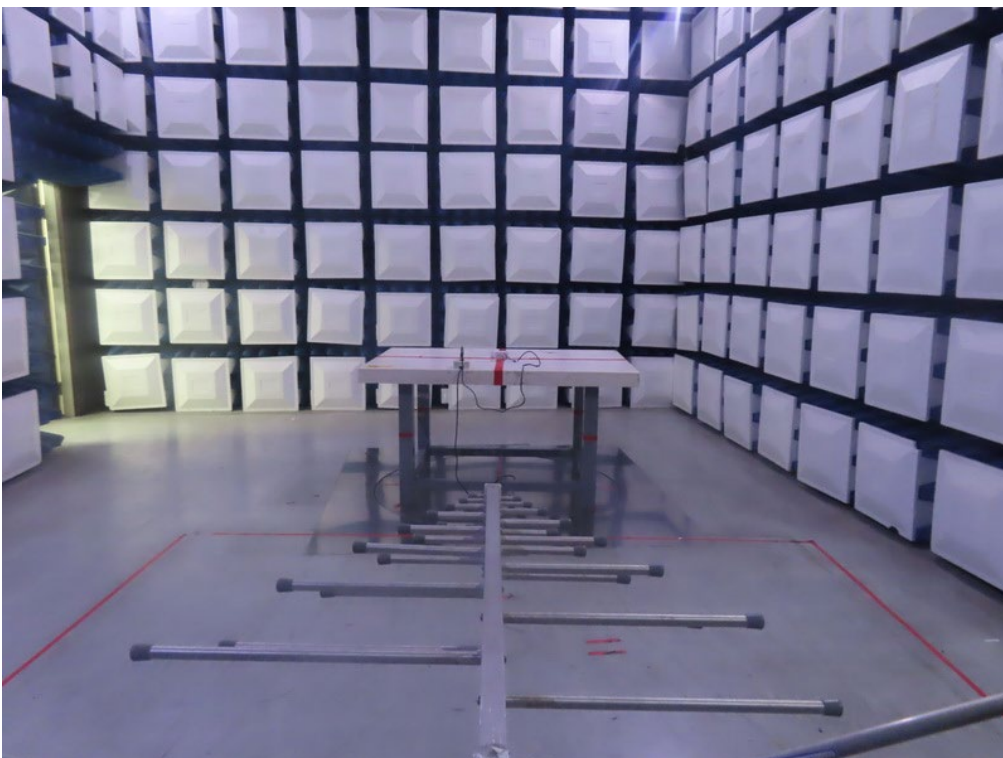
Radiated Emissions Test Photos**30 MHz to 1 GHz**

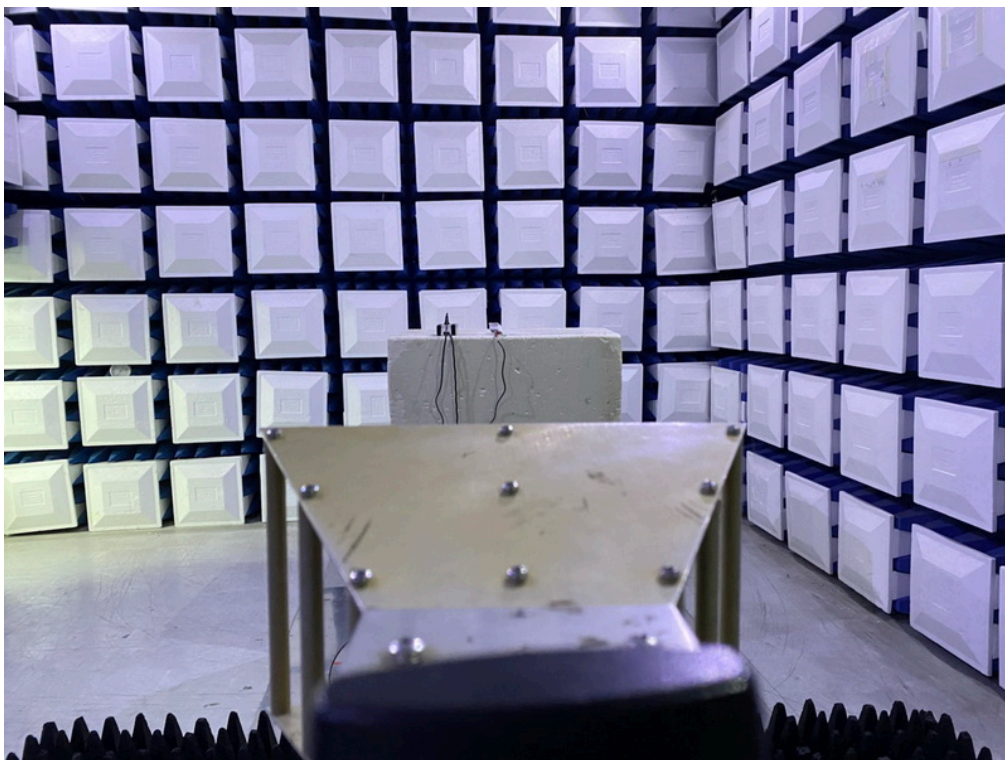
Radiated Emissions Test Photos**Above 1 GHz**

Conducted Test Photos

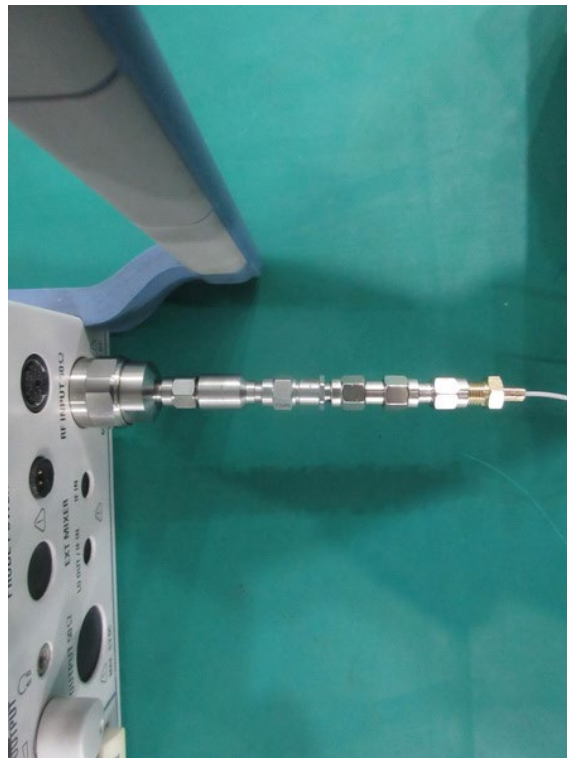

APPENDIX A - AC POWER LINE CONDUCTED EMISSIONS

| | | | |
|-----------|----------------------|-------|------|
| Test Mode | TX B Mode Channel 01 | Phase | Line |
|-----------|----------------------|-------|------|

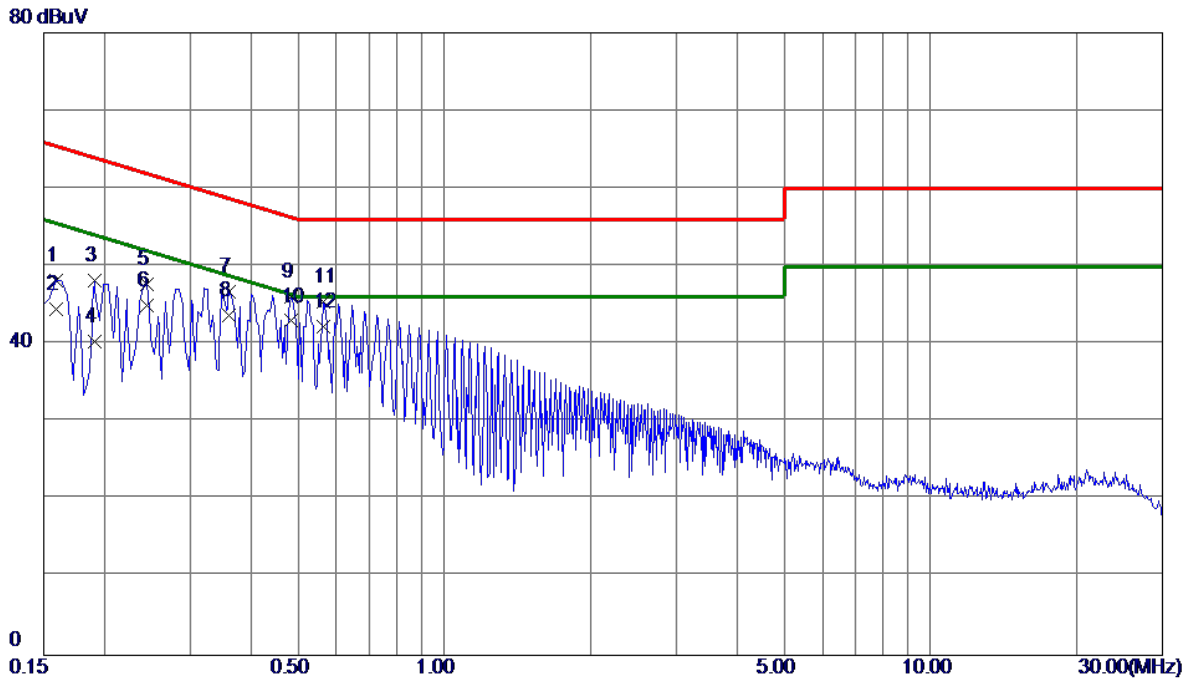

| No. | Freq. MHz | Reading Level dBuV | Correct Factor dB | Measure ment dBuV | Limit dBuV | Margin dB | Detector | Comment |
|------|--------------|--------------------------|-------------------------|-------------------------|---------------|--------------|----------|---------|
| 1 | 0.1590 | 38.51 | 9.66 | 48.17 | 65.52 | -17.35 | QP | |
| 2 | 0.1590 | 34.80 | 9.66 | 44.46 | 55.52 | -11.06 | AVG | |
| 3 | 0.1905 | 38.43 | 9.68 | 48.11 | 64.01 | -15.90 | QP | |
| 4 | 0.1905 | 30.71 | 9.68 | 40.39 | 54.01 | -13.62 | AVG | |
| 5 | 0.2445 | 38.04 | 9.70 | 47.74 | 61.94 | -14.20 | QP | |
| 6 | 0.2445 | 35.30 | 9.70 | 45.00 | 51.94 | -6.94 | AVG | |
| 7 | 0.3615 | 37.05 | 9.74 | 46.79 | 58.69 | -11.90 | QP | |
| 8 | 0.3615 | 34.00 | 9.74 | 43.74 | 48.69 | -4.95 | AVG | |
| 9 | 0.4830 | 36.25 | 9.76 | 46.01 | 56.29 | -10.28 | QP | |
| 10 * | 0.4830 | 33.20 | 9.76 | 42.96 | 46.29 | -3.33 | AVG | |
| 11 | 0.5639 | 35.59 | 9.78 | 45.37 | 56.00 | -10.63 | QP | |
| 12 | 0.5639 | 32.50 | 9.78 | 42.28 | 46.00 | -3.72 | AVG | |

REMARKS:

- (1) Measurement Value = Reading Level + Correct Factor.
- (2) Margin Level = Measurement Value - Limit Value.

| | | | |
|-----------|----------------------|-------|---------|
| Test Mode | TX B Mode Channel 01 | Phase | Neutral |
|-----------|----------------------|-------|---------|

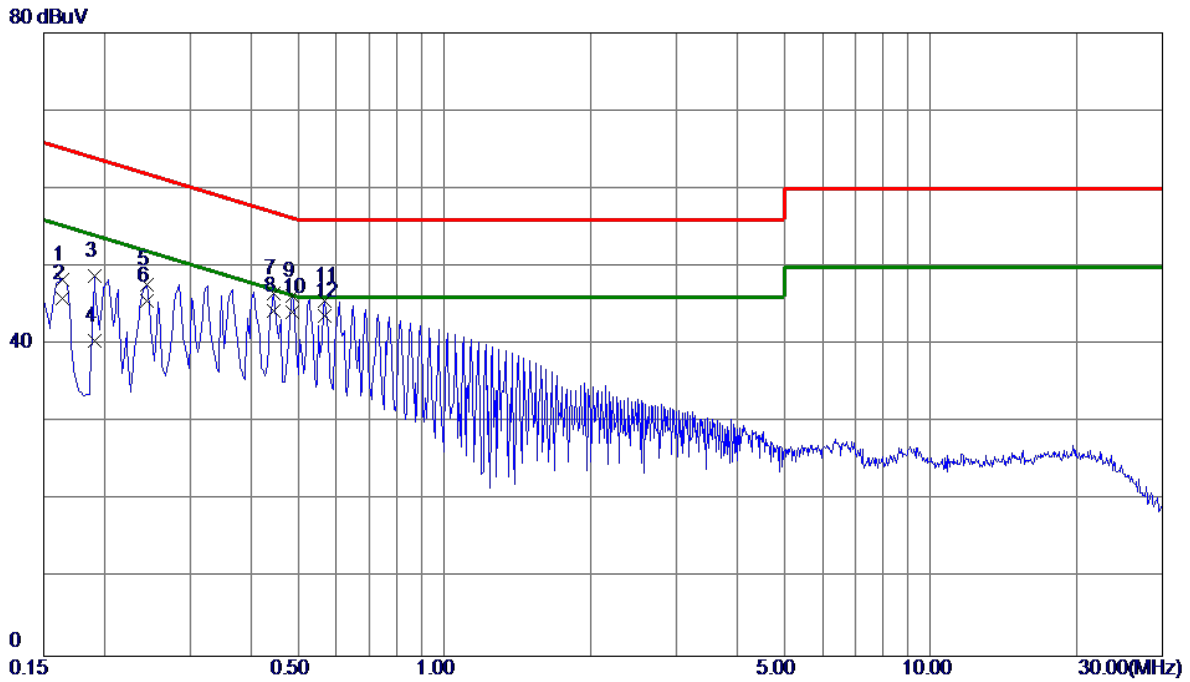

| No. | Freq. MHz | Reading Level dBuV | Correct Factor dB | Measure ment dBuV | Limit dBuV | Margin dB | Detector | Comment |
|------|--------------|--------------------------|-------------------------|-------------------------|---------------|--------------|----------|---------|
| 1 | 0.1635 | 38.66 | 9.71 | 48.37 | 65.28 | -16.91 | QP | |
| 2 | 0.1635 | 36.20 | 9.71 | 45.91 | 55.28 | -9.37 | AVG | |
| 3 | 0.1905 | 39.02 | 9.72 | 48.74 | 64.01 | -15.27 | QP | |
| 4 | 0.1905 | 30.71 | 9.72 | 40.43 | 54.01 | -13.58 | AVG | |
| 5 | 0.2445 | 37.91 | 9.74 | 47.65 | 61.94 | -14.29 | QP | |
| 6 | 0.2445 | 35.80 | 9.74 | 45.54 | 51.94 | -6.40 | AVG | |
| 7 | 0.4470 | 36.71 | 9.79 | 46.50 | 56.93 | -10.43 | QP | |
| 8 | 0.4470 | 34.50 | 9.79 | 44.29 | 46.93 | -2.64 | AVG | |
| 9 | 0.4875 | 36.51 | 9.79 | 46.30 | 56.21 | -9.91 | QP | |
| 10 * | 0.4875 | 34.30 | 9.79 | 44.09 | 46.21 | -2.12 | AVG | |
| 11 | 0.5685 | 35.82 | 9.81 | 45.63 | 56.00 | -10.37 | QP | |
| 12 | 0.5685 | 33.80 | 9.81 | 43.61 | 46.00 | -2.39 | AVG | |

REMARKS:

- (1) Measurement Value = Reading Level + Correct Factor.
- (2) Margin Level = Measurement Value - Limit Value.

APPENDIX B - RADIATED EMISSION - 9 KHZ TO 30 MHZ

| | | | |
|-----------|----------------------|--------------|--------|
| Test Mode | TX B Mode Channel 01 | Polarization | Ant 0° |
|-----------|----------------------|--------------|--------|

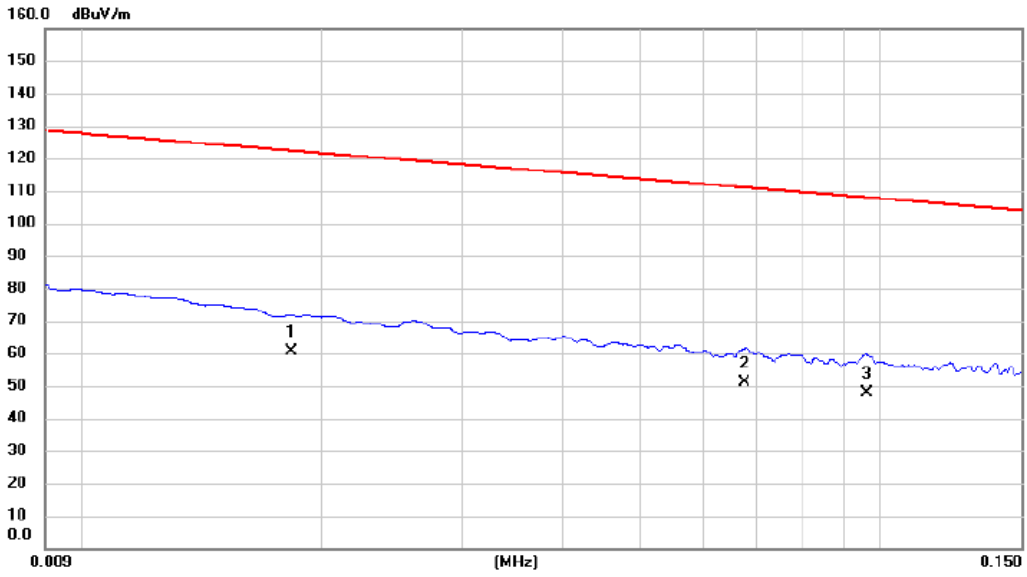

| No. Mk. | Freq. MHz | Reading Level dBuV | Correct Factor dB | Measurement dBuV/m | Limit dBuV/m | Margin dB | Detector | Comment |
|---------|-----------|--------------------|-------------------|--------------------|--------------|-----------|----------|---------|
| 1 | 0.018 | 45.62 | 14.82 | 60.44 | 122.36 | -61.92 | AVG | |
| 2 * | 0.068 | 37.58 | 13.61 | 51.19 | 110.99 | -59.80 | AVG | |
| 3 | 0.096 | 34.12 | 13.77 | 47.89 | 107.96 | -60.07 | QP | |

REMARKS:

- (1) Measurement Value = Reading Level + Correct Factor.
- (2) Margin Level = Measurement Value - Limit Value.

| | | | |
|-----------|----------------------|--------------|--------|
| Test Mode | TX B Mode Channel 01 | Polarization | Ant 0° |
|-----------|----------------------|--------------|--------|

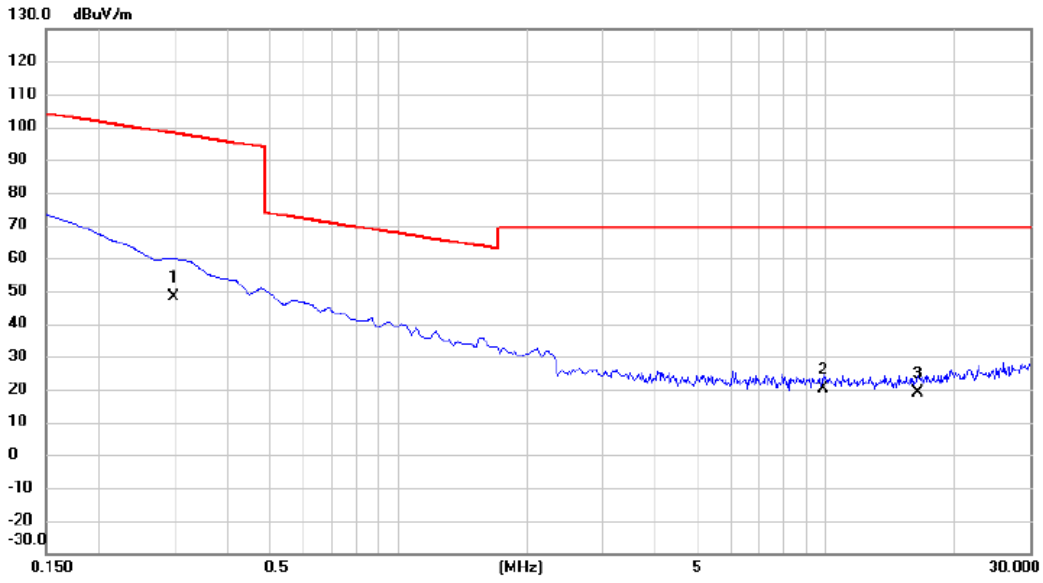

| No. Mk. | Freq. MHz | Reading Level dBuV | Correct Factor dB | Measurement dBuV/m | Limit dBuV/m | Margin dB | Detector | Comment |
|---------|-----------|--------------------|-------------------|--------------------|--------------|-----------|----------|---------|
| 1 | 0.299 | 34.26 | 13.84 | 48.10 | 98.08 | -49.98 | AVG | |
| 2 * | 9.851 | 7.84 | 12.37 | 20.21 | 69.54 | -49.33 | QP | |
| 3 | 16.418 | 6.53 | 12.43 | 18.96 | 69.54 | -50.58 | QP | |

REMARKS:

- (1) Measurement Value = Reading Level + Correct Factor.
- (2) Margin Level = Measurement Value - Limit Value.

| | | | |
|-----------|----------------------|--------------|---------|
| Test Mode | TX B Mode Channel 01 | Polarization | Ant 90° |
|-----------|----------------------|--------------|---------|

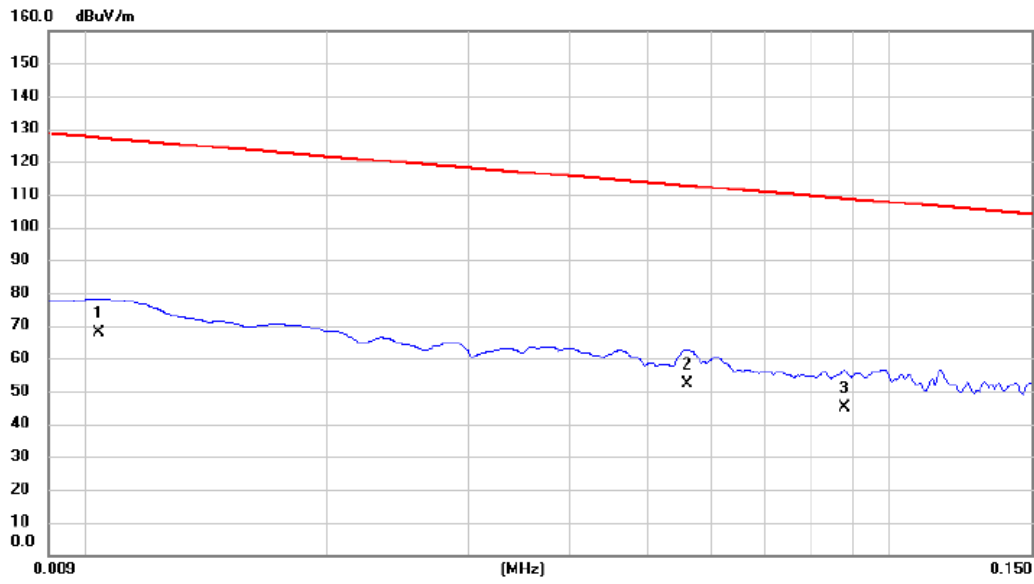

| No. Mk. | Freq. MHz | Reading Level dBuV | Correct Factor dB | Measurement dBuV/m | Limit dBuV/m | Margin dB | Detector | Comment |
|---------|-----------|--------------------|-------------------|--------------------|--------------|-----------|----------|---------|
| 1 * | 0.010 | 50.42 | 17.31 | 67.73 | 127.26 | -59.53 | AVG | |
| 2 | 0.056 | 38.62 | 13.60 | 52.22 | 112.63 | -60.41 | AVG | |
| 3 | 0.088 | 31.47 | 13.65 | 45.12 | 108.73 | -63.61 | AVG | |

REMARKS:

- (1) Measurement Value = Reading Level + Correct Factor.
- (2) Margin Level = Measurement Value - Limit Value.

| | | | |
|-----------|----------------------|--------------|---------|
| Test Mode | TX B Mode Channel 01 | Polarization | Ant 90° |
|-----------|----------------------|--------------|---------|

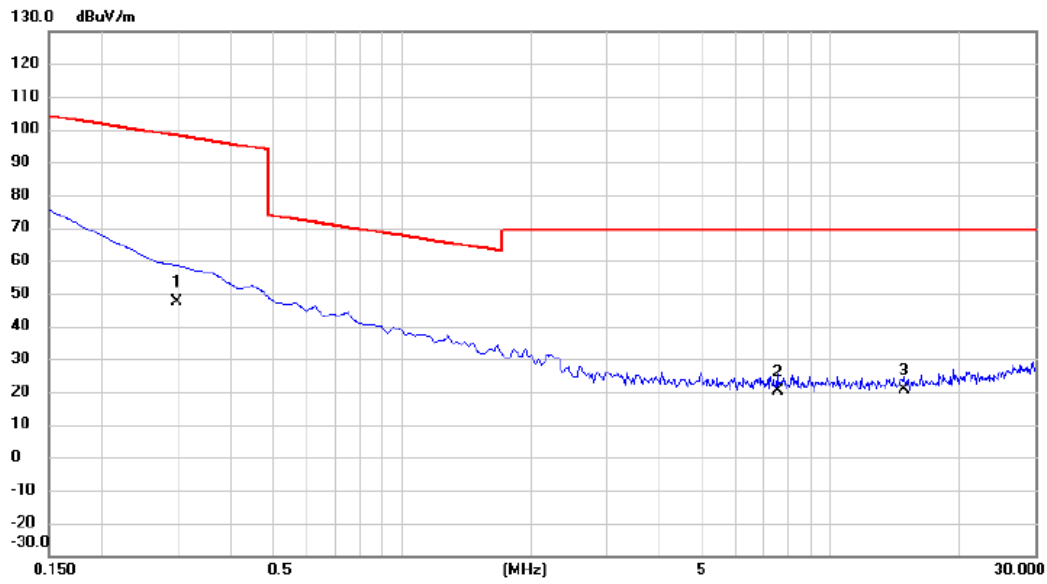

| No. Mk. | Freq. MHz | Reading Level dBuV | Correct Factor dB | Measurement dBuV/m | Limit dBuV/m | Margin dB | Detector | Comment |
|---------|-----------|--------------------|-------------------|--------------------|--------------|-----------|----------|---------|
| 1 | 0.299 | 33.52 | 13.84 | 47.36 | 98.08 | -50.72 | AVG | |
| 2 | 7.523 | 7.64 | 12.41 | 20.05 | 69.54 | -49.49 | QP | |
| 3 * | 14.806 | 8.51 | 12.17 | 20.68 | 69.54 | -48.86 | QP | |

REMARKS:

- (1) Measurement Value = Reading Level + Correct Factor.
- (2) Margin Level = Measurement Value - Limit Value.

APPENDIX C - RADIATED EMISSION - 30 MHZ TO 1000 MHZ

| | | | |
|-----------|----------------------|--------------|----------|
| Test Mode | TX B Mode Channel 01 | Polarization | Vertical |
|-----------|----------------------|--------------|----------|

80 dBuV/m

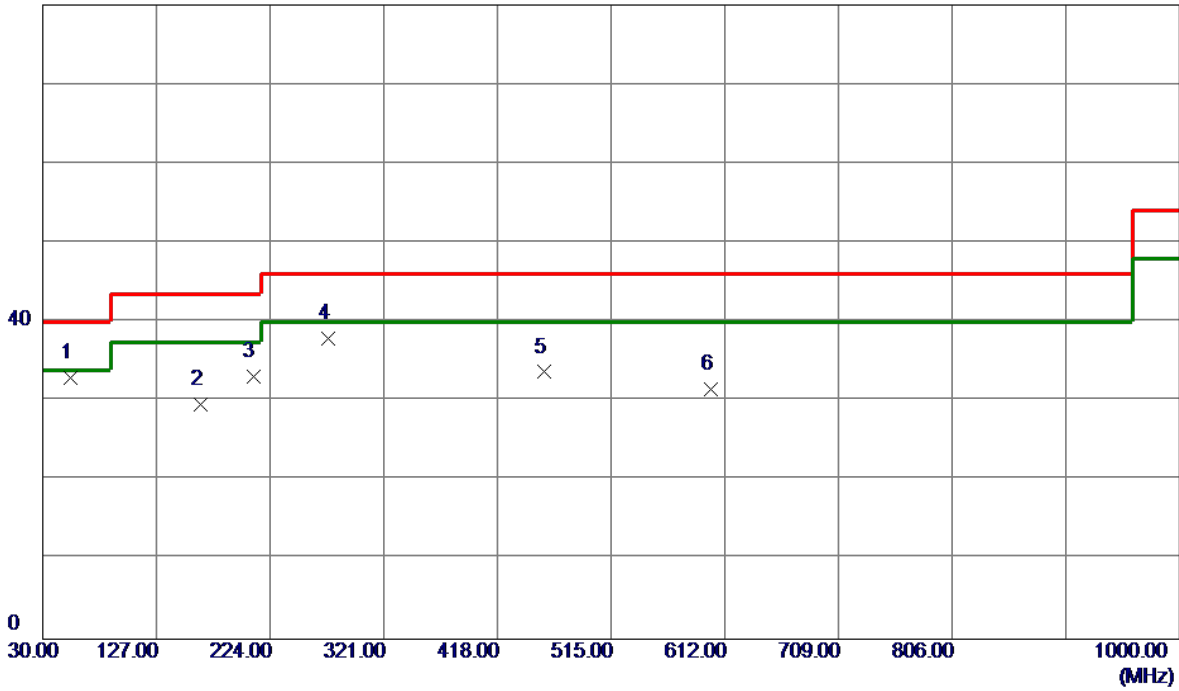

| No. | Freq. MHz | Reading Level dBuV/m | Correct Factor dB | Measurement dBuV/m | Limit dBuV/m | Margin dB | Detector | Comment |
|-----|-----------|----------------------|-------------------|--------------------|--------------|-----------|----------|---------|
| 1 * | 53.2800 | 46.88 | -13.89 | 32.99 | 40.00 | -7.01 | Peak | |
| 2 | 164.8300 | 41.85 | -12.29 | 29.56 | 43.50 | -13.94 | Peak | |
| 3 | 209.4500 | 48.09 | -15.02 | 33.07 | 43.50 | -10.43 | Peak | |
| 4 | 273.4700 | 49.70 | -11.75 | 37.95 | 46.00 | -8.05 | Peak | |
| 5 | 457.7700 | 40.66 | -6.98 | 33.68 | 46.00 | -12.32 | Peak | |
| 6 | 600.3600 | 35.72 | -4.19 | 31.53 | 46.00 | -14.47 | Peak | |

REMARKS:

- (1) Measurement Value = Reading Level + Correct Factor.
- (2) Margin Level = Measurement Value - Limit Value.

| | | | |
|-----------|----------------------|--------------|------------|
| Test Mode | TX B Mode Channel 01 | Polarization | Horizontal |
|-----------|----------------------|--------------|------------|

80 dBuV/m

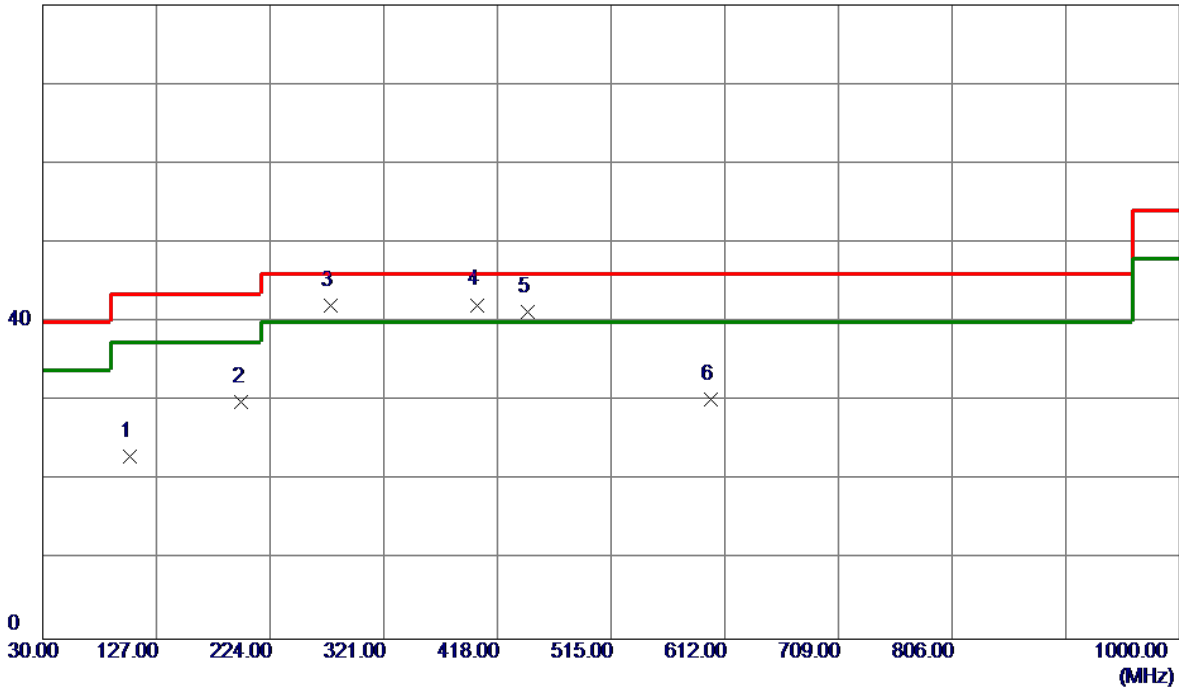

| No. | Freq. MHz | Reading Level dBuV/m | Correct Factor dB | Measure ment dBuV/m | Limit dBuV/m | Margin dB | Detector | Comment |
|-----|--------------|----------------------------|-------------------------|---------------------------|-----------------|--------------|----------|---------|
| 1 | 104.6900 | 38.79 | -15.72 | 23.07 | 43.50 | -20.43 | Peak | |
| 2 | 199.7500 | 45.14 | -15.18 | 29.96 | 43.50 | -13.54 | Peak | |
| 3 | 275.4100 | 53.78 | -11.63 | 42.15 | 46.00 | -3.85 | Peak | |
| 4 * | 400.5400 | 50.64 | -8.48 | 42.16 | 46.00 | -3.84 | Peak | |
| 5 | 444.1900 | 48.51 | -7.28 | 41.23 | 46.00 | -4.77 | Peak | |
| 6 | 600.3600 | 34.39 | -4.19 | 30.20 | 46.00 | -15.80 | Peak | |

REMARKS:

- (1) Measurement Value = Reading Level + Correct Factor.
- (2) Margin Level = Measurement Value - Limit Value.

APPENDIX D - RADIATED EMISSION- ABOVE 1000 MHZ

| | | | |
|-----------|--------------------|--------------|----------|
| Test Mode | TX B Mode 2412 MHz | Polarization | Vertical |
|-----------|--------------------|--------------|----------|

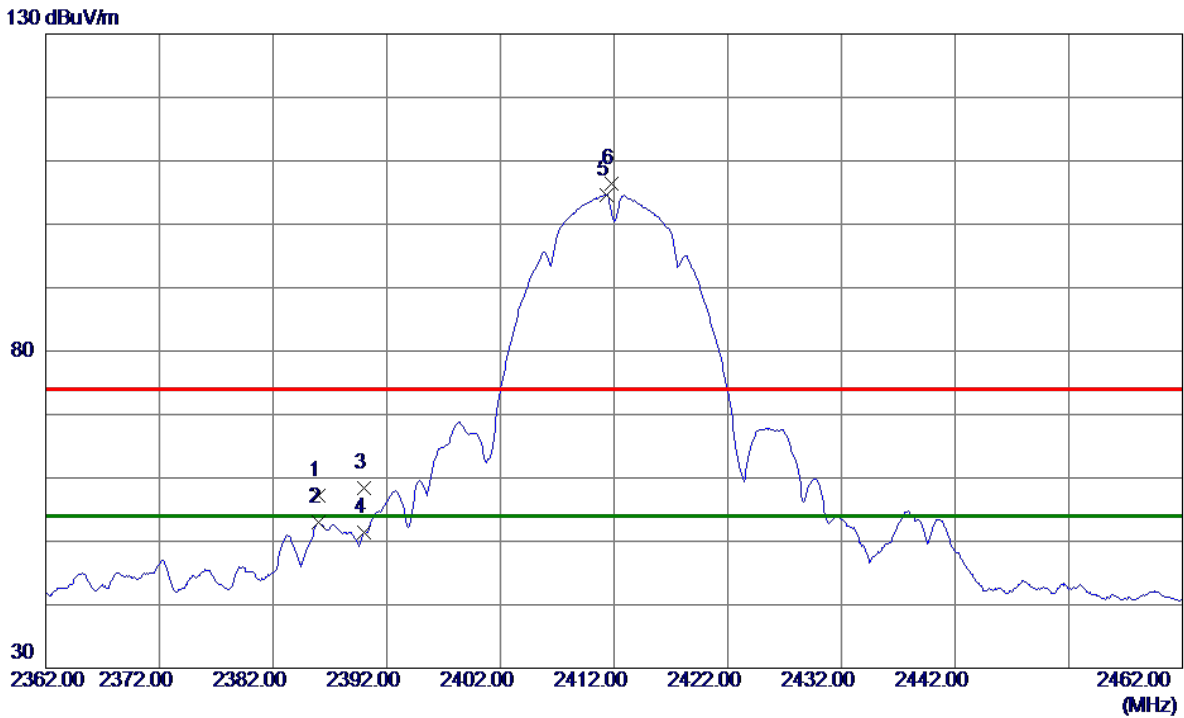

| No. | Freq. MHz | Reading Level dBuV/m | Correct Factor dB | Measure ment dBuV/m | Limit dBuV/m | Margin dB | Detector | Comment |
|-----|--------------|----------------------------|-------------------------|---------------------------|-----------------|--------------|----------|----------|
| 1 | 2386.0000 | 49.26 | 7.97 | 57.23 | 74.00 | -16.77 | Peak | |
| 2 | 2386.0000 | 45.06 | 7.97 | 53.03 | 54.00 | -0.97 | AVG | |
| 3 | 2390.0000 | 50.43 | 7.98 | 58.41 | 74.00 | -15.59 | Peak | |
| 4 | 2390.0000 | 43.46 | 7.98 | 51.44 | 54.00 | -2.56 | AVG | |
| 5 * | 2411.3000 | 96.60 | 8.01 | 104.61 | 54.00 | 50.61 | AVG | No Limit |
| 6 | 2411.8000 | 98.43 | 8.01 | 106.44 | 74.00 | 32.44 | Peak | No Limit |

REMARKS:

- (1) Measurement Value = Reading Level + Correct Factor.
- (2) Margin Level = Measurement Value - Limit Value.

| | | | |
|-----------|--------------------|--------------|------------|
| Test Mode | TX B Mode 2412 MHz | Polarization | Horizontal |
|-----------|--------------------|--------------|------------|

80 dBuV/m

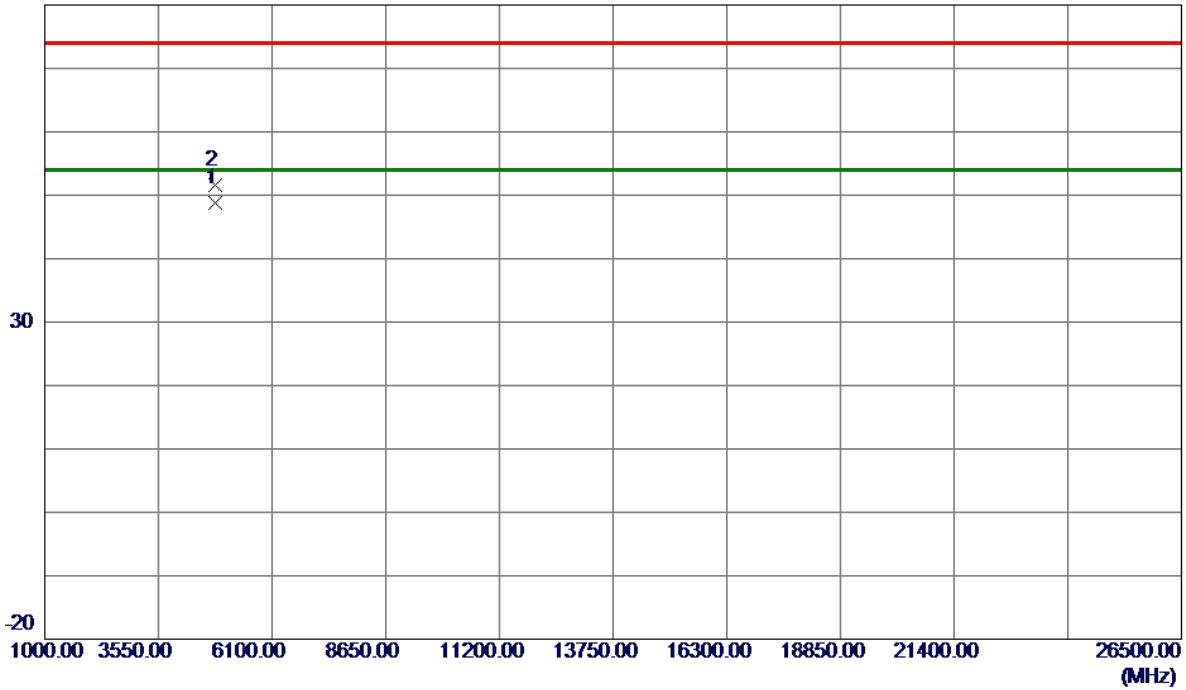

| No. | Freq. MHz | Reading Level dBuV/m | Correct Factor dB | Measure ment dBuV/m | Limit dBuV/m | Margin dB | Detector | Comment |
|-----|--------------|----------------------------|-------------------------|---------------------------|-----------------|--------------|----------|---------|
| 1 * | 4824.0700 | 44.46 | 4.33 | 48.79 | 54.00 | -5.21 | AVG | |
| 2 | 4824.2300 | 47.33 | 4.33 | 51.66 | 74.00 | -22.34 | Peak | |

REMARKS:

- (1) Measurement Value = Reading Level + Correct Factor.
- (2) Margin Level = Measurement Value - Limit Value.

| | | | |
|-----------|--------------------|--------------|----------|
| Test Mode | TX B Mode 2417 MHz | Polarization | Vertical |
|-----------|--------------------|--------------|----------|

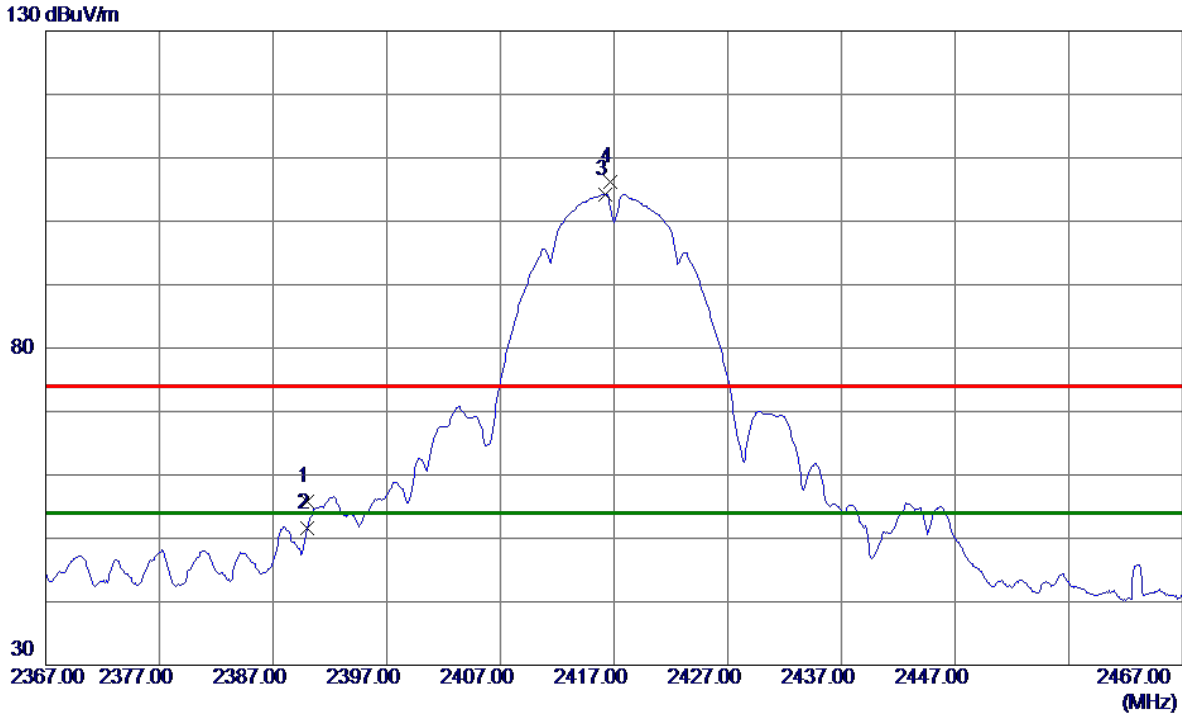

| No. | Freq. MHz | Reading Level dBuV/m | Correct Factor dB | Measure ment dBuV/m | Limit dBuV/m | Margin dB | Detector | Comment |
|-----|--------------|----------------------------|-------------------------|---------------------------|-----------------|--------------|----------|----------|
| 1 | 2390.0000 | 47.86 | 7.98 | 55.84 | 74.00 | -18.16 | Peak | |
| 2 | 2390.0000 | 43.58 | 7.98 | 51.56 | 54.00 | -2.44 | AVG | |
| 3 * | 2416.2000 | 96.19 | 8.02 | 104.21 | 54.00 | 50.21 | AVG | No Limit |
| 4 | 2416.7000 | 98.10 | 8.02 | 106.12 | 74.00 | 32.12 | Peak | No Limit |

REMARKS:

- (1) Measurement Value = Reading Level + Correct Factor.
- (2) Margin Level = Measurement Value - Limit Value.

| | | | |
|-----------|--------------------|--------------|------------|
| Test Mode | TX B Mode 2417 MHz | Polarization | Horizontal |
|-----------|--------------------|--------------|------------|

80 dBuV/m

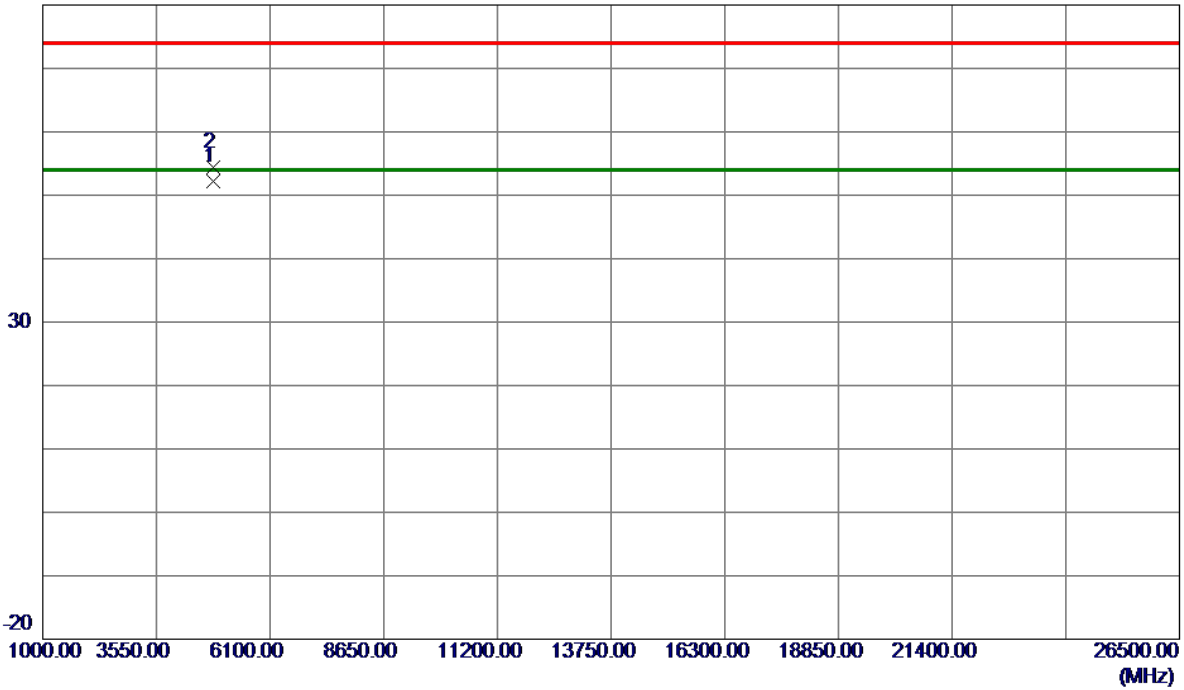

| No. | Freq. MHz | Reading Level dBuV/m | Correct Factor dB | Measure ment dBuV/m | Limit dBuV/m | Margin dB | Detector | Comment |
|-----|--------------|----------------------------|-------------------------|---------------------------|-----------------|--------------|----------|---------|
| 1 * | 4834.0000 | 47.59 | 4.60 | 52.19 | 54.00 | -1.81 | AVG | |
| 2 | 4834.0350 | 49.76 | 4.60 | 54.36 | 74.00 | -19.64 | Peak | |

REMARKS:

- (1) Measurement Value = Reading Level + Correct Factor.
- (2) Margin Level = Measurement Value - Limit Value.

| | | | |
|-----------|--------------------|--------------|----------|
| Test Mode | TX B Mode 2437 MHz | Polarization | Vertical |
|-----------|--------------------|--------------|----------|

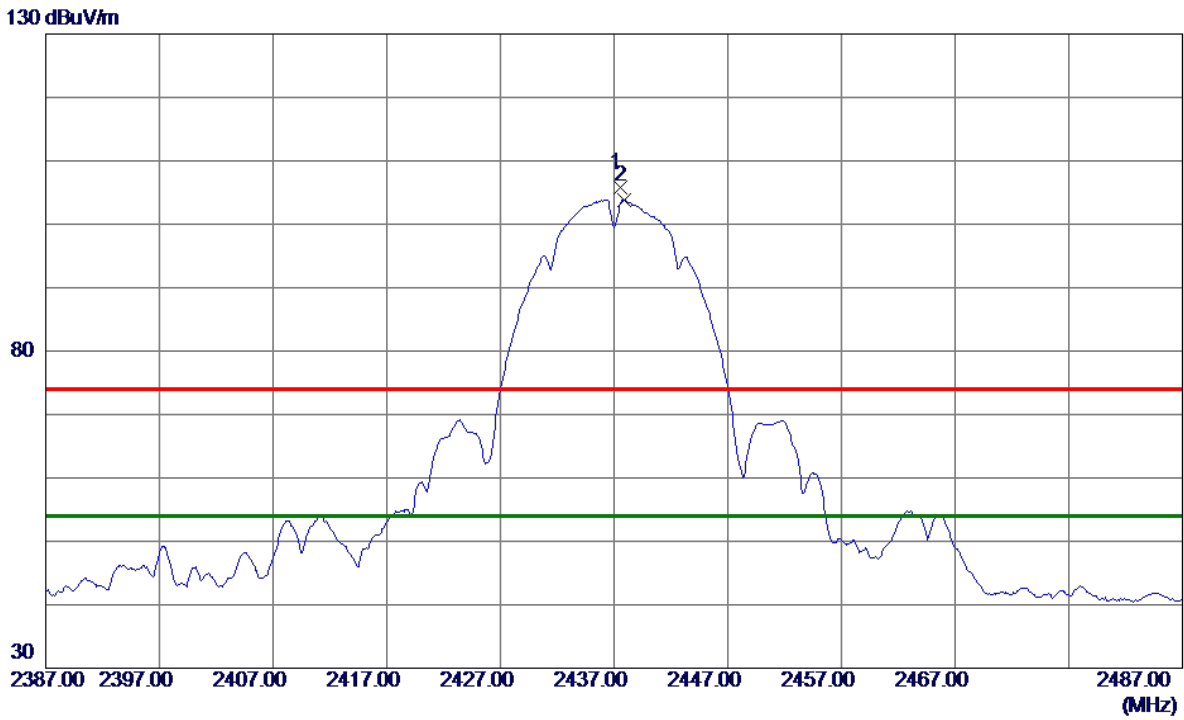

| No. | Freq. MHz | Reading Level dBuV/m | Correct Factor dB | Measure ment dBuV/m | Limit dBuV/m | Margin dB | Detector | Comment |
|-----|--------------|----------------------------|-------------------------|---------------------------|-----------------|--------------|----------|----------|
| 1 | 2437.5000 | 97.78 | 8.06 | 105.84 | 74.00 | 31.84 | Peak | No Limit |
| 2 * | 2437.9000 | 95.80 | 8.06 | 103.86 | 54.00 | 49.86 | AVG | No Limit |

REMARKS:

- (1) Measurement Value = Reading Level + Correct Factor.
- (2) Margin Level = Measurement Value - Limit Value.

| | | | |
|-----------|--------------------|--------------|------------|
| Test Mode | TX B Mode 2437 MHz | Polarization | Horizontal |
|-----------|--------------------|--------------|------------|

80 dBuV/m

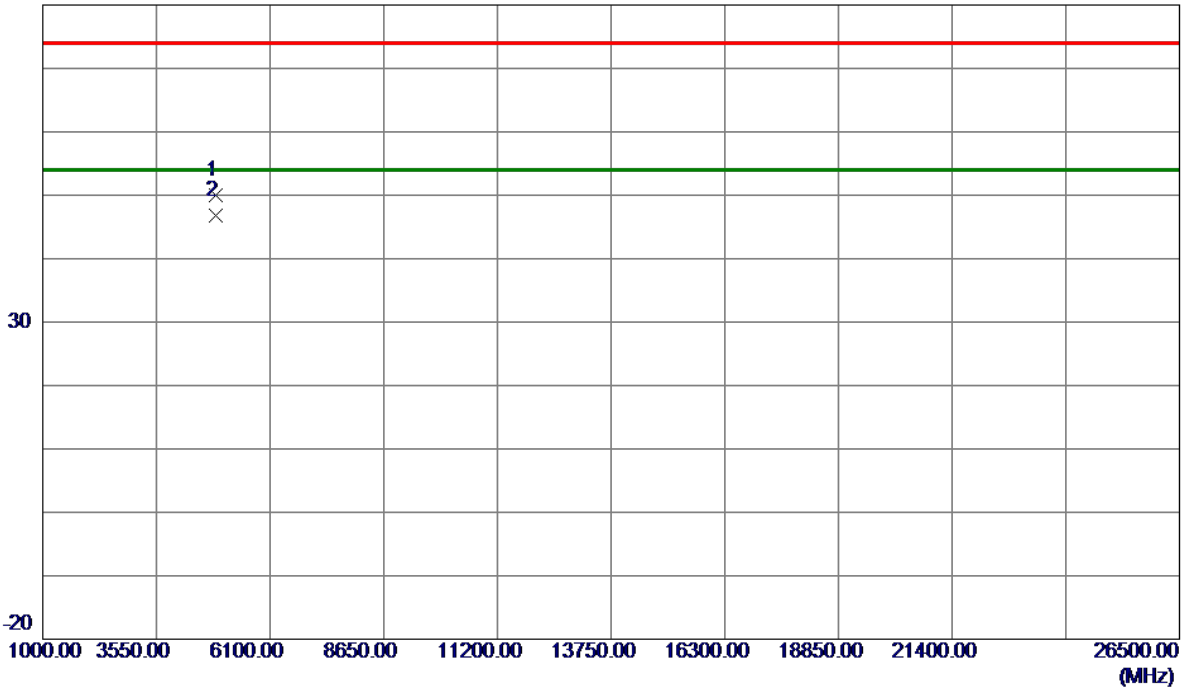

| No. | Freq. MHz | Reading Level dBuV/m | Correct Factor dB | Measure ment dBuV/m | Limit dBuV/m | Margin dB | Detector | Comment |
|-----|--------------|----------------------------|-------------------------|---------------------------|-----------------|--------------|----------|---------|
| 1 | 4874.0299 | 45.63 | 4.41 | 50.04 | 74.00 | -23.96 | Peak | |
| 2 * | 4874.0400 | 42.40 | 4.41 | 46.81 | 54.00 | -7.19 | AVG | |

REMARKS:

- (1) Measurement Value = Reading Level + Correct Factor.
- (2) Margin Level = Measurement Value - Limit Value.

| | | | |
|-----------|--------------------|--------------|----------|
| Test Mode | TX B Mode 2457 MHz | Polarization | Vertical |
|-----------|--------------------|--------------|----------|

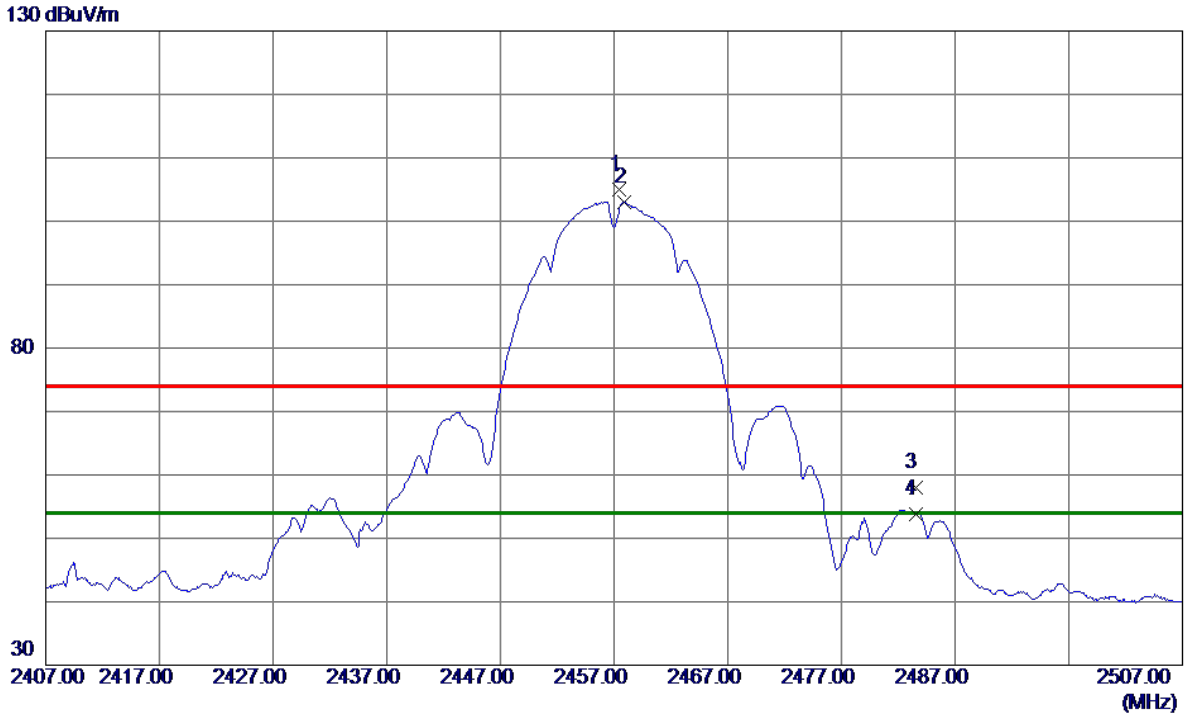

| No. | Freq. MHz | Reading Level dBuV/m | Correct Factor dB | Measure ment dBuV/m | Limit dBuV/m | Margin dB | Detector | Comment |
|-----|--------------|----------------------------|-------------------------|---------------------------|-----------------|--------------|----------|----------|
| 1 | 2457.4000 | 96.93 | 8.09 | 105.02 | 74.00 | 31.02 | Peak | No Limit |
| 2 * | 2457.9000 | 94.95 | 8.09 | 103.04 | 54.00 | 49.04 | AVG | No Limit |
| 3 | 2483.5000 | 49.82 | 8.14 | 57.96 | 74.00 | -16.04 | Peak | |
| 4 | 2483.5000 | 45.75 | 8.14 | 53.89 | 54.00 | -0.11 | AVG | |

REMARKS:

- (1) Measurement Value = Reading Level + Correct Factor.
- (2) Margin Level = Measurement Value - Limit Value.

| | | | |
|-----------|--------------------|--------------|------------|
| Test Mode | TX B Mode 2457 MHz | Polarization | Horizontal |
|-----------|--------------------|--------------|------------|

80 dBuV/m

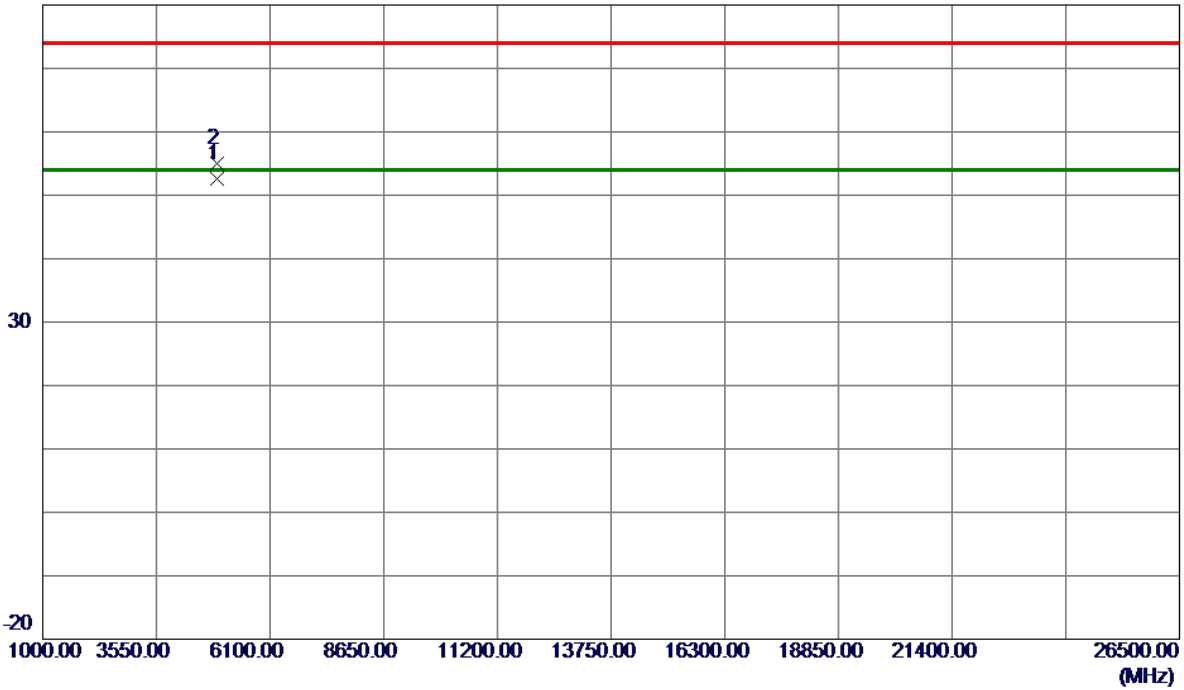

| No. | Freq. MHz | Reading Level dBuV/m | Correct Factor dB | Measure ment dBuV/m | Limit dBuV/m | Margin dB | Detector | Comment |
|-----|--------------|----------------------------|-------------------------|---------------------------|-----------------|--------------|----------|---------|
| 1 * | 4913.9950 | 47.71 | 4.93 | 52.64 | 54.00 | -1.36 | AVG | |
| 2 | 4914.0800 | 49.98 | 4.94 | 54.92 | 74.00 | -19.08 | Peak | |

REMARKS:

- (1) Measurement Value = Reading Level + Correct Factor.
- (2) Margin Level = Measurement Value - Limit Value.

| | | | |
|-----------|--------------------|--------------|----------|
| Test Mode | TX B Mode 2462 MHz | Polarization | Vertical |
|-----------|--------------------|--------------|----------|

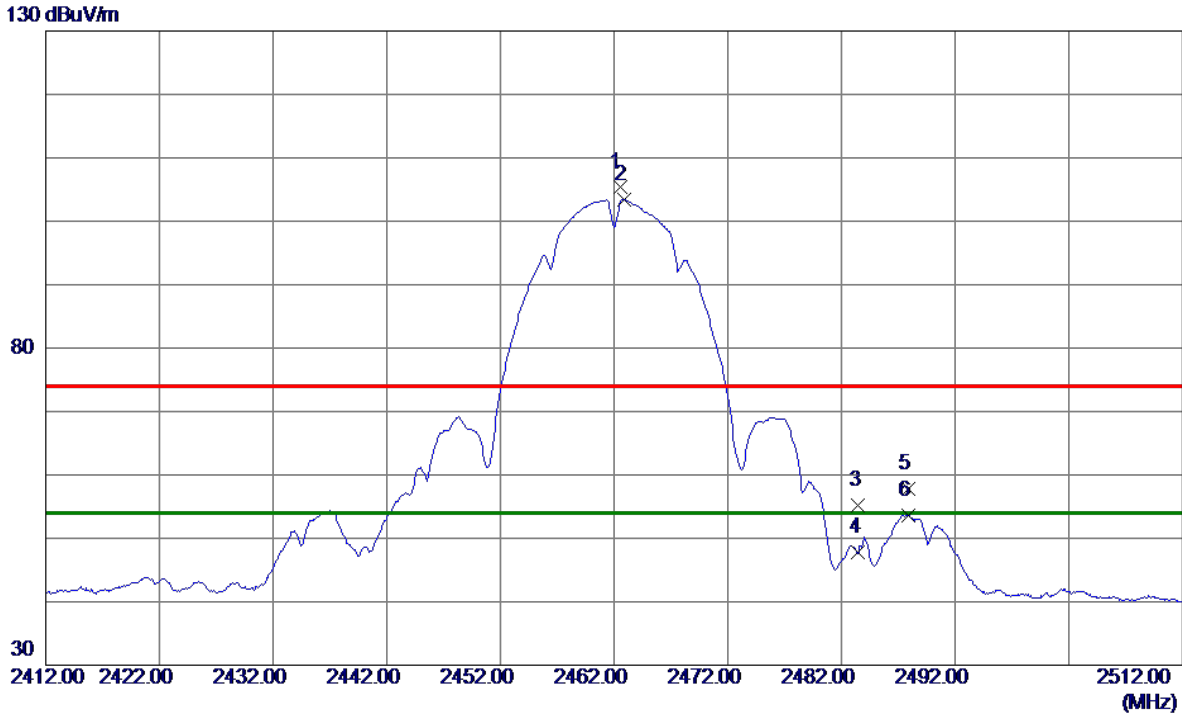

| No. | Freq. MHz | Reading Level dBuV/m | Correct Factor dB | Measure ment dBuV/m | Limit dBuV/m | Margin dB | Detector | Comment |
|-----|--------------|----------------------------|-------------------------|---------------------------|-----------------|--------------|----------|----------|
| 1 | 2462.5000 | 97.34 | 8.10 | 105.44 | 74.00 | 31.44 | Peak | No Limit |
| 2 * | 2462.9000 | 95.36 | 8.10 | 103.46 | 54.00 | 49.46 | AVG | No Limit |
| 3 | 2483.5000 | 46.98 | 8.14 | 55.12 | 74.00 | -18.88 | Peak | |
| 4 | 2483.5000 | 39.73 | 8.14 | 47.87 | 54.00 | -6.13 | AVG | |
| 5 | 2487.9000 | 49.65 | 8.14 | 57.79 | 74.00 | -16.21 | Peak | |
| 6 | 2487.9000 | 45.45 | 8.14 | 53.59 | 54.00 | -0.41 | AVG | |

REMARKS:

- (1) Measurement Value = Reading Level + Correct Factor.
- (2) Margin Level = Measurement Value - Limit Value.

| | | | |
|-----------|--------------------|--------------|------------|
| Test Mode | TX B Mode 2462 MHz | Polarization | Horizontal |
|-----------|--------------------|--------------|------------|

80 dBuV/m

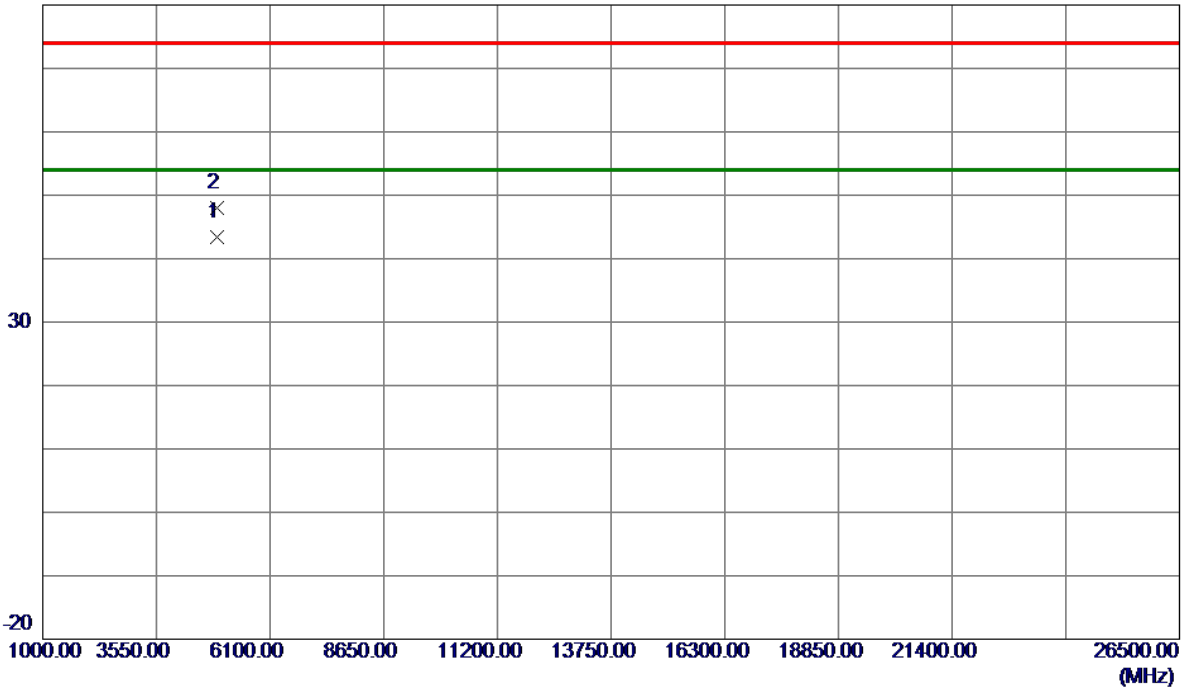

| No. | Freq. MHz | Reading Level dBuV/m | Correct Factor dB | Measure ment dBuV/m | Limit dBuV/m | Margin dB | Detector | Comment |
|-----|--------------|----------------------------|-------------------------|---------------------------|-----------------|--------------|----------|---------|
| 1 * | 4924.0350 | 38.85 | 4.49 | 43.34 | 54.00 | -10.66 | AVG | |
| 2 | 4924.0650 | 43.53 | 4.49 | 48.02 | 74.00 | -25.98 | Peak | |

REMARKS:

- (1) Measurement Value = Reading Level + Correct Factor.
- (2) Margin Level = Measurement Value - Limit Value.

| | | | |
|-----------|--------------------|--------------|----------|
| Test Mode | TX G Mode 2412 MHz | Polarization | Vertical |
|-----------|--------------------|--------------|----------|

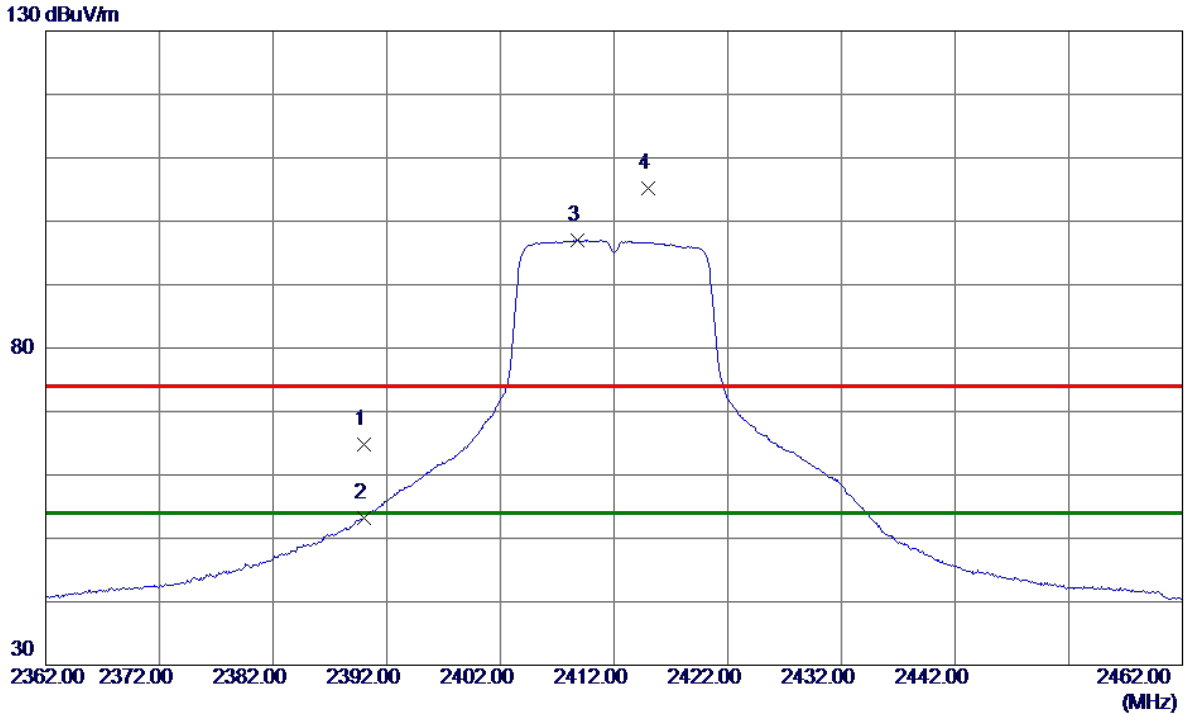

| No. | Freq. MHz | Reading Level dBuV/m | Correct Factor dB | Measure ment dBuV/m | Limit dBuV/m | Margin dB | Detector | Comment |
|-----|--------------|----------------------------|-------------------------|---------------------------|-----------------|--------------|----------|----------|
| 1 | 2390.0000 | 56.81 | 7.98 | 64.79 | 74.00 | -9.21 | Peak | |
| 2 | 2390.0000 | 45.15 | 7.98 | 53.13 | 54.00 | -0.87 | AVG | |
| 3 * | 2408.8000 | 88.95 | 8.01 | 96.96 | 54.00 | 42.96 | AVG | No Limit |
| 4 | 2415.0000 | 97.17 | 8.02 | 105.19 | 74.00 | 31.19 | Peak | No Limit |

REMARKS:

- (1) Measurement Value = Reading Level + Correct Factor.
- (2) Margin Level = Measurement Value - Limit Value.

| | | | |
|-----------|--------------------|--------------|------------|
| Test Mode | TX G Mode 2412 MHz | Polarization | Horizontal |
|-----------|--------------------|--------------|------------|

80 dBuV/m

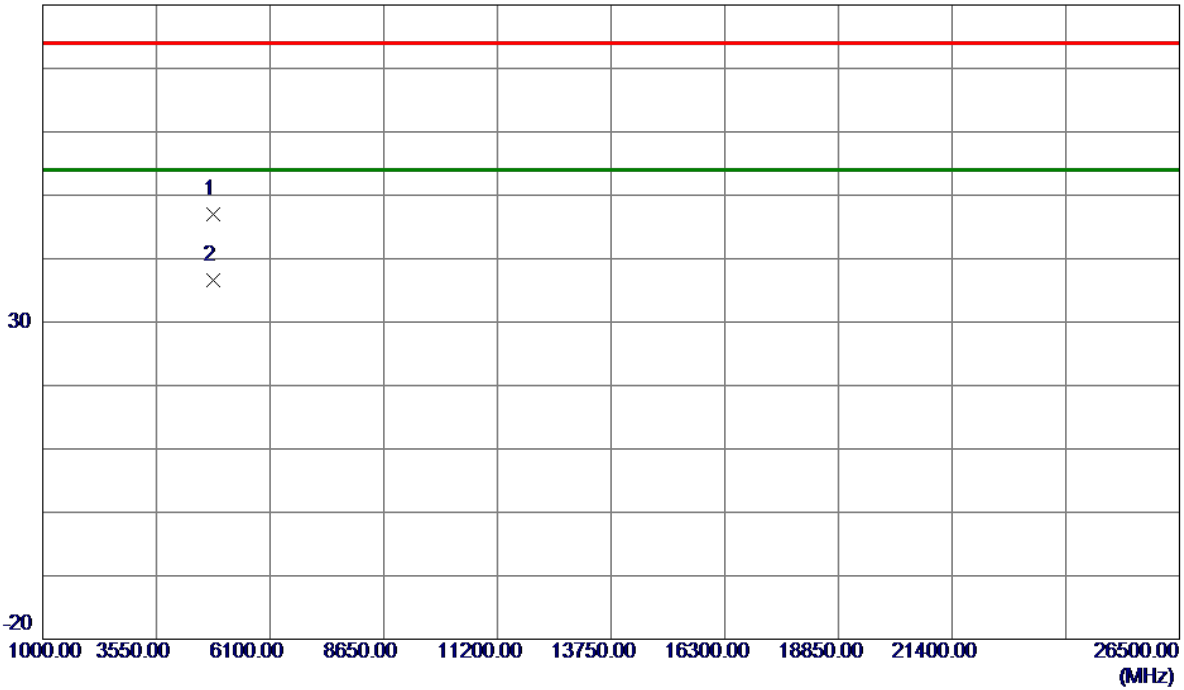

| No. | Freq. MHz | Reading Level dBuV/m | Correct Factor dB | Measure ment dBuV/m | Limit dBuV/m | Margin dB | Detector | Comment |
|-----|--------------|----------------------------|-------------------------|---------------------------|-----------------|--------------|----------|---------|
| 1 | 4819.7500 | 42.70 | 4.32 | 47.02 | 74.00 | -26.98 | Peak | |
| 2 * | 4823.3200 | 32.28 | 4.32 | 36.60 | 54.00 | -17.40 | AVG | |

REMARKS:

- (1) Measurement Value = Reading Level + Correct Factor.
- (2) Margin Level = Measurement Value - Limit Value.

| | | | |
|-----------|--------------------|--------------|----------|
| Test Mode | TX G Mode 2417 MHz | Polarization | Vertical |
|-----------|--------------------|--------------|----------|

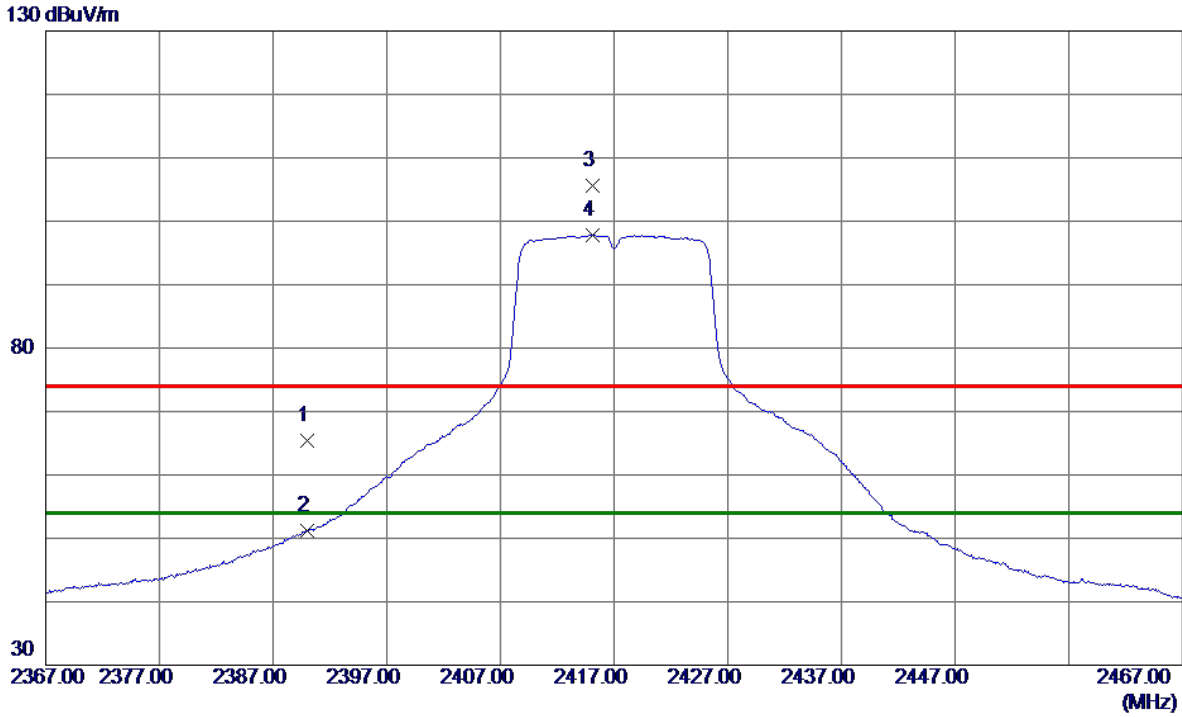

| No. | Freq. MHz | Reading Level dBuV/m | Correct Factor dB | Measurement dBuV/m | Limit dBuV/m | Margin dB | Detector | Comment |
|-----|-----------|----------------------|-------------------|--------------------|--------------|-----------|----------|----------|
| 1 | 2390.0000 | 57.42 | 7.98 | 65.40 | 74.00 | -8.60 | Peak | |
| 2 | 2390.0000 | 43.23 | 7.98 | 51.21 | 54.00 | -2.79 | AVG | |
| 3 | 2415.1000 | 97.59 | 8.02 | 105.61 | 74.00 | 31.61 | Peak | No Limit |
| 4 * | 2415.1000 | 89.84 | 8.02 | 97.86 | 54.00 | 43.86 | AVG | No Limit |

REMARKS:

- (1) Measurement Value = Reading Level + Correct Factor.
- (2) Margin Level = Measurement Value - Limit Value.

| | | | |
|-----------|--------------------|--------------|------------|
| Test Mode | TX G Mode 2417 MHz | Polarization | Horizontal |
|-----------|--------------------|--------------|------------|

80 dBuV/m

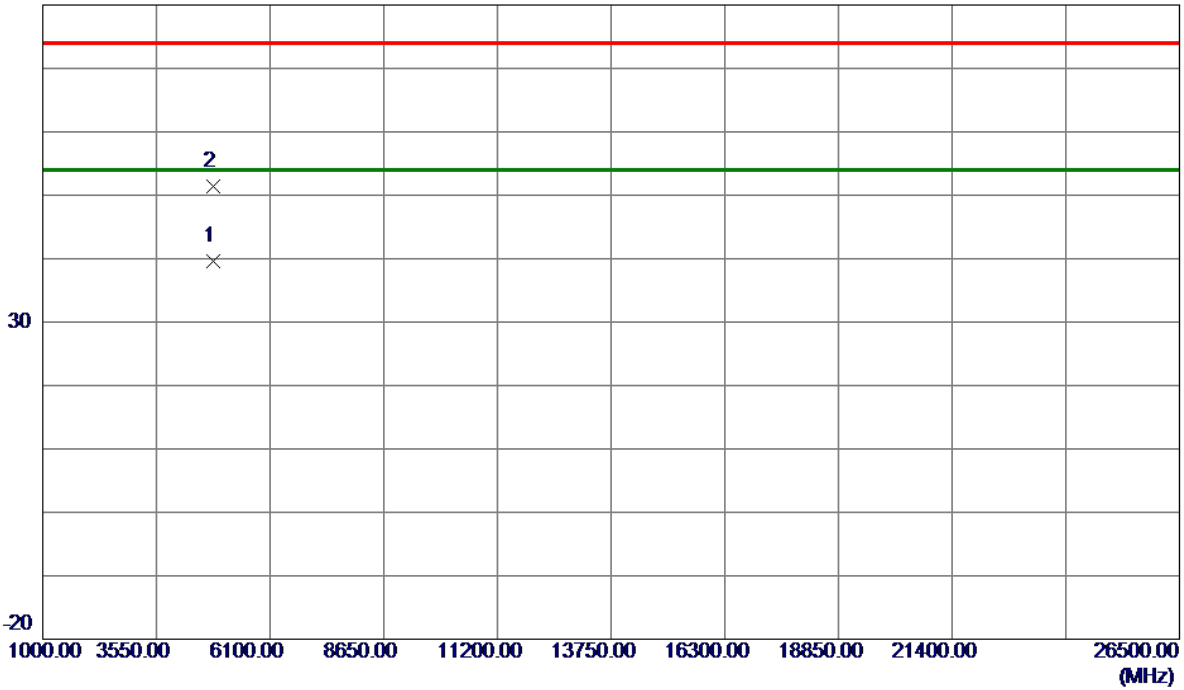

| No. | Freq. MHz | Reading Level dBuV/m | Correct Factor dB | Measure ment dBuV/m | Limit dBuV/m | Margin dB | Detector | Comment |
|-----|--------------|----------------------------|-------------------------|---------------------------|-----------------|--------------|----------|---------|
| 1 * | 4834.7050 | 34.91 | 4.61 | 39.52 | 54.00 | -14.48 | AVG | |
| 2 | 4835.9650 | 46.71 | 4.61 | 51.32 | 74.00 | -22.68 | Peak | |

REMARKS:

- (1) Measurement Value = Reading Level + Correct Factor.
- (2) Margin Level = Measurement Value - Limit Value.

| | | | |
|-----------|--------------------|--------------|----------|
| Test Mode | TX G Mode 2437 MHz | Polarization | Vertical |
|-----------|--------------------|--------------|----------|

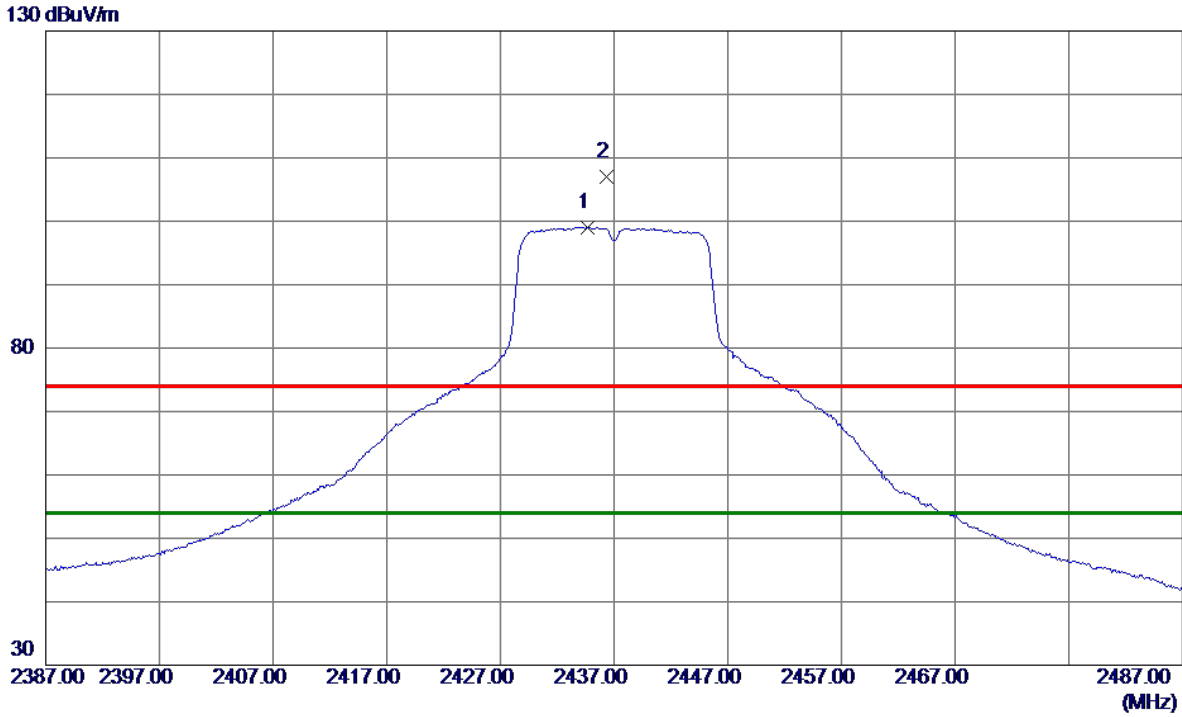

| No. | Freq. MHz | Reading Level dBuV/m | Correct Factor dB | Measure ment dBuV/m | Limit dBuV/m | Margin dB | Detector | Comment |
|-----|--------------|----------------------------|-------------------------|---------------------------|-----------------|--------------|----------|----------|
| 1 * | 2434.7000 | 91.01 | 8.05 | 99.06 | 54.00 | 45.06 | AVG | No Limit |
| 2 | 2436.3000 | 98.98 | 8.06 | 107.04 | 74.00 | 33.04 | Peak | No Limit |

REMARKS:

(1) Measurement Value = Reading Level + Correct Factor.

(2) Margin Level = Measurement Value - Limit Value.

| | | | |
|-----------|--------------------|--------------|------------|
| Test Mode | TX G Mode 2437 MHz | Polarization | Horizontal |
|-----------|--------------------|--------------|------------|

80 dBuV/m

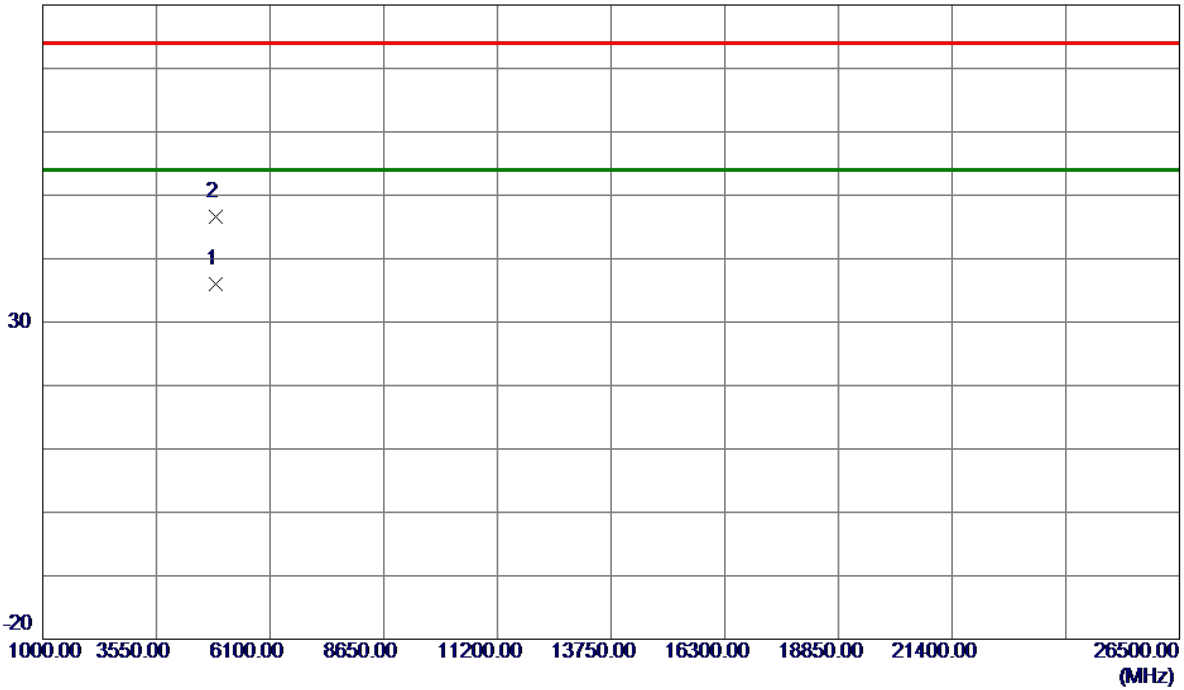

| No. | Freq. MHz | Reading Level dBuV/m | Correct Factor dB | Measure ment dBuV/m | Limit dBuV/m | Margin dB | Detector | Comment |
|-----|--------------|----------------------------|-------------------------|---------------------------|-----------------|--------------|----------|---------|
| 1 * | 4874.4200 | 31.66 | 4.41 | 36.07 | 54.00 | -17.93 | AVG | |
| 2 | 4874.9200 | 42.19 | 4.41 | 46.60 | 74.00 | -27.40 | Peak | |

REMARKS:

- (1) Measurement Value = Reading Level + Correct Factor.
- (2) Margin Level = Measurement Value - Limit Value.

| | | | |
|-----------|--------------------|--------------|----------|
| Test Mode | TX G Mode 2457 MHz | Polarization | Vertical |
|-----------|--------------------|--------------|----------|

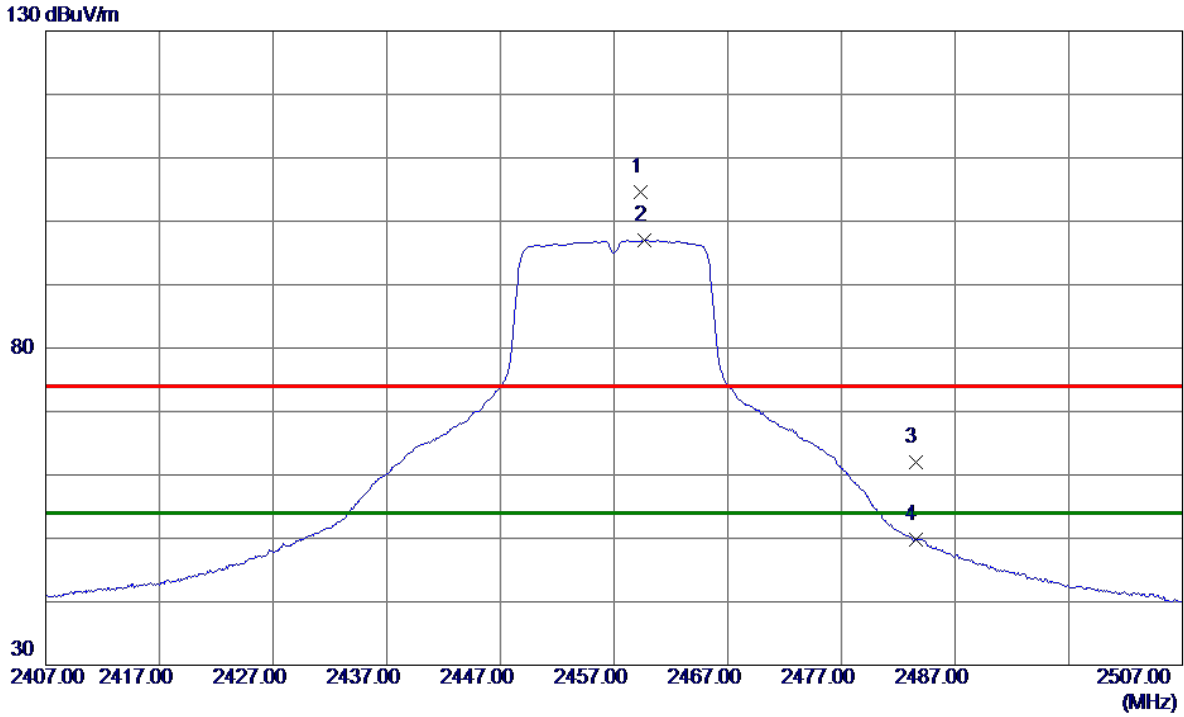

| No. | Freq. MHz | Reading Level dBuV/m | Correct Factor dB | Measure ment dBuV/m | Limit dBuV/m | Margin dB | Detector | Comment |
|-----|--------------|----------------------------|-------------------------|---------------------------|-----------------|--------------|----------|----------|
| 1 | 2459.3000 | 96.46 | 8.10 | 104.56 | 74.00 | 30.56 | Peak | No Limit |
| 2 * | 2459.7000 | 88.86 | 8.10 | 96.96 | 54.00 | 42.96 | AVG | No Limit |
| 3 | 2483.5000 | 53.93 | 8.14 | 62.07 | 74.00 | -11.93 | Peak | |
| 4 | 2483.5000 | 41.63 | 8.14 | 49.77 | 54.00 | -4.23 | AVG | |

REMARKS:

- (1) Measurement Value = Reading Level + Correct Factor.
- (2) Margin Level = Measurement Value - Limit Value.

| | | | |
|-----------|--------------------|--------------|------------|
| Test Mode | TX G Mode 2457 MHz | Polarization | Horizontal |
|-----------|--------------------|--------------|------------|

80 dBuV/m

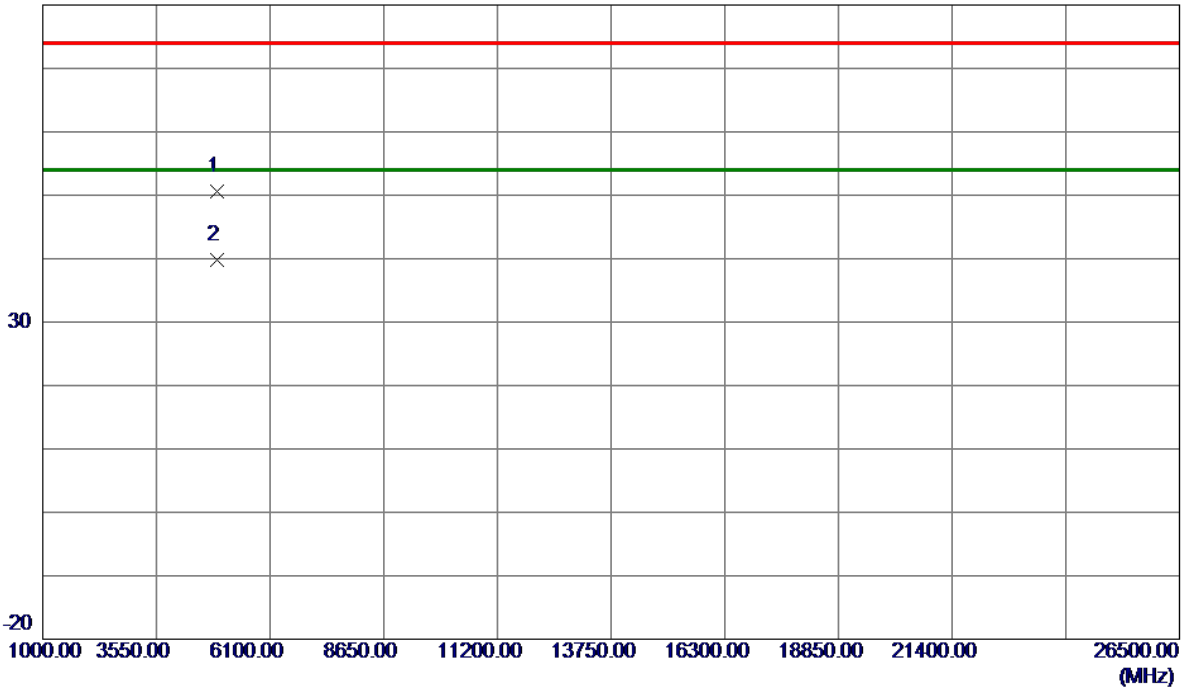

| No. | Freq. MHz | Reading Level dBuV/m | Correct Factor dB | Measure ment dBuV/m | Limit dBuV/m | Margin dB | Detector | Comment |
|-----|--------------|----------------------------|-------------------------|---------------------------|-----------------|--------------|----------|---------|
| 1 | 4916.0650 | 45.67 | 4.94 | 50.61 | 74.00 | -23.39 | Peak | |
| 2 * | 4916.2850 | 34.94 | 4.94 | 39.88 | 54.00 | -14.12 | AVG | |

REMARKS:

- (1) Measurement Value = Reading Level + Correct Factor.
- (2) Margin Level = Measurement Value - Limit Value.

| | | | |
|-----------|--------------------|--------------|----------|
| Test Mode | TX G Mode 2462 MHz | Polarization | Vertical |
|-----------|--------------------|--------------|----------|

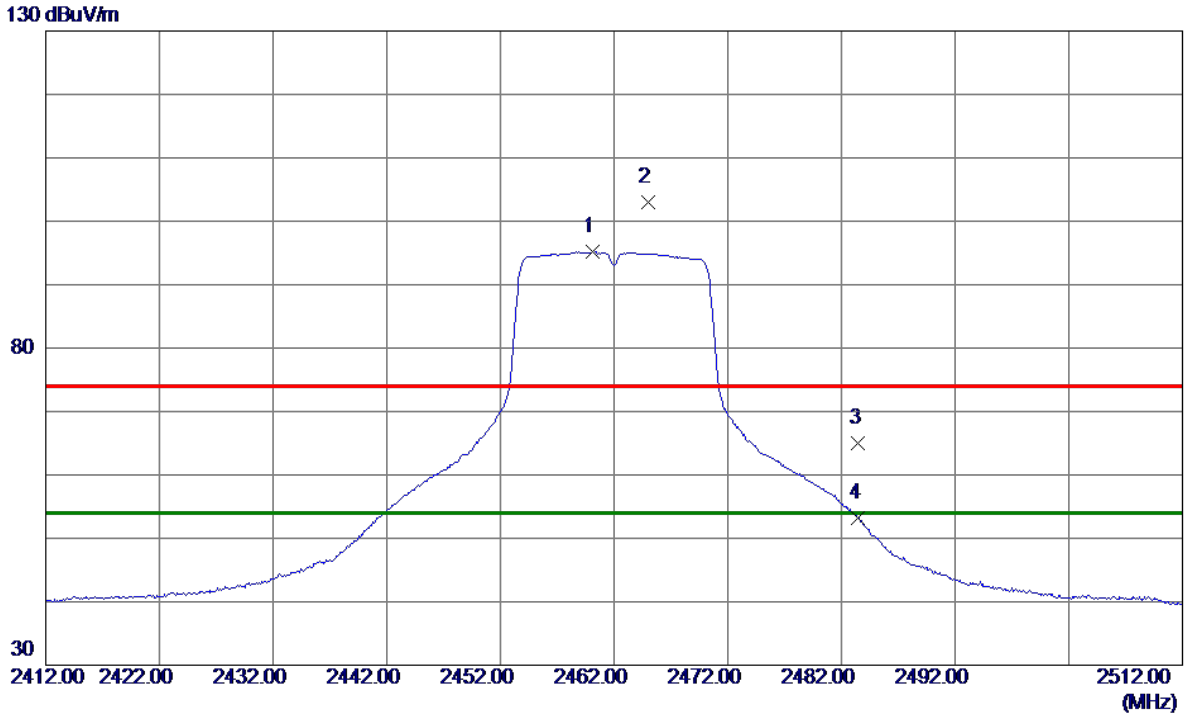

| No. | Freq. MHz | Reading Level dBuV/m | Correct Factor dB | Measure ment dBuV/m | Limit dBuV/m | Margin dB | Detector | Comment |
|-----|--------------|----------------------------|-------------------------|---------------------------|-----------------|--------------|----------|----------|
| 1 * | 2460.1000 | 87.06 | 8.10 | 95.16 | 54.00 | 41.16 | AVG | No Limit |
| 2 | 2465.0000 | 94.89 | 8.11 | 103.00 | 74.00 | 29.00 | Peak | No Limit |
| 3 | 2483.5000 | 56.94 | 8.14 | 65.08 | 74.00 | -8.92 | Peak | |
| 4 | 2483.5000 | 44.98 | 8.14 | 53.12 | 54.00 | -0.88 | AVG | |

REMARKS:

- (1) Measurement Value = Reading Level + Correct Factor.
- (2) Margin Level = Measurement Value - Limit Value.

| | | | |
|-----------|--------------------|--------------|------------|
| Test Mode | TX G Mode 2462 MHz | Polarization | Horizontal |
|-----------|--------------------|--------------|------------|

80 dBuV/m

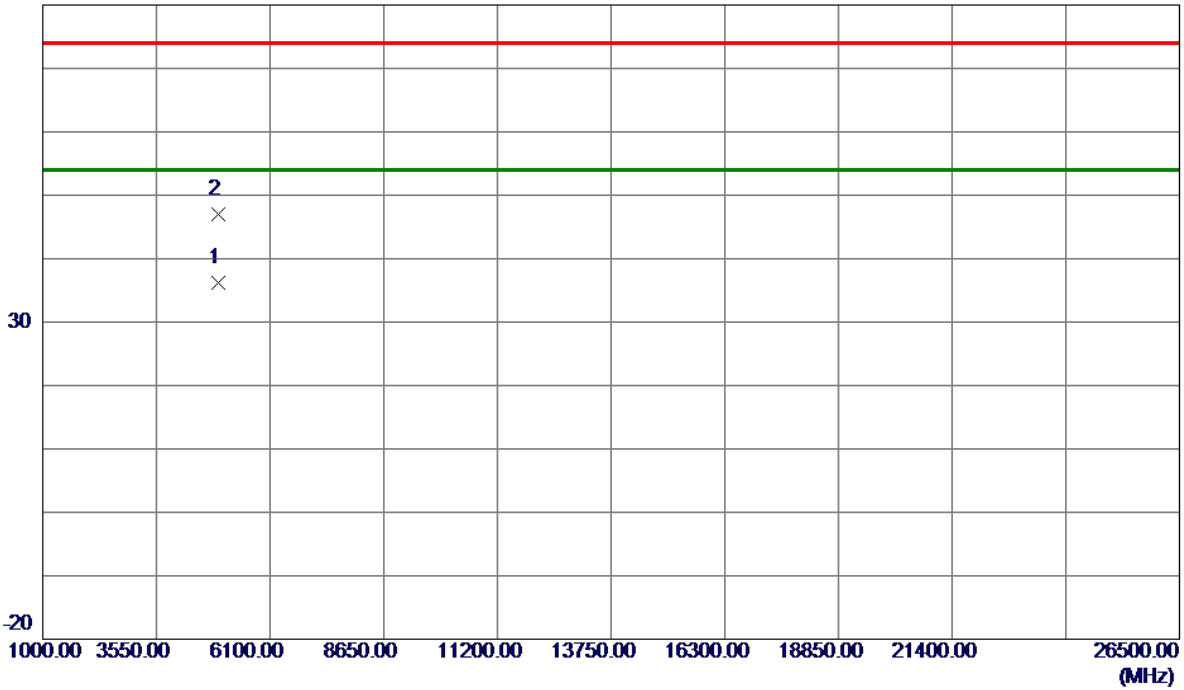

| No. | Freq. MHz | Reading Level dBuV/m | Correct Factor dB | Measure ment dBuV/m | Limit dBuV/m | Margin dB | Detector | Comment |
|-----|--------------|----------------------------|-------------------------|---------------------------|-----------------|--------------|----------|---------|
| 1 * | 4924.8500 | 31.65 | 4.49 | 36.14 | 54.00 | -17.86 | AVG | |
| 2 | 4925.4049 | 42.58 | 4.50 | 47.08 | 74.00 | -26.92 | Peak | |

REMARKS:

- (1) Measurement Value = Reading Level + Correct Factor.
- (2) Margin Level = Measurement Value - Limit Value.

| | | | |
|-----------|--------------------------|--------------|----------|
| Test Mode | TX N(HT20) Mode 2412 MHz | Polarization | Vertical |
|-----------|--------------------------|--------------|----------|

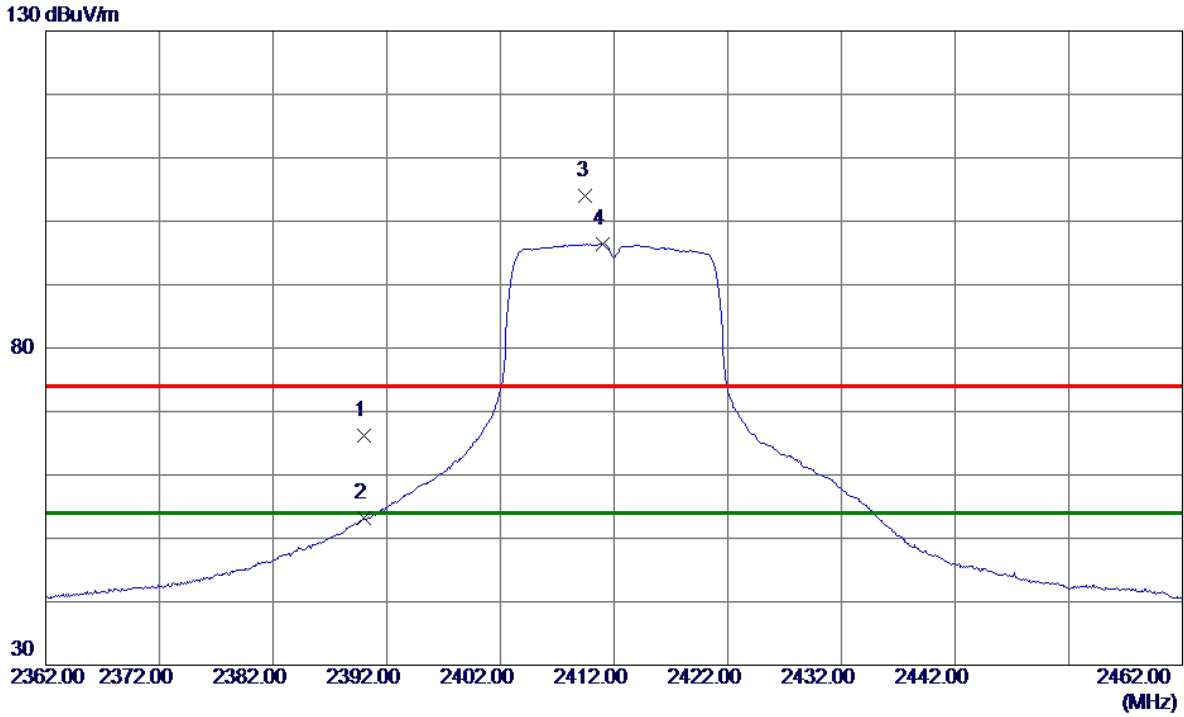

| No. | Freq. MHz | Reading Level dBuV/m | Correct Factor dB | Measure ment dBuV/m | Limit dBuV/m | Margin dB | Detector | Comment |
|-----|--------------|----------------------------|-------------------------|---------------------------|-----------------|--------------|----------|----------|
| 1 | 2390.0000 | 58.18 | 7.98 | 66.16 | 74.00 | -7.84 | Peak | |
| 2 | 2390.0000 | 45.16 | 7.98 | 53.14 | 54.00 | -0.86 | AVG | |
| 3 | 2409.5000 | 96.05 | 8.01 | 104.06 | 74.00 | 30.06 | Peak | No Limit |
| 4 * | 2411.0000 | 88.42 | 8.01 | 96.43 | 54.00 | 42.43 | AVG | No Limit |

REMARKS:

- (1) Measurement Value = Reading Level + Correct Factor.
- (2) Margin Level = Measurement Value - Limit Value.

| | | | |
|-----------|--------------------------|--------------|------------|
| Test Mode | TX N(HT20) Mode 2412 MHz | Polarization | Horizontal |
|-----------|--------------------------|--------------|------------|

80 dBuV/m

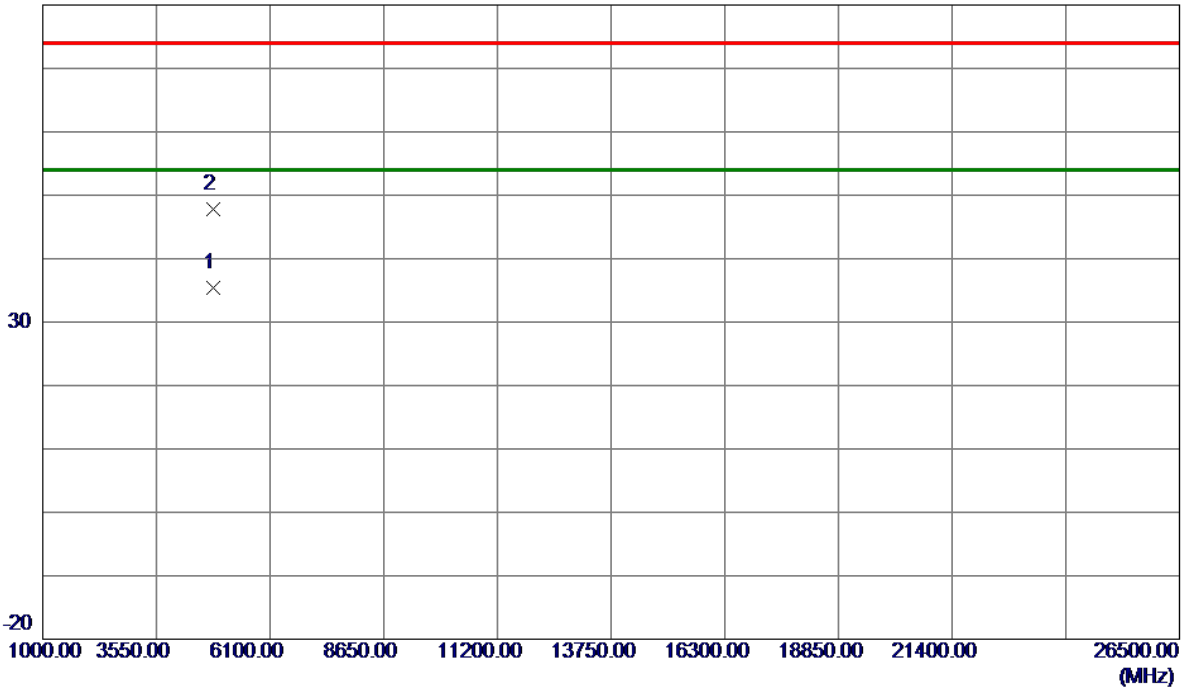

| No. | Freq. MHz | Reading Level dBuV/m | Correct Factor dB | Measure ment dBuV/m | Limit dBuV/m | Margin dB | Detector | Comment |
|-----|--------------|----------------------------|-------------------------|---------------------------|-----------------|--------------|----------|---------|
| 1 * | 4823.4049 | 31.01 | 4.33 | 35.34 | 54.00 | -18.66 | AVG | |
| 2 | 4823.4300 | 43.41 | 4.33 | 47.74 | 74.00 | -26.26 | Peak | |

REMARKS:

- (1) Measurement Value = Reading Level + Correct Factor.
- (2) Margin Level = Measurement Value - Limit Value.

| | | | |
|-----------|--------------------------|--------------|----------|
| Test Mode | TX N(HT20) Mode 2417 MHz | Polarization | Vertical |
|-----------|--------------------------|--------------|----------|

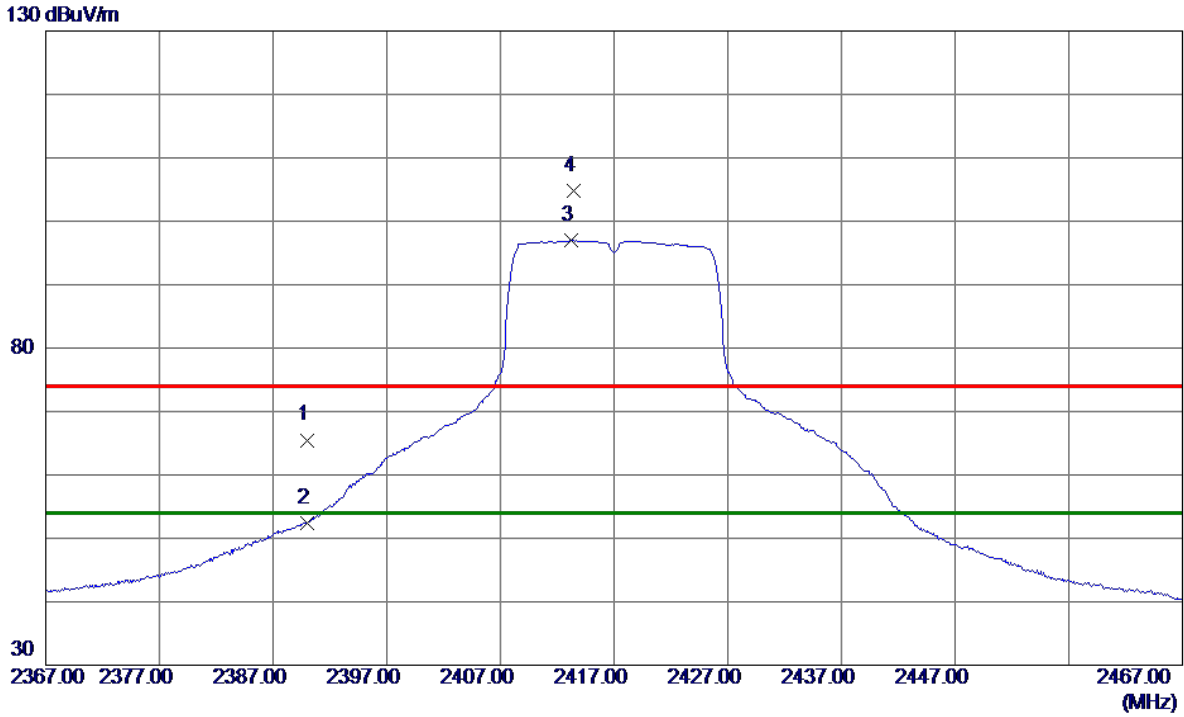

| No. | Freq. MHz | Reading Level dBuV/m | Correct Factor dB | Measure ment dBuV/m | Limit dBuV/m | Margin dB | Detector | Comment |
|-----|--------------|----------------------------|-------------------------|---------------------------|-----------------|--------------|----------|----------|
| 1 | 2390.0000 | 57.52 | 7.98 | 65.50 | 74.00 | -8.50 | Peak | |
| 2 | 2390.0000 | 44.50 | 7.98 | 52.48 | 54.00 | -1.52 | AVG | |
| 3 * | 2413.2000 | 88.95 | 8.02 | 96.97 | 54.00 | 42.97 | AVG | No Limit |
| 4 | 2413.4000 | 96.78 | 8.02 | 104.80 | 74.00 | 30.80 | Peak | No Limit |

REMARKS:

- (1) Measurement Value = Reading Level + Correct Factor.
- (2) Margin Level = Measurement Value - Limit Value.

| | | | |
|-----------|--------------------------|--------------|------------|
| Test Mode | TX N(HT20) Mode 2417 MHz | Polarization | Horizontal |
|-----------|--------------------------|--------------|------------|

80 dBuV/m

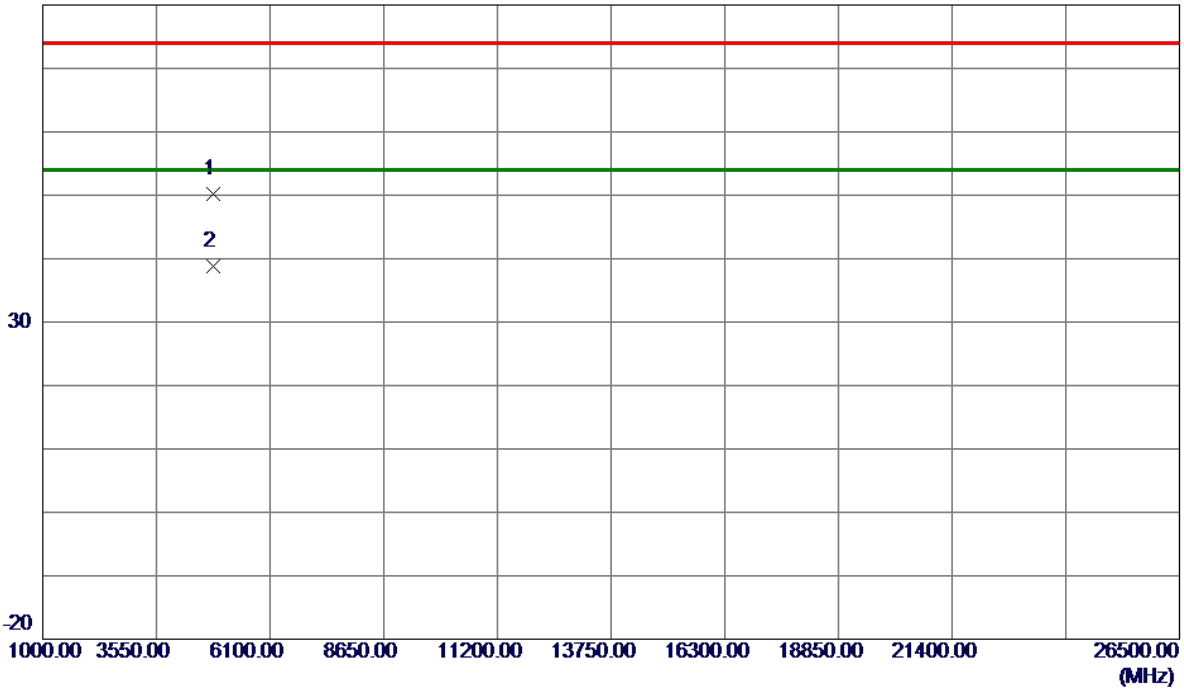

| No. | Freq. MHz | Reading Level dBuV/m | Correct Factor dB | Measure ment dBuV/m | Limit dBuV/m | Margin dB | Detector | Comment |
|-----|--------------|----------------------------|-------------------------|---------------------------|-----------------|--------------|----------|---------|
| 1 | 4833.1400 | 45.57 | 4.60 | 50.17 | 74.00 | -23.83 | Peak | |
| 2 * | 4833.2350 | 34.17 | 4.60 | 38.77 | 54.00 | -15.23 | AVG | |

REMARKS:

- (1) Measurement Value = Reading Level + Correct Factor.
- (2) Margin Level = Measurement Value - Limit Value.

| | | | |
|-----------|--------------------------|--------------|----------|
| Test Mode | TX N(HT20) Mode 2437 MHz | Polarization | Vertical |
|-----------|--------------------------|--------------|----------|

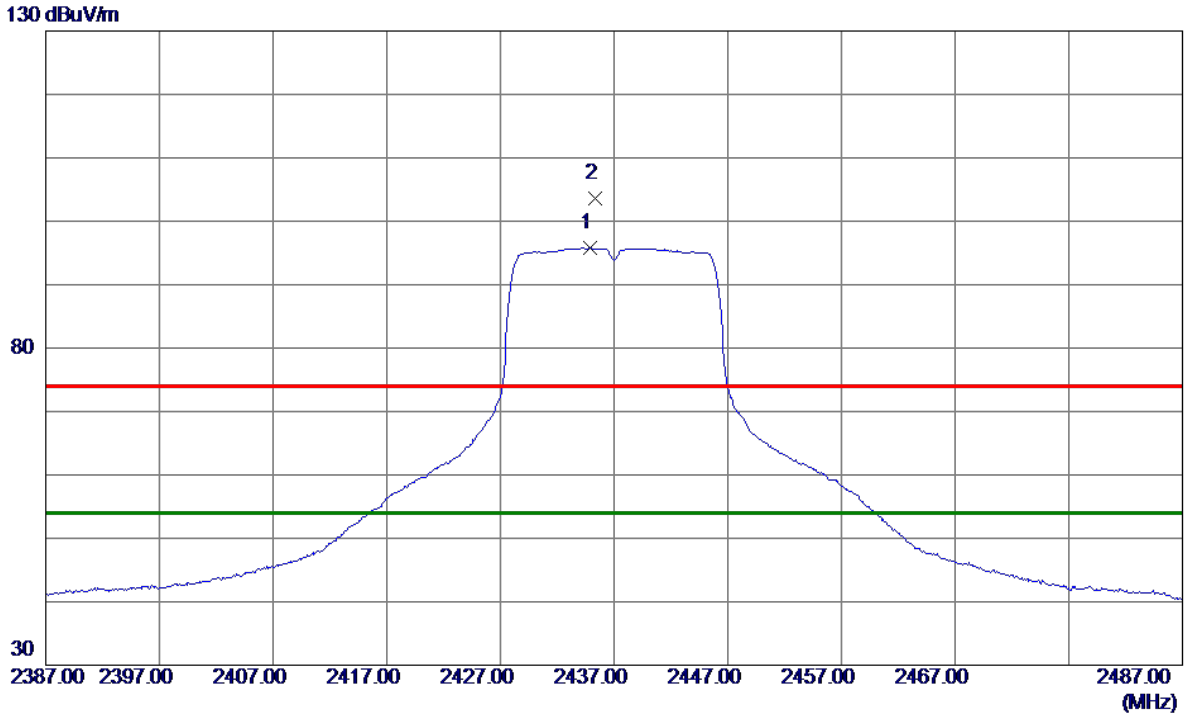

| No. | Freq. MHz | Reading Level dBuV/m | Correct Factor dB | Measure ment dBuV/m | Limit dBuV/m | Margin dB | Detector | Comment |
|-----|--------------|----------------------------|-------------------------|---------------------------|-----------------|--------------|----------|----------|
| 1 * | 2434.9000 | 87.69 | 8.05 | 95.74 | 54.00 | 41.74 | AVG | No Limit |
| 2 | 2435.3000 | 95.47 | 8.05 | 103.52 | 74.00 | 29.52 | Peak | No Limit |

REMARKS:

- (1) Measurement Value = Reading Level + Correct Factor.
- (2) Margin Level = Measurement Value - Limit Value.

| | | | |
|-----------|--------------------------|--------------|------------|
| Test Mode | TX N(HT20) Mode 2437 MHz | Polarization | Horizontal |
|-----------|--------------------------|--------------|------------|

80 dBuV/m

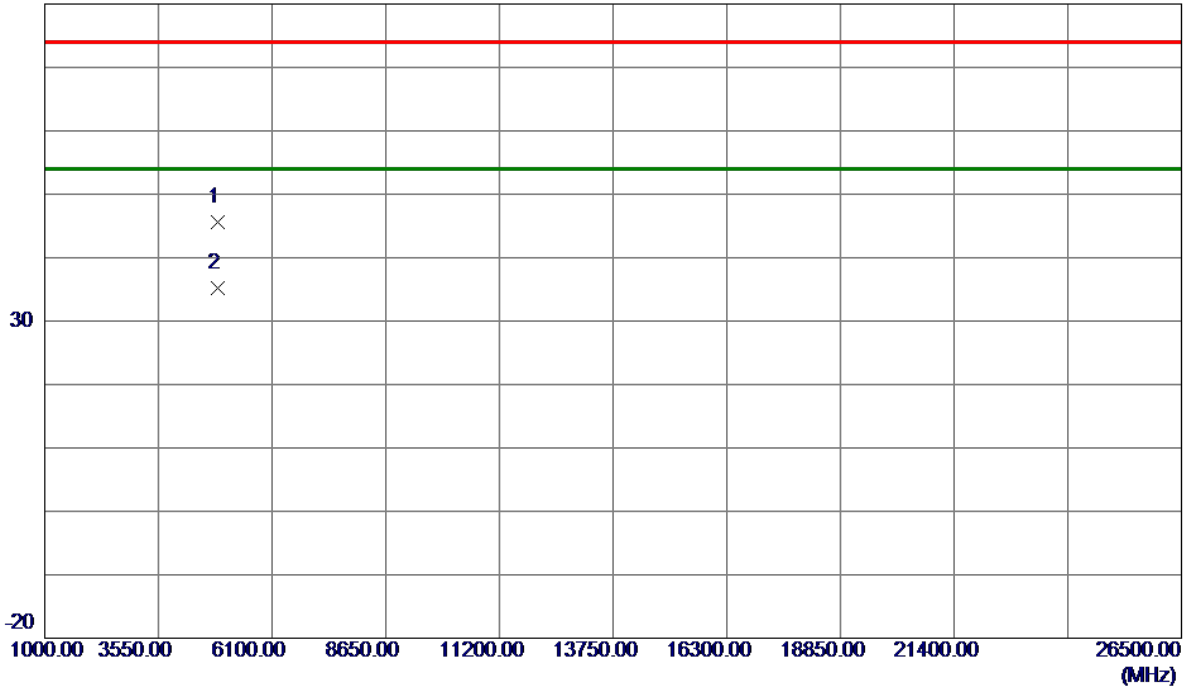

| No. | Freq. MHz | Reading Level dBuV/m | Correct Factor dB | Measure ment dBuV/m | Limit dBuV/m | Margin dB | Detector | Comment |
|-----|--------------|----------------------------|-------------------------|---------------------------|-----------------|--------------|----------|---------|
| 1 | 4872.9600 | 41.13 | 4.41 | 45.54 | 74.00 | -28.46 | Peak | |
| 2 * | 4873.4000 | 30.81 | 4.41 | 35.22 | 54.00 | -18.78 | AVG | |

REMARKS:

- (1) Measurement Value = Reading Level + Correct Factor.
- (2) Margin Level = Measurement Value - Limit Value.

| | | | |
|-----------|--------------------------|--------------|----------|
| Test Mode | TX N(HT20) Mode 2457 MHz | Polarization | Vertical |
|-----------|--------------------------|--------------|----------|

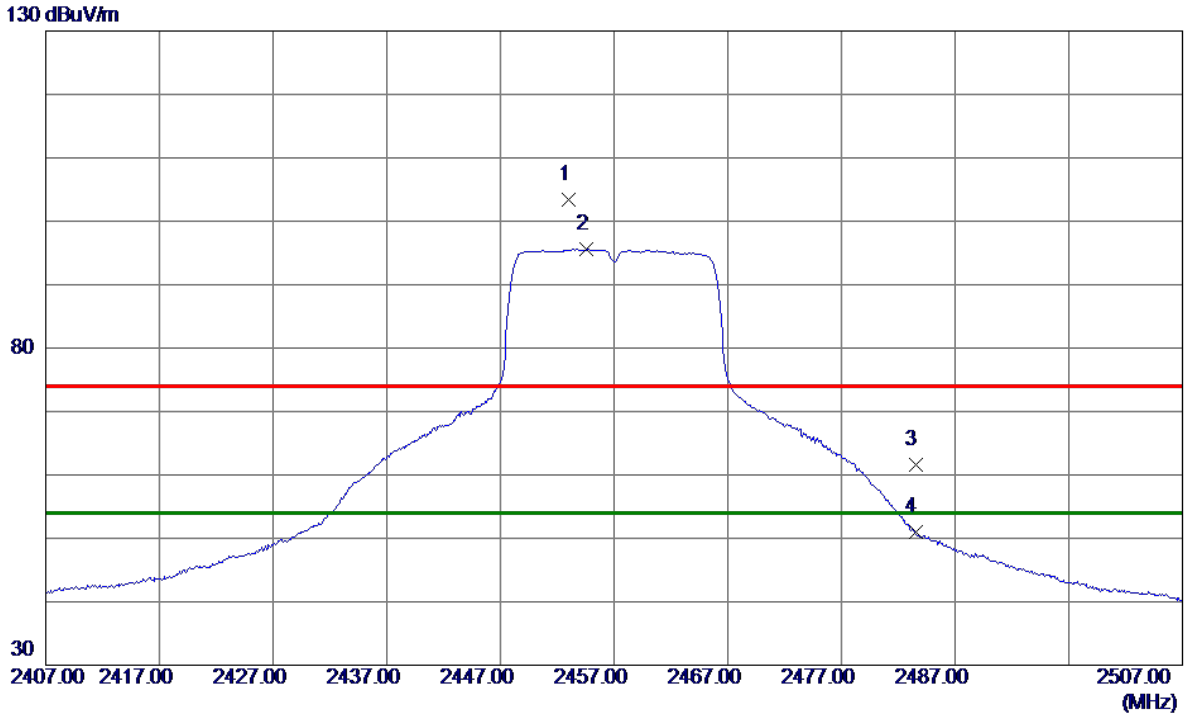

| No. | Freq. MHz | Reading Level dBuV/m | Correct Factor dB | Measure ment dBuV/m | Limit dBuV/m | Margin dB | Detector | Comment |
|-----|--------------|----------------------------|-------------------------|---------------------------|-----------------|--------------|----------|----------|
| 1 | 2453.0000 | 95.36 | 8.08 | 103.44 | 74.00 | 29.44 | Peak | No Limit |
| 2 * | 2454.6000 | 87.50 | 8.09 | 95.59 | 54.00 | 41.59 | AVG | No Limit |
| 3 | 2483.5000 | 53.54 | 8.14 | 61.68 | 74.00 | -12.32 | Peak | |
| 4 | 2483.5000 | 42.85 | 8.14 | 50.99 | 54.00 | -3.01 | AVG | |

REMARKS:

- (1) Measurement Value = Reading Level + Correct Factor.
- (2) Margin Level = Measurement Value - Limit Value.

| | | | |
|-----------|--------------------------|--------------|------------|
| Test Mode | TX N(HT20) Mode 2457 MHz | Polarization | Horizontal |
|-----------|--------------------------|--------------|------------|

80 dBuV/m

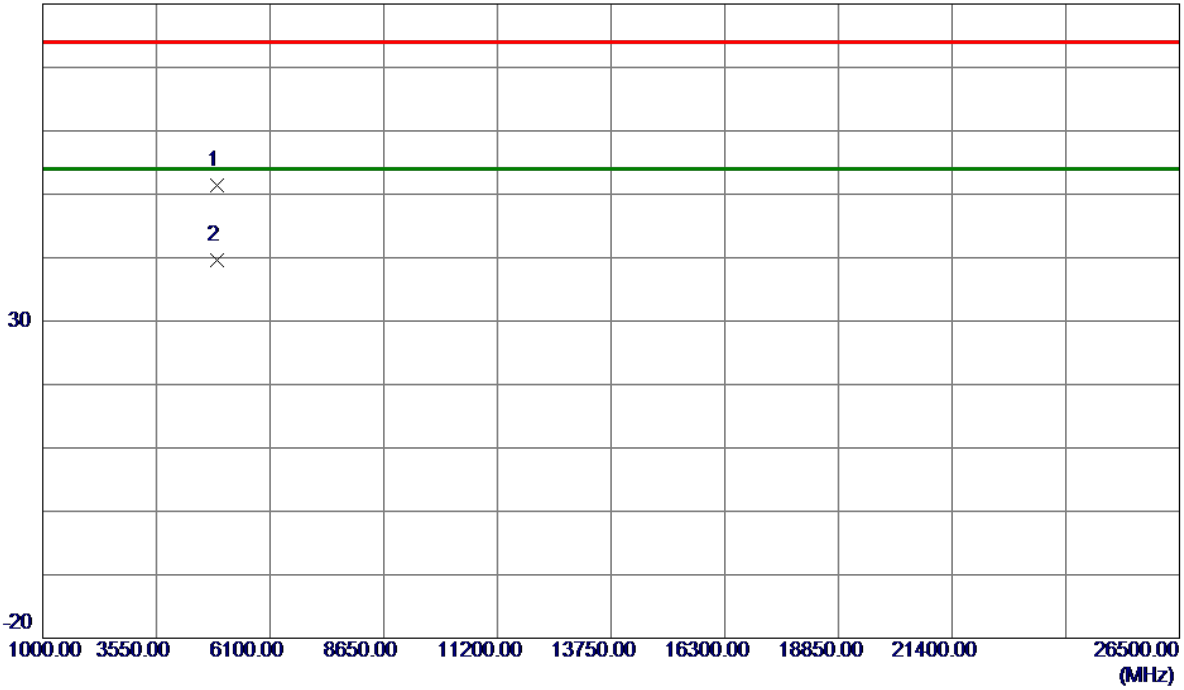

| No. | Freq. MHz | Reading Level dBuV/m | Correct Factor dB | Measure ment dBuV/m | Limit dBuV/m | Margin dB | Detector | Comment |
|-----|--------------|----------------------------|-------------------------|---------------------------|-----------------|--------------|----------|---------|
| 1 | 4913.5250 | 46.46 | 4.93 | 51.39 | 74.00 | -22.61 | Peak | |
| 2 * | 4915.9400 | 34.65 | 4.94 | 39.59 | 54.00 | -14.41 | AVG | |

REMARKS:

- (1) Measurement Value = Reading Level + Correct Factor.
- (2) Margin Level = Measurement Value - Limit Value.

| | | | |
|-----------|--------------------------|--------------|----------|
| Test Mode | TX N(HT20) Mode 2462 MHz | Polarization | Vertical |
|-----------|--------------------------|--------------|----------|

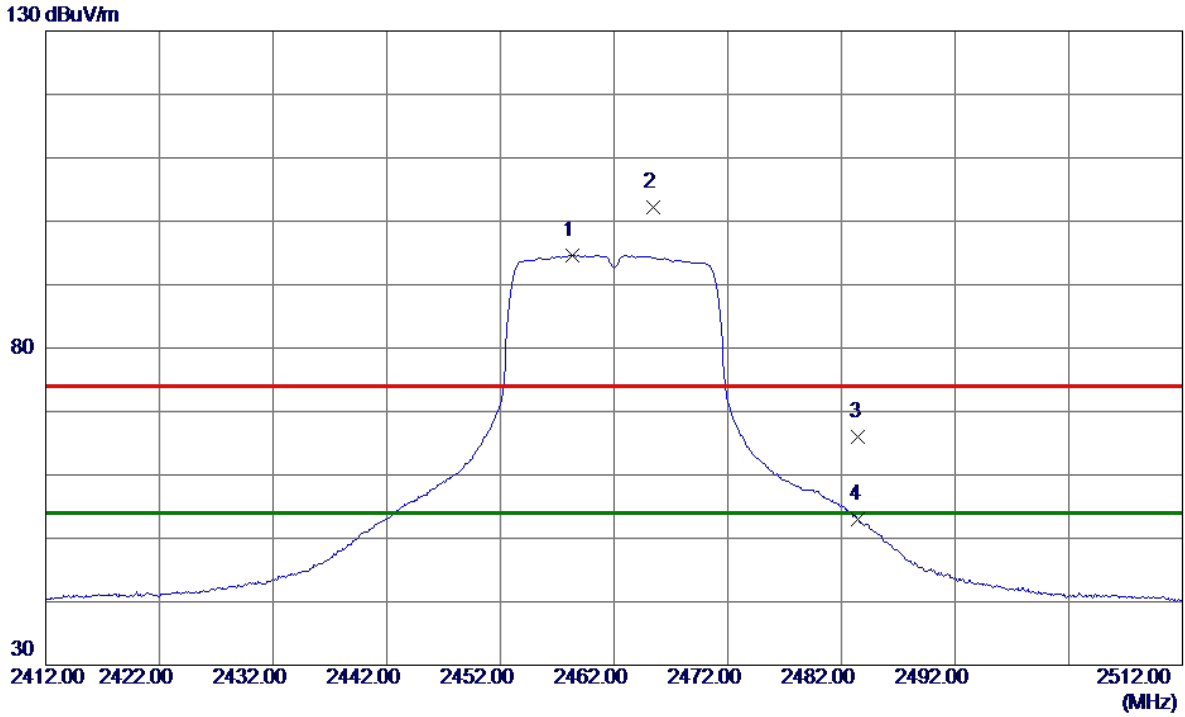

| No. | Freq. MHz | Reading Level dBuV/m | Correct Factor dB | Measure ment dBuV/m | Limit dBuV/m | Margin dB | Detector | Comment |
|-----|--------------|----------------------------|-------------------------|---------------------------|-----------------|--------------|----------|----------|
| 1 * | 2458.3000 | 86.54 | 8.09 | 94.63 | 54.00 | 40.63 | AVG | No Limit |
| 2 | 2465.4000 | 94.04 | 8.11 | 102.15 | 74.00 | 28.15 | Peak | No Limit |
| 3 | 2483.5000 | 57.79 | 8.14 | 65.93 | 74.00 | -8.07 | Peak | |
| 4 | 2483.5000 | 44.89 | 8.14 | 53.03 | 54.00 | -0.97 | AVG | |

REMARKS:

- (1) Measurement Value = Reading Level + Correct Factor.
- (2) Margin Level = Measurement Value - Limit Value.

| | | | |
|-----------|--------------------------|--------------|------------|
| Test Mode | TX N(HT20) Mode 2462 MHz | Polarization | Horizontal |
|-----------|--------------------------|--------------|------------|

80 dBuV/m

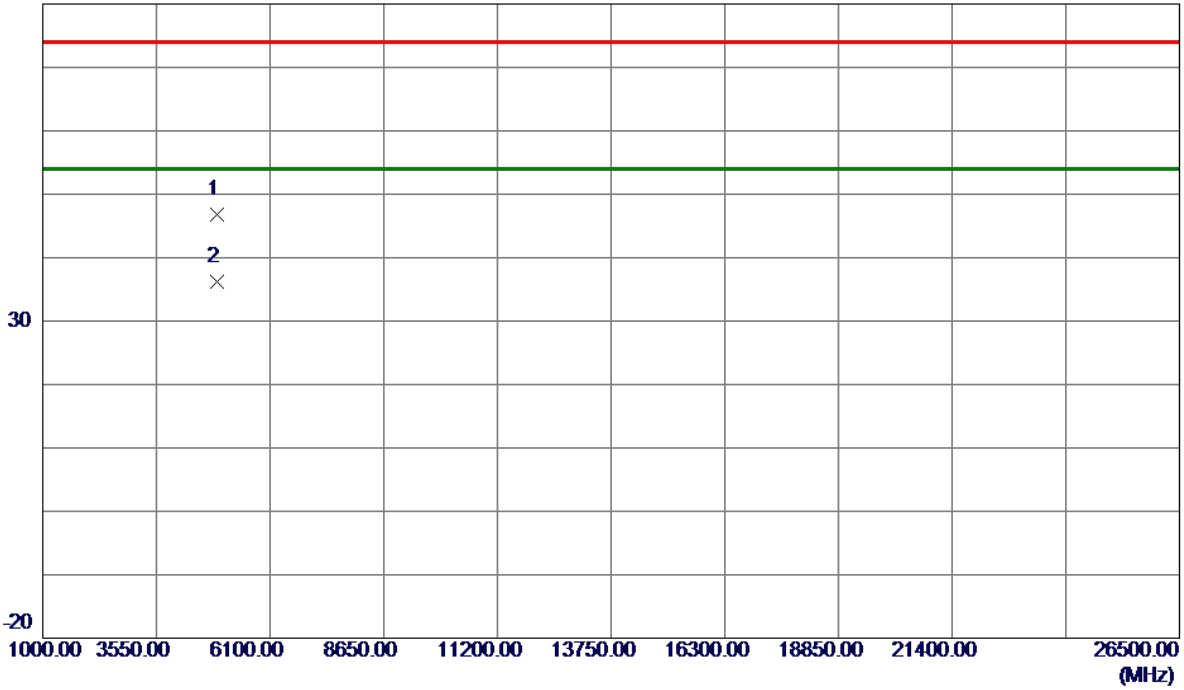

| No. | Freq. MHz | Reading Level dBuV/m | Correct Factor dB | Measure ment dBuV/m | Limit dBuV/m | Margin dB | Detector | Comment |
|-----|--------------|----------------------------|-------------------------|---------------------------|-----------------|--------------|----------|---------|
| 1 | 4922.8650 | 42.30 | 4.49 | 46.79 | 74.00 | -27.21 | Peak | |
| 2 * | 4923.1500 | 31.69 | 4.49 | 36.18 | 54.00 | -17.82 | AVG | |

REMARKS:

- (1) Measurement Value = Reading Level + Correct Factor.
- (2) Margin Level = Measurement Value - Limit Value.

APPENDIX E - BANDWIDTH

Test Mode TX B Mode

| Channel | Frequency (MHz) | 6 dB Bandwidth (MHz) | 99 % Occupied Bandwidth (MHz) | 6 dB Bandwidth Min. Limit (MHz) | Result |
|---------|-----------------|----------------------|-------------------------------|---------------------------------|----------|
| 01 | 2412 | 9.100 | 14.480 | 0.5 | Complies |
| 06 | 2437 | 9.110 | 14.560 | 0.5 | Complies |
| 11 | 2462 | 10.080 | 14.640 | 0.5 | Complies |

CH01

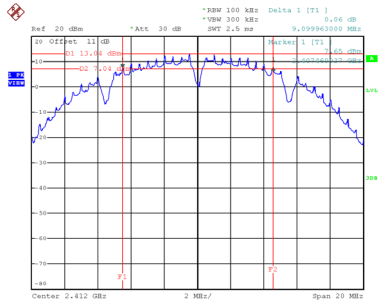

Date: 28.MAY.2022 12:11:03

CH06

6 dB Bandwidth

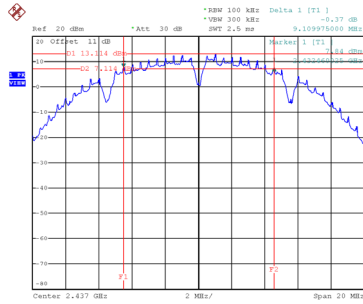

Date: 28.MAY.2022 12:13:49

CH11

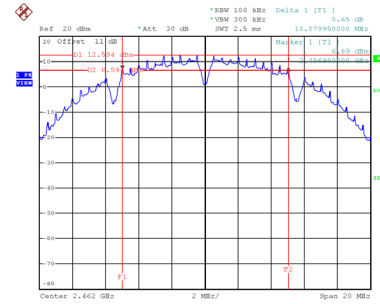

Date: 28.MAY.2022 12:15:27

99 % Occupied Bandwidth

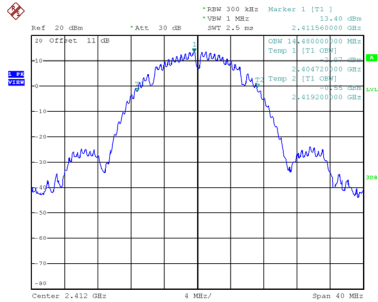

Date: 28.MAY.2022 12:11:11

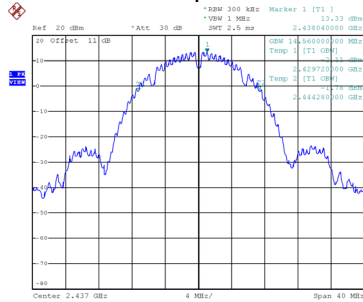

Date: 28.MAY.2022 12:13:56

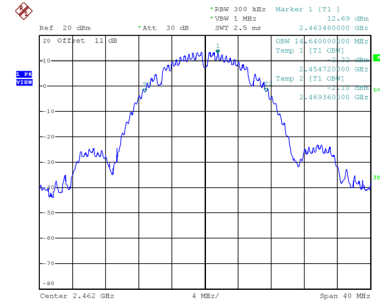

Date: 28.MAY.2022 12:15:34

| | |
|-----------|-----------|
| Test Mode | TX G Mode |
|-----------|-----------|

| Channel | Frequency (MHz) | 6 dB Bandwidth (MHz) | 99 % Occupied Bandwidth (MHz) | 6 dB Bandwidth Min. Limit (MHz) | Result |
|---------|-----------------|----------------------|-------------------------------|---------------------------------|----------|
| 01 | 2412 | 16.380 | 18.400 | 0.5 | Complies |
| 06 | 2437 | 16.380 | 18.480 | 0.5 | Complies |
| 11 | 2462 | 16.380 | 18.480 | 0.5 | Complies |

CH01

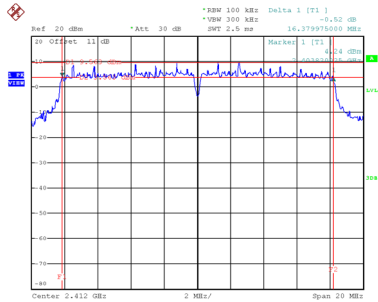

Date: 28.MAY.2022 12:17:07

CH06
6 dB Bandwidth

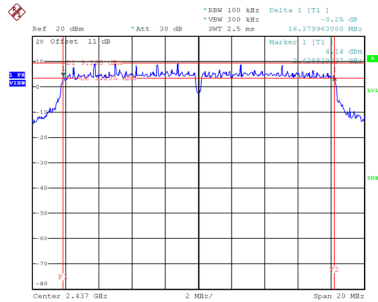

Date: 28.MAY.2022 12:18:27

CH11

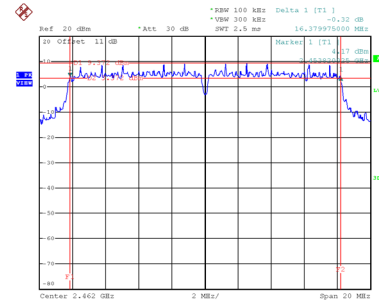

Date: 28.MAY.2022 12:19:51

99 % Occupied Bandwidth

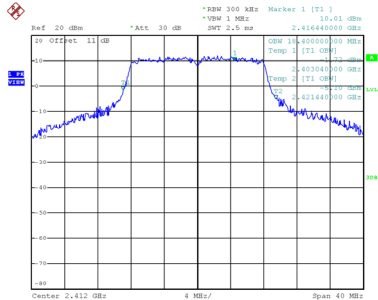

Date: 28.MAY.2022 12:17:14

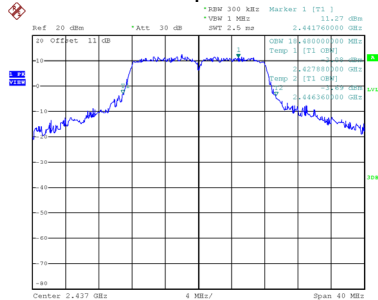

Date: 28.MAY.2022 12:18:34

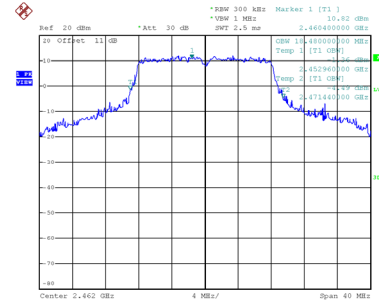

Date: 28.MAY.2022 12:19:59

Test Mode TX N(HT20) Mode

| Channel | Frequency (MHz) | 6 dB Bandwidth (MHz) | 99 % Occupied Bandwidth (MHz) | 6 dB Bandwidth Min. Limit (MHz) | Result |
|---------|-----------------|----------------------|-------------------------------|---------------------------------|----------|
| 01 | 2412 | 17.580 | 19.120 | 0.5 | Complies |
| 06 | 2437 | 17.640 | 19.280 | 0.5 | Complies |
| 11 | 2462 | 17.610 | 19.280 | 0.5 | Complies |

CH01

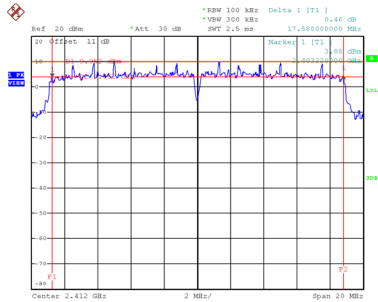

Date: 28.MAY.2022 12:21:14

CH06
6 dB Bandwidth

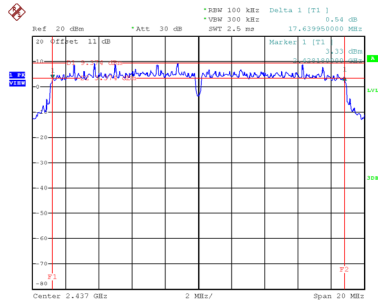

Date: 28.MAY.2022 12:22:35

CH11

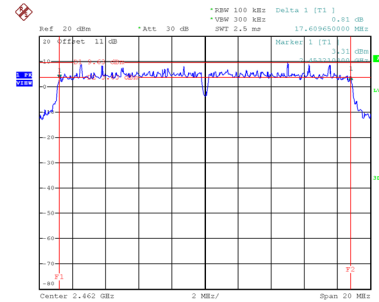

Date: 28.MAY.2022 12:24:03

99 % Occupied Bandwidth

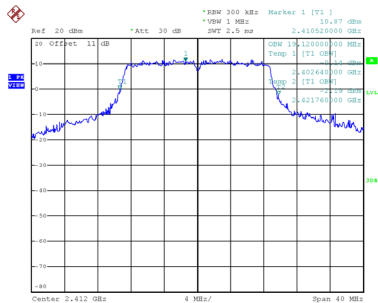

Date: 28.MAY.2022 12:21:22

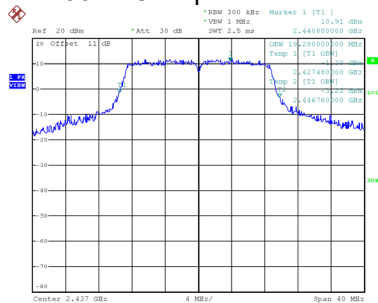

Date: 28.MAY.2022 12:22:47

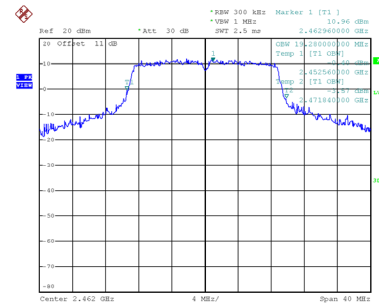

Date: 28.MAY.2022 12:24:11

APPENDIX F - MAXIMUM AVERAGE OUTPUT POWER

| | |
|-----------|-----------|
| Test Mode | TX B Mode |
|-----------|-----------|

| Channel | Frequency (MHz) | Average Output Power (dBm) | Duty Factor | Average Output Power + Duty Factor (dBm) | Max. Limit (dBm) | Max. Limit (W) | Result |
|---------|-----------------|----------------------------|-------------|--|------------------|----------------|----------|
| 01 | 2412 | 22.97 | 0.00 | 22.97 | 30.00 | 1.0000 | Complies |
| 06 | 2437 | 22.91 | 0.00 | 22.91 | 30.00 | 1.0000 | Complies |
| 11 | 2462 | 22.03 | 0.00 | 22.03 | 30.00 | 1.0000 | Complies |

| | |
|-----------|-----------|
| Test Mode | TX G Mode |
|-----------|-----------|

| Channel | Frequency (MHz) | Average Output Power (dBm) | Duty Factor | Average Output Power + Duty Factor (dBm) | Max. Limit (dBm) | Max. Limit (W) | Result |
|---------|-----------------|----------------------------|-------------|--|------------------|----------------|----------|
| 01 | 2412 | 18.33 | 0.26 | 18.59 | 30.00 | 1.0000 | Complies |
| 06 | 2437 | 21.11 | 0.26 | 21.37 | 30.00 | 1.0000 | Complies |
| 11 | 2462 | 18.29 | 0.26 | 18.55 | 30.00 | 1.0000 | Complies |

| | |
|-----------|-----------------|
| Test Mode | TX N(HT20) Mode |
|-----------|-----------------|

| Channel | Frequency (MHz) | Average Output Power (dBm) | Duty Factor | Average Output Power + Duty Factor (dBm) | Max. Limit (dBm) | Max. Limit (W) | Result |
|---------|-----------------|----------------------------|-------------|--|------------------|----------------|----------|
| 01 | 2412 | 18.35 | 0.28 | 18.63 | 30.00 | 1.0000 | Complies |
| 06 | 2437 | 21.22 | 0.28 | 21.50 | 30.00 | 1.0000 | Complies |
| 11 | 2462 | 17.38 | 0.28 | 17.66 | 30.00 | 1.0000 | Complies |

APPENDIX G - CONDUCTED SPURIOUS EMISSIONS

Test Mode TX B Mode

Reference Level-CH01

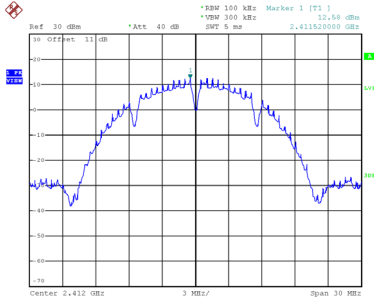

Date: 31.MAY.2022 13:22:42

Reference Level-CH06

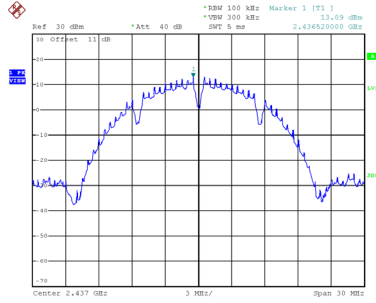

Date: 31.MAY.2022 13:23:23

Reference Level-CH11

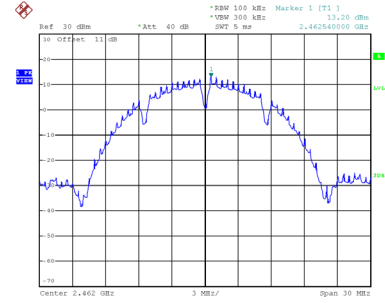

Date: 31.MAY.2022 13:23:59

Bandedge-CH01

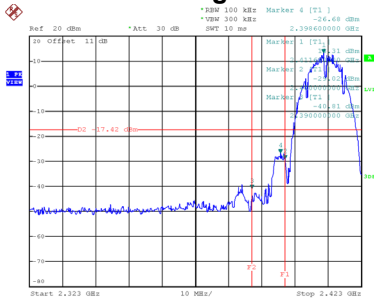

Date: 31.MAY.2022 13:45:15

Bandedge-CH11

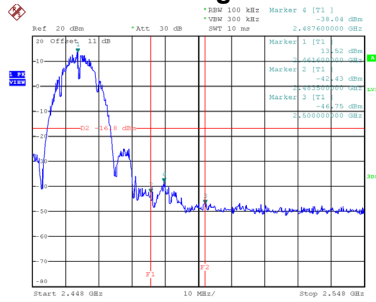

Date: 31.MAY.2022 13:54:33

CH01 – 10th Harmonic of the fundamental frequency

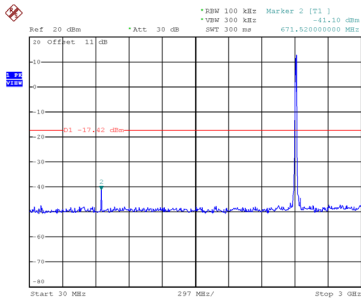

Date: 31.MAY.2022 14:16:20

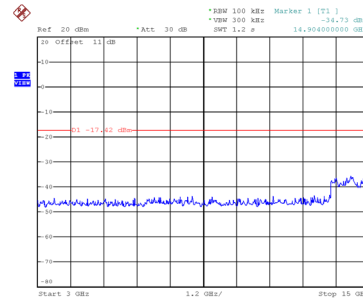

Date: 31.MAY.2022 14:16:28

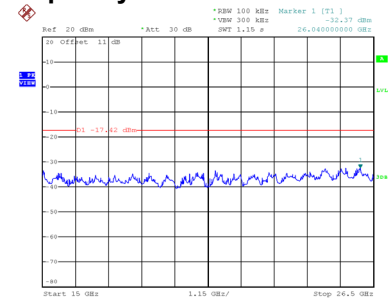

Date: 31.MAY.2022 14:16:35

CH06 – 10th Harmonic of the fundamental frequency

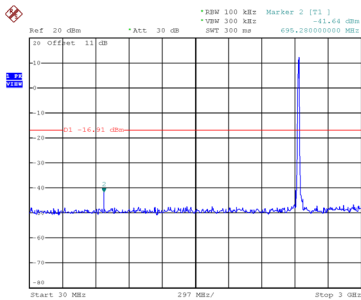

Date: 31.MAY.2022 14:18:11

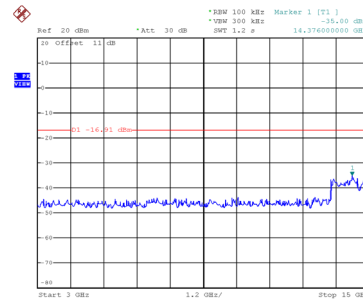

Date: 31.MAY.2022 14:18:18

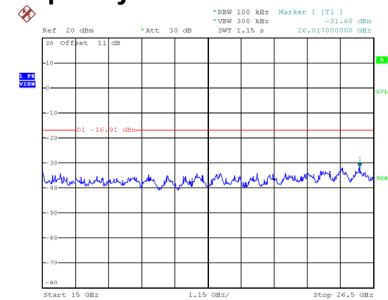

Date: 31.MAY.2022 14:18:26

CH11 – 10th Harmonic of the fundamental frequency

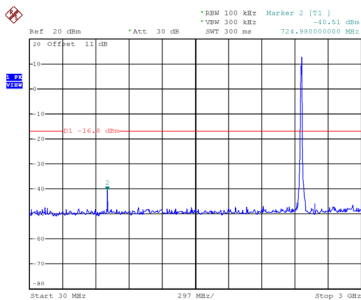

Date: 31.MAY.2022 14:18:58

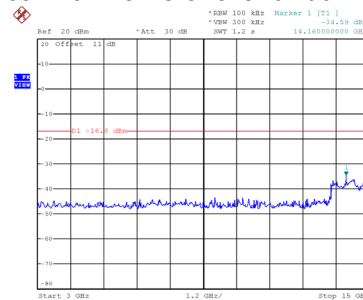

Date: 31.MAY.2022 14:19:06

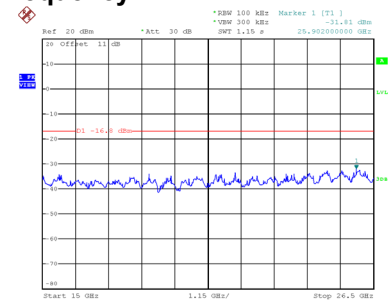

Date: 31.MAY.2022 14:19:13

Test Mode TX G Mode

Reference Level-CH01

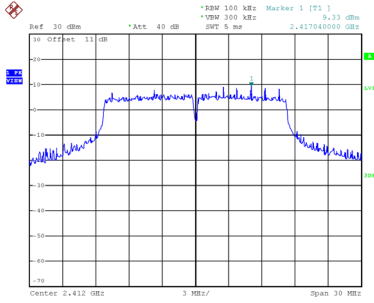

Date: 31.MAY.2022 13:24:30

Reference Level-CH06

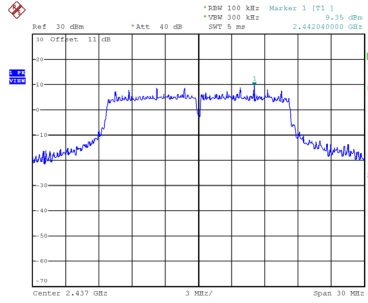

Date: 31.MAY.2022 13:24:54

Reference Level-CH11

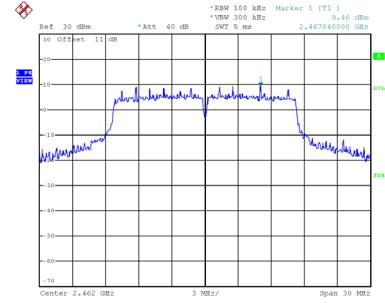

Date: 31.MAY.2022 13:25:17

Bandedge-CH01

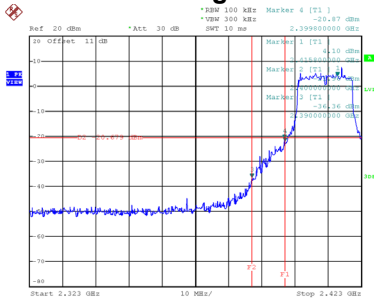

Date: 7.JUN.2022 17:16:56

Bandedge-CH11

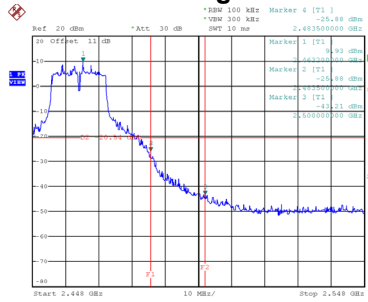

Date: 31.MAY.2022 13:25:27

CH01 – 10th Harmonic of the fundamental frequency

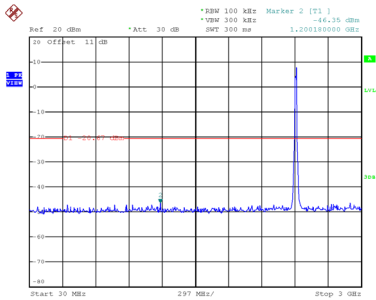

Date: 7.JUN.2022 17:18:21

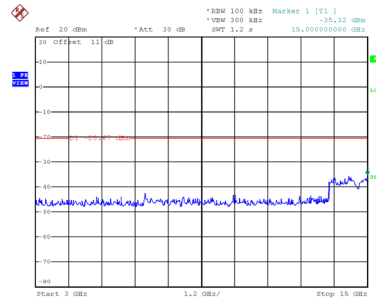

Date: 7.JUN.2022 17:18:29

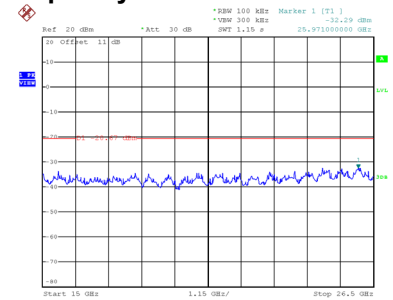

Date: 7.JUN.2022 17:18:37

CH06 – 10th Harmonic of the fundamental frequency

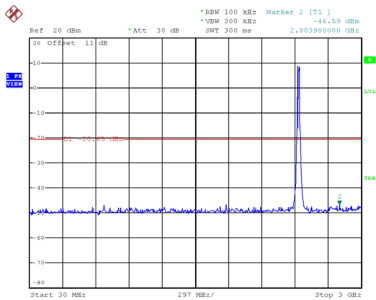

Date: 31.MAY.2022 14:21:45

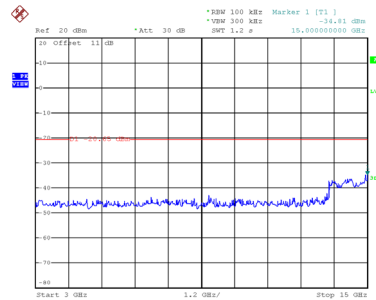

Date: 31.MAY.2022 14:21:52

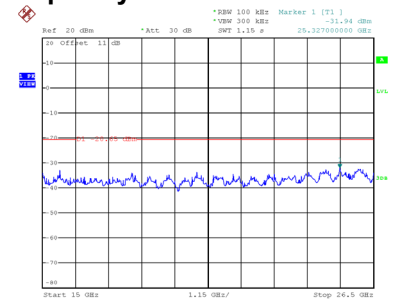

Date: 31.MAY.2022 14:22:00

CH11 – 10th Harmonic of the fundamental frequency

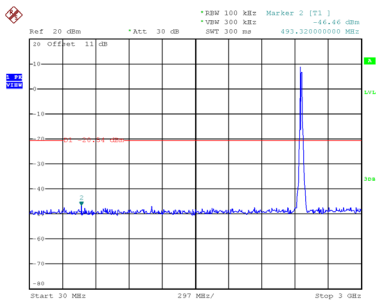

Date: 31.MAY.2022 14:22:29

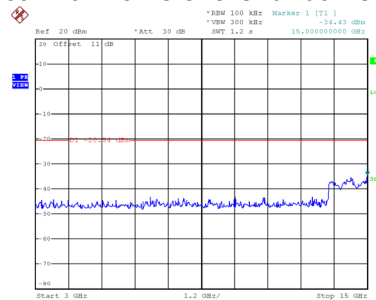

Date: 31.MAY.2022 14:22:37

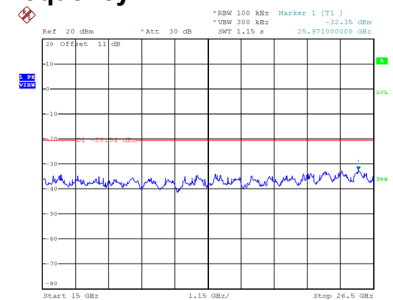

Date: 31.MAY.2022 14:22:44

Test Mode TX N(HT20) Mode

Reference Level-CH01

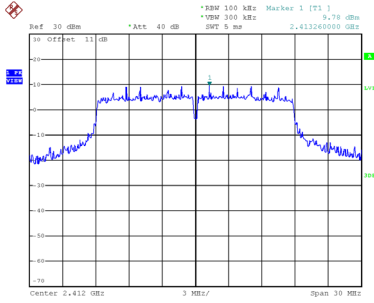

Date: 31.MAY.2022 13:25:44

Reference Level-CH06

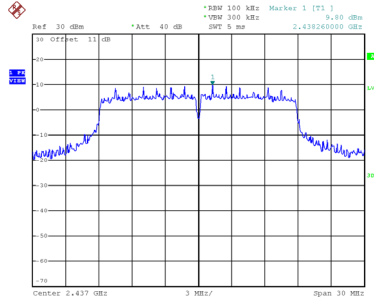

Date: 31.MAY.2022 13:26:10

Reference Level-CH11

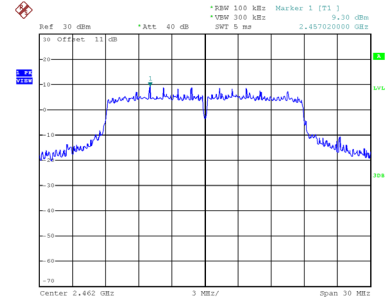

Date: 31.MAY.2022 13:26:32

Bandedge-CH01

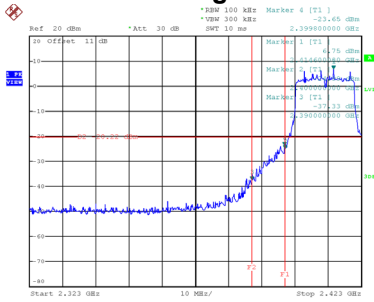

Date: 31.MAY.2022 14:01:43

Bandedge-CH11

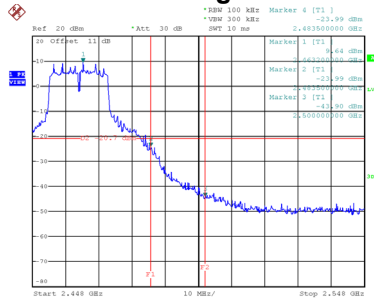

Date: 31.MAY.2022 14:06:09

CH01 – 10th Harmonic of the fundamental frequency

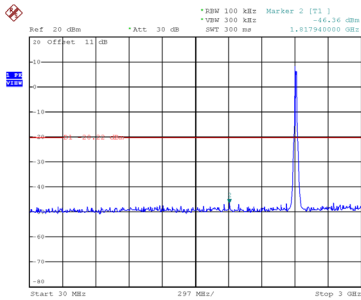

Date: 31.MAY.2022 14:23:14

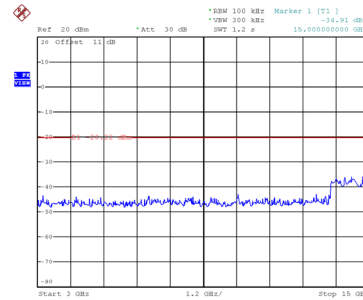

Date: 31.MAY.2022 14:23:22

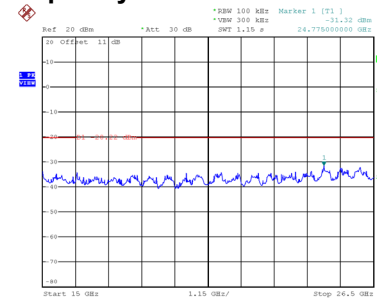

Date: 31.MAY.2022 14:23:29

CH06 – 10th Harmonic of the fundamental frequency

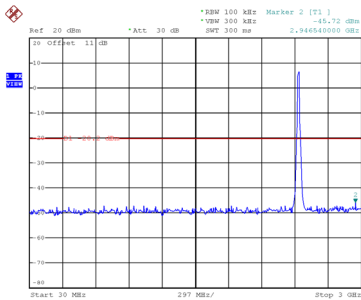

Date: 31.MAY.2022 14:23:52

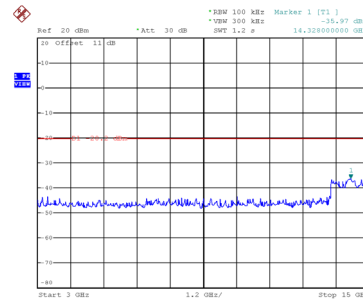

Date: 31.MAY.2022 14:24:00

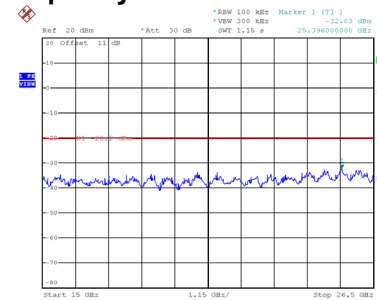

Date: 31.MAY.2022 14:24:07

CH11 – 10th Harmonic of the fundamental frequency

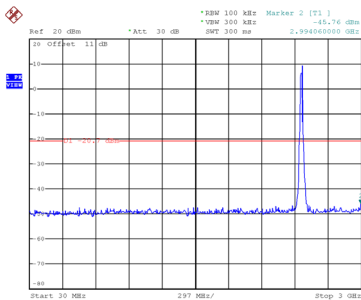

Date: 31.MAY.2022 14:24:35

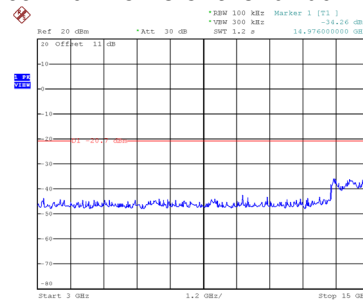

Date: 31.MAY.2022 14:24:42

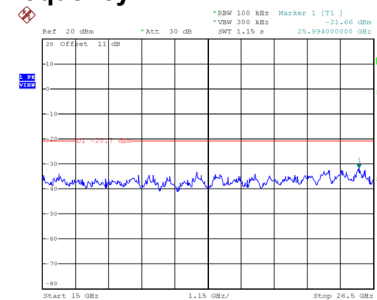

Date: 31.MAY.2022 14:24:50

APPENDIX H - POWER SPECTRAL DENSITY

| | |
|-----------|-----------|
| Test Mode | TX B Mode |
|-----------|-----------|

| Channel | Frequency (MHz) | Power Spectral Density (dBm/3kHz) | Max. Limit (dBm/3kHz) | Result |
|---------|-----------------|-----------------------------------|-----------------------|----------|
| 01 | 2412 | -0.72 | 8.00 | Complies |
| 06 | 2437 | -0.77 | 8.00 | Complies |
| 11 | 2462 | -0.61 | 8.00 | Complies |

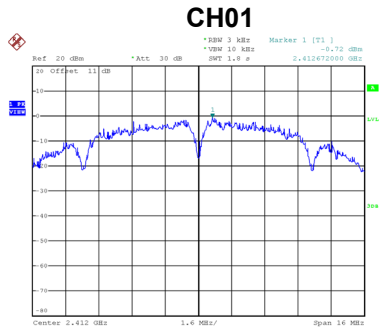

Date: 31.MAY.2022 13:07:54

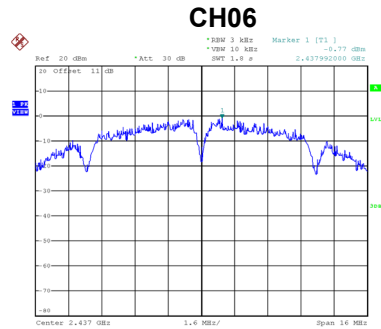

Date: 31.MAY.2022 13:08:41

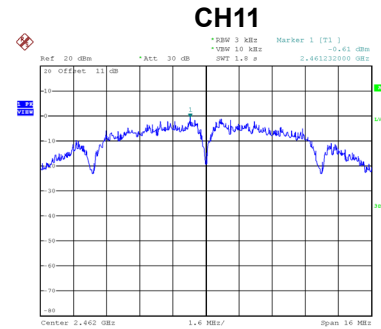

Date: 31.MAY.2022 13:09:19

| | |
|-----------|-----------|
| Test Mode | TX G Mode |
|-----------|-----------|

| Channel | Frequency (MHz) | Power Spectral Density (dBm/3kHz) | Max. Limit (dBm/3kHz) | Result |
|---------|-----------------|-----------------------------------|-----------------------|----------|
| 01 | 2412 | -4.49 | 8.00 | Complies |
| 06 | 2437 | -4.43 | 8.00 | Complies |
| 11 | 2462 | -4.84 | 8.00 | Complies |

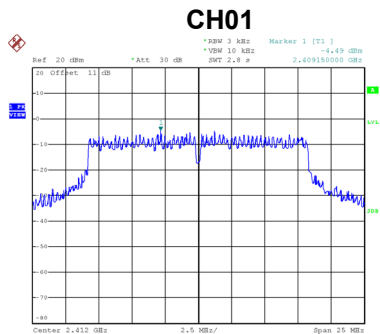

Date: 31.MAY.2022 13:10:58

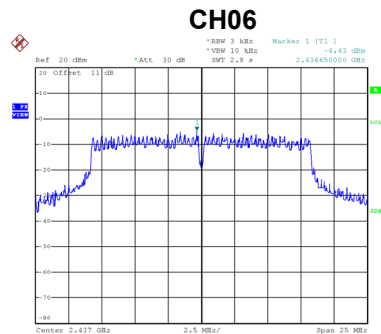

Date: 31.MAY.2022 13:12:01

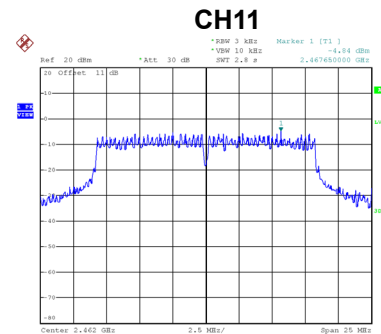

Date: 31.MAY.2022 13:12:46

| | |
|-----------|-----------------|
| Test Mode | TX N(HT20) Mode |
|-----------|-----------------|

| Channel | Frequency (MHz) | Power Spectral Density (dBm/3kHz) | Max. Limit (dBm/3kHz) | Result |
|---------|-----------------|-----------------------------------|-----------------------|----------|
| 01 | 2412 | -5.45 | 8.00 | Complies |
| 06 | 2437 | -4.74 | 8.00 | Complies |
| 11 | 2462 | -5.07 | 8.00 | Complies |

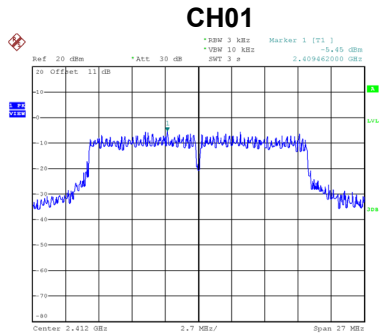

Date: 31.MAY.2022 13:14:04

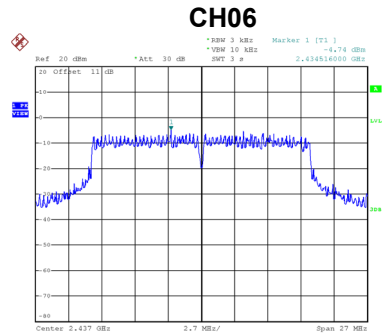

Date: 31.MAY.2022 13:15:12

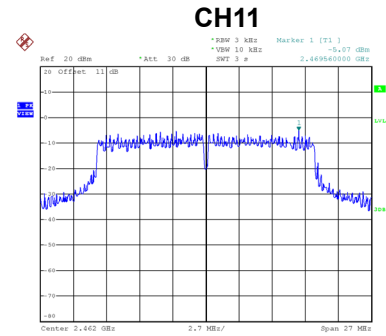

Date: 31.MAY.2022 13:15:49

End of Test Report