

FCC&ISED Radio Test Report

FCC ID: 2AXJ4KP125

This report concerns: Original Grant

Project No. : 2103C114
Equipment : Kasa Smart Wi-Fi Plug Slim, Energy Monitoring
Brand Name : tp-link
Test Model : KP125
Series Model : N/A
Applicant : TP-Link Corporation Limited
Address : Room 901, 9/F. , New East Ocean Centre, 9 Science Museum Road, Tsim Sha Tsui, Kowloon, Hong Kong
Manufacturer : TP-Link Corporation Limited
Address : Room 901, 9/F. , New East Ocean Centre, 9 Science Museum Road, Tsim Sha Tsui, Kowloon, Hong Kong
Date of Receipt : Mar. 12, 2021
Date of Test : Mar. 24, 2021 ~ Apr. 02, 2021
Issued Date : Apr. 23, 2021
Report Version : R00
Test Sample : Engineering Sample No.: DG2021031538 for conducted, DG2021031539 for radiated.
Standard(s) : FCC CFR Title 47, Part 15, Subpart C
ANSI C63.10-2013
FCC KDB 558074 D01 15.247 Meas Guidance v05r02

The above equipment has been tested and found compliance with the requirement of the relative standards by BTL Inc.



Prepared by : Sheldon Ou



Approved by : Ethan Ma



Certificate #5123.02

Add: No.3, Jinshagang 1st Road, Shixia, Dalang Town, Dongguan, Guangdong, China.

Tel: +86-769-8318-3000

Web: www.newbtl.com

Declaration

BTL represents to the client that testing is done in accordance with standard procedures as applicable and that test instruments used has been calibrated with standards traceable to international standard(s) and/or national standard(s).

BTL's reports apply only to the specific samples tested under conditions. It is manufacture's responsibility to ensure that additional production units of this model are manufactured with the identical electrical and mechanical components. **BTL** shall have no liability for any declarations, inferences or generalizations drawn by the client or others from **BTL** issued reports.

The report must not be used by the client to claim product certification, approval, or endorsement by NVLAP, NIST, A2LA, or any agency of the U.S. Government.

This report is the confidential property of the client. As a mutual protection to the clients, the public and ourselves, the test report shall not be reproduced, except in full, without our written approval.

BTL's laboratory quality assurance procedures are in compliance with the **ISO/IEC 17025** requirements, and accredited by the conformity assessment authorities listed in this test report.

BTL is not responsible for the sampling stage, so the results only apply to the sample as received.

The information, data and test plan are provided by manufacturer which may affect the validity of results, so it is manufacturer's responsibility to ensure that the apparatus meets the essential requirements of applied standards and in all the possible configurations as representative of its intended use.

Limitation

For the use of the authority's logo is limited unless the Test Standard(s)/Scope(s)/Item(s) mentioned in this test report is (are) included in the conformity assessment authorities acceptance respective.

Please note that the measurement uncertainty is provided for informational purpose only and are not use in determining the Pass/Fail results.

Table of Contents	Page
REPORT ISSUED HISTORY	6
1 . SUMMARY OF TEST RESULTS	7
1.1 TEST FACILITY	8
1.2 MEASUREMENT UNCERTAINTY	8
1.3 TEST ENVIRONMENT CONDITIONS	9
2 . GENERAL INFORMATION	10
2.1 GENERAL DESCRIPTION OF EUT	10
2.2 DESCRIPTION OF TEST MODES	11
2.3 PARAMETERS OF TEST SOFTWARE	12
2.4 DUTY CYCLE	13
2.5 BLOCK DIAGRAM SHOWING THE CONFIGURATION OF SYSTEM TESTED	14
2.6 SUPPORT UNITS	14
3 . AC POWER LINE CONDUCTED EMISSIONS	15
3.1 LIMIT	15
3.2 TEST PROCEDURE	15
3.3 DEVIATION FROM TEST STANDARD	15
3.4 TEST SETUP	16
3.5 EUT OPERATION CONDITIONS	16
3.6 TEST RESULTS	16
4 . RADIATED EMISSIONS	17
4.1 LIMIT	17
4.2 TEST PROCEDURE	17
4.3 DEVIATION FROM TEST STANDARD	18
4.4 TEST SETUP	18
4.5 EUT OPERATION CONDITIONS	20
4.6 TEST RESULTS - 9 KHZ TO 30 MHZ	20
4.7 TEST RESULTS - 30 MHZ TO 1000 MHZ	20
4.8 TEST RESULTS - ABOVE 1000 MHZ	20
5 . BANDWIDTH	21
5.1 LIMIT	21
5.2 TEST PROCEDURE	21
5.3 DEVIATION FROM STANDARD	21
5.4 TEST SETUP	21

Table of Contents	Page
5.5 EUT OPERATION CONDITIONS	21
5.6 TEST RESULTS	21
6 . MAXIMUM AVERAGE OUTPUT POWER	22
6.1 LIMIT	22
6.2 TEST PROCEDURE	22
6.3 DEVIATION FROM STANDARD	22
6.4 TEST SETUP	22
6.5 EUT OPERATION CONDITIONS	22
6.6 TEST RESULTS	22
7 . CONDUCTED SPURIOUS EMISSIONS	23
7.1 LIMIT	23
7.2 TEST PROCEDURE	23
7.3 DEVIATION FROM STANDARD	23
7.4 TEST SETUP	23
7.5 EUT OPERATION CONDITIONS	23
7.6 TEST RESULTS	23
8 . POWER SPECTRAL DENSITY	24
8.1 LIMIT	24
8.2 TEST PROCEDURE	24
8.3 DEVIATION FROM STANDARD	24
8.4 TEST SETUP	24
8.5 EUT OPERATION CONDITIONS	24
8.6 TEST RESULTS	24
9 . MEASUREMENT INSTRUMENTS LIST	25
10 . EUT TEST PHOTO	27
APPENDIX A - AC POWER LINE CONDUCTED EMISSIONS	31
APPENDIX B - RADIATED EMISSION - 9 KHZ TO 30 MHZ	34
APPENDIX C - RADIATED EMISSION - 30 MHZ TO 1000 MHZ	39
APPENDIX D - RADIATED EMISSION- ABOVE 1000 MHZ	42
APPENDIX E - BANDWIDTH	103
APPENDIX F - MAXIMUM AVERAGE OUTPUT POWER	107
APPENDIX G - CONDUCTED SPURIOUS EMISSIONS	109

Table of Contents**Page****APPENDIX H - POWER SPECTRAL DENSITY****113**

REPORT ISSUED HISTORY

Report Version	Description	Issued Date
R00	Original Issue.	Apr. 23, 2021

1. SUMMARY OF TEST RESULTS

Test procedures according to the technical standard(s):

FCC CFR Title 47, Part 15, Subpart C				
Standard(s) Section	Test Item	Test Result	Judgment	Remark
15.207	AC Power Line Conducted Emissions	APPENDIX A	PASS	-----
15.247(d) 15.205(a) 15.209(a)	Radiated Emissions	APPENDIX B APPENDIX C APPENDIX D	PASS	-----
15.247(a)(2)	Bandwidth	APPENDIX E	PASS	-----
15.247(b)(3)	Maximum Average Output Power	APPENDIX F	PASS	-----
15.247(d)	Conducted Spurious Emissions	APPENDIX G	PASS	-----
15.247(e)	Power Spectral Density	APPENDIX H	PASS	-----
15.203	Antenna Requirement	-----	PASS	Note(2)

Note:

- (1) "N/A" denotes test is not applicable in this test report.
- (2) The device what use a permanently attached antenna were considered sufficient to comply with the provisions of 15.203.

1.1 TEST FACILITY

The test facilities used to collect the test data in this report is at the location of No.3, Jinshagang 1st Road, Shixia, Dalang Town, Dongguan, Guangdong, China
 BTL's Test Firm Registration Number for FCC: 357015
 BTL's Designation Number for FCC: CN1240

1.2 MEASUREMENT UNCERTAINTY

ISO/IEC 17025 requires that an estimate of the measurement uncertainties associated with the emissions test results be included in the report. The measurement uncertainties given below are based on a 95% confidence level (based on a coverage factor (k=2))
 The BTL measurement uncertainty as below table:

A. AC power line conducted emissions test:

Test Site	Method	Measurement Frequency Range	U, (dB)
DG-C02	CISPR	150kHz ~ 30MHz	2.68

B. Radiated emissions test:

Test Site	Method	Measurement Frequency Range	Ant. H / V	U, (dB)
DG-CB03	CISPR	9kHz ~ 30MHz	-	3.02
		30MHz ~ 200MHz	V	4.26
		30MHz ~ 200MHz	H	3.38
		200MHz ~ 1,000MHz	V	3.98
		200MHz ~ 1,000MHz	H	3.94
		1GHz ~ 6GHz	-	3.96
		6GHz ~ 18GHz	-	5.24
		18GHz ~ 26.5GHz	-	3.62
		26.5GHz ~ 40GHz	-	4.00

C. Other Measurement:

Test Item	Uncertainty
Bandwidth	±3.8 %
Maximum Average Output Power	±0.95 dB
Conducted Spurious Emission	±2.71 dB
Power Spectral Density	±0.86 dB
Temperature	±0.08 °C
Humidity	±1.5%

Note: Unless specifically mentioned, the uncertainty of measurement has not been taken into account to declare the compliance or non-compliance to the specification.

1.3 TEST ENVIRONMENT CONDITIONS

Test Item	Temperature	Humidity	Test Voltage	Tested By
AC Power Line Conducted Emissions	25°C	53%	AC 120V/60Hz	Hayden Chen
Radiated Emissions-9kHz to 30 MHz	25°C	60%	AC 120V/60Hz	Hayden Chen
Radiated Emissions-30MHz to 1000MHz	26°C	52%	AC 120V/60Hz	Hayden Chen
Radiated Emissions-Above 1000MHz	24°C	60%	AC 120V/60Hz	Hayden Chen
Bandwidth	24°C	53%	AC 120V/60Hz	Rick Huang
Maximum Average Output Power	22°C	49%	AC 120V/60Hz	Howard Wei
Conducted Spurious Emissions	24°C	53%	AC 120V/60Hz	Rick Huang
Power Spectral Density	24°C	53%	AC 120V/60Hz	Rick Huang

2. GENERAL INFORMATION

2.1 GENERAL DESCRIPTION OF EUT

Equipment	Kasa Smart Wi-Fi Plug Slim, Energy Monitoring
Brand Name	tp-link
Test Model	KP125
Series Model	N/A
Model Difference(s)	N/A
Software Version	1.0
Hardware Version	1.0
Power Source	AC Mains.
Power Rating	100-120V ~ 60Hz; Max Load: 15A 1800W
Operation Frequency	2412 MHz ~ 2462 MHz
Modulation Type	IEEE 802.11b: DSSS IEEE 802.11g: OFDM IEEE 802.11n: OFDM
Bit Rate of Transmitter	IEEE 802.11b: 11/5.5/2/1 Mbps IEEE 802.11g: 54/48/36/24/18/12/9/6 Mbps IEEE 802.11n: up to 72.2 Mbps
Maximum Average Output Power	IEEE 802.11b: 18.55 dBm (0.0716 W)

Note:

- For a more detailed features description, please refer to the manufacturer's specifications or the user's manual.

2. Channel List:

CH01 - CH11 for IEEE 802.11b, IEEE 802.11g, IEEE 802.11n(HT20)							
Channel	Frequency (MHz)	Channel	Frequency (MHz)	Channel	Frequency (MHz)	Channel	Frequency (MHz)
01	2412	04	2427	07	2442	10	2457
02	2417	05	2432	08	2447	11	2462
03	2422	06	2437	09	2452		

3. Antenna Specification:

Ant.	Brand	P/N	Antenna Type	Connector	Gain (dBi)
1		N/A	IFA	N/A	3.5

Note:

- The antenna gain is provided by the manufacturer.

2.2 DESCRIPTION OF TEST MODES

The test system was pre-tested based on the consideration of all possible combinations of EUT operation mode.

Pretest Mode	Description
Mode 1	TX B Mode Channel 01/06/11
Mode 2	TX G Mode Channel 01/06/11
Mode 3	TX N(HT20) Mode Channel 01/06/11
Mode 4	TX B Mode Channel 01/02/06/10/11
Mode 5	TX G Mode Channel 01/02/06/10/11
Mode 6	TX N(HT20) MHz Mode Channel 01/02/06/10/11
Mode 7	TX B Mode Channel 01

Following mode(s) was (were) found to be the worst case(s) and selected for the final test.

AC power line conducted emissions test	
Final Test Mode	Description
Mode 7	TX B Mode Channel 01

Radiated emissions test - Below 1GHz	
Final Test Mode	Description
Mode 7	TX B Mode Channel 01

Radiated emissions test- Above 1GHz	
Final Test Mode	Description
Mode 4	TX B Mode Channel 01/02/06/10/11
Mode 5	TX G Mode Channel 01/02/06/10/11
Mode 6	TX N(HT20) MHz Mode Channel 01/02/06/10/11

Conducted test	
Final Test Mode	Description
Mode 1	TX B Mode Channel 01/06/11
Mode 2	TX G Mode Channel 01/06/11
Mode 3	TX N(HT20) Mode Channel 01/06/11

NOTE:

- (1) All the bit rate of transmitter have been tested and found the lowest rate is found to be the worst case and recorded.
- (2) For AC power line conducted emissions and radiated emission below 1 GHz test, the IEEE 802.11b channel 01 is found to be the worst case and recorded.
- (3) For radiated emission above 1 GHz test, the spurious points of 1GHz~26.5GHz have been pre-tested and in this report only recorded the worst case. The remaining spurious points are all below the limit value of 20dB.

2.3 PARAMETERS OF TEST SOFTWARE

Test Software Version	AmebaZ2_mptool_1V3
-----------------------	--------------------

2.4 DUTY CYCLE

If duty cycle is $\geq 98\%$, duty factor is not required.
 If duty cycle is $< 98\%$, duty factor shall be considered.
 The output power = measured power + duty factor.

IEEE 802.11b

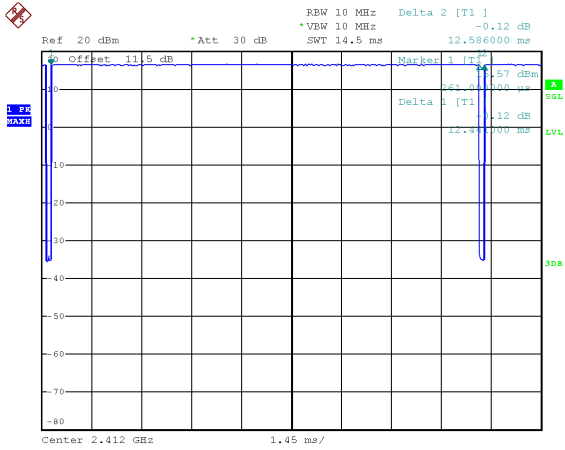

Date: 18.MAR.2021 16:57:44

Duty cycle = $12.441 \text{ ms} / 12.586 \text{ ms} = 98.85\%$
 Duty Factor = $10 \log(1/\text{Duty cycle}) = 0.00$

IEEE 802.11g

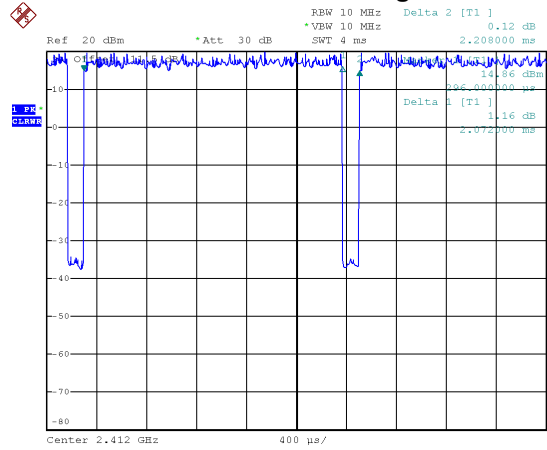

Date: 18.MAR.2021 16:58:11

Duty cycle = $2.072 \text{ ms} / 2.208 \text{ ms} = 93.84\%$
 Duty Factor = $10 \log(1/\text{Duty cycle}) = 0.28$

IEEE 802.11n(HT20)

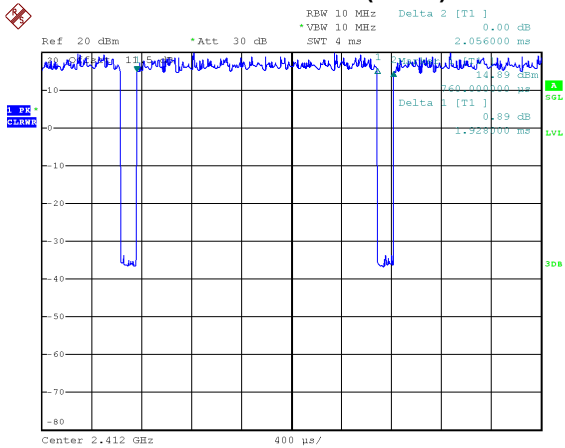

Date: 18.MAR.2021 16:58:31

Duty cycle = $1.928 \text{ ms} / 2.056 \text{ ms} = 93.77\%$
 Duty Factor = $10 \log(1/\text{Duty cycle}) = 0.28$

NOTE:

For IEEE 802.11b, IEEE 802.11g, IEEE 802.11n(HT20):
 For radiated emissions frequency above 1 GHz, the resolution bandwidth of test receiver/spectrum analyzer is 1 MHz and the video bandwidth is 1 kHz.

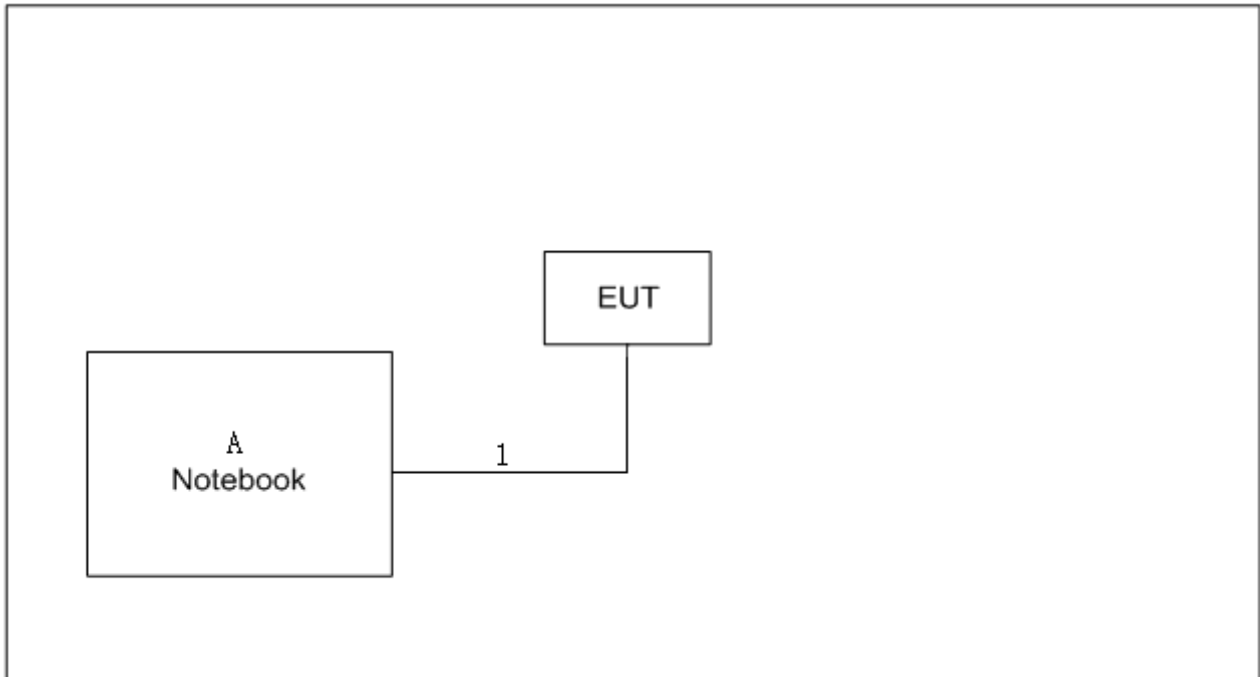
2.5 BLOCK DIAGRAM SHOWING THE CONFIGURATION OF SYSTEM TESTED**2.6 SUPPORT UNITS**

Item	Equipment	Brand	Model No.	Series No.
A	Notebook	Lenovo	V310-14ISK	LR07GZNB

Item	Cable Type	Shielded Type	Ferrite Core	Length
1	USB Cable	NO	NO	0.8m

3. AC POWER LINE CONDUCTED EMISSIONS

3.1 LIMIT

Frequency of Emission (MHz)	Limit (dB μ V)	
	Quasi-peak	Average
0.15 - 0.5	66 to 56*	56 to 46*
0.5 - 5.0	56	46
5.0 - 30.0	60	50

NOTE:

- (1) The tighter limit applies at the band edges.
- (2) The limit of "*" marked band means the limitation decreases linearly with the logarithm of the frequency in the range.

3.2 TEST PROCEDURE

- a. The EUT was placed 0.8 meters from the horizontal ground plane with EUT being connected to the power mains through a line impedance stabilization network (LISN). All other support equipment powered from additional LISN(s). The LISN provide 50 Ohm/ 50uH of coupling impedance for the measuring instrument.
- b. Interconnecting cables that hang closer than 40 cm to the ground plane shall be folded back and forth in the center forming a bundle 30 to 40 cm long.
- c. I/O cables that are not connected to a peripheral shall be bundled in the center. The end of the cable may be terminated, if required, using the correct terminating impedance. The overall length shall not exceed 1 m.
- d. LISN at least 80 cm from nearest part of EUT chassis.
- e. For the actual test configuration, please refer to the related Item -EUT Test Photos.

The following table is the setting of the receiver:

Receiver Parameters	Setting
Start Frequency	0.15 MHz
Stop Frequency	30 MHz
IF Bandwidth	9 kHz

3.3 DEVIATION FROM TEST STANDARD

No deviation.

3.4 TEST SETUP

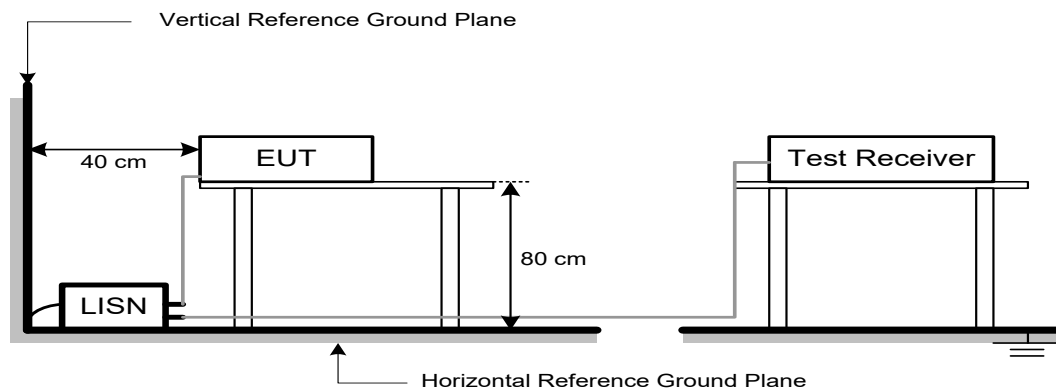

3.5 EUT OPERATION CONDITIONS

EUT was programmed to be in continuously transmitting mode.

3.6 TEST RESULTS

Please refer to the APPENDIX A.

4. RADIATED EMISSIONS

4.1 LIMIT

In case the emission fall within the restricted band specified on 15.205(a), then the 15.209(a) limit in the table below has to be followed.

LIMITS OF RADIATED EMISSION MEASUREMENT (9 kHz-1000 MHz)

Frequency (MHz)	Field Strength (microvolts/meter)	Measurement Distance (meters)
0.009-0.490	2400/F(kHz)	300
0.490-1.705	24000/F(kHz)	30
1.705-30.0	30	30
30-88	100	3
88-216	150	3
216-960	200	3
Above 960	500	3

LIMITS OF RADIATED EMISSION MEASUREMENT (Above 1000 MHz)

Frequency (MHz)	(dBuV/m at 3 m)	
	Peak	Average
Above 1000	74	54

NOTE:

- (1) The limit for radiated test was performed according to FCC CFR Title 47, Part 15, Subpart C.
- (2) The tighter limit applies at the band edges.
- (3) Emission level (dBuV/m)=20log Emission level (uV/m).

4.2 TEST PROCEDURE

- a. The measuring distance of 3 m shall be used for measurements. The EUT was placed on the top of a rotating table 0.8 meter above the ground at a 3 meter semi-anechoic chamber. The table was rotated 360 degrees to determine the position of the highest radiation.(below 1 GHz)
- b. The measuring distance of 3 m shall be used for measurements. The EUT was placed on the top of a rotating table 1.5 meter above the ground at a 3 meter semi-anechoic chamber. The table was rotated 360 degrees to determine the position of the highest radiation.(above 1 GHz)
- c. The height of the equipment or of the substitution antenna shall be 0.8m or 1.5m; the height of the test antenna shall vary between 1 m to 4 m. Both horizontal and vertical polarizations of the antenna are set to make the measurement.
- d. For each suspected emission, the EUT was arranged to its worst case and then the antenna was tuned to heights find the maximum reading (used Bore sight function).
- e. The receiver system was set to peak and average detect function and specified bandwidth with maximum hold mode when the test frequency is above 1 GHz.
- f. The initial step in collecting radiated emission data is a receiver peak detector mode pre-scanning the measurement frequency range. Significant peaks are then marked and then Quasi Peak detector mode re-measured.
- g. All readings are Peak unless otherwise stated QP in column of Note. Peak denotes that the Peak reading compliance with the QP Limits and then QP Mode measurement didn't perform. (below 1 GHz)
- h. All readings are Peak Mode value unless otherwise stated AVG in column of Note. If the Peak Mode Measured value compliance with the Peak Limits and lower than AVG Limits, the EUT shall be deemed to meet both Peak & AVG Limits and then only Peak Mode was measured, but AVG Mode didn't perform. (above 1 GHz)
- i. For the actual test configuration, please refer to the related Item -EUT Test Photos.

The following table is the setting of the receiver:

Spectrum Parameters	Setting
Start ~ Stop Frequency	9 kHz~150 kHz for RBW 200 Hz
Start ~ Stop Frequency	0.15 MHz~30 MHz for RBW 9 kHz
Start ~ Stop Frequency	30 MHz~1000 MHz for RBW 100 kHz

Spectrum Parameters	Setting
Start Frequency	1000 MHz
Stop Frequency	10th carrier harmonic
RBW / VBW (Emission in restricted band)	1 MHz / 3 MHz for PK value 1 MHz / 1/T Hz for AVG value

Receiver Parameters	Setting
Start ~ Stop Frequency	9 kHz~90 kHz for PK/AVG detector
Start ~ Stop Frequency	90 kHz~110 kHz for QP detector
Start ~ Stop Frequency	110 kHz~490 kHz for PK/AVG detector
Start ~ Stop Frequency	490 kHz~30 MHz for QP detector
Start ~ Stop Frequency	30 MHz~1000 MHz for QP detector
Start ~ Stop Frequency	1 GHz~26.5 GHz for PK/AVG detector

4.3 DEVIATION FROM TEST STANDARD

No deviation.

4.4 TEST SETUP

9 kHz to 30 MHz

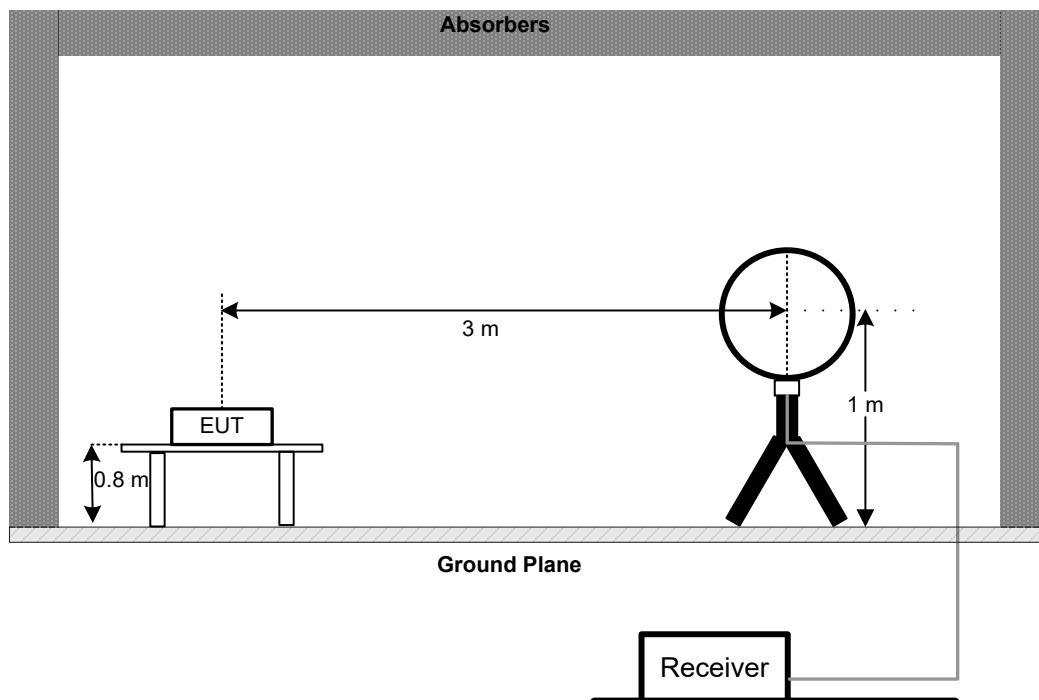

30 MHz to 1 GHz

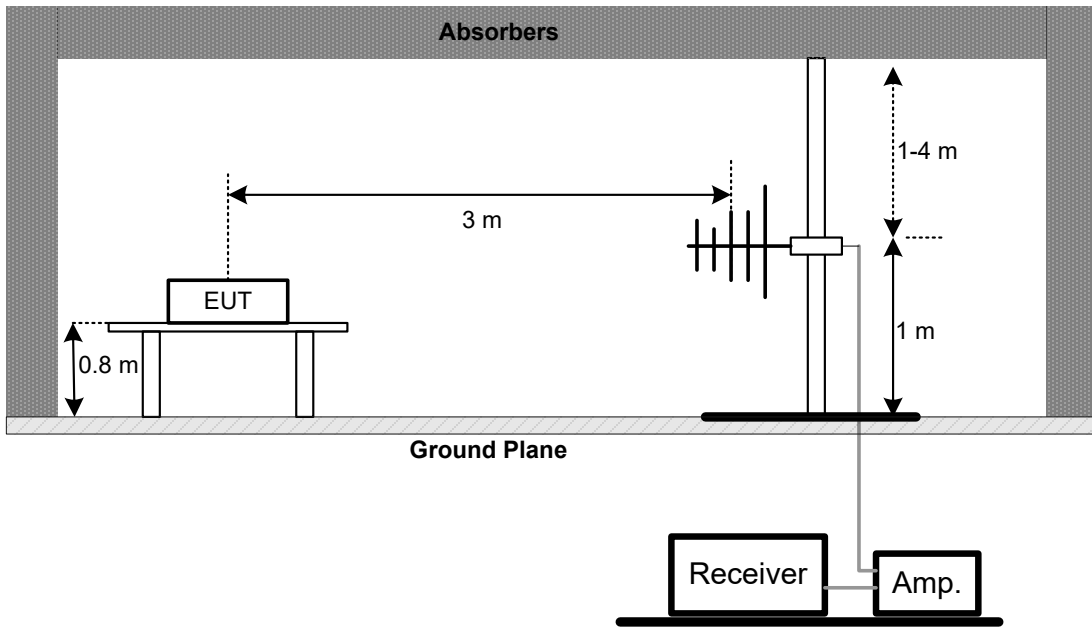

Above 1 GHz

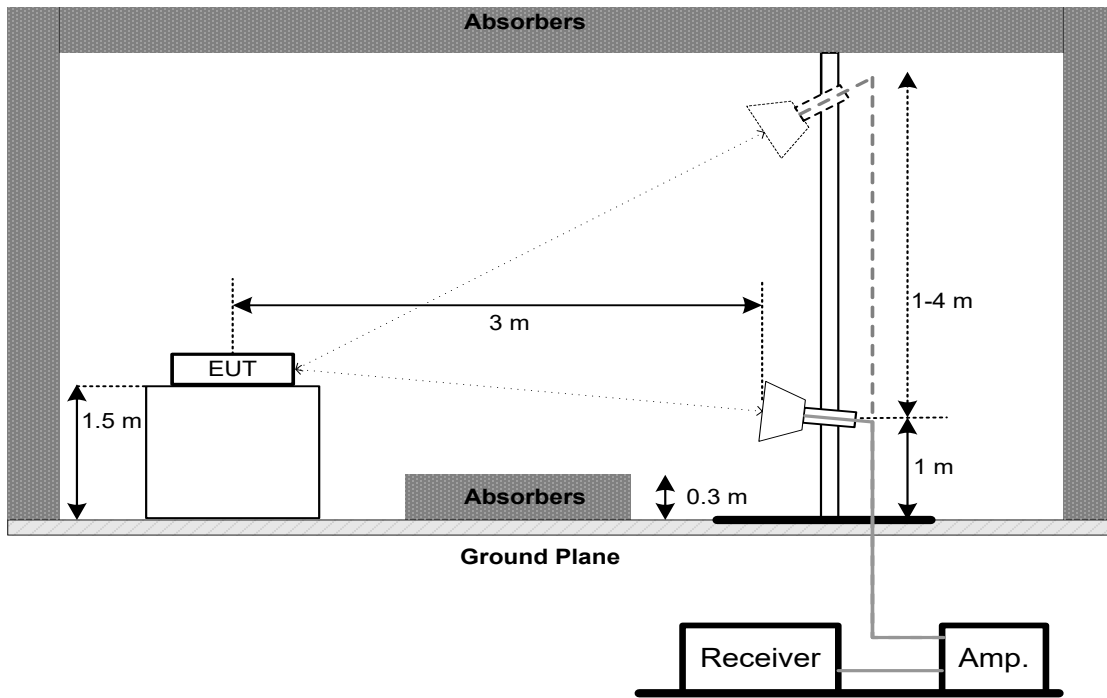

4.5 EUT OPERATION CONDITIONS

The EUT was programmed to be in continuously transmitting mode.

4.6 TEST RESULTS - 9 KHZ TO 30 MHZ

Please refer to the APPENDIX B.

Remark:

- (1) Distance extrapolation factor = $40 \log (\text{specific distance} / \text{test distance})$ (dB).
- (2) Limit line = specific limits (dBuV) + distance extrapolation factor.

4.7 TEST RESULTS - 30 MHZ TO 1000 MHZ

Please refer to the APPENDIX C.

4.8 TEST RESULTS - ABOVE 1000 MHZ

Please refer to the APPENDIX D.

Remark:

- (1) No limit: This is fundamental signal, the judgment is not applicable.
For fundamental signal judgment was referred to Peak output test.

5. BANDWIDTH

5.1 LIMIT

Section	Test Item	Limit
FCC 15.247(a)(2)	6 dB Bandwidth	Minimum 500 kHz
	99% Emission Bandwidth	-

5.2 TEST PROCEDURE

- The EUT was directly connected to the spectrum analyzer and antenna output port as show in the block diagram below.
- The following table is the setting of the spectrum analyzer:

For 6 dB Bandwidth:

Spectrum Parameters	Setting
Span Frequency	> Measurement Bandwidth
RBW	100 kHz
VBW	300 kHz
Detector	Peak
Trace	Max Hold
Sweep Time	Auto

For 99% Emission Bandwidth:

Spectrum Parameters	Setting
Span Frequency	Between 1.5 times and 5.0 times the OBW
RBW	300 kHz For 20MHz 1 MHz For 40MHz
VBW	1 MHz For 20MHz 3 MHz For 40MHz
Detector	Peak
Trace	Max Hold
Sweep Time	Auto

5.3 DEVIATION FROM STANDARD

No deviation.

5.4 TEST SETUP



5.5 EUT OPERATION CONDITIONS

The EUT was programmed to be in continuously transmitting mode.

5.6 TEST RESULTS

Please refer to the APPENDIX E.

6. MAXIMUM AVERAGE OUTPUT POWER

6.1 LIMIT

Section	Test Item	Limit
FCC 15.247(b)(3)	Maximum Average Output Power	1.0000 Watt or 30.00 dBm

6.2 TEST PROCEDURE

- The EUT was directly connected to the power meter and antenna output port as show in the block diagram below.
- The maximum conducted output power was performed in accordance with method 11.9.2.3.1 of ANSI C63.10-2013.

6.3 DEVIATION FROM STANDARD

No deviation.

6.4 TEST SETUP

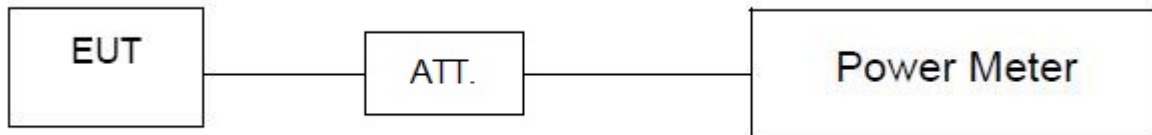

6.5 EUT OPERATION CONDITIONS

The EUT was programmed to be in continuously transmitting mode.

6.6 TEST RESULTS

Please refer to the APPENDIX F.

7. CONDUCTED SPURIOUS EMISSIONS

7.1 LIMIT

In any 100 kHz bandwidth outside the frequency band in which the spread spectrum or digitally modulated intentional radiator is operating, the radio frequency power that is produced by the intentional radiator shall be at least 20 dB below that in the 100 kHz bandwidth within the band that contains the highest level of the desired power, based on either an RF conducted or a radiated measurement, provided the transmitter demonstrates compliance with the peak Output Power limits. If the transmitter complies with the Output Power limits based on the use of RMS averaging over a time interval, as permitted under paragraph (b)(3) of this section, the attenuation required under this paragraph shall be 30 dB instead of 20 dB. Attenuation below the general limits specified in Section 15.209(a) is not required.

7.2 TEST PROCEDURE

- a. The EUT was directly connected to the spectrum analyzer and antenna output port as show in the block diagram below.
- b. The following table is the setting of the spectrum analyzer:

Spectrum Parameters	Setting
Start Frequency	30 MHz
Stop Frequency	26.5 GHz
RBW	100 kHz
VBW	100 kHz
Detector	Peak
Trace	Max Hold
Sweep Time	Auto

7.3 DEVIATION FROM STANDARD

No deviation.

7.4 TEST SETUP

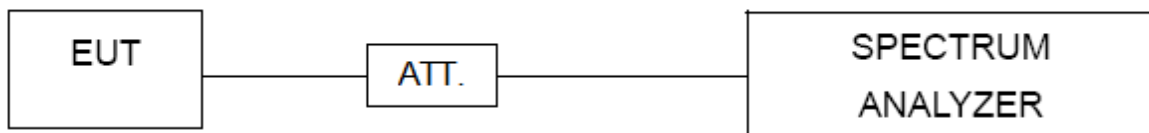

7.5 EUT OPERATION CONDITIONS

The EUT was programmed to be in continuously transmitting mode.

7.6 TEST RESULTS

Please refer to the APPENDIX G.

8. POWER SPECTRAL DENSITY

8.1 LIMIT

Section	Test Item	Limit
FCC 15.247(e)	Power Spectral Density	8 dBm (in any 3 kHz)

8.2 TEST PROCEDURE

- a. The EUT was directly connected to the spectrum analyzer and antenna output port as show in the block diagram below.
- b. The following table is the setting of the spectrum analyzer:

Spectrum Parameters	Setting
Span Frequency	25 MHz (20 MHz) / 60 MHz (40 MHz)
RBW	3 kHz
VBW	10 kHz
Detector	Peak
Trace	Max Hold
Sweep Time	Auto

8.3 DEVIATION FROM STANDARD

No deviation.

8.4 TEST SETUP

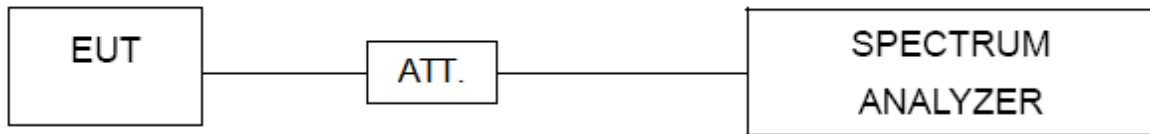

8.5 EUT OPERATION CONDITIONS

The EUT was programmed to be in continuously transmitting mode.

8.6 TEST RESULTS

Please refer to the APPENDIX H.

9. MEASUREMENT INSTRUMENTS LIST

AC Power Line Conducted Emissions					
Item	Kind of Equipment	Manufacturer	Type No.	Serial No.	Calibrated until
1	EMI Test Receiver	R&S	ESCI	100382	Feb. 28, 2022
2	LISN	EMCO	3816/2	52765	Feb. 27, 2022
3	TWO-LINE V-NETWORK	R&S	ENV216	101447	Feb. 27, 2022
4	50Ω Terminator	SHX	TF5-3	15041305	Feb. 27, 2022
5	Measurement Software	Farad	EZ-EMC Ver.NB-03A1-01	N/A	N/A
6	Cable	N/A	RG223	12m	Mar. 09, 2022
7	643 Shield Room	ETS	6*4*3m	N/A	N/A

Radiated Emissions - 9 kHz to 30 MHz					
Item	Kind of Equipment	Manufacturer	Type No.	Serial No.	Calibrated until
1	Antenna	EM	EM-6876-1	230	Apr. 16, 2021
2	Cable	N/A	RG 213/U	N/A	May 29, 2021
3	EMI Test Receiver	R&S	ESCI	100895	Feb. 27, 2022
4	Measurement Software	Farad	EZ-EMC Ver.NB-03A1-01	N/A	N/A
5	966 Chambe Room	RM	9*6*6m	N/A	Jul. 25, 2021

Radiated Emissions - 30 MHz to 1 GHz					
Item	Kind of Equipment	Manufacturer	Type No.	Serial No.	Calibrated until
1	Trilog-Broadband Antenna	Schwarzbeck	VULB9168	586	Nov. 27, 2021
2	Amplifier	HP	8447D	2944A08742	Feb. 28, 2022
3	Receiver	Agilent	N9038A	MY52130039	Jul. 25, 2021
4	Cable	emci	LMR-400(30MHz-1 GHz)(8m+5m)	N/A	May 22, 2021
5	Controller	CT	SC100	N/A	N/A
6	Controller	MF	MF-7802	MF780208416	N/A
7	Measurement Software	Farad	EZ-EMC Ver.NB-03A1-01	N/A	N/A
8	966 Chambe Room	RM	9*6*6m	N/A	Jul. 25, 2021

Radiated Emissions - Above 1 GHz					
Item	Kind of Equipment	Manufacturer	Type No.	Serial No.	Calibrated until
1	Double Ridged Guide Antenna	ETS	3115	75789	May 12, 2021
2	Broad-Band Horn Antenna	Schwarzbeck	BBHA 9170	9170319	Jul. 07, 2021
3	Amplifier	Agilent	8449B	3008A02584	Jul. 25, 2021
4	Microwave Preamplifier With Adaptor	EMC INSTRUMENT	EMC2654045	980039 & HA01	Feb. 28, 2022
5	Receiver	Agilent	N9038A	MY52130039	Jul. 25, 2021
6	Controller	CT	SC100	N/A	N/A
7	Controller	MF	MF-7802	MF780208416	N/A
8	Cable	N/A	EMC104-SM-SM-6000	N/A	Oct. 16, 2021
9	Measurement Software	Farad	EZ-EMC Ver.NB-03A1-01	N/A	N/A
10	Filter	STI	STI15-9912	N/A	Jul. 25, 2021
11	966 Chambe Room	RM	9*6*6m	N/A	Jul. 25, 2021

Bandwidth & Conducted Spurious Emissions & Power Spectral Density					
Item	Kind of Equipment	Manufacturer	Type No.	Serial No.	Calibrated until
1	Spectrum Analyzer	R&S	FSP40	100185	Jul. 25, 2021
2	RF Cable	Tongkaichuan	N/A	N/A	N/A
3	DC Block	Mini	N/A	N/A	N/A
4	Attenuator	WOKEN	6SM3502	VAS1214NL	Feb. 07, 2022

Maximum Average Output Power					
Item	Kind of Equipment	Manufacturer	Type No.	Serial No.	Calibrated until
1	Peak Power Analyzer	Keysight	8990B	MY51000506	Aug. 07, 2021
2	Wideband power sensor	Keysight	N1923A	MY58310004	Jul. 25, 2021
3	Attenuator	WOKEN	6SM3502	VAS1214NL	Feb. 07, 2022
4	RF Cable	Tongkaichuan	N/A	N/A	N/A

Remark: "N/A" denotes no model name, serial no. or calibration specified.

All calibration period of equipment list is one year.

10. EUT TEST PHOTO**AC Power Line Conducted Emissions Test Photos**

Radiated Emissions Test Photos**9 kHz to 30 MHz**

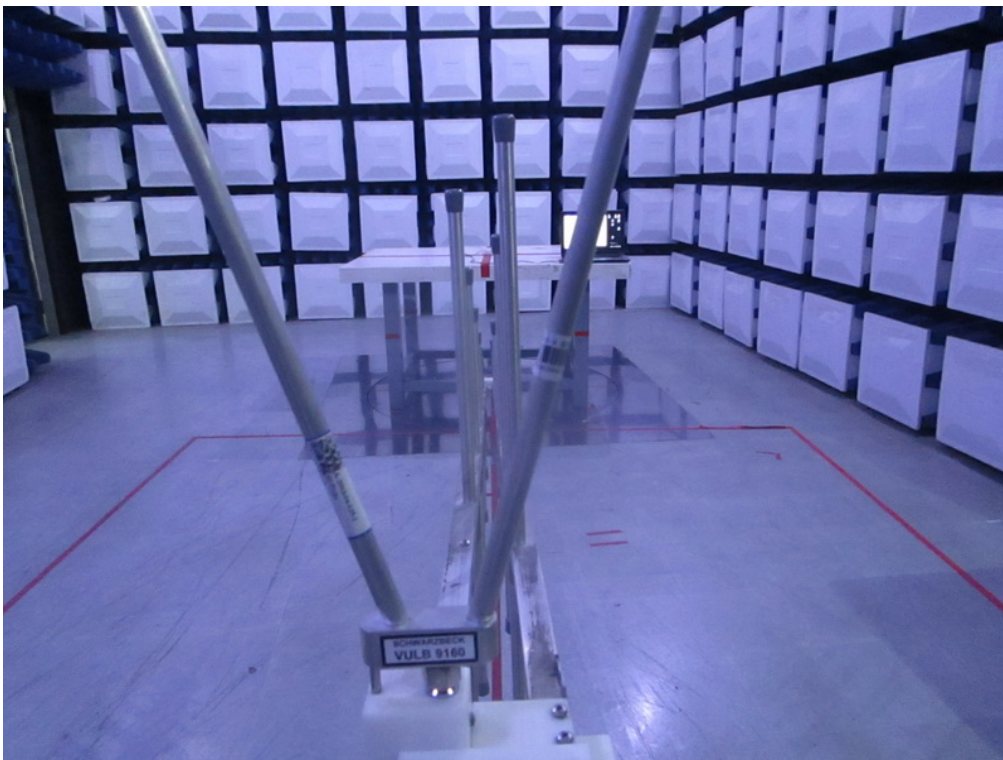
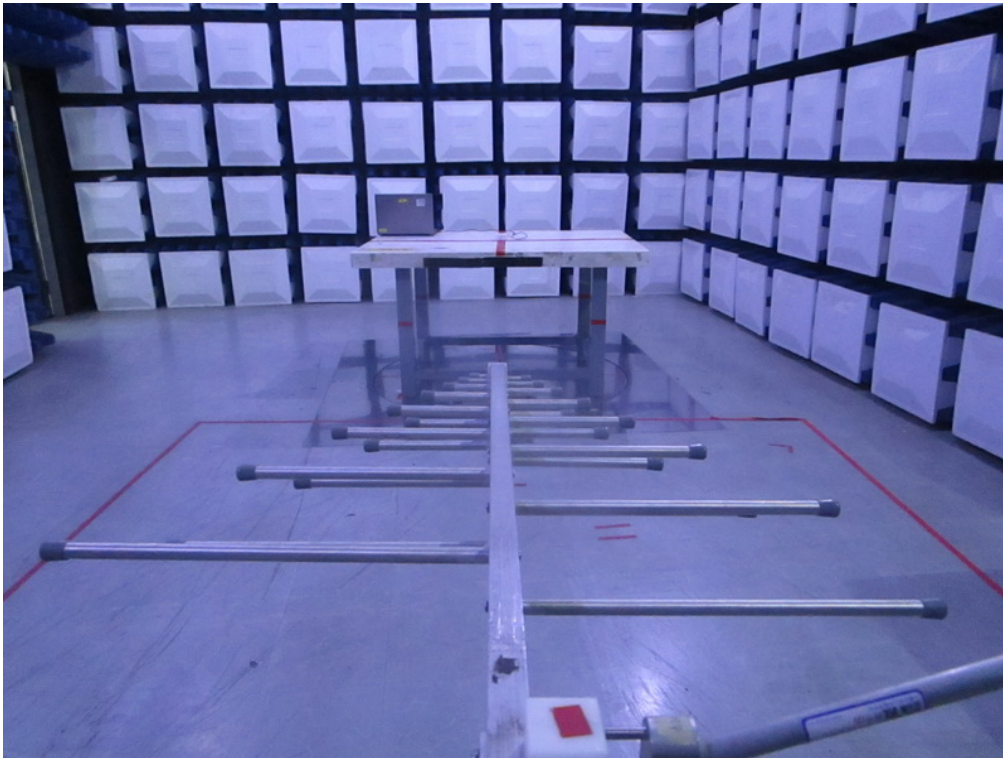
Radiated Emissions Test Photos**30 MHz to 1 GHz**

Radiated Emissions Test Photos

Above 1 GHz

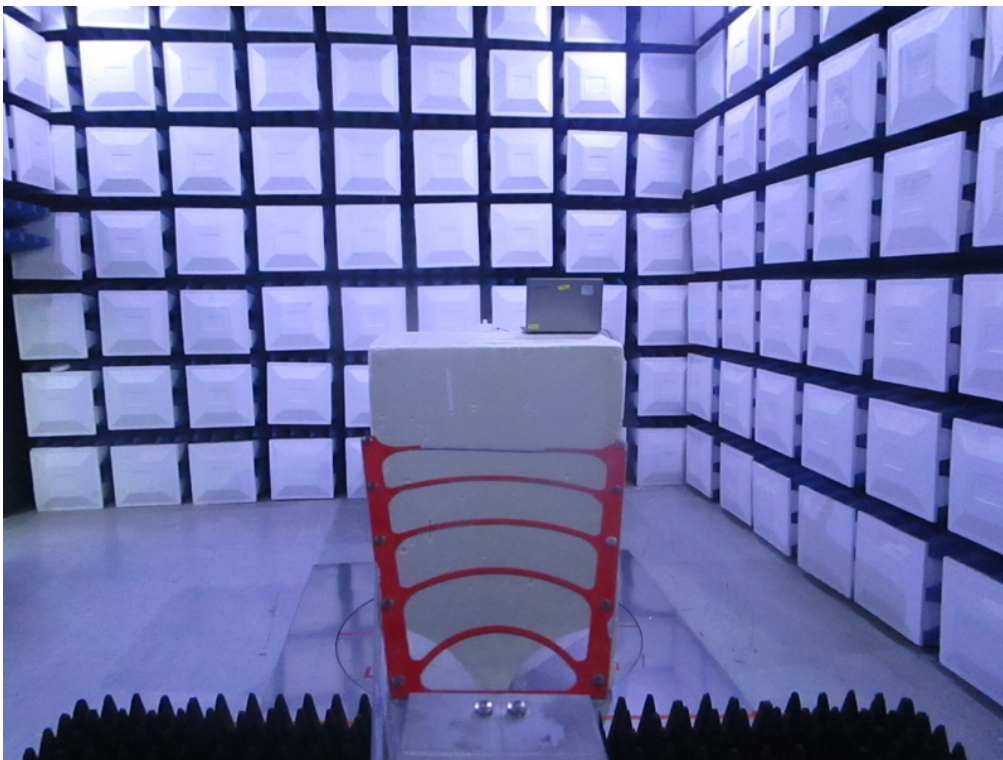

APPENDIX A - AC POWER LINE CONDUCTED EMISSIONS

Test Mode	TX B Mode Channel 01	Phase	Line
-----------	----------------------	-------	------

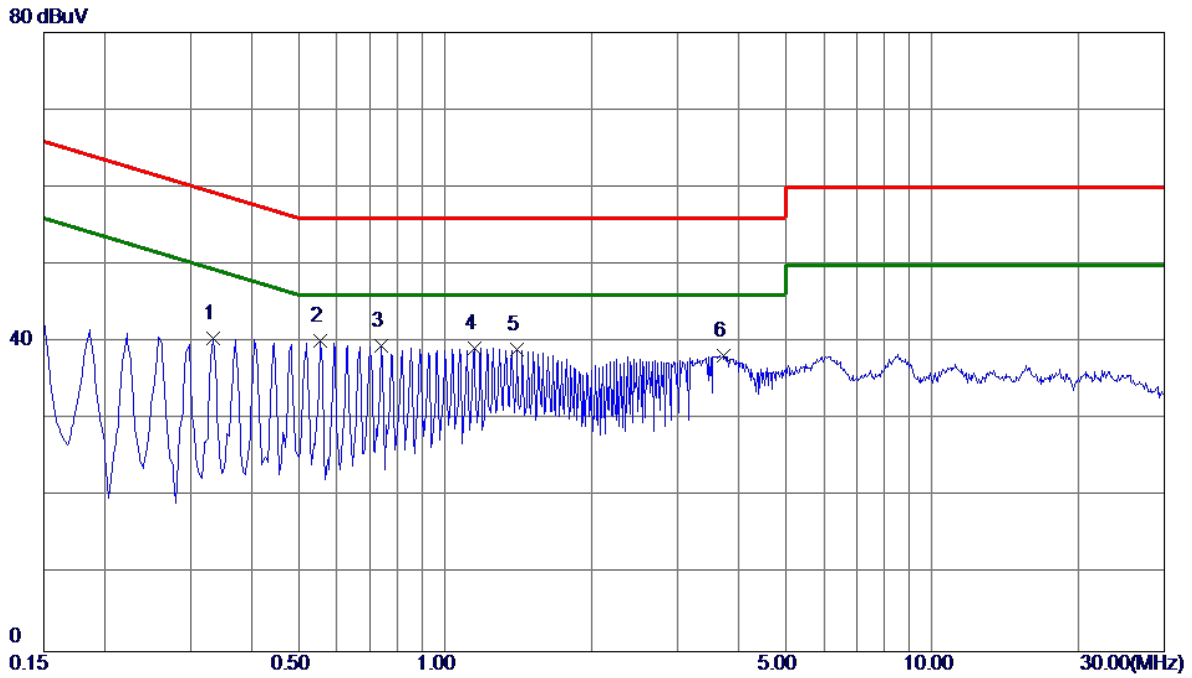

No.	Freq. MHz	Reading Level dBuV	Correct Factor dB	Measure ment dBuV	Limit dBuV	Margin dB	Detector	Comment
1	0.3345	30.55	9.89	40.44	59.34	-18.90	Peak	
2 *	0.5550	30.29	9.94	40.23	56.00	-15.77	Peak	
3	0.7395	29.57	9.89	39.46	56.00	-16.54	Peak	
4	1.1490	29.23	9.99	39.22	56.00	-16.78	Peak	
5	1.4055	29.07	10.00	39.07	56.00	-16.93	Peak	
6	3.7365	28.00	10.18	38.18	56.00	-17.82	Peak	

REMARKS:

- (1) Measurement Value = Reading Level + Correct Factor.
- (2) Margin Level = Measurement Value - Limit Value.

Test Mode	TX B Mode Channel 01	Phase	Neutral
-----------	----------------------	-------	---------

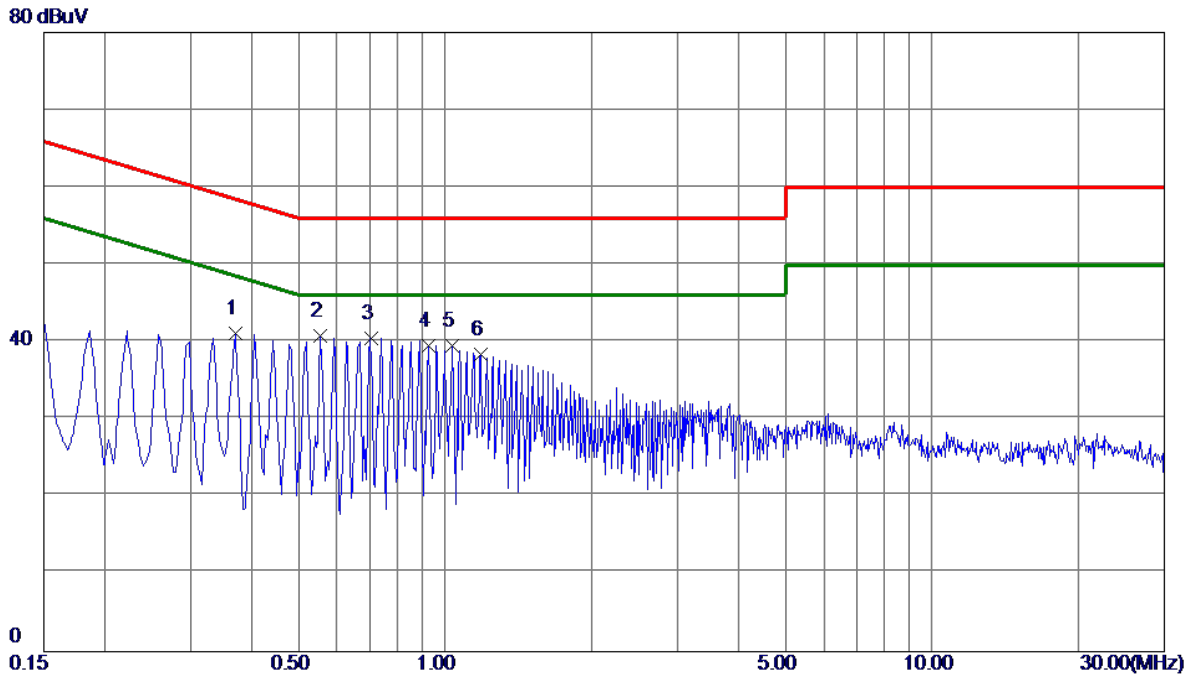

No.	Freq. MHz	Reading Level dBuV	Correct Factor dB	Measure ment dBuV	Limit dBuV	Margin dB	Detector	Comment
1	0.3704	31.00	10.05	41.05	58.49	-17.44	Peak	
2 *	0.5550	30.64	10.15	40.79	56.00	-15.21	Peak	
3	0.7035	30.38	10.09	40.47	56.00	-15.53	Peak	
4	0.9240	29.31	10.25	39.56	56.00	-16.44	Peak	
5	1.0365	29.29	10.27	39.56	56.00	-16.44	Peak	
6	1.1849	28.04	10.29	38.33	56.00	-17.67	Peak	

REMARKS:

- (1) Measurement Value = Reading Level + Correct Factor.
- (2) Margin Level = Measurement Value - Limit Value.

APPENDIX B - RADIATED EMISSION - 9 KHZ TO 30 MHZ

Test Mode	TX B Mode Channel 01	Polarization	Ant 0°
-----------	----------------------	--------------	--------

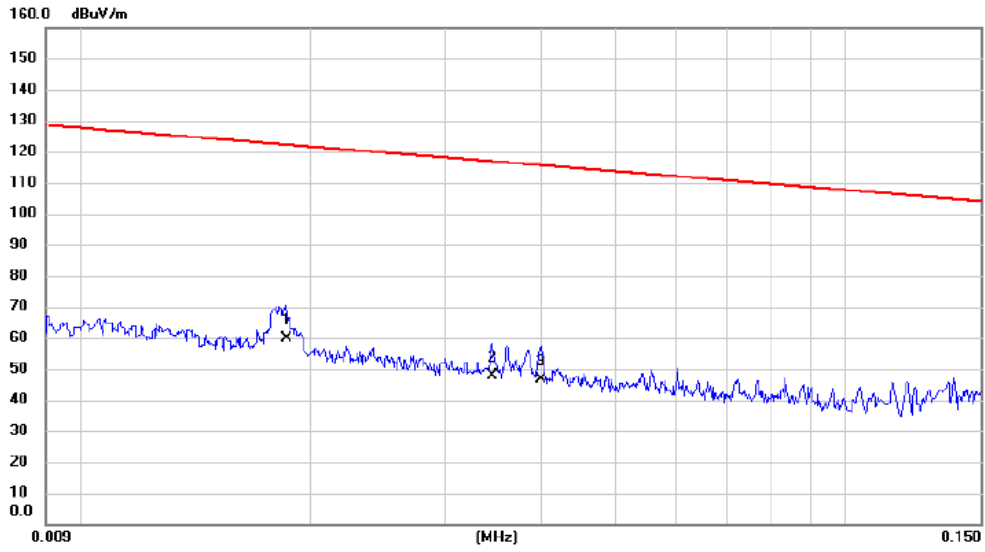

No.	Mk.	Freq. MHz	Reading Level dBuV	Correct Factor dB	Measure- ment dBuV/m	Limit dBuV/m	Margin dB	Detector	Comment
1	*	0.0186	45.96	13.65	59.61	122.21	-62.60	AVG	
2		0.0345	35.13	12.83	47.96	116.85	-68.89	AVG	
3		0.0400	33.94	12.69	46.63	115.56	-68.93	AVG	

REMARKS:

- (1) Measurement Value = Reading Level + Correct Factor.
- (2) Margin Level = Measurement Value - Limit Value.

Test Mode	TX B Mode Channel 01	Polarization	Ant 0°
-----------	----------------------	--------------	--------

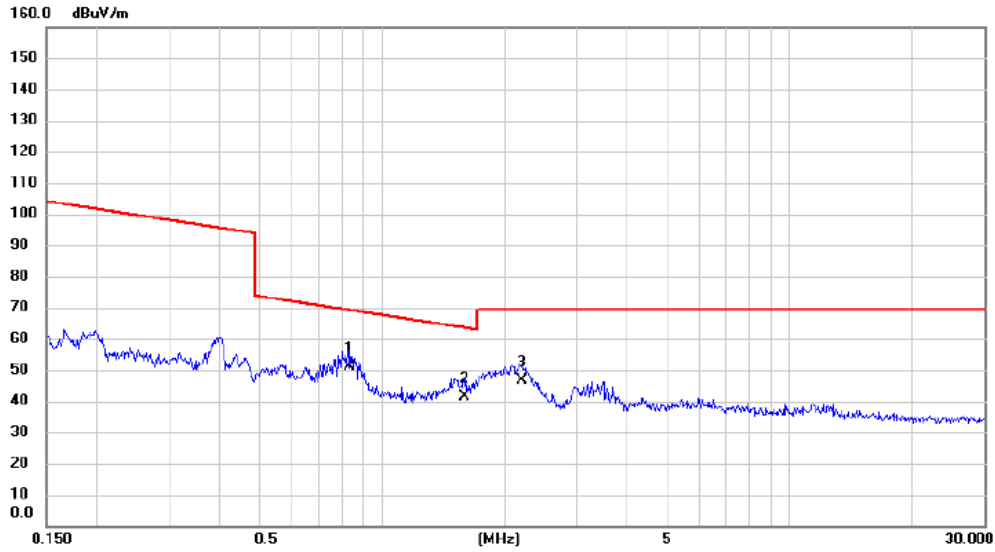

No. Mk.	Freq. MHz	Reading Level dBuV	Correct Factor dB	Measurement dBuV/m	Limit dBuV/m	Margin dB	Detector	Comment
1 *	0.8305	39.15	11.87	51.02	69.22	-18.20	QP	
2	1.5935	30.07	11.50	41.57	63.56	-21.99	QP	
3	2.2015	35.33	11.20	46.53	69.54	-23.01	QP	

REMARKS:

- (1) Measurement Value = Reading Level + Correct Factor.
- (2) Margin Level = Measurement Value - Limit Value.

Test Mode	TX B Mode Channel 01	Polarization	Ant 90°
-----------	----------------------	--------------	---------

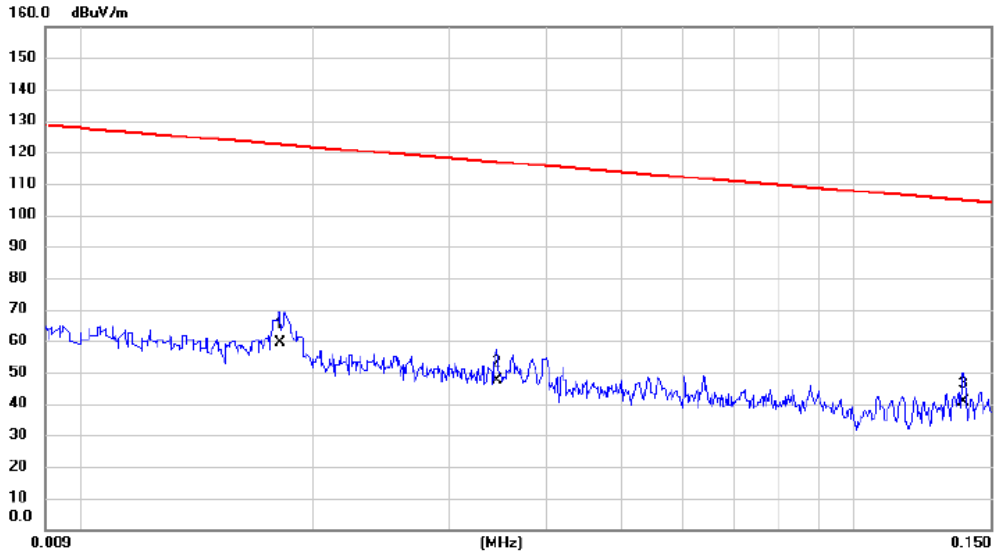

No.	Mk.	Freq. MHz	Reading Level dBuV	Correct Factor dB	Measure- ment dBuV/m	Limit dBuV/m	Margin dB	Detector	Comment
1	*	0.0181	45.41	13.81	59.22	122.45	-63.23	AVG	
2		0.0346	34.48	12.83	47.31	116.82	-69.51	AVG	
3		0.1386	27.78	12.74	40.52	104.77	-64.25	AVG	

REMARKS:

- (1) Measurement Value = Reading Level + Correct Factor.
- (2) Margin Level = Measurement Value - Limit Value.

Test Mode	TX B Mode Channel 01	Polarization	Ant 90°
-----------	----------------------	--------------	---------

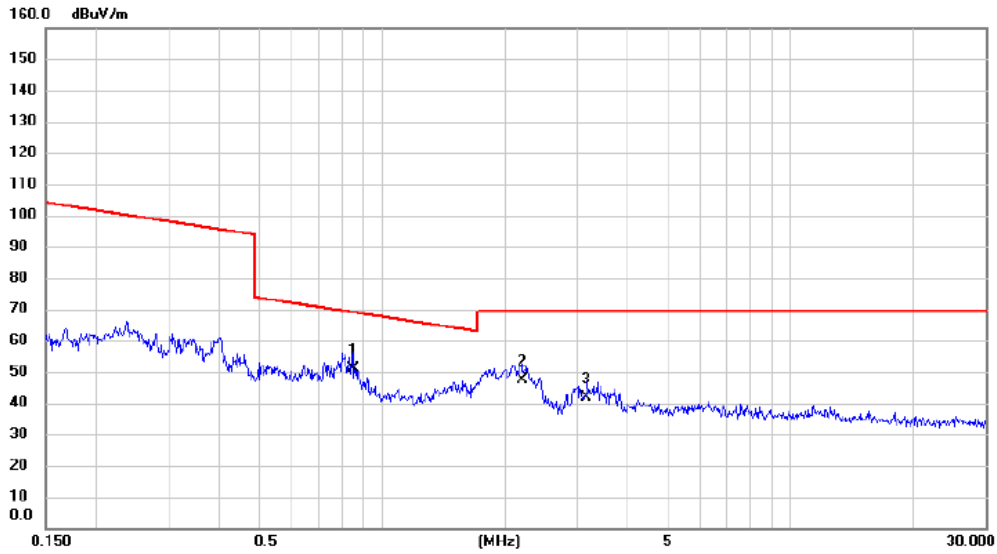

No.	Mk.	Freq. MHz	Reading Level dBuV	Correct Factor dB	Measure- ment dBuV/m	Limit dBuV/m	Margin dB	Detector	Comment
1	*	0.8483	39.32	11.86	51.18	69.03	-17.85	QP	
2		2.2015	36.15	11.20	47.35	69.54	-22.19	QP	
3		3.1731	30.87	10.83	41.70	69.54	-27.84	QP	

REMARKS:

(1) Measurement Value = Reading Level + Correct Factor.

(2) Margin Level = Measurement Value - Limit Value.

APPENDIX C - RADIATED EMISSION - 30 MHZ TO 1000 MHZ

Test Mode	TX B Mode Channel 01	Polarization	Vertical
-----------	----------------------	--------------	----------

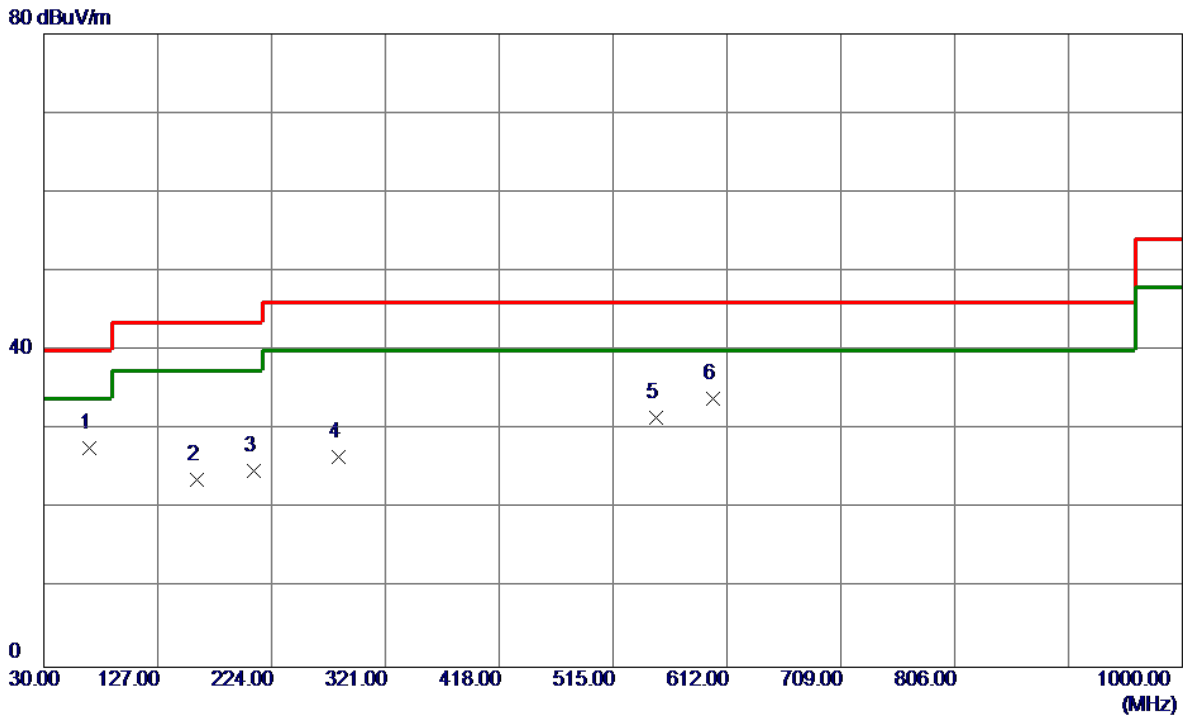

No.	Freq. MHz	Reading Level dBuV/m	Correct Factor dB	Measure ment dBuV/m	Limit dBuV/m	Margin dB	Detector	Comment
1	68.3150	43.52	-15.88	27.64	40.00	-12.36	Peak	
2	159.9800	36.11	-12.37	23.74	43.50	-19.76	Peak	
3	208.9650	40.11	-15.24	24.87	43.50	-18.63	Peak	
4	281.2300	38.15	-11.53	26.62	46.00	-19.38	Peak	
5	551.8600	37.34	-5.85	31.49	46.00	-14.51	Peak	
6 *	599.8750	38.52	-4.55	33.97	46.00	-12.03	Peak	

REMARKS:

- (1) Measurement Value = Reading Level + Correct Factor.
- (2) Margin Level = Measurement Value - Limit Value.

Test Mode	TX B Mode Channel 01	Polarization	Horizontal
-----------	----------------------	--------------	------------

80 dBuV/m

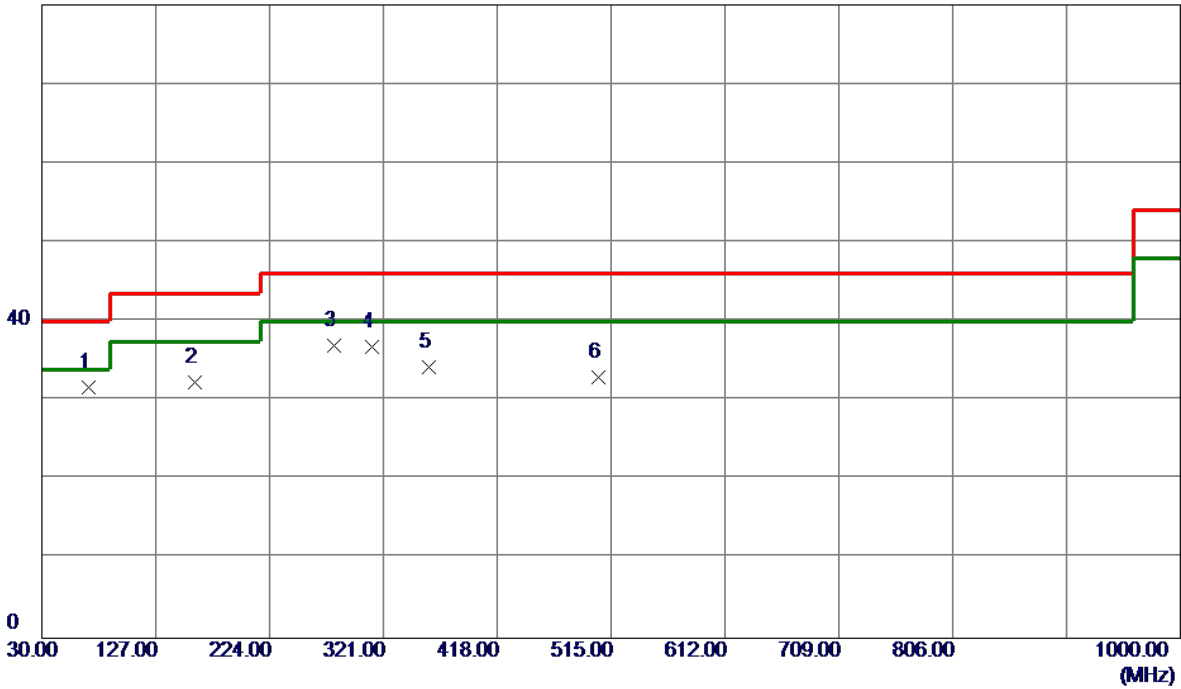

No.	Freq. MHz	Reading Level dBuV/m	Correct Factor dB	Measure ment dBuV/m	Limit dBuV/m	Margin dB	Detector	Comment
1 *	70.2550	47.99	-16.27	31.72	40.00	-8.28	Peak	
2	159.9800	44.76	-12.37	32.39	43.50	-11.11	Peak	
3	279.2900	48.60	-11.61	36.99	46.00	-9.01	Peak	
4	311.7850	47.47	-10.67	36.80	46.00	-9.20	Peak	
5	359.8000	43.93	-9.73	34.20	46.00	-11.80	Peak	
6	503.8450	39.52	-6.49	33.03	46.00	-12.97	Peak	

REMARKS:

- (1) Measurement Value = Reading Level + Correct Factor.
- (2) Margin Level = Measurement Value - Limit Value.

APPENDIX D - RADIATED EMISSION- ABOVE 1000 MHZ

Test Mode	TX B Mode 2412 MHz	Polarization	Vertical
-----------	--------------------	--------------	----------

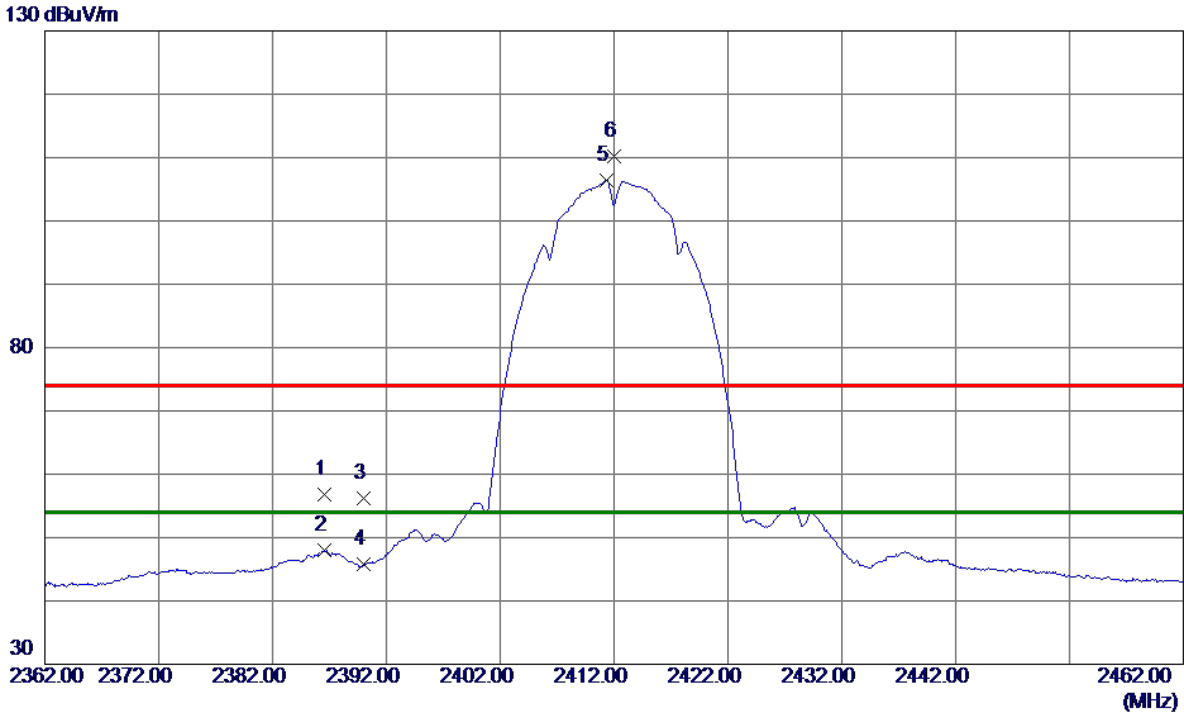

No.	Freq. MHz	Reading Level dBuV/m	Correct Factor dB	Measure ment dBuV/m	Limit dBuV/m	Margin dB	Detector	Comment
1	2386.6000	45.03	11.81	56.84	74.00	-17.16	Peak	
2	2386.6000	36.12	11.81	47.93	54.00	-6.07	AVG	
3	2390.0000	44.35	11.82	56.17	74.00	-17.83	Peak	
4	2390.0000	34.00	11.82	45.82	54.00	-8.18	AVG	
5 *	2411.3000	94.53	11.89	106.42	54.00	52.42	AVG	No Limit
6	2412.0000	98.39	11.89	110.28	74.00	36.28	Peak	No Limit

REMARKS:

- (1) Measurement Value = Reading Level + Correct Factor.
- (2) Margin Level = Measurement Value - Limit Value.

Test Mode	TX B Mode 2412 MHz	Polarization	Vertical
-----------	--------------------	--------------	----------

80 dBuV/m

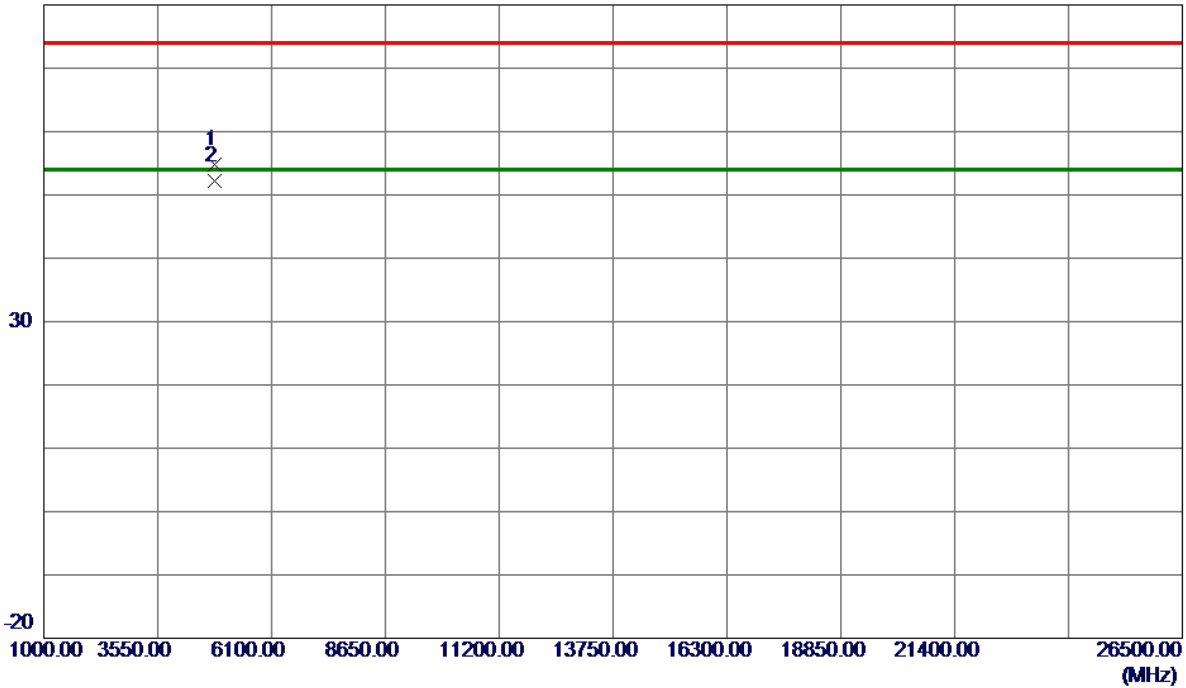

No.	Freq. MHz	Reading Level dBuV/m	Correct Factor dB	Measure ment dBuV/m	Limit dBuV/m	Margin dB	Detector	Comment
1	4824.0120	46.30	8.46	54.76	74.00	-19.24	Peak	
2 *	4824.0870	43.81	8.46	52.27	54.00	-1.73	AVG	

REMARKS:

- (1) Measurement Value = Reading Level + Correct Factor.
- (2) Margin Level = Measurement Value - Limit Value.

Test Mode	TX B Mode 2412 MHz	Polarization	Horizontal
-----------	--------------------	--------------	------------

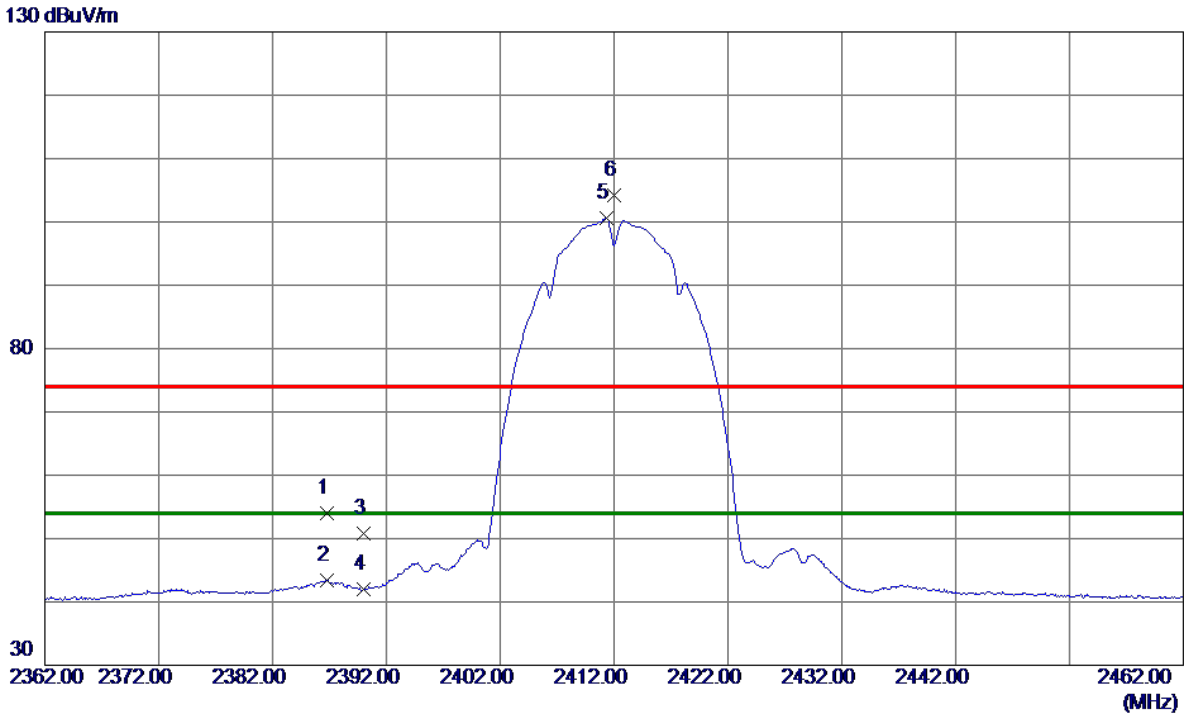

No.	Freq. MHz	Reading Level dBuV/m	Correct Factor dB	Measure ment dBuV/m	Limit dBuV/m	Margin dB	Detector	Comment
1	2386.8000	42.17	11.81	53.98	74.00	-20.02	Peak	
2	2386.8000	31.60	11.81	43.41	54.00	-10.59	AVG	
3	2390.0000	39.00	11.82	50.82	74.00	-23.18	Peak	
4	2390.0000	30.17	11.82	41.99	54.00	-12.01	AVG	
5 *	2411.3000	88.67	11.89	100.56	54.00	46.56	AVG	No Limit
6	2411.9500	92.27	11.89	104.16	74.00	30.16	Peak	No Limit

REMARKS:

- (1) Measurement Value = Reading Level + Correct Factor.
- (2) Margin Level = Measurement Value - Limit Value.

Test Mode	TX B Mode 2412 MHz	Polarization	Horizontal
-----------	--------------------	--------------	------------

80 dBuV/m

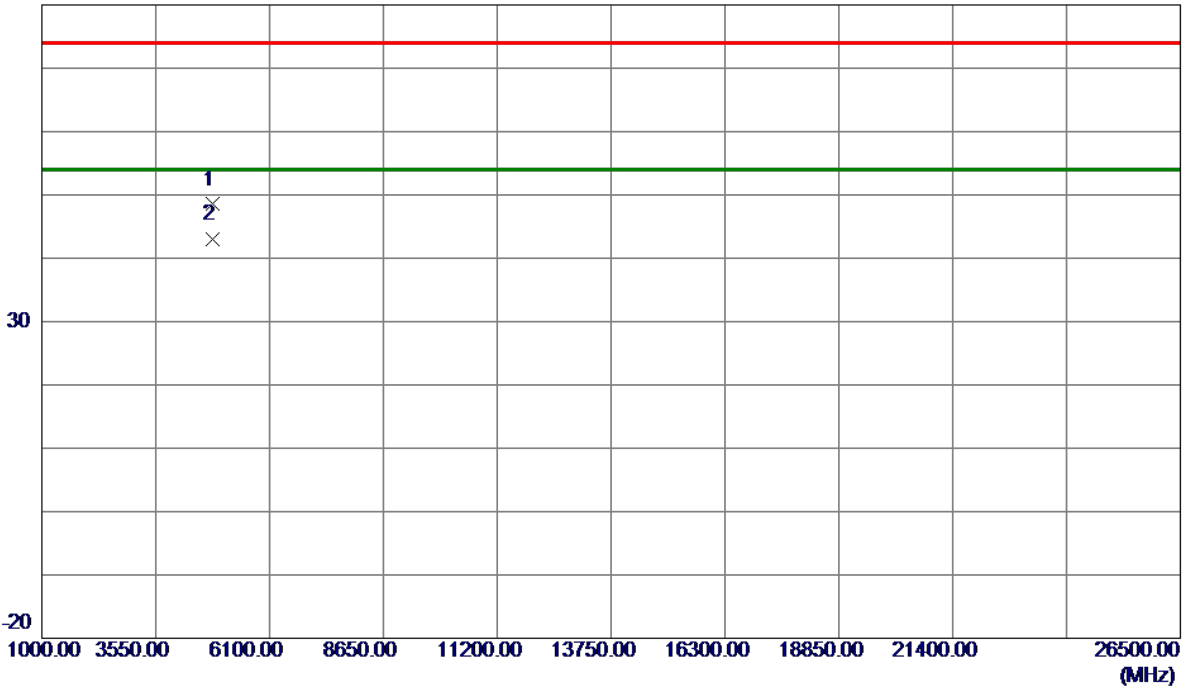

No.	Freq. MHz	Reading Level dBuV/m	Correct Factor dB	Measure ment dBuV/m	Limit dBuV/m	Margin dB	Detector	Comment
1	4824.0830	40.04	8.46	48.50	74.00	-25.50	Peak	
2 *	4824.1100	34.58	8.46	43.04	54.00	-10.96	AVG	

REMARKS:

- (1) Measurement Value = Reading Level + Correct Factor.
- (2) Margin Level = Measurement Value - Limit Value.

Test Mode	TX B Mode 2417 MHz	Polarization	Vertical
-----------	--------------------	--------------	----------

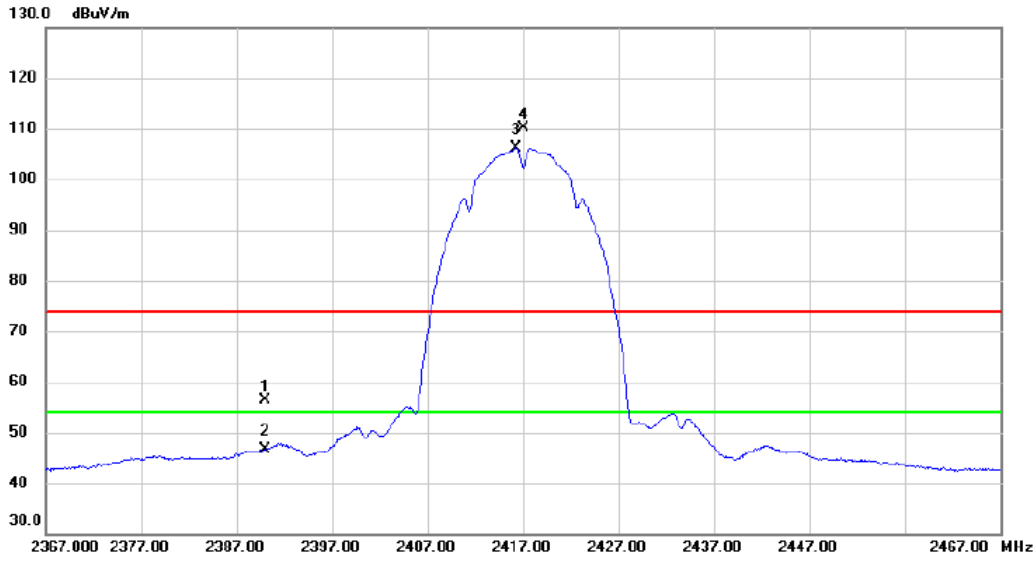

No.	Mk.	Freq. MHz	Reading Level dBuV	Correct Factor dB	Measure- ment dBuV/m	Limit dBuV/m	Margin dB	Detector	Comment
1		2390.000	44.47	11.83	56.30	74.00	-17.70	peak	
2		2390.000	34.91	11.83	46.74	54.00	-7.26	AVG	
3	*	2416.300	94.35	11.90	106.25	54.00	52.25	AVG	No Limit
4	X	2417.100	98.16	11.91	110.07	74.00	36.07	peak	No Limit

REMARKS:

- (1) Measurement Value = Reading Level + Correct Factor.
- (2) Margin Level = Measurement Value - Limit Value.

Test Mode	TX B Mode 2417 MHz	Polarization	Vertical
-----------	--------------------	--------------	----------

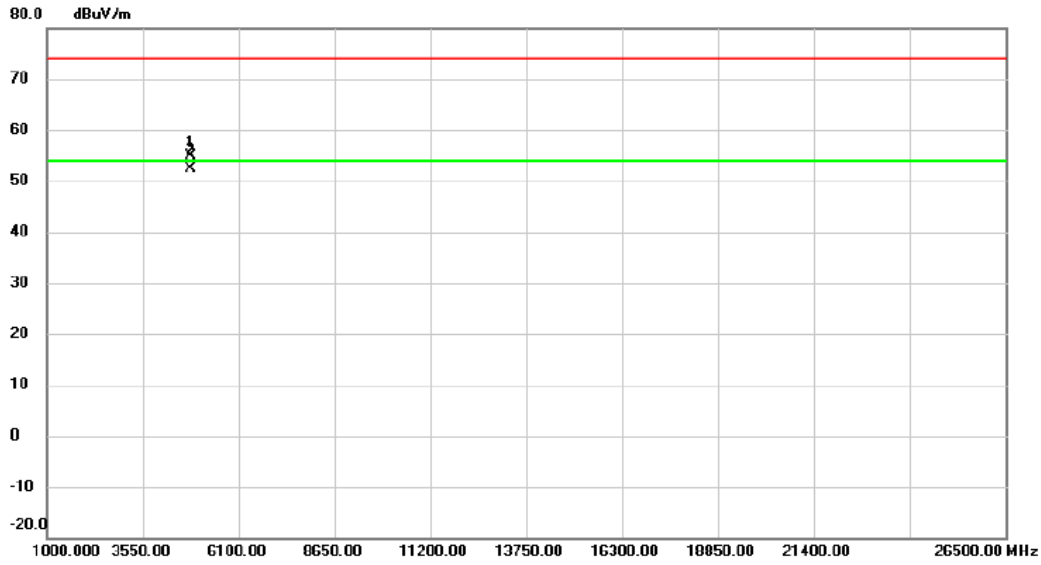

No.	Mk.	Freq. MHz	Reading Level dBuV	Correct Factor dB	Measure- ment dBuV/m	Limit dBuV/m	Margin dB	Detector	Comment
1		4834.080	46.49	8.47	54.96	74.00	-19.04	peak	
2	*	4834.085	43.79	8.47	52.26	54.00	-1.74	AVG	

REMARKS:

- (1) Measurement Value = Reading Level + Correct Factor.
- (2) Margin Level = Measurement Value - Limit Value.

Test Mode	TX B Mode 2417 MHz	Polarization	Horizontal
-----------	--------------------	--------------	------------

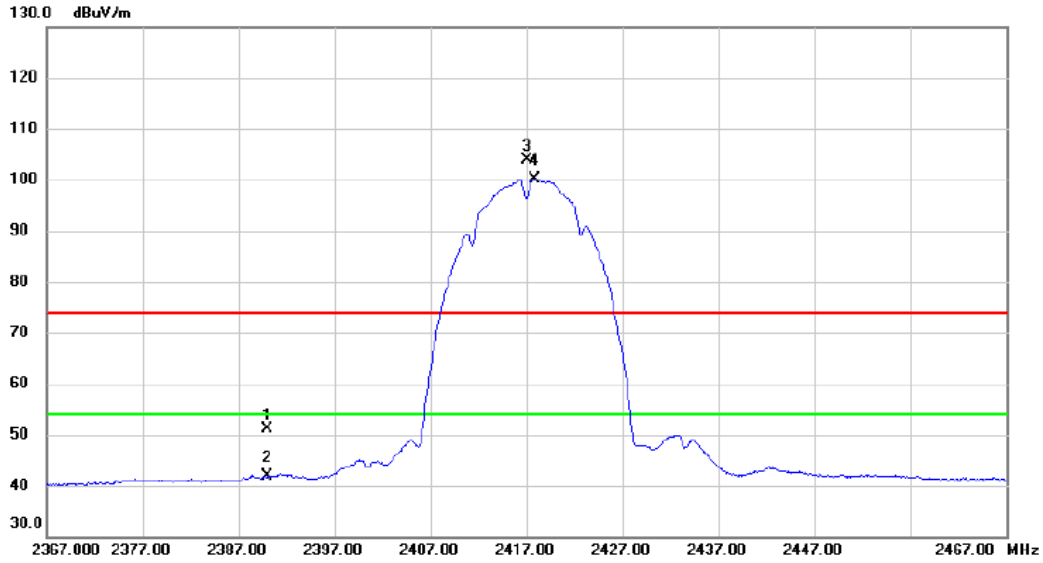

No.	Mk.	Freq. MHz	Reading Level dBuV	Correct Factor dB	Measure- ment dBuV/m	Limit dBuV/m	Margin dB	Detector	Comment
1		2390.000	39.42	11.83	51.25	74.00	-22.75	peak	
2		2390.000	30.00	11.83	41.83	54.00	-12.17	AVG	
3	X	2417.100	91.97	11.91	103.88	74.00	29.88	peak	No Limit
4	*	2417.800	88.31	11.91	100.22	54.00	46.22	AVG	No Limit

REMARKS:

(1) Measurement Value = Reading Level + Correct Factor.

(2) Margin Level = Measurement Value - Limit Value.

Test Mode	TX B Mode 2417 MHz	Polarization	Horizontal
-----------	--------------------	--------------	------------

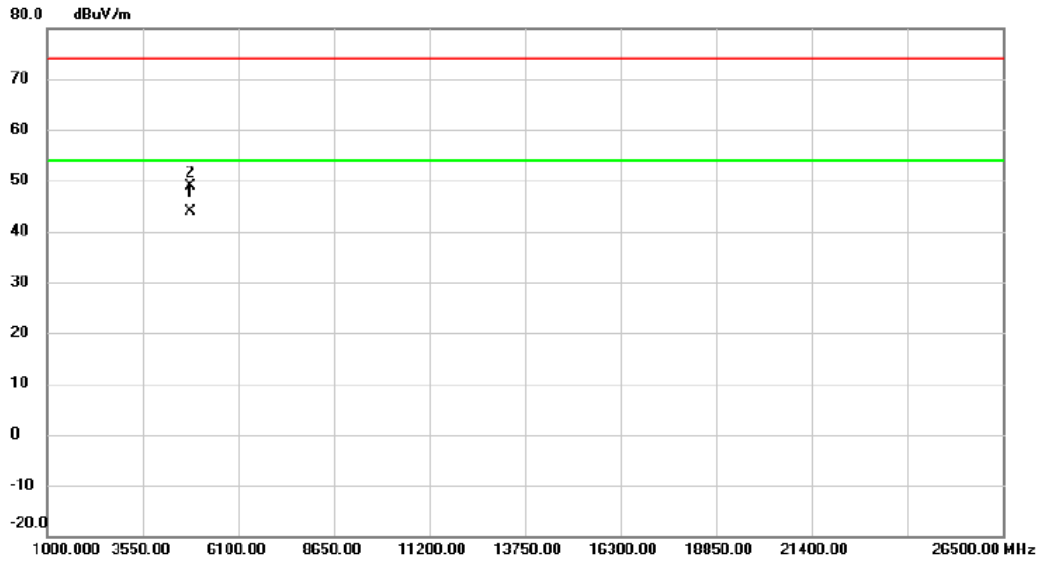

No.	Mk.	Freq. MHz	Reading Level dBuV	Correct Factor dB	Measure- ment dBuV/m	Limit dBuV/m	Margin dB	Detector	Comment
1	*	4834.115	35.51	8.47	43.98	54.00	-10.02	AVG	
2		4834.123	40.30	8.47	48.77	74.00	-25.23	peak	

REMARKS:

(1) Measurement Value = Reading Level + Correct Factor.

(2) Margin Level = Measurement Value - Limit Value.

Test Mode	TX B Mode 2437 MHz	Polarization	Vertical
-----------	--------------------	--------------	----------

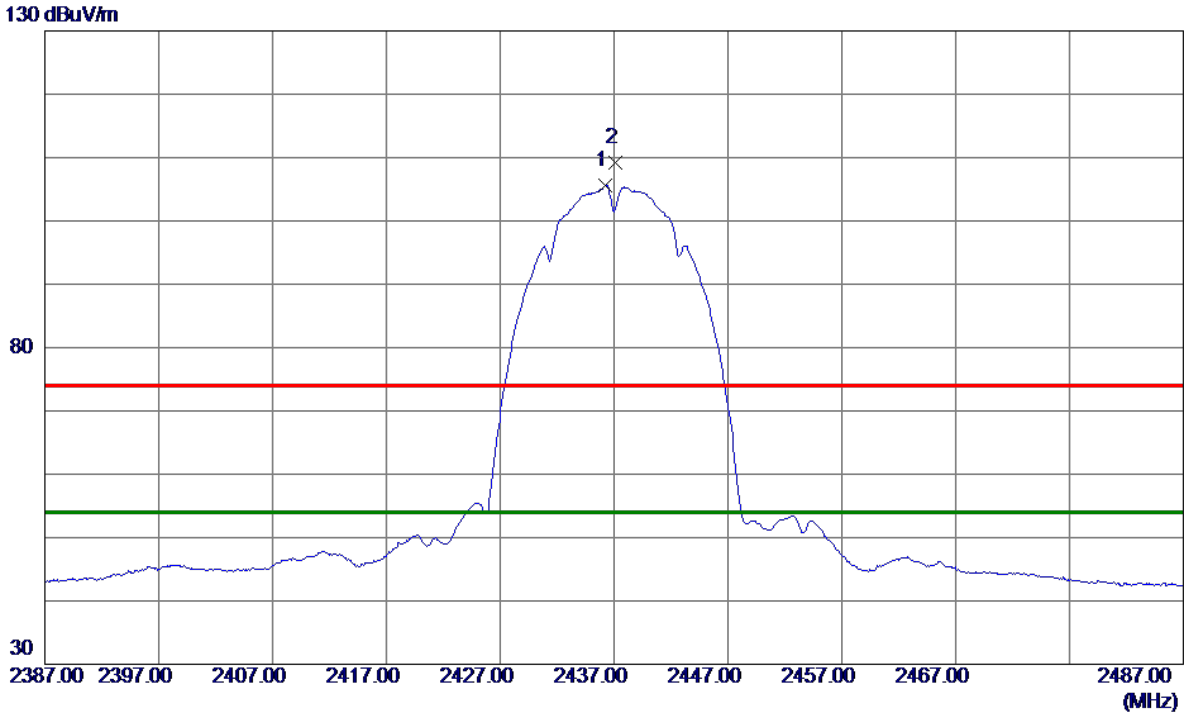

No.	Freq. MHz	Reading Level dBuV/m	Correct Factor dB	Measure ment dBuV/m	Limit dBuV/m	Margin dB	Detector	Comment
1 *	2436.2500	93.59	11.97	105.56	54.00	51.56	AVG	No Limit
2	2437.1000	97.14	11.97	109.11	74.00	35.11	Peak	No Limit

REMARKS:

- (1) Measurement Value = Reading Level + Correct Factor.
- (2) Margin Level = Measurement Value - Limit Value.

Test Mode	TX B Mode 2437 MHz	Polarization	Vertical
-----------	--------------------	--------------	----------



No.	Freq. MHz	Reading Level dBuV/m	Correct Factor dB	Measure ment dBuV/m	Limit dBuV/m	Margin dB	Detector	Comment
1 *	4874.0900	44.92	8.58	53.50	54.00	-0.50	AVG	
2	4874.1300	47.21	8.58	55.79	74.00	-18.21	Peak	

REMARKS:

- (1) Measurement Value = Reading Level + Correct Factor.
- (2) Margin Level = Measurement Value - Limit Value.

Test Mode	TX B Mode 2437 MHz	Polarization	Horizontal
-----------	--------------------	--------------	------------

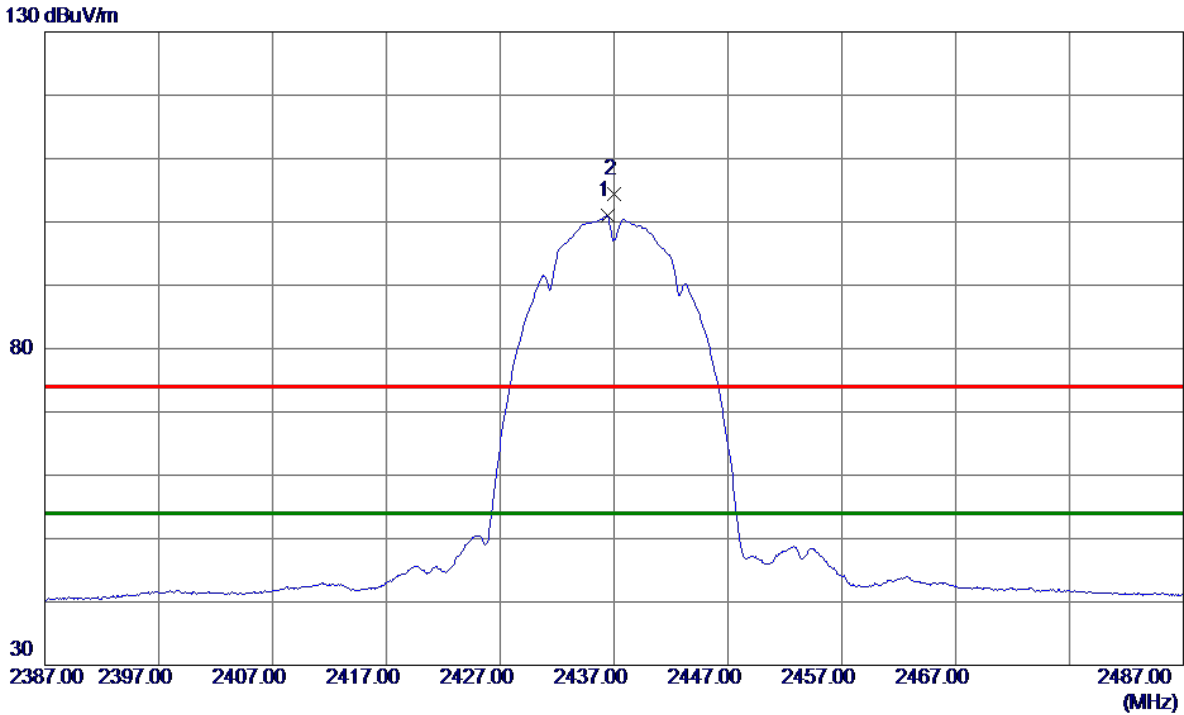

No.	Freq. MHz	Reading Level dBuV/m	Correct Factor dB	Measure ment dBuV/m	Limit dBuV/m	Margin dB	Detector	Comment
1 *	2436.4000	88.96	11.97	100.93	54.00	46.93	AVG	No Limit
2	2437.0500	92.46	11.97	104.43	74.00	30.43	Peak	No Limit

REMARKS:

- (1) Measurement Value = Reading Level + Correct Factor.
- (2) Margin Level = Measurement Value - Limit Value.

Test Mode	TX B Mode 2437 MHz	Polarization	Horizontal
-----------	--------------------	--------------	------------

80 dBuV/m

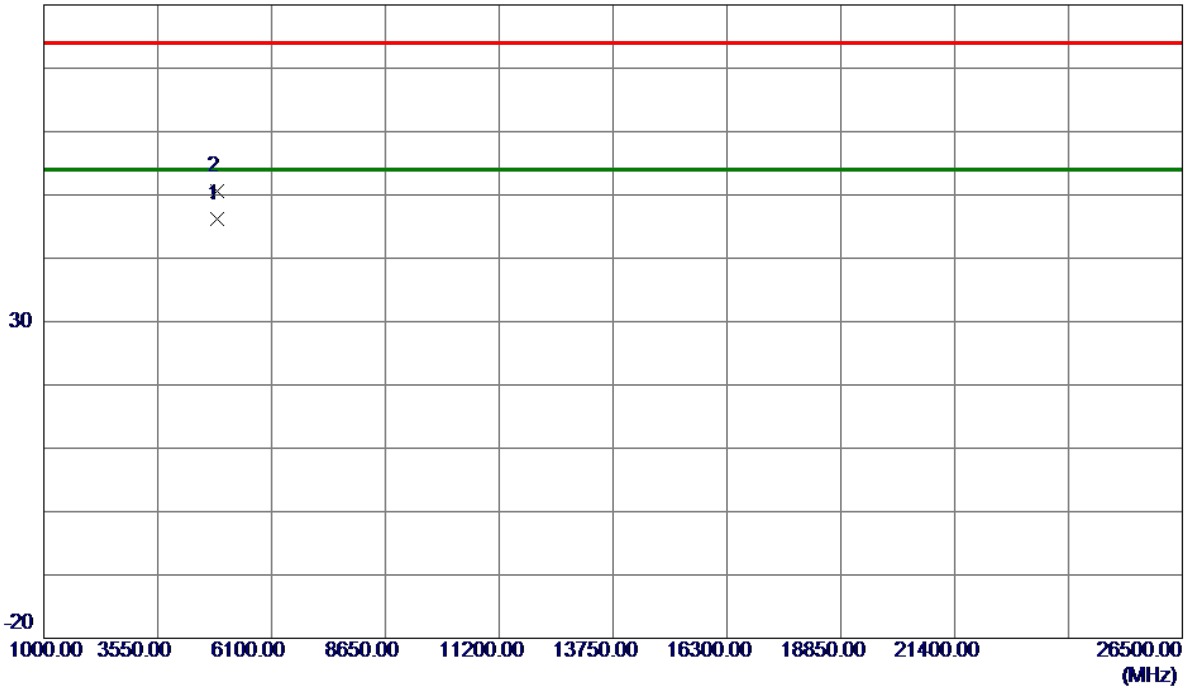

No.	Freq. MHz	Reading Level dBuV/m	Correct Factor dB	Measure ment dBuV/m	Limit dBuV/m	Margin dB	Detector	Comment
1 *	4874.0600	37.60	8.58	46.18	54.00	-7.82	AVG	
2	4874.1629	42.06	8.58	50.64	74.00	-23.36	Peak	

REMARKS:

- (1) Measurement Value = Reading Level + Correct Factor.
- (2) Margin Level = Measurement Value - Limit Value.

Test Mode	TX B Mode 2457 MHz	Polarization	Vertical
-----------	--------------------	--------------	----------

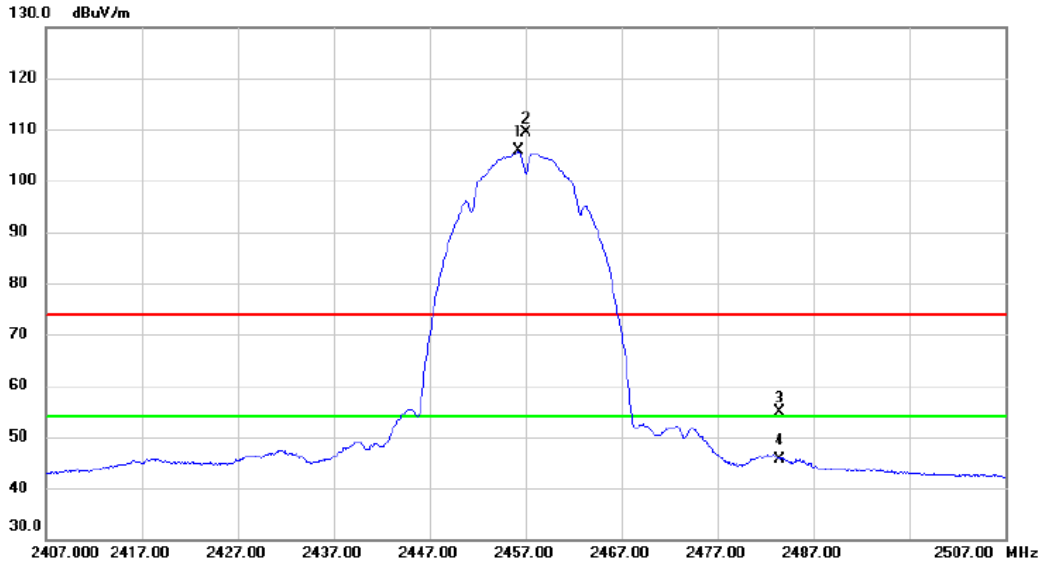

No.	Mk.	Freq. MHz	Reading Level dBuV	Correct Factor dB	Measure- ment dBuV/m	Limit dBuV/m	Margin dB	Detector	Comment
1	*	2456.300	93.76	12.02	105.78	54.00	51.78	AVG	No Limit
2	X	2457.000	97.44	12.04	109.48	74.00	35.48	peak	No Limit
3		2483.500	42.64	12.12	54.76	74.00	-19.24	peak	
4		2483.500	33.49	12.12	45.61	54.00	-8.39	AVG	

REMARKS:

(1) Measurement Value = Reading Level + Correct Factor.

(2) Margin Level = Measurement Value - Limit Value.

Test Mode	TX B Mode 2457 MHz	Polarization	Vertical
-----------	--------------------	--------------	----------

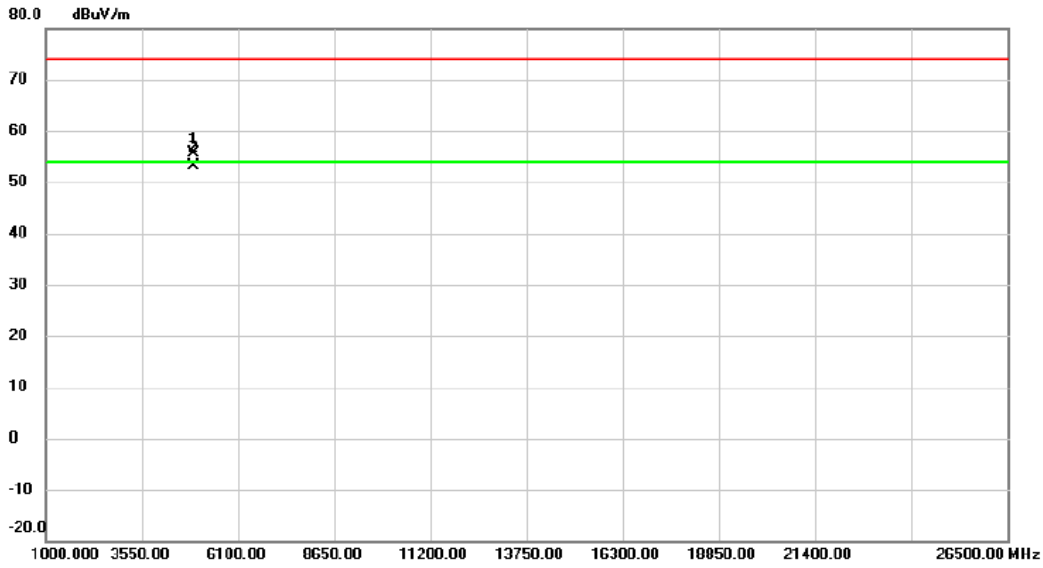

No. Mk.	Freq. MHz	Reading Level dBuV	Correct Factor dB	Measurement dBuV/m	Limit dBuV/m	Margin dB	Detector	Comment
1	4913.985	47.02	8.68	55.70	74.00	-18.30	peak	
2 *	4914.090	44.50	8.68	53.18	54.00	-0.82	AVG	

REMARKS:

- (1) Measurement Value = Reading Level + Correct Factor.
- (2) Margin Level = Measurement Value - Limit Value.

Test Mode	TX B Mode 2457 MHz	Polarization	Horizontal
-----------	--------------------	--------------	------------

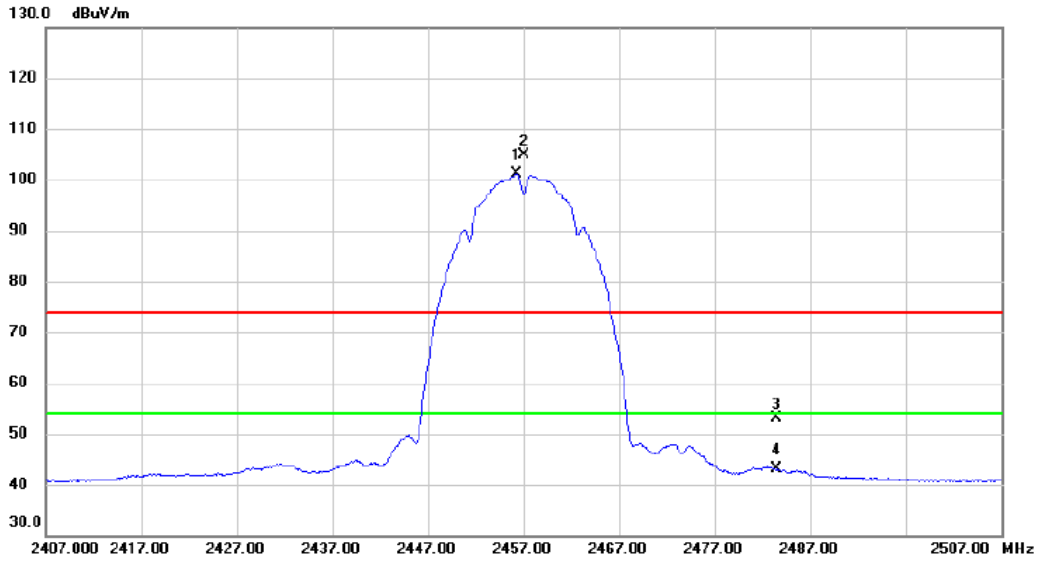

No.	Mk.	Freq. MHz	Reading Level dBuV	Correct Factor dB	Measure- ment dBuV/m	Limit dBuV/m	Margin dB	Detector	Comment
1	*	2456.300	89.14	12.02	101.16	54.00	47.16	AVG	No Limit
2	X	2457.000	92.84	12.04	104.88	74.00	30.88	peak	No Limit
3		2483.500	40.99	12.12	53.11	74.00	-20.89	peak	
4		2483.500	30.90	12.12	43.02	54.00	-10.98	AVG	

REMARKS:

- (1) Measurement Value = Reading Level + Correct Factor.
- (2) Margin Level = Measurement Value - Limit Value.

Test Mode	TX B Mode 2457 MHz	Polarization	Horizontal
-----------	--------------------	--------------	------------

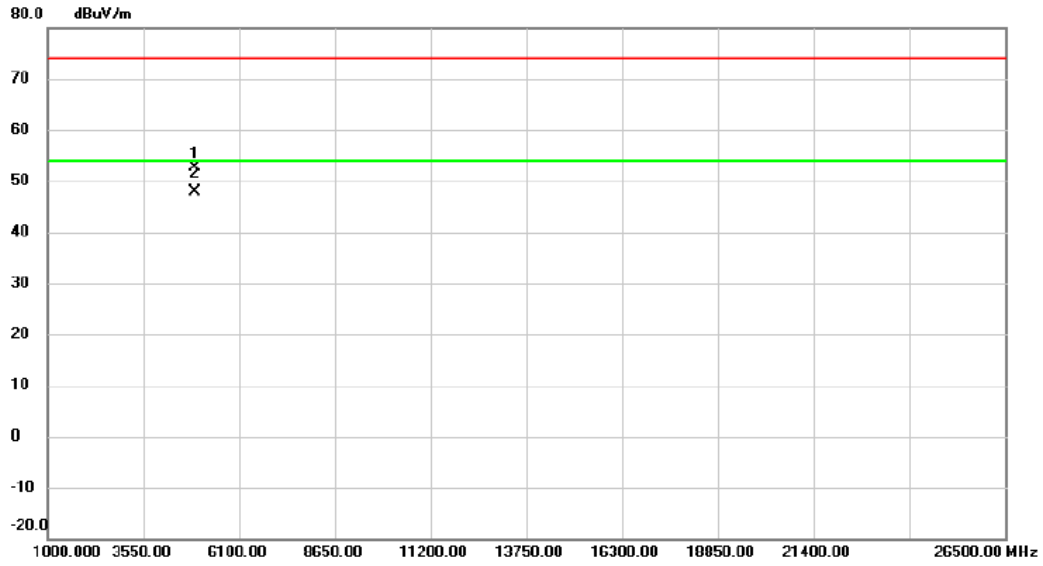

No.	Mk.	Freq. MHz	Reading Level dBuV	Correct Factor dB	Measure- ment dBuV/m	Limit dBuV/m	Margin dB	Detector	Comment
1		4914.023	43.90	8.68	52.58	74.00	-21.42	peak	
2	*	4914.102	39.32	8.68	48.00	54.00	-6.00	AVG	

REMARKS:

- (1) Measurement Value = Reading Level + Correct Factor.
- (2) Margin Level = Measurement Value - Limit Value.

Test Mode	TX B Mode 2462 MHz	Polarization	Vertical
-----------	--------------------	--------------	----------

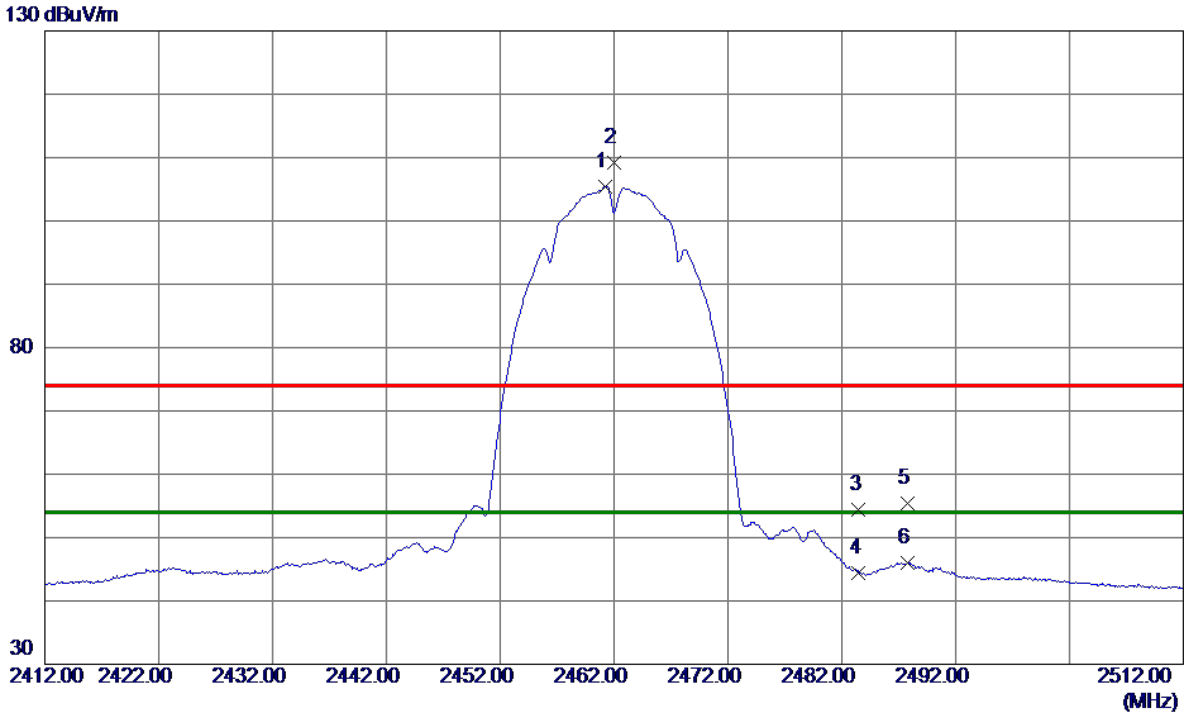

No.	Freq. MHz	Reading Level dBuV/m	Correct Factor dB	Measure ment dBuV/m	Limit dBuV/m	Margin dB	Detector	Comment
1 *	2461.2500	93.43	12.05	105.48	54.00	51.48	AVG	No Limit
2	2462.0500	97.17	12.05	109.22	74.00	35.22	Peak	No Limit
3	2483.5000	42.31	12.12	54.43	74.00	-19.57	Peak	
4	2483.5000	32.27	12.12	44.39	54.00	-9.61	AVG	
5	2487.7500	43.19	12.13	55.32	74.00	-18.68	Peak	
6	2487.7500	33.90	12.13	46.03	54.00	-7.97	AVG	

REMARKS:

- (1) Measurement Value = Reading Level + Correct Factor.
- (2) Margin Level = Measurement Value - Limit Value.

Test Mode	TX B Mode 2462 MHz	Polarization	Vertical
-----------	--------------------	--------------	----------

80 dBuV/m

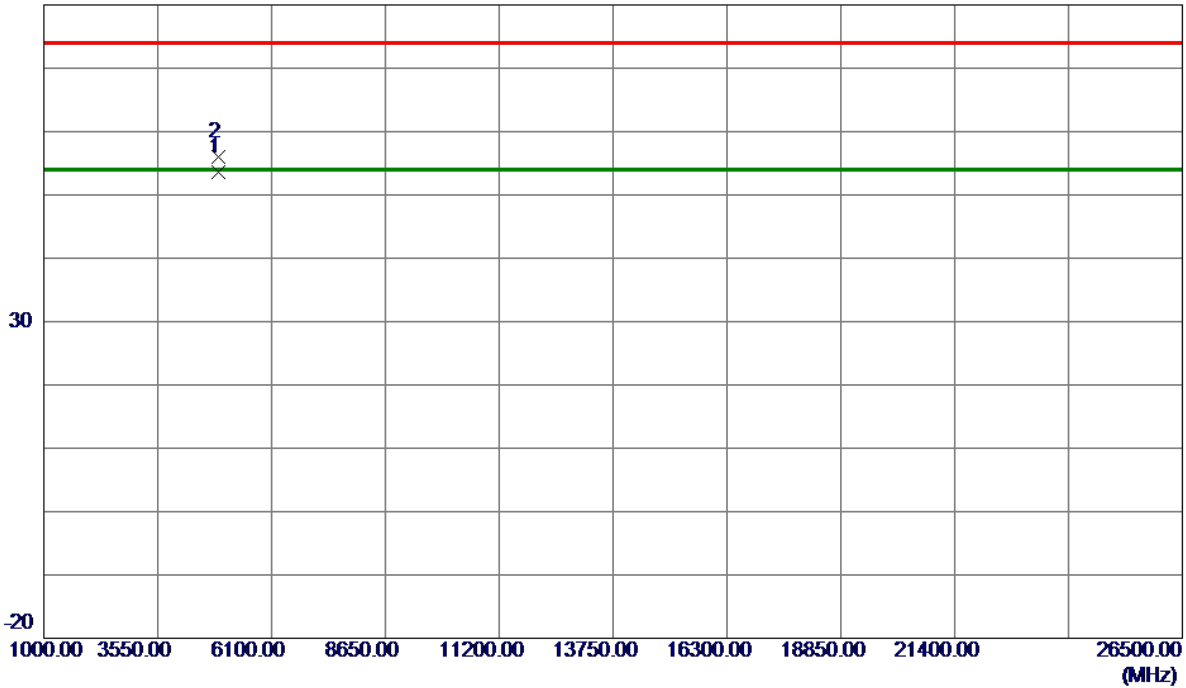

No.	Freq. MHz	Reading Level dBuV/m	Correct Factor dB	Measure ment dBuV/m	Limit dBuV/m	Margin dB	Detector	Comment
1 *	4924.0570	44.84	8.70	53.54	54.00	-0.46	AVG	
2	4924.1320	47.36	8.70	56.06	74.00	-17.94	Peak	

REMARKS:

- (1) Measurement Value = Reading Level + Correct Factor.
- (2) Margin Level = Measurement Value - Limit Value.

Test Mode	TX B Mode 2462 MHz	Polarization	Horizontal
-----------	--------------------	--------------	------------

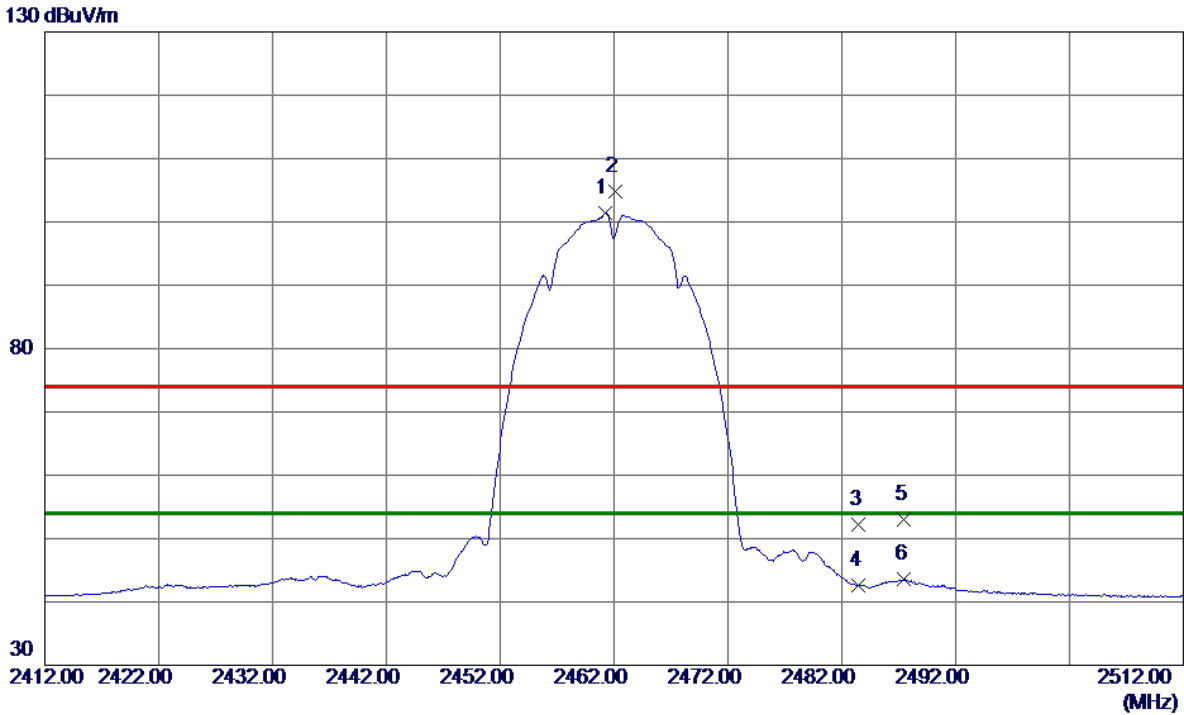

No.	Freq. MHz	Reading Level dBuV/m	Correct Factor dB	Measure ment dBuV/m	Limit dBuV/m	Margin dB	Detector	Comment
1 *	2461.2500	89.35	12.05	101.40	54.00	47.40	AVG	No Limit
2	2462.1000	92.70	12.05	104.75	74.00	30.75	Peak	No Limit
3	2483.5000	40.13	12.12	52.25	74.00	-21.75	Peak	
4	2483.5000	30.53	12.12	42.65	54.00	-11.35	AVG	
5	2487.5000	40.94	12.13	53.07	74.00	-20.93	Peak	
6	2487.5000	31.44	12.13	43.57	54.00	-10.43	AVG	

REMARKS:

- (1) Measurement Value = Reading Level + Correct Factor.
- (2) Margin Level = Measurement Value - Limit Value.

Test Mode	TX B Mode 2462 MHz	Polarization	Horizontal
-----------	--------------------	--------------	------------

80 dBuV/m

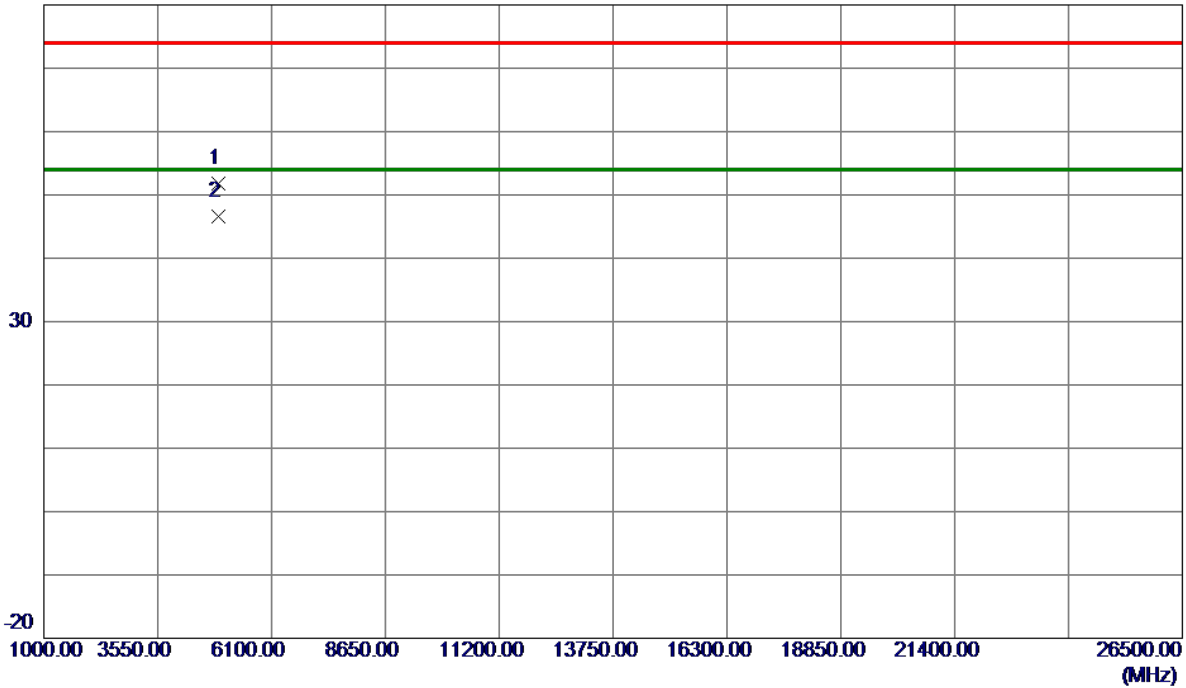

No.	Freq. MHz	Reading Level dBuV/m	Correct Factor dB	Measure ment dBuV/m	Limit dBuV/m	Margin dB	Detector	Comment
1	4924.0299	43.03	8.70	51.73	74.00	-22.27	Peak	
2 *	4924.1050	37.91	8.70	46.61	54.00	-7.39	AVG	

REMARKS:

- (1) Measurement Value = Reading Level + Correct Factor.
- (2) Margin Level = Measurement Value - Limit Value.

Test Mode	TX G Mode 2412 MHz	Polarization	Vertical
-----------	--------------------	--------------	----------

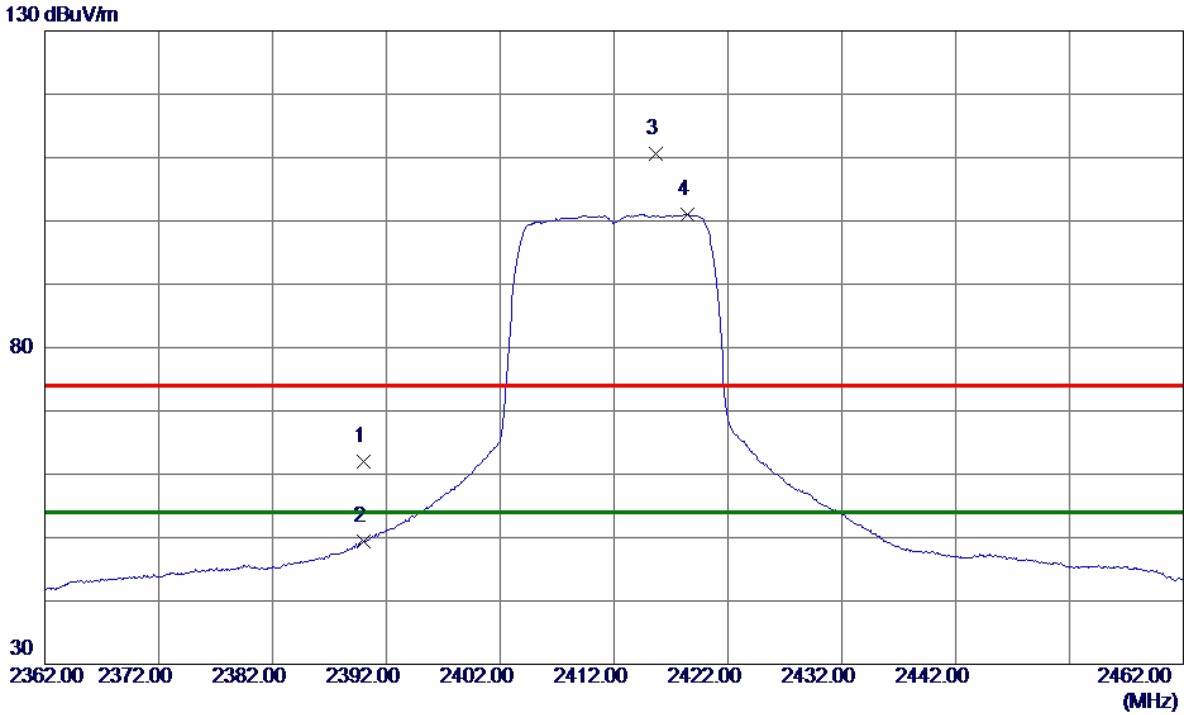

No.	Freq. MHz	Reading Level dBuV/m	Correct Factor dB	Measure ment dBuV/m	Limit dBuV/m	Margin dB	Detector	Comment
1	2390.0000	50.27	11.82	62.09	74.00	-11.91	Peak	
2	2390.0000	37.56	11.82	49.38	54.00	-4.62	AVG	
3	2415.7000	98.78	11.90	110.68	74.00	36.68	Peak	No Limit
4 *	2418.4000	89.14	11.91	101.05	54.00	47.05	AVG	No Limit

REMARKS:

- (1) Measurement Value = Reading Level + Correct Factor.
- (2) Margin Level = Measurement Value - Limit Value.

Test Mode	TX G Mode 2412 MHz	Polarization	Vertical
-----------	--------------------	--------------	----------

80 dBuV/m

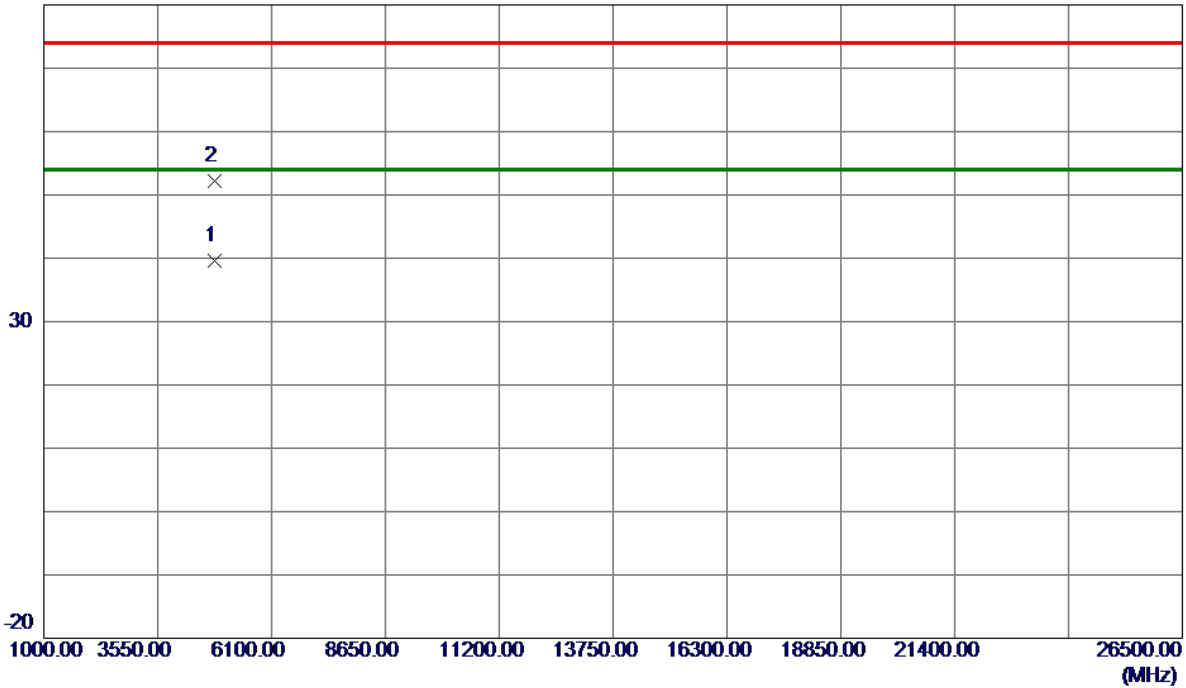

No.	Freq. MHz	Reading Level dBuV/m	Correct Factor dB	Measure ment dBuV/m	Limit dBuV/m	Margin dB	Detector	Comment
1 *	4822.4100	31.14	8.45	39.59	54.00	-14.41	AVG	
2	4824.9580	43.69	8.46	52.15	74.00	-21.85	Peak	

REMARKS:

- (1) Measurement Value = Reading Level + Correct Factor.
- (2) Margin Level = Measurement Value - Limit Value.

Test Mode	TX G Mode 2412 MHz	Polarization	Horizontal
-----------	--------------------	--------------	------------

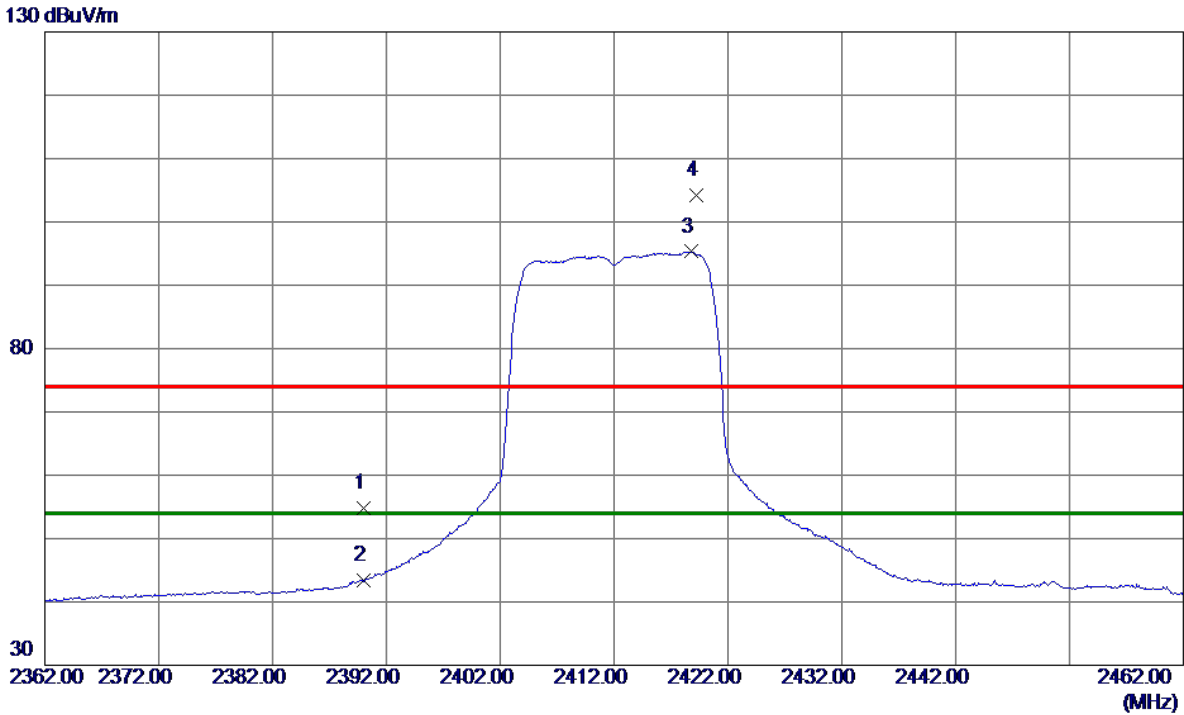

No.	Freq. MHz	Reading Level dBuV/m	Correct Factor dB	Measure ment dBuV/m	Limit dBuV/m	Margin dB	Detector	Comment
1	2390.0000	42.93	11.82	54.75	74.00	-19.25	Peak	
2	2390.0000	31.61	11.82	43.43	54.00	-10.57	AVG	
3 *	2418.8000	83.39	11.91	95.30	54.00	41.30	AVG	No Limit
4	2419.2500	92.31	11.91	104.22	74.00	30.22	Peak	No Limit

REMARKS:

- (1) Measurement Value = Reading Level + Correct Factor.
- (2) Margin Level = Measurement Value - Limit Value.

Test Mode	TX G Mode 2412 MHz	Polarization	Horizontal
-----------	--------------------	--------------	------------

80 dBuV/m

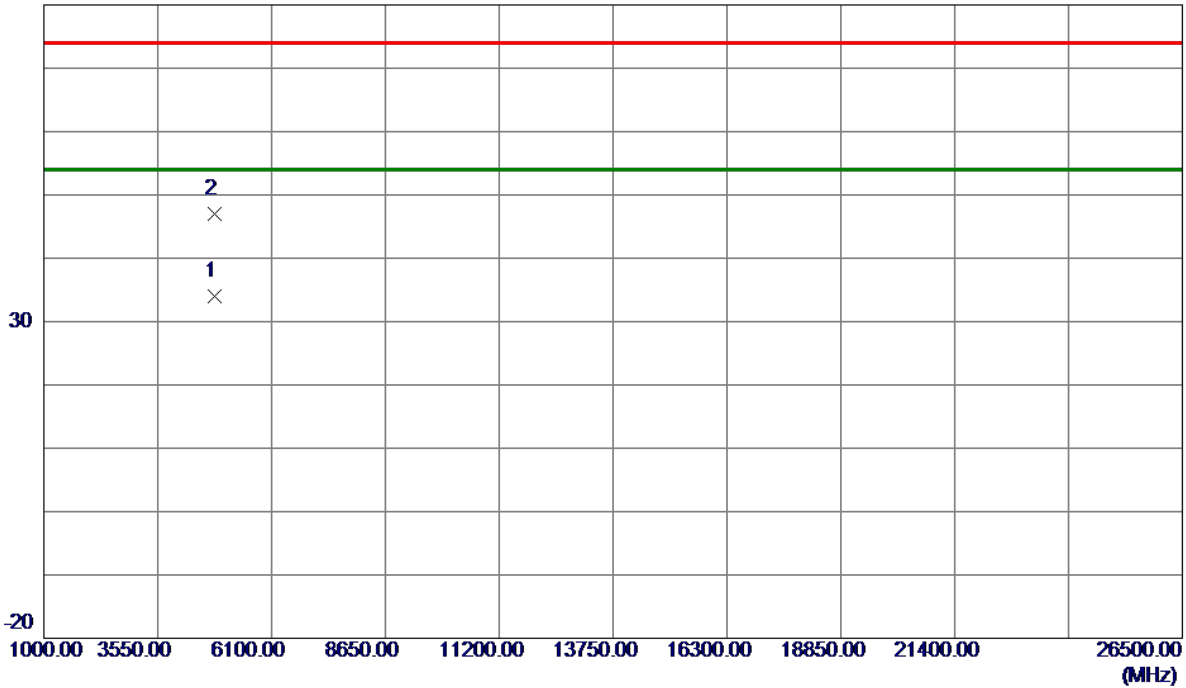

No.	Freq. MHz	Reading Level dBuV/m	Correct Factor dB	Measure ment dBuV/m	Limit dBuV/m	Margin dB	Detector	Comment
1 *	4821.6080	25.49	8.45	33.94	54.00	-20.06	AVG	
2	4822.9830	38.50	8.45	46.95	74.00	-27.05	Peak	

REMARKS:

- (1) Measurement Value = Reading Level + Correct Factor.
- (2) Margin Level = Measurement Value - Limit Value.

Test Mode	TX G Mode 2417 MHz	Polarization	Vertical
-----------	--------------------	--------------	----------

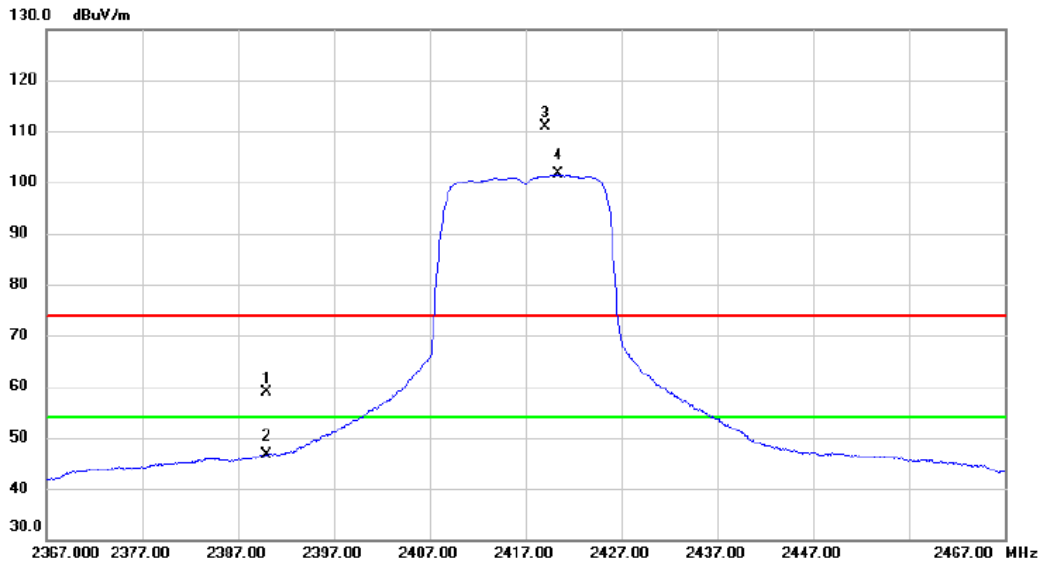

No.	Mk.	Freq. MHz	Reading Level dBuV	Correct Factor dB	Measure- ment dBuV/m	Limit dBuV/m	Margin dB	Detector	Comment
1		2390.000	47.07	11.83	58.90	74.00	-15.10	peak	
2		2390.000	34.78	11.83	46.61	54.00	-7.39	AVG	
3	X	2419.000	99.04	11.91	110.95	74.00	36.95	peak	No Limit
4	*	2420.400	89.60	11.91	101.51	54.00	47.51	AVG	No Limit

REMARKS:

- (1) Measurement Value = Reading Level + Correct Factor.
- (2) Margin Level = Measurement Value - Limit Value.

Test Mode	TX G Mode 2417 MHz	Polarization	Vertical
-----------	--------------------	--------------	----------

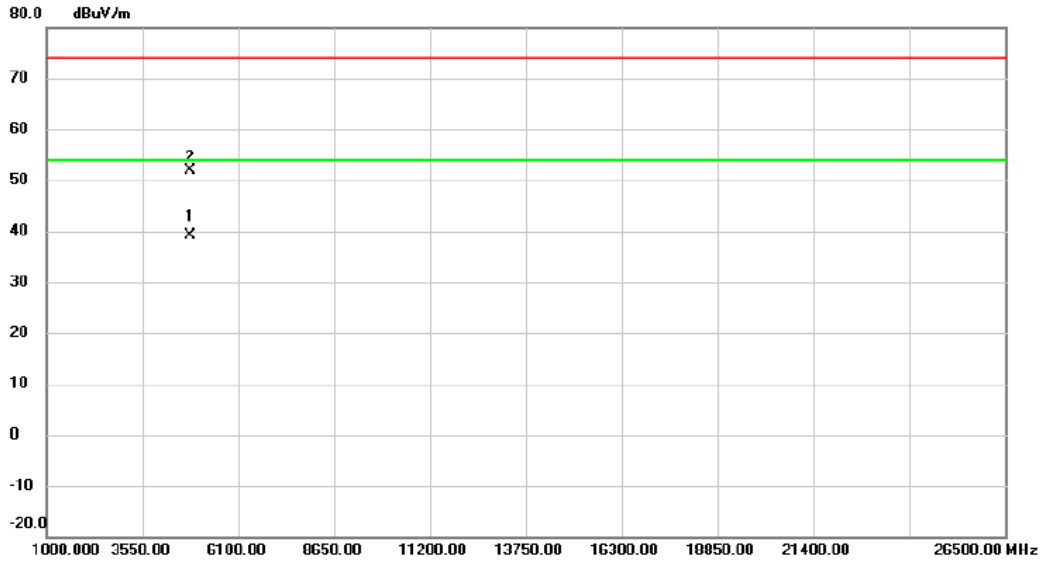

No.	Mk.	Freq. MHz	Reading Level dBuV	Correct Factor dB	Measure- ment dBuV/m	Limit dBuV/m	Margin dB	Detector	Comment
1	*	4833.385	30.64	8.47	39.11	54.00	-14.89	AVG	
2		4835.805	43.42	8.49	51.91	74.00	-22.09	peak	

REMARKS:

(1) Measurement Value = Reading Level + Correct Factor.

(2) Margin Level = Measurement Value - Limit Value.

Test Mode	TX G Mode 2417 MHz	Polarization	Horizontal
-----------	--------------------	--------------	------------

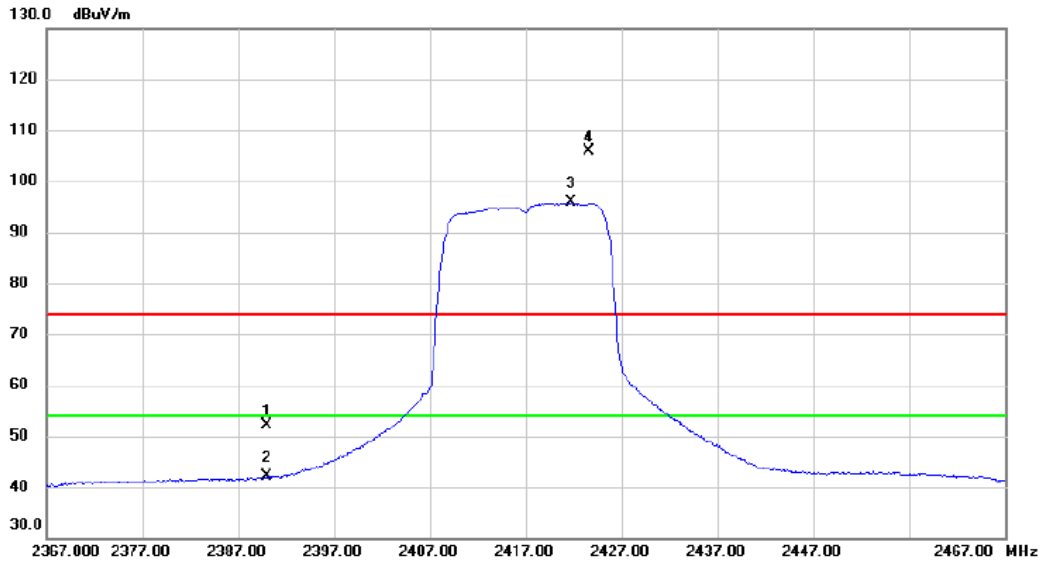

No.	Mk.	Freq. MHz	Reading Level dBuV	Correct Factor dB	Measure- ment dBuV/m	Limit dBuV/m	Margin dB	Detector	Comment
1		2390.000	40.36	11.83	52.19	74.00	-21.81	peak	
2		2390.000	30.28	11.83	42.11	54.00	-11.89	AVG	
3	*	2421.750	83.84	11.92	95.76	54.00	41.76	AVG	No Limit
4	X	2423.550	94.00	11.93	105.93	74.00	31.93	peak	No Limit

REMARKS:

(1) Measurement Value = Reading Level + Correct Factor.

(2) Margin Level = Measurement Value - Limit Value.

Test Mode	TX G Mode 2417 MHz	Polarization	Horizontal
-----------	--------------------	--------------	------------

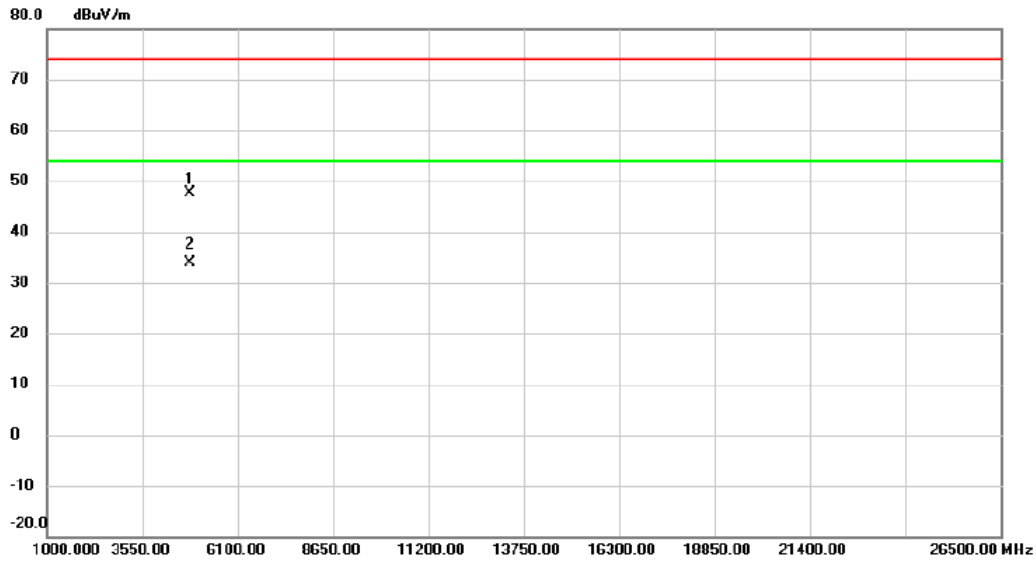

No.	Mk.	Freq. MHz	Reading Level dBuV	Correct Factor dB	Measure- ment dBuV/m	Limit dBuV/m	Margin dB	Detector	Comment
1		4833.455	39.14	8.47	47.61	74.00	-26.39	peak	
2	*	4833.818	25.46	8.47	33.93	54.00	-20.07	AVG	

REMARKS:

(1) Measurement Value = Reading Level + Correct Factor.

(2) Margin Level = Measurement Value - Limit Value.

Test Mode	TX G Mode 2437 MHz	Polarization	Vertical
-----------	--------------------	--------------	----------

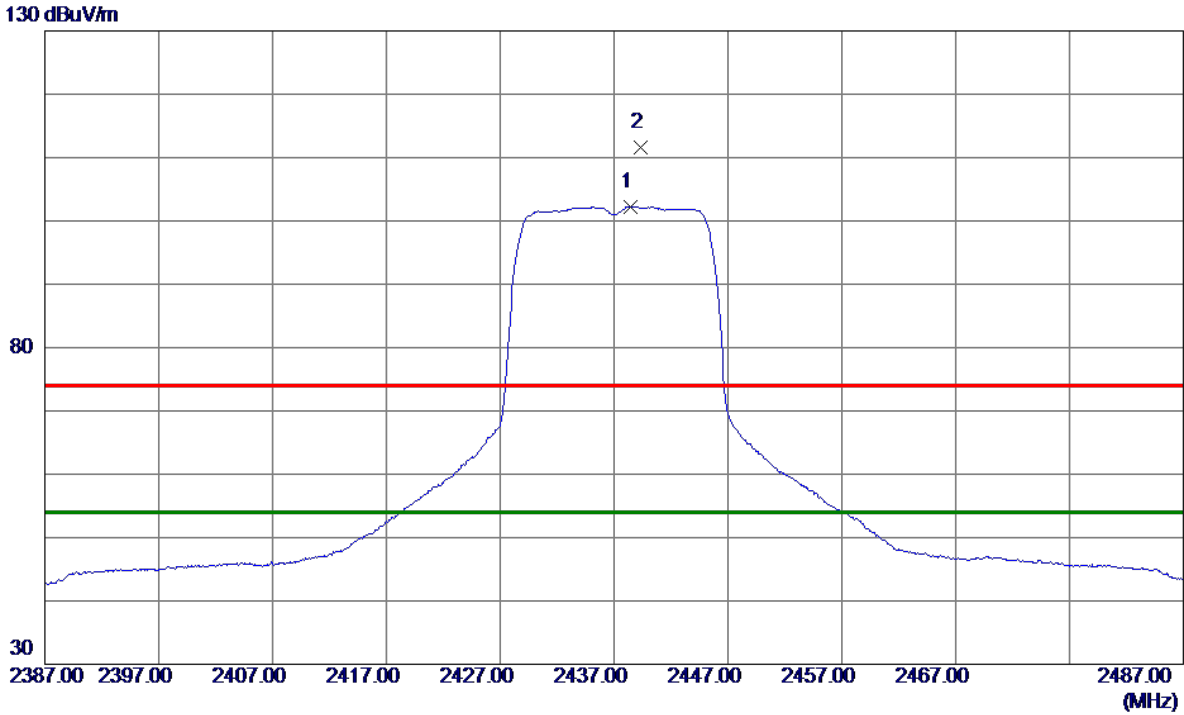

No.	Freq. MHz	Reading Level dBuV/m	Correct Factor dB	Measure ment dBuV/m	Limit dBuV/m	Margin dB	Detector	Comment
1 *	2438.4000	90.32	11.97	102.29	54.00	48.29	AVG	No Limit
2	2439.3500	99.54	11.98	111.52	74.00	37.52	Peak	No Limit

REMARKS:

- (1) Measurement Value = Reading Level + Correct Factor.
- (2) Margin Level = Measurement Value - Limit Value.

Test Mode	TX G Mode 2437 MHz	Polarization	Vertical
-----------	--------------------	--------------	----------

80 dBuV/m

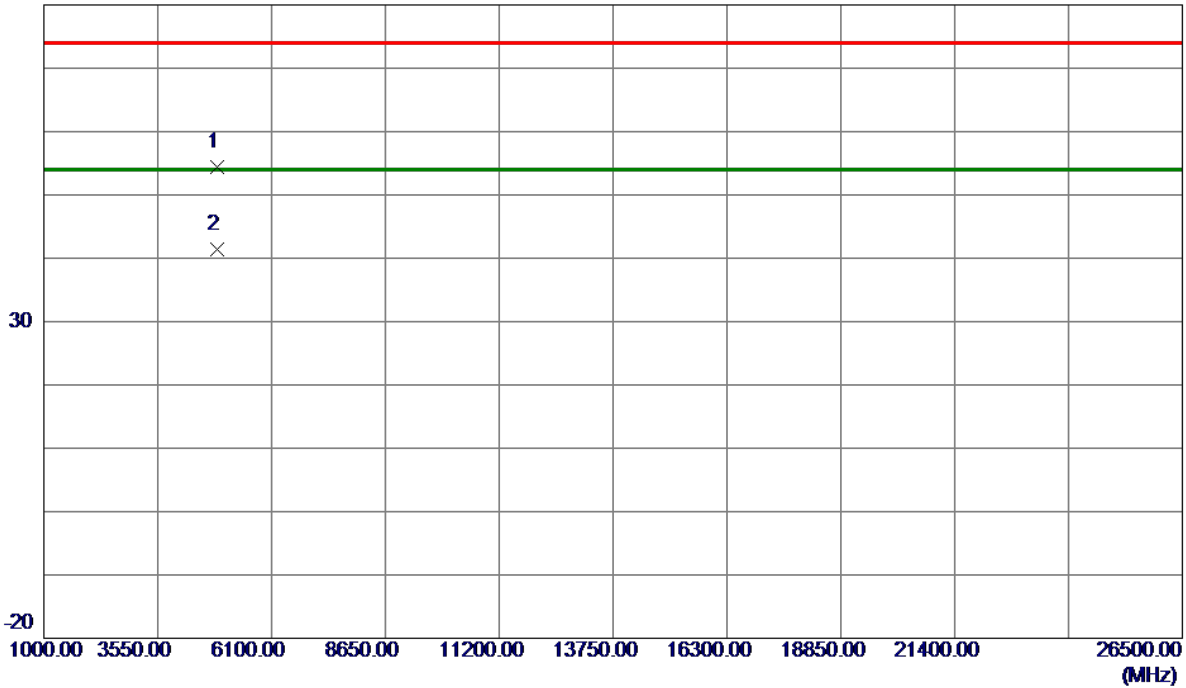

No.	Freq. MHz	Reading Level dBuV/m	Correct Factor dB	Measure ment dBuV/m	Limit dBuV/m	Margin dB	Detector	Comment
1	4871.9270	45.88	8.57	54.45	74.00	-19.55	Peak	
2 *	4874.3470	32.88	8.58	41.46	54.00	-12.54	AVG	

REMARKS:

- (1) Measurement Value = Reading Level + Correct Factor.
- (2) Margin Level = Measurement Value - Limit Value.

Test Mode	TX G Mode 2437 MHz	Polarization	Horizontal
-----------	--------------------	--------------	------------

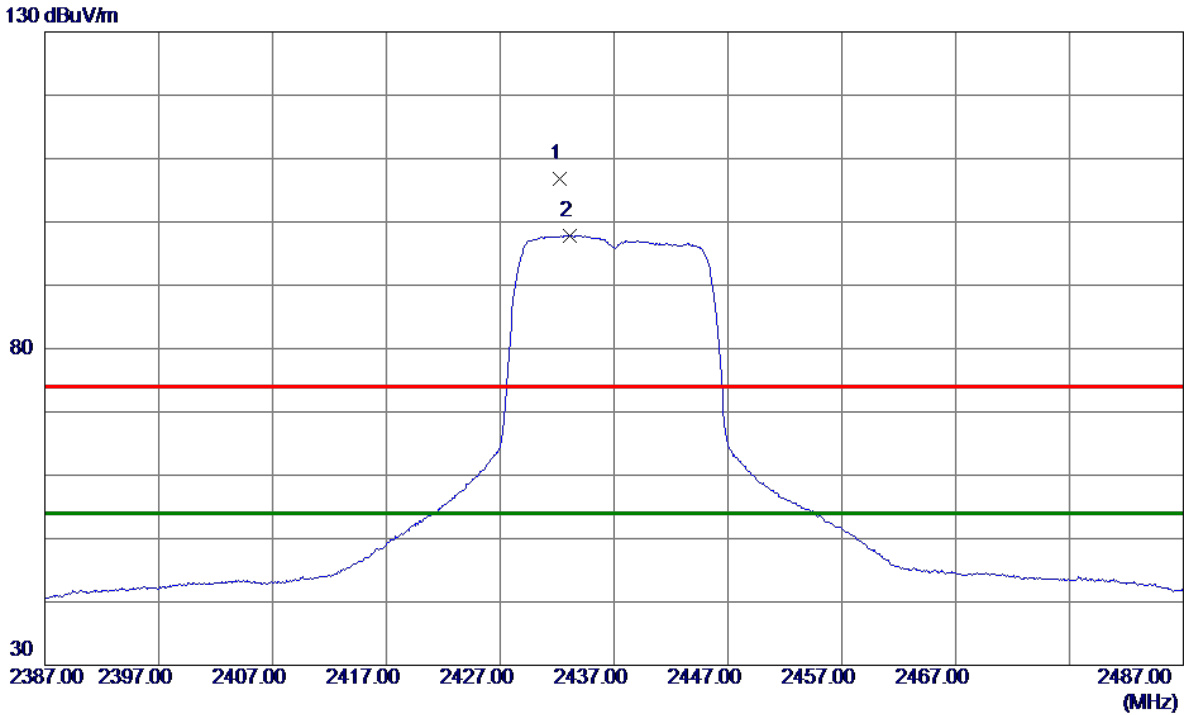

No.	Freq. MHz	Reading Level dBuV/m	Correct Factor dB	Measure ment dBuV/m	Limit dBuV/m	Margin dB	Detector	Comment
1	2432.2000	94.84	11.95	106.79	74.00	32.79	Peak	No Limit
2 *	2433.1500	85.91	11.96	97.87	54.00	43.87	AVG	No Limit

REMARKS:

- (1) Measurement Value = Reading Level + Correct Factor.
- (2) Margin Level = Measurement Value - Limit Value.

Test Mode	TX G Mode 2437 MHz	Polarization	Horizontal
-----------	--------------------	--------------	------------

80 dBuV/m

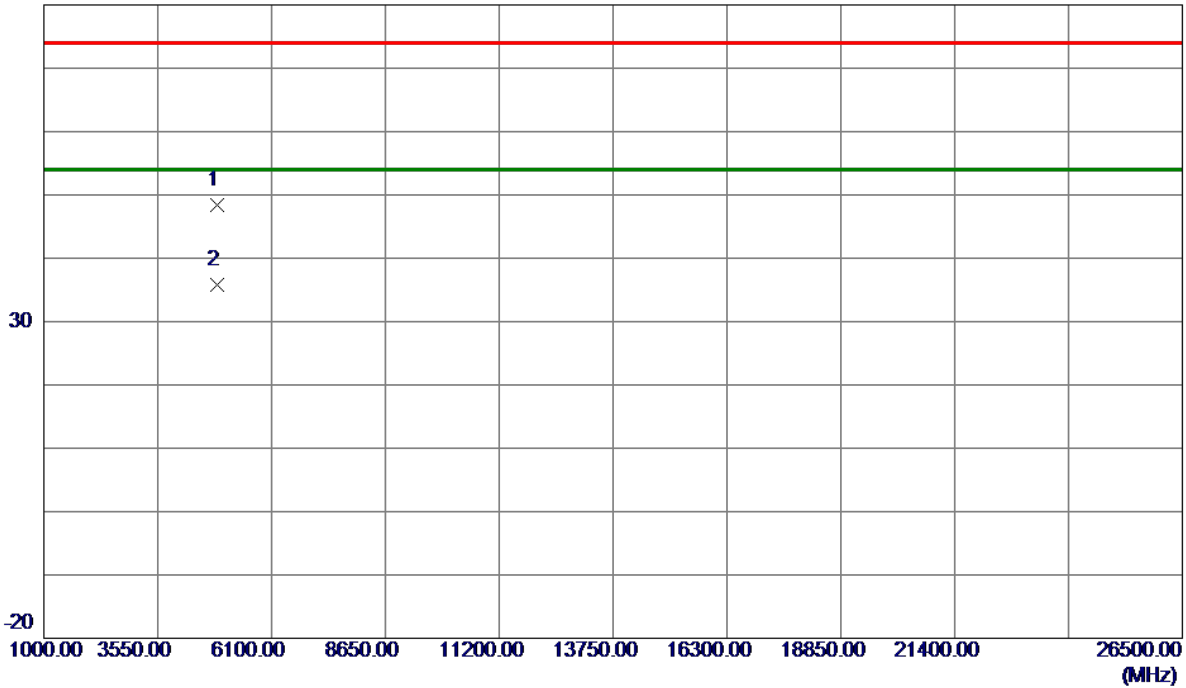

No.	Freq. MHz	Reading Level dBuV/m	Correct Factor dB	Measure ment dBuV/m	Limit dBuV/m	Margin dB	Detector	Comment
1	4874.9800	39.91	8.58	48.49	74.00	-25.51	Peak	
2 *	4875.4620	27.14	8.58	35.72	54.00	-18.28	AVG	

REMARKS:

- (1) Measurement Value = Reading Level + Correct Factor.
- (2) Margin Level = Measurement Value - Limit Value.

Test Mode	TX G Mode 2457 MHz	Polarization	Vertical
-----------	--------------------	--------------	----------

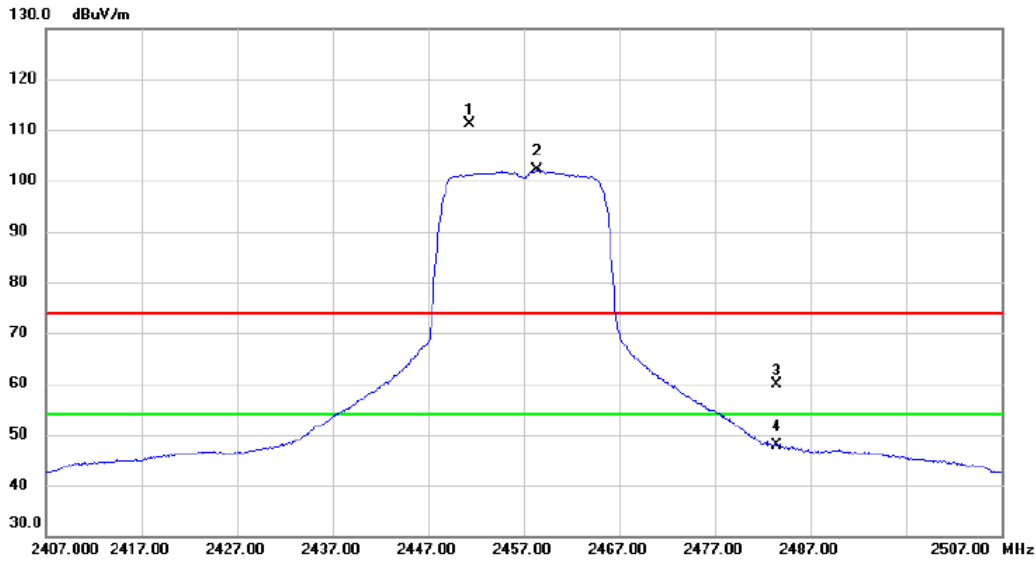

No.	Mk.	Freq. MHz	Reading Level dBuV	Correct Factor dB	Measure- ment dBuV/m	Limit dBuV/m	Margin dB	Detector	Comment
1	X	2451.300	99.17	12.01	111.18	74.00	37.18	peak	No Limit
2	*	2458.450	89.97	12.04	102.01	54.00	48.01	AVG	No Limit
3		2483.500	47.65	12.12	59.77	74.00	-14.23	peak	
4		2483.500	35.82	12.12	47.94	54.00	-6.06	AVG	

REMARKS:

- (1) Measurement Value = Reading Level + Correct Factor.
- (2) Margin Level = Measurement Value - Limit Value.

Test Mode	TX G Mode 2457 MHz	Polarization	Vertical
-----------	--------------------	--------------	----------

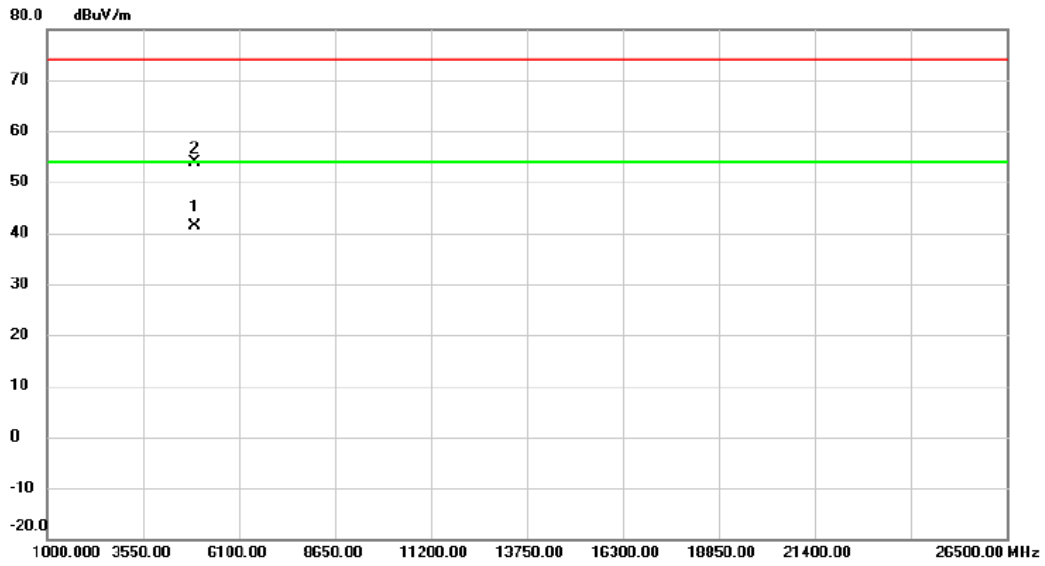

No.	Mk.	Freq. MHz	Reading Level dBuV	Correct Factor dB	Measure- ment dBuV/m	Limit dBuV/m	Margin dB	Detector	Comment
1	*	4913.575	32.61	8.68	41.29	54.00	-12.71	AVG	
2		4915.047	45.26	8.68	53.94	74.00	-20.06	peak	

REMARKS:

- (1) Measurement Value = Reading Level + Correct Factor.
- (2) Margin Level = Measurement Value - Limit Value.

Test Mode	TX G Mode 2457 MHz	Polarization	Horizontal
-----------	--------------------	--------------	------------

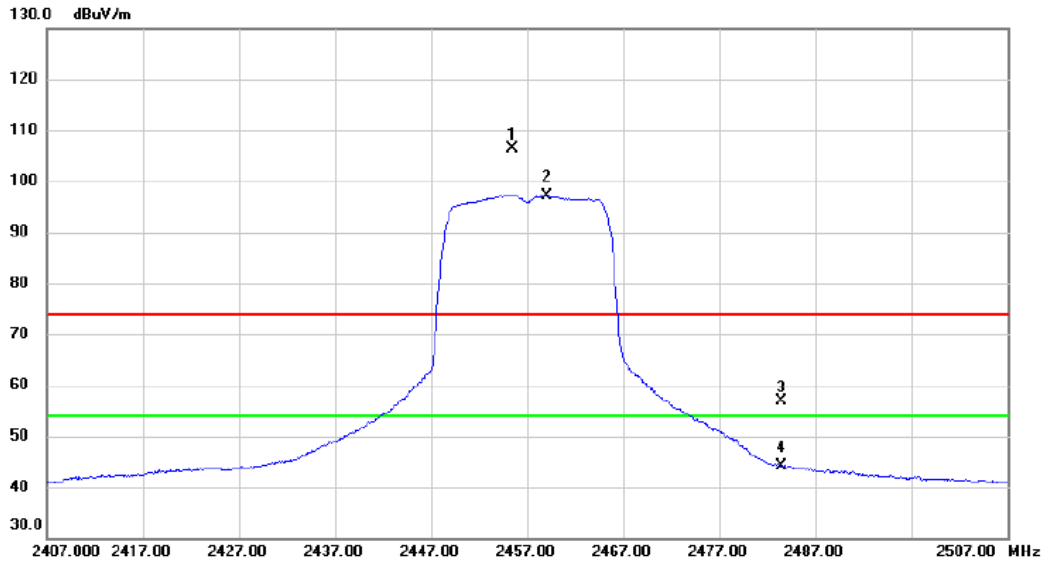

No.	Mk.	Freq. MHz	Reading Level dBuV	Correct Factor dB	Measure- ment dBuV/m	Limit dBuV/m	Margin dB	Detector	Comment
1	X	2455.450	94.39	12.02	106.41	74.00	32.41	peak	No Limit
2	*	2459.000	85.21	12.04	97.25	54.00	43.25	AVG	No Limit
3		2483.500	44.75	12.12	56.87	74.00	-17.13	peak	
4		2483.500	32.08	12.12	44.20	54.00	-9.80	AVG	

REMARKS:

(1) Measurement Value = Reading Level + Correct Factor.

(2) Margin Level = Measurement Value - Limit Value.

Test Mode	TX G Mode 2457 MHz	Polarization	Horizontal
-----------	--------------------	--------------	------------

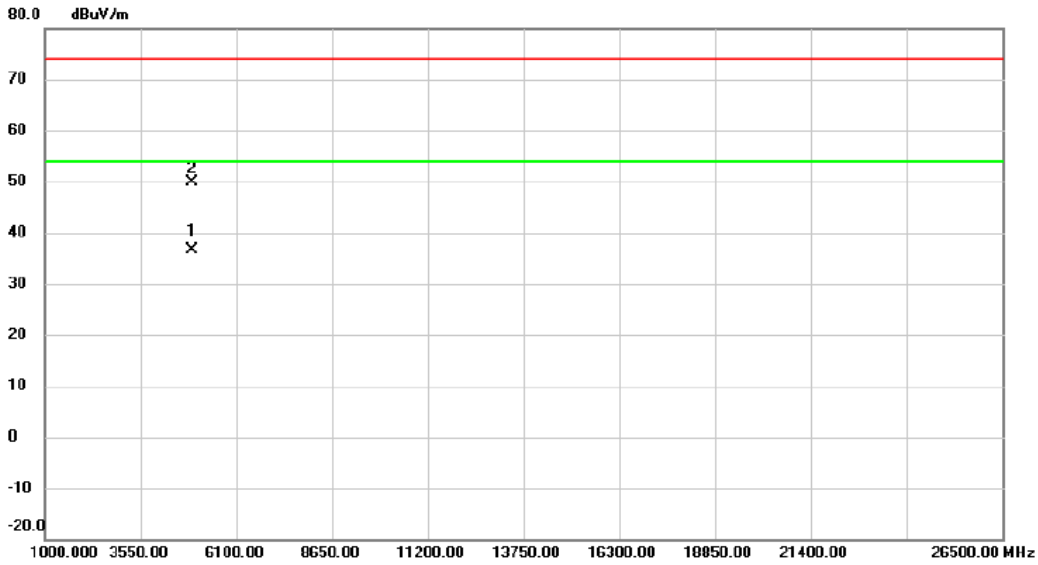

No.	Mk.	Freq. MHz	Reading Level dBuV	Correct Factor dB	Measure- ment dBuV/m	Limit dBuV/m	Margin dB	Detector	Comment
1	*	4913.868	28.04	8.68	36.72	54.00	-17.28	AVG	
2		4914.587	41.08	8.68	49.76	74.00	-24.24	peak	

REMARKS:

- (1) Measurement Value = Reading Level + Correct Factor.
- (2) Margin Level = Measurement Value - Limit Value.

Test Mode	TX G Mode 2462 MHz	Polarization	Vertical
-----------	--------------------	--------------	----------

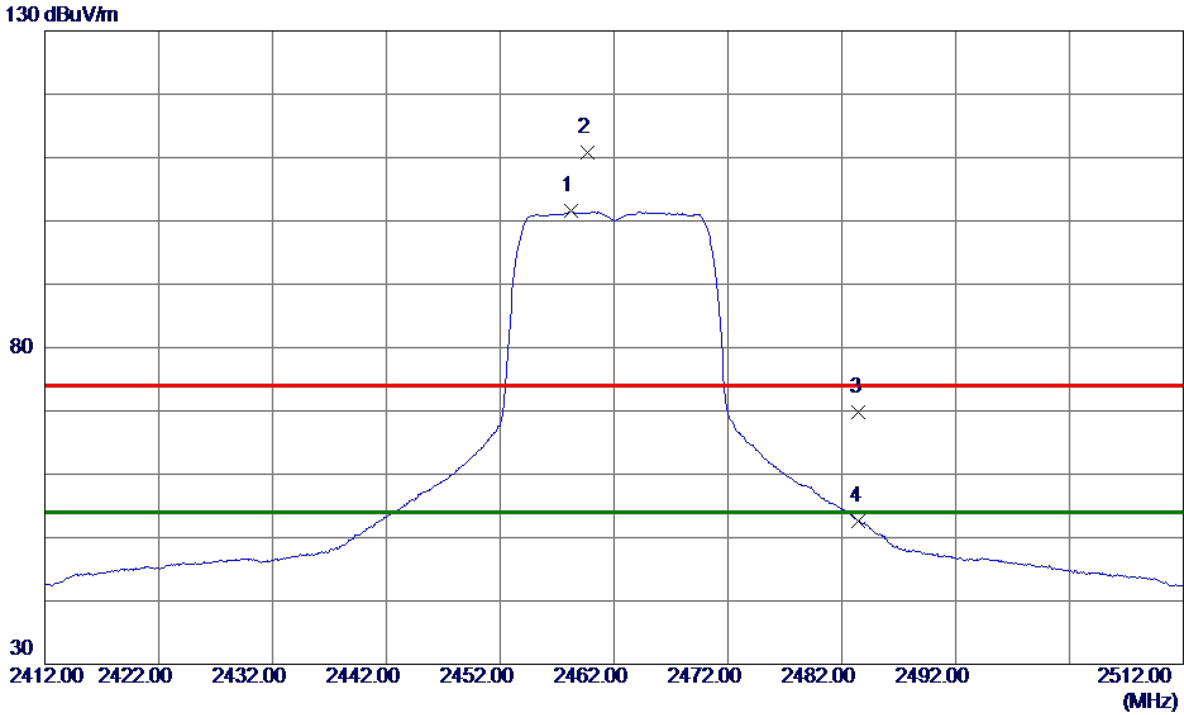

No.	Freq. MHz	Reading Level dBuV/m	Correct Factor dB	Measure ment dBuV/m	Limit dBuV/m	Margin dB	Detector	Comment
1 *	2458.2000	89.47	12.04	101.51	54.00	47.51	AVG	No Limit
2	2459.6500	98.74	12.04	110.78	74.00	36.78	Peak	No Limit
3	2483.5000	57.74	12.12	69.86	74.00	-4.14	Peak	
4	2483.5000	40.45	12.12	52.57	54.00	-1.43	AVG	

REMARKS:

- (1) Measurement Value = Reading Level + Correct Factor.
- (2) Margin Level = Measurement Value - Limit Value.

Test Mode	TX G Mode 2462 MHz	Polarization	Vertical
-----------	--------------------	--------------	----------

80 dBuV/m

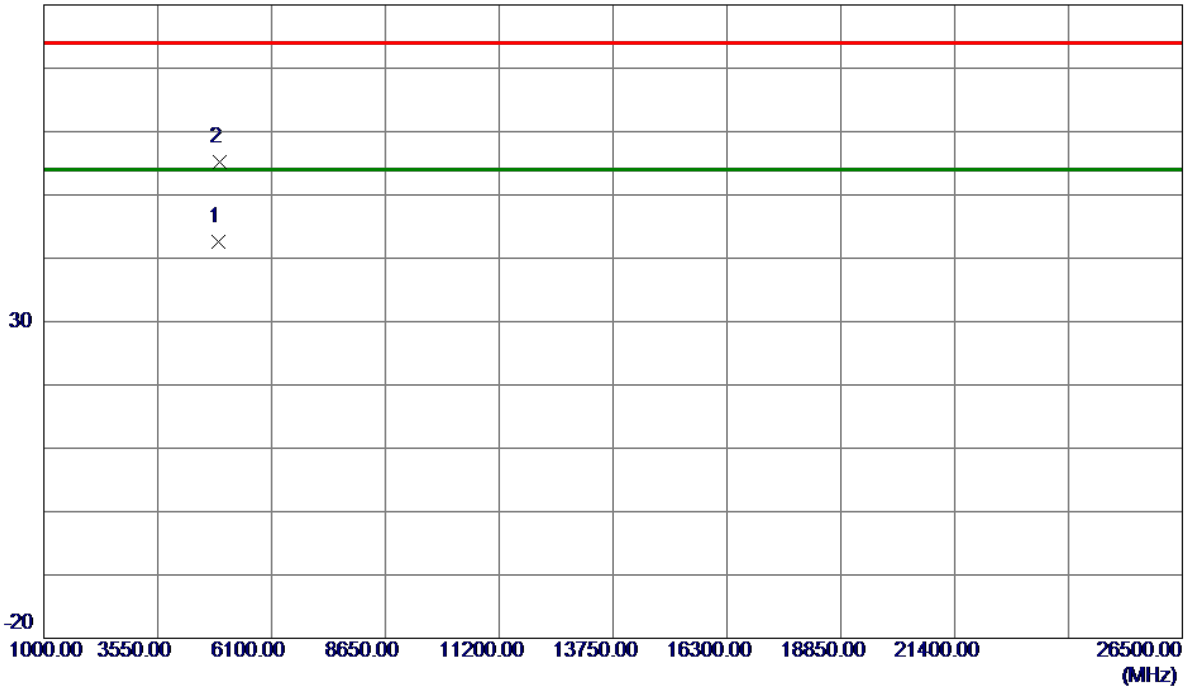

No.	Freq. MHz	Reading Level dBuV/m	Correct Factor dB	Measure ment dBuV/m	Limit dBuV/m	Margin dB	Detector	Comment
1 *	4923.8950	33.89	8.70	42.59	54.00	-11.41	AVG	
2	4924.4620	46.53	8.70	55.23	74.00	-18.77	Peak	

REMARKS:

- (1) Measurement Value = Reading Level + Correct Factor.
- (2) Margin Level = Measurement Value - Limit Value.

Test Mode	TX G Mode 2462 MHz	Polarization	Horizontal
-----------	--------------------	--------------	------------

130 dBuV/m

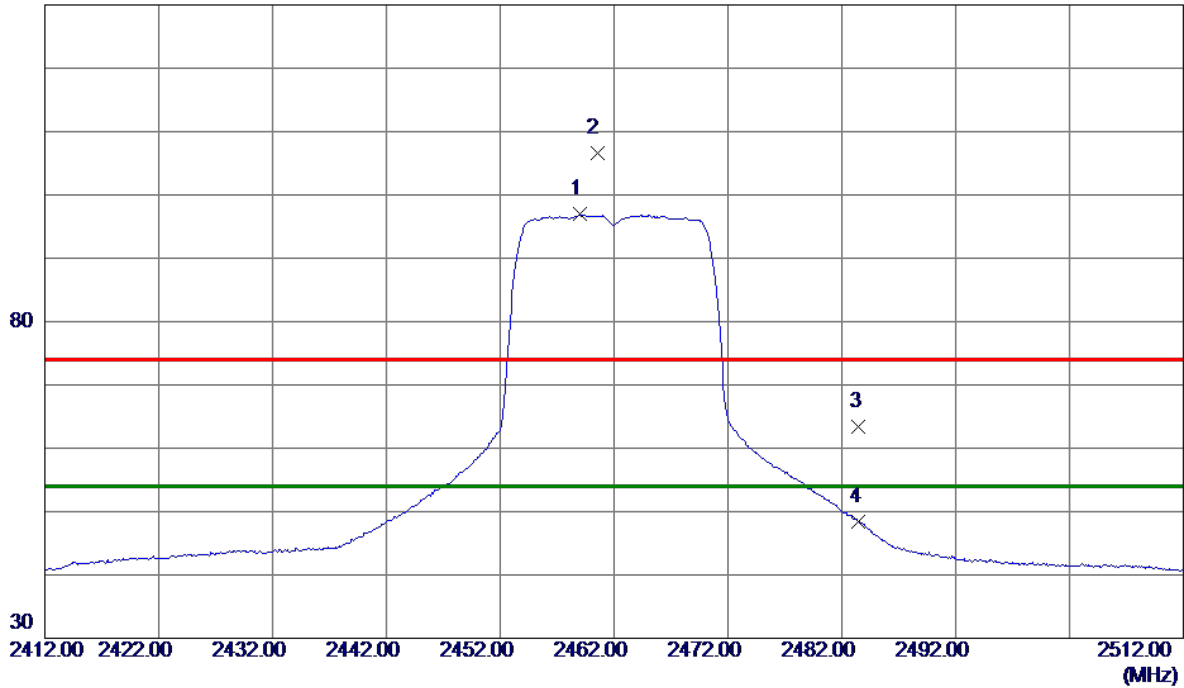

No.	Freq. MHz	Reading Level dBuV/m	Correct Factor dB	Measure ment dBuV/m	Limit dBuV/m	Margin dB	Detector	Comment
1 *	2459.0000	84.89	12.04	96.93	54.00	42.93	AVG	No Limit
2	2460.5000	94.49	12.04	106.53	74.00	32.53	Peak	No Limit
3	2483.5000	51.31	12.12	63.43	74.00	-10.57	Peak	
4	2483.5000	36.26	12.12	48.38	54.00	-5.62	AVG	

REMARKS:

- (1) Measurement Value = Reading Level + Correct Factor.
- (2) Margin Level = Measurement Value - Limit Value.

Test Mode	TX G Mode 2462 MHz	Polarization	Horizontal
-----------	--------------------	--------------	------------

80 dBuV/m

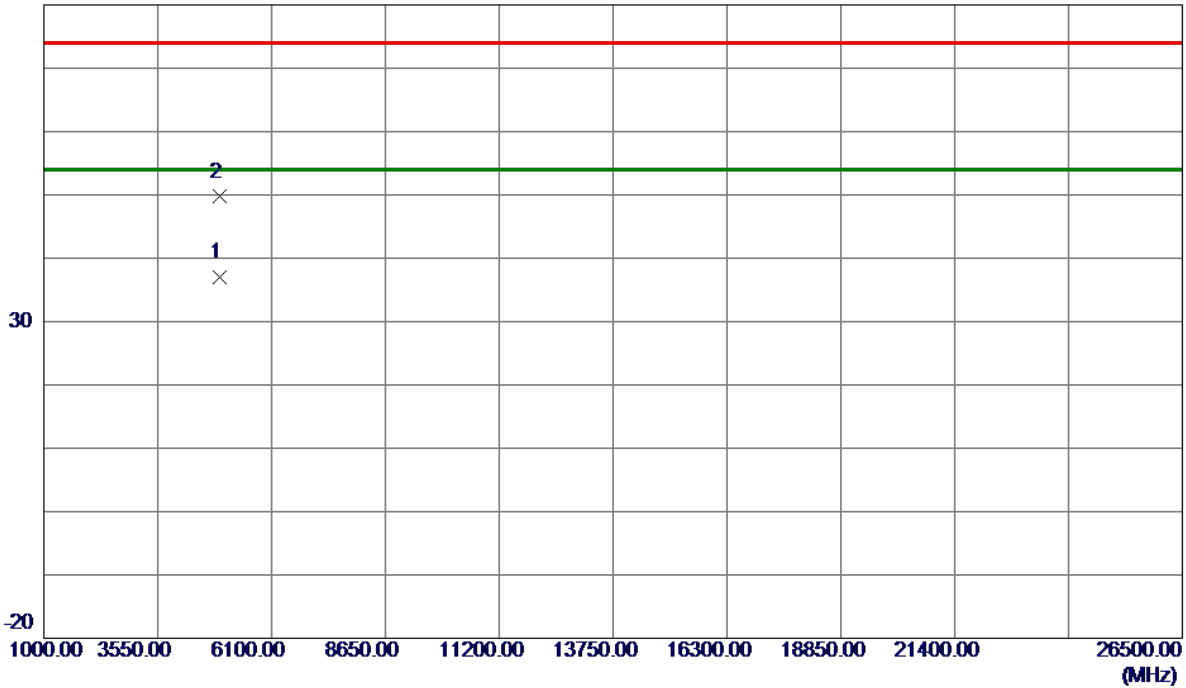

No.	Freq. MHz	Reading Level dBuV/m	Correct Factor dB	Measure ment dBuV/m	Limit dBuV/m	Margin dB	Detector	Comment
1 *	4924.3520	28.30	8.70	37.00	54.00	-17.00	AVG	
2	4924.6349	41.00	8.70	49.70	74.00	-24.30	Peak	

REMARKS:

- (1) Measurement Value = Reading Level + Correct Factor.
- (2) Margin Level = Measurement Value - Limit Value.

Test Mode	TX N(HT20) Mode 2412 MHz	Polarization	Vertical
-----------	--------------------------	--------------	----------

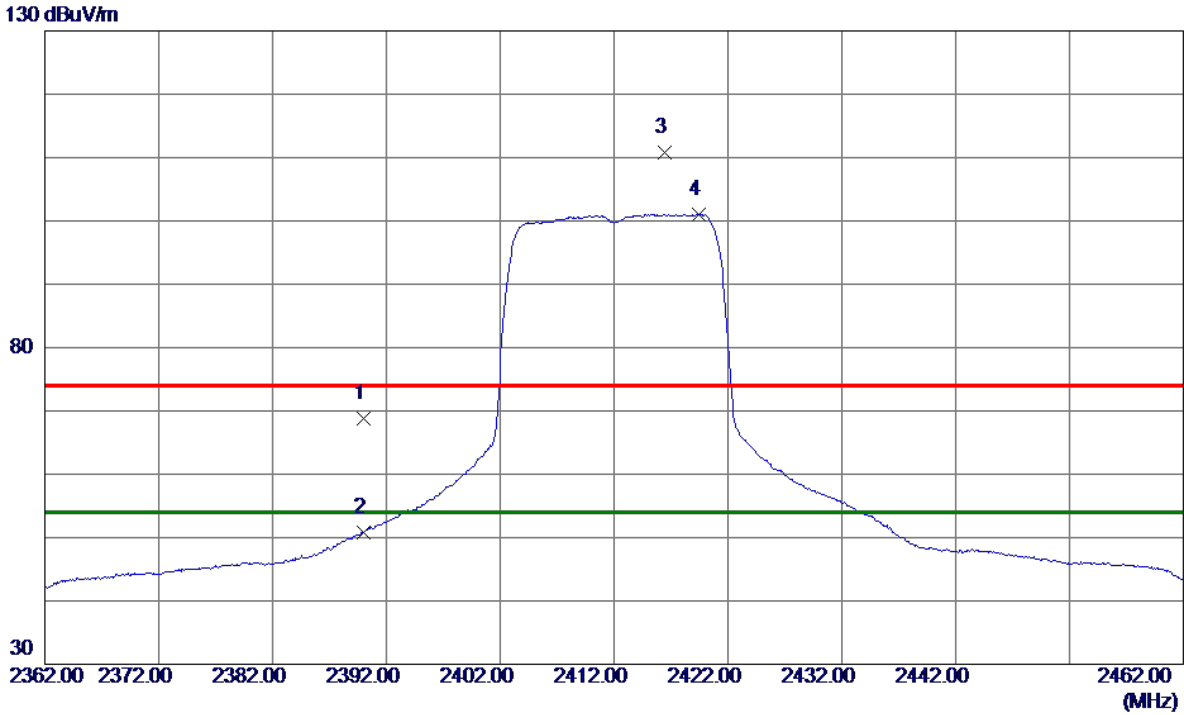

No.	Freq. MHz	Reading Level dBuV/m	Correct Factor dB	Measure ment dBuV/m	Limit dBuV/m	Margin dB	Detector	Comment
1	2390.0000	56.95	11.82	68.77	74.00	-5.23	Peak	
2	2390.0000	38.96	11.82	50.78	54.00	-3.22	AVG	
3	2416.4500	98.97	11.90	110.87	74.00	36.87	Peak	No Limit
4 *	2419.4000	89.12	11.91	101.03	54.00	47.03	AVG	No Limit

REMARKS:

- (1) Measurement Value = Reading Level + Correct Factor.
- (2) Margin Level = Measurement Value - Limit Value.

Test Mode	TX N(HT20) Mode 2412 MHz	Polarization	Vertical
-----------	--------------------------	--------------	----------

80 dBuV/m

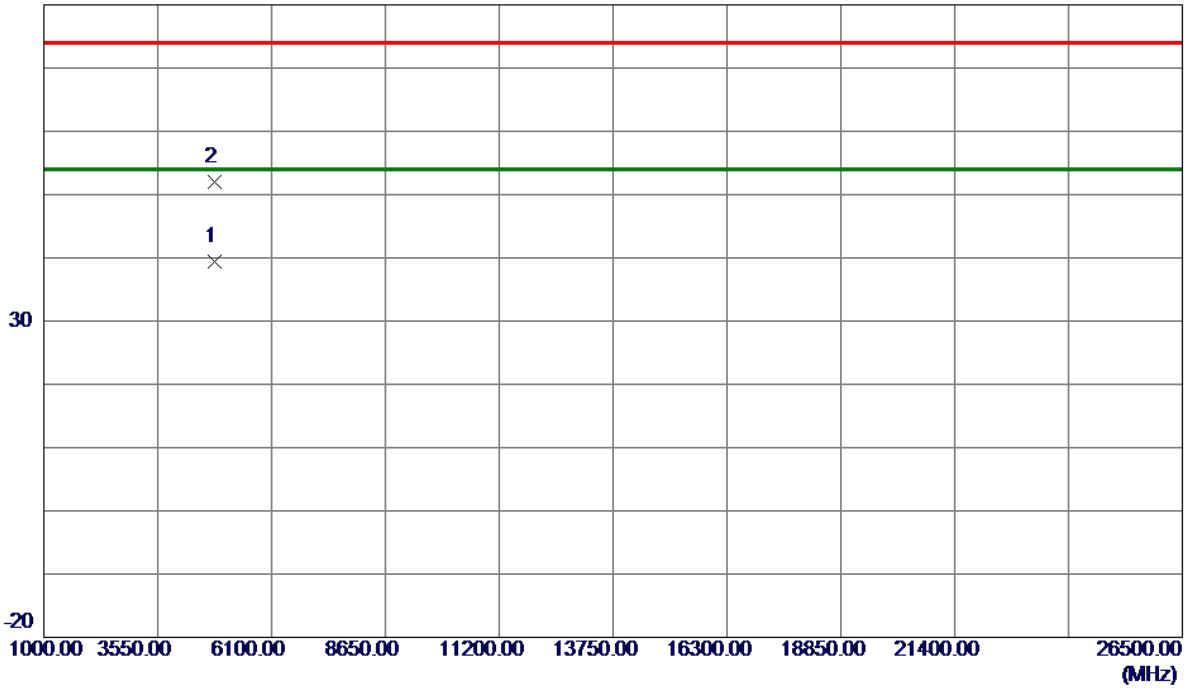

No.	Freq. MHz	Reading Level dBuV/m	Correct Factor dB	Measure ment dBuV/m	Limit dBuV/m	Margin dB	Detector	Comment
1 *	4822.2799	30.99	8.45	39.44	54.00	-14.56	AVG	
2	4825.1370	43.50	8.46	51.96	74.00	-22.04	Peak	

REMARKS:

- (1) Measurement Value = Reading Level + Correct Factor.
- (2) Margin Level = Measurement Value - Limit Value.

Test Mode	TX N(HT20) Mode 2412 MHz	Polarization	Horizontal
-----------	--------------------------	--------------	------------

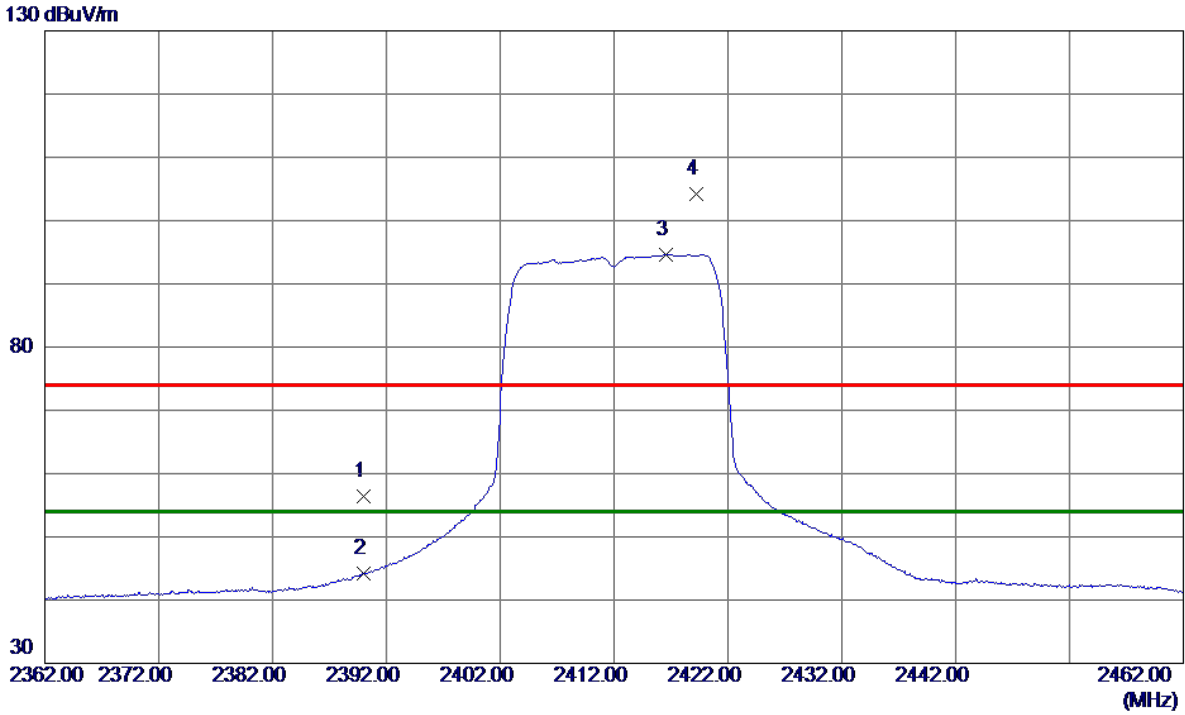

No.	Freq. MHz	Reading Level dBuV/m	Correct Factor dB	Measure ment dBuV/m	Limit dBuV/m	Margin dB	Detector	Comment
1	2390.0000	44.65	11.82	56.47	74.00	-17.53	Peak	
2	2390.0000	32.41	11.82	44.23	54.00	-9.77	AVG	
3 *	2416.6000	82.75	11.90	94.65	54.00	40.65	AVG	No Limit
4	2419.2500	92.31	11.91	104.22	74.00	30.22	Peak	No Limit

REMARKS:

- (1) Measurement Value = Reading Level + Correct Factor.
- (2) Margin Level = Measurement Value - Limit Value.

Test Mode	TX N(HT20) Mode 2412 MHz	Polarization	Horizontal
-----------	--------------------------	--------------	------------

80 dBuV/m

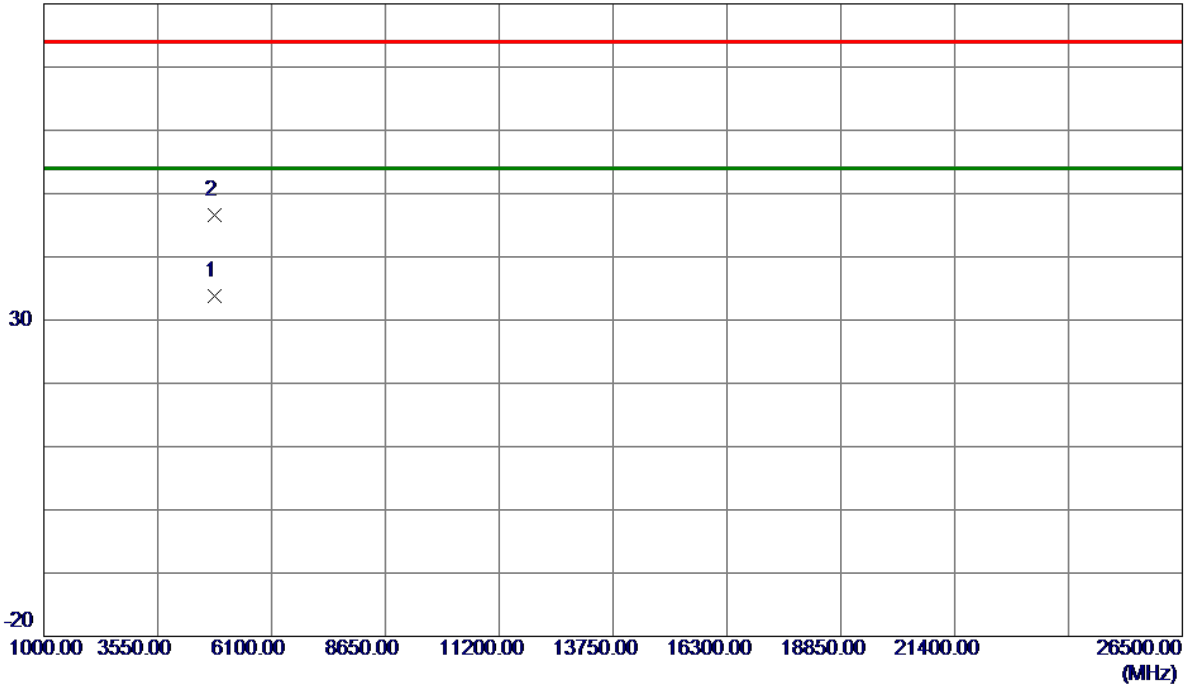

No.	Freq. MHz	Reading Level dBuV/m	Correct Factor dB	Measure ment dBuV/m	Limit dBuV/m	Margin dB	Detector	Comment
1 *	4821.5330	25.37	8.45	33.82	54.00	-20.18	AVG	
2	4821.6130	38.17	8.45	46.62	74.00	-27.38	Peak	

REMARKS:

- (1) Measurement Value = Reading Level + Correct Factor.
- (2) Margin Level = Measurement Value - Limit Value.

Test Mode	TX N(HT20) Mode 2417 MHz	Polarization	Vertical
-----------	--------------------------	--------------	----------

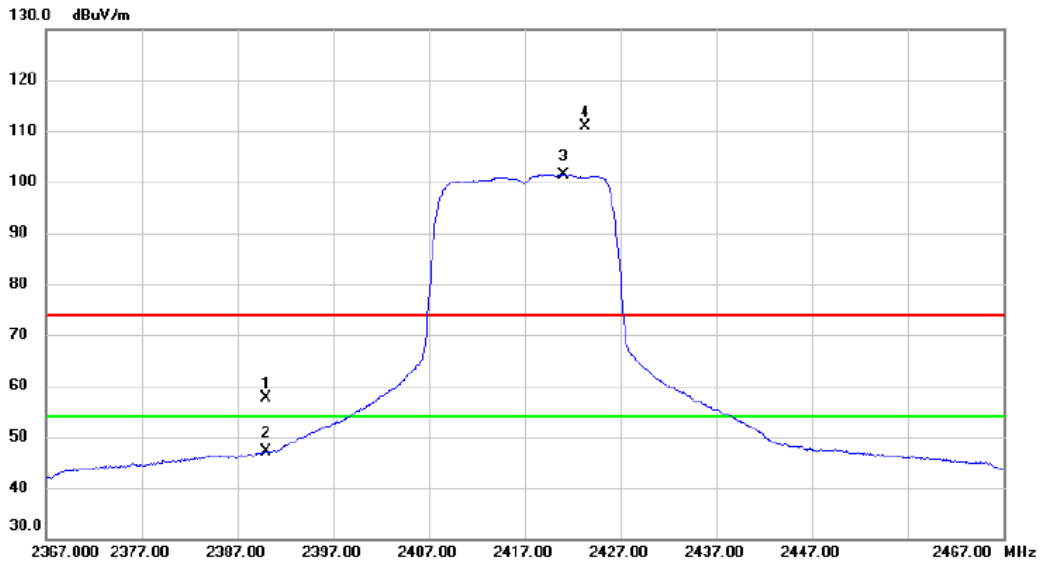

No.	Mk.	Freq. MHz	Reading Level dBuV	Correct Factor dB	Measure- ment dBuV/m	Limit dBuV/m	Margin dB	Detector	Comment
1		2390.000	45.92	11.83	57.75	74.00	-16.25	peak	
2		2390.000	35.36	11.83	47.19	54.00	-6.81	AVG	
3	*	2421.050	89.55	11.92	101.47	54.00	47.47	AVG	No Limit
4	X	2423.350	98.93	11.93	110.86	74.00	36.86	peak	No Limit

REMARKS:

(1) Measurement Value = Reading Level + Correct Factor.

(2) Margin Level = Measurement Value - Limit Value.

Test Mode	TX N(HT20) Mode 2417 MHz	Polarization	Vertical
-----------	--------------------------	--------------	----------

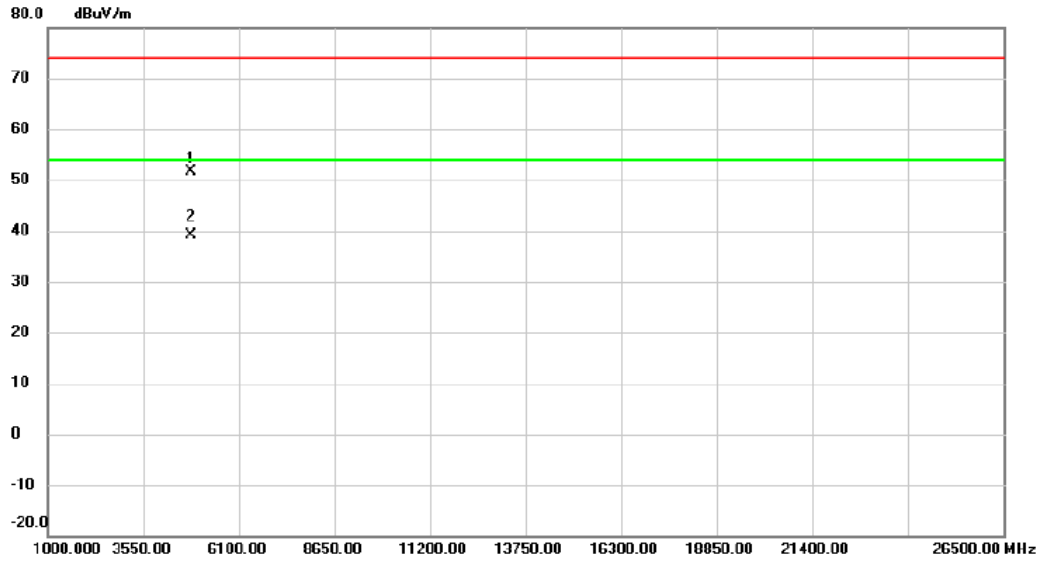

No.	Mk.	Freq. MHz	Reading Level dBuV	Correct Factor dB	Measure- ment dBuV/m	Limit dBuV/m	Margin dB	Detector	Comment
1		4832.443	43.20	8.47	51.67	74.00	-22.33	peak	
2	*	4836.477	30.68	8.49	39.17	54.00	-14.83	AVG	

REMARKS:

- (1) Measurement Value = Reading Level + Correct Factor.
- (2) Margin Level = Measurement Value - Limit Value.

Test Mode	TX N(HT20) Mode 2417 MHz	Polarization	Horizontal
-----------	--------------------------	--------------	------------

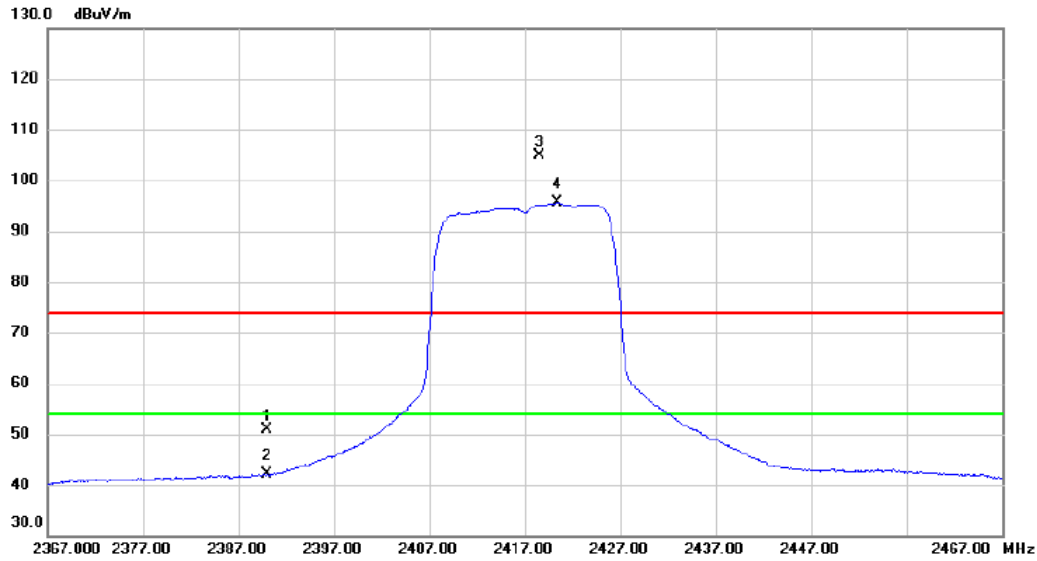

No.	Mk.	Freq. MHz	Reading Level dBuV	Correct Factor dB	Measure- ment dBuV/m	Limit dBuV/m	Margin dB	Detector	Comment
1		2390.000	38.95	11.83	50.78	74.00	-23.22	peak	
2		2390.000	30.39	11.83	42.22	54.00	-11.78	AVG	
3	X	2418.500	92.99	11.91	104.90	74.00	30.90	peak	No Limit
4	*	2420.450	83.83	11.91	95.74	54.00	41.74	AVG	No Limit

REMARKS:

- (1) Measurement Value = Reading Level + Correct Factor.
- (2) Margin Level = Measurement Value - Limit Value.

Test Mode	TX N(HT20) Mode 2417 MHz	Polarization	Horizontal
-----------	--------------------------	--------------	------------

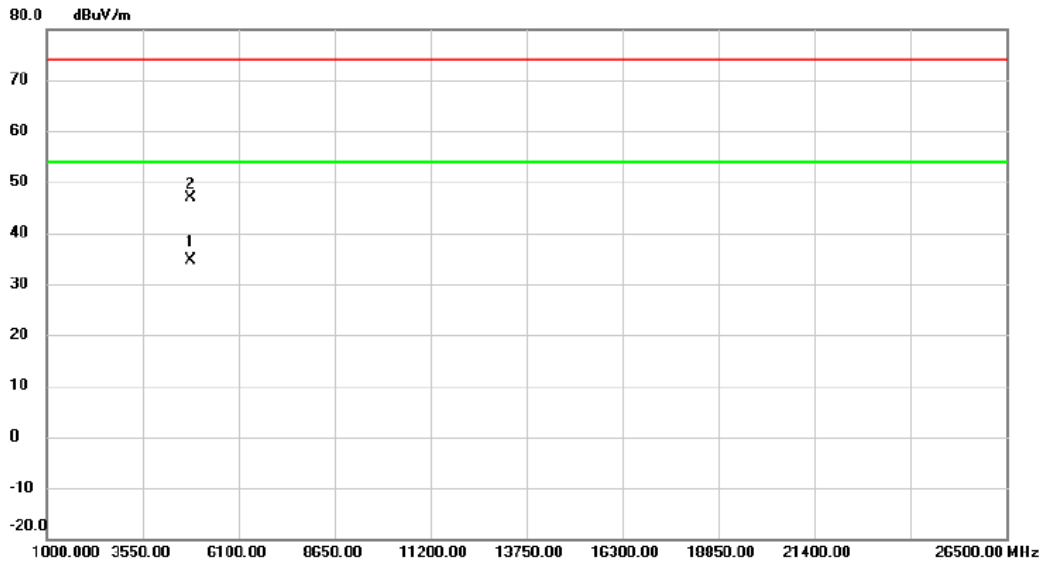

No.	Mk.	Freq. MHz	Reading Level dBuV	Correct Factor dB	Measure- ment dBuV/m	Limit dBuV/m	Margin dB	Detector	Comment
1	*	4831.738	26.22	8.47	34.69	54.00	-19.31	AVG	
2		4832.528	38.52	8.47	46.99	74.00	-27.01	peak	

REMARKS:

- (1) Measurement Value = Reading Level + Correct Factor.
- (2) Margin Level = Measurement Value - Limit Value.

Test Mode	TX N(HT20) Mode 2437 MHz	Polarization	Vertical
-----------	--------------------------	--------------	----------

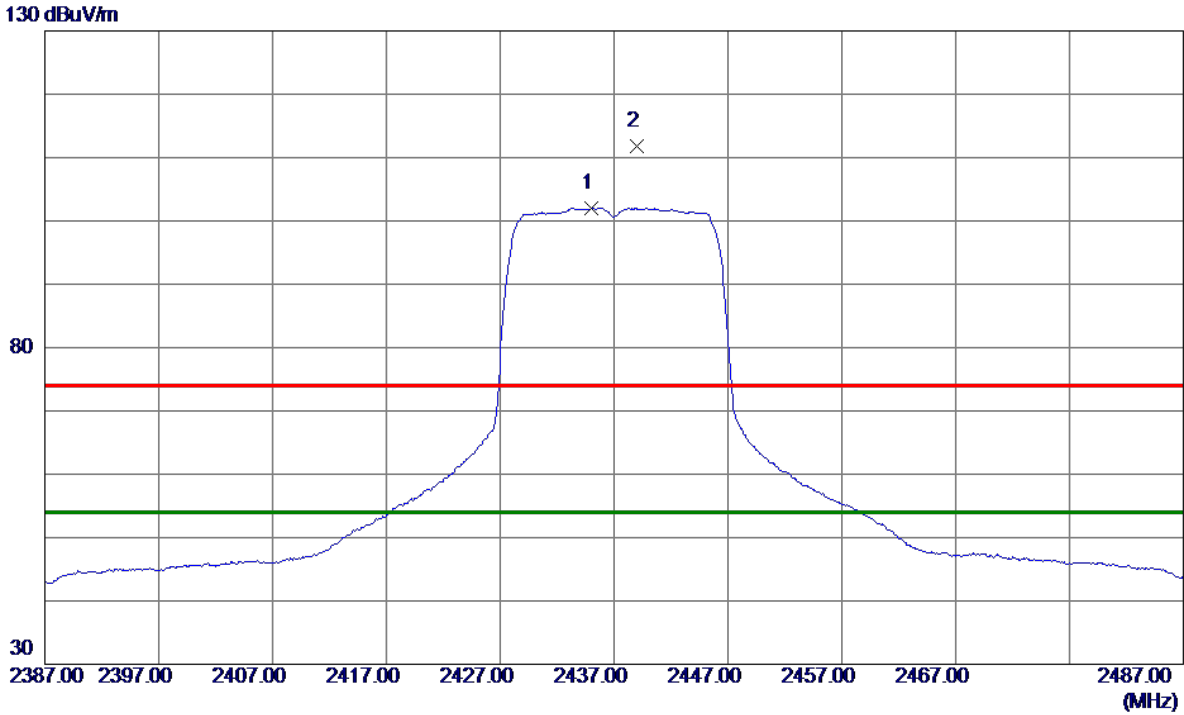

No.	Freq. MHz	Reading Level dBuV/m	Correct Factor dB	Measure ment dBuV/m	Limit dBuV/m	Margin dB	Detector	Comment
1 *	2435.0500	90.04	11.96	102.00	54.00	48.00	AVG	No Limit
2	2438.9500	99.89	11.97	111.86	74.00	37.86	Peak	No Limit

REMARKS:

- (1) Measurement Value = Reading Level + Correct Factor.
- (2) Margin Level = Measurement Value - Limit Value.

Test Mode	TX N(HT20) Mode 2437 MHz	Polarization	Vertical
-----------	--------------------------	--------------	----------

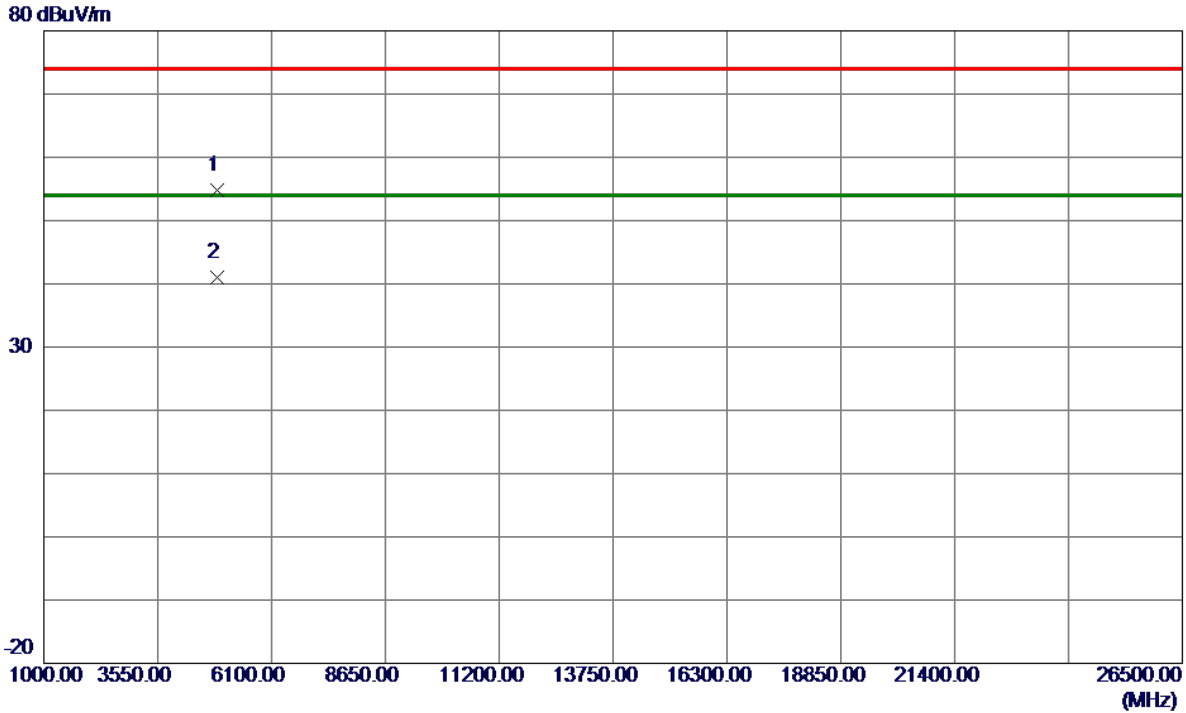

No.	Freq. MHz	Reading Level dBuV/m	Correct Factor dB	Measure ment dBuV/m	Limit dBuV/m	Margin dB	Detector	Comment
1	4871.6880	46.22	8.57	54.79	74.00	-19.21	Peak	
2 *	4874.1850	32.43	8.58	41.01	54.00	-12.99	AVG	

REMARKS:

- (1) Measurement Value = Reading Level + Correct Factor.
- (2) Margin Level = Measurement Value - Limit Value.

Test Mode	TX N(HT20) Mode 2437 MHz	Polarization	Horizontal
-----------	--------------------------	--------------	------------

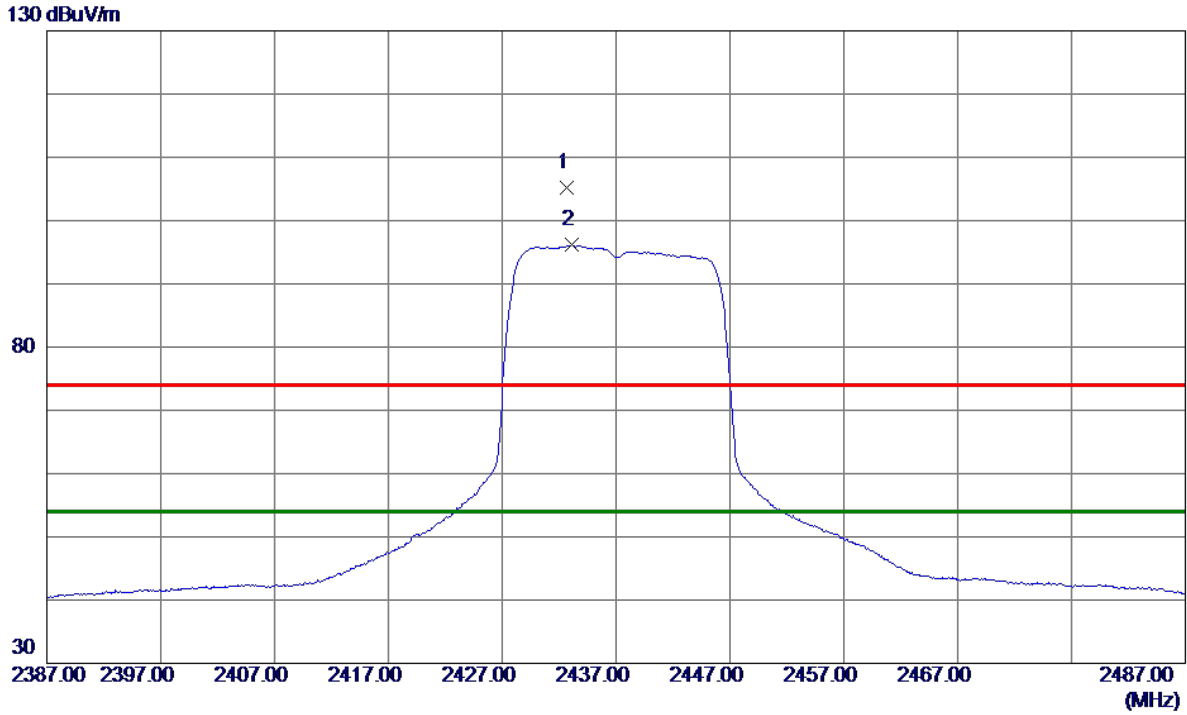

No.	Freq. MHz	Reading Level dBuV/m	Correct Factor dB	Measure ment dBuV/m	Limit dBuV/m	Margin dB	Detector	Comment
1	2432.6500	93.34	11.95	105.29	74.00	31.29	Peak	No Limit
2 *	2433.1000	84.15	11.96	96.11	54.00	42.11	AVG	No Limit

REMARKS:

- (1) Measurement Value = Reading Level + Correct Factor.
- (2) Margin Level = Measurement Value - Limit Value.

Test Mode	TX N(HT20) Mode 2437 MHz	Polarization	Horizontal
-----------	--------------------------	--------------	------------

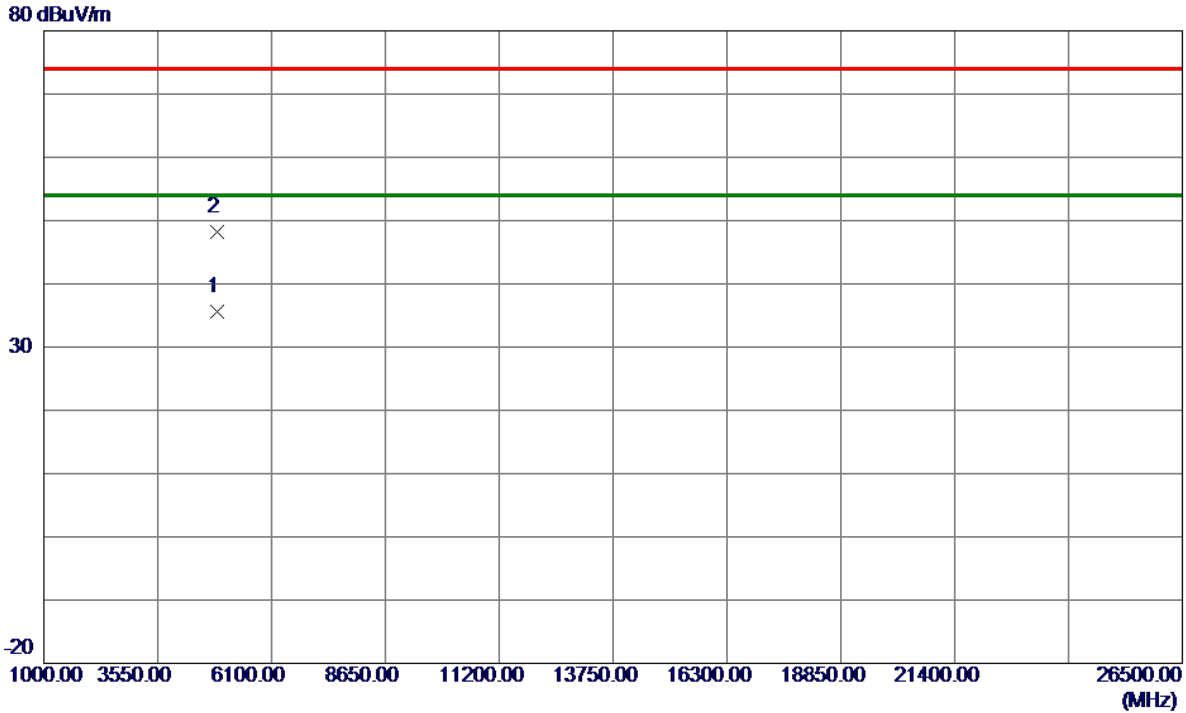

No.	Freq. MHz	Reading Level dBuV/m	Correct Factor dB	Measure ment dBuV/m	Limit dBuV/m	Margin dB	Detector	Comment
1 *	4874.1400	27.07	8.58	35.65	54.00	-18.35	AVG	
2	4876.3180	39.63	8.58	48.21	74.00	-25.79	Peak	

REMARKS:

- (1) Measurement Value = Reading Level + Correct Factor.
- (2) Margin Level = Measurement Value - Limit Value.

Test Mode	TX N(HT20) Mode 2457 MHz	Polarization	Vertical
-----------	--------------------------	--------------	----------

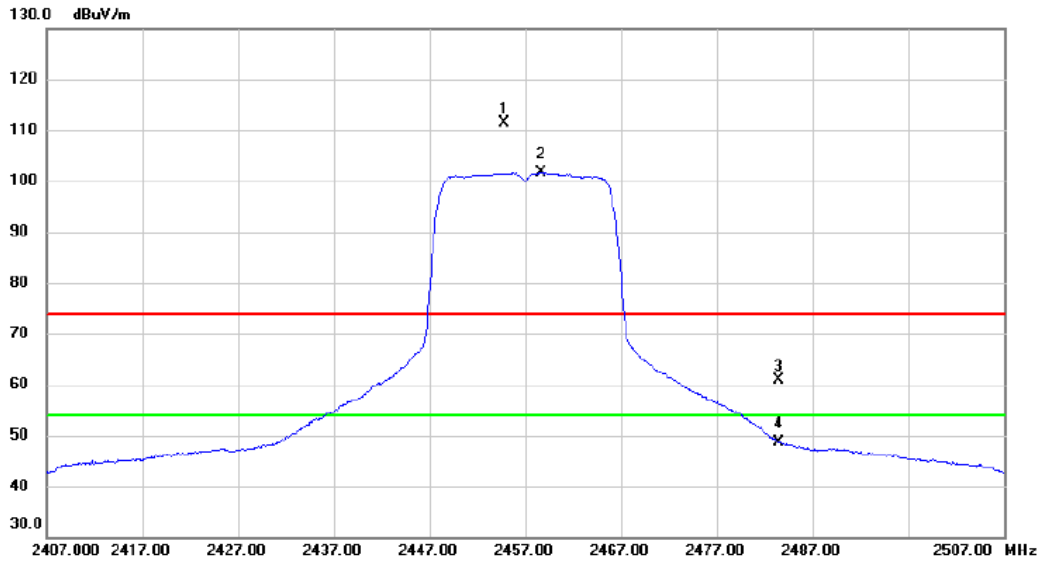

No.	Mk.	Freq. MHz	Reading Level dBuV	Correct Factor dB	Measure- ment dBuV/m	Limit dBuV/m	Margin dB	Detector	Comment
1	X	2454.800	99.39	12.02	111.41	74.00	37.41	peak	No Limit
2	*	2458.700	89.64	12.04	101.68	54.00	47.68	AVG	No Limit
3		2483.500	48.69	12.12	60.81	74.00	-13.19	peak	
4		2483.500	36.50	12.12	48.62	54.00	-5.38	AVG	

REMARKS:

(1) Measurement Value = Reading Level + Correct Factor.

(2) Margin Level = Measurement Value - Limit Value.

Test Mode	TX N(HT20) Mode 2457 MHz	Polarization	Vertical
-----------	--------------------------	--------------	----------

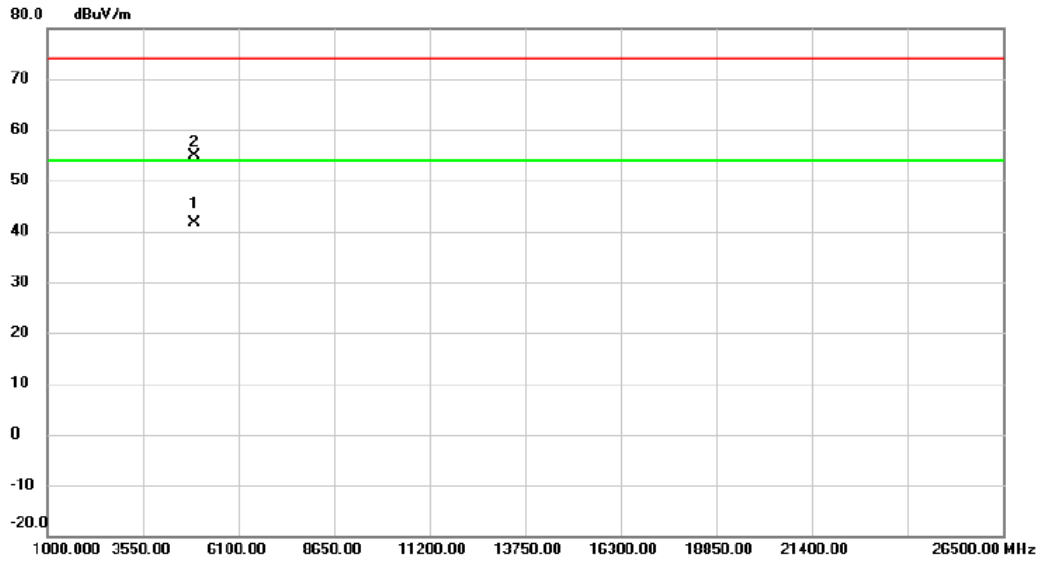

No.	Mk.	Freq. MHz	Reading Level dBuV	Correct Factor dB	Measure- ment dBuV/m	Limit dBuV/m	Margin dB	Detector	Comment
1	*	4913.740	32.91	8.68	41.59	54.00	-12.41	AVG	
2		4915.025	46.17	8.68	54.85	74.00	-19.15	peak	

REMARKS:

- (1) Measurement Value = Reading Level + Correct Factor.
- (2) Margin Level = Measurement Value - Limit Value.

Test Mode	TX N(HT20) Mode 2457 MHz	Polarization	Horizontal
-----------	--------------------------	--------------	------------

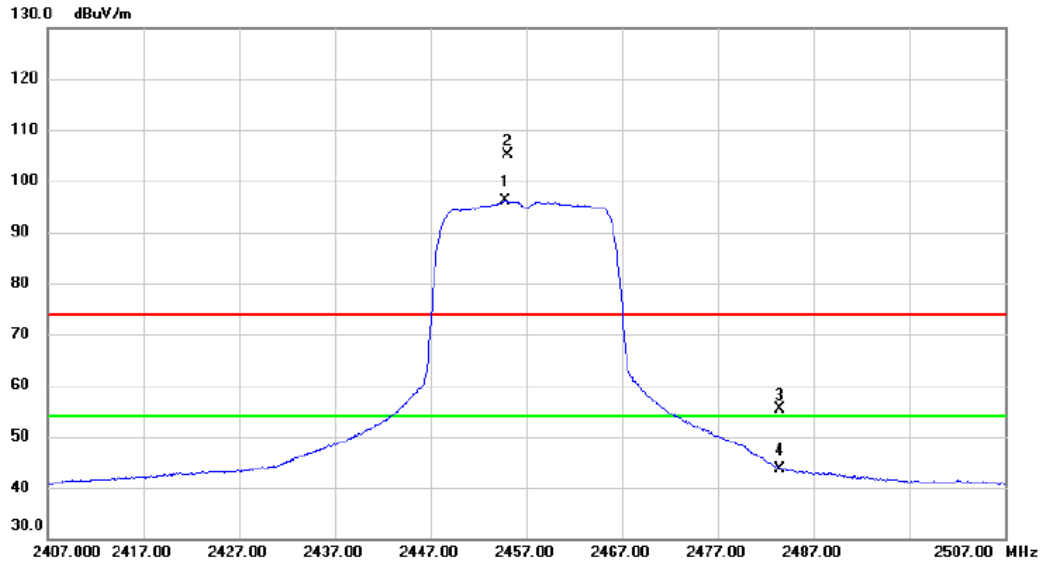

No.	Mk.	Freq.	Reading Level	Correct Factor	Measurement	Limit	Margin		
		MHz	dBuV	dB	dBuV/m	dBuV/m	dB	Detector	Comment
1	*	2454.850	84.10	12.02	96.12	54.00	42.12	AVG	No Limit
2	X	2455.000	93.01	12.02	105.03	74.00	31.03	peak	No Limit
3		2483.500	43.28	12.12	55.40	74.00	-18.60	peak	
4		2483.500	31.51	12.12	43.63	54.00	-10.37	AVG	

REMARKS:

- (1) Measurement Value = Reading Level + Correct Factor.
- (2) Margin Level = Measurement Value - Limit Value.

Test Mode	TX N(HT20) Mode 2457 MHz	Polarization	Horizontal
-----------	--------------------------	--------------	------------

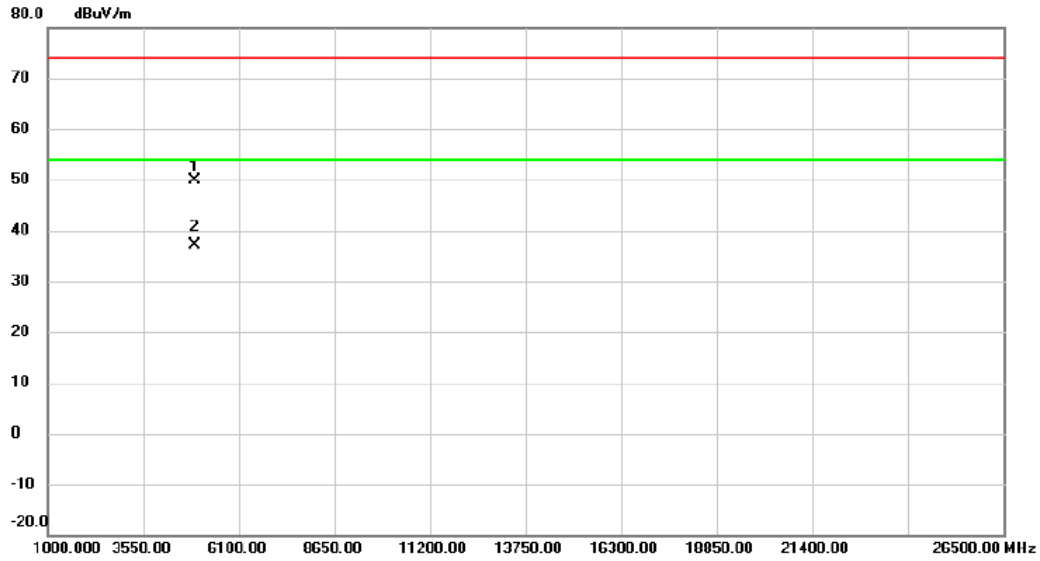

No.	Mk.	Freq. MHz	Reading Level dBuV	Correct Factor dB	Measure- ment dBuV/m	Limit dBuV/m	Margin dB	Detector	Comment
1		4912.608	41.27	8.68	49.95	74.00	-24.05	peak	
2	*	4913.738	28.36	8.68	37.04	54.00	-16.96	AVG	

REMARKS:

- (1) Measurement Value = Reading Level + Correct Factor.
- (2) Margin Level = Measurement Value - Limit Value.

Test Mode	TX N(HT20) Mode 2462 MHz	Polarization	Vertical
-----------	--------------------------	--------------	----------

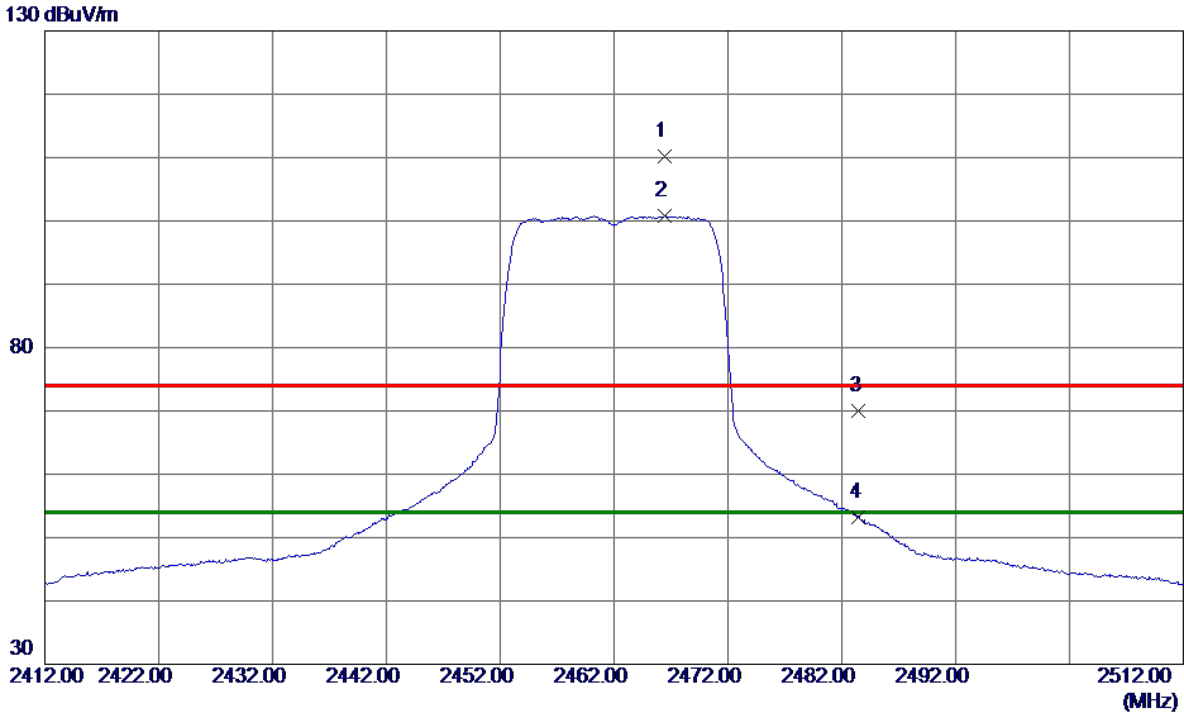

No.	Freq. MHz	Reading Level dBuV/m	Correct Factor dB	Measure ment dBuV/m	Limit dBuV/m	Margin dB	Detector	Comment
1	2466.4500	98.09	12.06	110.15	74.00	36.15	Peak	No Limit
2 *	2466.4500	88.69	12.06	100.75	54.00	46.75	AVG	No Limit
3	2483.5000	57.85	12.12	69.97	74.00	-4.03	Peak	
4	2483.5000	41.03	12.12	53.15	54.00	-0.85	AVG	

REMARKS:

- (1) Measurement Value = Reading Level + Correct Factor.
- (2) Margin Level = Measurement Value - Limit Value.

Test Mode	TX N(HT20) Mode 2462 MHz	Polarization	Vertical
-----------	--------------------------	--------------	----------

80 dBuV/m

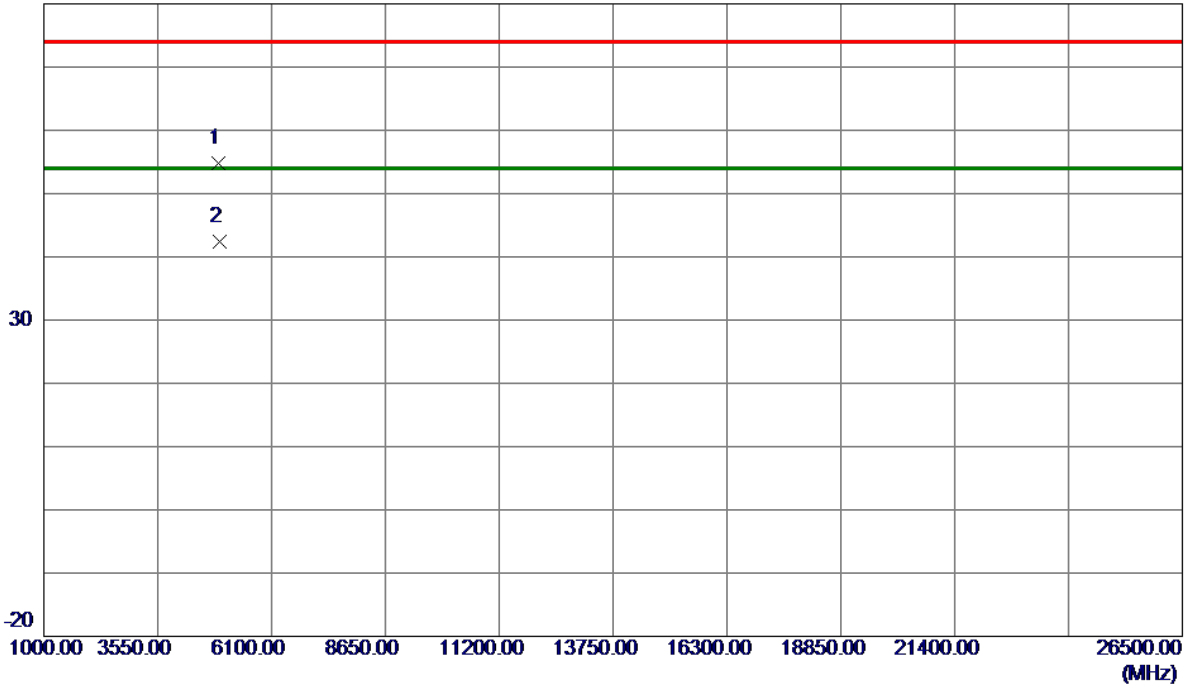

No.	Freq. MHz	Reading Level dBuV/m	Correct Factor dB	Measure ment dBuV/m	Limit dBuV/m	Margin dB	Detector	Comment
1	4923.6500	46.05	8.70	54.75	74.00	-19.25	Peak	
2 *	4925.1370	33.70	8.71	42.41	54.00	-11.59	AVG	

REMARKS:

- (1) Measurement Value = Reading Level + Correct Factor.
- (2) Margin Level = Measurement Value - Limit Value.

Test Mode	TX N(HT20) Mode 2462 MHz	Polarization	Horizontal
-----------	--------------------------	--------------	------------

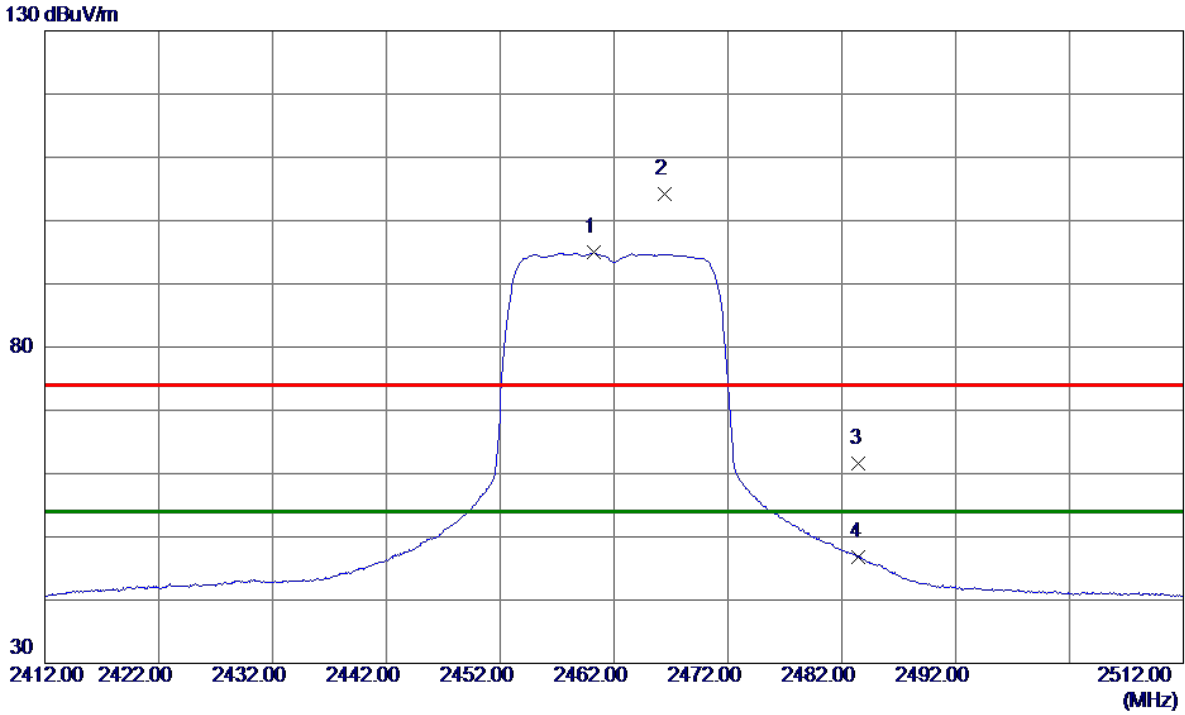

No.	Freq. MHz	Reading Level dBuV/m	Correct Factor dB	Measure ment dBuV/m	Limit dBuV/m	Margin dB	Detector	Comment
1 *	2460.2000	82.86	12.04	94.90	54.00	40.90	AVG	No Limit
2	2466.4000	92.18	12.06	104.24	74.00	30.24	Peak	No Limit
3	2483.5000	49.51	12.12	61.63	74.00	-12.37	Peak	
4	2483.5000	34.76	12.12	46.88	54.00	-7.12	AVG	

REMARKS:

- (1) Measurement Value = Reading Level + Correct Factor.
- (2) Margin Level = Measurement Value - Limit Value.

Test Mode	TX N(HT20) Mode 2462 MHz	Polarization	Horizontal
-----------	--------------------------	--------------	------------

80 dBuV/m

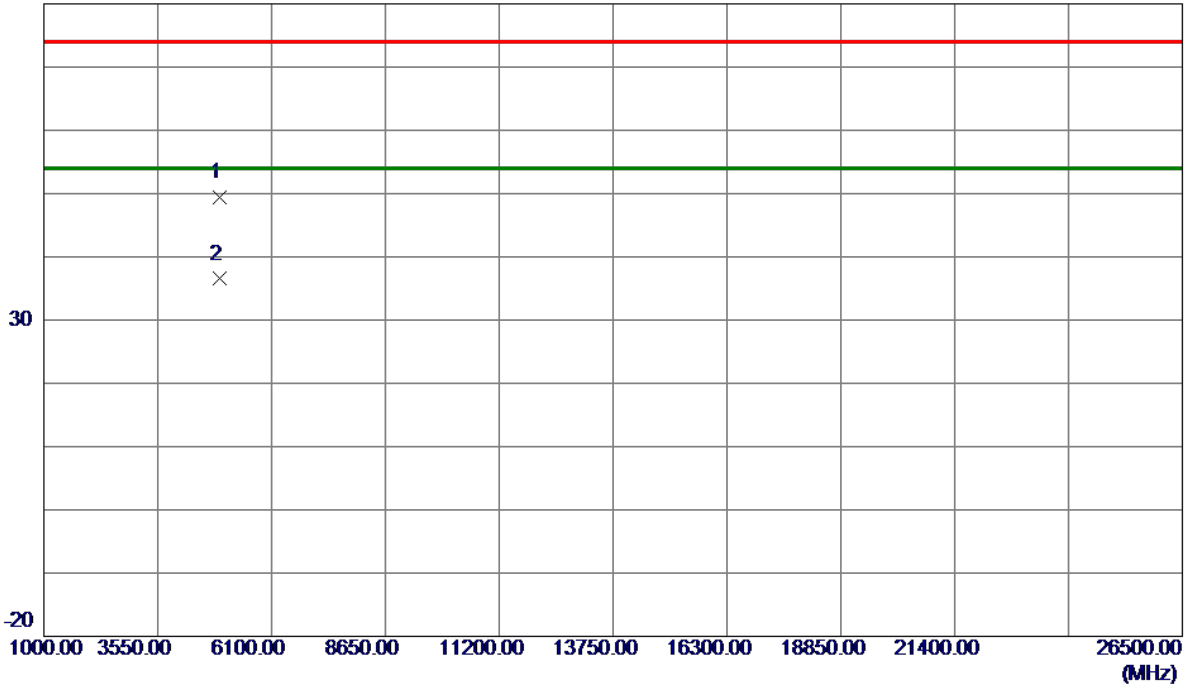

No.	Freq. MHz	Reading Level dBuV/m	Correct Factor dB	Measure ment dBuV/m	Limit dBuV/m	Margin dB	Detector	Comment
1	4924.7120	40.77	8.70	49.47	74.00	-24.53	Peak	
2 *	4924.8849	27.80	8.70	36.50	54.00	-17.50	AVG	

REMARKS:

- (1) Measurement Value = Reading Level + Correct Factor.
- (2) Margin Level = Measurement Value - Limit Value.

APPENDIX E - BANDWIDTH

Test Mode TX B Mode

Channel	Frequency (MHz)	6 dB Bandwidth (MHz)	99 % Occupied Bandwidth (MHz)	6 dB Bandwidth Min. Limit (MHz)	Result
01	2412	9.079	14.160	0.5	Complies
06	2437	9.159	14.160	0.5	Complies
11	2462	9.100	14.160	0.5	Complies

CH01

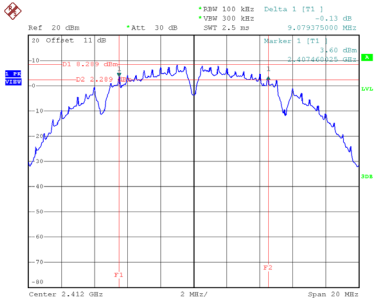

Date: 19_MAR.2021 08:51:33

CH06

6 dB Bandwidth

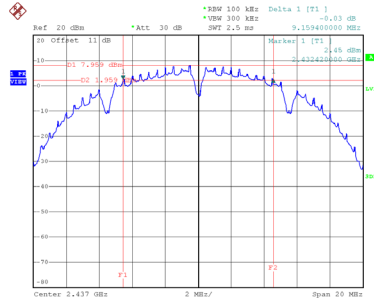

Date: 19_MAR.2021 08:53:07

CH11

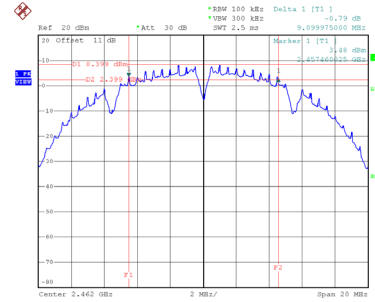

Date: 19_MAR.2021 08:54:41

99 % Occupied Bandwidth

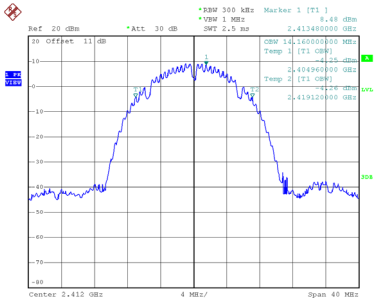

Date: 19_MAR.2021 08:51:41

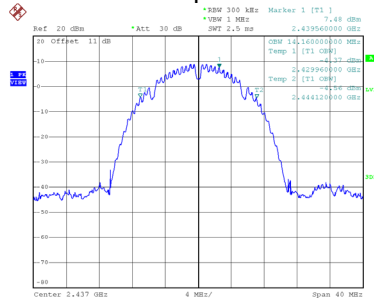

Date: 19_MAR.2021 08:53:15

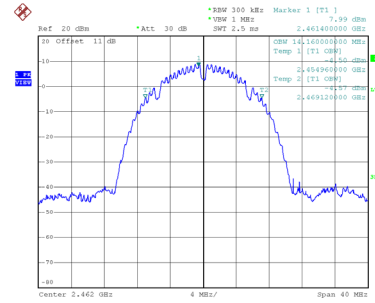

Date: 19_MAR.2021 08:54:48

Test Mode	TX G Mode
-----------	-----------

Channel	Frequency (MHz)	6 dB Bandwidth (MHz)	99 % Occupied Bandwidth (MHz)	6 dB Bandwidth Min. Limit (MHz)	Result
01	2412	16.360	17.200	0.5	Complies
06	2437	16.440	17.040	0.5	Complies
11	2462	16.380	17.200	0.5	Complies

CH01

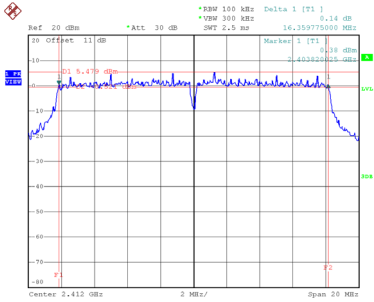

Date: 19_MAR.2021 08:56:08

CH06

6 dB Bandwidth

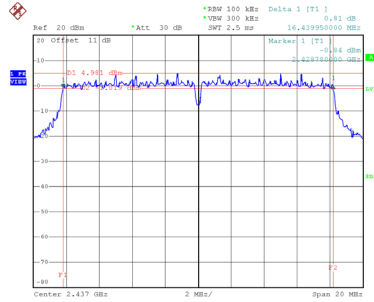

Date: 19_MAR.2021 08:57:32

CH11

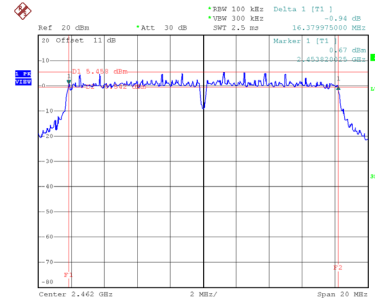

Date: 19_MAR.2021 08:58:51

99 % Occupied Bandwidth

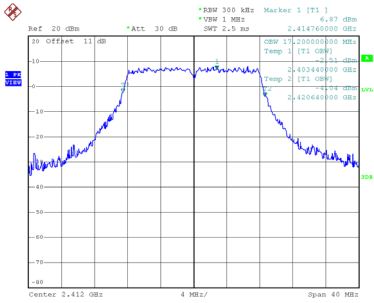

Date: 19_MAR.2021 08:56:16

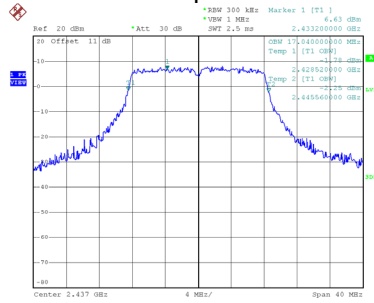

Date: 19_MAR.2021 08:57:40

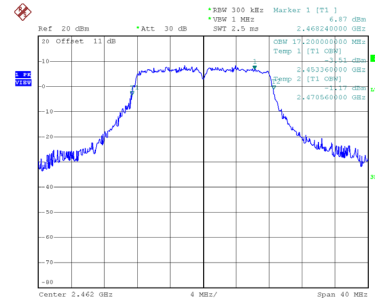

Date: 19_MAR.2021 08:58:58

Test Mode TX N(HT20) Mode

Channel	Frequency (MHz)	6 dB Bandwidth (MHz)	99 % Occupied Bandwidth (MHz)	6 dB Bandwidth Min. Limit (MHz)	Result
01	2412	17.650	18.080	0.5	Complies
06	2437	17.640	18.160	0.5	Complies
11	2462	17.620	18.320	0.5	Complies

CH01

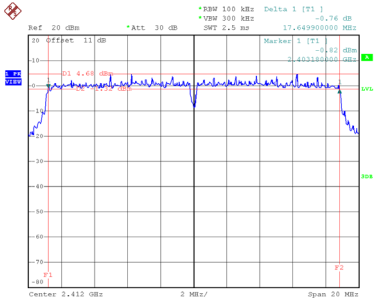

Date: 19_MAR.2021 09:00:12

CH06

6 dB Bandwidth

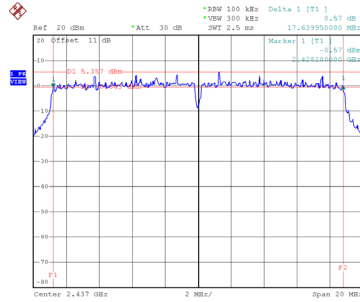

Date: 19_MAR.2021 09:01:28

CH11

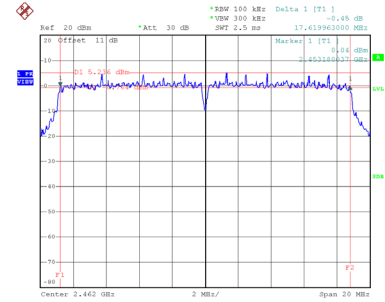

Date: 19_MAR.2021 09:02:43

99 % Occupied Bandwidth

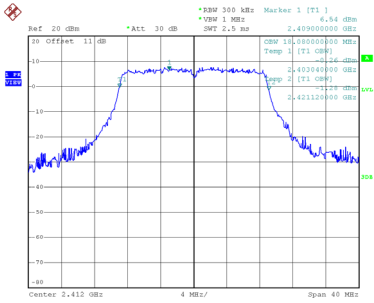

Date: 19_MAR.2021 09:00:19

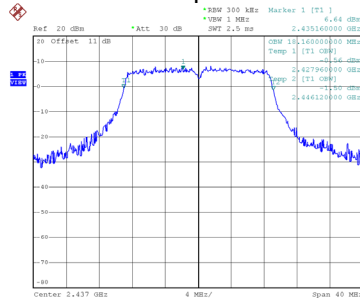

Date: 19_MAR.2021 09:01:35

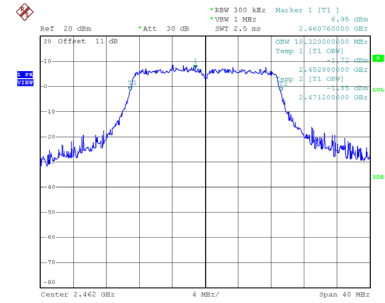

Date: 19_MAR.2021 09:02:51

APPENDIX F - MAXIMUM AVERAGE OUTPUT POWER

Test Mode	TX B Mode
-----------	-----------

Channel	Frequency (MHz)	Average Output Power (dBm)	Duty Factor	Average Output Power + Duty Factor (dBm)	Max. Limit (dBm)	Max. Limit (W)	Result
01	2412	18.55	0.00	18.55	30.00	1.0000	Complies
06	2437	17.96	0.00	17.96	30.00	1.0000	Complies
11	2462	17.88	0.00	17.88	30.00	1.0000	Complies

Test Mode	TX G Mode
-----------	-----------

Channel	Frequency (MHz)	Average Output Power (dBm)	Duty Factor	Average Output Power + Duty Factor (dBm)	Max. Limit (dBm)	Max. Limit (W)	Result
01	2412	17.62	0.28	17.90	30.00	1.0000	Complies
06	2437	17.66	0.28	17.94	30.00	1.0000	Complies
11	2462	17.79	0.28	18.07	30.00	1.0000	Complies

Test Mode	TX N(HT20) Mode
-----------	-----------------

Channel	Frequency (MHz)	Average Output Power (dBm)	Duty Factor	Average Output Power + Duty Factor (dBm)	Max. Limit (dBm)	Max. Limit (W)	Result
01	2412	17.49	0.28	17.77	30.00	1.0000	Complies
06	2437	17.61	0.28	17.89	30.00	1.0000	Complies
11	2462	16.46	0.28	16.74	30.00	1.0000	Complies

APPENDIX G - CONDUCTED SPURIOUS EMISSIONS

Test Mode TX B Mode

Bandedge-CH01

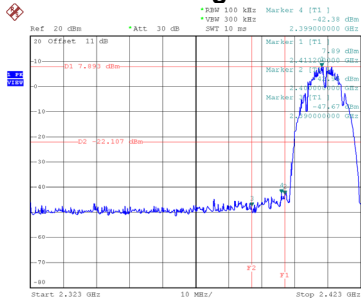

Date: 19.MAR.2021 08:51:49

Bandedge-CH11

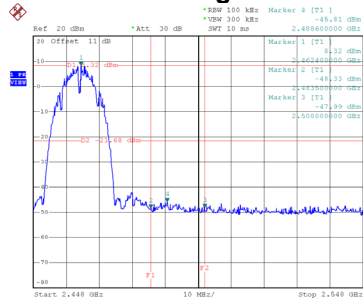

Date: 19.MAR.2021 08:54:56

CH01 – 10th Harmonic of the fundamental frequency

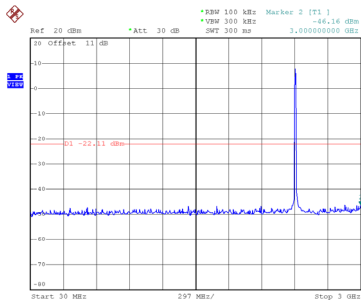

Date: 19.MAR.2021 08:52:03

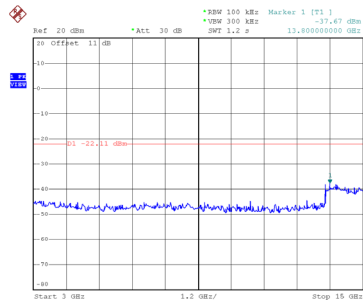

Date: 19.MAR.2021 08:52:11

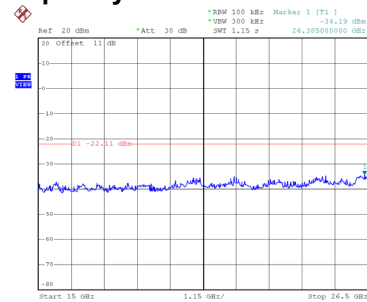

Date: 19.MAR.2021 08:52:19

CH06 – 10th Harmonic of the fundamental frequency

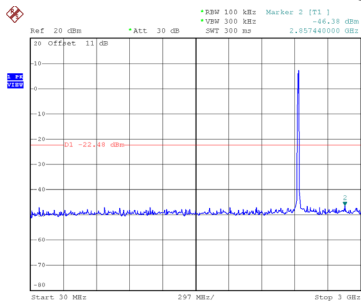

Date: 19.MAR.2021 08:53:36

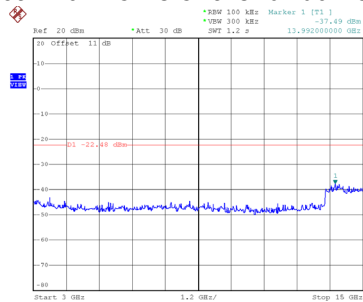

Date: 19.MAR.2021 08:53:45

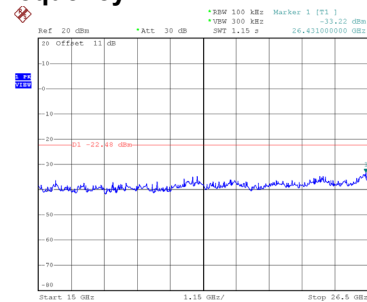

Date: 19.MAR.2021 08:53:53

CH11 – 10th Harmonic of the fundamental frequency

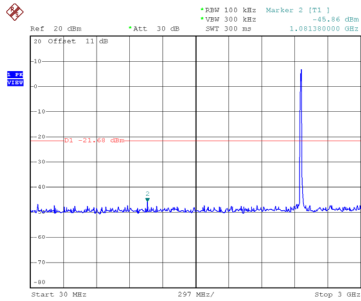

Date: 19.MAR.2021 08:55:10

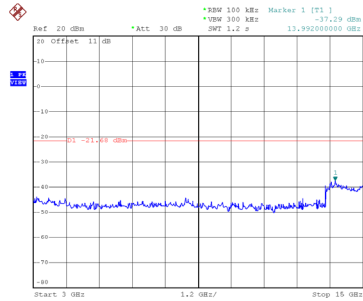

Date: 19.MAR.2021 08:55:18

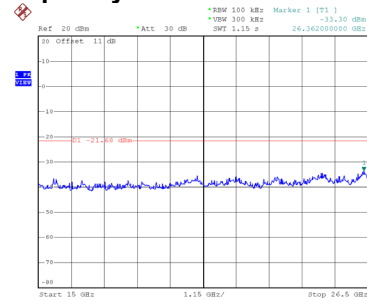

Date: 19.MAR.2021 08:55:26

Test Mode TX G Mode

Bandedge-CH01

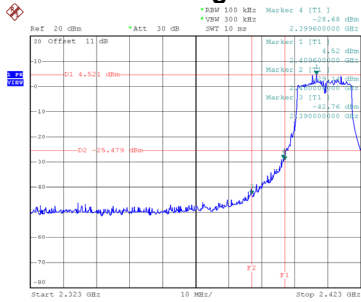

Date: 19.MAR.2021 08:56:24

Bandedge-CH11

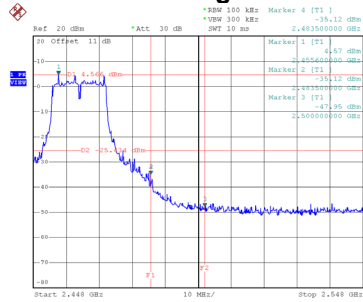

Date: 19.MAR.2021 08:59:06

CH01 – 10th Harmonic of the fundamental frequency

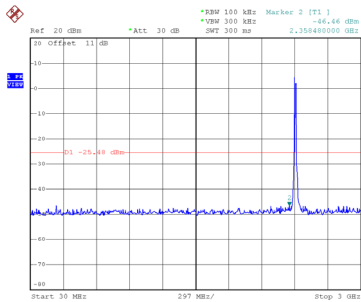

Date: 19.MAR.2021 08:56:37

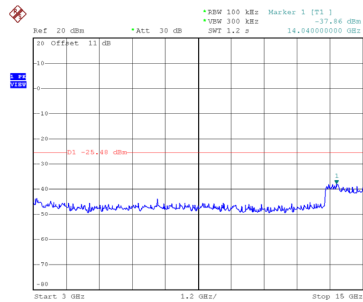

Date: 19.MAR.2021 08:56:46

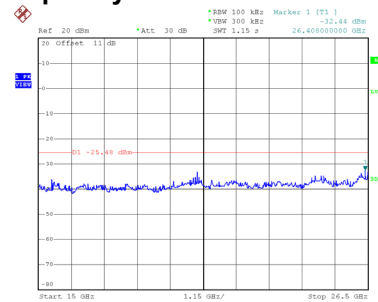

Date: 19.MAR.2021 08:56:54

CH06 – 10th Harmonic of the fundamental frequency

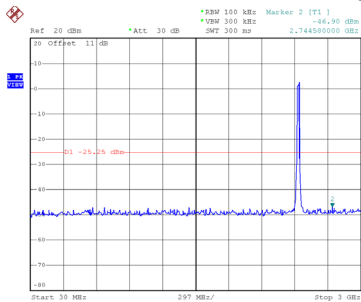

Date: 19.MAR.2021 08:58:01

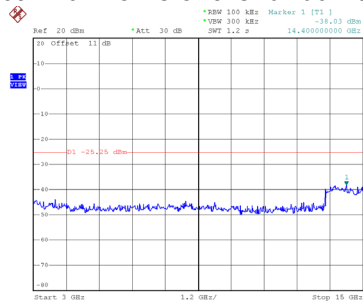

Date: 19.MAR.2021 08:58:09

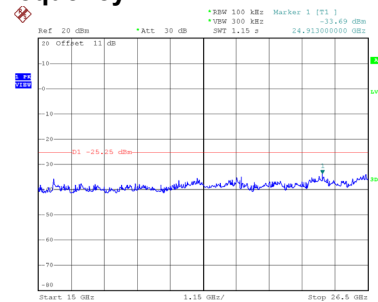

Date: 19.MAR.2021 08:58:10

CH11 – 10th Harmonic of the fundamental frequency

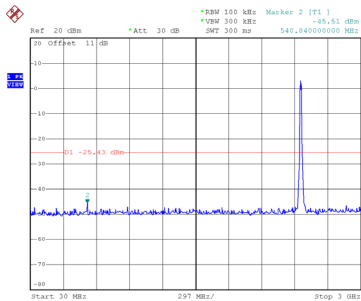

Date: 19.MAR.2021 08:59:20

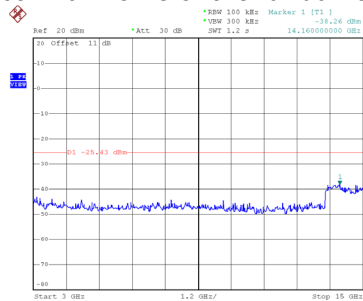

Date: 19.MAR.2021 08:59:28

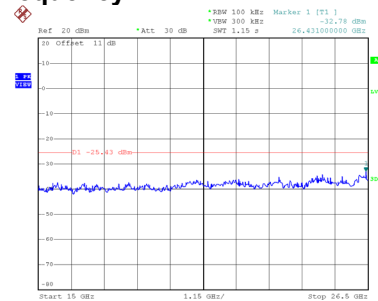

Date: 19.MAR.2021 08:59:36

Test Mode TX N(HT20) Mode

Bandedge-CH01

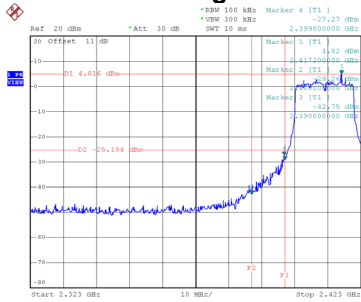

Date: 19.MAR.2021 09:00:27

Bandedge-CH11

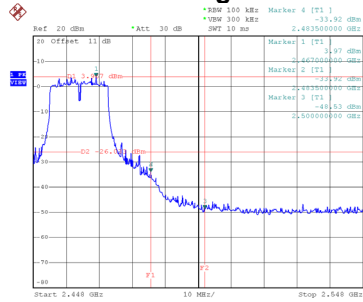

Date: 19.MAR.2021 09:02:59

CH01 – 10th Harmonic of the fundamental frequency

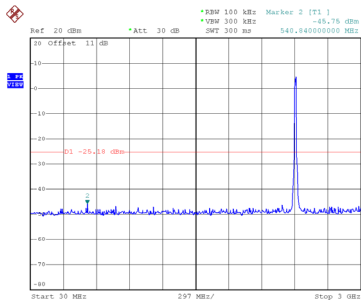

Date: 19.MAR.2021 09:00:41

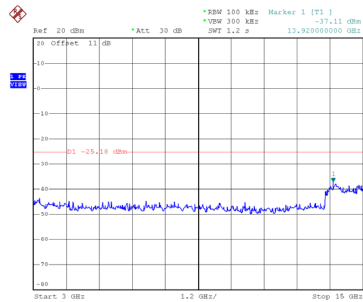

Date: 19.MAR.2021 09:00:49

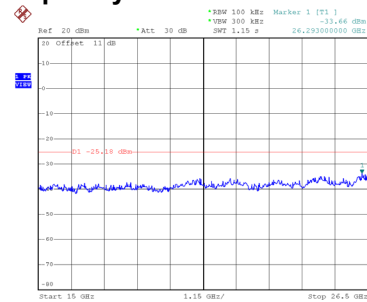

Date: 19.MAR.2021 09:00:57

CH06 – 10th Harmonic of the fundamental frequency

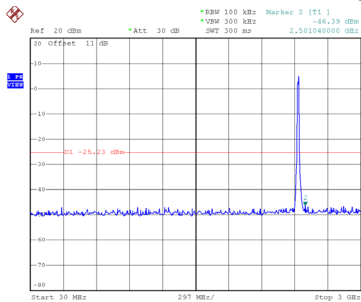

Date: 19.MAR.2021 09:01:57

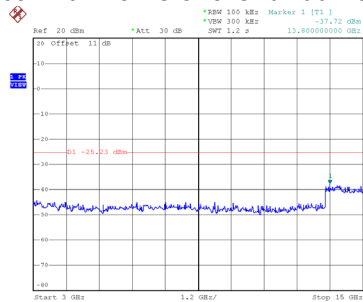

Date: 19.MAR.2021 09:02:05

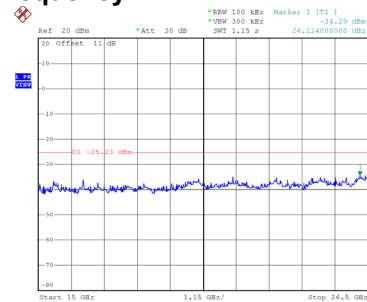

Date: 19.MAR.2021 09:02:13

CH11 – 10th Harmonic of the fundamental frequency

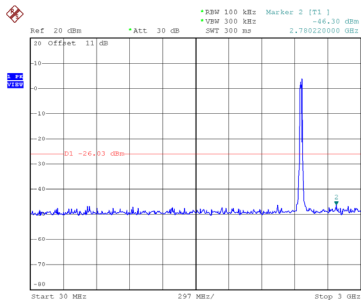

Date: 19.MAR.2021 09:03:12

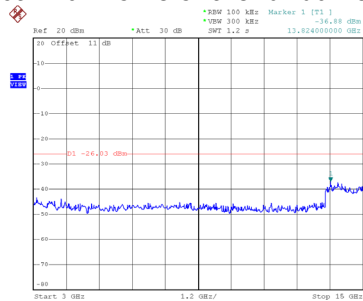

Date: 19.MAR.2021 09:03:20

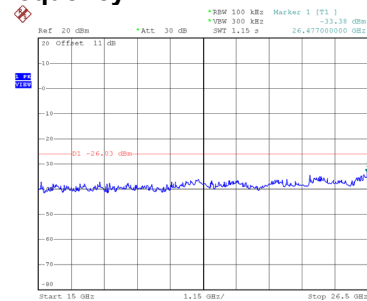

Date: 19.MAR.2021 09:03:29

APPENDIX H - POWER SPECTRAL DENSITY

Test Mode	TX B Mode
-----------	-----------

Channel	Frequency (MHz)	Power Spectral Density (dBm/3kHz)	Max. Limit (dBm/3kHz)	Result
01	2412	-6.94	8.00	Complies
06	2437	-7.18	8.00	Complies
11	2462	-6.71	8.00	Complies

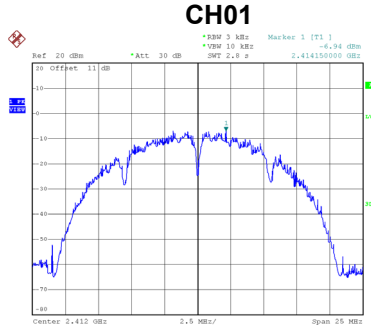

Date: 19_MAR.2021 08:15:28

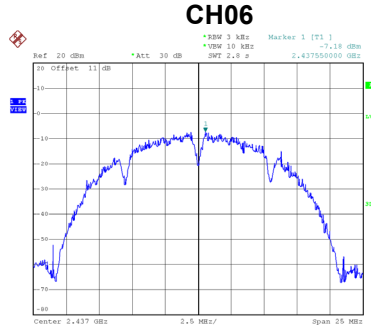

Date: 19_MAR.2021 08:15:42

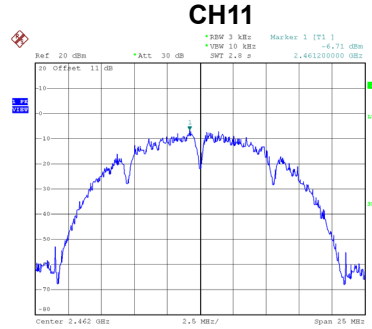

Date: 19_MAR.2021 08:15:35

Test Mode	TX G Mode
-----------	-----------

Channel	Frequency (MHz)	Power Spectral Density (dBm/3kHz)	Max. Limit (dBm/3kHz)	Result
01	2412	-9.67	8.00	Complies
06	2437	-7.90	8.00	Complies
11	2462	-9.34	8.00	Complies

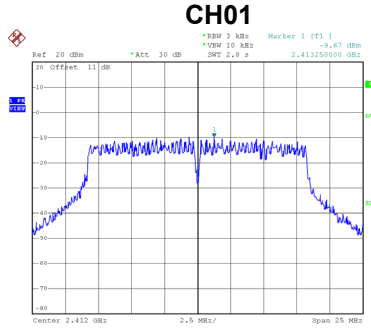

Date: 19_MAR.2021 08:15:03

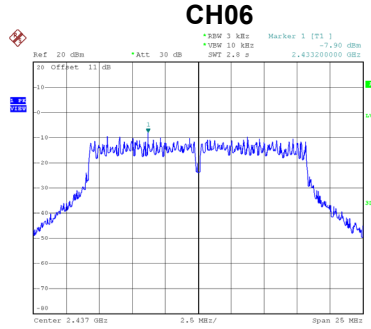

Date: 19_MAR.2021 08:15:27

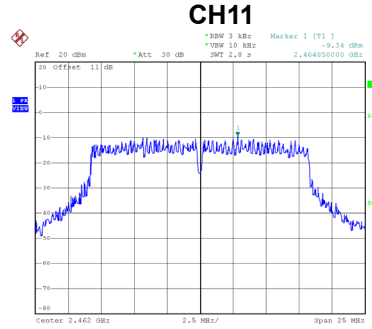

Date: 19_MAR.2021 08:15:46

Test Mode	TX N(HT20) Mode
-----------	-----------------

Channel	Frequency (MHz)	Power Spectral Density (dBm/3kHz)	Max. Limit (dBm/3kHz)	Result
01	2412	-9.43	8.00	Complies
06	2437	-9.13	8.00	Complies
11	2462	-9.51	8.00	Complies

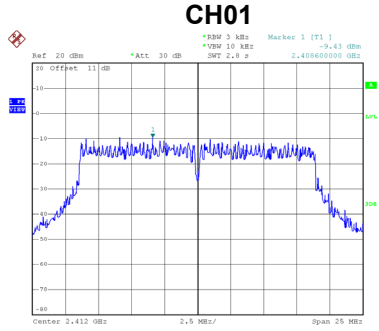

Date: 19_MAR.2021 09:10:107

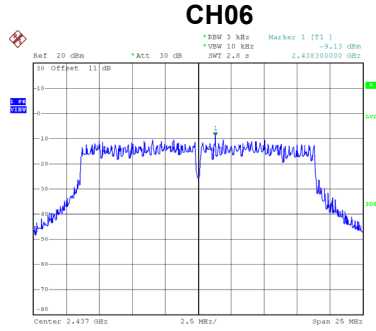

Date: 19_MAR.2021 09:10:222

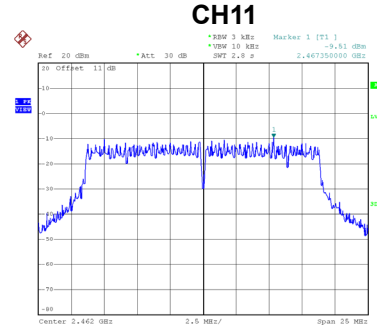

Date: 19_MAR.2021 09:10:338

End of Test Report