



**CFR 47 FCC PART 15 SUBPART C
CERTIFICATION TEST REPORT**

For

Kasa Smart Doorbell

MODEL NUMBER: KD110

FCC ID: 2AXJ4KD110

REPORT NUMBER: 4789567348-4

ISSUE DATE: September 21, 2020

Prepared for

**TP-Link Corporation Limited.
Room 901, 9/F. , New East Ocean Centre, 9 Science Museum Road, Tsim Sha
Tsui, Kowloon, Hong Kong**

Prepared by

**UL Verification Services (Guangzhou) Co., Ltd, Song Shan Lake Branch
Room 101, Building 10, Innovation Technology Park,
Song Shan Lake Hi tech Development Zone, Dongguan, 523808, China
Tel: +86 769 22038881
Fax: +86 769 33871725
Website: www.ul.com**



Revision History

<u>Rev.</u>	<u>Issue Date</u>	<u>Revisions</u>	<u>Revised By</u>
V0	09/21/2020	Initial Issue	



Summary of Test Results			
Clause	Test Items	FCC Rules	Test Results
1	Transmitter Timeout	FCC Part 15.231 (a) (1)	PASS
2	20dB Bandwidth	FCC Part 15.231 (c)	PASS
3	Radiated emission	FCC Part 15.231 (b) FCC Part 15.205 FCC Part 15.209	PASS
4	Conducted Emission Test for AC Power Port	CFR 47 FCC §15.207	Pass
5	Antenna Requirement	FCC Part 15.203	PASS



TABLE OF CONTENTS

1. ATTESTATION OF TEST RESULTS	5
2. TEST METHODOLOGY	6
3. FACILITIES AND ACCREDITATION	6
4. CALIBRATION AND UNCERTAINTY	7
4.1. <i>MEASURING INSTRUMENT CALIBRATION</i>	<i>7</i>
4.2. <i>MEASUREMENT UNCERTAINTY.....</i>	<i>7</i>
5. EQUIPMENT UNDER TEST	8
5.1. <i>DESCRIPTION OF EUT</i>	<i>8</i>
5.2. <i>TEST CHANNEL CONFIGURATION.....</i>	<i>8</i>
5.3. <i>TEST ENVIRONMENT</i>	<i>8</i>
5.4. <i>DESCRIPTION OF AVAILABLE ANTENNAS</i>	<i>9</i>
5.5. <i>WORST-CASE CONFIGURATIONS.....</i>	<i>9</i>
5.6. <i>DESCRIPTION OF TEST SETUP.....</i>	<i>10</i>
5.7. <i>MEASURING INSTRUMENT AND SOFTWARE USED.....</i>	<i>11</i>
6. ANTENNA PORT TEST RESULTS.....	12
6.1. <i>ON TIME AND DUTY CYCLE.....</i>	<i>12</i>
6.2. <i>TRANSMITTER TIMEOUT</i>	<i>15</i>
6.3. <i>20dB BANDWIDTH.....</i>	<i>17</i>
6.4. <i>RADIATED EMISSION</i>	<i>19</i>
6.4.1. <i>FUNDAMENTAL FIELD STRENGTH.....</i>	<i>24</i>
6.4.2. <i>SPURIOUS EMISSIONS BELOW 1G.....</i>	<i>26</i>
6.4.3. <i>SPURIOUS EMISSIONS ABOVE 1G</i>	<i>28</i>
6.4.4. <i>SPURIOUS EMISSIONS BELOW 30M.....</i>	<i>30</i>
7. AC POWER LINE CONDUCTED EMISSIONS.....	33
8. ANTENNA REQUIREMENTS.....	37



1. ATTESTATION OF TEST RESULTS

Applicant Information

Company Name: TP-Link Corporation Limited.
Address: Room 901, 9/F. , New East Ocean Centre, 9 Science Museum Road, Tsim Sha Tsui, Kowloon, Hong Kong

Manufacturer Information

Company Name: TP-Link Corporation Limited.
Address: Room 901, 9/F. , New East Ocean Centre, 9 Science Museum Road, Tsim Sha Tsui, Kowloon, Hong Kong

EUT Information

EUT Name: Kasa Smart Doorbell
Model: KD110
Brand Name: tp-link
Sample Status: Normal
Sample ID: 3274254
Sample Received Date: August 24, 2020
Date of Tested: August 25, 2020~September 18, 2020

APPLICABLE STANDARDS	
STANDARD	TEST RESULTS
CFR 47 Part 15 Subpart C	PASS

Prepared By:

Mick Zhang
Project Engineer

Checked By:

Shawn Wen
Laboratory Leader

Approved By:

Stephen Guo
Laboratory Manager



2. TEST METHODOLOGY

The tests documented in this report were performed in accordance with ANSI C63.10-2013, CFR 47 FCC Part 2, CFR 47 FCC Part 15 and KDB414788 D01 Radiated Test Site v01r01.

3. FACILITIES AND ACCREDITATION

Accreditation Certificate	<p>A2LA (Certificate No.: 4102.01) UL Verification Services (Guangzhou) Co., Ltd. Song Shan Lake Branch. has been assessed and proved to be in compliance with A2LA.</p> <p>FCC (FCC Designation No.: CN1187) UL Verification Services (Guangzhou) Co., Ltd. Song Shan Lake Branch. Has been recognized to perform compliance testing on equipment subject to the Commission's Declaration of Conformity (DoC) and Certification rules</p> <p>ISED(Company No.: 21320) UL Verification Services (Guangzhou) Co., Ltd. Song Shan Lake Branch. has been registered and fully described in a report filed with ISED. The Company Number is 21320.</p> <p>VCCI (Registration No.: G-20019, R-20004, C-20012 and T-20011) UL Verification Services (Guangzhou) Co., Ltd. Song Shan Lake Branch. has been assessed and proved to be in compliance with VCCI, the Membership No. is 3793. Facility Name: Chamber D, the VCCI registration No. is G-20019 and R-20004 Shielding Room B , the VCCI registration No. is C-20012 and T-20011</p>
---------------------------	---

Note 1: All tests measurement facilities use to collect the measurement data are located at Building 10, Innovation Technology Park, Song Shan Lake Hi tech Development Zone, Dongguan, 523808, China

Note 2: The test anechoic chamber in UL Verification Services (Guangzhou) Co., Ltd. Song Shan Lake Branch had been calibrated and compared to the open field sites and the test anechoic chamber is shown to be equivalent to or worst case from the open field site.

Note 3: For below 30MHz, lab had performed measurements at test anechoic chamber and comparing to measurements obtained on an open field site. And these measurements below 30MHz had been correlated to measurements performed on an OFS.



4. CALIBRATION AND UNCERTAINTY

4.1. MEASURING INSTRUMENT CALIBRATION

The measuring equipment utilized to perform the tests documented in this report has been calibrated in accordance with the manufacturer's recommendations, and is traceable to recognize national standards.

4.2. MEASUREMENT UNCERTAINTY

Where relevant, the following measurement uncertainty levels have been estimated for tests performed on the apparatus:

Test Item	Uncertainty
Conduction emission	3.62dB
Radiation Emission test(include Fundamental emission) (9kHz-30MHz)	2.2dB
Radiation Emission test(include Fundamental emission) (30MHz-1GHz)	4.00dB
Radiation Emission test (1GHz to 26GHz)(include Fundamental emission)	5.78dB (1GHz-18GHz)
	5.23dB (18GHz-26GHz)
Note: This uncertainty represents an expanded uncertainty expressed at approximately the 95% confidence level using a coverage factor of k=2.	



5. EQUIPMENT UNDER TEST

5.1. DESCRIPTION OF EUT

EUT Name	Kasa Smart Doorbell
Model	KD110
Operation Frequency	433.92MHz
Modulation Type	ASK
Test Input	DC 5V
Rated input	16-24VAC,0.5A,50/60Hz

5.2. TEST CHANNEL CONFIGURATION

Test Mode	Frequency
ASK	433.92MHz

5.3. TEST ENVIRONMENT

Environment Parameter	Selected Values During Tests	
Relative Humidity	45 ~ 70%	
Atmospheric Pressure:	1025Pa	
Temperature	TN	22 ~ 28°C
Voltage :	VL	N/A
	VN	DC 5V
	VH	N/A

Note: VL= Lower Extreme Test Voltage
VN= Nominal Voltage
VH= Upper Extreme Test Voltage
TN= Normal Temperature



5.4. DESCRIPTION OF AVAILABLE ANTENNAS

Frequency (MHz)	Antenna Type	Antenna Gain (dBi)
433.92	Omni Antenna	-7.0

5.5. WORST-CASE CONFIGURATIONS

Mode
ASK

5.6. DESCRIPTION OF TEST SETUP

SUPPORT EQUIPMENT

Item	Equipment	Brand Name	Model Name	P/N
1	PC	Dell	Vostro 3902	8KNDDDB2
2	USB TO UART	/	/	/

I/O CABLES

Cable No	Port	Connector Type	Cable Type	Cable Length(m)	Remarks
1	USB	/	/	1.0	/

ACCESSORIES

Item	Accessory	Brand Name	Model Name	Description
/	/	/	/	/

TEST SETUP

The EUT can work in engineering mode with a software through a Laptop.

SETUP DIAGRAM FOR TESTS

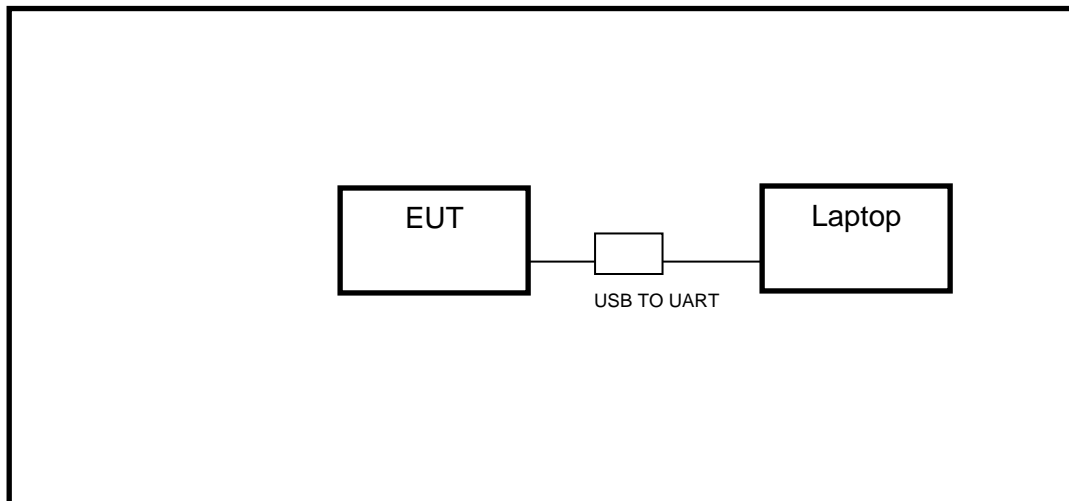



5.7. MEASURING INSTRUMENT AND SOFTWARE USED

AC Power Line Conducted Emissions (Shielding Room B)						
Instrument						
Used	Equipment	Manufacturer	Model No.	Serial No.	Last Cal.	Next Cal.
<input checked="" type="checkbox"/>	EMI Test Receiver	R&S	ESR3	101961	Dec.05,2019	Dec.05,2020
<input checked="" type="checkbox"/>	Two-Line V- Network	R&S	ENV216	101983	Dec.05,2019	Dec.05,2020
<input checked="" type="checkbox"/>	Artificial Mains Networks	Schwarzbeck	NSLK 8126	8126465	Dec.05,2019	Dec.05,2020
Software						
Used	Description			Manufacturer	Name	Version
<input checked="" type="checkbox"/>	Test Software for Conducted disturbance			Farad	EZ-EMC	Ver. UL-3A1
Radiated Emissions (Chamber C)						
Instrument						
Used	Equipment	Manufacturer	Model No.	Serial No.	Last Cal.	Next Cal.
<input checked="" type="checkbox"/>	MXE EMI Receiver	KESIGHT	N9038A	MY56400036	Dec.06,2019	Dec.05,2020
<input checked="" type="checkbox"/>	Hybrid Log Periodic Antenna	TDK	HLP-3003C	130960	Sep.17,2018	Sep.17,2021
<input checked="" type="checkbox"/>	Preamplifier	HP	8447D	2944A09099	Dec.05,2019	Dec.05,2020
<input checked="" type="checkbox"/>	EMI Measurement Receiver	R&S	ESR26	101377	Dec.05,2019	Dec.05,2020
<input checked="" type="checkbox"/>	Horn Antenna	TDK	HRN-0118	130939	Sep.17,2018	Sep.17,2021
<input checked="" type="checkbox"/>	High Gain Horn Antenna	Schwarzbeck	BBHA-9170	691	Aug.11,2018	Aug.11,2021
<input checked="" type="checkbox"/>	Preamplifier	TDK	PA-02-0118	TRS-305- 00067	Dec.05,2019	Dec.05,2020
<input checked="" type="checkbox"/>	Preamplifier	TDK	PA-02-2	TRS-307- 00003	Dec.05,2019	Dec.05,2020
<input checked="" type="checkbox"/>	Loop antenna	Schwarzbeck	1519B	00008	Jan.07,2019	Jan.07,2022
<input checked="" type="checkbox"/>	Band Reject Filter	Wainwright	WRCJV8-2350-2400- 2483.5-2533.5-40SS	4	Dec.05,2019	Dec.05,2020
<input checked="" type="checkbox"/>	High Pass Filter	Wi	WHKX10-2700-3000- 18000-40SS	23	Dec.05,2019	Dec.05,2020
Software						
Used	Description			Manufacturer	Name	Version
<input checked="" type="checkbox"/>	Test Software for Radiated disturbance			Farad	EZ-EMC	Ver. UL-3A1

6. ANTENNA PORT TEST RESULTS

6.1. ON TIME AND DUTY CYCLE

LIMITS

None; for reporting purposes only

PROCEDURE

FCC Reference:	CFR 47 Part 15.35(c)
Test Method Used:	ANSI C63.10 Section 7.5

TEST SETUP

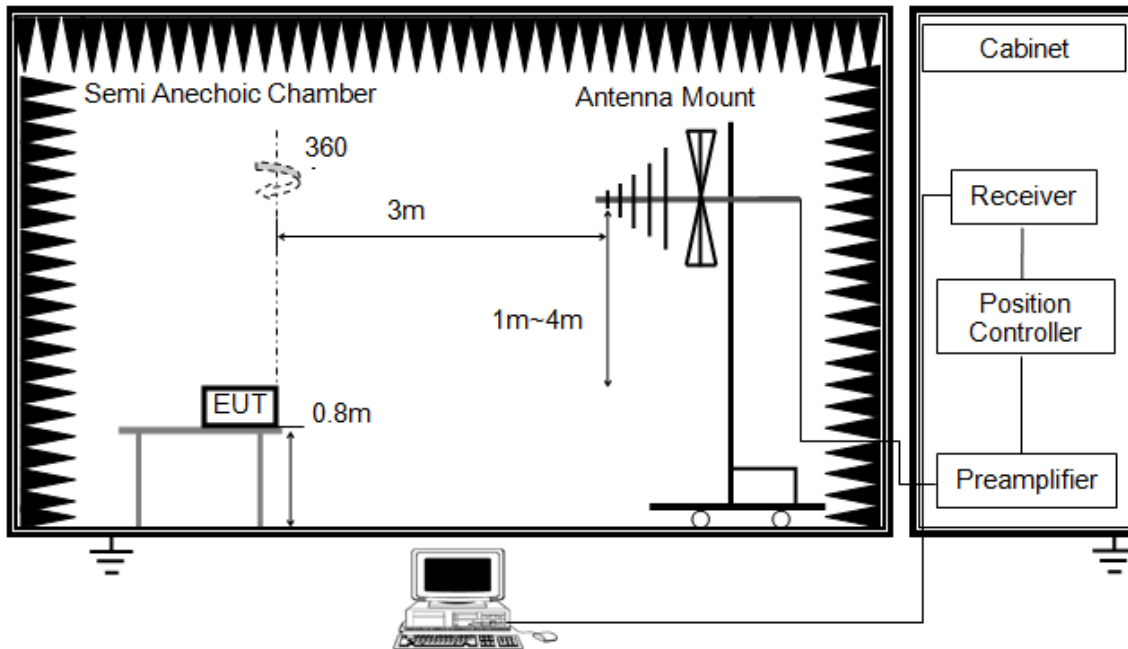

- Set RBW of spectrum analyzer to 100KHz and VBW to 300KHz.
- Use a video trigger with the trigger level set to enable triggering only on full pulses.
- Sweep Time is at least a 100 ms.
- Set the center frequency on any frequency would be measure and set the frequency span to zero span.
- Measure the maximum time duration of one single pulse.

TEST ENVIRONMENT

Temperature	24.8°C	Relative Humidity	60.9%
Atmosphere Pressure	101kPa	Test Voltage	DC 5V



RESULTS

	On Time (ms)	Times	Ton (ms)	Total Ton times (ms)
Ton 1	0.24	19	4.56	8.58
Ton 2	0.67	6	4.02	

Note: Total Ton times= Ton1*7+Ton2*18

Total Ton times (ms)	Period (ms)	Duty Cycle (Linear)	Duty Cycle Correction Factor
8.58	26.60	0.323	-9.83

Note: Duty Cycle Correction Factor=20log(x).
Where: x is Duty Cycle

Ton

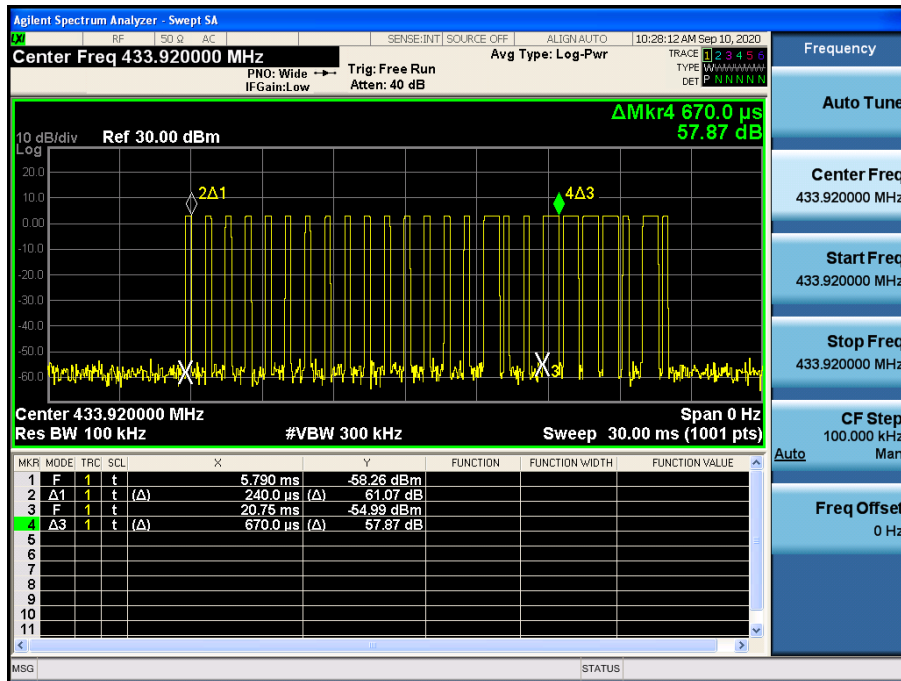



Period

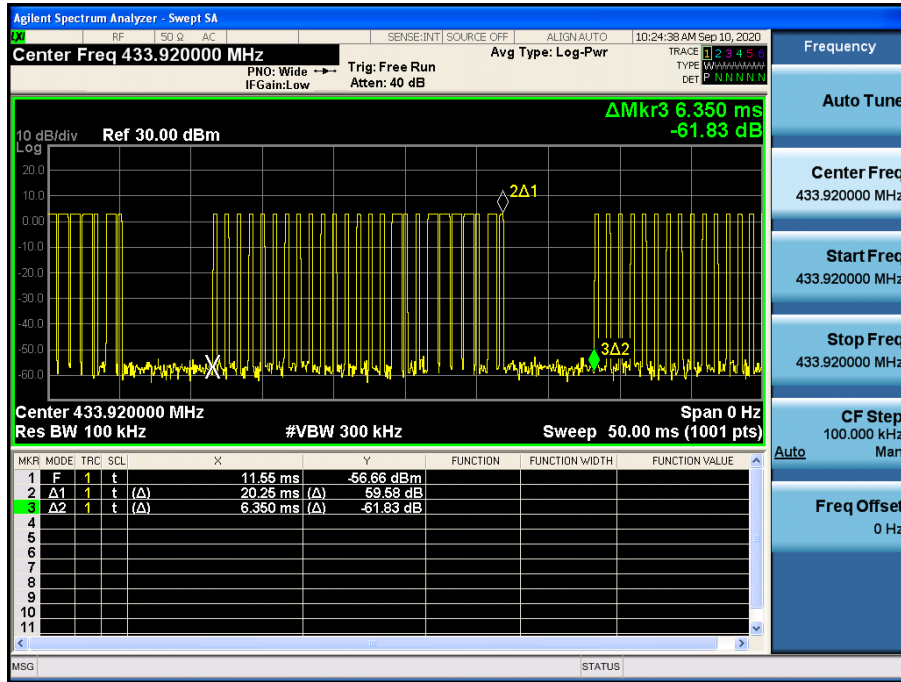

Note: All test mode has been tested, only the worst data record in the report.

6.2. TRANSMITTER TIMEOUT

LIMITS

A manually operated transmitter shall employ a switch that will automatically deactivate the transmitter within not more than 5 seconds of being released.

TEST PROCEDURE

FCC Reference:	CFR 47 Part 15.231(a)
Test Method Used:	The EUT transmitter was activated and monitored using a spectrum analyser for a period of 10 seconds.

TEST SETUP

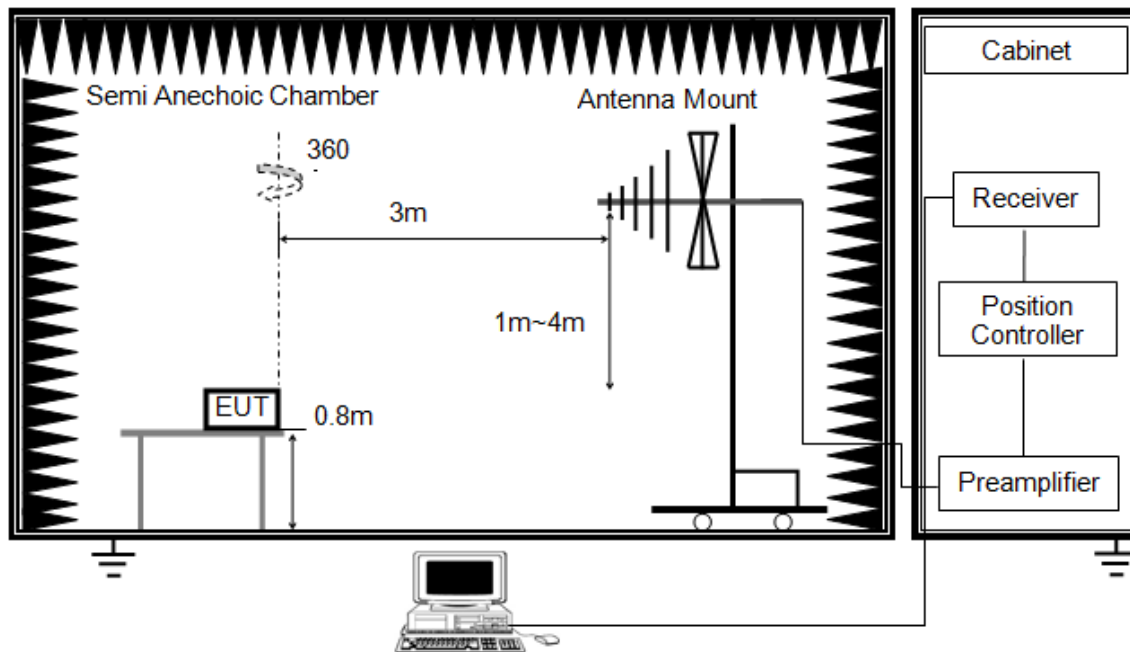

- Set RBW of spectrum analyzer to 100KHz and VBW to 100KHz.
- Use a video trigger with the trigger level set to enable triggering only on full pulses.
- Set Sweep Time to 10 s.
- Set the center frequency on any frequency would be measure and set the frequency span to zero span.
- Measure the maximum time duration of one single pulse.

TEST ENVIRONMENT

Temperature	24.8°C	Relative Humidity	60.9%
Atmosphere Pressure	101kPa	Test Voltage	DC 5V



RESULTS

Deactivation Time (seconds)	Limit (seconds)	Margin (seconds)	Result
0.496	5.000	4.504	PASS

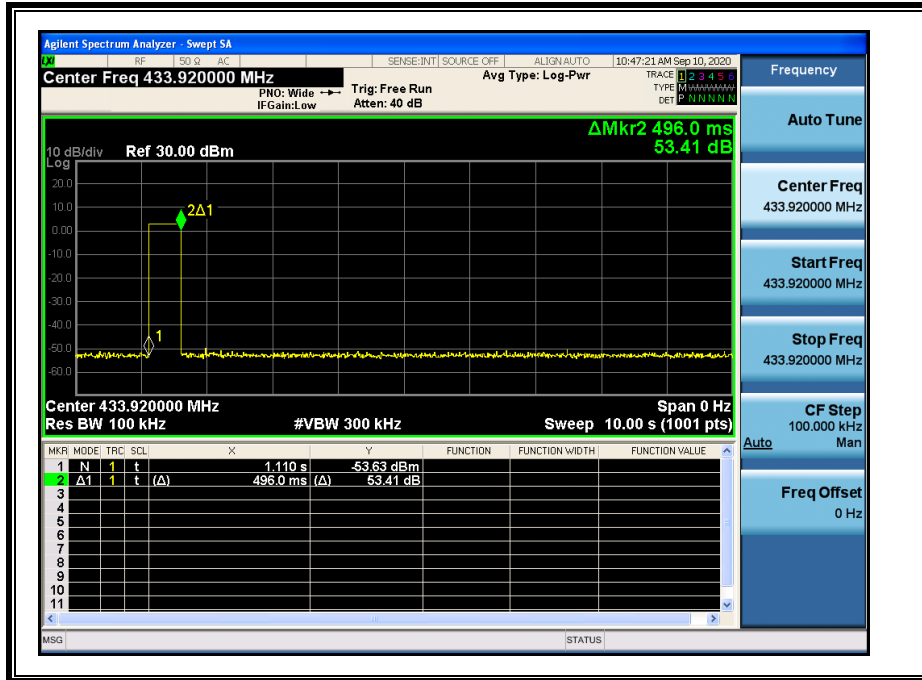

Note: All test mode has been tested, only the worst data record in the report.

6.3. 20dB BANDWIDTH

LIMITS

1. The bandwidth of the emission shall be no wider than 0.25% of the center frequency for devices operating above 70 MHz and below 900 MHz.
2. The limit has been calculated as: $0.0025 * 433.92 \text{ MHz} = 1.0848 \text{ MHz}$

TEST PROCEDURE

FCC Reference:	CFR 47 Part 15.231(c)
Test Method Used:	ANSI C63.10 Section 6.9.2

TEST SETUP

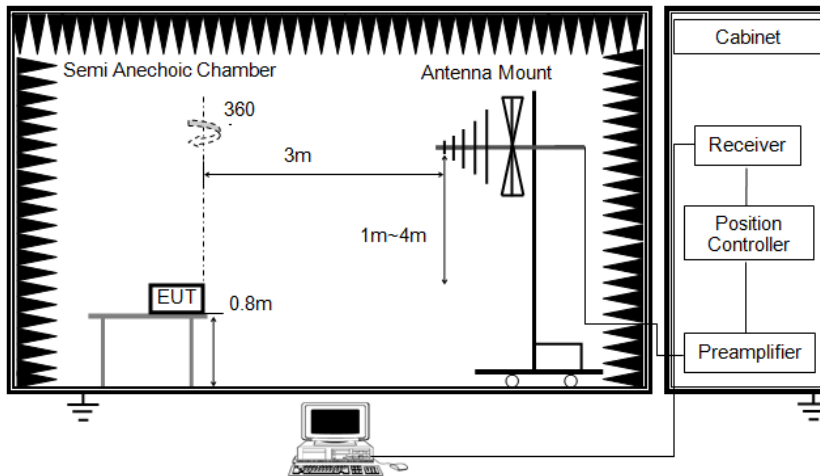

1. The EUT was arranged to its worst case and then turntable (from 0 degree to 360 degrees) to find the maximum reading. A pre-amp and a high pass filter are used for the test in order to get better signal level.
2. The EUT was placed on a turntable with 0.8 meter above ground.
3. The EUT was set 3 meters from the interference receiving antenna, which was mounted on the top of a variable height antenna tower
4. Set the spectrum analyzer in the following setting as:

Center Frequency	The centre frequency of the channel under test
Detector	Peak
RBW	1% to 5% of the 20 dB bandwidth
VBW	approximately three times RBW
Span	approximately 2 to 3 times the 20 dB bandwidth
Trace	Max hold
Sweep	Auto couple



TEST ENVIRONMENT

Temperature	24.8°C	Relative Humidity	60.9%
Atmosphere Pressure	101kPa	Test Voltage	DC 5V

RESULTS

Transmitter 20 dB Bandwidth (MHz)	Limit (MHz)	Result
0.007461	1.0848	Pass

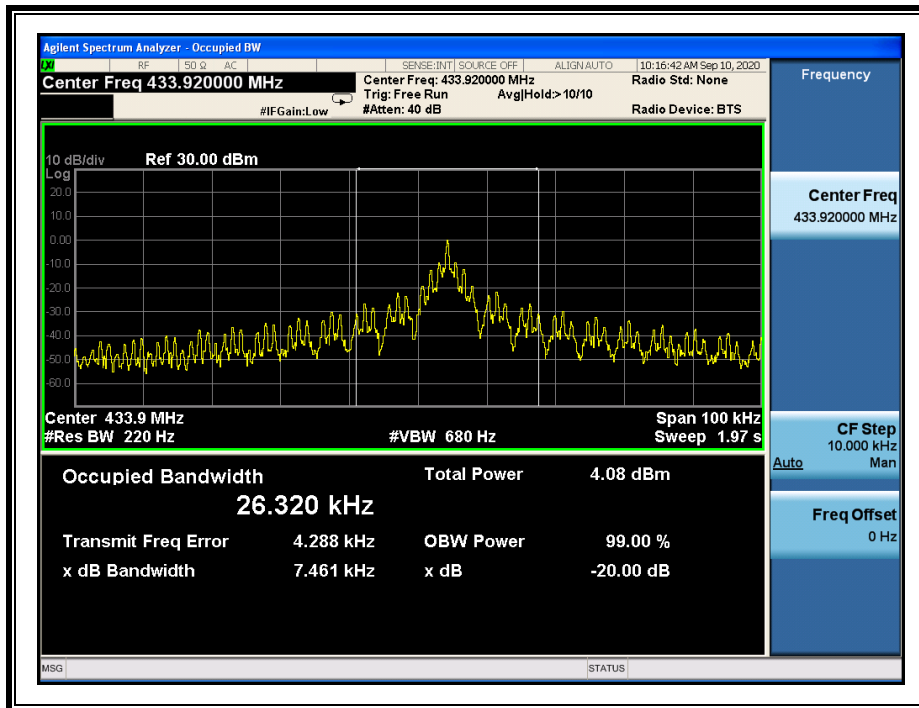

6.4. RADIATED EMISSION

LIMITS

- In addition to the provisions of §15.205, the field strength of emissions from intentional radiators operated under this section shall not exceed the following:

Fundamental frequency (MHz)	Field strength of fundamental (microvolts/meter)	Field strength of spurious emissions (microvolts/meter)
40.66-40.70	2,250	225
70-130	1,250	125
130-174	¹ 1,250 to 3,750	¹ 125 to 375
174-260	3,750	375
260-470	¹ 3,750 to 12,500	¹ 375 to 1,250
Above 470	12,500	1,250

Note:

1. To obtain the average limit at the test frequency the values given in the table of FCC part 15.231(b) have to be linear interpolated and then converted to dB μ V/m. The limit at 260 MHz is 3750 μ V/m and at 470 MHz it is 12500 μ V/m. Limit at 433.92 MHz is calculated as shown in ANSI C63.10 Section 7.6.2:

Limit [μ V/m] = Lim_{lower} + ΔF [(Lim_{upper} – Lim_{lower}) / (f_{upper} – f_{lower})]
where $\Delta F = f_c - f_{lower} = 433.92 - 260 = 173.92$

Limit = 3750 + 173.92 * [(12500 – 3750) / (470 -260)]
= 3750 + 173.92 * [8750 / 210]
= 10996.7 μ V/m

dB μ V/m = 20 * log (μ V/m)
= 20 * log (10996.7)

Average Limit at 433.92 MHz = 80.8 dB μ V/m

2. If the average limit is specified for the EUT, the peak limit is 20 dB above the average limit as specified in FCC 15.35 (b)

- Except as provided elsewhere in this subpart, the emissions from an intentional radiator shall not exceed the field strength levels specified in the following table:

Frequency (MHz)	Field strength (microvolts/meter)	Measurement distance (meters)
0.009-0.490	2400/F(kHz)	300
0.490-1.705	24000/F(kHz)	30
1.705-30.0	30	30
30-88	100**	3
88-216	150**	3
216-960	200**	3
Above 960	500	3

**Except as provided in paragraph (g), fundamental emissions from intentional radiators operating under this section shall not be located in the frequency bands 54-72 MHz, 76-88 MHz, 174-216 MHz or 470-806 MHz. However, operation within these frequency bands is permitted under other sections of this part, e.g., §§15.231 and 15.241.



3. Radiation Disturbance Test Limit for FCC (Class B)(9KHz-1GHz)

Frequency (MHz)	Field Strength (microvolts/meter)	Measurement Distance (meters)
0.009~0.490	2400/F(KHz)	300
0.490~1.705	24000/F(KHz)	30
1.705~30.0	30	30
30~88	100	3
88~216	150	3
216~960	200	3
960~1000	500	3

Note: 1) At frequencies at or above 30 MHz, measurements may be performed at a distance other than what is specified provided: measurements are not made in the near field except where it can be shown that near field measurements are appropriate due to the characteristics of the device; and it can be demonstrated that the signal levels needed to be measured at the distance employed can be detected by the measurement equipment. Measurements shall not be performed at a distance greater than 30 meters unless it can be further demonstrated that measurements at a distance of 30 meters or less are impractical. When performing measurements at a distance other than that specified, the results shall be extrapolated to the specified distance using an extrapolation factor of 20 dB/decade (inverse linear-distance for field strength measurements; inverse-linear-distance-squared for power density measurements).

(2) At frequencies below 30 MHz, measurements may be performed at a distance closer than that specified in the regulations; however, an attempt should be made to avoid making measurements in the near field. Pending the development of an appropriate measurement procedure for measurements performed below 30 MHz, when performing measurements at a closer distance than specified, the results shall be extrapolated to the specified distance by either making measurements at a minimum of two distances on at least one radial to determine the proper extrapolation factor or by using the square of an inverse linear distance extrapolation factor (40 dB/decade). This paragraph (f) shall not apply to Access BPL devices operating below 30 MHz.

Restricted bands of operation

MHz	MHz	MHz	GHz
0.090-0.110	16.42-16.423	399.9-410	4.5-5.15
¹ 0.495-0.505	16.69475-16.69525	608-614	5.35-5.46
2.1735-2.1905	16.80425-16.80475	960-1240	7.25-7.75
4.125-4.128	25.5-25.67	1300-1427	8.025-8.5
4.17725-4.17775	37.5-38.25	1435-1626.5	9.0-9.2
4.20725-4.20775	73-74.6	1645.5-1646.5	9.3-9.5
6.215-6.218	74.8-75.2	1660-1710	10.6-12.7
6.26775-6.26825	108-121.94	1718.8-1722.2	13.25-13.4
6.31175-6.31225	123-138	2200-2300	14.47-14.5
8.291-8.294	149.9-150.05	2310-2390	15.35-16.2
8.362-8.366	156.52475-156.52525	2483.5-2500	17.7-21.4
8.37625-8.38675	156.7-156.9	2690-2900	22.01-23.12
8.41425-8.41475	162.0125-167.17	3260-3267	23.6-24.0
12.29-12.293	167.72-173.2	3332-3339	31.2-31.8
12.51975-12.52025	240-285	3345.8-3358	36.43-36.5
12.57675-12.57725	322-335.4	3600-4400	(²)
13.36-13.41			

Note: ¹Until February 1, 1999, this restricted band shall be 0.490-0.510 MHz.

²Above 38.6c

TEST PROCEDURE

FCC Reference:	CFR 47 Parts 15.231(b) / 15.209
Test Method Used:	ANSI C63.10 Sections 6.3 and 6.5

TEST SETUP

Below 30MHz

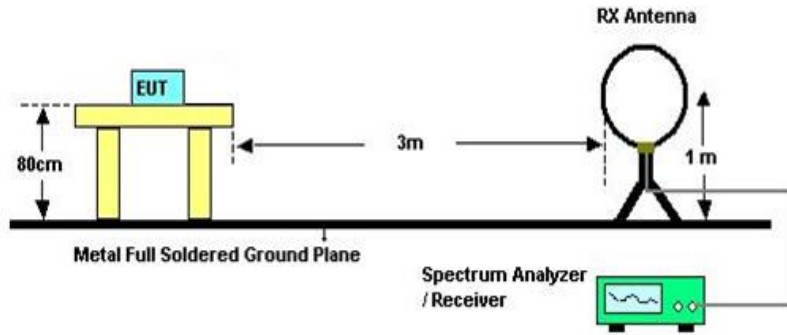

The setting of the spectrum analyser

RBW	200Hz (From 9kHz to 0.15MHz)/ 9KHz (From 0.15MHz to 30MHz)
VBW	200Hz (From 9kHz to 0.15MHz)/ 9KHz (From 0.15MHz to 30MHz)
Sweep	Auto
Detector	Peak/QP/ Average
Trace	Max hold

1. The testing follows the guidelines in ANSI C63.10-2013
2. The EUT was arranged to its worst case and then turntable (from 0 degree to 360 degrees) to find the maximum reading. A pre-amp and a high pass filter are used for the test in order to get better signal level. 3 polarizations(Horizontal, Face-on and Face-off) of the loop antenna are set to make the measurement.
3. The EUT was placed on a turntable with 0.8 meter above ground.
4. The EUT was set 3 meters from the interference receiving antenna, which was mounted on the top of a variable height antenna tower.
5. The radiated emission limits are based on measurements employing a CISPR quasi-peak detector except for the frequency bands 9-90 kHz, 110-490 kHz and above 1000 MHz. Radiated emission limits in these three bands are based on measurements employing an average detector.
6. For measurement below 1GHz, the initial step in collecting conducted emission data is a spectrum analyzer peak detector mode pre-scanning the measurement frequency range. Significant peaks are then marked and then Quasi Peak and average detector mode re-measured. If the emission level of the EUT measured by the peak detector is 3 dB lower than the applicable limit, the peak emission level will be reported. Otherwise, the emission measurement will be repeated using the quasi-peak and average detector and reported.
7. Although these tests were performed other than open field site, adequate comparison measurements were confirmed against 30m open field site. Therefore sufficient tests were made to demonstrate that the alternative site produces results that correlate with the ones of tests made in an open field site based on KDB 414788.

Below 1G

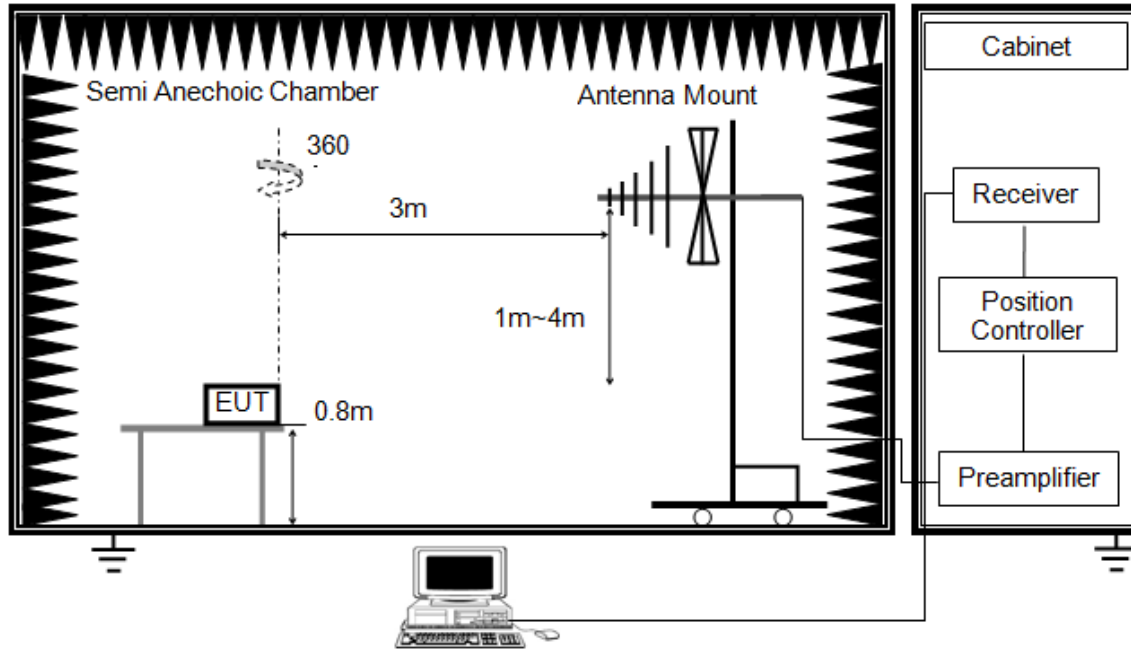

The setting of the spectrum analyser

RBW	120K
VBW	300K
Sweep	Auto
Detector	Peak/QP
Trace	Max hold

1. The testing follows the guidelines in ANSI C63.10-2013.
2. The EUT was arranged to its worst case and then tune the antenna tower (from 1 m to 4 m) and turntable (from 0 degree to 360 degrees) to find the maximum reading. A pre-amp and a high pass filter are used for the test in order to get better signal level. Both horizontal and vertical polarizations of the antenna are set to make the measurement.
3. The EUT was placed on a turntable with 0.8 meter above ground.
4. The EUT was set 3 meters from the interference receiving antenna, which was mounted on the top of a variable height antenna tower

ABOVE 1G

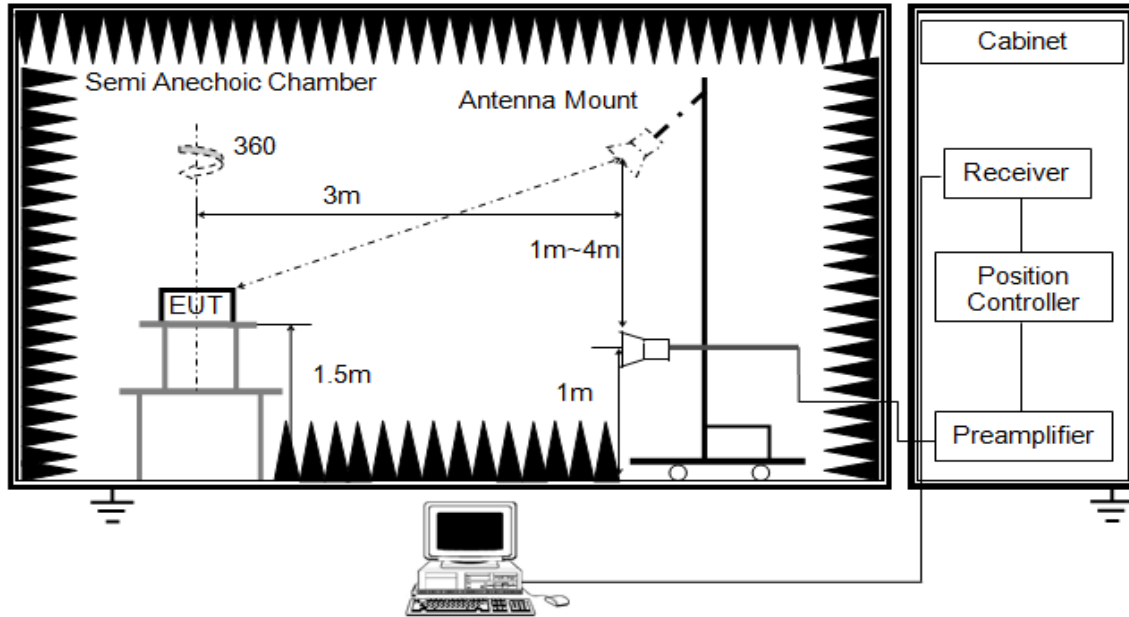

RBW	1M
VBW	3M
Sweep	Auto
Detector	Peak For Average see note 6
Trace	Max hold

1. The testing follows the guidelines in ANSI C63.10-2013.
2. The EUT was arranged to its worst case and then tune the antenna tower (from 1 m to 4 m) and turntable (from 0 degree to 360 degrees) to find the maximum reading. A pre-amp and a high pass filter are used for the test in order to get better signal level. Both horizontal and vertical polarizations of the antenna are set to make the measurement.
3. The EUT was placed on a turntable with 1.5m above ground.
4. The EUT was set 3 meters from the interference receiving antenna, which was mounted on the top of a variable height antenna tower.
5. For measurement above 1GHz, the emission measurement will be measured by the peak detector. This peak level, once corrected, must comply with the limit specified in Section 15.209.
6. Average Value=Peak Value + Duty Correction Factor
For the Duty Cycle and Correction Factor please refer to clause 6.1.ON TIME AND DUTY CYCLE.
8. For the actual test configuration, please refer to the related item in this test report.
(Photographs of the Test Configuration)

RESULTS

X axis, Y axis, Z axis positions:

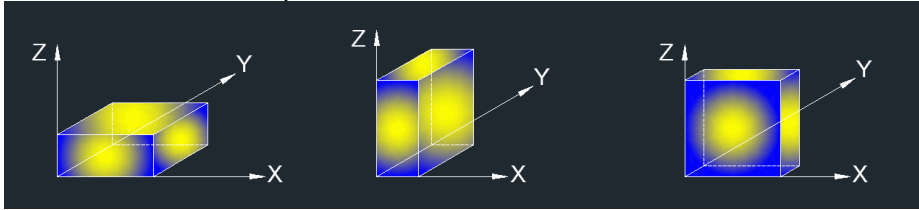

Note: For all radiated test, EUT in each of three orthogonal axis emissions had been tested, but only the worst case (Y axis) data recorded in the report.

TEST ENVIRONMENT

Temperature	23.7°C	Relative Humidity	64.4%
Atmosphere Pressure	101kPa	Test Voltage	DC 5V

6.4.1. FUNDAMENTAL FIELD STRENGTH

HORIZONTAL

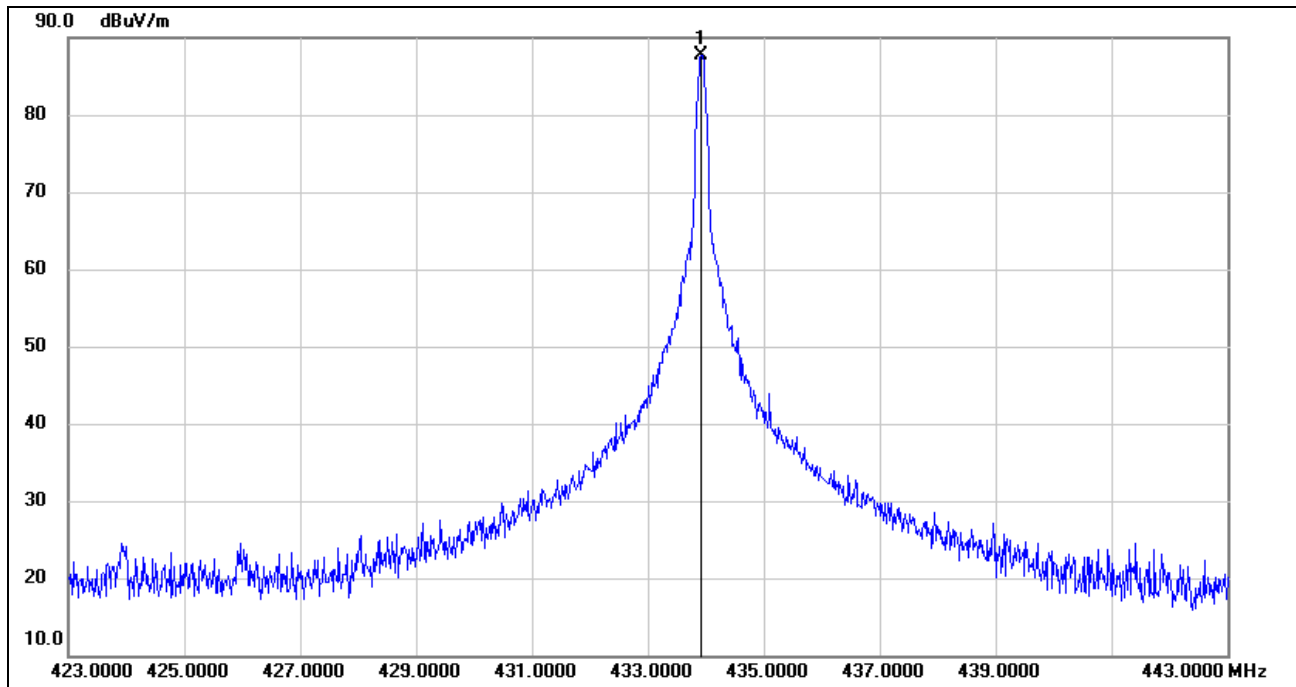

Frequency (MHz)	Reading (dBuV)	Correct (dB/m)	PEAK Result (dBuV/m)	Average Result (dBuV/m)	Limit (dBuV/m)	Margin (dB)	Remark
433.9200	99.82	-12.09	87.73	/	100.8	-12.35	peak
			/	77.90	80.8	-2.90	Average

Note: 1. Peak Result = Reading+ Correction Factor
2. Average Result= Peak Result+ Duty Correct Factor



VERTICAL

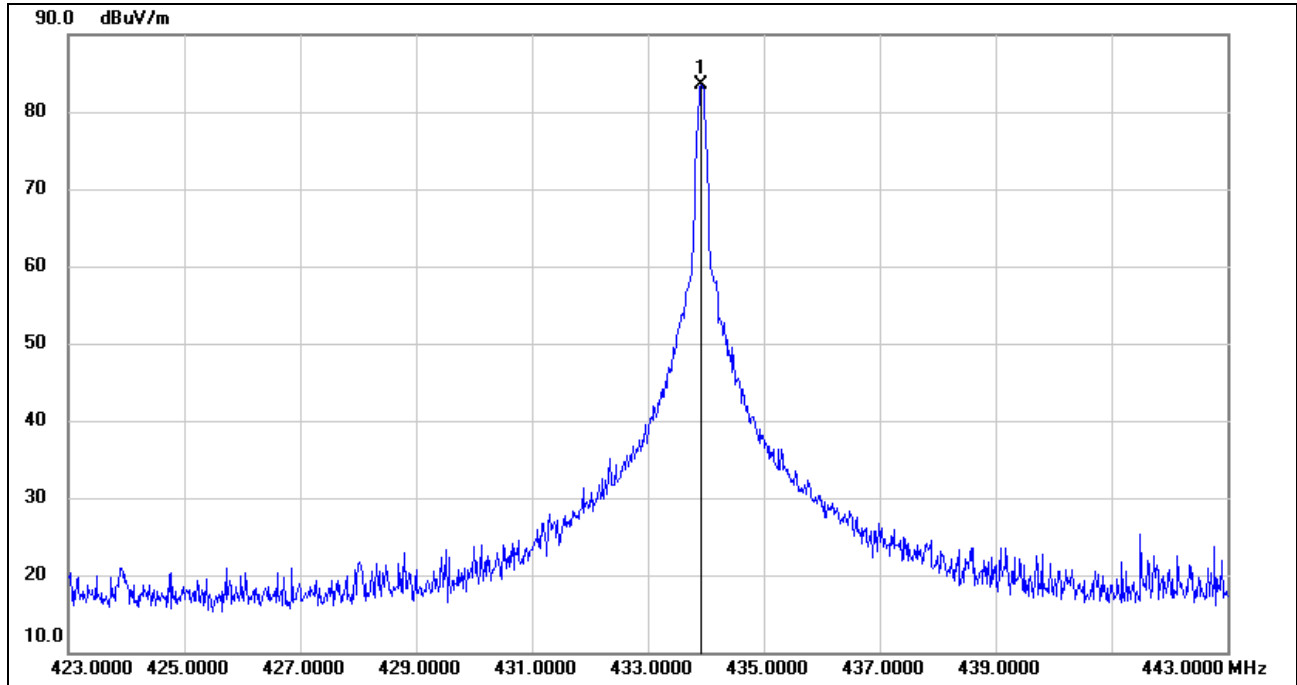

Frequency	Reading	Correct	PEAK Result	Average Result	Limit	Margin	Remark
(MHz)	(dBuV)	(dB/m)	(dBuV/m)	(dBuV/m)	(dBuV/m)	(dB)	
433.9200	95.56	-12.09	83.47	/	100.80	-17.33	peak
			/	73.64	80.80	-7.16	Average

Note: 1. Peak Result = Reading+ Correction Factor
2. Average Result= Peak Result+ Duty Correct Factor



6.4.2. SPURIOUS EMISSIONS BELOW 1G

SPURIOUS EMISSIONS (HORIZONTAL)

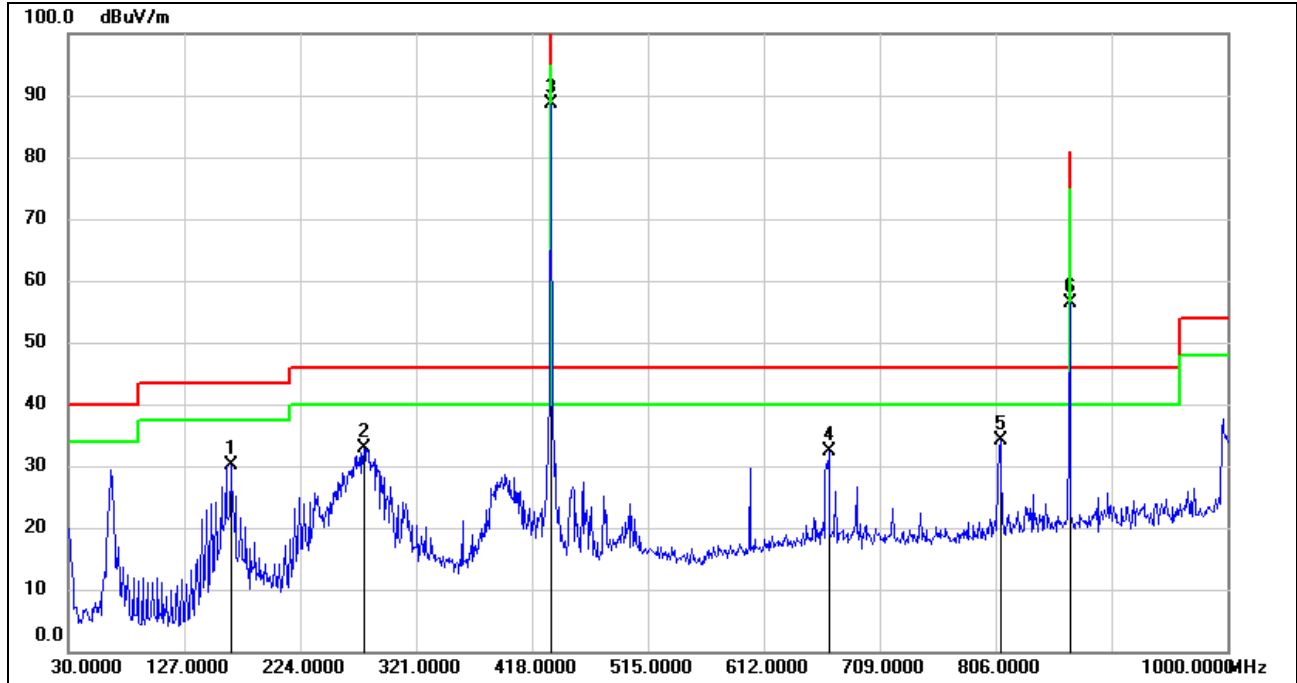

No.	Frequency (MHz)	Reading (dBuV)	Correct (dB/m)	Result (dBuV/m)	Limit (dBuV/m)	Margin (dB)	Remark
1	165.8000	47.41	-17.36	30.05	43.50	-13.45	QP
2	277.3500	48.06	-15.26	32.80	46.00	-13.20	QP
3(fundamental)	433.5200	100.64	-12.09	88.55	100.8	-12.25	peak
4	666.3200	40.06	-7.65	32.41	46.00	-13.59	QP
5	809.8800	39.76	-5.54	34.22	46.00	-11.78	QP
6(2 th harmonic)	868.0800	60.99	-4.67	56.32	80.8	-24.48	peak
				46.49	60.8	-14.31	Average

- Note: 1. Result Level = Read Level + Correct Factor.
 2. If Peak Result complies with QP limit, QP Result is deemed to comply with QP limit.
 3. Test setup: RBW: 120 kHz, VBW: 300 kHz, Sweep time: auto.
 4. Mark 3 is the fundamental frequency, Mark 6 is 2th harmonic.
 5. For the average value of the fundamental frequency(Mark 4), please refer to clause 6.4.1.
 6. Average Result= Peak Result+ Correct Factor



SPURIOUS EMISSIONS (VERTICAL)

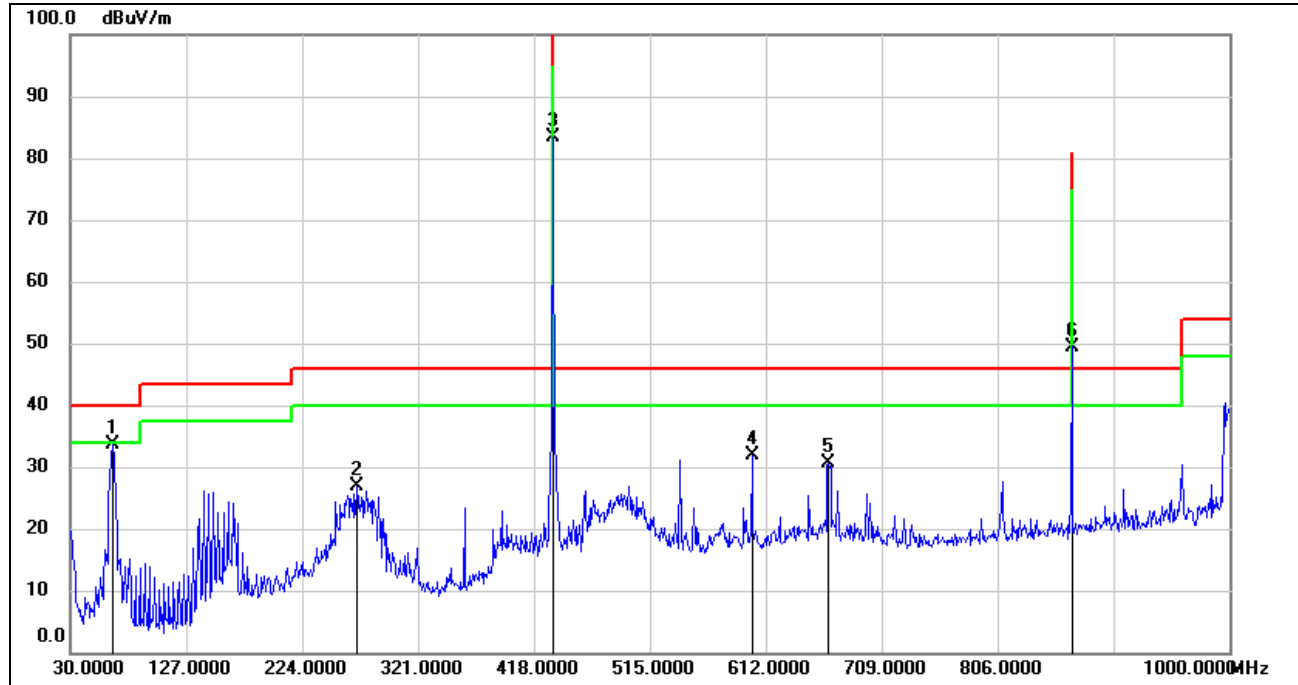

No.	Frequency (MHz)	Reading (dBuV)	Correct (dB/m)	Result (dBuV/m)	Limit (dBuV/m)	Margin (dB)	Remark
1	64.9200	53.26	-19.63	33.63	40.00	-6.37	QP
2	269.5900	42.59	-15.64	26.95	46.00	-19.05	QP
3(fundamental)	433.5200	95.53	-12.09	83.44	100.8	-17.36	peak
4	600.3600	40.74	-8.80	31.94	46.00	-14.06	QP
5	664.3800	38.28	-7.67	30.61	46.00	-15.39	QP
6(2 th harmonic)	868.0800	54.17	-4.67	49.50	80.8	-31.30	peak
				49.67	60.8	-21.13	Average

- Note: 1. Result Level = Read Level + Correct Factor.
 2. If Peak Result complies with QP limit, QP Result is deemed to comply with QP limit.
 3. Test setup: RBW: 120 kHz, VBW: 300 kHz, Sweep time: auto.
 4. Mark 3 is the fundamental frequency, Mark 6 is 2th harmonic.
 5. For the average value of the fundamental frequency(Mark 4), please refer to clause 6.4.1.
 6. Average Result= Peak Result+ Correct Factor

Note: All test mode has been tested, only the worst data record in the report.



6.4.3. SPURIOUS EMISSIONS ABOVE 1G

HARMONICS AND SPURIOUS EMISSIONS (HORIZONTAL)

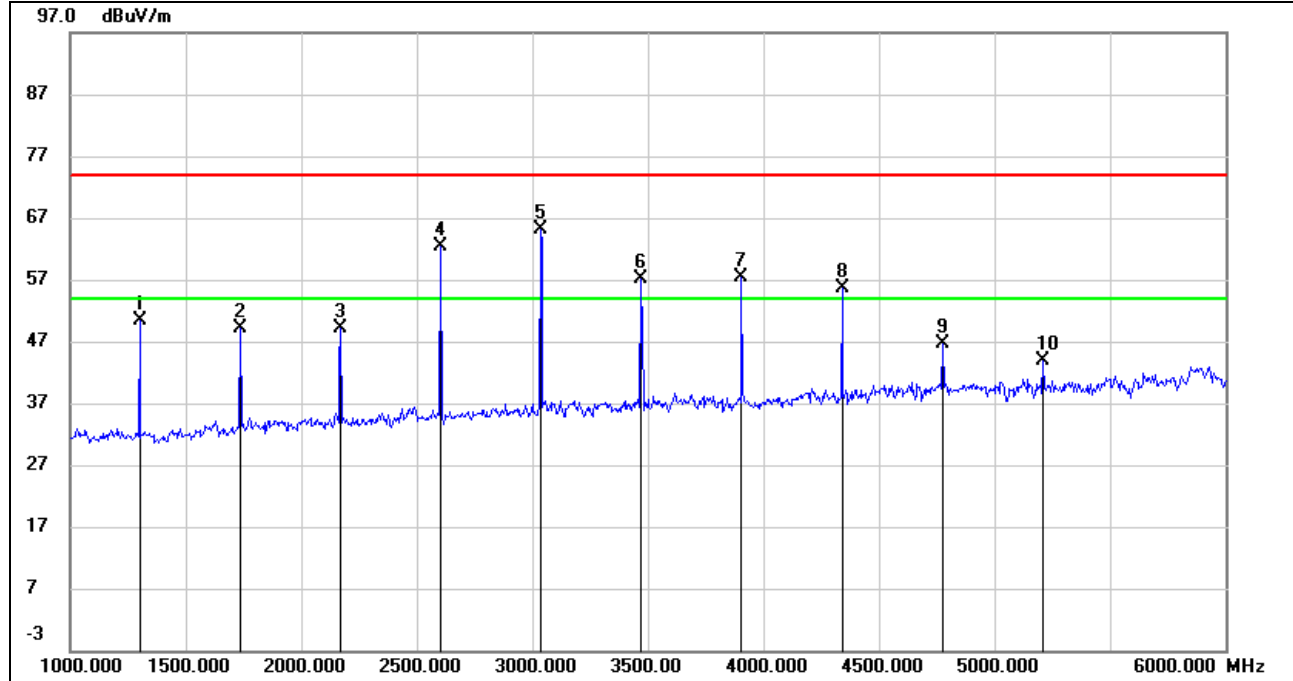

No.	Frequency (MHz)	Reading (dBuV)	Correct (dB/m)	Result (dBuV/m)	Limit (dBuV/m)	Margin (dB)	Remark
1(3 th harmonic)	1300.000	63.57	-13.10	50.47	80.8	-30.33	peak
				40.64	60.8	-20.16	average
2(4 th harmonic)	1735.000	60.85	-11.66	49.19	80.8	-31.61	peak
				39.36	60.8	-21.44	average
3(5 th harmonic)	2170.000	58.99	-9.97	49.02	80.8	-31.78	peak
				39.19	60.8	-21.61	average
4(6 th harmonic)	2605.000	71.14	-8.75	62.39	80.8	-18.41	peak
				52.56	60.8	-8.24	average
5(7 th harmonic)	3035.000	71.49	-6.43	65.06	80.8	-15.74	peak
				55.23	60.8	-5.57	average
6(8 th harmonic)	3470.000	63.08	-5.87	57.21	80.8	-23.59	peak
				47.38	60.8	-13.42	average
7(9 th harmonic)	3905.000	62.00	-4.53	57.47	80.8	-23.33	peak
				47.64	60.8	-13.16	average
8(10 th harmonic)	4340.000	58.89	-3.34	55.55	80.8	-25.25	peak
				45.72	60.8	-15.08	average
9	4775.000	47.60	-1.02	46.58	74.00	-27.42	peak
10	5210.000	43.14	0.65	43.79	74.00	-30.21	peak

Note: 1. Peak Result = Reading Level + Correct Factor.
2. Average Result = Peak Result + Duty Correction Factor.



HARMONICS AND SPURIOUS EMISSIONS (VERTICAL)

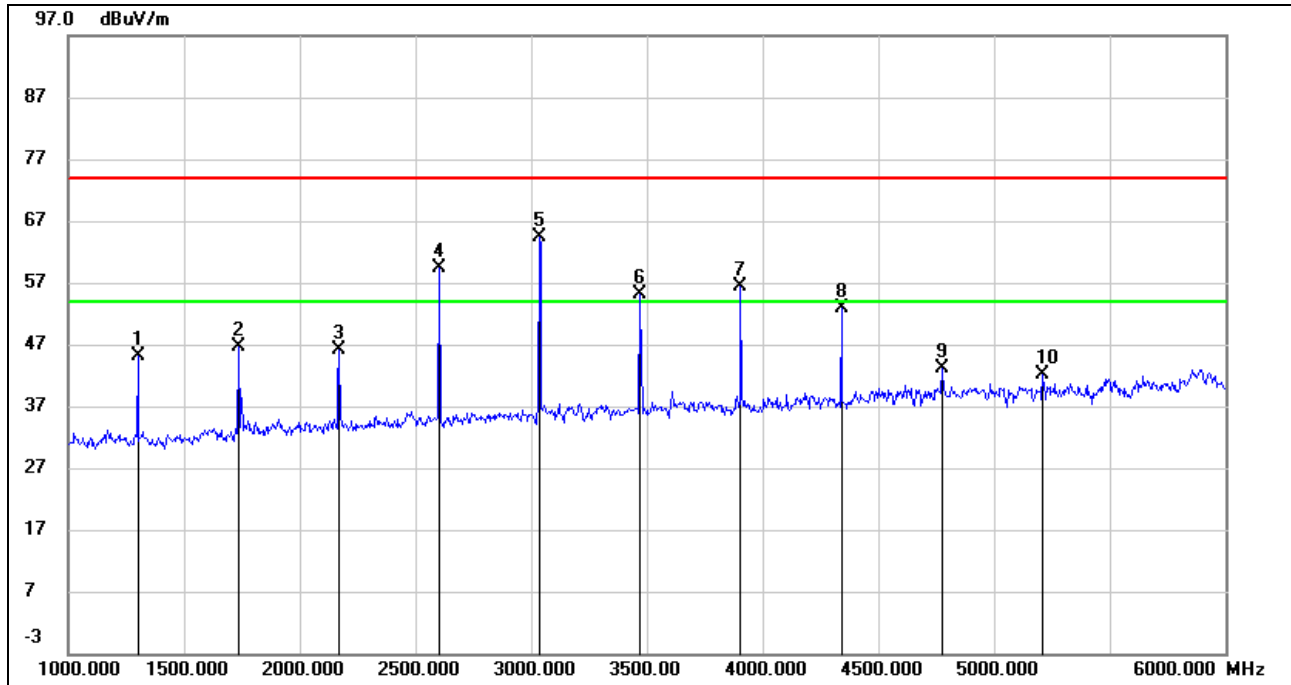

No.	Frequency (MHz)	Reading (dBuV)	Correct (dB/m)	Result (dBuV/m)	Limit (dBuV/m)	Margin (dB)	Remark
1(3 th harmonic)	1300.000	58.14	-13.10	45.04	80.8	-35.76	peak
				35.21	60.8	-25.59	average
2(4 th harmonic)	1735.000	58.33	-11.66	46.67	80.8	-34.13	peak
				36.84	60.8	-23.96	average
3(5 th harmonic)	2170.000	56.12	-9.97	46.15	80.8	-34.65	peak
				36.32	60.8	-24.48	average
4(6 th harmonic)	2605.000	68.17	-8.75	59.42	80.8	-21.38	peak
				49.59	60.8	-11.21	average
5(7 th harmonic)	3035.000	70.85	-6.43	64.42	80.8	-16.38	peak
				54.59	60.8	-6.21	average
6(8 th harmonic)	3470.000	61.00	-5.87	55.13	80.8	-25.67	peak
				45.30	60.8	-15.5	average
7(9 th harmonic)	3905.000	60.96	-4.53	56.43	80.8	-24.37	peak
				46.60	60.8	-14.2	average
8(10 th harmonic)	4340.000	56.14	-3.34	52.80	80.8	-28.00	peak
				42.97	60.8	-17.83	average
9	4775.000	44.15	-1.02	43.13	74.00	-30.87	peak
10	5210.000	41.43	0.65	42.08	74.00	-31.92	peak

Note: 1. Peak Result = Reading Level + Correct Factor.
2. Average Result = Peak Result + Duty Correction Factor.

Note: All test mode has been tested, only the worst data record in the report.



6.4.4. SPURIOUS EMISSIONS BELOW 30M

SPURIOUS EMISSIONS (MID CHANNEL, LOOP ANTENNA FACE ON TO THE EUT, WORST-CASE CONFIGURATION)

9kHz~ 150kHz

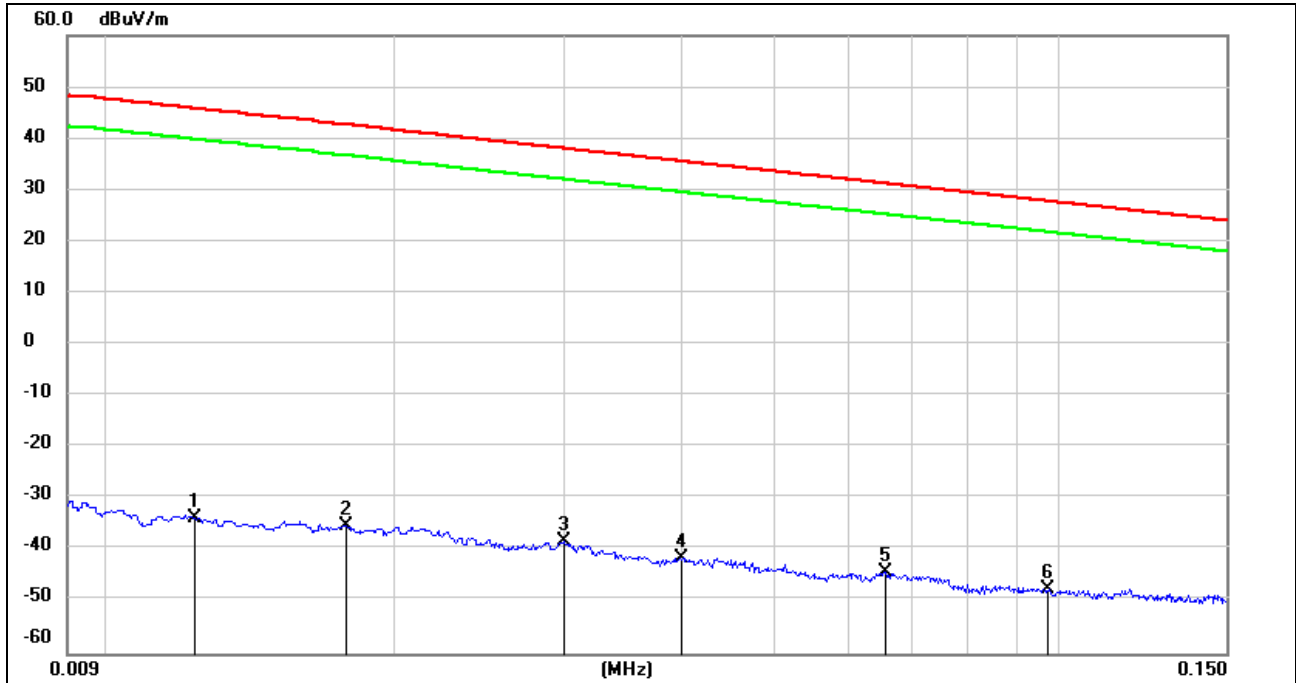

No.	Frequency (MHz)	Reading (dBuV)	Correct (dB/m)	Result (dBuV/m)	Limit (dBuV/m)	Margin (dB)	Remark
1	0.0124	67.69	-101.39	-33.70	45.80	-79.50	peak
2	0.0178	66.07	-101.35	-35.28	42.64	-77.92	peak
3	0.0300	63.18	-101.39	-38.21	38.06	-76.27	peak
4	0.0400	59.98	-101.43	-41.45	35.56	-77.01	peak
5	0.0656	57.36	-101.55	-44.19	31.26	-75.45	peak
6	0.0974	54.27	-101.78	-47.51	27.83	-75.34	peak

Note: 1. Measurement = Reading Level + Correct Factor.

2. If Peak Result complies with AV and QP limit, AV and QP Result are deemed to comply with AV limit.

3. All 3 polarizations(Horizontal, Face-on and Face-off) of the loop antenna had been tested, but only the worst data recorded in the report.



150kHz ~ 490kHz

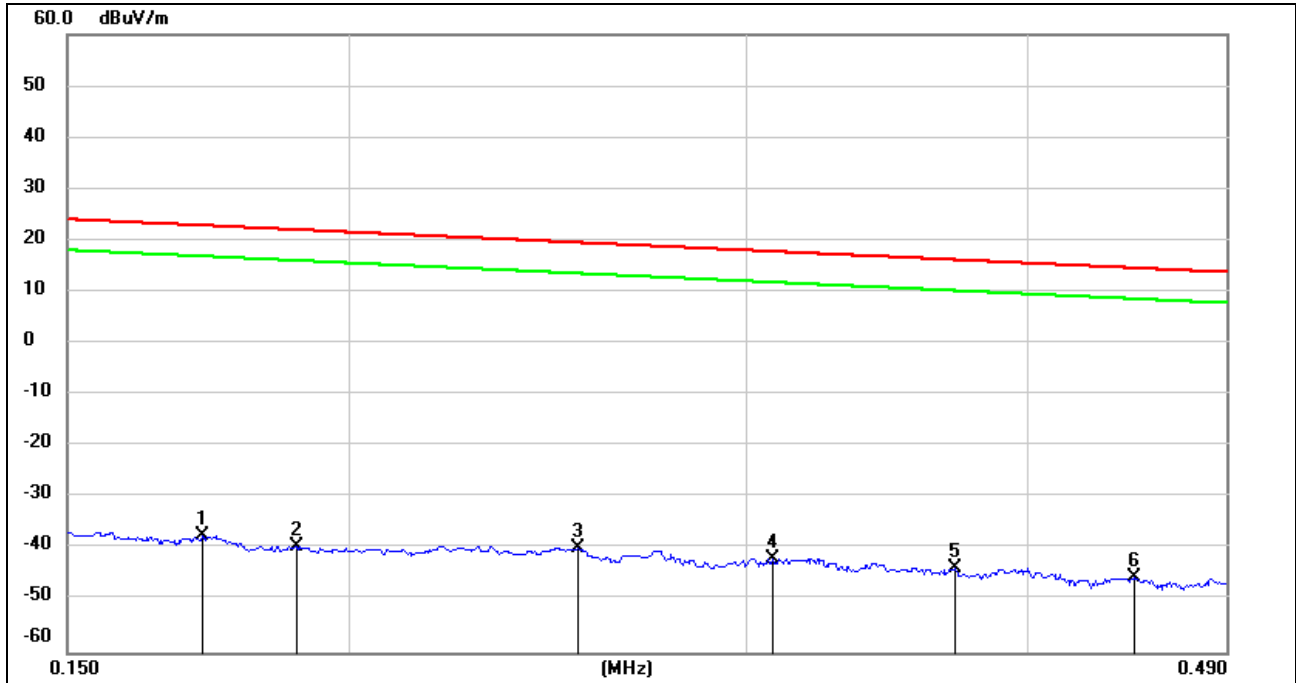

No.	Frequency (MHz)	Reading (dBuV)	Correct (dB/m)	Result (dBuV/m)	Limit (dBuV/m)	Margin (dB)	Remark
1	0.1725	64.19	-101.67	-37.48	22.90	-60.38	peak
2	0.1875	62.15	-101.70	-39.55	22.05	-61.60	peak
3	0.2530	62.09	-101.80	-39.71	19.54	-59.25	peak
4	0.3084	59.95	-101.86	-41.91	17.82	-59.73	peak
5	0.3714	58.28	-101.93	-43.65	16.20	-59.85	peak
6	0.4460	56.58	-102.01	-45.43	14.62	-60.05	peak

Note: 1. Measurement = Reading Level + Correct Factor.

2. If Peak Result complies with AV and QP limit, AV and QP Result are deemed to comply with AV limit.

3. All 3 polarizations(Horizontal, Face-on and Face-off) of the loop antenna had been tested, but only the worst data recorded in the report.



490kHz ~ 30MHz

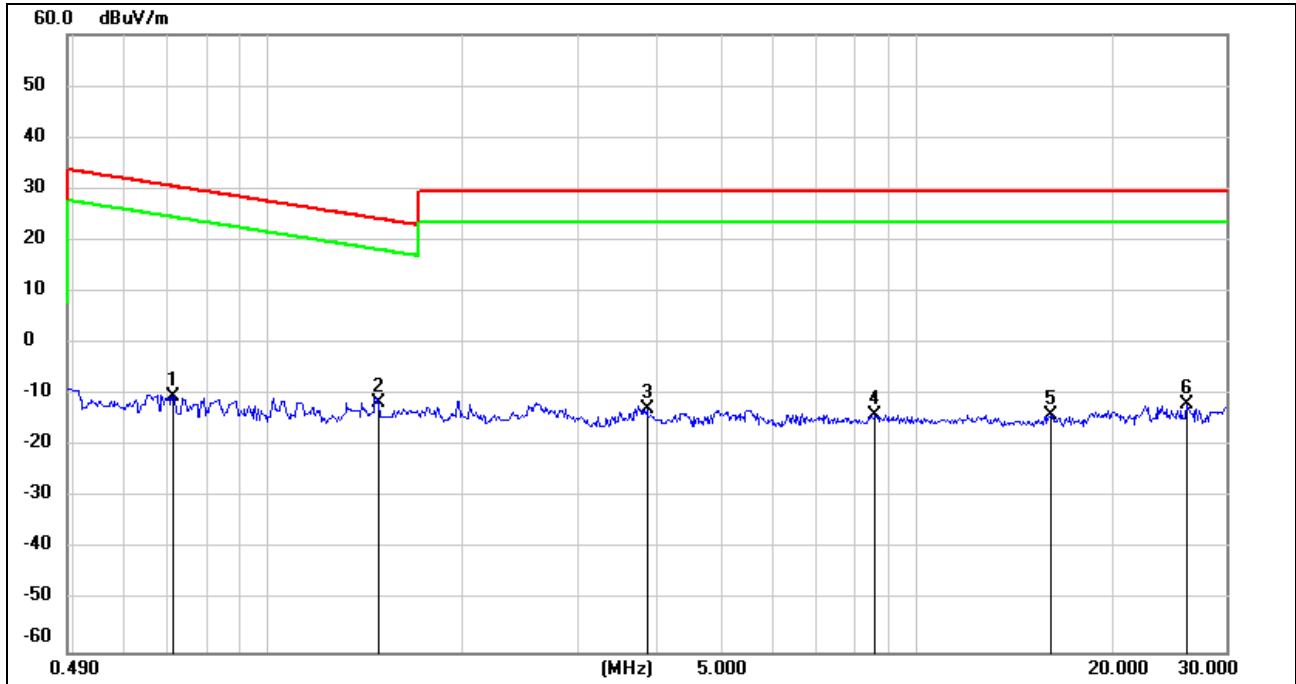

No.	Frequency (MHz)	Reading (dBuV)	Correct (dB/m)	Result (dBuV/m)	Limit (dBuV/m)	Margin (dB)	Remark
1	0.7129	51.82	-62.12	-10.30	30.55	-40.85	peak
2	1.4818	50.61	-62.05	-11.44	24.19	-35.63	peak
3	3.8340	48.51	-61.38	-12.87	29.54	-42.41	peak
4	8.6348	47.10	-60.99	-13.89	29.54	-43.43	peak
5	16.1598	47.11	-60.97	-13.86	29.54	-43.40	peak
6	26.1047	48.48	-60.34	-11.86	29.54	-41.40	peak

Note: 1. Measurement = Reading Level + Correct Factor.

2. If Peak Result complies with AV and QP limit, AV and QP Result are deemed to comply with AV limit.

3. All 3 polarizations(Horizontal, Face-on and Face-off) of the loop antenna had been tested, but only the worst data recorded in the report.

Note: All the test modes have been tested, only the worst data record in the report.



7. AC POWER LINE CONDUCTED EMISSIONS

LIMITS

Please refer to CFR 47 FCC §15.207 (a) and ISED RSS-Gen Clause 8.8

FREQUENCY (MHz)	Quasi-peak	Average
0.15 -0.5	66 - 56 *	56 - 46 *
0.50 -5.0	56.00	46.00
5.0 -30.0	60.00	50.00

Note:

- (1) The tighter limit applies at the band edges.
- (2) The limit of " * " marked band means the limitation decreases linearly with the logarithm of the frequency in the range.

TEST SETUP AND PROCEDURE

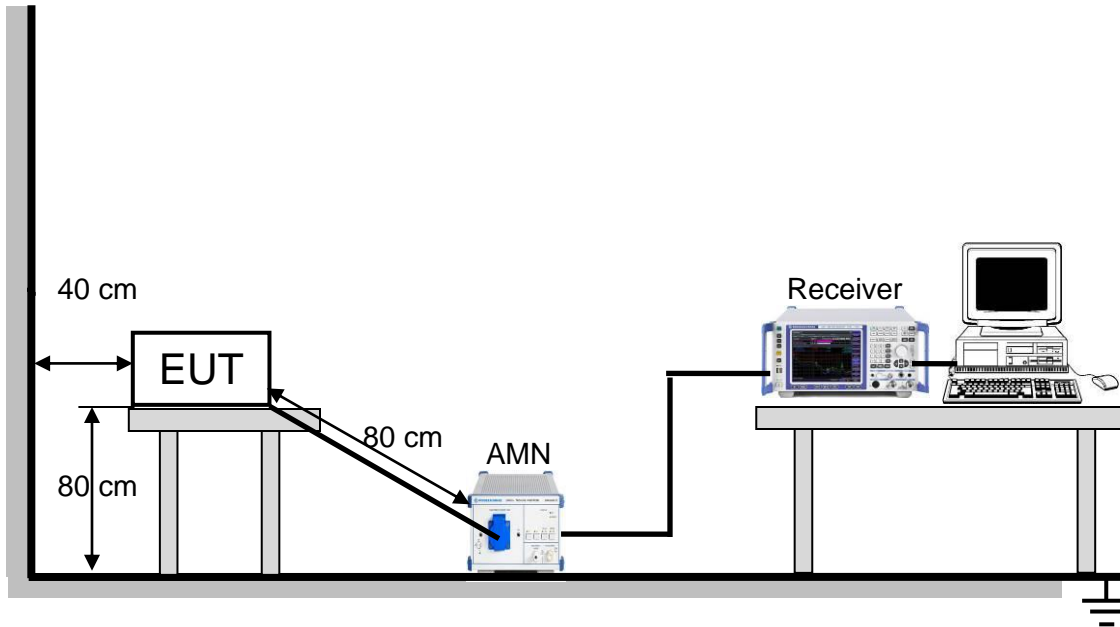

The following table is the setting of the receiver:

Receiver Parameters	Setting
Attenuation	10 dB
Start Frequency	0.15 MHz
Stop Frequency	30 MHz
IF Bandwidth	9 kHz

1. The testing follows the guidelines in ANSI C63.10-2013.
2. The EUT was placed on the top of a rotating table 0.8 meters above the horizontal ground plane and being connected to the power mains through a line impedance stabilization network (LISN). All other support equipment powered from additional LISN(s). The LISN provide 50 ohm/ 50uH of coupling impedance for the measuring instrument.
3. Interconnecting cables that hang closer than 40 cm to the ground plane shall be folded back and forth in the center forming a bundle 30 to 40 cm long.
4. I/O cables that are not connected to a peripheral shall be bundled in the center. The end of the cable may be terminated, if required, using the correct terminating impedance. The overall length shall not exceed 1 m.
5. LISN at least 80 cm from nearest part of EUT chassis.
6. Conducted emissions from the EUT measured in the frequency range between 0.15 MHz and 30MHz using CISPR Quasi-Peak and average detector mode.
7. The arrangement of the equipment is installed to meet the standards and operating in a manner, which tends to maximize its emission characteristics in a normal application.



TEST ENVIRONMENT

Temperature	24.3°C	Relative Humidity	67.2%
Atmosphere Pressure	101kPa	Test Voltage	DC 5 V

LINE N RESULTS

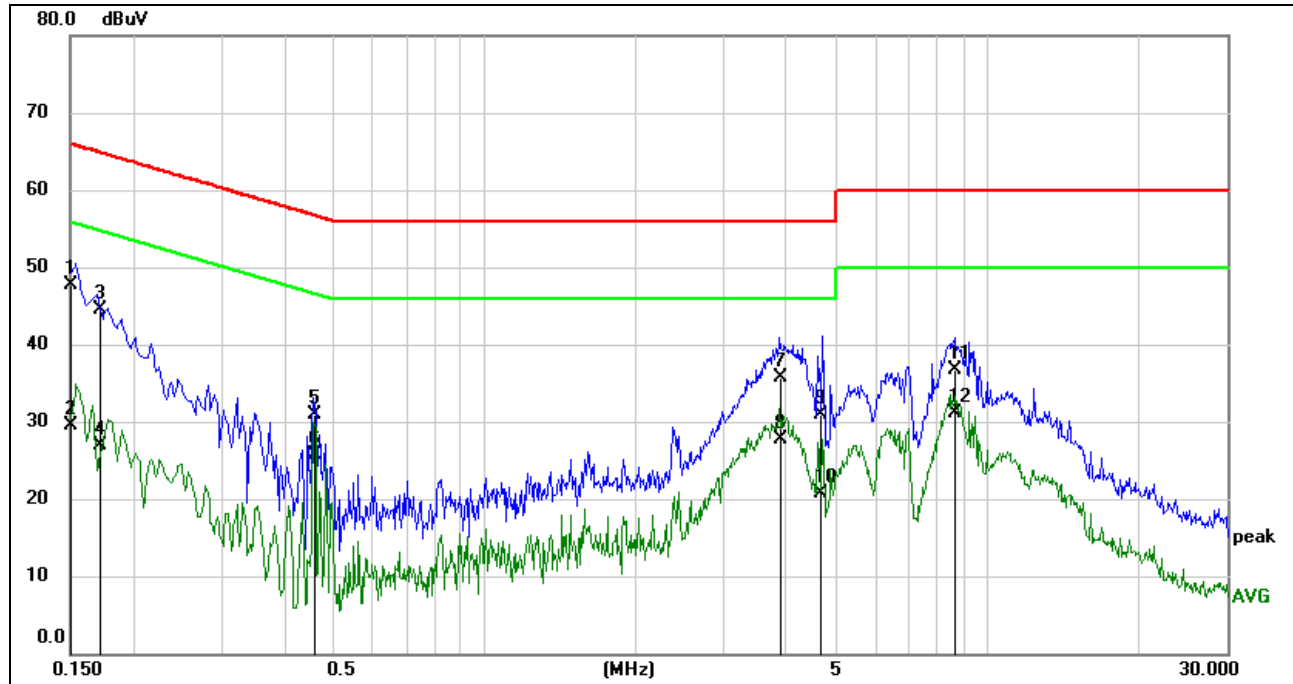

No.	Frequency (MHz)	Reading (dBuV)	Correct (dB)	Result (dBuV)	Limit (dBuV)	Margin (dB)	Remark
1	0.1504	38.10	9.60	47.70	65.98	-18.28	QP
2	0.1504	20.00	9.60	29.60	55.98	-26.38	AVG
3	0.1726	34.86	9.60	44.46	64.83	-20.37	QP
4	0.1726	17.38	9.60	26.98	54.83	-27.85	AVG
5	0.4590	21.23	9.60	30.83	56.71	-25.88	QP
6	0.4590	16.06	9.60	25.66	46.71	-21.05	AVG
7	3.9090	25.96	9.66	35.62	56.00	-20.38	QP
8	3.9090	18.04	9.66	27.70	46.00	-18.30	AVG
9	4.6526	21.24	9.67	30.91	56.00	-25.09	QP
10	4.6526	10.97	9.67	20.64	46.00	-25.36	AVG
11	8.6768	27.00	9.74	36.74	60.00	-23.26	QP
12	8.6768	21.30	9.74	31.04	50.00	-18.96	AVG

- Note: 1. Result = Reading +Correct Factor.
2. If QP Result complies with AV limit, AV Result is deemed to comply with AV limit.



LINE L RESULTS

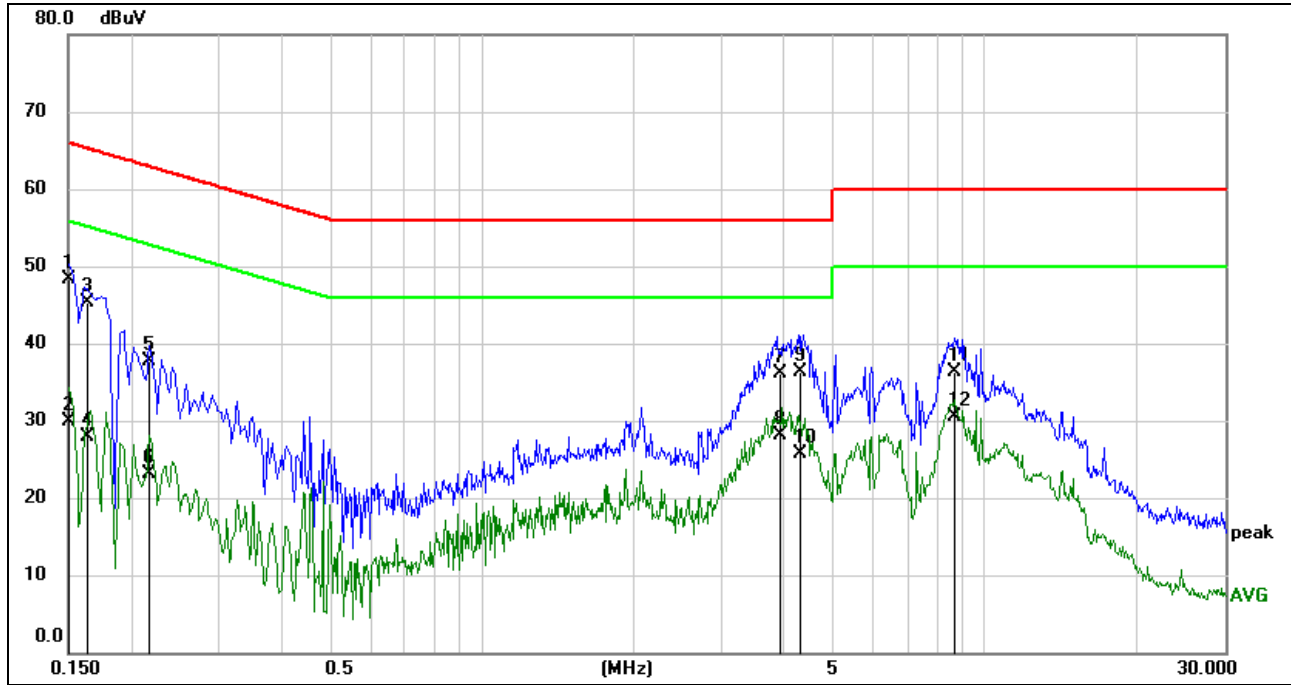

No.	Frequency (MHz)	Reading (dBuV)	Correct (dB)	Result (dBuV)	Limit (dBuV)	Margin (dB)	Remark
1	0.1508	38.73	9.61	48.34	65.96	-17.62	QP
2	0.1508	20.26	9.61	29.87	55.96	-26.09	AVG
3	0.1646	35.78	9.61	45.39	65.23	-19.84	QP
4	0.1646	18.27	9.61	27.88	55.23	-27.35	AVG
5	0.2179	28.20	9.60	37.80	62.90	-25.10	QP
6	0.2179	13.47	9.60	23.07	52.90	-29.83	AVG
7	3.9205	26.43	9.66	36.09	56.00	-19.91	QP
8	3.9205	18.42	9.66	28.08	46.00	-17.92	AVG
9	4.2879	26.60	9.66	36.26	56.00	-19.74	QP
10	4.2879	16.11	9.66	25.77	46.00	-20.23	AVG
11	8.6856	26.51	9.73	36.24	60.00	-23.76	QP
12	8.6856	20.71	9.73	30.44	50.00	-19.56	AVG

Note: 1. Result = Reading +Correct Factor.

2. If QP Result complies with AV limit, AV Result is deemed to comply with AV limit.

Note: All the test modes had been tested, only the worst data record in the report.



8. ANTENNA REQUIREMENTS

Applicable requirements

Please refer to FCC §15.203

An intentional radiator shall be designed to ensure that no antenna other than that furnished by the responsible party shall be used with the device. The use of a permanently attached antenna or of an antenna that uses a unique coupling to the intentional radiator shall be considered sufficient to comply with the provisions of this section. The manufacturer may design the unit so that a broken antenna can be replaced by the user, but the use of a standard antenna jack or electrical connector is prohibited.

RESULTS

Complies

END OF REPORT