

**IEEE 802.11n(HT40) Mode**

Radar Burst at the End of the Channel Availability Check Time

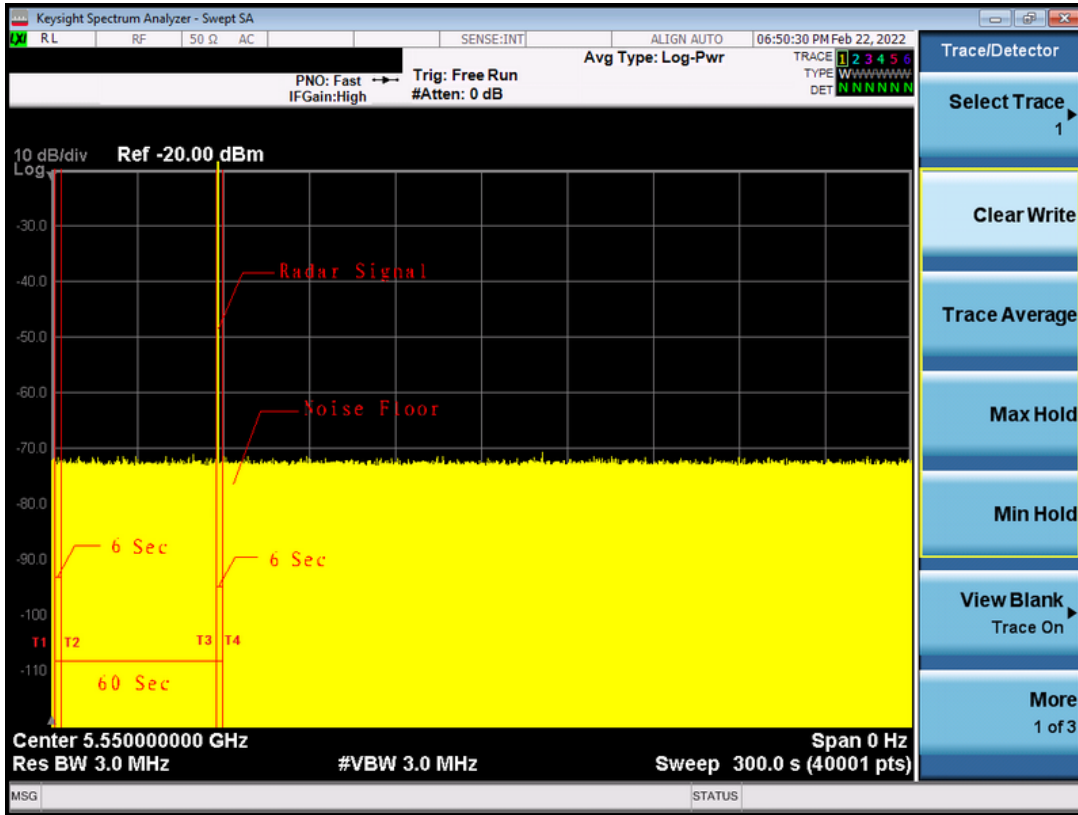

**Note:** T1 denotes the end of power up time period is 0 second.  
 T3 denotes 54 second and radar burst was commenced within 54 second to 60 second indow starting from the end of power-up sequence.  
 T4 denotes the 60 second

### IEEE 802.11ac(VHT80) Mode

Initial Channel Availability Check Time

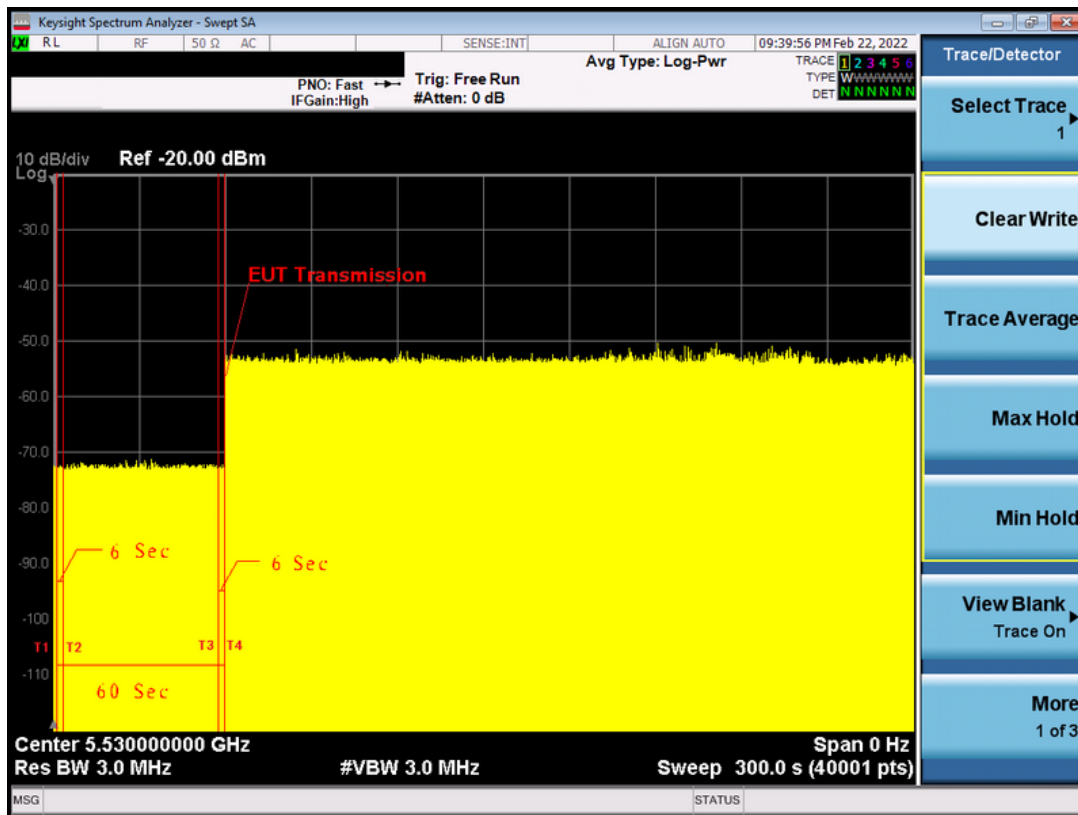

**Note:** T1 denotes the end of power-up time period is 0 second.

T4 denotes the end of Channel Availability Check time is 60 second. Channel Availability Check time is equal to (T4 - T1) 60 seconds.

### IEEE 802.11ac(VHT80) Mode

Radar Burst at the Beginning of the Channel Availability Check Time

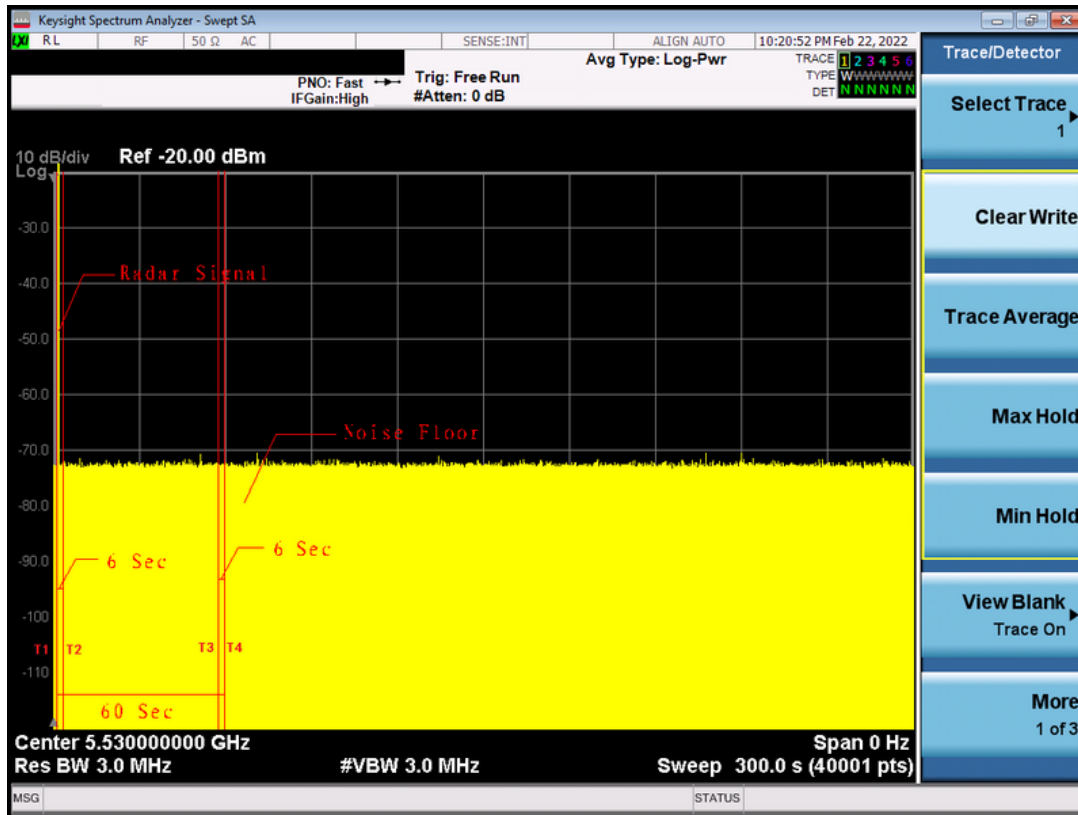

**Note:** T1 denotes the end of power up time period is 0 second.  
 T2 denotes 6 second. The radar burst was commenced within a 6 second window starting from the end of power-up sequence.  
 T4 denotes the 60 second.

### IEEE 802.11ac(VHT80) Mode

Radar Burst at the End of the Channel Availability Check Time

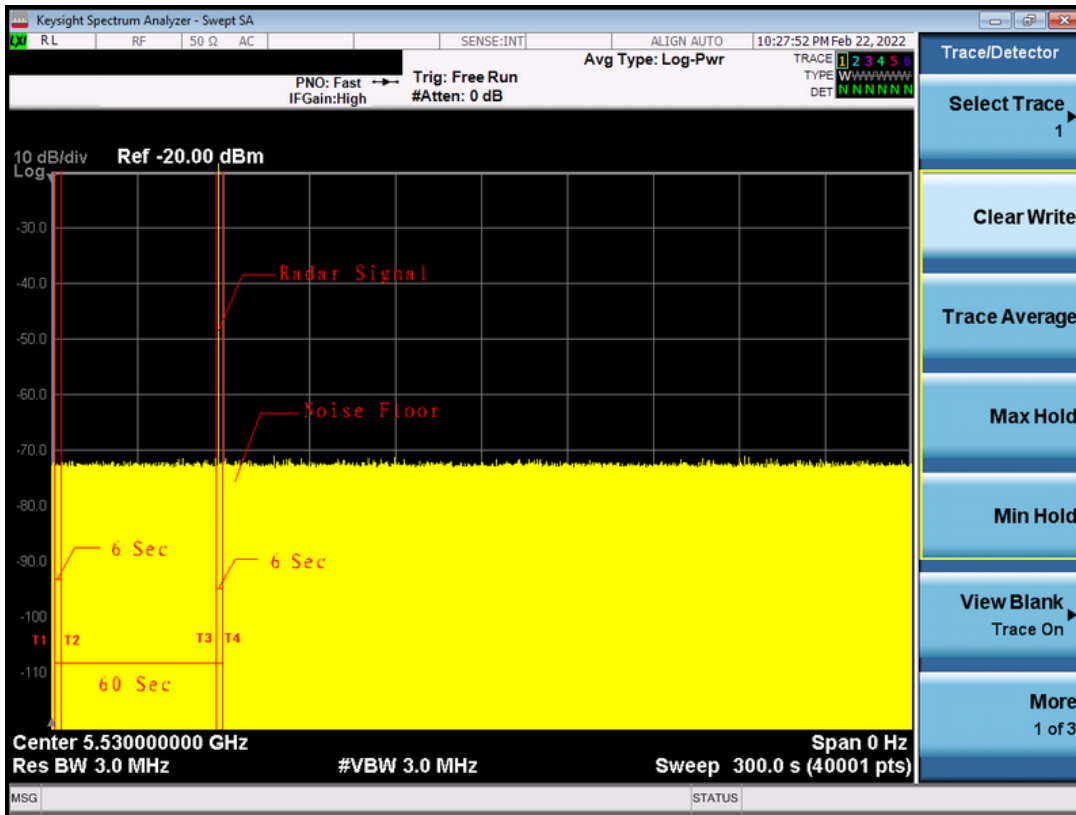

**Note:** T1 denotes the end of power up time period is 0 second.  
 T3 denotes 54 second and radar burst was commenced within 54 second to 60 second indow starting from the end of power-up sequence.  
 T4 denotes the 60 second.

### IEEE 802.11ax(HE20) Mode

Initial Channel Availability Check Time

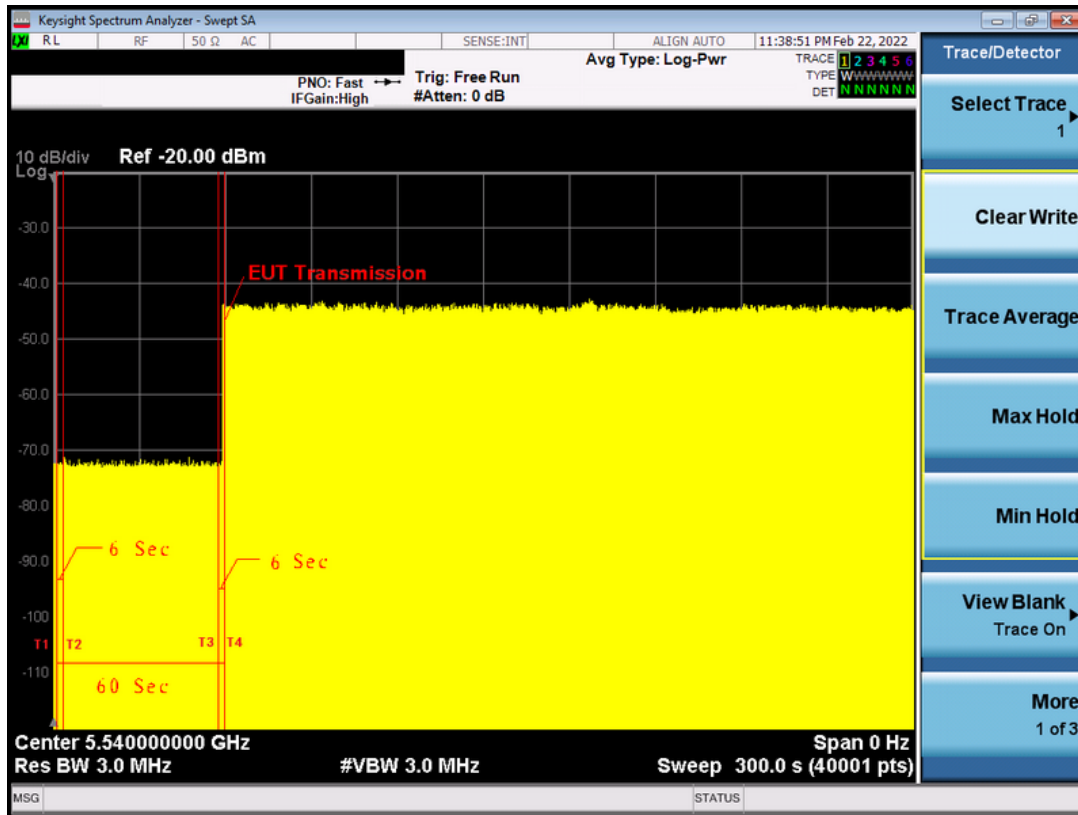

**Note:** T1 denotes the end of power-up time period is 0 second.  
 T4 denotes the end of Channel Availability Check time is 60 second. Channel Availability Check time is equal to (T4 - T1) 60 seconds.

**IEEE 802.11ax(HE20) Mode**  
 Radar Burst at the Beginning of the Channel Availability Check Time

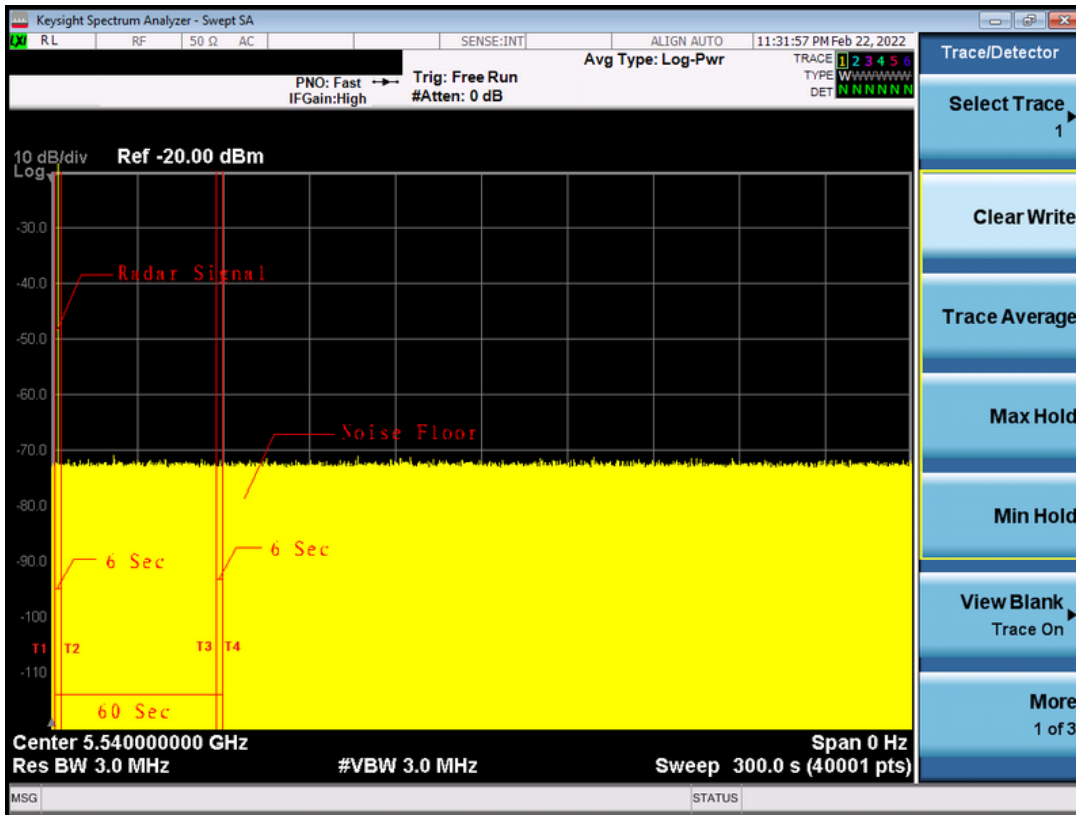

**Note:** T1 denotes the end of power up time period is 0 second.  
 T2 denotes 6 second. The radar burst was commenced within a 6 second window starting from the end of power-up sequence.  
 T4 denotes the 64 second.

**IEEE 802.11ax(HE20) Mode**

Radar Burst at the End of the Channel Availability Check Time

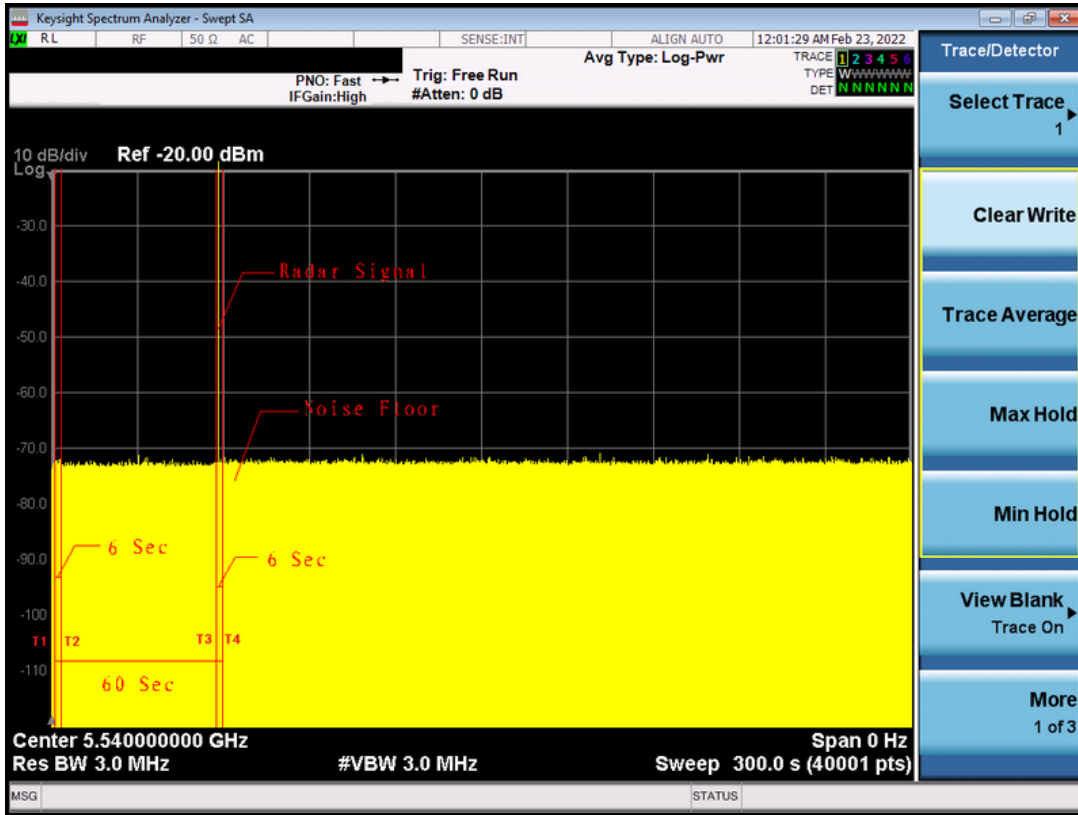

**Note:** T1 denotes the end of power up time period is 0 second.  
 T3 denotes 54 second and radar burst was commenced within 54 second to 60 second indow starting from the end of power-up sequence.  
 T4 denotes the 60 second.

## 8.5 CHANNEL MOVE TIME AND CHANNEL CLOSING TRANSMISSION TIME

TX (IEEE 802.11a Mode)

Radar signal 0

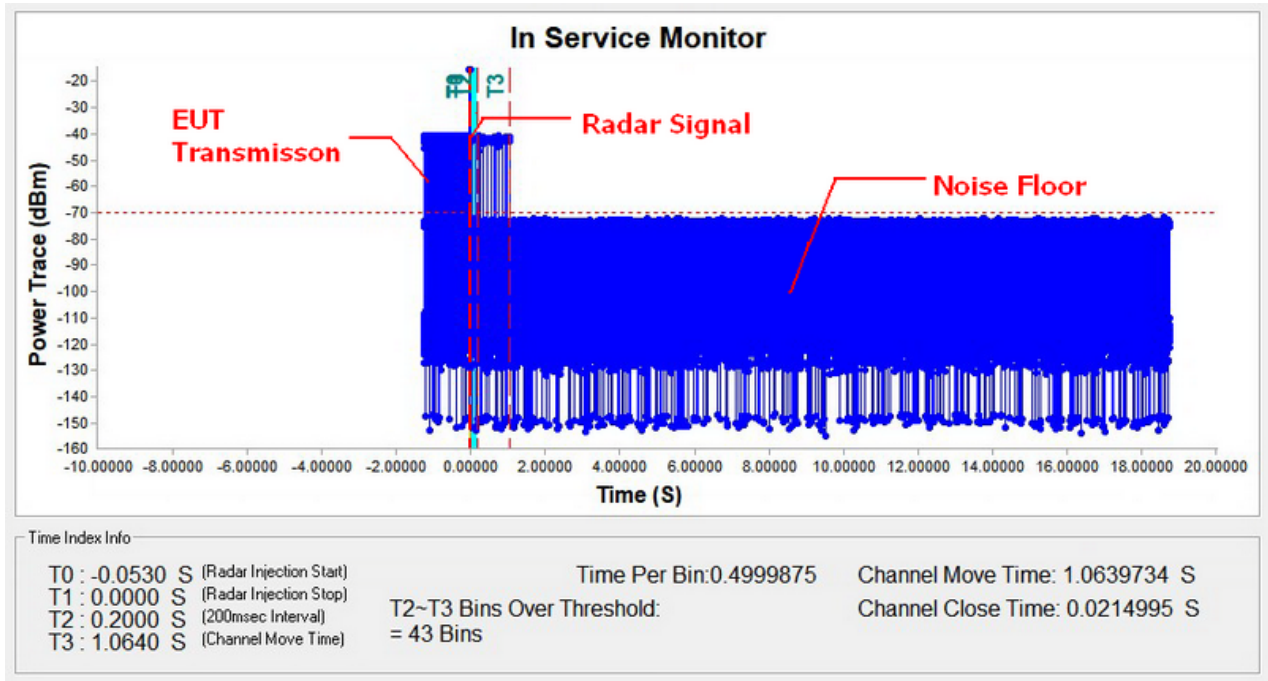

**Note:** T0 denotes the Radar Injection Start.  
 T1 denotes the start of Channel Move Time upon the end of the last Radar burst.  
 T2 denotes the data transmission time of 200ms from T1.  
 T3 denotes the end of Channel Move Time.

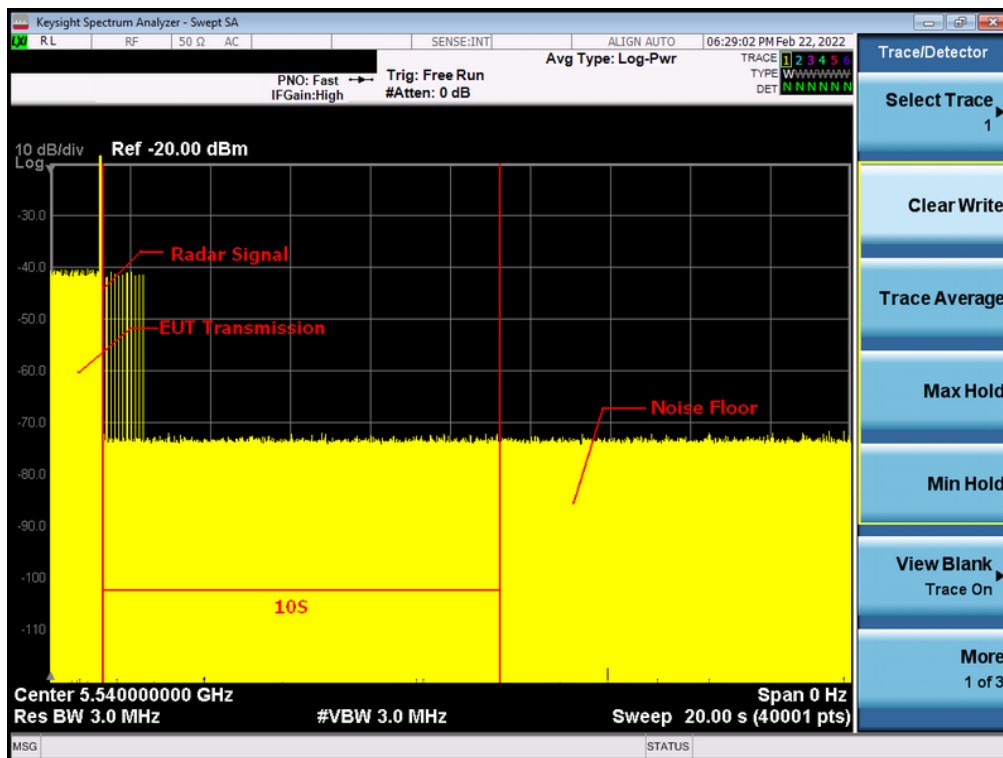

**Note:** An expanded plot for the device vacates the channel in the required 500ms



TX (IEEE 802.11n(HT40) Mode)

Radar signal 0

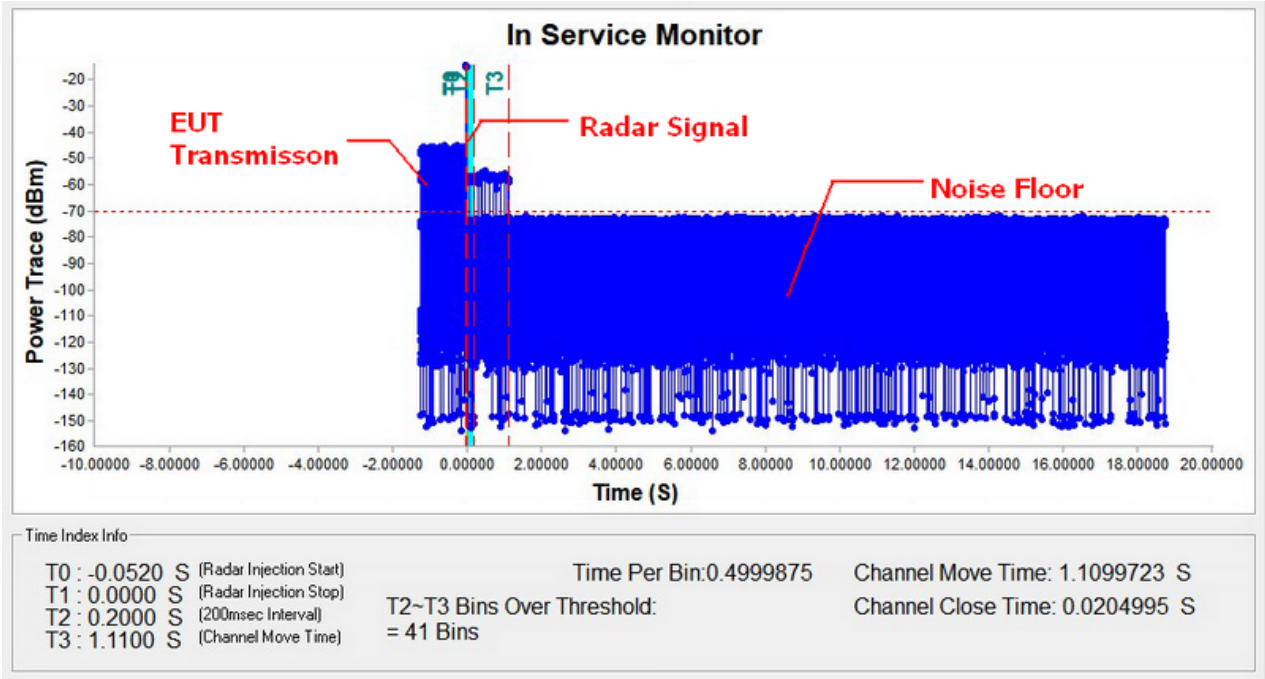

**Note:** T0 denotes the Radar Injection Start.  
 T1 denotes the start of Channel Move Time upon the end of the last Radar burst.  
 T2 denotes the data transmission time of 200ms from T1.  
 T3 denotes the end of Channel Move Time.

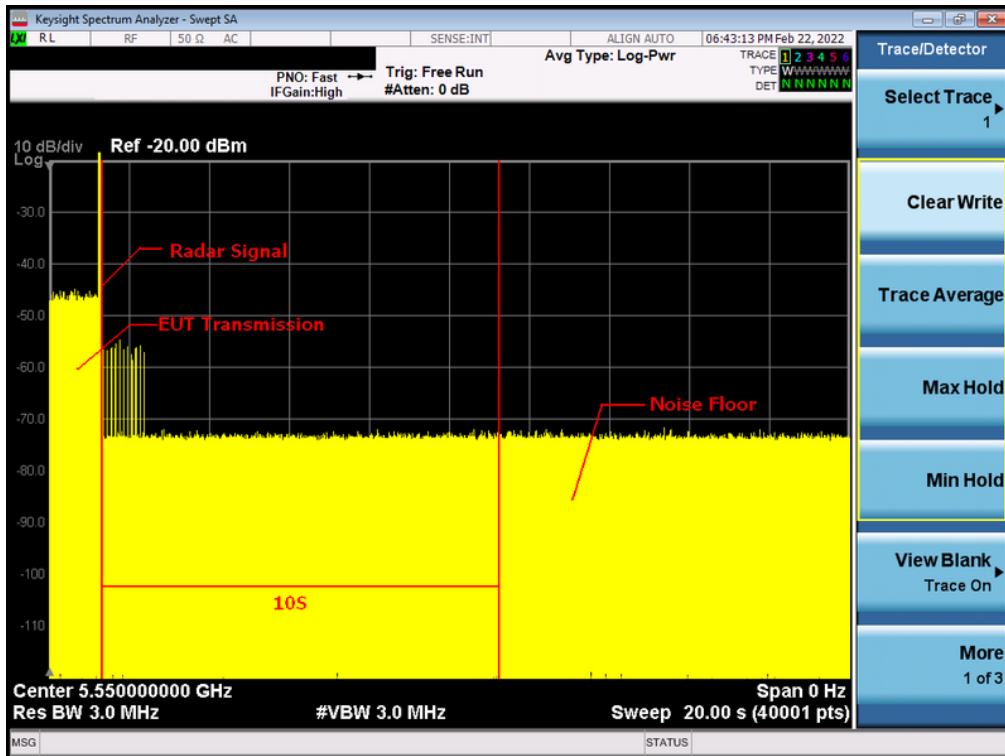

**Note:** An expanded plot for the device vacates the channel in the required 500ms

TX (IEEE 802.11ac(VHT80) Mode)

Radar signal 0

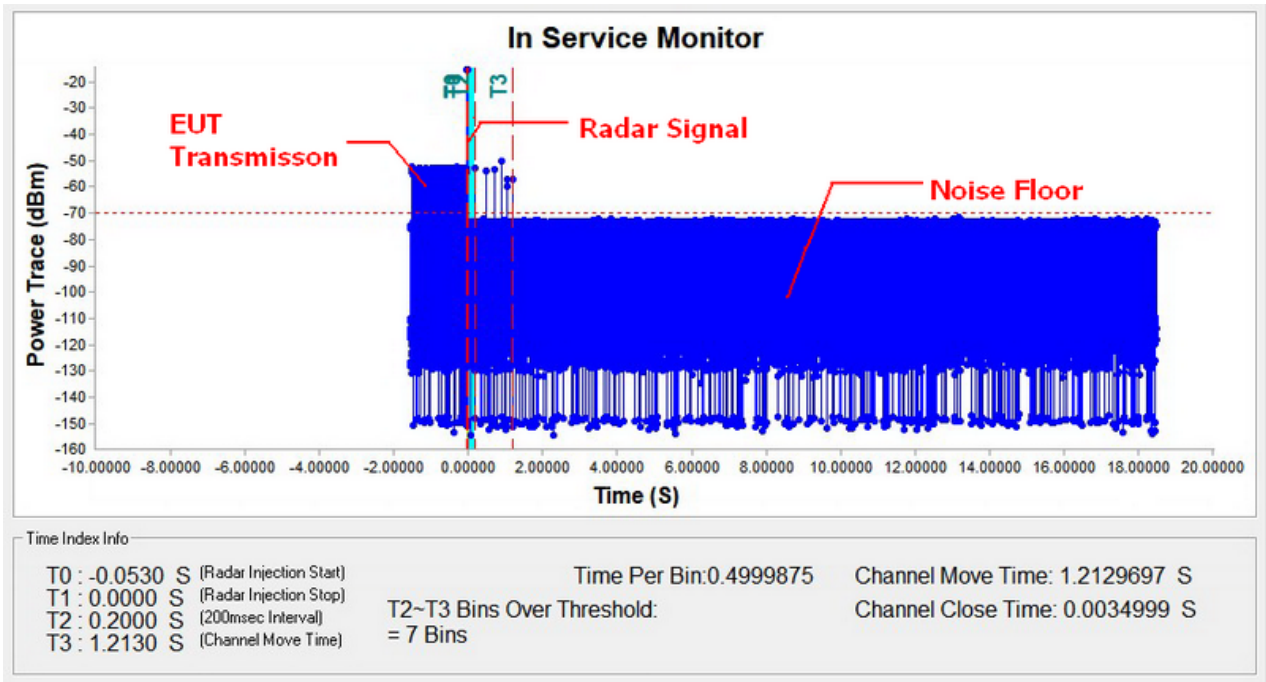

**Note:** T0 denotes the Radar Injection Start.  
 T1 denotes the start of Channel Move Time upon the end of the last Radar burst.  
 T2 denotes the data transmission time of 200ms from T1.  
 T3 denotes the end of Channel Move Time.

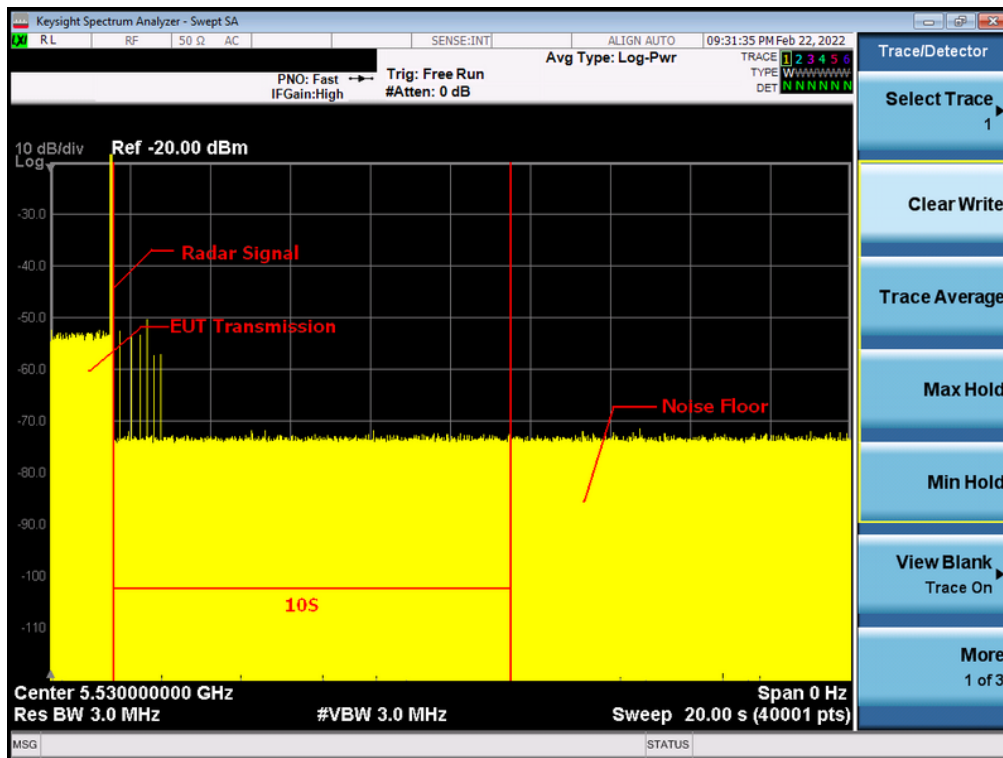

**Note:** An expanded plot for the device vacates the channel in the required 500ms

TX (IEEE 802.11ax(HE20) Mode)

Radar signal 0

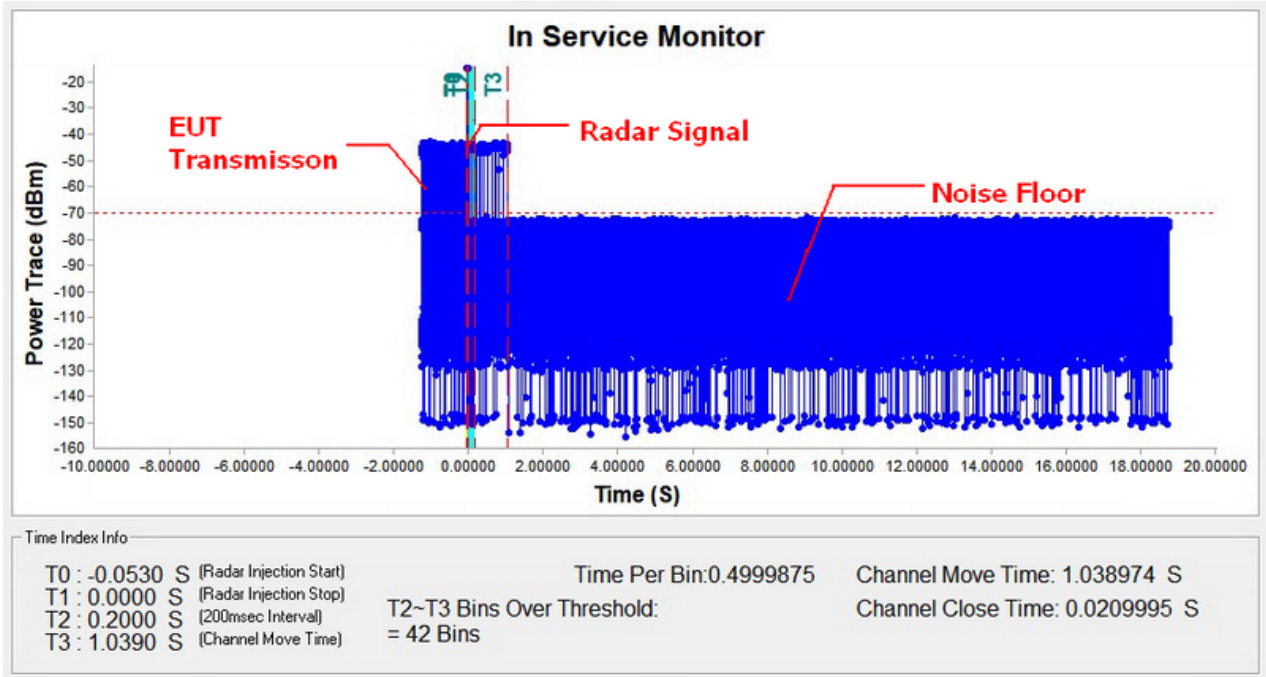

**Note:** T0 denotes the Radar Injection Start.  
 T1 denotes the start of Channel Move Time upon the end of the last Radar burst.  
 T2 denotes the data transmission time of 200ms from T1.  
 T3 denotes the end of Channel Move Time.

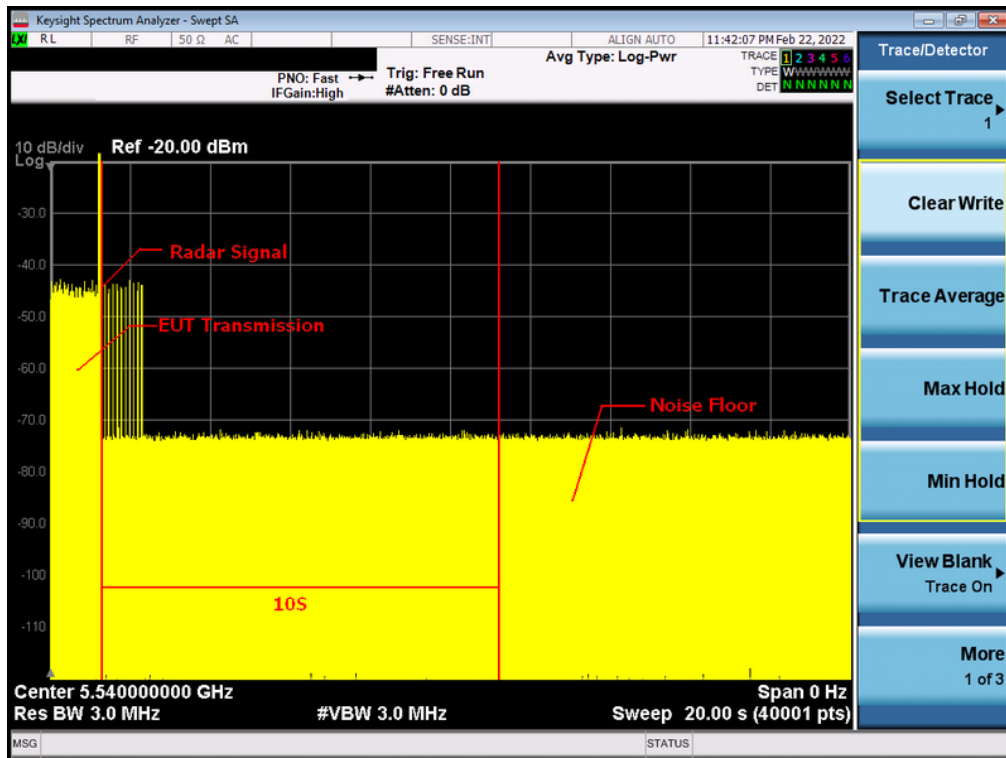

**Note:** An expanded plot for the device vacates the channel in the required 500ms

IEEE 802.11a Mode		
Item	Measured Value(s)	Limit(s)
Channel Move Time	1.0639734	10
Channel Close Time	0.0214995	200 milliseconds + an aggregate of 60 milliseconds over remaining 10 second period.

IEEE 802.11n(HT40) Mode		
Item	Measured Value(s)	Limit(s)
Channel Move Time	1.1099723	10
Channel Close Time	0.0204995	200 milliseconds + an aggregate of 60 milliseconds over remaining 10 second period.

IEEE 802.11ac(VHT80) Mode		
Item	Measured Value(s)	Limit(s)
Channel Move Time	1.2129697	10
Channel Close Time	0.0034999	200 milliseconds + an aggregate of 60 milliseconds over remaining 10 second period.

IEEE 802.11ax(HE20) Mode		
Item	Measured Value(s)	Limit(s)
Channel Move Time	1.038974	10
Channel Close Time	0.0209995	200 milliseconds + an aggregate of 60 milliseconds over remaining 10 second period.

**8.6 STATISTICAL PERFORMANCE CHECK**
**Master**

TX (IEEE 802.11a Mode)

Table 1: Short Pulse Radar Test Waveforms.

Radar Type	Pulse Width (μsec)	PRI (μsec)	Number of Pulses	Pass times	Fail times	Percentage of Successful Detection (%)
1	1	Test A: 15 unique PRI values randomly selected from the list of 23 PRI values in Table 5a <hr/> Test B: 15 unique PRI values randomly selected within the range of 518-3066 μsec, with a minimum increment of 1 μsec, excluding PRI values selected in Test A	$\text{Roundup} \left\{ \begin{array}{l} \left( \frac{1}{360} \right) \\ \left( \frac{19 \cdot 10^6}{\text{PRI}_{\mu\text{sec}}} \right) \end{array} \right\}$	28	2	93%
2	1-5	150-230	23-29	30	0	100%
3	6-10	200-500	16-18	27	3	90%
4	11-20	200-500	12-16	28	2	93%
Aggregate (Radar Types 1-4)				113	7	94%

Table 2: Long Pulse Radar Test Waveform

Radar Type	Pulse Width (μsec)	Chirp Width (MHz)	PRI (μsec)	Number of Pulses Per Burst	Number of Bursts	Pass times	Fail times	Percentage of Successful Detection (%)
5	50-100	5-20	1000-2000	1-3	8-20	25	5	83%

Table 3: Frequency Hopping Radar Test Waveform

Radar Type	Pulse Width (μsec)	PRI (μsec)	Pulses per Hop	Hopping Rate (kHz)	Hopping Sequence Length (msec)	Pass times	Fail times	Percentage of Successful Detection (%)
6	1	333	9	0.333	300	28	2	93%

Radar Type	Trial #	Detection	Trial #	Detection
		YES / NO		YES / NO
Type1	1	YES	16	YES
	2	YES	17	YES
	3	YES	18	YES
	4	YES	19	YES
	5	YES	20	YES
	6	YES	21	YES
	7	YES	22	YES
	8	YES	23	YES
	9	YES	24	YES
	10	NO	25	YES
	11	YES	26	YES
	12	NO	27	YES
	13	YES	28	YES
	14	YES	29	YES
	15	YES	30	YES
Type2	1	YES	16	YES
	2	YES	17	YES
	3	YES	18	YES
	4	YES	19	YES
	5	YES	20	YES
	6	YES	21	YES
	7	YES	22	YES
	8	YES	23	YES
	9	YES	24	YES
	10	YES	25	YES
	11	YES	26	YES
	12	YES	27	YES
	13	YES	28	YES
	14	YES	29	YES
	15	YES	30	YES

Radar Type	Trial #	Detection	Trial #	Detection
		YES / NO		YES / NO
Type3	1	YES	16	YES
	2	YES	17	YES
	3	YES	18	YES
	4	NO	19	YES
	5	YES	20	NO
	6	YES	21	YES
	7	YES	22	YES
	8	YES	23	YES
	9	YES	24	YES
	10	YES	25	YES
	11	NO	26	YES
	12	YES	27	YES
	13	YES	28	YES
	14	YES	29	YES
	15	YES	30	YES
Type4	1	YES	16	YES
	2	YES	17	YES
	3	NO	18	YES
	4	YES	19	YES
	5	YES	20	YES
	6	YES	21	YES
	7	YES	22	YES
	8	YES	23	YES
	9	YES	24	YES
	10	YES	25	YES
	11	YES	26	YES
	12	YES	27	YES
	13	YES	28	YES
	14	NO	29	YES
	15	YES	30	YES

Radar Type	Trial #	Detection	Trial #	Detection
		YES / NO		YES / NO
Type5	1	YES	16	NO
	2	YES	17	YES
	3	YES	18	NO
	4	YES	19	NO
	5	YES	20	YES
	6	YES	21	YES
	7	YES	22	YES
	8	YES	23	YES
	9	YES	24	YES
	10	YES	25	YES
	11	YES	26	YES
	12	YES	27	YES
	13	YES	28	YES
	14	NO	29	NO
	15	YES	30	YES
Type6	1	YES	16	YES
	2	YES	17	NO
	3	YES	18	YES
	4	YES	19	YES
	5	NO	20	YES
	6	YES	21	YES
	7	YES	22	YES
	8	YES	23	YES
	9	YES	24	YES
	10	YES	25	YES
	11	YES	26	YES
	12	YES	27	YES
	13	YES	28	YES
	14	YES	29	YES
	15	YES	30	YES



TX (IEEE 802.11n(HT40) Mode)

Table 1: Short Pulse Radar Test Waveforms.

Radar Type	Pulse Width (μsec)	PRI (μsec)	Number of Pulses	Pass times	Fail times	Percentage of Successful Detection (%)
1	1	Test A: 15 unique PRI values randomly selected from the list of 23 PRI values in Table 5a Test B: 15 unique PRI values randomly selected within the range of 518-3066 μsec, with a minimum increment of 1 μsec, excluding PRI values selected in Test A	$\text{Roundup} \left\{ \begin{array}{l} \left( \frac{1}{360} \right) \\ \left( \frac{19 \cdot 10^6}{\text{PRI}_{\mu\text{sec}}} \right) \end{array} \right\}$	27	3	90%
2	1-5	150-230	23-29	29	1	97%
3	6-10	200-500	16-18	28	2	93%
4	11-20	200-500	12-16	28	2	93%
Aggregate (Radar Types 1-4)				112	8	93%

Table 2: Long Pulse Radar Test Waveform

Radar Type	Pulse Width (μsec)	Chirp Width (MHz)	PRI (μsec)	Number of Pulses Per Burst	Number of Bursts	Pass times	Fail times	Percentage of Successful Detection (%)
5	50-100	5-20	1000-2000	1-3	8-20	26	4	87%

Table 3: Frequency Hopping Radar Test Waveform

Radar Type	Pulse Width (μsec)	PRI (μsec)	Pulses per Hop	Hopping Rate (kHz)	Hopping Sequence Length (msec)	Pass times	Fail times	Percentage of Successful Detection (%)
6	1	333	9	0.333	300	29	1	97%

Radar Type	Trial #	Detection	Trial #	Detection
		YES / NO		YES / NO
Type1	1	YES	16	YES
	2	YES	17	YES
	3	YES	18	YES
	4	YES	19	NO
	5	YES	20	YES
	6	NO	21	YES
	7	YES	22	YES
	8	YES	23	YES
	9	NO	24	YES
	10	YES	25	YES
	11	YES	26	YES
	12	YES	27	YES
	13	YES	28	YES
	14	YES	29	YES
	15	YES	30	YES
Type2	1	YES	16	YES
	2	YES	17	YES
	3	YES	18	NO
	4	YES	19	YES
	5	YES	20	YES
	6	YES	21	YES
	7	YES	22	YES
	8	YES	23	YES
	9	YES	24	YES
	10	YES	25	YES
	11	YES	26	YES
	12	YES	27	YES
	13	YES	28	YES
	14	YES	29	YES
	15	YES	30	YES

Radar Type	Trial #	Detection	Trial #	Detection
		YES / NO		YES / NO
Type3	1	YES	16	YES
	2	YES	17	NO
	3	YES	18	YES
	4	YES	19	YES
	5	YES	20	YES
	6	YES	21	YES
	7	YES	22	NO
	8	YES	23	YES
	9	YES	24	YES
	10	YES	25	YES
	11	YES	26	YES
	12	YES	27	YES
	13	YES	28	YES
	14	YES	29	YES
	15	YES	30	YES
Type4	1	YES	16	YES
	2	YES	17	YES
	3	YES	18	YES
	4	YES	19	YES
	5	YES	20	YES
	6	YES	21	YES
	7	YES	22	YES
	8	YES	23	YES
	9	YES	24	YES
	10	YES	25	YES
	11	YES	26	YES
	12	YES	27	YES
	13	NO	28	YES
	14	NO	29	YES
	15	YES	30	YES

Radar Type	Trial #	Detection	Trial #	Detection
		YES / NO		YES / NO
Type5	1	YES	16	NO
	2	YES	17	YES
	3	YES	18	NO
	4	YES	19	YES
	5	YES	20	YES
	6	YES	21	YES
	7	YES	22	YES
	8	YES	23	YES
	9	YES	24	YES
	10	YES	25	YES
	11	YES	26	YES
	12	YES	27	YES
	13	NO	28	YES
	14	NO	29	YES
	15	YES	30	YES
Type6	1	YES	16	YES
	2	YES	17	NO
	3	YES	18	YES
	4	YES	19	YES
	5	YES	20	YES
	6	YES	21	YES
	7	YES	22	YES
	8	YES	23	YES
	9	YES	24	YES
	10	YES	25	YES
	11	YES	26	YES
	12	YES	27	YES
	13	YES	28	YES
	14	YES	29	YES
	15	YES	30	YES

TX (IEEE 802.11ac(VHT80) Mode)

Table 1: Short Pulse Radar Test Waveforms.

Radar Type	Pulse Width (μsec)	PRI (μsec)	Number of Pulses	Pass times	Fail times	Percentage of Successful Detection (%)
1	1	Test A: 15 unique PRI values randomly selected from the list of 23 PRI values in Table 5a <hr/> Test B: 15 unique PRI values randomly selected within the range of 518-3066 μsec, with a minimum increment of 1 μsec, excluding PRI values selected in Test A	$\text{Roundup} \left\{ \left( \frac{1}{360} \right) \cdot \left( \frac{19 \cdot 10^6}{\text{PRI}_{\mu\text{sec}}} \right) \right\}$	28	2	93%
2	1-5	150-230	23-29	29	1	97%
3	6-10	200-500	16-18	29	1	97%
4	11-20	200-500	12-16	27	3	90%
Aggregate (Radar Types 1-4)				113	7	94%

Table 2: Long Pulse Radar Test Waveform

Radar Type	Pulse Width (μsec)	Chirp Width (MHz)	PRI (μsec)	Number of Pulses Per Burst	Number of Bursts	Pass times	Fail times	Percentage of Successful Detection (%)
5	50-100	5-20	1000-2000	1-3	8-20	26	4	87%

Table 3: Frequency Hopping Radar Test Waveform

Radar Type	Pulse Width (μsec)	PRI (μsec)	Pulses per Hop	Hopping Rate (kHz)	Hopping Sequence Length (msec)	Pass times	Fail times	Percentage of Successful Detection (%)
6	1	333	9	0.333	300	27	3	90%

Radar Type	Trial #	Detection	Trial #	Detection
		YES / NO		YES / NO
Type1	1	YES	16	YES
	2	YES	17	YES
	3	YES	18	YES
	4	YES	19	YES
	5	YES	20	YES
	6	YES	21	YES
	7	YES	22	YES
	8	YES	23	YES
	9	YES	24	YES
	10	NO	25	YES
	11	YES	26	YES
	12	YES	27	YES
	13	YES	28	YES
	14	NO	29	YES
	15	YES	30	YES
Type2	1	YES	16	YES
	2	YES	17	YES
	3	YES	18	YES
	4	YES	19	YES
	5	YES	20	YES
	6	YES	21	YES
	7	YES	22	YES
	8	YES	23	YES
	9	YES	24	YES
	10	NO	25	YES
	11	YES	26	YES
	12	YES	27	YES
	13	YES	28	YES
	14	YES	29	YES
	15	YES	30	YES

Radar Type	Trial #	Detection	Trial #	Detection
		YES / NO		YES / NO
Type3	1	YES	16	YES
	2	YES	17	YES
	3	YES	18	YES
	4	YES	19	YES
	5	YES	20	YES
	6	YES	21	YES
	7	YES	22	YES
	8	YES	23	YES
	9	YES	24	YES
	10	YES	25	YES
	11	YES	26	YES
	12	NO	27	YES
	13	YES	28	YES
	14	YES	29	YES
	15	YES	30	YES
Type4	1	YES	16	YES
	2	YES	17	YES
	3	YES	18	YES
	4	YES	19	NO
	5	NO	20	YES
	6	YES	21	YES
	7	YES	22	YES
	8	YES	23	YES
	9	YES	24	YES
	10	YES	25	YES
	11	YES	26	YES
	12	YES	27	NO
	13	YES	28	YES
	14	YES	29	YES
	15	YES	30	YES

Radar Type	Trial #	Detection	Trial #	Detection
		YES / NO		YES / NO
Type5	1	YES	16	YES
	2	NO	17	YES
	3	NO	18	YES
	4	YES	19	NO
	5	YES	20	YES
	6	YES	21	YES
	7	YES	22	YES
	8	YES	23	YES
	9	YES	24	YES
	10	YES	25	YES
	11	YES	26	YES
	12	YES	27	YES
	13	YES	28	YES
	14	YES	29	YES
	15	NO	30	YES
Type6	1	YES	16	YES
	2	YES	17	NO
	3	YES	18	YES
	4	YES	19	YES
	5	YES	20	YES
	6	NO	21	YES
	7	NO	22	YES
	8	YES	23	YES
	9	YES	24	YES
	10	YES	25	YES
	11	YES	26	YES
	12	YES	27	YES
	13	YES	28	YES
	14	YES	29	YES
	15	YES	30	YES



TX (IEEE 802.11ax(HE20) Mode)

Table 1: Short Pulse Radar Test Waveforms.

Radar Type	Pulse Width (μsec)	PRI (μsec)	Number of Pulses	Pass times	Fail times	Percentage of Successful Detection (%)
1	1	Test A: 15 unique PRI values randomly selected from the list of 23 PRI values in Table 5a <hr/> Test B: 15 unique PRI values randomly selected within the range of 518-3066 μsec, with a minimum increment of 1 μsec, excluding PRI values selected in Test A	$\text{Roundup} \left\{ \begin{array}{l} \left( \frac{1}{360} \right) \\ \left( \frac{19 \cdot 10^6}{\text{PRI}_{\mu\text{sec}}} \right) \end{array} \right\}$	29	1	97%
2	1-5	150-230	23-29	29	1	97%
3	6-10	200-500	16-18	29	1	97%
4	11-20	200-500	12-16	28	2	93%
Aggregate (Radar Types 1-4)				115	5	96%

Table 2: Long Pulse Radar Test Waveform

Radar Type	Pulse Width (μsec)	Chirp Width (MHz)	PRI (μsec)	Number of Pulses Per Burst	Number of Bursts	Pass times	Fail times	Percentage of Successful Detection (%)
5	50-100	5-20	1000-2000	1-3	8-20	26	4	87%

Table 3: Frequency Hopping Radar Test Waveform

Radar Type	Pulse Width (μsec)	PRI (μsec)	Pulses per Hop	Hopping Rate (kHz)	Hopping Sequence Length (msec)	Pass times	Fail times	Percentage of Successful Detection (%)
6	1	333	9	0.333	300	30	0	100%

Radar Type	Trial #	Detection	Trial #	Detection
		YES / NO		YES / NO
Type1	1	YES	16	YES
	2	YES	17	YES
	3	YES	18	YES
	4	YES	19	YES
	5	YES	20	YES
	6	YES	21	YES
	7	YES	22	YES
	8	YES	23	YES
	9	YES	24	YES
	10	YES	25	YES
	11	NO	26	YES
	12	YES	27	YES
	13	YES	28	YES
	14	YES	29	YES
	15	YES	30	YES
Type2	1	YES	16	YES
	2	YES	17	YES
	3	YES	18	YES
	4	YES	19	YES
	5	YES	20	YES
	6	YES	21	YES
	7	YES	22	NO
	8	YES	23	YES
	9	YES	24	YES
	10	YES	25	YES
	11	YES	26	YES
	12	YES	27	YES
	13	YES	28	YES
	14	YES	29	YES
	15	YES	30	YES

Radar Type	Trial #	Detection	Trial #	Detection
		YES / NO		YES / NO
Type3	1	YES	16	YES
	2	YES	17	YES
	3	YES	18	YES
	4	YES	19	YES
	5	YES	20	YES
	6	YES	21	YES
	7	YES	22	YES
	8	YES	23	YES
	9	YES	24	YES
	10	NO	25	YES
	11	YES	26	YES
	12	YES	27	YES
	13	YES	28	YES
	14	YES	29	YES
	15	YES	30	YES
Type4	1	YES	16	YES
	2	YES	17	YES
	3	YES	18	YES
	4	YES	19	YES
	5	YES	20	NO
	6	NO	21	YES
	7	YES	22	YES
	8	YES	23	YES
	9	YES	24	YES
	10	YES	25	YES
	11	YES	26	YES
	12	YES	27	YES
	13	YES	28	YES
	14	YES	29	YES
	15	YES	30	YES

Radar Type	Trial #	Detection	Trial #	Detection
		YES / NO		YES / NO
Type5	1	YES	16	YES
	2	YES	17	YES
	3	YES	18	YES
	4	YES	19	NO
	5	YES	20	NO
	6	YES	21	YES
	7	YES	22	YES
	8	YES	23	YES
	9	YES	24	YES
	10	YES	25	YES
	11	YES	26	YES
	12	YES	27	YES
	13	NO	28	YES
	14	YES	29	YES
	15	NO	30	YES
Type6	1	YES	16	YES
	2	YES	17	YES
	3	YES	18	YES
	4	YES	19	YES
	5	YES	20	YES
	6	YES	21	YES
	7	YES	22	YES
	8	YES	23	YES
	9	YES	24	YES
	10	YES	25	YES
	11	YES	26	YES
	12	YES	27	YES
	13	YES	28	YES
	14	YES	29	YES
	15	YES	30	YES

**Mesh**

TX (IEEE 802.11a Mode)

Table 1: Short Pulse Radar Test Waveforms.

Radar Type	Pulse Width (μsec)	PRI (μsec)	Number of Pulses	Pass times	Fail times	Percentage of Successful Detection (%)
1	1	Test A: 15 unique PRI values randomly selected from the list of 23 PRI values in Table 5a <hr/> Test B: 15 unique PRI values randomly selected within the range of 518-3066 μsec, with a minimum increment of 1 μsec, excluding PRI values selected in Test A	$\text{Roundup} \left\{ \begin{array}{l} \left( \frac{1}{360} \right) \\ \left( \frac{19 \cdot 10^6}{\text{PRI}_{\mu\text{sec}}} \right) \end{array} \right\}$	30	0	100%
2	1-5	150-230	23-29	29	1	97%
3	6-10	200-500	16-18	29	1	97%
4	11-20	200-500	12-16	28	2	93%
Aggregate (Radar Types 1-4)				116	4	97%

Table 2: Long Pulse Radar Test Waveform

Radar Type	Pulse Width (μsec)	Chirp Width (MHz)	PRI (μsec)	Number of Pulses Per Burst	Number of Bursts	Pass times	Fail times	Percentage of Successful Detection (%)
5	50-100	5-20	1000-2000	1-3	8-20	27	3	90%

Table 3: Frequency Hopping Radar Test Waveform

Radar Type	Pulse Width (μsec)	PRI (μsec)	Pulses per Hop	Hopping Rate (kHz)	Hopping Sequence Length (msec)	Pass times	Fail times	Percentage of Successful Detection (%)
6	1	333	9	0.333	300	29	1	97%

Radar Type	Trial #	Detection	Trial #	Detection
		YES / NO		YES / NO
Type1	1	YES	16	YES
	2	YES	17	YES
	3	YES	18	YES
	4	YES	19	YES
	5	YES	20	YES
	6	YES	21	YES
	7	YES	22	YES
	8	YES	23	YES
	9	YES	24	YES
	10	YES	25	YES
	11	YES	26	YES
	12	YES	27	YES
	13	YES	28	YES
	14	YES	29	YES
	15	YES	30	YES
Type2	1	YES	16	YES
	2	YES	17	YES
	3	YES	18	YES
	4	YES	19	YES
	5	YES	20	YES
	6	YES	21	YES
	7	YES	22	YES
	8	YES	23	NO
	9	YES	24	YES
	10	YES	25	YES
	11	YES	26	YES
	12	YES	27	YES
	13	YES	28	YES
	14	YES	29	YES
	15	YES	30	YES

Radar Type	Trial #	Detection	Trial #	Detection
		YES / NO		YES / NO
Type3	1	YES	16	YES
	2	YES	17	YES
	3	YES	18	YES
	4	YES	19	YES
	5	YES	20	YES
	6	YES	21	YES
	7	YES	22	YES
	8	YES	23	YES
	9	NO	24	YES
	10	YES	25	YES
	11	YES	26	YES
	12	YES	27	YES
	13	YES	28	YES
	14	YES	29	YES
	15	YES	30	YES
Type4	1	YES	16	YES
	2	YES	17	YES
	3	YES	18	YES
	4	YES	19	NO
	5	YES	20	YES
	6	YES	21	YES
	7	YES	22	YES
	8	NO	23	YES
	9	YES	24	YES
	10	YES	25	YES
	11	YES	26	YES
	12	YES	27	YES
	13	YES	28	YES
	14	YES	29	YES
	15	YES	30	YES

Radar Type	Trial #	Detection	Trial #	Detection
		YES / NO		YES / NO
Type5	1	YES	16	YES
	2	YES	17	YES
	3	YES	18	YES
	4	YES	19	YES
	5	YES	20	NO
	6	NO	21	YES
	7	YES	22	YES
	8	YES	23	YES
	9	YES	24	YES
	10	YES	25	YES
	11	YES	26	YES
	12	YES	27	YES
	13	NO	28	YES
	14	YES	29	YES
	15	YES	30	YES
Type6	1	YES	16	YES
	2	YES	17	YES
	3	YES	18	YES
	4	YES	19	YES
	5	YES	20	YES
	6	YES	21	YES
	7	YES	22	YES
	8	YES	23	NO
	9	YES	24	YES
	10	YES	25	YES
	11	YES	26	YES
	12	YES	27	YES
	13	YES	28	YES
	14	YES	29	YES
	15	YES	30	YES



TX (IEEE 802.11n(HT40) Mode)

Table 1: Short Pulse Radar Test Waveforms.

Radar Type	Pulse Width (μsec)	PRI (μsec)	Number of Pulses	Pass times	Fail times	Percentage of Successful Detection (%)
1	1	Test A: 15 unique PRI values randomly selected from the list of 23 PRI values in Table 5a Test B: 15 unique PRI values randomly selected within the range of 518-3066 μsec, with a minimum increment of 1 μsec, excluding PRI values selected in Test A	$\text{Roundup} \left\{ \begin{array}{l} \left( \frac{1}{360} \right) \\ \left( \frac{19 \cdot 10^6}{\text{PRI}_{\mu\text{sec}}} \right) \end{array} \right\}$	29	1	97%
2	1-5	150-230	23-29	30	0	100%
3	6-10	200-500	16-18	28	2	93%
4	11-20	200-500	12-16	29	1	97%
Aggregate (Radar Types 1-4)				116	4	97%

Table 2: Long Pulse Radar Test Waveform

Radar Type	Pulse Width (μsec)	Chirp Width (MHz)	PRI (μsec)	Number of Pulses Per Burst	Number of Bursts	Pass times	Fail times	Percentage of Successful Detection (%)
5	50-100	5-20	1000-2000	1-3	8-20	27	3	90%

Table 3: Frequency Hopping Radar Test Waveform

Radar Type	Pulse Width (μsec)	PRI (μsec)	Pulses per Hop	Hopping Rate (kHz)	Hopping Sequence Length (msec)	Pass times	Fail times	Percentage of Successful Detection (%)
6	1	333	9	0.333	300	28	2	93%

Radar Type	Trial #	Detection	Trial #	Detection
		YES / NO		YES / NO
Type1	1	YES	16	YES
	2	YES	17	YES
	3	YES	18	YES
	4	YES	19	YES
	5	YES	20	YES
	6	YES	21	YES
	7	YES	22	YES
	8	YES	23	YES
	9	YES	24	YES
	10	YES	25	YES
	11	YES	26	YES
	12	YES	27	YES
	13	NO	28	YES
	14	YES	29	YES
	15	YES	30	YES
Type2	1	YES	16	YES
	2	YES	17	YES
	3	YES	18	YES
	4	YES	19	YES
	5	YES	20	YES
	6	YES	21	YES
	7	YES	22	YES
	8	YES	23	YES
	9	YES	24	YES
	10	YES	25	YES
	11	YES	26	YES
	12	YES	27	YES
	13	YES	28	YES
	14	YES	29	YES
	15	YES	30	YES

Radar Type	Trial #	Detection	Trial #	Detection
		YES / NO		YES / NO
Type3	1	YES	16	YES
	2	YES	17	YES
	3	YES	18	YES
	4	YES	19	YES
	5	YES	20	YES
	6	YES	21	YES
	7	NO	22	YES
	8	YES	23	YES
	9	YES	24	YES
	10	YES	25	NO
	11	YES	26	YES
	12	YES	27	YES
	13	YES	28	YES
	14	YES	29	YES
	15	YES	30	YES
Type4	1	YES	16	YES
	2	YES	17	YES
	3	YES	18	YES
	4	YES	19	YES
	5	YES	20	YES
	6	YES	21	YES
	7	YES	22	YES
	8	YES	23	YES
	9	YES	24	YES
	10	YES	25	YES
	11	YES	26	YES
	12	YES	27	YES
	13	NO	28	YES
	14	YES	29	YES
	15	YES	30	YES

Radar Type	Trial #	Detection	Trial #	Detection
		YES / NO		YES / NO
Type5	1	YES	16	NO
	2	YES	17	YES
	3	YES	18	YES
	4	YES	19	YES
	5	YES	20	YES
	6	YES	21	YES
	7	YES	22	NO
	8	YES	23	YES
	9	YES	24	YES
	10	YES	25	YES
	11	YES	26	YES
	12	YES	27	YES
	13	NO	28	YES
	14	YES	29	YES
	15	YES	30	YES
Type6	1	YES	16	YES
	2	YES	17	NO
	3	YES	18	YES
	4	YES	19	YES
	5	YES	20	YES
	6	YES	21	YES
	7	YES	22	YES
	8	YES	23	YES
	9	YES	24	YES
	10	YES	25	YES
	11	YES	26	YES
	12	YES	27	NO
	13	YES	28	YES
	14	YES	29	YES
	15	YES	30	YES

TX (IEEE 802.11ac(VHT80) Mode)

Table 1: Short Pulse Radar Test Waveforms.

Radar Type	Pulse Width (μsec)	PRI (μsec)	Number of Pulses	Pass times	Fail times	Percentage of Successful Detection (%)
1	1	Test A: 15 unique PRI values randomly selected from the list of 23 PRI values in Table 5a Test B: 15 unique PRI values randomly selected within the range of 518-3066 μsec, with a minimum increment of 1 μsec, excluding PRI values selected in Test A	$\text{Roundup} \left\{ \left( \frac{1}{360} \right) \cdot \left( \frac{19 \cdot 10^6}{\text{PRI}_{\mu\text{sec}}} \right) \right\}$	29	1	97%
2	1-5	150-230	23-29	29	1	97%
3	6-10	200-500	16-18	29	1	97%
4	11-20	200-500	12-16	27	3	90%
Aggregate (Radar Types 1-4)				114	6	95%

Table 2: Long Pulse Radar Test Waveform

Radar Type	Pulse Width (μsec)	Chirp Width (MHz)	PRI (μsec)	Number of Pulses Per Burst	Number of Bursts	Pass times	Fail times	Percentage of Successful Detection (%)
5	50-100	5-20	1000-2000	1-3	8-20	26	4	87%

Table 3: Frequency Hopping Radar Test Waveform

Radar Type	Pulse Width (μsec)	PRI (μsec)	Pulses per Hop	Hopping Rate (kHz)	Hopping Sequence Length (msec)	Pass times	Fail times	Percentage of Successful Detection (%)
6	1	333	9	0.333	300	29	1	97%

Radar Type	Trial #	Detection	Trial #	Detection
		YES / NO		YES / NO
Type1	1	YES	16	YES
	2	YES	17	YES
	3	YES	18	YES
	4	YES	19	YES
	5	YES	20	YES
	6	YES	21	YES
	7	YES	22	YES
	8	YES	23	YES
	9	YES	24	NO
	10	YES	25	YES
	11	YES	26	YES
	12	YES	27	YES
	13	YES	28	YES
	14	YES	29	YES
	15	YES	30	YES
Type2	1	YES	16	YES
	2	YES	17	YES
	3	YES	18	YES
	4	YES	19	YES
	5	YES	20	YES
	6	YES	21	YES
	7	YES	22	YES
	8	YES	23	YES
	9	YES	24	YES
	10	NO	25	YES
	11	YES	26	YES
	12	YES	27	YES
	13	YES	28	YES
	14	YES	29	YES
	15	YES	30	YES

Radar Type	Trial #	Detection	Trial #	Detection
		YES / NO		YES / NO
Type3	1	YES	16	YES
	2	YES	17	YES
	3	YES	18	YES
	4	YES	19	YES
	5	YES	20	YES
	6	YES	21	YES
	7	YES	22	NO
	8	YES	23	YES
	9	YES	24	YES
	10	YES	25	YES
	11	YES	26	YES
	12	YES	27	YES
	13	YES	28	YES
	14	YES	29	YES
	15	YES	30	YES
Type4	1	YES	16	YES
	2	YES	17	YES
	3	YES	18	YES
	4	YES	19	NO
	5	NO	20	YES
	6	YES	21	YES
	7	YES	22	YES
	8	YES	23	YES
	9	YES	24	YES
	10	YES	25	YES
	11	YES	26	YES
	12	YES	27	NO
	13	YES	28	YES
	14	YES	29	YES
	15	YES	30	YES

Radar Type	Trial #	Detection	Trial #	Detection
		YES / NO		YES / NO
Type5	1	YES	16	NO
	2	YES	17	YES
	3	YES	18	YES
	4	YES	19	NO
	5	YES	20	YES
	6	YES	21	YES
	7	YES	22	YES
	8	YES	23	YES
	9	YES	24	YES
	10	YES	25	YES
	11	YES	26	YES
	12	YES	27	YES
	13	NO	28	YES
	14	YES	29	YES
	15	NO	30	YES
Type6	1	YES	16	YES
	2	YES	17	NO
	3	YES	18	YES
	4	YES	19	YES
	5	YES	20	YES
	6	YES	21	YES
	7	YES	22	YES
	8	YES	23	YES
	9	YES	24	YES
	10	YES	25	YES
	11	YES	26	YES
	12	YES	27	YES
	13	YES	28	YES
	14	YES	29	YES
	15	YES	30	YES



TX (IEEE 802.11ax(HE20) Mode)

Table 1: Short Pulse Radar Test Waveforms.

Radar Type	Pulse Width (μsec)	PRI (μsec)	Number of Pulses	Pass times	Fail times	Percentage of Successful Detection (%)
1	1	Test A: 15 unique PRI values randomly selected from the list of 23 PRI values in Table 5a <hr/> Test B: 15 unique PRI values randomly selected within the range of 518-3066 μsec, with a minimum increment of 1 μsec, excluding PRI values selected in Test A	$\text{Roundup} \left\{ \begin{array}{l} \left( \frac{1}{360} \right) \\ \left( \frac{19 \cdot 10^6}{\text{PRI}_{\mu\text{sec}}} \right) \end{array} \right\}$	28	2	93%
2	1-5	150-230	23-29	28	2	93%
3	6-10	200-500	16-18	27	3	90%
4	11-20	200-500	12-16	28	2	93%
Aggregate (Radar Types 1-4)				111	9	93%

Table 2: Long Pulse Radar Test Waveform

Radar Type	Pulse Width (μsec)	Chirp Width (MHz)	PRI (μsec)	Number of Pulses Per Burst	Number of Bursts	Pass times	Fail times	Percentage of Successful Detection (%)
5	50-100	5-20	1000-2000	1-3	8-20	26	4	87%

Table 3: Frequency Hopping Radar Test Waveform

Radar Type	Pulse Width (μsec)	PRI (μsec)	Pulses per Hop	Hopping Rate (kHz)	Hopping Sequence Length (msec)	Pass times	Fail times	Percentage of Successful Detection (%)
6	1	333	9	0.333	300	28	2	93%

Radar Type	Trial #	Detection	Trial #	Detection
		YES / NO		YES / NO
Type1	1	YES	16	YES
	2	YES	17	YES
	3	YES	18	NO
	4	YES	19	YES
	5	YES	20	YES
	6	NO	21	YES
	7	YES	22	YES
	8	YES	23	YES
	9	YES	24	YES
	10	YES	25	YES
	11	YES	26	YES
	12	YES	27	YES
	13	YES	28	YES
	14	YES	29	YES
	15	YES	30	YES
Type2	1	YES	16	YES
	2	YES	17	YES
	3	YES	18	YES
	4	YES	19	YES
	5	YES	20	YES
	6	YES	21	NO
	7	YES	22	YES
	8	NO	23	YES
	9	YES	24	YES
	10	YES	25	YES
	11	YES	26	YES
	12	YES	27	YES
	13	YES	28	YES
	14	YES	29	YES
	15	YES	30	YES

Radar Type	Trial #	Detection	Trial #	Detection
		YES / NO		YES / NO
Type3	1	YES	16	YES
	2	YES	17	YES
	3	YES	18	YES
	4	YES	19	YES
	5	YES	20	YES
	6	NO	21	YES
	7	YES	22	NO
	8	YES	23	YES
	9	YES	24	YES
	10	YES	25	YES
	11	YES	26	YES
	12	YES	27	YES
	13	NO	28	YES
	14	YES	29	YES
	15	YES	30	YES
Type4	1	YES	16	YES
	2	YES	17	YES
	3	NO	18	YES
	4	YES	19	YES
	5	YES	20	YES
	6	YES	21	YES
	7	YES	22	YES
	8	YES	23	YES
	9	YES	24	YES
	10	YES	25	YES
	11	YES	26	NO
	12	YES	27	YES
	13	YES	28	YES
	14	YES	29	YES
	15	YES	30	YES

Radar Type	Trial #	Detection	Trial #	Detection
		YES / NO		YES / NO
Type5	1	YES	16	YES
	2	YES	17	YES
	3	YES	18	YES
	4	NO	19	YES
	5	YES	20	YES
	6	YES	21	YES
	7	YES	22	NO
	8	YES	23	YES
	9	YES	24	YES
	10	YES	25	YES
	11	NO	26	NO
	12	YES	27	YES
	13	YES	28	YES
	14	YES	29	YES
	15	YES	30	YES
Type6	1	YES	16	YES
	2	YES	17	YES
	3	YES	18	YES
	4	YES	19	YES
	5	YES	20	YES
	6	NO	21	YES
	7	YES	22	YES
	8	YES	23	YES
	9	YES	24	NO
	10	YES	25	YES
	11	YES	26	YES
	12	YES	27	YES
	13	YES	28	YES
	14	YES	29	YES
	15	YES	30	YES

## 8.7 NON-OCCUPANCY PERIOD

During the 30 minutes observation time, UUT did not make any transmissions on a channel after a radar signal was detected on that channel by either the Channel Availability Check or the In-Service Monitoring.

**TX (IEEE 802.11a Mode)  
5540MHz\_Non-Occupancy Period**

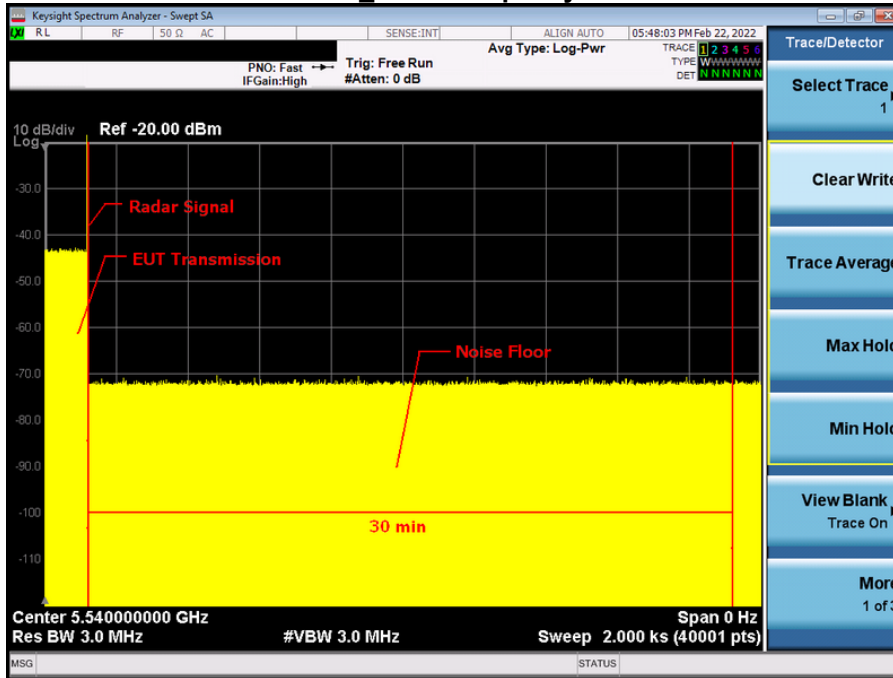

**TX (IEEE 802.11n(HT40) Mode)  
5550MHz\_Non-Occupancy Period**

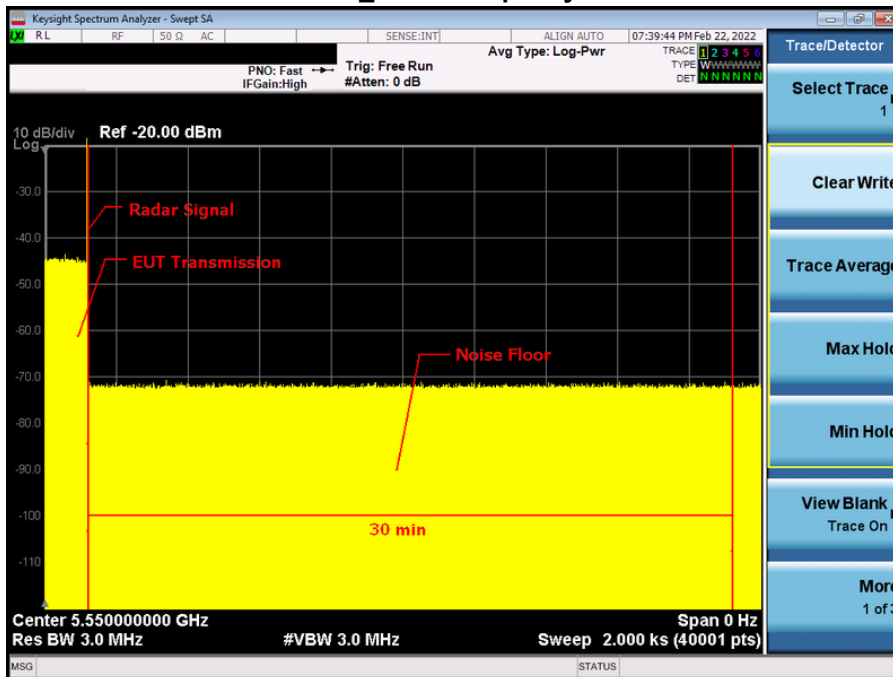

### TX (IEEE 802.11ac(VHT80) Mode) 5530MHz\_Non-Occupancy Period

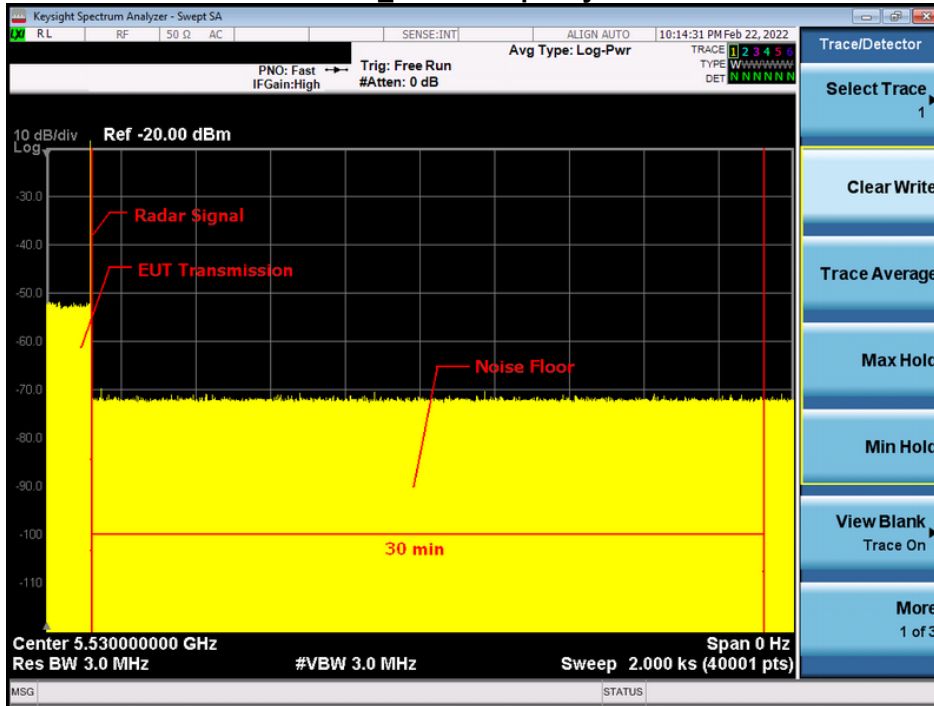

### TX (IEEE 802.11ax(HE20) Mode) 5540MHz\_Non-Occupancy Period

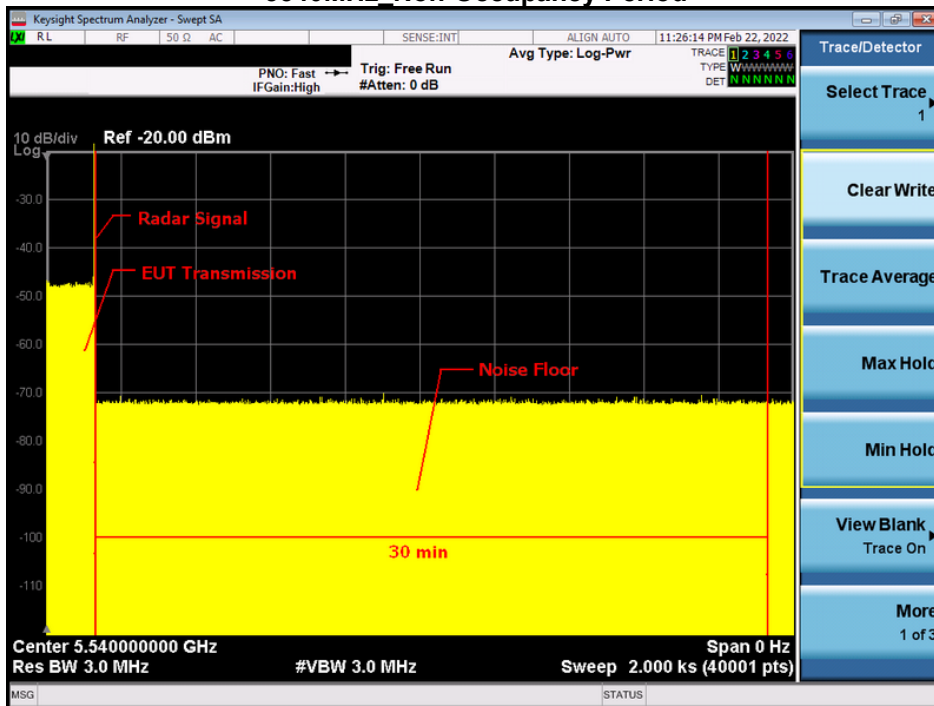

## 8.8 U-NII DETECTION BANDWIDTH

### TX (IEEE 802.11a Mode) U-NII 99% Channel bandwidth

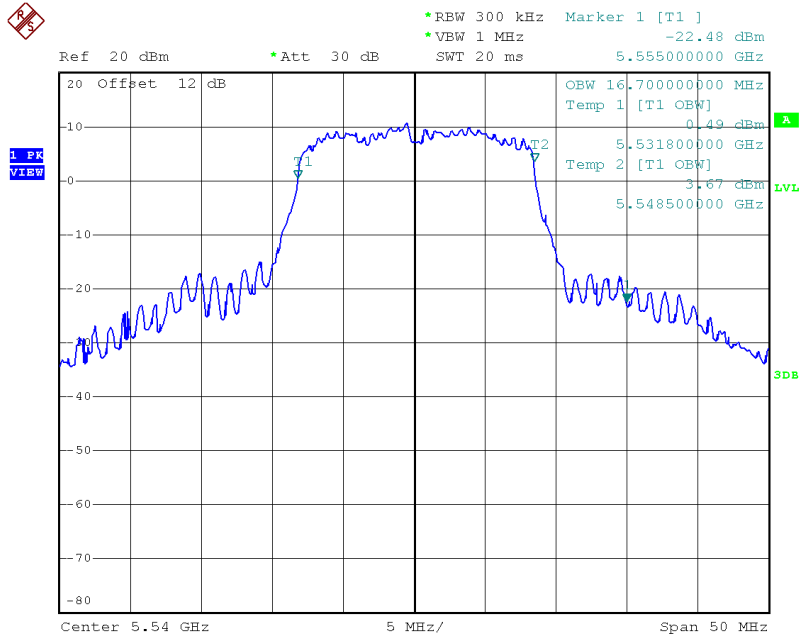

Date: 8.MAR.2022 16:38:31

## TX (IEEE 802.11n(HT40) Mode) U-NII 99% Channel bandwidth

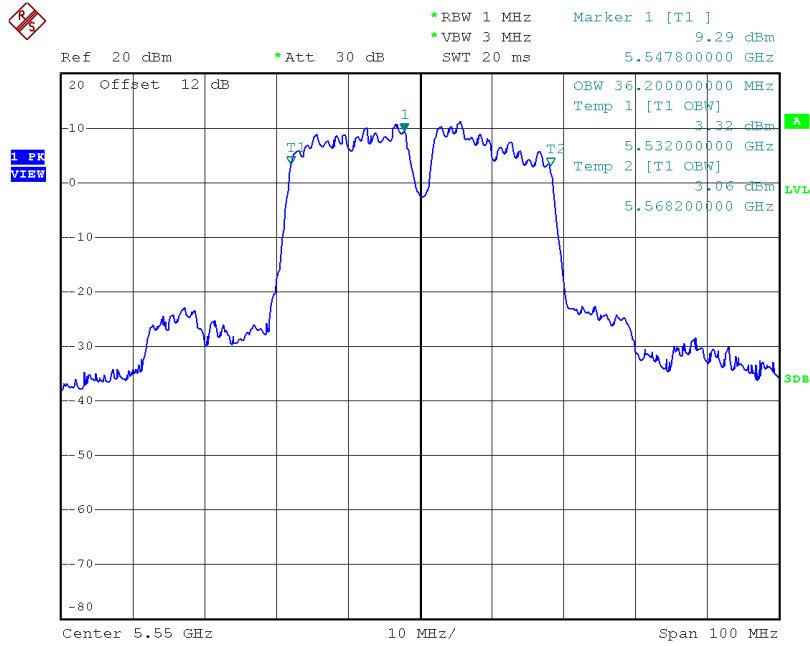

Date: 8.MAR.2022 16:43:22

## TX (IEEE 802.11ac(VHT80) Mode) U-NII 99% Channel bandwidth

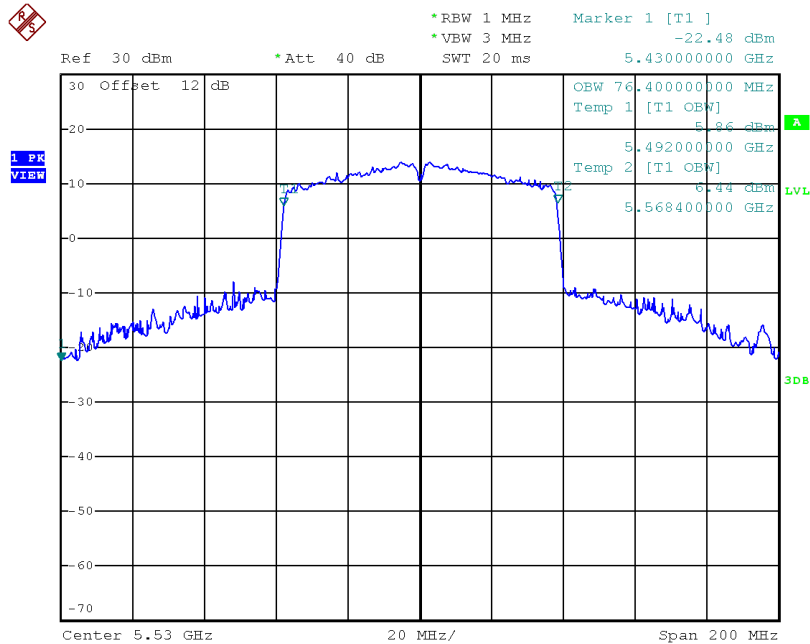

Date: 15.FEB.2022 14:20:08



## TX (IEEE 802.11ax(HE20) Mode) U-NII 99% Channel bandwidth

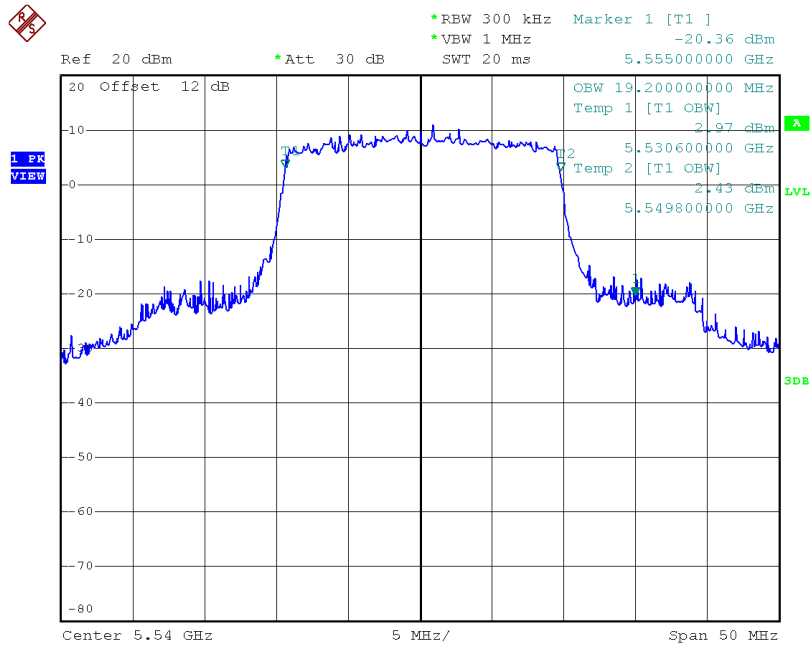

Date: 8.MAR.2022 16:39:37

IEEE 802.11a Mode

Detection Bandwidth test transmission 20M											
EUT FREQUENCY		5540M									
EUT power bandwidth		16.7MHz									
Detection Bandwidth limit(100%of EUT 99% Power bandwidth)		18									
Detection Bandwidth(5549(FH)-5531(FL))		18									
Test Result		PASS									
		DFS Detection Trials (1=Detection, 0= No Detection)									
Radar Freq (MHz)	1	2	3	4	5	6	7	8	9	10	Detection Rate (%)
5529	0	0	0	0	0	0	0	0	0	0	0
5530	0	0	0	0	0	0	0	0	0	0	0
5531(FL)	1	1	1	1	1	1	1	1	1	1	100
5532	1	1	1	1	1	1	1	1	1	1	100
5533	1	1	1	1	1	1	1	1	1	1	100
5534	1	1	1	1	1	1	1	1	1	1	100
5535	1	1	1	1	1	1	1	1	1	1	100
5536	1	1	1	1	1	1	1	1	1	1	100
5537	1	1	1	1	1	1	1	1	1	1	100
5538	1	1	1	1	1	1	1	1	1	1	100
5539	1	1	1	1	1	1	1	1	1	1	100
5540	1	1	1	1	1	1	1	1	1	1	100
5541	1	1	1	1	1	1	1	1	1	1	100
5542	1	1	1	1	1	1	1	1	1	1	100
5543	1	1	1	1	1	1	1	1	1	1	100
5544	1	1	1	1	1	1	1	1	1	1	100
5545	1	1	1	1	1	1	1	1	1	1	100
5546	1	1	1	1	1	1	1	1	1	1	100
5547	1	1	1	1	1	1	1	1	1	1	100
5548	1	1	1	1	1	1	1	1	1	1	100
5549(FH)	1	1	1	1	1	1	1	1	1	1	100
5550	0	0	0	0	0	0	0	0	0	0	0
5551	0	0	0	0	0	0	0	0	0	0	0

## IEEE 802.11n(HT40) Mode

Detection Bandwith test transmission 40M											
EUT FREQUENCY	5550M										
EUT power bandwith	36.2MHZ										
Detection Bandwith limit(100%of EUT 99% Power bandwith)											38
Detection Bandwith(5569(FH)-5531(FL))	38										
Test Result	PASS										
Radar Freq (MHz)	DFS Detection Trials (1=Detection, 0= No Detection)										Detection Rate (%)
	1	2	3	4	5	6	7	8	9	10	
5529	0	0	0	0	0	0	0	0	0	0	0
5530	0	0	0	0	0	0	0	0	0	0	0
5531(FL)	1	1	1	1	1	1	1	1	1	1	100
5532	1	1	1	1	1	1	1	1	1	1	100
5533	1	1	1	1	1	1	1	1	1	1	100
5534	1	1	1	1	1	1	1	1	1	1	100
5535	1	1	1	1	1	1	1	1	1	1	100
5536	1	1	1	1	1	1	1	1	1	1	100
5537	1	1	1	1	1	1	1	1	1	1	100
5538	1	1	1	1	1	1	1	1	1	1	100
5539	1	1	1	1	1	1	1	1	1	1	100
5540	1	1	1	1	1	1	1	1	1	1	100
5541	1	1	1	1	1	1	1	1	1	1	100
5542	1	1	1	1	1	1	1	1	1	1	100
5543	1	1	1	1	1	1	1	1	1	1	100
5544	1	1	1	1	1	1	1	1	1	1	100
5545	1	1	1	1	1	1	1	1	1	1	100
5546	1	1	1	1	1	1	1	1	1	1	100
5547	1	1	1	1	1	1	1	1	1	1	100
5548	1	1	1	1	1	1	1	1	1	1	100
5549	1	1	1	1	1	1	1	1	1	1	100
5550	1	1	1	1	1	1	1	1	1	1	100
5551	1	1	1	1	1	1	1	1	1	1	100
5552	1	1	1	1	1	1	1	1	1	1	100
5553	1	1	1	1	1	1	1	1	1	1	100
5554	1	1	1	1	1	1	1	1	1	1	100
5555	1	1	1	1	1	1	1	1	1	1	100
5556	1	1	1	1	1	1	1	1	1	1	100
5557	1	1	1	1	1	1	1	1	1	1	100
5558	1	1	1	1	1	1	1	1	1	1	100
5559	1	1	1	1	1	1	1	1	1	1	100
5560	1	1	1	1	1	1	1	1	1	1	100
5561	1	1	1	1	1	1	1	1	1	1	100
5562	1	1	1	1	1	1	1	1	1	1	100
5563	1	1	1	1	1	1	1	1	1	1	100
5564	1	1	1	1	1	1	1	1	1	1	100
5565	1	1	1	1	1	1	1	1	1	1	100
5566	1	1	1	1	1	1	1	1	1	1	100
5567	1	1	1	1	1	1	1	1	1	1	100
5568	1	1	1	1	1	1	1	1	1	1	100
5569(FH)	1	1	1	1	1	1	1	1	1	1	100
5570	0	0	0	0	0	0	0	0	0	0	0
5571	0	0	0	0	0	0	0	0	0	0	0

IEEE 802.11ac(VHT80) Mode

Detection Bandwidth test transmission		80M										
EUT FREQUENCY		5530M										
EUT power bandwidth		76.4										
Detection Bandwidth limit(100%of EUT 99% Power bandwidth)		78										
Detection Bandwidth(5569(FH)-5491(FL))		78										
Test Result		PASS										
Radar Freq (MHz)	DFS Detection Trials (1=Detection, 0= No Detection)										Detection Rate (%)	
	1	2	3	4	5	6	7	8	9	10		
5489	0	0	0	0	0	0	0	0	0	0	0	0
5490	0	0	0	0	0	0	0	0	0	0	0	0
5491(FL)	1	1	1	1	1	1	1	1	1	1	1	100
5492	1	1	1	1	1	1	1	1	1	1	1	100
5493	1	1	1	1	1	1	1	1	1	1	1	100
5494	1	1	1	1	1	1	1	1	1	1	1	100
5495	1	1	1	1	1	1	1	1	1	1	1	100
5496	1	1	1	1	1	1	1	1	1	1	1	100
5497	1	1	1	1	1	1	1	1	1	1	1	100
5498	1	1	1	1	1	1	1	1	1	1	1	100
5499	1	1	1	1	1	1	1	1	1	1	1	100
5500	1	1	1	1	1	1	1	1	1	1	1	100
5501	1	1	1	1	1	1	1	1	1	1	1	100
5502	1	1	1	1	1	1	1	1	1	1	1	100
5503	1	1	1	1	1	1	1	1	1	1	1	100
5504	1	1	1	1	1	1	1	1	1	1	1	100
5505	1	1	1	1	1	1	1	1	1	1	1	100
5506	1	1	1	1	1	1	1	1	1	1	1	100
5507	1	1	1	1	1	1	1	1	1	1	1	100
5508	1	1	1	1	1	1	1	1	1	1	1	100
5509	1	1	1	1	1	1	1	1	1	1	1	100
5510	1	1	1	1	1	1	1	1	1	1	1	100
5511	1	1	1	1	1	1	1	1	1	1	1	100
5512	1	1	1	1	1	1	1	1	1	1	1	100
5513	1	1	1	1	1	1	1	1	1	1	1	100
5514	1	1	1	1	1	1	1	1	1	1	1	100
5515	1	1	1	1	1	1	1	1	1	1	1	100
5516	1	1	1	1	1	1	1	1	1	1	1	100
5517	1	1	1	1	1	1	1	1	1	1	1	100
5518	1	1	1	1	1	1	1	1	1	1	1	100
5519	1	1	1	1	1	1	1	1	1	1	1	100
5520	1	1	1	1	1	1	1	1	1	1	1	100
5521	1	1	1	1	1	1	1	1	1	1	1	100
5522	1	1	1	1	1	1	1	1	1	1	1	100
5523	1	1	1	1	1	1	1	1	1	1	1	100
5524	1	1	1	1	1	1	1	1	1	1	1	100
5525	1	1	1	1	1	1	1	1	1	1	1	100
5526	1	1	1	1	1	1	1	1	1	1	1	100
5527	1	1	1	1	1	1	1	1	1	1	1	100
5528	1	1	1	1	1	1	1	1	1	1	1	100
5529	1	1	1	1	1	1	1	1	1	1	1	100
5530	1	1	1	1	1	1	1	1	1	1	1	100
5531	1	1	1	1	1	1	1	1	1	1	1	100
5532	1	1	1	1	1	1	1	1	1	1	1	100
5533	1	1	1	1	1	1	1	1	1	1	1	100
5534	1	1	1	1	1	1	1	1	1	1	1	100
5535	1	1	1	1	1	1	1	1	1	1	1	100
5536	1	1	1	1	1	1	1	1	1	1	1	100
5537	1	1	1	1	1	1	1	1	1	1	1	100
5538	1	1	1	1	1	1	1	1	1	1	1	100
5539	1	1	1	1	1	1	1	1	1	1	1	100
5540	1	1	1	1	1	1	1	1	1	1	1	100
5541	1	1	1	1	1	1	1	1	1	1	1	100
5542	1	1	1	1	1	1	1	1	1	1	1	100
5543	1	1	1	1	1	1	1	1	1	1	1	100
5544	1	1	1	1	1	1	1	1	1	1	1	100
5545	1	1	1	1	1	1	1	1	1	1	1	100
5546	1	1	1	1	1	1	1	1	1	1	1	100
5547	1	1	1	1	1	1	1	1	1	1	1	100
5548	1	1	1	1	1	1	1	1	1	1	1	100
5549	1	1	1	1	1	1	1	1	1	1	1	100
5550	1	1	1	1	1	1	1	1	1	1	1	100
5551	1	1	1	1	1	1	1	1	1	1	1	100
5552	1	1	1	1	1	1	1	1	1	1	1	100
5553	1	1	1	1	1	1	1	1	1	1	1	100
5554	1	1	1	1	1	1	1	1	1	1	1	100
5555	1	1	1	1	1	1	1	1	1	1	1	100
5556	1	1	1	1	1	1	1	1	1	1	1	100
5557	1	1	1	1	1	1	1	1	1	1	1	100
5558	1	1	1	1	1	1	1	1	1	1	1	100
5559	1	1	1	1	1	1	1	1	1	1	1	100
5560	1	1	1	1	1	1	1	1	1	1	1	100
5561	1	1	1	1	1	1	1	1	1	1	1	100
5562	1	1	1	1	1	1	1	1	1	1	1	100
5563	1	1	1	1	1	1	1	1	1	1	1	100
5564	1	1	1	1	1	1	1	1	1	1	1	100
5565	1	1	1	1	1	1	1	1	1	1	1	100
5566	1	1	1	1	1	1	1	1	1	1	1	100
5567	1	1	1	1	1	1	1	1	1	1	1	100
5568	1	1	1	1	1	1	1	1	1	1	1	100
5569(FH)	1	1	1	1	1	1	1	1	1	1	1	100
5570	0	0	0	0	0	0	0	0	0	0	0	0
5571	0	0	0	0	0	0	0	0	0	0	0	0

IEEE 802.11ax(HE20) Mode

Detection Bandwidth test transmission 20M											
EUT FREQUENCY	5540M										
EUT power bandwidth	19.2MHz										
Detection Bandwidth limit(100%of EUT 99% Power bandwidth)	20										
Detection Bandwidth(5550(FH)-5530(FL))	20										
Test Result	PASS										
Radar Freq (MHz)	DFS Detection Trials (1=Detection, 0= No Detection)										Detection Rate (%)
	1	2	3	4	5	6	7	8	9	10	
5529	0	0	0	0	0	0	0	0	0	0	0
5530(FL)	1	1	1	1	1	1	1	1	1	1	1
5531	1	1	1	1	1	1	1	1	1	1	1
5532	1	1	1	1	1	1	1	1	1	1	1
5533	1	1	1	1	1	1	1	1	1	1	1
5534	1	1	1	1	1	1	1	1	1	1	1
5535	1	1	1	1	1	1	1	1	1	1	1
5536	1	1	1	1	1	1	1	1	1	1	1
5537	1	1	1	1	1	1	1	1	1	1	1
5538	1	1	1	1	1	1	1	1	1	1	1
5539	1	1	1	1	1	1	1	1	1	1	1
5540	1	1	1	1	1	1	1	1	1	1	1
5541	1	1	1	1	1	1	1	1	1	1	1
5542	1	1	1	1	1	1	1	1	1	1	1
5543	1	1	1	1	1	1	1	1	1	1	1
5544	1	1	1	1	1	1	1	1	1	1	1
5545	1	1	1	1	1	1	1	1	1	1	1
5546	1	1	1	1	1	1	1	1	1	1	1
5547	1	1	1	1	1	1	1	1	1	1	1
5548	1	1	1	1	1	1	1	1	1	1	1
5549	1	1	1	1	1	1	1	1	1	1	1
5550(FH)	1	1	1	1	1	1	1	1	1	1	1
5551	0	0	0	0	0	0	0	0	0	0	0

## 9. EUT TEST PHOTO

Master

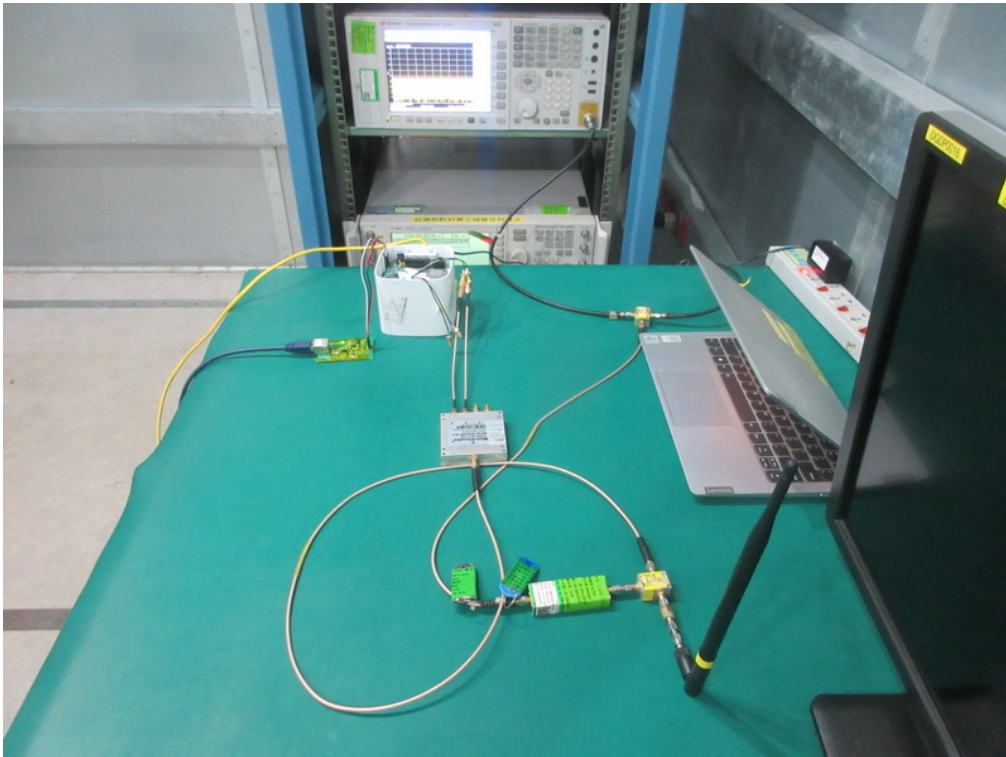
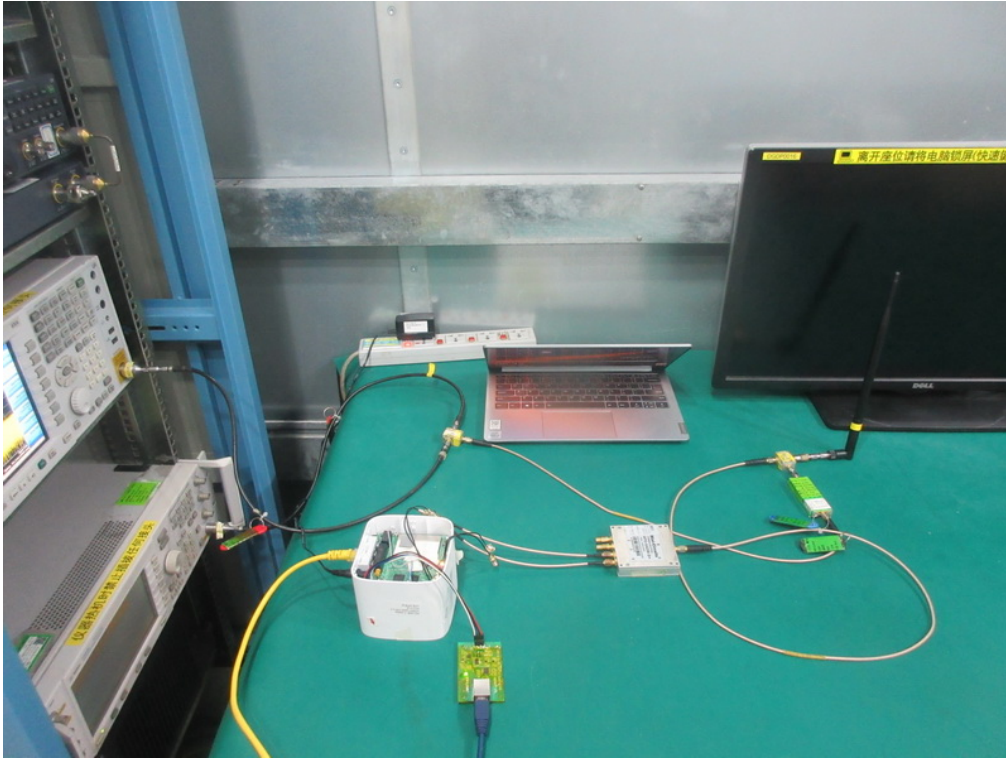

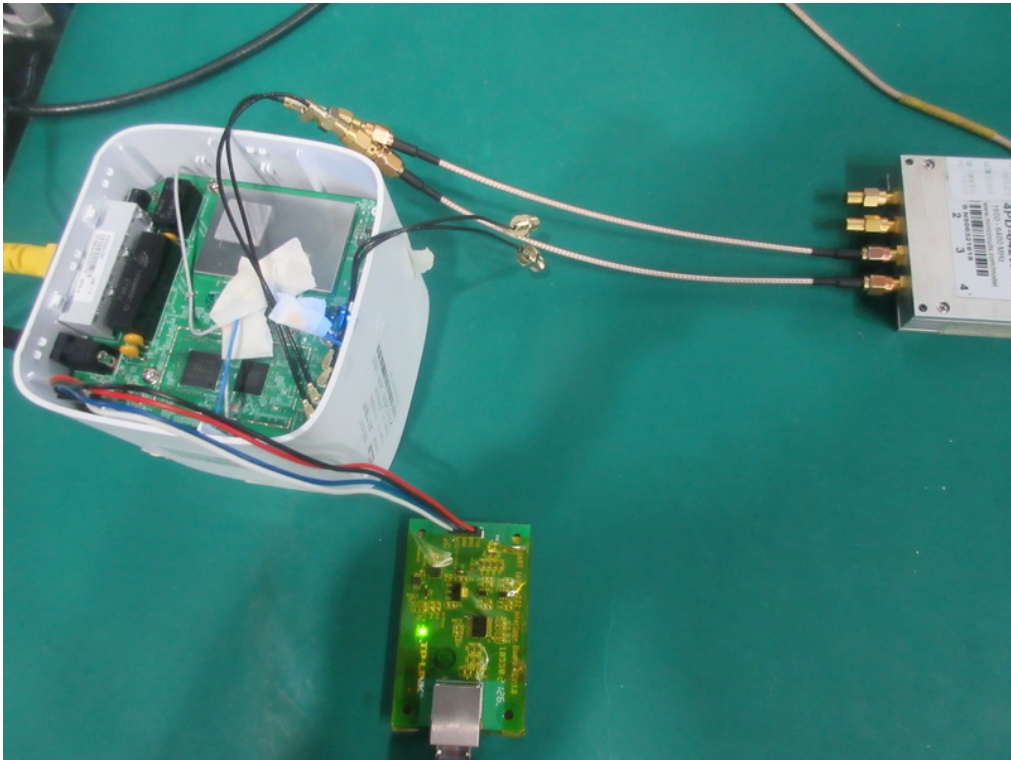

### Mesh

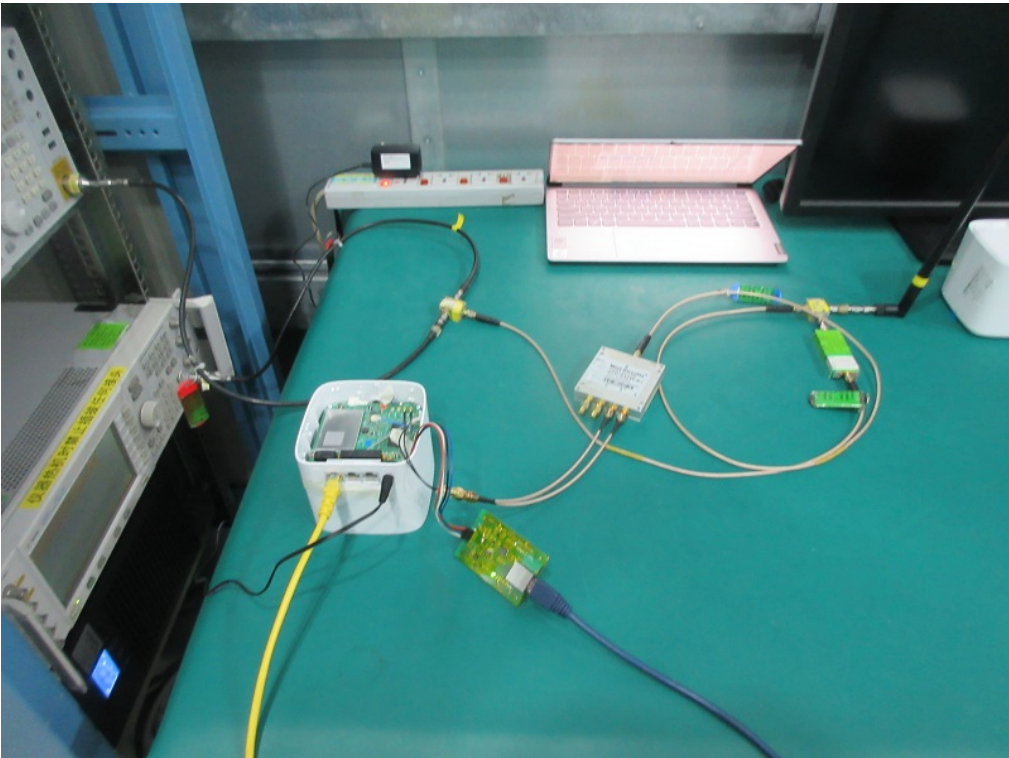



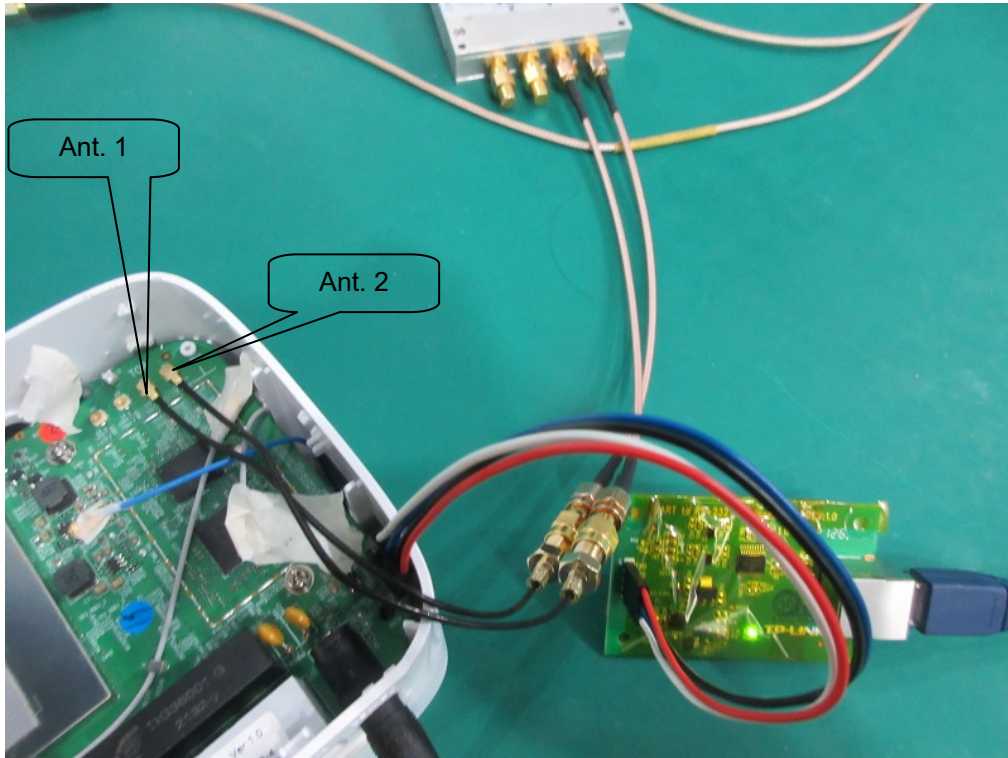

**End of Test Report**