

FCC Radio Test Report

FCC ID: 2AXJ4HS300V2

This report concerns: **Original Grant**

Project No. : 2010C149
Equipment : Kasa Smart Wi-Fi Power Strip, 6-Outlet
Brand Name : tp-link
Test Model : HS300
Series Model : N/A
Applicant : TP-Link Corporation Limited
Address : Room 901, 9/F. , New East Ocean Centre, 9 Science Museum Road,
Tsim Sha Tsui, Kowloon, Hong Kong
Manufacturer : TP-Link Corporation Limited
Address : Room 901, 9/F. , New East Ocean Centre, 9 Science Museum Road,
Tsim Sha Tsui, Kowloon, Hong Kong
Date of Receipt : Oct. 30, 2020
Date of Test : Oct. 30, 2020 ~ Nov. 12, 2020
Issued Date : Nov. 30, 2020
Report Version : R01
Test Sample : Engineering Sample No.: DG2020103040 for conducted,
DG2020103039 for radiated
Standard(s) : FCC Part15, Subpart C (15.247)
ANSI C63.10-2013
FCC KDB 558074 D01 15.247 Meas Guidance v05r02

The above equipment has been tested and found compliance with the requirement of the relative standards by BTL Inc.

Simon Ling

Prepared by : Simon Ling

Ethan Ma

Approved by : Ethan Ma



Certificate #5123.02

Add: No.3, Jinshagang 1st Road, Shixia, Dalang Town, Dongguan, Guangdong, China.

Tel: +86-769-8318-3000

Web: www.newbtl.com

Declaration

BTL represents to the client that testing is done in accordance with standard procedures as applicable and that test instruments used has been calibrated with standards traceable to international standard(s) and/or national standard(s).

BTL's reports apply only to the specific samples tested under conditions. It is manufacture's responsibility to ensure that additional production units of this model are manufactured with the identical electrical and mechanical components. **BTL** shall have no liability for any declarations, inferences or generalizations drawn by the client or others from **BTL** issued reports.

The report must not be used by the client to claim product certification, approval, or endorsement by NVLAP, NIST, A2LA, or any agency of the U.S. Government.

This report is the confidential property of the client. As a mutual protection to the clients, the public and ourselves, the test report shall not be reproduced, except in full, without our written approval.

BTL's laboratory quality assurance procedures are in compliance with the **ISO/IEC 17025** requirements, and accredited by the conformity assessment authorities listed in this test report.

BTL is not responsible for the sampling stage, so the results only apply to the sample as received.

The information, data and test plan are provided by manufacturer which may affect the validity of results, so it is manufacturer's responsibility to ensure that the apparatus meets the essential requirements of applied standards and in all the possible configurations as representative of its intended use.

Limitation

For the use of the authority's logo is limited unless the Test Standard(s)/Scope(s)/Item(s) mentioned in this test report is (are) included in the conformity assessment authorities acceptance respective.

Please note that the measurement uncertainty is provided for informational purpose only and are not use in determining the Pass/Fail results.

Table of Contents	Page
REPORT ISSUED HISTORY	6
1 . SUMMARY OF TEST RESULTS	7
1.1 TEST FACILITY	8
1.2 MEASUREMENT UNCERTAINTY	8
1.3 TEST ENVIRONMENT CONDITIONS	9
2 . GENERAL INFORMATION	10
2.1 GENERAL DESCRIPTION OF EUT	10
2.2 DESCRIPTION OF TEST MODES	11
2.3 PARAMETERS OF TEST SOFTWARE	12
2.4 DUTY CYCLE	13
2.5 BLOCK DIAGRAM SHOWING THE CONFIGURATION OF SYSTEM TESTED	14
2.6 SUPPORT UNITS	14
3 . AC POWER LINE CONDUCTED EMISSIONS TEST	15
3.1 LIMIT	15
3.2 TEST PROCEDURE	15
3.3 DEVIATION FROM TEST STANDARD	15
3.4 TEST SETUP	16
3.5 EUT OPERATION CONDITIONS	16
3.6 TEST RESULTS	16
4 . RADIATED EMISSIONS TEST	17
4.1 LIMIT	17
4.2 TEST PROCEDURE	18
4.3 DEVIATION FROM TEST STANDARD	18
4.4 TEST SETUP	19
4.5 EUT OPERATION CONDITIONS	20
4.6 TEST RESULTS - 9 KHZ TO 30 MHZ	20
4.7 TEST RESULTS - 30 MHZ TO 1000 MHZ	20
4.8 TEST RESULTS - ABOVE 1000 MHZ	20
5 . BANDWIDTH TEST	21
5.1 LIMIT	21
5.2 TEST PROCEDURE	21
5.3 DEVIATION FROM STANDARD	21
5.4 TEST SETUP	21

Table of Contents	Page
5.5 EUT OPERATION CONDITIONS	21
5.6 TEST RESULTS	21
6 . MAXIMUM AVERAGE OUTPUT POWER TEST	22
6.1 LIMIT	22
6.2 TEST PROCEDURE	22
6.3 DEVIATION FROM STANDARD	22
6.4 TEST SETUP	22
6.5 EUT OPERATION CONDITIONS	22
6.6 TEST RESULTS	22
7 . CONDUCTED SPURIOUS EMISSIONS	23
7.1 LIMIT	23
7.2 TEST PROCEDURE	23
7.3 DEVIATION FROM STANDARD	23
7.4 TEST SETUP	23
7.5 EUT OPERATION CONDITIONS	23
7.6 TEST RESULTS	23
8 . POWER SPECTRAL DENSITY TEST	24
8.1 LIMIT	24
8.2 TEST PROCEDURE	24
8.3 DEVIATION FROM STANDARD	24
8.4 TEST SETUP	24
8.5 EUT OPERATION CONDITIONS	24
8.6 TEST RESULTS	24
9 . MEASUREMENT INSTRUMENTS LIST	25
10 . EUT TEST PHOTO	27
APPENDIX A - AC POWER LINE CONDUCTED EMISSIONS	32
APPENDIX B - RADIATED EMISSION - 9 KHZ TO 30 MHZ	35
APPENDIX C - RADIATED EMISSION - 30 MHZ TO 1000 MHZ	40
APPENDIX D - RADIATED EMISSION- ABOVE 1000 MHZ	43
APPENDIX E - BANDWIDTH	104
APPENDIX F - MAXIMUM AVERAGE OUTPUT POWER	108
APPENDIX G - CONDUCTED SPURIOUS EMISSIONS	110

Table of Contents	Page
APPENDIX H - POWER SPECTRAL DENSITY	114

REPORT ISSUED HISTORY

Report Version	Description	Issued Date
R00	Original Issue.	Nov. 26, 2020
R01	Added the Note(5) of page 12	Nov. 30, 2020

1. SUMMARY OF TEST RESULTS

Test procedures according to the technical standard(s):

FCC Part15, Subpart C (15.247)				
Standard(s) Section	Test Item	Test Result	Judgment	Remark
15.207	AC Power Line Conducted Emissions	APPENDIX A	PASS	-----
15.247(d) 15.205(a) 15.209(a)	Radiated Emissions	APPENDIX B APPENDIX C APPENDIX D	PASS	-----
15.247(a)(2)	Bandwidth	APPENDIX E	PASS	-----
15.247(b)(3)	Maximum Average Output Power	APPENDIX F	PASS	-----
15.247(d)	Conducted Spurious Emissions	APPENDIX G	PASS	-----
15.247(e)	Power Spectral Density	APPENDIX H	PASS	-----
15.203	Antenna Requirement	-----	PASS	Note(2)

Note:

- (1) "N/A" denotes test is not applicable in this test report.
- (2) The device what use a permanently attached antenna were considered sufficient to comply with the provisions of 15.203.

1.1 TEST FACILITY

The test facilities used to collect the test data in this report is at the location of No.3,Jinshagang 1st Road, Shixia, Dalang Town, Dongguan, Guangdong, China.

BTL's Test Firm Registration Number for FCC: 357015

BTL's Designation Number for FCC: CN1240

1.2 MEASUREMENT UNCERTAINTY

ISO/IEC 17025 requires that an estimate of the measurement uncertainties associated with the emissions test results be included in the report. The measurement uncertainties given below are based on a 95% confidence level (based on a coverage factor (k=2))

The BTL measurement uncertainty as below table:

A. AC power line conducted emissions test:

Test Site	Method	Measurement Frequency Range	U, (dB)
DG-C02	CISPR	150kHz ~ 30MHz	2.68

B. Radiated emissions test:

Test Site	Method	Measurement Frequency Range	Ant. H / V	U, (dB)
DG-CB03	CISPR	9kHz ~ 30MHz	V	3.02
		9kHz ~ 30MHz	H	4.26
		30MHz ~ 200MHz	V	3.38
		30MHz ~ 200MHz	H	3.98
		200MHz ~ 1,000MHz	V	3.94
		200MHz ~ 1,000MHz	H	3.96
		1GHz ~ 6GHz	-	5.24
		6GHz ~ 18GHz	-	3.02
		18GHz ~ 26.5GHz	-	3.62
		26.5GHz ~ 40GHz	-	4.00

C. Other Measurement:

Parameter	Uncertainty
Bandwidth	±3.8 %
Maximum Average Output Power	±0.95 dB
Conducted Spurious Emission	±2.71 dB
Power Spectral Density	±0.86 dB
Temperature	±0.08 °C
Time	±0.58 %
Supply voltages	±0.3 %

Note: Unless specifically mentioned, the uncertainty of measurement has not been taken into account to declare the compliance or non-compliance to the specification.

1.3 TEST ENVIRONMENT CONDITIONS

Test Item	Temperature	Humidity	Test Voltage	Tested By
AC Power Line Conducted Emissions	25°C	46%	AC 120V/60Hz	Kwok Guo
Radiated Emissions-9K-30MHz	25°C	60%	AC 120V/60Hz	Kwok Guo
Radiated Emissions-30 MHz to 1GHz	26°C	52%	AC 120V/60Hz	Kwok Guo
Radiated Emissions-Above 1000 MHz	24°C	60%	AC 120V/60Hz	Kwok Guo
Bandwidth	25°C	46%	AC 120V/60Hz	Hayden Chen
Maximum Average output power	25°C	46%	AC 120V/60Hz	Laughing Zhang
Conducted Spurious Emissions	25°C	46%	AC 120V/60Hz	Hayden Chen
Power Spectral Density	25°C	46%	AC 120V/60Hz	Hayden Chen

2. GENERAL INFORMATION

2.1 GENERAL DESCRIPTION OF EUT

Equipment	Kasa Smart Wi-Fi Power Strip, 6-Outlet
Brand Name	tp-link
Test Model	HS300
Series Model	N/A
Model Difference(s)	N/A
Power Source	AC Mains.
Power Rating	120V~
Operation Frequency	2412 MHz ~ 2462 MHz
Modulation Type	IEEE 802.11b: DSSS IEEE 802.11g: OFDM IEEE 802.11n: OFDM
Bit Rate of Transmitter	IEEE 802.11b: 11/5.5/2/1 Mbps IEEE 802.11g: 54/48/36/24/18/12/9/6 Mbps IEEE 802.11n: up to 72.2 Mbps
Maximum Average Output Power	IEEE 802.11b: 17.95 dBm (0.0624 W) IEEE 802.11g: 20.70 dBm (0.1175 W) IEEE 802.11n (HT20): 20.63 dBm (0.1156 W)

Note:

- For a more detailed features description, please refer to the manufacturer's specifications or the user's manual.

2. Channel List:

CH01 - CH11 for IEEE 802.11b, IEEE 802.11g, IEEE 802.11n (HT20)							
Channel	Frequency (MHz)	Channel	Frequency (MHz)	Channel	Frequency (MHz)	Channel	Frequency (MHz)
01	2412	04	2427	07	2442	10	2457
02	2417	05	2432	08	2447	11	2462
03	2422	06	2437	09	2452		

3. Antenna Specification:

Ant.	Brand	Model Name	Antenna Type	Connector	Gain (dBi)
1		N/A	Internal	N/A	3

2.2 DESCRIPTION OF TEST MODES

The test system was pre-tested based on the consideration of all possible combinations of EUT operation mode.

Pretest Mode	Description
Mode 1	TX B Mode Channel 01/06/11
Mode 2	TX G Mode Channel 01/06/11
Mode 3	TX N-20 MHz Mode Channel 01/06/11
Mode 4	TX G Mode Channel 06
Mode 5	TX B Mode Channel 01/02/06/10/11
Mode 6	TX G Mode Channel 01/02/06/10/11
Mode 7	TX N-20 MHz Mode Channel 01/02/06/10/11

Following mode(s) was (were) found to be the worst case(s) and selected for the final test.

AC power line conducted emissions test	
Final Test Mode	Description
Mode 4	TX G Mode Channel 06

Radiated emissions test - Below 1GHz	
Final Test Mode	Description
Mode 4	TX G Mode Channel 06

Radiated emissions test- Above 1GHz	
Final Test Mode	Description
Mode 5	TX B Mode Channel 01/02/06/10/11
Mode 6	TX G Mode Channel 01/02/06/10/11
Mode 7	TX N-20 MHz Mode Channel 01/02/06/10/11

Conducted test	
Final Test Mode	Description
Mode 1	TX B Mode Channel 01/06/11
Mode 2	TX G Mode Channel 01/06/11
Mode 3	TX N-20 MHz Mode Channel 01/06/11

NOTE:

- (1) The measurements are performed at the high, middle, low available channels.
- (2) All the bit rate of transmitter have been tested and found the lowest rate is found to be the worst case and recorded.
- (3) For radiated emission below 1 GHz test, the IEEE 802.11g Channel 06 is found to be the worst case and recorded.
- (4) For radiated emission above 1 GHz test, 1GHz~26.5GHz have been pre-tested and in this report only recorded the worst case. The remaining spurious points are all below the limit value of 20dB.
- (5) With load and No-load have been tested and No-load is found to be the worst case and recorded.

2.3 PARAMETERS OF TEST SOFTWARE

Test Software	mptool V3		
Frequency (MHz)	2412	2437	2462
IEEE 802.11b	86	85	83
IEEE 802.11g	110	120	102
IEEE 802.11n (HT20)	107	116	101

2.4 DUTY CYCLE

If duty cycle is $\geq 98\%$, duty factor is not required.
 If duty cycle is $< 98\%$, duty factor shall be considered.
 The output power = measured power + duty factor.

IEEE 802.11b

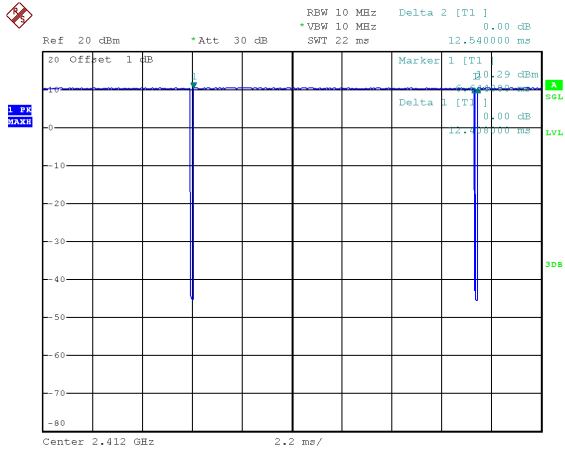

Date: 4.NOV.2020 10:42:36

Duty cycle = $12.408 \text{ ms} / 12.540 \text{ ms} = 98.95\%$
 Duty Factor = $10 \log(1/\text{Duty cycle}) = 0.00$

IEEE 802.11n (HT20)

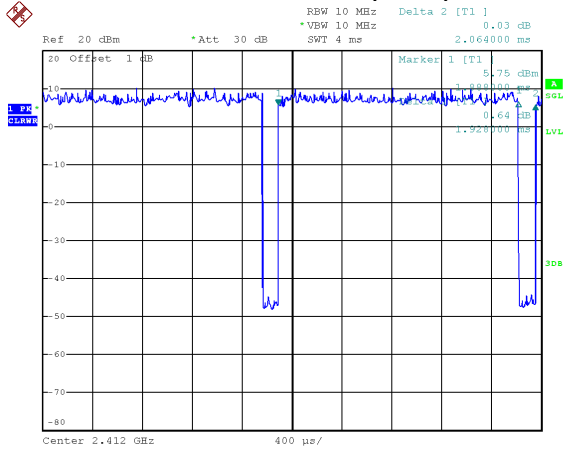

Date: 4.NOV.2020 10:43:36

Duty cycle = $1.928 \text{ ms} / 2.064 \text{ ms} = 93.41\%$
 Duty Factor = $10 \log(1/\text{Duty cycle}) = 0.30$

NOTE:

For IEEE 802.11b, IEEE 802.11g and IEEE 802.11n (HT20):
 For radiated emissions frequency above 1 GHz, the resolution bandwidth of test receiver/spectrum analyzer is 1 MHz and the video bandwidth is 1 kHz (Duty cycle $< 98\%$).

IEEE 802.11g

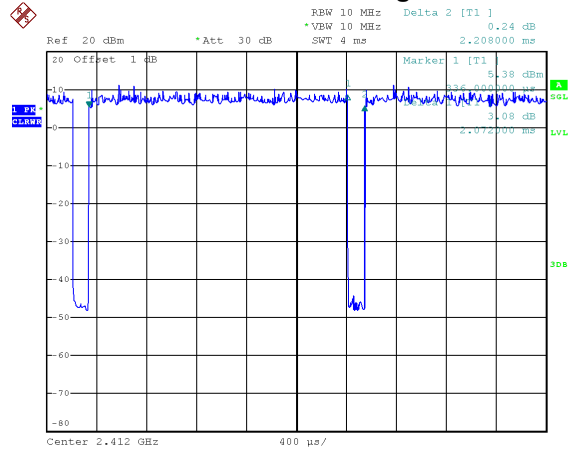

Date: 4.NOV.2020 10:43:06

Duty cycle = $2.072 \text{ ms} / 2.208 \text{ ms} = 93.84\%$
 Duty Factor = $10 \log(1/\text{Duty cycle}) = 0.28$

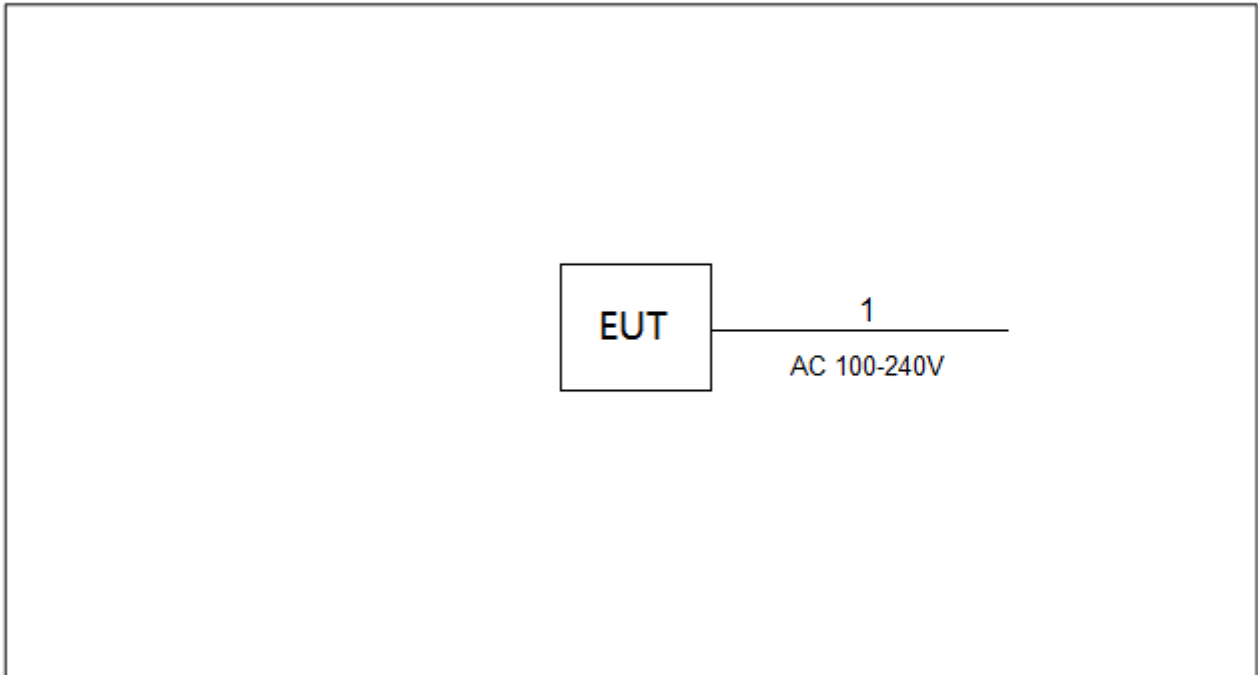
2.5 BLOCK DIAGRAM SHOWING THE CONFIGURATION OF SYSTEM TESTED**2.6 SUPPORT UNITS**

Item	Equipment	Brand	Model No.	Series No.
-	-	-	-	-

Item	Cable Type	Shielded Type	Ferrite Core	Length
1	AC Cable	NO	NO	1m

3. AC POWER LINE CONDUCTED EMISSIONS TEST

3.1 LIMIT

Frequency of Emission (MHz)	Limit (dB μ V)	
	Quasi-peak	Average
0.15 - 0.50	66 to 56*	56 to 46*
0.50 - 5.0	56	46
5.0 - 30.0	60	50

NOTE:

- (1) The tighter limit applies at the band edges.
- (2) The limit of "*" marked band means the limitation decreases linearly with the logarithm of the frequency in the range.

The following table is the setting of the receiver

Receiver Parameters	Setting
Attenuation	10 dB
Start Frequency	0.15 MHz
Stop Frequency	30 MHz
IF Bandwidth	9 kHz

3.2 TEST PROCEDURE

- a. The EUT was placed 0.8 meters from the horizontal ground plane with EUT being connected to the power mains through a line impedance stabilization network (LISN). All other support equipment powered from additional LISN(s). The LISN provide 50 Ohm/ 50uH of coupling impedance for the measuring instrument.
- b. Interconnecting cables that hang closer than 40 cm to the ground plane shall be folded back and forth in the center forming a bundle 30 to 40 cm long.
- c. I/O cables that are not connected to a peripheral shall be bundled in the center. The end of the cable may be terminated, if required, using the correct terminating impedance. The overall length shall not exceed 1 m.
- d. LISN at least 80 cm from nearest part of EUT chassis.
- e. For the actual test configuration, please refer to the related Item -EUT Test Photos.

3.3 DEVIATION FROM TEST STANDARD

No deviation

3.4 TEST SETUP

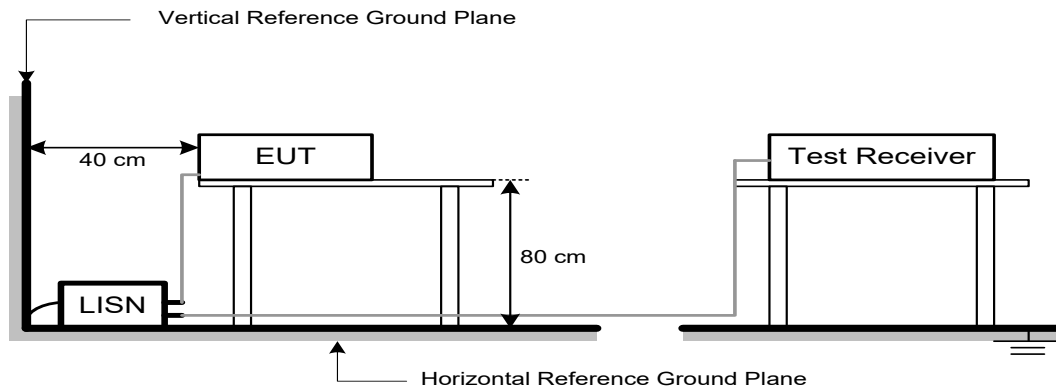

3.5 EUT OPERATION CONDITIONS

EUT was programmed to be in continuously transmitting mode.

3.6 TEST RESULTS

Please refer to the APPENDIX A.

4. RADIATED EMISSIONS TEST

4.1 LIMIT

In case the emission fall within the restricted band specified on 15.205(a), then the 15.209(a) limit in the table below has to be followed.

LIMITS OF RADIATED EMISSION MEASUREMENT (9 kHz-1000 MHz)

Frequency (MHz)	Field Strength (microvolts/meter)	Measurement Distance (meters)
0.009-0.490	2400/F(kHz)	300
0.490-1.705	24000/F(kHz)	30
1.705-30.0	30	30
30-88	100	3
88-216	150	3
216-960	200	3
Above 960	500	3

LIMITS OF RADIATED EMISSION MEASUREMENT (Above 1000 MHz)

Frequency (MHz)	(dBuV/m at 3 m)	
	Peak	Average
Above 1000	74	54

NOTE:

- (1) The limit for radiated test was performed according to FCC PART 15C.
- (2) The tighter limit applies at the band edges.
- (3) Emission level (dBuV/m)=20log Emission level (uV/m).

Spectrum Parameter	Setting
Attenuation	Auto
Start Frequency	1000 MHz
Stop Frequency	10th carrier harmonic
RBW / VBW (Emission in restricted band)	1 MHz / 3 MHz for Peak, 1 MHz / 1/T for Average

Receiver Parameter	Setting
Attenuation	Auto
Start ~ Stop Frequency	9 kHz~90 kHz for PK/AVG detector
Start ~ Stop Frequency	90 kHz~110 kHz for QP detector
Start ~ Stop Frequency	110 kHz~490 kHz for PK/AVG detector
Start ~ Stop Frequency	490 kHz~30 MHz for QP detector
Start ~ Stop Frequency	30 MHz~1000 MHz for QP detector

4.2 TEST PROCEDURE

- a. The measuring distance of 3 m shall be used for measurements. The EUT was placed on the top of a rotating table 0.8 meter above the ground at a 3 meter semi-anechoic chamber. The table was rotated 360 degrees to determine the position of the highest radiation.(below 1 GHz)
- b. The measuring distance of 3 m shall be used for measurements. The EUT was placed on the top of a rotating table 1.5 meter above the ground at a 3 meter semi-anechoic chamber. The table was rotated 360 degrees to determine the position of the highest radiation.(above 1 GHz)
- c. The height of the equipment or of the substitution antenna shall be 0.8m or 1.5m; the height of the test antenna shall vary between 1 m to 4 m. Both horizontal and vertical polarizations of the antenna are set to make the measurement.
- d. For each suspected emission, the EUT was arranged to its worst case and then the antenna was tuned to heights find the maximum reading (used Bore sight function).
- e. The receiver system was set to peak and average detect function and specified bandwidth with maximum hold mode when the test frequency is above 1 GHz.
- f. The initial step in collecting radiated emission data is a receiver peak detector mode pre-scanning the measurement frequency range. Significant peaks are then marked and then Quasi Peak detector mode re-measured.
- g. All readings are Peak unless otherwise stated QP in column of Note. Peak denotes that the Peak reading compliance with the QP Limits and then QP Mode measurement didn't perform.
(below 1 GHz)
- h. All readings are Peak Mode value unless otherwise stated AVG in column of Note. If the Peak Mode Measured value compliance with the Peak Limits and lower than AVG Limits, the EUT shall be deemed to meet both Peak & AVG Limits and then only Peak Mode was measured, but AVG Mode didn't perform. (above 1 GHz)
- i. For the actual test configuration, please refer to the related Item -EUT Test Photos.

4.3 DEVIATION FROM TEST STANDARD

No deviation

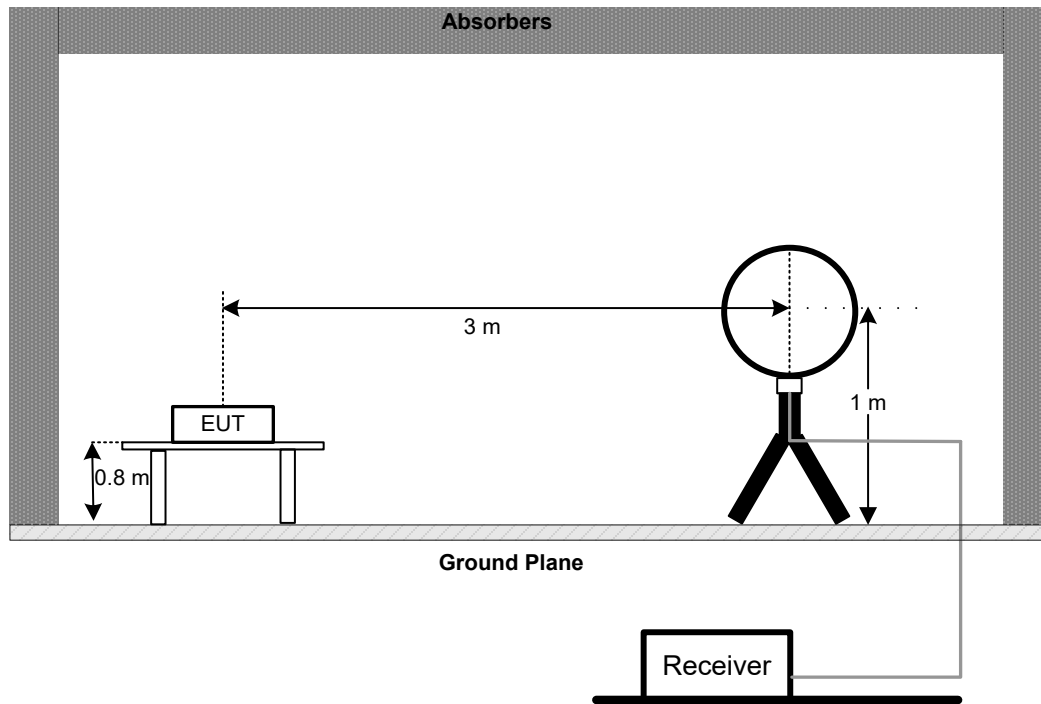
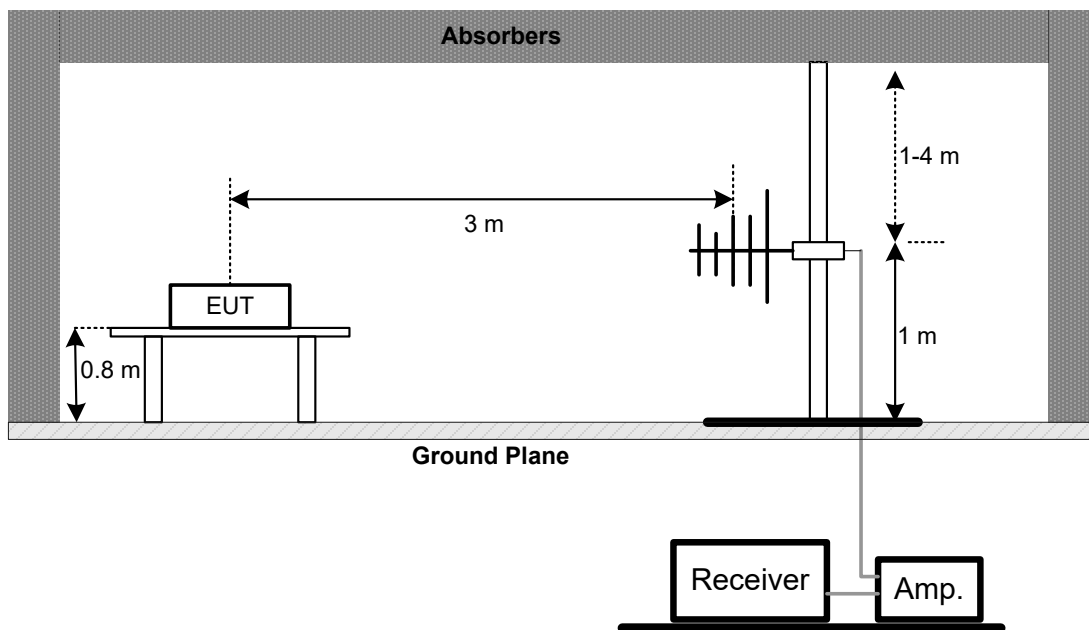
4.4 TEST SETUP**9 kHz-30 MHz****30 MHz to 1 GHz**

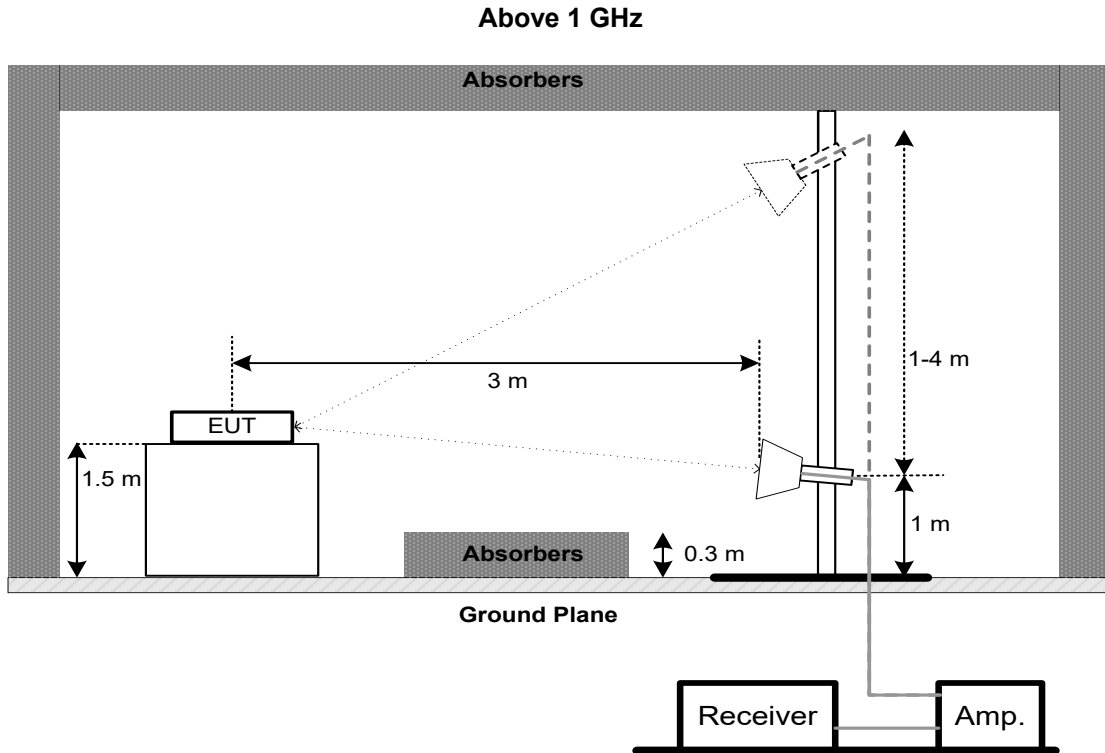

4.5 EUT OPERATION CONDITIONS

The EUT was programmed to be in continuously transmitting mode.

4.6 TEST RESULTS - 9 KHZ TO 30 MHZ

Please refer to the APPENDIX B

Remark:

- (1) Distance extrapolation factor = $40 \log (\text{specific distance} / \text{test distance})$ (dB).
- (2) Limit line = specific limits (dBuV) + distance extrapolation factor.

4.7 TEST RESULTS - 30 MHZ TO 1000 MHZ

Please refer to the APPENDIX C.

4.8 TEST RESULTS - ABOVE 1000 MHZ

Please refer to the APPENDIX D.

Remark:

- (1) No limit: This is fundamental signal, the judgment is not applicable.
For fundamental signal judgment was referred to Peak output test.

5. BANDWIDTH TEST

5.1 LIMIT

FCC Part15, Subpart C (15.247)		
Section	Test Item	Limit
15.247(a)(2)	6 dB Bandwidth	Minimum 500 kHz
	99% Emission Bandwidth	-

5.2 TEST PROCEDURE

- The EUT was directly connected to the spectrum analyzer and antenna output port as show in the block diagram below.
- Spectrum Setting:
For 6 dB Bandwidth : RBW= 100 kHz, VBW=300 kHz, Sweep time = auto.
For 99% Emission Bandwidth B/G/N-20 Mode: RBW= 300 KHz, VBW=1 MHz, Sweep time = 2.5 ms.
- The bandwidth was performed in accordance with method 11.8.1 of ANSI C63.10-2013.

5.3 DEVIATION FROM STANDARD

No deviation.

5.4 TEST SETUP

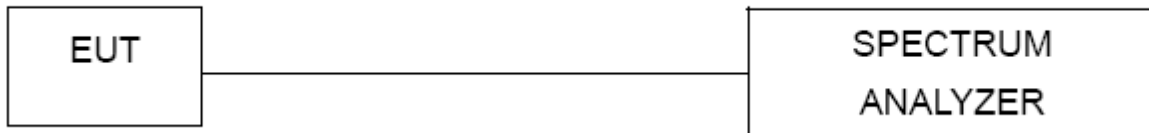

5.5 EUT OPERATION CONDITIONS

The EUT was programmed to be in continuously transmitting mode.

5.6 TEST RESULTS

Please refer to the APPENDIX E.

6. MAXIMUM AVERAGE OUTPUT POWER TEST

6.1 LIMIT

FCC Part15, Subpart C (15.247)		
Section	Test Item	Limit
15.247(b)(3)	Maximum Average Output Power	1 Watt or 30dBm

6.2 TEST PROCEDURE

- The EUT was directly connected to the power meter and antenna output port as show in the block diagram below.
- The maximum conducted output power was performed in accordance with method 11.9.2.3.1 of ANSI C63.10-2013.

6.3 DEVIATION FROM STANDARD

No deviation.

6.4 TEST SETUP



6.5 EUT OPERATION CONDITIONS

The EUT was programmed to be in continuously transmitting mode.

6.6 TEST RESULTS

Please refer to the APPENDIX F.

7. CONDUCTED SPURIOUS EMISSIONS

7.1 LIMIT

In any 100 kHz bandwidth outside the frequency band in which the spread spectrum or digitally modulated intentional radiator is operating, the radio frequency power that is produced by the intentional radiator shall be at least 20 dB below that in the 100 kHz bandwidth within the band that contains the highest level of the desired power, based on either an RF conducted or a radiated measurement, provided the transmitter demonstrates compliance with the peak Output Power limits. If the transmitter complies with the Output Power limits based on the use of RMS averaging over a time interval, as permitted under paragraph (b)(3) of this section, the attenuation required under this paragraph shall be 30 dB instead of 20 dB. Attenuation below the general limits specified in Section 15.209(a) is not required.

7.2 TEST PROCEDURE

- a. The EUT was directly connected to the spectrum analyzer and antenna output port as show in the block diagram below.
- b. Spectrum Setting: RBW= 100 kHz, VBW=300 kHz, Sweep time = Auto.

7.3 DEVIATION FROM STANDARD

No deviation.

7.4 TEST SETUP



7.5 EUT OPERATION CONDITIONS

The EUT was programmed to be in continuously transmitting mode.

7.6 TEST RESULTS

Please refer to the APPENDIX G.

8. POWER SPECTRAL DENSITY TEST

8.1 LIMIT

FCC Part15, Subpart C (15.247)		
Section	Test Item	Limit
15.247(e)	Power Spectral Density	8 dBm (in any 3 kHz)

8.2 TEST PROCEDURE

- The EUT was directly connected to the spectrum analyzer and antenna output port as show in the block diagram below.
- Spectrum Setting: RBW=3 kHz, VBW=10 kHz, Sweep time = Auto.
- The Power Spectral Density was performed in accordance with method 11.10.2 of ANSI C63.10-2013.

8.3 DEVIATION FROM STANDARD

No deviation.

8.4 TEST SETUP

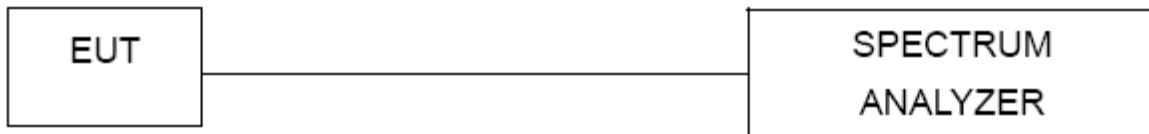

8.5 EUT OPERATION CONDITIONS

The EUT was programmed to be in continuously transmitting mode.

8.6 TEST RESULTS

Please refer to the APPENDIX H.

9. MEASUREMENT INSTRUMENTS LIST

AC Power Line Conducted Emissions					
Item	Kind of Equipment	Manufacturer	Type No.	Serial No.	Calibrated until
1	EMI Test Receiver	R&S	ESCI	100382	Feb. 28, 2021
2	LISN	EMCO	3816/2	52765	Mar. 01, 2021
3	TWO-LINE V-NETWORK	R&S	ENV216	101447	Feb. 28, 2021
4	50Ω Terminator	SHX	TF5-3	15041305	Mar. 01, 2021
5	Measurement Software	Farad	EZ-EMC Ver.NB-03A1-01	N/A	N/A
6	Cable	N/A	RG223	12m	Mar. 10, 2021
7	643 Shield Room	ETS	6*4*3m	N/A	N/A

Radiated Emissions - 9 kHz to 30 MHz					
Item	Kind of Equipment	Manufacturer	Type No.	Serial No.	Calibrated until
1	Antenna	EM	EM-6876-1	230	Apr. 16, 2021
2	Cable	N/A	RG 213/U	N/A	May 29, 2021
3	EMI Test Receiver	R&S	ESCI	100895	Feb. 28, 2021
4	Measurement Software	Farad	EZ-EMC Ver.NB-03A1-01	N/A	N/A
5	966 Chambe Room	RM	9*6*6m	N/A	Jul. 25, 2021

Radiated Emissions - 30 MHz to 1 GHz					
Item	Kind of Equipment	Manufacturer	Type No.	Serial No.	Calibrated until
1	Antenna	Schwarzbeck	VULB9160	9160-3232	Mar. 09, 2021
2*	Amplifier	HP	8447D	2944A09673	Aug. 11, 2021
3	Receiver	Agilent	N9038A	MY52130039	Jul. 25, 2021
4	Cable	emci	LMR-400(30MHz-1 GHz)(8m+5m)	N/A	May 22, 2021
5	Controller	CT	SC100	N/A	N/A
6	Controller	MF	MF-7802	MF780208416	N/A
7	Measurement Software	Farad	EZ-EMC Ver.NB-03A1-01	N/A	N/A
8	966 Chambe Room	RM	9*6*6m	N/A	Jul. 25, 2021

Radiated Emissions - Above 1 GHz					
Item	Kind of Equipment	Manufacturer	Type No.	Serial No.	Calibrated until
1	Double Ridged Guide Antenna	ETS	3115	75789	May 12, 2021
2	Broad-Band Horn Antenna	Schwarzbeck	BBHA 9170	9170319	Jul. 07, 2021
3	Amplifier	Agilent	8449B	3008A02333	Mar. 01, 2021
4	Microwave Preamplifier With Adaptor	EMC INSTRUMENT	EMC2654045	980039 & HA01	Mar. 07, 2021
5	Receiver	Agilent	N9038A	MY52130039	Jul. 25, 2021
6	Controller	CT	SC100	N/A	N/A
7	Controller	MF	MF-7802	MF780208416	N/A
8	Cable	N/A	EMC104-SM-SM-6000	N/A	May 09, 2021
9	Measurement Software	Farad	EZ-EMC Ver.NB-03A1-01	N/A	N/A
10	Filter	STI	STI15-9912	N/A	Jul. 25, 2021
11	966 Chambe Room	RM	9*6*6m	N/A	Jul. 25, 2021

Bandwidth & Antenna Conducted Spurious Emissions & Power Spectral Density					
Item	Kind of Equipment	Manufacturer	Type No.	Serial No.	Calibrated until
1	Spectrum Analyzer	R&S	FSP40	100185	Jul. 25, 2021
2	RF Cable	Tongkaichuan	N/A	N/A	N/A
3	DC Block	Mini	N/A	N/A	N/A

Maximum Average Output Power					
Item	Kind of Equipment	Manufacturer	Type No.	Serial No.	Calibrated until
1	Peak Power Analyzer	Keysight	8990B	MY51000506	Aug. 07, 2021
2	Wideband power sensor	Keysight	N1923A	MY58310004	Jul. 25, 2021
3	Attenuator	WOKEN	6SM3502	VAS1214NL	Feb. 11, 2021
4	RF Cable	Tongkaichuan	N/A	N/A	N/A

Remark: "N/A" denotes no model name, serial no. or calibration specified.

"**" calibration period of equipment list is three year.

Except * item, all calibration period of equipment list is one year.

10. EUT TEST PHOTO

AC Power Line Conducted Emissions Test Photos



Radiated Emissions Test Photos**9 kHz to 30 MHz**

Radiated Emissions Test Photos**30 MHz to 1 GHz**

Radiated Emissions Test Photos

Above 1 GHz

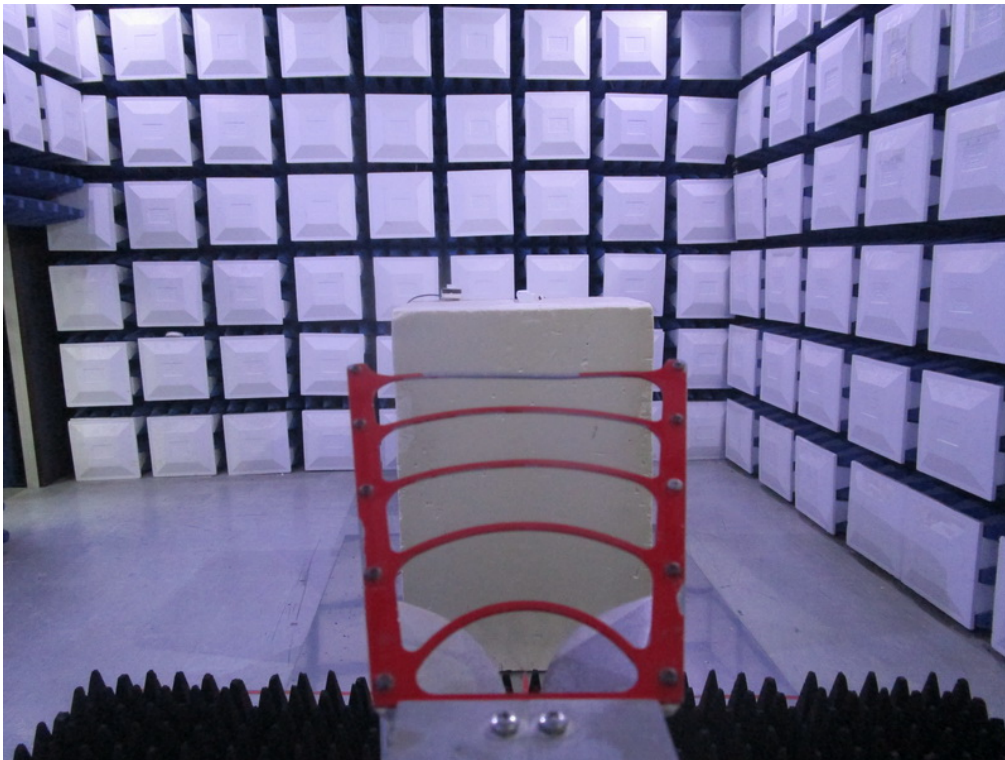

Conducted Emissions Test Photos

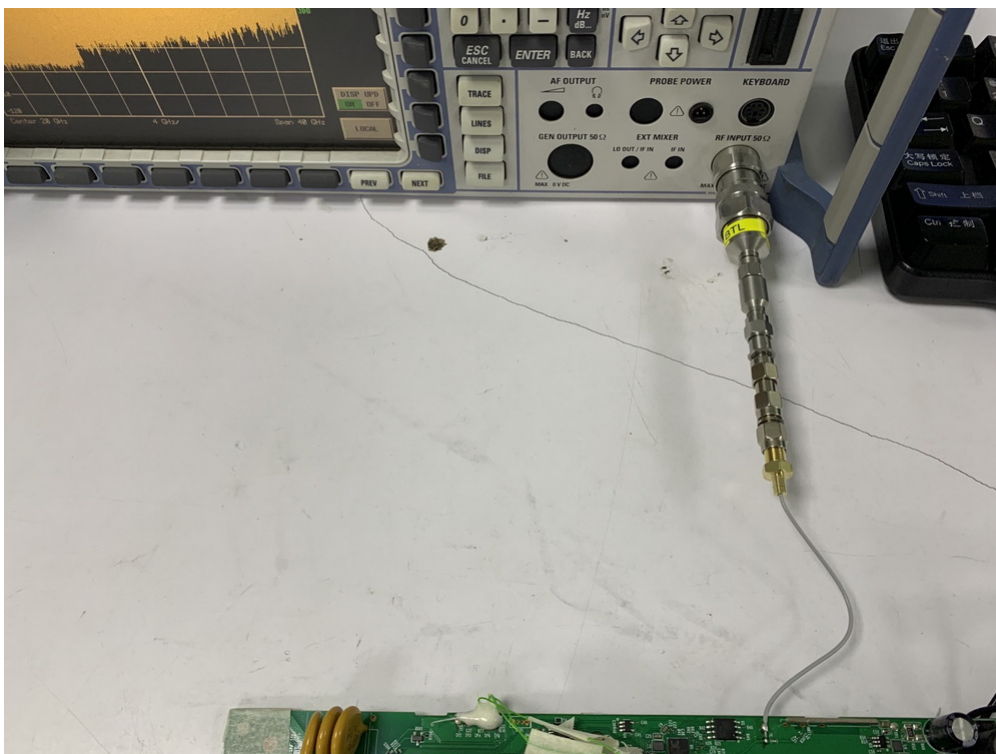
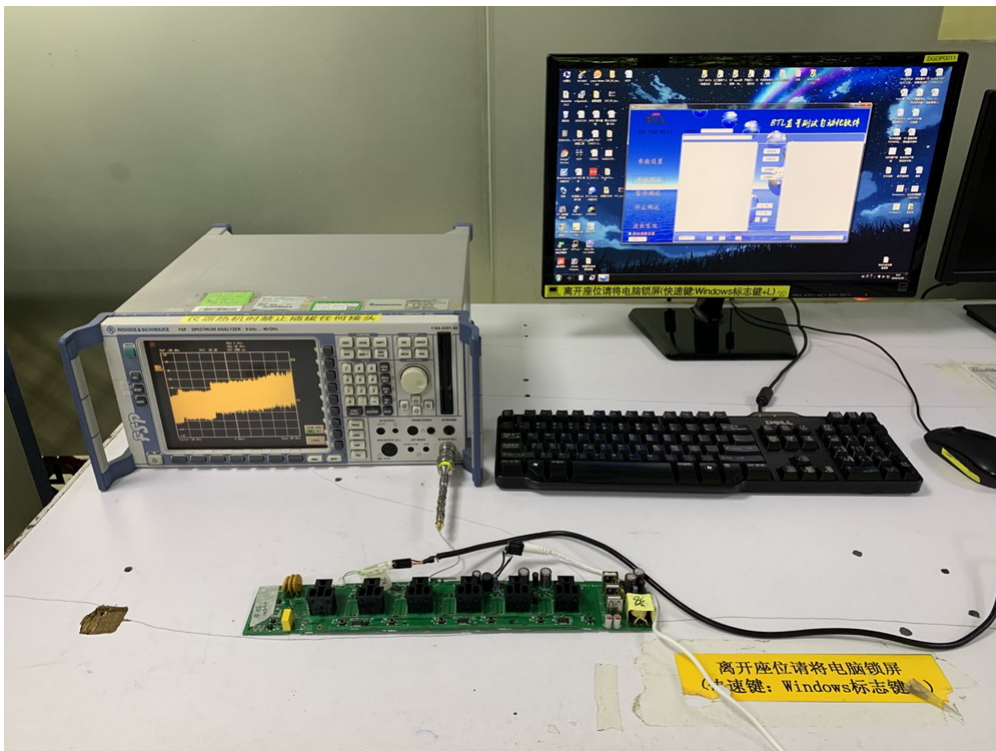

APPENDIX A - AC POWER LINE CONDUCTED EMISSIONS

Test Mode: TX G Mode Channel 06

Line

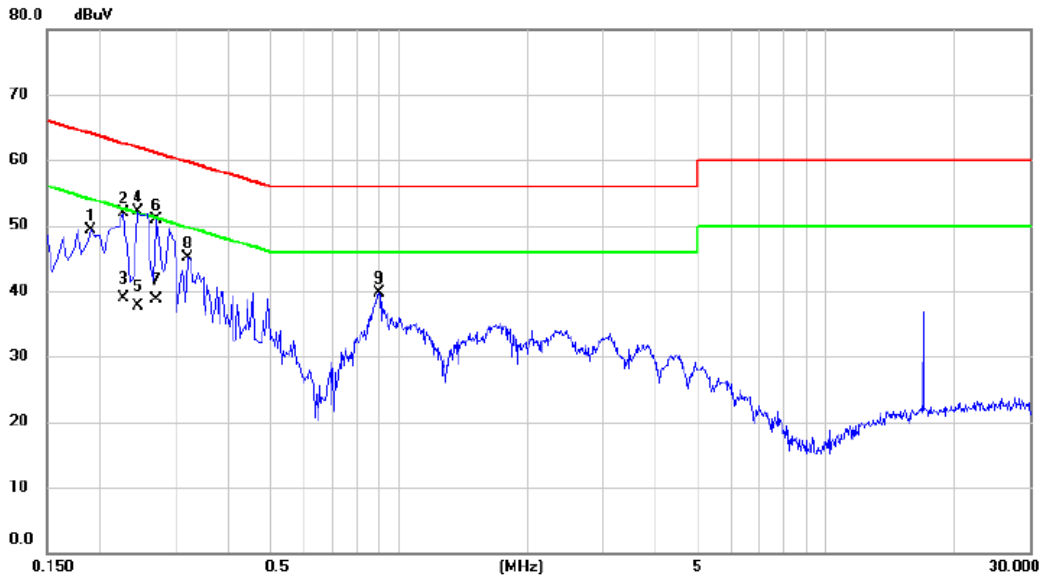

No. Mk.	Freq. MHz	Reading Level dBuV	Correct Factor dB	Measurement dBuV	Limit dBuV	Margin dB	Detector	Comment
1	0.1905	39.40	9.88	49.28	64.01	-14.73	peak	
2	0.2265	42.00	9.89	51.89	62.58	-10.69	peak	
3	0.2265	29.00	9.89	38.89	52.58	-13.69	AVG	
4 *	0.2445	42.31	9.87	52.18	61.94	-9.76	peak	
5	0.2445	27.90	9.87	37.77	51.94	-14.17	AVG	
6	0.2714	41.12	9.88	51.00	61.07	-10.07	peak	
7	0.2714	28.90	9.88	38.78	51.07	-12.29	AVG	
8	0.3210	35.24	9.89	45.13	59.68	-14.55	peak	
9	0.9015	29.61	10.00	39.61	56.00	-16.39	peak	

REMARKS:

(1) Measurement Value = Reading Level + Correct Factor.

(2) Margin Level = Measurement Value - Limit Value.

Test Mode: TX G Mode Channel 06

Neutral

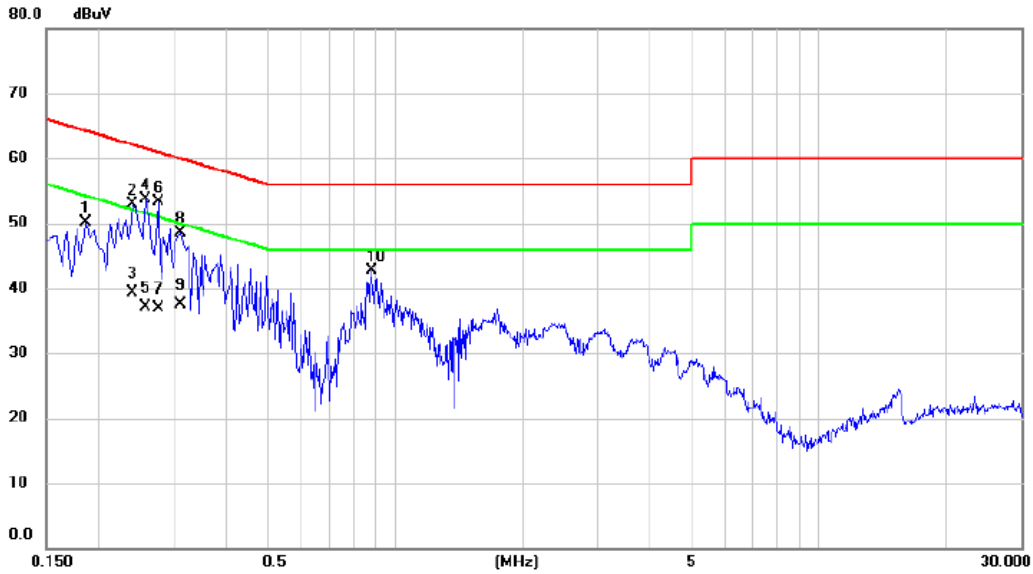

No. Mk.	Freq. MHz	Reading Level dBuV	Correct Factor dB	Measure- ment dBuV	Limit dBuV	Margin dB	Detector	Comment
1	0.1860	40.18	9.95	50.13	64.21	-14.08	peak	
2	0.2400	42.99	9.98	52.97	62.10	-9.13	peak	
3	0.2400	29.30	9.98	39.28	52.10	-12.82	AVG	
4	0.2580	43.71	9.99	53.70	61.50	-7.80	peak	
5	0.2580	27.10	9.99	37.09	51.50	-14.41	AVG	
6 *	0.2760	43.38	10.00	53.38	60.94	-7.56	peak	
7	0.2760	26.90	10.00	36.90	50.94	-14.04	AVG	
8	0.3120	38.46	10.02	48.48	59.92	-11.44	peak	
9	0.3120	27.40	10.02	37.42	49.92	-12.50	AVG	
10	0.8790	32.39	10.27	42.66	56.00	-13.34	peak	

REMARKS:

- (1) Measurement Value = Reading Level + Correct Factor.
- (2) Margin Level = Measurement Value - Limit Value.

APPENDIX B - RADIATED EMISSION - 9 KHZ TO 30 MHZ

Test Mode: TX G Mode Channel 06

Ant 0°

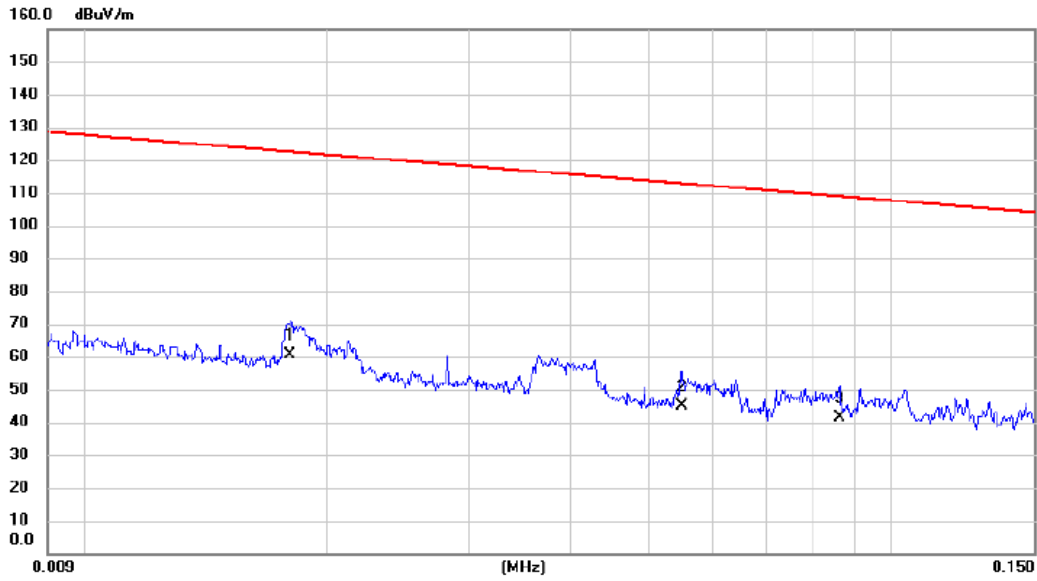

No.	Mk.	Freq. MHz	Reading Level dBuV	Correct Factor dB	Measure- ment dBuV/m	Limit dBuV/m	Margin dB	Detector	Comment
1	*	0.0180	46.85	13.84	60.69	122.50	-61.81	AVG	
2		0.0550	32.46	12.45	44.91	112.80	-67.89	AVG	
3		0.0862	28.77	12.64	41.41	108.89	-67.48	AVG	

REMARKS:

- (1) Measurement Value = Reading Level + Correct Factor.
- (2) Margin Level = Measurement Value - Limit Value.

Test Mode: TX G Mode Channel 06

Ant 0°

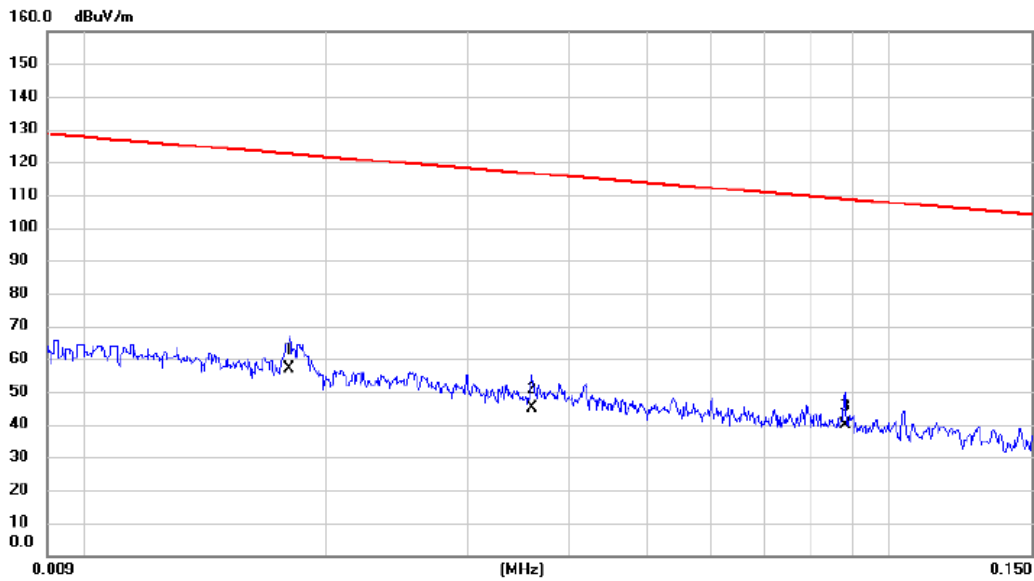

No.	Mk.	Freq. MHz	Reading Level dBuV	Correct Factor dB	Measure- ment dBuV/m	Limit dBuV/m	Margin dB	Detector	Comment
1	*	0.0180	43.22	13.84	57.06	122.50	-65.44	AVG	
2		0.0360	32.19	12.79	44.98	116.48	-71.50	AVG	
3		0.0881	27.03	12.65	39.68	108.71	-69.03	AVG	

REMARKS:

- (1) Measurement Value = Reading Level + Correct Factor.
- (2) Margin Level = Measurement Value - Limit Value.

Test Mode: TX G Mode Channel 06

Ant 90°

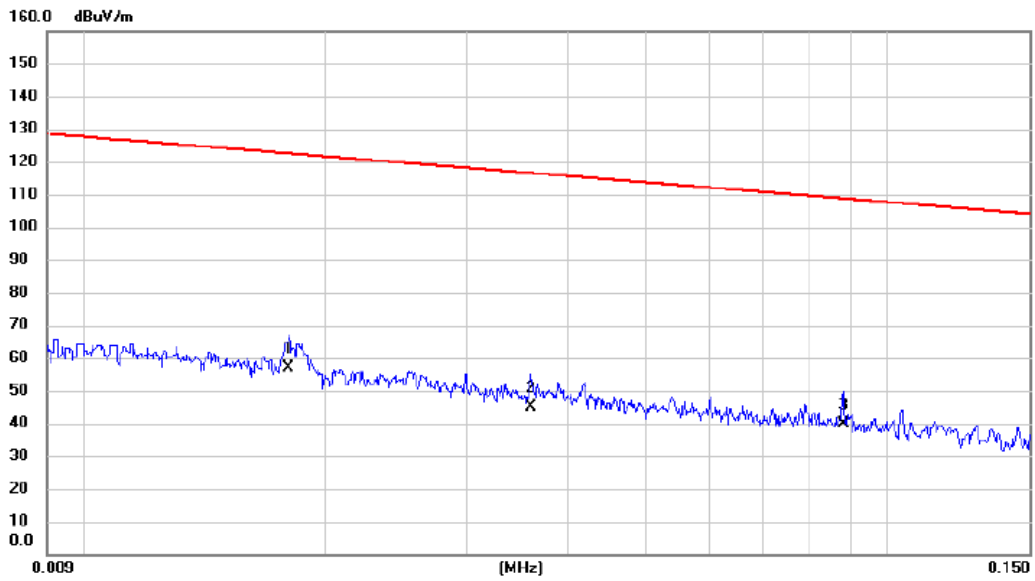

No.	Mk.	Freq.	Reading Level	Correct Factor	Measurement	Limit	Margin	Detector	Comment
		MHz	dBuV	dB	dBuV/m	dBuV/m	dB		
1	*	0.0180	43.22	13.84	57.06	122.50	-65.44	AVG	
2		0.0360	32.19	12.79	44.98	116.48	-71.50	AVG	
3		0.0881	27.03	12.65	39.68	108.71	-69.03	AVG	

REMARKS:

- (1) Measurement Value = Reading Level + Correct Factor.
- (2) Margin Level = Measurement Value - Limit Value.

Test Mode: TX G Mode Channel 06

Ant 90°

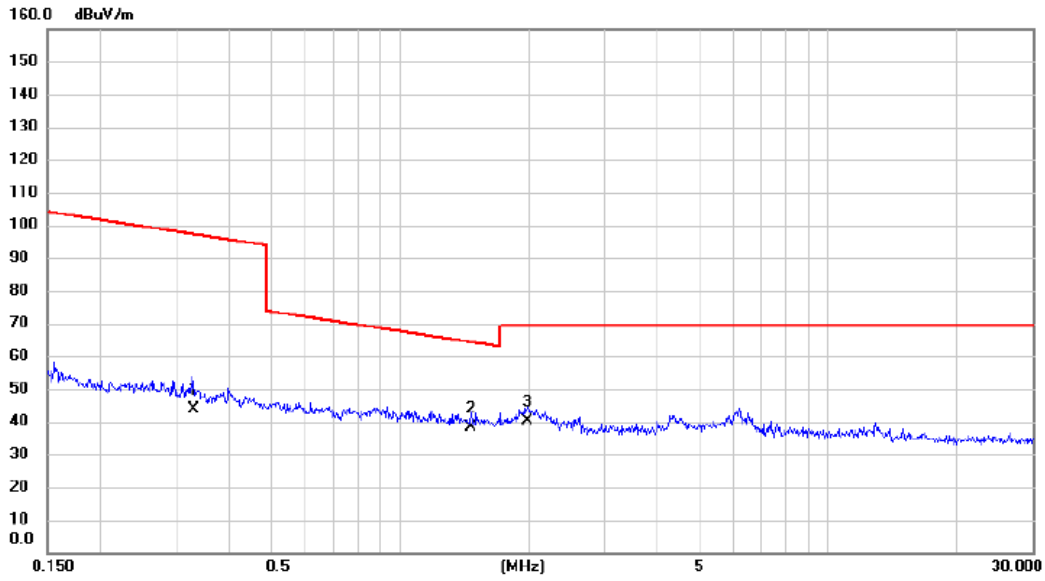

No.	Mk.	Freq. MHz	Reading Level dBuV	Correct Factor dB	Measure- ment dBuV/m	Limit dBuV/m	Margin dB	Detector	Comment
1		0.3286	31.46	12.44	43.90	97.27	-53.37	AVG	
2	*	1.4640	26.82	11.57	38.39	64.29	-25.90	QP	
3		1.9906	28.77	11.31	40.08	69.54	-29.46	QP	

REMARKS:

- (1) Measurement Value = Reading Level + Correct Factor.
- (2) Margin Level = Measurement Value - Limit Value.

APPENDIX C - RADIATED EMISSION - 30 MHZ TO 1000 MHZ

Test Mode: TX G Mode Channel 06

Vertical

80 dBuV/m

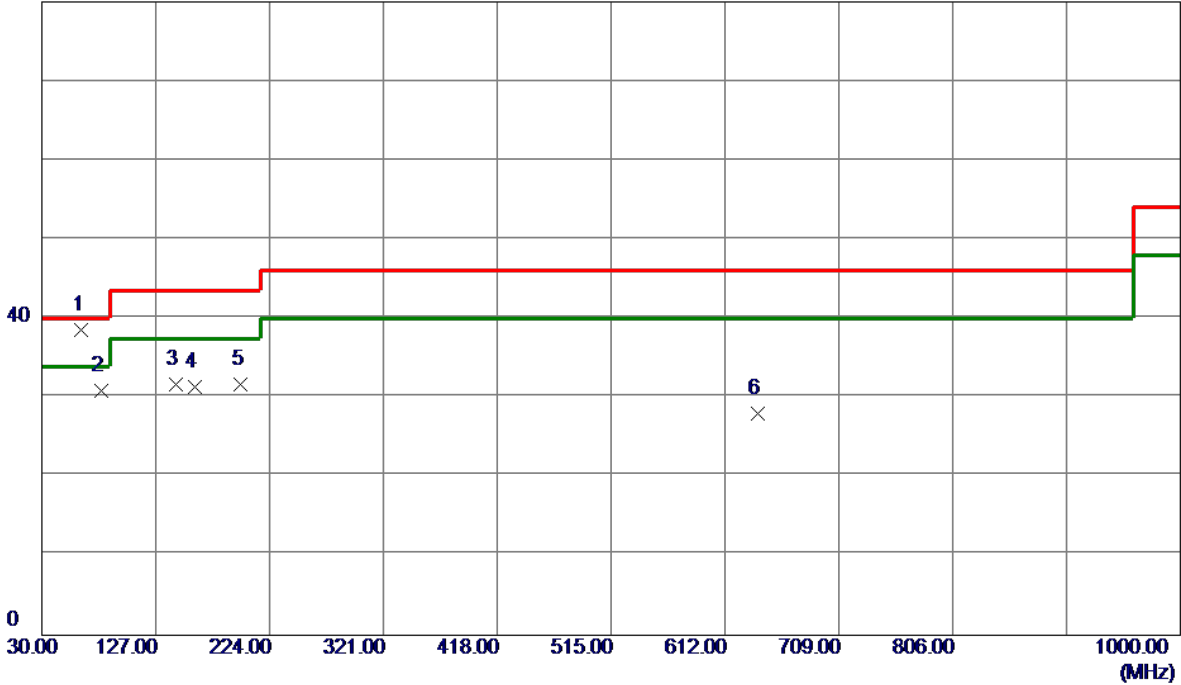

No.	Freq. MHz	Reading Level dBuV/m	Correct Factor dB	Measure ment dBuV/m	Limit dBuV/m	Margin dB	Detector	Comment
1 *	63.9500	53.28	-14.79	38.49	40.00	-1.51	QP	
2	80.4400	48.46	-17.62	30.84	40.00	-9.16	Peak	
3	144.4600	43.91	-12.29	31.62	43.50	-11.88	Peak	
4	159.9800	42.00	-10.67	31.33	43.50	-12.17	Peak	
5	199.7500	46.41	-14.79	31.62	43.50	-11.88	Peak	
6	640.1300	32.50	-4.48	28.02	46.00	-17.98	Peak	

REMARKS:

- (1) Measurement Value = Reading Level + Correct Factor.
- (2) Margin Level = Measurement Value - Limit Value.

Test Mode: TX G Mode Channel 06

Horizontal

80 dBuV/m

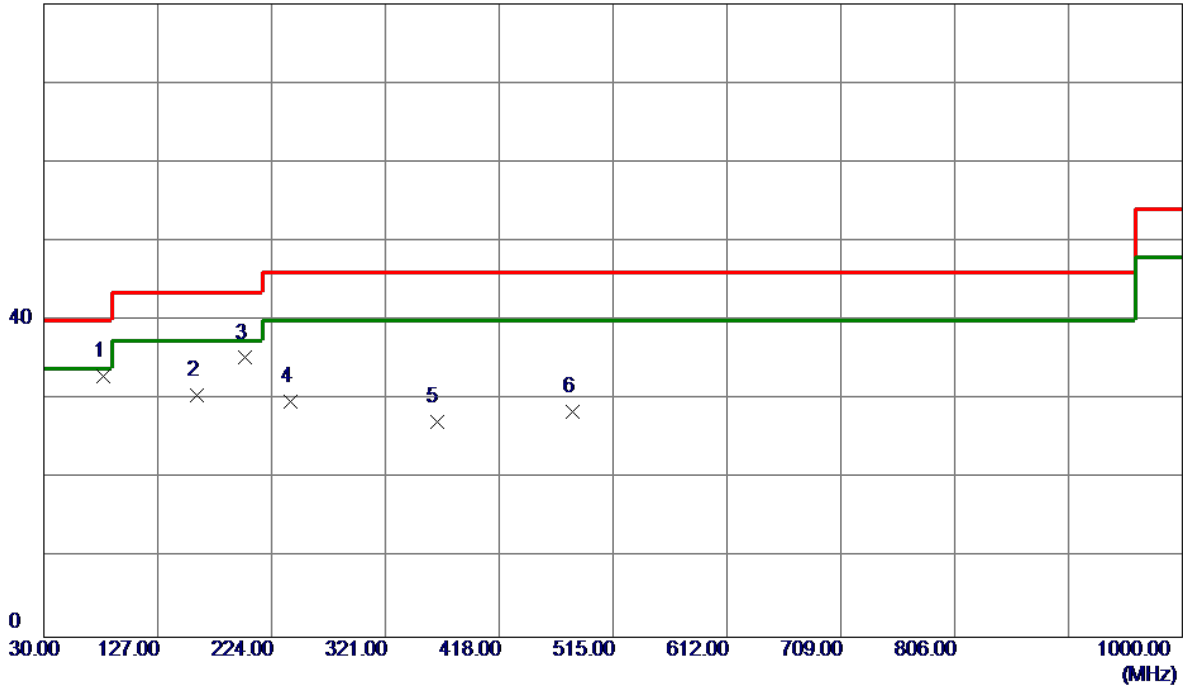

No.	Freq. MHz	Reading Level dBuV/m	Correct Factor dB	Measure ment dBuV/m	Limit dBuV/m	Margin dB	Detector	Comment
1 *	80.4400	50.55	-17.62	32.93	40.00	-7.07	Peak	
2	159.9800	41.19	-10.67	30.52	43.50	-12.98	Peak	
3	201.6900	50.16	-14.88	35.28	43.50	-8.22	Peak	
4	240.4900	43.28	-13.57	29.71	46.00	-16.29	Peak	
5	364.6500	37.12	-9.85	27.27	46.00	-18.73	Peak	
6	480.0800	35.95	-7.41	28.54	46.00	-17.46	Peak	

REMARKS:

(1) Measurement Value = Reading Level + Correct Factor.

(2) Margin Level = Measurement Value - Limit Value.

APPENDIX D - RADIATED EMISSION- ABOVE 1000 MHZ

Test Mode: TX B Mode 2412 MHz

Vertical

130 dBuV/m

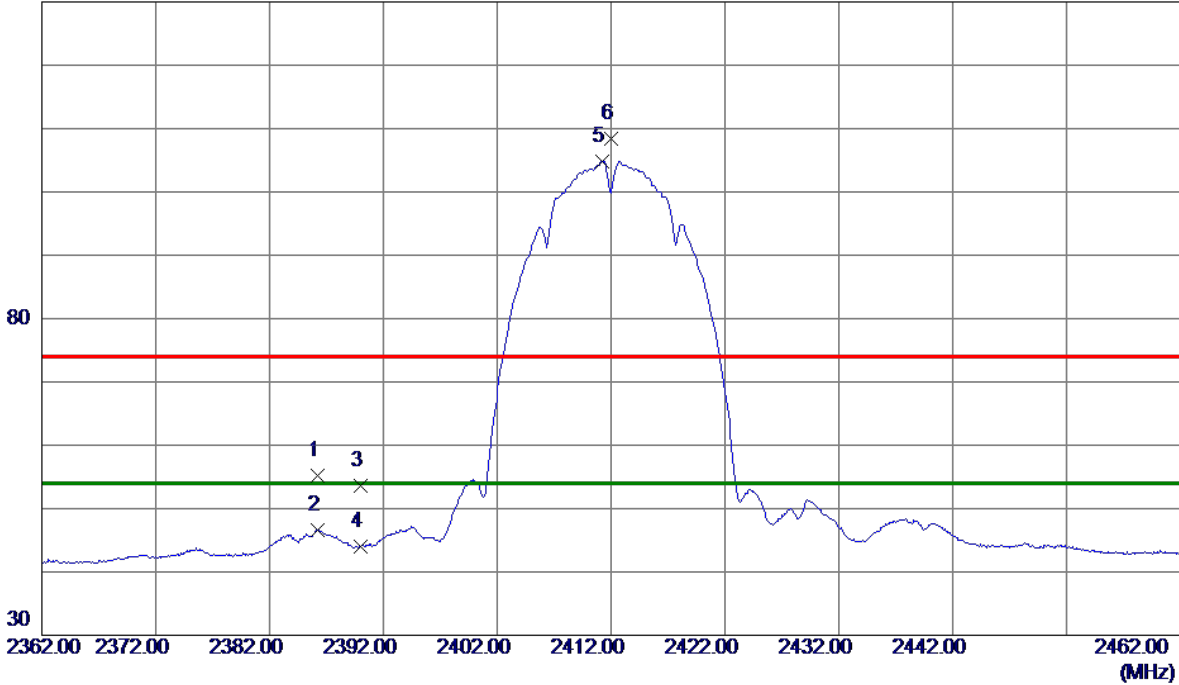

No.	Freq. MHz	Reading Level dBuV/m	Correct Factor dB	Measure ment dBuV/m	Limit dBuV/m	Margin dB	Detector	Comment
1	2386.2000	44.66	10.61	55.27	74.00	-18.73	Peak	
2	2386.2000	36.01	10.61	46.62	54.00	-7.38	AVG	
3	2390.0000	42.93	10.62	53.55	74.00	-20.45	Peak	
4	2390.0000	33.36	10.62	43.98	54.00	-10.02	AVG	
5 *	2411.2500	94.20	10.69	104.89	54.00	50.89	AVG	No Limit
6	2412.0500	97.65	10.69	108.34	74.00	34.34	Peak	No Limit

REMARKS:

- (1) Measurement Value = Reading Level + Correct Factor.
- (2) Margin Level = Measurement Value - Limit Value.

Test Mode: TX B Mode 2412 MHz

Vertical

80 dBuV/m

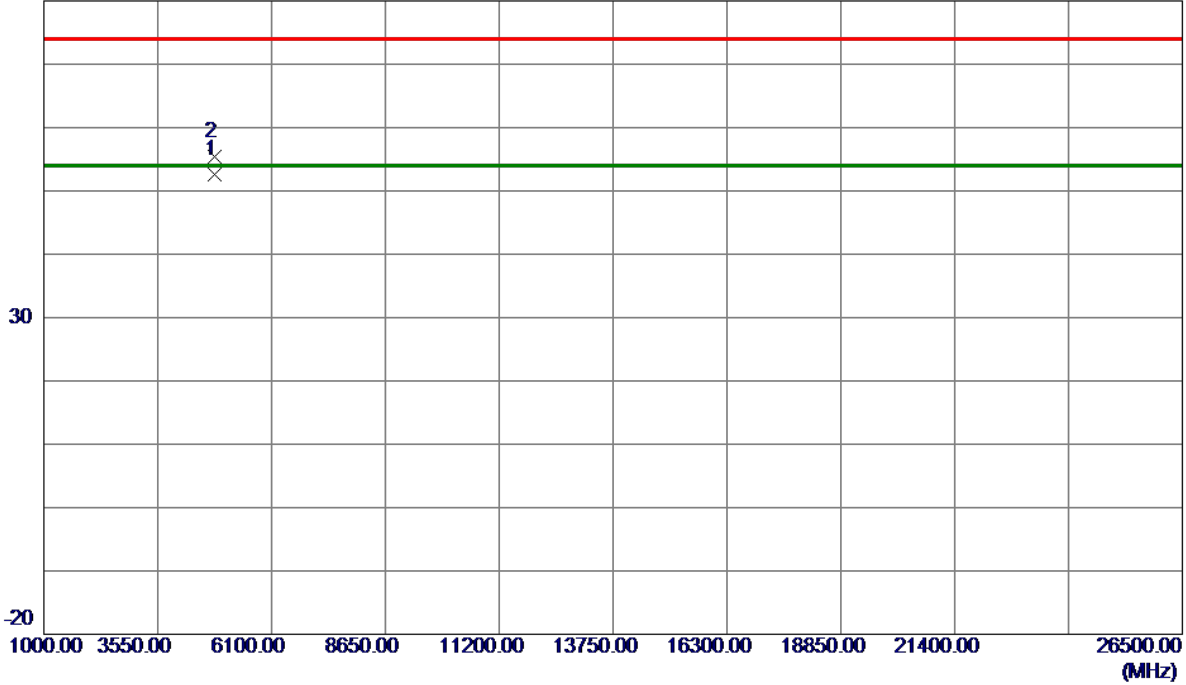

No.	Freq. MHz	Reading Level dBuV/m	Correct Factor dB	Measure ment dBuV/m	Limit dBuV/m	Margin dB	Detector	Comment
1 *	4824.0070	44.79	7.86	52.65	54.00	-1.35	AVG	
2	4824.1020	47.47	7.86	55.33	74.00	-18.67	Peak	

REMARKS:

- (1) Measurement Value = Reading Level + Correct Factor.
- (2) Margin Level = Measurement Value - Limit Value.

Test Mode: TX B Mode 2412 MHz

Horizontal

130 dBuV/m

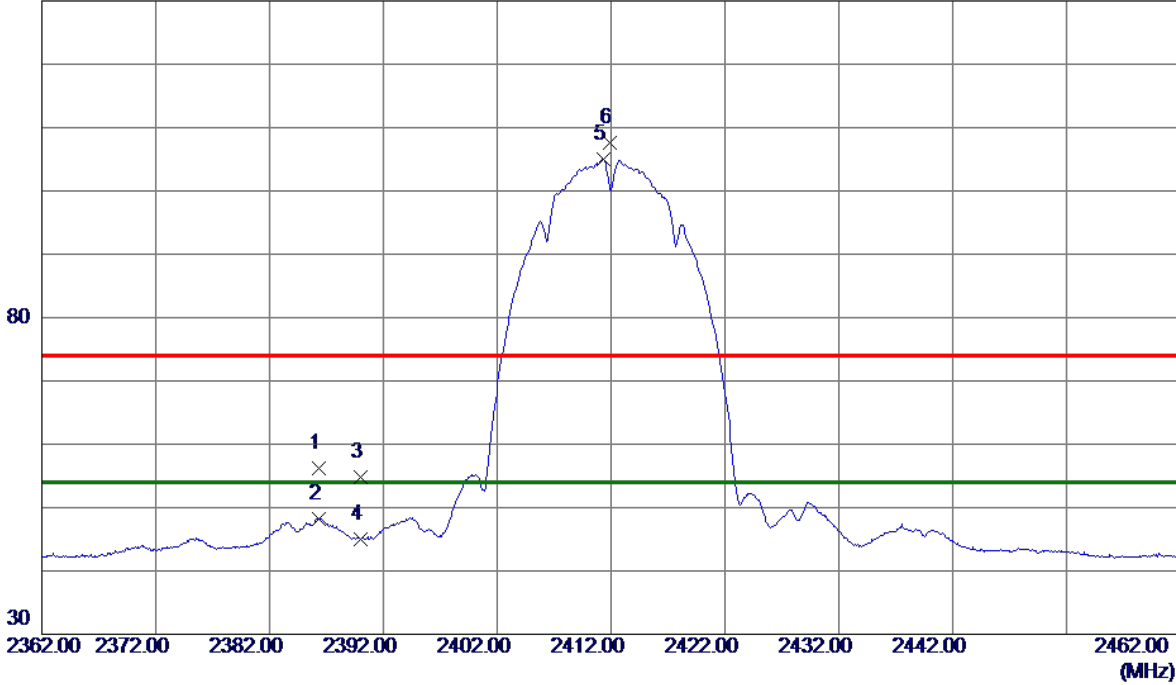

No.	Freq. MHz	Reading Level dBuV/m	Correct Factor dB	Measure ment dBuV/m	Limit dBuV/m	Margin dB	Detector	Comment
1	2386.3000	45.52	10.61	56.13	74.00	-17.87	Peak	
2	2386.3000	37.68	10.61	48.29	54.00	-5.71	AVG	
3	2390.0000	44.23	10.62	54.85	74.00	-19.15	Peak	
4	2390.0000	34.44	10.62	45.06	54.00	-8.94	AVG	
5 *	2411.3000	94.29	10.69	104.98	54.00	50.98	AVG	No Limit
6	2411.8500	96.90	10.69	107.59	74.00	33.59	Peak	No Limit

REMARKS:

- (1) Measurement Value = Reading Level + Correct Factor.
- (2) Margin Level = Measurement Value - Limit Value.

Test Mode: TX B Mode 2412 MHz

Horizontal

80 dBuV/m

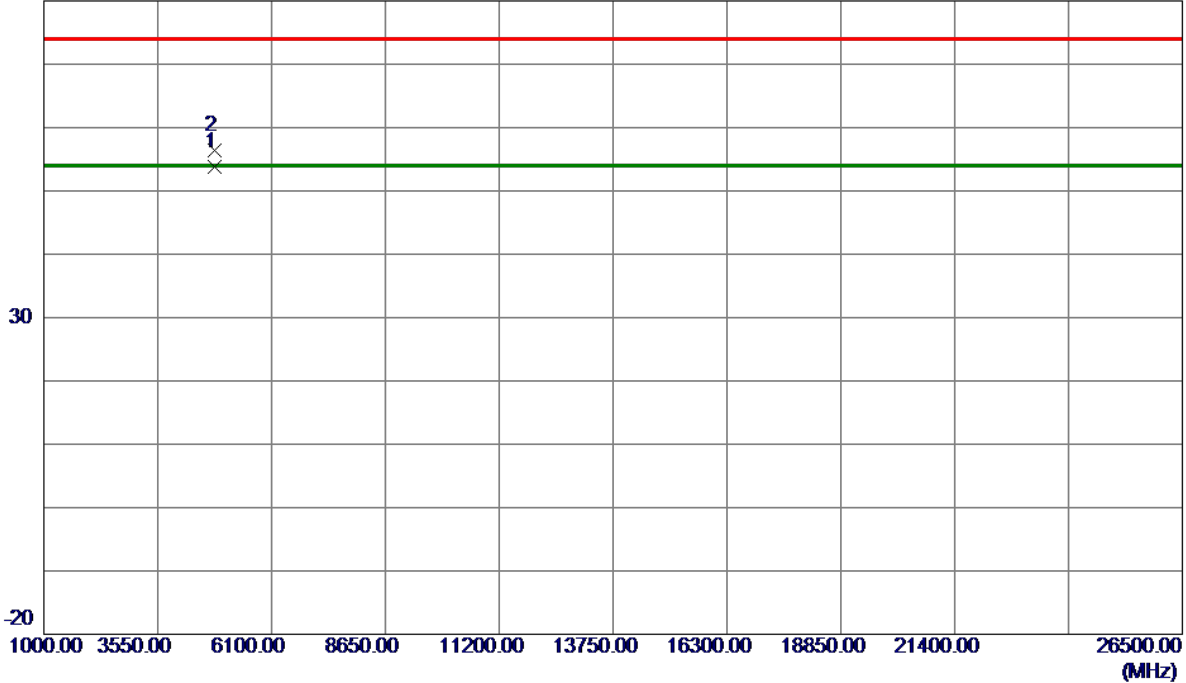

No.	Freq. MHz	Reading Level dBuV/m	Correct Factor dB	Measure ment dBuV/m	Limit dBuV/m	Margin dB	Detector	Comment
1 *	4823.9880	45.98	7.86	53.84	54.00	-0.16	AVG	
2	4824.1480	48.49	7.86	56.35	74.00	-17.65	Peak	

REMARKS:

(1) Measurement Value = Reading Level + Correct Factor.

(2) Margin Level = Measurement Value - Limit Value.

Test Mode: TX B Mode 2417 MHz

Vertical

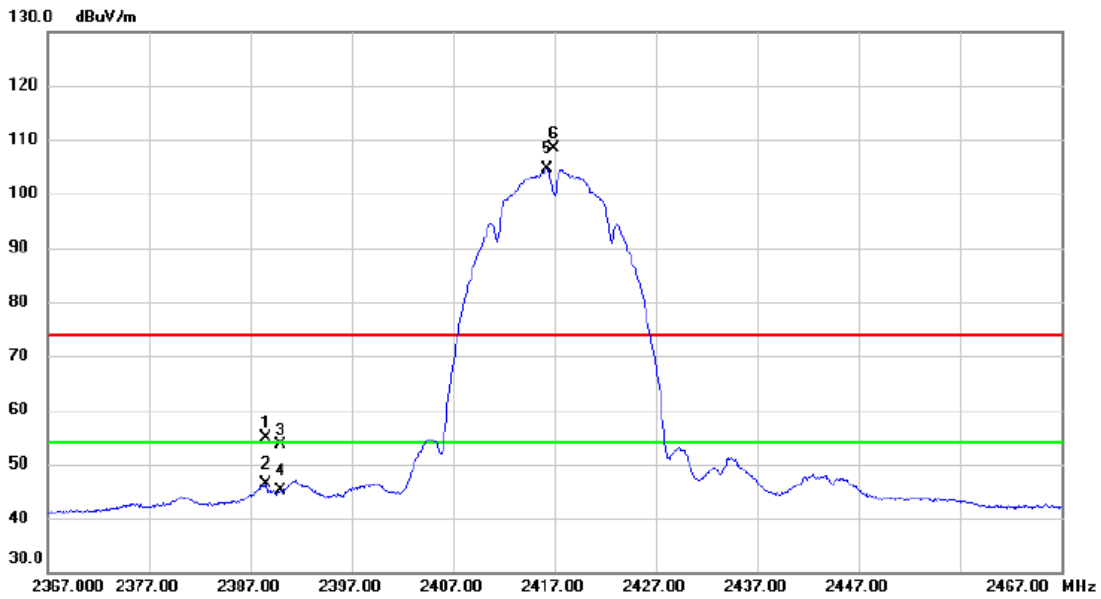

No.	Mk.	Freq. MHz	Reading Level dBuV	Correct Factor dB	Measure- ment dBuV/m	Limit dBuV/m	Margin dB	Detector	Comment
1		2388.550	44.18	10.62	54.80	74.00	-19.20	peak	
2		2388.550	35.72	10.62	46.34	54.00	-7.66	AVG	
3		2390.000	42.96	10.63	53.59	74.00	-20.41	peak	
4		2390.000	34.44	10.63	45.07	54.00	-8.93	AVG	
5	*	2416.250	93.84	10.70	104.54	54.00	50.54	AVG	No Limit
6	X	2416.950	97.80	10.70	108.50	74.00	34.50	peak	No Limit

REMARKS:

- (1) Measurement Value = Reading Level + Correct Factor.
- (2) Margin Level = Measurement Value - Limit Value.

Test Mode: TX B Mode 2417 MHz

Vertical

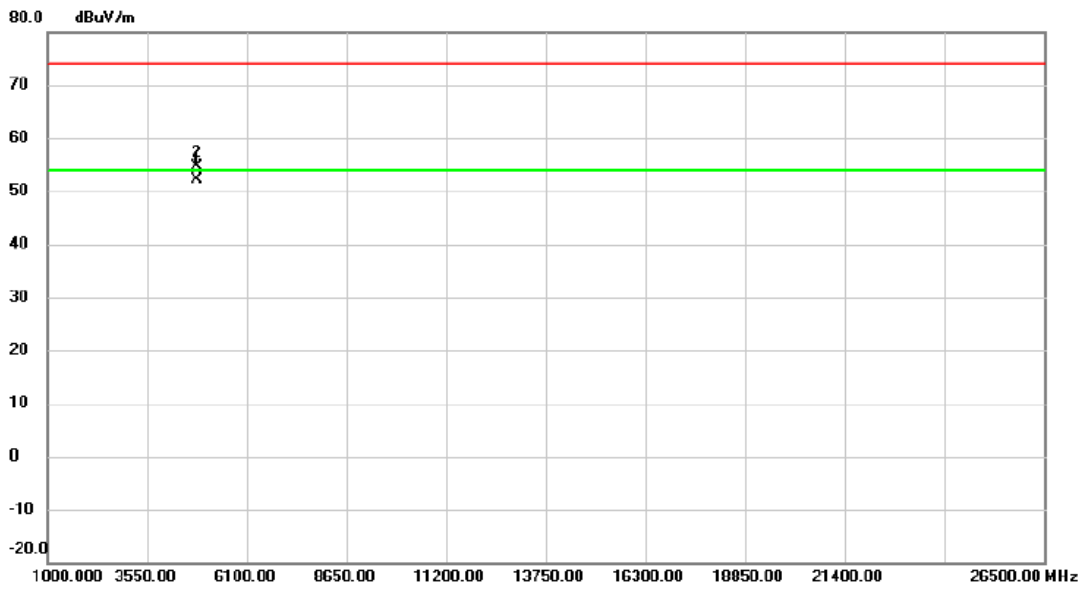

No.	Mk.	Freq. MHz	Reading Level dBuV	Correct Factor dB	Measure- ment dBuV/m	Limit dBuV/m	Margin dB	Detector	Comment
1	*	4833.988	44.14	7.89	52.03	54.00	-1.97	AVG	
2		4834.023	46.67	7.89	54.56	74.00	-19.44	peak	

REMARKS:

- (1) Measurement Value = Reading Level + Correct Factor.
- (2) Margin Level = Measurement Value - Limit Value.

Test Mode: TX B Mode 2417 MHz

Horizontal

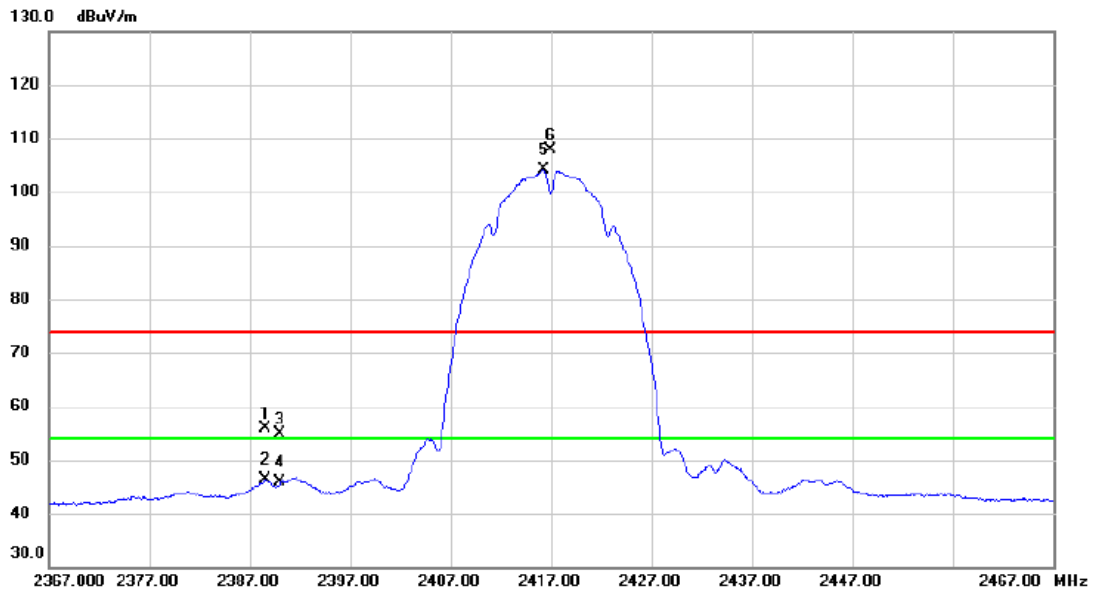

No.	Mk.	Freq. MHz	Reading Level dBuV	Correct Factor dB	Measure- ment dBuV/m	Limit dBuV/m	Margin dB	Detector	Comment
1		2388.500	45.33	10.62	55.95	74.00	-18.05	peak	
2		2388.500	35.65	10.62	46.27	54.00	-7.73	AVG	
3		2390.000	44.36	10.63	54.99	74.00	-19.01	peak	
4		2390.000	35.14	10.63	45.77	54.00	-8.23	AVG	
5	*	2416.250	93.42	10.70	104.12	54.00	50.12	AVG	No Limit
6	X	2416.950	97.11	10.70	107.81	74.00	33.81	peak	No Limit

REMARKS:

- (1) Measurement Value = Reading Level + Correct Factor.
- (2) Margin Level = Measurement Value - Limit Value.

Test Mode: TX B Mode 2417 MHz

Horizontal

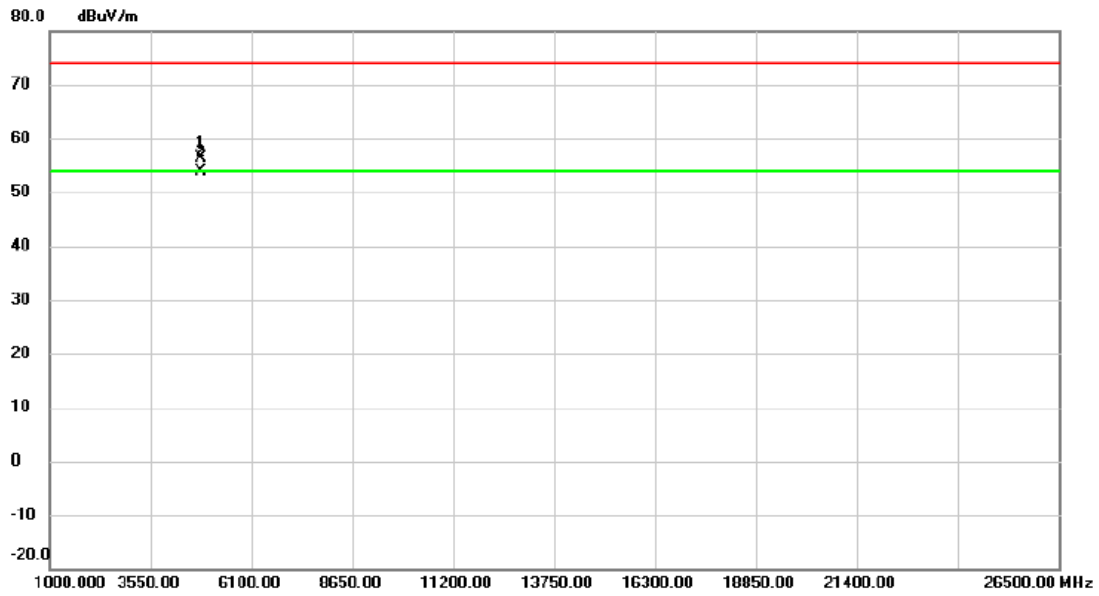

No.	Mk.	Freq.	Reading Level	Correct Factor	Measurement	Limit	Margin	Detector	Comment
		MHz	dBuV	dB	dBuV/m	dBuV/m	dB		
1		4833.980	48.51	7.89	56.40	74.00	-17.60	peak	
2	*	4833.988	46.07	7.89	53.96	54.00	-0.04	AVG	

REMARKS:

- (1) Measurement Value = Reading Level + Correct Factor.
- (2) Margin Level = Measurement Value - Limit Value.

Test Mode: TX B Mode 2437 MHz

Vertical

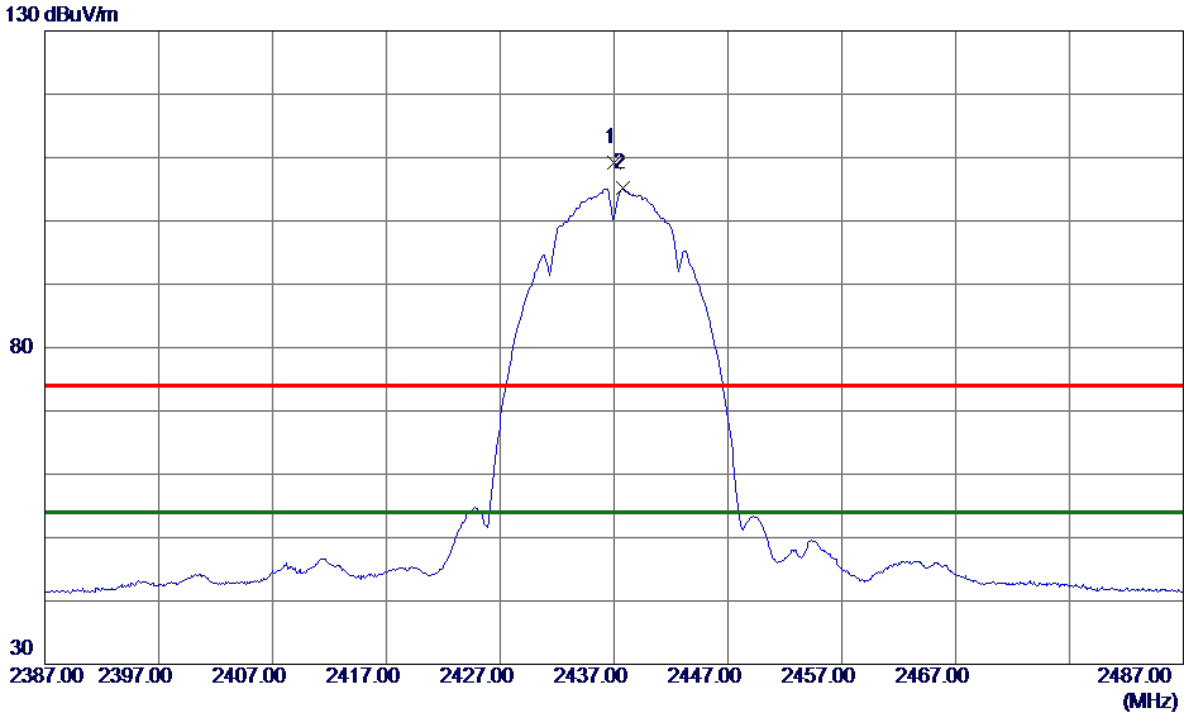

No.	Freq. MHz	Reading Level dBuV/m	Correct Factor dB	Measure ment dBuV/m	Limit dBuV/m	Margin dB	Detector	Comment
1	2437.0000	98.36	10.76	109.12	74.00	35.12	Peak	No Limit
2 *	2437.7500	94.35	10.76	105.11	54.00	51.11	AVG	No Limit

REMARKS:

- (1) Measurement Value = Reading Level + Correct Factor.
- (2) Margin Level = Measurement Value - Limit Value.

Test Mode: TX B Mode 2437 MHz

Vertical

80 dBuV/m

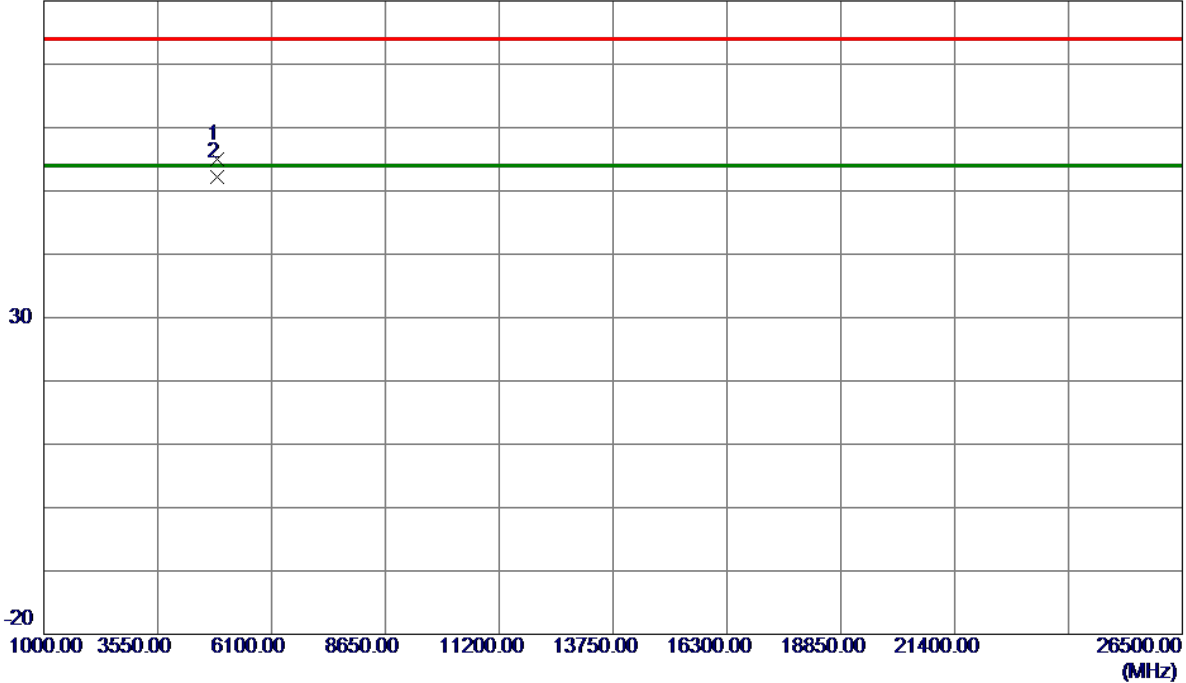

No.	Freq. MHz	Reading Level dBuV/m	Correct Factor dB	Measure ment dBuV/m	Limit dBuV/m	Margin dB	Detector	Comment
1	4873.9350	47.01	8.06	55.07	74.00	-18.93	Peak	
2 *	4874.0070	44.23	8.06	52.29	54.00	-1.71	AVG	

REMARKS:

- (1) Measurement Value = Reading Level + Correct Factor.
- (2) Margin Level = Measurement Value - Limit Value.

Test Mode: TX B Mode 2437 MHz

Horizontal

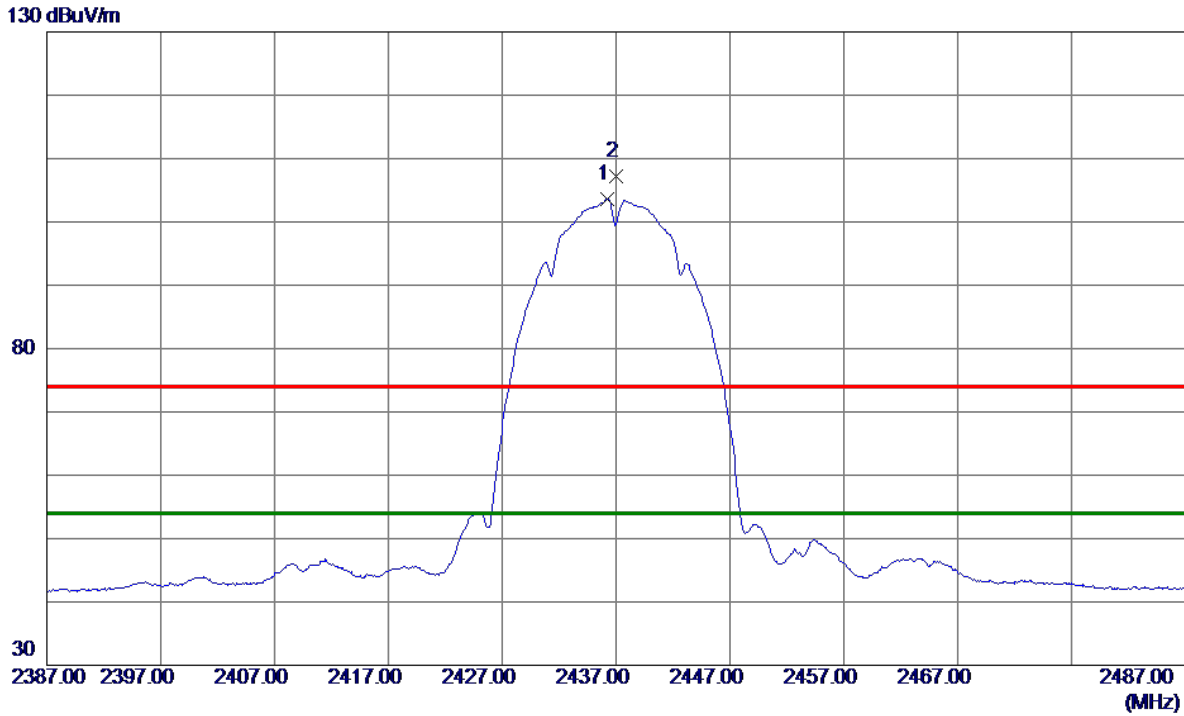

No.	Freq. MHz	Reading Level dBuV/m	Correct Factor dB	Measure ment dBuV/m	Limit dBuV/m	Margin dB	Detector	Comment
1 *	2436.2500	92.83	10.76	103.59	54.00	49.59	AVG	No Limit
2	2437.0000	96.53	10.76	107.29	74.00	33.29	Peak	No Limit

REMARKS:

- (1) Measurement Value = Reading Level + Correct Factor.
- (2) Margin Level = Measurement Value - Limit Value.

Test Mode: TX B Mode 2437 MHz

Horizontal

80 dBuV/m

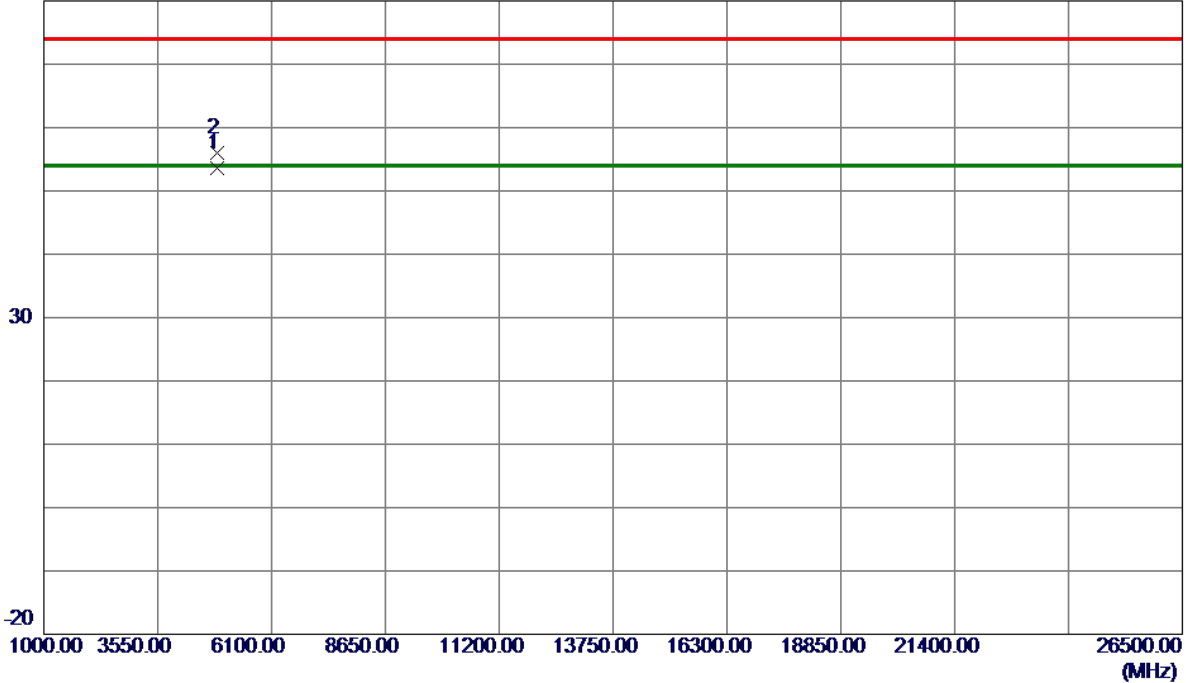

No.	Freq. MHz	Reading Level dBuV/m	Correct Factor dB	Measure ment dBuV/m	Limit dBuV/m	Margin dB	Detector	Comment
1 *	4873.9900	45.53	8.06	53.59	54.00	-0.41	AVG	
2	4874.0550	47.97	8.06	56.03	74.00	-17.97	Peak	

REMARKS:

(1) Measurement Value = Reading Level + Correct Factor.

(2) Margin Level = Measurement Value - Limit Value.

Test Mode: TX B Mode 2457 MHz

Vertical

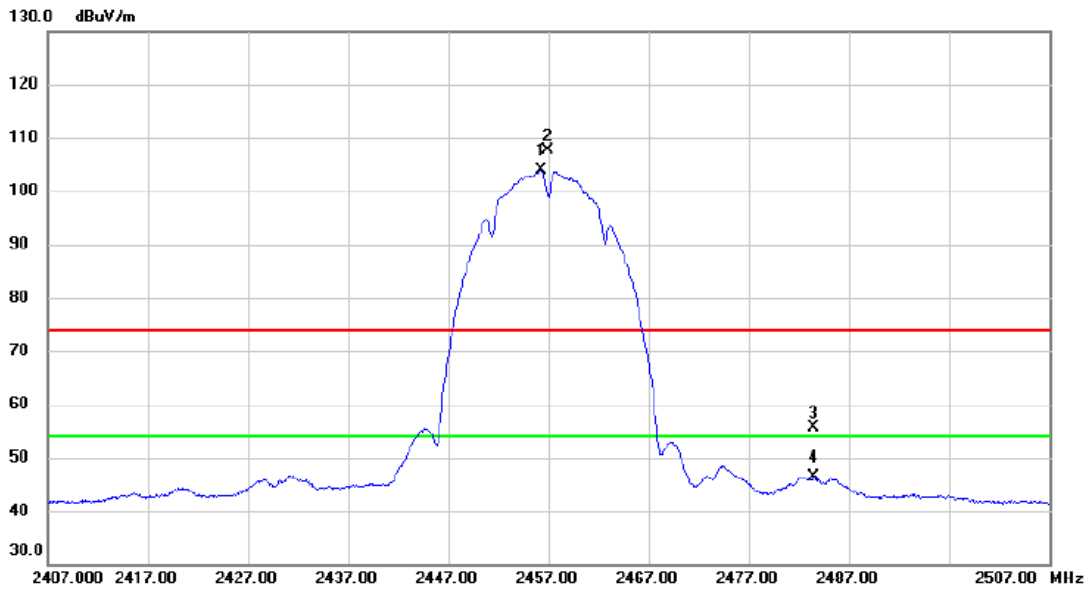

No.	Mk.	Freq. MHz	Reading Level dBuV	Correct Factor dB	Measure- ment dBuV/m	Limit dBuV/m	Margin dB	Detector	Comment
1	*	2456.250	93.11	10.81	103.92	54.00	49.92	AVG	No Limit
2	X	2456.900	96.82	10.82	107.64	74.00	33.64	peak	No Limit
3		2483.500	44.81	10.90	55.71	74.00	-18.29	peak	
4		2483.500	35.58	10.90	46.48	54.00	-7.52	AVG	

REMARKS:

- (1) Measurement Value = Reading Level + Correct Factor.
- (2) Margin Level = Measurement Value - Limit Value.

Test Mode: TX B Mode 2457 MHz

Vertical

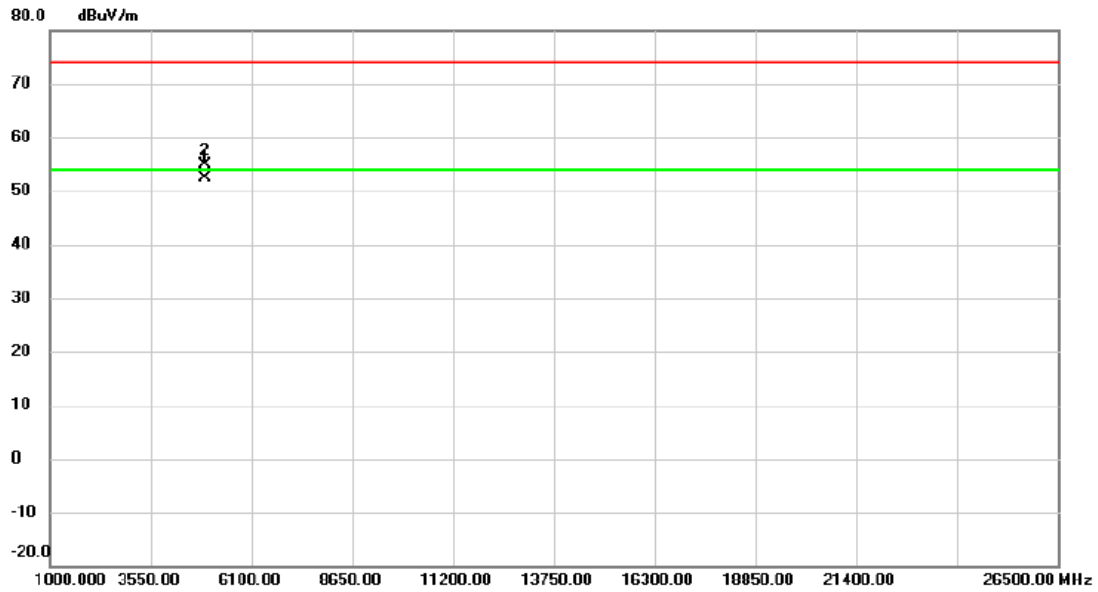

No.	Mk.	Freq. MHz	Reading Level dBuV	Correct Factor dB	Measure- ment dBuV/m	Limit dBuV/m	Margin dB	Detector	Comment
1	*	4913.990	44.08	8.22	52.30	54.00	-1.70	AVG	
2		4914.137	46.71	8.22	54.93	74.00	-19.07	peak	

REMARKS:

- (1) Measurement Value = Reading Level + Correct Factor.
- (2) Margin Level = Measurement Value - Limit Value.

Test Mode: TX B Mode 2457 MHz

Horizontal

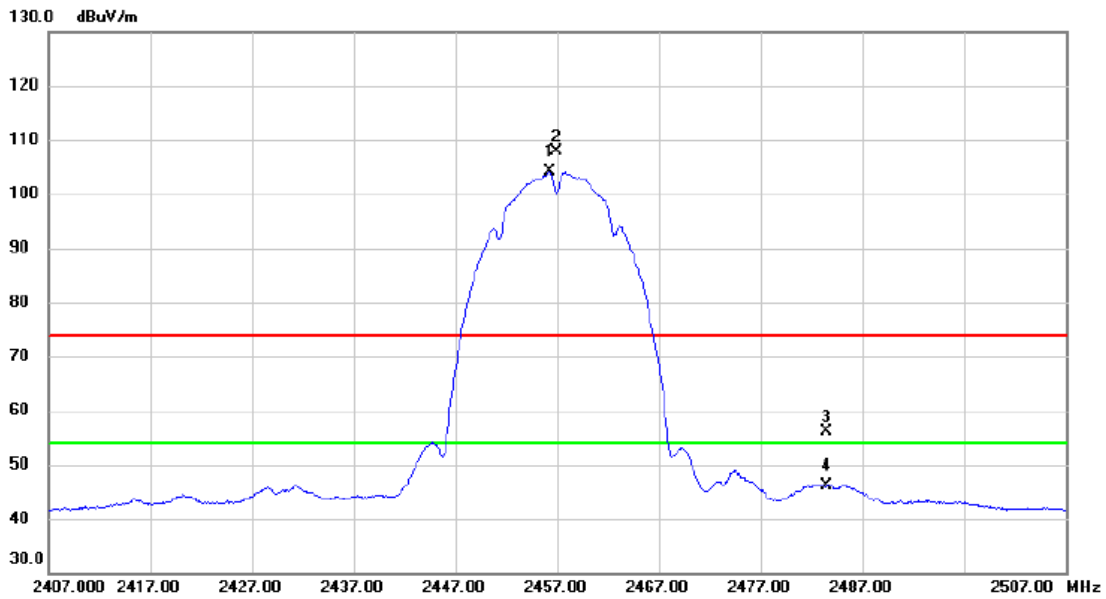

No.	Mk.	Freq. MHz	Reading Level dBuV	Correct Factor dB	Measure- ment dBuV/m	Limit dBuV/m	Margin dB	Detector	Comment
1	*	2456.250	93.22	10.81	104.03	54.00	50.03	AVG	No Limit
2	X	2456.900	97.11	10.82	107.93	74.00	33.93	peak	No Limit
3		2483.500	45.24	10.90	56.14	74.00	-17.86	peak	
4		2483.500	35.31	10.90	46.21	54.00	-7.79	AVG	

REMARKS:

- (1) Measurement Value = Reading Level + Correct Factor.
- (2) Margin Level = Measurement Value - Limit Value.

Test Mode: TX B Mode 2457 MHz

Horizontal

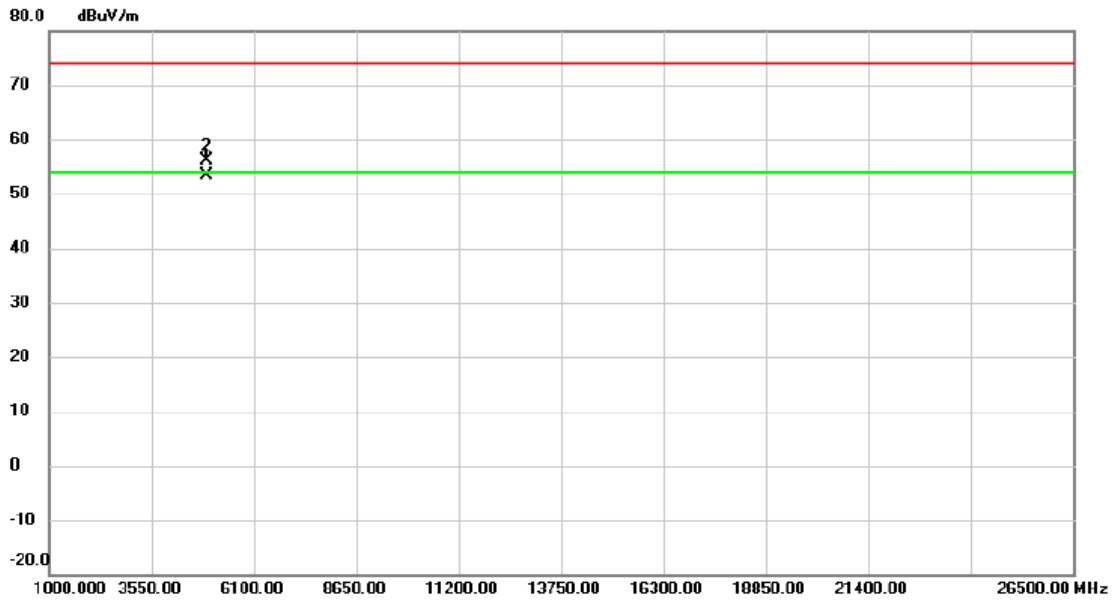

No.	Mk.	Freq. MHz	Reading Level dBuV	Correct Factor dB	Measure- ment dBuV/m	Limit dBuV/m	Margin dB	Detector	Comment
1	*	4913.980	45.20	8.22	53.42	54.00	-0.58	AVG	
2		4914.015	47.83	8.22	56.05	74.00	-17.95	peak	

REMARKS:

- (1) Measurement Value = Reading Level + Correct Factor.
- (2) Margin Level = Measurement Value - Limit Value.

Test Mode: TX B Mode 2462 MHz

Vertical

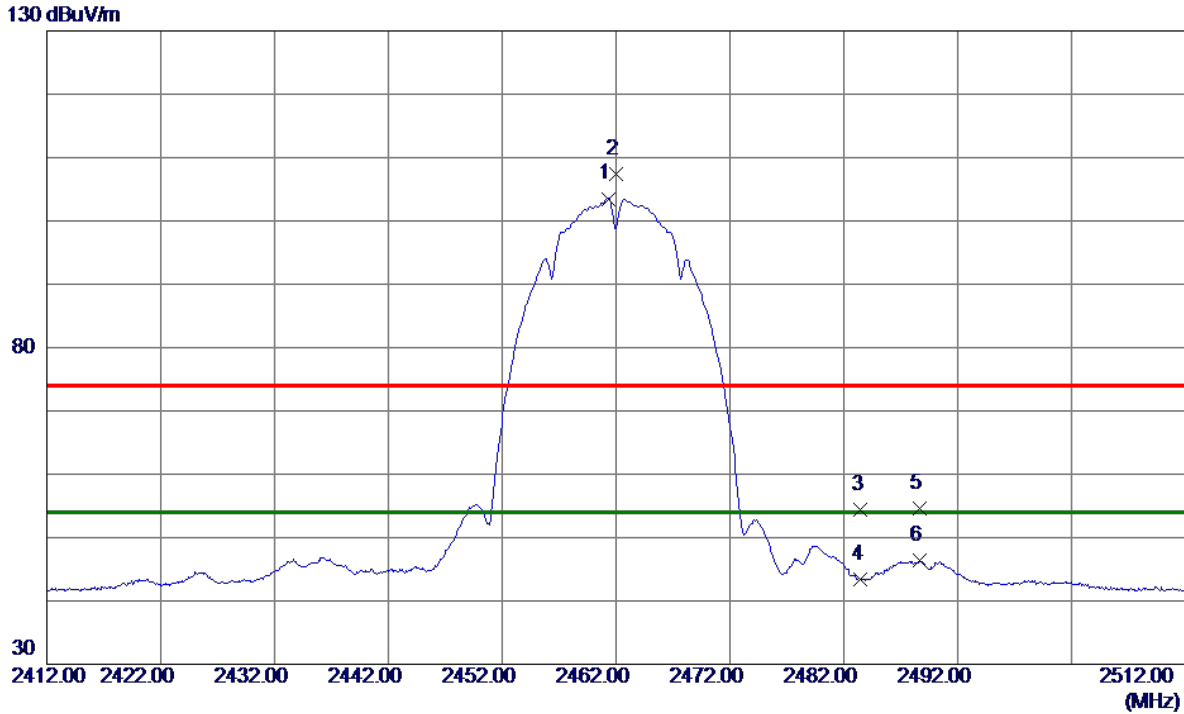

No.	Freq. MHz	Reading Level dBuV/m	Correct Factor dB	Measure ment dBuV/m	Limit dBuV/m	Margin dB	Detector	Comment
1 *	2461.3000	92.67	10.83	103.50	54.00	49.50	AVG	No Limit
2	2462.0500	96.57	10.84	107.41	74.00	33.41	Peak	No Limit
3	2483.5000	43.57	10.90	54.47	74.00	-19.53	Peak	
4	2483.5000	32.49	10.90	43.39	54.00	-10.61	AVG	
5	2488.6500	43.66	10.92	54.58	74.00	-19.42	Peak	
6	2488.6500	35.44	10.92	46.36	54.00	-7.64	AVG	

REMARKS:

- (1) Measurement Value = Reading Level + Correct Factor.
- (2) Margin Level = Measurement Value - Limit Value.

Test Mode: TX B Mode 2462 MHz

Vertical

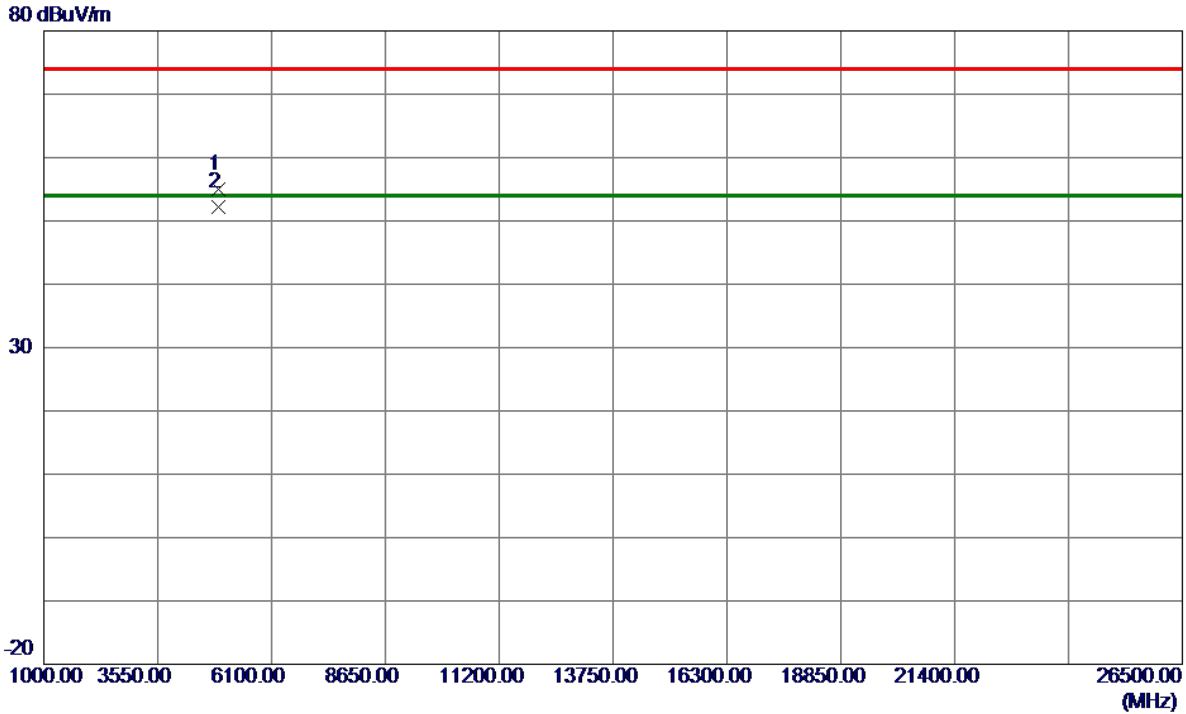

No.	Freq. MHz	Reading Level dBuV/m	Correct Factor dB	Measure ment dBuV/m	Limit dBuV/m	Margin dB	Detector	Comment
1	4924.0000	46.73	8.26	54.99	74.00	-19.01	Peak	
2 *	4924.0000	44.00	8.26	52.26	54.00	-1.74	AVG	

REMARKS:

- (1) Measurement Value = Reading Level + Correct Factor.
- (2) Margin Level = Measurement Value - Limit Value.

Test Mode: TX B Mode 2462 MHz

Horizontal

130 dBuV/m

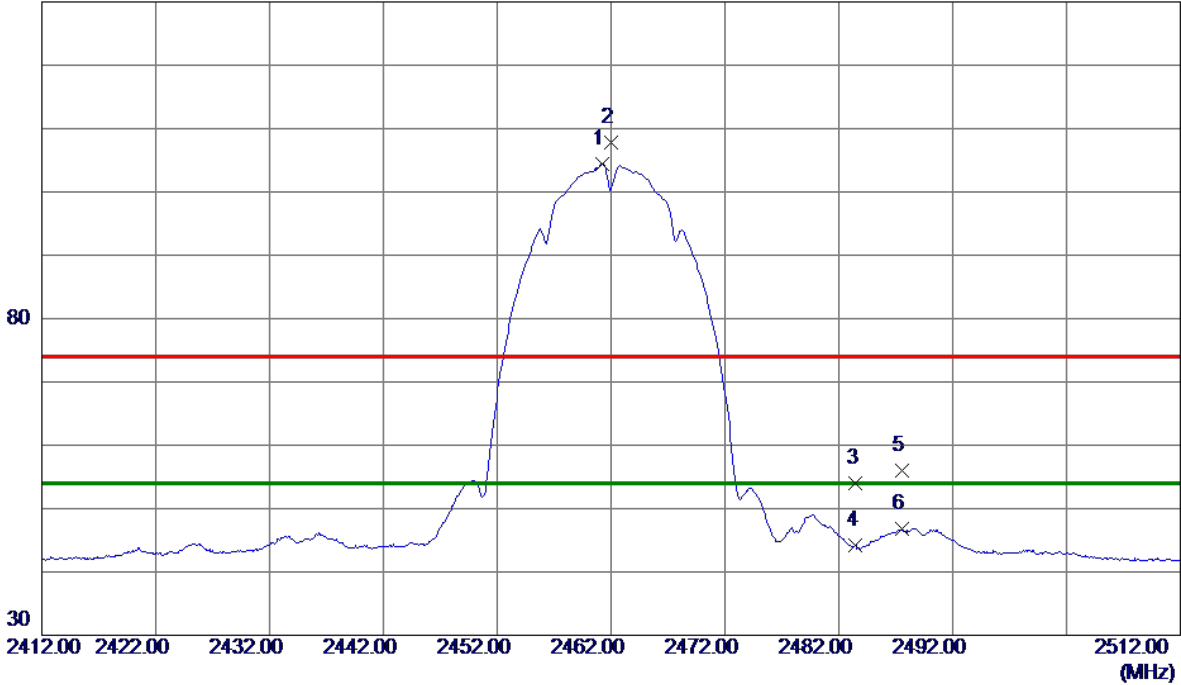

No.	Freq. MHz	Reading Level dBuV/m	Correct Factor dB	Measure ment dBuV/m	Limit dBuV/m	Margin dB	Detector	Comment
1 *	2461.2000	93.55	10.83	104.38	54.00	50.38	AVG	No Limit
2	2461.9500	96.98	10.84	107.82	74.00	33.82	Peak	No Limit
3	2483.5000	43.19	10.90	54.09	74.00	-19.91	Peak	
4	2483.5000	33.21	10.90	44.11	54.00	-9.89	AVG	
5	2487.6000	45.16	10.91	56.07	74.00	-17.93	Peak	
6	2487.6000	35.92	10.91	46.83	54.00	-7.17	AVG	

REMARKS:

- (1) Measurement Value = Reading Level + Correct Factor.
- (2) Margin Level = Measurement Value - Limit Value.

Test Mode: TX B Mode 2462 MHz

Horizontal

80 dBuV/m

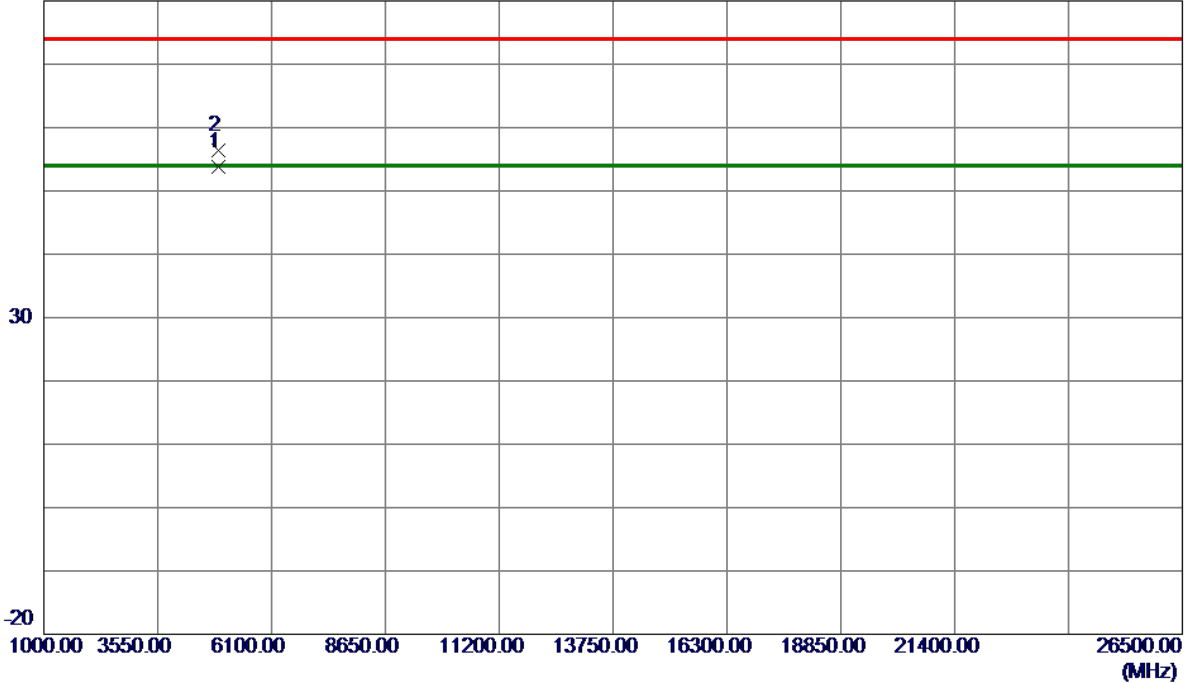

No.	Freq. MHz	Reading Level dBuV/m	Correct Factor dB	Measure ment dBuV/m	Limit dBuV/m	Margin dB	Detector	Comment
1 *	4923.9830	45.57	8.26	53.83	54.00	-0.17	AVG	
2	4924.1420	48.07	8.26	56.33	74.00	-17.67	Peak	

REMARKS:

(1) Measurement Value = Reading Level + Correct Factor.

(2) Margin Level = Measurement Value - Limit Value.

Test Mode: TX G Mode 2412 MHz

Vertical

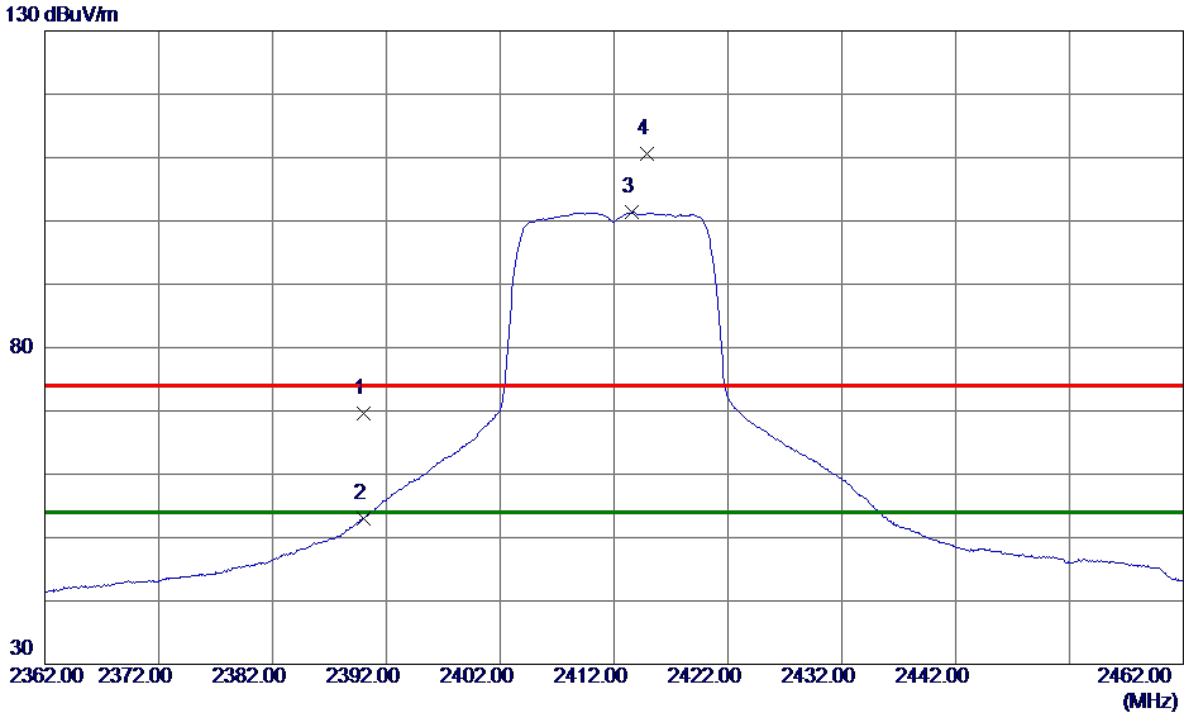

No.	Freq. MHz	Reading Level dBuV/m	Correct Factor dB	Measure ment dBuV/m	Limit dBuV/m	Margin dB	Detector	Comment
1	2390.0000	58.98	10.62	69.60	74.00	-4.40	Peak	
2	2390.0000	42.45	10.62	53.07	54.00	-0.93	AVG	
3 *	2413.6000	90.72	10.69	101.41	54.00	47.41	AVG	No Limit
4	2414.9000	99.94	10.70	110.64	74.00	36.64	Peak	No Limit

REMARKS:

- (1) Measurement Value = Reading Level + Correct Factor.
- (2) Margin Level = Measurement Value - Limit Value.

Test Mode: TX G Mode 2412 MHz

Vertical

80 dBuV/m

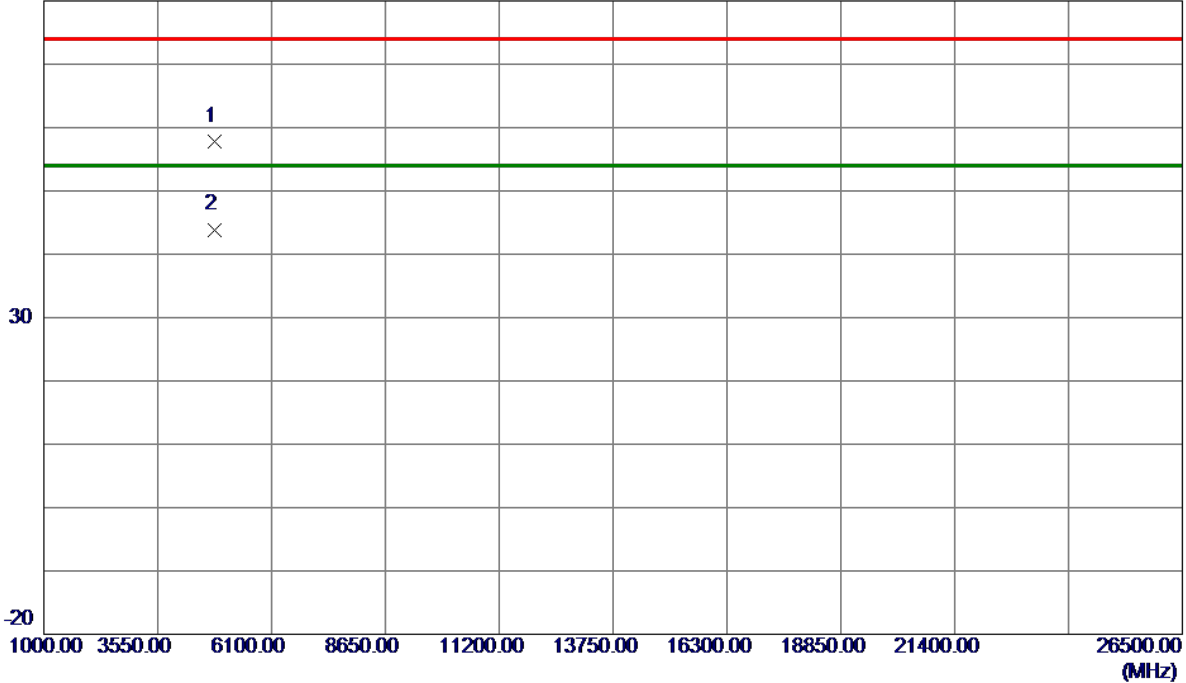

No.	Freq. MHz	Reading Level dBuV/m	Correct Factor dB	Measure ment dBuV/m	Limit dBuV/m	Margin dB	Detector	Comment
1	4822.5350	49.88	7.85	57.73	74.00	-16.27	Peak	
2 *	4824.6450	36.04	7.86	43.90	54.00	-10.10	AVG	

REMARKS:

- (1) Measurement Value = Reading Level + Correct Factor.
- (2) Margin Level = Measurement Value - Limit Value.

Test Mode: TX G Mode 2412 MHz

Horizontal

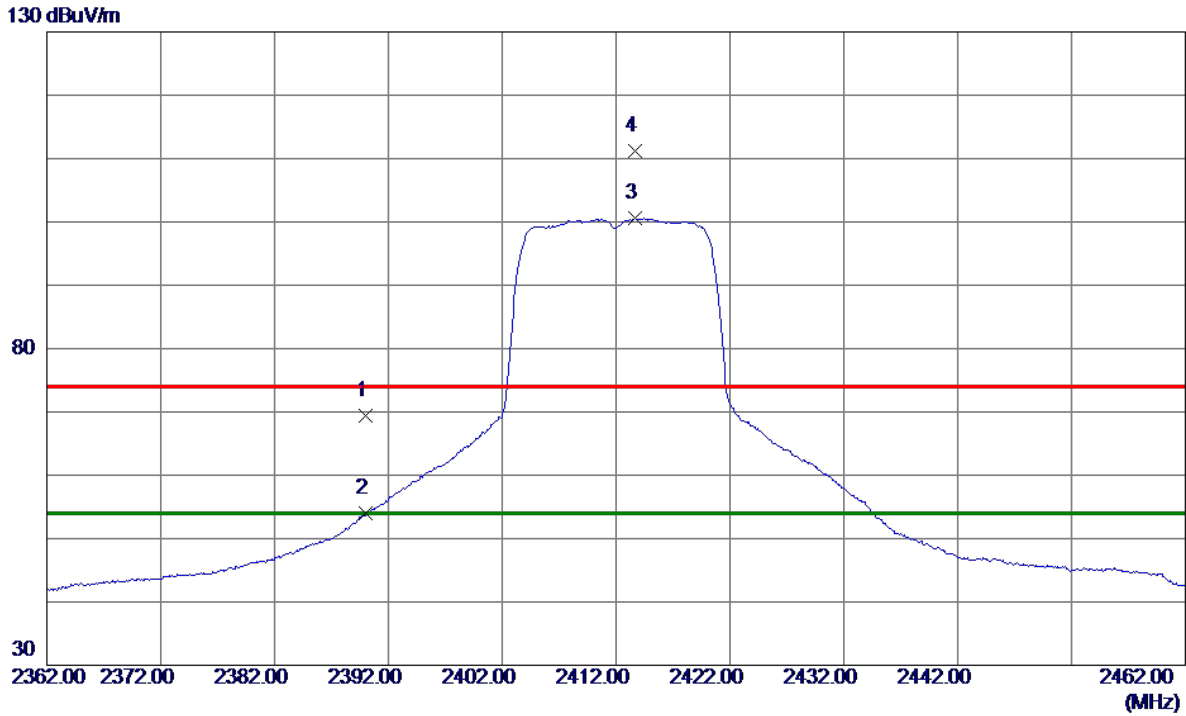

No.	Freq. MHz	Reading Level dBuV/m	Correct Factor dB	Measure ment dBuV/m	Limit dBuV/m	Margin dB	Detector	Comment
1	2390.0000	58.80	10.62	69.42	74.00	-4.58	Peak	
2	2390.0000	43.30	10.62	53.92	54.00	-0.08	AVG	
3 *	2413.6500	89.88	10.69	100.57	54.00	46.57	AVG	No Limit
4	2413.7000	100.58	10.69	111.27	74.00	37.27	Peak	No Limit

REMARKS:

- (1) Measurement Value = Reading Level + Correct Factor.
- (2) Margin Level = Measurement Value - Limit Value.

Test Mode: TX G Mode 2412 MHz

Horizontal

80 dBuV/m

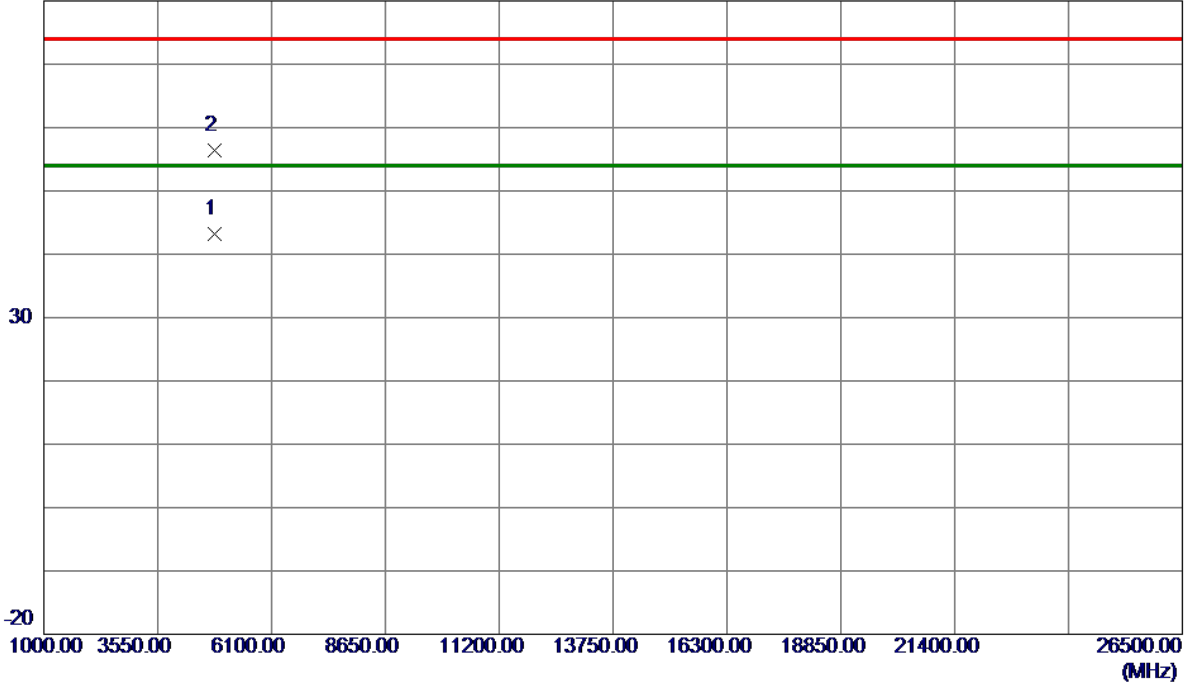

No.	Freq. MHz	Reading Level dBuV/m	Correct Factor dB	Measure ment dBuV/m	Limit dBuV/m	Margin dB	Detector	Comment
1 *	4824.0050	35.43	7.86	43.29	54.00	-10.71	AVG	
2	4824.8230	48.48	7.86	56.34	74.00	-17.66	Peak	

REMARKS:

(1) Measurement Value = Reading Level + Correct Factor.

(2) Margin Level = Measurement Value - Limit Value.

Test Mode: TX G Mode 2417 MHz

Vertical

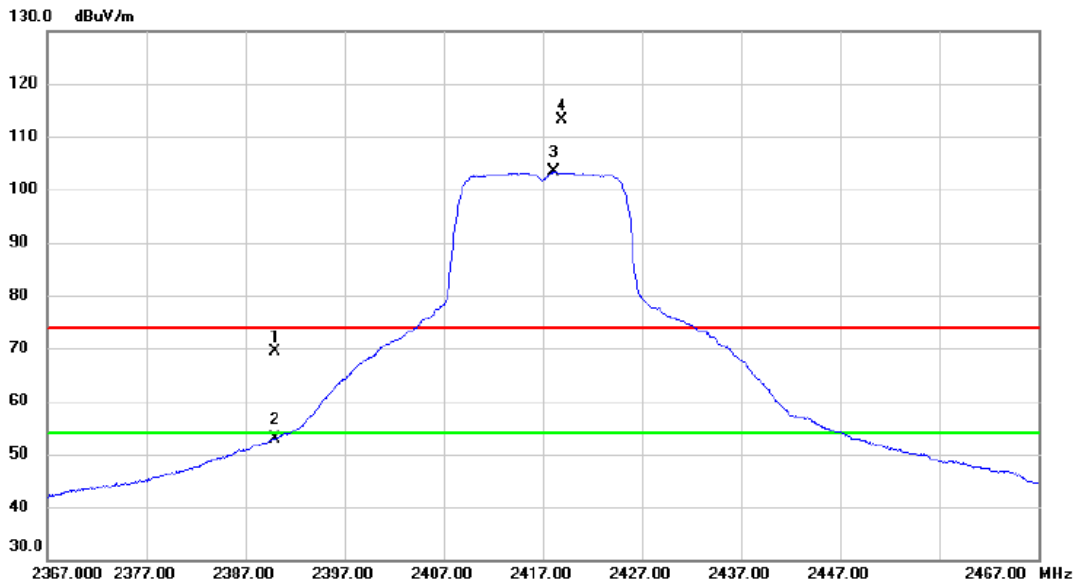

No.	Mk.	Freq. MHz	Reading Level dBuV	Correct Factor dB	Measure- ment dBuV/m	Limit dBuV/m	Margin dB	Detector	Comment
1		2390.000	58.69	10.63	69.32	74.00	-4.68	peak	
2		2390.000	42.34	10.63	52.97	54.00	-1.03	AVG	
3	*	2418.100	92.65	10.71	103.36	54.00	49.36	AVG	No Limit
4	X	2418.900	102.39	10.71	113.10	74.00	39.10	peak	No Limit

REMARKS:

- (1) Measurement Value = Reading Level + Correct Factor.
- (2) Margin Level = Measurement Value - Limit Value.

Test Mode: TX G Mode 2417 MHz

Vertical

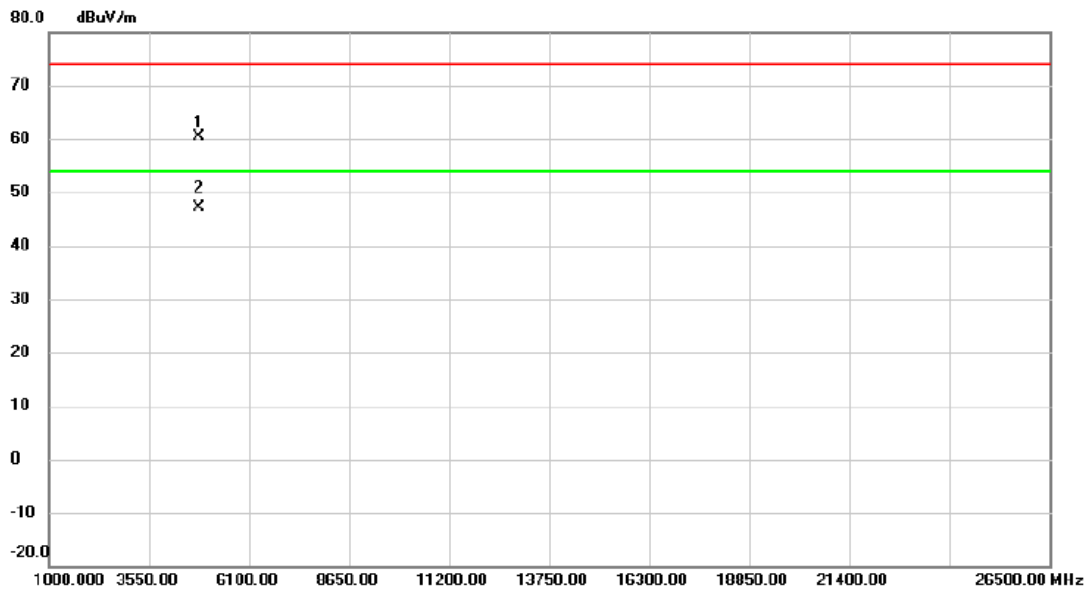

No. Mk.	Freq. MHz	Reading Level dBuV	Correct Factor dB	Measure- ment dBuV/m	Limit dBuV/m	Margin dB	Detector	Comment
1	4831.945	52.53	7.89	60.42	74.00	-13.58	peak	
2 *	4834.525	39.29	7.90	47.19	54.00	-6.81	AVG	

REMARKS:

- (1) Measurement Value = Reading Level + Correct Factor.
- (2) Margin Level = Measurement Value - Limit Value.

Test Mode: TX G Mode 2417 MHz

Horizontal

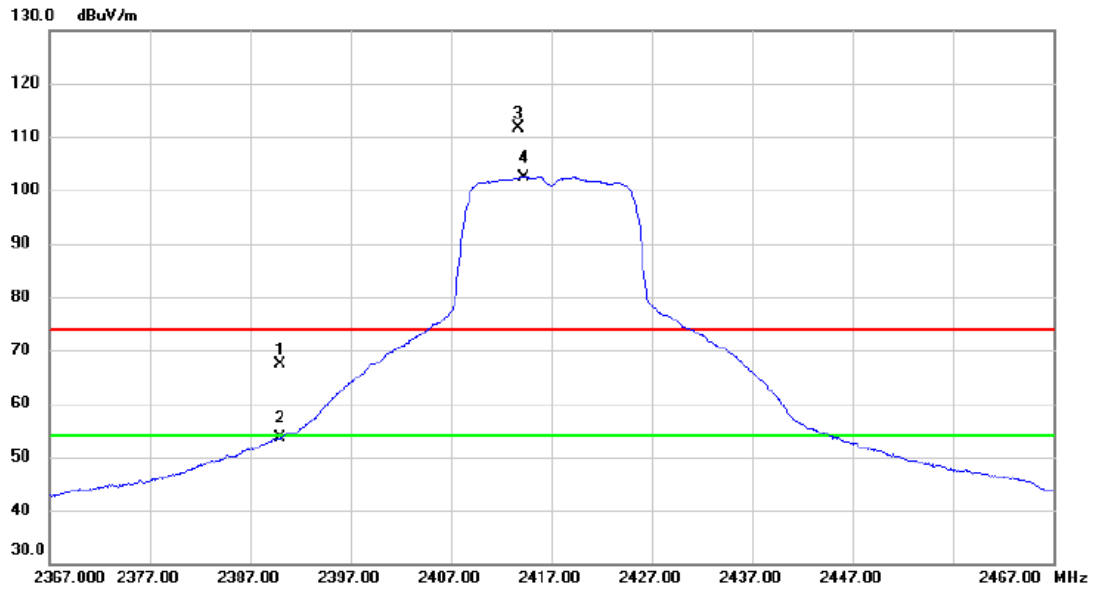

No.	Mk.	Freq. MHz	Reading Level dBuV	Correct Factor dB	Measure- ment dBuV/m	Limit dBuV/m	Margin dB	Detector	Comment
1		2390.000	56.77	10.63	67.40	74.00	-6.60	peak	
2		2390.000	43.04	10.63	53.67	54.00	-0.33	AVG	
3	X	2413.750	100.87	10.69	111.56	74.00	37.56	peak	No Limit
4	*	2414.250	91.73	10.69	102.42	54.00	48.42	AVG	No Limit

REMARKS:

- (1) Measurement Value = Reading Level + Correct Factor.
- (2) Margin Level = Measurement Value - Limit Value.

Test Mode: TX G Mode 2417 MHz

Horizontal

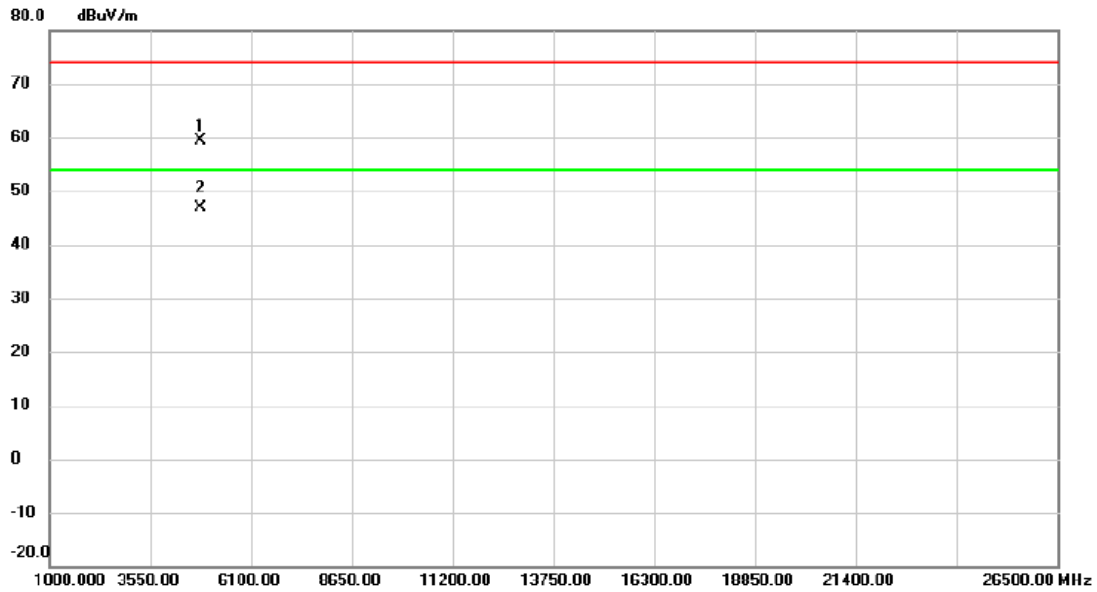

No.	Mk.	Freq. MHz	Reading Level dBuV	Correct Factor dB	Measure- ment dBuV/m	Limit dBuV/m	Margin dB	Detector	Comment
1		4834.820	51.42	7.90	59.32	74.00	-14.68	peak	
2	*	4835.342	39.00	7.90	46.90	54.00	-7.10	AVG	

REMARKS:

- (1) Measurement Value = Reading Level + Correct Factor.
- (2) Margin Level = Measurement Value - Limit Value.

Test Mode: TX G Mode 2437 MHz

Vertical

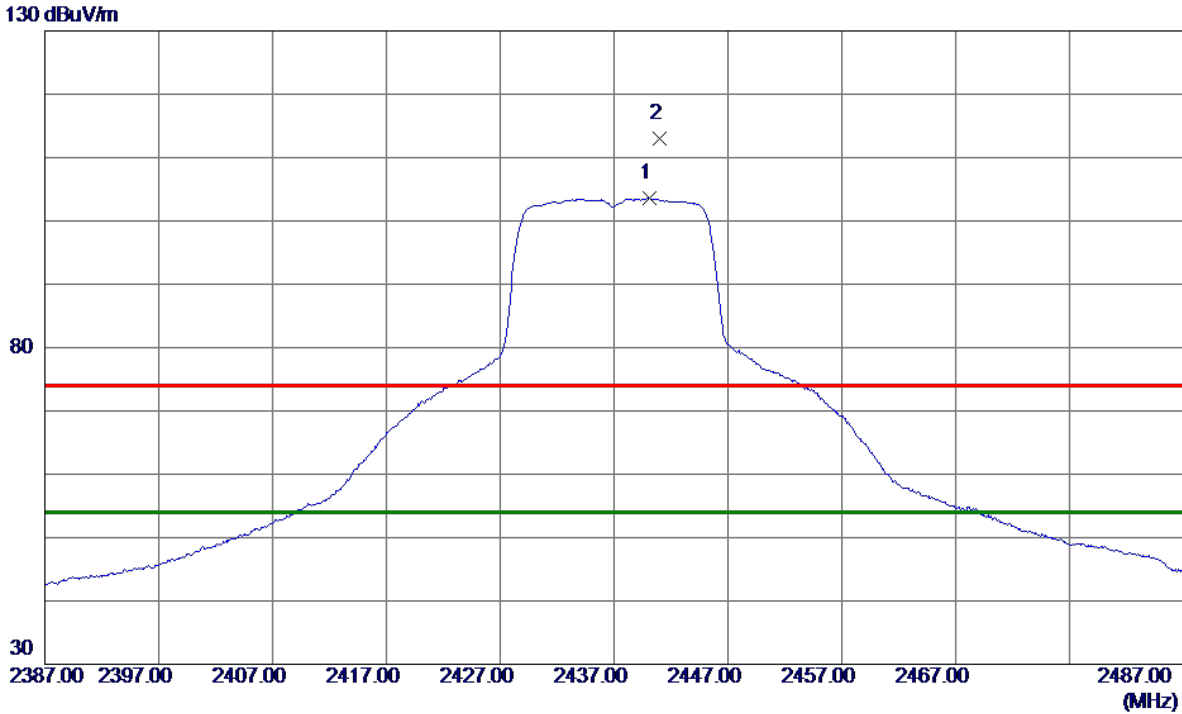

No.	Freq. MHz	Reading Level dBuV/m	Correct Factor dB	Measure ment dBuV/m	Limit dBuV/m	Margin dB	Detector	Comment
1 *	2440.1000	92.84	10.77	103.61	54.00	49.61	AVG	No Limit
2	2440.9500	102.31	10.77	113.08	74.00	39.08	Peak	No Limit

REMARKS:

- (1) Measurement Value = Reading Level + Correct Factor.
- (2) Margin Level = Measurement Value - Limit Value.

Test Mode: TX G Mode 2437 MHz

Vertical

80 dBuV/m

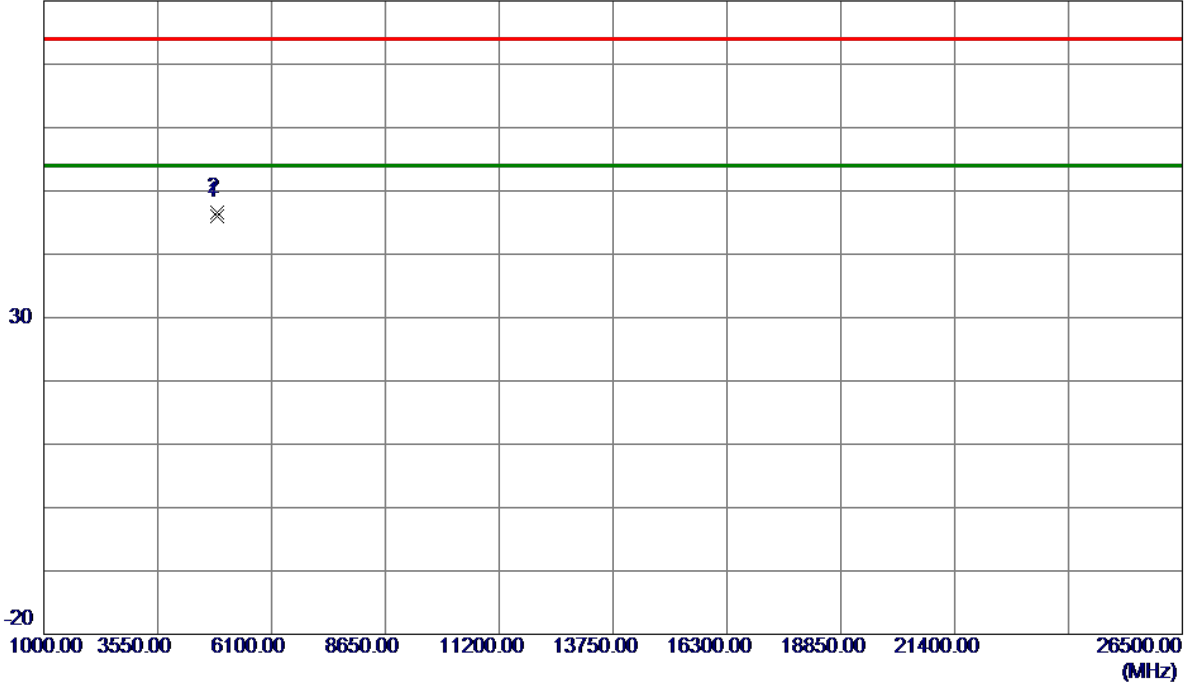

No.	Freq. MHz	Reading Level dBuV/m	Correct Factor dB	Measure ment dBuV/m	Limit dBuV/m	Margin dB	Detector	Comment
1 *	4874.3000	38.03	8.06	46.09	54.00	-7.91	AVG	
2	4874.3630	38.52	8.06	46.58	74.00	-27.42	Peak	

REMARKS:

- (1) Measurement Value = Reading Level + Correct Factor.
- (2) Margin Level = Measurement Value - Limit Value.

Test Mode: TX G Mode 2437 MHz

Horizontal

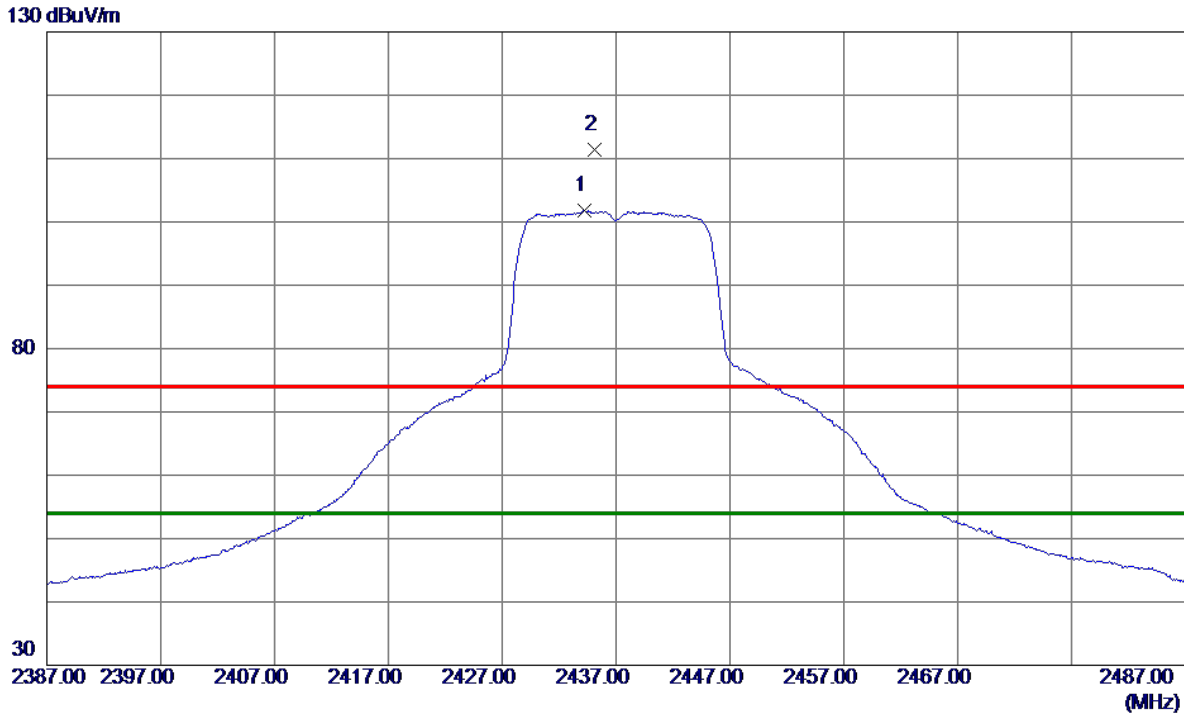

No.	Freq. MHz	Reading Level dBuV/m	Correct Factor dB	Measure ment dBuV/m	Limit dBuV/m	Margin dB	Detector	Comment
1 *	2434.2000	90.98	10.75	101.73	54.00	47.73	AVG	No Limit
2	2435.1500	100.69	10.76	111.45	74.00	37.45	Peak	No Limit

REMARKS:

- (1) Measurement Value = Reading Level + Correct Factor.
- (2) Margin Level = Measurement Value - Limit Value.

Test Mode: TX G Mode 2437 MHz

Horizontal

80 dBuV/m

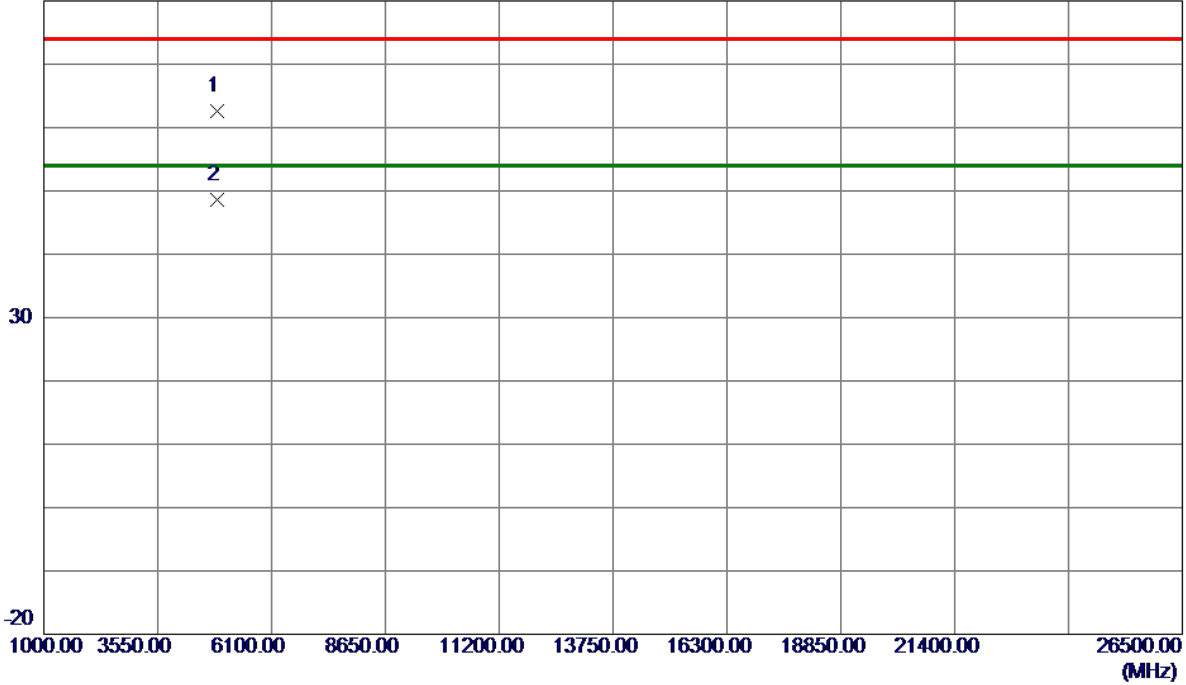

No.	Freq. MHz	Reading Level dBuV/m	Correct Factor dB	Measure ment dBuV/m	Limit dBuV/m	Margin dB	Detector	Comment
1	4873.5700	54.63	8.06	62.69	74.00	-11.31	Peak	
2 *	4875.4250	40.60	8.06	48.66	54.00	-5.34	AVG	

REMARKS:

(1) Measurement Value = Reading Level + Correct Factor.

(2) Margin Level = Measurement Value - Limit Value.

Test Mode: TX G Mode 2457 MHz

Vertical

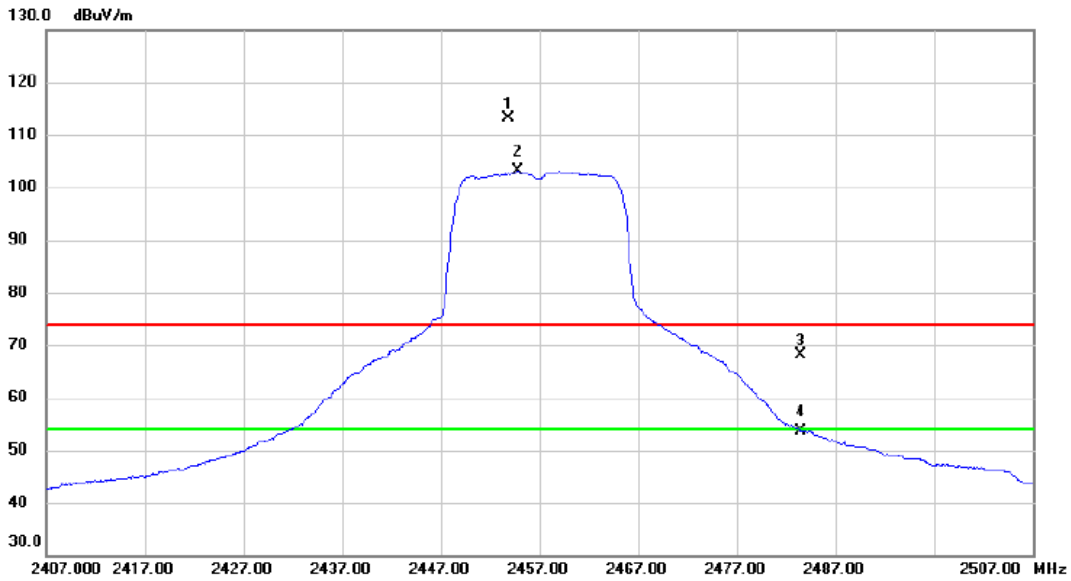

No.	Mk.	Freq. MHz	Reading Level dBuV	Correct Factor dB	Measure- ment dBuV/m	Limit dBuV/m	Margin dB	Detector	Comment
1	X	2453.900	102.37	10.81	113.18	74.00	39.18	peak	No Limit
2	*	2454.800	92.23	10.81	103.04	54.00	49.04	AVG	No Limit
3		2483.500	57.16	10.90	68.06	74.00	-5.94	peak	
4		2483.500	42.83	10.90	53.73	54.00	-0.27	AVG	

REMARKS:

- (1) Measurement Value = Reading Level + Correct Factor.
- (2) Margin Level = Measurement Value - Limit Value.

Test Mode: TX G Mode 2457 MHz

Vertical

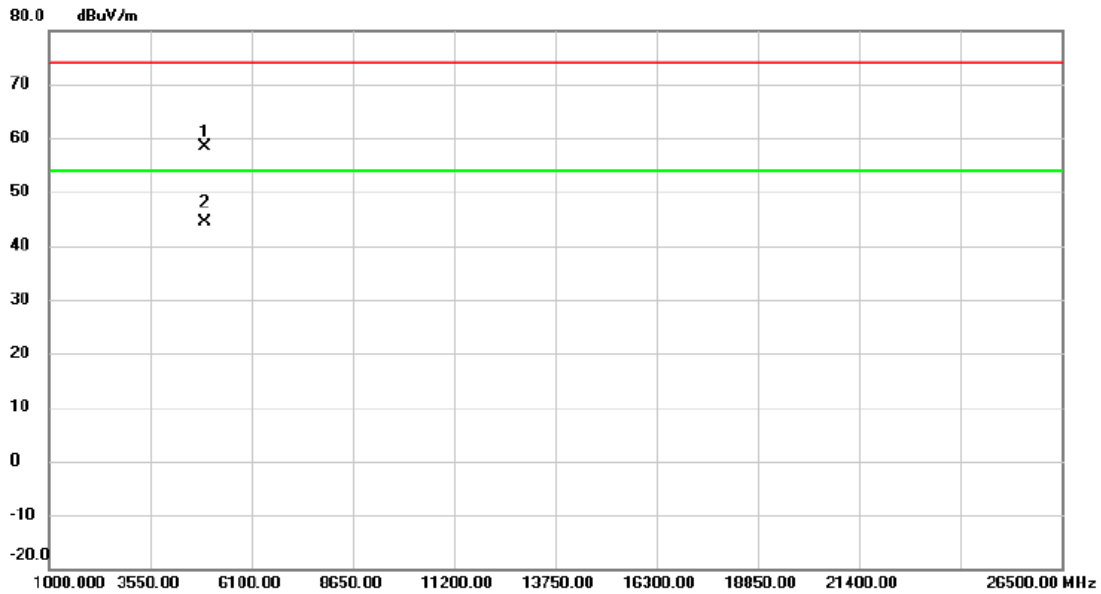

No.	Mk.	Freq. MHz	Reading Level dBuV	Correct Factor dB	Measure- ment dBuV/m	Limit dBuV/m	Margin dB	Detector	Comment
1		4912.825	50.13	8.22	58.35	74.00	-15.65	peak	
2	*	4914.290	36.24	8.22	44.46	54.00	-9.54	AVG	

REMARKS:

- (1) Measurement Value = Reading Level + Correct Factor.
- (2) Margin Level = Measurement Value - Limit Value.

Test Mode: TX G Mode 2457 MHz

Horizontal

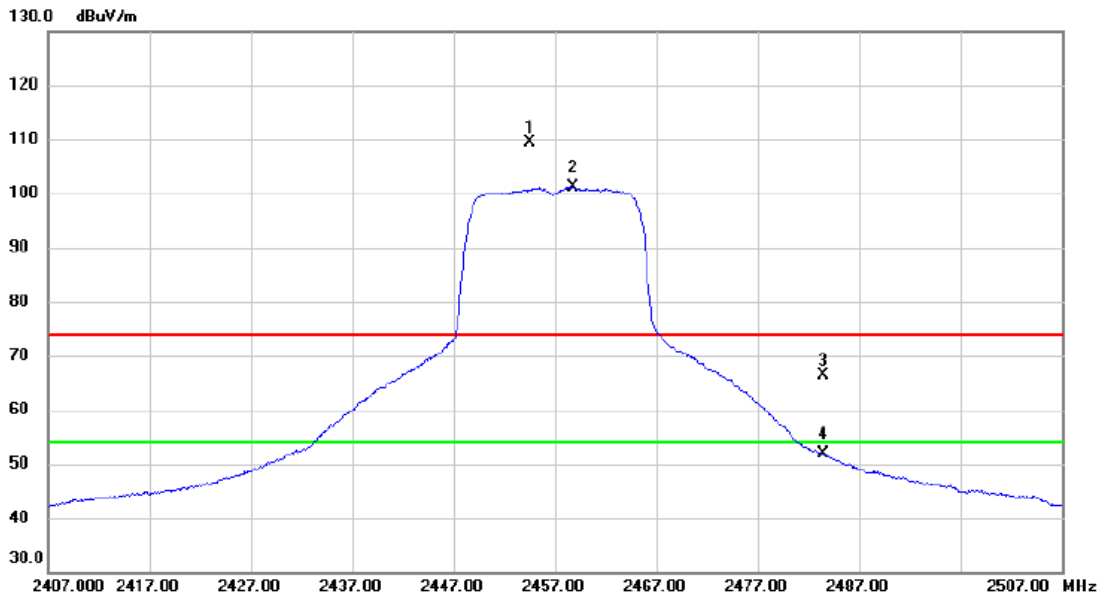

No.	Mk.	Freq. MHz	Reading Level dBuV	Correct Factor dB	Measure- ment dBuV/m	Limit dBuV/m	Margin dB	Detector	Comment
1	X	2454.500	98.49	10.81	109.30	74.00	35.30	peak	No Limit
2	*	2458.750	90.34	10.83	101.17	54.00	47.17	AVG	No Limit
3		2483.500	55.52	10.90	66.42	74.00	-7.58	peak	
4		2483.500	40.98	10.90	51.88	54.00	-2.12	AVG	

REMARKS:

- (1) Measurement Value = Reading Level + Correct Factor.
- (2) Margin Level = Measurement Value - Limit Value.

Test Mode: TX G Mode 2457 MHz

Horizontal

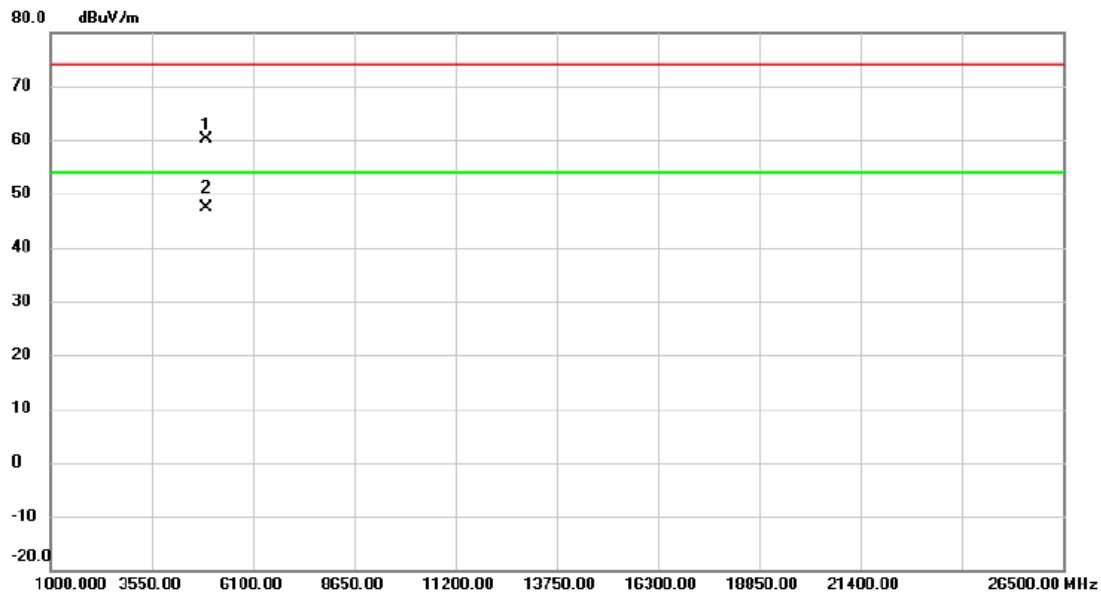

No.	Mk.	Freq. MHz	Reading Level dBuV	Correct Factor dB	Measure- ment dBuV/m	Limit dBuV/m	Margin dB	Detector	Comment
1		4912.540	51.80	8.22	60.02	74.00	-13.98	peak	
2	*	4913.115	39.11	8.22	47.33	54.00	-6.67	AVG	

REMARKS:

- (1) Measurement Value = Reading Level + Correct Factor.
- (2) Margin Level = Measurement Value - Limit Value.

Test Mode: TX G Mode 2462 MHz

Vertical

130 dBuV/m

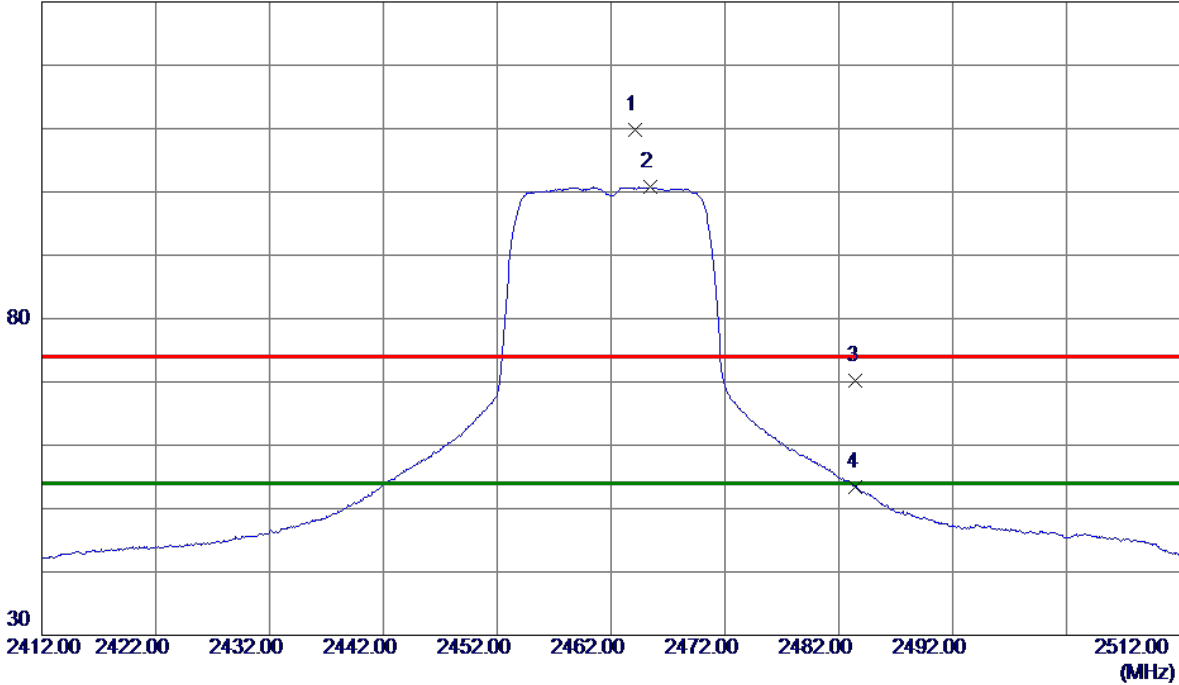

No.	Freq. MHz	Reading Level dBuV/m	Correct Factor dB	Measure ment dBuV/m	Limit dBuV/m	Margin dB	Detector	Comment
1	2464.1500	99.04	10.84	109.88	74.00	35.88	Peak	No Limit
2 *	2465.4500	89.88	10.85	100.73	54.00	46.73	AVG	No Limit
3	2483.5000	59.30	10.90	70.20	74.00	-3.80	Peak	
4	2483.5000	42.52	10.90	53.42	54.00	-0.58	AVG	

REMARKS:

- (1) Measurement Value = Reading Level + Correct Factor.
- (2) Margin Level = Measurement Value - Limit Value.

Test Mode: TX G Mode 2462 MHz

Vertical

80 dBuV/m

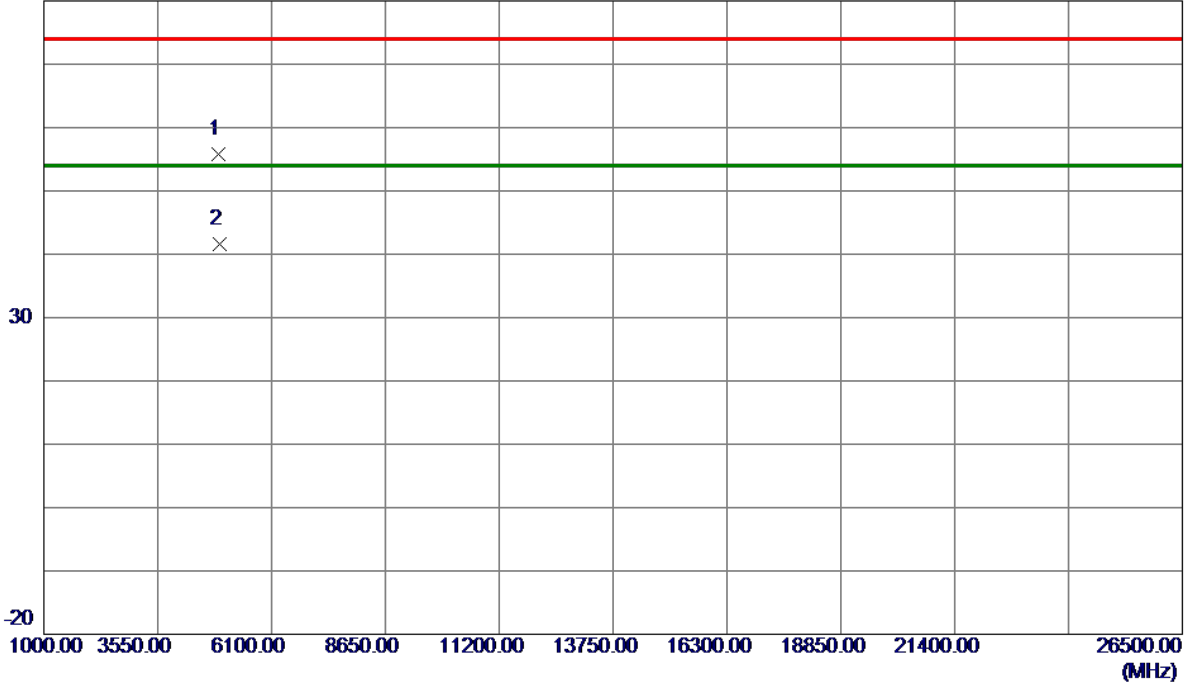

No.	Freq. MHz	Reading Level dBuV/m	Correct Factor dB	Measure ment dBuV/m	Limit dBuV/m	Margin dB	Detector	Comment
1	4921.6950	47.54	8.25	55.79	74.00	-18.21	Peak	
2 *	4925.2220	33.37	8.26	41.63	54.00	-12.37	AVG	

REMARKS:

- (1) Measurement Value = Reading Level + Correct Factor.
- (2) Margin Level = Measurement Value - Limit Value.

Test Mode: TX G Mode 2462 MHz

Horizontal

130 dBuV/m

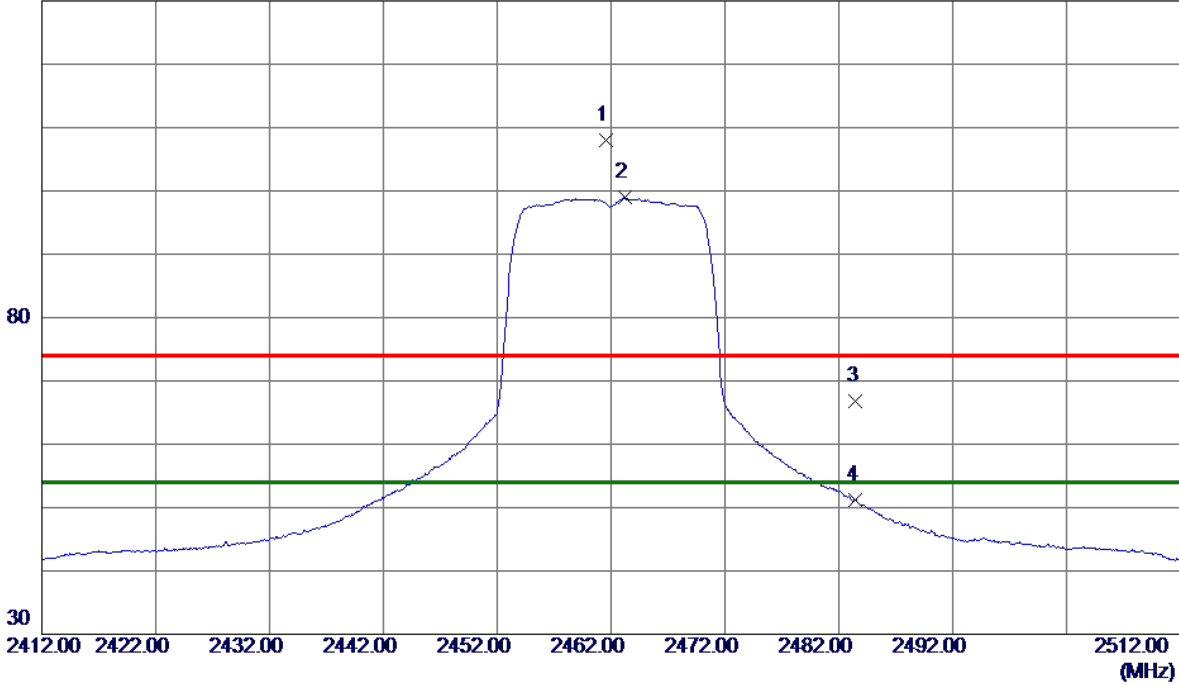

No.	Freq. MHz	Reading Level dBuV/m	Correct Factor dB	Measure ment dBuV/m	Limit dBuV/m	Margin dB	Detector	Comment
1	2461.6000	97.22	10.84	108.06	74.00	34.06	Peak	No Limit
2 *	2463.2000	88.17	10.84	99.01	54.00	45.01	AVG	No Limit
3	2483.5000	55.83	10.90	66.73	74.00	-7.27	Peak	
4	2483.5000	40.31	10.90	51.21	54.00	-2.79	AVG	

REMARKS:

- (1) Measurement Value = Reading Level + Correct Factor.
- (2) Margin Level = Measurement Value - Limit Value.

Test Mode: TX G Mode 2462 MHz

Horizontal

80 dBuV/m

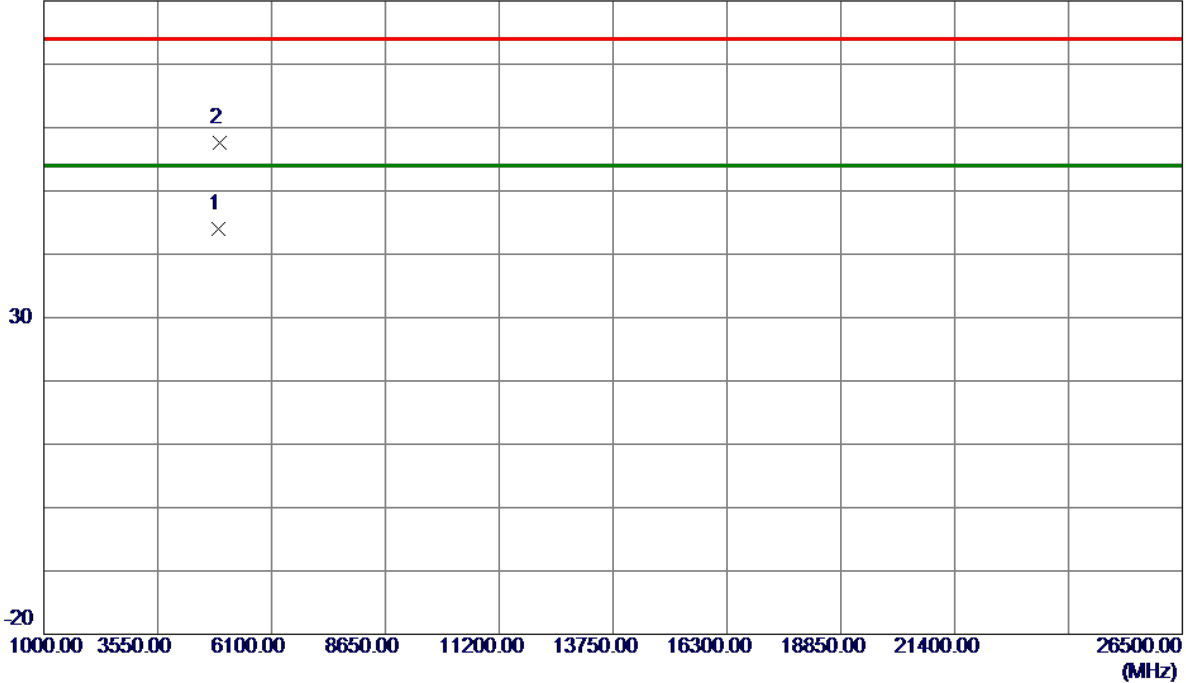

No.	Freq. MHz	Reading Level dBuV/m	Correct Factor dB	Measure ment dBuV/m	Limit dBuV/m	Margin dB	Detector	Comment
1 *	4923.2030	35.75	8.25	44.00	54.00	-10.00	AVG	
2	4924.9930	49.30	8.26	57.56	74.00	-16.44	Peak	

REMARKS:

- (1) Measurement Value = Reading Level + Correct Factor.
- (2) Margin Level = Measurement Value - Limit Value.

Test Mode: TX N-20M Mode 2412 MHz

Vertical

130 dBuV/m

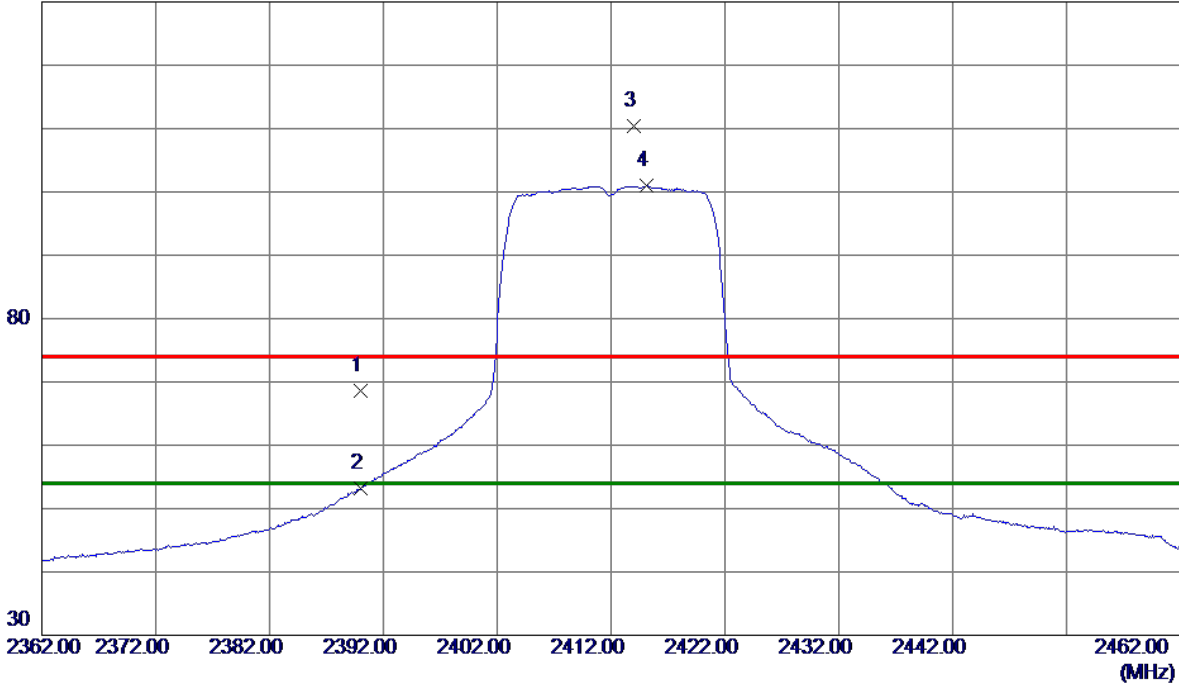

No.	Freq. MHz	Reading Level dBuV/m	Correct Factor dB	Measure ment dBuV/m	Limit dBuV/m	Margin dB	Detector	Comment
1	2390.0000	58.06	10.62	68.68	74.00	-5.32	Peak	
2	2390.0000	42.63	10.62	53.25	54.00	-0.75	AVG	
3	2414.0000	99.78	10.69	110.47	74.00	36.47	Peak	No Limit
4 *	2415.1500	90.27	10.70	100.97	54.00	46.97	AVG	No Limit

REMARKS:

- (1) Measurement Value = Reading Level + Correct Factor.
- (2) Margin Level = Measurement Value - Limit Value.

Test Mode: TX N-20M Mode 2412 MHz

Vertical

80 dBuV/m

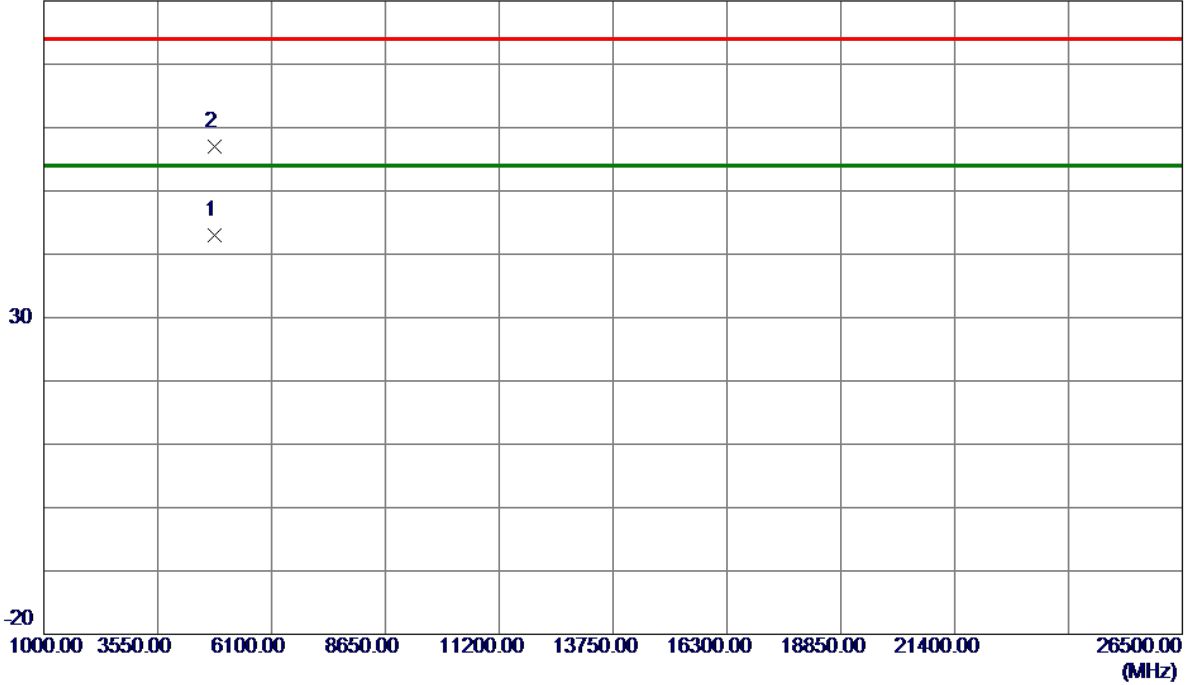

No.	Freq. MHz	Reading Level dBuV/m	Correct Factor dB	Measure ment dBuV/m	Limit dBuV/m	Margin dB	Detector	Comment
1 *	4823.8650	35.13	7.86	42.99	54.00	-11.01	AVG	
2	4826.1020	49.22	7.87	57.09	74.00	-16.91	Peak	

REMARKS:

- (1) Measurement Value = Reading Level + Correct Factor.
- (2) Margin Level = Measurement Value - Limit Value.

Test Mode: TX N-20M Mode 2412 MHz

Horizontal

130 dBuV/m

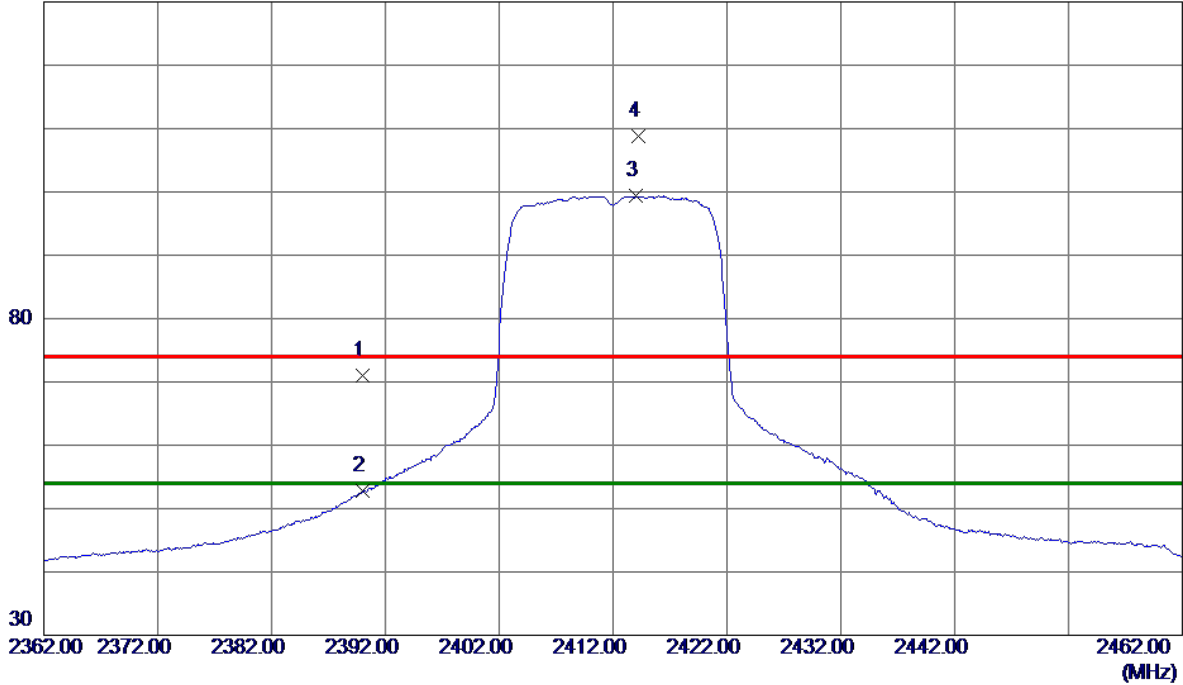

No.	Freq. MHz	Reading Level dBuV/m	Correct Factor dB	Measure ment dBuV/m	Limit dBuV/m	Margin dB	Detector	Comment
1	2390.0000	60.38	10.62	71.00	74.00	-3.00	Peak	
2	2390.0000	42.18	10.62	52.80	54.00	-1.20	AVG	
3 *	2414.0000	88.64	10.69	99.33	54.00	45.33	AVG	No Limit
4	2414.2000	98.12	10.69	108.81	74.00	34.81	Peak	No Limit

REMARKS:

- (1) Measurement Value = Reading Level + Correct Factor.
- (2) Margin Level = Measurement Value - Limit Value.

Test Mode: TX N-20M Mode 2412 MHz

Horizontal

80 dBuV/m

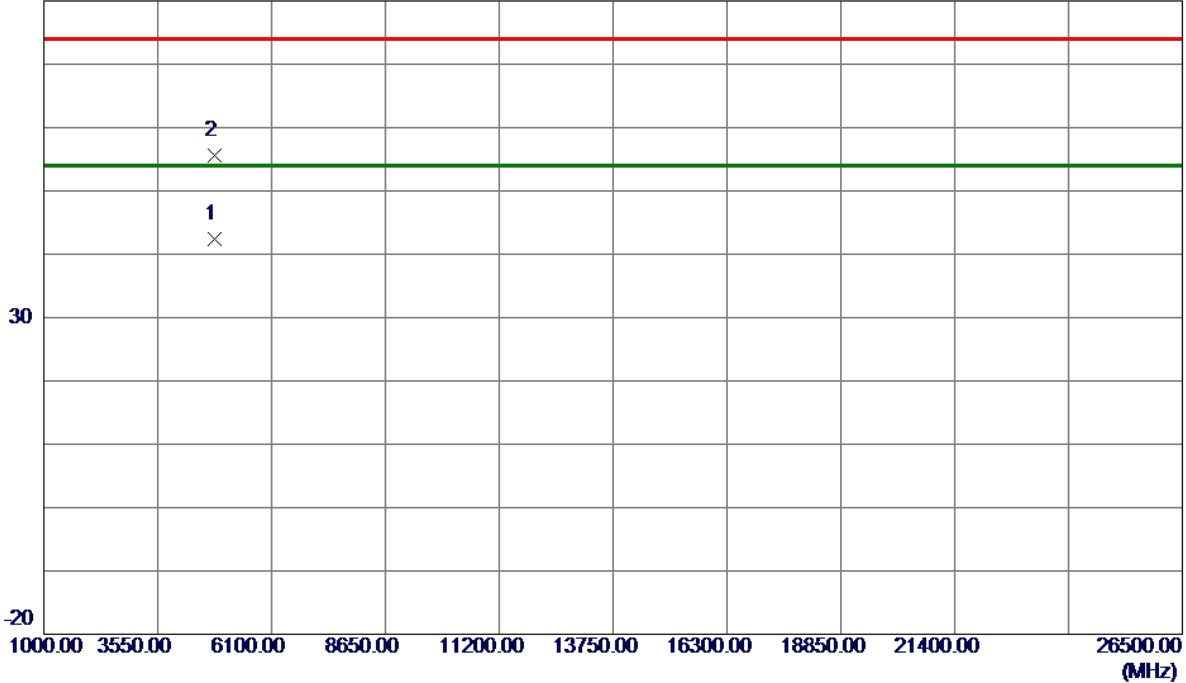

No.	Freq. MHz	Reading Level dBuV/m	Correct Factor dB	Measure ment dBuV/m	Limit dBuV/m	Margin dB	Detector	Comment
1 *	4823.7430	34.61	7.86	42.47	54.00	-11.53	AVG	
2	4823.7879	47.75	7.86	55.61	74.00	-18.39	Peak	

REMARKS:

- (1) Measurement Value = Reading Level + Correct Factor.
- (2) Margin Level = Measurement Value - Limit Value.

Test Mode: TX N-20M Mode 2417 MHz

Vertical

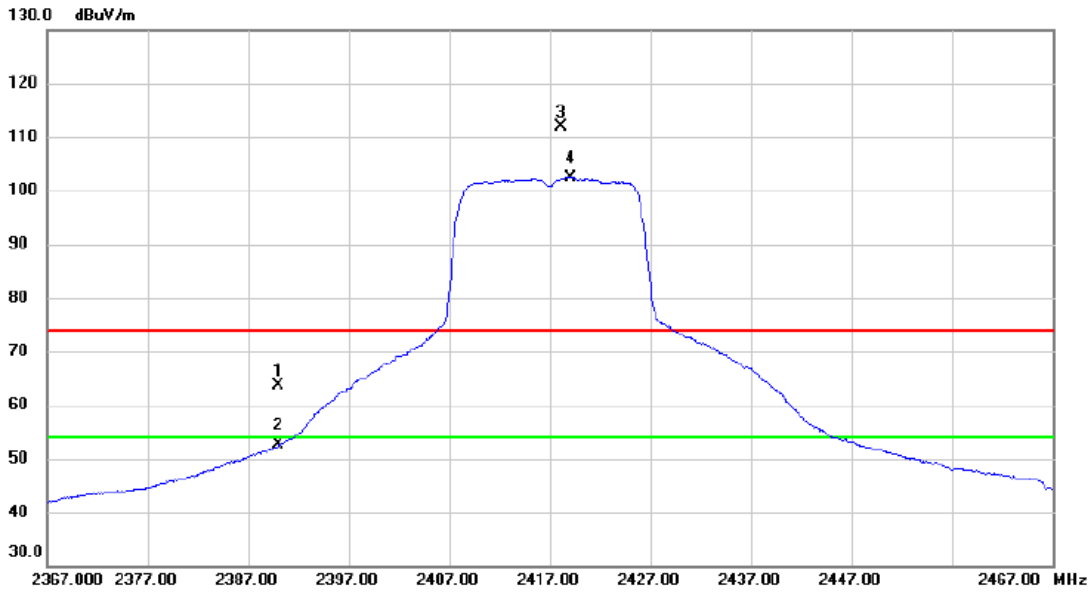

No.	Mk.	Freq. MHz	Reading Level dBuV	Correct Factor dB	Measure- ment dBuV/m	Limit dBuV/m	Margin dB	Detector	Comment
1		2390.000	52.88	10.63	63.51	74.00	-10.49	peak	
2		2390.000	41.96	10.63	52.59	54.00	-1.41	AVG	
3	X	2418.150	101.13	10.71	111.84	74.00	37.84	peak	No Limit
4	*	2419.100	91.67	10.71	102.38	54.00	48.38	AVG	No Limit

REMARKS:

(1) Measurement Value = Reading Level + Correct Factor.

(2) Margin Level = Measurement Value - Limit Value.

Test Mode: TX N-20M Mode 2417 MHz

Vertical

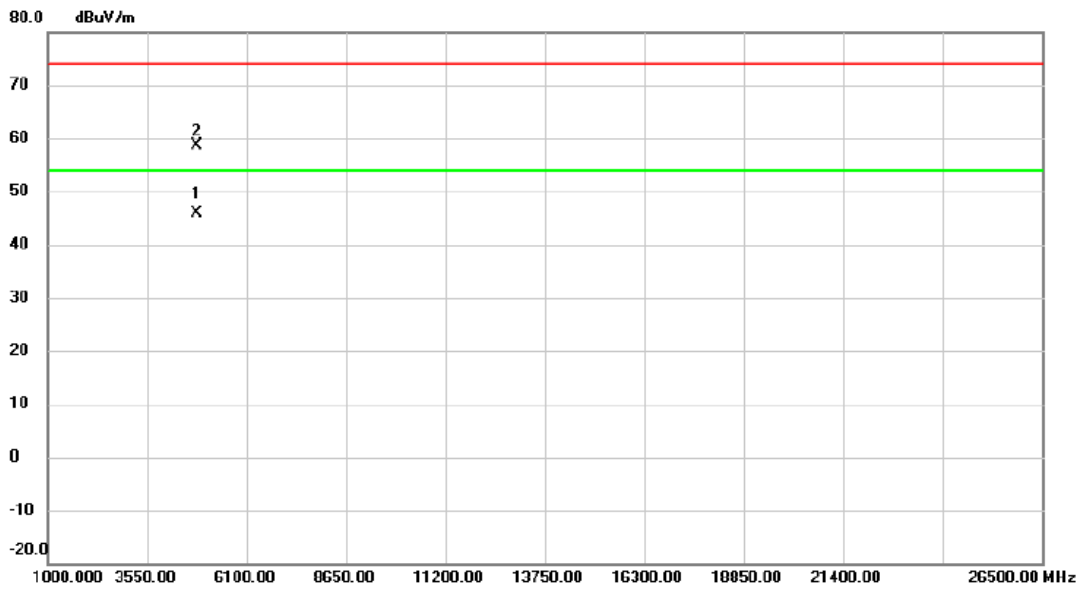

No.	Mk.	Freq. MHz	Reading Level dBuV	Correct Factor dB	Measure- ment dBuV/m	Limit dBuV/m	Margin dB	Detector	Comment
1	*	4833.962	37.87	7.89	45.76	54.00	-8.24	AVG	
2		4834.583	50.75	7.90	58.65	74.00	-15.35	peak	

REMARKS:

- (1) Measurement Value = Reading Level + Correct Factor.
- (2) Margin Level = Measurement Value - Limit Value.

Test Mode: TX N-20M Mode 2417 MHz

Horizontal

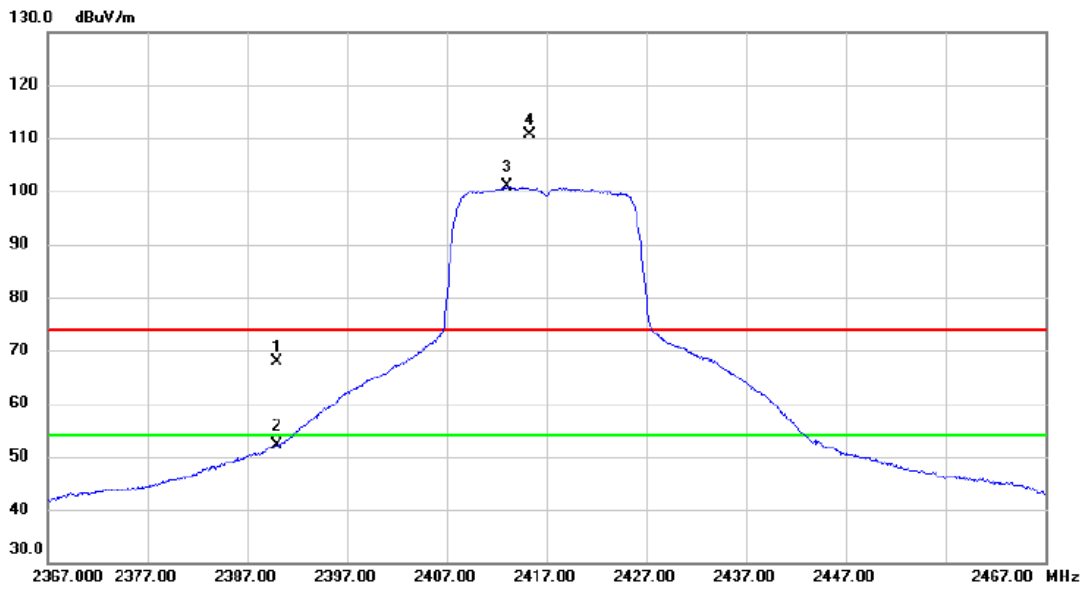

No.	Mk.	Freq. MHz	Reading Level dBuV	Correct Factor dB	Measure- ment dBuV/m	Limit dBuV/m	Margin dB	Detector	Comment
1		2390.000	57.15	10.63	67.78	74.00	-6.22	peak	
2		2390.000	41.57	10.63	52.20	54.00	-1.80	AVG	
3	*	2413.100	90.15	10.69	100.84	54.00	46.84	AVG	No Limit
4	X	2415.350	99.88	10.69	110.57	74.00	36.57	peak	No Limit

REMARKS:

- (1) Measurement Value = Reading Level + Correct Factor.
- (2) Margin Level = Measurement Value - Limit Value.

Test Mode: TX N-20M Mode 2417 MHz

Horizontal

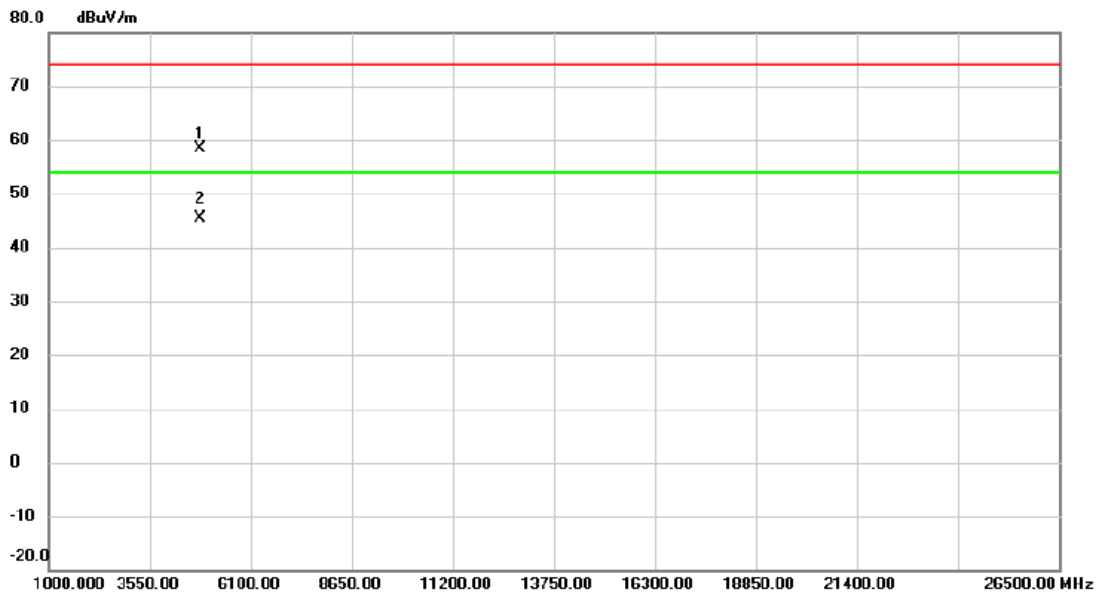

No.	Mk.	Freq. MHz	Reading Level dBuV	Correct Factor dB	Measure- ment dBuV/m	Limit dBuV/m	Margin dB	Detector	Comment
1		4831.698	50.54	7.89	58.43	74.00	-15.57	peak	
2	*	4833.455	37.40	7.89	45.29	54.00	-8.71	AVG	

REMARKS:

- (1) Measurement Value = Reading Level + Correct Factor.
- (2) Margin Level = Measurement Value - Limit Value.

Test Mode: TX N-20M Mode 2437 MHz

Vertical

130 dBuV/m

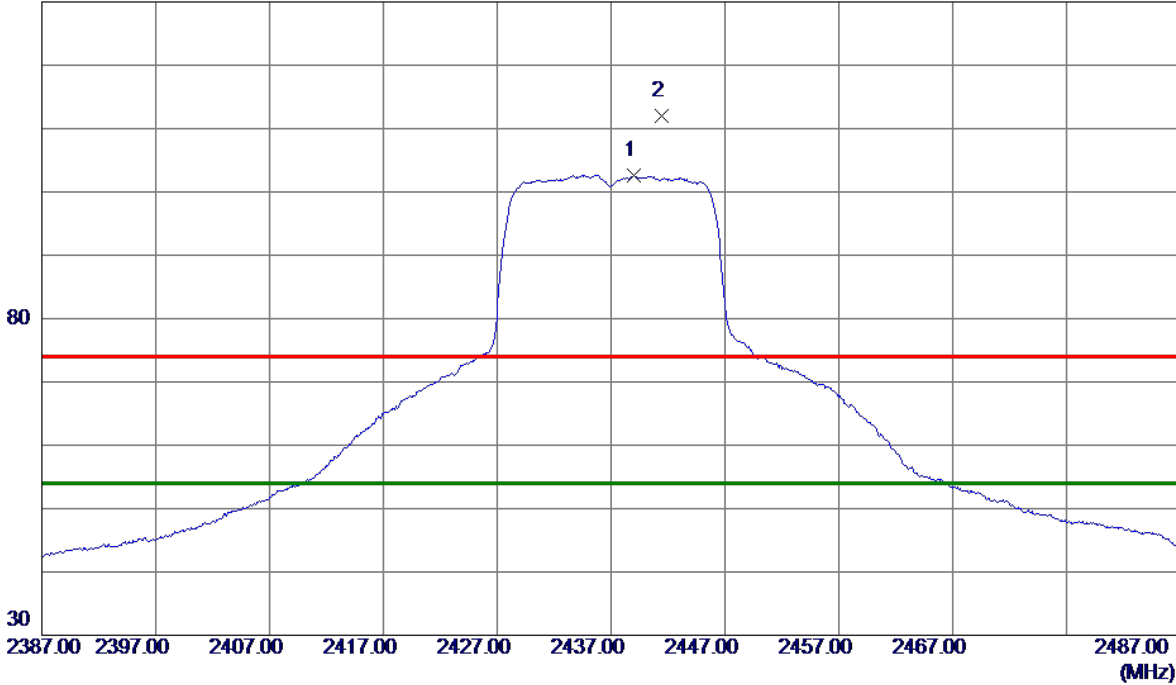

No.	Freq. MHz	Reading Level dBuV/m	Correct Factor dB	Measure ment dBuV/m	Limit dBuV/m	Margin dB	Detector	Comment
1 *	2439.0000	91.87	10.77	102.64	54.00	48.64	AVG	No Limit
2	2441.4000	101.22	10.78	112.00	74.00	38.00	Peak	No Limit

REMARKS:

- (1) Measurement Value = Reading Level + Correct Factor.
- (2) Margin Level = Measurement Value - Limit Value.

Test Mode: TX N-20M Mode 2437 MHz

Vertical

80 dBuV/m

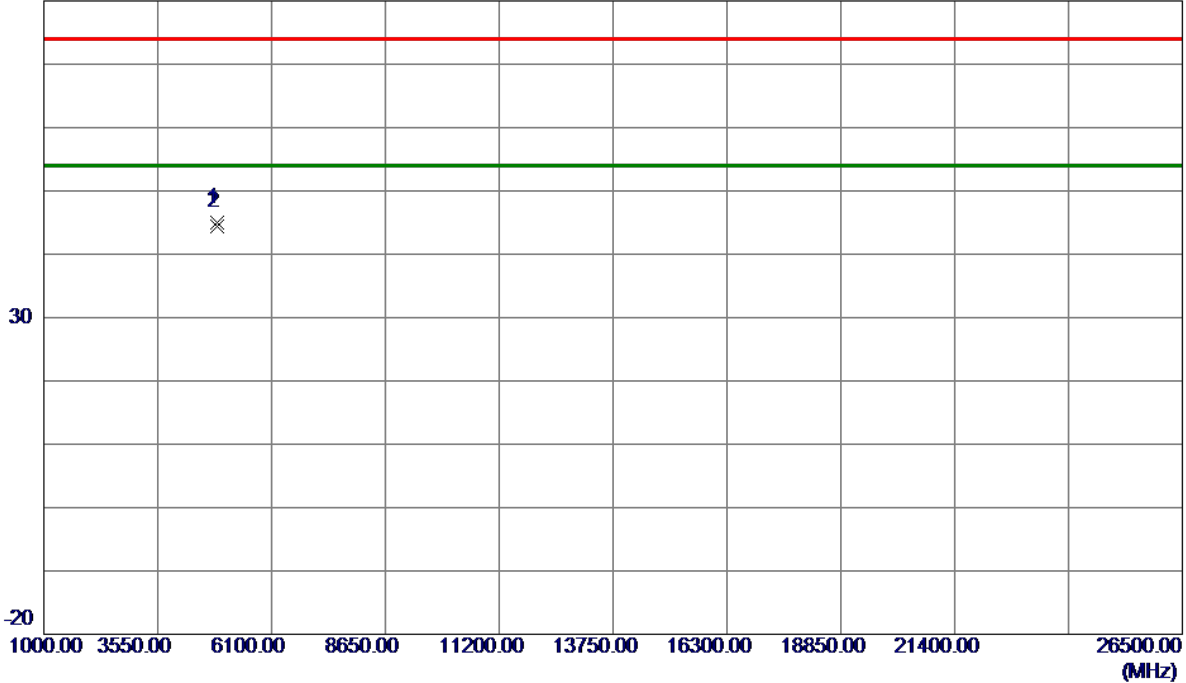

No.	Freq. MHz	Reading Level dBuV/m	Correct Factor dB	Measure ment dBuV/m	Limit dBuV/m	Margin dB	Detector	Comment
1	4875.5299	36.94	8.06	45.00	74.00	-29.00	Peak	
2 *	4875.8330	36.42	8.06	44.48	54.00	-9.52	AVG	

REMARKS:

- (1) Measurement Value = Reading Level + Correct Factor.
- (2) Margin Level = Measurement Value - Limit Value.

Test Mode: TX N-20M Mode 2437 MHz

Horizontal

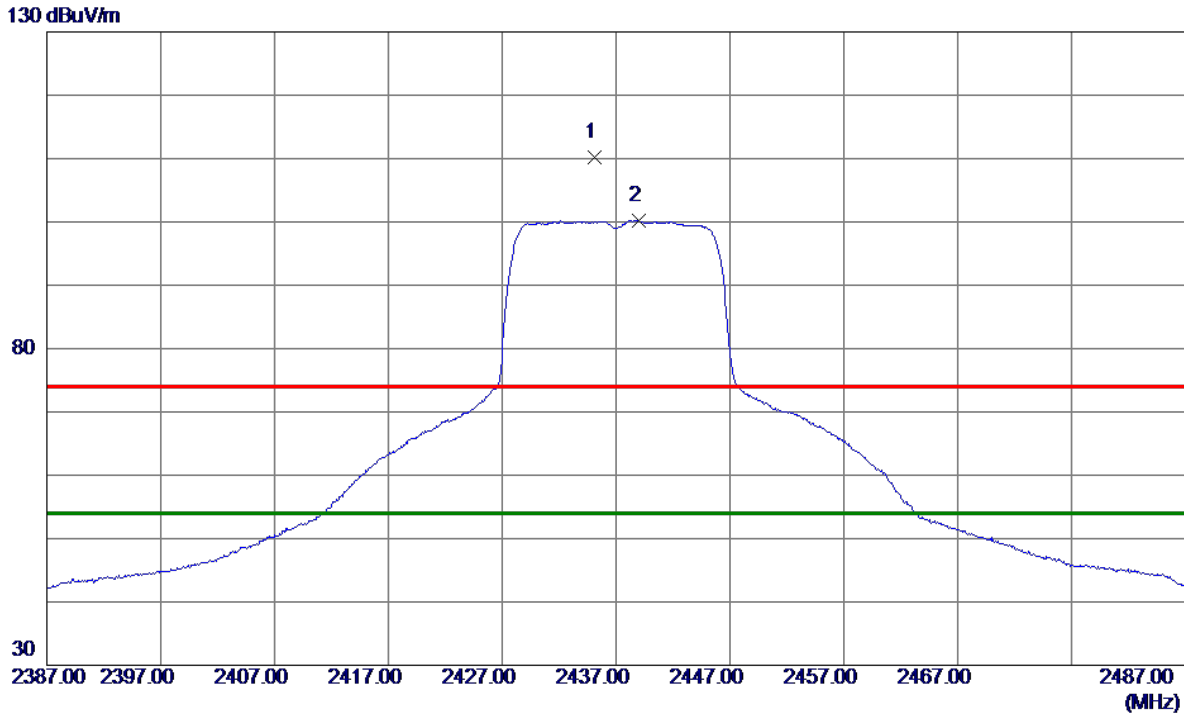

No.	Freq. MHz	Reading Level dBuV/m	Correct Factor dB	Measure ment dBuV/m	Limit dBuV/m	Margin dB	Detector	Comment
1	2435.1000	99.46	10.76	110.22	74.00	36.22	Peak	No Limit
2 *	2438.9500	89.45	10.77	100.22	54.00	46.22	AVG	No Limit

REMARKS:

- (1) Measurement Value = Reading Level + Correct Factor.
- (2) Margin Level = Measurement Value - Limit Value.

Test Mode: TX N-20M Mode 2437 MHz

Horizontal

80 dBuV/m

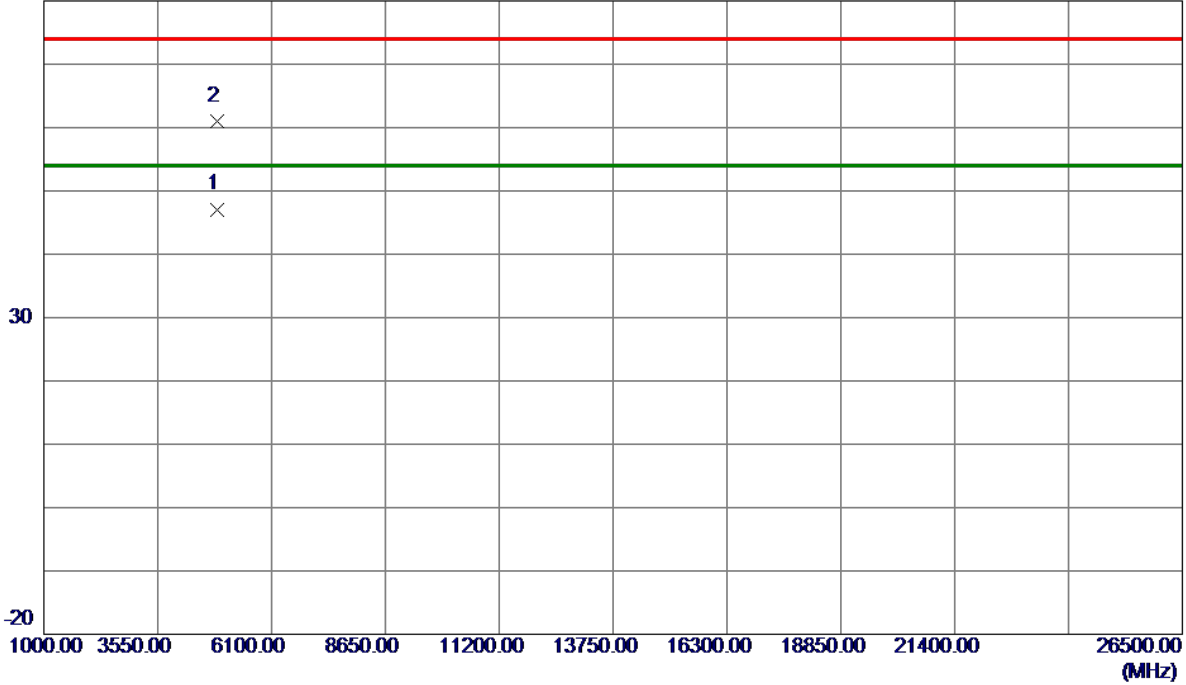

No.	Freq. MHz	Reading Level dBuV/m	Correct Factor dB	Measure ment dBuV/m	Limit dBuV/m	Margin dB	Detector	Comment
1 *	4874.6250	39.04	8.06	47.10	54.00	-6.90	AVG	
2	4874.6980	52.98	8.06	61.04	74.00	-12.96	Peak	

REMARKS:

- (1) Measurement Value = Reading Level + Correct Factor.
- (2) Margin Level = Measurement Value - Limit Value.

Test Mode: TX N-20M Mode 2457 MHz

Vertical

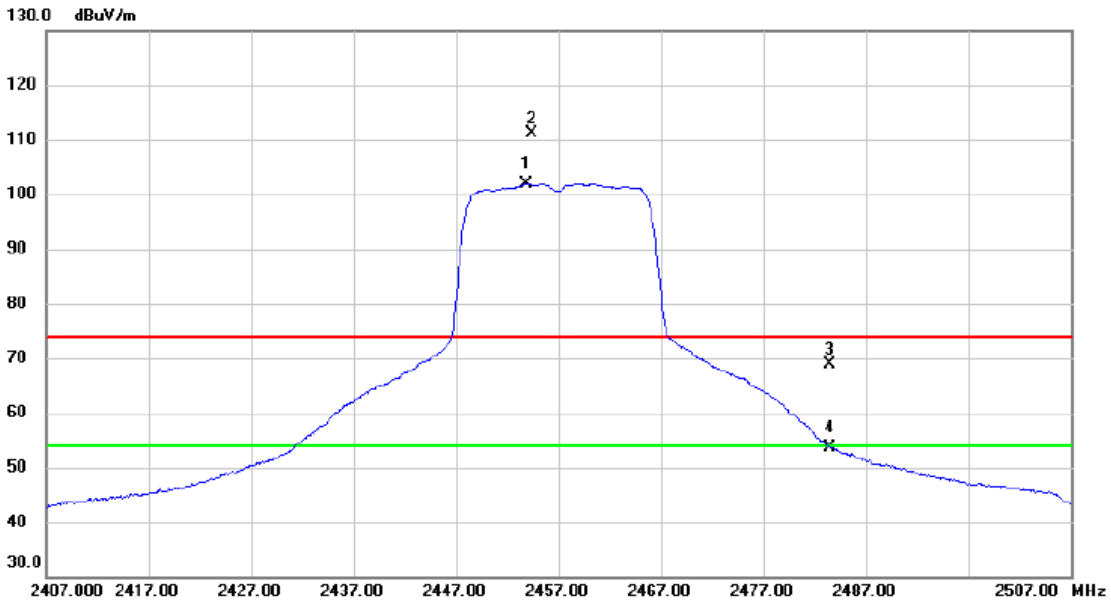

No.	Mk.	Freq. MHz	Reading Level dBuV	Correct Factor dB	Measure- ment dBuV/m	Limit dBuV/m	Margin dB	Detector	Comment
1	*	2453.850	91.17	10.81	101.98	54.00	47.98	AVG	No Limit
2	X	2454.350	100.30	10.81	111.11	74.00	37.11	peak	No Limit
3		2483.500	57.94	10.90	68.84	74.00	-5.16	peak	
4		2483.500	42.80	10.90	53.70	54.00	-0.30	AVG	

REMARKS:

- (1) Measurement Value = Reading Level + Correct Factor.
- (2) Margin Level = Measurement Value - Limit Value.

Test Mode: TX N-20M Mode 2457 MHz

Vertical

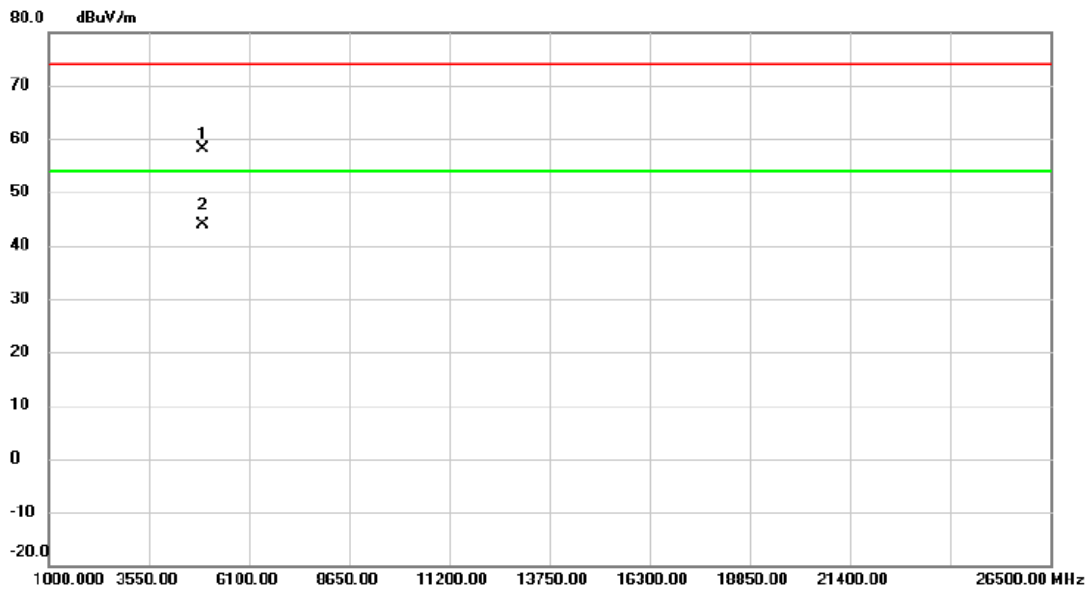

No.	Mk.	Freq. MHz	Reading Level dBuV	Correct Factor dB	Measure- ment dBuV/m	Limit dBuV/m	Margin dB	Detector	Comment
1		4911.630	49.99	8.21	58.20	74.00	-15.80	peak	
2	*	4913.783	35.72	8.22	43.94	54.00	-10.06	AVG	

REMARKS:

- (1) Measurement Value = Reading Level + Correct Factor.
- (2) Margin Level = Measurement Value - Limit Value.

Test Mode: TX N-20M Mode 2457 MHz

Horizontal

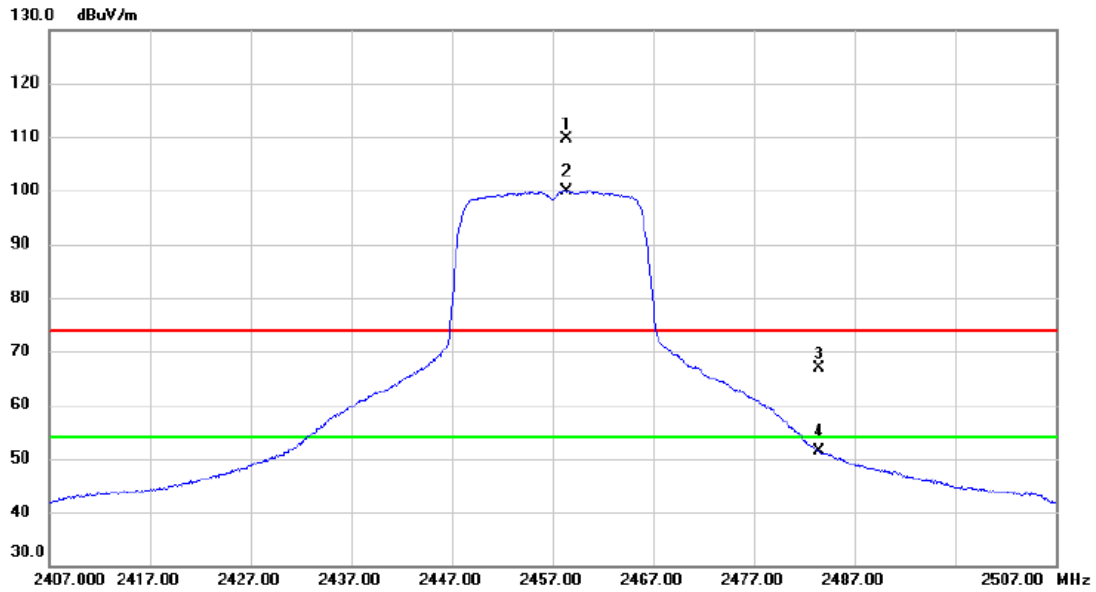

No.	Mk.	Freq. MHz	Reading Level dBuV	Correct Factor dB	Measure- ment dBuV/m	Limit dBuV/m	Margin dB	Detector	Comment
1	X	2458.350	98.85	10.83	109.68	74.00	35.68	peak	No Limit
2	*	2458.350	89.14	10.83	99.97	54.00	45.97	AVG	No Limit
3		2483.500	56.05	10.90	66.95	74.00	-7.05	peak	
4		2483.500	40.42	10.90	51.32	54.00	-2.68	AVG	

REMARKS:

(1) Measurement Value = Reading Level + Correct Factor.

(2) Margin Level = Measurement Value - Limit Value.

Test Mode: TX N-20M Mode 2457 MHz

Horizontal

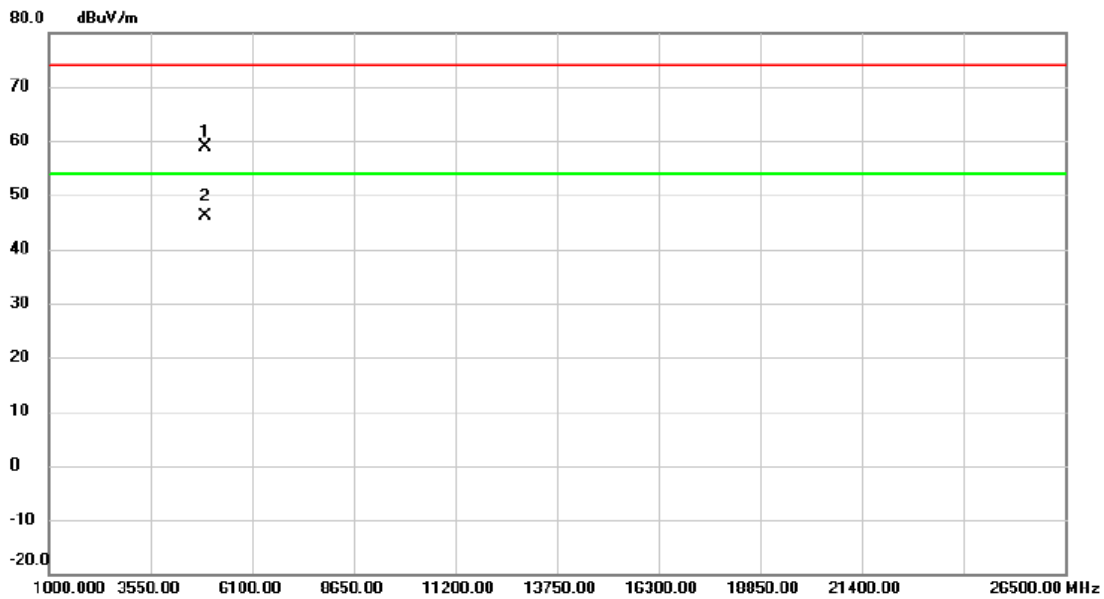

No.	Mk.	Freq.	Reading Level	Correct Factor	Measurement	Limit	Margin	Detector	Comment
		MHz	dBuV	dB	dBuV/m	dBuV/m	dB		
1		4913.498	50.54	8.22	58.76	74.00	-15.24	peak	
2	*	4913.515	37.87	8.22	46.09	54.00	-7.91	AVG	

REMARKS:

- (1) Measurement Value = Reading Level + Correct Factor.
- (2) Margin Level = Measurement Value - Limit Value.

Test Mode: TX N-20M Mode 2462 MHz

Vertical

130 dBuV/m

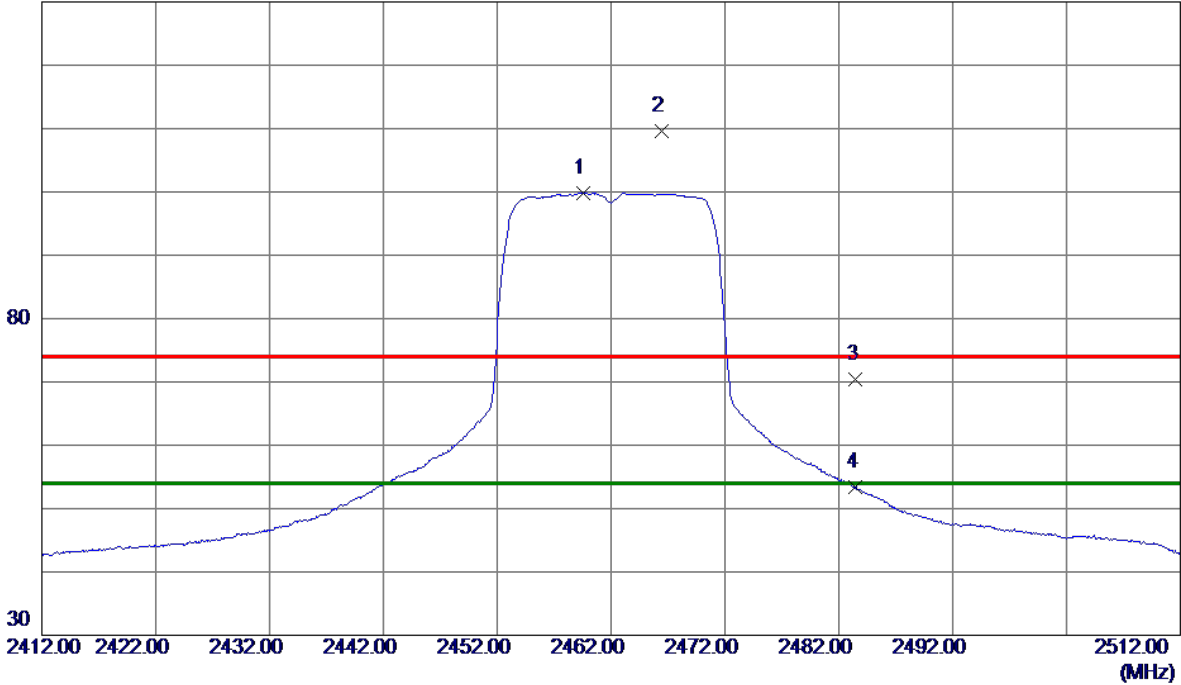

No.	Freq. MHz	Reading Level dBuV/m	Correct Factor dB	Measure ment dBuV/m	Limit dBuV/m	Margin dB	Detector	Comment
1 *	2459.5500	89.04	10.83	99.87	54.00	45.87	AVG	No Limit
2	2466.4500	98.71	10.85	109.56	74.00	35.56	Peak	No Limit
3	2483.5000	59.51	10.90	70.41	74.00	-3.59	Peak	
4	2483.5000	42.42	10.90	53.32	54.00	-0.68	AVG	

REMARKS:

- (1) Measurement Value = Reading Level + Correct Factor.
- (2) Margin Level = Measurement Value - Limit Value.

Test Mode: TX N-20M Mode 2462 MHz

Vertical

80 dBuV/m

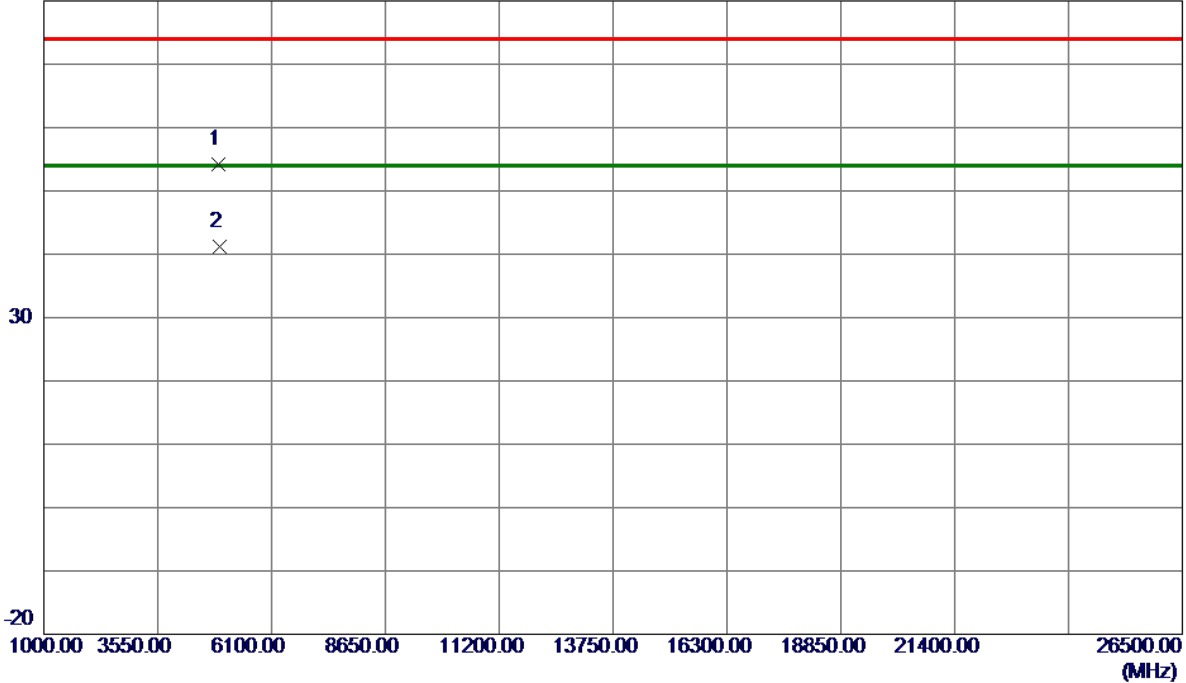

No.	Freq. MHz	Reading Level dBuV/m	Correct Factor dB	Measure ment dBuV/m	Limit dBuV/m	Margin dB	Detector	Comment
1	4923.2550	45.94	8.25	54.19	74.00	-19.81	Peak	
2 *	4925.2380	32.89	8.26	41.15	54.00	-12.85	AVG	

REMARKS:

- (1) Measurement Value = Reading Level + Correct Factor.
- (2) Margin Level = Measurement Value - Limit Value.

Test Mode: TX N-20M Mode 2462 MHz

Horizontal

130 dBuV/m

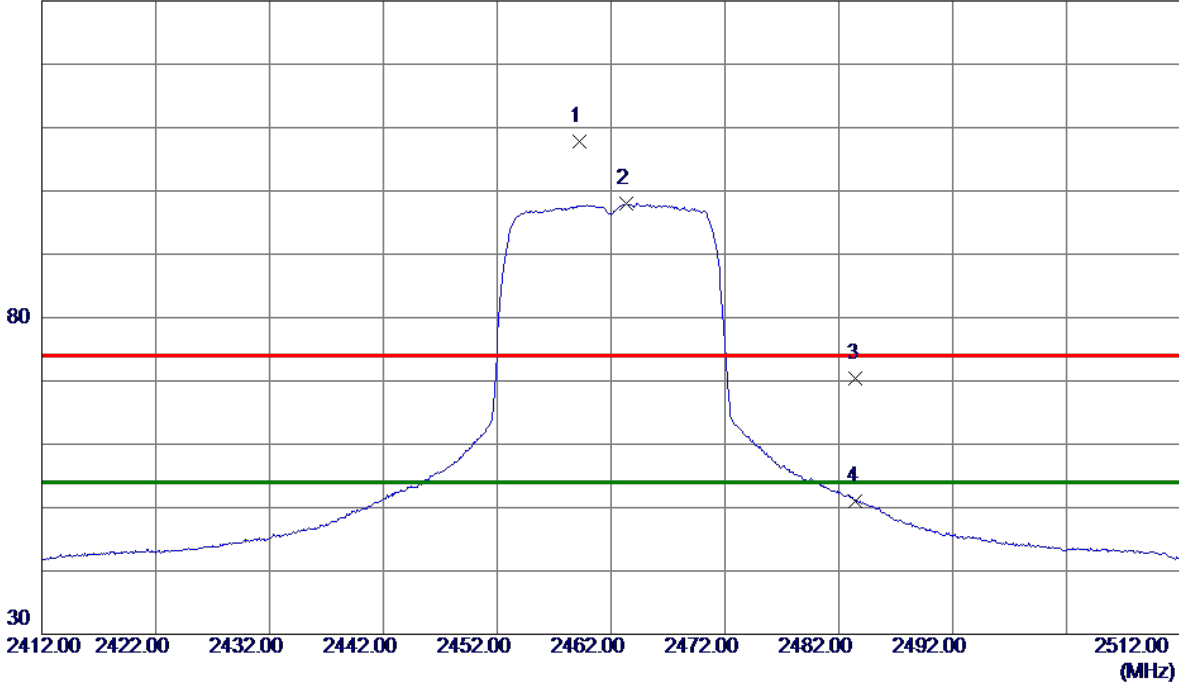

No.	Freq. MHz	Reading Level dBuV/m	Correct Factor dB	Measure ment dBuV/m	Limit dBuV/m	Margin dB	Detector	Comment
1	2459.2000	97.03	10.83	107.86	74.00	33.86	Peak	No Limit
2 *	2463.3500	87.12	10.84	97.96	54.00	43.96	AVG	No Limit
3	2483.5000	59.41	10.90	70.31	74.00	-3.69	Peak	
4	2483.5000	40.16	10.90	51.06	54.00	-2.94	AVG	

REMARKS:

- (1) Measurement Value = Reading Level + Correct Factor.
- (2) Margin Level = Measurement Value - Limit Value.

Test Mode: TX N-20M Mode 2462 MHz

Horizontal

80 dBuV/m

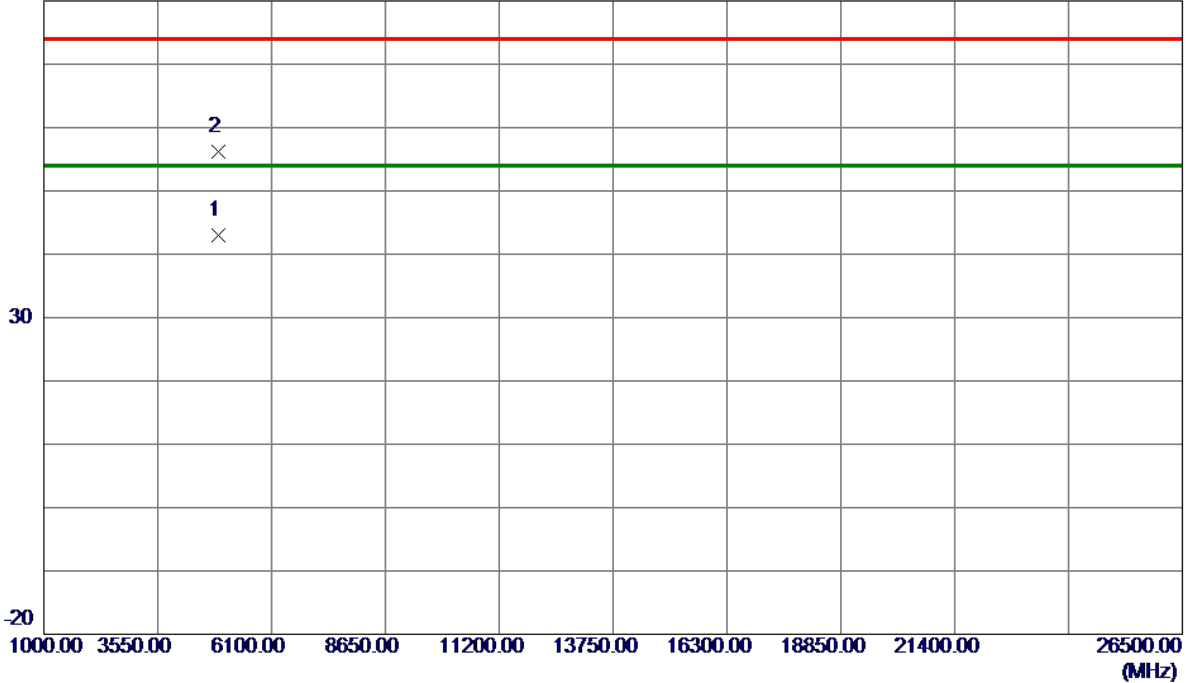

No.	Freq. MHz	Reading Level dBuV/m	Correct Factor dB	Measure ment dBuV/m	Limit dBuV/m	Margin dB	Detector	Comment
1 *	4922.5450	34.79	8.25	43.04	54.00	-10.96	AVG	
2	4923.7350	47.97	8.26	56.23	74.00	-17.77	Peak	

REMARKS:

- (1) Measurement Value = Reading Level + Correct Factor.
- (2) Margin Level = Measurement Value - Limit Value.

APPENDIX E - BANDWIDTH

Test Mode	TX B Mode
-----------	-----------

Channel	Frequency (MHz)	6 dB Bandwidth (MHz)	6 dB Bandwidth Min. Limit (kHz)	Result
01	2412	9.60	500	Complies
06	2437	8.65	500	Complies
11	2462	9.58	500	Complies

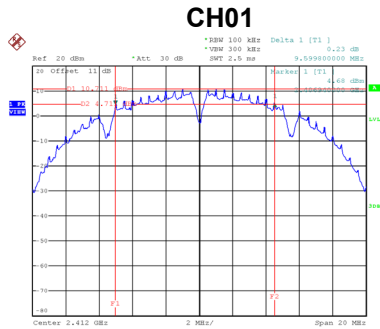

Date: 5.NOV.2020 17:03:31

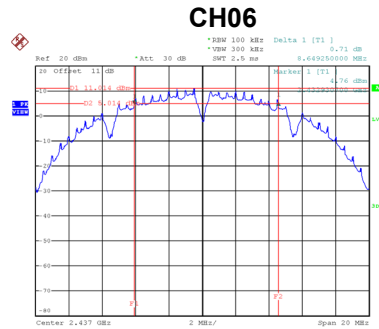

Date: 5.NOV.2020 17:05:08

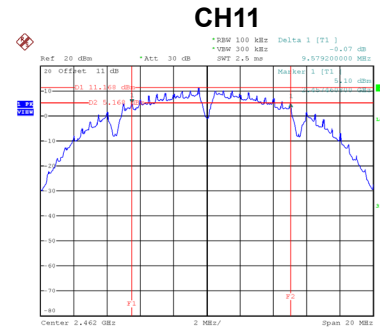

Date: 5.NOV.2020 17:06:30

Channel	Frequency (MHz)	99 % Emission Bandwidth (MHz)	Result
01	2412	14.16	Complies
06	2437	14.16	Complies
11	2462	14.16	Complies

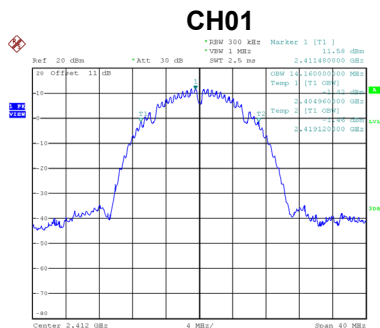

Date: 5.NOV.2020 17:03:38

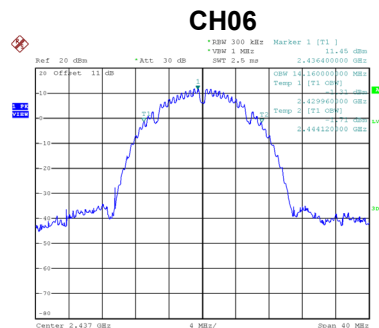

Date: 5.NOV.2020 17:05:15

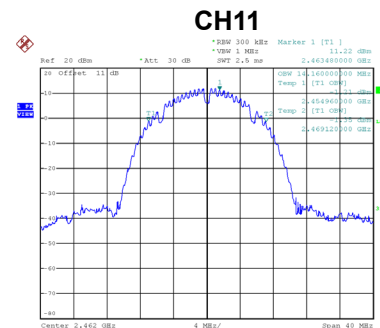

Date: 5.NOV.2020 17:06:37

Test Mode	TX G Mode
-----------	-----------

Channel	Frequency (MHz)	6 dB Bandwidth (MHz)	6 dB Bandwidth Min. Limit (kHz)	Result
01	2412	16.39	500	Complies
06	2437	16.38	500	Complies
11	2462	16.38	500	Complies

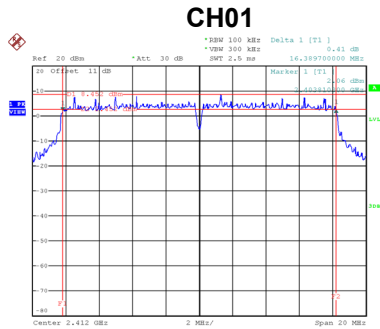

Date: 5.NOV.2020 17:23:57

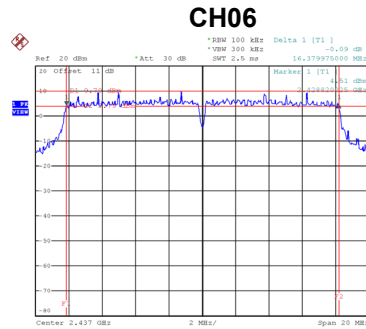

Date: 5.NOV.2020 17:09:48

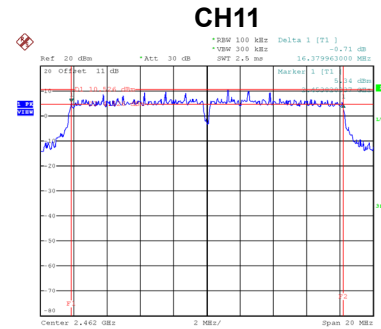

Date: 5.NOV.2020 17:11:00

Channel	Frequency (MHz)	99 % Emission Bandwidth (MHz)	Result
01	2412	17.28	Complies
06	2437	17.68	Complies
11	2462	17.84	Complies

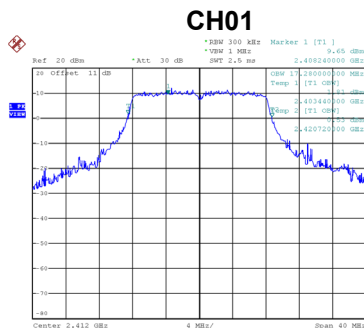

Date: 5.NOV.2020 17:24:03

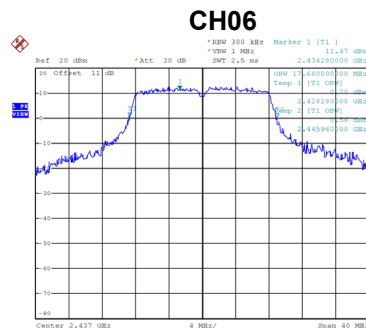

Date: 5.NOV.2020 17:09:55

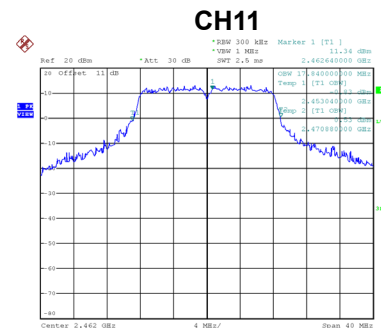

Date: 5.NOV.2020 17:11:07

APPENDIX F - MAXIMUM AVERAGE OUTPUT POWER

Test Mode	TX B Mode
-----------	-----------

Channel	Frequency (MHz)	Avg Output Power (dBm)	Duty Factor	Avg Output Power + Duty Factor (dBm)	Max. Limit (dBm)	Max. Limit (W)	Result
01	2412	17.95	0.00	17.95	30.00	1.0000	Complies
06	2437	17.75	0.00	17.75	30.00	1.0000	Complies
11	2462	17.23	0.00	17.23	30.00	1.0000	Complies

Test Mode	TX G Mode
-----------	-----------

Channel	Frequency (MHz)	Avg Output Power (dBm)	Duty Factor	Avg Output Power + Duty Factor (dBm)	Max. Limit (dBm)	Max. Limit (W)	Result
01	2412	19.08	0.28	19.36	30.00	1.0000	Complies
06	2437	20.42	0.28	20.70	30.00	1.0000	Complies
11	2462	17.82	0.28	18.10	30.00	1.0000	Complies

Test Mode	TX N-20M Mode
-----------	---------------

Channel	Frequency (MHz)	Avg Output Power (dBm)	Duty Factor	Avg Output Power + Duty Factor (dBm)	Max. Limit (dBm)	Max. Limit (W)	Result
01	2412	18.31	0.30	18.61	30.00	1.0000	Complies
06	2437	20.33	0.30	20.63	30.00	1.0000	Complies
11	2462	17.41	0.30	17.71	30.00	1.0000	Complies

APPENDIX G - CONDUCTED SPURIOUS EMISSIONS

Test Mode TX B Mode

Bandedge-CH01

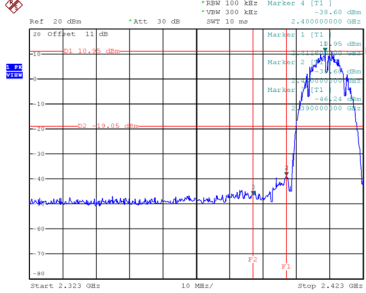

Date: 5.NOV.2020 17:03:45

Bandedge-CH11

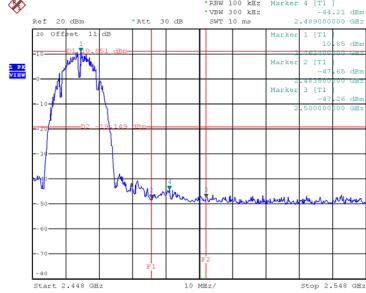

Date: 5.NOV.2020 17:06:44

CH01 – 10th Harmonic of the fundamental frequency

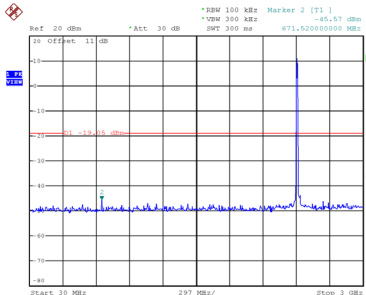

Date: 5.NOV.2020 17:03:58

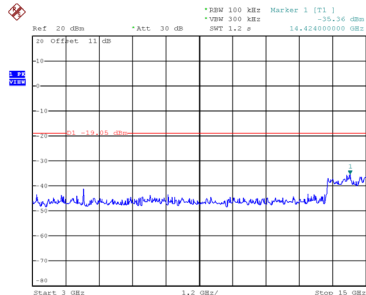

Date: 5.NOV.2020 17:04:05

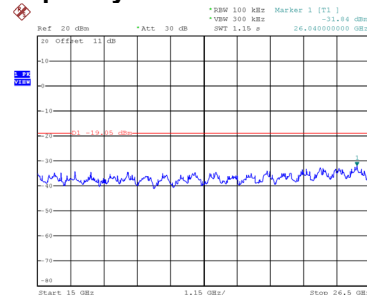

Date: 5.NOV.2020 17:04:11

CH06 – 10th Harmonic of the fundamental frequency

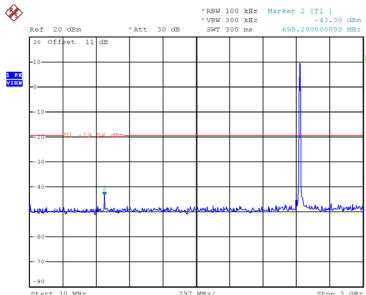

Date: 5.NOV.2020 17:05:34

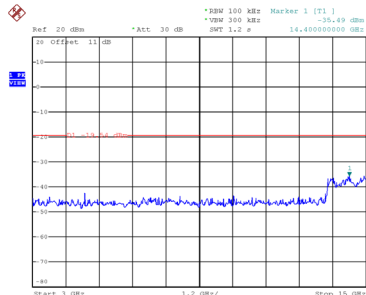

Date: 5.NOV.2020 17:05:41

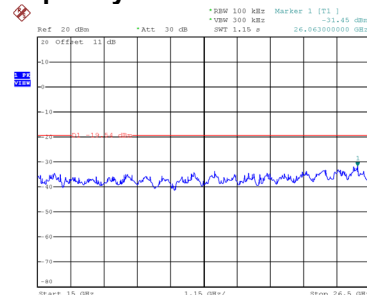

Date: 5.NOV.2020 17:05:48

CH11 – 10th Harmonic of the fundamental frequency

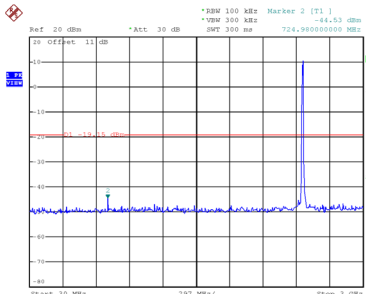

Date: 5.NOV.2020 17:06:56

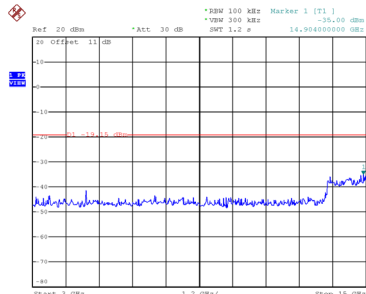

Date: 5.NOV.2020 17:07:03

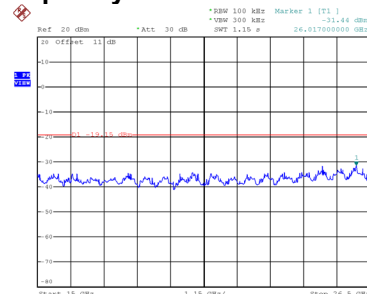

Date: 5.NOV.2020 17:07:09