



CFR 47 FCC PART 15 SUBPART E

CERTIFICATION TEST REPORT

For

AXE7800 Tri-Band Wi-Fi 6E Router

MODEL NUMBER: EX920

REPORT NUMBER: 4790653203-RF-4

ISSUE DATE: January 16, 2023

Prepared for

**TP-Link Corporation Limited
Room 901, 9/F. , New East Ocean Centre, 9 Science Museum Road, Tsim Sha Tsui,
Kowloon, Hong Kong**

Prepared by

UL Verification Services (Guangzhou) Co., Ltd, Song Shan Lake Branch

Building 10, Innovation Technology Park, No. 1, Li Bin Road, Song Shan Lake Hi-Tech Development Zone Dongguan, 523808, People's Republic of China

Tel: +86 769 22038881

Fax: +86 769 33244054

Website: www.ul.com

The results reported herein have been performed in accordance with the laboratory's terms of accreditation. This report shall not be reproduced except in full without the written approval of the Laboratory. The results in this report apply to the test sample(s) mentioned above at the time of the testing period only and are not to be used to indicate applicability to other similar products.



Revision History

Rev.	Issue Date	Revisions	Revised By
V0	January 16, 2023	Initial Issue	



Summary of Test Results			
Clause	Test Items	FCC Rules	Test Results
1	6dB/26dB Bandwidth	FCC 15.407 (a)&(e)	PASS
2	99% Occupied Bandwidth	/	PASS
3	Conducted Output Power	FCC 15.407 (a)	PASS
4	Power Spectral Density	FCC 15.407 (a)	PASS
5	Radiated Bandedge and Spurious Emission	FCC 15.407 (b) FCC 15.209 FCC 15.205	PASS
6	Conducted Emission Test for AC Power Port	FCC 15.207	PASS
7	Frequency Stability	FCC 15.407 (g)	PASS
8	Antenna Requirement	FCC 15.203	PASS
Note: 1. This test report is only published to and used by the applicant, and it is not for evidence purpose in China. 2. The measurement result for the sample received is <Pass> according to < CFR 47 FCC PART 15 SUBPART C > when <Accuracy Method> decision rule is applied.			

CONTENTS

1. ATTESTATION OF TEST RESULTS	6
2. TEST METHODOLOGY	7
3. FACILITIES AND ACCREDITATION	7
4. CALIBRATION AND UNCERTAINTY	8
4.1. <i>MEASURING INSTRUMENT CALIBRATION</i>	8
4.2. <i>MEASUREMENT UNCERTAINTY</i>	8
5. EQUIPMENT UNDER TEST	9
5.1. <i>DESCRIPTION OF EUT</i>	9
5.2. <i>MAXIMUM EIRP</i>	9
5.3. <i>CHANNEL LIST</i>	10
5.4. <i>TEST CHANNEL CONFIGURATION</i>	11
5.5. <i>THE WORSE CASE POWER SETTING PARAMETER</i>	12
5.6. <i>THE WORSE CASE CONFIGURATIONS</i>	14
5.7. <i>DESCRIPTION OF AVAILABLE ANTENNAS</i>	15
5.8. <i>DESCRIPTION OF TEST SETUP</i>	16
6. MEASURING EQUIPMENT AND SOFTWARE USED	17
7. ANTENNA PORT TEST RESULTS	19
7.1. <i>ON TIME AND DUTY CYCLE</i>	19
7.2. <i>6DB AND 26DB EMISSION BANDWIDTH AND 99% OCCUPIED BANDWIDTH</i> ...	20
7.3. <i>CONDUCTED OUTPUT POWER</i>	22
7.4. <i>POWER SPECTRAL DENSITY</i>	24
7.5. <i>FREQUENCY STABILITY</i>	26
8. RADIATED TEST RESULTS	28
8.1. <i>RESTRICTED BANDEDGE</i>	37
8.2. <i>SPURIOUS EMISSIONS (1 GHZ ~ 7 GHZ)</i>	66
8.3. <i>SPURIOUS EMISSIONS (7 GHZ ~ 18 GHZ)</i>	80
8.4. <i>SPURIOUS EMISSIONS (9 KHZ ~ 30 MHZ)</i>	132
8.5. <i>SPURIOUS EMISSIONS (18 GHZ ~ 26 GHZ)</i>	135
8.6. <i>SPURIOUS EMISSIONS (26 GHZ ~ 40 GHZ)</i>	137
8.7. <i>SPURIOUS EMISSIONS (30 MHZ ~ 1 GHZ)</i>	139
9. AC POWER LINE CONDUCTED EMISSION	141



10.	ANTENNA REQUIREMENT	144
11.	TEST DATA.....	145
11.1.	<i>APPENDIX A: EMISSION BANDWIDTH.....</i>	<i>145</i>
11.1.1.	Test Result.....	145
11.1.2.	Test Graphs	148
11.2.	<i>APPENDIX B: OCCUPIED CHANNEL BANDWIDTH.....</i>	<i>183</i>
11.2.1.	Test Result.....	183
11.2.2.	Test Graphs	186
11.3.	<i>APPENDIX C: MIN EMISSION BANDWIDTH</i>	<i>221</i>
11.3.1.	Test Result.....	221
11.3.2.	Test Graphs	222
11.4.	<i>APPENDIX D: MAXIMUM AVERAGE CONDUCTED OUTPUT POWER.....</i>	<i>228</i>
11.4.1.	Test Result.....	228
11.5.	<i>APPENDIX E: MAXIMUM POWER SPECTRAL DENSITY</i>	<i>229</i>
11.5.1.	Test Result.....	229
11.5.2.	Test Graphs	230
11.6.	<i>APPENDIX F: DUTY CYCLE</i>	<i>297</i>
11.6.1.	Test Result.....	297
11.6.2.	Test Graphs	298
11.7.	<i>APPENDIX G: FREQUENCY STABILITY</i>	<i>300</i>
11.7.1.	Test Result.....	300



1. ATTESTATION OF TEST RESULTS

Applicant Information

Company Name: TP-Link Corporation Limited
Address: Room 901, 9/F. , New East Ocean Centre, 9 Science Museum Road, Tsim Sha Tsui, Kowloon, Hong Kong

Manufacturer Information

Company Name: TP-Link Corporation Limited
Address: Room 901, 9/F. , New East Ocean Centre, 9 Science Museum Road, Tsim Sha Tsui, Kowloon, Hong Kong

EUT Information

EUT Name: AXE7800 Tri-Band Wi-Fi 6E Router
Model: EX920
Sample Received Date: November 28, 2022
Sample Status: Normal
Sample ID: 5571490
Date of Tested: December 1, 2022 ~ January 12, 2023

APPLICABLE STANDARDS	
STANDARD	TEST RESULTS
CFR 47 FCC PART 15 SUBPART E	PASS

Prepared By:

Denny Huang
Senior Project Engineer

Checked By:

Kebo Zhang
Senior Project Engineer

Approved By:

Stephen Guo
Operations Manager



2. TEST METHODOLOGY

All tests were performed in accordance with the standard CFR 47 FCC PART 15 SUBPART E ISED RSS-247 ISSUE 2, ANSI C63.10-2013, CFR 47 FCC Part 2, KDB 789033 D02 v02r01, KDB414788 D01 Radiated Test Site v01, KDB 662911 D01 Multiple Transmitter Output v02r01.

3. FACILITIES AND ACCREDITATION

Accreditation Certificate	<p>A2LA (Certificate No.: 4102.01) UL Verification Services (Guangzhou) Co., Ltd. Song Shan Lake Branch. has been assessed and proved to be in compliance with A2LA.</p> <p>FCC (FCC Designation No.: CN1187) UL Verification Services (Guangzhou) Co., Ltd. Song Shan Lake Branch. Has been recognized to perform compliance testing on equipment subject to the Commission's Declaration of Conformity (DoC) and Certification rules</p> <p>ISED (Company No.: 21320) UL Verification Services (Guangzhou) Co., Ltd. Song Shan Lake Branch. has been registered and fully described in a report filed with ISED. The Company Number is 21320 and the test lab Conformity Assessment Body Identifier (CABID) is CN0046.</p> <p>VCCI (Registration No.: G-20019, R-20004, C-20012 and T-20011) UL Verification Services (Guangzhou) Co., Ltd. Song Shan Lake Branch. has been assessed and proved to be in compliance with VCCI, the Membership No. is 3793. Facility Name: Chamber D, the VCCI registration No. is G-20019 and R-20004 Shielding Room B , the VCCI registration No. is C-20012 and T-20011</p>
---------------------------	---

Note 1:

All tests measurement facilities use to collect the measurement data are located at Building 10, Innovation Technology Park, No. 1, Li Bin Road, Song Shan Lake Hi-Tech Development Zone Dongguan, 523808, People's Republic of China.

Note 2:

The test anechoic chamber in UL Verification Services (Guangzhou) Co., Ltd. Song Shan Lake Branch had been calibrated and compared to the open field sites and the test anechoic chamber is shown to be equivalent to or worst case from the open field site.

Note 3:

For below 30 MHz, lab had performed measurements at test anechoic chamber and comparing to measurements obtained on an open field site. And these measurements below 30 MHz had been correlated to measurements performed on an OFS.



4. CALIBRATION AND UNCERTAINTY

4.1. MEASURING INSTRUMENT CALIBRATION

The measuring equipment utilized to perform the tests documented in this report has been calibrated in accordance with the manufacturer's recommendations and is traceable to recognized national standards.

4.2. MEASUREMENT UNCERTAINTY

Where relevant, the following measurement uncertainty levels have been estimated for tests performed on the apparatus:

Test Item	Uncertainty
Conduction emission	3.62 dB
Radiated Emission (Included Fundamental Emission) (9 kHz ~ 30 MHz)	2.2 dB
Radiated Emission (Included Fundamental Emission) (30 MHz ~ 1 GHz)	4.00 dB
Radiated Emission (Included Fundamental Emission) (1 GHz to 40 GHz)	5.78 dB (1 GHz ~ 18 GHz)
	5.23 dB (18 GHz ~ 26 GHz)
	5.37 dB (26 GHz ~ 40 GHz)
Note: This uncertainty represents an expanded uncertainty expressed at approximately the 95% confidence level using a coverage factor of k=2.	



5. EQUIPMENT UNDER TEST

5.1. DESCRIPTION OF EUT

Equipment	AXE7800 Tri-Band Wi-Fi 6E Router
Model Name	EX920
Radio Technology	WLAN (IEEE 802.11a 20/n HT20/n HT40/ac VHT20/ac VHT40/ac VHT 80/ac VHT 160/ax HE20/ax HE40/ax HE80/ax HE160)
Modulation	IEEE 802.11a 20: OFDM (64QAM, 16QAM, QPSK, BPSK) IEEE 802.11n HT20: OFDM (64QAM, 16QAM, QPSK, BPSK) IEEE 802.11n HT40: OFDM (64QAM, 16QAM, QPSK, BPSK) IEEE 802.11ac VHT20: OFDM (256QAM, 64QAM, 16QAM, QPSK, BPSK) IEEE 802.11ac VHT40: OFDM (256QAM, 64QAM, 16QAM, QPSK, BPSK) IEEE 802.11ac VHT80: OFDM (256QAM, 64QAM, 16QAM, QPSK, BPSK) IEEE 802.11ac VHT160: OFDM (256QAM, 64QAM, 16QAM, QPSK, BPSK) IEEE 802.11ax HE20: OFDMA (1024QAM, 256QAM, 64QAM, 16QAM, QPSK, BPSK) IEEE 802.11ax HE40: OFDMA (1024QAM, 256QAM, 64QAM, 16QAM, QPSK, BPSK) IEEE 802.11ax HE80: OFDMA (1024QAM, 256QAM, 64QAM, 16QAM, QPSK, BPSK) IEEE 802.11ax HE160: OFDMA (1024QAM, 256QAM, 64QAM, 16QAM, QPSK, BPSK)
Operation Frequency	UNII-2A/UNII-2C
Power Supply	DC 12 V

5.2. MAXIMUM EIRP

UNII-2A BAND

IEEE Std. 802.11	Frequency (MHz)	Maximum Average Conducted Power (dBm)
a 20	5250 ~ 5350	19.60
ax HE20		17.95
ax HE40		20.47
ax HE80		20.98
ax HE160		22.93

UNII-2C BAND

IEEE Std. 802.11	Frequency (MHz)	Maximum Average Conducted Power (dBm)
a 20	5470 ~ 5725	19.57
ax HE20		18.53
ax HE40		20.71
ax HE80		21.72
ax HE160		23.21



5.3. CHANNEL LIST

UNII-2A (For Bandwidth=20 MHz)		UNII-2A (For Bandwidth=40 MHz)		UNII-2A (For Bandwidth=80 MHz)	
Channel	Frequency (MHz)	Channel	Frequency (MHz)	Channel	Frequency (MHz)
52	5260	54	5270	58	5290
56	5280	62	5310		
60	5300				
64	5320				

UNII-1 (For Bandwidth=160 MHz)	
Channel	Frequency (MHz)
50	5250

UNII-2C (For Bandwidth=20 MHz)		UNII-2C (For Bandwidth=40 MHz)		UNII-2C (For Bandwidth=80 MHz)	
Channel	Frequency (MHz)	Channel	Frequency (MHz)	Channel	Frequency (MHz)
100	5500	102	5510	106	5530
104	5520	110	5550	122	5610
108	5540	118	5590	138	5690
112	5560	126	5630		
116	5580	134	5670		
120	5600	142	5710		
124	5620				
128	5640				
132	5660				
136	5680				
140	5700				
144	5720				

UNII-2C (For Bandwidth=160 MHz)	
Channel	Frequency (MHz)
114	5570

**5.4. TEST CHANNEL CONFIGURATION**

UNII-2A Test Channel Configuration		
IEEE Std.	Test Channel Number	Frequency
802.11a 20	CH 52(Low Channel), CH 56(MID Channel), CH 64(High Channel)	5260 MHz, 5280 MHz, 5320 MHz
802.11n HT20	CH 52(Low Channel), CH 56(MID Channel), CH 64(High Channel)	5260 MHz, 5280 MHz, 5320 MHz
802.11n HT40	CH 54(Low Channel), CH 62(High Channel)	5270 MHz, 5310 MHz
802.11ac VHT80	CH 58(Low Channel)	5290 MHz
802.11ax HE20	CH 52(Low Channel), CH 56(MID Channel), CH 64(High Channel)	5260 MHz, 5280 MHz, 5320 MHz
802.11ax HE40	CH 54(Low Channel), CH 62(High Channel)	5270 MHz, 5310 MHz
802.11ax HE80	CH 58(Low Channel)	5290 MHz
802.11ax HE160	CH 50(Low Channel)	5250 MHz

UNII-2C Test Channel Configuration		
IEEE Std.	Test Channel Number	Frequency
802.11a 20	CH 100(Low Channel), CH 116(MID Channel), CH 140(High Channel)	5500 MHz, 5580 MHz, 5700 MHz
802.11n HT20	CH 100(Low Channel), CH 116(MID Channel), CH 140(High Channel)	5500 MHz, 5580 MHz, 5700 MHz
802.11n HT40	CH 102(Low Channel), CH 110(MID Channel), CH 134(High Channel)	5510 MHz, 5550 MHz, 5670 MHz
802.11ac VHT80	CH 102(Low Channel), CH 122(High Channel)	5530 MHz, 5610 MHz
802.11ax HE20	CH 100(Low Channel), CH 116(MID Channel), CH 140(High Channel)	5500 MHz, 5580 MHz, 5700 MHz
802.11ax HE40	CH 102(Low Channel), CH 110(MID Channel), CH 134(High Channel)	5510 MHz, 5550 MHz, 5670 MHz
802.11ax HE80	CH 102(Low Channel), CH 122(High Channel)	5530 MHz, 5610 MHz
802.11ax HE160	CH 114(Low Channel)	5570 MHz

Straddle Test Channel Configuration		
IEEE Std.	Test Channel Number	Frequency
802.11a 20	CH 144	5720 MHz
802.11n HT20	CH 144	5720 MHz
802.11n HT40	CH 142	5710 MHz
802.11ac VHT80	CH 138	5690 MHz
802.11ax HE20	CH 144	5720 MHz
802.11ax HE40	CH 142	5710 MHz
802.11ax HE80	CH 138	5690 MHz

**5.5. THE WORSE CASE POWER SETTING PARAMETER**

The Worse Case Power Setting Parameter	
Test Software	QA tool

UNII-2A

IEEE Std.	Rate	Channel	Soft set value			
			ANT 1	ANT 2	ANT 3	ANT 4
802.11a 20	6M	52	15	15	15	15
		56	15	15	15	15
		64	15	15	15	15
802.11n HT20	MCS0	52	Cover by 802.11ax HE20			
		56				
		64				
802.11n HT40	MCS0	54	Cover by 802.11ax HE40			
		62				
802.11ac VHT20	MCS0	52	Cover by 802.11ax HE20			
		56				
		64				
802.11ac VHT40	MCS0	54	Cover by 802.11ax HE80			
		62				
802.11ac VHT80	MCS0	58	Cover by 802.11ax HE80			
802.11ax HE20	MCS0	52	7	7	7	7
		56	8	8	8	8
		64	9	9	9	9
802.11ax HE40	MCS0	54	12	12	12	12
		62	11	11	11	11
802.11ax HE80	MCS0	58	15	15	15	15
802.11ax HE160	MCS0	50	16	16	16	16



UNII-2C

IEEE Std.	Rate	Channel	Soft set value			
			ANT 1	ANT 2	ANT 3	ANT 4
802.11a 20	6M	100	15	15	15	15
		116	14	14	14	14
		140	15	15	15	15
		144	15	15	15	15
802.11n HT20	MCS0	100	Cover by 802.11ax HE20			
		116				
		140				
		144				
802.11n HT40	MCS0	102	Cover by 802.11ax HE40			
		118				
		134				
		142				
802.11ac VHT20	MCS0	100	Cover by 802.11ax HE20			
		116				
		140				
		144				
802.11ac VHT40	MCS0	102	Cover by 802.11ax HE40			
		118				
		134				
		142				
802.11ac VHT80	MCS0	106	Cover by 802.11ax HE80			
		122				
		138				
802.11ax HE20	MCS0	100	8	8	8	8
		116	7	7	7	7
		140	8	8	8	8
		144	8	8	8	8
802.11ax HE40	MCS0	102	10	10	10	10
		118	11	11	11	11
		134	10	10	10	10
		142	10	10	10	10
802.11ax HE80	MCS0	106	11	11	11	11
		122	12	12	12	12
		138	12	12	12	12
802.11ax HE160	MCS0	114	13	13	13	13

5.6. THE WORSE CASE CONFIGURATIONS

The EUT was tested in the following configuration(s):

Controlled in test mode using a software application on the EUT supplied by customer. The application was used to enable a continuous transmission and to select the mode, test channels, bandwidth, data rates as required.

Test channels referring to section 5.4.

Maximum power setting referring to section 5.5.

Worst case Data Rates declared by the customer:

IEEE 802.11a / SISO – BPSK / 6 Mbps
IEEE 802.11ax HE20 / MIMO / STBC / CDD / TxBF – BPSK / MCS0
IEEE 802.11ax HE40 / MIMO / STBC / CDD / TxBF – BPSK / MCS0
IEEE 802.11ax HE80 / MIMO / STBC / CDD / TxBF – BPSK / MCS0
IEEE 802.11ax HE160 / MIMO / STBC / CDD / TxBF – BPSK / MCS0

The EUT support STBC, CDD and TxBF (Tx Beamforming) modes, all the modes had been tested, but only the worst data was recorded in the report.

The EUT has 4 separate antennas which correspond to 4 separate antenna ports. Core 1 to Core 4 correspond to antenna 1 to antenna 4 respectively.

802.11ac VHT20/VHT40/VHT80 mode, 802.11n HT20/HT40 and 802.11ax HE20/HE40/HE80 were performed on the worst case (802.11ax HE20/HE40/HE80) mode and only the worst data was recorded in this report.

The measured additional path loss was included in any path loss calculations for all RF cable used during tested.

Conducted output power, power spectral density tests separately on each port with all supported SISO & MIMO port combinations.

Duty cycle and 6 dB / 26 dB DTS bandwidth/occupied channel bandwidth tests, only SISO mode and one chain were tested since the duty cycle and bandwidth does not change depending on chains used.

Conducted bandedge and spurious emissions tests were performed with SISO mode, as this port was found to have the worst case in terms of power settings amongst all supported possible SISO & MIMO port combinations.

Radiated emissions tests were performed with the MIMO modes. These were found to be the worst modulation scheme with regards to emissions after preliminary investigations and, as this mode emits the highest conducted output power level, it was deemed to be the worst case.

The 5 GHz beamforming function is enabled by test program, the carrier wave will be under radio chip phase control and sent to the antennas through the test program.

5.7. DESCRIPTION OF AVAILABLE ANTENNAS

Antenna No.	Frequency Band	Antenna Type	Maximum Antenna Gain (dBi)
1	5180 ~ 5825	PCB	2
2	5180 ~ 5825	PCB	2
3	5180 ~ 5825	PCB	2
4	5180 ~ 5825	PCB	2

The EUT support Cyclic Shift Diversity (CDD) mode.

MIMO output power port and MIMO PSD port summing was performed in accordance with KDB 662911 D01. For the CDD mode results the Directional Gain was calculated in accordance with the following method.

For output power measurements:

Directional gain = $G_{ANT} + \text{Array Gain} = 2 \text{ dBi}$

G_{ANT} : equal to the gain of the antenna having the highest gain

Array Gain = 0 dB (i.e., no array gain) for $N_{ANT} \leq 4$

For power spectral density (PSD) measurements:

Directional gain = $G_{ANT} + \text{Array Gain} = 8 \text{ dBi}$

Array Gain = $10 \log(N_{ANT}/N_{SS}) \text{ dB}$.

N_{ANT} : number of transmit antennas

N_{SS} : number of spatial streams, the worst case directional gain will occur when $N_{SS} = 1$

The EUT support Tx beamforming mode.

MIMO output power port and MIMO PSD port summing was performed in accordance with KDB 662911 D01. For the Tx beamforming mode results the Directional Gain was calculated in accordance with the following method.

For output power measurements:

Directional gain = $G_{ANT} + 10 \log(N_{ANT}) \text{ dBi} = 8 \text{ dBi}$

G_{ANT} : equal to the gain of the antenna having the highest gain

For power spectral density (PSD) measurements:

Directional gain = $G_{ANT} + 10 \log(N_{ANT}) \text{ dBi} = 8 \text{ dBi}$

G_{ANT} : equal to the gain of the antenna having the highest gain

The EUT support Space Time Block Codes (STBC) mode.

MIMO output power port and MIMO PSD port summing was performed in accordance with KDB 662911 D01. For the STBC mode results the Directional Gain was calculated in accordance with the following method.

For output power measurements:

Directional gain = $G_{ANT} \text{ dBi} = 2 \text{ dBi}$

G_{ANT} : equal to the gain of the antenna having the highest gain

For power spectral density (PSD) measurements:

Directional gain = $G_{ANT} \text{ dBi} = 2 \text{ dBi}$

G_{ANT} : equal to the gain of the antenna having the highest gain

5.8. DESCRIPTION OF TEST SETUP

SUPPORT EQUIPMENT

Item	Equipment	Brand Name	Model Name	Remarks
1	Laptop	ThinkPad	X230i	/

I/O CABLES

Cable No	Port	Connector Type	Cable Type	Cable Length(m)	Remarks
1	USB	USB	Unshielded	1.0 m	/
2	LAN1	RJ45	Unshielded	1.0 m	/
3	LAN2	RJ45	Unshielded	1.0 m	/
4	LAN3	RJ45	Unshielded	1.0 m	/
5	POWER	/	Unshielded	1.5 m	/

ACCESSORIES

Item	Accessory	Brand Name	Model Name	Description
1	I.T.E. POWER SUPPLY	Tp-link	T120330-2B4	Input: AC 100-240 V, 50 / 60 Hz, 1 A Output: DC 12.0 V, 3.3 A

TEST SETUP

The EUT can work in engineering mode with a software through a Laptop.

SETUP DIAGRAM FOR TESTS

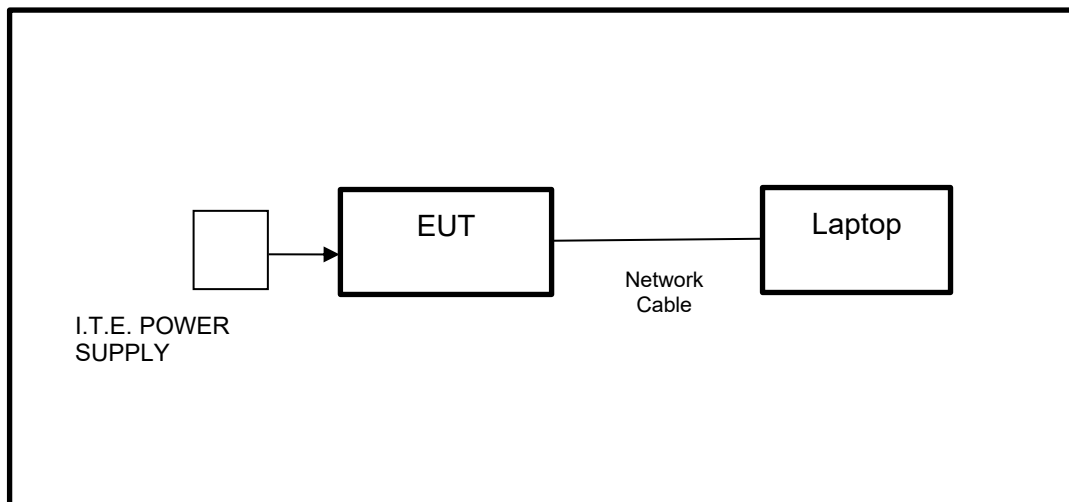

**6. MEASURING EQUIPMENT AND SOFTWARE USED**

R&S TS 8997 Test System					
Equipment	Manufacturer	Model No.	Serial No.	Last Cal.	Due. Date
Power sensor, Power Meter	R&S	OSP120	100921	Apr.02,2022	Apr.01,2023
Vector Signal Generator	R&S	SMBV100A	261637	Oct.17, 2022	Oct.16, 2023
Signal Generator	R&S	SMB100A	178553	Oct.17, 2022	Oct.16, 2023
Signal Analyzer	R&S	FSV40	101118	Oct.17, 2022	Oct.16, 2023
Software					
Description	Manufacturer	Name		Version	
For R&S TS 8997 Test System	Rohde & Schwarz	EMC 32		10.60.10	
Tonsend RF Test System					
Equipment	Manufacturer	Model No.	Serial No.	Last Cal.	Due. Date
Wideband Radio Communication Tester	R&S	CMW500	155523	Oct.17, 2022	Oct.16, 2023
Wireless Connectivity Tester	R&S	CMW270	1201.0002N75-102	Sep.28, 2022	Sep.27, 2023
PXA Signal Analyzer	Keysight	N9030A	MY55410512	Oct.17, 2022	Oct.16, 2023
MXG Vector Signal Generator	Keysight	N5182B	MY56200284	Oct.17, 2022	Oct.16, 2023
MXG Vector Signal Generator	Keysight	N5172B	MY56200301	Oct.17, 2022	Oct.16, 2023
Attenuator	Agilent	8495B	2814a12853	Oct.18, 2022	Oct.17, 2023
Temperature & Humidity Chamber	SANMOOD	SG-80-CC-2	2088	Oct.17, 2022	Oct.16, 2023
Software					
Description	Manufacturer	Name		Version	
Tonsend SRD Test System	Tonsend	JS1120-3 RF Test System		2.6.77.0518	

Conducted Emissions					
Equipment	Manufacturer	Model No.	Serial No.	Last Cal.	Due Date
EMI Test Receiver	R&S	ESR3	101961	Oct.17, 2022	Oct.16, 2023
Two-Line V-Network	R&S	ENV216	101983	Oct.17, 2022	Oct.16, 2023
Software					
Description	Manufacturer	Name		Version	
Test Software for Conducted Emissions	Farad	EZ-EMC		Ver. UL-3A1	



Radiated Emissions					
Equipment	Manufacturer	Model No.	Serial No.	Last Cal.	Due Date
MXE EMI Receiver	KESIGHT	N9038A	MY56400036	Oct.17, 2022	Oct.16, 2023
Hybrid Log Periodic Antenna	TDK	HLP-3003C	130959	Aug.02, 2021	Aug.01, 2024
Preamplifier	HP	8447D	2944A09099	Oct.17, 2022	Oct.16, 2023
EMI Measurement Receiver	R&S	ESR26	101377	Oct.17, 2022	Oct.16, 2023
Horn Antenna	TDK	HRN-0118	130940	July 20, 2021	July 19, 2024
Preamplifier	TDK	PA-02-0118	TRS-305-00067	Oct.17, 2022	Oct.16, 2023
Horn Antenna	Schwarzbeck	BBHA9170	697	July 20, 2021	July 19, 2024
Preamplifier	TDK	PA-02-2	TRS-307-00003	Oct.17, 2022	Oct.16, 2023
Preamplifier	TDK	PA-02-3	TRS-308-00002	Oct.17, 2022	Oct.16, 2023
Loop antenna	Schwarzbeck	1519B	00008	Dec.14, 2021	Dec.13, 2024
Preamplifier	TDK	PA-02-001-3000	TRS-302-00050	Oct.17, 2022	Oct.16, 2023
Highpass Filter	Wainwright	WHKX10-5850-6500-1800-40SS	4	/	/
Band Reject Filter	Wainwright	WRCJV12-5695-5725-5850-5880-40SS	4	/	/
Band Reject Filter	Wainwright	WRCJV20-5120-5150-5350-5380-60SS	2	/	/
Band Reject Filter	Wainwright	WRCJV20-5440-5470-5725-5755-60SS	1	/	/
Software					
Description			Manufacturer	Name	Version
Test Software for Radiated Emissions			Farad	EZ-EMC	Ver. UL-3A1

7. ANTENNA PORT TEST RESULTS

7.1. ON TIME AND DUTY CYCLE

LIMITS

None; for reporting purposes only.

TEST PROCEDURE

Refer to KDB 789033 D02 General U-NII Test Procedures New Rules v02r01 section II.B.

The zero-span mode on a spectrum analyzer or EMI receiver, if the response time and spacing between bins on the sweep are sufficient to permit accurate measurements of the on and off times of the transmitted signal. Set the center frequency of the instrument to the center frequency of the transmission. Set $RBW \geq EBW$ if possible; otherwise, set RBW to the largest available value. Set $VBW \geq RBW$. Set detector = peak or average. The zero-span measurement method shall not be used unless both RBW and VBW are $> 50/T$, where T is defined in II.B.1.a), and the number of sweep points across duration T exceeds 100. (For example, if VBW and/or RBW are limited to 3 MHz, then the zero-span method of measuring duty cycle shall not be used if $T \leq 16.7$ microseconds.)

TEST SETUP

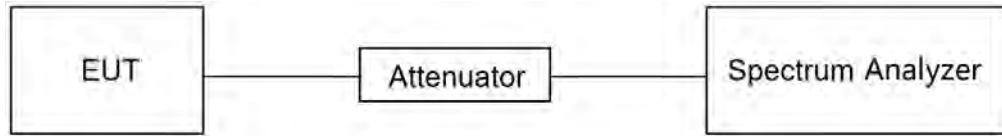

TEST ENVIRONMENT

Temperature	24.2 °C	Relative Humidity	53.5%
Atmosphere Pressure	101 kPa	Test Voltage	DC 12 V

TEST RESULTS

Please refer to section "Test Data" - Appendix F



7.2. 6DB AND 26DB EMISSION BANDWIDTH AND 99% OCCUPIED BANDWIDTH

LIMITS

CFR 47 FCC Part15, Subpart E		
Test Item	Limit	Frequency Range (MHz)
26 dB Emission Bandwidth	For reporting purposes only.	5150 ~ 5250
26 dB Emission Bandwidth	For reporting purposes only.	5250 ~ 5350
26 dB Emission Bandwidth	For reporting purposes only.	5470 ~ 5725 (For FCC) 5470 ~ 5600 (For ISSED) 5650 ~ 5725 (For ISSED)
6 dB Emission Bandwidth	The minimum 6 dB emission bandwidth shall be 500 kHz.	5725 ~ 5850
99 % Occupied Bandwidth	For reporting purposes only.	5150 ~ 5825 (For ISSED)

TEST PROCEDURE

Refer to KDB 789033 D02 General U-NII Test Procedures New Rules v02r01 section II.C1. for 26 dB Emission Bandwidth; section II.C2. for 6 dB Emission Bandwidth; section II.D. for 99 % Occupied Bandwidth.

Connect the EUT to the spectrum analyser and use the following settings:

Center Frequency	The center frequency of the channel under test
Detector	Peak
RBW	For 6 dB Emission Bandwidth: RBW=100 kHz For 26 dB Emission bandwidth: approximately 1 % of the EBW. For 99 % Occupied Bandwidth: approximately 1 % ~ 5 % of the OBW.
VBW	For 6 dB Bandwidth: $\geq 3 \times \text{RBW}$ For 26 dB Bandwidth: $> 3 \times \text{RBW}$ For 99 % Bandwidth: $> 3 \times \text{RBW}$
Trace	Max hold
Sweep	Auto couple

a) Use the 99 % power bandwidth function of the instrument, allow the trace to stabilize and report the measured bandwidth.

b) Allow the trace to stabilize and measure the maximum width of the emission that is constrained by the frequencies associated with the two outermost amplitude points (upper and lower frequencies) that are attenuated by 6/26 dB relative to the maximum level measured in the fundamental emission.

Calculation for 99 % Bandwidth of UNII-2C and UNII-3 Straddle Channel:

For Example: Fundamental Frequency: 5720 MHz

99 % OBW: 21.00 MHz

Turning Frequency: 5725 MHz

99 % Bandwidth of UNII-2C Band Portion = $(5725 - (5720 - (21.00/2))) = 15.50 \text{ MHz}$

99 % Bandwidth of UNII-3 Band Portion = $(5720 + (21.00/2) - 5725) = 5.50 \text{ MHz}$

Calculation for 26 dB Bandwidth of UNII-2C Straddle Channel:

For Example: Fundamental frequency: 5720 MHz

26 dB BW: 20.00 MHz

FL: 5710.16 MHz

FH: 5730.16 MHz

Turning Frequency: 5725 MHz

26 dB Bandwidth of UNII-2C Band Portion = $5725 - 5710.16 = 14.84$ MHz

Calculation for 6dB Bandwidth of UNII-3 Straddle Channel:

For Example: Fundamental frequency: 5720 MHz

6 dB BW: 16.44 MHz

FL: 5711.76 MHz

FH: 5728.2 MHz

Turning Frequency: 5725 MHz

6 dB Bandwidth of UNII-3 band Portion = $5728.2 - 5725 = 3.2$ MHz

TEST SETUP

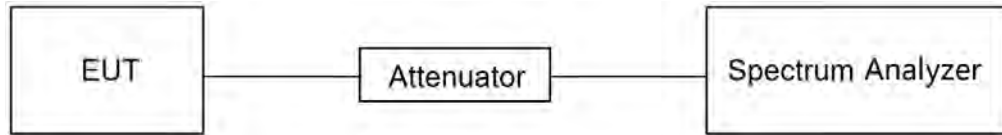

TEST ENVIRONMENT

Temperature	24.2 °C	Relative Humidity	53.5%
Atmosphere Pressure	101 kPa	Test Voltage	DC 12 V

TEST RESULTS

Please refer to section "Test Data" - Appendix A & B & C



7.3. CONDUCTED OUTPUT POWER

LIMITS

CFR 47 FCC Part15, Subpart E		
Test Item	Limit	Frequency Range (MHz)
Conducted Output Power	<input type="checkbox"/> Outdoor Access Point: 1 W (30 dBm) <input checked="" type="checkbox"/> Indoor Access Point: 1 W (30 dBm) <input type="checkbox"/> Fixed Point-To-Point Access Points: 1 W (30 dBm) <input type="checkbox"/> Client Devices: 250 mW (24 dBm)	5150 ~ 5250
	Shall not exceed the lesser of 250 mW (24dBm) or 11 dBm + 10 log B, where B is the 26 dB emission bandwidth in megahertz.	5250 ~ 5350 5470 ~ 5725
	Shall not exceed 1 Watt (30 dBm).	5725 ~ 5850

Note:

The above limits are based upon the maximum antenna gain does not exceed 6 dBi. If transmitting antennas of directional gain greater than 6 dBi are used, the maximum conducted output power shall be reduced by the amount in dB that the directional gain of the antenna exceeds 6 dBi.

TEST PROCEDURE

Refer to KDB 789033 D02 General U-NII Test Procedures New Rules v02r01 section II.E.

Method SA-1 (trace averaging with the EUT transmitting at full power throughout each sweep):

- (i) Set span to encompass the entire emission bandwidth (EBW) (or, alternatively, the entire 99% occupied bandwidth) of the signal.
- (ii) Set RBW = 1 MHz.
- (iii) Set VBW \geq 3 MHz.
- (iv) Number of points in sweep $\geq 2 \times$ span / RBW. (This ensures that bin-to-bin spacing is \leq RBW/2, so that narrowband signals are not lost between frequency bins.)
- (v) Sweep time = auto.
- (vi) Detector = power averaging (rms), if available. Otherwise, use sample detector mode.
- (vii) If transmit duty cycle $<$ 98 %, use a video trigger with the trigger level set to enable triggering only on full power pulses. Transmitter must operate at maximum power control level for the entire duration of every sweep. If the EUT transmits continuously (i.e., with no off intervals) or at duty cycle \geq 98 %, and if each transmission is entirely at the maximum power control level, then the trigger shall be set to "free run."
- (viii) Trace average at least 100 traces in power averaging (rms) mode.
- (ix) Compute power by integrating the spectrum across the EBW (or, alternatively, the entire 99% occupied bandwidth) of the signal using the instrument's band power measurement function with band limits set equal to the EBW (or occupied bandwidth) band edges. If the instrument does not have a band power function, sum the spectrum levels (in power units) at 1 MHz intervals extending across the EBW (or, alternatively, the entire 99% occupied bandwidth) of the spectrum.

Method PM (Measurement using an RF average power meter):

- (i) Measurements may be performed using a wideband RF power meter with a thermocouple detector or equivalent if all of the following conditions are satisfied:
 - a. The EUT is configured to transmit continuously or to transmit with a constant duty cycle.
 - b. At all times when the EUT is transmitting, it must be transmitting at its maximum power control level.
 - c. The integration period of the power meter exceeds the repetition period of the transmitted signal by at least a factor of five.
- (ii) If the transmitter does not transmit continuously, measure the duty cycle, x, of the transmitter output signal as described in II.B.
- (iii) Measure the average power of the transmitter. This measurement is an average over both the on and off periods of the transmitter.
- (iv) Adjust the measurement in dBm by adding $10 \log (1/x)$ where x is the duty cycle (e.g., $10 \log (1/0.25)$ if the duty cycle is 25 %).

TEST SETUP

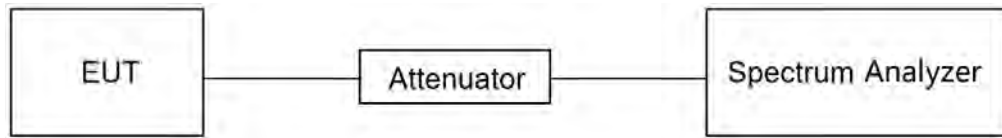

TEST ENVIRONMENT

Temperature	24.2 °C	Relative Humidity	53.5%
Atmosphere Pressure	101 kPa	Test Voltage	DC 12 V

TEST RESULTS

Please refer to section "Test Data" - Appendix D



7.4. POWER SPECTRAL DENSITY

LIMITS

CFR 47 FCC Part15, Subpart E		
Test Item	Limit	Frequency Range (MHz)
Power Spectral Density	<input type="checkbox"/> Outdoor Access Point: 17 dBm/MHz <input checked="" type="checkbox"/> Indoor Access Point: 17 dBm/MHz <input type="checkbox"/> Fixed Point-To-Point Access Points: 17 dBm/MHz <input type="checkbox"/> Client Devices: 11 dBm/MHz	5150 ~ 5250
	11 dBm/MHz	5250 ~ 5350 5470 ~ 5725
	30 dBm/500kHz	5725 ~ 5850

Note:

The above limits are based upon the maximum antenna gain does not exceed 6 dBi. If transmitting antennas of directional gain greater than 6 dBi are used, maximum power spectral density shall be reduced by the amount in dB that the directional gain of the antenna exceeds 6 dBi.

TEST PROCEDURE

Refer to KDB 789033 D02 General U-NII Test Procedures New Rules v02r01 section II.F.

Connect the EUT to the spectrum analyser and use the following settings:

For U-NII-1, U-NII-2A and U-NII-2C band:

Center Frequency	The center frequency of the channel under test
Detector	RMS
RBW	1 MHz
VBW	$\geq 3 \times$ RBW
Span	Encompass the entire emissions bandwidth (EBW) of the signal
Trace	Max hold
Sweep time	Auto

For U-NII-3:

Center Frequency	The center frequency of the channel under test
Detector	RMS
RBW	500 kHz
VBW	$\geq 3 \times$ RBW
Span	Encompass the entire emissions bandwidth (EBW) of the signal
Trace	Max hold
Sweep time	Auto

Allow trace to fully stabilize and Use the peak search function on the instrument to find the peak of the spectrum and record its value.

Add $10 \log (1/x)$, where x is the duty cycle, to the peak of the spectrum, the result is the Maximum PSD over 1 MHz / 500 kHz reference bandwidth.

TEST SETUP

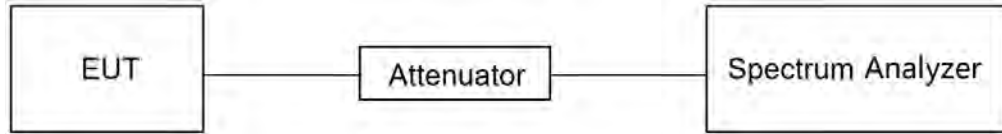

TEST ENVIRONMENT

Temperature	24.2 °C	Relative Humidity	53.5%
Atmosphere Pressure	101 kPa	Test Voltage	DC 12 V

TEST RESULTS

Please refer to section "Test Data" - Appendix E



7.5. FREQUENCY STABILITY

LIMITS

The frequency of the carrier signal shall be maintained within band of operation.

TEST PROCEDURE

1. The EUT was placed inside an environmental chamber as the temperature in the chamber was varied between 0 °C ~ 40 °C (declared by customer).
2. The temperature was incremented by 10 °C intervals and the unit allowed to stabilize at each temperature before each measurement. The center frequency of the transmitting channel was evaluated at each temperature and the frequency deviation from the channel's center frequency was recorded.
3. The primary supply voltage is varied from 85 % to 115 % of the nominal value for non hand-carried battery and AC powered equipment. For hand-carried, battery-powered equipment, primary supply voltage is reduced to the battery operating end point which shall be specified by the manufacturer.

Connect the EUT to the spectrum analyser and use the following settings:

Center Frequency	The center frequency of the channel under test
Detector	Peak
RBW	10 kHz
VBW	$\geq 3 \times \text{RBW}$
Span	Encompass the entire emissions bandwidth (EBW) of the signal
Trace	Max hold
Sweep time	Auto

4. While maintaining a constant temperature inside the environmental chamber, turn the EUT on and record the operating frequency at startup, and at 2 minutes, 5minutes, and 10 minutes after the EUT is energized.
5. Allow the trace to stabilize, find the peak value of the power envelope and record the frequency, then calculated the frequency drift.

TEST ENVIRONMENT

	Normal Test Conditions	Extreme Test Conditions
Relative Humidity	20 % - 75 %	/
Atmospheric Pressure	100 kPa ~ 102 kPa	/
Temperature	T _N (Normal Temperature): 25.1 °C	T _L (Low Temperature): 0 °C
		T _H (High Temperature): 40 °C
Supply Voltage	V _N (Normal Voltage): DC 12 V	V _L (Low Voltage): DC 10.20 V
		V _H (High Voltage): DC 13.80 V

TEST SETUP

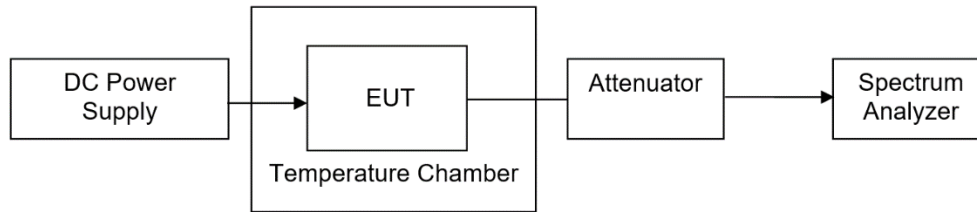

TEST ENVIRONMENT

Temperature	24.2 °C	Relative Humidity	53.5%
Atmosphere Pressure	101 kPa	Test Voltage	DC 12 V

TEST RESULTS

Please refer to section "Test Data" - Appendix G



8. RADIATED TEST RESULTS

LIMITS

Refer to CFR 47 FCC §15.205, §15.209 and §15.407 (b).

Radiation Disturbance Test Limit for FCC (Class B) (9 kHz ~ 1 GHz)

Emissions radiated outside of the specified frequency bands above 30 MHz			
Frequency Range (MHz)	Field Strength Limit (uV/m) at 3 m	Field Strength Limit (dBuV/m) at 3 m	
		Quasi-Peak	
30 - 88	100	40	
88 - 216	150	43.5	
216 - 960	200	46	
Above 960	500	54	
Above 1000	500	Peak	Average
		74	54

FCC Emissions radiated outside of the specified frequency bands below 30 MHz		
Frequency (MHz)	Field strength (microvolts/meter)	Measurement distance (meters)
0.009-0.490	2400/F(kHz)	300
0.490-1.705	24000/F(kHz)	30
1.705-30.0	30	30

FCC Restricted bands of operation refer to FCC §15.205 (a):

MHz	MHz	MHz	GHz
0.090-0.110	16.42-16.423	399.9-410	4.5-5.15
¹ 0.495-0.505	16.69475-16.69525	608-614	5.35-5.46
2.1735-2.1905	16.80425-16.80475	960-1240	7.25-7.75
4.125-4.128	25.5-25.67	1300-1427	8.025-8.5
4.17725-4.17775	37.5-38.25	1435-1626.5	9.0-9.2
4.20725-4.20775	73-74.6	1645.5-1646.5	9.3-9.5
6.215-6.218	74.8-75.2	1660-1710	10.6-12.7
6.26775-6.26825	108-121.94	1718.8-1722.2	13.25-13.4
6.31175-6.31225	123-138	2200-2300	14.47-14.5
8.291-8.294	149.9-150.05	2310-2390	15.35-16.2
8.362-8.366	156.52475-156.52525	2483.5-2500	17.7-21.4
8.37625-8.38675	156.7-156.9	2690-2900	22.01-23.12
8.41425-8.41475	162.0125-167.17	3260-3267	23.6-24.0
12.29-12.293	167.72-173.2	3332-3339	31.2-31.8
12.51975-12.52025	240-285	3345.8-3358	36.43-36.5
12.57675-12.57725	322-335.4	3600-4400	(²)
13.36-13.41			

Note: ¹Until February 1, 1999, this restricted band shall be 0.490-0.510 MHz.

²Above 38.6c



Limits of unwanted/undesirable emission out of the restricted bands refer to CFR 47 FCC §15.407 (b) and ISED RSS-247 6.2.

LIMITS OF RADIATED EMISSION MEASUREMENT (Above 1GHz)		
Frequency Range (MHz)	EIRP Limit	Field Strength Limit (dBuV/m) at 3 m
5150~5250 MHz	PK: -27 (dBm/MHz)	PK:68.2(dBμV/m)
5250~5350 MHz		
5470~5725 MHz		
5725~5850 MHz	PK: -27 (dBm/MHz) *1 PK: 10 (dBm/MHz) *2 PK: 15.6 (dBm/MHz) *3 PK: 27 (dBm/MHz) *4	PK: 68.2(dBμV/m) *1 PK: 105.2 (dBμV/m) *2 PK: 110.8(dBμV/m) *3 PK: 122.2 (dBμV/m) *4
<p>Note:</p> <p>*1 beyond 75 MHz or more above of the band edge.</p> <p>*2 below the band edge increasing linearly to 10 dBm/MHz at 25 MHz above.</p> <p>*3 below the band edge increasing linearly to a level of 15.6 dBm/MHz at 5 MHz above.</p> <p>*4 from 5 MHz above or below the band edge increasing linearly to a level of 27 dBm/MHz at the band edge.</p>		

TEST PROCEDURE

Below 30 MHz

The setting of the spectrum analyser

RBW	200 Hz (From 9 kHz to 0.15 MHz)/ 9 kHz (From 0.15 MHz to 30 MHz)
VBW	200 Hz (From 9 kHz to 0.15 MHz)/ 9 kHz (From 0.15 MHz to 30 MHz)
Sweep	Auto

1. The testing follows the guidelines in ANSI C63.10-2013 clause 6.4.
2. The EUT was arranged to its worst case and then turntable (from 0 degree to 360 degrees) to find the maximum reading. A pre-amp and a high pass filter are used for the test in order to get better signal level. Both Horizontal, Face-on and Face-off polarizations of the antenna are set to make the measurement.
3. The EUT was placed on a turntable with 80 cm above ground.
4. The EUT was set 3 meters from the interference receiving antenna, which was mounted on the top of a 1 m height antenna tower.
5. The radiated emission limits are based on measurements employing a CISPR quasi-peak detector except for the frequency bands 9-90 kHz, 110-490 kHz and above 1000 MHz Radiated emission limits in these three bands are based on measurements employing an average detector.
6. For measurement below 1 GHz, the initial step in collecting conducted emission data is a spectrum analyzer peak detector mode pre-scanning the measurement frequency range. Significant peaks are then marked and then Quasi Peak and average detector mode re-measured. If the emission level of the EUT measured by the peak detector is 3 dB lower than the applicable limit, the peak emission level will be reported. Otherwise, the emission measurement will be repeated using the quasi-peak and average detector and reported.
7. Although these tests were performed other than open field site, adequate comparison measurements were confirmed against 30m open field site. Therefore sufficient tests were made to demonstrate that the alternative site produces results that correlate with the ones of tests made in an open field site based on KDB 414788.
8. The limits in CFR 47, Part 15, Subpart C, paragraph 15.209 (a), are identical to those in RSS-GEN Section 8.9, Table 6, since the measurements are performed in terms of magnetic field strength and converted to electric field strength levels (as reported in the table) using the free space impedance of 377Ω . For example, the measurement frequency X KHz resulted in a level of Y dBuV/m, which is equivalent to $Y-51.5 = Z$ dBuA/m, which has the same margin, W dB, to the corresponding RSS-GEN Table 6 limit as it has to be 15.209(a) limit.



Below 1 GHz and above 30 MHz

The setting of the spectrum analyser

RBW	120 kHz
VBW	300 kHz
Sweep	Auto
Detector	Peak/QP
Trace	Max hold

1. The testing follows the guidelines in ANSI C63.10-2013 clause 6.5.
2. The EUT was arranged to its worst case and then tune the antenna tower (from 1 m to 4 m) and turntable (from 0 degree to 360 degrees) to find the maximum reading. A pre-amp and a high pass filter are used for the test in order to get better signal level. Both horizontal and vertical polarizations of the antenna are set to make the measurement.
3. The EUT was placed on a turntable with 80 cm above ground.
4. The EUT was set 3 meters from the interference receiving antenna, which was mounted on the top of a variable height antenna tower.
5. For measurement below 1 GHz, the initial step in collecting conducted emission data is a spectrum analyzer peak detector mode pre-scanning the measurement frequency range. Significant peaks are then marked and then Quasi Peak detector mode re-measured. If the emission level of the EUT measured by the peak detector is 3 dB lower than the applicable limit, the peak emission level will be reported. Otherwise, the emission measurement will be repeated using the quasi-peak detector and reported.



Above 1 GHz

The setting of the spectrum analyser

RBW	1 MHz
VBW	PEAK: 3 MHz AVG: see note 6
Sweep	Auto
Detector	Peak
Trace	Max hold

1. The testing follows the guidelines in KDB 789033 D02 General U-NII Test Procedures New Rules v02r01 section II.G.3 ~ II.G.6.
2. The EUT was arranged to its worst case and then tune the antenna tower (from 1 m to 4 m) and turntable (from 0 degree to 360 degrees) to find the maximum reading. A pre-amp and a high pass filter are used for the test in order to get better signal level. Both horizontal and vertical polarizations of the antenna are set to make the measurement.
3. The EUT was placed on a turntable with 1.5 m above ground.
4. The EUT was set 3 meters from the interference receiving antenna, which was mounted on the top of a variable height antenna tower.
5. For measurement above 1 GHz, the emission measurement will be measured by the peak detector. This peak level, once corrected, must comply with the limit specified in Section 15.209.
6. For measurements above 1 GHz the resolution bandwidth is set to 1 MHz, then the video bandwidth is set to 3 MHz for peak measurements and 1 MHz resolution bandwidth with 1/T video bandwidth with peak detector for average measurements. For the Duty Cycle please refer to clause 7.1. ON TIME AND DUTY CYCLE.

For Restricted Bandedge:

Note:

1. Measurement = Reading Level + Correct Factor.
2. If the peak values are less than the average limit of 54 dBuV/m, the average result is deemed to comply with average limit.
3. Peak: Peak detector.
4. AVG: $VBW=1/Ton$, where: Ton is the transmitting duration.
5. For the transmitting duration, please refer to clause 7.1.
6. Only the worst data was recorded, if it complies with the limit, the other emissions deemed to comply with the limit.
7. Both horizontal and vertical have been tested, only the worst data was recorded in the report.
8. All modes, channels and antennas have been tested, only the worst data was recorded in the report.

For Radiate Spurious emission (9 kHz ~ 30 MHz):

Note:

1. Measurement = Reading Level + Correct Factor.
2. If the peak values are less than the QP limit, the QP result is deemed to comply with QP limit.
3. All 3 polarizations (Horizontal, Face-on and Face-off) of the loop antenna had been tested, but only the worst data recorded in the report.
4. All modes, channels and antennas have been tested, only the worst data was recorded in the report.

For Radiate Spurious Emission (30 MHz ~ 1 GHz):

Note:

1. Result Level = Read Level + Correct Factor.
2. If the peak values are less than the QP limit, the QP result is deemed to comply with QP limit.
3. All modes, channels and antennas have been tested, only the worst data was recorded in the report.

For Radiate Spurious Emission (1 GHz ~ 7 GHz):

1. Measurement = Reading Level + Correct Factor.
2. If the peak values are less than the average limit of 54 dBuV/m, the average result is deemed to comply with average limit.
3. Peak: Peak detector.
4. AVG: $VBW=1/Ton$, where: Ton is the transmitting duration.
5. For the transmitting duration, please refer to clause 7.1.
6. Filter losses were only considered in the spurious frequency bands and the authorized band was not corrected for Band reject filter losses.
7. Proper operation of the transmitter prior to adding the filter to the measurement chain.
8. Since non-restricted band peak emissions are less than the average limit, they also comply with the -27dBm/MHz (68.2dBuV/m) limit.
9. All modes, channels and antennas have been tested, only the worst data was recorded in the report.



For Radiate Spurious Emission (7 GHz ~ 18 GHz):

Note:

1. Peak Result = Reading Level + Correct Factor.
2. If the peak values are less than the average limit of 54 dBuV/m, the average result is deemed to comply with average limit.
3. Peak: Peak detector.
4. AVG: $VBW=1/Ton$, where: Ton is the transmitting duration.
5. For the transmitting duration, please refer to clause 7.1.
6. Filter losses were only considered in the spurious frequency bands and the authorized band was not corrected for High Pass Filter losses.
7. Proper operation of the transmitter prior to adding the filter to the measurement chain.
8. Since non-restricted band peak emissions are less than the average limit, they also comply with the -27dBm/MHz (68.2dBuV/m) limit.
9. All modes, channels and antennas have been tested, only the worst data was recorded in the report.

For Radiate Spurious emission (18 GHz ~ 26 GHz):

Note:

1. Measurement = Reading Level + Correct Factor.
2. If the peak values are less than the average limit of 54 dBuV/m, the average result is deemed to comply with average limit.
3. Peak: Peak detector.
4. All modes, channels and antennas have been tested, only the worst data was recorded in the report.

For Radiate Spurious emission (26 GHz ~ 40 GHz):

Note:

1. Measurement = Reading Level + Correct Factor.
2. If the peak values are less than the average limit of 54 dBuV/m, the average result is deemed to comply with average limit.
3. Peak: Peak detector.
4. All modes, channels and antennas have been tested, only the worst data was recorded in the report.

TEST SETUP

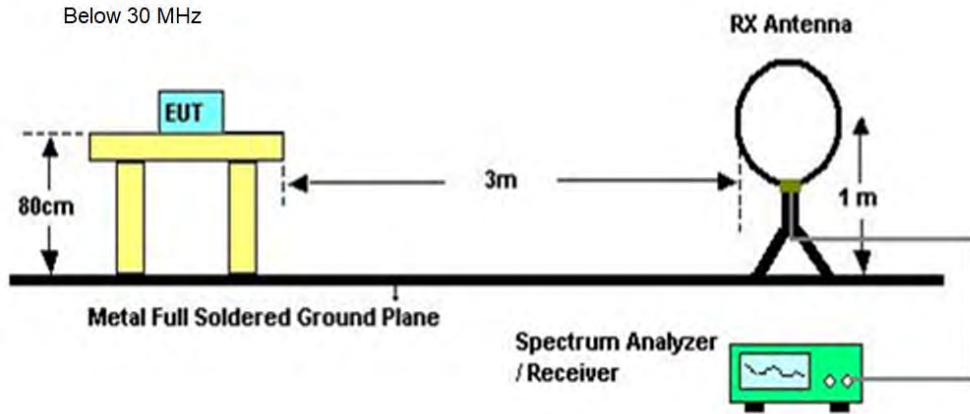

Below 1 GHz and above 30 MHz

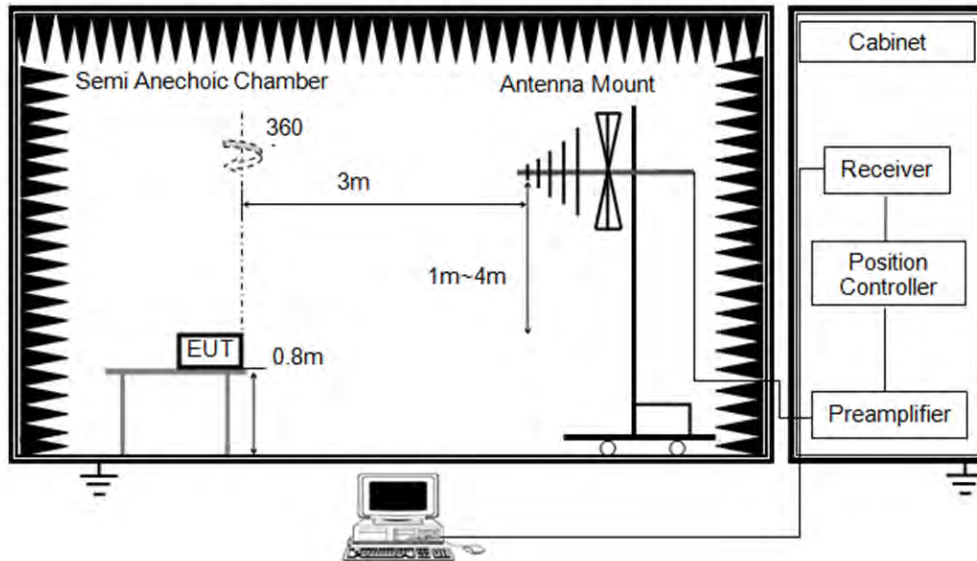

Above 1 GHz

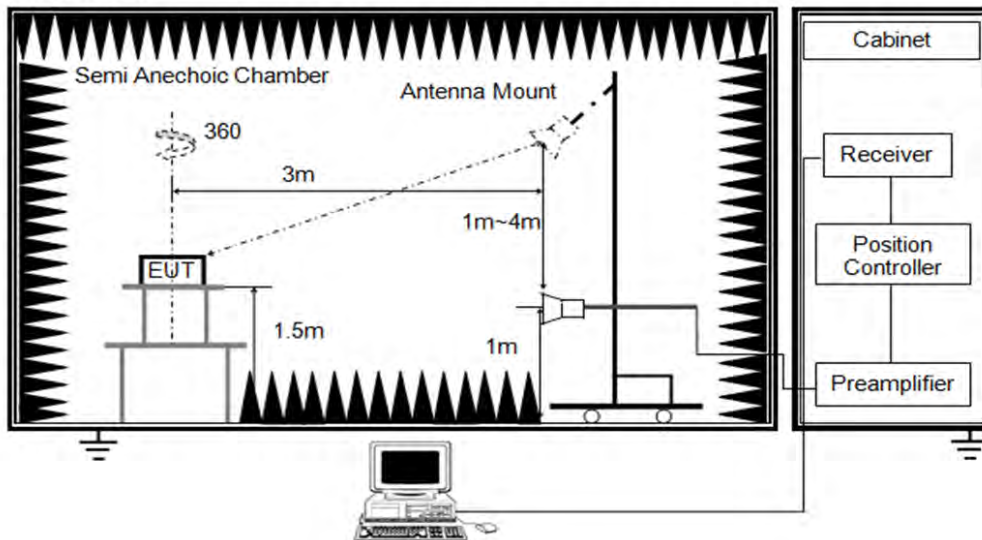



TEST ENVIRONMENT

Temperature	24.3 °C	Relative Humidity	61%
Atmosphere Pressure	101 kPa	Test Voltage	DC 12 V

TEST RESULTS



8.1. RESTRICTED BANDEDGE

Test Mode:	802.11a 20 Peak	Channel:	5260 MHz
Polarity:	Vertical	Test Voltage:	DC 12 V

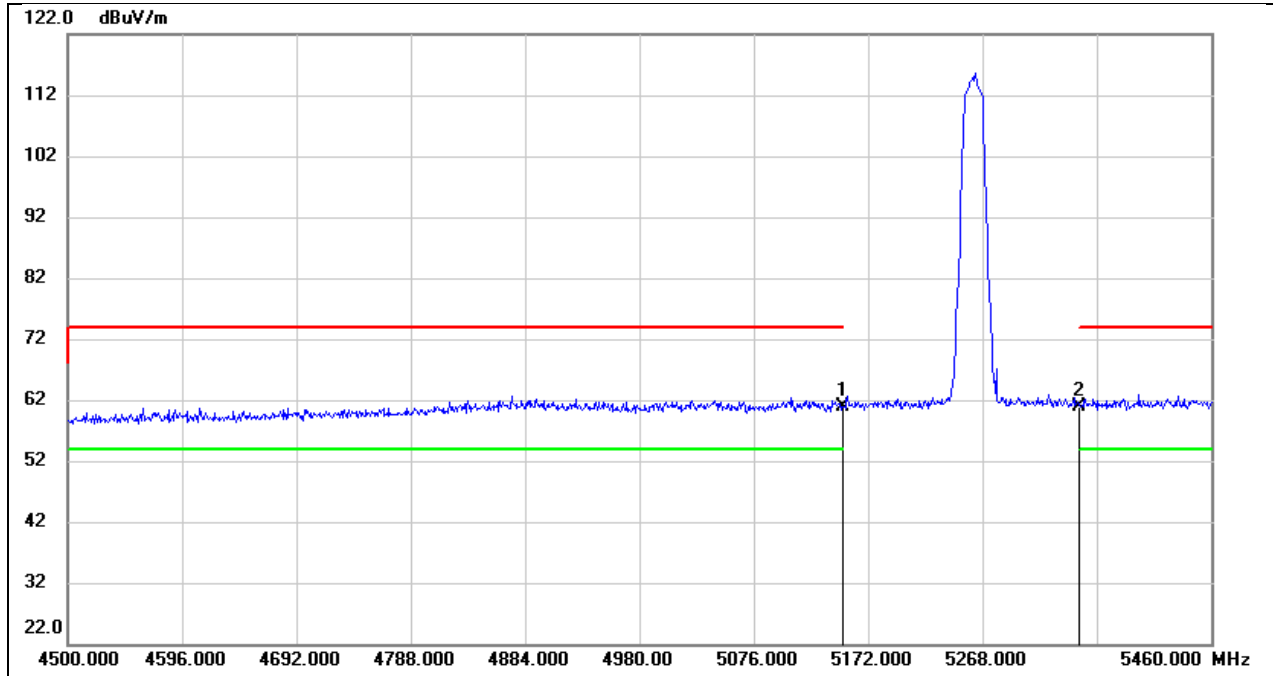

No.	Frequency (MHz)	Reading (dBuV)	Correct (dB/m)	Result (dBuV/m)	Limit (dBuV/m)	Margin (dB)	Remark
1	5150.000	20.68	40.27	60.95	74.00	-13.05	peak
2	5350.000	20.41	40.49	60.90	74.00	-13.10	peak



Test Mode:	802.11a 20 Average	Channel:	5260 MHz
Polarity:	Vertical	Test Voltage:	DC 12 V

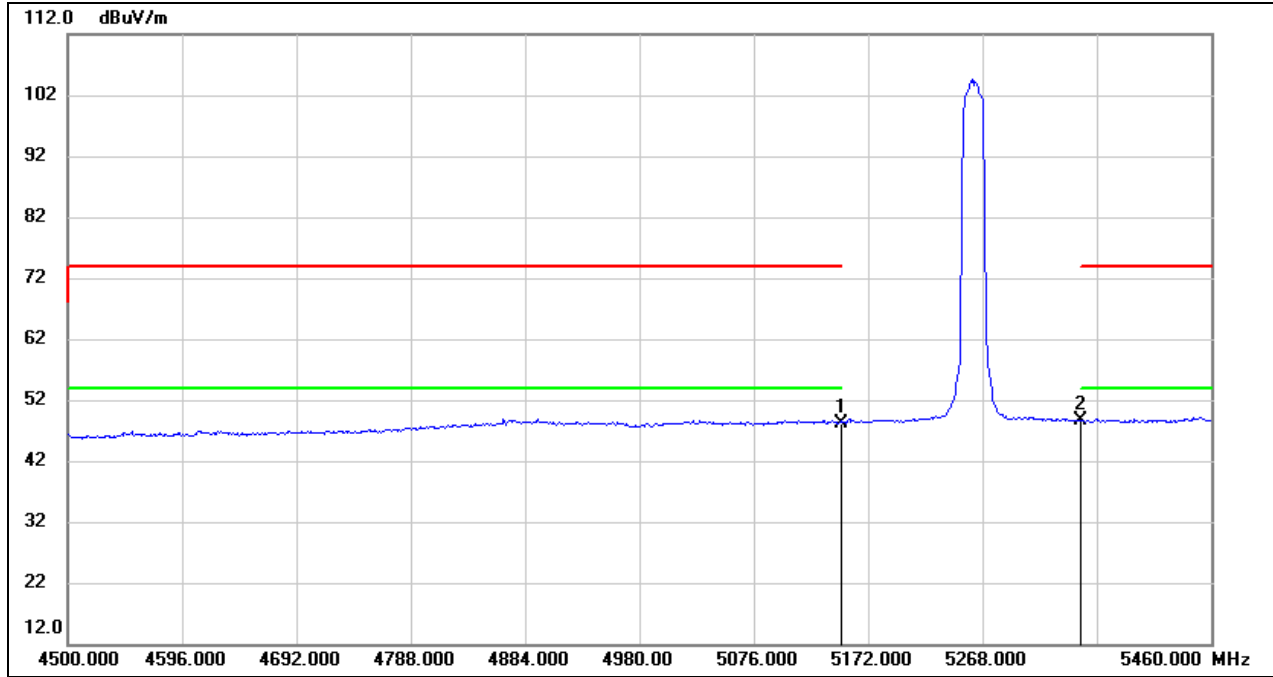

No.	Frequency (MHz)	Reading (dBuV)	Correct (dB/m)	Result (dBuV/m)	Limit (dBuV/m)	Margin (dB)	Remark
1	5150.000	7.98	40.27	48.25	54.00	-5.75	AVG
2	5350.000	8.09	40.49	48.58	54.00	-5.42	AVG



Test Mode:	802.11a 20 Peak	Channel:	5320 MHz
Polarity:	Vertical	Test Voltage:	DC 12 V

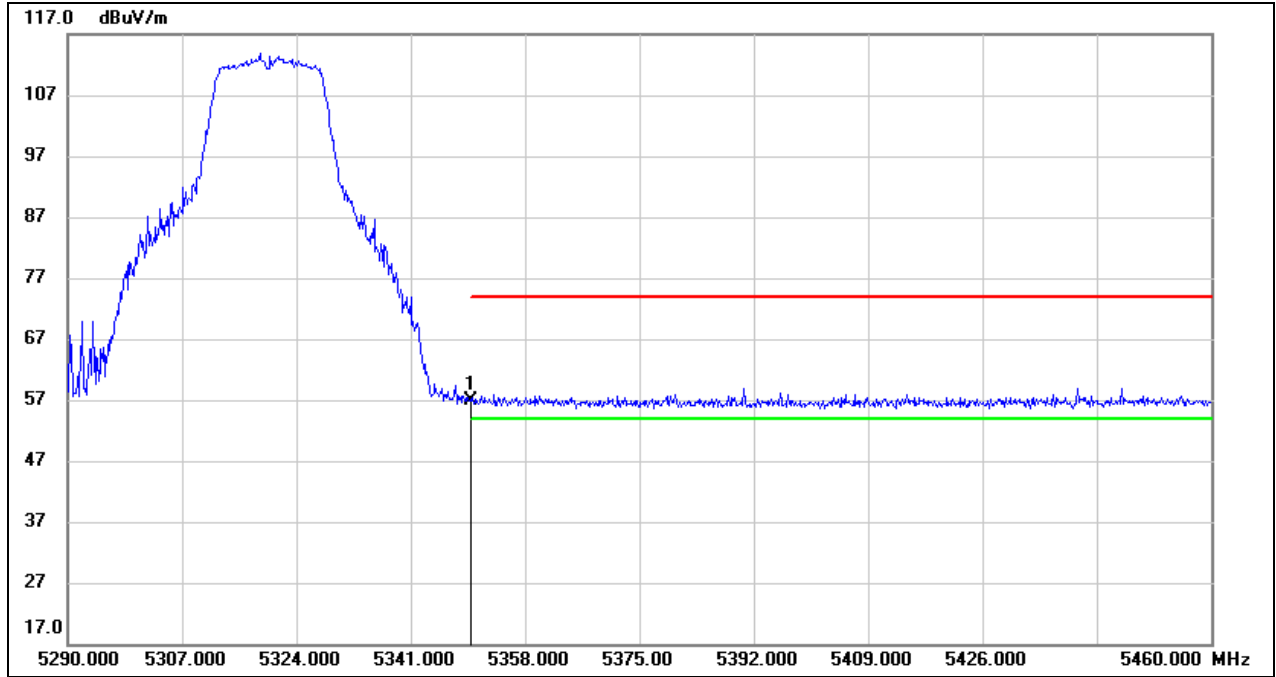

No.	Frequency (MHz)	Reading (dBuV)	Correct (dB/m)	Result (dBuV/m)	Limit (dBuV/m)	Margin (dB)	Remark
1	5350.000	16.43	40.49	56.92	74.00	-17.08	peak



Test Mode:	802.11a 20 Average	Channel:	5320 MHz
Polarity:	Vertical	Test Voltage:	DC 12 V

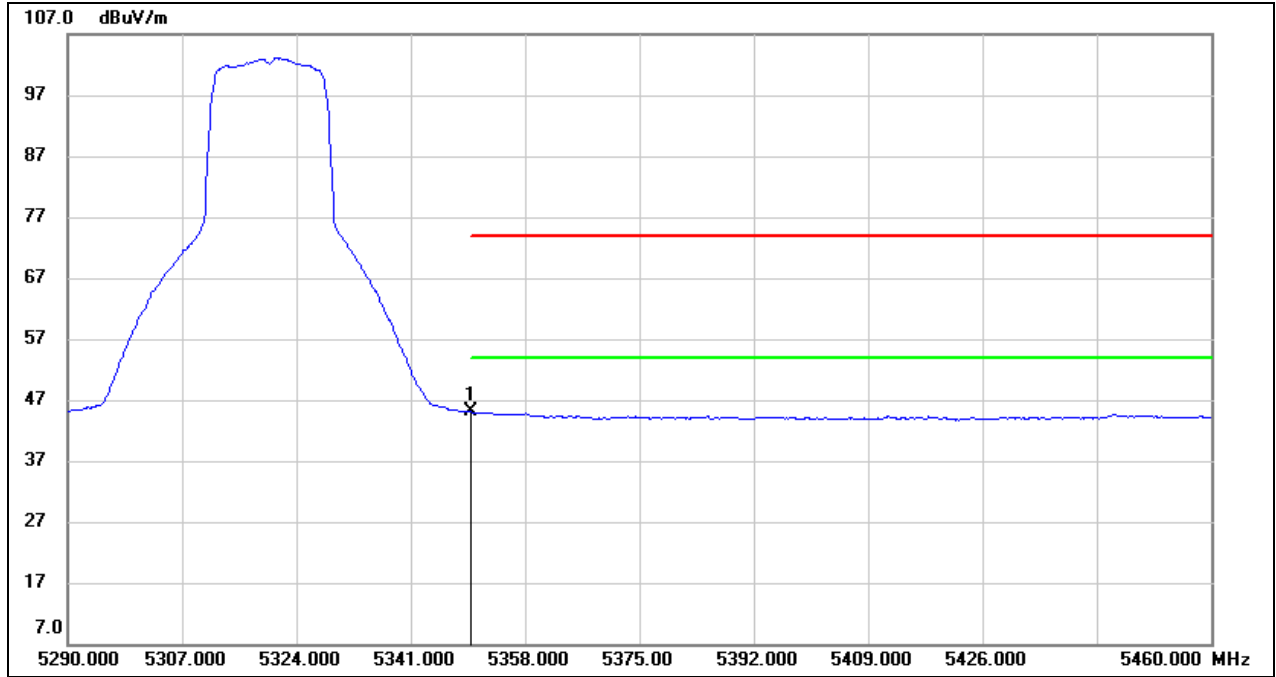

No.	Frequency (MHz)	Reading (dBuV)	Correct (dB/m)	Result (dBuV/m)	Limit (dBuV/m)	Margin (dB)	Remark
1	5350.000	4.54	40.49	45.03	54.00	-8.97	AVG



Test Mode:	802.11a 20 Peak	Channel:	5500 MHz
Polarity:	Vertical	Test Voltage:	DC 12 V

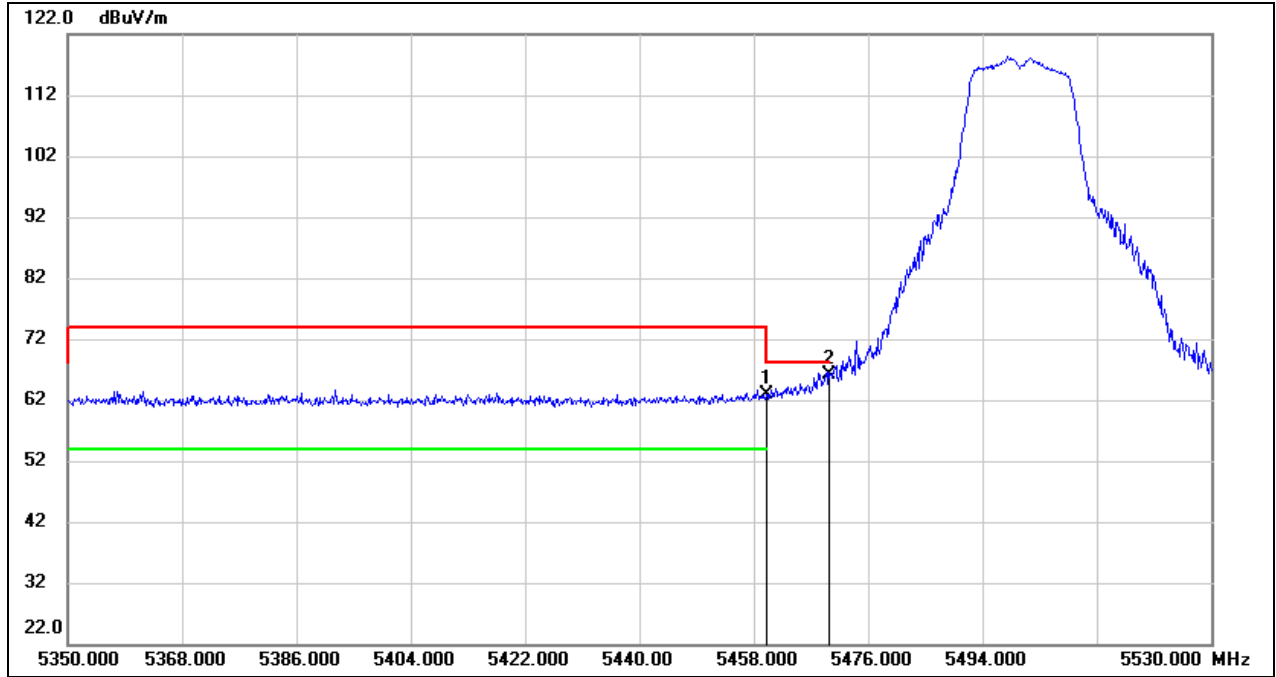

No.	Frequency (MHz)	Reading (dBuV)	Correct (dB/m)	Result (dBuV/m)	Limit (dBuV/m)	Margin (dB)	Remark
1	5460.000	22.17	40.62	62.79	68.20	-5.41	peak
2	5470.000	25.43	40.63	66.06	68.20	-2.14	peak



Test Mode:	802.11a 20 Average	Channel:	5500 MHz
Polarity:	Vertical	Test Voltage:	DC 12 V

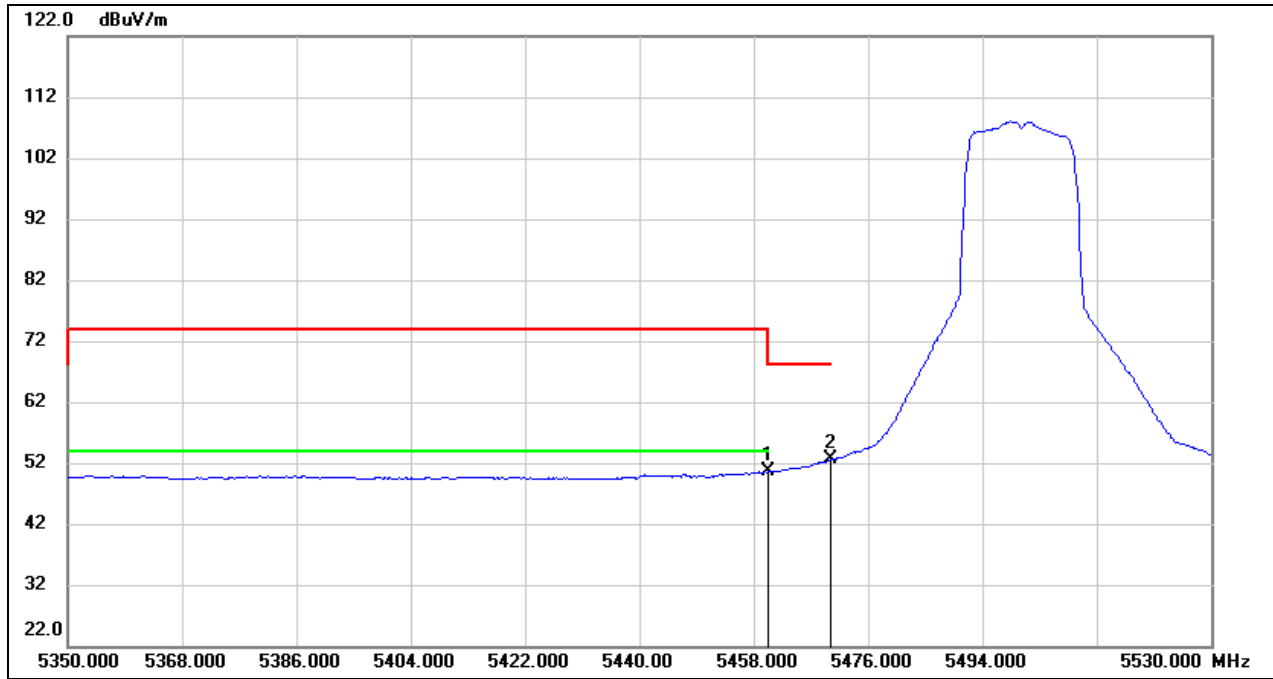

No.	Frequency (MHz)	Reading (dBuV)	Correct (dB/m)	Result (dBuV/m)	Limit (dBuV/m)	Margin (dB)	Remark
1	5460.000	10.02	40.62	50.64	54.00	-3.36	AVG
2	5470.000	11.91	40.63	52.54	68.20	-15.66	AVG



Test Mode:	802.11a 20 Peak	Channel:	5700 MHz
Polarity:	Vertical	Test Voltage:	DC 12 V

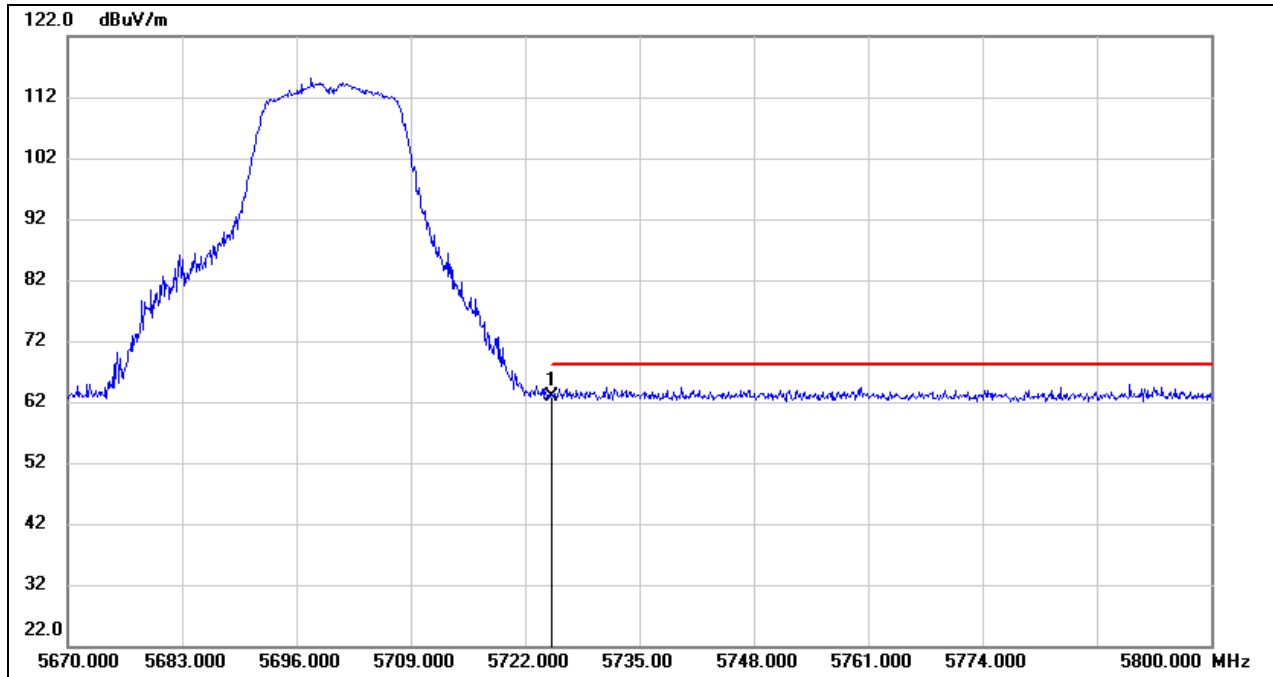

No.	Frequency (MHz)	Reading (dBuV)	Correct (dB/m)	Result (dBuV/m)	Limit (dBuV/m)	Margin (dB)	Remark
1	5725.000	21.63	41.27	62.90	68.20	-5.30	peak



Test Mode:	802.11ax HE20 Peak	Channel:	5260 MHz
Polarity:	Vertical	Test Voltage:	DC 12 V

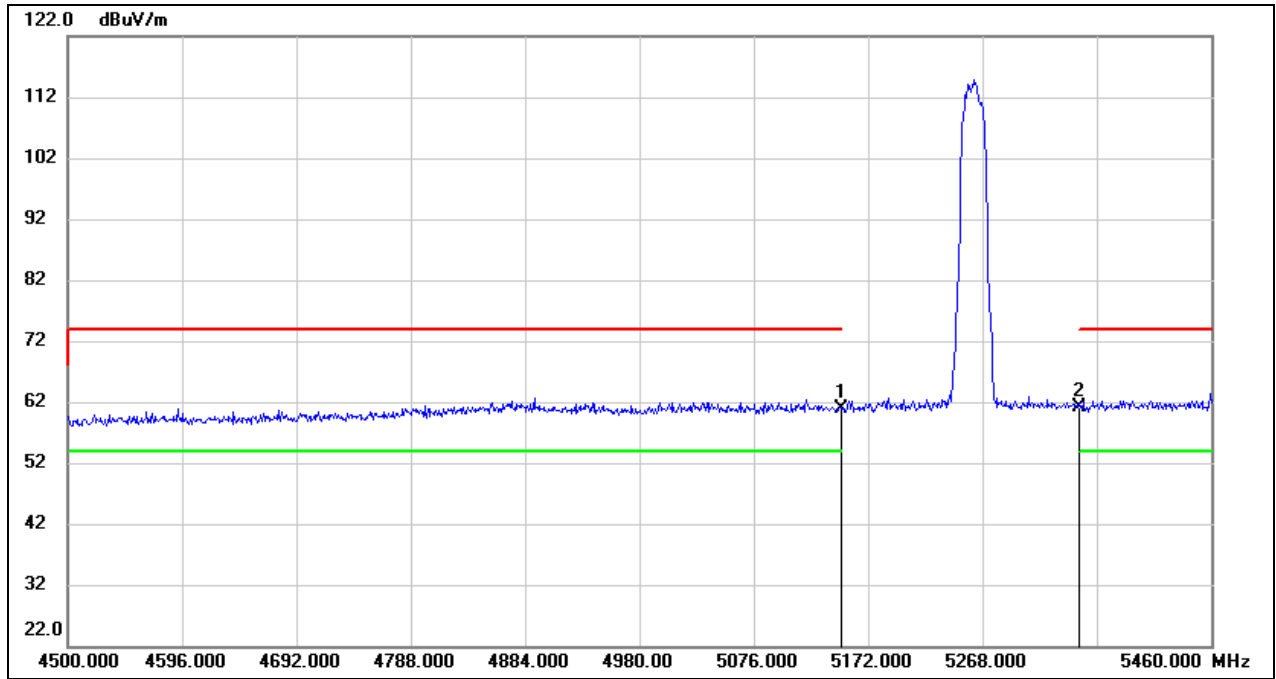

No.	Frequency (MHz)	Reading (dBuV)	Correct (dB/m)	Result (dBuV/m)	Limit (dBuV/m)	Margin (dB)	Remark
1	5150.000	20.59	40.27	60.86	74.00	-13.14	peak
2	5350.000	20.75	40.49	61.24	74.00	-12.76	peak



Test Mode:	802.11ax HE20 Average	Channel:	5260 MHz
Polarity:	Vertical	Test Voltage:	DC 12 V

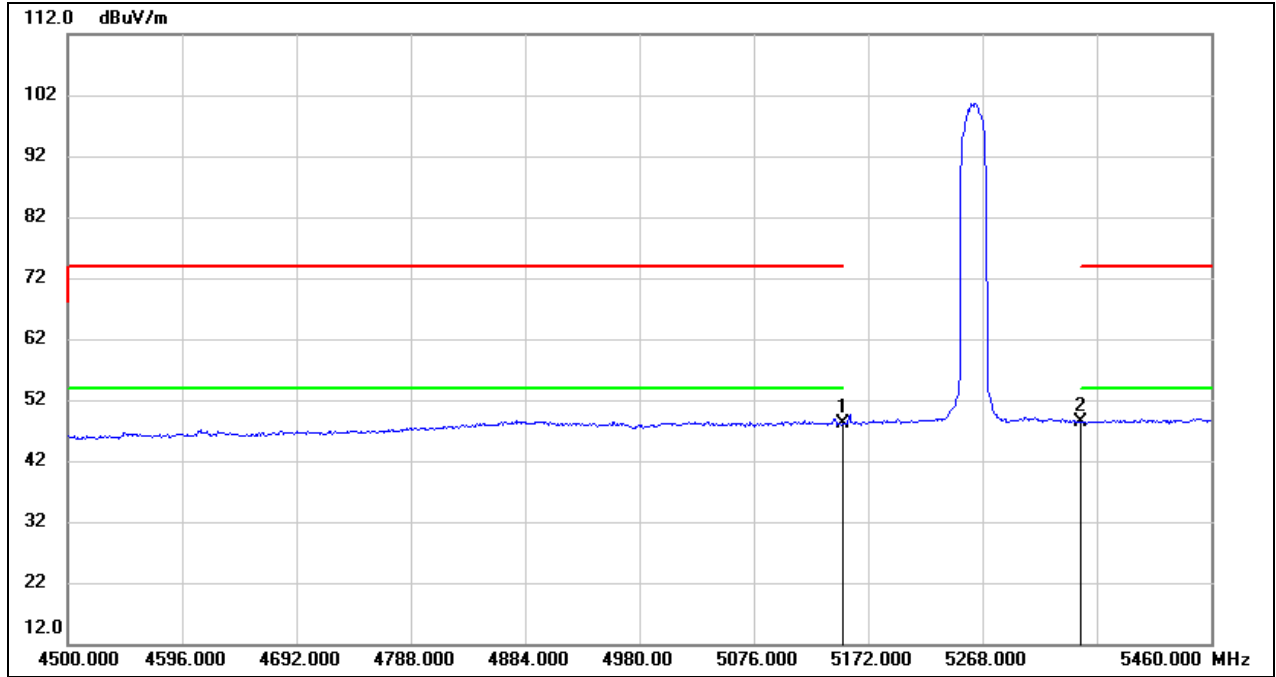

No.	Frequency (MHz)	Reading (dBuV)	Correct (dB/m)	Result (dBuV/m)	Limit (dBuV/m)	Margin (dB)	Remark
1	5150.000	7.85	40.27	48.12	54.00	-5.88	AVG
2	5350.000	8.01	40.49	48.50	54.00	-5.50	AVG



Test Mode:	802.11ax HE20 Peak	Channel:	5320 MHz
Polarity:	Vertical	Test Voltage:	DC 12 V

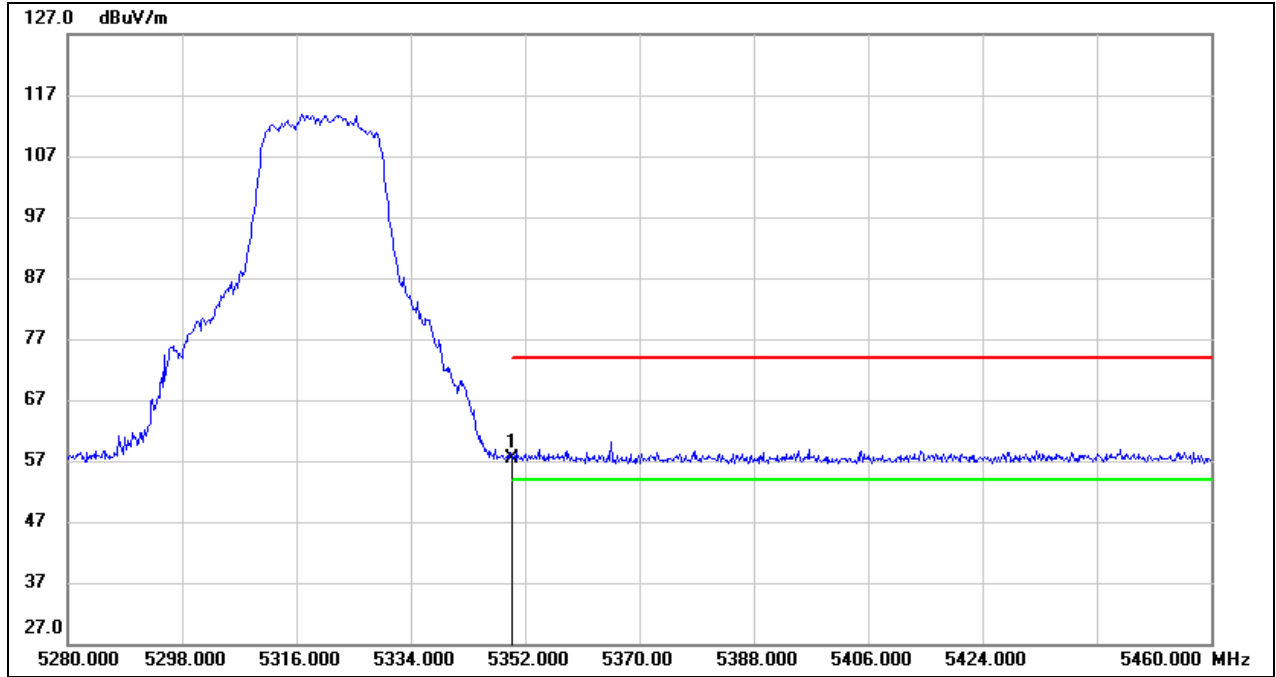

No.	Frequency (MHz)	Reading (dBuV)	Correct (dB/m)	Result (dBuV/m)	Limit (dBuV/m)	Margin (dB)	Remark
1	5350.000	16.92	40.49	57.41	74.00	-16.59	peak



Test Mode:	802.11ax HE20 Average	Channel:	5320 MHz
Polarity:	Vertical	Test Voltage:	DC 12 V

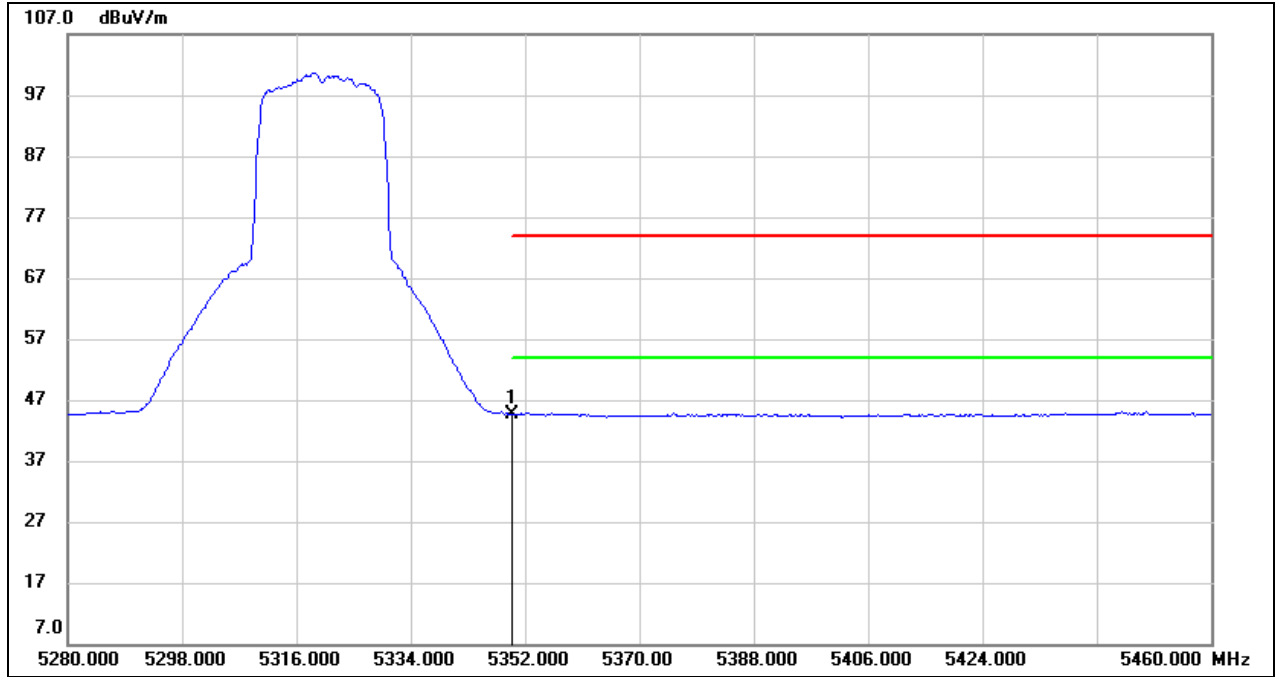

No.	Frequency (MHz)	Reading (dBuV)	Correct (dB/m)	Result (dBuV/m)	Limit (dBuV/m)	Margin (dB)	Remark
1	5350.000	4.21	40.49	44.70	54.00	-9.30	AVG



Test Mode:	802.11ax HE20 Peak	Channel:	5500 MHz
Polarity:	Vertical	Test Voltage:	DC 12 V

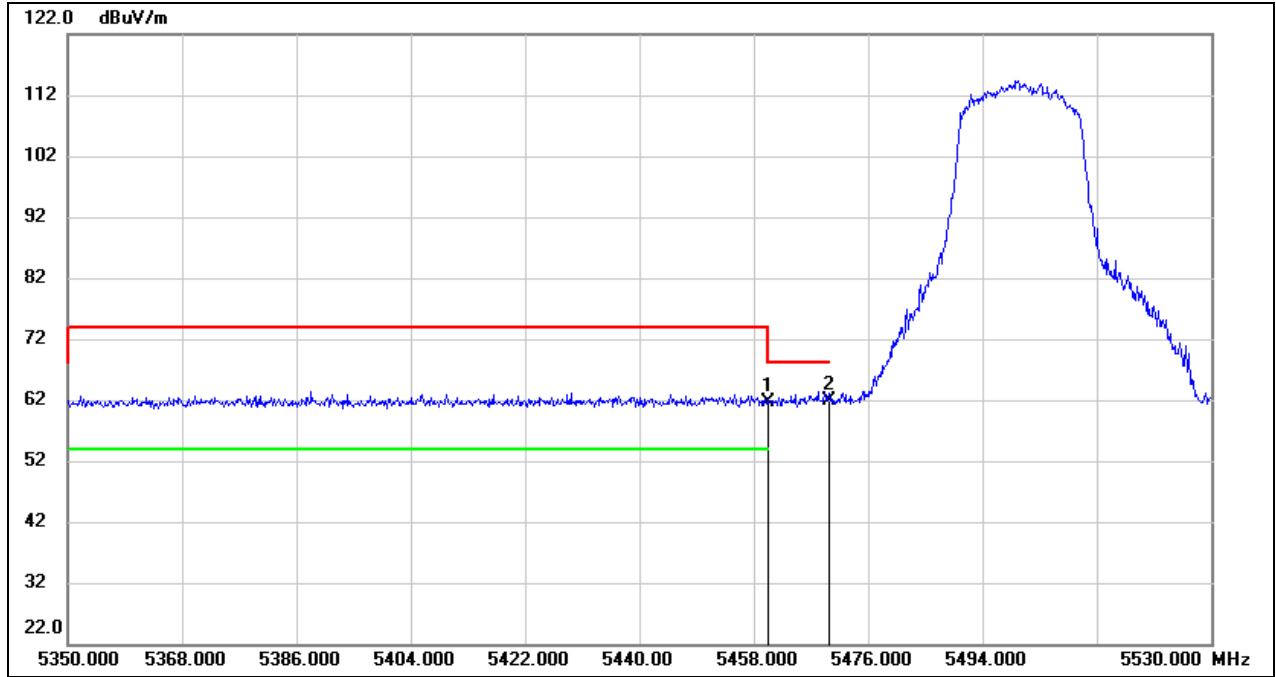

No.	Frequency (MHz)	Reading (dBuV)	Correct (dB/m)	Result (dBuV/m)	Limit (dBuV/m)	Margin (dB)	Remark
1	5460.000	21.03	40.62	61.65	68.20	-6.55	peak
2	5470.000	21.16	40.63	61.79	68.20	-6.41	peak



Test Mode:	802.11ax HE20 Average	Channel:	5500 MHz
Polarity:	Vertical	Test Voltage:	DC 12 V

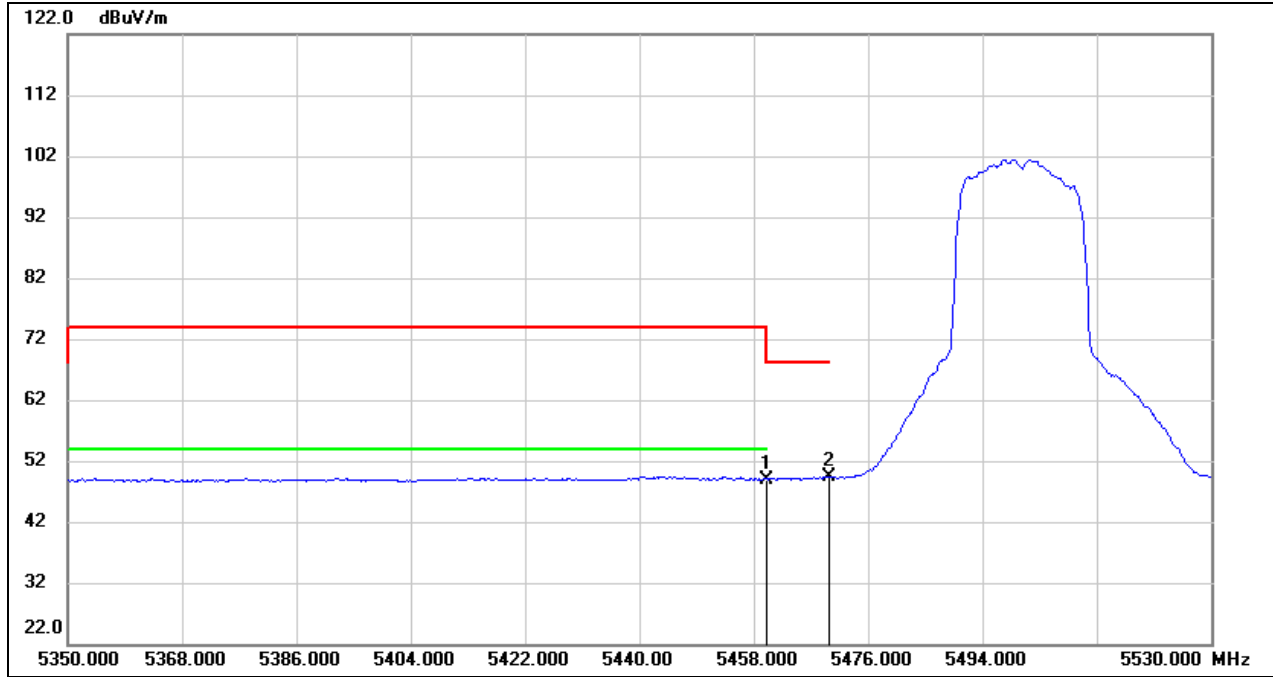

No.	Frequency (MHz)	Reading (dBuV)	Correct (dB/m)	Result (dBuV/m)	Limit (dBuV/m)	Margin (dB)	Remark
1	5460.000	8.37	40.62	48.99	54.00	-5.01	AVG
2	5470.000	8.63	40.63	49.26	68.20	-18.94	AVG



Test Mode:	802.11ax HE20 Peak	Channel:	5700 MHz
Polarity:	Vertical	Test Voltage:	DC 12 V

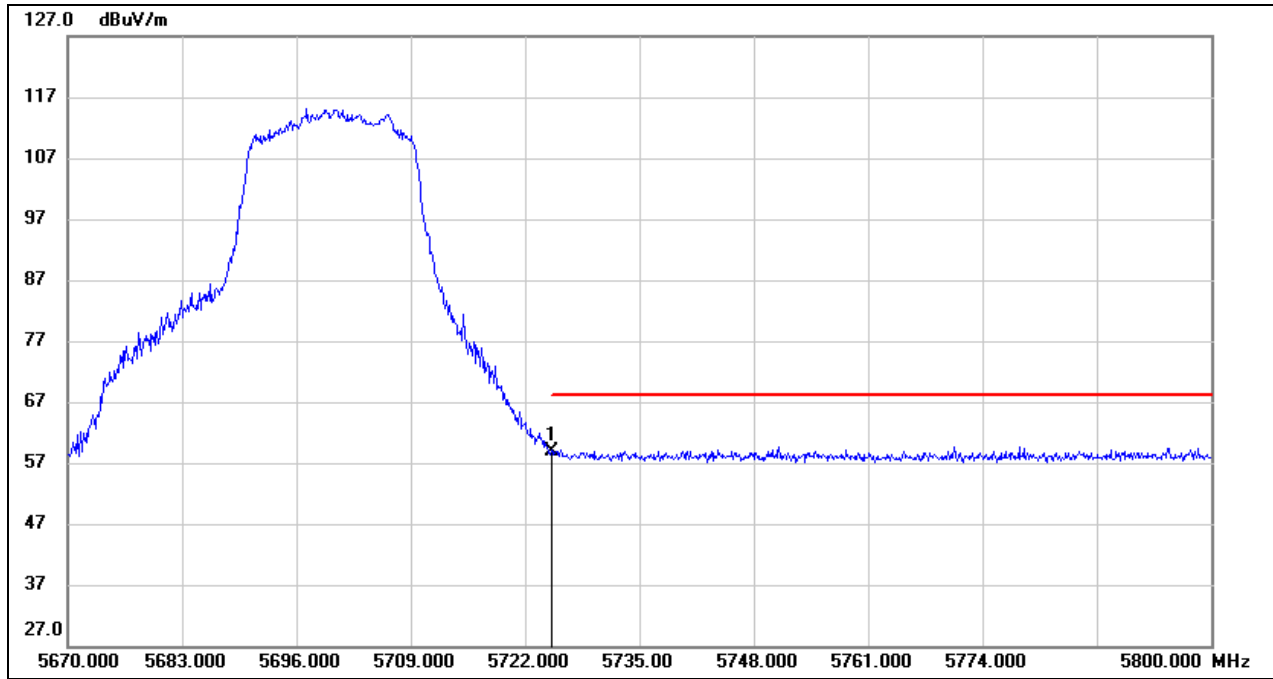

No.	Frequency (MHz)	Reading (dBuV)	Correct (dB/m)	Result (dBuV/m)	Limit (dBuV/m)	Margin (dB)	Remark
1	5725.000	17.61	41.27	58.88	68.20	-9.32	peak



Test Mode:	802.11ax HE40 Peak	Channel:	5270 MHz
Polarity:	Vertical	Test Voltage:	DC 12 V

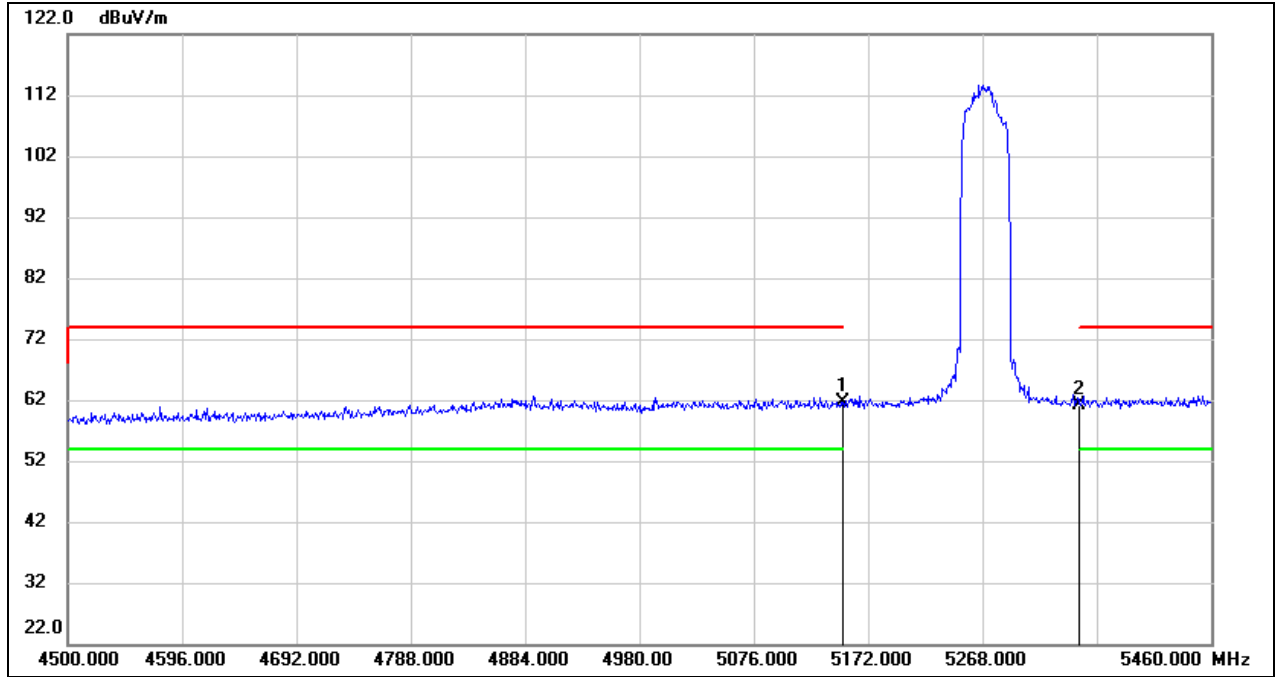

No.	Frequency (MHz)	Reading (dBuV)	Correct (dB/m)	Result (dBuV/m)	Limit (dBuV/m)	Margin (dB)	Remark
1	5150.000	21.29	40.27	61.56	74.00	-12.44	peak
2	5350.000	20.71	40.49	61.20	74.00	-12.80	peak



Test Mode:	802.11ax HE40 Average	Channel:	5270 MHz
Polarity:	Vertical	Test Voltage:	DC 12 V

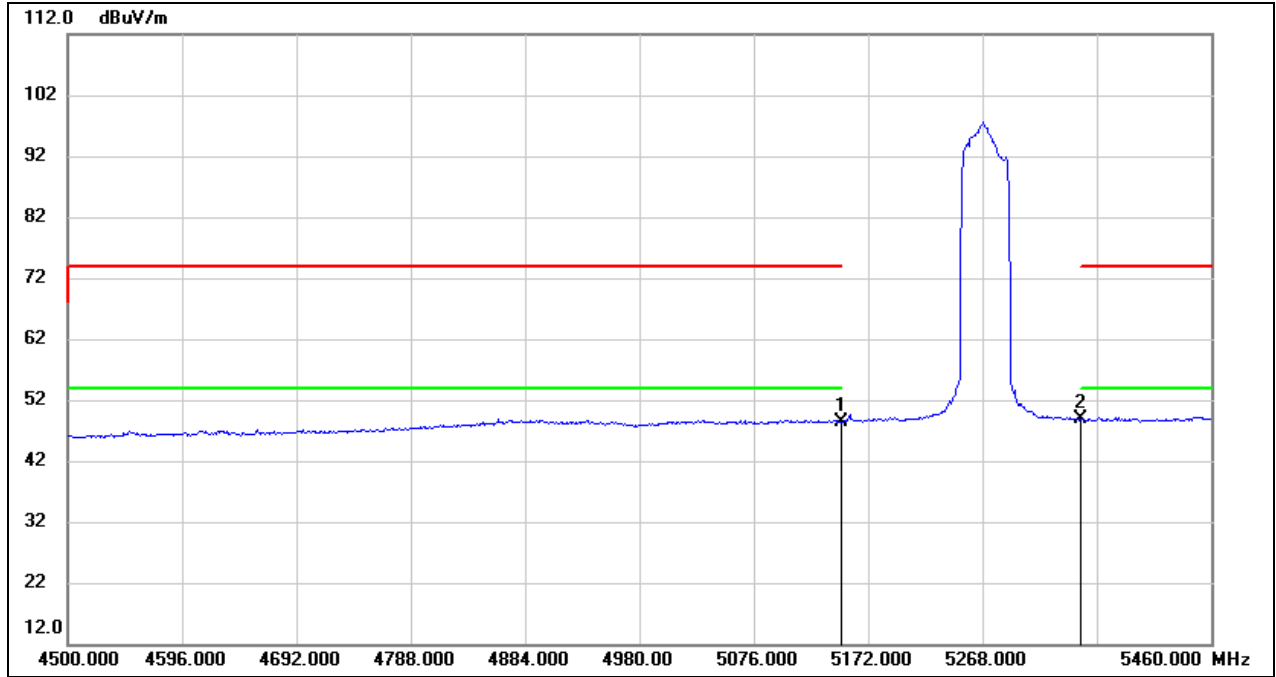

No.	Frequency (MHz)	Reading (dBuV)	Correct (dB/m)	Result (dBuV/m)	Limit (dBuV/m)	Margin (dB)	Remark
1	5150.000	8.07	40.27	48.34	54.00	-5.66	AVG
2	5350.000	8.40	40.49	48.89	54.00	-5.11	AVG



Test Mode:	802.11ax HE40 Peak	Channel:	5310 MHz
Polarity:	Vertical	Test Voltage:	DC 12 V

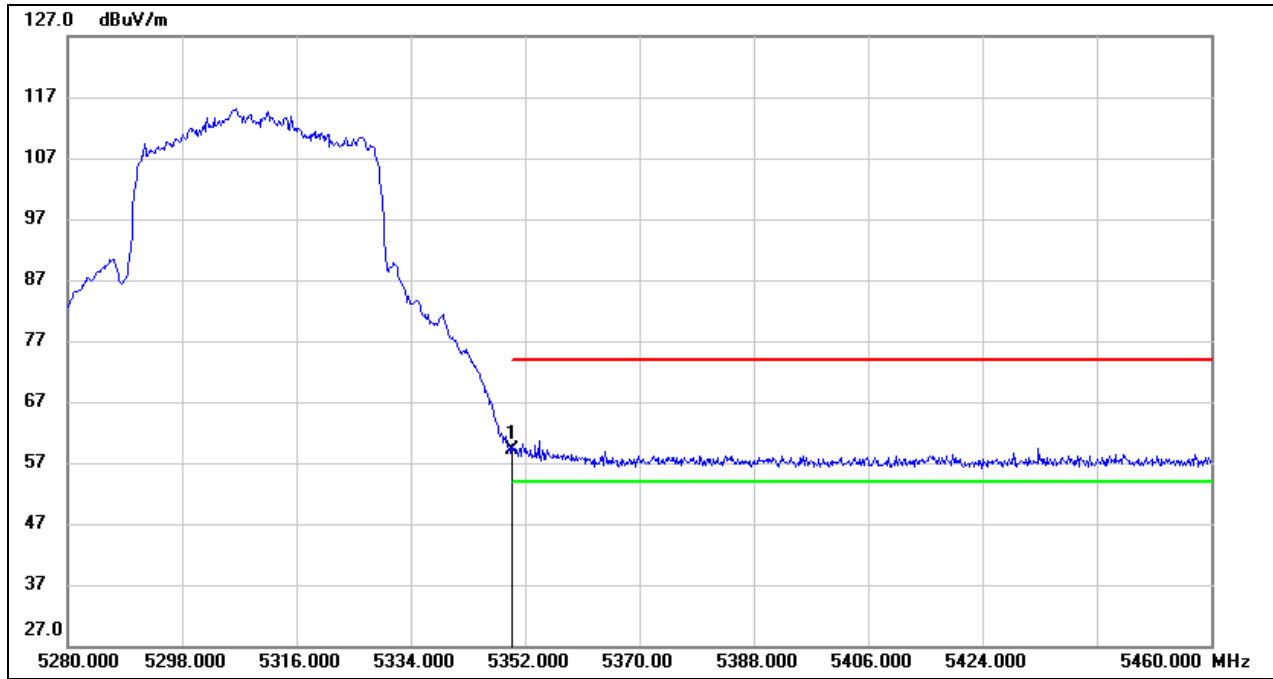

No.	Frequency (MHz)	Reading (dBuV)	Correct (dB/m)	Result (dBuV/m)	Limit (dBuV/m)	Margin (dB)	Remark
1	5350.000	18.71	40.49	59.20	74.00	-14.80	peak



Test Mode:	802.11ax HE40 Average	Channel:	5310 MHz
Polarity:	Vertical	Test Voltage:	DC 12 V

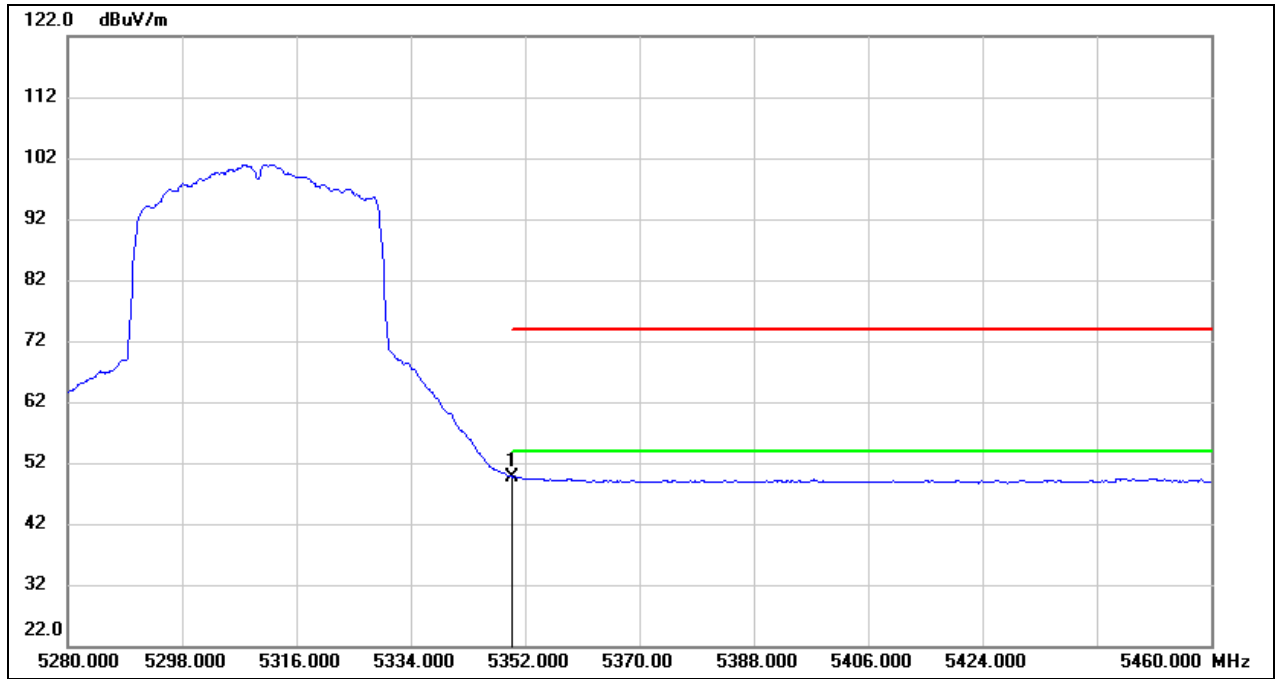

No.	Frequency (MHz)	Reading (dBuV)	Correct (dB/m)	Result (dBuV/m)	Limit (dBuV/m)	Margin (dB)	Remark
1	5350.000	9.17	40.49	49.66	54.00	-4.34	AVG



Test Mode:	802.11ax HE40 Peak	Channel:	5510 MHz
Polarity:	Vertical	Test Voltage:	DC 12 V

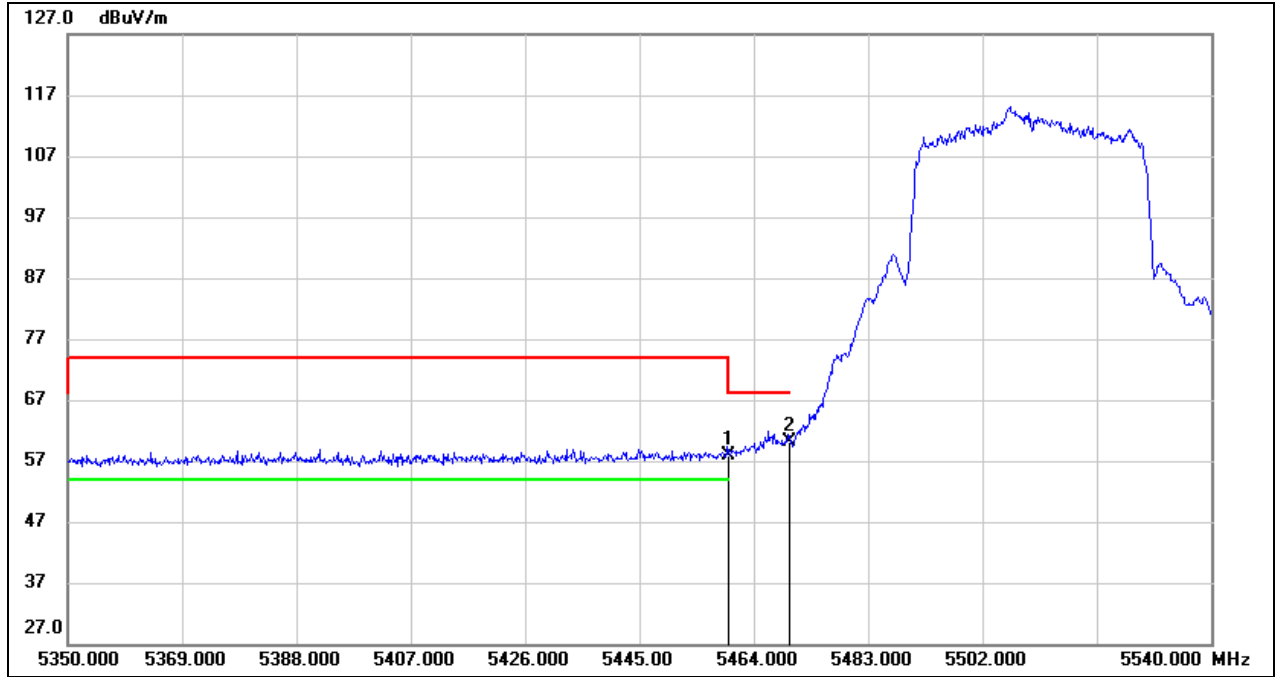

No.	Frequency (MHz)	Reading (dBuV)	Correct (dB/m)	Result (dBuV/m)	Limit (dBuV/m)	Margin (dB)	Remark
1	5460.000	17.25	40.62	57.87	68.20	-10.33	peak
2	5470.000	19.51	40.63	60.14	68.20	-8.06	peak



Test Mode:	802.11ax HE40 Peak	Channel:	5670 MHz
Polarity:	Vertical	Test Voltage:	DC 12 V

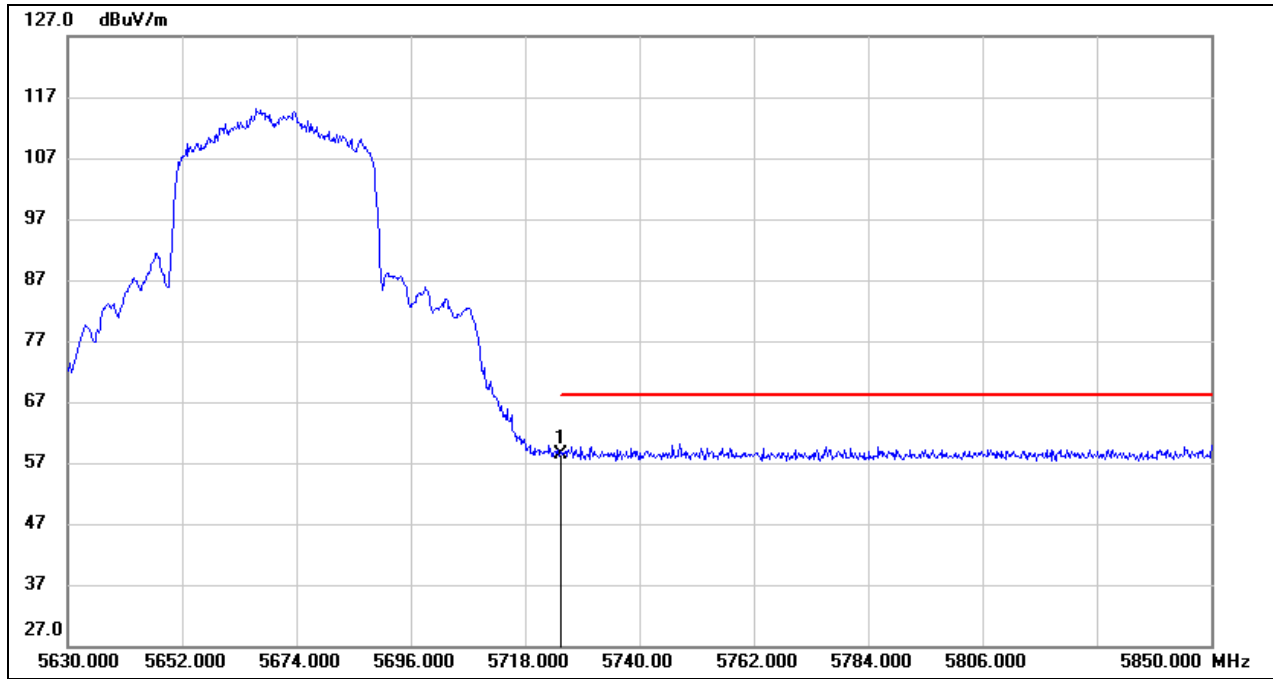

No.	Frequency (MHz)	Reading (dBuV)	Correct (dB/m)	Result (dBuV/m)	Limit (dBuV/m)	Margin (dB)	Remark
1	5725.000	17.12	41.27	58.39	68.20	-9.81	peak



Test Mode:	802.11ax HE80 Peak	Channel:	5290 MHz
Polarity:	Vertical	Test Voltage:	DC 12 V

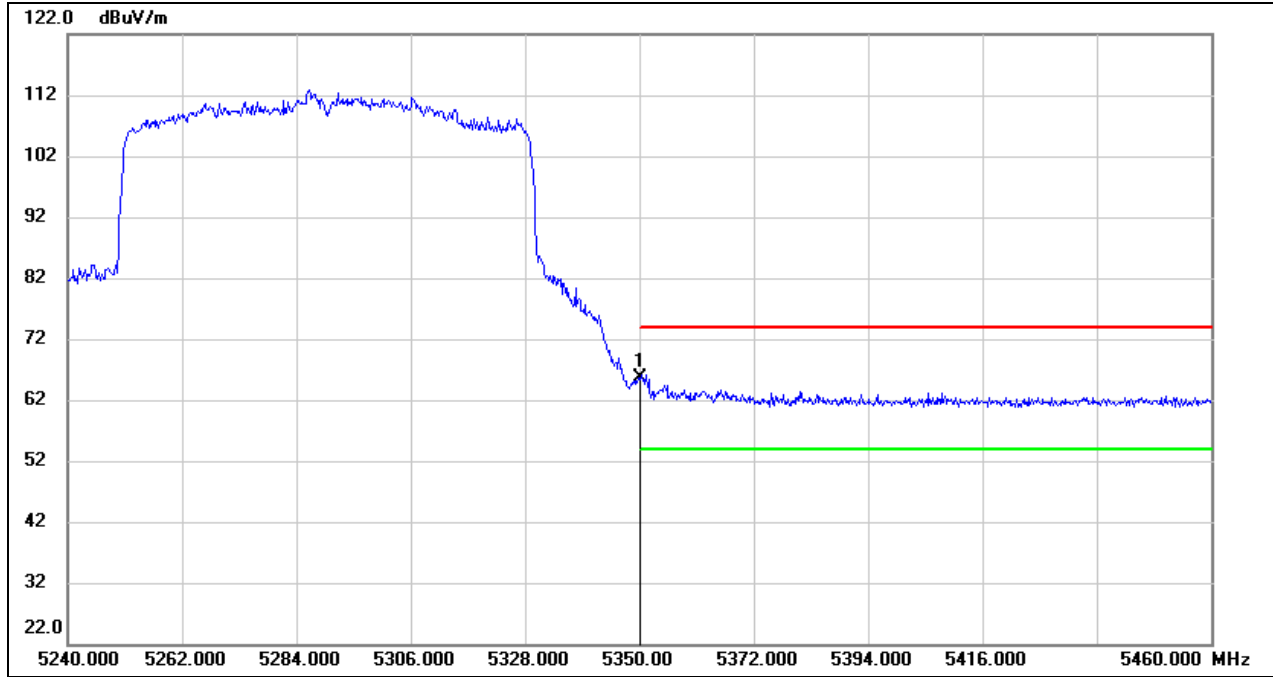

No.	Frequency (MHz)	Reading (dBuV)	Correct (dB/m)	Result (dBuV/m)	Limit (dBuV/m)	Margin (dB)	Remark
1	5350.000	25.19	40.49	65.68	74.00	-8.32	peak



Test Mode:	802.11ax HE80 Average	Channel:	5290 MHz
Polarity:	Vertical	Test Voltage:	DC 12 V

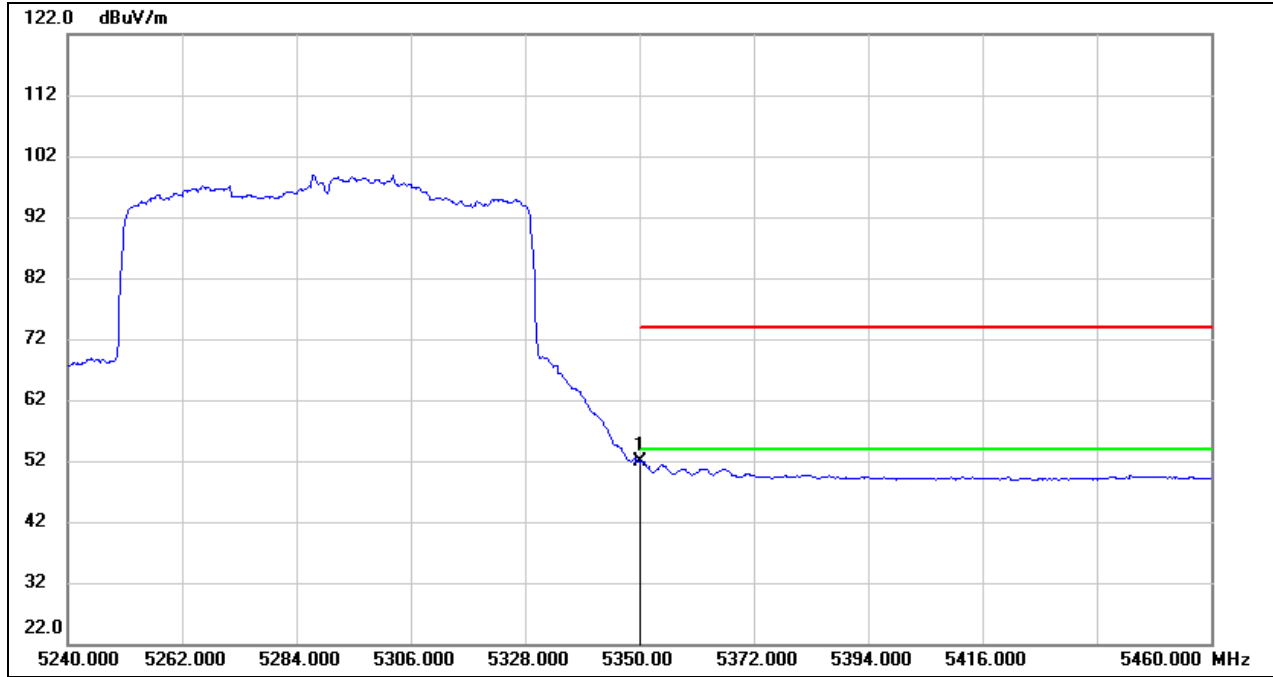

No.	Frequency (MHz)	Reading (dBuV)	Correct (dB/m)	Result (dBuV/m)	Limit (dBuV/m)	Margin (dB)	Remark
1	5350.000	11.37	40.49	51.86	54.00	-2.14	AVG



Test Mode:	802.11ax HE80 Peak	Channel:	5530 MHz
Polarity:	Vertical	Test Voltage:	DC 12 V

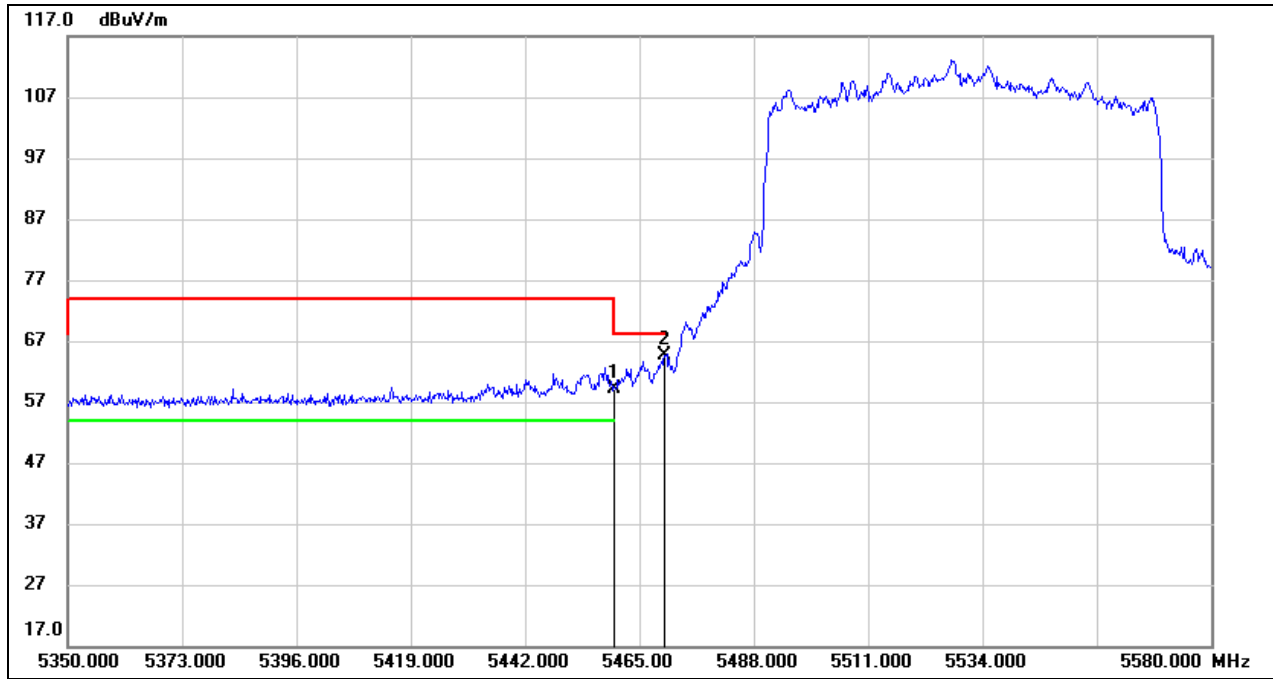

No.	Frequency (MHz)	Reading (dBuV)	Correct (dB/m)	Result (dBuV/m)	Limit (dBuV/m)	Margin (dB)	Remark
1	5460.000	18.53	40.62	59.15	68.20	-9.05	peak
2	5470.000	23.91	40.63	64.54	68.20	-3.66	peak



Test Mode:	802.11ax HE80 Average	Channel:	5530 MHz
Polarity:	Vertical	Test Voltage:	DC 12 V

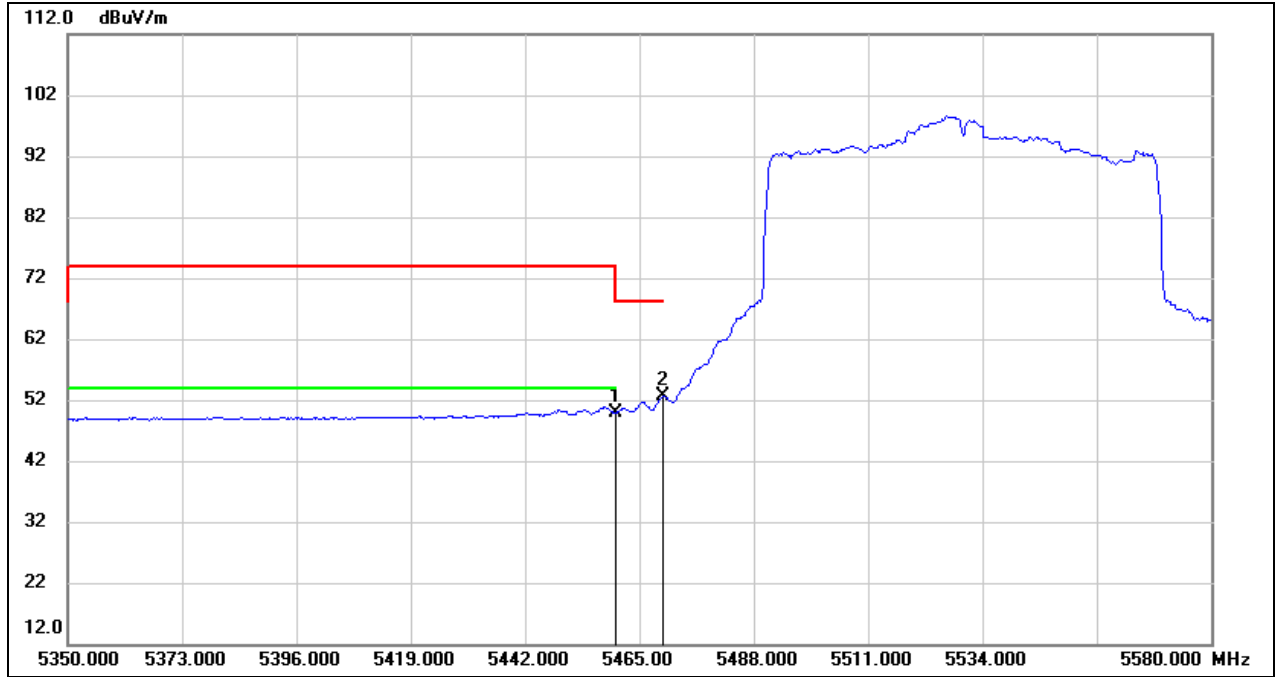

No.	Frequency (MHz)	Reading (dBuV)	Correct (dB/m)	Result (dBuV/m)	Limit (dBuV/m)	Margin (dB)	Remark
1	5460.000	9.36	40.62	49.98	54.00	-4.02	AVG
2	5470.000	12.03	40.63	52.66	68.20	-15.54	AVG



Test Mode:	802.11ax HE80 Peak	Channel:	5610 MHz
Polarity:	Vertical	Test Voltage:	DC 12 V

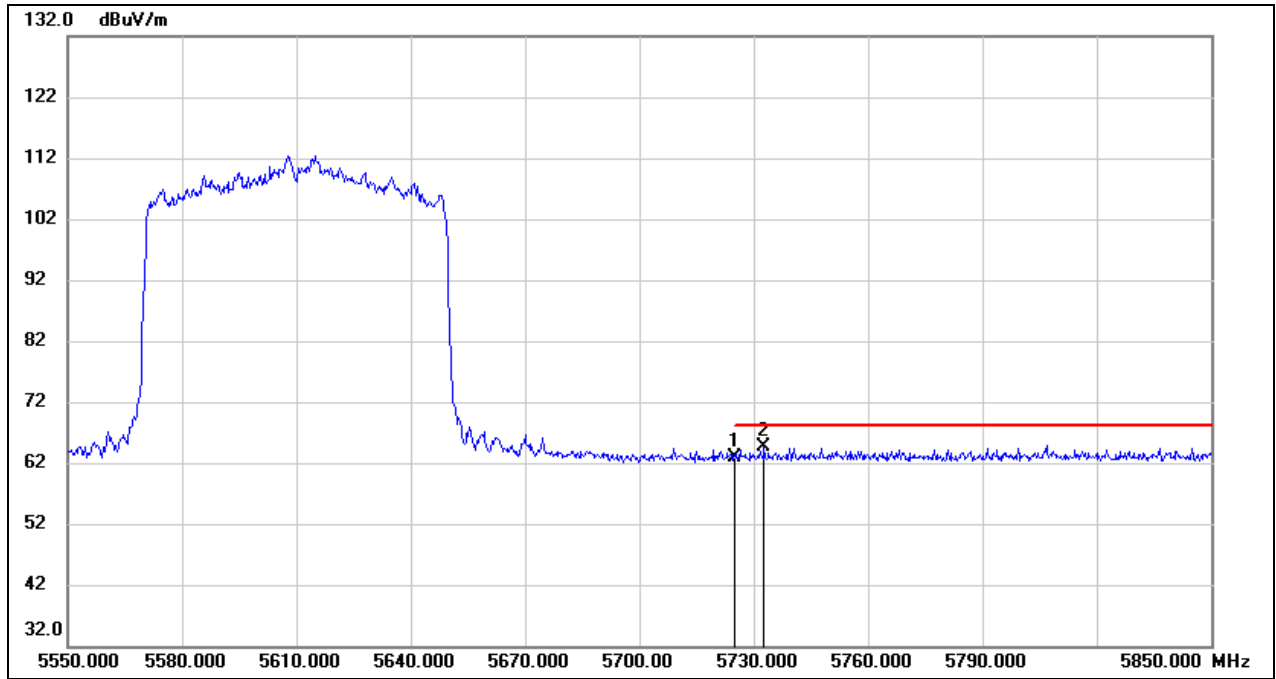

No.	Frequency (MHz)	Reading (dBuV)	Correct (dB/m)	Result (dBuV/m)	Limit (dBuV/m)	Margin (dB)	Remark
1	5725.000	21.59	41.27	62.86	68.20	-5.34	peak
2	5732.700	23.30	41.28	64.58	68.20	-3.62	peak



Test Mode:	802.11ax HE160 Peak	Channel:	5250 MHz
Polarity:	Vertical	Test Voltage:	DC 12 V

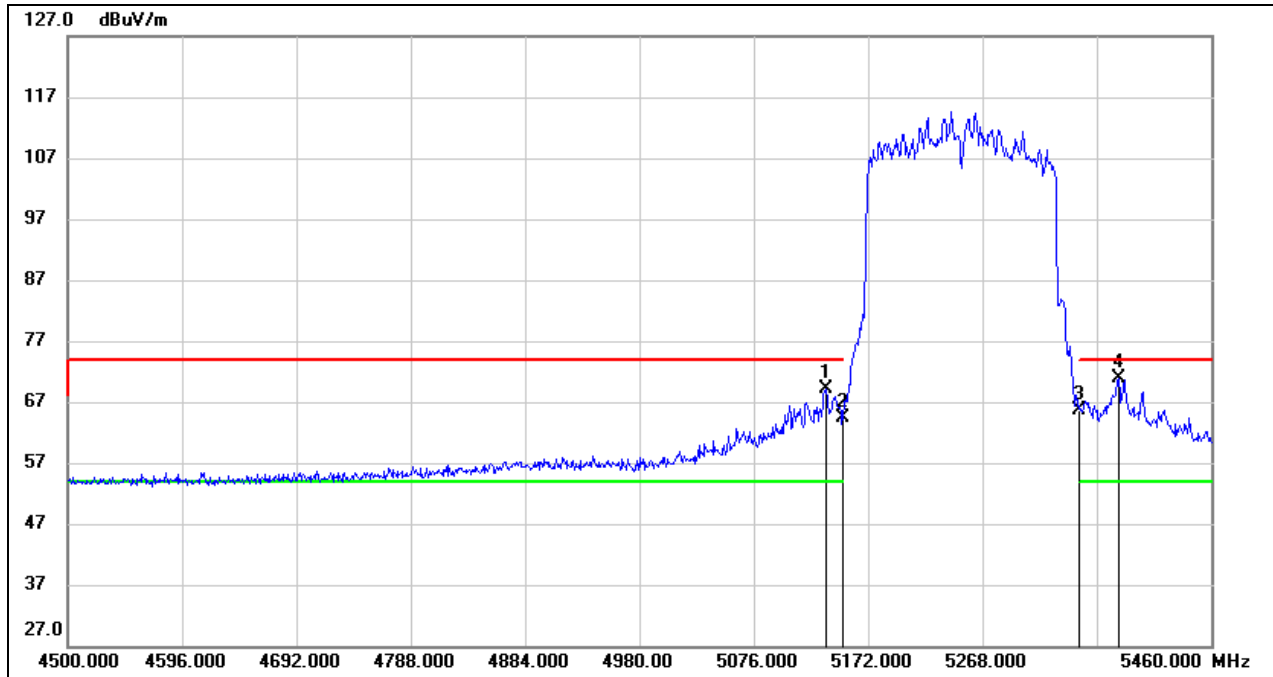

No.	Frequency (MHz)	Reading (dBuV)	Correct (dB/m)	Result (dBuV/m)	Limit (dBuV/m)	Margin (dB)	Remark
1	5136.480	28.78	40.26	69.04	74.00	-4.96	peak
2	5150.000	24.19	40.27	64.46	74.00	-9.54	peak
3	5350.000	25.14	40.49	65.63	74.00	-8.37	peak
4	5382.240	30.42	40.53	70.95	74.00	-3.05	peak



Test Mode:	802.11ax HE160 Average	Channel:	5250 MHz
Polarity:	Vertical	Test Voltage:	DC 12 V

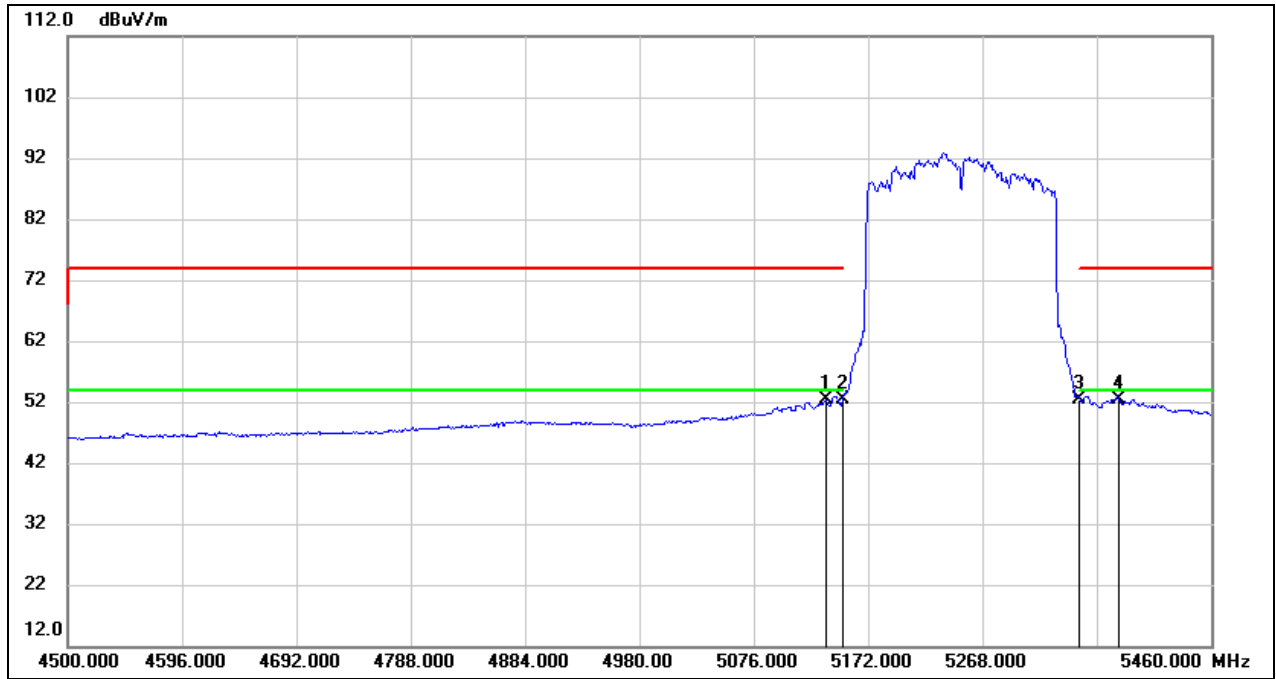

No.	Frequency (MHz)	Reading (dBuV)	Correct (dB/m)	Result (dBuV/m)	Limit (dBuV/m)	Margin (dB)	Remark
1	5136.480	12.02	40.26	52.28	54.00	-1.72	AVG
2	5150.000	12.20	40.27	52.47	54.00	-1.53	AVG
3	5350.000	11.83	40.49	52.32	54.00	-1.68	AVG
4	5382.240	11.87	40.53	52.40	54.00	-1.60	AVG



Test Mode:	802.11ax HE160 Peak	Channel:	5570 MHz
Polarity:	Vertical	Test Voltage:	DC 12 V

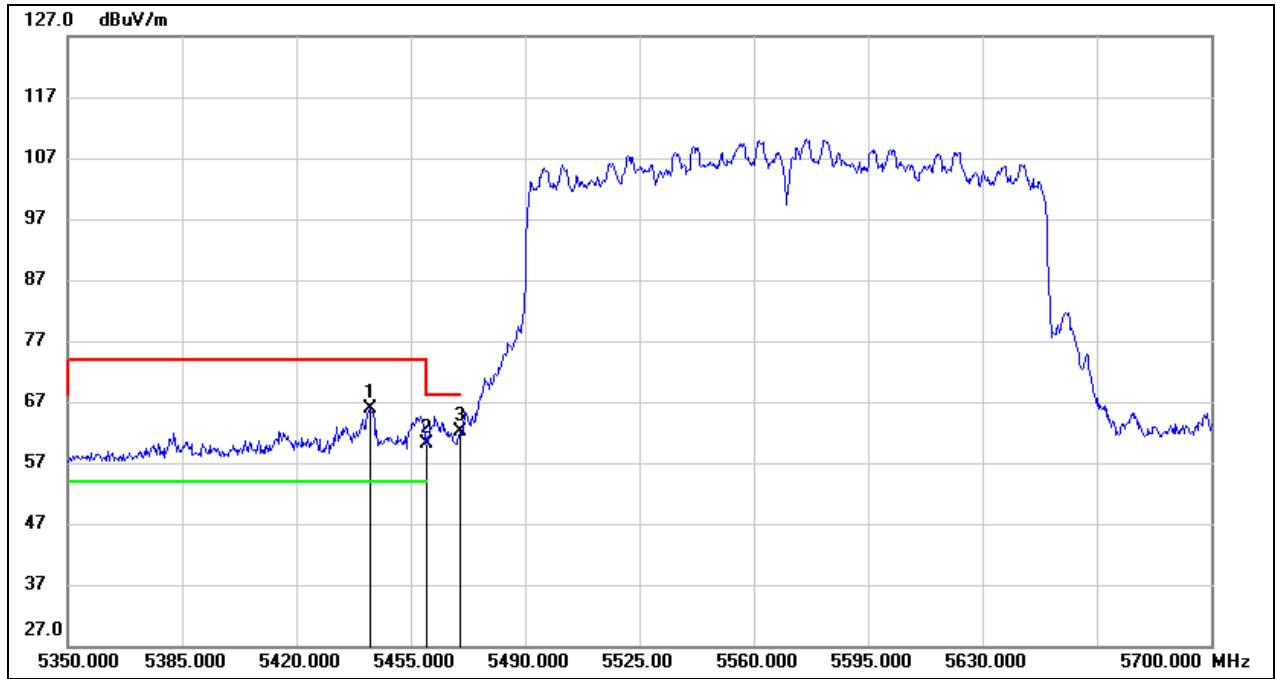

No.	Frequency (MHz)	Reading (dBuV)	Correct (dB/m)	Result (dBuV/m)	Limit (dBuV/m)	Margin (dB)	Remark
1	5442.750	25.36	40.60	65.96	74.00	-8.04	peak
2	5460.000	19.52	40.62	60.14	68.20	-8.06	peak
3	5470.000	21.48	40.63	62.11	68.20	-6.09	peak



Test Mode:	802.11ax HE160 Average	Channel:	5570 MHz
Polarity:	Vertical	Test Voltage:	DC 12 V

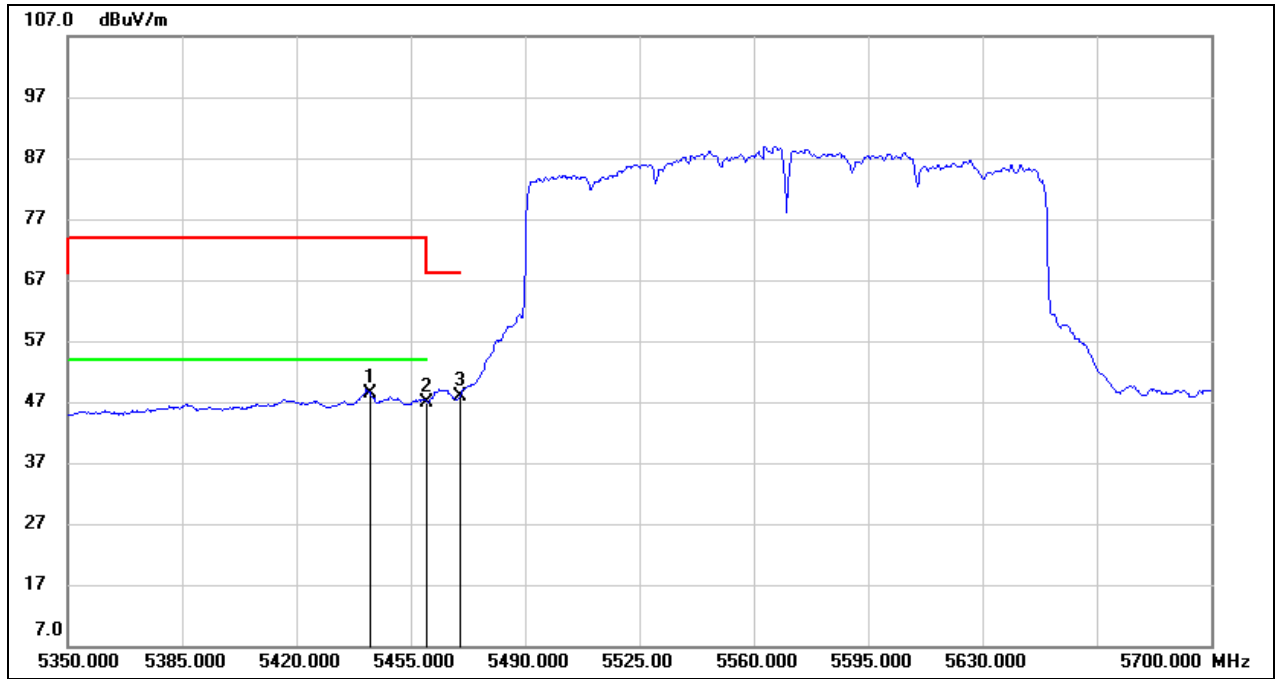

No.	Frequency (MHz)	Reading (dBuV)	Correct (dB/m)	Result (dBuV/m)	Limit (dBuV/m)	Margin (dB)	Remark
1	5442.750	7.82	40.60	48.42	54.00	-5.58	AVG
2	5460.000	6.33	40.62	46.95	54.00	-7.05	AVG
3	5470.000	7.37	40.63	48.00	68.20	-20.20	AVG



8.2. SPURIOUS EMISSIONS (1 GHZ ~ 7 GHZ)

Test Mode:	802.11ax HE20	Channel:	5260 MHz
Polarity:	Horizontal	Test Voltage:	DC 12 V

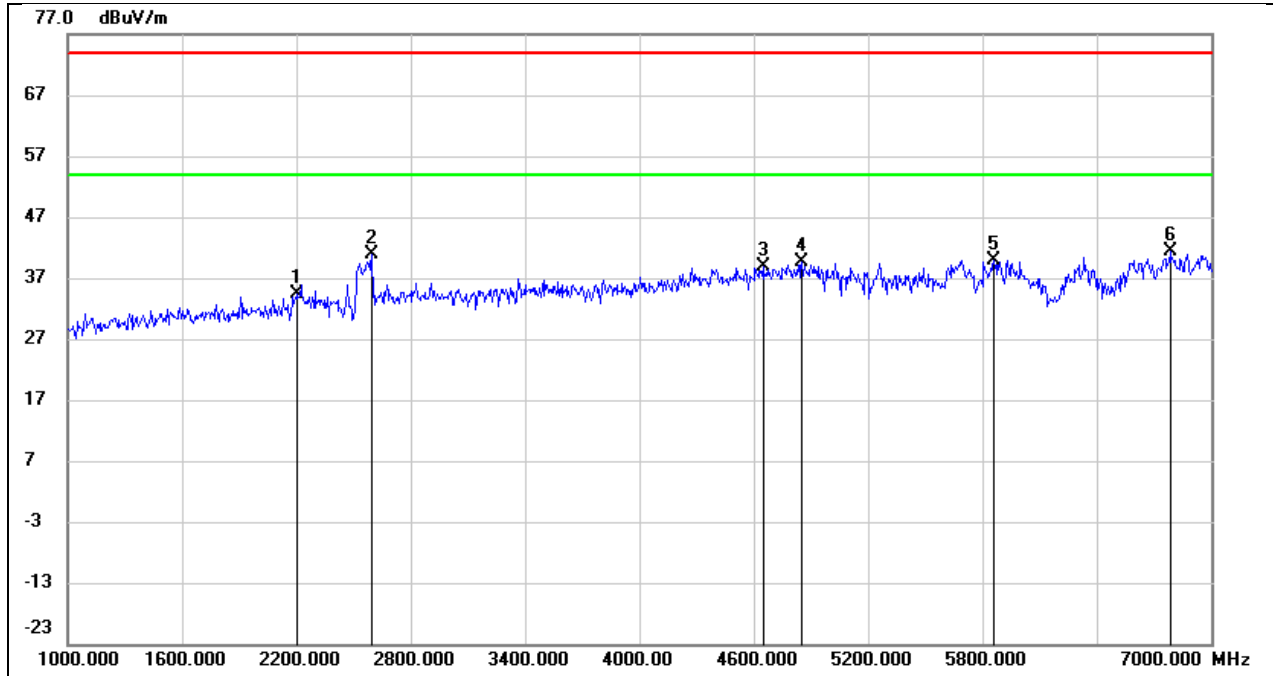

No.	Frequency (MHz)	Reading (dBuV)	Correct (dB/m)	Result (dBuV/m)	Limit (dBuV/m)	Margin (dB)	Remark
1	2206.000	44.36	-10.00	34.36	74.00	-39.64	peak
2	2596.000	49.08	-8.20	40.88	74.00	-33.12	peak
3	4648.000	40.38	-1.55	38.83	74.00	-35.17	peak
4	4852.000	40.42	-0.74	39.68	74.00	-34.32	peak
5	5860.000	38.50	1.45	39.95	74.00	-34.05	peak
6	6784.000	36.25	5.13	41.38	74.00	-32.62	peak



Test Mode:	802.11ax HE20	Channel:	5260 MHz
Polarity:	Vertical	Test Voltage:	DC 12 V

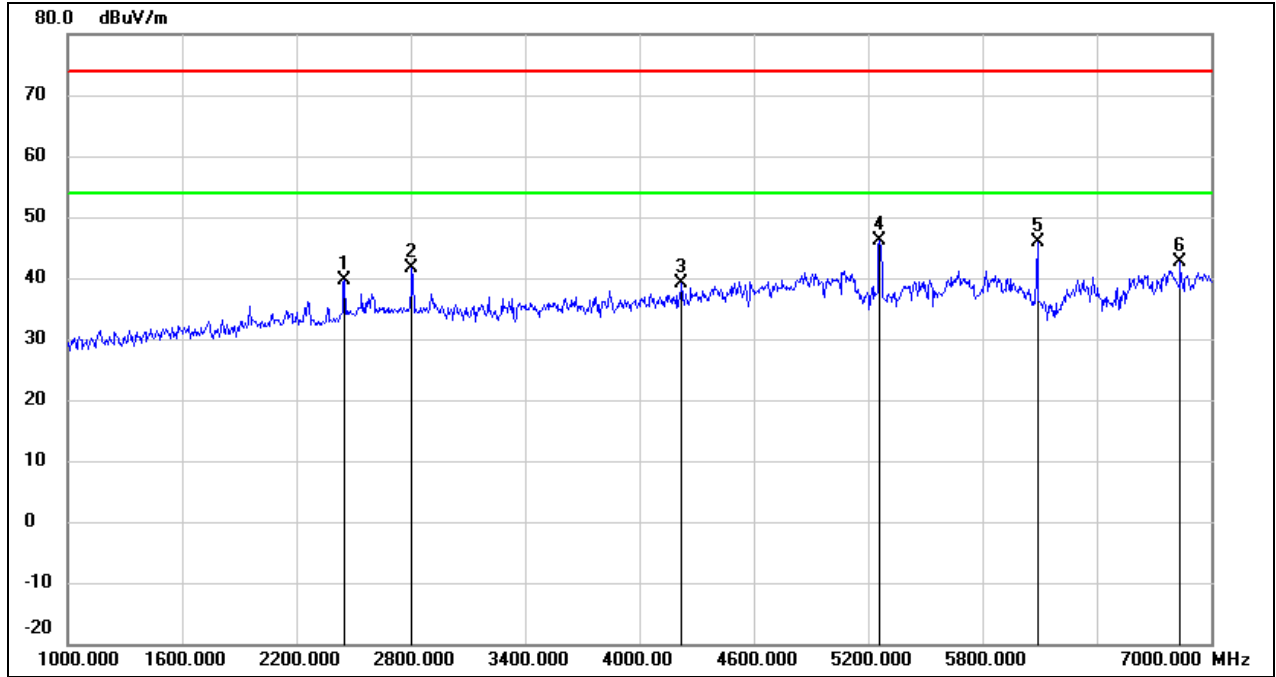

No.	Frequency (MHz)	Reading (dBuV)	Correct (dB/m)	Result (dBuV/m)	Limit (dBuV/m)	Margin (dB)	Remark
1	2452.000	48.33	-8.73	39.60	74.00	-34.40	peak
2	2806.000	49.16	-7.57	41.59	74.00	-32.41	peak
3	4222.000	42.50	-3.44	39.06	74.00	-34.94	peak
4	5260.000	45.99	0.15	46.14	74.00	-27.86	peak
5	6088.000	43.74	2.18	45.92	74.00	-28.08	peak
6	6838.000	37.16	5.40	42.56	74.00	-31.44	peak



Test Mode:	802.11ax HE20	Channel:	5280 MHz
Polarity:	Horizontal	Test Voltage:	DC 12 V

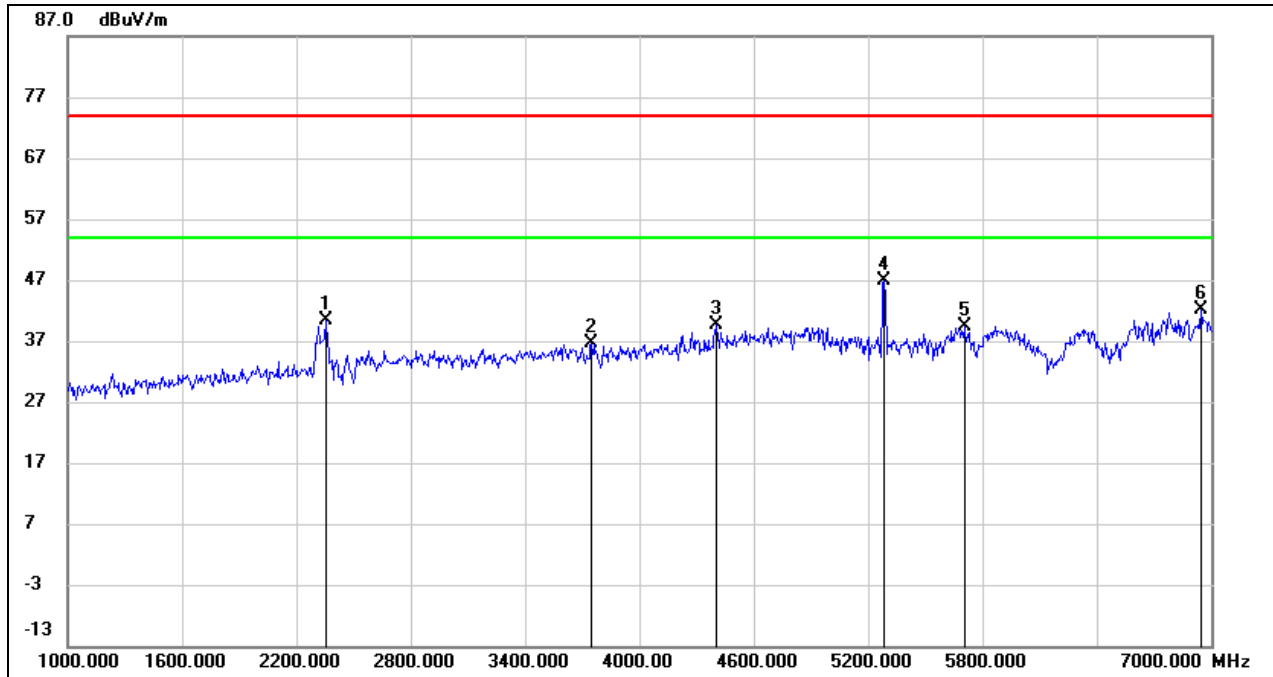

No.	Frequency (MHz)	Reading (dBuV)	Correct (dB/m)	Result (dBuV/m)	Limit (dBuV/m)	Margin (dB)	Remark
1	2356.000	49.66	-9.22	40.44	74.00	-33.56	peak
2	3748.000	41.72	-5.17	36.55	74.00	-37.45	peak
3	4402.000	42.13	-2.60	39.53	74.00	-34.47	peak
4	5284.000	46.69	0.18	46.87	74.00	-27.13	peak
5	5704.000	38.39	1.00	39.39	74.00	-34.61	peak
6	6946.000	36.21	5.93	42.14	74.00	-31.86	peak



Test Mode:	802.11ax HE20	Channel:	5280 MHz
Polarity:	Vertical	Test Voltage:	DC 12 V

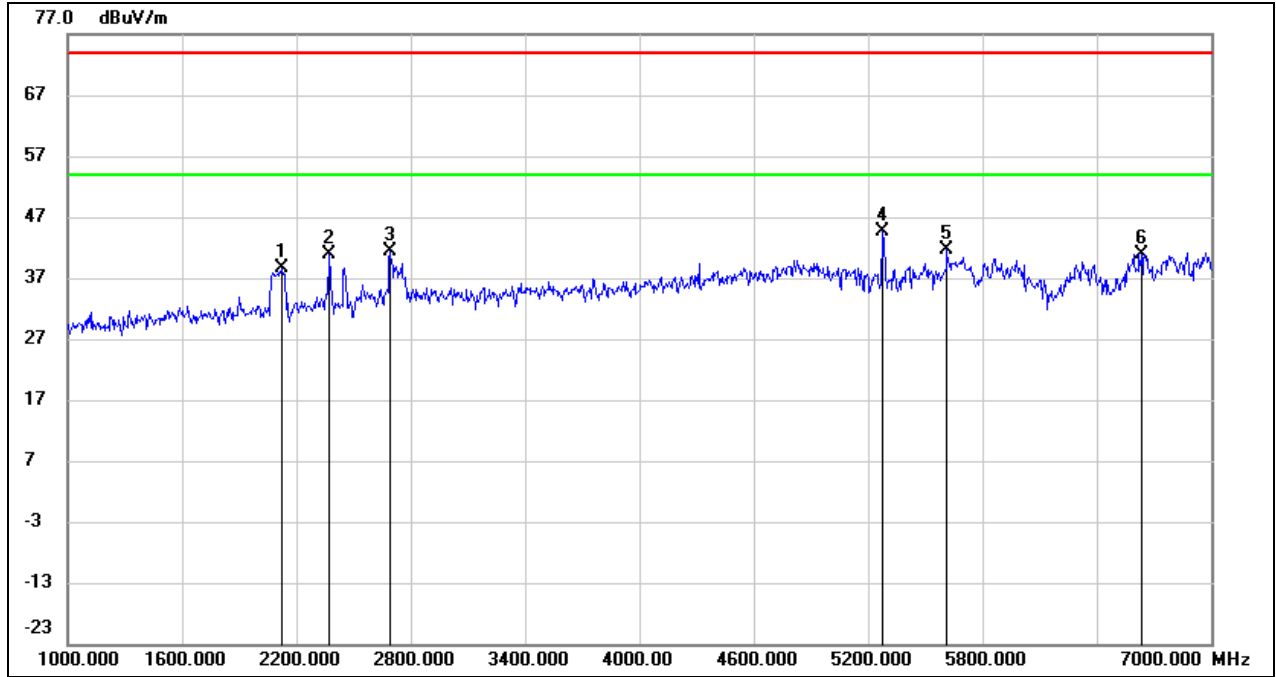

No.	Frequency (MHz)	Reading (dBuV)	Correct (dB/m)	Result (dBuV/m)	Limit (dBuV/m)	Margin (dB)	Remark
1	2122.000	49.01	-10.43	38.58	74.00	-35.42	peak
2	2374.000	49.92	-9.14	40.78	74.00	-33.22	peak
3	2692.000	49.24	-7.91	41.33	74.00	-32.67	peak
4	5278.000	44.52	0.17	44.69	74.00	-29.31	peak
5	5614.000	40.88	0.74	41.62	74.00	-32.38	peak
6	6634.000	36.57	4.38	40.95	74.00	-33.05	peak



Test Mode:	802.11ax HE20	Channel:	5320 MHz
Polarity:	Horizontal	Test Voltage:	DC 12 V

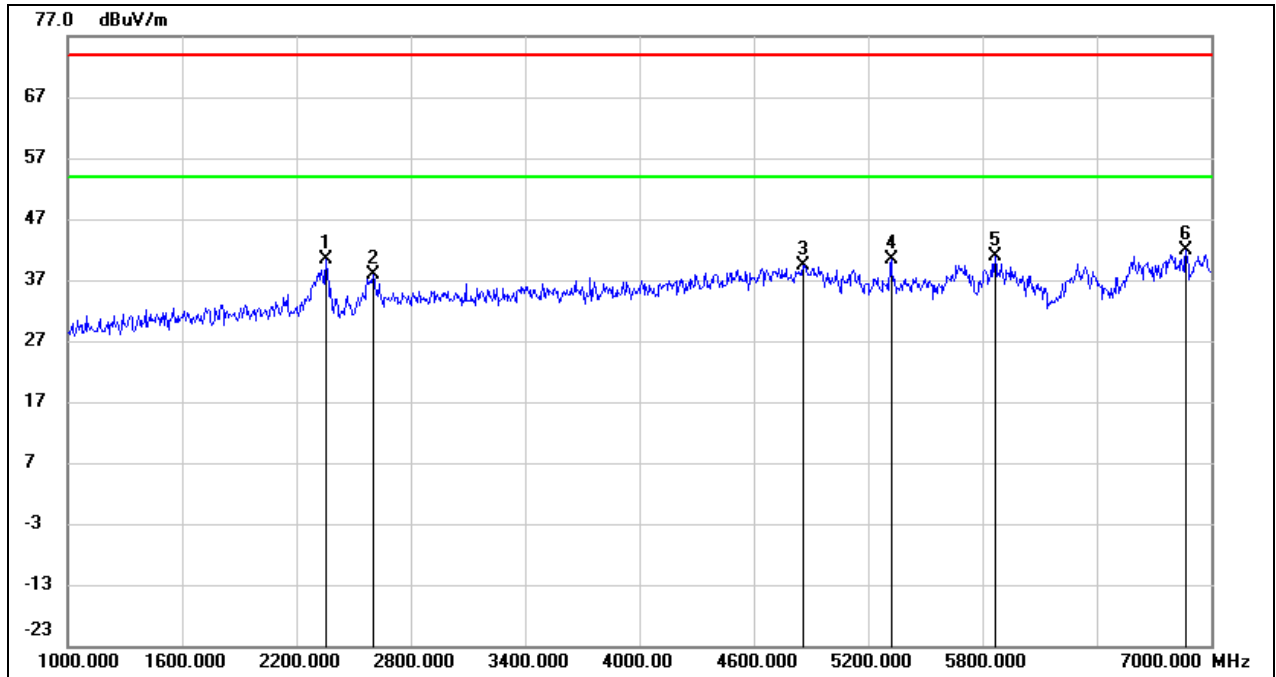

No.	Frequency (MHz)	Reading (dBuV)	Correct (dB/m)	Result (dBuV/m)	Limit (dBuV/m)	Margin (dB)	Remark
1	2356.000	49.65	-9.22	40.43	74.00	-33.57	peak
2	2602.000	46.11	-8.19	37.92	74.00	-36.08	peak
3	4858.000	40.09	-0.72	39.37	74.00	-34.63	peak
4	5320.000	40.28	0.21	40.49	74.00	-33.51	peak
5	5866.000	39.35	1.47	40.82	74.00	-33.18	peak
6	6868.000	36.28	5.54	41.82	74.00	-32.18	peak



Test Mode:	802.11ax HE20	Channel:	5320 MHz
Polarity:	Vertical	Test Voltage:	DC 12 V

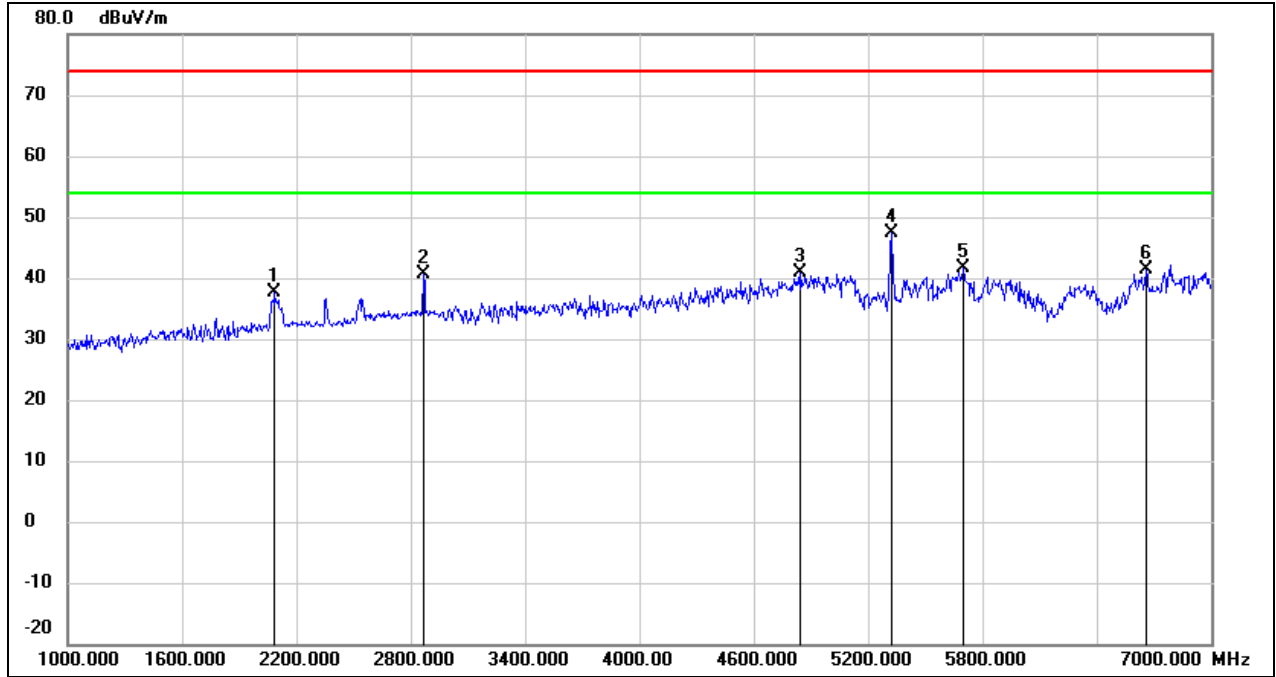

No.	Frequency (MHz)	Reading (dBuV)	Correct (dB/m)	Result (dBuV/m)	Limit (dBuV/m)	Margin (dB)	Remark
1	2086.000	48.20	-10.62	37.58	74.00	-36.42	peak
2	2866.000	48.02	-7.38	40.64	74.00	-33.36	peak
3	4846.000	41.60	-0.77	40.83	74.00	-33.17	peak
4	5320.000	47.08	0.21	47.29	74.00	-26.71	peak
5	5698.000	40.54	0.99	41.53	74.00	-32.47	peak
6	6658.000	36.90	4.49	41.39	74.00	-32.61	peak



Test Mode:	802.11ax HE20	Channel:	5500 MHz
Polarity:	Horizontal	Test Voltage:	DC 12 V

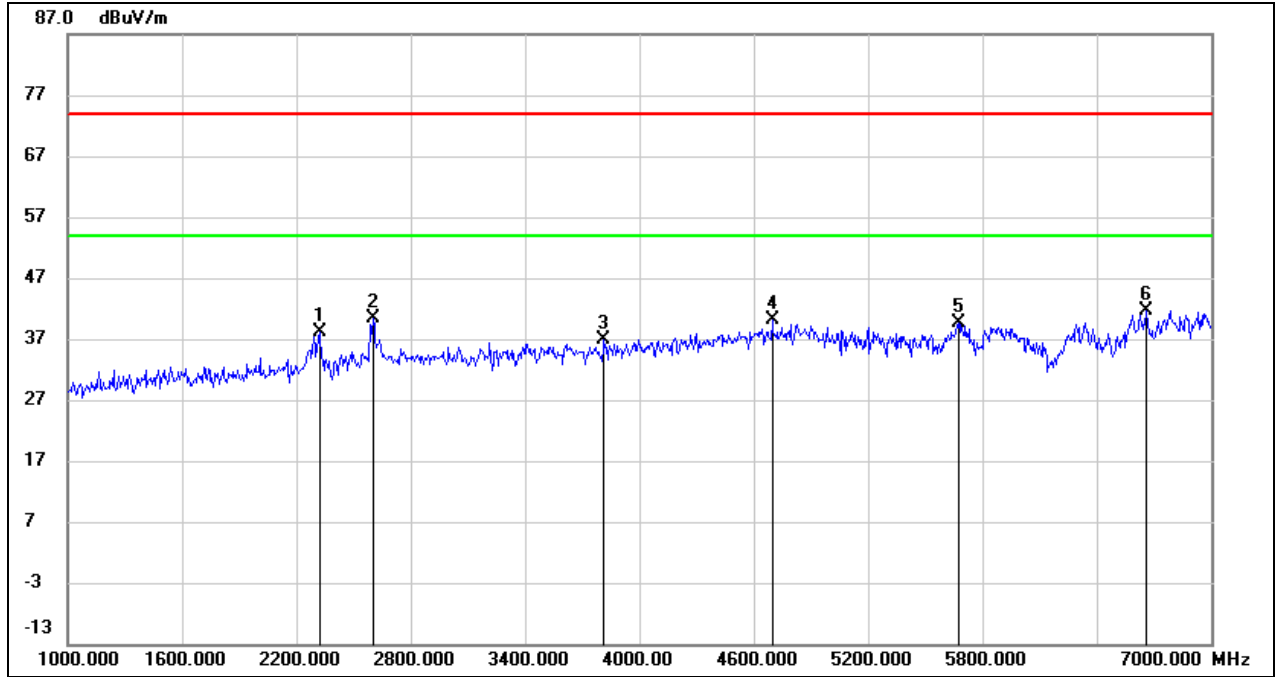

No.	Frequency (MHz)	Reading (dBuV)	Correct (dB/m)	Result (dBuV/m)	Limit (dBuV/m)	Margin (dB)	Remark
1	2320.000	47.47	-9.42	38.05	74.00	-35.95	peak
2	2602.000	48.54	-8.19	40.35	74.00	-33.65	peak
3	3814.000	41.94	-4.99	36.95	74.00	-37.05	peak
4	4696.000	41.52	-1.36	40.16	74.00	-33.84	peak
5	5674.000	38.75	0.92	39.67	74.00	-34.33	peak
6	6658.000	37.22	4.49	41.71	74.00	-32.29	peak



Test Mode:	802.11ax HE20	Channel:	5500 MHz
Polarity:	Vertical	Test Voltage:	DC 12 V

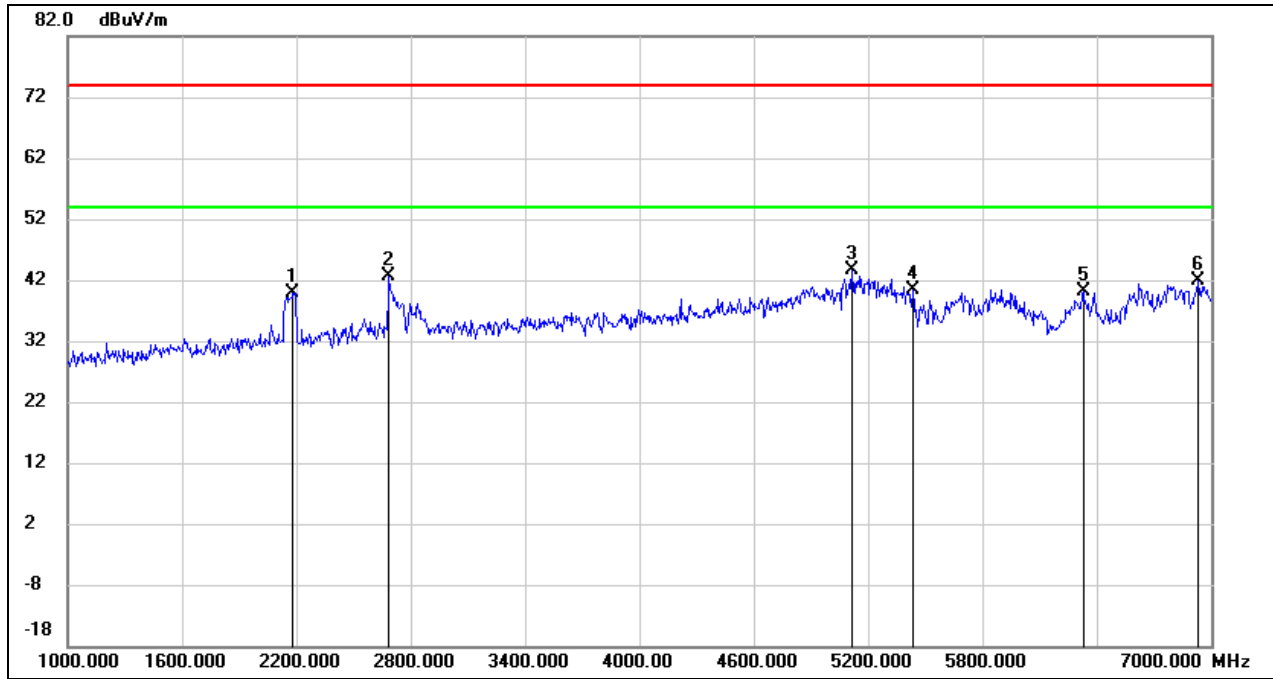

No.	Frequency (MHz)	Reading (dBuV)	Correct (dB/m)	Result (dBuV/m)	Limit (dBuV/m)	Margin (dB)	Remark
1	2182.000	50.02	-10.13	39.89	74.00	-34.11	peak
2	2686.000	50.55	-7.93	42.62	74.00	-31.38	peak
3	5116.000	43.55	-0.02	43.53	74.00	-30.47	peak
4	5434.000	40.06	0.34	40.40	74.00	-33.60	peak
5	6328.000	36.94	3.08	40.02	74.00	-33.98	peak
6	6934.000	35.90	5.87	41.77	74.00	-32.23	peak



Test Mode:	802.11ax HE20	Channel:	5580 MHz
Polarity:	Horizontal	Test Voltage:	DC 12 V

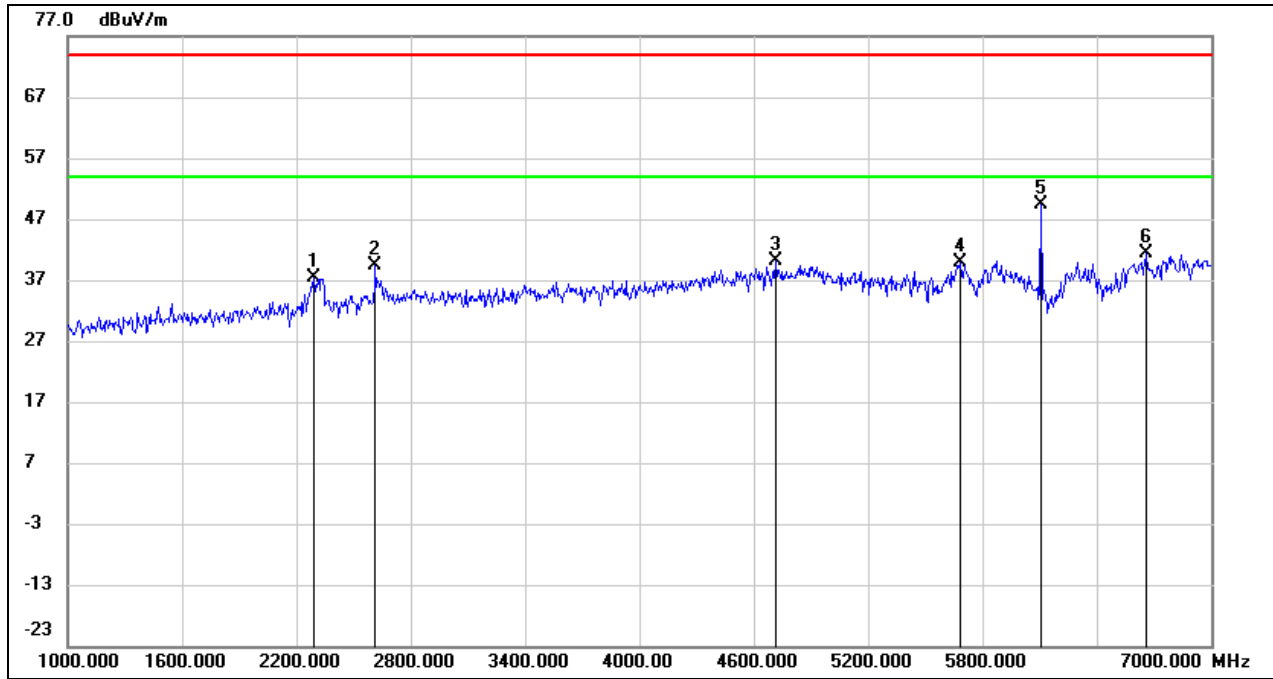

No.	Frequency (MHz)	Reading (dBuV)	Correct (dB/m)	Result (dBuV/m)	Limit (dBuV/m)	Margin (dB)	Remark
1	2290.000	46.92	-9.58	37.34	74.00	-36.66	peak
2	2614.000	47.60	-8.14	39.46	74.00	-34.54	peak
3	4714.000	41.52	-1.29	40.23	74.00	-33.77	peak
4	5686.000	38.95	0.96	39.91	74.00	-34.09	peak
5	6106.000	47.05	2.24	49.29	74.00	-24.71	peak
6	6658.000	36.86	4.49	41.35	74.00	-32.65	peak



Test Mode:	802.11ax HE20	Channel:	5580 MHz
Polarity:	Vertical	Test Voltage:	DC 12 V

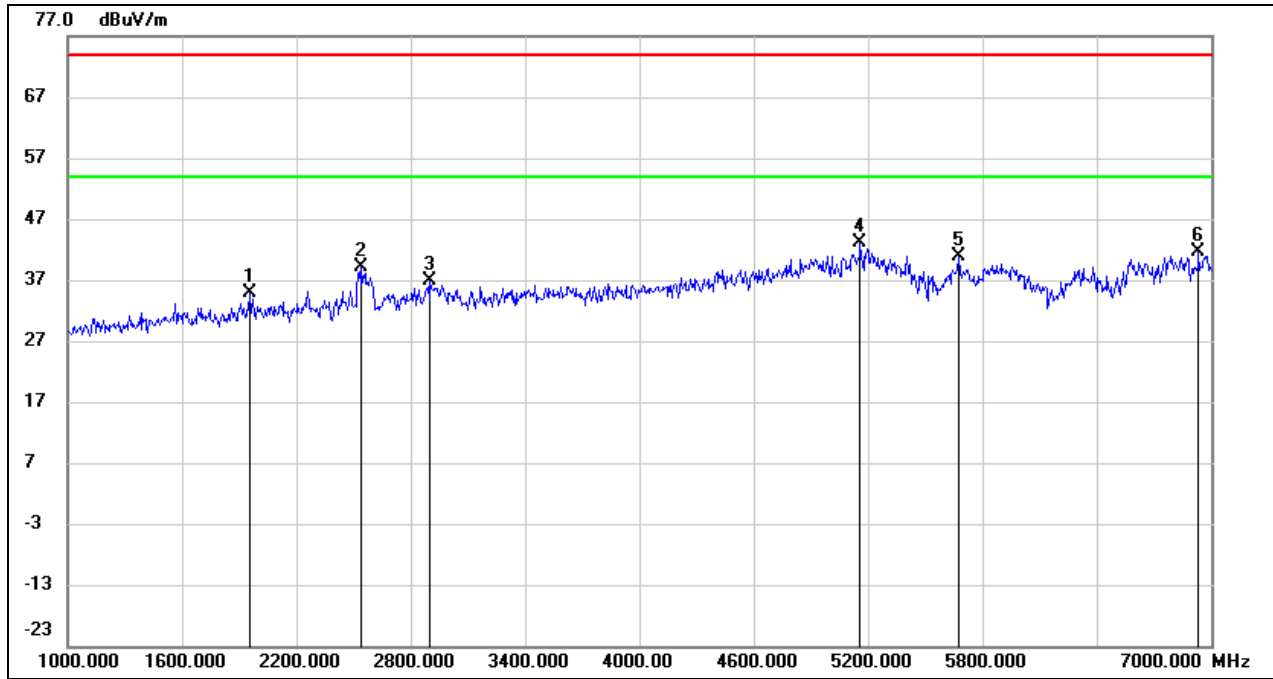

No.	Frequency (MHz)	Reading (dBuV)	Correct (dB/m)	Result (dBuV/m)	Limit (dBuV/m)	Margin (dB)	Remark
1	1954.000	45.99	-11.21	34.78	74.00	-39.22	peak
2	2542.000	47.42	-8.36	39.06	74.00	-34.94	peak
3	2902.000	44.14	-7.28	36.86	74.00	-37.14	peak
4	5158.000	43.12	0.04	43.16	74.00	-30.84	peak
5	5674.000	39.89	0.92	40.81	74.00	-33.19	peak
6	6934.000	35.69	5.87	41.56	74.00	-32.44	peak



Test Mode:	802.11ax HE20	Channel:	5700 MHz
Polarity:	Horizontal	Test Voltage:	DC 12 V

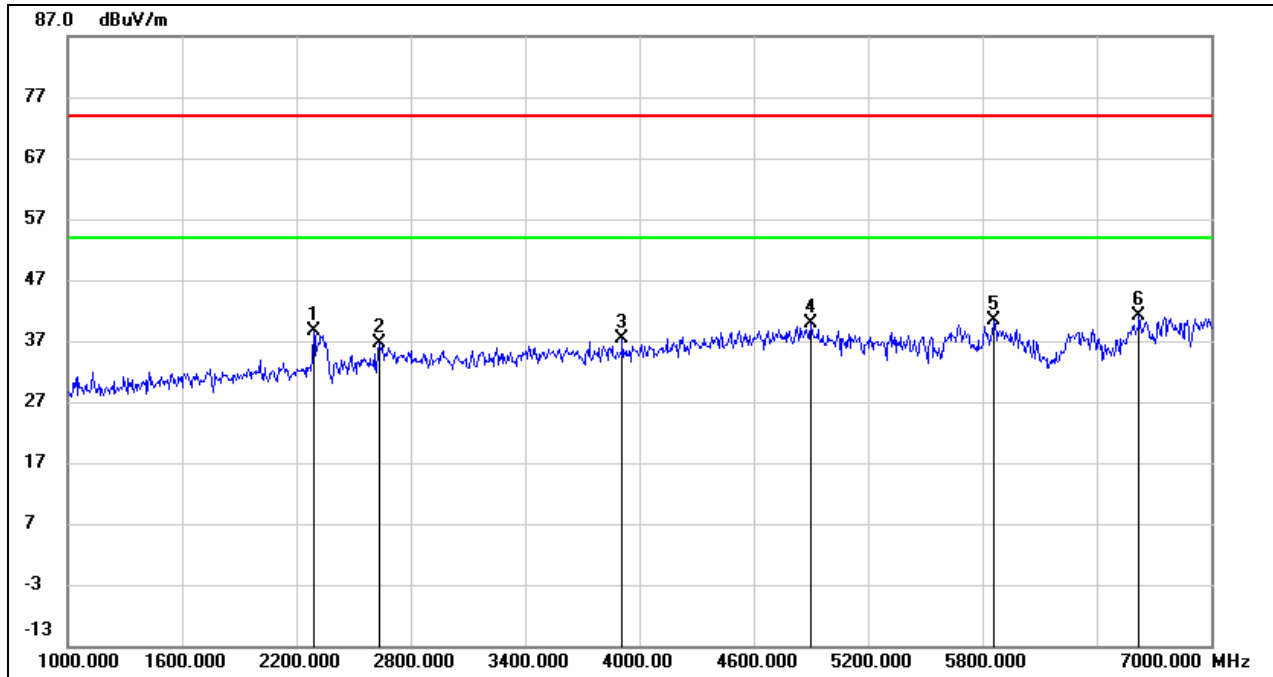

No.	Frequency (MHz)	Reading (dBuV)	Correct (dB/m)	Result (dBuV/m)	Limit (dBuV/m)	Margin (dB)	Remark
1	2290.000	48.15	-9.58	38.57	74.00	-35.43	peak
2	2638.000	44.81	-8.07	36.74	74.00	-37.26	peak
3	3910.000	42.10	-4.73	37.37	74.00	-36.63	peak
4	4900.000	40.38	-0.55	39.83	74.00	-34.17	peak
5	5860.000	39.00	1.45	40.45	74.00	-33.55	peak
6	6622.000	36.71	4.32	41.03	74.00	-32.97	peak



Test Mode:	802.11ax HE20	Channel:	5700 MHz
Polarity:	Vertical	Test Voltage:	DC 12 V

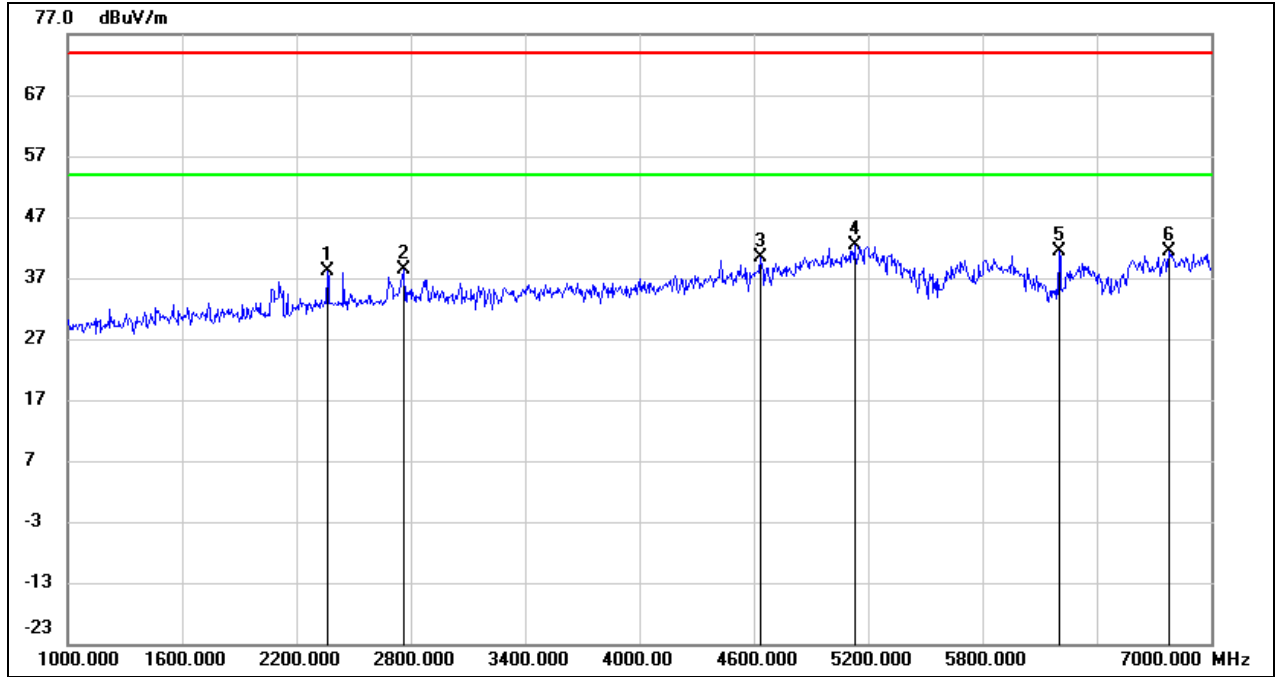

No.	Frequency (MHz)	Reading (dBuV)	Correct (dB/m)	Result (dBuV/m)	Limit (dBuV/m)	Margin (dB)	Remark
1	2362.000	47.40	-9.20	38.20	74.00	-35.80	peak
2	2764.000	46.17	-7.69	38.48	74.00	-35.52	peak
3	4636.000	42.08	-1.59	40.49	74.00	-33.51	peak
4	5128.000	42.33	0.00	42.33	74.00	-31.67	peak
5	6202.000	38.82	2.60	41.42	74.00	-32.58	peak
6	6778.000	36.26	5.10	41.36	74.00	-32.64	peak



Test Mode:	802.11ax HE20	Channel:	5720 MHz
Polarity:	Horizontal	Test Voltage:	DC 12 V

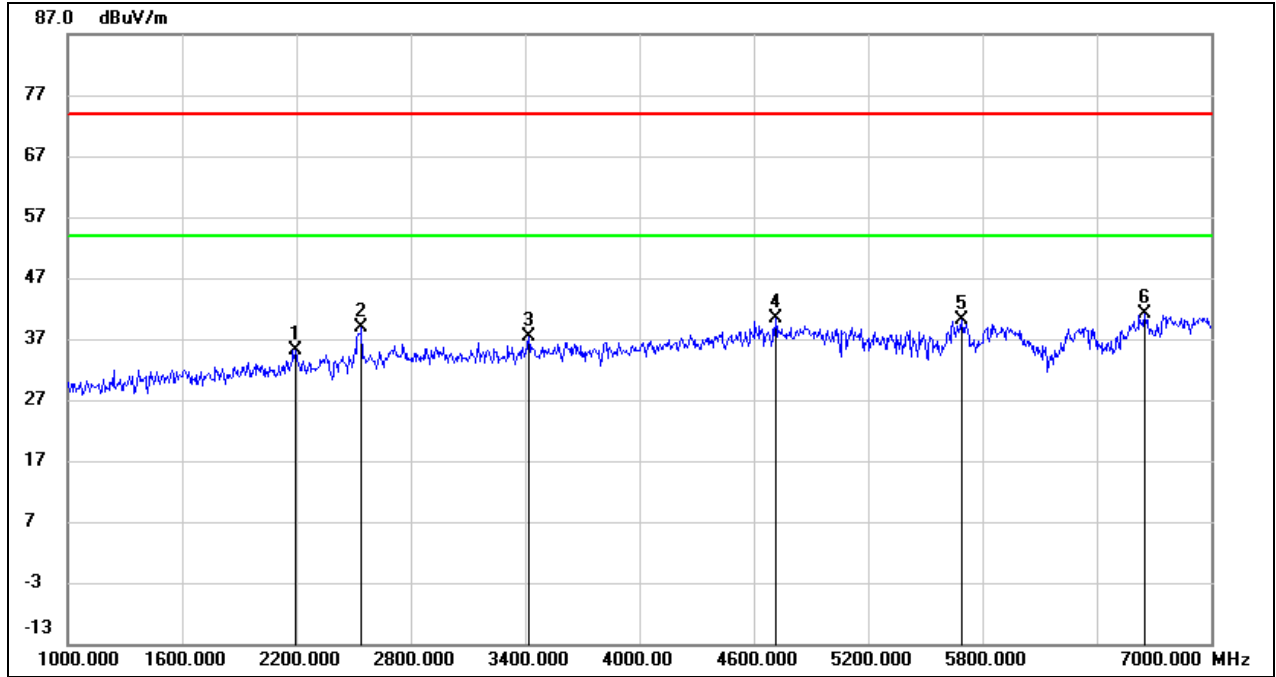

No.	Frequency (MHz)	Reading (dBuV)	Correct (dB/m)	Result (dBuV/m)	Limit (dBuV/m)	Margin (dB)	Remark
1	2194.000	45.14	-10.06	35.08	74.00	-38.92	peak
2	2542.000	47.20	-8.36	38.84	74.00	-35.16	peak
3	3418.000	43.33	-6.03	37.30	74.00	-36.70	peak
4	4714.000	41.56	-1.29	40.27	74.00	-33.73	peak
5	5692.000	39.17	0.97	40.14	74.00	-33.86	peak
6	6652.000	36.72	4.47	41.19	74.00	-32.81	peak



Test Mode:	802.11ax HE20	Channel:	5720 MHz
Polarity:	Vertical	Test Voltage:	DC 12 V

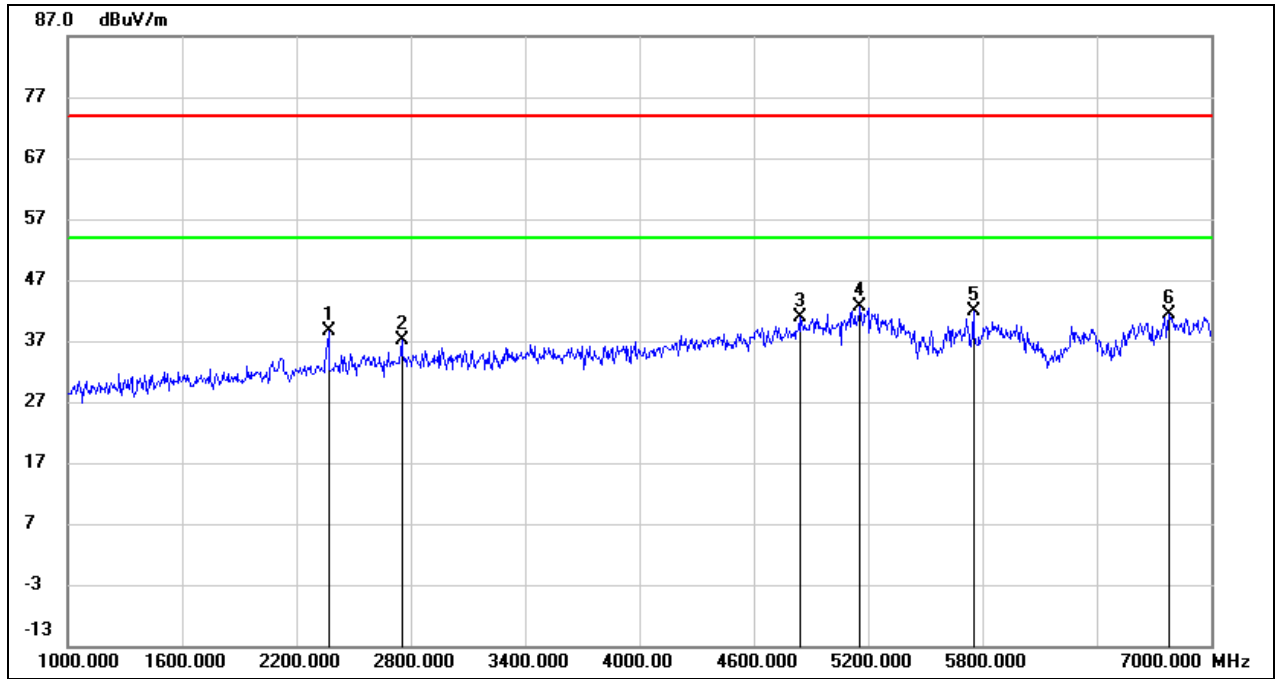

No.	Frequency (MHz)	Reading (dBuV)	Correct (dB/m)	Result (dBuV/m)	Limit (dBuV/m)	Margin (dB)	Remark
1	2368.000	47.73	-9.16	38.57	74.00	-35.43	peak
2	2752.000	44.97	-7.73	37.24	74.00	-36.76	peak
3	4840.000	41.57	-0.78	40.79	74.00	-33.21	peak
4	5158.000	42.64	0.04	42.68	74.00	-31.32	peak
5	5752.000	40.86	1.14	42.00	74.00	-32.00	peak
6	6778.000	36.21	5.10	41.31	74.00	-32.69	peak



8.3. SPURIOUS EMISSIONS (7 GHZ ~ 18 GHZ)

Test Mode:	802.11a 20	Channel:	5260 MHz
Polarity:	Horizontal	Test Voltage:	DC 12 V

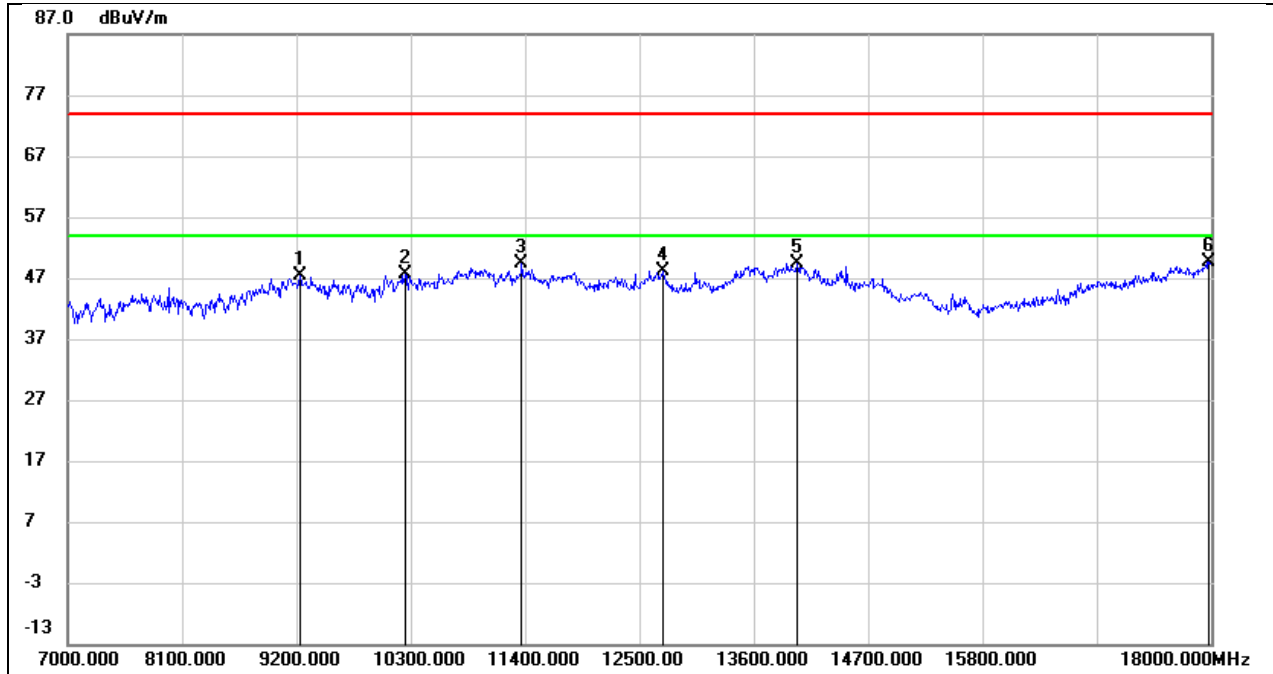

No.	Frequency (MHz)	Reading (dBuV)	Correct (dB/m)	Result (dBuV/m)	Limit (dBuV/m)	Margin (dB)	Remark
1	9233.000	37.01	10.48	47.49	74.00	-26.51	peak
2	10245.000	35.27	12.28	47.55	74.00	-26.45	peak
3	11367.000	33.23	16.22	49.45	74.00	-24.55	peak
4	12720.000	30.15	18.09	48.24	74.00	-25.76	peak
5	14018.000	27.56	21.80	49.36	74.00	-24.64	peak
6	17978.000	23.58	25.97	49.55	74.00	-24.45	peak



Test Mode:	802.11a 20	Channel:	5260 MHz
Polarity:	Vertical	Test Voltage:	DC 12 V

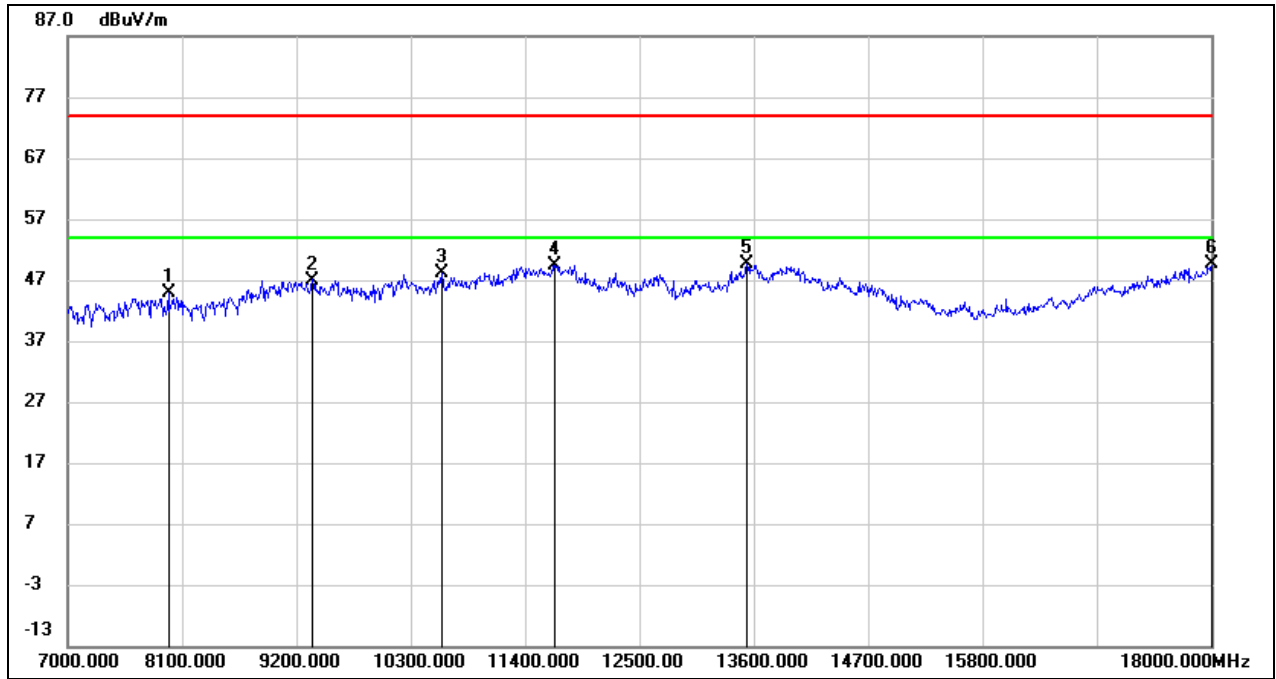

No.	Frequency (MHz)	Reading (dBuV)	Correct (dB/m)	Result (dBuV/m)	Limit (dBuV/m)	Margin (dB)	Remark
1	7968.000	38.34	6.45	44.79	74.00	-29.21	peak
2	9354.000	36.44	10.56	47.00	74.00	-27.00	peak
3	10597.000	34.98	13.19	48.17	74.00	-25.83	peak
4	11686.000	32.29	17.12	49.41	74.00	-24.59	peak
5	13534.000	29.00	20.73	49.73	74.00	-24.27	peak
6	18000.000	23.60	26.12	49.72	74.00	-24.28	peak



Test Mode:	802.11a 20	Channel:	5280 MHz
Polarity:	Horizontal	Test Voltage:	DC 12 V

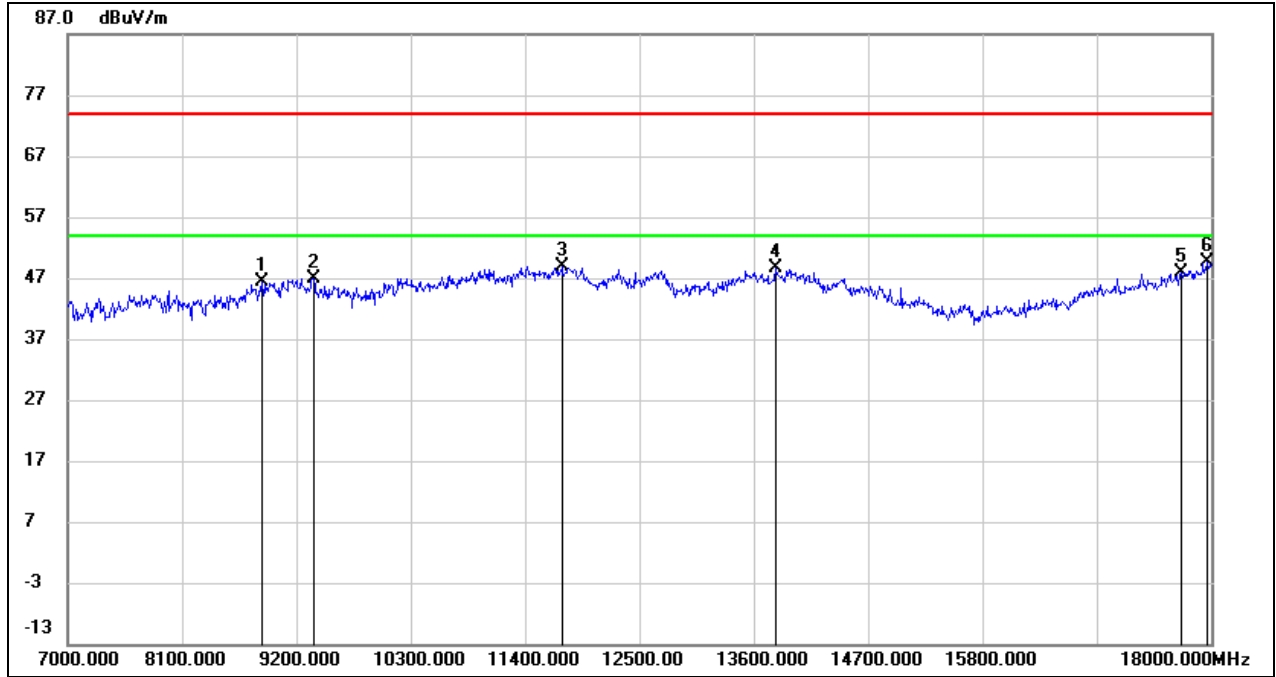

No.	Frequency (MHz)	Reading (dBuV)	Correct (dB/m)	Result (dBuV/m)	Limit (dBuV/m)	Margin (dB)	Remark
1	8870.000	36.96	9.44	46.40	74.00	-27.60	peak
2	9365.000	36.42	10.57	46.99	74.00	-27.01	peak
3	11752.000	31.76	17.24	49.00	74.00	-25.00	peak
4	13809.000	27.11	21.41	48.52	74.00	-25.48	peak
5	17714.000	23.80	24.16	47.96	74.00	-26.04	peak
6	17967.000	23.72	25.89	49.61	74.00	-24.39	peak



Test Mode:	802.11a 20	Channel:	5280 MHz
Polarity:	Vertical	Test Voltage:	DC 12 V

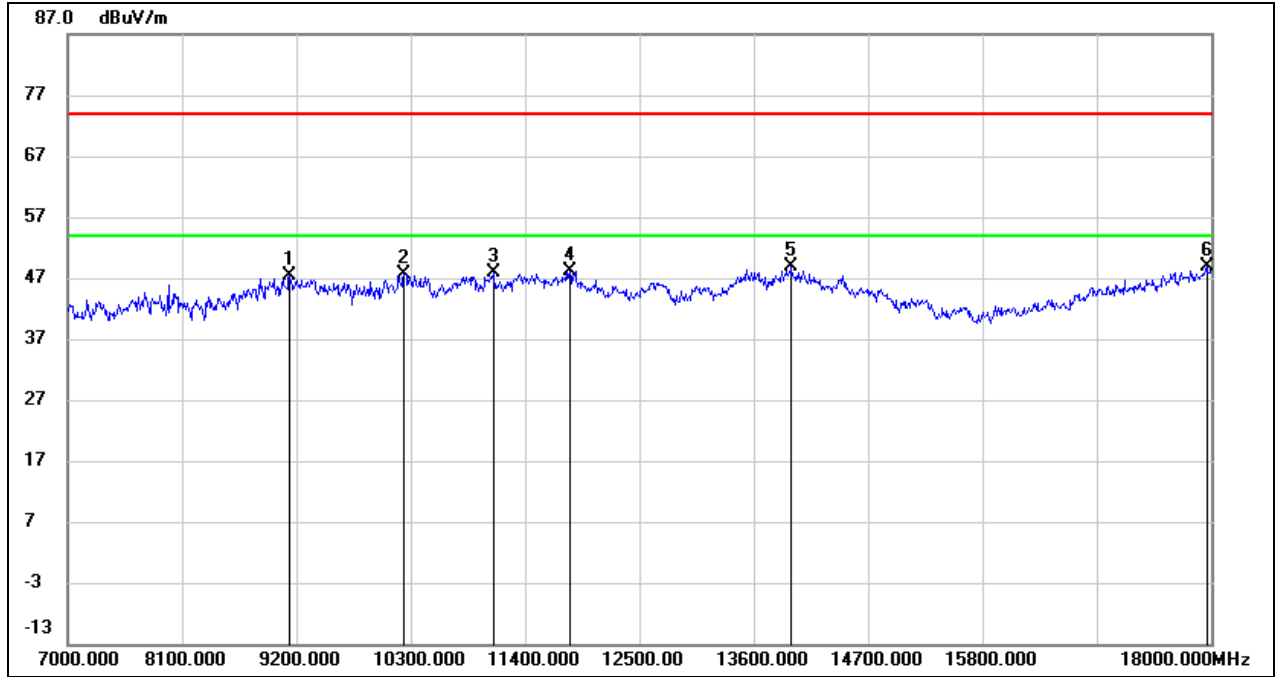

No.	Frequency (MHz)	Reading (dBuV)	Correct (dB/m)	Result (dBuV/m)	Limit (dBuV/m)	Margin (dB)	Remark
1	9134.000	36.97	10.41	47.38	74.00	-26.62	peak
2	10234.000	35.47	12.26	47.73	74.00	-26.27	peak
3	11092.000	32.85	15.10	47.95	74.00	-26.05	peak
4	11829.000	30.82	17.38	48.20	74.00	-25.80	peak
5	13963.000	27.02	21.78	48.80	74.00	-25.20	peak
6	17956.000	23.02	25.82	48.84	74.00	-25.16	peak



Test Mode:	802.11a 20	Channel:	5320 MHz
Polarity:	Horizontal	Test Voltage:	DC 12 V

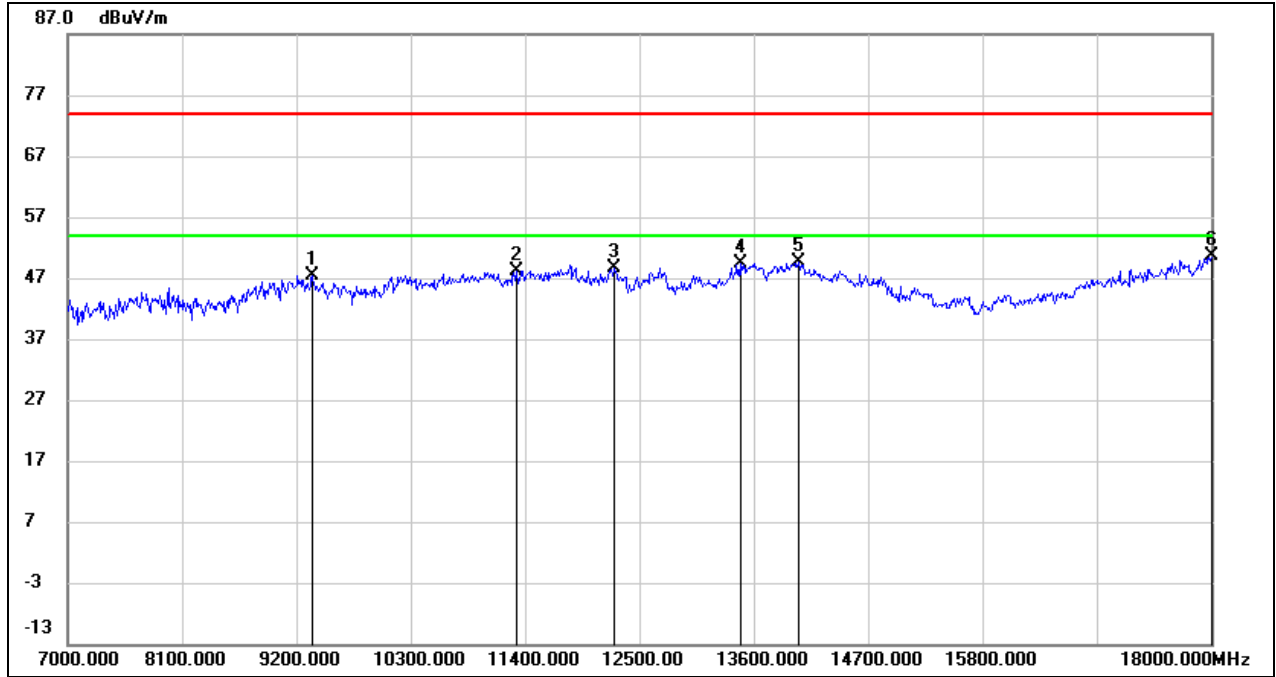

No.	Frequency (MHz)	Reading (dBuV)	Correct (dB/m)	Result (dBuV/m)	Limit (dBuV/m)	Margin (dB)	Remark
1	9354.000	36.88	10.56	47.44	74.00	-26.56	peak
2	11323.000	32.12	16.05	48.17	74.00	-25.83	peak
3	12258.000	30.91	17.77	48.68	74.00	-25.32	peak
4	13468.000	28.94	20.50	49.44	74.00	-24.56	peak
5	14029.000	27.90	21.76	49.66	74.00	-24.34	peak
6	18000.000	24.61	26.12	50.73	74.00	-23.27	peak



Test Mode:	802.11a 20	Channel:	5320 MHz
Polarity:	Vertical	Test Voltage:	DC 12 V

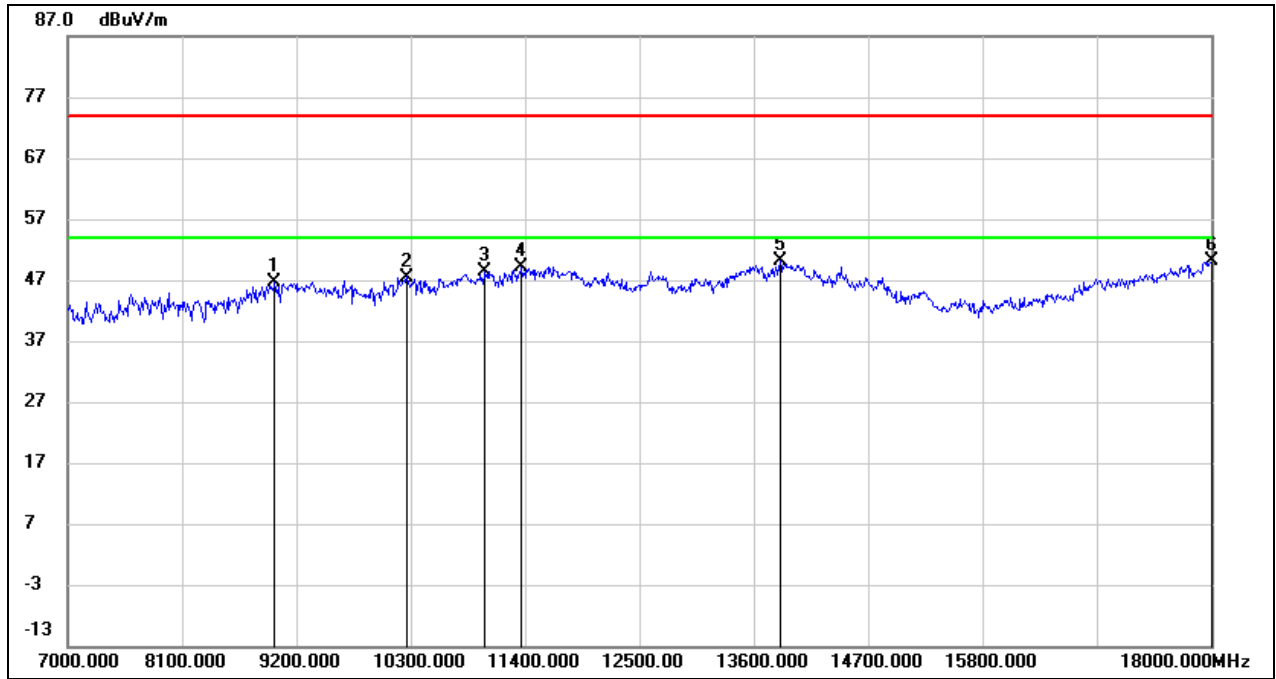

No.	Frequency (MHz)	Reading (dBuV)	Correct (dB/m)	Result (dBuV/m)	Limit (dBuV/m)	Margin (dB)	Remark
1	8991.000	36.40	10.28	46.68	74.00	-27.32	peak
2	10256.000	35.19	12.31	47.50	74.00	-26.50	peak
3	11015.000	33.49	14.79	48.28	74.00	-25.72	peak
4	11367.000	33.00	16.22	49.22	74.00	-24.78	peak
5	13853.000	28.49	21.52	50.01	74.00	-23.99	peak
6	18000.000	23.94	26.12	50.06	74.00	-23.94	peak



Test Mode:	802.11a 20	Channel:	5500 MHz
Polarity:	Horizontal	Test Voltage:	DC 12 V

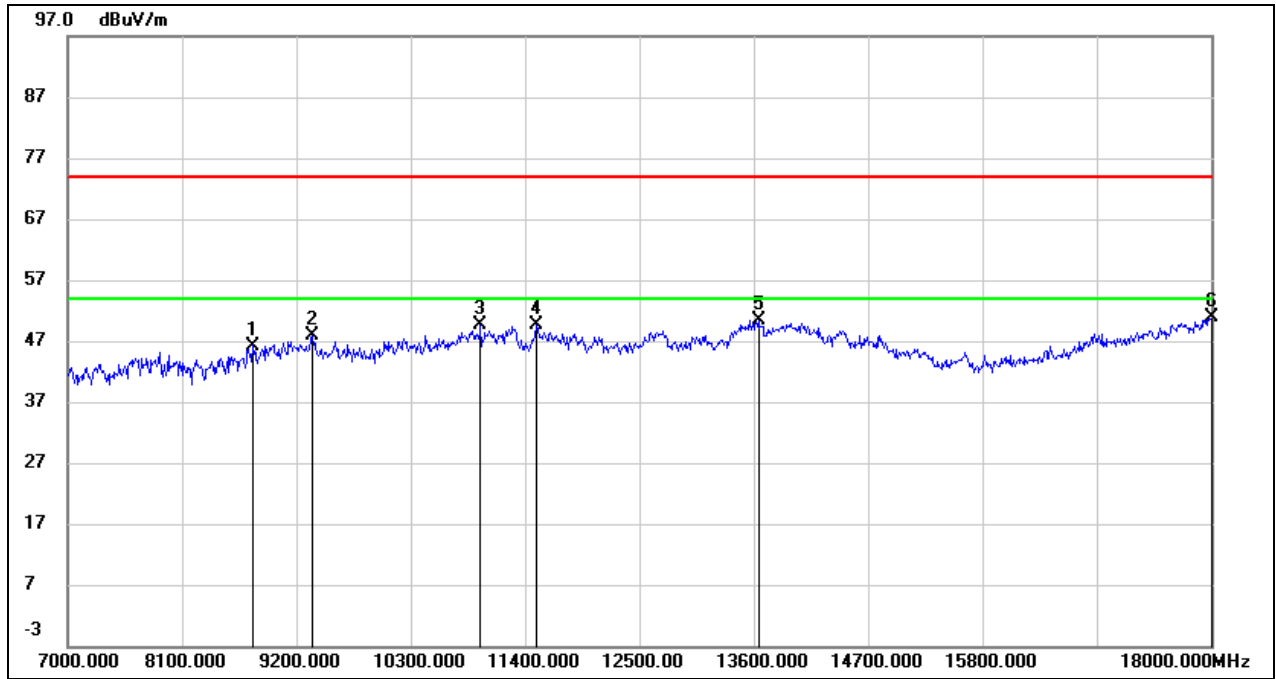

No.	Frequency (MHz)	Reading (dBuV)	Correct (dB/m)	Result (dBuV/m)	Limit (dBuV/m)	Margin (dB)	Remark
1	8782.000	37.41	8.84	46.25	74.00	-27.75	peak
2	9354.000	37.24	10.56	47.80	74.00	-26.20	peak
3	10971.000	35.03	14.61	49.64	74.00	-24.36	peak
4	11510.000	32.86	16.79	49.65	74.00	-24.35	peak
5	13644.000	29.36	20.99	50.35	74.00	-23.65	peak
6	18000.000	24.87	26.12	50.99	74.00	-23.01	peak



Test Mode:	802.11a 20	Channel:	5500 MHz
Polarity:	Vertical	Test Voltage:	DC 12 V

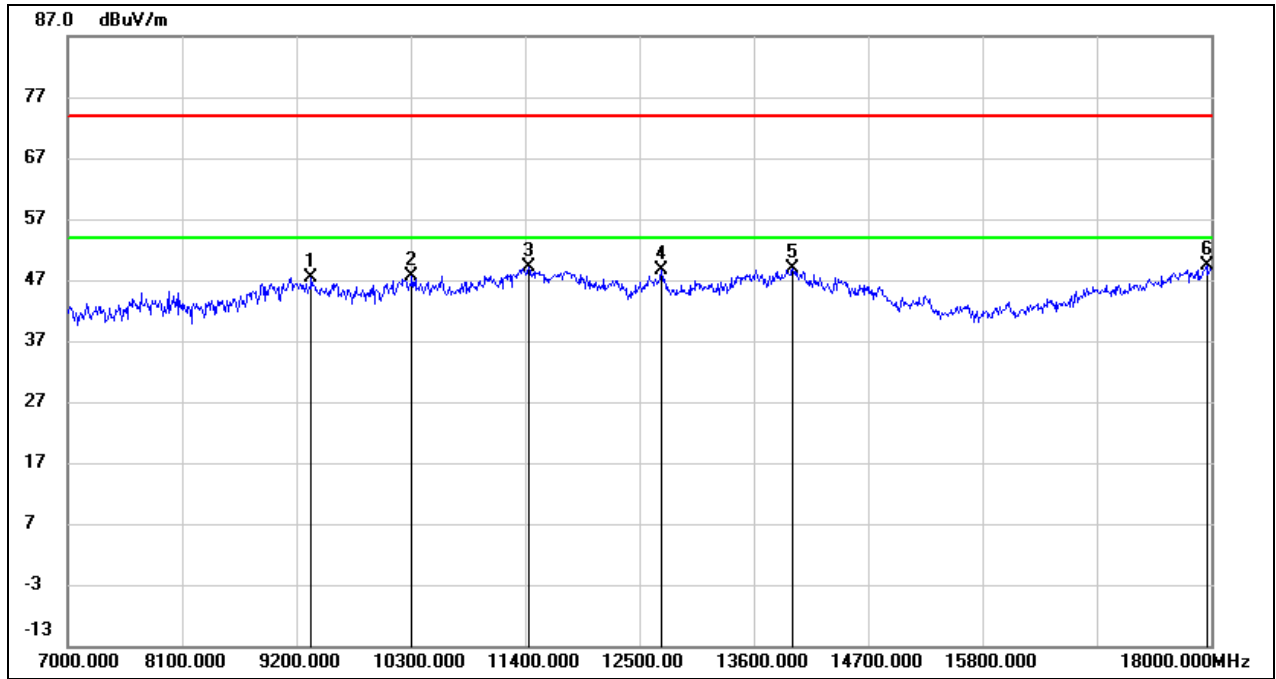

No.	Frequency (MHz)	Reading (dBuV)	Correct (dB/m)	Result (dBuV/m)	Limit (dBuV/m)	Margin (dB)	Remark
1	9343.000	36.88	10.55	47.43	74.00	-26.57	peak
2	10311.000	35.22	12.42	47.64	74.00	-26.36	peak
3	11433.000	32.61	16.50	49.11	74.00	-24.89	peak
4	12709.000	30.54	18.09	48.63	74.00	-25.37	peak
5	13974.000	27.09	21.82	48.91	74.00	-25.09	peak
6	17956.000	23.49	25.82	49.31	74.00	-24.69	peak



Test Mode:	802.11a 20	Channel:	5580 MHz
Polarity:	Horizontal	Test Voltage:	DC 12 V

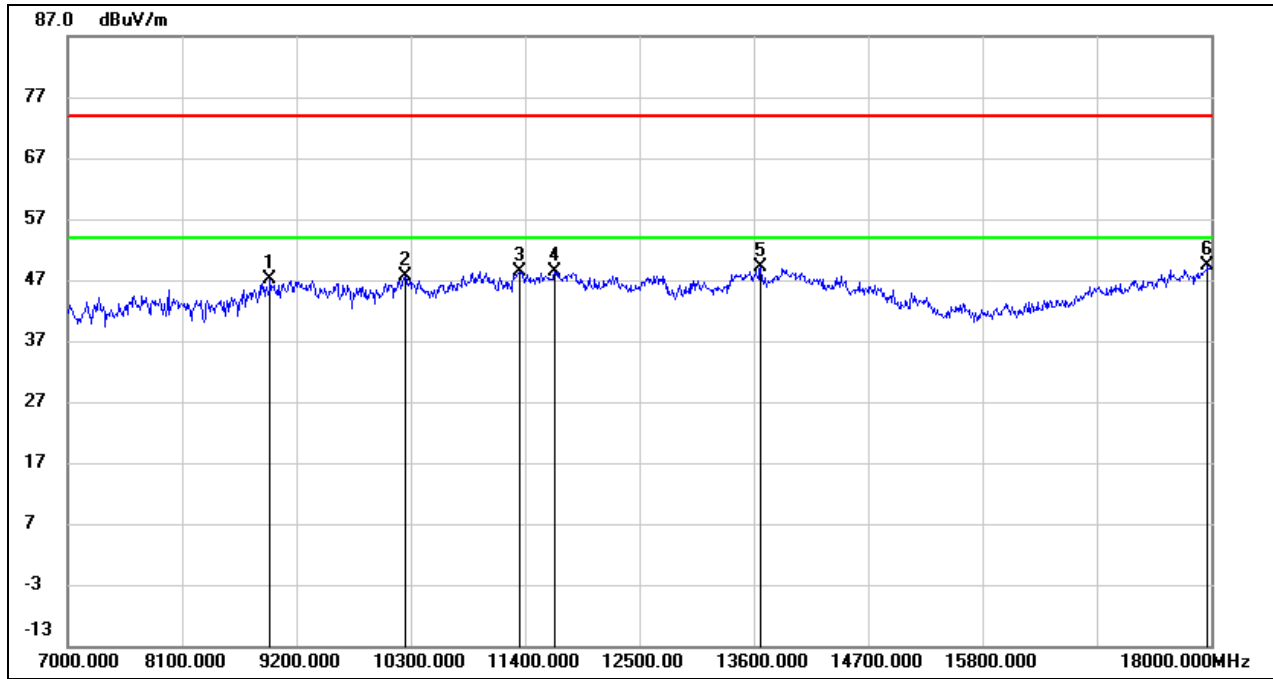

No.	Frequency (MHz)	Reading (dBuV)	Correct (dB/m)	Result (dBuV/m)	Limit (dBuV/m)	Margin (dB)	Remark
1	8947.000	37.06	9.98	47.04	74.00	-26.96	peak
2	10245.000	35.26	12.28	47.54	74.00	-26.46	peak
3	11345.000	32.23	16.14	48.37	74.00	-25.63	peak
4	11686.000	31.25	17.12	48.37	74.00	-25.63	peak
5	13666.000	28.17	21.05	49.22	74.00	-24.78	peak
6	17967.000	23.59	25.89	49.48	74.00	-24.52	peak



Test Mode:	802.11a 20	Channel:	5580 MHz
Polarity:	Vertical	Test Voltage:	DC 12 V

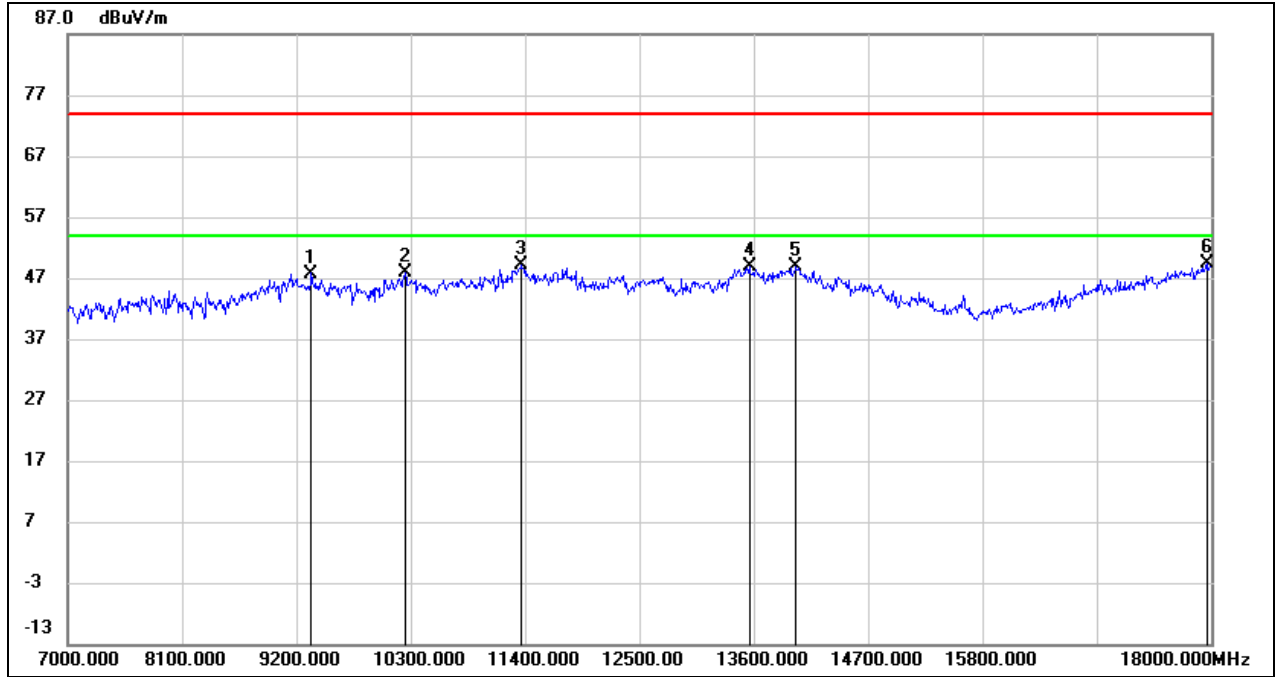

No.	Frequency (MHz)	Reading (dBuV)	Correct (dB/m)	Result (dBuV/m)	Limit (dBuV/m)	Margin (dB)	Remark
1	9343.000	37.20	10.55	47.75	74.00	-26.25	peak
2	10245.000	35.54	12.28	47.82	74.00	-26.18	peak
3	11367.000	32.96	16.22	49.18	74.00	-24.82	peak
4	13556.000	28.17	20.78	48.95	74.00	-25.05	peak
5	14007.000	27.11	21.85	48.96	74.00	-25.04	peak
6	17956.000	23.64	25.82	49.46	74.00	-24.54	peak



Test Mode:	802.11a 20	Channel:	5700 MHz
Polarity:	Horizontal	Test Voltage:	DC 12 V

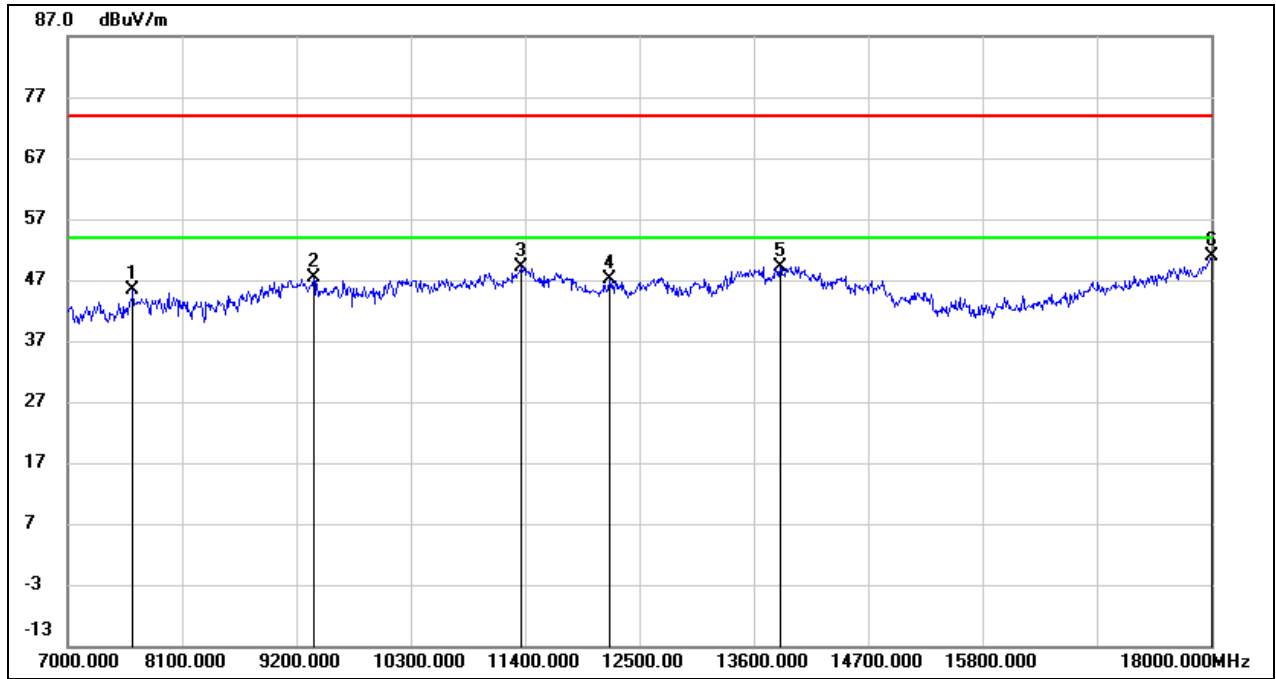

No.	Frequency (MHz)	Reading (dBuV)	Correct (dB/m)	Result (dBuV/m)	Limit (dBuV/m)	Margin (dB)	Remark
1	7627.000	38.59	6.76	45.35	74.00	-28.65	peak
2	9365.000	36.84	10.57	47.41	74.00	-26.59	peak
3	11356.000	33.05	16.19	49.24	74.00	-24.76	peak
4	12214.000	29.38	17.76	47.14	74.00	-26.86	peak
5	13853.000	27.71	21.52	49.23	74.00	-24.77	peak
6	18000.000	24.82	26.12	50.94	74.00	-23.06	peak



Test Mode:	802.11a 20	Channel:	5700 MHz
Polarity:	Vertical	Test Voltage:	DC 12 V

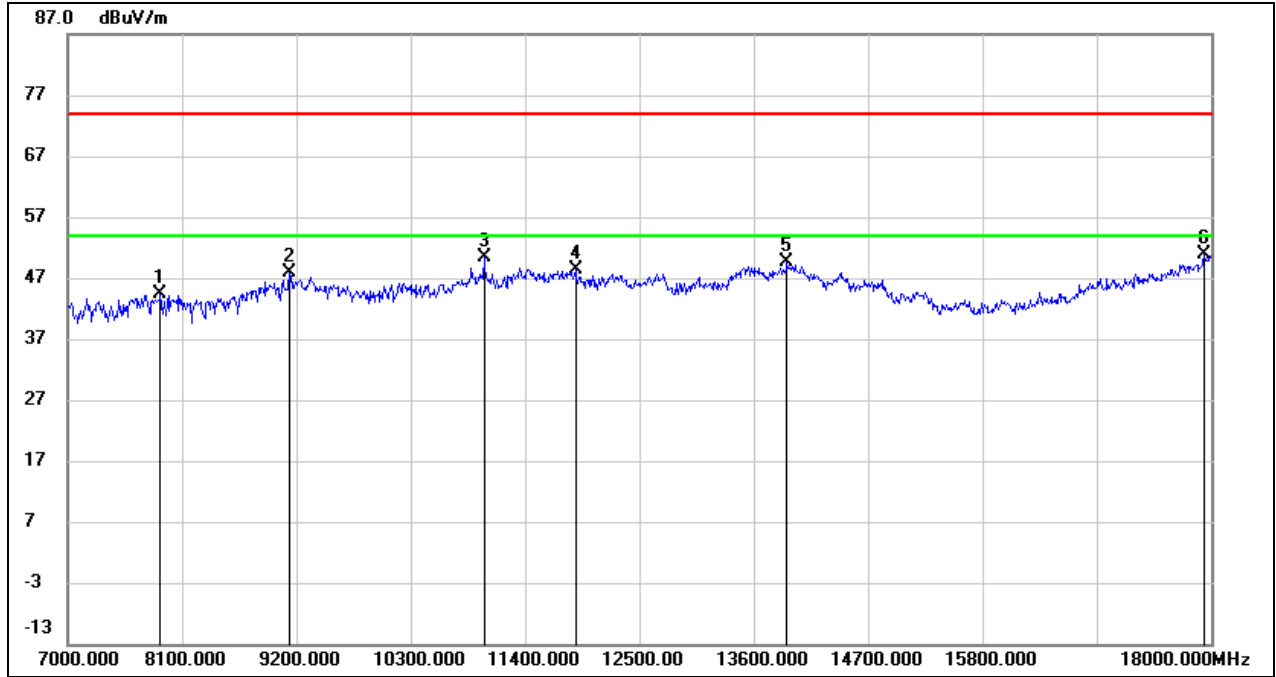

No.	Frequency (MHz)	Reading (dBuV)	Correct (dB/m)	Result (dBuV/m)	Limit (dBuV/m)	Margin (dB)	Remark
1	7891.000	37.90	6.52	44.42	74.00	-29.58	peak
2	9134.000	37.37	10.41	47.78	74.00	-26.22	peak
3	11004.000	35.63	14.74	50.37	74.00	-23.63	peak
4	11884.000	30.82	17.48	48.30	74.00	-25.70	peak
5	13919.000	27.84	21.68	49.52	74.00	-24.48	peak
6	17934.000	25.30	25.67	50.97	74.00	-23.03	peak



Test Mode:	802.11a 20	Channel:	5720 MHz
Polarity:	Horizontal	Test Voltage:	DC 12 V

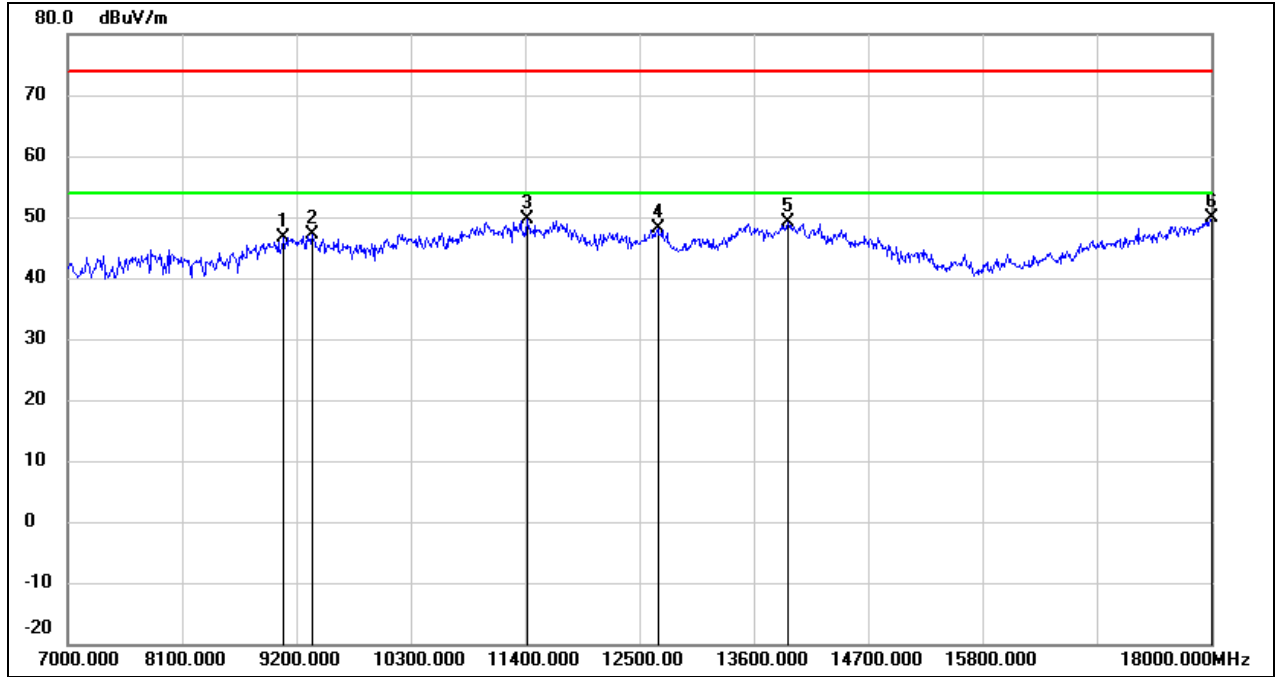

No.	Frequency (MHz)	Reading (dBuV)	Correct (dB/m)	Result (dBuV/m)	Limit (dBuV/m)	Margin (dB)	Remark
1	9079.000	36.35	10.39	46.74	74.00	-27.26	peak
2	9354.000	36.56	10.56	47.12	74.00	-26.88	peak
3	11422.000	33.06	16.46	49.52	74.00	-24.48	peak
4	12676.000	30.15	18.05	48.20	74.00	-25.80	peak
5	13930.000	27.37	21.71	49.08	74.00	-24.92	peak
6	18000.000	23.68	26.12	49.80	74.00	-24.20	peak



Test Mode:	802.11a 20	Channel:	5720 MHz
Polarity:	Vertical	Test Voltage:	DC 12 V

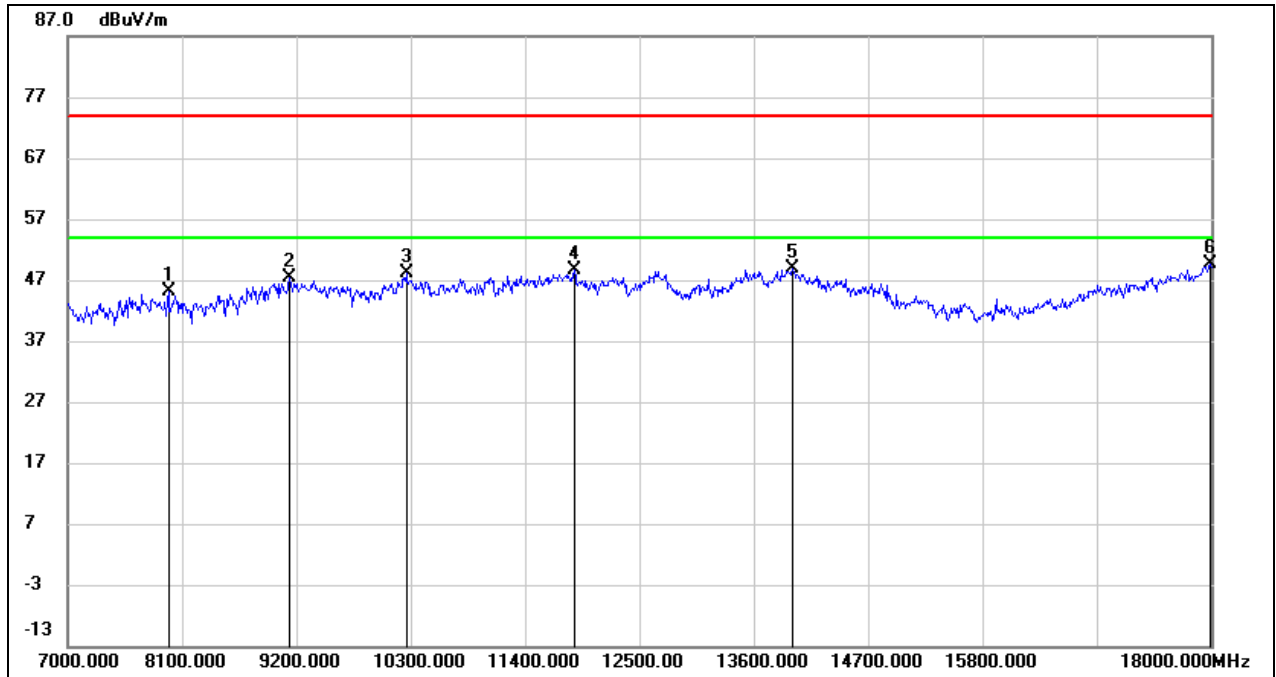

No.	Frequency (MHz)	Reading (dBuV)	Correct (dB/m)	Result (dBuV/m)	Limit (dBuV/m)	Margin (dB)	Remark
1	7968.000	38.73	6.45	45.18	74.00	-28.82	peak
2	9134.000	36.95	10.41	47.36	74.00	-26.64	peak
3	10256.000	35.83	12.31	48.14	74.00	-25.86	peak
4	11873.000	31.26	17.46	48.72	74.00	-25.28	peak
5	13974.000	27.04	21.82	48.86	74.00	-25.14	peak
6	17989.000	23.55	26.04	49.59	74.00	-24.41	peak



Test Mode:	802.11ax HE20	Channel:	5260 MHz
Polarity:	Horizontal	Test Voltage:	DC 12 V

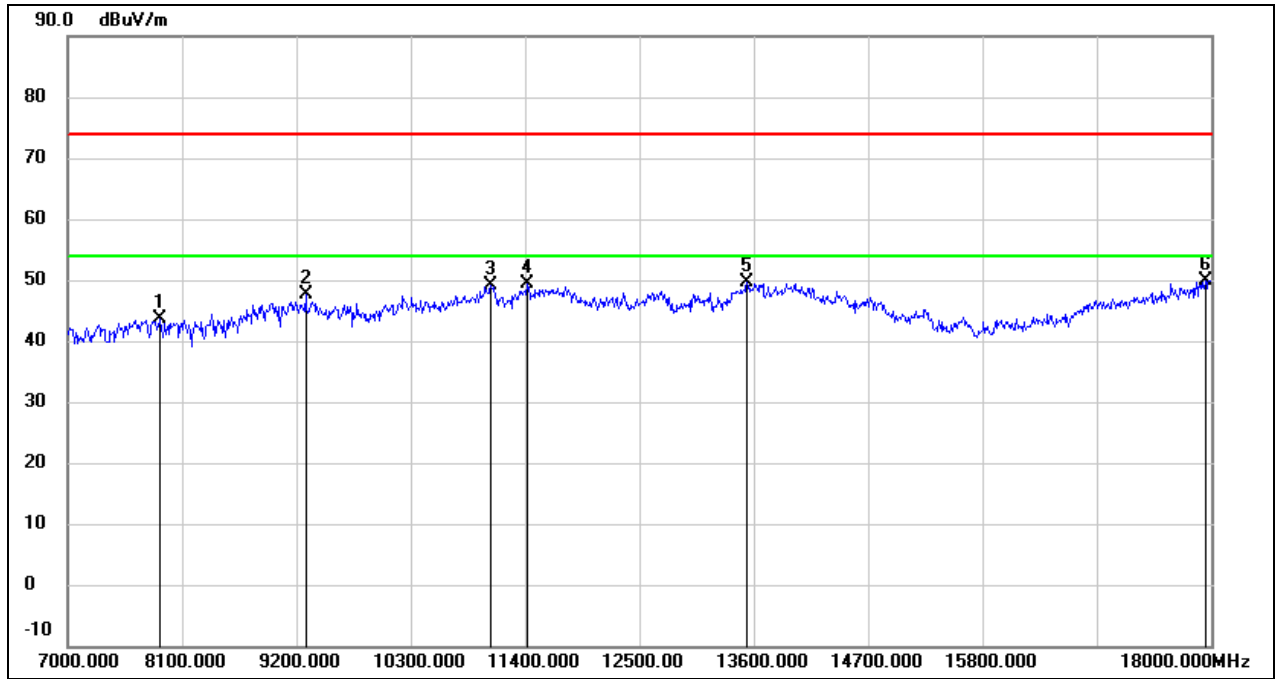

No.	Frequency (MHz)	Reading (dBuV)	Correct (dB/m)	Result (dBuV/m)	Limit (dBuV/m)	Margin (dB)	Remark
1	7880.000	37.12	6.54	43.66	74.00	-30.34	peak
2	9288.000	37.18	10.52	47.70	74.00	-26.30	peak
3	11070.000	34.21	15.01	49.22	74.00	-24.78	peak
4	11422.000	32.88	16.46	49.34	74.00	-24.66	peak
5	13534.000	29.01	20.73	49.74	74.00	-24.26	peak
6	17945.000	24.22	25.75	49.97	74.00	-24.03	peak



Test Mode:	802.11ax HE20	Channel:	5260 MHz
Polarity:	Vertical	Test Voltage:	DC 12 V

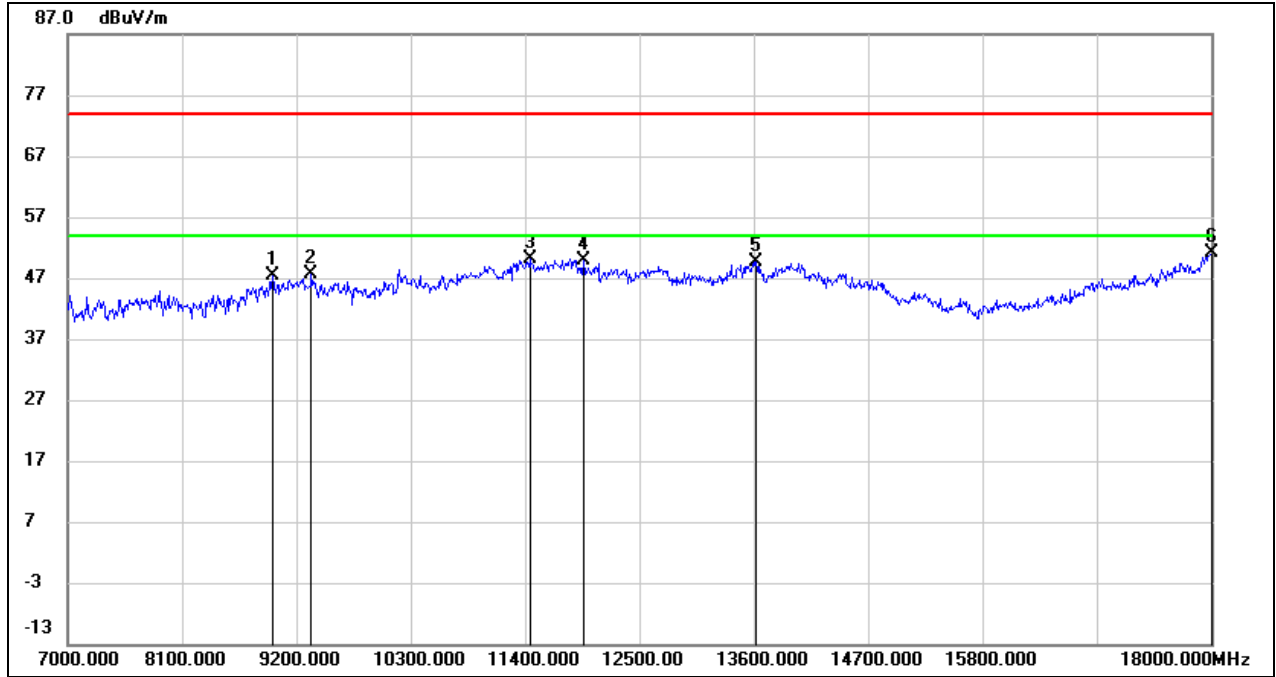

No.	Frequency (MHz)	Reading (dBuV)	Correct (dB/m)	Result (dBuV/m)	Limit (dBuV/m)	Margin (dB)	Remark
1	8969.000	37.13	10.13	47.26	74.00	-26.74	peak
2	9343.000	36.98	10.55	47.53	74.00	-26.47	peak
3	11444.000	33.71	16.53	50.24	74.00	-23.76	peak
4	11961.000	32.34	17.62	49.96	74.00	-24.04	peak
5	13622.000	28.70	20.95	49.65	74.00	-24.35	peak
6	18000.000	25.12	26.12	51.24	74.00	-22.76	peak



Test Mode:	802.11ax HE20	Channel:	5280 MHz
Polarity:	Horizontal	Test Voltage:	DC 12 V

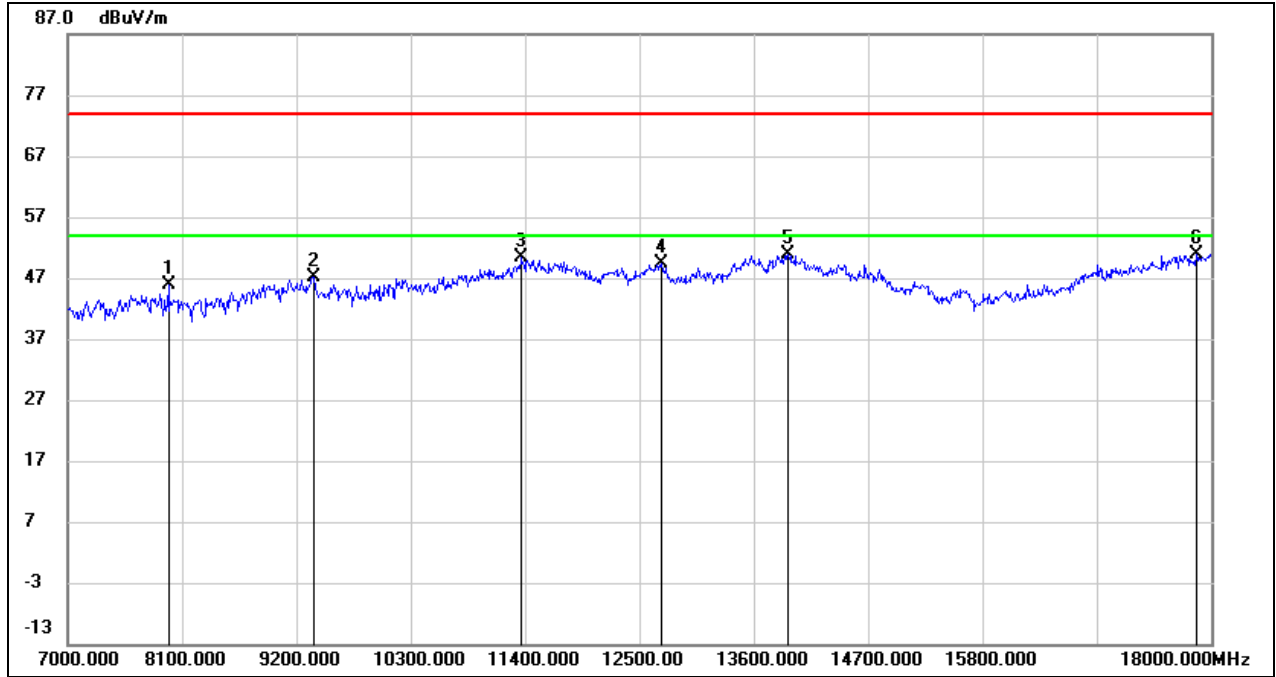

No.	Frequency (MHz)	Reading (dBuV)	Correct (dB/m)	Result (dBuV/m)	Limit (dBuV/m)	Margin (dB)	Remark
1	7968.000	39.50	6.45	45.95	74.00	-28.05	peak
2	9365.000	36.62	10.57	47.19	74.00	-26.81	peak
3	11367.000	34.13	16.22	50.35	74.00	-23.65	peak
4	12709.000	31.26	18.09	49.35	74.00	-24.65	peak
5	13930.000	29.12	21.71	50.83	74.00	-23.17	peak
6	17857.000	25.81	25.14	50.95	74.00	-23.05	peak



Test Mode:	802.11ax HE20	Channel:	5280 MHz
Polarity:	Vertical	Test Voltage:	DC 12 V

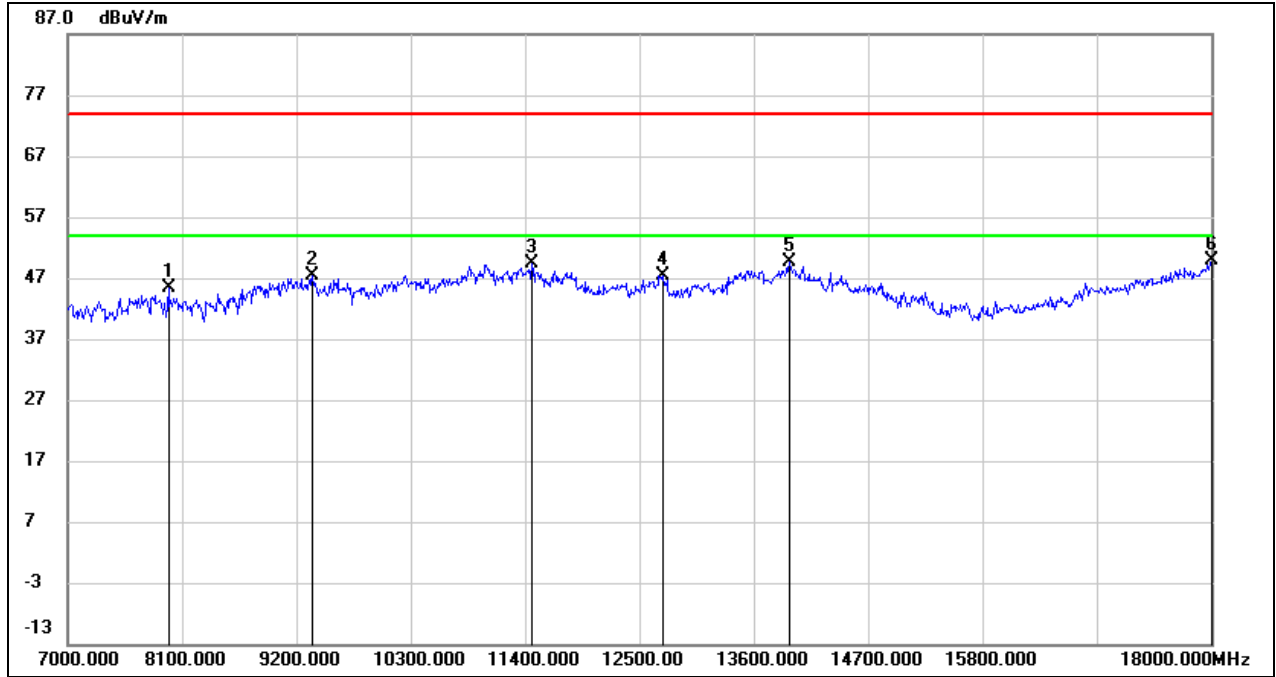

No.	Frequency (MHz)	Reading (dBuV)	Correct (dB/m)	Result (dBuV/m)	Limit (dBuV/m)	Margin (dB)	Remark
1	7968.000	38.99	6.45	45.44	74.00	-28.56	peak
2	9354.000	36.77	10.56	47.33	74.00	-26.67	peak
3	11466.000	32.71	16.63	49.34	74.00	-24.66	peak
4	12731.000	29.35	18.12	47.47	74.00	-26.53	peak
5	13941.000	27.90	21.73	49.63	74.00	-24.37	peak
6	18000.000	23.67	26.12	49.79	74.00	-24.21	peak



Test Mode:	802.11ax HE20	Channel:	5320 MHz
Polarity:	Horizontal	Test Voltage:	DC 12 V

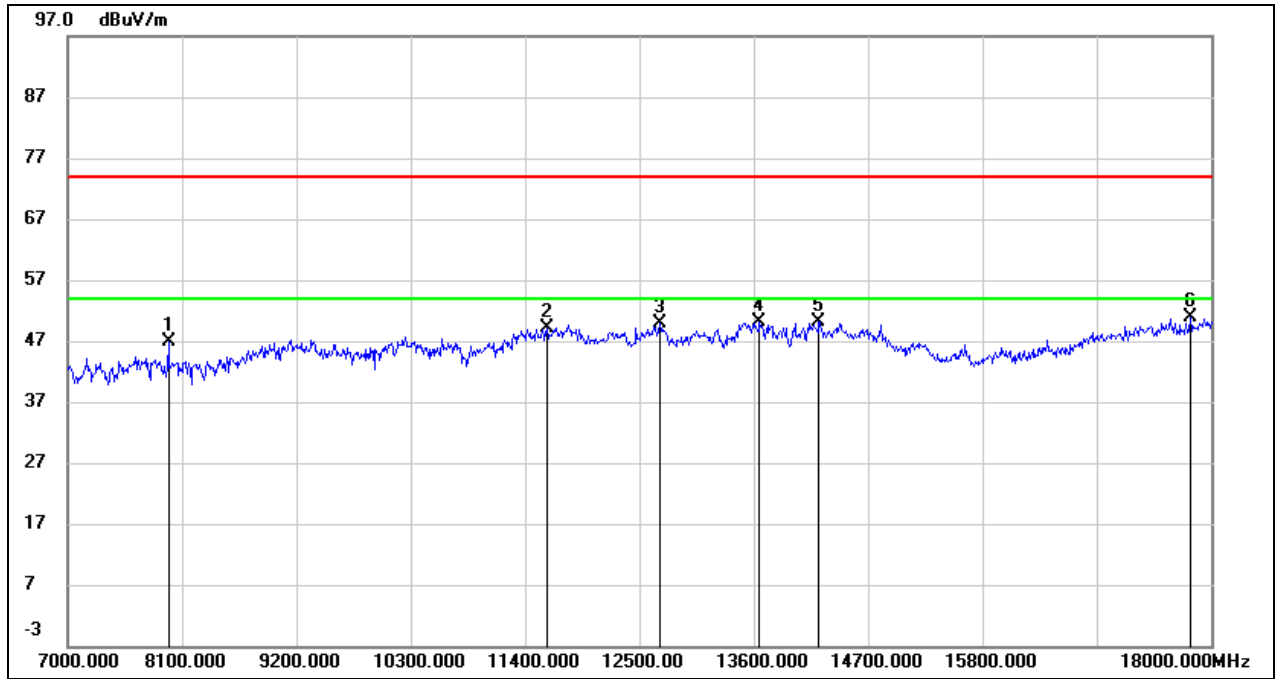

No.	Frequency (MHz)	Reading (dBuV)	Correct (dB/m)	Result (dBuV/m)	Limit (dBuV/m)	Margin (dB)	Remark
1	7968.000	40.44	6.45	46.89	74.00	-27.11	peak
2	11609.000	32.03	16.98	49.01	74.00	-24.99	peak
3	12698.000	31.87	18.08	49.95	74.00	-24.05	peak
4	13655.000	29.14	21.03	50.17	74.00	-23.83	peak
5	14227.000	29.13	20.93	50.06	74.00	-23.94	peak
6	17802.000	26.07	24.76	50.83	74.00	-23.17	peak



Test Mode:	802.11ax HE20	Channel:	5320 MHz
Polarity:	Vertical	Test Voltage:	DC 12 V

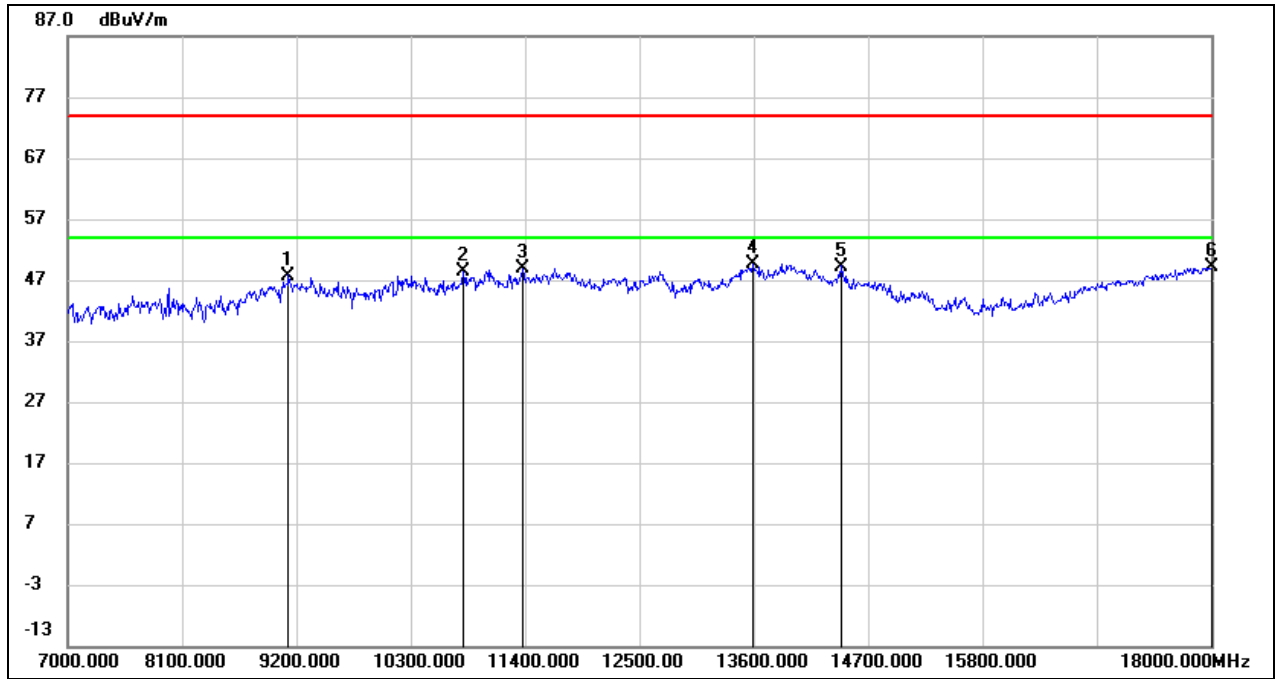

No.	Frequency (MHz)	Reading (dBuV)	Correct (dB/m)	Result (dBuV/m)	Limit (dBuV/m)	Margin (dB)	Remark
1	9123.000	37.33	10.42	47.75	74.00	-26.25	peak
2	10806.000	34.30	13.98	48.28	74.00	-25.72	peak
3	11378.000	32.59	16.26	48.85	74.00	-25.15	peak
4	13589.000	28.81	20.86	49.67	74.00	-24.33	peak
5	14436.000	29.20	20.05	49.25	74.00	-24.75	peak
6	18000.000	23.05	26.12	49.17	74.00	-24.83	peak



Test Mode:	802.11ax HE20	Channel:	5500 MHz
Polarity:	Horizontal	Test Voltage:	DC 12 V

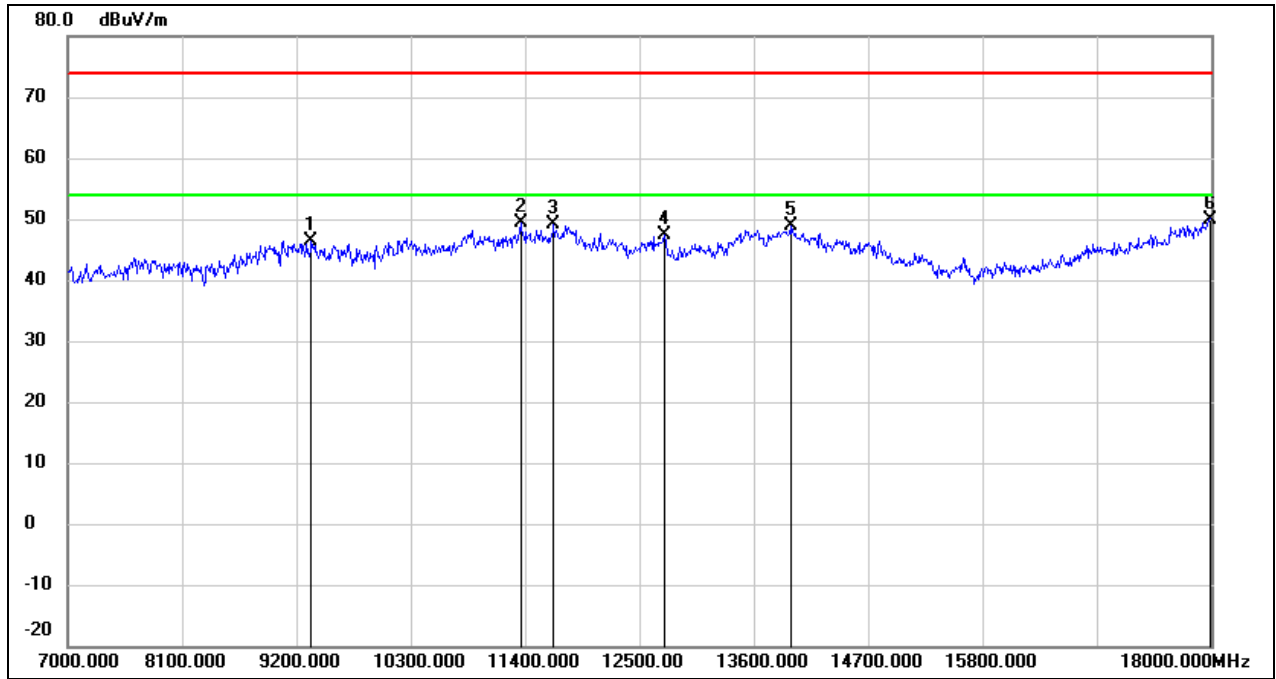

No.	Frequency (MHz)	Reading (dBuV)	Correct (dB/m)	Result (dBuV/m)	Limit (dBuV/m)	Margin (dB)	Remark
1	9343.000	35.81	10.55	46.36	74.00	-27.64	peak
2	11356.000	33.26	16.19	49.45	74.00	-24.55	peak
3	11675.000	32.15	17.10	49.25	74.00	-24.75	peak
4	12742.000	29.16	18.13	47.29	74.00	-26.71	peak
5	13952.000	27.02	21.76	48.78	74.00	-25.22	peak
6	17989.000	23.96	26.04	50.00	74.00	-24.00	peak



Test Mode:	802.11ax HE20	Channel:	5500 MHz
Polarity:	Vertical	Test Voltage:	DC 12 V

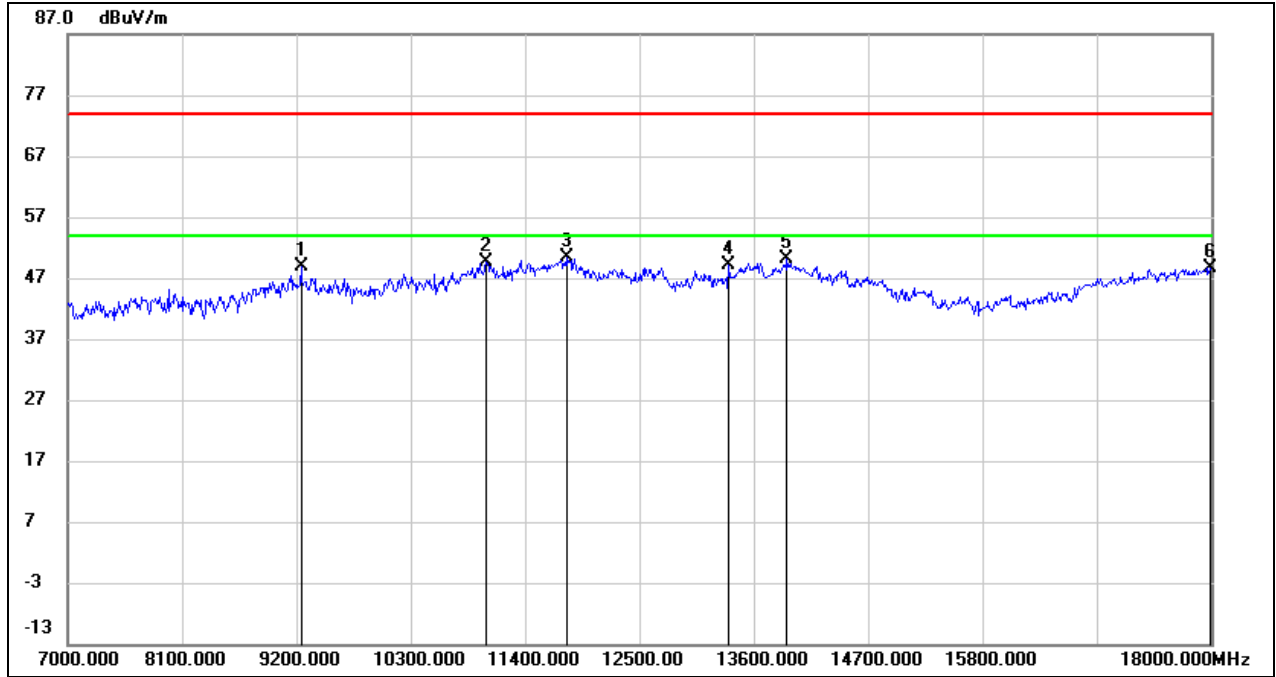

No.	Frequency (MHz)	Reading (dBuV)	Correct (dB/m)	Result (dBuV/m)	Limit (dBuV/m)	Margin (dB)	Remark
1	9244.000	38.48	10.49	48.97	74.00	-25.03	peak
2	11026.000	34.85	14.82	49.67	74.00	-24.33	peak
3	11796.000	33.05	17.32	50.37	74.00	-23.63	peak
4	13358.000	29.16	20.02	49.18	74.00	-24.82	peak
5	13919.000	28.53	21.68	50.21	74.00	-23.79	peak
6	17989.000	22.65	26.04	48.69	74.00	-25.31	peak



Test Mode:	802.11ax HE20	Channel:	5580 MHz
Polarity:	Horizontal	Test Voltage:	DC 12 V

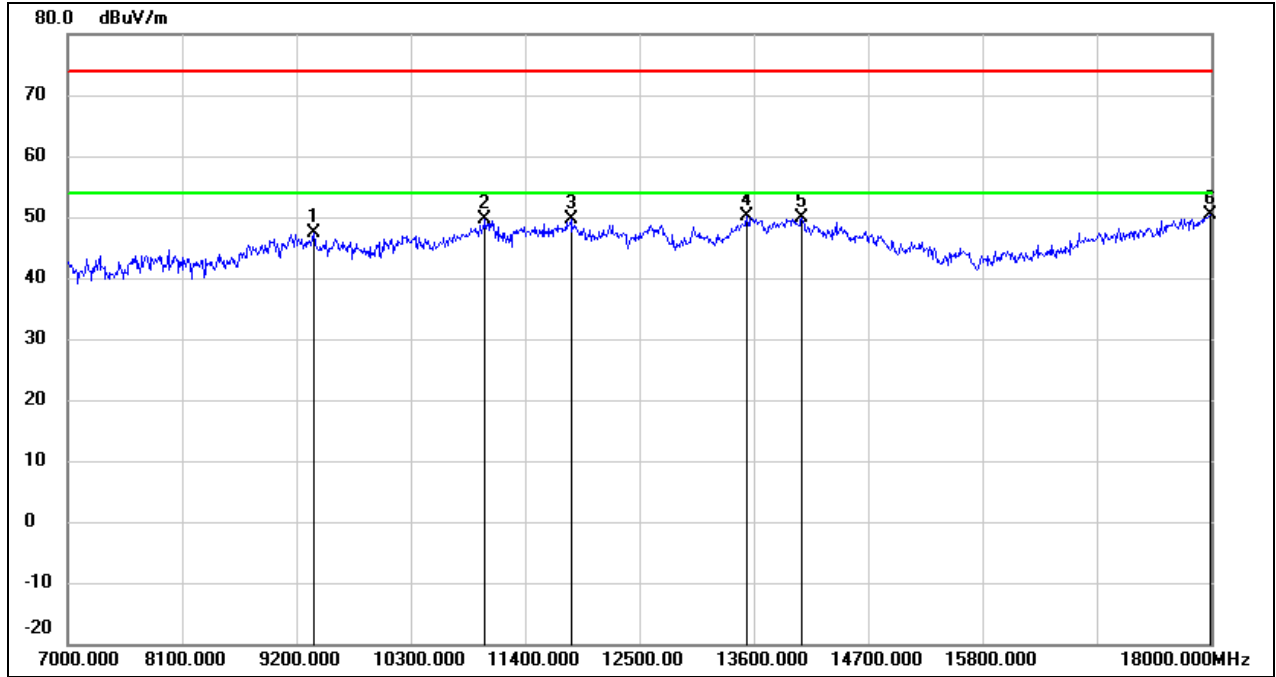

No.	Frequency (MHz)	Reading (dBuV)	Correct (dB/m)	Result (dBuV/m)	Limit (dBuV/m)	Margin (dB)	Remark
1	9365.000	36.76	10.57	47.33	74.00	-26.67	peak
2	11015.000	34.88	14.79	49.67	74.00	-24.33	peak
3	11840.000	32.16	17.40	49.56	74.00	-24.44	peak
4	13534.000	29.46	20.73	50.19	74.00	-23.81	peak
5	14062.000	28.22	21.62	49.84	74.00	-24.16	peak
6	17989.000	24.32	26.04	50.36	74.00	-23.64	peak



Test Mode:	802.11ax HE20	Channel:	5580 MHz
Polarity:	Vertical	Test Voltage:	DC 12 V

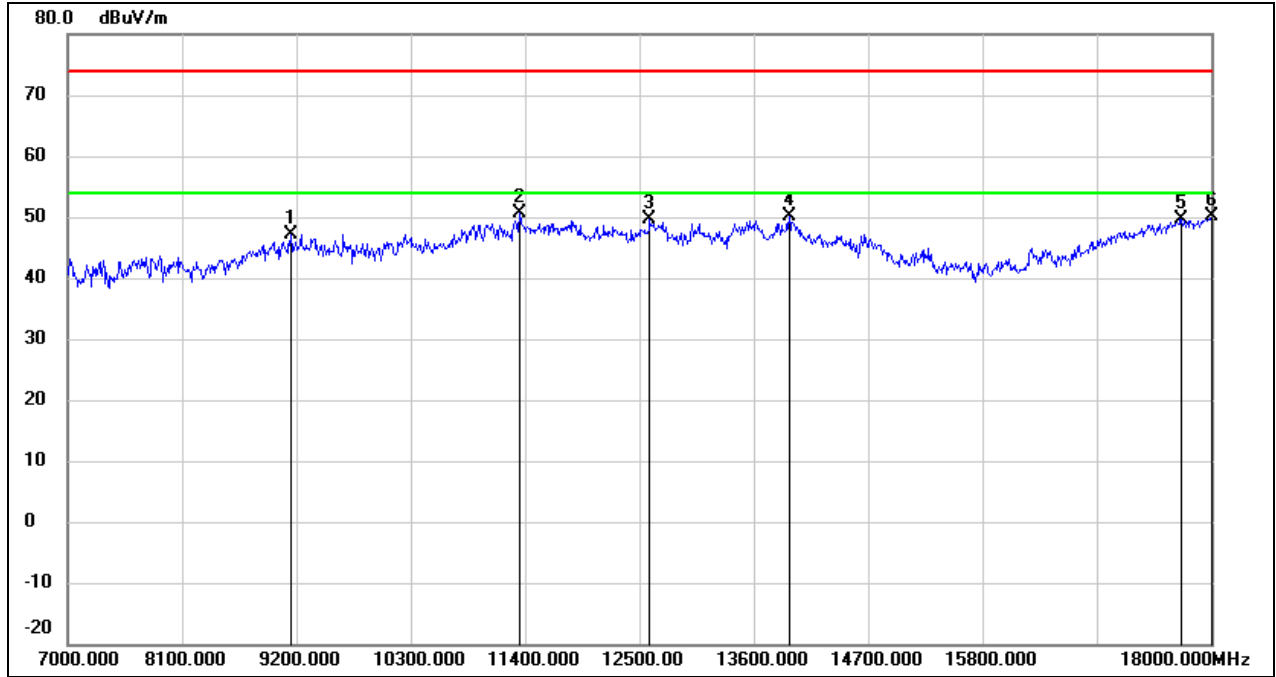

No.	Frequency (MHz)	Reading (dBuV)	Correct (dB/m)	Result (dBuV/m)	Limit (dBuV/m)	Margin (dB)	Remark
1	9145.000	36.69	10.43	47.12	74.00	-26.88	peak
2	11345.000	34.39	16.14	50.53	74.00	-23.47	peak
3	12599.000	31.60	17.95	49.55	74.00	-24.45	peak
4	13941.000	28.35	21.73	50.08	74.00	-23.92	peak
5	17714.000	25.48	24.16	49.64	74.00	-24.36	peak
6	18000.000	24.04	26.12	50.16	74.00	-23.84	peak



Test Mode:	802.11ax HE20	Channel:	5700 MHz
Polarity:	Horizontal	Test Voltage:	DC 12 V

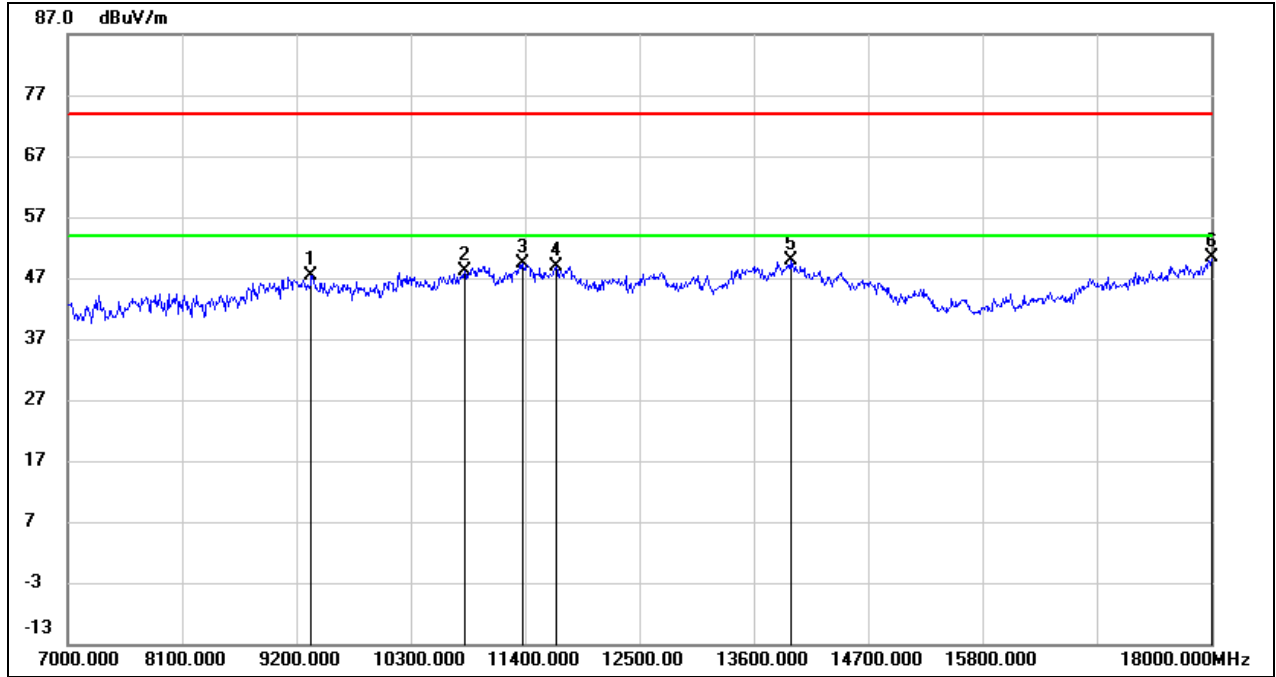

No.	Frequency (MHz)	Reading (dBuV)	Correct (dB/m)	Result (dBuV/m)	Limit (dBuV/m)	Margin (dB)	Remark
1	9343.000	36.81	10.55	47.36	74.00	-26.64	peak
2	10817.000	34.02	14.03	48.05	74.00	-25.95	peak
3	11378.000	33.07	16.26	49.33	74.00	-24.67	peak
4	11697.000	31.82	17.13	48.95	74.00	-25.05	peak
5	13952.000	28.06	21.76	49.82	74.00	-24.18	peak
6	18000.000	24.20	26.12	50.32	74.00	-23.68	peak



Test Mode:	802.11ax HE20	Channel:	5700 MHz
Polarity:	Vertical	Test Voltage:	DC 12 V

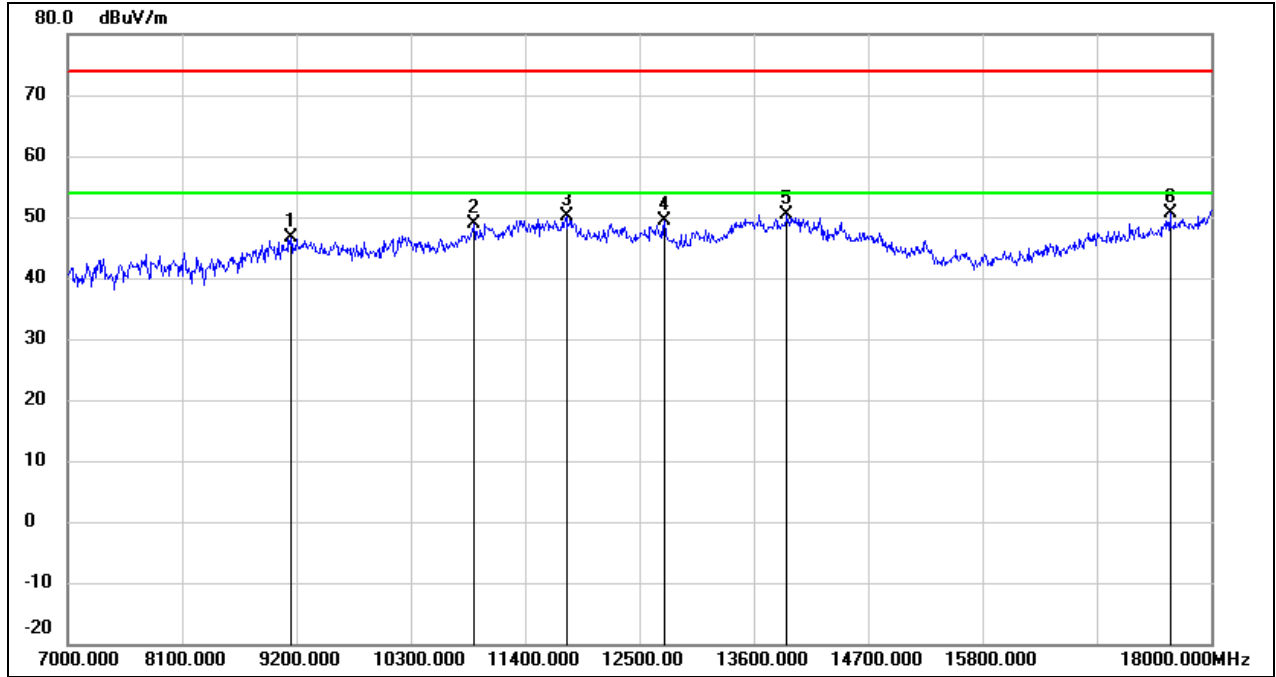

No.	Frequency (MHz)	Reading (dBuV)	Correct (dB/m)	Result (dBuV/m)	Limit (dBuV/m)	Margin (dB)	Remark
1	9145.000	36.12	10.43	46.55	74.00	-27.45	peak
2	10905.000	34.55	14.36	48.91	74.00	-25.09	peak
3	11796.000	32.81	17.32	50.13	74.00	-23.87	peak
4	12742.000	31.17	18.13	49.30	74.00	-24.70	peak
5	13919.000	28.80	21.68	50.48	74.00	-23.52	peak
6	17604.000	27.25	23.41	50.66	74.00	-23.34	peak



Test Mode:	802.11ax HE20	Channel:	5720 MHz
Polarity:	Horizontal	Test Voltage:	DC 12 V

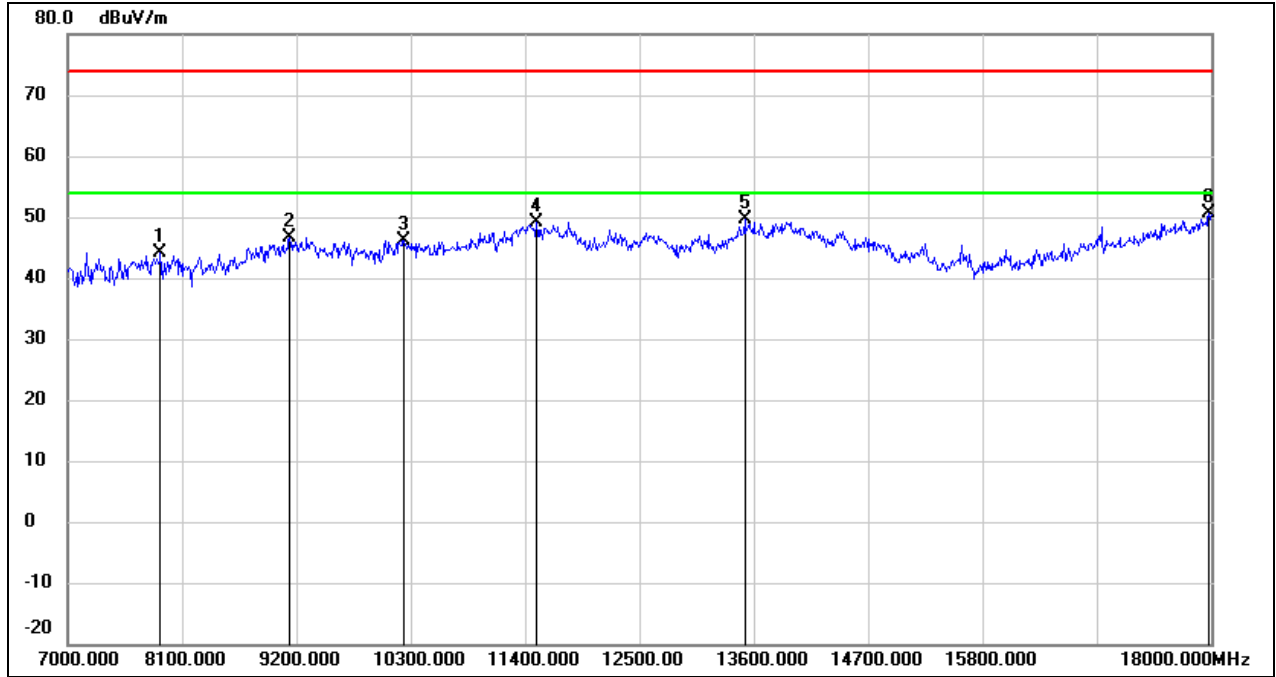

No.	Frequency (MHz)	Reading (dBuV)	Correct (dB/m)	Result (dBuV/m)	Limit (dBuV/m)	Margin (dB)	Remark
1	7891.000	37.61	6.52	44.13	74.00	-29.87	peak
2	9134.000	36.18	10.41	46.59	74.00	-27.41	peak
3	10234.000	33.99	12.26	46.25	74.00	-27.75	peak
4	11510.000	32.30	16.79	49.09	74.00	-24.91	peak
5	13512.000	28.94	20.68	49.62	74.00	-24.38	peak
6	17978.000	24.55	25.97	50.52	74.00	-23.48	peak



Test Mode:	802.11ax HE20	Channel:	5720 MHz
Polarity:	Vertical	Test Voltage:	DC 12 V

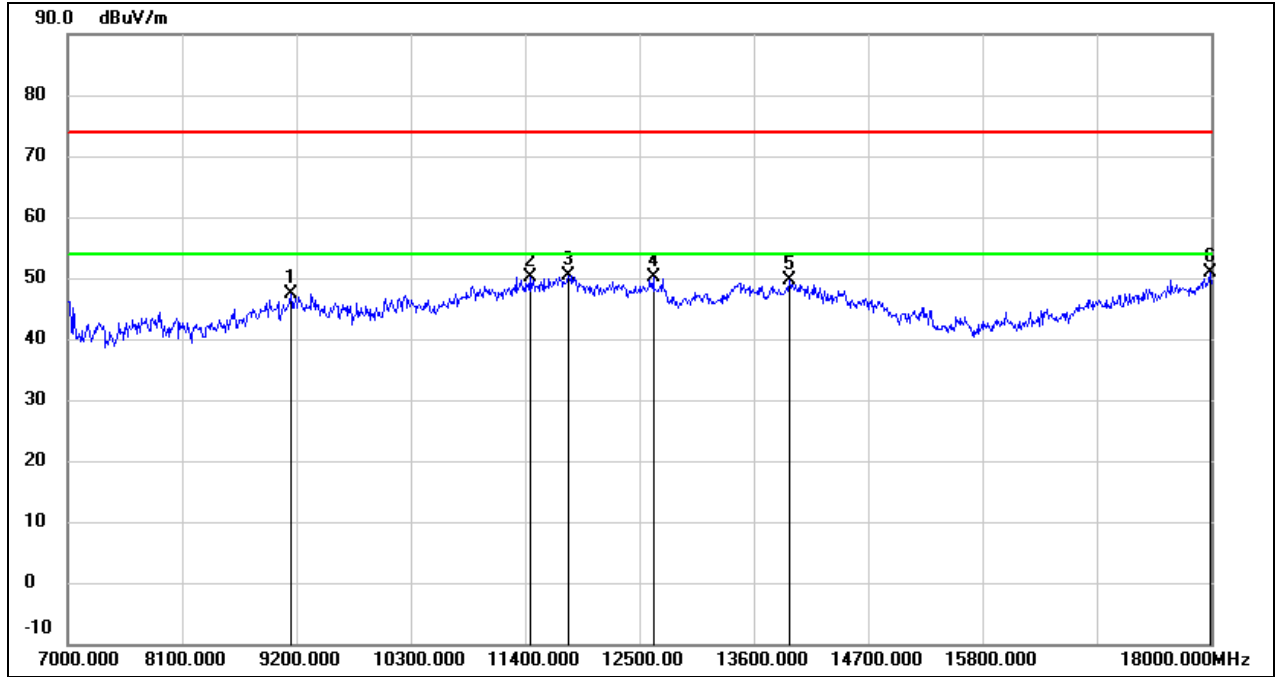

No.	Frequency (MHz)	Reading (dBuV)	Correct (dB/m)	Result (dBuV/m)	Limit (dBuV/m)	Margin (dB)	Remark
1	9145.000	37.06	10.43	47.49	74.00	-26.51	peak
2	11444.000	33.57	16.53	50.10	74.00	-23.90	peak
3	11818.000	33.12	17.36	50.48	74.00	-23.52	peak
4	12632.000	32.11	17.99	50.10	74.00	-23.90	peak
5	13941.000	27.92	21.73	49.65	74.00	-24.35	peak
6	17989.000	24.87	26.04	50.91	74.00	-23.09	peak



Test Mode:	802.11ax HE40	Channel:	5270 MHz
Polarity:	Horizontal	Test Voltage:	DC 12 V

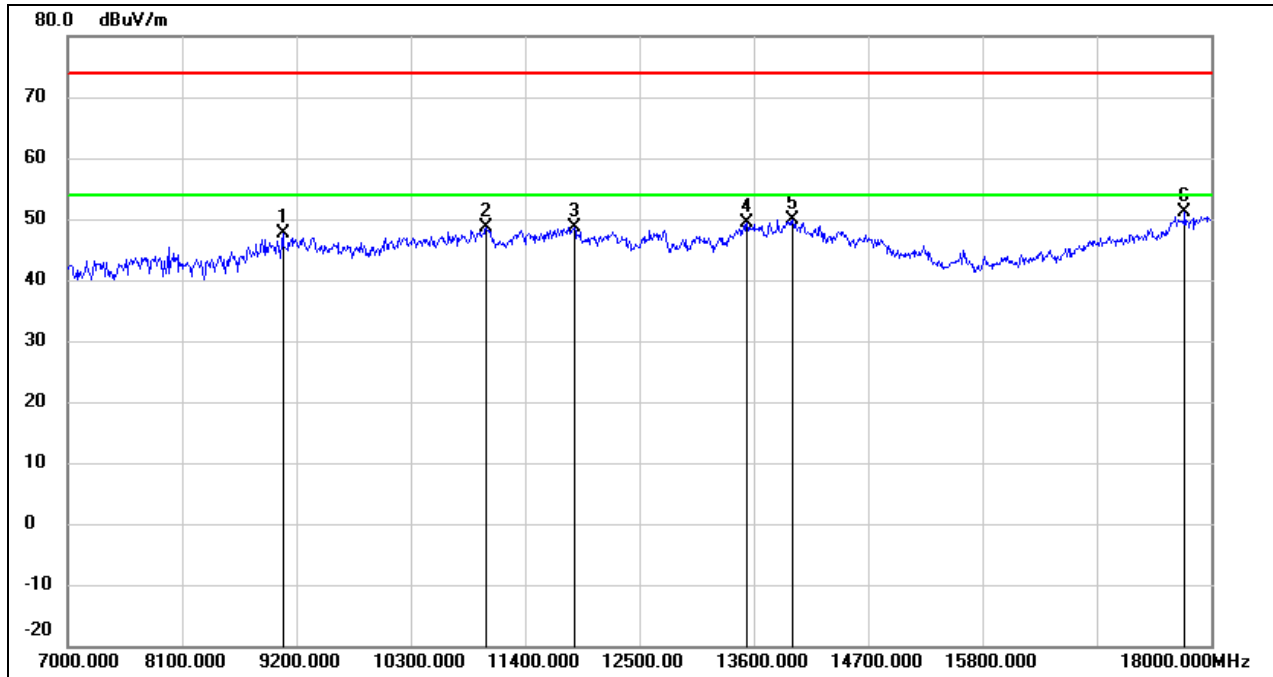

No.	Frequency (MHz)	Reading (dBuV)	Correct (dB/m)	Result (dBuV/m)	Limit (dBuV/m)	Margin (dB)	Remark
1	9068.000	37.21	10.39	47.60	74.00	-26.40	peak
2	11026.000	33.76	14.82	48.58	74.00	-25.42	peak
3	11873.000	31.06	17.46	48.52	74.00	-25.48	peak
4	13534.000	28.65	20.73	49.38	74.00	-24.62	peak
5	13974.000	28.03	21.82	49.85	74.00	-24.15	peak
6	17747.000	26.63	24.39	51.02	74.00	-22.98	peak



Test Mode:	802.11ax HE40	Channel:	5270 MHz
Polarity:	Vertical	Test Voltage:	DC 12 V

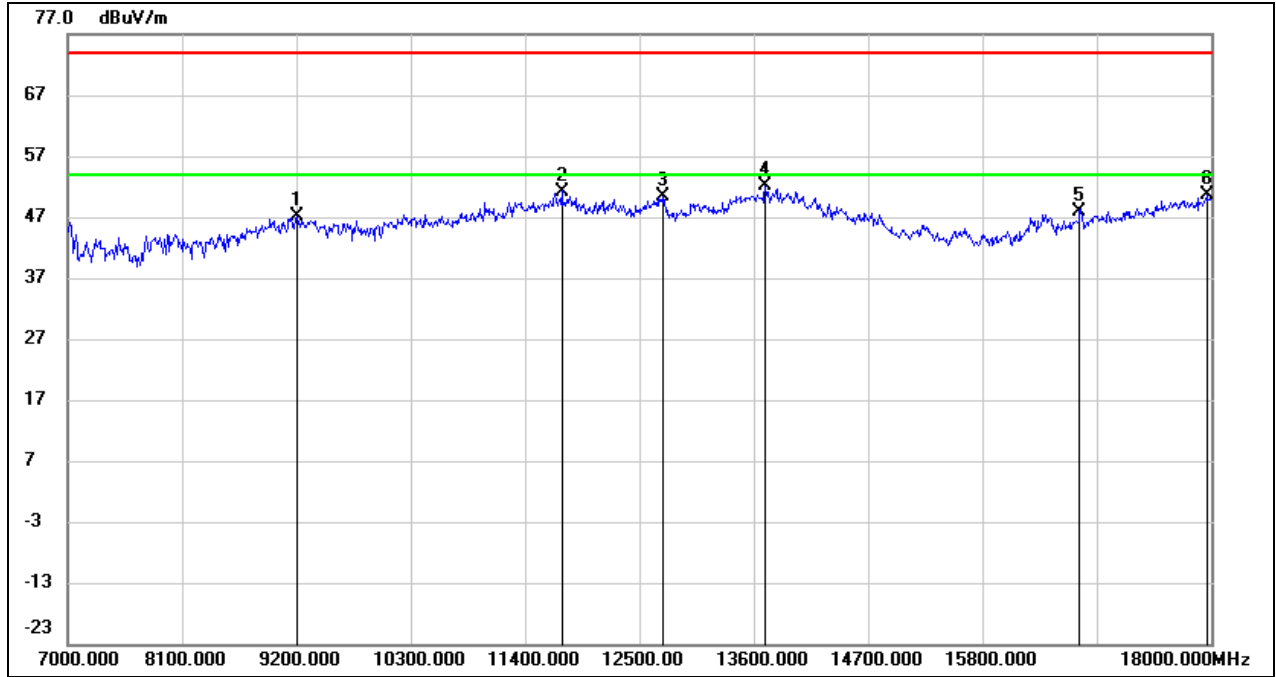

No.	Frequency (MHz)	Reading (dBuV)	Correct (dB/m)	Result (dBuV/m)	Limit (dBuV/m)	Margin (dB)	Remark
1	9200.000	36.67	10.46	47.13	74.00	-26.87	peak
2	11752.000	34.01	17.24	51.25	74.00	-22.75	peak
3	12731.000	32.36	18.12	50.48	74.00	-23.52	peak
4	13710.000	30.86	21.16	52.02	74.00	-21.98	peak
5	16735.000	28.46	19.41	47.87	74.00	-26.13	peak
6	17956.000	24.77	25.82	50.59	74.00	-23.41	peak



Test Mode:	802.11ax HE40	Channel:	5310 MHz
Polarity:	Horizontal	Test Voltage:	DC 12 V

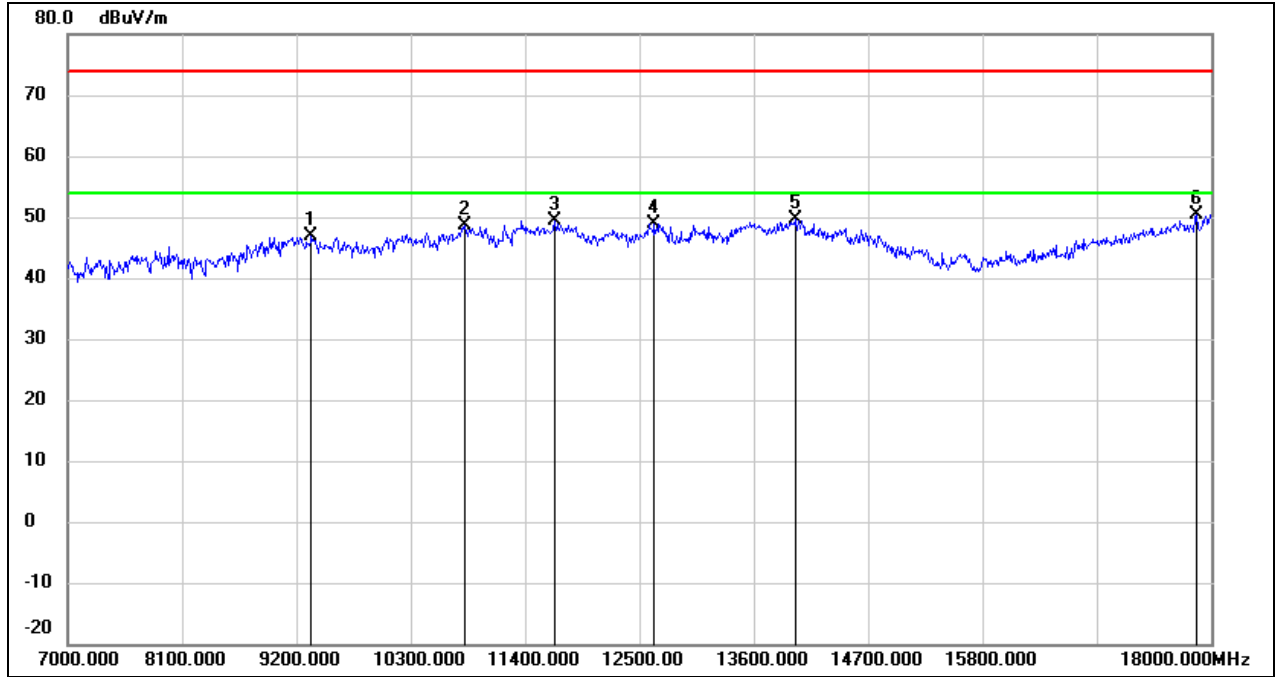

No.	Frequency (MHz)	Reading (dBuV)	Correct (dB/m)	Result (dBuV/m)	Limit (dBuV/m)	Margin (dB)	Remark
1	9343.000	36.28	10.55	46.83	74.00	-27.17	peak
2	10817.000	34.61	14.03	48.64	74.00	-25.36	peak
3	11686.000	32.35	17.12	49.47	74.00	-24.53	peak
4	12643.000	30.87	18.01	48.88	74.00	-25.12	peak
5	13996.000	27.68	21.87	49.55	74.00	-24.45	peak
6	17857.000	25.26	25.14	50.40	74.00	-23.60	peak



Test Mode:	802.11ax HE40	Channel:	5310 MHz
Polarity:	Vertical	Test Voltage:	DC 12 V

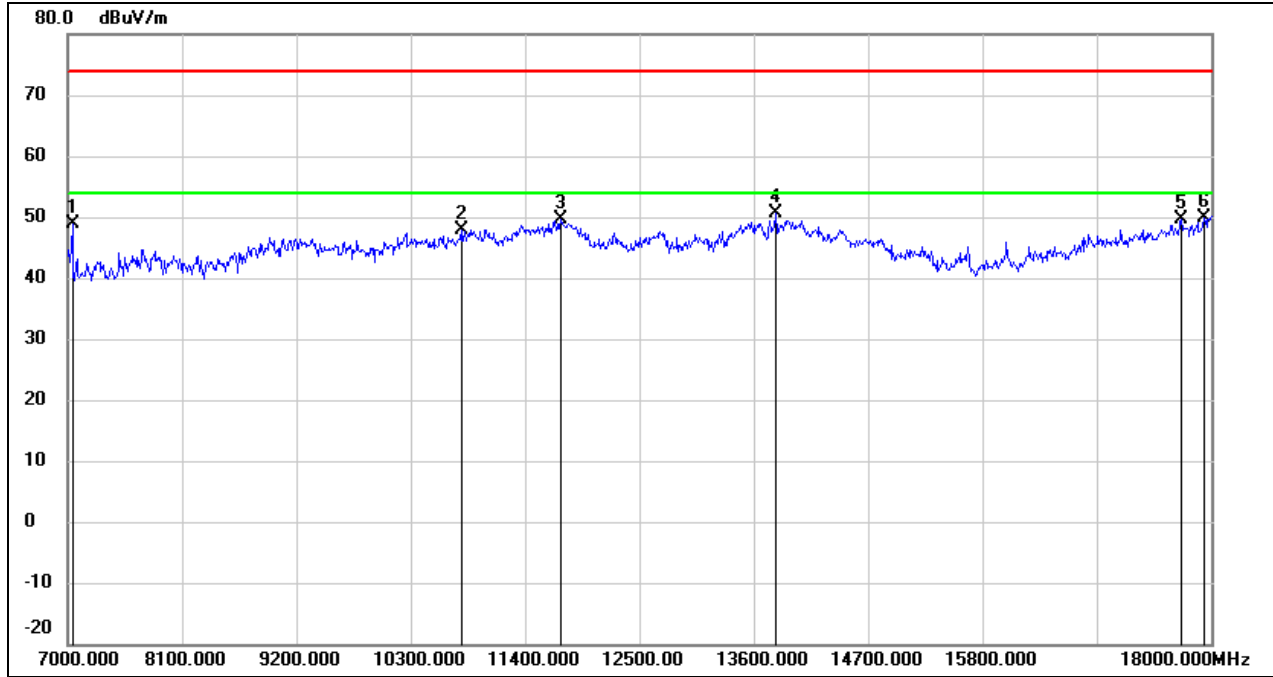

No.	Frequency (MHz)	Reading (dBuV)	Correct (dB/m)	Result (dBuV/m)	Limit (dBuV/m)	Margin (dB)	Remark
1	7044.000	41.90	7.04	48.94	74.00	-25.06	peak
2	10784.000	33.99	13.91	47.90	74.00	-26.10	peak
3	11741.000	32.35	17.22	49.57	74.00	-24.43	peak
4	13809.000	29.29	21.41	50.70	74.00	-23.30	peak
5	17714.000	25.41	24.16	49.57	74.00	-24.43	peak
6	17934.000	24.14	25.67	49.81	74.00	-24.19	peak



Test Mode:	802.11ax HE40	Channel:	5510 MHz
Polarity:	Horizontal	Test Voltage:	DC 12 V

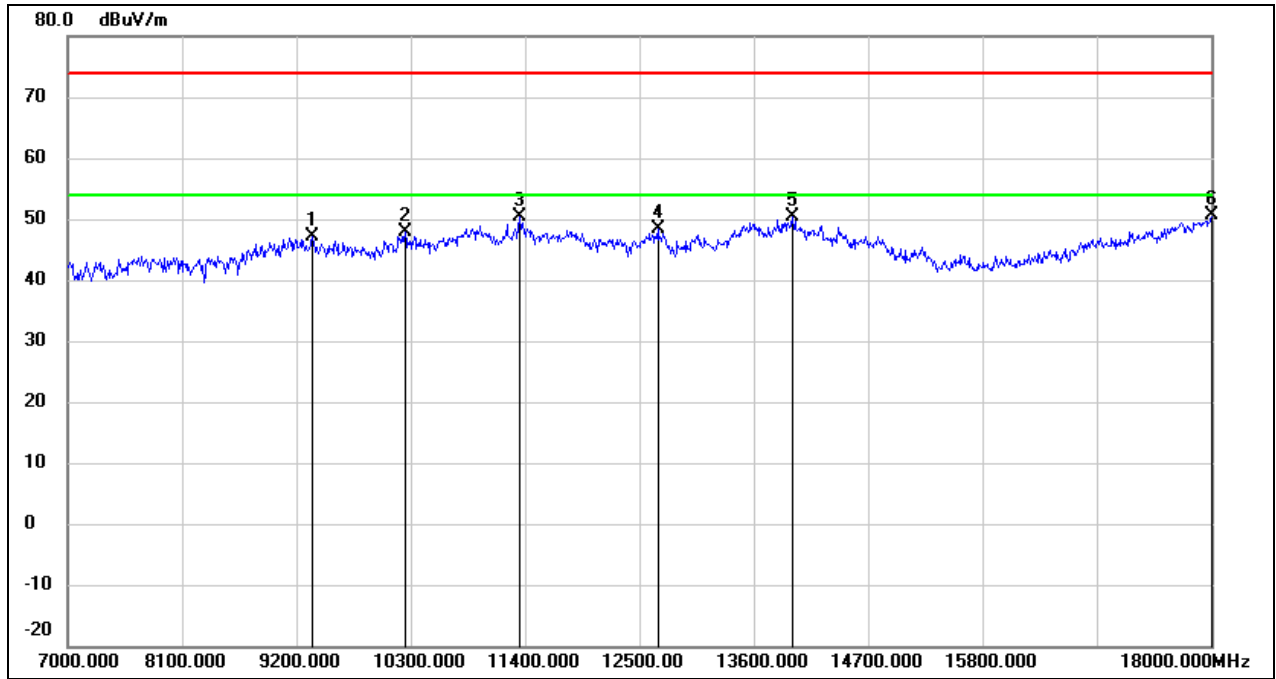

No.	Frequency (MHz)	Reading (dBuV)	Correct (dB/m)	Result (dBuV/m)	Limit (dBuV/m)	Margin (dB)	Remark
1	9354.000	36.57	10.56	47.13	74.00	-26.87	peak
2	10245.000	35.62	12.28	47.90	74.00	-26.10	peak
3	11345.000	34.26	16.14	50.40	74.00	-23.60	peak
4	12676.000	30.35	18.05	48.40	74.00	-25.60	peak
5	13974.000	28.45	21.82	50.27	74.00	-23.73	peak
6	18000.000	24.54	26.12	50.66	74.00	-23.34	peak



Test Mode:	802.11ax HE40	Channel:	5510 MHz
Polarity:	Vertical	Test Voltage:	DC 12 V

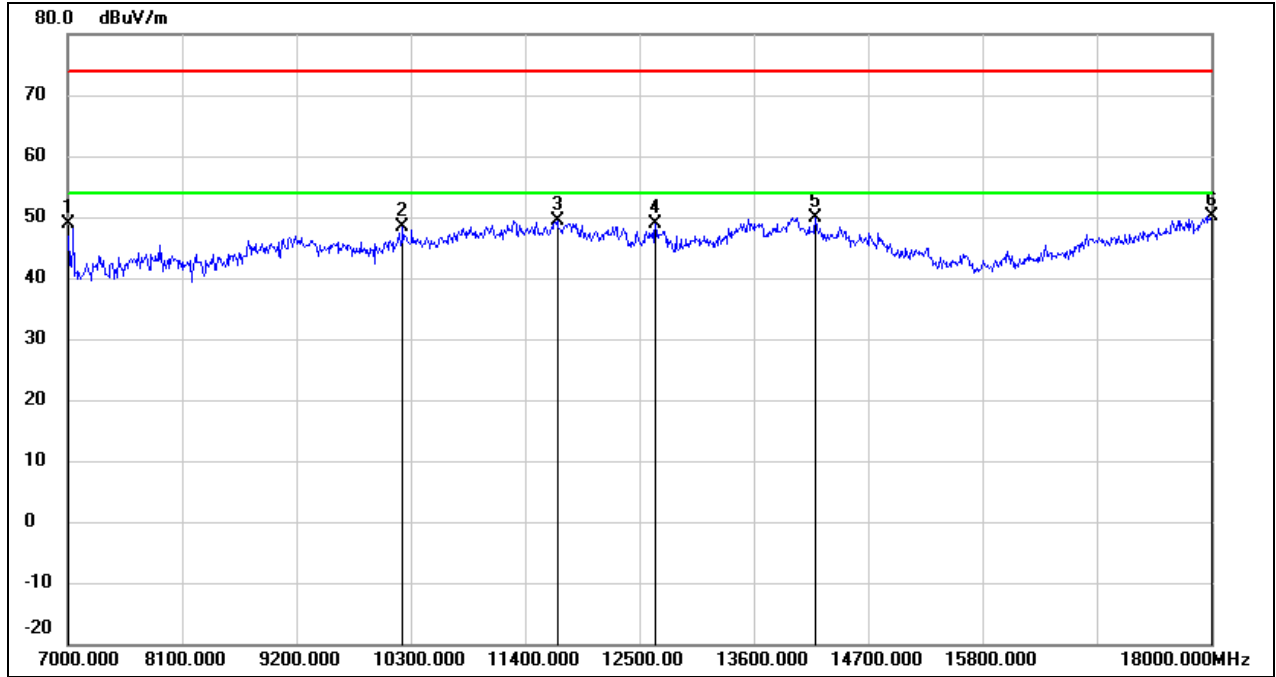

No.	Frequency (MHz)	Reading (dBuV)	Correct (dB/m)	Result (dBuV/m)	Limit (dBuV/m)	Margin (dB)	Remark
1	7000.000	41.83	7.05	48.88	74.00	-25.12	peak
2	10223.000	36.02	12.24	48.26	74.00	-25.74	peak
3	11708.000	32.25	17.16	49.41	74.00	-24.59	peak
4	12654.000	30.84	18.01	48.85	74.00	-25.15	peak
5	14194.000	28.75	21.07	49.82	74.00	-24.18	peak
6	18000.000	23.97	26.12	50.09	74.00	-23.91	peak



Test Mode:	802.11ax HE40	Channel:	5590 MHz
Polarity:	Horizontal	Test Voltage:	DC 12 V

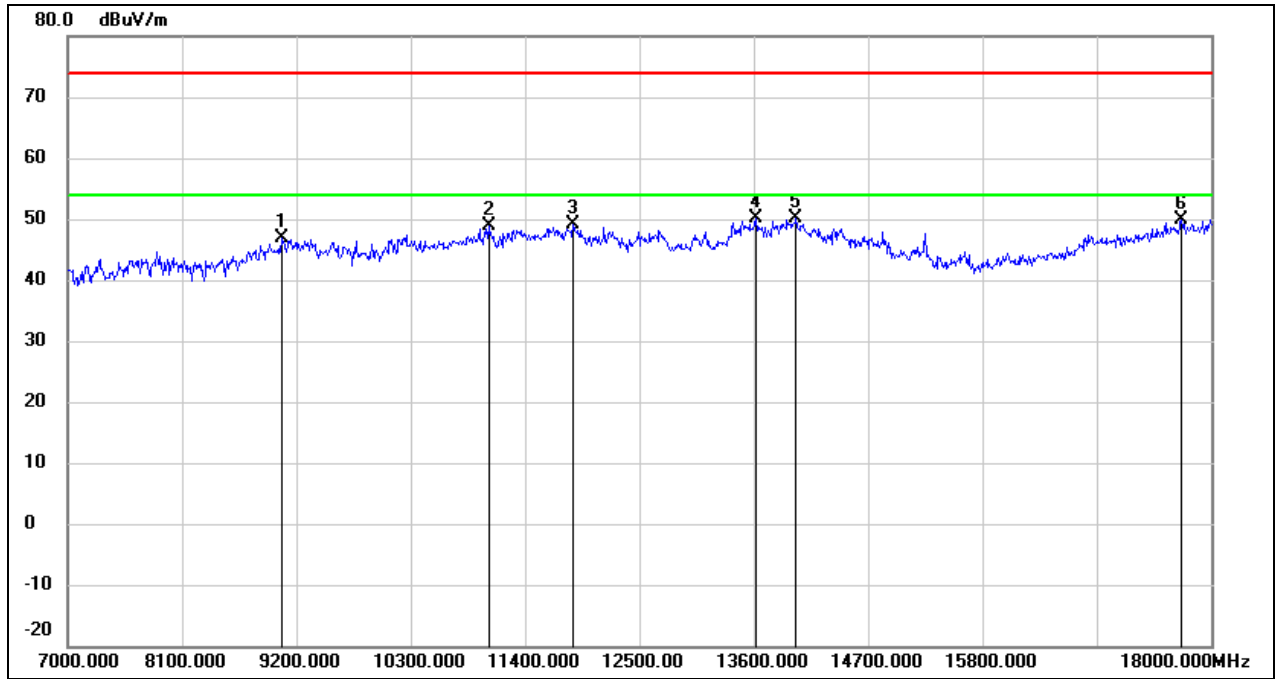

No.	Frequency (MHz)	Reading (dBuV)	Correct (dB/m)	Result (dBuV/m)	Limit (dBuV/m)	Margin (dB)	Remark
1	9057.000	36.40	10.38	46.78	74.00	-27.22	peak
2	11048.000	33.87	14.91	48.78	74.00	-25.22	peak
3	11862.000	31.78	17.45	49.23	74.00	-24.77	peak
4	13622.000	29.12	20.95	50.07	74.00	-23.93	peak
5	14007.000	28.25	21.85	50.10	74.00	-23.90	peak
6	17714.000	25.67	24.16	49.83	74.00	-24.17	peak



Test Mode:	802.11ax HE40	Channel:	5590 MHz
Polarity:	Vertical	Test Voltage:	DC 12 V

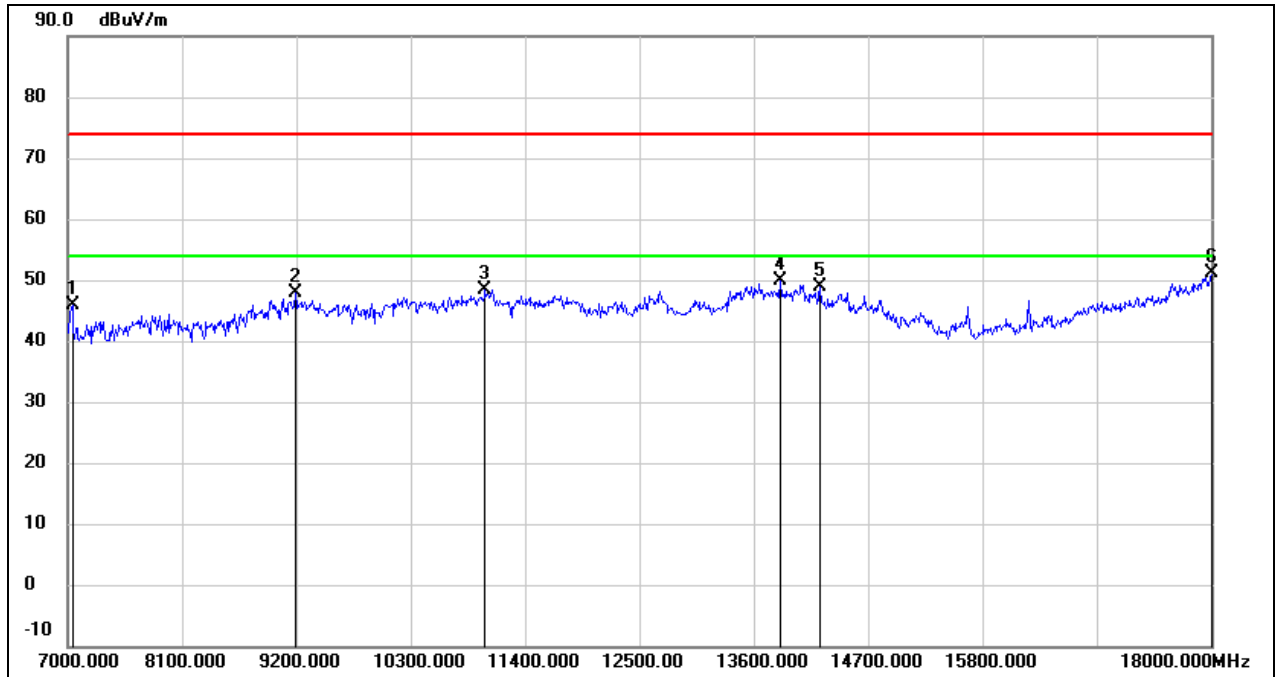

No.	Frequency (MHz)	Reading (dBuV)	Correct (dB/m)	Result (dBuV/m)	Limit (dBuV/m)	Margin (dB)	Remark
1	7044.000	38.80	7.04	45.84	74.00	-28.16	peak
2	9189.000	37.43	10.46	47.89	74.00	-26.11	peak
3	11015.000	33.68	14.79	48.47	74.00	-25.53	peak
4	13853.000	28.41	21.52	49.93	74.00	-24.07	peak
5	14238.000	27.95	20.88	48.83	74.00	-25.17	peak
6	18000.000	24.99	26.12	51.11	74.00	-22.89	peak



Test Mode:	802.11ax HE40	Channel:	5670 MHz
Polarity:	Horizontal	Test Voltage:	DC 12 V

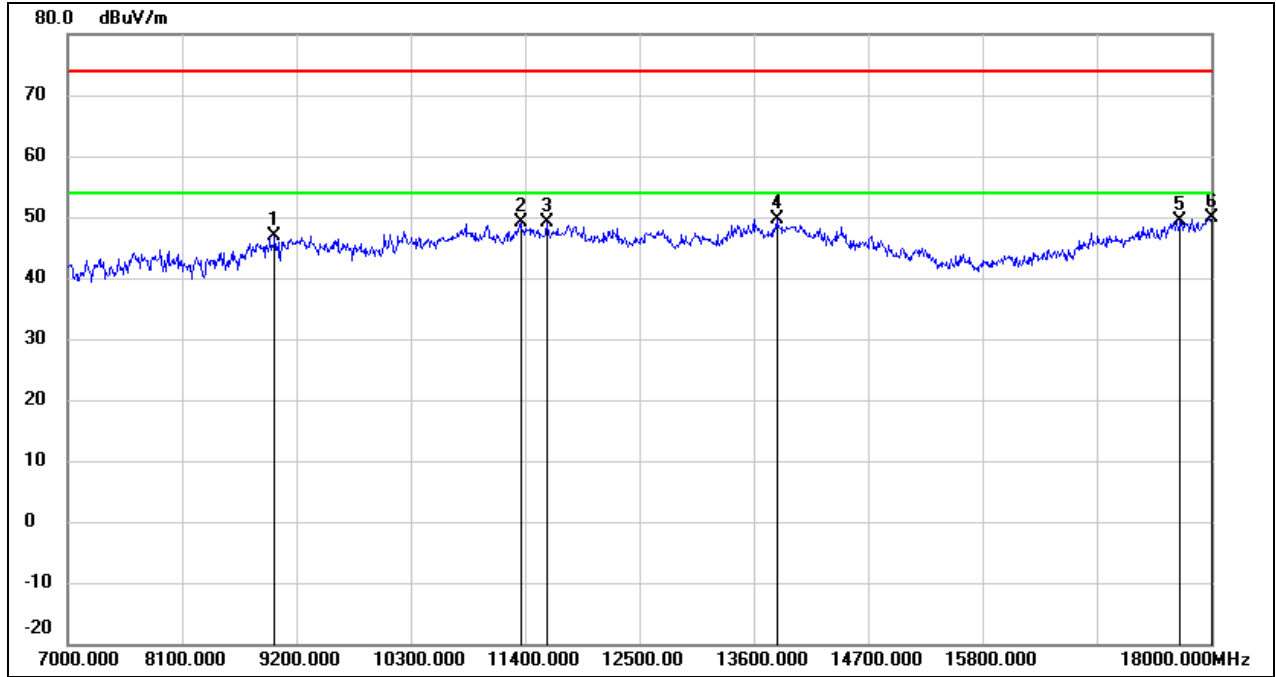

No.	Frequency (MHz)	Reading (dBuV)	Correct (dB/m)	Result (dBuV/m)	Limit (dBuV/m)	Margin (dB)	Remark
1	8991.000	36.53	10.28	46.81	74.00	-27.19	peak
2	11356.000	32.87	16.19	49.06	74.00	-24.94	peak
3	11609.000	32.04	16.98	49.02	74.00	-24.98	peak
4	13820.000	28.21	21.43	49.64	74.00	-24.36	peak
5	17703.000	25.22	24.09	49.31	74.00	-24.69	peak
6	18000.000	23.74	26.12	49.86	74.00	-24.14	peak



Test Mode:	802.11ax HE40	Channel:	5670 MHz
Polarity:	Vertical	Test Voltage:	DC 12 V

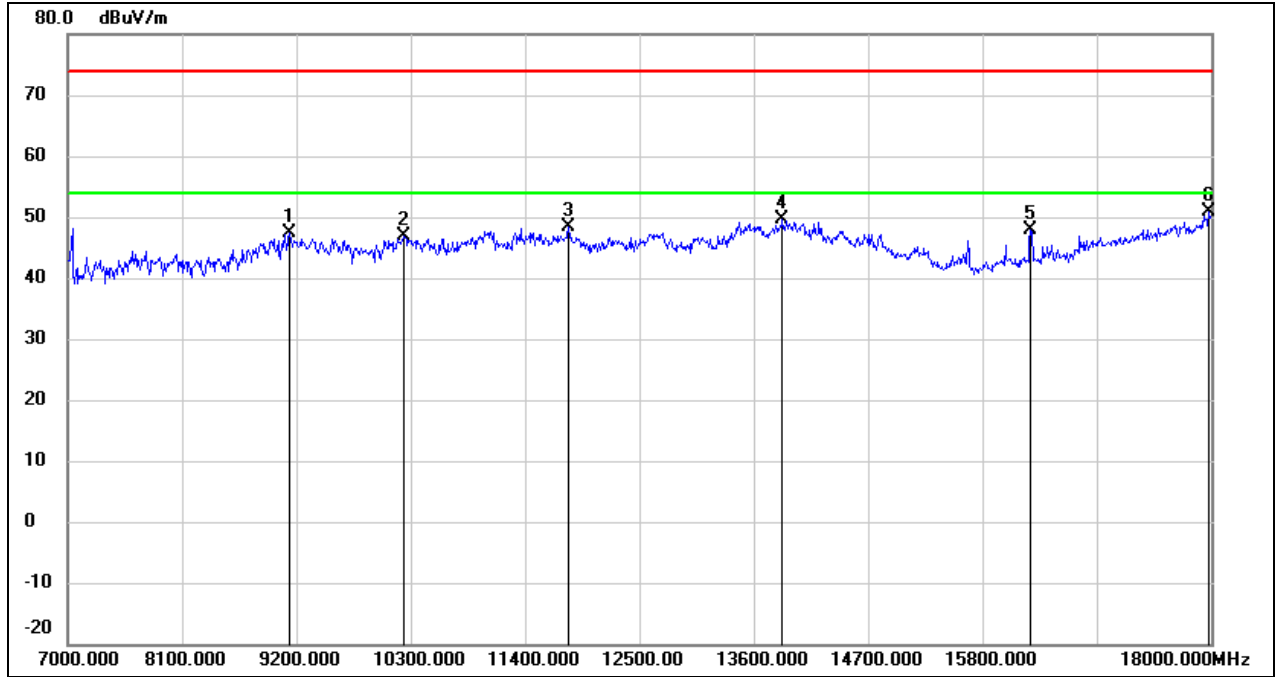

No.	Frequency (MHz)	Reading (dBuV)	Correct (dB/m)	Result (dBuV/m)	Limit (dBuV/m)	Margin (dB)	Remark
1	9134.000	37.00	10.41	47.41	74.00	-26.59	peak
2	10234.000	34.66	12.26	46.92	74.00	-27.08	peak
3	11818.000	30.99	17.36	48.35	74.00	-25.65	peak
4	13875.000	27.94	21.57	49.51	74.00	-24.49	peak
5	16262.000	30.08	17.68	47.76	74.00	-26.24	peak
6	17978.000	24.91	25.97	50.88	74.00	-23.12	peak



Test Mode:	802.11ax HE40	Channel:	5710 MHz
Polarity:	Horizontal	Test Voltage:	DC 12 V

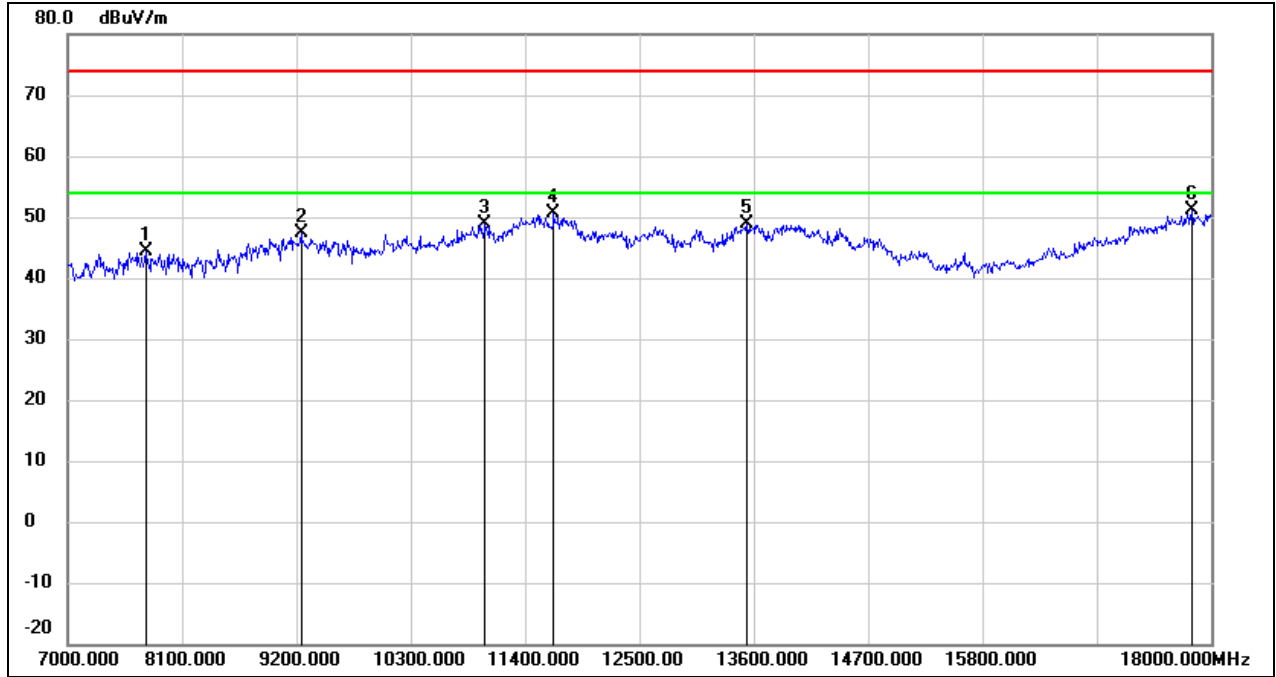

No.	Frequency (MHz)	Reading (dBuV)	Correct (dB/m)	Result (dBuV/m)	Limit (dBuV/m)	Margin (dB)	Remark
1	7748.000	37.83	6.66	44.49	74.00	-29.51	peak
2	9244.000	36.98	10.49	47.47	74.00	-26.53	peak
3	11015.000	33.98	14.79	48.77	74.00	-25.23	peak
4	11675.000	33.64	17.10	50.74	74.00	-23.26	peak
5	13534.000	28.23	20.73	48.96	74.00	-25.04	peak
6	17813.000	26.22	24.84	51.06	74.00	-22.94	peak



Test Mode:	802.11ax HE40	Channel:	5710 MHz
Polarity:	Vertical	Test Voltage:	DC 12 V

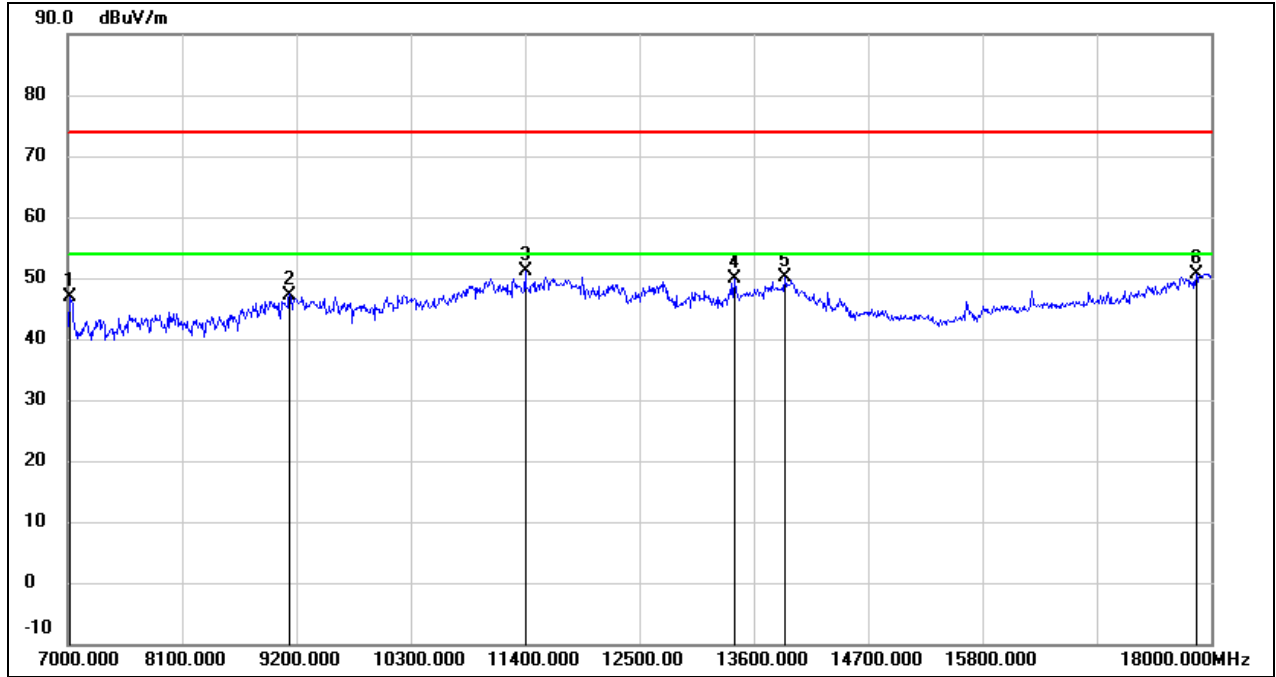

No.	Frequency (MHz)	Reading (dBuV)	Correct (dB/m)	Result (dBuV/m)	Limit (dBuV/m)	Margin (dB)	Remark
1	7022.000	39.84	7.05	46.89	74.00	-27.11	peak
2	9134.000	36.84	10.41	47.25	74.00	-26.75	peak
3	11400.000	34.78	16.36	51.14	74.00	-22.86	peak
4	13413.000	29.68	20.26	49.94	74.00	-24.06	peak
5	13897.000	28.62	21.62	50.24	74.00	-23.76	peak
6	17857.000	25.61	25.14	50.75	74.00	-23.25	peak



Test Mode:	802.11ax HE80	Channel:	5290 MHz
Polarity:	Horizontal	Test Voltage:	DC 12 V

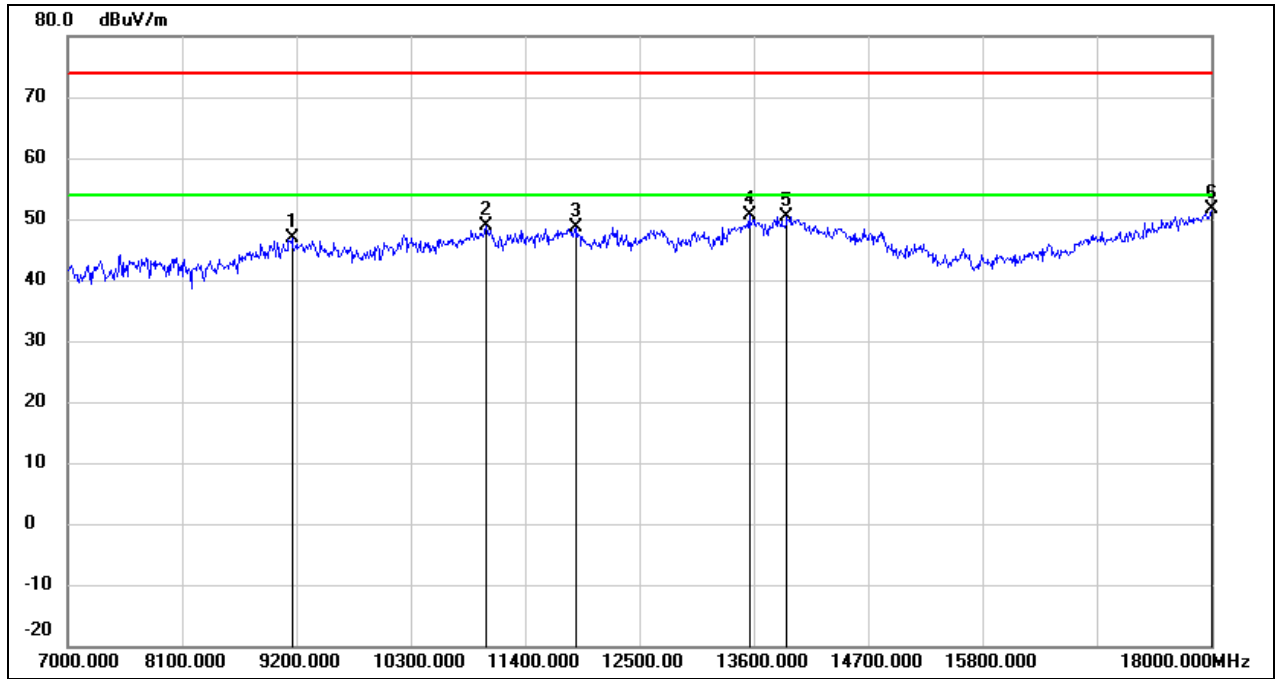

No.	Frequency (MHz)	Reading (dBuV)	Correct (dB/m)	Result (dBuV/m)	Limit (dBuV/m)	Margin (dB)	Remark
1	9156.000	36.35	10.44	46.79	74.00	-27.21	peak
2	11026.000	34.09	14.82	48.91	74.00	-25.09	peak
3	11895.000	31.14	17.51	48.65	74.00	-25.35	peak
4	13556.000	29.83	20.78	50.61	74.00	-23.39	peak
5	13919.000	28.66	21.68	50.34	74.00	-23.66	peak
6	18000.000	25.41	26.12	51.53	74.00	-22.47	peak



Test Mode:	802.11ax HE80	Channel:	5290 MHz
Polarity:	Vertical	Test Voltage:	DC 12 V

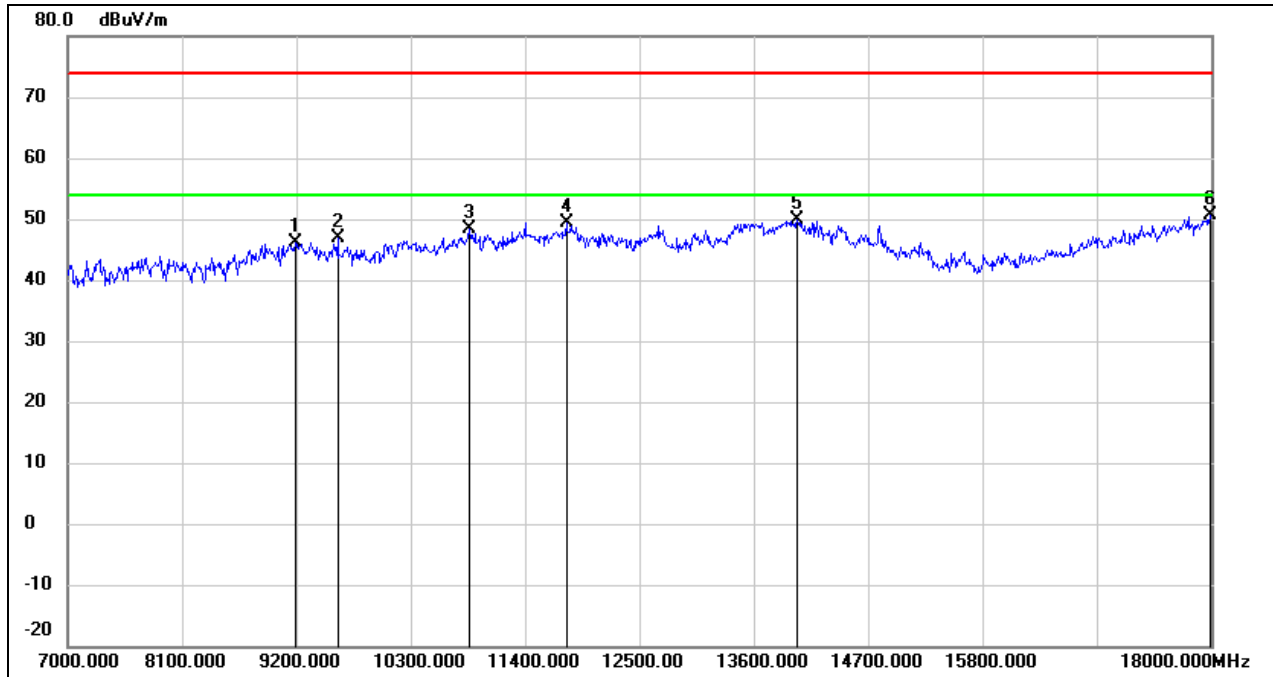

No.	Frequency (MHz)	Reading (dBuV)	Correct (dB/m)	Result (dBuV/m)	Limit (dBuV/m)	Margin (dB)	Remark
1	9189.000	35.78	10.46	46.24	74.00	-27.76	peak
2	9596.000	36.02	10.87	46.89	74.00	-27.11	peak
3	10861.000	34.10	14.20	48.30	74.00	-25.70	peak
4	11796.000	32.13	17.32	49.45	74.00	-24.55	peak
5	14018.000	27.99	21.80	49.79	74.00	-24.21	peak
6	17989.000	24.54	26.04	50.58	74.00	-23.42	peak



Test Mode:	802.11ax HE80	Channel:	5530 MHz
Polarity:	Horizontal	Test Voltage:	DC 12 V

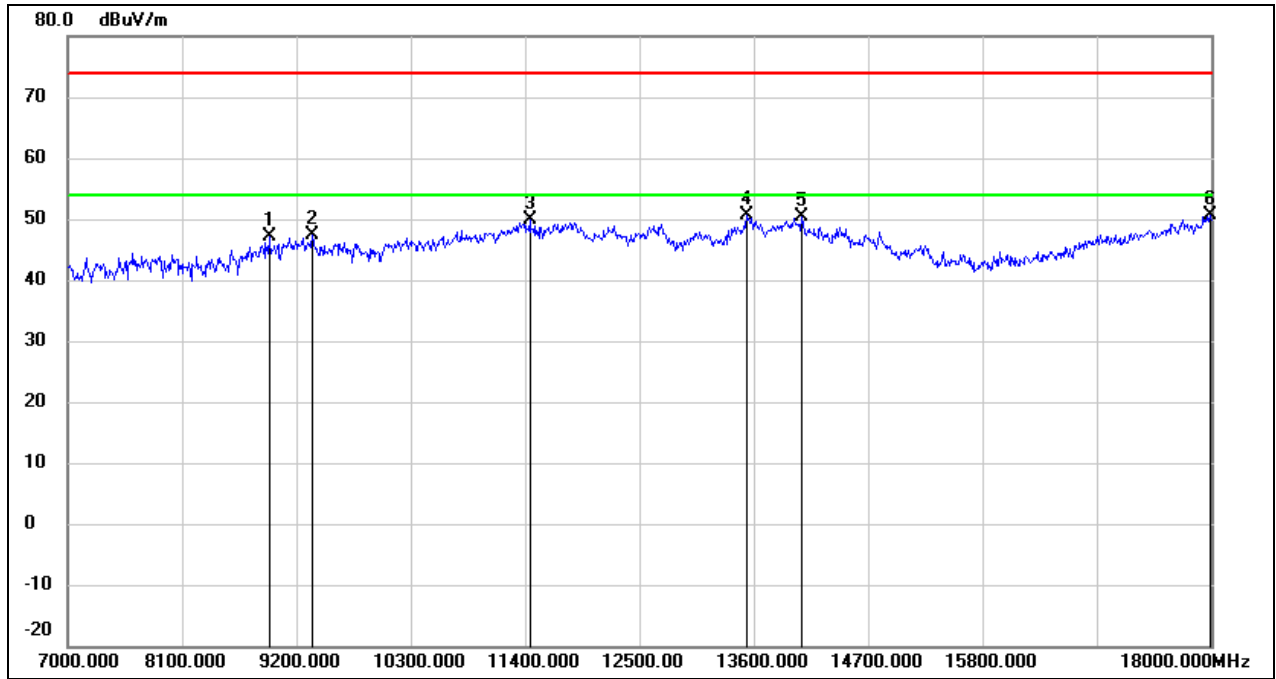

No.	Frequency (MHz)	Reading (dBuV)	Correct (dB/m)	Result (dBuV/m)	Limit (dBuV/m)	Margin (dB)	Remark
1	8936.000	37.30	9.90	47.20	74.00	-26.80	peak
2	9354.000	36.74	10.56	47.30	74.00	-26.70	peak
3	11444.000	33.23	16.53	49.76	74.00	-24.24	peak
4	13534.000	29.80	20.73	50.53	74.00	-23.47	peak
5	14062.000	28.72	21.62	50.34	74.00	-23.66	peak
6	17989.000	24.52	26.04	50.56	74.00	-23.44	peak



Test Mode:	802.11ax HE80	Channel:	5530 MHz
Polarity:	Vertical	Test Voltage:	DC 12 V

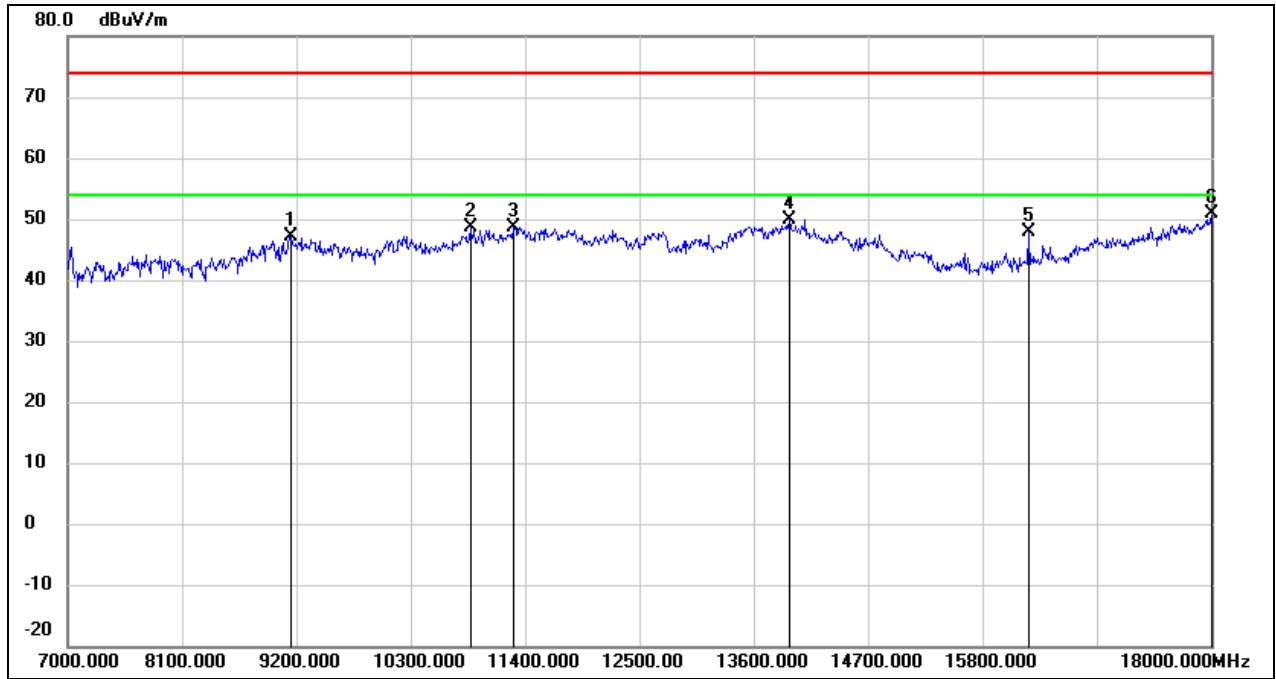

No.	Frequency (MHz)	Reading (dBuV)	Correct (dB/m)	Result (dBuV/m)	Limit (dBuV/m)	Margin (dB)	Remark
1	9145.000	36.64	10.43	47.07	74.00	-26.93	peak
2	10872.000	34.51	14.23	48.74	74.00	-25.26	peak
3	11290.000	32.75	15.90	48.65	74.00	-25.35	peak
4	13941.000	28.11	21.73	49.84	74.00	-24.16	peak
5	16240.000	30.33	17.60	47.93	74.00	-26.07	peak
6	18000.000	24.82	26.12	50.94	74.00	-23.06	peak



Test Mode:	802.11ax HE80	Channel:	5610 MHz
Polarity:	Horizontal	Test Voltage:	DC 12 V

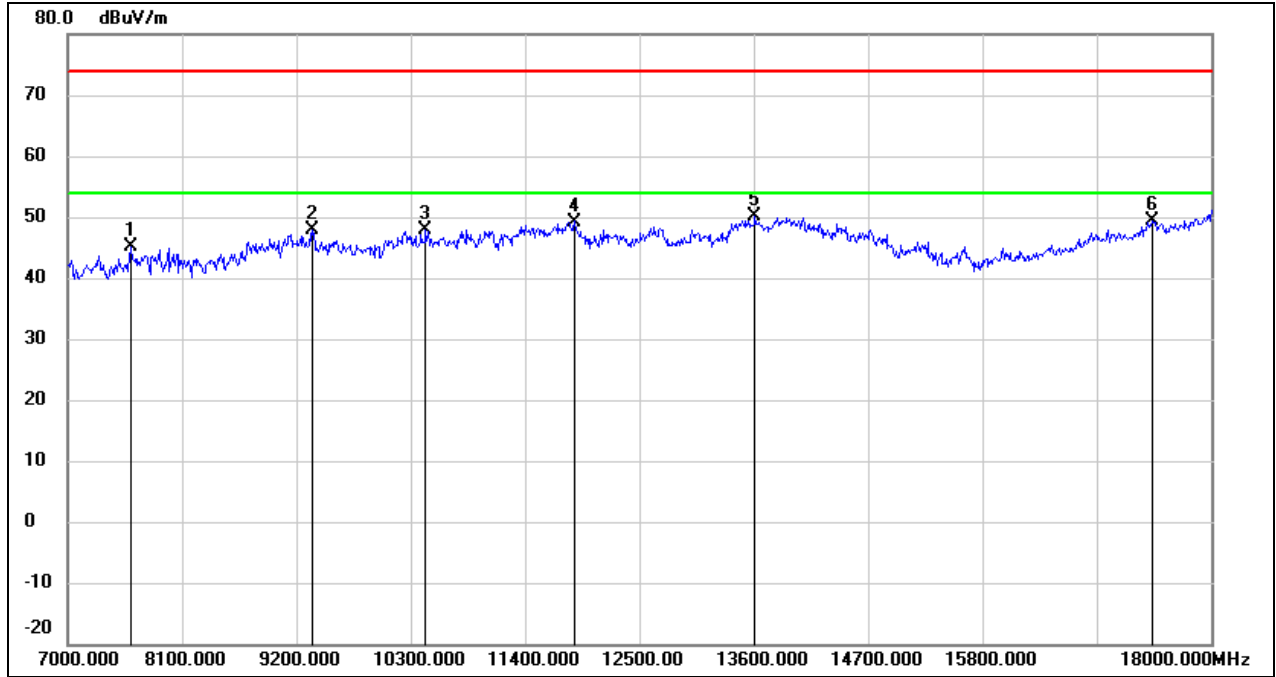

No.	Frequency (MHz)	Reading (dBuV)	Correct (dB/m)	Result (dBuV/m)	Limit (dBuV/m)	Margin (dB)	Remark
1	7605.000	38.38	6.78	45.16	74.00	-28.84	peak
2	9354.000	37.23	10.56	47.79	74.00	-26.21	peak
3	10443.000	35.13	12.70	47.83	74.00	-26.17	peak
4	11873.000	31.79	17.46	49.25	74.00	-24.75	peak
5	13611.000	29.10	20.92	50.02	74.00	-23.98	peak
6	17439.000	26.84	22.45	49.29	74.00	-24.71	peak



Test Mode:	802.11ax HE80	Channel:	5610 MHz
Polarity:	Vertical	Test Voltage:	DC 12 V

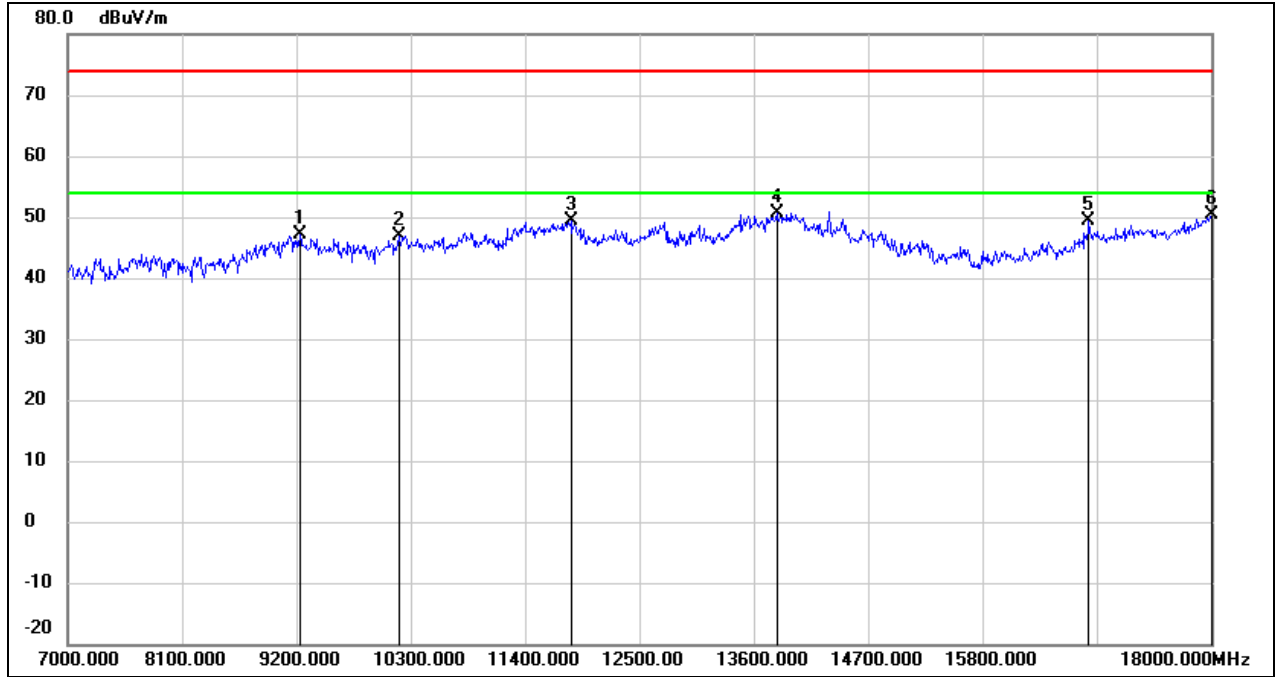

No.	Frequency (MHz)	Reading (dBuV)	Correct (dB/m)	Result (dBuV/m)	Limit (dBuV/m)	Margin (dB)	Remark
1	9233.000	36.56	10.48	47.04	74.00	-26.96	peak
2	10190.000	34.70	12.18	46.88	74.00	-27.12	peak
3	11840.000	31.89	17.40	49.29	74.00	-24.71	peak
4	13820.000	29.25	21.43	50.68	74.00	-23.32	peak
5	16823.000	29.57	19.81	49.38	74.00	-24.62	peak
6	18000.000	24.31	26.12	50.43	74.00	-23.57	peak



Test Mode:	802.11ax HE80	Channel:	5690 MHz
Polarity:	Horizontal	Test Voltage:	DC 12 V

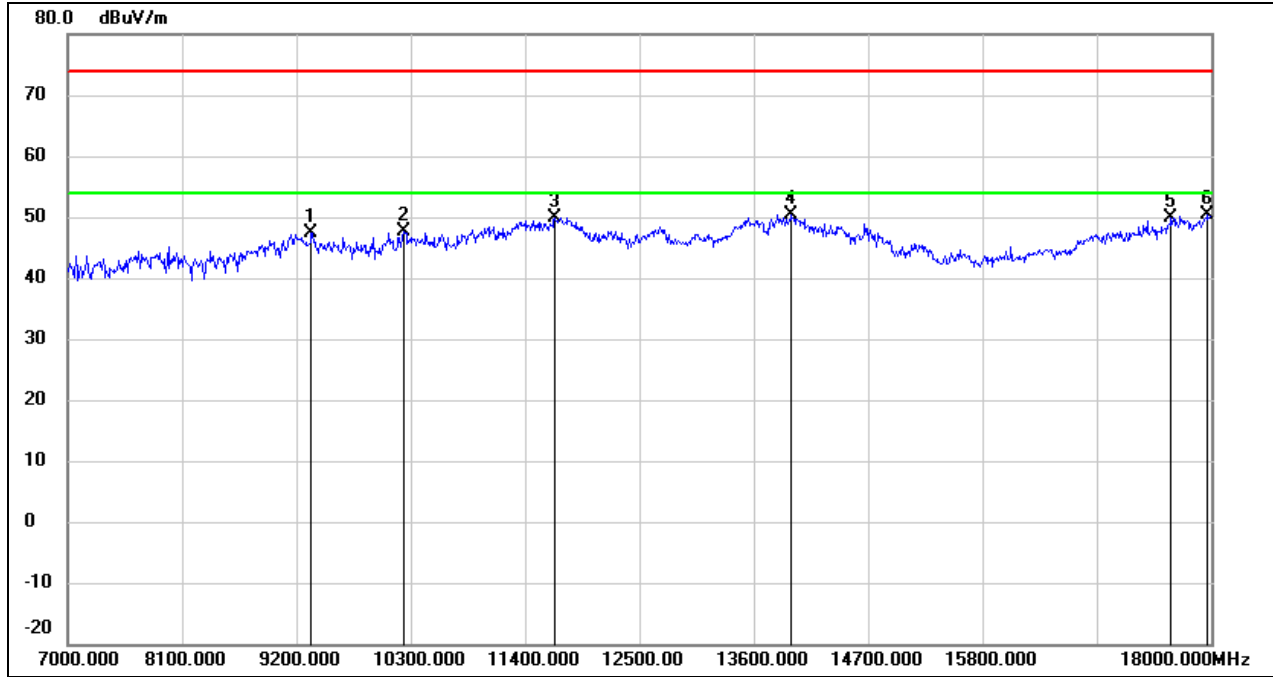

No.	Frequency (MHz)	Reading (dBuV)	Correct (dB/m)	Result (dBuV/m)	Limit (dBuV/m)	Margin (dB)	Remark
1	9343.000	36.94	10.55	47.49	74.00	-26.51	peak
2	10234.000	35.38	12.26	47.64	74.00	-26.36	peak
3	11686.000	32.80	17.12	49.92	74.00	-24.08	peak
4	13963.000	28.70	21.78	50.48	74.00	-23.52	peak
5	17615.000	26.41	23.49	49.90	74.00	-24.10	peak
6	17967.000	24.45	25.89	50.34	74.00	-23.66	peak



Test Mode:	802.11ax HE80	Channel:	5690 MHz
Polarity:	Vertical	Test Voltage:	DC 12 V

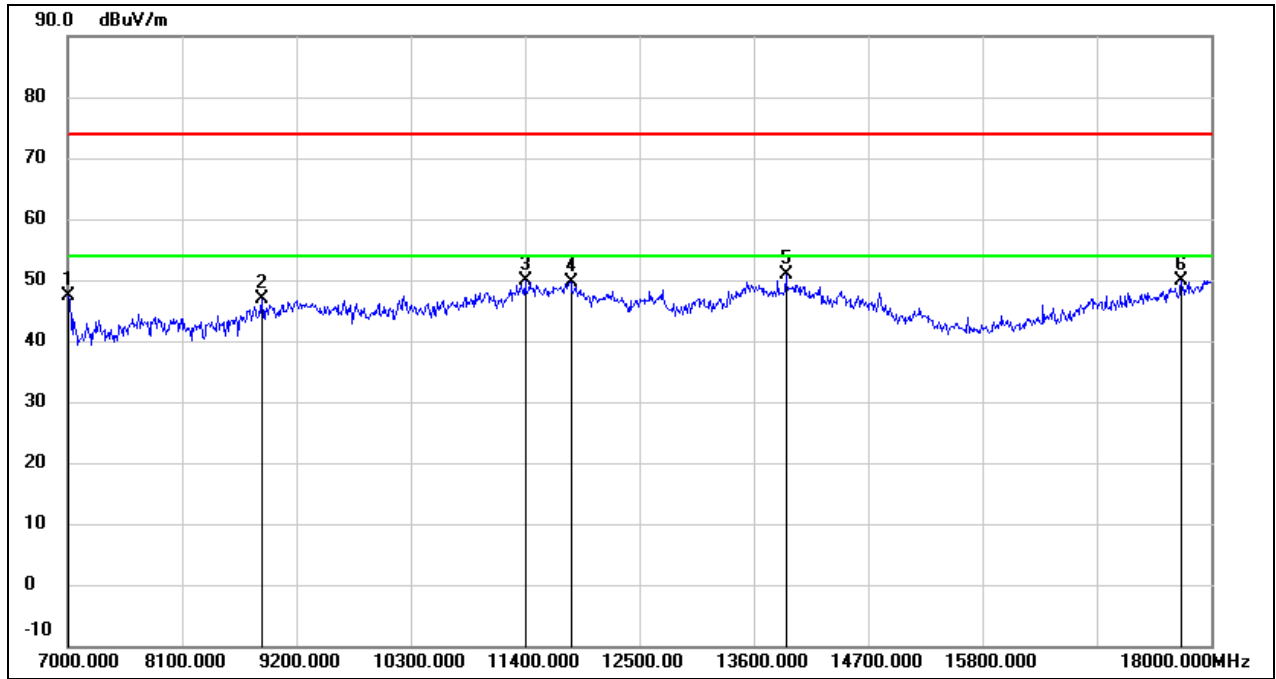

No.	Frequency (MHz)	Reading (dBuV)	Correct (dB/m)	Result (dBuV/m)	Limit (dBuV/m)	Margin (dB)	Remark
1	7011.000	40.39	7.04	47.43	74.00	-26.57	peak
2	8870.000	37.41	9.44	46.85	74.00	-27.15	peak
3	11400.000	33.43	16.36	49.79	74.00	-24.21	peak
4	11840.000	32.20	17.40	49.60	74.00	-24.40	peak
5	13908.000	29.10	21.66	50.76	74.00	-23.24	peak
6	17714.000	25.82	24.16	49.98	74.00	-24.02	peak



Test Mode:	802.11ax HE160	Channel:	5250 MHz
Polarity:	Horizontal	Test Voltage:	DC 12 V

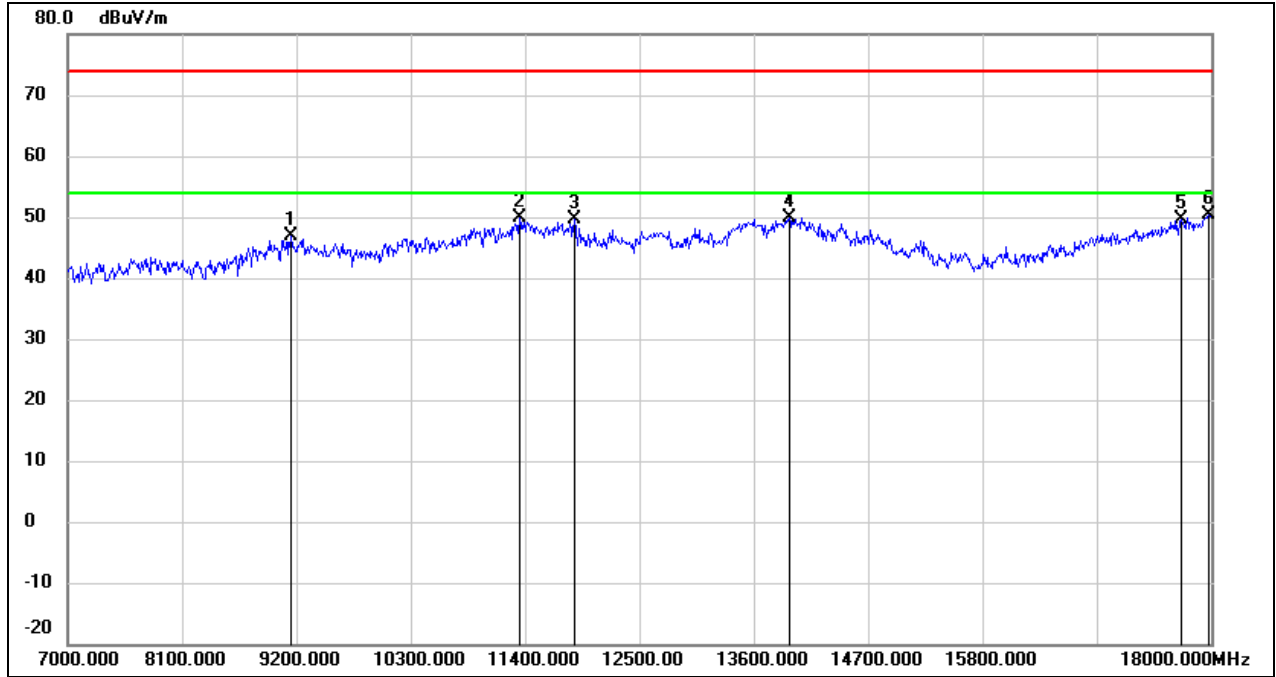

No.	Frequency (MHz)	Reading (dBuV)	Correct (dB/m)	Result (dBuV/m)	Limit (dBuV/m)	Margin (dB)	Remark
1	9145.000	36.38	10.43	46.81	74.00	-27.19	peak
2	11345.000	33.83	16.14	49.97	74.00	-24.03	peak
3	11873.000	32.24	17.46	49.70	74.00	-24.30	peak
4	13941.000	28.03	21.73	49.76	74.00	-24.24	peak
5	17714.000	25.40	24.16	49.56	74.00	-24.44	peak
6	17978.000	24.38	25.97	50.35	74.00	-23.65	peak



Test Mode:	802.11ax HE160	Channel:	5250 MHz
Polarity:	Vertical	Test Voltage:	DC 12 V

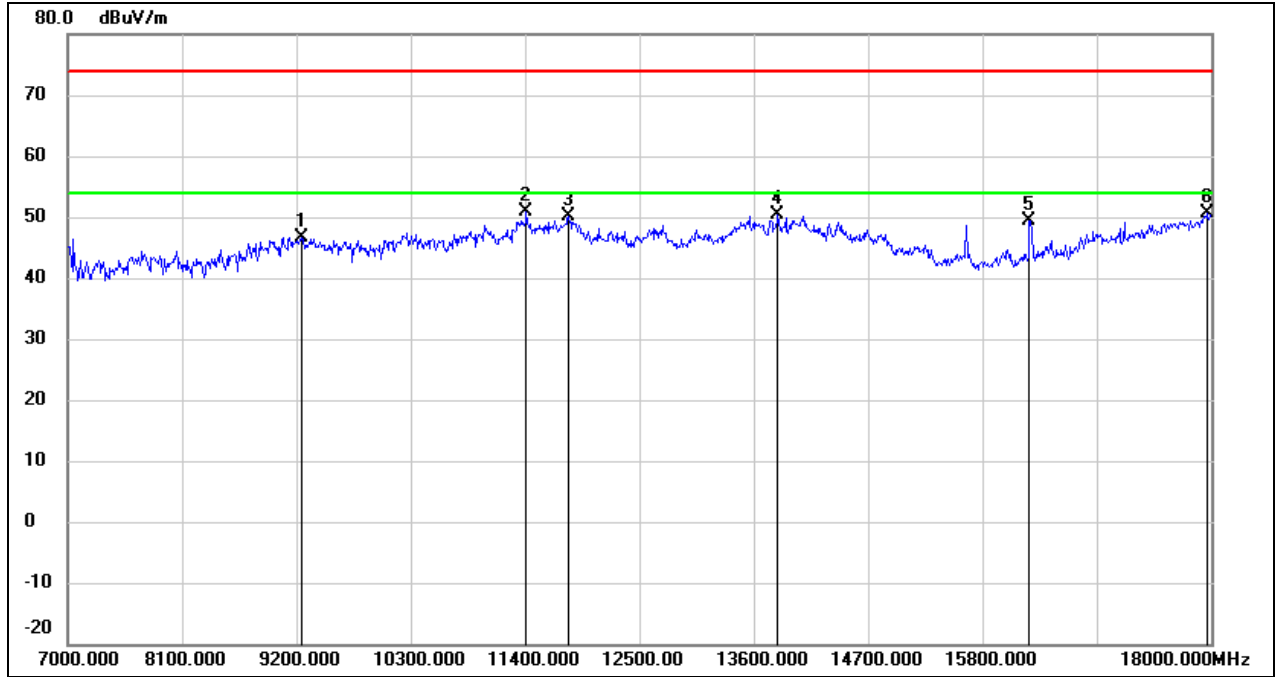

No.	Frequency (MHz)	Reading (dBuV)	Correct (dB/m)	Result (dBuV/m)	Limit (dBuV/m)	Margin (dB)	Remark
1	9244.000	36.24	10.49	46.73	74.00	-27.27	peak
2	11411.000	34.35	16.41	50.76	74.00	-23.24	peak
3	11818.000	32.68	17.36	50.04	74.00	-23.96	peak
4	13831.000	29.01	21.47	50.48	74.00	-23.52	peak
5	16251.000	31.81	17.64	49.45	74.00	-24.55	peak
6	17967.000	24.82	25.89	50.71	74.00	-23.29	peak



Test Mode:	802.11ax HE160	Channel:	5570 MHz
Polarity:	Horizontal	Test Voltage:	DC 12 V

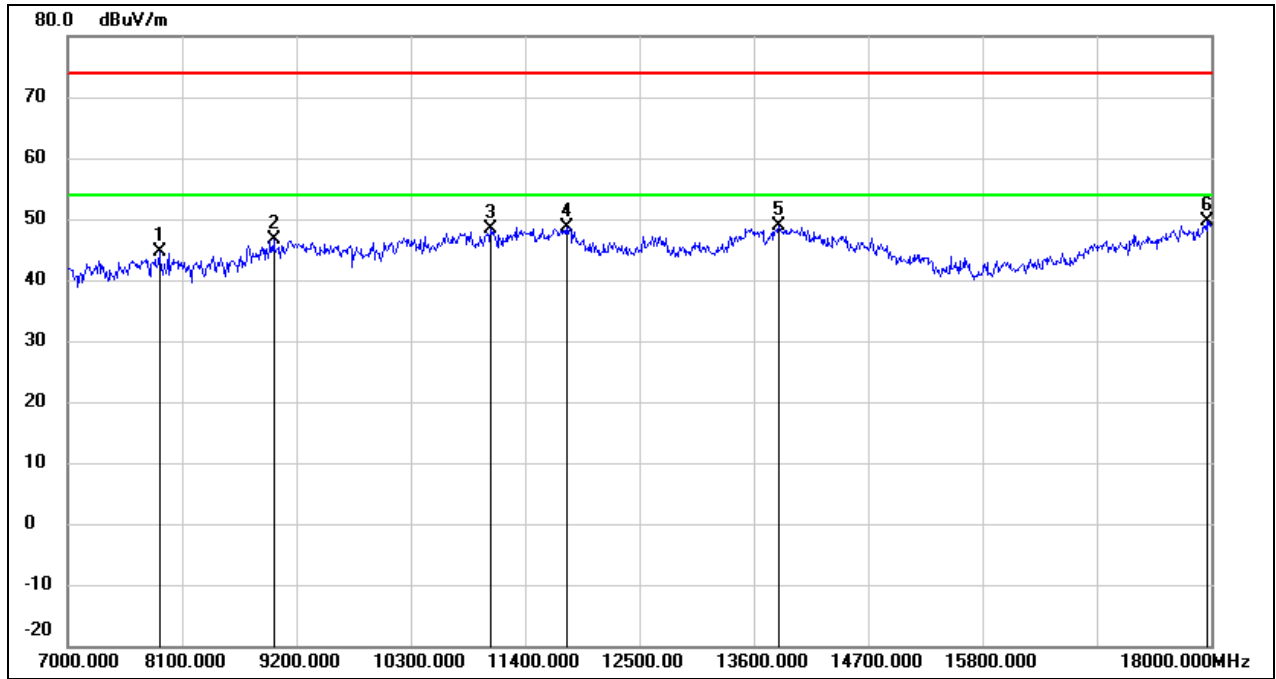

No.	Frequency (MHz)	Reading (dBuV)	Correct (dB/m)	Result (dBuV/m)	Limit (dBuV/m)	Margin (dB)	Remark
1	7880.000	38.08	6.54	44.62	74.00	-29.38	peak
2	8980.000	36.42	10.21	46.63	74.00	-27.37	peak
3	11070.000	33.46	15.01	48.47	74.00	-25.53	peak
4	11796.000	31.35	17.32	48.67	74.00	-25.33	peak
5	13842.000	27.36	21.49	48.85	74.00	-25.15	peak
6	17956.000	23.70	25.82	49.52	74.00	-24.48	peak



Test Mode:	802.11ax HE160	Channel:	5570 MHz
Polarity:	Vertical	Test Voltage:	DC 12 V

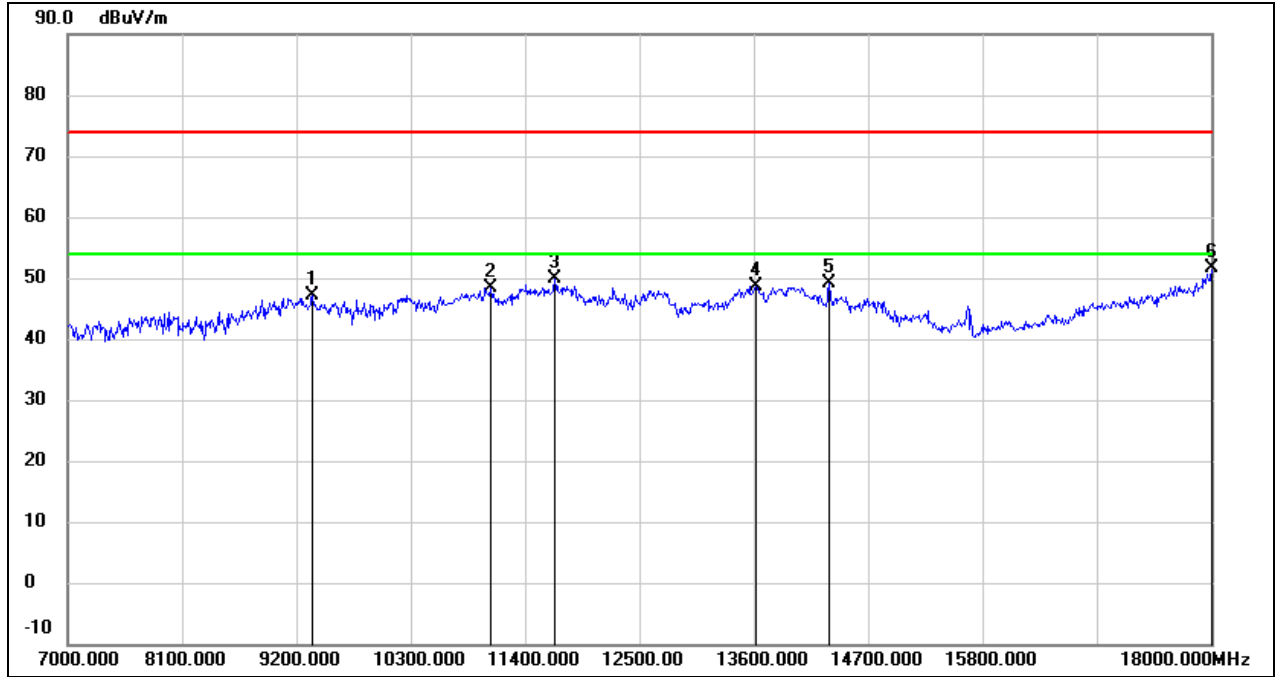

No.	Frequency (MHz)	Reading (dBuV)	Correct (dB/m)	Result (dBuV/m)	Limit (dBuV/m)	Margin (dB)	Remark
1	9354.000	36.45	10.56	47.01	74.00	-26.99	peak
2	11070.000	33.33	15.01	48.34	74.00	-25.66	peak
3	11686.000	32.67	17.12	49.79	74.00	-24.21	peak
4	13622.000	27.63	20.95	48.58	74.00	-25.42	peak
5	14326.000	28.63	20.51	49.14	74.00	-24.86	peak
6	18000.000	25.52	26.12	51.64	74.00	-22.36	peak



8.4. SPURIOUS EMISSIONS (9 KHZ ~ 30 MHZ)

Test Mode:	802.11ax HE160	Channel:	5570 MHz
Polarity:	Loop Antenna Face On To The EUT	Test Voltage:	DC 12 V

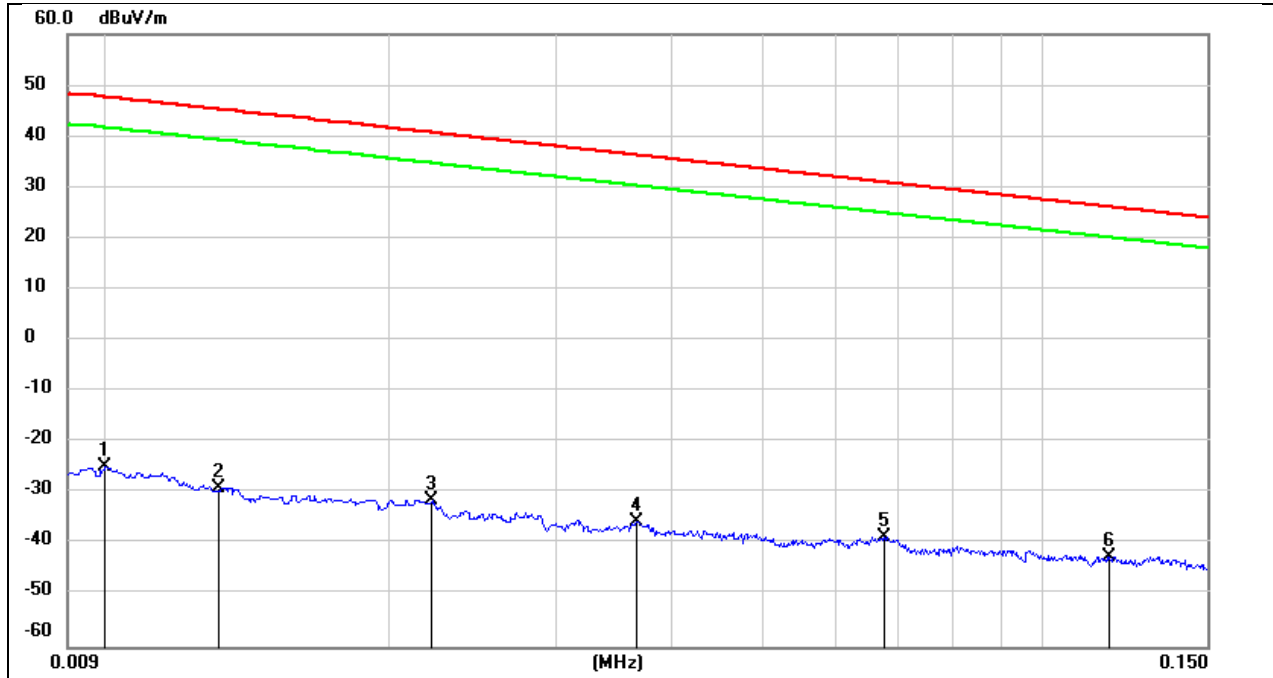

No.	Frequency (MHz)	Reading (dBuV)	Correct (dB/m)	Result (dBuV/m)	Limit (dBuV/m)	Margin (dB)	Remark
1	0.0100	76.72	-101.40	-24.68	47.60	-72.28	peak
2	0.0131	72.47	-101.38	-28.91	45.25	-74.16	peak
3	0.0221	70.13	-101.35	-31.22	40.71	-71.93	peak
4	0.0366	65.87	-101.42	-35.55	36.33	-71.88	peak
5	0.0675	63.14	-101.56	-38.42	31.02	-69.44	peak
6	0.1179	59.33	-101.74	-42.41	26.17	-68.58	peak



Test Mode:	802.11ax HE160	Channel:	5570 MHz
Polarity:	Loop Antenna Face On To The EUT	Test Voltage:	DC 12 V

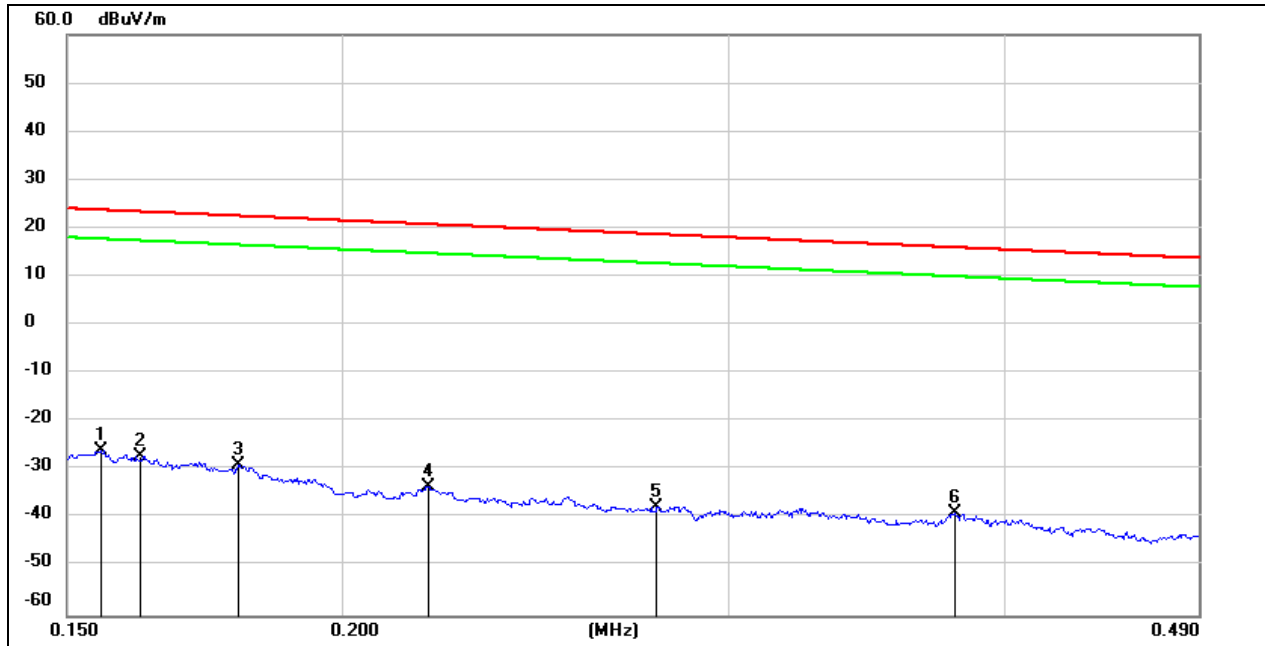

No.	Frequency (MHz)	Reading (dBuV)	Correct (dB/m)	Result (dBuV/m)	Limit (dBuV/m)	Margin (dB)	Remark
1	0.1554	75.77	-101.65	-25.88	23.77	-49.65	peak
2	0.1621	74.42	-101.65	-27.23	23.41	-50.64	peak
3	0.1794	72.77	-101.68	-28.91	22.53	-51.44	peak
4	0.2190	68.27	-101.75	-33.48	20.79	-54.27	peak
5	0.2782	64.29	-101.83	-37.54	18.71	-56.25	peak
6	0.3800	63.02	-101.94	-38.92	16.01	-54.93	peak



Test Mode:	802.11ax HE160	Channel:	5570 MHz
Polarity:	Loop Antenna Face On To The EUT	Test Voltage:	DC 12 V

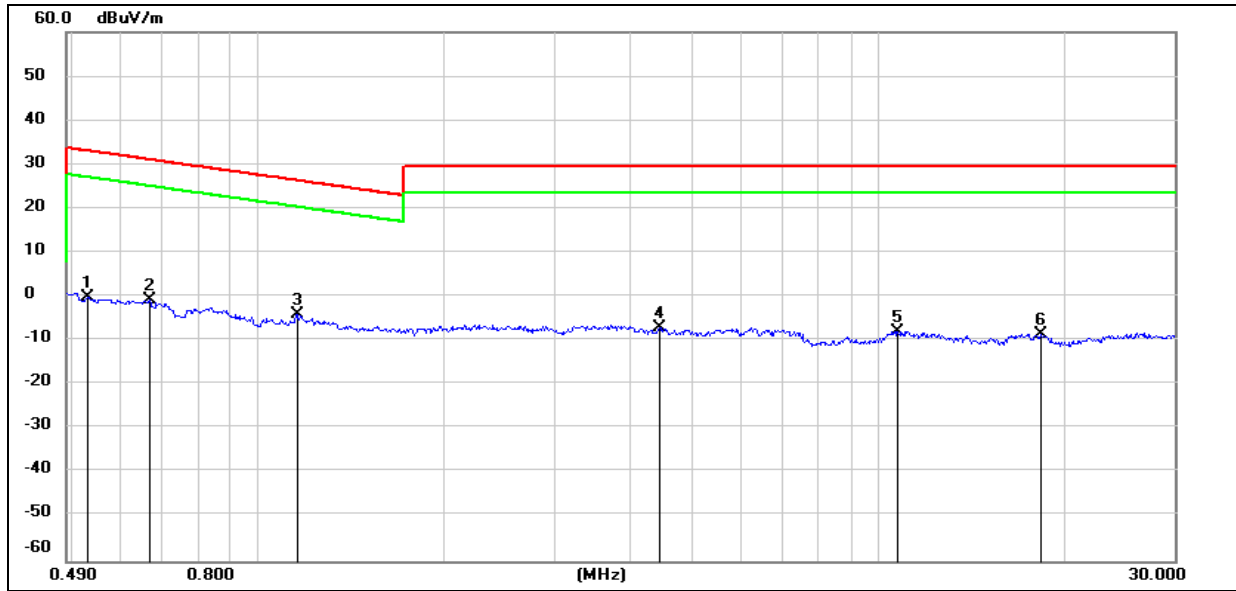

No.	Frequency (MHz)	Reading (dBuV)	Correct (dB/m)	Result (dBuV/m)	Limit (dBuV/m)	Margin (dB)	Remark
1	0.5298	62.03	-62.08	-0.05	33.12	-33.17	peak
2	0.6671	61.25	-62.10	-0.85	31.12	-31.97	peak
3	1.1531	58.25	-62.20	-3.95	26.37	-30.32	peak
4	4.4443	54.29	-61.40	-7.11	29.54	-36.65	peak
5	10.7299	52.98	-60.83	-7.85	29.54	-37.39	peak
6	18.2545	52.43	-60.90	-8.47	29.54	-38.01	peak



8.5. SPURIOUS EMISSIONS (18 GHZ ~ 26 GHZ)

Test Mode:	802.11ax HE160	Channel:	5570 MHz
Polarity:	Horizontal	Test Voltage:	DC 12 V

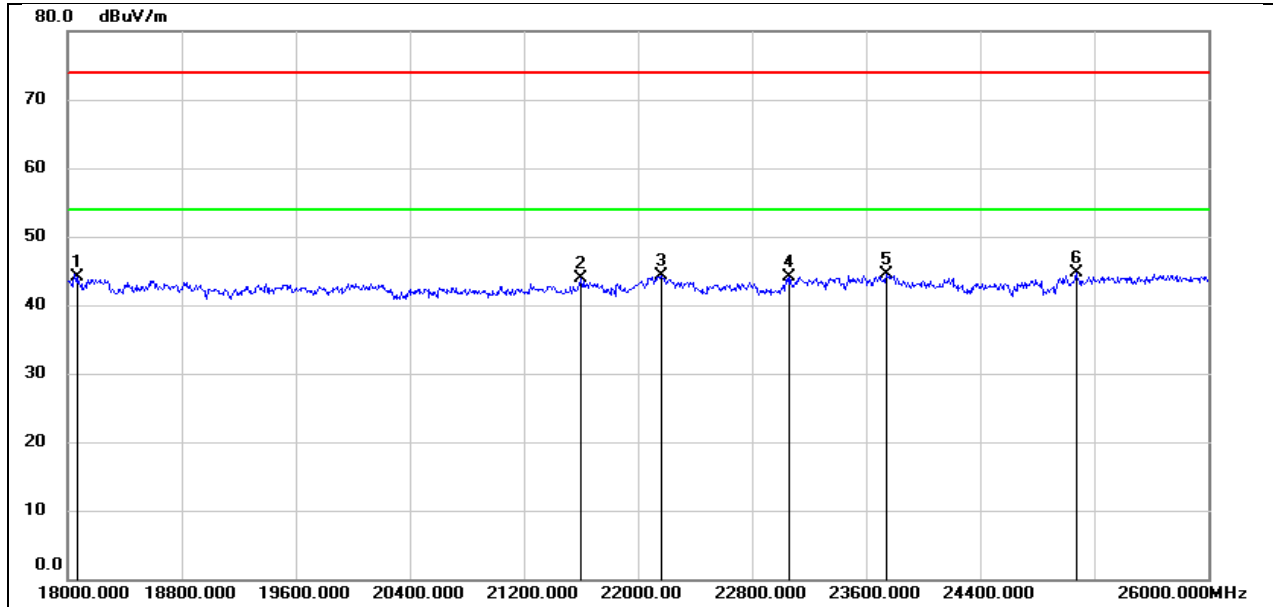

No.	Frequency (MHz)	Reading (dBuV)	Correct (dB/m)	Result (dBuV/m)	Limit (dBuV/m)	Margin (dB)	Remark
1	18072.000	49.45	-5.43	44.02	74.00	-29.98	peak
2	21600.000	48.52	-4.54	43.98	74.00	-30.02	peak
3	22160.000	48.58	-4.31	44.27	74.00	-29.73	peak
4	23064.000	47.49	-3.42	44.07	74.00	-29.93	peak
5	23744.000	47.65	-3.20	44.45	74.00	-29.55	peak
6	25072.000	46.67	-1.97	44.70	74.00	-29.30	peak



Test Mode:	802.11ax HE160	Channel:	5570 MHz
Polarity:	Vertical	Test Voltage:	DC 12 V

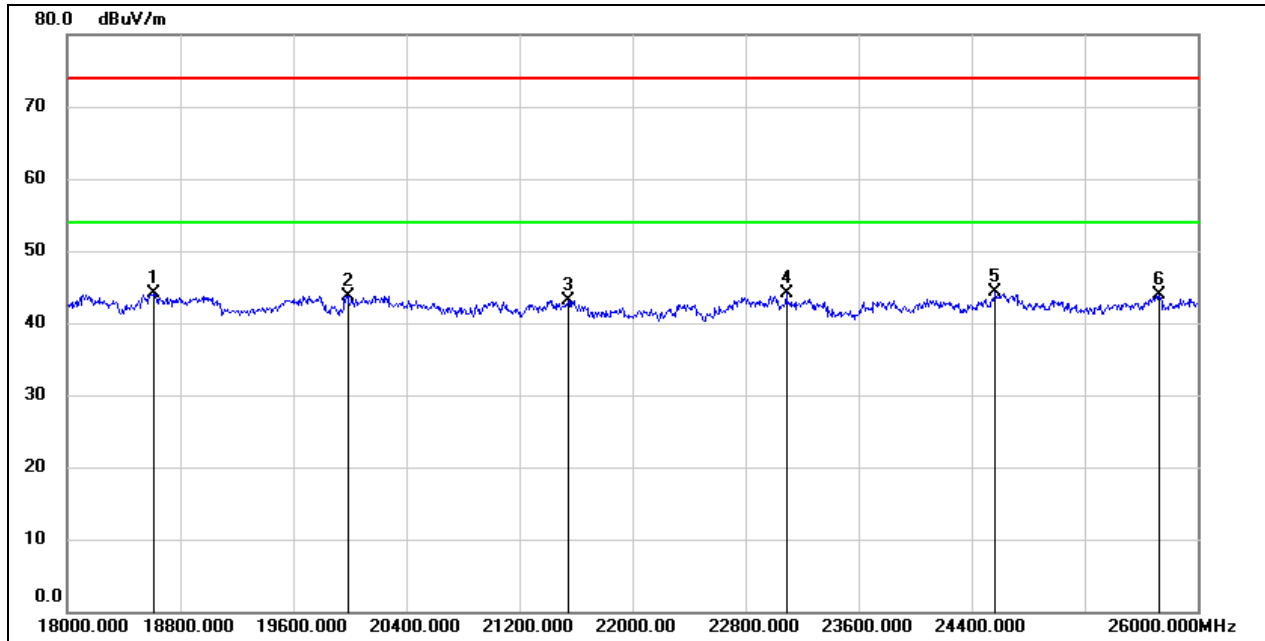

No.	Frequency (MHz)	Reading (dBuV)	Correct (dB/m)	Result (dBuV/m)	Limit (dBuV/m)	Margin (dB)	Remark
1	18616.000	49.39	-5.34	44.05	74.00	-29.95	peak
2	19984.000	49.21	-5.44	43.77	74.00	-30.23	peak
3	21544.000	47.76	-4.63	43.13	74.00	-30.87	peak
4	23088.000	47.52	-3.41	44.11	74.00	-29.89	peak
5	24568.000	46.60	-2.33	44.27	74.00	-29.73	peak
6	25728.000	44.61	-0.72	43.89	74.00	-30.11	peak



8.6. SPURIOUS EMISSIONS (26 GHZ ~ 40 GHZ)

Test Mode:	802.11ax HE160	Channel:	5570 MHz
Polarity:	Horizontal	Test Voltage:	DC 12 V

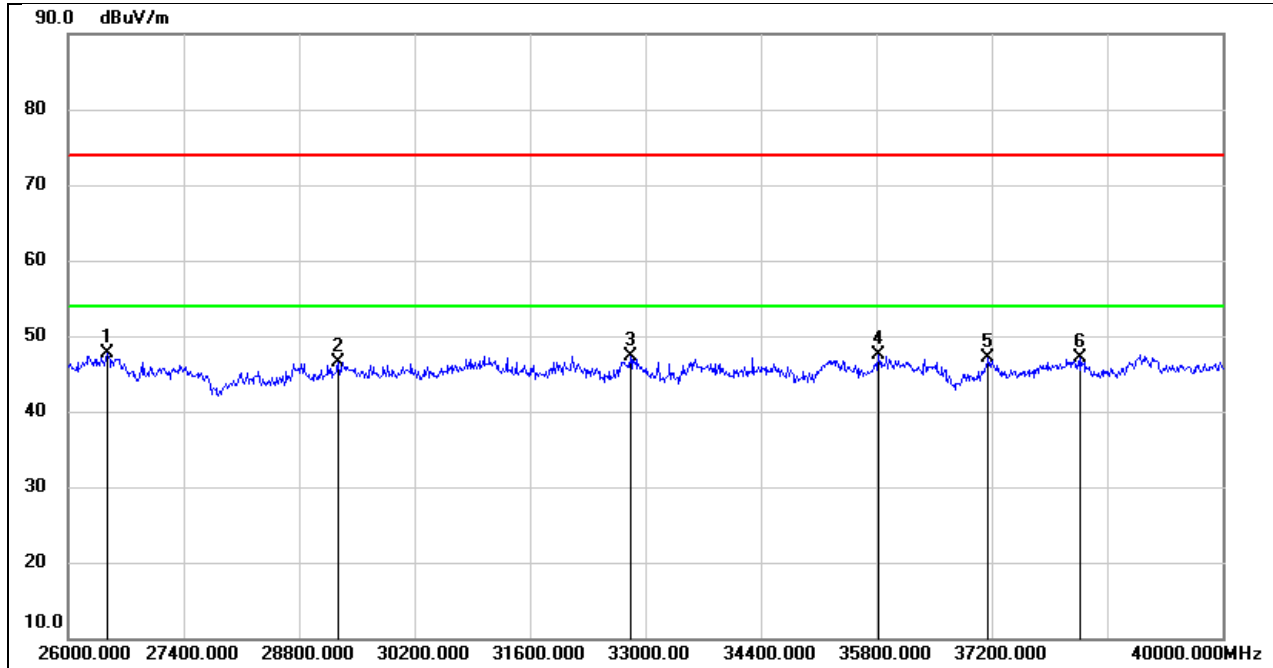

No.	Frequency (MHz)	Reading (dBuV)	Correct (dB/m)	Result (dBuV/m)	Limit (dBuV/m)	Margin (dB)	Remark
1	26476.000	52.53	-4.78	47.75	74.00	-26.25	peak
2	29276.000	47.51	-1.01	46.50	74.00	-27.50	peak
3	32818.000	48.31	-1.08	47.23	74.00	-26.77	peak
4	35828.000	43.75	3.67	47.42	74.00	-26.58	peak
5	37158.000	43.84	3.17	47.01	74.00	-26.99	peak
6	38278.000	43.32	3.82	47.14	74.00	-26.86	peak



Test Mode:	802.11ax HE160	Channel:	5570 MHz
Polarity:	Vertical	Test Voltage:	DC 12 V

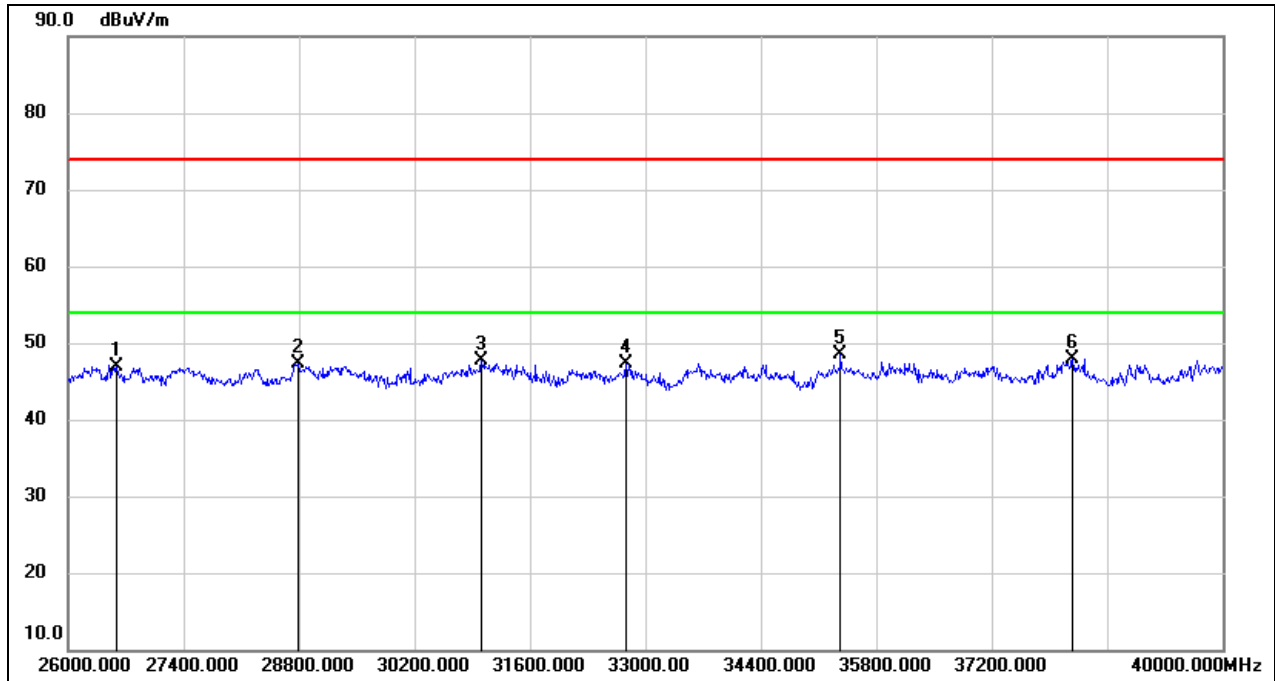

No.	Frequency (MHz)	Reading (dBuV)	Correct (dB/m)	Result (dBuV/m)	Limit (dBuV/m)	Margin (dB)	Remark
1	26588.000	51.62	-4.80	46.82	74.00	-27.18	peak
2	28786.000	47.99	-0.64	47.35	74.00	-26.65	peak
3	31012.000	48.33	-0.71	47.62	74.00	-26.38	peak
4	32762.000	48.45	-1.21	47.24	74.00	-26.76	peak
5	35366.000	45.90	2.59	48.49	74.00	-25.51	peak
6	38180.000	44.14	3.69	47.83	74.00	-26.17	peak



8.7. SPURIOUS EMISSIONS (30 MHz ~ 1 GHz)

Test Mode:	802.11ax HE160	Channel:	5570 MHz
Polarity:	Horizontal	Test Voltage:	DC 12 V

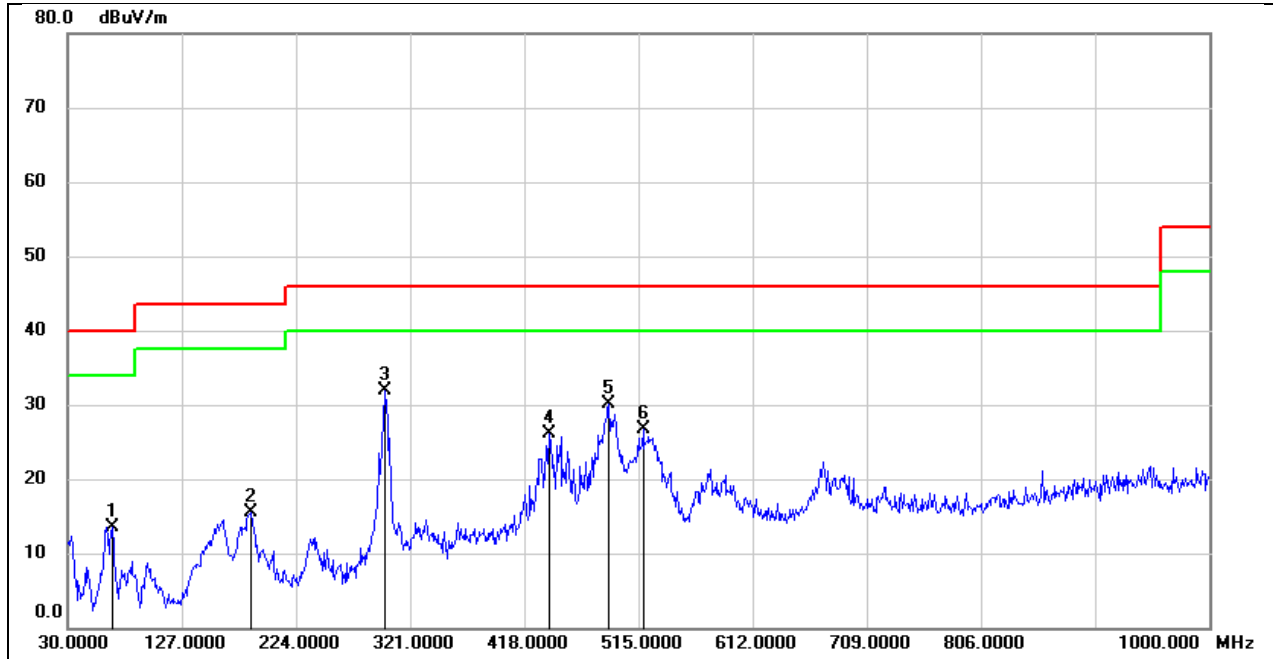

No.	Frequency (MHz)	Reading (dBuV)	Correct (dB/m)	Result (dBuV/m)	Limit (dBuV/m)	Margin (dB)	Remark
1	67.8300	34.09	-20.55	13.54	40.00	-26.46	QP
2	185.2000	32.27	-16.75	15.52	43.50	-27.98	QP
3	299.6600	47.16	-15.32	31.84	46.00	-14.16	QP
4	439.3400	38.65	-12.58	26.07	46.00	-19.93	QP
5	489.7800	41.88	-11.70	30.18	46.00	-15.82	QP
6	518.8800	37.76	-11.11	26.65	46.00	-19.35	QP



Test Mode:	802.11ax HE160	Channel:	5570 MHz
Polarity:	Vertical	Test Voltage:	DC 12 V

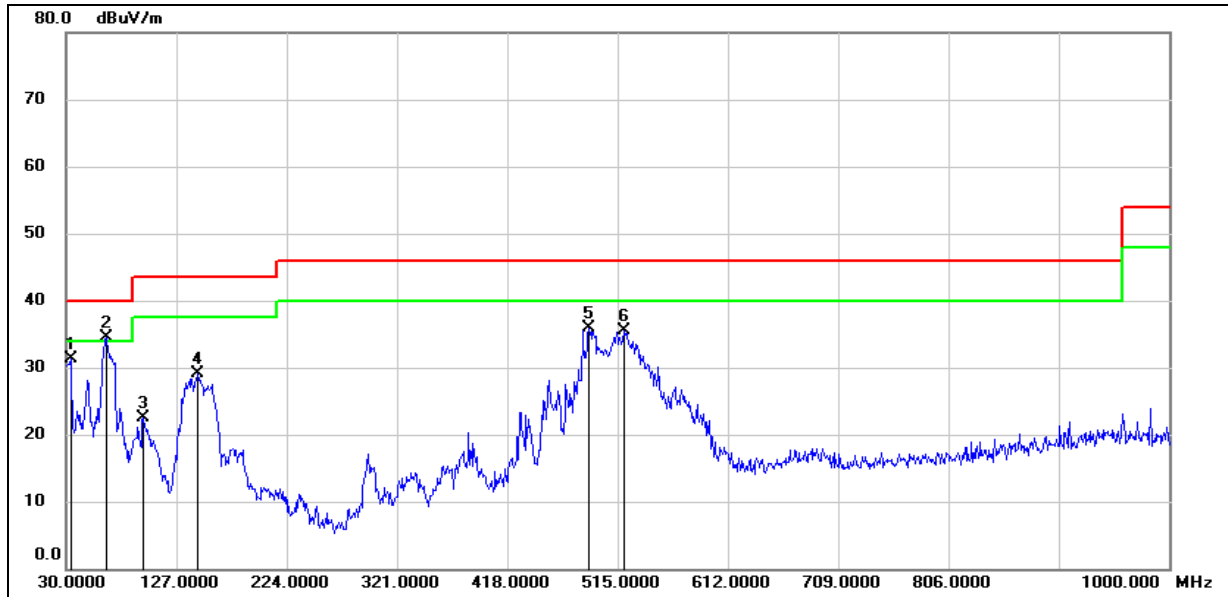

No.	Frequency (MHz)	Reading (dBuV)	Correct (dB/m)	Result (dBuV/m)	Limit (dBuV/m)	Margin (dB)	Remark
1	33.8800	50.66	-19.31	31.35	40.00	-8.65	QP
2	64.9200	55.01	-20.54	34.47	40.00	-5.53	QP
3	97.9000	43.74	-21.30	22.44	43.50	-21.06	QP
4	145.4299	47.60	-18.55	29.05	43.50	-14.45	QP
5	489.7800	47.58	-11.70	35.88	46.00	-10.12	QP
6	520.8200	46.49	-11.07	35.42	46.00	-10.58	QP

9. AC POWER LINE CONDUCTED EMISSION

LIMITS

Please refer to CFR 47 FCC §15.207 (a) and ISED RSS-Gen Clause 8.8

FREQUENCY (MHz)	Quasi-peak	Average
0.15 -0.5	66 - 56 *	56 - 46 *
0.50 -5.0	56.00	46.00
5.0 -30.0	60.00	50.00

TEST PROCEDURE

Refer to ANSI C63.10-2013 clause 6.2.

The EUT is put on a table of non-conducting material that is 80 cm high. The vertical conducting wall of shielding is located 40 cm to the rear of the EUT. The power line of the EUT is connected to the AC mains through a Artificial Mains Network (A.M.N.). A EMI Measurement Receiver (R&S Test Receiver ESR3) is used to test the emissions from both sides of AC line. According to the requirements in Section 6.2 of ANSI C63.10-2013. Conducted emissions from the EUT measured in the frequency range between 0.15 MHz and 30 MHz using CISPR Quasi-Peak and average detector mode. The bandwidth of EMI test receiver is set at 9 kHz.

The arrangement of the equipment is installed to meet the standards and operating in a manner, which tends to maximize its emission characteristics in a normal application.

TEST SETUP

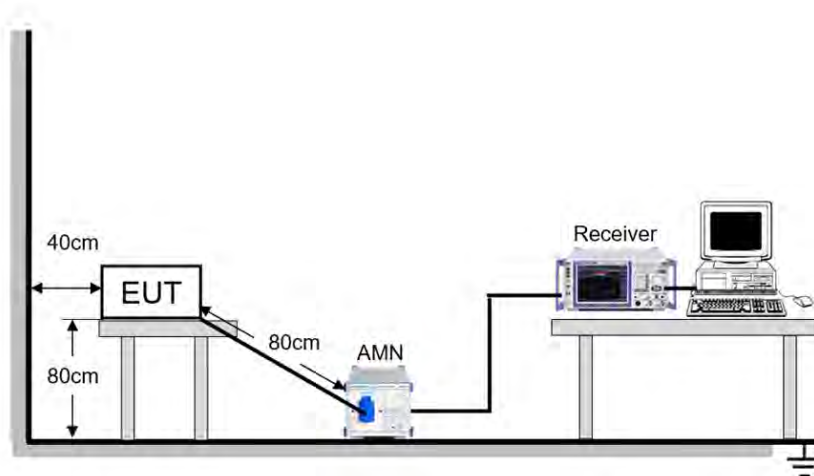

TEST ENVIRONMENT

Temperature	20.1°C	Relative Humidity	57.7%
Atmosphere Pressure	101kPa	Test Voltage	DC 12 V



TEST RESULTS

Test Mode:	802.11ax HE160	Channel:	5570 MHz
Line	N	Test Voltage	DC 12 V

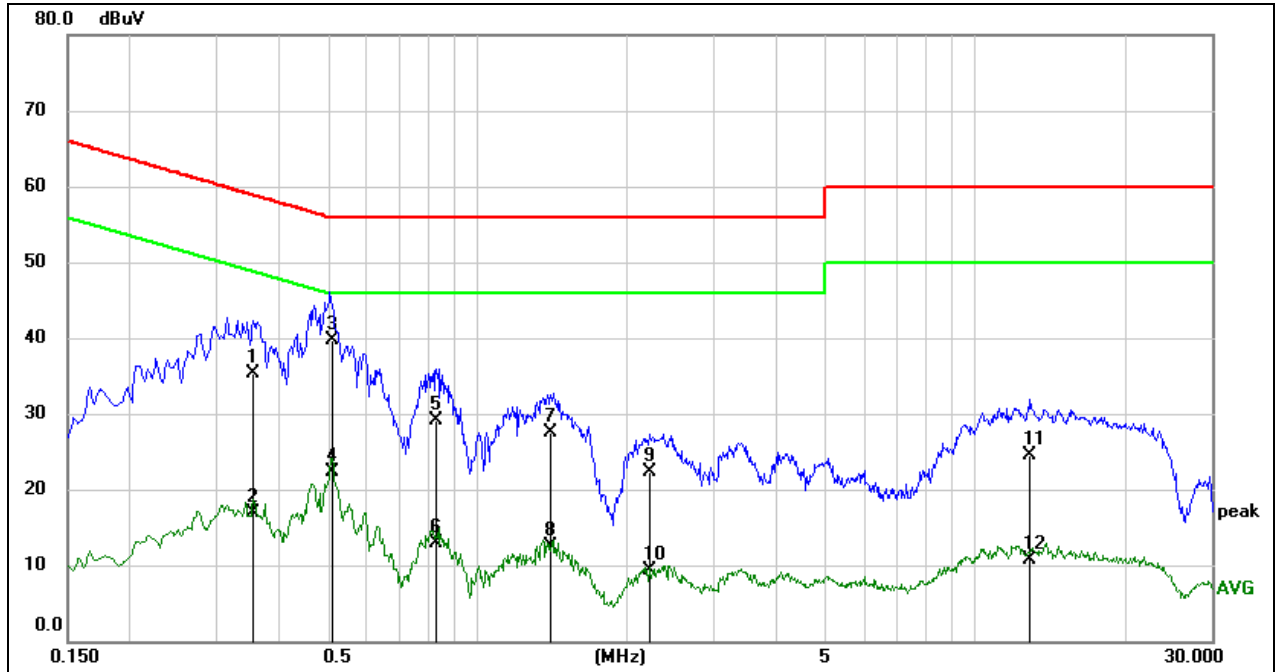

No.	Frequency (MHz)	Reading (dBuV)	Correct (dB)	Result (dBuV)	Limit (dBuV)	Margin (dB)	Remark
1	0.3529	25.75	9.59	35.34	58.89	-23.55	QP
2	0.3529	7.23	9.59	16.82	48.89	-32.07	AVG
3	0.5130	30.03	9.60	39.63	56.00	-16.37	QP
4	0.5130	12.71	9.60	22.31	46.00	-23.69	AVG
5	0.8268	19.48	9.60	29.08	56.00	-26.92	QP
6	0.8268	3.36	9.60	12.96	46.00	-33.04	AVG
7	1.4175	17.86	9.62	27.48	56.00	-28.52	QP
8	1.4175	2.79	9.62	12.41	46.00	-33.59	AVG
9	2.2229	12.67	9.64	22.31	56.00	-33.69	QP
10	2.2229	-0.30	9.64	9.34	46.00	-36.66	AVG
11	12.9892	14.70	9.76	24.46	60.00	-35.54	QP
12	12.9892	1.02	9.76	10.78	50.00	-39.22	AVG

Note:

1. Result = Reading + Correct Factor.
2. If QP Result complies with AV limit, AV Result is deemed to comply with AV limit.
3. Test setup: RBW: 200 Hz (9 kHz ~ 150 kHz), 9 kHz (150 kHz ~ 30 MHz).
4. Step size: 80 Hz (0.009 MHz ~ 0.15 MHz), 4 kHz (0.15 MHz ~ 30 MHz), Scan time: auto.



Test Mode:	802.11ax HE160	Channel:	5570 MHz
Line	N	Test Voltage	DC 12 V

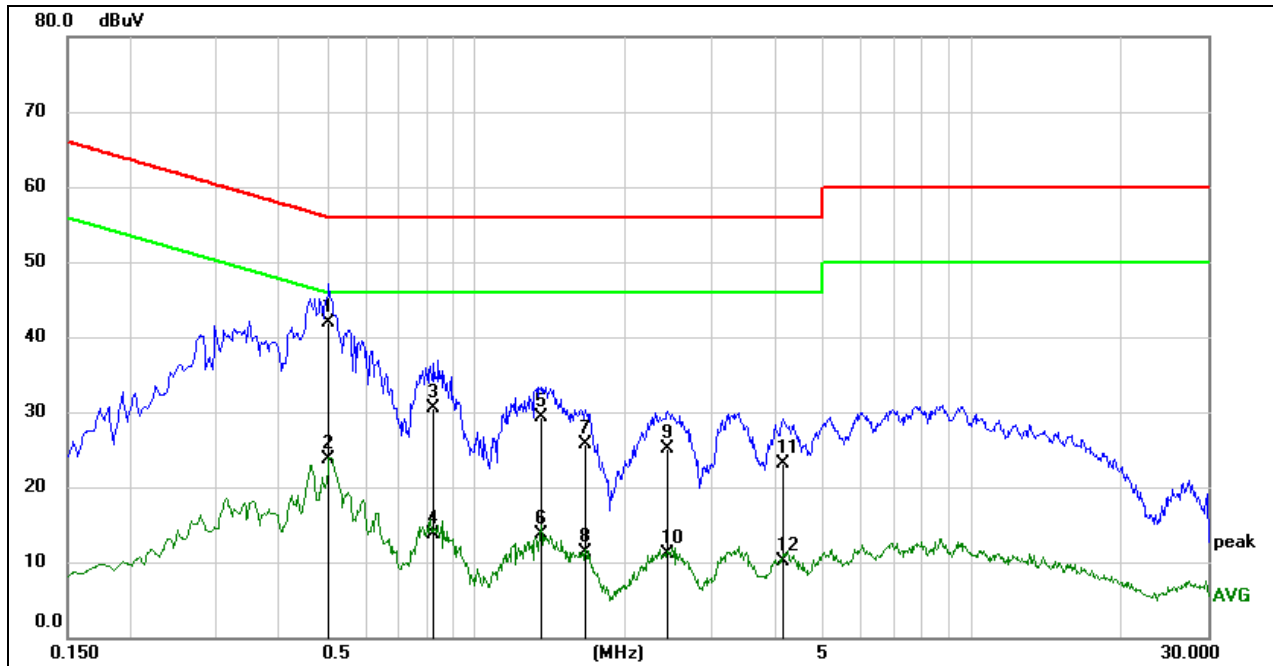

No.	Frequency (MHz)	Reading (dBuV)	Correct (dB)	Result (dBuV)	Limit (dBuV)	Margin (dB)	Remark
1	0.5081	32.21	9.60	41.81	56.00	-14.19	QP
2	0.5081	14.11	9.60	23.71	46.00	-22.29	AVG
3	0.8277	20.83	9.60	30.43	56.00	-25.57	QP
4	0.8277	4.12	9.60	13.72	46.00	-32.28	AVG
5	1.3581	19.79	9.61	29.40	56.00	-26.60	QP
6	1.3581	4.11	9.61	13.72	46.00	-32.28	AVG
7	1.6698	16.11	9.62	25.73	56.00	-30.27	QP
8	1.6698	1.65	9.62	11.27	46.00	-34.73	AVG
9	2.4360	15.50	9.65	25.15	56.00	-30.85	QP
10	2.4360	1.44	9.65	11.09	46.00	-34.91	AVG
11	4.1700	13.43	9.70	23.13	56.00	-32.87	QP
12	4.1700	0.44	9.70	10.14	46.00	-35.86	AVG

Note:

1. Result = Reading + Correct Factor.
2. If QP Result complies with AV limit, AV Result is deemed to comply with AV limit.
3. Test setup: RBW: 200 Hz (9 kHz ~ 150 kHz), 9 kHz (150 kHz ~ 30 MHz).
4. Step size: 80 Hz (0.009 MHz ~ 0.15 MHz), 4 kHz (0.15 MHz ~ 30 MHz), Scan time: auto.

Note: All the modes have been tested, only the worst data was recorded in the report.



10. ANTENNA REQUIREMENT

REQUIREMENT

Please refer to FCC part 15.203

An intentional radiator shall be designed to ensure that no antenna other than that furnished by the responsible party shall be used with the device. The use of a permanently attached antenna or of an antenna that uses a unique coupling to the intentional radiator shall be considered sufficient to comply with the provisions of this section. The manufacturer may design the unit so that a broken antenna can be replaced by the user, but the use of a standard antenna jack or electrical connector is prohibited.

Please refer to FCC part 15.247(b)(4)

The conducted output power limit specified in paragraph (b) of this section is based on the use of antennas with directional gains that do not exceed 6 dBi. Except as shown in paragraph (c) of this section, if transmitting antennas of directional gain greater than 6 dBi are used, the conducted output power from the intentional radiator shall be reduced below the stated values in paragraphs (b)(1), (b)(2), and (b)(3) of this section, as appropriate, by the amount in dB that the directional gain of the antenna exceeds 6 dBi.

DESCRIPTION

Pass



11. TEST DATA

11.1. APPENDIX A: EMISSION BANDWIDTH

11.1.1. Test Result

Test Mode	Antenna	Channel	26db EBW [MHz]	FL[MHz]	FH[MHz]	Verdict
11A	Ant1	5260	19.240	5250.720	5269.960	PASS
	Ant2	5260	18.680	5250.720	5269.400	PASS
	Ant3	5260	19.200	5250.640	5269.840	PASS
	Ant4	5260	19.080	5250.440	5269.520	PASS
	Ant1	5280	19.040	5270.440	5289.480	PASS
	Ant2	5280	18.800	5270.560	5289.360	PASS
	Ant3	5280	19.160	5270.520	5289.680	PASS
	Ant4	5280	18.680	5270.560	5289.240	PASS
	Ant1	5320	19.640	5310.280	5329.920	PASS
	Ant2	5320	20.280	5310.200	5330.480	PASS
	Ant3	5320	20.840	5309.640	5330.480	PASS
	Ant4	5320	20.200	5310.040	5330.240	PASS
	Ant1	5500	20.120	5490.080	5510.200	PASS
	Ant2	5500	19.760	5490.080	5509.840	PASS
	Ant3	5500	19.960	5490.080	5510.040	PASS
	Ant4	5500	20.320	5490.160	5510.480	PASS
	Ant1	5580	19.040	5570.600	5589.640	PASS
	Ant2	5580	18.200	5570.920	5589.120	PASS
	Ant3	5580	18.520	5570.680	5589.200	PASS
	Ant4	5580	18.920	5570.800	5589.720	PASS
	Ant1	5700	20.120	5689.520	5709.640	PASS
	Ant2	5700	20.520	5689.600	5710.120	PASS
	Ant3	5700	19.040	5690.400	5709.440	PASS
	Ant4	5700	20.280	5689.720	5710.000	PASS
	Ant1	5720	19.240	5710.080	5729.320	PASS
	Ant2	5720	18.960	5710.240	5729.200	PASS
	Ant3	5720	19.280	5710.480	5729.760	PASS
	Ant4	5720	18.880	5710.720	5729.600	PASS
	Ant1	5720 UNII-2C	14.92	5710.080	5725	PASS
	Ant2	5720 UNII-2C	14.76	5710.240	5725	PASS
	Ant3	5720 UNII-2C	14.52	5710.480	5725	PASS
	Ant4	5720 UNII-2C	14.28	5710.720	5725	PASS
Ant1	5720 UNII-3	4.32	5725	5729.320	PASS	
Ant2	5720 UNII-3	4.2	5725	5729.200	PASS	
Ant3	5720 UNII-3	4.76	5725	5729.760	PASS	
Ant4	5720 UNII-3	4.6	5725	5729.600	PASS	
11AX20MIMO	Ant1	5260	20.200	5250.000	5270.200	PASS
	Ant2	5260	20.880	5249.280	5270.160	PASS
	Ant3	5260	21.240	5249.320	5270.560	PASS
	Ant4	5260	20.560	5249.560	5270.120	PASS
	Ant1	5280	20.160	5269.960	5290.120	PASS
	Ant2	5280	20.160	5270.040	5290.200	PASS
	Ant3	5280	20.200	5269.720	5289.920	PASS
	Ant4	5280	20.040	5269.920	5289.960	PASS
	Ant1	5320	20.120	5310.080	5330.200	PASS
	Ant2	5320	20.920	5309.640	5330.560	PASS
	Ant3	5320	21.280	5309.440	5330.720	PASS
	Ant4	5320	19.800	5310.000	5329.800	PASS
	Ant1	5500	20.920	5489.320	5510.240	PASS
	Ant2	5500	20.360	5490.280	5510.640	PASS
	Ant3	5500	20.480	5489.640	5510.120	PASS
	Ant4	5500	20.840	5490.120	5510.960	PASS
	Ant1	5580	19.720	5570.120	5589.840	PASS



	Ant2	5580	20.920	5569.680	5590.600	PASS
	Ant3	5580	20.160	5569.920	5590.080	PASS
	Ant4	5580	19.920	5570.120	5590.040	PASS
	Ant1	5700	21.200	5689.560	5710.760	PASS
	Ant2	5700	20.600	5689.840	5710.440	PASS
	Ant3	5700	21.040	5689.160	5710.200	PASS
	Ant4	5700	21.240	5689.000	5710.240	PASS
	Ant1	5720	20.880	5709.680	5730.560	PASS
	Ant2	5720	20.480	5709.880	5730.360	PASS
	Ant3	5720	20.520	5709.680	5730.200	PASS
	Ant4	5720	21.280	5709.360	5730.640	PASS
	Ant1	5720 UNII-2C	15.32	5709.680	5725	PASS
	Ant2	5720 UNII-2C	15.12	5709.880	5725	PASS
	Ant3	5720 UNII-2C	15.32	5709.680	5725	PASS
	Ant4	5720 UNII-2C	15.64	5709.360	5725	PASS
	Ant1	5720 UNII-3	5.56	5725	5730.560	PASS
	Ant2	5720 UNII-3	5.36	5725	5730.360	PASS
	Ant3	5720 UNII-3	5.2	5725	5730.200	PASS
	Ant4	5720 UNII-3	5.64	5725	5730.640	PASS
11AX40MIMO	Ant1	5270	39.040	5250.560	5289.600	PASS
	Ant2	5270	39.120	5250.560	5289.680	PASS
	Ant3	5270	39.120	5250.560	5289.680	PASS
	Ant4	5270	39.200	5250.480	5289.680	PASS
	Ant1	5310	39.120	5290.480	5329.600	PASS
	Ant2	5310	39.120	5290.560	5329.680	PASS
	Ant3	5310	39.520	5290.400	5329.920	PASS
	Ant4	5310	38.960	5290.640	5329.600	PASS
	Ant1	5510	39.200	5490.400	5529.600	PASS
	Ant2	5510	39.440	5490.320	5529.760	PASS
	Ant3	5510	39.280	5490.560	5529.840	PASS
	Ant4	5510	39.200	5490.560	5529.760	PASS
	Ant1	5590	39.040	5570.560	5609.600	PASS
	Ant2	5590	39.200	5570.560	5609.760	PASS
	Ant3	5590	39.040	5570.560	5609.600	PASS
	Ant4	5590	39.120	5570.480	5609.600	PASS
	Ant1	5670	39.280	5650.480	5689.760	PASS
	Ant2	5670	39.040	5650.560	5689.600	PASS
	Ant3	5670	39.760	5649.920	5689.680	PASS
	Ant4	5670	39.200	5650.480	5689.680	PASS
	Ant1	5710	39.360	5690.480	5729.840	PASS
	Ant2	5710	39.040	5690.480	5729.520	PASS
	Ant3	5710	39.120	5690.480	5729.600	PASS
	Ant4	5710	39.360	5690.320	5729.680	PASS
	Ant1	5710 UNII-2C	34.52	5690.480	5725	PASS
	Ant2	5710 UNII-2C	34.52	5690.480	5725	PASS
	Ant3	5710 UNII-2C	34.52	5690.480	5725	PASS
	Ant4	5710 UNII-2C	34.68	5690.320	5725	PASS
	Ant1	5710 UNII-3	4.84	5725	5729.840	PASS
	Ant2	5710 UNII-3	4.52	5725	5729.520	PASS
	Ant3	5710 UNII-3	4.6	5725	5729.600	PASS
	Ant4	5710 UNII-3	4.68	5725	5729.680	PASS
11AX80MIMO	Ant1	5290	80.000	5250.160	5330.160	PASS
	Ant2	5290	80.000	5250.160	5330.160	PASS
	Ant3	5290	80.000	5250.160	5330.160	PASS
	Ant4	5290	80.000	5250.160	5330.160	PASS
	Ant1	5530	80.160	5490.160	5570.320	PASS
	Ant2	5530	82.720	5490.320	5573.040	PASS
	Ant3	5530	80.160	5490.160	5570.320	PASS
	Ant4	5530	80.000	5490.160	5570.160	PASS
	Ant1	5610	79.680	5570.160	5649.840	PASS
	Ant2	5610	79.840	5570.160	5650.000	PASS



	Ant3	5610	80.000	5570.000	5650.000	PASS
	Ant4	5610	79.840	5570.320	5650.160	PASS
	Ant1	5690	79.840	5650.160	5730.000	PASS
	Ant2	5690	79.840	5650.320	5730.160	PASS
	Ant3	5690	80.160	5650.160	5730.320	PASS
	Ant4	5690	80.000	5650.160	5730.160	PASS
	Ant1	5690 UNII-2C	74.84	5650.160	5725	PASS
	Ant2	5690 UNII-2C	74.68	5650.320	5725	PASS
	Ant3	5690 UNII-2C	74.84	5650.160	5725	PASS
	Ant4	5690 UNII-2C	74.84	5650.160	5725	PASS
	Ant1	5690 UNII-3	5	5725	5730.000	PASS
	Ant2	5690 UNII-3	5.16	5725	5730.160	PASS
	Ant3	5690 UNII-3	5.32	5725	5730.320	PASS
	Ant4	5690 UNII-3	5.16	5725	5730.160	PASS
11AX160MIMO	Ant1	5250	161.600	5169.680	5331.280	PASS
	Ant2	5250	161.280	5169.680	5330.960	PASS
	Ant3	5250	161.600	5169.680	5331.280	PASS
	Ant4	5250	161.280	5169.680	5330.960	PASS
	Ant1	5250 UNII-1	80.32	5169.680	5250	PASS
	Ant2	5250 UNII-1	80.32	5169.680	5250	PASS
	Ant3	5250 UNII-1	80.32	5169.680	5250	PASS
	Ant4	5250 UNII-1	80.32	5169.680	5250	PASS
	Ant1	5250 UNII-2A	81.28	5250	5331.280	PASS
	Ant2	5250 UNII-2A	80.96	5250	5330.960	PASS
	Ant3	5250 UNII-2A	81.28	5250	5331.280	PASS
	Ant4	5250 UNII-2A	80.96	5250	5330.960	PASS
	Ant1	5570	161.600	5489.680	5651.280	PASS
	Ant2	5570	161.600	5489.680	5651.280	PASS
	Ant3	5570	161.600	5489.680	5651.280	PASS
	Ant4	5570	161.920	5489.680	5651.600	PASS

11.1.2. Test Graphs





11A Ant4 5260



11A Ant1 5280



11A Ant2 5280



11A Ant3 5280



11A Ant4 5280



11A Ant1 5320



11A Ant2 5320



11A Ant3 5320



11A Ant4 5320



11A Ant1 5500



11A Ant2 5500



11A Ant3 5500

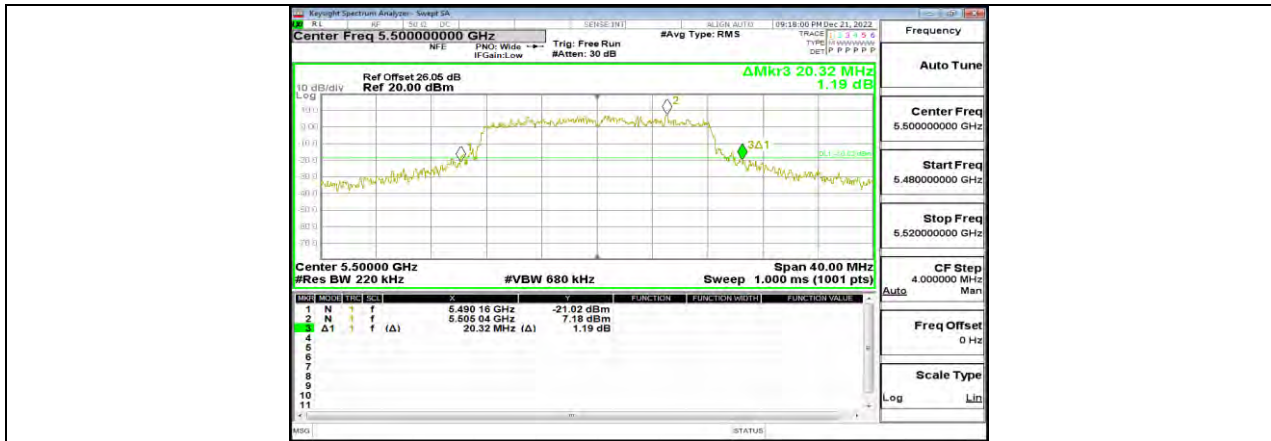

11A Ant4 5500

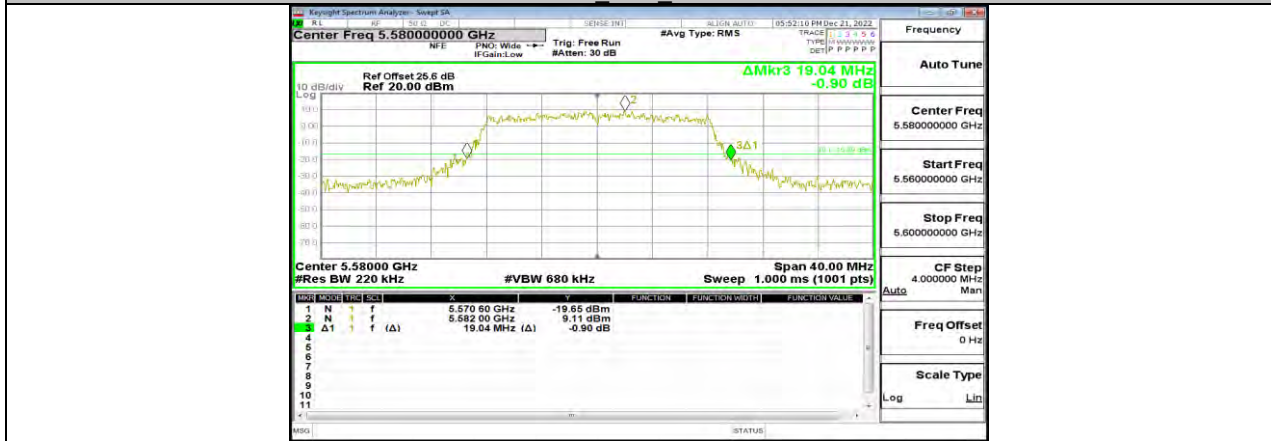

11A Ant1 5580



11A Ant2 5580