

CFR 47 FCC PART 15 SUBPART C

TEST REPORT

For

AX1500 Dual Band Gigabit Wi-Fi 6 Router

MODEL NUMBER: EX141

REPORT NUMBER: 4790868921-RF-1

ISSUE DATE: June 26, 2023

FCC ID: 2AXJ4EX141

Prepared for

TP-Link Corporation Limited
Room 901, 9/F. , New East Ocean Centre, 9 Science Museum Road, Tsim Sha Tsui,
Kowloon, Hong Kong

Prepared by

UL Verification Services (Guangzhou) Co., Ltd, Song Shan Lake Branch

Building 10, Innovation Technology Park, No. 1, Li Bin Road, Song Shan Lake Hi-Tech Development Zone Dongguan, 523808, People's Republic of China

Tel: +86 769 22038881

Fax: +86 769 33244054

Website: www.ul.com

Revision History

Rev.	Issue Date	Revisions	Revised By
V0	June 26, 2023	Initial Issue	

Summary of Test Results

Test Item	Clause	Limit/Requirement	Result
Antenna Requirement	/	FCC Part 15.203/15.247 (c) RSS-GEN Clause 6.8	Pass
AC Power Line Conducted Emission	ANSI C63.10-2013, Clause 6.2	FCC Part 15.207 RSS-GEN Clause 8.8	Pass
Conducted Output Power	ANSI C63.10-2013, Clause 11.9.1.3	FCC Part 15.247 (b)(3) RSS-247 Clause 5.4 (d)	Pass
6dB Bandwidth and 99% Occupied Bandwidth	ANSI C63.10-2013, Clause 11.8.1	FCC Part 15.247 (a)(2) RSS-247 Clause 5.2 (a) RSS-Gen Clause 6.7	Pass
Power Spectral Density	ANSI C63.10-2013, Clause 11.10.2	FCC Part 15.247 (e) RSS-247 Clause 5.2 (b)	Pass
Conducted Band edge and spurious emission	ANSI C63.10-2013, Clause 11.11	FCC Part 15.247(d) RSS-247 Clause 5.5	Pass
Radiated Band edge and Spurious Emission	ANSI C63.10-2013, Clause 11.12 & Clause 11.13	FCC Part 15.247 (d) FCC Part 15.205/15.209 RSS-247 Clause 5.5 RSS-GEN Clause 8.9	Pass
Duty Cycle	ANSI C63.10-2013, Clause 11.6	None; for reporting purposes only.	Pass

*This test report is only published to and used by the applicant, and it is not for evidence purpose in China.

*The measurement result for the sample received is <Pass> according to <CFR 47 FCC PART 15 SUBPART C > when <Accuracy Method> decision rule is applied.

CONTENTS

1. ATTESTATION OF TEST RESULTS	6
2. TEST METHODOLOGY	7
3. FACILITIES AND ACCREDITATION	7
4. CALIBRATION AND UNCERTAINTY	8
4.1. <i>MEASURING INSTRUMENT CALIBRATION</i>	8
4.2. <i>MEASUREMENT UNCERTAINTY</i>	8
5. EQUIPMENT UNDER TEST	9
5.1. <i>DESCRIPTION OF EUT</i>	9
5.2. <i>CHANNEL LIST</i>	9
5.3. <i>MAXIMUM POWER</i>	9
5.4. <i>TEST CHANNEL CONFIGURATION</i>	9
5.5. <i>THE WORSE CASE POWER SETTING PARAMETER</i>	10
5.6. <i>WORST-CASE CONFIGURATIONS</i>	10
5.7. <i>DESCRIPTION OF AVAILABLE ANTENNAS</i>	11
5.8. <i>SUPPORT UNITS FOR SYSTEM TEST</i>	12
6. MEASURING EQUIPMENT AND SOFTWARE USED	13
7. ANTENNA PORT TEST RESULTS	15
7.1. <i>CONDUCTED OUTPUT POWER</i>	15
7.2. <i>6DB BANDWIDTH AND 99% OCCUPIED BANDWIDTH</i>	16
7.3. <i>POWER SPECTRAL DENSITY</i>	18
7.4. <i>CONDUCTED BAND EDGE AND SPURIOUS EMISSION</i>	19
7.5. <i>DUTY CYCLE</i>	21
8. RADIATED TEST RESULTS	22
8.1. <i>RESTRICTED BANDEDGE</i>	31
8.2. <i>SPURIOUS EMISSIONS (1 GHZ ~ 3 GHZ)</i>	71
8.3. <i>SPURIOUS EMISSIONS (3 GHZ ~ 18 GHZ)</i>	81
8.4. <i>SPURIOUS EMISSIONS (9 KHZ ~ 30 MHZ)</i>	117
8.5. <i>SPURIOUS EMISSIONS (18 GHZ ~ 26 GHZ)</i>	120
8.6. <i>SPURIOUS EMISSIONS (30 MHZ ~ 1 GHZ)</i>	122
9. ANTENNA REQUIREMENT	124
10. AC POWER LINE CONDUCTED EMISSION	125

11.	TEST DATA	128
11.1.	<i>APPENDIX A: DTS BANDWIDTH</i>	128
11.1.1.	Test Result	128
11.1.2.	Test Graphs	129
11.2.	<i>APPENDIX B: OCCUPIED CHANNEL BANDWIDTH</i>	143
11.2.1.	Test Result	143
11.2.2.	Test Graphs	144
11.3.	<i>APPENDIX C: MAXIMUM AVERAGE CONDUCTED OUTPUT POWER.....</i>	158
11.3.1.	Test Result	158
11.4.	<i>APPENDIX D: MAXIMUM POWER SPECTRAL DENSITY</i>	160
11.4.1.	Test Result	160
11.4.2.	Test Graphs	162
11.5.	<i>APPENDIX E: BAND EDGE MEASUREMENTS</i>	176
11.5.1.	Test Result	176
11.5.2.	Test Graphs	177
11.6.	<i>APPENDIX F: CONDUCTED SPURIOUS EMISSION</i>	188
11.6.1.	Test Result	188
11.6.2.	Test Graphs	191
11.7.	<i>APPENDIX G: DUTY CYCLE.....</i>	231
11.7.1.	Test Result	231
11.7.2.	Test Graphs	232

1. ATTESTATION OF TEST RESULTS

Applicant Information

Company Name: TP-Link Corporation Limited
Address: Room 901, 9/F. , New East Ocean Centre, 9 Science Museum Road, Tsim Sha Tsui, Kowloon, Hong Kong

Manufacturer Information

Company Name: TP-Link Corporation Limited
Address: Room 901, 9/F. , New East Ocean Centre, 9 Science Museum Road, Tsim Sha Tsui, Kowloon, Hong Kong

EUT Information

EUT Name: AX1500 Dual Band Gigabit Wi-Fi 6 Router
Model: EX141
Sample Received Date: May 29, 2023
Sample ID: 6125501
Date of Tested: May 29, 2023 to June 25, 2023

APPLICABLE STANDARDS	
STANDARD	TEST RESULTS
CFR 47 FCC PART 15 SUBPART C	Pass

Prepared By:

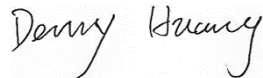

Denny Huang
Senior Project Engineer

Checked By:



Kebo Zhang
Senior Project Engineer

Approved By:



Stephen Guo
Operations Manager

2. TEST METHODOLOGY

All tests were performed in accordance with the standard CFR 47 FCC PART 15 SUBPART C, KDB 558074 D01 15.247 Meas Guidance v05r02, KDB 414788 D01 Radiated Test Site v01r01, KDB 662911 D01 Multiple Transmitter Output v02r01, CFR 47 FCC Part 2, ANSI C63.10-2013.

3. FACILITIES AND ACCREDITATION

Accreditation Certificate	<p>A2LA (Certificate No.: 4102.01) UL Verification Services (Guangzhou) Co., Ltd. Song Shan Lake Branch. has been assessed and proved to be in compliance with A2LA.</p> <p>FCC (FCC Designation No.: CN1187) UL Verification Services (Guangzhou) Co., Ltd. Song Shan Lake Branch. Has been recognized to perform compliance testing on equipment subject to the Commission's Declaration of Conformity (DoC) and Certification rules</p> <p>ISED (Company No.: 21320) UL Verification Services (Guangzhou) Co., Ltd. Song Shan Lake Branch. has been registered and fully described in a report filed with ISED. The Company Number is 21320 and the test lab Conformity Assessment Body Identifier (CABID) is CN0046.</p> <p>VCCI (Registration No.: G-20019, R-20004, C-20012 and T-20011) UL Verification Services (Guangzhou) Co., Ltd. Song Shan Lake Branch. has been assessed and proved to be in compliance with VCCI, the Membership No. is 3793. Facility Name: Chamber D, the VCCI registration No. is G-20019 and R-20004 Shielding Room B , the VCCI registration No. is C-20012 and T-20011</p>
---------------------------	--

Note 1:

All tests measurement facilities use to collect the measurement data are located at Building 10, Innovation Technology Park, No. 1, Li Bin Road, Song Shan Lake Hi-Tech Development Zone Dongguan, 523808, People's Republic of China.

Note 2:

The test anechoic chamber in UL Verification Services (Guangzhou) Co., Ltd. Song Shan Lake Branch had been calibrated and compared to the open field sites and the test anechoic chamber is shown to be equivalent to or worst case from the open field site.

Note 3:

For below 30 MHz, lab had performed measurements at test anechoic chamber and comparing to measurements obtained on an open field site. And these measurements below 30 MHz had been correlated to measurements performed on an OFS.

4. CALIBRATION AND UNCERTAINTY

4.1. MEASURING INSTRUMENT CALIBRATION

The measuring equipment utilized to perform the tests documented in this report has been calibrated in accordance with the manufacturer's recommendations and is traceable to recognized national standards.

4.2. MEASUREMENT UNCERTAINTY

Where relevant, the following measurement uncertainty levels have been estimated for tests performed on the apparatus:

Test Item	Uncertainty
Conduction emission	3.62 dB
Radiated Emission (Included Fundamental Emission) (9 kHz ~ 30 MHz)	2.2 dB
Radiated Emission (Included Fundamental Emission) (30 MHz ~ 1 GHz)	4.00 dB
Radiated Emission (Included Fundamental Emission) (1 GHz to 26 GHz)	5.78 dB (1 GHz ~ 18 GHz)
	5.23 dB (18 GHz ~ 26 GHz)
Duty Cycle	±0.028%
DTS and 99% Occupied Bandwidth	±0.0196%
Maximum Conducted Output Power	±0.686 dB
Maximum Power Spectral Density Level	±0.743 dB
Conducted Band-edge Compliance	±1.328 dB
Conducted Unwanted Emissions In Non-restricted Frequency Bands	±0.746 dB (9 kHz ~ 1 GHz)
	±1.328dB (1 GHz ~ 26 GHz)
Note: This uncertainty represents an expanded uncertainty expressed at approximately the 95% confidence level using a coverage factor of k=2.	

5. EQUIPMENT UNDER TEST

5.1. DESCRIPTION OF EUT

EUT Name/PMN:	AX1500 Dual Band Gigabit Wi-Fi 6 Router
Model/HVIN:	EX141
Frequency Range:	2412 MHz to 2462 MHz
Type of Modulation:	IEEE 802.11b: DSSS (CCK, DQPSK, DBPSK) IEEE 802.11g/n: OFDM (64-QAM, 16-QAM, QPSK, BPSK)
Radio Technology:	IEEE802.11b/g/n HT20/n HT40/n VHT20/n VHT40
Normal Test Voltage:	DC 12 V via adapter

5.2. CHANNEL LIST

Channel List for 802.11b/g/n (20 MHz)							
Channel	Frequency (MHz)	Channel	Frequency (MHz)	Channel	Frequency (MHz)	Channel	Frequency (MHz)
1	2412	4	2427	7	2442	10	2457
2	2417	5	2432	8	2447	11	2462
3	2422	6	2437	9	2452	/	/

Channel List for 802.11n (40 MHz)							
Channel	Frequency (MHz)	Channel	Frequency (MHz)	Channel	Frequency (MHz)	Channel	Frequency (MHz)
3	2422	5	2432	7	2442	9	2452
4	2427	6	2437	8	2447	/	/

5.3. MAXIMUM POWER

IEEE Std. 802.11	Frequency (MHz)	Channel Number	Maximum Conducted AVG Output Power (dBm)
b	2412 ~ 2462	1-11[11]	22.78
g	2412 ~ 2462	1-11[11]	23.82
n HT20	2412 ~ 2462	1-11[11]	21.82
n HT40	2422 ~ 2452	3-9[7]	14.67

5.4. TEST CHANNEL CONFIGURATION

IEEE Std. 802.11	Test Channel Number	Frequency
b	CH 1, CH2, CH 6, CH10, CH 11	2412, 2417, 2437, 2457, 2462
g	CH 1, CH2, CH 6, CH10, CH 11	2412, 2417, 2437, 2457, 2462
n HT20	CH 1, CH2, CH 6, CH10, CH 11	2412, 2417, 2437, 2457, 2462
n HT40	CH 3, CH4, CH 6, CH8, CH 9	2422, 2427, 2437, 2447, 2452

5.5. THE WORSE CASE POWER SETTING PARAMETER

The Worse Case Power Setting Parameter under 2400 ~ 2483.5 MHz Band											
Test Software		Putty									
Modulation Mode	Transmit Antenna Number	Test Channel									
		NCB: 20 MHz					NCB: 40 MHz				
		CH 1	CH 2	CH 6	CH 10	CH 11	CH 3	CH 4	CH 6	CH 8	CH 9
802.11b	1~2	106	108	108	97	96	/				
802.11g	1~2	86	114	118	118	86					
802.11n HT20	1~2	80	98	110	89	76					
802.11n HT40	1~2	/					62	66	74	62	60

5.6. WORST-CASE CONFIGURATIONS

The EUT was tested in the following configuration(s):

Controlled in test mode using a software application on the EUT supplied by customer. The application was used to enable a continuous transmission and to select the mode, test channels, bandwidth, data rates as required.

Test channels referring to section 5.4.

Maximum power setting referring to section 5.5.

Worst-case data rates as provided by the client were:

802.11b CDD mode: 1 Mbps

802.11g CDD mode: 6 Mbps

802.11n HT20/VHT20 CDD mode: MCS0

802.11n HT40/VHT40 CDD mode: MCS0

The EUT has 2 separate antennas which correspond to 2 separate antenna ports. Core 1, Core 2 correspond to antenna 1, antenna 2 respectively and they support WLAN 2.4G.

The measured additional path loss was included in any path loss calculations for all RF cable used during tested.

5.7. DESCRIPTION OF AVAILABLE ANTENNAS

Antenna	Frequency (MHz)	Antenna Type	Maximum Antenna Gain (dBi)
1	2412-2462	Franklin	2
2	2412-2462	Franklin	2

The EUT support Cyclic Shift Diversity (CDD) mode and not support Tx beamforming.

MIMO output power port and MIMO PSD port summing were performed in accordance with KDB 662911 D01. For the CDD results the Directional Gain was calculated in accordance with the following method.

For output power measurements:

Directional gain = $G_{ANT} + \text{Array Gain} = 2 \text{ dBi}$

G_{ANT} : equal to the gain of the antenna having the highest gain

Array Gain = 0 dB (i.e., no array gain) for $N_{ANT} \leq 4$

For power spectral density (PSD) measurements:

Directional gain = $G_{ANT} + \text{Array Gain} = 5.01 \text{ dBi}$

Array Gain = $10 \log(N_{ANT}/N_{SS}) \text{ dB}$.

N_{ANT} : number of transmit antennas

N_{SS} : number of spatial streams, The worst case directional gain will occur when $N_{SS} = 1$

Note: The EUT support different N_{SS} , but different N_{SS} used the same power setting, only the worst case $N_{SS} = 1$ was reported.

Test Mode	Transmit and Receive Mode	Description
IEEE 802.11b	<input checked="" type="checkbox"/> 2TX, 2RX	ANT 1 and ANT 2 can be used as transmitting/receiving antenna.
IEEE 802.11g	<input checked="" type="checkbox"/> 2TX, 2RX	ANT 1 and ANT 2 can be used as transmitting/receiving antenna.
IEEE 802.11n HT20	<input checked="" type="checkbox"/> 2TX, 2RX	ANT 1 and ANT 2 can be used as transmitting/receiving antenna.
IEEE 802.11n HT40	<input checked="" type="checkbox"/> 2TX, 2RX	ANT 1 and ANT 2 can be used as transmitting/receiving antenna.

Note: The value of the antenna gain was declared by customer.

5.8. SUPPORT UNITS FOR SYSTEM TEST

SUPPORT EQUIPMENT

Item	Equipment	Brand Name	Model Name	Remarks
1	Laptop	ThinkPad	X230i	/
2	USB to Serial Cable	/	/	/

I/O CABLES

Cable No	Port	Connector Type	Cable Type	Cable Length(m)	Remarks
1	LAN1	RJ45	Unshielded	1.0 m	/
2	LAN2	RJ45	Unshielded	1.0 m	/
3	LAN3	RJ45	Unshielded	1.0 m	/
4	WAN	RJ45	Unshielded	1.0 m	/
5	Power	DC	Unshielded	1.5 m	/

ACCESSORIES

Item	Accessory	Brand Name	Model Name	Description
1	I.T.E POWER SUPPLY	tp-link	T120100-2B1	Input: AC 100-240 V, 50 / 60 Hz, 0.3 A Output: DC 12.0 V, 1.0 A

TEST SETUP

The EUT can work in engineering mode with a software through a laptop.

SETUP DIAGRAM FOR TESTS

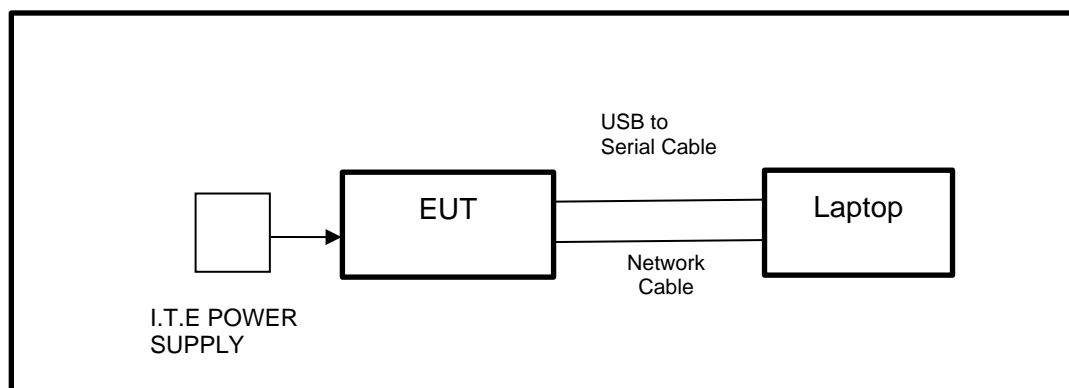

6. MEASURING EQUIPMENT AND SOFTWARE USED

R&S TS 8997 Test System					
Equipment	Manufacturer	Model No.	Serial No.	Last Cal.	Due. Date
Power sensor, Power Meter	R&S	OSP120	100921	Mar.31,2023	Mar.30,2024
Vector Signal Generator	R&S	SMBV100A	261637	Oct.17, 2022	Oct.16, 2023
Signal Generator	R&S	SMB100A	178553	Oct.17, 2022	Oct.16, 2023
Signal Analyzer	R&S	FSV40	101118	Oct.17, 2022	Oct.16, 2023
Software					
Description	Manufacturer	Name	Version		
For R&S TS 8997 Test System	Rohde & Schwarz	EMC 32	10.60.10		
Tonsend RF Test System					
Equipment	Manufacturer	Model No.	Serial No.	Last Cal.	Due. Date
Wideband Radio Communication Tester	R&S	CMW500	155523	Oct.17, 2022	Oct.16, 2023
Wireless Connectivity Tester	R&S	CMW270	1201.0002N75-102	Sep.28, 2022	Sep.27, 2023
PXA Signal Analyzer	Keysight	N9030A	MY55410512	Oct.17, 2022	Oct.16, 2023
MXG Vector Signal Generator	Keysight	N5182B	MY56200284	Oct.17, 2022	Oct.16, 2023
MXG Vector Signal Generator	Keysight	N5172B	MY56200301	Oct.17, 2022	Oct.16, 2023
DC power supply	Keysight	E3642A	MY55159130	Oct.17, 2022	Oct.16, 2023
Temperature & Humidity Chamber	SANMOOD	SG-80-CC-2	2088	Oct.17, 2022	Oct.16, 2023
Attenuator	Aglient	8495B	2814a12853	Oct.18, 2022	Oct.17, 2023
RF Control Unit	Tonscend	JS0806-2	23B80620666	April 18,2023	April 17,2024
Software					
Description	Manufacturer	Name	Version		
Tonsend SRD Test System	Tonsend	JS1120-3 RF Test System	V3.2.22		

Conducted Emissions					
Equipment	Manufacturer	Model No.	Serial No.	Last Cal.	Due Date
EMI Test Receiver	R&S	ESR3	101961	Oct.17, 2022	Oct.16, 2023
Two-Line V-Network	R&S	ENV216	101983	Oct.17, 2022	Oct.16, 2023
Software					
Description			Manufacturer	Name	Version
Test Software for Conducted Emissions			Farad	EZ-EMC	Ver. UL-3A1

Radiated Emissions					
Equipment	Manufacturer	Model No.	Serial No.	Last Cal.	Due Date
MXE EMI Receiver	KESIGHT	N9038A	MY56400036	Oct.17, 2022	Oct.16, 2023
Hybrid Log Periodic Antenna	TDK	HLP-3003C	130959	Aug.02, 2021	Aug.01, 2024
Preamplifier	HP	8447D	2944A09099	Oct.17, 2022	Oct.16, 2023
EMI Measurement Receiver	R&S	ESR26	101377	Oct.17, 2022	Oct.16, 2023
Horn Antenna	TDK	HRN-0118	130940	July 20, 2021	July 19, 2024
Preamplifier	TDK	PA-02-0118	TRS-305-00067	Oct.17, 2022	Oct.16, 2023
Horn Antenna	Schwarzbeck	BBHA9170	697	July 20, 2021	July 19, 2024
Preamplifier	TDK	PA-02-2	TRS-307-00003	Oct.17, 2022	Oct.16, 2023
Preamplifier	TDK	PA-02-3	TRS-308-00002	Oct.17, 2022	Oct.16, 2023
Loop antenna	Schwarzbeck	1519B	00008	Dec.14, 2021	Dec.13, 2024
Preamplifier	TDK	PA-02-001-3000	TRS-302-00050	Oct.17, 2022	Oct.16, 2023
Preamplifier	Mini-Circuits	ZX60-83LN-S+	SUP01202035	Oct.17, 2022	Oct.16, 2023
High Pass Filter	Wi	WHKX10-2700-3000-18000-40SS	23	Oct.17, 2022	Oct.16, 2023
Band Reject Filter	Wainwright	WRCJV8-2350-2400-2483.5-2533.5-40SS	4	Oct.17, 2022	Oct.16, 2023
Software					
Description			Manufacturer	Name	Version
Test Software for Radiated Emissions			Farad	EZ-EMC	Ver. UL-3A1

7. ANTENNA PORT TEST RESULTS

7.1. CONDUCTED OUTPUT POWER

LIMITS

CFR 47 FCC Part15 (15.247) Subpart C			
Section	Test Item	Limit	Frequency Range (MHz)
CFR 47 FCC 15.247(b)(3)	AVG Output Power	1 watt or 30 dBm	2400-2483.5

TEST PROCEDURE

Refer to ANSI C63.10-2013 clause 11.9.2.3.1.

Connect the EUT to a low loss RF cable from the antenna port to the power sensor (video bandwidth is greater than the occupied bandwidth).

Measure peak emission level, the indicated level is the average output power, after any corrections for external attenuators and cables.

The test result in dBm by adding $[10 \log (1 / D)]$, where D is the duty cycle.

TEST SETUP

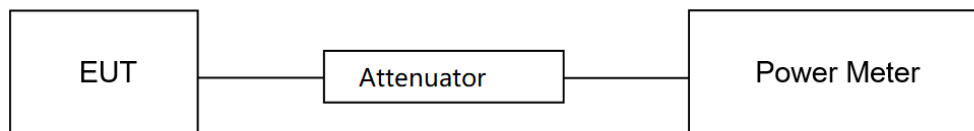

TEST ENVIRONMENT

Temperature	26.6 °C	Relative Humidity	68.7%
Atmosphere Pressure	101 kPa	Test Voltage	DC 12 V

TEST RESULTS

Please refer to section "Test Data" - Appendix C

7.2. 6DB BANDWIDTH AND 99% OCCUPIED BANDWIDTH

LIMITS

CFR 47 FCC Part15 (15.247) Subpart C			
Section	Test Item	Limit	Frequency Range (MHz)
CFR 47 FCC 15.247(a)(2)	6 dB Bandwidth	≥ 500 kHz	2400-2483.5
ISED RSS-Gen Clause 6.7	99 % Occupied Bandwidth	For reporting purposes only.	2400-2483.5

TEST PROCEDURE

Refer to ANSI C63.10-2013 clause 11.8 for DTS bandwidth and clause 6.9 for Occupied Bandwidth.

Connect the EUT to the spectrum analyzer and use the following settings:

Center Frequency	The center frequency of the channel under test
Frequency Span	For 6 dB Bandwidth: Enough to capture all products of the modulation carrier emission For 99 % Occupied Bandwidth: Between 1.5 times and 5.0 times the OBW
Detector	Peak
RBW	For 6 dB Bandwidth: 100 kHz For 99 % Occupied Bandwidth: 1 % to 5 % of the occupied bandwidth
VBW	For 6 dB Bandwidth: ≥3 × RBW For 99 % Occupied Bandwidth: ≥3 × RBW
Trace	Max hold
Sweep	Auto couple

a) Use the 99 % power bandwidth function of the instrument, allow the trace to stabilize and report the measured bandwidth.

b) Allow the trace to stabilize and measure the maximum width of the emission that is constrained by the frequencies associated with the two outermost amplitude points (upper and lower frequencies) that are attenuated by 6 dB relative to the maximum level measured in the fundamental emission.

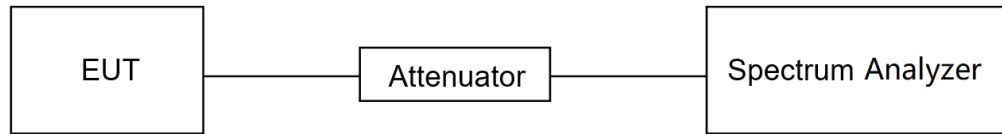
TEST SETUP**TEST ENVIRONMENT**

Temperature	26.6 °C	Relative Humidity	68.7%
Atmosphere Pressure	101 kPa	Test Voltage	DC 12 V

TEST RESULTS

Please refer to section "Test Data" - Appendix A&B

7.3. POWER SPECTRAL DENSITY

LIMITS

CFR 47 FCC Part15 (15.247) Subpart C			
Section	Test Item	Limit	Frequency Range (MHz)
CFR 47 FCC §15.247 (e)	Power Spectral Density	8 dBm in any 3 kHz band	2400-2483.5

TEST PROCEDURE

Refer to ANSI C63.10-2013 clause 11.10.5.

Connect the EUT to the spectrum analyzer and use the following settings:

Center Frequency	The center frequency of the channel under test
Detector	power averaging (rms)
RBW	$3 \text{ kHz} \leq \text{RBW} \leq 100 \text{ kHz}$
VBW	$\geq 3 \times \text{RBW}$
Span	1.5 x OBW bandwidth
Trace	Average
Sweep time	Auto couple

Allow trace to fully stabilize and use the peak marker function to determine the maximum amplitude level within the RBW.

If measured value exceeds limit, reduce RBW (no less than 3 kHz) and repeat.

TEST SETUP

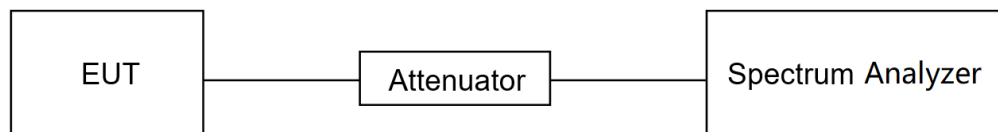

TEST ENVIRONMENT

Temperature	26.6 °C	Relative Humidity	68.7%
Atmosphere Pressure	101 kPa	Test Voltage	DC 12 V

TEST RESULTS

Please refer to section "Test Data" - Appendix D

7.4. CONDUCTED BAND EDGE AND SPURIOUS EMISSION

LIMITS

CFR 47 FCC Part15 (15.247) Subpart C ISED RSS-247 ISSUE 2		
Section	Test Item	Limit
CFR 47 FCC §15.247 (d) ISED RSS-247 5.5	Conducted Bandedge and Spurious Emissions	at least 30 dB below that in the 100 kHz bandwidth within the band that contains the highest level of the desired power

TEST PROCEDURE

Refer to ANSI C63.10-2013 clause 11.11 and 11.13.

Connect the EUT to the spectrum analyzer and use the following settings for reference level measurement:

Center Frequency	The center frequency of the channel under test
Detector	Peak
RBW	100 kHz
VBW	$\geq 3 \times \text{RBW}$
Span	1.5 x DTS bandwidth
Trace	Max hold
Sweep time	Auto couple.

Allow trace to fully stabilize and use the peak marker function to determine the maximum PSD level.

Change the settings for emission level measurement:

Span	Set the center frequency and span to encompass frequency range to be measured
Detector	Peak
RBW	100 kHz
VBW	$\geq 3 \times \text{RBW}$
measurement points	$\geq \text{span}/\text{RBW}$
Trace	Max hold
Sweep time	Auto couple.

Allow trace to fully stabilize and use the peak marker function to determine the maximum PSD level. Ensure that the amplitude of all unwanted emissions outside of the authorized frequency band (excluding restricted frequency bands) is attenuated by at least the minimum requirements specified in 11.11.

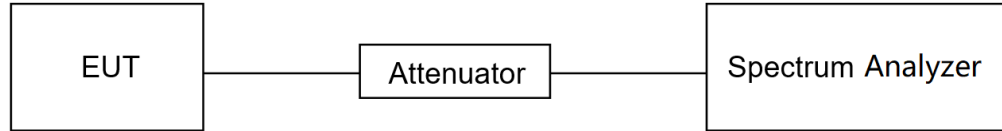
TEST SETUP**TEST ENVIRONMENT**

Temperature	26.6 °C	Relative Humidity	68.7%
Atmosphere Pressure	101 kPa	Test Voltage	DC 12 V

TEST RESULTS

Please refer to section "Test Data" - Appendix E&F

7.5. DUTY CYCLE

LIMITS

None; for reporting purposes only.

TEST PROCEDURE

Refer to ANSI C63.10-2013 clause 11.6 Zero – Span Spectrum Analyzer method.

TEST SETUP

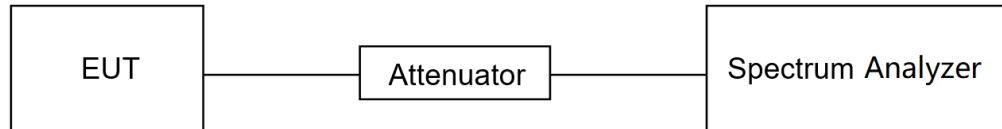

TEST ENVIRONMENT

Temperature	26.6 °C	Relative Humidity	68.7%
Atmosphere Pressure	101 kPa	Test Voltage	DC 12 V

TEST RESULTS

Please refer to section "Test Data" - Appendix G

8. RADIATED TEST RESULTS

LIMITS

Please refer to CFR 47 FCC §15.205 and §15.209.

Radiation Disturbance Test Limit for FCC (Class B) (9 kHz ~ 1 GHz)

Emissions radiated outside of the specified frequency bands above 30 MHz			
Frequency Range (MHz)	Field Strength Limit ($\mu\text{V}/\text{m}$) at 3 m	Field Strength Limit (dB $\mu\text{V}/\text{m}$) at 3 m	
		Quasi-Peak	
30 - 88	100	40	
88 - 216	150	43.5	
216 - 960	200	46	
Above 960	500	54	
Above 1000	500	Peak	Average
		74	54

FCC Emissions radiated outside of the specified frequency bands below 30 MHz		
Frequency (MHz)	Field strength (microvolts/meter)	Measurement distance (meters)
0.009-0.490	2400/F(kHz)	300
0.490-1.705	24000/F(kHz)	30
1.705-30.0	30	30

FCC Restricted bands of operation refer to FCC §15.205 (a):

MHz	MHz	MHz	GHz
0.090-0.110	16.42-16.423	399.9-410	4.5-5.15
¹ 0.495-0.505	16.69475-16.69525	608-614	5.35-5.46
2.1735-2.1905	16.80425-16.80475	960-1240	7.25-7.75
4.125-4.128	25.5-25.67	1300-1427	8.025-8.5
4.17725-4.17775	37.5-38.25	1435-1626.5	9.0-9.2
4.20725-4.20775	73-74.6	1645.5-1646.5	9.3-9.5
6.215-6.218	74.8-75.2	1660-1710	10.6-12.7
6.26775-6.26825	108-121.94	1718.8-1722.2	13.25-13.4
6.31175-6.31225	123-138	2200-2300	14.47-14.5
8.291-8.294	149.9-150.05	2310-2390	15.35-16.2
8.362-8.366	156.52475-156.52525	2483.5-2500	17.7-21.4
8.37625-8.38675	156.7-156.9	2690-2900	22.01-23.12
8.41425-8.41475	162.0125-167.17	3260-3267	23.6-24.0
12.29-12.293	167.72-173.2	3332-3339	31.2-31.8
12.51975-12.52025	240-285	3345.8-3358	36.43-36.5
12.57675-12.57725	322-335.4	3600-4400	(²)
13.36-13.41			

Note: ¹Until February 1, 1999, this restricted band shall be 0.490-0.510 MHz.

²Above 38.6c

TEST PROCEDURE

Below 30 MHz

The setting of the spectrum analyzer

RBW	200 Hz (From 9 kHz to 0.15 MHz)/ 9 kHz (From 0.15 MHz to 30 MHz)
VBW	200 Hz (From 9 kHz to 0.15 MHz)/ 9 kHz (From 0.15 MHz to 30 MHz)
Sweep	Auto

1. The testing follows the guidelines in ANSI C63.10-2013 clause 6.4.
2. The EUT was arranged to its worst case and then turntable (from 0 degree to 360 degrees) to find the maximum reading. A pre-amp and a high pass filter are used for the test in order to get better signal level. Both Horizontal, Face-on and Face-off polarizations of the antenna are set to make the measurement.
3. The EUT was placed on a turntable with 80 cm above ground.
4. The EUT was set 3 meters from the interference receiving antenna, which was mounted on the top of a 1 m height antenna tower.
5. The radiated emission limits are based on measurements employing a CISPR quasi-peak detector except for the frequency bands 9-90 kHz, 110-490 kHz and above 1000 MHz Radiated emission limits in these three bands are based on measurements employing an average detector.
6. For measurement below 1 GHz, the initial step in collecting conducted emission data is a spectrum analyzer peak detector mode pre-scanning the measurement frequency range. Significant peaks are then marked and then Quasi Peak and average detector mode re-measured. If the emission level of the EUT measured by the peak detector is 3 dB lower than the applicable limit, the peak emission level will be reported. Otherwise, the emission measurement will be repeated using the quasi-peak and average detector and reported.
7. Although these tests were performed other than open field site, adequate comparison measurements were confirmed against 30m open field site. Therefore sufficient tests were made to demonstrate that the alternative site produces results that correlate with the ones of tests made in an open field site based on KDB 414788.
8. The limits in CFR 47, Part 15, Subpart C, paragraph 15.209 (a), are identical to those in RSS-GEN Section 8.9, Table 6, since the measurements are performed in terms of magnetic field strength and converted to electric field strength levels (as reported in the table) using the free space impedance of 377Ω . For example, the measurement frequency X KHz resulted in a level of Y dBuV/m, which is equivalent to $Y-51.5 = Z$ dBuA/m, which has the same margin, W dB, to the corresponding RSS-GEN Table 6 limit as it has to be 15.209(a) limit.

Below 1 GHz and above 30 MHz

The setting of the spectrum analyzer

RBW	120 kHz
VBW	300 kHz
Sweep	Auto
Detector	Peak/QP
Trace	Max hold

1. The testing follows the guidelines in ANSI C63.10-2013 clause 6.5.
2. The EUT was arranged to its worst case and then tune the antenna tower (from 1 m to 4 m) and turntable (from 0 degree to 360 degrees) to find the maximum reading. A pre-amp and a high pass filter are used for the test in order to get better signal level. Both horizontal and vertical polarizations of the antenna are set to make the measurement.
3. The EUT was placed on a turntable with 80 cm above ground.
4. The EUT was set 3 meters from the interference receiving antenna, which was mounted on the top of a variable height antenna tower.
5. For measurement below 1 GHz, the initial step in collecting conducted emission data is a spectrum analyzer peak detector mode pre-scanning the measurement frequency range. Significant peaks are then marked and then Quasi Peak detector mode re-measured. If the emission level of the EUT measured by the peak detector is 3 dB lower than the applicable limit, the peak emission level will be reported. Otherwise, the emission measurement will be repeated using the quasi-peak detector and reported.

Above 1 GHz

The setting of the spectrum analyzer

RBW	1 MHz
VBW	PEAK: 3 MHz AVG: see note 6
Sweep	Auto
Detector	Peak
Trace	Max hold

1. The testing follows the guidelines in ANSI C63.10-2013 clause 6.6.
2. The EUT was arranged to its worst case and then tune the antenna tower (from 1 m to 4 m) and turntable (from 0 degree to 360 degrees) to find the maximum reading. A pre-amp and a high pass filter are used for the test in order to get better signal level. Both horizontal and vertical polarizations of the antenna are set to make the measurement.
3. The EUT was placed on a turntable with 1.5 m above ground.
4. The EUT was set 3 meters from the interference receiving antenna, which was mounted on the top of a variable height antenna tower.
5. For measurement above 1 GHz, the emission measurement will be measured by the peak detector. This peak level, once corrected, must comply with the limit specified in Section 15.209.
6. For measurements above 1 GHz the resolution bandwidth is set to 1 MHz, then the video bandwidth is set to 3 MHz for peak measurements and 1 MHz resolution bandwidth with 1/T video bandwidth with peak detector for average measurements. For the Duty Cycle please refer to clause 7.5.ON TIME AND DUTY CYCLE.

Note: The EUT was fully exercised with external accessories during the test. In the case of multiple accessory external ports, an external accessory shall be connected to one of each type of port.

For Restricted Bandedge:

Note:

1. Measurement = Reading Level + Correct Factor.
2. If the peak values are less than the average limit of 54 dBuV/m, the average result is deemed to comply with average limit.
3. Peak: Peak detector.
4. AVG: $VBW=1/Ton$, where: Ton is the transmitting duration.
5. For the transmitting duration, please refer to clause 7.5.
6. Only the worst data was recorded, if it complies with the limit, the other emissions deemed to comply with the limit.
7. Both horizontal and vertical have been tested, only the worst data was recorded in the report.
8. All modes, channels and antennas have been tested, only the worst data was recorded in the report.

For Radiate Spurious emission (9 kHz ~ 30 MHz):

Note:

1. Measurement = Reading Level + Correct Factor.
2. If the peak values are less than the QP limit, the QP result is deemed to comply with QP limit.
3. All 3 polarizations (Horizontal, Face-on and Face-off) of the loop antenna had been tested, but only the worst data recorded in the report.
4. All modes, channels and antennas have been tested, only the worst data was recorded in the report.

For Radiate Spurious Emission (30 MHz ~ 1 GHz):

Note:

1. Result Level = Read Level + Correct Factor.
2. If the peak values are less than the QP limit, the QP result is deemed to comply with QP limit.
3. All modes, channels and antennas have been tested, only the worst data was recorded in the report.

For Radiate Spurious Emission (1 GHz ~ 3 GHz):

1. Measurement = Reading Level + Correct Factor.
2. If the peak values are less than the average limit of 54 dBuV/m, the average result is deemed to comply with average limit.
3. Peak: Peak detector.
4. AVG: $VBW=1/Ton$, where: Ton is the transmitting duration.
5. For the transmitting duration, please refer to clause 7.5.
6. Filter losses were only considered in the spurious frequency bands and the authorized band was not corrected for Band reject filter losses.
7. Proper operation of the transmitter prior to adding the filter to the measurement chain.
8. All modes, channels and antennas have been tested, only the worst data was recorded in the report.

For Radiate Spurious Emission (3 GHz ~ 18 GHz):

Note:

1. Peak Result = Reading Level + Correct Factor.
2. If the peak values are less than the average limit of 54 dBuV/m, the average result is deemed to comply with average limit.
3. Peak: Peak detector.
4. AVG: $VBW=1/Ton$, where: Ton is the transmitting duration.
5. For the transmitting duration, please refer to clause 7.5.
6. Filter losses were only considered in the spurious frequency bands and the authorized band was not corrected for High Pass Filter losses.
7. Proper operation of the transmitter prior to adding the filter to the measurement chain.
8. All modes, channels and antennas have been tested, only the worst data was recorded in the report.

For Radiate Spurious emission (18 GHz ~ 26 GHz):

Note:

1. Measurement = Reading Level + Correct Factor.
2. If the peak values are less than the average limit of 54 dBuV/m, the average result is deemed to comply with average limit.
3. Peak: Peak detector.
4. All modes, channels and antennas have been tested, only the worst data was recorded in the report.

TEST SETUP

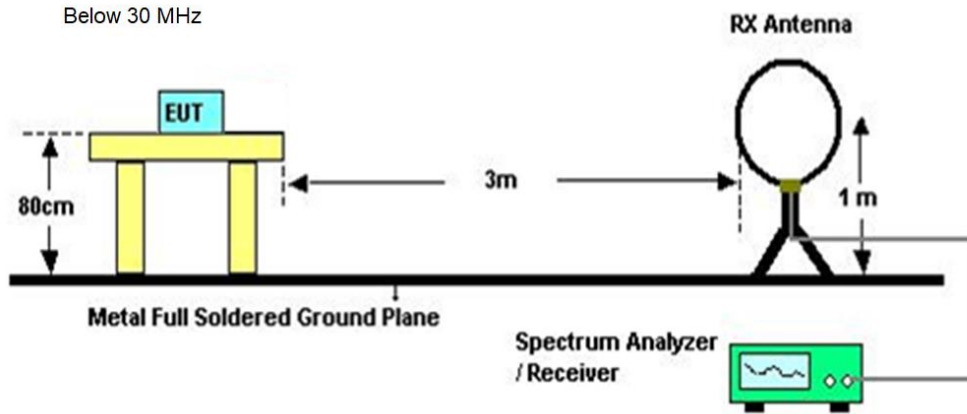

Below 1 GHz and above 30 MHz

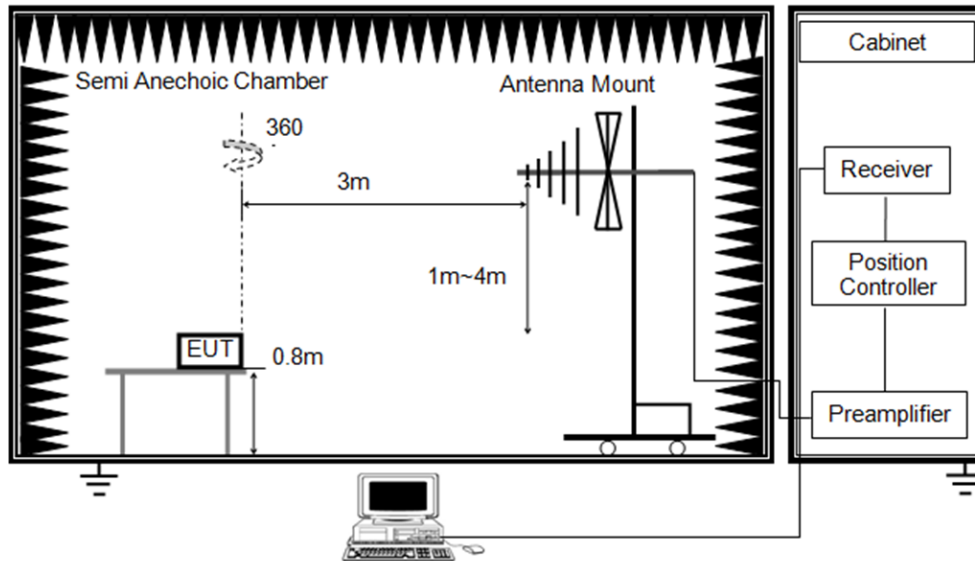

Above 1 GHz

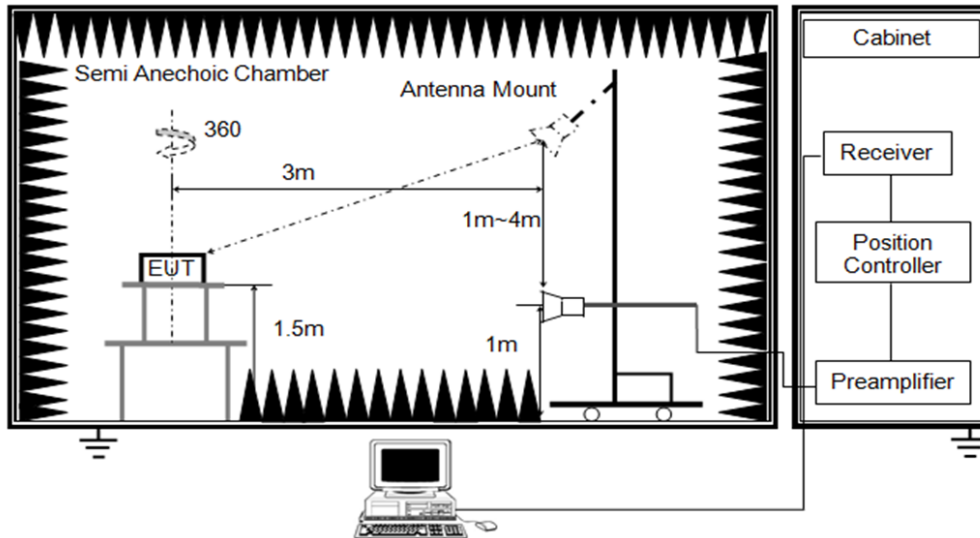

TEST ENVIRONMENT

Temperature	25.1 °C	Relative Humidity	63%
Atmosphere Pressure	101 kPa	Test Voltage	DC 12 V

TEST RESULTS

8.1. RESTRICTED BANDEDGE

Test Mode:	802.11b Peak	Channel:	2412 MHz
Polarity:	Vertical	Test Voltage:	DC 12 V

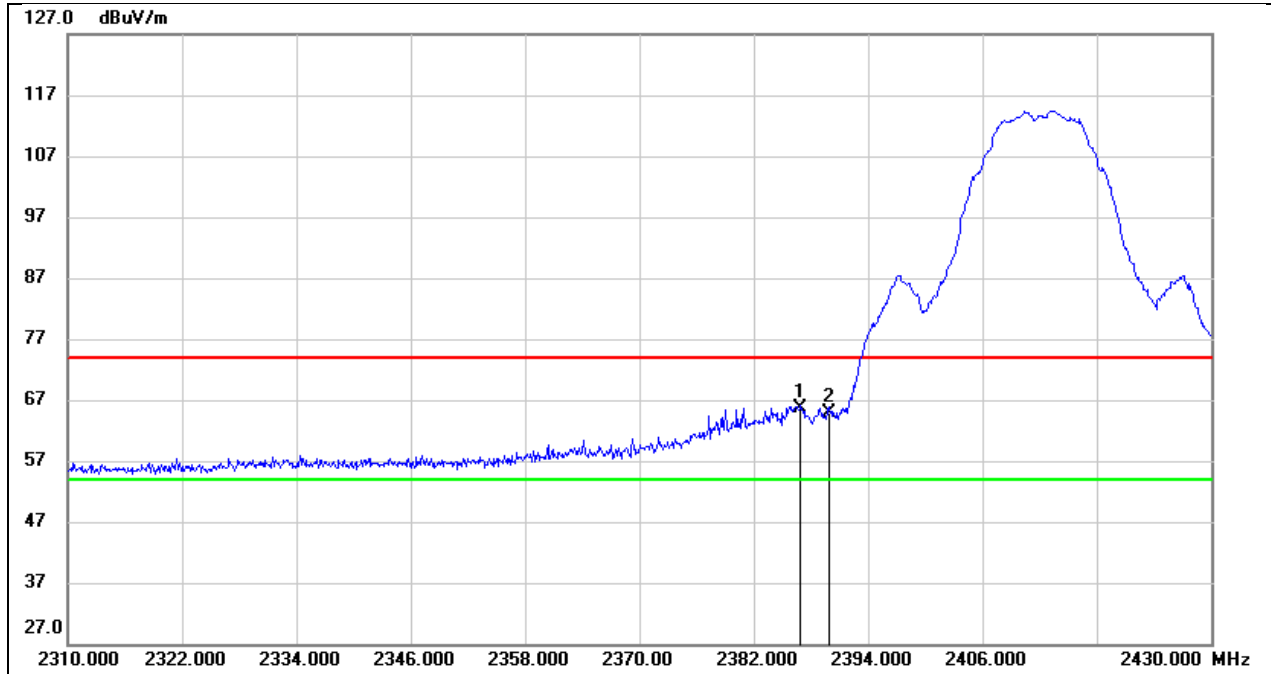

No.	Frequency (MHz)	Reading (dBuV)	Correct (dB/m)	Result (dBuV/m)	Limit (dBuV/m)	Margin (dB)	Remark
1	2386.800	33.42	32.15	65.57	74.00	-8.43	peak
2	2390.000	32.75	32.16	64.91	74.00	-9.09	peak

Test Mode:	802.11b Average	Channel:	2412 MHz
Polarity:	Vertical	Test Voltage:	DC 12 V

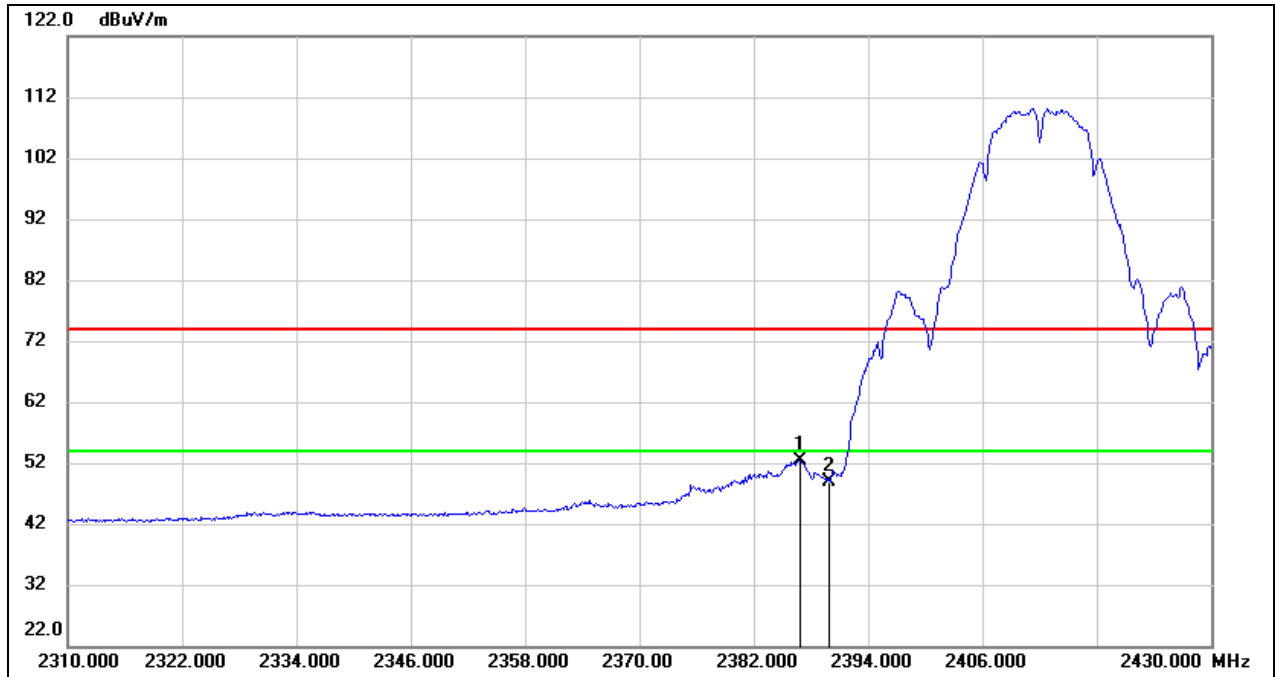

No.	Frequency (MHz)	Reading (dBuV)	Correct (dB/m)	Result (dBuV/m)	Limit (dBuV/m)	Margin (dB)	Remark
1	2386.800	20.32	32.15	52.47	54.00	-1.53	AVG
2	2390.000	16.62	32.16	48.78	54.00	-5.22	AVG

Test Mode:	802.11b Peak	Channel:	2417 MHz
Polarity:	Vertical	Test Voltage:	DC 12 V

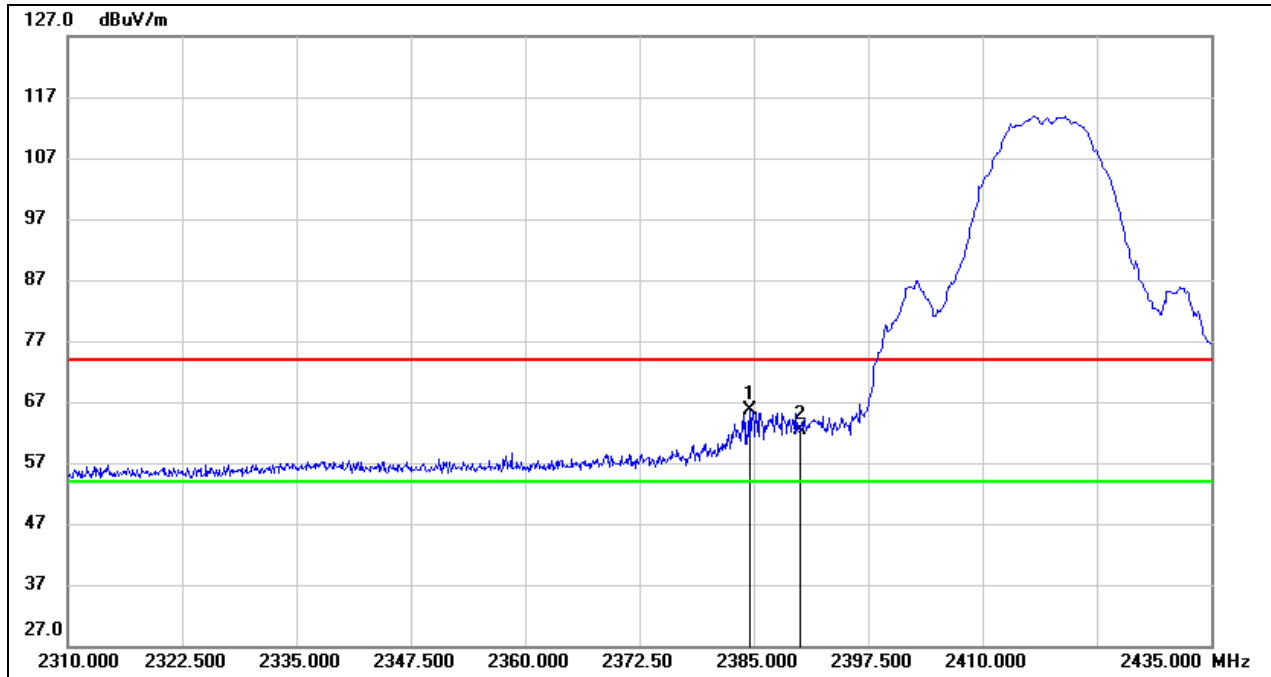

No.	Frequency (MHz)	Reading (dBuV)	Correct (dB/m)	Result (dBuV/m)	Limit (dBuV/m)	Margin (dB)	Remark
1	2384.500	33.42	32.14	65.56	74.00	-8.44	peak
2	2390.000	30.24	32.16	62.40	74.00	-11.60	peak

Test Mode:	802.11b Average	Channel:	2417 MHz
Polarity:	Vertical	Test Voltage:	DC 12 V

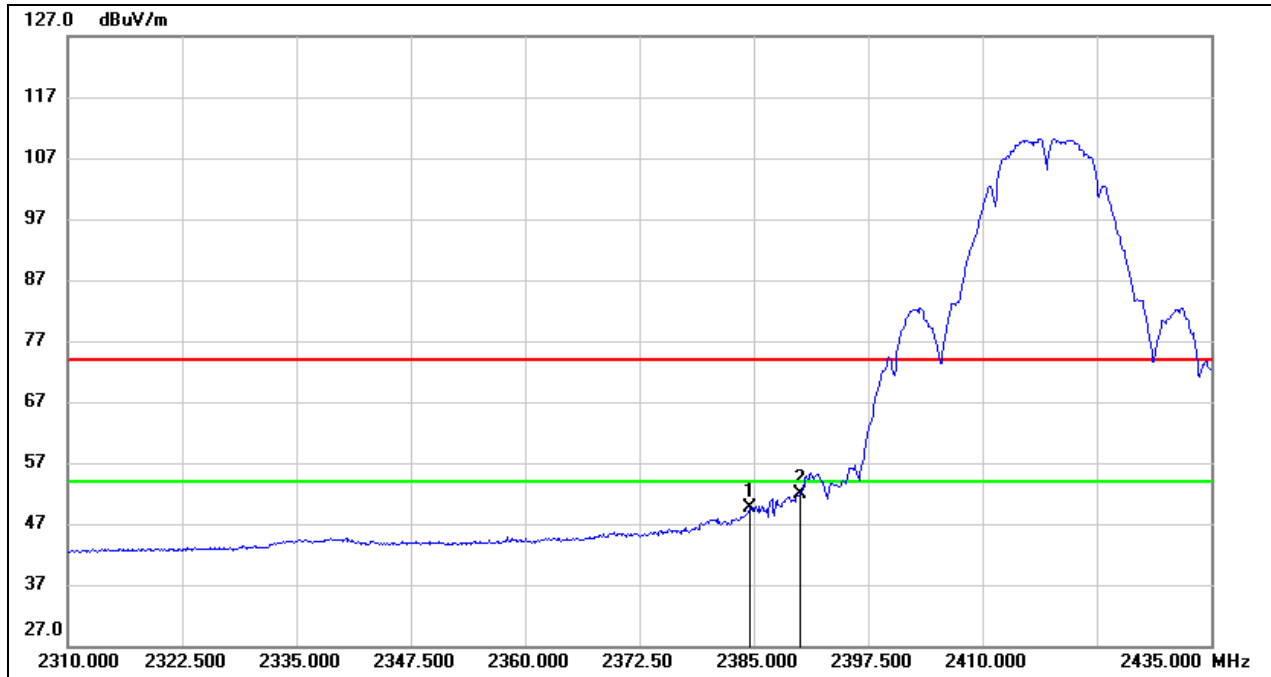

No.	Frequency (MHz)	Reading (dBuV)	Correct (dB/m)	Result (dBuV/m)	Limit (dBuV/m)	Margin (dB)	Remark
1	2384.500	17.52	32.14	49.66	54.00	-4.34	AVG
2	2390.000	19.64	32.16	51.80	54.00	-2.20	AVG

Test Mode:	802.11b Peak	Channel:	2437 MHz
Polarity:	Vertical	Test Voltage:	DC 12 V

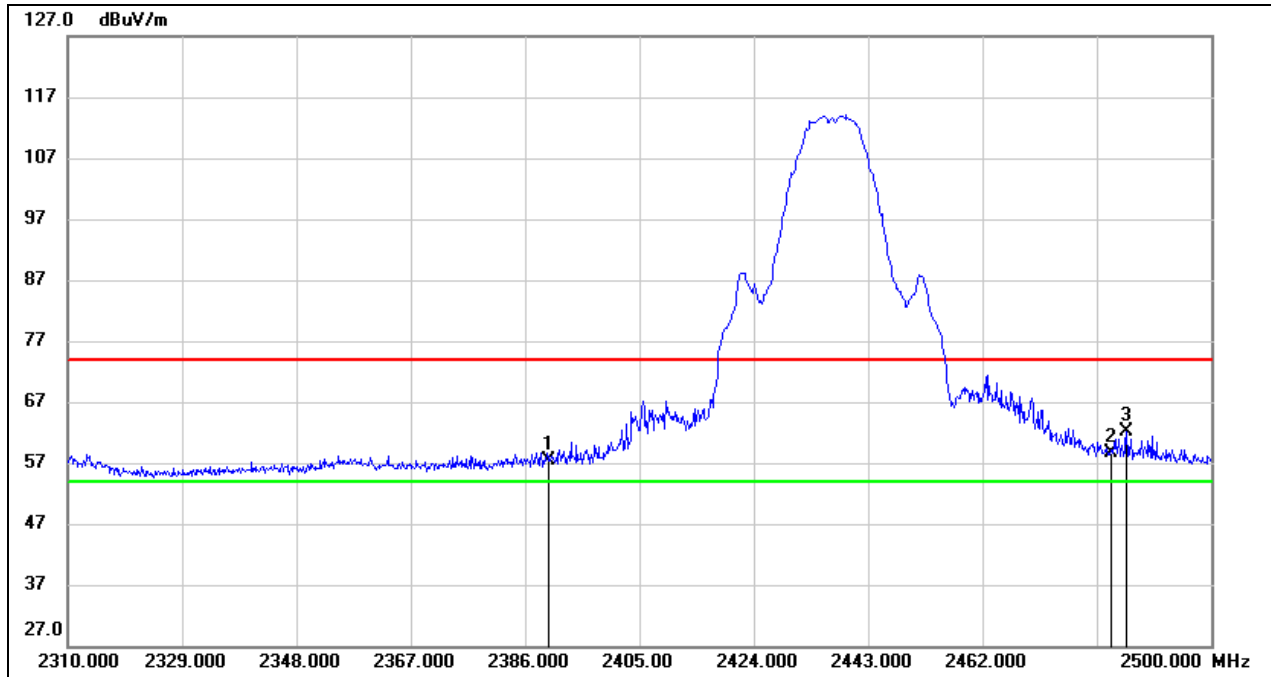

No.	Frequency (MHz)	Reading (dBuV)	Correct (dB/m)	Result (dBuV/m)	Limit (dBuV/m)	Margin (dB)	Remark
1	2390.000	25.30	32.16	57.46	74.00	-16.54	peak
2	2483.500	26.25	32.44	58.69	74.00	-15.31	peak
3	2485.940	29.63	32.44	62.07	74.00	-11.93	peak

Test Mode:	802.11b Average	Channel:	2437 MHz
Polarity:	Vertical	Test Voltage:	DC 12 V

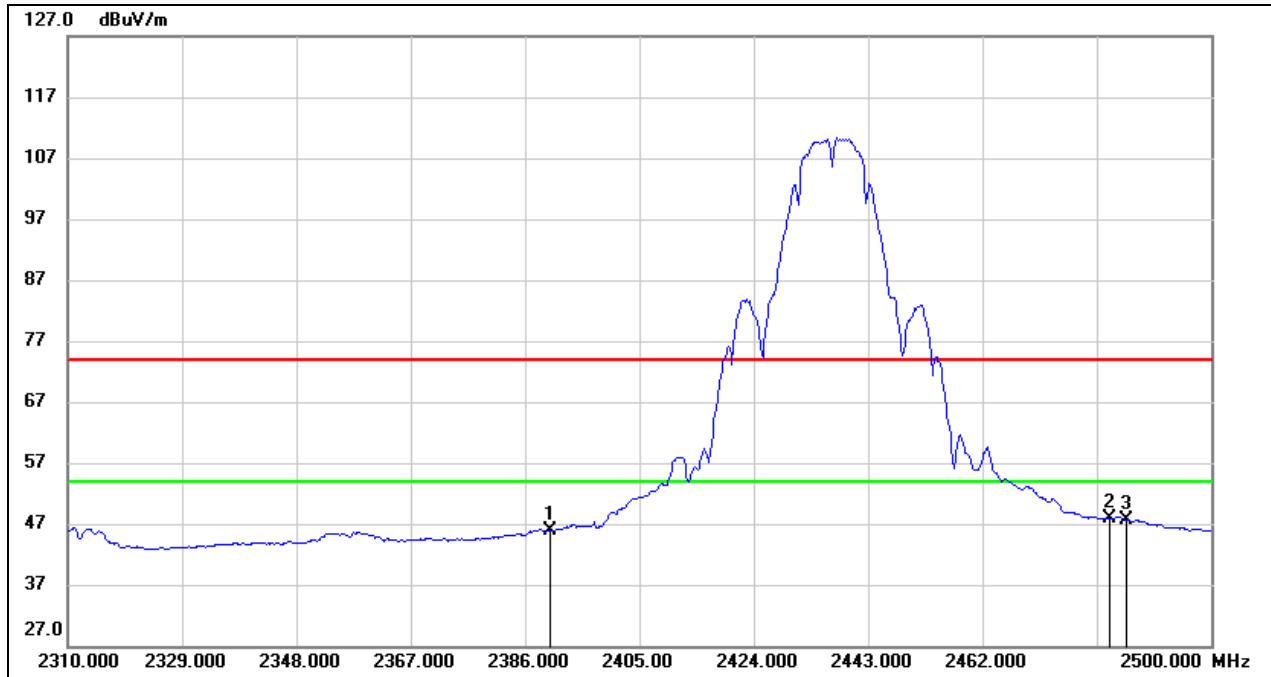

No.	Frequency (MHz)	Reading (dBuV)	Correct (dB/m)	Result (dBuV/m)	Limit (dBuV/m)	Margin (dB)	Remark
1	2390.000	13.68	32.16	45.84	54.00	-8.16	AVG
2	2483.000	15.51	32.44	47.95	54.00	-6.05	AVG
3	2485.940	15.17	32.44	47.61	54.00	-6.39	AVG

Test Mode:	802.11b Peak	Channel:	2457 MHz
Polarity:	Vertical	Test Voltage:	DC 12 V

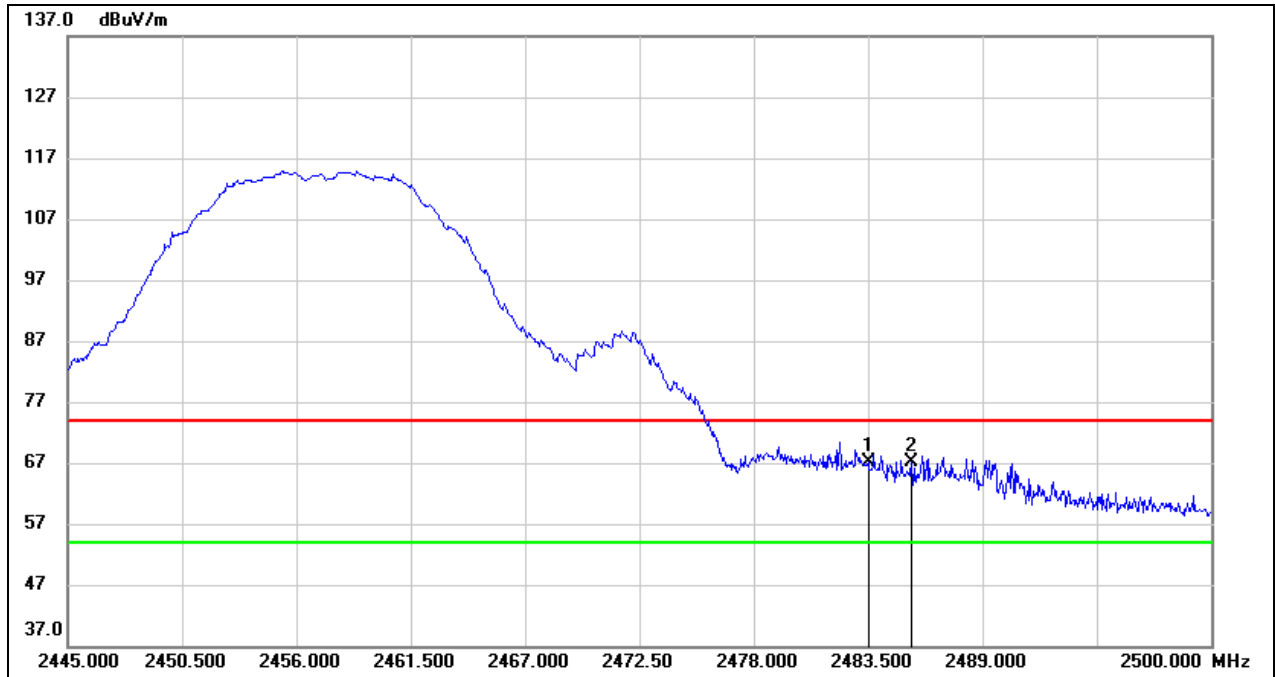

No.	Frequency (MHz)	Reading (dBuV)	Correct (dB/m)	Result (dBuV/m)	Limit (dBuV/m)	Margin (dB)	Remark
1	2483.500	34.81	32.44	67.25	74.00	-6.75	peak
2	2485.590	34.62	32.44	67.06	74.00	-6.94	peak

Test Mode:	802.11b Average	Channel:	2457 MHz
Polarity:	Vertical	Test Voltage:	DC 12 V

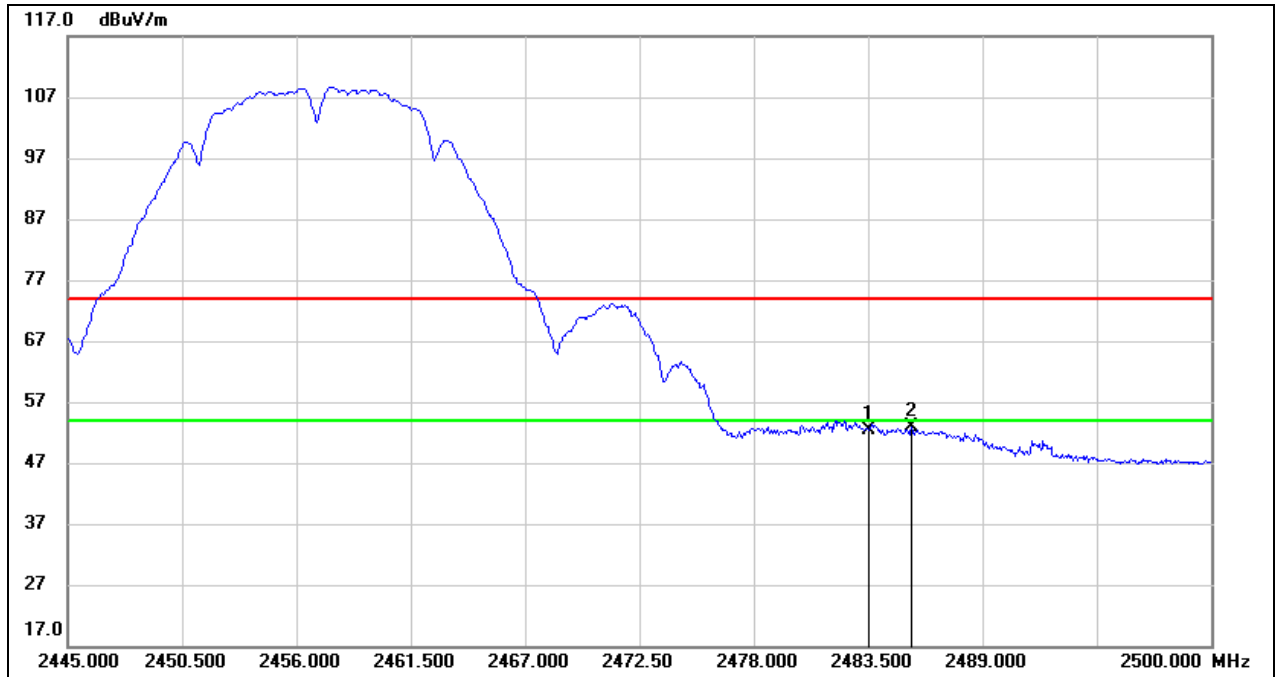

No.	Frequency (MHz)	Reading (dBuV)	Correct (dB/m)	Result (dBuV/m)	Limit (dBuV/m)	Margin (dB)	Remark
1	2483.500	19.89	32.44	52.33	54.00	-1.67	AVG
2	2485.590	20.38	32.44	52.82	54.00	-1.18	AVG

Test Mode:	802.11b Peak	Channel:	2462 MHz
Polarity:	Vertical	Test Voltage:	DC 12 V

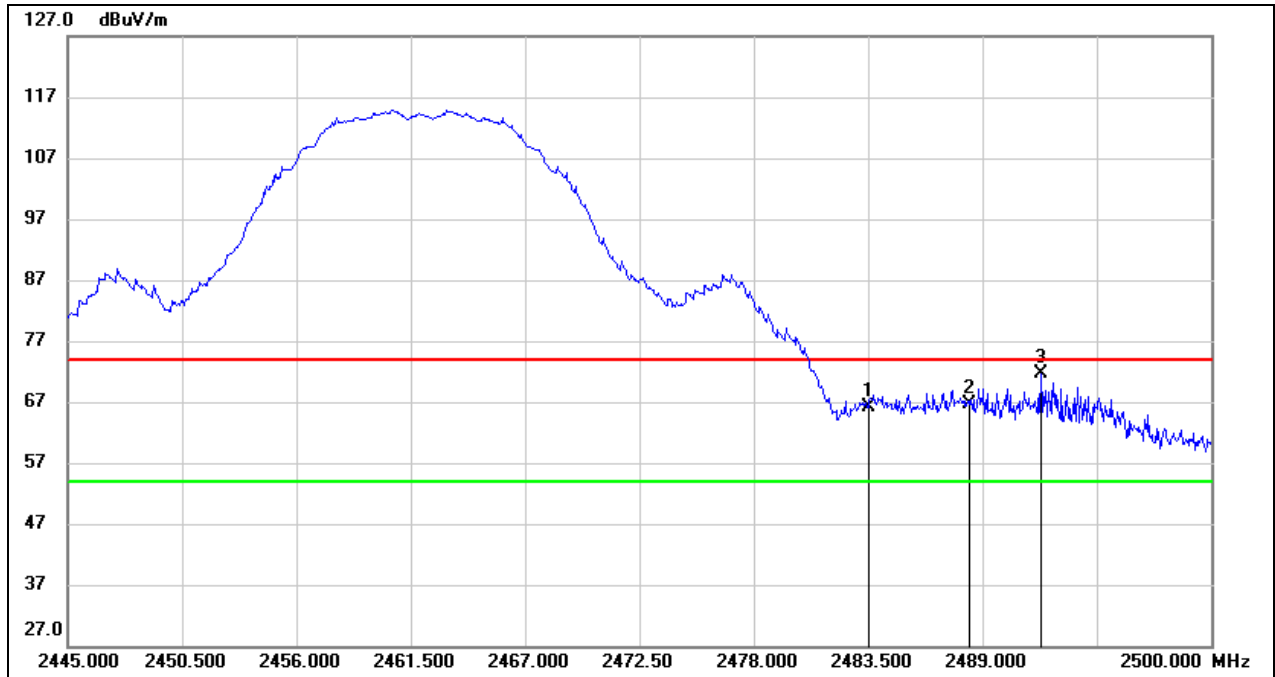

No.	Frequency (MHz)	Reading (dBuV)	Correct (dB/m)	Result (dBuV/m)	Limit (dBuV/m)	Margin (dB)	Remark
1	2483.500	33.80	32.44	66.24	74.00	-7.76	peak
2	2488.340	34.18	32.46	66.64	74.00	-7.36	peak
3	2491.805	39.20	32.47	71.67	74.00	-2.33	peak

Test Mode:	802.11b AV	Channel:	2462 MHz
Polarity:	Vertical	Test Voltage:	DC 12 V

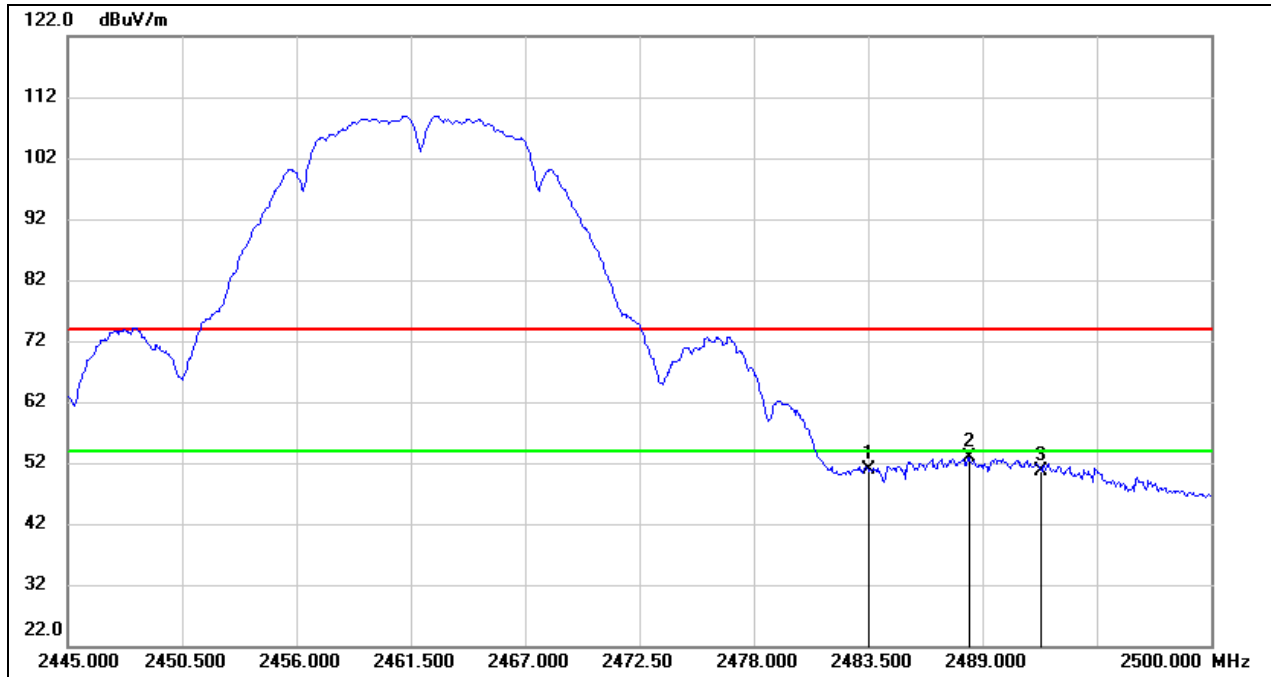

No.	Frequency (MHz)	Reading (dBuV)	Correct (dB/m)	Result (dBuV/m)	Limit (dBuV/m)	Margin (dB)	Remark
1	2483.500	18.52	32.44	50.96	54.00	-3.04	AVG
2	2488.340	20.54	32.46	53.00	54.00	-1.00	AVG
3	2491.805	18.28	32.47	50.75	54.00	-3.25	AVG

Test Mode:	802.11g Peak	Channel:	2412 MHz
Polarity:	Vertical	Test Voltage:	DC 12 V

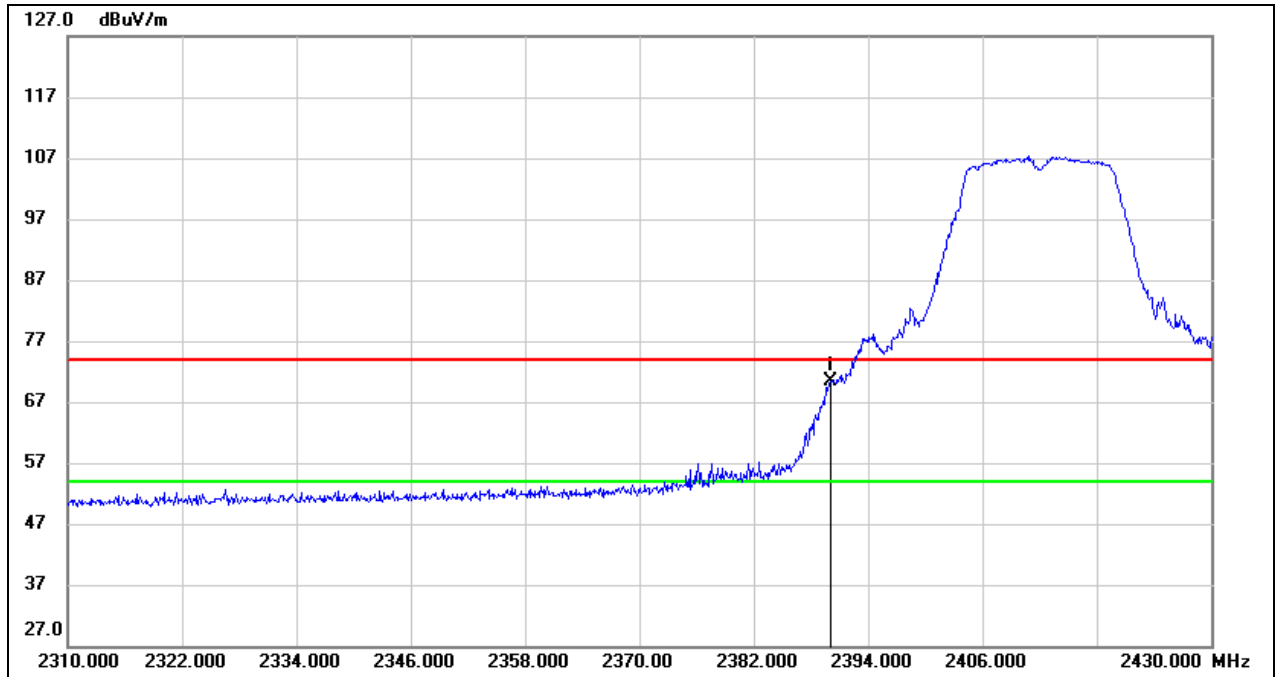

No.	Frequency (MHz)	Reading (dBuV)	Correct (dB/m)	Result (dBuV/m)	Limit (dBuV/m)	Margin (dB)	Remark
1	2390.000	42.91	27.51	70.42	74.00	-3.58	peak

Test Mode:	802.11g Average	Channel:	2412 MHz
Polarity:	Vertical	Test Voltage:	DC 12 V

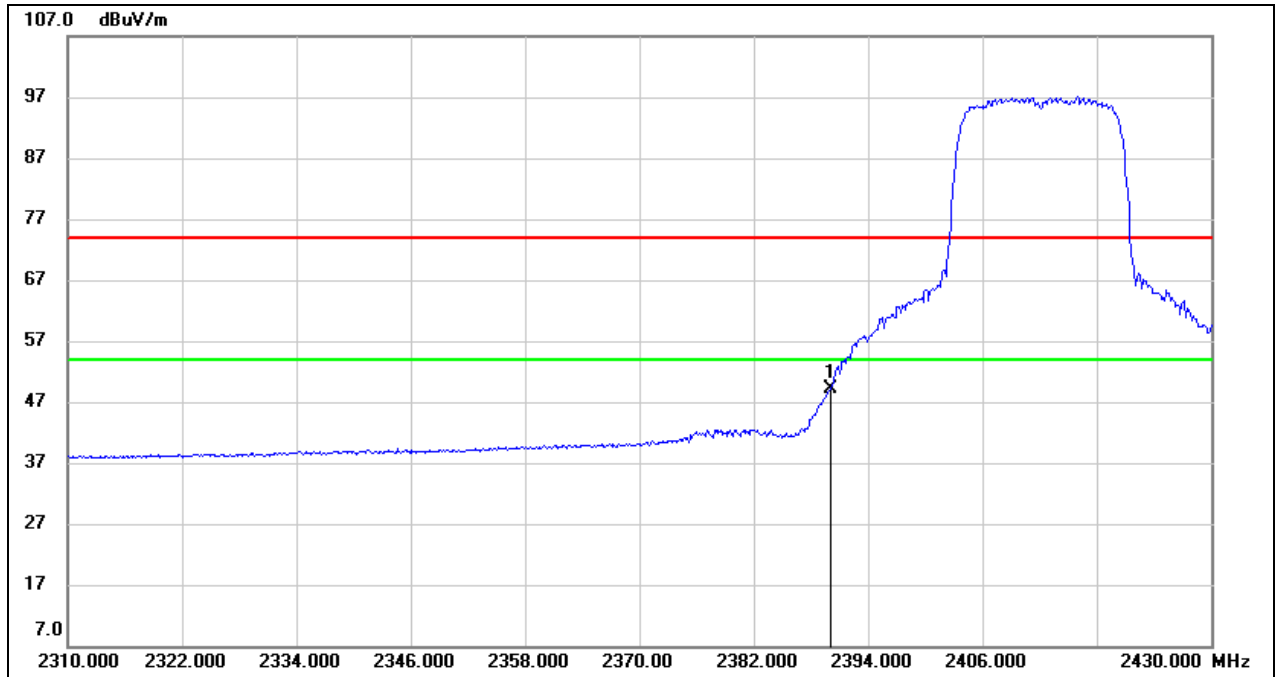

No.	Frequency (MHz)	Reading (dBuV)	Correct (dB/m)	Result (dBuV/m)	Limit (dBuV/m)	Margin (dB)	Remark
1	2390.000	21.59	27.51	49.10	54.00	-4.90	AVG

Test Mode:	802.11g Peak	Channel:	2417 MHz
Polarity:	Vertical	Test Voltage:	DC 12 V

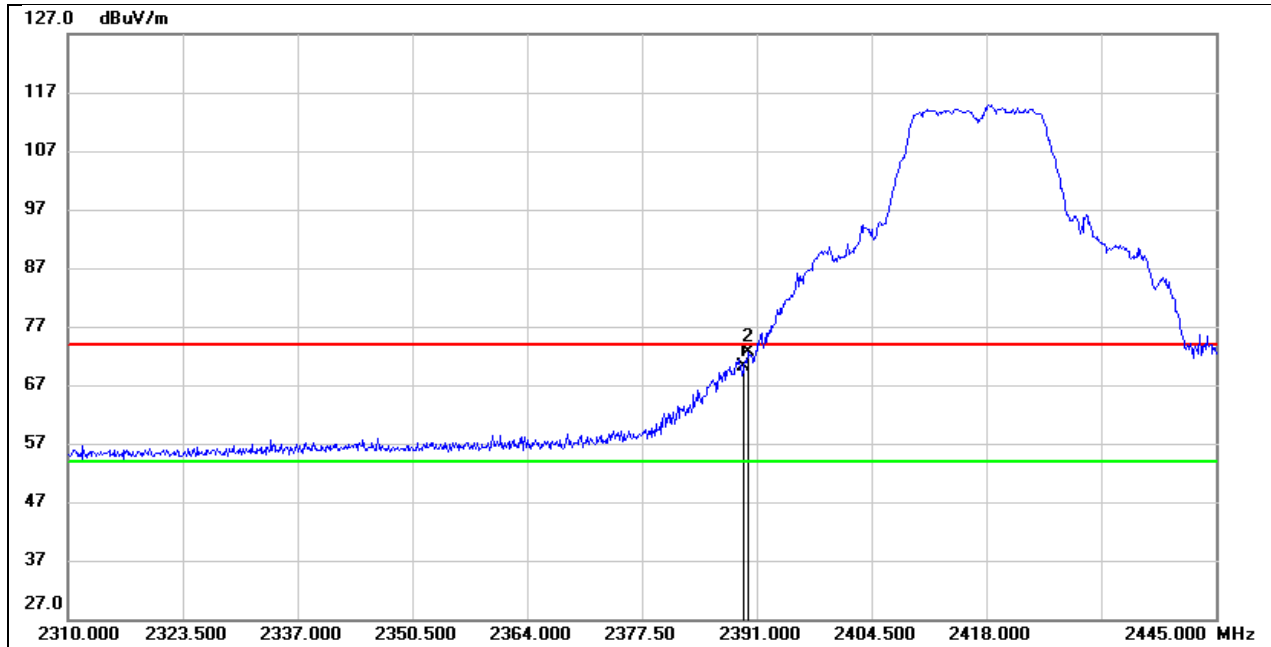

No.	Frequency (MHz)	Reading (dBuV)	Correct (dB/m)	Result (dBuV/m)	Limit (dBuV/m)	Margin (dB)	Remark
1	2389.425	37.91	32.16	70.07	74.00	-3.93	peak
2	2390.000	40.35	32.16	72.51	74.00	-1.49	peak

Test Mode:	802.11g Average	Channel:	2417 MHz
Polarity:	Vertical	Test Voltage:	DC 12 V

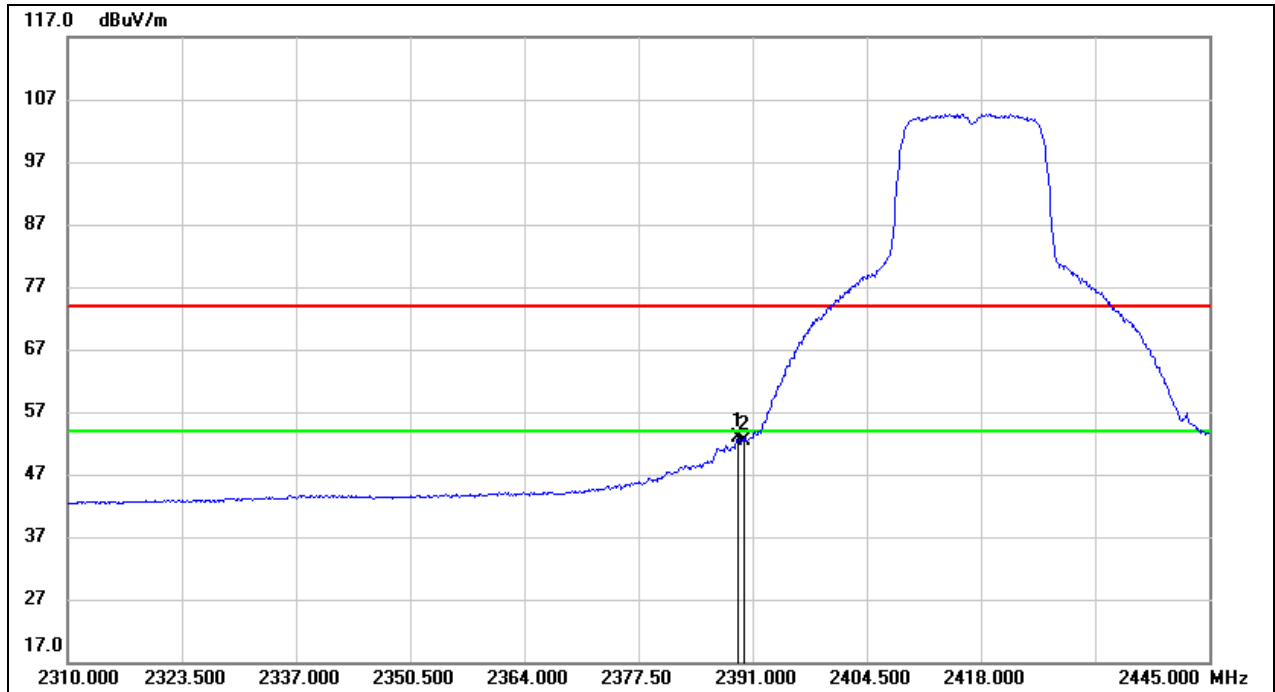

No.	Frequency (MHz)	Reading (dBuV)	Correct (dB/m)	Result (dBuV/m)	Limit (dBuV/m)	Margin (dB)	Remark
1	2389.245	20.61	32.16	52.77	54.00	-1.23	AVG
2	2390.000	20.24	32.16	52.40	54.00	-1.60	AVG

Test Mode:	802.11g Peak	Channel:	2437 MHz
Polarity:	Vertical	Test Voltage:	DC 12 V

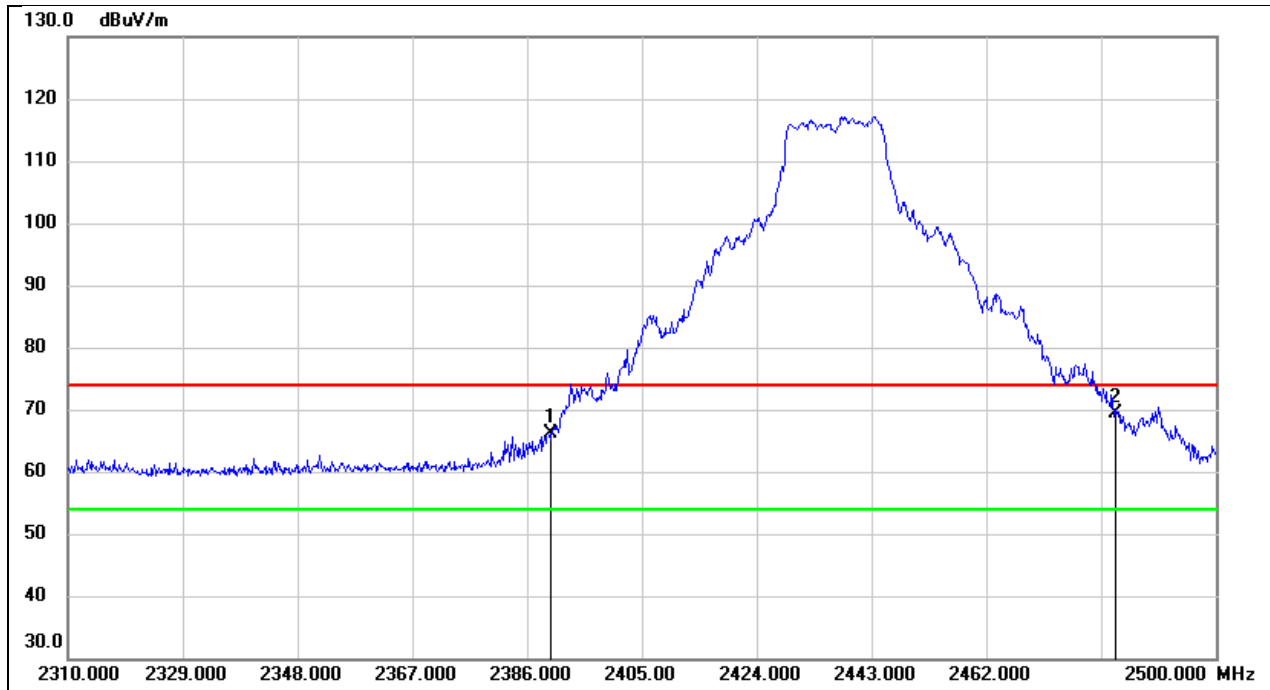

No.	Frequency (MHz)	Reading (dBuV)	Correct (dB/m)	Result (dBuV/m)	Limit (dBuV/m)	Margin (dB)	Remark
1	2390.000	33.85	32.16	66.01	74.00	-7.99	peak
2	2483.500	37.04	32.44	69.48	74.00	-4.52	peak

Test Mode:	802.11g Average	Channel:	2437 MHz
Polarity:	Vertical	Test Voltage:	DC 12 V

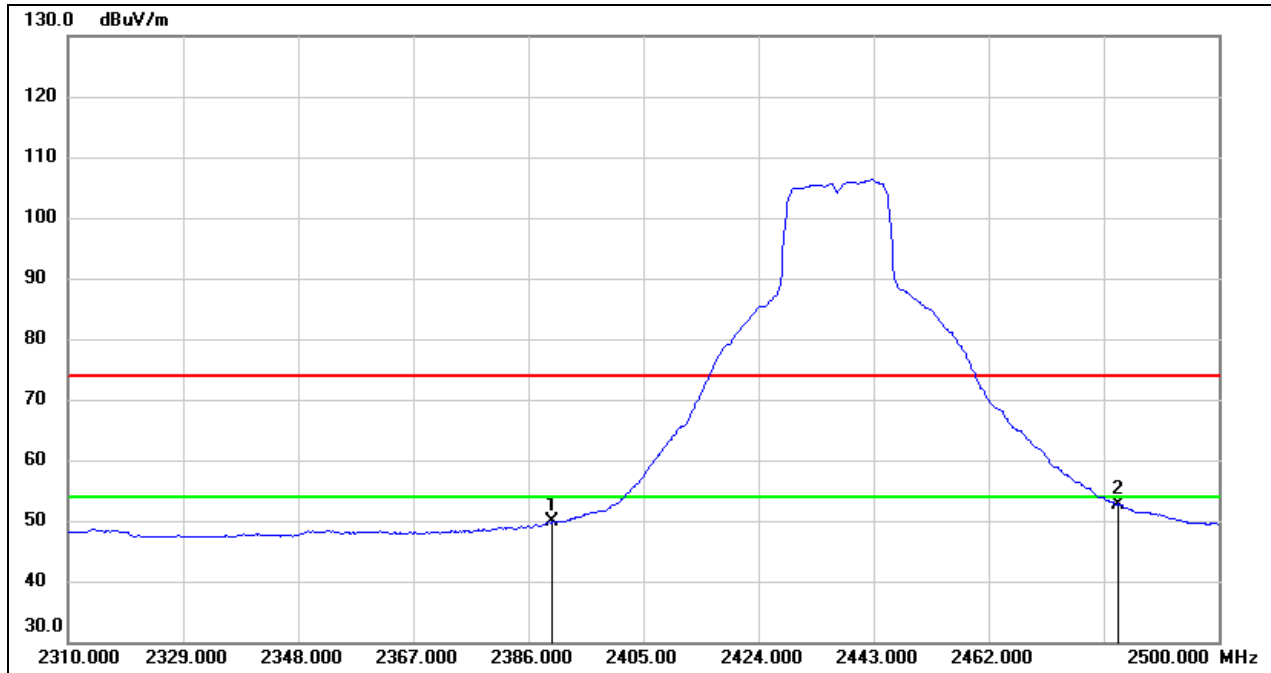

No.	Frequency (MHz)	Reading (dBuV)	Correct (dB/m)	Result (dBuV/m)	Limit (dBuV/m)	Margin (dB)	Remark
1	2390.000	17.61	32.16	49.77	54.00	-4.23	AVG
2	2483.500	20.14	32.44	52.58	54.00	-1.42	AVG

Test Mode:	802.11g Peak	Channel:	2457 MHz
Polarity:	Vertical	Test Voltage:	DC 12 V

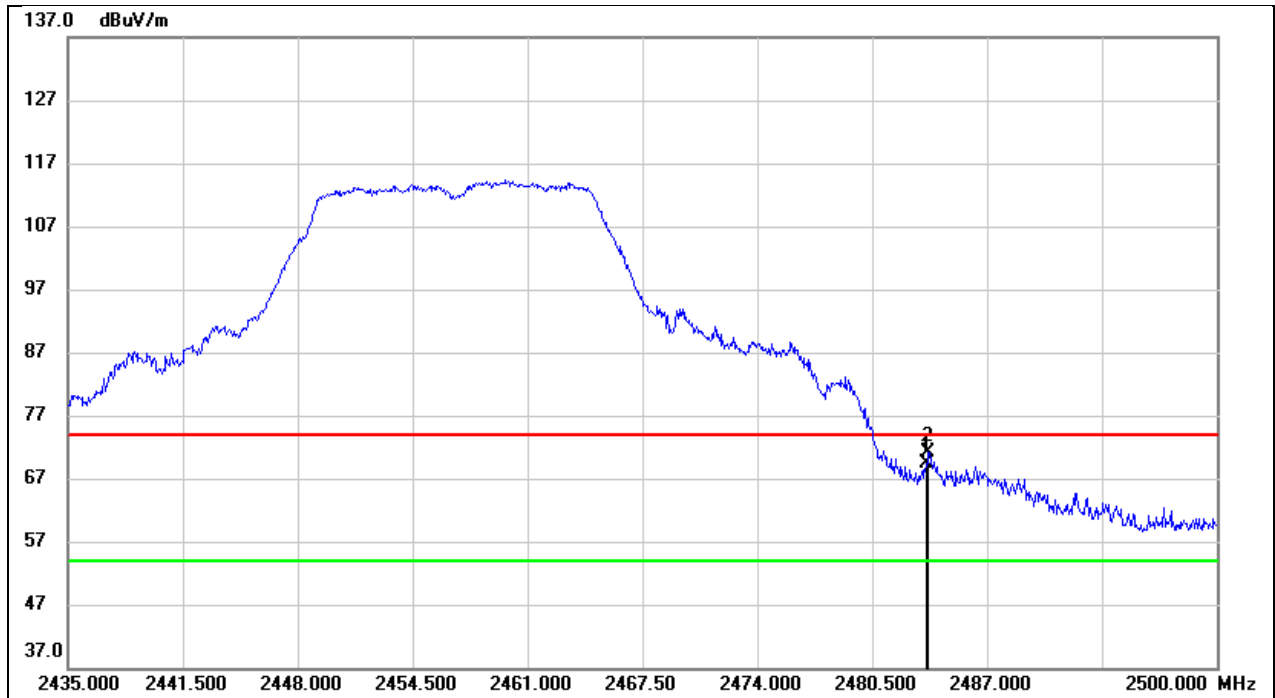

No.	Frequency (MHz)	Reading (dBuV)	Correct (dB/m)	Result (dBuV/m)	Limit (dBuV/m)	Margin (dB)	Remark
1	2483.500	36.89	32.44	69.33	74.00	-4.67	peak
2	2483.685	38.69	32.44	71.13	74.00	-2.87	peak

Test Mode:	802.11g Average	Channel:	2457 MHz
Polarity:	Vertical	Test Voltage:	DC 12 V

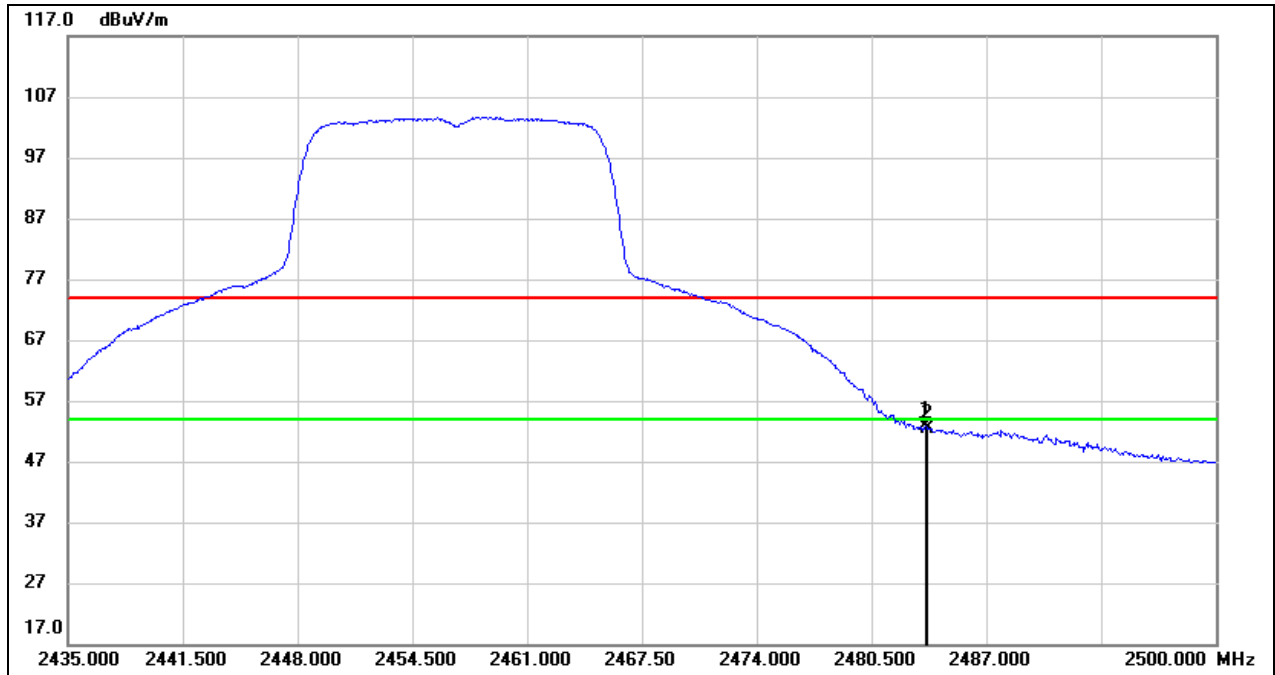

No.	Frequency (MHz)	Reading (dBuV)	Correct (dB/m)	Result (dBuV/m)	Limit (dBuV/m)	Margin (dB)	Remark
1	2483.500	20.33	32.44	52.77	54.00	-1.23	AVG
2	2483.685	19.87	32.44	52.31	54.00	-1.69	AVG

Test Mode:	802.11g Peak	Channel:	2462 MHz
Polarity:	Vertical	Test Voltage:	DC 12 V

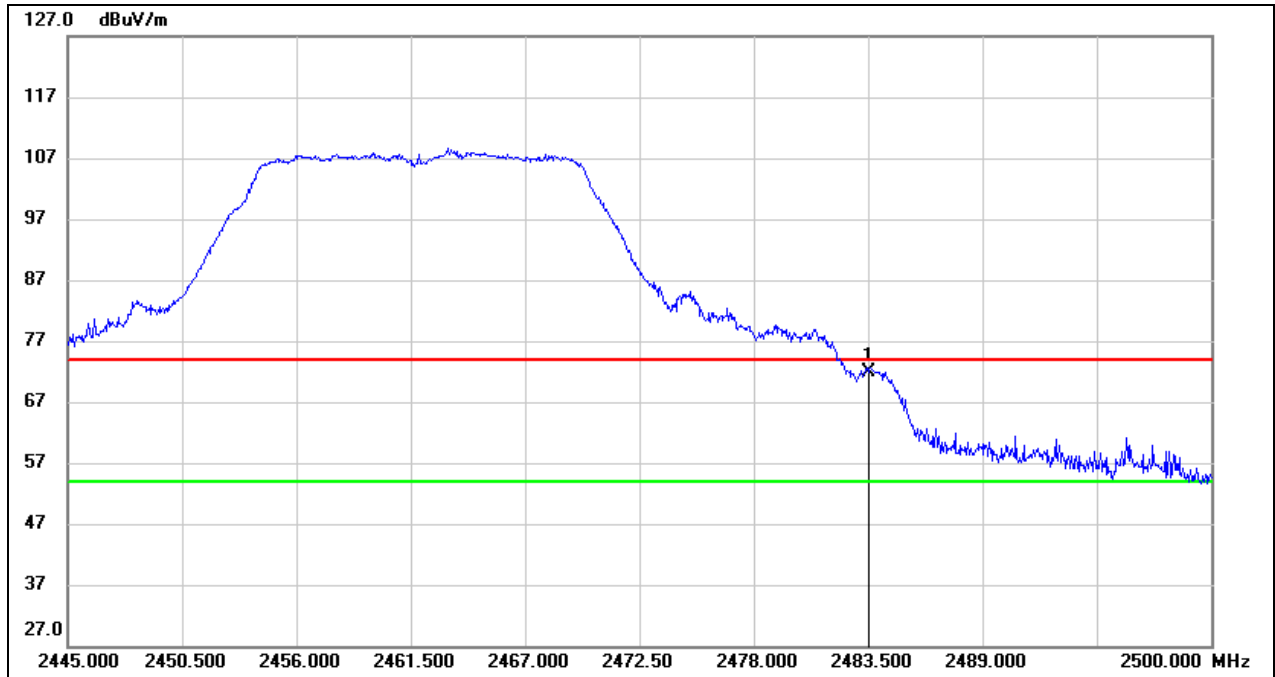

No.	Frequency (MHz)	Reading (dBuV)	Correct (dB/m)	Result (dBuV/m)	Limit (dBuV/m)	Margin (dB)	Remark
1	2483.500	44.23	27.76	71.99	74.00	-2.01	peak

Test Mode:	802.11g Average	Channel:	2462 MHz
Polarity:	Vertical	Test Voltage:	DC 12 V

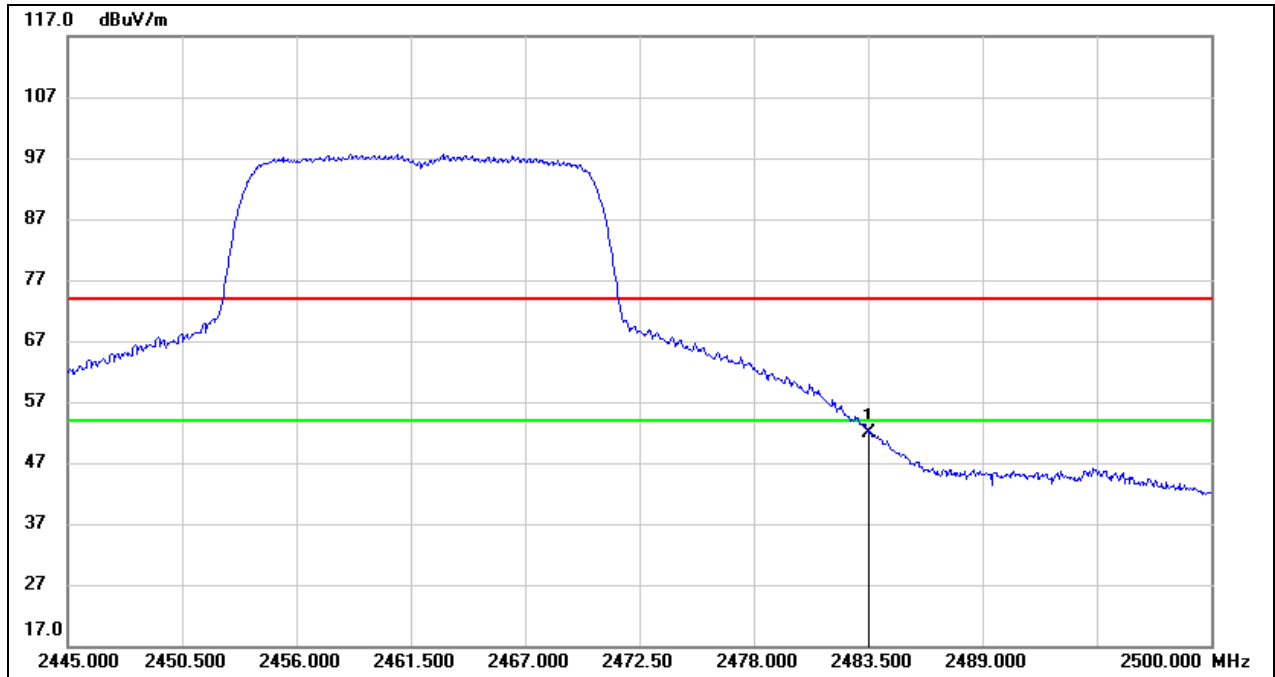

No.	Frequency (MHz)	Reading (dBuV)	Correct (dB/m)	Result (dBuV/m)	Limit (dBuV/m)	Margin (dB)	Remark
1	2483.500	24.16	27.76	51.92	54.00	-2.08	AVG

Test Mode:	802.11n HT20 Peak	Channel:	2412 MHz
Polarity:	Vertical	Test Voltage:	DC 12 V

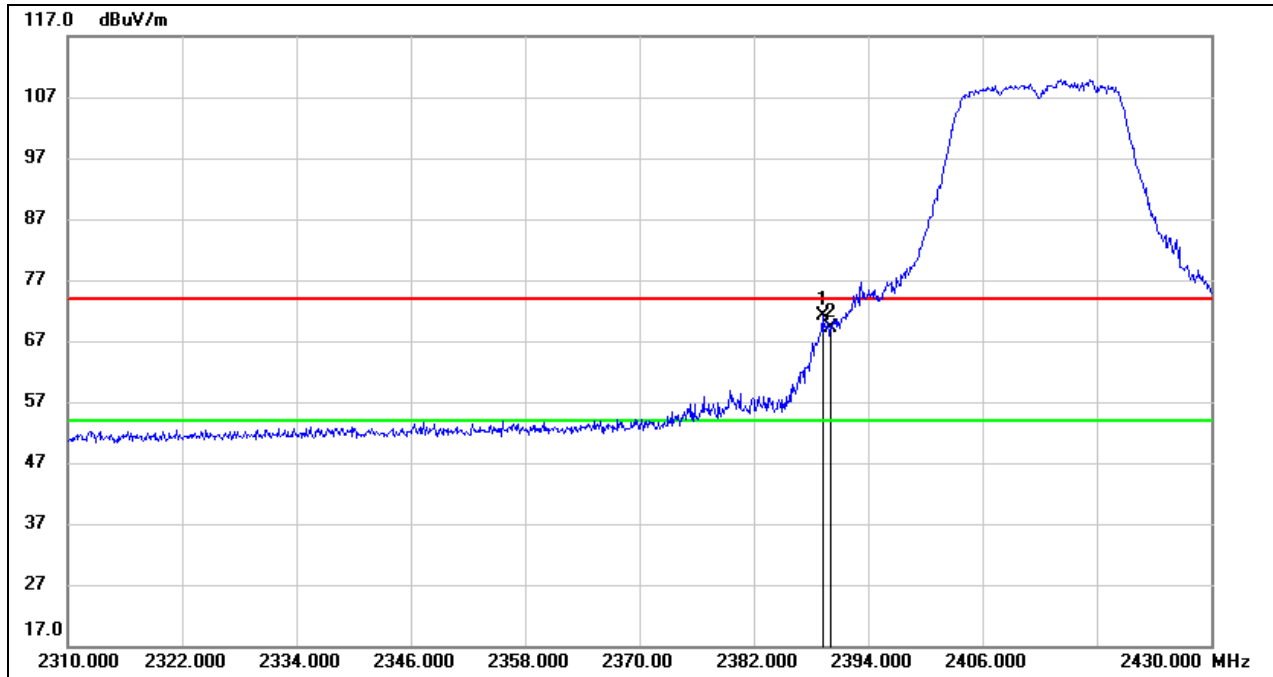

No.	Frequency (MHz)	Reading (dBuV)	Correct (dB/m)	Result (dBuV/m)	Limit (dBuV/m)	Margin (dB)	Remark
1	2389.200	43.66	27.51	71.17	74.00	-2.83	peak
2	2390.000	41.72	27.51	69.23	74.00	-4.77	peak

Test Mode:	802.11n HT20 Average	Channel:	2412 MHz
Polarity:	Vertical	Test Voltage:	DC 12 V

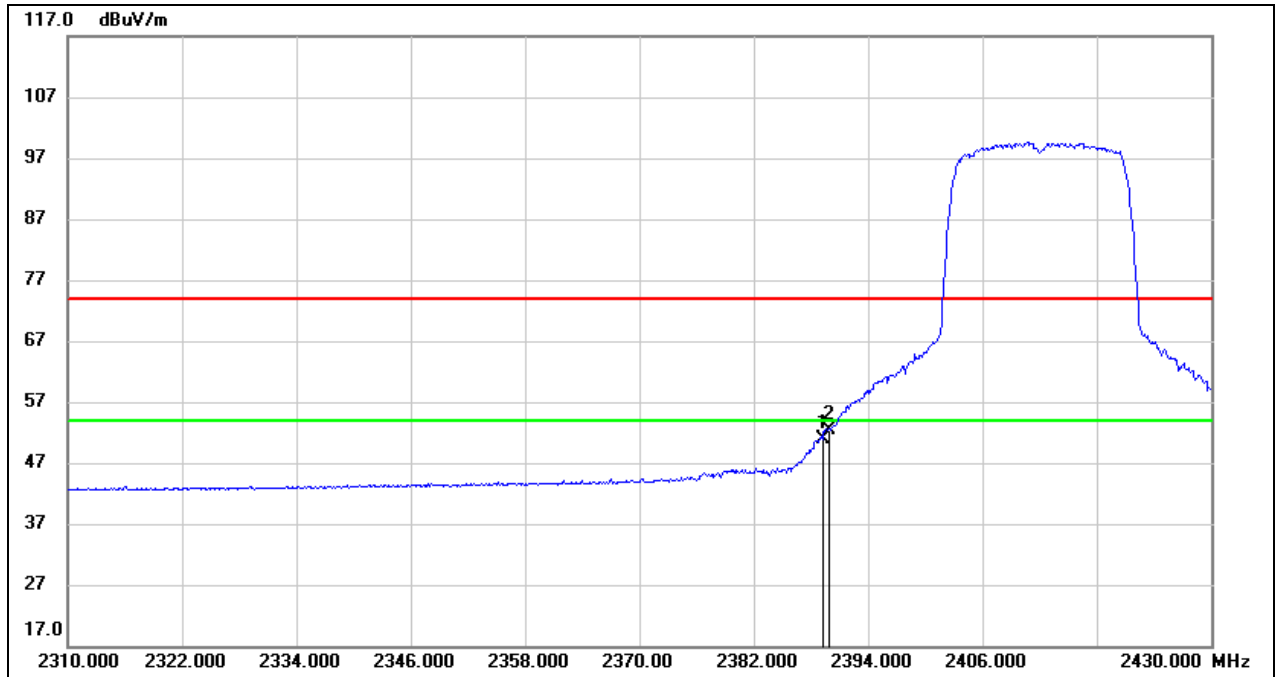

No.	Frequency (MHz)	Reading (dBuV)	Correct (dB/m)	Result (dBuV/m)	Limit (dBuV/m)	Margin (dB)	Remark
1	2389.200	23.35	27.51	50.86	54.00	-3.14	AVG
2	2390.000	24.79	27.51	52.30	54.00	-1.70	AVG

Test Mode:	802.11n HT20 Peak	Channel:	2417 MHz
Polarity:	Vertical	Test Voltage:	DC 12 V

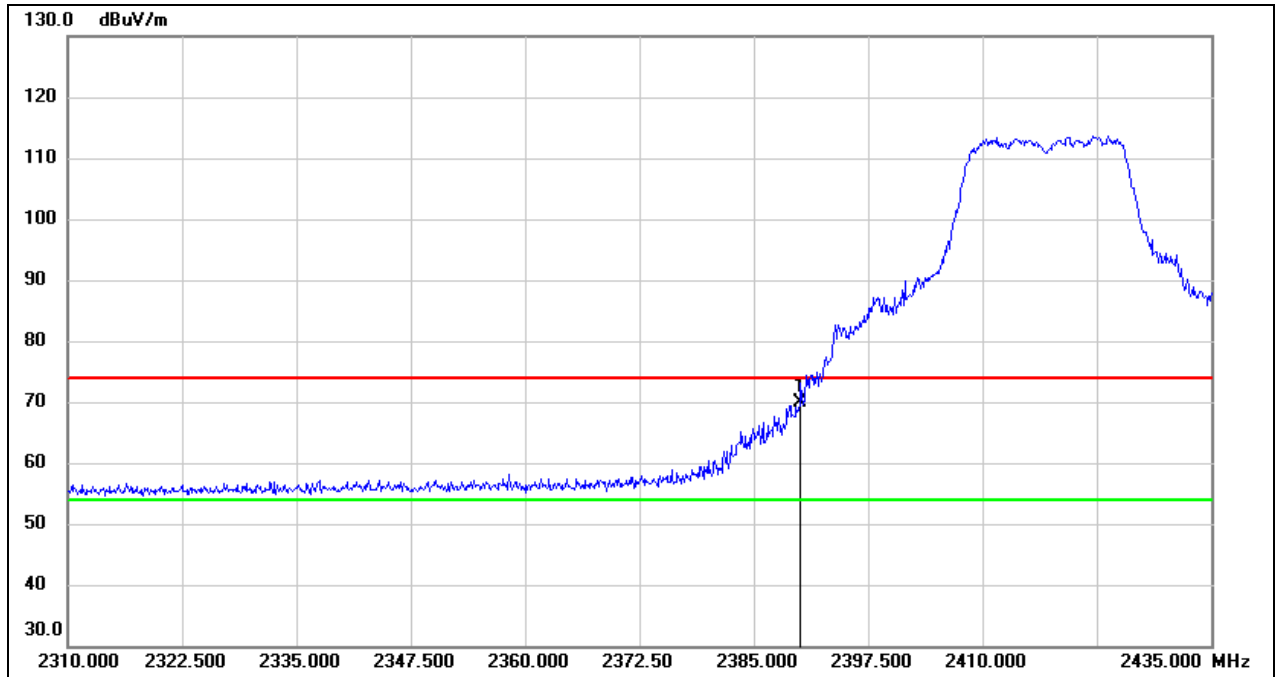

No.	Frequency (MHz)	Reading (dBuV)	Correct (dB/m)	Result (dBuV/m)	Limit (dBuV/m)	Margin (dB)	Remark
1	2390.000	42.45	27.51	69.96	74.00	-4.04	peak

Test Mode:	802.11n HT20 Average	Channel:	2417 MHz
Polarity:	Vertical	Test Voltage:	DC 12 V

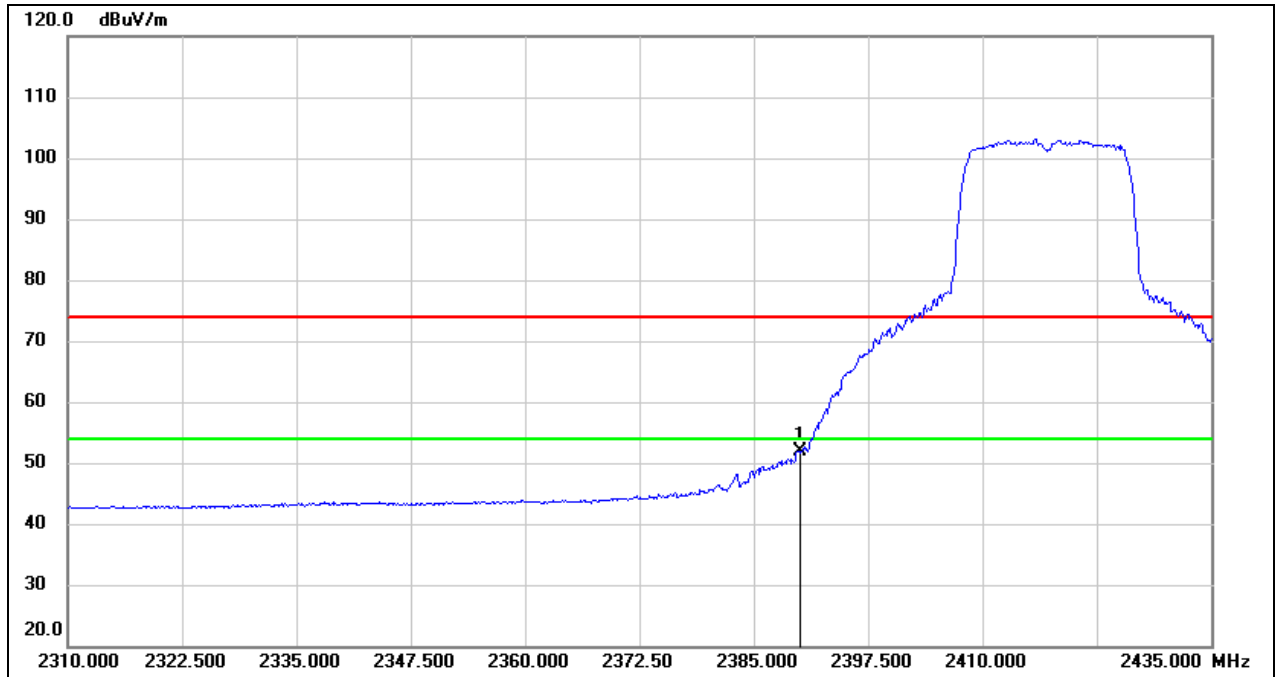

No.	Frequency (MHz)	Reading (dBuV)	Correct (dB/m)	Result (dBuV/m)	Limit (dBuV/m)	Margin (dB)	Remark
1	2390.000	24.45	27.51	51.96	54.00	-2.04	AVG

Test Mode:	802.11n HT20 Peak	Channel:	2437 MHz
Polarity:	Vertical	Test Voltage:	DC 12 V

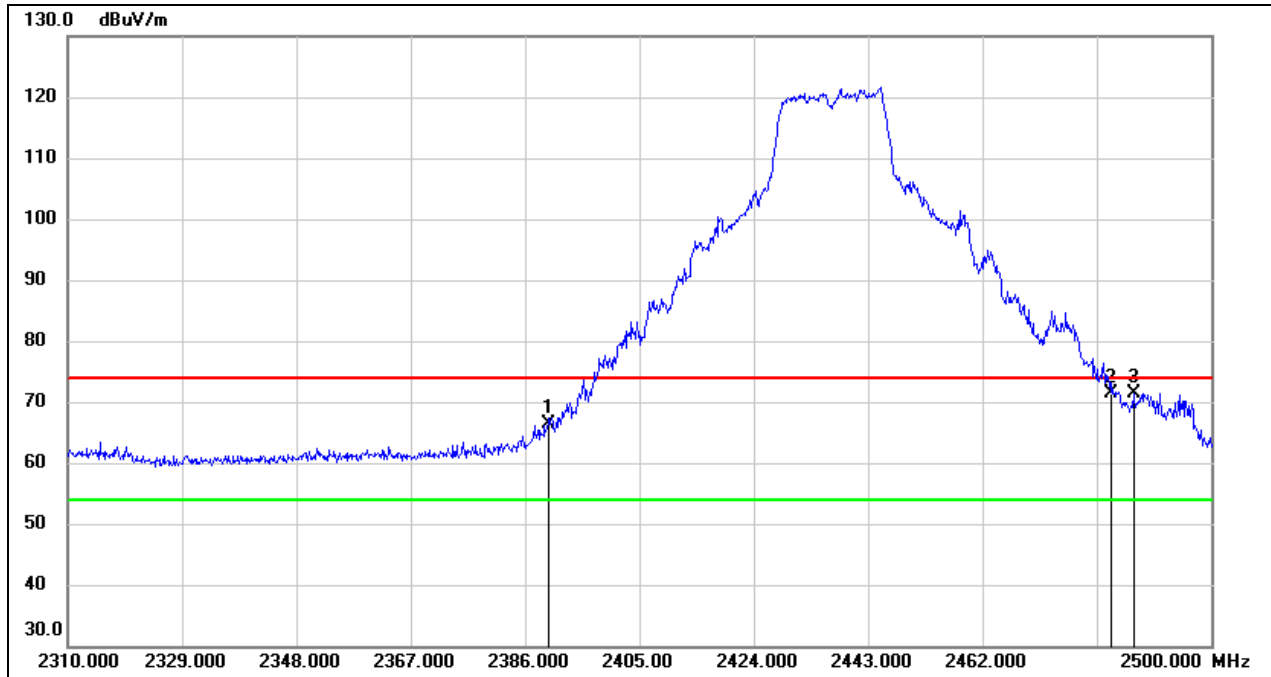

No.	Frequency (MHz)	Reading (dBuV)	Correct (dB/m)	Result (dBuV/m)	Limit (dBuV/m)	Margin (dB)	Remark
1	2390.000	34.31	32.16	66.47	74.00	-7.53	peak
2	2483.500	38.88	32.44	71.32	74.00	-2.68	peak
3	2487.080	39.01	32.45	71.46	74.00	-2.54	peak

Test Mode:	802.11n HT20 Average	Channel:	2437 MHz
Polarity:	Vertical	Test Voltage:	DC 12 V

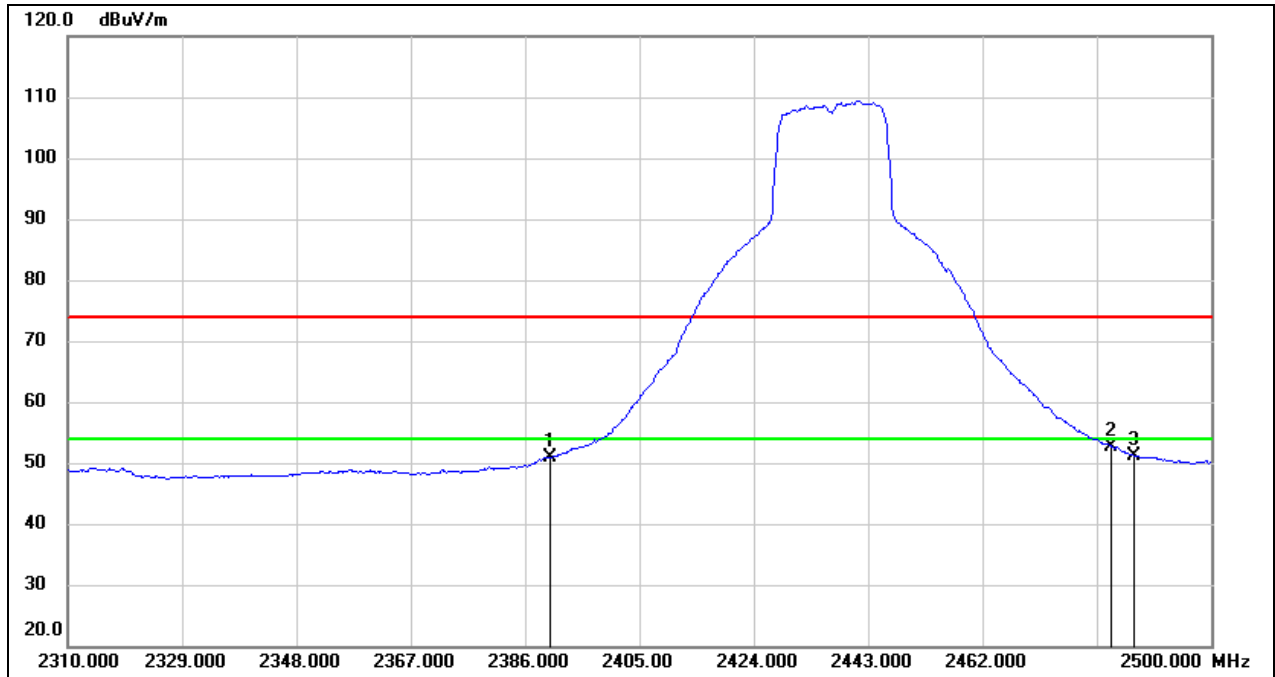

No.	Frequency (MHz)	Reading (dBuV)	Correct (dB/m)	Result (dBuV/m)	Limit (dBuV/m)	Margin (dB)	Remark
1	2390.000	18.77	32.16	50.93	54.00	-3.07	AVG
2	2483.500	20.21	32.44	52.65	54.00	-1.35	AVG
3	2487.080	18.80	32.45	51.25	54.00	-2.75	AVG

Test Mode:	802.11n HT20 Peak	Channel:	2457 MHz
Polarity:	Vertical	Test Voltage:	DC 12 V

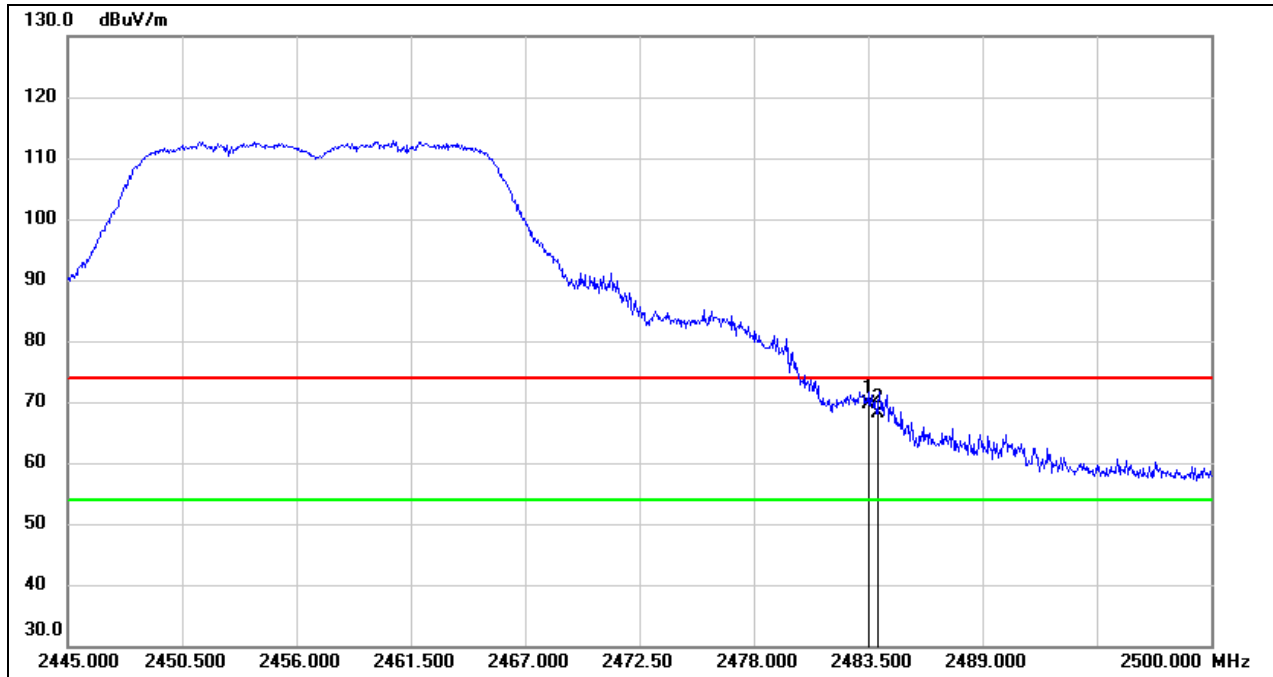

No.	Frequency (MHz)	Reading (dBuV)	Correct (dB/m)	Result (dBuV/m)	Limit (dBuV/m)	Margin (dB)	Remark
1	2483.500	41.97	27.76	69.73	74.00	-4.27	peak
2	2483.940	40.47	27.76	68.23	74.00	-5.77	peak

Test Mode:	802.11n HT20 Average	Channel:	2457 MHz
Polarity:	Vertical	Test Voltage:	DC 12 V

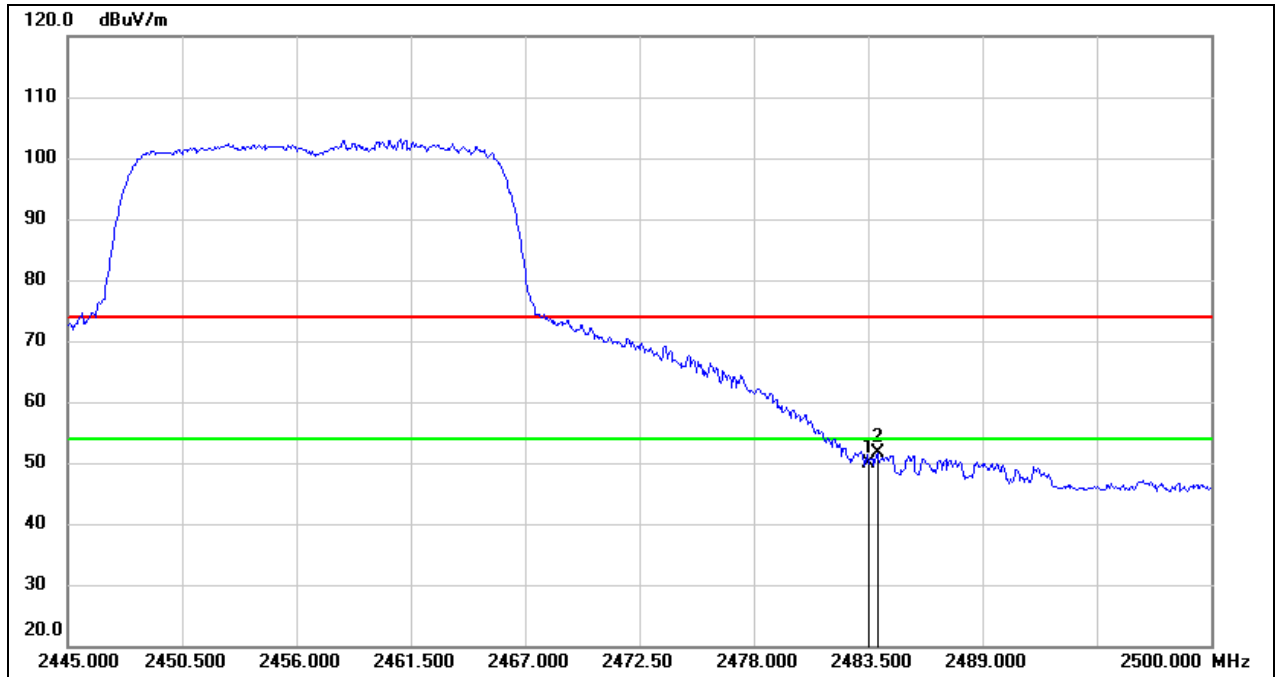

No.	Frequency (MHz)	Reading (dBuV)	Correct (dB/m)	Result (dBuV/m)	Limit (dBuV/m)	Margin (dB)	Remark
1	2483.500	22.12	27.76	49.88	54.00	-4.12	AVG
2	2483.940	23.97	27.76	51.73	54.00	-2.27	AVG

Test Mode:	802.11n HT20 Peak	Channel:	2462 MHz
Polarity:	Vertical	Test Voltage:	DC 12 V

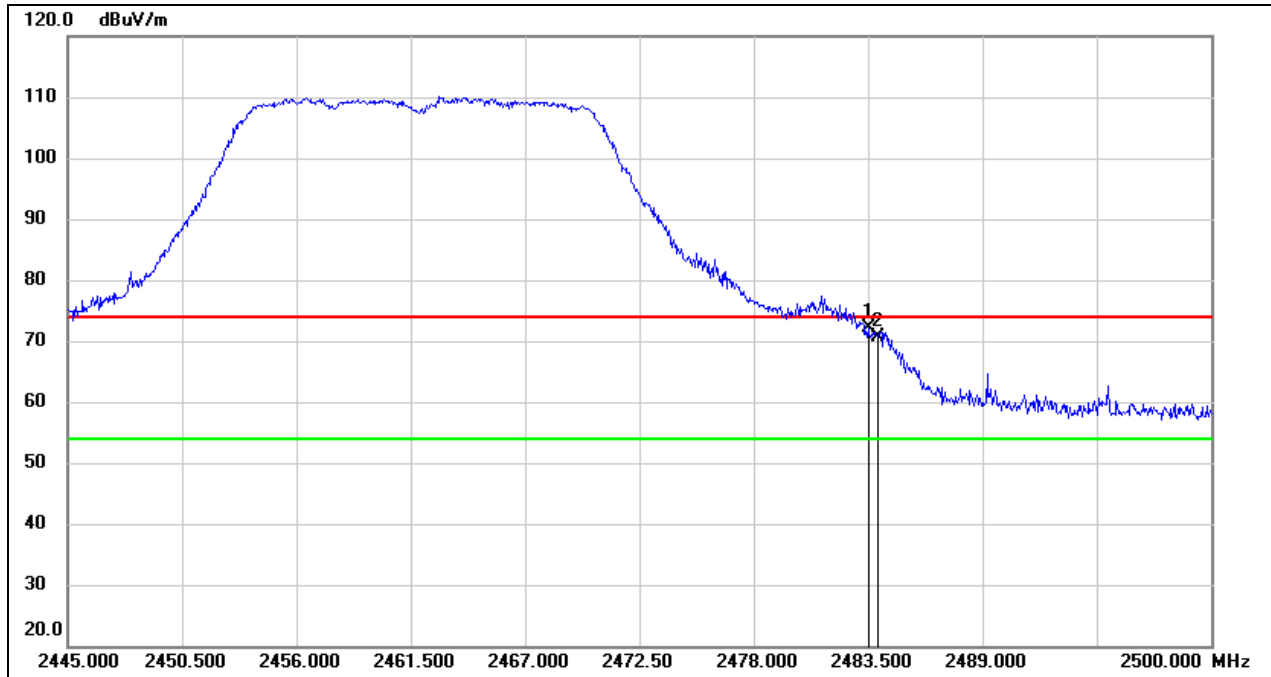

No.	Frequency (MHz)	Reading (dBuV)	Correct (dB/m)	Result (dBuV/m)	Limit (dBuV/m)	Margin (dB)	Remark
1	2483.500	44.46	27.76	72.22	74.00	-1.78	peak
2	2483.940	42.91	27.76	70.67	74.00	-3.33	peak

Test Mode:	802.11n HT20 Average	Channel:	2462 MHz
Polarity:	Vertical	Test Voltage:	DC 12 V

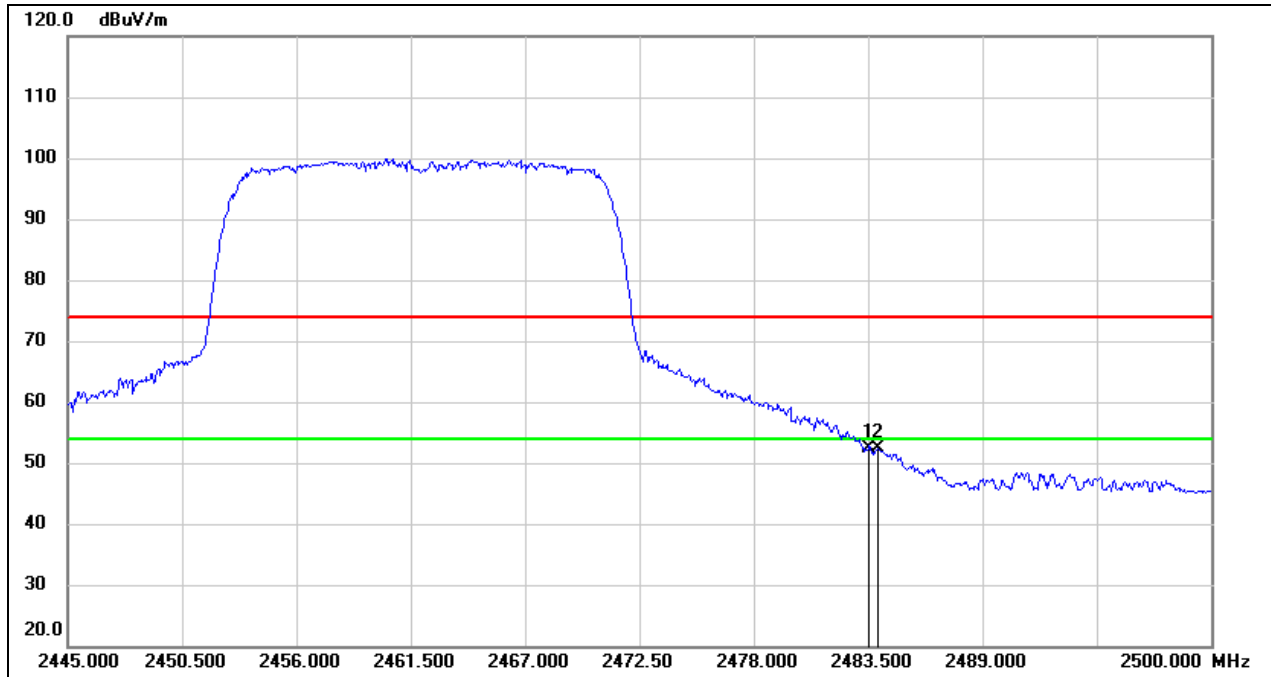

No.	Frequency (MHz)	Reading (dBuV)	Correct (dB/m)	Result (dBuV/m)	Limit (dBuV/m)	Margin (dB)	Remark
1	2483.500	24.74	27.76	52.50	54.00	-1.50	AVG
2	2483.940	24.64	27.76	52.40	54.00	-1.60	AVG

Test Mode:	802.11n HT40 Peak	Channel:	2422 MHz
Polarity:	Vertical	Test Voltage:	DC 12 V

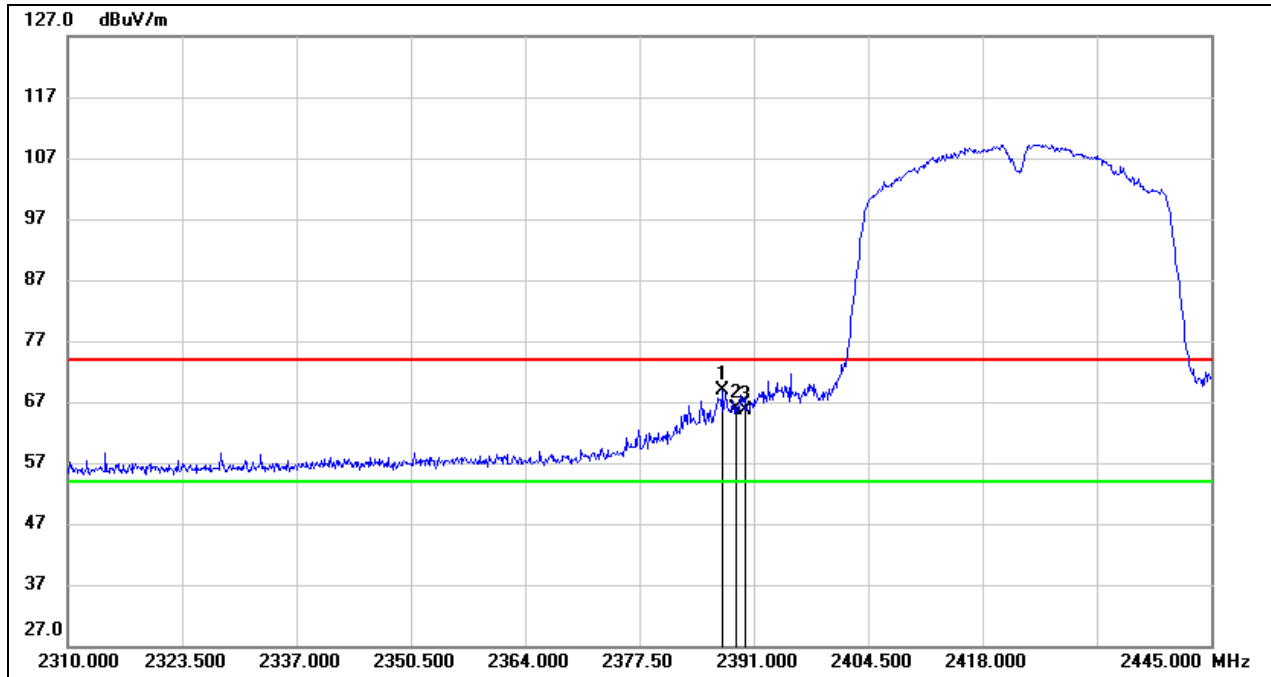

No.	Frequency (MHz)	Reading (dBuV)	Correct (dB/m)	Result (dBuV/m)	Limit (dBuV/m)	Margin (dB)	Remark
1	2387.355	36.67	32.15	68.82	74.00	-5.18	peak
2	2388.705	33.70	32.16	65.86	74.00	-8.14	peak
3	2390.000	33.48	32.16	65.64	74.00	-8.36	peak

Test Mode:	802.11n HT40 Average	Channel:	2422 MHz
Polarity:	Vertical	Test Voltage:	DC 12 V

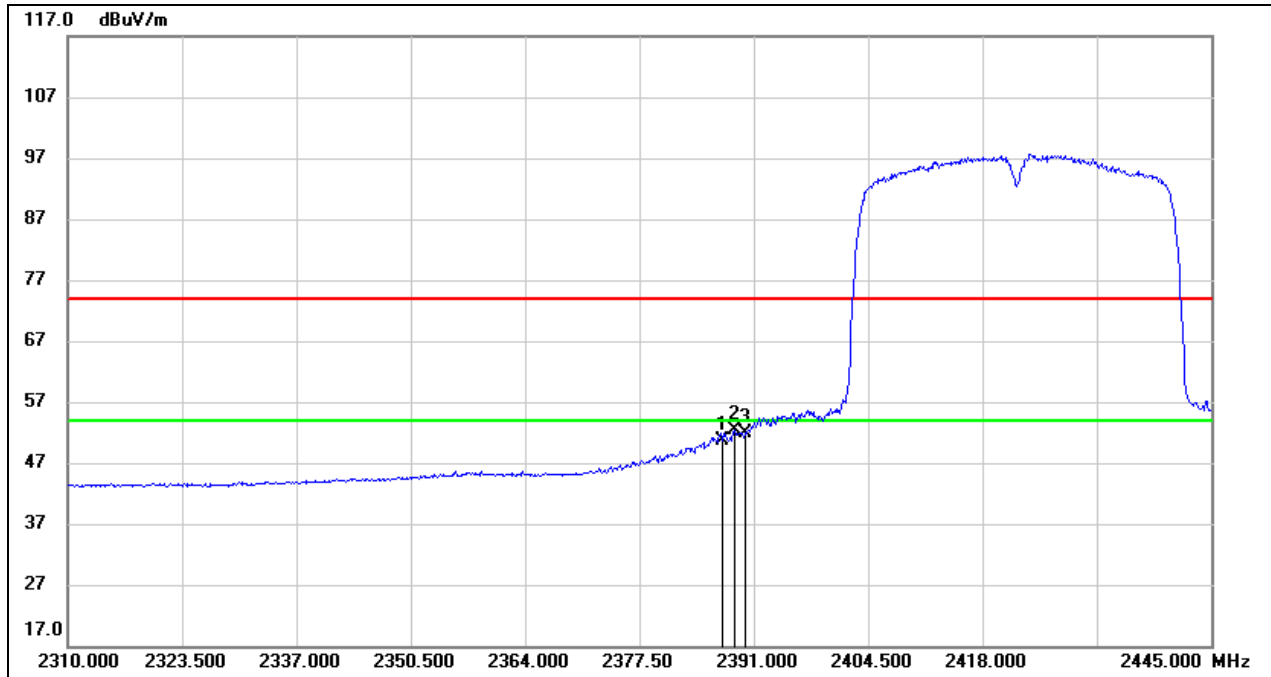

No.	Frequency (MHz)	Reading (dBuV)	Correct (dB/m)	Result (dBuV/m)	Limit (dBuV/m)	Margin (dB)	Remark
1	2387.355	18.58	32.15	50.73	54.00	-3.27	AVG
2	2388.705	20.10	32.16	52.26	54.00	-1.74	AVG
3	2390.000	19.65	32.16	51.81	54.00	-2.19	AVG

Test Mode:	802.11n HT40 Peak	Channel:	2427 MHz
Polarity:	Vertical	Test Voltage:	DC 12 V

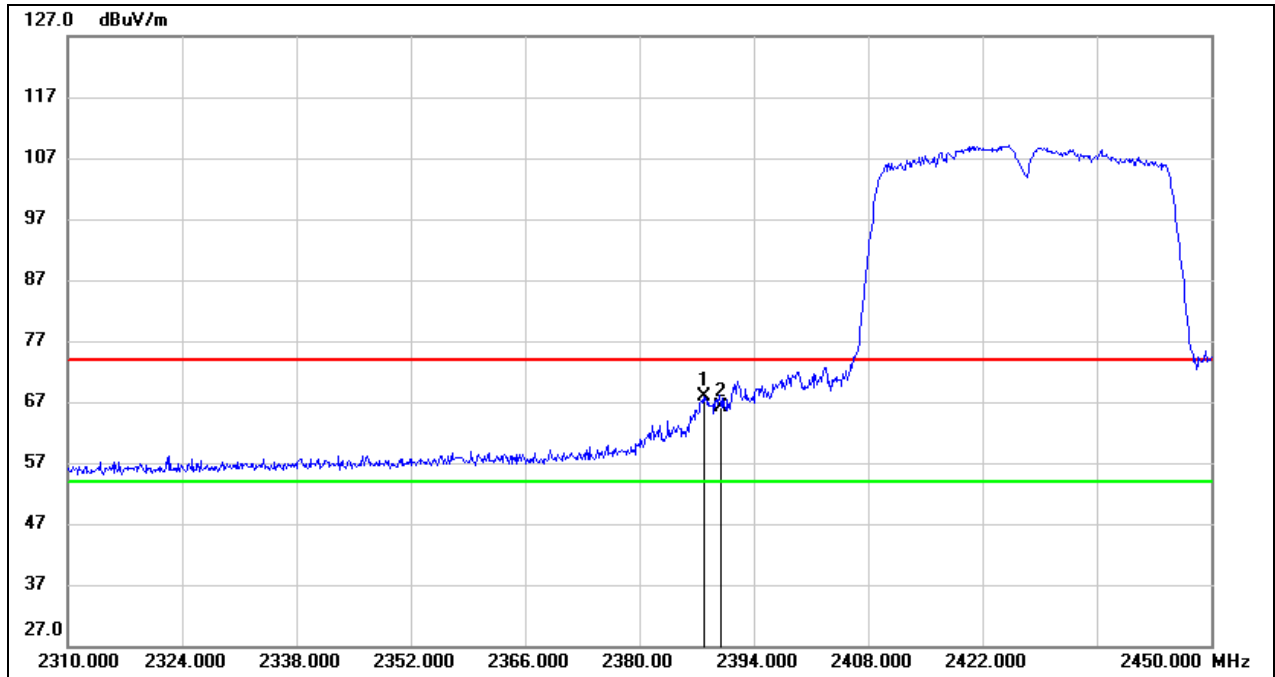

No.	Frequency (MHz)	Reading (dBuV)	Correct (dB/m)	Result (dBuV/m)	Limit (dBuV/m)	Margin (dB)	Remark
1	2387.840	35.74	32.16	67.90	74.00	-6.10	peak
2	2390.000	33.94	32.16	66.10	74.00	-7.90	peak

Test Mode:	802.11n HT40 Average	Channel:	2427 MHz
Polarity:	Vertical	Test Voltage:	DC 12 V

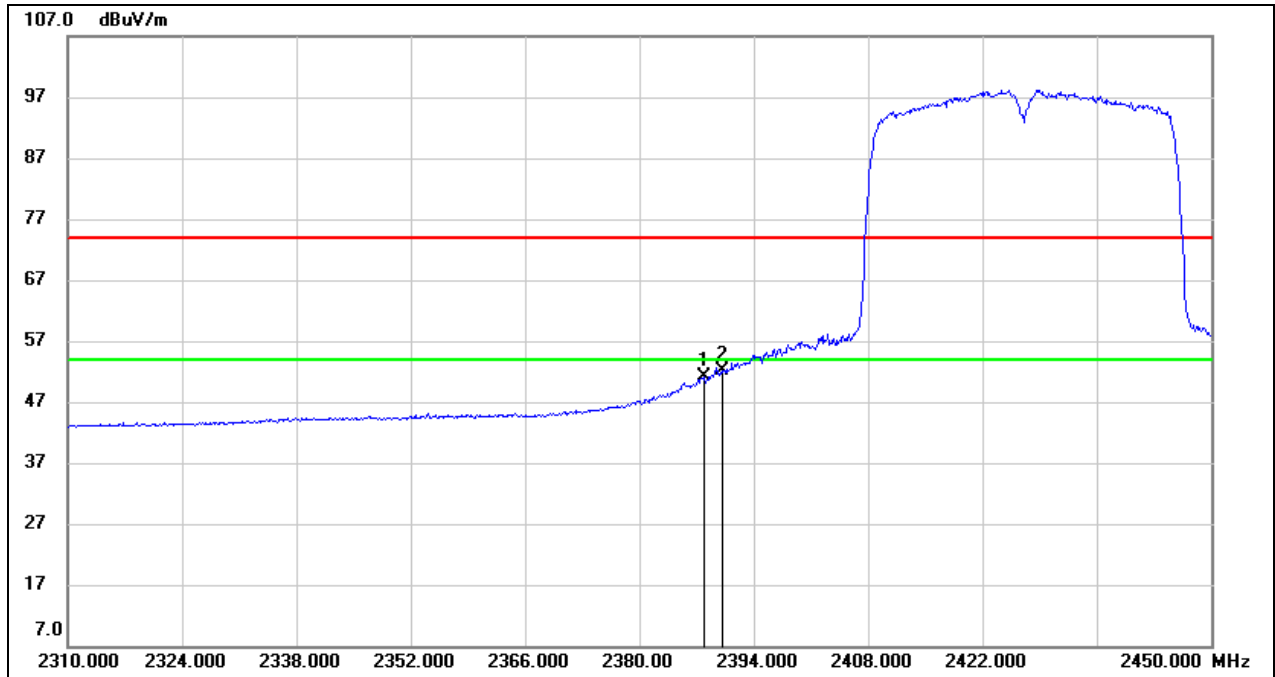

No.	Frequency (MHz)	Reading (dBuV)	Correct (dB/m)	Result (dBuV/m)	Limit (dBuV/m)	Margin (dB)	Remark
1	2387.840	18.99	32.16	51.15	54.00	-2.85	AVG
2	2390.000	19.90	32.16	52.06	54.00	-1.94	AVG

Test Mode:	802.11n HT40 Peak	Channel:	2437 MHz
Polarity:	Vertical	Test Voltage:	DC 12 V

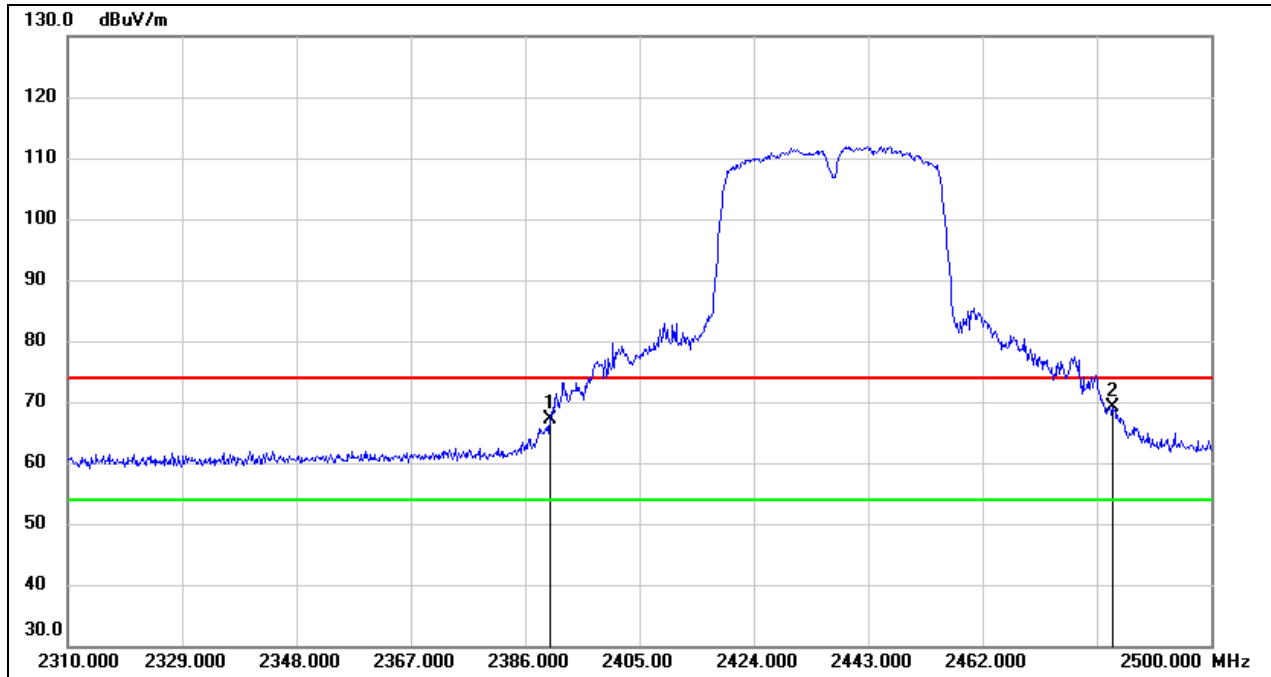

No.	Frequency (MHz)	Reading (dBuV)	Correct (dB/m)	Result (dBuV/m)	Limit (dBuV/m)	Margin (dB)	Remark
1	2390.000	34.95	32.16	67.11	74.00	-6.89	peak
2	2483.500	36.65	32.44	69.09	74.00	-4.91	peak

Test Mode:	802.11n HT40 Average	Channel:	2437 MHz
Polarity:	Vertical	Test Voltage:	DC 12 V

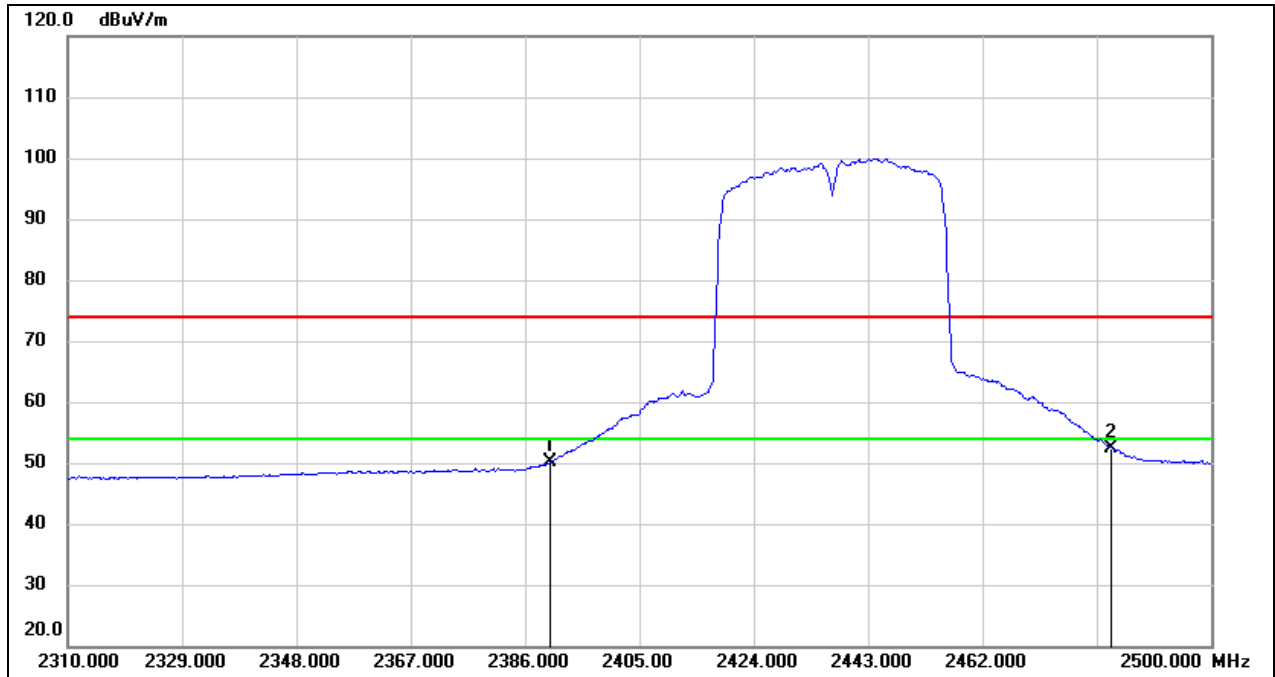

No.	Frequency (MHz)	Reading (dBuV)	Correct (dB/m)	Result (dBuV/m)	Limit (dBuV/m)	Margin (dB)	Remark
1	2390.000	17.98	32.16	50.14	54.00	-3.86	AVG
2	2483.500	19.90	32.44	52.34	54.00	-1.66	AVG

Test Mode:	802.11n HT40 Peak	Channel:	2447 MHz
Polarity:	Vertical	Test Voltage:	DC 12 V

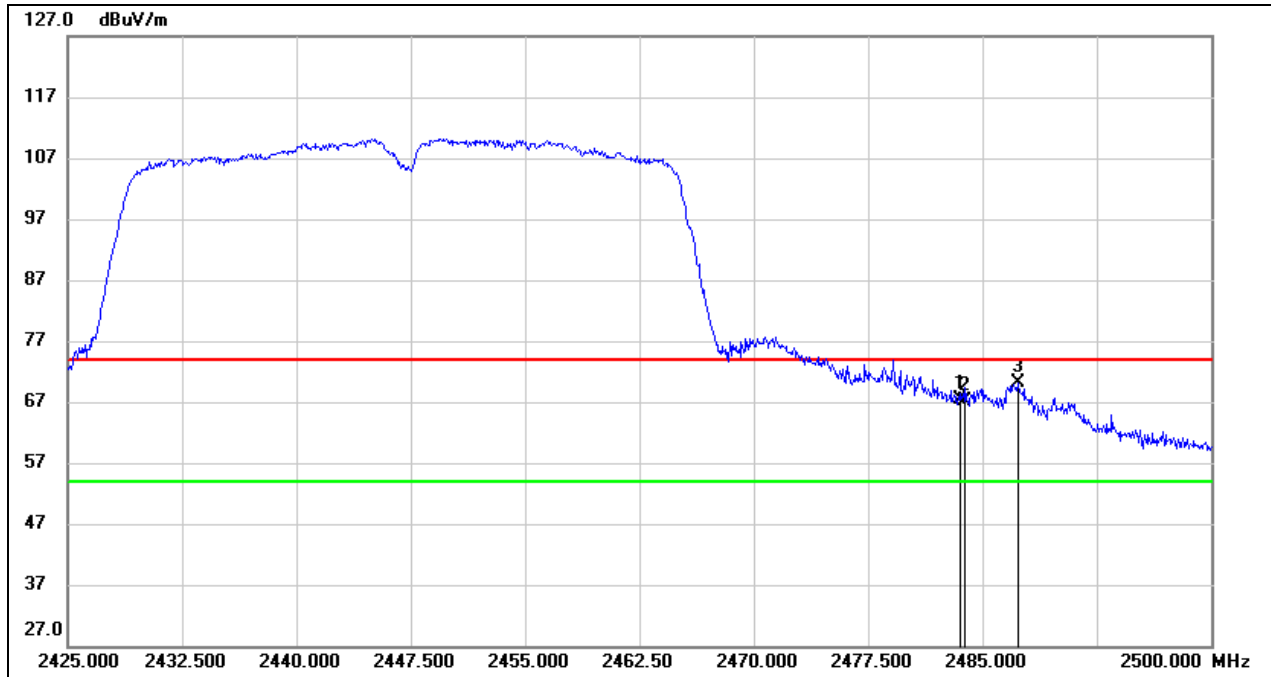

No.	Frequency (MHz)	Reading (dBuV)	Correct (dB/m)	Result (dBuV/m)	Limit (dBuV/m)	Margin (dB)	Remark
1	2483.500	34.99	32.44	67.43	74.00	-6.57	peak
2	2483.800	34.67	32.44	67.11	74.00	-6.89	peak
3	2487.325	37.74	32.45	70.19	74.00	-3.81	peak

Test Mode:	802.11n HT40 Average	Channel:	2447 MHz
Polarity:	Vertical	Test Voltage:	DC 12 V

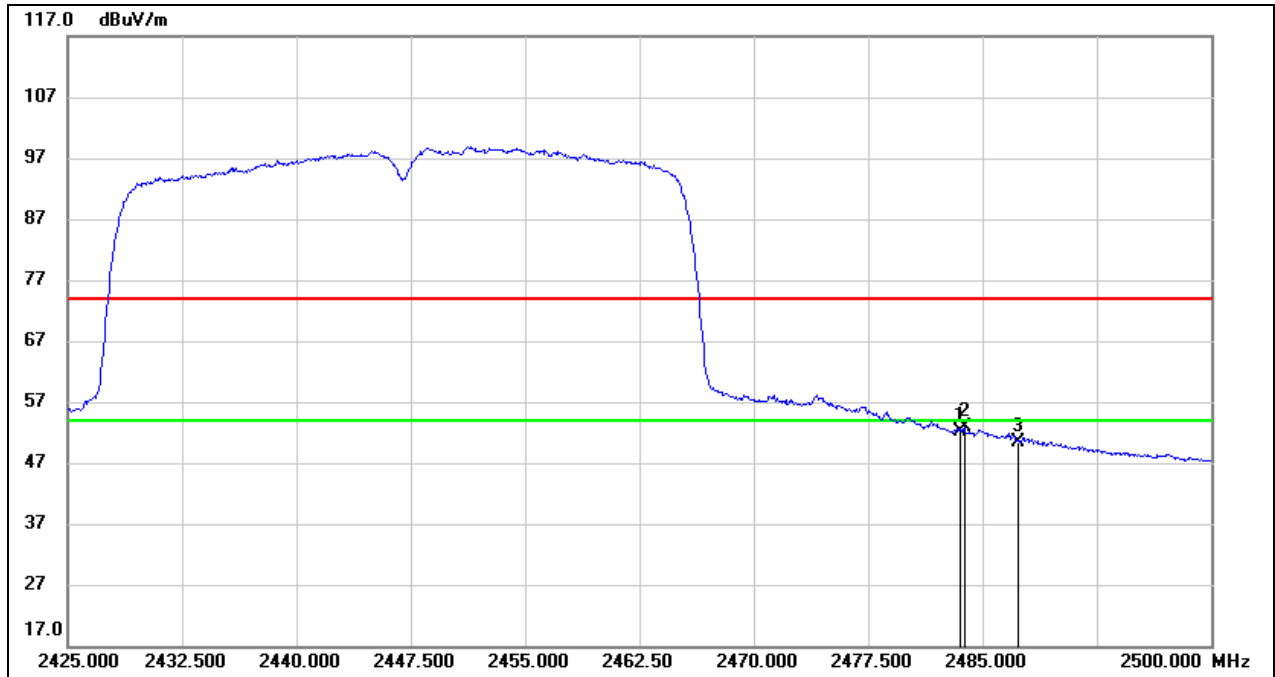

No.	Frequency (MHz)	Reading (dBuV)	Correct (dB/m)	Result (dBuV/m)	Limit (dBuV/m)	Margin (dB)	Remark
1	2483.500	19.59	32.44	52.03	54.00	-1.97	AVG
2	2483.800	20.55	32.44	52.99	54.00	-1.01	AVG
3	2487.325	18.03	32.45	50.48	54.00	-3.52	AVG

Test Mode:	802.11n HT40 Peak	Channel:	2452 MHz
Polarity:	Vertical	Test Voltage:	DC 12 V

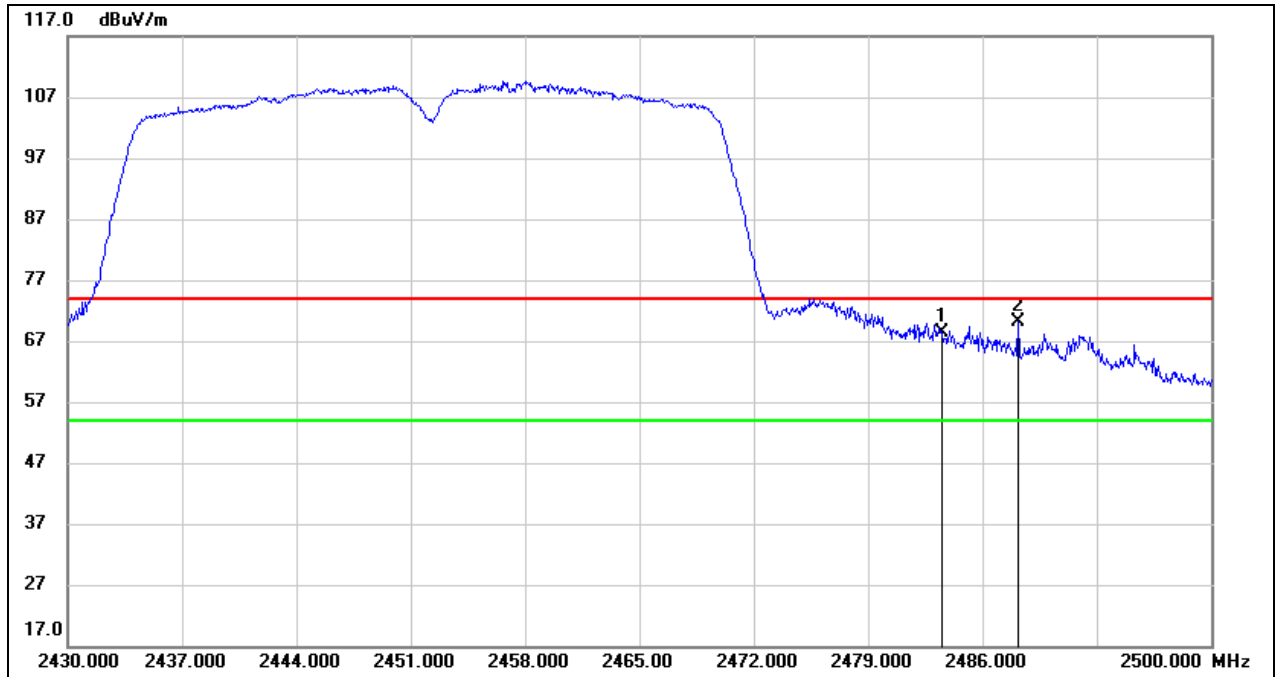

No.	Frequency (MHz)	Reading (dBuV)	Correct (dB/m)	Result (dBuV/m)	Limit (dBuV/m)	Margin (dB)	Remark
1	2483.500	35.82	32.44	68.26	74.00	-5.74	peak
2	2488.170	37.64	32.46	70.10	74.00	-3.90	peak

Test Mode:	802.11n HT40 Average	Channel:	2452 MHz
Polarity:	Vertical	Test Voltage:	DC 12 V

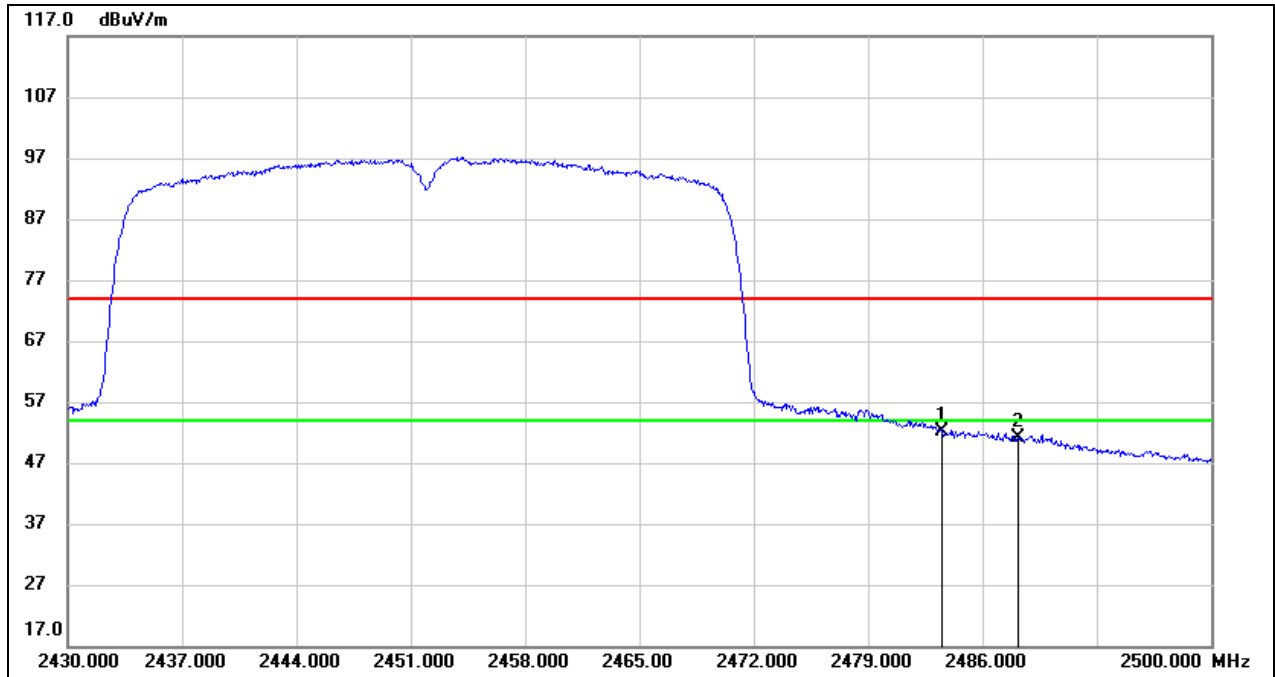

No.	Frequency (MHz)	Reading (dBuV)	Correct (dB/m)	Result (dBuV/m)	Limit (dBuV/m)	Margin (dB)	Remark
1	2483.500	19.58	32.44	52.02	54.00	-1.98	AVG
2	2488.170	18.75	32.46	51.21	54.00	-2.79	AVG

8.2. SPURIOUS EMISSIONS (1 GHZ ~ 3 GHZ)

Test Mode:	802.11g	Channel:	2412 MHz
Polarity:	Horizontal	Test Voltage:	DC 12 V

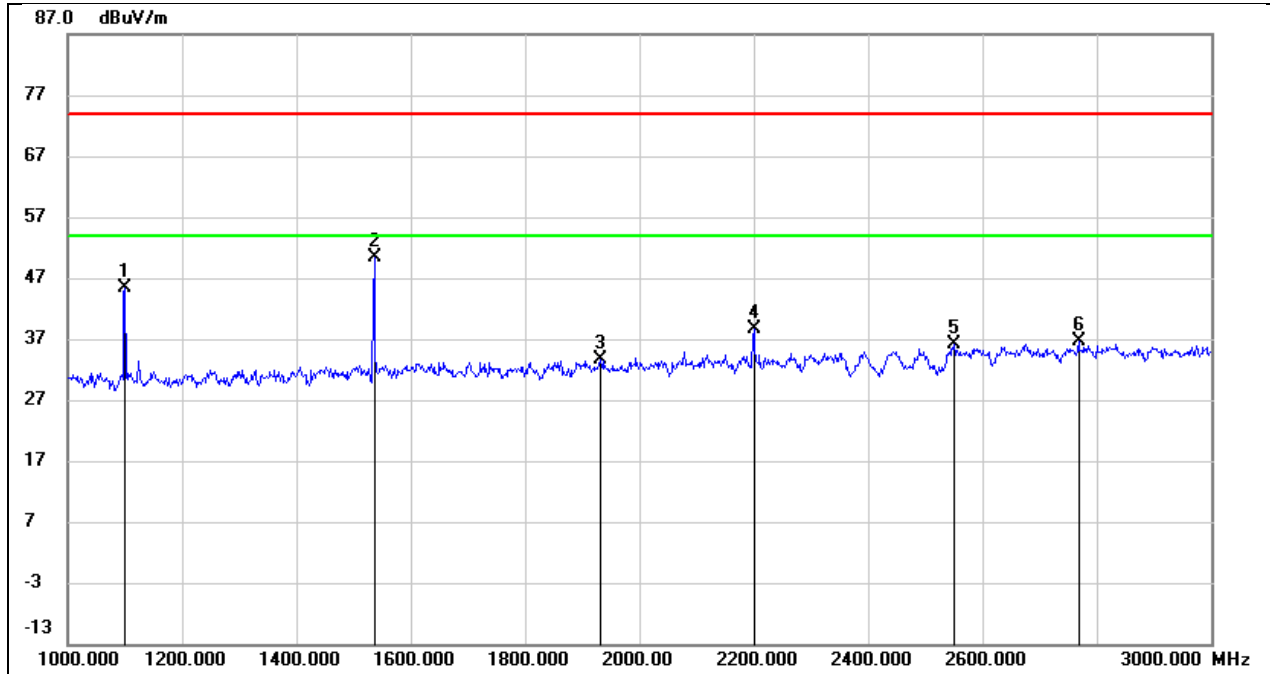

No.	Frequency (MHz)	Reading (dBuV)	Correct (dB/m)	Result (dBuV/m)	Limit (dBuV/m)	Margin (dB)	Remark
1	1100.000	60.03	-14.57	45.46	74.00	-28.54	peak
2	1536.000	63.06	-12.59	50.47	74.00	-23.53	peak
3	1932.000	44.94	-11.28	33.66	74.00	-40.34	peak
4	2200.000	48.58	-10.03	38.55	74.00	-35.45	peak
5	2550.000	44.55	-8.33	36.22	74.00	-37.78	peak
6	2768.000	44.22	-7.68	36.54	74.00	-37.46	peak

Test Mode:	802.11g	Channel:	2412 MHz
Polarity:	Vertical	Test Voltage:	DC 12 V

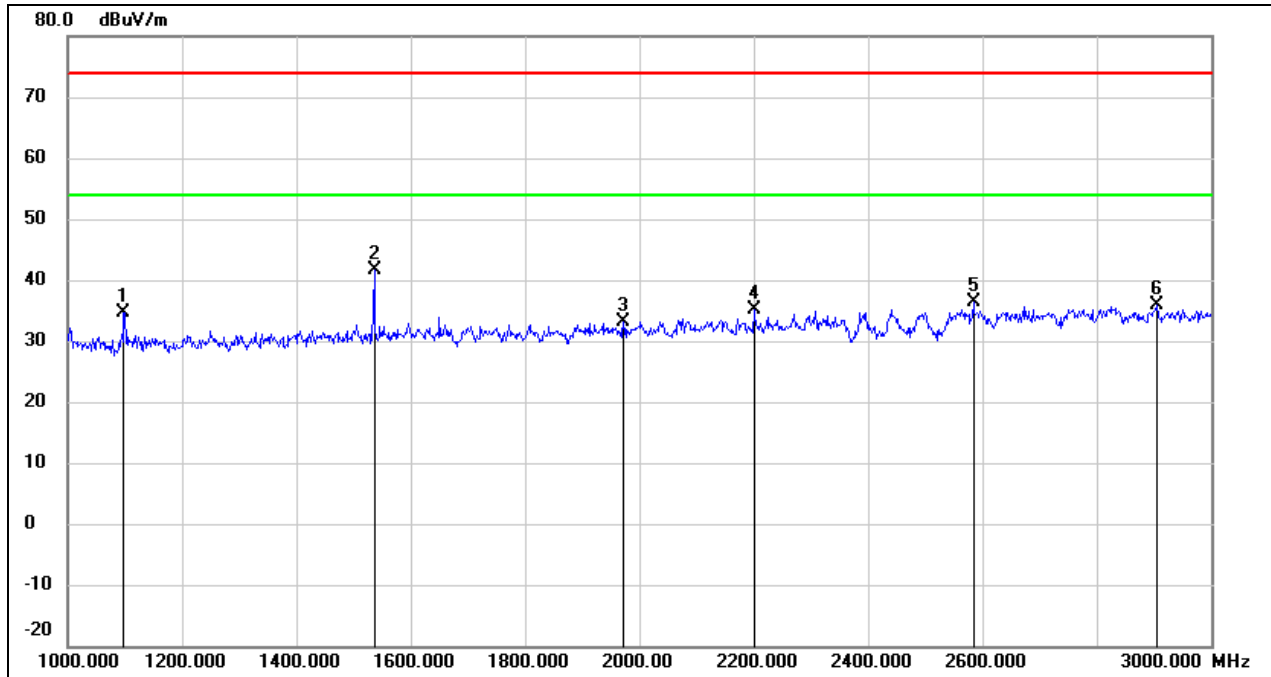

No.	Frequency (MHz)	Reading (dBuV)	Correct (dB/m)	Result (dBuV/m)	Limit (dBuV/m)	Margin (dB)	Remark
1	1098.000	49.30	-14.58	34.72	74.00	-39.28	peak
2	1536.000	54.22	-12.59	41.63	74.00	-32.37	peak
3	1972.000	44.21	-11.16	33.05	74.00	-40.95	peak
4	2200.000	45.25	-10.03	35.22	74.00	-38.78	peak
5	2584.000	44.63	-8.24	36.39	74.00	-37.61	peak
6	2904.000	43.12	-7.27	35.85	74.00	-38.15	peak

Test Mode:	802.11g	Channel:	2417 MHz
Polarity:	Horizontal	Test Voltage:	DC 12 V

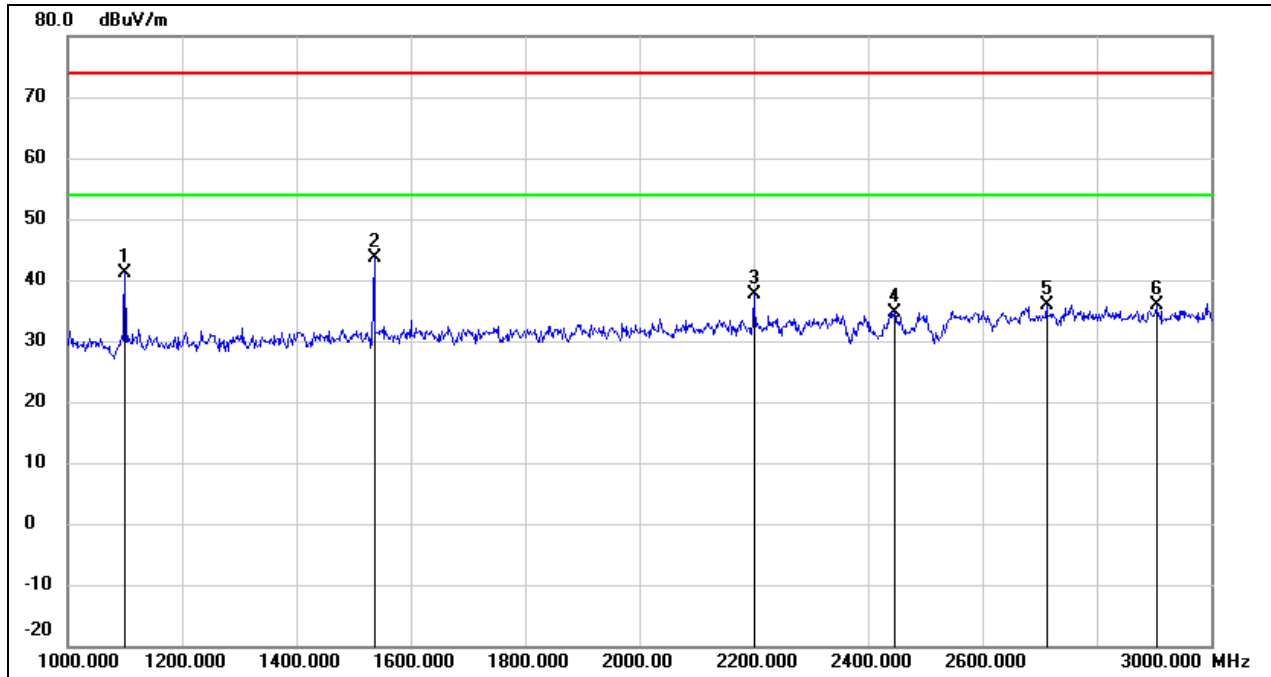

No.	Frequency (MHz)	Reading (dBuV)	Correct (dB/m)	Result (dBuV/m)	Limit (dBuV/m)	Margin (dB)	Remark
1	1100.000	55.76	-14.57	41.19	74.00	-32.81	peak
2	1536.000	56.27	-12.59	43.68	74.00	-30.32	peak
3	2200.000	47.75	-10.03	37.72	74.00	-36.28	peak
4	2446.000	43.51	-8.77	34.74	74.00	-39.26	peak
5	2712.000	43.80	-7.85	35.95	74.00	-38.05	peak
6	2904.000	43.05	-7.27	35.78	74.00	-38.22	peak

Test Mode:	802.11g	Channel:	2417 MHz
Polarity:	Vertical	Test Voltage:	DC 12 V

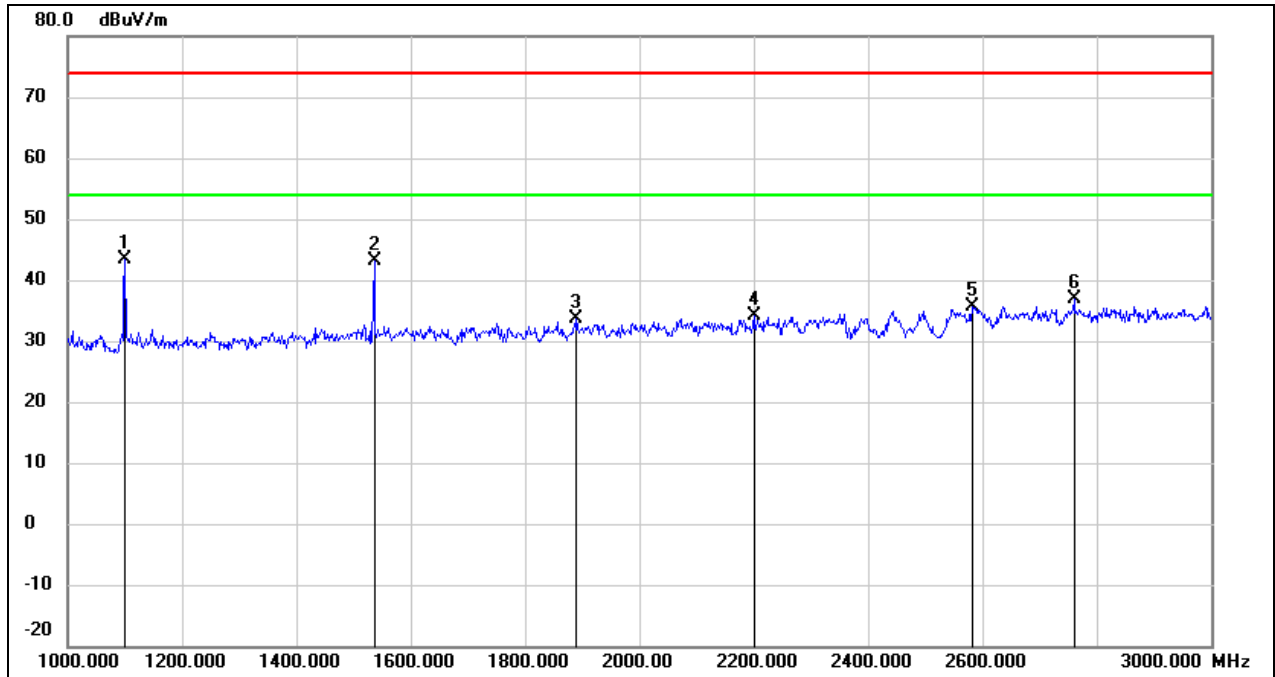

No.	Frequency (MHz)	Reading (dBuV)	Correct (dB/m)	Result (dBuV/m)	Limit (dBuV/m)	Margin (dB)	Remark
1	1100.000	58.02	-14.57	43.45	74.00	-30.55	peak
2	1536.000	55.80	-12.59	43.21	74.00	-30.79	peak
3	1890.000	45.02	-11.42	33.60	74.00	-40.40	peak
4	2200.000	44.19	-10.03	34.16	74.00	-39.84	peak
5	2582.000	43.97	-8.24	35.73	74.00	-38.27	peak
6	2760.000	44.57	-7.70	36.87	74.00	-37.13	peak

Test Mode:	802.11g	Channel:	2437 MHz
Polarity:	Horizontal	Test Voltage:	DC 12 V

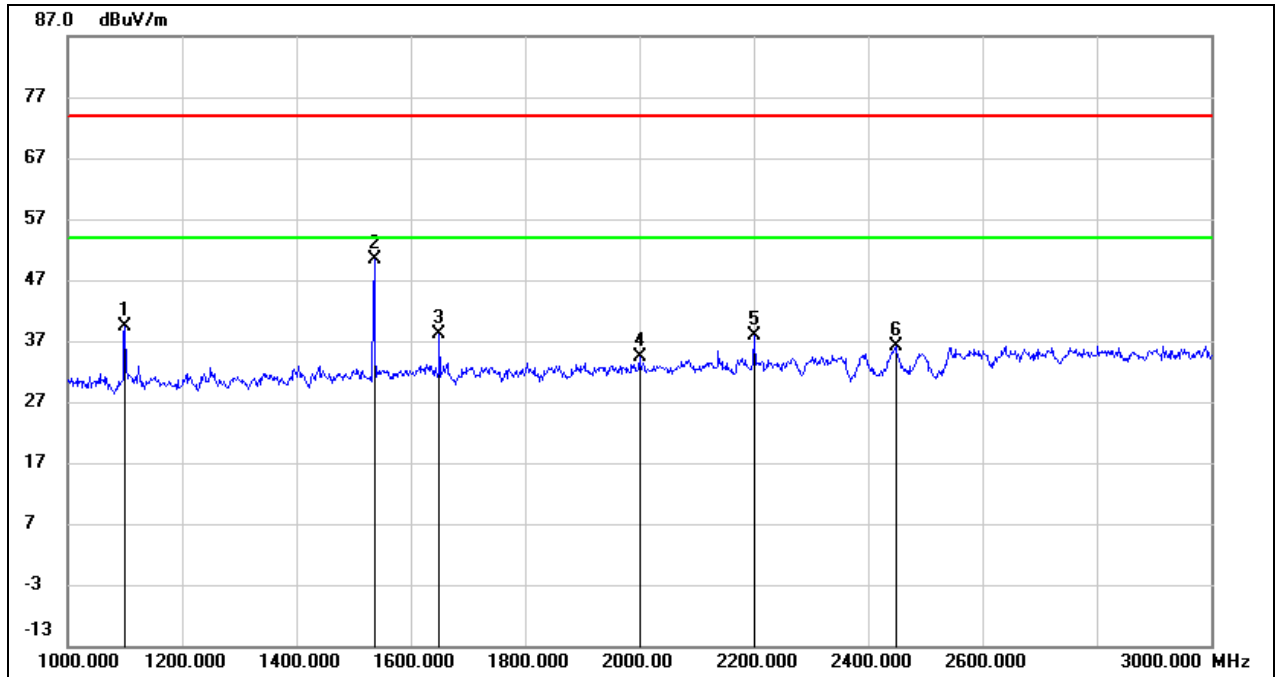

No.	Frequency (MHz)	Reading (dBuV)	Correct (dB/m)	Result (dBuV/m)	Limit (dBuV/m)	Margin (dB)	Remark
1	1100.000	53.91	-14.57	39.34	74.00	-34.66	peak
2	1536.000	63.09	-12.59	50.50	74.00	-23.50	peak
3	1650.000	50.40	-12.21	38.19	74.00	-35.81	peak
4	2000.000	45.34	-11.06	34.28	74.00	-39.72	peak
5	2200.000	47.96	-10.03	37.93	74.00	-36.07	peak
6	2448.000	44.82	-8.77	36.05	74.00	-37.95	peak

Test Mode:	802.11g	Channel:	2437 MHz
Polarity:	Vertical	Test Voltage:	DC 12 V

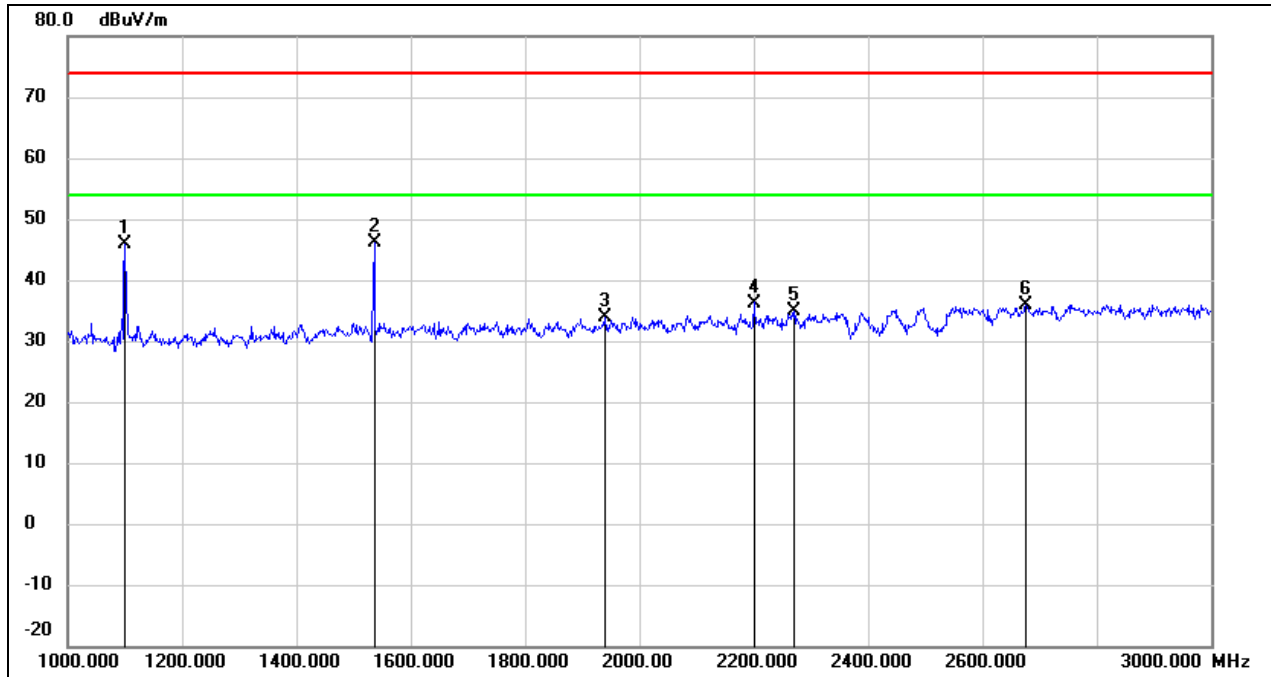

No.	Frequency (MHz)	Reading (dBuV)	Correct (dB/m)	Result (dBuV/m)	Limit (dBuV/m)	Margin (dB)	Remark
1	1100.000	60.35	-14.57	45.78	74.00	-28.22	peak
2	1536.000	58.81	-12.59	46.22	74.00	-27.78	peak
3	1940.000	45.11	-11.25	33.86	74.00	-40.14	peak
4	2200.000	46.28	-10.03	36.25	74.00	-37.75	peak
5	2270.000	44.55	-9.67	34.88	74.00	-39.12	peak
6	2676.000	43.77	-7.96	35.81	74.00	-38.19	peak

Test Mode:	802.11g	Channel:	2457 MHz
Polarity:	Horizontal	Test Voltage:	DC 12 V

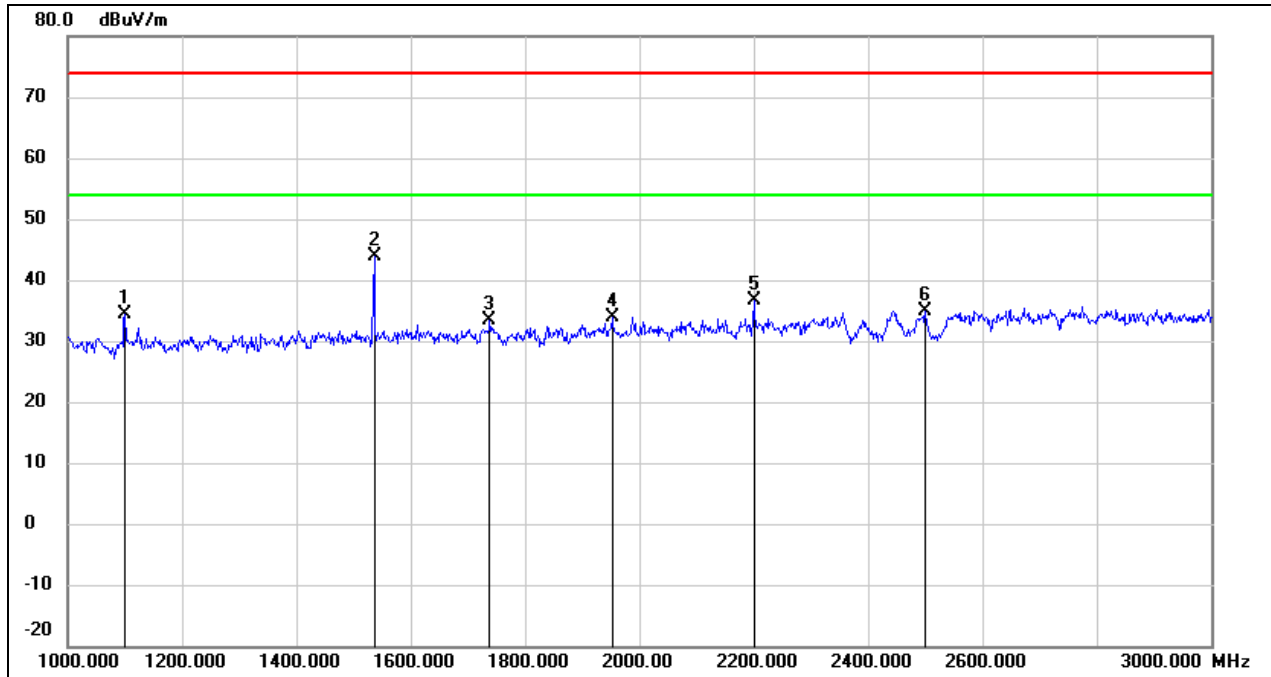

No.	Frequency (MHz)	Reading (dBuV)	Correct (dB/m)	Result (dBuV/m)	Limit (dBuV/m)	Margin (dB)	Remark
1	1100.000	49.01	-14.57	34.44	74.00	-39.56	peak
2	1536.000	56.43	-12.59	43.84	74.00	-30.16	peak
3	1738.000	45.27	-11.93	33.34	74.00	-40.66	peak
4	1952.000	45.13	-11.22	33.91	74.00	-40.09	peak
5	2200.000	46.65	-10.03	36.62	74.00	-37.38	peak
6	2500.000	43.45	-8.49	34.96	74.00	-39.04	peak

Test Mode:	802.11g	Channel:	2457 MHz
Polarity:	Vertical	Test Voltage:	DC 12 V

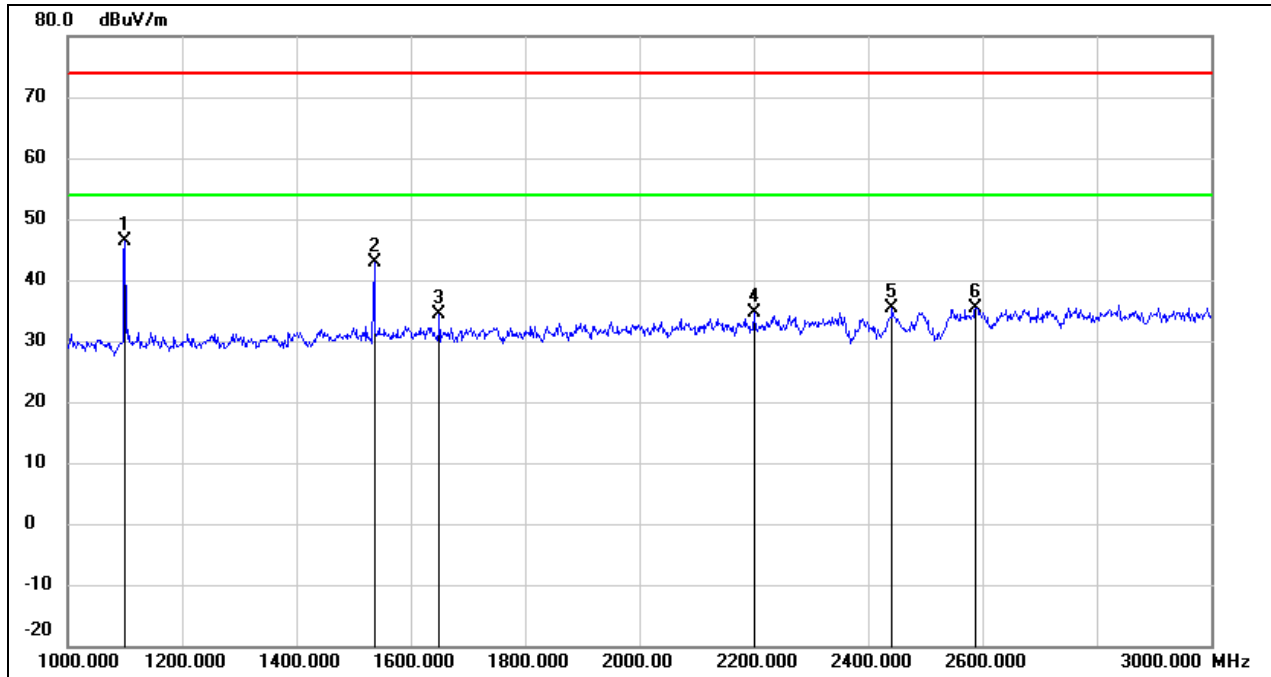

No.	Frequency (MHz)	Reading (dBuV)	Correct (dB/m)	Result (dBuV/m)	Limit (dBuV/m)	Margin (dB)	Remark
1	1100.000	60.94	-14.57	46.37	74.00	-27.63	peak
2	1536.000	55.59	-12.59	43.00	74.00	-31.00	peak
3	1650.000	46.61	-12.21	34.40	74.00	-39.60	peak
4	2200.000	44.77	-10.03	34.74	74.00	-39.26	peak
5	2442.000	44.05	-8.79	35.26	74.00	-38.74	peak
6	2588.000	43.71	-8.22	35.49	74.00	-38.51	peak

Test Mode:	802.11g	Channel:	2462 MHz
Polarity:	Horizontal	Test Voltage:	DC 12 V

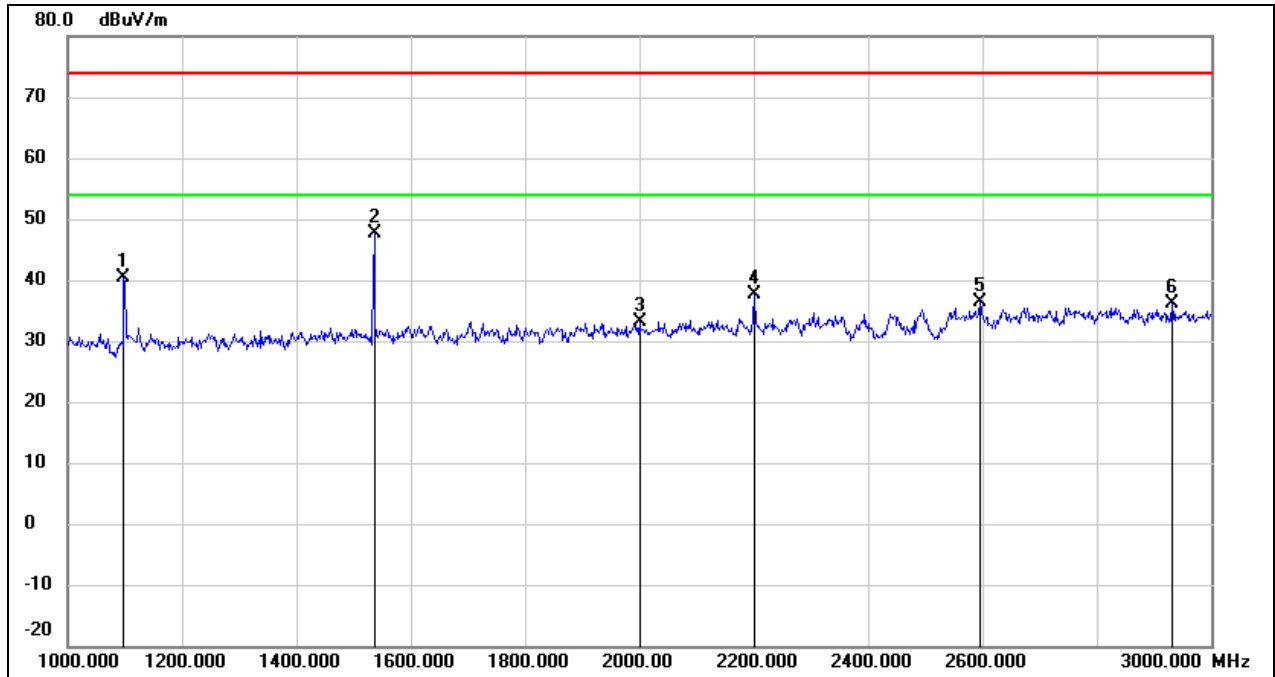

No.	Frequency (MHz)	Reading (dBuV)	Correct (dB/m)	Result (dBuV/m)	Limit (dBuV/m)	Margin (dB)	Remark
1	1098.000	54.98	-14.58	40.40	74.00	-33.60	peak
2	1536.000	60.27	-12.59	47.68	74.00	-26.32	peak
3	2000.000	44.26	-11.06	33.20	74.00	-40.80	peak
4	2200.000	47.77	-10.03	37.74	74.00	-36.26	peak
5	2596.000	44.46	-8.20	36.26	74.00	-37.74	peak
6	2932.000	43.36	-7.19	36.17	74.00	-37.83	peak

Test Mode:	802.11g	Channel:	2462 MHz
Polarity:	Vertical	Test Voltage:	DC 12 V

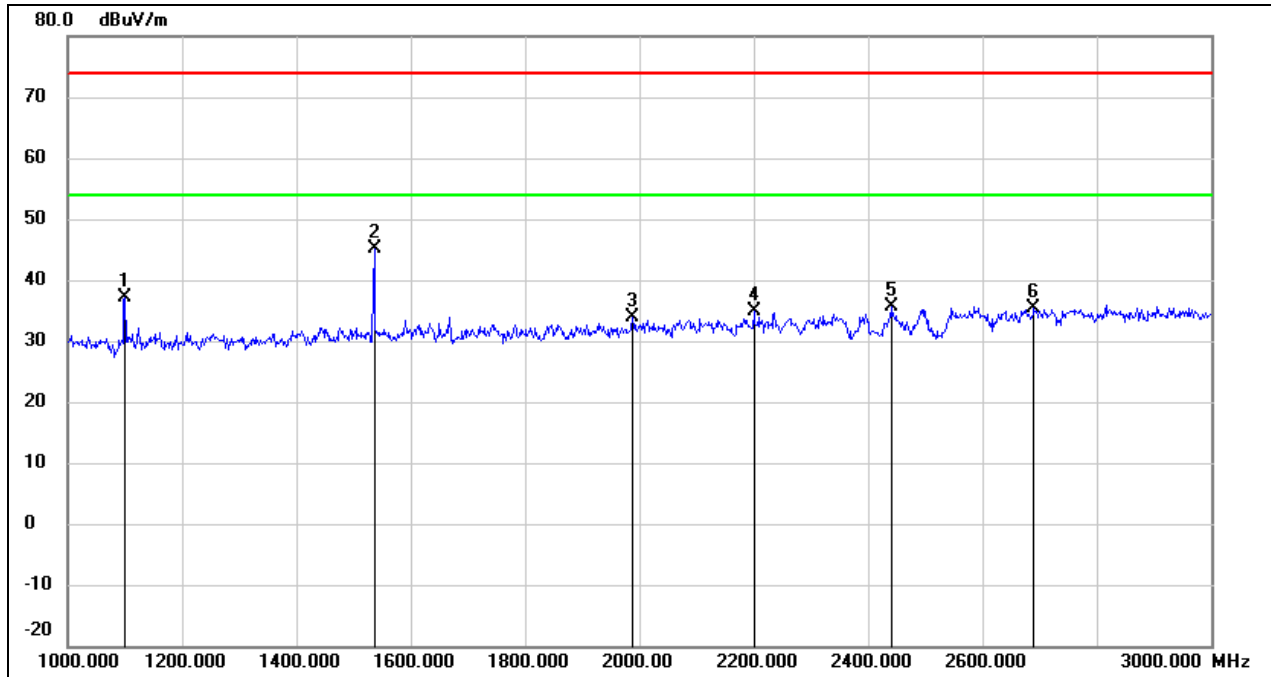

No.	Frequency (MHz)	Reading (dBuV)	Correct (dB/m)	Result (dBuV/m)	Limit (dBuV/m)	Margin (dB)	Remark
1	1100.000	51.81	-14.57	37.24	74.00	-36.76	peak
2	1536.000	57.74	-12.59	45.15	74.00	-28.85	peak
3	1988.000	44.95	-11.10	33.85	74.00	-40.15	peak
4	2200.000	44.99	-10.03	34.96	74.00	-39.04	peak
5	2440.000	44.43	-8.80	35.63	74.00	-38.37	peak
6	2690.000	43.18	-7.92	35.26	74.00	-38.74	peak

8.3. SPURIOUS EMISSIONS (3 GHZ ~ 18 GHZ)

Test Mode:	802.11b	Channel:	2412 MHz
Polarity:	Horizontal	Test Voltage:	DC 12 V

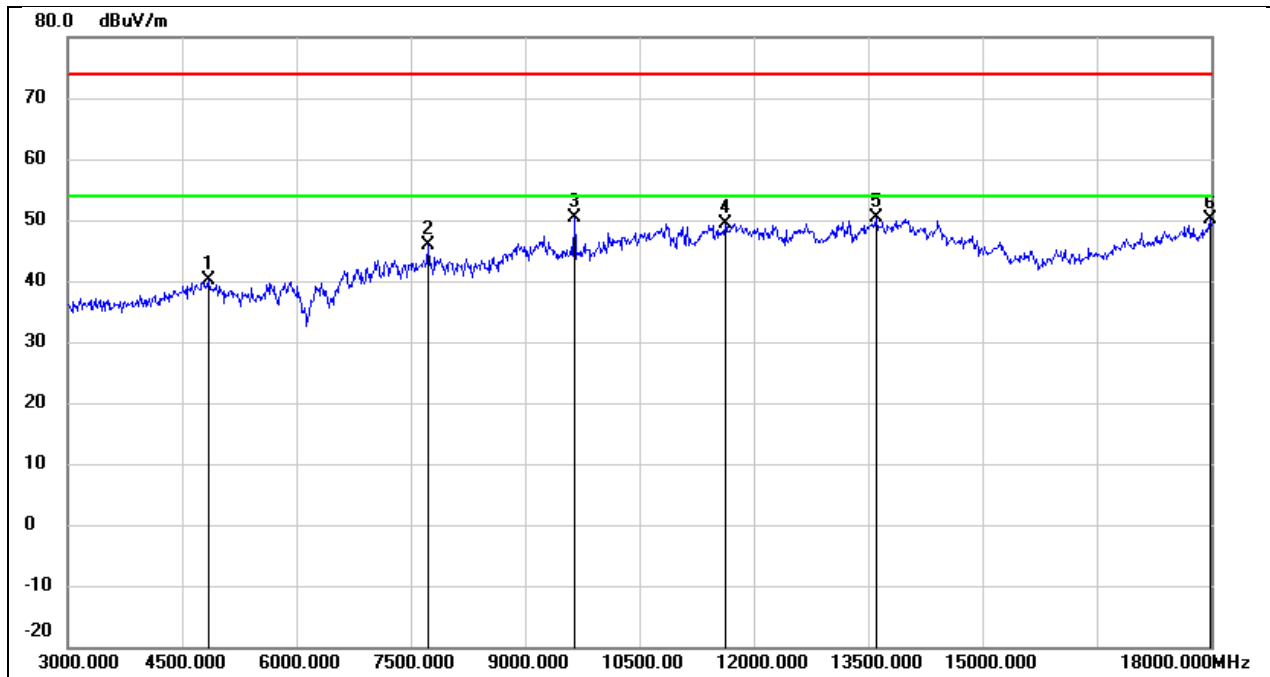

No.	Frequency (MHz)	Reading (dBuV)	Correct (dB/m)	Result (dBuV/m)	Limit (dBuV/m)	Margin (dB)	Remark
1	4845.000	40.28	-0.15	40.13	74.00	-33.87	peak
2	7725.000	39.68	6.32	46.00	74.00	-28.00	peak
3	9645.000	39.30	11.08	50.38	74.00	-23.62	peak
4	11625.000	32.45	16.94	49.39	74.00	-24.61	peak
5	13605.000	29.24	21.12	50.36	74.00	-23.64	peak
6	17985.000	24.54	25.60	50.14	74.00	-23.86	peak

Test Mode:	802.11b	Channel:	2412 MHz
Polarity:	Vertical	Test Voltage:	DC 12 V

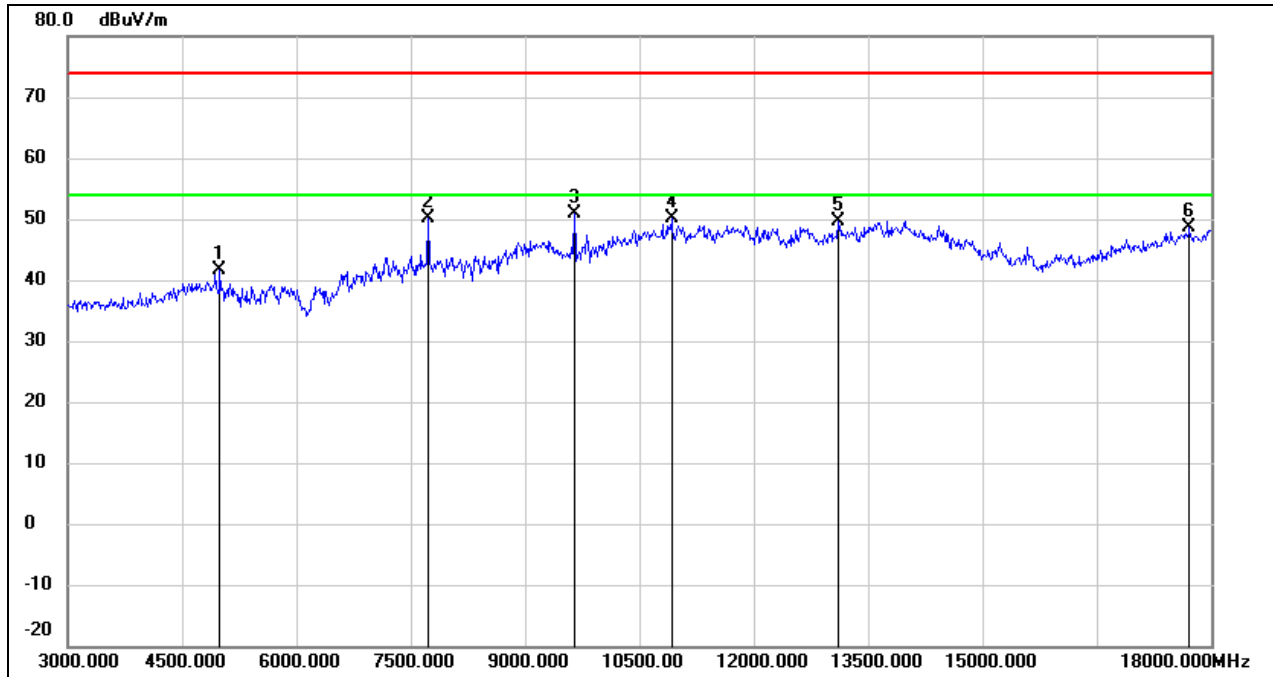

No.	Frequency (MHz)	Reading (dBuV)	Correct (dB/m)	Result (dBuV/m)	Limit (dBuV/m)	Margin (dB)	Remark
1	4995.000	41.11	0.43	41.54	74.00	-32.46	peak
2	7725.000	43.90	6.32	50.22	74.00	-23.78	peak
3	9645.000	39.74	11.08	50.82	74.00	-23.18	peak
4	10920.000	35.60	14.49	50.09	74.00	-23.91	peak
5	13110.000	30.54	19.20	49.74	74.00	-24.26	peak
6	17715.000	24.73	24.00	48.73	74.00	-25.27	peak

Test Mode:	802.11b	Channel:	2417 MHz
Polarity:	Horizontal	Test Voltage:	DC 12 V

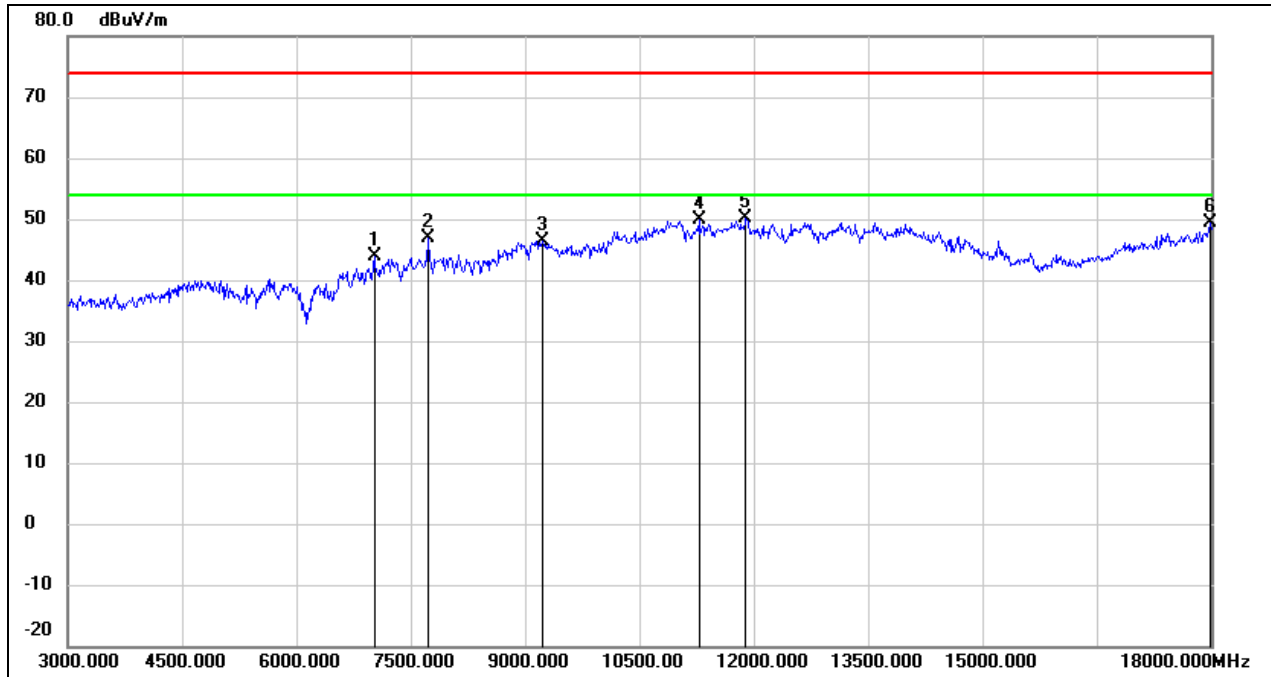

No.	Frequency (MHz)	Reading (dBuV)	Correct (dB/m)	Result (dBuV/m)	Limit (dBuV/m)	Margin (dB)	Remark
1	7020.000	37.29	6.67	43.96	74.00	-30.04	peak
2	7725.000	40.56	6.32	46.88	74.00	-27.12	peak
3	9225.000	35.90	10.58	46.48	74.00	-27.52	peak
4	11280.000	33.99	15.80	49.79	74.00	-24.21	peak
5	11895.000	32.50	17.68	50.18	74.00	-23.82	peak
6	17985.000	23.84	25.60	49.44	74.00	-24.56	peak

Test Mode:	802.11b	Channel:	2417 MHz
Polarity:	Vertical	Test Voltage:	DC 12 V

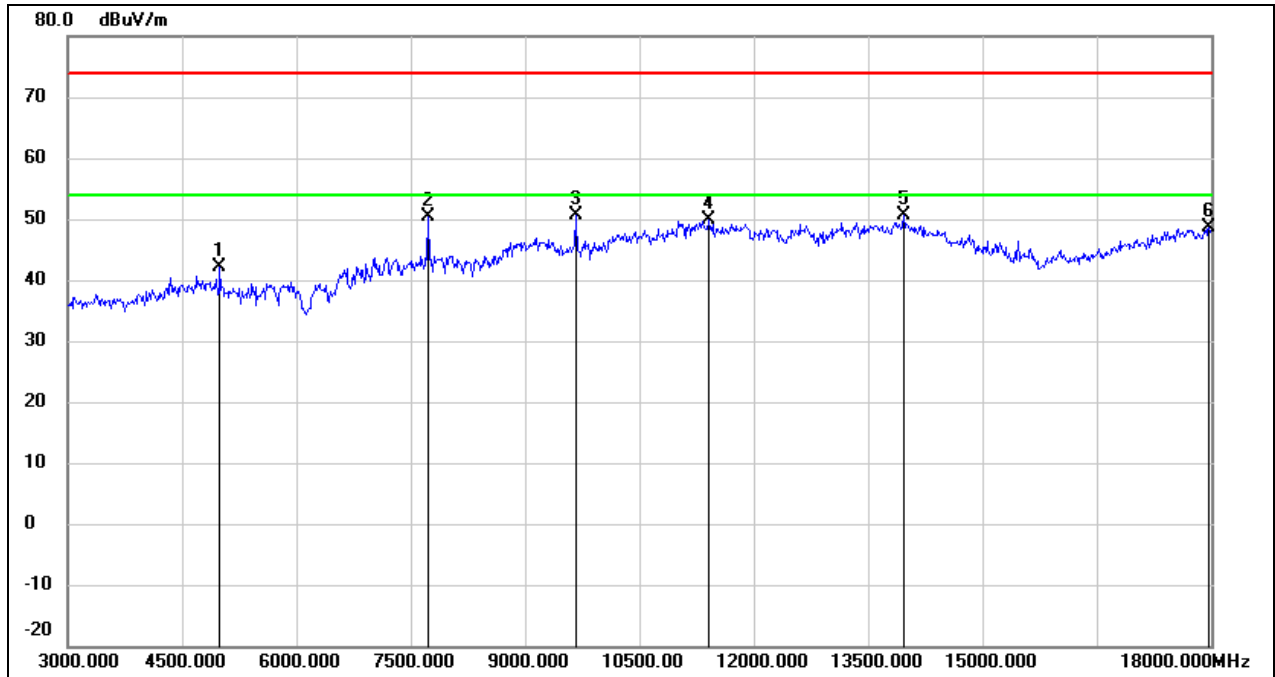

No.	Frequency (MHz)	Reading (dBuV)	Correct (dB/m)	Result (dBuV/m)	Limit (dBuV/m)	Margin (dB)	Remark
1	4995.000	41.65	0.43	42.08	74.00	-31.92	peak
2	7725.000	44.18	6.32	50.50	74.00	-23.50	peak
3	9660.000	39.43	11.11	50.54	74.00	-23.46	peak
4	11415.000	33.59	16.29	49.88	74.00	-24.12	peak
5	13965.000	28.64	21.89	50.53	74.00	-23.47	peak
6	17970.000	23.04	25.51	48.55	74.00	-25.45	peak

Test Mode:	802.11b	Channel:	2437 MHz
Polarity:	Horizontal	Test Voltage:	DC 12 V

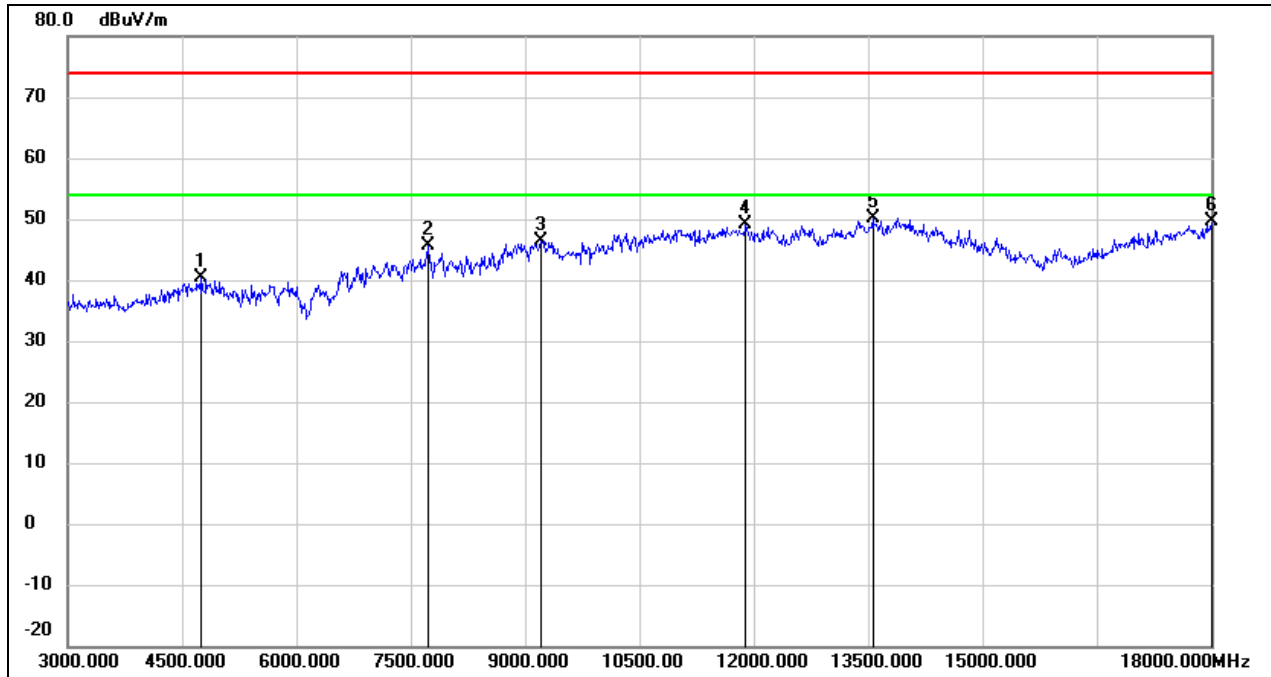

No.	Frequency (MHz)	Reading (dBuV)	Correct (dB/m)	Result (dBuV/m)	Limit (dBuV/m)	Margin (dB)	Remark
1	4755.000	40.78	-0.48	40.30	74.00	-33.70	peak
2	7725.000	39.24	6.32	45.56	74.00	-28.44	peak
3	9210.000	35.83	10.57	46.40	74.00	-27.60	peak
4	11895.000	31.47	17.68	49.15	74.00	-24.85	peak
5	13560.000	28.99	21.04	50.03	74.00	-23.97	peak
6	18000.000	23.91	25.69	49.60	74.00	-24.40	peak

Test Mode:	802.11b	Channel:	2437 MHz
Polarity:	Vertical	Test Voltage:	DC 12 V

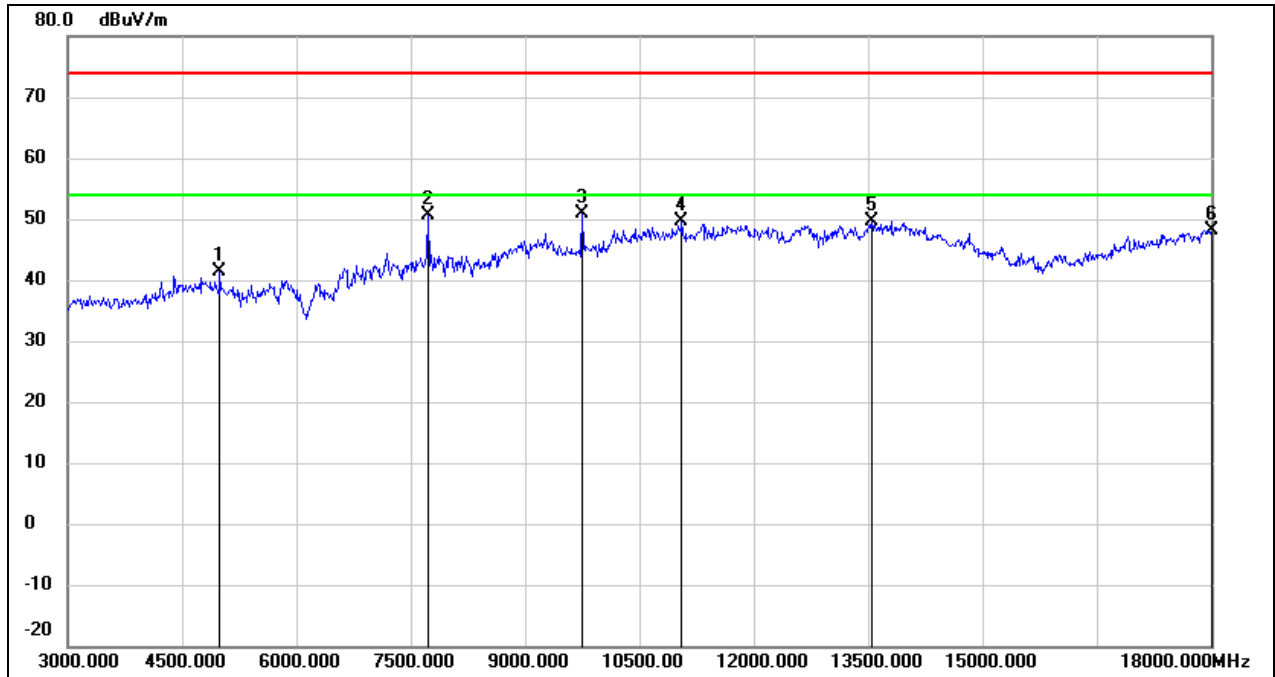

No.	Frequency (MHz)	Reading (dBuV)	Correct (dB/m)	Result (dBuV/m)	Limit (dBuV/m)	Margin (dB)	Remark
1	4995.000	40.92	0.43	41.35	74.00	-32.65	peak
2	7725.000	44.40	6.32	50.72	74.00	-23.28	peak
3	9750.000	39.60	11.35	50.95	74.00	-23.05	peak
4	11055.000	34.63	14.96	49.59	74.00	-24.41	peak
5	13545.000	28.72	20.99	49.71	74.00	-24.29	peak
6	18000.000	22.44	25.69	48.13	74.00	-25.87	peak

Test Mode:	802.11b	Channel:	2457 MHz
Polarity:	Horizontal	Test Voltage:	DC 12 V

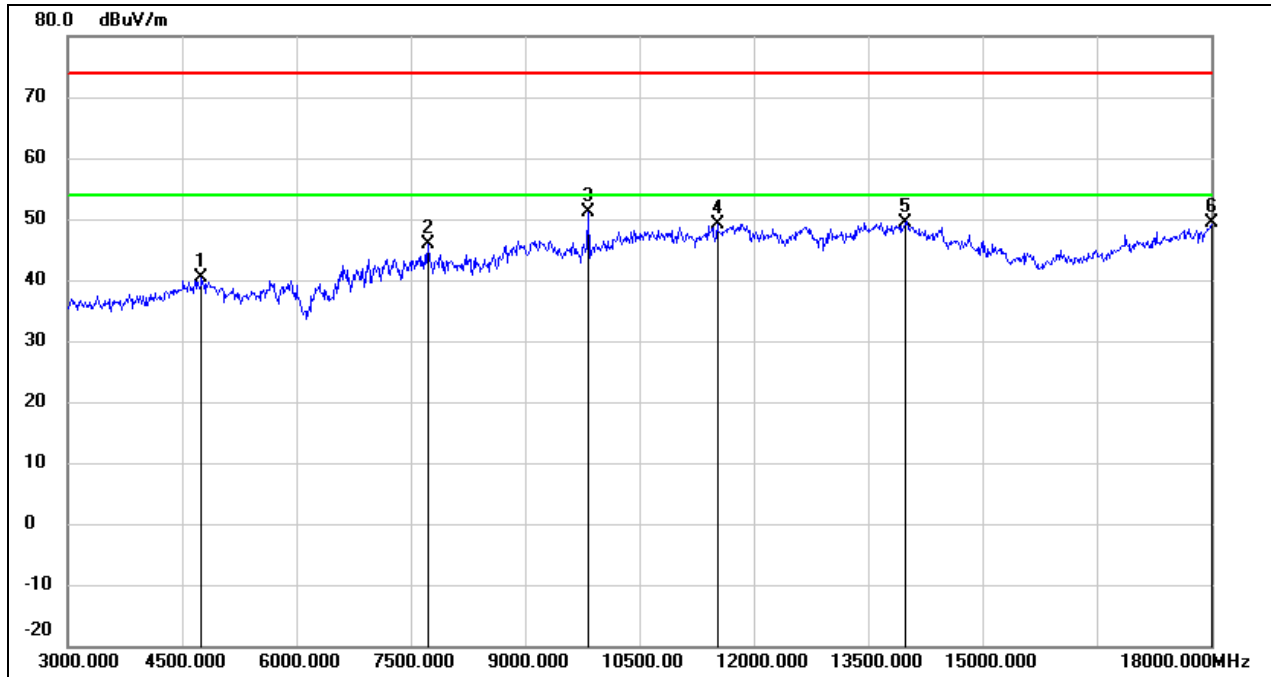

No.	Frequency (MHz)	Reading (dBuV)	Correct (dB/m)	Result (dBuV/m)	Limit (dBuV/m)	Margin (dB)	Remark
1	4755.000	40.88	-0.48	40.40	74.00	-33.60	peak
2	7725.000	39.58	6.32	45.90	74.00	-28.10	peak
3	9825.000	39.68	11.56	51.24	74.00	-22.76	peak
4	11520.000	32.56	16.65	49.21	74.00	-24.79	peak
5	13980.000	27.57	21.92	49.49	74.00	-24.51	peak
6	18000.000	23.58	25.69	49.27	74.00	-24.73	peak

Test Mode:	802.11b	Channel:	2457 MHz
Polarity:	Vertical	Test Voltage:	DC 12 V

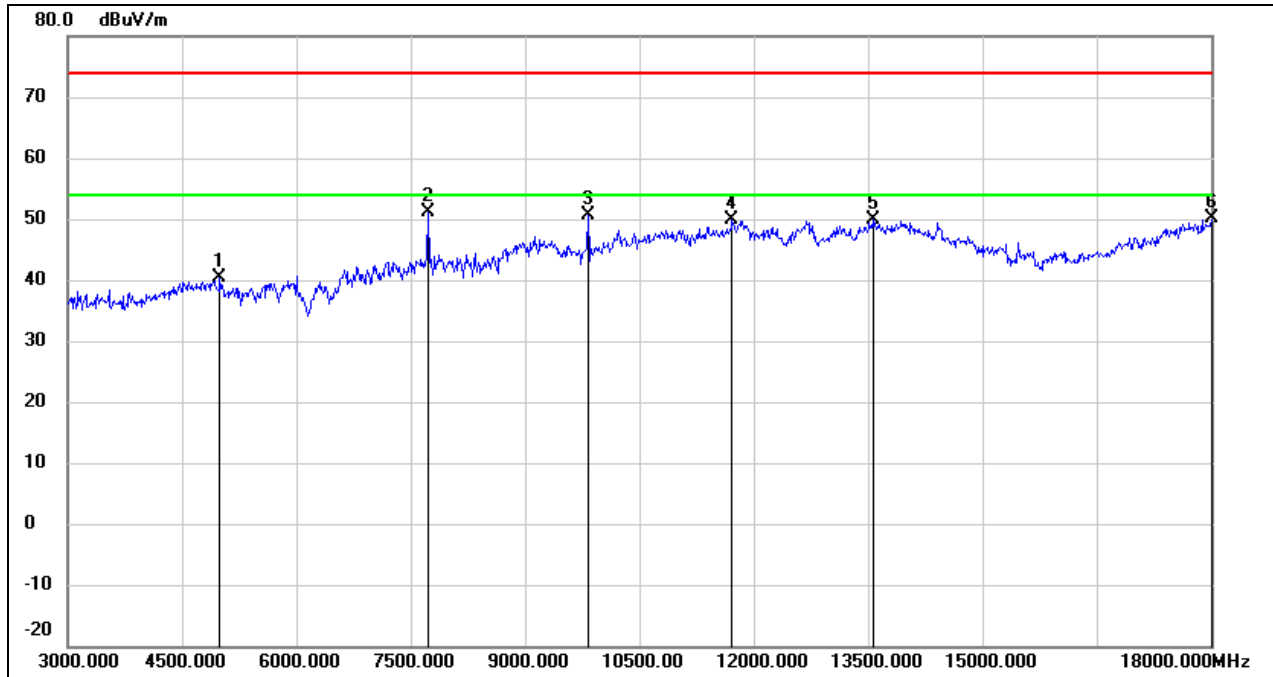

No.	Frequency (MHz)	Reading (dBuV)	Correct (dB/m)	Result (dBuV/m)	Limit (dBuV/m)	Margin (dB)	Remark
1	4995.000	39.88	0.43	40.31	74.00	-33.69	peak
2	7725.000	44.74	6.32	51.06	74.00	-22.94	peak
3	9825.000	39.02	11.56	50.58	74.00	-23.42	peak
4	11715.000	32.68	17.19	49.87	74.00	-24.13	peak
5	13560.000	28.78	21.04	49.82	74.00	-24.18	peak
6	18000.000	24.36	25.69	50.05	74.00	-23.95	peak

Test Mode:	802.11b	Channel:	2462 MHz
Polarity:	Horizontal	Test Voltage:	DC 12 V

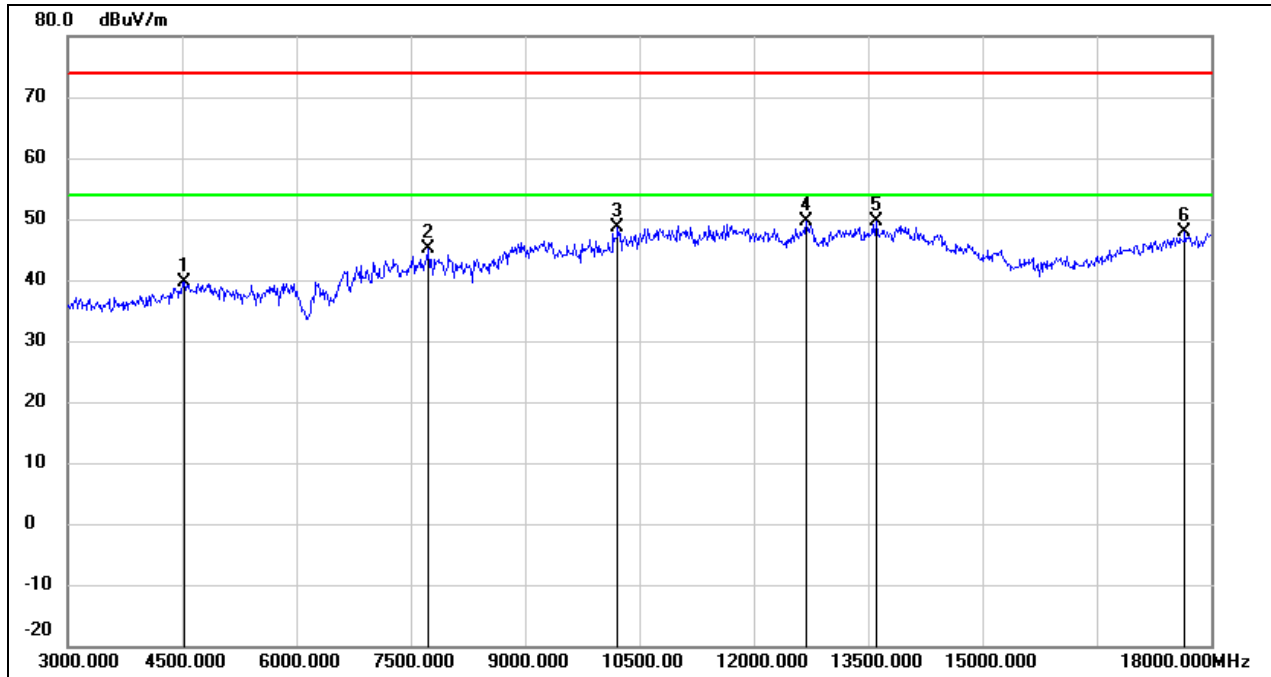

No.	Frequency (MHz)	Reading (dBuV)	Correct (dB/m)	Result (dBuV/m)	Limit (dBuV/m)	Margin (dB)	Remark
1	4530.000	40.99	-1.35	39.64	74.00	-34.36	peak
2	7725.000	38.69	6.32	45.01	74.00	-28.99	peak
3	10215.000	36.20	12.43	48.63	74.00	-25.37	peak
4	12690.000	31.72	18.02	49.74	74.00	-24.26	peak
5	13605.000	28.52	21.12	49.64	74.00	-24.36	peak
6	17655.000	24.15	23.64	47.79	74.00	-26.21	peak

Test Mode:	802.11b	Channel:	2462 MHz
Polarity:	Vertical	Test Voltage:	DC 12 V

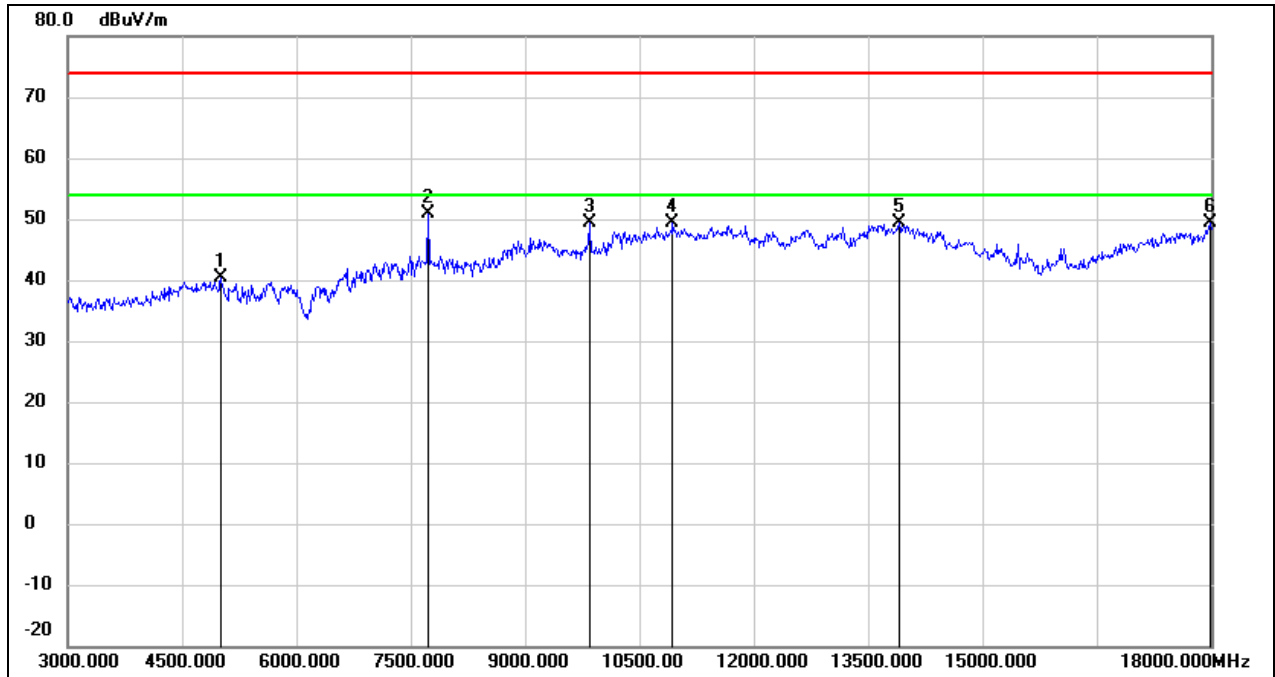

No.	Frequency (MHz)	Reading (dBuV)	Correct (dB/m)	Result (dBuV/m)	Limit (dBuV/m)	Margin (dB)	Remark
1	5010.000	39.83	0.46	40.29	74.00	-33.71	peak
2	7725.000	44.58	6.32	50.90	74.00	-23.10	peak
3	9840.000	37.77	11.59	49.36	74.00	-24.64	peak
4	10935.000	34.76	14.54	49.30	74.00	-24.70	peak
5	13905.000	27.58	21.76	49.34	74.00	-24.66	peak
6	17985.000	23.84	25.60	49.44	74.00	-24.56	peak

Test Mode:	802.11g	Channel:	2412 MHz
Polarity:	Horizontal	Test Voltage:	DC 12 V

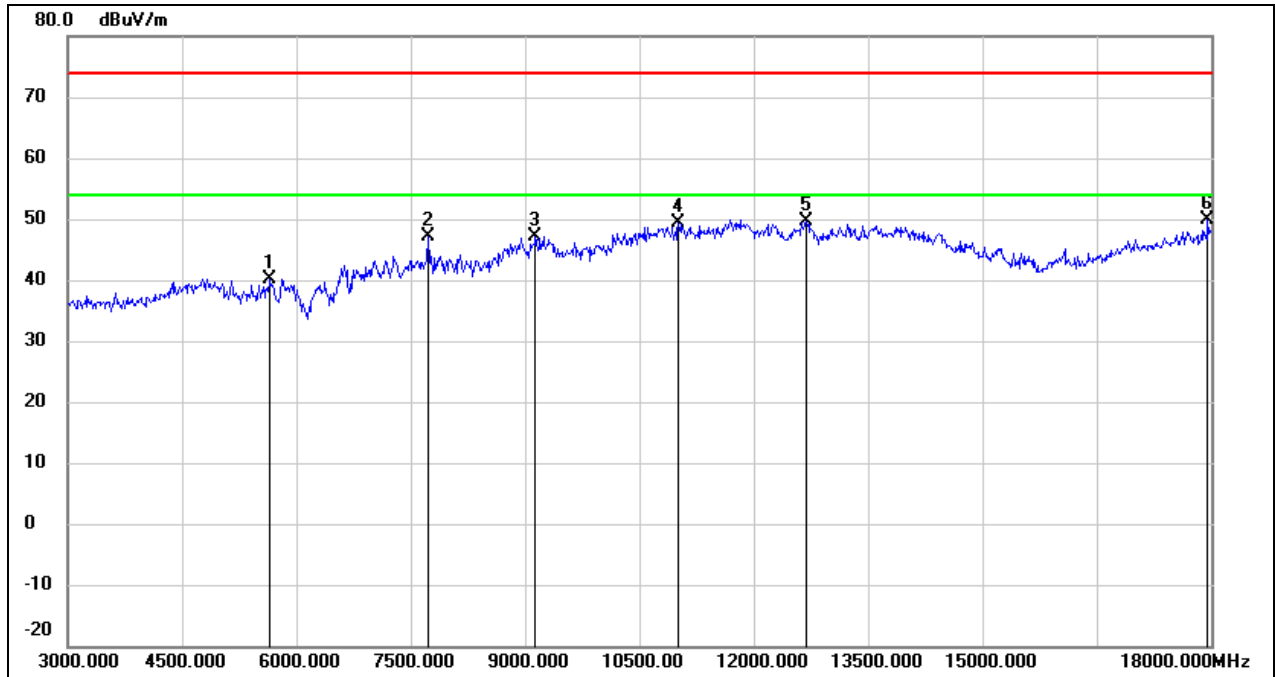

No.	Frequency (MHz)	Reading (dBuV)	Correct (dB/m)	Result (dBuV/m)	Limit (dBuV/m)	Margin (dB)	Remark
1	5655.000	38.81	1.29	40.10	74.00	-33.90	peak
2	7725.000	40.84	6.32	47.16	74.00	-26.84	peak
3	9135.000	36.67	10.55	47.22	74.00	-26.78	peak
4	11010.000	34.51	14.81	49.32	74.00	-24.68	peak
5	12690.000	31.58	18.02	49.60	74.00	-24.40	peak
6	17955.000	24.50	25.42	49.92	74.00	-24.08	peak

Test Mode:	802.11g	Channel:	2412 MHz
Polarity:	Vertical	Test Voltage:	DC 12 V

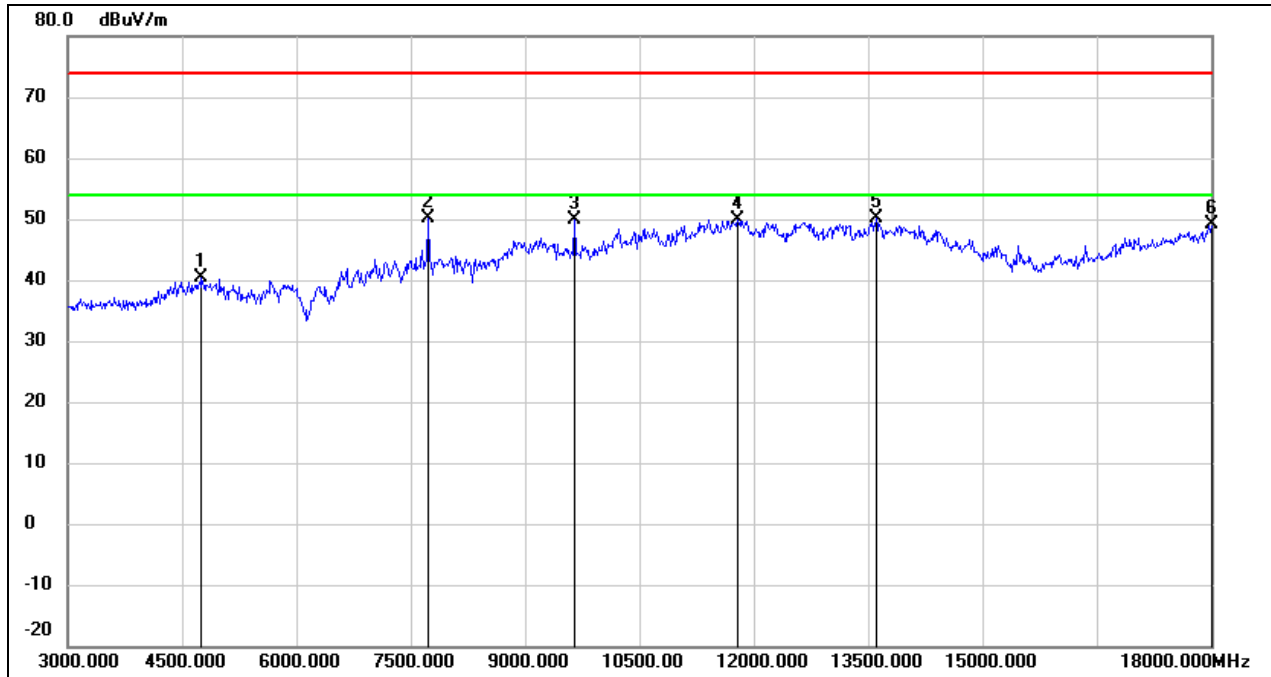

No.	Frequency (MHz)	Reading (dBuV)	Correct (dB/m)	Result (dBuV/m)	Limit (dBuV/m)	Margin (dB)	Remark
1	4755.000	40.75	-0.48	40.27	74.00	-33.73	peak
2	7725.000	43.89	6.32	50.21	74.00	-23.79	peak
3	9645.000	38.81	11.08	49.89	74.00	-24.11	peak
4	11790.000	32.55	17.38	49.93	74.00	-24.07	peak
5	13605.000	28.95	21.12	50.07	74.00	-23.93	peak
6	18000.000	23.36	25.69	49.05	74.00	-24.95	peak

Test Mode:	802.11g	Channel:	2437 MHz
Polarity:	Horizontal	Test Voltage:	DC 12 V

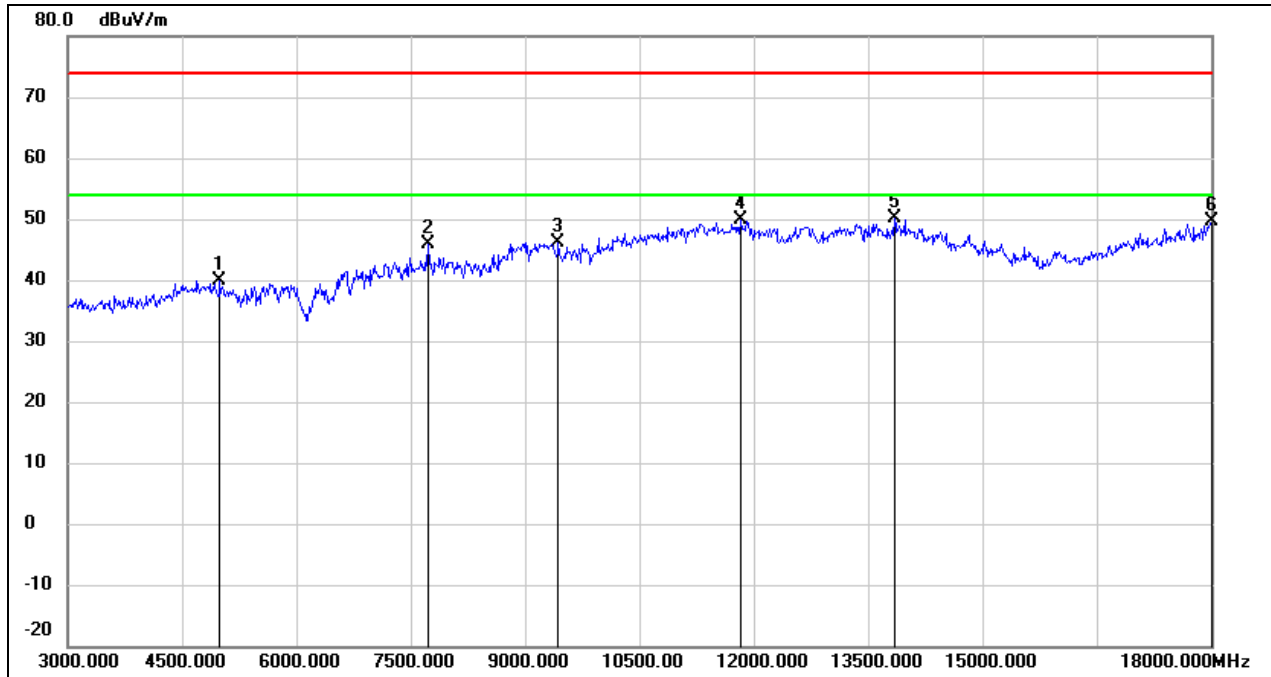

No.	Frequency (MHz)	Reading (dBuV)	Correct (dB/m)	Result (dBuV/m)	Limit (dBuV/m)	Margin (dB)	Remark
1	4995.000	39.43	0.43	39.86	74.00	-34.14	peak
2	7725.000	39.59	6.32	45.91	74.00	-28.09	peak
3	9435.000	35.54	10.67	46.21	74.00	-27.79	peak
4	11820.000	32.40	17.47	49.87	74.00	-24.13	peak
5	13845.000	28.50	21.62	50.12	74.00	-23.88	peak
6	18000.000	23.86	25.69	49.55	74.00	-24.45	peak

Test Mode:	802.11g	Channel:	2437 MHz
Polarity:	Vertical	Test Voltage:	DC 12 V

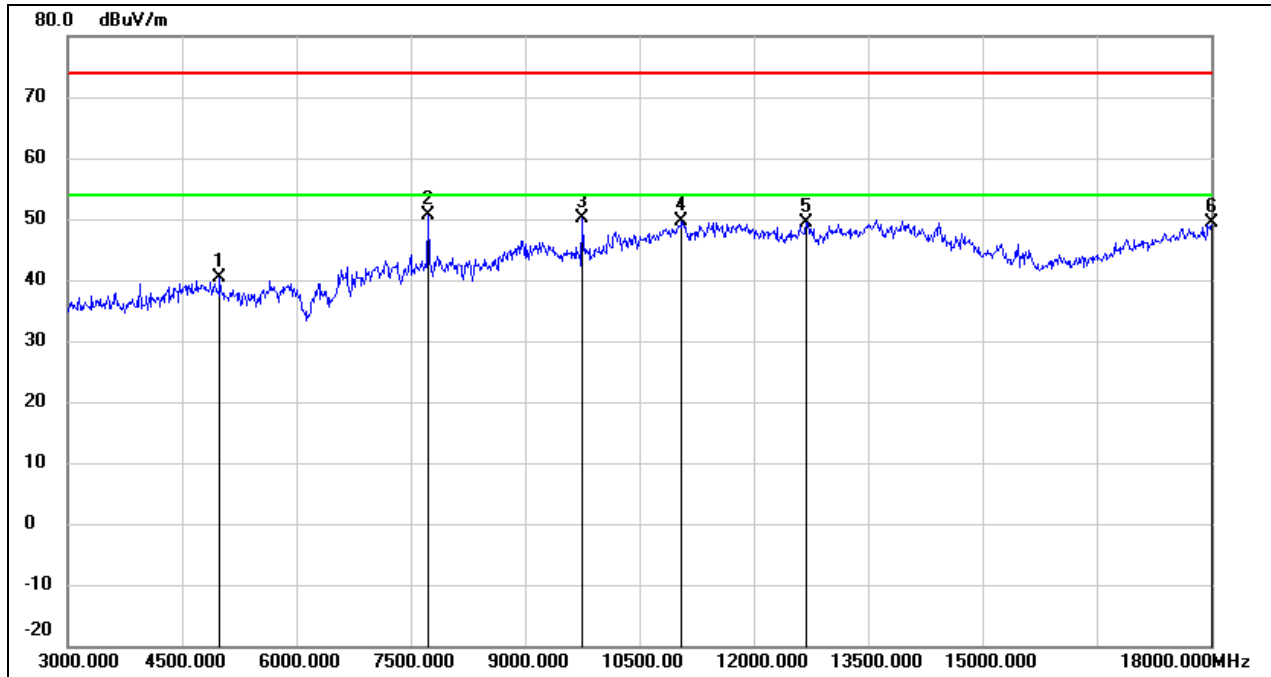

No.	Frequency (MHz)	Reading (dBuV)	Correct (dB/m)	Result (dBuV/m)	Limit (dBuV/m)	Margin (dB)	Remark
1	4995.000	39.88	0.43	40.31	74.00	-33.69	peak
2	7725.000	44.22	6.32	50.54	74.00	-23.46	peak
3	9750.000	38.73	11.35	50.08	74.00	-23.92	peak
4	11055.000	34.65	14.96	49.61	74.00	-24.39	peak
5	12690.000	31.45	18.02	49.47	74.00	-24.53	peak
6	18000.000	23.58	25.69	49.27	74.00	-24.73	peak

Test Mode:	802.11g	Channel:	2462 MHz
Polarity:	Horizontal	Test Voltage:	DC 12 V

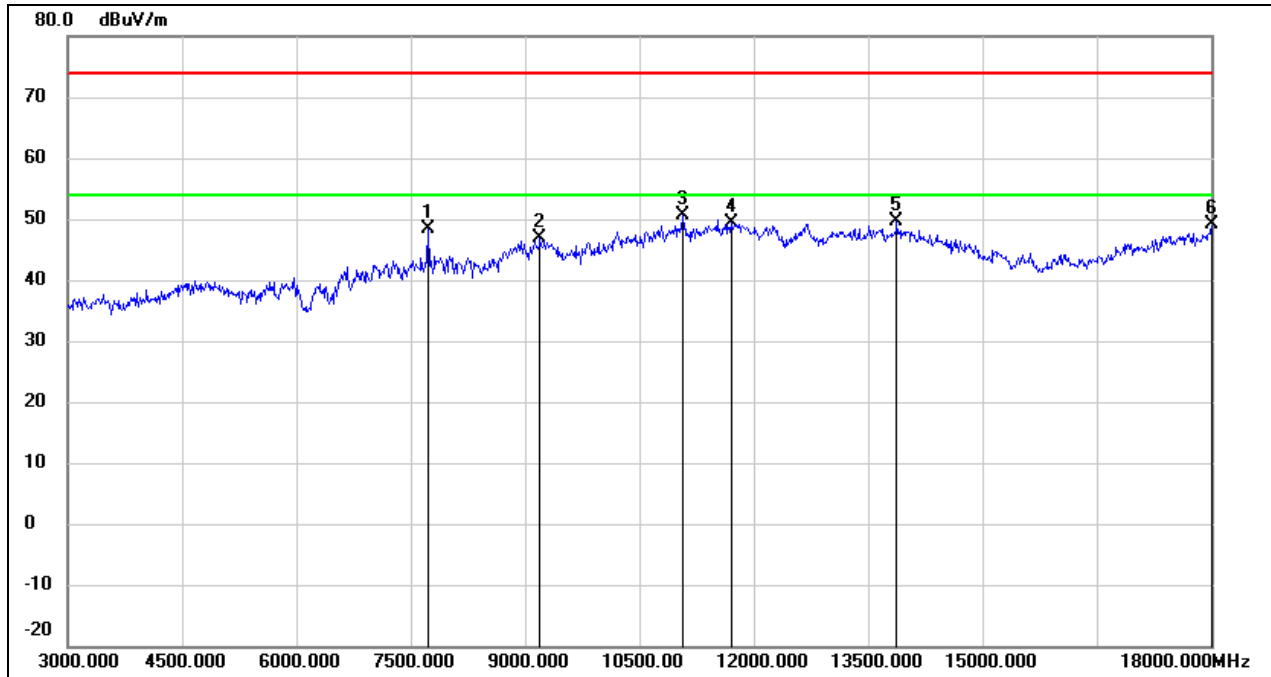

No.	Frequency (MHz)	Reading (dBuV)	Correct (dB/m)	Result (dBuV/m)	Limit (dBuV/m)	Margin (dB)	Remark
1	7725.000	42.08	6.32	48.40	74.00	-25.60	peak
2	9195.000	36.31	10.56	46.87	74.00	-27.13	peak
3	11070.000	35.49	15.03	50.52	74.00	-23.48	peak
4	11700.000	32.24	17.14	49.38	74.00	-24.62	peak
5	13875.000	27.85	21.70	49.55	74.00	-24.45	peak
6	18000.000	23.37	25.69	49.06	74.00	-24.94	peak

Test Mode:	802.11g	Channel:	2462 MHz
Polarity:	Vertical	Test Voltage:	DC 12 V

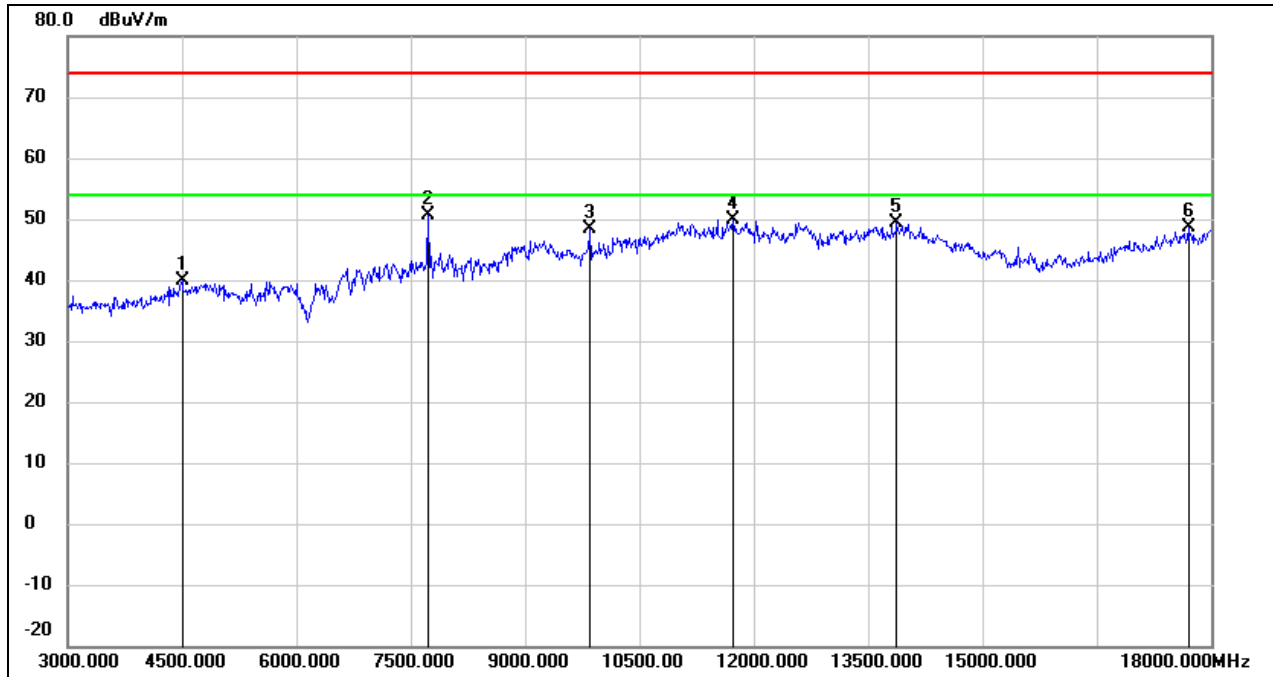

No.	Frequency (MHz)	Reading (dBuV)	Correct (dB/m)	Result (dBuV/m)	Limit (dBuV/m)	Margin (dB)	Remark
1	4500.000	41.35	-1.46	39.89	74.00	-34.11	peak
2	7725.000	44.23	6.32	50.55	74.00	-23.45	peak
3	9855.000	36.71	11.63	48.34	74.00	-25.66	peak
4	11730.000	32.76	17.22	49.98	74.00	-24.02	peak
5	13875.000	27.79	21.70	49.49	74.00	-24.51	peak
6	17700.000	24.68	23.91	48.59	74.00	-25.41	peak

Test Mode:	802.11n HT20	Channel:	2412 MHz
Polarity:	Horizontal	Test Voltage:	DC 12 V

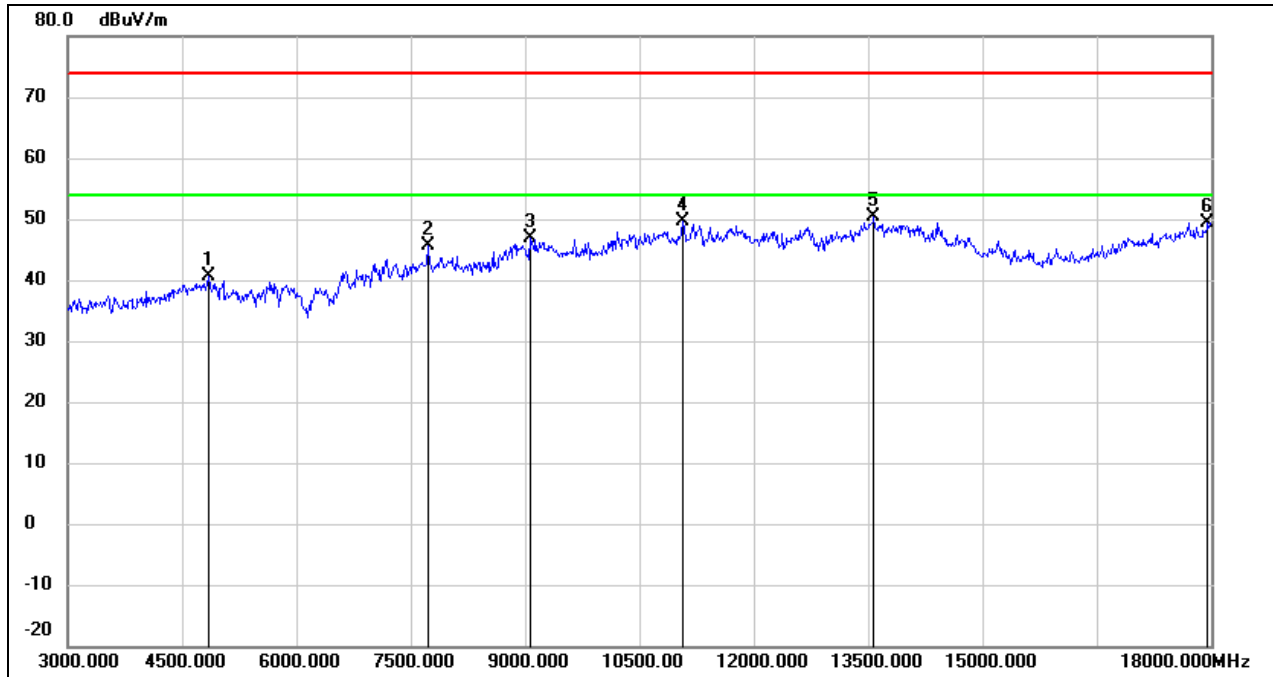

No.	Frequency (MHz)	Reading (dBuV)	Correct (dB/m)	Result (dBuV/m)	Limit (dBuV/m)	Margin (dB)	Remark
1	4845.000	40.75	-0.15	40.60	74.00	-33.40	peak
2	7725.000	39.42	6.32	45.74	74.00	-28.26	peak
3	9060.000	36.26	10.51	46.77	74.00	-27.23	peak
4	11070.000	34.67	15.03	49.70	74.00	-24.30	peak
5	13575.000	29.20	21.06	50.26	74.00	-23.74	peak
6	17955.000	24.06	25.42	49.48	74.00	-24.52	peak

Test Mode:	802.11n HT20	Channel:	2412 MHz
Polarity:	Vertical	Test Voltage:	DC 12 V

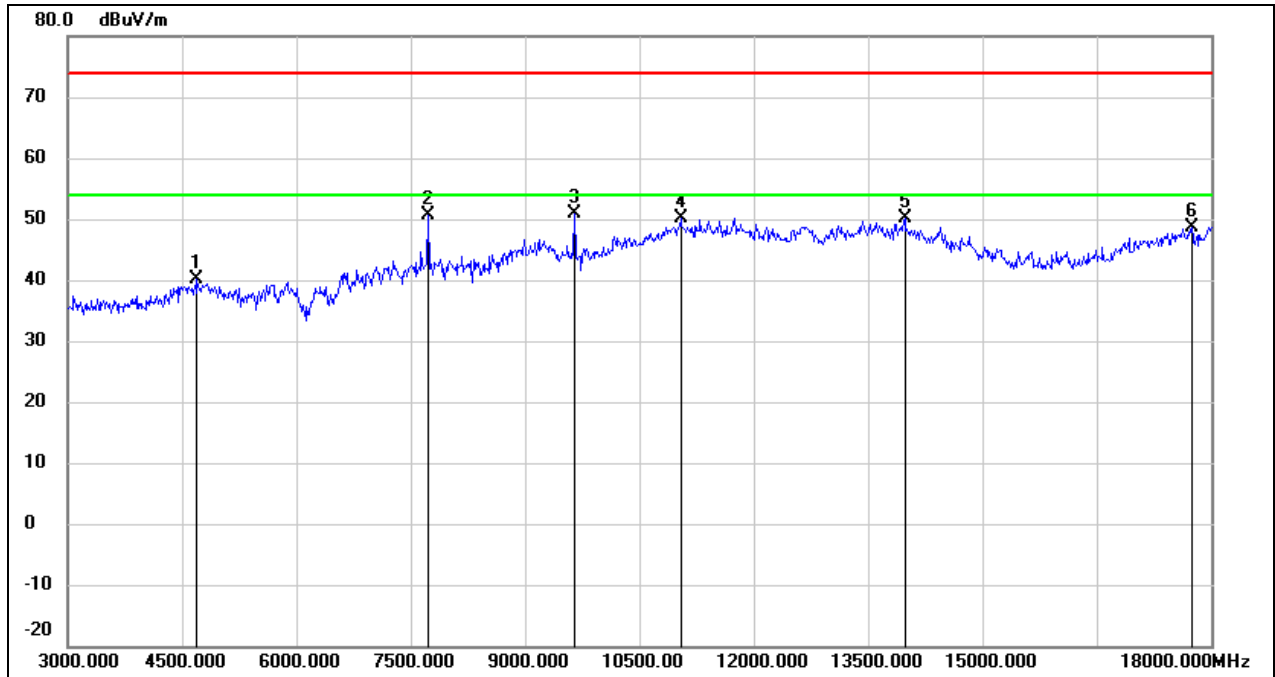

No.	Frequency (MHz)	Reading (dBuV)	Correct (dB/m)	Result (dBuV/m)	Limit (dBuV/m)	Margin (dB)	Remark
1	4695.000	40.85	-0.71	40.14	74.00	-33.86	peak
2	7725.000	44.27	6.32	50.59	74.00	-23.41	peak
3	9645.000	39.89	11.08	50.97	74.00	-23.03	peak
4	11040.000	35.29	14.91	50.20	74.00	-23.80	peak
5	13980.000	28.33	21.92	50.25	74.00	-23.75	peak
6	17745.000	24.55	24.18	48.73	74.00	-25.27	peak

Test Mode:	802.11n HT20	Channel:	2417 MHz
Polarity:	Horizontal	Test Voltage:	DC 12 V

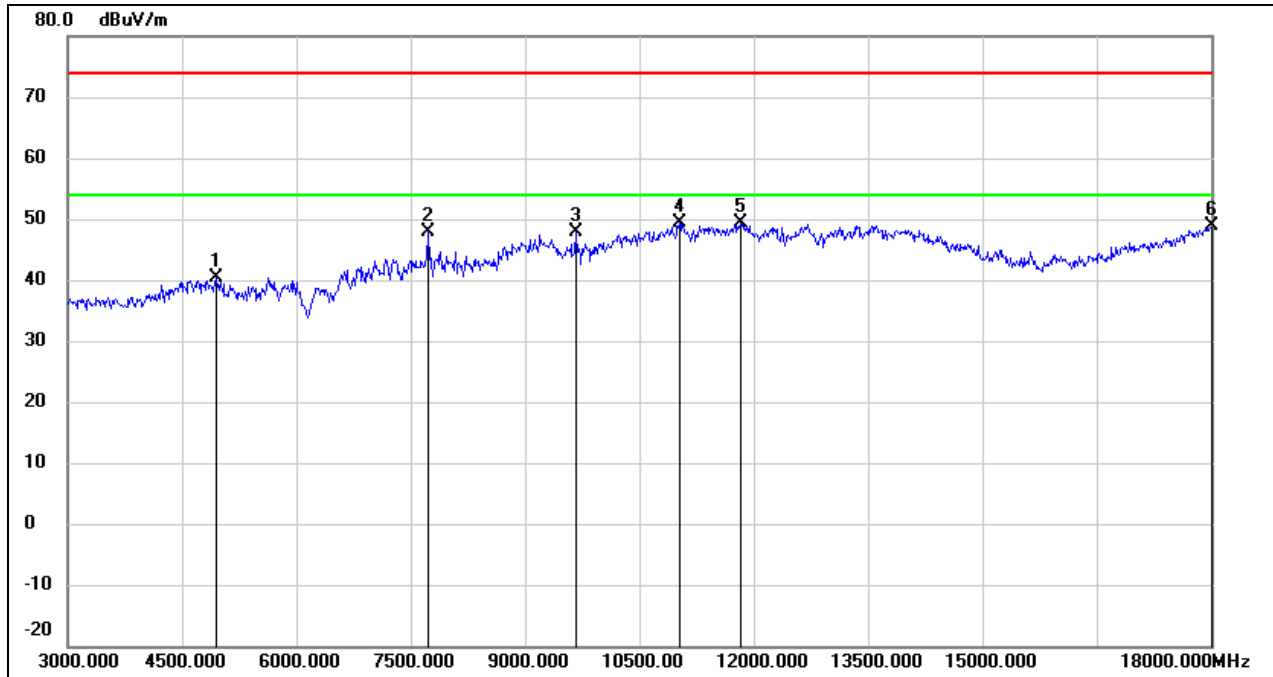

No.	Frequency (MHz)	Reading (dBuV)	Correct (dB/m)	Result (dBuV/m)	Limit (dBuV/m)	Margin (dB)	Remark
1	4950.000	40.09	0.26	40.35	74.00	-33.65	peak
2	7725.000	41.63	6.32	47.95	74.00	-26.05	peak
3	9660.000	36.83	11.11	47.94	74.00	-26.06	peak
4	11025.000	34.56	14.85	49.41	74.00	-24.59	peak
5	11820.000	32.02	17.47	49.49	74.00	-24.51	peak
6	18000.000	23.22	25.69	48.91	74.00	-25.09	peak

Test Mode:	802.11n HT20	Channel:	2417 MHz
Polarity:	Vertical	Test Voltage:	DC 12 V

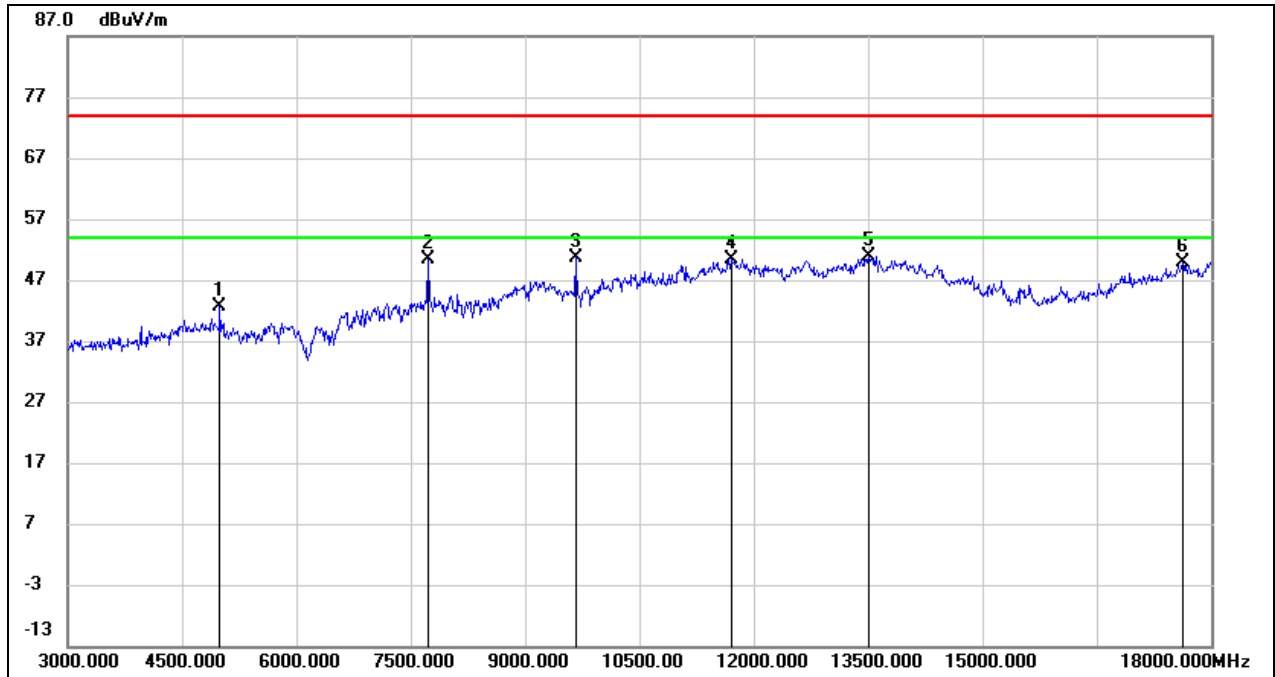

No.	Frequency (MHz)	Reading (dBuV)	Correct (dB/m)	Result (dBuV/m)	Limit (dBuV/m)	Margin (dB)	Remark
1	4995.000	42.25	0.43	42.68	74.00	-31.32	peak
2	7725.000	43.99	6.32	50.31	74.00	-23.69	peak
3	9660.000	39.64	11.11	50.75	74.00	-23.25	peak
4	11715.000	33.30	17.19	50.49	74.00	-23.51	peak
5	13515.000	29.88	20.93	50.81	74.00	-23.19	peak
6	17625.000	26.48	23.47	49.95	74.00	-24.05	peak

Test Mode:	802.11n HT20	Channel:	2437 MHz
Polarity:	Horizontal	Test Voltage:	DC 12 V

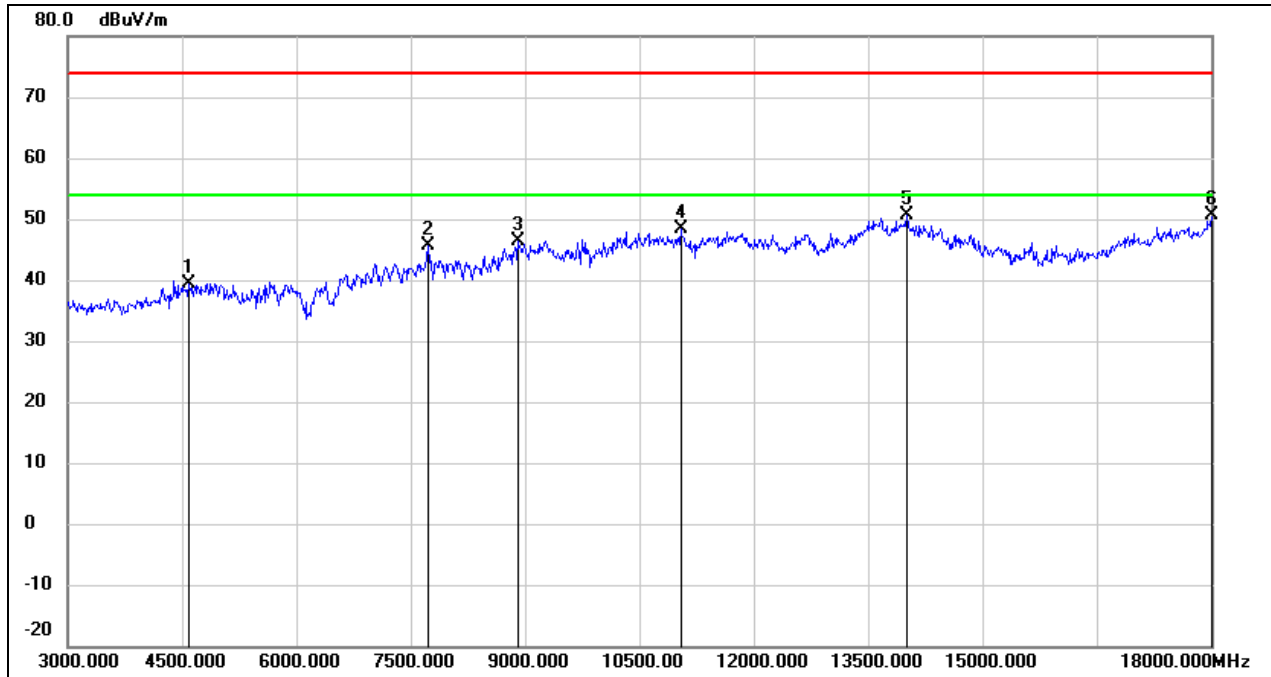

No.	Frequency (MHz)	Reading (dBuV)	Correct (dB/m)	Result (dBuV/m)	Limit (dBuV/m)	Margin (dB)	Remark
1	4590.000	40.56	-1.12	39.44	74.00	-34.56	peak
2	7725.000	39.35	6.32	45.67	74.00	-28.33	peak
3	8910.000	36.52	9.82	46.34	74.00	-27.66	peak
4	11040.000	33.49	14.91	48.40	74.00	-25.60	peak
5	14010.000	28.81	21.93	50.74	74.00	-23.26	peak
6	18000.000	24.93	25.69	50.62	74.00	-23.38	peak

Test Mode:	802.11n HT20	Channel:	2437 MHz
Polarity:	Vertical	Test Voltage:	DC 12 V

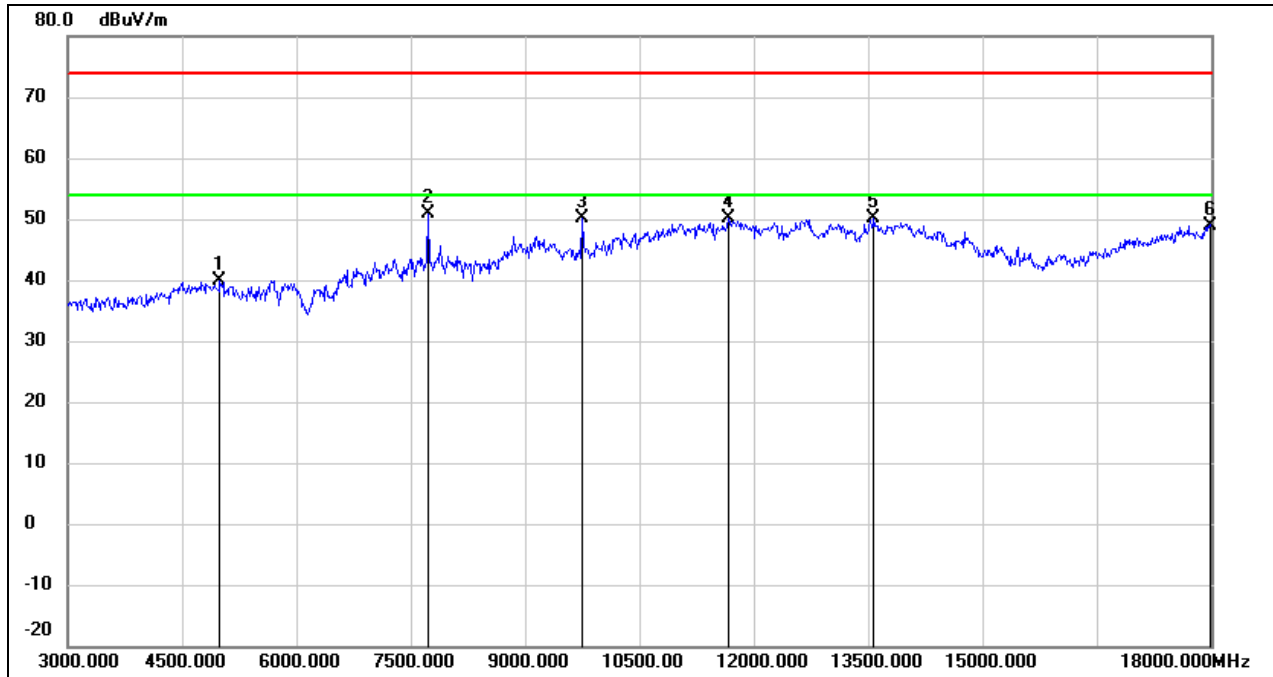

No.	Frequency (MHz)	Reading (dBuV)	Correct (dB/m)	Result (dBuV/m)	Limit (dBuV/m)	Margin (dB)	Remark
1	4995.000	39.41	0.43	39.84	74.00	-34.16	peak
2	7725.000	44.51	6.32	50.83	74.00	-23.17	peak
3	9750.000	38.86	11.35	50.21	74.00	-23.79	peak
4	11670.000	33.08	17.07	50.15	74.00	-23.85	peak
5	13575.000	29.15	21.06	50.21	74.00	-23.79	peak
6	17985.000	23.40	25.60	49.00	74.00	-25.00	peak

Test Mode:	802.11n HT20	Channel:	2457 MHz
Polarity:	Horizontal	Test Voltage:	DC 12 V

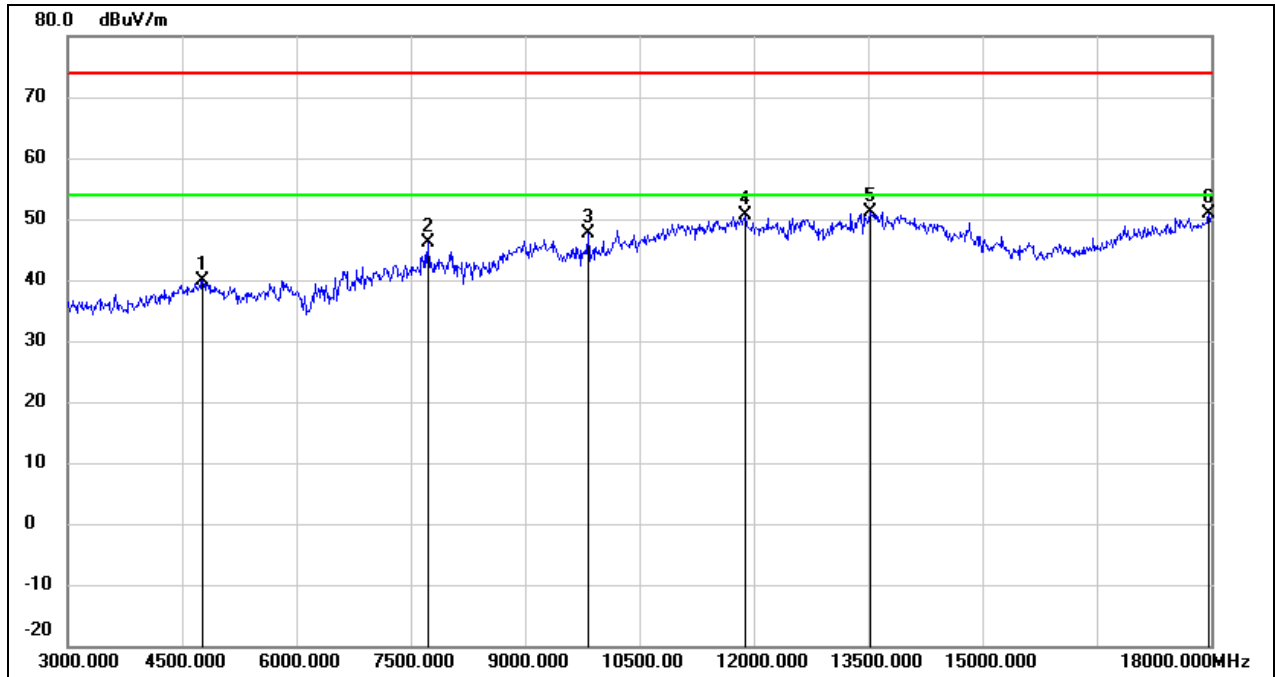

No.	Frequency (MHz)	Reading (dBuV)	Correct (dB/m)	Result (dBuV/m)	Limit (dBuV/m)	Margin (dB)	Remark
1	4770.000	40.37	-0.43	39.94	74.00	-34.06	peak
2	7725.000	39.87	6.32	46.19	74.00	-27.81	peak
3	9825.000	36.16	11.56	47.72	74.00	-26.28	peak
4	11895.000	33.05	17.68	50.73	74.00	-23.27	peak
5	13530.000	30.25	20.96	51.21	74.00	-22.79	peak
6	17970.000	25.34	25.51	50.85	74.00	-23.15	peak

Test Mode:	802.11n HT20	Channel:	2457 MHz
Polarity:	Vertical	Test Voltage:	DC 12 V

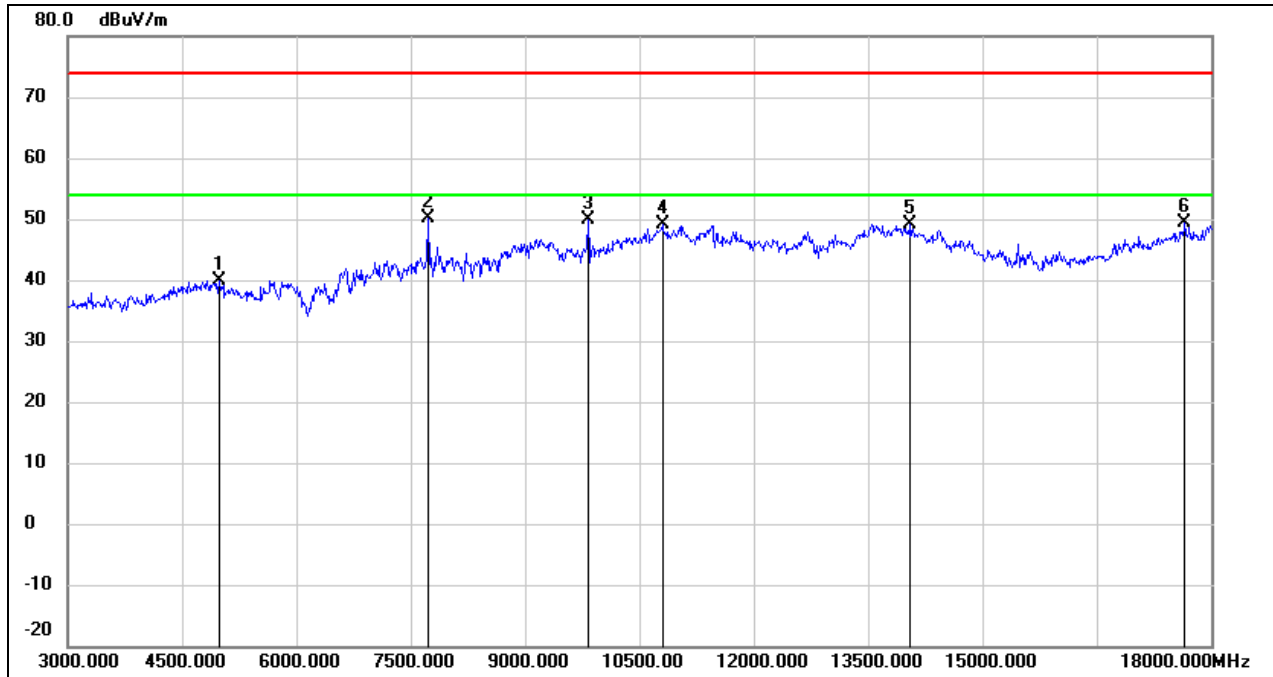

No.	Frequency (MHz)	Reading (dBuV)	Correct (dB/m)	Result (dBuV/m)	Limit (dBuV/m)	Margin (dB)	Remark
1	4980.000	39.61	0.38	39.99	74.00	-34.01	peak
2	7725.000	43.81	6.32	50.13	74.00	-23.87	peak
3	9825.000	38.34	11.56	49.90	74.00	-24.10	peak
4	10800.000	34.97	14.06	49.03	74.00	-24.97	peak
5	14055.000	27.42	21.73	49.15	74.00	-24.85	peak
6	17655.000	25.71	23.64	49.35	74.00	-24.65	peak

Test Mode:	802.11n HT20	Channel:	2462 MHz
Polarity:	Horizontal	Test Voltage:	DC 12 V

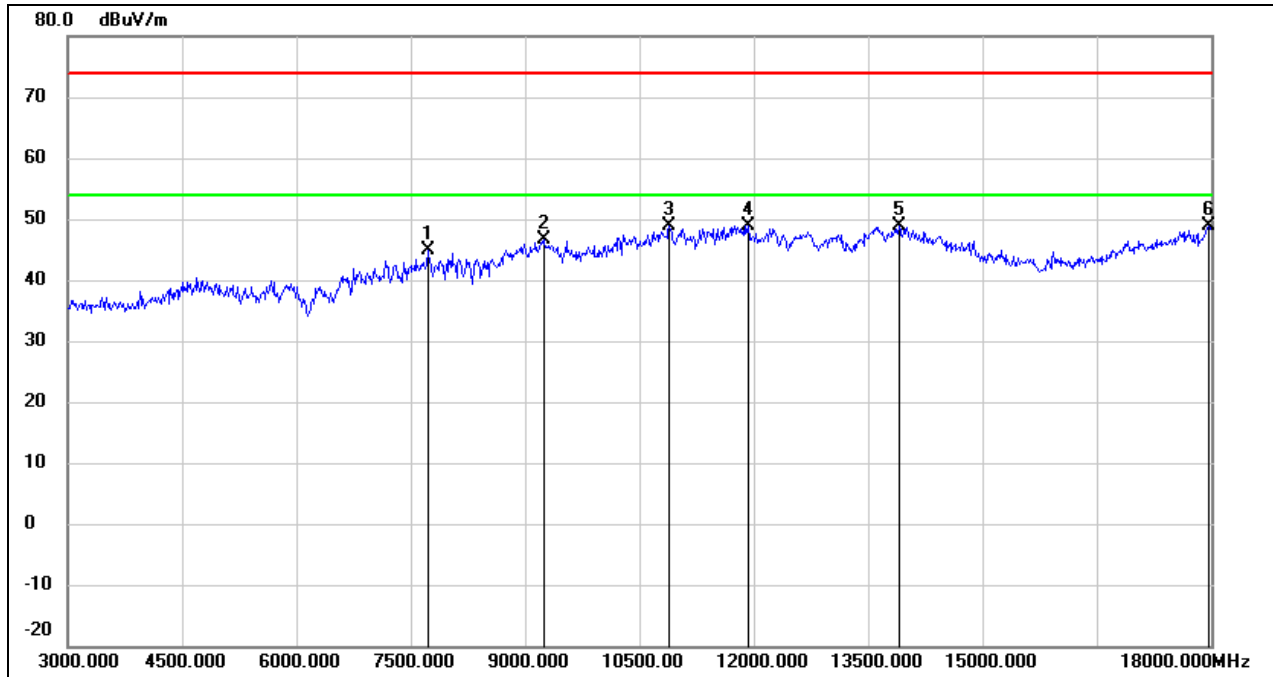

No.	Frequency (MHz)	Reading (dBuV)	Correct (dB/m)	Result (dBuV/m)	Limit (dBuV/m)	Margin (dB)	Remark
1	7725.000	38.66	6.32	44.98	74.00	-29.02	peak
2	9240.000	36.02	10.58	46.60	74.00	-27.40	peak
3	10890.000	34.49	14.39	48.88	74.00	-25.12	peak
4	11925.000	31.25	17.75	49.00	74.00	-25.00	peak
5	13905.000	27.22	21.76	48.98	74.00	-25.02	peak
6	17970.000	23.48	25.51	48.99	74.00	-25.01	peak

Test Mode:	802.11n HT20	Channel:	2462 MHz
Polarity:	Vertical	Test Voltage:	DC 12 V

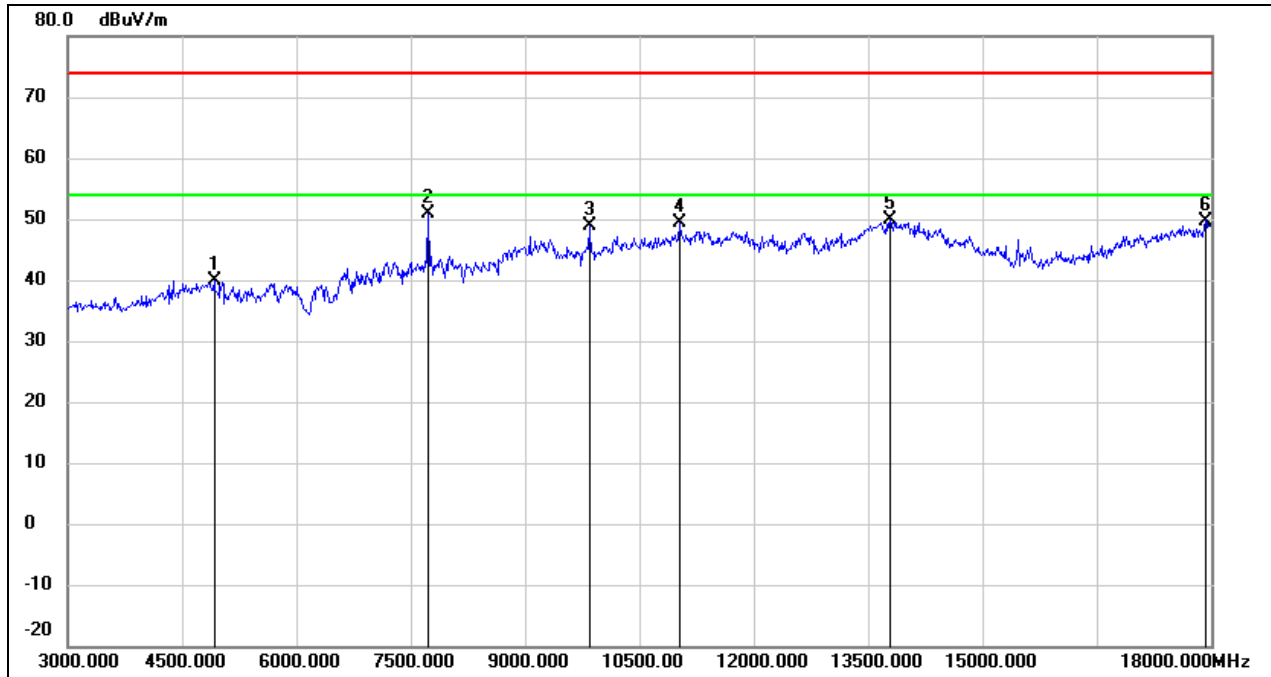

No.	Frequency (MHz)	Reading (dBuV)	Correct (dB/m)	Result (dBuV/m)	Limit (dBuV/m)	Margin (dB)	Remark
1	4920.000	39.66	0.14	39.80	74.00	-34.20	peak
2	7725.000	44.56	6.32	50.88	74.00	-23.12	peak
3	9840.000	37.30	11.59	48.89	74.00	-25.11	peak
4	11025.000	34.41	14.85	49.26	74.00	-24.74	peak
5	13785.000	28.40	21.51	49.91	74.00	-24.09	peak
6	17925.000	24.50	25.25	49.75	74.00	-24.25	peak

Test Mode:	802.11n HT40	Channel:	2422 MHz
Polarity:	Horizontal	Test Voltage:	DC 12 V

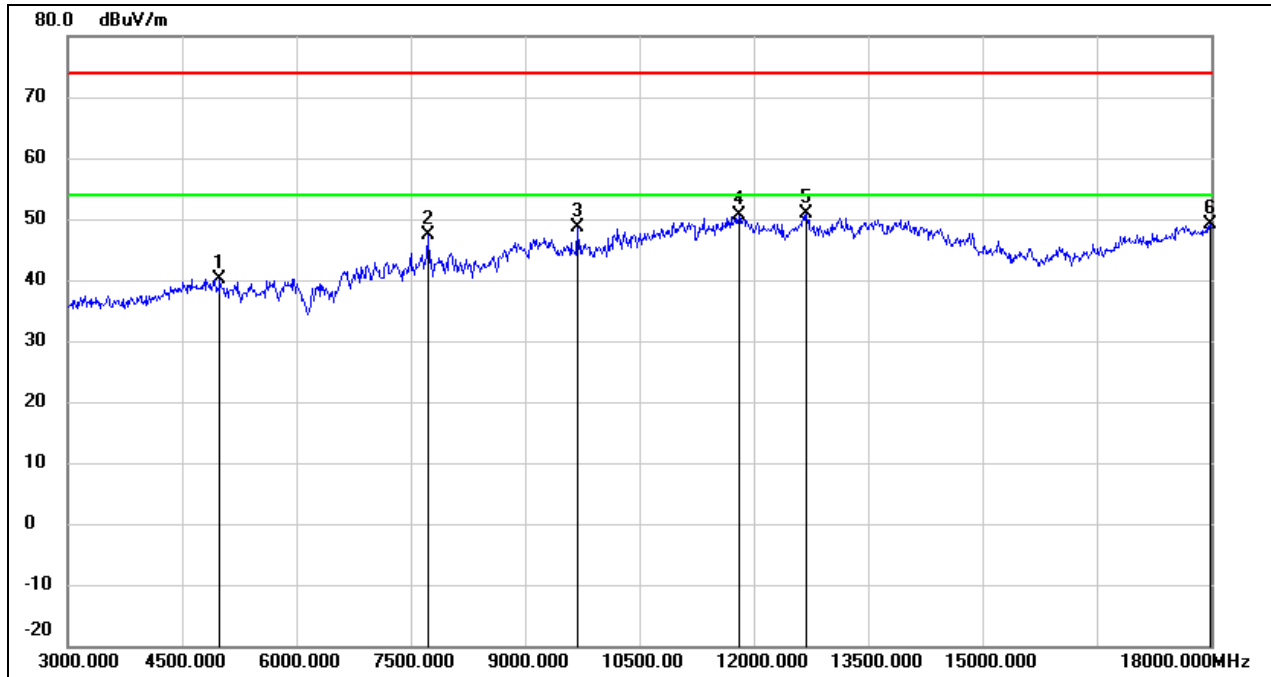

No.	Frequency (MHz)	Reading (dBuV)	Correct (dB/m)	Result (dBuV/m)	Limit (dBuV/m)	Margin (dB)	Remark
1	4995.000	39.73	0.43	40.16	74.00	-33.84	peak
2	7725.000	41.05	6.32	47.37	74.00	-26.63	peak
3	9690.000	37.43	11.19	48.62	74.00	-25.38	peak
4	11805.000	33.12	17.43	50.55	74.00	-23.45	peak
5	12690.000	32.96	18.02	50.98	74.00	-23.02	peak
6	17985.000	23.43	25.60	49.03	74.00	-24.97	peak

Test Mode:	802.11n HT40	Channel:	2422 MHz
Polarity:	Vertical	Test Voltage:	DC 12 V

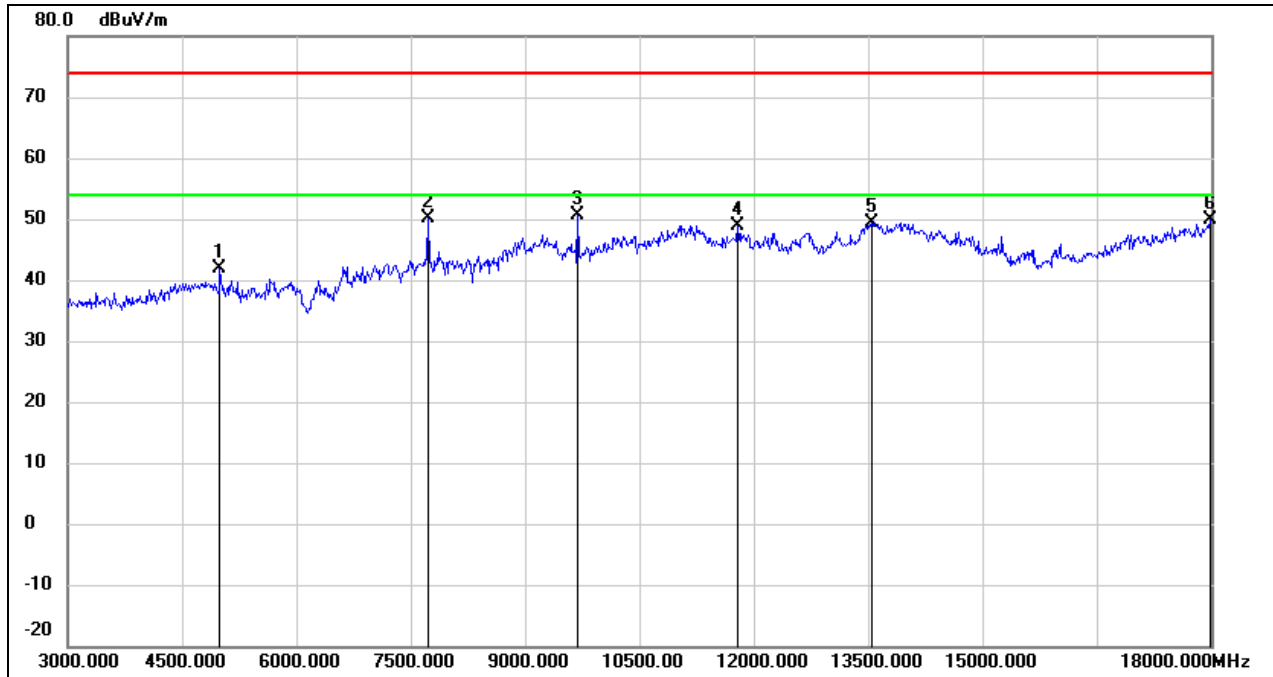

No.	Frequency (MHz)	Reading (dBuV)	Correct (dB/m)	Result (dBuV/m)	Limit (dBuV/m)	Margin (dB)	Remark
1	4995.000	41.45	0.43	41.88	74.00	-32.12	peak
2	7725.000	43.85	6.32	50.17	74.00	-23.83	peak
3	9690.000	39.54	11.19	50.73	74.00	-23.27	peak
4	11790.000	31.57	17.38	48.95	74.00	-25.05	peak
5	13545.000	28.38	20.99	49.37	74.00	-24.63	peak
6	17985.000	24.18	25.60	49.78	74.00	-24.22	peak

Test Mode:	802.11n HT40	Channel:	2427 MHz
Polarity:	Horizontal	Test Voltage:	DC 12 V

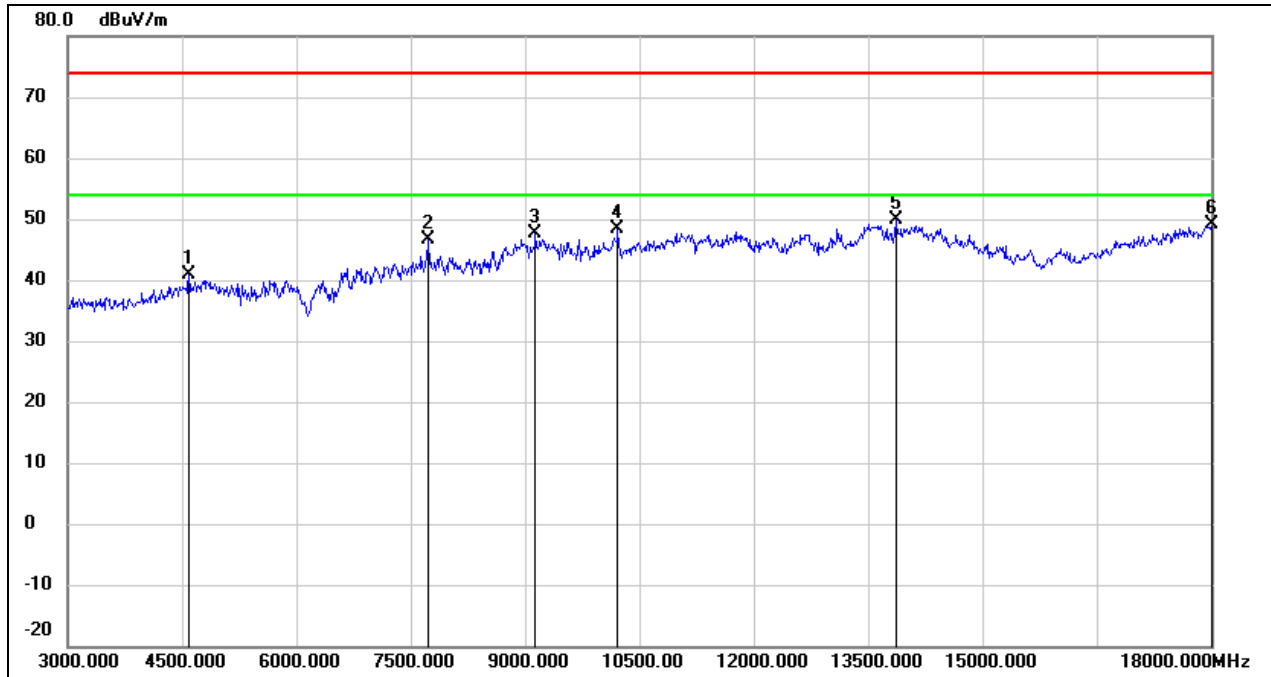

No.	Frequency (MHz)	Reading (dBuV)	Correct (dB/m)	Result (dBuV/m)	Limit (dBuV/m)	Margin (dB)	Remark
1	4590.000	42.04	-1.12	40.92	74.00	-33.08	peak
2	7725.000	40.26	6.32	46.58	74.00	-27.42	peak
3	9135.000	37.10	10.55	47.65	74.00	-26.35	peak
4	10215.000	35.91	12.43	48.34	74.00	-25.66	peak
5	13860.000	28.23	21.67	49.90	74.00	-24.10	peak
6	18000.000	23.34	25.69	49.03	74.00	-24.97	peak

Test Mode:	802.11n HT40	Channel:	2427 MHz
Polarity:	Vertical	Test Voltage:	DC 12 V

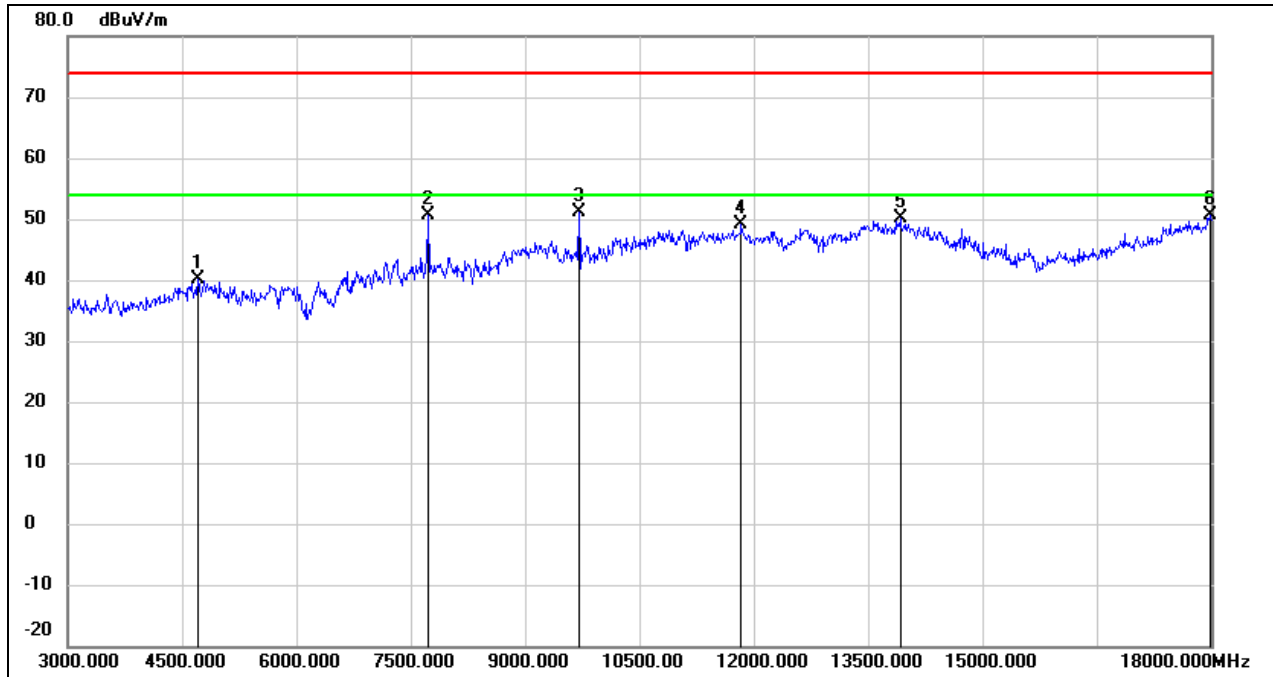

No.	Frequency (MHz)	Reading (dBuV)	Correct (dB/m)	Result (dBuV/m)	Limit (dBuV/m)	Margin (dB)	Remark
1	4710.000	40.81	-0.66	40.15	74.00	-33.85	peak
2	7725.000	44.35	6.32	50.67	74.00	-23.33	peak
3	9705.000	39.83	11.23	51.06	74.00	-22.94	peak
4	11835.000	31.54	17.51	49.05	74.00	-24.95	peak
5	13920.000	28.36	21.79	50.15	74.00	-23.85	peak
6	17985.000	25.13	25.60	50.73	74.00	-23.27	peak

Test Mode:	802.11n HT40	Channel:	2437 MHz
Polarity:	Horizontal	Test Voltage:	DC 12 V

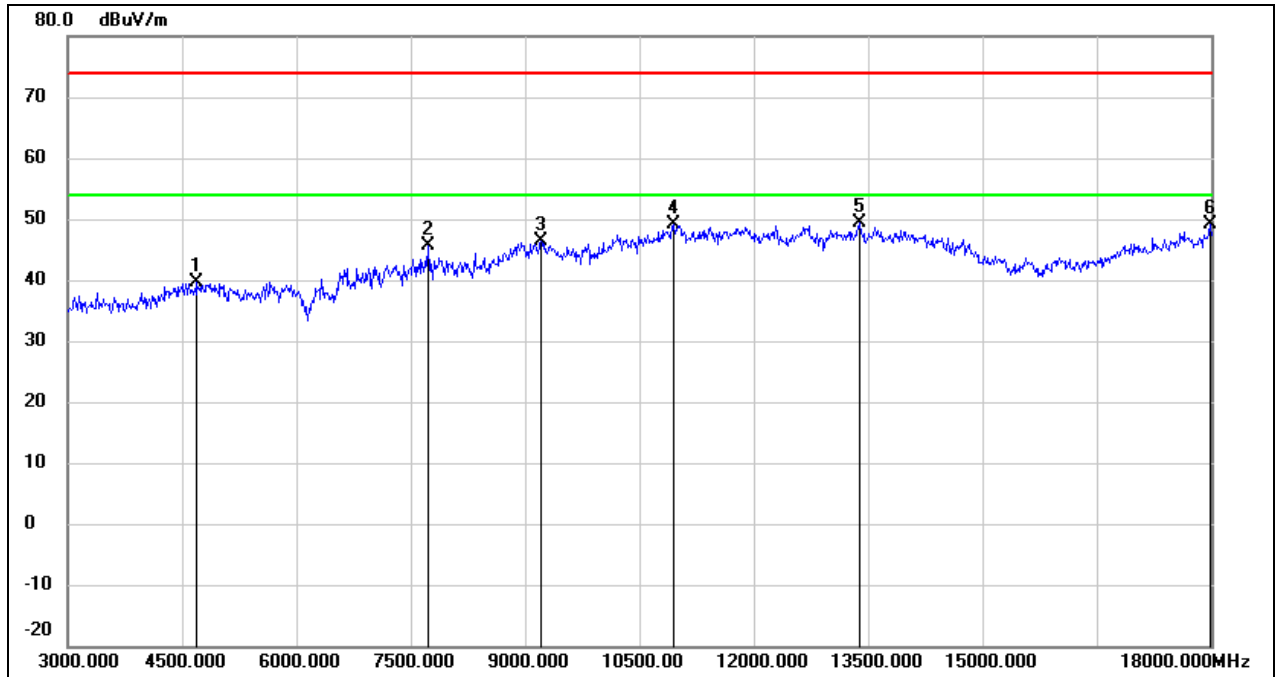

No.	Frequency (MHz)	Reading (dBuV)	Correct (dB/m)	Result (dBuV/m)	Limit (dBuV/m)	Margin (dB)	Remark
1	4695.000	40.25	-0.71	39.54	74.00	-34.46	peak
2	7725.000	39.33	6.32	45.65	74.00	-28.35	peak
3	9210.000	35.69	10.57	46.26	74.00	-27.74	peak
4	10950.000	34.44	14.60	49.04	74.00	-24.96	peak
5	13395.000	29.02	20.44	49.46	74.00	-24.54	peak
6	17985.000	23.42	25.60	49.02	74.00	-24.98	peak

Test Mode:	802.11n HT40	Channel:	2437 MHz
Polarity:	Vertical	Test Voltage:	DC 12 V

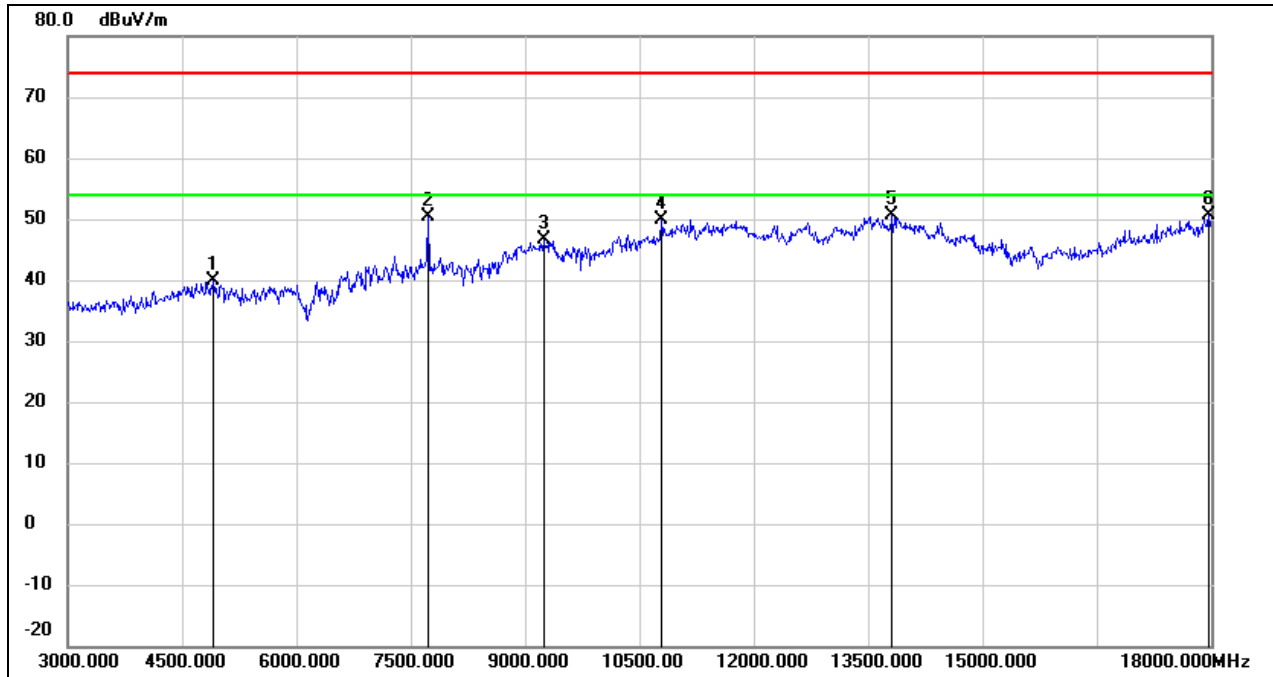

No.	Frequency (MHz)	Reading (dBuV)	Correct (dB/m)	Result (dBuV/m)	Limit (dBuV/m)	Margin (dB)	Remark
1	4905.000	39.68	0.09	39.77	74.00	-34.23	peak
2	7725.000	43.94	6.32	50.26	74.00	-23.74	peak
3	9240.000	36.15	10.58	46.73	74.00	-27.27	peak
4	10785.000	35.95	14.01	49.96	74.00	-24.04	peak
5	13815.000	28.97	21.56	50.53	74.00	-23.47	peak
6	17970.000	25.23	25.51	50.74	74.00	-23.26	peak

Test Mode:	802.11n HT40	Channel:	2447 MHz
Polarity:	Horizontal	Test Voltage:	DC 12 V

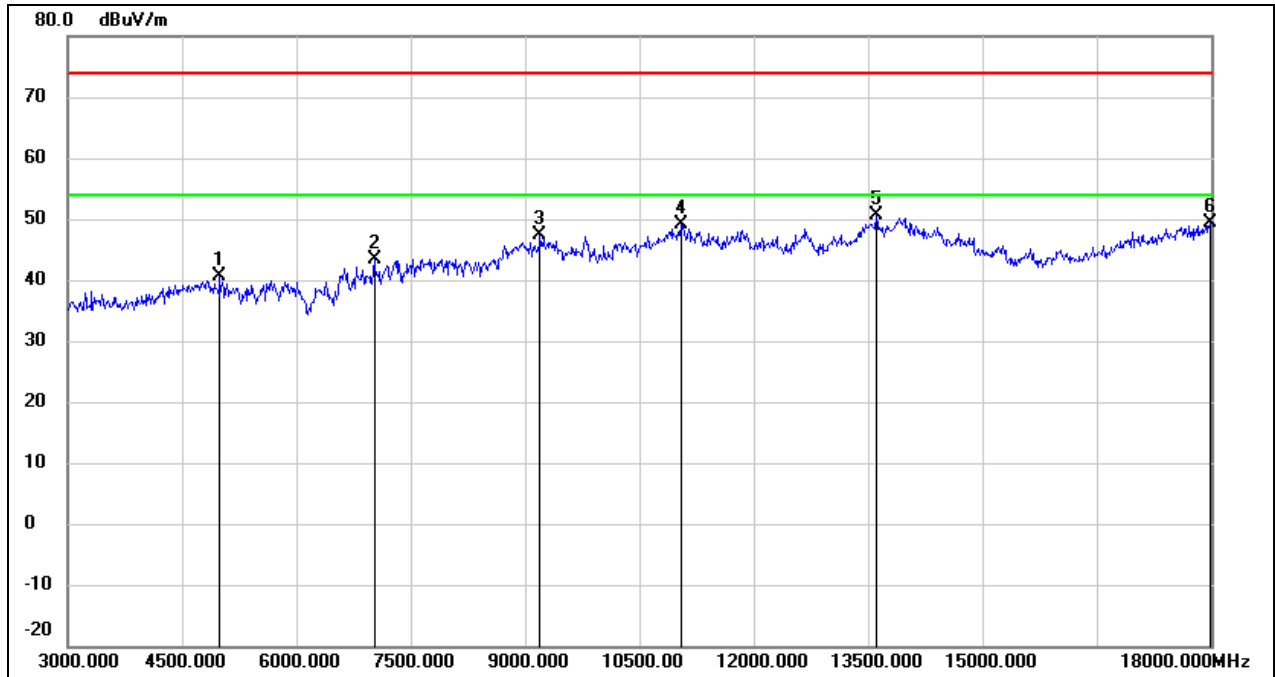

No.	Frequency (MHz)	Reading (dBuV)	Correct (dB/m)	Result (dBuV/m)	Limit (dBuV/m)	Margin (dB)	Remark
1	4995.000	40.16	0.43	40.59	74.00	-33.41	peak
2	7020.000	36.61	6.67	43.28	74.00	-30.72	peak
3	9195.000	36.71	10.56	47.27	74.00	-26.73	peak
4	11040.000	34.26	14.91	49.17	74.00	-24.83	peak
5	13605.000	29.47	21.12	50.59	74.00	-23.41	peak
6	17985.000	23.74	25.60	49.34	74.00	-24.66	peak

Test Mode:	802.11n HT40	Channel:	2447 MHz
Polarity:	Vertical	Test Voltage:	DC 12 V

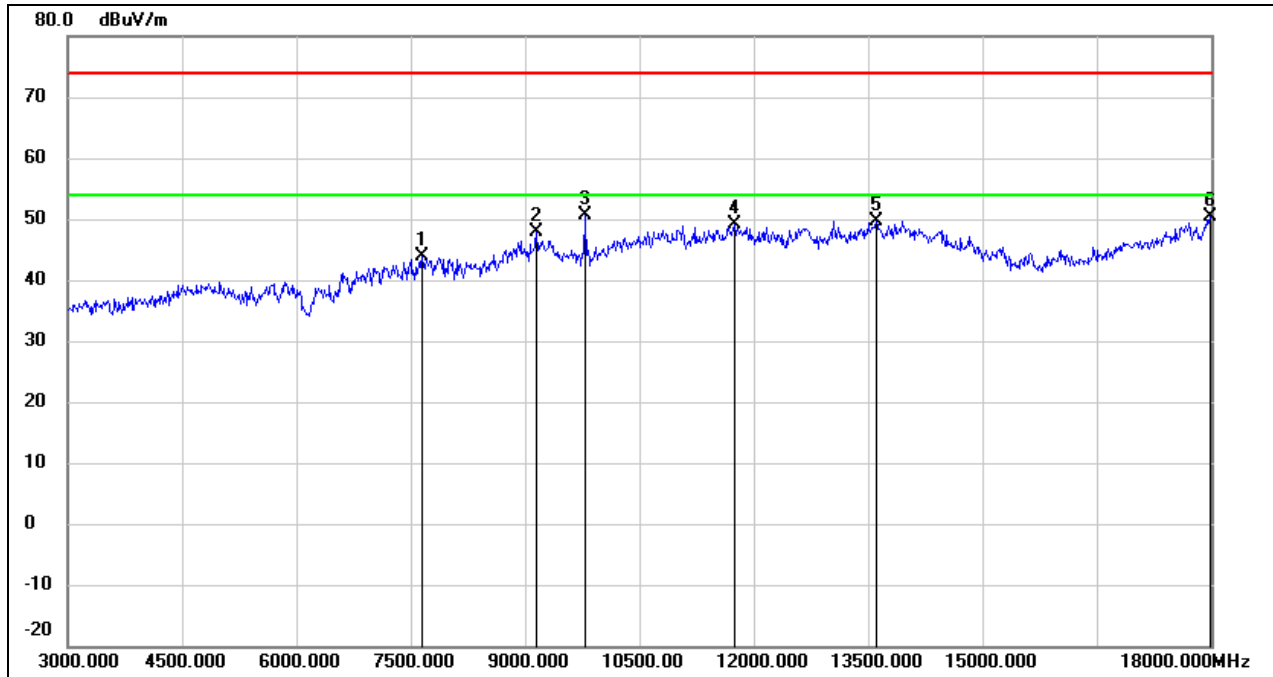

No.	Frequency (MHz)	Reading (dBuV)	Correct (dB/m)	Result (dBuV/m)	Limit (dBuV/m)	Margin (dB)	Remark
1	7650.000	37.59	6.33	43.92	74.00	-30.08	peak
2	9150.000	37.42	10.54	47.96	74.00	-26.04	peak
3	9780.000	39.21	11.43	50.64	74.00	-23.36	peak
4	11745.000	31.76	17.27	49.03	74.00	-24.97	peak
5	13605.000	28.52	21.12	49.64	74.00	-24.36	peak
6	17985.000	24.85	25.60	50.45	74.00	-23.55	peak

Test Mode:	802.11n HT40	Channel:	2452 MHz
Polarity:	Horizontal	Test Voltage:	DC 12 V

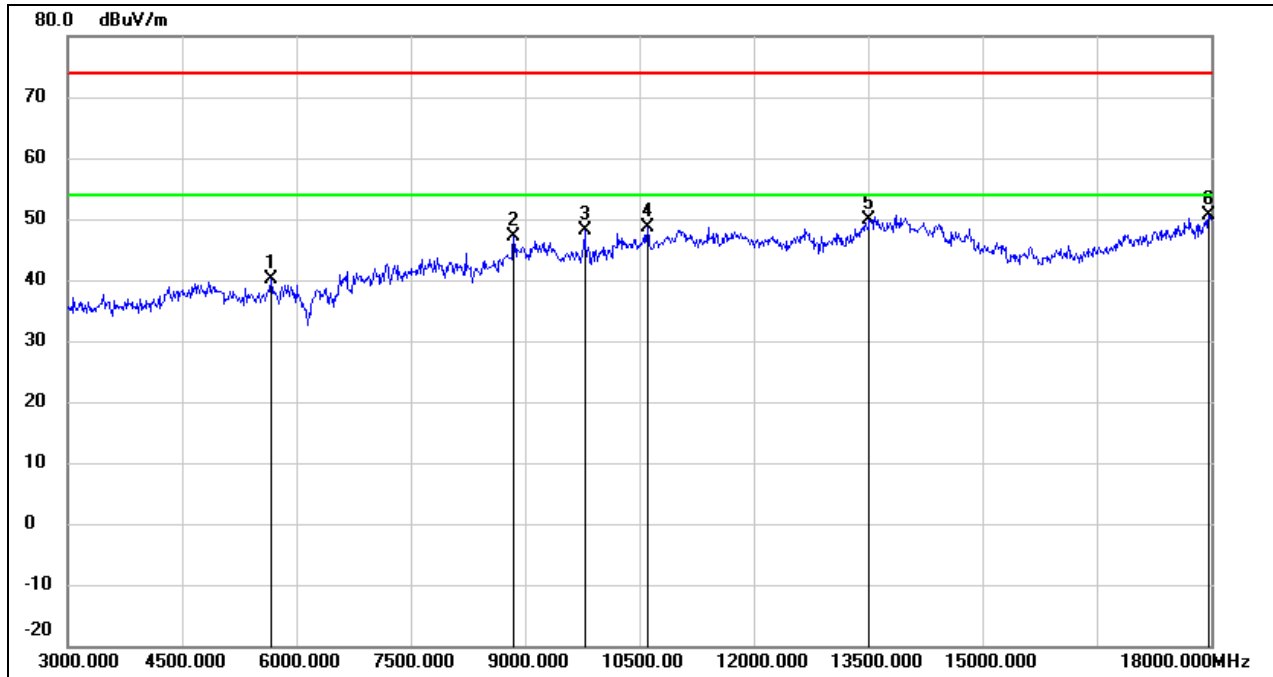

No.	Frequency (MHz)	Reading (dBuV)	Correct (dB/m)	Result (dBuV/m)	Limit (dBuV/m)	Margin (dB)	Remark
1	5670.000	38.86	1.33	40.19	74.00	-33.81	peak
2	8850.000	37.81	9.39	47.20	74.00	-26.80	peak
3	9780.000	36.68	11.43	48.11	74.00	-25.89	peak
4	10605.000	35.35	13.37	48.72	74.00	-25.28	peak
5	13515.000	28.89	20.93	49.82	74.00	-24.18	peak
6	17970.000	25.06	25.51	50.57	74.00	-23.43	peak

Test Mode:	802.11n HT40	Channel:	2452 MHz
Polarity:	Vertical	Test Voltage:	DC 12 V

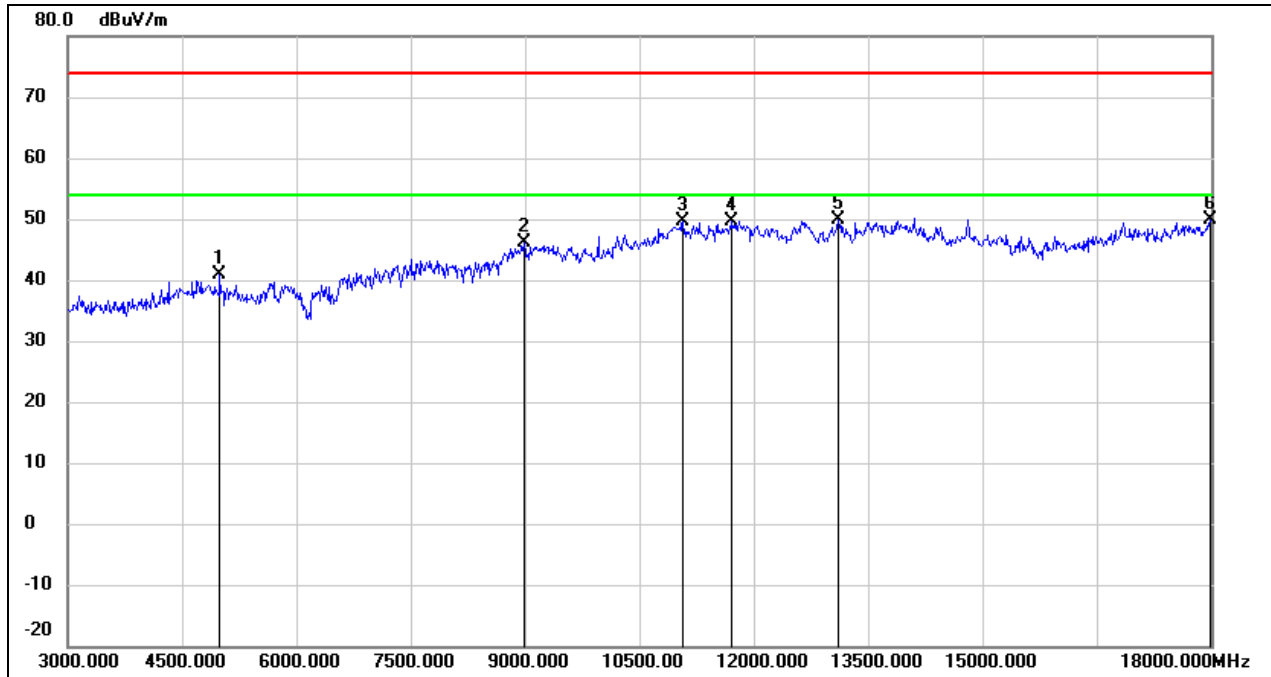

No.	Frequency (MHz)	Reading (dBuV)	Correct (dB/m)	Result (dBuV/m)	Limit (dBuV/m)	Margin (dB)	Remark
1	4995.000	40.52	0.43	40.95	74.00	-33.05	peak
2	8985.000	35.83	10.37	46.20	74.00	-27.80	peak
3	11070.000	34.71	15.03	49.74	74.00	-24.26	peak
4	11715.000	32.35	17.19	49.54	74.00	-24.46	peak
5	13110.000	30.59	19.20	49.79	74.00	-24.21	peak
6	17985.000	24.21	25.60	49.81	74.00	-24.19	peak

8.4. SPURIOUS EMISSIONS (9 KHZ ~ 30 MHZ)

Test Mode:	802.11g	Channel:	2437 MHz
Polarity:	Loop Antenna Face On To The EUT	Test Voltage:	DC 12 V

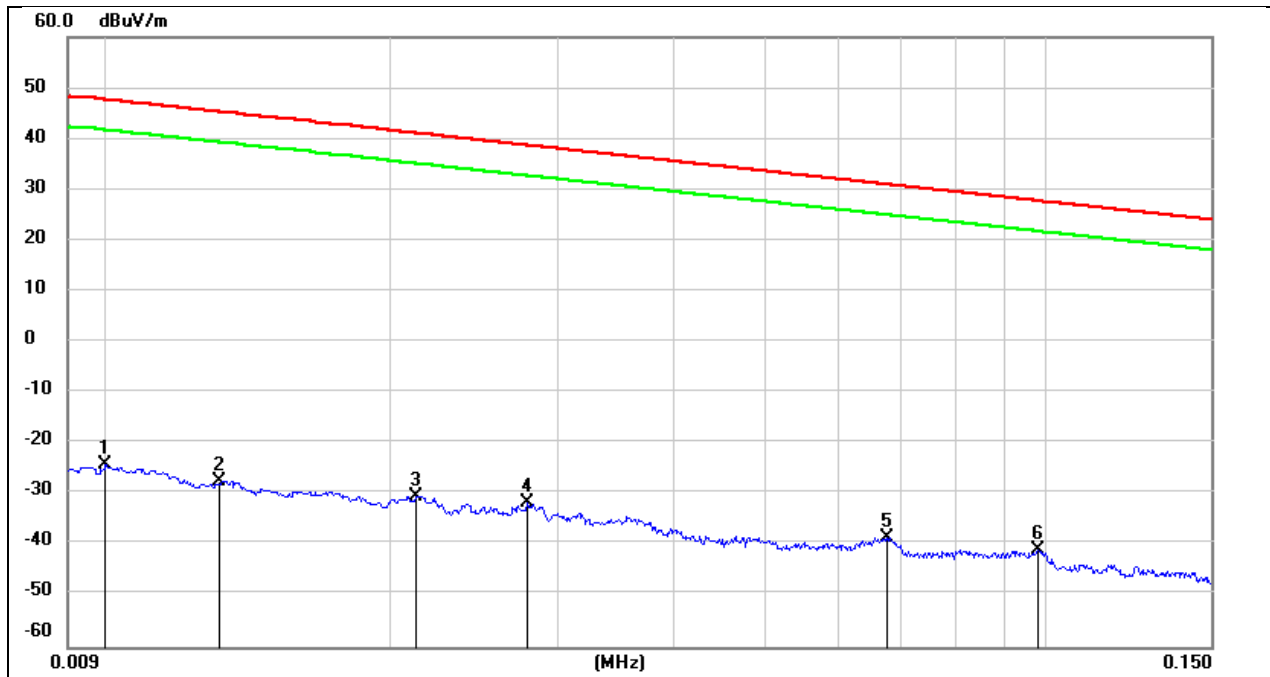

No.	Frequency (MHz)	Reading (dBuV)	Correct (dB/m)	Result (dBuV/m)	Limit (dBuV/m)	Margin (dB)	Remark
1	0.0100	77.22	-101.40	-24.18	47.60	-71.78	peak
2	0.0131	73.97	-101.38	-27.41	45.25	-72.66	peak
3	0.0212	71.04	-101.35	-30.31	41.07	-71.38	peak
4	0.0279	69.67	-101.38	-31.71	38.69	-70.40	peak
5	0.0675	63.14	-101.56	-38.42	31.02	-69.44	peak
6	0.0981	60.77	-101.78	-41.01	27.77	-68.78	peak

Test Mode:	802.11g	Channel:	2437 MHz
Polarity:	Loop Antenna Face On To The EUT	Test Voltage:	DC 12 V

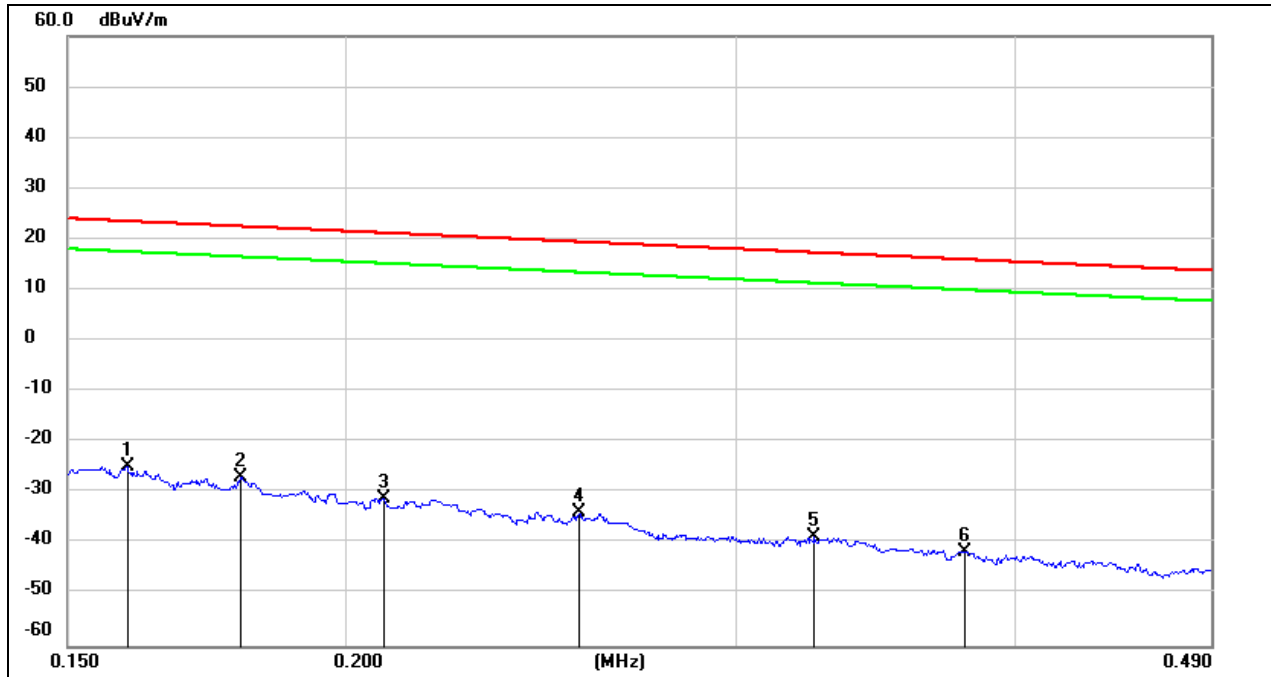

No.	Frequency (MHz)	Reading (dBuV)	Correct (dB/m)	Result (dBuV/m)	Limit (dBuV/m)	Margin (dB)	Remark
1	0.1595	76.86	-101.65	-24.79	23.55	-48.34	peak
2	0.1794	74.77	-101.68	-26.91	22.53	-49.44	peak
3	0.2081	70.58	-101.73	-31.15	21.23	-52.38	peak
4	0.2545	67.90	-101.80	-33.90	19.49	-53.39	peak
5	0.3251	63.21	-101.88	-38.67	17.36	-56.03	peak
6	0.3800	60.52	-101.94	-41.42	16.01	-57.43	peak

Test Mode:	802.11g	Channel:	2437 MHz
Polarity:	Loop Antenna Face On To The EUT	Test Voltage:	DC 12 V

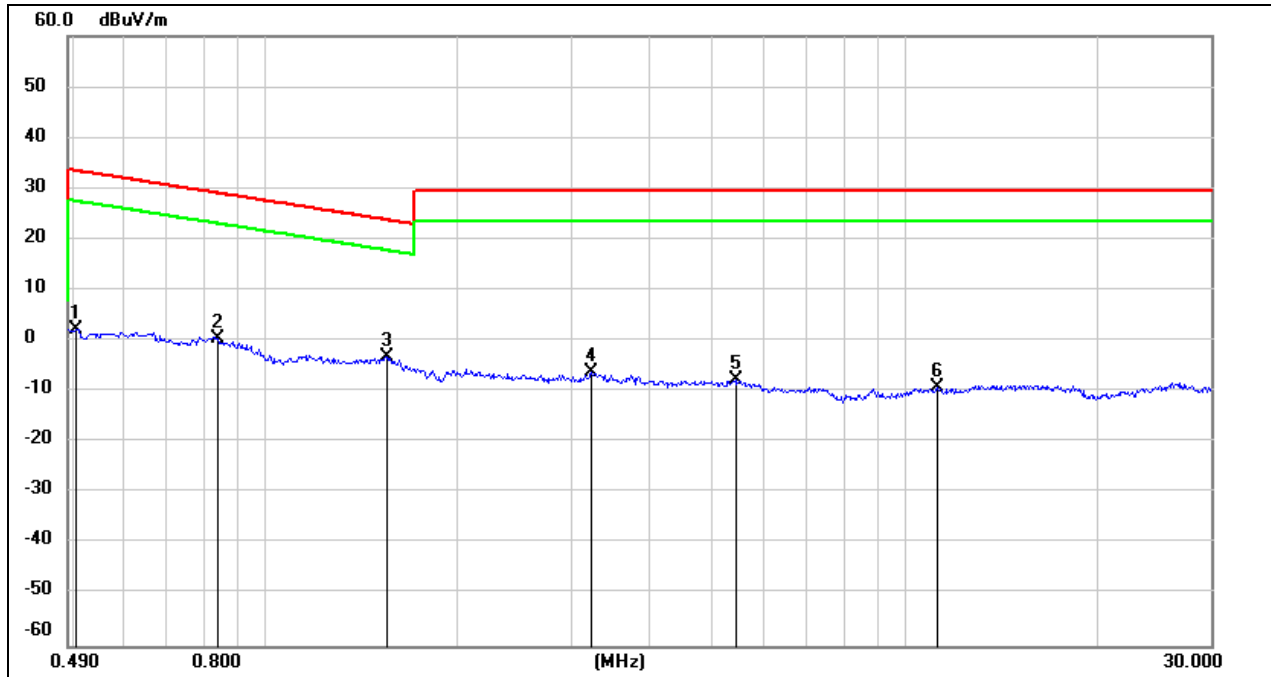

No.	Frequency (MHz)	Reading (dBuV)	Correct (dB/m)	Result (dBuV/m)	Limit (dBuV/m)	Margin (dB)	Remark
1	0.5039	64.43	-62.07	2.36	33.56	-31.20	peak
2	0.8400	62.71	-62.17	0.54	29.12	-28.58	peak
3	1.5443	58.85	-62.03	-3.18	23.83	-27.01	peak
4	3.2343	55.29	-61.53	-6.24	29.54	-35.78	peak
5	5.4180	53.66	-61.43	-7.77	29.54	-37.31	peak
6	11.2018	51.64	-60.85	-9.21	29.54	-38.75	peak

8.5. SPURIOUS EMISSIONS (18 GHZ ~ 26 GHZ)

Test Mode:	802.11g	Channel:	2437 MHz
Polarity:	Horizontal	Test Voltage:	DC 5V

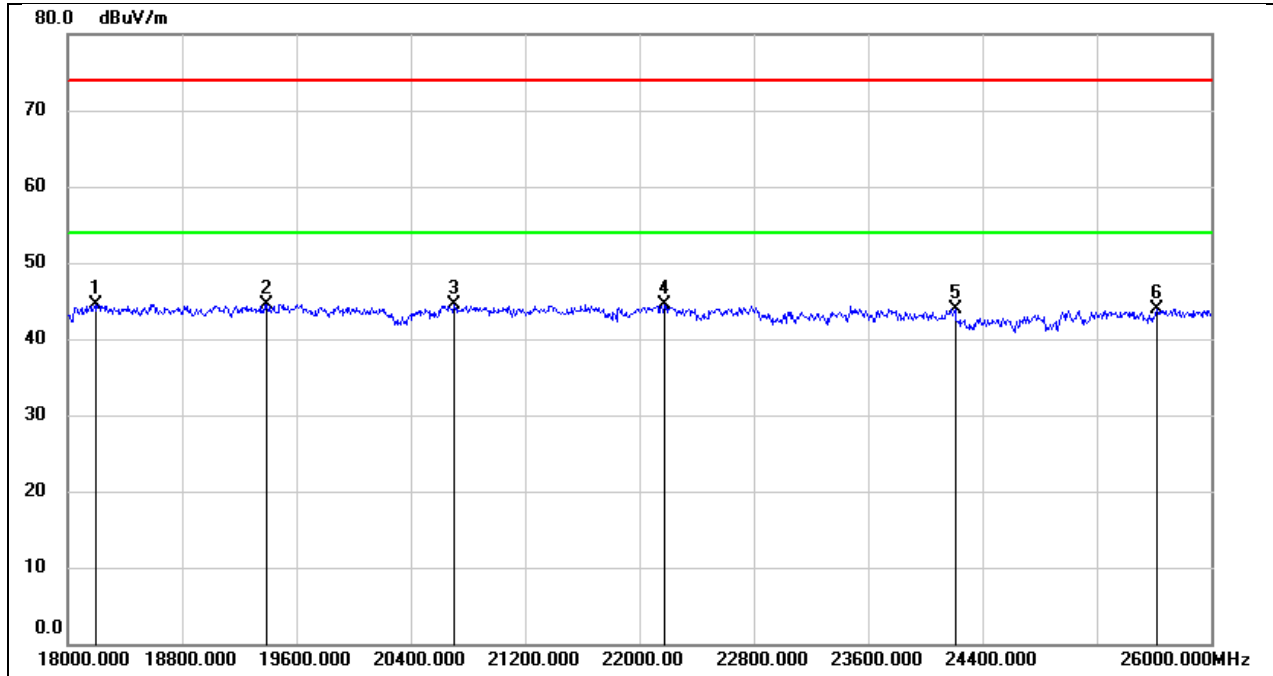

No.	Frequency (MHz)	Reading (dBuV)	Correct (dB/m)	Result (dBuV/m)	Limit (dBuV/m)	Margin (dB)	Remark
1	18192.000	49.98	-5.51	44.47	74.00	-29.53	peak
2	19392.000	50.12	-5.57	44.55	74.00	-29.45	peak
3	20704.000	49.62	-5.16	44.46	74.00	-29.54	peak
4	22176.000	48.76	-4.29	44.47	74.00	-29.53	peak
5	24208.000	46.71	-2.81	43.90	74.00	-30.10	peak
6	25616.000	45.18	-1.24	43.94	74.00	-30.06	peak

Test Mode:	802.11g	Channel:	2437 MHz
Polarity:	Vertical	Test Voltage:	DC 5V

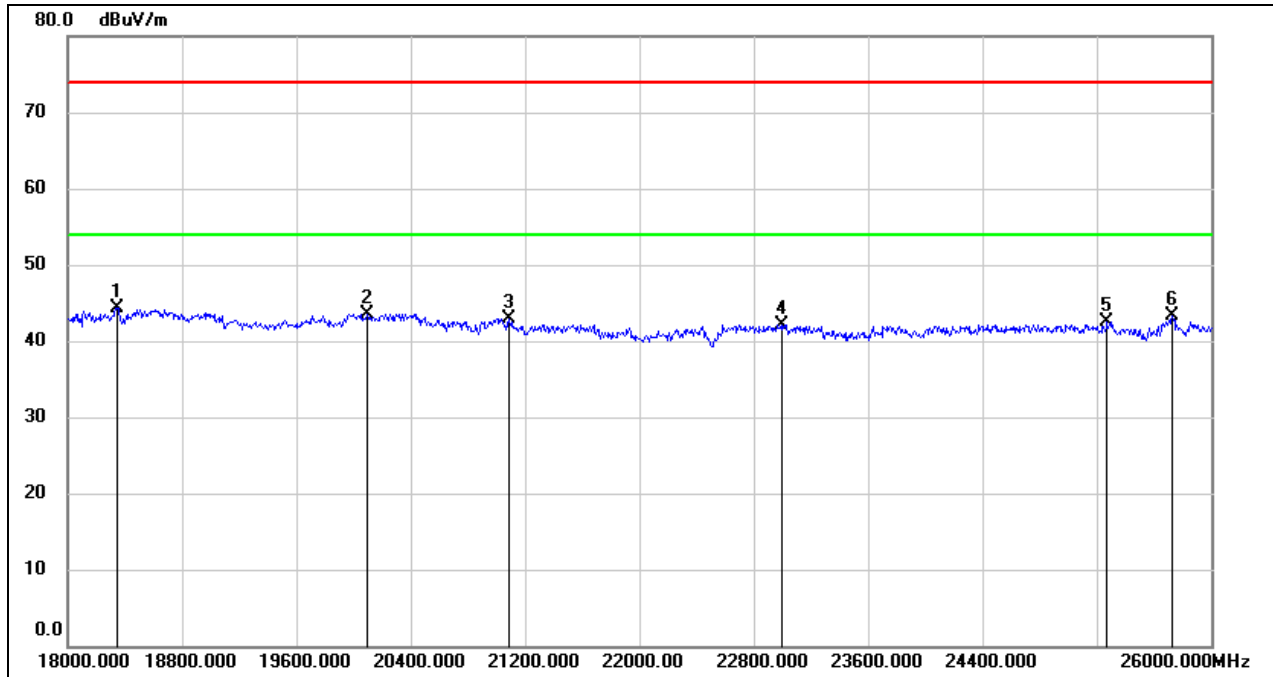

No.	Frequency (MHz)	Reading (dBuV)	Correct (dB/m)	Result (dBuV/m)	Limit (dBuV/m)	Margin (dB)	Remark
1	18344.000	49.84	-5.44	44.40	74.00	-29.60	peak
2	20096.000	49.10	-5.51	43.59	74.00	-30.41	peak
3	21088.000	47.78	-4.84	42.94	74.00	-31.06	peak
4	22992.000	45.55	-3.45	42.10	74.00	-31.90	peak
5	25272.000	44.23	-1.67	42.56	74.00	-31.44	peak
6	25728.000	44.11	-0.72	43.39	74.00	-30.61	peak

8.6. SPURIOUS EMISSIONS (30 MHZ ~ 1 GHZ)

Test Mode:	802.11g	Channel:	2437 MHz
Polarity:	Horizontal	Test Voltage:	DC5V

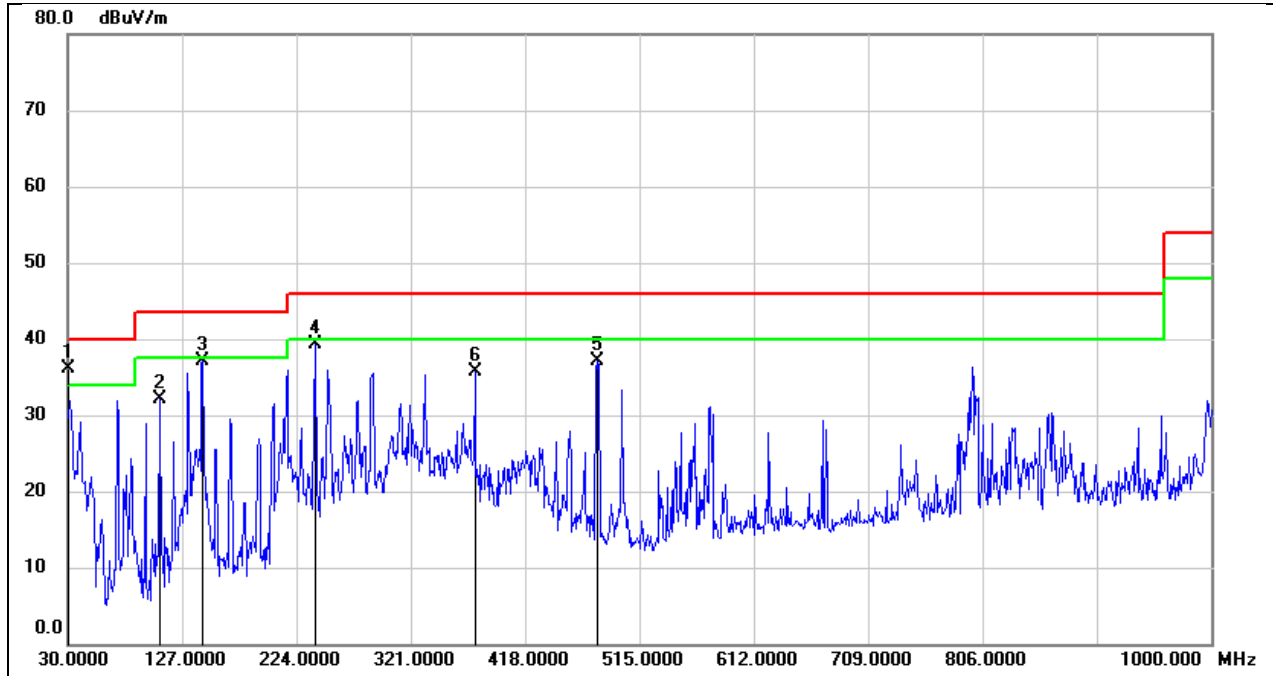

No.	Frequency (MHz)	Reading (dBuV)	Correct (dB/m)	Result (dBuV/m)	Limit (dBuV/m)	Margin (dB)	Remark
1	30.0000	54.39	-18.24	36.15	40.00	-3.85	QP
2	108.5700	52.59	-20.43	32.16	43.50	-11.34	QP
3	144.4600	55.78	-18.64	37.14	43.50	-6.36	QP
4	239.5200	57.73	-18.40	39.33	46.00	-6.67	QP
5	479.1100	48.10	-11.08	37.02	46.00	-8.98	QP
6	375.3200	48.70	-12.92	35.78	46.00	-10.22	QP

Test Mode:	802.11g	Channel:	2437 MHz
Polarity:	Vertical	Test Voltage:	DC5V

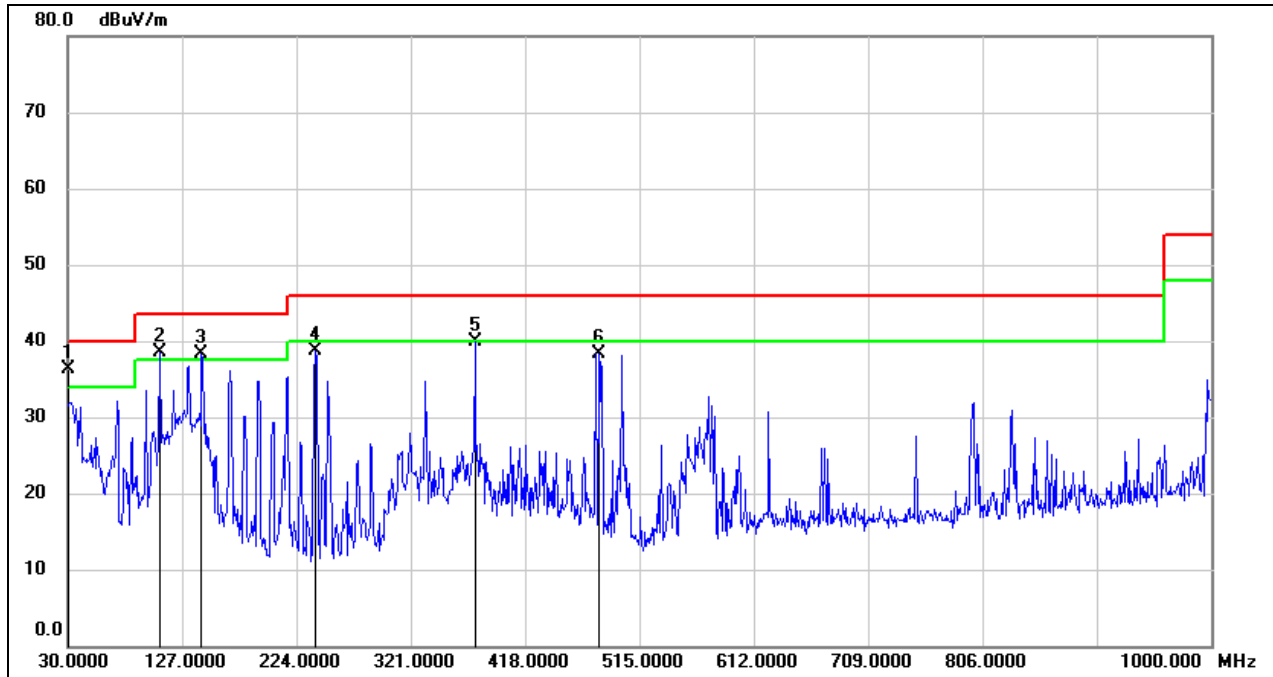

No.	Frequency (MHz)	Reading (dBuV)	Correct (dB/m)	Result (dBuV/m)	Limit (dBuV/m)	Margin (dB)	Remark
1	30.0000	54.46	-18.24	36.22	40.00	-3.78	QP
2	107.6000	58.94	-20.52	38.42	43.50	-5.08	QP
3	143.4900	57.07	-18.69	38.38	43.50	-5.12	QP
4	240.4900	57.10	-18.45	38.65	46.00	-7.35	QP
5	375.3200	52.81	-12.92	39.89	46.00	-6.11	QP
6	480.0800	49.30	-11.05	38.25	46.00	-7.75	QP

9. ANTENNA REQUIREMENT

REQUIREMENT

Please refer to FCC part 15.203

An intentional radiator shall be designed to ensure that no antenna other than that furnished by the responsible party shall be used with the device. The use of a permanently attached antenna or of an antenna that uses a unique coupling to the intentional radiator shall be considered sufficient to comply with the provisions of this section. The manufacturer may design the unit so that a broken antenna can be replaced by the user, but the use of a standard antenna jack or electrical connector is prohibited.

Please refer to FCC part 15.247(b)(4)

The conducted output power limit specified in paragraph (b) of this section is based on the use of antennas with directional gains that do not exceed 6 dBi. Except as shown in paragraph (c) of this section, if transmitting antennas of directional gain greater than 6 dBi are used, the conducted output power from the intentional radiator shall be reduced below the stated values in paragraphs (b)(1), (b)(2), and (b)(3) of this section, as appropriate, by the amount in dB that the directional gain of the antenna exceeds 6 dBi.

DESCRIPTION

Pass

10. AC POWER LINE CONDUCTED EMISSION

LIMITS

Please refer to CFR 47 FCC §15.207 (a) and ISED RSS-Gen Clause 8.8

FREQUENCY (MHz)	Quasi-peak	Average
0.15 -0.5	66 - 56 *	56 - 46 *
0.50 -5.0	56.00	46.00
5.0 -30.0	60.00	50.00

TEST PROCEDURE

The EUT is put on a table of non-conducting material that is 80 cm high. The vertical conducting wall of shielding is located 40 cm to the rear of the EUT. The power line of the EUT is connected to the AC mains through a Artificial Mains Network (A.M.N.). A EMI Measurement Receiver (R&S Test Receiver ESR3) is used to test the emissions from both sides of AC line. According to the requirements in Section 6.2 of ANSI C63.10-2013. Conducted emissions from the EUT measured in the frequency range between 0.15 MHz and 30 MHz using CISPR Quasi-Peak and average detector mode. The bandwidth of EMI test receiver is set at 9 kHz.

The arrangement of the equipment is installed to meet the standards and operating in a manner, which tends to maximize its emission characteristics in a normal application.

TEST SETUP

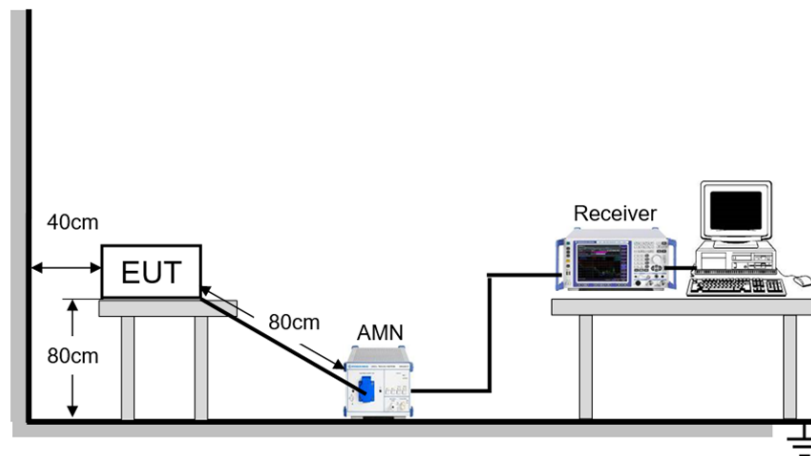

TEST ENVIRONMENT

Temperature	22.5 °C	Relative Humidity	53%
Atmosphere Pressure	101 kPa	Test Voltage	AC 120 V, 60 Hz

TEST RESULTS

Test Mode:	802.11g	Channel:	2437 MHz
Line	L		

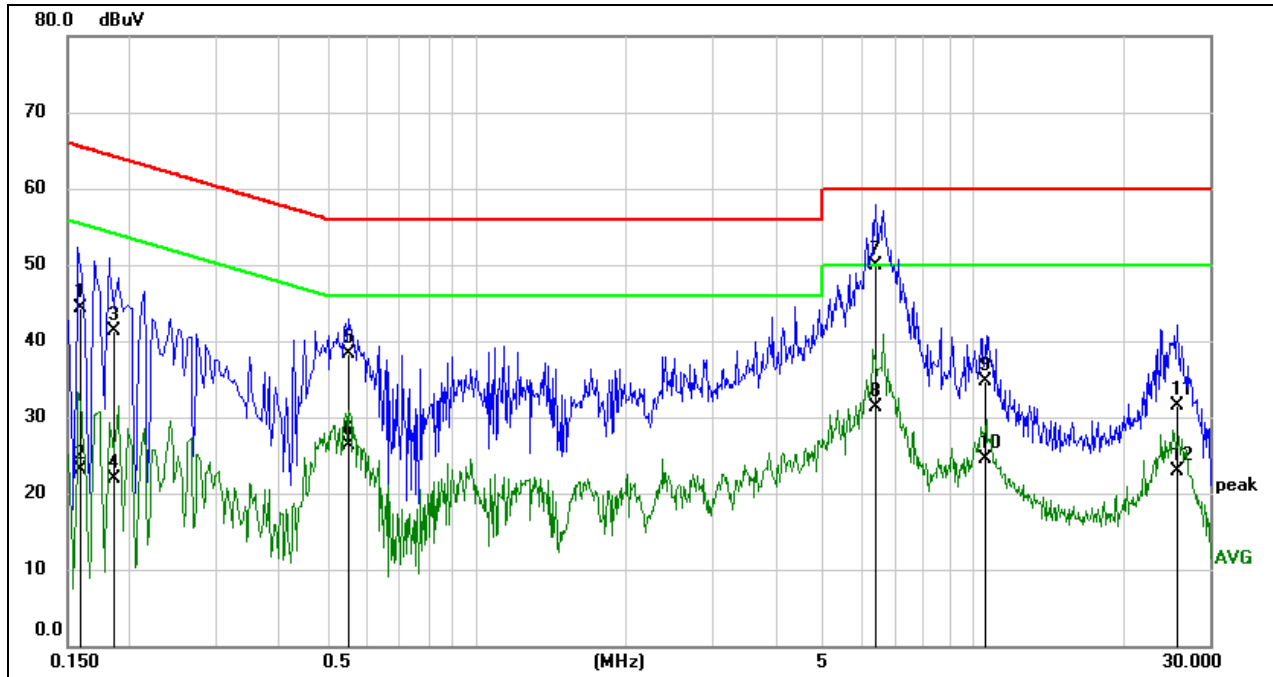

No.	Frequency (MHz)	Reading (dBuV)	Correct (dB)	Result (dBuV)	Limit (dBuV)	Margin (dB)	Remark
1	0.1596	34.80	9.59	44.39	65.48	-21.09	QP
2	0.1596	13.55	9.59	23.14	55.48	-32.34	AVG
3	0.1861	31.67	9.59	41.26	64.21	-22.95	QP
4	0.1861	12.26	9.59	21.85	54.21	-32.36	AVG
5	0.5530	28.66	9.60	38.26	56.00	-17.74	QP
6	0.5530	16.64	9.60	26.24	46.00	-19.76	AVG
7	6.4043	40.15	9.74	49.89	60.00	-10.11	QP
8	6.4043	21.50	9.74	31.24	50.00	-18.76	AVG
9	10.5766	25.03	9.73	34.76	60.00	-25.24	QP
10	10.5766	14.79	9.73	24.52	50.00	-25.48	AVG
11	25.7764	21.86	9.73	31.59	60.00	-28.41	QP
12	25.7764	13.22	9.73	22.95	50.00	-27.05	AVG

Note:

1. Result = Reading + Correct Factor.
2. If QP Result complies with AV limit, AV Result is deemed to comply with AV limit.
3. Test setup: RBW: 200 Hz (9 kHz ~ 150 kHz), 9 kHz (150 kHz ~ 30 MHz).
4. Step size: 80 Hz (0.009 MHz ~ 0.15 MHz), 4 kHz (0.15 MHz ~ 30 MHz), Scan time: auto.

Test Mode:	802.11g	Channel:	2437 MHz
Line	N		

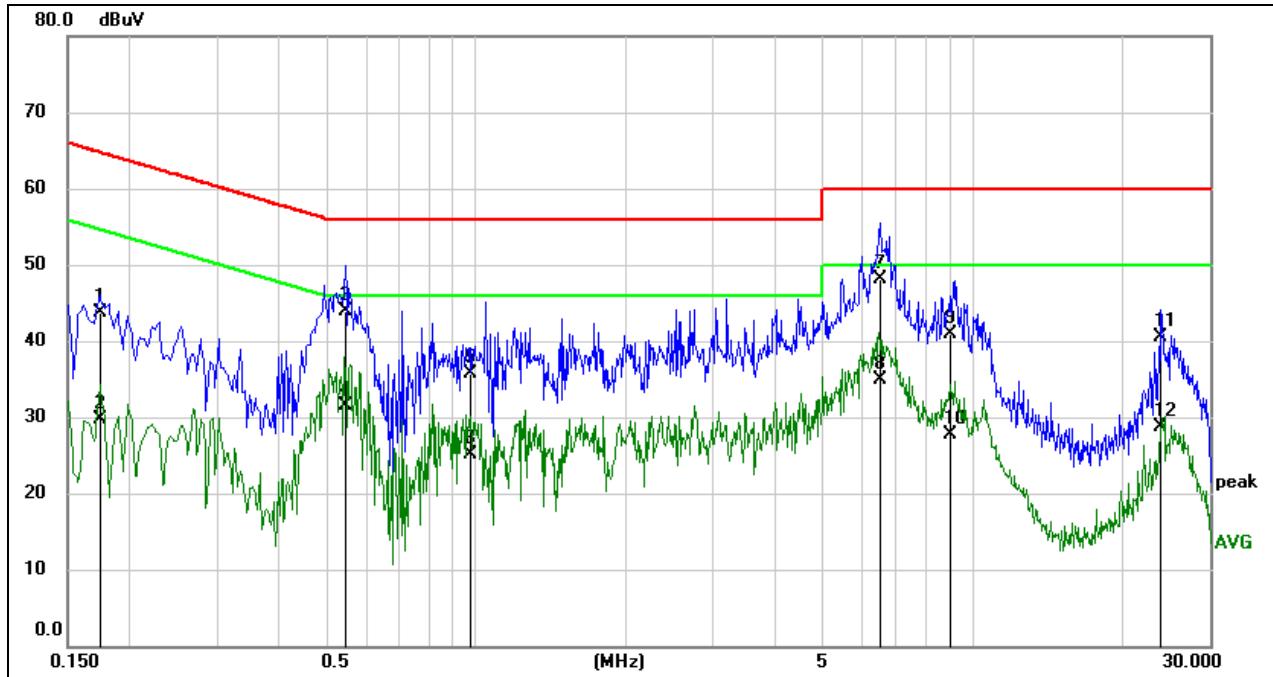

No.	Frequency (MHz)	Reading (dBuV)	Correct (dB)	Result (dBuV)	Limit (dBuV)	Margin (dB)	Remark
1	0.1739	34.24	9.54	43.78	64.77	-20.99	QP
2	0.1739	20.10	9.54	29.64	54.77	-25.13	AVG
3	0.5435	34.44	9.50	43.94	56.00	-12.06	QP
4	0.5435	22.00	9.50	31.50	46.00	-14.50	AVG
5	0.9796	26.14	9.51	35.65	56.00	-20.35	QP
6	0.9796	15.67	9.51	25.18	46.00	-20.82	AVG
7	6.5073	38.38	9.63	48.01	60.00	-11.99	QP
8	6.5073	25.36	9.63	34.99	50.00	-15.01	AVG
9	9.1001	31.28	9.61	40.89	60.00	-19.11	QP
10	9.1001	18.06	9.61	27.67	50.00	-22.33	AVG
11	23.9146	30.71	9.71	40.42	60.00	-19.58	QP
12	23.9146	19.05	9.71	28.76	50.00	-21.24	AVG

Note:

1. Result = Reading + Correct Factor.
2. If QP Result complies with AV limit, AV Result is deemed to comply with AV limit.
3. Test setup: RBW: 200 Hz (9 kHz ~ 150 kHz), 9 kHz (150 kHz ~ 30 MHz).
4. Step size: 80 Hz (0.009 MHz ~ 0.15 MHz), 4 kHz (0.15 MHz ~ 30 MHz), Scan time: auto.

Note: All the modes have been tested, only the worst data was recorded in the report.

11. TEST DATA

11.1. APPENDIX A: DTS BANDWIDTH

11.1.1. Test Result

Test Mode	Antenna	Channel	DTS BW [MHz]	FL[MHz]	FH[MHz]	Limit[MHz]	Verdict
11B-CDD	Ant1	2412	10.080	2406.960	2417.040	0.5	PASS
	Ant2	2412	9.800	2407.240	2417.040	0.5	PASS
	Ant1	2417	10.000	2412.000	2422.000	0.5	PASS
	Ant2	2417	9.680	2411.960	2421.640	0.5	PASS
	Ant1	2437	10.080	2431.960	2442.040	0.5	PASS
	Ant2	2437	10.040	2431.960	2442.000	0.5	PASS
	Ant1	2457	10.040	2452.000	2462.040	0.5	PASS
	Ant2	2457	10.120	2451.960	2462.080	0.5	PASS
	Ant1	2462	10.120	2456.960	2467.080	0.5	PASS
Ant2	2462	10.120	2456.960	2467.080	0.5	PASS	
11G-CDD	Ant1	2412	16.280	2403.880	2420.160	0.5	PASS
	Ant2	2412	16.320	2403.880	2420.200	0.5	PASS
	Ant1	2417	15.760	2409.440	2425.200	0.5	PASS
	Ant2	2417	15.640	2409.520	2425.160	0.5	PASS
	Ant1	2437	16.320	2428.880	2445.200	0.5	PASS
	Ant2	2437	15.640	2429.520	2445.160	0.5	PASS
	Ant1	2457	16.320	2448.880	2465.200	0.5	PASS
	Ant2	2457	15.680	2449.480	2465.160	0.5	PASS
	Ant1	2462	15.920	2454.240	2470.160	0.5	PASS
Ant2	2462	16.320	2453.880	2470.200	0.5	PASS	
11N20-CDD	Ant1	2412	17.560	2403.240	2420.800	0.5	PASS
	Ant2	2412	17.560	2403.240	2420.800	0.5	PASS
	Ant1	2417	17.520	2408.280	2425.800	0.5	PASS
	Ant2	2417	17.320	2408.240	2425.560	0.5	PASS
	Ant1	2437	17.440	2428.400	2445.840	0.5	PASS
	Ant2	2437	14.480	2430.120	2444.600	0.5	PASS
	Ant1	2457	14.720	2449.880	2464.600	0.5	PASS
	Ant2	2457	16.280	2448.880	2465.160	0.5	PASS
	Ant1	2462	17.240	2453.280	2470.520	0.5	PASS
Ant2	2462	16.880	2453.640	2470.520	0.5	PASS	
11N40-CDD	Ant1	2422	33.840	2405.680	2439.520	0.5	PASS
	Ant2	2422	33.840	2405.760	2439.600	0.5	PASS
	Ant1	2427	35.040	2409.480	2444.520	0.5	PASS
	Ant2	2427	33.920	2410.680	2444.600	0.5	PASS
	Ant1	2437	33.840	2420.760	2454.600	0.5	PASS
	Ant2	2437	32.560	2420.760	2453.320	0.5	PASS
	Ant1	2447	34.960	2429.560	2464.520	0.5	PASS
	Ant2	2447	31.360	2430.760	2462.120	0.5	PASS
	Ant1	2452	33.840	2434.480	2468.320	0.5	PASS
Ant2	2452	32.560	2436.960	2469.520	0.5	PASS	

11.1.2. Test Graphs





11B-CDD_Ant2_2417

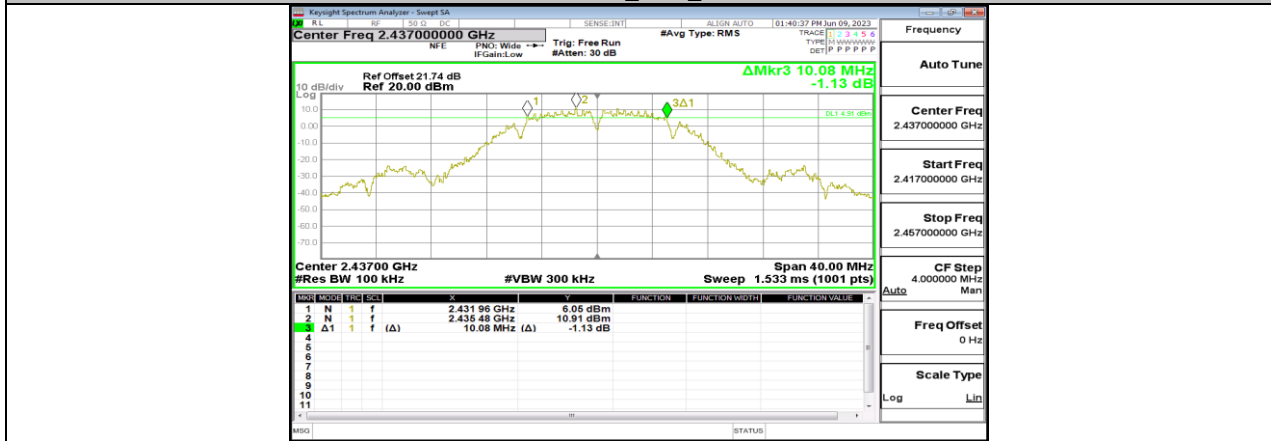

11B-CDD_Ant1_2437

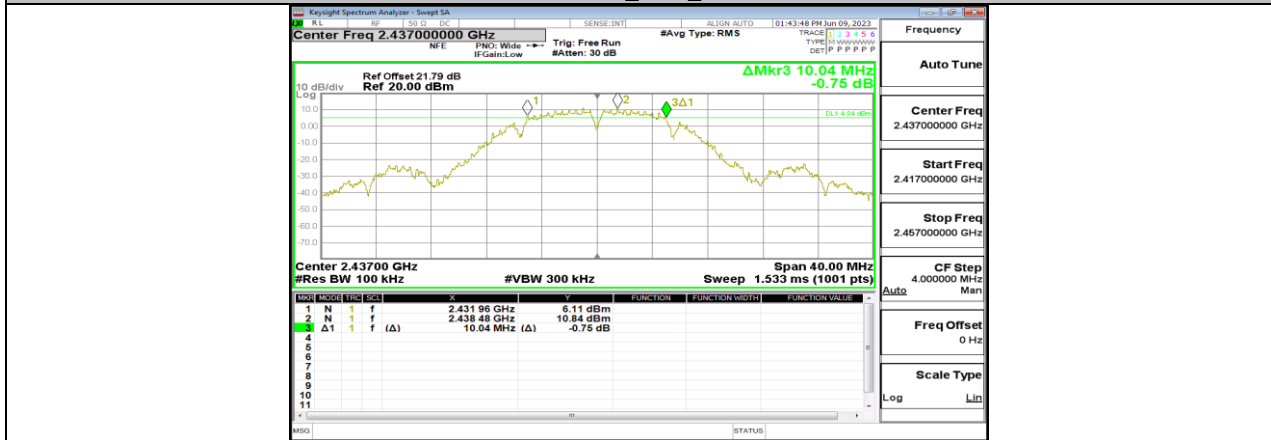

11B-CDD_Ant2_2437

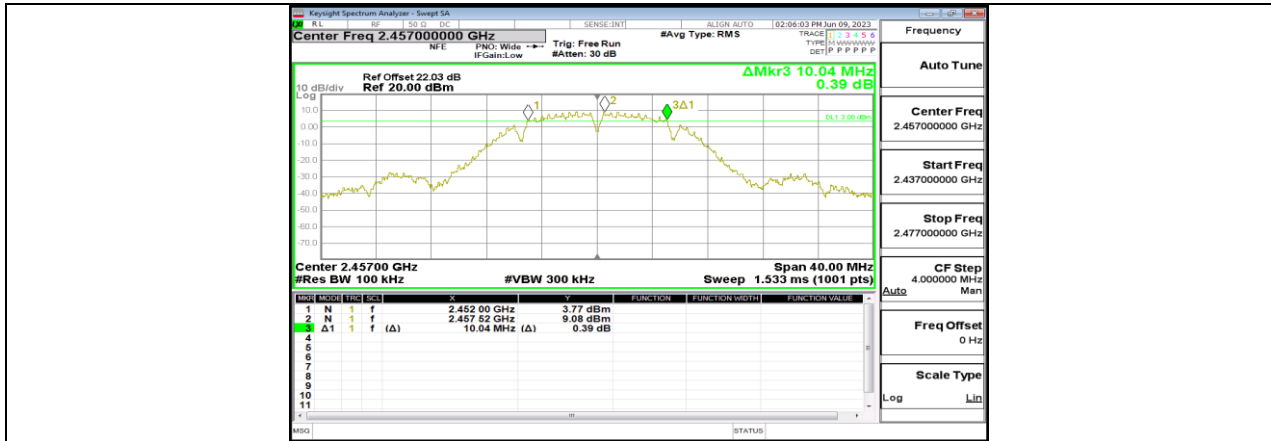

11B-CDD_Ant1_2457

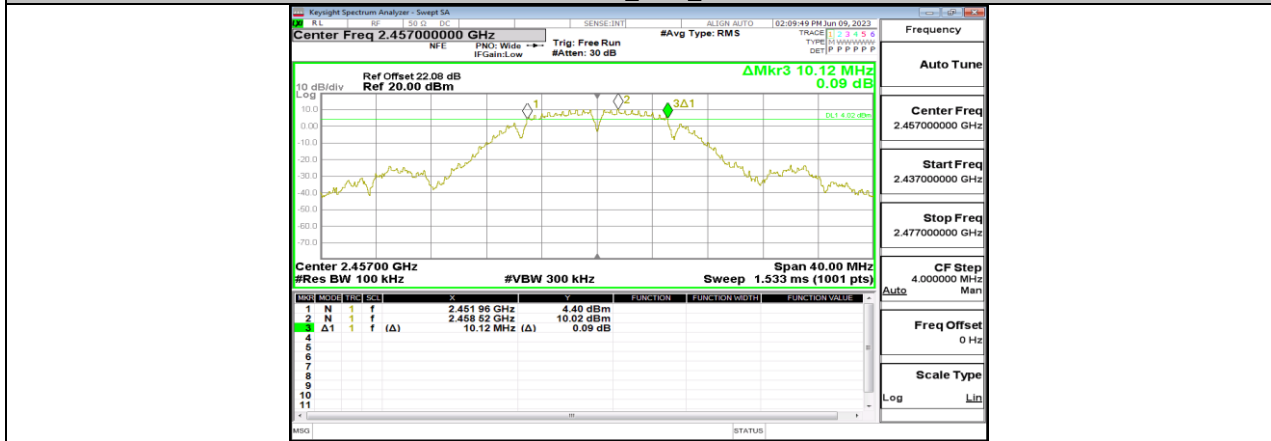

11B-CDD_Ant2_2457

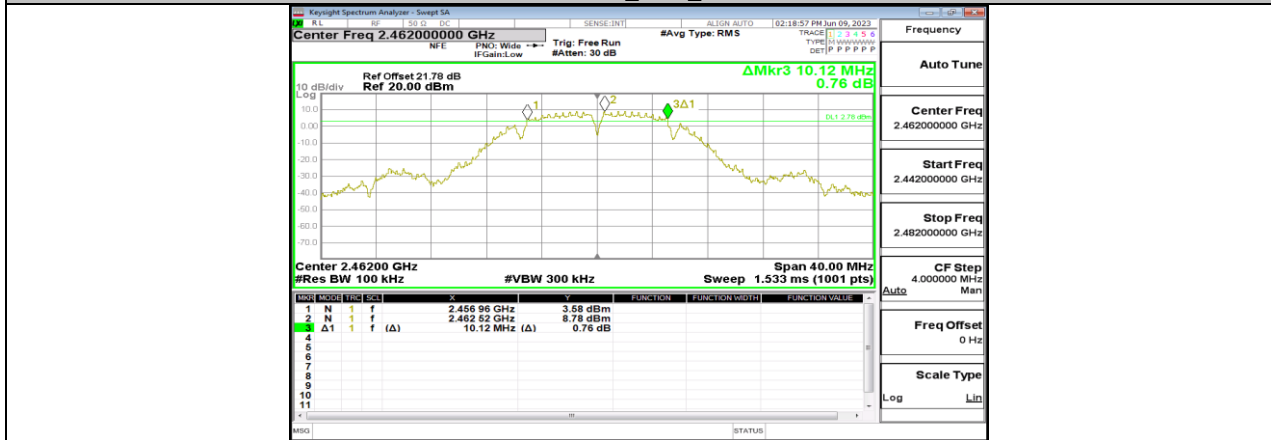

11B-CDD_Ant1_2462

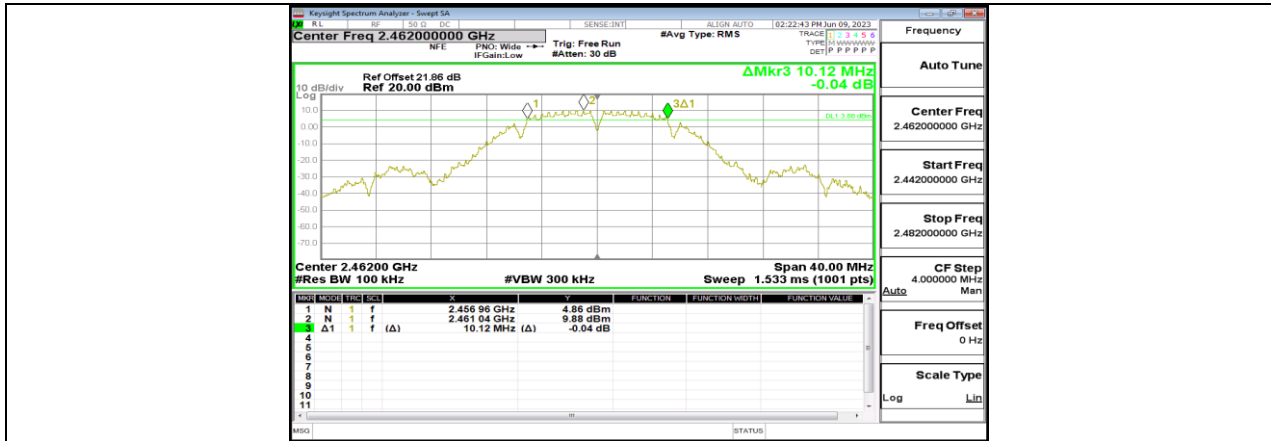

11B-CDD_Ant2_2462

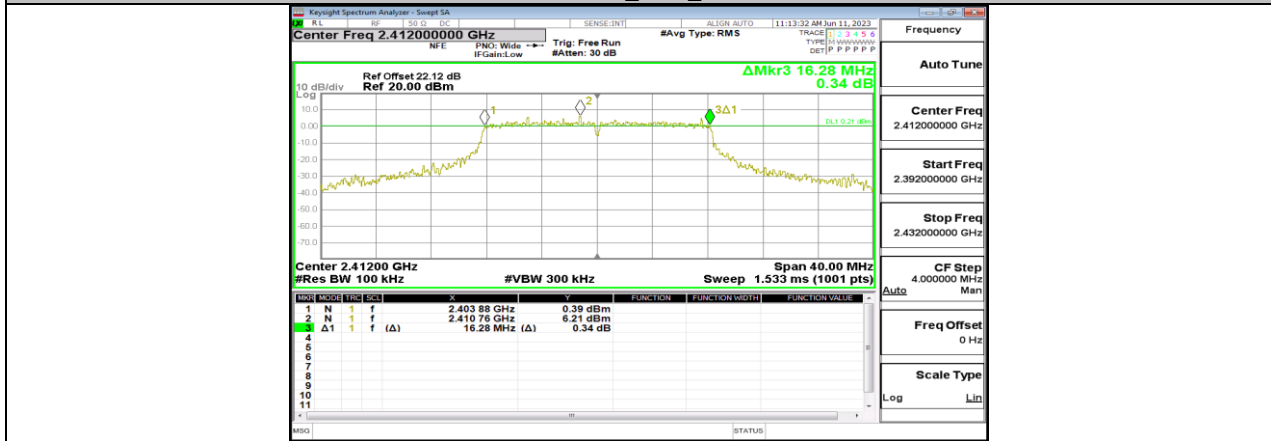

11G-CDD_Ant1_2412

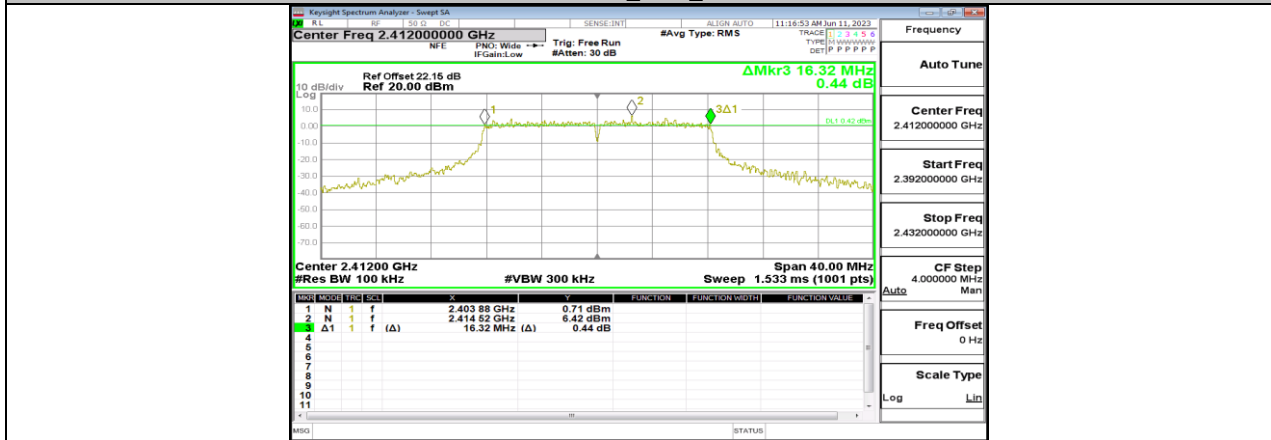

11G-CDD_Ant2_2412

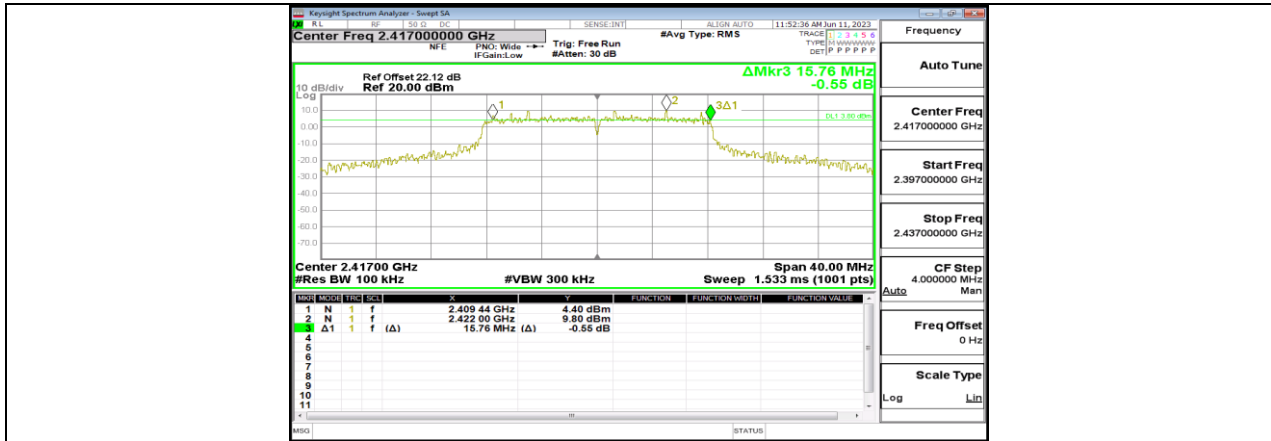

11G-CDD_Ant1_2417

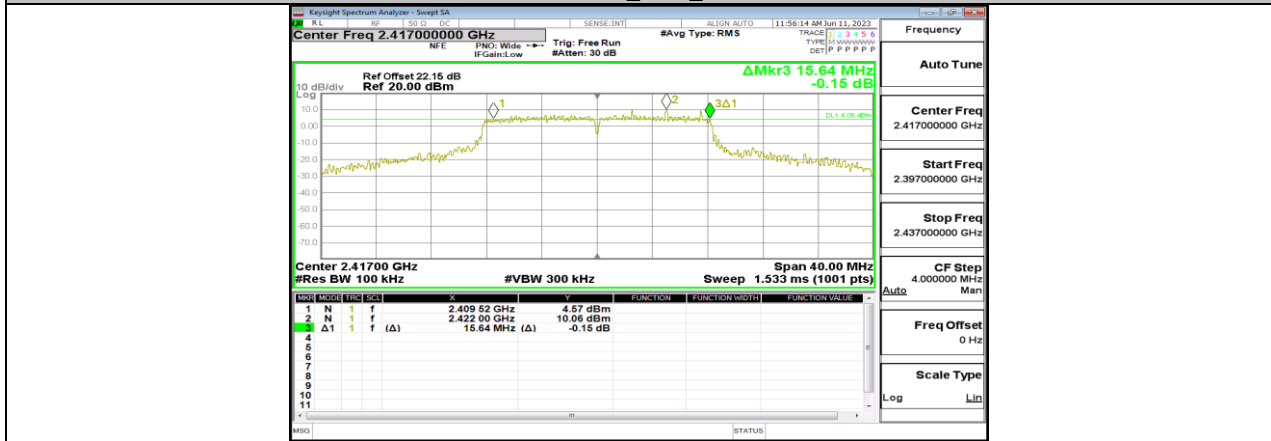

11G-CDD_Ant2_2417

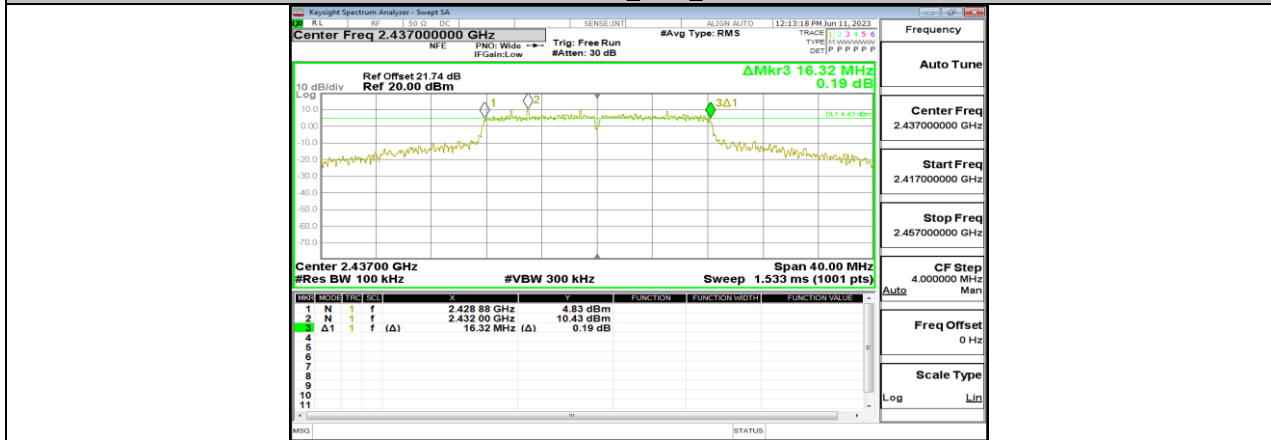

11G-CDD_Ant1_2437