

**CFR 47 FCC PART 15 SUBPART C**

**TEST REPORT**

*For*

**AXE11000 Tri-Band 10G Wi-Fi 6E Router**

**MODEL NUMBER: EX1110**

**REPORT NUMBER: 4790787142-1-RF-1**

**ISSUE DATE: April 21, 2023**

**FCC ID: 2AXJ4EX1110**

*Prepared for*

**TP-Link Corporation Limited**

**Room 901, 9/F. , New East Ocean Centre, 9 Science Museum Road, Tsim Sha Tsui,  
Kowloon, Hong Kong**

*Prepared by*

**UL Verification Services (Guangzhou) Co., Ltd, Song Shan Lake Branch**

**Building 10, Innovation Technology Park, No. 1, Li Bin Road, Song Shan Lake Hi-Tech Development Zone Dongguan, 523808, People's Republic of China**

**Tel: +86 769 22038881**

**Fax: +86 769 33244054**

**Website: [www.ul.com](http://www.ul.com)**

## Revision History

<u>Rev.</u>	<u>Issue Date</u>	<u>Revisions</u>	<u>Revised By</u>
<u>V0</u>	<u>April 21, 2023</u>	<u>Initial Issue</u>	<u></u>

### Summary of Test Results

Test Item	Clause	Limit/Requirement	Result
Antenna Requirement	N/A	FCC Part 15.203/15.247 (c)	Pass
AC Power Line Conducted Emission	ANSI C63.10-2013, Clause 6.2	FCC Part 15.207	Pass
Conducted Output Power	ANSI C63.10-2013, Clause 11.9.1.3	FCC Part 15.247 (b)(3)	Pass
6dB Bandwidth	ANSI C63.10-2013, Clause 11.8.1	FCC Part 15.247 (a)(2)	Pass
Power Spectral Density	ANSI C63.10-2013, Clause 11.10.2	FCC Part 15.247 (e)	Pass
Conducted Band edge and spurious emission	ANSI C63.10-2013, Clause 11.11	FCC Part 15.247(d)	Pass
Radiated Band edge and Spurious Emission	ANSI C63.10-2013, Clause 11.12 & Clause 11.13	FCC Part 15.247 (d) FCC Part 15.205/15.209	Pass
Duty Cycle	ANSI C63.10-2013, Clause 11.6	None; for reporting purposes only.	Pass

\*This test report is only published to and used by the applicant, and it is not for evidence purpose in China.

\*The measurement result for the sample received is <Pass> according to <CFR 47 FCC PART 15 SUBPART C > when <Accuracy Method> decision rule is applied.

## CONTENTS

<b>1. ATTESTATION OF TEST RESULTS.....</b>	<b>6</b>
<b>2. TEST METHODOLOGY.....</b>	<b>7</b>
<b>3. FACILITIES AND ACCREDITATION.....</b>	<b>7</b>
<b>4. CALIBRATION AND UNCERTAINTY .....</b>	<b>8</b>
4.1. <i>MEASURING INSTRUMENT CALIBRATION .....</i>	<i>8</i>
4.2. <i>MEASUREMENT UNCERTAINTY.....</i>	<i>8</i>
<b>5. EQUIPMENT UNDER TEST .....</b>	<b>9</b>
5.1. <i>DESCRIPTION OF EUT .....</i>	<i>9</i>
5.2. <i>CHANNEL LIST .....</i>	<i>9</i>
5.3. <i>MAXIMUM EIRP .....</i>	<i>10</i>
5.4. <i>TEST CHANNEL CONFIGURATION.....</i>	<i>10</i>
5.5. <i>THE WORSE CASE POWER SETTING PARAMETER.....</i>	<i>10</i>
5.6. <i>WORST-CASE CONFIGURATIONS.....</i>	<i>11</i>
5.7. <i>DESCRIPTION OF AVAILABLE ANTENNAS .....</i>	<i>12</i>
5.8. <i>SUPPORT UNITS FOR SYSTEM TEST .....</i>	<i>13</i>
<b>6. MEASURING EQUIPMENT AND SOFTWARE USED.....</b>	<b>14</b>
<b>7. ANTENNA PORT TEST RESULTS .....</b>	<b>17</b>
7.1. <i>CONDUCTED OUTPUT POWER.....</i>	<i>17</i>
7.2. <i>6DB BANDWIDTH AND 99% OCCUPIED BANDWIDTH.....</i>	<i>18</i>
7.3. <i>POWER SPECTRAL DENSITY .....</i>	<i>20</i>
7.4. <i>CONDUCTED BAND EDGE AND SPURIOUS EMISSION.....</i>	<i>22</i>
7.5. <i>DUTY CYCLE.....</i>	<i>24</i>
<b>8. RADIATED TEST RESULTS.....</b>	<b>25</b>
8.1. <i>RESTRICTED BANDEDGE .....</i>	<i>34</i>
8.2. <i>SPURIOUS EMISSIONS(1 GHZ~3 GHZ) .....</i>	<i>70</i>
8.3. <i>SPURIOUS EMISSIONS(3 GHZ~18 GHZ) .....</i>	<i>76</i>
8.4. <i>SPURIOUS EMISSIONS(9 KHZ~30 MHZ) .....</i>	<i>112</i>
8.5. <i>SPURIOUS EMISSIONS(18 GHZ~26 GHZ) .....</i>	<i>115</i>
8.6. <i>SPURIOUS EMISSIONS(30 MHZ~1 GHZ).....</i>	<i>117</i>
<b>9. ANTENNA REQUIREMENT .....</b>	<b>119</b>
<b>10. AC POWER LINE CONDUCTED EMISSION .....</b>	<b>120</b>
<b>11. TEST DATA.....</b>	<b>123</b>

---

11.1.	<i>APPENDIX A: DTS BANDWIDTH</i> .....	123
11.1.1.	Test Result.....	123
11.1.2.	Test Graphs .....	125
11.2.	<i>APPENDIX B: OCCUPIED CHANNEL BANDWIDTH</i> .....	152
11.2.1.	Test Result.....	152
11.2.2.	Test Graphs .....	153
11.3.	<i>APPENDIX C: MAXIMUM CONDUCTED OUTPUT POWER</i> .....	180
11.3.1.	Test Result.....	180
11.4.	<i>APPENDIX D: MAXIMUM POWER SPECTRAL DENSITY</i> .....	182
11.4.1.	Test Result.....	182
11.4.2.	Test Graphs .....	184
11.5.	<i>APPENDIX E: BAND EDGE MEASUREMENTS</i> .....	211
11.5.1.	Test Result.....	211
11.5.2.	Test Graphs .....	212
11.6.	<i>APPENDIX F: CONDUCTED SPURIOUS EMISSION</i> .....	218
11.6.1.	Test Result.....	218
11.6.2.	Test Graphs .....	220
11.7.	<i>APPENDIX G: DUTY CYCLE</i> .....	240
11.7.1.	Test Result.....	240
11.7.2.	Test Graphs .....	241

# 1. ATTESTATION OF TEST RESULTS

## Applicant Information

Company Name: TP-Link Corporation Limited  
Address: Room 901, 9/F. , New East Ocean Centre, 9 Science Museum Road, Tsim Sha Tsui, Kowloon, Hong Kong

## Manufacturer Information

Company Name: TP-Link Corporation Limited  
Address: Room 901, 9/F. , New East Ocean Centre, 9 Science Museum Road, Tsim Sha Tsui, Kowloon, Hong Kong

## EUT Information

EUT Name: AXE11000 Tri-Band 10G Wi-Fi 6E Router  
Model: EX1110  
Brand: tp-link  
Sample Received Date: March 23, 2023  
Sample Status: Normal  
Sample ID: 5910999  
Date of Tested: March 23, 2023 to April 21, 2023

APPLICABLE STANDARDS	
STANDARD	TEST RESULTS
CFR 47 FCC PART 15 SUBPART C	Pass

Prepared By:



Fanny Huang

Engineer Project Associate

Checked By:

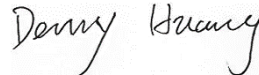

Denny Huang

Senior Project Engineer

Approved By:



Stephen Guo

Operations Manager

## 2. TEST METHODOLOGY

All tests were performed in accordance with the standard CFR 47 FCC PART 15 SUBPART C, KDB 558074 D01 15.247 Meas Guidance v05r02, KDB 414788 D01 Radiated Test Site v01r01, KDB 662911 D01 Multiple Transmitter Output v02r01, CFR 47 FCC Part 2 and ANSI C63.10-2013.

## 3. FACILITIES AND ACCREDITATION

Accreditation Certificate	<p><b>A2LA (Certificate No.: 4102.01)</b>                  UL Verification Services (Guangzhou) Co., Ltd. Song Shan Lake Branch. has been assessed and proved to be in compliance with A2LA.</p> <p><b>FCC (FCC Designation No.: CN1187)</b>                  UL Verification Services (Guangzhou) Co., Ltd. Song Shan Lake Branch. Has been recognized to perform compliance testing on equipment subject to the Commission's Declaration of Conformity (DoC) and Certification rules</p> <p><b>ISED (Company No.: 21320)</b>                  UL Verification Services (Guangzhou) Co., Ltd. Song Shan Lake Branch. has been registered and fully described in a report filed with ISED. The Company Number is 21320 and the test lab Conformity Assessment Body Identifier (CABID) is CN0046.</p> <p><b>VCCI (Registration No.: G-20019, R-20004, C-20012 and T-20011)</b>                  UL Verification Services (Guangzhou) Co., Ltd. Song Shan Lake Branch. has been assessed and proved to be in compliance with VCCI, the Membership No. is 3793.                  Facility Name:                  Chamber D, the VCCI registration No. is G-20019 and R-20004                  Shielding Room B , the VCCI registration No. is C-20012 and T-20011</p>
---------------------------	--

Note1:

All tests measurement facilities use to collect the measurement data are located at Building 10, Innovation Technology Park, No. 1, Li Bin Road, Song Shan Lake Hi-Tech Development Zone Dongguan, 523808, People's Republic of China.

Note2:

The test anechoic chamber in UL Verification Services (Guangzhou) Co., Ltd. Song Shan Lake Branch had been calibrated and compared to the open field sites and the test anechoic chamber is shown to be equivalent to or worst case from the open field site.

Note3:

For below 30 MHz, lab had performed measurements at test anechoic chamber and comparing to measurements obtained on an open field site. And these measurements below 30 MHz had been correlated to measurements performed on an OFS.

## 4. CALIBRATION AND UNCERTAINTY

### 4.1. MEASURING INSTRUMENT CALIBRATION

The measuring equipment utilized to perform the tests documented in this report has been calibrated in accordance with the manufacturer's recommendations and is traceable to recognized national standards.

### 4.2. MEASUREMENT UNCERTAINTY

Where relevant, the following measurement uncertainty levels have been estimated for tests performed on the apparatus:

Test Item	Uncertainty
Conduction emission	3.62 dB
Radiated Emission (Included Fundamental Emission) (9 kHz ~ 30 MHz)	2.2 dB
Radiated Emission (Included Fundamental Emission) (30 MHz ~ 1 GHz)	4.00 dB
Radiated Emission (Included Fundamental Emission) (1 GHz to 26 GHz)	5.78 dB (1 GHz ~ 18 GHz)
	5.23 dB (18 GHz ~ 26 GHz)
Duty Cycle	±0.028%
DTS and 99% Occupied Bandwidth	±0.0196%
Maximum Conducted Output Power	±0.686 dB
Maximum Power Spectral Density Level	±0.743 dB
Conducted Band-edge Compliance	±1.328 dB
Conducted Unwanted Emissions In Non-restricted Frequency Bands	±0.746 dB (9 kHz ~ 1 GHz)
	±1.328dB (1 GHz ~ 26 GHz)
Note: This uncertainty represents an expanded uncertainty expressed at approximately the 95% confidence level using a coverage factor of k=2.	



## 5. EQUIPMENT UNDER TEST

### 5.1. DESCRIPTION OF EUT

EUT Name	AXE11000 Tri-Band 10G Wi-Fi 6E Router
Model	EX1110
Frequency Range:	2412 MHz to 2462 MHz
Radio Technology:	IEEE802.11b/g/n HT20/n HT40/ax HE20/ax HE40
Type of Modulation:	IEEE 802.11b: DSSS(CCK, DQPSK, DBPSK) IEEE 802.11g/n: OFDM(64-QAM, 16-QAM, QPSK, BPSK) IEEE 802.11ax: OFDMA(1024-QAM,64-QAM, 16-QAM, QPSK, BPSK)
Normal Test Voltage:	DC 12 V via adapter

### 5.2. CHANNEL LIST

Channel List for 802.11b/g/n/ax (20 MHz)							
Channel	Frequency (MHz)	Channel	Frequency (MHz)	Channel	Frequency (MHz)	Channel	Frequency (MHz)
1	2412	4	2427	7	2442	10	2457
2	2417	5	2432	8	2447	11	2462
3	2422	6	2437	9	2452	/	/

Channel List for 802.11n/ax (40 MHz)							
Channel	Frequency (MHz)	Channel	Frequency (MHz)	Channel	Frequency (MHz)	Channel	Frequency (MHz)
3	2422	5	2432	7	2442	9	2452
4	2427	6	2437	8	2447	/	/

### 5.3. MAXIMUM EIRP

IEEE Std. 802.11	Frequency (MHz)	Channel Number	Maximum Conducted AVG Output Power (dBm)	Maximum AVG EIRP (dBm)
b	2412 ~ 2462	1-11[11]	29.64	31.64
g	2412 ~ 2462	1-11[11]	29.21	31.21
ax HE20	2412 ~ 2462	1-11[11]	29.26	31.26
ax HE40	2422 ~ 2452	3-9[7]	26.67	31.67

### 5.4. TEST CHANNEL CONFIGURATION

IEEE Std. 802.11	Test Channel Number	Frequency (MHz)
b	CH 1, CH2, CH 6, CH10, CH 11	2412, 2417, 2437, 2457, 2462
g	CH 1, CH2, CH 6, CH10, CH 11	2412, 2417, 2437, 2457, 2462
ax HE20	CH 1, CH2, CH 6, CH10, CH 11	2412, 2417, 2437, 2457, 2462
ax HE40	CH 3, CH4, CH 6, CH8, CH 9	2422, 2427, 2437, 2447, 2452

### 5.5. THE WORSE CASE POWER SETTING PARAMETER

The Worse Case Power Setting Parameter under 2400 ~ 2483.5 MHz Band											
Test Software		QSPR									
Modulation Mode	Transmit Antenna Number	Test Channel									
		NCB: 20 MHz					NCB: 40 MHz				
		CH 1	CH 2	CH 6	CH 10	CH 11	CH 3	CH 4	CH 6	CH 8	CH 9
802.11b	1~4	23	23	23	23	23	/				
802.11g	1~4	21	22.5	23	22	20					
802.11n HT20	1~4	Cover by 802.11ax HE20					Cover by 802.11ax HE40				
802.11n HT40	1~4	/									
802.11n VHT20	1~4	Cover by 802.11ax HE20					Cover by 802.11ax HE40				
802.11n VHT40	1~4	/									
802.11ax HE20	1~4	20	21	23	21	18	/				
802.11ax HE40	1~4	/									

## 5.6. WORST-CASE CONFIGURATIONS

The EUT was tested in the following configuration(s):

Controlled in test mode using a software application on the EUT supplied by customer. The application was used to enable a continuous transmission and to select the mode, test channels, bandwidth, data rates as required.

Test channels referring to section 5.4.

Maximum power setting referring to section 5.5.

Worst-case data rates as provided by the client were:

802.11b CDD mode: 1 Mbps  
802.11g CDD mode: 6 Mbps  
802.11n HT20 CDD mode: MCS0  
802.11n HT40 CDD mode: MCS0  
802.11n VHT20 CDD mode: MCS0  
802.11n VHT40 CDD mode: MCS0  
802.11ax HE20 CDD mode: MCS0  
802.11ax HE40 CDD mode: MCS0

802.11n HT20/HT40/VHT20/VHT40 and 802.11ax HE20/HE40 were performed on the worst case (802.11ax HE20/HE40) mode and only the worst data was recorded in this report.

The EUT has 8 separate antennas which correspond to 16 separate antenna ports. Core 6, Core 8, Core 12 and Core 14 correspond to antenna 6, antenna 8, antenna 12 and antenna 14 respectively and they support WLAN 2.4G. Core 1, Core 2, Core 3, Core 4, Core 9, Core 10, Core 15 and Core 16 correspond to antenna 1, antenna 2, antenna 3, antenna 4, antenna 9, antenna 10, antenna 15 and antenna 16 respectively and they support RLAN 5G. Core 5, Core 7, Core 11 and Core 13 correspond to antenna 5, antenna 7, antenna 11 and antenna 13 respectively and they support RLAN 6G.

The measured additional path loss was included in any path loss calculations for all RF cable used during tested.

## 5.7. DESCRIPTION OF AVAILABLE ANTENNAS

Antenna	Frequency (MHz)	Antenna Type	MAX Antenna Gain (dBi)
6	2412-2462	Dipole Antenna	2
8	2412-2462	Dipole Antenna	2
12	2412-2462	Dipole Antenna	2
14	2412-2462	Dipole Antenna	2

The EUT support Cyclic Shift Diversity(CDD) mode.

MIMO output power port and MIMO PSD port summing were performed in accordance with KDB 662911 D01. For the CDD results the Directional Gain was calculated in accordance with the following method.

For output power measurements:

Directional gain=  $G_{ANT} + \text{Array Gain} = 2 \text{ dBi}$

$G_{ANT}$  : equal to the gain of the antenna having the highest gain

Array Gain = 0 dB (i.e., no array gain) for  $N_{ANT} \leq 4$

For power spectral density (PSD) measurements:

Directional gain=  $G_{ANT} + \text{Array Gain} = 8.02 \text{ dBi}$

Array Gain =  $10 \log(N_{ANT}/N_{SS}) \text{ dB}$ .

$N_{ANT}$  : number of transmit antennas

$N_{SS}$  : number of spatial streams, The worst case directional gain will occur when  $N_{SS} = 1$

Test Mode	Transmit and Receive Mode	Description
IEEE 802.11b	<input checked="" type="checkbox"/> 4TX, 4RX	ANT 6, ANT 8, ANT 12 and ANT 14 can be used as transmitting/receiving antenna.
IEEE 802.11g	<input checked="" type="checkbox"/> 4TX, 4RX	ANT 6, ANT 8, ANT 12 and ANT 14 can be used as transmitting/receiving antenna.
IEEE 802.11n HT20	<input checked="" type="checkbox"/> 4TX, 4RX	ANT 6, ANT 8, ANT 12 and ANT 14 can be used as transmitting/receiving antenna.
IEEE 802.11n HT40	<input checked="" type="checkbox"/> 4TX, 4RX	ANT 6, ANT 8, ANT 12 and ANT 14 can be used as transmitting/receiving antenna.
IEEE 802.11n VHT20	<input checked="" type="checkbox"/> 4TX, 4RX	ANT 6, ANT 8, ANT 12 and ANT 14 can be used as transmitting/receiving antenna.
IEEE 802.11n VHT40	<input checked="" type="checkbox"/> 4TX, 4RX	ANT 6, ANT 8, ANT 12 and ANT 14 can be used as transmitting/receiving antenna.
IEEE 802.11ax HE20	<input checked="" type="checkbox"/> 4TX, 4RX	ANT 6, ANT 8, ANT 12 and ANT 14 can be used as transmitting/receiving antenna.
IEEE 802.11ax HE40	<input checked="" type="checkbox"/> 4TX, 4RX	ANT 6, ANT 8, ANT 12 and ANT 14 can be used as transmitting/receiving antenna.

Note: The value of the antenna gain was declared by customer.

## 5.8. SUPPORT UNITS FOR SYSTEM TEST

### SUPPORT EQUIPMENT

Item	Equipment	Brand Name	Model Name	Remarks
1	Laptop	ThinkPad	X230i	/

### I/O CABLES

Cable No	Port	Connector Type	Cable Type	Cable Length(m)	Remarks
1	LAN1	RJ45	Unshielded	1.0 m	/

### ACCESSORIES

Item	Accessory	Brand Name	Model Name	Description
1	I.T.E POWER SUPPLY	tp-link	T120450-2B4	Input: AC 100-240 V, 50 / 60 Hz, 1.5 A Output: DC 12.0 V, 4.5 A

### TEST SETUP

The EUT can work in engineering mode with a software through a laptop.

### SETUP DIAGRAM FOR TESTS

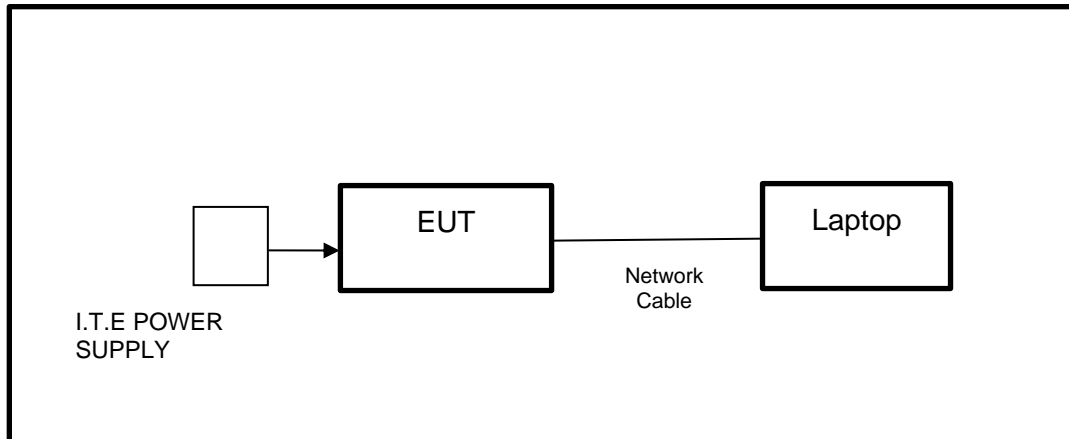

## 6. MEASURING EQUIPMENT AND SOFTWARE USED

R&S TS 8997 Test System						
Equipment	Manufacturer	Model No.	Serial No.	Upper Last Cal.	Last Cal.	Due. Date
Power sensor, Power Meter	R&S	OSP120	100921	Apr.02,2022	Mar.31,2023	Mar.30,2024
Vector Signal Generator	R&S	SMBV100A	261637	/	Oct.17, 2022	Oct.16, 2023
Signal Generator	R&S	SMB100A	178553	/	Oct.17, 2022	Oct.16, 2023
Signal Analyzer	R&S	FSV40	101118	/	Oct.17, 2022	Oct.16, 2023
Software						
Description	Manufacturer		Name		Version	
For R&S TS 8997 Test System	Rohde & Schwarz		EMC 32		10.60.10	
Tonsend RF Test System						
Equipment	Manufacturer	Model No.	Serial No.	Last Cal.		Due. Date
Wideband Radio Communication Tester	R&S	CMW500	155523	Oct.17, 2022		Oct.16, 2023
Wireless Connectivity Tester	R&S	CMW270	1201.0002N75-102	Sep.28, 2022		Sep.27, 2023
PXA Signal Analyzer	Keysight	N9030A	MY55410512	Oct.17, 2022		Oct.16, 2023
MXG Vector Signal Generator	Keysight	N5182B	MY56200284	Oct.17, 2022		Oct.16, 2023
MXG Vector Signal Generator	Keysight	N5172B	MY56200301	Oct.17, 2022		Oct.16, 2023
DC power supply	Keysight	E3642A	MY55159130	Oct.17, 2022		Oct.16, 2023
Temperature & Humidity Chamber	SANMOOD	SG-80-CC-2	2088	Oct.17, 2022		Oct.16, 2023
Software						
Description	Manufacturer	Name			Version	
Tonsend SRD Test System	Tonsend	JS1120-3 RF Test System			3.2.22	

Conducted Emissions					
Equipment	Manufacturer	Model No.	Serial No.	Last Cal.	Due Date
EMI Test Receiver	R&S	ESR3	101961	Oct.17, 2022	Oct.16, 2023
Two-Line V-Network	R&S	ENV216	101983	Oct.17, 2022	Oct.16, 2023
Artificial Mains Networks	Schwarzbeck	NSLK 8126	8126465	Oct.17, 2022	Oct.16, 2023
Software					
Description			Manufacturer	Name	Version
Test Software for Conducted Emissions			Farad	EZ-EMC	Ver. UL-3A1

Radiated Emissions					
Equipment	Manufacturer	Model No.	Serial No.	Last Cal.	Due Date
MXE EMI Receiver	KESIGHT	N9038A	MY56400036	Oct.17, 2022	Oct.16, 2023
Hybrid Log Periodic Antenna	TDK	HLP-3003C	130959	Aug.02, 2021	Aug.01, 2024
Preamplifier	HP	8447D	2944A09099	Oct.17, 2022	Oct.16, 2023
EMI Measurement Receiver	R&S	ESR26	101377	Oct.17, 2022	Oct.16, 2023
Horn Antenna	TDK	HRN-0118	130940	July 20, 2021	July 19, 2024
Preamplifier	TDK	PA-02-0118	TRS-305-00067	Oct.17, 2022	Oct.16, 2023
Horn Antenna	Schwarzbeck	BBHA9170	697	July 20, 2021	July 19, 2024
Preamplifier	TDK	PA-02-2	TRS-307-00003	Oct.17, 2022	Oct.16, 2023
Preamplifier	TDK	PA-02-3	TRS-308-00002	Oct.17, 2022	Oct.16, 2023
Loop antenna	Schwarzbeck	1519B	00008	Dec.14, 2021	Dec.13, 2024
Preamplifier	TDK	PA-02-001-3000	TRS-302-00050	Oct.17, 2022	Oct.16, 2023
Preamplifier	Mini-Circuits	ZX60-83LN-S+	SUP01202035	Oct.17, 2022	Oct.16, 2023
High Pass Filter	Wi	WHKX10-2700-3000-18000-40SS	23	/	/
Highpass Filter	Wainwright	WHKX10-5850-6500-1800-40SS	4	/	/
Band Reject Filter	Wainwright	WRCJV12-5695-5725-5850-5880-40SS	4	/	/
Band Reject Filter	Wainwright	WRCJV20-5120-5150-	2	/	/

		5350-5380-60SS			
Band Reject Filter	Wainwright	WRCJV20-5440-5470-5725-5755-60SS	1	/	/
Band Reject Filter	Wainwright	WRCJV8-2350-2400-2483.5-2533.5-40SS	4	/	/
Band Reject Filter	Wainwright	WRCD5-1879-1879.85-1880.15-1881-40SS	1	/	/
Notch Filter	Wainwright	WHJ10-882-980-7000-40SS	1	/	/
Software					
Description			Manufacturer	Name	Version
Test Software for Radiated Emissions			Farad	EZ-EMC	Ver. UL-3A1

Other Instrument					
Equipment	Manufacturer	Model No.	Serial No.	Last Cal.	Due Date
Temperature humidity probe	OMEGA	ITHX-SD-5	18470007	Oct.22, 2022	Oct.21, 2023
Barometer	Yiyi	Baro	N/A	Oct.24, 2022	Oct.23, 2023
Attenuator	Agilent	8495B	2814a12853	Oct.18, 2022	Oct.17, 2023



## 7. ANTENNA PORT TEST RESULTS

### 7.1. CONDUCTED OUTPUT POWER

#### LIMITS

CFR 47 FCC Part15 (15.247) Subpart C			
Section	Test Item	Limit	Frequency Range (MHz)
CFR 47 FCC 15.247(b)(3)	AVG Output Power	1 watt or 30 dBm	2400-2483.5

#### TEST PROCEDURE

Refer to ANSI C63.10-2013 clause 11.9.2.3.1.

Connect the EUT to a low loss RF cable from the antenna port to the power sensor (video bandwidth is greater than the occupied bandwidth).

Measure peak emission level, the indicated level is the average output power, after any corrections for external attenuators and cables.

The test result in dBm by adding  $[10 \log (1 / D)]$ , where D is the duty cycle.

#### TEST SETUP

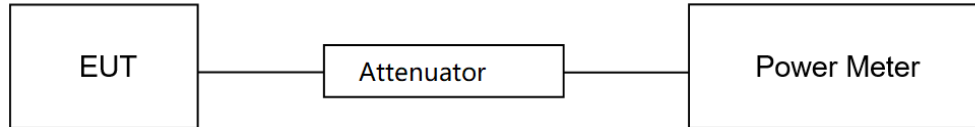

#### TEST ENVIRONMENT

Temperature	24°C	Relative Humidity	58%
Atmosphere Pressure	101kPa	Test Voltage	DC 12 V

#### TEST DATE / ENGINEER

Test Date	April 19, 2023	Test By	Walker Yuan
-----------	----------------	---------	-------------

#### TEST RESULTS

Please refer to section "Test Data" - Appendix C

## 7.2. 6DB BANDWIDTH AND 99% OCCUPIED BANDWIDTH

### LIMITS

CFR 47 FCC Part15 (15.247) Subpart C			
Section	Test Item	Limit	Frequency Range (MHz)
CFR 47 FCC 15.247(a)(2) ISED RSS-247 5.2 (a)	6 dB Bandwidth	≥ 500 kHz	2400-2483.5
ISED RSS-Gen Clause 6.7	99 % Occupied Bandwidth	For reporting purposes only.	2400-2483.5

### TEST PROCEDURE

Refer to ANSI C63.10-2013 clause 11.8 for DTS bandwidth and clause 6.9 for Occupied Bandwidth.

Connect the EUT to the spectrum analyser and use the following settings:

Center Frequency	The center frequency of the channel under test
Frequency Span	For 6 dB Bandwidth: Enough to capture all products of the modulation carrier emission For 99 % Occupied Bandwidth: Between 1.5 times and 5.0 times the OBW
Detector	Peak
RBW	For 6 dB Bandwidth: 100 kHz For 99 % Occupied Bandwidth: 1 % to 5 % of the occupied bandwidth
VBW	For 6 dB Bandwidth: ≥3 × RBW For 99 % Occupied Bandwidth: ≥3 × RBW
Trace	Max hold
Sweep	Auto couple

a) Use the 99 % power bandwidth function of the instrument, allow the trace to stabilize and report the measured bandwidth.

b) Allow the trace to stabilize and measure the maximum width of the emission that is constrained by the frequencies associated with the two outermost amplitude points (upper and lower frequencies) that are attenuated by 6 dB relative to the maximum level measured in the fundamental emission.

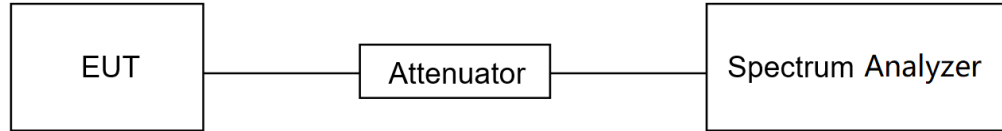
**TEST SETUP****TEST ENVIRONMENT**

Temperature	24°C	Relative Humidity	58%
Atmosphere Pressure	101kPa	Test Voltage	DC 12 V

**TEST DATE / ENGINEER**

Test Date	April 19, 2023	Test By	Walker Yuan
-----------	----------------	---------	-------------

**TEST RESULTS**

Please refer to section "Test Data" - Appendix A&B

### 7.3. POWER SPECTRAL DENSITY

#### LIMITS

CFR 47 FCC Part15 (15.247) Subpart C			
Section	Test Item	Limit	Frequency Range (MHz)
CFR 47 FCC §15.247 (e)	Power Spectral Density	8 dBm in any 3 kHz band	2400-2483.5

#### TEST PROCEDURE

Refer to ANSI C63.10-2013 clause 11.10.5.

Connect the EUT to the spectrum analyser and use the following settings:

Center Frequency	The center frequency of the channel under test
Detector	power averaging (rms)
RBW	$3 \text{ kHz} \leq \text{RBW} \leq 100 \text{ kHz}$
VBW	$\geq 3 \times \text{RBW}$
Span	1.5 x OBW bandwidth
Trace	Average
Sweep time	Auto couple

Allow trace to fully stabilize and use the peak marker function to determine the maximum amplitude level within the RBW.

If measured value exceeds limit, reduce RBW (no less than 3 kHz) and repeat.

#### TEST SETUP

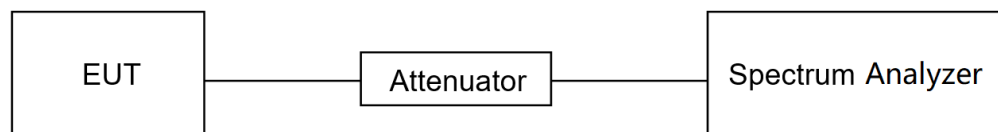

#### TEST ENVIRONMENT

Temperature	24°C	Relative Humidity	58%
Atmosphere Pressure	101kPa	Test Voltage	DC 12 V

#### TEST DATE / ENGINEER

Test Date	April 19, 2023	Test By	Walker Yuan
-----------	----------------	---------	-------------

**TEST RESULTS**

Please refer to section "Test Data" - Appendix D

## 7.4. CONDUCTED BAND EDGE AND SPURIOUS EMISSION

### LIMITS

CFR 47 FCC Part15 (15.247) Subpart C		
Section	Test Item	Limit
CFR 47 FCC §15.247 (d)	Conducted Bandedge and Spurious Emissions	at least 30 dB below that in the 100 kHz bandwidth within the band that contains the highest level of the desired power

### TEST PROCEDURE

Refer to ANSI C63.10-2013 clause 11.11 and 11.13.

Connect the EUT to the spectrum analyser and use the following settings for reference level measurement:

Center Frequency	The center frequency of the channel under test
Detector	Peak
RBW	100 kHz
VBW	$\geq 3 \times \text{RBW}$
Span	1.5 x DTS bandwidth
Trace	Max hold
Sweep time	Auto couple.

Allow trace to fully stabilize and use the peak marker function to determine the maximum PSD level.

Change the settings for emission level measurement:

Span	Set the center frequency and span to encompass frequency range to be measured
Detector	Peak
RBW	100 kHz
VBW	$\geq 3 \times \text{RBW}$
measurement points	$\geq \text{span}/\text{RBW}$
Trace	Max hold
Sweep time	Auto couple.

Allow trace to fully stabilize and use the peak marker function to determine the maximum PSD level. Ensure that the amplitude of all unwanted emissions outside of the authorized frequency band (excluding restricted frequency bands) is attenuated by at least the minimum requirements specified in 11.11.

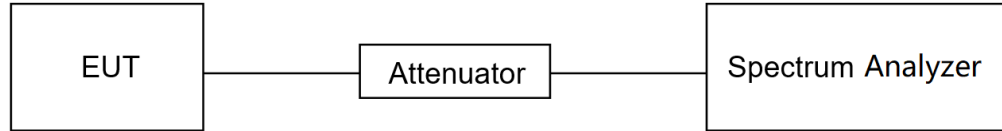
**TEST SETUP****TEST ENVIRONMENT**

Temperature	24°C	Relative Humidity	57%
Atmosphere Pressure	101kPa	Test Voltage	DC 12 V

**TEST DATE / ENGINEER**

Test Date	April 19, 2023	Test By	Walker Yuan
-----------	----------------	---------	-------------

**TEST RESULTS**

Please refer to section "Test Data" - Appendix E&F

## 7.5. DUTY CYCLE

### LIMITS

None; for reporting purposes only.

### TEST PROCEDURE

Refer to ANSI C63.10-2013 clause 11.6 Zero – Span Spectrum Analyzer method.

### TEST SETUP

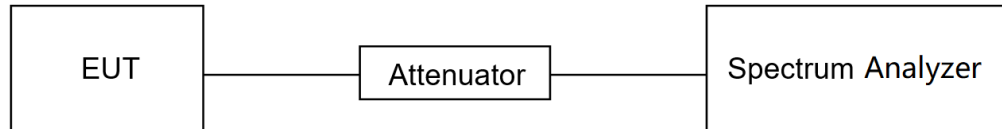

### TEST ENVIRONMENT

Temperature	24°C	Relative Humidity	58%
Atmosphere Pressure	101kPa	Test Voltage	DC 12 V

### TEST DATE / ENGINEER

Test Date	April 19, 2023	Test By	Walker Yuan
-----------	----------------	---------	-------------

### TEST RESULTS

Please refer to section "Test Data" - Appendix G



## 8. RADIATED TEST RESULTS

### LIMITS

Please refer to CFR 47 FCC §15.205 and §15.209.

Radiation Disturbance Test Limit for FCC (Class B) (9 kHz ~ 1 GHz)

Emissions radiated outside of the specified frequency bands above 30 MHz			
Frequency Range (MHz)	Field Strength Limit (uV/m) at 3 m	Field Strength Limit (dBuV/m) at 3 m	
		Quasi-Peak	
30 - 88	100	40	
88 - 216	150	43.5	
216 - 960	200	46	
Above 960	500	54	
Above 1000	500	Peak	Average
		74	54

FCC Emissions radiated outside of the specified frequency bands below 30 MHz		
Frequency (MHz)	Field strength (microvolts/meter)	Measurement distance (meters)
0.009-0.490	2400/F(kHz)	300
0.490-1.705	24000/F(kHz)	30
1.705-30.0	30	30

FCC Restricted bands of operation refer to FCC §15.205 (a):

MHz	MHz	MHz	GHz
0.090-0.110	16.42-16.423	399.9-410	4.5-5.15
<sup>1</sup> 0.495-0.505	16.69475-16.69525	608-614	5.35-5.46
2.1735-2.1905	16.80425-16.80475	960-1240	7.25-7.75
4.125-4.128	25.5-25.67	1300-1427	8.025-8.5
4.17725-4.17775	37.5-38.25	1435-1626.5	9.0-9.2
4.20725-4.20775	73-74.6	1645.5-1646.5	9.3-9.5
6.215-6.218	74.8-75.2	1660-1710	10.6-12.7
6.26775-6.26825	108-121.94	1718.8-1722.2	13.25-13.4
6.31175-6.31225	123-138	2200-2300	14.47-14.5
8.291-8.294	149.9-150.05	2310-2390	15.35-16.2
8.362-8.366	156.52475-156.52525	2483.5-2500	17.7-21.4
8.37625-8.38675	156.7-156.9	2690-2900	22.01-23.12
8.41425-8.41475	162.0125-167.17	3260-3267	23.6-24.0
12.29-12.293	167.72-173.2	3332-3339	31.2-31.8
12.51975-12.52025	240-285	3345.8-3358	36.43-36.5
12.57675-12.57725	322-335.4	3600-4400	( <sup>2</sup> )
13.36-13.41			

Note: <sup>1</sup>Until February 1, 1999, this restricted band shall be 0.490-0.510 MHz.

<sup>2</sup>Above 38.6c

## TEST PROCEDURE

Below 30 MHz

The setting of the spectrum analyser

RBW	200 Hz (From 9 kHz to 0.15 MHz)/ 9 kHz (From 0.15 MHz to 30 MHz)
VBW	200 Hz (From 9 kHz to 0.15 MHz)/ 9 kHz (From 0.15 MHz to 30 MHz)
Sweep	Auto

1. The testing follows the guidelines in ANSI C63.10-2013 clause 6.4.
2. The EUT was arranged to its worst case and then turntable (from 0 degree to 360 degrees) to find the maximum reading. A pre-amp and a high pass filter are used for the test in order to get better signal level. Both Horizontal, Face-on and Face-off polarizations of the antenna are set to make the measurement.
3. The EUT was placed on a turntable with 80 cm above ground.
4. The EUT was set 3 meters from the interference receiving antenna, which was mounted on the top of a 1 m height antenna tower.
5. The radiated emission limits are based on measurements employing a CISPR quasi-peak detector except for the frequency bands 9-90 kHz, 110-490 kHz and above 1000 MHz Radiated emission limits in these three bands are based on measurements employing an average detector.
6. For measurement below 1 GHz, the initial step in collecting conducted emission data is a spectrum analyzer peak detector mode pre-scanning the measurement frequency range. Significant peaks are then marked and then Quasi Peak and average detector mode re-measured. If the emission level of the EUT measured by the peak detector is 3 dB lower than the applicable limit, the peak emission level will be reported. Otherwise, the emission measurement will be repeated using the quasi-peak and average detector and reported.
7. Although these tests were performed other than open field site, adequate comparison measurements were confirmed against 30m open field site. Therefore sufficient tests were made to demonstrate that the alternative site produces results that correlate with the ones of tests made in an open field site based on KDB 414788.
8. The limits in CFR 47, Part 15, Subpart C, paragraph 15.209 (a), are identical to those in RSS-GEN Section 8.9, Table 6, since the measurements are performed in terms of magnetic field strength and converted to electric field strength levels (as reported in the table) using the free space impedance of  $377\Omega$ . For example, the measurement frequency X KHz resulted in a level of Y dBuV/m, which is equivalent to  $Y-51.5 = Z$  dBuA/m, which has the same margin, W dB, to the corresponding RSS-GEN Table 6 limit as it has to be 15.209(a) limit.

Below 1 GHz and above 30 MHz

The setting of the spectrum analyser

RBW	120 kHz
VBW	300 kHz
Sweep	Auto
Detector	Peak/QP
Trace	Max hold

1. The testing follows the guidelines in ANSI C63.10-2013 clause 6.5.
2. The EUT was arranged to its worst case and then tune the antenna tower (from 1 m to 4 m) and turntable (from 0 degree to 360 degrees) to find the maximum reading. A pre-amp and a high pass filter are used for the test in order to get better signal level. Both horizontal and vertical polarizations of the antenna are set to make the measurement.
3. The EUT was placed on a turntable with 80 cm above ground.
4. The EUT was set 3 meters from the interference receiving antenna, which was mounted on the top of a variable height antenna tower.
5. For measurement below 1 GHz, the initial step in collecting conducted emission data is a spectrum analyzer peak detector mode pre-scanning the measurement frequency range. Significant peaks are then marked and then Quasi Peak detector mode re-measured. If the emission level of the EUT measured by the peak detector is 3 dB lower than the applicable limit, the peak emission level will be reported. Otherwise, the emission measurement will be repeated using the quasi-peak detector and reported.

Above 1G

The setting of the spectrum analyser

RBW	1 MHz
VBW	PEAK: 3 MHz AVG: see note 6
Sweep	Auto
Detector	Peak
Trace	Max hold

1. The testing follows the guidelines in ANSI C63.10-2013 clause 6.6.
2. The EUT was arranged to its worst case and then tune the antenna tower (from 1 m to 4 m) and turntable (from 0 degree to 360 degrees) to find the maximum reading. A pre-amp and a high pass filter are used for the test in order to get better signal level. Both horizontal and vertical polarizations of the antenna are set to make the measurement.
3. The EUT was placed on a turntable with 1.5 m above ground.
4. The EUT was set 3 meters from the interference receiving antenna, which was mounted on the top of a variable height antenna tower.
5. For measurement above 1 GHz, the emission measurement will be measured by the peak detector. This peak level, once corrected, must comply with the limit specified in Section 15.209.
6. For measurements above 1 GHz the resolution bandwidth is set to 1 MHz, then the video bandwidth is set to 3 MHz for peak measurements and 1 MHz resolution bandwidth with 1/T video bandwidth with peak detector for average measurements. For the Duty Cycle please refer to clause 7.5.ON TIME AND DUTY CYCLE.

X axis, Y axis, Z axis positions:

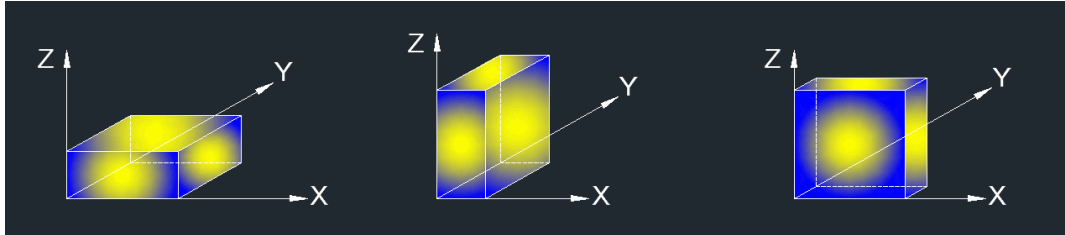

Note 1: For all radiated test, EUT in each of three orthogonal axis emissions had been tested, but only the worst case (X axis) data recorded in the report.

Note 2: The EUT was fully exercised with external accessories during the test. In the case of multiple accessory external ports, an external accessory shall be connected to one of each type of port.

For Band edge:

Note:

1. Measurement = Reading Level + Correct Factor.
2. If the peak values are less than the average limit of 54 dBuV/m, the average result is deemed to comply with average limit.
3. Peak: Peak detector.
4. AVG:  $VBW=1/T_{on}$ , where:  $T_{on}$  is the transmitting duration.
5. For the transmitting duration, please refer to clause 7.5.
6. Only the worst data was recorded, if it complies with the limit, the other emissions deemed to comply with the limit.
7. Horizontal and Vertical have been tested, only the worst data was recorded in the report.
8. All modes, channels and antennas have been tested, only the worst data was recorded in the report.

For Radiate Spurious emission 1GHz-3GHz:

Note:

1. Measurement = Reading Level + Correct Factor.
2. If the Peak values are less than the Average limit of 54 dBuV/m, the Average result is deemed to comply with Average limit.
3. Peak: Peak detector.
4. AVG:  $VBW=1/T_{on}$ , where:  $T_{on}$  is the transmitting duration.
5. For the transmitting duration, please refer to clause 7.5.
6. Filter losses were only considered in the spurious frequency bands and the authorized band was not corrected for Band reject filter losses.
7. Proper operation of the transmitter prior to adding the filter to the measurement chain.
8. All modes, channels and antennas have been tested, only the worst data was recorded in the report.

For Radiate Spurious emission 3GHz-18GHz:

Note:

1. Peak Result = Reading Level + Correct Factor.
2. If the Peak values are less than the Average limit of 54 dBuV/m, the Average result is deemed to comply with Average limit.
3. Peak: Peak detector.
4. AVG:  $VBW=1/Ton$ , where: Ton is the transmitting duration.
5. For the transmitting duration, please refer to clause 7.5.
6. Filter losses were only considered in the spurious frequency bands and the authorized band was not corrected for High Pass Filter losses.
7. Proper operation of the transmitter prior to adding the filter to the measurement chain.
8. All modes, channels and antennas have been tested, only the worst data was recorded in the report.

For Radiate Spurious emission 9kHz-30MHz:

Note:

1. Measurement = Reading Level + Correct Factor.
2. If the Peak values are less than the QP limit, the QP result is deemed to comply with QP limit.
3. All 3 polarizations (Horizontal, Face-on and Face-off) of the loop antenna had been tested, but only the worst data recorded in the report.
4. All modes, channels and antennas have been tested, only the worst data was recorded in the report.

For Radiate Spurious emission 18GHz-26GHz:

Note:

1. Measurement = Reading Level + Correct Factor.
2. If the Peak values are less than the Average limit of 54 dBuV/m, the Average result is deemed to comply with Average limit.
3. Peak: Peak detector.
4. All modes, channels and antennas have been tested, only the worst data was recorded in the report.

For Radiate Spurious emission 30MHz-1GHz:

Note:

1. Result Level = Read Level + Correct Factor.
2. If the Peak values are less than the QP limit, the QP result is deemed to comply with QP limit.
3. Test setup: RBW: 120 kHz, VBW: 300 kHz, Sweep time: auto.
4. All modes, channels and antennas have been tested, only the worst data was recorded in the report.

**TEST SETUP**

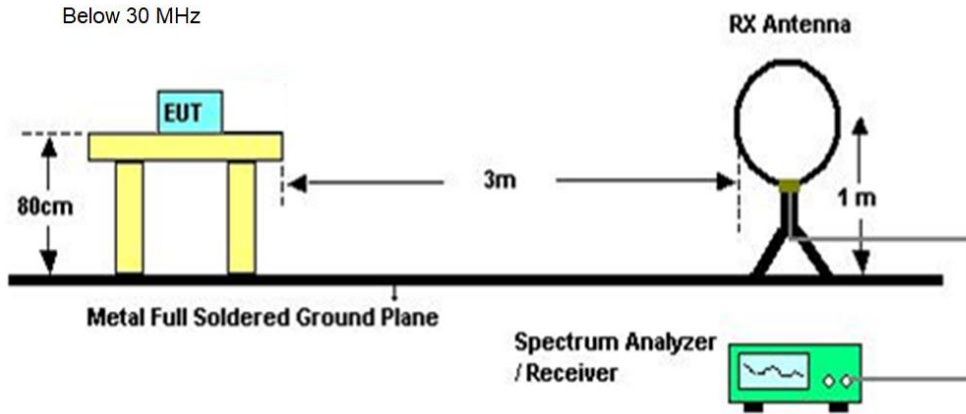

Below 1 GHz and above 30 MHz

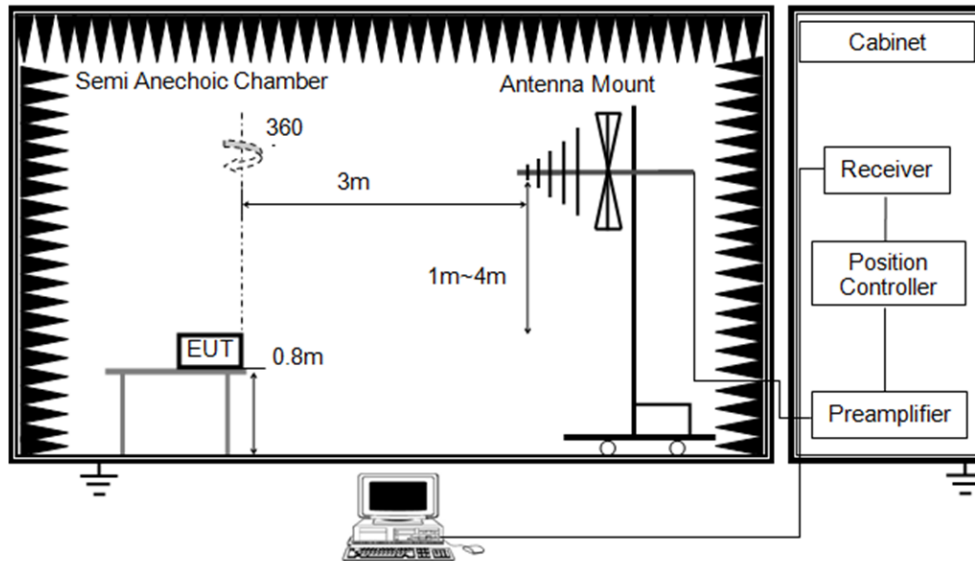

Above 1 GHz

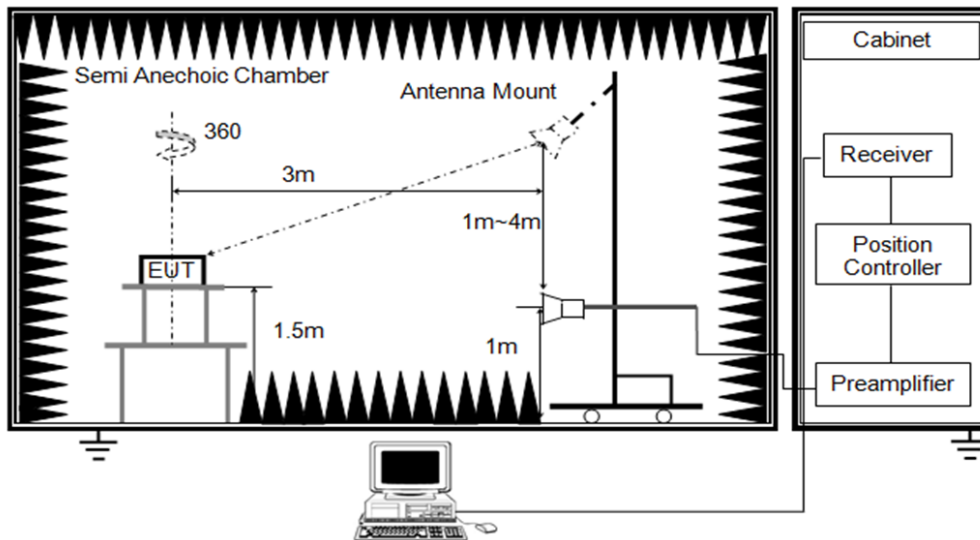



**TEST ENVIRONMENT**

Temperature	25.4°C	Relative Humidity	62%
Atmosphere Pressure	101kPa	Test Voltage	DC 12 V

**TEST DATE / ENGINEER**

Test Date	April 18, 2023	Test By	Rex Huang
-----------	----------------	---------	-----------

**TEST RESULTS**

### 8.1. RESTRICTED BANDEDGE

Test Mode:	802.11b PK	Channel:	2412
Polarity:	Horizontal	Test Voltage:	DC 12 V

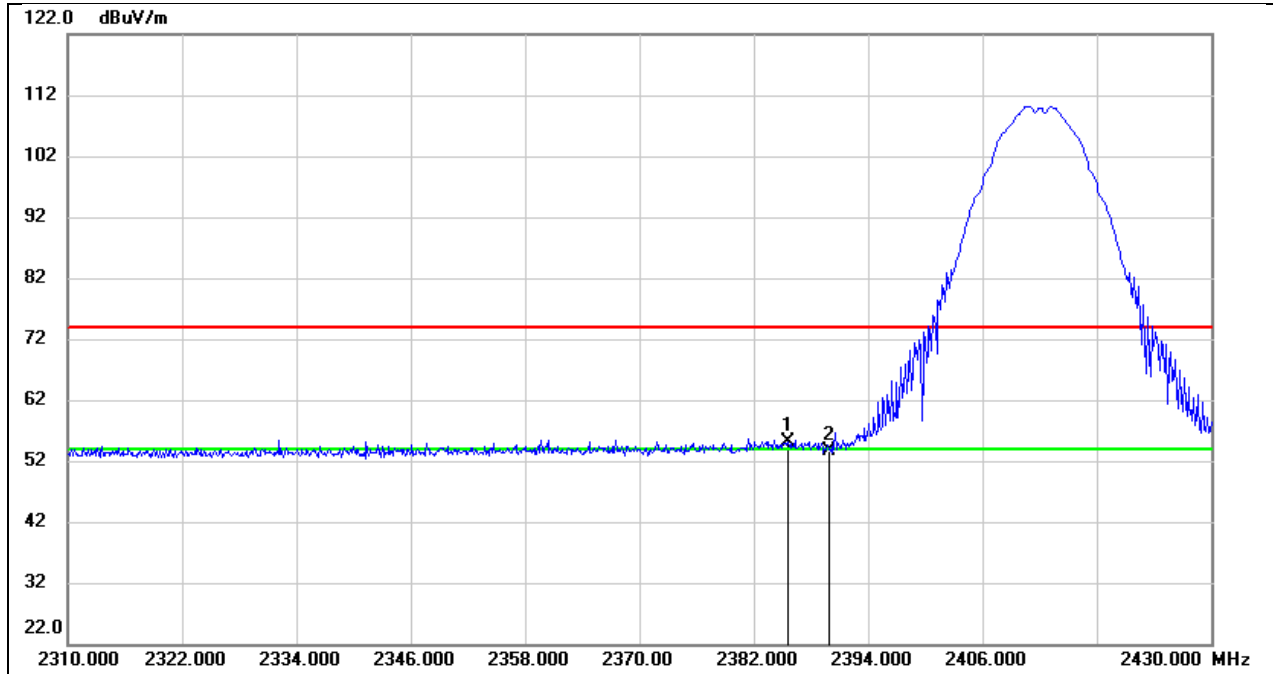

No.	Frequency (MHz)	Reading (dBuV)	Correct (dB/m)	Result (dBuV/m)	Limit (dBuV/m)	Margin (dB)	Remark
1	2385.600	19.89	35.14	55.03	74.00	-18.97	peak
2	2390.000	18.53	35.16	53.69	74.00	-20.31	peak

Test Mode:	802.11b AV	Channel:	2412
Polarity:	Horizontal	Test Voltage:	DC 12 V

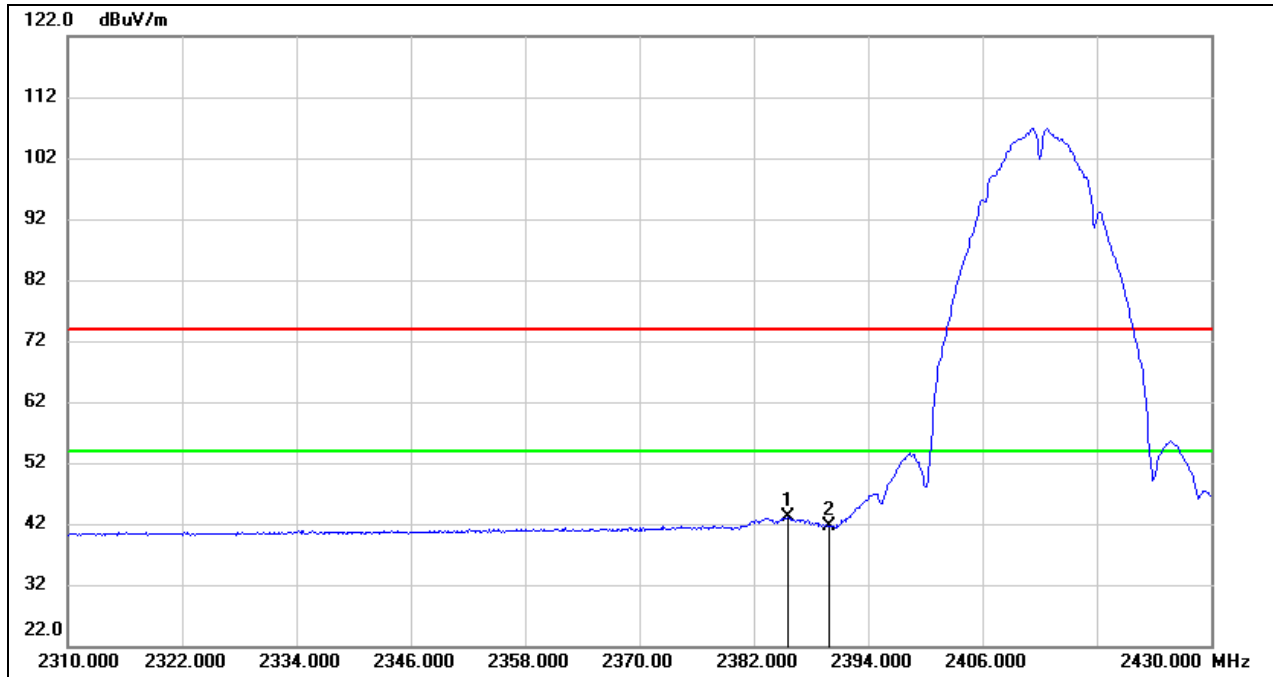

No.	Frequency (MHz)	Reading (dBuV)	Correct (dB/m)	Result (dBuV/m)	Limit (dBuV/m)	Margin (dB)	Remark
1	2385.600	7.90	35.14	43.04	54.00	-10.96	AVG
2	2390.000	6.36	35.16	41.52	54.00	-12.48	AVG

Test Mode:	802.11b PK	Channel:	2412
Polarity:	Vertical	Test Voltage:	DC 12 V

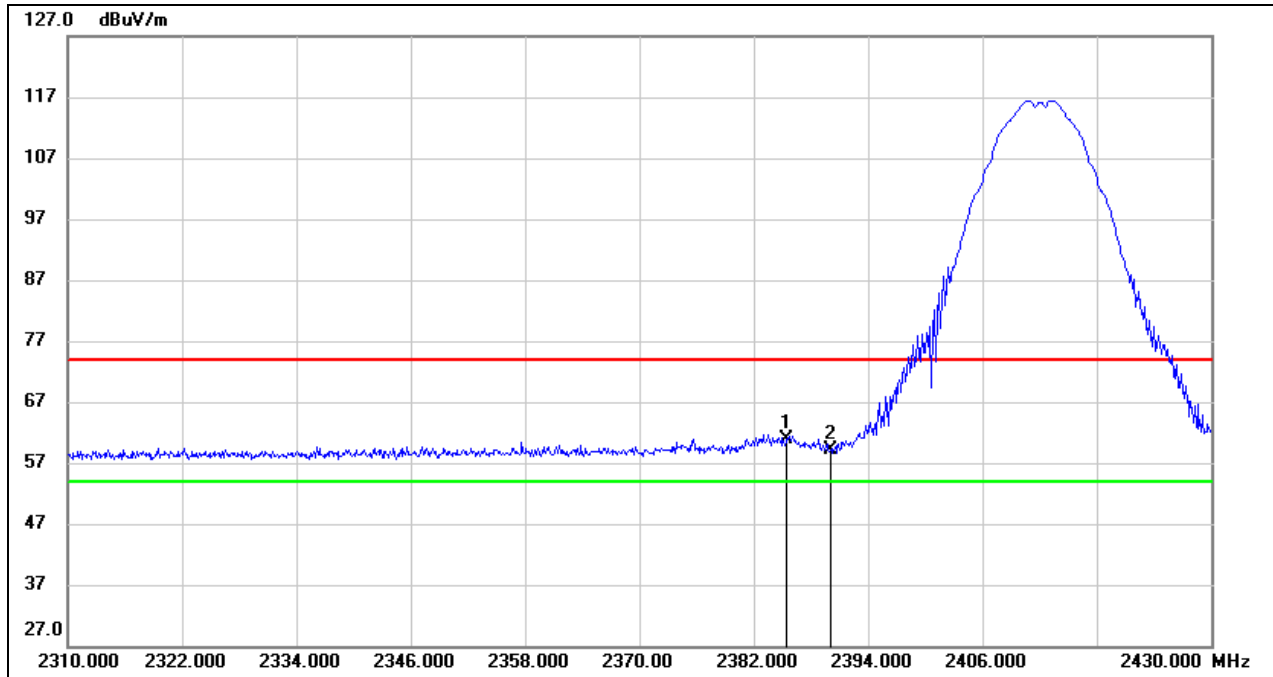

No.	Frequency (MHz)	Reading (dBuV)	Correct (dB/m)	Result (dBuV/m)	Limit (dBuV/m)	Margin (dB)	Remark
1	2385.480	25.71	35.14	60.85	74.00	-13.15	peak
2	2390.000	23.88	35.16	59.04	74.00	-14.96	peak

Test Mode:	802.11b AV	Channel:	2412
Polarity:	Vertical	Test Voltage:	DC 12 V

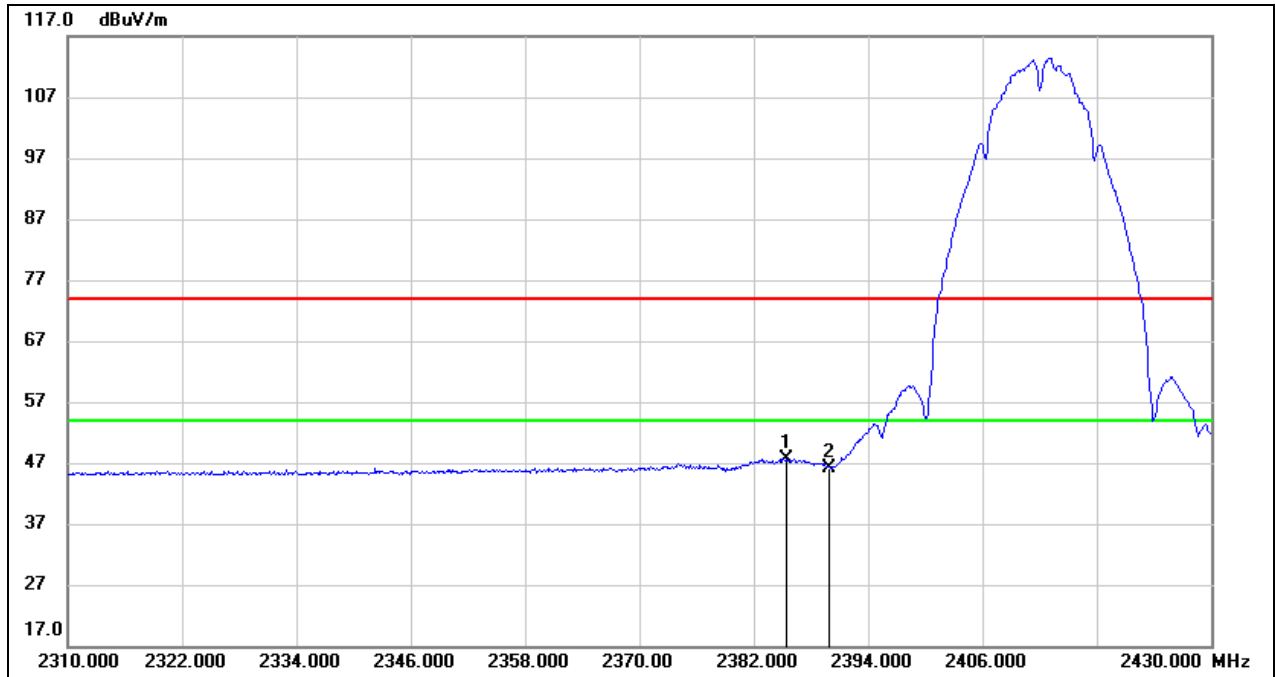

No.	Frequency (MHz)	Reading (dBuV)	Correct (dB/m)	Result (dBuV/m)	Limit (dBuV/m)	Margin (dB)	Remark
1	2385.480	12.54	35.14	47.68	54.00	-6.32	AVG
2	2390.000	10.94	35.16	46.10	54.00	-7.90	AVG

Test Mode:	802.11b PK	Channel:	2462
Polarity:	Vertical	Test Voltage:	DC 12 V

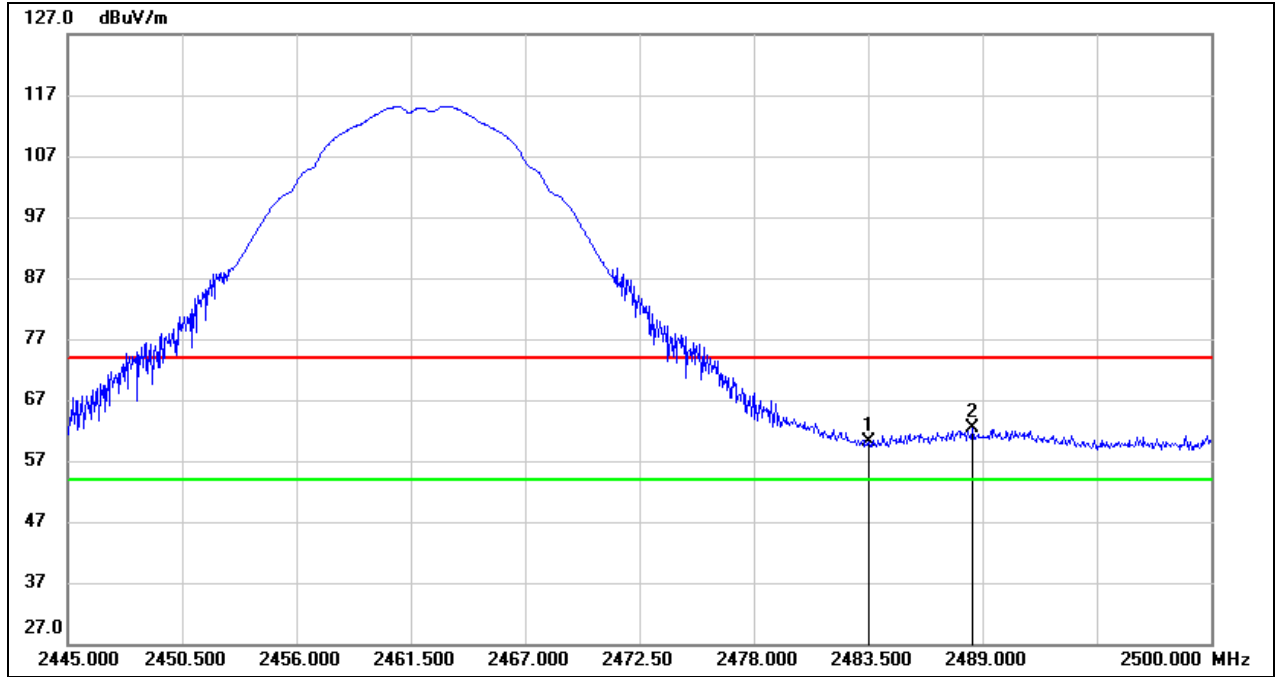

No.	Frequency (MHz)	Reading (dBuV)	Correct (dB/m)	Result (dBuV/m)	Limit (dBuV/m)	Margin (dB)	Remark
1	2483.500	24.61	35.44	60.05	74.00	-13.95	peak
2	2488.505	26.92	35.46	62.38	74.00	-11.62	peak

Test Mode:	802.11b AV	Channel:	2462
Polarity:	Vertical	Test Voltage:	DC 12 V

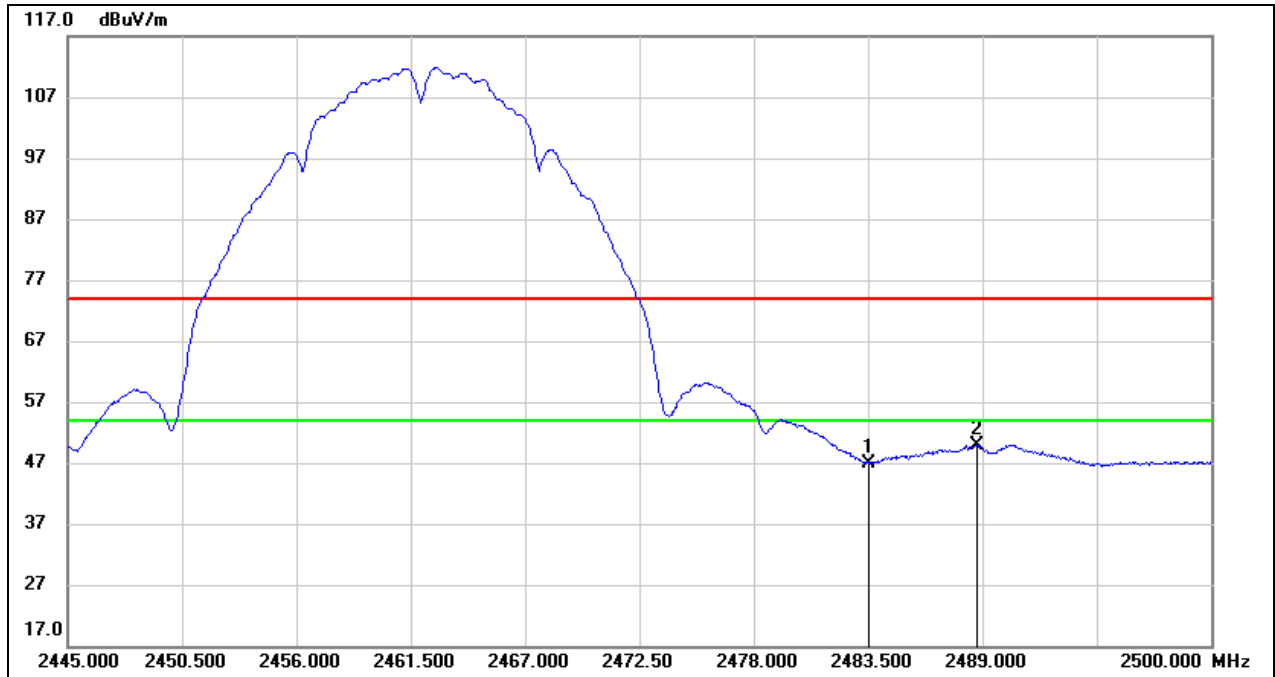

No.	Frequency (MHz)	Reading (dBuV)	Correct (dB/m)	Result (dBuV/m)	Limit (dBuV/m)	Margin (dB)	Remark
1	2483.500	11.55	35.44	46.99	54.00	-7.01	AVG
2	2488.725	14.45	35.46	49.91	54.00	-4.09	AVG

Test Mode:	802.11g PK	Channel:	2412
Polarity:	Vertical	Test Voltage:	DC 12 V

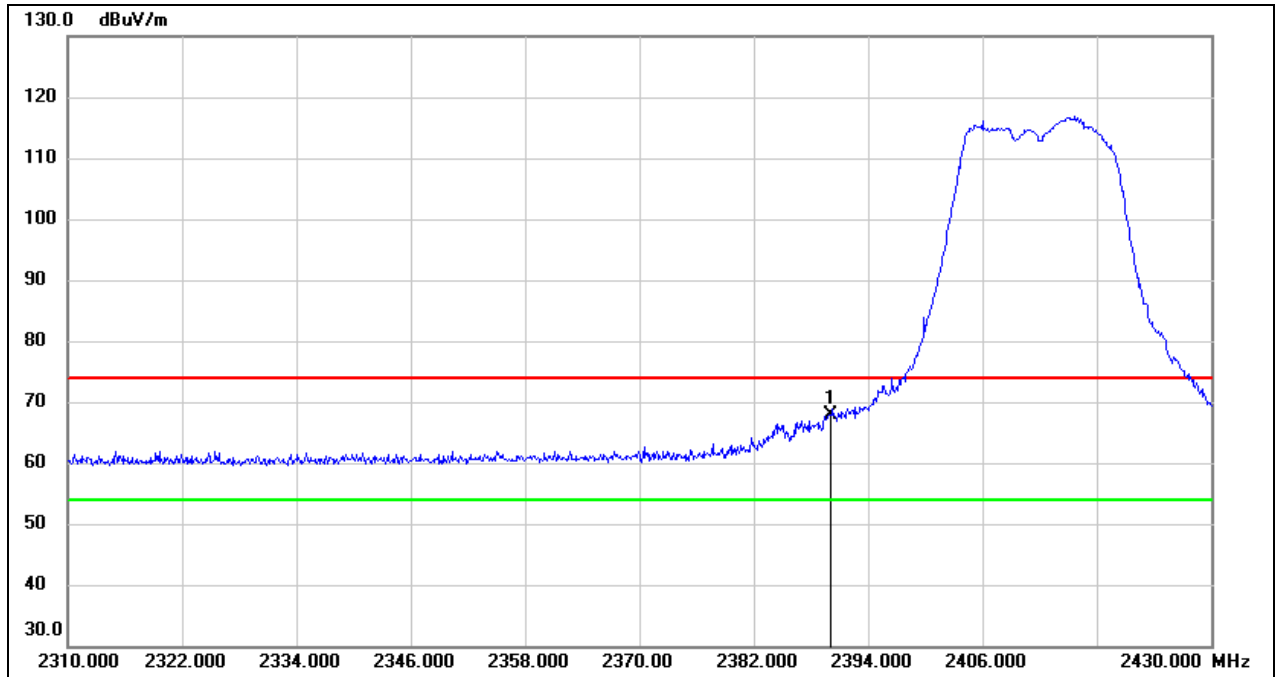

No.	Frequency (MHz)	Reading (dBuV)	Correct (dB/m)	Result (dBuV/m)	Limit (dBuV/m)	Margin (dB)	Remark
1	2390.000	35.77	32.16	67.93	74.00	-6.07	peak



Test Mode:	802.11g AV	Channel:	2412
Polarity:	Vertical	Test Voltage:	DC 12 V

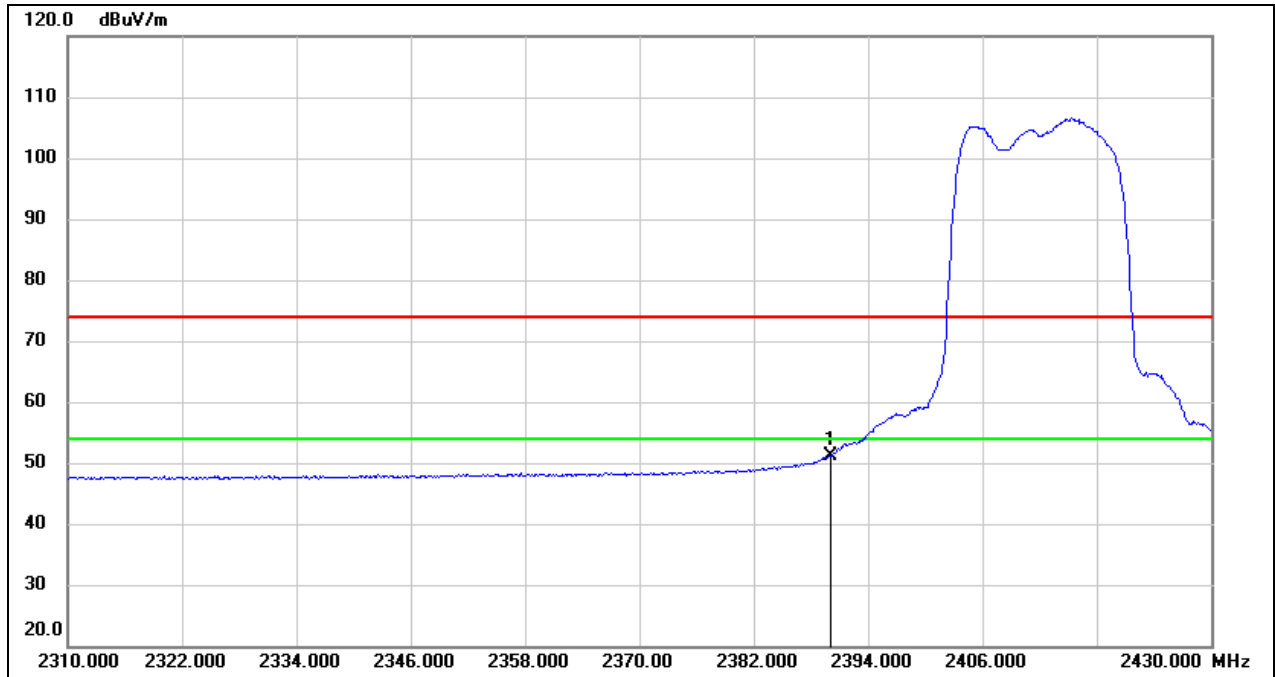

No.	Frequency (MHz)	Reading (dBuV)	Correct (dB/m)	Result (dBuV/m)	Limit (dBuV/m)	Margin (dB)	Remark
1	2390.000	19.08	32.16	51.24	54.00	-2.76	AVG

Test Mode:	802.11g PK	Channel:	2417
Polarity:	Vertical	Test Voltage:	DC 12 V

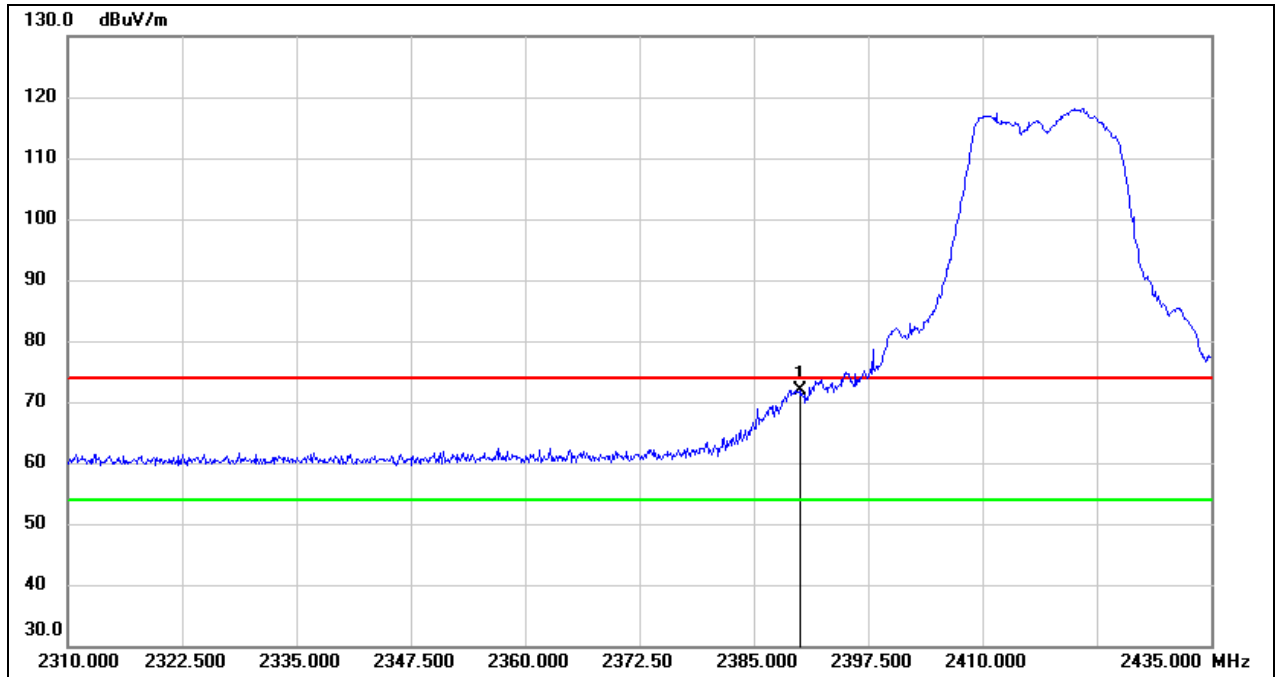

No.	Frequency (MHz)	Reading (dBuV)	Correct (dB/m)	Result (dBuV/m)	Limit (dBuV/m)	Margin (dB)	Remark
1	2390.000	39.64	32.16	71.80	74.00	-2.20	peak

Test Mode:	802.11g AV	Channel:	2417
Polarity:	Vertical	Test Voltage:	DC 12 V

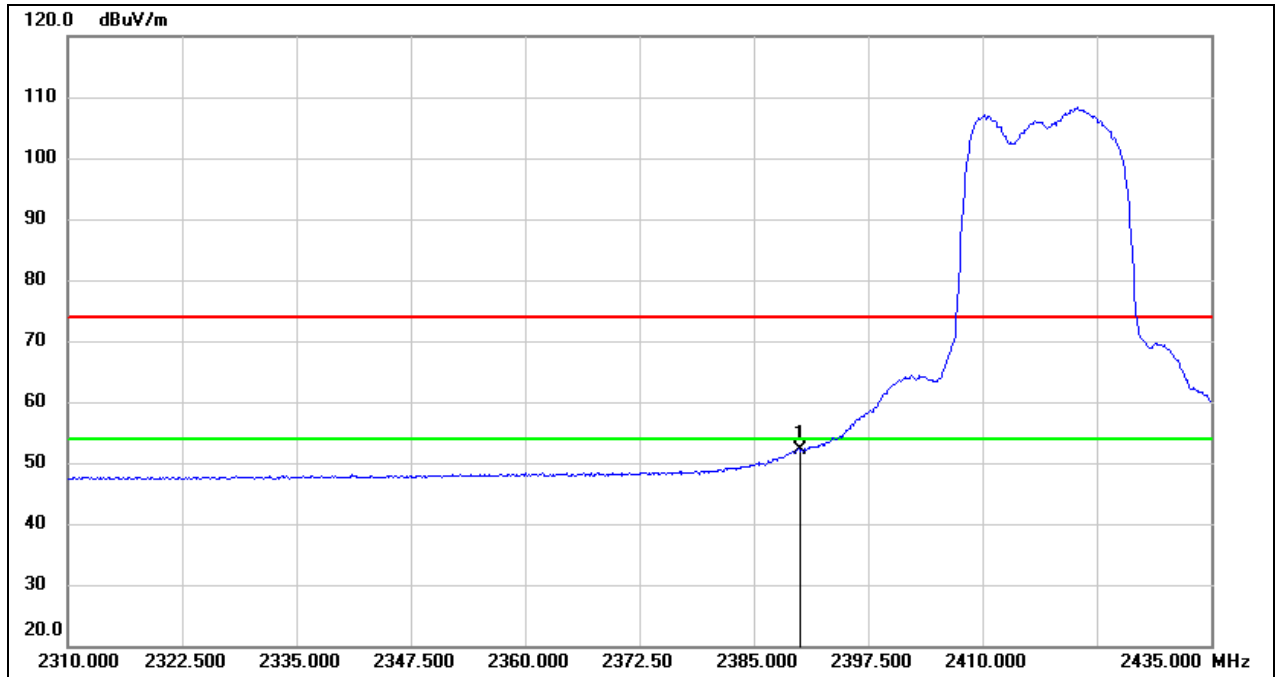

No.	Frequency (MHz)	Reading (dBuV)	Correct (dB/m)	Result (dBuV/m)	Limit (dBuV/m)	Margin (dB)	Remark
1	2390.000	19.87	32.16	52.03	54.00	-1.97	AVG

Test Mode:	802.11g PK	Channel:	2437
Polarity:	Vertical	Test Voltage:	DC 12 V

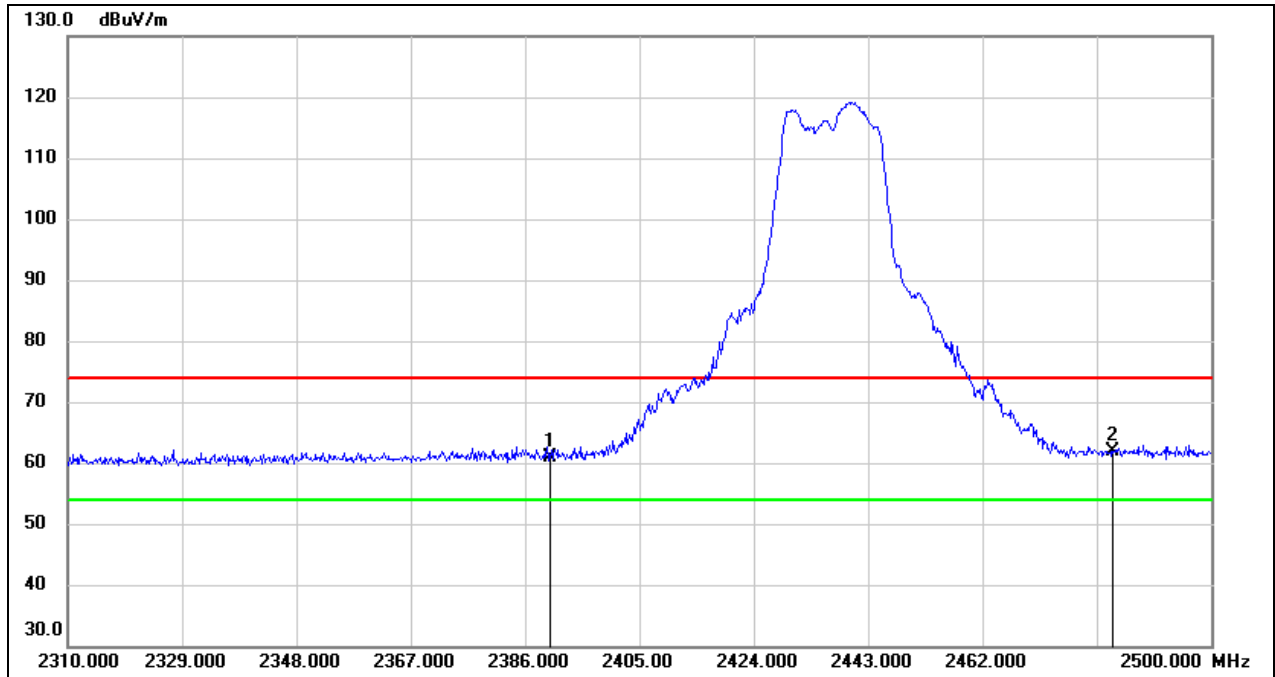

No.	Frequency (MHz)	Reading (dBuV)	Correct (dB/m)	Result (dBuV/m)	Limit (dBuV/m)	Margin (dB)	Remark
1	2390.000	28.61	32.16	60.77	74.00	-13.23	peak
2	2483.500	29.55	32.44	61.99	74.00	-12.01	peak

Test Mode:	802.11g AV	Channel:	2437
Polarity:	Vertical	Test Voltage:	DC 12 V

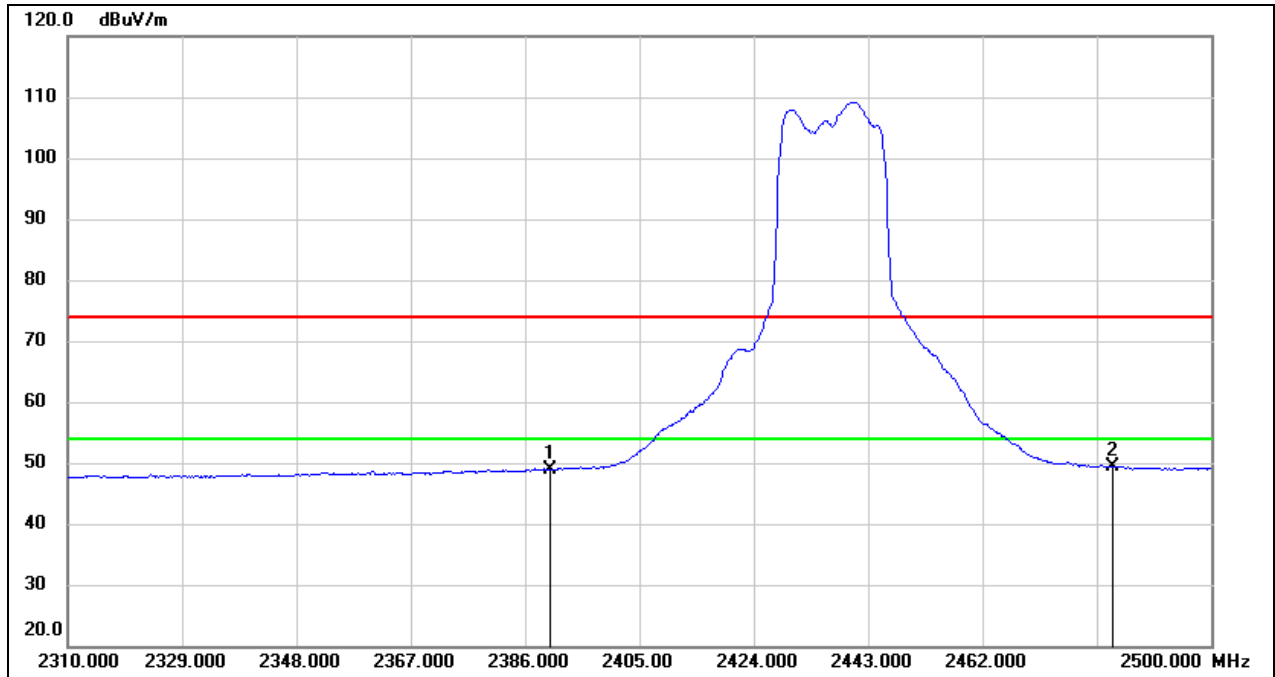

No.	Frequency (MHz)	Reading (dBuV)	Correct (dB/m)	Result (dBuV/m)	Limit (dBuV/m)	Margin (dB)	Remark
1	2390.000	16.66	32.16	48.82	54.00	-5.18	AVG
2	2483.500	17.01	32.44	49.45	54.00	-4.55	AVG

Test Mode:	802.11g PK	Channel:	2457
Polarity:	Vertical	Test Voltage:	DC 12 V

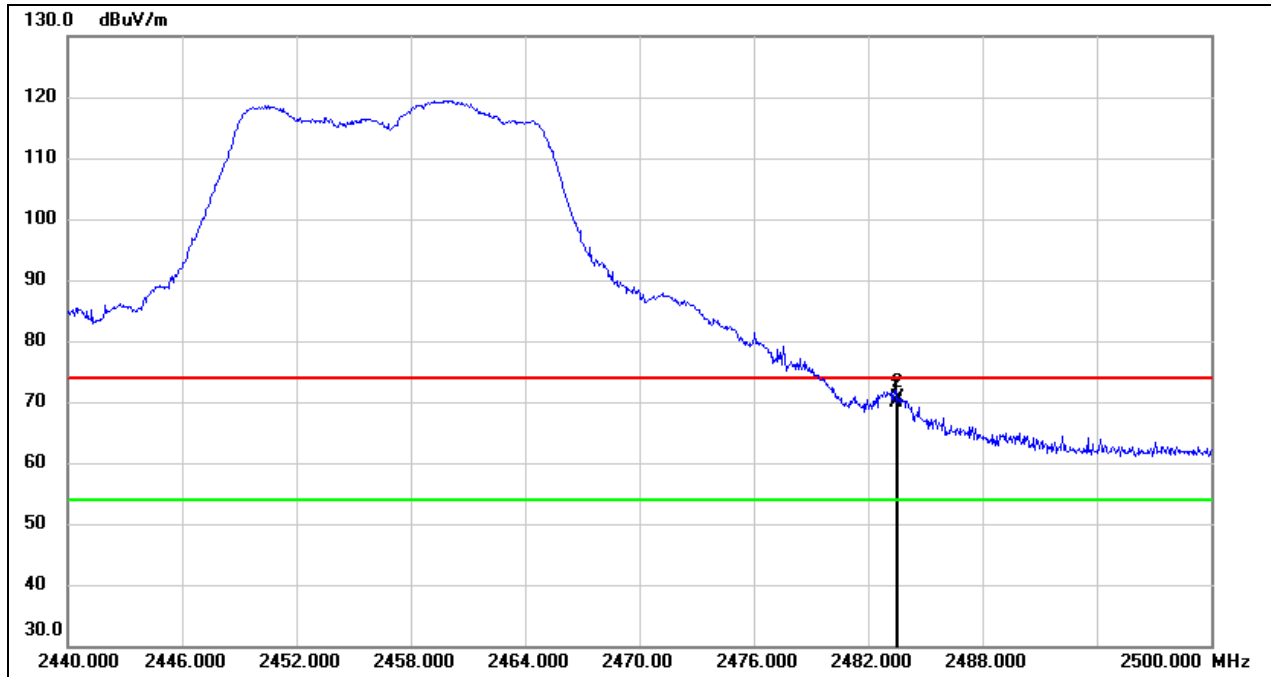

No.	Frequency (MHz)	Reading (dBuV)	Correct (dB/m)	Result (dBuV/m)	Limit (dBuV/m)	Margin (dB)	Remark
1	2483.500	37.48	32.44	69.92	74.00	-4.08	peak
2	2483.560	38.29	32.44	70.73	74.00	-3.27	peak

Test Mode:	802.11g AV	Channel:	2457
Polarity:	Vertical	Test Voltage:	DC 12 V

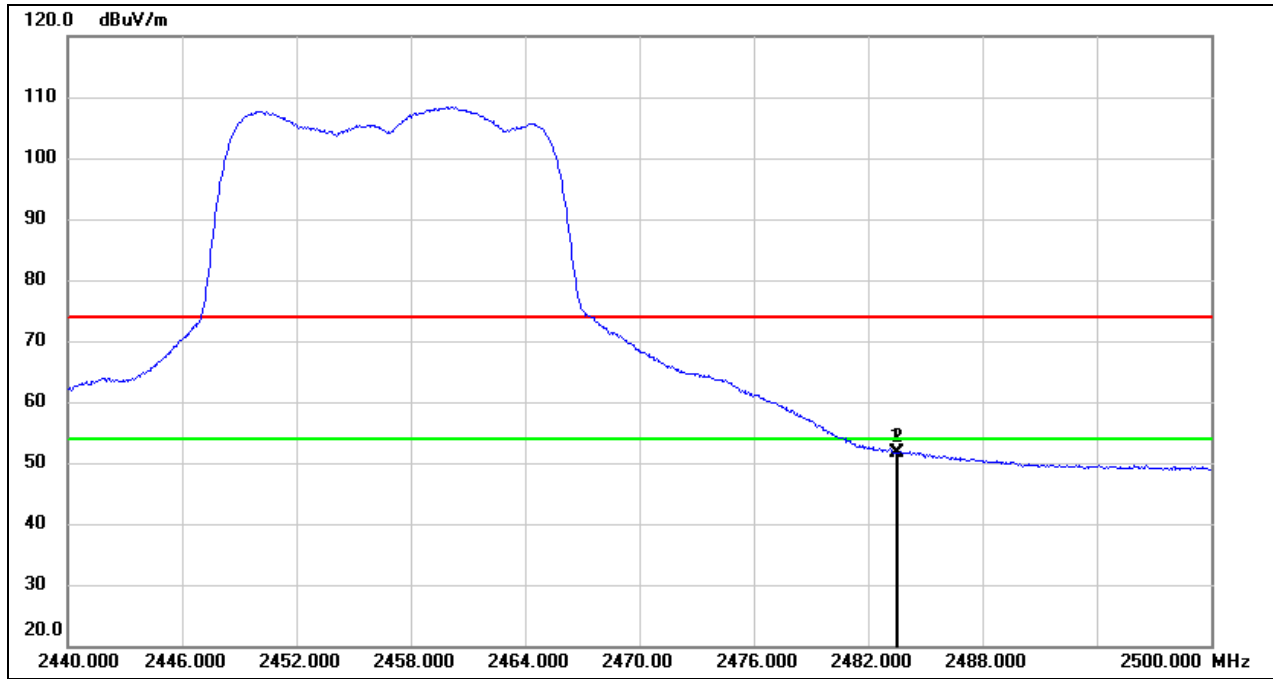

No.	Frequency (MHz)	Reading (dBuV)	Correct (dB/m)	Result (dBuV/m)	Limit (dBuV/m)	Margin (dB)	Remark
1	2483.500	19.18	32.44	51.62	54.00	-2.38	AVG
2	2483.560	19.28	32.44	51.72	54.00	-2.28	AVG

Test Mode:	802.11g PK	Channel:	2462
Polarity:	Vertical	Test Voltage:	DC 12 V

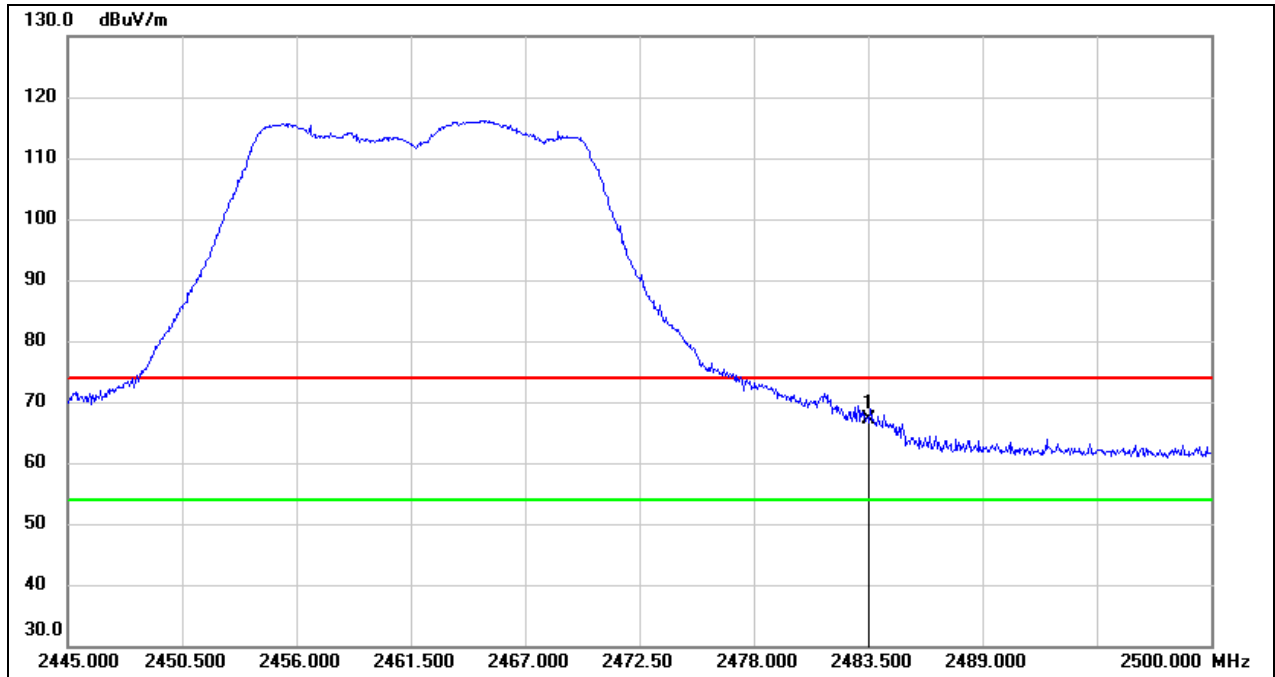

No.	Frequency (MHz)	Reading (dBuV)	Correct (dB/m)	Result (dBuV/m)	Limit (dBuV/m)	Margin (dB)	Remark
1	2483.500	34.77	32.44	67.21	74.00	-6.79	peak



Test Mode:	802.11g AV	Channel:	2462
Polarity:	Vertical	Test Voltage:	DC 12 V

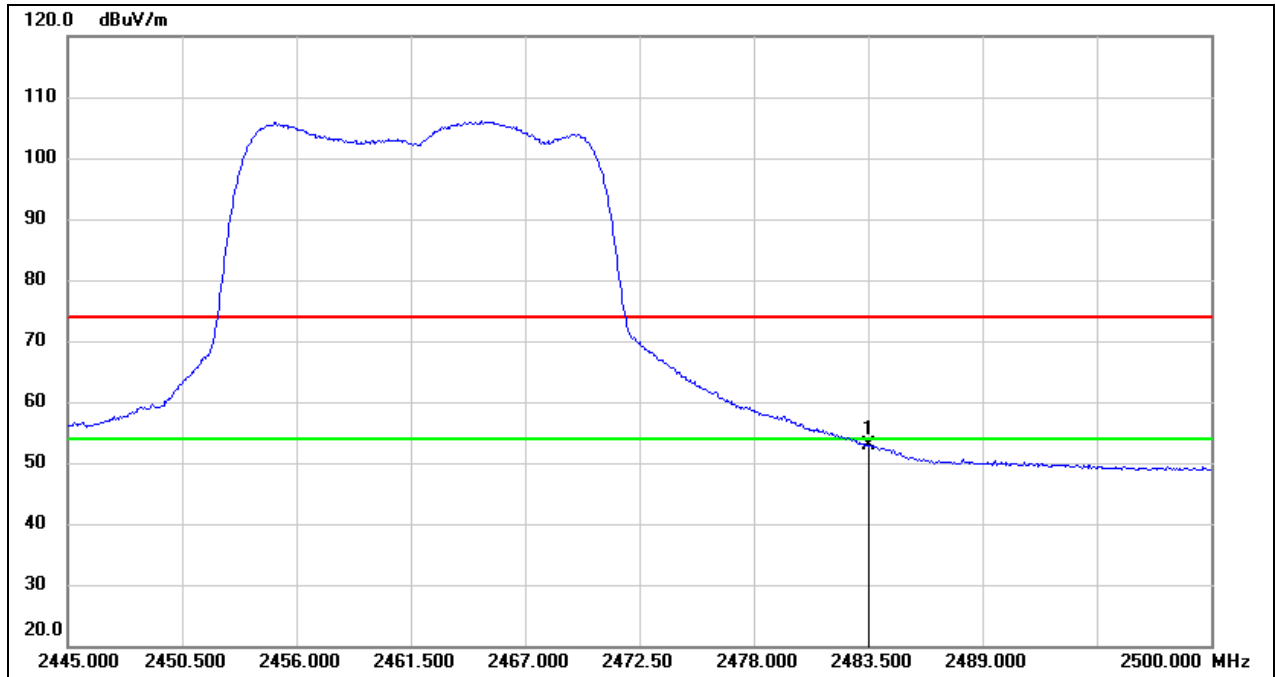

No.	Frequency (MHz)	Reading (dBuV)	Correct (dB/m)	Result (dBuV/m)	Limit (dBuV/m)	Margin (dB)	Remark
1	2483.500	20.36	32.44	52.80	54.00	-1.20	AVG

Test Mode:	802.11ax HE20 PK	Channel:	2412
Polarity:	Vertical	Test Voltage:	DC 12 V

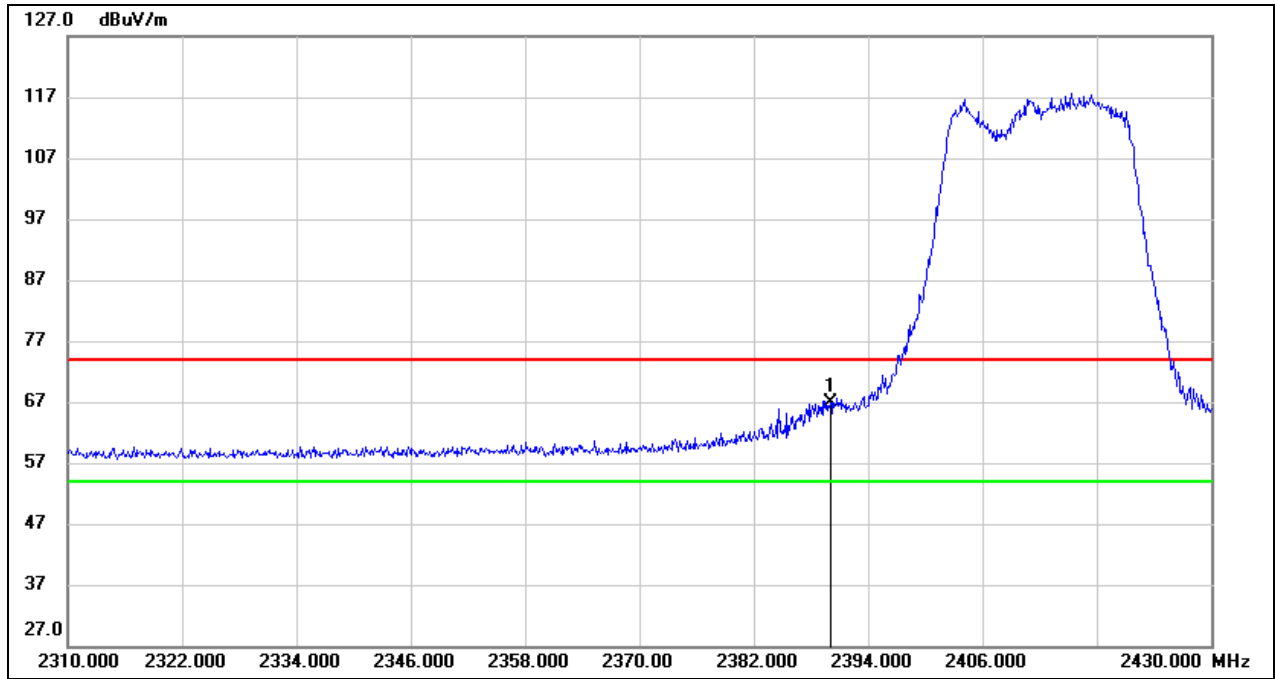

No.	Frequency (MHz)	Reading (dBuV)	Correct (dB/m)	Result (dBuV/m)	Limit (dBuV/m)	Margin (dB)	Remark
1	2390.000	31.76	35.16	66.92	74.00	-7.08	peak

Test Mode:	802.11ax HE20 AV	Channel:	2412
Polarity:	Vertical	Test Voltage:	DC 12 V

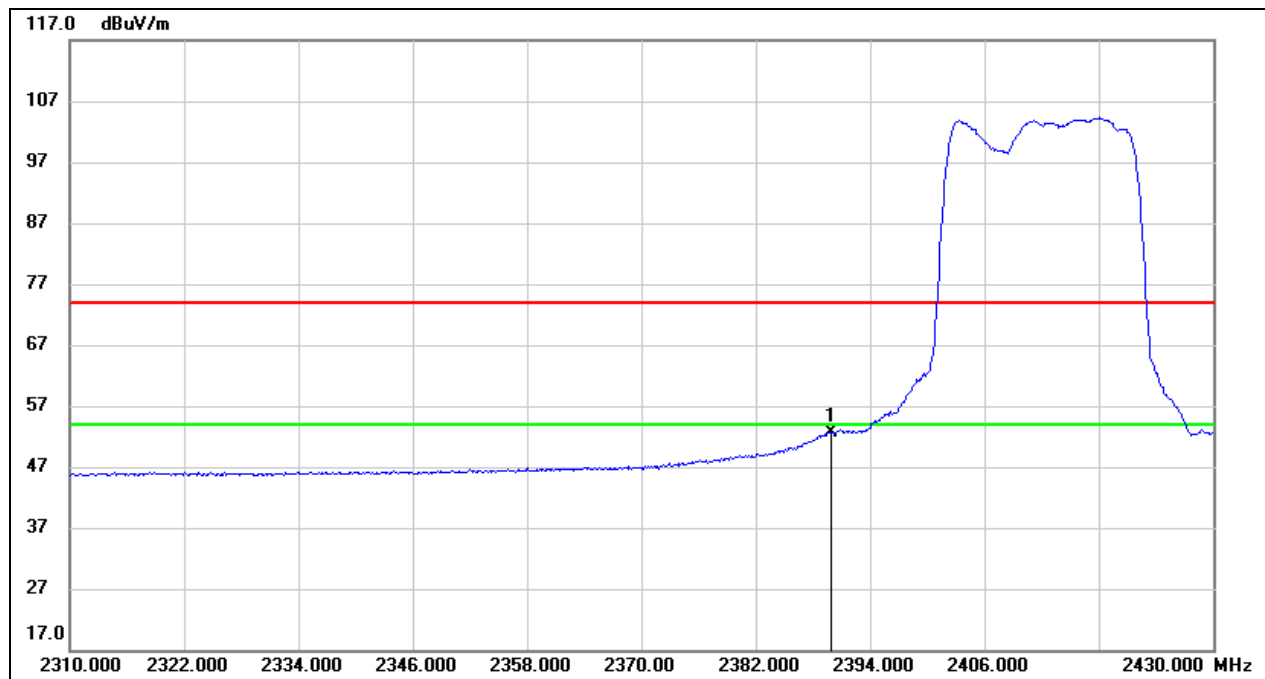

No.	Frequency (MHz)	Reading (dBuV)	Correct (dB/m)	Result (dBuV/m)	Limit (dBuV/m)	Margin (dB)	Remark
1	2390.000	17.35	35.16	52.51	54.00	-1.49	AVG

Test Mode:	802.11ax HE20 PK	Channel:	2417
Polarity:	Vertical	Test Voltage:	DC 12 V

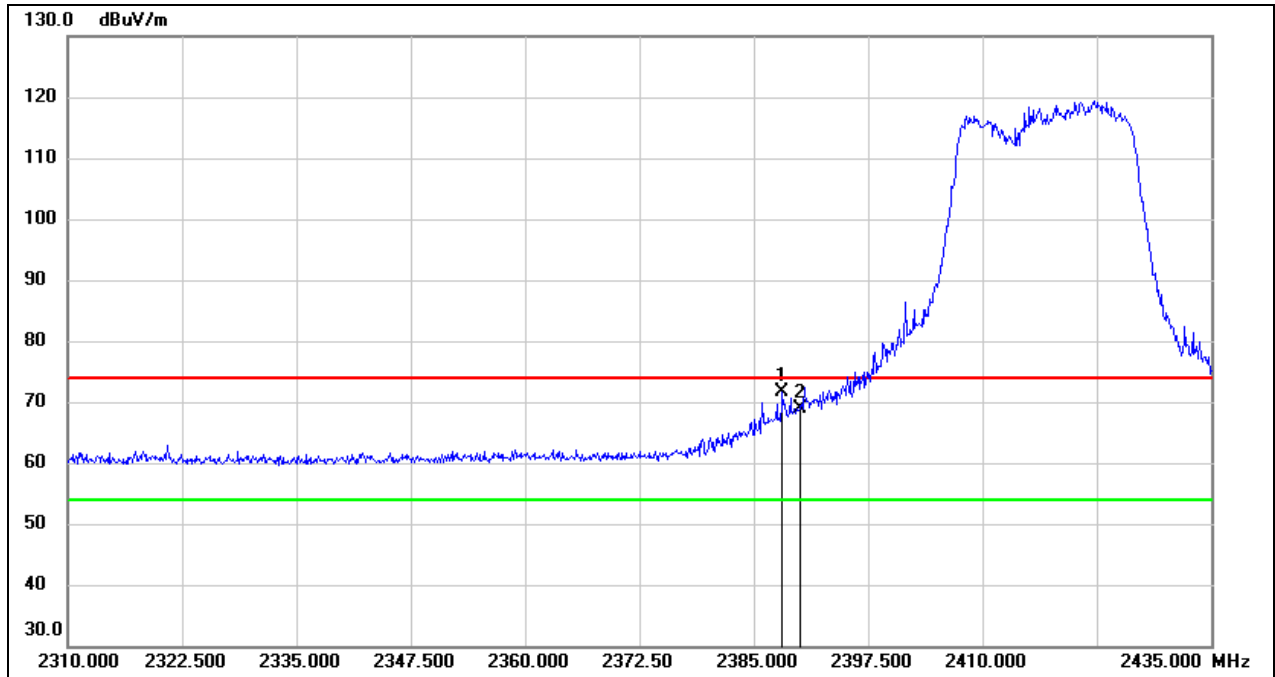

No.	Frequency (MHz)	Reading (dBuV)	Correct (dB/m)	Result (dBuV/m)	Limit (dBuV/m)	Margin (dB)	Remark
1	2388.125	39.46	32.16	71.62	74.00	-2.38	peak
2	2390.000	36.77	32.16	68.93	74.00	-5.07	peak

Test Mode:	802.11ax HE20 AV	Channel:	2417
Polarity:	Vertical	Test Voltage:	DC 12 V

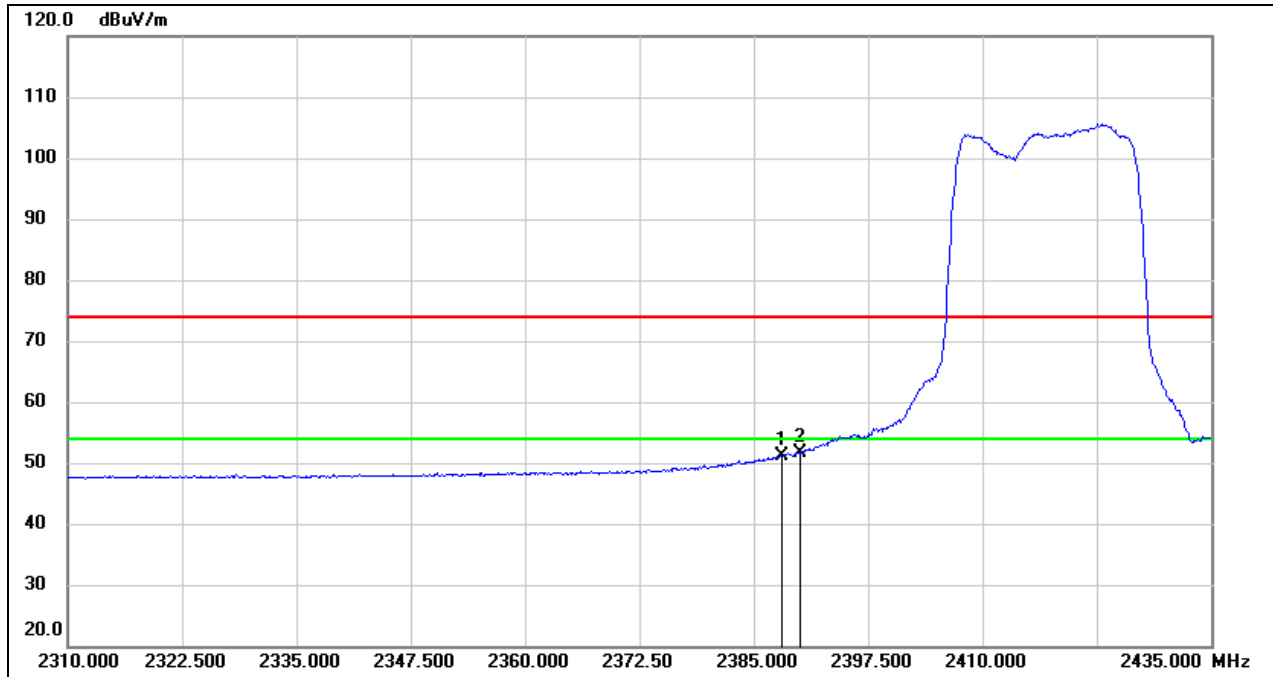

No.	Frequency (MHz)	Reading (dBuV)	Correct (dB/m)	Result (dBuV/m)	Limit (dBuV/m)	Margin (dB)	Remark
1	2388.125	18.89	32.16	51.05	54.00	-2.95	AVG
2	2390.000	19.59	32.16	51.75	54.00	-2.25	AVG

Test Mode:	802.11ax HE20 PK	Channel:	2437
Polarity:	Vertical	Test Voltage:	DC 12 V

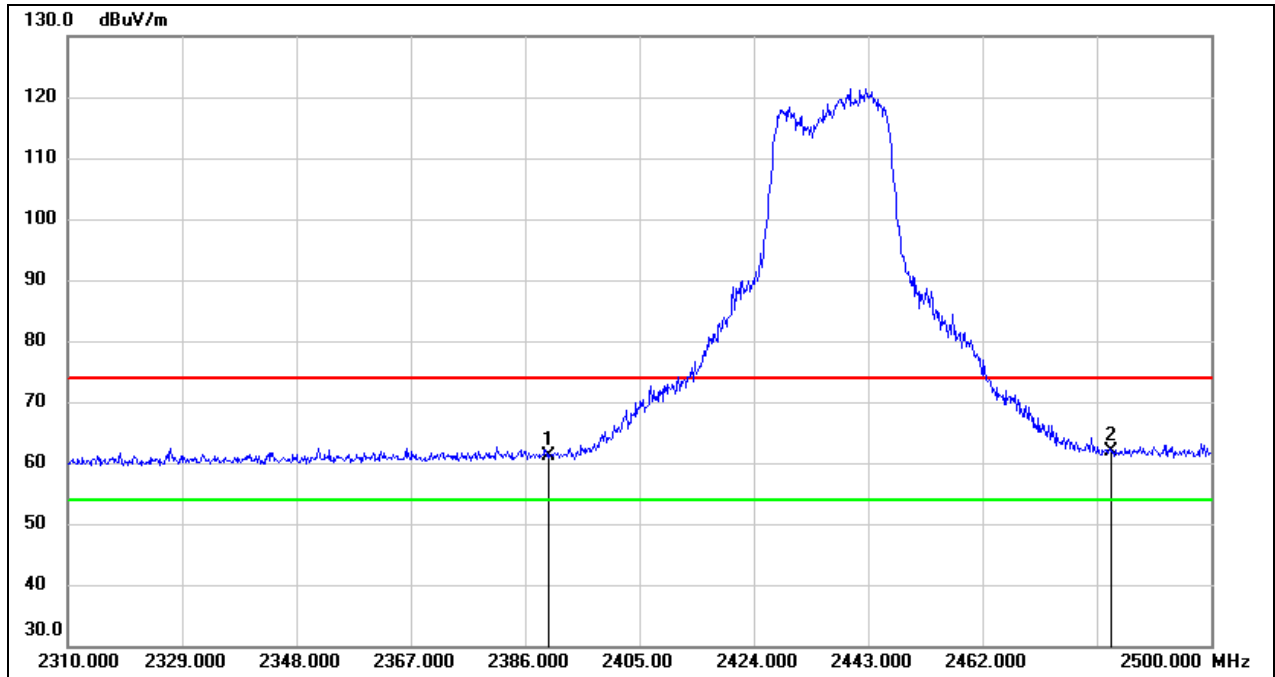

No.	Frequency (MHz)	Reading (dBuV)	Correct (dB/m)	Result (dBuV/m)	Limit (dBuV/m)	Margin (dB)	Remark
1	2390.000	28.92	32.16	61.08	74.00	-12.92	peak
2	2483.500	29.52	32.44	61.96	74.00	-12.04	peak

Test Mode:	802.11ax HE20 AV	Channel:	2437
Polarity:	Vertical	Test Voltage:	DC 12 V

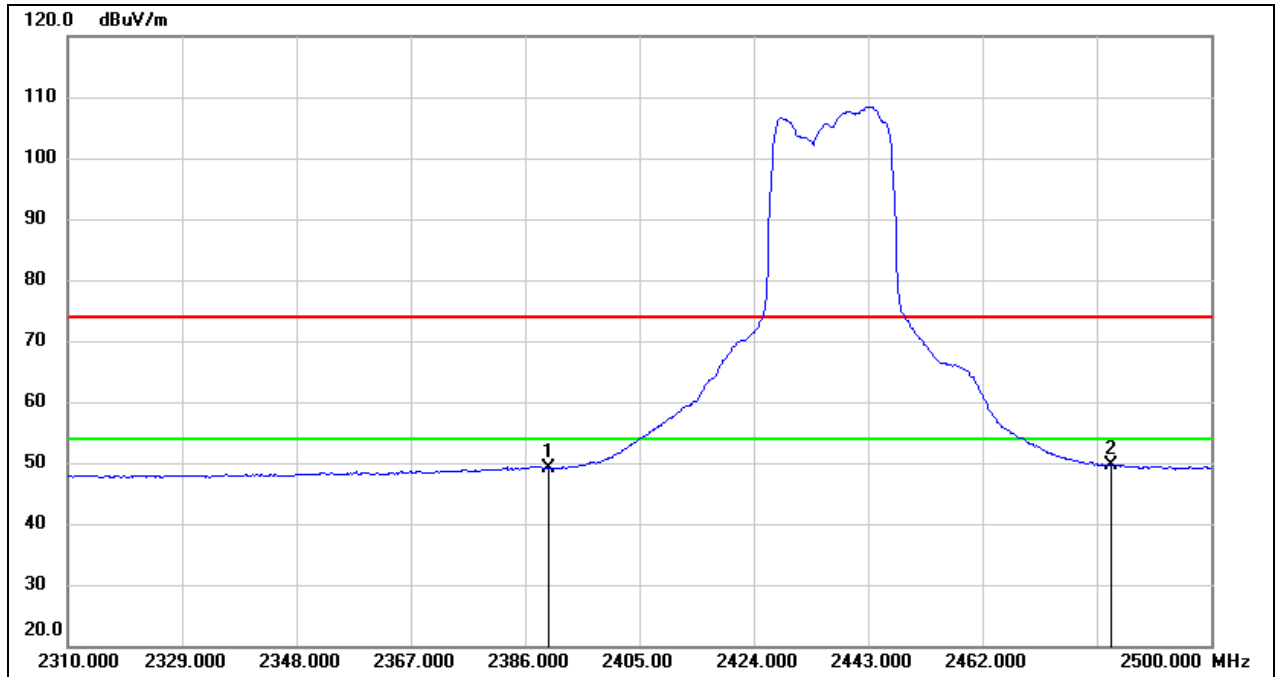

No.	Frequency (MHz)	Reading (dBuV)	Correct (dB/m)	Result (dBuV/m)	Limit (dBuV/m)	Margin (dB)	Remark
1	2390.000	17.00	32.16	49.16	54.00	-4.84	AVG
2	2483.500	17.07	32.44	49.51	54.00	-4.49	AVG

Test Mode:	802.11ax HE20 PK	Channel:	2457
Polarity:	Vertical	Test Voltage:	DC 12 V

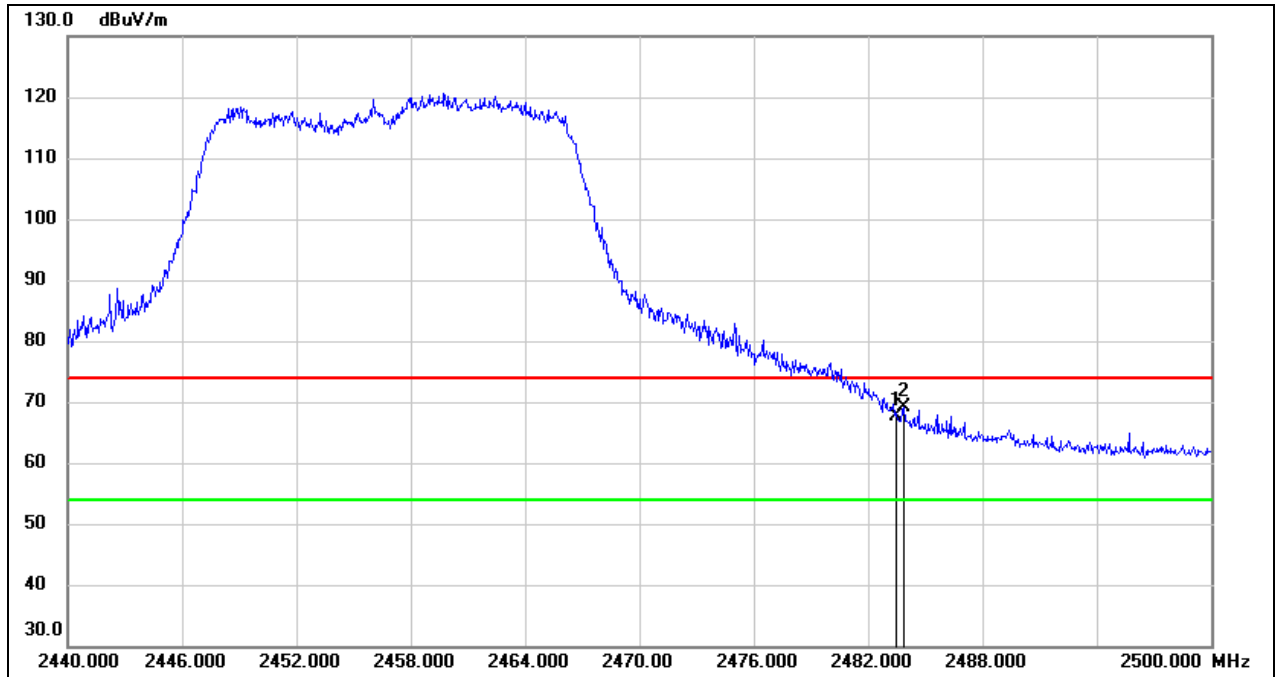

No.	Frequency (MHz)	Reading (dBuV)	Correct (dB/m)	Result (dBuV/m)	Limit (dBuV/m)	Margin (dB)	Remark
1	2483.500	35.28	32.44	67.72	74.00	-6.28	peak
2	2483.860	36.75	32.44	69.19	74.00	-4.81	peak



Test Mode:	802.11ax HE20 AV	Channel:	2457
Polarity:	Vertical	Test Voltage:	DC 12 V

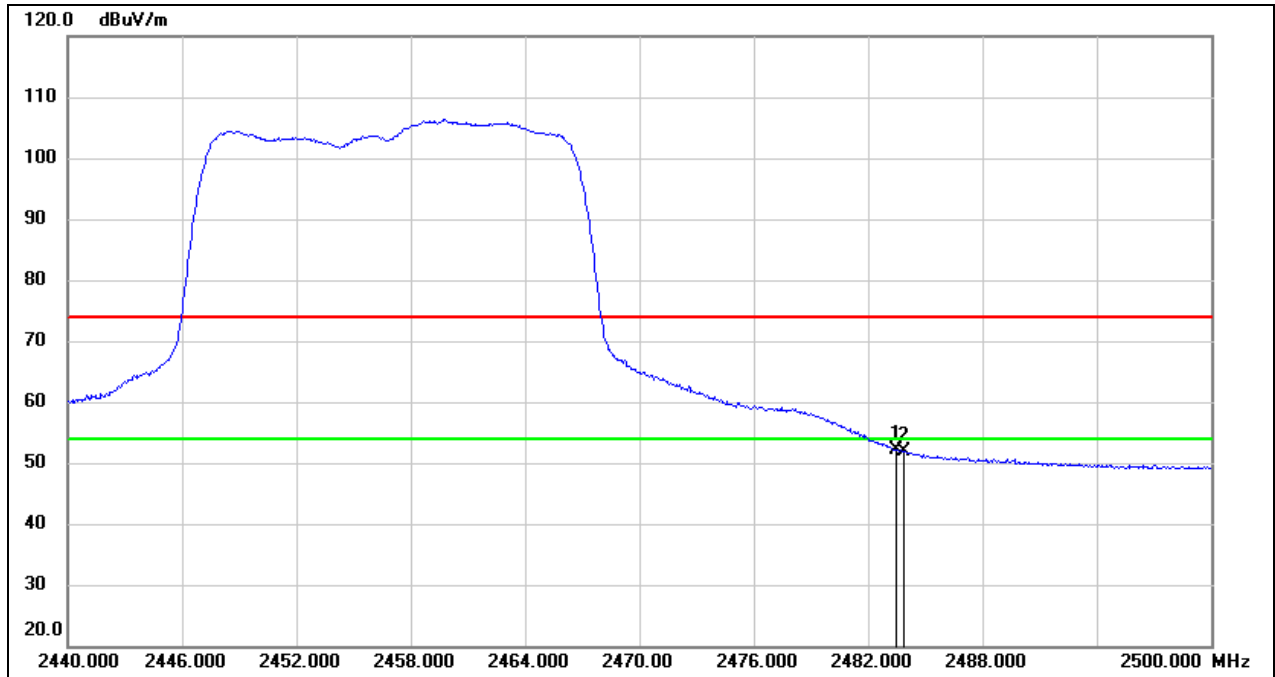

No.	Frequency (MHz)	Reading (dBuV)	Correct (dB/m)	Result (dBuV/m)	Limit (dBuV/m)	Margin (dB)	Remark
1	2483.500	19.60	32.44	52.04	54.00	-1.96	AVG
2	2483.860	19.45	32.44	51.89	54.00	-2.11	AVG

Test Mode:	802.11ax HE20 PK	Channel:	2462
Polarity:	Vertical	Test Voltage:	DC 12 V

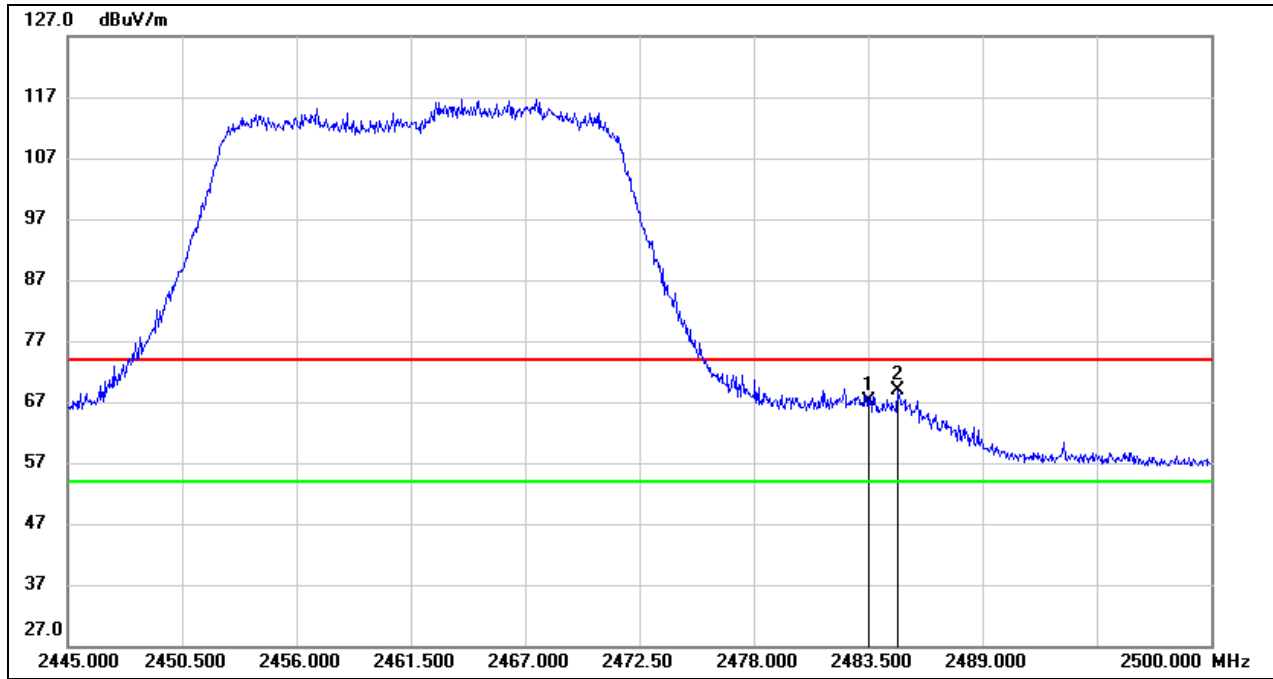

No.	Frequency (MHz)	Reading (dBuV)	Correct (dB/m)	Result (dBuV/m)	Limit (dBuV/m)	Margin (dB)	Remark
1	2483.500	34.75	32.44	67.19	74.00	-6.81	peak
2	2484.930	36.38	32.44	68.82	74.00	-5.18	peak

Test Mode:	802.11ax HE20 AV	Channel:	2462
Polarity:	Vertical	Test Voltage:	DC 12 V

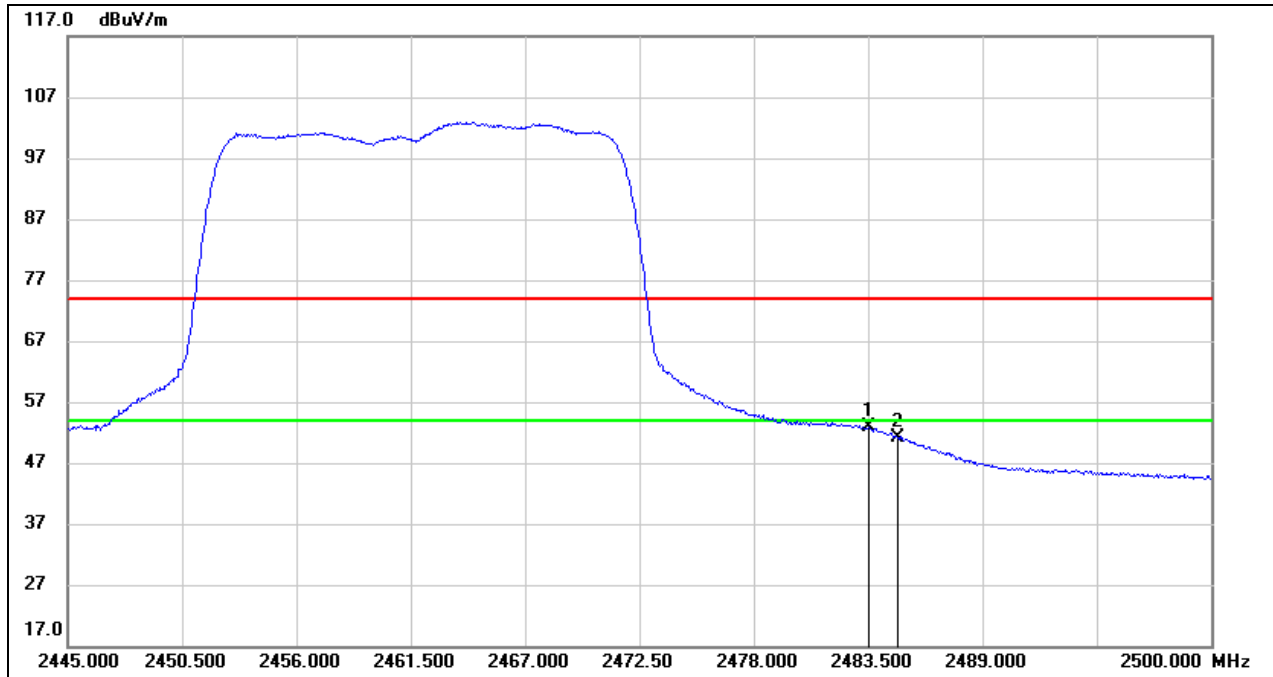

No.	Frequency (MHz)	Reading (dBuV)	Correct (dB/m)	Result (dBuV/m)	Limit (dBuV/m)	Margin (dB)	Remark
1	2483.500	20.45	32.44	52.89	54.00	-1.11	AVG
2	2484.930	18.75	32.44	51.19	54.00	-2.81	AVG

Test Mode:	802.11ax HE40 PK	Channel:	2422
Polarity:	Vertical	Test Voltage:	DC 12 V

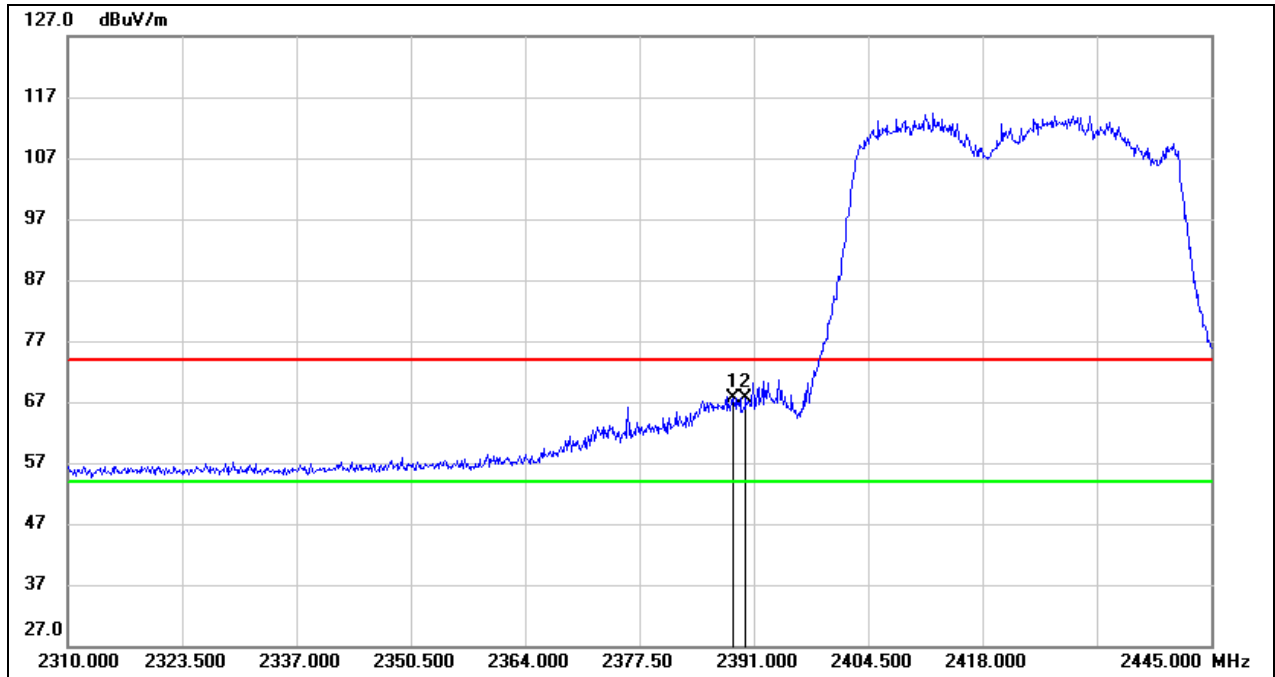

No.	Frequency (MHz)	Reading (dBuV)	Correct (dB/m)	Result (dBuV/m)	Limit (dBuV/m)	Margin (dB)	Remark
1	2388.435	35.39	32.16	67.55	74.00	-6.45	peak
2	2390.000	35.43	32.16	67.59	74.00	-6.41	peak

Test Mode:	802.11ax HE40 AV	Channel:	2422
Polarity:	Vertical	Test Voltage:	DC 12 V

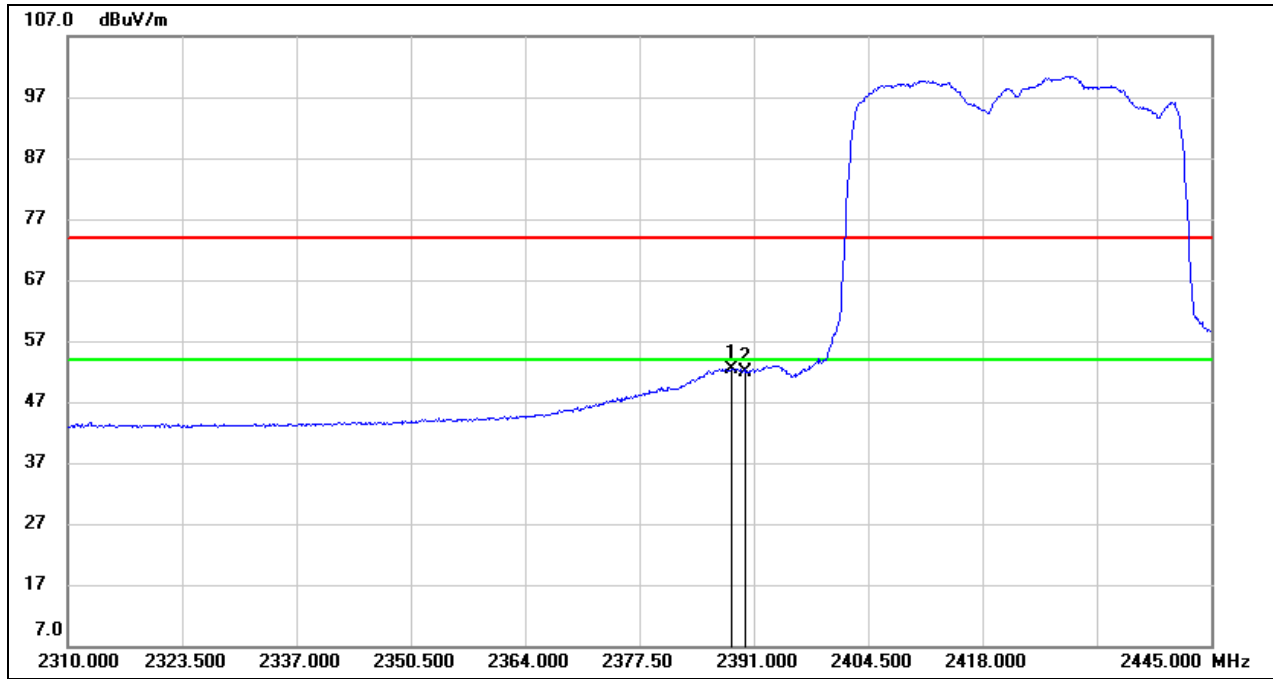

No.	Frequency (MHz)	Reading (dBuV)	Correct (dB/m)	Result (dBuV/m)	Limit (dBuV/m)	Margin (dB)	Remark
1	2388.435	20.32	32.16	52.48	54.00	-1.52	AVG
2	2390.000	19.77	32.16	51.93	54.00	-2.07	AVG

Test Mode:	802.11ax HE40 PK	Channel:	2427
Polarity:	Vertical	Test Voltage:	DC 12 V

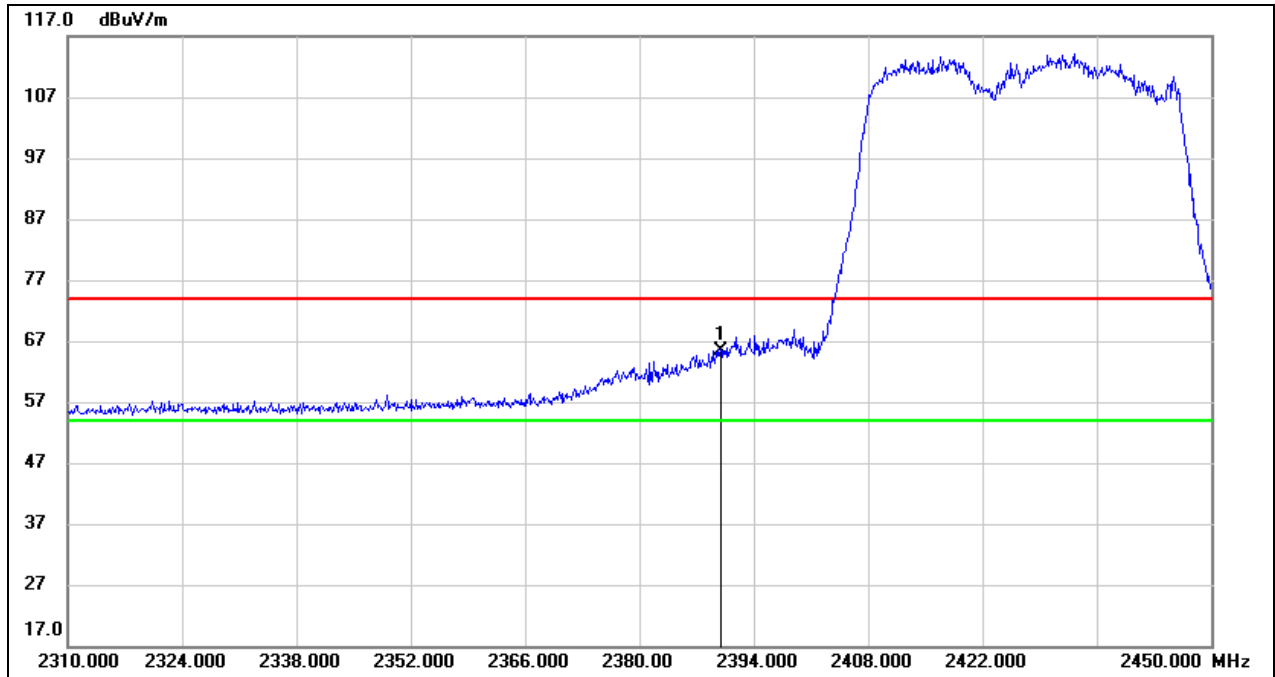

No.	Frequency (MHz)	Reading (dBuV)	Correct (dB/m)	Result (dBuV/m)	Limit (dBuV/m)	Margin (dB)	Remark
1	2390.000	33.22	32.16	65.38	74.00	-8.62	peak

Test Mode:	802.11ax HE40 AV	Channel:	2427
Polarity:	Vertical	Test Voltage:	DC 12 V

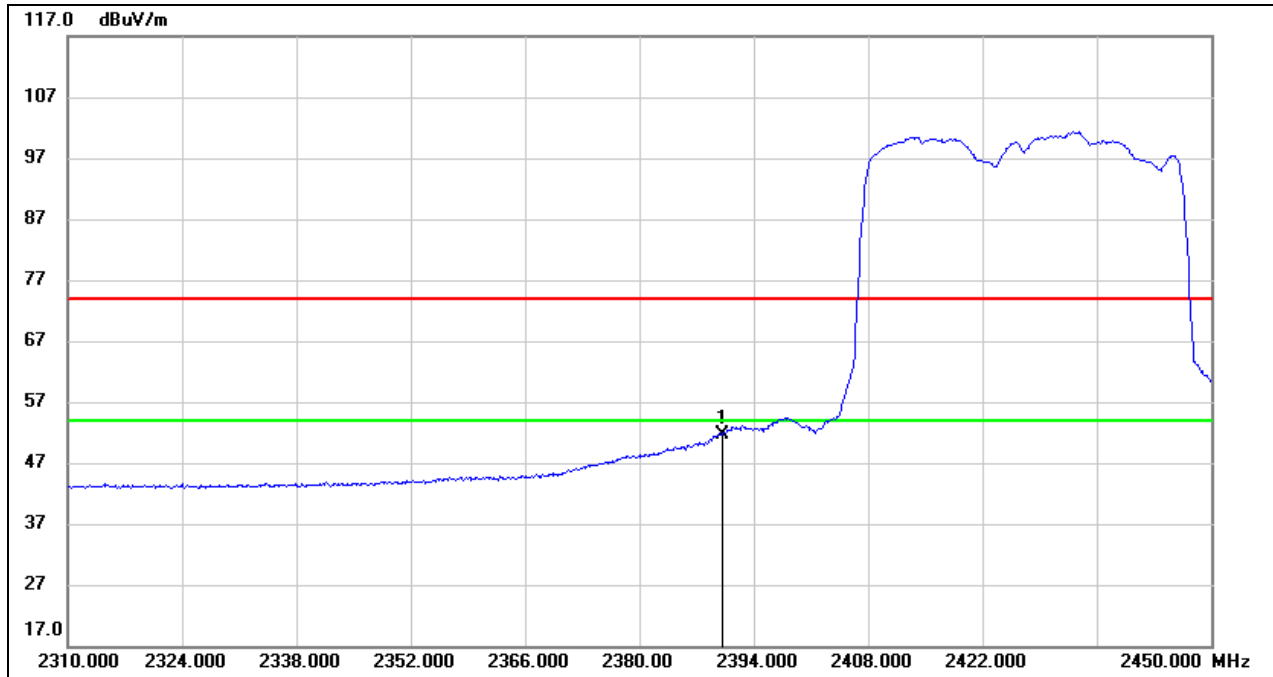

No.	Frequency (MHz)	Reading (dBuV)	Correct (dB/m)	Result (dBuV/m)	Limit (dBuV/m)	Margin (dB)	Remark
1	2390.000	19.56	32.16	51.72	54.00	-2.28	AVG

Test Mode:	802.11ax HE40 PK	Channel:	2437
Polarity:	Vertical	Test Voltage:	DC 12 V

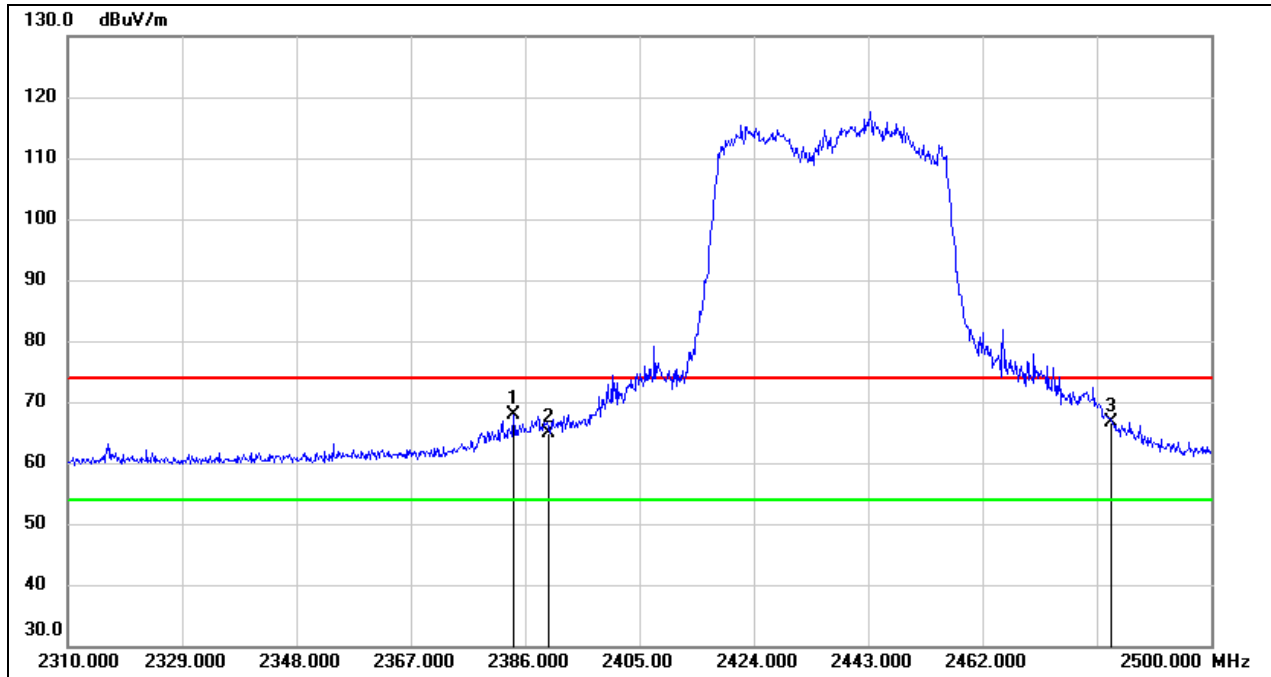

No.	Frequency (MHz)	Reading (dBuV)	Correct (dB/m)	Result (dBuV/m)	Limit (dBuV/m)	Margin (dB)	Remark
1	2384.100	35.72	32.14	67.86	74.00	-6.14	peak
2	2390.000	32.65	32.16	64.81	74.00	-9.19	peak
3	2483.500	34.15	32.44	66.59	74.00	-7.41	peak



Test Mode:	802.11ax HE40 AV	Channel:	2437
Polarity:	Vertical	Test Voltage:	DC 12 V

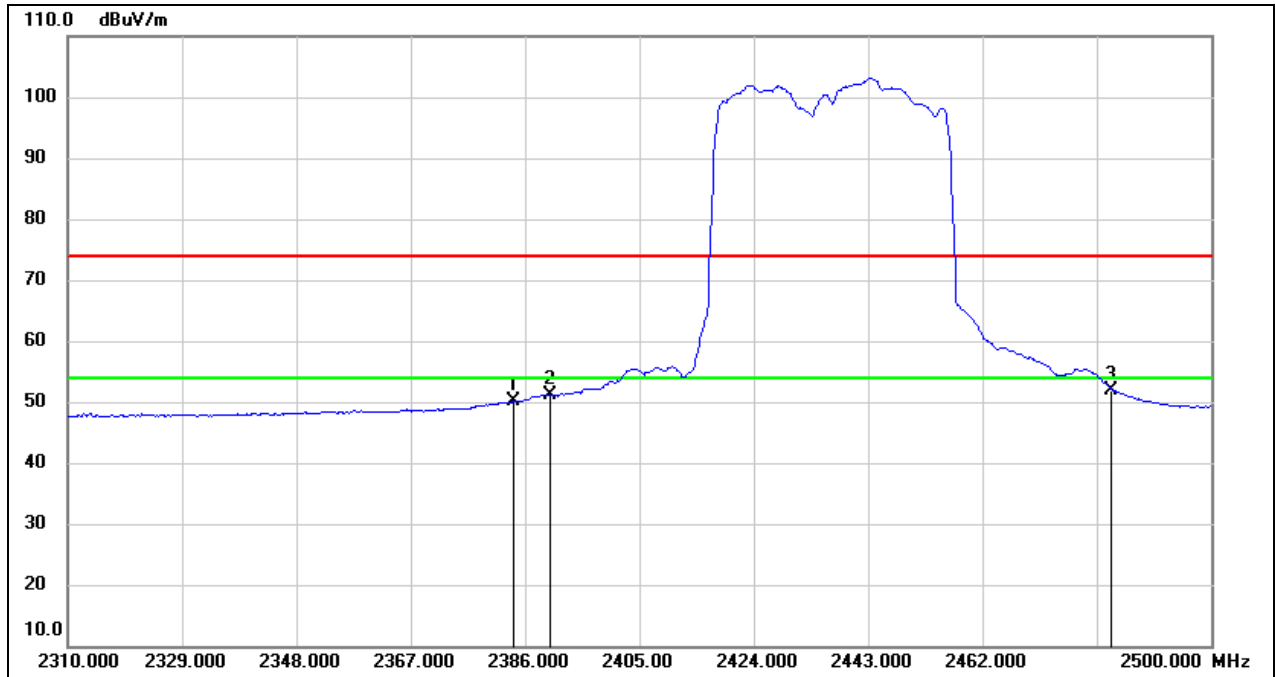

No.	Frequency (MHz)	Reading (dBuV)	Correct (dB/m)	Result (dBuV/m)	Limit (dBuV/m)	Margin (dB)	Remark
1	2384.100	17.93	32.14	50.07	54.00	-3.93	AVG
2	2390.000	18.98	32.16	51.14	54.00	-2.86	AVG
3	2483.500	19.50	32.44	51.94	54.00	-2.06	AVG

Test Mode:	802.11ax HE40 PK	Channel:	2447
Polarity:	Vertical	Test Voltage:	DC 12 V

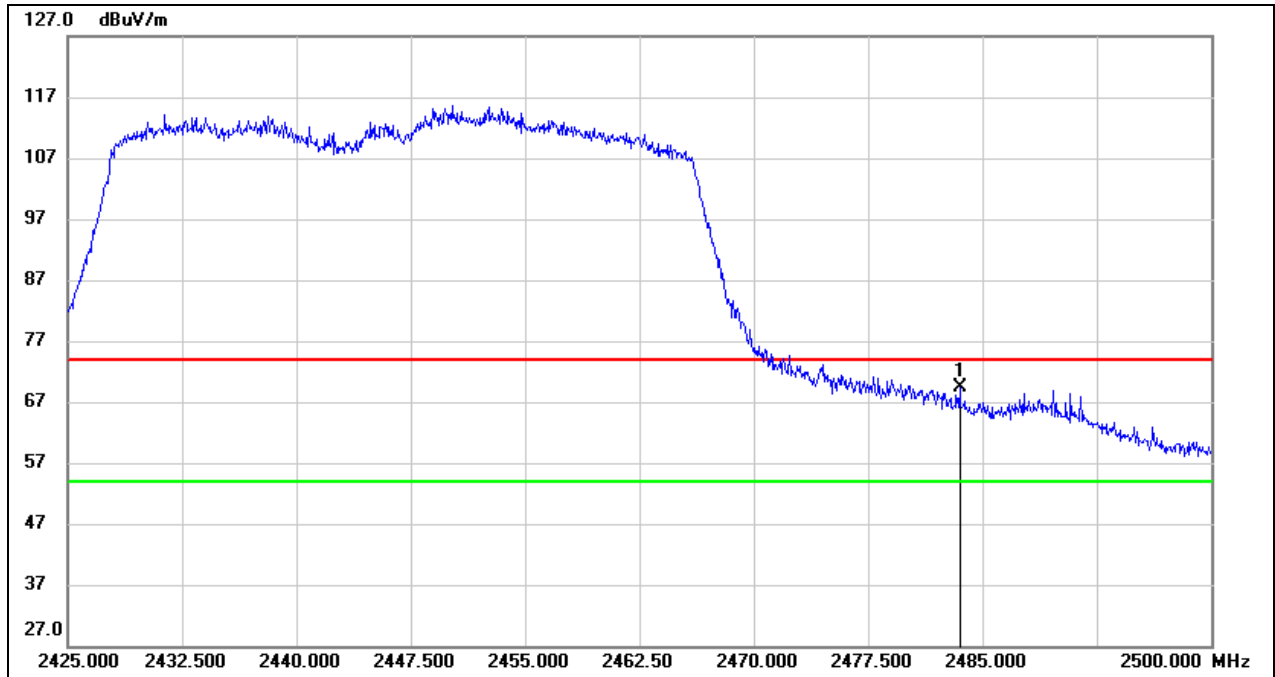

No.	Frequency (MHz)	Reading (dBuV)	Correct (dB/m)	Result (dBuV/m)	Limit (dBuV/m)	Margin (dB)	Remark
1	2483.500	36.84	32.44	69.28	74.00	-4.72	peak

Test Mode:	802.11ax HE40 AV	Channel:	2447
Polarity:	Vertical	Test Voltage:	DC 12 V

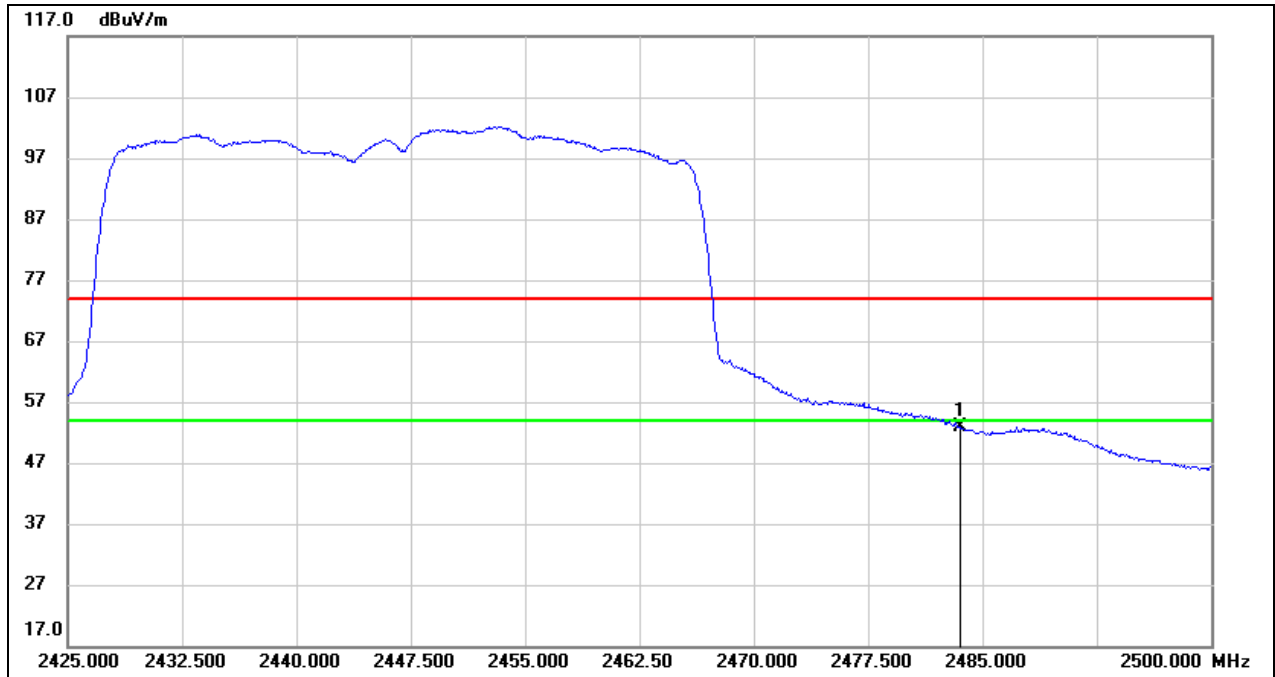

No.	Frequency (MHz)	Reading (dBuV)	Correct (dB/m)	Result (dBuV/m)	Limit (dBuV/m)	Margin (dB)	Remark
1	2483.500	20.41	32.44	52.85	54.00	-1.15	AVG

Test Mode:	802.11ax HE40 PK	Channel:	2452
Polarity:	Vertical	Test Voltage:	DC 12 V

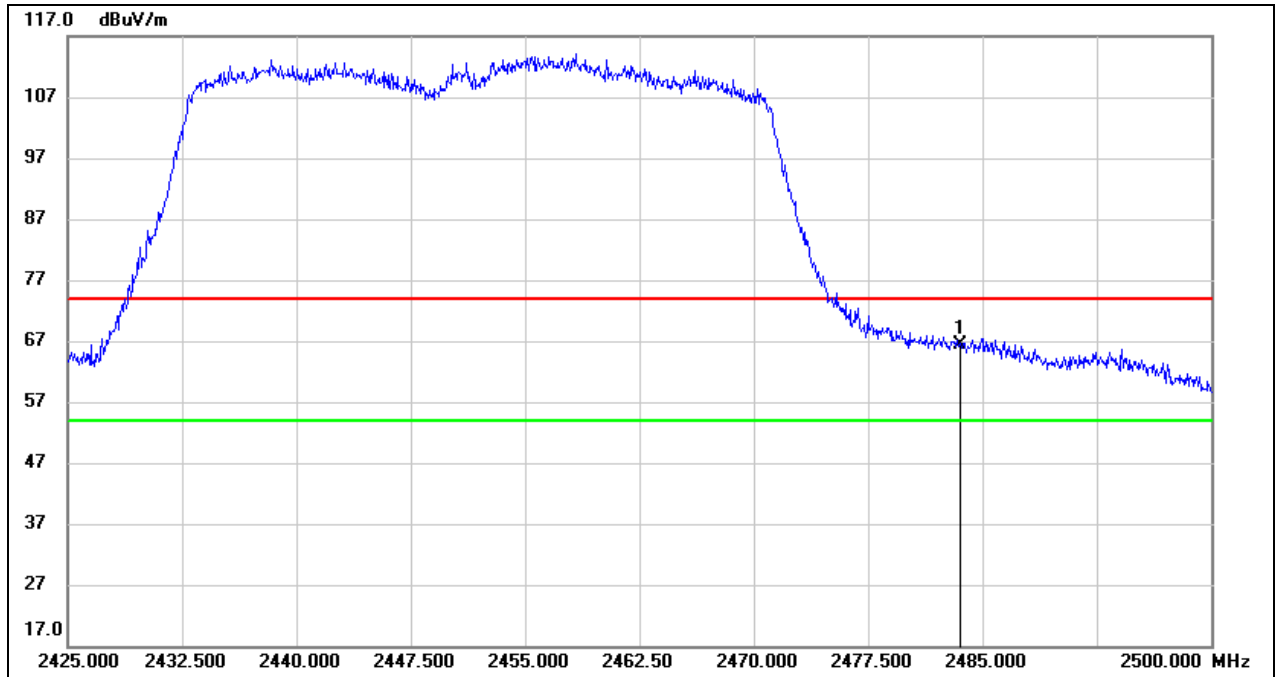

No.	Frequency (MHz)	Reading (dBuV)	Correct (dB/m)	Result (dBuV/m)	Limit (dBuV/m)	Margin (dB)	Remark
1	2483.500	33.96	32.44	66.40	74.00	-7.60	peak

Test Mode:	802.11ax HE40 AV	Channel:	2452
Polarity:	Vertical	Test Voltage:	DC 12 V

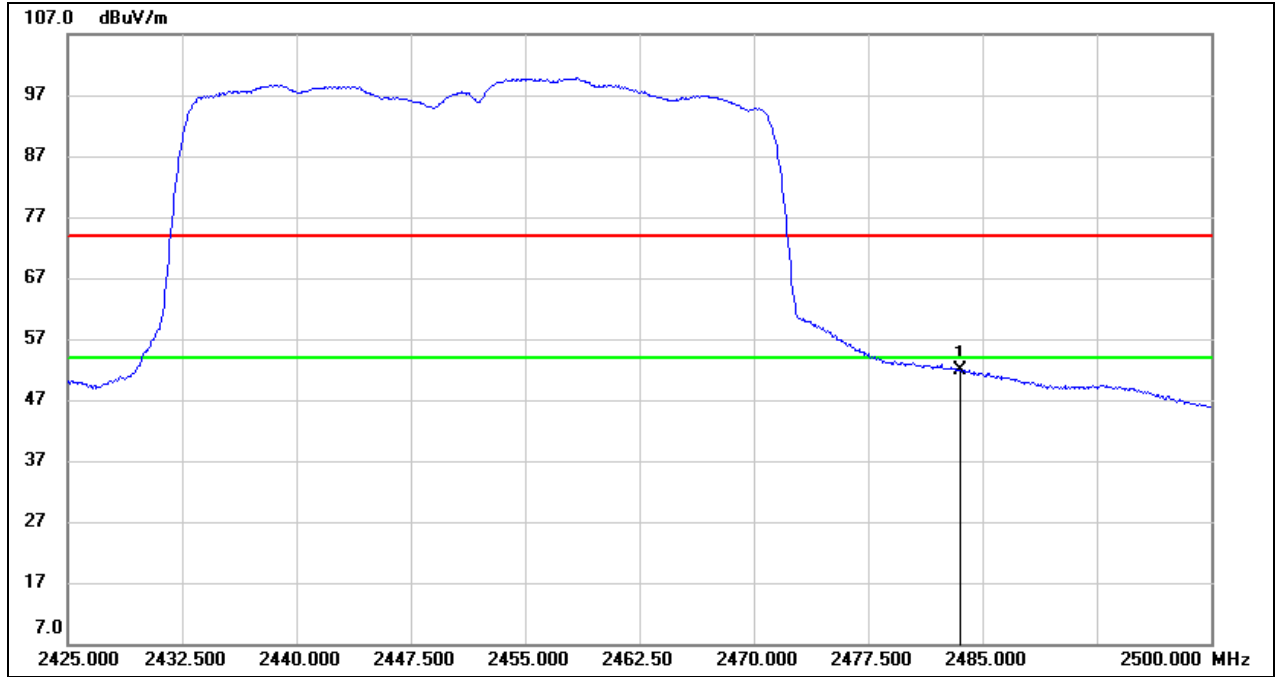

No.	Frequency (MHz)	Reading (dBuV)	Correct (dB/m)	Result (dBuV/m)	Limit (dBuV/m)	Margin (dB)	Remark
1	2483.500	19.39	32.44	51.83	54.00	-2.17	AVG

### 8.2. SPURIOUS EMISSIONS(1 GHZ~3 GHZ)

Test Mode:	802.11b	Channel:	2412
Polarity:	Horizontal	Test Voltage:	DC 12 V

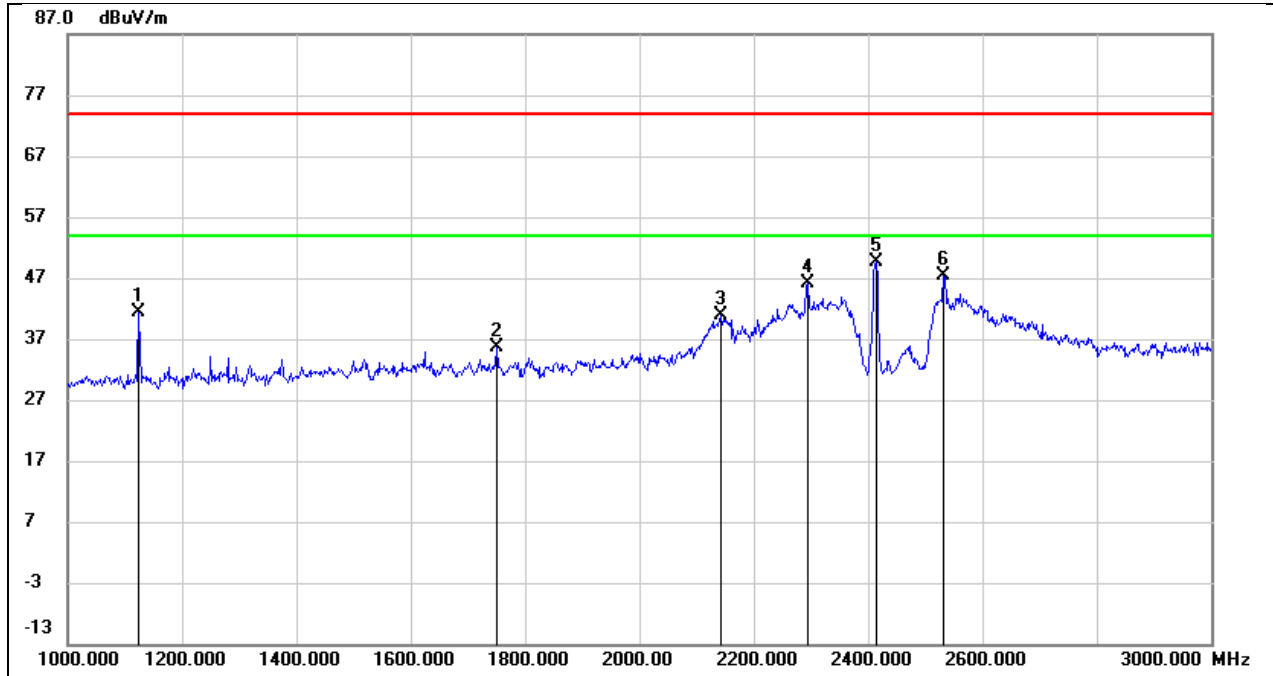

No.	Frequency (MHz)	Reading (dBuV)	Correct (dB/m)	Result (dBuV/m)	Limit (dBuV/m)	Margin (dB)	Remark
1	1124.000	55.92	-14.46	41.46	74.00	-32.54	peak
2	1750.000	47.53	-11.89	35.64	74.00	-38.36	peak
3	2142.000	51.31	-10.33	40.98	74.00	-33.02	peak
4	2294.000	55.71	-9.55	46.16	74.00	-27.84	peak
5	2414.000	58.62	-8.93	49.69	74.00	-24.31	peak
6	2532.000	55.86	-8.39	47.47	74.00	-26.53	peak

Test Mode:	802.11b	Channel:	2412
Polarity:	Vertical	Test Voltage:	DC 12 V

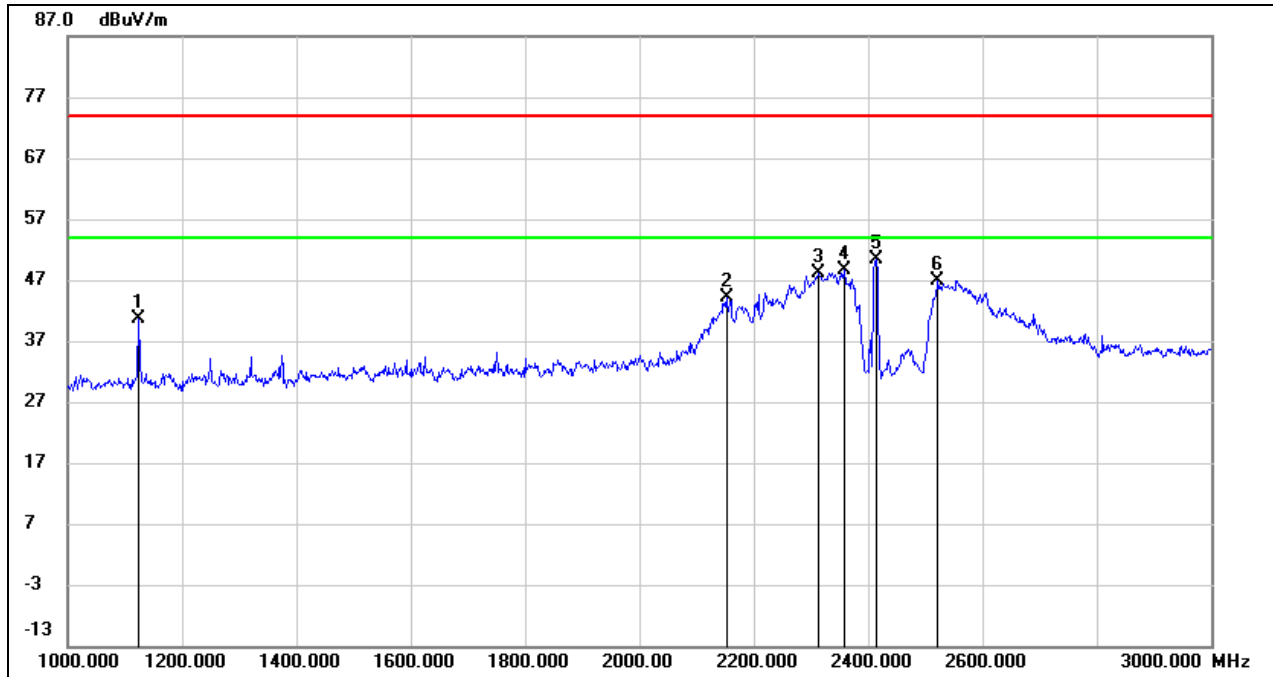

No.	Frequency (MHz)	Reading (dBuV)	Correct (dB/m)	Result (dBuV/m)	Limit (dBuV/m)	Margin (dB)	Remark
1	1124.000	55.18	-14.46	40.72	74.00	-33.28	peak
2	2152.000	54.38	-10.27	44.11	74.00	-29.89	peak
3	2314.000	57.57	-9.44	48.13	74.00	-25.87	peak
4	2358.000	57.78	-9.22	48.56	74.00	-25.44	peak
5	2414.000	59.33	-8.93	50.40	74.00	-23.60	peak
6	2522.000	55.38	-8.42	46.96	74.00	-27.04	peak

Test Mode:	802.11b	Channel:	2437
Polarity:	Horizontal	Test Voltage:	DC 12 V

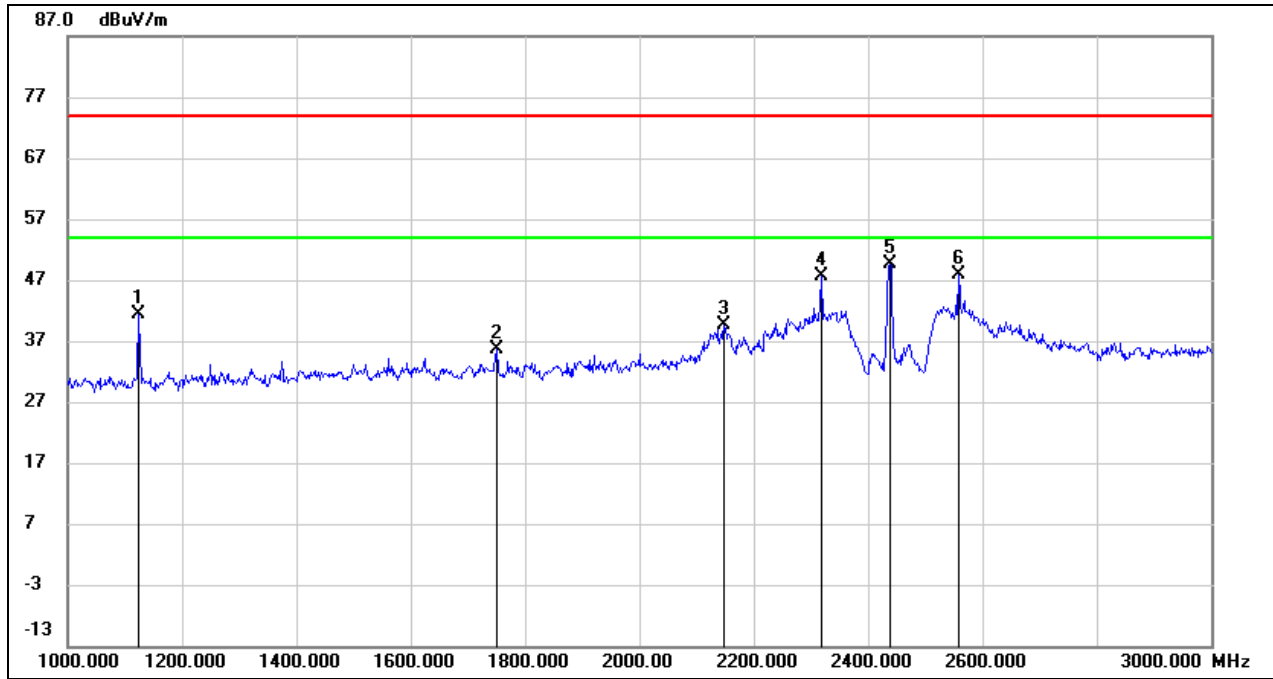

No.	Frequency (MHz)	Reading (dBuV)	Correct (dB/m)	Result (dBuV/m)	Limit (dBuV/m)	Margin (dB)	Remark
1	1124.000	55.96	-14.46	41.50	74.00	-32.50	peak
2	1750.000	47.62	-11.89	35.73	74.00	-38.27	peak
3	2148.000	49.85	-10.31	39.54	74.00	-34.46	peak
4	2318.000	56.93	-9.42	47.51	74.00	-26.49	peak
5	2438.000	58.44	-8.80	49.64	74.00	-24.36	peak
6	2558.000	56.17	-8.32	47.85	74.00	-26.15	peak



Test Mode:	802.11b	Channel:	2437
Polarity:	Vertical	Test Voltage:	DC 12 V

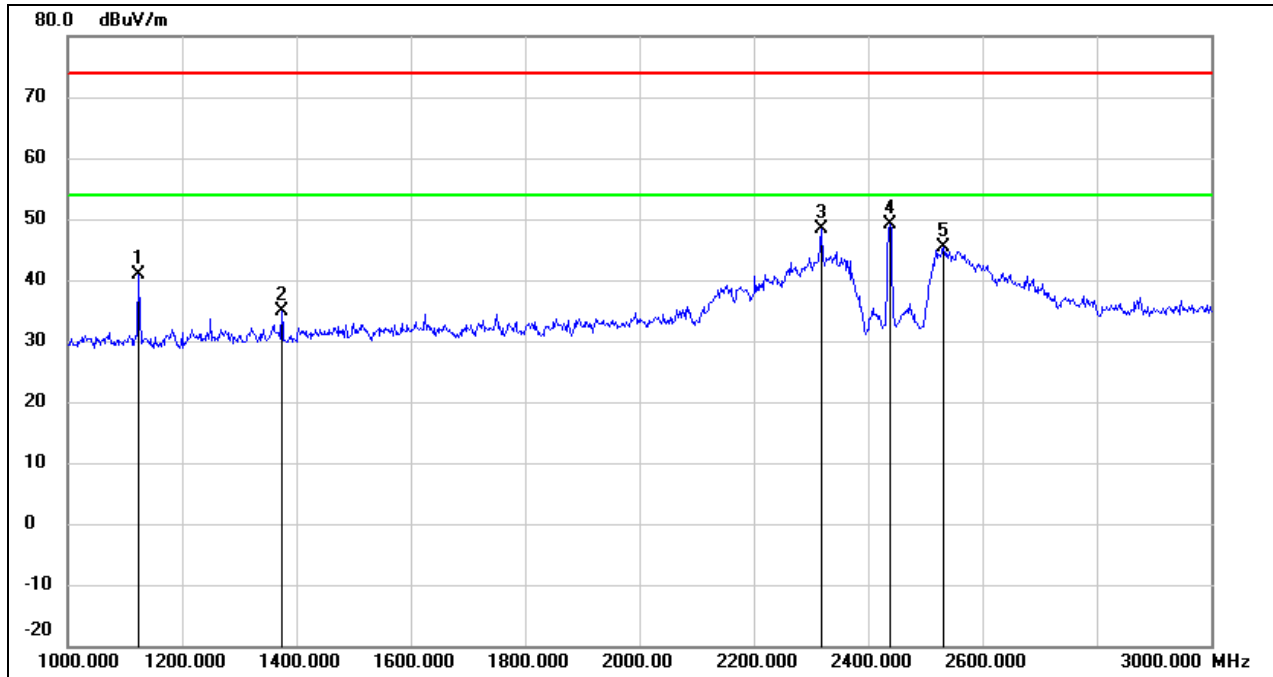

No.	Frequency (MHz)	Reading (dBuV)	Correct (dB/m)	Result (dBuV/m)	Limit (dBuV/m)	Margin (dB)	Remark
1	1124.000	55.32	-14.46	40.86	74.00	-33.14	peak
2	1374.000	48.20	-13.30	34.90	74.00	-39.10	peak
3	2318.000	57.75	-9.42	48.33	74.00	-25.67	peak
4	2438.000	57.89	-8.80	49.09	74.00	-24.91	peak
5	2532.000	53.72	-8.39	45.33	74.00	-28.67	peak

Test Mode:	802.11b	Channel:	2462
Polarity:	Horizontal	Test Voltage:	DC 12 V

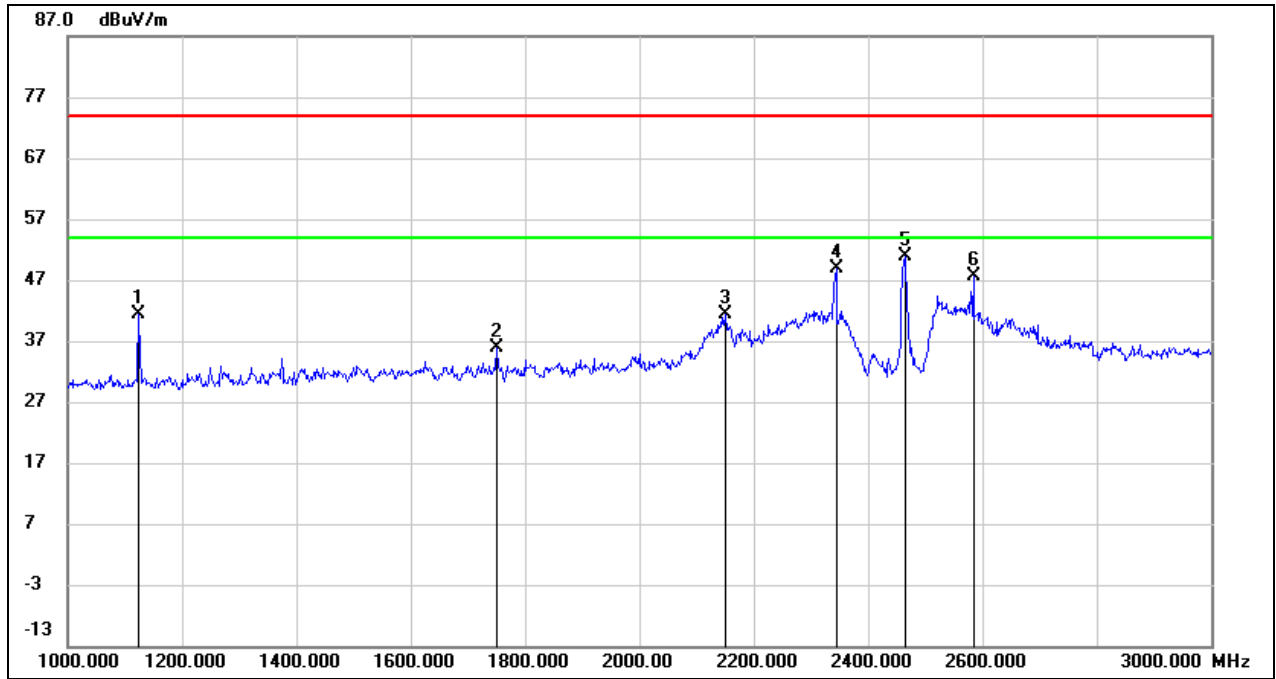

No.	Frequency (MHz)	Reading (dBuV)	Correct (dB/m)	Result (dBuV/m)	Limit (dBuV/m)	Margin (dB)	Remark
1	1124.000	55.88	-14.46	41.42	74.00	-32.58	peak
2	1750.000	47.72	-11.89	35.83	74.00	-38.17	peak
3	2150.000	51.77	-10.28	41.49	74.00	-32.51	peak
4	2344.000	58.17	-9.30	48.87	74.00	-25.13	peak
5	2464.000	59.51	-8.68	50.83	74.00	-23.17	peak
6	2584.000	55.87	-8.24	47.63	74.00	-26.37	peak

Test Mode:	802.11b	Channel:	2462
Polarity:	Vertical	Test Voltage:	DC 12 V

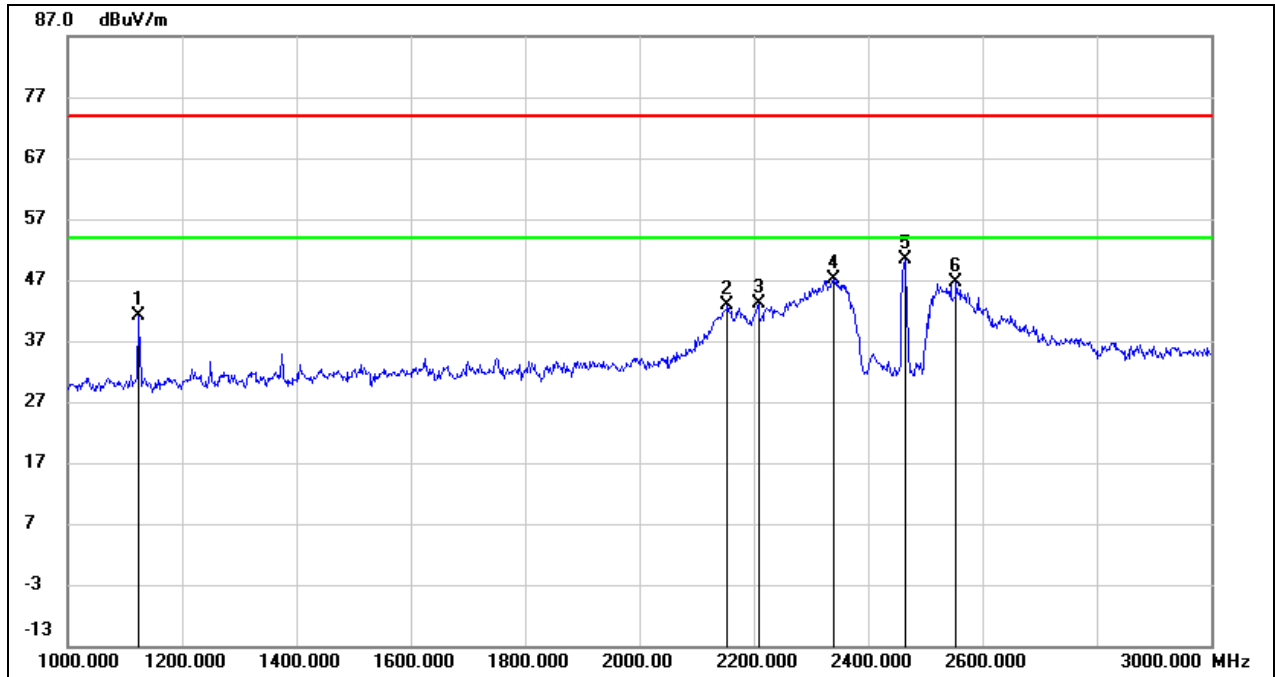

No.	Frequency (MHz)	Reading (dBuV)	Correct (dB/m)	Result (dBuV/m)	Limit (dBuV/m)	Margin (dB)	Remark
1	1124.000	55.52	-14.46	41.06	74.00	-32.94	peak
2	2154.000	53.20	-10.27	42.93	74.00	-31.07	peak
3	2208.000	53.06	-9.99	43.07	74.00	-30.93	peak
4	2340.000	56.54	-9.31	47.23	74.00	-26.77	peak
5	2464.000	58.99	-8.68	50.31	74.00	-23.69	peak
6	2554.000	54.91	-8.32	46.59	74.00	-27.41	peak

### 8.3. SPURIOUS EMISSIONS(3 GHZ~18 GHZ)

Test Mode:	802.11b	Channel:	2412
Polarity:	Horizontal	Test Voltage:	DC 12 V

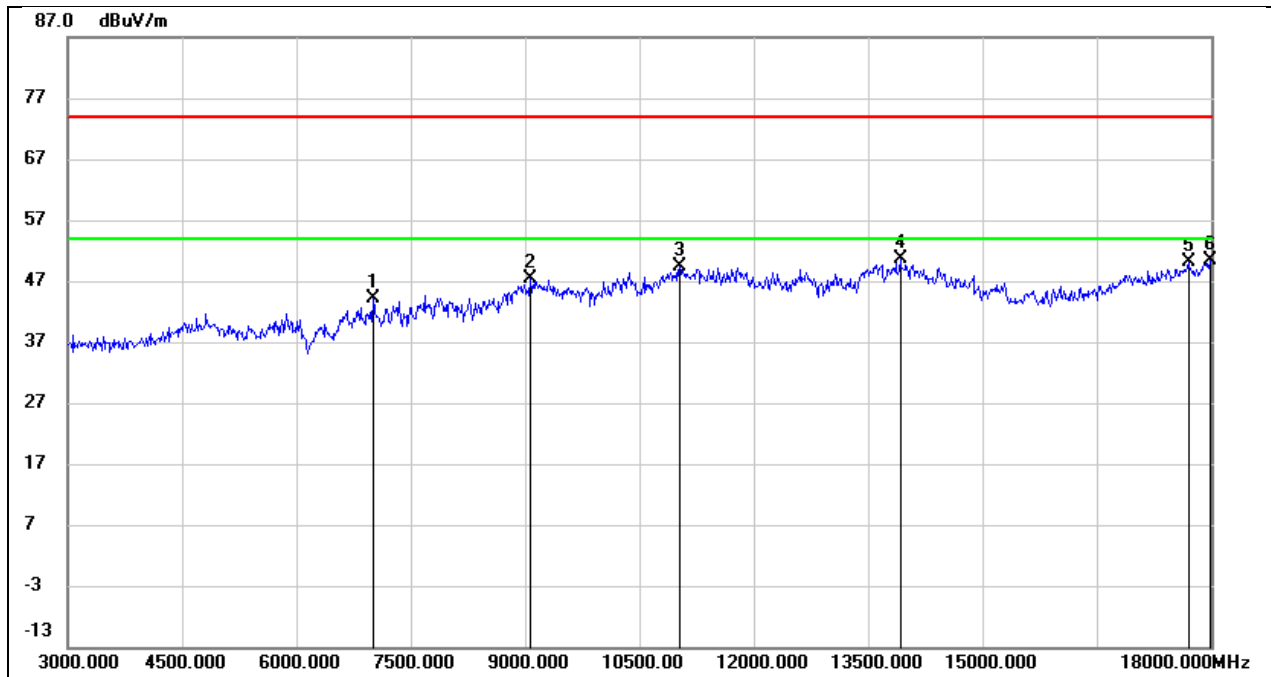

No.	Frequency (MHz)	Reading (dBuV)	Correct (dB/m)	Result (dBuV/m)	Limit (dBuV/m)	Margin (dB)	Remark
1	7005.000	37.41	6.69	44.10	74.00	-29.90	peak
2	9075.000	36.75	10.52	47.27	74.00	-26.73	peak
3	11025.000	34.47	14.85	49.32	74.00	-24.68	peak
4	13920.000	28.74	21.79	50.53	74.00	-23.47	peak
5	17700.000	26.15	23.91	50.06	74.00	-23.94	peak
6	17985.000	24.67	25.60	50.27	74.00	-23.73	peak

Test Mode:	802.11b	Channel:	2412
Polarity:	Vertical	Test Voltage:	DC 12 V

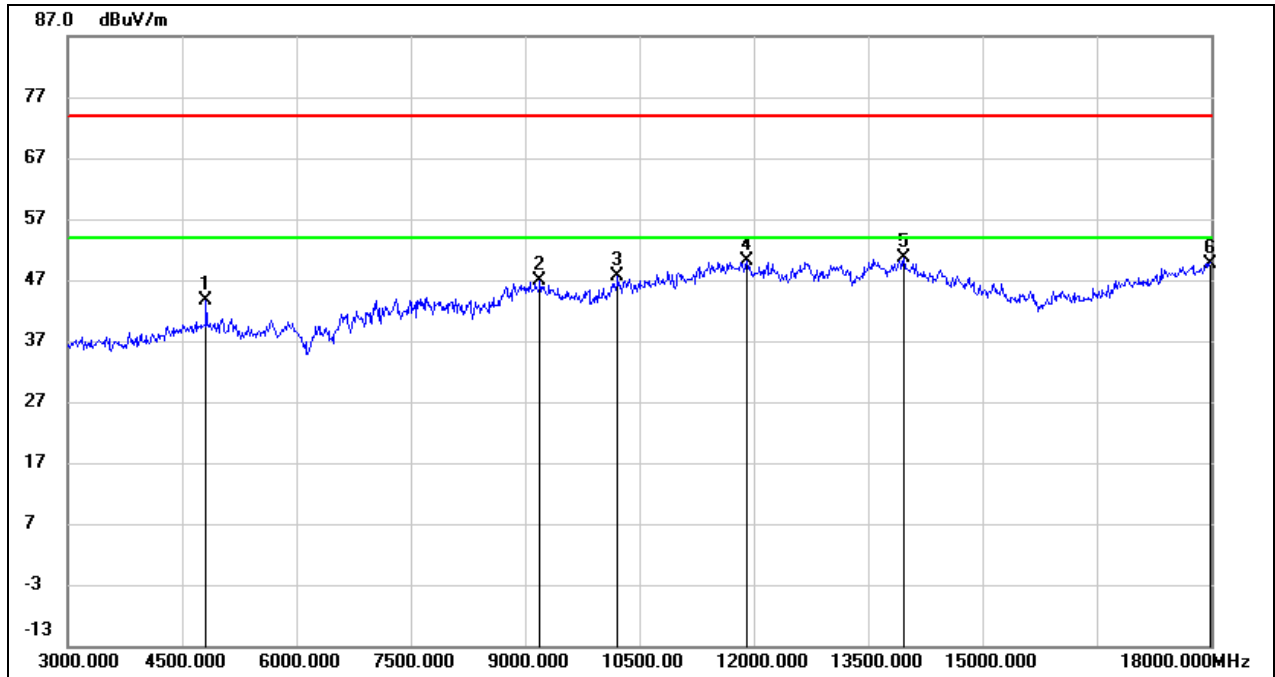

No.	Frequency (MHz)	Reading (dBuV)	Correct (dB/m)	Result (dBuV/m)	Limit (dBuV/m)	Margin (dB)	Remark
1	4815.000	43.82	-0.26	43.56	74.00	-30.44	peak
2	9195.000	36.22	10.56	46.78	74.00	-27.22	peak
3	10215.000	35.09	12.43	47.52	74.00	-26.48	peak
4	11910.000	32.32	17.72	50.04	74.00	-23.96	peak
5	13965.000	28.67	21.89	50.56	74.00	-23.44	peak
6	17985.000	24.15	25.60	49.75	74.00	-24.25	peak

Test Mode:	802.11b	Channel:	2437
Polarity:	Horizontal	Test Voltage:	DC 12 V

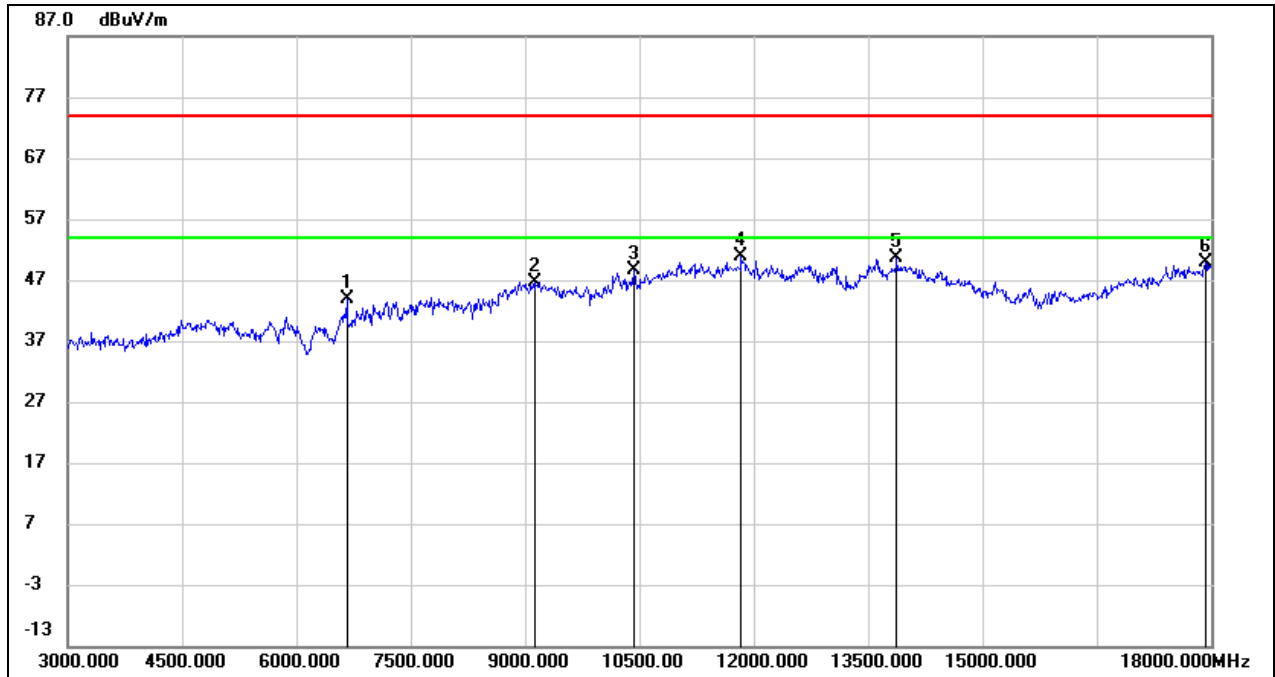

No.	Frequency (MHz)	Reading (dBuV)	Correct (dB/m)	Result (dBuV/m)	Limit (dBuV/m)	Margin (dB)	Remark
1	6660.000	38.81	5.02	43.83	74.00	-30.17	peak
2	9135.000	36.18	10.55	46.73	74.00	-27.27	peak
3	10425.000	35.84	12.84	48.68	74.00	-25.32	peak
4	11835.000	33.44	17.51	50.95	74.00	-23.05	peak
5	13875.000	28.82	21.70	50.52	74.00	-23.48	peak
6	17925.000	24.52	25.25	49.77	74.00	-24.23	peak

Test Mode:	802.11b	Channel:	2437
Polarity:	Vertical	Test Voltage:	DC 12 V

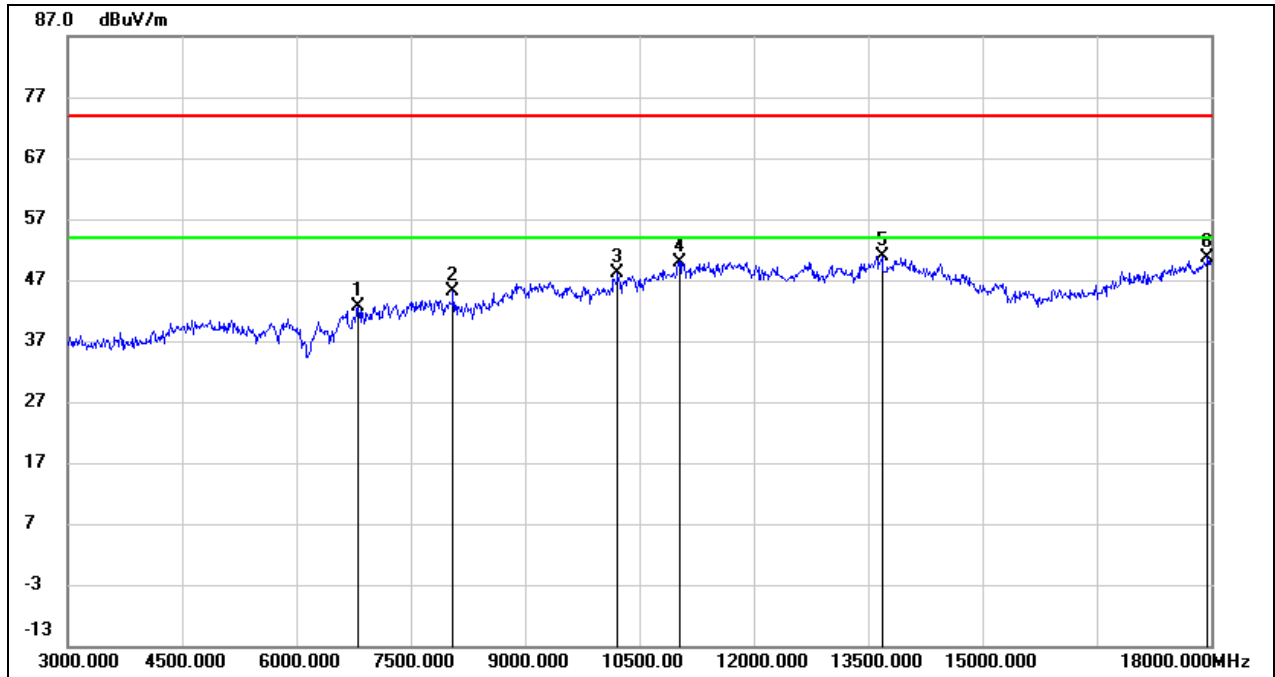

No.	Frequency (MHz)	Reading (dBuV)	Correct (dB/m)	Result (dBuV/m)	Limit (dBuV/m)	Margin (dB)	Remark
1	6810.000	36.98	5.76	42.74	74.00	-31.26	peak
2	8055.000	38.65	6.37	45.02	74.00	-28.98	peak
3	10215.000	35.62	12.43	48.05	74.00	-25.95	peak
4	11025.000	35.15	14.85	50.00	74.00	-24.00	peak
5	13680.000	29.66	21.29	50.95	74.00	-23.05	peak
6	17955.000	25.33	25.42	50.75	74.00	-23.25	peak

Test Mode:	802.11b	Channel:	2462
Polarity:	Horizontal	Test Voltage:	DC 12 V

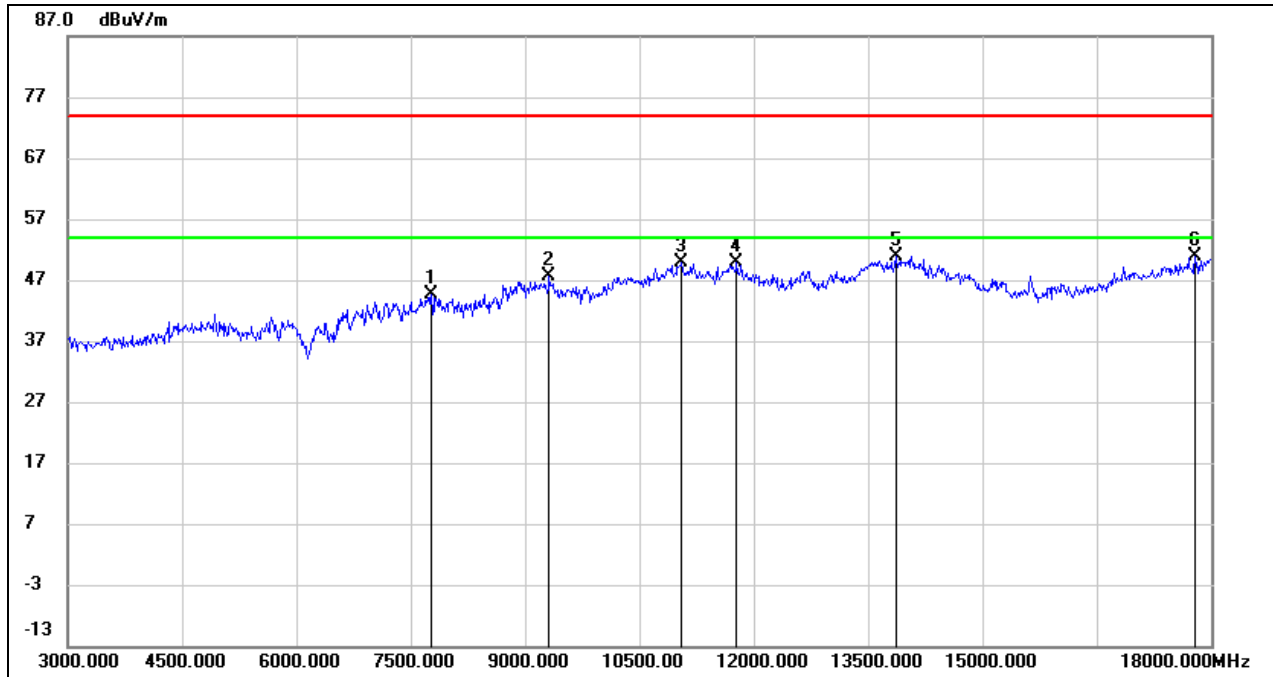

No.	Frequency (MHz)	Reading (dBuV)	Correct (dB/m)	Result (dBuV/m)	Limit (dBuV/m)	Margin (dB)	Remark
1	7770.000	38.29	6.31	44.60	74.00	-29.40	peak
2	9315.000	36.94	10.61	47.55	74.00	-26.45	peak
3	11055.000	34.93	14.96	49.89	74.00	-24.11	peak
4	11775.000	32.55	17.35	49.90	74.00	-24.10	peak
5	13860.000	29.32	21.67	50.99	74.00	-23.01	peak
6	17790.000	26.39	24.45	50.84	74.00	-23.16	peak



Test Mode:	802.11b	Channel:	2462
Polarity:	Vertical	Test Voltage:	DC 12 V

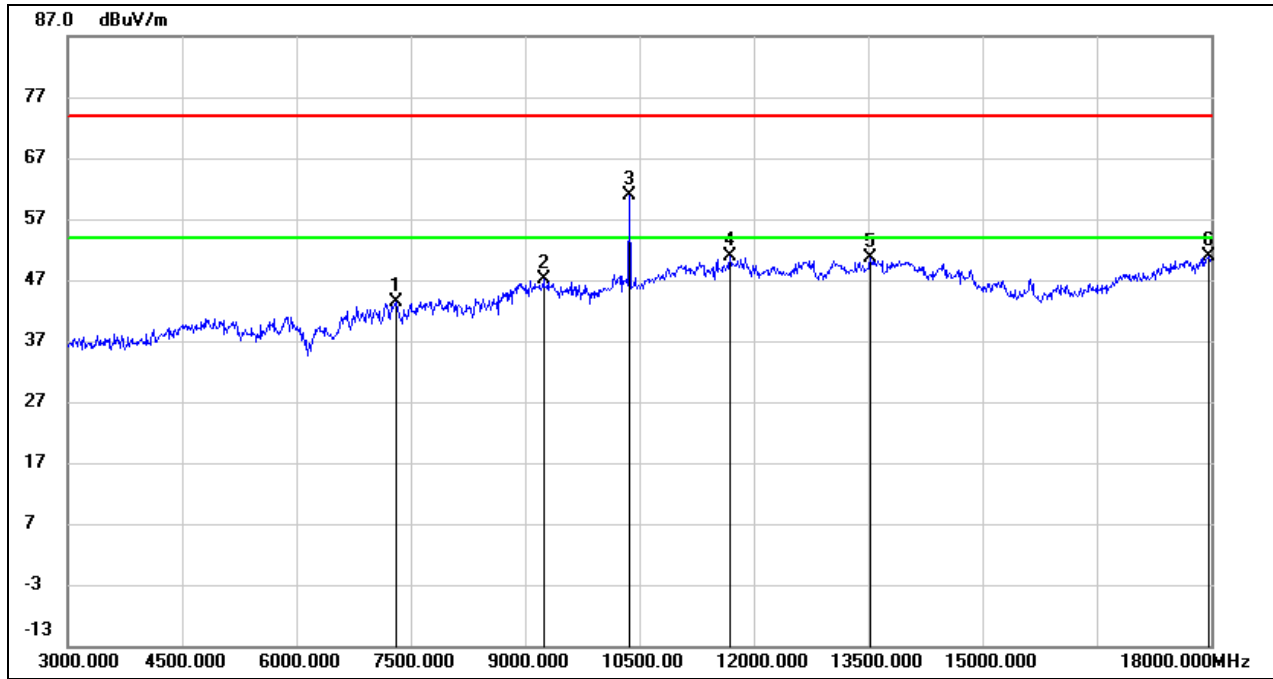

No.	Frequency (MHz)	Reading (dBuV)	Correct (dB/m)	Result (dBuV/m)	Limit (dBuV/m)	Margin (dB)	Remark
1	7305.000	36.87	6.47	43.34	74.00	-30.66	peak
2	9240.000	36.56	10.58	47.14	74.00	-26.86	peak
3	10365.000	48.04	12.72	60.76	74.00	-13.24	peak
4	11685.000	33.66	17.10	50.76	74.00	-23.24	peak
5	13530.000	29.60	20.96	50.56	74.00	-23.44	peak
6	17970.000	25.25	25.51	50.76	74.00	-23.24	peak

Test Mode:	802.11g	Channel:	2412
Polarity:	Horizontal	Test Voltage:	DC 12 V

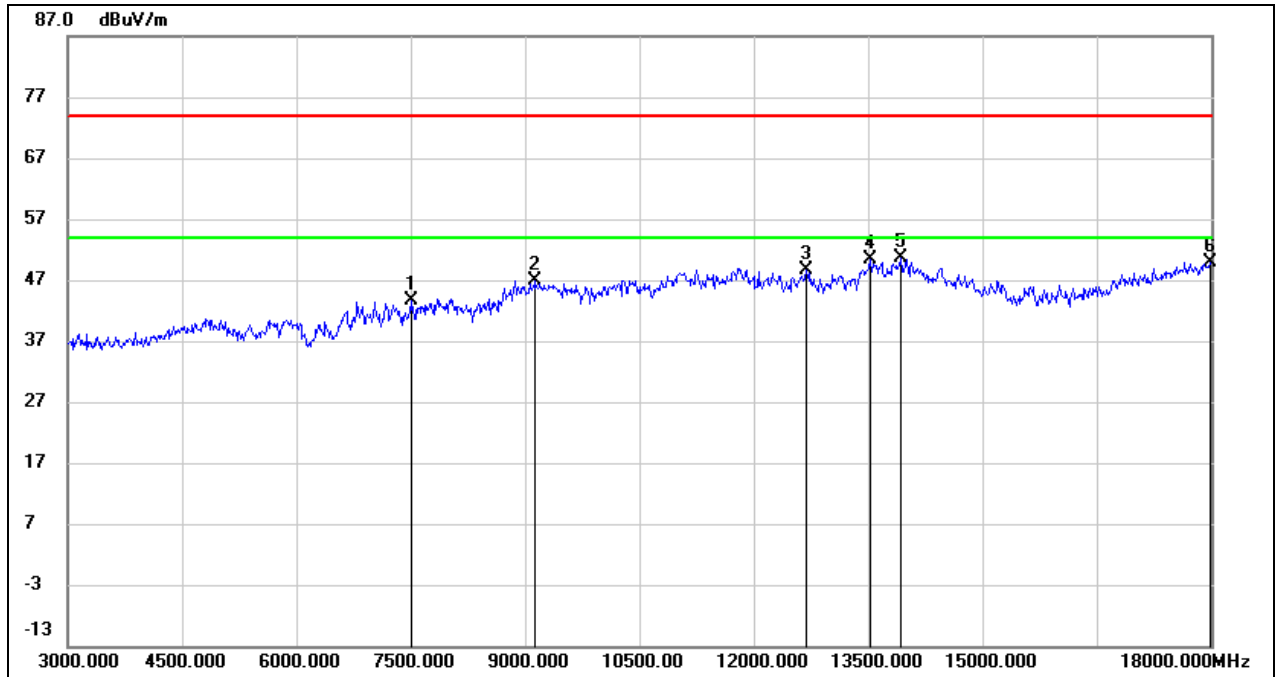

No.	Frequency (MHz)	Reading (dBuV)	Correct (dB/m)	Result (dBuV/m)	Limit (dBuV/m)	Margin (dB)	Remark
1	7500.000	37.32	6.33	43.65	74.00	-30.35	peak
2	9135.000	36.23	10.55	46.78	74.00	-27.22	peak
3	12690.000	30.64	18.02	48.66	74.00	-25.34	peak
4	13530.000	29.48	20.96	50.44	74.00	-23.56	peak
5	13935.000	28.86	21.82	50.68	74.00	-23.32	peak
6	17985.000	24.29	25.60	49.89	74.00	-24.11	peak

Test Mode:	802.11g	Channel:	2412
Polarity:	Vertical	Test Voltage:	DC 12 V

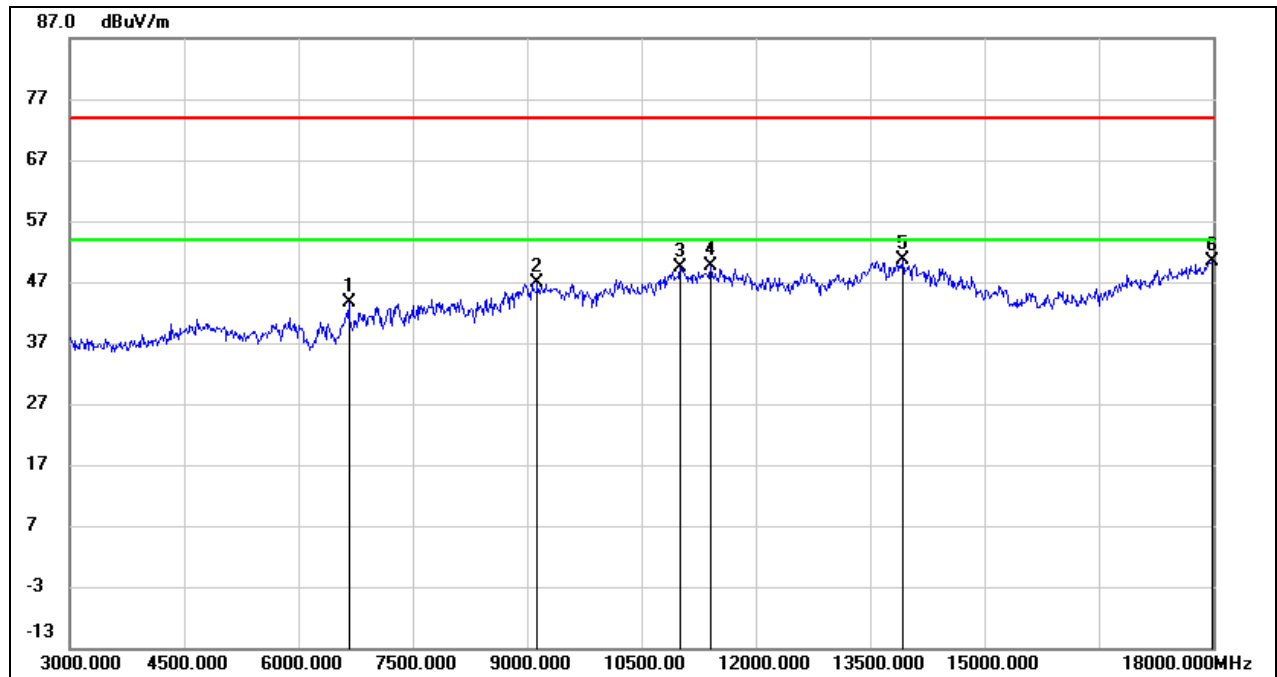

No.	Frequency (MHz)	Reading (dBuV)	Correct (dB/m)	Result (dBuV/m)	Limit (dBuV/m)	Margin (dB)	Remark
1	6660.000	38.57	5.02	43.59	74.00	-30.41	peak
2	9135.000	36.38	10.55	46.93	74.00	-27.07	peak
3	11010.000	34.53	14.81	49.34	74.00	-24.66	peak
4	11415.000	33.43	16.29	49.72	74.00	-24.28	peak
5	13935.000	28.89	21.82	50.71	74.00	-23.29	peak
6	17985.000	24.88	25.60	50.48	74.00	-23.52	peak

Test Mode:	802.11g	Channel:	2417
Polarity:	Horizontal	Test Voltage:	DC 12 V

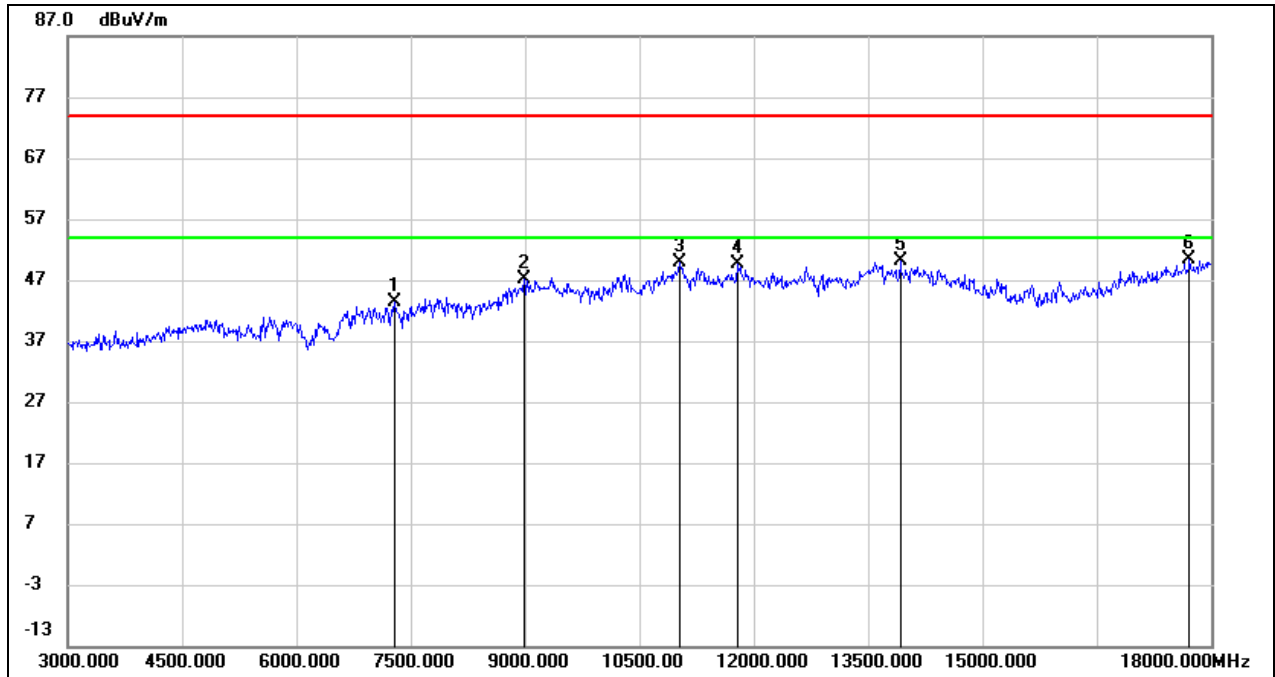

No.	Frequency (MHz)	Reading (dBuV)	Correct (dB/m)	Result (dBuV/m)	Limit (dBuV/m)	Margin (dB)	Remark
1	7290.000	36.84	6.48	43.32	74.00	-30.68	peak
2	8985.000	36.81	10.37	47.18	74.00	-26.82	peak
3	11025.000	34.95	14.85	49.80	74.00	-24.20	peak
4	11790.000	32.18	17.38	49.56	74.00	-24.44	peak
5	13920.000	28.33	21.79	50.12	74.00	-23.88	peak
6	17715.000	26.37	24.00	50.37	74.00	-23.63	peak

Test Mode:	802.11g	Channel:	2417
Polarity:	Vertical	Test Voltage:	DC 12 V

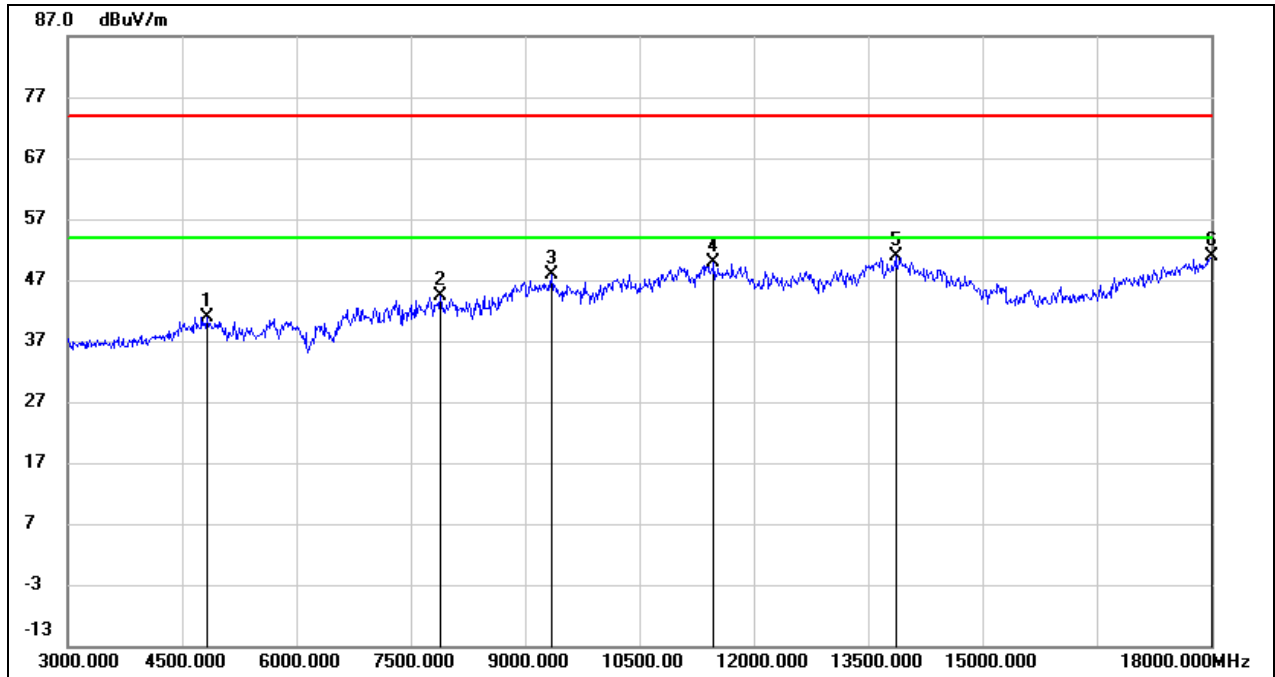

No.	Frequency (MHz)	Reading (dBuV)	Correct (dB/m)	Result (dBuV/m)	Limit (dBuV/m)	Margin (dB)	Remark
1	4830.000	41.17	-0.20	40.97	74.00	-33.03	peak
2	7890.000	38.11	6.31	44.42	74.00	-29.58	peak
3	9345.000	37.31	10.63	47.94	74.00	-26.06	peak
4	11475.000	33.41	16.51	49.92	74.00	-24.08	peak
5	13860.000	29.17	21.67	50.84	74.00	-23.16	peak
6	18000.000	25.30	25.69	50.99	74.00	-23.01	peak

Test Mode:	802.11g	Channel:	2437
Polarity:	Horizontal	Test Voltage:	DC 12 V

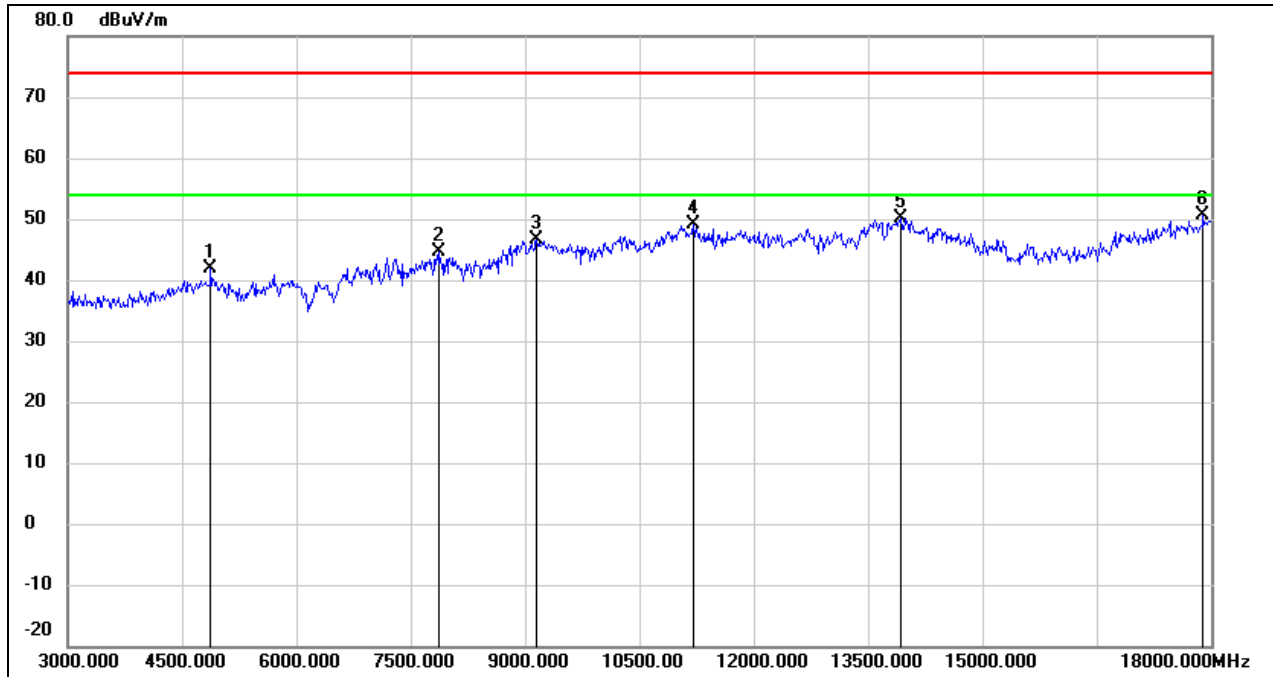

No.	Frequency (MHz)	Reading (dBuV)	Correct (dB/m)	Result (dBuV/m)	Limit (dBuV/m)	Margin (dB)	Remark
1	4875.000	41.89	-0.03	41.86	74.00	-32.14	peak
2	7875.000	38.32	6.31	44.63	74.00	-29.37	peak
3	9150.000	35.99	10.54	46.53	74.00	-27.47	peak
4	11205.000	33.51	15.52	49.03	74.00	-24.97	peak
5	13920.000	28.36	21.79	50.15	74.00	-23.85	peak
6	17895.000	25.47	25.07	50.54	74.00	-23.46	peak

Test Mode:	802.11g	Channel:	2437
Polarity:	Vertical	Test Voltage:	DC 12 V

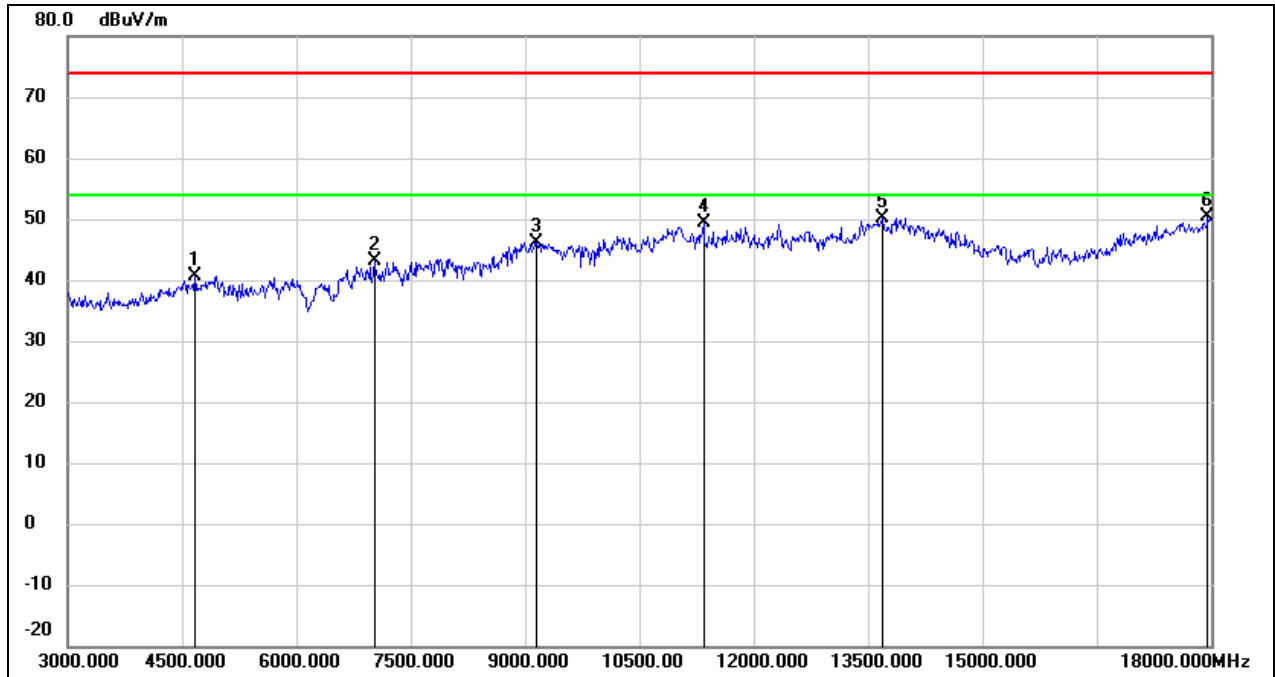

No.	Frequency (MHz)	Reading (dBuV)	Correct (dB/m)	Result (dBuV/m)	Limit (dBuV/m)	Margin (dB)	Remark
1	4665.000	41.51	-0.83	40.68	74.00	-33.32	peak
2	7020.000	36.35	6.67	43.02	74.00	-30.98	peak
3	9150.000	35.58	10.54	46.12	74.00	-27.88	peak
4	11340.000	33.32	16.01	49.33	74.00	-24.67	peak
5	13695.000	28.87	21.31	50.18	74.00	-23.82	peak
6	17955.000	24.95	25.42	50.37	74.00	-23.63	peak

Test Mode:	802.11g	Channel:	2457
Polarity:	Horizontal	Test Voltage:	DC 12 V

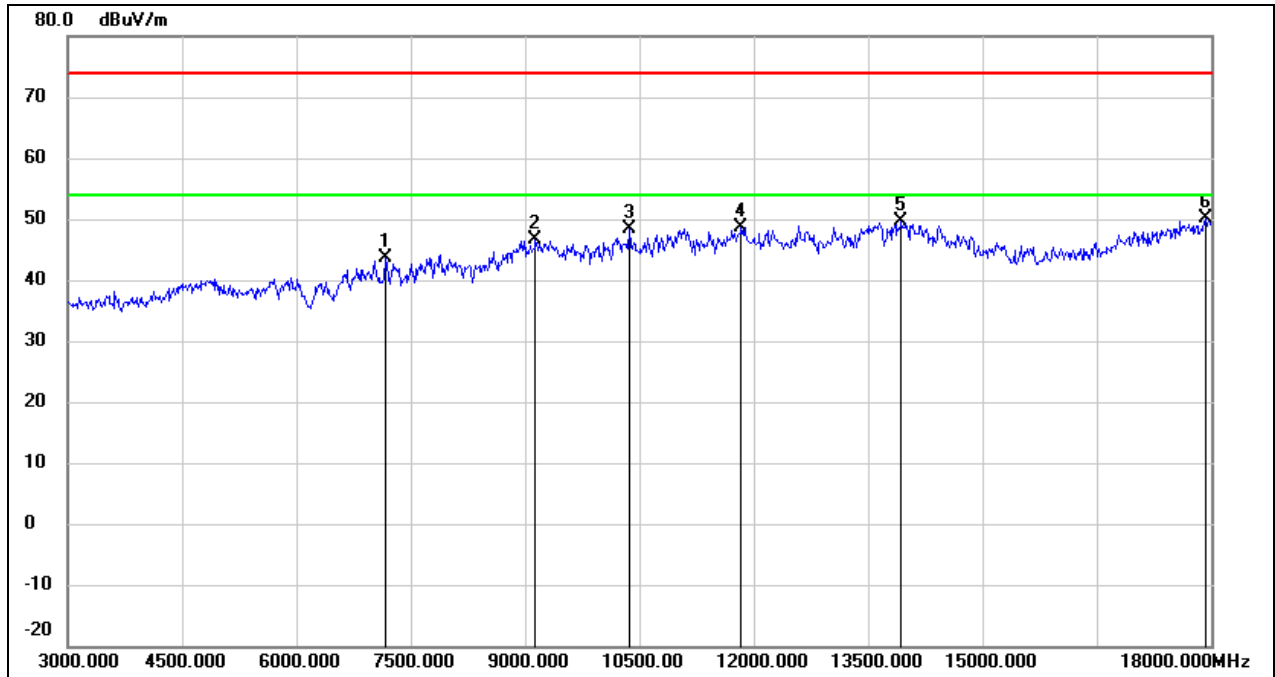

No.	Frequency (MHz)	Reading (dBuV)	Correct (dB/m)	Result (dBuV/m)	Limit (dBuV/m)	Margin (dB)	Remark
1	7170.000	37.13	6.56	43.69	74.00	-30.31	peak
2	9135.000	36.03	10.55	46.58	74.00	-27.42	peak
3	10365.000	35.76	12.72	48.48	74.00	-25.52	peak
4	11835.000	31.13	17.51	48.64	74.00	-25.36	peak
5	13935.000	27.71	21.82	49.53	74.00	-24.47	peak
6	17925.000	24.98	25.25	50.23	74.00	-23.77	peak



Test Mode:	802.11g	Channel:	2457
Polarity:	Vertical	Test Voltage:	DC 12 V

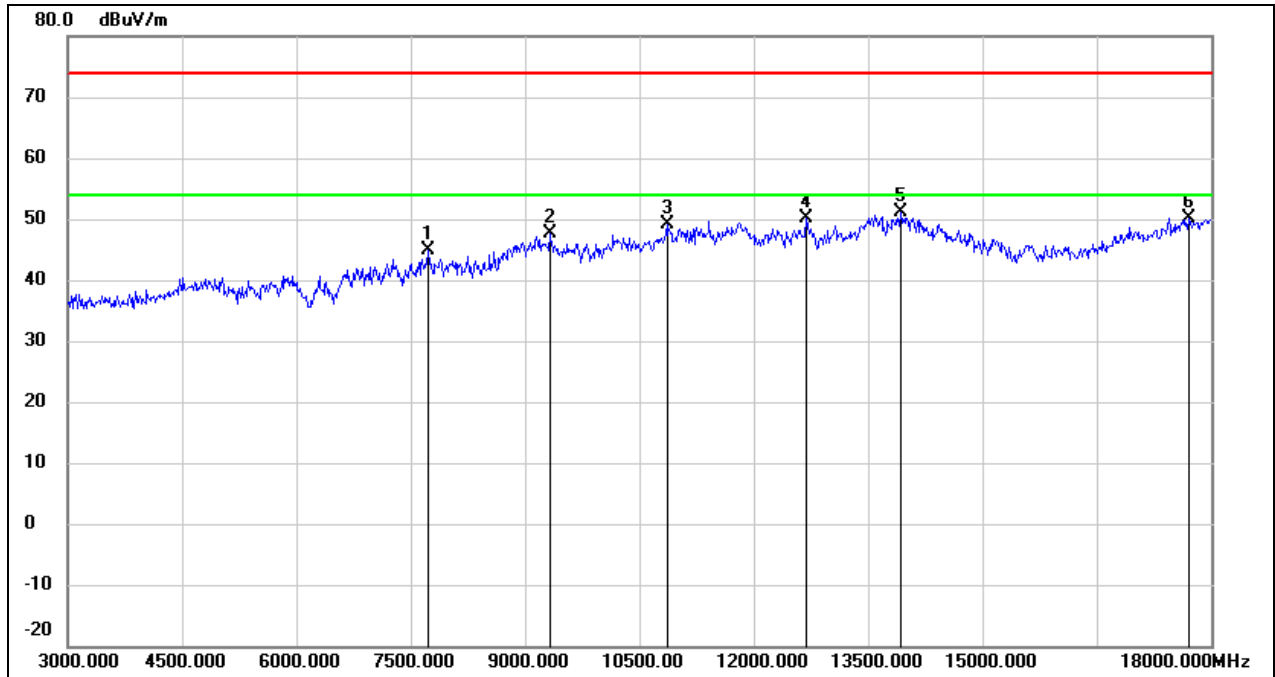

No.	Frequency (MHz)	Reading (dBuV)	Correct (dB/m)	Result (dBuV/m)	Limit (dBuV/m)	Margin (dB)	Remark
1	7725.000	38.55	6.32	44.87	74.00	-29.13	peak
2	9330.000	37.01	10.62	47.63	74.00	-26.37	peak
3	10860.000	34.80	14.27	49.07	74.00	-24.93	peak
4	12690.000	32.14	18.02	50.16	74.00	-23.84	peak
5	13920.000	29.40	21.79	51.19	74.00	-22.81	peak
6	17715.000	26.09	24.00	50.09	74.00	-23.91	peak

Test Mode:	802.11g	Channel:	2462
Polarity:	Horizontal	Test Voltage:	DC 12 V

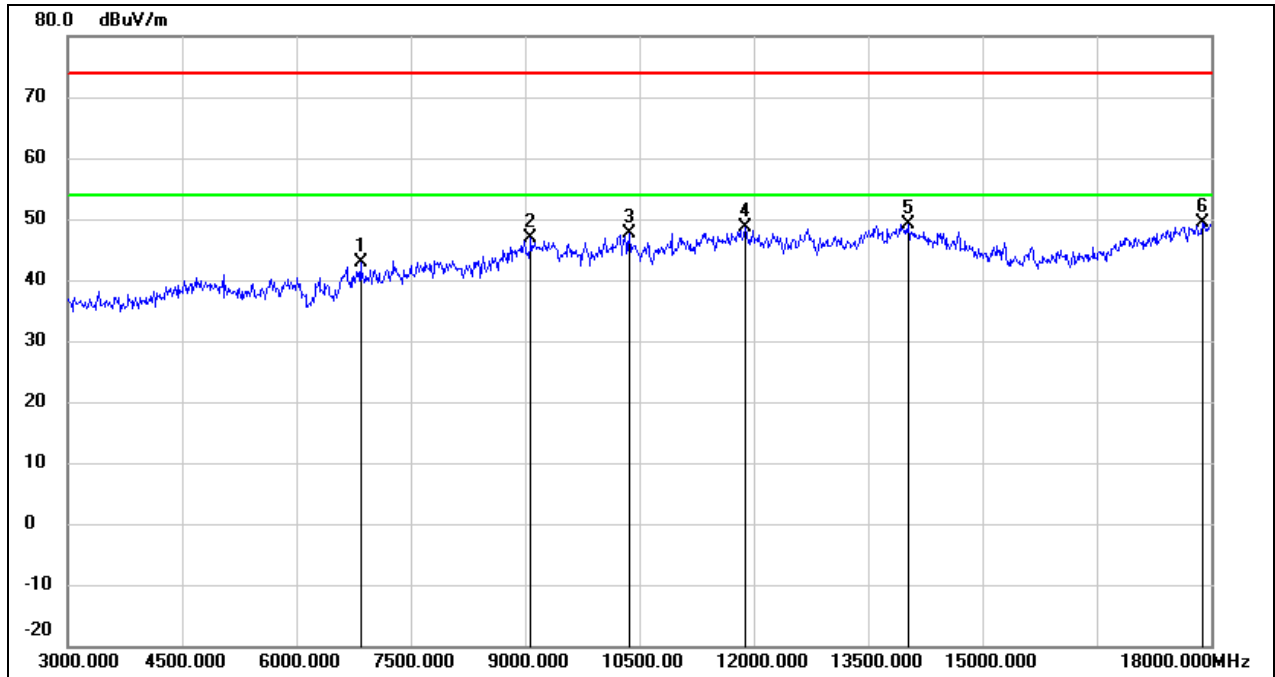

No.	Frequency (MHz)	Reading (dBuV)	Correct (dB/m)	Result (dBuV/m)	Limit (dBuV/m)	Margin (dB)	Remark
1	6840.000	37.01	5.89	42.90	74.00	-31.10	peak
2	9075.000	36.33	10.52	46.85	74.00	-27.15	peak
3	10365.000	35.03	12.72	47.75	74.00	-26.25	peak
4	11895.000	30.91	17.68	48.59	74.00	-25.41	peak
5	14025.000	27.27	21.86	49.13	74.00	-24.87	peak
6	17880.000	24.33	24.98	49.31	74.00	-24.69	peak

Test Mode:	802.11g	Channel:	2462
Polarity:	Vertical	Test Voltage:	DC 12 V

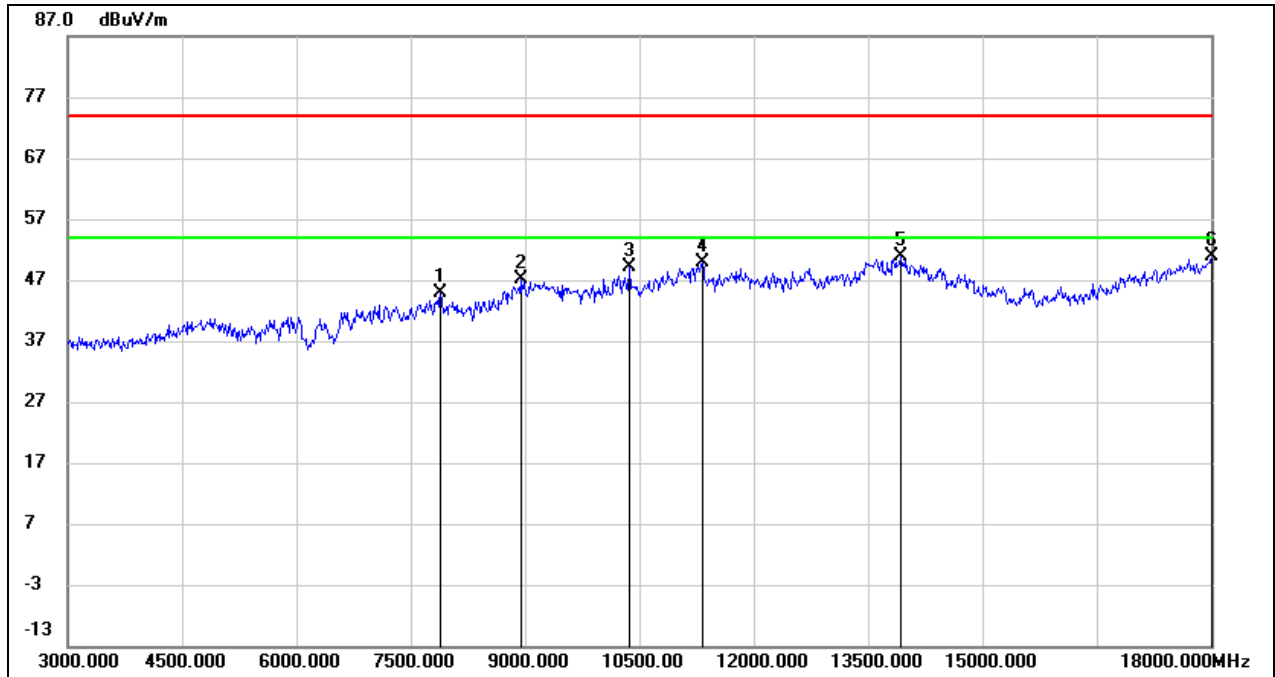

No.	Frequency (MHz)	Reading (dBuV)	Correct (dB/m)	Result (dBuV/m)	Limit (dBuV/m)	Margin (dB)	Remark
1	7890.000	38.56	6.31	44.87	74.00	-29.13	peak
2	8940.000	37.16	10.04	47.20	74.00	-26.80	peak
3	10365.000	36.49	12.72	49.21	74.00	-24.79	peak
4	11325.000	34.01	15.95	49.96	74.00	-24.04	peak
5	13920.000	29.17	21.79	50.96	74.00	-23.04	peak
6	18000.000	25.12	25.69	50.81	74.00	-23.19	peak

Test Mode:	802.11ax HE20	Channel:	2412
Polarity:	Horizontal	Test Voltage:	DC 12 V

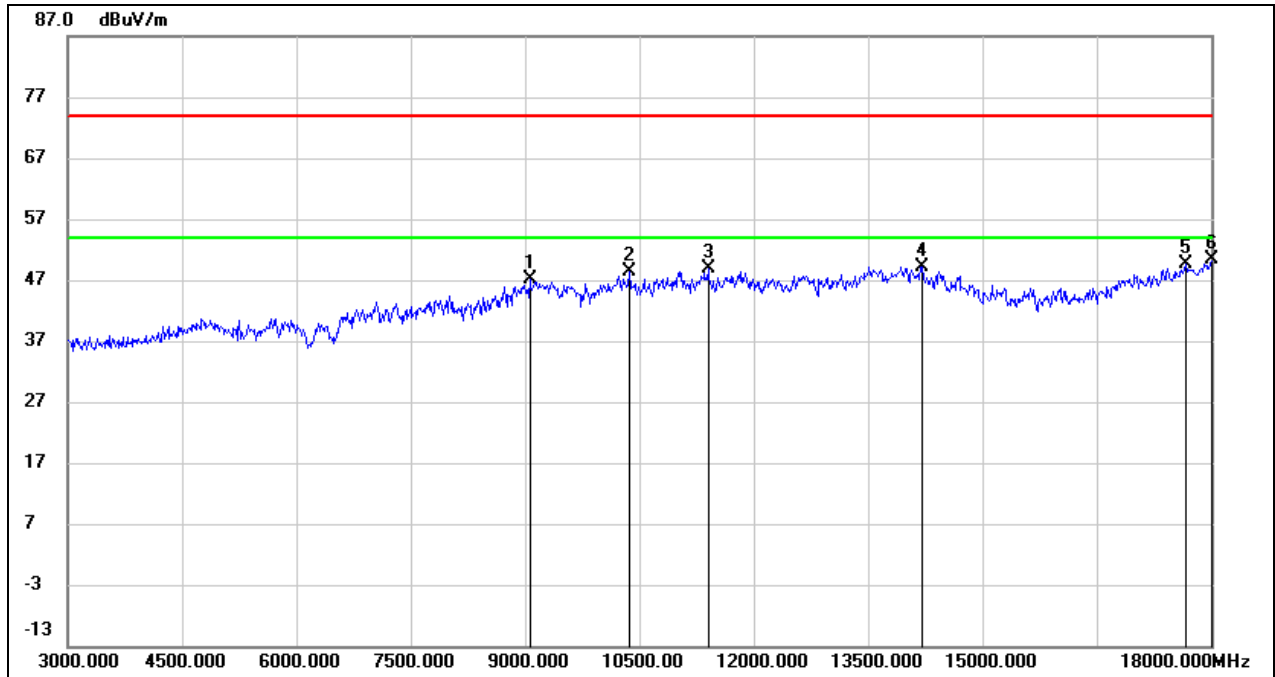

No.	Frequency (MHz)	Reading (dBuV)	Correct (dB/m)	Result (dBuV/m)	Limit (dBuV/m)	Margin (dB)	Remark
1	9060.000	36.54	10.51	47.05	74.00	-26.95	peak
2	10365.000	35.67	12.72	48.39	74.00	-25.61	peak
3	11400.000	32.57	16.23	48.80	74.00	-25.20	peak
4	14205.000	28.00	21.11	49.11	74.00	-24.89	peak
5	17670.000	26.02	23.73	49.75	74.00	-24.25	peak
6	18000.000	24.65	25.69	50.34	74.00	-23.66	peak

Test Mode:	802.11ax HE20	Channel:	2412
Polarity:	Vertical	Test Voltage:	DC 12 V

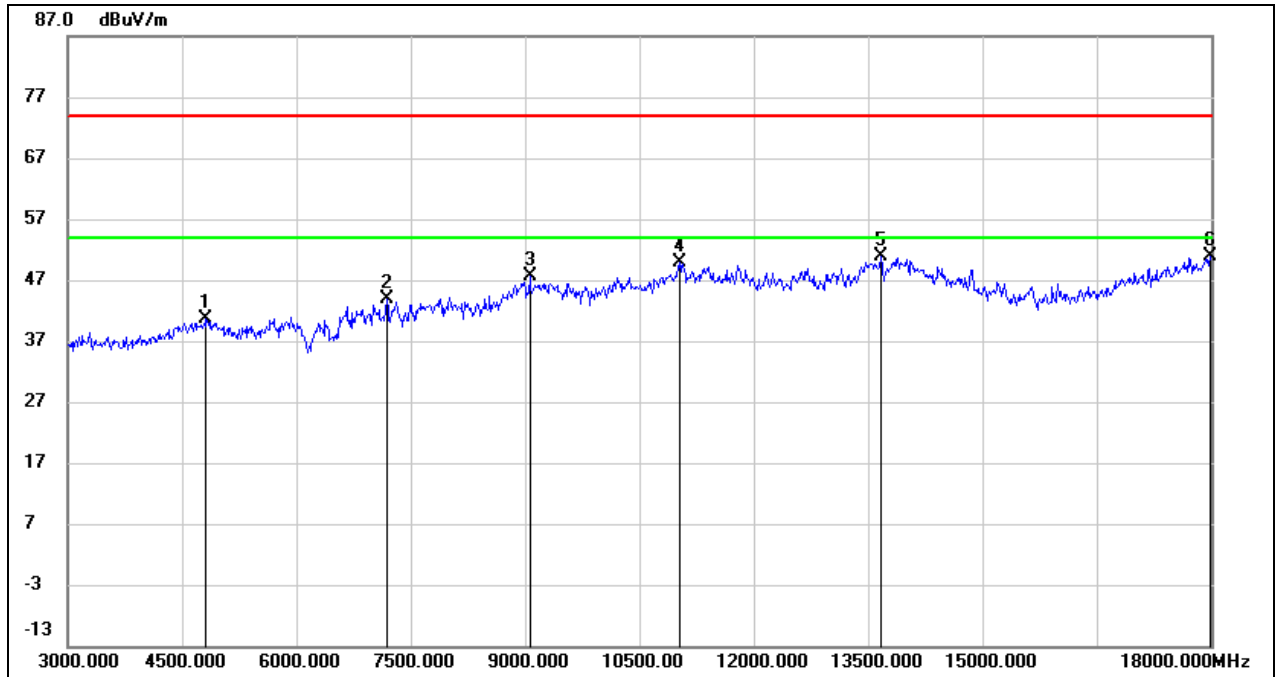

No.	Frequency (MHz)	Reading (dBuV)	Correct (dB/m)	Result (dBuV/m)	Limit (dBuV/m)	Margin (dB)	Remark
1	4815.000	40.79	-0.26	40.53	74.00	-33.47	peak
2	7185.000	37.28	6.55	43.83	74.00	-30.17	peak
3	9060.000	37.08	10.51	47.59	74.00	-26.41	peak
4	11025.000	34.99	14.85	49.84	74.00	-24.16	peak
5	13665.000	29.53	21.25	50.78	74.00	-23.22	peak
6	17985.000	25.38	25.60	50.98	74.00	-23.02	peak

Test Mode:	802.11ax HE20	Channel:	2417
Polarity:	Horizontal	Test Voltage:	DC 12 V

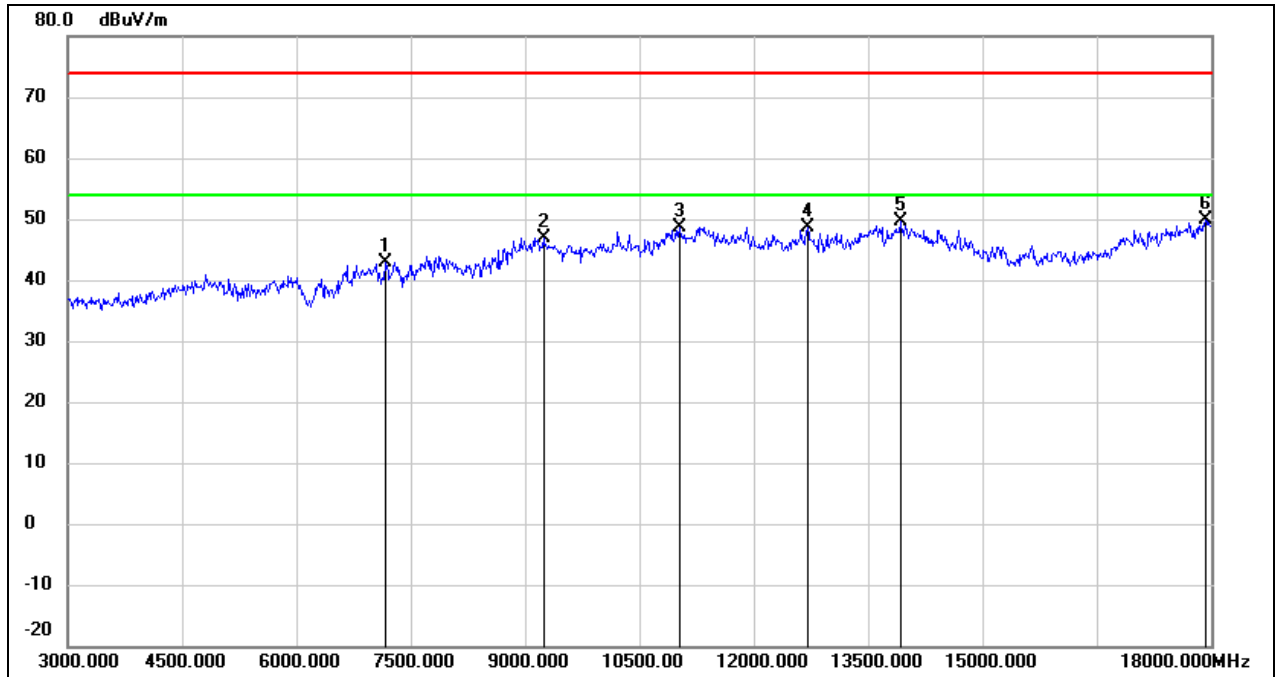

No.	Frequency (MHz)	Reading (dBuV)	Correct (dB/m)	Result (dBuV/m)	Limit (dBuV/m)	Margin (dB)	Remark
1	7170.000	36.41	6.56	42.97	74.00	-31.03	peak
2	9240.000	36.32	10.58	46.90	74.00	-27.10	peak
3	11025.000	33.67	14.85	48.52	74.00	-25.48	peak
4	12705.000	30.52	18.06	48.58	74.00	-25.42	peak
5	13920.000	27.81	21.79	49.60	74.00	-24.40	peak
6	17925.000	24.67	25.25	49.92	74.00	-24.08	peak

Test Mode:	802.11ax HE20	Channel:	2417
Polarity:	Vertical	Test Voltage:	DC 12 V

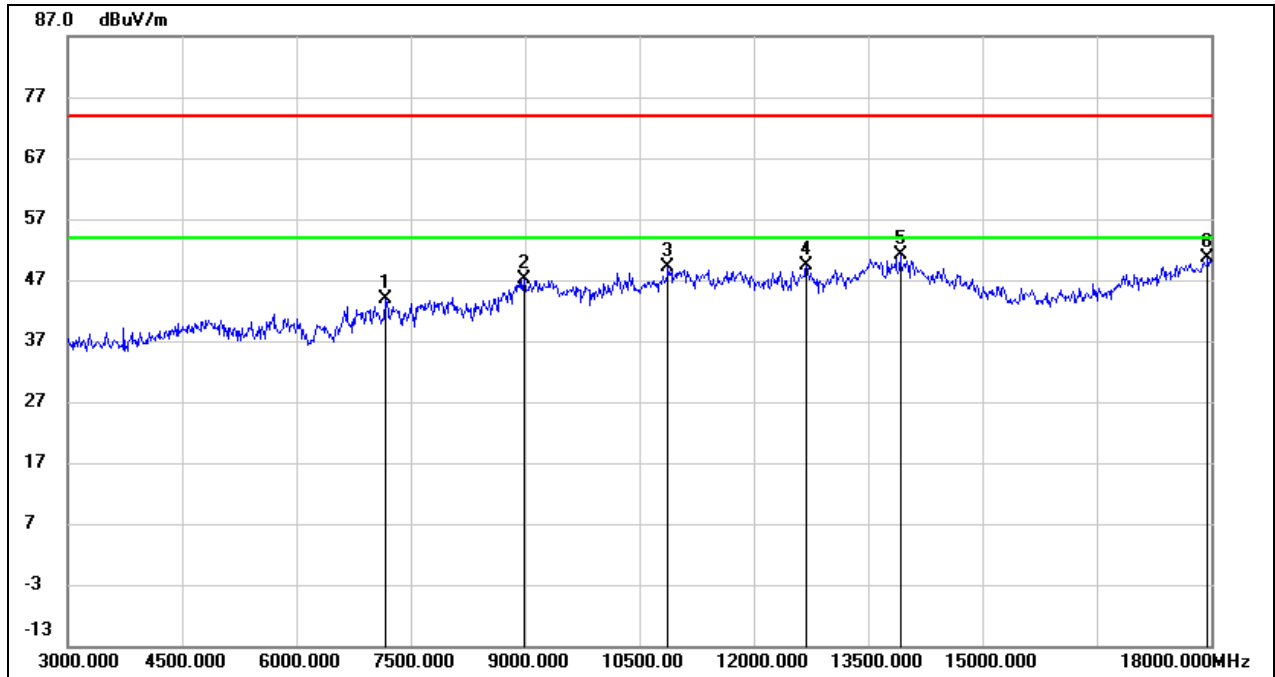

No.	Frequency (MHz)	Reading (dBuV)	Correct (dB/m)	Result (dBuV/m)	Limit (dBuV/m)	Margin (dB)	Remark
1	7170.000	37.21	6.56	43.77	74.00	-30.23	peak
2	8985.000	36.69	10.37	47.06	74.00	-26.94	peak
3	10875.000	34.84	14.32	49.16	74.00	-24.84	peak
4	12690.000	31.31	18.02	49.33	74.00	-24.67	peak
5	13920.000	29.28	21.79	51.07	74.00	-22.93	peak
6	17955.000	25.24	25.42	50.66	74.00	-23.34	peak

Test Mode:	802.11ax HE20	Channel:	2437
Polarity:	Horizontal	Test Voltage:	DC 12 V

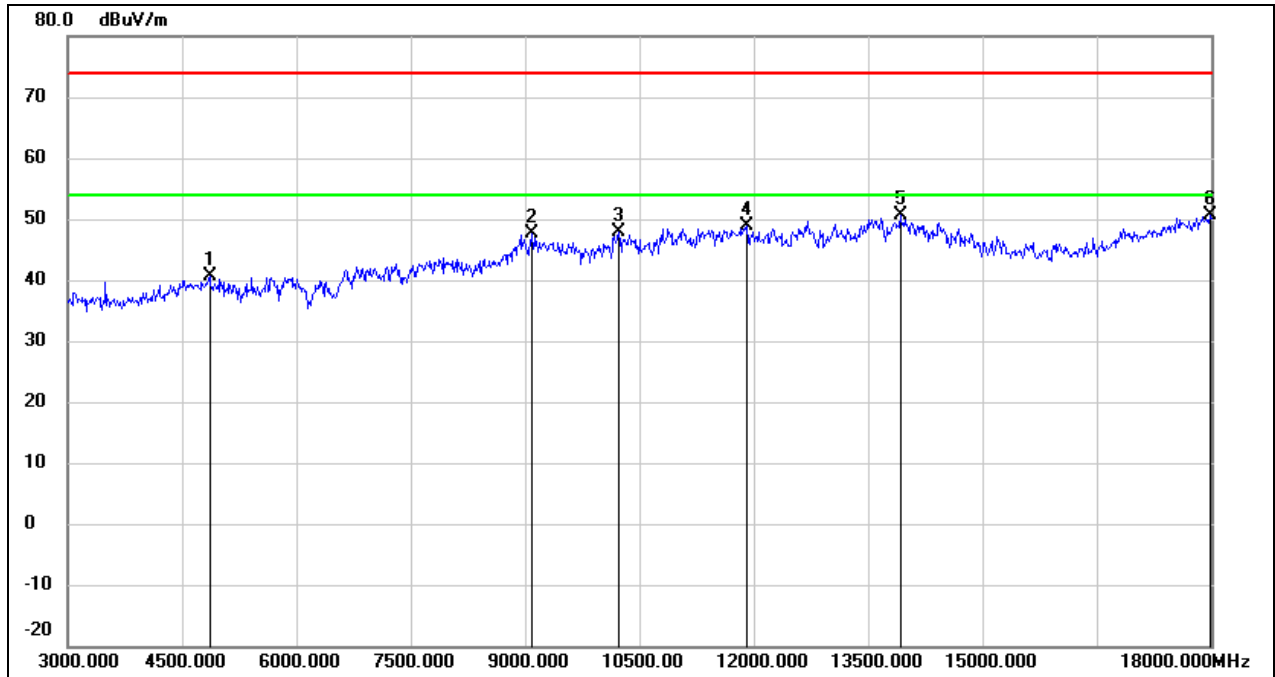

No.	Frequency (MHz)	Reading (dBuV)	Correct (dB/m)	Result (dBuV/m)	Limit (dBuV/m)	Margin (dB)	Remark
1	4860.000	40.73	-0.09	40.64	74.00	-33.36	peak
2	9090.000	37.03	10.51	47.54	74.00	-26.46	peak
3	10230.000	35.40	12.46	47.86	74.00	-26.14	peak
4	11910.000	31.09	17.72	48.81	74.00	-25.19	peak
5	13920.000	28.84	21.79	50.63	74.00	-23.37	peak
6	17985.000	25.00	25.60	50.60	74.00	-23.40	peak



Test Mode:	802.11ax HE20	Channel:	2437
Polarity:	Vertical	Test Voltage:	DC 12 V

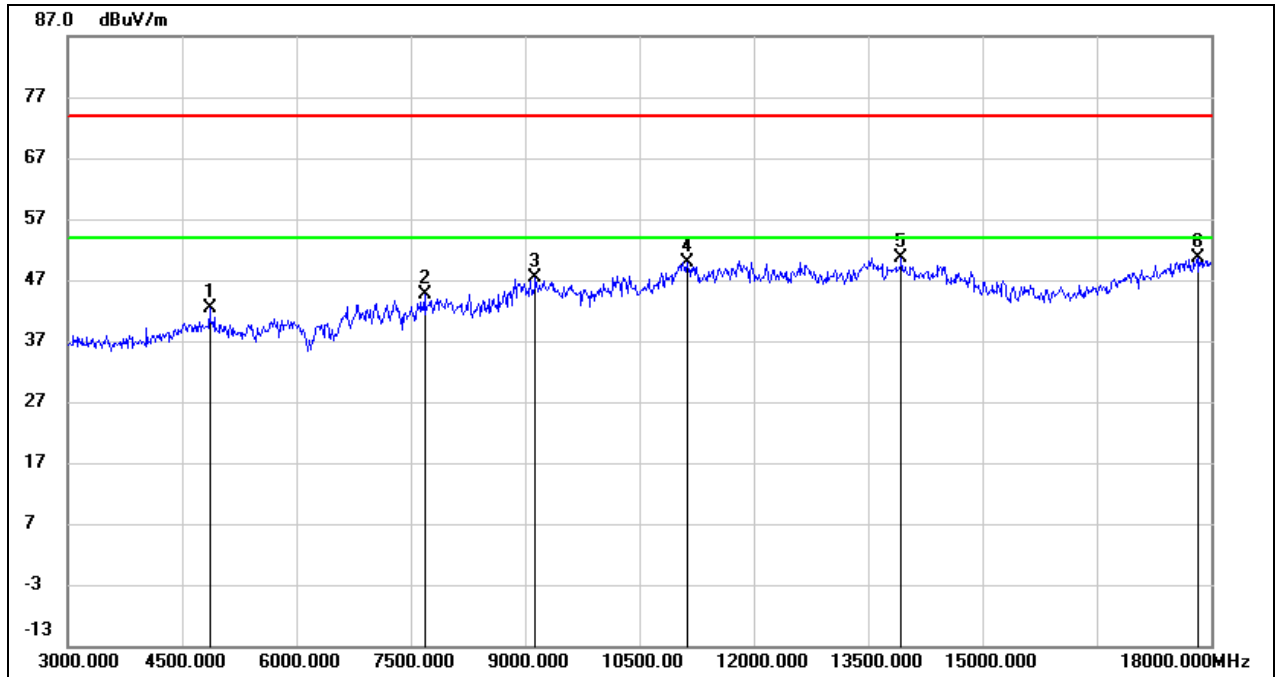

No.	Frequency (MHz)	Reading (dBuV)	Correct (dB/m)	Result (dBuV/m)	Limit (dBuV/m)	Margin (dB)	Remark
1	4860.000	42.54	-0.09	42.45	74.00	-31.55	peak
2	7680.000	38.22	6.32	44.54	74.00	-29.46	peak
3	9135.000	36.73	10.55	47.28	74.00	-26.72	peak
4	11130.000	34.69	15.25	49.94	74.00	-24.06	peak
5	13935.000	28.84	21.82	50.66	74.00	-23.34	peak
6	17820.000	25.97	24.63	50.60	74.00	-23.40	peak

Test Mode:	802.11ax HE20	Channel:	2457
Polarity:	Horizontal	Test Voltage:	DC 12 V

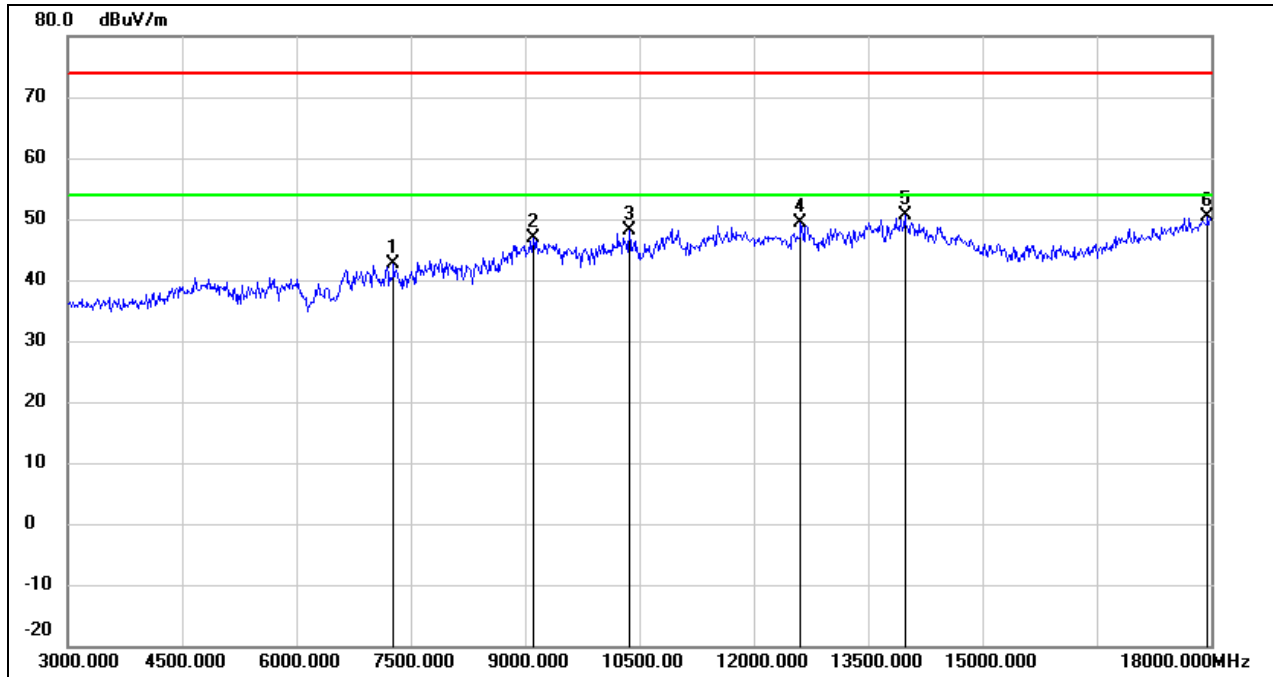

No.	Frequency (MHz)	Reading (dBuV)	Correct (dB/m)	Result (dBuV/m)	Limit (dBuV/m)	Margin (dB)	Remark
1	7275.000	36.22	6.49	42.71	74.00	-31.29	peak
2	9105.000	36.35	10.53	46.88	74.00	-27.12	peak
3	10365.000	35.49	12.72	48.21	74.00	-25.79	peak
4	12615.000	31.60	17.86	49.46	74.00	-24.54	peak
5	13980.000	28.64	21.92	50.56	74.00	-23.44	peak
6	17955.000	24.90	25.42	50.32	74.00	-23.68	peak

Test Mode:	802.11ax HE20	Channel:	2457
Polarity:	Vertical	Test Voltage:	DC 12 V

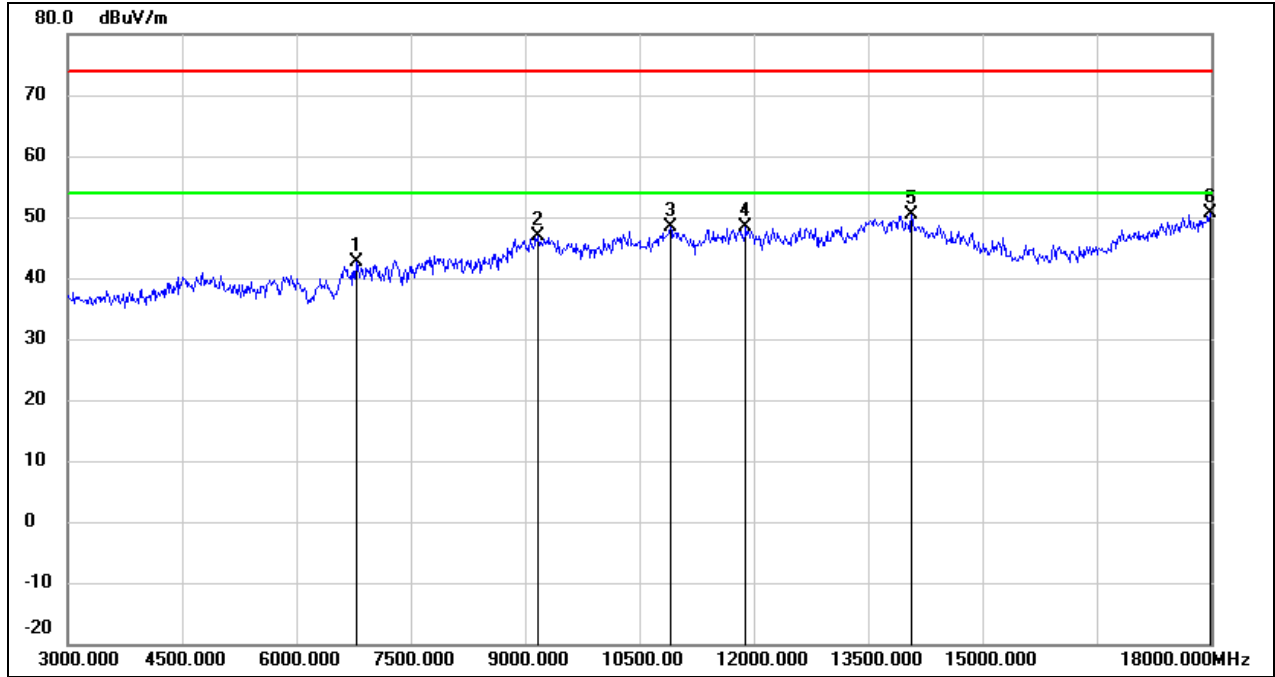

No.	Frequency (MHz)	Reading (dBuV)	Correct (dB/m)	Result (dBuV/m)	Limit (dBuV/m)	Margin (dB)	Remark
1	6780.000	37.02	5.60	42.62	74.00	-31.38	peak
2	9165.000	36.43	10.55	46.98	74.00	-27.02	peak
3	10905.000	33.98	14.43	48.41	74.00	-25.59	peak
4	11895.000	30.77	17.68	48.45	74.00	-25.55	peak
5	14070.000	28.65	21.67	50.32	74.00	-23.68	peak
6	17985.000	25.05	25.60	50.65	74.00	-23.35	peak

Test Mode:	802.11ax HE20	Channel:	2462
Polarity:	Horizontal	Test Voltage:	DC 12 V

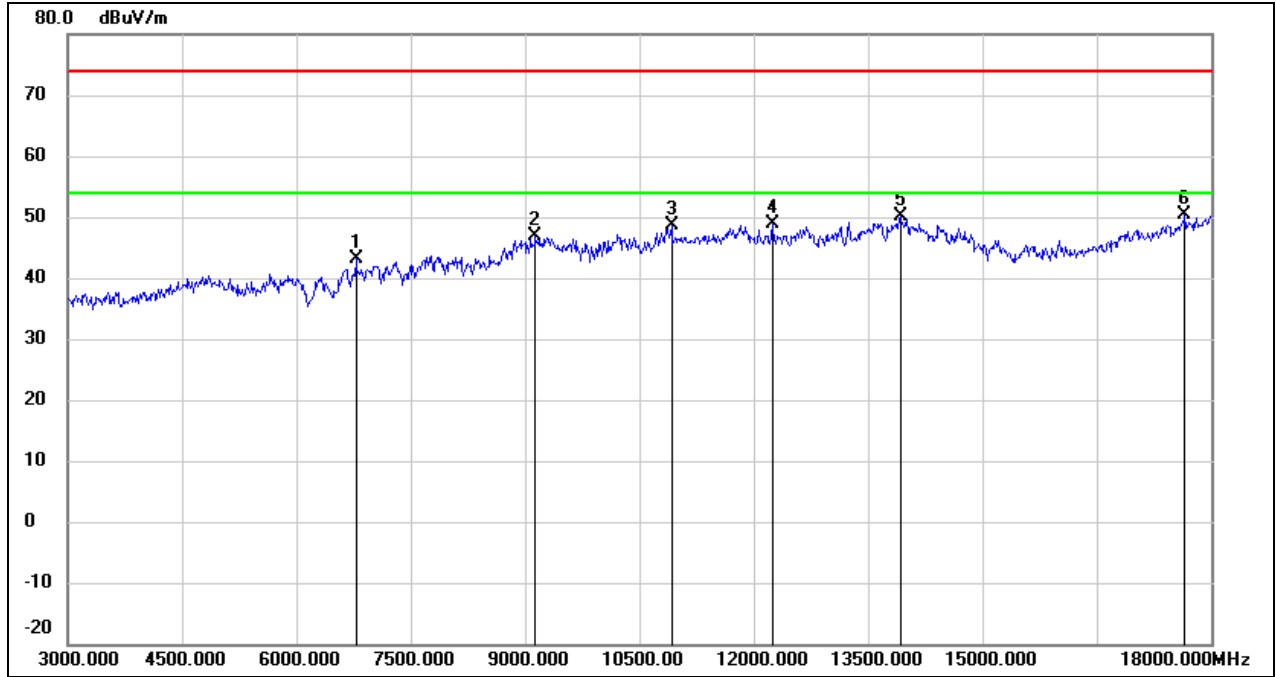

No.	Frequency (MHz)	Reading (dBuV)	Correct (dB/m)	Result (dBuV/m)	Limit (dBuV/m)	Margin (dB)	Remark
1	6780.000	37.45	5.60	43.05	74.00	-30.95	peak
2	9135.000	36.29	10.55	46.84	74.00	-27.16	peak
3	10920.000	34.07	14.49	48.56	74.00	-25.44	peak
4	12240.000	31.12	17.79	48.91	74.00	-25.09	peak
5	13920.000	28.25	21.79	50.04	74.00	-23.96	peak
6	17655.000	26.69	23.64	50.33	74.00	-23.67	peak

Test Mode:	802.11ax HE20	Channel:	2462
Polarity:	Vertical	Test Voltage:	DC 12 V

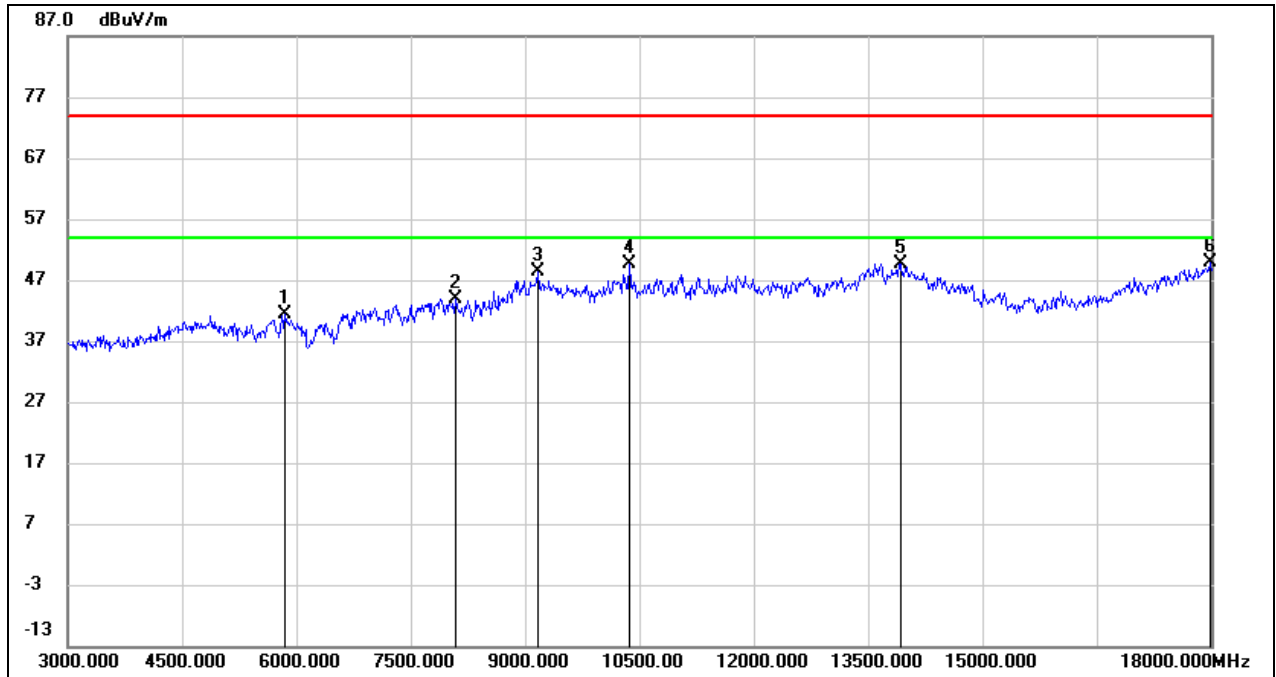

No.	Frequency (MHz)	Reading (dBuV)	Correct (dB/m)	Result (dBuV/m)	Limit (dBuV/m)	Margin (dB)	Remark
1	5850.000	39.52	1.82	41.34	74.00	-32.66	peak
2	8085.000	37.45	6.40	43.85	74.00	-30.15	peak
3	9165.000	37.73	10.55	48.28	74.00	-25.72	peak
4	10365.000	36.79	12.72	49.51	74.00	-24.49	peak
5	13920.000	27.93	21.79	49.72	74.00	-24.28	peak
6	17985.000	24.23	25.60	49.83	74.00	-24.17	peak

Test Mode:	802.11ax HE40	Channel:	2422
Polarity:	Horizontal	Test Voltage:	DC 12 V

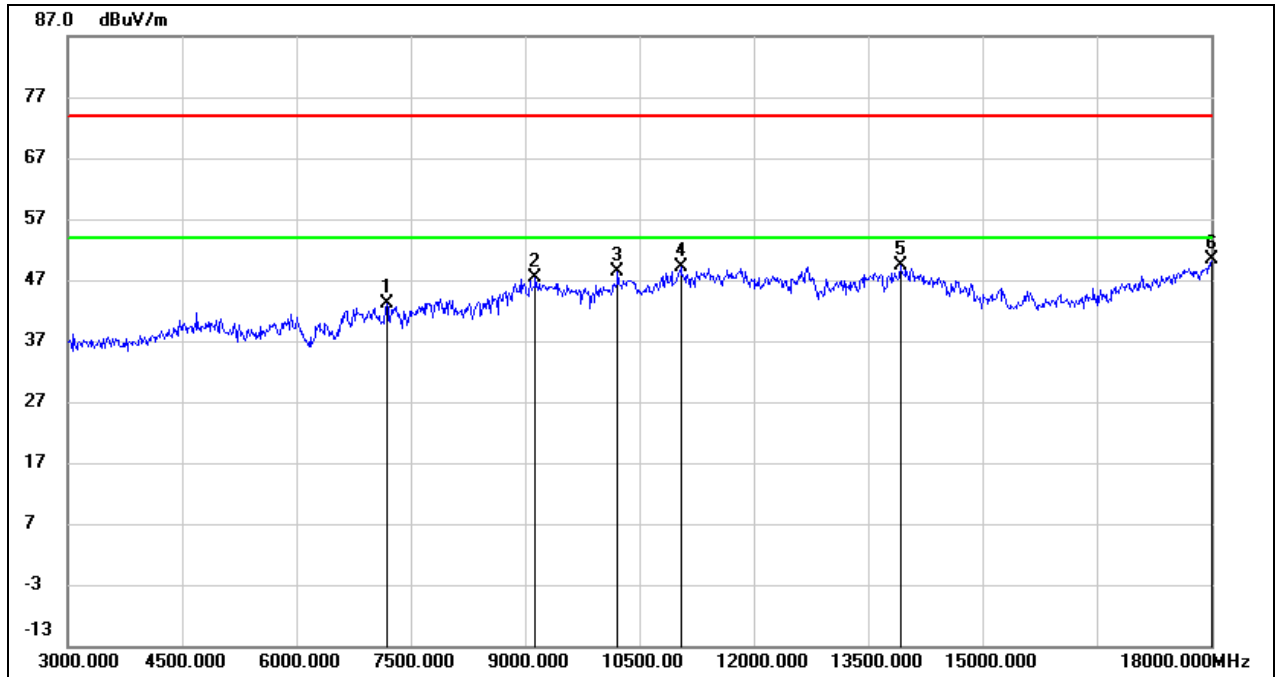

No.	Frequency (MHz)	Reading (dBuV)	Correct (dB/m)	Result (dBuV/m)	Limit (dBuV/m)	Margin (dB)	Remark
1	7185.000	36.62	6.55	43.17	74.00	-30.83	peak
2	9135.000	36.75	10.55	47.30	74.00	-26.70	peak
3	10215.000	35.91	12.43	48.34	74.00	-25.66	peak
4	11040.000	34.30	14.91	49.21	74.00	-24.79	peak
5	13920.000	27.66	21.79	49.45	74.00	-24.55	peak
6	18000.000	24.59	25.69	50.28	74.00	-23.72	peak

Test Mode:	802.11ax HE40	Channel:	2422
Polarity:	Vertical	Test Voltage:	DC 12 V

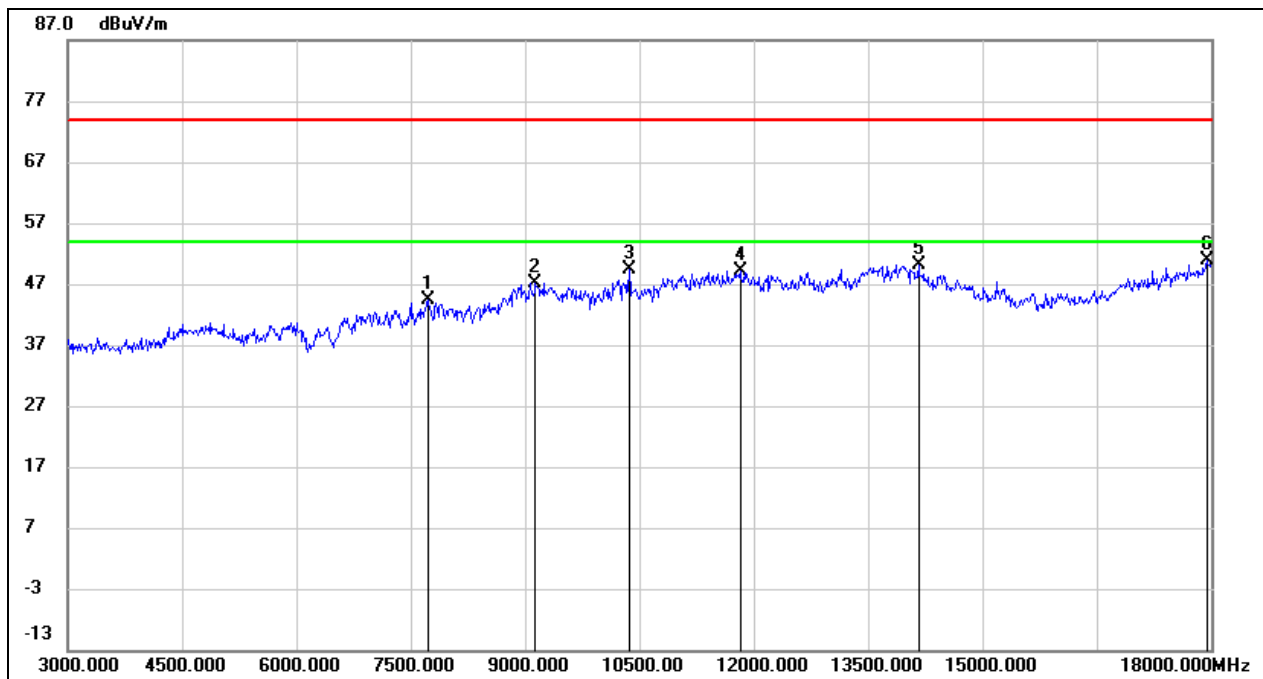

No.	Frequency (MHz)	Reading (dBuV)	Correct (dB/m)	Result (dBuV/m)	Limit (dBuV/m)	Margin (dB)	Remark
1	7725.000	37.98	6.32	44.30	74.00	-29.70	peak
2	9135.000	36.69	10.55	47.24	74.00	-26.76	peak
3	10365.000	36.64	12.72	49.36	74.00	-24.64	peak
4	11820.000	31.63	17.47	49.10	74.00	-24.90	peak
5	14160.000	28.84	21.31	50.15	74.00	-23.85	peak
6	17940.000	25.42	25.34	50.76	74.00	-23.24	peak

Test Mode:	802.11ax HE40	Channel:	2427
Polarity:	Horizontal	Test Voltage:	DC 12 V

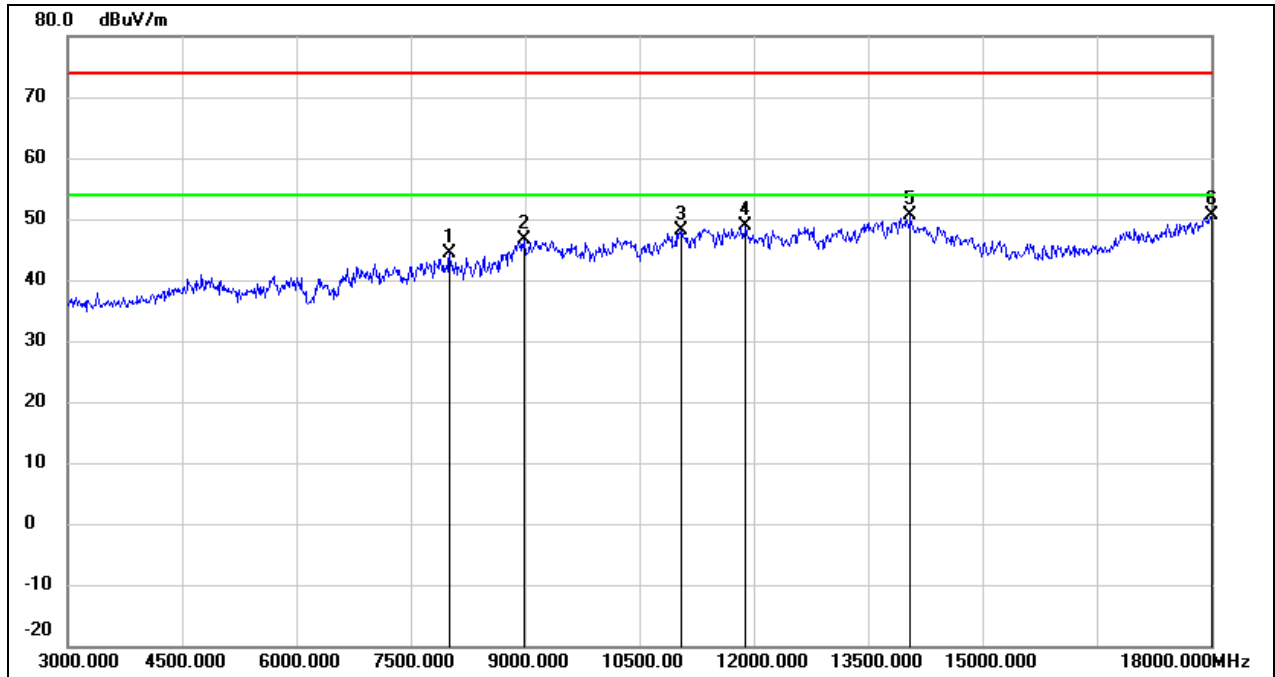

No.	Frequency (MHz)	Reading (dBuV)	Correct (dB/m)	Result (dBuV/m)	Limit (dBuV/m)	Margin (dB)	Remark
1	8010.000	38.13	6.32	44.45	74.00	-29.55	peak
2	8985.000	36.25	10.37	46.62	74.00	-27.38	peak
3	11055.000	33.21	14.96	48.17	74.00	-25.83	peak
4	11895.000	31.10	17.68	48.78	74.00	-25.22	peak
5	14055.000	28.83	21.73	50.56	74.00	-23.44	peak
6	18000.000	24.92	25.69	50.61	74.00	-23.39	peak



Test Mode:	802.11ax HE40	Channel:	2427
Polarity:	Vertical	Test Voltage:	DC 12 V

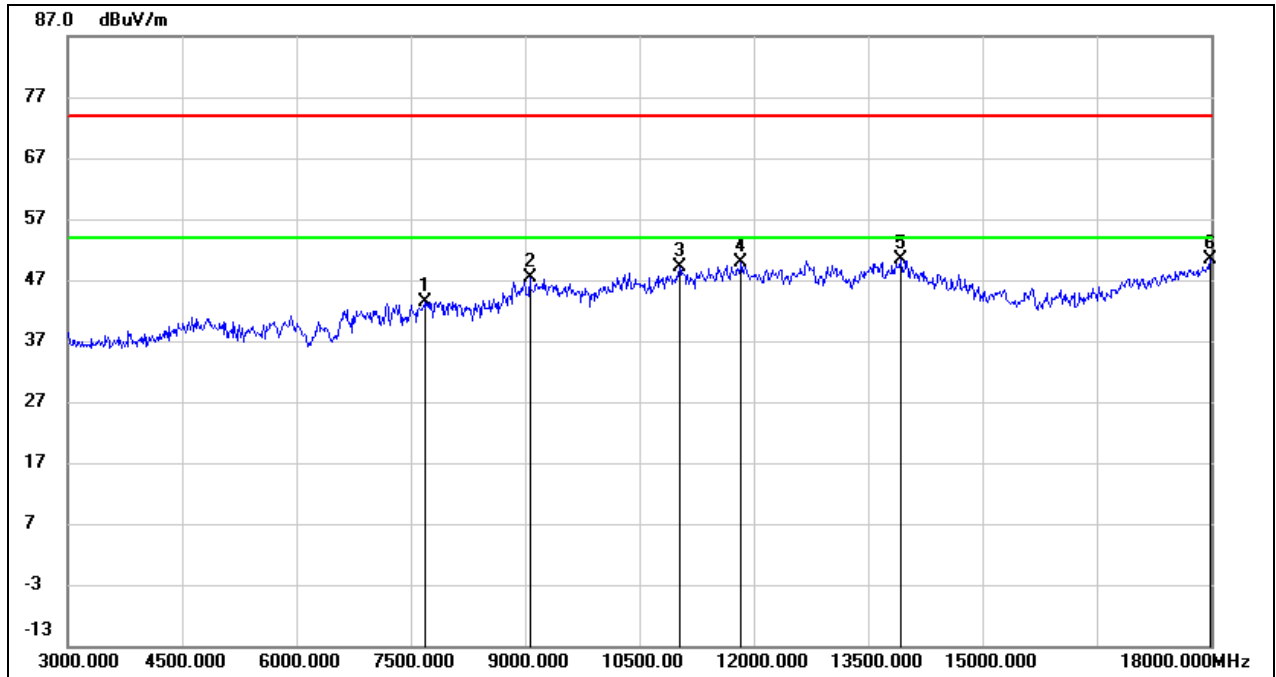

No.	Frequency (MHz)	Reading (dBuV)	Correct (dB/m)	Result (dBuV/m)	Limit (dBuV/m)	Margin (dB)	Remark
1	7680.000	37.13	6.32	43.45	74.00	-30.55	peak
2	9060.000	36.80	10.51	47.31	74.00	-26.69	peak
3	11025.000	34.22	14.85	49.07	74.00	-24.93	peak
4	11835.000	32.44	17.51	49.95	74.00	-24.05	peak
5	13935.000	28.44	21.82	50.26	74.00	-23.74	peak
6	17985.000	24.69	25.60	50.29	74.00	-23.71	peak

Test Mode:	802.11ax HE40	Channel:	2437
Polarity:	Horizontal	Test Voltage:	DC 12 V

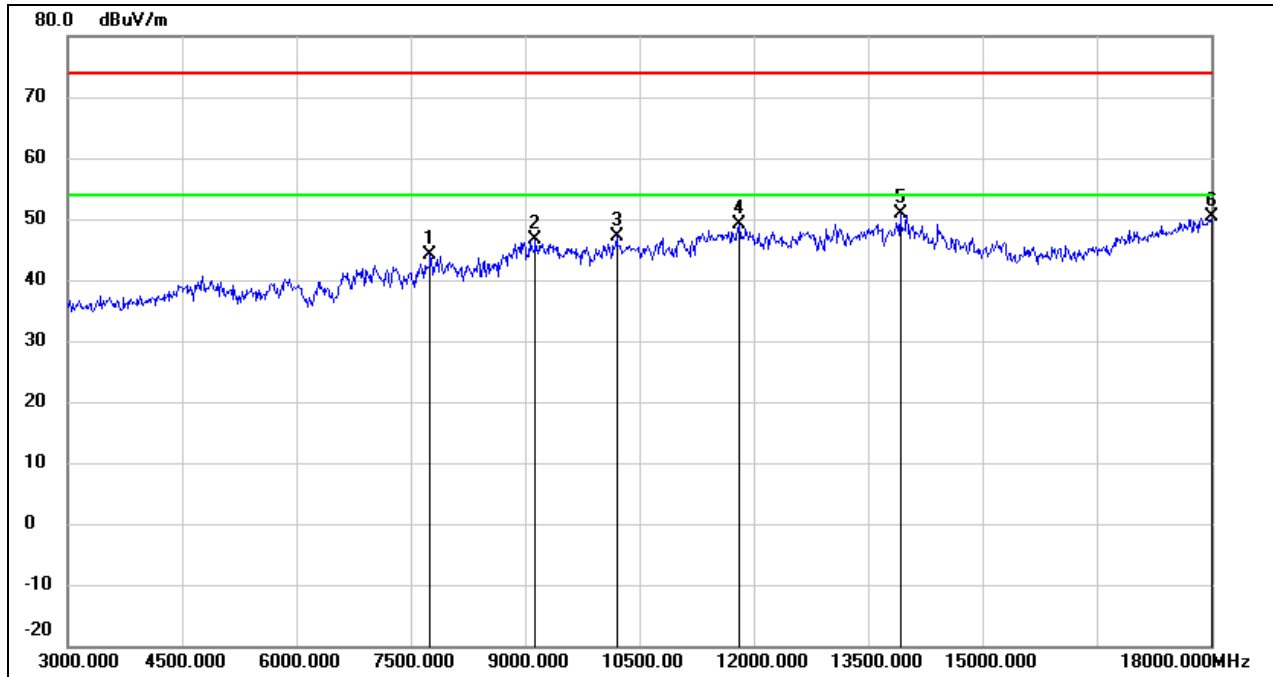

No.	Frequency (MHz)	Reading (dBuV)	Correct (dB/m)	Result (dBuV/m)	Limit (dBuV/m)	Margin (dB)	Remark
1	7755.000	37.92	6.31	44.23	74.00	-29.77	peak
2	9135.000	35.97	10.55	46.52	74.00	-27.48	peak
3	10200.000	34.72	12.40	47.12	74.00	-26.88	peak
4	11805.000	31.65	17.43	49.08	74.00	-24.92	peak
5	13920.000	29.08	21.79	50.87	74.00	-23.13	peak
6	18000.000	24.59	25.69	50.28	74.00	-23.72	peak

Test Mode:	802.11ax HE40	Channel:	2437
Polarity:	Vertical	Test Voltage:	DC 12 V

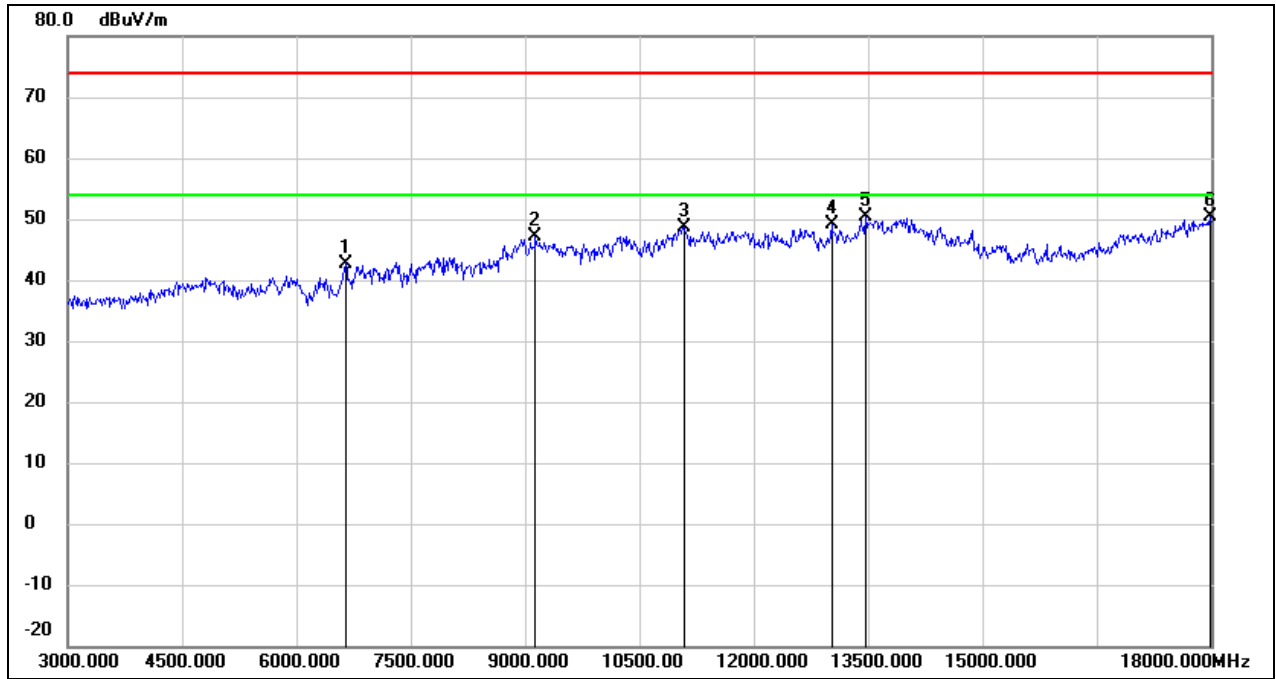

No.	Frequency (MHz)	Reading (dBuV)	Correct (dB/m)	Result (dBuV/m)	Limit (dBuV/m)	Margin (dB)	Remark
1	6645.000	37.81	4.94	42.75	74.00	-31.25	peak
2	9135.000	36.61	10.55	47.16	74.00	-26.84	peak
3	11085.000	33.50	15.08	48.58	74.00	-25.42	peak
4	13020.000	30.34	18.80	49.14	74.00	-24.86	peak
5	13470.000	29.59	20.77	50.36	74.00	-23.64	peak
6	17985.000	24.81	25.60	50.41	74.00	-23.59	peak

Test Mode:	802.11ax HE40	Channel:	2447
Polarity:	Horizontal	Test Voltage:	DC 12 V

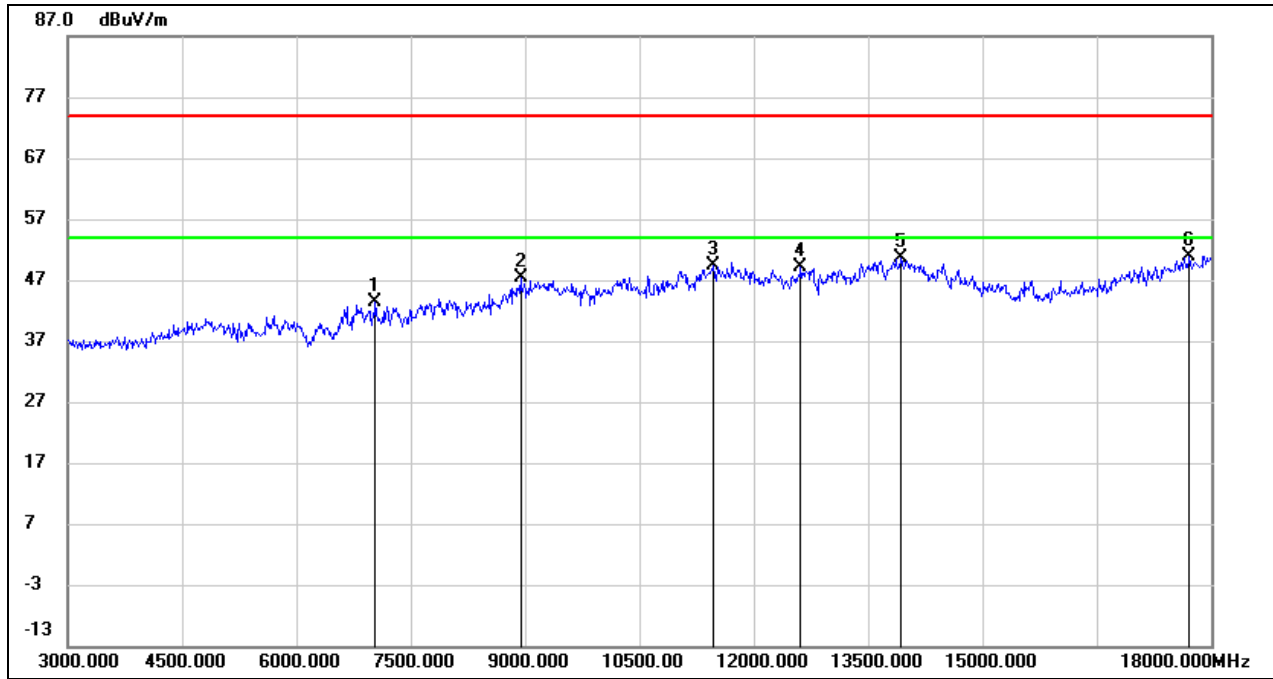

No.	Frequency (MHz)	Reading (dBuV)	Correct (dB/m)	Result (dBuV/m)	Limit (dBuV/m)	Margin (dB)	Remark
1	7035.000	36.75	6.67	43.42	74.00	-30.58	peak
2	8940.000	37.23	10.04	47.27	74.00	-26.73	peak
3	11475.000	32.88	16.51	49.39	74.00	-24.61	peak
4	12615.000	31.37	17.86	49.23	74.00	-24.77	peak
5	13935.000	28.72	21.82	50.54	74.00	-23.46	peak
6	17715.000	26.94	24.00	50.94	74.00	-23.06	peak

Test Mode:	802.11ax HE40	Channel:	2447
Polarity:	Vertical	Test Voltage:	DC 12 V

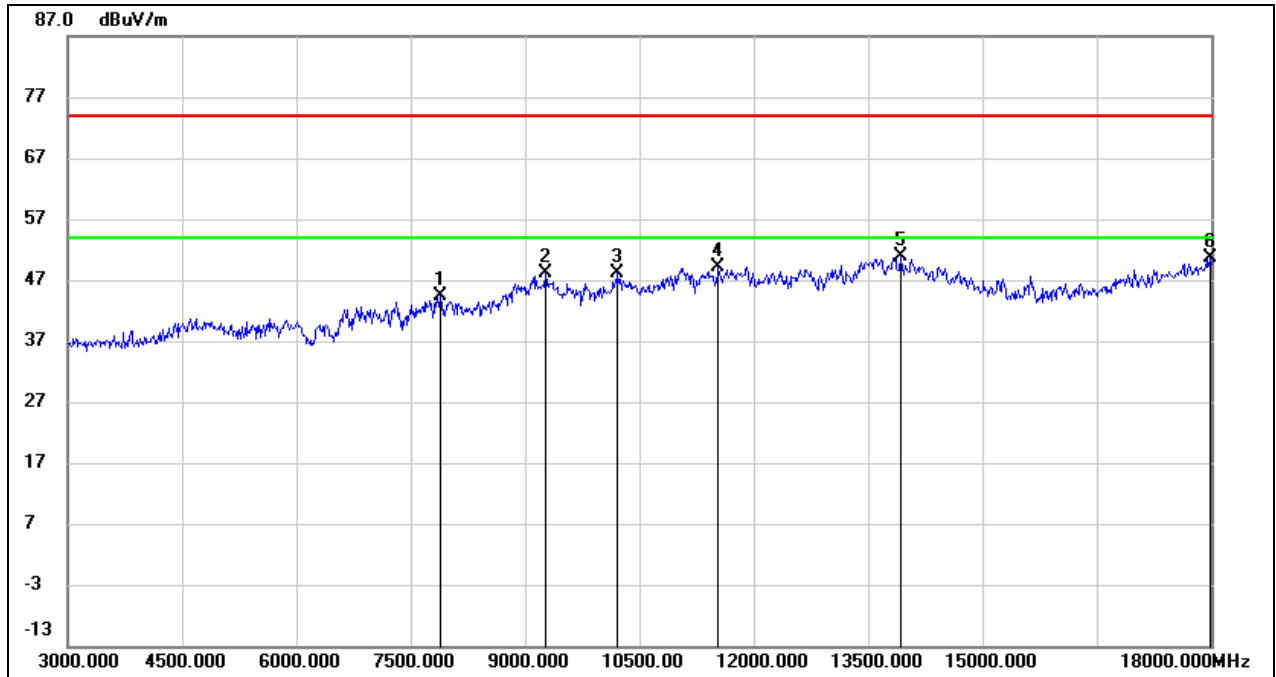

No.	Frequency (MHz)	Reading (dBuV)	Correct (dB/m)	Result (dBuV/m)	Limit (dBuV/m)	Margin (dB)	Remark
1	7890.000	38.18	6.31	44.49	74.00	-29.51	peak
2	9270.000	37.51	10.59	48.10	74.00	-25.90	peak
3	10215.000	35.76	12.43	48.19	74.00	-25.81	peak
4	11535.000	32.53	16.70	49.23	74.00	-24.77	peak
5	13920.000	29.10	21.79	50.89	74.00	-23.11	peak
6	17985.000	24.99	25.60	50.59	74.00	-23.41	peak

Test Mode:	802.11ax HE40	Channel:	2452
Polarity:	Horizontal	Test Voltage:	DC 12 V

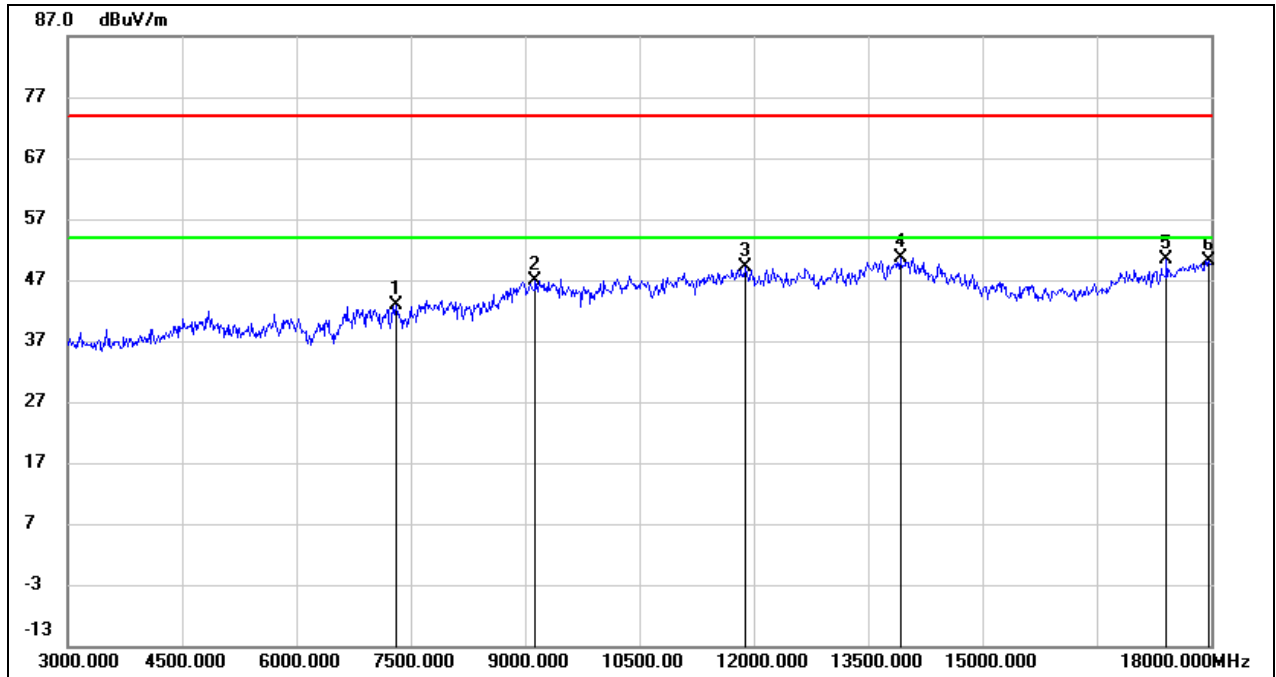

No.	Frequency (MHz)	Reading (dBuV)	Correct (dB/m)	Result (dBuV/m)	Limit (dBuV/m)	Margin (dB)	Remark
1	7305.000	36.42	6.47	42.89	74.00	-31.11	peak
2	9135.000	36.35	10.55	46.90	74.00	-27.10	peak
3	11895.000	31.38	17.68	49.06	74.00	-24.94	peak
4	13920.000	28.84	21.79	50.63	74.00	-23.37	peak
5	17415.000	27.93	22.42	50.35	74.00	-23.65	peak
6	17970.000	24.51	25.51	50.02	74.00	-23.98	peak

Test Mode:	802.11ax HE40	Channel:	2452
Polarity:	Vertical	Test Voltage:	DC 12 V

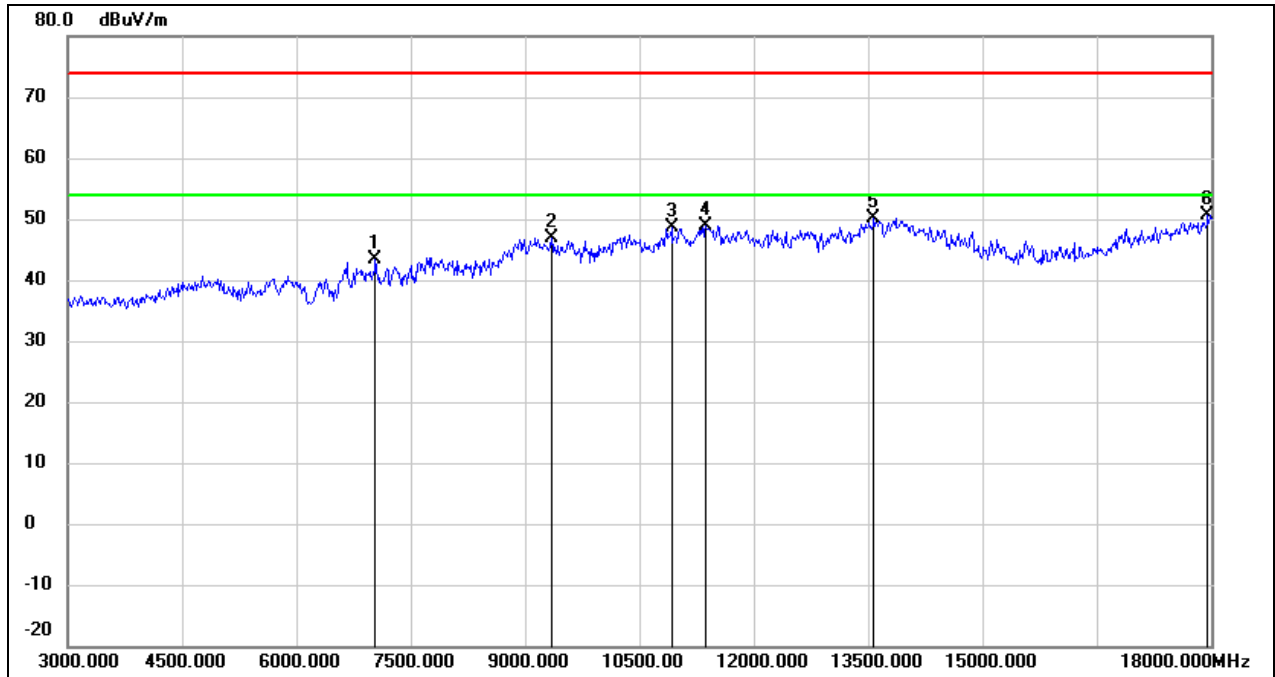

No.	Frequency (MHz)	Reading (dBuV)	Correct (dB/m)	Result (dBuV/m)	Limit (dBuV/m)	Margin (dB)	Remark
1	7035.000	36.65	6.67	43.32	74.00	-30.68	peak
2	9345.000	36.16	10.63	46.79	74.00	-27.21	peak
3	10920.000	34.14	14.49	48.63	74.00	-25.37	peak
4	11370.000	32.75	16.12	48.87	74.00	-25.13	peak
5	13575.000	29.02	21.06	50.08	74.00	-23.92	peak
6	17955.000	25.20	25.42	50.62	74.00	-23.38	peak

### 8.4. SPURIOUS EMISSIONS(9 KHZ~30 MHZ)

Test Mode:	802.11b	Channel:	2412
Polarity:	Horizontal	Test Voltage:	DC 12 V

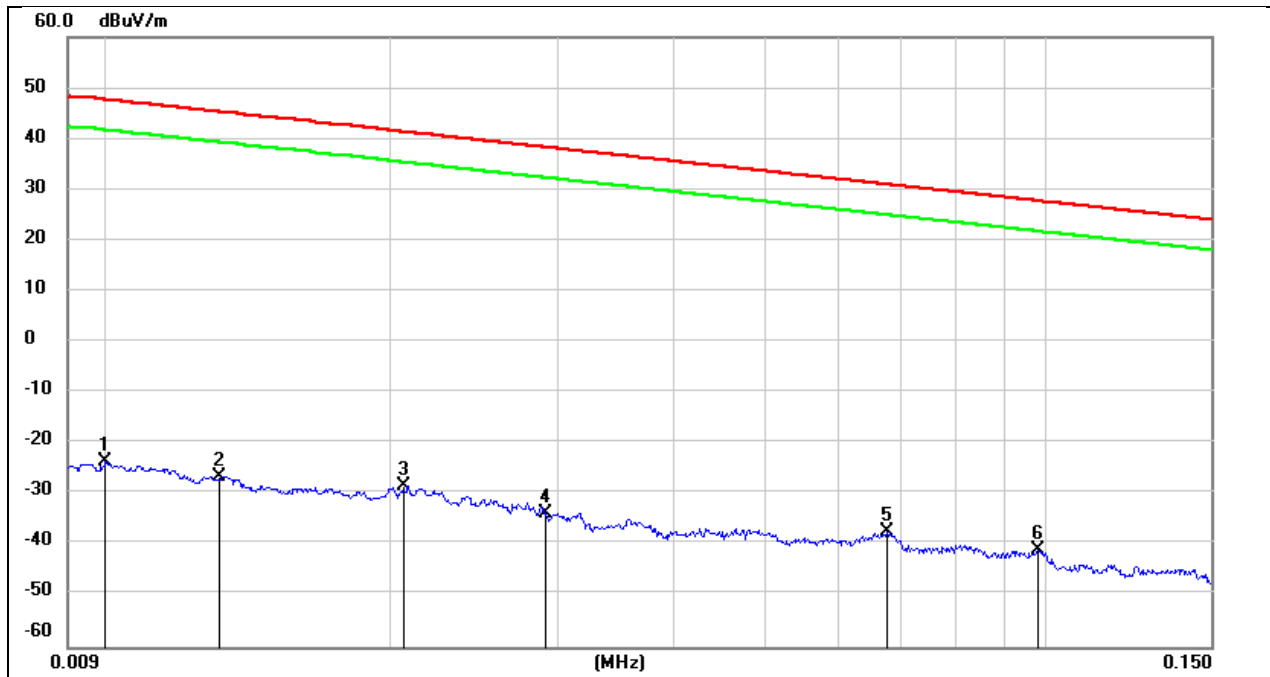

No.	Frequency (MHz)	Reading (dBuV)	Correct (dB/m)	Result (dBuV/m)	Limit (dBuV/m)	Margin (dB)	Remark
1	0.0100	77.72	-101.40	-23.68	47.60	-71.28	peak
2	0.0131	74.97	-101.38	-26.41	45.25	-71.66	peak
3	0.0206	72.92	-101.35	-28.43	41.32	-69.75	peak
4	0.0292	67.79	-101.39	-33.60	38.29	-71.89	peak
5	0.0675	64.14	-101.56	-37.42	31.02	-68.44	peak
6	0.0981	60.77	-101.78	-41.01	27.77	-68.78	peak



Test Mode:	802.11b	Channel:	2412
Polarity:	Horizontal	Test Voltage:	DC 12 V

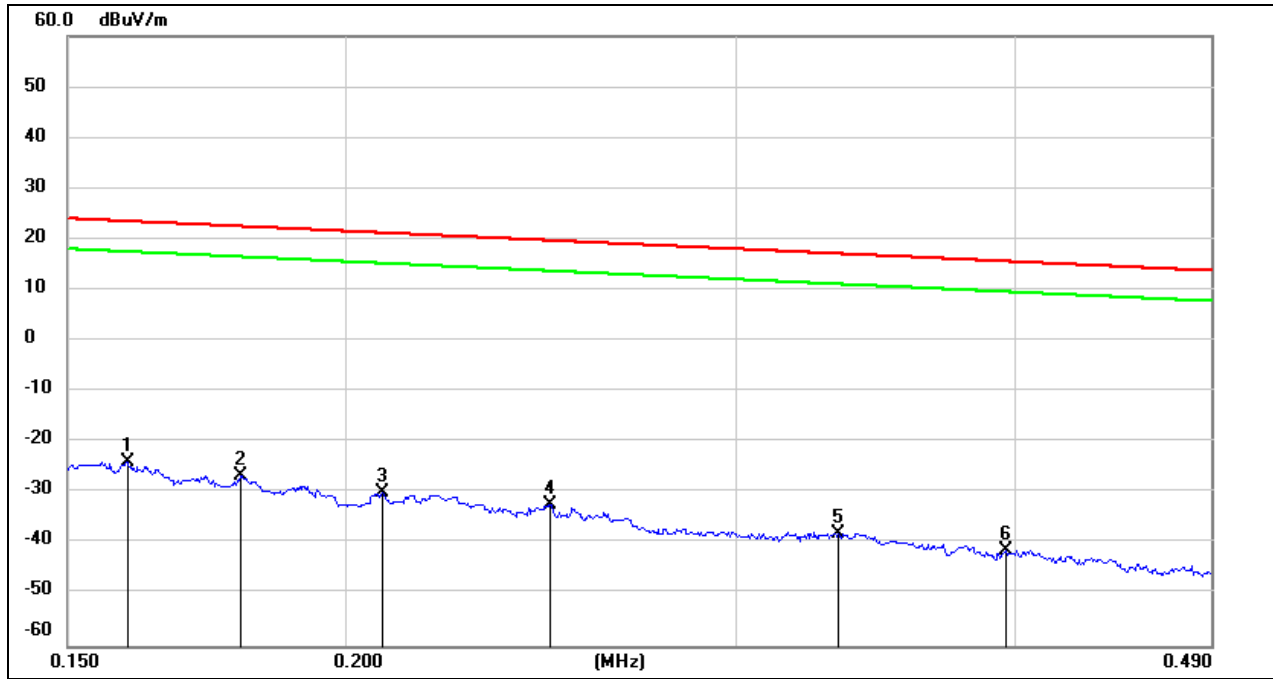

No.	Frequency (MHz)	Reading (dBuV)	Correct (dB/m)	Result (dBuV/m)	Limit (dBuV/m)	Margin (dB)	Remark
1	0.1595	77.86	-101.65	-23.79	23.55	-47.34	peak
2	0.1794	75.27	-101.68	-26.41	22.53	-48.94	peak
3	0.2078	71.74	-101.73	-29.99	21.25	-51.24	peak
4	0.2472	69.45	-101.80	-32.35	19.74	-52.09	peak
5	0.3331	63.96	-101.89	-37.93	17.15	-55.08	peak
6	0.3966	60.68	-101.96	-41.28	15.63	-56.91	peak

Test Mode:	802.11b	Channel:	2412
Polarity:	Horizontal	Test Voltage:	DC 12 V

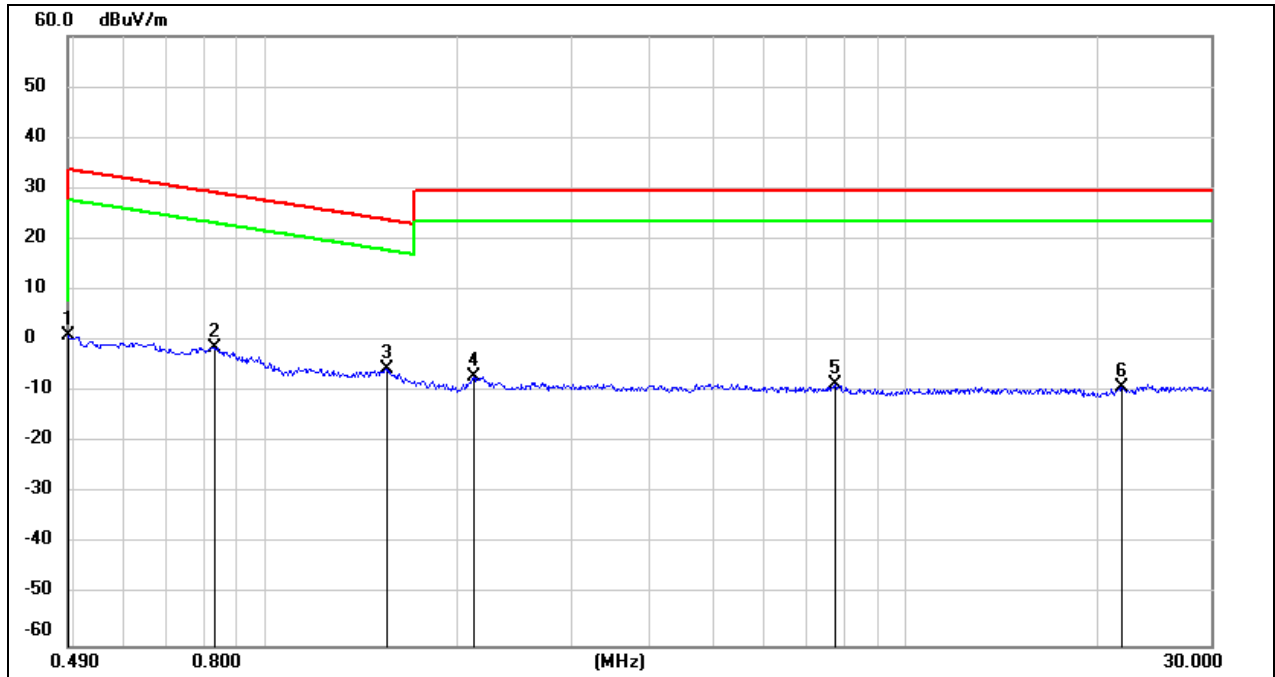

No.	Frequency (MHz)	Reading (dBuV)	Correct (dB/m)	Result (dBuV/m)	Limit (dBuV/m)	Margin (dB)	Remark
1	0.4900	63.22	-62.06	1.16	13.80	-12.64	peak
2	0.8296	60.94	-62.17	-1.23	29.23	-30.46	peak
3	1.5443	56.35	-62.03	-5.68	23.83	-29.51	peak
4	2.1131	54.61	-61.79	-7.18	29.54	-36.72	peak
5	7.7495	52.48	-61.11	-8.63	29.54	-38.17	peak
6	21.7667	51.62	-60.70	-9.08	29.54	-38.62	peak

### 8.5. SPURIOUS EMISSIONS(18 GHZ~26 GHZ)

Test Mode:	802.11b	Channel:	2412
Polarity:	Horizontal	Test Voltage:	DC 12 V

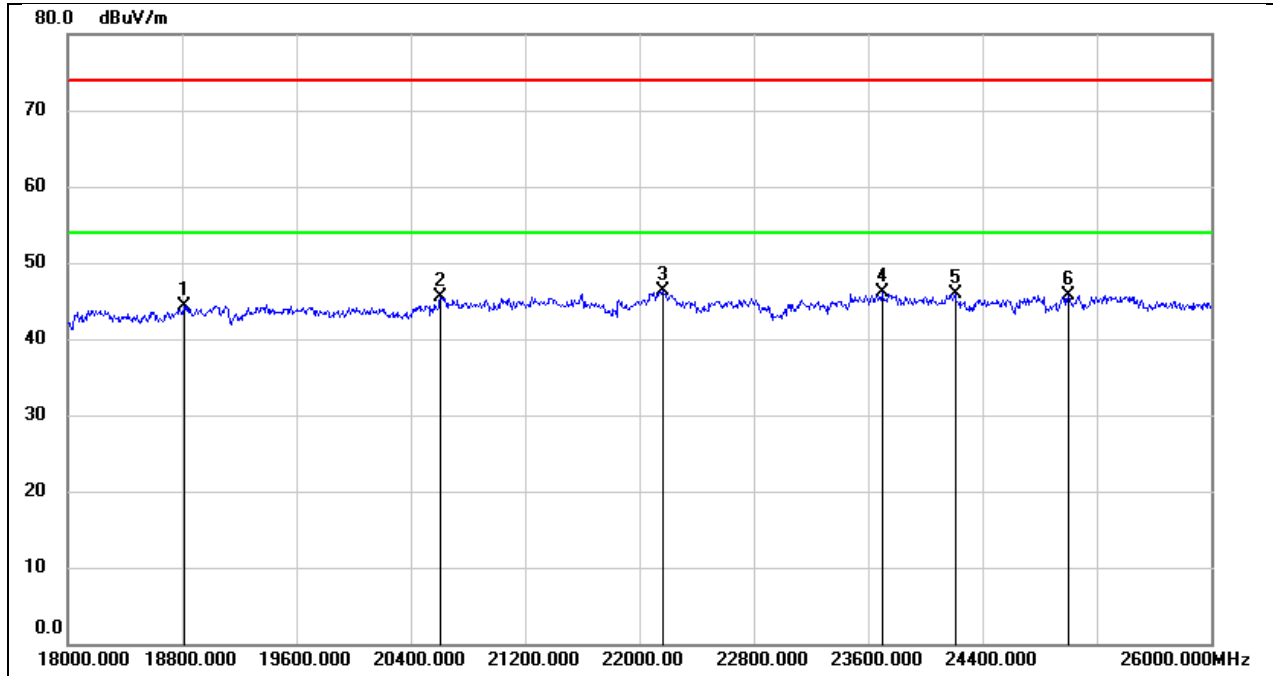

No.	Frequency (MHz)	Reading (dBuV)	Correct (dB/m)	Result (dBuV/m)	Limit (dBuV/m)	Margin (dB)	Remark
1	18816.000	49.71	-5.38	44.33	74.00	-29.67	peak
2	20608.000	50.76	-5.25	45.51	74.00	-28.49	peak
3	22160.000	50.58	-4.31	46.27	74.00	-27.73	peak
4	23696.000	49.26	-3.18	46.08	74.00	-27.92	peak
5	24208.000	48.71	-2.81	45.90	74.00	-28.10	peak
6	25000.000	47.86	-2.10	45.76	74.00	-28.24	peak

Test Mode:	802.11b	Channel:	2412
Polarity:	Vertical	Test Voltage:	DC 12 V

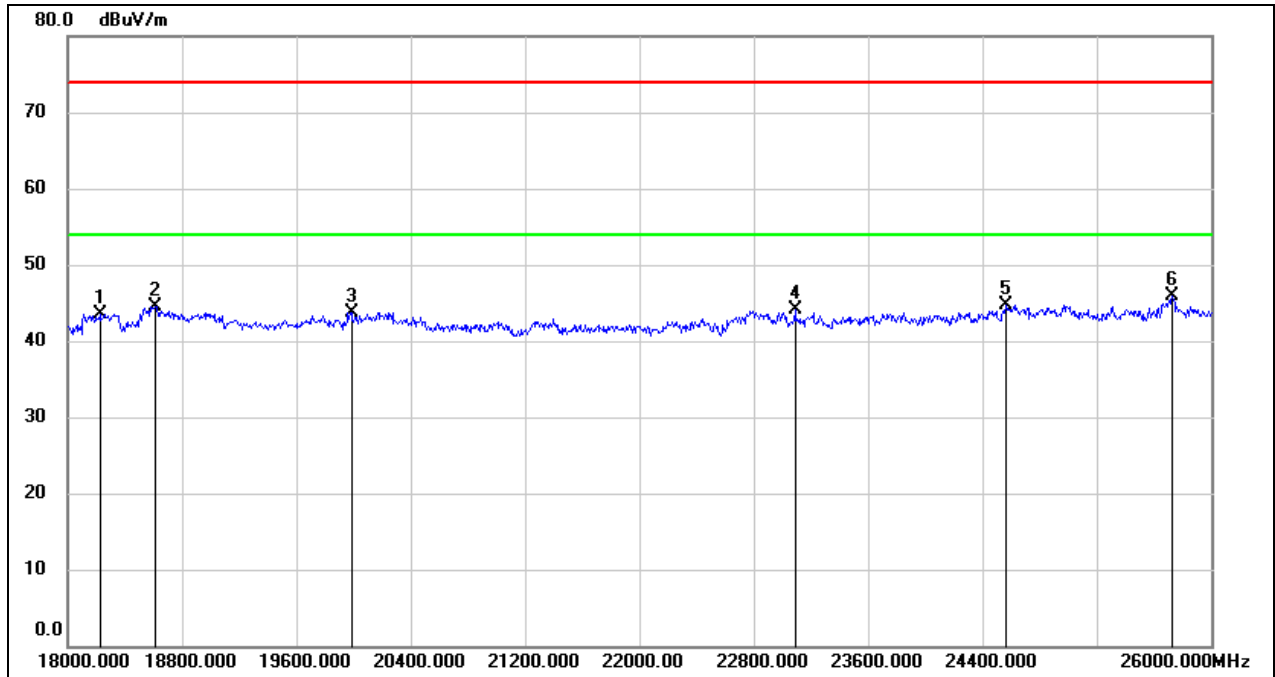

No.	Frequency (MHz)	Reading (dBuV)	Correct (dB/m)	Result (dBuV/m)	Limit (dBuV/m)	Margin (dB)	Remark
1	18224.000	49.08	-5.53	43.55	74.00	-30.45	peak
2	18616.000	49.89	-5.34	44.55	74.00	-29.45	peak
3	19984.000	49.21	-5.44	43.77	74.00	-30.23	peak
4	23088.000	47.52	-3.41	44.11	74.00	-29.89	peak
5	24568.000	47.10	-2.33	44.77	74.00	-29.23	peak
6	25728.000	46.61	-0.72	45.89	74.00	-28.11	peak

### 8.6. SPURIOUS EMISSIONS(30 MHZ~1 GHZ)

Test Mode:	802.11b	Channel:	2412
Polarity:	Horizontal	Test Voltage:	DC 12 V

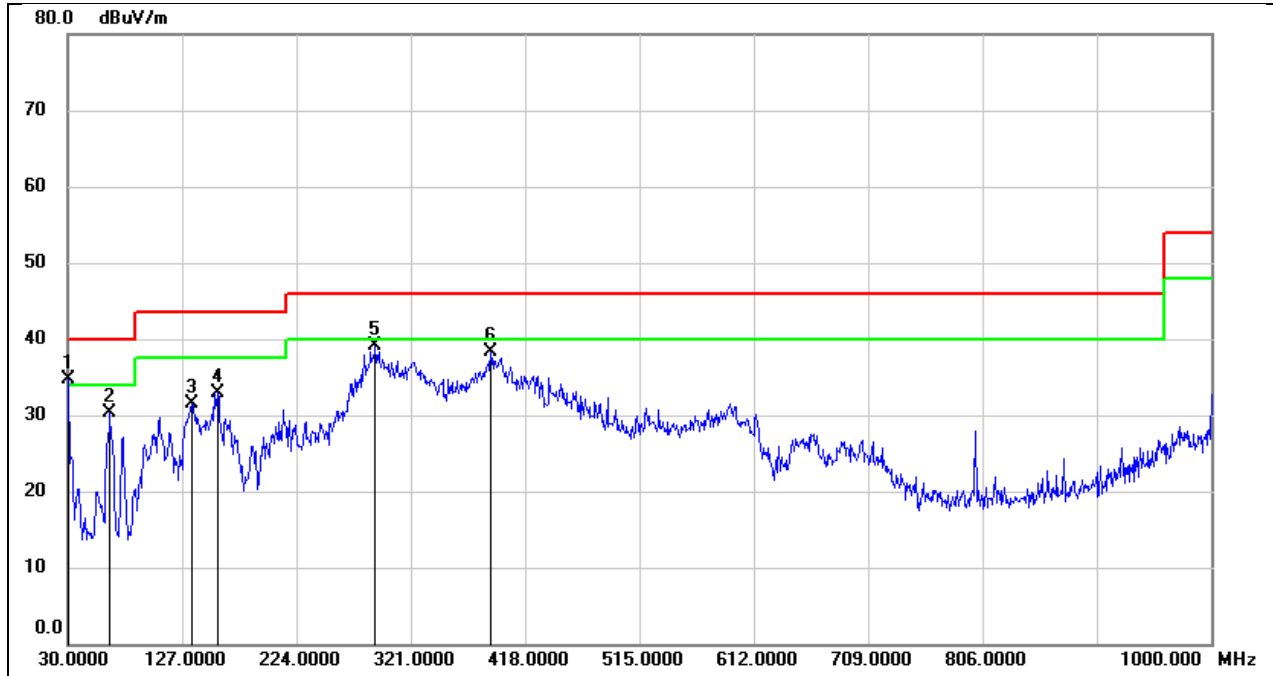

No.	Frequency (MHz)	Reading (dBuV)	Correct (dB/m)	Result (dBuV/m)	Limit (dBuV/m)	Margin (dB)	Remark
1	30.9700	53.68	-19.04	34.64	40.00	-5.36	QP
2	65.8900	50.79	-20.55	30.24	40.00	-9.76	QP
3	135.7300	50.61	-19.06	31.55	43.50	-11.95	QP
4	157.0700	50.89	-17.92	32.97	43.50	-10.53	QP
5	290.9300	54.89	-15.84	39.05	46.00	-6.95	QP
6	388.9000	51.89	-13.51	38.38	46.00	-7.62	QP

Test Mode:	802.11b	Channel:	2412
Polarity:	Vertical	Test Voltage:	DC 12 V

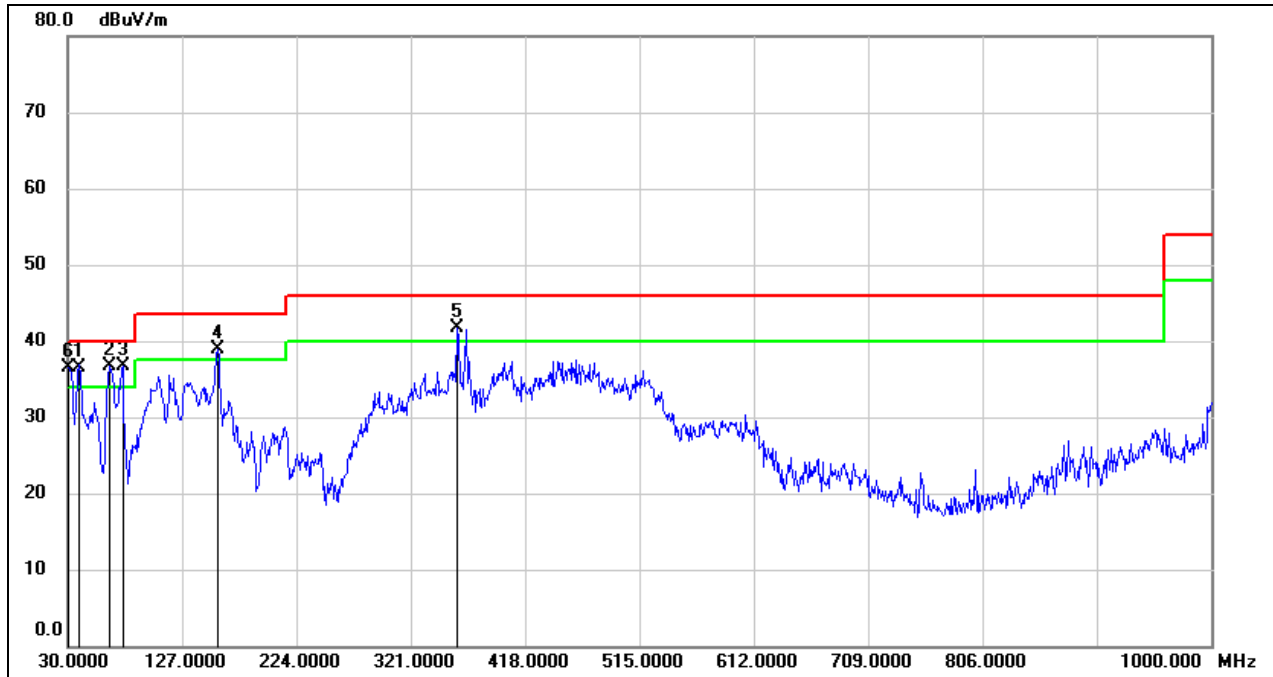

No.	Frequency (MHz)	Reading (dBuV)	Correct (dB/m)	Result (dBuV/m)	Limit (dBuV/m)	Margin (dB)	Remark
1	39.7000	56.54	-19.96	36.58	40.00	-3.42	QP
2	64.9200	57.28	-20.54	36.74	40.00	-3.26	QP
3	76.5600	57.74	-21.07	36.67	40.00	-3.33	QP
4	157.0700	56.84	-17.92	38.92	43.50	-4.58	QP
5	360.7700	55.77	-14.08	41.69	46.00	-4.31	QP
6	30.9700	55.55	-19.04	36.51	40.00	-3.49	QP

## 9. ANTENNA REQUIREMENT

### REQUIREMENT

Please refer to FCC part 15.203

An intentional radiator shall be designed to ensure that no antenna other than that furnished by the responsible party shall be used with the device. The use of a permanently attached antenna or of an antenna that uses a unique coupling to the intentional radiator shall be considered sufficient to comply with the provisions of this section. The manufacturer may design the unit so that a broken antenna can be replaced by the user, but the use of a standard antenna jack or electrical connector is prohibited.

Please refer to FCC part 15.247(b)(4)

The conducted output power limit specified in paragraph (b) of this section is based on the use of antennas with directional gains that do not exceed 6 dBi. Except as shown in paragraph (c) of this section, if transmitting antennas of directional gain greater than 6 dBi are used, the conducted output power from the intentional radiator shall be reduced below the stated values in paragraphs (b)(1), (b)(2), and (b)(3) of this section, as appropriate, by the amount in dB that the directional gain of the antenna exceeds 6 dBi.

### DESCRIPTION

Pass

## 10. AC POWER LINE CONDUCTED EMISSION

### LIMITS

Please refer to CFR 47 FCC §15.207 (a) and ISED RSS-Gen Clause 8.8

FREQUENCY (MHz)	Quasi-peak	Average
0.15 -0.5	66 - 56 *	56 - 46 *
0.50 -5.0	56.00	46.00
5.0 -30.0	60.00	50.00

### TEST PROCEDURE

The EUT is put on a table of non-conducting material that is 80 cm high. The vertical conducting wall of shielding is located 40 cm to the rear of the EUT. The power line of the EUT is connected to the AC mains through a Artificial Mains Network (A.M.N.). A EMI Measurement Receiver (R&S Test Receiver ESR3) is used to test the emissions from both sides of AC line. According to the requirements in Section 6.2 of ANSI C63.10-2013. Conducted emissions from the EUT measured in the frequency range between 0.15 MHz and 30 MHz using CISPR Quasi-Peak and average detector mode. The bandwidth of EMI test receiver is set at 9 kHz.

The arrangement of the equipment is installed to meet the standards and operating in a manner, which tends to maximize its emission characteristics in a normal application.

### TEST SETUP

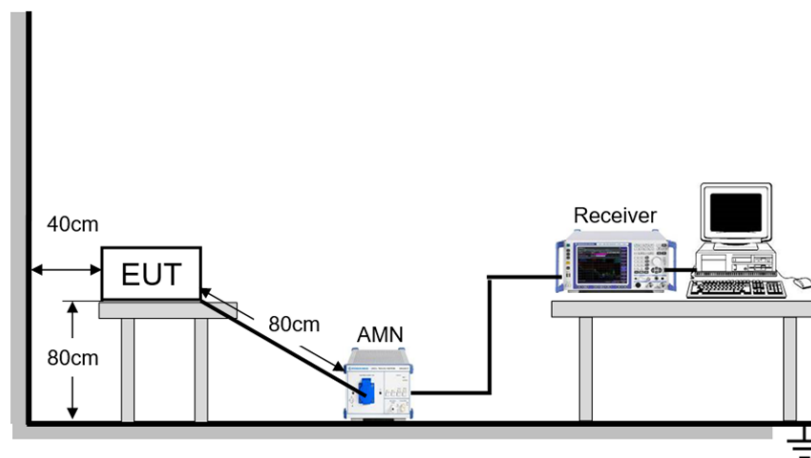

### TEST ENVIRONMENT

Temperature	24.3°C	Relative Humidity	60%
Atmosphere Pressure	101kPa	Test Voltage	AC 120 V, 60 Hz



**TEST DATE / ENGINEER**

Test Date	April 19, 2023	Test By	Wite Chen
-----------	----------------	---------	-----------

**TEST RESULTS**

Test Mode:	802.11b	Channel:	2412
Line:	Line	Test Voltage:	AC 120 V, 60 Hz

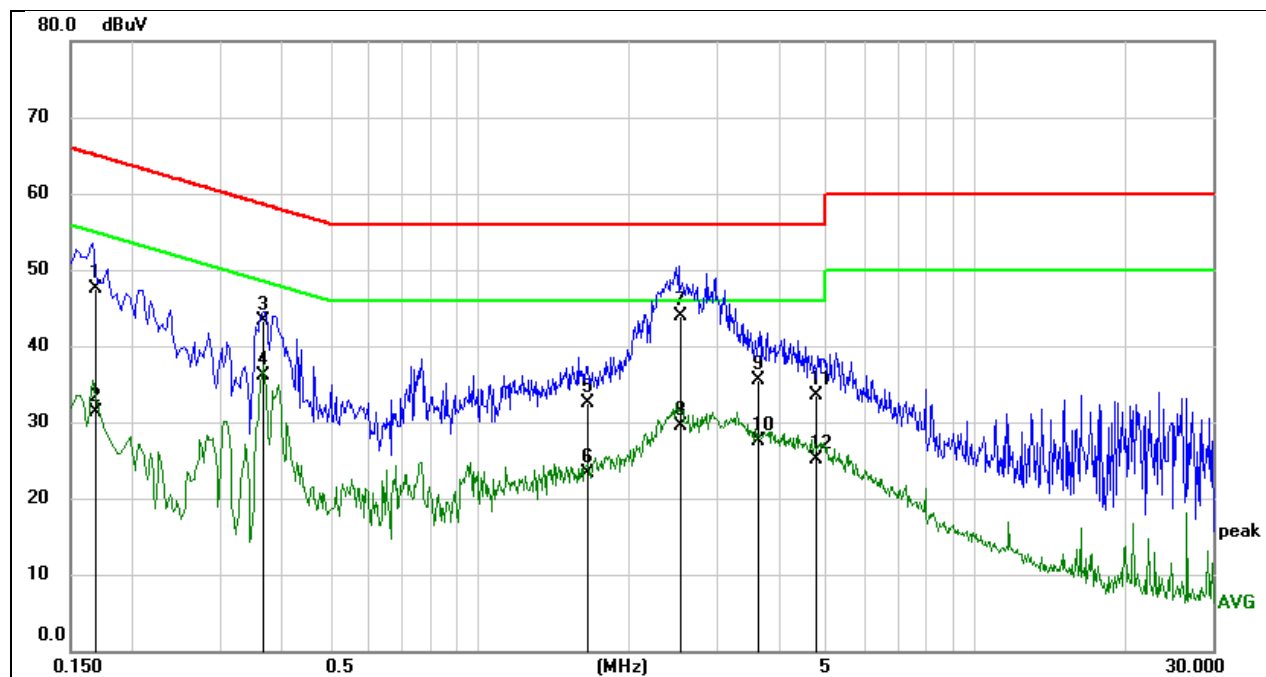

No.	Frequency (MHz)	Reading (dBuV)	Correct (dB)	Result (dBuV)	Limit (dBuV)	Margin (dB)	Remark
1	0.1689	37.83	9.59	47.42	65.01	-17.59	QP
2	0.1689	21.75	9.59	31.34	55.01	-23.67	AVG
3	0.3665	33.69	9.59	43.28	58.58	-15.30	QP
4	0.3665	26.56	9.59	36.15	48.58	-12.43	AVG
5	1.6600	22.86	9.62	32.48	56.00	-23.52	QP
6	1.6600	13.63	9.62	23.25	46.00	-22.75	AVG
7	2.5304	34.21	9.65	43.86	56.00	-12.14	QP
8	2.5304	19.81	9.65	29.46	46.00	-16.54	AVG
9	3.6394	25.91	9.69	35.60	56.00	-20.40	QP
10	3.6394	17.77	9.69	27.46	46.00	-18.54	AVG
11	4.7624	23.75	9.71	33.46	56.00	-22.54	QP
12	4.7624	15.47	9.71	25.18	46.00	-20.82	AVG

**Note:**

1. Result = Reading + Correct Factor.
2. If QP Result complies with AV limit, AV Result is deemed to comply with AV limit.
3. Test setup: RBW: 200 Hz (9 kHz ~ 150 kHz), 9 kHz (150 kHz ~ 30 MHz).
4. Step size: 80 Hz (0.009 MHz ~ 0.15 MHz), 4 kHz (0.15 MHz ~ 30 MHz), Scan time: auto.

Note: All the modes have been tested, only the worst data was recorded in the report.

Test Mode:	802.11b	Channel:	2412
Line:	Neutral	Test Voltage:	AC 120 V, 60 Hz

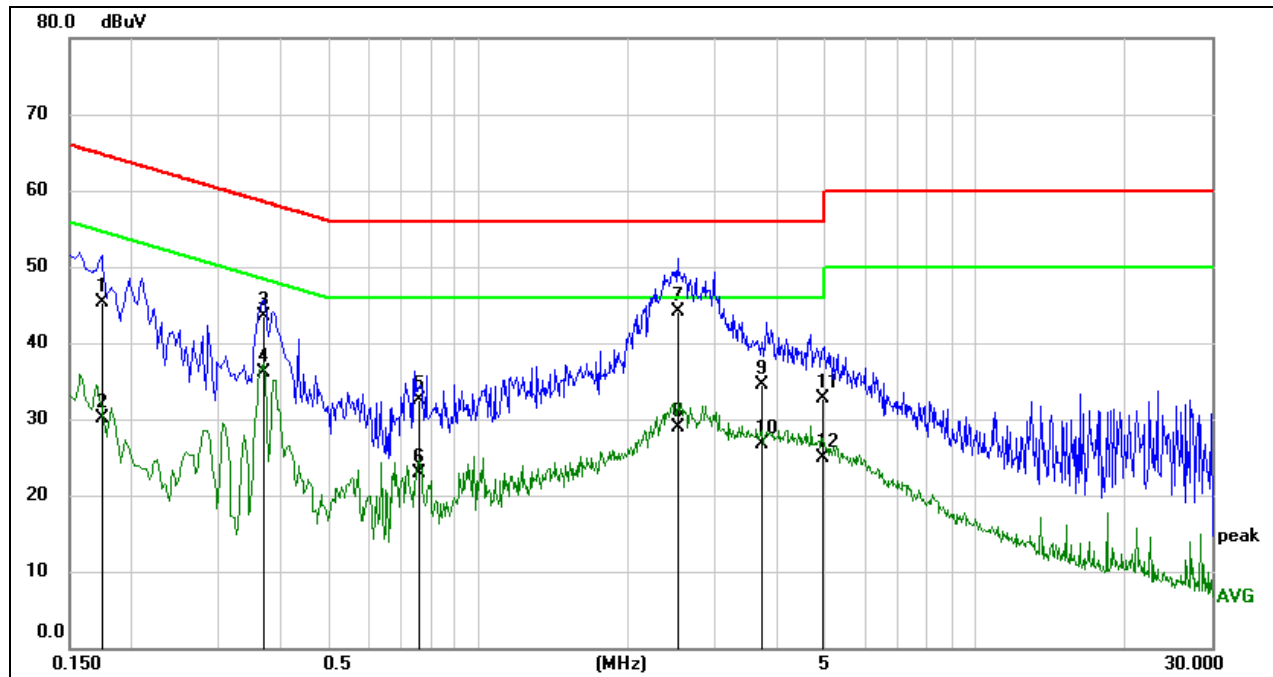

No.	Frequency (MHz)	Reading (dBuV)	Correct (dB)	Result (dBuV)	Limit (dBuV)	Margin (dB)	Remark
1	0.1734	35.81	9.59	45.40	64.80	-19.40	QP
2	0.1734	20.53	9.59	30.12	54.80	-24.68	AVG
3	0.3688	33.83	9.59	43.42	58.53	-15.11	QP
4	0.3688	26.44	9.59	36.03	48.53	-12.50	AVG
5	0.7610	22.89	9.60	32.49	56.00	-23.51	QP
6	0.7610	13.33	9.60	22.93	46.00	-23.07	AVG
7	2.5166	34.39	9.65	44.04	56.00	-11.96	QP
8	2.5166	19.33	9.65	28.98	46.00	-17.02	AVG
9	3.7328	24.84	9.70	34.54	56.00	-21.46	QP
10	3.7328	16.97	9.70	26.67	46.00	-19.33	AVG
11	4.9094	23.00	9.72	32.72	56.00	-23.28	QP
12	4.9094	15.20	9.72	24.92	46.00	-21.08	AVG

**Note:**

1. Result = Reading + Correct Factor.
2. If QP Result complies with AV limit, AV Result is deemed to comply with AV limit.
3. Test setup: RBW: 200 Hz (9 kHz ~ 150 kHz), 9 kHz (150 kHz ~ 30 MHz).
4. Step size: 80 Hz (0.009 MHz ~ 0.15 MHz), 4 kHz (0.15 MHz ~ 30 MHz), Scan time: auto.

Note: All the modes have been tested, only the worst data was recorded in the report.

## 11. TEST DATA

### 11.1. APPENDIX A: DTS BANDWIDTH

#### 11.1.1. Test Result

Test Mode	Antenna	Channel	DTS BW [MHz]	FL[MHz]	FH[MHz]	Limit[MHz]	Verdict
11B-CDD	Ant6	2412	7.080	2408.480	2415.560	0.5	PASS
	Ant8	2412	8.040	2408.000	2416.040	0.5	PASS
	Ant12	2412	8.040	2407.520	2415.560	0.5	PASS
	Ant14	2412	7.120	2408.440	2415.560	0.5	PASS
	Ant6	2417	7.120	2413.440	2420.560	0.5	PASS
	Ant8	2417	7.080	2413.480	2420.560	0.5	PASS
	Ant12	2417	8.040	2413.000	2421.040	0.5	PASS
	Ant14	2417	7.120	2413.440	2420.560	0.5	PASS
	Ant6	2437	6.640	2433.920	2440.560	0.5	PASS
	Ant8	2437	7.120	2433.440	2440.560	0.5	PASS
	Ant12	2437	7.600	2433.440	2441.040	0.5	PASS
	Ant14	2437	8.040	2433.000	2441.040	0.5	PASS
	Ant6	2457	8.040	2453.000	2461.040	0.5	PASS
	Ant8	2457	8.040	2453.000	2461.040	0.5	PASS
	Ant12	2457	7.120	2453.440	2460.560	0.5	PASS
	Ant14	2457	8.040	2453.000	2461.040	0.5	PASS
11G-CDD	Ant6	2462	7.120	2458.440	2465.560	0.5	PASS
	Ant8	2462	7.120	2458.440	2465.560	0.5	PASS
	Ant12	2462	8.040	2458.000	2466.040	0.5	PASS
	Ant14	2462	8.040	2458.000	2466.040	0.5	PASS
	Ant6	2412	16.280	2403.880	2420.160	0.5	PASS
	Ant8	2412	15.520	2404.240	2419.760	0.5	PASS
	Ant12	2412	16.320	2403.840	2420.160	0.5	PASS
	Ant14	2412	16.320	2403.840	2420.160	0.5	PASS
	Ant6	2417	16.320	2408.840	2425.160	0.5	PASS
	Ant8	2417	16.080	2408.840	2424.920	0.5	PASS
	Ant12	2417	16.320	2408.840	2425.160	0.5	PASS
	Ant14	2417	16.280	2408.880	2425.160	0.5	PASS
	Ant6	2437	16.320	2428.840	2445.160	0.5	PASS
	Ant8	2437	16.280	2428.880	2445.160	0.5	PASS
	Ant12	2437	16.280	2428.880	2445.160	0.5	PASS
	Ant14	2437	16.320	2428.840	2445.160	0.5	PASS
11AX20MIMO	Ant6	2457	16.240	2448.920	2465.160	0.5	PASS
	Ant8	2457	15.920	2448.840	2464.760	0.5	PASS
	Ant12	2457	16.320	2448.840	2465.160	0.5	PASS
	Ant14	2457	16.320	2448.840	2465.160	0.5	PASS
	Ant6	2462	16.320	2453.840	2470.160	0.5	PASS
	Ant8	2462	16.320	2453.840	2470.160	0.5	PASS
	Ant12	2462	16.320	2453.840	2470.160	0.5	PASS
	Ant14	2462	16.320	2453.840	2470.160	0.5	PASS
	Ant6	2412	18.960	2402.520	2421.480	0.5	PASS
	Ant8	2412	18.280	2403.040	2421.320	0.5	PASS
	Ant12	2412	17.600	2403.320	2420.920	0.5	PASS
	Ant14	2412	18.760	2402.720	2421.480	0.5	PASS
	Ant6	2417	18.800	2407.600	2426.400	0.5	PASS
	Ant8	2417	18.440	2407.720	2426.160	0.5	PASS
	Ant12	2417	17.520	2408.160	2425.680	0.5	PASS
	Ant14	2417	18.720	2407.600	2426.320	0.5	PASS
Ant6	2437	18.080	2428.000	2446.080	0.5	PASS	
Ant8	2437	19.040	2427.480	2446.520	0.5	PASS	
Ant12	2437	18.600	2427.720	2446.320	0.5	PASS	
Ant14	2437	18.240	2427.840	2446.080	0.5	PASS	
Ant6	2457	18.920	2447.560	2466.480	0.5	PASS	
Ant8	2457	17.200	2447.880	2465.080	0.5	PASS	
Ant12	2457	18.960	2447.560	2466.520	0.5	PASS	

	Ant14	2457	18.960	2447.520	2466.480	0.5	PASS
	Ant6	2462	18.880	2452.520	2471.400	0.5	PASS
	Ant8	2462	18.960	2452.520	2471.480	0.5	PASS
	Ant12	2462	18.600	2452.640	2471.240	0.5	PASS
	Ant14	2462	18.240	2452.800	2471.040	0.5	PASS
11AX40MIMO	Ant6	2422	37.440	2403.040	2440.480	0.5	PASS
	Ant8	2422	37.280	2403.200	2440.480	0.5	PASS
	Ant12	2422	38.160	2402.880	2441.040	0.5	PASS
	Ant14	2422	37.680	2403.200	2440.880	0.5	PASS
	Ant6	2427	37.760	2407.960	2445.720	0.5	PASS
	Ant8	2427	37.840	2408.120	2445.960	0.5	PASS
	Ant12	2427	38.080	2408.040	2446.120	0.5	PASS
	Ant14	2427	37.600	2408.200	2445.800	0.5	PASS
	Ant6	2437	37.120	2418.200	2455.320	0.5	PASS
	Ant8	2437	36.960	2418.520	2455.480	0.5	PASS
	Ant12	2437	38.080	2417.960	2456.040	0.5	PASS
	Ant14	2437	37.680	2418.280	2455.960	0.5	PASS
	Ant6	2447	36.640	2428.120	2464.760	0.5	PASS
	Ant8	2447	37.680	2428.200	2465.880	0.5	PASS
	Ant12	2447	37.600	2428.040	2465.640	0.5	PASS
	Ant14	2447	37.680	2428.120	2465.800	0.5	PASS
	Ant6	2452	37.600	2433.120	2470.720	0.5	PASS
	Ant8	2452	36.560	2433.120	2469.680	0.5	PASS
	Ant12	2452	38.000	2433.040	2471.040	0.5	PASS
	Ant14	2452	37.360	2433.360	2470.720	0.5	PASS

11.1.2. Test Graphs

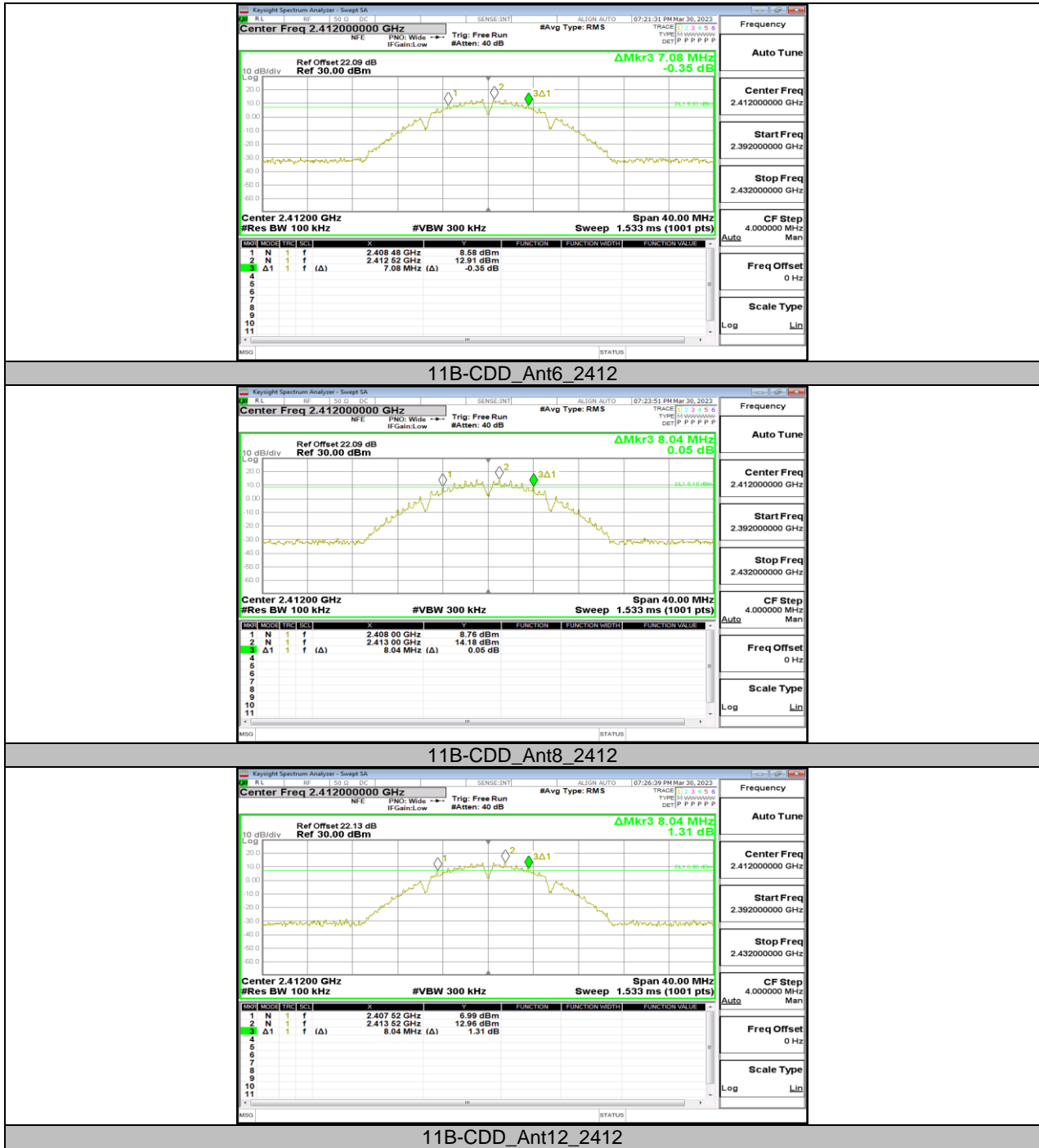



11B-CDD\_Ant14\_2412

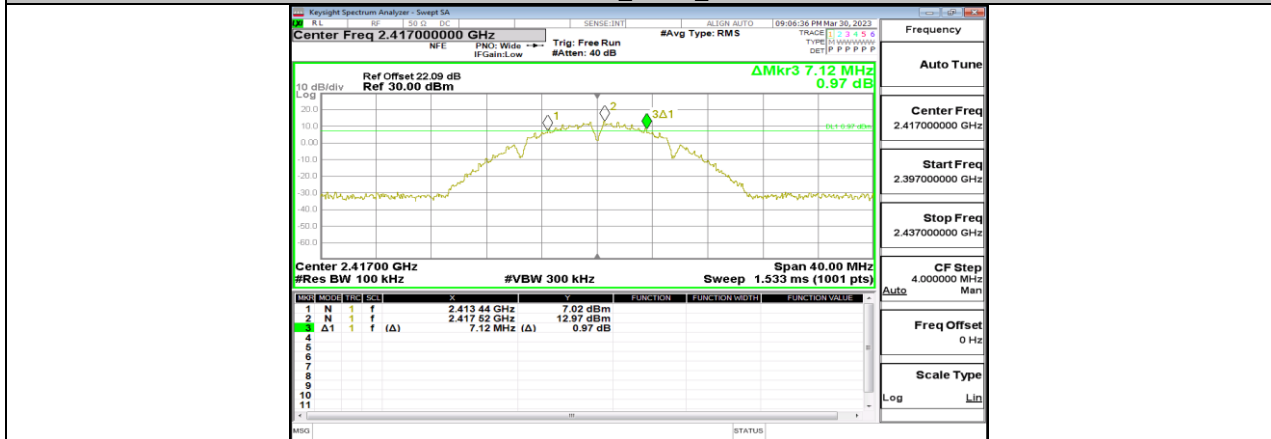

11B-CDD\_Ant6\_2417

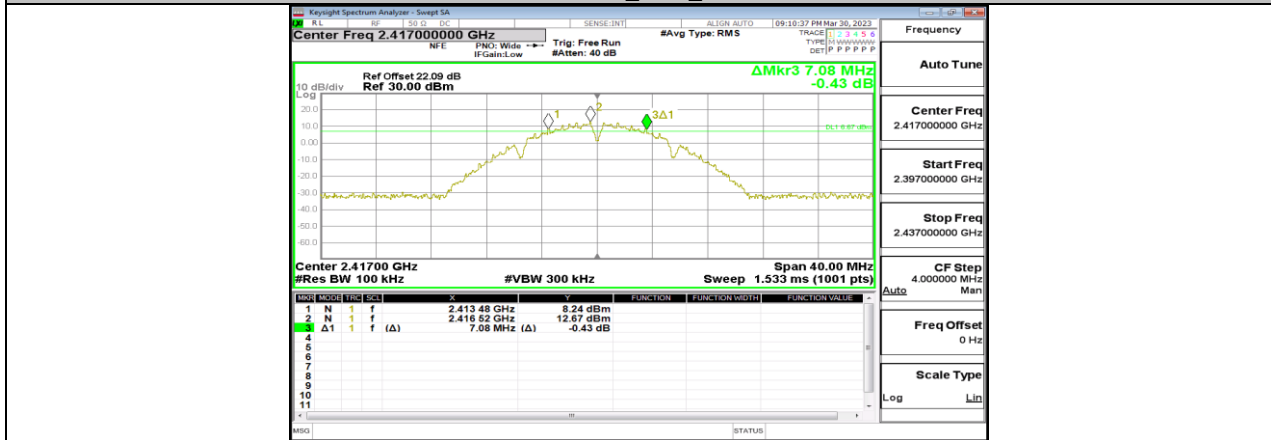

11B-CDD\_Ant8\_2417



11B-CDD\_Ant12\_2417



11B-CDD\_Ant14\_2417



11B-CDD\_Ant6\_2437

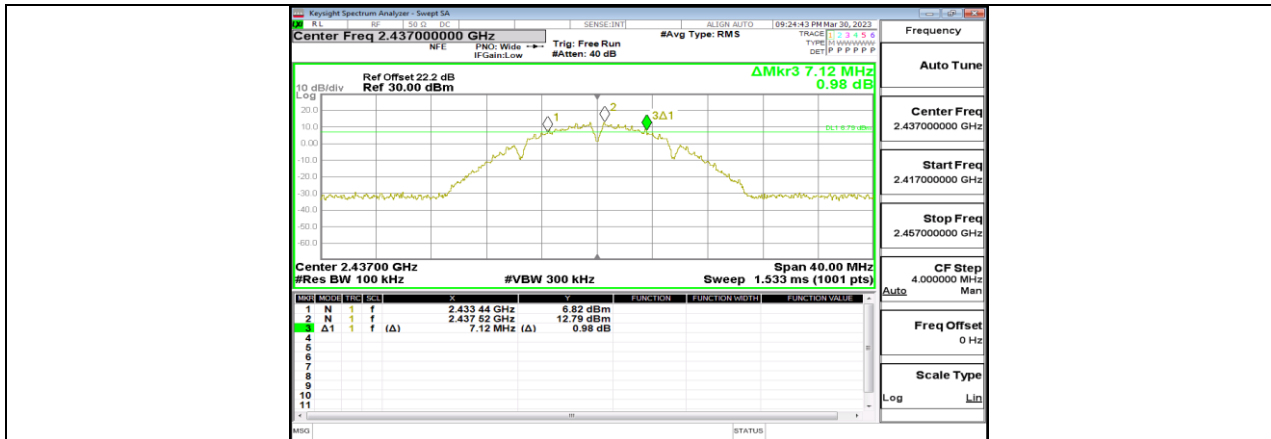

11B-CDD\_Ant8\_2437

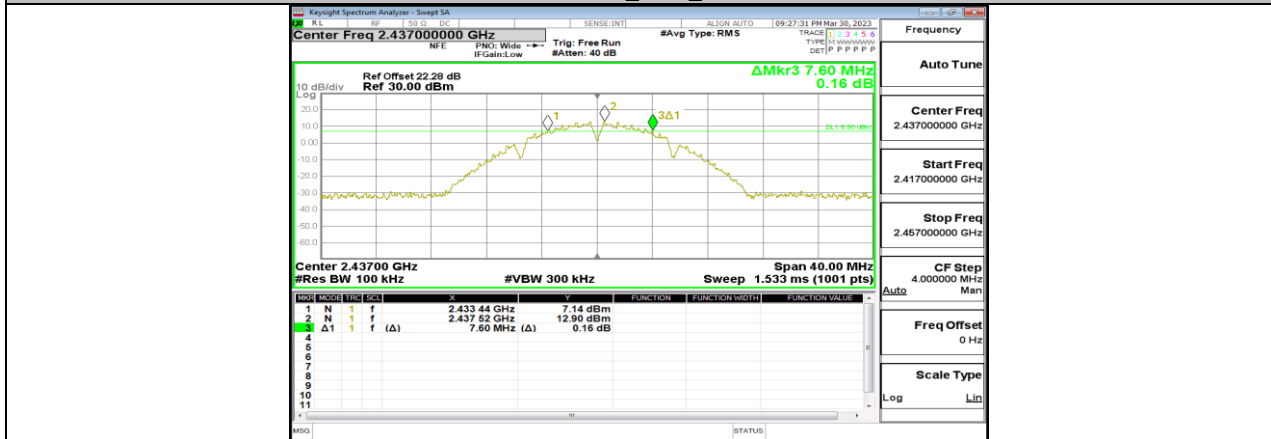

11B-CDD\_Ant12\_2437



11B-CDD\_Ant14\_2437



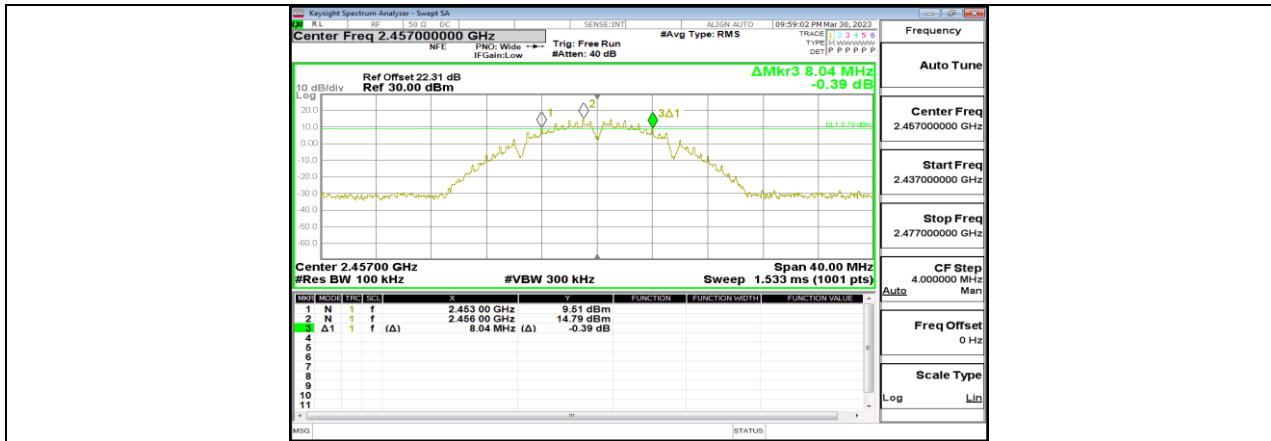

11B-CDD\_Ant6\_2457



11B-CDD\_Ant8\_2457

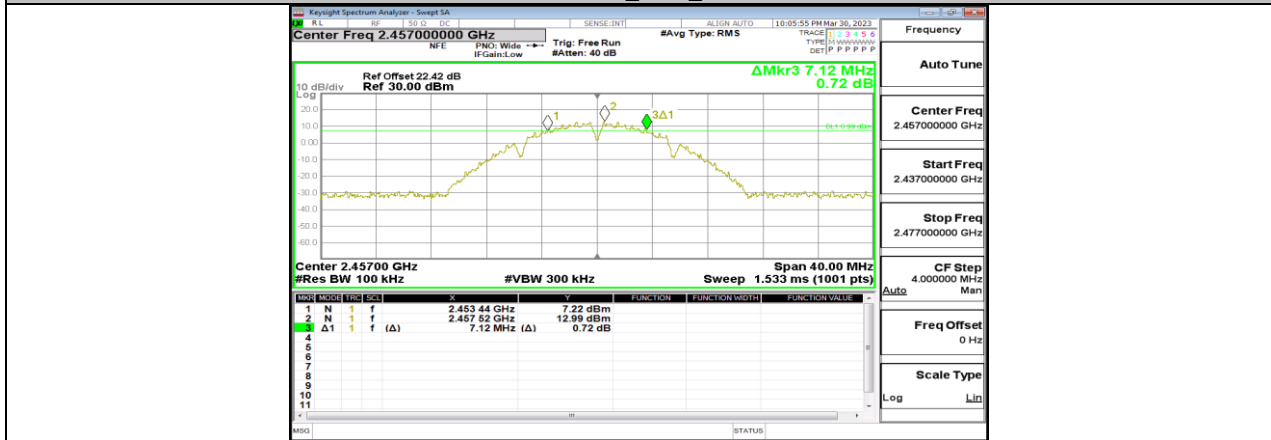

11B-CDD\_Ant12\_2457



11B-CDD\_Ant14\_2457

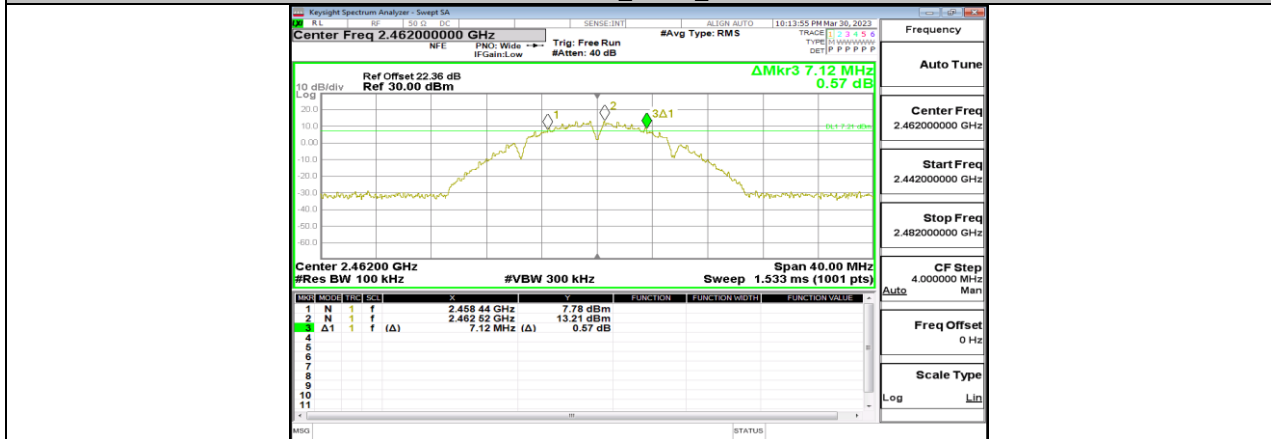

11B-CDD\_Ant6\_2462



11B-CDD\_Ant8\_2462



11B-CDD\_Ant12\_2462

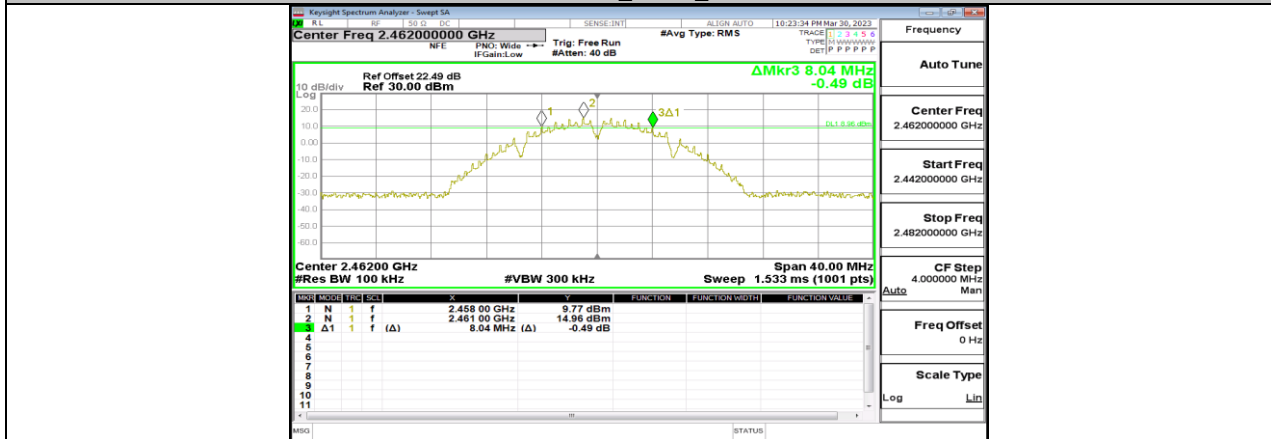

11B-CDD\_Ant14\_2462

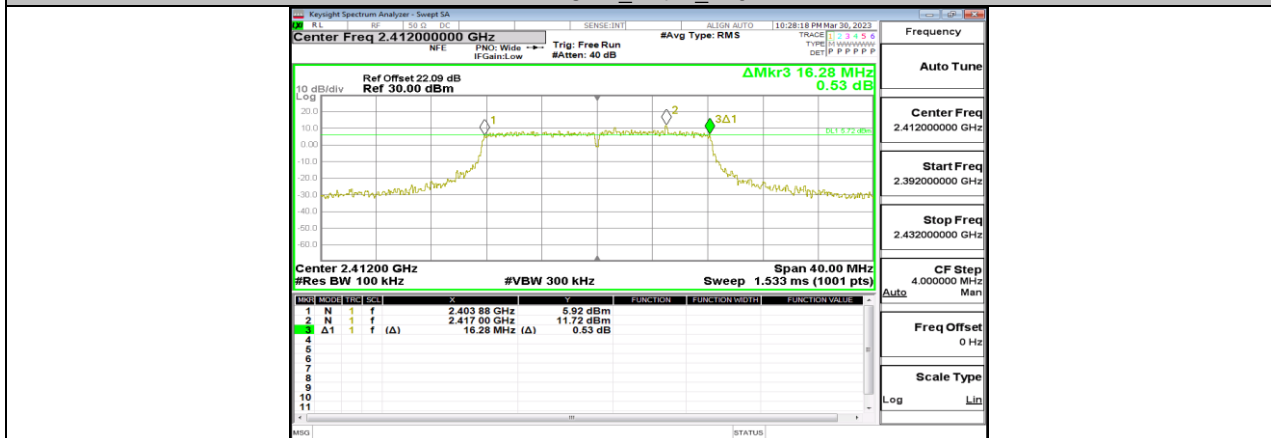

11G-CDD\_Ant6\_2412

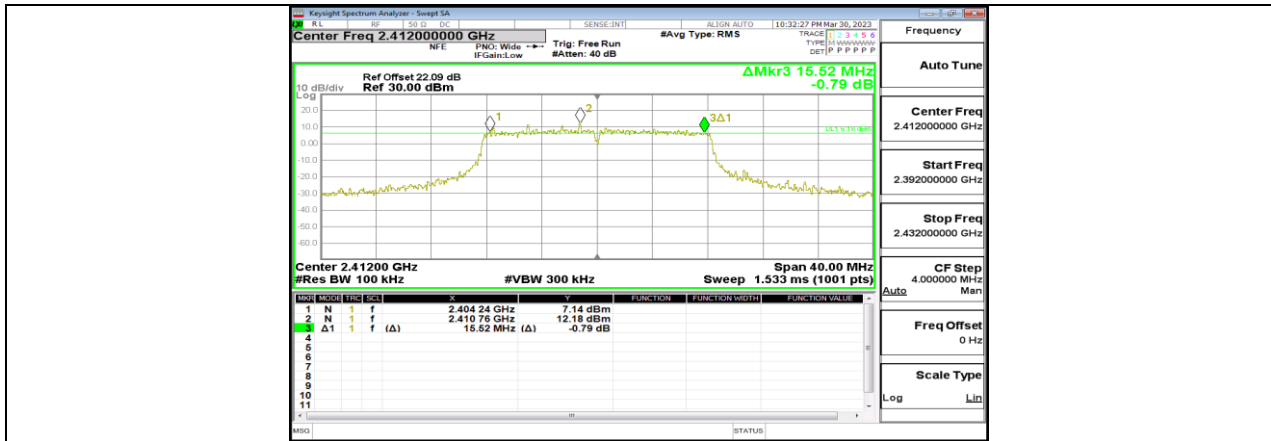

11G-CDD\_Ant8\_2412

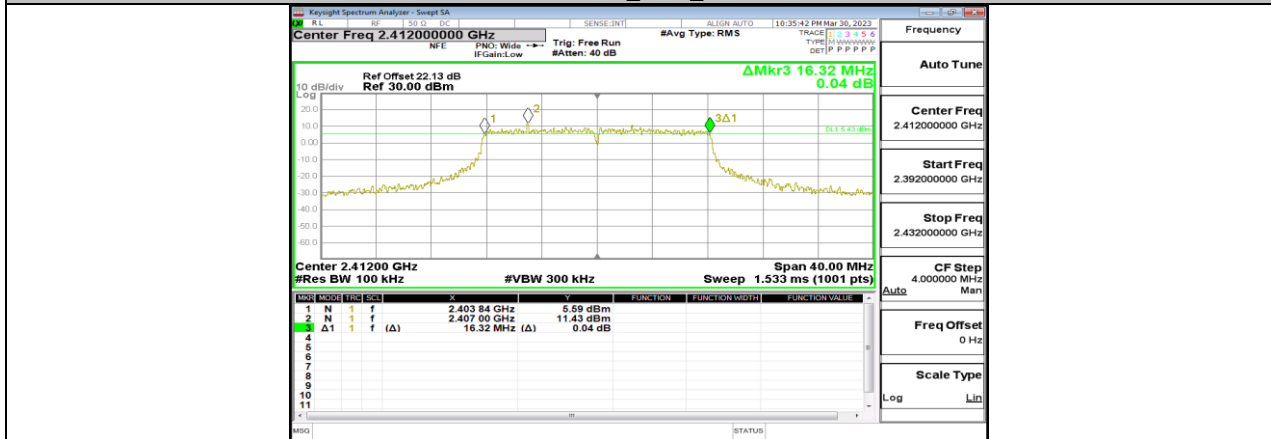

11G-CDD\_Ant12\_2412

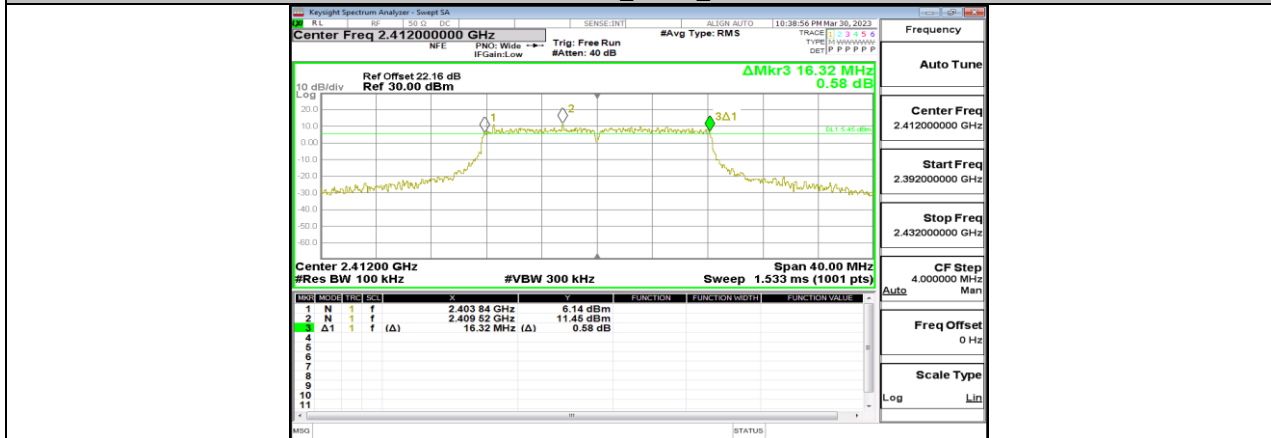

11G-CDD\_Ant14\_2412

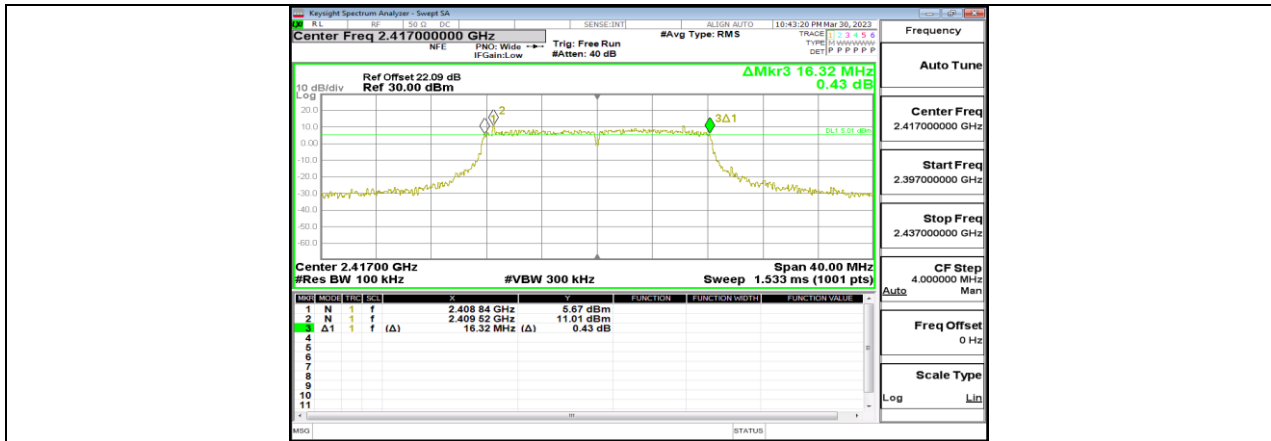

11G-CDD\_Ant6\_2417



11G-CDD\_Ant8\_2417

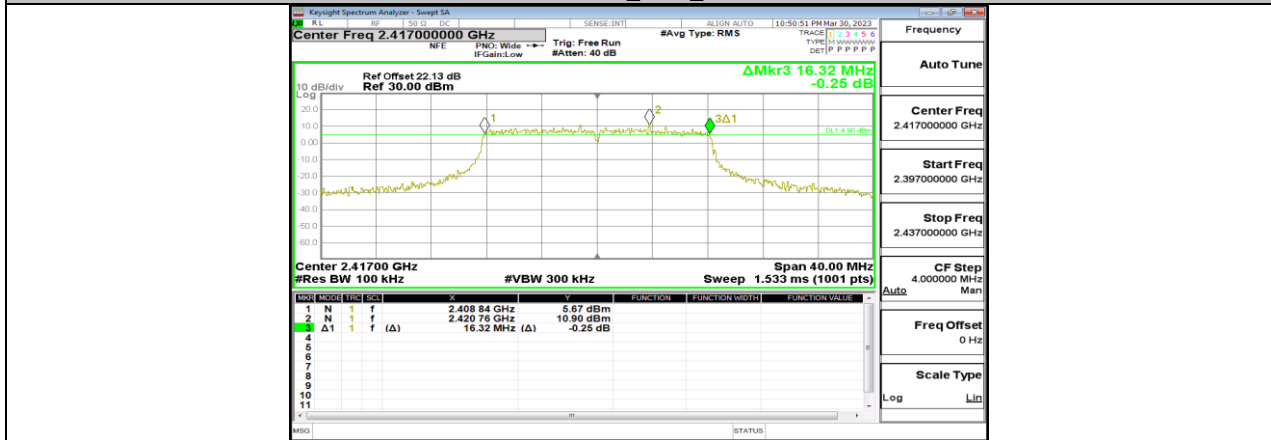

11G-CDD\_Ant12\_2417