

**CFR 47 FCC PART 15 SUBPART E
ISED RSS-247 Issue 3**

TEST REPORT

For

BE22000 Ceiling Mount Wi-Fi 7 Access Point

MODEL NUMBER: EAP783

REPORT NUMBER: 4790941545-1-RF-3

ISSUE DATE: October 27, 2023

FCC ID: 2AXJ4EAP783

IC: 26583-EAP783

Prepared for

**TP-Link Corporation Limited
Room 901, 9/F. , New East Ocean Centre, 9 Science Museum Road, Tsim Sha Tsui,
Kowloon, Hong Kong**

Prepared by

UL Verification Services (Guangzhou) Co., Ltd, Song Shan Lake Branch

Building 10, Innovation Technology Park, No. 1, Li Bin Road, Song Shan Lake Hi-Tech Development Zone Dongguan, 523808, People's Republic of China

Tel: +86 769 22038881

Fax: +86 769 33244054

Website: www.ul.com

Revision History

Rev.	Issue Date	Revisions	Revised By
V0	October 27, 2023	Initial Issue	

Summary of Test Results

Test Item	Clause	Limit/Requirement	Result
ON TIME AND DUTY CYCLE	ANSI C63.10-2013, Clause 12.2	None; for reporting purposes only.	Pass
6dB AND 26dB EMISSION BANDWIDTH AND 99% OCCUPIED BANDWIDTH	KDB 789033 D02 v02r01 Section C.1	FCC Part 15.407 (a)/(e), RSS-247 Issue 3, Clause 6.2.1.2 RSS-Gen Clause 6.7	Pass
CONDUCTED OUTPUT POWER	KDB 789033 D02 v02r01 Section E.3.a (Method PM)	FCC 15.407 (a) RSS-247 Clause 6.2	Pass
POWER SPECTRAL DENSITY	KDB 789033 D02 v02r01 Section F	FCC 15.407 (a) RSS-247 Clause 6.2	Pass
AC Power Line Conducted Emission	ANSI C63.10-2013, Clause 6.2.	FCC 15.207 RSS-GEN Clause 8.8	Pass
Radiated Emissions and Band Edge Measurement	KDB 789033 D02 v02r01 Section G.3, G.4, G.5, and G.6	FCC 15.407 (b) FCC 15.209 FCC 15.205 RSS-247 Clause 6.2 RSS-GEN Clause 8.9	Pass
Antenna Requirement	N/A	FCC 47 CFR Part 15.203/ 15.407(a)(1) (2), RSS-Gen Issue 5, Clause 6.8	Pass

Note:

1. N/A: In this whole report not applicable.

*This test report is only published to and used by the applicant, and it is not for evidence purpose in China.

*The measurement result for the sample received is <Pass> according to <CFR 47 FCC PART 15 SUBPART E ISED RSS-247 Issue 3> when <Simple Acceptance> decision rule is applied.

CONTENTS

1. ATTESTATION OF TEST RESULTS	6
2. TEST METHODOLOGY	7
3. FACILITIES AND ACCREDITATION	7
4. CALIBRATION AND UNCERTAINTY	8
4.1. <i>MEASURING INSTRUMENT CALIBRATION</i>	8
4.2. <i>MEASUREMENT UNCERTAINTY</i>	8
5. EQUIPMENT UNDER TEST	9
5.1. <i>DESCRIPTION OF EUT</i>	9
5.2. <i>CHANNEL LIST</i>	10
5.3. <i>MAXIMUM POWER</i>	12
5.4. <i>TEST CHANNEL CONFIGURATION</i>	13
5.5. <i>THE WORSE CASE POWER SETTING PARAMETER</i>	15
5.6. <i>WORSE CASE CONFIGURATIONS</i>	20
5.7. <i>DESCRIPTION OF AVAILABLE ANTENNAS</i>	21
5.8. <i>SUPPORT UNITS FOR SYSTEM TEST</i>	22
6. MEASURING EQUIPMENT AND SOFTWARE USED	23
7. ANTENNA PORT TEST RESULTS	26
7.1. <i>ON TIME AND DUTY CYCLE</i>	26
7.2. <i>6DB AND 26DB EMISSION BANDWIDTH AND 99% OCCUPIED BANDWIDTH</i> ...	27
7.3. <i>CONDUCTED OUTPUT POWER</i>	29
7.4. <i>POWER SPECTRAL DENSITY</i>	32
8. RADIATED TEST RESULTS	34
8.1. <i>RESTRICTED BANDEDGE</i>	43
8.2. <i>RESTRICTED BANDEDGE</i>	134
8.3. <i>SPURIOUS EMISSIONS(1 GHZ~7 GHZ)</i>	158
8.4. <i>SPURIOUS EMISSIONS(1 GHZ~7 GHZ)</i>	184
8.5. <i>SPURIOUS EMISSIONS(7 GHZ~18 GHZ)</i>	190
8.6. <i>SPURIOUS EMISSIONS(7 GHZ~18 GHZ)</i>	342
8.7. <i>SPURIOUS EMISSIONS(9 KHZ~30 MHZ)</i>	372
8.8. <i>SPURIOUS EMISSIONS(18 GHZ~26 GHZ)</i>	375
8.9. <i>SPURIOUS EMISSIONS(26 GHZ~40 GHZ)</i>	377
8.10. <i>SPURIOUS EMISSIONS(30 MHZ~1 GHZ)</i>	379
9. AC POWER LINE CONDUCTED EMISSION	381

10.	ANTENNA REQUIREMENT	384
11.	TEST DATA	385
11.1.	<i>APPENDIX A: EMISSION BANDWIDTH.....</i>	385
11.1.1.	Test Result.....	385
11.1.2.	Test Graphs	392
11.1.3.	Test Result.....	479
11.1.4.	Test Graphs	481
11.2.	<i>APPENDIX B: OCCUPIED CHANNEL BANDWIDTH</i>	501
11.2.1.	Test Result.....	501
11.2.2.	Test Graphs	508
11.2.3.	Test Result.....	595
11.2.4.	Test Graphs	597
11.3.	<i>APPENDIX C: MIN EMISSION BANDWIDTH.....</i>	617
11.3.1.	Test Result.....	617
11.3.2.	Test Graphs	620
11.4.	<i>APPENDIX D: MAXIMUM CONDUCTED OUTPUT POWER</i>	646
11.4.1.	FCC Test Result.....	646
11.4.2.	FCC Test Graphs.....	653
11.4.3.	ISED Test Result.....	676
11.4.4.	ISED Test Graphs	684
11.5.	<i>APPENDIX E: MAXIMUM POWER SPECTRAL DENSITY</i>	707
11.5.1.	FCC Test Result.....	707
11.5.2.	FCC Test Graphs	714
11.5.3.	ISED Test Result.....	813
11.5.4.	ISED Test Graphs	820
11.6.	<i>APPENDIX F: DUTY CYCLE</i>	920
11.6.1.	Test Result.....	920
11.6.2.	Test Graphs	921

1. ATTESTATION OF TEST RESULTS

Applicant Information

Company Name: TP-Link Corporation Limited
Address: Room 901, 9/F. , New East Ocean Centre, 9 Science Museum Road, Tsim Sha Tsui, Kowloon, Hong Kong

Manufacturer Information

Company Name: TP-Link Corporation Limited
Address: Room 901, 9/F. , New East Ocean Centre, 9 Science Museum Road, Tsim Sha Tsui, Kowloon, Hong Kong

EUT Information

EUT Name: BE22000 Ceiling Mount Wi-Fi 7 Access Point
Model: EAP783
Brand: tp-link
Sample Received Date: July 25, 2023
Sample Status: Normal
Sample ID: 6298058
Date of Tested: August 7, 2023 to October 27, 2023

APPLICABLE STANDARDS	
STANDARD	TEST RESULTS
CFR 47 FCC PART 15 SUBPART E ISED RSS-247 Issue 3	Pass

Prepared By:

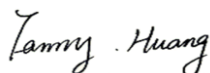

Fanny Huang
Engineer Project Associate

Checked By:

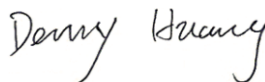

Denny Huang
Senior Project Engineer

Approved By:



Stephen Guo
Operations Manager

2. TEST METHODOLOGY

All tests were performed in accordance with the standard CFR 47 FCC PART 15 SUBPART E ISED RSS-247 ISSUE 3, ANSI C63.10-2013, CFR 47 FCC Part 2, KDB 789033 D02 v02r01, RSS-GEN Issue 5, KDB414788 D01 Radiated Test Site v01, KDB 662911 D01 Multiple Transmitter Output v02r01.

3. FACILITIES AND ACCREDITATION

Accreditation Certificate	<p>A2LA (Certificate No.: 4102.01) UL Verification Services (Guangzhou) Co., Ltd. Song Shan Lake Branch. has been assessed and proved to be in compliance with A2LA.</p> <p>FCC (FCC Designation No.: CN1187) UL Verification Services (Guangzhou) Co., Ltd. Song Shan Lake Branch. Has been recognized to perform compliance testing on equipment subject to the Commission's Declaration of Conformity (DoC) and Certification rules</p> <p>ISED (Company No.: 21320) UL Verification Services (Guangzhou) Co., Ltd. Song Shan Lake Branch. has been registered and fully described in a report filed with ISED. The Company Number is 21320 and the test lab Conformity Assessment Body Identifier (CABID) is CN0046.</p> <p>VCCI (Registration No.: G-20019, R-20004, C-20012 and T-20011) UL Verification Services (Guangzhou) Co., Ltd. Song Shan Lake Branch. has been assessed and proved to be in compliance with VCCI, the Membership No. is 3793. Facility Name: Chamber D, the VCCI registration No. is G-20019 and R-20004 Shielding Room B , the VCCI registration No. is C-20012 and T-20011</p>
---------------------------	---

Note 1:

All tests measurement facilities use to collect the measurement data are located at Building 10, Innovation Technology Park, No. 1, Li Bin Road, Song Shan Lake Hi-Tech Development Zone Dongguan, 523808, People's Republic of China.

Note 2:

The test anechoic chamber in UL Verification Services (Guangzhou) Co., Ltd. Song Shan Lake Branch had been calibrated and compared to the open field sites and the test anechoic chamber is shown to be equivalent to or worst case from the open field site.

Note 3:

For below 30 MHz, lab had performed measurements at test anechoic chamber and comparing to measurements obtained on an open field site. And these measurements below 30 MHz had been correlated to measurements performed on an OFS.

4. CALIBRATION AND UNCERTAINTY

4.1. MEASURING INSTRUMENT CALIBRATION

The measuring equipment utilized to perform the tests documented in this report has been calibrated in accordance with the manufacturer's recommendations and is traceable to recognized national standards.

4.2. MEASUREMENT UNCERTAINTY

Where relevant, the following measurement uncertainty levels have been estimated for tests performed on the apparatus:

Test Item	Uncertainty
Conduction emission	3.62 dB
Radiated Emission (Included Fundamental Emission) (9 kHz ~ 30 MHz)	2.2 dB
Radiated Emission (Included Fundamental Emission) (30 MHz ~ 1 GHz)	4.00 dB
Radiated Emission (Included Fundamental Emission) (1 GHz to 40 GHz)	5.78 dB (1 GHz ~ 18 GHz)
	5.23 dB (18 GHz ~ 26 GHz)
	5.37 dB (26 GHz ~ 40 GHz)
Duty Cycle	±0.028%
Emission Bandwidth and 99% Occupied Bandwidth	±0.0196%
Maximum Conducted Output Power	±0.766 dB
Maximum Power Spectral Density Level	±1.22 dB
Frequency Stability	±2.76%
Conducted Band-edge Compliance	±1.328 dB
Conducted Unwanted Emissions In Non-restricted Frequency Bands	±0.746 dB (9 kHz ~ 1 GHz)
	±1.328dB (1 GHz ~ 26 GHz)
Note: This uncertainty represents an expanded uncertainty expressed at approximately the 95% confidence level using a coverage factor of k=2.	

5. EQUIPMENT UNDER TEST

5.1. DESCRIPTION OF EUT

EUT Name:	BE22000 Ceiling Mount Wi-Fi 7 Access Point
Model/PMN :	EAP783
HVIN:	EAP783
FVIN:	V1.0
Frequency Range:	5180 MHz to 5240 MHz(U-NII-1) 5260 MHz to 5320 MHz(U-NII-2A) 5500 MHz to 5720 MHz(U-NII-2C) 5745 MHz to 5825 MHz(U-NII-3)
DFS Operational mode:	Master
Type of Modulation:	IEEE 802.11a: OFDM(64QAM, 16QAM, QPSK, BPSK) IEEE 802.11n: OFDM(64QAM, 16QAM, QPSK, BPSK) IEEE 802.11ac: OFDM(256QAM, 64QAM, 16QAM, QPSK, BPSK) IEEE 802.11ax: OFDMA (1024QAM, 256QAM, 64QAM, 16QAM, QPSK, BPSK) IEEE 802.11be: OFDMA (4096QAM, 1024QAM, 256QAM, 64QAM, 16QAM, QPSK, BPSK)
Radio Technology:	IEEE802.11a/n HT20/n HT40/ ac VHT20/ac VHT40/ac VHT80/ac VHT160/ ax HE20/ax HE40/ax HE80/ax HE160/ be EHT20/be EHT40/be EHT80/be EHT160/be EHT240
Normal Test Voltage:	DC 12 V via adapter

5.2. CHANNEL LIST

UNII-1 (For Bandwidth=20MHz)		UNII-1 (For Bandwidth=40MHz)		UNII-1 (For Bandwidth=80MHz)	
Channel	Frequency (MHz)	Channel	Frequency (MHz)	Channel	Frequency (MHz)
36	5180	38	5190	42	5210
40	5200	46	5230		
44	5220				
48	5240				

UNII-2A (For Bandwidth=20MHz)		UNII-2A (For Bandwidth=40MHz)		UNII-2A (For Bandwidth=80MHz)	
Channel	Frequency (MHz)	Channel	Frequency (MHz)	Channel	Frequency (MHz)
52	5260	54	5270	58	5290
56	5280	62	5310		
60	5300				
64	5320				

UNII-2A (For Bandwidth=160 MHz)	
Channel	Frequency (MHz)
50	5250

UNII-2C (For Bandwidth =20MHz)		UNII-2C (For Bandwidth =40MHz)		UNII-2C (For Bandwidth =80MHz)	
Channel	Frequency (MHz)	Channel	Frequency (MHz)	Channel	Frequency (MHz)
100	5500	102	5510	106	5530
104	5520	110	5550	122	5610
108	5540	118	5590	138	5690
112	5560	126	5630		
116	5580	134	5670		
120	5600	142	5710		
124	5620				
128	5640				
132	5660				
136	5680				
140	5700				
144	5720				

UNII-2C (For Bandwidth=160 MHz)		UNII-2C (For Bandwidth=240 MHz)	
Channel	Frequency (MHz)	Channel	Frequency (MHz)
114	5570	122	5610

UNII-3 (For Bandwidth=20MHz)		UNII-3 (For Bandwidth=40MHz)		UNII-3 (For Bandwidth=80MHz)	
---------------------------------	--	---------------------------------	--	---------------------------------	--

Channel	Frequency (MHz)	Channel	Frequency (MHz)	Channel	Frequency (MHz)
149	5745	151	5755	155	5775
153	5765	159	5795		
157	5785				
161	5805				
165	5825				

Note: All channels in the 5600-5650MHz band were not operational in Canada.

5.3. MAXIMUM POWER

IEEE Std. 802.11	Frequency (MHz)	Maximum Average Conducted Power (dBm)	Maximum Average EIRP (dBm)
a	5180 ~ 5825	29.51	31.51
ax HE20		29.50	31.5
ax HE40		29.82	31.82
ax HE80		26.28	28.28
ax HE160		23.61	25.61
be EHT20		28.75	30.75
be EHT40		29.61	31.61
be EHT80		26.64	28.64
be EHT160		23.62	25.62
be EHT240		17.86	19.86

5.4. TEST CHANNEL CONFIGURATION

UNII-1 Test Channel Configuration		
IEEE Std.	Test Channel Number	Frequency
802.11a	CH 36(Low Channel), CH 40(MID Channel), CH 48(High Channel)	5180 MHz, 5200 MHz, 5240 MHz
802.11n HT20	CH 36(Low Channel), CH 40(MID Channel), CH 48(High Channel)	5180 MHz, 5200 MHz, 5240 MHz
802.11n HT40	CH 38(Low Channel), CH 46(High Channel)	5190 MHz, 5230 MHz
802.11ac VHT80	CH 42(Low Channel)	5210 MHz
802.11ax HE20	CH 36(Low Channel), CH 40(MID Channel), CH 48(High Channel)	5180 MHz, 5200 MHz, 5240 MHz
802.11ax HE40	CH 38(Low Channel), CH 46(High Channel)	5190 MHz, 5230 MHz
802.11ax HE80	CH 42(Low Channel)	5210 MHz

UNII-2A Test Channel Configuration		
IEEE Std.	Test Channel Number	Frequency
802.11a	CH 52(Low Channel), CH 56(MID Channel), CH 64(High Channel)	5260 MHz, 5280 MHz, 5320 MHz
802.11n HT20	CH 52(Low Channel), CH 56(MID Channel), CH 64(High Channel)	5260 MHz, 5280 MHz, 5320 MHz
802.11n HT40	CH 54(Low Channel), CH 62(High Channel)	5270 MHz, 5310 MHz
802.11ac VHT80	CH 58(Low Channel)	5290 MHz
802.11ax HE20	CH 52(Low Channel), CH 56(MID Channel), CH 64(High Channel)	5260 MHz, 5280 MHz, 5320 MHz
802.11ax HE40	CH 54(Low Channel), CH 62(High Channel)	5270 MHz, 5310 MHz
802.11ax HE80	CH 58(Low Channel)	5290 MHz

UNII-2C Test Channel Configuration		
IEEE Std.	Test Channel Number	Frequency
802.11a	CH 100(Low Channel), CH 116(MID Channel), CH 140(High Channel)	5500 MHz, 5580 MHz, 5700 MHz
802.11n HT20	CH 100(Low Channel), CH 116(MID Channel), CH 140(High Channel)	5500 MHz, 5580 MHz, 5700 MHz
802.11n HT40	CH 102(Low Channel), CH 110(MID Channel), CH 134(High Channel)	5510 MHz, 5550 MHz, 5670 MHz
802.11ac VHT80	CH 102(Low Channel), CH 122(High Channel)	5530 MHz, 5610 MHz
802.11ax HE20	CH 100(Low Channel), CH 116(MID Channel), CH 140(High Channel)	5500 MHz, 5580 MHz, 5700 MHz
802.11ax HE40	CH 102(Low Channel), CH 110(MID Channel), CH 134(High Channel)	5510 MHz, 5550 MHz, 5670 MHz
802.11ax HE80	CH 102(Low Channel), CH 122(High Channel)	5530 MHz, 5610 MHz

UNII-3 Test Channel Configuration

IEEE Std.	Test Channel Number	Frequency
802.11a	CH 149(Low Channel), CH 157(MID Channel), CH 165(High Channel)	5745 MHz, 5785 MHz, 5825 MHz
802.11n HT20	CH 149(Low Channel), CH 157(MID Channel), CH 165(High Channel)	5745 MHz, 5785 MHz, 5825 MHz
802.11n HT40	CH 151(Low Channel), CH 159(High Channel)	5755MHz, 5795MHz
802.11ac VHT80	CH 155(Low Channel)	5775 MHz
802.11ax HE20	CH 149(Low Channel), CH 157(MID Channel), CH 165(High Channel)	5745 MHz, 5785 MHz, 5825 MHz
802.11ax HE40	CH 151(Low Channel), CH 159(High Channel)	5755MHz, 5795MHz
802.11ax HE80	CH 155(Low Channel)	5775 MHz

Straddle Test Channel Configuration

IEEE Std.	Test Channel Number	Frequency
802.11a	CH 144	5720 MHz
802.11n HT20	CH 144	5720 MHz
802.11n HT40	CH 142	5710 MHz
802.11ac VHT80	CH 138	5690 MHz
802.11ax HE20	CH 144	5720 MHz
802.11ax HE40	CH 142	5710 MHz
802.11ax HE80	CH 138	5690 MHz

5.5. THE WORSE CASE POWER SETTING PARAMETER

The Worst Case Power Setting Parameter	
Test Software	QSPR

FCC		
Mode	Freq(MHz)	Soft set value 4TX
802.11a-CDD	5180	21
	5200	21
	5240	21.5
	5260	15.5
	5280	15.5
	5320	15.5
	5500	15.5
	5580	15.5
	5700	15.5
	5720-2C	15.5
	5720-3	15.5
	5745	22.5
	5785	22.5
	5825	22.5
802.11AC 20M	5180	20.5
	5200	20.5
	5240	21
	5260	15
	5280	15
	5320	15
	5500	15
	5580	15.5
	5700	15.5
	5720-2C	15.5
	5720-3	15.5
	5745	23
	5785	23.5
	5825	23.5
802.11AC 40M	5190	18.5
	5230	22
	5270	16

	5310	16.5
	5510	16.5
	5550	17.5
	5670	17.5
	5710-2C	17.5
	5710-3	17.5
	5755	22.5
	5795	23
802.11AC 80M	5210	19
	5290	17
	5530	17
	5610	17.5
	5690-2C	17.5
	5690-3	17.5
	5775	20.5
802.11AC 160M	5250-1	19
	5250-2a	19
	5570	16.5
802.11be 20M	5180	20
	5200	21.5
	5240	21.5
	5260	15.5
	5280	15.5
	5320	15.5
	5500	16.5
	5580	16.5
	5700	17
	5720-2C	17
	5720-3	17
	5745	23
	5785	24
	5825	24
802.11be 40M	5190	18
	5230	22
	5270	17
	5310	17
	5510	17
	5550	18
	5670	18
	5710-2C	18
	5710-3	18
	5755	22.5
	5795	23

802.11be 80M	5210	19
	5290	16.5
	5530	16.5
	5610	16.5
	5690-2C	16.5
	5690-3	16.5
	5775	20
802.11be 160M	5250-1	19.5
	5250-2a	19.5
	5570	16.5
802.11be 240M	5610	12

ISED		
Mode	Freq(MHz)	Soft set value 4TX
802.11a-CDD	5180	7
	5200	7
	5240	7
	5260	15.5
	5280	15.5
	5320	15.5
	5500	15.5
	5580	15.5
	5700	15.5
	5720-2C	15.5
	5720-3	15.5
	5745	22.5
	5785	22.5
	5825	22.5
802.11AC 20M	5180	7.5
	5200	7.5
	5240	7.5
	5260	15
	5280	15
	5320	15

	5500	15
	5580	15.5
	5700	15.5
	5720-2C	15.5
	5720-3	15.5
	5745	23
	5785	23.5
	5825	23.5
802.11AC 40M	5190	10
	5230	10
	5270	16
	5310	16.5
	5510	16.5
	5550	17.5
	5670	17.5
	5710-2C	17.5
	5710-3	17.5
	5755	22.5
	5795	23
802.11AC 80M	5210	13.5
	5290	17
	5530	17
	5610	17.5
	5690-2C	17.5
	5690-3	17.5
	5775	20.5
802.11AC 160M	5250-1	16.5
	5250-2a	16.5
	5570	16.5
802.11be 20M	5180	7.5
	5200	7.5
	5240	7.5
	5260	15.5
	5280	15.5
	5320	15.5
	5500	16.5
	5580	16.5
	5700	17
	5720-2C	17
	5720-3	17
	5745	23
	5785	24
5825	24	
802.11be 40M	5190	11

	5230	11
	5270	17
	5310	17
	5510	17
	5550	18
	5670	18
	5710-2C	18
	5710-3	18
	5755	22.5
	5795	23
802.11be 80M	5210	13
	5290	16.5
	5530	16.5
	5610	16.5
	5690-2C	16.5
	5690-3	16.5
	5775	20
802.11be 160M	5250-1	16
	5250-2a	16
	5570	16.5
802.11be 240M	5610-2c	12
	5610-3	12

5.6. WORSE CASE CONFIGURATIONS

The EUT was tested in the following configuration(s):

Controlled in test mode using a software application on the EUT supplied by customer. The application was used to enable continuous transmission and to select the mode, test channels, bandwidth, data rates as required.

Test channels referring to section 5.4.

Maximum power setting referring to section 5.5.

Worst case Data Rates declared by the customer:

802.11a 20 CDD mode : 6 Mbps

802.11n HT20 CDD/ TX beamforming mode mode : MCS0

802.11n HT40 CDD mode/ TX beamforming mode mode : MCS0

802.11ac VHT20 CDD mode/ TX beamforming mode mode : MCS0

802.11ac VHT40 CDD mode / TX beamforming mode mode: MCS0

802.11ac VHT80 CDD mode/ TX beamforming mode mode : MCS0

802.11ac VHT160 CDD mode/ TX beamforming mode mode : MCS0

802.11ax HE20 CDD mode / TX beamforming mode mode: MCS0

802.11ax HE40 CDD mode/ TX beamforming mode mode : MCS0

802.11ax HE80 CDD mode/ TX beamforming mode mode : MCS0

802.11ax HE80 CDD mode / TX beamforming mode mode: MCS0

802.11ax HE160 CDD mode/ TX beamforming mode mode : MCS0

802.11be EHT20 CDD mode / TX beamforming mode mode: MCS0

802.11be EHT40 CDD mode / TX beamforming mode mode: MCS0

802.11be EHT80 CDD mode / TX beamforming mode mode: MCS0

802.11be EHT160 CDD mode/ TX beamforming mode mode : MCS0

802.11be EHT240 CDD mode / TX beamforming mode mode: MCS0

All modes support CDD mode.

All modes support TX beamforming mode except 802.11a.

For 802.11n/ac/ax/be mode, the EUT support Cyclic Shift Diversity (CDD) and TX Beamforming. The conducted power of CDD mode is higher than TX Beamforming mode, and the EIRP of CDD is the same as TX Beamforming mode, so we only chose the worst-case mode CDD for final testing.

802.11n HT20/HT40/ac VHT20/VHT40/VHT80/VHT160 and 802.11ax HE20/HE40/HE80/HE160 were performed on the worst case (802.11ax HE20/HE40/HE80/HE160) mode and only the worst data was recorded in this report.

The EUT has 8 antennas, ANT5 support BLE, ANT1, ANT2, ANT3, ANT4 support WIFI 2.4G band and WIFI 5G band, ANT5, ANT6, ANT7, ANT8 support WIFIF 6G band.

The measured additional path loss was included in any path loss calculations for all RF cable used during tested.

The EUT not support partial Rus and channel puncturing mode.

US and CA country codes changed the power table for U-NII band 1. For other bands have the same power table. Therefore U-NII-1 was tested to both powers. The CA country code also disabled any channels in the 5600-5650 MHz band.

Sample ID:	6072980-1	For FCC full band and ISED UNII-2A& UNII-2C&UNII-3 test
Sample ID:	6072980-2	For ISED UNII-1 test

5.7. DESCRIPTION OF AVAILABLE ANTENNAS

Antenna No.	Frequency Band	Antenna Type	Max Antenna Gain (dBi)
1	5150-5850	PIFA antenna	2
2	5150-5850	PIFA antenna	2
3	5150-5850	PIFA antenna	2
4	5150-5850	PIFA antenna	2

The EUT support Cyclic Shift Diversity(CDD) mode.

MIMO output power port and MIMO PSD port summing were performed in accordance with KDB 662911 D01. For the CDD results the Directional Gain was calculated in accordance with the following method.

For output power measurements:

Directional gain= $G_{ANT} + \text{Array Gain} = 2 \text{ dBi}$

G_{ANT} : equal to the gain of the antenna having the highest gain

Array Gain = 0 dB (i.e., no array gain) for $N_{ANT} \leq 4$

For power spectral density (PSD) measurements:

Directional gain= $G_{ANT} + \text{Array Gain} = 8.02 \text{ dBi}$

Array Gain = $10 \log(N_{ANT}/N_{SS}) \text{ dB}$.

N_{ANT} : number of transmit antennas

N_{SS} : number of spatial streams, The worst case directional gain will occur when $N_{SS} = 1$

For TX Beamforming:

Directional gain= $G_{ANT} + 10 \log(N_{ANT}/N_{SS}) = 8.02 \text{ dBi}$

5.8. SUPPORT UNITS FOR SYSTEM TEST

SUPPORT EQUIPMENT

Item	Equipment	Brand Name	Model Name	Remarks
1	Laptop	ThinkPad	X230i	/

I/O CABLES

Cable No	Port	Connector Type	Cable Type	Cable Length(m)	Remarks
1	LAN1	RJ45	Unshielded	1.0 m	/

ACCESSORIES

Item	Accessory	Brand Name	Model Name	Description
1	I.T.E POWER SUPPLY	tp-link	T120450-2B4	Input: AC 100-240 V, 50 / 60 Hz, 1.5 A Output: DC 12.0 V, 4.5 A

TEST SETUP

The EUT can work in engineering mode with a software through a laptop.

SETUP DIAGRAM FOR TESTS

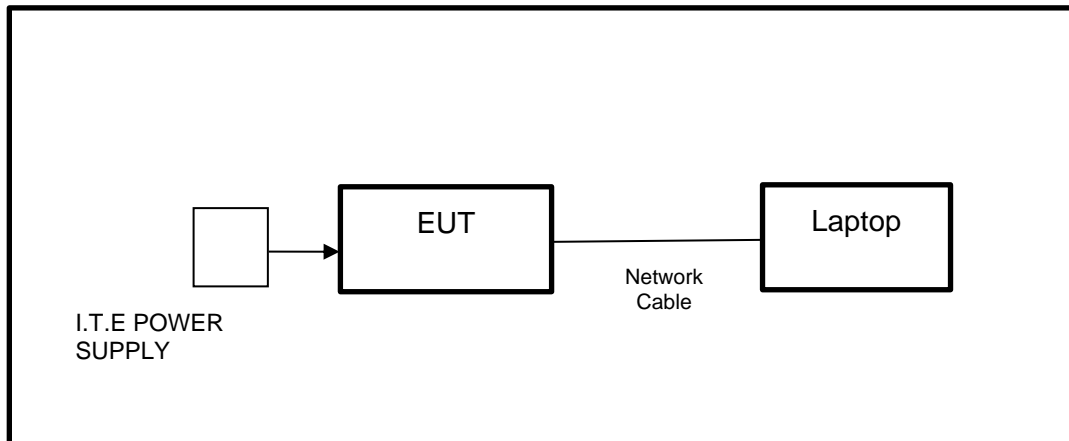

6. MEASURING EQUIPMENT AND SOFTWARE USED

R&S TS 8997 Test System						
Equipment	Manufacturer	Model No.	Serial No.	Upper Last Cal.	Last Cal.	Due. Date
Power sensor, Power Meter	R&S	OSP120	100921	/	Mar.31, 2023	Mar.30, 2024
Vector Signal Generator	R&S	SMBV100A	261637	Oct.17, 2022	Oct.12, 2023	Oct.11, 2024
Signal Generator	R&S	SMB100A	178553	Oct.17, 2022	Oct.12, 2023	Oct.11, 2024
Signal Analyzer	R&S	FSV40	101118	Oct.17, 2022	Oct.12, 2023	Oct.11, 2024
Software						
Description	Manufacturer	Name	Version			
For R&S TS 8997 Test System	Rohde & Schwarz	EMC 32	10.60.10			
Tonsend RF Test System						
Equipment	Manufacturer	Model No.	Serial No.	Upper Last Cal.	Last Cal.	Due. Date
Wideband Radio Communication Tester	R&S	CMW500	155523	Oct.17, 2022	Oct.12, 2023	Oct.11, 2024
Wireless Connectivity Tester	R&S	CMW270	1201.0002N75-102	Sep.28, 2022	Sep.27, 2023	Sep.26, 2024
PXA Signal Analyzer	Keysight	N9030A	MY55410512	Oct.17, 2022	Oct.12, 2023	Oct.11, 2024
MXG Vector Signal Generator	Keysight	N5182B	MY56200284	Oct.17, 2022	Oct.12, 2023	Oct.11, 2024
MXG Vector Signal Generator	Keysight	N5172B	MY56200301	Oct.17, 2022	Oct.12, 2023	Oct.11, 2024
DC power supply	Keysight	E3642A	MY55159130	Oct.17, 2022	Oct.12, 2023	Oct.11, 2024
Temperature & Humidity Chamber	SANMOOD	SG-80-CC-2	2088	Oct.17, 2022	Oct.12, 2023	Oct.11, 2024
Attenuator	Aglient	8495B	2814a12853	Oct.18, 2022	Oct.12, 2023	Oct.11, 2024
RF Control Unit	Tonscend	JS0806-2	23B80620666	/	April 18,2023	April 17,2024
Software						
Description	Manufacturer	Name	Version			
Tonsend SRD Test System	Tonsend	JS1120-3 RF Test System	V3.2.22			

Conducted Emissions						
Equipment	Manufacturer	Model No.	Serial No.	Upper Last Cal.	Last Cal.	Due. Date
EMI Test Receiver	R&S	ESR3	101961	Oct.17, 2022	Oct.13, 2023	Oct.12, 2024
Two-Line V-Network	R&S	ENV216	101983	Oct.17, 2022	Oct.13, 2023	Oct.12, 2024
Artificial Mains Networks	Schwarzbeck	NSLK 8126	8126465	Oct.17, 2022	Oct.13, 2023	Oct.12, 2024
Software						
Description			Manufacturer	Name	Version	
Test Software for Conducted Emissions			Farad	EZ-EMC	Ver. UL-3A1	

Radiated Emissions						
Equipment	Manufacturer	Model No.	Serial No.	Upper Last Cal.	Last Cal.	Due. Date
MXE EMI Receiver	KESIGHT	N9038A	MY56400036	Oct.17, 2022	Oct.12, 2023	Oct.11, 2024
Hybrid Log Periodic Antenna	TDK	HLP-3003C	130959	/	Aug.02, 2021	Aug.01, 2024
Preamplifier	HP	8447D	2944A09099	Oct.17, 2022	Oct.12, 2023	Oct.11, 2024
EMI Measurement Receiver	R&S	ESR26	101377	Oct.17, 2022	Oct.12, 2023	Oct.11, 2024
Horn Antenna	TDK	HRN-0118	130940	/	July 20, 2021	July 19, 2024
Preamplifier	TDK	PA-02-0118	TRS-305-00067	Oct.17, 2022	Oct.12, 2023	Oct.11, 2024
Horn Antenna	Schwarzbeck	BBHA9170	697	/	July 20, 2021	July 19, 2024
Preamplifier	TDK	PA-02-2	TRS-307-00003	Oct.17, 2022	Oct.12, 2023	Oct.11, 2024
Preamplifier	TDK	PA-02-3	TRS-308-00002	Oct.17, 2022	Oct.12, 2023	Oct.11, 2024
Loop antenna	Schwarzbeck	1519B	00008	/	Dec.14, 2021	Dec.13, 2024
Preamplifier	TDK	PA-02-001-3000	TRS-302-00050	Oct.17, 2022	Oct.12, 2023	Oct.11, 2024
Preamplifier	Mini-Circuits	ZX60-83LN-S+	SUP01202035	Oct.17, 2022	Oct.12, 2023	Oct.11, 2024
High Pass Filter	Wi	WHKX10-2700-3000-18000-40SS	23	/	Dec.01,2022	Nov.30,2023
Highpass Filter	Wainwright	WHKX10-5850-6500-1800-40SS	4	/	Dec.01,2022	Nov.30,2023

Band Reject Filter	Wainwright	WRCJV12-5695-5725-5850-5880-40SS	4	/	Dec.01,2022	Nov.30,2023
Band Reject Filter	Wainwright	WRCJV20-5120-5150-5350-5380-60SS	2	/	Dec.01,2022	Nov.30,2023
Band Reject Filter	Wainwright	WRCJV20-5440-5470-5725-5755-60SS	1	/	Dec.01,2022	Nov.30,2023
Band Reject Filter	Wainwright	WRCJV8-2350-2400-2483.5-2533.5-40SS	4	/	Dec.01,2022	Nov.30,2023
Band Reject Filter	Wainwright	WRCD5-1879-1879.85-1880.15-1881-40SS	1	/	Dec.01,2022	Nov.30,2023
Notch Filter	Wainwright	WHJ10-882-980-7000-40SS	1	/	Dec.01,2022	Nov.30,2023
Software						
Description			Manufacturer	Name	Version	
Test Software for Radiated Emissions			Farad	EZ-EMC	Ver. UL-3A1	

Other Instrument						
Equipment	Manufacturer	Model No.	Serial No.	Upper Last Cal.	Last Cal.	Due. Date
Temperature humidity probe	OMEGA	ITHX-SD-5	18470007	Oct.22, 2022	Oct.19, 2023	Oct.18, 2024
Barometer	Yiyi	Baro	N/A	Oct.24, 2022	Oct.19, 2023	Oct.18, 2024
Attenuator	Agilent	8495B	2814a12853	Oct.18, 2022	Oct.12, 2023	Oct.11, 2024

7. ANTENNA PORT TEST RESULTS

7.1. ON TIME AND DUTY CYCLE

LIMITS

None; for reporting purposes only.

TEST PROCEDURE

Refer to KDB 789033 D02 General U-NII Test Procedures New Rules v02r01 section II.B.

The zero-span mode on a spectrum analyzer or EMI receiver, if the response time and spacing between bins on the sweep are sufficient to permit accurate measurements of the on and off times of the transmitted signal. Set the center frequency of the instrument to the center frequency of the transmission. Set RBW \geq EBW if possible; otherwise, set RBW to the largest available value. Set VBW \geq RBW. Set detector = peak or average. The zero-span measurement method shall not be used unless both RBW and VBW are $> 50/T$, where T is defined in II.B.1.a), and the number of sweep points across duration T exceeds 100. (For example, if VBW and/or RBW are limited to 3 MHz, then the zero-span method of measuring duty cycle shall not be used if $T \leq 16.7$ microseconds.)

TEST SETUP

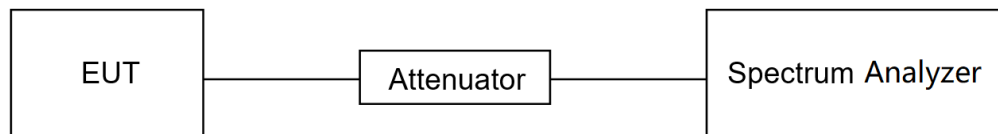

TEST ENVIRONMENT

Temperature	26.2°C	Relative Humidity	63.0%
Atmosphere Pressure	101kPa	Test Voltage	DC 12 V

TEST DATE / ENGINEER

Test Date	September 14, 2023	Test By	Johnson Liu
-----------	--------------------	---------	-------------

TEST RESULTS

Please refer to section "Test Data" - Appendix F

7.2. 6DB AND 26DB EMISSION BANDWIDTH AND 99% OCCUPIED BANDWIDTH

LIMITS

CFR 47 FCC Part15, Subpart E ISED RSS-247 ISSUE 3		
Test Item	Limit	Frequency Range (MHz)
26 dB Emission Bandwidth	For reporting purposes only.	5150 ~ 5250
26 dB Emission Bandwidth	For reporting purposes only.	5250 ~ 5350
26 dB Emission Bandwidth	For reporting purposes only.	5470 ~ 5725 (For FCC) 5470 ~ 5600 (For ISED) 5650 ~ 5725 (For ISED)
6 dB Emission Bandwidth	The minimum 6 dB emission bandwidth shall be 500 kHz.	5725 ~ 5850
99 % Occupied Bandwidth	For reporting purposes only.	5150 ~ 5825 (For ISED)

TEST PROCEDURE

Refer to KDB 789033 D02 General U-NII Test Procedures New Rules v02r01 section II.C1. for 26 dB Emission Bandwidth; section II.C2. for 6 dB Emission Bandwidth; section II.D. for 99 % Occupied Bandwidth.

Connect the EUT to the spectrum analyser and use the following settings:

Center Frequency	The center frequency of the channel under test
Detector	Peak
RBW	For 6 dB Emission Bandwidth: RBW=100 kHz For 26 dB Emission bandwidth: approximately 1 % of the EBW. For 99 % Occupied Bandwidth: approximately 1 % ~ 5 % of the OBW.
VBW	For 6 dB Bandwidth: $\geq 3 \times \text{RBW}$ For 26 dB Bandwidth: $> 3 \times \text{RBW}$ For 99 % Bandwidth: $> 3 \times \text{RBW}$
Trace	Max hold
Sweep	Auto couple

- Use the 99 % power bandwidth function of the instrument, allow the trace to stabilize and report the measured bandwidth.
- Allow the trace to stabilize and measure the maximum width of the emission that is constrained by the frequencies associated with the two outermost amplitude points (upper and lower frequencies) that are attenuated by 6/26 dB relative to the maximum level measured in the fundamental emission.

Calculation for 99 % Bandwidth of UNII-2C and UNII-3 Straddle Channel:

For Example: Fundamental Frequency: 5720 MHz

99 % OBW: 21.00 MHz

Turning Frequency: 5725 MHz

99 % Bandwidth of UNII-2C Band Portion = $(5725 - (5720 - (21.00/2))) = 15.50$ MHz

99 % Bandwidth of UNII-3 Band Portion = $(5720 + (21.00/2) - 5725) = 5.50$ MHz

Calculation for 26 dB Bandwidth of UNII-2C Straddle Channel:

For Example: Fundamental frequency: 5720 MHz

26 dB BW: 20.00 MHz

FL: 5710.16 MHz

FH: 5730.16 MHz

Turning Frequency: 5725 MHz

26 dB Bandwidth of UNII-2C Band Portion = $5725 - 5710.16 = 14.84$ MHz

Calculation for 6dB Bandwidth of UNII-3 Straddle Channel:

For Example: Fundamental frequency: 5720 MHz

6 dB BW: 16.44 MHz

FL: 5711.76 MHz

FH: 5728.2 MHz

Turning Frequency: 5725 MHz

6 dB Bandwidth of UNII-3 band Portion = $5728.2 - 5725 = 3.2$ MHz

TEST SETUP

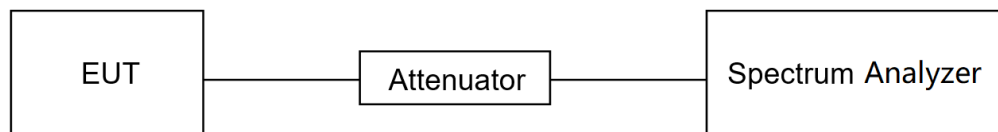

TEST ENVIRONMENT

Temperature	26.2°C	Relative Humidity	63.0%
Atmosphere Pressure	101kPa	Test Voltage	DC 12 V

TEST DATE / ENGINEER

Test Date	August 9~September 19, 2023	Test By	Johnson Liu
-----------	-----------------------------	---------	-------------

TEST RESULTS

Please refer to section "Test Data" - Appendix A&B&C

7.3. CONDUCTED OUTPUT POWER

LIMITS

CFR 47 FCC Part15, Subpart E		
Test Item	Limit	Frequency Range (MHz)
Conducted Output Power	<input type="checkbox"/> Outdoor Access Point: 1 W (30 dBm) <input checked="" type="checkbox"/> Indoor Access Point: 1 W (30 dBm) <input type="checkbox"/> Fixed Point-To-Point Access Points: 1 W (30 dBm) <input type="checkbox"/> Client Devices: 250 mW (24 dBm)	5150 ~ 5250
	Shall not exceed the lesser of 250 mW (24dBm) or 11 dBm + 10 log B, where B is the 26 dB emission bandwidth in megahertz.	5250 ~ 5350 5470 ~ 5725
	Shall not exceed 1 Watt (30 dBm).	5725 ~ 5850

ISED RSS-247 ISSUE 3		
Test Item	Limit	Frequency Range (MHz)
Conducted Output Power or e.i.r.p.	The maximum e.i.r.p. shall not exceed 200 mW (23 dBm) or 10 + 10 log ₁₀ B, dBm, whichever power is less. B is the 99 % emission bandwidth in megahertz.	5150 ~ 5250
	a. The maximum conducted output power shall not exceed 250 mW (24 dBm) or 11 + 10 log ₁₀ B dBm, whichever is less. b. The maximum e.i.r.p. shall not exceed 1.0 W (30 dBm) or 17 + 10 log ₁₀ B dBm, whichever is less. B is the 99 % emission bandwidth in megahertz. Note that devices with a maximum e.i.r.p. greater than 500 mW shall implement TPC in order to have the capability to operate at least 6 dB below the maximum permitted e.i.r.p. of 1 W.	5250 ~ 5350 5470 ~ 5600 5650 ~ 5725
	Shall not exceed 1 Watt (30 dBm). The e.i.r.p. shall not exceed 4 W	5725 ~ 5850

Note:

The above limits are based upon the maximum antenna gain does not exceed 6 dBi. If transmitting antennas of directional gain greater than 6 dBi are used, the maximum conducted output power shall be reduced by the amount in dB that the directional gain of the antenna exceeds 6 dBi.

TEST PROCEDURE

Refer to KDB 789033 D02 General U-NII Test Procedures New Rules v02r01 section II.E.

Method SA-2 (trace averaging across ON and OFF times of the EUT transmissions, followed by duty cycle correction.):

- Measure the duty cycle D of the transmitter output signal.
- Set span to encompass the entire 26 dB EBW or 99% OBW of the signal.
- Set RBW = 1 MHz.
- Set VBW ≥ 3 MHz.

- (e) Number of points in sweep $\geq [2 \times \text{span} / \text{RBW}]$. (This gives bin-to-bin spacing $\leq \text{RBW} / 2$, so that narrowband signals are not lost between frequency bins.)
- (f) Sweep time = auto.
- (g) Detector = RMS (i.e., power averaging), if available. Otherwise, use sample detector mode.
- (h) Do not use sweep triggering. Allow the sweep to “free run.”
- (i) Trace average at least 100 traces in power averaging (rms) mode; however, the number of traces to be averaged shall be increased above 100 as needed such that the average accurately represents the true average over the ON and OFF periods of the transmitter.
- j) Compute power by integrating the spectrum across the 26 dB EBW or 99% OBW of the signal using the instrument’s band power measurement function with band limits set equal to the EBW or OBW band edges. If the instrument does not have a band power function, then sum the spectrum levels (in power units) at 1 MHz intervals extending across the 26 dB EBW or 99% OBW of the spectrum.
- k) Add $[10 \log (1 / D)]$, where D is the duty cycle, to the measured power to compute the average power during the actual transmission times (because the measurement represents an average over both the ON and OFF times of the transmission). For example, add $[10 \log (1 / 0.25)] = 6 \text{ dB}$ if the duty cycle is 25%.

Method PM (Measurement using an RF average power meter):

- (i) Measurements may be performed using a wideband RF power meter with a thermocouple detector or equivalent if all of the following conditions are satisfied:
 - a. The EUT is configured to transmit continuously or to transmit with a constant duty cycle.
 - b. At all times when the EUT is transmitting, it must be transmitting at its maximum power control level.
 - c. The integration period of the power meter exceeds the repetition period of the transmitted signal by at least a factor of five.
- (ii) If the transmitter does not transmit continuously, measure the duty cycle, x, of the transmitter output signal as described in II.B.
- (iii) Measure the average power of the transmitter. This measurement is an average over both the on and off periods of the transmitter.
- (iv) Adjust the measurement in dBm by adding $10 \log (1/x)$ where x is the duty cycle (e.g., $10 \log (1/0.25)$ if the duty cycle is 25 %).

Note: Method SA-2 was used for straddle channel output power test, and Method PM was used for testing rest channels

TEST SETUP

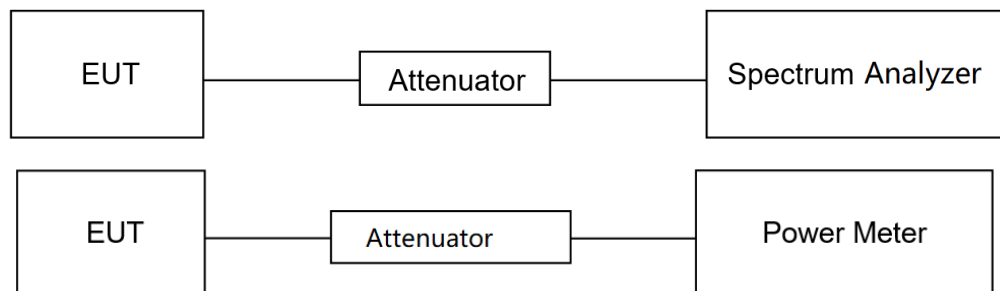

TEST ENVIRONMENT

Temperature	26.2°C	Relative Humidity	63.0%
Atmosphere Pressure	101kPa	Test Voltage	DC 12 V

TEST DATE / ENGINEER

Test Date	September 14, 2023	Test By	Johnson Liu
-----------	--------------------	---------	-------------

TEST RESULTS

Please refer to section "Test Data" - Appendix D

7.4. POWER SPECTRAL DENSITY

LIMITS

CFR 47 FCC Part15, Subpart E		
Test Item	Limit	Frequency Range (MHz)
Power Spectral Density	<input type="checkbox"/> Outdoor Access Point: 17 dBm/MHz <input checked="" type="checkbox"/> Indoor Access Point: 17 dBm/MHz <input type="checkbox"/> Fixed Point-To-Point Access Points: 17 dBm/MHz <input type="checkbox"/> Client Devices: 11 dBm/MHz	5150 ~ 5250
	11 dBm/MHz	5250 ~ 5350 5470 ~ 5725
	30 dBm/500kHz	5725 ~ 5850

ISED RSS-247 ISSUE 3		
Test Item	Limit	Frequency Range (MHz)
Power Spectral Density	The e.i.r.p. spectral density shall not exceed 10 dBm in any 1.0 MHz band.	5150 ~ 5250
	The power spectral density shall not exceed 11 dBm in any 1.0 MHz band.	5250 ~ 5350 5470 ~ 5600 5650 ~ 5725
	30 dBm / 500 kHz	5725 ~ 5850

Note:

The above limits are based upon the maximum antenna gain does not exceed 6 dBi. If transmitting antennas of directional gain greater than 6 dBi are used, maximum power spectral density shall be reduced by the amount in dB that the directional gain of the antenna exceeds 6 dBi.

TEST PROCEDURE

Refer to KDB 789033 D02 General U-NII Test Procedures New Rules v02r01 section II.F.

Connect the EUT to the spectrum analyzer and use the following settings:

For U-NII-1, U-NII-2A and U-NII-2C band:

Center Frequency	The center frequency of the channel under test
Detector	RMS
RBW	1 MHz
VBW	$\geq 3 \times \text{RBW}$
Span	Encompass the entire emissions bandwidth (EBW) of the signal
Trace	Max hold
Sweep time	Auto

For U-NII-3:

Center Frequency	The center frequency of the channel under test
Detector	RMS
RBW	500 kHz
VBW	$\geq 3 \times \text{RBW}$
Span	Encompass the entire emissions bandwidth (EBW) of the signal
Trace	Max hold
Sweep time	Auto

Allow trace to fully stabilize and use the peak search function on the instrument to find the peak of the spectrum and record its value.

Add $10 \log(1/x)$, where x is the duty cycle, to the peak of the spectrum, the result is the Maximum PSD over 1 MHz / 500 kHz reference bandwidth.

TEST SETUP

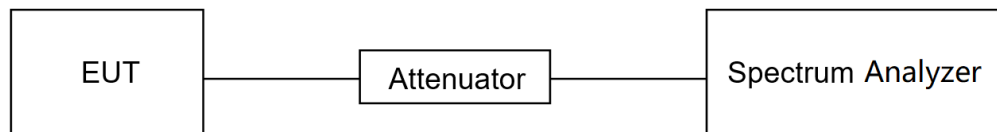

TEST ENVIRONMENT

Temperature	26.2°C	Relative Humidity	63.0%
Atmosphere Pressure	101kPa	Test Voltage	DC 12 V

TEST DATE / ENGINEER

Test Date	September 14, 2023	Test By	Johnson Liu
-----------	--------------------	---------	-------------

TEST RESULTS

Please refer to section "Test Data" - Appendix E

8. RADIATED TEST RESULTS

LIMITS

Refer to CFR 47 FCC §15.205, §15.209 and §15.407 (b).

Refer to ISED RSS-GEN Clause 8.9, Clause 8.10 and ISED RSS-247 6.2.

Radiation Disturbance Test Limit for FCC (Class B) (9 kHz ~ 1 GHz)

Emissions radiated outside of the specified frequency bands above 30 MHz			
Frequency Range (MHz)	Field Strength Limit (uV/m) at 3 m	Field Strength Limit (dBuV/m) at 3 m	
		Quasi-Peak	
30 - 88	100	40	
88 - 216	150	43.5	
216 - 960	200	46	
Above 960	500	54	
Above 1000	500	Peak	Average
		74	54

FCC Emissions radiated outside of the specified frequency bands below 30 MHz		
Frequency (MHz)	Field strength (microvolts/meter)	Measurement distance (meters)
0.009-0.490	2400/F(kHz)	300
0.490-1.705	24000/F(kHz)	30
1.705-30.0	30	30

ISED General field strength limits at frequencies below 30 MHz

Table 6 – General field strength limits at frequencies below 30 MHz		
Frequency	Magnetic field strength (H-Field) (μA/m)	Measurement distance (m)
9 - 490 kHz ^{Note 1}	6.37/F (F in kHz)	300
490 - 1705 kHz	63.7/F (F in kHz)	30
1.705 - 30 MHz	0.08	30

Note 1: The emission limits for the ranges 9-90 kHz and 110-490 kHz are based on measurements employing a linear average detector.

ISED Restricted bands refer to ISED RSS-GEN Clause 8.10

Table 7 – Restricted frequency bands ^{Note 1}		
MHz	MHz	GHz
0.090 - 0.110	149.9 - 150.05	9.0 - 9.2
0.495 - 0.505	156.52475 - 156.52525	9.3 - 9.5
2.1735 - 2.1905	156.7 - 156.9	10.6 - 12.7
3.020 - 3.028	162.0125 - 167.17	13.25 - 13.4
4.125 - 4.128	167.72 - 173.2	14.47 - 14.5
4.17725 - 4.17775	240 - 285	15.35 - 16.2
4.20725 - 4.20775	322 - 335.4	17.7 - 21.4
5.677 - 5.683	399.9 - 410	22.01 - 23.12
6.215 - 6.218	608 - 614	23.6 - 24.0
6.26775 - 6.26825	960 - 1427	31.2 - 31.8
6.31175 - 6.31225	1435 - 1626.5	36.43 - 36.5
8.291 - 8.294	1645.5 - 1646.5	Above 38.6
8.362 - 8.366	1660 - 1710	
8.37625 - 8.38675	1718.8 - 1722.2	
8.41425 - 8.41475	2200 - 2300	
12.29 - 12.293	2310 - 2390	
12.51975 - 12.52025	2483.5 - 2500	
12.57675 - 12.57725	2656 - 2900	
13.36 - 13.41	3260 - 3267	
16.42 - 16.423	3332 - 3339	
16.69475 - 16.69525	3345.8 - 3358	
16.80425 - 16.80475	3500 - 4400	
25.5 - 25.67	4500 - 5150	
37.5 - 38.25	5350 - 5480	
73 - 74.6	7250 - 7750	
74.8 - 75.2	8025 - 8500	
108 - 138		

Note 1: Certain frequency bands listed in table 7 and in bands above 38.6 GHz are designated for licence-exempt applications. These frequency bands and the requirements that apply to related devices are set out in the 200 and 300 series of RSSs.

FCC Restricted bands of operation refer to FCC §15.205 (a):

MHz	MHz	MHz	GHz
0.090-0.110	16.42-16.423	399.9-410	4.5-5.15
¹ 0.495-0.505	16.69475-16.69525	608-614	5.35-5.46
2.1735-2.1905	16.80425-16.80475	960-1240	7.25-7.75
4.125-4.128	25.5-25.67	1300-1427	8.025-8.5
4.17725-4.17775	37.5-38.25	1435-1626.5	9.0-9.2
4.20725-4.20775	73-74.6	1645.5-1646.5	9.3-9.5
6.215-6.218	74.8-75.2	1660-1710	10.6-12.7
6.26775-6.26825	108-121.94	1718.8-1722.2	13.25-13.4
6.31175-6.31225	123-138	2200-2300	14.47-14.5
8.291-8.294	149.9-150.05	2310-2390	15.35-16.2
8.362-8.366	156.52475-156.52525	2483.5-2500	17.7-21.4
8.37625-8.38675	156.7-156.9	2690-2900	22.01-23.12
8.41425-8.41475	162.0125-167.17	3260-3267	23.6-24.0
12.29-12.293	167.72-173.2	3332-3339	31.2-31.8
12.51975-12.52025	240-285	3345.8-3358	36.43-36.5
12.57675-12.57725	322-335.4	3600-4400	(²)
13.36-13.41			

Note: ¹Until February 1, 1999, this restricted band shall be 0.490-0.510 MHz.

²Above 38.6c

Limits of unwanted/undesirable emission out of the restricted bands refer to CFR 47 FCC §15.407 (b) and ISED RSS-247 6.2.

LIMITS OF RADIATED EMISSION MEASUREMENT (Above 1GHz)		
Frequency Range (MHz)	EIRP Limit	Field Strength Limit (dBuV/m) at 3 m
5150~5250 MHz	PK: -27 (dBm/MHz)	PK:68.2(dBμV/m)
5250~5350 MHz		
5470~5725 MHz		
5725~5850 MHz	PK: -27 (dBm/MHz) *1 PK: 10 (dBm/MHz) *2 PK: 15.6 (dBm/MHz) *3 PK: 27 (dBm/MHz) *4	PK: 68.2(dBμV/m) *1 PK: 105.2 (dBμV/m) *2 PK: 110.8(dBμV/m) *3 PK: 122.2 (dBμV/m) *4
Note: *1 beyond 75 MHz or more above of the band edge. *2 below the band edge increasing linearly to 10 dBm/MHz at 25 MHz above. *3 below the band edge increasing linearly to a level of 15.6 dBm/MHz at 5 MHz above. *4 from 5 MHz above or below the band edge increasing linearly to a level of 27 dBm/MHz at the band edge.		

TEST PROCEDURE

Below 30 MHz

The setting of the spectrum analyzer

RBW	200 Hz (From 9 kHz to 0.15 MHz)/ 9 kHz (From 0.15 MHz to 30 MHz)
VBW	200 Hz (From 9 kHz to 0.15 MHz)/ 9 kHz (From 0.15 MHz to 30 MHz)
Sweep	Auto

1. The testing follows the guidelines in ANSI C63.10-2013 clause 6.4.
2. The EUT was arranged to its worst case and then turntable (from 0 degree to 360 degrees) to find the maximum reading. A pre-amp and a high pass filter are used for the test in order to get better signal level. Both Horizontal, Face-on and Face-off polarizations of the antenna are set to make the measurement.
3. The EUT was placed on a turntable with 80 cm above ground.
4. The EUT was set 3 meters from the interference receiving antenna, which was mounted on the top of a 1 m height antenna tower.
5. The radiated emission limits are based on measurements employing a CISPR quasi-peak detector except for the frequency bands 9-90 kHz, 110-490 kHz and above 1000 MHz Radiated emission limits in these three bands are based on measurements employing an average detector.
6. For measurement below 1 GHz, the initial step in collecting conducted emission data is a spectrum analyzer peak detector mode pre-scanning the measurement frequency range. Significant peaks are then marked and then Quasi Peak and average detector mode re-measured. If the emission level of the EUT measured by the peak detector is 3 dB lower than the applicable limit, the peak emission level will be reported. Otherwise, the emission measurement will be repeated using the quasi-peak and average detector and reported.
7. Although these tests were performed other than open field site, adequate comparison measurements were confirmed against 30m open field site. Therefore sufficient tests were made to demonstrate that the alternative site produces results that correlate with the ones of tests made in an open field site based on KDB 414788.

8. The limits in CFR 47, Part 15, Subpart C, paragraph 15.209 (a), are identical to those in RSS-GEN Section 8.9, Table 6, since the measurements are performed in terms of magnetic field strength and converted to electric field strength levels (as reported in the table) using the free space impedance of 377Ω . For example, the measurement frequency X kHz resulted in a level of Y dBuV/m, which is equivalent to $Y-51.5 = Z$ dBuA/m, which has the same margin, W dB, to the corresponding RSS-GEN Table 6 limit as it has to be 15.209(a) limit.

Below 1 GHz and above 30 MHz

The setting of the spectrum analyzer

RBW	120 kHz
VBW	300 kHz
Sweep	Auto
Detector	Peak/QP
Trace	Max hold

1. The testing follows the guidelines in ANSI C63.10-2013 clause 6.5.
2. The EUT was arranged to its worst case and then tune the antenna tower (from 1 m to 4 m) and turntable (from 0 degree to 360 degrees) to find the maximum reading. A pre-amp and a high pass filter are used for the test in order to get better signal level. Both horizontal and vertical polarizations of the antenna are set to make the measurement.
3. The EUT was placed on a turntable with 80 cm above ground.
4. The EUT was set 3 meters from the interference receiving antenna, which was mounted on the top of a variable height antenna tower.
5. For measurement below 1 GHz, the initial step in collecting conducted emission data is a spectrum analyzer peak detector mode pre-scanning the measurement frequency range. Significant peaks are then marked and then Quasi Peak detector mode re-measured. If the emission level of the EUT measured by the peak detector is 3 dB lower than the applicable limit, the peak emission level will be reported. Otherwise, the emission measurement will be repeated using the quasi-peak detector and reported.

Above 1 GHz

The setting of the spectrum analyzer

RBW	1 MHz
VBW	PEAK: 3 MHz AVG: see note 6
Sweep	Auto
Detector	Peak
Trace	Max hold

1. The testing follows the guidelines in KDB 789033 D02 General U-NII Test Procedures New Rules v02r01 section II.G.3 ~ II.G.6.
2. The EUT was arranged to its worst case and then tune the antenna tower (from 1 m to 4 m) and turntable (from 0 degree to 360 degrees) to find the maximum reading. A pre-amp and a high pass filter are used for the test in order to get better signal level. Both horizontal and vertical polarizations of the antenna are set to make the measurement.
3. The EUT was placed on a turntable with 1.5 m above ground.
4. The EUT was set 3 meters from the interference receiving antenna, which was mounted on the top of a variable height antenna tower.
5. For measurement above 1 GHz, the emission measurement will be measured by the peak detector. This peak level, once corrected, must comply with the limit specified in Section 15.209.
6. For measurements above 1 GHz the resolution bandwidth is set to 1 MHz, then the video bandwidth is set to 3 MHz for peak measurements and 1 MHz resolution bandwidth with 1/T video bandwidth with peak detector for average measurements. For the Duty Cycle please refer to clause 7.1. ON TIME AND DUTY CYCLE.

X axis, Y axis, Z axis positions:

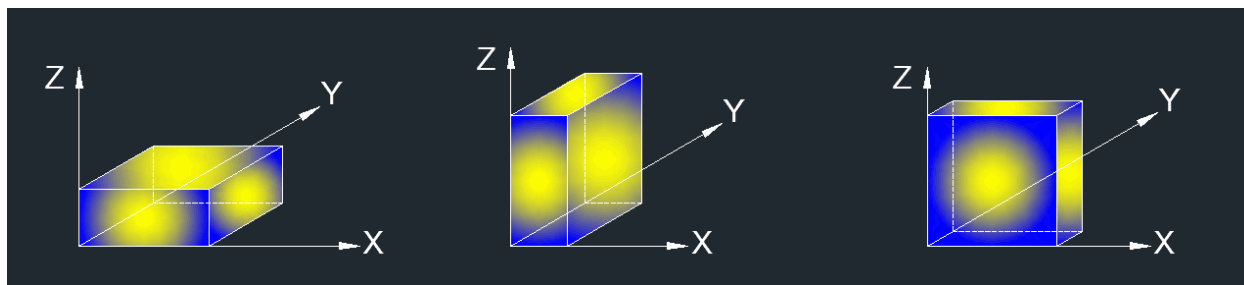

Note 1: For all radiated test, EUT in each of three orthogonal axis emissions had been tested, but only the worst case (X axis) data recorded in the report.

For Restricted Bandedge:

Note:

1. Measurement = Reading Level + Correct Factor.
2. If the peak values are less than the average limit of 54 dBuV/m, the average result is deemed to comply with average limit.
3. PK=Peak: Peak detector.
4. AV=Average: $VBW=1/T_{on}$, where: T_{on} is the transmitting duration.

5. For the transmitting duration, please refer to clause 7.1.
6. Only the worst data was recorded, if it complies with the limit, the other emissions deemed to comply with the limit.
7. Both horizontal and vertical have been tested, only the worst data was recorded in the report.
8. All modes have been tested, but only the worst data was recorded in the report.

For Radiate Spurious emission (9 kHz ~ 30 MHz):

Note:

1. Measurement = Reading Level + Correct Factor.
2. If the peak values are less than the QP limit, the QP result is deemed to comply with QP limit.
3. All 3 polarizations (Horizontal, Face-on and Face-off) of the loop antenna had been tested, but only the worst data recorded in the report.
4. All modes have been tested, but only the worst data was recorded in the report.
5. $\text{dBuA/m} = \text{dBuV/m} - 20\text{Log}_{10}[120\pi] = \text{dBuV/m} - 51.5$

For Radiate Spurious Emission (30 MHz ~ 1 GHz):

Note:

1. Result Level = Read Level + Correct Factor.
2. If the peak values are less than the QP limit, the QP result is deemed to comply with QP limit.
3. All modes have been tested, but only the worst data was recorded in the report.

For Radiate Spurious Emission (1 GHz ~ 7 GHz):

1. Measurement = Reading Level + Correct Factor.
2. If the peak values are less than the average limit of 54 dBuV/m, the average result is deemed to comply with average limit.
3. Peak: Peak detector.
4. AVG: $\text{VBW} = 1/\text{Ton}$, where: Ton is the transmitting duration.
5. For the transmitting duration, please refer to clause 7.1.
6. Filter losses were only considered in the spurious frequency bands and the authorized band was not corrected for Band reject filter losses.
7. Proper operation of the transmitter prior to adding the filter to the measurement chain.
8. Since non-restricted band peak emissions are less than the average limit, they also comply with the -27 dBm/MHz (68.2 dBuV/m) limit.
9. All modes have been tested, but only the worst data was recorded in the report.

For Radiate Spurious Emission (7 GHz ~ 18 GHz):

Note:

1. Peak Result = Reading Level + Correct Factor.
2. If the peak values are less than the average limit of 54 dBuV/m, the average result is deemed to comply with average limit.
3. Peak: Peak detector.
4. AVG: $VBW=1/T_{on}$, where: T_{on} is the transmitting duration.
5. For the transmitting duration, please refer to clause 7.1.
6. Filter losses were only considered in the spurious frequency bands and the authorized band was not corrected for High Pass Filter losses.
7. Proper operation of the transmitter prior to adding the filter to the measurement chain.
8. Since non-restricted band peak emissions are less than the average limit, they also comply with the -27 dBm/MHz (68.2 dBuV/m) limit.
9. All modes have been tested, but only the worst data was recorded in the report.

For Radiate Spurious emission (18 GHz ~ 26 GHz):

Note:

1. Measurement = Reading Level + Correct Factor.
2. If the peak values are less than the average limit of 54 dBuV/m, the average result is deemed to comply with average limit.
3. Peak: Peak detector.
4. All modes have been tested, but only the worst data was recorded in the report.

For Radiate Spurious emission (26 GHz ~ 40 GHz):

Note:

1. Measurement = Reading Level + Correct Factor.
2. If the peak values are less than the average limit of 54 dBuV/m, the average result is deemed to comply with average limit.
3. Peak: Peak detector.
4. All modes have been tested, but only the worst data was recorded in the report.

TEST SETUP

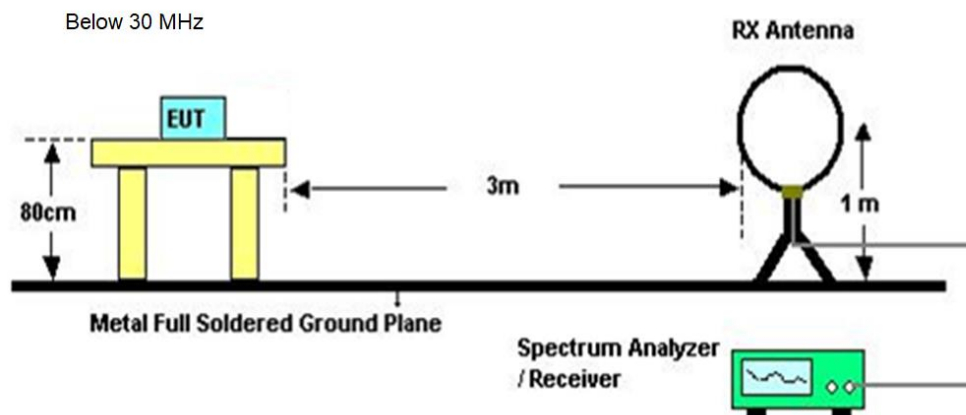

Below 1 GHz and above 30 MHz

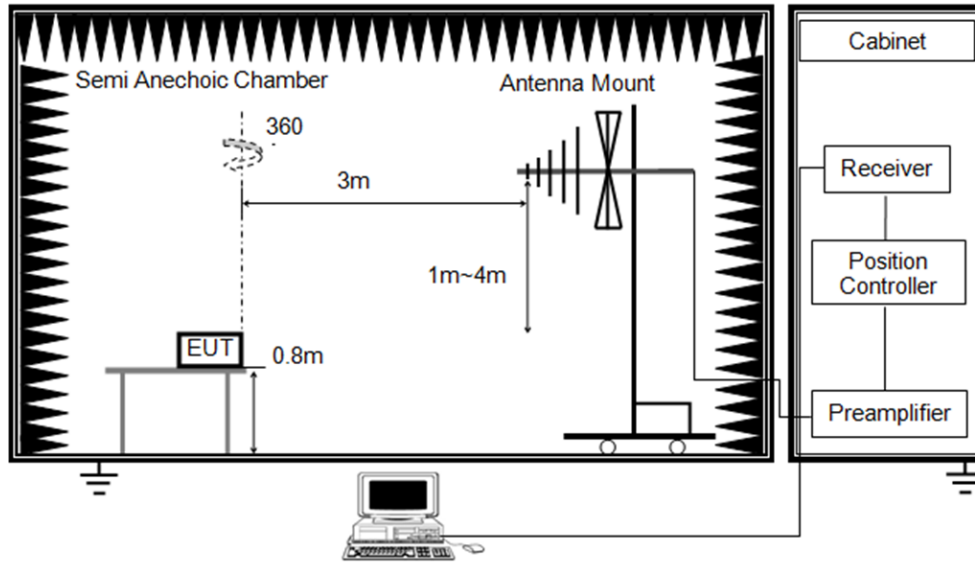

Above 1 GHz

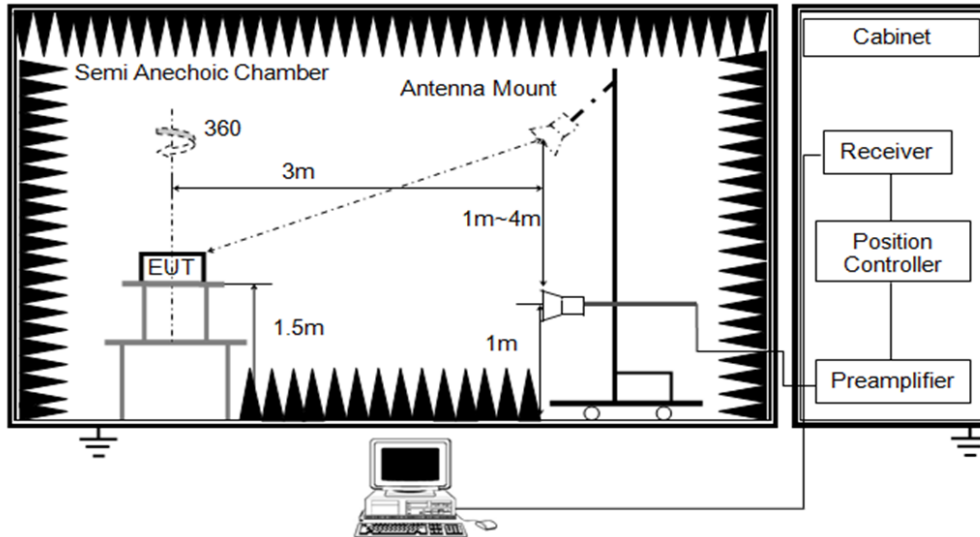

TEST ENVIRONMENT

Temperature	25.3°C	Relative Humidity	62%
Atmosphere Pressure	101kPa	Test Voltage	

TEST DATE / ENGINEER

Test Date	October 9, 2023	Test By	Rex Huang
-----------	-----------------	---------	-----------

TEST RESULTS

8.1. RESTRICTED BANDEDGE

For FCC UNII-1&UNII-2A&UNII-2C&UNII-3; ISSED UNII-2A&UNII-2C&UNII-3 test data:

Test Mode:	802.11a 20 PK	Frequency(MHz):	5180
Polarity:	Vertical	Test Voltage:	DC 12 V

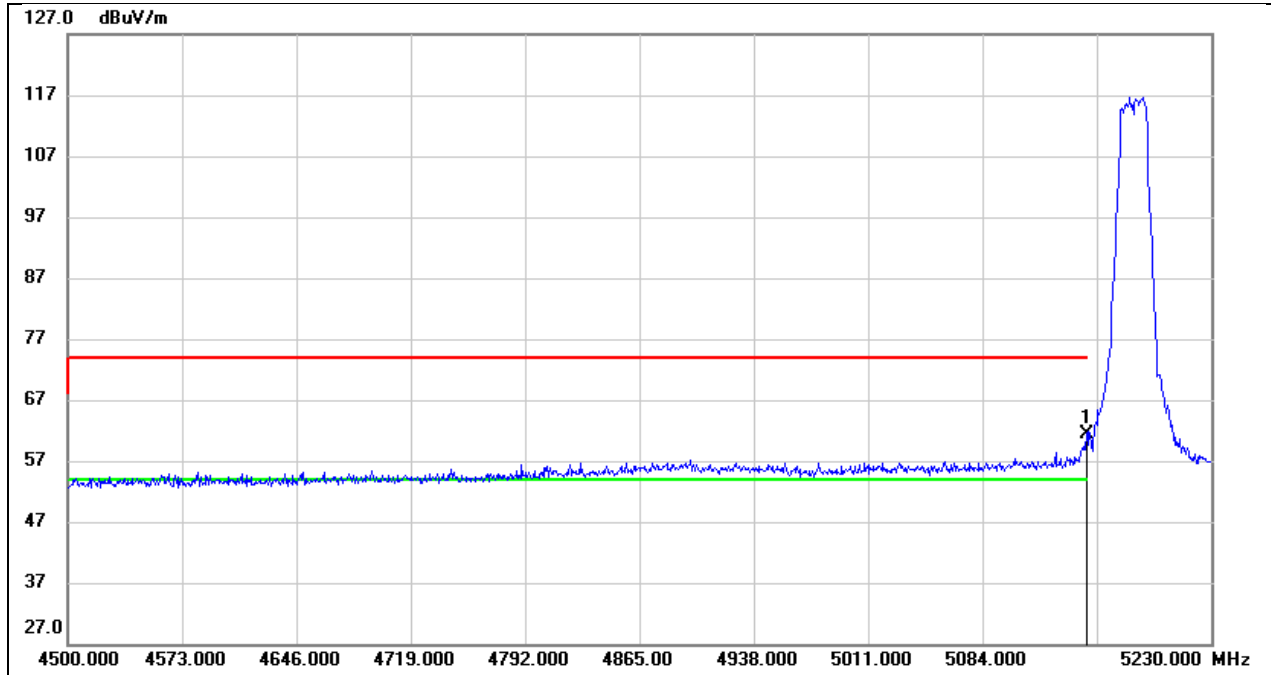

No.	Frequency (MHz)	Reading (dBuV)	Correct (dB/m)	Result (dBuV/m)	Limit (dBuV/m)	Margin (dB)	Remark
1	5150.000	21.00	40.27	61.27	74.00	-12.73	peak

Test Mode:	802.11a 20 AV	Frequency(MHz):	5180
Polarity:	Vertical	Test Voltage:	DC 12 V

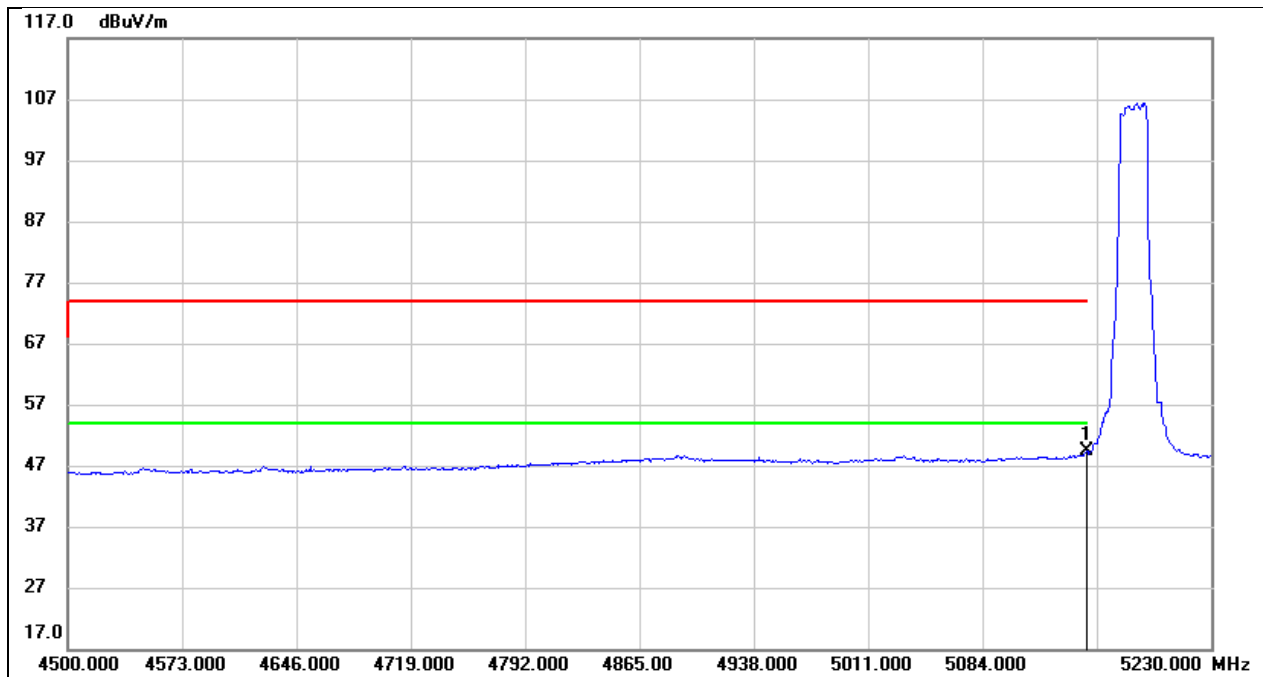

No.	Frequency (MHz)	Reading (dBuV)	Correct (dB/m)	Result (dBuV/m)	Limit (dBuV/m)	Margin (dB)	Remark
1	5150.000	9.03	40.27	49.30	54.00	-4.70	AVG

Test Mode:	802.11a 20 PK	Frequency(MHz):	5240
Polarity:	Vertical	Test Voltage:	DC 12 V

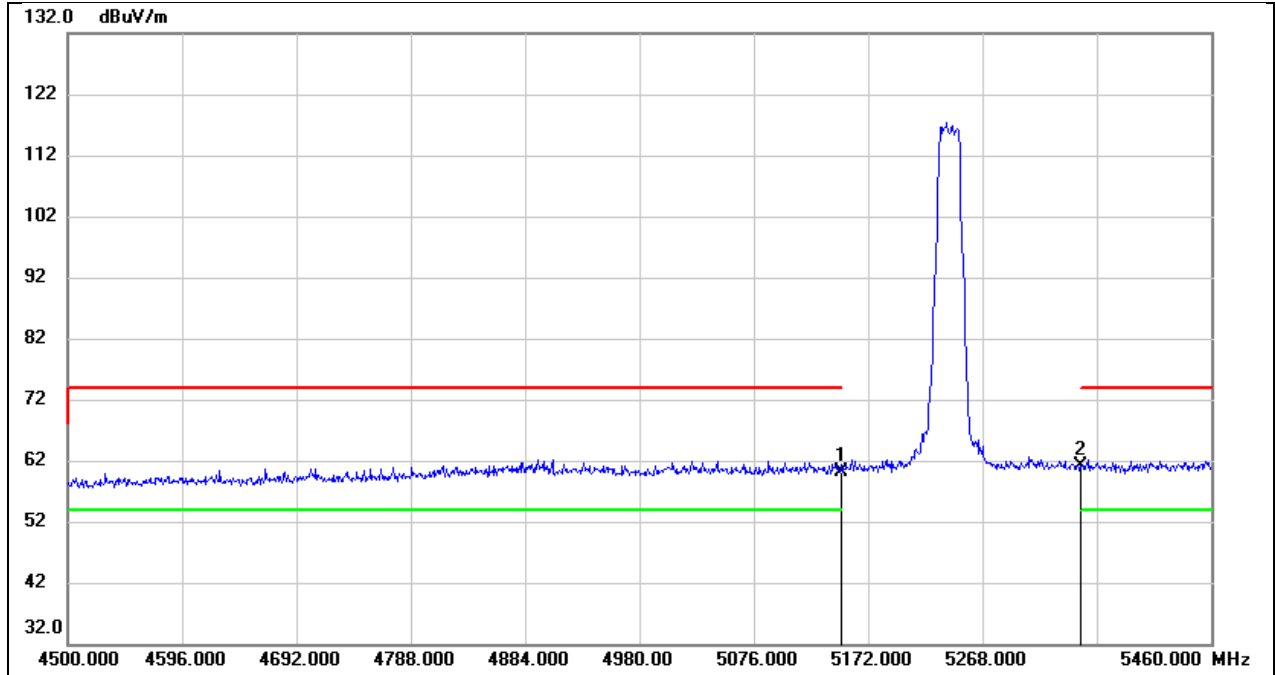

No.	Frequency (MHz)	Reading (dBuV)	Correct (dB/m)	Result (dBuV/m)	Limit (dBuV/m)	Margin (dB)	Remark
1	5150.000	19.88	40.27	60.15	74.00	-13.85	peak
2	5350.000	20.63	40.49	61.12	74.00	-12.88	peak

Test Mode:	802.11a 20 AV	Frequency(MHz):	5240
Polarity:	Vertical	Test Voltage:	DC 12 V

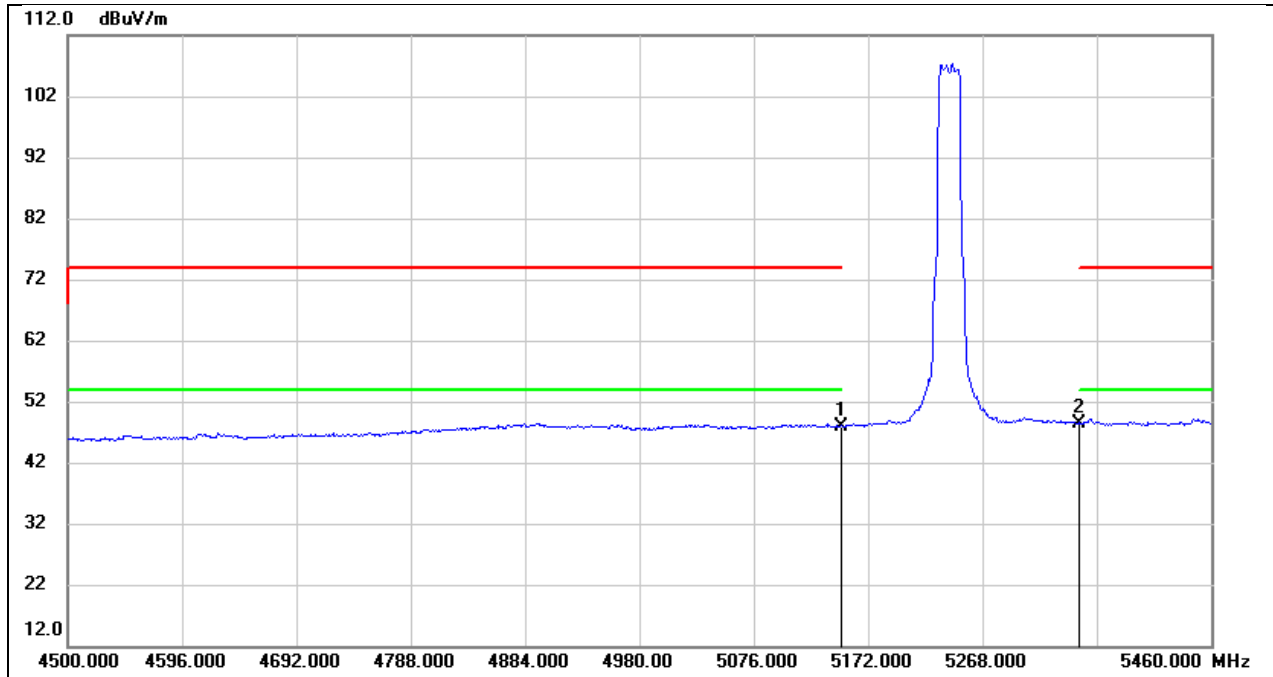

No.	Frequency (MHz)	Reading (dBuV)	Correct (dB/m)	Result (dBuV/m)	Limit (dBuV/m)	Margin (dB)	Remark
1	5150.000	7.63	40.27	47.90	54.00	-6.10	AVG
2	5350.000	7.85	40.49	48.34	54.00	-5.66	AVG

Test Mode:	802.11a 20 PK	Frequency(MHz):	5260
Polarity:	Vertical	Test Voltage:	DC 12 V

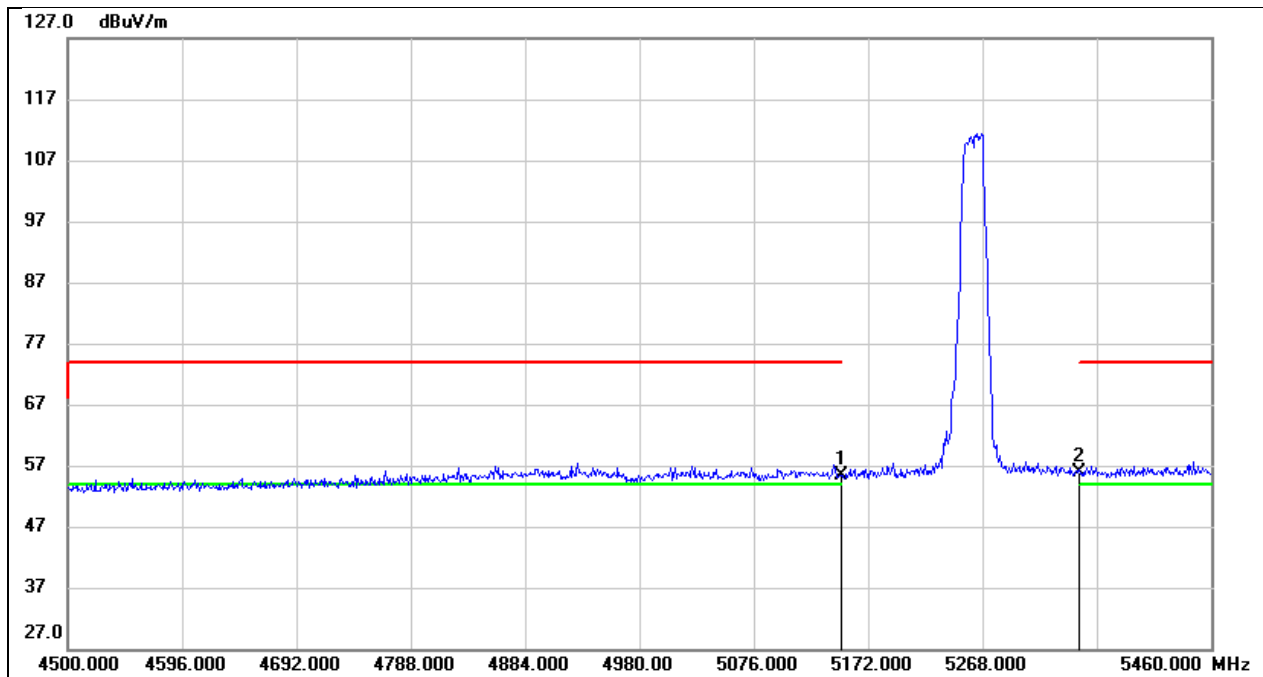

No.	Frequency (MHz)	Reading (dBuV)	Correct (dB/m)	Result (dBuV/m)	Limit (dBuV/m)	Margin (dB)	Remark
1	5150.000	15.01	40.27	55.28	74.00	-18.72	peak
2	5350.000	15.49	40.49	55.98	74.00	-18.02	peak

Test Mode:	802.11a 20 AV	Frequency(MHz):	5260
Polarity:	Vertical	Test Voltage:	DC 12 V

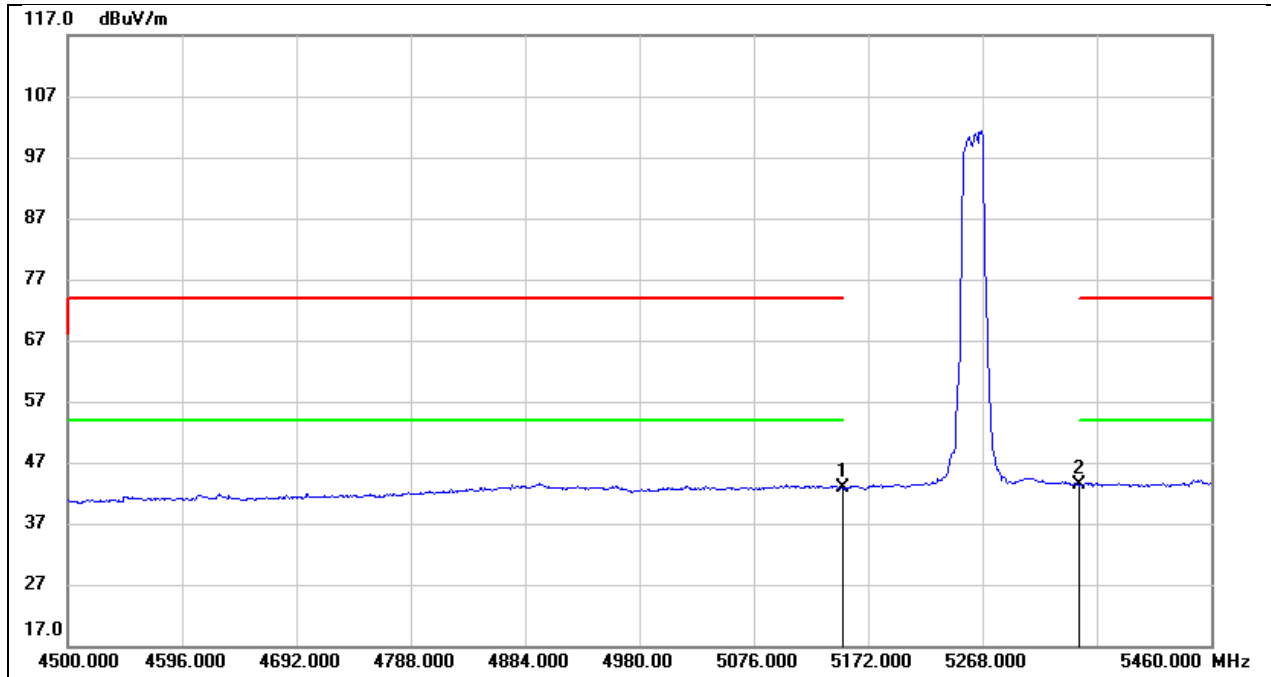

No.	Frequency (MHz)	Reading (dBuV)	Correct (dB/m)	Result (dBuV/m)	Limit (dBuV/m)	Margin (dB)	Remark
1	5150.000	2.56	40.27	42.83	54.00	-11.17	AVG
2	5350.000	2.81	40.49	43.30	54.00	-10.70	AVG

Test Mode:	802.11a 20 PK	Frequency(MHz):	5320
Polarity:	Vertical	Test Voltage:	DC 12 V

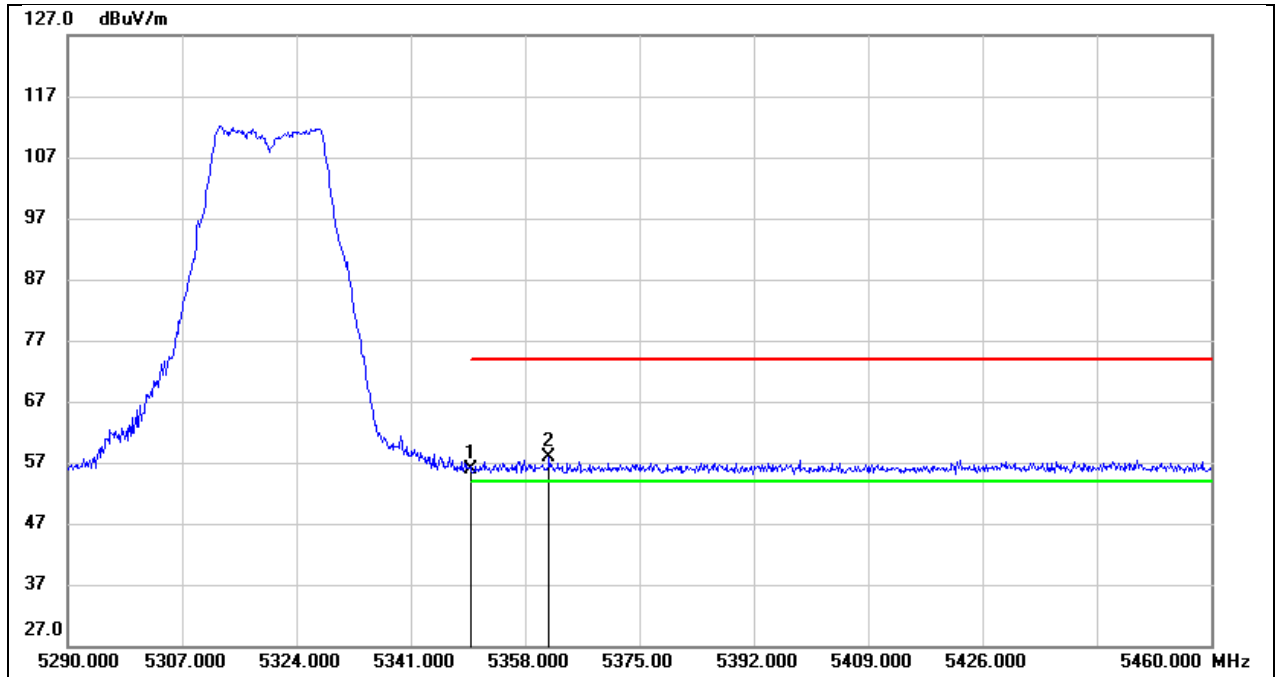

No.	Frequency (MHz)	Reading (dBuV)	Correct (dB/m)	Result (dBuV/m)	Limit (dBuV/m)	Margin (dB)	Remark
1	5350.000	15.45	40.49	55.94	74.00	-18.06	peak
2	5361.570	17.29	40.50	57.79	74.00	-16.21	peak

Test Mode:	802.11a 20 AV	Frequency(MHz):	5320
Polarity:	Vertical	Test Voltage:	DC 12 V

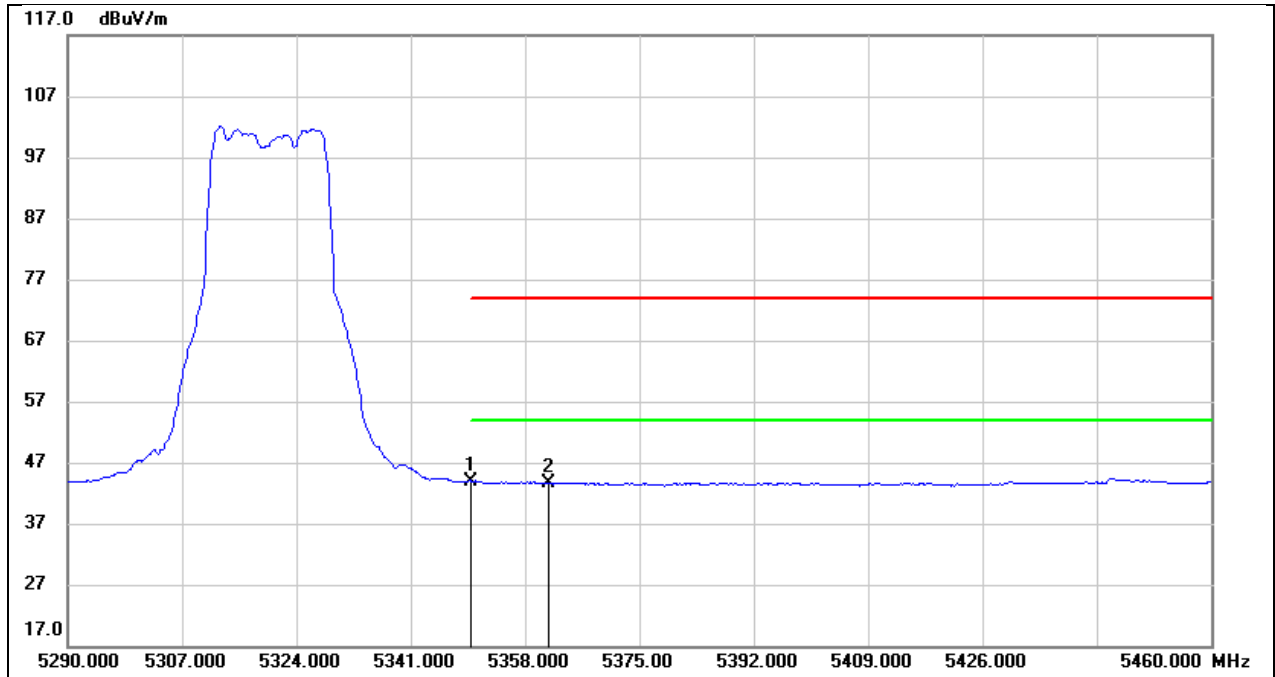

No.	Frequency (MHz)	Reading (dBuV)	Correct (dB/m)	Result (dBuV/m)	Limit (dBuV/m)	Margin (dB)	Remark
1	5350.000	3.44	40.49	43.93	54.00	-10.07	AVG
2	5361.570	3.09	40.50	43.59	54.00	-10.41	AVG

Test Mode:	802.11a 20 PK	Frequency(MHz):	5500
Polarity:	Vertical	Test Voltage:	DC 12 V

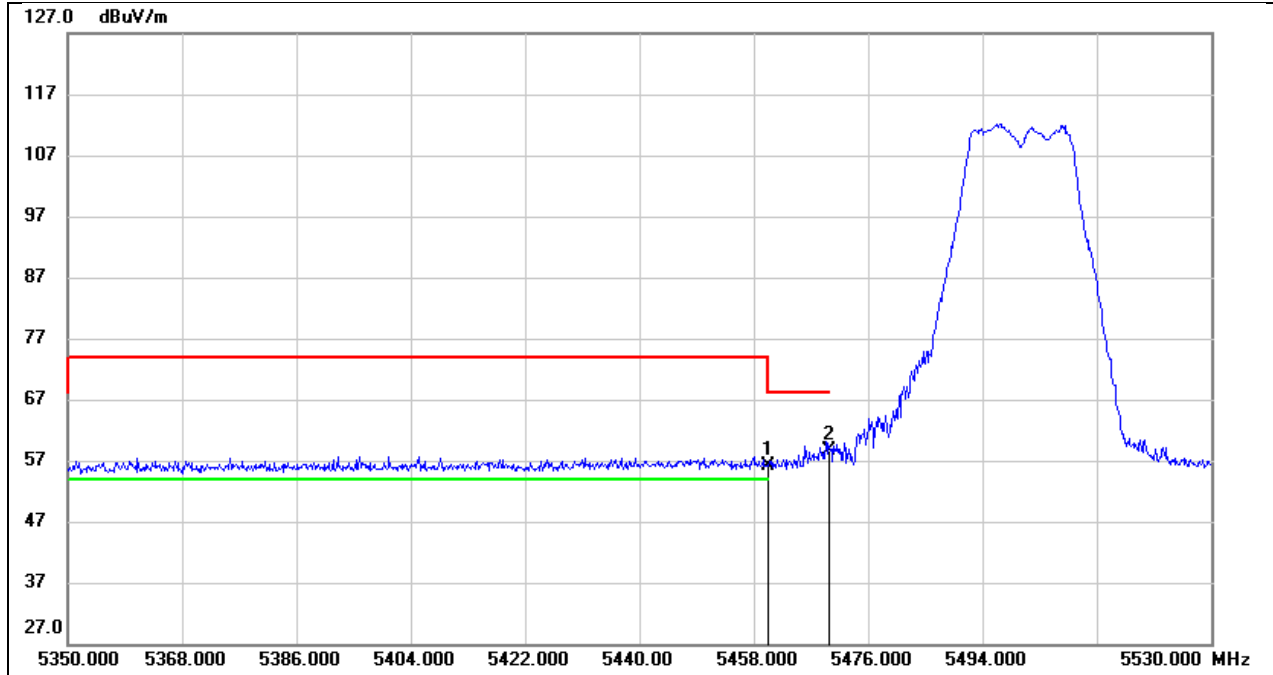

No.	Frequency (MHz)	Reading (dBuV)	Correct (dB/m)	Result (dBuV/m)	Limit (dBuV/m)	Margin (dB)	Remark
1	5460.000	15.61	40.62	56.23	68.20	-11.97	peak
2	5470.000	18.12	40.63	58.75	68.20	-9.45	peak

Test Mode:	802.11a 20 AV	Frequency(MHz):	5500
Polarity:	Vertical	Test Voltage:	DC 12 V

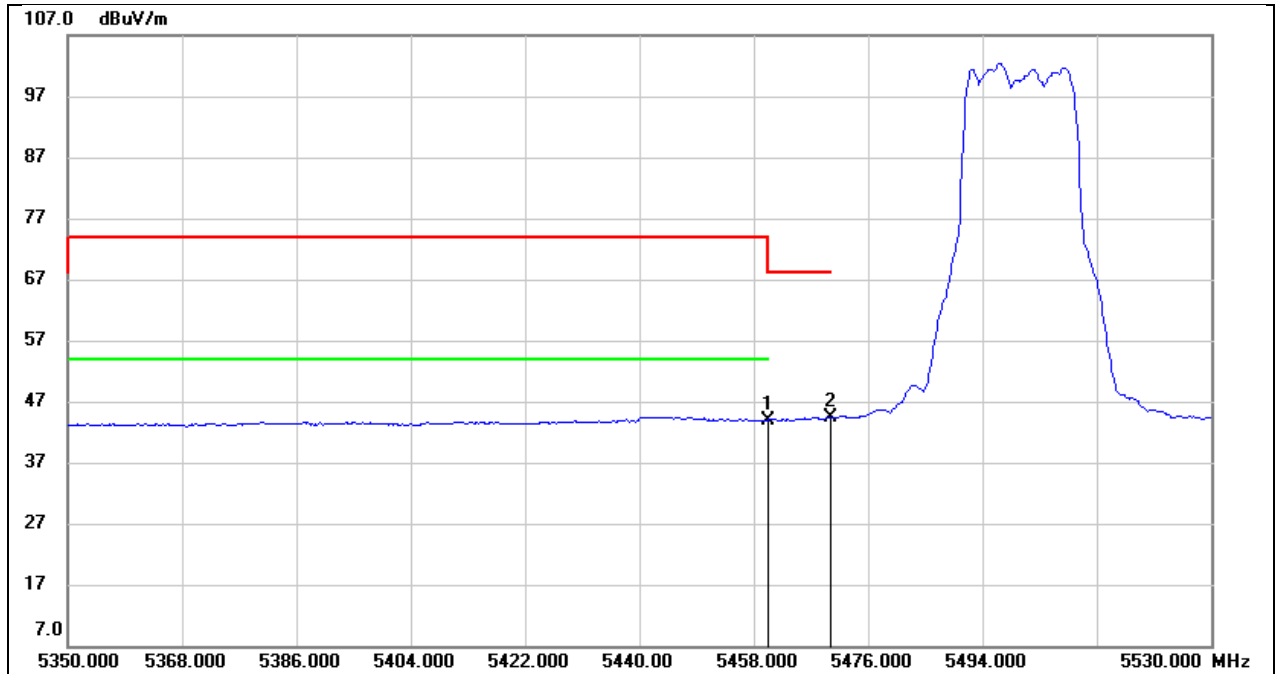

No.	Frequency (MHz)	Reading (dBuV)	Correct (dB/m)	Result (dBuV/m)	Limit (dBuV/m)	Margin (dB)	Remark
1	5460.000	3.33	40.62	43.95	54.00	-10.05	AVG
2	5470.000	3.77	40.63	44.40	68.20	-23.80	AVG

Test Mode:	802.11a 20 PK	Frequency(MHz):	5700
Polarity:	Vertical	Test Voltage:	DC 12 V

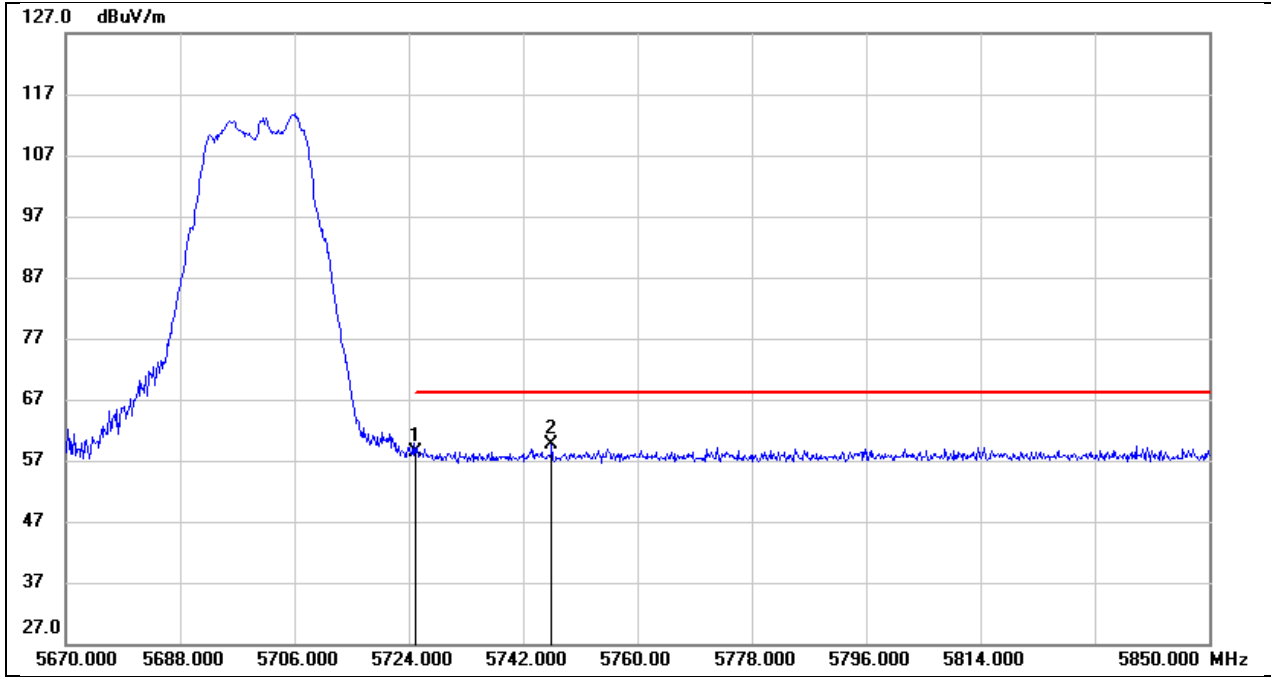

No.	Frequency (MHz)	Reading (dBuV)	Correct (dB/m)	Result (dBuV/m)	Limit (dBuV/m)	Margin (dB)	Remark
1	5725.000	17.23	41.27	58.50	68.20	-9.70	peak
2	5746.500	18.30	41.32	59.62	68.20	-8.58	peak

Test Mode:	802.11a 20 PK	Frequency(MHz):	5745
Polarity:	Vertical	Test Voltage:	DC 12 V

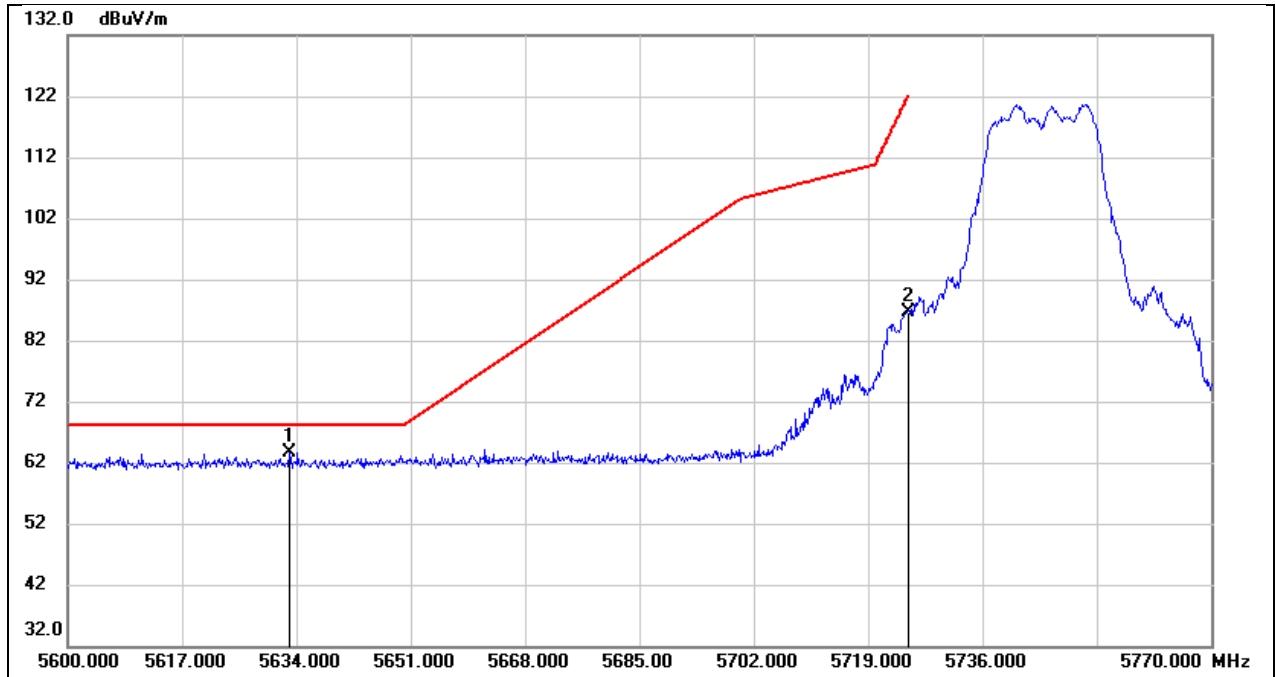

No.	Frequency (MHz)	Reading (dBuV)	Correct (dB/m)	Result (dBuV/m)	Limit (dBuV/m)	Margin (dB)	Remark
1	5632.980	22.65	41.01	63.66	68.20	-4.54	peak
2	5725.000	45.45	41.27	86.72	122.20	-35.48	peak

Test Mode:	802.11a 20 PK	Frequency(MHz):	5825
Polarity:	Vertical	Test Voltage:	DC 12 V

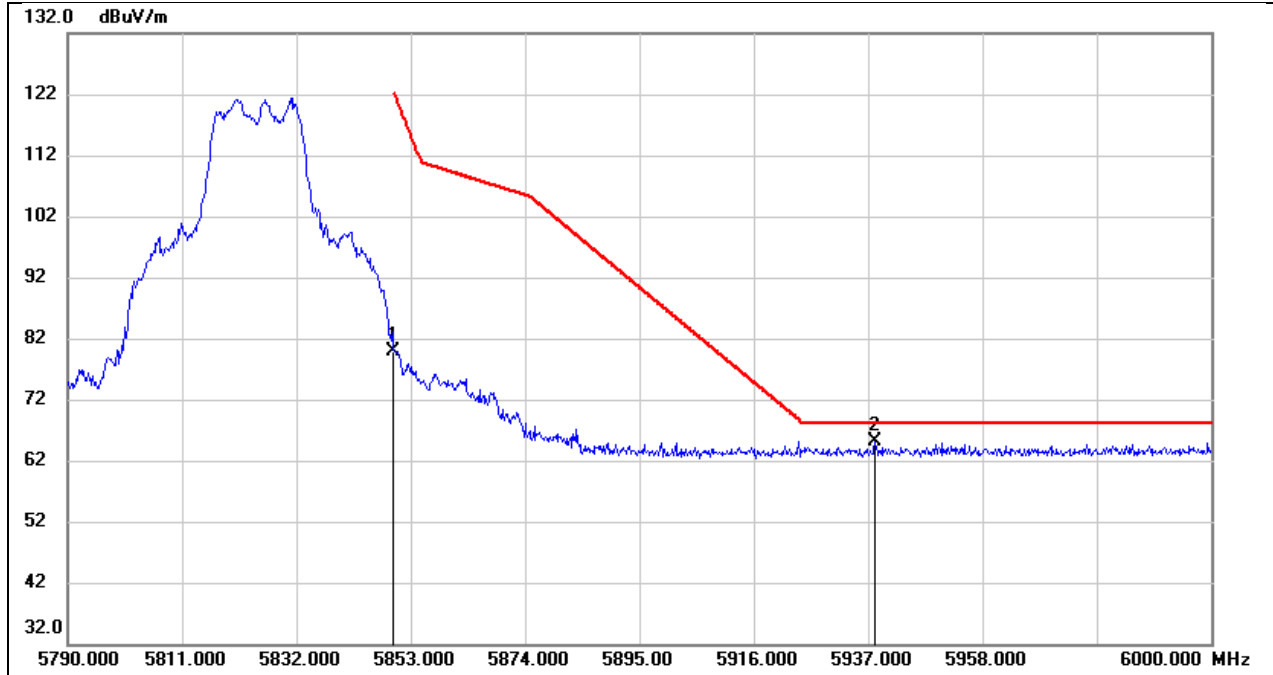

No.	Frequency (MHz)	Reading (dBuV)	Correct (dB/m)	Result (dBuV/m)	Limit (dBuV/m)	Margin (dB)	Remark
1	5850.000	38.33	41.60	79.93	122.20	-42.27	peak
2	5938.260	23.20	41.84	65.04	68.20	-3.16	peak

Test Mode:	802.11ac VHT20 PK	Frequency(MHz):	5180
Polarity:	Vertical	Test Voltage:	DC 12 V

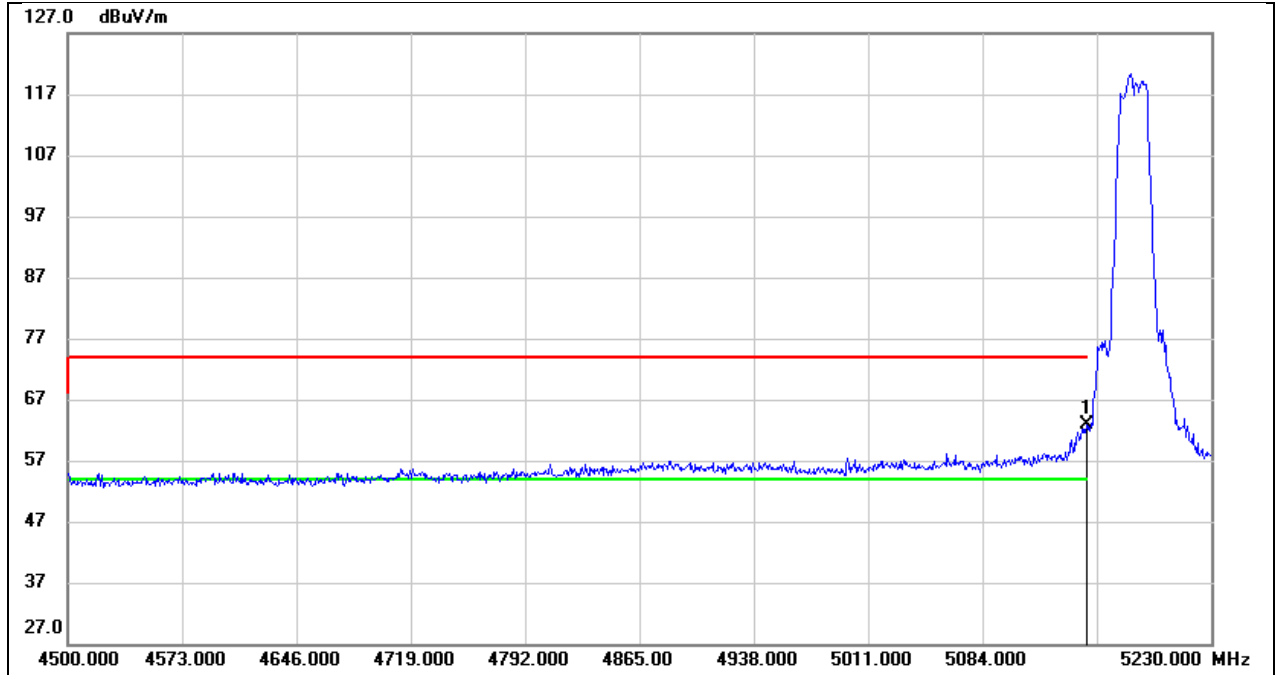

No.	Frequency (MHz)	Reading (dBuV)	Correct (dB/m)	Result (dBuV/m)	Limit (dBuV/m)	Margin (dB)	Remark
1	5150.000	22.60	40.27	62.87	74.00	-11.13	peak

Test Mode:	802.11ac VHT20 AV	Frequency(MHz):	5180
Polarity:	Vertical	Test Voltage:	DC 12 V

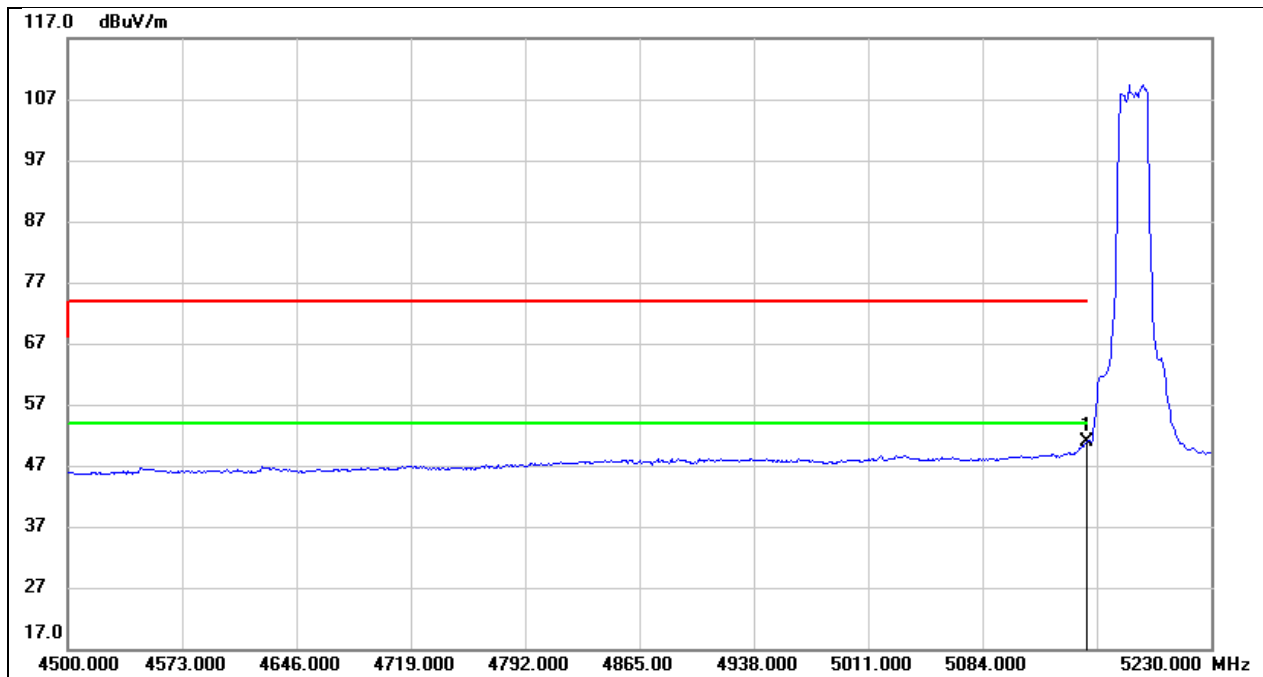

No.	Frequency (MHz)	Reading (dBuV)	Correct (dB/m)	Result (dBuV/m)	Limit (dBuV/m)	Margin (dB)	Remark
1	5150.000	10.56	40.27	50.83	54.00	-3.17	AVG

Test Mode:	802.11ac VHT20 PK	Frequency(MHz):	5240
Polarity:	Vertical	Test Voltage:	DC 12 V

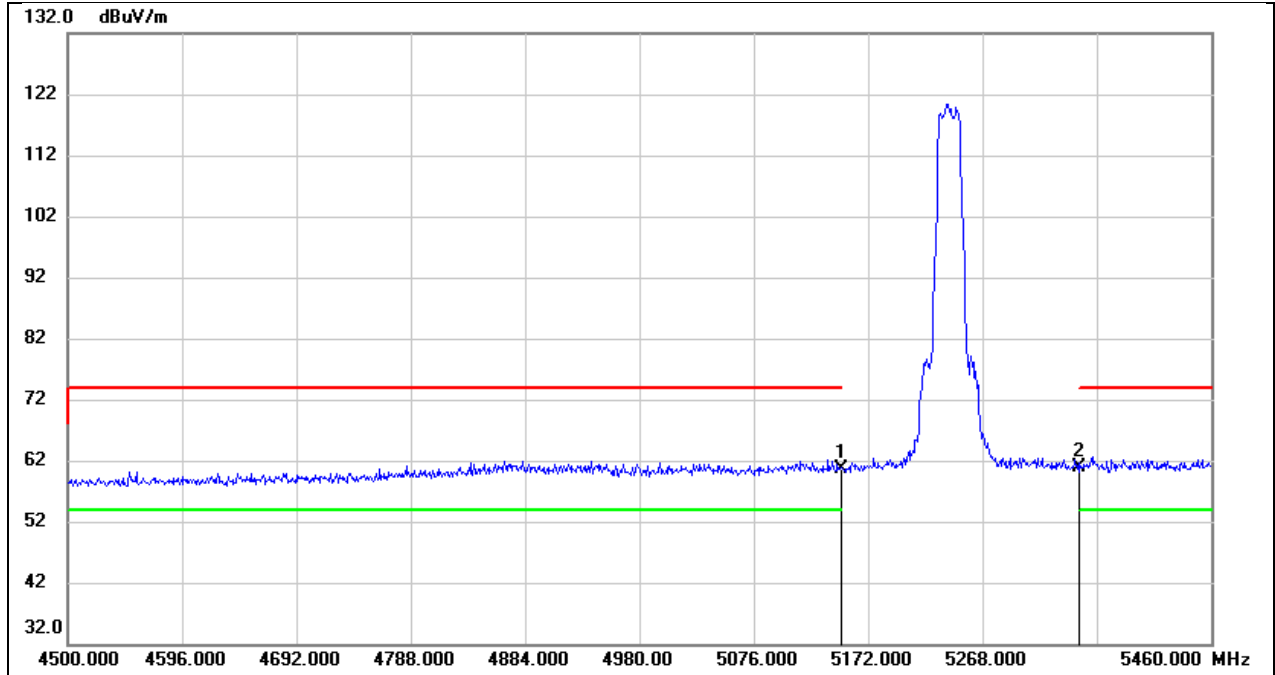

No.	Frequency (MHz)	Reading (dBuV)	Correct (dB/m)	Result (dBuV/m)	Limit (dBuV/m)	Margin (dB)	Remark
1	5150.000	20.27	40.27	60.54	74.00	-13.46	peak
2	5350.000	20.42	40.49	60.91	74.00	-13.09	peak

Test Mode:	802.11ac VHT20 AV	Frequency(MHz):	5240
Polarity:	Vertical	Test Voltage:	DC 12 V

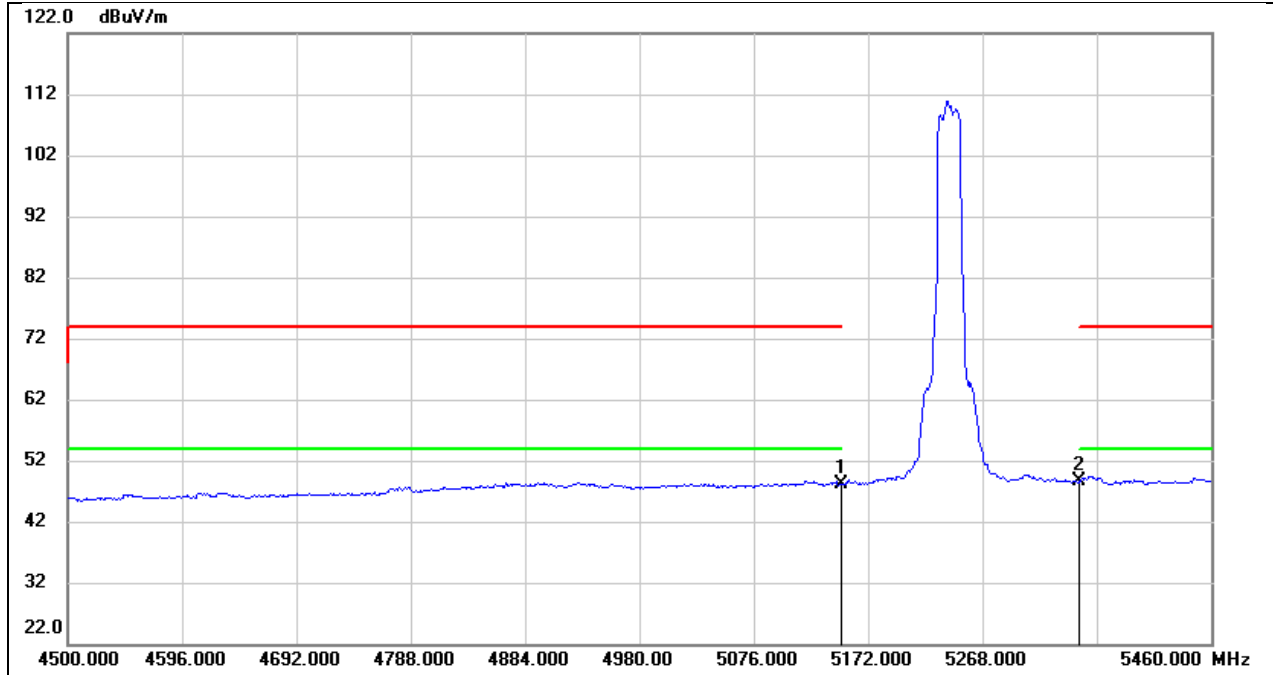

No.	Frequency (MHz)	Reading (dBuV)	Correct (dB/m)	Result (dBuV/m)	Limit (dBuV/m)	Margin (dB)	Remark
1	5150.000	7.80	40.27	48.07	54.00	-5.93	AVG
2	5350.000	8.02	40.49	48.51	54.00	-5.49	AVG

Test Mode:	802.11ac VHT20 PK	Frequency(MHz):	5260
Polarity:	Vertical	Test Voltage:	DC 12 V

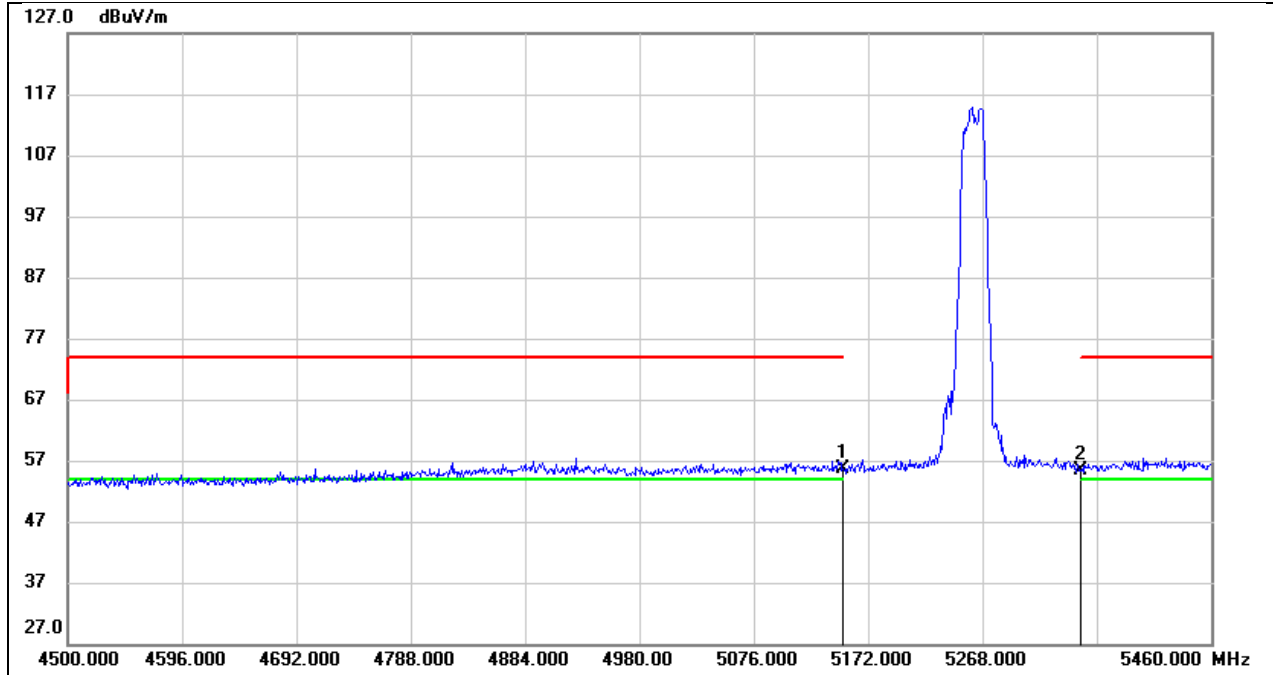

No.	Frequency (MHz)	Reading (dBuV)	Correct (dB/m)	Result (dBuV/m)	Limit (dBuV/m)	Margin (dB)	Remark
1	5150.000	15.27	40.27	55.54	74.00	-18.46	peak
2	5350.000	14.98	40.49	55.47	74.00	-18.53	peak

Test Mode:	802.11ac VHT20 AV	Frequency(MHz):	5260
Polarity:	Vertical	Test Voltage:	DC 12 V

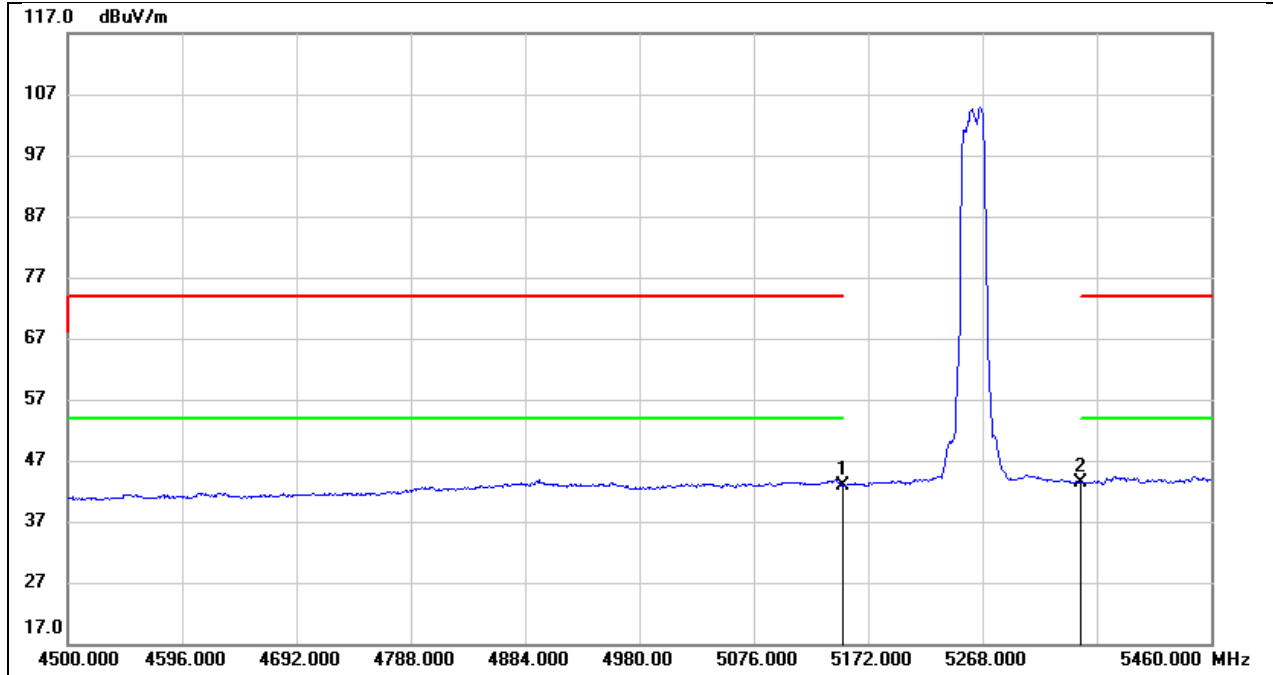

No.	Frequency (MHz)	Reading (dBuV)	Correct (dB/m)	Result (dBuV/m)	Limit (dBuV/m)	Margin (dB)	Remark
1	5150.000	2.66	40.27	42.93	54.00	-11.07	AVG
2	5350.000	2.98	40.49	43.47	54.00	-10.53	AVG

Test Mode:	802.11ac VHT20 PK	Frequency(MHz):	5320
Polarity:	Vertical	Test Voltage:	DC 12 V

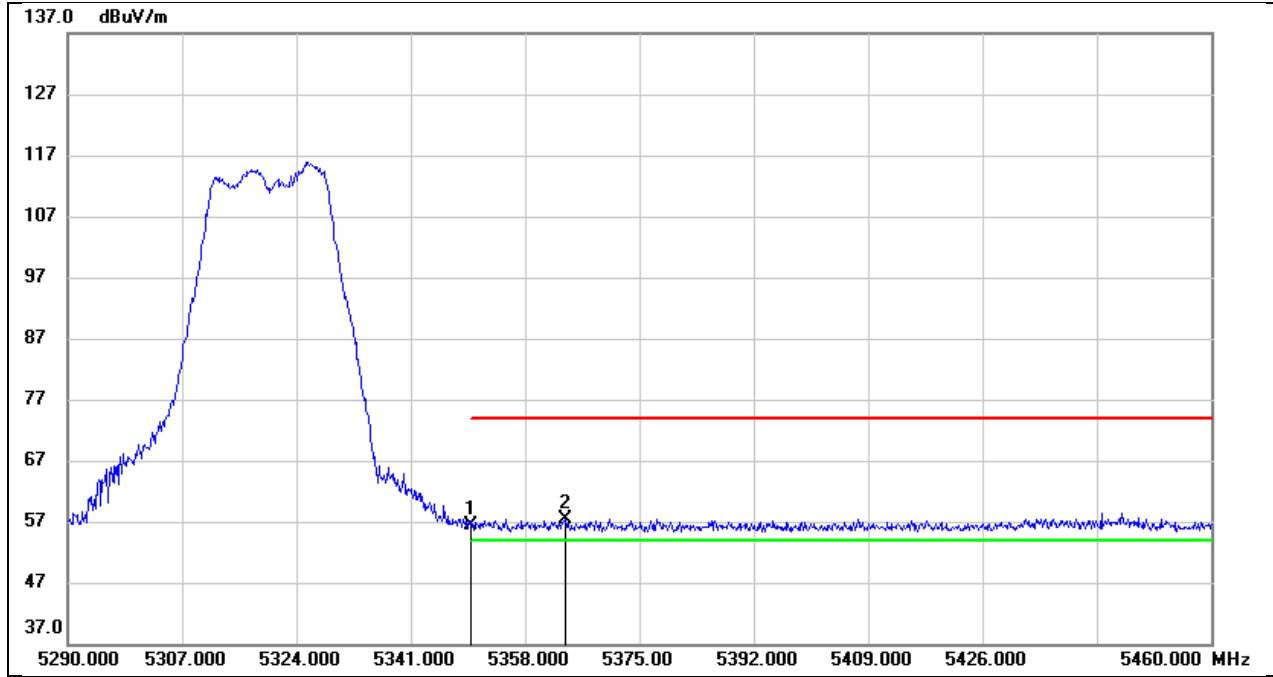

No.	Frequency (MHz)	Reading (dBuV)	Correct (dB/m)	Result (dBuV/m)	Limit (dBuV/m)	Margin (dB)	Remark
1	5350.000	15.85	40.49	56.34	74.00	-17.66	peak
2	5363.950	16.96	40.51	57.47	74.00	-16.53	peak

Test Mode:	802.11ac VHT20 AV	Frequency(MHz):	5320
Polarity:	Vertical	Test Voltage:	DC 12 V

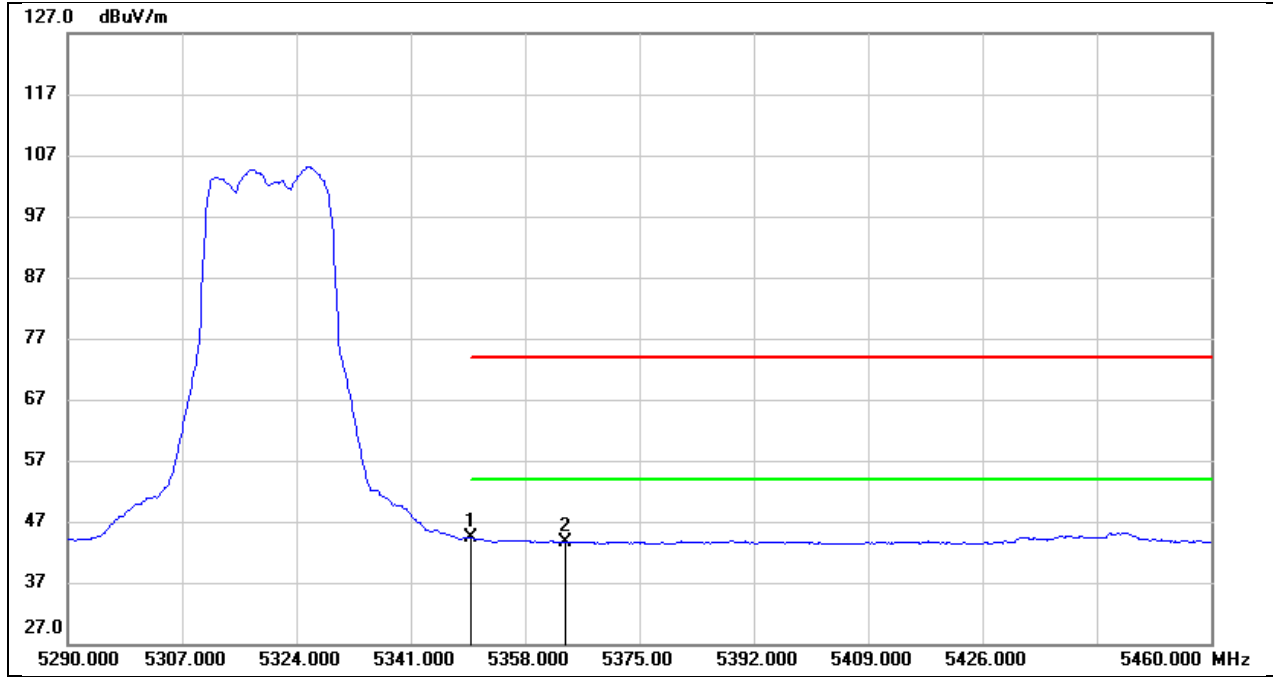

No.	Frequency (MHz)	Reading (dBuV)	Correct (dB/m)	Result (dBuV/m)	Limit (dBuV/m)	Margin (dB)	Remark
1	5350.000	3.85	40.49	44.34	54.00	-9.66	AVG
2	5363.950	3.20	40.51	43.71	54.00	-10.29	AVG

Test Mode:	802.11ac VHT20 PK	Frequency(MHz):	5500
Polarity:	Vertical	Test Voltage:	DC 12 V

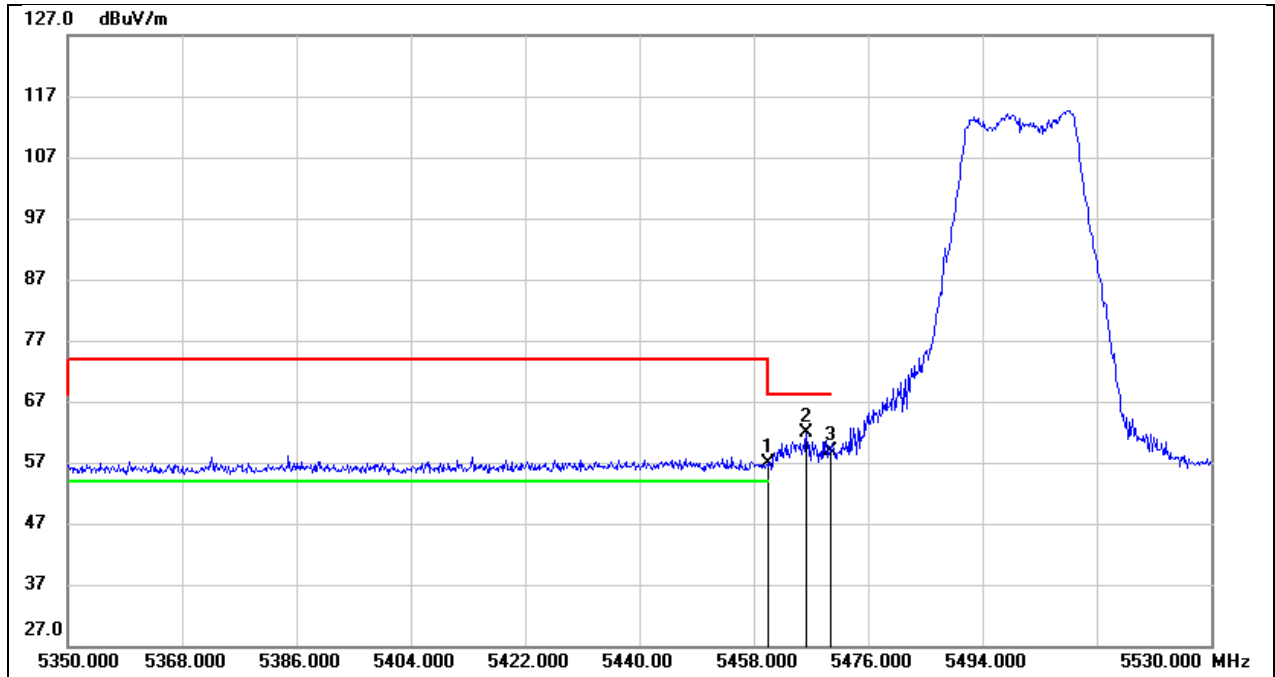

No.	Frequency (MHz)	Reading (dBuV)	Correct (dB/m)	Result (dBuV/m)	Limit (dBuV/m)	Margin (dB)	Remark
1	5460.000	16.36	40.62	56.98	68.20	-11.22	peak
2	5466.280	21.24	40.62	61.86	68.20	-6.34	peak
3	5470.000	18.37	40.63	59.00	68.20	-9.20	peak

Test Mode:	802.11ac VHT20 AV	Frequency(MHz):	5500
Polarity:	Vertical	Test Voltage:	DC 12 V

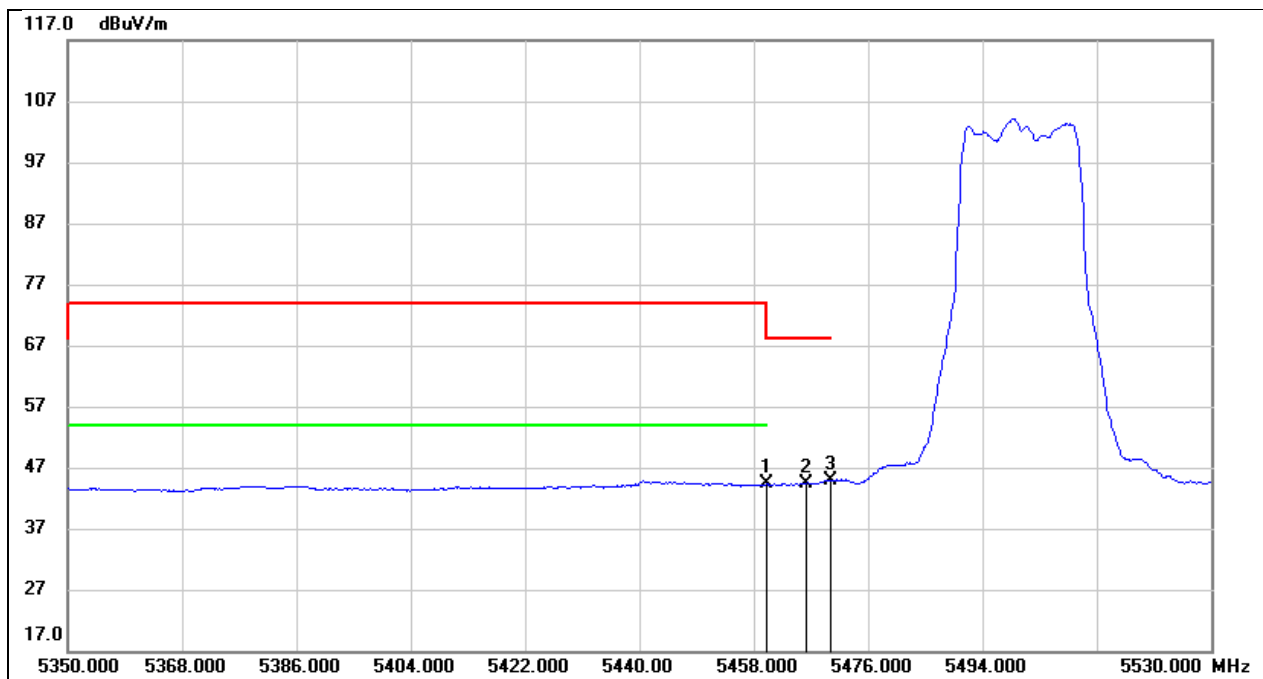

No.	Frequency (MHz)	Reading (dBuV)	Correct (dB/m)	Result (dBuV/m)	Limit (dBuV/m)	Margin (dB)	Remark
1	5460.000	3.66	40.62	44.28	54.00	-9.72	AVG
2	5466.280	3.87	40.62	44.49	68.20	-23.71	AVG
3	5470.000	4.33	40.63	44.96	68.20	-23.24	AVG

Test Mode:	802.11ac VHT20 PK	Frequency(MHz):	5700
Polarity:	Vertical	Test Voltage:	DC 12 V

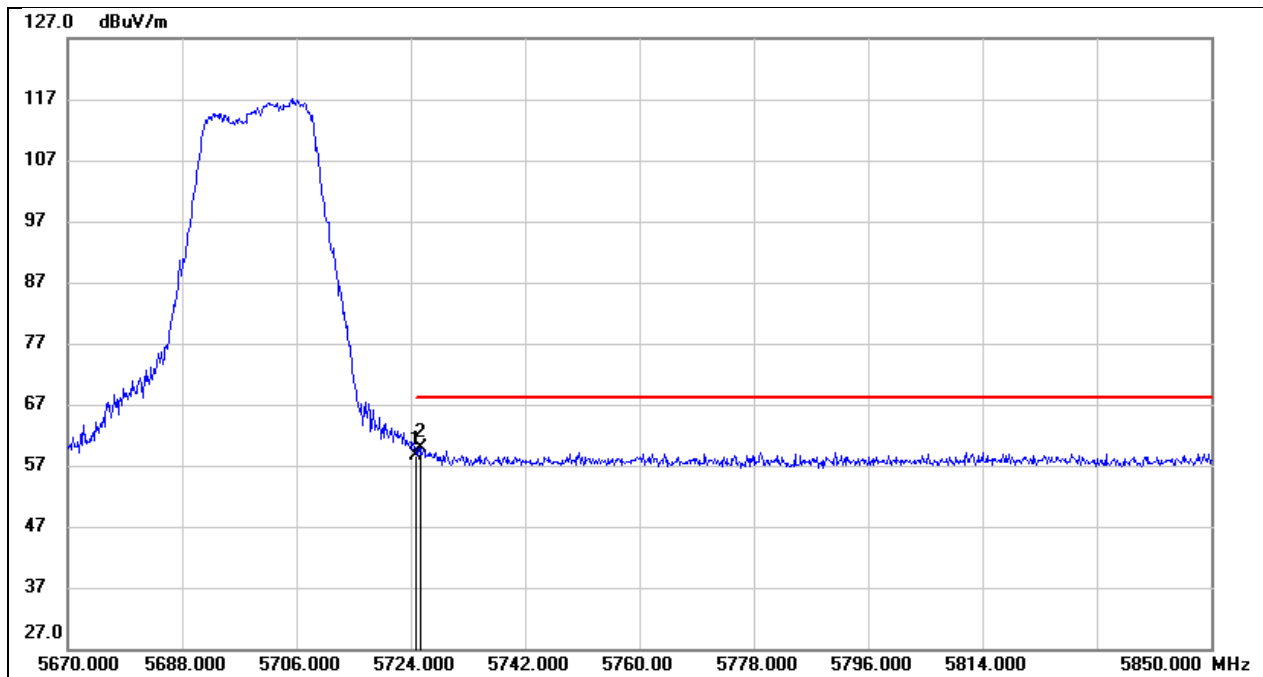

No.	Frequency (MHz)	Reading (dBuV)	Correct (dB/m)	Result (dBuV/m)	Limit (dBuV/m)	Margin (dB)	Remark
1	5725.000	17.35	41.27	58.62	68.20	-9.58	peak
2	5725.620	18.72	41.27	59.99	68.20	-8.21	peak

Test Mode:	802.11ac VHT20 PK	Frequency(MHz):	5745
Polarity:	Vertical	Test Voltage:	DC 12 V

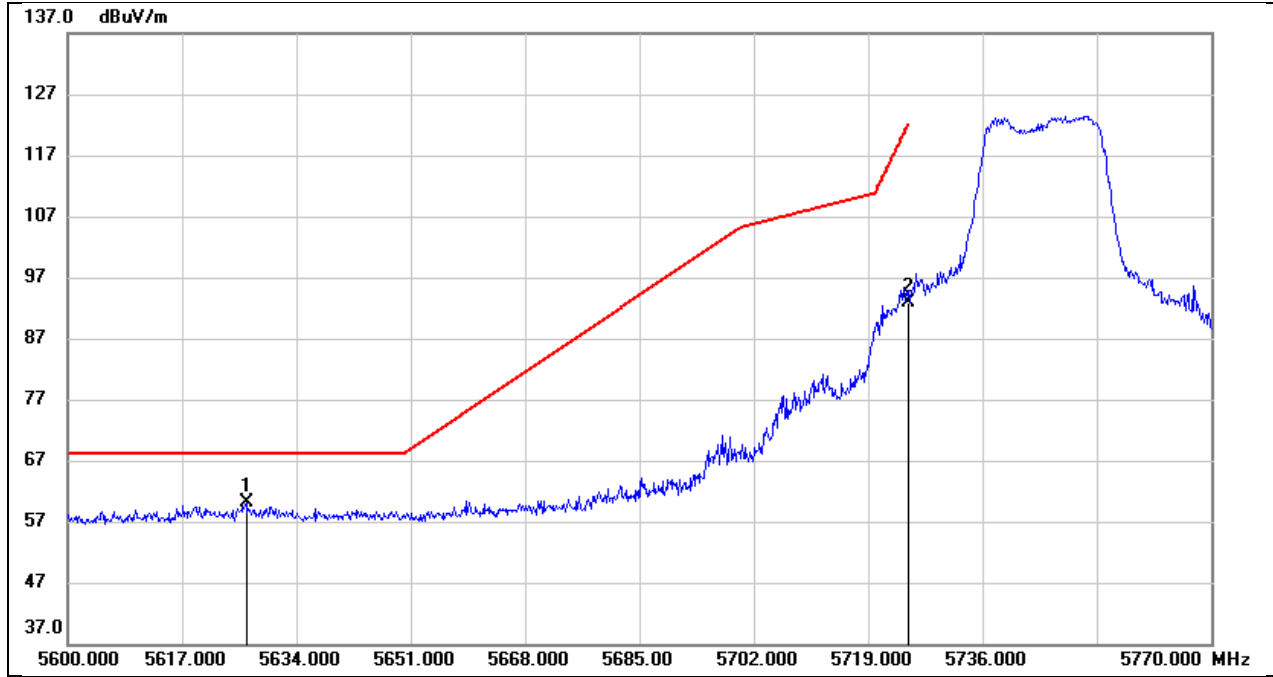

No.	Frequency (MHz)	Reading (dBuV)	Correct (dB/m)	Result (dBuV/m)	Limit (dBuV/m)	Margin (dB)	Remark
1	5626.520	19.20	41.00	60.20	68.20	-8.00	peak
2	5725.000	51.72	41.27	92.99	122.20	-29.21	peak

Test Mode:	802.11ac VHT20 PK	Frequency(MHz):	5825
Polarity:	Vertical	Test Voltage:	DC 12 V

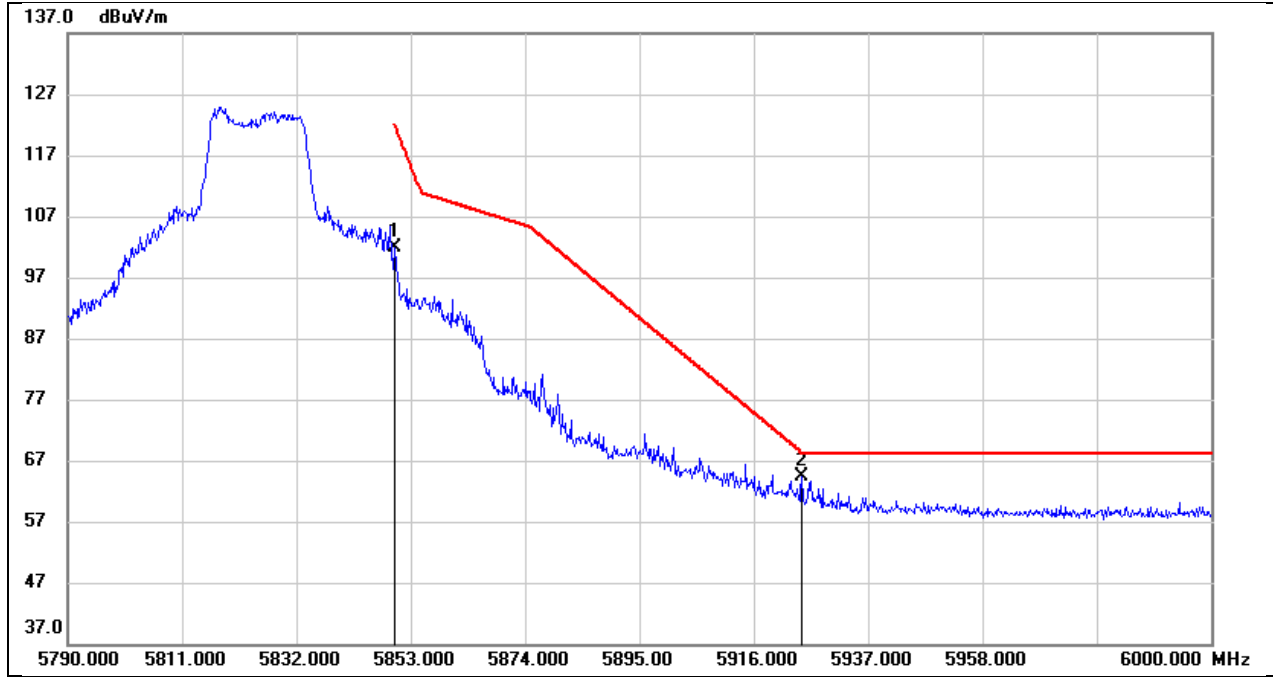

No.	Frequency (MHz)	Reading (dBuV)	Correct (dB/m)	Result (dBuV/m)	Limit (dBuV/m)	Margin (dB)	Remark
1	5850.000	60.23	41.60	101.83	122.20	-20.37	peak
2	5924.820	22.68	41.79	64.47	68.33	-3.86	peak

Test Mode:	802.11ac VHT40 PK	Frequency(MHz):	5190
Polarity:	Vertical	Test Voltage:	DC 12 V

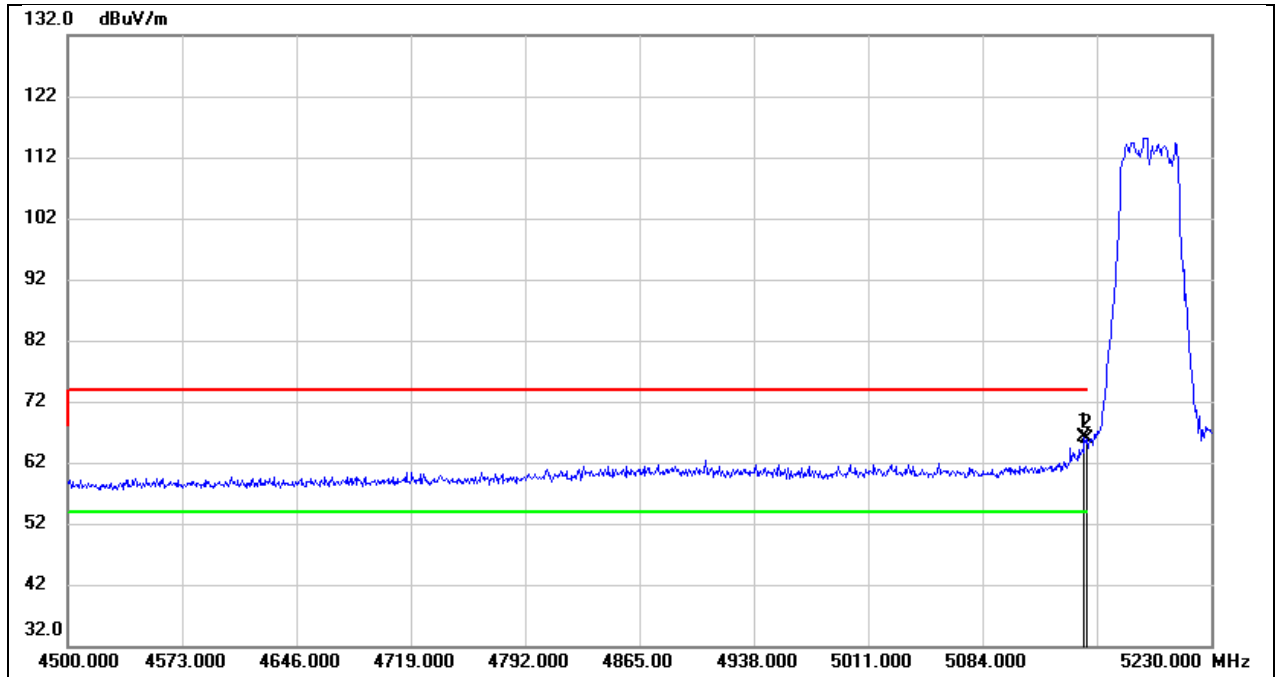

No.	Frequency (MHz)	Reading (dBuV)	Correct (dB/m)	Result (dBuV/m)	Limit (dBuV/m)	Margin (dB)	Remark
1	5148.970	25.73	40.28	66.01	74.00	-7.99	peak
2	5150.000	25.57	40.27	65.84	74.00	-8.16	peak

Test Mode:	802.11ac VHT40 AV	Frequency(MHz):	5190
Polarity:	Vertical	Test Voltage:	DC 12 V

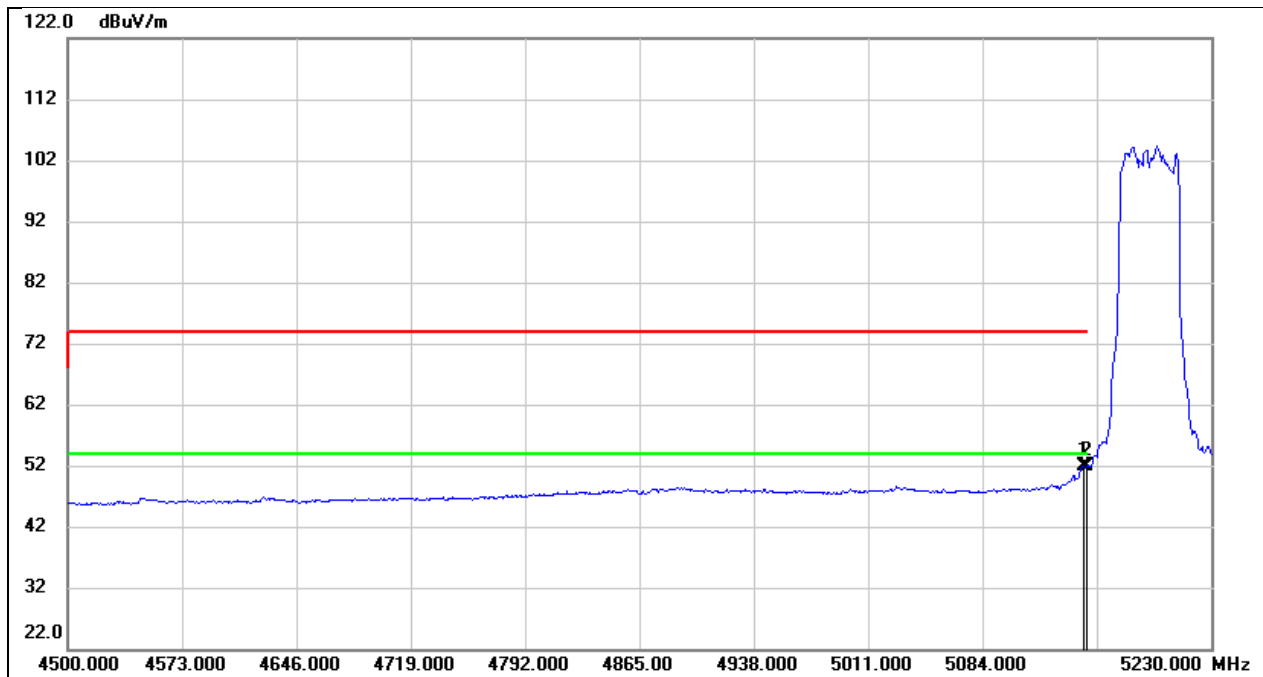

No.	Frequency (MHz)	Reading (dBuV)	Correct (dB/m)	Result (dBuV/m)	Limit (dBuV/m)	Margin (dB)	Remark
1	5148.970	11.71	40.28	51.99	54.00	-2.01	AVG
2	5150.000	11.56	40.27	51.83	54.00	-2.17	AVG

Test Mode:	802.11ac VHT40 PK	Frequency(MHz):	5230
Polarity:	Vertical	Test Voltage:	DC 12 V

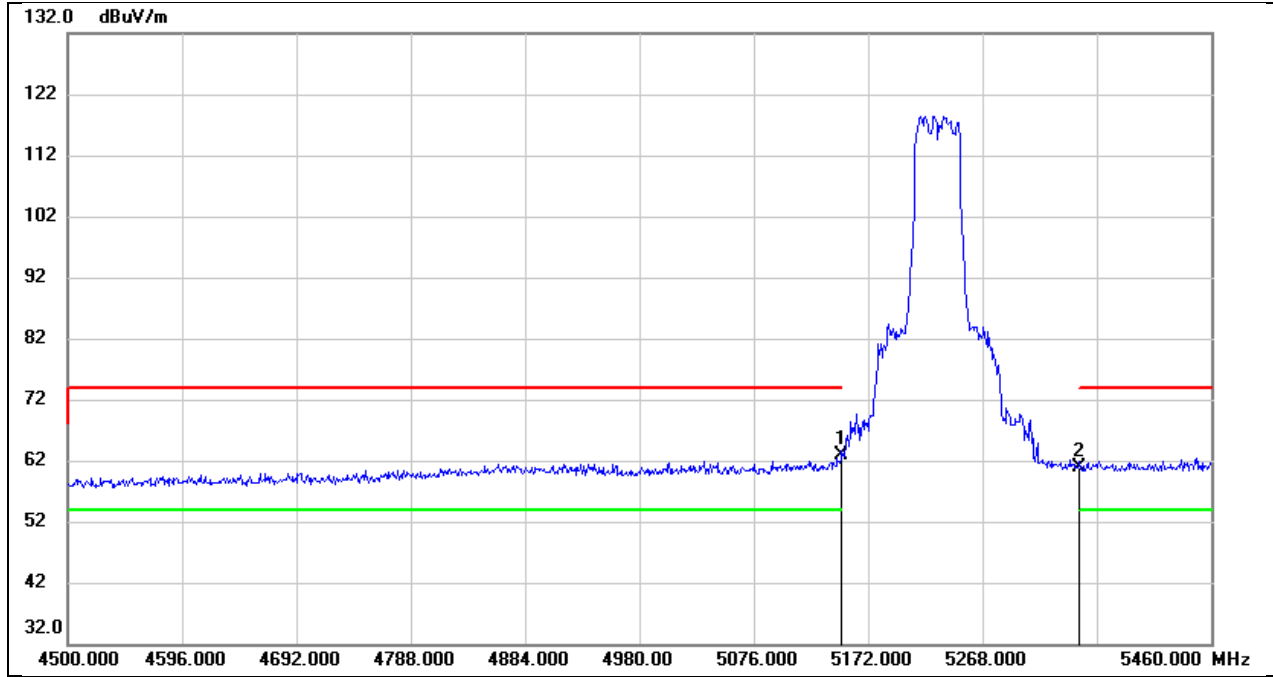

No.	Frequency (MHz)	Reading (dBuV)	Correct (dB/m)	Result (dBuV/m)	Limit (dBuV/m)	Margin (dB)	Remark
1	5150.000	22.70	40.27	62.97	74.00	-11.03	peak
2	5350.000	20.48	40.49	60.97	74.00	-13.03	peak

Test Mode:	802.11ac VHT40 AV	Frequency(MHz):	5230
Polarity:	Vertical	Test Voltage:	DC 12 V

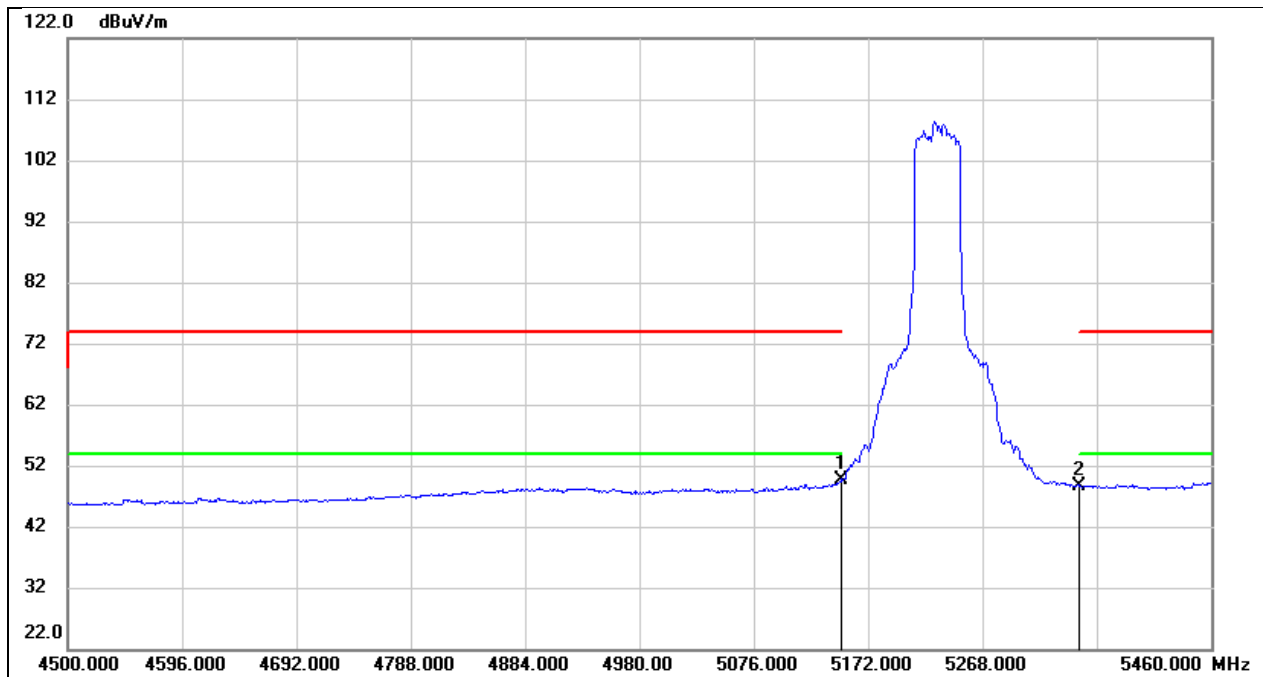

No.	Frequency (MHz)	Reading (dBuV)	Correct (dB/m)	Result (dBuV/m)	Limit (dBuV/m)	Margin (dB)	Remark
1	5150.000	9.38	40.27	49.65	54.00	-4.35	AVG
2	5350.000	8.13	40.49	48.62	54.00	-5.38	AVG

Test Mode:	802.11ac VHT40 PK	Frequency(MHz):	5270
Polarity:	Vertical	Test Voltage:	DC 12 V

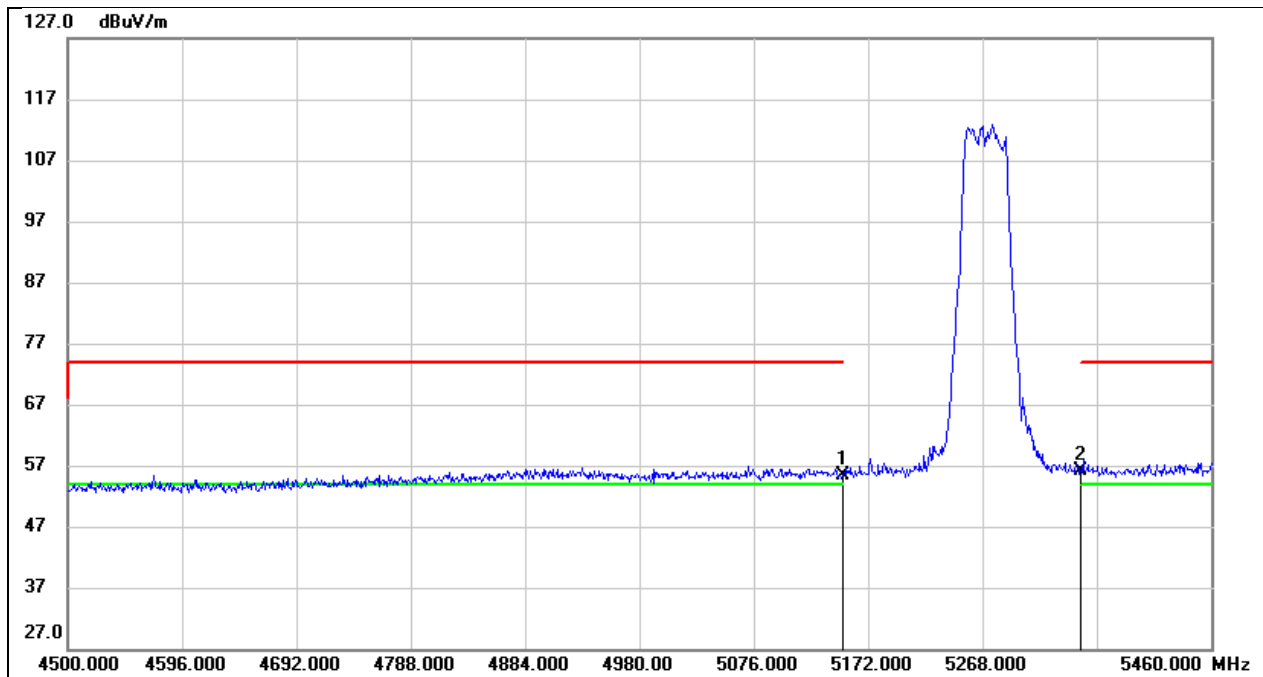

No.	Frequency (MHz)	Reading (dBuV)	Correct (dB/m)	Result (dBuV/m)	Limit (dBuV/m)	Margin (dB)	Remark
1	5150.000	15.22	40.27	55.49	74.00	-18.51	peak
2	5350.000	15.70	40.49	56.19	74.00	-17.81	peak

Test Mode:	802.11ac VHT40 AV	Frequency(MHz):	5270
Polarity:	Vertical	Test Voltage:	DC 12 V

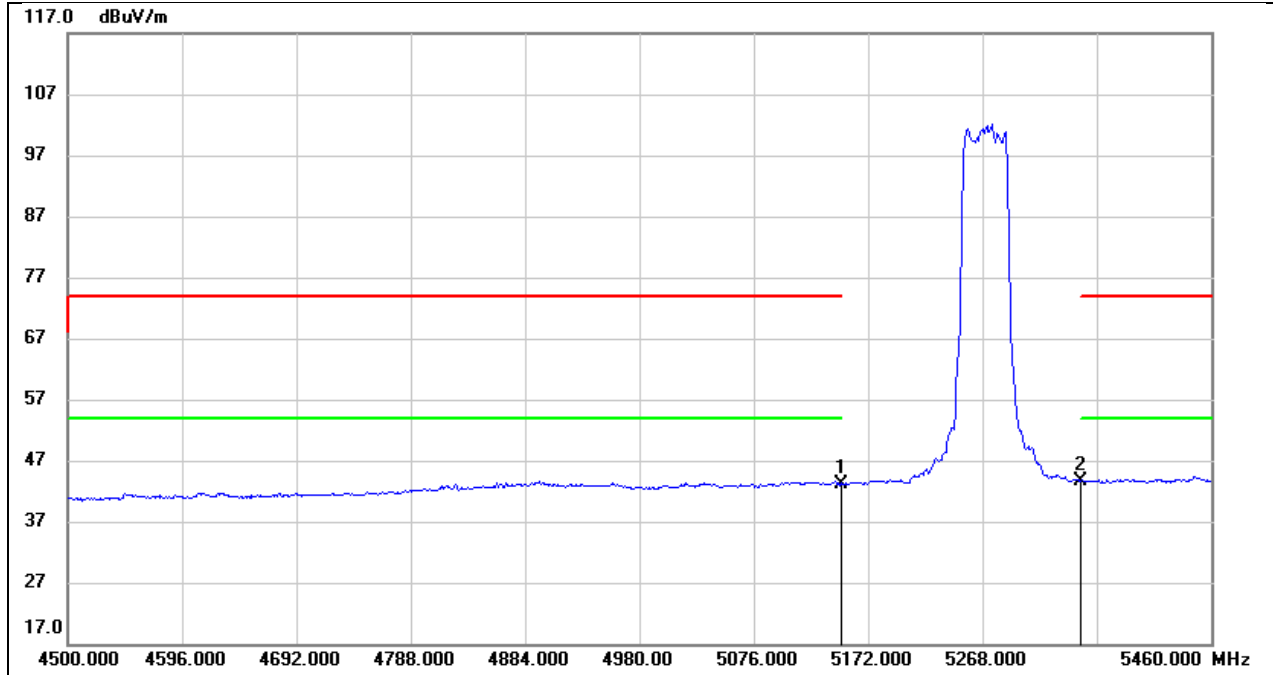

No.	Frequency (MHz)	Reading (dBuV)	Correct (dB/m)	Result (dBuV/m)	Limit (dBuV/m)	Margin (dB)	Remark
1	5150.000	2.93	40.27	43.20	54.00	-10.80	AVG
2	5350.000	3.22	40.49	43.71	54.00	-10.29	AVG

Test Mode:	802.11ac VHT40 PK	Frequency(MHz):	5310
Polarity:	Vertical	Test Voltage:	DC 12 V

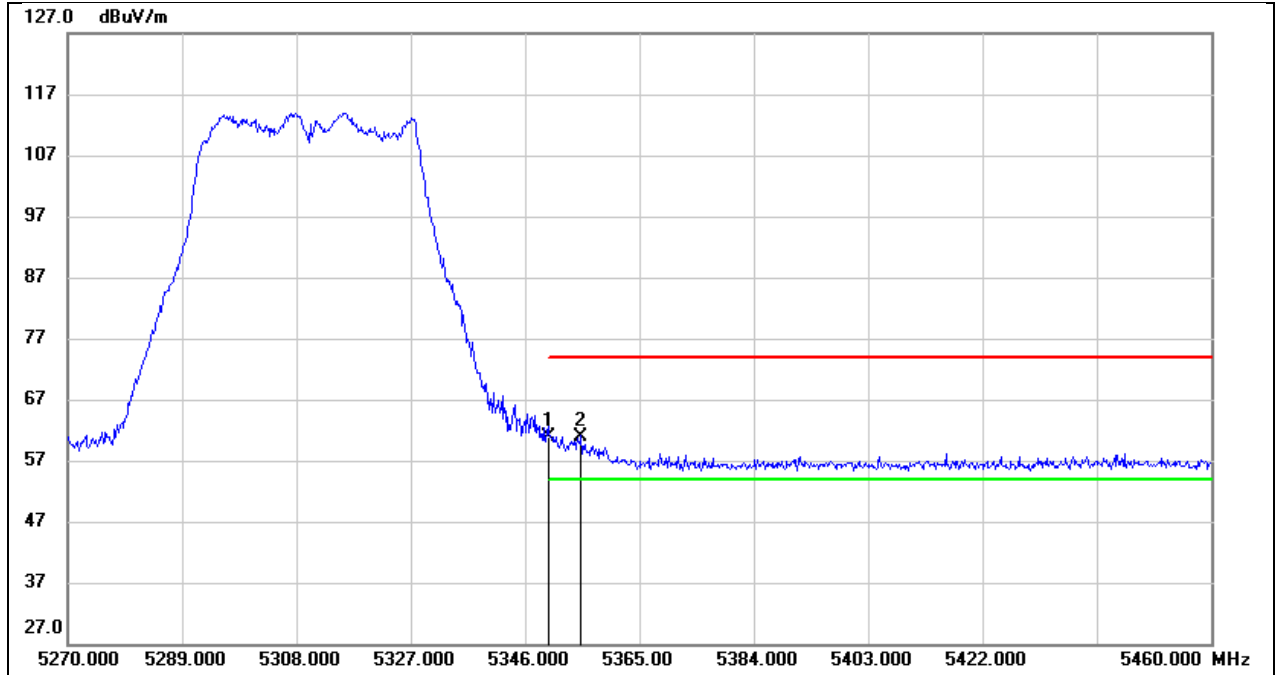

No.	Frequency (MHz)	Reading (dBuV)	Correct (dB/m)	Result (dBuV/m)	Limit (dBuV/m)	Margin (dB)	Remark
1	5350.000	20.34	40.49	60.83	74.00	-13.17	peak
2	5355.310	20.50	40.50	61.00	74.00	-13.00	peak

Test Mode:	802.11ac VHT40 AV	Frequency(MHz):	5310
Polarity:	Vertical	Test Voltage:	DC 12 V

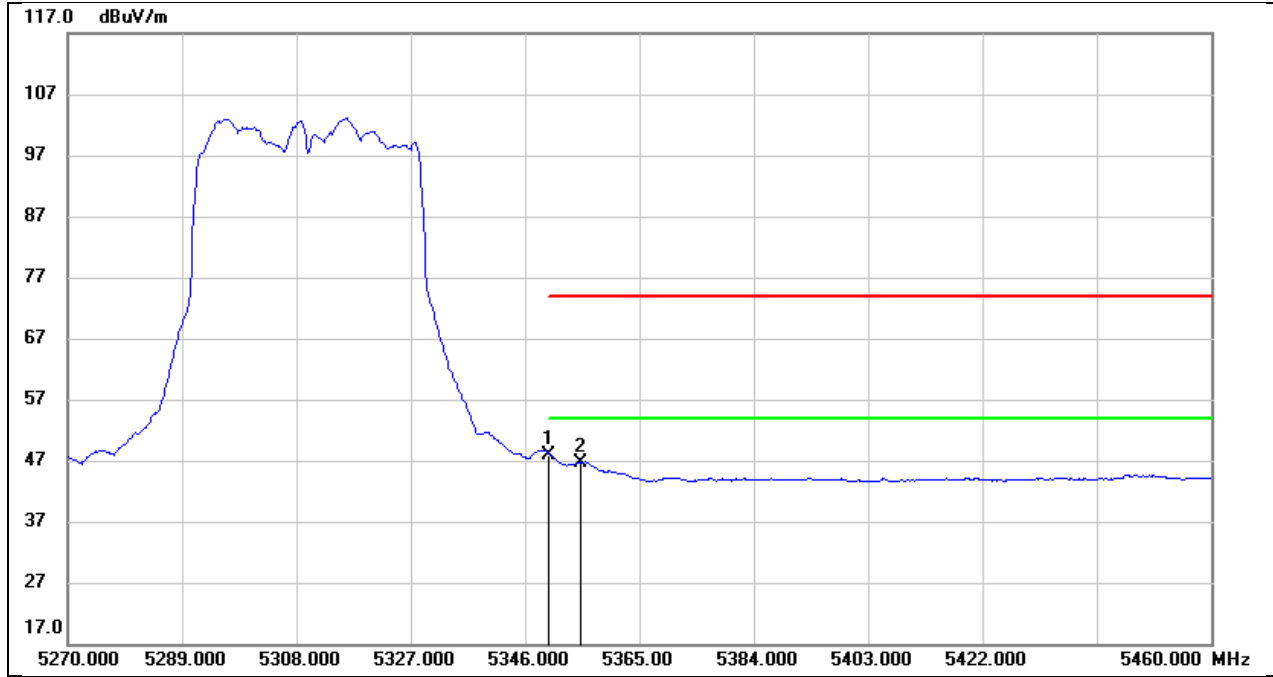

No.	Frequency (MHz)	Reading (dBuV)	Correct (dB/m)	Result (dBuV/m)	Limit (dBuV/m)	Margin (dB)	Remark
1	5350.000	7.49	40.49	47.98	54.00	-6.02	AVG
2	5355.310	6.23	40.50	46.73	54.00	-7.27	AVG

Test Mode:	802.11ac VHT40 PK	Frequency(MHz):	5510
Polarity:	Vertical	Test Voltage:	DC 12 V

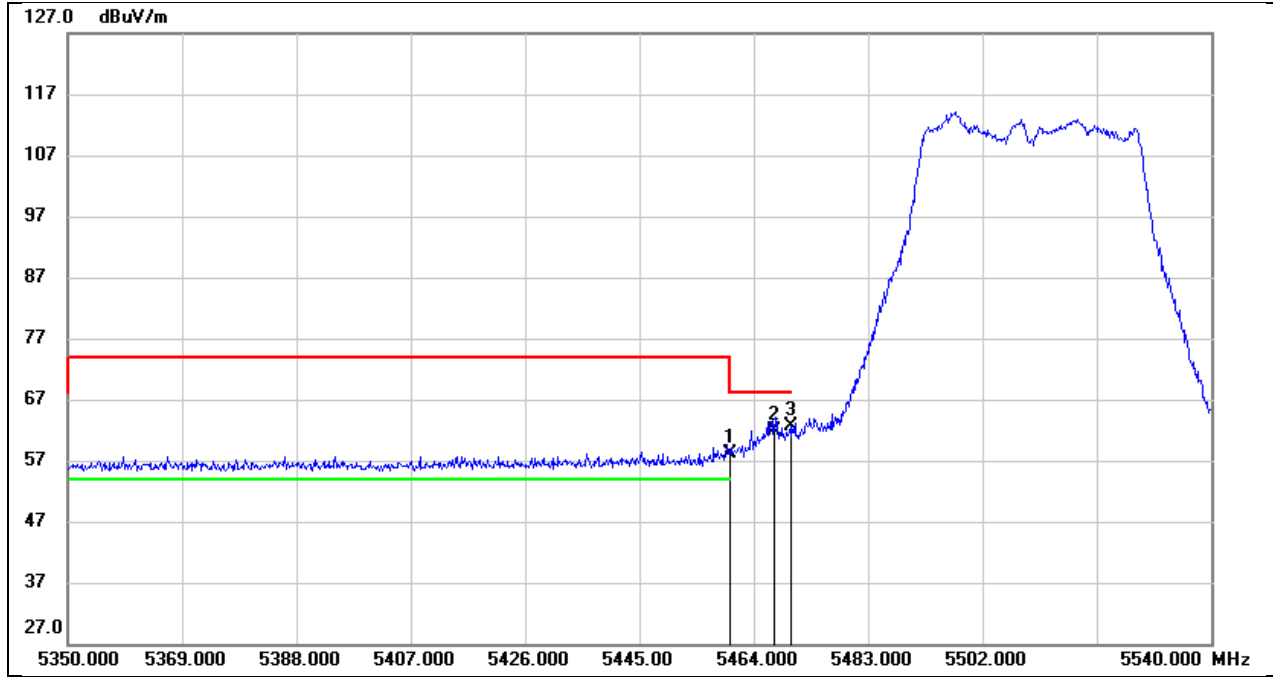

No.	Frequency (MHz)	Reading (dBuV)	Correct (dB/m)	Result (dBuV/m)	Limit (dBuV/m)	Margin (dB)	Remark
1	5460.000	17.62	40.62	58.24	68.20	-9.96	peak
2	5467.420	21.20	40.62	61.82	68.20	-6.38	peak
3	5470.000	21.92	40.63	62.55	68.20	-5.65	peak

Test Mode:	802.11ac VHT40 AV	Frequency(MHz):	5510
Polarity:	Vertical	Test Voltage:	DC 12 V

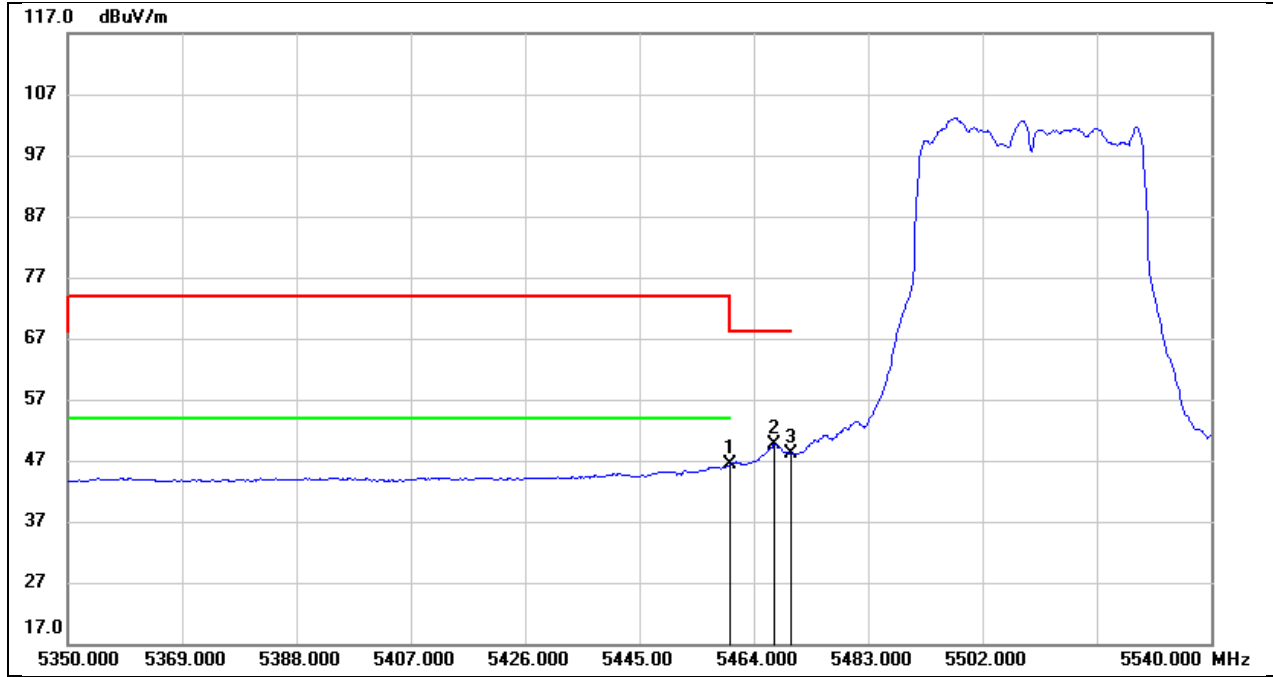

No.	Frequency (MHz)	Reading (dBuV)	Correct (dB/m)	Result (dBuV/m)	Limit (dBuV/m)	Margin (dB)	Remark
1	5460.000	5.74	40.62	46.36	54.00	-7.64	AVG
2	5467.420	8.98	40.62	49.60	68.20	-18.60	AVG
3	5470.000	7.54	40.63	48.17	68.20	-20.03	AVG

Test Mode:	802.11ac VHT40 PK	Frequency(MHz):	5670
Polarity:	Vertical	Test Voltage:	DC 12 V

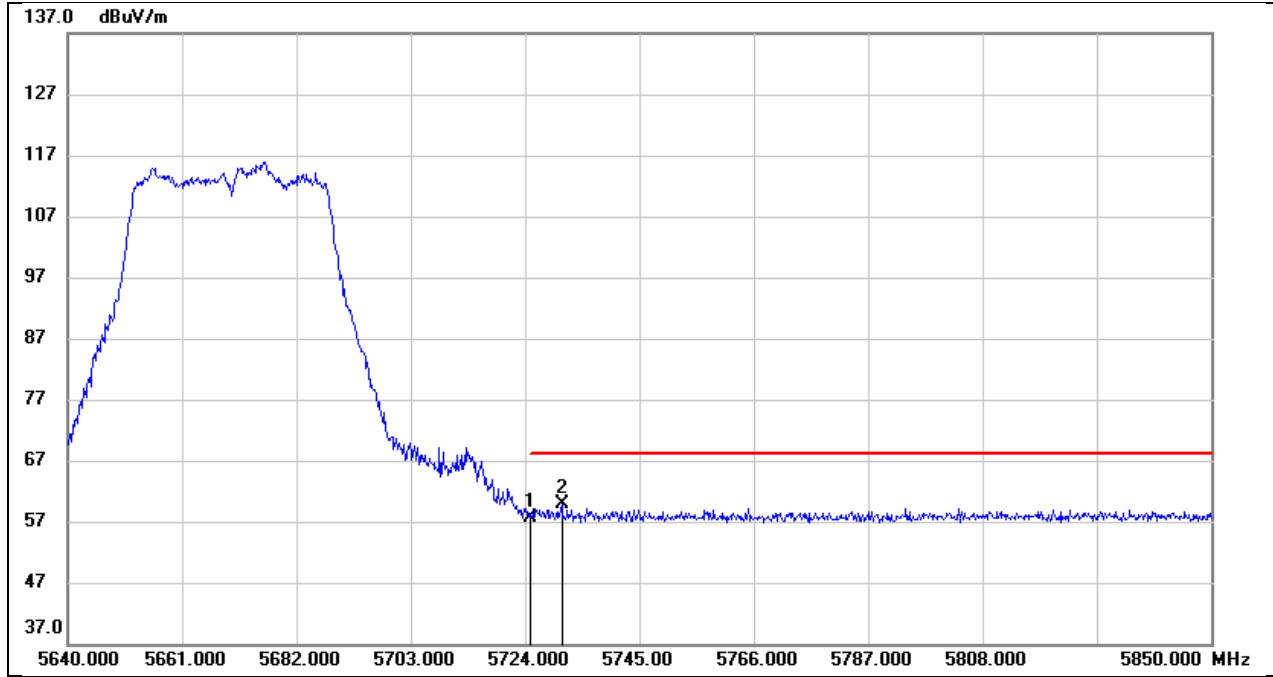

No.	Frequency (MHz)	Reading (dBuV)	Correct (dB/m)	Result (dBuV/m)	Limit (dBuV/m)	Margin (dB)	Remark
1	5725.000	16.38	41.27	57.65	68.20	-10.55	peak
2	5730.720	18.49	41.28	59.77	68.20	-8.43	peak

Test Mode:	802.11ac VHT40 PK	Frequency(MHz):	5755
Polarity:	Vertical	Test Voltage:	DC 12 V

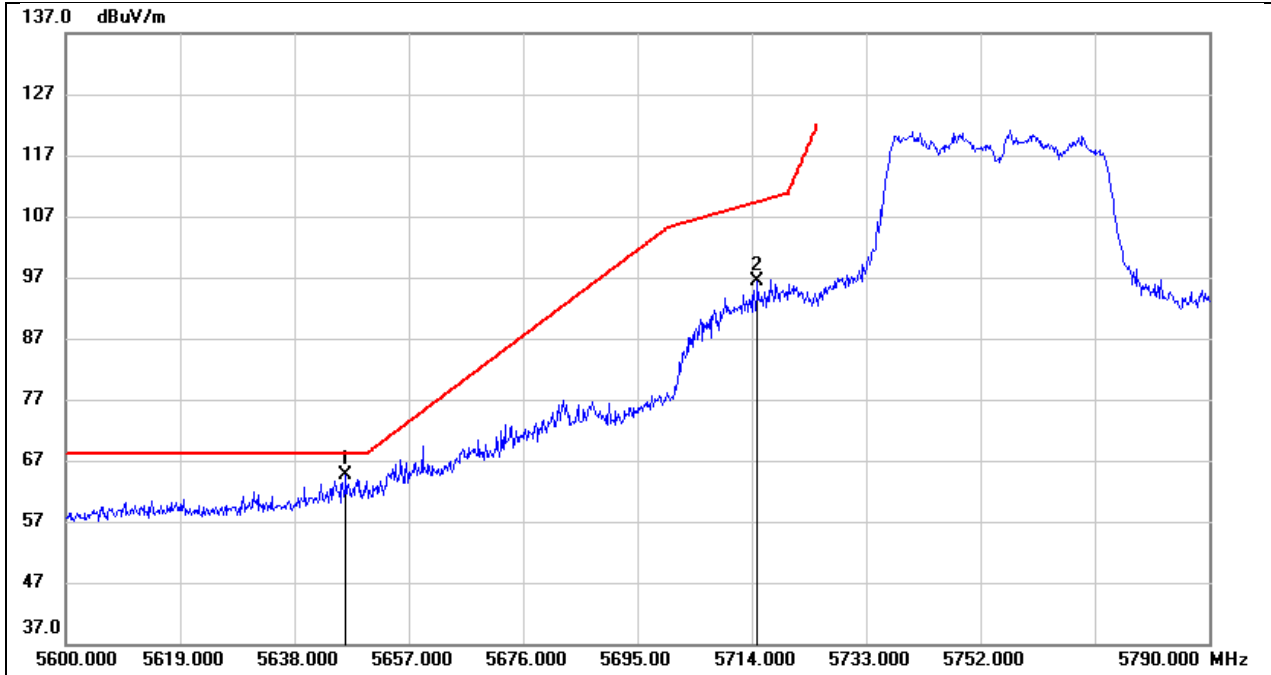

No.	Frequency (MHz)	Reading (dBuV)	Correct (dB/m)	Result (dBuV/m)	Limit (dBuV/m)	Margin (dB)	Remark
1	5646.550	23.45	41.06	64.51	68.20	-3.69	peak
2	5714.950	55.15	41.23	96.38	109.39	-13.01	peak

Test Mode:	802.11ac VHT40 PK	Frequency(MHz):	5795
Polarity:	Vertical	Test Voltage:	DC 12 V

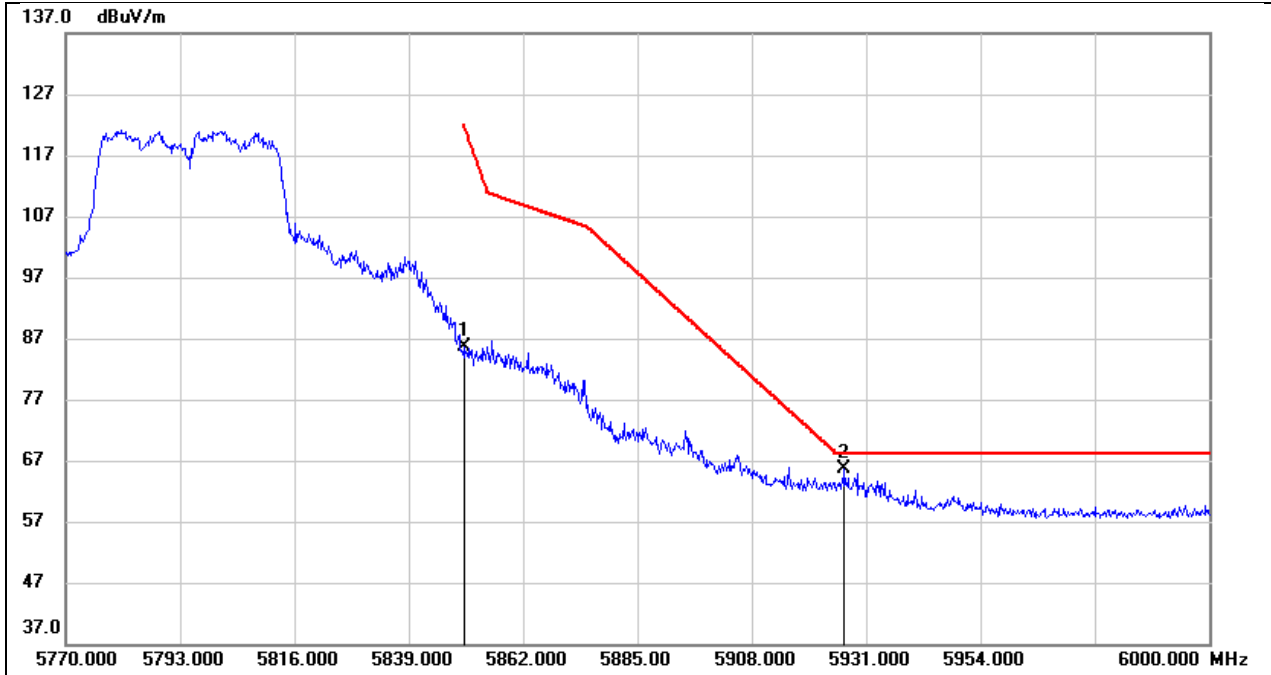

No.	Frequency (MHz)	Reading (dBuV)	Correct (dB/m)	Result (dBuV/m)	Limit (dBuV/m)	Margin (dB)	Remark
1	5850.000	44.04	41.60	85.64	122.20	-36.56	peak
2	5926.630	23.76	41.81	65.57	68.20	-2.63	peak

Test Mode:	802.11ac VHT80 PK	Frequency(MHz):	5210
Polarity:	Vertical	Test Voltage:	DC 12 V

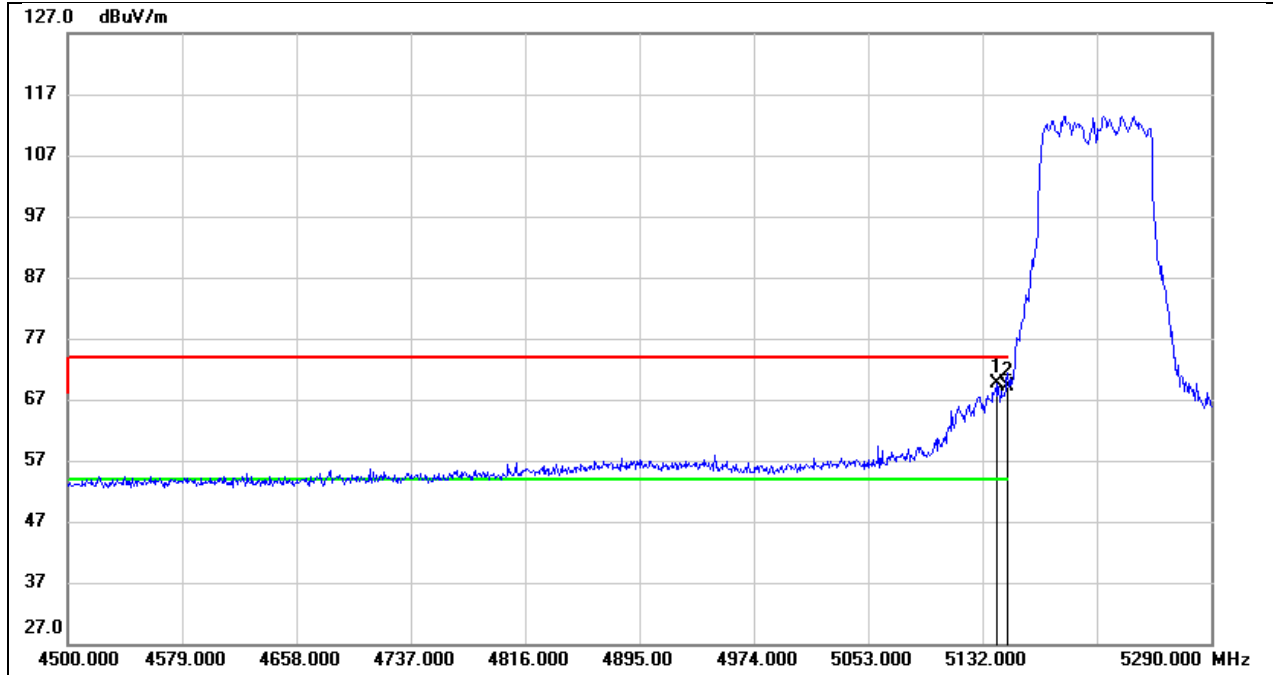

No.	Frequency (MHz)	Reading (dBuV)	Correct (dB/m)	Result (dBuV/m)	Limit (dBuV/m)	Margin (dB)	Remark
1	5141.480	29.49	40.26	69.75	74.00	-4.25	peak
2	5150.000	28.82	40.27	69.09	74.00	-4.91	peak

Test Mode:	802.11ac VHT80 AV	Frequency(MHz):	5210
Polarity:	Vertical	Test Voltage:	DC 12 V

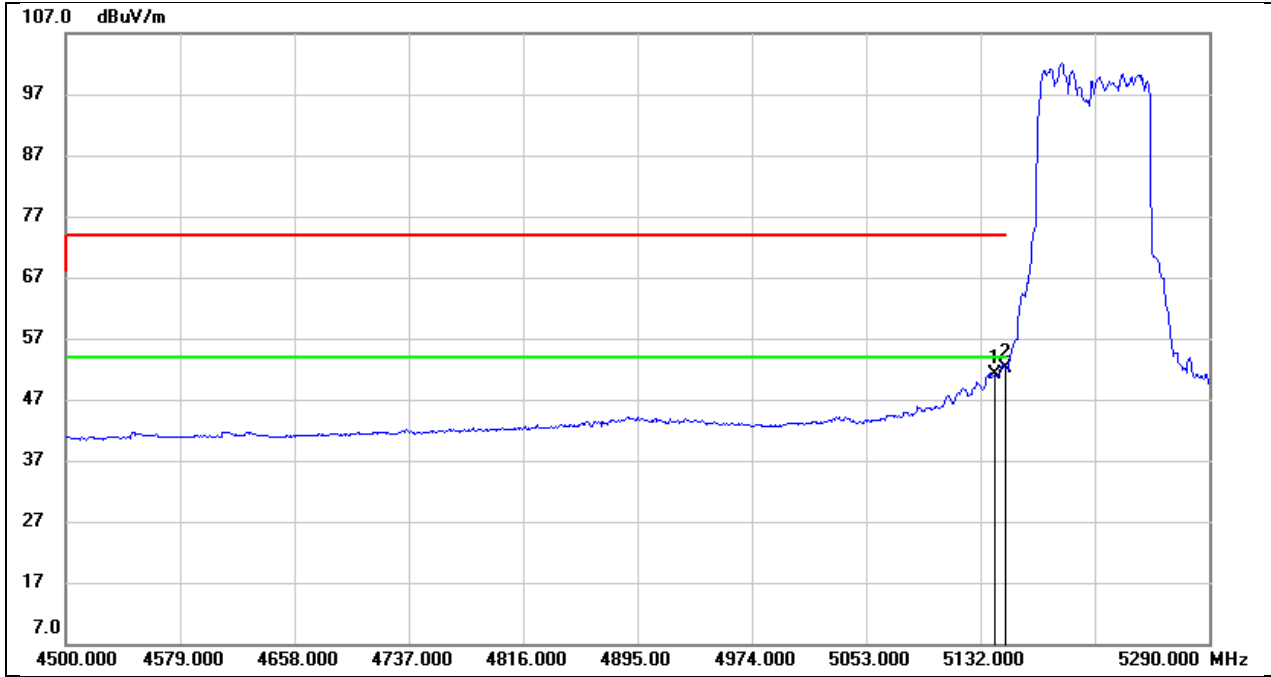

No.	Frequency (MHz)	Reading (dBuV)	Correct (dB/m)	Result (dBuV/m)	Limit (dBuV/m)	Margin (dB)	Remark
1	5141.480	10.97	40.26	51.23	54.00	-2.77	AVG
2	5150.000	11.89	40.27	52.16	54.00	-1.84	AVG

Test Mode:	802.11ac VHT80 PK	Frequency(MHz):	5290
Polarity:	Vertical	Test Voltage:	DC 12 V

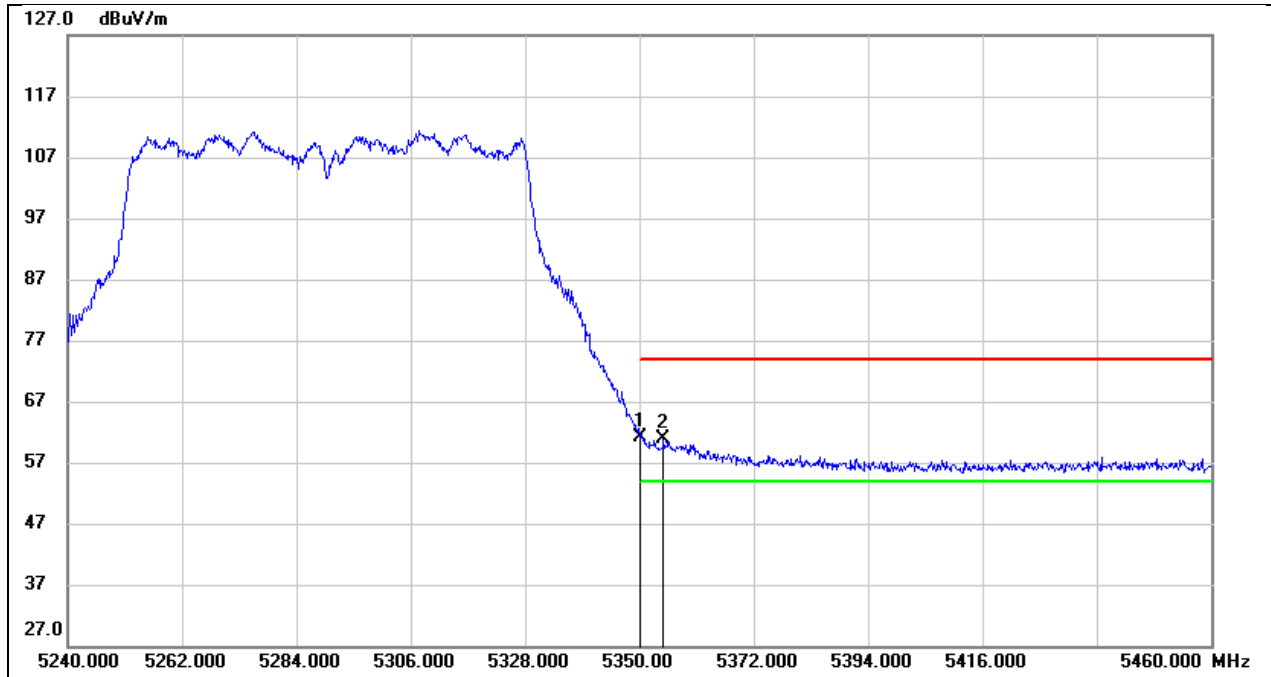

No.	Frequency (MHz)	Reading (dBuV)	Correct (dB/m)	Result (dBuV/m)	Limit (dBuV/m)	Margin (dB)	Remark
1	5350.000	20.72	40.49	61.21	74.00	-12.79	peak
2	5354.620	20.28	40.50	60.78	74.00	-13.22	peak

Test Mode:	802.11ac VHT80 AV	Frequency(MHz):	5290
Polarity:	Vertical	Test Voltage:	DC 12 V

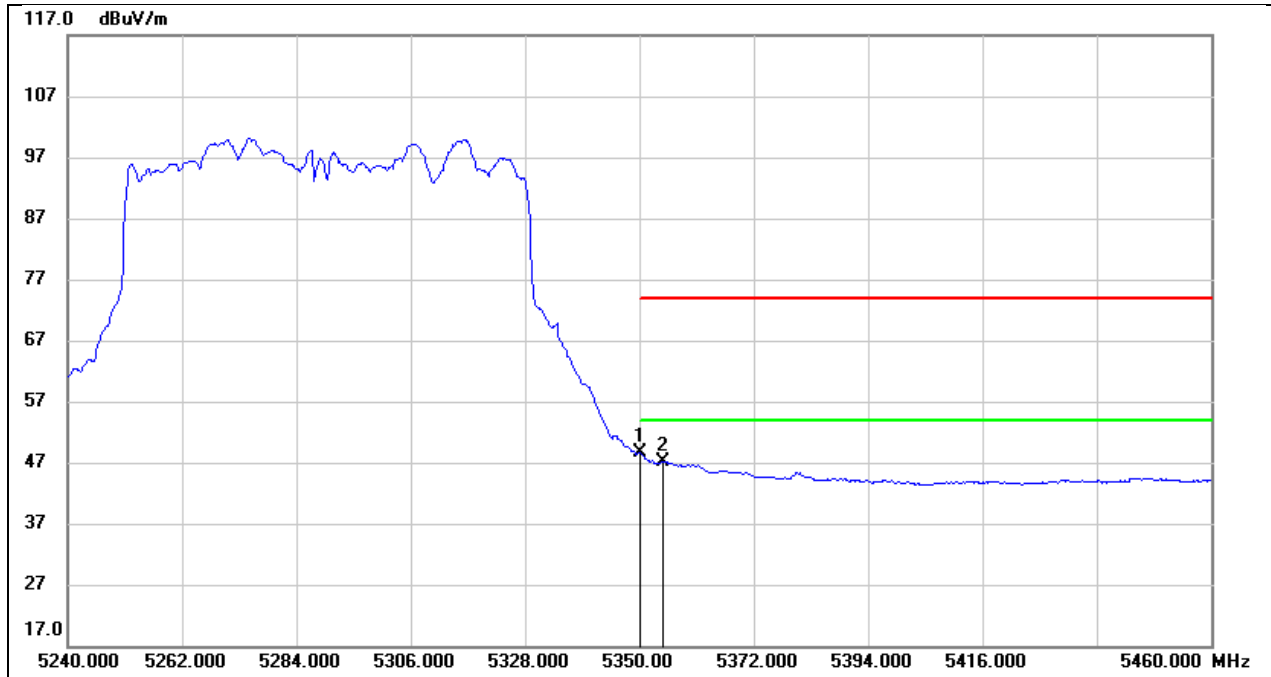

No.	Frequency (MHz)	Reading (dBuV)	Correct (dB/m)	Result (dBuV/m)	Limit (dBuV/m)	Margin (dB)	Remark
1	5350.000	8.20	40.49	48.69	54.00	-5.31	AVG
2	5354.620	6.74	40.50	47.24	54.00	-6.76	AVG

Test Mode:	802.11ac VHT80 PK	Frequency(MHz):	5530
Polarity:	Vertical	Test Voltage:	DC 12 V

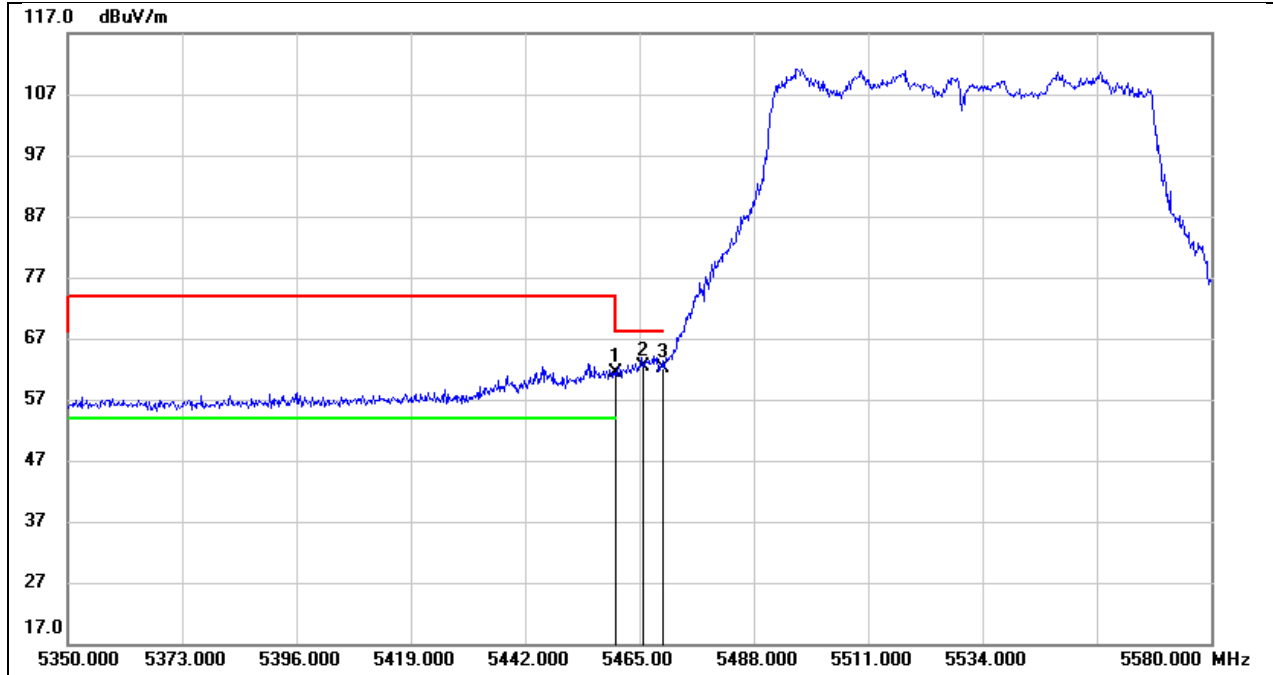

No.	Frequency (MHz)	Reading (dBuV)	Correct (dB/m)	Result (dBuV/m)	Limit (dBuV/m)	Margin (dB)	Remark
1	5460.000	20.87	40.62	61.49	68.20	-6.71	peak
2	5465.690	21.65	40.62	62.27	68.20	-5.93	peak
3	5470.000	21.39	40.63	62.02	68.20	-6.18	peak

Test Mode:	802.11ac VHT80 AV	Frequency(MHz):	5530
Polarity:	Vertical	Test Voltage:	DC 12 V

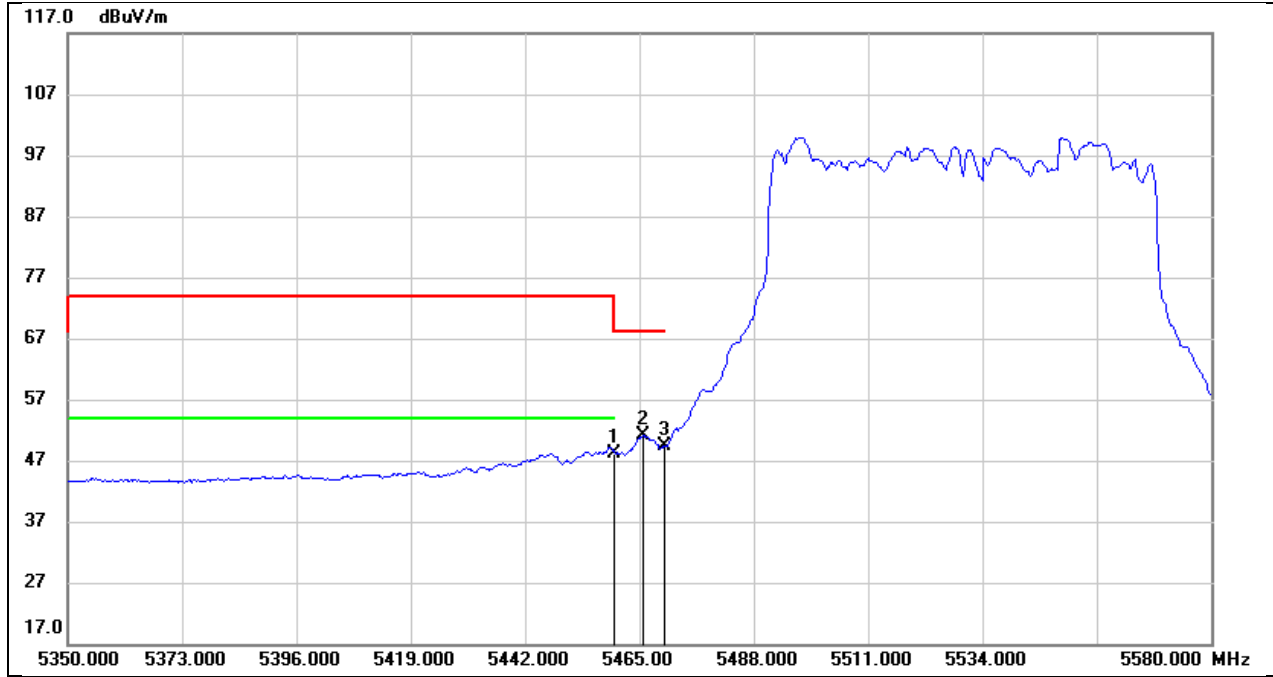

No.	Frequency (MHz)	Reading (dBuV)	Correct (dB/m)	Result (dBuV/m)	Limit (dBuV/m)	Margin (dB)	Remark
1	5460.000	7.57	40.62	48.19	54.00	-5.81	AVG
2	5465.690	10.51	40.62	51.13	68.20	-17.07	AVG
3	5470.000	8.85	40.63	49.48	68.20	-18.72	AVG

Test Mode:	802.11ac VHT80 PK	Frequency(MHz):	5610
Polarity:	Vertical	Test Voltage:	DC 12 V

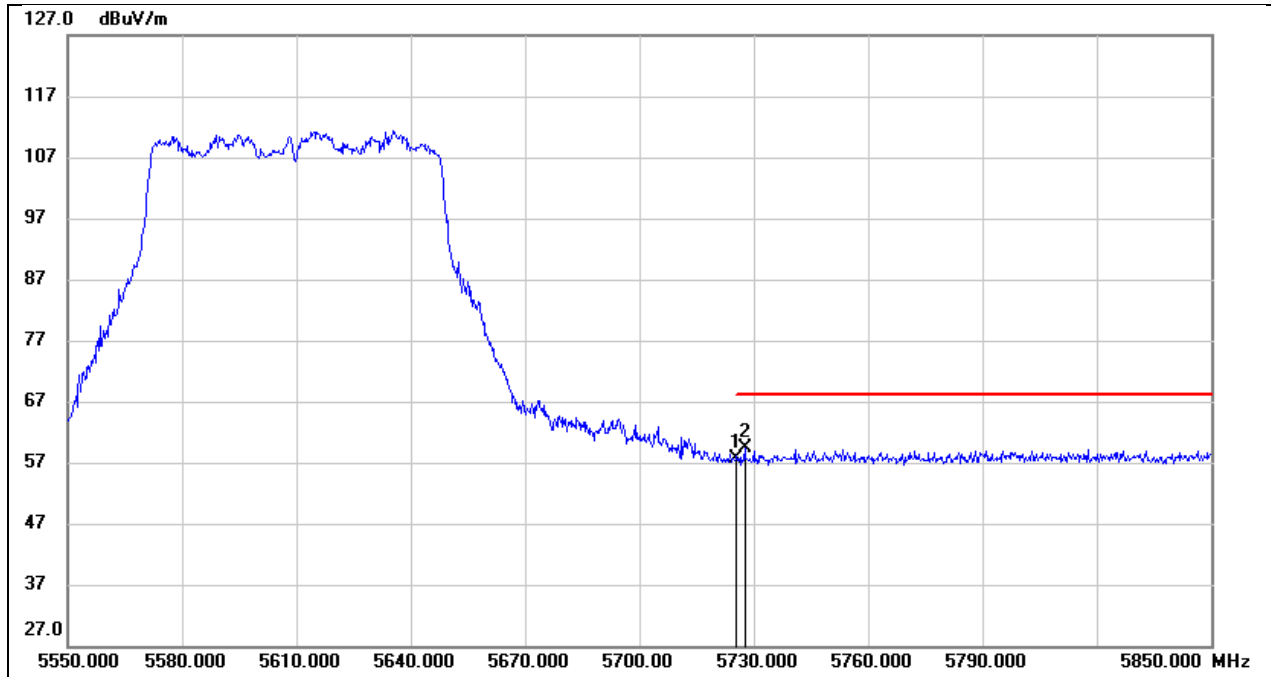

No.	Frequency (MHz)	Reading (dBuV)	Correct (dB/m)	Result (dBuV/m)	Limit (dBuV/m)	Margin (dB)	Remark
1	5725.000	16.24	41.27	57.51	68.20	-10.69	peak
2	5727.600	18.02	41.27	59.29	68.20	-8.91	peak

Test Mode:	802.11ac VHT80 PK	Frequency(MHz):	5775
Polarity:	Vertical	Test Voltage:	DC 12 V

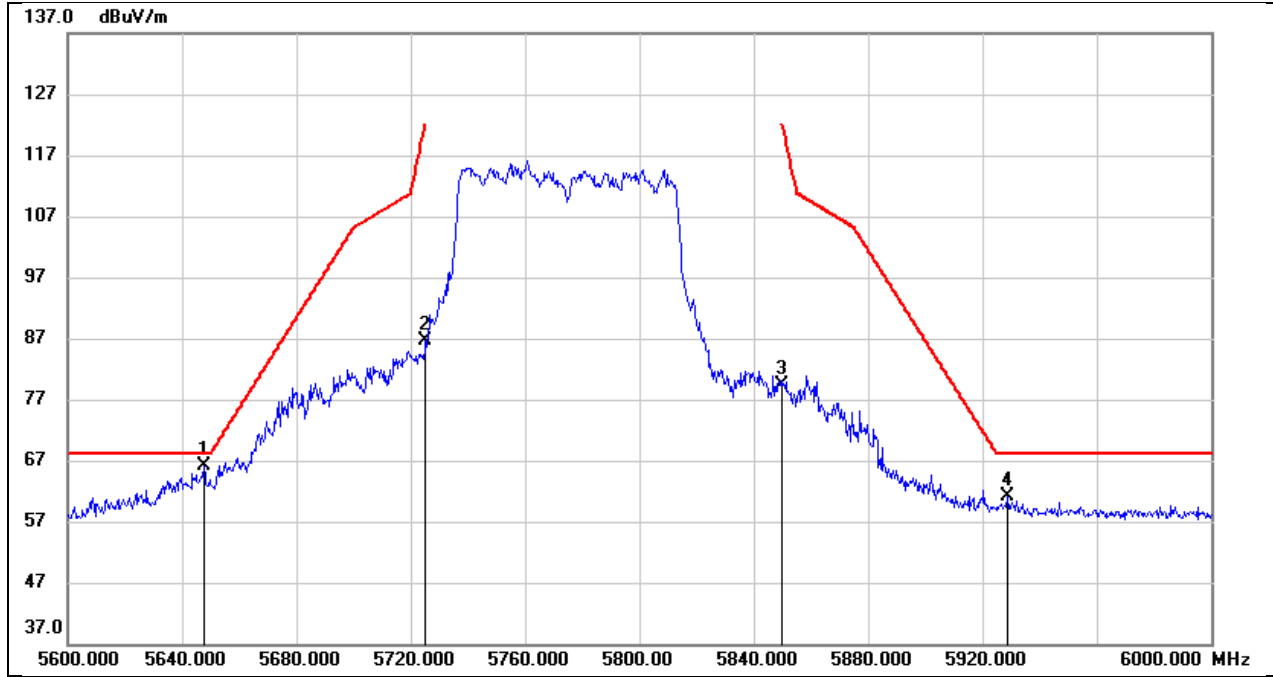

No.	Frequency (MHz)	Reading (dBuV)	Correct (dB/m)	Result (dBuV/m)	Limit (dBuV/m)	Margin (dB)	Remark
1	5647.600	25.04	41.06	66.10	68.20	-2.10	peak
2	5725.000	45.34	41.27	86.61	122.20	-35.59	peak
3	5850.000	37.71	41.60	79.31	122.20	-42.89	peak
4	5928.800	19.21	41.81	61.02	68.20	-7.18	peak

Test Mode:	802.11ac VHT160 PK	Frequency(MHz):	5250
Polarity:	Vertical	Test Voltage:	DC 12 V

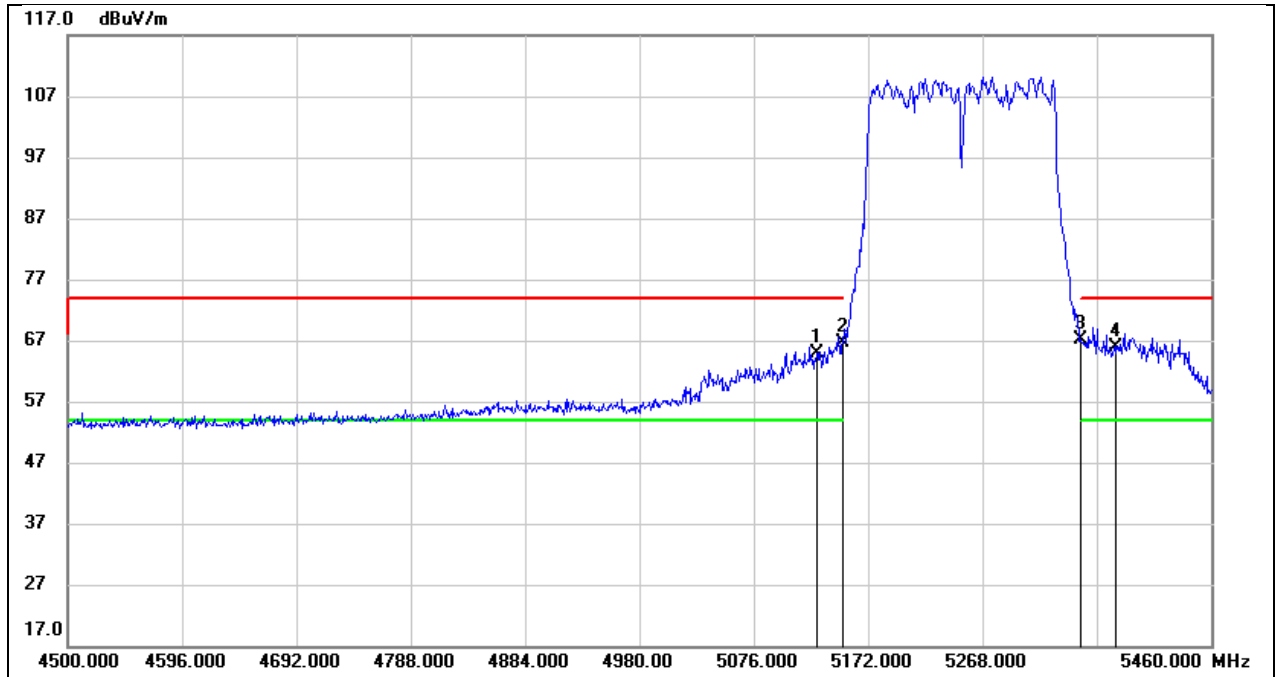

No.	Frequency (MHz)	Reading (dBuV)	Correct (dB/m)	Result (dBuV/m)	Limit (dBuV/m)	Margin (dB)	Remark
1	5128.800	24.51	40.25	64.76	74.00	-9.24	peak
2	5150.000	26.35	40.27	66.62	74.00	-7.38	peak
3	5350.000	26.75	40.49	67.24	74.00	-6.76	peak
4	5381.280	25.46	40.53	65.99	74.00	-8.01	peak

Test Mode:	802.11ac VHT160 AV	Frequency(MHz):	5250
Polarity:	Vertical	Test Voltage:	DC 12 V

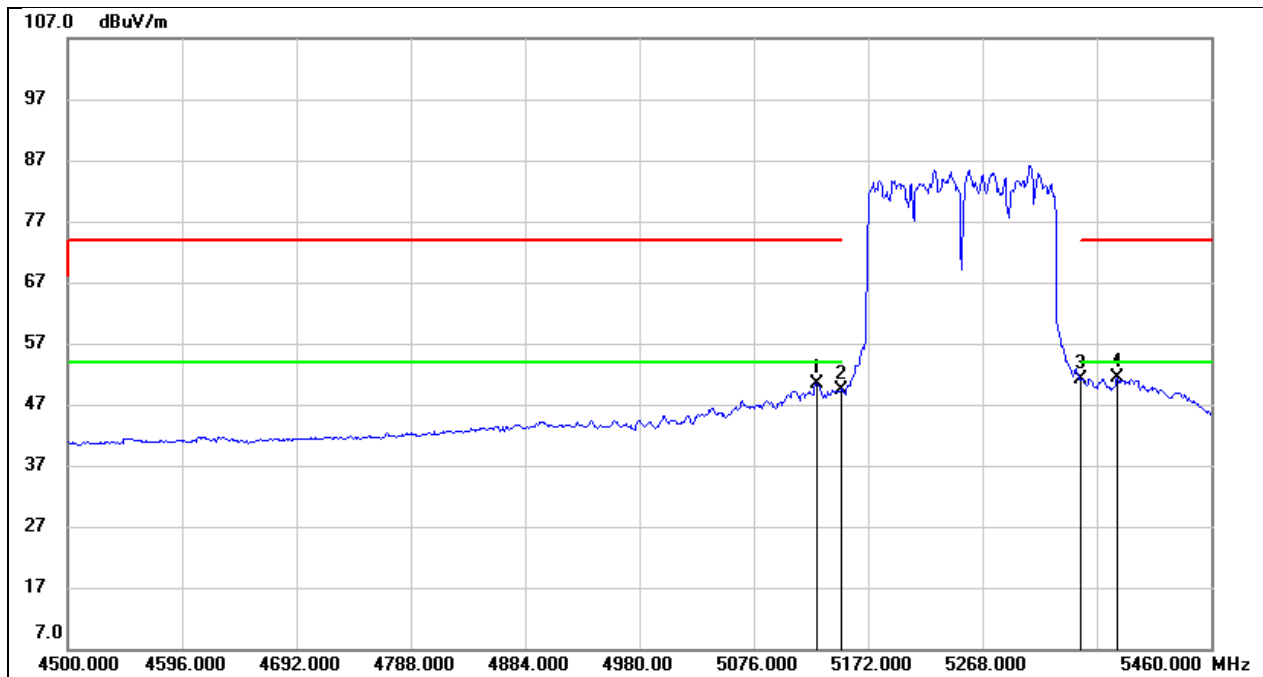

No.	Frequency (MHz)	Reading (dBuV)	Correct (dB/m)	Result (dBuV/m)	Limit (dBuV/m)	Margin (dB)	Remark
1	5128.800	10.10	40.25	50.35	54.00	-3.65	AVG
2	5150.000	9.19	40.27	49.46	54.00	-4.54	AVG
3	5350.000	10.67	40.49	51.16	54.00	-2.84	AVG
4	5381.280	10.81	40.53	51.34	54.00	-2.66	AVG

Test Mode:	802.11ac VHT160 PK	Frequency(MHz):	5570
Polarity:	Vertical	Test Voltage:	DC 12 V

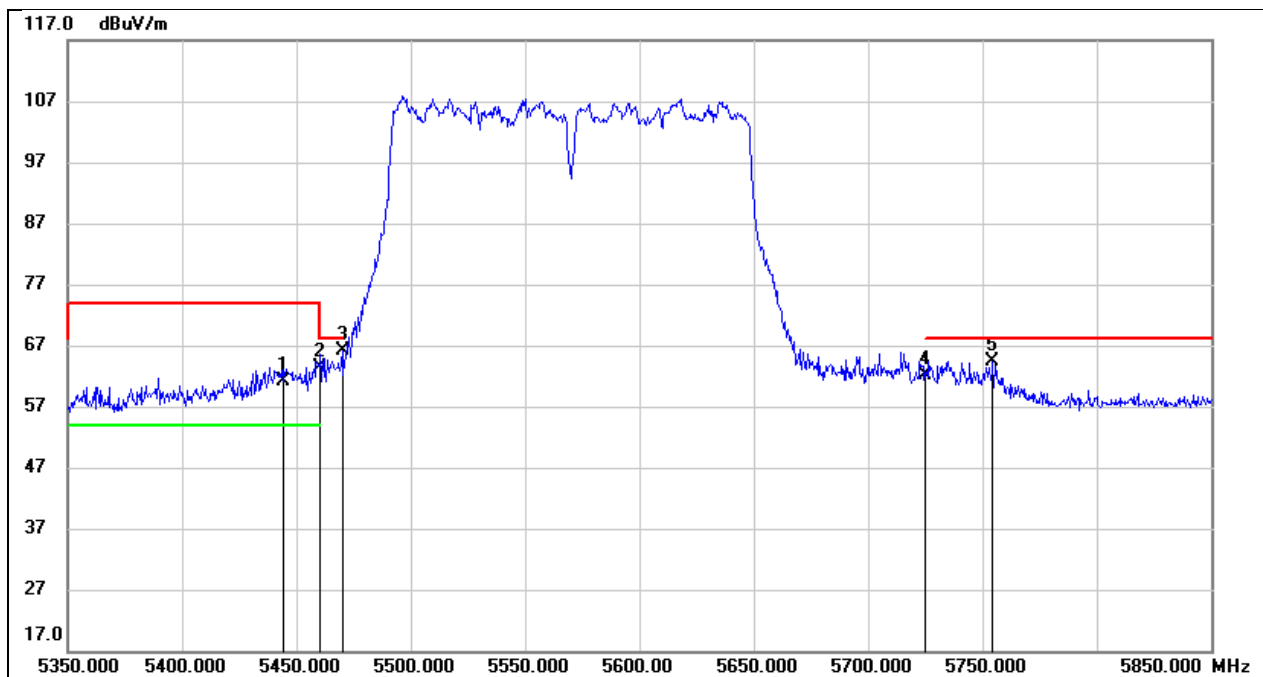

No.	Frequency (MHz)	Reading (dBuV)	Correct (dB/m)	Result (dBuV/m)	Limit (dBuV/m)	Margin (dB)	Remark
1	5444.000	20.65	40.60	61.25	74.00	-12.75	peak
2	5460.000	22.82	40.62	63.44	68.20	-4.76	peak
3	5470.000	25.62	40.63	66.25	68.20	-1.95	peak
4	5725.000	20.96	41.27	62.23	68.20	-5.97	peak
5	5754.500	22.98	41.34	64.32	68.20	-3.88	peak

Test Mode:	802.11ac VHT160 AV	Frequency(MHz):	5570
Polarity:	Vertical	Test Voltage:	DC 12 V

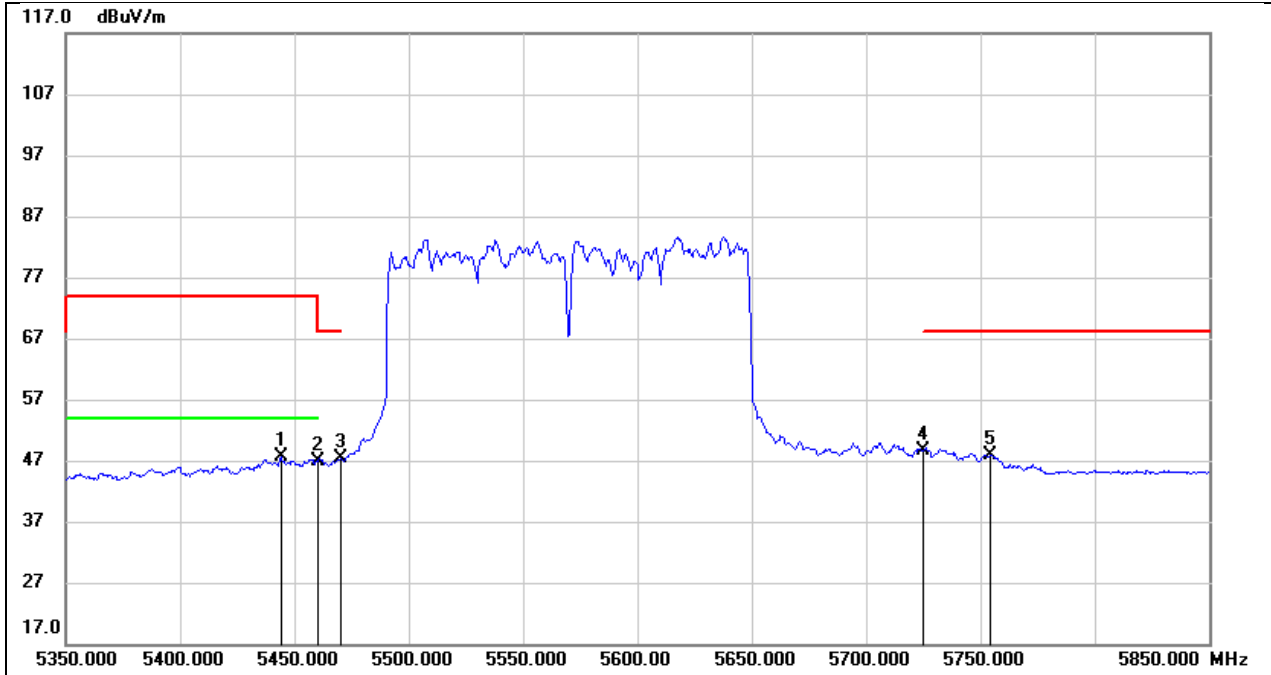

No.	Frequency (MHz)	Reading (dBuV)	Correct (dB/m)	Result (dBuV/m)	Limit (dBuV/m)	Margin (dB)	Remark
1	5444.000	7.10	40.60	47.70	54.00	-6.30	AVG
2	5460.000	6.18	40.62	46.80	54.00	-7.20	AVG
3	5470.000	6.69	40.63	47.32	68.20	-20.88	AVG
4	5725.000	7.44	41.27	48.71	68.20	-19.49	AVG
5	5754.500	6.57	41.34	47.91	68.20	-20.29	AVG

Test Mode:	802.11be EHT20 PK	Frequency(MHz):	5180
Polarity:	Vertical	Test Voltage:	DC 12 V

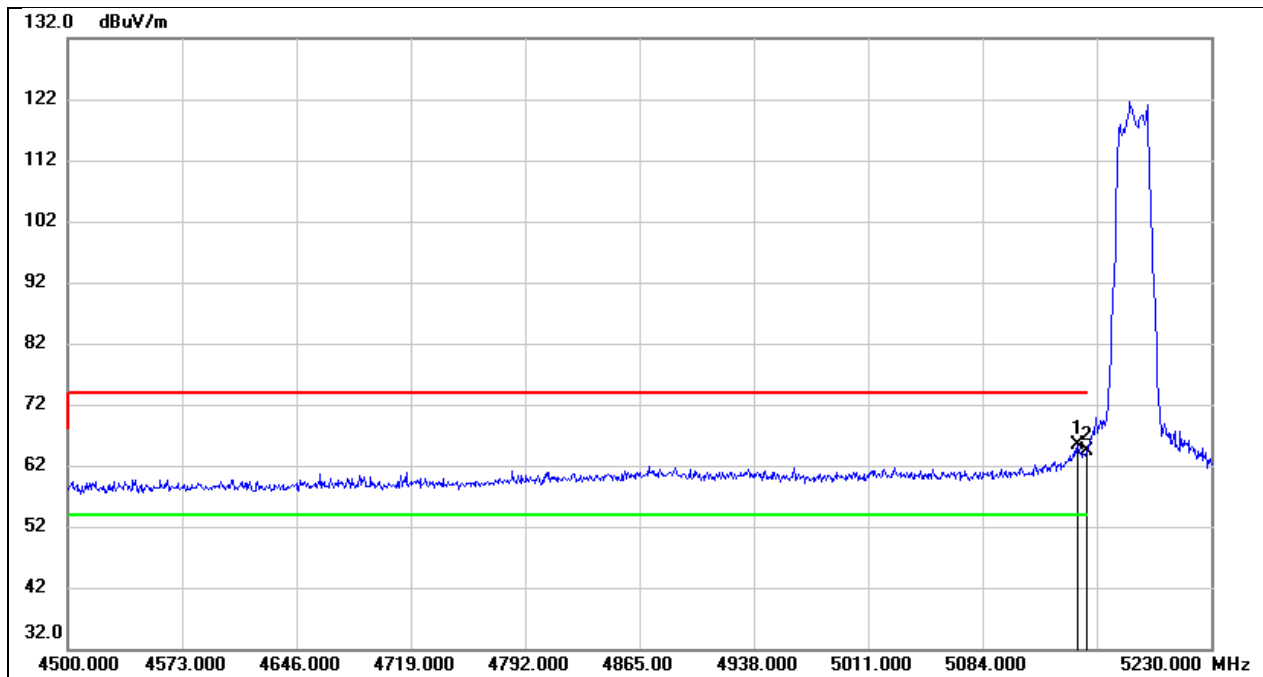

No.	Frequency (MHz)	Reading (dBuV)	Correct (dB/m)	Result (dBuV/m)	Limit (dBuV/m)	Margin (dB)	Remark
1	5144.590	25.10	40.27	65.37	74.00	-8.63	peak
2	5150.000	24.23	40.27	64.50	74.00	-9.50	peak

Test Mode:	802.11be EHT20 AV	Frequency(MHz):	5180
Polarity:	Vertical	Test Voltage:	DC 12 V

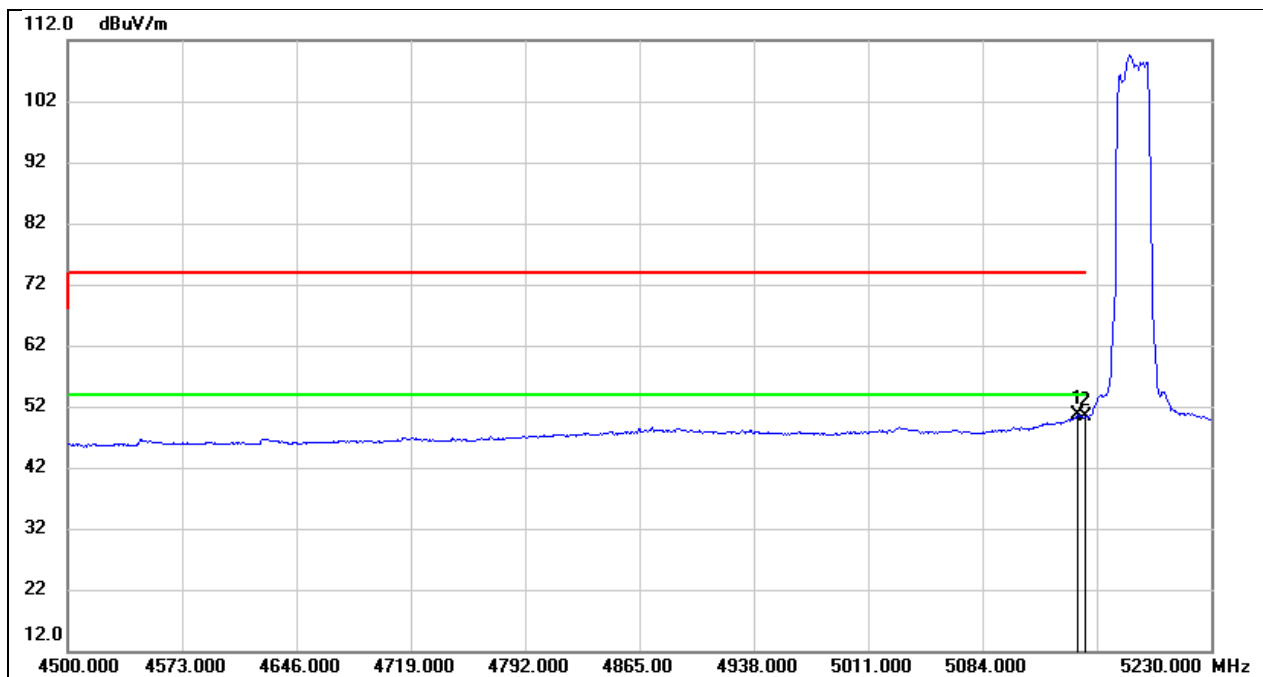

No.	Frequency (MHz)	Reading (dBuV)	Correct (dB/m)	Result (dBuV/m)	Limit (dBuV/m)	Margin (dB)	Remark
1	5144.590	10.25	40.27	50.52	54.00	-3.48	AVG
2	5150.000	10.04	40.27	50.31	54.00	-3.69	AVG

Test Mode:	802.11be EHT20 PK	Frequency(MHz):	5240
Polarity:	Vertical	Test Voltage:	DC 12 V

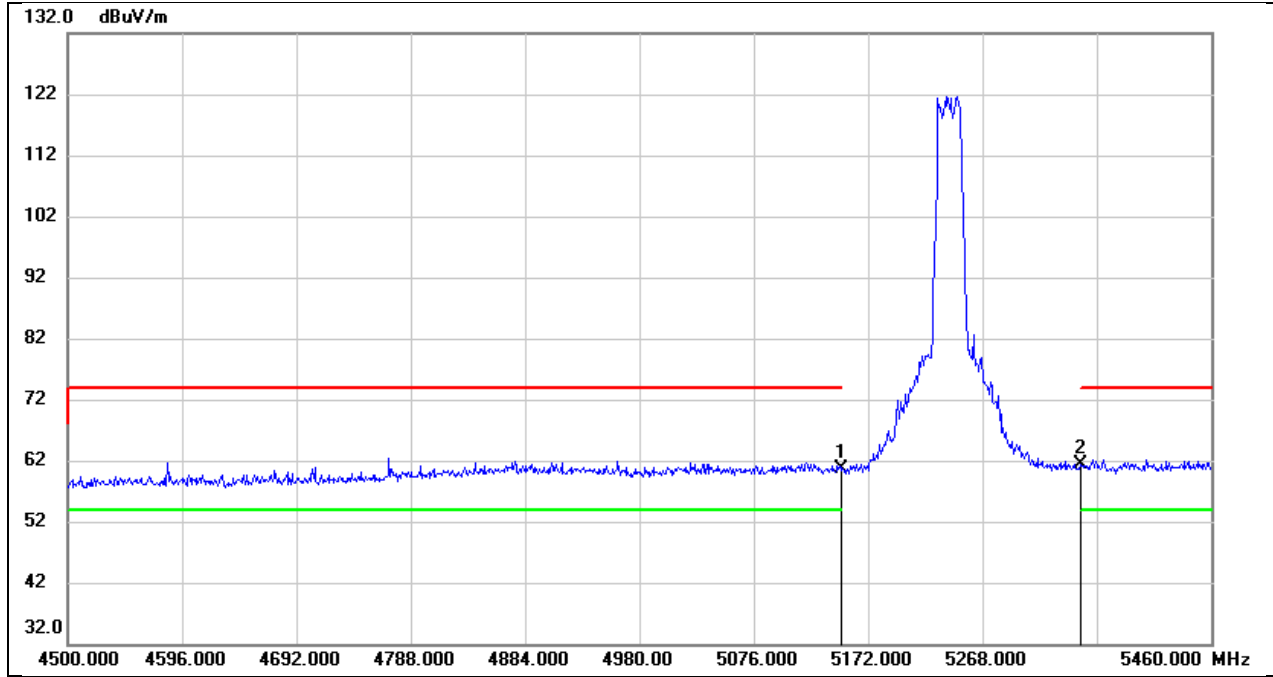

No.	Frequency (MHz)	Reading (dBuV)	Correct (dB/m)	Result (dBuV/m)	Limit (dBuV/m)	Margin (dB)	Remark
1	5150.000	20.38	40.27	60.65	74.00	-13.35	peak
2	5350.000	20.80	40.49	61.29	74.00	-12.71	peak

Test Mode:	802.11be EHT20 AV	Frequency(MHz):	5240
Polarity:	Vertical	Test Voltage:	DC 12 V

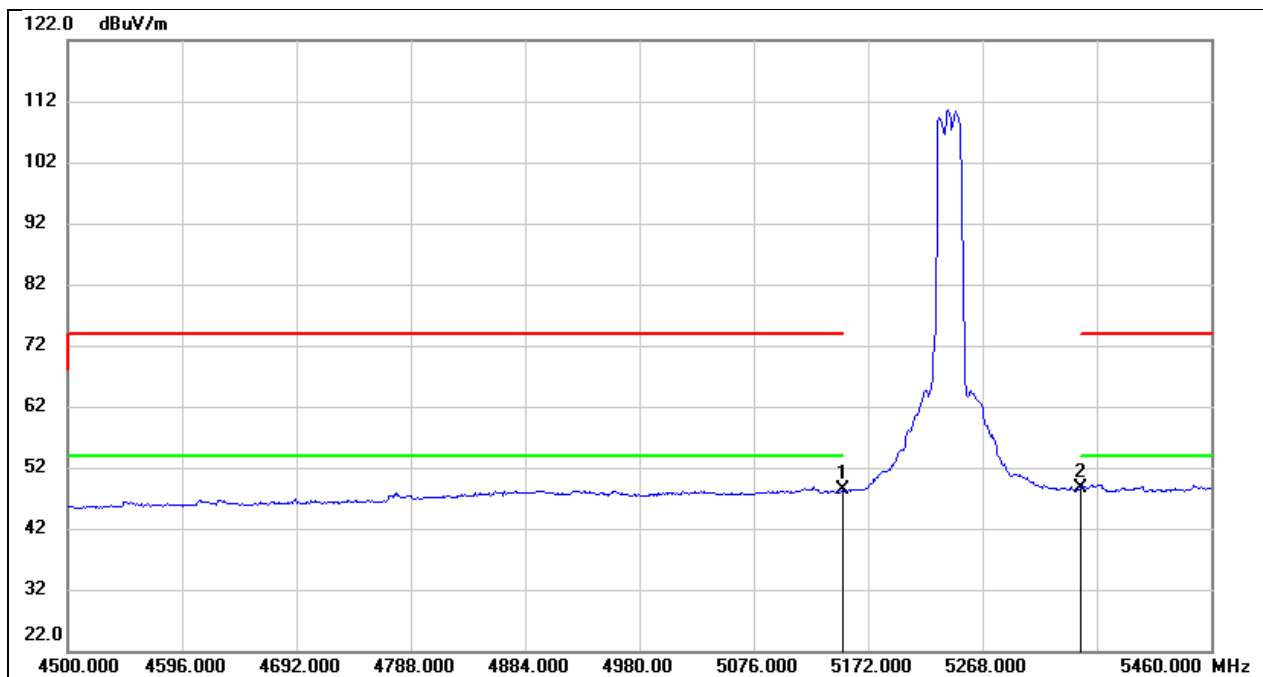

No.	Frequency (MHz)	Reading (dBuV)	Correct (dB/m)	Result (dBuV/m)	Limit (dBuV/m)	Margin (dB)	Remark
1	5150.000	8.02	40.27	48.29	54.00	-5.71	AVG
2	5350.000	8.21	40.49	48.70	54.00	-5.30	AVG

Test Mode:	802.11be EHT20 PK	Frequency(MHz):	5260
Polarity:	Vertical	Test Voltage:	DC 12 V

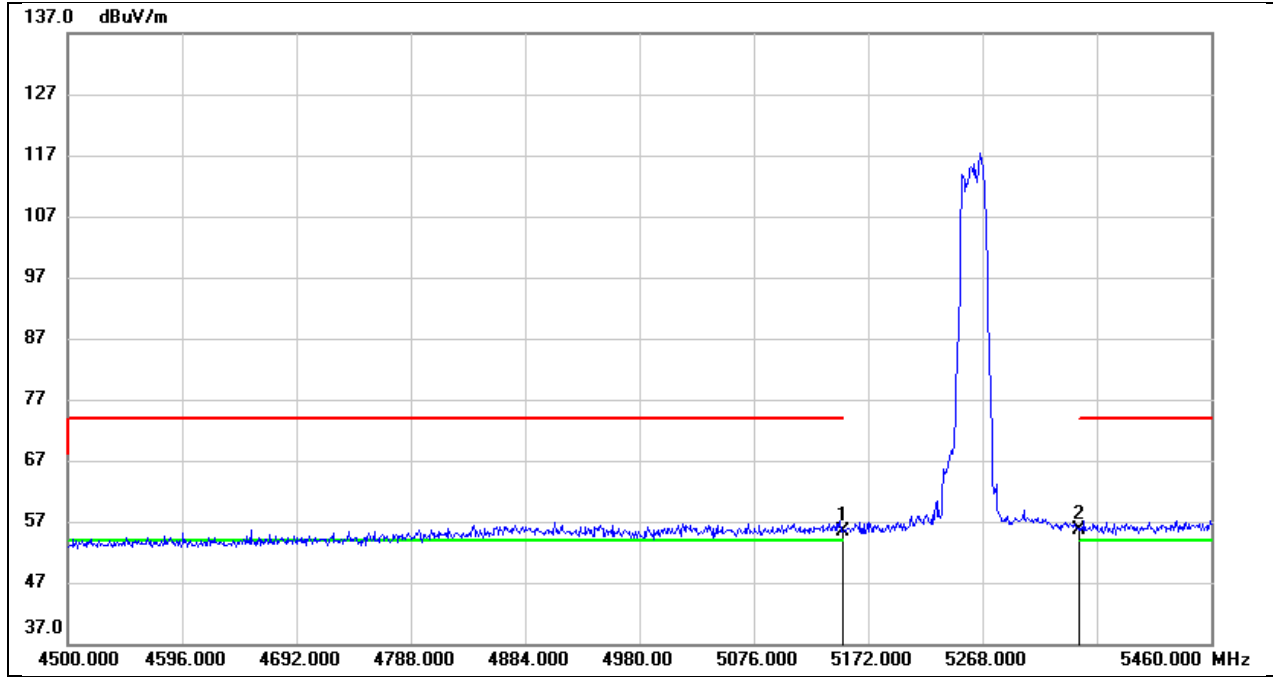

No.	Frequency (MHz)	Reading (dBuV)	Correct (dB/m)	Result (dBuV/m)	Limit (dBuV/m)	Margin (dB)	Remark
1	5150.000	15.23	40.27	55.50	74.00	-18.50	peak
2	5350.000	15.17	40.49	55.66	74.00	-18.34	peak

Test Mode:	802.11be EHT20 AV	Frequency(MHz):	5260
Polarity:	Vertical	Test Voltage:	DC 12 V

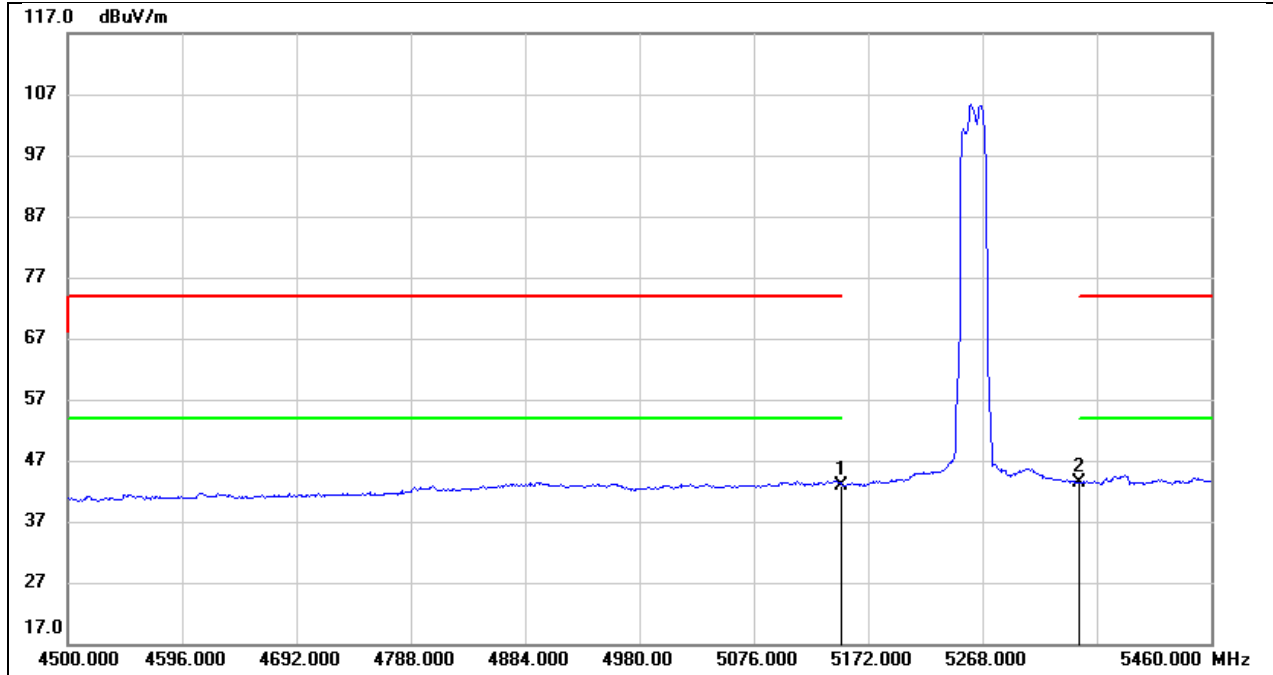

No.	Frequency (MHz)	Reading (dBuV)	Correct (dB/m)	Result (dBuV/m)	Limit (dBuV/m)	Margin (dB)	Remark
1	5150.000	2.58	40.27	42.85	54.00	-11.15	AVG
2	5350.000	2.84	40.49	43.33	54.00	-10.67	AVG

Test Mode:	802.11be EHT20 PK	Frequency(MHz):	5320
Polarity:	Vertical	Test Voltage:	DC 12 V

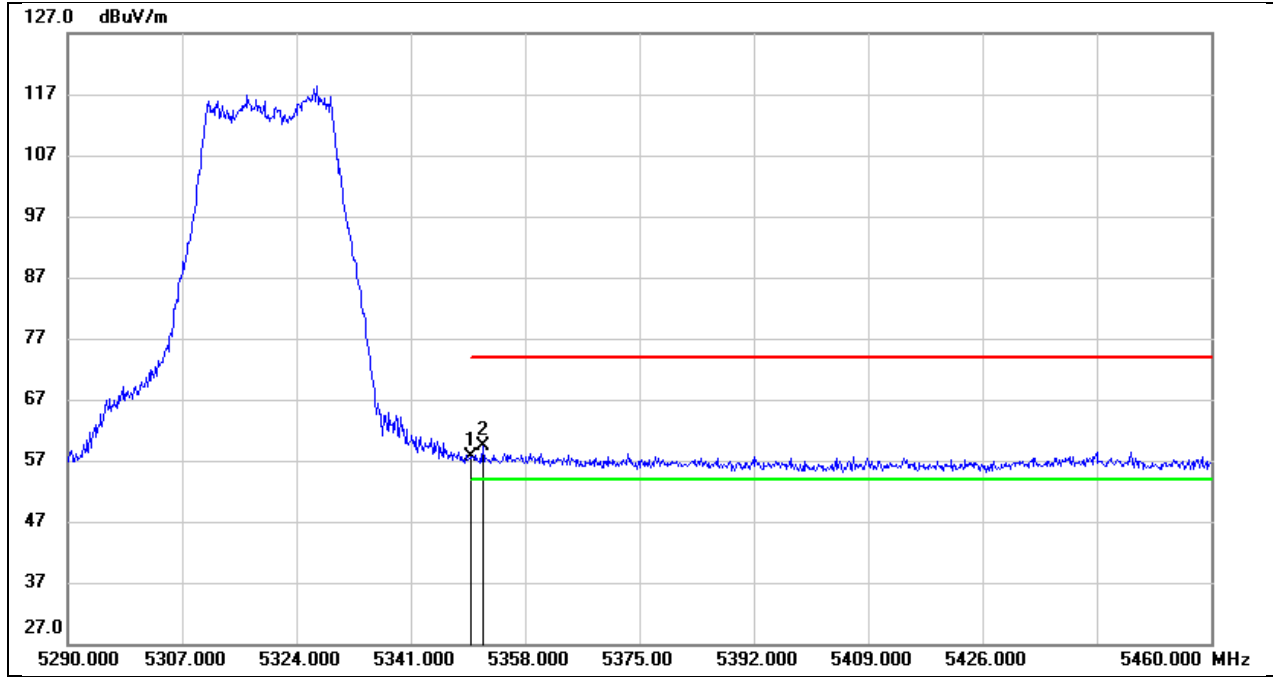

No.	Frequency (MHz)	Reading (dBuV)	Correct (dB/m)	Result (dBuV/m)	Limit (dBuV/m)	Margin (dB)	Remark
1	5350.000	17.08	40.49	57.57	74.00	-16.43	peak
2	5351.710	18.87	40.49	59.36	74.00	-14.64	peak

Test Mode:	802.11be EHT20 AV	Frequency(MHz):	5320
Polarity:	Vertical	Test Voltage:	DC 12 V

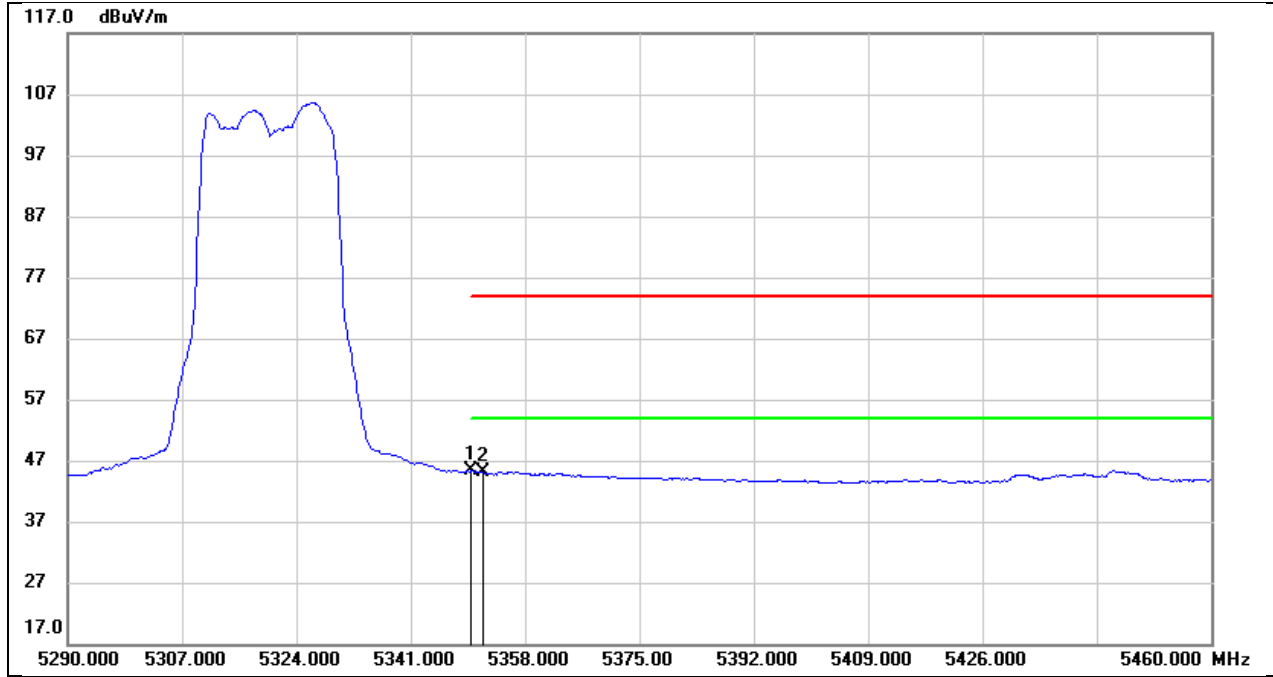

No.	Frequency (MHz)	Reading (dBuV)	Correct (dB/m)	Result (dBuV/m)	Limit (dBuV/m)	Margin (dB)	Remark
1	5350.000	4.80	40.49	45.29	54.00	-8.71	AVG
2	5351.710	4.60	40.49	45.09	54.00	-8.91	AVG

Test Mode:	802.11be EHT20 PK	Frequency(MHz):	5500
Polarity:	Vertical	Test Voltage:	DC 12 V

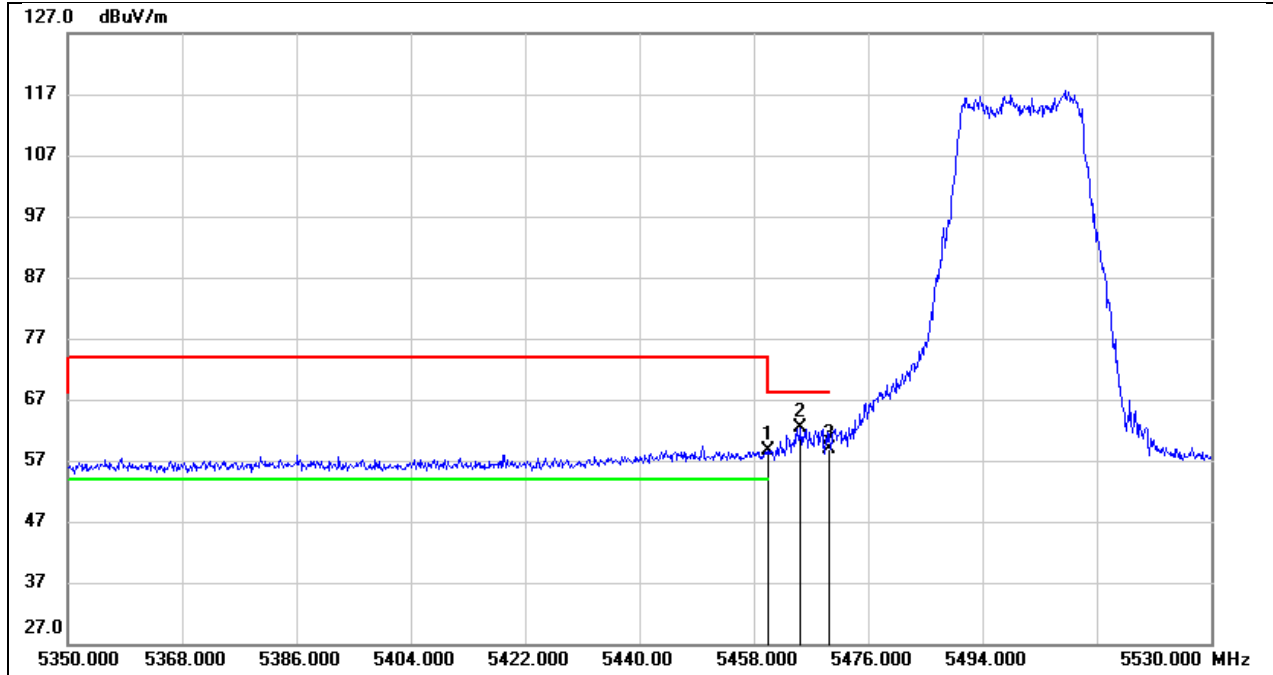

No.	Frequency (MHz)	Reading (dBuV)	Correct (dB/m)	Result (dBuV/m)	Limit (dBuV/m)	Margin (dB)	Remark
1	5460.000	17.90	40.62	58.52	68.20	-9.68	peak
2	5465.380	21.78	40.62	62.40	68.20	-5.80	peak
3	5470.000	18.21	40.63	58.84	68.20	-9.36	peak

Test Mode:	802.11be EHT20 AV	Frequency(MHz):	5500
Polarity:	Vertical	Test Voltage:	DC 12 V

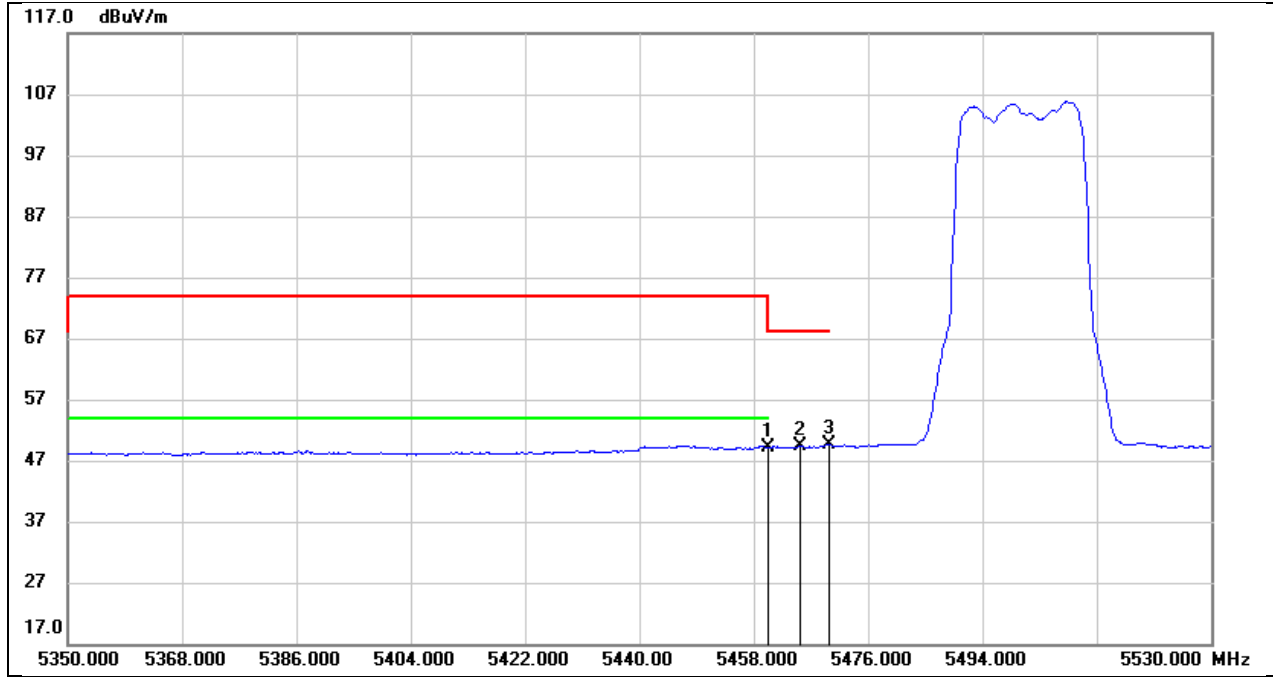

No.	Frequency (MHz)	Reading (dBuV)	Correct (dB/m)	Result (dBuV/m)	Limit (dBuV/m)	Margin (dB)	Remark
1	5460.000	8.57	40.62	49.19	54.00	-4.81	AVG
2	5465.380	8.72	40.62	49.34	68.20	-18.86	AVG
3	5470.000	8.97	40.63	49.60	68.20	-18.60	AVG

Test Mode:	802.11be EHT20 PK	Frequency(MHz):	5700
Polarity:	Vertical	Test Voltage:	DC 12 V

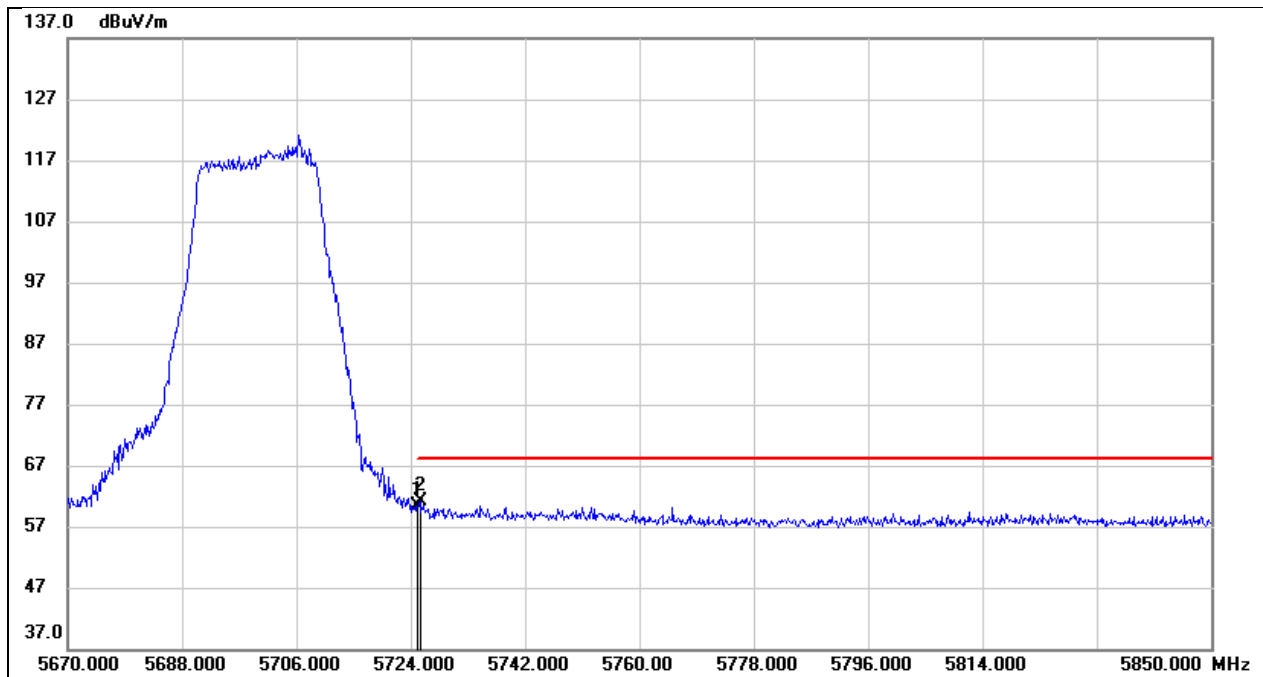

No.	Frequency (MHz)	Reading (dBuV)	Correct (dB/m)	Result (dBuV/m)	Limit (dBuV/m)	Margin (dB)	Remark
1	5725.000	19.14	41.27	60.41	68.20	-7.79	peak
2	5725.440	19.74	41.27	61.01	68.20	-7.19	peak

Test Mode:	802.11be EHT20 PK	Frequency(MHz):	5745
Polarity:	Vertical	Test Voltage:	DC 12 V

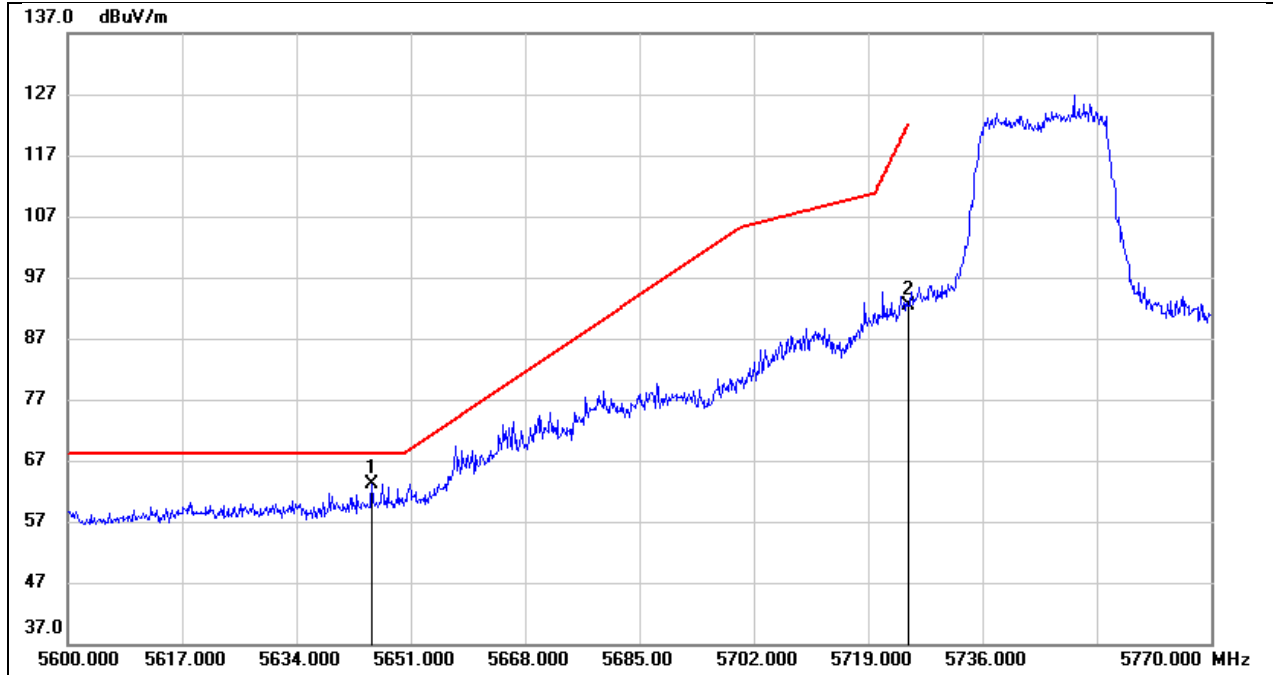

No.	Frequency (MHz)	Reading (dBuV)	Correct (dB/m)	Result (dBuV/m)	Limit (dBuV/m)	Margin (dB)	Remark
1	5645.220	22.00	41.05	63.05	68.20	-5.15	peak
2	5725.000	51.15	41.27	92.42	122.20	-29.78	peak

Test Mode:	802.11be EHT20 PK	Frequency(MHz):	5825
Polarity:	Vertical	Test Voltage:	DC 12 V

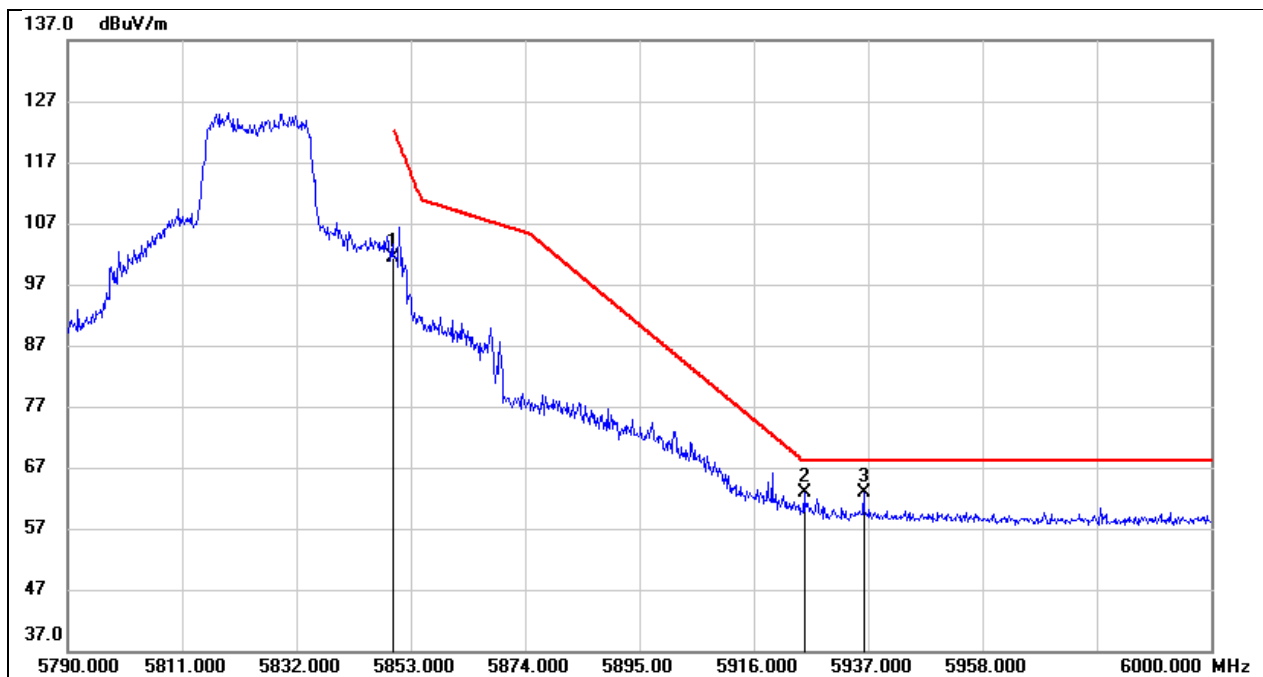

No.	Frequency (MHz)	Reading (dBuV)	Correct (dB/m)	Result (dBuV/m)	Limit (dBuV/m)	Margin (dB)	Remark
1	5850.000	59.81	41.60	101.41	122.20	-20.79	peak
2	5925.240	21.17	41.80	62.97	68.20	-5.23	peak
3	5936.160	21.13	41.83	62.96	68.20	-5.24	peak

Test Mode:	802.11be EHT40 PK	Frequency(MHz):	5190
Polarity:	Vertical	Test Voltage:	DC 12 V

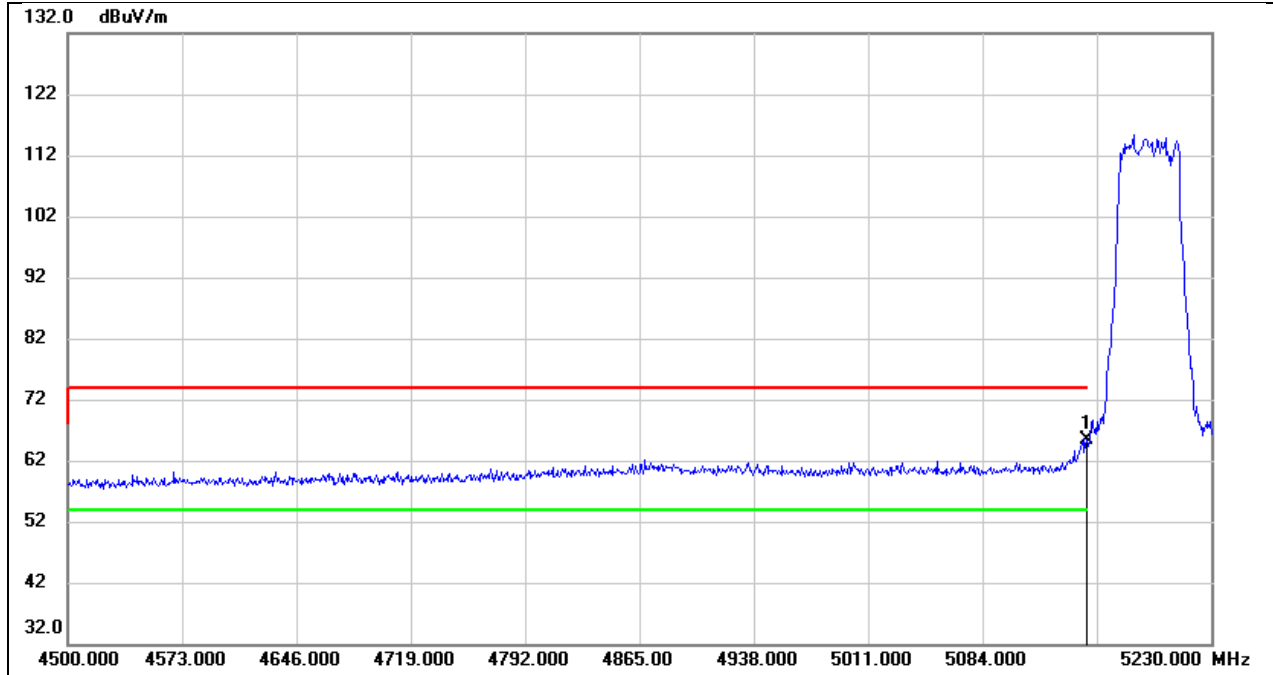

No.	Frequency (MHz)	Reading (dBuV)	Correct (dB/m)	Result (dBuV/m)	Limit (dBuV/m)	Margin (dB)	Remark
1	5150.000	25.03	40.27	65.30	74.00	-8.70	peak

Test Mode:	802.11be EHT40 AV	Frequency(MHz):	5190
Polarity:	Vertical	Test Voltage:	DC 12 V

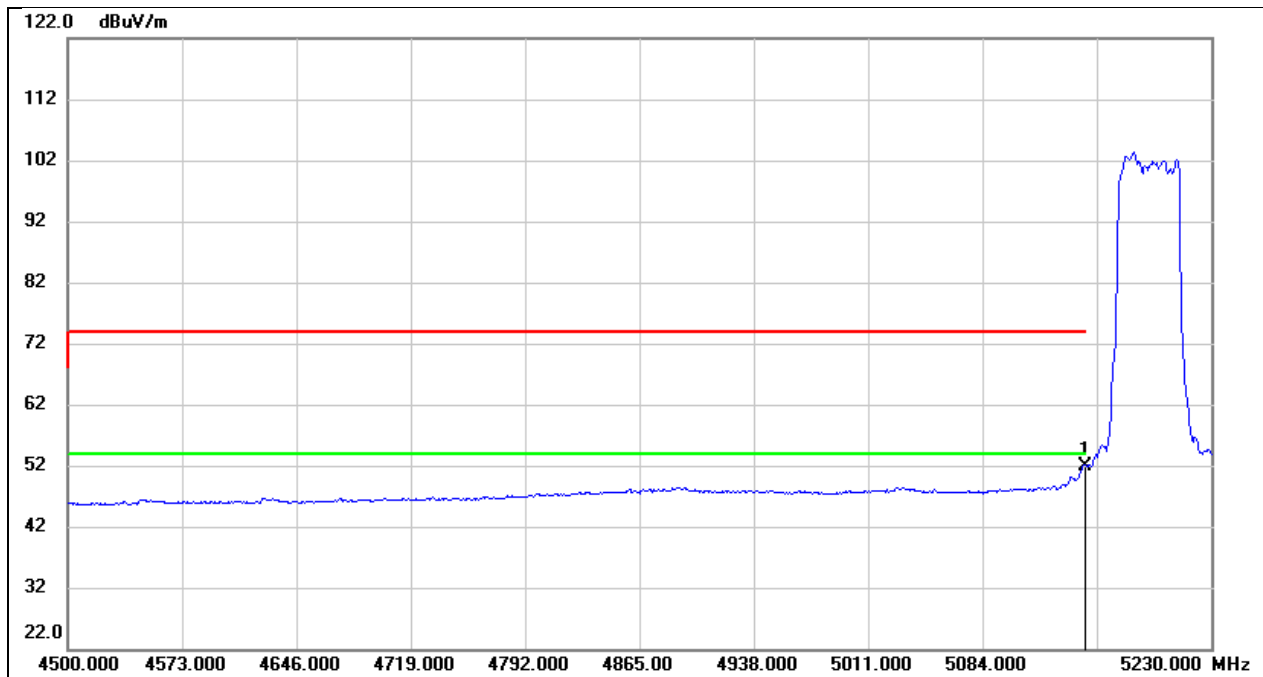

No.	Frequency (MHz)	Reading (dBuV)	Correct (dB/m)	Result (dBuV/m)	Limit (dBuV/m)	Margin (dB)	Remark
1	5150.000	11.71	40.27	51.98	54.00	-2.02	AVG

Test Mode:	802.11be EHT40 PK	Frequency(MHz):	5230
Polarity:	Vertical	Test Voltage:	DC 12 V

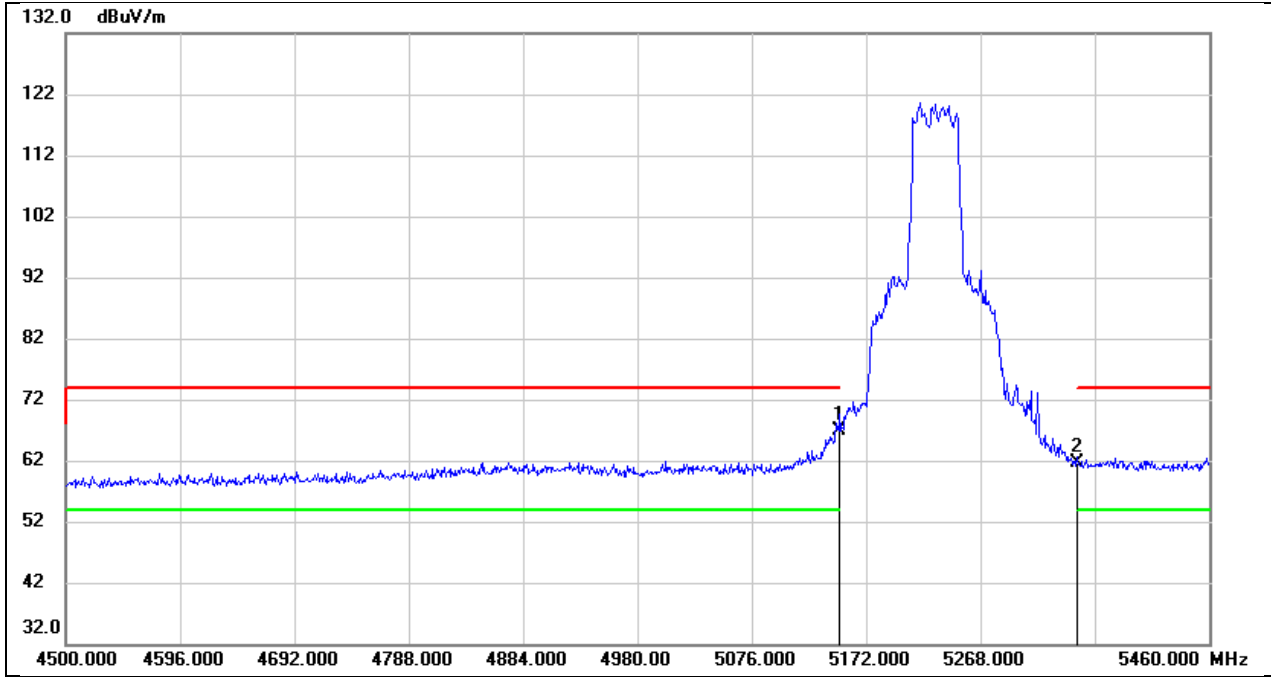

No.	Frequency (MHz)	Reading (dBuV)	Correct (dB/m)	Result (dBuV/m)	Limit (dBuV/m)	Margin (dB)	Remark
1	5150.000	26.72	40.27	66.99	74.00	-7.01	peak
2	5350.000	21.11	40.49	61.60	74.00	-12.40	peak

Test Mode:	802.11be EHT40 AV	Frequency(MHz):	5230
Polarity:	Vertical	Test Voltage:	DC 12 V

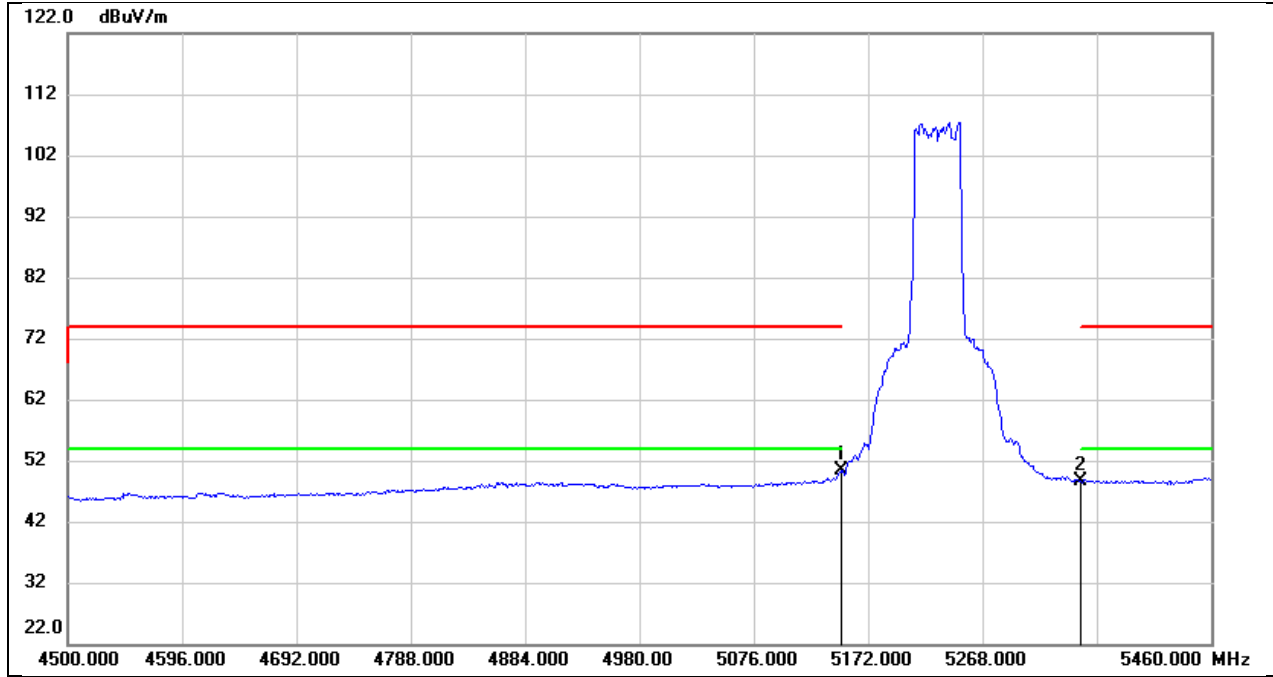

No.	Frequency (MHz)	Reading (dBuV)	Correct (dB/m)	Result (dBuV/m)	Limit (dBuV/m)	Margin (dB)	Remark
1	5150.000	10.04	40.27	50.31	54.00	-3.69	AVG
2	5350.000	8.21	40.49	48.70	54.00	-5.30	AVG

Test Mode:	802.11be EHT40 PK	Frequency(MHz):	5270
Polarity:	Vertical	Test Voltage:	DC 12 V

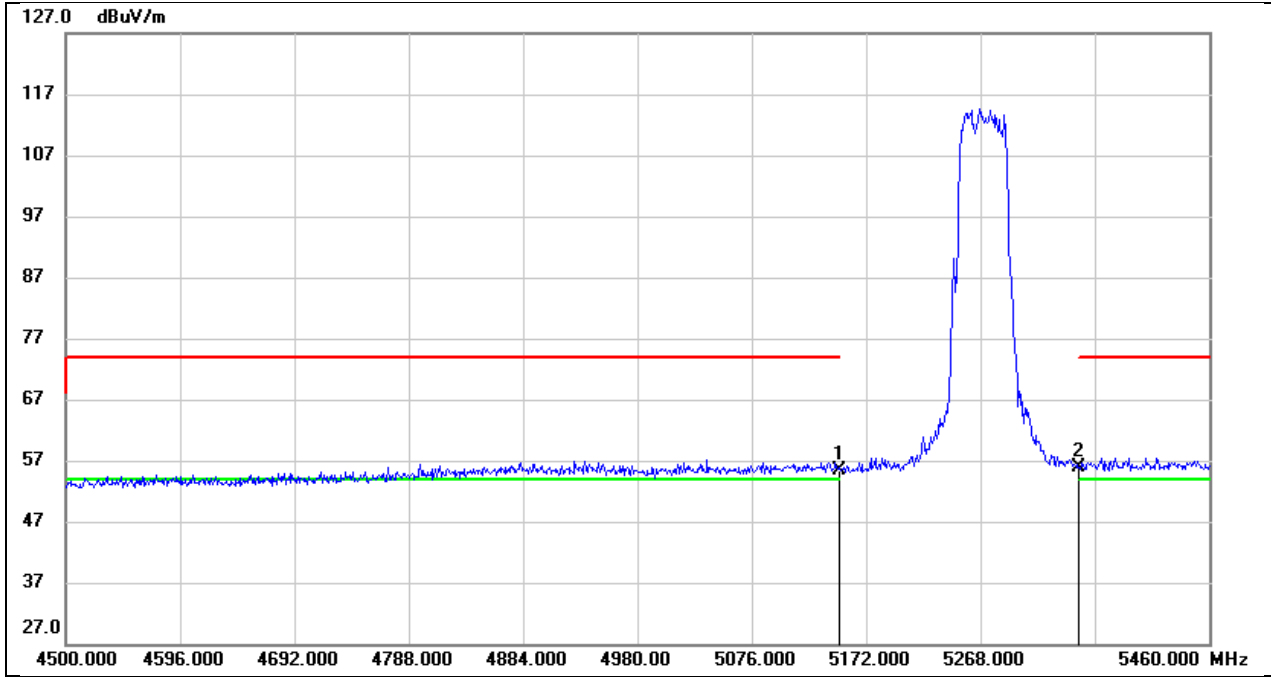

No.	Frequency (MHz)	Reading (dBuV)	Correct (dB/m)	Result (dBuV/m)	Limit (dBuV/m)	Margin (dB)	Remark
1	5150.000	15.21	40.27	55.48	74.00	-18.52	peak
2	5350.000	15.41	40.49	55.90	74.00	-18.10	peak

Test Mode:	802.11be EHT40 AV	Frequency(MHz):	5270
Polarity:	Vertical	Test Voltage:	DC 12 V

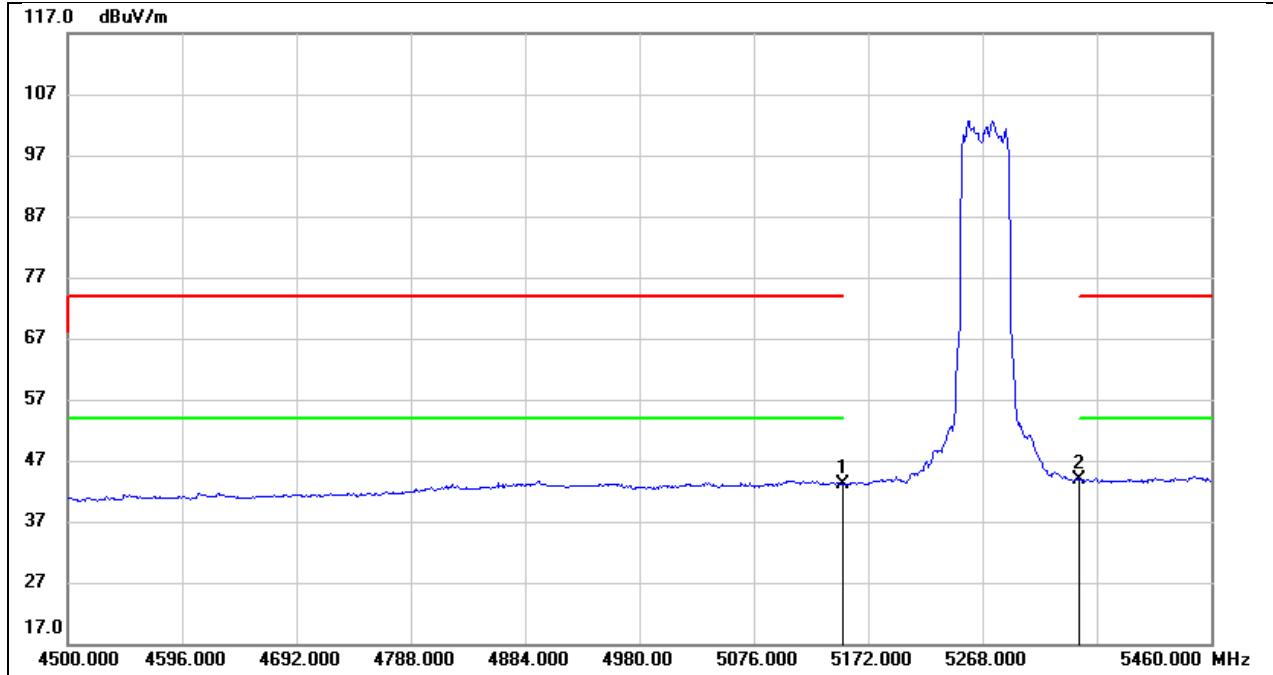

No.	Frequency (MHz)	Reading (dBuV)	Correct (dB/m)	Result (dBuV/m)	Limit (dBuV/m)	Margin (dB)	Remark
1	5150.000	2.84	40.27	43.11	54.00	-10.89	AVG
2	5350.000	3.29	40.49	43.78	54.00	-10.22	AVG

Test Mode:	802.11be EHT40 PK	Frequency(MHz):	5310
Polarity:	Vertical	Test Voltage:	DC 12 V

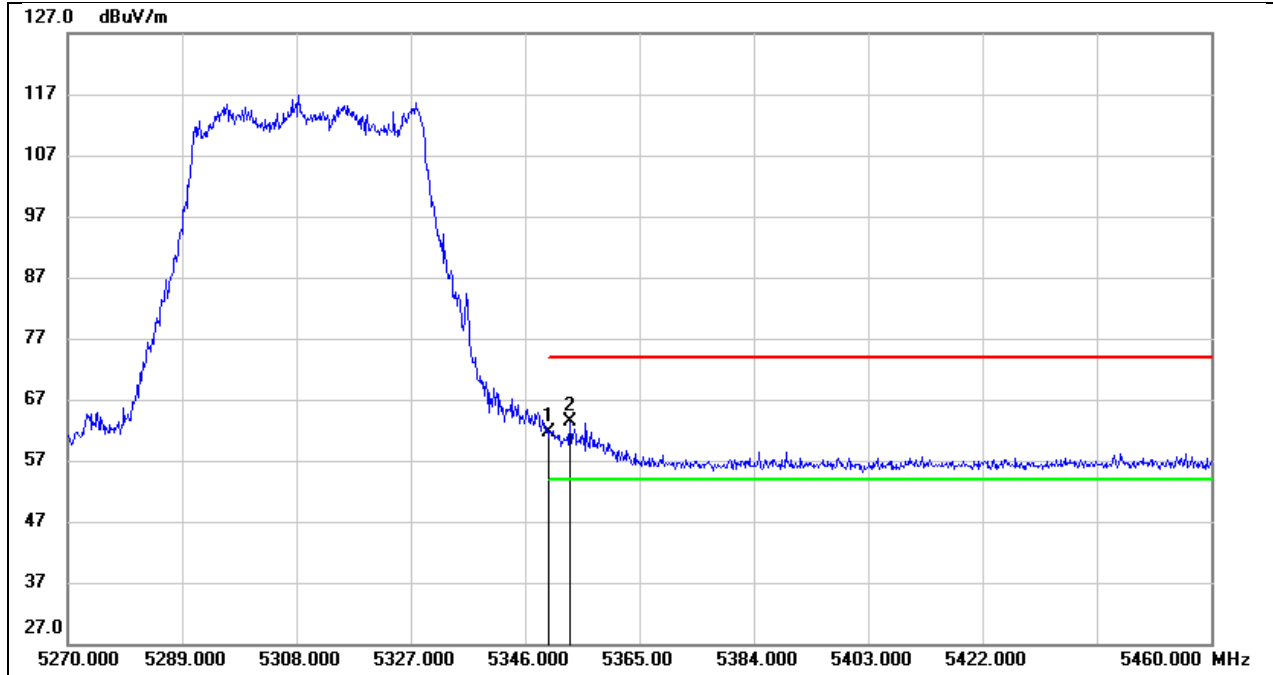

No.	Frequency (MHz)	Reading (dBuV)	Correct (dB/m)	Result (dBuV/m)	Limit (dBuV/m)	Margin (dB)	Remark
1	5350.000	21.02	40.49	61.51	74.00	-12.49	peak
2	5353.410	22.77	40.50	63.27	74.00	-10.73	peak

Test Mode:	802.11be EHT40 AV	Frequency(MHz):	5310
Polarity:	Vertical	Test Voltage:	DC 12 V

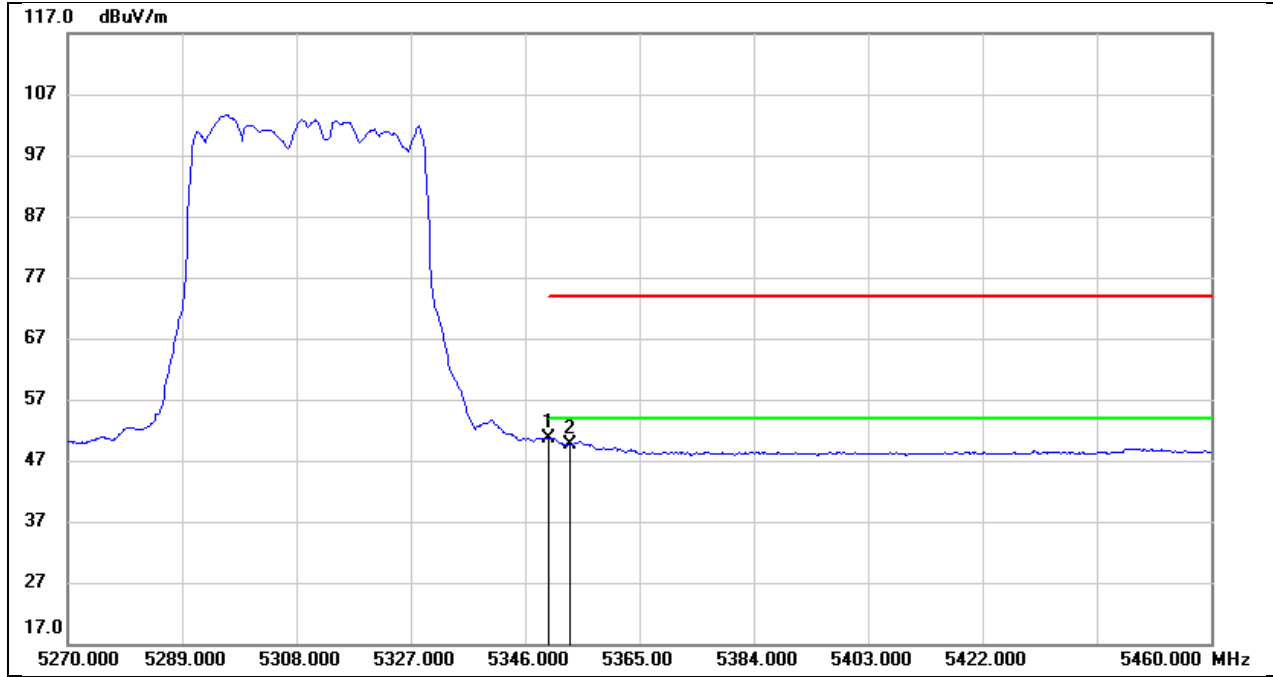

No.	Frequency (MHz)	Reading (dBuV)	Correct (dB/m)	Result (dBuV/m)	Limit (dBuV/m)	Margin (dB)	Remark
1	5350.000	10.09	40.49	50.58	54.00	-3.42	AVG
2	5353.410	9.12	40.50	49.62	54.00	-4.38	AVG

Test Mode:	802.11be EHT40 PK	Frequency(MHz):	5510
Polarity:	Vertical	Test Voltage:	DC 12 V

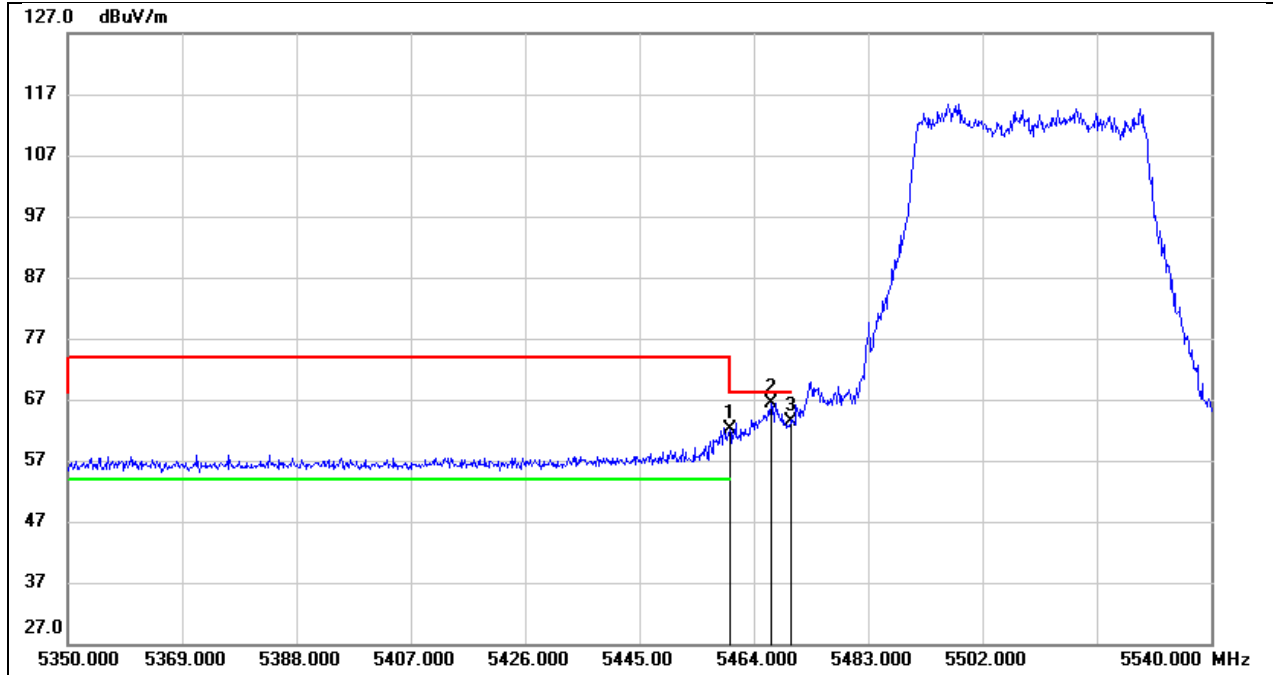

No.	Frequency (MHz)	Reading (dBuV)	Correct (dB/m)	Result (dBuV/m)	Limit (dBuV/m)	Margin (dB)	Remark
1	5460.000	21.44	40.62	62.06	68.20	-6.14	peak
2	5466.850	25.88	40.62	66.50	68.20	-1.70	peak
3	5470.000	22.80	40.63	63.43	68.20	-4.77	peak

Test Mode:	802.11be EHT40 AV	Frequency(MHz):	5510
Polarity:	Vertical	Test Voltage:	DC 12 V

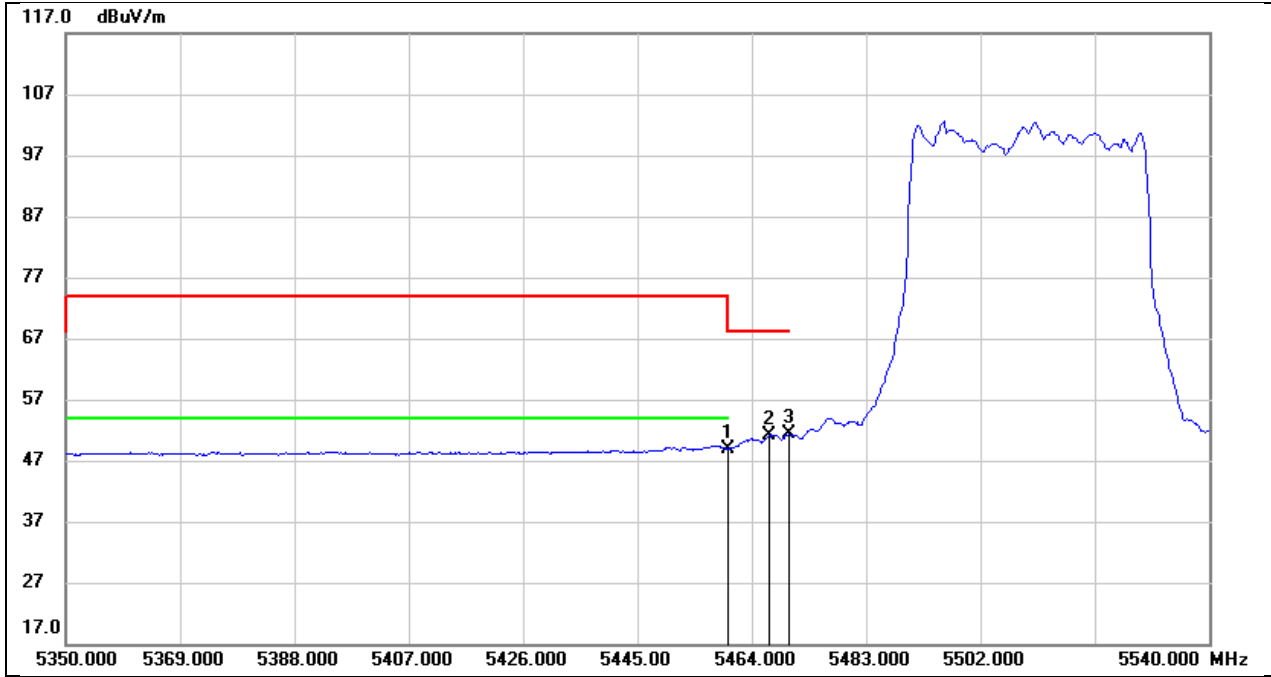

No.	Frequency (MHz)	Reading (dBuV)	Correct (dB/m)	Result (dBuV/m)	Limit (dBuV/m)	Margin (dB)	Remark
1	5460.000	8.36	40.62	48.98	54.00	-5.02	AVG
2	5466.850	10.45	40.62	51.07	68.20	-17.13	AVG
3	5470.000	10.70	40.63	51.33	68.20	-16.87	AVG

Test Mode:	802.11be EHT40 PK	Frequency(MHz):	5670
Polarity:	Vertical	Test Voltage:	DC 12 V

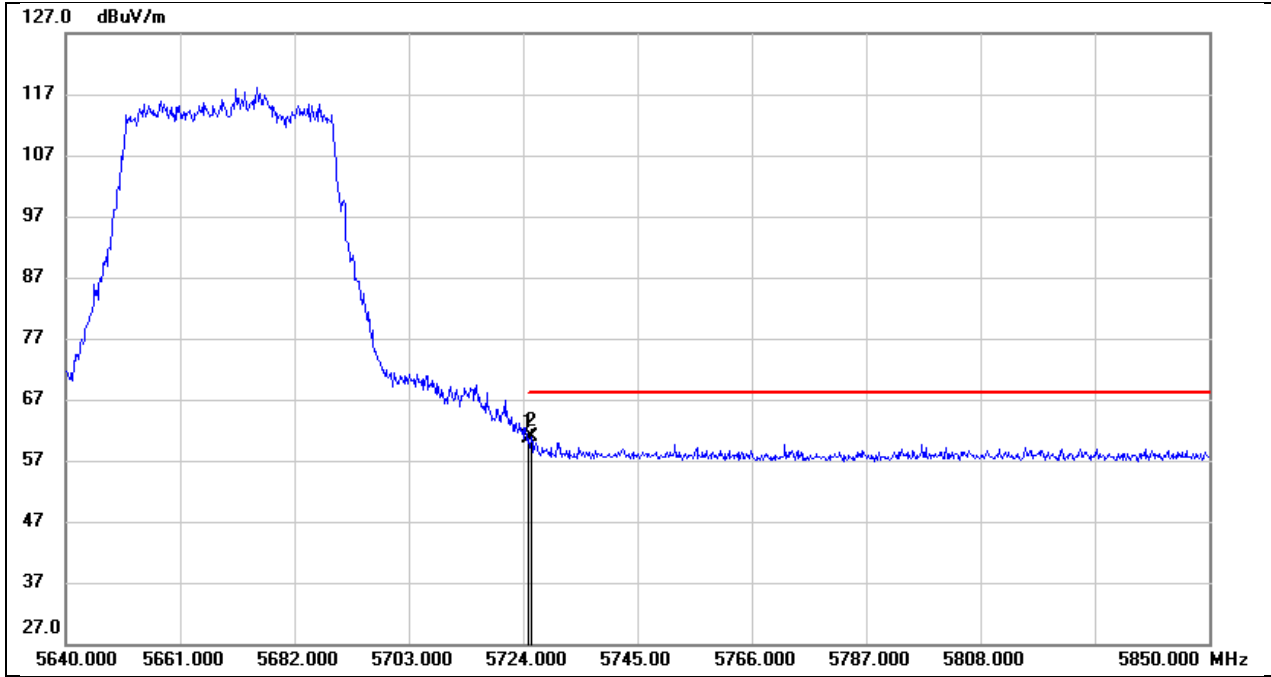

No.	Frequency (MHz)	Reading (dBuV)	Correct (dB/m)	Result (dBuV/m)	Limit (dBuV/m)	Margin (dB)	Remark
1	5725.000	19.47	41.27	60.74	68.20	-7.46	peak
2	5725.470	19.57	41.27	60.84	68.20	-7.36	peak

Test Mode:	802.11be EHT40 PK	Frequency(MHz):	5755
Polarity:	Vertical	Test Voltage:	DC 12 V

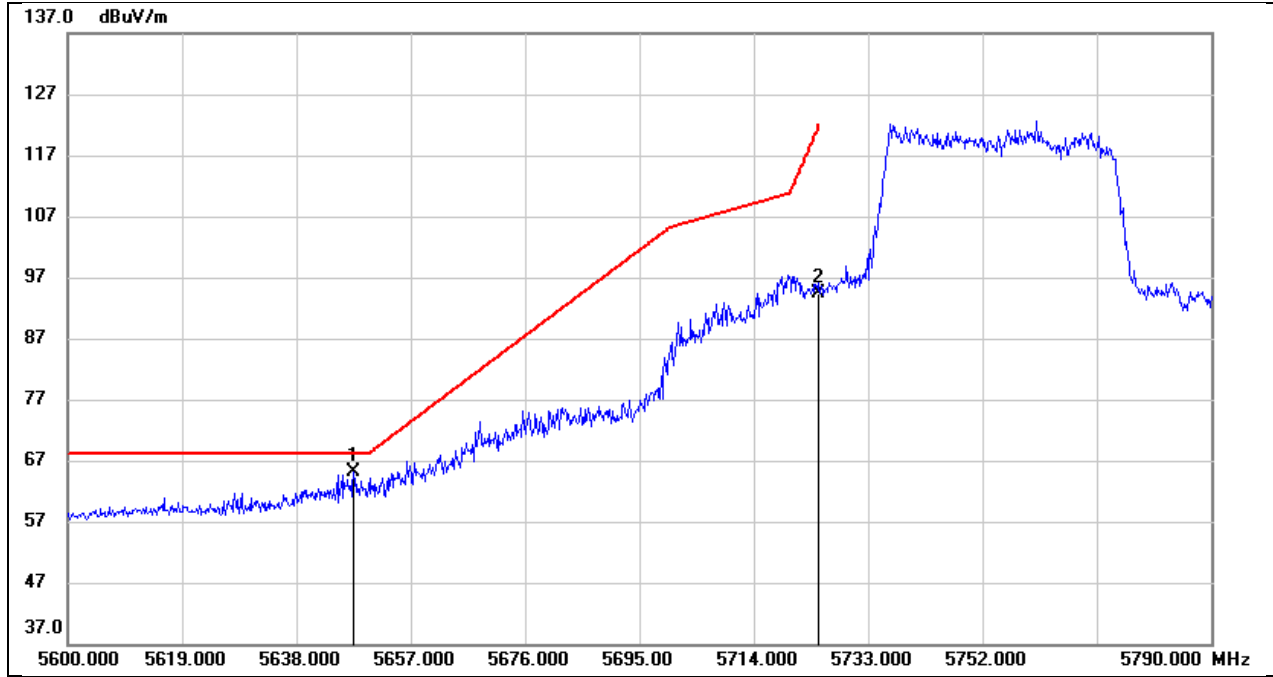

No.	Frequency (MHz)	Reading (dBuV)	Correct (dB/m)	Result (dBuV/m)	Limit (dBuV/m)	Margin (dB)	Remark
1	5647.500	24.04	41.06	65.10	68.20	-3.10	peak
2	5725.000	53.19	41.27	94.46	122.20	-27.74	peak

Test Mode:	802.11be EHT40 PK	Frequency(MHz):	5795
Polarity:	Vertical	Test Voltage:	DC 12 V

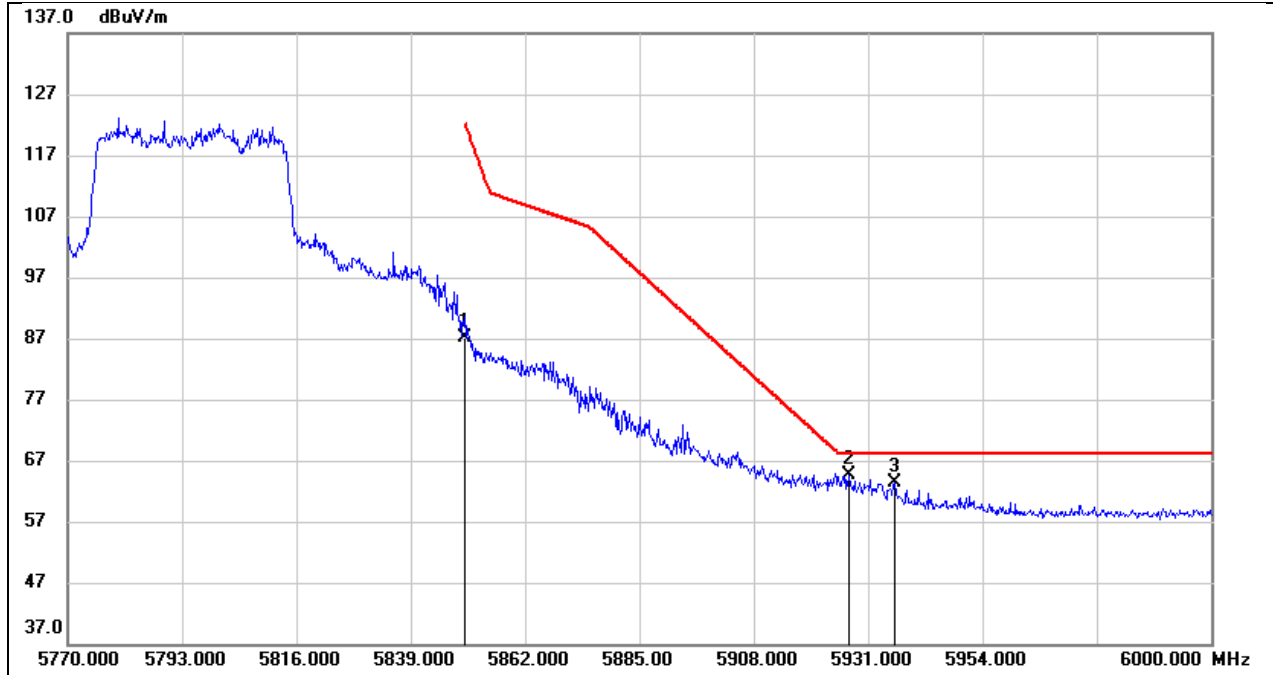

No.	Frequency (MHz)	Reading (dBuV)	Correct (dB/m)	Result (dBuV/m)	Limit (dBuV/m)	Margin (dB)	Remark
1	5850.000	45.41	41.60	87.01	122.20	-35.19	peak
2	5927.090	22.83	41.81	64.64	68.20	-3.56	peak
3	5936.290	21.51	41.83	63.34	68.20	-4.86	peak

Test Mode:	802.11be EHT80 PK	Frequency(MHz):	5210
Polarity:	Vertical	Test Voltage:	DC 12 V

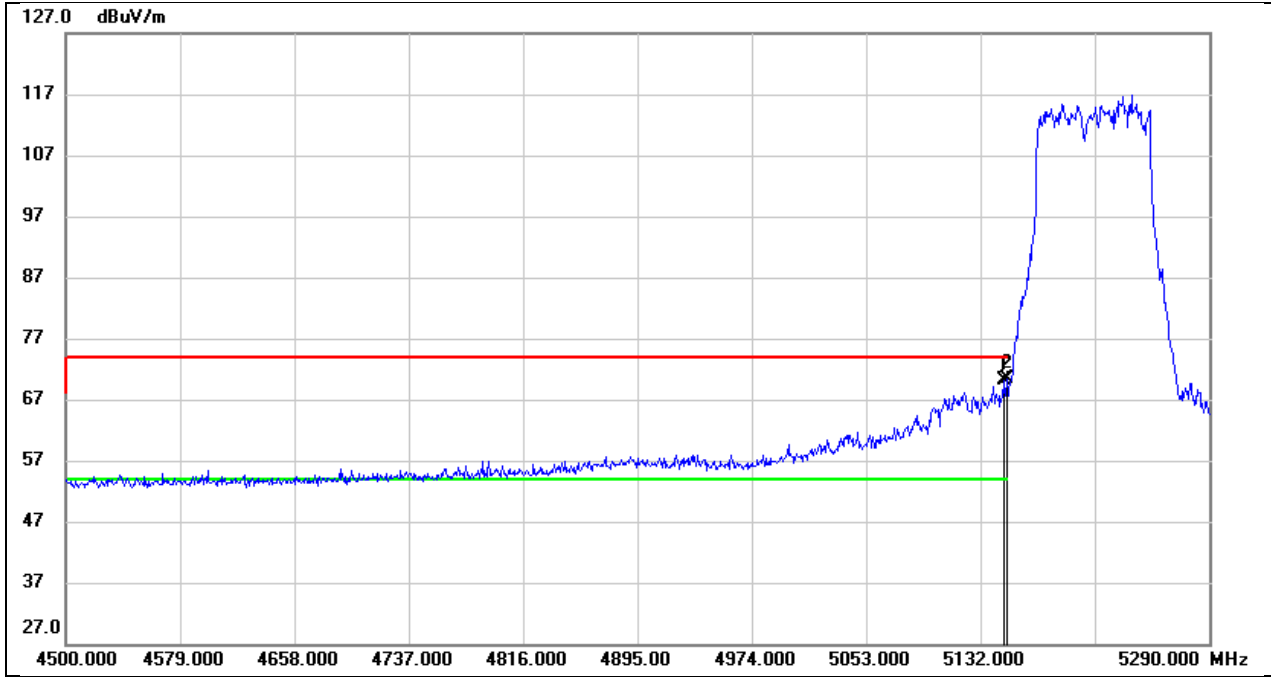

No.	Frequency (MHz)	Reading (dBuV)	Correct (dB/m)	Result (dBuV/m)	Limit (dBuV/m)	Margin (dB)	Remark
1	5147.800	29.75	40.28	70.03	74.00	-3.97	peak
2	5150.000	30.22	40.27	70.49	74.00	-3.51	peak

Test Mode:	802.11be EHT80 AV	Frequency(MHz):	5210
Polarity:	Vertical	Test Voltage:	DC 12 V

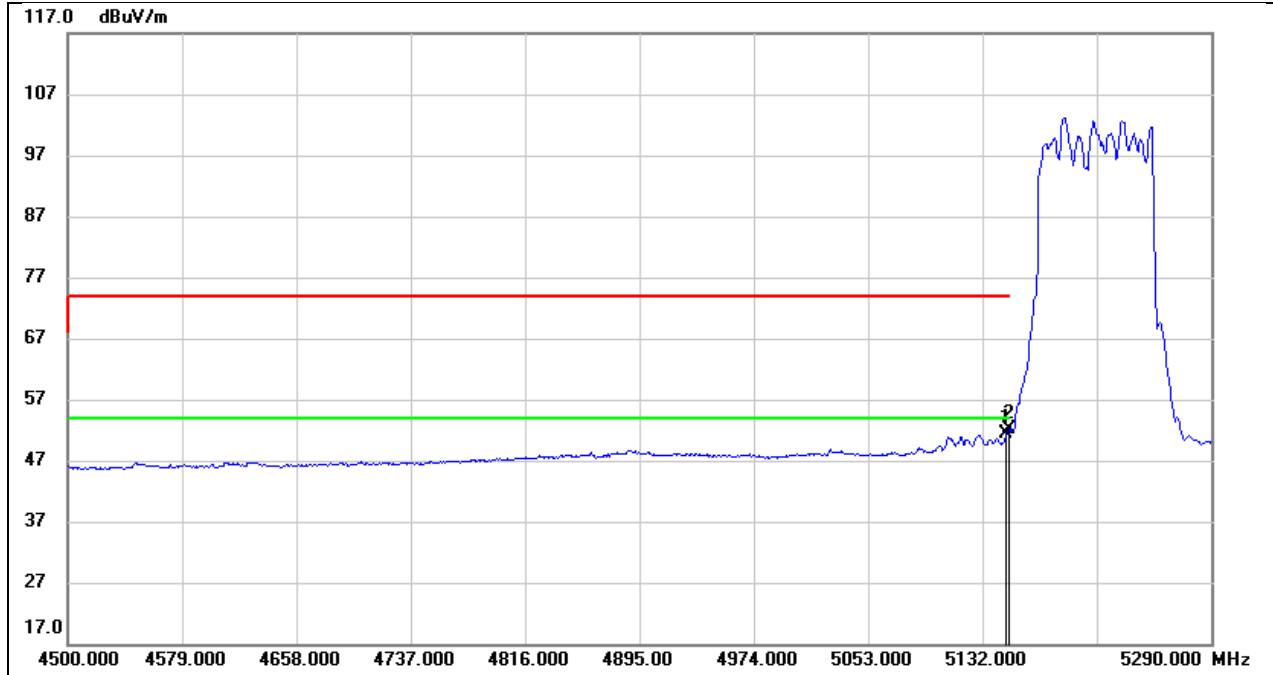

No.	Frequency (MHz)	Reading (dBuV)	Correct (dB/m)	Result (dBuV/m)	Limit (dBuV/m)	Margin (dB)	Remark
1	5147.800	11.07	40.28	51.35	54.00	-2.65	AVG
2	5150.000	11.76	40.27	52.03	54.00	-1.97	AVG

Test Mode:	802.11be EHT80 PK	Frequency(MHz):	5290
Polarity:	Vertical	Test Voltage:	DC 12 V

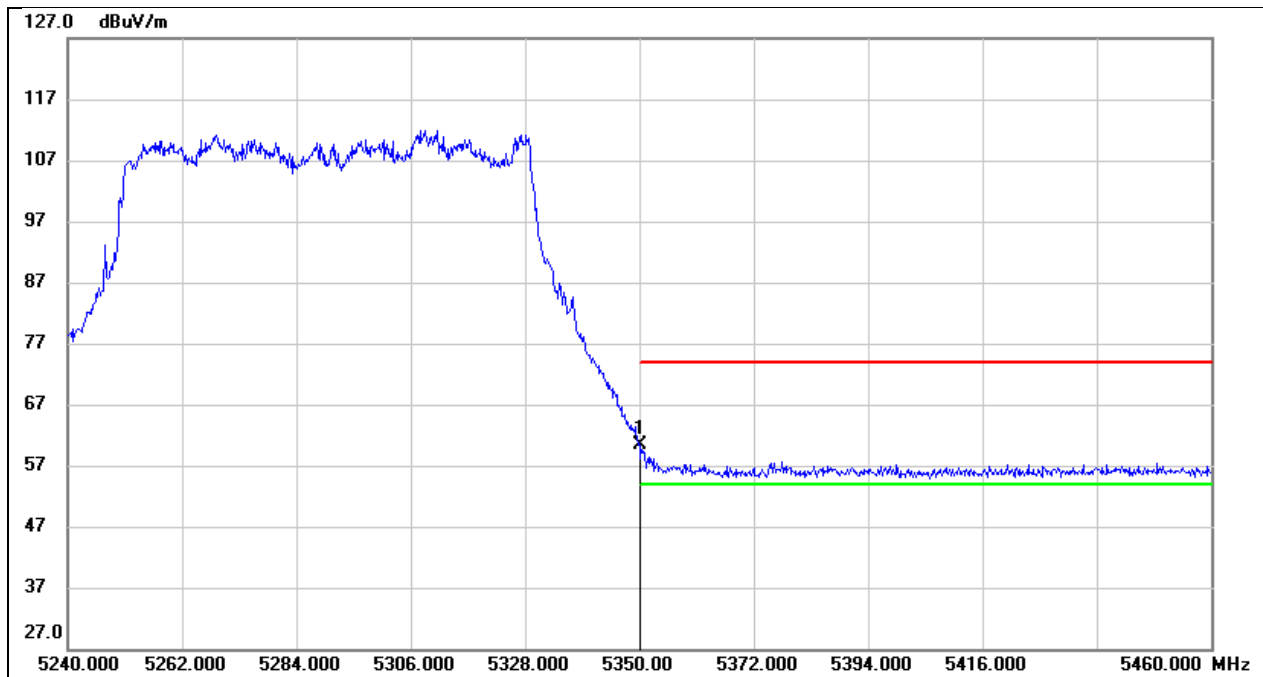

No.	Frequency (MHz)	Reading (dBuV)	Correct (dB/m)	Result (dBuV/m)	Limit (dBuV/m)	Margin (dB)	Remark
1	5350.000	19.88	40.49	60.37	74.00	-13.63	peak

Test Mode:	802.11be EHT80 AV	Frequency(MHz):	5290
Polarity:	Vertical	Test Voltage:	DC 12 V

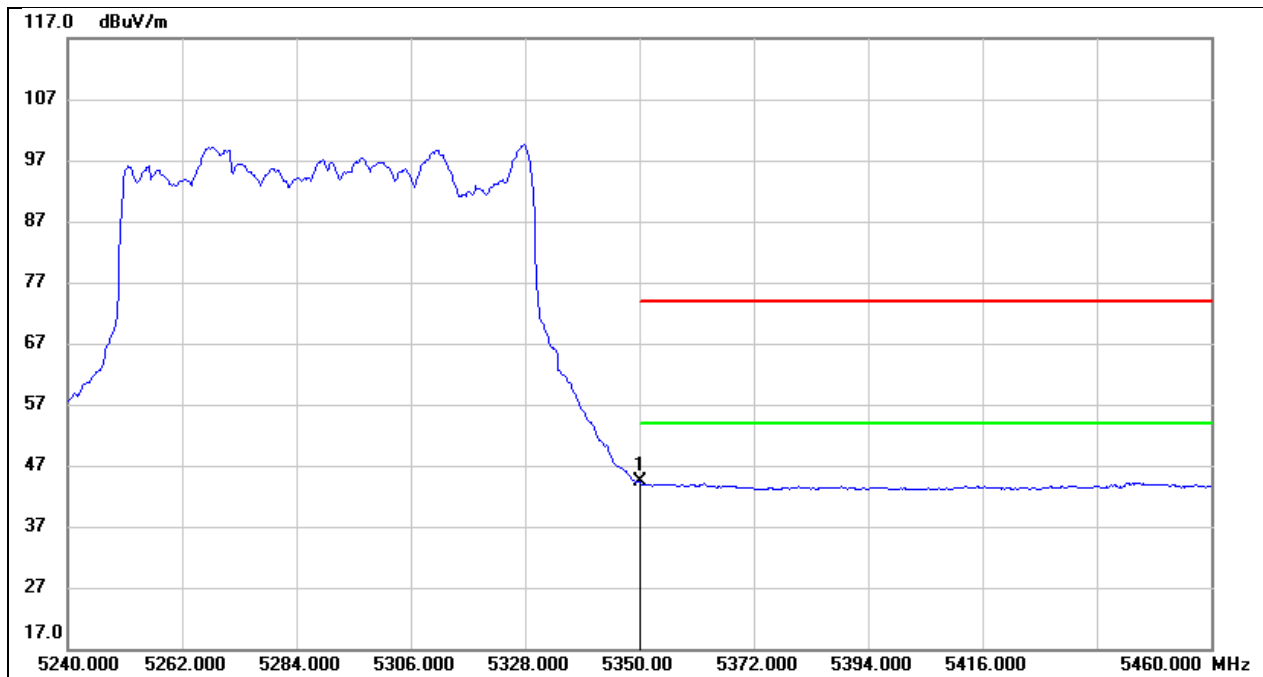

No.	Frequency (MHz)	Reading (dBuV)	Correct (dB/m)	Result (dBuV/m)	Limit (dBuV/m)	Margin (dB)	Remark
1	5350.000	3.87	40.49	44.36	54.00	-9.64	AVG

Test Mode:	802.11be EHT80 PK	Frequency(MHz):	5530
Polarity:	Vertical	Test Voltage:	DC 12 V

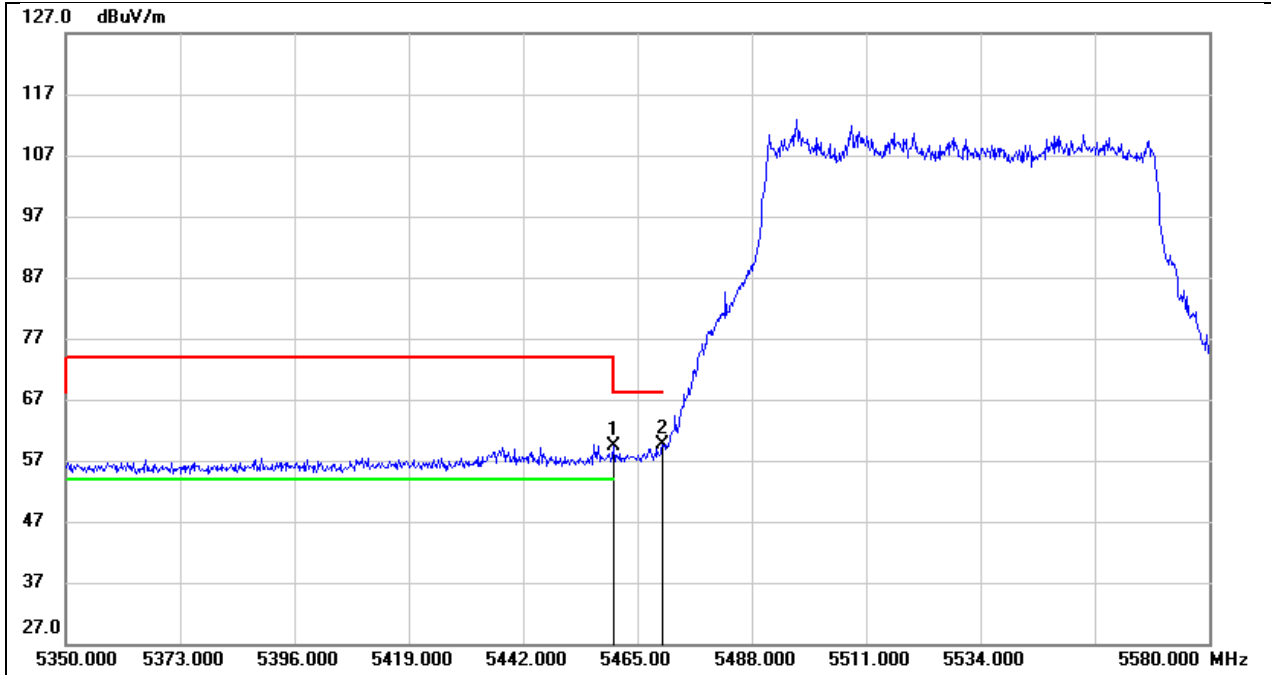

No.	Frequency (MHz)	Reading (dBuV)	Correct (dB/m)	Result (dBuV/m)	Limit (dBuV/m)	Margin (dB)	Remark
1	5460.000	18.73	40.62	59.35	68.20	-8.85	peak
2	5470.000	18.94	40.63	59.57	68.20	-8.63	peak

Test Mode:	802.11be EHT80 AV	Frequency(MHz):	5530
Polarity:	Vertical	Test Voltage:	DC 12 V

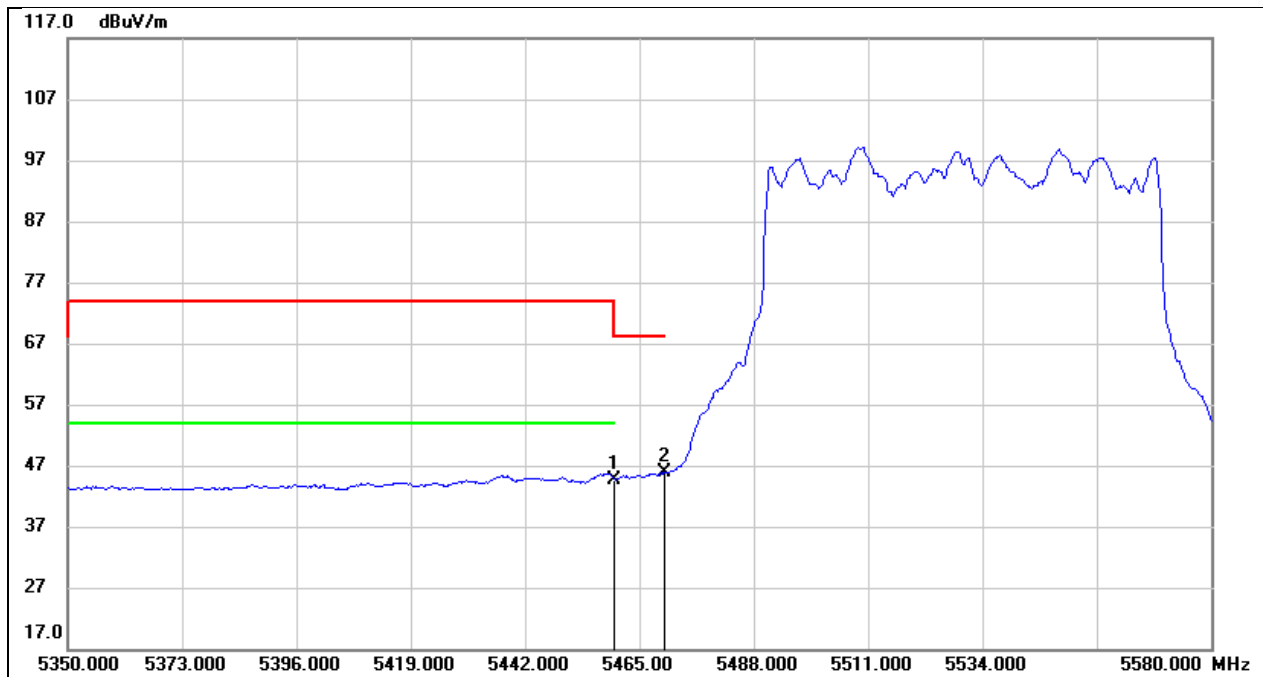

No.	Frequency (MHz)	Reading (dBuV)	Correct (dB/m)	Result (dBuV/m)	Limit (dBuV/m)	Margin (dB)	Remark
1	5460.000	4.06	40.62	44.68	54.00	-9.32	AVG
2	5470.000	5.31	40.63	45.94	68.20	-22.26	AVG

Test Mode:	802.11be EHT80 PK	Frequency(MHz):	5610
Polarity:	Vertical	Test Voltage:	DC 12 V

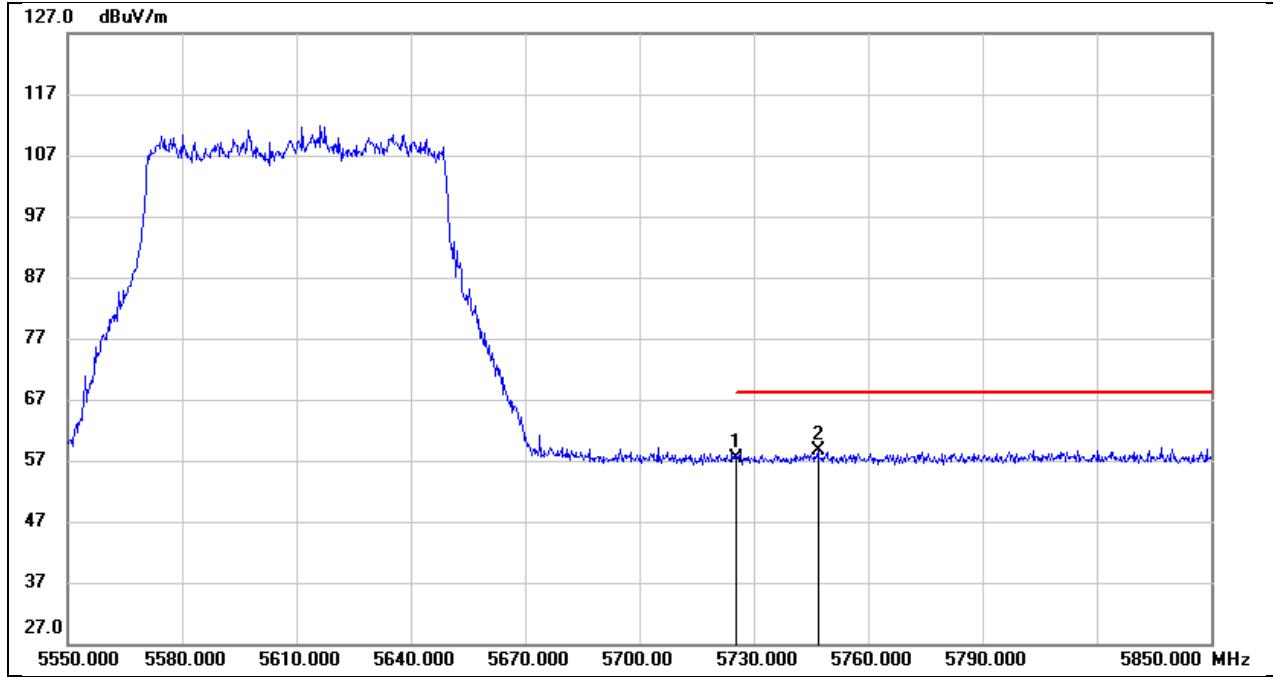

No.	Frequency (MHz)	Reading (dBuV)	Correct (dB/m)	Result (dBuV/m)	Limit (dBuV/m)	Margin (dB)	Remark
1	5725.000	16.11	41.27	57.38	68.20	-10.82	peak
2	5746.800	17.39	41.32	58.71	68.20	-9.49	peak

Test Mode:	802.11be EHT80 PK	Frequency(MHz):	5775
Polarity:	Vertical	Test Voltage:	DC 12 V

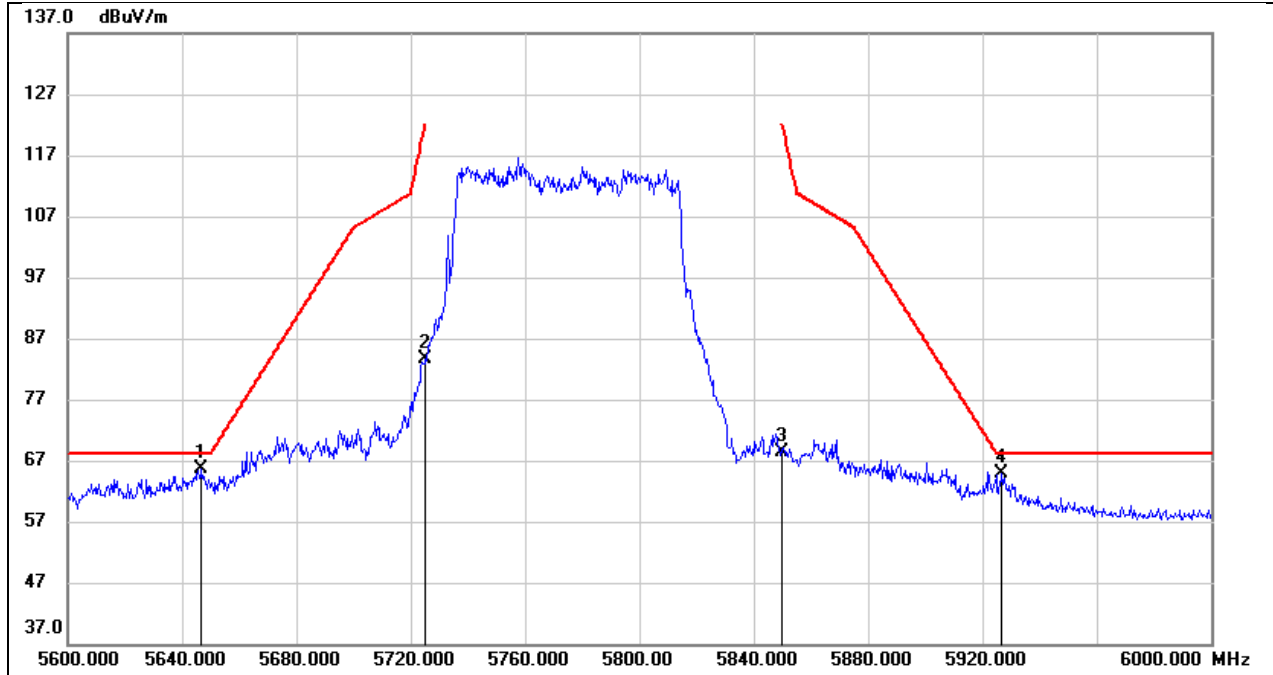

No.	Frequency (MHz)	Reading (dBuV)	Correct (dB/m)	Result (dBuV/m)	Limit (dBuV/m)	Margin (dB)	Remark
1	5646.800	24.66	41.06	65.72	68.20	-2.48	peak
2	5725.000	42.48	41.27	83.75	122.20	-38.45	peak
3	5850.000	26.79	41.60	68.39	122.20	-53.81	peak
4	5926.800	23.01	41.81	64.82	68.20	-3.38	peak

Test Mode:	802.11be EHT160 PK	Frequency(MHz):	5250
Polarity:	Vertical	Test Voltage:	DC 12 V

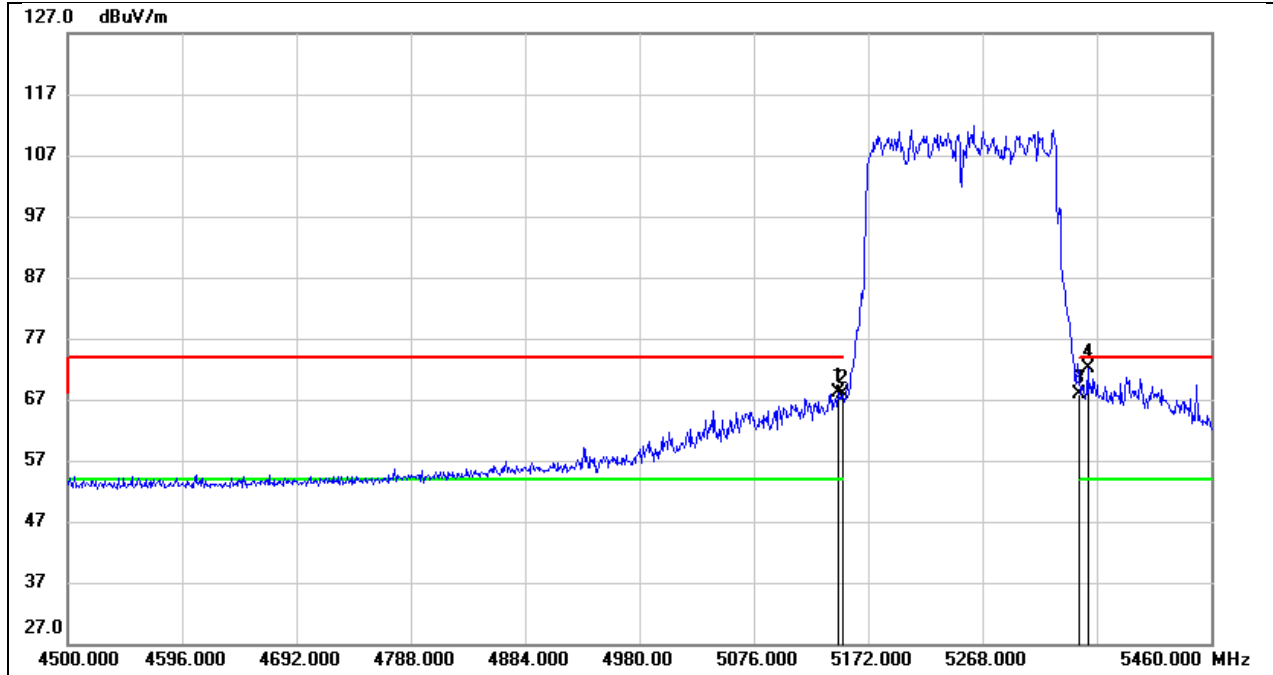

No.	Frequency (MHz)	Reading (dBuV)	Correct (dB/m)	Result (dBuV/m)	Limit (dBuV/m)	Margin (dB)	Remark
1	5147.040	27.93	40.27	68.20	74.00	-5.80	peak
2	5150.000	27.58	40.27	67.85	74.00	-6.15	peak
3	5350.000	27.48	40.49	67.97	74.00	-6.03	peak
4	5356.320	31.56	40.50	72.06	74.00	-1.94	peak

Test Mode:	802.11be EHT160 AV	Frequency(MHz):	5250
Polarity:	Vertical	Test Voltage:	DC 12 V

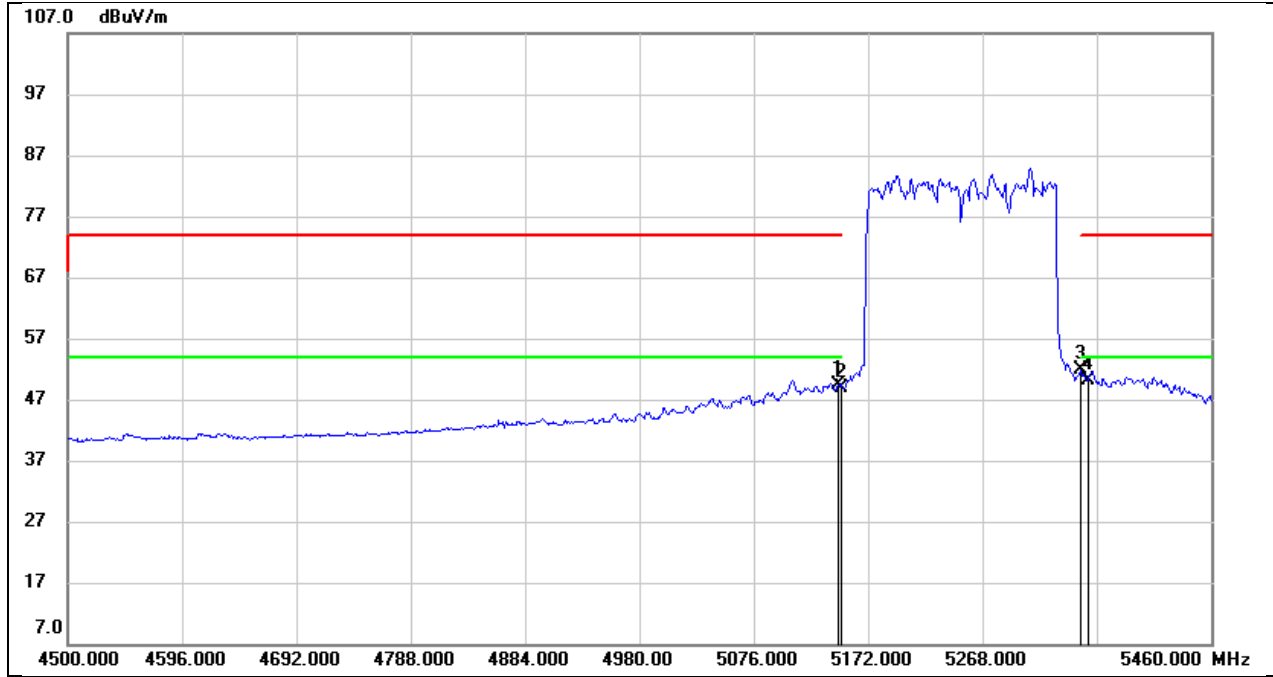

No.	Frequency (MHz)	Reading (dBuV)	Correct (dB/m)	Result (dBuV/m)	Limit (dBuV/m)	Margin (dB)	Remark
1	5147.040	9.00	40.27	49.27	54.00	-4.73	AVG
2	5150.000	8.50	40.27	48.77	54.00	-5.23	AVG
3	5350.000	11.41	40.49	51.90	54.00	-2.10	AVG
4	5356.320	9.73	40.50	50.23	54.00	-3.77	AVG

Test Mode:	802.11be EHT160 PK	Frequency(MHz):	5570
Polarity:	Vertical	Test Voltage:	DC 12 V

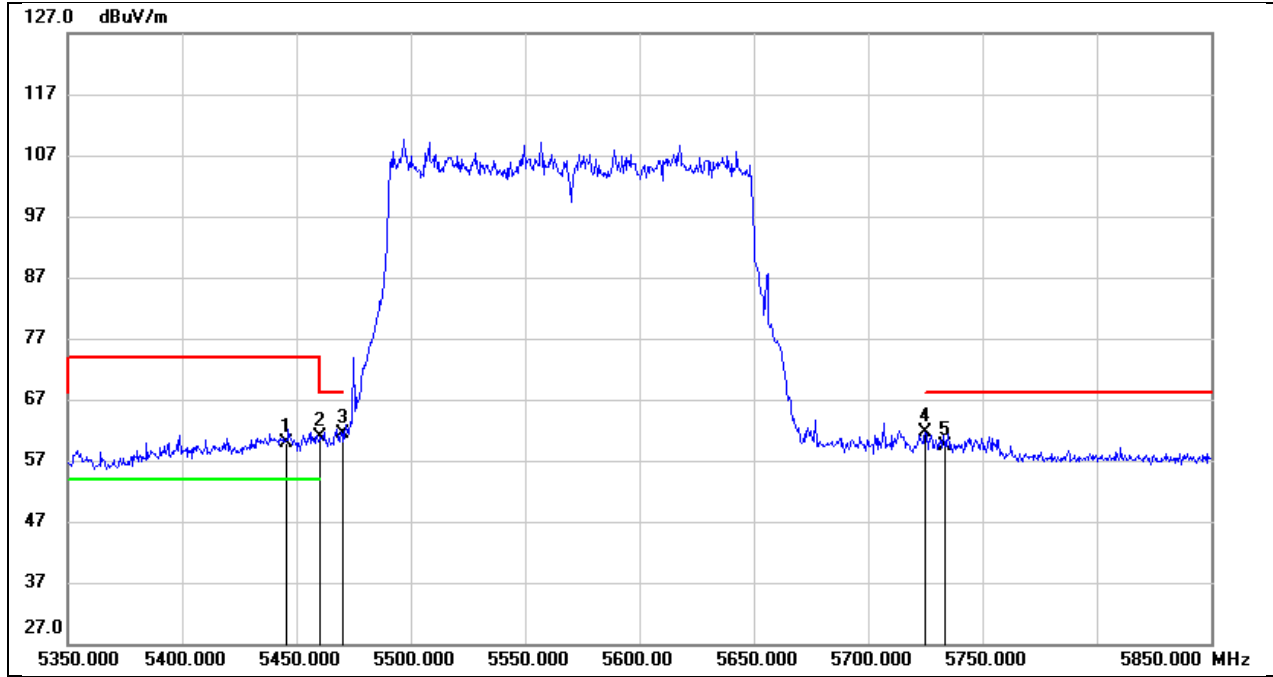

No.	Frequency (MHz)	Reading (dBuV)	Correct (dB/m)	Result (dBuV/m)	Limit (dBuV/m)	Margin (dB)	Remark
1	5445.500	19.28	40.60	59.88	74.00	-14.12	peak
2	5460.000	20.28	40.62	60.90	68.20	-7.30	peak
3	5470.000	20.72	40.63	61.35	68.20	-6.85	peak
4	5725.000	20.33	41.27	61.60	68.20	-6.60	peak
5	5733.500	18.06	41.28	59.34	68.20	-8.86	peak

Test Mode:	802.11be EHT160 AV	Frequency(MHz):	5570
Polarity:	Vertical	Test Voltage:	DC 12 V

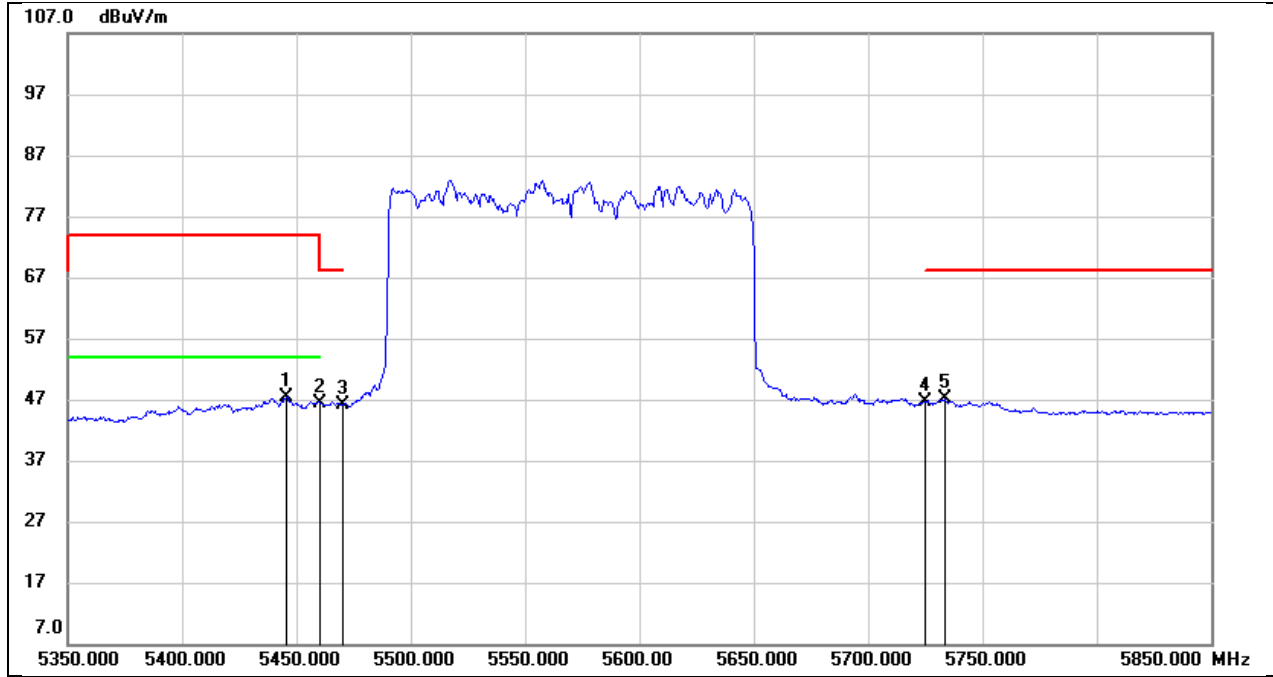

No.	Frequency (MHz)	Reading (dBuV)	Correct (dB/m)	Result (dBuV/m)	Limit (dBuV/m)	Margin (dB)	Remark
1	5445.500	6.76	40.60	47.36	54.00	-6.64	AVG
2	5460.000	5.80	40.62	46.42	54.00	-7.58	AVG
3	5470.000	5.55	40.63	46.18	68.20	-22.02	AVG
4	5725.000	5.32	41.27	46.59	68.20	-21.61	AVG
5	5733.500	5.75	41.28	47.03	68.20	-21.17	AVG

Test Mode:	802.11be EHT240 PK	Frequency(MHz):	5610
Polarity:	Vertical	Test Voltage:	DC 12 V

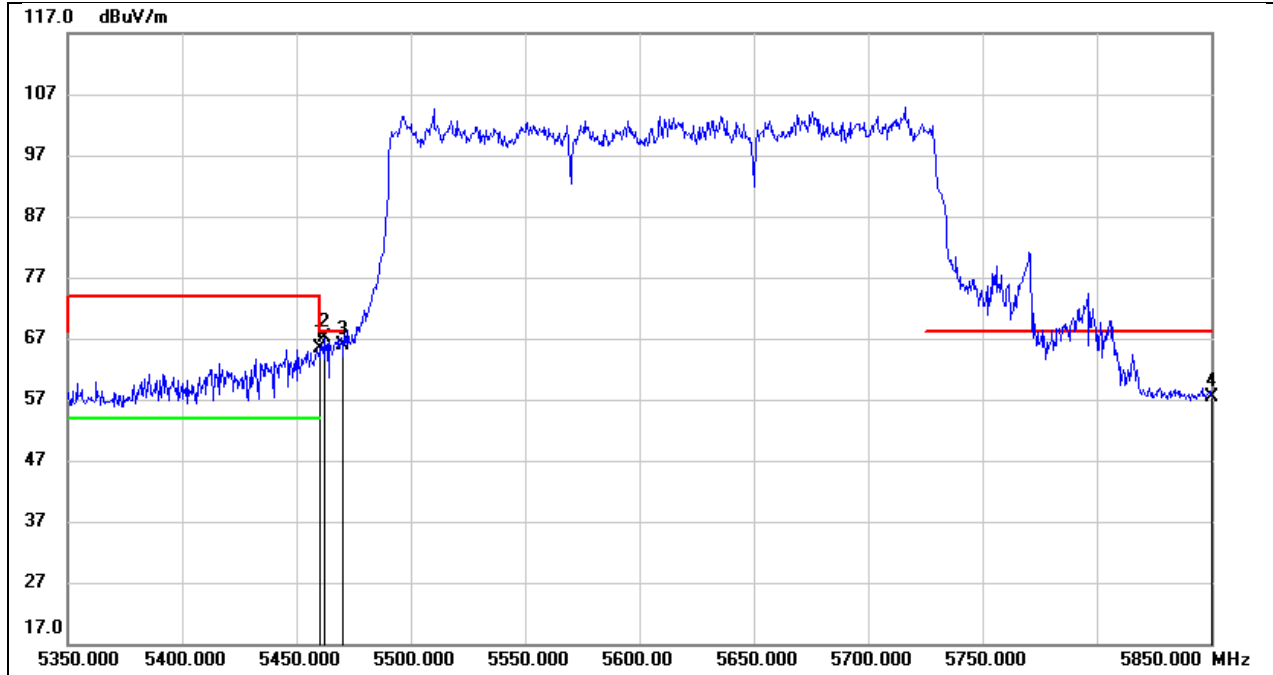

No.	Frequency (MHz)	Reading (dBuV)	Correct (dB/m)	Result (dBuV/m)	Limit (dBuV/m)	Margin (dB)	Remark
1	5460.000	24.71	40.62	65.33	68.20	-2.87	peak
2	5462.500	26.58	40.62	67.20	68.20	-1.00	peak
3	5470.000	25.34	40.63	65.97	68.20	-2.23	peak
4	5850.000	15.87	41.60	57.47	68.20	-10.73	peak

Test Mode:	802.11be EHT240 AV	Frequency(MHz):	5610
Polarity:	Vertical	Test Voltage:	DC 12 V

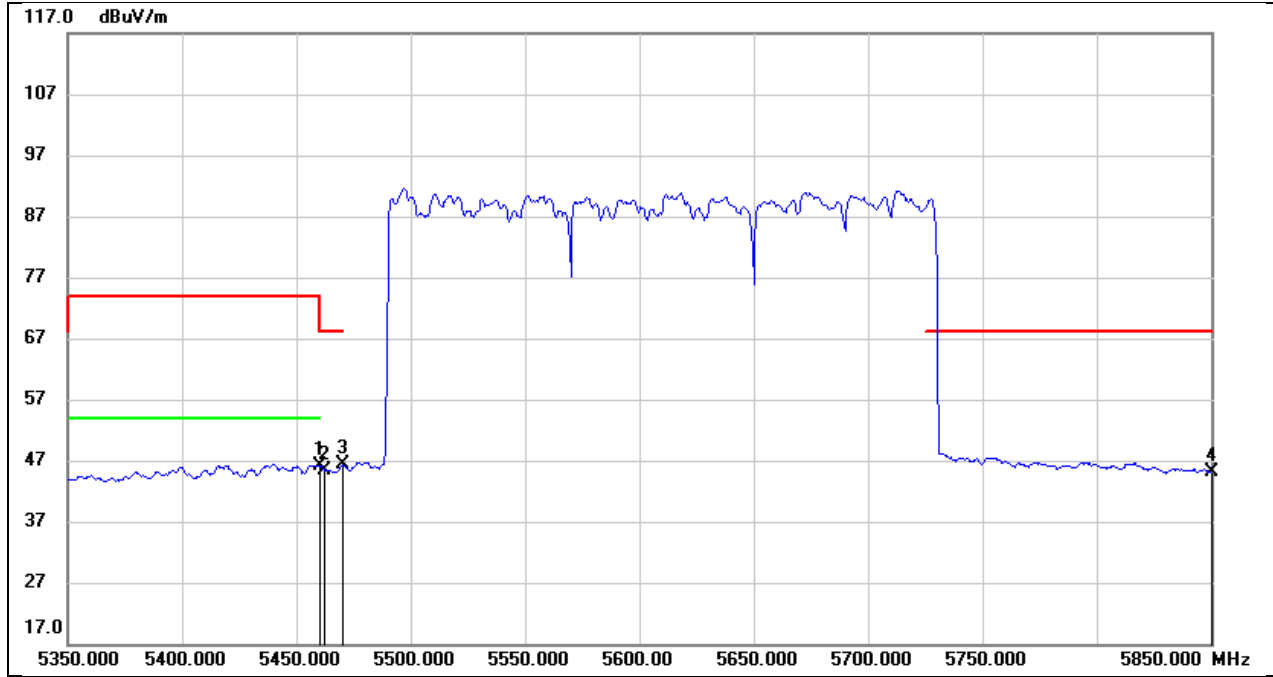

No.	Frequency (MHz)	Reading (dBuV)	Correct (dB/m)	Result (dBuV/m)	Limit (dBuV/m)	Margin (dB)	Remark
1	5460.000	5.54	40.62	46.16	54.00	-7.84	AVG
2	5462.500	4.68	40.62	45.30	68.20	-22.90	AVG
3	5470.000	5.70	40.63	46.33	68.20	-21.87	AVG
4	5850.000	3.47	41.60	45.07	68.20	-23.13	AVG

8.2. RESTRICTED BANDEDGE

For ISED UNII-1 test data:

Test Mode:	802.11a 20 PK	Frequency(MHz):	5180
Polarity:	Vertical	Test Voltage:	DC 12 V

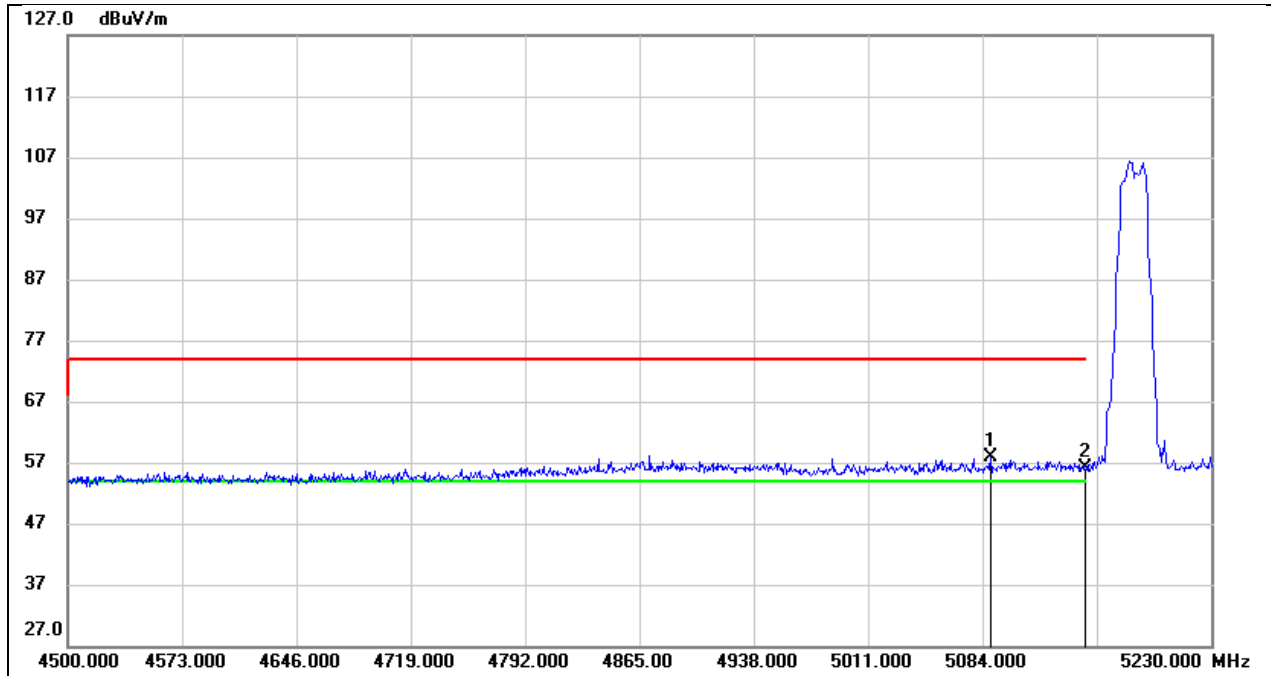

No.	Frequency (MHz)	Reading (dBuV)	Correct (dB/m)	Result (dBuV/m)	Limit (dBuV/m)	Margin (dB)	Remark
1	5089.110	17.71	40.21	57.92	74.00	-16.08	peak
2	5150.000	15.86	40.27	56.13	74.00	-17.87	peak

Test Mode:	802.11a 20 AV	Frequency(MHz):	5180
Polarity:	Vertical	Test Voltage:	DC 12 V

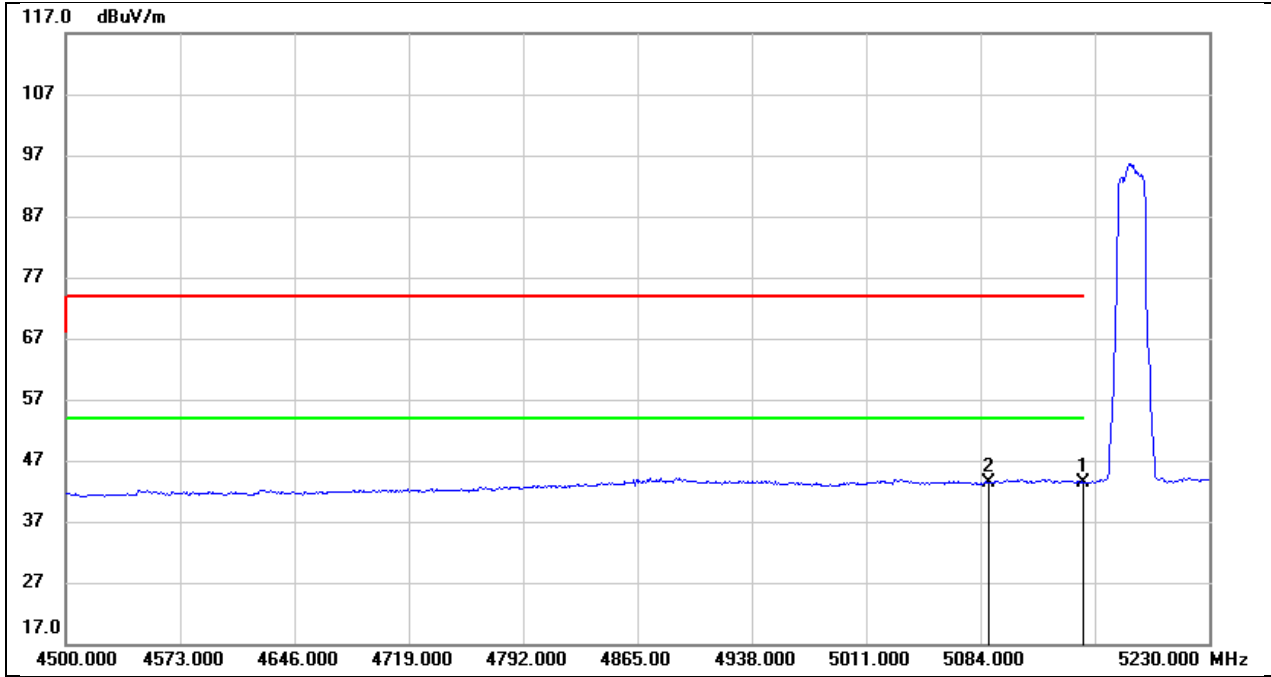

No.	Frequency (MHz)	Reading (dBuV)	Correct (dB/m)	Result (dBuV/m)	Limit (dBuV/m)	Margin (dB)	Remark
1	5150.000	3.04	40.27	43.31	54.00	-10.69	AVG
2	5089.110	3.20	40.21	43.41	54.00	-10.59	AVG

Test Mode:	802.11a 20 PK	Frequency(MHz):	5240
Polarity:	Vertical	Test Voltage:	DC 12 V

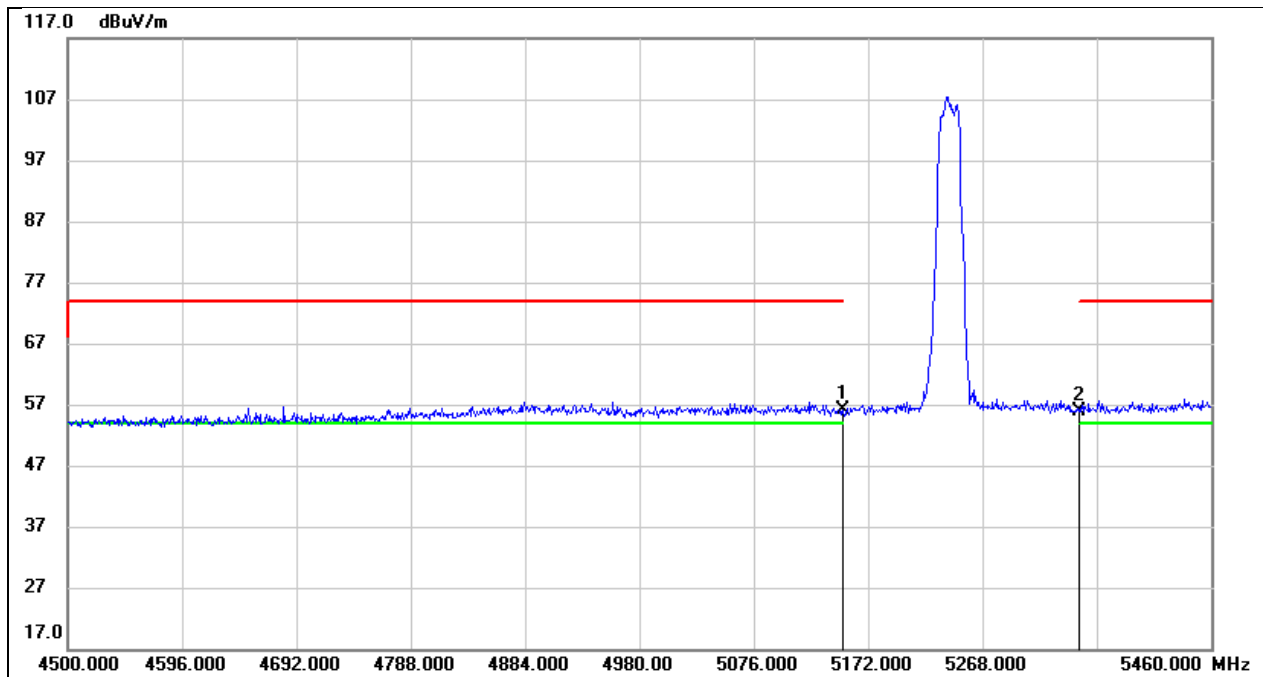

No.	Frequency (MHz)	Reading (dBuV)	Correct (dB/m)	Result (dBuV/m)	Limit (dBuV/m)	Margin (dB)	Remark
1	5150.000	15.81	40.27	56.08	74.00	-17.92	peak
2	5350.000	15.34	40.49	55.83	74.00	-18.17	peak

Test Mode:	802.11a 20 AV	Frequency(MHz):	5240
Polarity:	Vertical	Test Voltage:	DC 12 V

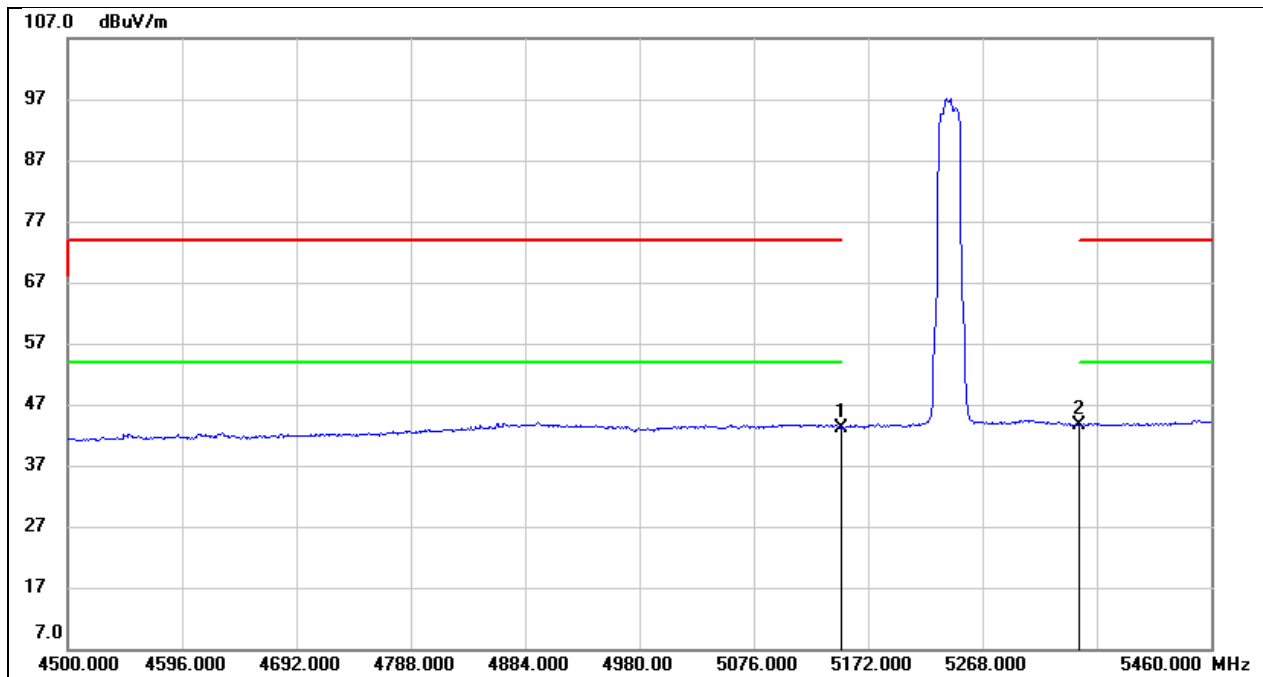

No.	Frequency (MHz)	Reading (dBuV)	Correct (dB/m)	Result (dBuV/m)	Limit (dBuV/m)	Margin (dB)	Remark
1	5150.000	2.95	40.27	43.22	54.00	-10.78	AVG
2	5350.000	3.15	40.49	43.64	54.00	-10.36	AVG

Test Mode:	802.11ac VHT20 PK	Frequency(MHz):	5180
Polarity:	Vertical	Test Voltage:	DC 12 V

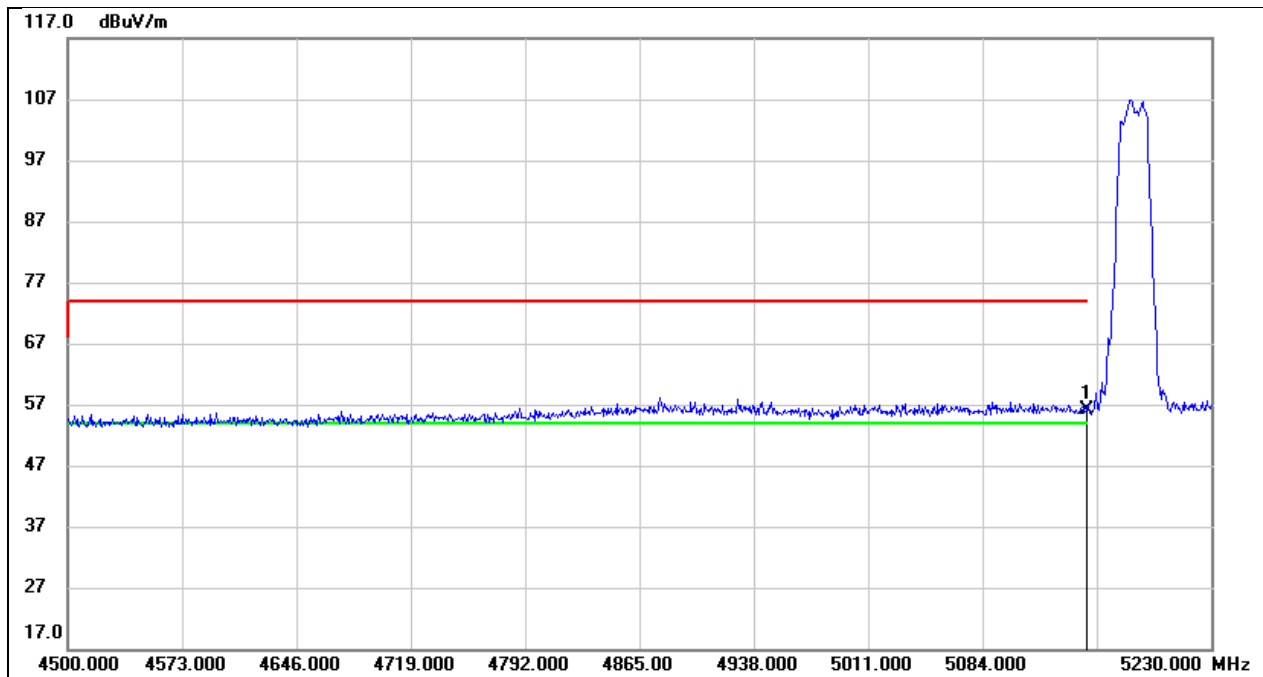

No.	Frequency (MHz)	Reading (dBuV)	Correct (dB/m)	Result (dBuV/m)	Limit (dBuV/m)	Margin (dB)	Remark
1	5150.000	15.77	40.27	56.04	74.00	-17.96	peak

Test Mode:	802.11ac VHT20 AV	Frequency(MHz):	5180
Polarity:	Vertical	Test Voltage:	DC 12 V

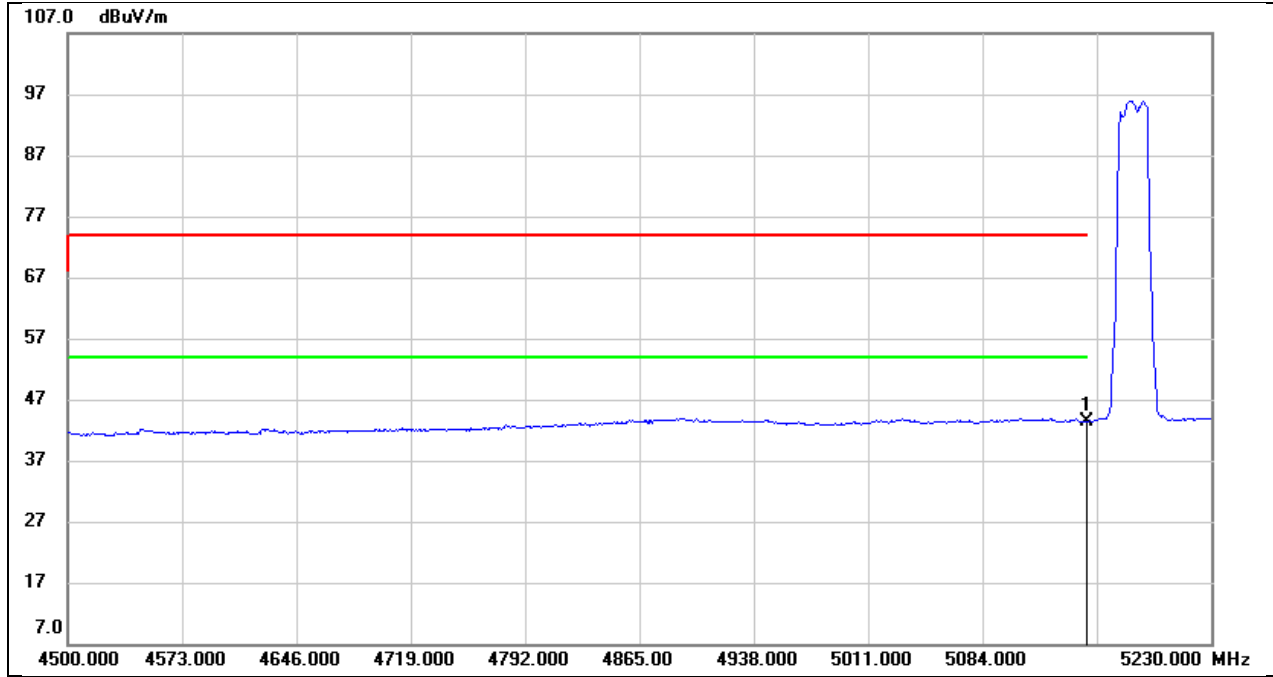

No.	Frequency (MHz)	Reading (dBuV)	Correct (dB/m)	Result (dBuV/m)	Limit (dBuV/m)	Margin (dB)	Remark
1	5150.000	3.15	40.27	43.42	54.00	-10.58	AVG

Test Mode:	802.11ac VHT20 PK	Frequency(MHz):	5240
Polarity:	Vertical	Test Voltage:	DC 12 V

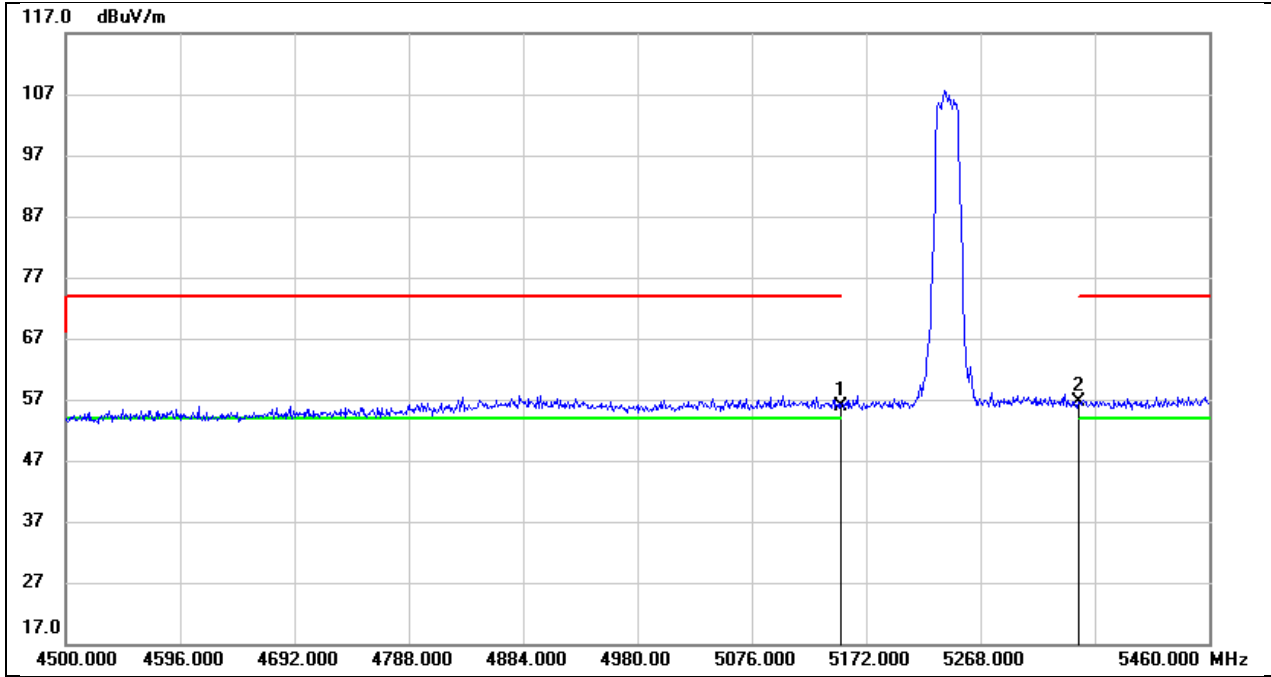

No.	Frequency (MHz)	Reading (dBuV)	Correct (dB/m)	Result (dBuV/m)	Limit (dBuV/m)	Margin (dB)	Remark
1	5150.000	15.62	40.27	55.89	74.00	-18.11	peak
2	5350.000	16.19	40.49	56.68	74.00	-17.32	peak

Test Mode:	802.11ac VHT20 AV	Frequency(MHz):	5240
Polarity:	Vertical	Test Voltage:	DC 12 V

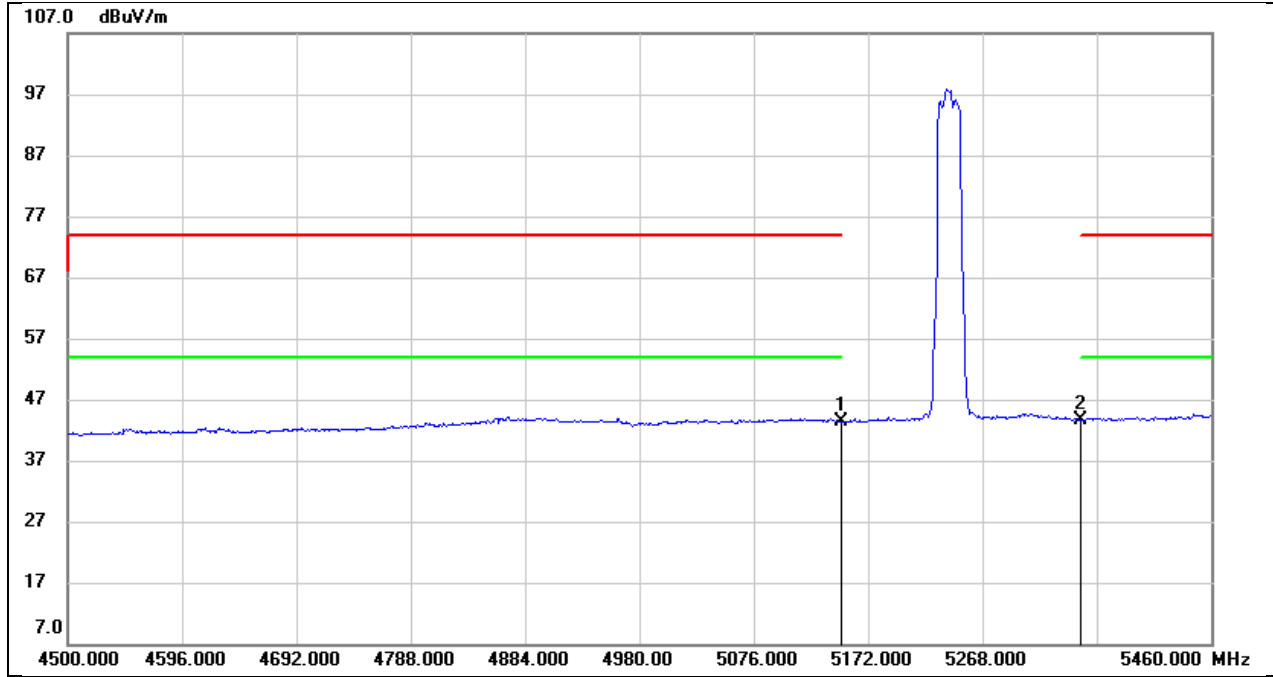

No.	Frequency (MHz)	Reading (dBuV)	Correct (dB/m)	Result (dBuV/m)	Limit (dBuV/m)	Margin (dB)	Remark
1	5150.000	3.06	40.27	43.33	54.00	-10.67	AVG
2	5350.000	3.19	40.49	43.68	54.00	-10.32	AVG

Test Mode:	802.11ac VHT40 PK	Frequency(MHz):	5190
Polarity:	Vertical	Test Voltage:	DC 12 V

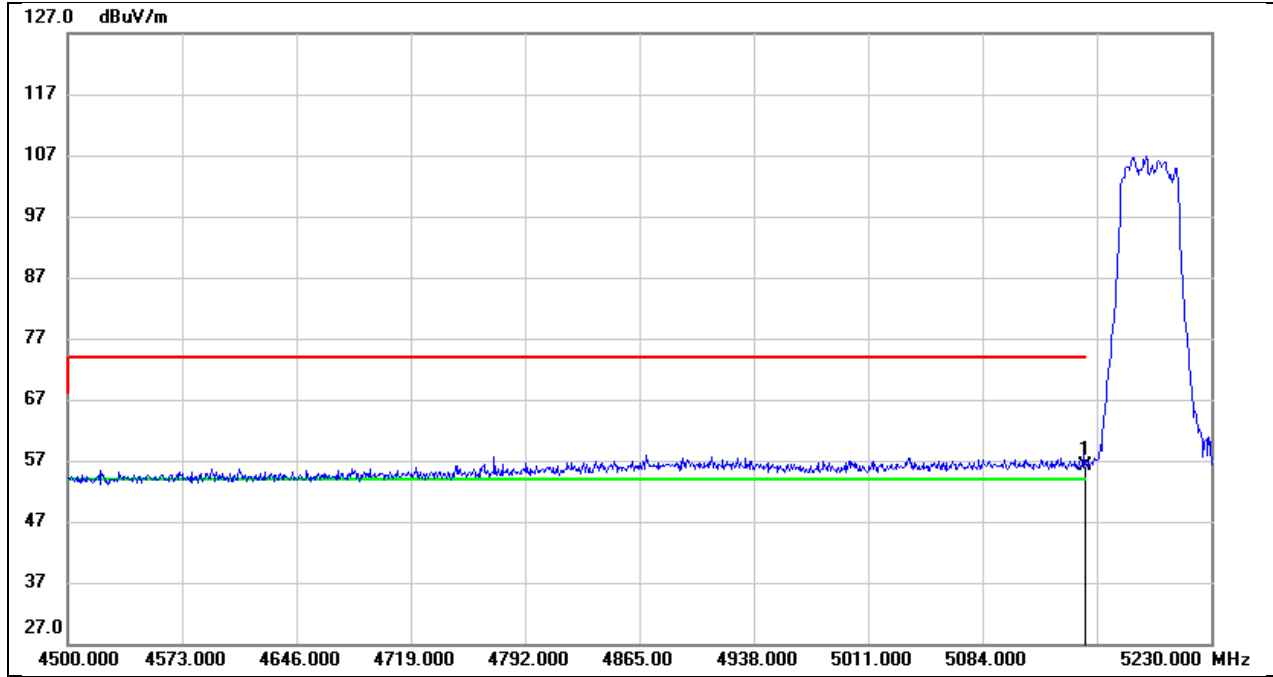

No.	Frequency (MHz)	Reading (dBuV)	Correct (dB/m)	Result (dBuV/m)	Limit (dBuV/m)	Margin (dB)	Remark
1	5150.000	15.80	40.27	56.07	74.00	-17.93	peak

Test Mode:	802.11ac VHT40 AV	Frequency(MHz):	5190
Polarity:	Vertical	Test Voltage:	DC 12 V

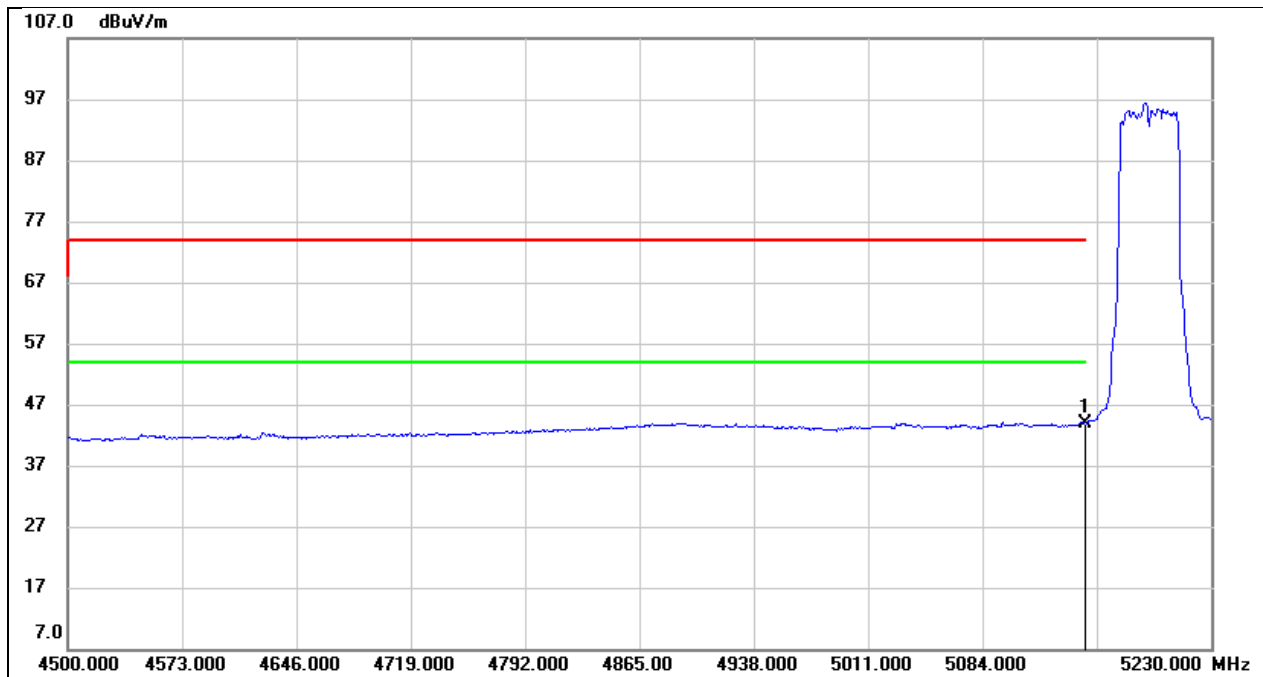

No.	Frequency (MHz)	Reading (dBuV)	Correct (dB/m)	Result (dBuV/m)	Limit (dBuV/m)	Margin (dB)	Remark
1	5150.000	3.70	40.27	43.97	54.00	-10.03	AVG

Test Mode:	802.11ac VHT40 PK	Frequency(MHz):	5230
Polarity:	Vertical	Test Voltage:	DC 12 V

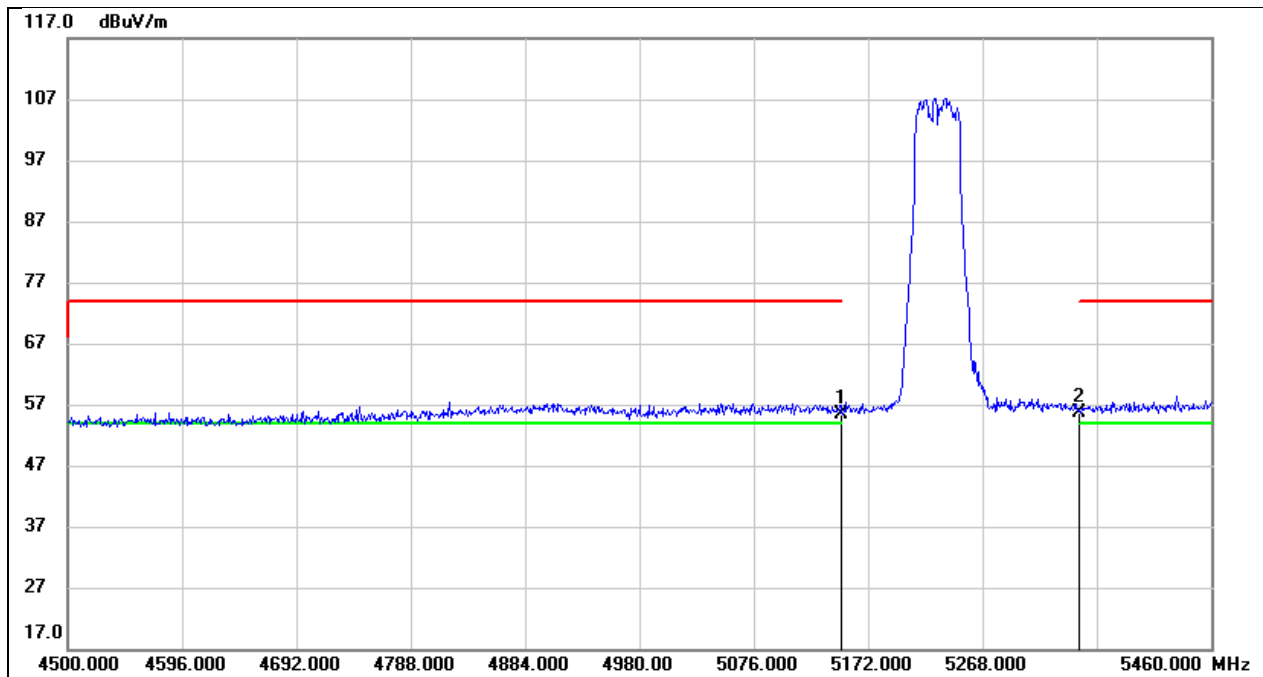

No.	Frequency (MHz)	Reading (dBuV)	Correct (dB/m)	Result (dBuV/m)	Limit (dBuV/m)	Margin (dB)	Remark
1	5150.000	15.17	40.27	55.44	74.00	-18.56	peak
2	5350.000	15.15	40.49	55.64	74.00	-18.36	peak

Test Mode:	802.11ac VHT40 AV	Frequency(MHz):	5230
Polarity:	Vertical	Test Voltage:	DC 12 V

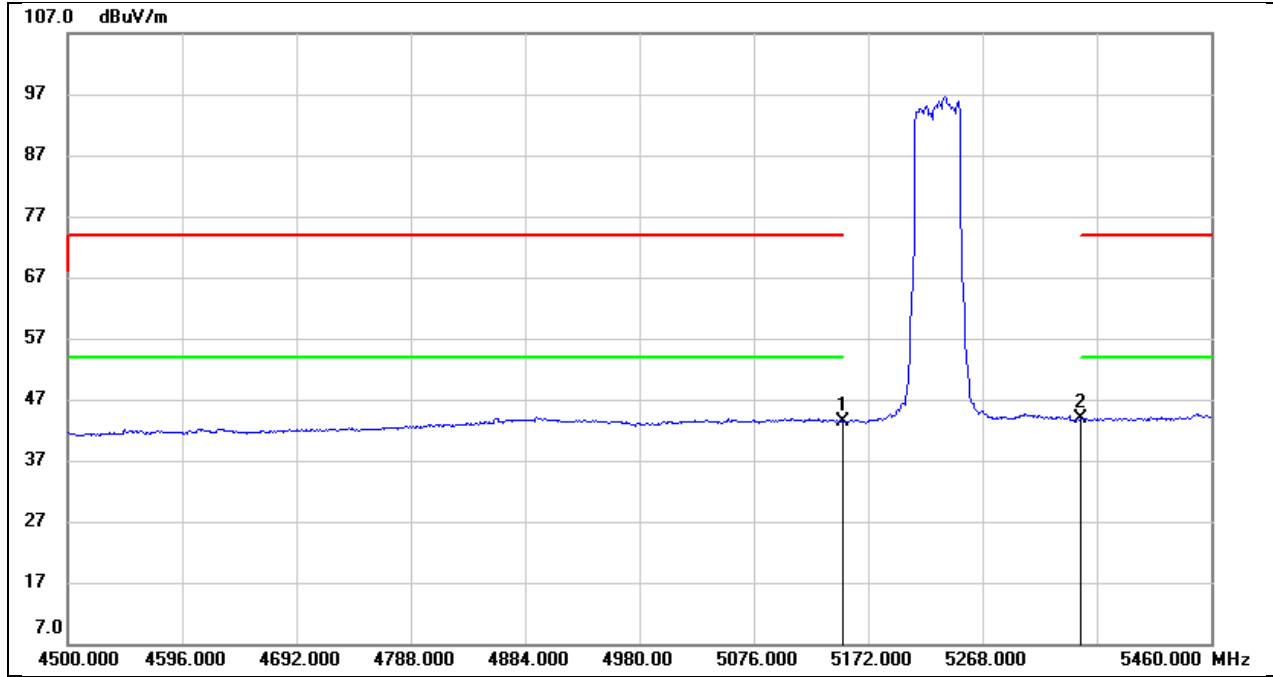

No.	Frequency (MHz)	Reading (dBuV)	Correct (dB/m)	Result (dBuV/m)	Limit (dBuV/m)	Margin (dB)	Remark
1	5150.000	3.12	40.27	43.39	54.00	-10.61	AVG
2	5350.000	3.35	40.49	43.84	54.00	-10.16	AVG

Test Mode:	802.11ac VHT80 PK	Frequency(MHz):	5210
Polarity:	Vertical	Test Voltage:	DC 12 V

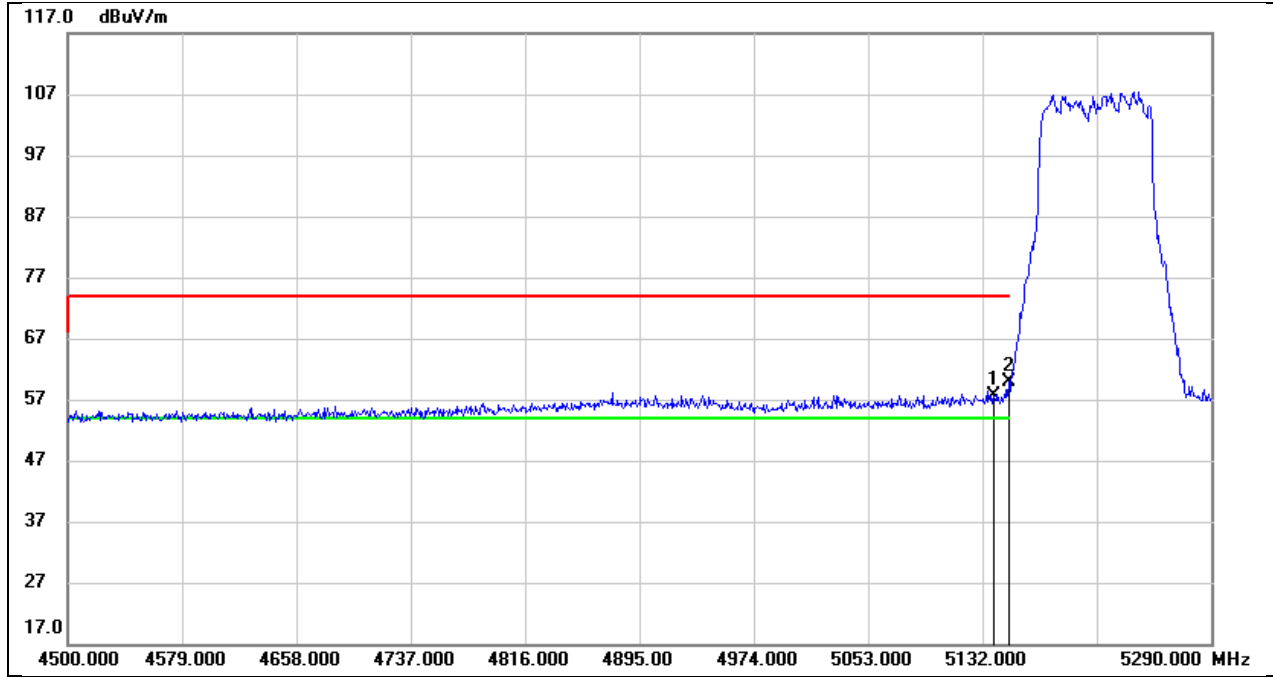

No.	Frequency (MHz)	Reading (dBuV)	Correct (dB/m)	Result (dBuV/m)	Limit (dBuV/m)	Margin (dB)	Remark
1	5139.900	17.28	40.26	57.54	74.00	-16.46	peak
2	5150.000	19.58	40.27	59.85	74.00	-14.15	peak

Test Mode:	802.11ac VHT80 AV	Frequency(MHz):	5210
Polarity:	Vertical	Test Voltage:	DC 12 V

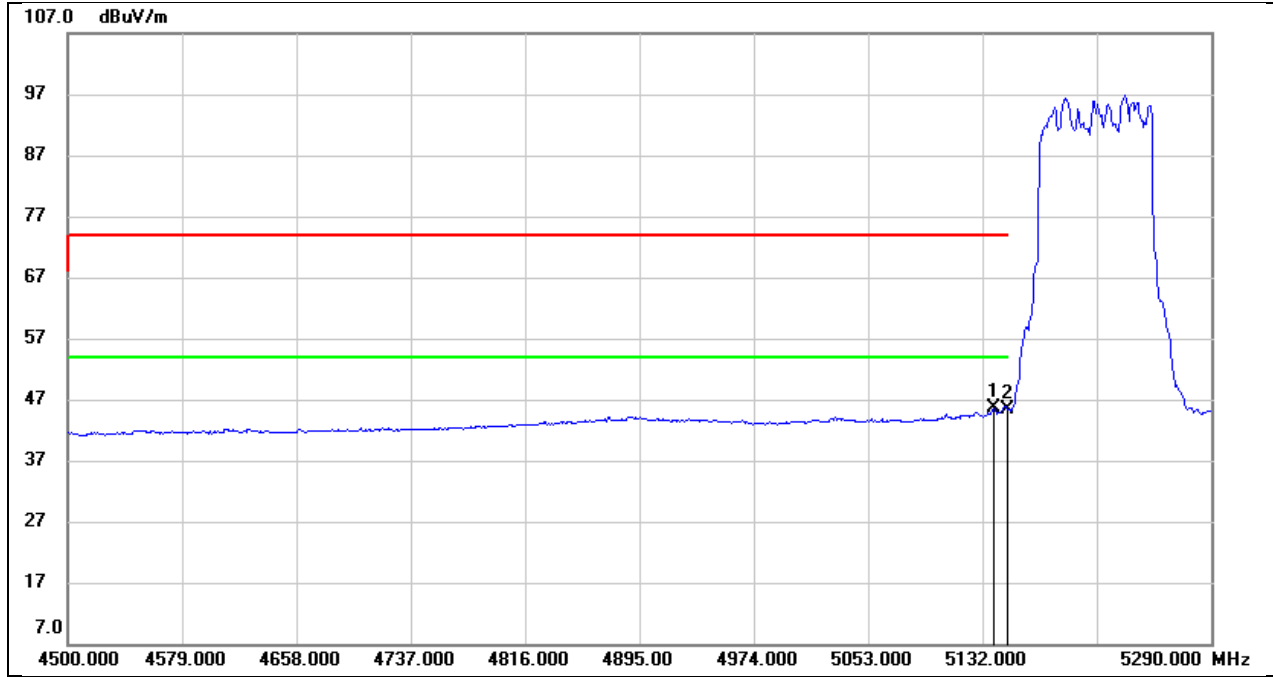

No.	Frequency (MHz)	Reading (dBuV)	Correct (dB/m)	Result (dBuV/m)	Limit (dBuV/m)	Margin (dB)	Remark
1	5139.900	5.31	40.26	45.57	54.00	-8.43	AVG
2	5150.000	5.10	40.27	45.37	54.00	-8.63	AVG

Test Mode:	802.11be EHT20 PK	Frequency(MHz):	5180
Polarity:	Vertical	Test Voltage:	DC 12 V

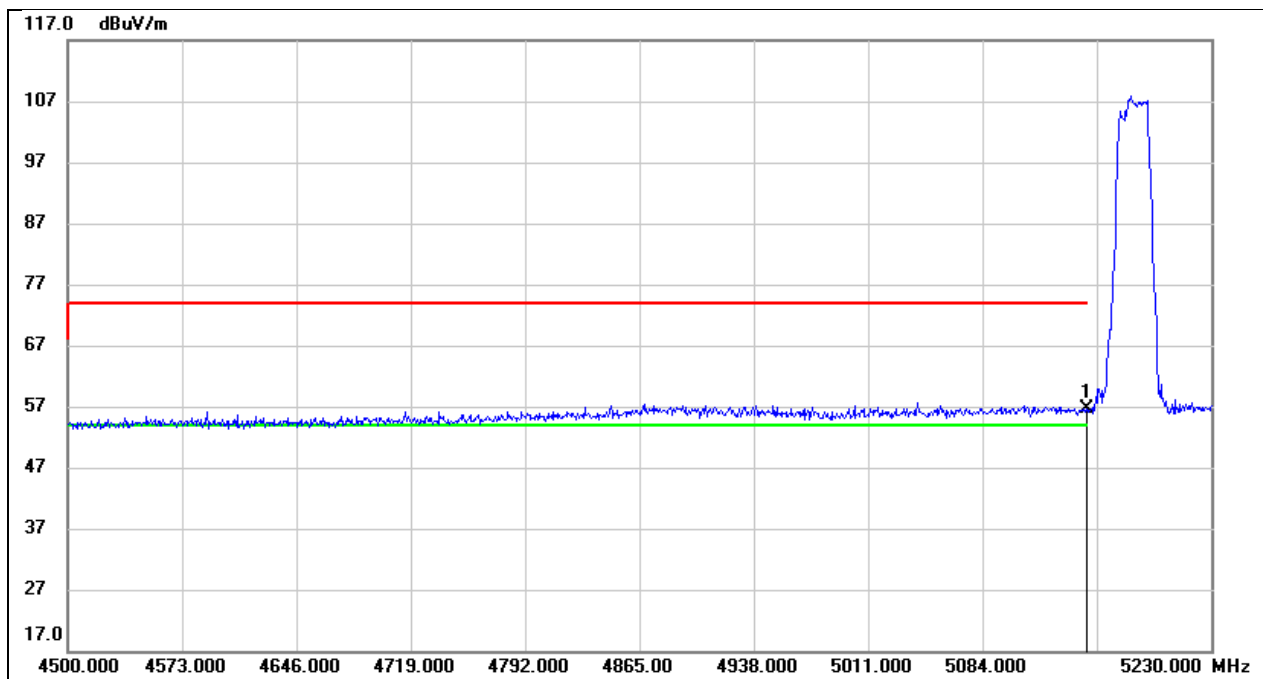

No.	Frequency (MHz)	Reading (dBuV)	Correct (dB/m)	Result (dBuV/m)	Limit (dBuV/m)	Margin (dB)	Remark
1	5180.000	16.26	40.27	56.53	74.00	-17.47	peak

Test Mode:	802.11be EHT20 AV	Frequency(MHz):	5180
Polarity:	Vertical	Test Voltage:	DC 12 V

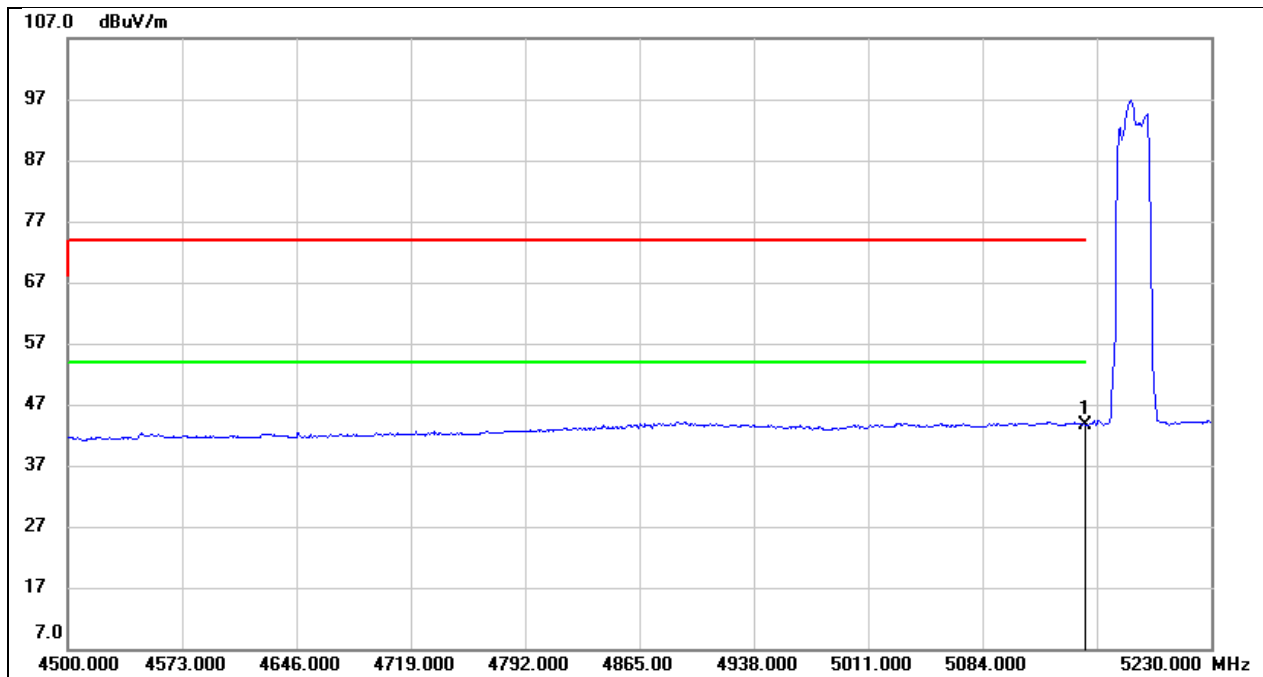

No.	Frequency (MHz)	Reading (dBuV)	Correct (dB/m)	Result (dBuV/m)	Limit (dBuV/m)	Margin (dB)	Remark
1	5150.000	3.27	40.27	43.54	54.00	-10.46	AVG

Test Mode:	802.11be EHT20 PK	Frequency(MHz):	5240
Polarity:	Vertical	Test Voltage:	DC 12 V

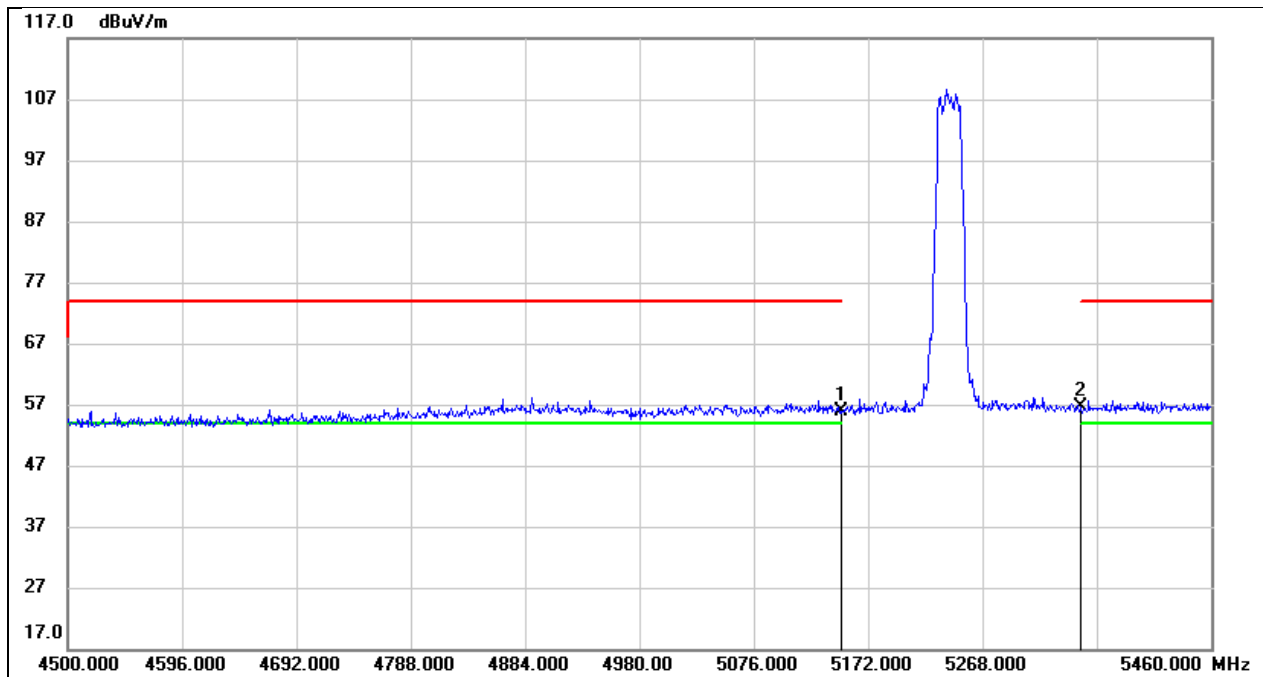

No.	Frequency (MHz)	Reading (dBuV)	Correct (dB/m)	Result (dBuV/m)	Limit (dBuV/m)	Margin (dB)	Remark
1	5150.000	15.55	40.27	55.82	74.00	-18.18	peak
2	5350.000	16.13	40.49	56.62	74.00	-17.38	peak

Test Mode:	802.11be EHT20 AV	Frequency(MHz):	5240
Polarity:	Vertical	Test Voltage:	DC 12 V

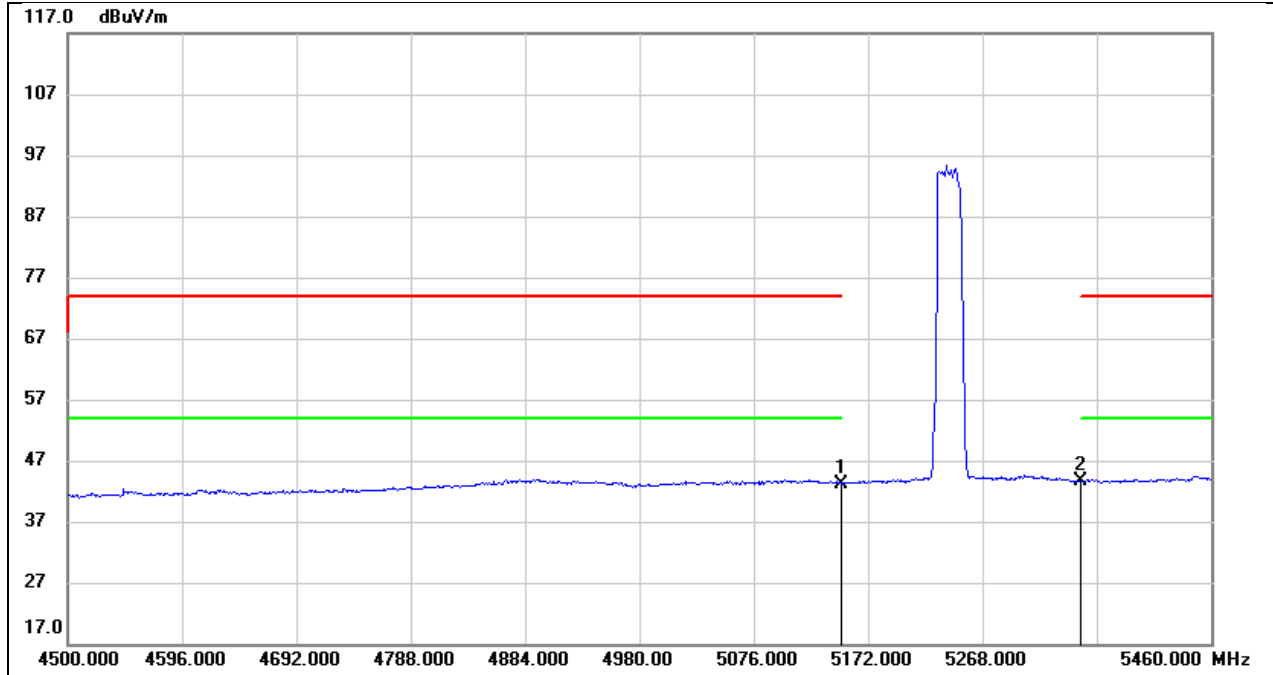

No.	Frequency (MHz)	Reading (dBuV)	Correct (dB/m)	Result (dBuV/m)	Limit (dBuV/m)	Margin (dB)	Remark
1	5150.000	2.91	40.27	43.18	54.00	-10.82	AVG
2	5350.000	3.03	40.49	43.52	54.00	-10.48	AVG

Test Mode:	802.11be EHT40 PK	Frequency(MHz):	5190
Polarity:	Vertical	Test Voltage:	DC 12 V

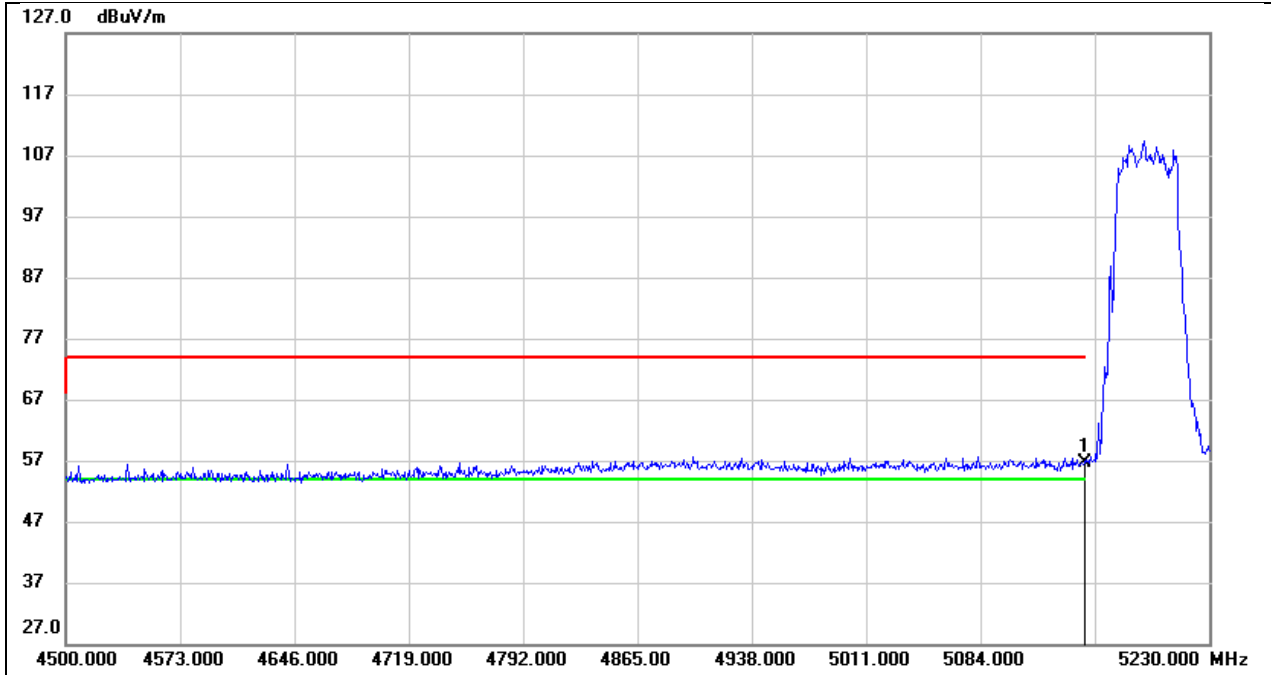

No.	Frequency (MHz)	Reading (dBuV)	Correct (dB/m)	Result (dBuV/m)	Limit (dBuV/m)	Margin (dB)	Remark
1	5150.000	16.36	40.27	56.63	74.00	-17.37	peak

Test Mode:	802.11be EHT40 AV	Frequency(MHz):	5190
Polarity:	Vertical	Test Voltage:	DC 12 V

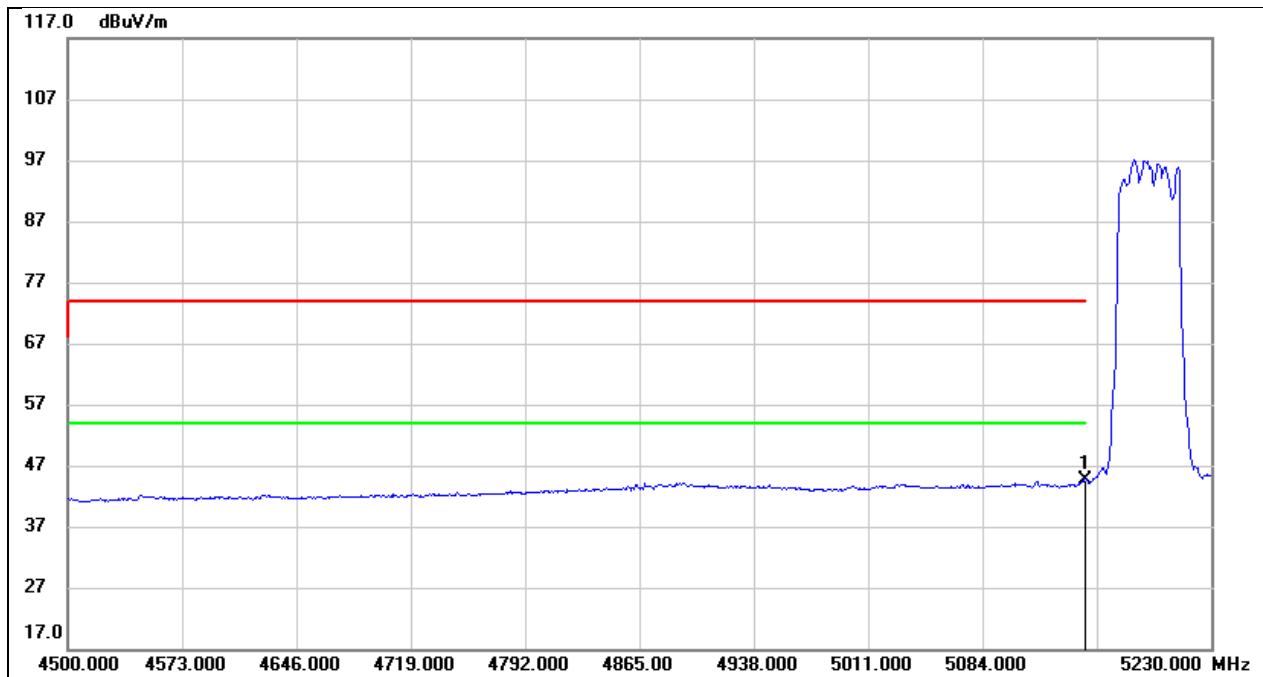

No.	Frequency (MHz)	Reading (dBuV)	Correct (dB/m)	Result (dBuV/m)	Limit (dBuV/m)	Margin (dB)	Remark
1	5150.000	4.27	40.27	44.54	54.00	-9.46	AVG

Test Mode:	802.11be EHT40 PK	Frequency(MHz):	5230
Polarity:	Vertical	Test Voltage:	DC 12 V

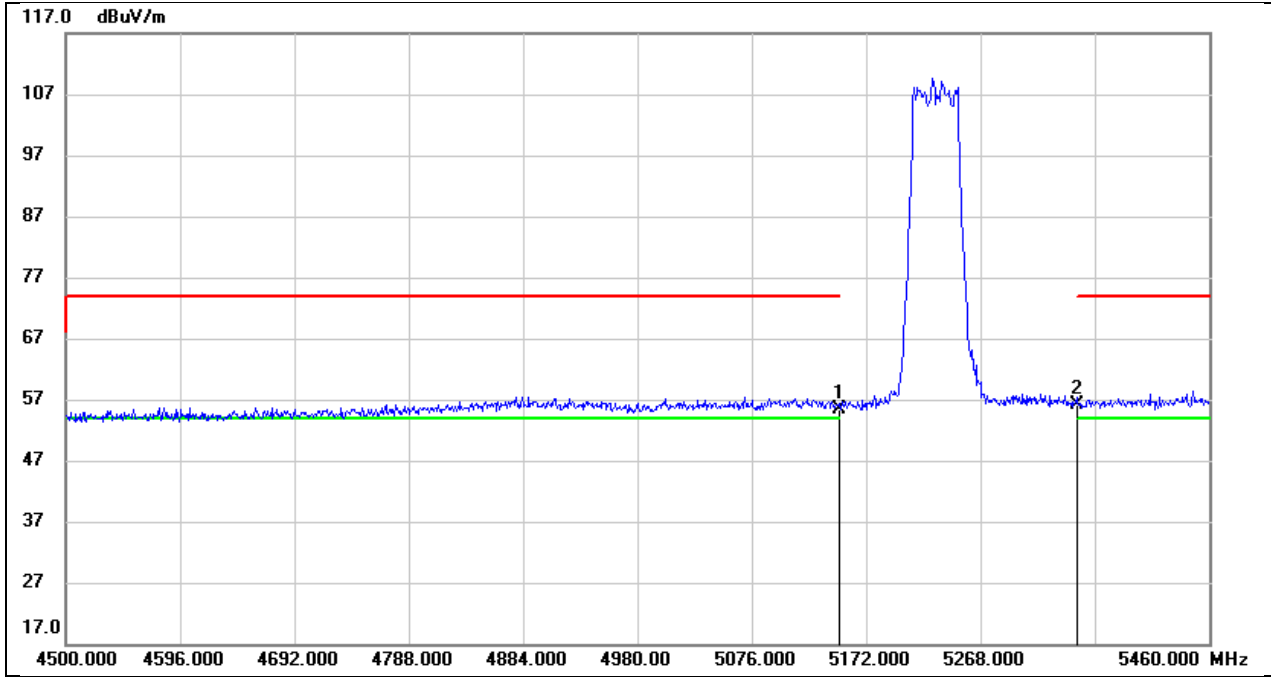

No.	Frequency (MHz)	Reading (dBuV)	Correct (dB/m)	Result (dBuV/m)	Limit (dBuV/m)	Margin (dB)	Remark
1	5150.000	15.20	40.27	55.47	74.00	-18.53	peak
2	5350.000	15.69	40.49	56.18	74.00	-17.82	peak

Test Mode:	802.11be EHT40 AV	Frequency(MHz):	5230
Polarity:	Vertical	Test Voltage:	DC 12 V

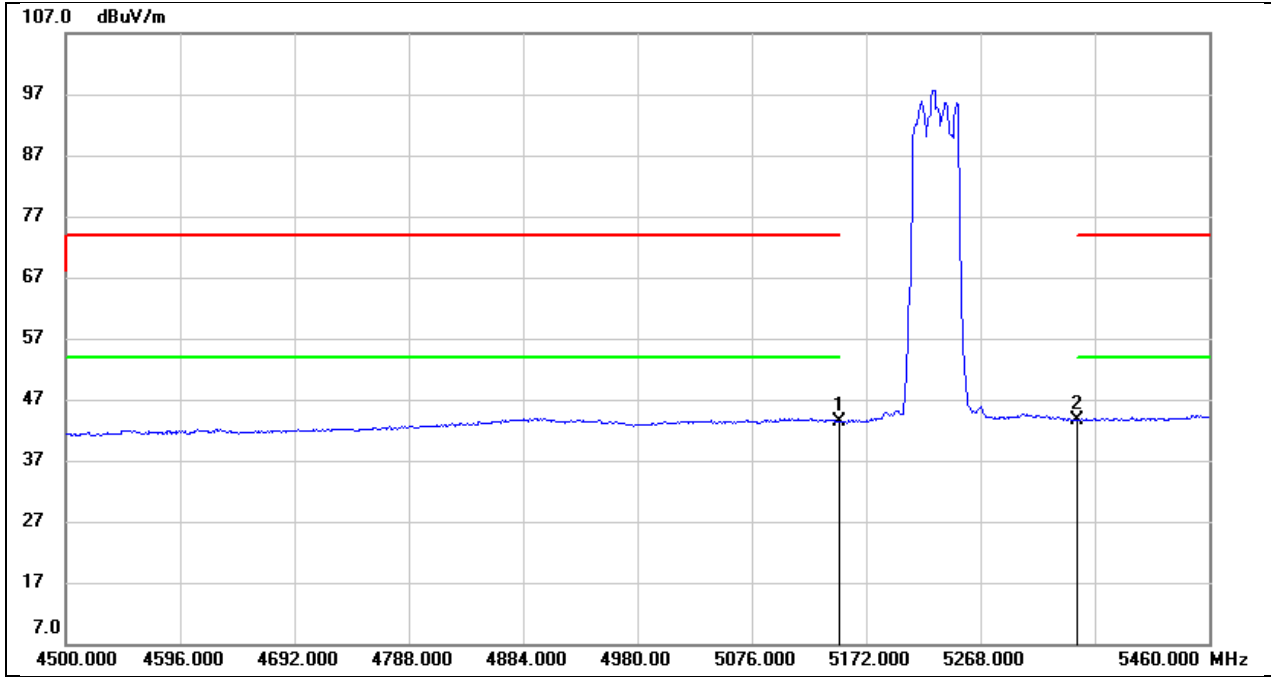

No.	Frequency (MHz)	Reading (dBuV)	Correct (dB/m)	Result (dBuV/m)	Limit (dBuV/m)	Margin (dB)	Remark
1	5150.000	3.14	40.27	43.41	54.00	-10.59	AVG
2	5350.000	3.05	40.49	43.54	54.00	-10.46	AVG

Test Mode:	802.11be EHT80 PK	Frequency(MHz):	5210
Polarity:	Vertical	Test Voltage:	DC 12 V

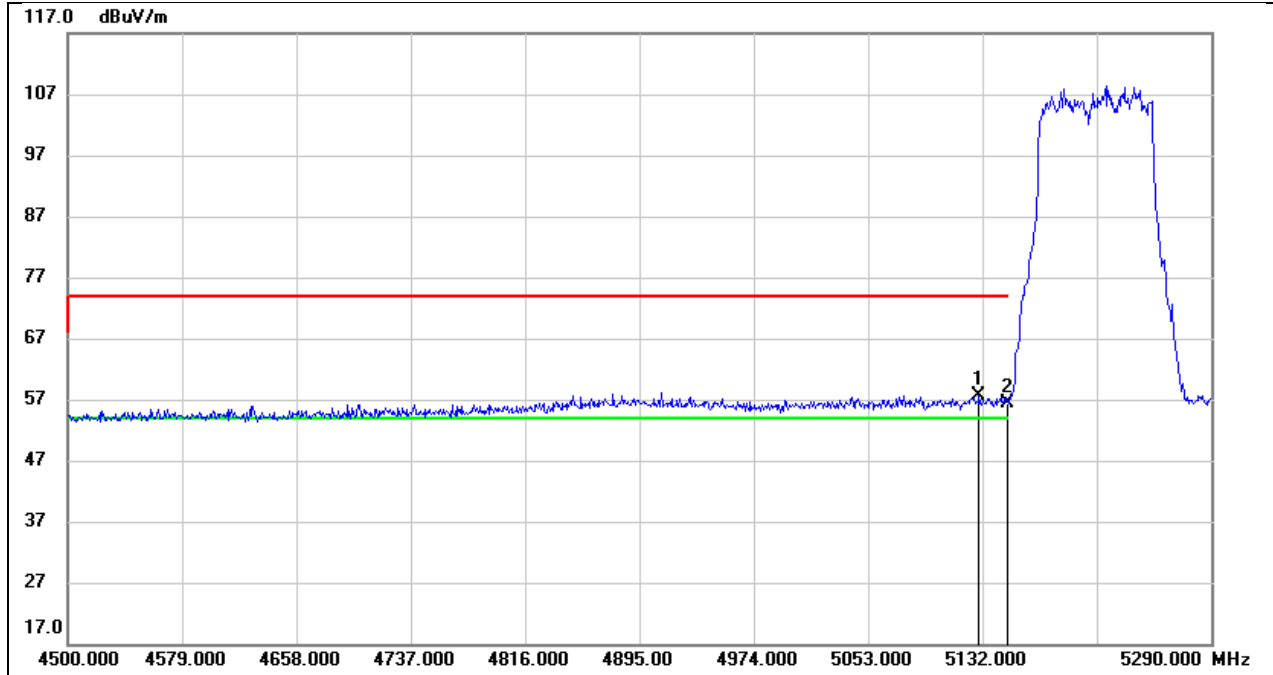

No.	Frequency (MHz)	Reading (dBuV)	Correct (dB/m)	Result (dBuV/m)	Limit (dBuV/m)	Margin (dB)	Remark
1	5129.630	17.38	40.25	57.63	74.00	-16.37	peak
2	5150.000	16.19	40.27	56.46	74.00	-17.54	peak

Test Mode:	802.11be EHT80 AV	Frequency(MHz):	5210
Polarity:	Vertical	Test Voltage:	DC 12 V

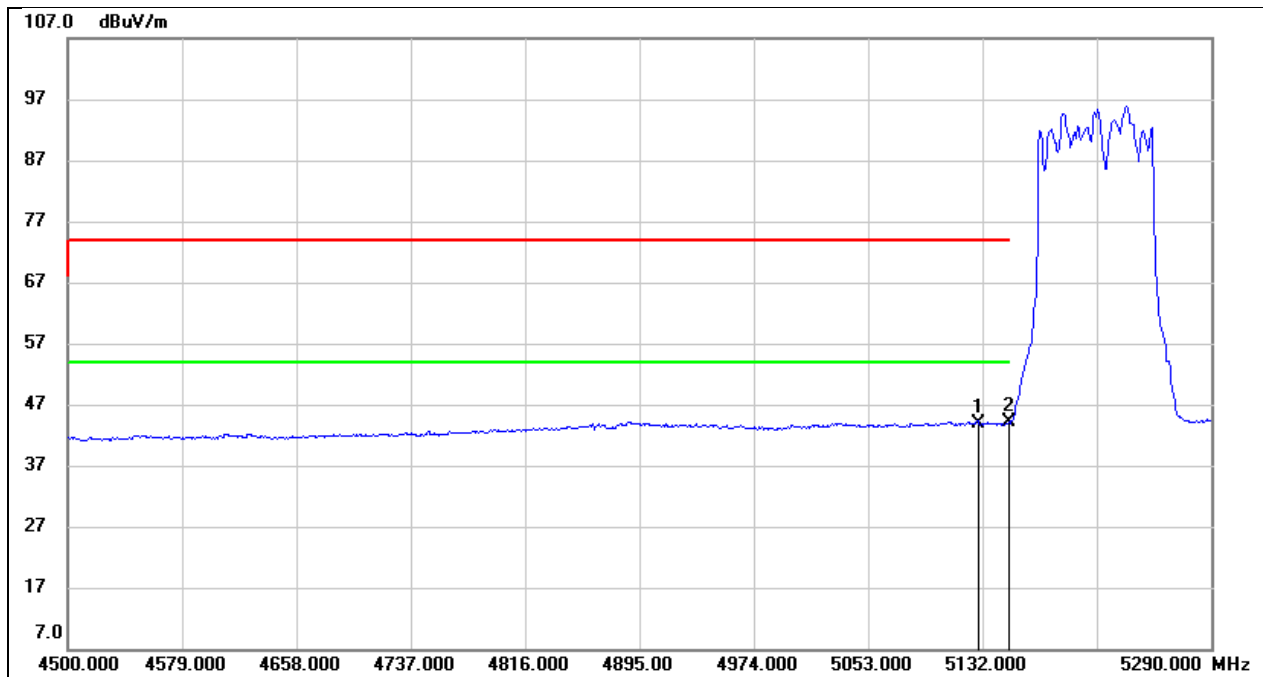

No.	Frequency (MHz)	Reading (dBuV)	Correct (dB/m)	Result (dBuV/m)	Limit (dBuV/m)	Margin (dB)	Remark
1	5129.630	3.64	40.25	43.89	54.00	-10.11	AVG
2	5150.000	3.86	40.27	44.13	54.00	-9.87	AVG

8.3. SPURIOUS EMISSIONS(1 GHZ~7 GHZ)

For FCC UNII-1&UNII-2A&UNII-2C&UNII-3; ISED UNII-2A&UNII-2C&UNII-3 test data:

Test Mode:	802.11a 20	Frequency(MHz):	5180
Polarity:	Horizontal	Test Voltage:	DC 12 V

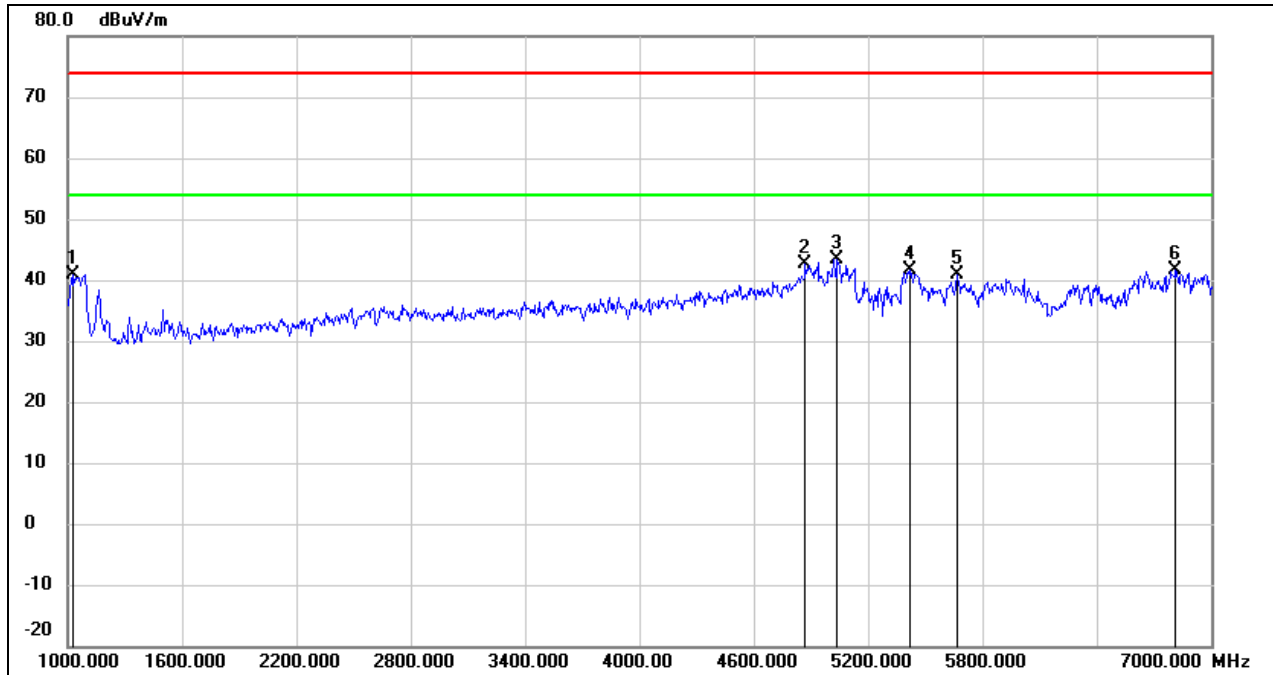

No.	Frequency (MHz)	Reading (dBuV)	Correct (dB/m)	Result (dBuV/m)	Limit (dBuV/m)	Margin (dB)	Remark
1	1030.000	55.80	-14.89	40.91	74.00	-33.09	peak
2	4870.000	43.36	-0.66	42.70	74.00	-31.30	peak
3	5038.000	43.46	-0.11	43.35	74.00	-30.65	peak
4	5422.000	41.29	0.32	41.61	74.00	-32.39	peak
5	5668.000	39.97	0.91	40.88	74.00	-33.12	peak
6	6814.000	36.34	5.28	41.62	74.00	-32.38	peak

Test Mode:	802.11a 20	Frequency(MHz):	5180
Polarity:	Vertical	Test Voltage:	DC 12 V

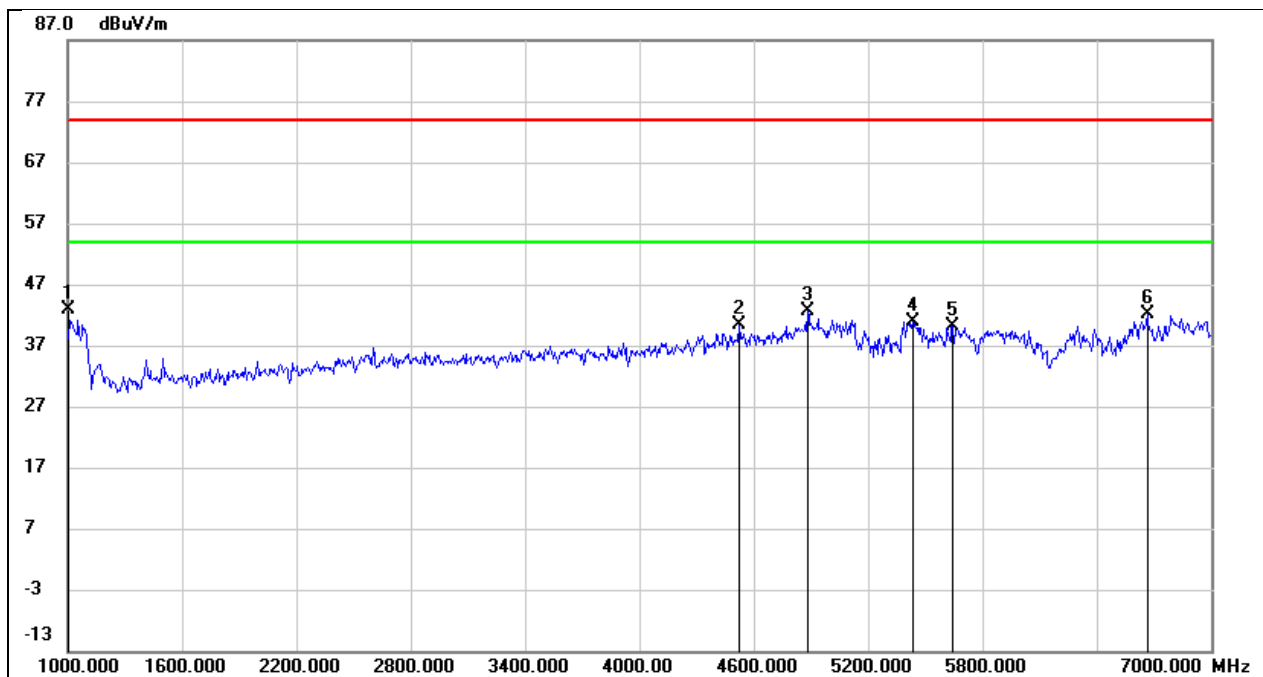

No.	Frequency (MHz)	Reading (dBuV)	Correct (dB/m)	Result (dBuV/m)	Limit (dBuV/m)	Margin (dB)	Remark
1	1000.0000	57.87	-15.03	42.84	74.00	-31.16	peak
2	4522.000	42.32	-2.05	40.27	74.00	-33.73	peak
3	4882.000	43.28	-0.62	42.66	74.00	-31.34	peak
4	5434.000	40.47	0.34	40.81	74.00	-33.19	peak
5	5644.000	39.34	0.82	40.16	74.00	-33.84	peak
6	6664.000	37.64	4.54	42.18	74.00	-31.82	peak

Test Mode:	802.11a 20	Frequency(MHz):	5200
Polarity:	Horizontal	Test Voltage:	DC 12 V

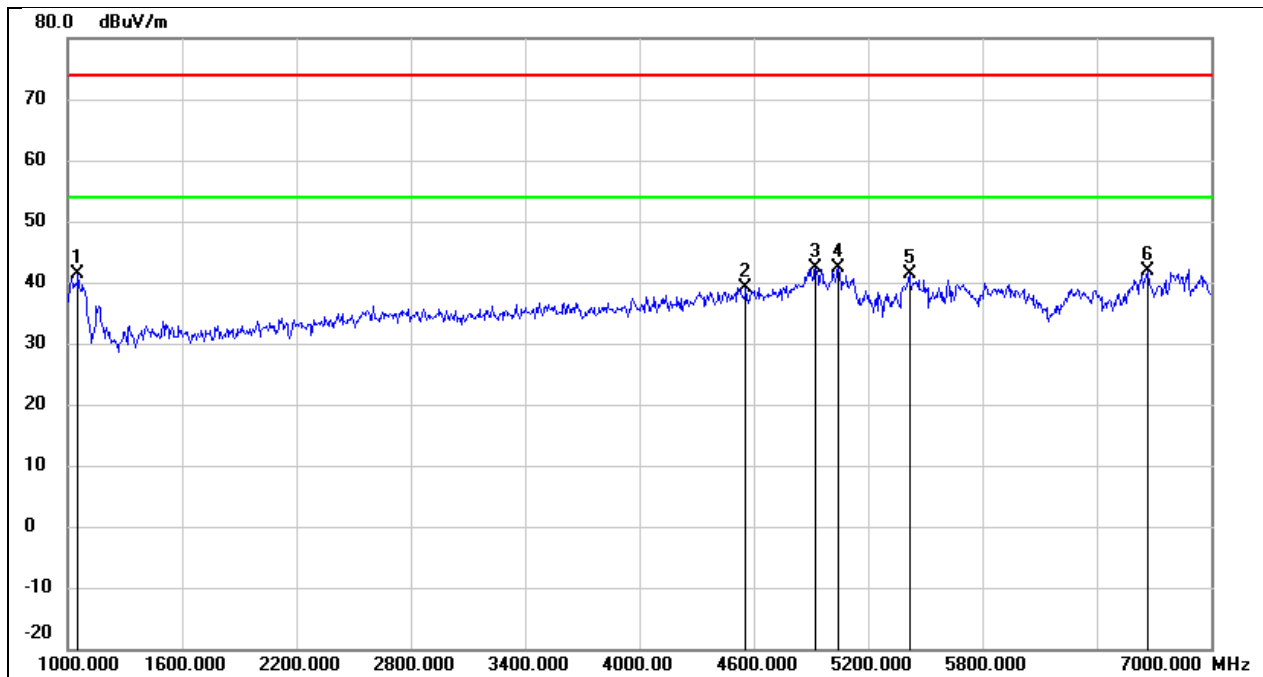

No.	Frequency (MHz)	Reading (dBuV)	Correct (dB/m)	Result (dBuV/m)	Limit (dBuV/m)	Margin (dB)	Remark
1	1054.000	56.23	-14.78	41.45	74.00	-32.55	peak
2	4558.000	41.11	-1.91	39.20	74.00	-34.80	peak
3	4924.000	42.84	-0.45	42.39	74.00	-31.61	peak
4	5044.000	42.44	-0.10	42.34	74.00	-31.66	peak
5	5416.000	41.10	0.32	41.42	74.00	-32.58	peak
6	6664.000	37.31	4.54	41.85	74.00	-32.15	peak

Test Mode:	802.11a 20	Frequency(MHz):	5200
Polarity:	Vertical	Test Voltage:	DC 12 V

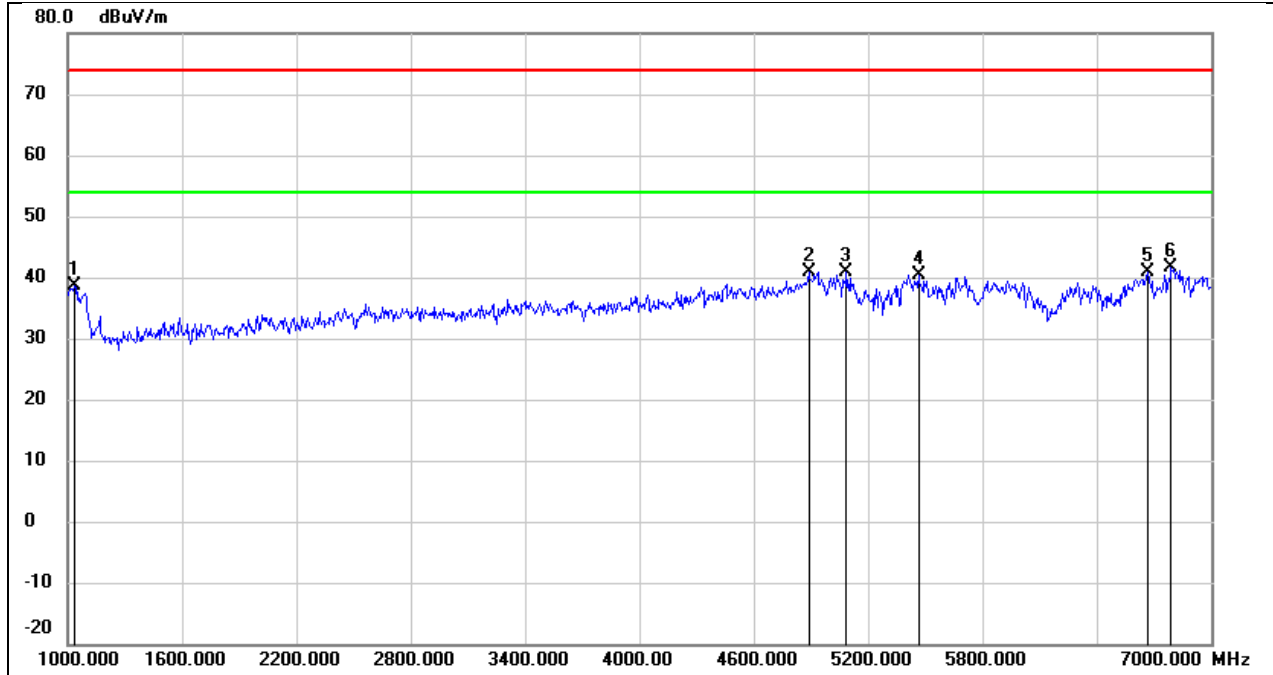

No.	Frequency (MHz)	Reading (dBuV)	Correct (dB/m)	Result (dBuV/m)	Limit (dBuV/m)	Margin (dB)	Remark
1	1036.000	53.38	-14.87	38.51	74.00	-35.49	peak
2	4888.000	41.46	-0.60	40.86	74.00	-33.14	peak
3	5086.000	40.81	-0.05	40.76	74.00	-33.24	peak
4	5464.000	39.99	0.38	40.37	74.00	-33.63	peak
5	6670.000	36.27	4.57	40.84	74.00	-33.16	peak
6	6790.000	36.50	5.15	41.65	74.00	-32.35	peak

Test Mode:	802.11a 20	Frequency(MHz):	5240
Polarity:	Horizontal	Test Voltage:	DC 12 V

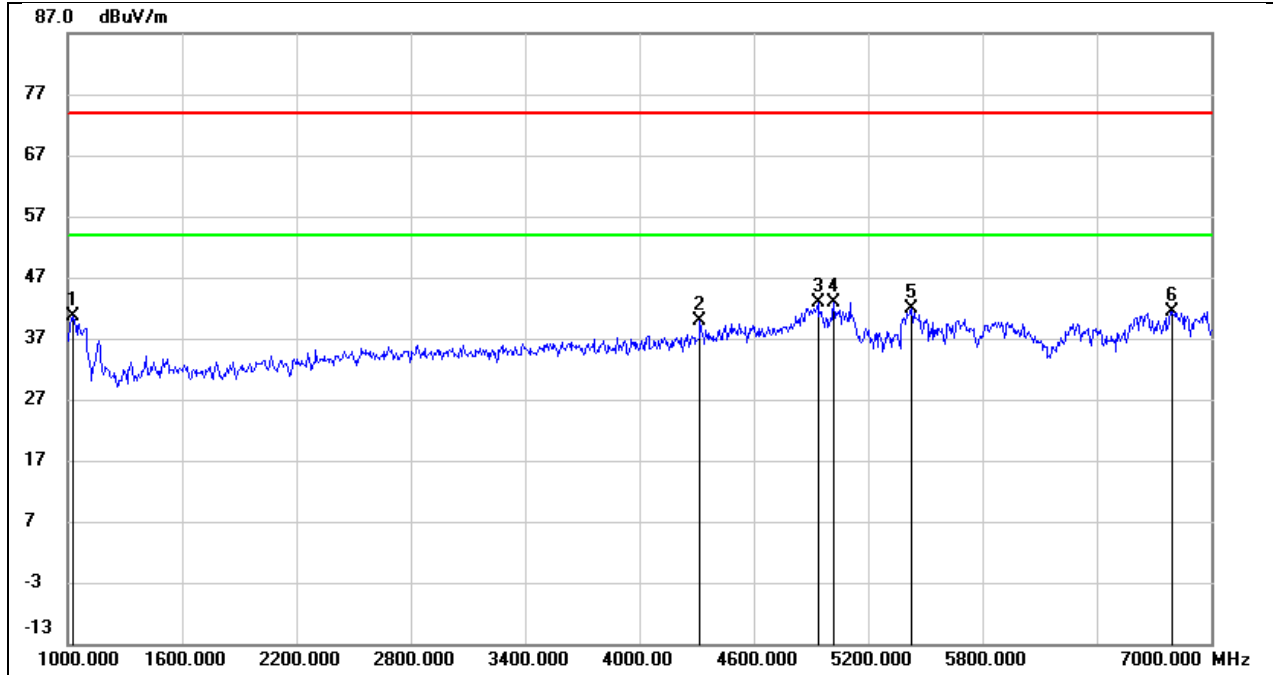

No.	Frequency (MHz)	Reading (dBuV)	Correct (dB/m)	Result (dBuV/m)	Limit (dBuV/m)	Margin (dB)	Remark
1	1030.000	55.47	-14.89	40.58	74.00	-33.42	peak
2	4318.000	42.75	-2.99	39.76	74.00	-34.24	peak
3	4936.000	43.22	-0.40	42.82	74.00	-31.18	peak
4	5020.000	43.07	-0.13	42.94	74.00	-31.06	peak
5	5428.000	41.45	0.34	41.79	74.00	-32.21	peak
6	6796.000	36.19	5.19	41.38	74.00	-32.62	peak

Test Mode:	802.11a 20	Frequency(MHz):	5240
Polarity:	Vertical	Test Voltage:	DC 12 V

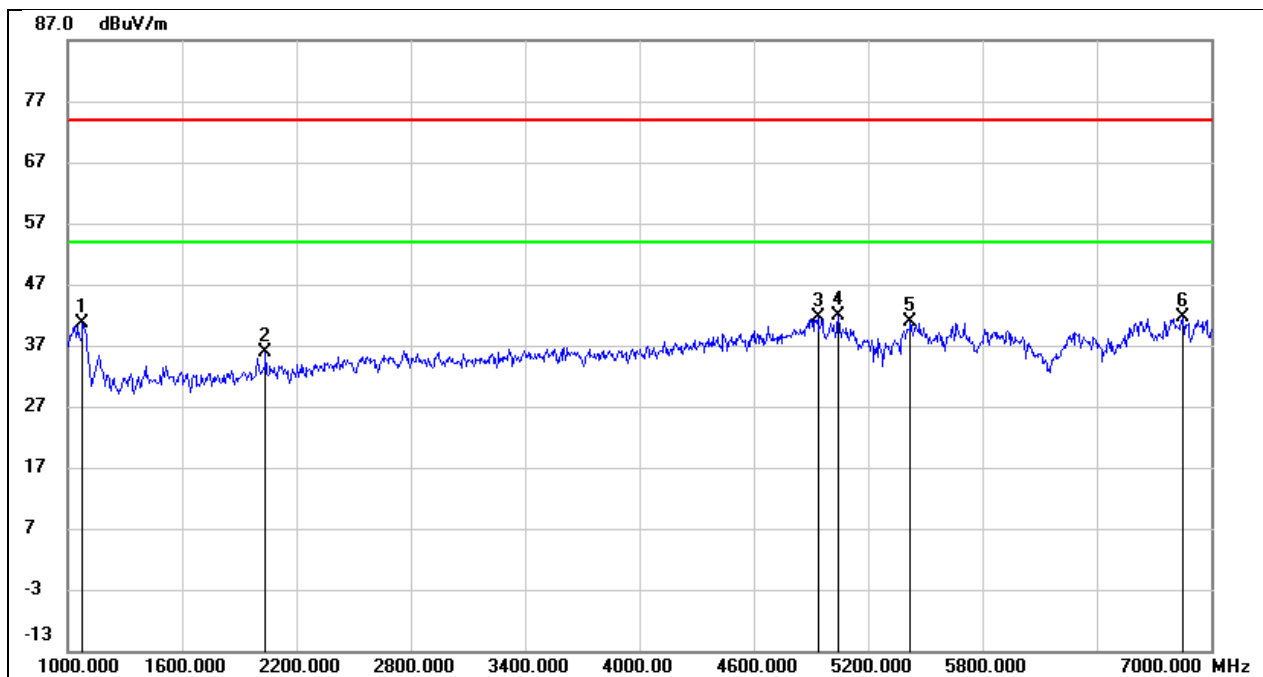

No.	Frequency (MHz)	Reading (dBuV)	Correct (dB/m)	Result (dBuV/m)	Limit (dBuV/m)	Margin (dB)	Remark
1	1078.000	55.38	-14.66	40.72	74.00	-33.28	peak
2	2038.000	46.76	-10.86	35.90	74.00	-38.10	peak
3	4936.000	42.10	-0.40	41.70	74.00	-32.30	peak
4	5044.000	42.08	-0.10	41.98	74.00	-32.02	peak
5	5422.000	40.67	0.32	40.99	74.00	-33.01	peak
6	6850.000	36.19	5.46	41.65	74.00	-32.35	peak

Test Mode:	802.11a 20	Frequency(MHz):	5260
Polarity:	Horizontal	Test Voltage:	DC 12 V

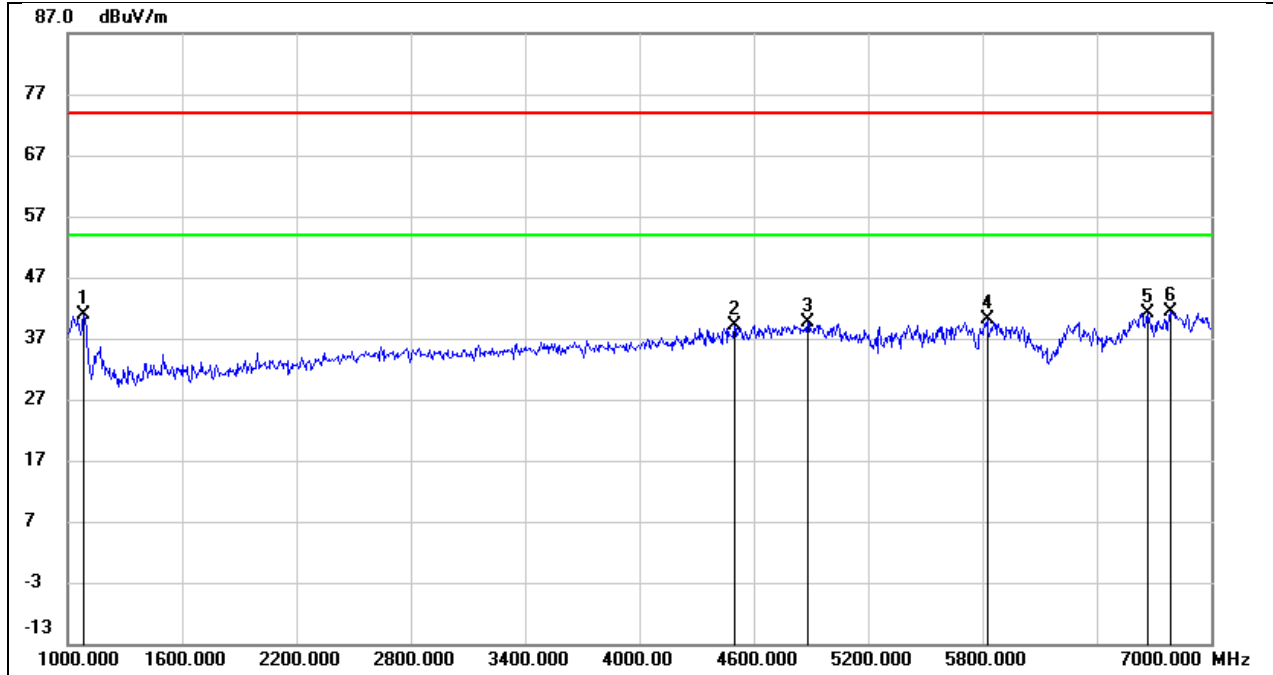

No.	Frequency (MHz)	Reading (dBuV)	Correct (dB/m)	Result (dBuV/m)	Limit (dBuV/m)	Margin (dB)	Remark
1	1084.000	55.52	-14.64	40.88	74.00	-33.12	peak
2	4498.000	41.22	-2.14	39.08	74.00	-34.92	peak
3	4882.000	40.15	-0.62	39.53	74.00	-34.47	peak
4	5824.000	38.86	1.34	40.20	74.00	-33.80	peak
5	6664.000	36.60	4.54	41.14	74.00	-32.86	peak
6	6790.000	36.33	5.15	41.48	74.00	-32.52	peak

Test Mode:	802.11a 20	Frequency(MHz):	5260
Polarity:	Vertical	Test Voltage:	DC 12 V

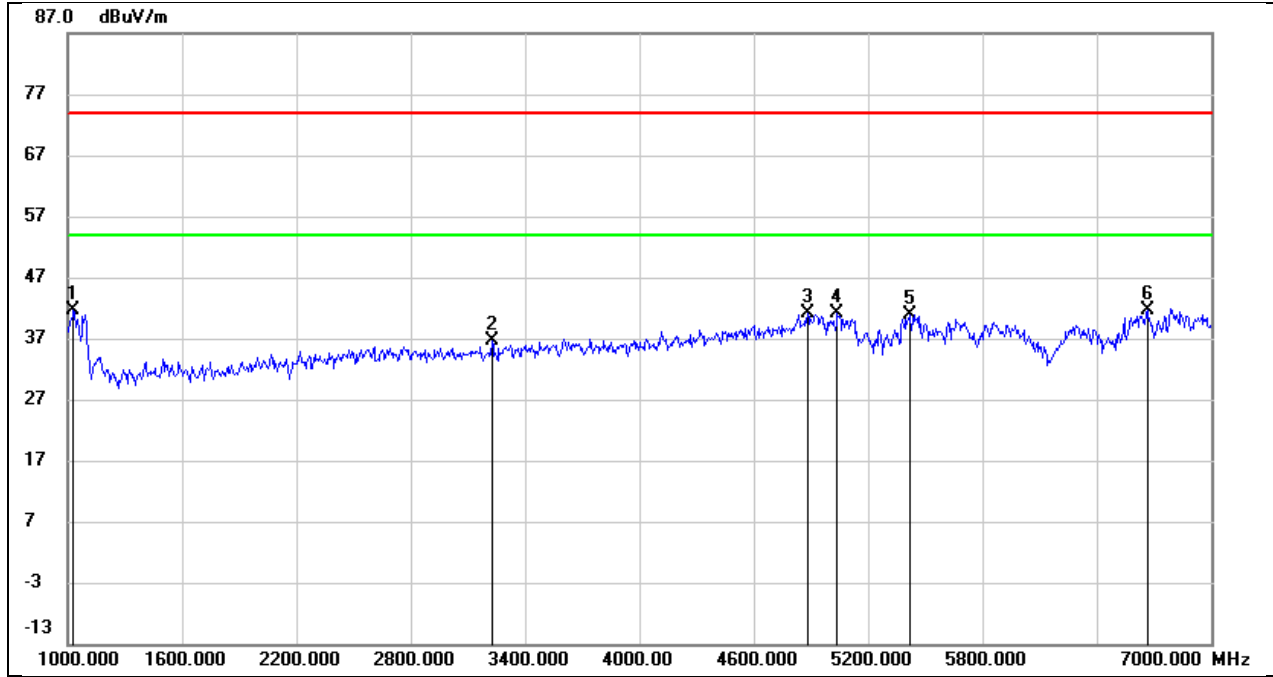

No.	Frequency (MHz)	Reading (dBuV)	Correct (dB/m)	Result (dBuV/m)	Limit (dBuV/m)	Margin (dB)	Remark
1	1030.000	56.48	-14.89	41.59	74.00	-32.41	peak
2	3226.000	43.13	-6.47	36.66	74.00	-37.34	peak
3	4882.000	41.73	-0.62	41.11	74.00	-32.89	peak
4	5038.000	41.33	-0.11	41.22	74.00	-32.78	peak
5	5422.000	40.59	0.32	40.91	74.00	-33.09	peak
6	6664.000	36.98	4.54	41.52	74.00	-32.48	peak

Test Mode:	802.11a 20	Frequency(MHz):	5280
Polarity:	Horizontal	Test Voltage:	DC 12 V

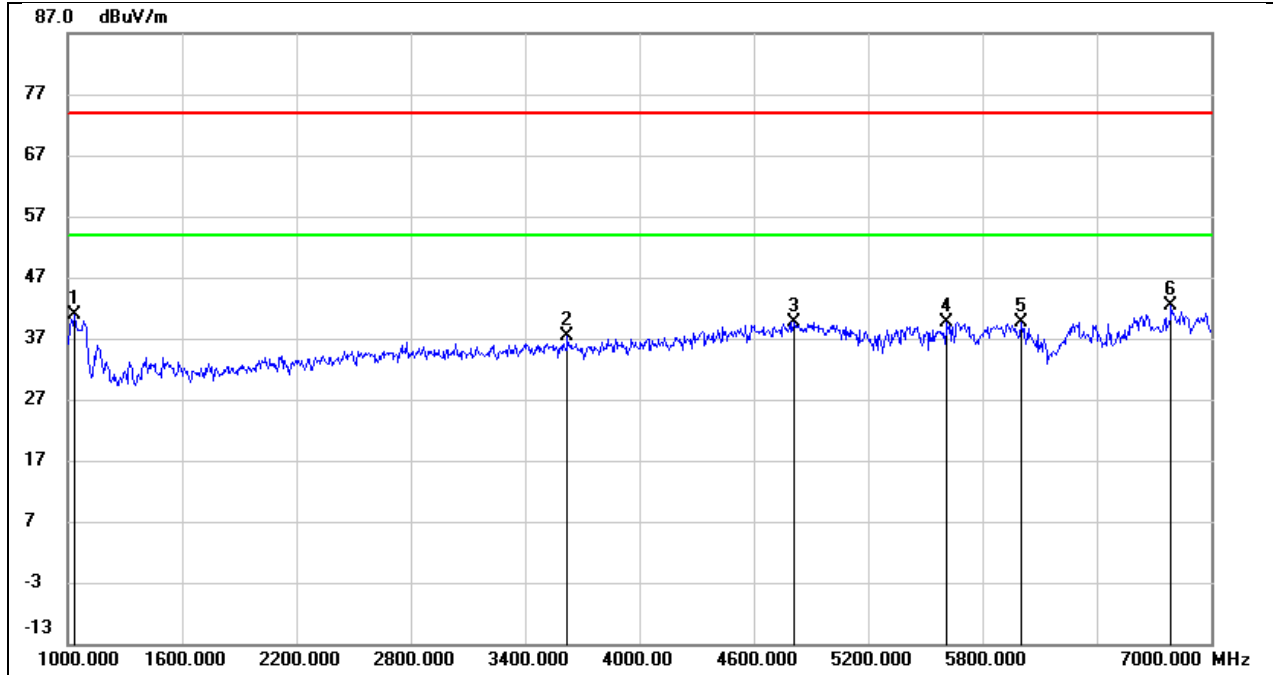

No.	Frequency (MHz)	Reading (dBuV)	Correct (dB/m)	Result (dBuV/m)	Limit (dBuV/m)	Margin (dB)	Remark
1	1036.000	55.64	-14.87	40.77	74.00	-33.23	peak
2	3622.000	42.86	-5.52	37.34	74.00	-36.66	peak
3	4810.000	40.58	-0.91	39.67	74.00	-34.33	peak
4	5614.000	38.92	0.74	39.66	74.00	-34.34	peak
5	6004.000	37.88	1.87	39.75	74.00	-34.25	peak
6	6790.000	37.14	5.15	42.29	74.00	-31.71	peak

Test Mode:	802.11a 20	Frequency(MHz):	5280
Polarity:	Vertical	Test Voltage:	DC 12 V

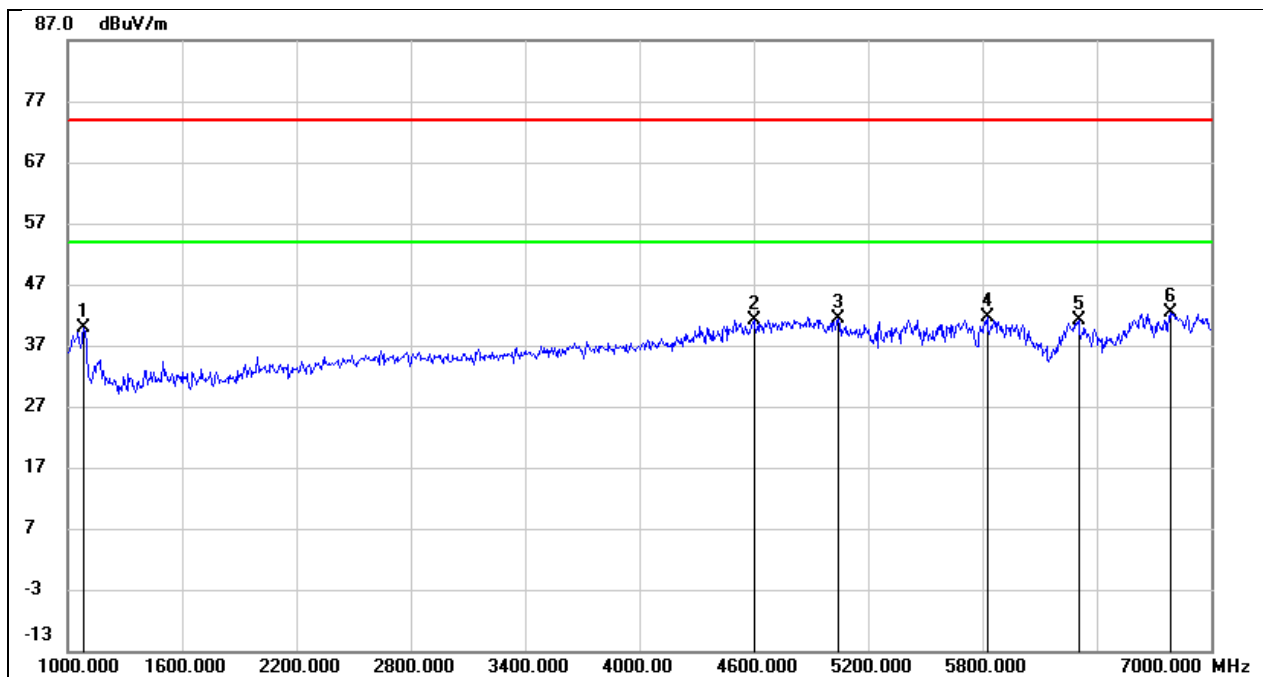

No.	Frequency (MHz)	Reading (dBuV)	Correct (dB/m)	Result (dBuV/m)	Limit (dBuV/m)	Margin (dB)	Remark
1	1084.000	54.52	-14.64	39.88	74.00	-34.12	peak
2	4600.000	42.87	-1.74	41.13	74.00	-32.87	peak
3	5044.000	41.50	-0.10	41.40	74.00	-32.60	peak
4	5824.000	40.36	1.34	41.70	74.00	-32.30	peak
5	6304.000	38.04	2.99	41.03	74.00	-32.97	peak
6	6790.000	37.33	5.15	42.48	74.00	-31.52	peak

Test Mode:	802.11a 20	Frequency(MHz):	5320
Polarity:	Horizontal	Test Voltage:	DC 12 V

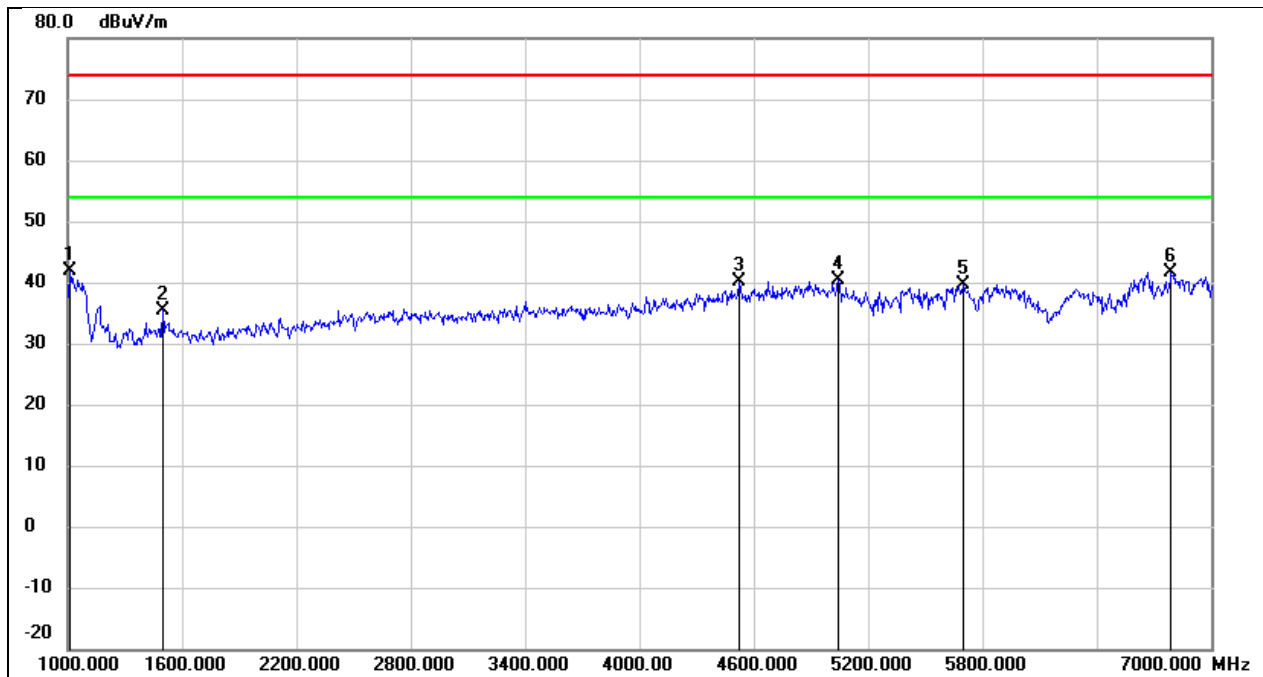

No.	Frequency (MHz)	Reading (dBuV)	Correct (dB/m)	Result (dBuV/m)	Limit (dBuV/m)	Margin (dB)	Remark
1	1012.000	56.93	-14.98	41.95	74.00	-32.05	peak
2	1498.000	48.22	-12.72	35.50	74.00	-38.50	peak
3	4522.000	42.14	-2.05	40.09	74.00	-33.91	peak
4	5044.000	40.38	-0.10	40.28	74.00	-33.72	peak
5	5698.000	38.72	0.99	39.71	74.00	-34.29	peak
6	6790.000	36.38	5.15	41.53	74.00	-32.47	peak

Test Mode:	802.11a 20	Frequency(MHz):	5320
Polarity:	Vertical	Test Voltage:	DC 12 V

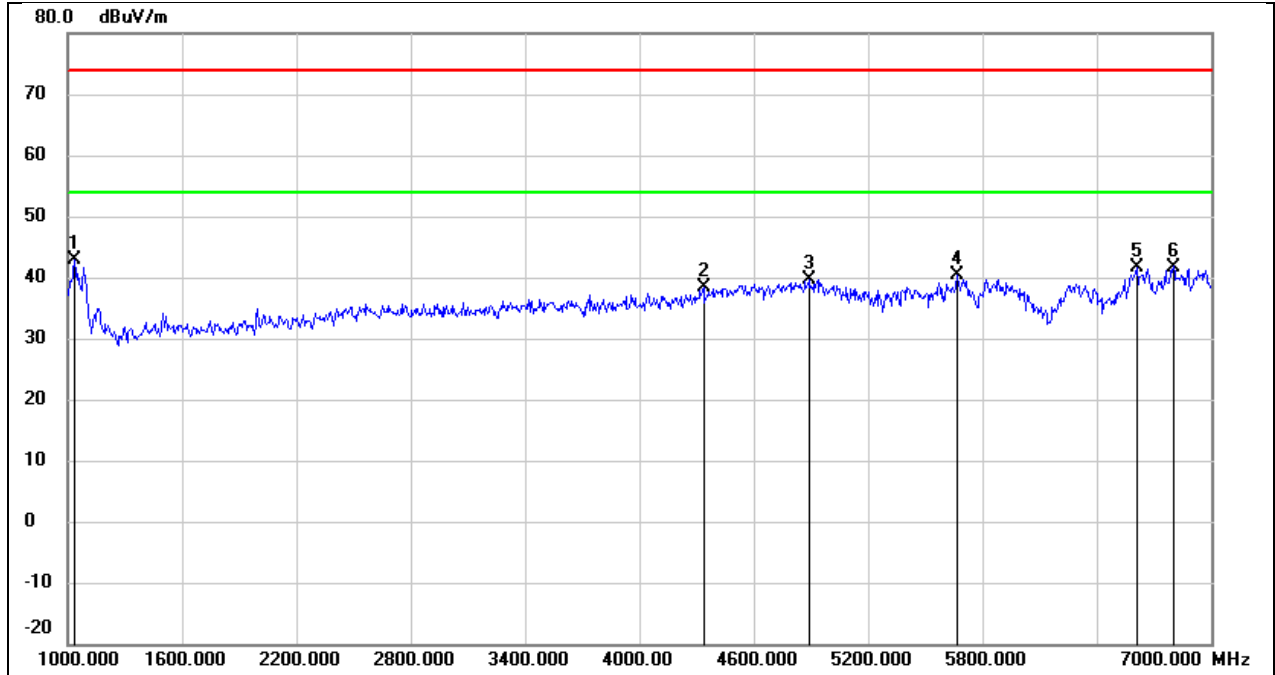

No.	Frequency (MHz)	Reading (dBuV)	Correct (dB/m)	Result (dBuV/m)	Limit (dBuV/m)	Margin (dB)	Remark
1	1036.000	57.70	-14.87	42.83	74.00	-31.17	peak
2	4336.000	41.25	-2.90	38.35	74.00	-35.65	peak
3	4888.000	40.32	-0.60	39.72	74.00	-34.28	peak
4	5668.000	39.40	0.91	40.31	74.00	-33.69	peak
5	6610.000	37.46	4.27	41.73	74.00	-32.27	peak
6	6802.000	36.54	5.21	41.75	74.00	-32.25	peak

Test Mode:	802.11a 20	Frequency(MHz):	5500
Polarity:	Horizontal	Test Voltage:	DC 12 V

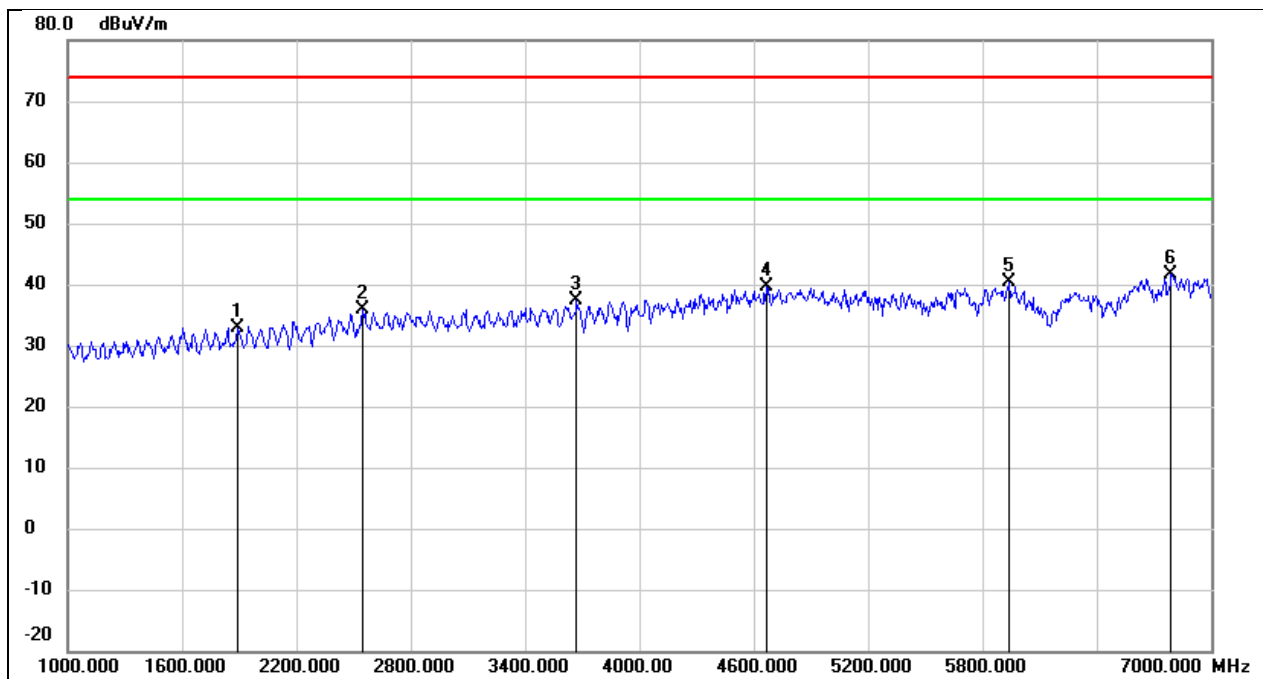

No.	Frequency (MHz)	Reading (dBuV)	Correct (dB/m)	Result (dBuV/m)	Limit (dBuV/m)	Margin (dB)	Remark
1	1888.000	44.35	-11.43	32.92	74.00	-41.08	peak
2	2548.000	44.23	-8.35	35.88	74.00	-38.12	peak
3	3670.000	42.87	-5.38	37.49	74.00	-36.51	peak
4	4666.000	41.19	-1.48	39.71	74.00	-34.29	peak
5	5938.000	38.75	1.67	40.42	74.00	-33.58	peak
6	6790.000	36.37	5.15	41.52	74.00	-32.48	peak

Test Mode:	802.11a 20	Frequency(MHz):	5500
Polarity:	Vertical	Test Voltage:	DC 12 V

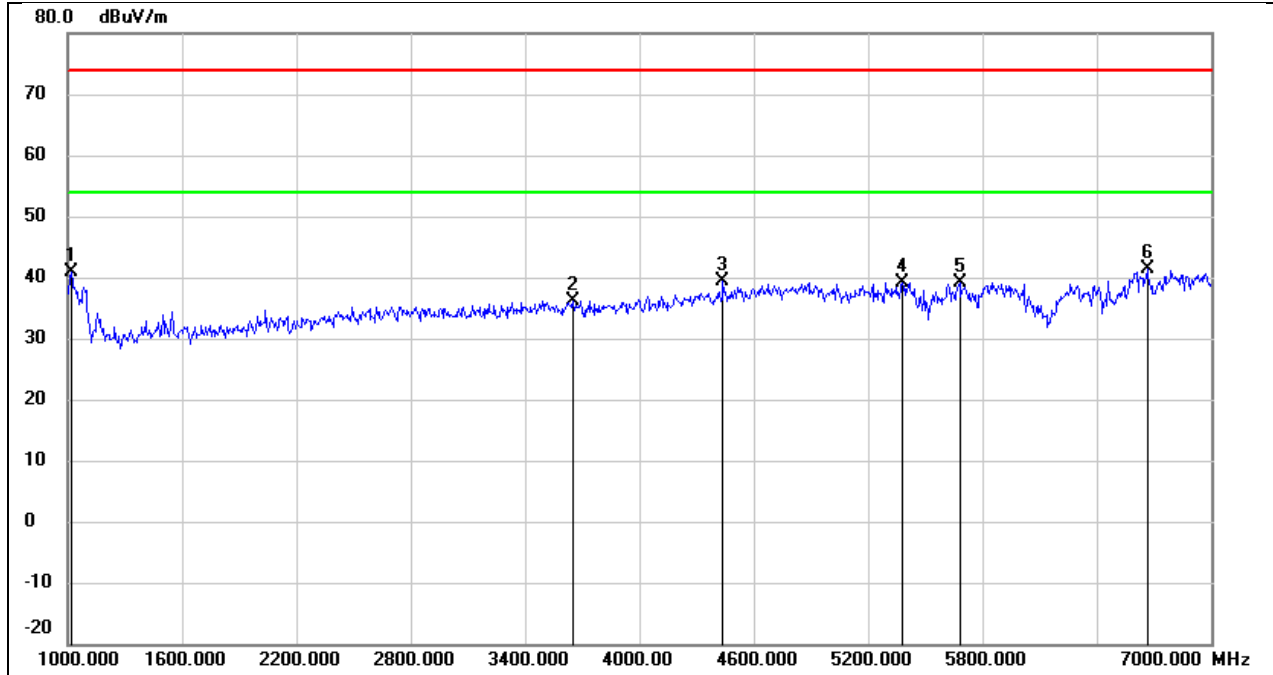

No.	Frequency (MHz)	Reading (dBuV)	Correct (dB/m)	Result (dBuV/m)	Limit (dBuV/m)	Margin (dB)	Remark
1	1018.000	55.86	-14.95	40.91	74.00	-33.09	peak
2	3652.000	41.56	-5.44	36.12	74.00	-37.88	peak
3	4438.000	41.82	-2.42	39.40	74.00	-34.60	peak
4	5380.000	38.83	0.29	39.12	74.00	-34.88	peak
5	5680.000	38.14	0.94	39.08	74.00	-34.92	peak
6	6664.000	36.87	4.54	41.41	74.00	-32.59	peak

Test Mode:	802.11a 20	Frequency(MHz):	5580
Polarity:	Horizontal	Test Voltage:	DC 12 V

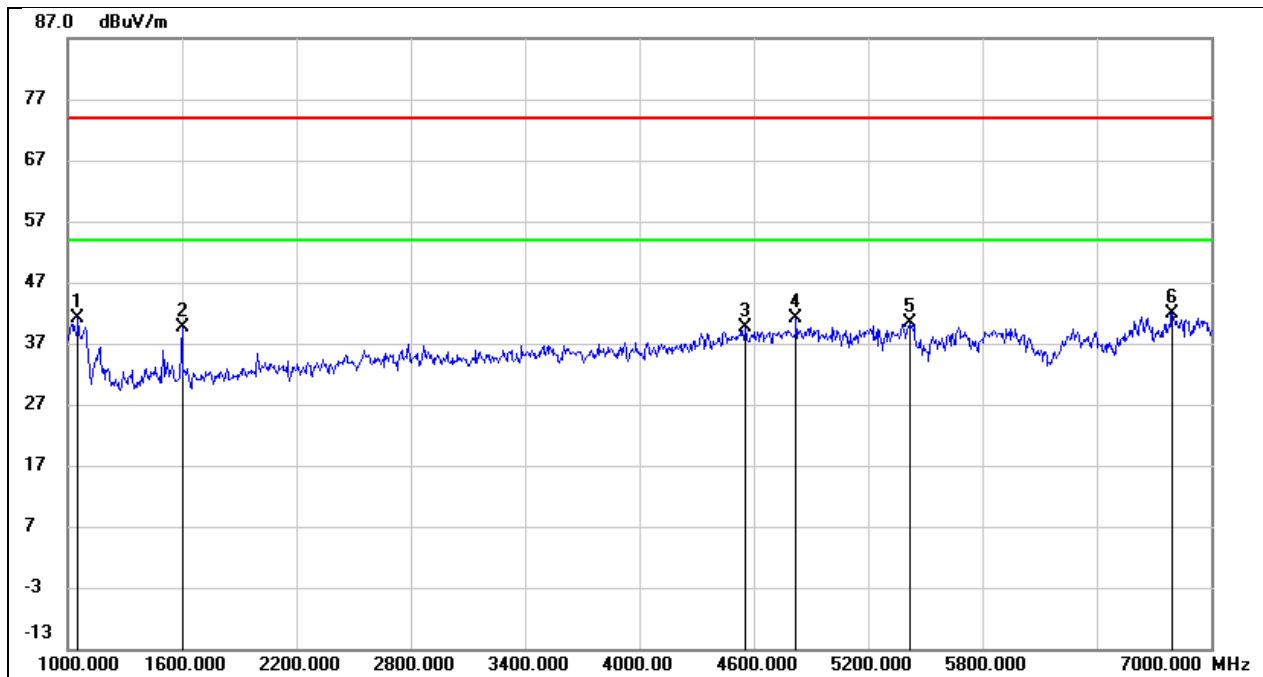

No.	Frequency (MHz)	Reading (dBuV)	Correct (dB/m)	Result (dBuV/m)	Limit (dBuV/m)	Margin (dB)	Remark
1	1054.000	55.87	-14.78	41.09	74.00	-32.91	peak
2	1600.000	52.07	-12.38	39.69	74.00	-34.31	peak
3	4558.000	41.52	-1.91	39.61	74.00	-34.39	peak
4	4822.000	41.97	-0.85	41.12	74.00	-32.88	peak
5	5422.000	40.05	0.32	40.37	74.00	-33.63	peak
6	6796.000	36.65	5.19	41.84	74.00	-32.16	peak

Test Mode:	802.11a 20	Frequency(MHz):	5580
Polarity:	Vertical	Test Voltage:	DC 12 V

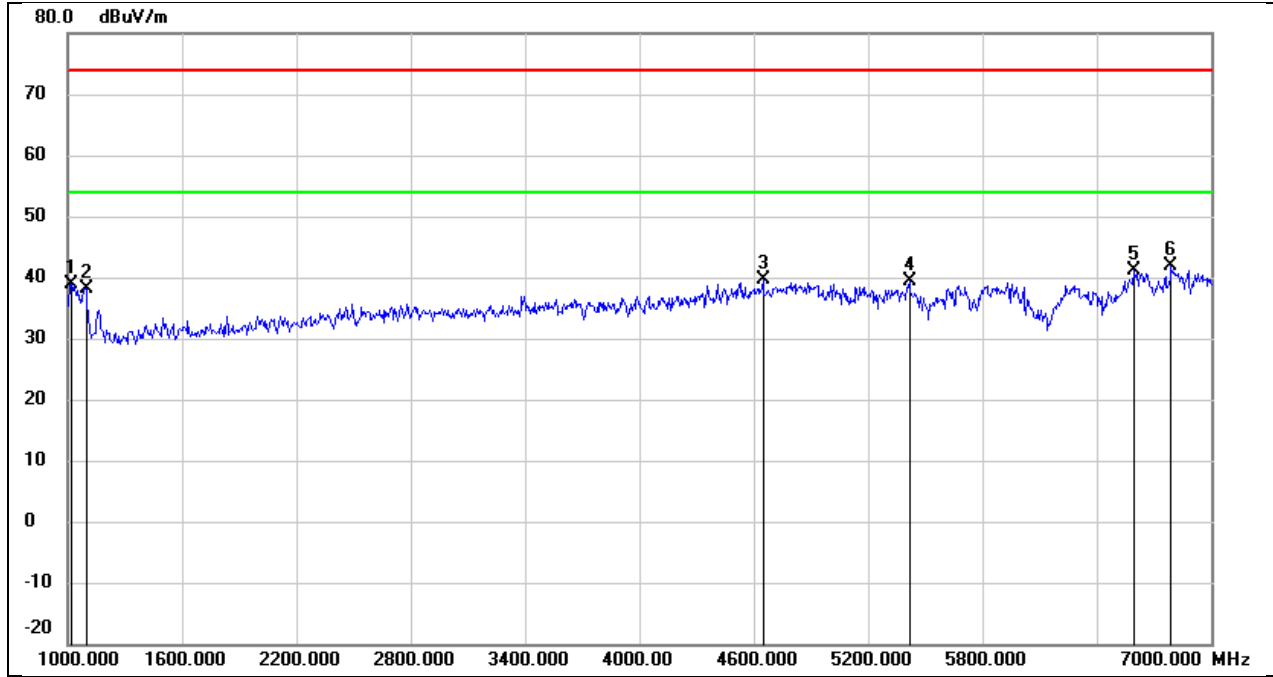

No.	Frequency (MHz)	Reading (dBuV)	Correct (dB/m)	Result (dBuV/m)	Limit (dBuV/m)	Margin (dB)	Remark
1	1018.000	53.90	-14.95	38.95	74.00	-35.05	peak
2	1096.000	52.74	-14.58	38.16	74.00	-35.84	peak
3	4648.000	41.21	-1.55	39.66	74.00	-34.34	peak
4	5416.000	38.98	0.32	39.30	74.00	-34.70	peak
5	6592.000	36.84	4.19	41.03	74.00	-32.97	peak
6	6790.000	36.76	5.15	41.91	74.00	-32.09	peak

Test Mode:	802.11a 20	Frequency(MHz):	5700
Polarity:	Horizontal	Test Voltage:	DC 12 V

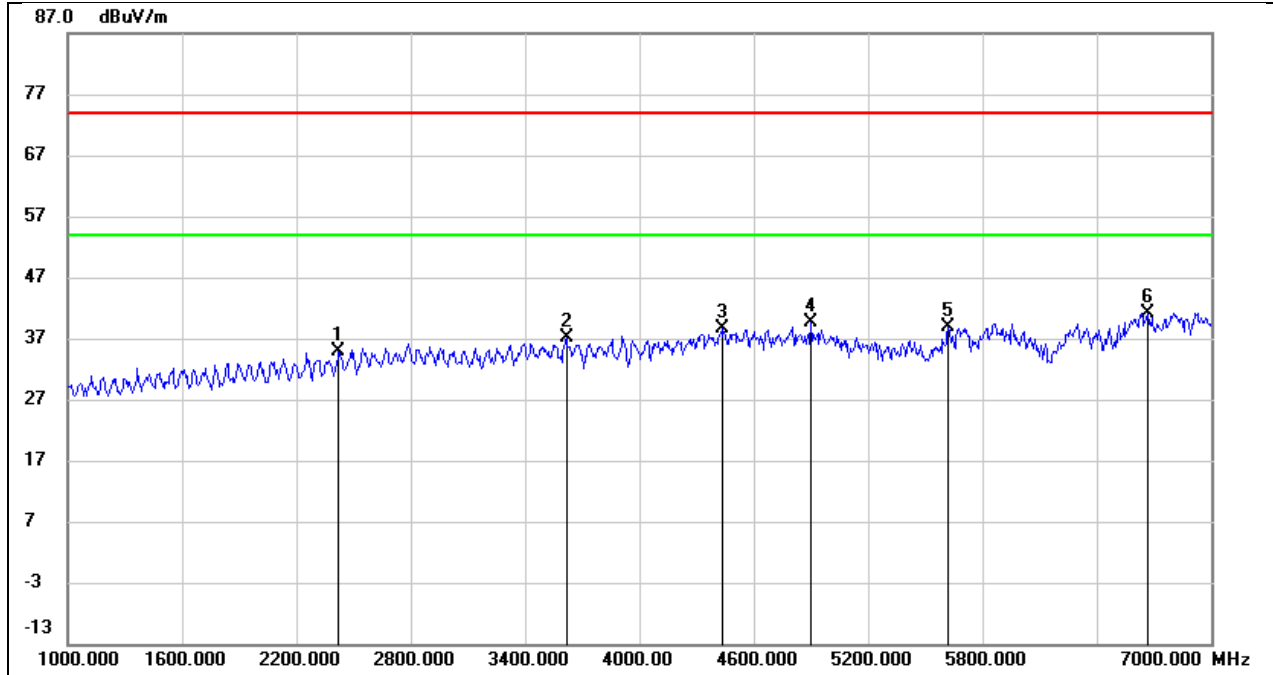

No.	Frequency (MHz)	Reading (dBuV)	Correct (dB/m)	Result (dBuV/m)	Limit (dBuV/m)	Margin (dB)	Remark
1	2422.000	43.82	-8.88	34.94	74.00	-39.06	peak
2	3616.000	42.62	-5.53	37.09	74.00	-36.91	peak
3	4438.000	40.95	-2.42	38.53	74.00	-35.47	peak
4	4900.000	40.11	-0.55	39.56	74.00	-34.44	peak
5	5620.000	38.07	0.76	38.83	74.00	-35.17	peak
6	6664.000	36.65	4.54	41.19	74.00	-32.81	peak

Test Mode:	802.11a 20	Frequency(MHz):	5700
Polarity:	Vertical	Test Voltage:	DC 12 V

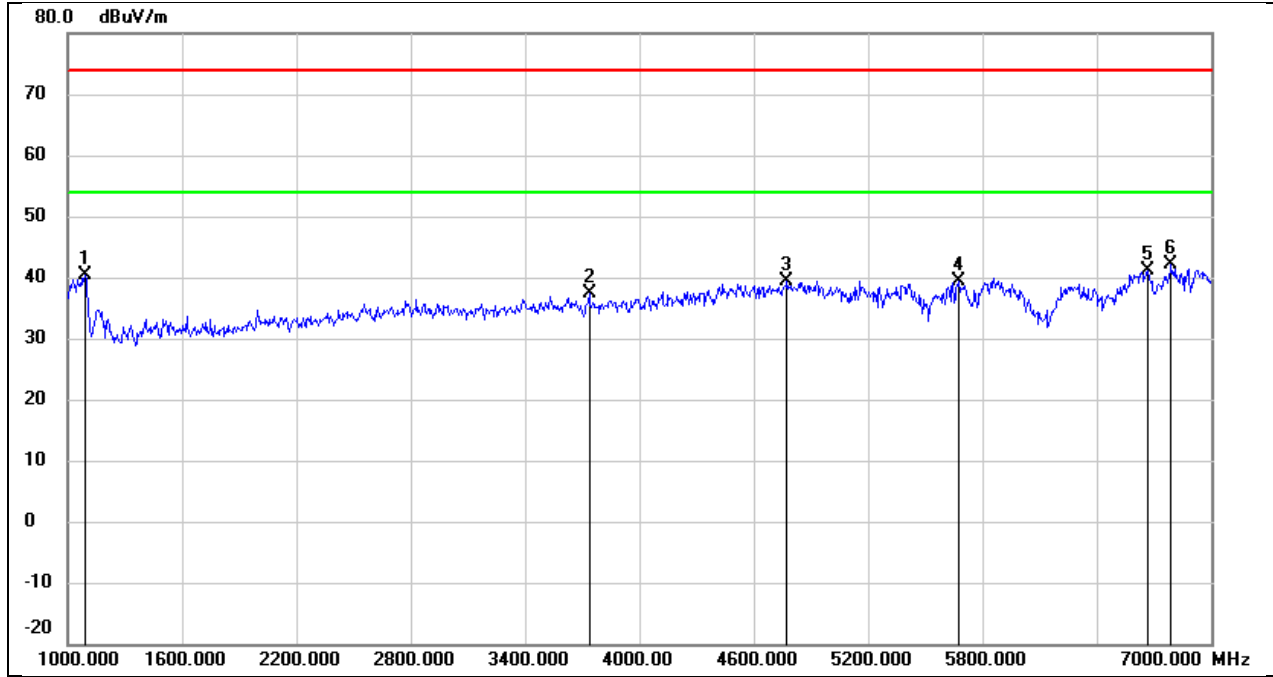

No.	Frequency (MHz)	Reading (dBuV)	Correct (dB/m)	Result (dBuV/m)	Limit (dBuV/m)	Margin (dB)	Remark
1	1090.000	55.00	-14.61	40.39	74.00	-33.61	peak
2	3736.000	42.62	-5.21	37.41	74.00	-36.59	peak
3	4774.000	40.54	-1.05	39.49	74.00	-34.51	peak
4	5674.000	38.45	0.92	39.37	74.00	-34.63	peak
5	6664.000	36.61	4.54	41.15	74.00	-32.85	peak
6	6790.000	36.90	5.15	42.05	74.00	-31.95	peak

Test Mode:	802.11a 20	Frequency(MHz):	5720
Polarity:	Horizontal	Test Voltage:	DC 12 V

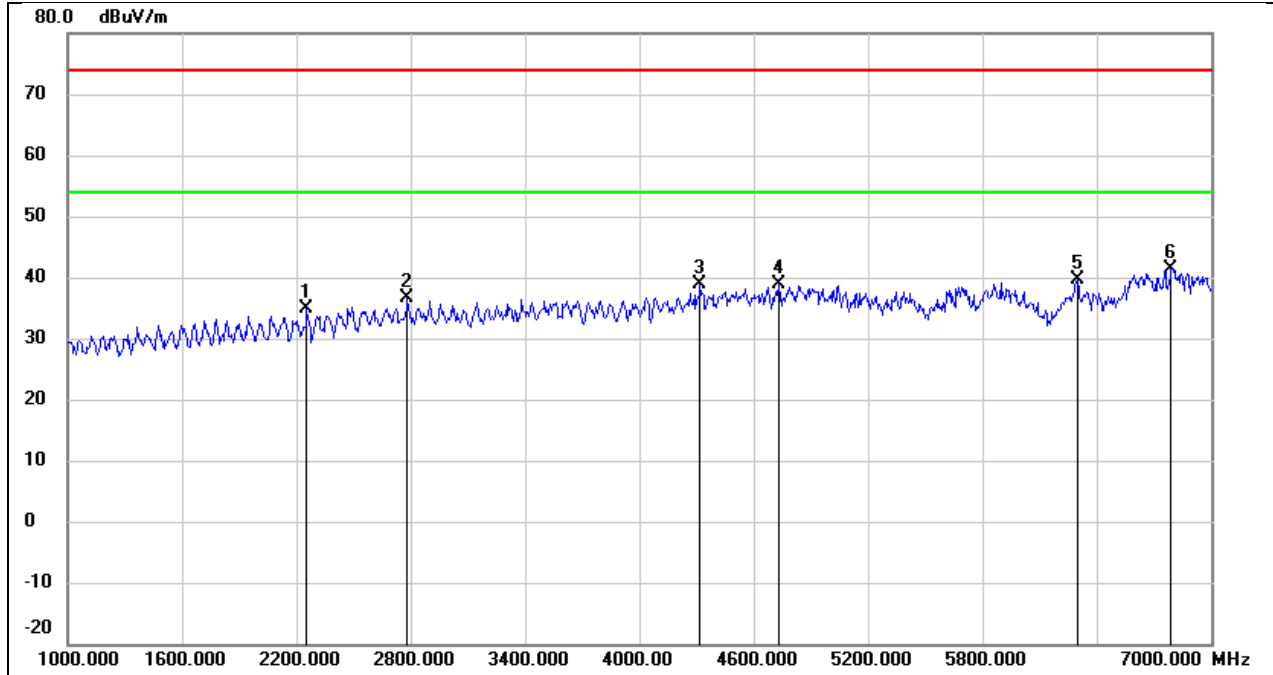

No.	Frequency (MHz)	Reading (dBuV)	Correct (dB/m)	Result (dBuV/m)	Limit (dBuV/m)	Margin (dB)	Remark
1	2254.000	44.69	-9.75	34.94	74.00	-39.06	peak
2	2782.000	44.15	-7.63	36.52	74.00	-37.48	peak
3	4318.000	41.98	-2.99	38.99	74.00	-35.01	peak
4	4732.000	40.17	-1.22	38.95	74.00	-35.05	peak
5	6298.000	36.54	2.97	39.51	74.00	-34.49	peak
6	6790.000	36.25	5.15	41.40	74.00	-32.60	peak

Test Mode:	802.11a 20	Frequency(MHz):	5720
Polarity:	Vertical	Test Voltage:	DC 12 V

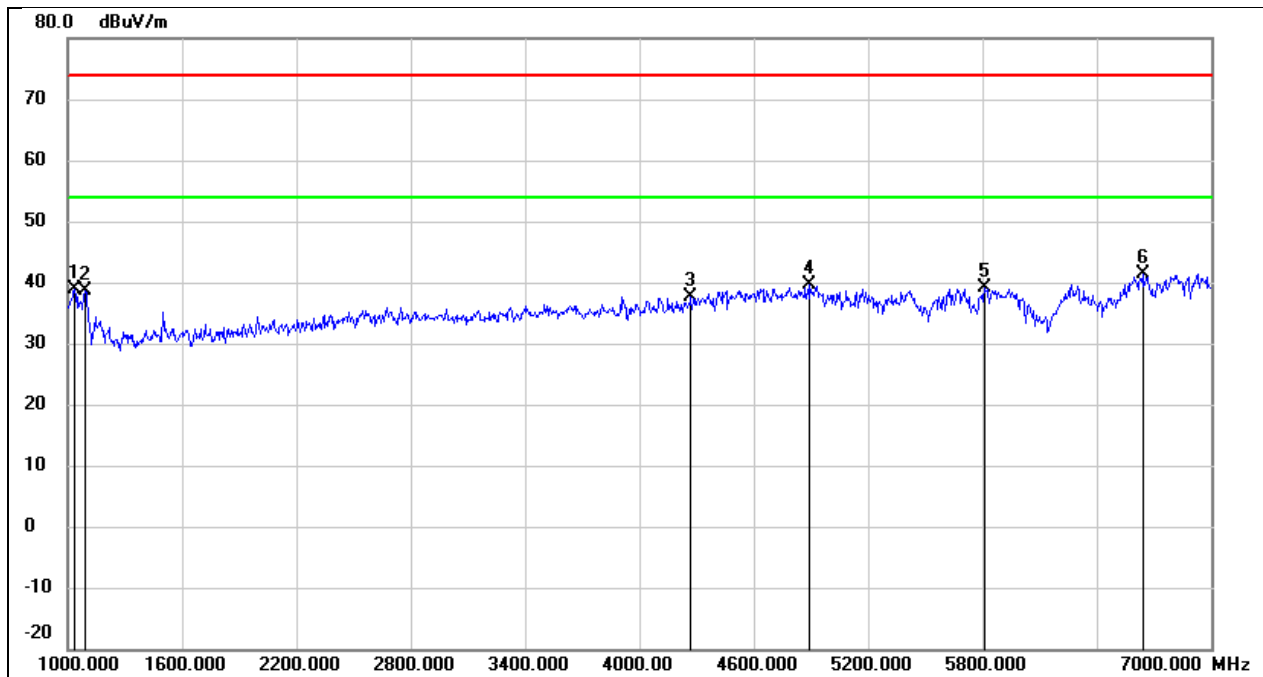

No.	Frequency (MHz)	Reading (dBuV)	Correct (dB/m)	Result (dBuV/m)	Limit (dBuV/m)	Margin (dB)	Remark
1	1036.000	53.80	-14.87	38.93	74.00	-35.07	peak
2	1090.000	53.13	-14.61	38.52	74.00	-35.48	peak
3	4270.000	40.77	-3.22	37.55	74.00	-36.45	peak
4	4888.000	40.25	-0.60	39.65	74.00	-34.35	peak
5	5812.000	37.79	1.31	39.10	74.00	-34.90	peak
6	6640.000	36.96	4.41	41.37	74.00	-32.63	peak

Test Mode:	802.11a 20	Frequency(MHz):	5745
Polarity:	Horizontal	Test Voltage:	DC 12 V

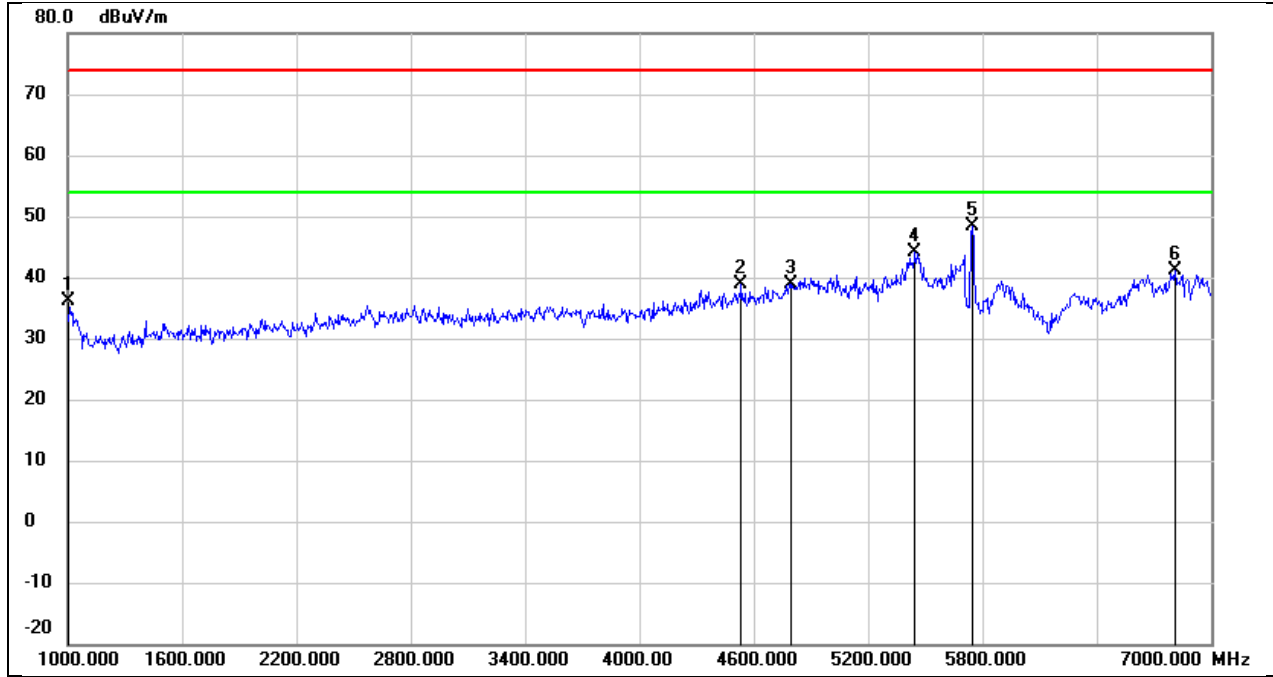

No.	Frequency (MHz)	Reading (dBuV)	Correct (dB/m)	Result (dBuV/m)	Limit (dBuV/m)	Margin (dB)	Remark
1	1000.0000	51.16	-15.03	36.13	74.00	-37.87	peak
2	4534.000	40.77	-2.01	38.76	74.00	-35.24	peak
3	4792.000	39.79	-0.98	38.81	74.00	-35.19	peak
4	5446.000	43.79	0.35	44.14	74.00	-29.86	peak
5	5746.000	47.18	1.12	48.30	74.00	-25.70	peak
6	6814.000	35.83	5.28	41.11	74.00	-32.89	peak

Test Mode:	802.11a 20	Frequency(MHz):	5745
Polarity:	Vertical	Test Voltage:	DC 12 V

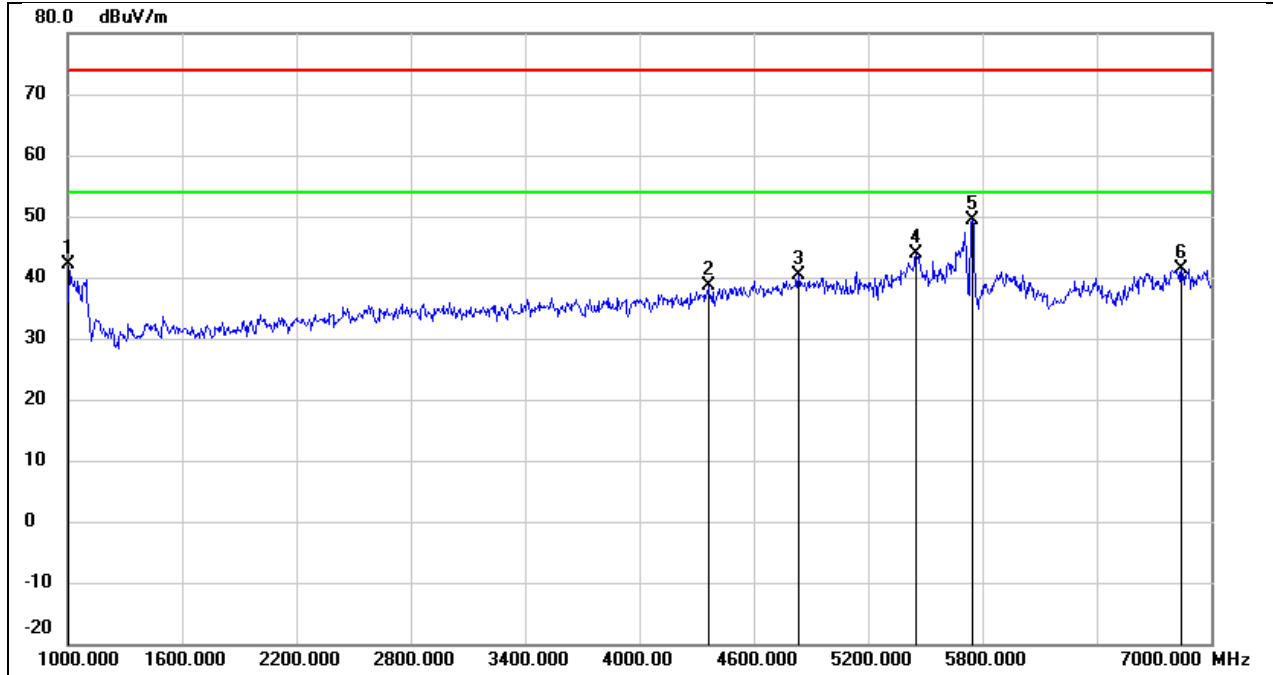

No.	Frequency (MHz)	Reading (dBuV)	Correct (dB/m)	Result (dBuV/m)	Limit (dBuV/m)	Margin (dB)	Remark
1	1000.0000	57.23	-15.03	42.20	74.00	-31.80	peak
2	4360.000	41.31	-2.80	38.51	74.00	-35.49	peak
3	4834.000	41.09	-0.81	40.28	74.00	-33.72	peak
4	5452.000	43.59	0.37	43.96	74.00	-30.04	peak
5	5746.000	48.19	1.12	49.31	74.00	-24.69	peak
6	6844.000	35.85	5.43	41.28	74.00	-32.72	peak

Test Mode:	802.11a 20	Frequency(MHz):	5785
Polarity:	Horizontal	Test Voltage:	DC 12 V

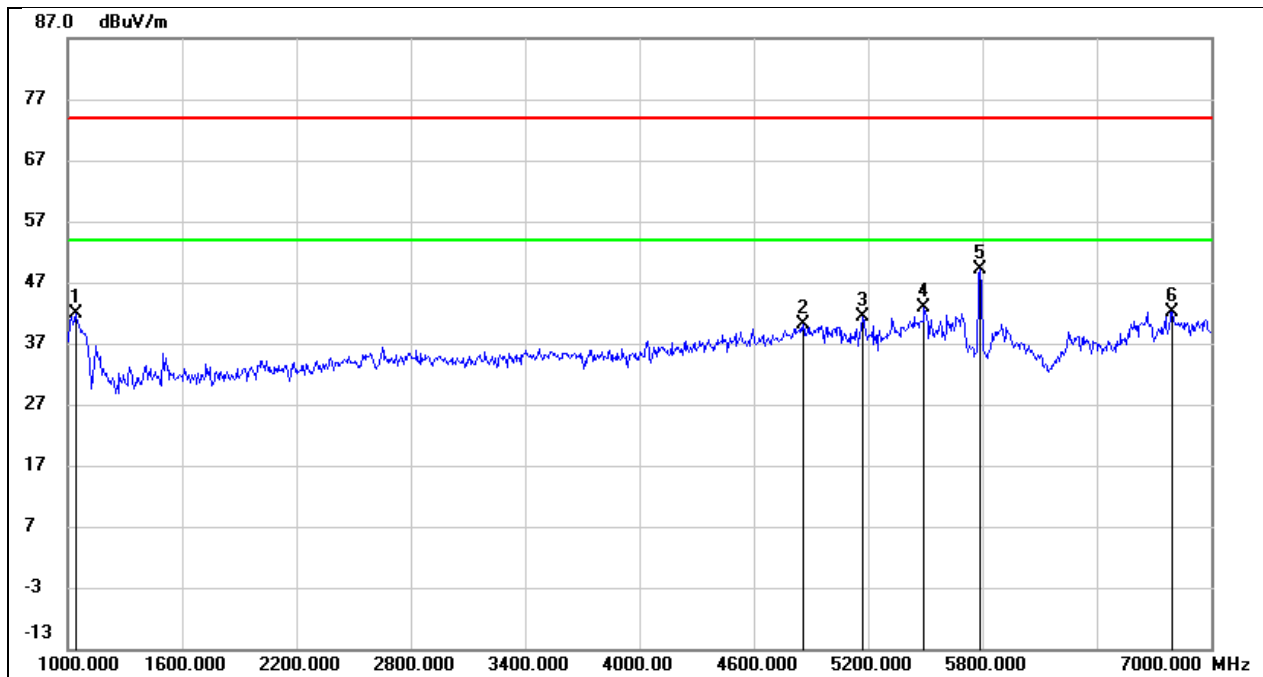

No.	Frequency (MHz)	Reading (dBuV)	Correct (dB/m)	Result (dBuV/m)	Limit (dBuV/m)	Margin (dB)	Remark
1	1042.000	56.72	-14.84	41.88	74.00	-32.12	peak
2	4858.000	40.90	-0.72	40.18	74.00	-33.82	peak
3	5170.000	41.33	0.05	41.38	74.00	-32.62	peak
4	5494.000	42.41	0.42	42.83	74.00	-31.17	peak
5	5788.000	47.76	1.25	49.01	74.00	-24.99	peak
6	6796.000	36.85	5.19	42.04	74.00	-31.96	peak

Test Mode:	802.11a 20	Frequency(MHz):	5785
Polarity:	Vertical	Test Voltage:	DC 12 V

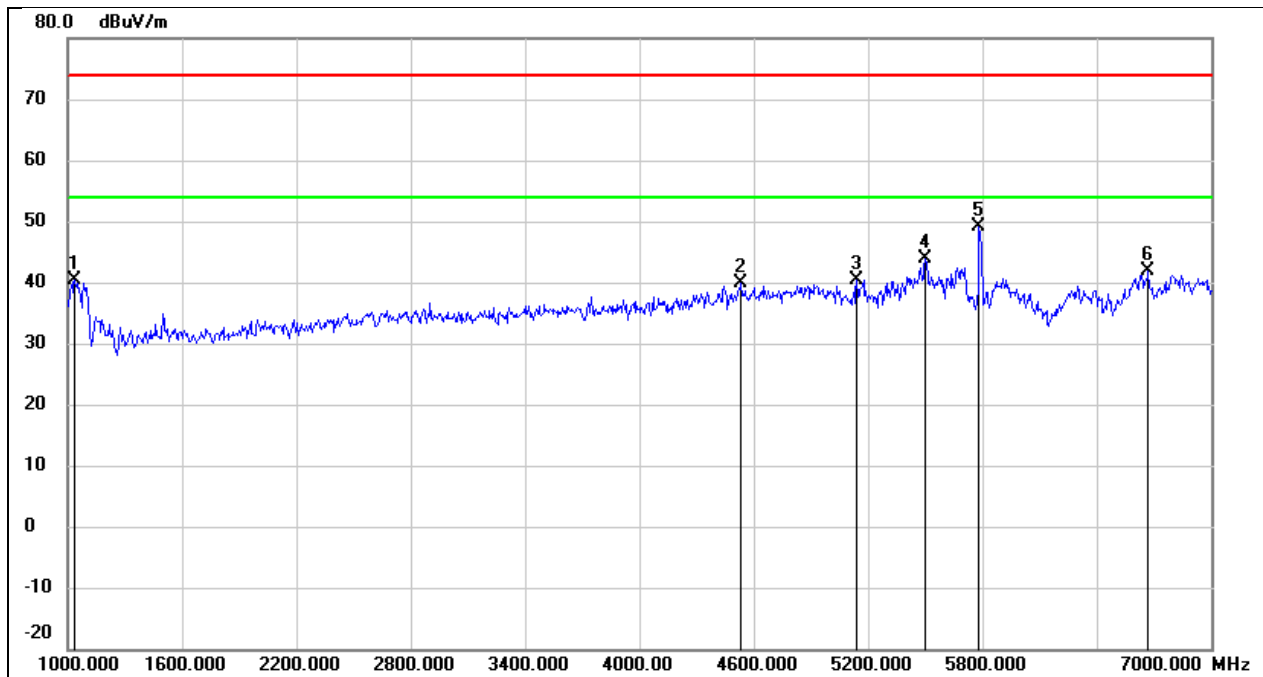

No.	Frequency (MHz)	Reading (dBuV)	Correct (dB/m)	Result (dBuV/m)	Limit (dBuV/m)	Margin (dB)	Remark
1	1036.000	55.17	-14.87	40.30	74.00	-33.70	peak
2	4534.000	41.77	-2.01	39.76	74.00	-34.24	peak
3	5140.000	40.48	0.01	40.49	74.00	-33.51	peak
4	5500.000	43.36	0.42	43.78	74.00	-30.22	peak
5	5782.000	47.91	1.23	49.14	74.00	-24.86	peak
6	6670.000	37.19	4.57	41.76	74.00	-32.24	peak

Test Mode:	802.11a 20	Frequency(MHz):	5825
Polarity:	Horizontal	Test Voltage:	DC 12 V

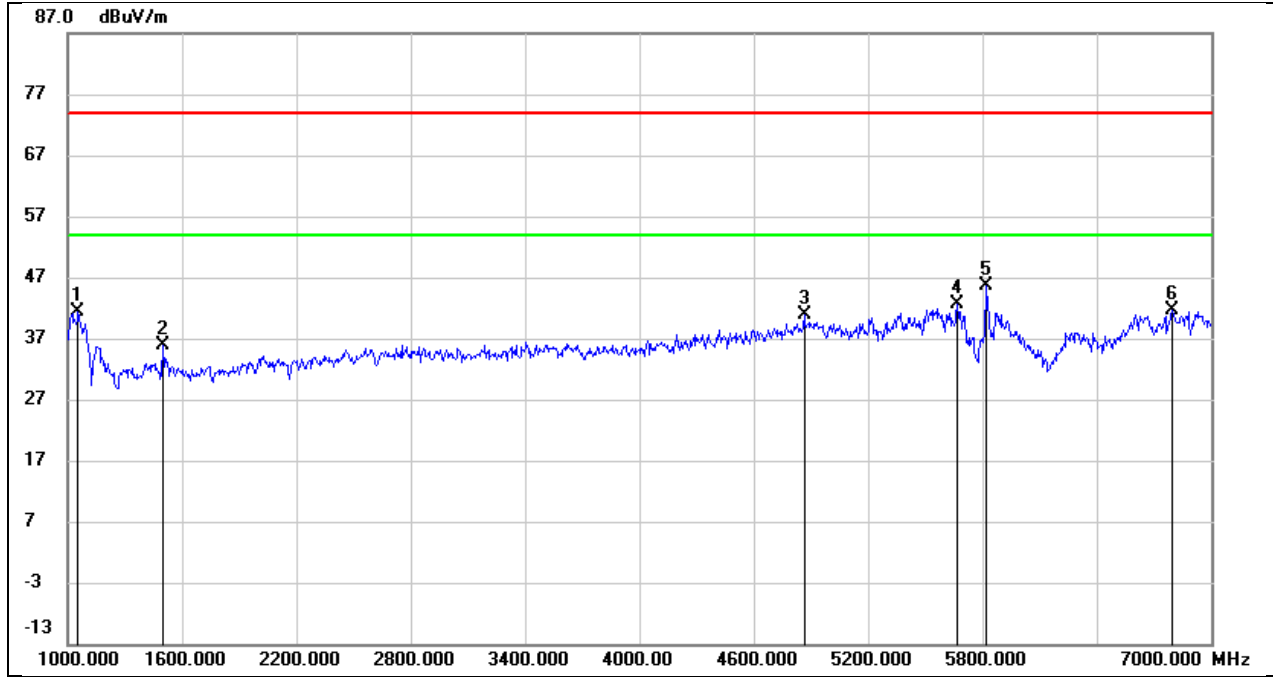

No.	Frequency (MHz)	Reading (dBuV)	Correct (dB/m)	Result (dBuV/m)	Limit (dBuV/m)	Margin (dB)	Remark
1	1054.000	56.05	-14.78	41.27	74.00	-32.73	peak
2	1498.000	48.57	-12.72	35.85	74.00	-38.15	peak
3	4864.000	41.48	-0.70	40.78	74.00	-33.22	peak
4	5668.000	41.76	0.91	42.67	74.00	-31.33	peak
5	5818.000	44.22	1.33	45.55	74.00	-28.45	peak
6	6796.000	36.42	5.19	41.61	74.00	-32.39	peak

Test Mode:	802.11a 20	Frequency(MHz):	5825
Polarity:	Vertical	Test Voltage:	DC 12 V

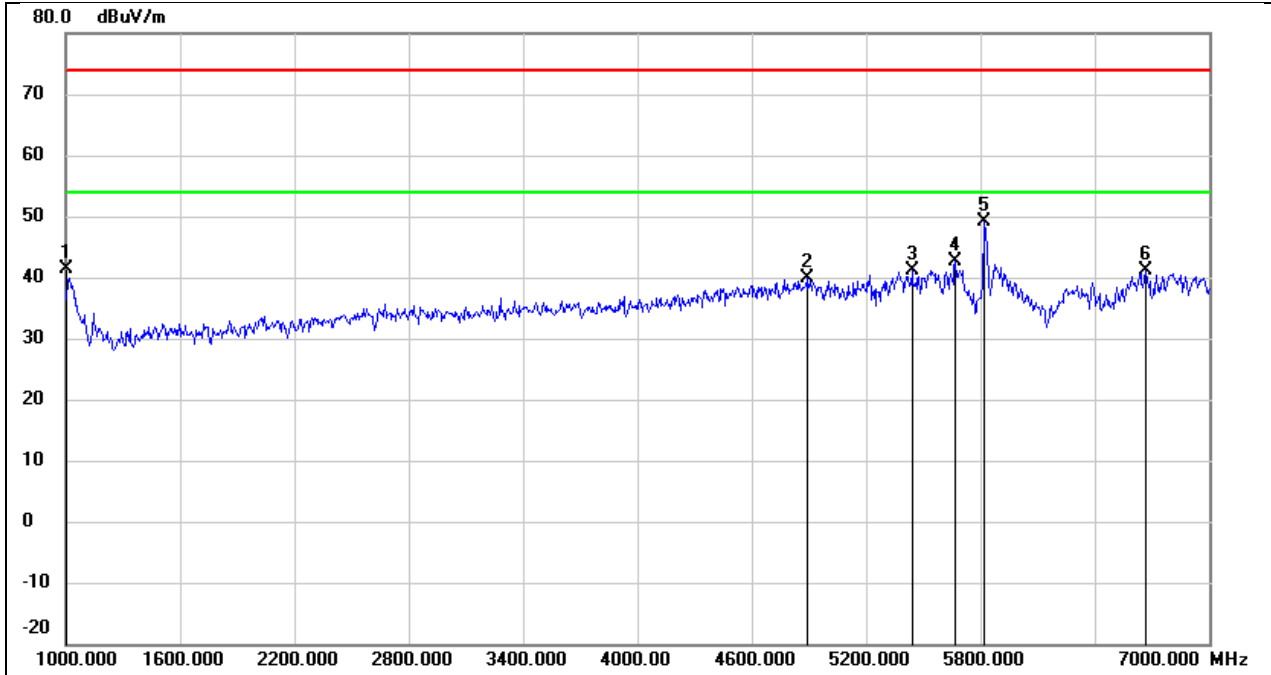

No.	Frequency (MHz)	Reading (dBuV)	Correct (dB/m)	Result (dBuV/m)	Limit (dBuV/m)	Margin (dB)	Remark
1	1000.0000	56.43	-15.03	41.40	74.00	-32.60	peak
2	4888.000	40.51	-0.60	39.91	74.00	-34.09	peak
3	5440.000	40.75	0.35	41.10	74.00	-32.90	peak
4	5668.000	41.76	0.91	42.67	74.00	-31.33	peak
5	5818.000	47.81	1.33	49.14	74.00	-24.86	peak
6	6664.000	36.48	4.54	41.02	74.00	-32.98	peak

8.4. SPURIOUS EMISSIONS(1 GHZ~7 GHZ)

For ISED UNII-1 test data:

Test Mode:	802.11a 20	Frequency(MHz):	5180
Polarity:	Horizontal	Test Voltage:	DC 12 V

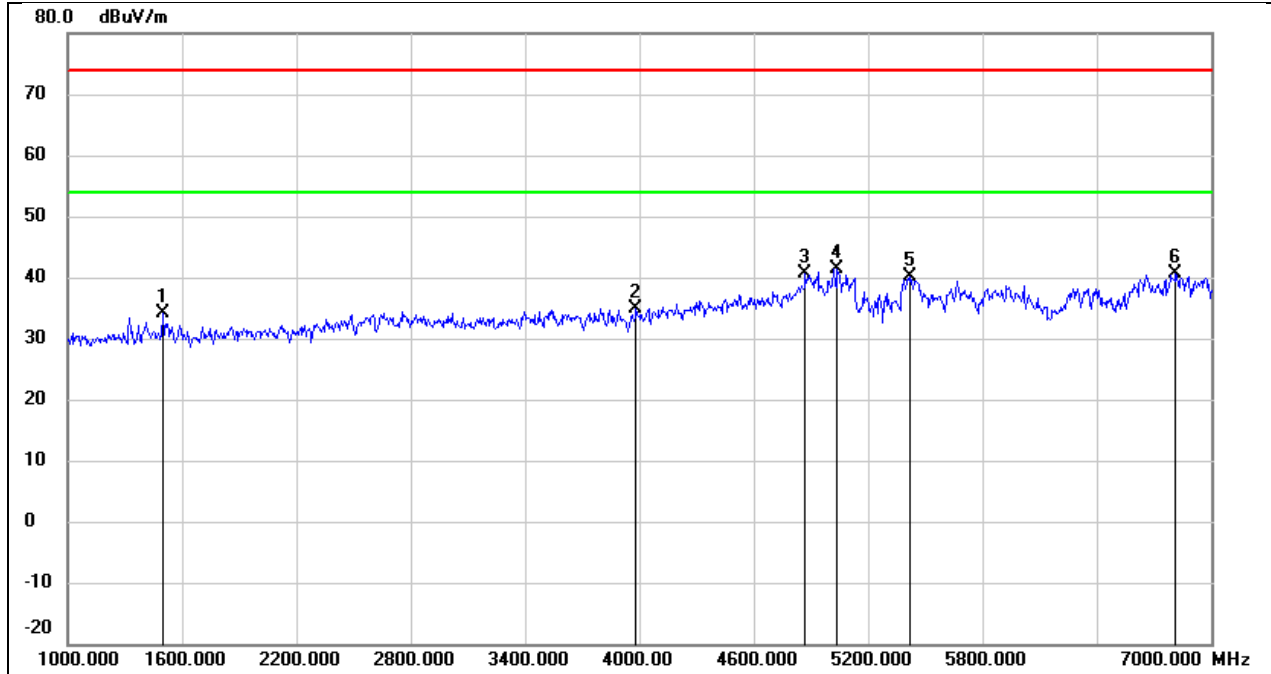

No.	Frequency (MHz)	Reading (dBuV)	Correct (dB/m)	Result (dBuV/m)	Limit (dBuV/m)	Margin (dB)	Remark
1	1498.000	46.87	-12.72	34.15	74.00	-39.85	peak
2	3982.000	39.42	-4.53	34.89	74.00	-39.11	peak
3	4870.000	41.36	-0.66	40.70	74.00	-33.30	peak
4	5038.000	41.46	-0.11	41.35	74.00	-32.65	peak
5	5422.000	39.79	0.32	40.11	74.00	-33.89	peak
6	6814.000	35.34	5.28	40.62	74.00	-33.38	peak

Test Mode:	802.11a 20	Frequency(MHz):	5180
Polarity:	Vertical	Test Voltage:	DC 12 V

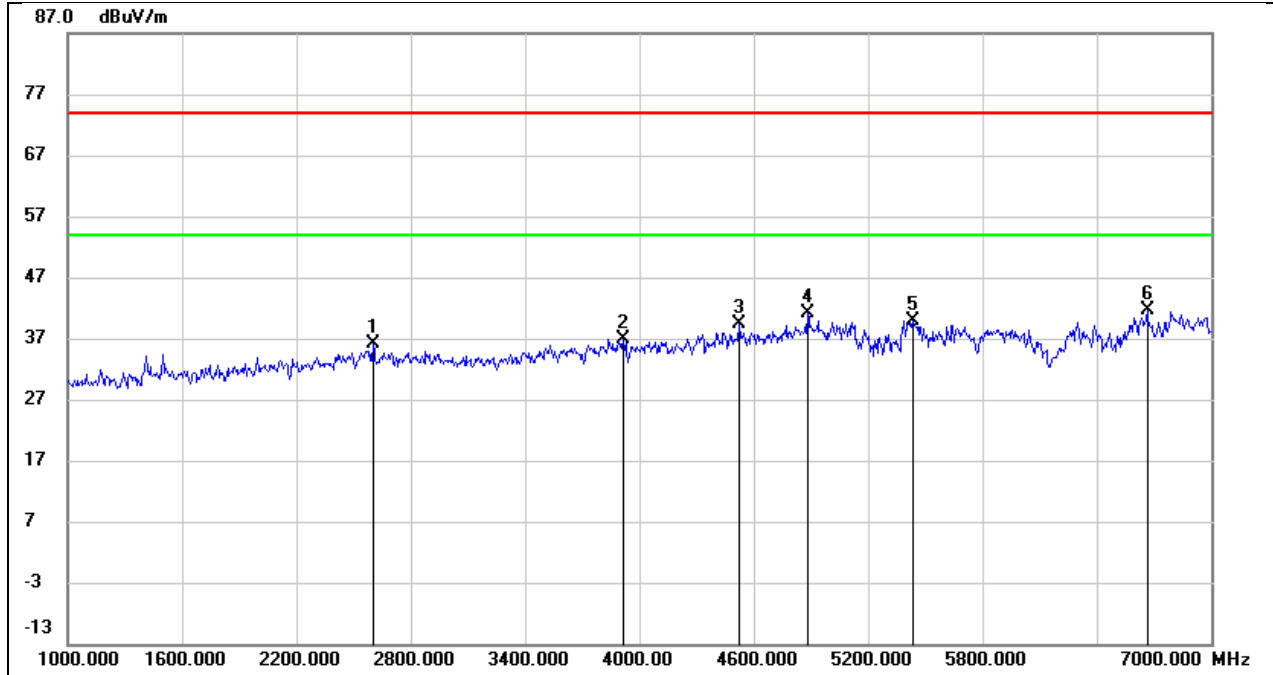

No.	Frequency (MHz)	Reading (dBuV)	Correct (dB/m)	Result (dBuV/m)	Limit (dBuV/m)	Margin (dB)	Remark
1	2602.000	44.21	-8.19	36.02	74.00	-37.98	peak
2	3916.000	41.61	-4.71	36.90	74.00	-37.10	peak
3	4522.000	41.32	-2.05	39.27	74.00	-34.73	peak
4	4882.000	41.78	-0.62	41.16	74.00	-32.84	peak
5	5434.000	39.47	0.34	39.81	74.00	-34.19	peak
6	6664.000	37.14	4.54	41.68	74.00	-32.32	peak

Test Mode:	802.11a 20	Frequency(MHz):	5200
Polarity:	Horizontal	Test Voltage:	DC 12 V

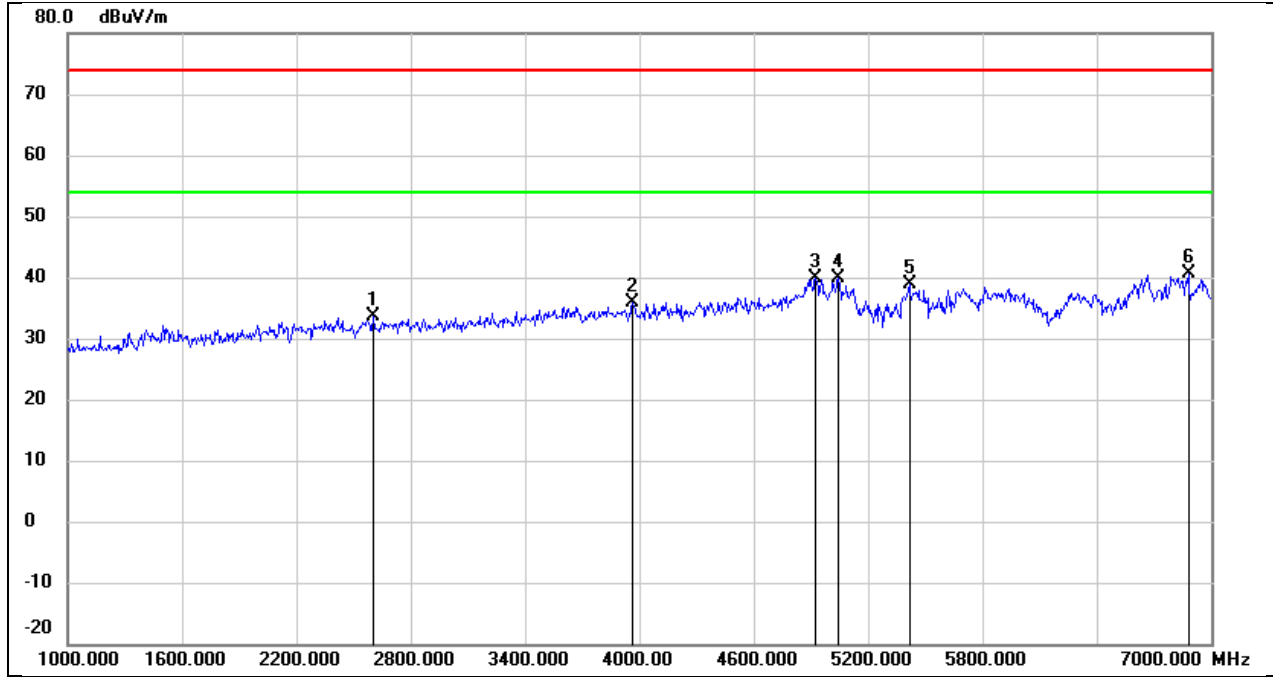

No.	Frequency (MHz)	Reading (dBuV)	Correct (dB/m)	Result (dBuV/m)	Limit (dBuV/m)	Margin (dB)	Remark
1	2602.000	41.75	-8.19	33.56	74.00	-40.44	peak
2	3964.000	40.47	-4.58	35.89	74.00	-38.11	peak
3	4924.000	40.34	-0.45	39.89	74.00	-34.11	peak
4	5044.000	39.94	-0.10	39.84	74.00	-34.16	peak
5	5416.000	38.60	0.32	38.92	74.00	-35.08	peak
6	6880.000	34.99	5.60	40.59	74.00	-33.41	peak

Test Mode:	802.11a 20	Frequency(MHz):	5200
Polarity:	Vertical	Test Voltage:	DC 12 V

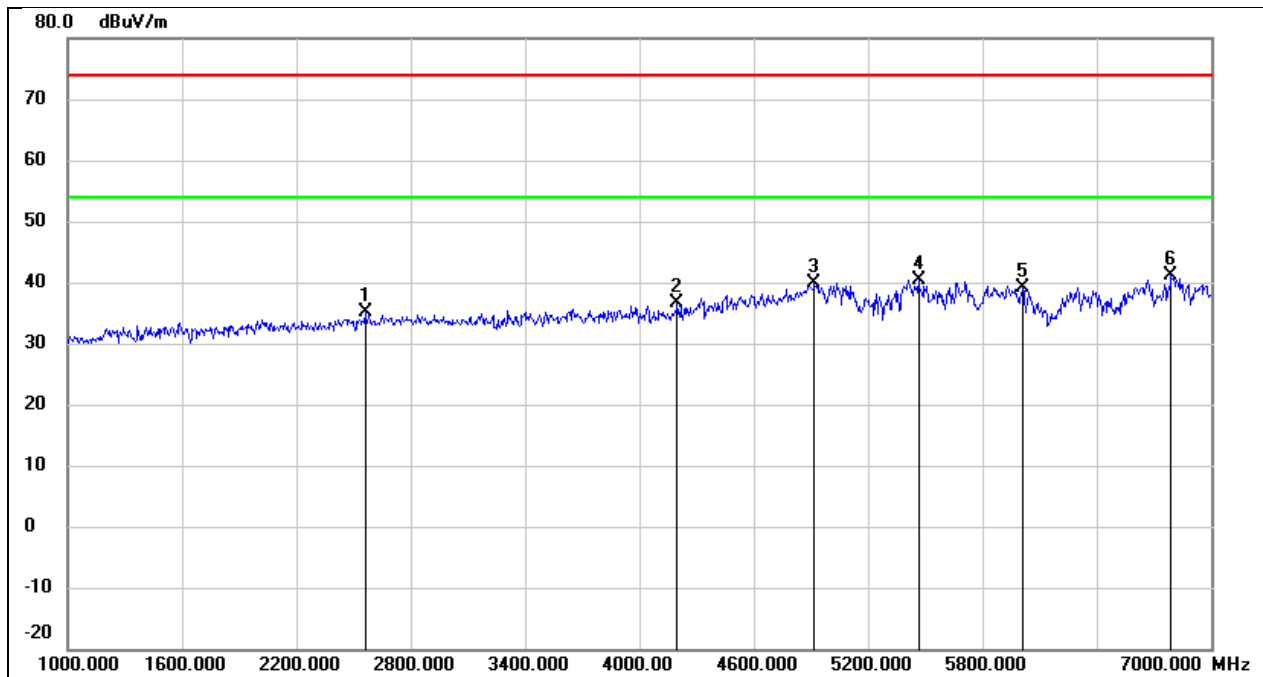

No.	Frequency (MHz)	Reading (dBuV)	Correct (dB/m)	Result (dBuV/m)	Limit (dBuV/m)	Margin (dB)	Remark
1	2560.000	43.35	-8.31	35.04	74.00	-38.96	peak
2	4198.000	40.24	-3.55	36.69	74.00	-37.31	peak
3	4918.000	40.40	-0.47	39.93	74.00	-34.07	peak
4	5464.000	39.99	0.38	40.37	74.00	-33.63	peak
5	6010.000	37.26	1.89	39.15	74.00	-34.85	peak
6	6790.000	36.00	5.15	41.15	74.00	-32.85	peak

Test Mode:	802.11a 20	Frequency(MHz):	5240
Polarity:	Horizontal	Test Voltage:	DC 12 V

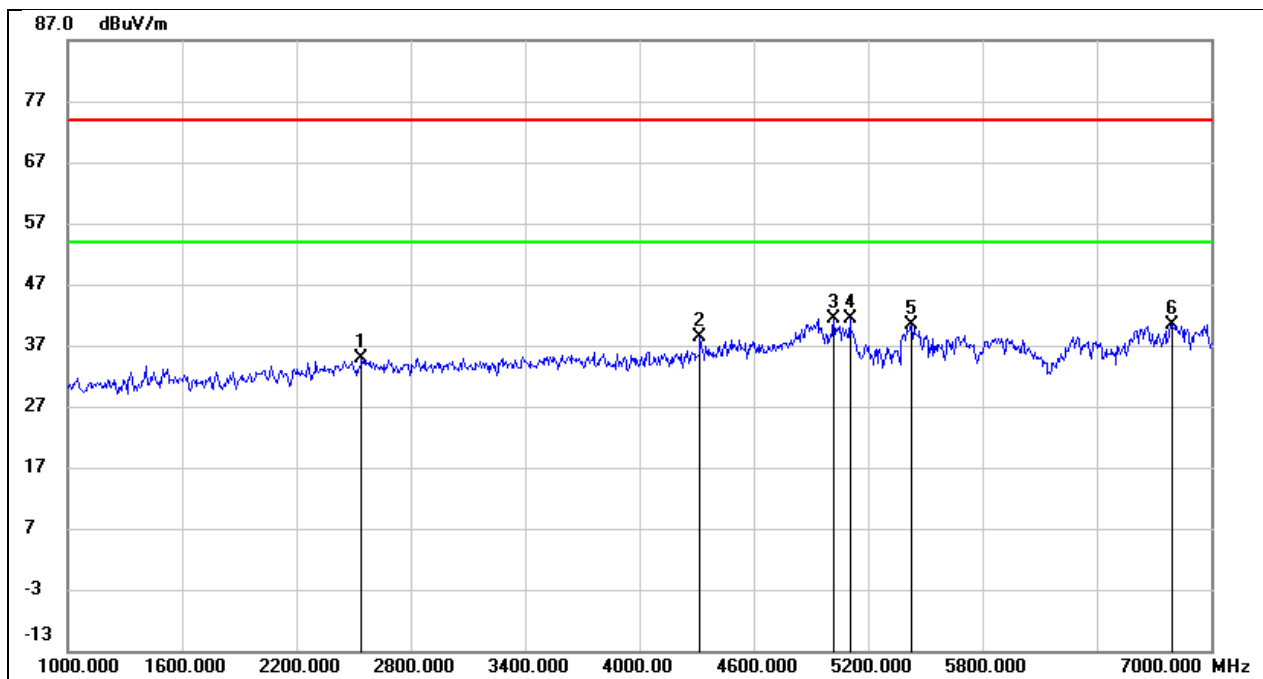

No.	Frequency (MHz)	Reading (dBuV)	Correct (dB/m)	Result (dBuV/m)	Limit (dBuV/m)	Margin (dB)	Remark
1	2542.000	43.30	-8.36	34.94	74.00	-39.06	peak
2	4318.000	41.25	-2.99	38.26	74.00	-35.74	peak
3	5020.000	41.57	-0.13	41.44	74.00	-32.56	peak
4	5104.000	41.32	-0.03	41.29	74.00	-32.71	peak
5	5428.000	39.95	0.34	40.29	74.00	-33.71	peak
6	6796.000	35.19	5.19	40.38	74.00	-33.62	peak

Test Mode:	802.11a 20	Frequency(MHz):	5240
Polarity:	Vertical	Test Voltage:	DC 12 V

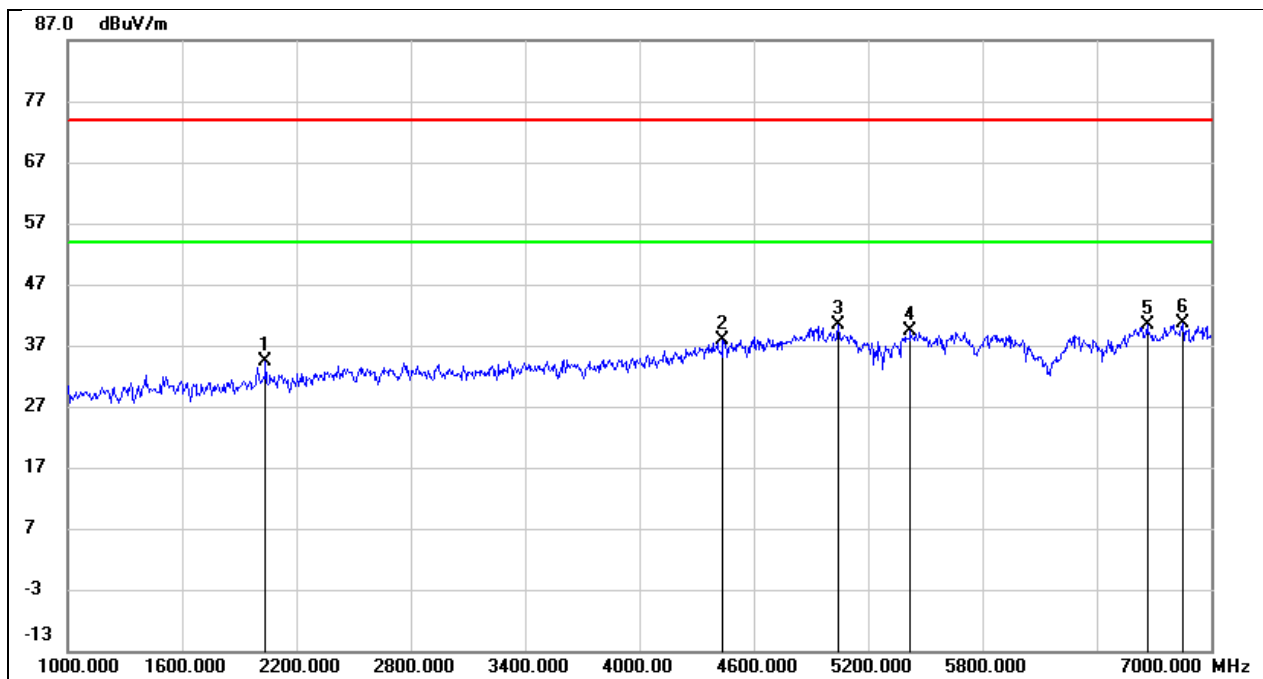

No.	Frequency (MHz)	Reading (dBuV)	Correct (dB/m)	Result (dBuV/m)	Limit (dBuV/m)	Margin (dB)	Remark
1	2038.000	45.26	-10.86	34.40	74.00	-39.60	peak
2	4438.000	40.26	-2.42	37.84	74.00	-36.16	peak
3	5044.000	40.58	-0.10	40.48	74.00	-33.52	peak
4	5422.000	39.17	0.32	39.49	74.00	-34.51	peak
5	6664.000	35.79	4.54	40.33	74.00	-33.67	peak
6	6850.000	35.19	5.46	40.65	74.00	-33.35	peak

8.5. SPURIOUS EMISSIONS(7 GHZ~18 GHZ)

For FCC UNII-1&UNII-2A&UNII-2C&UNII-3; ISCED UNII-2A&UNII-2C&UNII-3 test data:

Test Mode:	802.11a 20	Frequency(MHz):	5180
Polarity:	Horizontal	Test Voltage:	DC 12 V

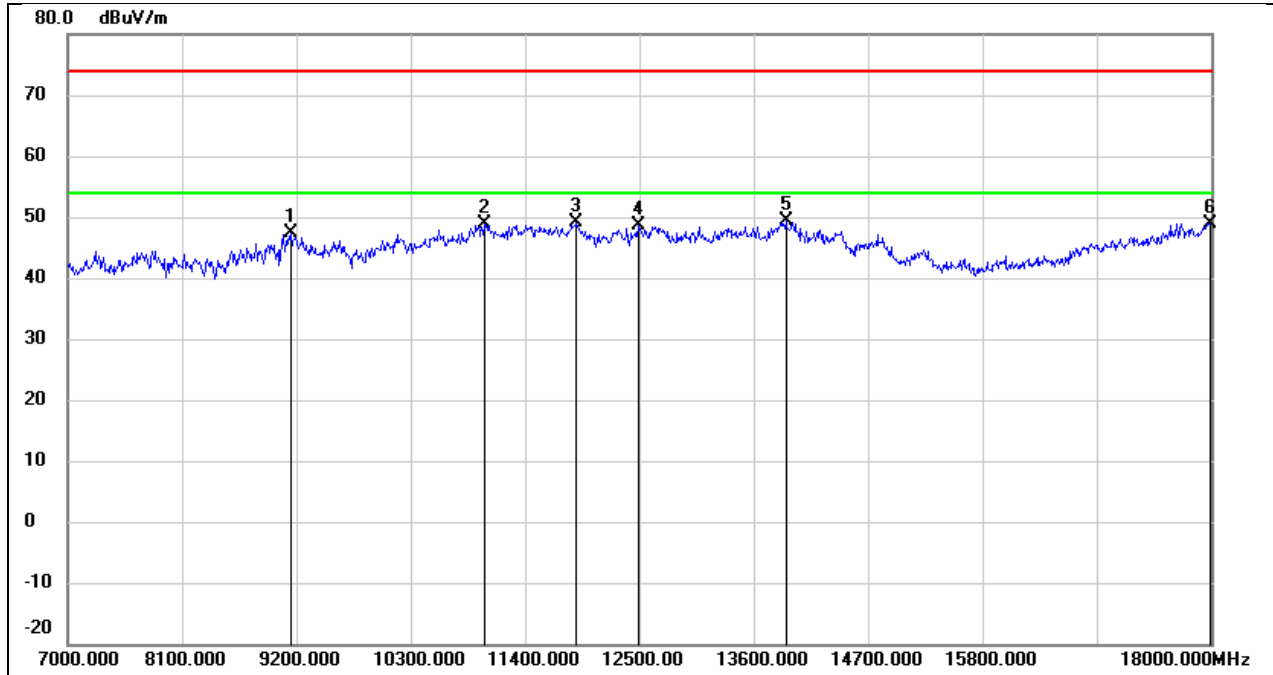

No.	Frequency (MHz)	Reading (dBuV)	Correct (dB/m)	Result (dBuV/m)	Limit (dBuV/m)	Margin (dB)	Remark
1	9145.000	36.90	10.43	47.33	74.00	-26.67	peak
2	11004.000	34.16	14.74	48.90	74.00	-25.10	peak
3	11895.000	31.52	17.51	49.03	74.00	-24.97	peak
4	12489.000	30.73	17.83	48.56	74.00	-25.44	peak
5	13908.000	27.84	21.66	49.50	74.00	-24.50	peak
6	17989.000	22.92	26.04	48.96	74.00	-25.04	peak