

**CFR 47 FCC PART 15 SUBPART E
ISED RSS-248 ISSUE 2**

TEST REPORT

For

BE22000 Ceiling Mount Wi-Fi 7 Access Point

MODEL NUMBER: EAP783

REPORT NUMBER: 4790941545-1-RF-4

ISSUE DATE: October 27, 2023

**FCC ID: 2AXJ4EAP783
IC: 26583-EAP783**

Prepared for

**TP-Link Corporation Limited
Room 901, 9/F. , New East Ocean Centre, 9 Science Museum Road, Tsim Sha Tsui,
Kowloon, Hong Kong**

Prepared by

UL Verification Services (Guangzhou) Co., Ltd, Song Shan Lake Branch

Building 10, Innovation Technology Park, No. 1, Li Bin Road, Song Shan Lake Hi-Tech Development Zone Dongguan, 523808, People's Republic of China

**Tel: +86 769 22038881
Fax: +86 769 33244054
Website: www.ul.com**

Revision History

Rev.	Issue Date	Revisions	Revised By
V0	October 27, 2023	Initial Issue	

Summary of Test Results

Test Item	Clause	Limit/Requirement	Result
On Time And Duty Cycle	ANSI C63.10-2013, Clause 12.2	None; for reporting purposes only.	Pass
26dB Emission Bandwidth And 99% Occupied Bandwidth	KDB 789033 D02 v02r01 Section C.1	FCC Part 15.407 (a) (10) RSS-248 Issue 2, Clause 4.4 RSS-Gen Clause 6.7	Pass
Conducted Output Power	KDB 789033 D02 v02r01 Section E.3.a (Method PM)	FCC 15.407 (a) RSS-248 Issue 2, Clause 4.5	Pass
Power Spectral Density	KDB 789033 D02 v02r01 Section F	FCC 15.407 (a) RSS-248 Issue 2, Clause 4.5	Pass
In-Band Emissions (Mask)	KDB 987594 D02 U-NII 6GHz EMC Measurement v01r01 J	FCC 15.407 (b) RSS-248 Issue 2, Clause 4.6	Pass
Contention-based Protocol	KDB 987594 D02 U-NII 6GHz EMC Measurement v01r01 I	FCC 15.407 (d) (6) RSS-248 Issue 2, Clause 4.7	Pass
Radiated Emissions And Band Edge Measurement	KDB 789033 D02 v02r01 Section G.3, G.4, G.5, and G.6	FCC 15.407 (b) FCC 15.209 FCC 15.205 RSS-248 Issue 2, Clause 4.6 RSS-GEN Clause 8.9	Pass
AC Power Line Conducted Emission	ANSI C63.10-2013, Clause 6.2.	FCC 15.207 RSS-GEN Clause 8.8	Pass
Antenna Requirement	N/A	FCC 47 CFR Part 15.203/ 15.407(a)(1) (2), RSS-Gen Issue 5, Clause 6.8	Pass

*This test report is only published to and used by the applicant, and it is not for evidence purpose in China.

*The measurement result for the sample received is <Pass> according to <CFR 47 FCC PART 15 SUBPART E
ISED RSS-248 ISSUE 2> when <Simple Acceptance> decision rule is applied.

CONTENTS

1.	ATTESTATION OF TEST RESULTS	6
2.	TEST METHODOLOGY	7
3.	FACILITIES AND ACCREDITATION	7
4.	CALIBRATION AND UNCERTAINTY	8
4.1.	<i>MEASURING INSTRUMENT CALIBRATION</i>	8
4.2.	<i>MEASUREMENT UNCERTAINTY</i>	8
5.	EQUIPMENT UNDER TEST	9
5.1.	<i>DESCRIPTION OF EUT</i>	9
5.2.	<i>CHANNEL LIST</i>	10
5.3.	<i>MAXIMUM POWER</i>	14
5.4.	<i>TEST CHANNEL CONFIGURATION</i>	15
5.6.	<i>THE WORSE CASE POWER SETTING PARAMETER</i>	16
5.7.	<i>WORSE CASE CONFIGURATIONS</i>	19
5.8.	<i>DESCRIPTION OF AVAILABLE ANTENNAS</i>	20
5.9.	<i>SUPPORT UNITS FOR SYSTEM TEST</i>	21
6.	MEASURING EQUIPMENT AND SOFTWARE USED	22
7.	ANTENNA PORT TEST RESULTS	25
7.1.	<i>ON TIME AND DUTY CYCLE</i>	25
7.2.	<i>26DB EMISSION BANDWIDTH AND 99% OCCUPIED BANDWIDTH</i>	26
7.3.	<i>CONDUCTED OUTPUT POWER</i>	28
7.4.	<i>POWER SPECTRAL DENSITY</i>	31
7.5.	<i>IN-BAND EMISSIONS (MASK)</i>	34
7.6.	<i>CONTENTION-BASED PROTOCOL</i>	36
8.	RADIATED TEST RESULTS	40
8.1.	<i>RESTRICTED BANDEDGE</i>	48
8.2.	<i>SPURIOUS EMISSIONS(1 GHZ~9 GHZ)</i>	68
8.3.	<i>SPURIOUS EMISSIONS(9 GHZ~18 GHZ)</i>	92
8.4.	<i>SPURIOUS EMISSIONS(9 KHZ~30 MHZ)</i>	178
8.5.	<i>SPURIOUS EMISSIONS(18 GHZ~26 GHZ)</i>	181
8.6.	<i>SPURIOUS EMISSIONS(26 GHZ~40 GHZ)</i>	183
8.7.	<i>SPURIOUS EMISSIONS(30 MHZ~1 GHZ)</i>	185
9.	AC POWER LINE CONDUCTED EMISSION	187
10.	ANTENNA REQUIREMENT	191

11.	TEST DATA	192
11.1.	<i>APPENDIX A: EMISSION BANDWIDTH.....</i>	192
11.1.1.	Test Result.....	192
11.1.2.	Test Graphs	195
11.2.	<i>APPENDIX B: OCCUPIED CHANNEL BANDWIDTH</i>	244
11.2.1.	Test Result.....	244
11.2.2.	Test Graphs	247
11.3.	<i>APPENDIX C: DUTY CYCLE.....</i>	296
11.3.1.	Test Result.....	296
11.3.2.	Test Graphs	297
11.4.	<i>APPENDIX D: MAXIMUM CONDUCTED OUTPUT POWER.....</i>	299
11.4.1.	NSS=4 Test Result	299
11.4.2.	NSS=1 Test Result	303
11.5.	<i>APPENDIX E: MAXIMUM POWER SPECTRAL DENSITY</i>	307
11.5.1.	NSS=4 Test Result	307
11.5.2.	NSS=4 Test Graphs.....	311
11.5.3.	NSS=1 Test Result	360
11.5.4.	NSS=1 Test Graphs.....	364
11.6.	<i>APPENDIX F: INBAND EMISSIONS.....</i>	413
11.6.1.	Test Result.....	413
11.6.2.	Test Graphs	414
11.7.	<i>APPENDIX G: CONTENTION BASED PROTOCOL</i>	427
11.7.1.	Test Result.....	427
11.7.2.	Test Graphs (Worst Case).....	431
11.7.3.	Mesh Mode Test Result	445
11.7.4.	Mesh Mode Test Graphs (Worst Case)	449

1. ATTESTATION OF TEST RESULTS

Applicant Information

Company Name: TP-Link Corporation Limited
 Address: Room 901, 9/F. , New East Ocean Centre, 9 Science Museum Road, Tsim Sha Tsui, Kowloon, Hong Kong

Manufacturer Information

Company Name: TP-Link Corporation Limited
 Address: Room 901, 9/F. , New East Ocean Centre, 9 Science Museum Road, Tsim Sha Tsui, Kowloon, Hong Kong

EUT Information

EUT Name: BE22000 Ceiling Mount Wi-Fi 7 Access Point
 Model: EAP783
 Brand: tp-link
 Sample Received Date: July 25, 2023
 Sample Status: Normal
 Sample ID: 6298058
 Date of Tested: August 7, 2023 to October 27, 2023

APPLICABLE STANDARDS	
STANDARD	TEST RESULTS
CFR 47 FCC PART 15 SUBPART E ISED RSS-248 ISSUE 2	Pass

Prepared By:

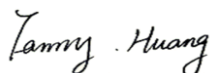

Fanny Huang
 Engineer Project Associate

Checked By:

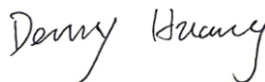

Denny Huang
 Senior Project Engineer

Approved By:



Stephen Guo
 Operations Manager

2. TEST METHODOLOGY

All tests were performed in accordance with the standard CFR 47 FCC PART 15 SUBPART E ISED RSS-248 ISSUE 2, ANSI C63.10-2013, CFR 47 FCC Part 2, CFR 47 FCC Part 15, KDB 789033 D02 v02r01, RSS-GEN Issue 5, RSS-248 Issue 2, KDB414788 D01 Radiated Test Site v01r01, KDB 662911 D01 Multiple Transmitter Output v02r01, KDB987594 D01 U-NII 6GHz General Requirements v02r02, KDB987594 D02 U-NII 6 GHz EMC Measurement v02r01.

3. FACILITIES AND ACCREDITATION

Accreditation Certificate	<p>A2LA (Certificate No.: 4102.01) UL Verification Services (Guangzhou) Co., Ltd. Song Shan Lake Branch. has been assessed and proved to be in compliance with A2LA.</p> <p>FCC (FCC Designation No.: CN1187) UL Verification Services (Guangzhou) Co., Ltd. Song Shan Lake Branch. Has been recognized to perform compliance testing on equipment subject to the Commission's Declaration of Conformity (DoC) and Certification rules</p> <p>ISED (Company No.: 21320) UL Verification Services (Guangzhou) Co., Ltd. Song Shan Lake Branch. has been registered and fully described in a report filed with ISED. The Company Number is 21320 and the test lab Conformity Assessment Body Identifier (CABID) is CN0046.</p> <p>VCCI (Registration No.: G-20019, R-20004, C-20012 and T-20011) UL Verification Services (Guangzhou) Co., Ltd. Song Shan Lake Branch. has been assessed and proved to be in compliance with VCCI, the Membership No. is 3793. Facility Name: Chamber D, the VCCI registration No. is G-20019 and R-20004 Shielding Room B , the VCCI registration No. is C-20012 and T-20011</p>
---------------------------	--

Note 1:

All tests measurement facilities use to collect the measurement data are located at Building 10, Innovation Technology Park, No. 1, Li Bin Road, Song Shan Lake Hi-Tech Development Zone Dongguan, 523808, People's Republic of China.

Note 2:

The test anechoic chamber in UL Verification Services (Guangzhou) Co., Ltd. Song Shan Lake Branch had been calibrated and compared to the open field sites and the test anechoic chamber is shown to be equivalent to or worst case from the open field site.

Note 3:

For below 30 MHz, lab had performed measurements at test anechoic chamber and comparing to measurements obtained on an open field site. And these measurements below 30 MHz had been correlated to measurements performed on an OFS.

4. CALIBRATION AND UNCERTAINTY

4.1. MEASURING INSTRUMENT CALIBRATION

The measuring equipment utilized to perform the tests documented in this report has been calibrated in accordance with the manufacturer's recommendations and is traceable to recognized national standards.

4.2. MEASUREMENT UNCERTAINTY

Where relevant, the following measurement uncertainty levels have been estimated for tests performed on the apparatus:

Test Item	Uncertainty
Conduction emission	3.62 dB
Radiated Emission (Included Fundamental Emission) (9 kHz ~ 30 MHz)	2.2 dB
Radiated Emission (Included Fundamental Emission) (30 MHz ~ 1 GHz)	4.00 dB
Radiated Emission (Included Fundamental Emission) (1 GHz to 40 GHz)	5.78 dB (1 GHz ~ 18 GHz)
	5.23 dB (18 GHz ~ 26 GHz)
	5.37 dB (26 GHz ~ 40 GHz)
Duty Cycle	±0.028%
Emission Bandwidth and 99% Occupied Bandwidth	±0.0196%
Maximum Conducted Output Power	±0.766 dB
Maximum Power Spectral Density Level	±1.22 dB
Frequency Stability	±2.76%
Conducted Band-edge Compliance	±1.328 dB
Conducted Unwanted Emissions In Non-restricted Frequency Bands	±0.746 dB (9 kHz ~ 1 GHz)
	±1.328dB (1 GHz ~ 26 GHz)
Note: This uncertainty represents an expanded uncertainty expressed at approximately the 95% confidence level using a coverage factor of k=2.	

5. EQUIPMENT UNDER TEST

5.1. DESCRIPTION OF EUT

EUT Name:	BE22000 Ceiling Mount Wi-Fi 7 Access Point
Model/PMN :	EAP783
HVIN:	EAP783
FVIN:	V1.0

Radio Technology:	IEEE802.11ax HE20/ax HE40/ax HE80/ax HE160/be EHT20/be EHT40/be EHT80/be EHT160/be EHT320
Operation Frequency:	UNII-5 Band: 6115 MHz ~ 6415 MHz UNII-6 Band: 6435 MHz ~ 6515 MHz UNII-7 Band: 6535 MHz ~ 6875 MHz UNII-8 Band: 6895 MHz ~ 7095 MHz
Type of Modulation:	IEEE 802.11ax: OFDMA (BPSK, QPSK,16QAM,64QAM, 256QAM, 1024QAM) IEEE 802.11be: OFDMA (BPSK, QPSK,16QAM,64QAM, 256QAM, 1024QAM, 4096QAM)
Normal Test Voltage:	DC 12 V via adapter

5.2. CHANNEL LIST

UNII-5 (For Bandwidth=20MHz)					
Channel	Frequency (MHz)	Channel	Frequency (MHz)	Channel	Frequency (MHz)
/	/	33	6115	65	6275
/	/	37	6135	69	6295
/	/	41	6155	73	6315
/	/	45	6175	77	6335
/	/	49	6195	81	6355
/	/	53	6215	85	6375
/	/	57	6235	89	6395
/	/	61	6255	93	6415

UNII-6 (For Bandwidth=20 MHz)					
Channel	Frequency (MHz)	Channel	Frequency (MHz)	Channel	Frequency (MHz)
97	6435	105	6475	113	6515
101	6455	109	6495	/	/

UNII-7 (For Bandwidth=20 MHz)					
Channel	Frequency (MHz)	Channel	Frequency (MHz)	Channel	Frequency (MHz)
117	6535	141	6655	165	6775
121	6555	145	6675	169	6795
125	6575	149	6695	173	6815
129	6595	153	6715	177	6835
133	6615	157	6735	181	6855
137	6635	161	6755	185	6875

UNII-8 (For Bandwidth=20 MHz)					
Channel	Frequency (MHz)	Channel	Frequency (MHz)	Channel	Frequency (MHz)
189	6895	205	6975	221	7055
193	6915	209	6995	225	7075
197	6935	213	7015	229	7095
201	6955	217	7035	/	/

UNII-5 (For Bandwidth=40MHz)					
Channel	Frequency (MHz)	Channel	Frequency (MHz)	Channel	Frequency (MHz)
/	/	35	6125	67	6285
/	/	43	6165	75	6325
/	/	51	6205	83	6365
/	/	59	6245	91	6405

UNII-6 (For Bandwidth=40 MHz)					
Channel	Frequency (MHz)	Channel	Frequency (MHz)	Channel	Frequency (MHz)
99	6445	107	6485	/	/

UNII-7 (For Bandwidth=40 MHz)					
Channel	Frequency (MHz)	Channel	Frequency (MHz)	Channel	Frequency (MHz)
115	6525	139	6645	163	6765
123	6605	147	6685	171	6805
131	6645	155	6725	179	6845

UNII-8 (For Bandwidth=40 MHz)					
Channel	Frequency (MHz)	Channel	Frequency (MHz)	Channel	Frequency (MHz)
187	6885	203	6965	219	7045
195	6925	211	7005	227	7085

UNII-5 (For Bandwidth=80MHz)					
Channel	Frequency (MHz)	Channel	Frequency (MHz)	Channel	Frequency (MHz)
/	/	39	6145	71	6305
/	/	55	6225	87	6385

UNII-6 (For Bandwidth=80 MHz)					
Channel	Frequency (MHz)	Channel	Frequency (MHz)	Channel	Frequency (MHz)
103	6465	/	/	/	/

UNII-7 (For Bandwidth=80 MHz)					
Channel	Frequency (MHz)	Channel	Frequency (MHz)	Channel	Frequency (MHz)
119	6545	151	6705	183	6865
135	6625	167	6785	/	/

UNII-8 (For Bandwidth=80 MHz)					
Channel	Frequency (MHz)	Channel	Frequency (MHz)	Channel	Frequency (MHz)
199	6945	215	7025	/	/

UNII-5 (For Bandwidth=160 MHz)					
Channel	Frequency (MHz)	Channel	Frequency (MHz)	Channel	Frequency (MHz)
/	/	47	6185	79	6345

UNII-6 (For Bandwidth=160 MHz)					
Channel	Frequency (MHz)	Channel	Frequency (MHz)	Channel	Frequency (MHz)
111	6505	/	/	/	/

UNII-7 (For Bandwidth=160 MHz)					
Channel	Frequency (MHz)	Channel	Frequency (MHz)	Channel	Frequency (MHz)
143	6665	175	6825	/	/

UNII-8 (For Bandwidth=160 MHz)					
Channel	Frequency (MHz)	Channel	Frequency (MHz)	Channel	Frequency (MHz)
207	6985	/	/	/	/

UNII-5 (For Bandwidth=320 MHz)					
Channel	Frequency (MHz)	Channel	Frequency (MHz)	Channel	Frequency (MHz)
/	/	63	6265	95	6425

UNII-6 (For Bandwidth=320 MHz)					
Channel	Frequency (MHz)	Channel	Frequency (MHz)	Channel	Frequency (MHz)
127	6585	/	/	/	/

UNII-7 (For Bandwidth=320 MHz)					
Channel	Frequency (MHz)	Channel	Frequency (MHz)	Channel	Frequency (MHz)
159	6745	/	/	/	/

UNII-8 (For Bandwidth=320 MHz)					
Channel	Frequency (MHz)	Channel	Frequency (MHz)	Channel	Frequency (MHz)
191	6905	/	/	/	/

5.3. MAXIMUM POWER

IEEE Std. 802.11	Frequency (MHz)	Maximum Average Conducted Power (dBm)	Maximum Average EIRP (dBm)
be EHT20	5955 ~ 7115	14.31	16.31
be EHT40		17.74	19.74
be EHT80		20.51	22.51
be EHT160		23.35	25.35
be EHT320		26.22	28.22

5.4. TEST CHANNEL CONFIGURATION

UNII-5 Test Channel Configuration		
IEEE Std.	Test Channel Number	Frequency
802.11be EHT20	CH 33(Low Channel), CH 65(MID Channel), CH 93(High Channel)	6115 MHz, 6275 MHz, 6415 MHz
802.11be EHT40	CH 35(Low Channel), CH 67(MID Channel), CH 91(High Channel)	6125 MHz, 6285 MHz, 6405 MHz
802.11be EHT80	CH 39(Low Channel), CH 55(MID Channel), CH 87(High Channel)	6145 MHz, 6225 MHz, 6385 MHz
802.11be EHT160	CH 47(Low Channel), CH 79(High Channel)	6185 MHz, 6345 MHz
802.11be EHT320	CH 63(Low Channel),	6265 MHz

UNII-6 Test Channel Configuration		
IEEE Std.	Test Channel Number	Frequency
802.11be EHT20	CH 97(Low Channel), CH 105(MID Channel), CH 113(High Channel)	6435 MHz, 6475 MHz, 6515 MHz
802.11be EHT40	CH 99(Low Channel), CH 107(High Channel)	6445 MHz, 6485 MHz
802.11be EHT80	CH 103(Low Channel)	6465 MHz
802.11be EHT160	CH 111(Low Channel)	6505 MHz
802.11be EHT320	CH 127(Low Channel)	6585 MHz

UNII-7 Test Channel Configuration		
IEEE Std.	Test Channel Number	Frequency
802.11be EHT20	CH 117(Low Channel), CH 153(MID Channel), CH 185(High Channel)	6535 MHz, 6715 MHz, 6875 MHz
802.11be EHT40	CH 115(Low Channel), CH 155(MID Channel), CH 179(High Channel)	6525 MHz, 6725 MHz, 6845 MHz
802.11be EHT80	CH 119(Low Channel), CH 151(MID Channel), CH 183(High Channel)	6545 MHz, 6705 MHz, 6865 MHz
802.11be EHT160	CH 143(Low Channel), CH 175(High Channel)	6665 MHz, 6825 MHz

UNII-8 Test Channel Configuration		
IEEE Std.	Test Channel Number	Frequency
802.11be EHT20	CH 185(Low Channel), CH 213(MID Channel), CH 229 (High Channel)	6895 MHz, 7015 MHz, 7095 MHz
802.11be EHT40	CH 187(Low Channel), CH 211(MID Channel), CH 227(High Channel)	6885 MHz, 7005 MHz, 7085 MHz
802.11be EHT80	CH 119(Low Channel), CH 183(High Channel)	6945 MHz, 7025 MHz
802.11be EHT160	CH 207(Low Channel)	6985 MHz
802.11be EHT320	CH 191(Low Channel)	6905 MHz

5.6. THE WORSE CASE POWER SETTING PARAMETER

Power Setting Parameter for NSS4		
Test Software	QSPR	
Mode	Freq(MHz)	Soft set value 4TX
802.11be 20M	6115	7.5
	6275	8.5
	6415	8.5
	6435	8
	6475	8
	6515	8.5
	6535	8.5
	6715	10
	6875	10
	6895	10.5
	7015	10
7095	9	
802.11be 40M	6125	11
	6285	11.5
	6405	11.5
	6445	11.5
	6485	11.5
	6525	11.5
	6565	12
	6725	13.5
	6845	13.5
	6885	13.5
	7005	13
7085	12	
802.11be 80M	6145	13.5
	6225	14
	6385	14.5
	6465	14.5
	6545	14.5
	6705	16
	6865	16
	6945	16
7025	15.5	
802.11be 160M	6185	16.5
	6345	17
	6505	16.5
	6665	17
	6825	18.5

	6985	17.5
802.11be 320M	6265	20
	6585	20.5
	6905	19

Power Setting Parameter for NSS1		
Mode	Freq(MHz)	Soft set value 4TX
802.11be 20M	6115	2
	6275	2.5
	6415	2.5
	6435	2.5
	6475	2.5
	6515	2.5
	6535	2.5
	6715	3.5
	6875	4.5
	6895	4.5
	7015	4
	7095	3
802.11be 40M	6125	5
	6285	5.5
	6405	5.5
	6445	5.5
	6485	5.5
	6525	5.5
	6565	6
	6725	7.5
	6845	7.5
	6885	7.5
	7005	7
	7085	6
802.11be 80M	6145	7.5
	6225	8
	6385	8.5
	6465	8.5
	6545	8.5
	6705	10
	6865	10
	6945	10
	7025	9.5
802.11be 160M	6185	10.5
	6345	11

	6505	10.5
	6665	11
	6825	12.5
	6985	12.5
802.11be 320M	6265	14
	6585	14.5
	6905	15

5.7. WORSE CASE CONFIGURATIONS

The EUT was tested in the following configuration(s):

Controlled in test mode using a software application on the EUT supplied by customer. The application was used to enable a continuous transmission and to select the mode, test channels, bandwidth, data rates as required.

Test channels referring to section 5.4.

Maximum power setting referring to section 5.5.

Worst case Data Rates declared by the customer:

802.11ax HE20 CDD mode : MCS0
 802.11ax HE40 CDD mode : MCS0
 802.11ax HE80 CDD mode : MCS0
 802.11ax HE160 CDD mode : MCS0
 802.11be EHT20 CDD mode : MCS0
 802.11be EHT40 CDD mode : MCS0
 802.11be EHT80 CDD mode : MCS0
 802.11be EHT160 CDD mode : MCS0
 802.11be EHT320 CDD mode : MCS0

The EUT support Cyclic Shift Diversity (CDD) and TX Beamforming. The conducted power of CDD mode is higher than TX Beamforming mode, so we only chose the worst-case mode CDD for final testing.

EHT20/ EHT40/ EHT80/ EHT160 covers HE20/ HE40/ HE80/ HE160 due to similar modulation.

The power setting for HE20/ HE40/ HE80/ HE160 is the same or lower than EHT20/EHT40/ EHT80 / EHT160.

The EUT has 8 antennas, ANT5 support BLE, ANT1, ANT2, ANT3, ANT4 support WIFI 2.4G band and WIFI 5G band, ANT5, ANT6, ANT7, ANT8 support WIFIF 6G band.

The measured additional path loss was included in any path loss calculations for all RF cable used during tested.

The EUT does not support partial Rus and channel puncturing mode.

Simultaneously Transmission Conditions:

Support Technology			Support (YES/NO)
WIFI (2.4G)	WIFI (5G)	WIFI (6G)	YES

Note: The emission of the simultaneous operation has been evaluated and no non-compliance was found.

The EUT does not support multi-link operation in same frequency band for 802.11be mode.

5.8. DESCRIPTION OF AVAILABLE ANTENNAS

Antenna No.	Frequency Band	Antenna Type	Max Antenna Gain (dBi)
5	5925 ~ 7125	PIFA antenna	2
6	5925 ~ 7125	PIFA antenna	2
7	5925 ~ 7125	PIFA antenna	2
8	5925 ~ 7125	PIFA antenna	2

The EUT support Cyclic Shift Diversity(CDD) mode.

MIMO output power port and MIMO PSD port summing were performed in accordance with KDB 662911 D01. For the CDD results the Directional Gain was calculated in accordance with the following method.

For output power measurements:

Directional gain= $G_{ANT} + \text{Array Gain} = 2 \text{ dBi}$

G_{ANT} : equal to the gain of the antenna having the highest gain

Array Gain = 0 dB (i.e., no array gain) for $N_{ANT} \leq 4$

For power spectral density (PSD) measurements:

Directional gain= $G_{ANT} + \text{Array Gain} = 8.02 \text{ dBi}$

Array Gain = $10 \log(N_{ANT}/N_{SS}) \text{ dB}$.

N_{ANT} : number of transmit antennas

N_{SS} : number of spatial streams, The worst case directional gain will occur when $N_{SS} = 1$

For TX Beamforming:

Directional gain= $G_{ANT} + 10 \log(N_{ANT}/N_{SS}) = 8.02 \text{ dBi}$

5.9. SUPPORT UNITS FOR SYSTEM TEST

SUPPORT EQUIPMENT

Item	Equipment	Brand Name	Model Name	Remarks
1	Laptop	ThinkPad	X230i	/

I/O CABLES

Cable No	Port	Connector Type	Cable Type	Cable Length(m)	Remarks
1	LAN1	RJ45	Unshielded	1.0 m	/

ACCESSORIES

Item	Accessory	Brand Name	Model Name	Description
1	I.T.E POWER SUPPLY	tp-link	T120450-2B4	Input: AC 100-240 V, 50 / 60 Hz, 1.5 A Output: DC 12.0 V, 4.5 A

TEST SETUP

The EUT can work in engineering mode with a software through a laptop.

SETUP DIAGRAM FOR TESTS

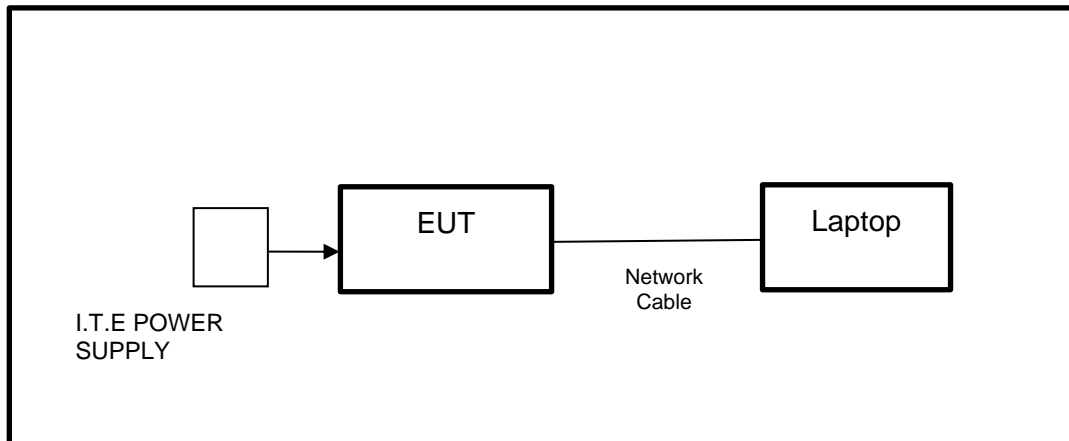

6. MEASURING EQUIPMENT AND SOFTWARE USED

R&S TS 8997 Test System						
Equipment	Manufacturer	Model No.	Serial No.	Upper Last Cal.	Last Cal.	Due. Date
Power sensor, Power Meter	R&S	OSP120	100921	/	Mar.31, 2023	Mar.30, 2024
Vector Signal Generator	R&S	SMBV100A	261637	Oct.17, 2022	Oct.12, 2023	Oct.11, 2024
Signal Generator	R&S	SMB100A	178553	Oct.17, 2022	Oct.12, 2023	Oct.11, 2024
Signal Analyzer	R&S	FSV40	101118	Oct.17, 2022	Oct.12, 2023	Oct.11, 2024
Software						
Description	Manufacturer	Name		Version		
For R&S TS 8997 Test System	Rohde & Schwarz	EMC 32		10.60.10		
Tonsend RF Test System						
Equipment	Manufacturer	Model No.	Serial No.	Upper Last Cal.	Last Cal.	Due. Date
Wideband Radio Communication Tester	R&S	CMW500	155523	Oct.17, 2022	Oct.12, 2023	Oct.11, 2024
Wireless Connectivity Tester	R&S	CMW270	1201.0002N75-102	Sep.28, 2022	Sep.27, 2023	Sep.26, 2024
PXA Signal Analyzer	Keysight	N9030A	MY55410512	Oct.17, 2022	Oct.12, 2023	Oct.11, 2024
MXG Vector Signal Generator	Keysight	N5182B	MY56200284	Oct.17, 2022	Oct.12, 2023	Oct.11, 2024
MXG Vector Signal Generator	Keysight	N5172B	MY56200301	Oct.17, 2022	Oct.12, 2023	Oct.11, 2024
DC power supply	Keysight	E3642A	MY55159130	Oct.17, 2022	Oct.12, 2023	Oct.11, 2024
Temperature & Humidity Chamber	SANMOOD	SG-80-CC-2	2088	Oct.17, 2022	Oct.12, 2023	Oct.11, 2024
Attenuator	Aglient	8495B	2814a12853	Oct.18, 2022	Oct.12, 2023	Oct.11, 2024
RF Control Unit	Tonscend	JS0806-2	23B80620666	/	April 18,2023	April 17,2024
Software						
Description	Manufacturer	Name		Version		
Tonsend SRD Test System	Tonsend	JS1120-3 RF Test System		V3.2.22		

Conducted Emissions						
Equipment	Manufacturer	Model No.	Serial No.	Upper Last Cal.	Last Cal.	Due. Date
EMI Test Receiver	R&S	ESR3	101961	Oct.17, 2022	Oct.13, 2023	Oct.12, 2024
Two-Line V-Network	R&S	ENV216	101983	Oct.17, 2022	Oct.13, 2023	Oct.12, 2024
Artificial Mains Networks	Schwarzbeck	NSLK 8126	8126465	Oct.17, 2022	Oct.13, 2023	Oct.12, 2024
Software						
Description			Manufacturer	Name	Version	
Test Software for Conducted Emissions			Farad	EZ-EMC	Ver. UL-3A1	

Radiated Emissions						
Equipment	Manufacturer	Model No.	Serial No.	Upper Last Cal.	Last Cal.	Due. Date
MXE EMI Receiver	KESIGHT	N9038A	MY56400036	Oct.17, 2022	Oct.12, 2023	Oct.11, 2024
Hybrid Log Periodic Antenna	TDK	HLP-3003C	130959	/	Aug.02, 2021	Aug.01, 2024
Preamplifier	HP	8447D	2944A09099	Oct.17, 2022	Oct.12, 2023	Oct.11, 2024
EMI Measurement Receiver	R&S	ESR26	101377	Oct.17, 2022	Oct.12, 2023	Oct.11, 2024
Horn Antenna	TDK	HRN-0118	130940	/	July 20, 2021	July 19, 2024
Preamplifier	TDK	PA-02-0118	TRS-305-00067	Oct.17, 2022	Oct.12, 2023	Oct.11, 2024
Horn Antenna	Schwarzbeck	BBHA9170	697	/	July 20, 2021	July 19, 2024
Preamplifier	TDK	PA-02-2	TRS-307-00003	Oct.17, 2022	Oct.12, 2023	Oct.11, 2024
Preamplifier	TDK	PA-02-3	TRS-308-00002	Oct.17, 2022	Oct.12, 2023	Oct.11, 2024
Loop antenna	Schwarzbeck	1519B	00008	/	Dec.14, 2021	Dec.13, 2024
Preamplifier	TDK	PA-02-001-3000	TRS-302-00050	Oct.17, 2022	Oct.12, 2023	Oct.11, 2024
Preamplifier	Mini-Circuits	ZX60-83LN-S+	SUP01202035	Oct.17, 2022	Oct.12, 2023	Oct.11, 2024
High Pass Filter	Wi	WHKX10-2700-3000-18000-40SS	23	/	Dec.01,2022	Nov.30,2023
Highpass Filter	Wainwright	WHKX10-5850-6500-1800-40SS	4	/	Dec.01,2022	Nov.30,2023

Band Reject Filter	Wainwright	WRCJV12-5695-5725-5850-5880-40SS	4	/	Dec.01,2022	Nov.30,2023
Band Reject Filter	Wainwright	WRCJV20-5120-5150-5350-5380-60SS	2	/	Dec.01,2022	Nov.30,2023
Band Reject Filter	Wainwright	WRCJV20-5440-5470-5725-5755-60SS	1	/	Dec.01,2022	Nov.30,2023
Band Reject Filter	Wainwright	WRCJV8-2350-2400-2483.5-2533.5-40SS	4	/	Dec.01,2022	Nov.30,2023
Band Reject Filter	Wainwright	WRCD5-1879-1879.85-1880.15-1881-40SS	1	/	Dec.01,2022	Nov.30,2023
Notch Filter	Wainwright	WHJ10-882-980-7000-40SS	1	/	Dec.01,2022	Nov.30,2023
Software						
Description			Manufacturer	Name	Version	
Test Software for Radiated Emissions			Farad	EZ-EMC	Ver. UL-3A1	

Other Instrument						
Equipment	Manufacturer	Model No.	Serial No.	Upper Last Cal.	Last Cal.	Due. Date
Temperature humidity probe	OMEGA	ITHX-SD-5	18470007	Oct.22, 2022	Oct.19, 2023	Oct.18, 2024
Barometer	Yiyi	Baro	N/A	Oct.24, 2022	Oct.19, 2023	Oct.18, 2024
Attenuator	Agilent	8495B	2814a12853	Oct.18, 2022	Oct.12, 2023	Oct.11, 2024

7. ANTENNA PORT TEST RESULTS

7.1. ON TIME AND DUTY CYCLE

LIMITS

None; for reporting purposes only.

TEST PROCEDURE

Refer to KDB 789033 D02 General U-NII Test Procedures New Rules v02r01 section II.B.

The zero-span mode on a spectrum analyzer or EMI receiver, if the response time and spacing between bins on the sweep are sufficient to permit accurate measurements of the on and off times of the transmitted signal. Set the center frequency of the instrument to the center frequency of the transmission. Set RBW \geq EBW if possible; otherwise, set RBW to the largest available value. Set VBW \geq RBW. Set detector = peak or average. The zero-span measurement method shall not be used unless both RBW and VBW are $> 50/T$, where T is defined in II.B.1.a), and the number of sweep points across duration T exceeds 100. (For example, if VBW and/or RBW are limited to 3 MHz, then the zero-span method of measuring duty cycle shall not be used if $T \leq 16.7$ microseconds.)

TEST SETUP

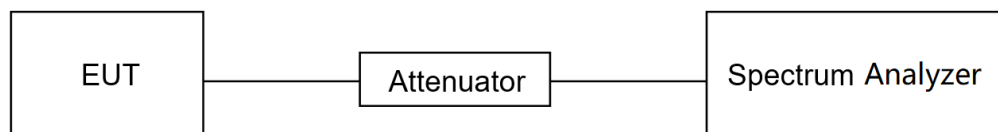

TEST ENVIRONMENT

Temperature	26.2°C	Relative Humidity	63.0%
Atmosphere Pressure	101kPa	Test Voltage	DC 12 V

TEST DATE / ENGINEER

Test Date	September 12, 2023	Test By	Johnson Liu
-----------	--------------------	---------	-------------

TEST RESULTS

Please refer to section "Test Data" - Appendix C

7.2. 26DB EMISSION BANDWIDTH AND 99% OCCUPIED BANDWIDTH

LIMITS

CFR 47 FCC Part15, Subpart E ISED RSS-248 ISSUE 2		
Test Item	Limit	Frequency Range (MHz)
26 dB Emission Bandwidth	The 26 bandwidth of the device shall not exceed 320 MHz for all channels except the 320 MHz	5.925-7.125 GHz
99 % Occupied Bandwidth	The occupied bandwidth of the device shall not exceed 320 MHz.	5.925-7.125 GHz

TEST PROCEDURE

Refer to KDB 789033 D02 General U-NII Test Procedures New Rules v02r01 section II.C1. for 26 dB Emission Bandwidth; section II.D. for 99 % Occupied Bandwidth.

Connect the EUT to the spectrum analyzer and use the following settings:

Center Frequency	The center frequency of the channel under test
Detector	Peak
RBW	For 26 dB Emission bandwidth: approximately 1 % of the EBW. For 99 % Occupied Bandwidth: approximately 1 % ~ 5 % of the OBW.
VBW	For 26 dB Bandwidth: >3*RBW For 99 % Bandwidth: >3*RBW
Trace	Max hold
Sweep	Auto couple

- a) Use the 99 % power bandwidth function of the instrument, allow the trace to stabilize and report the measured bandwidth.
- b) Allow the trace to stabilize and measure the maximum width of the emission that is constrained by the frequencies associated with the two outermost amplitude points (upper and lower frequencies) that are attenuated by 6/26 dB relative to the maximum level measured in the fundamental emission.

TEST SETUP

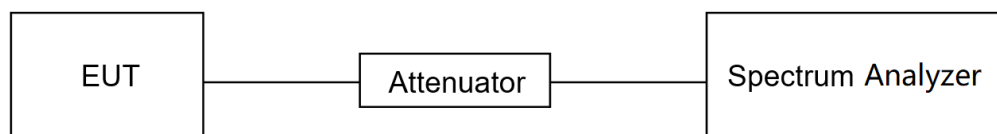

TEST ENVIRONMENT

Temperature	24.4°C	Relative Humidity	64.5%
Atmosphere Pressure	101kPa	Test Voltage	DC 12 V

TEST DATE / ENGINEER

Test Date	September 12, 2023	Test By	Johnson Liu
-----------	--------------------	---------	-------------

TEST RESULTS

Please refer to section "Test Data" - Appendix A&B

7.3. CONDUCTED OUTPUT POWER

LIMITS

CFR 47 FCC Part15, Subpart E		
Test Item	Limit	Frequency Range (MHz)
Conducted Output Power	<input type="checkbox"/> Standard Power Access Point The maximum e.i.r.p. over the frequency band of operation must not exceed 36 dBm. For outdoor devices, the maximum e.i.r.p. at any elevation angle above 30 degrees as measured from the horizon must not exceed 125 mW (21 dBm).	5.925-6.425 GHz 6.525-6.875 GHz
	<input checked="" type="checkbox"/> Indoor Access Point The maximum e.i.r.p. over the frequency band of operation must not exceed 30 dBm.	5.925-7.125 GHz
	<input type="checkbox"/> Subordinate Device The maximum e.i.r.p. over the frequency band of operation must not exceed 30 dBm.	5.925-7.125 GHz
	<input type="checkbox"/> Client Devices, Operating Under The Control Of A Standard Power Access Point The maximum e.i.r.p. over the frequency band of operation must not exceed 30 dBm and the device must limit its power to no more than 6 dB below its associated standard power access point's authorized transmit power.	5.925-6.425 GHz 6.525-6.875 GHz
	<input type="checkbox"/> Client Devices, Operating Under The Control Of An Indoor Access Point The maximum e.i.r.p. over the frequency band of operation must not exceed 24 dBm.	5.925-7.125 GHz

ISED RSS-248 ISSUE 2		
Test Item	Limit	Frequency Range (MHz)
Conducted Output Power	<input type="checkbox"/> Standard Power Access Point The maximum e.i.r.p. over the 5925-6875 MHz frequency band shall not exceed 36 dBm and the maximum e.i.r.p. for a device not enclosed by walls and a ceiling, measured at any elevation angle greater than 30 degrees above the horizon, shall not exceed 21 dBm over the 5925-6875 MHz frequency band	5.925-6.425 GHz 6.525-6.875 GHz
	<input checked="" type="checkbox"/> Low-Power Indoor Access-Points The maximum e.i.r.p. over the 5925-7125 MHz frequency band shall not exceed 30 dBm	5.925-7.125 GHz
	<input type="checkbox"/> Subordinate Device The maximum e.i.r.p. over the 5925-7125 MHz frequency band shall not exceed 30 dBm	5.925-7.125 GHz
	<input type="checkbox"/> Standard Client Devices The maximum e.i.r.p. over the 5925-6875 MHz frequency band shall not exceed 30 dBm and the maximum power limits shall remain at least 6 dB below the power levels authorized for the associated standard-power access point	5.925-6.425 GHz 6.525-6.875 GHz
	<input type="checkbox"/> Low-Power Client Devices The maximum e.i.r.p. over the 5925-7125 MHz frequency band shall not exceed 24 dBm	5.925-7.125 GHz

TEST PROCEDURE

Refer to KDB 789033 D02 General U-NII Test Procedures New Rules v02r01 section II.E.

Method SA-1 (trace averaging with the EUT transmitting at full power throughout each sweep):

- (i) Set span to encompass the entire emission bandwidth (EBW) (or, alternatively, the entire 99% occupied bandwidth) of the signal.
- (ii) Set RBW = 1 MHz.
- (iii) Set VBW \geq 3 MHz.
- (iv) Number of points in sweep $\geq 2 \times$ span / RBW. (This ensures that bin-to-bin spacing is \leq RBW/2, so that narrowband signals are not lost between frequency bins.)
- (v) Sweep time = auto.
- (vi) Detector = power averaging (rms), if available. Otherwise, use sample detector mode.
- (vii) If transmit duty cycle $<$ 98 %, use a video trigger with the trigger level set to enable triggering only on full power pulses. Transmitter must operate at maximum power control level for the entire duration of every sweep. If the EUT transmits continuously (i.e., with no off intervals) or at duty cycle \geq 98 %, and if each transmission is entirely at the maximum power control level, then the trigger shall be set to "free run."
- (viii) Trace average at least 100 traces in power averaging (rms) mode.
- (ix) Compute power by integrating the spectrum across the EBW (or, alternatively, the entire 99% occupied bandwidth) of the signal using the instrument's band power measurement function with

band limits set equal to the EBW (or occupied bandwidth) band edges. If the instrument does not have a band power function, sum the spectrum levels (in power units) at 1 MHz intervals extending across the EBW (or, alternatively, the entire 99% occupied bandwidth) of the spectrum.

Method PM (Measurement using an RF average power meter):

- (i) Measurements may be performed using a wideband RF power meter with a thermocouple detector or equivalent if all of the following conditions are satisfied:
 - a. The EUT is configured to transmit continuously or to transmit with a constant duty cycle.
 - b. At all times when the EUT is transmitting, it must be transmitting at its maximum power control level.
 - c. The integration period of the power meter exceeds the repetition period of the transmitted signal by at least a factor of five.
- (ii) If the transmitter does not transmit continuously, measure the duty cycle, x, of the transmitter output signal as described in II.B.
- (iii) Measure the average power of the transmitter. This measurement is an average over both the on and off periods of the transmitter.
- (iv) Adjust the measurement in dBm by adding $10 \log (1/x)$ where x is the duty cycle (e.g., $10 \log (1/0.25)$ if the duty cycle is 25 %).

Method PM-G (Measurement using a gated RF average power meter):

Measurements may be performed using a wideband gated RF power meter provided that the gate parameters are adjusted such that the power is measured only when the EUT is transmitting at its maximum power control level. Since the measurement is made only during the ON time of the transmitter, no duty cycle correction factor is required.

Straddle channel power was measured using spectrum analyzer.

TEST SETUP

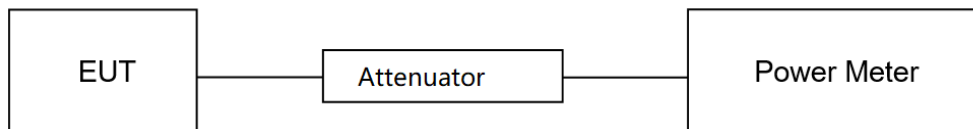

TEST ENVIRONMENT

Temperature	26.2°C	Relative Humidity	63.0%
Atmosphere Pressure	101kPa	Test Voltage	DC 12 V

TEST DATE / ENGINEER

Test Date	September 14, 2023	Test By	Johnson Liu
-----------	--------------------	---------	-------------

TEST RESULTS

Please refer to section "Test Data" - Appendix d

7.4. POWER SPECTRAL DENSITY

LIMITS

CFR 47 FCC Part15, Subpart E		
Test Item	Limit	Frequency Range (MHz)
Conducted Output Power	<input type="checkbox"/> Standard Power Access Point The maximum power spectral density must not exceed 23 dBm e.i.r.p. in any 1-megahertz band.	5.925-6.425 GHz 6.525-6.875 GHz
	<input checked="" type="checkbox"/> Indoor Access Point The maximum power spectral density must not exceed 5 dBm e.i.r.p. in any 1-megahertz band.	5.925-7.125 GHz
	<input type="checkbox"/> Subordinate Device The maximum power spectral density must not exceed 5 dBm e.i.r.p. in any 1-megahertz band.	5.925-7.125 GHz
	<input type="checkbox"/> Client Devices, Operating Under The Control Of A Standard Power Access Point The maximum power spectral density must not exceed 17 dBm e.i.r.p. in any 1-megahertz band.	5.925-6.425 GHz 6.525-6.875 GHz
	<input type="checkbox"/> Client Devices, Operating Under The Control Of An Indoor Access Point The maximum power spectral density must not exceed -1 dBm e.i.r.p. in any 1-megahertz band.	5.925-7.125 GHz

ISED RSS-248 ISSUE 2		
Test Item	Limit	Frequency Range (MHz)
Conducted Output Power	<input type="checkbox"/> Standard Power Access Point The maximum e.i.r.p. spectral density shall not exceed 23 dBm/MHz	5.925-6.425 GHz 6.525-6.875 GHz
	<input checked="" type="checkbox"/> Low-Power Indoor Access-Points The maximum e.i.r.p. spectral density shall not exceed 5 dBm/MHz	5.925-7.125 GHz
	<input type="checkbox"/> Subordinate Device The maximum e.i.r.p. spectral density shall not exceed 5 dBm/MHz	5.925-7.125 GHz
	<input type="checkbox"/> Standard Client Devices The maximum e.i.r.p. spectral density shall not exceed 17 dBm/MHz	5.925-6.425 GHz 6.525-6.875 GHz
	<input type="checkbox"/> Low-Power Client Devices The maximum e.i.r.p. spectral density shall not exceed -1 dBm/MHz	5.925-7.125 GHz

TEST PROCEDURE

Refer to KDB 789033 D02 General U-NII Test Procedures New Rules v02r01 section II.F.

Connect the EUT to the spectrum analyzer and use the following settings:

Center Frequency	The center frequency of the channel under test
Detector	RMS
RBW	1 MHz
VBW	$\geq 3 \times \text{RBW}$
Span	Encompass the entire emissions bandwidth (EBW) of the signal
Trace	Max hold
Sweep time	Auto

Allow trace to fully stabilize and use the peak search function on the instrument to find the peak of the spectrum and record its value.

Add $10 \log(1/x)$, where x is the duty cycle, to the peak of the spectrum, the result is the Maximum PSD over 1 MHz reference bandwidth.

TEST SETUP

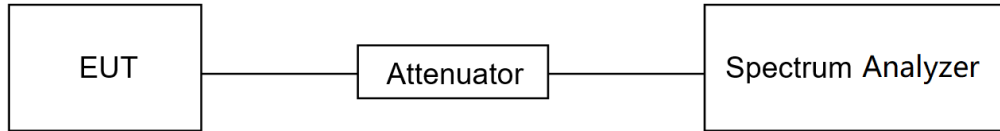

TEST ENVIRONMENT

Temperature	26.2°C	Relative Humidity	63.0%
Atmosphere Pressure	101kPa	Test Voltage	DC 12 V

TEST DATE / ENGINEER

Test Date	September 12, 2023	Test By	Johnson Liu
-----------	--------------------	---------	-------------

TEST RESULTS

Please refer to section "Test Data" - Appendix E

7.5. IN-BAND EMISSIONS (MASK)

LIMITS

Please refer to CFR 47 FCC §15.407 (b) (7) and RSS-248 Issue 2, Clause 4.2 (b)

For transmitters operating within the 5.925-7.125 GHz bands: Power spectral density must be suppressed by 20 dB at 1 MHz outside of channel edge, by 28 dB at one channel bandwidth from the channel center, and by 40 dB at one- and one-half times the channel bandwidth away from channel center. At frequencies between one megahertz outside an unlicensed device's channel edge and one channel bandwidth from the center of the channel, the limits must be linearly interpolated between 20 dB and 28 dB suppression, and at frequencies between one and one- and one-half times an unlicensed device's channel bandwidth, the limits must be linearly interpolated between 28 dB and 40 dB suppression. Emissions removed from the channel center by more than one- and one-half times the channel bandwidth must be suppressed by at least 40 dB.

TEST PROCEDURE

Refer to 987594 D02 U-NII 6GHz EMC Measurement v01r01 J.

Connect output of the antenna port to a spectrum analyzer or EMI receiver, with appropriate attenuation, as to not damage the instrumentation.

2. Set the reference level of the measuring equipment in accordance with procedure 4.1.5.2 of ANSI C63.10-2013.

3. Measure the 26 dB EBW using the test procedure 12.4.1 of ANSI C63.10-2013. (This will be used to determine the channel edge.)

4. Measure the power spectral density (which will be used for emissions mask reference) using the following procedure:

a) Set the span to encompass the entire 26 dB EBW of the signal.

b) Set RBW = same RBW used for 26 dB EBW measurement.

c) Set VBW $\geq 3 \times$ RBW

d) Number of points in sweep $\geq [2 \times \text{span} / \text{RBW}]$.

e) Sweep time = auto.

f) Detector = RMS (i.e., power averaging)

g) Trace average at least 100 traces in power averaging (rms) mode.

h) Use the peak search function on the instrument to find the peak of the spectrum.

5. For the purposes of developing the emission mask, the channel bandwidth is defined as the 26 dB EBW.

6. Using the measuring equipment limit line function, develop the emissions mask based on the following requirements. The emissions power spectral density must be reduced below the peak power spectral density (in dB) as follows:

a. Suppressed by 20 dB at 1 MHz outside of the channel edge. (The channel edge is defined as the 26-dB point on either side of the carrier center frequency.)

b. Suppressed by 28 dB at one channel bandwidth from the channel center.

c. Suppressed by 40 dB at one- and one-half times the channel bandwidth from the channel center.

7. Adjust the span to encompass the entire mask as necessary.

8. Clear trace.

9. Trace average at least 100 traces in power averaging (rms) mode.

10. Adjust the reference level as necessary so that the crest of the channel touches the top of the emission mask.

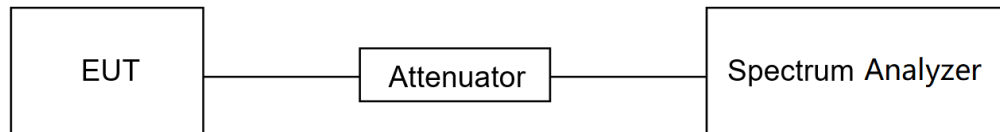
TEST SETUP**TEST ENVIRONMENT**

Temperature	26.2°C	Relative Humidity	63.0%
Atmosphere Pressure	101kPa	Test Voltage	DC 12 V

TEST DATE / ENGINEER

Test Date	September 12, 2023	Test By	Johnson Liu
-----------	--------------------	---------	-------------

TEST RESULTS

Please refer to section "Test Data" - Appendix F

7.6. CONTENTION-BASED PROTOCOL

LIMITS

Please refer to CFR 47 FCC §15.407 (d) (6) and RSS-248 Issue 2 Clause 4.7

Indoor access points, subordinate devices and client devices operating in the 5.925-7.125 GHz band (herein referred to as unlicensed devices) are required to use technologies that include a contention-based protocol to avoid co-channel interference with incumbent devices sharing the band. To ensure incumbent co-channel operations are detected in a technology-agnostic manner, unlicensed devices are required to detect co-channel radio frequency energy (energy detect) and avoid simultaneous transmission.

Unlicensed low-power indoor devices must detect co-channel radio frequency power that is at least -62 dBm or lower. Upon detection of energy in the band, unlicensed low power indoor devices must vacate the channel (in which incumbent signal is transmitted) and stay off the incumbent channel as long as detected radio frequency power is equal to or greater than the threshold (-62 dBm)¹. The -62 dBm (or lower) threshold is referenced to a 0 dBi antenna gain. To ensure incumbent operations are reliably detected in the band, low power indoor devices must detect RF energy throughout their intended operating channel. For example, an 802.11 device that plans to transmit a 40 MHz- wide signal (on a primary 20 MHz channel and a secondary 20 MHz channel) must detect energy throughout the entire 40 MHz channel. Additionally, low-power indoor devices must detect co-channel energy with 90% or greater certainty.

a) Simulating Incumbent Signal

The incumbent signal is assumed to be noise-like. One example of such transmission could be Digital Video Broadcasting (DVB) systems that use Orthogonal Frequency Division Multiplexing (OFDM). Incumbent systems may also use different bandwidths for their transmissions. A 10 MHz-wide additive white Gaussian noise (AWGN) signal is selected to simulate and represent incumbent transmission.

b) Required number of tests

Incumbent and EUT (access point, subordinate or client) signals may occupy different portions of the channel. Depending on the EUT transmission bandwidth and incumbent signal center frequency (simulated by a 10 MHz-wide AWGN signal), the center frequency of the EUT signal f_{fcc1} may fall within the incumbent's occupied bandwidth (Figure 1.a), or outside of it (Figure 1.b).

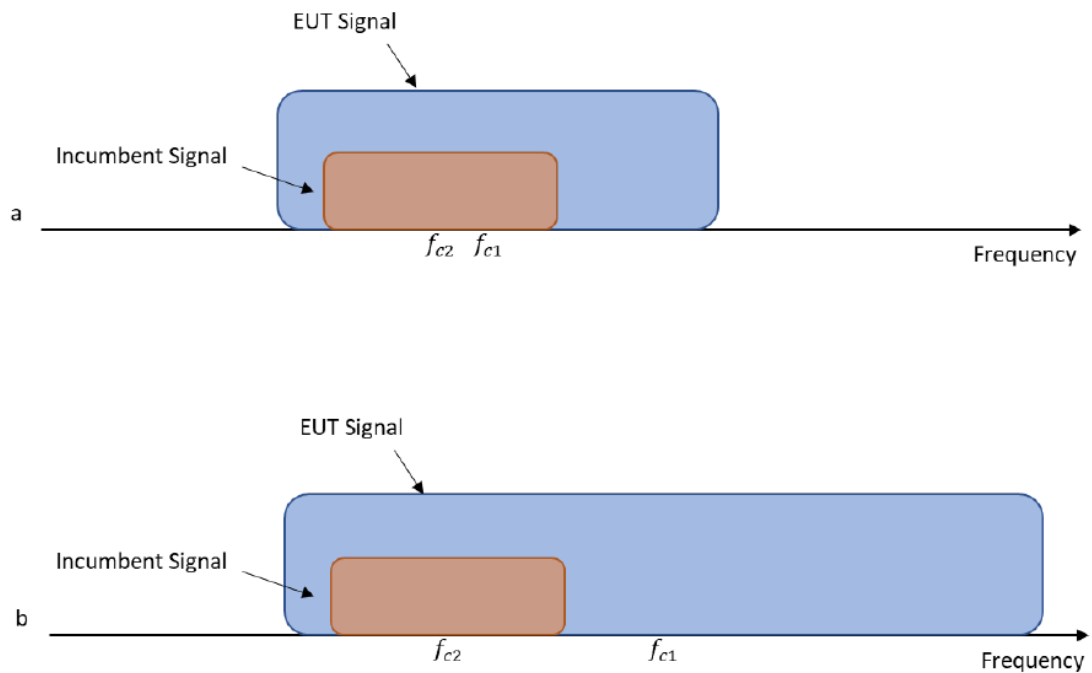

Figure 1. Two possible scenarios where a) center frequency of EUT transmission falls within incumbent's bandwidth, or b) outside of it

To ensure EUT reliably detects an incumbent signal in both scenarios shown in Figure 1, the detection threshold test may be repeated more than once with the incumbent signal (having center frequency f_{cc2}) tuned to different center frequencies within the UT transmission bandwidth. The criteria specified in Table 1 determines how many times the detection threshold test must be performed;

Table 1. Criteria to determine number of times detection threshold test may be performed

If	Number of Tests	Placement of Incumbent Transmission
$BW_{EUT} \leq BW_{Inc}$	Once	Tune incumbent and EUT transmissions ($f_{c1} = f_{c2}$)
$BW_{Inc} < BW_{EUT} \leq 2BW_{Inc}$	Once	Incumbent transmission is contained within BW_{EUT}
$2BW_{Inc} < BW_{EUT} \leq 4BW_{Inc}$	Twice. Incumbent transmission is contained within BW_{EUT}	Incumbent transmission is located as closely as possible to the lower edge and upper edge, respectively, of the EUT channel
$BW_{EUT} > 4BW_{Inc}$	Three times	Incumbent transmission is located as closely as possible to the lower edge of the EUT channel, in the middle of EUT channel, and as closely as possible to the upper edge of the EUT channel

where:

BW_{EUT} : Transmission bandwidth of EUT signal

BW_{Inc} : Transmission bandwidth of the simulated incumbent signal (10 MHz wide AWGN signal)

f_{c1} : Center frequency of EUT transmission

f_{c2} : Center frequency of simulated incumbent signal

TEST PROCEDURE

To ensure the EUT is capable of detecting co-channel energy, the first step is to configure the EUT to transmit with a constant duty cycle.² To simulate an incumbent signal, a signal generator (or similar source) that is capable of generating band-limited additive white Gaussian noise (AWGN) is required. Depending on the EUT antenna configuration, the AWGN signal can be provided to the EUT receiver via a conducted method (Figure 2) or a radiated method (Figure 3). Figure 2 shows the conducted test setup where a band-limited AWGN signal is generated at a very low power level and injected into the EUT's antenna port. The AWGN signal power level is then incrementally increased while the EUT transmission is monitored on a signal analyzer 2 to verify if the EUT can sense the AWGN signal and can subsequently cease its transmission. A triggered measurement, as shown in Figure 2, is optional, and assists with determining the time it takes the EUT to cease transmission (or vacate the channel) upon detecting RF energy. If the EUT has only one antenna port, then an AWGN signal source can be connected to the same antenna port.

1. Configure the EUT to transmit with a constant duty cycle.
2. Set the operating parameters of the EUT including power level, operating frequency, modulation and bandwidth.
3. Set the signal analyzer center frequency to the nominal EUT channel center frequency. The span range of the signal analyzer shall be between two times and five times the OBW of the EUT. Connect the output port of the EUT to the signal analyzer 2, as shown in Figure 2. Ensure that the attenuator 2 provides enough attenuation to not overload the signal analyzer 2 receiver.
4. Monitoring the signal analyzer 2, verify the EUT is operating and transmitting with the parameters set at step two.
5. Using an AWGN signal source, generate (but do not transmit, i.e., RF OFF) a 10 MHz-wide AWGN signal. Use Table 1 to determine the center frequency of the 10 MHz AWGN signal relative to the EUT's channel bandwidth and center frequency.
6. Set the AWGN signal power to an extremely low level (more than 20 dB below the -62 dBm threshold). Connect the AWGN signal source, via a 3-dB splitter, to the signal analyzer 1 and the EUT as shown in Figure 2.
7. Transmit the AWGN signal (RF ON) and verify its characteristics on the signal analyzer 1.
8. Monitor the signal analyzer 2 to verify if the AWGN signal has been detected and the EUT has ceased transmission. If the EUT continues to transmit, then incrementally increase the AWGN signal power level until the EUT stops transmitting.
9. (Including all losses in the RF paths) Determine and record the AWGN signal power level (at the EUT's antenna port) at which the EUT ceased transmission. Repeat the procedure at least 10 times to verify the EUT can detect an AWGN signal with 90% (or better) level of certainty.
10. Refer to Table 1 to determine number of times the detection threshold testing needs to be repeated. If testing is required more than once, then go back to step 5, choose a different center frequency for the AWGN signal and repeat the process.

TEST SETUP

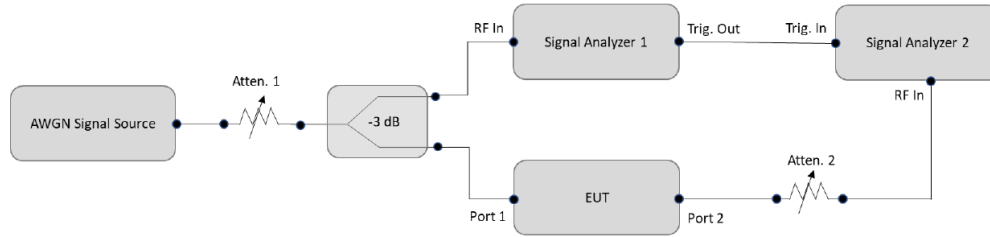

TEST ENVIRONMENT

Temperature	26.2°C	Relative Humidity	63.0%
Atmosphere Pressure	101kPa	Test Voltage	DC 12 V

TEST DATE / ENGINEER

Test Date	September 23, 2023	Test By	Johnson Liu
-----------	--------------------	---------	-------------

TEST RESULTS

Please refer to section "Test Data" - Appendix G

8. RADIATED TEST RESULTS

LIMITS

Refer to CFR 47 FCC §15.205, §15.209 and §15.407 (b) (6).

Refer to ISED RSS-GEN Clause 8.9, Clause 8.10 and ISED RSS-248 4.6.

Radiation Disturbance Test Limit for FCC (Class B) (9 kHz ~ 1 GHz)

Emissions radiated outside of the specified frequency bands above 30 MHz			
Frequency Range (MHz)	Field Strength Limit (uV/m) at 3 m	Field Strength Limit (dBuV/m) at 3 m	
		Quasi-Peak	
30 - 88	100	40	
88 - 216	150	43.5	
216 - 960	200	46	
Above 960	500	54	
Above 1000	500	Peak	Average
		74	54

FCC Emissions radiated outside of the specified frequency bands below 30 MHz		
Frequency (MHz)	Field strength (microvolts/meter)	Measurement distance (meters)
0.009-0.490	2400/F(kHz)	300
0.490-1.705	24000/F(kHz)	30
1.705-30.0	30	30

ISED General field strength limits at frequencies below 30 MHz

Table 6 – General field strength limits at frequencies below 30 MHz		
Frequency	Magnetic field strength (H-Field) (µA/m)	Measurement distance (m)
9 - 490 kHz ^{Note 1}	6.37/F (F in kHz)	300
490 - 1705 kHz	63.7/F (F in kHz)	30
1.705 - 30 MHz	0.08	30

Note 1: The emission limits for the ranges 9-90 kHz and 110-490 kHz are based on measurements employing a linear average detector.

ISED Restricted bands refer to ISED RSS-GEN Clause 8.10

Table 7 – Restricted frequency bands ^{Note 1}		
MHz	MHz	GHz
0.090 - 0.110	149.9 - 150.05	9.0 - 9.2
0.495 - 0.505	166.52475 - 166.52525	9.3 - 9.5
2.1735 - 2.1905	156.7 - 156.9	10.8 - 12.7
3.020 - 3.026	162.0125 - 167.17	13.25 - 13.4
4.125 - 4.128	167.72 - 173.2	14.47 - 14.5
4.17725 - 4.17775	240 - 285	15.35 - 16.2
4.20725 - 4.20775	322 - 335.4	17.7 - 21.4
5.677 - 5.683	399.9 - 410	22.01 - 23.12
6.215 - 6.218	608 - 614	23.6 - 24.0
6.26775 - 6.26825	960 - 1427	31.2 - 31.8
6.31175 - 6.31225	1435 - 1626.5	36.43 - 36.5
8.291 - 8.294	1645.5 - 1646.5	Above 38.6
8.362 - 8.366	1660 - 1710	
8.37625 - 8.38675	1718.8 - 1722.2	
8.41425 - 8.41475	2200 - 2300	
12.29 - 12.293	2310 - 2390	
12.51975 - 12.52025	2483.5 - 2500	
12.57675 - 12.57725	2655 - 2900	
13.36 - 13.41	3260 - 3267	
16.42 - 16.423	3332 - 3339	
16.80475 - 16.80525	3345.8 - 3358	
16.80425 - 16.80475	3500 - 4400	
25.5 - 25.67	4500 - 5150	
37.5 - 38.25	5350 - 5480	
73 - 74.6	7250 - 7750	
74.8 - 75.2	8025 - 8500	
108 - 138		

Note 1: Certain frequency bands listed in table 7 and in bands above 38.6 GHz are designated for licence-exempt applications. These frequency bands and the requirements that apply to related devices are set out in the 200 and 300 series of RSSs.

FCC Restricted bands of operation refer to FCC §15.205 (a):

MHz	MHz	MHz	GHz
0.090-0.110	16.42-16.423	399.9-410	4.5-5.15
¹ 0.495-0.505	16.69475-16.69525	608-614	5.35-5.46
2.1735-2.1905	16.80425-16.80475	960-1240	7.25-7.75
4.125-4.128	25.5-25.67	1300-1427	8.025-8.5
4.17725-4.17775	37.5-38.25	1435-1626.5	9.0-9.2
4.20725-4.20775	73-74.6	1645.5-1646.5	9.3-9.5
6.215-6.218	74.8-75.2	1660-1710	10.6-12.7
6.26775-6.26825	108-121.94	1718.8-1722.2	13.25-13.4
6.31175-6.31225	123-138	2200-2300	14.47-14.5
8.291-8.294	149.9-150.05	2310-2390	15.35-16.2
8.362-8.366	156.52475-156.52525	2483.5-2500	17.7-21.4
8.37625-8.38675	156.7-156.9	2690-2900	22.01-23.12
8.41425-8.41475	162.0125-167.17	3260-3267	23.6-24.0
12.29-12.293	167.72-173.2	3332-3339	31.2-31.8
12.51975-12.52025	240-285	3345.8-3358	36.43-36.5
12.57675-12.57725	322-335.4	3600-4400	(²)
13.36-13.41			

Note: ¹Until February 1, 1999, this restricted band shall be 0.490-0.510 MHz.

²Above 38.6c

Limits of unwanted/undesirable emission out of the restricted bands refer to CFR 47 FCC §15.407 (b) (6) and ISED RSS-247 4.6.

For transmitters operating within the 5.925-7.125 GHz band: Any emissions outside of the 5.925-7.125 GHz band must not exceed an e.i.r.p. of -27 dBm/MHz.

TEST PROCEDURE

Below 30 MHz

The setting of the spectrum analyzer

RBW	200 Hz (From 9 kHz to 0.15 MHz)/ 9 kHz (From 0.15 MHz to 30 MHz)
VBW	200 Hz (From 9 kHz to 0.15 MHz)/ 9 kHz (From 0.15 MHz to 30 MHz)
Sweep	Auto

1. The testing follows the guidelines in ANSI C63.10-2013 clause 6.4.
2. The EUT was arranged to its worst case and then turntable (from 0 degree to 360 degrees) to find the maximum reading. A pre-amp and a high pass filter are used for the test in order to get better signal level. Both Horizontal, Face-on and Face-off polarizations of the antenna are set to make the measurement.
3. The EUT was placed on a turntable with 80 cm above ground.
4. The EUT was set 3 meters from the interference receiving antenna, which was mounted on the top of a 1 m height antenna tower.
5. The radiated emission limits are based on measurements employing a CISPR quasi-peak detector except for the frequency bands 9-90 kHz, 110-490 kHz and above 1000 MHz Radiated emission limits in these three bands are based on measurements employing an average detector.
6. For measurement below 1 GHz, the initial step in collecting conducted emission data is a spectrum analyzer peak detector mode pre-scanning the measurement frequency range. Significant peaks are then marked and then Quasi Peak and average detector mode re-measured. If the emission level of the EUT measured by the peak detector is 3 dB lower than the applicable limit, the peak emission level will be reported. Otherwise, the emission measurement will be repeated using the quasi-peak and average detector and reported.
7. Although these tests were performed other than open field site, adequate comparison measurements were confirmed against 30m open field site. Therefore sufficient tests were made to demonstrate that the alternative site produces results that correlate with the ones of tests made in an open field site based on KDB 414788.
8. The limits in CFR 47, Part 15, Subpart C, paragraph 15.209 (a), are identical to those in RSS-GEN Section 8.9, Table 6, since the measurements are performed in terms of magnetic field strength and converted to electric field strength levels (as reported in the table) using the free space impedance of 377Ω . For example, the measurement frequency X kHz resulted in a level of Y dBuV/m, which is equivalent to $Y-51.5 = Z$ dBuA/m, which has the same margin, W dB, to the corresponding RSS-GEN Table 6 limit as it has to be 15.209(a) limit.

Below 1 GHz and above 30 MHz

The setting of the spectrum analyzer

RBW	120 kHz
VBW	300 kHz
Sweep	Auto
Detector	Peak/QP
Trace	Max hold

1. The testing follows the guidelines in ANSI C63.10-2013 clause 6.5.
2. The EUT was arranged to its worst case and then tune the antenna tower (from 1 m to 4 m) and turntable (from 0 degree to 360 degrees) to find the maximum reading. A pre-amp and a high pass filter are used for the test in order to get better signal level. Both horizontal and vertical polarizations of the antenna are set to make the measurement.
3. The EUT was placed on a turntable with 80 cm above ground.
4. The EUT was set 3 meters from the interference receiving antenna, which was mounted on the top of a variable height antenna tower.
5. For measurement below 1 GHz, the initial step in collecting conducted emission data is a spectrum analyzer peak detector mode pre-scanning the measurement frequency range. Significant peaks are then marked and then Quasi Peak detector mode re-measured. If the emission level of the EUT measured by the peak detector is 3 dB lower than the applicable limit, the peak emission level will be reported. Otherwise, the emission measurement will be repeated using the quasi-peak detector and reported.

Above 1 GHz

The setting of the spectrum analyzer

RBW	1 MHz
VBW	PEAK: 3 MHz AVG: see note 6
Sweep	Auto
Detector	Peak
Trace	Max hold

1. The testing follows the guidelines in KDB 789033 D02 General U-NII Test Procedures New Rules v02r01 section II.G.3 ~ II.G.6.
2. The EUT was arranged to its worst case and then tune the antenna tower (from 1 m to 4 m) and turntable (from 0 degree to 360 degrees) to find the maximum reading. A pre-amp and a high pass filter are used for the test in order to get better signal level. Both horizontal and vertical polarizations of the antenna are set to make the measurement.
3. The EUT was placed on a turntable with 1.5 m above ground.
4. The EUT was set 3 meters from the interference receiving antenna, which was mounted on the top of a variable height antenna tower.
5. For measurement above 1 GHz, the emission measurement will be measured by the peak detector. This peak level, once corrected, must comply with the limit specified in Section 15.209.
6. For measurements above 1 GHz the resolution bandwidth is set to 1 MHz, then the video bandwidth is set to 3 MHz for peak measurements and 1 MHz resolution bandwidth with 1/T video bandwidth with peak detector for average measurements. For the Duty Cycle please refer to clause 7.1. ON TIME AND DUTY CYCLE.

X axis, Y axis, Z axis positions:

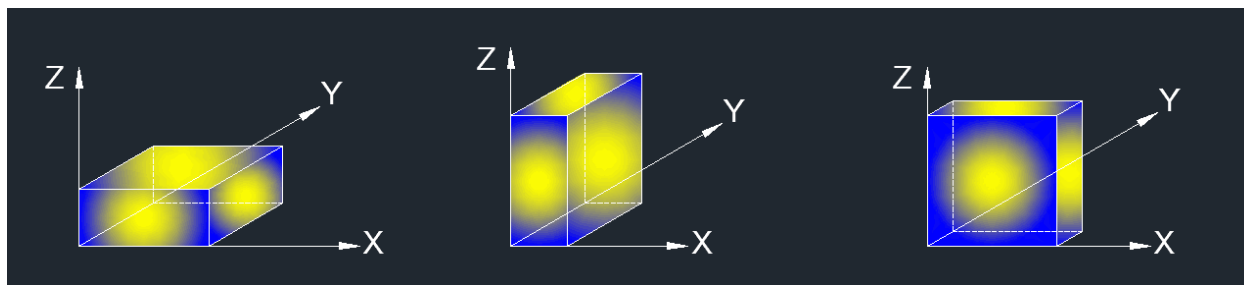

Note 1: For all radiated test, EUT in each of three orthogonal axis emissions had been tested, but only the worst case (X axis) data recorded in the report.

Note 2: The EUT was fully exercised with external accessories during the test. In the case of multiple accessory external ports, an external accessory shall be connected to one of each type of port.

For Restricted Bandedge:

Note:

1. Measurement = Reading Level + Correct Factor.

2. If the peak values are less than the average limit of 54 dBuV/m, the average result is deemed to comply with average limit.
3. PK=Peak: Peak detector.
4. AV=Average: $VBW=1/Ton$, where: Ton is the transmitting duration.
5. For the transmitting duration, please refer to clause 7.1.
6. Only the worst data was recorded, if it complies with the limit, the other emissions deemed to comply with the limit.
7. Both horizontal and vertical have been tested, only the worst data was recorded in the report.
8. All modes have been tested, but only the worst data was recorded in the report.

For Radiate Spurious emission (9 kHz ~ 30 MHz):

Note:

1. Measurement = Reading Level + Correct Factor.
2. If the peak values are less than the QP limit, the QP result is deemed to comply with QP limit.
3. All 3 polarizations (Horizontal, Face-on and Face-off) of the loop antenna had been tested, but only the worst data recorded in the report.
4. All modes have been tested, but only the worst data was recorded in the report.
5. $dBuA/m = dBuV/m - 20\log_{10}[120\pi] = dBuV/m - 51.5$

For Radiate Spurious Emission (30 MHz ~ 1 GHz):

Note:

1. Result Level = Read Level + Correct Factor.
2. If the peak values are less than the QP limit, the QP result is deemed to comply with QP limit.
3. All modes have been tested, but only the worst data was recorded in the report.

For Radiate Spurious Emission (1 GHz ~ 7 GHz):

1. Measurement = Reading Level + Correct Factor.
2. If the peak values are less than the average limit of 54 dBuV/m, the average result is deemed to comply with average limit.
3. Peak: Peak detector.
4. AVG: $VBW=1/Ton$, where: Ton is the transmitting duration.
5. For the transmitting duration, please refer to clause 7.1.
6. Filter losses were only considered in the spurious frequency bands and the authorized band was not corrected for Band reject filter losses.
7. Proper operation of the transmitter prior to adding the filter to the measurement chain.
8. Since non-restricted band peak emissions are less than the average limit, they also comply with the -27 dBm/MHz (68.2 dBuV/m) limit.
9. All modes have been tested, but only the worst data was recorded in the report.

For Radiate Spurious Emission (7 GHz ~ 18 GHz):

Note:

1. Peak Result = Reading Level + Correct Factor.
2. If the peak values are less than the average limit of 54 dBuV/m, the average result is deemed to comply with average limit.
3. Peak: Peak detector.
4. AVG: $VBW=1/T_{on}$, where: T_{on} is the transmitting duration.
5. For the transmitting duration, please refer to clause 7.1.
6. Filter losses were only considered in the spurious frequency bands and the authorized band was not corrected for High Pass Filter losses.
7. Proper operation of the transmitter prior to adding the filter to the measurement chain.
8. Since non-restricted band peak emissions are less than the average limit, they also comply with the -27 dBm/MHz (68.2 dBuV/m) limit.
9. All modes have been tested, but only the worst data was recorded in the report.

For Radiate Spurious emission (18 GHz ~ 26 GHz):

Note:

1. Measurement = Reading Level + Correct Factor.
2. If the peak values are less than the average limit of 54 dBuV/m, the average result is deemed to comply with average limit.
3. Peak: Peak detector.
4. All modes have been tested, but only the worst data was recorded in the report.

For Radiate Spurious emission (26 GHz ~ 40 GHz):

Note:

1. Measurement = Reading Level + Correct Factor.
2. If the peak values are less than the average limit of 54 dBuV/m, the average result is deemed to comply with average limit.
3. Peak: Peak detector.
4. All modes have been tested, but only the worst data was recorded in the report.

TEST SETUP

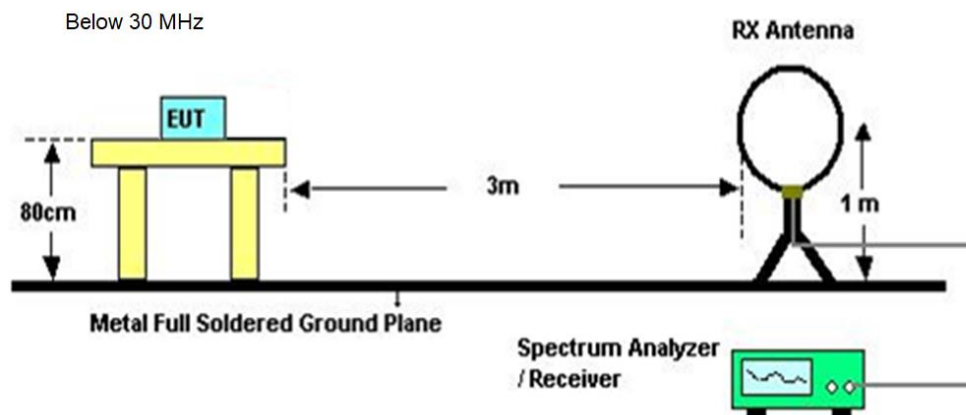

Below 1 GHz and above 30 MHz

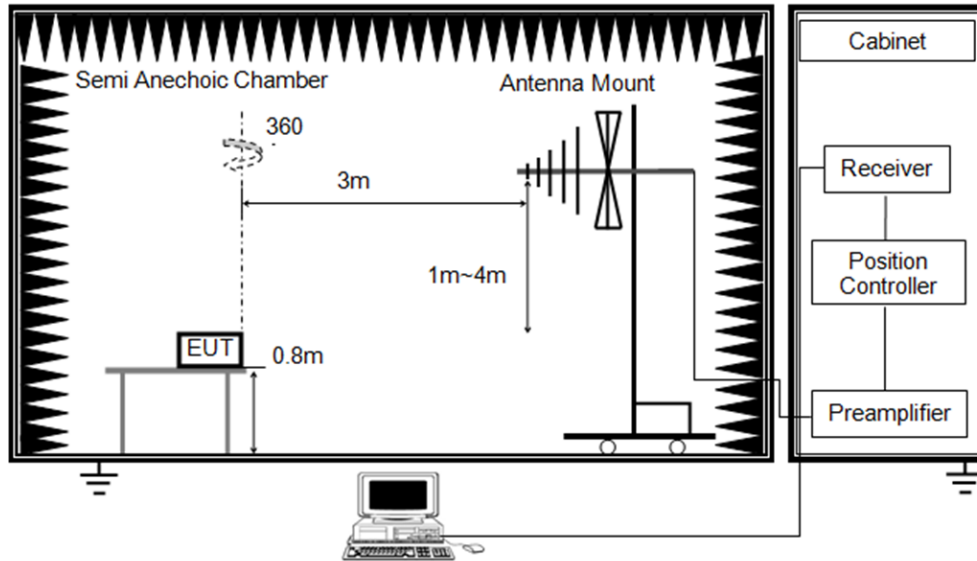

Above 1 GHz

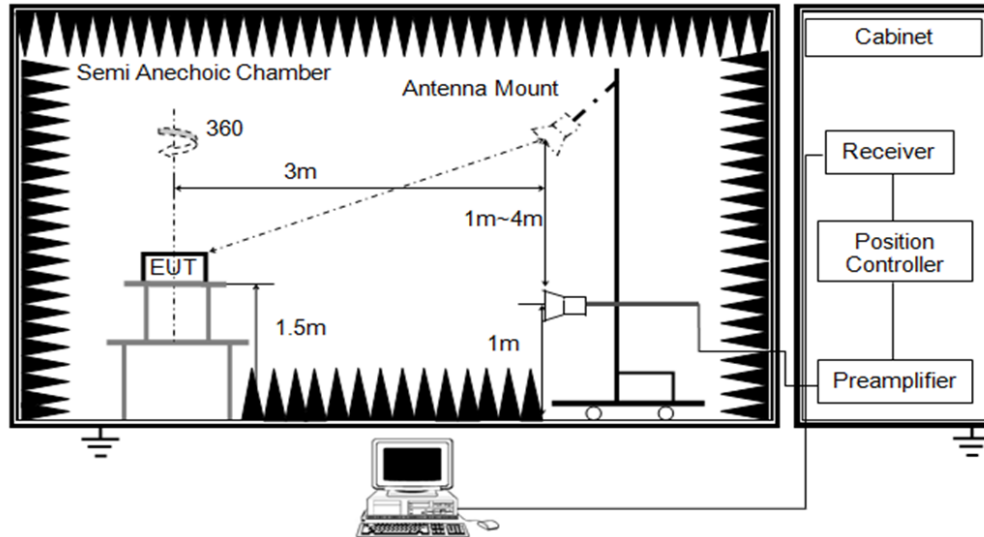

TEST ENVIRONMENT

Temperature	25.3°C	Relative Humidity	62%
Atmosphere Pressure	101kPa	Test Voltage	DC 12 V

TEST DATE / ENGINEER

Test Date	October 9, 2023	Test By	Rex Huang
-----------	-----------------	---------	-----------

TEST RESULTS

8.1. RESTRICTED BANDEDGE

Test Mode:	802.11be EHT20 PK	Frequency(MHz):	6115
Polarity:	Vertical	Test Voltage:	DC 12 V

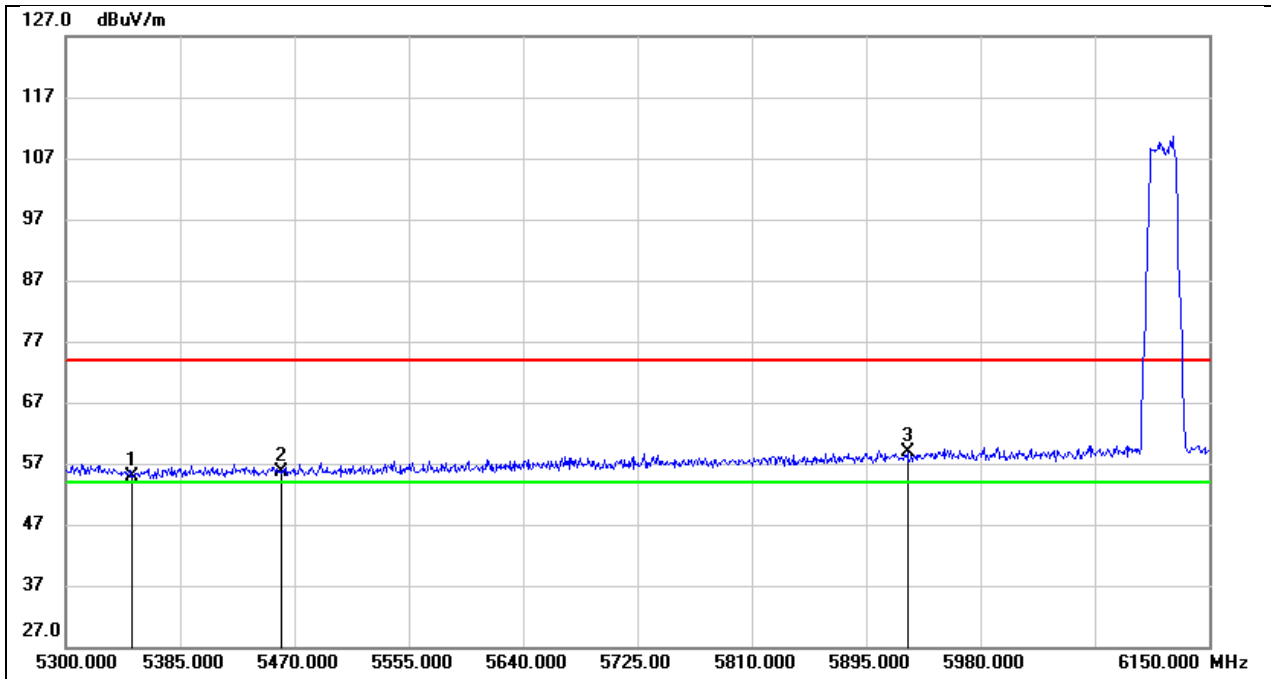

No.	Frequency (MHz)	Reading (dBuV)	Correct (dB/m)	Result (dBuV/m)	Limit (dBuV/m)	Margin (dB)	Remark
1	5350.000	14.43	40.49	54.92	74.00	-19.08	peak
2	5460.000	14.90	40.62	55.52	74.00	-18.48	peak
3	5925.000	17.07	41.80	58.87	74.00	-15.13	peak

Test Mode:	802.11be EHT20 AV	Frequency(MHz):	6115
Polarity:	Vertical	Test Voltage:	DC 12 V

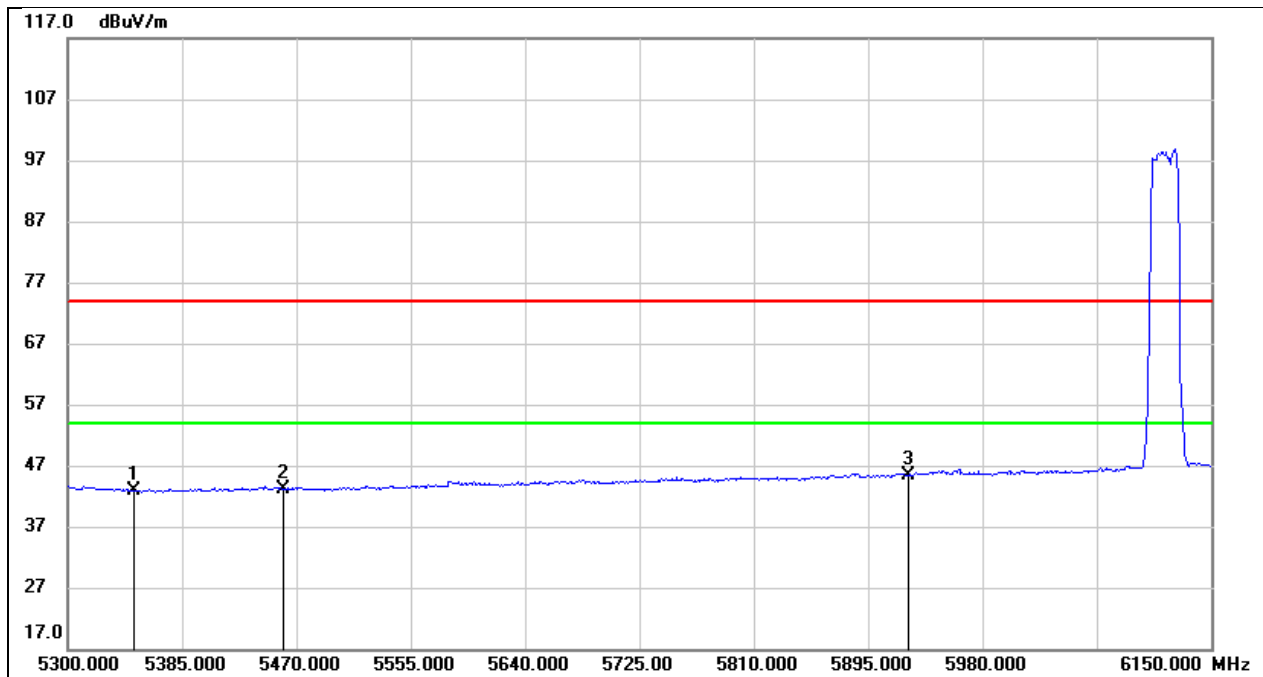

No.	Frequency (MHz)	Reading (dBuV)	Correct (dB/m)	Result (dBuV/m)	Limit (dBuV/m)	Margin (dB)	Remark
1	5350.000	2.41	40.49	42.90	54.00	-11.10	AVG
2	5460.000	2.58	40.62	43.20	54.00	-10.80	AVG
3	5925.000	3.62	41.80	45.42	54.00	-8.58	AVG

Test Mode:	802.11be EHT20 PK	Frequency(MHz):	7095
Polarity:	Vertical	Test Voltage:	DC 12 V

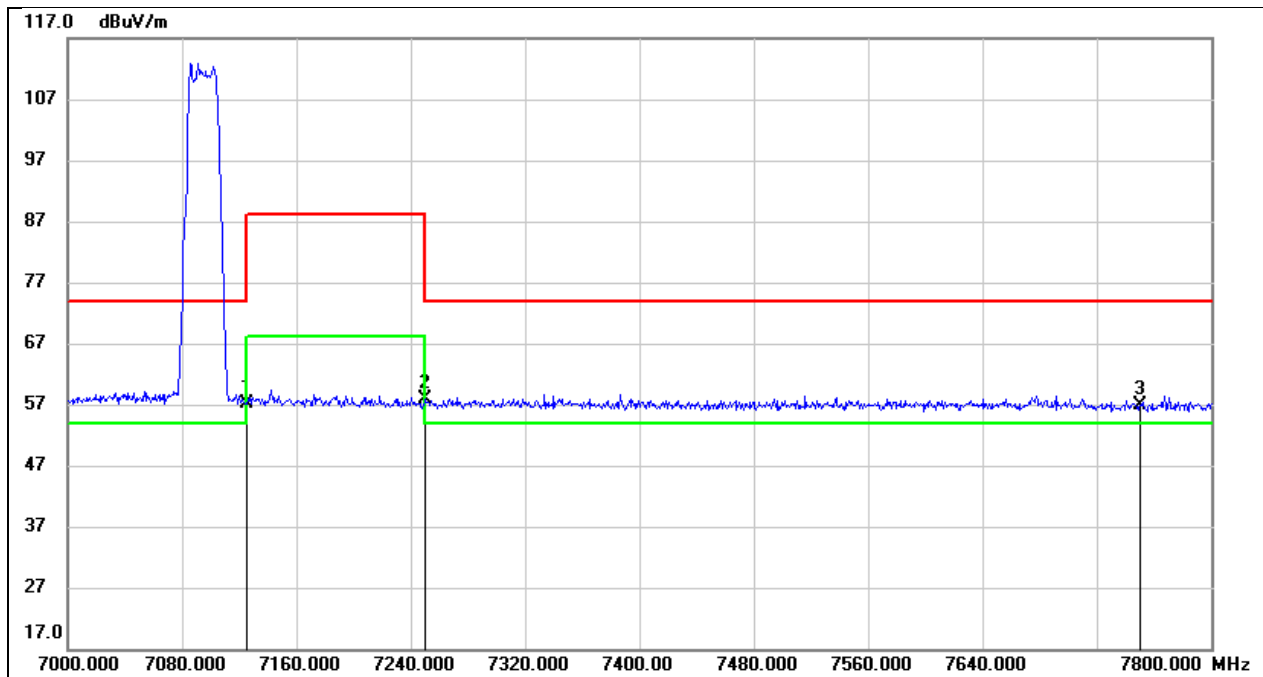

No.	Frequency (MHz)	Reading (dBuV)	Correct (dB/m)	Result (dBuV/m)	Limit (dBuV/m)	Margin (dB)	Remark
1	7125.000	11.88	45.36	57.24	74.00	-16.76	peak
2	7250.000	12.64	45.27	57.91	74.00	-16.09	peak
3	7750.000	11.80	45.08	56.88	74.00	-17.12	peak

Test Mode:	802.11be EHT20 AV	Frequency(MHz):	7095
Polarity:	Vertical	Test Voltage:	DC 12 V

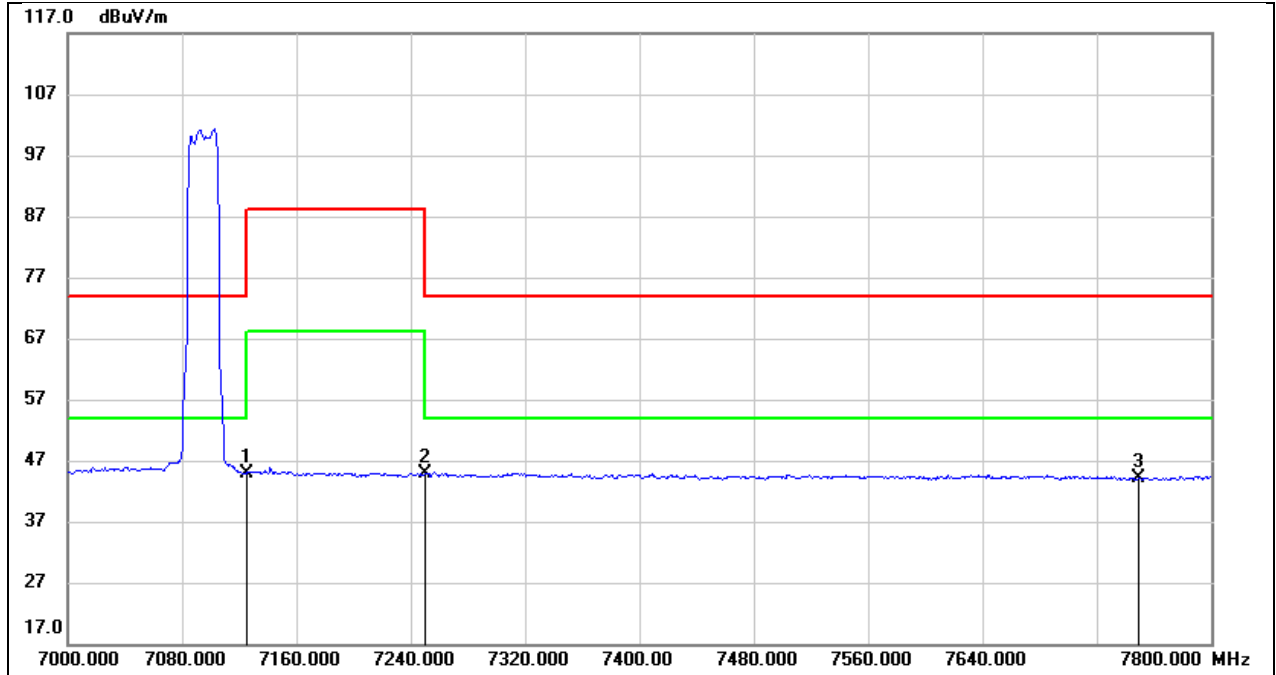

No.	Frequency (MHz)	Reading (dBuV)	Correct (dB/m)	Result (dBuV/m)	Limit (dBuV/m)	Margin (dB)	Remark
1	7125.000	-0.36	45.36	45.00	54.00	-9.00	AVG
2	7250.000	-0.47	45.27	44.80	54.00	-9.20	AVG
3	7750.000	-1.02	45.08	44.06	54.00	-9.94	AVG

Test Mode:	802.11be EHT40 PK	Frequency(MHz):	6125
Polarity:	Vertical	Test Voltage:	DC 12 V

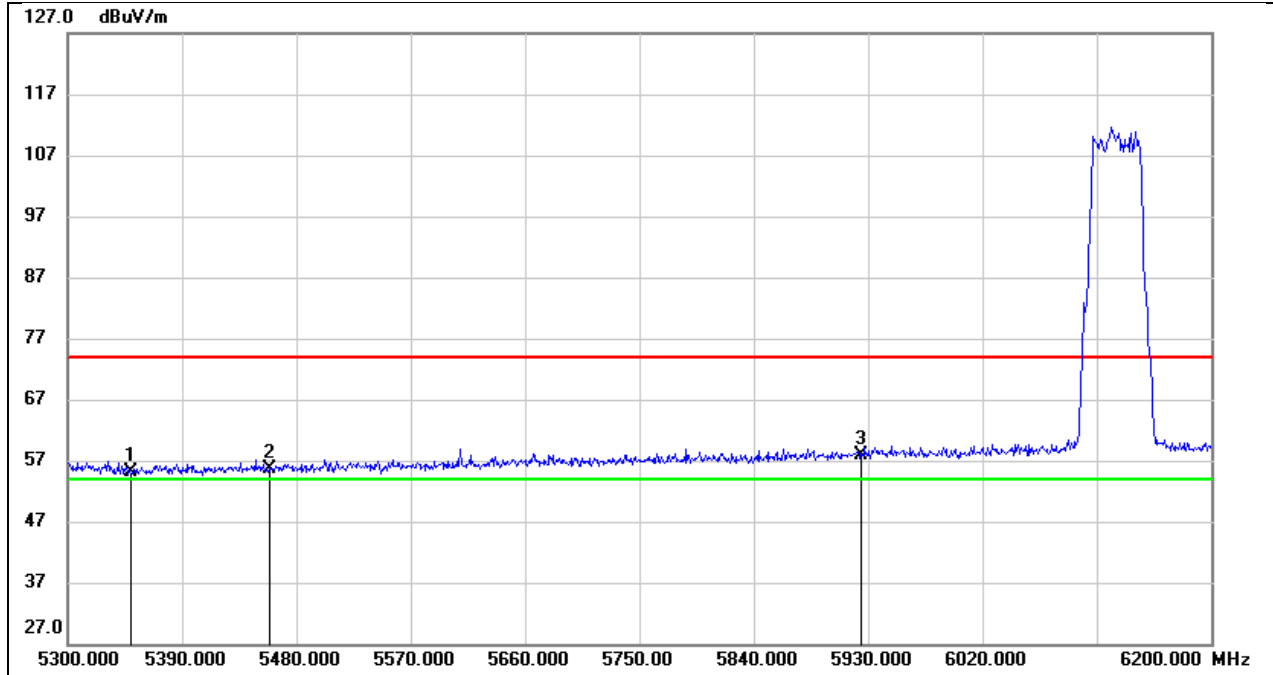

No.	Frequency (MHz)	Reading (dBuV)	Correct (dB/m)	Result (dBuV/m)	Limit (dBuV/m)	Margin (dB)	Remark
1	5350.000	14.55	40.49	55.04	74.00	-18.96	peak
2	5460.000	14.97	40.62	55.59	74.00	-18.41	peak
3	5925.000	16.08	41.80	57.88	74.00	-16.12	peak

Test Mode:	802.11be EHT40 AV	Frequency(MHz):	6125
Polarity:	Vertical	Test Voltage:	DC 12 V

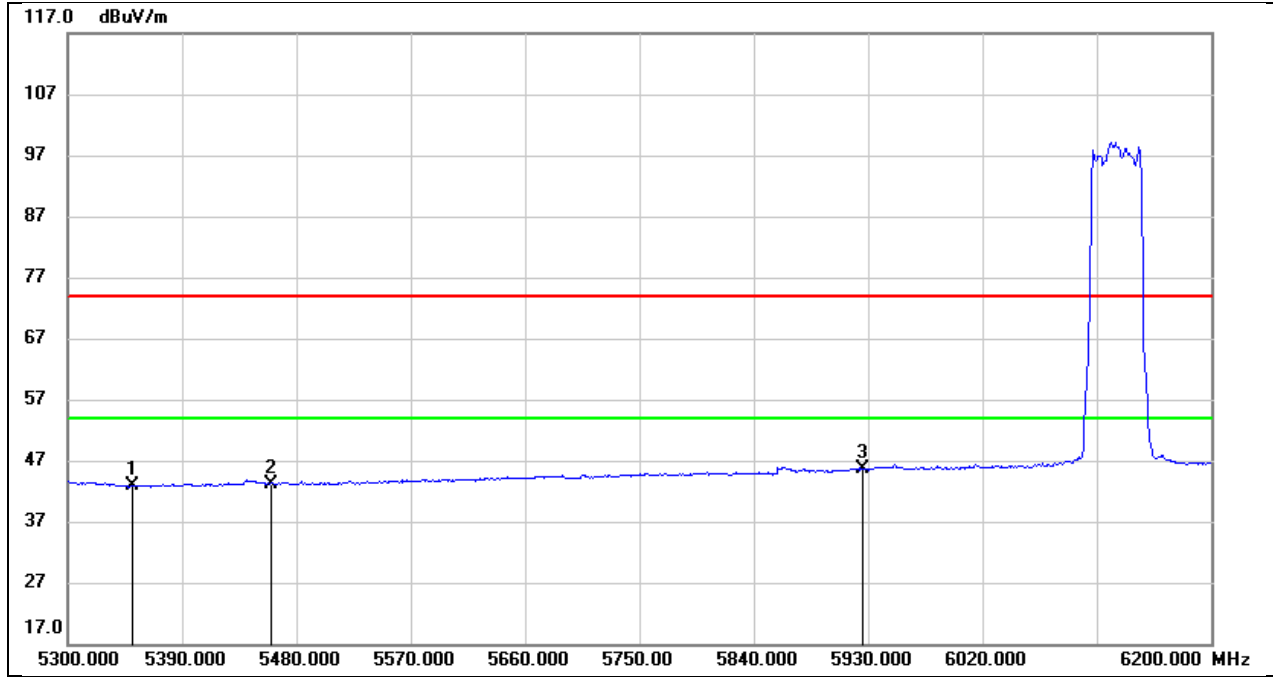

No.	Frequency (MHz)	Reading (dBuV)	Correct (dB/m)	Result (dBuV/m)	Limit (dBuV/m)	Margin (dB)	Remark
1	5350.000	2.34	40.49	42.83	54.00	-11.17	AVG
2	5460.000	2.63	40.62	43.25	54.00	-10.75	AVG
3	5925.000	3.78	41.80	45.58	54.00	-8.42	AVG

Test Mode:	802.11be EHT40 PK	Frequency(MHz):	7085
Polarity:	Vertical	Test Voltage:	DC 12 V

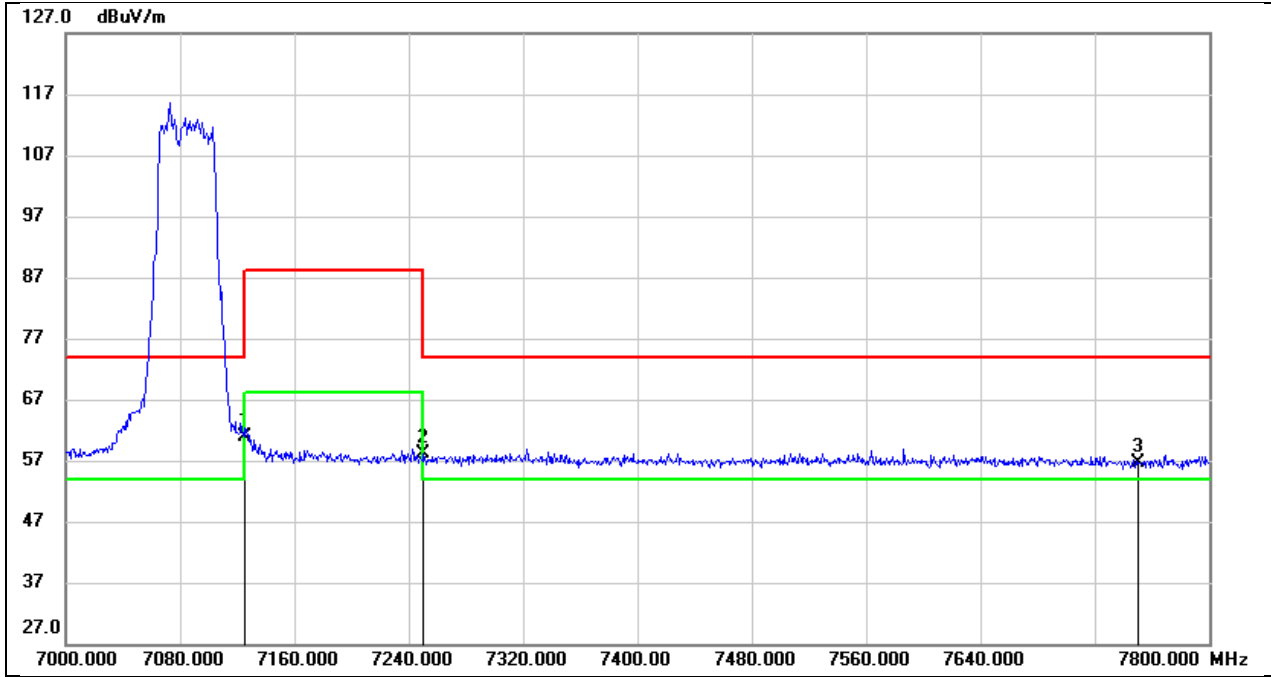

No.	Frequency (MHz)	Reading (dBuV)	Correct (dB/m)	Result (dBuV/m)	Limit (dBuV/m)	Margin (dB)	Remark
1	7125.000	15.51	45.36	60.87	74.00	-13.13	peak
2	7250.000	12.87	45.27	58.14	74.00	-15.86	peak
3	7750.000	11.54	45.08	56.62	74.00	-17.38	peak

Test Mode:	802.11be EHT40 AV	Frequency(MHz):	7085
Polarity:	Vertical	Test Voltage:	DC 12 V

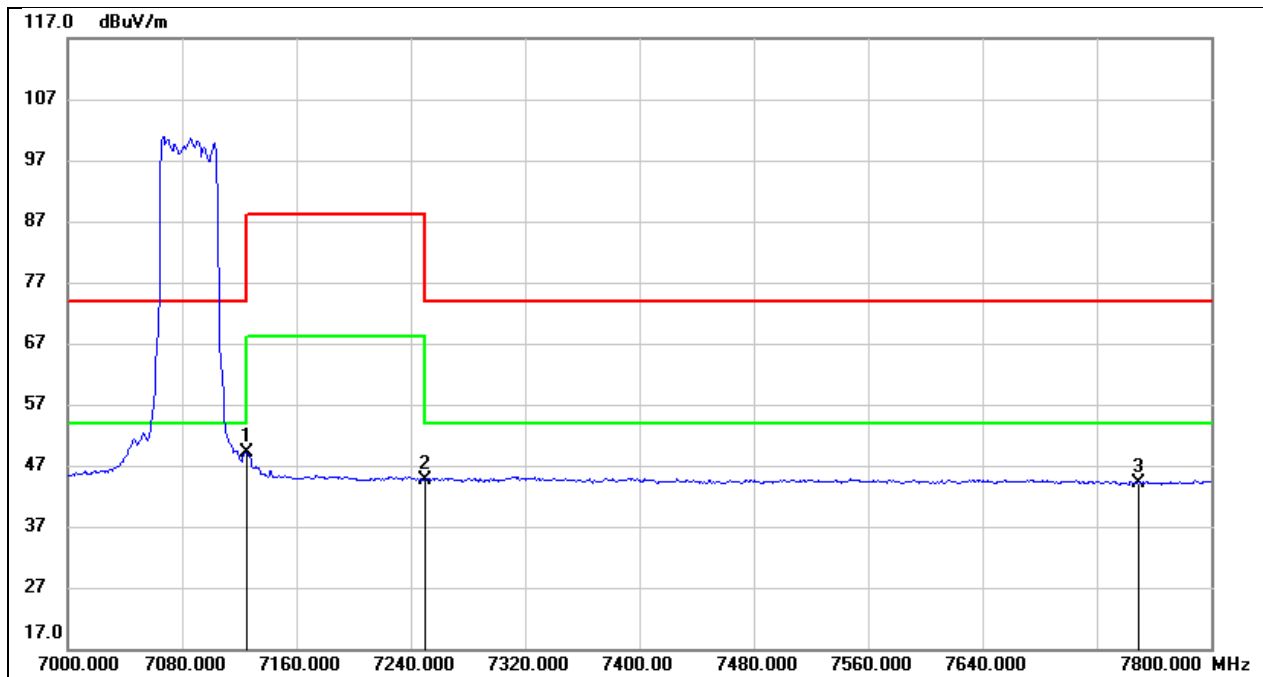

No.	Frequency (MHz)	Reading (dBuV)	Correct (dB/m)	Result (dBuV/m)	Limit (dBuV/m)	Margin (dB)	Remark
1	7125.000	3.71	45.36	49.07	54.00	-4.93	AVG
2	7250.000	-0.63	45.27	44.64	54.00	-9.36	AVG
3	7750.000	-0.85	45.08	44.23	54.00	-9.77	AVG

Test Mode:	802.11be EHT80 PK	Frequency(MHz):	6145
Polarity:	Vertical	Test Voltage:	DC 12 V

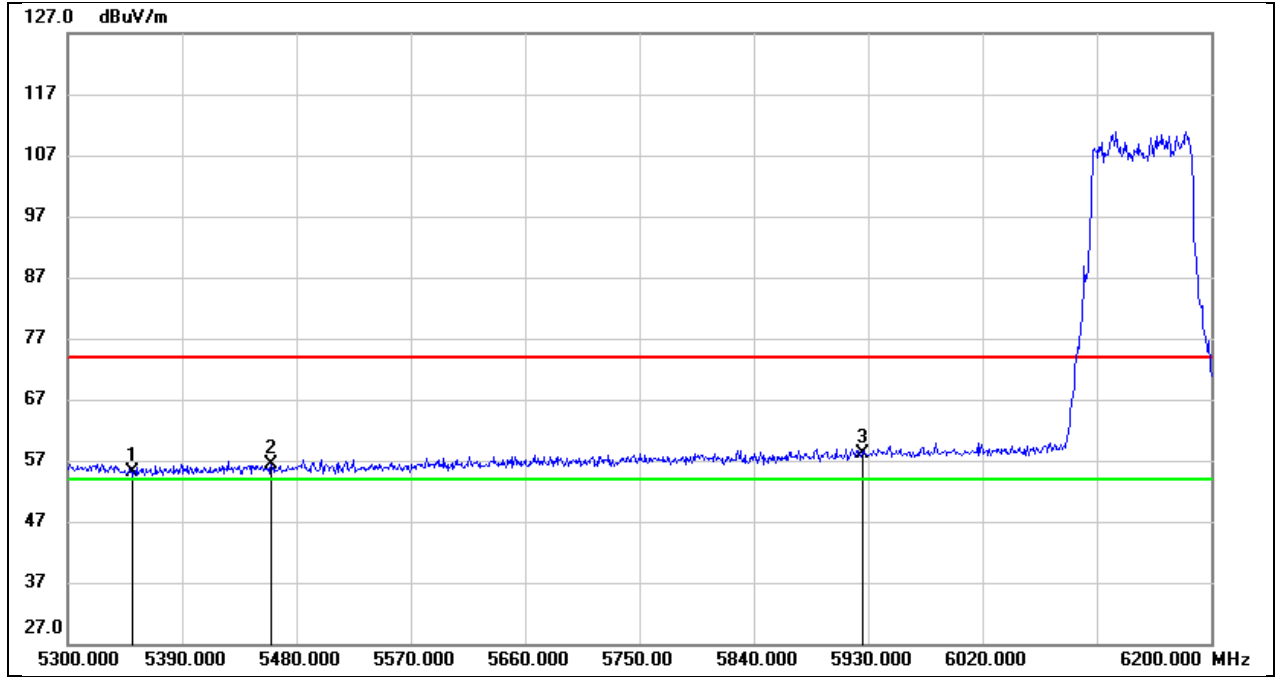

No.	Frequency (MHz)	Reading (dBuV)	Correct (dB/m)	Result (dBuV/m)	Limit (dBuV/m)	Margin (dB)	Remark
1	5350.000	14.65	40.49	55.14	74.00	-18.86	peak
2	5460.000	15.66	40.62	56.28	74.00	-17.72	peak
3	5925.000	16.37	41.80	58.17	74.00	-15.83	peak

Test Mode:	802.11be EHT80 AV	Frequency(MHz):	6145
Polarity:	Vertical	Test Voltage:	DC 12 V

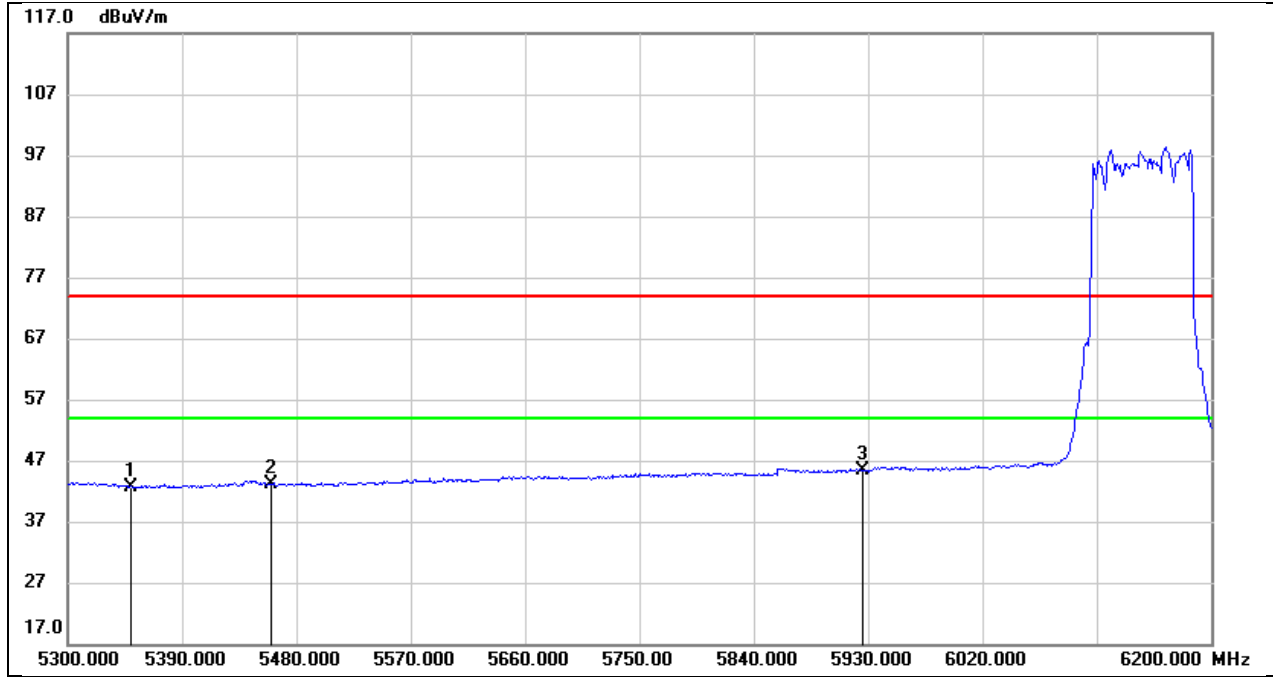

No.	Frequency (MHz)	Reading (dBuV)	Correct (dB/m)	Result (dBuV/m)	Limit (dBuV/m)	Margin (dB)	Remark
1	5350.000	2.21	40.49	42.70	54.00	-11.30	AVG
2	5460.000	2.62	40.62	43.24	54.00	-10.76	AVG
3	5925.000	3.70	41.80	45.50	54.00	-8.50	AVG

Test Mode:	802.11be EHT80 PK	Frequency(MHz):	7025
Polarity:	Vertical	Test Voltage:	DC 12 V

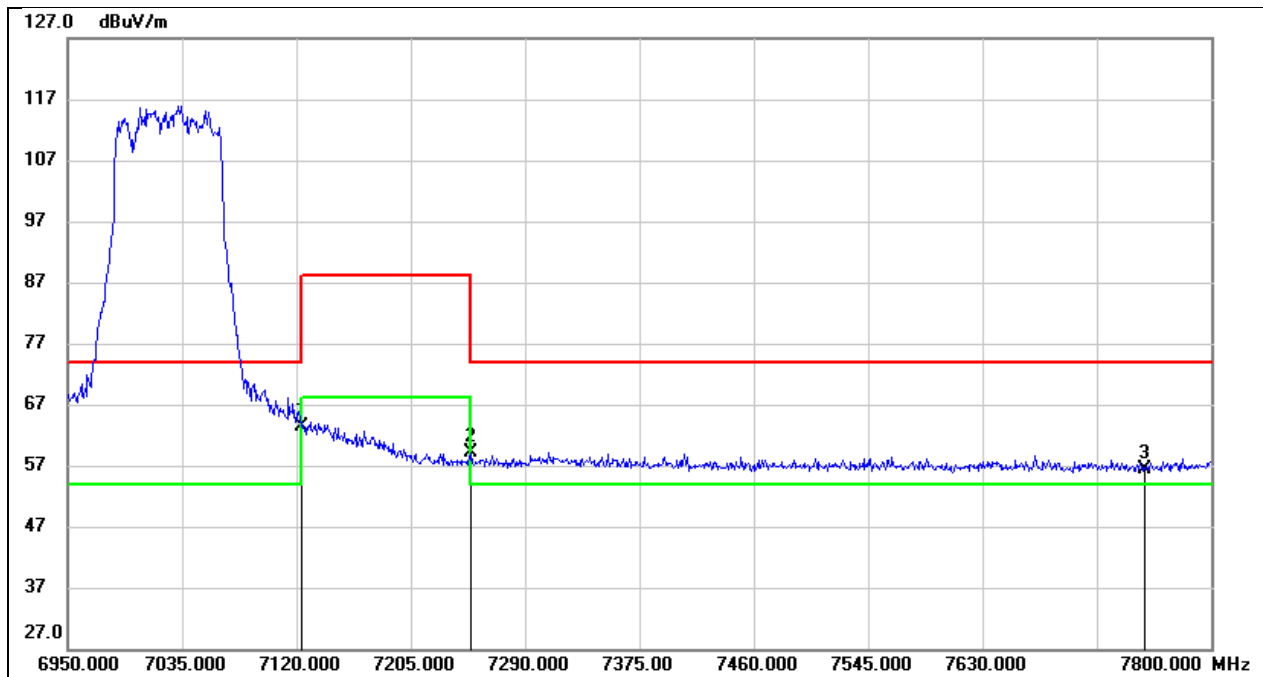

No.	Frequency (MHz)	Reading (dBuV)	Correct (dB/m)	Result (dBuV/m)	Limit (dBuV/m)	Margin (dB)	Remark
1	7125.000	17.97	45.36	63.33	74.00	-10.67	peak
2	7250.000	13.81	45.27	59.08	74.00	-14.92	peak
3	7750.000	11.37	45.08	56.45	74.00	-17.55	peak

Test Mode:	802.11be EHT80 AV	Frequency(MHz):	7025
Polarity:	Vertical	Test Voltage:	DC 12 V

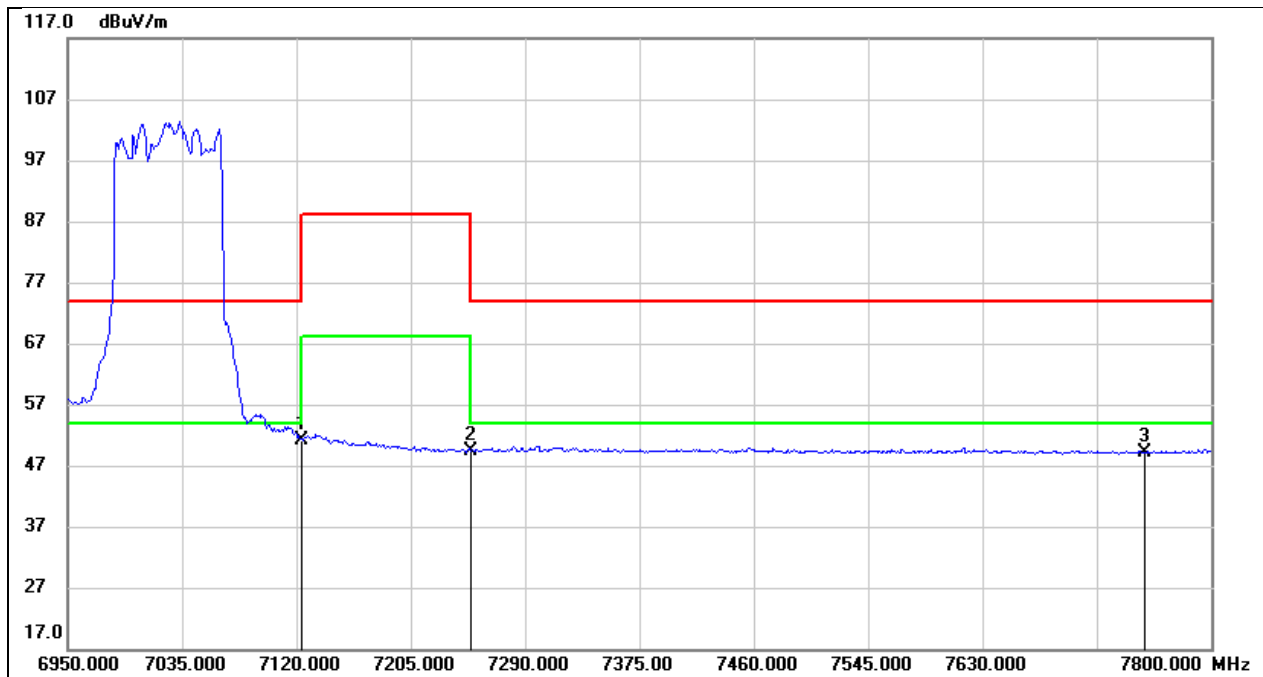

No.	Frequency (MHz)	Reading (dBuV)	Correct (dB/m)	Result (dBuV/m)	Limit (dBuV/m)	Margin (dB)	Remark
1	7125.000	5.81	45.36	51.17	54.00	-2.83	AVG
2	7250.000	4.08	45.27	49.35	54.00	-4.65	AVG
3	7750.000	4.14	45.08	49.22	54.00	-4.78	AVG

Test Mode:	802.11be EHT160 PK	Frequency(MHz):	6185
Polarity:	Vertical	Test Voltage:	DC 12 V

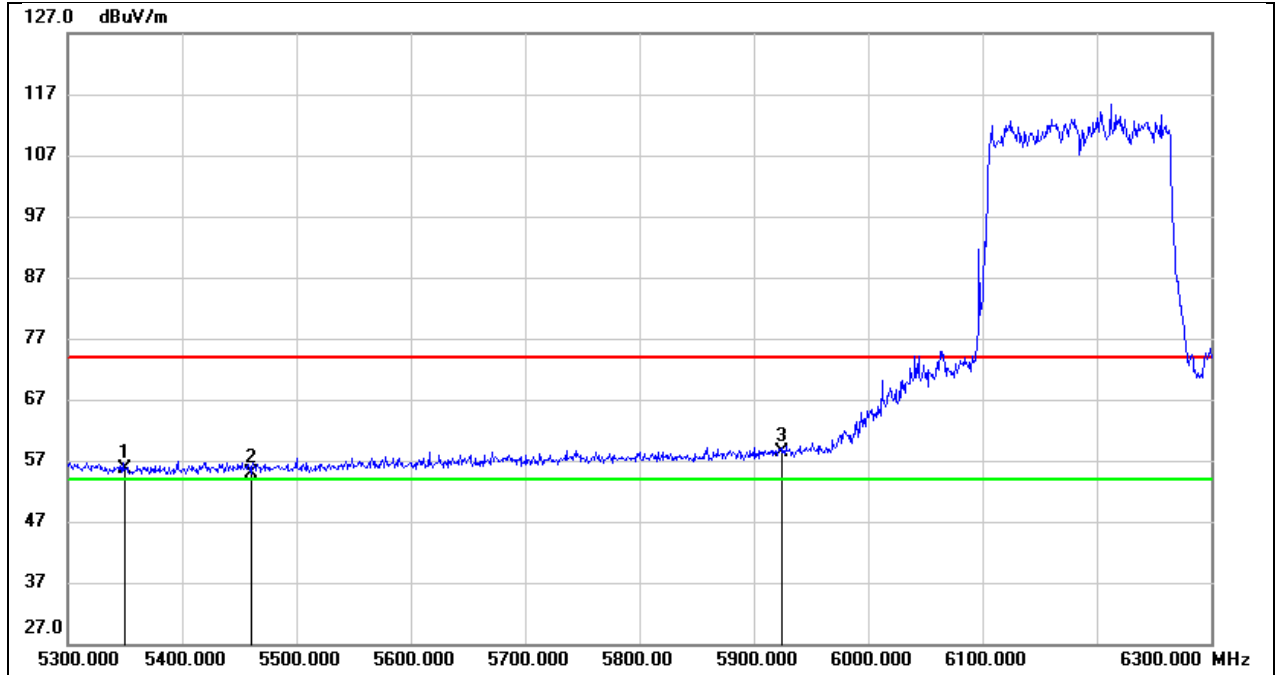

No.	Frequency (MHz)	Reading (dBuV)	Correct (dB/m)	Result (dBuV/m)	Limit (dBuV/m)	Margin (dB)	Remark
1	5350.000	15.25	40.49	55.74	74.00	-18.26	peak
2	5460.000	14.38	40.62	55.00	74.00	-19.00	peak
3	5925.000	16.64	41.80	58.44	74.00	-15.56	peak

Test Mode:	802.11be EHT160 AV	Frequency(MHz):	6185
Polarity:	Vertical	Test Voltage:	DC 12 V

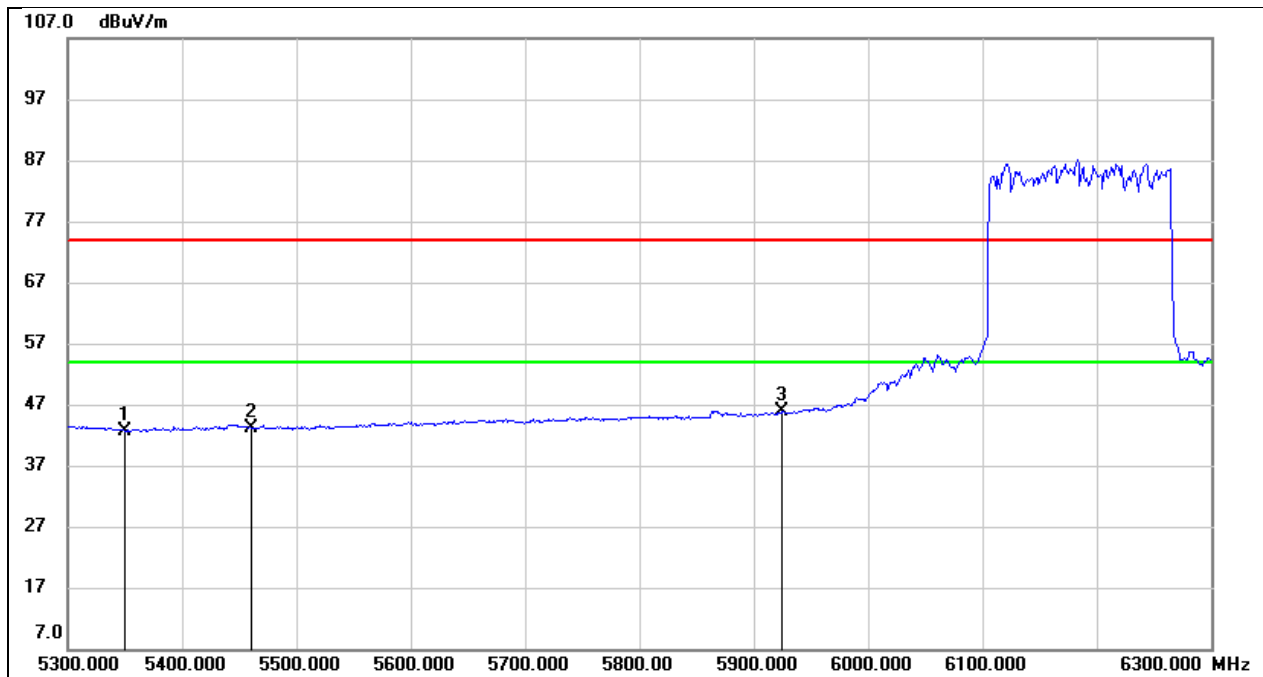

No.	Frequency (MHz)	Reading (dBuV)	Correct (dB/m)	Result (dBuV/m)	Limit (dBuV/m)	Margin (dB)	Remark
1	5350.000	2.21	40.49	42.70	54.00	-11.30	AVG
2	5460.000	2.55	40.62	43.17	54.00	-10.83	AVG
3	5925.000	4.08	41.80	45.88	54.00	-8.12	AVG

Test Mode:	802.11be EHT160 PK	Frequency(MHz):	6985
Polarity:	Vertical	Test Voltage:	DC 12 V

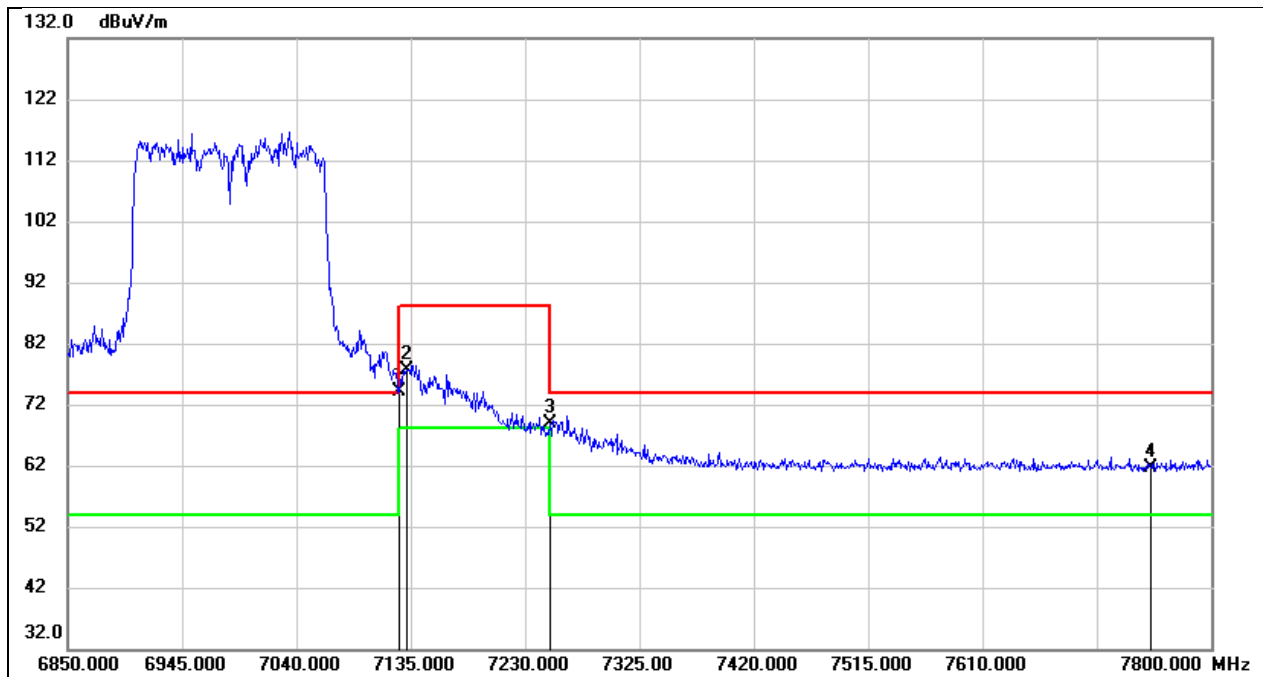

No.	Frequency (MHz)	Reading (dBuV)	Correct (dB/m)	Result (dBuV/m)	Limit (dBuV/m)	Margin (dB)	Remark
1	7125.000	28.86	45.36	74.22	74.00	0.22	peak
2	7131.200	32.39	45.36	77.75	88.20	-10.45	peak
3	7250.000	23.68	45.27	68.95	74.00	-5.05	peak
4	7750.000	16.51	45.08	61.59	74.00	-12.41	peak

Test Mode:	802.11be EHT160 AV	Frequency(MHz):	6985
Polarity:	Vertical	Test Voltage:	DC 12 V

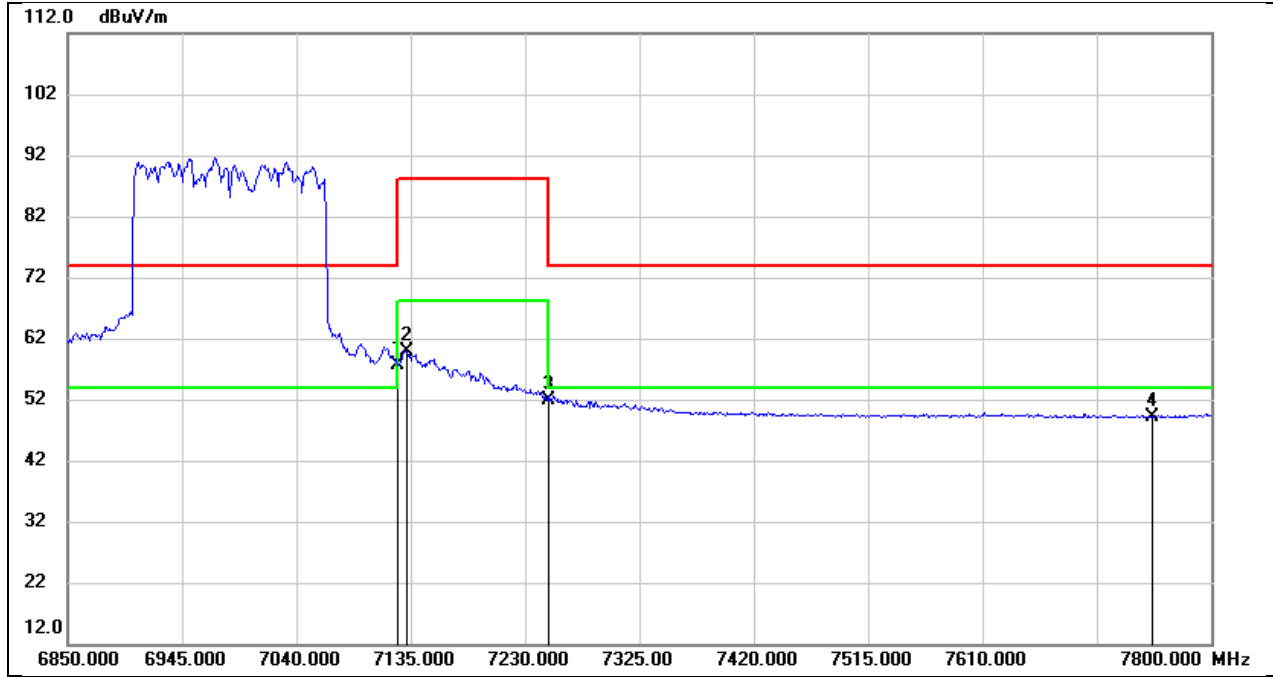

No.	Frequency (MHz)	Reading (dBuV)	Correct (dB/m)	Result (dBuV/m)	Limit (dBuV/m)	Margin (dB)	Remark
1	7125.000	12.17	45.36	57.53	54.00	3.53	AVG
2	7131.200	14.64	45.36	60.00	68.20	-8.20	AVG
3	7250.000	6.62	45.27	51.89	54.00	-2.11	AVG
4	7750.000	4.03	45.08	49.11	54.00	-4.89	AVG

Test Mode:	802.11be EHT320 PK	Frequency(MHz):	6265
Polarity:	Vertical	Test Voltage:	DC 12 V

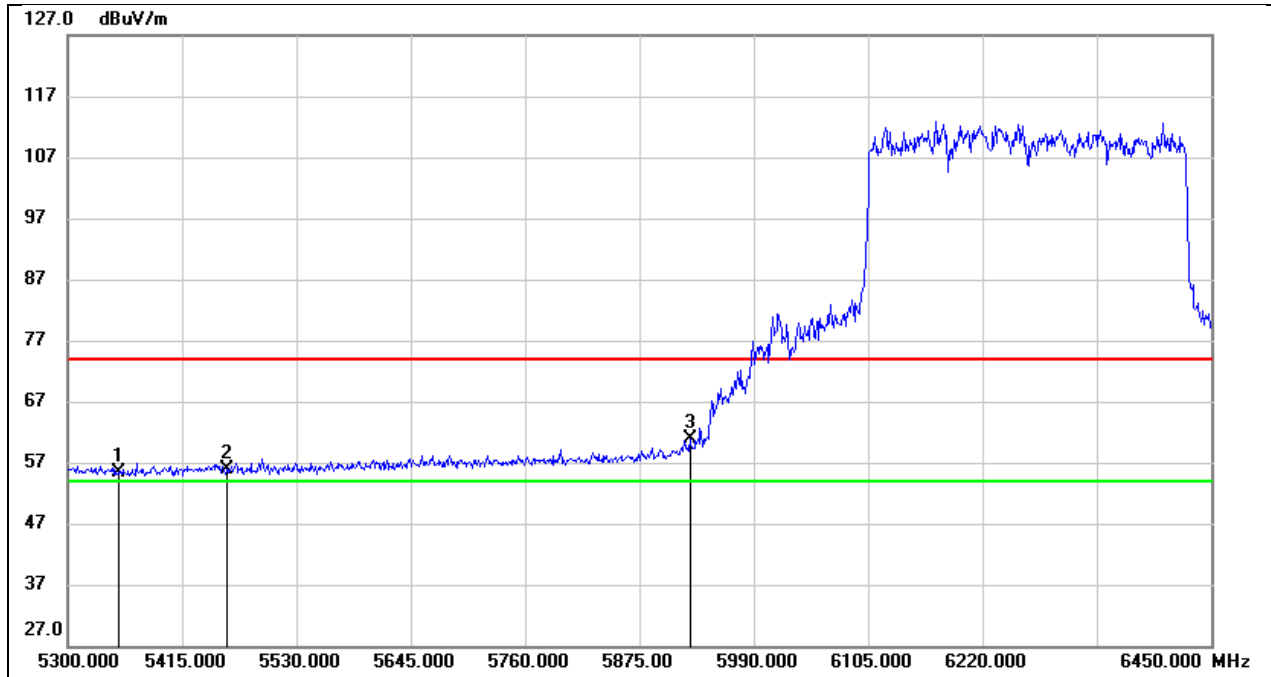

No.	Frequency (MHz)	Reading (dBuV)	Correct (dB/m)	Result (dBuV/m)	Limit (dBuV/m)	Margin (dB)	Remark
1	5350.000	14.84	40.49	55.33	74.00	-18.67	peak
2	5460.000	15.21	40.62	55.83	74.00	-18.17	peak
3	5925.000	19.09	41.80	60.89	74.00	-13.11	peak

Test Mode:	802.11be EHT320 AV	Frequency(MHz):	6265
Polarity:	Vertical	Test Voltage:	DC 12 V

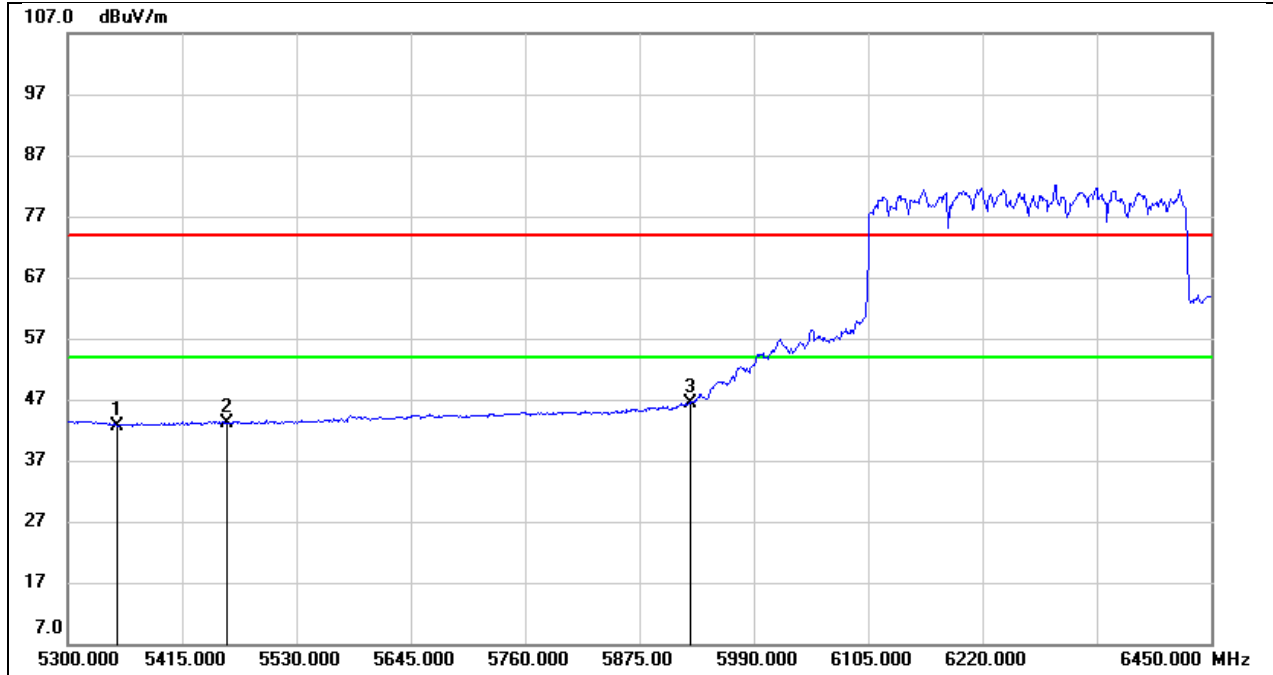

No.	Frequency (MHz)	Reading (dBuV)	Correct (dB/m)	Result (dBuV/m)	Limit (dBuV/m)	Margin (dB)	Remark
1	5350.000	2.24	40.49	42.73	54.00	-11.27	AVG
2	5460.000	2.61	40.62	43.23	54.00	-10.77	AVG
3	5925.000	4.57	41.80	46.37	54.00	-7.63	AVG

Test Mode:	802.11be EHT320 PK	Frequency(MHz):	6905
Polarity:	Vertical	Test Voltage:	DC 12 V

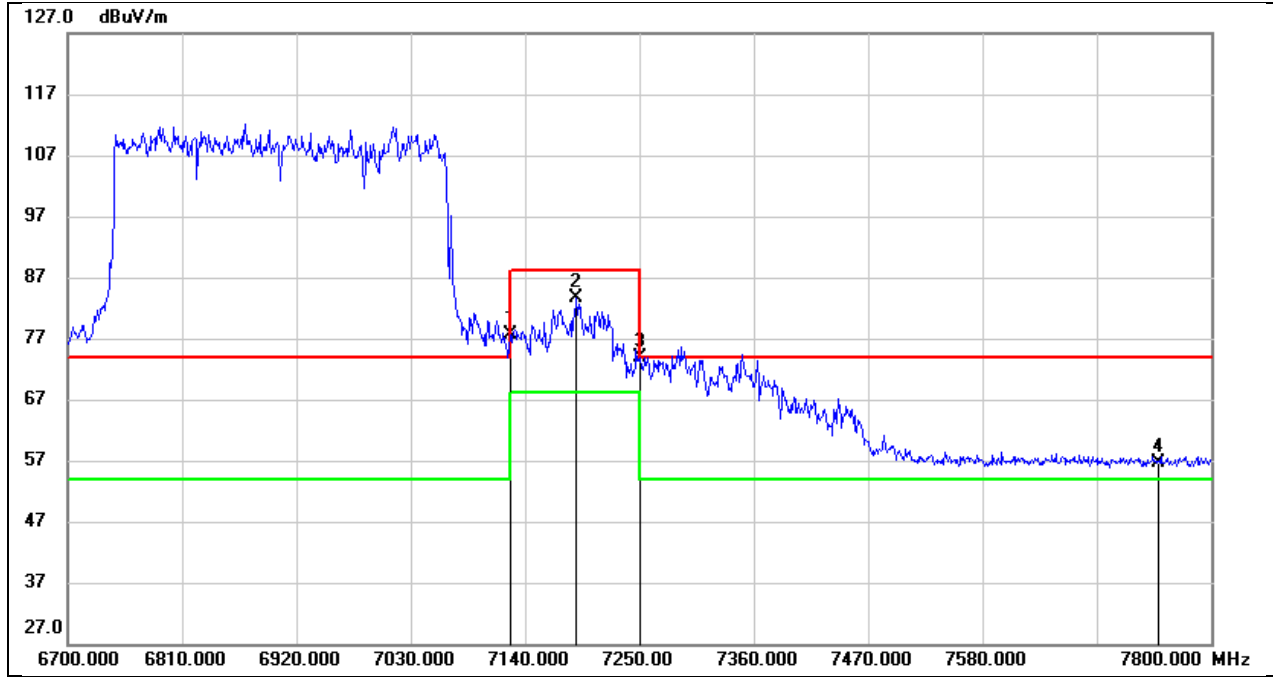

No.	Frequency (MHz)	Reading (dBuV)	Correct (dB/m)	Result (dBuV/m)	Limit (dBuV/m)	Margin (dB)	Remark
1	7125.000	32.38	45.36	77.74	74.00	3.74	peak
2	7189.500	38.23	45.32	83.55	88.20	-4.65	peak
3	7250.000	28.71	45.27	73.98	74.00	-0.02	peak
4	7750.000	11.63	45.08	56.71	74.00	-17.29	peak

Test Mode:	802.11be EHT320 AV	Frequency(MHz):	6905
Polarity:	Vertical	Test Voltage:	DC 12 V

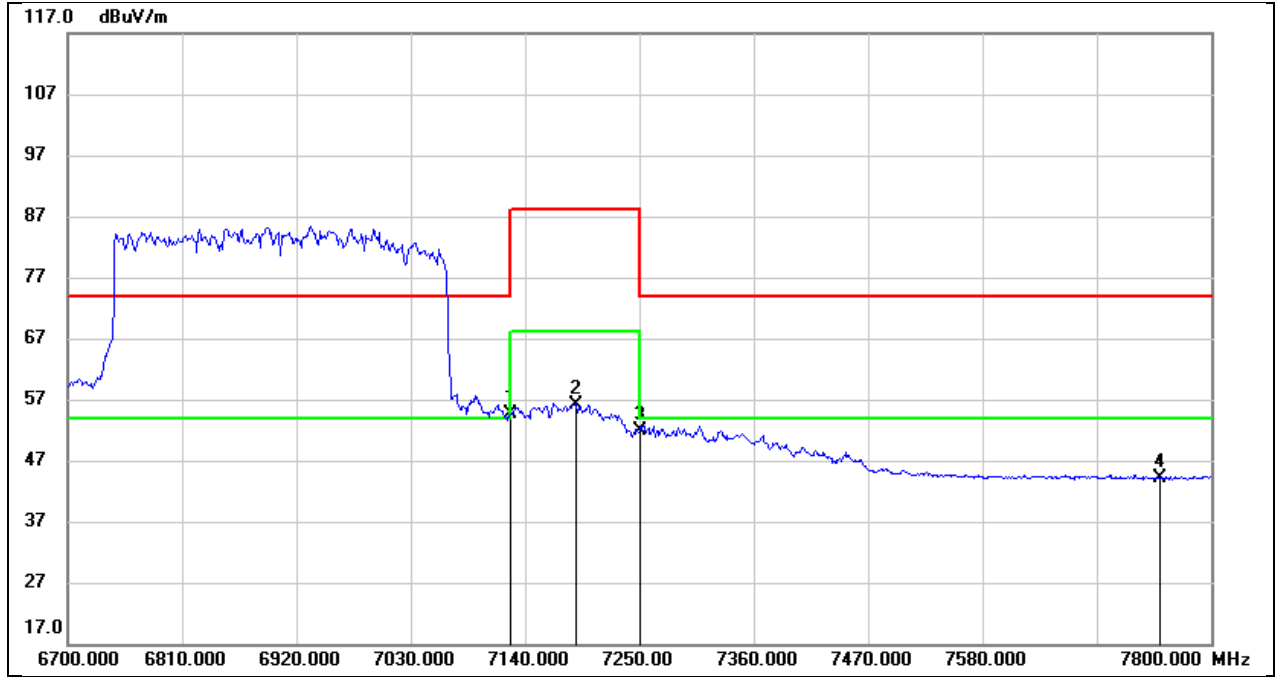

No.	Frequency (MHz)	Reading (dBuV)	Correct (dB/m)	Result (dBuV/m)	Limit (dBuV/m)	Margin (dB)	Remark
1	7125.000	9.16	45.36	54.52	54.00	0.52	AVG
2	7189.500	10.82	45.32	56.14	68.20	-12.06	AVG
3	7250.000	6.55	45.27	51.82	54.00	-2.18	AVG
4	7750.000	-0.93	45.08	44.15	54.00	-9.85	AVG

8.2. SPURIOUS EMISSIONS(1 GHZ~9 GHZ)

Test Mode:	802.11be EHT20	Frequency(MHz):	6115
Polarity:	Horizontal	Test Voltage:	DC 12 V

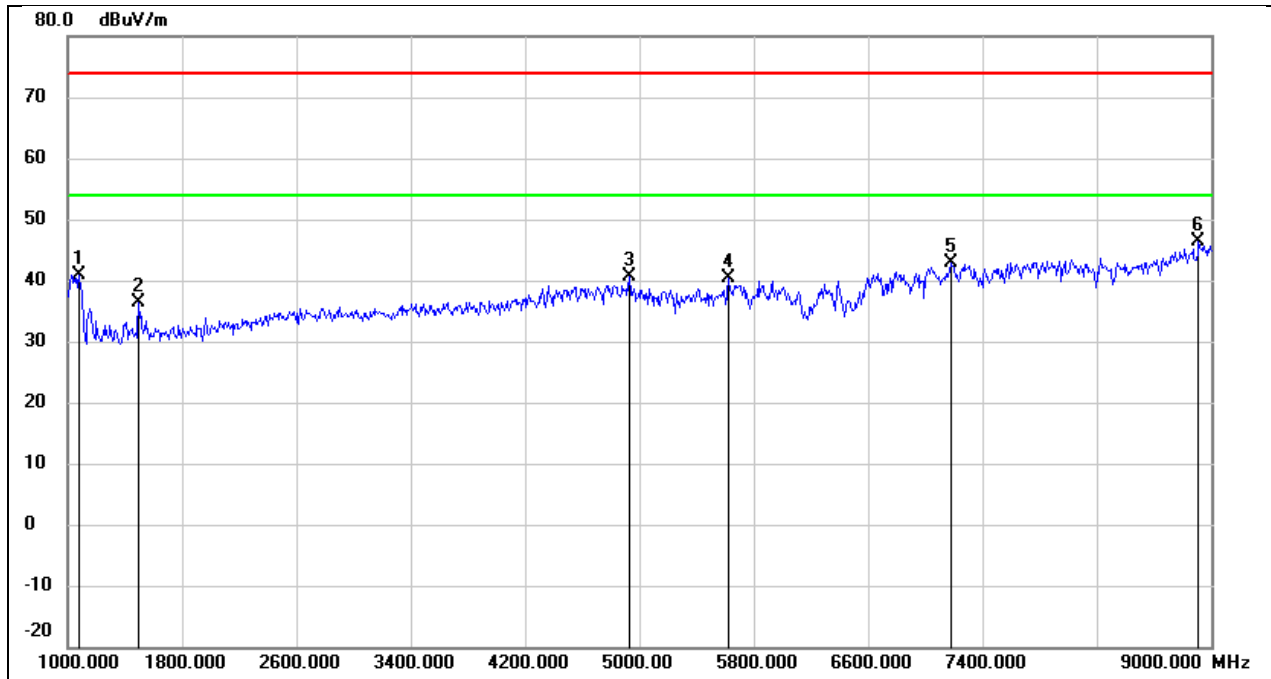

No.	Frequency (MHz)	Reading (dBuV)	Correct (dB/m)	Result (dBuV/m)	Limit (dBuV/m)	Margin (dB)	Remark
1	1080.000	55.46	-14.66	40.80	74.00	-33.20	peak
2	1496.000	49.03	-12.72	36.31	74.00	-37.69	peak
3	4928.000	41.05	-0.44	40.61	74.00	-33.39	peak
4	5624.000	39.54	0.77	40.31	74.00	-33.69	peak
5	7184.000	36.81	6.01	42.82	74.00	-31.18	peak
6	8912.000	37.19	9.11	46.30	74.00	-27.70	peak

Test Mode:	802.11be EHT20	Frequency(MHz):	6115
Polarity:	Vertical	Test Voltage:	DC 12 V

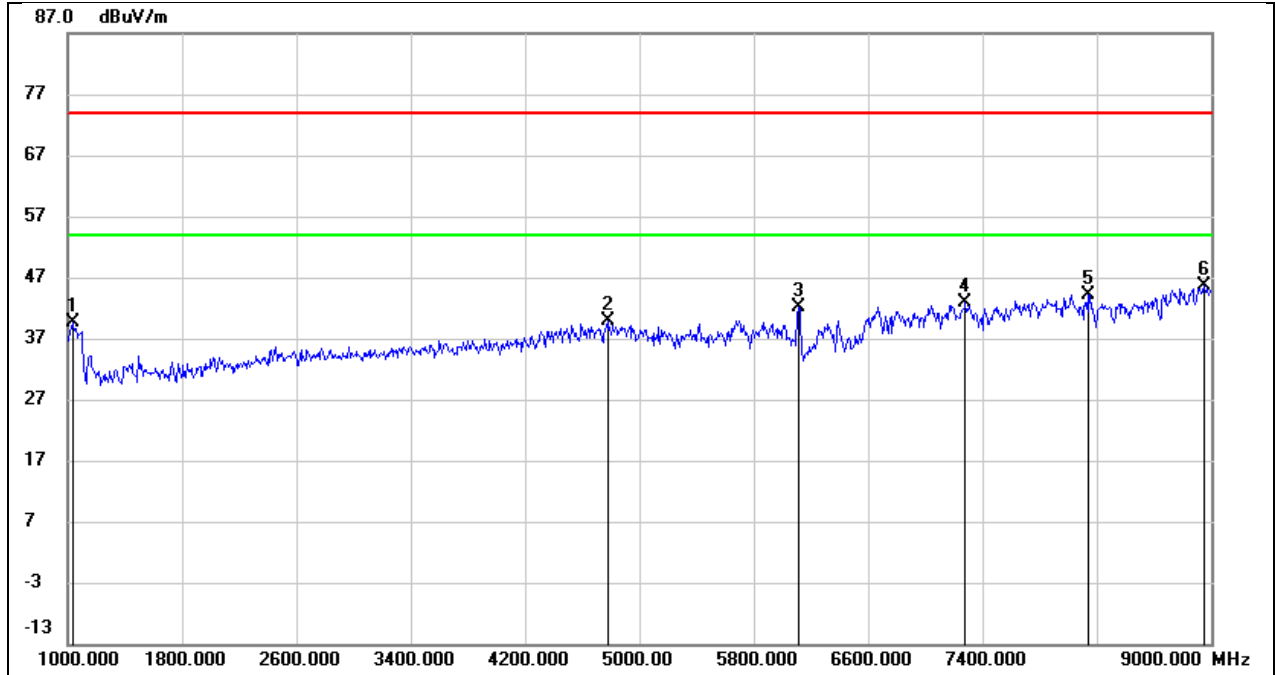

No.	Frequency (MHz)	Reading (dBuV)	Correct (dB/m)	Result (dBuV/m)	Limit (dBuV/m)	Margin (dB)	Remark
1	1032.000	54.61	-14.88	39.73	74.00	-34.27	peak
2	4776.000	40.83	-1.04	39.79	74.00	-34.21	peak
3	6112.000	39.83	2.27	42.10	74.00	-31.90	peak
4	7280.000	36.85	5.92	42.77	74.00	-31.23	peak
5	8136.000	38.25	5.81	44.06	74.00	-29.94	peak
6	8952.000	36.19	9.40	45.59	74.00	-28.41	peak

Test Mode:	802.11be EHT20	Frequency(MHz):	6275
Polarity:	Horizontal	Test Voltage:	DC 12 V

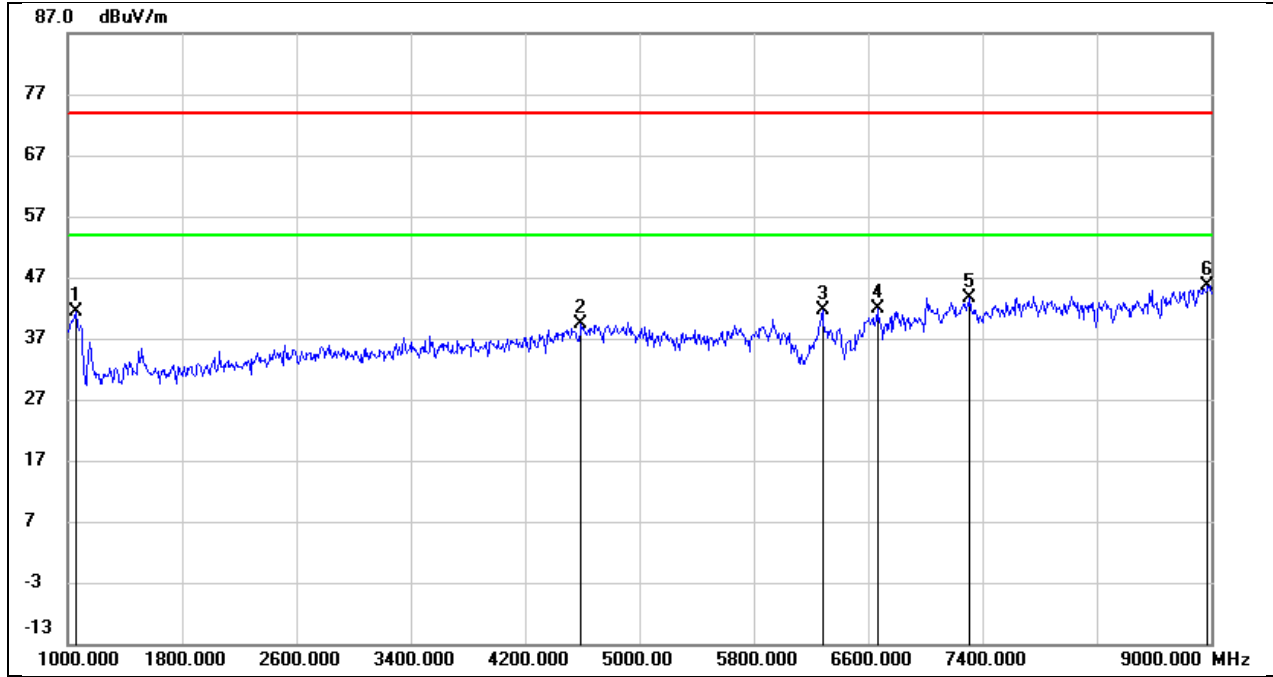

No.	Frequency (MHz)	Reading (dBuV)	Correct (dB/m)	Result (dBuV/m)	Limit (dBuV/m)	Margin (dB)	Remark
1	1056.000	56.13	-14.77	41.36	74.00	-32.64	peak
2	4592.000	41.15	-1.78	39.37	74.00	-34.63	peak
3	6280.000	38.68	2.90	41.58	74.00	-32.42	peak
4	6664.000	37.29	4.54	41.83	74.00	-32.17	peak
5	7312.000	37.64	5.88	43.52	74.00	-30.48	peak
6	8976.000	36.07	9.57	45.64	74.00	-28.36	peak

Test Mode:	802.11be EHT20	Frequency(MHz):	6275
Polarity:	Vertical	Test Voltage:	DC 12 V

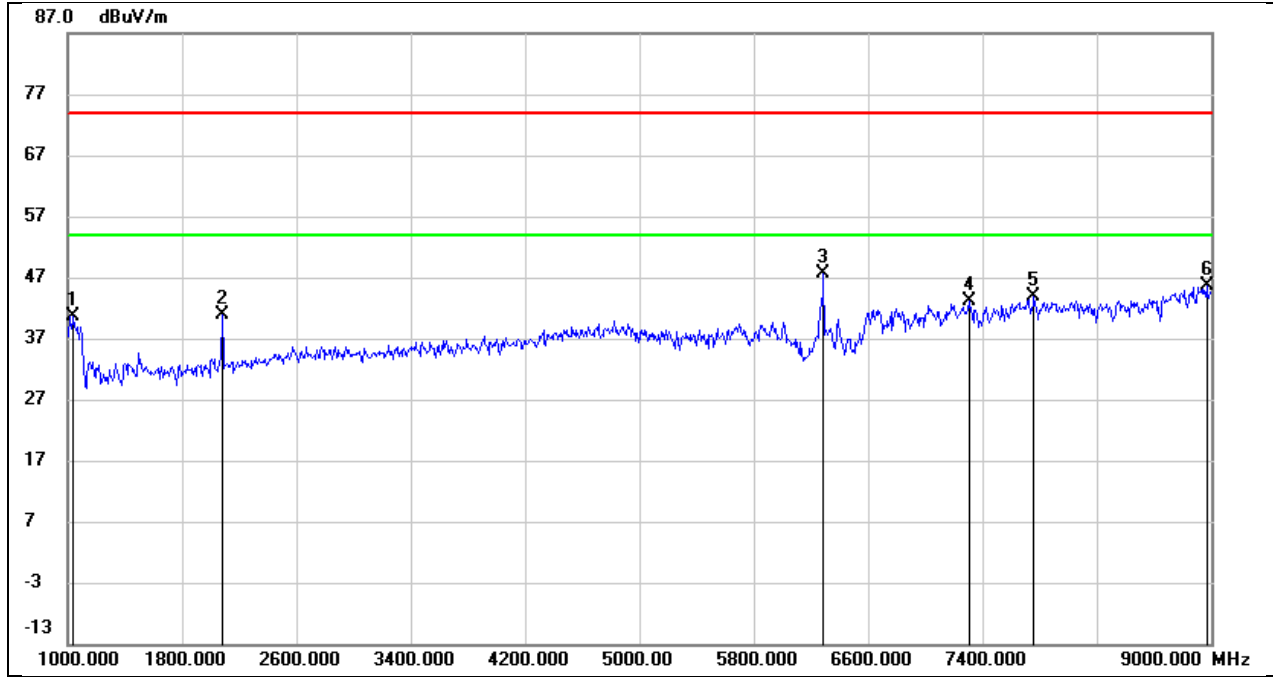

No.	Frequency (MHz)	Reading (dBuV)	Correct (dB/m)	Result (dBuV/m)	Limit (dBuV/m)	Margin (dB)	Remark
1	1040.000	55.49	-14.84	40.65	74.00	-33.35	peak
2	2080.000	51.51	-10.64	40.87	74.00	-33.13	peak
3	6288.000	44.62	2.93	47.55	74.00	-26.45	peak
4	7304.000	37.29	5.89	43.18	74.00	-30.82	peak
5	7760.000	38.25	5.67	43.92	74.00	-30.08	peak
6	8968.000	36.17	9.51	45.68	74.00	-28.32	peak

Test Mode:	802.11be EHT20	Frequency(MHz):	6415
Polarity:	Horizontal	Test Voltage:	DC 12 V

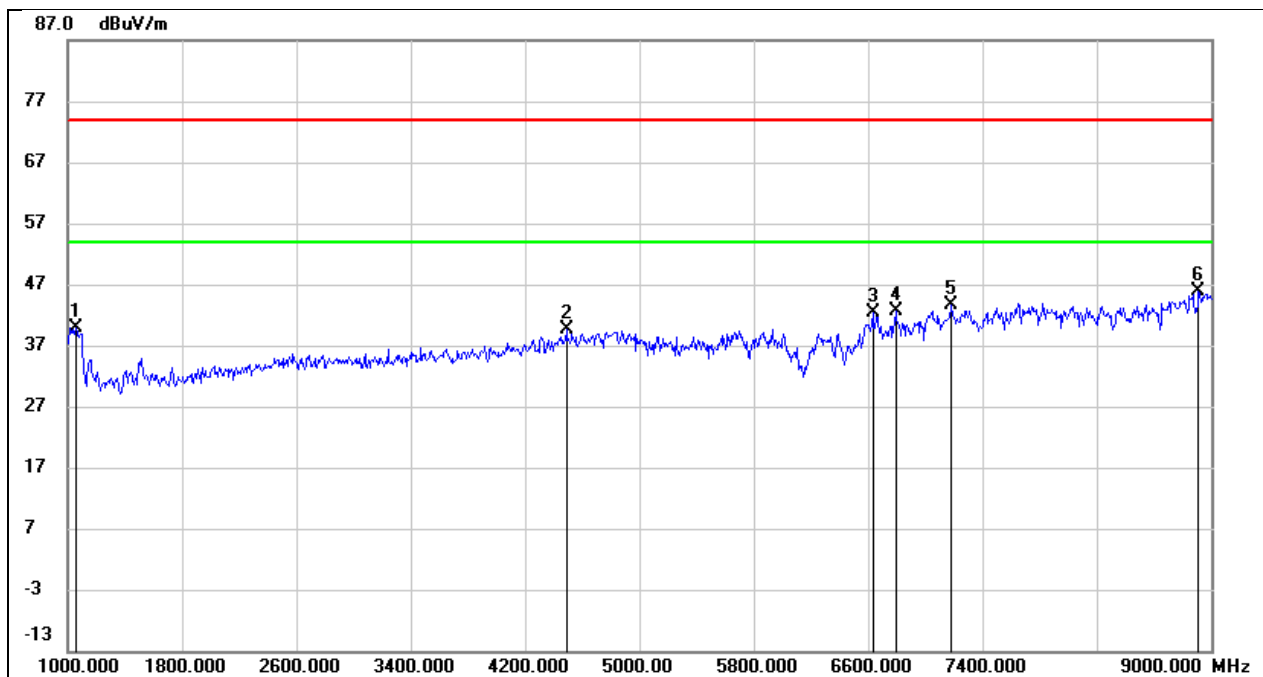

No.	Frequency (MHz)	Reading (dBuV)	Correct (dB/m)	Result (dBuV/m)	Limit (dBuV/m)	Margin (dB)	Remark
1	1056.000	54.63	-14.77	39.86	74.00	-34.14	peak
2	4488.000	41.77	-2.19	39.58	74.00	-34.42	peak
3	6632.000	38.03	4.38	42.41	74.00	-31.59	peak
4	6792.000	37.39	5.18	42.57	74.00	-31.43	peak
5	7184.000	37.64	6.01	43.65	74.00	-30.35	peak
6	8912.000	36.77	9.11	45.88	74.00	-28.12	peak

Test Mode:	802.11be EHT20	Frequency(MHz):	6415
Polarity:	Vertical	Test Voltage:	DC 12 V

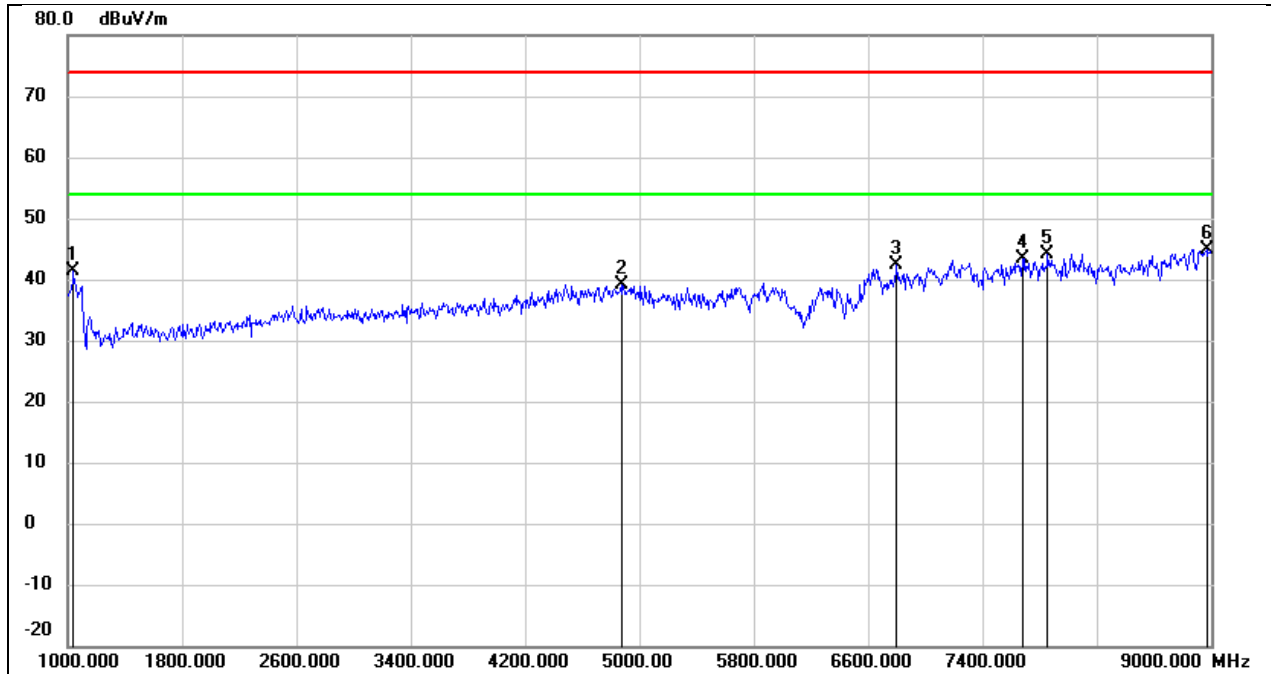

No.	Frequency (MHz)	Reading (dBuV)	Correct (dB/m)	Result (dBuV/m)	Limit (dBuV/m)	Margin (dB)	Remark
1	1040.000	56.25	-14.84	41.41	74.00	-32.59	peak
2	4872.000	39.74	-0.66	39.08	74.00	-34.92	peak
3	6800.000	37.20	5.21	42.41	74.00	-31.59	peak
4	7680.000	37.65	5.68	43.33	74.00	-30.67	peak
5	7856.000	38.42	5.65	44.07	74.00	-29.93	peak
6	8968.000	35.39	9.51	44.90	74.00	-29.10	peak

Test Mode:	802.11be EHT20	Frequency(MHz):	6435
Polarity:	Horizontal	Test Voltage:	DC 12 V

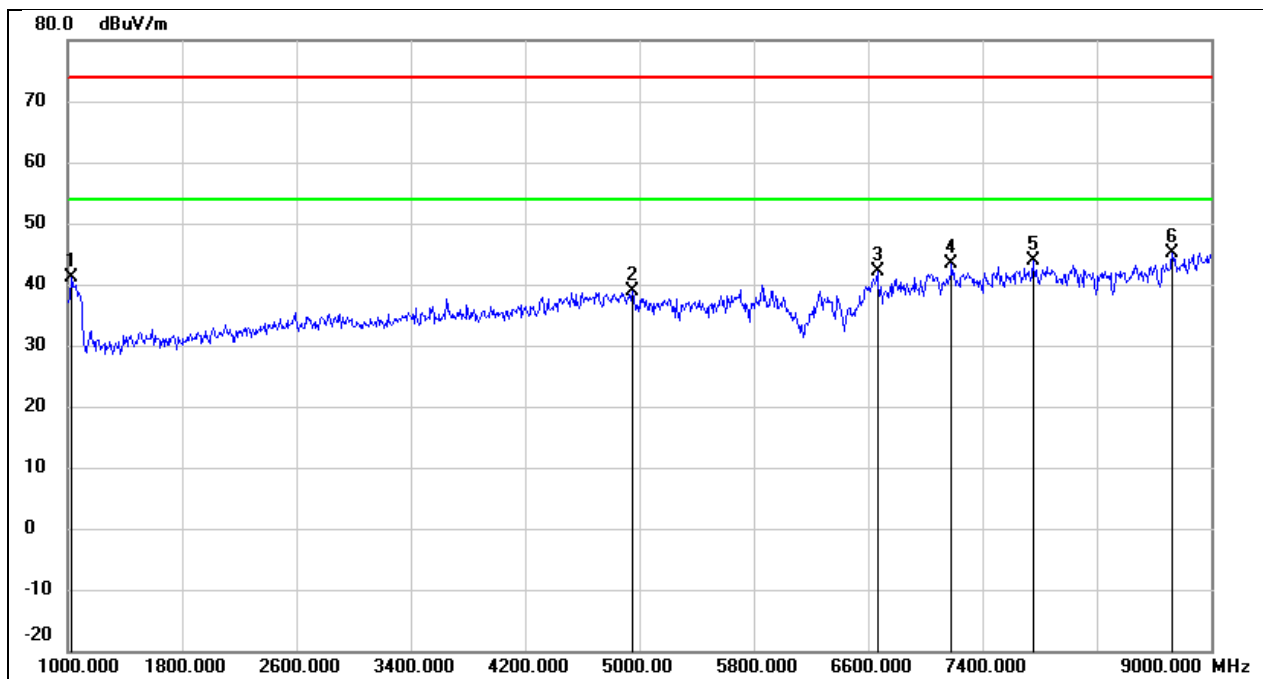

No.	Frequency (MHz)	Reading (dBuV)	Correct (dB/m)	Result (dBuV/m)	Limit (dBuV/m)	Margin (dB)	Remark
1	1024.000	56.01	-14.92	41.09	74.00	-32.91	peak
2	4952.000	39.25	-0.34	38.91	74.00	-35.09	peak
3	6664.000	37.60	4.54	42.14	74.00	-31.86	peak
4	7184.000	37.47	6.01	43.48	74.00	-30.52	peak
5	7752.000	38.32	5.66	43.98	74.00	-30.02	peak
6	8728.000	37.21	7.83	45.04	74.00	-28.96	peak

Test Mode:	802.11be EHT20	Frequency(MHz):	6435
Polarity:	Vertical	Test Voltage:	DC 12 V

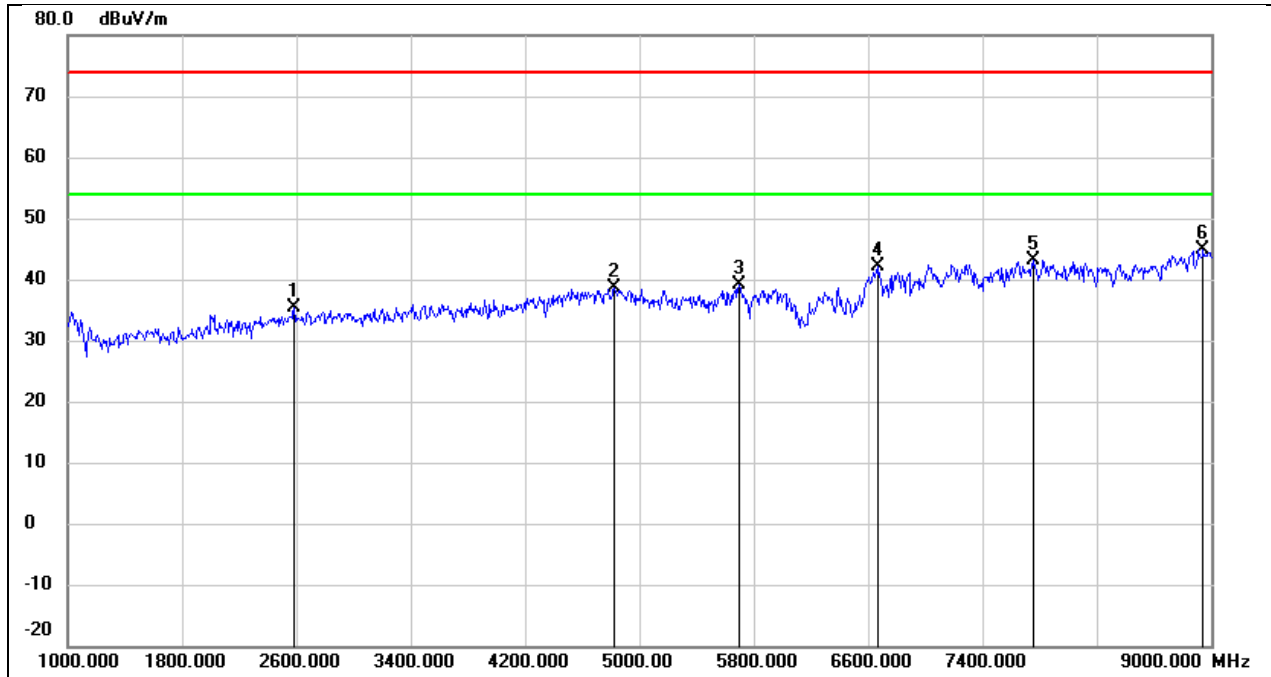

No.	Frequency (MHz)	Reading (dBuV)	Correct (dB/m)	Result (dBuV/m)	Limit (dBuV/m)	Margin (dB)	Remark
1	2584.000	43.65	-8.24	35.41	74.00	-38.59	peak
2	4824.000	39.36	-0.85	38.51	74.00	-35.49	peak
3	5696.000	38.04	0.98	39.02	74.00	-34.98	peak
4	6664.000	37.64	4.54	42.18	74.00	-31.82	peak
5	7760.000	37.38	5.67	43.05	74.00	-30.95	peak
6	8944.000	35.58	9.35	44.93	74.00	-29.07	peak

Test Mode:	802.11be EHT20	Frequency(MHz):	6475
Polarity:	Horizontal	Test Voltage:	DC 12 V

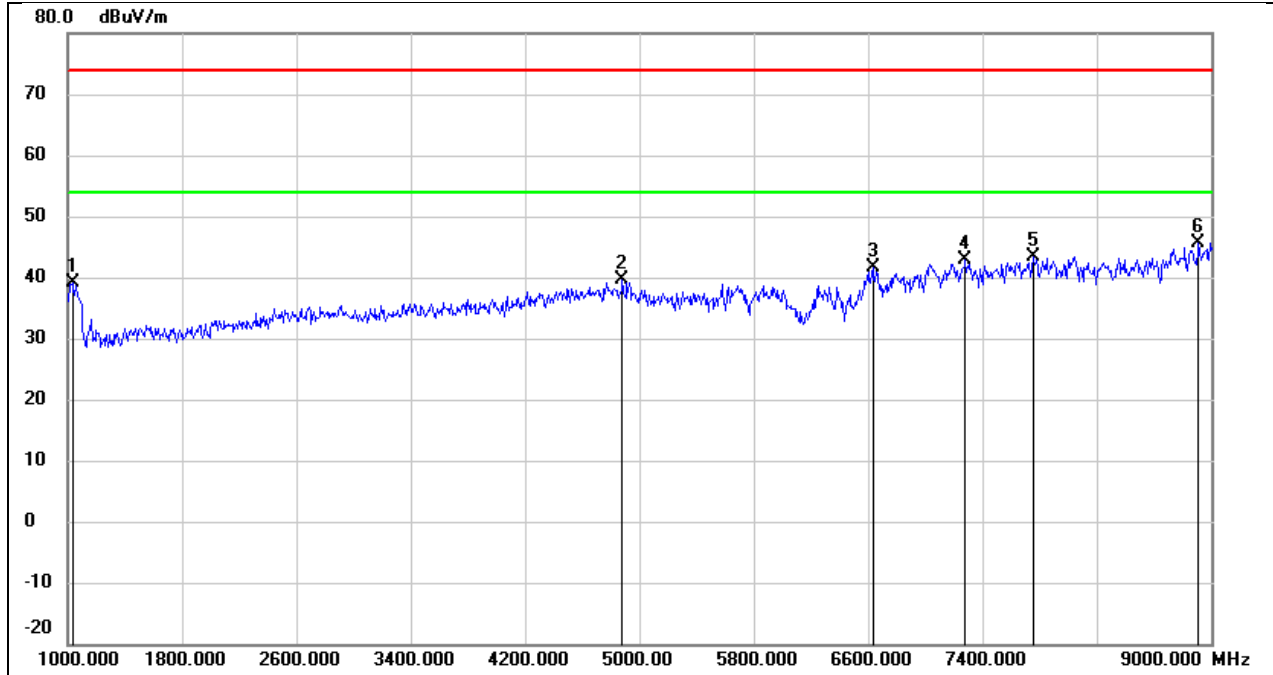

No.	Frequency (MHz)	Reading (dBuV)	Correct (dB/m)	Result (dBuV/m)	Limit (dBuV/m)	Margin (dB)	Remark
1	1032.000	54.13	-14.88	39.25	74.00	-34.75	peak
2	4880.000	40.20	-0.63	39.57	74.00	-34.43	peak
3	6632.000	37.14	4.38	41.52	74.00	-32.48	peak
4	7280.000	37.02	5.92	42.94	74.00	-31.06	peak
5	7752.000	37.84	5.66	43.50	74.00	-30.50	peak
6	8912.000	36.44	9.11	45.55	74.00	-28.45	peak

Test Mode:	802.11be EHT20	Frequency(MHz):	6475
Polarity:	Vertical	Test Voltage:	DC 12 V

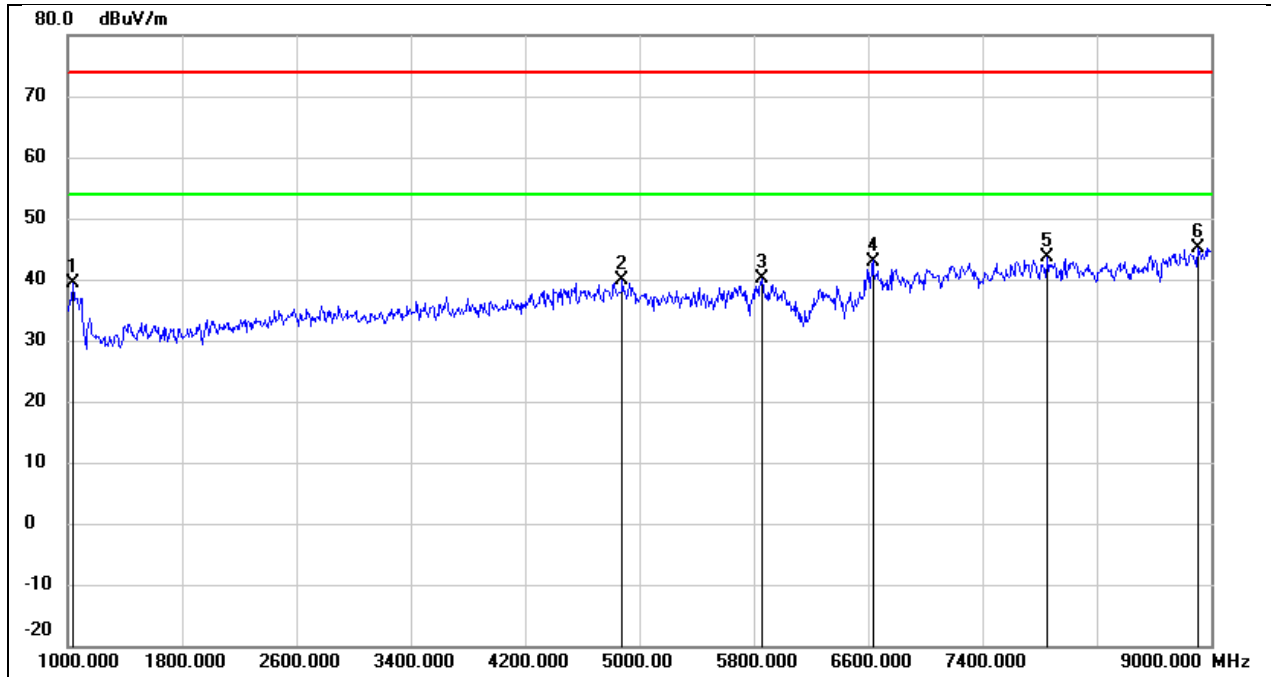

No.	Frequency (MHz)	Reading (dBuV)	Correct (dB/m)	Result (dBuV/m)	Limit (dBuV/m)	Margin (dB)	Remark
1	1040.000	54.24	-14.84	39.40	74.00	-34.60	peak
2	4880.000	40.40	-0.63	39.77	74.00	-34.23	peak
3	5856.000	38.67	1.45	40.12	74.00	-33.88	peak
4	6632.000	38.62	4.38	43.00	74.00	-31.00	peak
5	7856.000	38.08	5.65	43.73	74.00	-30.27	peak
6	8904.000	36.04	9.06	45.10	74.00	-28.90	peak

Test Mode:	802.11be EHT20	Frequency(MHz):	6515
Polarity:	Horizontal	Test Voltage:	DC 12 V

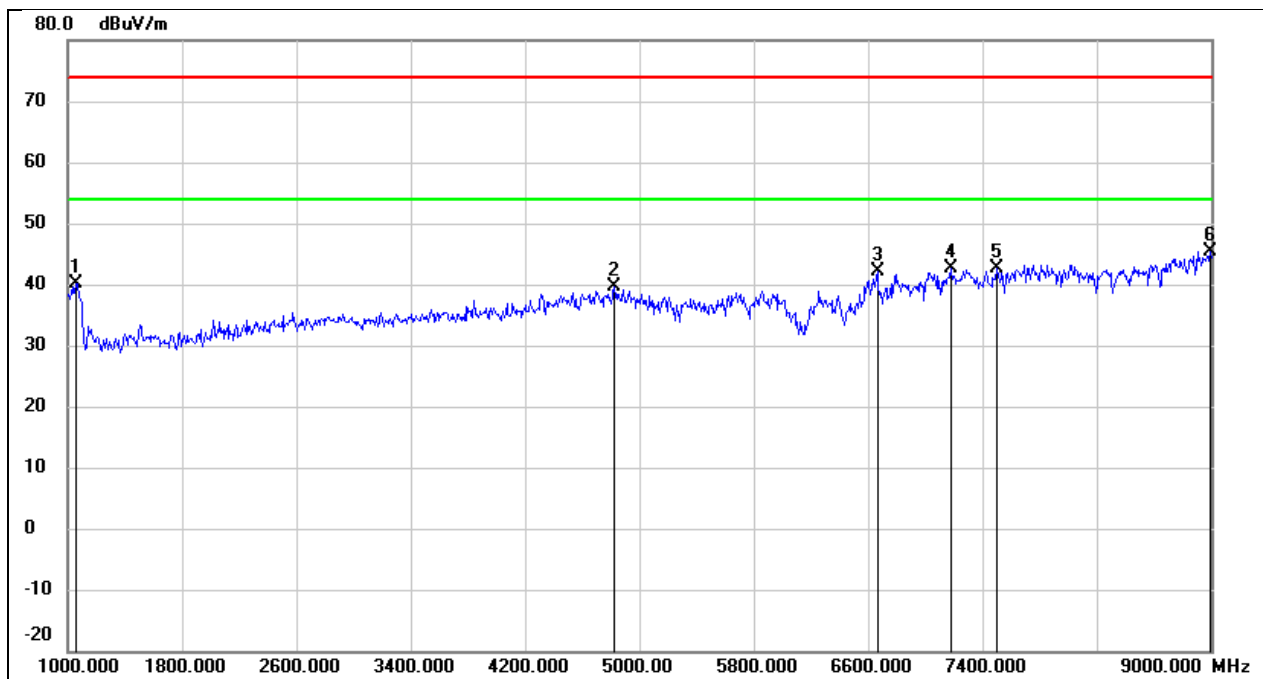

No.	Frequency (MHz)	Reading (dBuV)	Correct (dB/m)	Result (dBuV/m)	Limit (dBuV/m)	Margin (dB)	Remark
1	1056.000	54.86	-14.77	40.09	74.00	-33.91	peak
2	4824.000	40.50	-0.85	39.65	74.00	-34.35	peak
3	6664.000	37.65	4.54	42.19	74.00	-31.81	peak
4	7176.000	36.52	6.02	42.54	74.00	-31.46	peak
5	7496.000	36.97	5.70	42.67	74.00	-31.33	peak
6	8992.000	35.77	9.68	45.45	74.00	-28.55	peak

Test Mode:	802.11be EHT20	Frequency(MHz):	6515
Polarity:	Vertical	Test Voltage:	DC 12 V

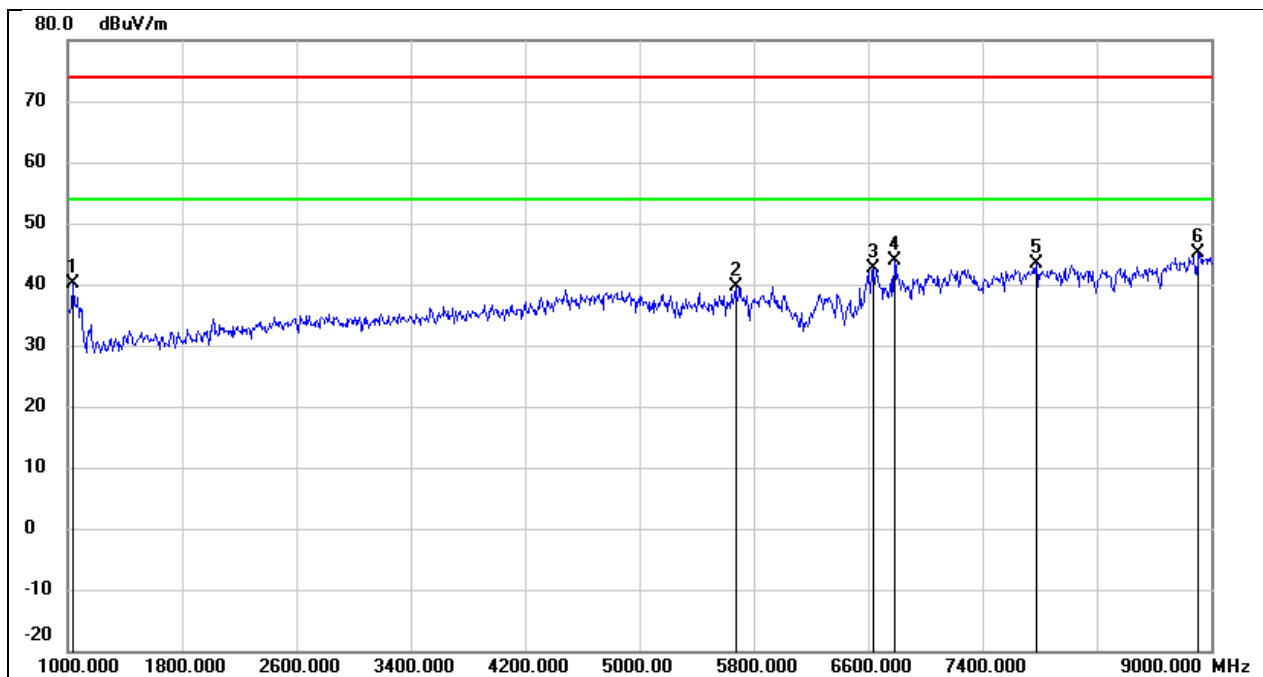

No.	Frequency (MHz)	Reading (dBuV)	Correct (dB/m)	Result (dBuV/m)	Limit (dBuV/m)	Margin (dB)	Remark
1	1040.000	55.01	-14.84	40.17	74.00	-33.83	peak
2	5672.000	38.62	0.91	39.53	74.00	-34.47	peak
3	6632.000	38.34	4.38	42.72	74.00	-31.28	peak
4	6784.000	38.66	5.13	43.79	74.00	-30.21	peak
5	7776.000	37.62	5.67	43.29	74.00	-30.71	peak
6	8912.000	35.97	9.11	45.08	74.00	-28.92	peak

Test Mode:	802.11be EHT20	Frequency(MHz):	6535
Polarity:	Horizontal	Test Voltage:	DC 12 V

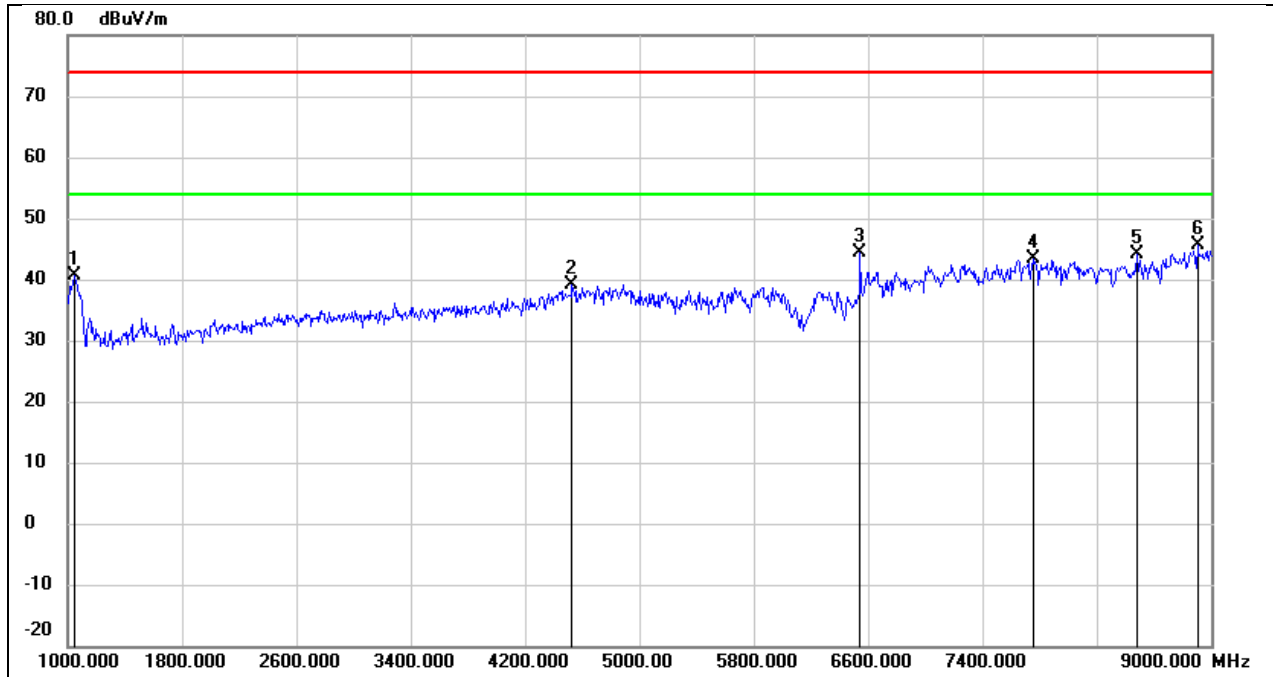

No.	Frequency (MHz)	Reading (dBuV)	Correct (dB/m)	Result (dBuV/m)	Limit (dBuV/m)	Margin (dB)	Remark
1	1048.000	55.48	-14.81	40.67	74.00	-33.33	peak
2	4528.000	41.25	-2.03	39.22	74.00	-34.78	peak
3	6544.000	40.55	3.94	44.49	74.00	-29.51	peak
4	7760.000	37.73	5.67	43.40	74.00	-30.60	peak
5	8480.000	38.03	6.21	44.24	74.00	-29.76	peak
6	8904.000	36.49	9.06	45.55	74.00	-28.45	peak

Test Mode:	802.11be EHT20	Frequency(MHz):	6535
Polarity:	Vertical	Test Voltage:	DC 12 V

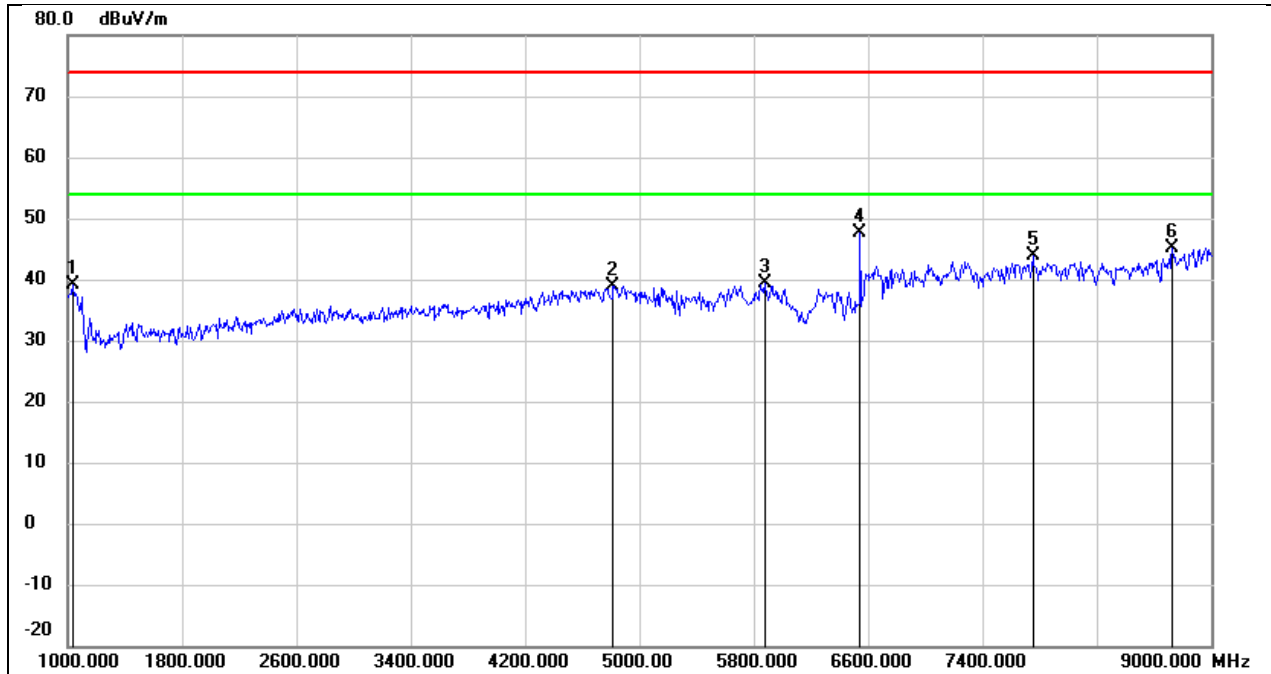

No.	Frequency (MHz)	Reading (dBuV)	Correct (dB/m)	Result (dBuV/m)	Limit (dBuV/m)	Margin (dB)	Remark
1	1032.000	53.94	-14.88	39.06	74.00	-34.94	peak
2	4816.000	39.79	-0.89	38.90	74.00	-35.10	peak
3	5880.000	37.94	1.51	39.45	74.00	-34.55	peak
4	6544.000	43.62	3.94	47.56	74.00	-26.44	peak
5	7752.000	38.21	5.66	43.87	74.00	-30.13	peak
6	8728.000	37.30	7.83	45.13	74.00	-28.87	peak

Test Mode:	802.11be EHT20	Frequency(MHz):	6715
Polarity:	Horizontal	Test Voltage:	DC 12 V

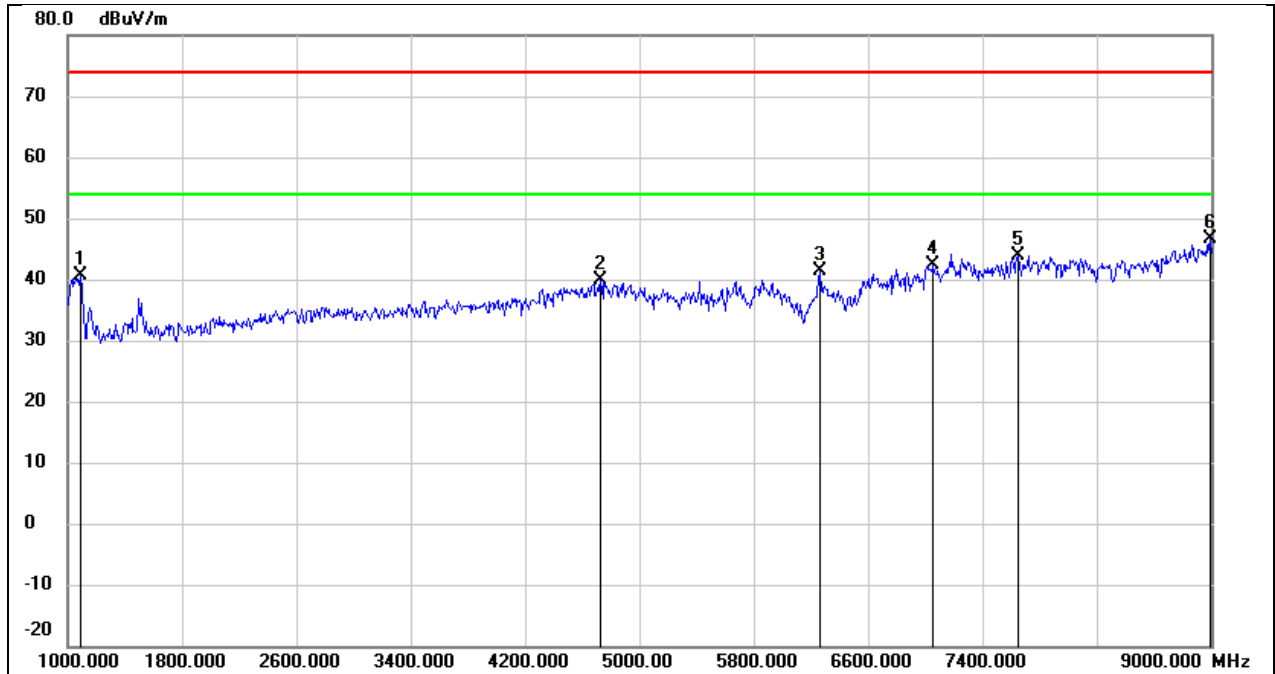

No.	Frequency (MHz)	Reading (dBuV)	Correct (dB/m)	Result (dBuV/m)	Limit (dBuV/m)	Margin (dB)	Remark
1	1088.000	55.27	-14.62	40.65	74.00	-33.35	peak
2	4728.000	40.99	-1.23	39.76	74.00	-34.24	peak
3	6264.000	38.45	2.84	41.29	74.00	-32.71	peak
4	7056.000	36.31	6.14	42.45	74.00	-31.55	peak
5	7648.000	38.18	5.68	43.86	74.00	-30.14	peak
6	8992.000	36.84	9.68	46.52	74.00	-27.48	peak

Test Mode:	802.11be EHT20	Frequency(MHz):	6715
Polarity:	Vertical	Test Voltage:	DC 12 V

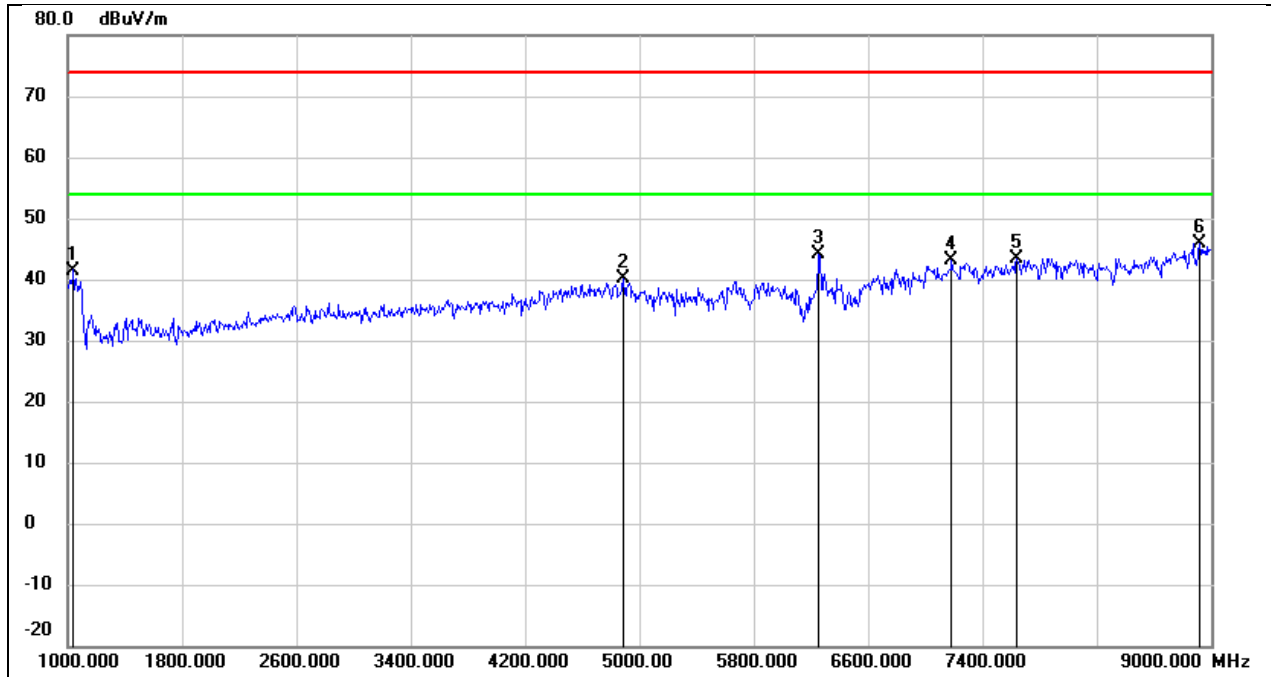

No.	Frequency (MHz)	Reading (dBuV)	Correct (dB/m)	Result (dBuV/m)	Limit (dBuV/m)	Margin (dB)	Remark
1	1040.000	56.34	-14.84	41.50	74.00	-32.50	peak
2	4888.000	40.81	-0.60	40.21	74.00	-33.79	peak
3	6256.000	41.31	2.80	44.11	74.00	-29.89	peak
4	7184.000	37.01	6.01	43.02	74.00	-30.98	peak
5	7640.000	37.76	5.68	43.44	74.00	-30.56	peak
6	8920.000	36.68	9.17	45.85	74.00	-28.15	peak

Test Mode:	802.11be EHT20	Frequency(MHz):	6875
Polarity:	Horizontal	Test Voltage:	DC 12 V

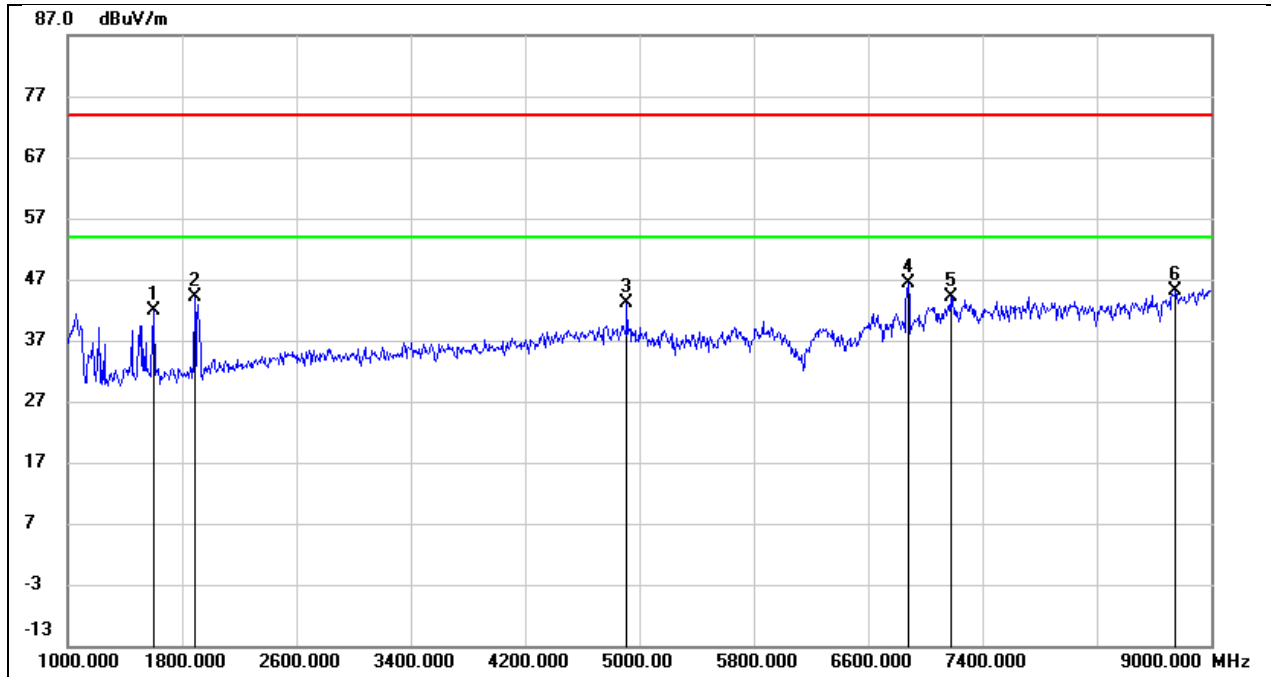

No.	Frequency (MHz)	Reading (dBuV)	Correct (dB/m)	Result (dBuV/m)	Limit (dBuV/m)	Margin (dB)	Remark
1	1600.000	54.22	-12.38	41.84	74.00	-32.16	peak
2	1888.000	55.58	-11.43	44.15	74.00	-29.85	peak
3	4912.000	43.74	-0.50	43.24	74.00	-30.76	peak
4	6880.000	40.80	5.60	46.40	74.00	-27.60	peak
5	7176.000	38.09	6.02	44.11	74.00	-29.89	peak
6	8752.000	37.14	8.00	45.14	74.00	-28.86	peak

Test Mode:	802.11be EHT20	Frequency(MHz):	6875
Polarity:	Vertical	Test Voltage:	DC 12 V

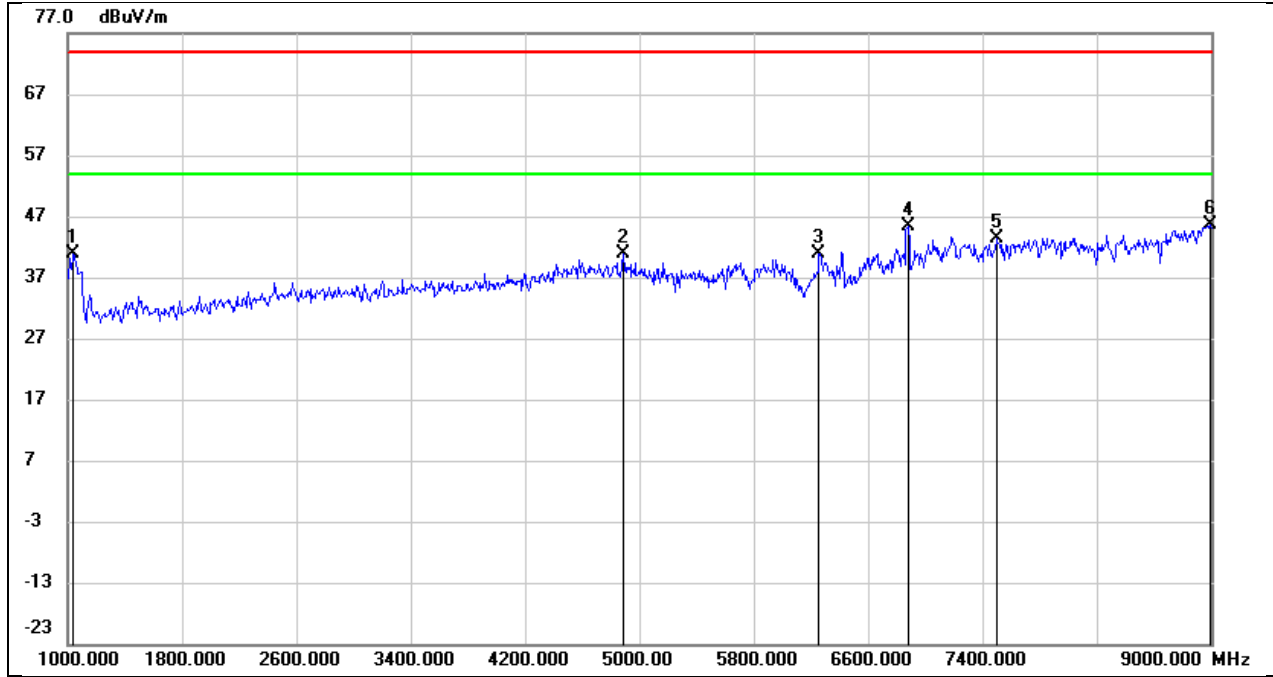

No.	Frequency (MHz)	Reading (dBuV)	Correct (dB/m)	Result (dBuV/m)	Limit (dBuV/m)	Margin (dB)	Remark
1	1040.000	55.78	-14.84	40.94	74.00	-33.06	peak
2	4888.000	41.38	-0.60	40.78	74.00	-33.22	peak
3	6256.000	38.16	2.80	40.96	74.00	-33.04	peak
4	6880.000	39.74	5.60	45.34	74.00	-28.66	peak
5	7496.000	37.80	5.70	43.50	74.00	-30.50	peak
6	8992.000	35.86	9.68	45.54	74.00	-28.46	peak

Test Mode:	802.11be EHT20	Frequency(MHz):	6895
Polarity:	Horizontal	Test Voltage:	DC 12 V

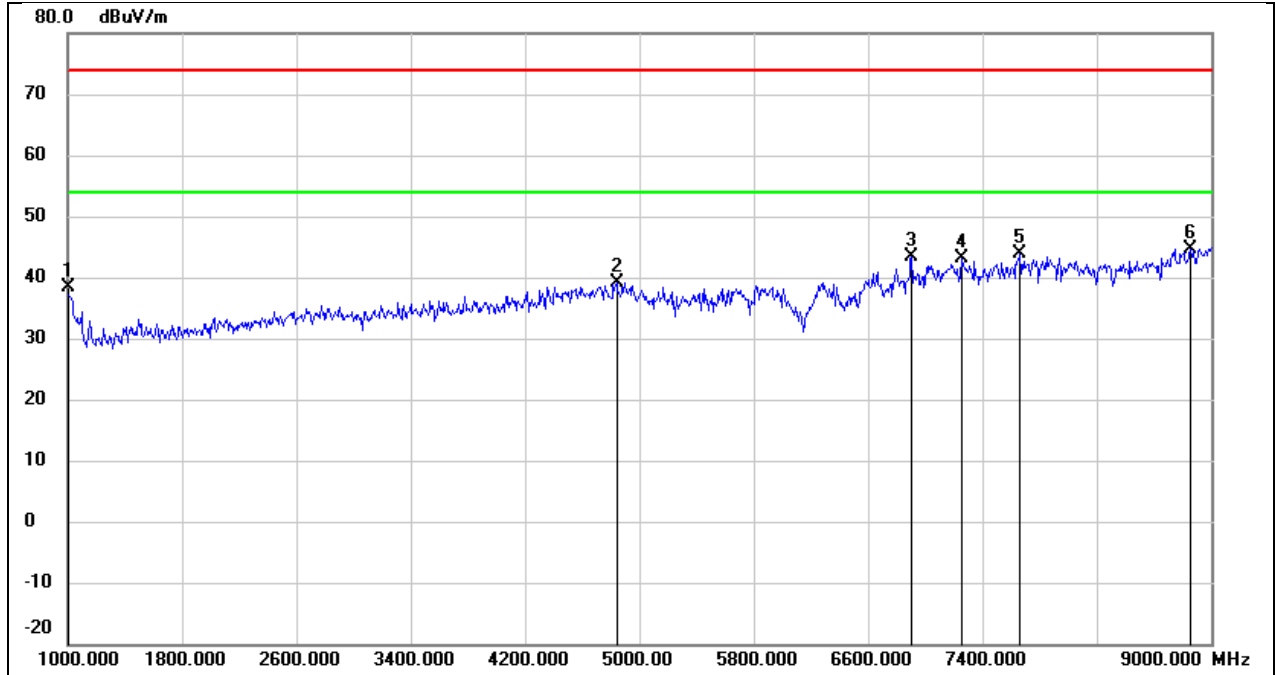

No.	Frequency (MHz)	Reading (dBuV)	Correct (dB/m)	Result (dBuV/m)	Limit (dBuV/m)	Margin (dB)	Remark
1	1000.0000	53.51	-15.03	38.48	74.00	-35.52	peak
2	4840.000	39.93	-0.78	39.15	74.00	-34.85	peak
3	6904.000	37.65	5.72	43.37	74.00	-30.63	peak
4	7256.000	37.08	5.94	43.02	74.00	-30.98	peak
5	7664.000	38.10	5.67	43.77	74.00	-30.23	peak
6	8856.000	35.79	8.73	44.52	74.00	-29.48	peak

Test Mode:	802.11be EHT20	Frequency(MHz):	6895
Polarity:	Vertical	Test Voltage:	DC 12 V

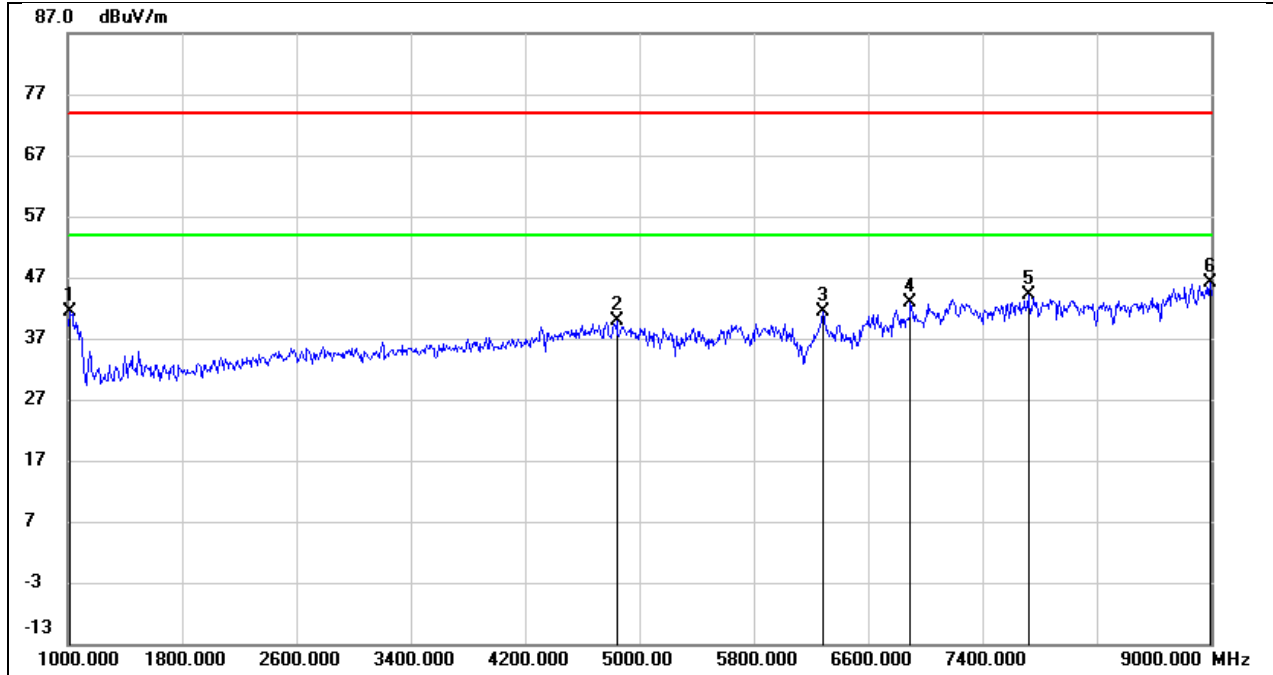

No.	Frequency (MHz)	Reading (dBuV)	Correct (dB/m)	Result (dBuV/m)	Limit (dBuV/m)	Margin (dB)	Remark
1	1016.000	56.39	-14.96	41.43	74.00	-32.57	peak
2	4840.000	40.67	-0.78	39.89	74.00	-34.11	peak
3	6280.000	38.38	2.90	41.28	74.00	-32.72	peak
4	6896.000	37.31	5.68	42.99	74.00	-31.01	peak
5	7720.000	38.56	5.67	44.23	74.00	-29.77	peak
6	8992.000	36.38	9.68	46.06	74.00	-27.94	peak

Test Mode:	802.11be EHT20	Frequency(MHz):	7015
Polarity:	Horizontal	Test Voltage:	DC 12 V

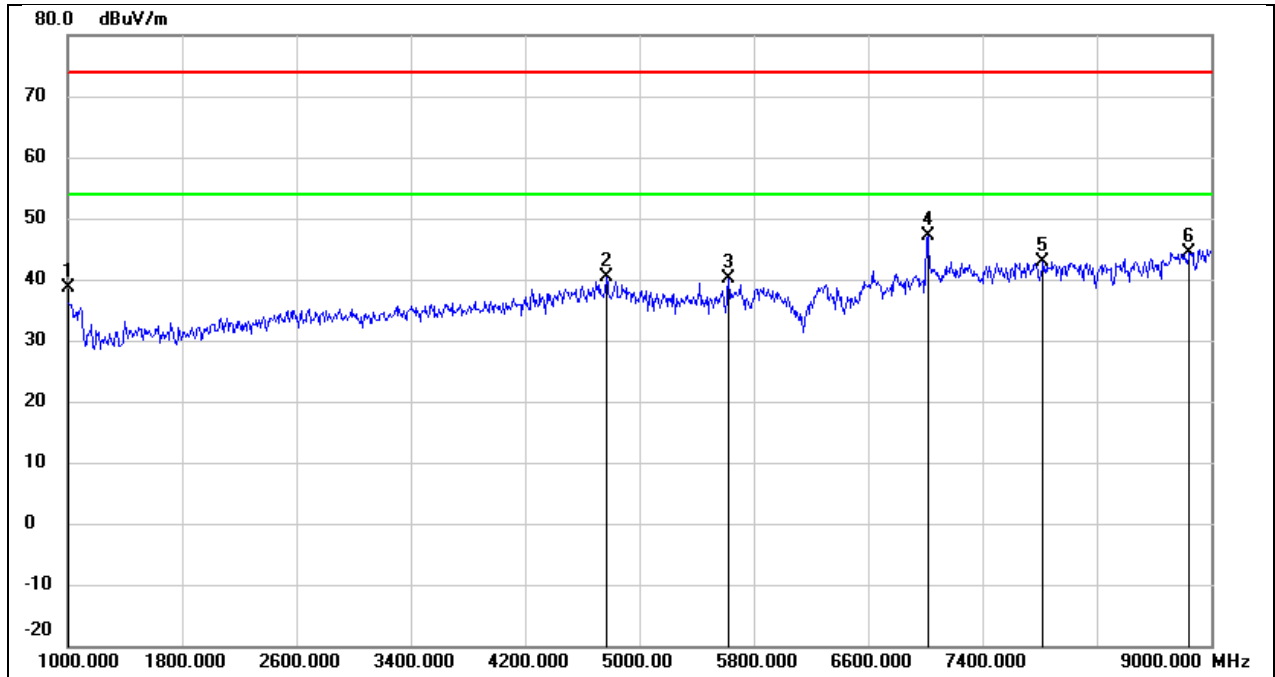

No.	Frequency (MHz)	Reading (dBuV)	Correct (dB/m)	Result (dBuV/m)	Limit (dBuV/m)	Margin (dB)	Remark
1	1000.0000	53.71	-15.03	38.68	74.00	-35.32	peak
2	4768.000	41.44	-1.07	40.37	74.00	-33.63	peak
3	5624.000	39.38	0.77	40.15	74.00	-33.85	peak
4	7016.000	40.91	6.19	47.10	74.00	-26.90	peak
5	7824.000	37.18	5.66	42.84	74.00	-31.16	peak
6	8848.000	35.81	8.67	44.48	74.00	-29.52	peak

Test Mode:	802.11be EHT20	Frequency(MHz):	7015
Polarity:	Vertical	Test Voltage:	DC 12 V

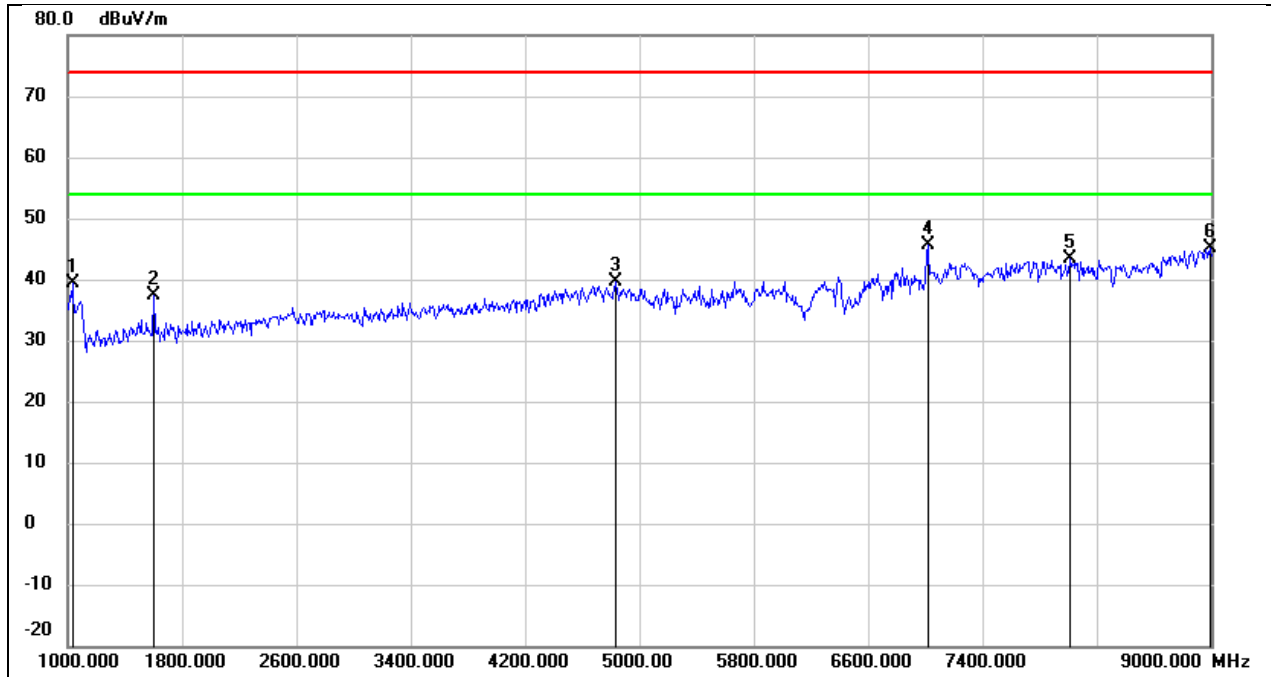

No.	Frequency (MHz)	Reading (dBuV)	Correct (dB/m)	Result (dBuV/m)	Limit (dBuV/m)	Margin (dB)	Remark
1	1032.000	54.33	-14.88	39.45	74.00	-34.55	peak
2	1600.000	49.77	-12.38	37.39	74.00	-36.61	peak
3	4832.000	40.36	-0.83	39.53	74.00	-34.47	peak
4	7016.000	39.39	6.19	45.58	74.00	-28.42	peak
5	8016.000	37.80	5.67	43.47	74.00	-30.53	peak
6	8992.000	35.41	9.68	45.09	74.00	-28.91	peak

Test Mode:	802.11be EHT20	Frequency(MHz):	7095
Polarity:	Horizontal	Test Voltage:	DC 12 V

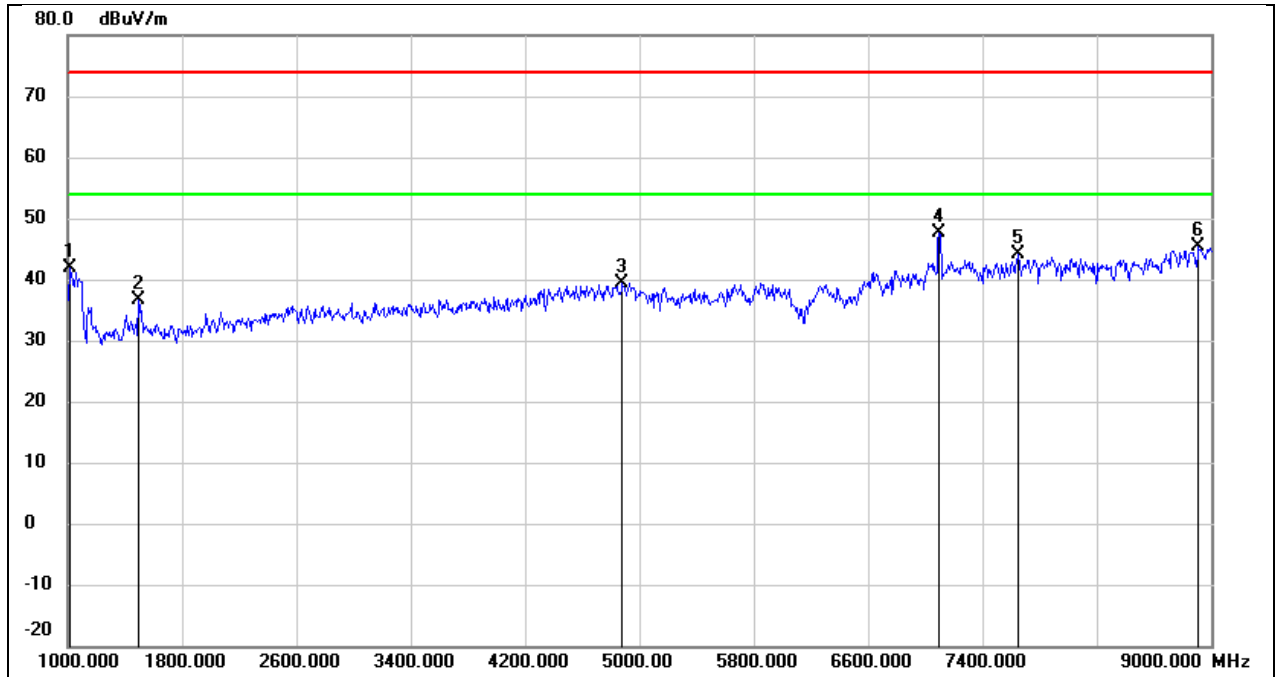

No.	Frequency (MHz)	Reading (dBuV)	Correct (dB/m)	Result (dBuV/m)	Limit (dBuV/m)	Margin (dB)	Remark
1	1016.000	56.89	-14.96	41.93	74.00	-32.07	peak
2	1496.000	49.38	-12.72	36.66	74.00	-37.34	peak
3	4880.000	40.08	-0.63	39.45	74.00	-34.55	peak
4	7096.000	41.64	6.11	47.75	74.00	-26.25	peak
5	7648.000	38.40	5.68	44.08	74.00	-29.92	peak
6	8912.000	36.30	9.11	45.41	74.00	-28.59	peak

Test Mode:	802.11be EHT20	Frequency(MHz):	7095
Polarity:	Vertical	Test Voltage:	DC 12 V

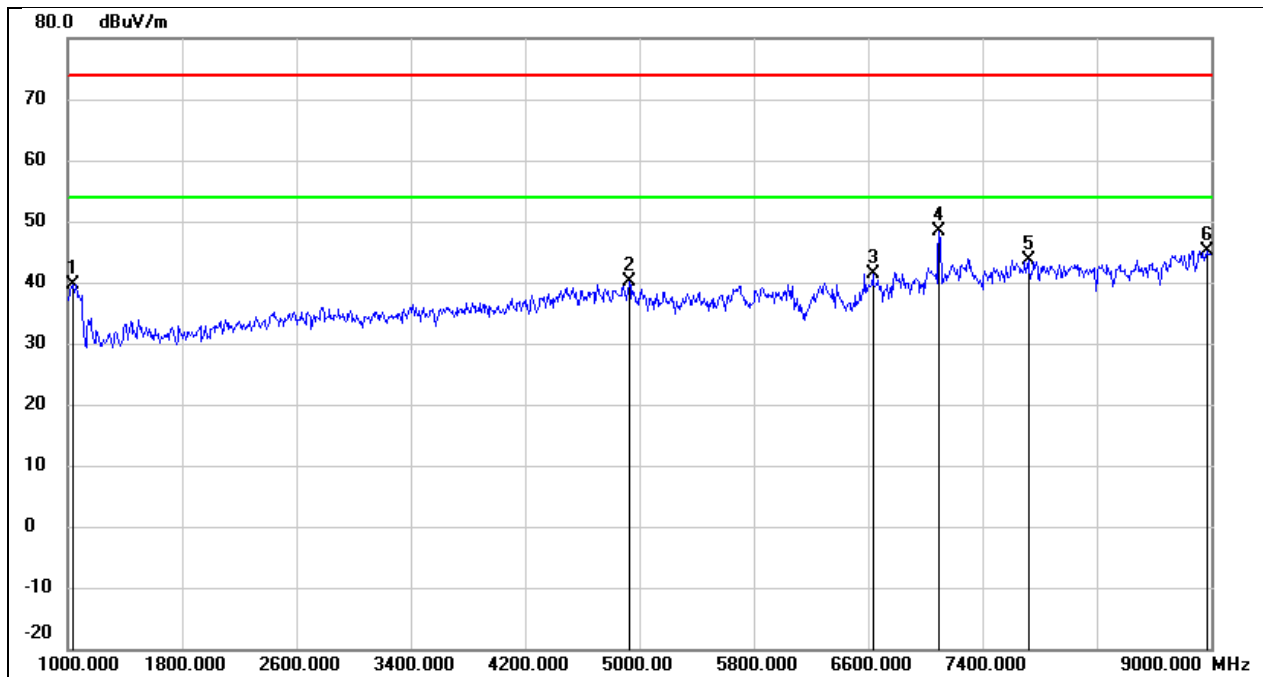

No.	Frequency (MHz)	Reading (dBuV)	Correct (dB/m)	Result (dBuV/m)	Limit (dBuV/m)	Margin (dB)	Remark
1	1040.000	54.44	-14.84	39.60	74.00	-34.40	peak
2	4928.000	40.57	-0.44	40.13	74.00	-33.87	peak
3	6632.000	36.93	4.38	41.31	74.00	-32.69	peak
4	7096.000	42.27	6.11	48.38	74.00	-25.62	peak
5	7720.000	37.99	5.67	43.66	74.00	-30.34	peak
6	8968.000	35.58	9.51	45.09	74.00	-28.91	peak

8.3. SPURIOUS EMISSIONS(9 GHZ~18 GHZ)

Test Mode:	802.11be EHT20	Frequency(MHz):	6115
Polarity:	Horizontal	Test Voltage:	DC 12 V

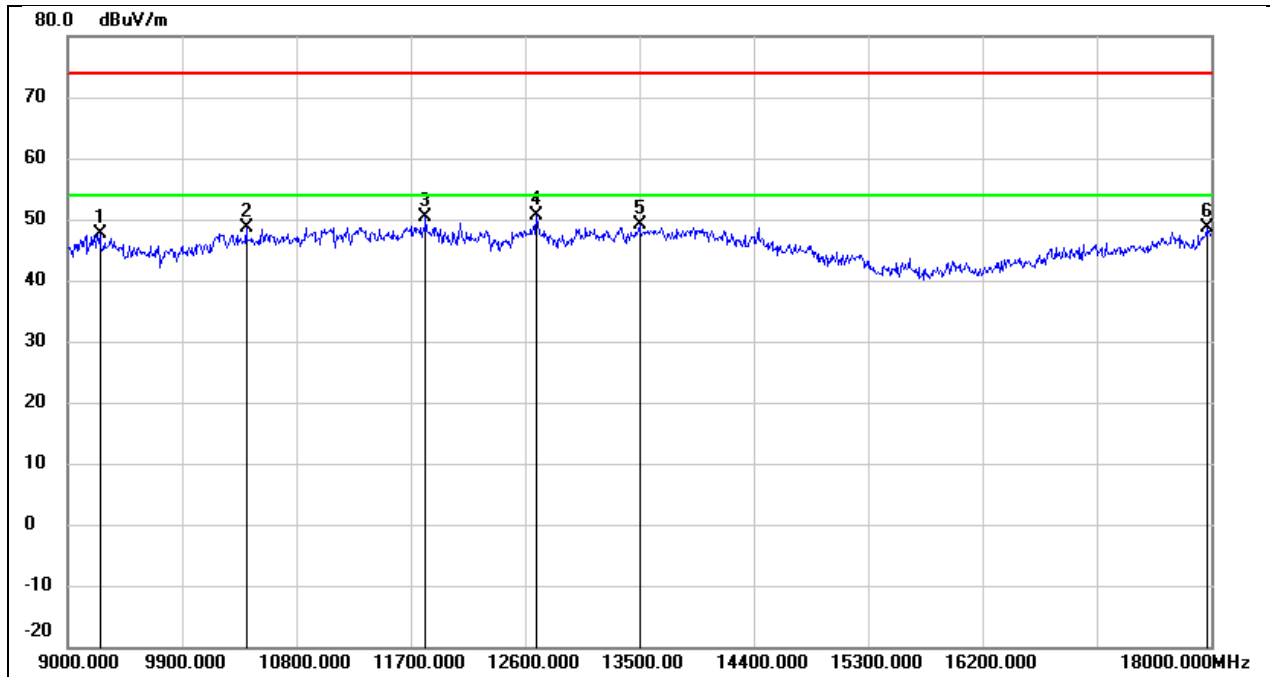

No.	Frequency (MHz)	Reading (dBuV)	Correct (dB/m)	Result (dBuV/m)	Limit (dBuV/m)	Margin (dB)	Remark
1	9252.000	36.75	10.85	47.60	74.00	-26.40	peak
2	10404.000	35.61	12.92	48.53	74.00	-25.47	peak
3	11817.000	33.04	17.40	50.44	74.00	-23.56	peak
4	12690.000	32.57	18.05	50.62	74.00	-23.38	peak
5	13500.000	28.32	20.81	49.13	74.00	-24.87	peak
6	17964.000	23.80	24.92	48.72	74.00	-25.28	peak

Test Mode:	802.11be EHT20	Frequency(MHz):	6115
Polarity:	Vertical	Test Voltage:	DC 12 V

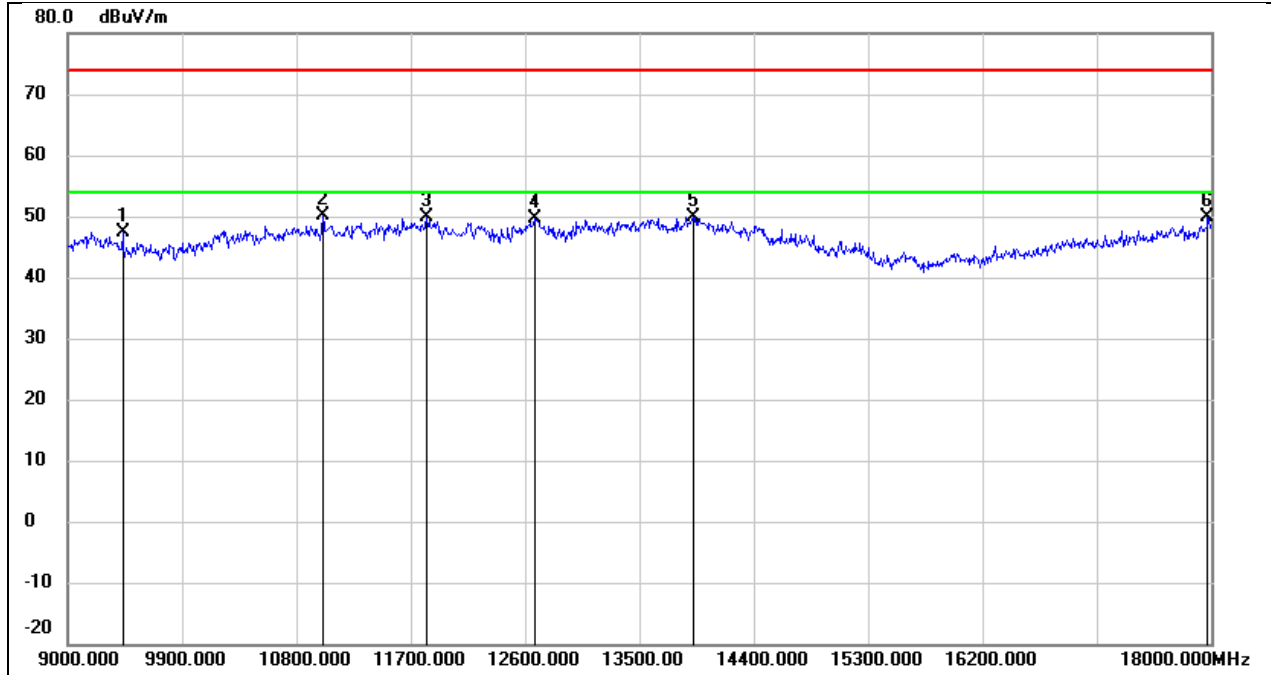

No.	Frequency (MHz)	Reading (dBuV)	Correct (dB/m)	Result (dBuV/m)	Limit (dBuV/m)	Margin (dB)	Remark
1	9432.000	36.55	10.88	47.43	74.00	-26.57	peak
2	11007.000	35.37	14.77	50.14	74.00	-23.86	peak
3	11826.000	32.47	17.42	49.89	74.00	-24.11	peak
4	12672.000	31.63	18.00	49.63	74.00	-24.37	peak
5	13923.000	28.20	21.72	49.92	74.00	-24.08	peak
6	17973.000	24.77	24.99	49.76	74.00	-24.24	peak

Test Mode:	802.11be EHT20	Frequency(MHz):	6275
Polarity:	Horizontal	Test Voltage:	DC 12 V

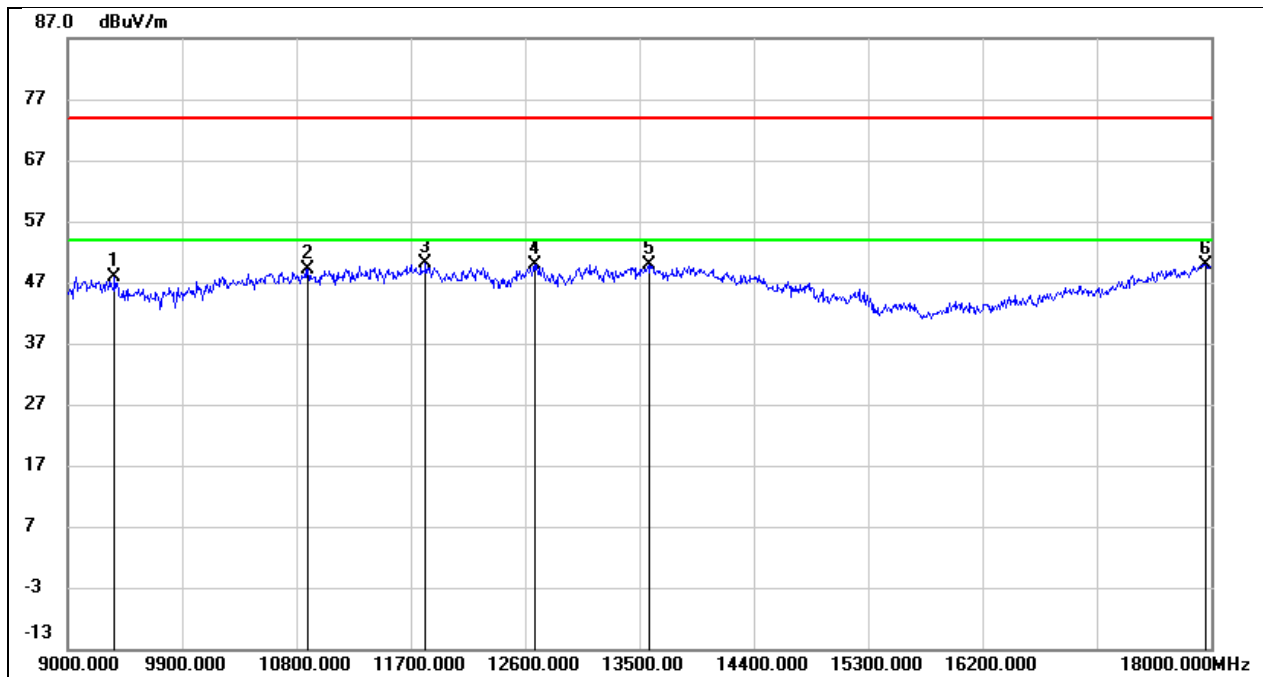

No.	Frequency (MHz)	Reading (dBuV)	Correct (dB/m)	Result (dBuV/m)	Limit (dBuV/m)	Margin (dB)	Remark
1	9369.000	36.97	10.87	47.84	74.00	-26.16	peak
2	10890.000	34.74	14.40	49.14	74.00	-24.86	peak
3	11817.000	32.66	17.40	50.06	74.00	-23.94	peak
4	12672.000	31.98	18.00	49.98	74.00	-24.02	peak
5	13572.000	28.90	20.96	49.86	74.00	-24.14	peak
6	17955.000	25.12	24.87	49.99	74.00	-24.01	peak

Test Mode:	802.11be EHT20	Frequency(MHz):	6275
Polarity:	Vertical	Test Voltage:	DC 12 V

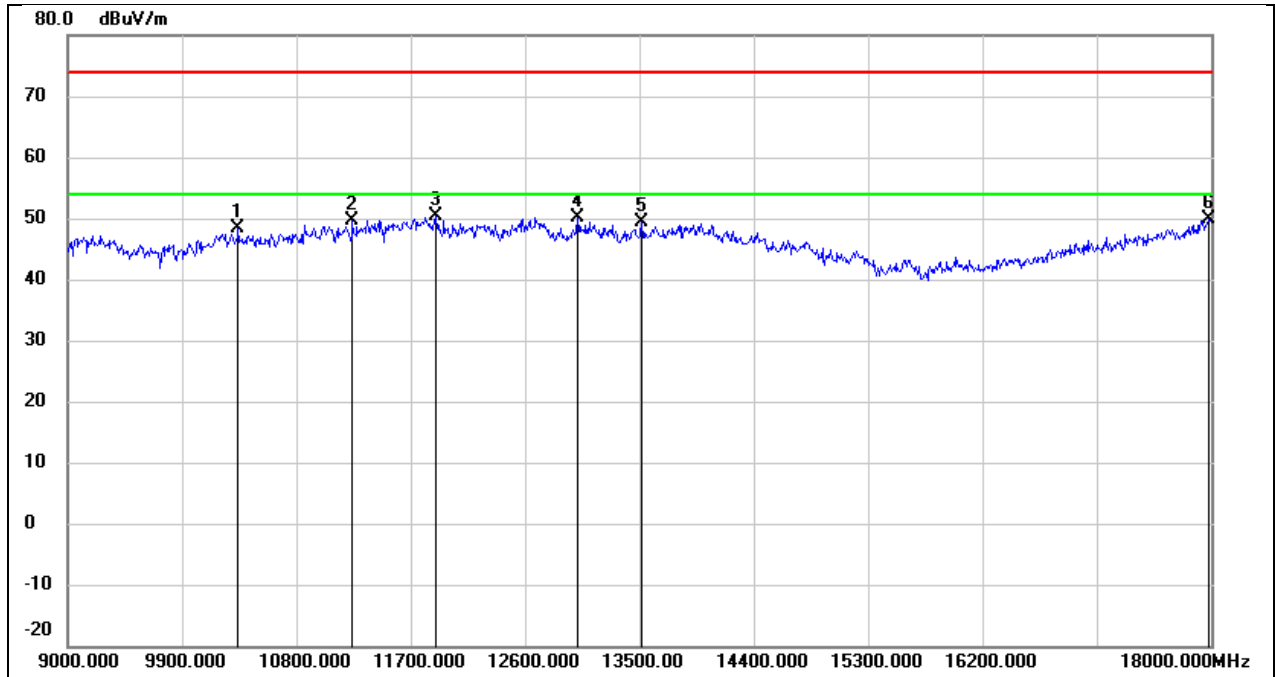

No.	Frequency (MHz)	Reading (dBuV)	Correct (dB/m)	Result (dBuV/m)	Limit (dBuV/m)	Margin (dB)	Remark
1	10341.000	35.48	12.79	48.27	74.00	-25.73	peak
2	11241.000	33.93	15.61	49.54	74.00	-24.46	peak
3	11898.000	32.75	17.63	50.38	74.00	-23.62	peak
4	13014.000	31.07	18.94	50.01	74.00	-23.99	peak
5	13518.000	28.59	20.85	49.44	74.00	-24.56	peak
6	17982.000	24.73	25.04	49.77	74.00	-24.23	peak

Test Mode:	802.11be EHT20	Frequency(MHz):	6415
Polarity:	Horizontal	Test Voltage:	DC 12 V

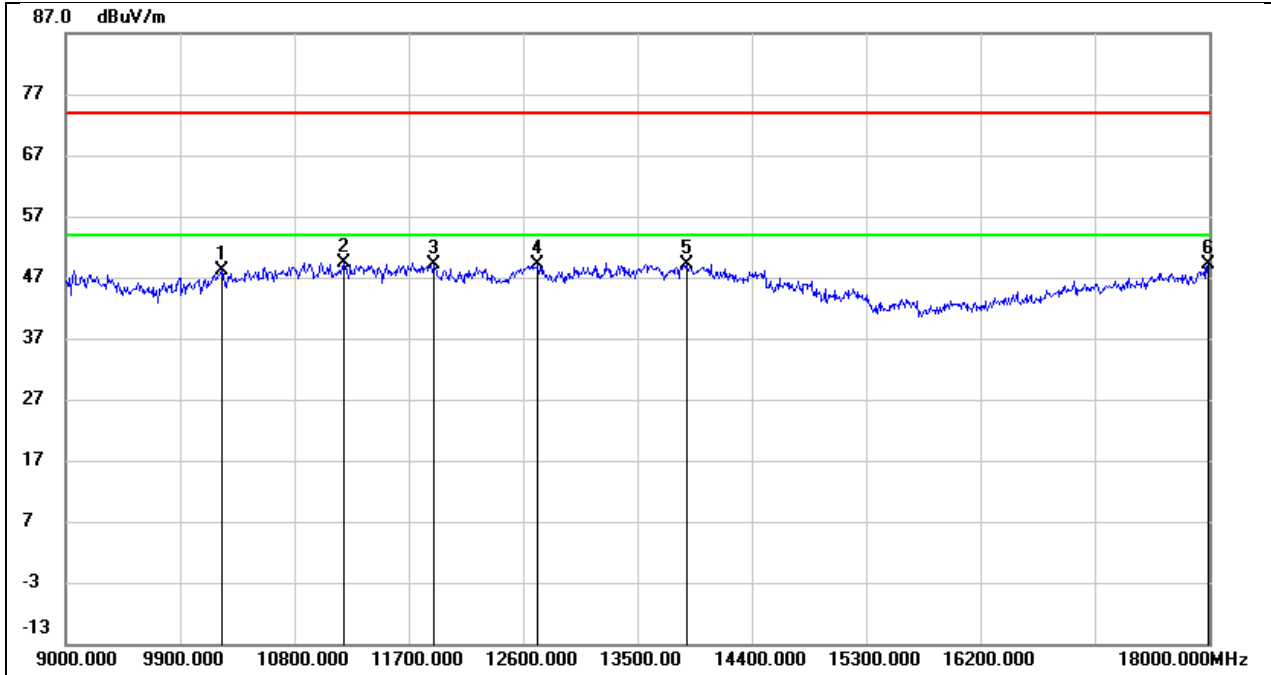

No.	Frequency (MHz)	Reading (dBuV)	Correct (dB/m)	Result (dBuV/m)	Limit (dBuV/m)	Margin (dB)	Remark
1	10224.000	35.70	12.55	48.25	74.00	-25.75	peak
2	11187.000	34.01	15.42	49.43	74.00	-24.57	peak
3	11898.000	31.50	17.63	49.13	74.00	-24.87	peak
4	12717.000	31.00	18.11	49.11	74.00	-24.89	peak
5	13887.000	27.47	21.64	49.11	74.00	-24.89	peak
6	17991.000	24.07	25.11	49.18	74.00	-24.82	peak

Test Mode:	802.11be EHT20	Frequency(MHz):	6415
Polarity:	Vertical	Test Voltage:	DC 12 V

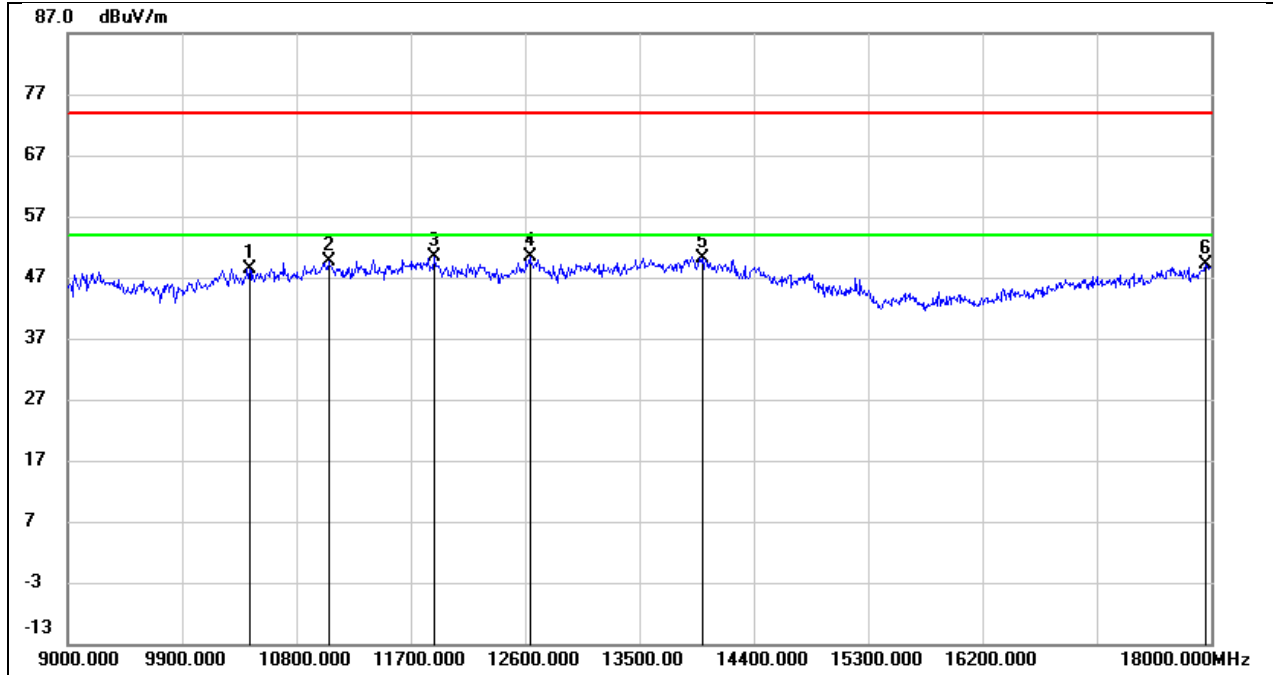

No.	Frequency (MHz)	Reading (dBuV)	Correct (dB/m)	Result (dBuV/m)	Limit (dBuV/m)	Margin (dB)	Remark
1	10431.000	35.51	12.97	48.48	74.00	-25.52	peak
2	11052.000	34.65	14.94	49.59	74.00	-24.41	peak
3	11889.000	32.75	17.60	50.35	74.00	-23.65	peak
4	12636.000	32.49	17.90	50.39	74.00	-23.61	peak
5	13995.000	28.35	21.87	50.22	74.00	-23.78	peak
6	17955.000	24.15	24.87	49.02	74.00	-24.98	peak

Test Mode:	802.11be EHT20	Frequency(MHz):	6435
Polarity:	Horizontal	Test Voltage:	DC 12 V

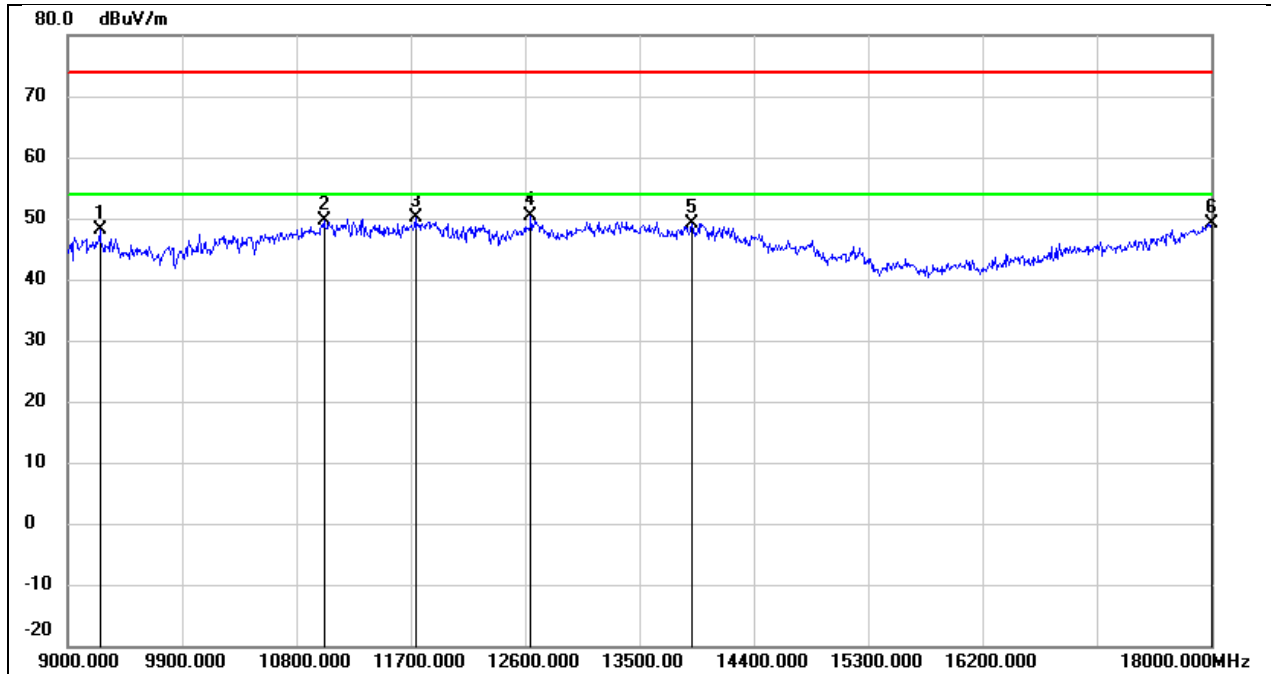

No.	Frequency (MHz)	Reading (dBuV)	Correct (dB/m)	Result (dBuV/m)	Limit (dBuV/m)	Margin (dB)	Remark
1	9252.000	37.24	10.85	48.09	74.00	-25.91	peak
2	11016.000	34.75	14.81	49.56	74.00	-24.44	peak
3	11736.000	32.97	17.18	50.15	74.00	-23.85	peak
4	12645.000	32.53	17.92	50.45	74.00	-23.55	peak
5	13914.000	27.56	21.69	49.25	74.00	-24.75	peak
6	18000.000	23.91	25.16	49.07	74.00	-24.93	peak

Test Mode:	802.11be EHT20	Frequency(MHz):	6435
Polarity:	Vertical	Test Voltage:	DC 12 V

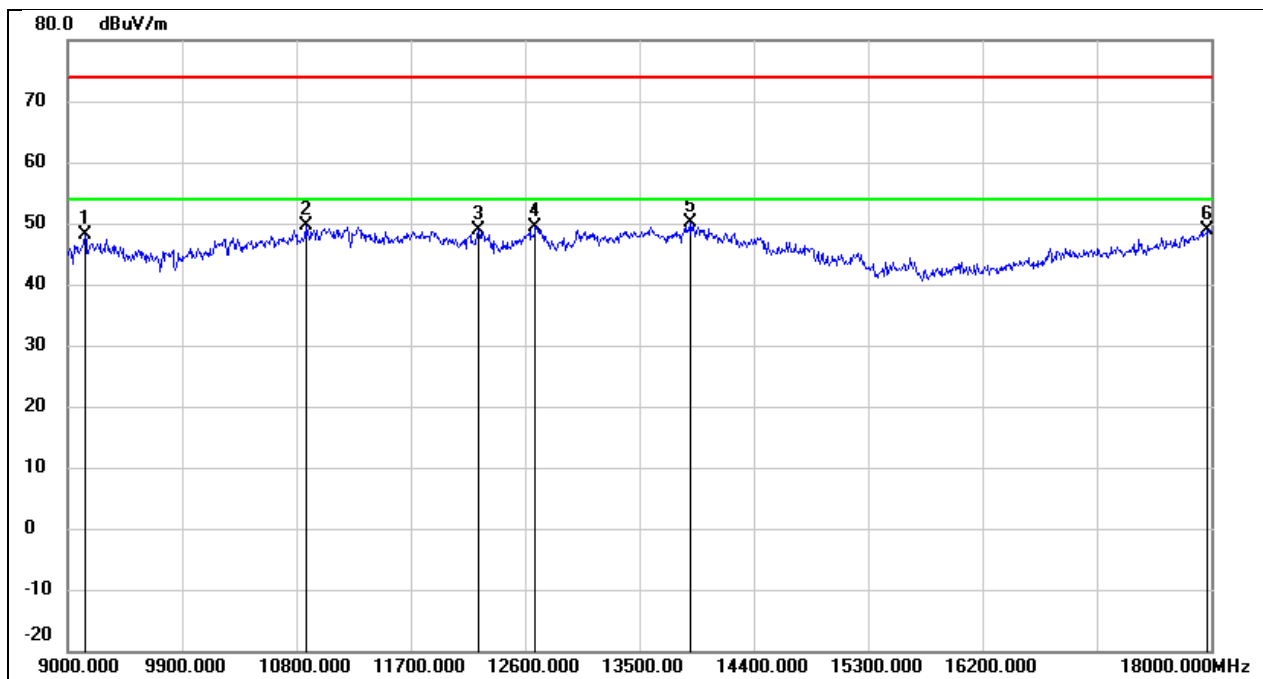

No.	Frequency (MHz)	Reading (dBuV)	Correct (dB/m)	Result (dBuV/m)	Limit (dBuV/m)	Margin (dB)	Remark
1	9135.000	37.31	10.84	48.15	74.00	-25.85	peak
2	10872.000	35.27	14.33	49.60	74.00	-24.40	peak
3	12231.000	31.20	17.73	48.93	74.00	-25.07	peak
4	12681.000	31.41	18.03	49.44	74.00	-24.56	peak
5	13905.000	28.38	21.68	50.06	74.00	-23.94	peak
6	17973.000	23.87	24.99	48.86	74.00	-25.14	peak

Test Mode:	802.11be EHT20	Frequency(MHz):	6475
Polarity:	Horizontal	Test Voltage:	DC 12 V

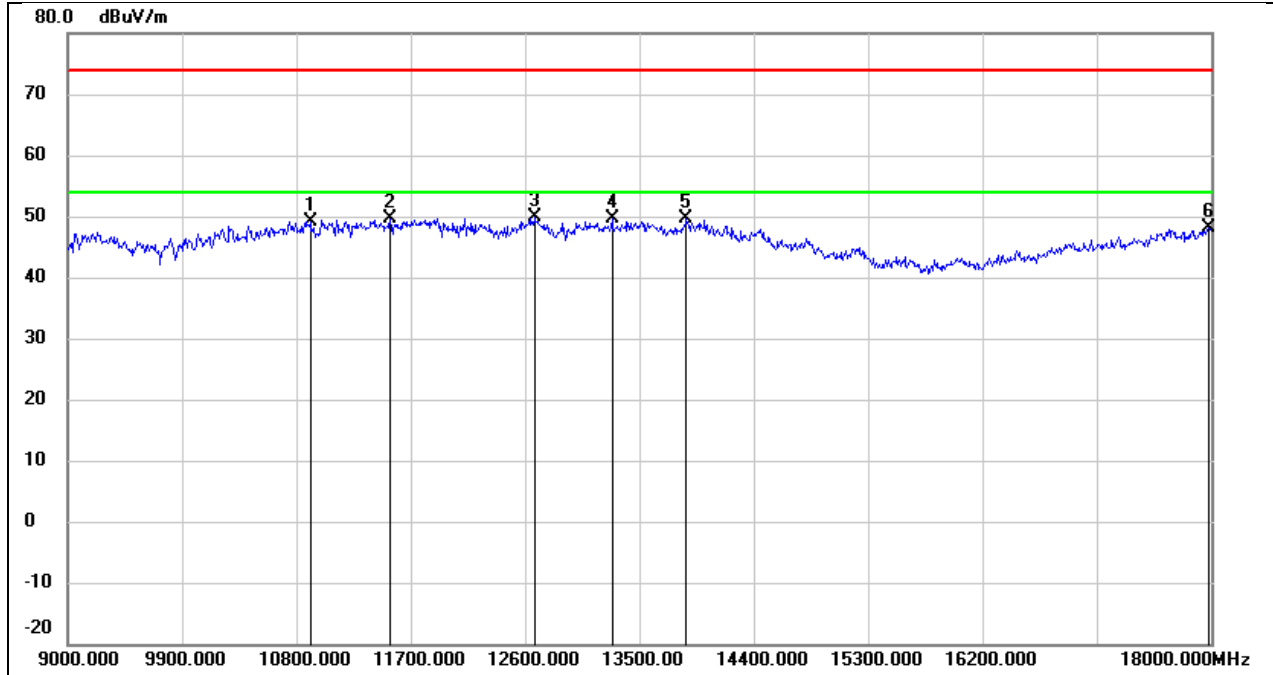

No.	Frequency (MHz)	Reading (dBuV)	Correct (dB/m)	Result (dBuV/m)	Limit (dBuV/m)	Margin (dB)	Remark
1	10908.000	34.73	14.45	49.18	74.00	-24.82	peak
2	11538.000	32.93	16.63	49.56	74.00	-24.44	peak
3	12672.000	31.86	18.00	49.86	74.00	-24.14	peak
4	13284.000	29.74	19.98	49.72	74.00	-24.28	peak
5	13869.000	28.09	21.59	49.68	74.00	-24.32	peak
6	17982.000	23.19	25.04	48.23	74.00	-25.77	peak

Test Mode:	802.11be EHT20	Frequency(MHz):	6475
Polarity:	Vertical	Test Voltage:	DC 12 V

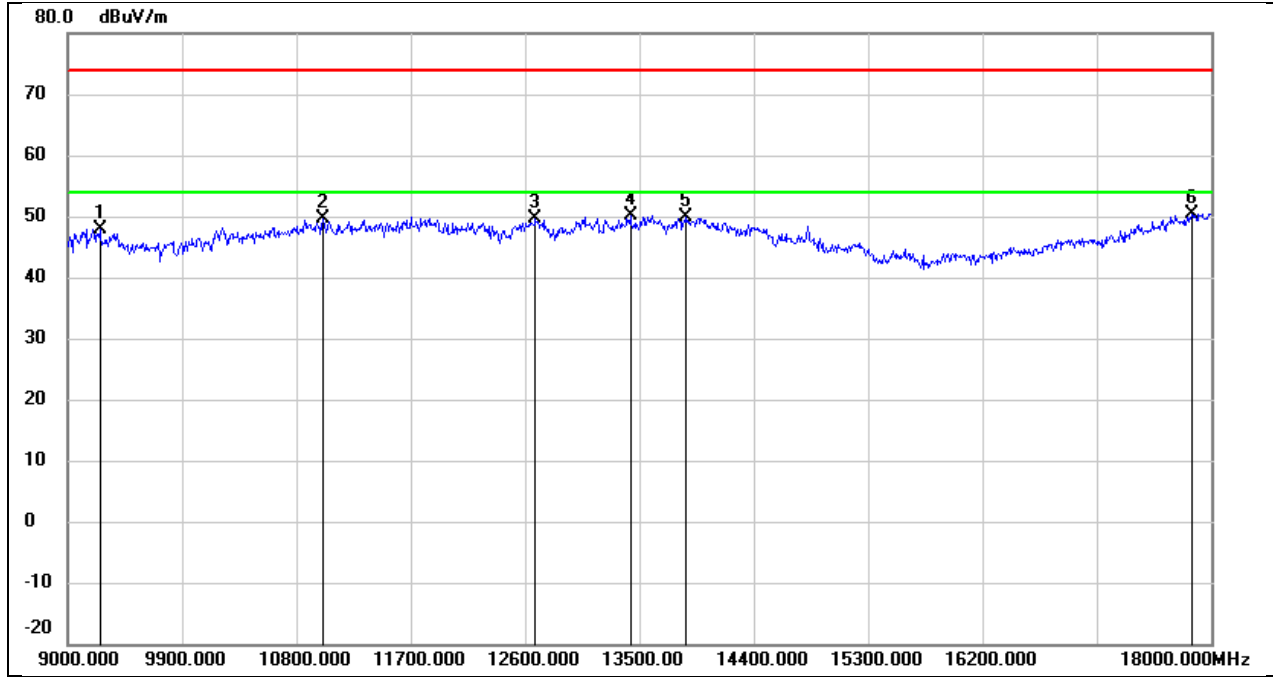

No.	Frequency (MHz)	Reading (dBuV)	Correct (dB/m)	Result (dBuV/m)	Limit (dBuV/m)	Margin (dB)	Remark
1	9252.000	37.11	10.85	47.96	74.00	-26.04	peak
2	11007.000	34.89	14.77	49.66	74.00	-24.34	peak
3	12681.000	31.71	18.03	49.74	74.00	-24.26	peak
4	13428.000	29.60	20.53	50.13	74.00	-23.87	peak
5	13869.000	28.19	21.59	49.78	74.00	-24.22	peak
6	17847.000	26.32	24.18	50.50	74.00	-23.50	peak

Test Mode:	802.11be EHT20	Frequency(MHz):	6515
Polarity:	Horizontal	Test Voltage:	DC 12 V

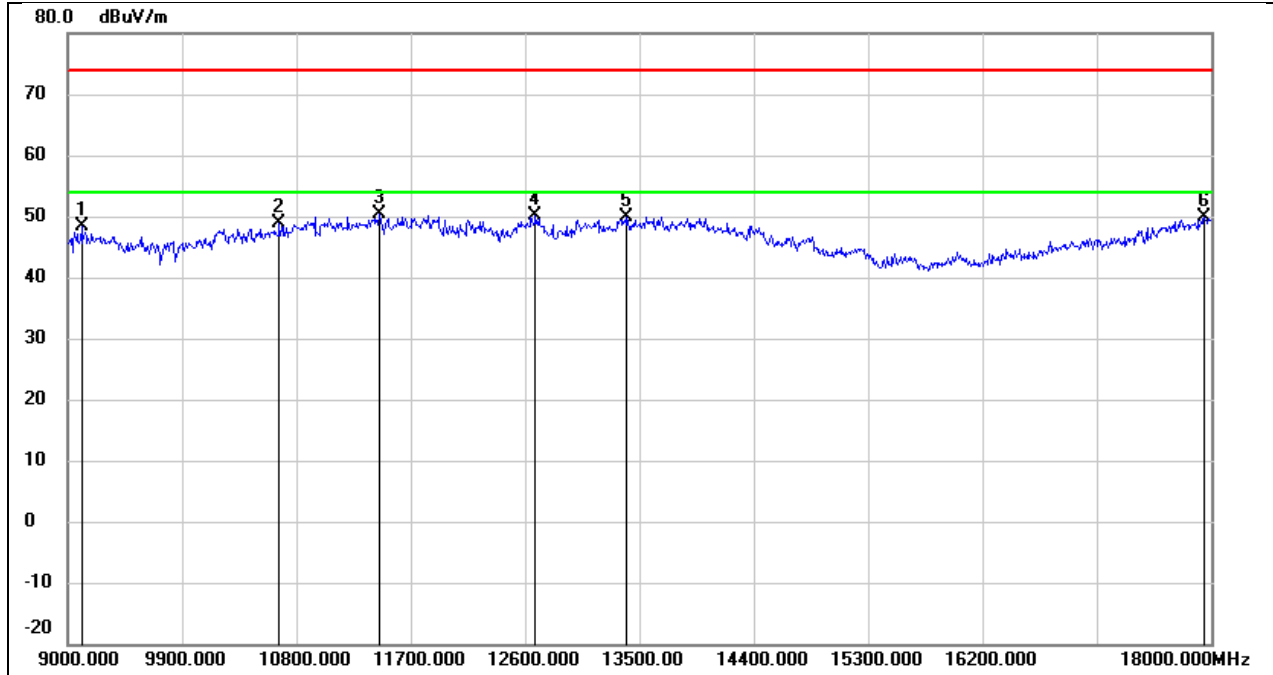

No.	Frequency (MHz)	Reading (dBuV)	Correct (dB/m)	Result (dBuV/m)	Limit (dBuV/m)	Margin (dB)	Remark
1	9108.000	37.64	10.83	48.47	74.00	-25.53	peak
2	10665.000	35.17	13.66	48.83	74.00	-25.17	peak
3	11448.000	34.00	16.34	50.34	74.00	-23.66	peak
4	12681.000	32.16	18.03	50.19	74.00	-23.81	peak
5	13401.000	29.56	20.43	49.99	74.00	-24.01	peak
6	17946.000	25.02	24.82	49.84	74.00	-24.16	peak

Test Mode:	802.11be EHT20	Frequency(MHz):	6515
Polarity:	Vertical	Test Voltage:	DC 12 V

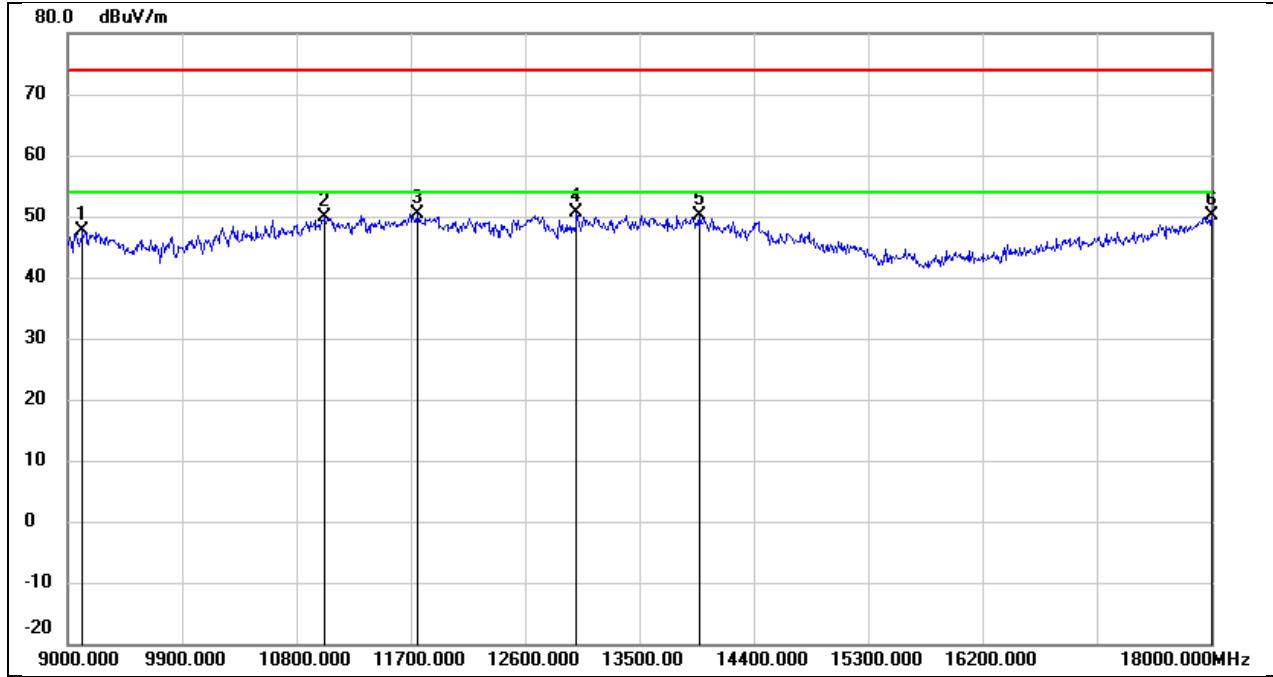

No.	Frequency (MHz)	Reading (dBuV)	Correct (dB/m)	Result (dBuV/m)	Limit (dBuV/m)	Margin (dB)	Remark
1	9117.000	36.69	10.83	47.52	74.00	-26.48	peak
2	11025.000	35.09	14.83	49.92	74.00	-24.08	peak
3	11754.000	33.16	17.23	50.39	74.00	-23.61	peak
4	13005.000	31.65	18.91	50.56	74.00	-23.44	peak
5	13968.000	28.27	21.81	50.08	74.00	-23.92	peak
6	18000.000	24.90	25.16	50.06	74.00	-23.94	peak

Test Mode:	802.11be EHT20	Frequency(MHz):	6535
Polarity:	Horizontal	Test Voltage:	DC 12 V

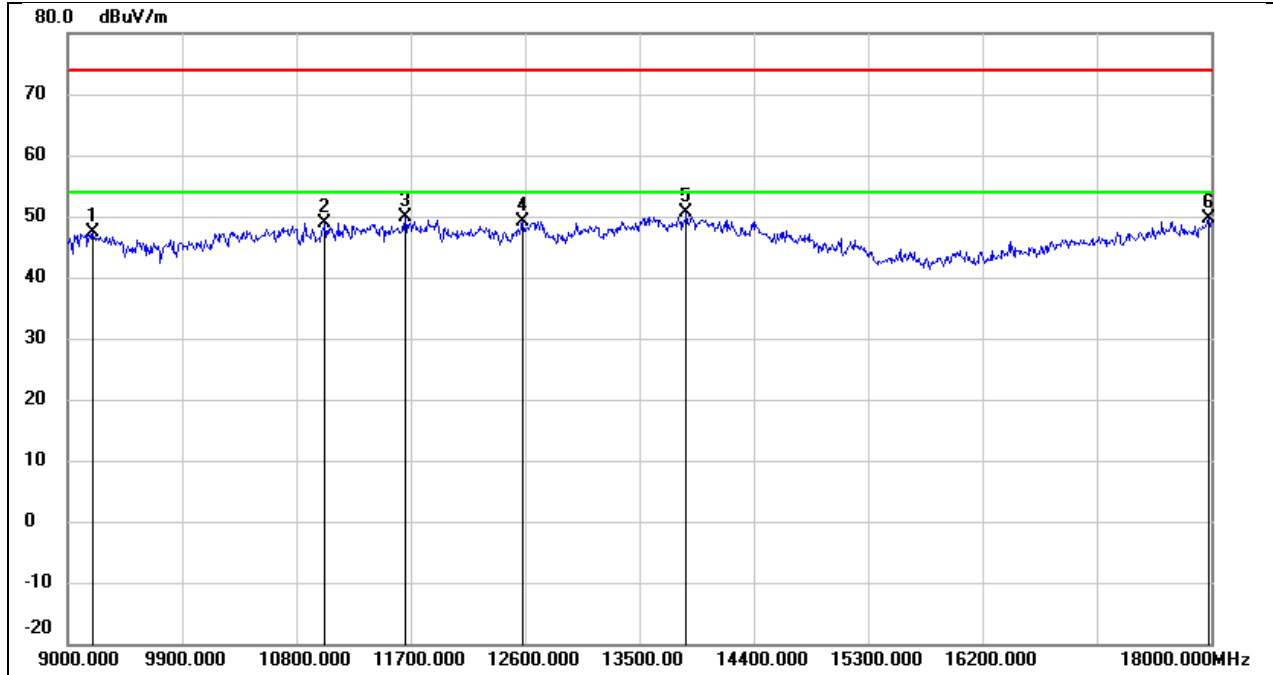

No.	Frequency (MHz)	Reading (dBuV)	Correct (dB/m)	Result (dBuV/m)	Limit (dBuV/m)	Margin (dB)	Remark
1	9198.000	36.56	10.85	47.41	74.00	-26.59	peak
2	11025.000	34.07	14.83	48.90	74.00	-25.10	peak
3	11655.000	32.92	16.95	49.87	74.00	-24.13	peak
4	12582.000	31.29	17.76	49.05	74.00	-24.95	peak
5	13869.000	28.94	21.59	50.53	74.00	-23.47	peak
6	17982.000	24.48	25.04	49.52	74.00	-24.48	peak

Test Mode:	802.11be EHT20	Frequency(MHz):	6535
Polarity:	Vertical	Test Voltage:	DC 12 V

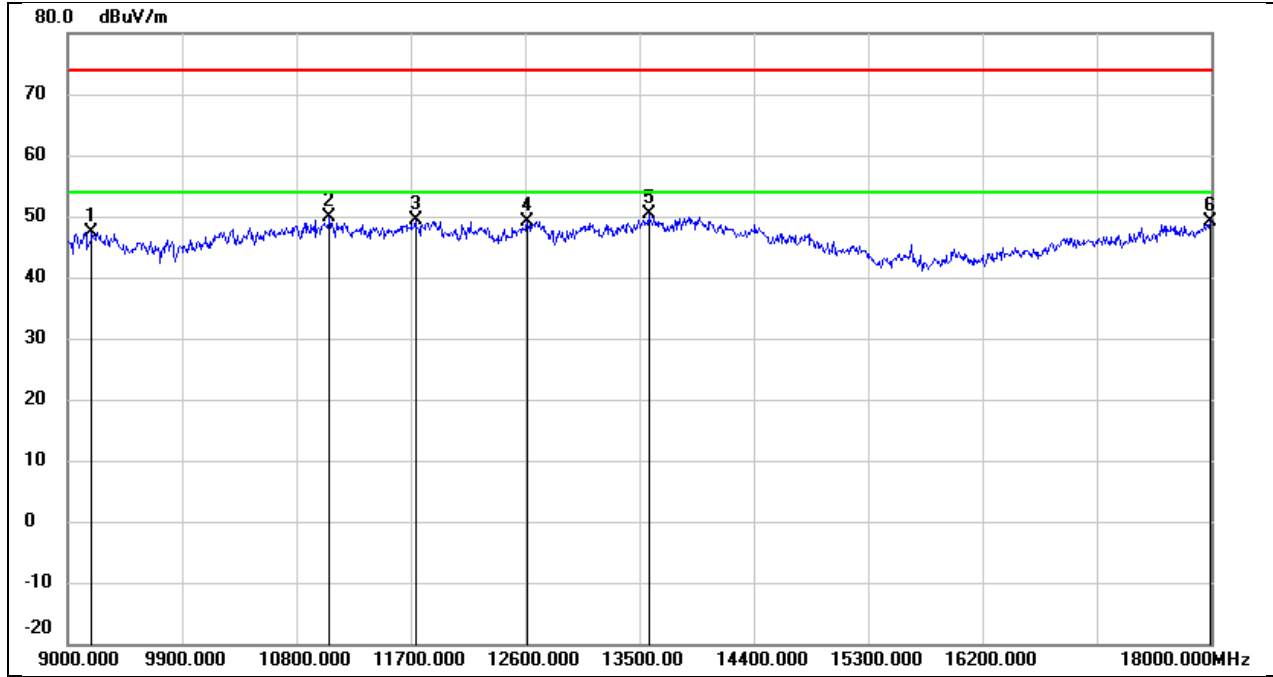

No.	Frequency (MHz)	Reading (dBuV)	Correct (dB/m)	Result (dBuV/m)	Limit (dBuV/m)	Margin (dB)	Remark
1	9189.000	36.62	10.84	47.46	74.00	-26.54	peak
2	11061.000	34.95	14.96	49.91	74.00	-24.09	peak
3	11736.000	32.08	17.18	49.26	74.00	-24.74	peak
4	12618.000	31.21	17.84	49.05	74.00	-24.95	peak
5	13572.000	29.45	20.96	50.41	74.00	-23.59	peak
6	17991.000	24.09	25.11	49.20	74.00	-24.80	peak

Test Mode:	802.11be EHT20	Frequency(MHz):	6715
Polarity:	Horizontal	Test Voltage:	DC 12 V

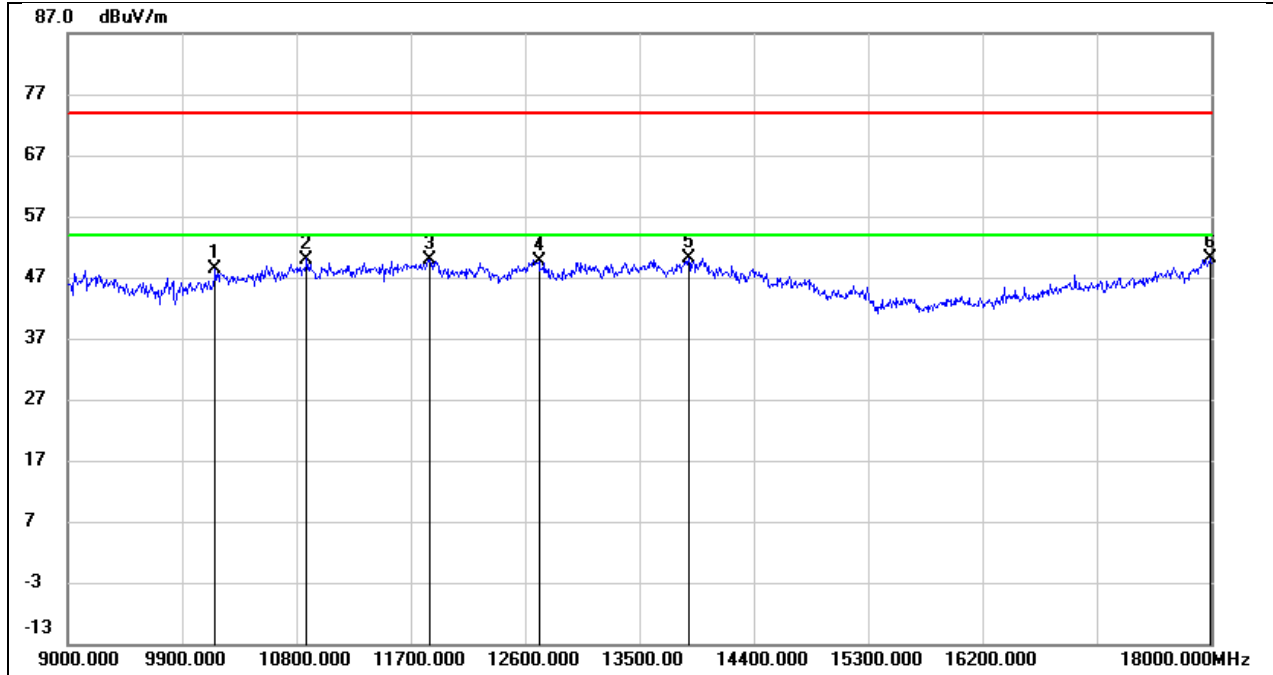

No.	Frequency (MHz)	Reading (dBuV)	Correct (dB/m)	Result (dBuV/m)	Limit (dBuV/m)	Margin (dB)	Remark
1	10161.000	36.00	12.42	48.42	74.00	-25.58	peak
2	10881.000	35.65	14.35	50.00	74.00	-24.00	peak
3	11853.000	32.38	17.50	49.88	74.00	-24.12	peak
4	12708.000	31.47	18.10	49.57	74.00	-24.43	peak
5	13887.000	28.55	21.64	50.19	74.00	-23.81	peak
6	17991.000	25.00	25.11	50.11	74.00	-23.89	peak

Test Mode:	802.11be EHT20	Frequency(MHz):	6715
Polarity:	Vertical	Test Voltage:	DC 12 V

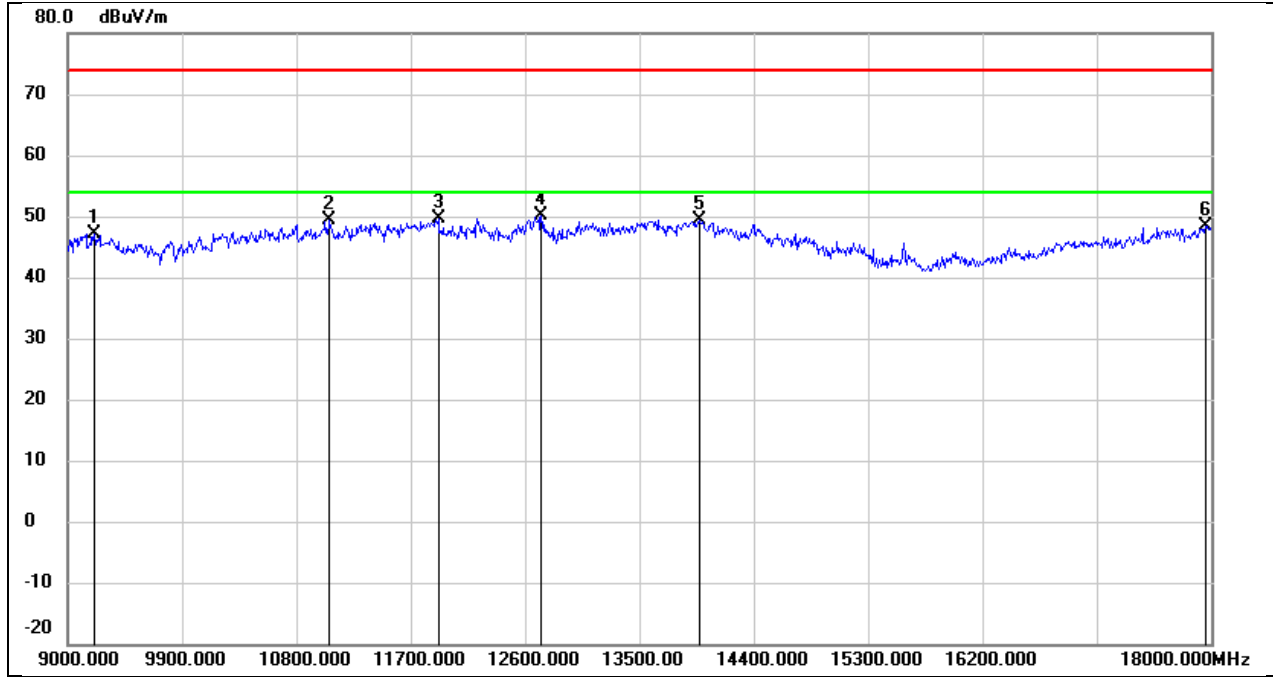

No.	Frequency (MHz)	Reading (dBuV)	Correct (dB/m)	Result (dBuV/m)	Limit (dBuV/m)	Margin (dB)	Remark
1	9207.000	36.33	10.84	47.17	74.00	-26.83	peak
2	11061.000	34.47	14.96	49.43	74.00	-24.57	peak
3	11916.000	31.90	17.68	49.58	74.00	-24.42	peak
4	12726.000	31.91	18.14	50.05	74.00	-23.95	peak
5	13968.000	27.67	21.81	49.48	74.00	-24.52	peak
6	17955.000	23.59	24.87	48.46	74.00	-25.54	peak

Test Mode:	802.11be EHT20	Frequency(MHz):	6875
Polarity:	Horizontal	Test Voltage:	DC 12 V

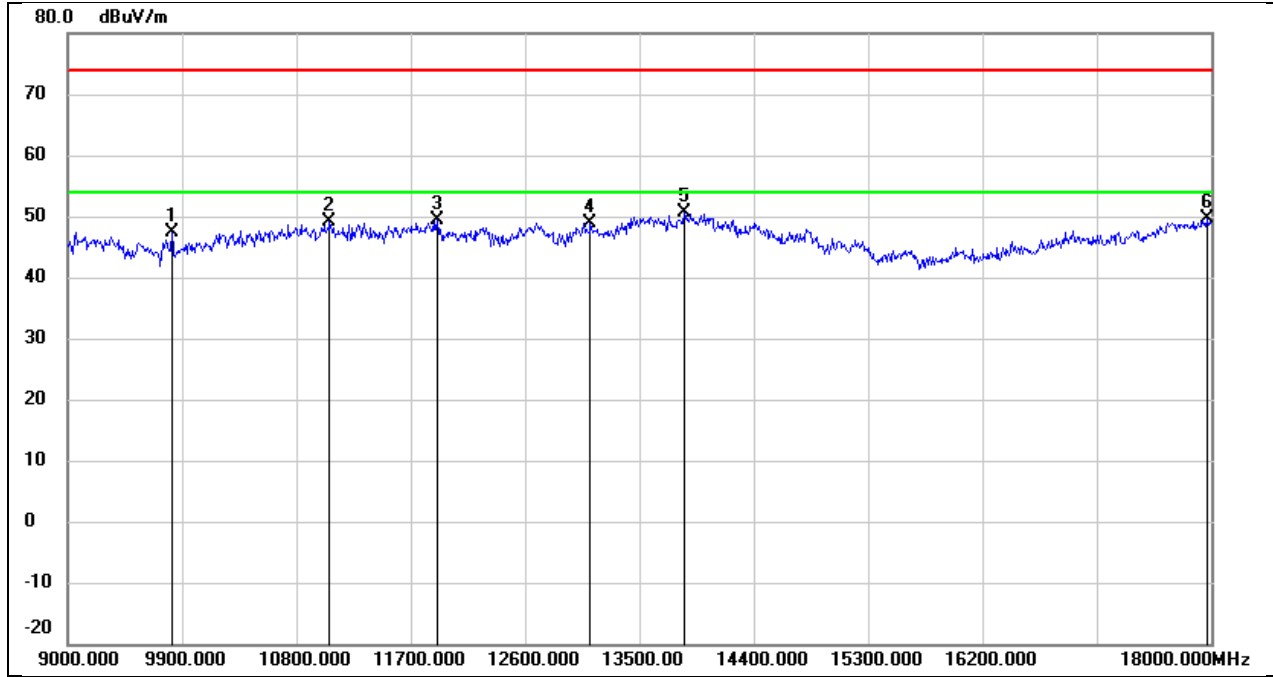

No.	Frequency (MHz)	Reading (dBuV)	Correct (dB/m)	Result (dBuV/m)	Limit (dBuV/m)	Margin (dB)	Remark
1	9819.000	35.66	11.65	47.31	74.00	-26.69	peak
2	11061.000	34.19	14.96	49.15	74.00	-24.85	peak
3	11907.000	31.71	17.66	49.37	74.00	-24.63	peak
4	13113.000	29.54	19.33	48.87	74.00	-25.13	peak
5	13851.000	29.12	21.56	50.68	74.00	-23.32	peak
6	17964.000	24.61	24.92	49.53	74.00	-24.47	peak

Test Mode:	802.11be EHT20	Frequency(MHz):	6875
Polarity:	Vertical	Test Voltage:	DC 12 V

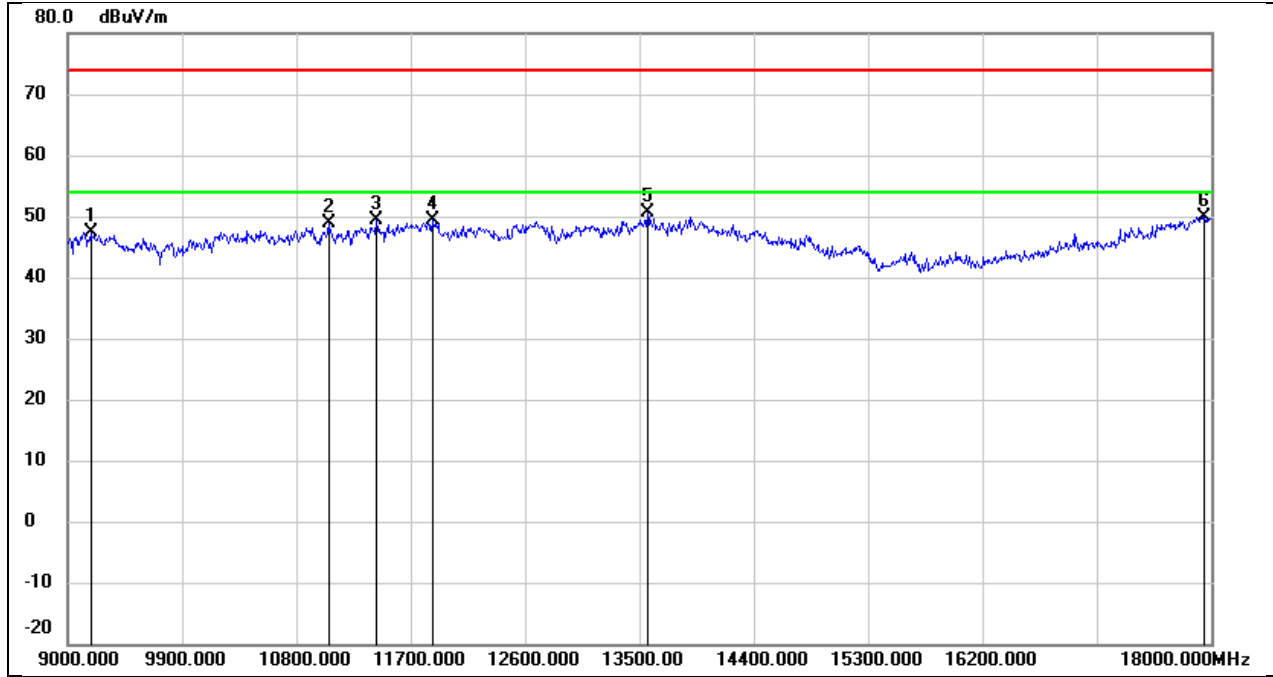

No.	Frequency (MHz)	Reading (dBuV)	Correct (dB/m)	Result (dBuV/m)	Limit (dBuV/m)	Margin (dB)	Remark
1	9180.000	36.56	10.84	47.40	74.00	-26.60	peak
2	11052.000	33.91	14.94	48.85	74.00	-25.15	peak
3	11430.000	33.06	16.28	49.34	74.00	-24.66	peak
4	11871.000	31.71	17.56	49.27	74.00	-24.73	peak
5	13563.000	29.68	20.94	50.62	74.00	-23.38	peak
6	17946.000	25.14	24.82	49.96	74.00	-24.04	peak

Test Mode:	802.11be EHT20	Frequency(MHz):	6895
Polarity:	Horizontal	Test Voltage:	DC 12 V

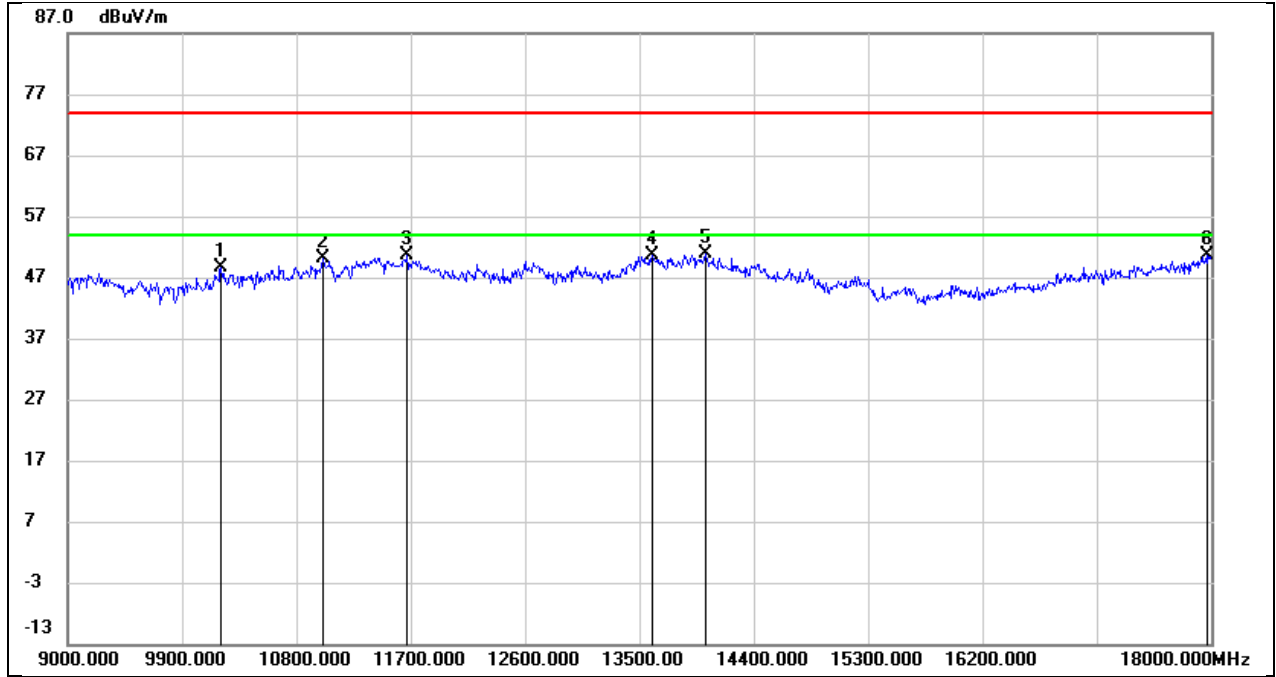

No.	Frequency (MHz)	Reading (dBuV)	Correct (dB/m)	Result (dBuV/m)	Limit (dBuV/m)	Margin (dB)	Remark
1	10206.000	36.04	12.51	48.55	74.00	-25.45	peak
2	11007.000	35.24	14.77	50.01	74.00	-23.99	peak
3	11673.000	33.56	17.00	50.56	74.00	-23.44	peak
4	13599.000	29.50	21.02	50.52	74.00	-23.48	peak
5	14022.000	29.10	21.79	50.89	74.00	-23.11	peak
6	17964.000	25.82	24.92	50.74	74.00	-23.26	peak

Test Mode:	802.11be EHT20	Frequency(MHz):	6895
Polarity:	Vertical	Test Voltage:	DC 12 V

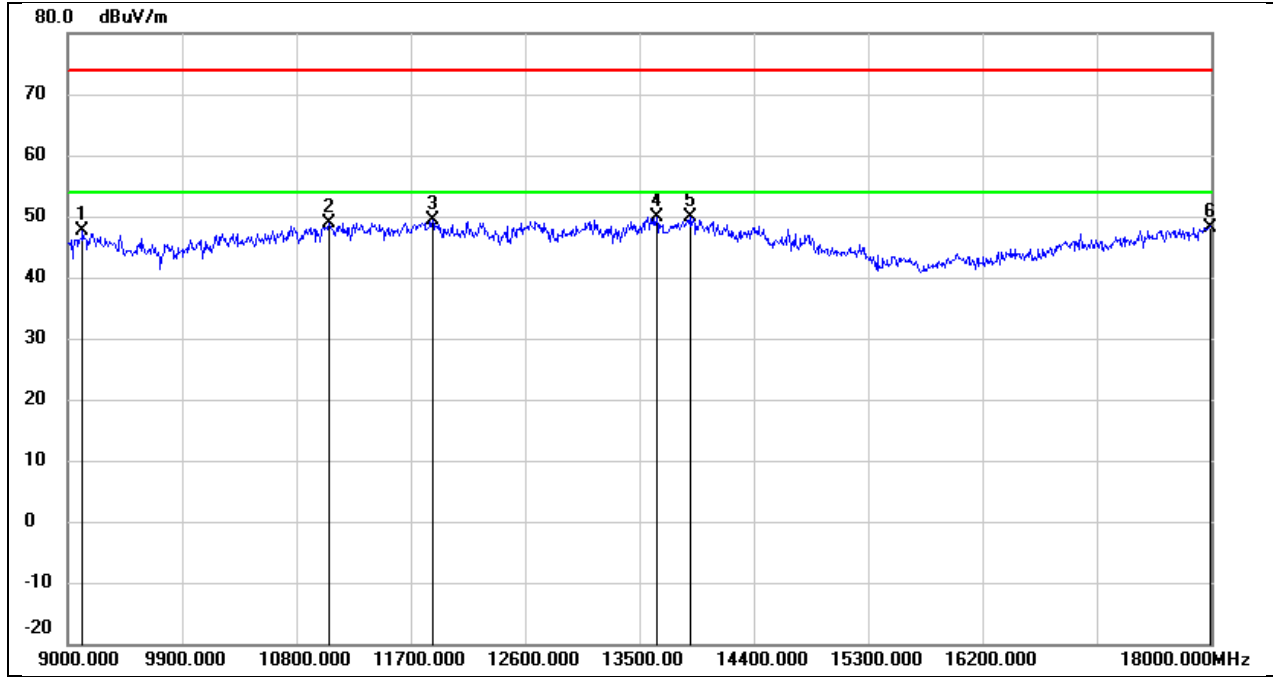

No.	Frequency (MHz)	Reading (dBuV)	Correct (dB/m)	Result (dBuV/m)	Limit (dBuV/m)	Margin (dB)	Remark
1	9117.000	36.71	10.83	47.54	74.00	-26.46	peak
2	11052.000	33.93	14.94	48.87	74.00	-25.13	peak
3	11871.000	31.92	17.56	49.48	74.00	-24.52	peak
4	13635.000	28.81	21.10	49.91	74.00	-24.09	peak
5	13896.000	28.26	21.65	49.91	74.00	-24.09	peak
6	17991.000	23.14	25.11	48.25	74.00	-25.75	peak

Test Mode:	802.11be EHT20	Frequency(MHz):	7015
Polarity:	Horizontal	Test Voltage:	DC 12 V

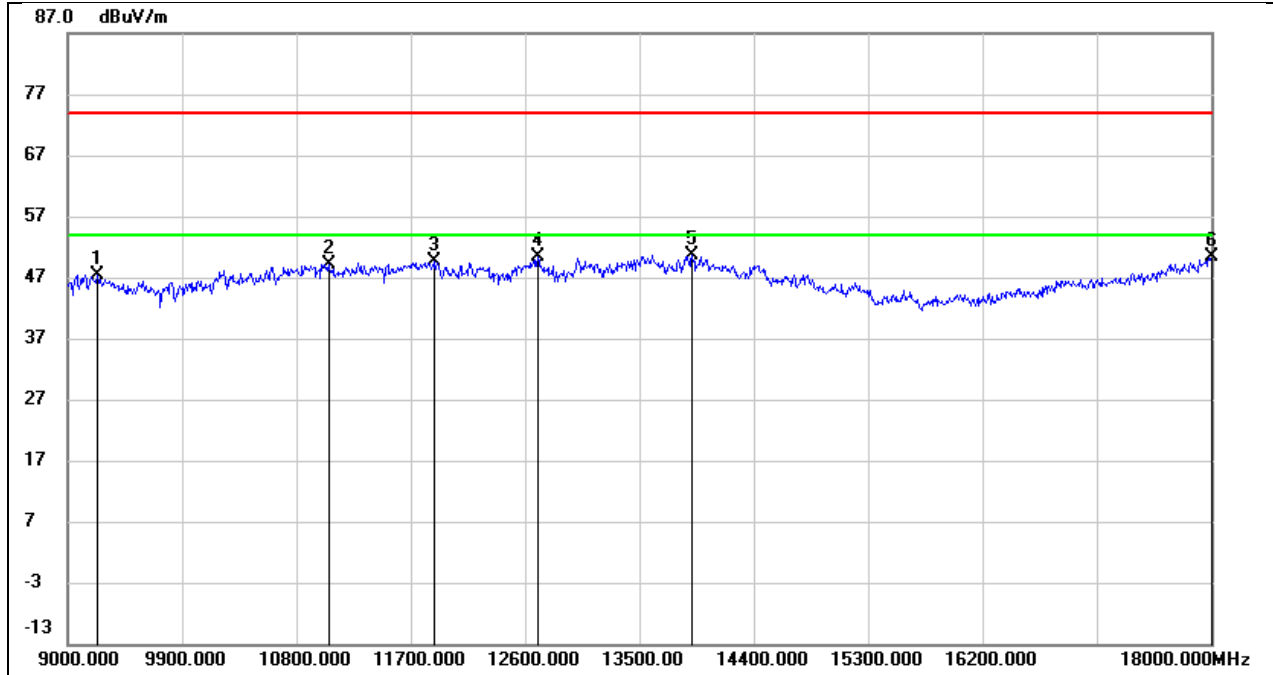

No.	Frequency (MHz)	Reading (dBuV)	Correct (dB/m)	Result (dBuV/m)	Limit (dBuV/m)	Margin (dB)	Remark
1	9234.000	36.61	10.84	47.45	74.00	-26.55	peak
2	11052.000	34.30	14.94	49.24	74.00	-24.76	peak
3	11880.000	32.06	17.58	49.64	74.00	-24.36	peak
4	12699.000	32.23	18.07	50.30	74.00	-23.70	peak
5	13914.000	28.90	21.69	50.59	74.00	-23.41	peak
6	18000.000	25.29	25.16	50.45	74.00	-23.55	peak

Test Mode:	802.11be EHT20	Frequency(MHz):	7015
Polarity:	Vertical	Test Voltage:	DC 12 V

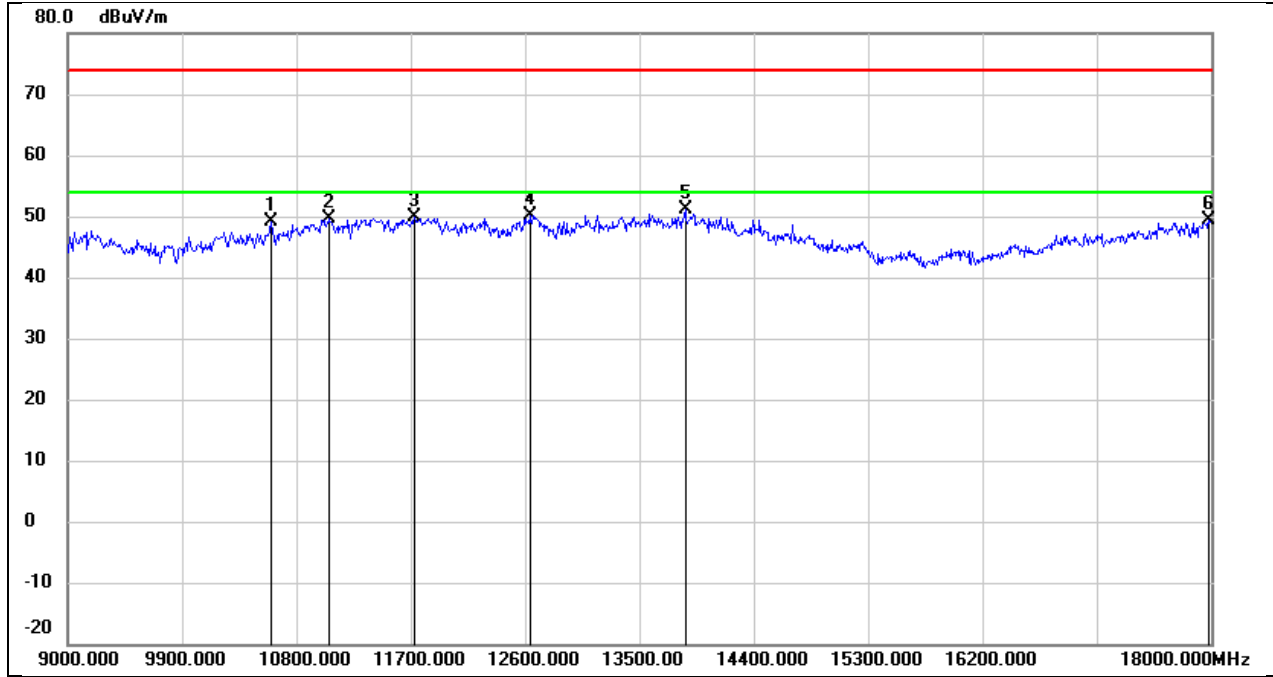

No.	Frequency (MHz)	Reading (dBuV)	Correct (dB/m)	Result (dBuV/m)	Limit (dBuV/m)	Margin (dB)	Remark
1	10602.000	35.61	13.45	49.06	74.00	-24.94	peak
2	11061.000	34.58	14.96	49.54	74.00	-24.46	peak
3	11727.000	32.64	17.16	49.80	74.00	-24.20	peak
4	12636.000	32.23	17.90	50.13	74.00	-23.87	peak
5	13860.000	29.49	21.59	51.08	74.00	-22.92	peak
6	17982.000	24.40	25.04	49.44	74.00	-24.56	peak

Test Mode:	802.11be EHT20	Frequency(MHz):	7095
Polarity:	Horizontal	Test Voltage:	DC 12 V

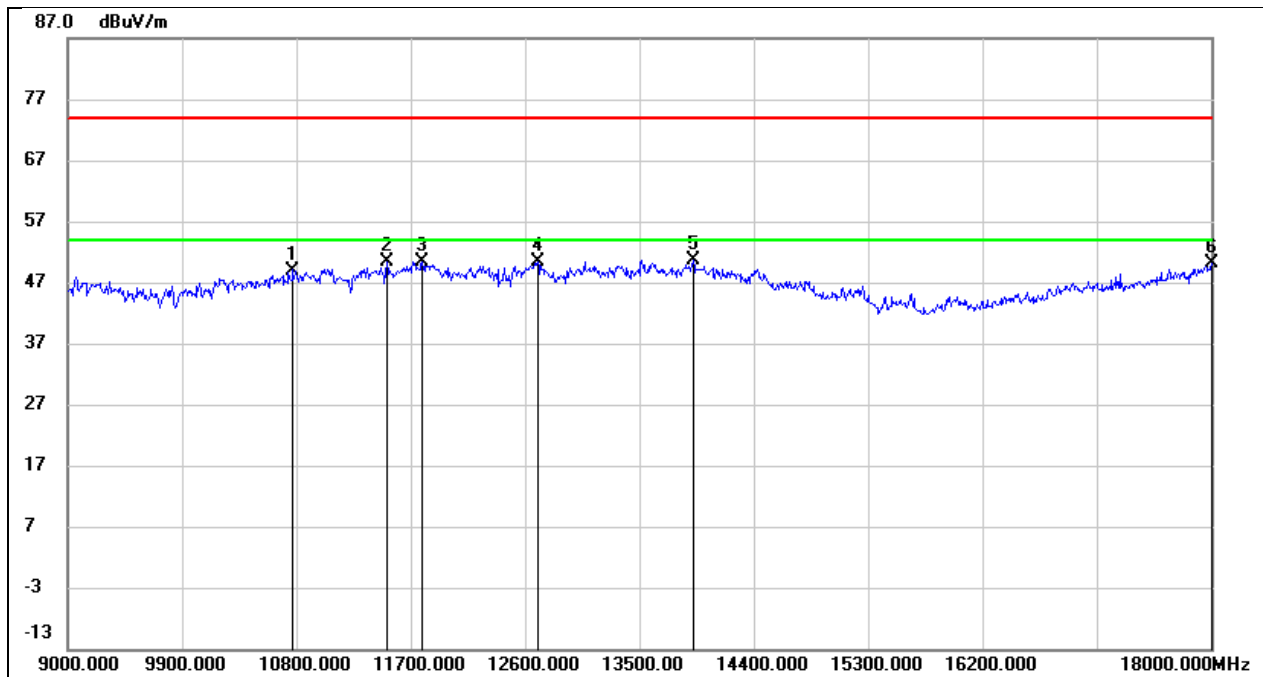

No.	Frequency (MHz)	Reading (dBuV)	Correct (dB/m)	Result (dBuV/m)	Limit (dBuV/m)	Margin (dB)	Remark
1	10773.000	34.99	14.01	49.00	74.00	-25.00	peak
2	11511.000	33.77	16.56	50.33	74.00	-23.67	peak
3	11790.000	33.12	17.33	50.45	74.00	-23.55	peak
4	12699.000	32.31	18.07	50.38	74.00	-23.62	peak
5	13923.000	28.81	21.72	50.53	74.00	-23.47	peak
6	18000.000	25.09	25.16	50.25	74.00	-23.75	peak

Test Mode:	802.11be EHT20	Frequency(MHz):	7095
Polarity:	Vertical	Test Voltage:	DC 12 V

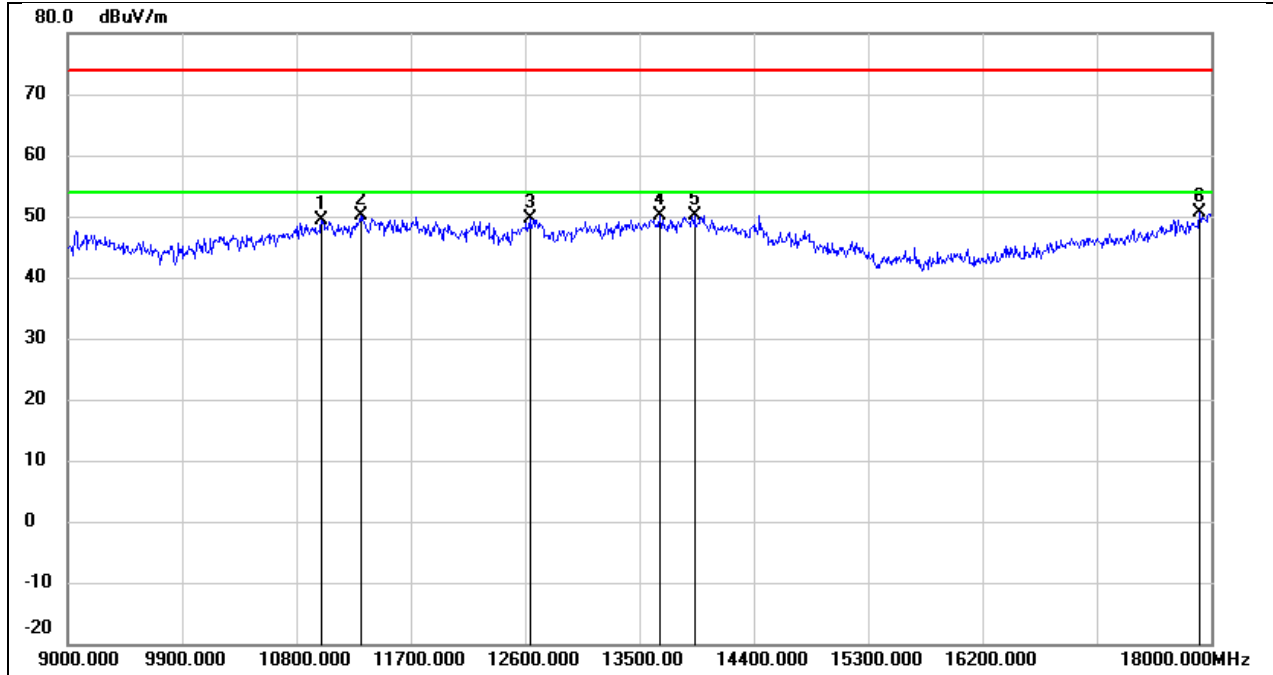

No.	Frequency (MHz)	Reading (dBuV)	Correct (dB/m)	Result (dBuV/m)	Limit (dBuV/m)	Margin (dB)	Remark
1	10998.000	34.51	14.75	49.26	74.00	-24.74	peak
2	11304.000	34.31	15.84	50.15	74.00	-23.85	peak
3	12636.000	31.79	17.90	49.69	74.00	-24.31	peak
4	13662.000	29.06	21.16	50.22	74.00	-23.78	peak
5	13932.000	28.33	21.74	50.07	74.00	-23.93	peak
6	17910.000	26.07	24.59	50.66	74.00	-23.34	peak

Test Mode:	802.11be EHT40	Frequency(MHz):	6125
Polarity:	Horizontal	Test Voltage:	DC 12 V

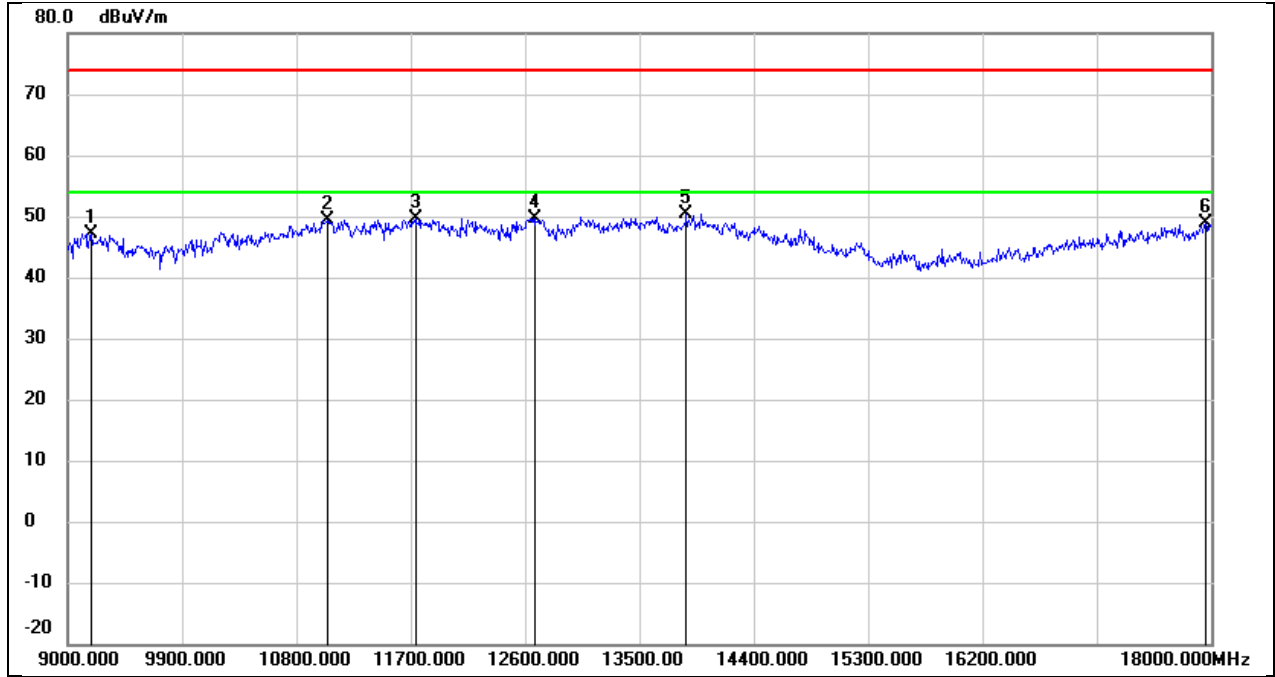

No.	Frequency (MHz)	Reading (dBuV)	Correct (dB/m)	Result (dBuV/m)	Limit (dBuV/m)	Margin (dB)	Remark
1	9189.000	36.32	10.84	47.16	74.00	-26.84	peak
2	11043.000	34.53	14.90	49.43	74.00	-24.57	peak
3	11736.000	32.56	17.18	49.74	74.00	-24.26	peak
4	12681.000	31.71	18.03	49.74	74.00	-24.26	peak
5	13869.000	28.74	21.59	50.33	74.00	-23.67	peak
6	17955.000	24.12	24.87	48.99	74.00	-25.01	peak

Test Mode:	802.11be EHT40	Frequency(MHz):	6125
Polarity:	Vertical	Test Voltage:	DC 12 V

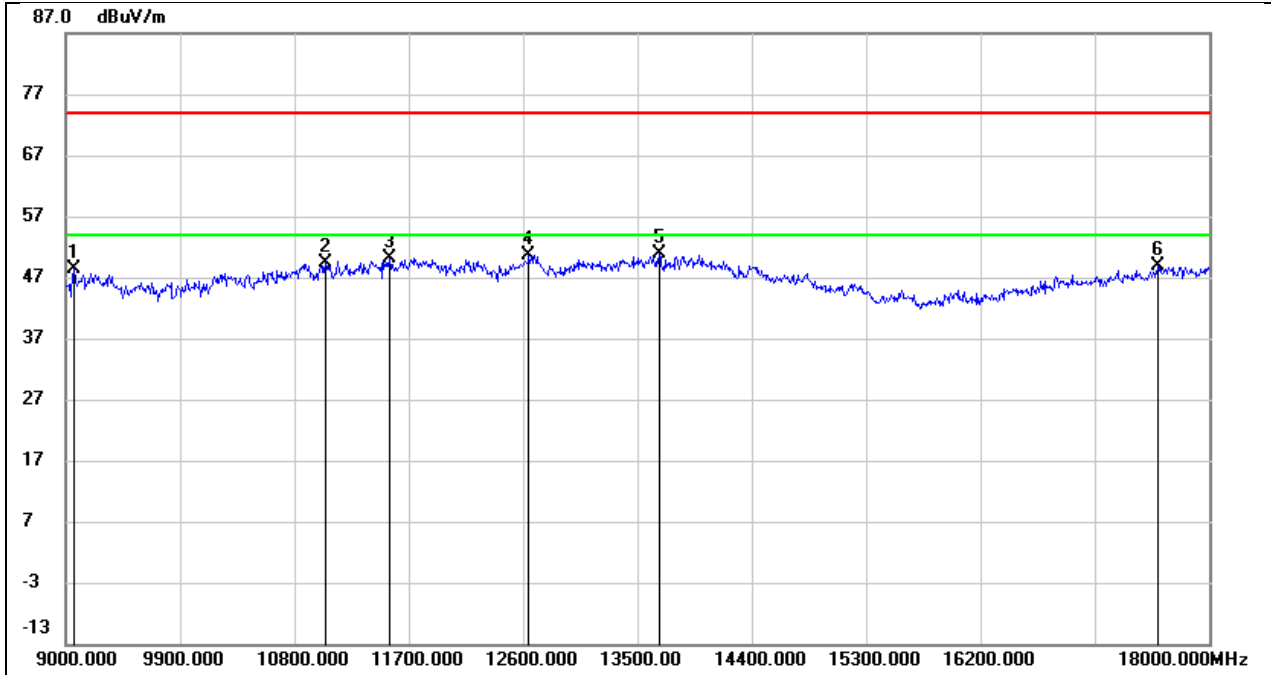

No.	Frequency (MHz)	Reading (dBuV)	Correct (dB/m)	Result (dBuV/m)	Limit (dBuV/m)	Margin (dB)	Remark
1	9063.000	37.64	10.82	48.46	74.00	-25.54	peak
2	11043.000	34.56	14.90	49.46	74.00	-24.54	peak
3	11547.000	33.49	16.66	50.15	74.00	-23.85	peak
4	12645.000	32.71	17.92	50.63	74.00	-23.37	peak
5	13671.000	29.82	21.18	51.00	74.00	-23.00	peak
6	17595.000	26.27	22.57	48.84	74.00	-25.16	peak

Test Mode:	802.11be EHT40	Frequency(MHz):	6285
Polarity:	Horizontal	Test Voltage:	DC 12 V

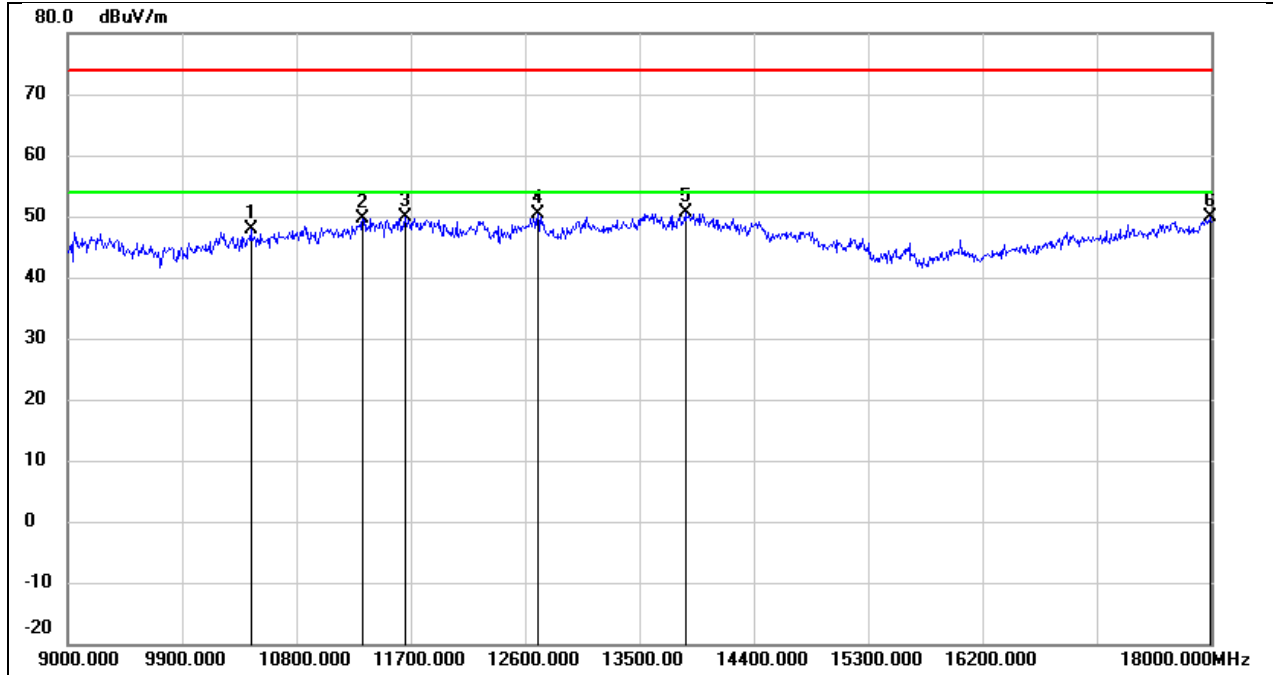

No.	Frequency (MHz)	Reading (dBuV)	Correct (dB/m)	Result (dBuV/m)	Limit (dBuV/m)	Margin (dB)	Remark
1	10440.000	34.87	13.00	47.87	74.00	-26.13	peak
2	11322.000	33.73	15.90	49.63	74.00	-24.37	peak
3	11655.000	32.97	16.95	49.92	74.00	-24.08	peak
4	12699.000	32.31	18.07	50.38	74.00	-23.62	peak
5	13860.000	28.96	21.59	50.55	74.00	-23.45	peak
6	17991.000	24.78	25.11	49.89	74.00	-24.11	peak

Test Mode:	802.11be EHT40	Frequency(MHz):	6285
Polarity:	Vertical	Test Voltage:	DC 12 V

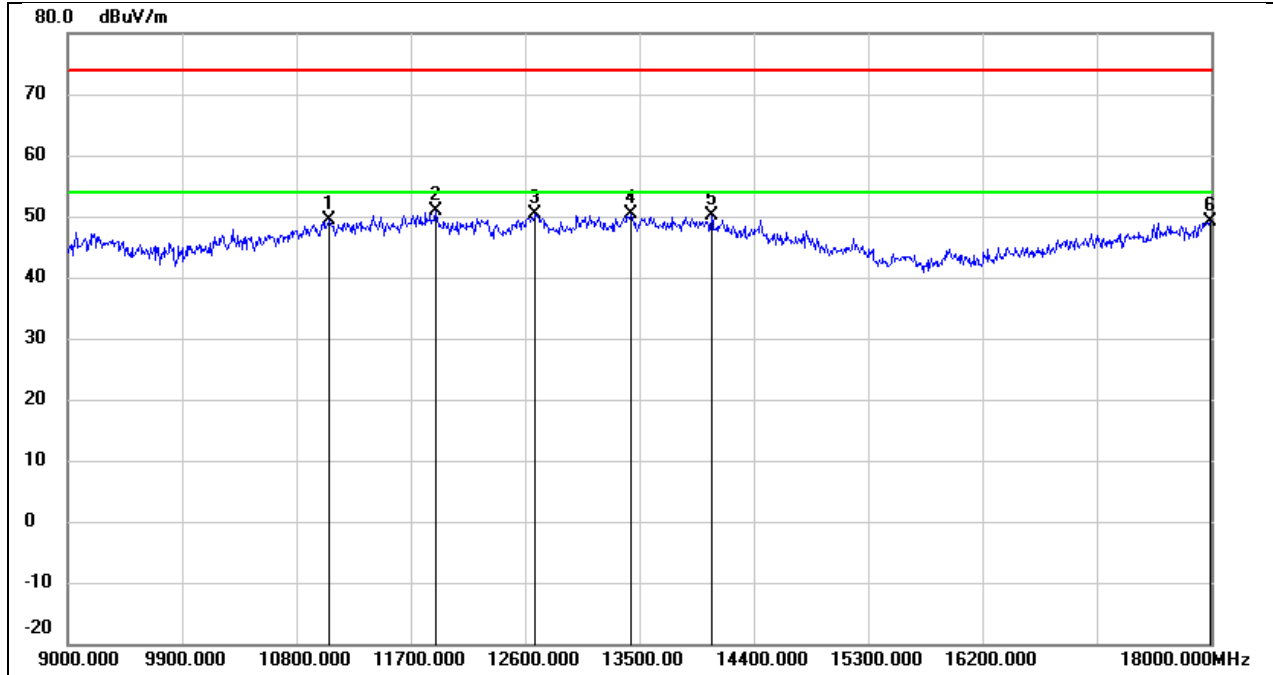

No.	Frequency (MHz)	Reading (dBuV)	Correct (dB/m)	Result (dBuV/m)	Limit (dBuV/m)	Margin (dB)	Remark
1	11052.000	34.48	14.94	49.42	74.00	-24.58	peak
2	11898.000	33.25	17.63	50.88	74.00	-23.12	peak
3	12681.000	32.23	18.03	50.26	74.00	-23.74	peak
4	13437.000	29.88	20.57	50.45	74.00	-23.55	peak
5	14067.000	28.43	21.59	50.02	74.00	-23.98	peak
6	17991.000	23.98	25.11	49.09	74.00	-24.91	peak

Test Mode:	802.11be EHT40	Frequency(MHz):	6405
Polarity:	Horizontal	Test Voltage:	DC 12 V

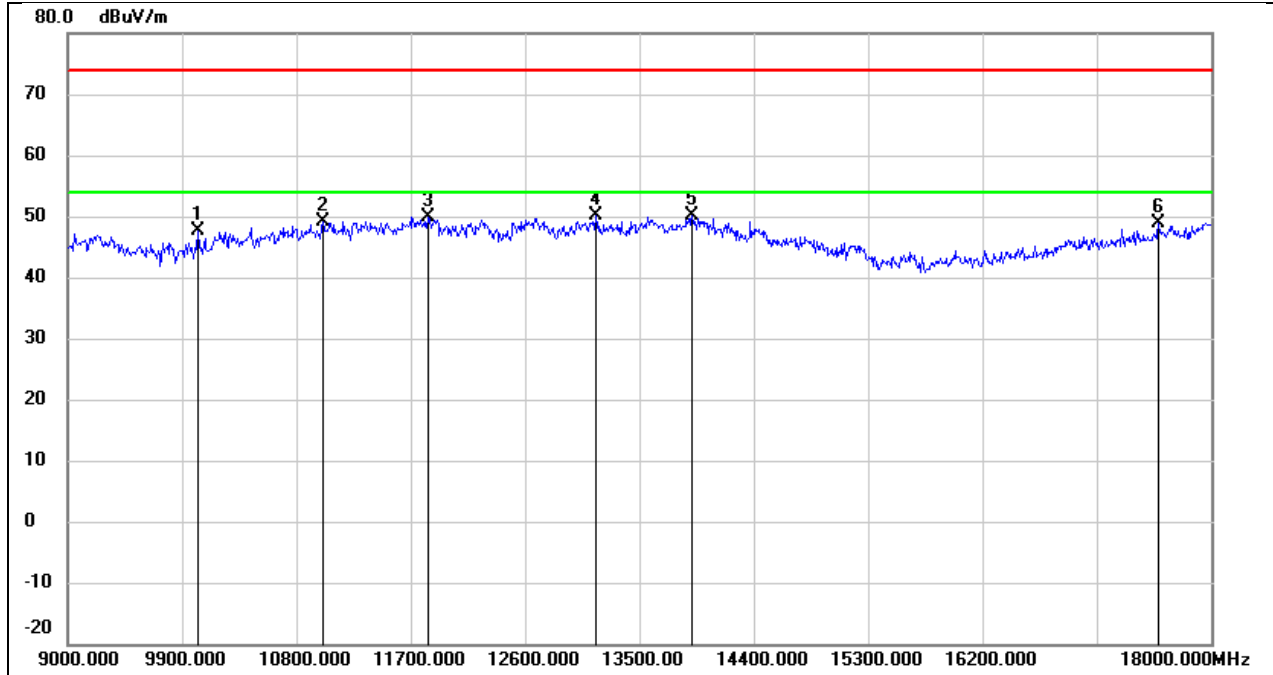

No.	Frequency (MHz)	Reading (dBuV)	Correct (dB/m)	Result (dBuV/m)	Limit (dBuV/m)	Margin (dB)	Remark
1	10026.000	35.41	12.14	47.55	74.00	-26.45	peak
2	11007.000	34.32	14.77	49.09	74.00	-24.91	peak
3	11835.000	32.39	17.46	49.85	74.00	-24.15	peak
4	13158.000	30.71	19.50	50.21	74.00	-23.79	peak
5	13914.000	28.53	21.69	50.22	74.00	-23.78	peak
6	17586.000	26.37	22.51	48.88	74.00	-25.12	peak

Test Mode:	802.11be EHT40	Frequency(MHz):	6405
Polarity:	Vertical	Test Voltage:	DC 12 V

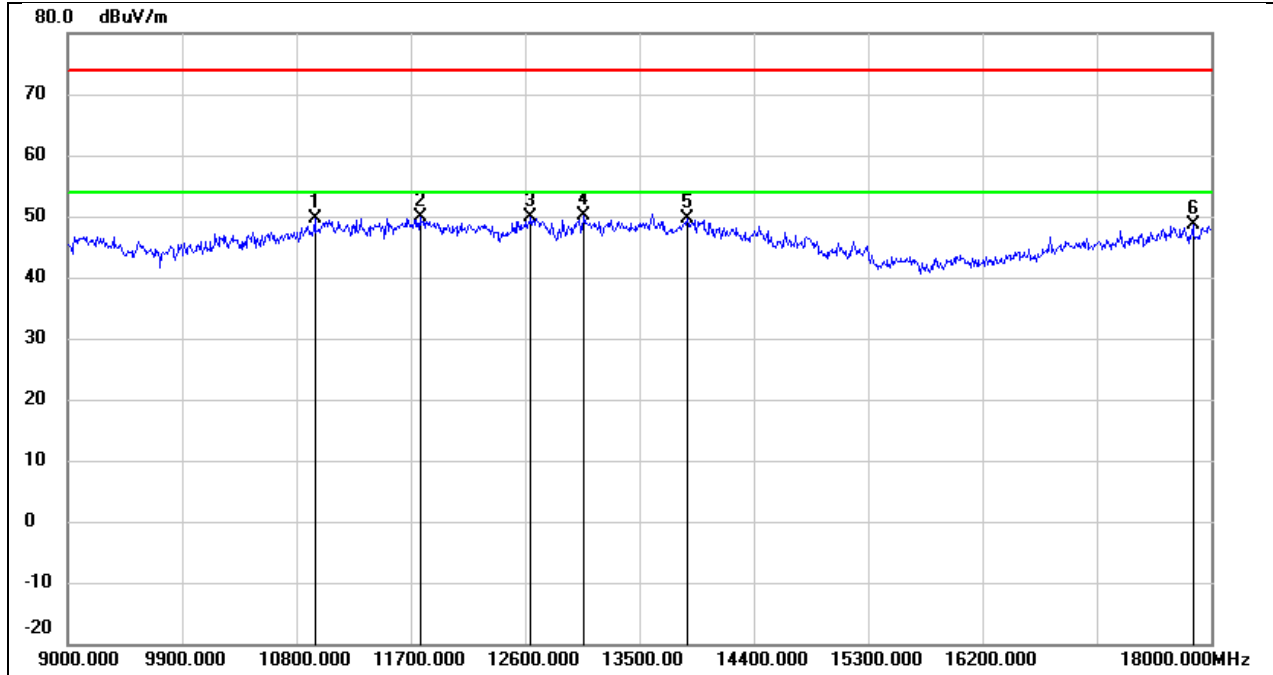

No.	Frequency (MHz)	Reading (dBuV)	Correct (dB/m)	Result (dBuV/m)	Limit (dBuV/m)	Margin (dB)	Remark
1	10944.000	35.17	14.56	49.73	74.00	-24.27	peak
2	11772.000	32.51	17.28	49.79	74.00	-24.21	peak
3	12645.000	31.92	17.92	49.84	74.00	-24.16	peak
4	13059.000	30.95	19.11	50.06	74.00	-23.94	peak
5	13878.000	28.08	21.62	49.70	74.00	-24.30	peak
6	17856.000	24.40	24.24	48.64	74.00	-25.36	peak

Test Mode:	802.11be EHT40	Frequency(MHz):	6445
Polarity:	Horizontal	Test Voltage:	DC 12 V

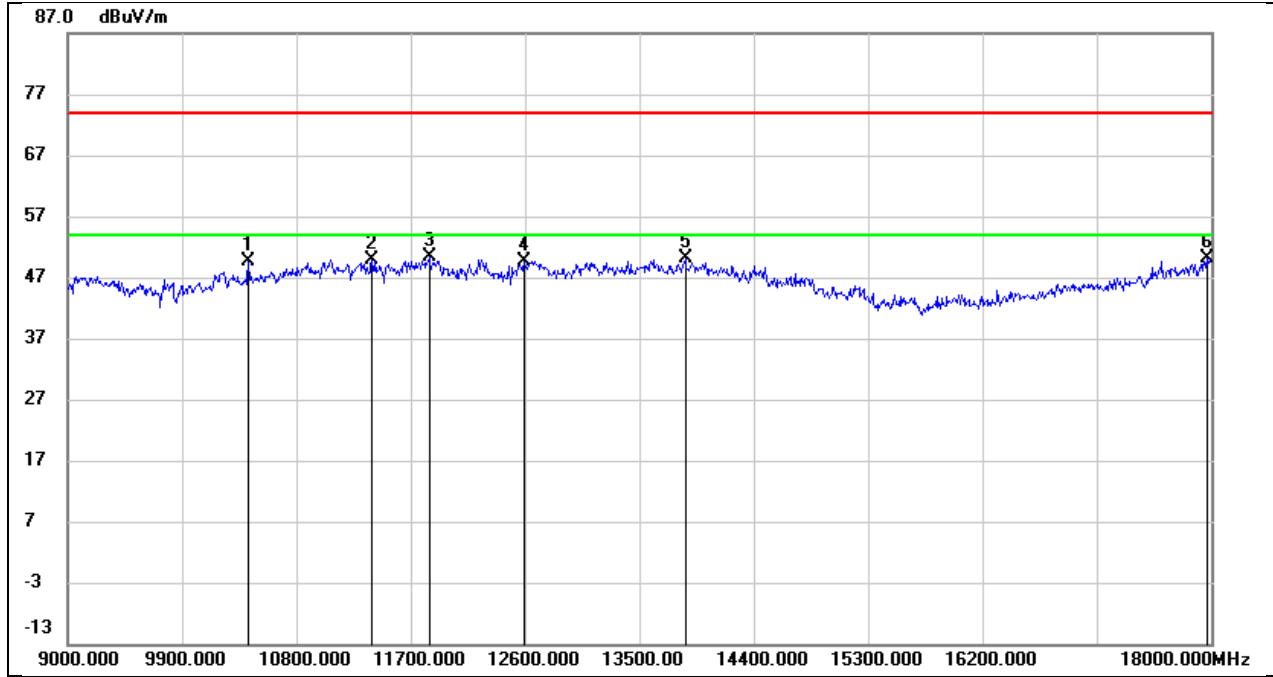

No.	Frequency (MHz)	Reading (dBuV)	Correct (dB/m)	Result (dBuV/m)	Limit (dBuV/m)	Margin (dB)	Remark
1	10422.000	36.73	12.96	49.69	74.00	-24.31	peak
2	11394.000	33.69	16.15	49.84	74.00	-24.16	peak
3	11844.000	32.82	17.48	50.30	74.00	-23.70	peak
4	12591.000	31.89	17.78	49.67	74.00	-24.33	peak
5	13860.000	28.43	21.59	50.02	74.00	-23.98	peak
6	17964.000	25.33	24.92	50.25	74.00	-23.75	peak

Test Mode:	802.11be EHT40	Frequency(MHz):	6445
Polarity:	Vertical	Test Voltage:	DC 12 V

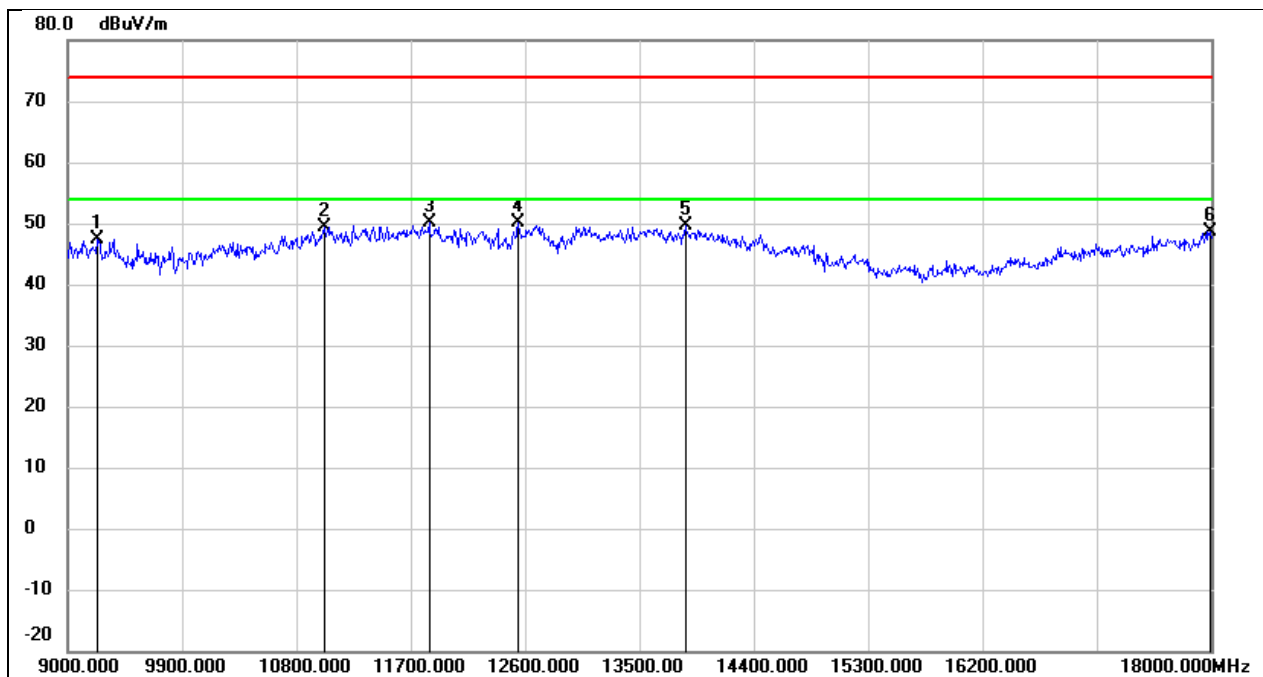

No.	Frequency (MHz)	Reading (dBuV)	Correct (dB/m)	Result (dBuV/m)	Limit (dBuV/m)	Margin (dB)	Remark
1	9234.000	36.64	10.84	47.48	74.00	-26.52	peak
2	11025.000	34.62	14.83	49.45	74.00	-24.55	peak
3	11844.000	32.54	17.48	50.02	74.00	-23.98	peak
4	12546.000	32.51	17.66	50.17	74.00	-23.83	peak
5	13860.000	27.98	21.59	49.57	74.00	-24.43	peak
6	17991.000	23.53	25.11	48.64	74.00	-25.36	peak

Test Mode:	802.11be EHT40	Frequency(MHz):	6485
Polarity:	Horizontal	Test Voltage:	DC 12 V

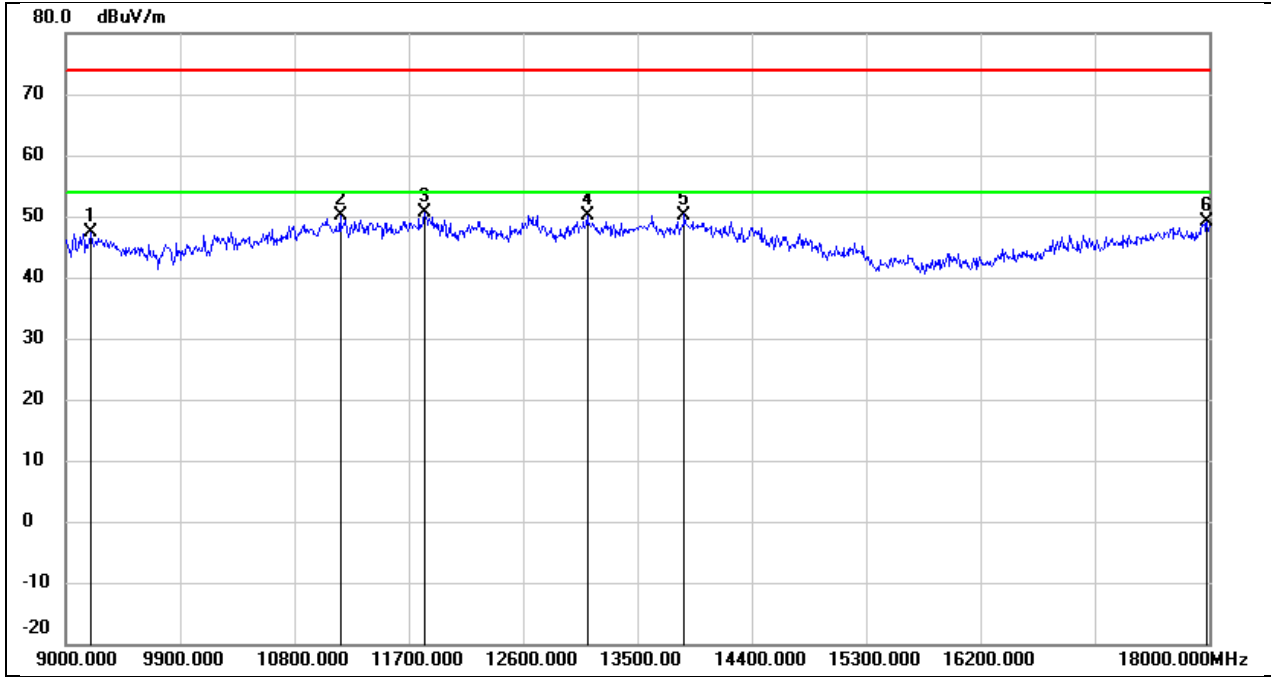

No.	Frequency (MHz)	Reading (dBuV)	Correct (dB/m)	Result (dBuV/m)	Limit (dBuV/m)	Margin (dB)	Remark
1	9198.000	36.50	10.85	47.35	74.00	-26.65	peak
2	11160.000	34.90	15.32	50.22	74.00	-23.78	peak
3	11826.000	33.13	17.42	50.55	74.00	-23.45	peak
4	13104.000	30.81	19.29	50.10	74.00	-23.90	peak
5	13869.000	28.66	21.59	50.25	74.00	-23.75	peak
6	17982.000	24.03	25.04	49.07	74.00	-24.93	peak

Test Mode:	802.11be EHT40	Frequency(MHz):	6485
Polarity:	Vertical	Test Voltage:	DC 12 V

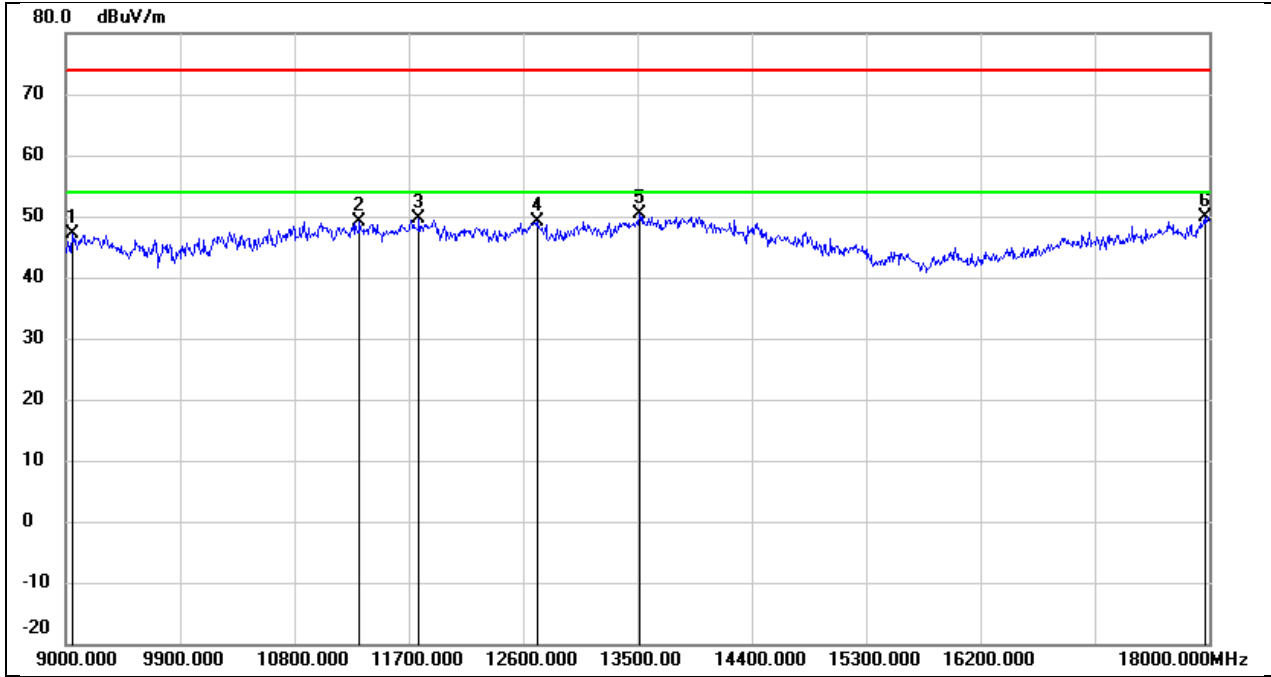

No.	Frequency (MHz)	Reading (dBuV)	Correct (dB/m)	Result (dBuV/m)	Limit (dBuV/m)	Margin (dB)	Remark
1	9054.000	36.28	10.82	47.10	74.00	-26.90	peak
2	11313.000	33.37	15.86	49.23	74.00	-24.77	peak
3	11781.000	32.25	17.30	49.55	74.00	-24.45	peak
4	12717.000	30.92	18.11	49.03	74.00	-24.97	peak
5	13518.000	29.64	20.85	50.49	74.00	-23.51	peak
6	17964.000	25.03	24.92	49.95	74.00	-24.05	peak

Test Mode:	802.11be EHT40	Frequency(MHz):	6525
Polarity:	Horizontal	Test Voltage:	DC 12 V

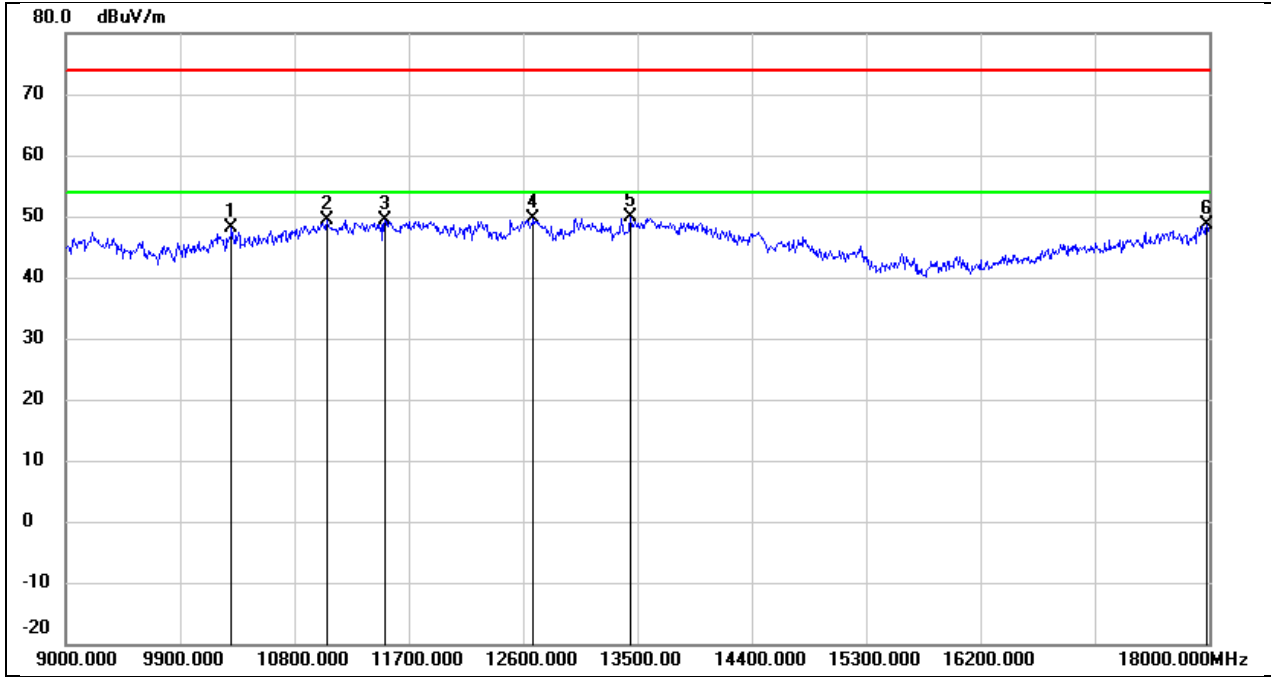

No.	Frequency (MHz)	Reading (dBuV)	Correct (dB/m)	Result (dBuV/m)	Limit (dBuV/m)	Margin (dB)	Remark
1	10305.000	35.41	12.72	48.13	74.00	-25.87	peak
2	11052.000	34.54	14.94	49.48	74.00	-24.52	peak
3	11511.000	32.72	16.56	49.28	74.00	-24.72	peak
4	12681.000	31.65	18.03	49.68	74.00	-24.32	peak
5	13446.000	29.16	20.60	49.76	74.00	-24.24	peak
6	17982.000	23.55	25.04	48.59	74.00	-25.41	peak

Test Mode:	802.11be EHT40	Frequency(MHz):	6525
Polarity:	Vertical	Test Voltage:	DC 12 V

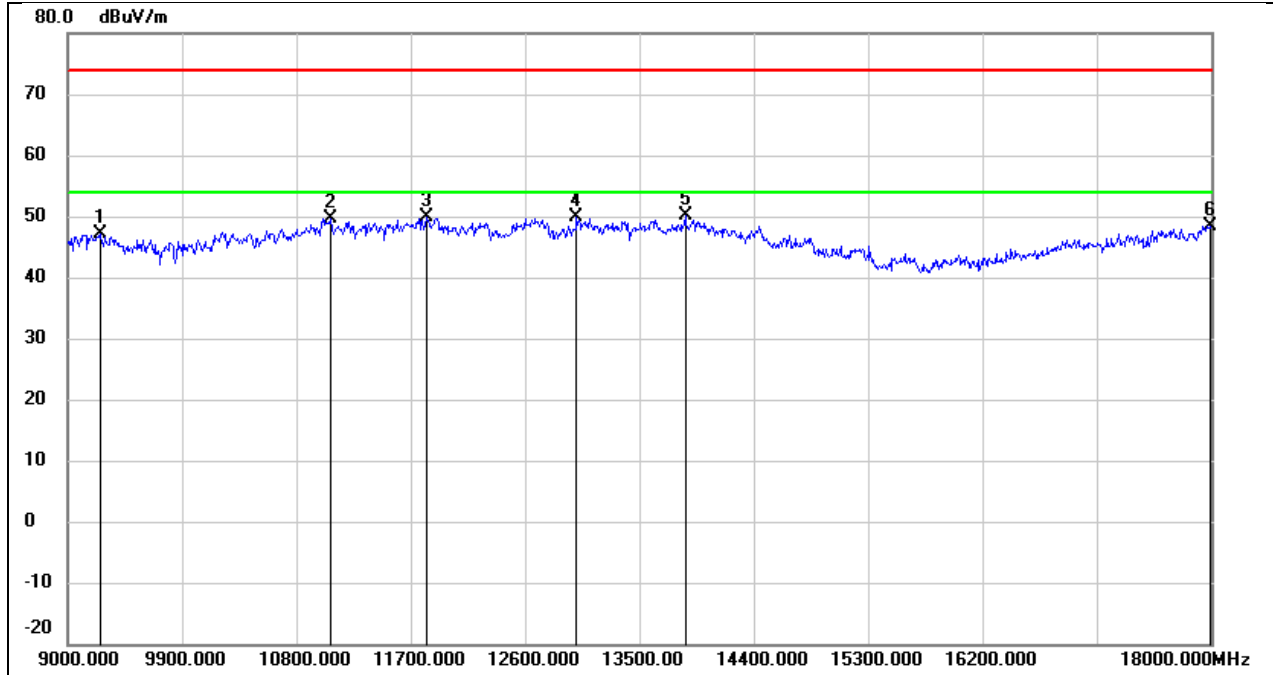

No.	Frequency (MHz)	Reading (dBuV)	Correct (dB/m)	Result (dBuV/m)	Limit (dBuV/m)	Margin (dB)	Remark
1	9252.000	36.23	10.85	47.08	74.00	-26.92	peak
2	11070.000	34.70	15.00	49.70	74.00	-24.30	peak
3	11826.000	32.41	17.42	49.83	74.00	-24.17	peak
4	13005.000	30.85	18.91	49.76	74.00	-24.24	peak
5	13860.000	28.42	21.59	50.01	74.00	-23.99	peak
6	17991.000	23.28	25.11	48.39	74.00	-25.61	peak

Test Mode:	802.11be EHT40	Frequency(MHz):	6565
Polarity:	Horizontal	Test Voltage:	DC 12 V

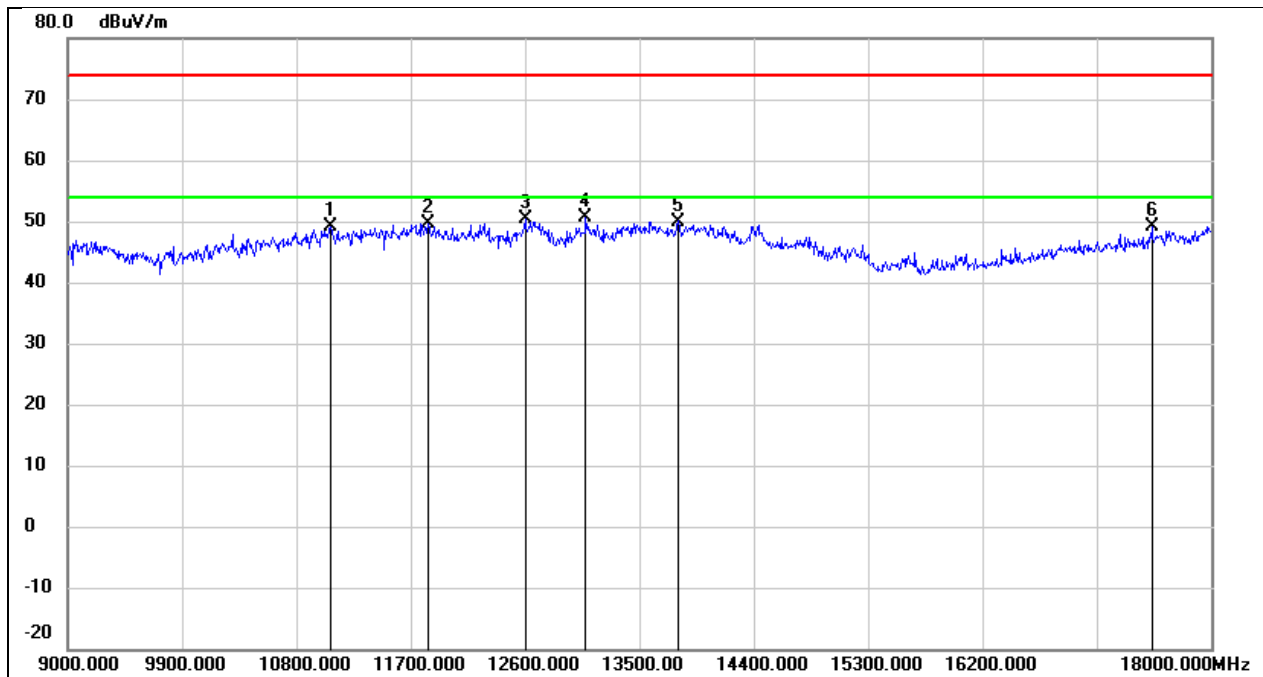

No.	Frequency (MHz)	Reading (dBuV)	Correct (dB/m)	Result (dBuV/m)	Limit (dBuV/m)	Margin (dB)	Remark
1	11070.000	34.24	15.00	49.24	74.00	-24.76	peak
2	11835.000	32.16	17.46	49.62	74.00	-24.38	peak
3	12600.000	32.61	17.80	50.41	74.00	-23.59	peak
4	13077.000	31.40	19.18	50.58	74.00	-23.42	peak
5	13806.000	28.54	21.46	50.00	74.00	-24.00	peak
6	17532.000	26.99	22.17	49.16	74.00	-24.84	peak

Test Mode:	802.11be EHT40	Frequency(MHz):	6565
Polarity:	Vertical	Test Voltage:	DC 12 V

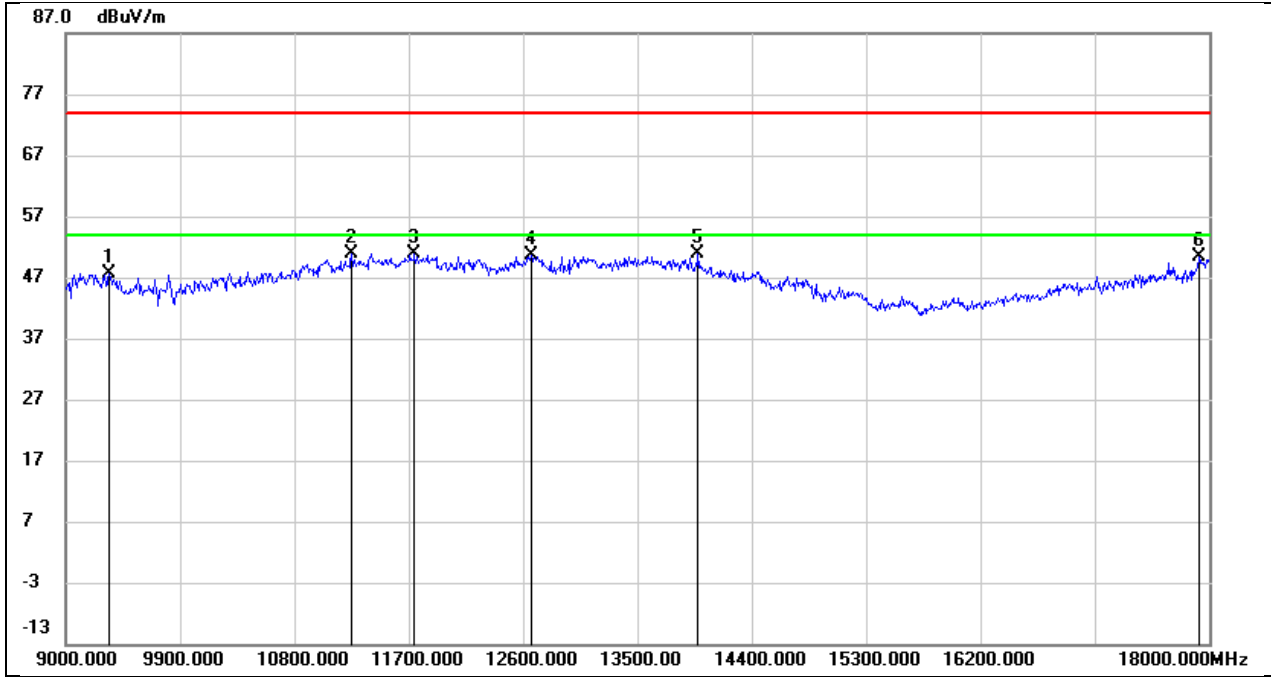

No.	Frequency (MHz)	Reading (dBuV)	Correct (dB/m)	Result (dBuV/m)	Limit (dBuV/m)	Margin (dB)	Remark
1	9342.000	36.76	10.87	47.63	74.00	-26.37	peak
2	11250.000	35.23	15.64	50.87	74.00	-23.13	peak
3	11745.000	33.70	17.21	50.91	74.00	-23.09	peak
4	12663.000	32.65	17.98	50.63	74.00	-23.37	peak
5	13977.000	29.04	21.83	50.87	74.00	-23.13	peak
6	17919.000	25.62	24.64	50.26	74.00	-23.74	peak

Test Mode:	802.11be EHT40	Frequency(MHz):	6725
Polarity:	Horizontal	Test Voltage:	DC 12 V

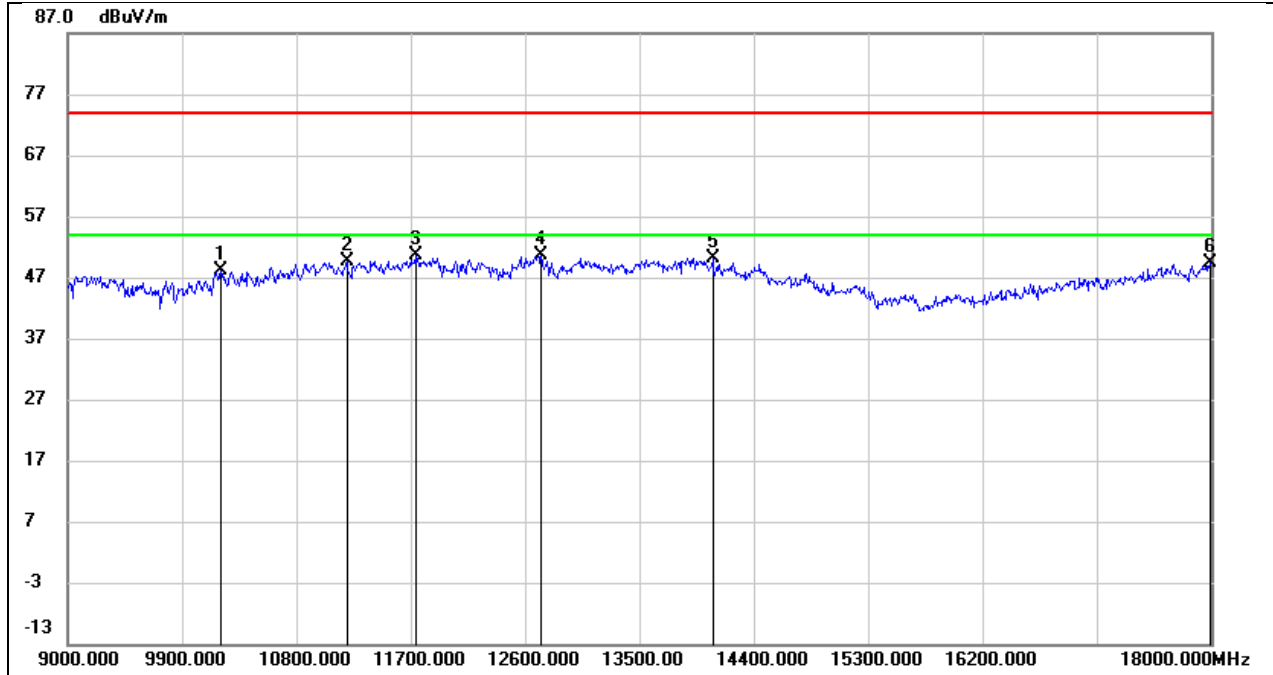

No.	Frequency (MHz)	Reading (dBuV)	Correct (dB/m)	Result (dBuV/m)	Limit (dBuV/m)	Margin (dB)	Remark
1	10206.000	35.72	12.51	48.23	74.00	-25.77	peak
2	11196.000	34.14	15.44	49.58	74.00	-24.42	peak
3	11736.000	33.56	17.18	50.74	74.00	-23.26	peak
4	12726.000	32.45	18.14	50.59	74.00	-23.41	peak
5	14076.000	28.62	21.54	50.16	74.00	-23.84	peak
6	17991.000	24.34	25.11	49.45	74.00	-24.55	peak

Test Mode:	802.11be EHT40	Frequency(MHz):	6725
Polarity:	Vertical	Test Voltage:	DC 12 V

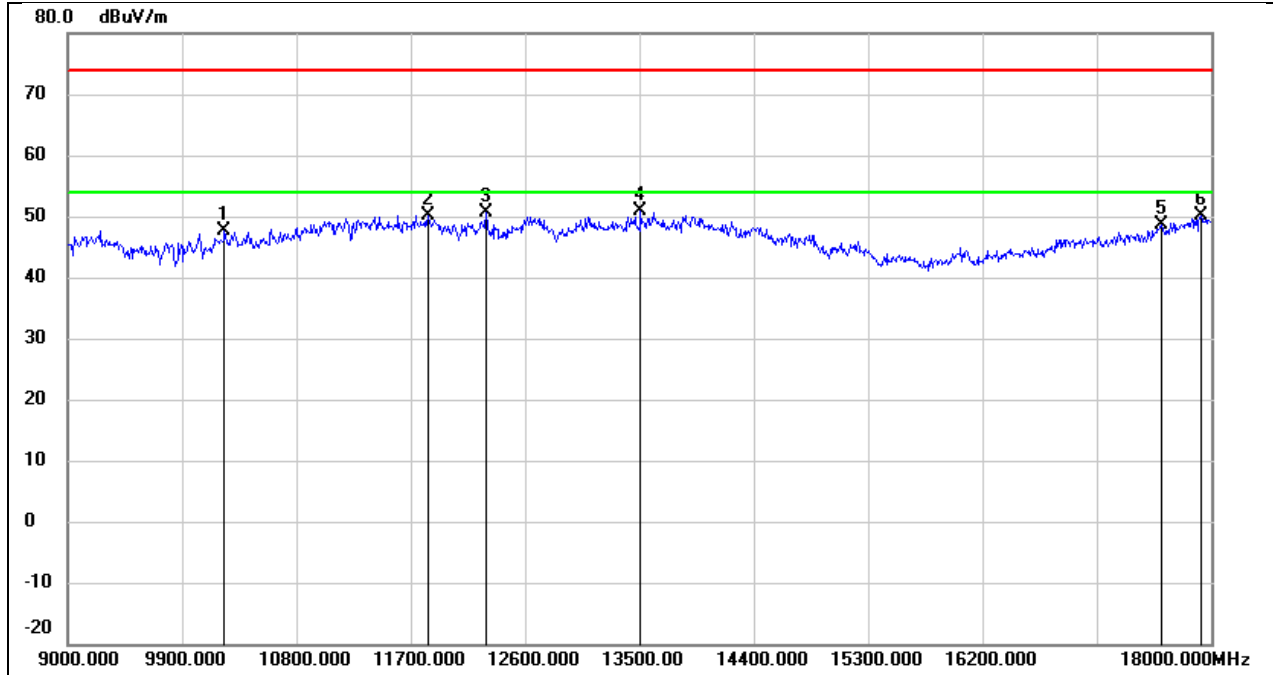

No.	Frequency (MHz)	Reading (dBuV)	Correct (dB/m)	Result (dBuV/m)	Limit (dBuV/m)	Margin (dB)	Remark
1	10233.000	35.13	12.57	47.70	74.00	-26.30	peak
2	11835.000	32.77	17.46	50.23	74.00	-23.77	peak
3	12294.000	32.84	17.68	50.52	74.00	-23.48	peak
4	13509.000	29.94	20.83	50.77	74.00	-23.23	peak
5	17613.000	26.01	22.69	48.70	74.00	-25.30	peak
6	17919.000	25.43	24.64	50.07	74.00	-23.93	peak

Test Mode:	802.11be EHT40	Frequency(MHz):	6845
Polarity:	Horizontal	Test Voltage:	DC 12 V

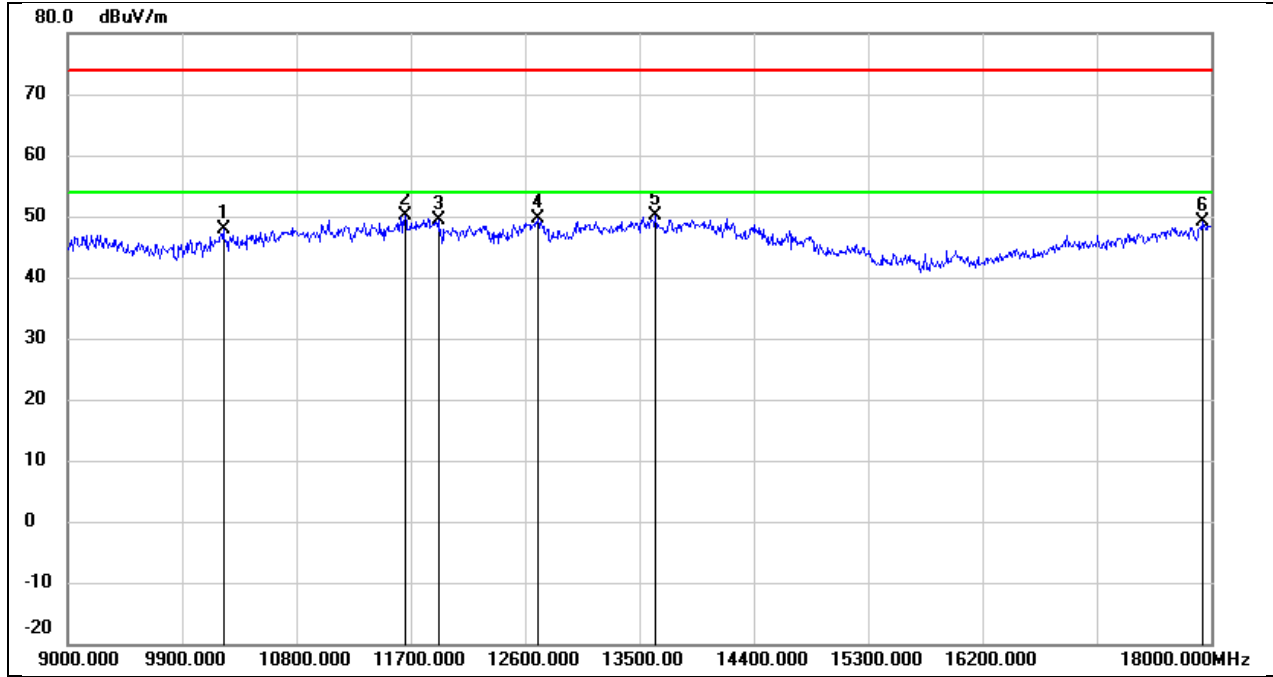

No.	Frequency (MHz)	Reading (dBuV)	Correct (dB/m)	Result (dBuV/m)	Limit (dBuV/m)	Margin (dB)	Remark
1	10224.000	35.24	12.55	47.79	74.00	-26.21	peak
2	11655.000	33.19	16.95	50.14	74.00	-23.86	peak
3	11916.000	31.69	17.68	49.37	74.00	-24.63	peak
4	12699.000	31.52	18.07	49.59	74.00	-24.41	peak
5	13626.000	28.95	21.08	50.03	74.00	-23.97	peak
6	17928.000	24.48	24.70	49.18	74.00	-24.82	peak

Test Mode:	802.11be EHT40	Frequency(MHz):	6845
Polarity:	Vertical	Test Voltage:	DC 12 V

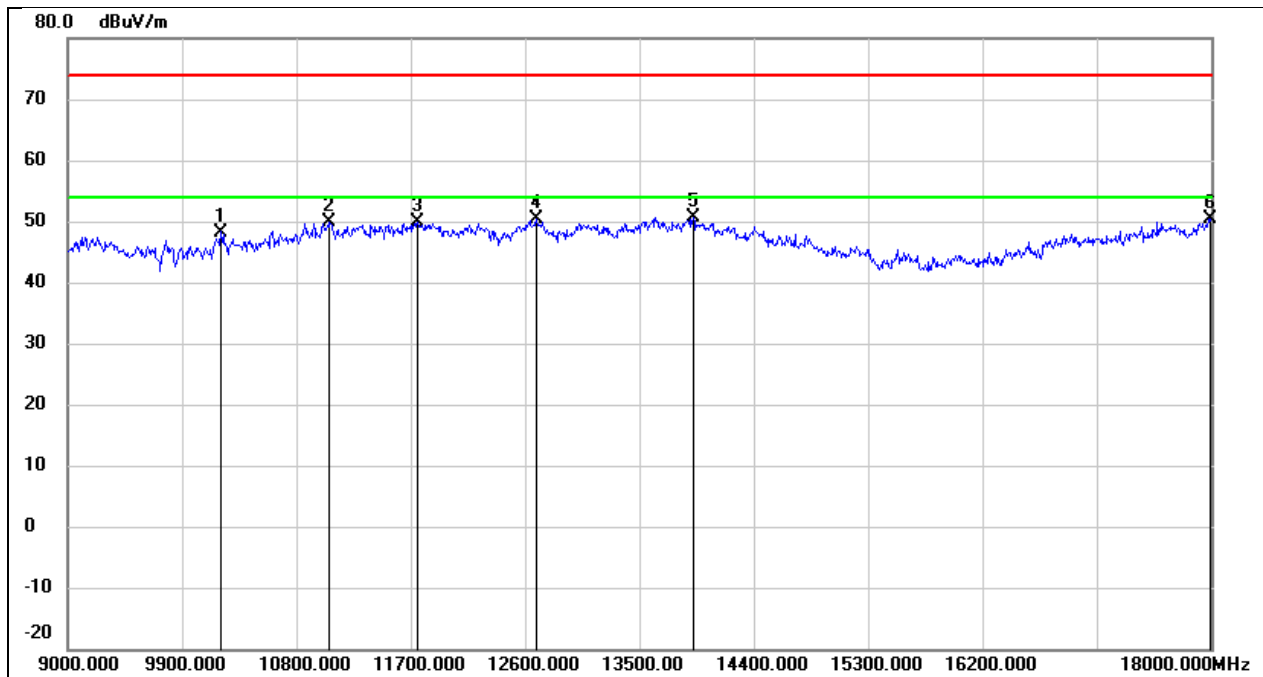

No.	Frequency (MHz)	Reading (dBuV)	Correct (dB/m)	Result (dBuV/m)	Limit (dBuV/m)	Margin (dB)	Remark
1	10206.000	35.74	12.51	48.25	74.00	-25.75	peak
2	11052.000	34.93	14.94	49.87	74.00	-24.13	peak
3	11754.000	32.59	17.23	49.82	74.00	-24.18	peak
4	12690.000	32.22	18.05	50.27	74.00	-23.73	peak
5	13923.000	28.88	21.72	50.60	74.00	-23.40	peak
6	17991.000	25.22	25.11	50.33	74.00	-23.67	peak

Test Mode:	802.11be EHT40	Frequency(MHz):	6885
Polarity:	Horizontal	Test Voltage:	DC 12 V

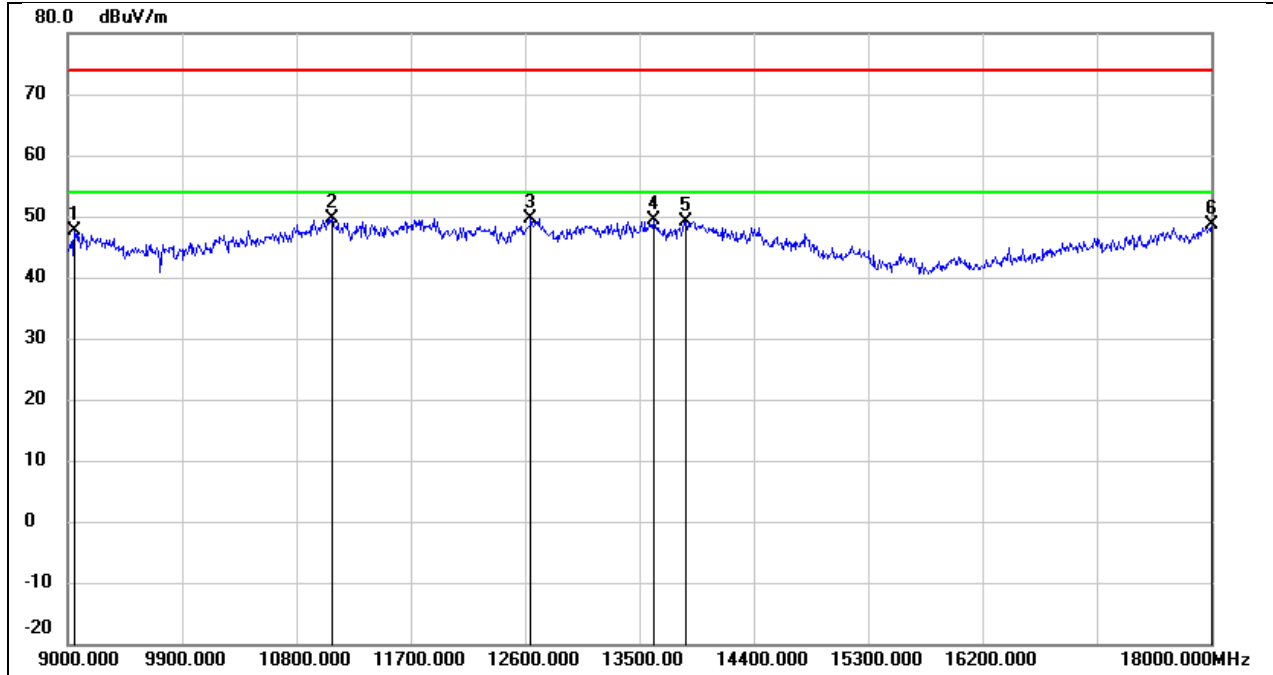

No.	Frequency (MHz)	Reading (dBuV)	Correct (dB/m)	Result (dBuV/m)	Limit (dBuV/m)	Margin (dB)	Remark
1	9054.000	36.76	10.82	47.58	74.00	-26.42	peak
2	11079.000	34.69	15.03	49.72	74.00	-24.28	peak
3	12645.000	31.80	17.92	49.72	74.00	-24.28	peak
4	13617.000	28.36	21.06	49.42	74.00	-24.58	peak
5	13869.000	27.57	21.59	49.16	74.00	-24.84	peak
6	18000.000	23.50	25.16	48.66	74.00	-25.34	peak

Test Mode:	802.11be EHT40	Frequency(MHz):	6885
Polarity:	Vertical	Test Voltage:	DC 12 V

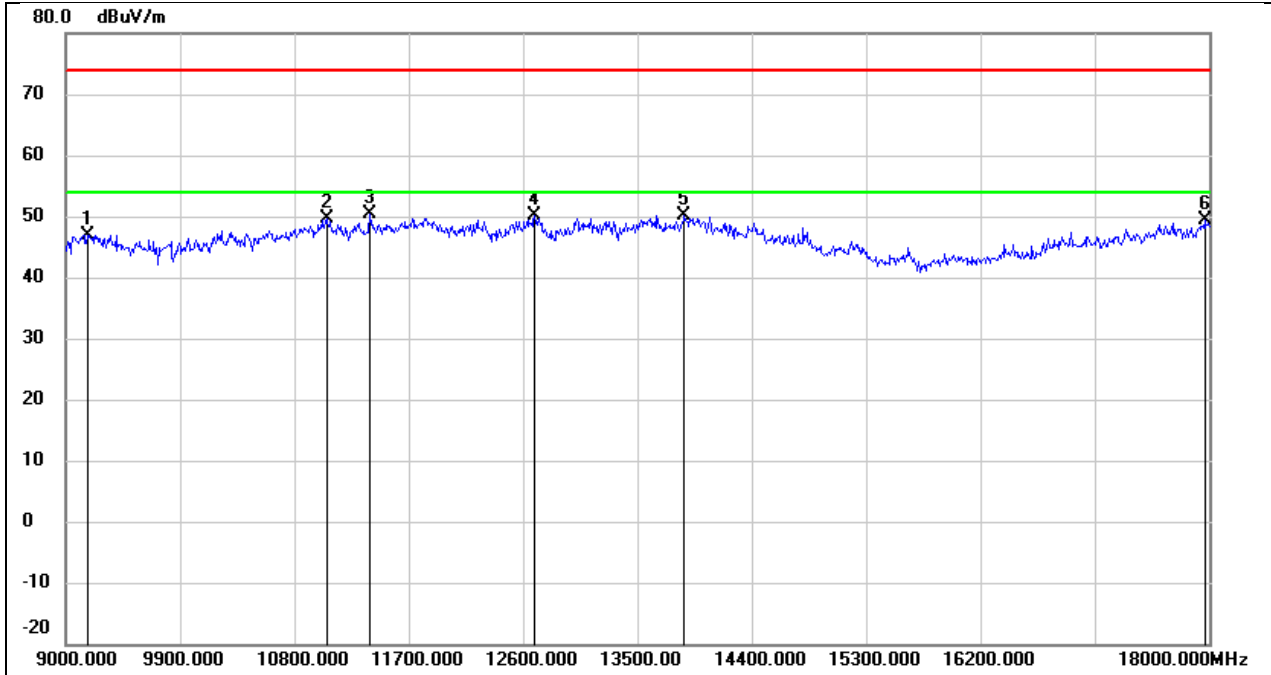

No.	Frequency (MHz)	Reading (dBuV)	Correct (dB/m)	Result (dBuV/m)	Limit (dBuV/m)	Margin (dB)	Remark
1	9171.000	36.16	10.83	46.99	74.00	-27.01	peak
2	11052.000	34.59	14.94	49.53	74.00	-24.47	peak
3	11394.000	34.24	16.15	50.39	74.00	-23.61	peak
4	12690.000	31.96	18.05	50.01	74.00	-23.99	peak
5	13869.000	28.61	21.59	50.20	74.00	-23.80	peak
6	17964.000	24.54	24.92	49.46	74.00	-24.54	peak

Test Mode:	802.11be EHT40	Frequency(MHz):	7005
Polarity:	Horizontal	Test Voltage:	DC 12 V

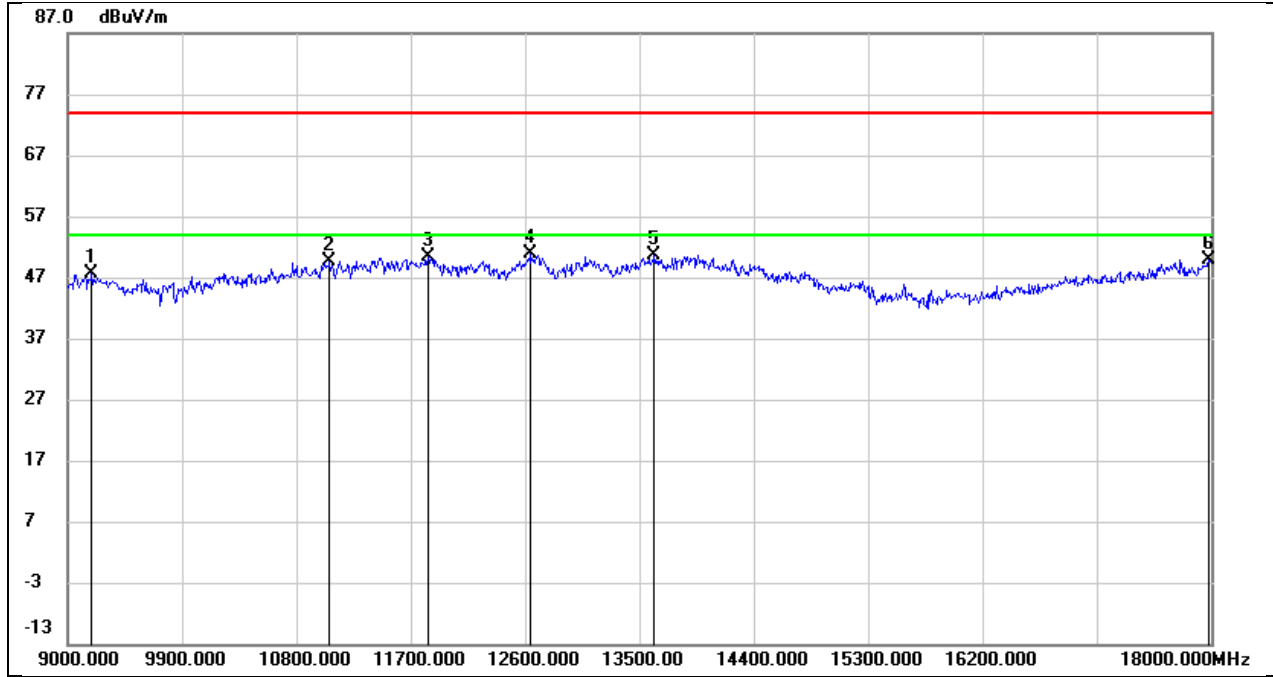

No.	Frequency (MHz)	Reading (dBuV)	Correct (dB/m)	Result (dBuV/m)	Limit (dBuV/m)	Margin (dB)	Remark
1	9189.000	36.67	10.84	47.51	74.00	-26.49	peak
2	11061.000	34.73	14.96	49.69	74.00	-24.31	peak
3	11835.000	33.02	17.46	50.48	74.00	-23.52	peak
4	12645.000	32.87	17.92	50.79	74.00	-23.21	peak
5	13617.000	29.65	21.06	50.71	74.00	-23.29	peak
6	17982.000	24.95	25.04	49.99	74.00	-24.01	peak

Test Mode:	802.11be EHT40	Frequency(MHz):	7005
Polarity:	Vertical	Test Voltage:	DC 12 V

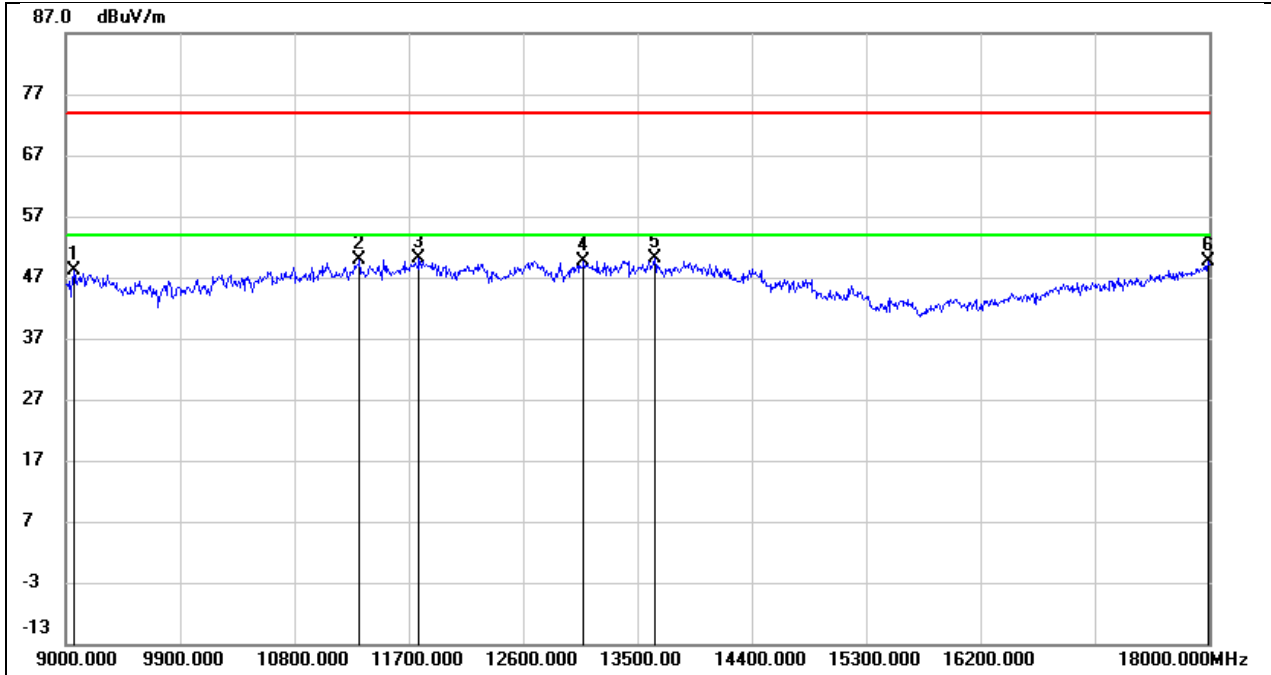

No.	Frequency (MHz)	Reading (dBuV)	Correct (dB/m)	Result (dBuV/m)	Limit (dBuV/m)	Margin (dB)	Remark
1	9063.000	37.27	10.82	48.09	74.00	-25.91	peak
2	11313.000	34.12	15.86	49.98	74.00	-24.02	peak
3	11781.000	32.71	17.30	50.01	74.00	-23.99	peak
4	13077.000	30.54	19.18	49.72	74.00	-24.28	peak
5	13635.000	29.07	21.10	50.17	74.00	-23.83	peak
6	17991.000	24.62	25.11	49.73	74.00	-24.27	peak

Test Mode:	802.11be EHT40	Frequency(MHz):	7085
Polarity:	Horizontal	Test Voltage:	DC 12 V

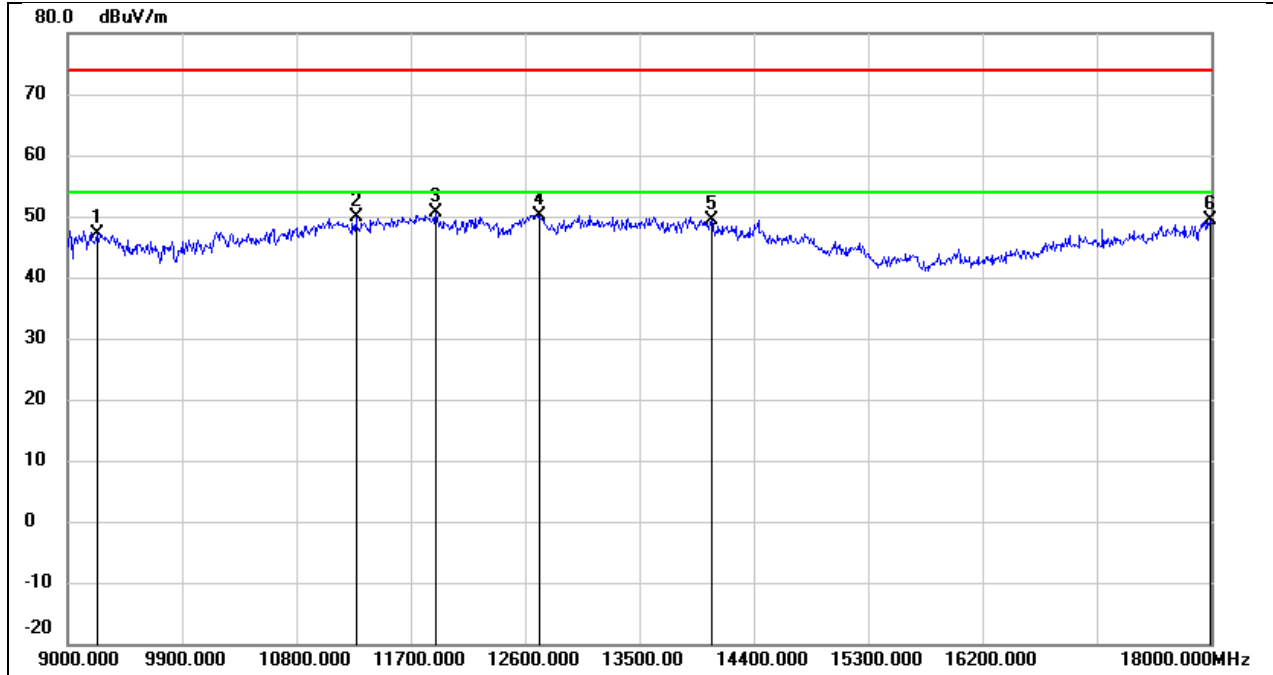

No.	Frequency (MHz)	Reading (dBuV)	Correct (dB/m)	Result (dBuV/m)	Limit (dBuV/m)	Margin (dB)	Remark
1	9234.000	36.27	10.84	47.11	74.00	-26.89	peak
2	11268.000	34.09	15.71	49.80	74.00	-24.20	peak
3	11898.000	32.94	17.63	50.57	74.00	-23.43	peak
4	12717.000	32.07	18.11	50.18	74.00	-23.82	peak
5	14067.000	27.84	21.59	49.43	74.00	-24.57	peak
6	17991.000	24.16	25.11	49.27	74.00	-24.73	peak

Test Mode:	802.11be EHT40	Frequency(MHz):	7085
Polarity:	Vertical	Test Voltage:	DC 12 V

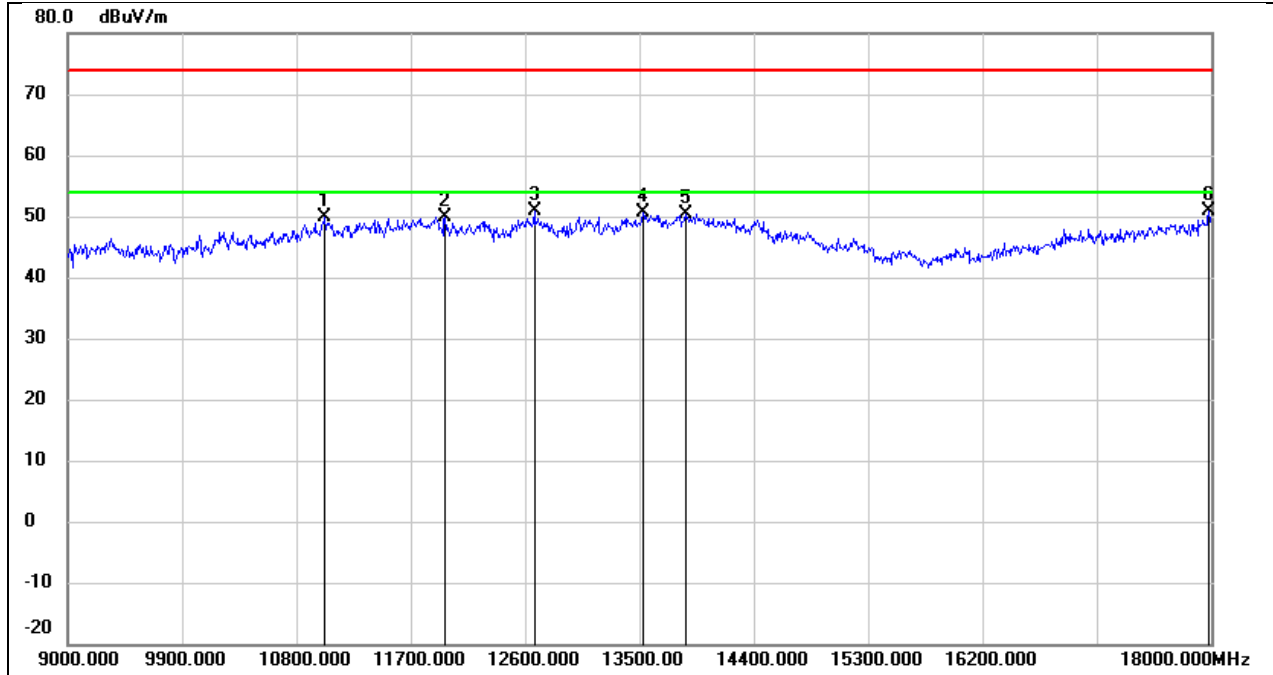

No.	Frequency (MHz)	Reading (dBuV)	Correct (dB/m)	Result (dBuV/m)	Limit (dBuV/m)	Margin (dB)	Remark
1	11025.000	35.10	14.83	49.93	74.00	-24.07	peak
2	11970.000	32.02	17.83	49.85	74.00	-24.15	peak
3	12672.000	32.85	18.00	50.85	74.00	-23.15	peak
4	13527.000	29.79	20.87	50.66	74.00	-23.34	peak
5	13860.000	28.84	21.59	50.43	74.00	-23.57	peak
6	17982.000	25.79	25.04	50.83	74.00	-23.17	peak

Test Mode:	802.11be EHT80	Frequency(MHz):	6145
Polarity:	Horizontal	Test Voltage:	DC 12 V

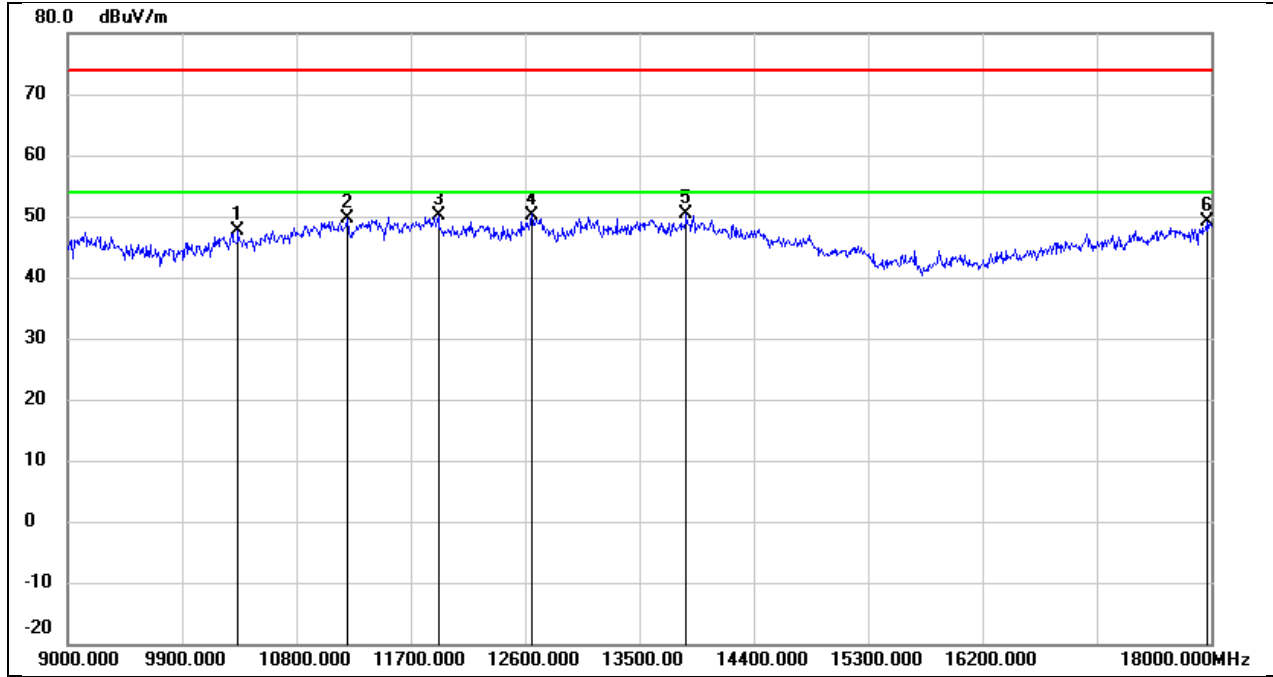

No.	Frequency (MHz)	Reading (dBuV)	Correct (dB/m)	Result (dBuV/m)	Limit (dBuV/m)	Margin (dB)	Remark
1	10341.000	34.87	12.79	47.66	74.00	-26.34	peak
2	11205.000	34.12	15.48	49.60	74.00	-24.40	peak
3	11916.000	32.34	17.68	50.02	74.00	-23.98	peak
4	12654.000	32.31	17.94	50.25	74.00	-23.75	peak
5	13869.000	28.71	21.59	50.30	74.00	-23.70	peak
6	17964.000	24.19	24.92	49.11	74.00	-24.89	peak

Test Mode:	802.11be EHT80	Frequency(MHz):	6145
Polarity:	Vertical	Test Voltage:	DC 12 V

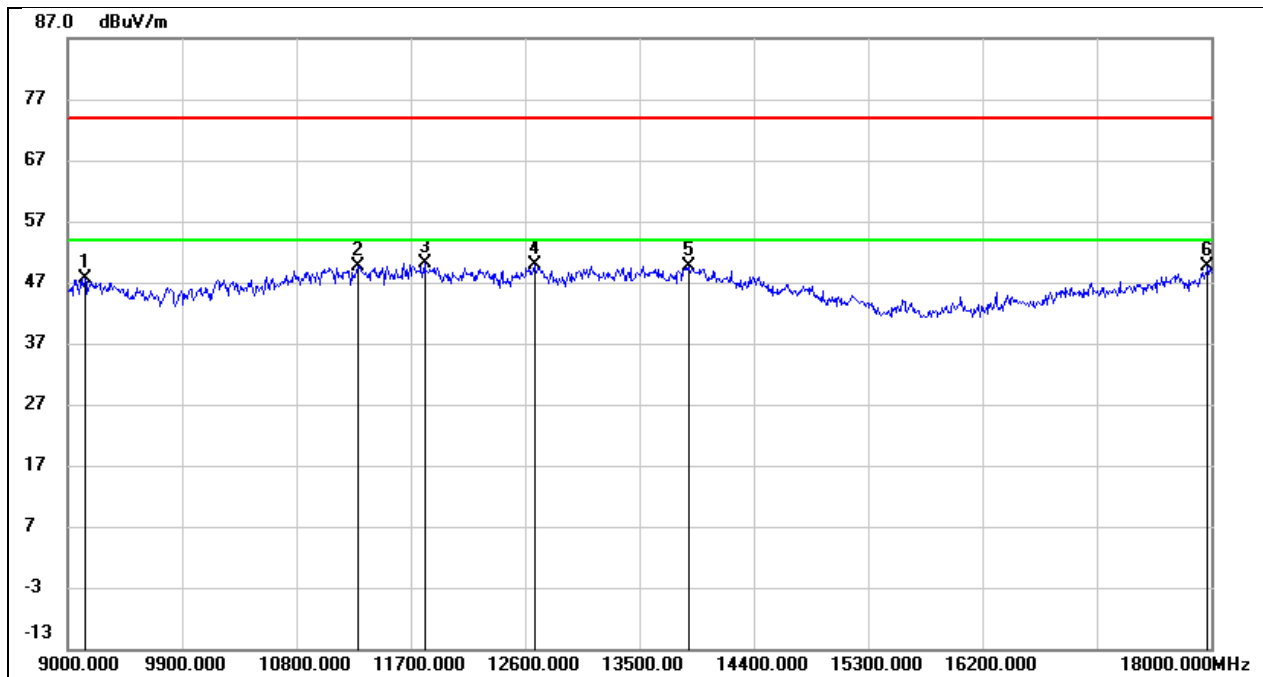

No.	Frequency (MHz)	Reading (dBuV)	Correct (dB/m)	Result (dBuV/m)	Limit (dBuV/m)	Margin (dB)	Remark
1	9135.000	36.81	10.84	47.65	74.00	-26.35	peak
2	11286.000	33.81	15.77	49.58	74.00	-24.42	peak
3	11808.000	32.73	17.38	50.11	74.00	-23.89	peak
4	12672.000	31.83	18.00	49.83	74.00	-24.17	peak
5	13887.000	28.02	21.64	49.66	74.00	-24.34	peak
6	17973.000	24.74	24.99	49.73	74.00	-24.27	peak

Test Mode:	802.11be EHT80	Frequency(MHz):	6225
Polarity:	Horizontal	Test Voltage:	DC 12 V

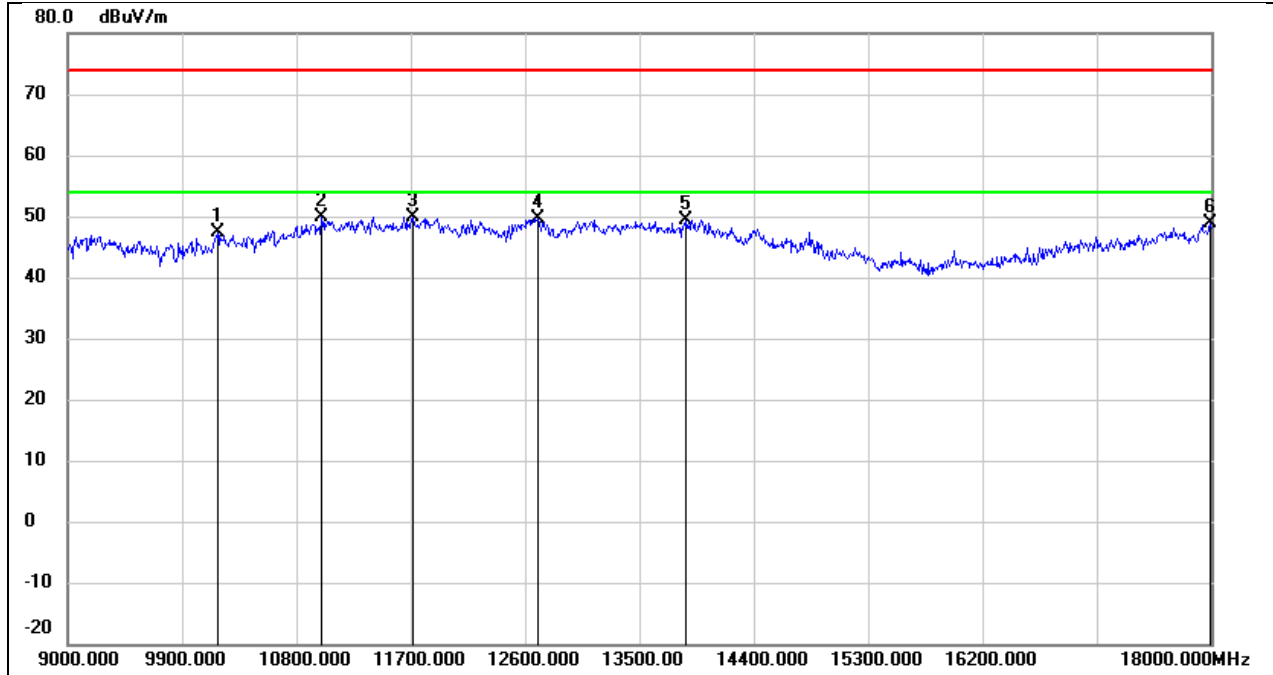

No.	Frequency (MHz)	Reading (dBuV)	Correct (dB/m)	Result (dBuV/m)	Limit (dBuV/m)	Margin (dB)	Remark
1	10179.000	34.87	12.45	47.32	74.00	-26.68	peak
2	10998.000	35.10	14.75	49.85	74.00	-24.15	peak
3	11718.000	32.75	17.13	49.88	74.00	-24.12	peak
4	12699.000	31.53	18.07	49.60	74.00	-24.40	peak
5	13869.000	27.86	21.59	49.45	74.00	-24.55	peak
6	17991.000	23.88	25.11	48.99	74.00	-25.01	peak

Test Mode:	802.11be EHT80	Frequency(MHz):	6225
Polarity:	Vertical	Test Voltage:	DC 12 V

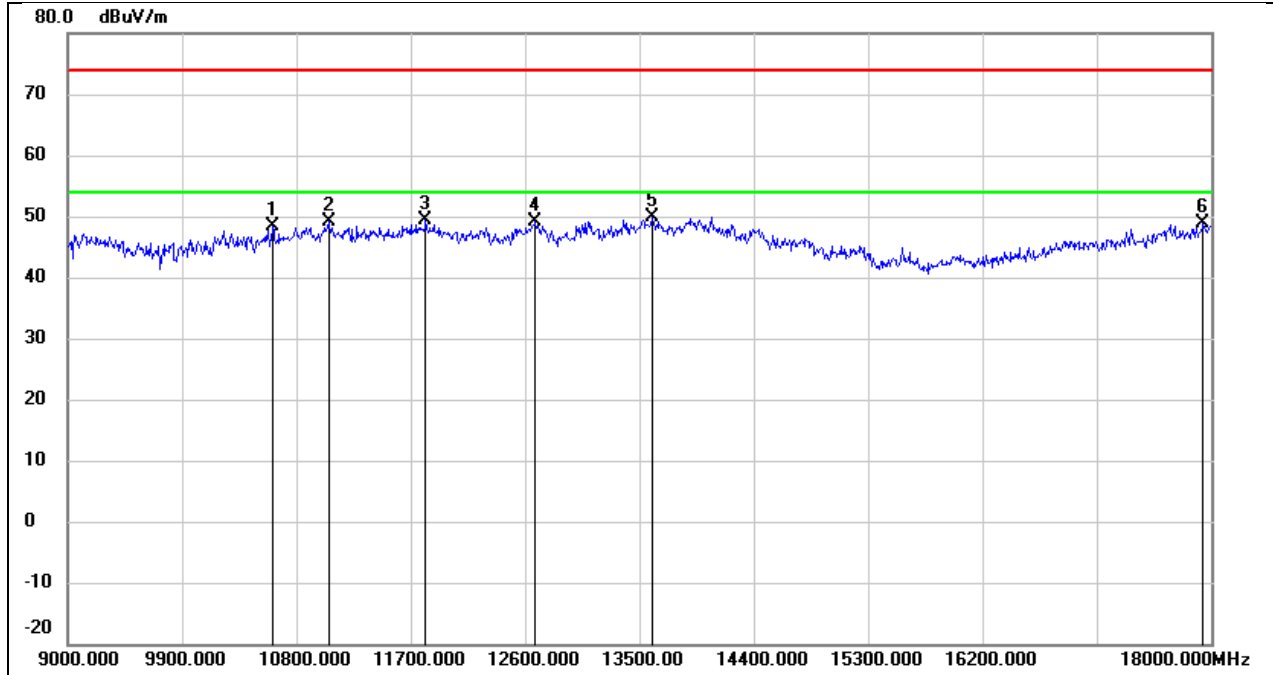

No.	Frequency (MHz)	Reading (dBuV)	Correct (dB/m)	Result (dBuV/m)	Limit (dBuV/m)	Margin (dB)	Remark
1	10611.000	34.99	13.48	48.47	74.00	-25.53	peak
2	11052.000	34.23	14.94	49.17	74.00	-24.83	peak
3	11817.000	32.08	17.40	49.48	74.00	-24.52	peak
4	12681.000	31.15	18.03	49.18	74.00	-24.82	peak
5	13599.000	28.79	21.02	49.81	74.00	-24.19	peak
6	17937.000	24.03	24.76	48.79	74.00	-25.21	peak

Test Mode:	802.11be EHT80	Frequency(MHz):	6385
Polarity:	Horizontal	Test Voltage:	DC 12 V

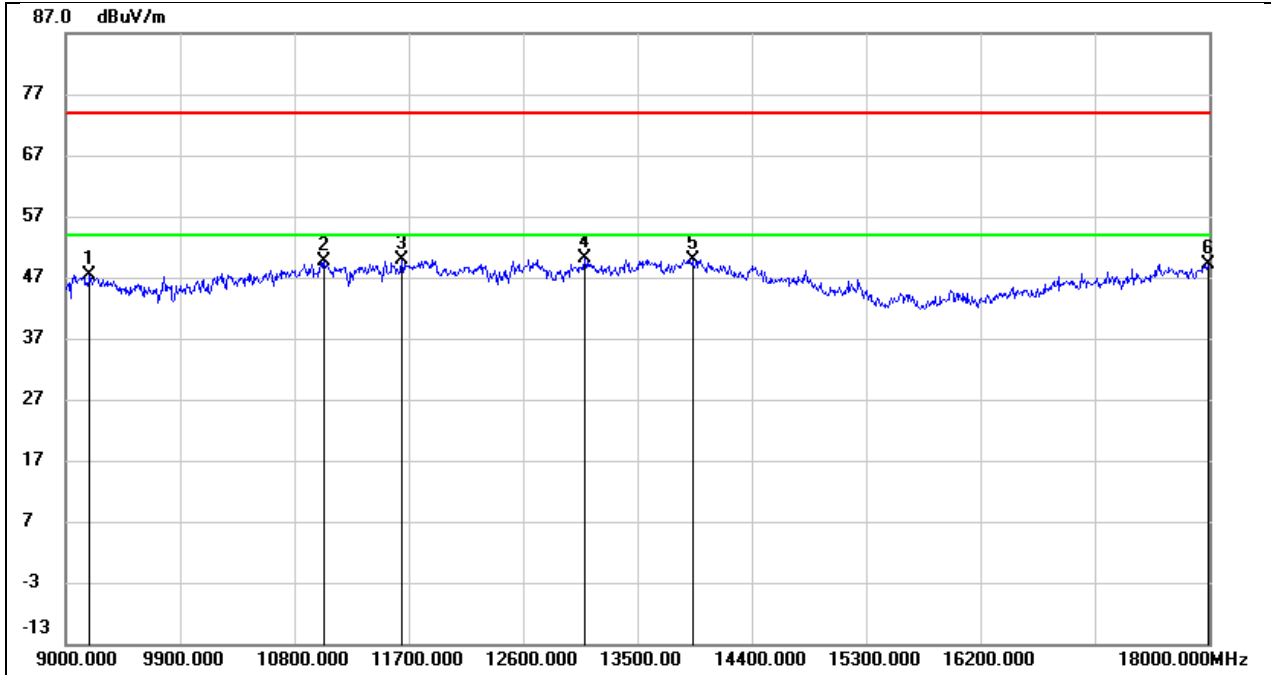

No.	Frequency (MHz)	Reading (dBuV)	Correct (dB/m)	Result (dBuV/m)	Limit (dBuV/m)	Margin (dB)	Remark
1	9189.000	36.55	10.84	47.39	74.00	-26.61	peak
2	11034.000	34.77	14.87	49.64	74.00	-24.36	peak
3	11646.000	32.86	16.94	49.80	74.00	-24.20	peak
4	13086.000	30.79	19.22	50.01	74.00	-23.99	peak
5	13932.000	28.21	21.74	49.95	74.00	-24.05	peak
6	17991.000	24.00	25.11	49.11	74.00	-24.89	peak

Test Mode:	802.11be EHT80	Frequency(MHz):	6385
Polarity:	Vertical	Test Voltage:	DC 12 V

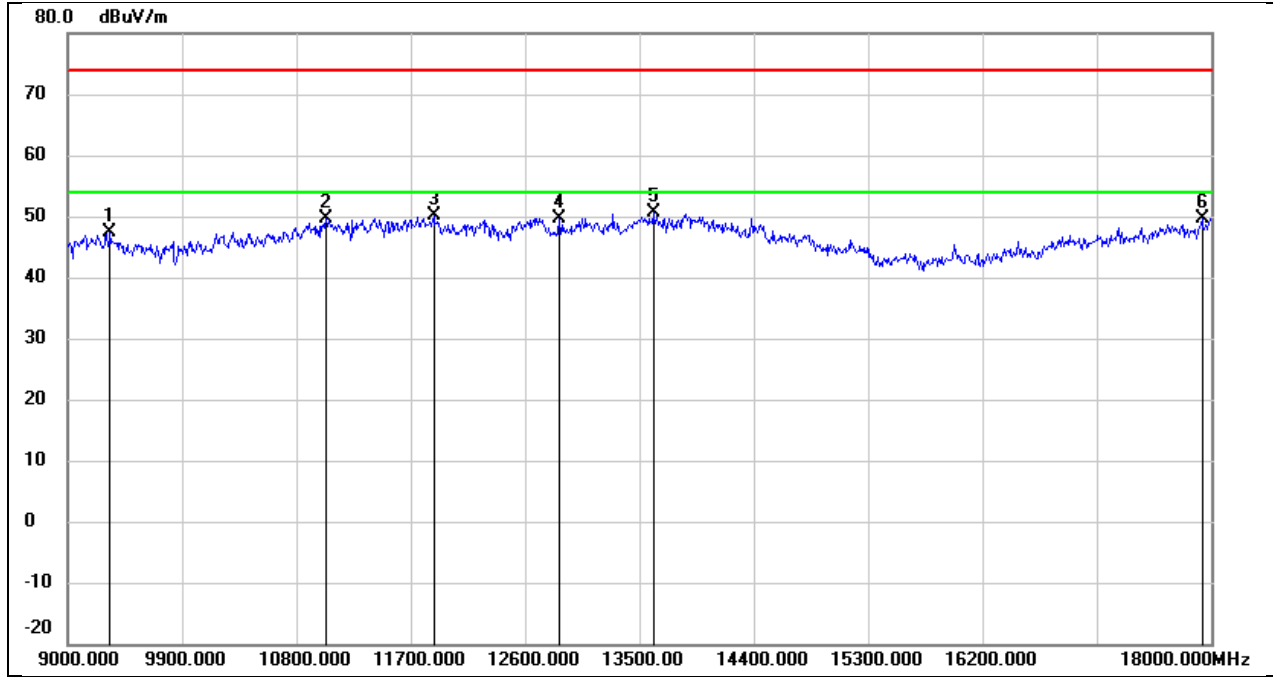

No.	Frequency (MHz)	Reading (dBuV)	Correct (dB/m)	Result (dBuV/m)	Limit (dBuV/m)	Margin (dB)	Remark
1	9333.000	36.57	10.86	47.43	74.00	-26.57	peak
2	11034.000	34.74	14.87	49.61	74.00	-24.39	peak
3	11880.000	32.49	17.58	50.07	74.00	-23.93	peak
4	12870.000	31.17	18.53	49.70	74.00	-24.30	peak
5	13608.000	29.58	21.05	50.63	74.00	-23.37	peak
6	17928.000	25.02	24.70	49.72	74.00	-24.28	peak

Test Mode:	802.11be EHT80	Frequency(MHz):	6465
Polarity:	Horizontal	Test Voltage:	DC 12 V

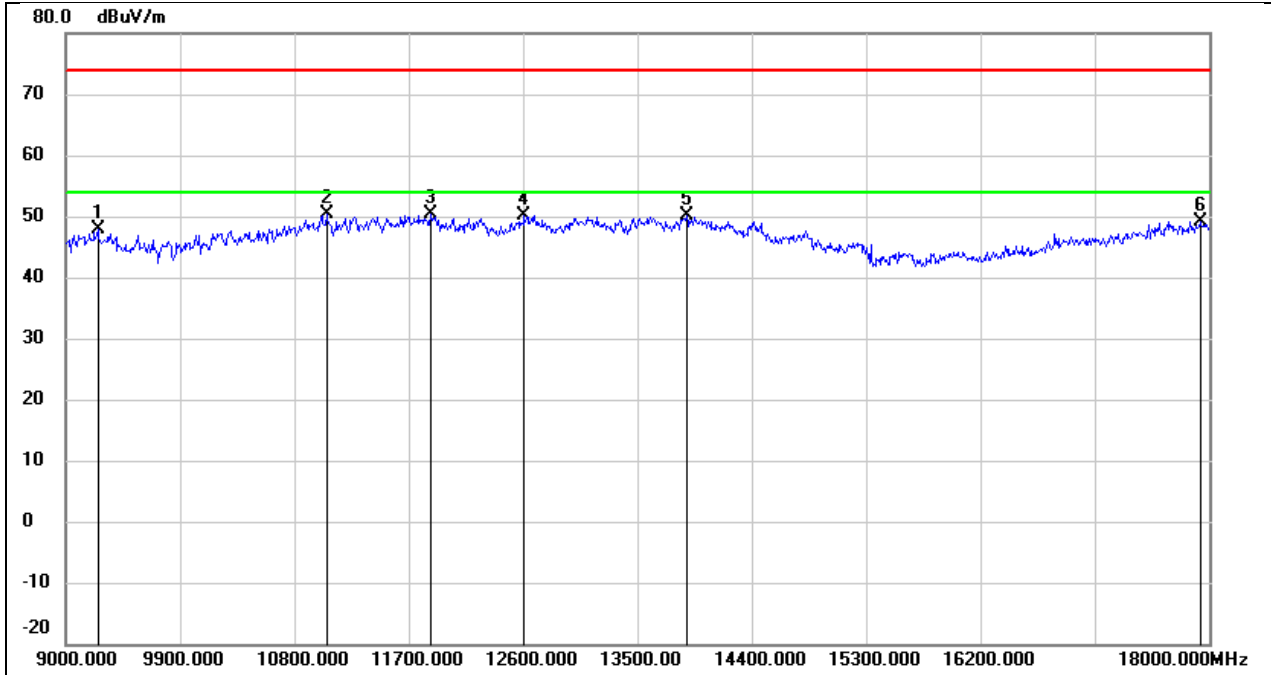

No.	Frequency (MHz)	Reading (dBuV)	Correct (dB/m)	Result (dBuV/m)	Limit (dBuV/m)	Margin (dB)	Remark
1	9252.000	36.93	10.85	47.78	74.00	-26.22	peak
2	11052.000	35.37	14.94	50.31	74.00	-23.69	peak
3	11871.000	32.79	17.56	50.35	74.00	-23.65	peak
4	12609.000	32.40	17.83	50.23	74.00	-23.77	peak
5	13887.000	28.38	21.64	50.02	74.00	-23.98	peak
6	17928.000	24.44	24.70	49.14	74.00	-24.86	peak

Test Mode:	802.11be EHT80	Frequency(MHz):	6465
Polarity:	Vertical	Test Voltage:	DC 12 V

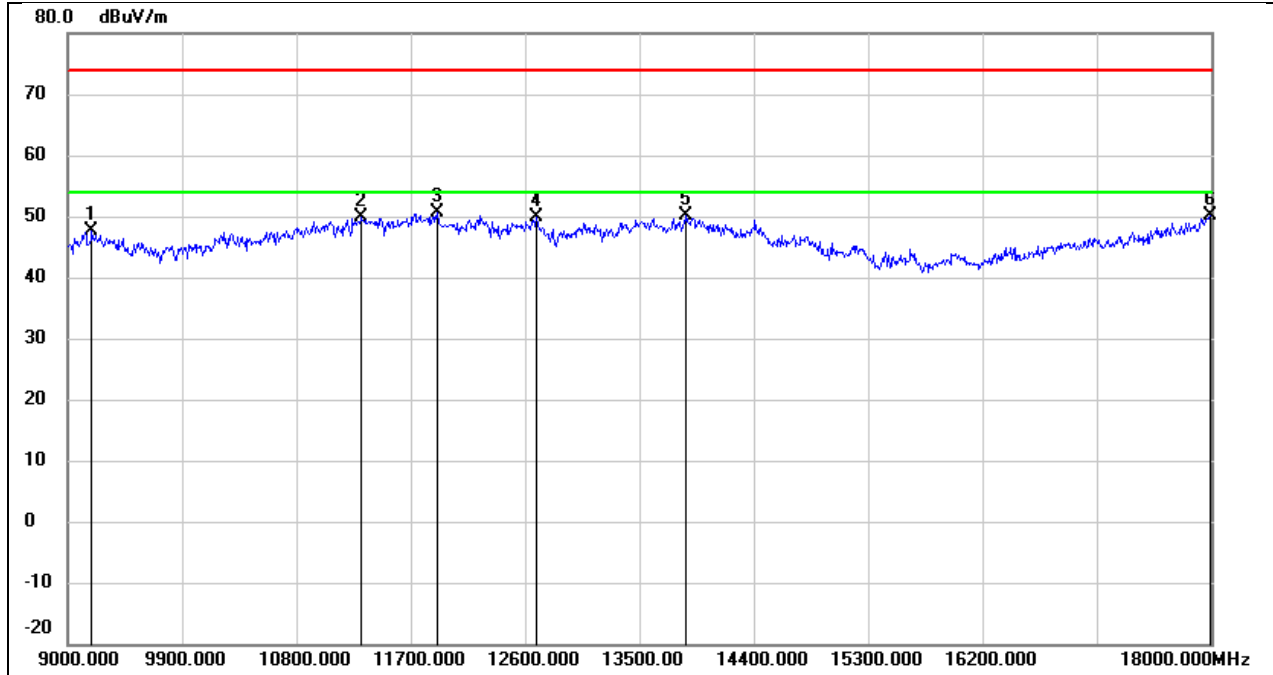

No.	Frequency (MHz)	Reading (dBuV)	Correct (dB/m)	Result (dBuV/m)	Limit (dBuV/m)	Margin (dB)	Remark
1	9189.000	36.78	10.84	47.62	74.00	-26.38	peak
2	11313.000	33.99	15.86	49.85	74.00	-24.15	peak
3	11907.000	32.99	17.66	50.65	74.00	-23.35	peak
4	12690.000	31.92	18.05	49.97	74.00	-24.03	peak
5	13869.000	28.53	21.59	50.12	74.00	-23.88	peak
6	17991.000	25.07	25.11	50.18	74.00	-23.82	peak

Test Mode:	802.11be EHT80	Frequency(MHz):	6545
Polarity:	Horizontal	Test Voltage:	DC 12 V

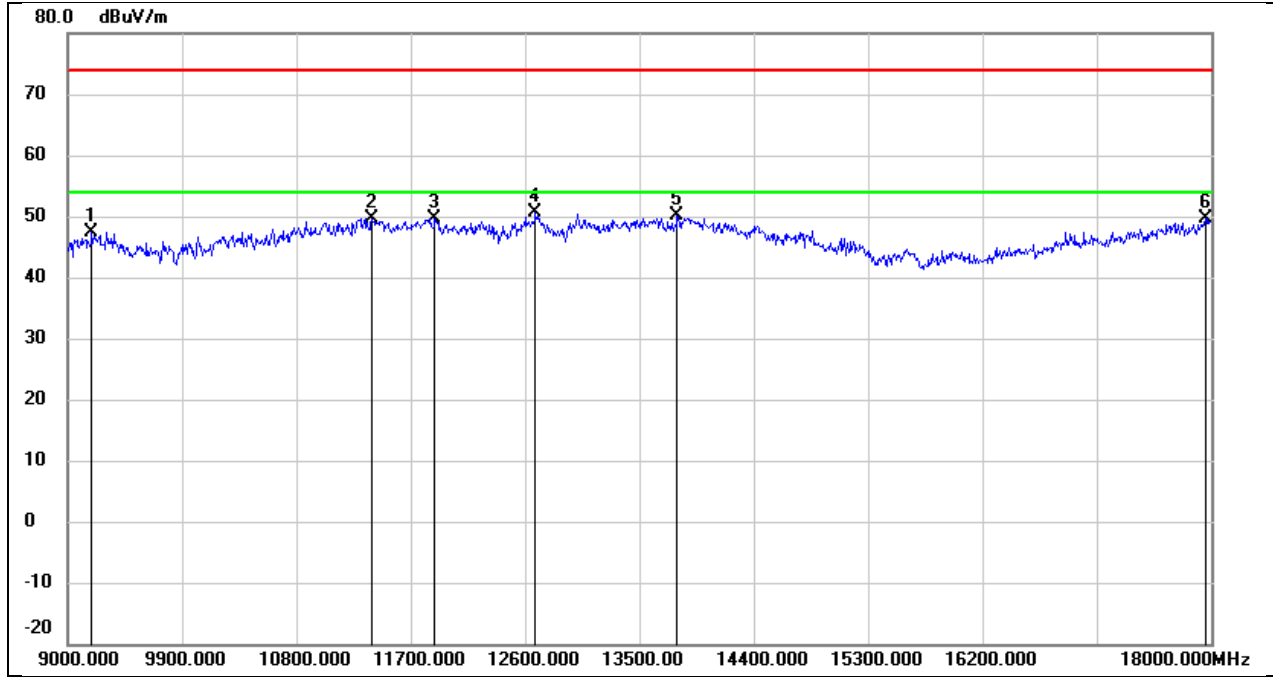

No.	Frequency (MHz)	Reading (dBuV)	Correct (dB/m)	Result (dBuV/m)	Limit (dBuV/m)	Margin (dB)	Remark
1	9189.000	36.66	10.84	47.50	74.00	-26.50	peak
2	11394.000	33.51	16.15	49.66	74.00	-24.34	peak
3	11889.000	32.12	17.60	49.72	74.00	-24.28	peak
4	12681.000	32.56	18.03	50.59	74.00	-23.41	peak
5	13797.000	28.64	21.44	50.08	74.00	-23.92	peak
6	17955.000	24.72	24.87	49.59	74.00	-24.41	peak

Test Mode:	802.11be EHT80	Frequency(MHz):	6545
Polarity:	Vertical	Test Voltage:	DC 12 V

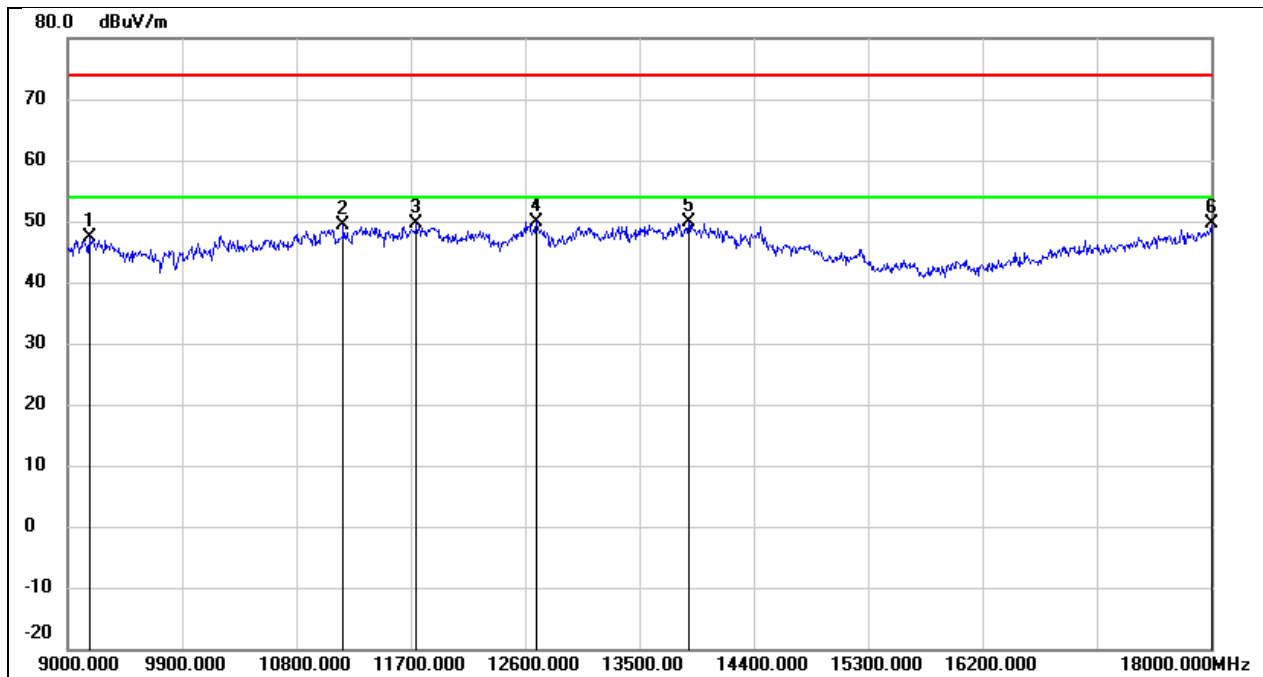

No.	Frequency (MHz)	Reading (dBuV)	Correct (dB/m)	Result (dBuV/m)	Limit (dBuV/m)	Margin (dB)	Remark
1	9171.000	36.46	10.83	47.29	74.00	-26.71	peak
2	11169.000	33.92	15.35	49.27	74.00	-24.73	peak
3	11745.000	32.50	17.21	49.71	74.00	-24.29	peak
4	12690.000	31.90	18.05	49.95	74.00	-24.05	peak
5	13887.000	28.14	21.64	49.78	74.00	-24.22	peak
6	18000.000	24.37	25.16	49.53	74.00	-24.47	peak

Test Mode:	802.11be EHT80	Frequency(MHz):	6705
Polarity:	Horizontal	Test Voltage:	DC 12 V

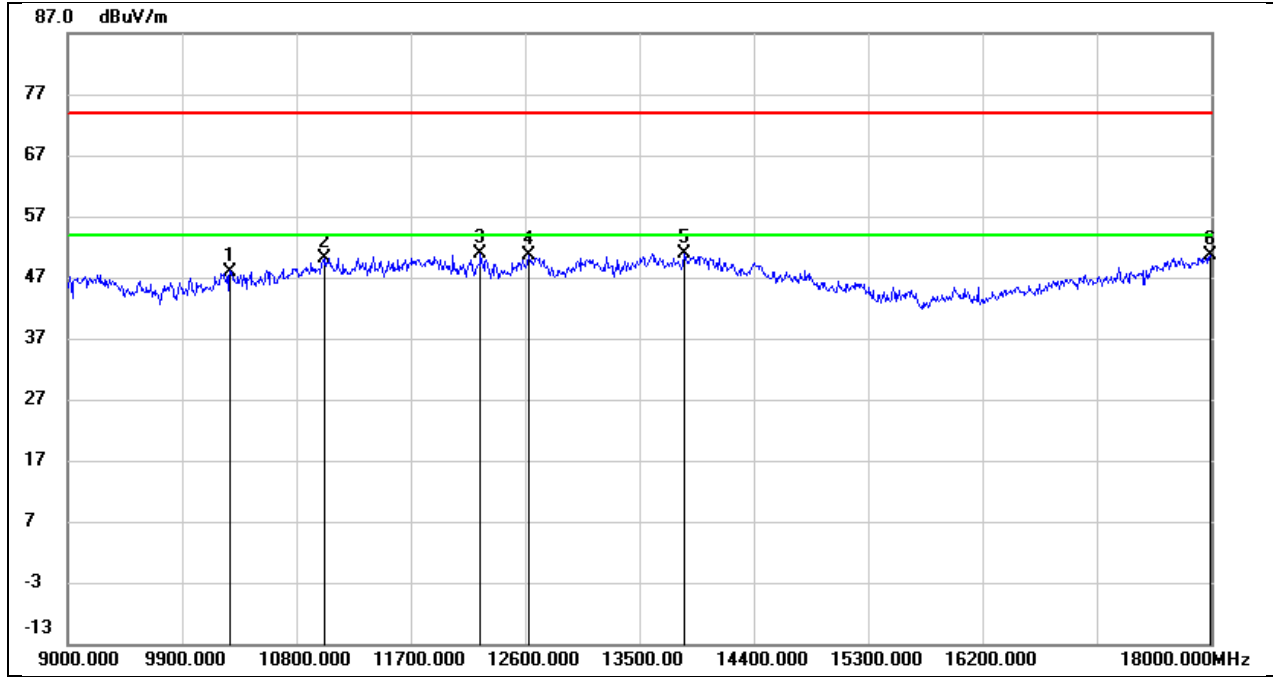

No.	Frequency (MHz)	Reading (dBuV)	Correct (dB/m)	Result (dBuV/m)	Limit (dBuV/m)	Margin (dB)	Remark
1	10278.000	35.34	12.66	48.00	74.00	-26.00	peak
2	11025.000	35.41	14.83	50.24	74.00	-23.76	peak
3	12249.000	33.15	17.72	50.87	74.00	-23.13	peak
4	12627.000	32.82	17.87	50.69	74.00	-23.31	peak
5	13851.000	29.41	21.56	50.97	74.00	-23.03	peak
6	17991.000	25.45	25.11	50.56	74.00	-23.44	peak

Test Mode:	802.11be EHT80	Frequency(MHz):	6705
Polarity:	Vertical	Test Voltage:	DC 12 V

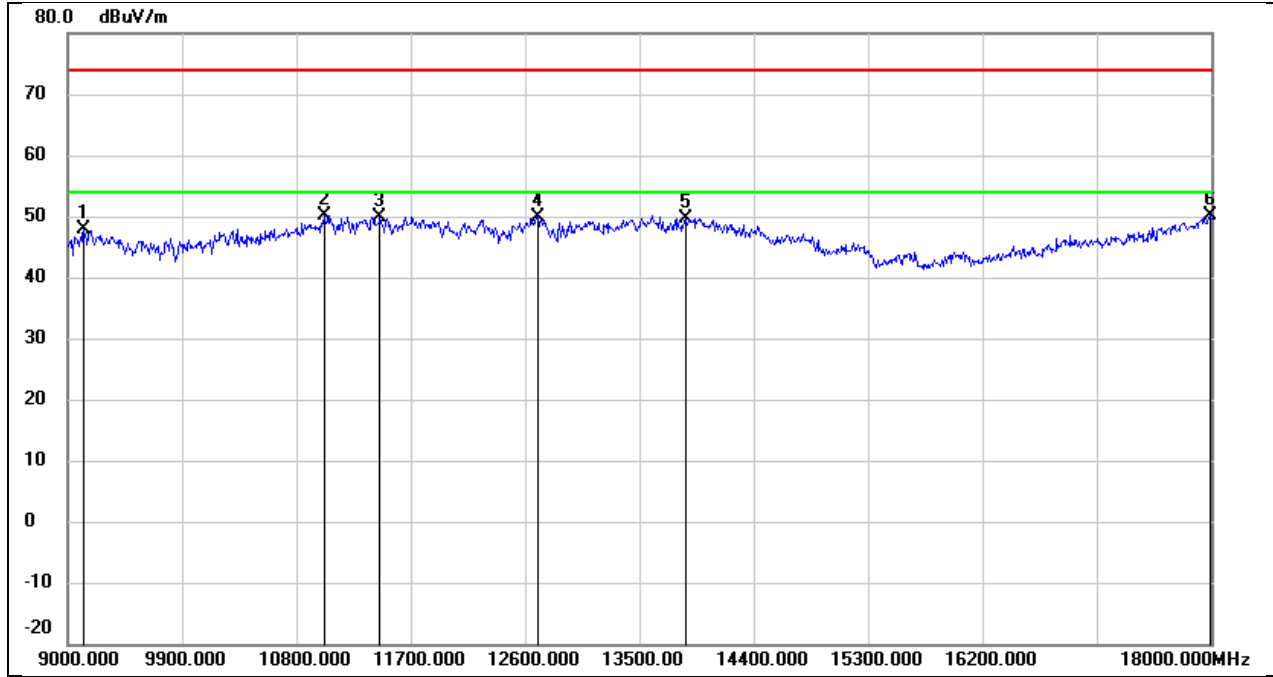

No.	Frequency (MHz)	Reading (dBuV)	Correct (dB/m)	Result (dBuV/m)	Limit (dBuV/m)	Margin (dB)	Remark
1	9126.000	37.10	10.83	47.93	74.00	-26.07	peak
2	11016.000	35.22	14.81	50.03	74.00	-23.97	peak
3	11457.000	33.59	16.38	49.97	74.00	-24.03	peak
4	12699.000	31.69	18.07	49.76	74.00	-24.24	peak
5	13860.000	28.11	21.59	49.70	74.00	-24.30	peak
6	17991.000	24.97	25.11	50.08	74.00	-23.92	peak

Test Mode:	802.11be EHT80	Frequency(MHz):	6865
Polarity:	Horizontal	Test Voltage:	DC 12 V

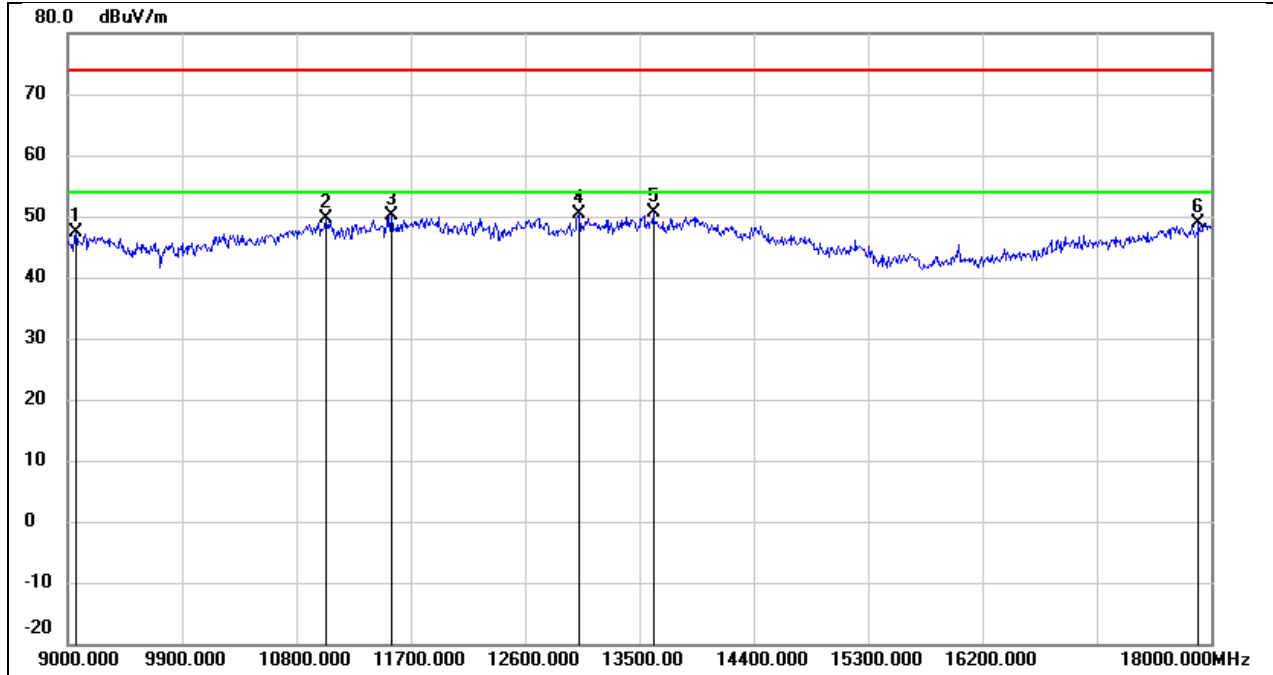

No.	Frequency (MHz)	Reading (dBuV)	Correct (dB/m)	Result (dBuV/m)	Limit (dBuV/m)	Margin (dB)	Remark
1	9063.000	36.51	10.82	47.33	74.00	-26.67	peak
2	11034.000	34.66	14.87	49.53	74.00	-24.47	peak
3	11547.000	33.38	16.66	50.04	74.00	-23.96	peak
4	13023.000	31.37	18.98	50.35	74.00	-23.65	peak
5	13608.000	29.63	21.05	50.68	74.00	-23.32	peak
6	17901.000	24.44	24.53	48.97	74.00	-25.03	peak

Test Mode:	802.11be EHT80	Frequency(MHz):	6865
Polarity:	Vertical	Test Voltage:	DC 12 V

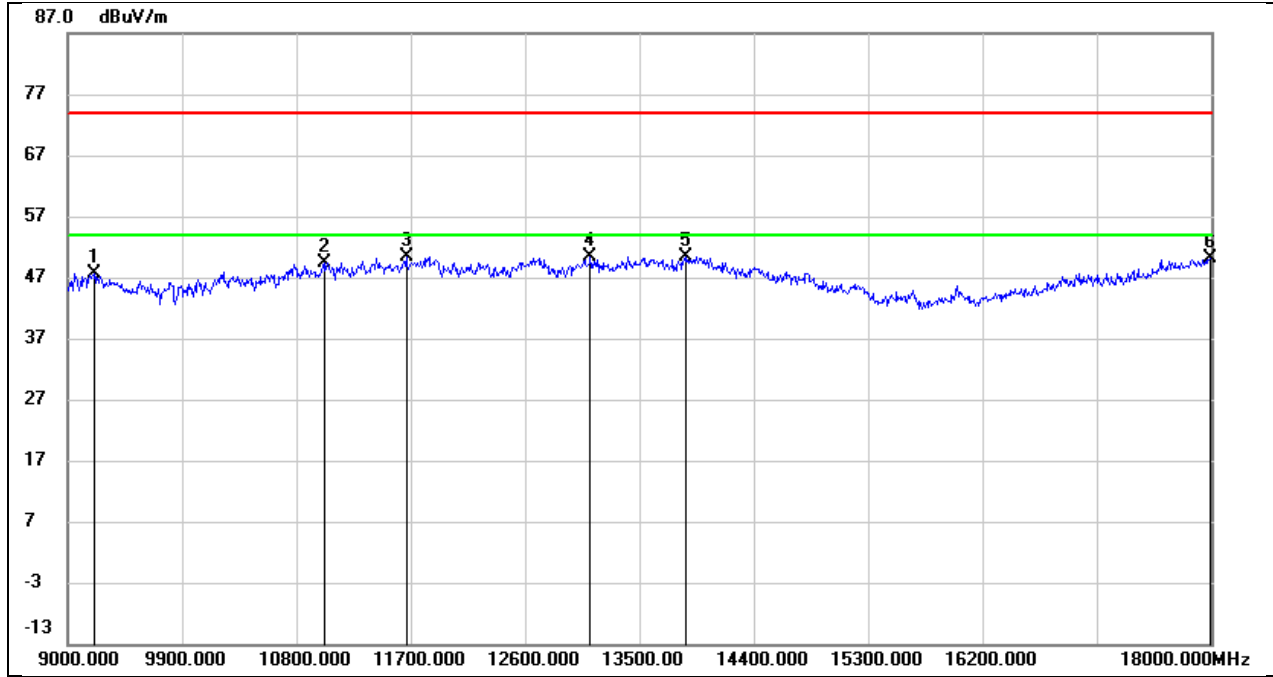

No.	Frequency (MHz)	Reading (dBuV)	Correct (dB/m)	Result (dBuV/m)	Limit (dBuV/m)	Margin (dB)	Remark
1	9207.000	36.82	10.84	47.66	74.00	-26.34	peak
2	11016.000	34.63	14.81	49.44	74.00	-24.56	peak
3	11664.000	33.48	16.98	50.46	74.00	-23.54	peak
4	13113.000	30.94	19.33	50.27	74.00	-23.73	peak
5	13860.000	28.78	21.59	50.37	74.00	-23.63	peak
6	17991.000	25.13	25.11	50.24	74.00	-23.76	peak

Test Mode:	802.11be EHT80	Frequency(MHz):	6945
Polarity:	Horizontal	Test Voltage:	DC 12 V

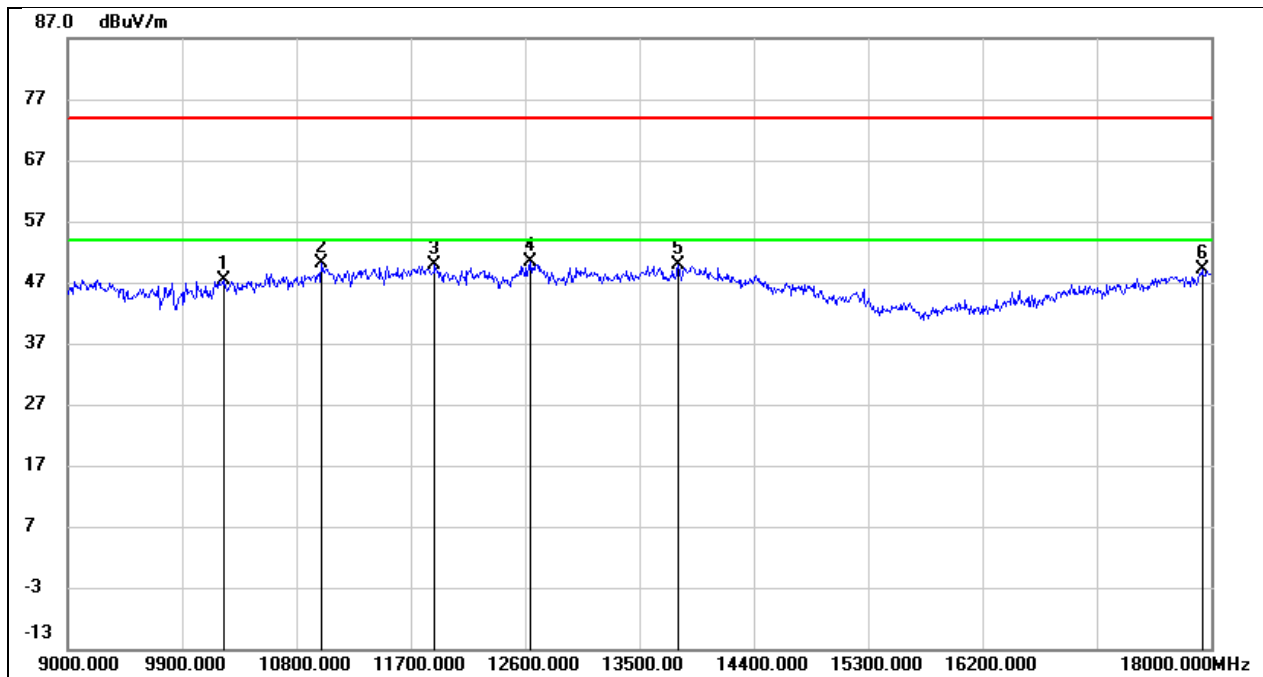

No.	Frequency (MHz)	Reading (dBuV)	Correct (dB/m)	Result (dBuV/m)	Limit (dBuV/m)	Margin (dB)	Remark
1	10224.000	34.72	12.55	47.27	74.00	-26.73	peak
2	10998.000	35.40	14.75	50.15	74.00	-23.85	peak
3	11889.000	32.19	17.60	49.79	74.00	-24.21	peak
4	12645.000	32.35	17.92	50.27	74.00	-23.73	peak
5	13806.000	28.37	21.46	49.83	74.00	-24.17	peak
6	17928.000	24.31	24.70	49.01	74.00	-24.99	peak

Test Mode:	802.11be EHT80	Frequency(MHz):	6945
Polarity:	Vertical	Test Voltage:	DC 12 V

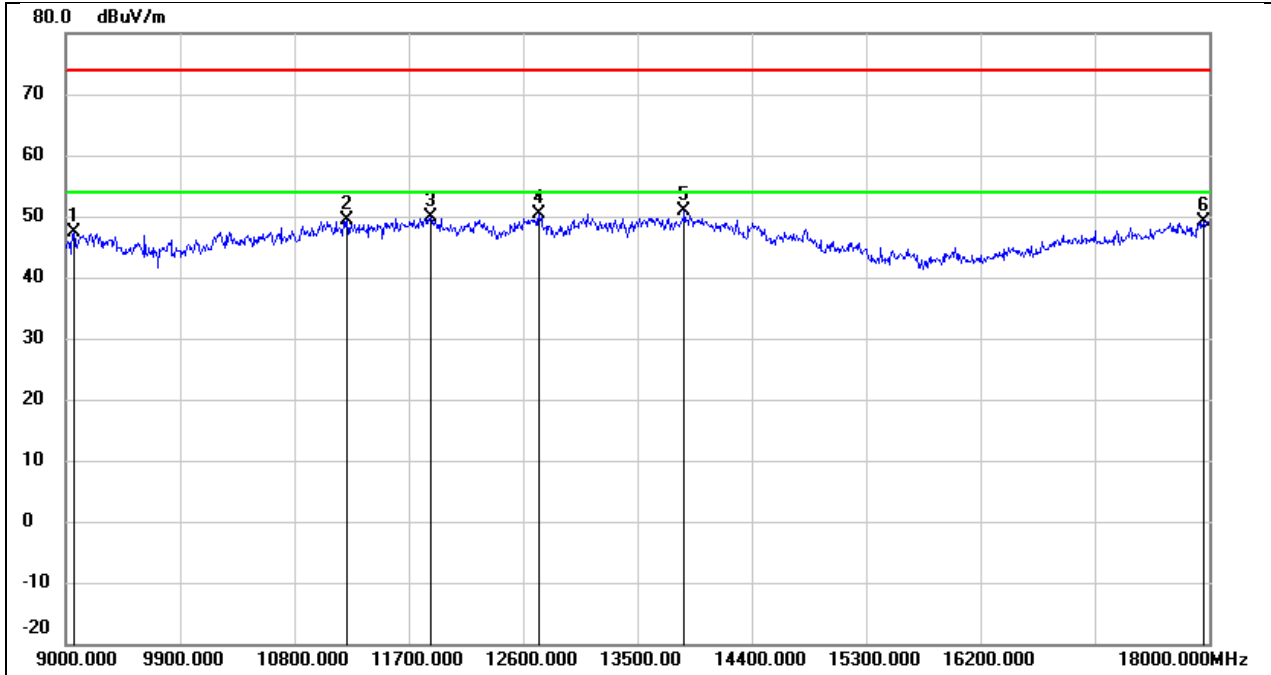

No.	Frequency (MHz)	Reading (dBuV)	Correct (dB/m)	Result (dBuV/m)	Limit (dBuV/m)	Margin (dB)	Remark
1	9063.000	36.48	10.82	47.30	74.00	-26.70	peak
2	11214.000	33.92	15.51	49.43	74.00	-24.57	peak
3	11871.000	32.28	17.56	49.84	74.00	-24.16	peak
4	12726.000	32.34	18.14	50.48	74.00	-23.52	peak
5	13869.000	29.21	21.59	50.80	74.00	-23.20	peak
6	17955.000	24.33	24.87	49.20	74.00	-24.80	peak

Test Mode:	802.11be EHT80	Frequency(MHz):	7025
Polarity:	Horizontal	Test Voltage:	DC 12 V

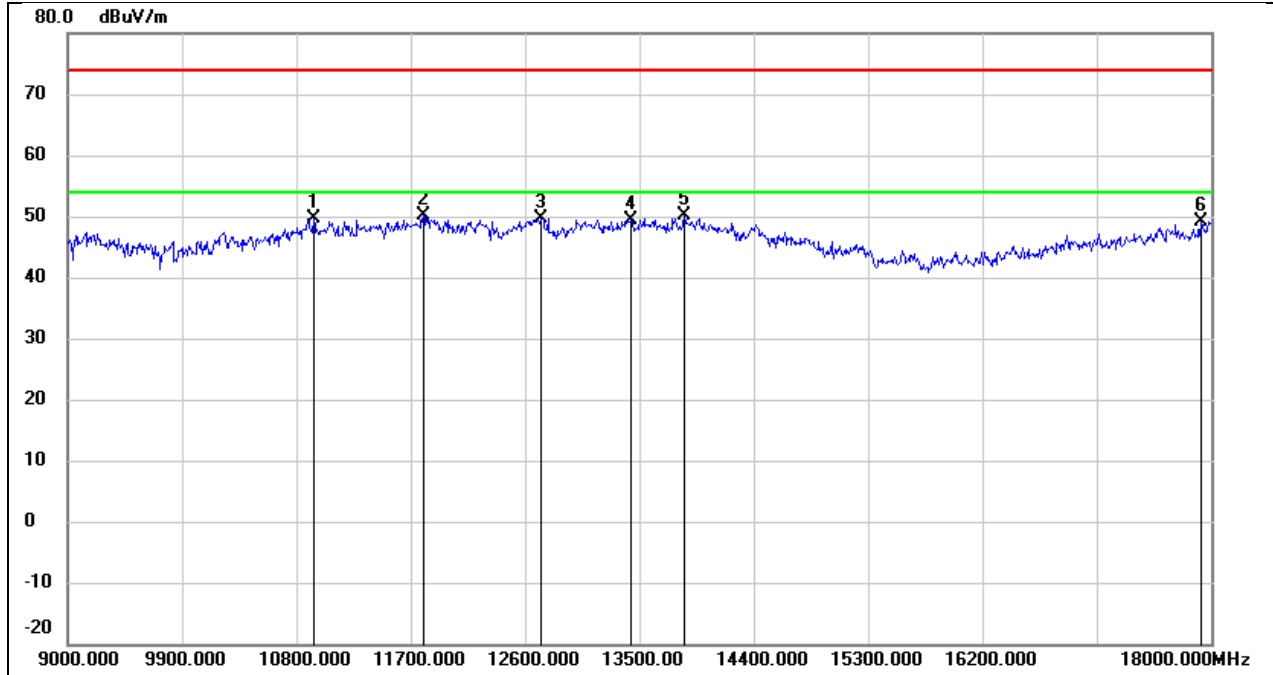

No.	Frequency (MHz)	Reading (dBuV)	Correct (dB/m)	Result (dBuV/m)	Limit (dBuV/m)	Margin (dB)	Remark
1	10935.000	35.02	14.54	49.56	74.00	-24.44	peak
2	11799.000	32.68	17.36	50.04	74.00	-23.96	peak
3	12726.000	31.53	18.14	49.67	74.00	-24.33	peak
4	13437.000	28.92	20.57	49.49	74.00	-24.51	peak
5	13851.000	28.59	21.56	50.15	74.00	-23.85	peak
6	17919.000	24.51	24.64	49.15	74.00	-24.85	peak

Test Mode:	802.11be EHT80	Frequency(MHz):	7025
Polarity:	Vertical	Test Voltage:	DC 12 V

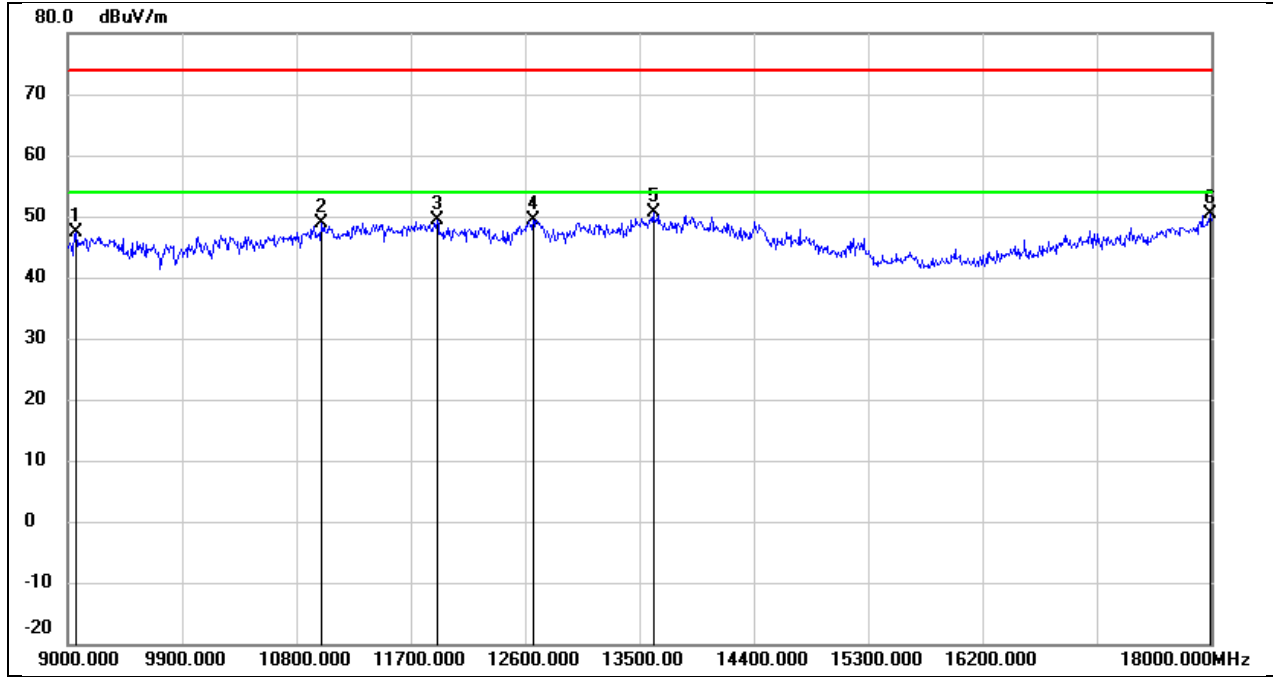

No.	Frequency (MHz)	Reading (dBuV)	Correct (dB/m)	Result (dBuV/m)	Limit (dBuV/m)	Margin (dB)	Remark
1	9063.000	36.49	10.82	47.31	74.00	-26.69	peak
2	10998.000	34.24	14.75	48.99	74.00	-25.01	peak
3	11907.000	31.69	17.66	49.35	74.00	-24.65	peak
4	12663.000	31.36	17.98	49.34	74.00	-24.66	peak
5	13608.000	29.57	21.05	50.62	74.00	-23.38	peak
6	17991.000	25.34	25.11	50.45	74.00	-23.55	peak

Test Mode:	802.11be EHT160	Frequency(MHz):	6185
Polarity:	Horizontal	Test Voltage:	DC 12 V

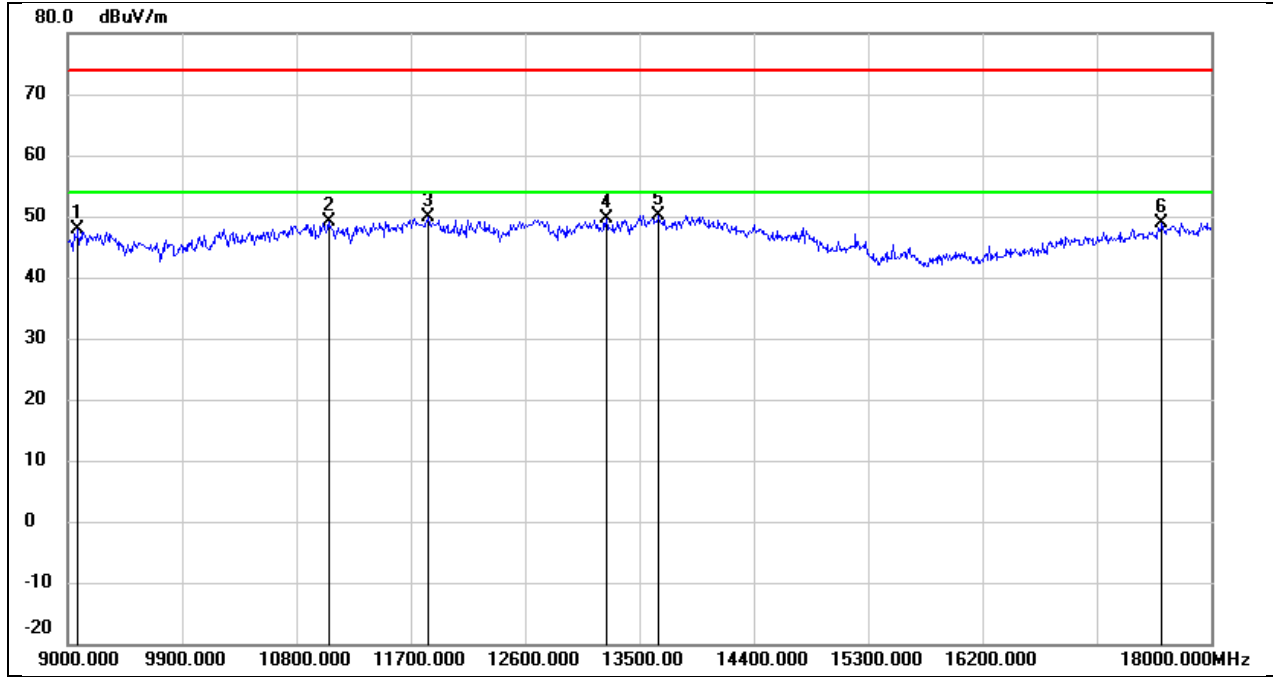

No.	Frequency (MHz)	Reading (dBuV)	Correct (dB/m)	Result (dBuV/m)	Limit (dBuV/m)	Margin (dB)	Remark
1	9081.000	36.98	10.82	47.80	74.00	-26.20	peak
2	11052.000	34.10	14.94	49.04	74.00	-24.96	peak
3	11835.000	32.38	17.46	49.84	74.00	-24.16	peak
4	13239.000	29.71	19.81	49.52	74.00	-24.48	peak
5	13653.000	29.10	21.14	50.24	74.00	-23.76	peak
6	17613.000	26.20	22.69	48.89	74.00	-25.11	peak

Test Mode:	802.11be EHT160	Frequency(MHz):	6185
Polarity:	Vertical	Test Voltage:	DC 12 V

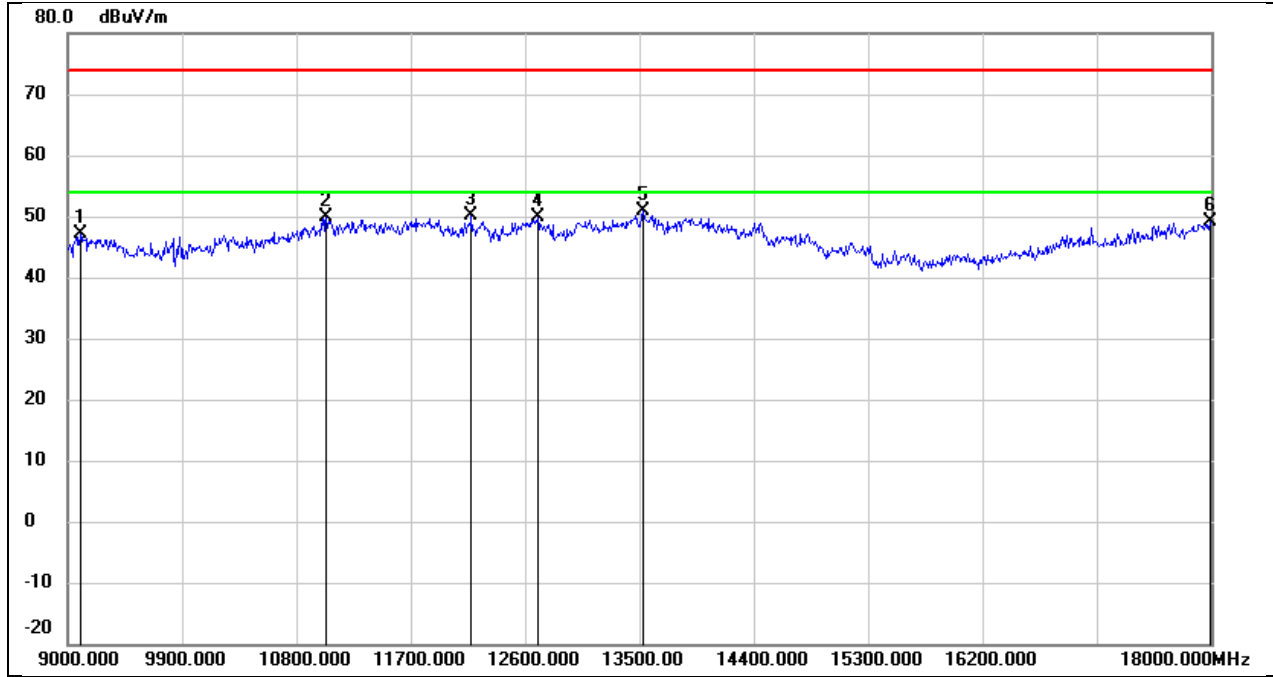

No.	Frequency (MHz)	Reading (dBuV)	Correct (dB/m)	Result (dBuV/m)	Limit (dBuV/m)	Margin (dB)	Remark
1	9099.000	36.30	10.83	47.13	74.00	-26.87	peak
2	11034.000	35.07	14.87	49.94	74.00	-24.06	peak
3	12177.000	32.41	17.77	50.18	74.00	-23.82	peak
4	12699.000	31.79	18.07	49.86	74.00	-24.14	peak
5	13527.000	29.93	20.87	50.80	74.00	-23.20	peak
6	17991.000	24.02	25.11	49.13	74.00	-24.87	peak

Test Mode:	802.11be EHT160	Frequency(MHz):	6345
Polarity:	Horizontal	Test Voltage:	DC 12 V

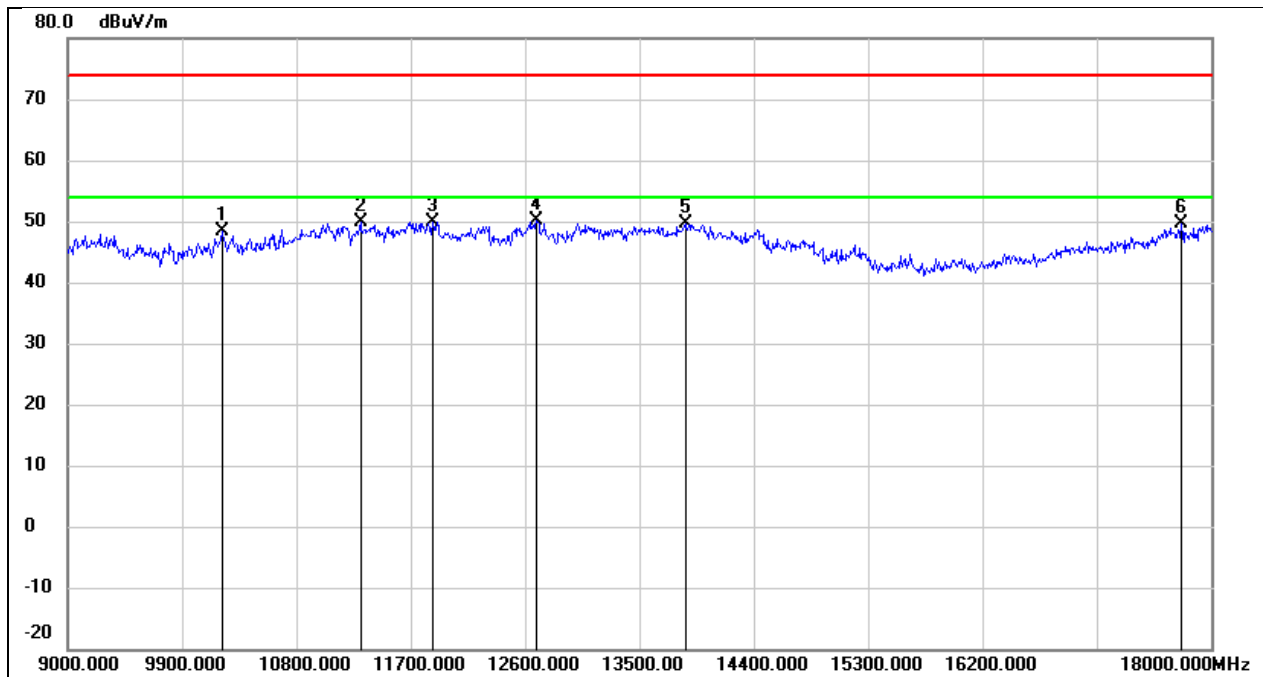

No.	Frequency (MHz)	Reading (dBuV)	Correct (dB/m)	Result (dBuV/m)	Limit (dBuV/m)	Margin (dB)	Remark
1	10215.000	35.81	12.52	48.33	74.00	-25.67	peak
2	11304.000	33.98	15.84	49.82	74.00	-24.18	peak
3	11871.000	32.40	17.56	49.96	74.00	-24.04	peak
4	12690.000	31.97	18.05	50.02	74.00	-23.98	peak
5	13860.000	27.97	21.59	49.56	74.00	-24.44	peak
6	17766.000	26.07	23.66	49.73	74.00	-24.27	peak

Test Mode:	802.11be EHT160	Frequency(MHz):	6345
Polarity:	Vertical	Test Voltage:	DC 12 V

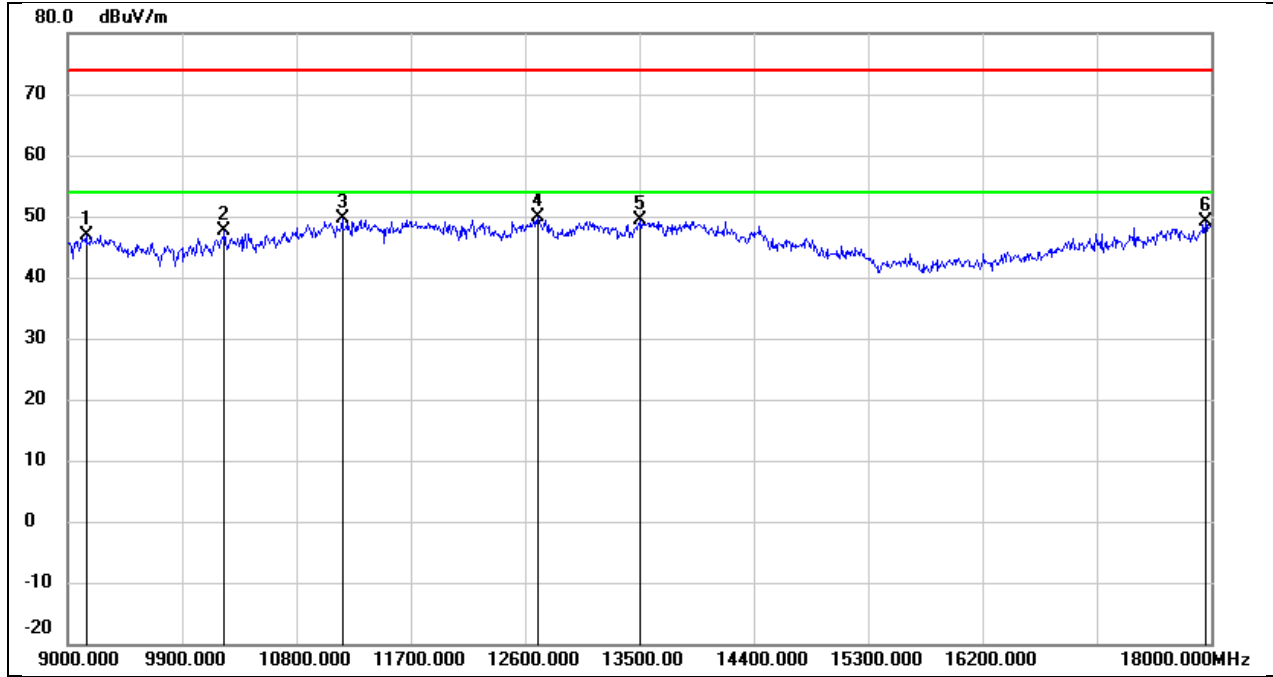

No.	Frequency (MHz)	Reading (dBuV)	Correct (dB/m)	Result (dBuV/m)	Limit (dBuV/m)	Margin (dB)	Remark
1	9144.000	36.16	10.83	46.99	74.00	-27.01	peak
2	10233.000	34.96	12.57	47.53	74.00	-26.47	peak
3	11160.000	34.37	15.32	49.69	74.00	-24.31	peak
4	12699.000	31.81	18.07	49.88	74.00	-24.12	peak
5	13509.000	28.62	20.83	49.45	74.00	-24.55	peak
6	17955.000	24.18	24.87	49.05	74.00	-24.95	peak

Test Mode:	802.11be EHT160	Frequency(MHz):	6505
Polarity:	Horizontal	Test Voltage:	DC 12 V

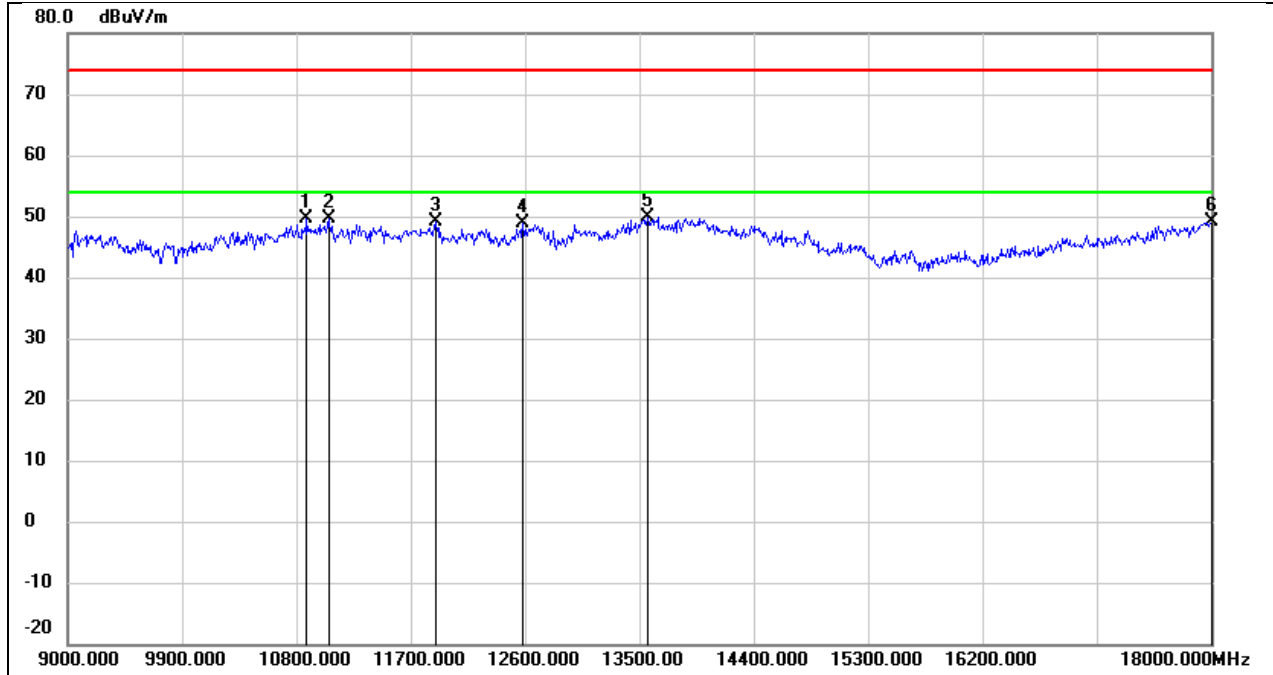

No.	Frequency (MHz)	Reading (dBuV)	Correct (dB/m)	Result (dBuV/m)	Limit (dBuV/m)	Margin (dB)	Remark
1	10881.000	35.37	14.35	49.72	74.00	-24.28	peak
2	11052.000	34.58	14.94	49.52	74.00	-24.48	peak
3	11898.000	31.45	17.63	49.08	74.00	-24.92	peak
4	12582.000	31.09	17.76	48.85	74.00	-25.15	peak
5	13563.000	28.96	20.94	49.90	74.00	-24.10	peak
6	18000.000	24.06	25.16	49.22	74.00	-24.78	peak

Test Mode:	802.11be EHT160	Frequency(MHz):	6505
Polarity:	Vertical	Test Voltage:	DC 12 V

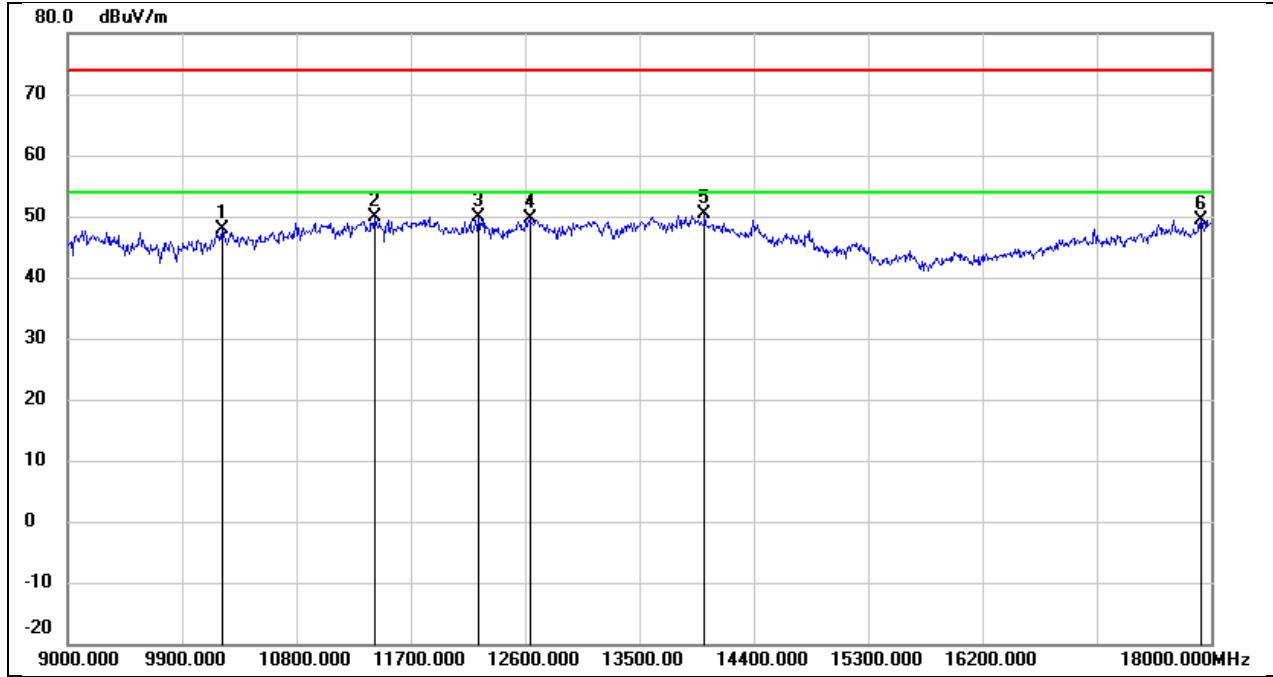

No.	Frequency (MHz)	Reading (dBuV)	Correct (dB/m)	Result (dBuV/m)	Limit (dBuV/m)	Margin (dB)	Remark
1	10215.000	35.26	12.52	47.78	74.00	-26.22	peak
2	11412.000	33.71	16.22	49.93	74.00	-24.07	peak
3	12231.000	32.10	17.73	49.83	74.00	-24.17	peak
4	12636.000	31.78	17.90	49.68	74.00	-24.32	peak
5	14013.000	28.49	21.82	50.31	74.00	-23.69	peak
6	17919.000	24.86	24.64	49.50	74.00	-24.50	peak

Test Mode:	802.11be EHT160	Frequency(MHz):	6665
Polarity:	Horizontal	Test Voltage:	DC 12 V

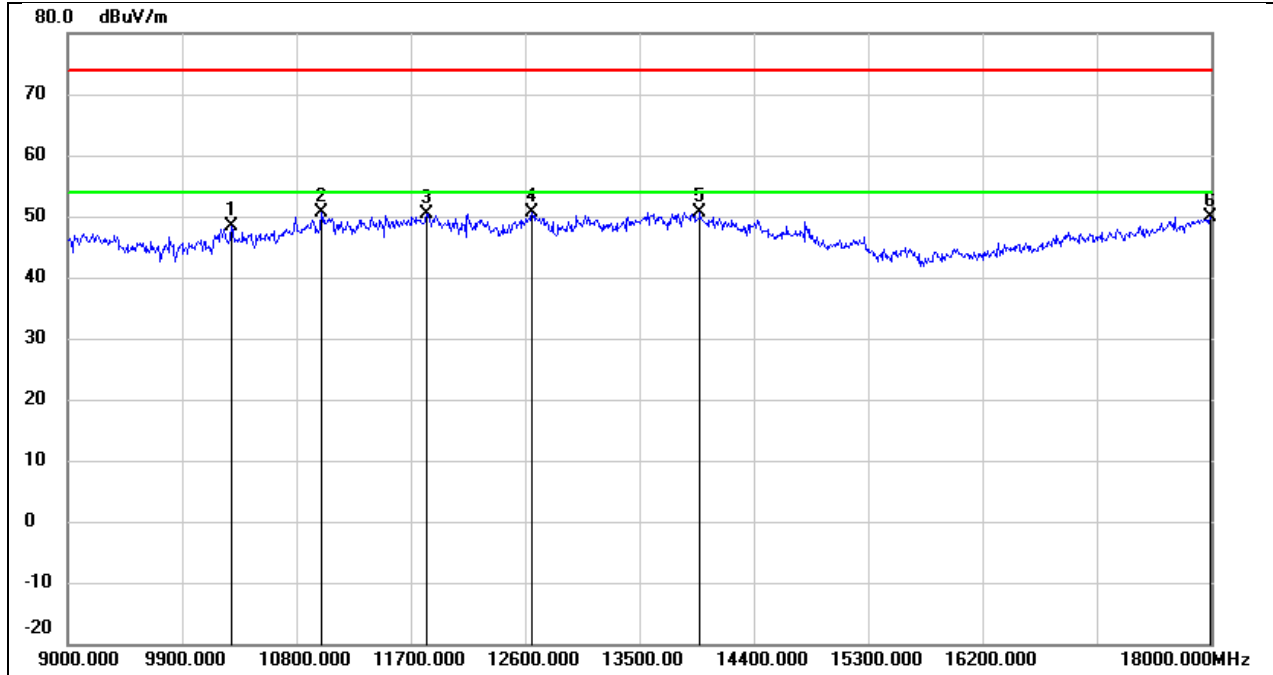

No.	Frequency (MHz)	Reading (dBuV)	Correct (dB/m)	Result (dBuV/m)	Limit (dBuV/m)	Margin (dB)	Remark
1	10287.000	35.65	12.68	48.33	74.00	-25.67	peak
2	10998.000	35.78	14.75	50.53	74.00	-23.47	peak
3	11826.000	32.97	17.42	50.39	74.00	-23.61	peak
4	12654.000	32.69	17.94	50.63	74.00	-23.37	peak
5	13977.000	28.77	21.83	50.60	74.00	-23.40	peak
6	17991.000	24.74	25.11	49.85	74.00	-24.15	peak

Test Mode:	802.11be EHT160	Frequency(MHz):	6665
Polarity:	Vertical	Test Voltage:	DC 12 V

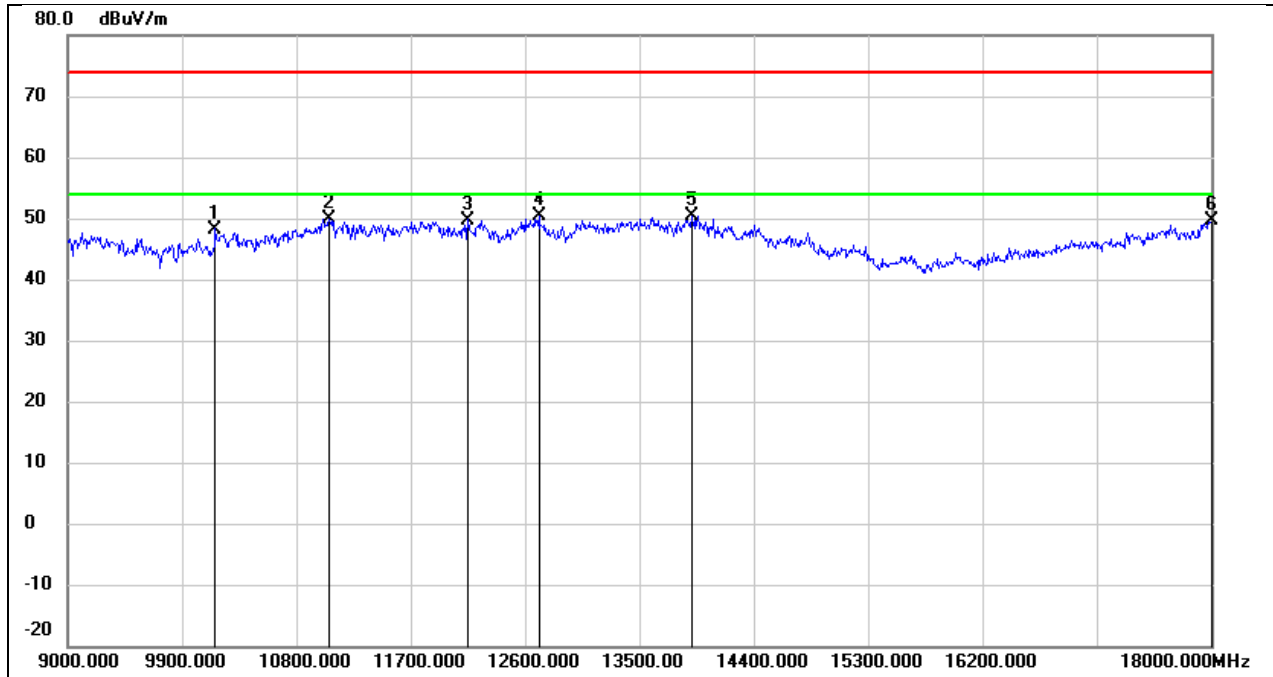

No.	Frequency (MHz)	Reading (dBuV)	Correct (dB/m)	Result (dBuV/m)	Limit (dBuV/m)	Margin (dB)	Remark
1	10161.000	35.83	12.42	48.25	74.00	-25.75	peak
2	11061.000	34.98	14.96	49.94	74.00	-24.06	peak
3	12150.000	31.95	17.80	49.75	74.00	-24.25	peak
4	12708.000	32.26	18.10	50.36	74.00	-23.64	peak
5	13914.000	28.68	21.69	50.37	74.00	-23.63	peak
6	18000.000	24.57	25.16	49.73	74.00	-24.27	peak

Test Mode:	802.11be EHT160	Frequency(MHz):	6825
Polarity:	Horizontal	Test Voltage:	DC 12 V

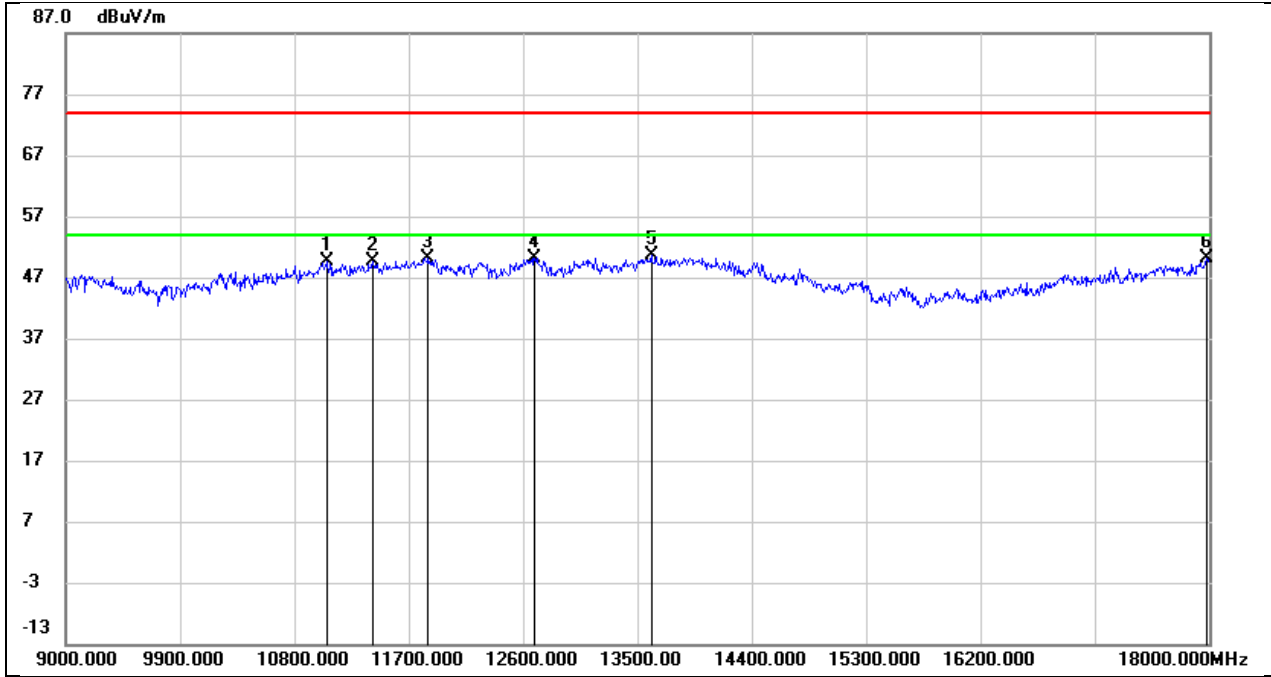

No.	Frequency (MHz)	Reading (dBuV)	Correct (dB/m)	Result (dBuV/m)	Limit (dBuV/m)	Margin (dB)	Remark
1	11052.000	34.58	14.94	49.52	74.00	-24.48	peak
2	11412.000	33.37	16.22	49.59	74.00	-24.41	peak
3	11853.000	32.55	17.50	50.05	74.00	-23.95	peak
4	12690.000	32.20	18.05	50.25	74.00	-23.75	peak
5	13608.000	29.62	21.05	50.67	74.00	-23.33	peak
6	17982.000	24.99	25.04	50.03	74.00	-23.97	peak

Test Mode:	802.11be EHT160	Frequency(MHz):	6825
Polarity:	Vertical	Test Voltage:	DC 12 V

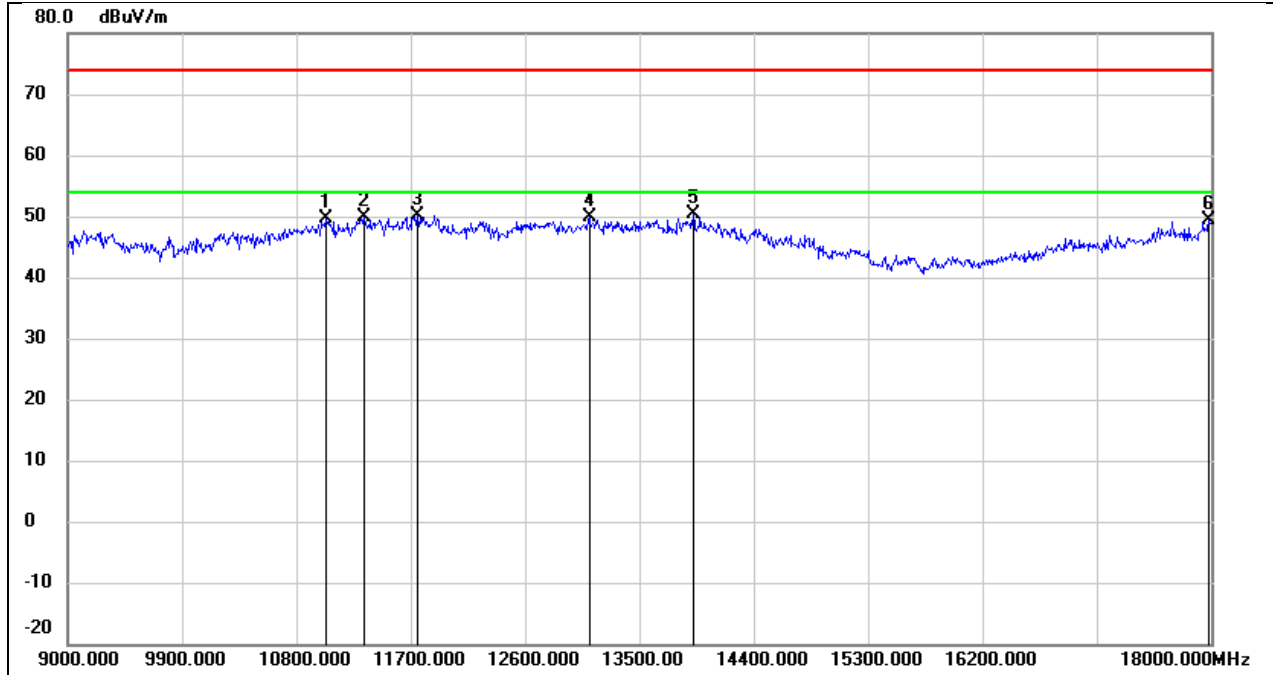

No.	Frequency (MHz)	Reading (dBuV)	Correct (dB/m)	Result (dBuV/m)	Limit (dBuV/m)	Margin (dB)	Remark
1	11034.000	34.82	14.87	49.69	74.00	-24.31	peak
2	11331.000	34.04	15.93	49.97	74.00	-24.03	peak
3	11754.000	32.87	17.23	50.10	74.00	-23.90	peak
4	13104.000	30.47	19.29	49.76	74.00	-24.24	peak
5	13923.000	28.69	21.72	50.41	74.00	-23.59	peak
6	17982.000	24.44	25.04	49.48	74.00	-24.52	peak

Test Mode:	802.11be EHT160	Frequency(MHz):	6985
Polarity:	Horizontal	Test Voltage:	DC 12 V

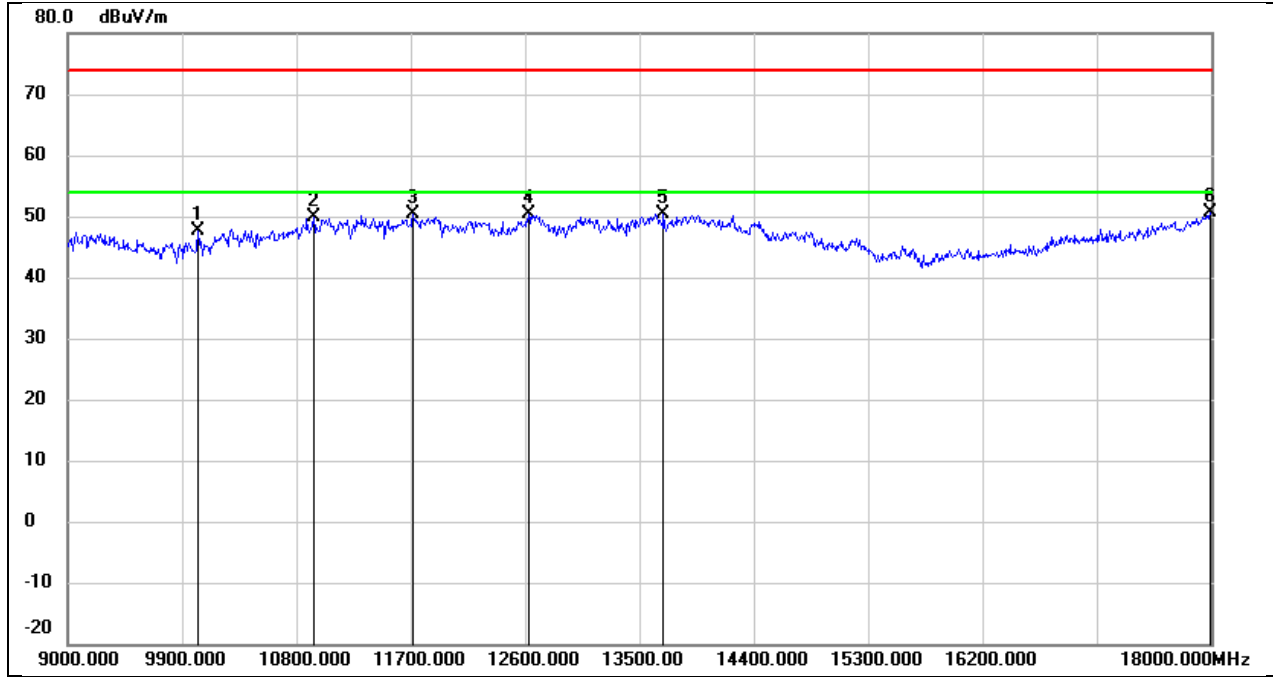

No.	Frequency (MHz)	Reading (dBuV)	Correct (dB/m)	Result (dBuV/m)	Limit (dBuV/m)	Margin (dB)	Remark
1	10026.000	35.38	12.14	47.52	74.00	-26.48	peak
2	10935.000	35.31	14.54	49.85	74.00	-24.15	peak
3	11718.000	33.17	17.13	50.30	74.00	-23.70	peak
4	12627.000	32.53	17.87	50.40	74.00	-23.60	peak
5	13689.000	29.20	21.21	50.41	74.00	-23.59	peak
6	17991.000	25.48	25.11	50.59	74.00	-23.41	peak