

RF MEASUREMENT REPORT

FCC ID : 2AXJ4EAP690EHD
Applicant : TP-Link Corporation Limited
Application Type : Certification
Product : AXE11000 Ceiling Mount Quad-Band Wi-Fi 6E Access Point
Model No. : EAP690E HD
Brand Name : tp-link
FCC Classification : 15E 6GHz Low Power Indoor Access Point (6ID)
FCC Rule Part(s) : Part 15 Subpart E (Section 15.407)
Received Date : December 2, 2022
Test Date : December 10~ 2022~February 09 ,2023

Tested By : Owen Tsai

(Owen Tsai)

Reviewed By : Paddy Chen

(Paddy Chen)

Approved By : Chenz Ker

(Chenz Ker)



The test results relate only to the samples tested.

This equipment has been shown to be capable of compliance with the applicable technical standards as indicated in the measurement report and was tested in accordance with the measurement procedures specified in KDB789033. Test results reported herein relate only to the item(s) tested.

The test report shall not be reproduced except in full without the written approval of MRT Technology (Taiwan) Co., Ltd.

Revision History

Report No.	Version	Description	Issue Date	Note
2212TW0111-U4	1.0	Original Report	2023-03-24	Valid

CONTENTS

Description	Page
General Information.....	6
1. INTRODUCTION	7
1.1. Scope.....	7
1.2. MRT Test Location.....	7
2. Product Information	8
2.1. Equipment Description.....	8
2.2. Radio Specification Subjective to this Report.....	8
2.3. Working Frequencies	9
2.4. Antenna Details.....	10
2.5. Test Mode	11
2.6. Test System Connection Diagram	12
2.7. Test System Details	12
2.8. Test Software	12
2.9. Applied Standards.....	13
2.10. Duty Cycle.....	13
2.11. Test Environment Condition	14
3. Antenna Requirements	15
4. Measuring Instrument	16
5. Measurement Uncertainty.....	17
6. Test Result.....	18
6.1. Summary.....	18
6.2. 26dB Bandwidth.....	19
6.2.1. Test Limit	19
6.2.2. Test Procedure used	19
6.2.3. Test Setting	19
6.2.4. Test Setup	20
6.2.5. Test Result	21
6.3. Output Power	30
6.3.1. Test Limit.....	30
6.3.2. Test Procedure Used	30
6.3.3. Test Setting	30
6.3.4. Test Setup	30
6.3.5. Test Result	31
6.4. Power Spectral Density.....	37
6.4.1. Test Limit.....	37

6.4.2.	Test Procedure Used	37
6.4.3.	Test Setting	37
6.4.4.	Test Setup	38
6.4.5.	Test Result	39
6.5.	In-Band Emission Measurement.....	99
6.5.1.	Test Limit	99
6.5.2.	Test Procedure used	99
6.5.3.	Test Setting	99
6.5.4.	Test Setup	100
6.5.5.	Test Result	101
6.6.	Frequency Stability Measurement	157
6.6.1.	Test Limit	157
6.6.2.	Test Procedure	157
6.6.3.	Test Setup	158
6.6.4.	Test Result	159
6.7.	Contention Based Protocol	160
6.7.1.	Test Limit	160
6.7.2.	Test Procedure Used	160
6.7.3.	Test Setting	160
6.7.4.	Test Setup	161
6.7.5.	Test Result	162
6.8.	Radiated Spurious Emission.....	173
6.8.1.	Test Limit	173
6.8.2.	Test Procedure Used	173
6.8.3.	Test Setting	173
6.8.4.	Test Setup	175
6.8.5.	Test Result	176
6.9.	Radiated Restricted Band Edge	348
6.9.1.	Test Limit	348
6.9.2.	Test Procedure Used	349
6.9.3.	Test Setting	349
6.9.4.	Test Setup	350
6.9.5.	Test Result	351
6.10.	AC Conducted Emissions	415
6.10.1.	Test Limit.....	415
6.10.2.	Test Setup.....	415
6.10.3.	Test Result.....	416
7.	Conclusion	420

Appendix A : Test Setup Photograph421

Appendix B : External Photograph422

Appendix C : Internal Photograph423

General Information

Applicant	TP-Link Corporation Limited
Applicant Address	Room 901, 9/F., New East Ocean Centre, 9 Science Museum Road, Tsim Sha Tsui, Kowloon, Hongkong
Manufacturer	TP-Link Corporation Limited
Test Site	MRT Technology (Taiwan) Co., Ltd
Test Site Address	No. 38, Fuxing Second Rd., Guishan Dist., Taoyuan City 333, Taiwan (R.O.C)
MRT FCC Registration No.	291082
FCC Rule Part(s)	Part 15.407

Test Facility / Accreditations

1. MRT facility is a FCC registered (Reg. No. 291082) test facility with the site description report on file and is designated by the FCC as an Accredited Test Firm.
2. MRT facility is an IC registered (MRT Reg. No. 21723) test laboratory with the site description on file at Industry Canada.
3. MRT Lab is accredited to ISO 17025 by the Taiwan Accreditation Foundation (TAF Cert. No. 3261) in EMC, Telecommunications and Radio testing for FCC (Designation Number: TW3261), Industry Taiwan, EU and TELEC Rules.

1. INTRODUCTION

1.1. Scope

Measurement and determination of electromagnetic emissions (EMC) of radio frequency devices including intentional and/or unintentional radiators for compliance with the technical rules and regulations of the Federal Communications Commission and the Innovation, Science and Economic Development Canada and Certification and Engineering Bureau.

1.2. MRT Test Location

The map below shows the location of the MRT LABORATORY, its proximity to the Taoyuan City. These measurement tests were conducted at the MRT Technology (Taiwan) Co., Ltd. Facility located at No.38, Fuxing 2nd Rd., Guishan Dist., Taoyuan City 33377, Taiwan (R.O.C).

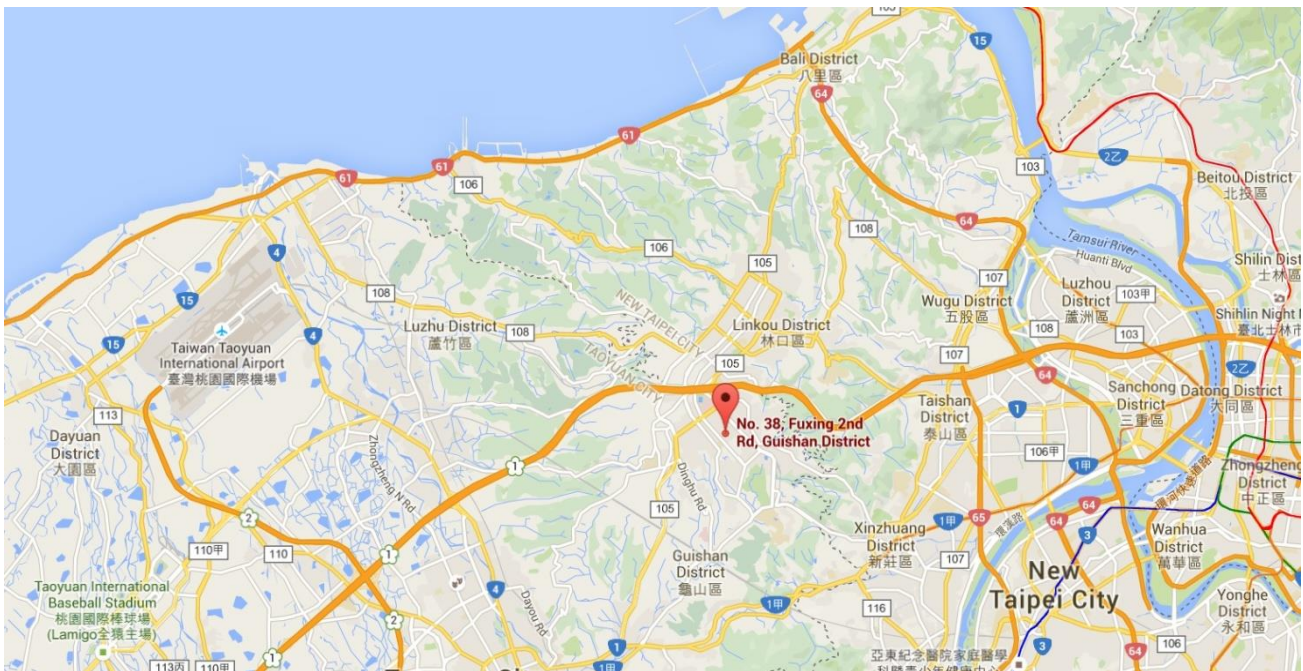

2. Product Information

2.1. Equipment Description

Product Name	AXE11000 Ceiling Mount Quad-Band Wi-Fi 6E Access Point
Model No.	EAP690E HD
Brand Name	tp-link
Specification	WLAN: 802.11a/b/g/n/ac/ax WPAN: Bluetooth Mode: V4.2 LE Only
Antenna Information	Refer to section 1.7
Power Supply	AC Adapter or PoE (42.5-57V, 1.2A 802.3bt)
Accessory	
Adapter	MODEL: T120450-2B4 INPUT: 100 - 240V ~ 50/60Hz 1.5A. OUTPUT: 12.0V=4.5A Cable Out: Non-shielding, 1.5m

2.2. Radio Specification Subjective to this Report

Frequency Range	For 802.11ax-HE20: 6115 ~ 7095MHz For 802.11ax-HE40: 6125 ~ 7085MHz For 802.11ax-HE80: 6145 ~ 7025MHz For 802.11ax-HE160: 6185 ~ 6985MHz
Type of Modulation	802.11ax: OFDMA
Data Rate	802.11ax: up to 4804Mbps

2.3. Working Frequencies

802.11ax-HE20

Channel	Frequency	Channel	Frequency	Channel	Frequency
33	6115 MHz	37	6135 MHz	41	6155 MHz
45	6175 MHz	49	6195 MHz	53	6215 MHz
57	6235 MHz	61	6255 MHz	65	6275 MHz
69	6295 MHz	73	6315 MHz	77	6335 MHz
81	6355 MHz	85	6375 MHz	89	6395 MHz
93	6415 MHz	97	6435 MHz	101	6455 MHz
105	6475 MHz	109	5495 MHz	113	6515 MHz
117	6535 MHz	121	6555 MHz	125	6575 MHz
129	6595 MHz	133	6615 MHz	137	6635 MHz
141	6655 MHz	145	6675 MHz	149	6695 MHz
153	6715 MHz	157	6735 MHz	161	6755 MHz
165	6775 MHz	169	6795 MHz	173	6815 MHz
177	6835 MHz	181	6855 MHz	185	6875 MHz
189	6895 MHz	193	6915 MHz	197	6935 MHz
201	6955 MHz	205	6975 MHz	209	6995 MHz
213	7015 MHz	217	7035 MHz	221	7055 MHz
225	7075 MHz	229	7095 MHz	--	--

802.11ax-HE40

Channel	Frequency	Channel	Frequency	Channel	Frequency
35	6125 MHz	43	6165 MHz	51	6205 MHz
59	6245 MHz	67	6285 MHz	75	6325 MHz
83	6365 MHz	91	6405 MHz	99	6445 MHz
107	6485 MHz	115	6525 MHz	123	6565 MHz
131	6605 MHz	139	6645 MHz	147	6685 MHz
155	6725 MHz	163	6765 MHz	171	6805 MHz
179	6845 MHz	187	6885 MHz	195	6925 MHz
203	6965 MHz	211	7005 MHz	219	7045 MHz
227	7085 MHz	--	--	--	--

802.11ax-HE80

Channel	Frequency	Channel	Frequency	Channel	Frequency
39	6145 MHz	55	6225 MHz	71	6305 MHz
87	6385 MHz	103	6465 MHz	119	6545 MHz
135	6625 MHz	151	6705 MHz	167	6785 MHz
183	6865 MHz	199	6945 MHz	215	7025 MHz

802.11ax-HE160

Channel	Frequency	Channel	Frequency	Channel	Frequency
47	6185 MHz	79	6345 MHz	111	6505 MHz
143	6665 MHz	175	6825 MHz	207	6985 MHz

2.4. Antenna Details

Antenna Type	Frequency Band (MHz)	Tx Paths	Number of spatial streams	Antenna Gain (dBi)				Beamforming Directional Gain (dBi)	CDD Directional Gain (dBi)	
				Ant 1	Ant 2	Ant 3	Ant 4		For Power	For PSD
PIFA	5925 ~ 7125	4	1	5.04	3.39	4.31	4.65	7.7	5.04	7.70
			4	5.04	3.39	4.31	4.65	--	5.04	5.04

- The device supports CDD Mode and Beamforming mode, details refer to the table as below.
- CDD signals are correlated, the directional gain as follows,
 When $N_{SS}=1$, for power measurements: Array Gain = 0 dB for $N_{ANT} \leq 4$, the directional gain = max antenna gain + array gain
 For power spectral density (PSD) measurements: the max directional gain (each angle) = $10 \log[(10^{G_1/20} + 10^{G_2/20} + \dots + 10^{G_N/20})^2 / N_{ANT}]$
 When $N_{SS}=4$, the Directional Gain = $G_{ANT MAX} + 10 \log(N_{ANT}/N_{SS})$ dBi
- Beamforming signals are correlated, the directional gain as follows,
 the max directional gain (each angle) = $10 \log[(10^{G_1/20} + 10^{G_2/20} + \dots + 10^{G_N/20})^2 / N_{ANT}]$
- The information as above is from the antenna specifications.

Test Mode	Tx Paths	CDD Mode	Beamforming Mode
802.11ax (6ID)	4	√	√

2.5. Test Mode

CDD Mode
Mode 1: Transmit by 802.11ax-HE20_Nss=1 (MCS0)
Mode 2: Transmit by 802.11ax-HE40_Nss=1 (MCS0)
Mode 3: Transmit by 802.11ax-HE80_Nss=1 (MCS0)
Mode 4: Transmit by 802.11ax-HE160_Nss=1 (MCS0)
Mode 5: Transmit by 802.11ax-HE20_Nss=4 (MCS0)
Mode 6: Transmit by 802.11ax-HE40_Nss=4 (MCS0)
Mode 7: Transmit by 802.11ax-HE80_Nss=4 (MCS0)
Mode 8: Transmit by 802.11ax-HE160_Nss=4 (MCS0)
Beamforming Mode
Mode 9: Transmit by 802.11ax-HE20_Nss=1 (MCS0)
Mode 10: Transmit by 802.11ax-HE40_Nss=1 (MCS0)
Mode 11: Transmit by 802.11ax-HE80_Nss=1 (MCS0)
Mode 12: Transmit by 802.11ax-HE160_Nss=1 (MCS0)
Remark: <ol style="list-style-type: none">1. For Radiated emission, the modulation and the data rate picked for testing are determined by the Max. RF conducted power.2. Due to CDD mode was the worst mode, so all test items were evaluated in this report. The beamforming mode only evaluated the RF output power.3. EUT supports one configuration only in 802.11ax full RU mode.4. As Designated by manufacturer, the lowest data rate was the worst condition, so all the tests were done with lowest data rate.

2.6. Test System Connection Diagram

The device was tested per the guidance ANSI C63.10: 2013 was used to reference the appropriate EUT setup for radiated emissions testing and AC line conducted testing.

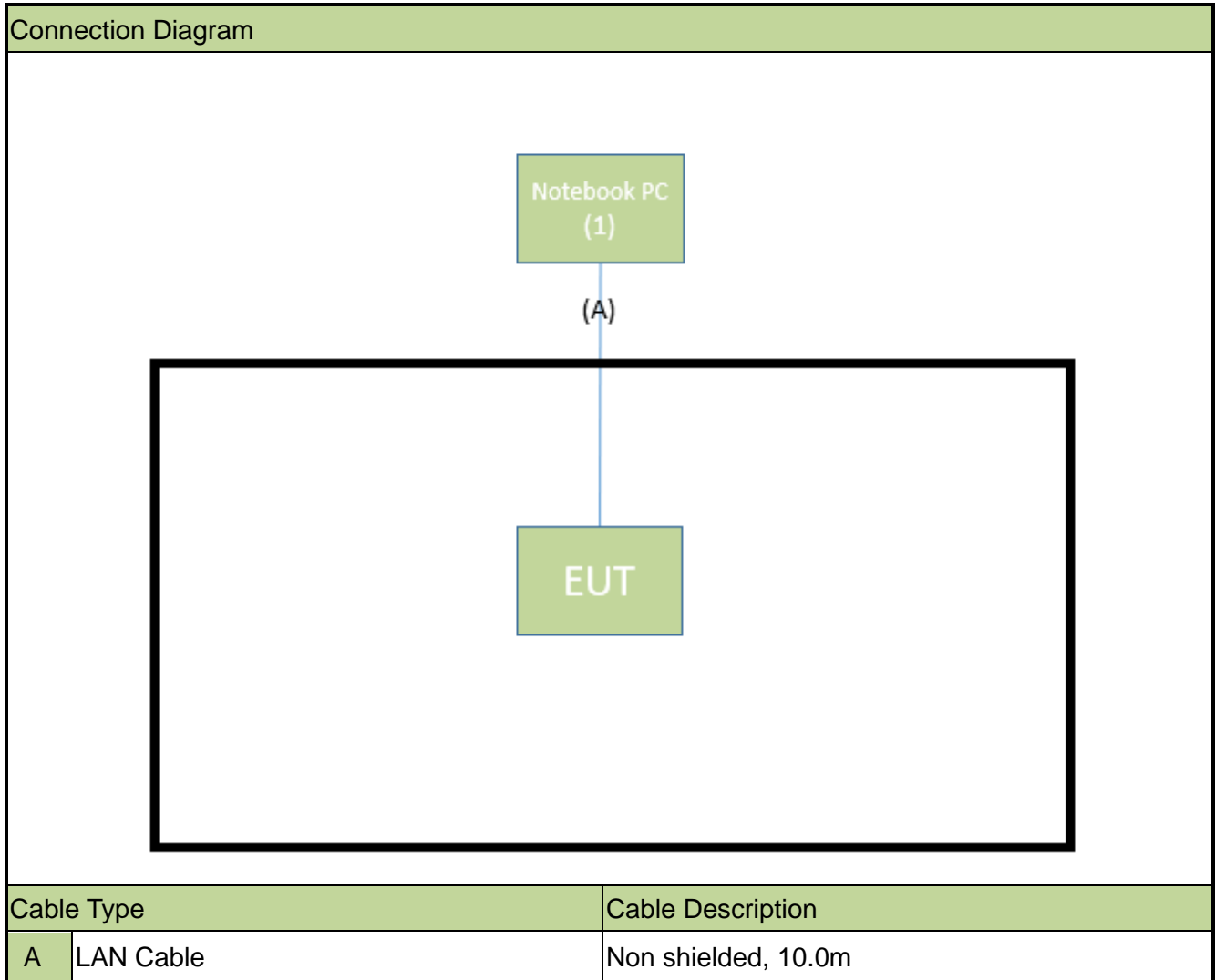

2.7. Test System Details

Product	Manufacturer	Model No.	Serial No.	Power Cord
1 Notebook PC	Dell	P65F	N/A	Non-Shielded, 0.8m

2.8. Test Software

The test utility software used during testing was "accessMTool", and the version was 3.2.1.2.

Note: Final power setting please refer to operational description.

2.9. Applied Standards

According to the specifications of the manufacturer, the EUT must comply with the requirements of the following standards:

- ANSI C63.10-2013
- FCC KDB 789033 D02v02r01
- FCC KDB 987594 D02v01
- FCC KDB 662911 D01v02r01
- FCC KDB 414788 D01v01r01
- FCC KDB 412172 D01v01r01

2.10. Duty Cycle

The maximum achievable duty cycles for all modes were determined based on measurements performed on a spectrum analyzer in zero-span mode with RBW = 8MHz, VBW = 50MHz. The RBW and VBW were both greater than 50/T, where T is the minimum transmission duration, and the number of sweep points across T was greater than 100. The duty cycles are as follows:

Test Mode	Duty Cycle
802.11ax-HE20	86.69%
802.11ax-HE40	85.80%
802.11ax-HE80	85.44%
802.11ax-HE160	92.87%

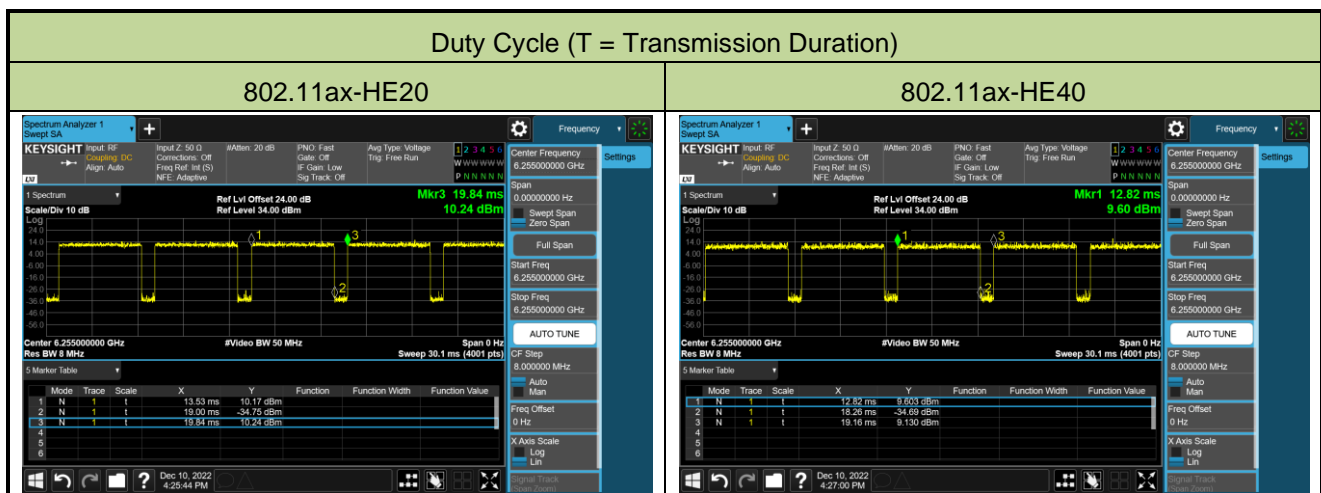

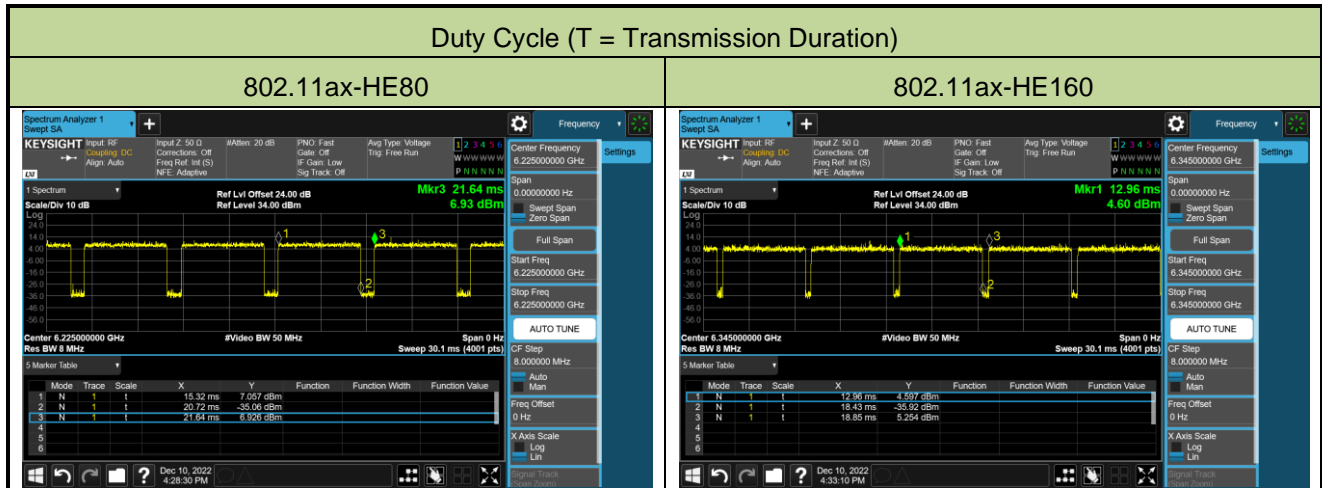

2.11. Test Environment Condition

Ambient Temperature	15°C~35°C
Relative Humidity	20%RH ~75%RH

3. Antenna Requirements

Excerpt from §15.407(a)(9) of the FCC Rules/Regulations:

Access points operating under the provisions of paragraphs (a)(5) and (a)(6) of this section must employ a permanently attached integrated antenna.

- The antenna of the device is built in and locked inside the enclosure.

Conclusion:

The device complies with the requirement of §15.407(a)(9).

4. Measuring Instrument

Conducted Emissions

Instrument	Manufacturer	Type No.	Asset No.	Cali. Interval	Cali. Due Date
Two-Line V-Network	R&S	ENV216	MRTTWA00019	1 year	2023/3/7
Two-Line V-Network	R&S	ENV216	MRTTWA00020	1 year	2023/4/20
EMI Test Receiver	R&S	ESR3	MRTTWA00045	1 year	2023/5/9
DIVA PLUS Funk-Wetterstation	TFA	35.1083	MRTTWA00050	1 year	2023/6/16

Radiated Emissions

Instrument	Manufacturer	Type No.	Asset No.	Cali. Interval	Cali. Due Date
Broadband TRILOG Antenna	SCHWARZBECK	VULB 9162	MRTTWA00001	1 year	2023/12/21
Active Loop Antenna	SCHWARZBECK	FMZB 1519B	MRTTWA00002	1 year	2023/5/24
Broadband Hornantenna	RFSPIN	DRH18-E	MRTTWA00087	1 year	2023/5/10
Breitband Hornantenna	SCHWARZBECK	BBHA 9170	MRTTWA00004	1 year	2023/3/29
Broadband Preamplifier	EMC Instruments corporation	EMC118A45S E	MRTTWA00088	1 year	2023/5/9
Broadband Amplifier	SCHWARZBECK	BBV 9721	MRTTWA00006	1 year	2023/3/30
Signal Analyzer	R&S	FSV40	MRTTWA00007	1 year	2023/3/16
EMI Test Receiver	R&S	ESR3	MRTTWA00009	1 year	2023/3/9
EXA Signal Analyzer	KEYSIGHT	N9010B	MRTTWA00074	1 year	2023/7/19
Antenna Cable	HUBERSUHNER	SF106	MRTTWE00010	1 year	2023/6/14
Temperature/Humidity Meter	TFA	35.1078.10.IT	MRTTWA00032	1 year	2023/6/5

Conducted Test Equipment

Instrument	Manufacturer	Type No.	Asset No.	Cali. Interval	Cali. Due Date
X-Series USB Peak and Average Power Sensor	KEYSIGHT	U2021XA	MRTTWA00014	1 year	2023/4/20
EXA Signal Analyzer	KEYSIGHT	N9010A	MRTTWA00012	1 year	2023/10/5
EXA Signal Analyzer	KEYSIGHT	N9010B	MRTTWA00074	1 year	2023/7/19
Attenuator	WTI	218FS-20	MRTTWE00026	1 year	2023/11/18
Attenuator	WTI	218FS-10	MRTTWE00027	1 year	2023/6/15
Temperature & Humidity Chamber	TEN BILLION	TTH-B3UP	MRTTWA00036	1 year	2023/6/14
DIVA PLUS Funk-Wetterstation	TFA	35.1083	MRTTWA00050	1 year	2023/6/16

Software	Version	Function
e3	9.160520a	EMI Test Software

5. Measurement Uncertainty

Where relevant, the following test uncertainty levels have been estimated for tests performed on the EUT as specified in CISPR 16-4-2. This uncertainty represents an expanded uncertainty expressed at approximately the 95% confidence level using a coverage factor of $k = 2$.

AC Conducted Emission Measurement
Measuring Uncertainty for a Level of Confidence of 95% ($U=2Uc(y)$): 150kHz~30MHz: $\pm 2.53\text{dB}$
Radiated Emission Measurement
Measuring Uncertainty for a Level of Confidence of 95% ($U=2Uc(y)$): 9kHz ~ 1GHz: $\pm 4.25\text{dB}$ 1GHz ~ 40GHz: $\pm 4.45\text{dB}$
Conducted Power (Carrier Power / Power Density)
Measuring Uncertainty for a Level of Confidence of 95% ($U=2Uc(y)$): $\pm 0.84\text{dB}$
Conducted Spurious Emission
Measuring Uncertainty for a Level of Confidence of 95% ($U=2Uc(y)$): $\pm 2.65\text{ dB}$
Occupied Bandwidth
Measuring Uncertainty for a Level of Confidence of 95% ($U=2Uc(y)$): $\pm 3.3\%$
Temp. / Humidity
Measuring Uncertainty for a Level of Confidence of 95% ($U=2Uc(y)$): $\pm 0.82^\circ\text{C} / \pm 3\%$
Frequency Error
Measuring Uncertainty for a Level of Confidence of 95% ($U=2Uc(y)$): $\pm 78.4\text{Hz}$

6. Test Result

6.1. Summary

FCC Section(s)	Test Description	Test Condition	Verdict
15.407(a)	26dB Bandwidth	Conducted	Pass
15.407(a)(5)	Maximum Equivalent Isotropically Radiated Power (E.I.R.P)		Pass
15.407(a)(5)	Peak Power Spectral Density (E.I.R.P)		Pass
15.407(b)(6)	In-Band Emission		Pass
15.407(g)	Frequency Stability		
15.407(d)(6)	Contention-Based Protocol		Pass
15.407(b)(5)	Unwanted Emissions		Pass
15.407(b)(7), (8), (9)	General Field Strength (Restricted Bands and Radiated Emission)	Radiated	Pass
15.207	AC Conducted Emissions 150kHz - 30MHz	Line Conducted	Pass

Notes:

1. Determining compliance is based on the test results met the regulation limits or requirements declared by clients, and the test results don't take into account the value of measurement uncertainty.
2. The analyzer plots shown in this section were all taken with a correction table loaded into the analyzer. The correction table was used to account for the losses of the cables and attenuators used as part of the system to connect the EUT to the analyzer at all frequencies of interest.
3. For radiated emission test, the test results shown in the following sections represent the worst-case emissions.

6.2. 26dB Bandwidth

6.2.1. Test Limit

N/A

6.2.2. Test Procedure used

KDB 789033 D02v02r01- Section II) C.1 (26dB Bandwidth)

KDB 789033 D02v02r01- Section II) D (99% Bandwidth)

6.2.3. Test Setting

26dB Bandwidth

1. The analyzers' automatic bandwidth measurement capability was used to perform the 26dB bandwidth measurement. The "X" dB bandwidth parameter was set to $X = 26$. The automatic bandwidth measurement function also has the capability of simultaneously measuring the 99% occupied bandwidth. The bandwidth measurement was not influenced by any intermediated power nulls in the fundamental emission.
2. RBW = approximately 1% of the emission bandwidth.
3. VBW > RBW.
4. Detector = Peak.
5. Trace mode = max hold.

99% Bandwidth

1. Set center frequency to the nominal EUT channel center frequency.
2. Set span = 1.5 times to 5.0 times the OBW.
3. Set RBW = 1% to 5% of the OBW
4. Set VBW $\geq 3 \times$ RBW
5. Detector = Peak.
6. Use the 99% power bandwidth function of the instrument.

6.2.4. Test Setup

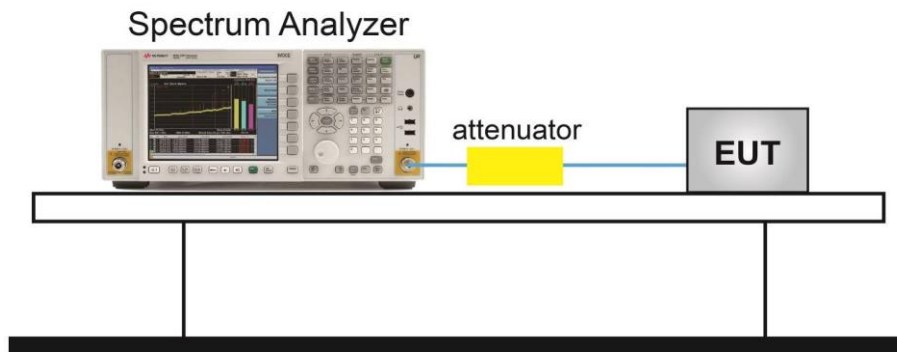

6.2.5. Test Result

Test Site	SR6	Test Engineer	Marvin
Test Date	2022/12/13		

Test Mode	Data Rate/ MCS	Channel No.	Frequency (MHz)	26dB Bandwidth (MHz)	99% Bandwidth (MHz)
802.11ax-HE20	MCS0	33	6115	21.270	19.129
802.11ax-HE20	MCS0	61	6255	21.420	19.081
802.11ax-HE20	MCS0	93	6415	21.770	19.070
802.11ax-HE20	MCS0	97	6435	21.480	19.092
802.11ax-HE20	MCS0	105	6475	21.380	19.096
802.11ax-HE20	MCS0	113	6515	21.480	19.068
802.11ax-HE20	MCS0	117	6535	20.850	19.099
802.11ax-HE20	MCS0	153	6715	21.250	19.079
802.11ax-HE20	MCS0	181	6855	21.760	19.098
802.11ax-HE20	MCS0	185	6875	21.280	19.102
802.11ax-HE20	MCS0	189	6895	21.400	19.073
802.11ax-HE20	MCS0	213	7015	21.390	19.079
802.11ax-HE20	MCS0	229	7095	22.040	19.110
802.11ax-HE40	MCS0	35	6125	39.680	37.686
802.11ax-HE40	MCS0	59	6245	39.800	37.638
802.11ax-HE40	MCS0	91	6405	39.640	37.698
802.11ax-HE40	MCS0	99	6445	39.390	37.713
802.11ax-HE40	MCS0	107	6485	40.040	37.717
802.11ax-HE40	MCS0	115	6525	39.760	37.699
802.11ax-HE40	MCS0	123	6565	40.070	37.616
802.11ax-HE40	MCS0	147	6685	39.480	37.719
802.11ax-HE40	MCS0	179	6845	39.690	37.706
802.11ax-HE40	MCS0	187	6885	40.200	37.750
802.11ax-HE40	MCS0	195	6925	39.870	37.768
802.11ax-HE40	MCS0	211	7005	39.910	37.739
802.11ax-HE40	MCS0	227	7085	39.910	37.743

Test Mode	Data Rate/ MCS	Channel No.	Frequency (MHz)	26dB Bandwidth (MHz)	99% Bandwidth (MHz)
802.11ax-HE80	MCS0	39	6145	81.550	77.342
802.11ax-HE80	MCS0	55	6225	80.720	77.379
802.11ax-HE80	MCS0	87	6385	80.420	77.172
802.11ax-HE80	MCS0	103	6465	80.880	77.217
802.11ax-HE80	MCS0	119	6545	80.860	77.082
802.11ax-HE80	MCS0	135	6625	80.980	77.212
802.11ax-HE80	MCS0	151	6705	80.860	77.129
802.11ax-HE80	MCS0	183	6865	80.440	77.289
802.11ax-HE80	MCS0	199	6945	81.270	77.236
802.11ax-HE80	MCS0	215	7025	80.450	77.226
802.11ax-HE160	MCS0	47	6185	162.200	155.140
802.11ax-HE160	MCS0	79	6345	162.100	155.310
802.11ax-HE160	MCS0	111	6505	163.200	155.060
802.11ax-HE160	MCS0	143	6665	162.200	155.220
802.11ax-HE160	MCS0	175	6825	161.900	155.150
802.11ax-HE160	MCS0	207	6985	162.500	155.330

802.11ax-HE20 26dB Bandwidth & 99% Bandwidth

Channel 33 (6115MHz)

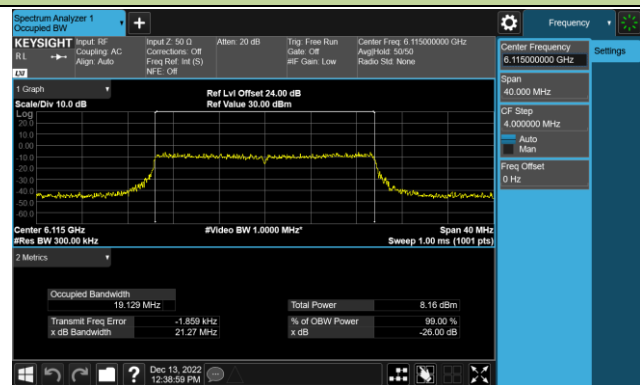

Channel 65 (6275MHz)

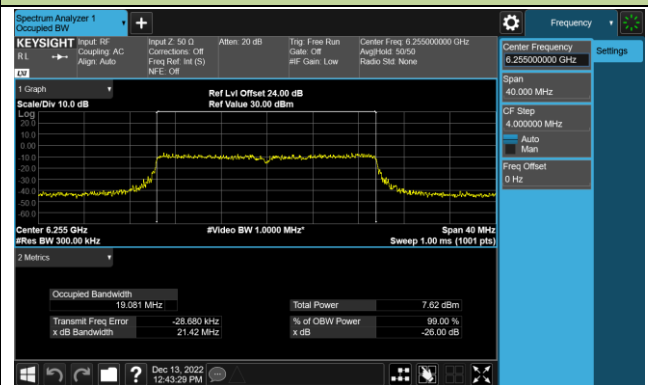

Channel 93 (6415MHz)

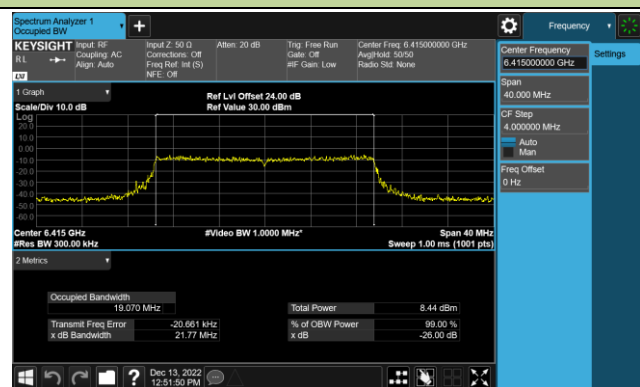

Channel 97 (6435MHz)

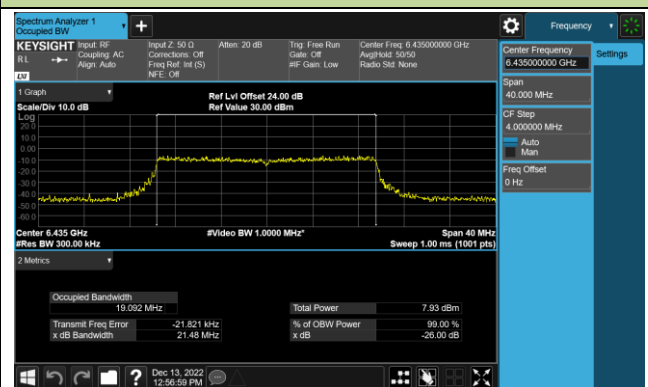

Channel 105 (6475MHz)

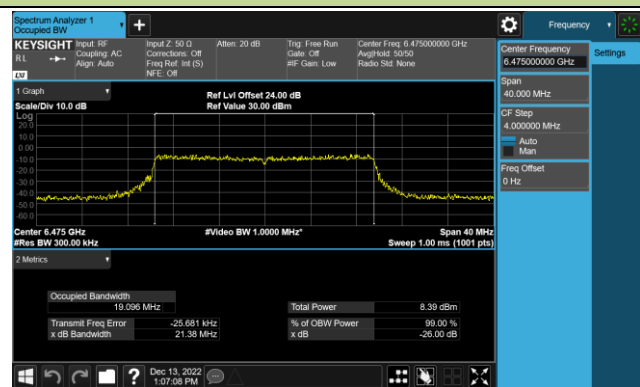

Channel 113 (6515MHz)

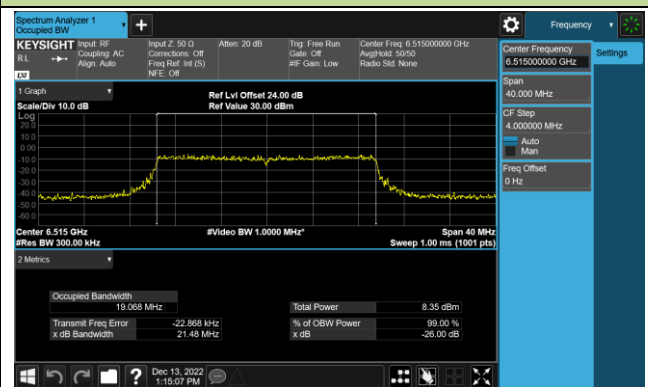

Channel 117 (6535MHz)

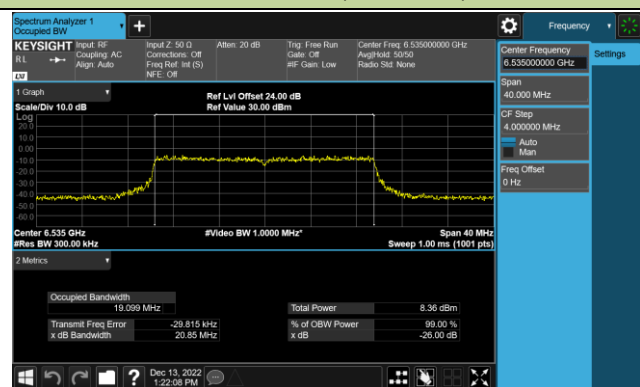

Channel 153 (6715MHz)

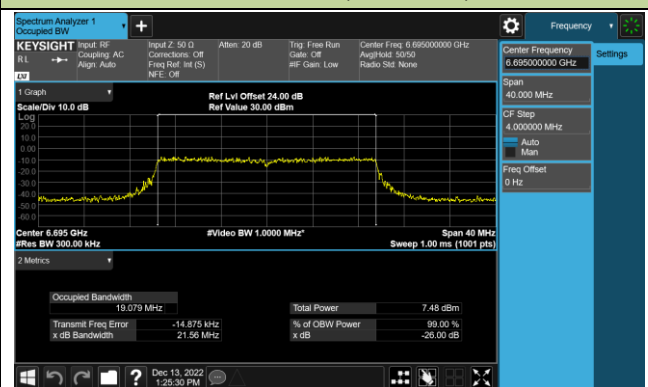

802.11ax-HE20 26dB Bandwidth & 99% Bandwidth

Channel 181 (6855MHz)

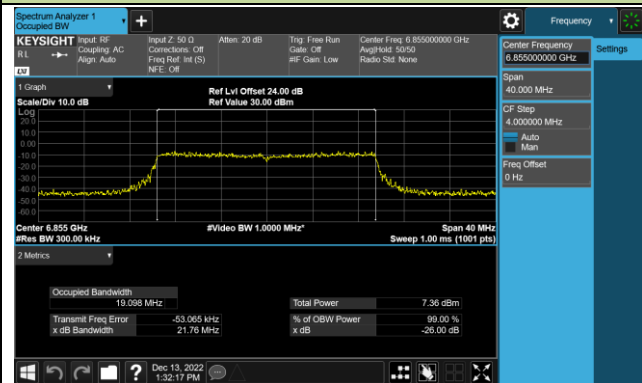

Channel 185 (6875MHz)

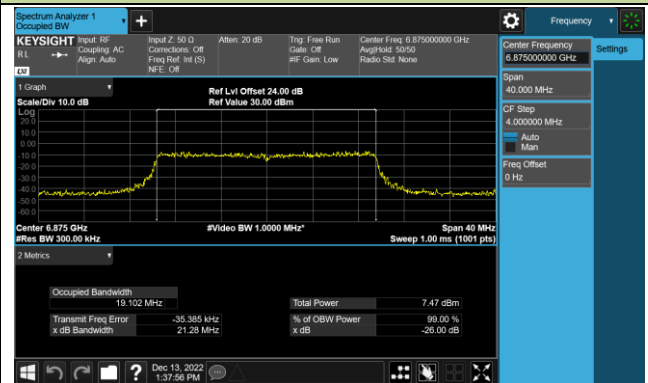

Channel 189 (6895MHz)

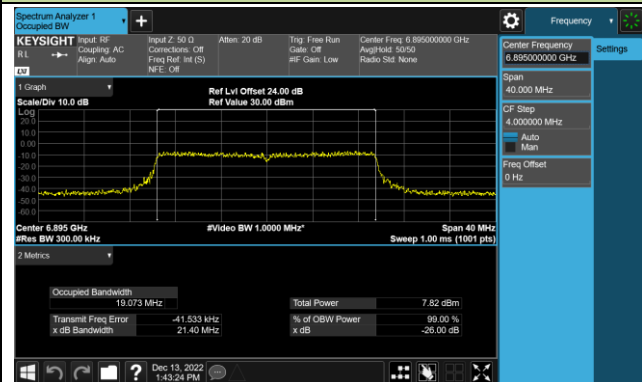

Channel 213 (7015MHz)

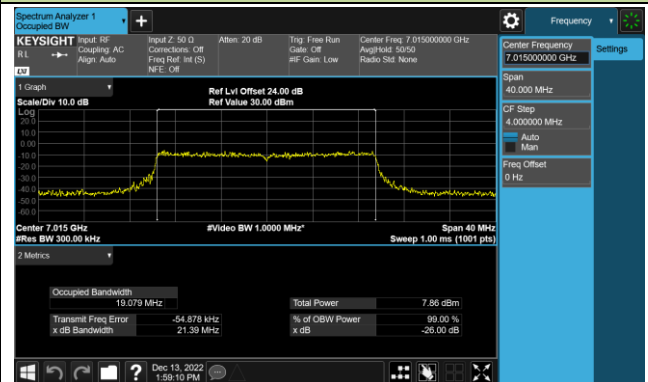

Channel 229 (7095MHz)

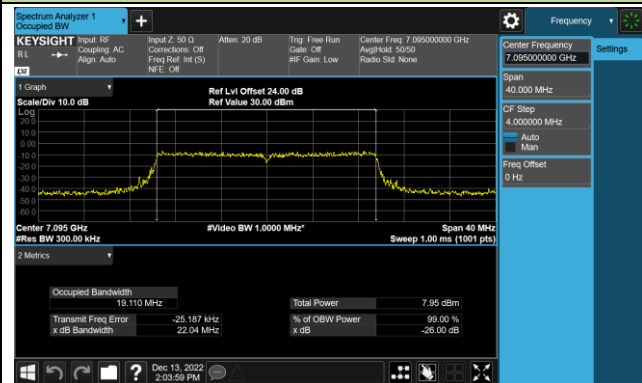

802.11ax-HE40 26dB Bandwidth & 99% Bandwidth

Channel 35 (6125MHz)

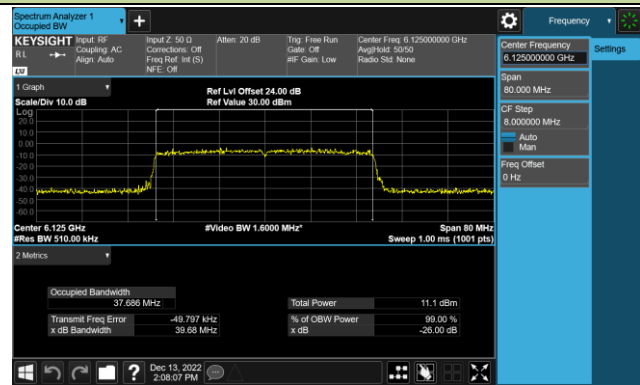

Channel 67 (6285MHz)

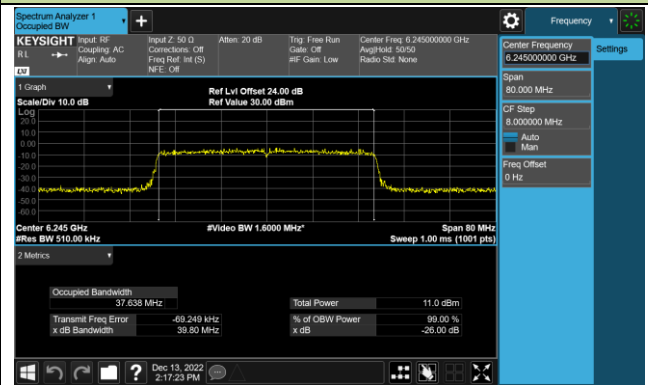

Channel 91 (6405MHz)

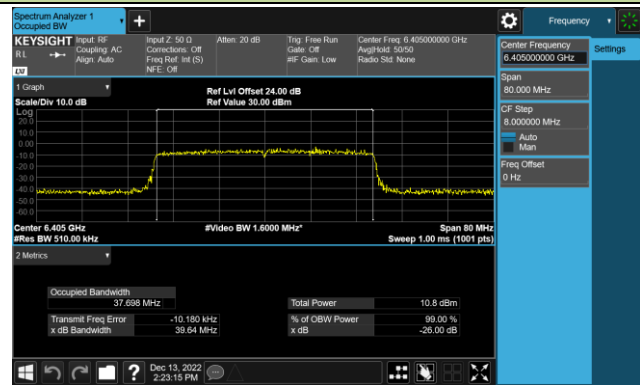

Channel 99 (6445MHz)

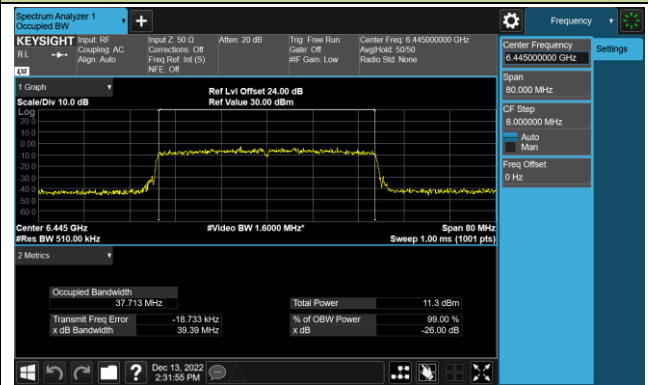

Channel 107 (6485MHz)

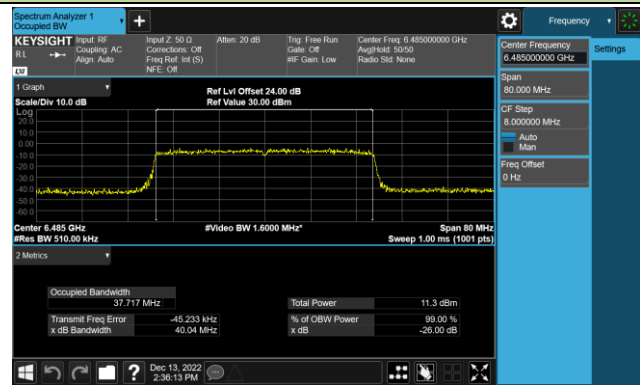

Channel 115 (6525MHz)

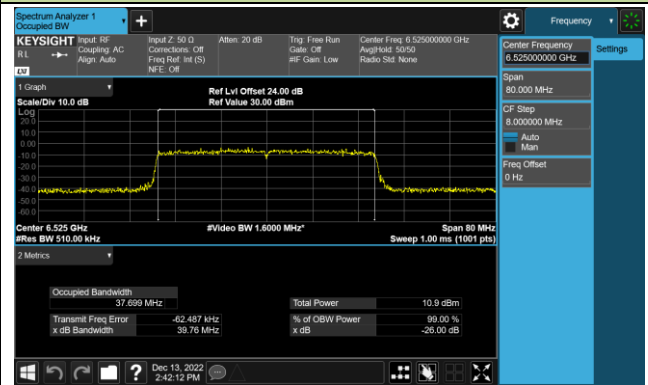

Channel 123 (6565MHz)

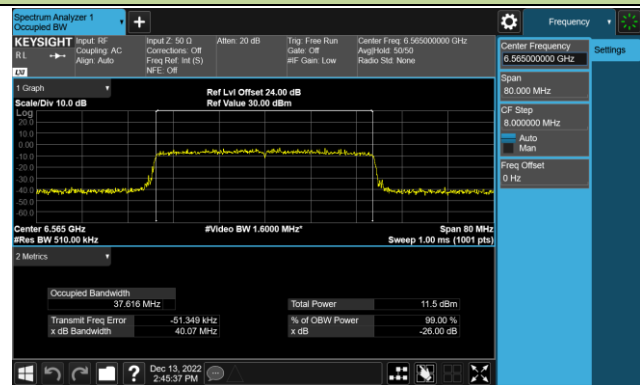

Channel 147 (6685MHz)

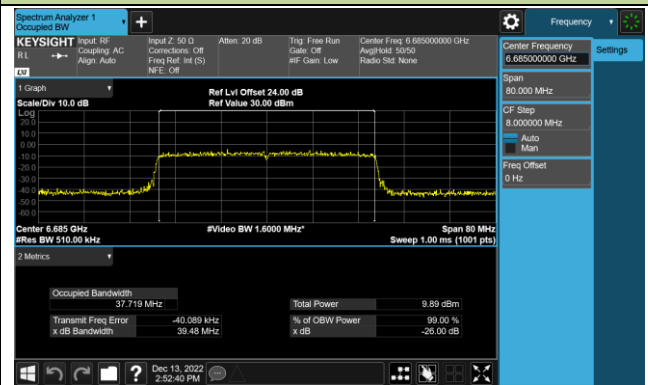

802.11ax-HE40 26dB Bandwidth & 99% Bandwidth

Channel 179 (6845MHz)

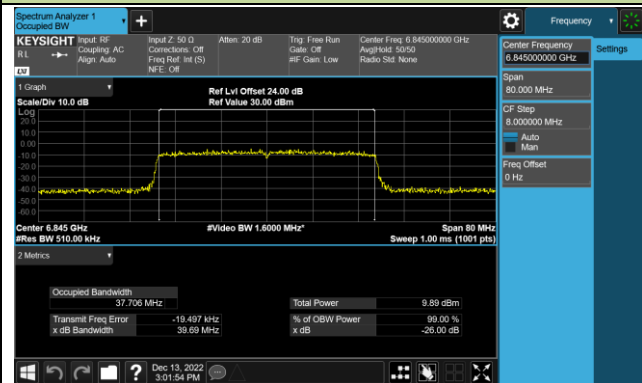

Channel 187 (6885MHz)

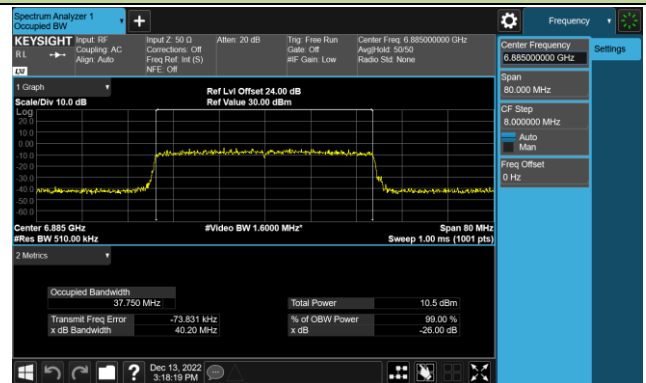

Channel 195 (6925MHz)

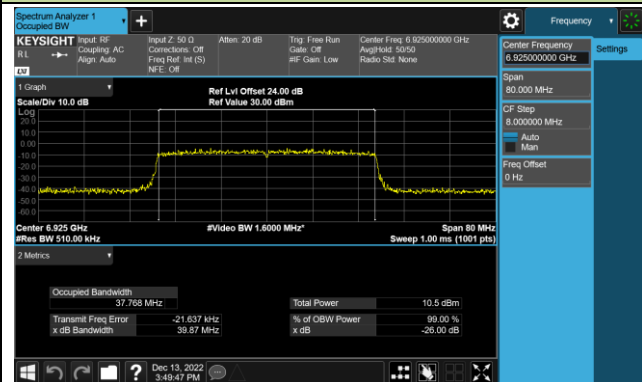

Channel 211 (7005MHz)

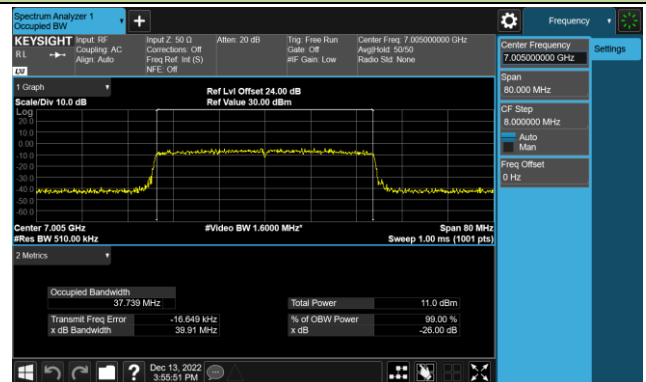

Channel 227 (7085MHz)

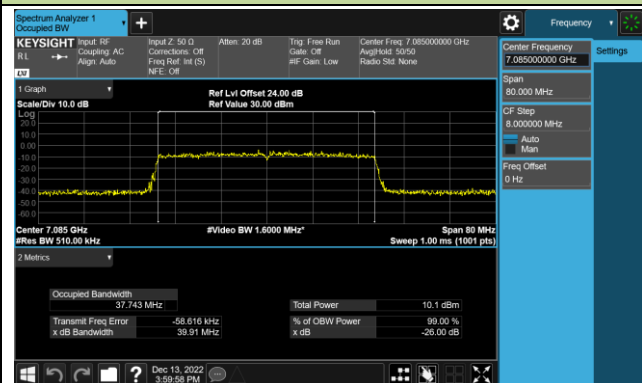

802.11ax-HE80 26dB Bandwidth & 99% Bandwidth

Channel 39 (6145MHz)

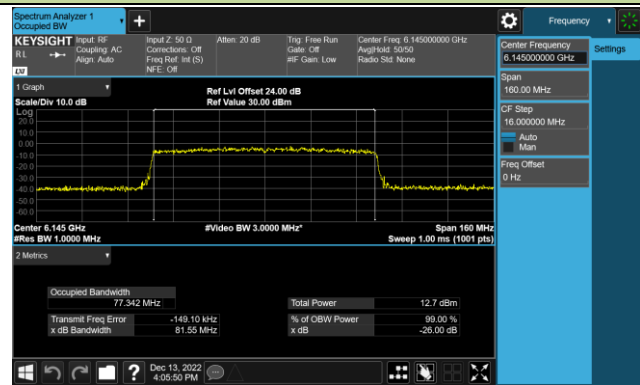

Channel 55 (6225MHz)

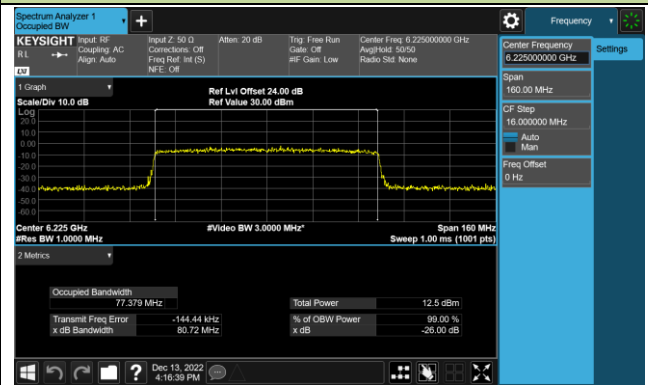

Channel 87 (6385MHz)

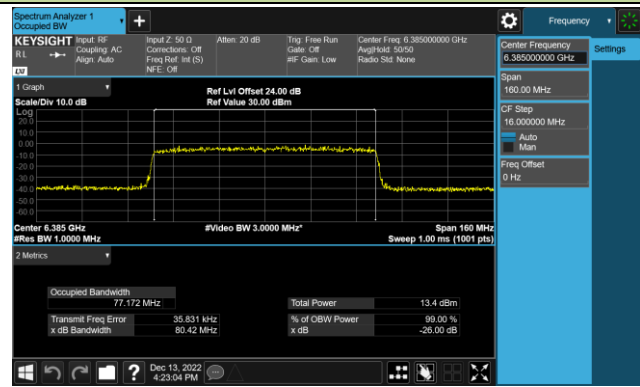

Channel 103 (6465MHz)

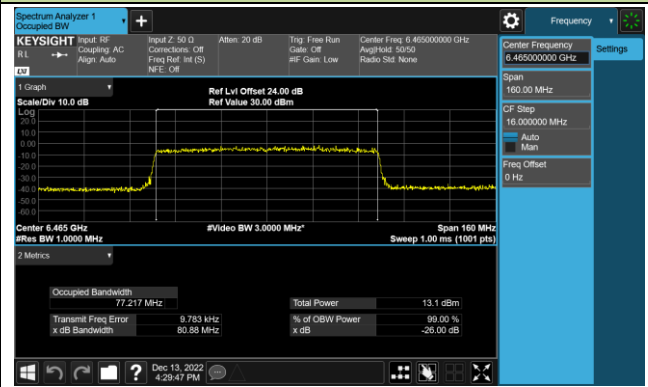

Channel 119 (6545MHz)

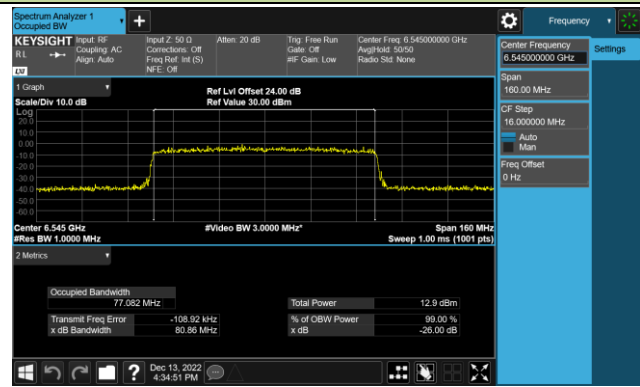

Channel 135 (6625MHz)

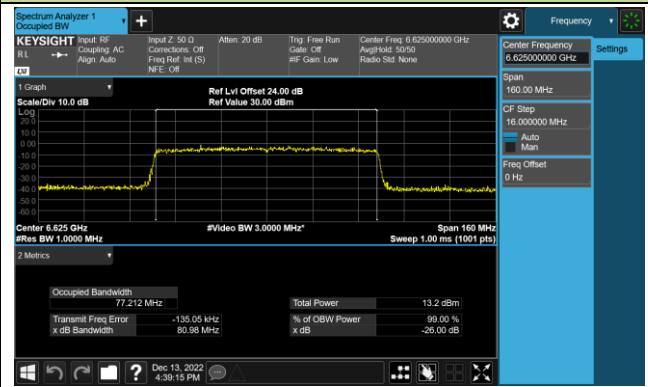

Channel 151 (6705MHz)

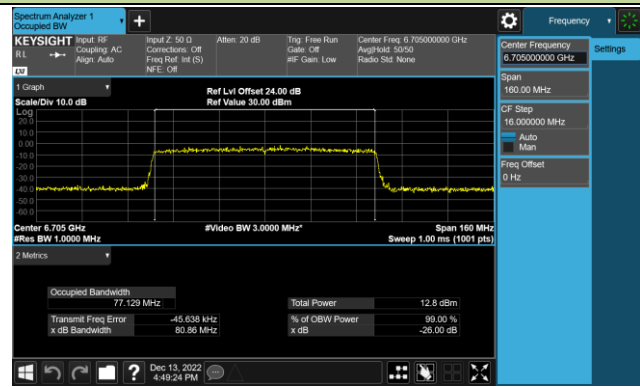

Channel 183 (6865MHz)

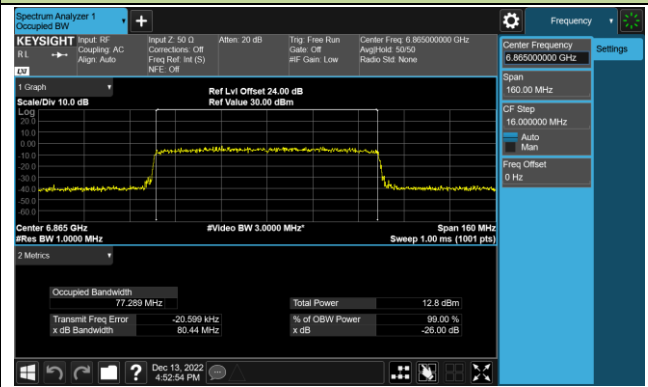

802.11ax-HE80 26dB Bandwidth & 99% Bandwidth (Nss=1)

Channel 199 (6945MHz)

Channel 215 (7025MHz)

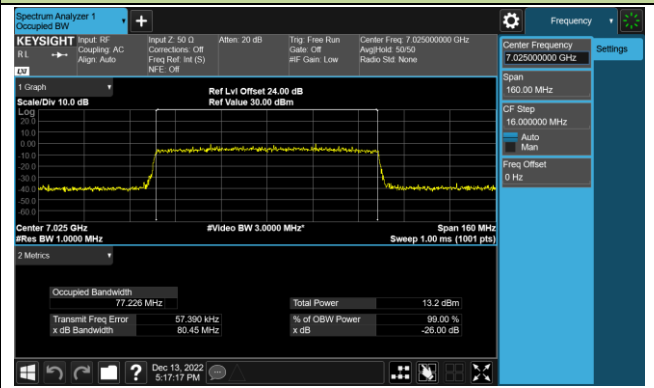
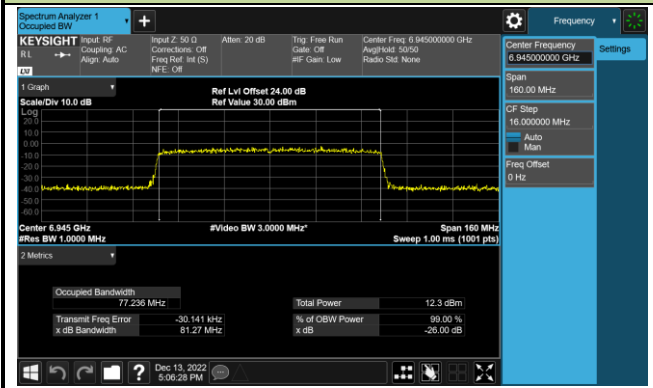

802.11ax-HE160 26dB Bandwidth & 99% Bandwidth

Channel 47 (6185MHz) Channel 79 (6345MHz)

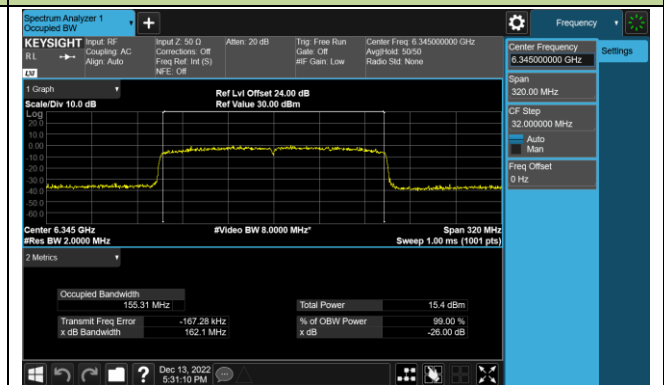
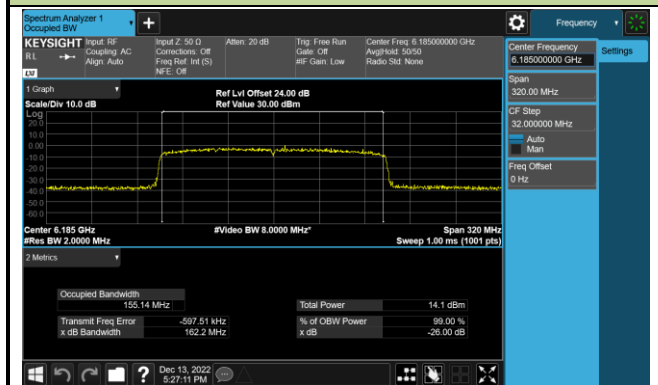

Channel 111 (6505MHz)

Channel 143 (6665MHz)

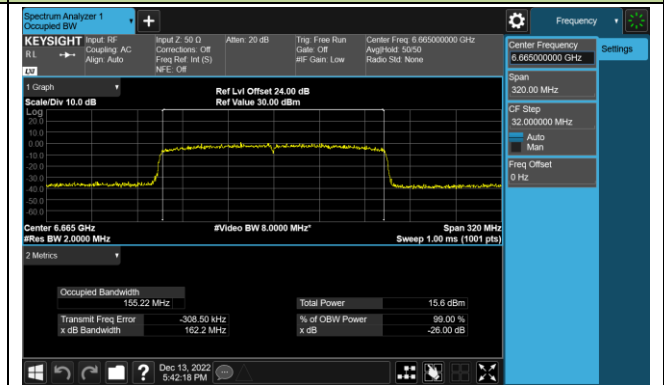
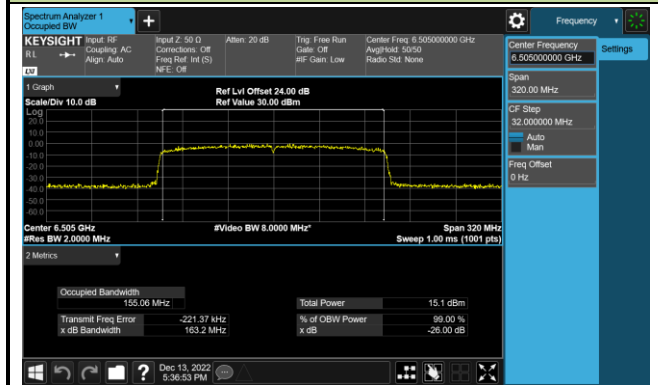

Channel 175 (6825MHz)

Channel 207 (6985MHz)

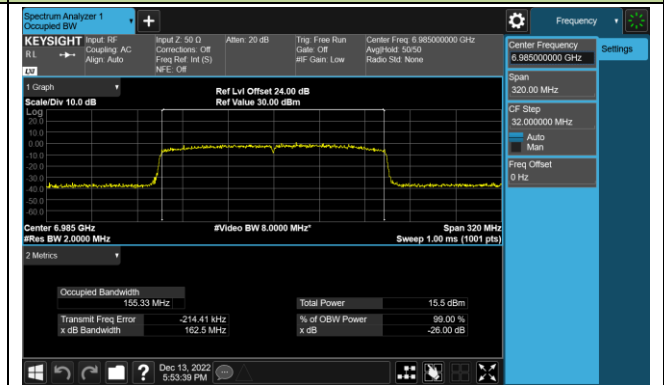
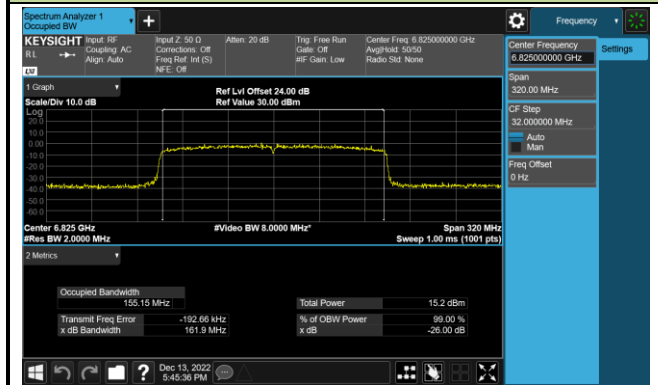

6.3. Output Power

6.3.1. Test Limit

For an indoor access point operating in the 5.925-7.125 GHz band, the maximum e.i.r.p. over the frequency band of operation must not exceed 30 dBm.

6.3.2. Test Procedure Used

KDB 789033D02v02r01- Section II) E)3)b) Method PM-G

6.3.3. Test Setting

Average Power Measurement

Average power measurements were performed only when the EUT was transmitting at its maximum power control level using a broadband power meter with a pulse sensor. The power meter implemented triggering and gating capabilities which were set up such that power measurements were recorded only during the ON time of the transmitter.

6.3.4. Test Setup

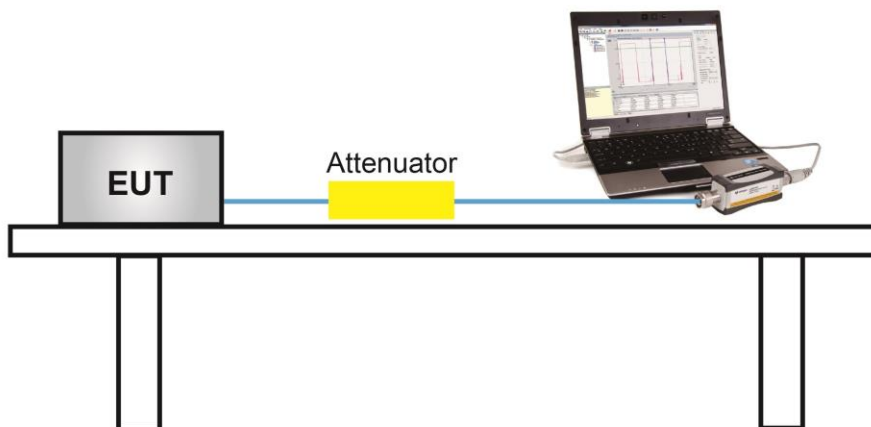

6.3.5. Test Result

Test Site	SR6	Test Engineer	Marvin
Test Date	2023/1/10		

Test Mode	Data Rate/ MCS	Channel No.	Freq. (MHz)	Average Power (dBm)				Total Average Power (dBm)	CDD Directional Gain (dBi)	EIRP (dBm)	EIRP Limit (dBm)
				Ant 1	Ant 2	Ant 3	Ant 4				
CDD Mode (Nss = 1)											
11ax-HE20	MCS0	33	6115	3.48	2.98	4.33	3.25	9.56	5.04	14.60	≤ 30.00
11ax-HE20	MCS0	61	6255	2.63	3.51	3.73	3.15	9.30	5.04	14.34	≤ 30.00
11ax-HE20	MCS0	93	6415	3.79	4.06	4.08	2.89	9.75	5.04	14.79	≤ 30.00
11ax-HE20	MCS0	97	6435	3.22	3.45	3.58	2.56	9.24	5.04	14.28	≤ 30.00
11ax-HE20	MCS0	105	6475	3.36	3.75	4.05	3.13	9.61	5.04	14.65	≤ 30.00
11ax-HE20	MCS0	113	6515	3.55	3.83	4.23	2.67	9.63	5.04	14.67	≤ 30.00
11ax-HE20	MCS0	117	6535	3.66	3.89	4.30	2.91	9.74	5.04	14.78	≤ 30.00
11ax-HE20	MCS0	153	6715	4.10	4.18	4.41	3.78	10.14	5.04	15.18	≤ 30.00
11ax-HE20	MCS0	181	6855	3.46	4.81	3.30	3.10	9.74	5.04	14.78	≤ 30.00
11ax-HE20	MCS0	185	6875	3.52	4.88	3.33	3.14	9.79	5.04	14.83	≤ 30.00
11ax-HE20	MCS0	189	6895	3.21	3.58	3.92	3.79	9.65	5.04	14.69	≤ 30.00
11ax-HE20	MCS0	213	7015	2.74	3.04	4.00	3.77	9.44	5.04	14.48	≤ 30.00
11ax-HE20	MCS0	229	7095	3.89	4.33	4.46	3.61	10.11	5.04	15.15	≤ 30.00
11ax-HE40	MCS0	35	6125	6.31	6.00	7.12	6.50	12.52	5.04	17.56	≤ 30.00
11ax-HE40	MCS0	59	6245	6.77	7.61	7.75	6.61	13.23	5.04	18.27	≤ 30.00
11ax-HE40	MCS0	91	6405	6.17	6.54	6.77	5.41	12.27	5.04	17.31	≤ 30.00
11ax-HE40	MCS0	99	6445	6.16	6.57	6.84	5.78	12.38	5.04	17.42	≤ 30.00
11ax-HE40	MCS0	107	6485	6.00	6.88	6.81	5.98	12.46	5.04	17.50	≤ 30.00
11ax-HE40	MCS0	115	6525	6.26	6.91	7.29	6.43	12.76	5.04	17.80	≤ 30.00
11ax-HE40	MCS0	123	6565	6.68	6.41	7.59	6.64	12.87	5.04	17.91	≤ 30.00
11ax-HE40	MCS0	147	6685	7.18	7.42	7.20	6.94	13.21	5.04	18.25	≤ 30.00
11ax-HE40	MCS0	179	6845	5.88	7.75	5.66	5.64	12.35	5.04	17.39	≤ 30.00
11ax-HE40	MCS0	187	6885	5.28	6.14	6.42	6.35	12.09	5.04	17.13	≤ 30.00
11ax-HE40	MCS0	195	6925	5.19	6.25	6.60	6.67	12.24	5.04	17.28	≤ 30.00
11ax-HE40	MCS0	211	7005	5.88	6.11	7.97	7.83	13.07	5.04	18.11	≤ 30.00
11ax-HE40	MCS0	227	7085	6.52	6.94	6.60	6.54	12.67	5.04	17.71	≤ 30.00

Test Mode	Data Rate/ MCS	Channel No.	Freq. (MHz)	Average Power (dBm)				Total Average Power (dBm)	CDD Directional Gain (dBi)	EIRP (dBm)	EIRP Limit (dBm)
				Ant 1	Ant 2	Ant 3	Ant 4				
CDD Mode (Nss = 1)											
11ax-HE80	MCS0	39	6145	9.17	9.93	9.80	8.97	15.51	5.04	20.55	≤ 30.00
11ax-HE80	MCS0	55	6225	8.76	9.73	9.12	8.73	15.12	5.04	20.16	≤ 30.00
11ax-HE80	MCS0	87	6385	9.35	9.69	9.96	8.84	15.50	5.04	20.54	≤ 30.00
11ax-HE80	MCS0	103	6465	8.60	9.86	9.24	8.54	15.11	5.04	20.15	≤ 30.00
11ax-HE80	MCS0	119	6545	8.31	9.30	9.42	8.65	14.96	5.04	20.00	≤ 30.00
11ax-HE80	MCS0	135	6625	9.42	9.78	10.09	9.27	15.67	5.04	20.71	≤ 30.00
11ax-HE80	MCS0	151	6705	9.31	9.86	9.90	9.18	15.59	5.04	20.63	≤ 30.00
11ax-HE80	MCS0	183	6865	8.58	9.94	9.32	8.70	15.19	5.04	20.23	≤ 30.00
11ax-HE80	MCS0	199	6945	8.26	9.12	9.29	9.02	14.96	5.04	20.00	≤ 30.00
11ax-HE80	MCS0	215	7025	8.56	8.81	10.11	9.91	15.42	5.04	20.46	≤ 30.00
11ax-HE160	MCS0	47	6185	11.79	12.30	12.42	11.89	18.13	5.04	23.17	≤ 30.00
11ax-HE160	MCS0	79	6345	11.38	11.92	12.52	11.40	17.85	5.04	22.89	≤ 30.00
11ax-HE160	MCS0	111	6505	11.38	12.84	12.43	11.54	18.11	5.04	23.15	≤ 30.00
11ax-HE160	MCS0	143	6665	11.60	12.37	12.93	11.90	18.25	5.04	23.29	≤ 30.00
11ax-HE160	MCS0	175	6825	11.48	12.63	12.30	11.31	17.99	5.04	23.03	≤ 30.00
11ax-HE160	MCS0	207	6985	11.15	11.55	12.65	12.03	17.90	5.04	22.94	≤ 30.00

Note 1: Total Average Power (dBm) = $10 \cdot \log \{10^{(\text{Ant 1 Average Power} / 10)} + 10^{(\text{Ant 2 Average Power} / 10)} + 10^{(\text{Ant 3 Average Power} / 10)} + 10^{(\text{Ant 4 Average Power} / 10)}\}$.

Note 2: CDD EIRP Power (dBm) = Total Average Power (dBm) + CDD Directional Gain (dBi).

Test Mode	Data Rate/ MCS	Channel No.	Freq. (MHz)	Average Power (dBm)				Total Average Power (dBm)	Beamforming Directional Gain (dBi)	EIRP (dBm)	EIRP Limit (dBm)
				Ant 1	Ant 2	Ant 3	Ant 4				
Beamforming Mode (Nss = 1)											
11ax-HE20	MCS0	33	6115	3.48	2.98	4.33	3.25	9.56	7.70	17.26	≤ 30.00
11ax-HE20	MCS0	61	6255	2.63	3.51	3.73	3.15	9.30	7.70	17.00	≤ 30.00
11ax-HE20	MCS0	93	6415	3.79	4.06	4.08	2.89	9.75	7.70	17.45	≤ 30.00
11ax-HE20	MCS0	97	6435	3.22	3.45	3.58	2.56	9.24	7.70	16.94	≤ 30.00
11ax-HE20	MCS0	105	6475	3.36	3.75	4.05	3.13	9.61	7.70	17.31	≤ 30.00
11ax-HE20	MCS0	113	6515	3.55	3.83	4.23	2.67	9.63	7.70	17.33	≤ 30.00
11ax-HE20	MCS0	117	6535	3.66	3.89	4.30	2.91	9.74	7.70	17.44	≤ 30.00
11ax-HE20	MCS0	153	6715	4.10	4.18	4.41	3.78	10.14	7.70	17.84	≤ 30.00
11ax-HE20	MCS0	181	6855	3.46	4.81	3.30	3.10	9.74	7.70	17.44	≤ 30.00
11ax-HE20	MCS0	185	6875	3.52	4.88	3.33	3.14	9.79	7.70	17.49	≤ 30.00
11ax-HE20	MCS0	189	6895	3.21	3.58	3.92	3.79	9.65	7.70	17.35	≤ 30.00
11ax-HE20	MCS0	213	7015	2.74	3.04	4.00	3.77	9.44	7.70	17.14	≤ 30.00
11ax-HE20	MCS0	229	7095	3.89	4.33	4.46	3.61	10.11	7.70	17.81	≤ 30.00
11ax-HE40	MCS0	35	6125	6.31	6.00	7.12	6.50	12.52	7.70	20.22	≤ 30.00
11ax-HE40	MCS0	59	6245	6.77	7.61	7.75	6.61	13.23	7.70	20.93	≤ 30.00
11ax-HE40	MCS0	91	6405	6.17	6.54	6.77	5.41	12.27	7.70	19.97	≤ 30.00
11ax-HE40	MCS0	99	6445	6.16	6.57	6.84	5.78	12.38	7.70	20.08	≤ 30.00
11ax-HE40	MCS0	107	6485	6.00	6.88	6.81	5.98	12.46	7.70	20.16	≤ 30.00
11ax-HE40	MCS0	115	6525	6.26	6.91	7.29	6.43	12.76	7.70	20.46	≤ 30.00
11ax-HE40	MCS0	123	6565	6.68	6.41	7.59	6.64	12.87	7.70	20.57	≤ 30.00
11ax-HE40	MCS0	147	6685	7.18	7.42	7.20	6.94	13.21	7.70	20.91	≤ 30.00
11ax-HE40	MCS0	179	6845	5.88	7.75	5.66	5.64	12.35	7.70	20.05	≤ 30.00
11ax-HE40	MCS0	187	6885	5.28	6.14	6.42	6.35	12.09	7.70	19.79	≤ 30.00
11ax-HE40	MCS0	195	6925	5.19	6.25	6.60	6.67	12.24	7.70	19.94	≤ 30.00
11ax-HE40	MCS0	211	7005	5.88	6.11	7.97	7.83	13.07	7.70	20.77	≤ 30.00
11ax-HE40	MCS0	227	7085	6.52	6.94	6.60	6.54	12.67	7.70	20.37	≤ 30.00

Test Mode	Data Rate/ MCS	Channel No.	Freq. (MHz)	Average Power (dBm)				Total Average Power (dBm)	Beamforming Directional Gain (dBi)	EIRP (dBm)	EIRP Limit (dBm)
				Ant 1	Ant 2	Ant 3	Ant 4				
Beamforming Mode (Nss = 1)											
11ax-HE80	MCS0	39	6145	9.17	9.93	9.80	8.97	15.51	7.70	23.21	≤ 30.00
11ax-HE80	MCS0	55	6225	8.76	9.73	9.12	8.73	15.12	7.70	22.82	≤ 30.00
11ax-HE80	MCS0	87	6385	9.35	9.69	9.96	8.84	15.50	7.70	23.20	≤ 30.00
11ax-HE80	MCS0	103	6465	8.60	9.86	9.24	8.54	15.11	7.70	22.81	≤ 30.00
11ax-HE80	MCS0	119	6545	8.31	9.30	9.42	8.65	14.96	7.70	22.66	≤ 30.00
11ax-HE80	MCS0	135	6625	9.42	9.78	10.09	9.27	15.67	7.70	23.37	≤ 30.00
11ax-HE80	MCS0	151	6705	9.31	9.86	9.90	9.18	15.59	7.70	23.29	≤ 30.00
11ax-HE80	MCS0	183	6865	8.58	9.94	9.32	8.70	15.19	7.70	22.89	≤ 30.00
11ax-HE80	MCS0	199	6945	8.26	9.12	9.29	9.02	14.96	7.70	22.66	≤ 30.00
11ax-HE80	MCS0	215	7025	8.56	8.81	10.11	9.91	15.42	7.70	23.12	≤ 30.00
11ax-HE160	MCS0	47	6185	11.79	12.30	12.42	11.89	18.13	7.70	25.83	≤ 30.00
11ax-HE160	MCS0	79	6345	11.38	11.92	12.52	11.40	17.85	7.70	25.55	≤ 30.00
11ax-HE160	MCS0	111	6505	11.38	12.84	12.43	11.54	18.11	7.70	25.81	≤ 30.00
11ax-HE160	MCS0	143	6665	11.60	12.37	12.93	11.90	18.25	7.70	25.95	≤ 30.00
11ax-HE160	MCS0	175	6825	11.48	12.63	12.30	11.31	17.99	7.70	25.69	≤ 30.00
11ax-HE160	MCS0	207	6985	11.15	11.55	12.65	12.03	17.90	7.70	25.60	≤ 30.00

Note 1: Total Average Power (dBm) = $10 \cdot \log \left\{ 10^{(\text{Ant 1 Average Power} / 10)} + 10^{(\text{Ant 2 Average Power} / 10)} + 10^{(\text{Ant 3 Average Power} / 10)} + 10^{(\text{Ant 4 Average Power} / 10)} \right\}$.

Note 2: Beamforming EIRP Power (dBm) = Total Average Power (dBm) + Beamforming Directional Gain (dBi).

Test Site	SR6	Test Engineer	Marvin
Test Date	2023/1/10		

Test Mode	Data Rate/ MCS	Channel No.	Freq. (MHz)	Average Power (dBm)				Total Average Power (dBm)	CDD Directional Gain (dBi)	CDD EIRP (dBm)	EIRP Limit (dBm)
				Ant 1	Ant 2	Ant 3	Ant 4				
CDD Mode (Nss = 4)											
11ax-HE20	MCS0	33	6115	6.12	4.75	6.07	6.27	11.86	5.04	16.90	≤ 30.00
11ax-HE20	MCS0	61	6255	6.28	5.57	6.87	6.35	12.31	5.04	17.35	≤ 30.00
11ax-HE20	MCS0	93	6415	5.83	5.15	5.64	5.81	11.64	5.04	16.68	≤ 30.00
11ax-HE20	MCS0	97	6435	5.76	5.06	5.80	5.88	11.66	5.04	16.70	≤ 30.00
11ax-HE20	MCS0	105	6475	5.96	4.86	6.34	6.38	11.95	5.04	16.99	≤ 30.00
11ax-HE20	MCS0	113	6515	6.30	5.31	6.52	6.38	12.17	5.04	17.21	≤ 30.00
11ax-HE20	MCS0	117	6535	6.40	5.55	6.44	6.55	12.27	5.04	17.31	≤ 30.00
11ax-HE20	MCS0	153	6715	6.69	6.07	6.56	6.70	12.53	5.04	17.57	≤ 30.00
11ax-HE20	MCS0	181	6855	5.47	6.65	4.61	5.98	11.76	5.04	16.80	≤ 30.00
11ax-HE20	MCS0	185	6875	6.06	7.33	5.22	6.18	12.28	5.04	17.32	≤ 30.00
11ax-HE20	MCS0	189	6895	5.39	5.59	6.50	7.26	12.27	5.04	17.31	≤ 30.00
11ax-HE20	MCS0	213	7015	4.99	4.51	6.89	7.14	12.05	5.04	17.09	≤ 30.00
11ax-HE20	MCS0	229	7095	6.74	6.35	6.10	6.90	12.55	5.04	17.59	≤ 30.00
11ax-HE40	MCS0	35	6125	8.83	8.74	8.83	8.76	14.81	5.04	19.85	≤ 30.00
11ax-HE40	MCS0	59	6245	9.51	9.77	9.97	9.85	15.80	5.04	20.84	≤ 30.00
11ax-HE40	MCS0	91	6405	8.86	8.67	8.60	8.82	14.76	5.04	19.80	≤ 30.00
11ax-HE40	MCS0	99	6445	8.24	8.68	8.50	8.42	14.48	5.04	19.52	≤ 30.00
11ax-HE40	MCS0	107	6485	8.19	8.72	8.77	8.50	14.57	5.04	19.61	≤ 30.00
11ax-HE40	MCS0	115	6525	8.36	8.75	9.07	9.06	14.84	5.04	19.88	≤ 30.00
11ax-HE40	MCS0	123	6565	8.65	9.50	9.46	9.45	15.30	5.04	20.34	≤ 30.00
11ax-HE40	MCS0	147	6685	9.70	9.35	10.11	10.12	15.85	5.04	20.89	≤ 30.00
11ax-HE40	MCS0	179	6845	8.91	9.73	8.85	9.64	15.32	5.04	20.36	≤ 30.00
11ax-HE40	MCS0	187	6885	8.94	10.13	9.36	10.20	15.71	5.04	20.75	≤ 30.00
11ax-HE40	MCS0	195	6925	8.71	8.94	9.15	9.92	15.23	5.04	20.27	≤ 30.00
11ax-HE40	MCS0	211	7005	8.98	8.74	10.25	10.42	15.68	5.04	20.72	≤ 30.00
11ax-HE40	MCS0	227	7085	9.18	9.06	9.27	10.13	15.45	5.04	20.49	≤ 30.00

Test Mode	Data Rate/ MCS	Channel No.	Freq. (MHz)	Average Power (dBm)				Total Average Power (dBm)	CDD Directional Gain (dBi)	CDD EIRP (dBm)	EIRP Limit (dBm)
				Ant 1	Ant 2	Ant 3	Ant 4				
CDD Mode (Nss = 4)											
11ax-HE80	MCS0	39	6145	11.76	11.98	12.06	11.84	17.93	5.04	22.97	≤ 30.00
11ax-HE80	MCS0	55	6225	11.87	12.23	12.01	11.91	18.03	5.04	23.07	≤ 30.00
11ax-HE80	MCS0	87	6385	11.81	11.73	11.97	11.92	17.88	5.04	22.92	≤ 30.00
11ax-HE80	MCS0	103	6465	11.12	11.87	11.32	11.72	17.54	5.04	22.58	≤ 30.00
11ax-HE80	MCS0	119	6545	11.03	11.95	11.74	11.92	17.70	5.04	22.74	≤ 30.00
11ax-HE80	MCS0	135	6625	11.89	11.91	12.39	12.32	18.15	5.04	23.19	≤ 30.00
11ax-HE80	MCS0	151	6705	12.40	12.33	12.79	12.57	18.55	5.04	23.59	≤ 30.00
11ax-HE80	MCS0	183	6865	11.14	12.00	11.32	12.09	17.68	5.04	22.72	≤ 30.00
11ax-HE80	MCS0	199	6945	11.53	11.50	12.36	12.59	18.04	5.04	23.08	≤ 30.00
11ax-HE80	MCS0	215	7025	11.06	10.82	12.45	12.38	17.76	5.04	22.80	≤ 30.00
11ax-HE160	MCS0	47	6185	14.45	14.27	14.52	14.80	20.53	5.04	25.57	≤ 30.00
11ax-HE160	MCS0	79	6345	14.49	14.28	14.87	14.77	20.63	5.04	25.67	≤ 30.00
11ax-HE160	MCS0	111	6505	14.51	15.29	14.94	14.96	20.95	5.04	25.99	≤ 30.00
11ax-HE160	MCS0	143	6665	14.97	14.89	15.37	15.30	21.16	5.04	26.20	≤ 30.00
11ax-HE160	MCS0	175	6825	13.98	14.59	14.03	14.51	20.31	5.04	25.35	≤ 30.00
11ax-HE160	MCS0	207	6985	14.27	14.12	15.36	15.41	20.85	5.04	25.89	≤ 30.00

Note 1: Total Average Power (dBm) = $10 \cdot \log \{ 10^{(\text{Ant 1 Average Power} / 10)} + 10^{(\text{Ant 2 Average Power} / 10)} + 10^{(\text{Ant 3 Average Power} / 10)} + 10^{(\text{Ant 4 Average Power} / 10)} \}$.

Note 2: CDD EIRP Power (dBm) = Total Average Power (dBm) + CDD Directional Gain (dBi).

6.4. Power Spectral Density

6.4.1. Test Limit

For an indoor access point operating in the 5.925-7.125 GHz band, the maximum power spectral density must not exceed 5 dBm e.i.r.p. in any 1-megahertz band.

6.4.2. Test Procedure Used

KDB 789033 D02v02r01-Section II) F

6.4.3. Test Setting

1. Analyzer was set to the center frequency of the UNII channel under investigation
2. Span was set to encompass the entire 26dB EBW of the signal.
3. RBW = 1MHz
4. VBW = 3MHz
5. Number of sweep points $\geq 2 \times (\text{span} / \text{RBW})$
6. Detector = power averaging (Average)
7. Sweep time = auto
8. Trigger = free run
9. Use the peak search function on the instrument to find the peak of the spectrum and record its value.
10. Add $10 \cdot \log(1/x)$, where x is the duty cycle, to the measured power in order to compute the average power during the actual transmission times (because the measurement represents an average over both the on and off times of the transmission). For example, add $10 \cdot \log(1/0.25) = 6$ dB if the duty cycle is 25 percent.

6.4.4. Test Setup

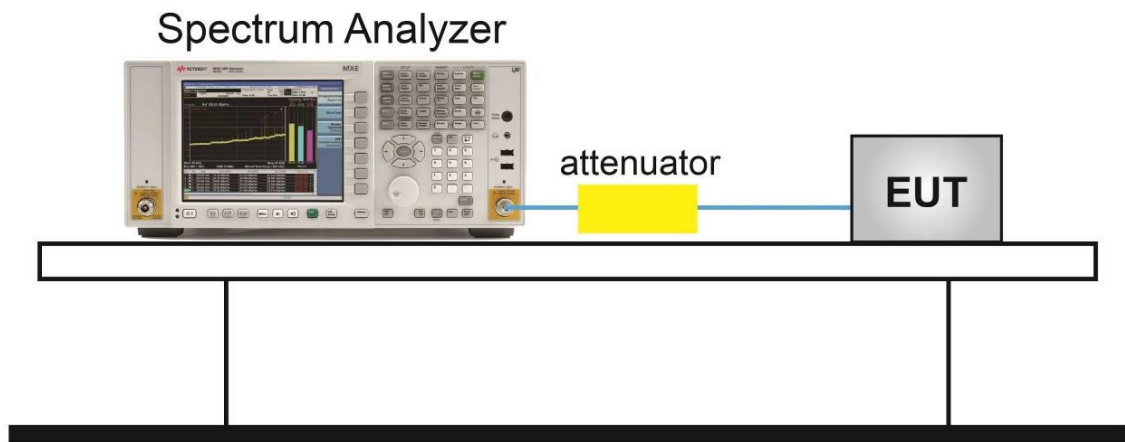

6.4.5. Test Result

Test Site	SR6	Test Engineer	Marvin
Test Date	2022/12/10~2023/1/11		

Test Mode	Data Rate/MCS	Channel No.	Freq. (MHz)	PSD (dBm/MHz)				Total PSD (dBm/MHz)	Duty Cycle (%)	Directional Gain (dBi)	EIRP PSD (dBm/MHz)	EIRP PSD Limit (dBm/MHz)
				Ant 1	Ant 2	Ant 3	Ant 4					
CDD Mode (Nss = 1)												
11ax-HE20	MCS0	33	6115	-9.532	-10.350	-9.465	-9.689	-3.725	86.69%	7.70	4.60	≤ 5.00
11ax-HE20	MCS0	61	6255	-9.526	-10.489	-9.358	-8.847	-3.495	86.69%	7.70	4.83	≤ 5.00
11ax-HE20	MCS0	93	6415	-9.255	-9.587	-9.210	-9.918	-3.463	86.69%	7.70	4.86	≤ 5.00
11ax-HE20	MCS0	97	6435	-9.730	-10.082	-9.560	-10.269	-3.881	86.69%	7.70	4.44	≤ 5.00
11ax-HE20	MCS0	105	6475	-9.453	-9.898	-9.298	-9.611	-3.539	86.69%	7.70	4.78	≤ 5.00
11ax-HE20	MCS0	113	6515	-9.315	-9.941	-9.007	-10.264	-3.583	86.69%	7.70	4.74	≤ 5.00
11ax-HE20	MCS0	117	6535	-9.577	-9.919	-8.955	-10.224	-3.622	86.69%	7.70	4.70	≤ 5.00
11ax-HE20	MCS0	153	6715	-9.314	-10.216	-9.393	-9.592	-3.594	86.69%	7.70	4.73	≤ 5.00
11ax-HE20	MCS0	181	6855	-9.508	-8.517	-10.182	-9.785	-3.433	86.69%	7.70	4.89	≤ 5.00
11ax-HE20	MCS0	185	6875	-9.709	-8.886	-9.641	-9.630	-3.432	86.69%	7.70	4.89	≤ 5.00
11ax-HE20	MCS0	189	6895	-9.854	-10.051	-9.070	-9.208	-3.505	86.69%	7.70	4.81	≤ 5.00
11ax-HE20	MCS0	213	7015	-10.344	-10.785	-9.274	-9.311	-3.859	86.69%	7.70	4.46	≤ 5.00
11ax-HE20	MCS0	229	7095	-9.702	-9.826	-9.720	-9.641	-3.701	86.69%	7.70	4.62	≤ 5.00
11ax-HE40	MCS0	35	6125	-9.427	-10.838	-9.548	-9.228	-3.696	85.80%	7.70	4.67	≤ 5.00
11ax-HE40	MCS0	59	6245	-9.614	-9.402	-9.888	-9.598	-3.601	85.80%	7.70	4.76	≤ 5.00
11ax-HE40	MCS0	91	6405	-9.717	-10.212	-9.393	-10.514	-3.917	85.80%	7.70	4.45	≤ 5.00
11ax-HE40	MCS0	99	6445	-9.294	-9.850	-9.637	-9.725	-3.601	85.80%	7.70	4.76	≤ 5.00
11ax-HE40	MCS0	107	6485	-9.683	-9.272	-9.379	-9.704	-3.485	85.80%	7.70	4.88	≤ 5.00
11ax-HE40	MCS0	115	6525	-9.578	-9.545	-9.600	-9.415	-3.513	85.80%	7.70	4.85	≤ 5.00
11ax-HE40	MCS0	123	6565	-9.305	-10.347	-9.156	-9.721	-3.588	85.80%	7.70	4.78	≤ 5.00
11ax-HE40	MCS0	147	6685	-9.437	-9.962	-9.573	-9.239	-3.524	85.80%	7.70	4.84	≤ 5.00
11ax-HE40	MCS0	179	6845	-10.038	-9.015	-10.510	-10.423	-3.934	85.80%	7.70	4.43	≤ 5.00
11ax-HE40	MCS0	187	6885	-10.414	-10.347	-9.867	-9.411	-3.970	85.80%	7.70	4.40	≤ 5.00
11ax-HE40	MCS0	195	6925	-10.267	-9.619	-10.067	-9.103	-3.720	85.80%	7.70	4.65	≤ 5.00
11ax-HE40	MCS0	211	7005	-10.226	-10.050	-9.144	-8.694	-3.462	85.80%	7.70	4.90	≤ 5.00
11ax-HE40	MCS0	227	7085	-9.737	-9.284	-10.068	-9.970	-3.733	85.80%	7.70	4.63	≤ 5.00

Test Mode	Data Rate/MCS	Channel No.	Freq. (MHz)	PSD (dBm/MHz)				Total PSD (dBm/MHz)	Duty Cycle (%)	Directional Gain (dBi)	EIRP PSD (dBm/MHz)	EIRP PSD Limit (dBm/MHz)
				Ant 1	Ant 2	Ant 3	Ant 4					
CDD Mode (Nss = 1)												
11ax-HE80	MCS0	39	6145	-9.963	-9.641	-9.448	-10.305	-3.807	85.44%	7.70	4.58	≤ 5.00
11ax-HE80	MCS0	55	6225	-10.330	-9.354	-9.730	-10.177	-3.860	85.44%	7.70	4.52	≤ 5.00
11ax-HE80	MCS0	87	6385	-9.344	-9.169	-9.589	-10.365	-3.573	85.44%	7.70	4.81	≤ 5.00
11ax-HE80	MCS0	103	6465	-10.158	-8.901	-9.292	-9.841	-3.500	85.44%	7.70	4.88	≤ 5.00
11ax-HE80	MCS0	119	6545	-10.254	-9.574	-9.693	-9.949	-3.839	85.44%	7.70	4.54	≤ 5.00
11ax-HE80	MCS0	135	6625	-9.558	-9.692	-9.217	-9.864	-3.556	85.44%	7.70	4.83	≤ 5.00
11ax-HE80	MCS0	151	6705	-9.728	-9.615	-9.227	-9.693	-3.540	85.44%	7.70	4.84	≤ 5.00
11ax-HE80	MCS0	183	6865	-9.735	-8.849	-9.486	-10.127	-3.504	85.44%	7.70	4.88	≤ 5.00
11ax-HE80	MCS0	199	6945	-10.450	-9.551	-9.179	-10.016	-3.752	85.44%	7.70	4.63	≤ 5.00
11ax-HE80	MCS0	215	7025	-10.509	-10.004	-9.280	-9.465	-3.768	85.44%	7.70	4.62	≤ 5.00
11ax-HE160	MCS0	47	6185	-9.466	-9.300	-9.031	-9.659	-3.337	92.87%	7.70	4.68	≤ 5.00
11ax-HE160	MCS0	79	6345	-9.821	-9.590	-9.363	-9.810	-3.621	92.87%	7.70	4.40	≤ 5.00
11ax-HE160	MCS0	111	6505	-9.953	-8.474	-8.832	-9.497	-3.131	92.87%	7.70	4.89	≤ 5.00
11ax-HE160	MCS0	143	6665	-10.007	-8.890	-8.851	-9.880	-3.353	92.87%	7.70	4.67	≤ 5.00
11ax-HE160	MCS0	175	6825	-9.813	-8.723	-9.254	-9.757	-3.343	92.87%	7.70	4.68	≤ 5.00
11ax-HE160	MCS0	207	6985	-10.499	-9.860	-8.677	-9.144	-3.470	92.87%	7.70	4.55	≤ 5.00

Note 1: Total PSD (dBm/MHz) = $10 \cdot \log \{10^{(\text{Ant 1 PSD}/10)} + 10^{(\text{Ant 2 PSD}/10)} + 10^{(\text{Ant 3 PSD}/10)} + 10^{(\text{Ant 4 PSD}/10)}\}$

Note 2: When EUT duty cycle ≥ 98%, EIRP PSD (dBm/MHz) = Total PSD (dBm/MHz) + Directional Gain (dBi).

When EUT duty cycle < 98%, EIRP PSD (dBm/MHz) = Total PSD (dBm/MHz) + $10 \cdot \log (1/\text{Duty Cycle})$ + Directional Gain (dBi).

Test Site	SR6	Test Engineer	Marvin
Test Date	2022/12/10~2023/1/11		

Test Mode	Data Rate/MCS	Channel No.	Freq. (MHz)	PSD (dBm/MHz)				Total PSD (dBm/MHz)	Duty Cycle (%)	Directional Gain (dBi)	EIRP PSD (dBm/MHz)	EIRP PSD Limit (dBm/MHz)
				Ant 1	Ant 2	Ant 3	Ant 4					
CDD Mode (Nss = 4)												
11ax-HE20	MCS0	33	6115	-7.378	-8.130	-6.429	-6.603	-1.063	86.69%	5.04	4.60	≤ 5.00
11ax-HE20	MCS0	61	6255	-7.531	-7.598	-6.238	-7.049	-1.049	86.69%	5.04	4.61	≤ 5.00
11ax-HE20	MCS0	93	6415	-7.310	-7.421	-6.637	-6.834	-1.018	86.69%	5.04	4.64	≤ 5.00
11ax-HE20	MCS0	97	6435	-7.390	-7.066	-6.618	-6.935	-0.973	86.69%	5.04	4.69	≤ 5.00
11ax-HE20	MCS0	105	6475	-7.365	-7.159	-6.315	-6.701	-0.845	86.69%	5.04	4.82	≤ 5.00
11ax-HE20	MCS0	113	6515	-7.220	-7.134	-6.212	-6.655	-0.766	86.69%	5.04	4.89	≤ 5.00
11ax-HE20	MCS0	117	6535	-7.013	-7.235	-6.159	-6.813	-0.765	86.69%	5.04	4.89	≤ 5.00
11ax-HE20	MCS0	153	6715	-7.613	-7.238	-6.363	-6.568	-0.896	86.69%	5.04	4.76	≤ 5.00
11ax-HE20	MCS0	181	6855	-7.630	-6.452	-7.300	-6.915	-1.031	86.69%	5.04	4.63	≤ 5.00
11ax-HE20	MCS0	185	6875	-7.384	-6.443	-7.141	-6.680	-0.876	86.69%	5.04	4.78	≤ 5.00
11ax-HE20	MCS0	189	6895	-7.619	-7.743	-6.104	-6.020	-0.776	86.69%	5.04	4.88	≤ 5.00
11ax-HE20	MCS0	213	7015	-8.111	-8.396	-6.403	-5.782	-1.012	86.69%	5.04	4.65	≤ 5.00
11ax-HE20	MCS0	229	7095	-7.193	-6.828	-7.461	-6.257	-0.890	86.69%	5.04	4.77	≤ 5.00
11ax-HE40	MCS0	35	6125	-7.310	-6.798	-6.911	-7.098	-1.004	85.80%	5.04	4.70	≤ 5.00
11ax-HE40	MCS0	59	6245	-7.492	-6.485	-6.706	-6.695	-0.807	85.80%	5.04	4.90	≤ 5.00
11ax-HE40	MCS0	91	6405	-7.478	-6.871	-6.822	-7.188	-1.061	85.80%	5.04	4.64	≤ 5.00
11ax-HE40	MCS0	99	6445	-8.055	-6.671	-6.974	-7.094	-1.148	85.80%	5.04	4.56	≤ 5.00
11ax-HE40	MCS0	107	6485	-8.160	-6.422	-6.771	-6.784	-0.965	85.80%	5.04	4.74	≤ 5.00
11ax-HE40	MCS0	115	6525	-7.966	-6.860	-6.661	-6.413	-0.916	85.80%	5.04	4.79	≤ 5.00
11ax-HE40	MCS0	123	6565	-7.852	-6.490	-6.665	-6.610	-0.850	85.80%	5.04	4.85	≤ 5.00
11ax-HE40	MCS0	147	6685	-7.135	-7.873	-7.154	-7.006	-1.258	85.80%	5.04	4.45	≤ 5.00
11ax-HE40	MCS0	179	6845	-7.412	-6.727	-6.748	-7.464	-1.053	85.80%	5.04	4.65	≤ 5.00
11ax-HE40	MCS0	187	6885	-7.189	-6.535	-6.791	-6.847	-0.814	85.80%	5.04	4.89	≤ 5.00
11ax-HE40	MCS0	195	6925	-7.289	-7.680	-6.752	-6.114	-0.898	85.80%	5.04	4.81	≤ 5.00
11ax-HE40	MCS0	211	7005	-7.244	-8.134	-6.223	-6.078	-0.822	85.80%	5.04	4.88	≤ 5.00
11ax-HE40	MCS0	227	7085	-6.972	-7.620	-7.022	-6.335	-0.943	85.80%	5.04	4.76	≤ 5.00

Test Mode	Data Rate/MCS	Channel No.	Freq. (MHz)	PSD (dBm/MHz)				Total PSD (dBm/MHz)	Duty Cycle (%)	Directional Gain (dBi)	EIRP PSD (dBm/MHz)	EIRP PSD Limit (dBm/MHz)
				Ant 1	Ant 2	Ant 3	Ant 4					
CDD Mode (Nss = 4)												
11ax-HE80	MCS0	39	6145	-6.636	-6.787	-6.681	-7.341	-0.832	85.44%	5.04	4.89	≤ 5.00
11ax-HE80	MCS0	55	6225	-6.846	-6.945	-6.853	-6.858	-0.855	85.44%	5.04	4.87	≤ 5.00
11ax-HE80	MCS0	87	6385	-6.986	-7.263	-6.729	-6.506	-0.841	85.44%	5.04	4.88	≤ 5.00
11ax-HE80	MCS0	103	6465	-7.365	-6.754	-7.031	-6.420	-0.858	85.44%	5.04	4.87	≤ 5.00
11ax-HE80	MCS0	119	6545	-7.474	-7.172	-6.892	-6.889	-1.080	85.44%	5.04	4.64	≤ 5.00
11ax-HE80	MCS0	135	6625	-7.489	-7.573	-6.643	-6.768	-1.078	85.44%	5.04	4.65	≤ 5.00
11ax-HE80	MCS0	151	6705	-7.099	-7.548	-6.510	-6.490	-0.869	85.44%	5.04	4.85	≤ 5.00
11ax-HE80	MCS0	183	6865	-7.482	-6.845	-7.089	-6.469	-0.935	85.44%	5.04	4.79	≤ 5.00
11ax-HE80	MCS0	199	6945	-7.339	-7.898	-6.466	-6.008	-0.845	85.44%	5.04	4.88	≤ 5.00
11ax-HE80	MCS0	215	7025	-7.843	-8.582	-6.396	-6.225	-1.131	85.44%	5.04	4.59	≤ 5.00
11ax-HE160	MCS0	47	6185	-6.905	-7.289	-6.598	-6.269	-0.728	92.87%	5.04	4.63	≤ 5.00
11ax-HE160	MCS0	79	6345	-6.731	-6.863	-7.107	-6.304	-0.721	92.87%	5.04	4.64	≤ 5.00
11ax-HE160	MCS0	111	6505	-6.380	-6.455	-6.820	-6.316	-0.468	92.87%	5.04	4.89	≤ 5.00
11ax-HE160	MCS0	143	6665	-6.701	-7.211	-6.790	-6.336	-0.728	92.87%	5.04	4.63	≤ 5.00
11ax-HE160	MCS0	175	6825	-7.097	-6.769	-7.277	-6.588	-0.904	92.87%	5.04	4.46	≤ 5.00
11ax-HE160	MCS0	207	6985	-7.017	-8.120	-5.905	-5.820	-0.597	92.87%	5.04	4.76	≤ 5.00

Note 1: Total PSD (dBm/MHz) = $10 \cdot \log \{10^{(\text{Ant 1 PSD}/10)} + 10^{(\text{Ant 2 PSD}/10)} + 10^{(\text{Ant 3 PSD}/10)} + 10^{(\text{Ant 4 PSD}/10)}\}$

Note 2: When EUT duty cycle ≥ 98%, EIRP PSD (dBm/MHz) = Total PSD (dBm/MHz) + Directional Gain (dBi).

When EUT duty cycle < 98%, EIRP PSD (dBm/MHz) = Total PSD (dBm/MHz) + $10 \cdot \log (1/\text{Duty Cycle})$ + Directional Gain (dBi).

802.11ax-HE20 Power Spectral Density – Ant 1 (Nss=1)

Channel 33 (6115MHz)

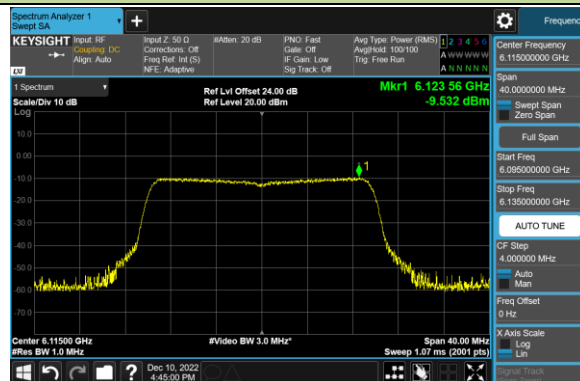

Channel 65 (6275MHz)

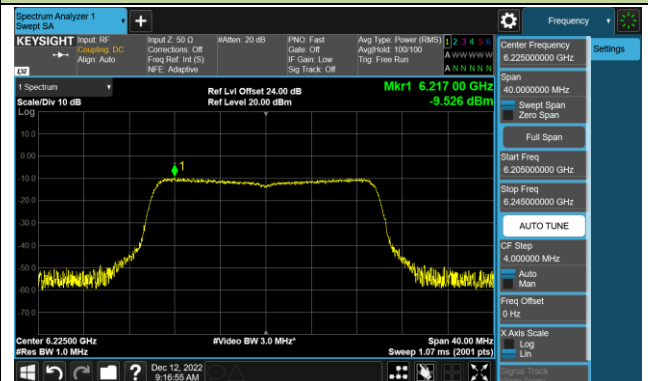

Channel 93 (6415MHz)

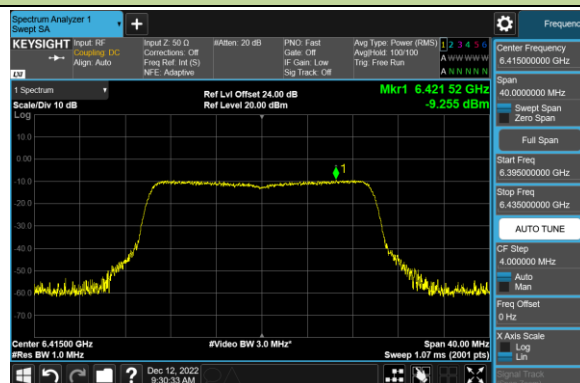

Channel 97 (6435MHz)

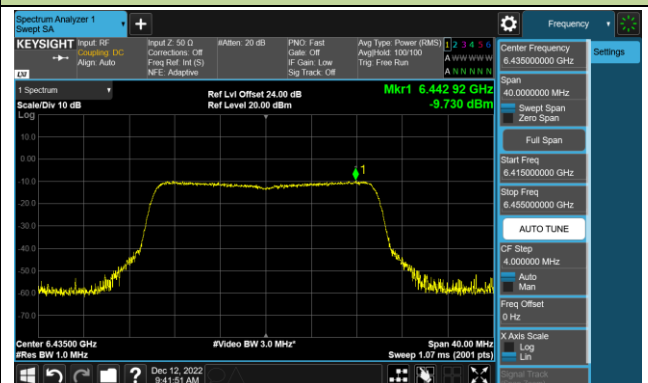

Channel 105 (6475MHz)

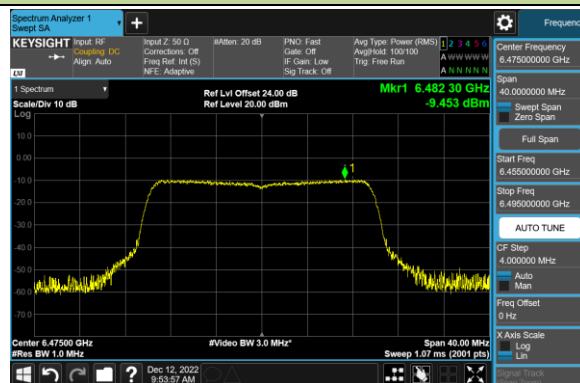

Channel 113 (6515MHz)

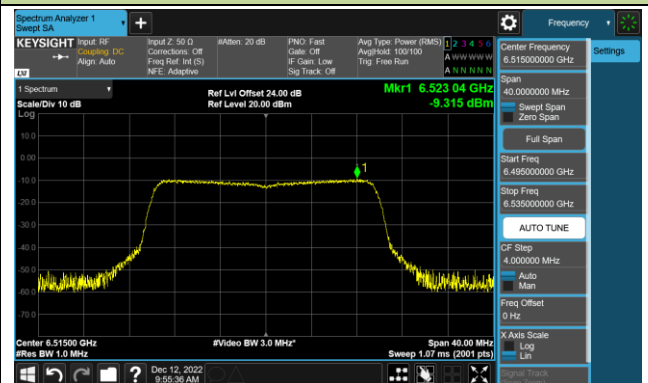

Channel 117 (6535MHz)

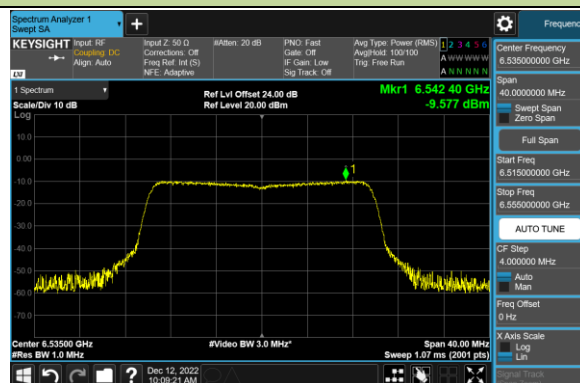

Channel 153 (6715MHz)

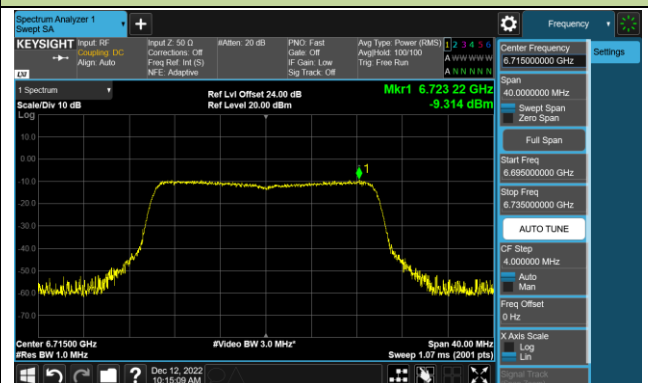

802.11ax-HE20 Power Spectral Density – Ant 1 (Nss=1)

Channel 181 (6855MHz)

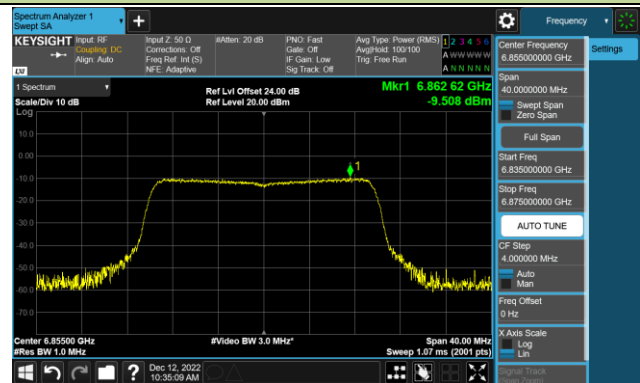

Channel 185 (6875MHz)

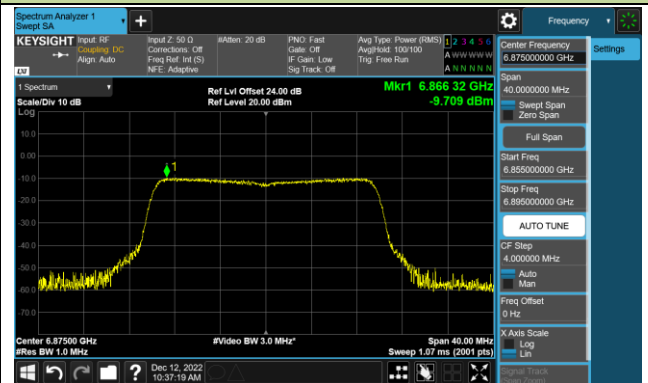

Channel 189 (6895MHz)

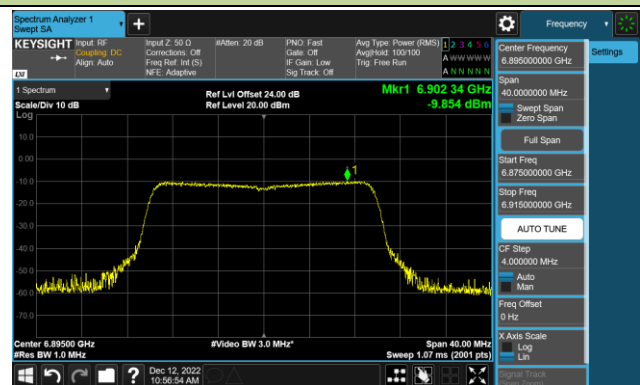

Channel 213 (7015MHz)

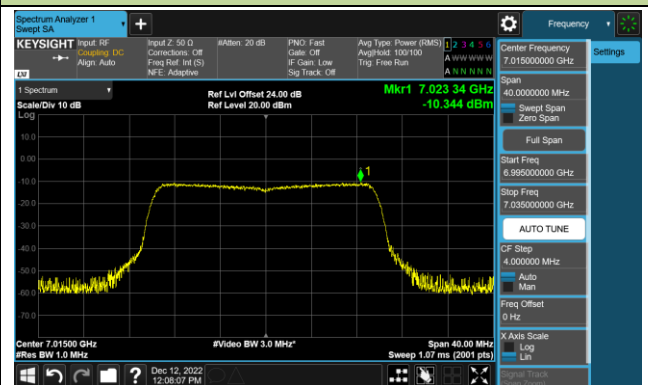

Channel 229 (7095MHz)

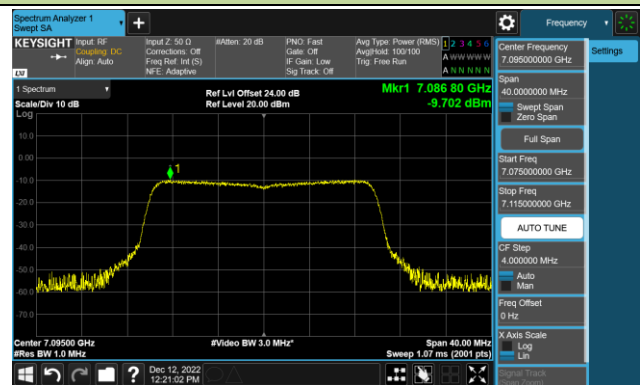

802.11ax-HE40 Power Spectral Density – Ant 1 (Nss=1)

Channel 35 (6125MHz)

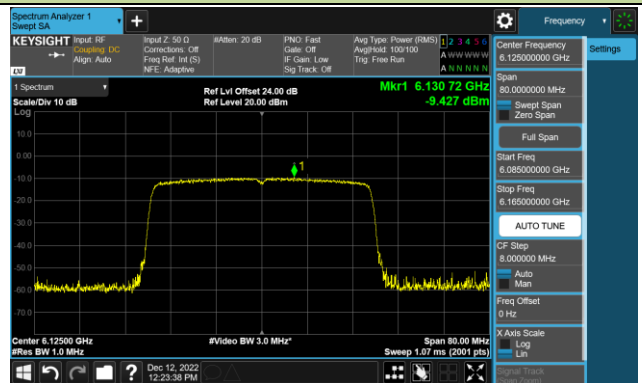

Channel 67 (6285MHz)

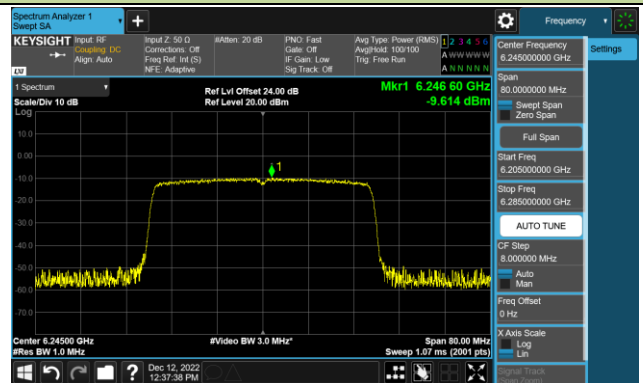

Channel 91 (6405MHz)

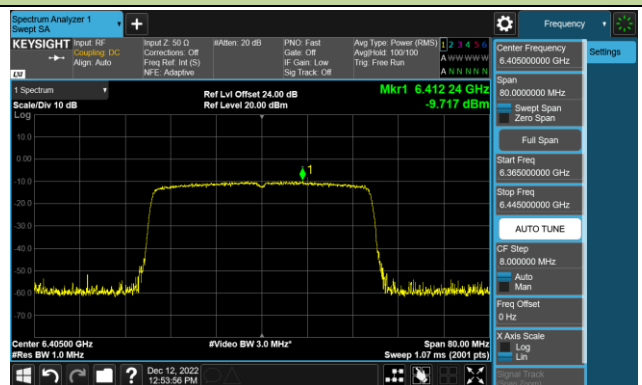

Channel 99 (6445MHz)

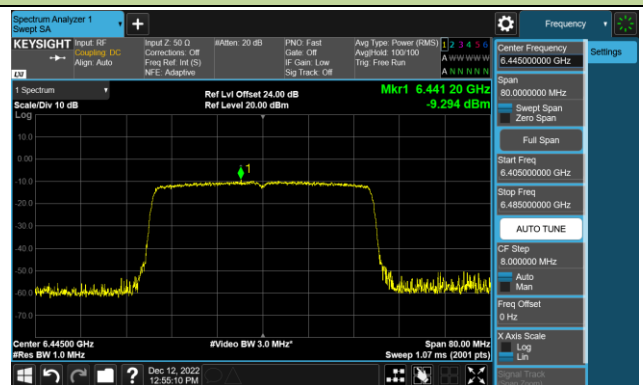

Channel 107 (6485MHz)

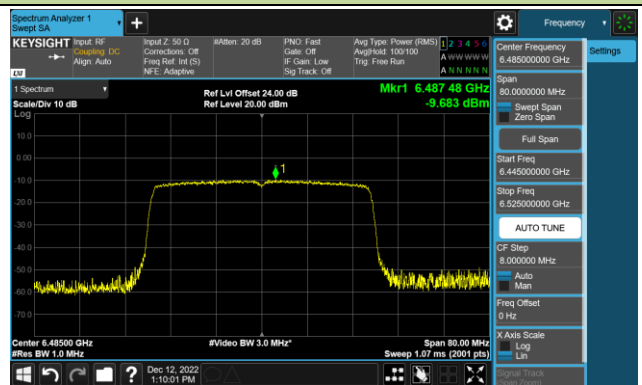

Channel 115 (6525MHz)

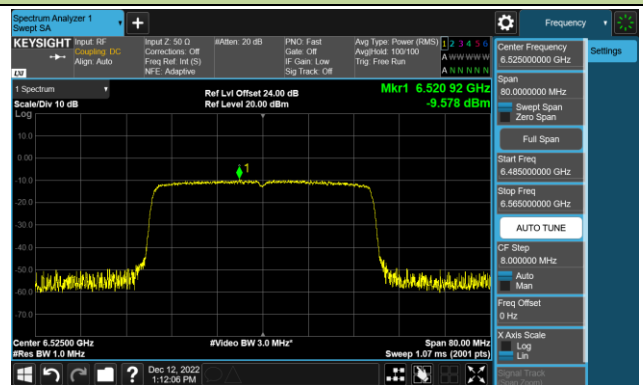

Channel 123 (6565MHz)

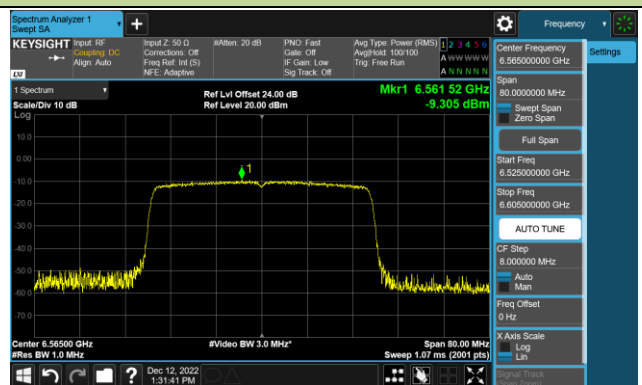

Channel 147 (6685MHz)

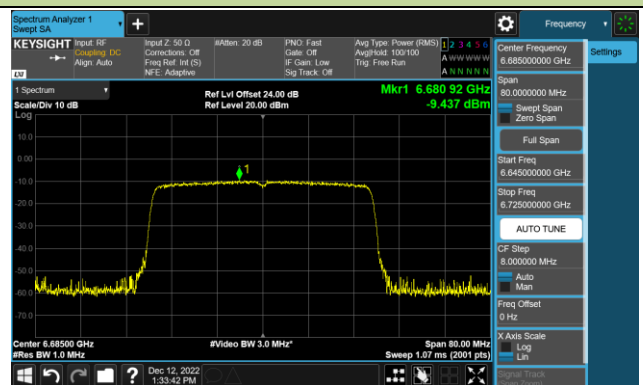

802.11ax-HE40 Power Spectral Density – Ant 1 (Nss=1)

Channel 179 (6845MHz)

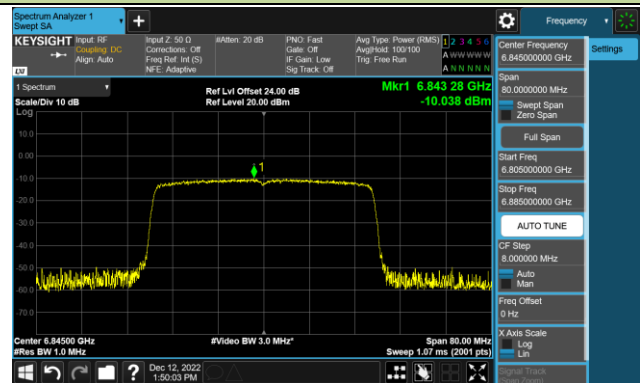

Channel 187 (6885MHz)

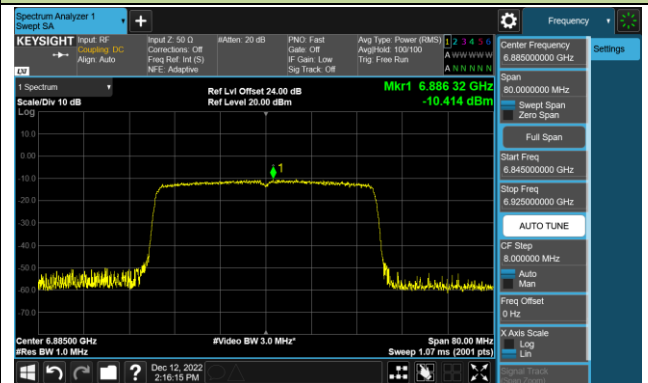

Channel 195 (6925MHz)

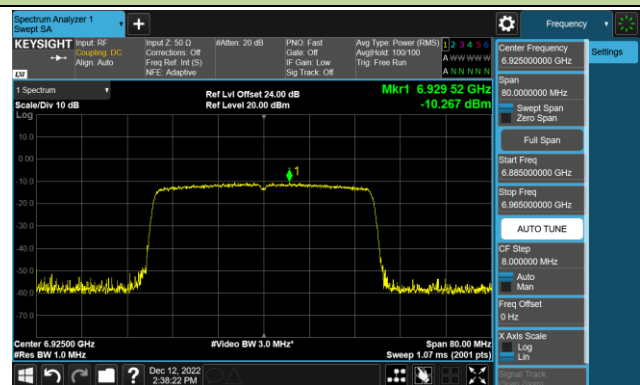

Channel 211 (7005MHz)

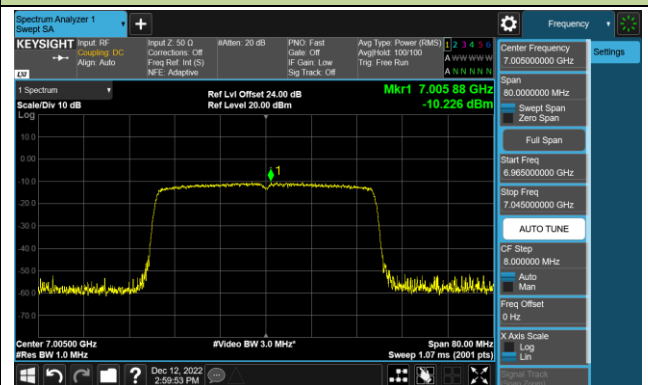

Channel 227 (7085MHz)

