



FCC Radio Test Report

FCC ID: 2AXJ4EAP670V2

This report concerns: Class II permissive Change

Project No. : 2405G122
Equipment : AX5400 Ceiling Mount Wi-Fi 6 Access Point
Brand Name : tp-link
Test Model : EAP670
Series Model : EAP673
Applicant : TP-Link Corporation Limited
Address : Room 901, 9/F. , New East Ocean Centre, 9 Science Museum Road, Tsim Sha Tsui, Kowloon, Hong Kong
Manufacturer : TP-Link Corporation Limited
Address : Room 901, 9/F. , New East Ocean Centre, 9 Science Museum Road, Tsim Sha Tsui, Kowloon, Hong Kong
Date of Receipt : May 27, 2024
Date of Test : May 28, 2024 ~ May 29, 2024
Issued Date : May 29, 2024
Report Version : R00
Test Sample : Engineering Sample No.: SSL20240527205
Standard(s) : FCC CFR Title 47, Part 15, Subpart E

The above equipment has been tested and found compliance with the requirement of the relative standards by BTL Inc.

Prepared by :

Grani Zhou

Grani Zhou

Approved by :

Chay Cai

Chay Cai

Room 108, Building 2, No.1, Yile Road, Songshan Lake Zone, Dongguan City, Guangdong, People's Republic of China

Tel: +86-769-8318-3000 Web: www.newbtl.com Service mail: btl_qa@newbtl.com

Declaration

BTL represents to the client that testing is done in accordance with standard procedures as applicable and that test instruments used has been calibrated with standards traceable to international standard(s) and/or national standard(s).

BTL's reports apply only to the specific samples tested under conditions. It is manufacture's responsibility to ensure that additional production units of this model are manufactured with the identical electrical and mechanical components. **BTL** assumes no responsibility for the data provided by the customer, any statements, inferences or generalizations drawn by the customer or others from the reports issued by **BTL**.

The report must not be used by the client to claim product certification, approval, or endorsement by A2LA or any agency of the U.S. Government.

This report is the confidential property of the client. As a mutual protection to the clients, the public and ourselves, the test report shall not be reproduced, except in full, without our written approval.

BTL's laboratory quality assurance procedures are in compliance with the ISO/IEC 17025: 2017 requirements, and accredited by the conformity assessment authorities listed in this test report.

BTL is not responsible for the sampling stage, so the results only apply to the sample as received.

The information, data and test plan are provided by manufacturer which may affect the validity of results, so it is manufacturer's responsibility to ensure that the apparatus meets the essential requirements of applied standards and in all the possible configurations as representative of its intended use.

Limitation

For the use of the authority's logo is limited unless the Test Standard(s)/Scope(s)/Item(s) mentioned in this test report is (are) included in the conformity assessment authorities acceptance respective.

Please note that the measurement uncertainty is provided for informational purpose only and are not use in determining the Pass/Fail results.

Table of Contents	Page
REPORT ISSUED HISTORY	4
1 . APPLICABLE STANDARDS	5
2 . SUMMARY OF TEST RESULTS	5
2.1 TEST FACILITY	6
2.2 MEASUREMENT UNCERTAINTY	6
2.3 TEST ENVIRONMENT CONDITIONS	6
3 . GENERAL INFORMATION	7
3.1 GENERAL DESCRIPTION OF EUT	7
3.2 DESCRIPTION OF TEST MODES	10
3.3 BLOCK DIAGRAM SHOWING THE CONFIGURATION OF SYSTEM TESTED	11
3.4 SUPPORT UNITS	11
3.5 CUSTOMER INFORMATION DESCRIPTION	11
4 . RADIATED EMISSIONS	12
4.1 LIMIT	12
4.2 TEST PROCEDURE	12
4.3 DEVIATION FROM TEST STANDARD	13
4.4 TEST SETUP	13
4.5 EUT OPERATING CONDITIONS	13
4.6 TEST RESULTS - 30 MHZ TO 1000 MHZ	13
5 . MEASUREMENT INSTRUMENTS LIST	14
6 . EUT TEST PHOTO	15
APPENDIX A - RADIATED EMISSION - 30 MHZ TO 1000 MHZ	16

REPORT ISSUED HISTORY

Report No.	Version	Description	Issued Date	Note
BTL-FCCP-3-2405G122	R00	Original Report.	May 29, 2024	Valid

1. APPLICABLE STANDARDS

According to the specifications of the manufacturer, the EUT must comply with the requirements of the following standards:

ANSI C63.10-2013

The following reference test guidance is not within the scope of accreditation of A2LA:

KDB 789033 D02 General UNII Test Procedures New Rules v02r01

KDB 662911 D01 Multiple Transmitter Output v02r01

2. SUMMARY OF TEST RESULTS

Test procedures according to the technical standard(s):

FCC CFR Title 47, Part 15, Subpart E				
Standard(s) Section	Test Item	Test Result	Judgment	Remark
15.407(b) 15.205(a) 15.209(a)	Radiated Emission	APPENDIX A	PASS	-----

Note:

- (1) "N/A" denotes test is not applicable in this test report.
- (2) The worst cases of radiated emissions below 1GHz have been re-evaluated by sample of FCC ID: 2AXJ4EAP670V2, model name: EAP670. It is found that the new data are the worse, so the test data are reissue from the FCC ID: 2AXJ4EAP670V2, model name: EAP670. Model difference(s): Changed the signal transformer of the network port.
- (3) The other test records and results please refer to the test report number: 2308TW0107-U4, issued date is 2023-11-22, and issued by:
Test Laboratory: MRT Technology (Taiwan) Co., Ltd
Address: No.38, Fuxing 2nd Rd., Guishan Dist., Taoyuan City 33377, Taiwan (R.O.C).

Which was accredited by TAF, FCC registration number is 291082, with the scopes of cited standards in this test report.

This report is only valid conjunction with the above referenced test report.

2.1 TEST FACILITY

The test facilities used to collect the test data in this report is at the location of No.3, Jinshagang 1st Road, Dalang, Dongguan City, Guangdong People's Republic of China.

BTL's Registration Number for FCC: 747969

BTL's Designation Number for FCC: CN1377

2.2 MEASUREMENT UNCERTAINTY

ISO/IEC 17025 requires that an estimate of the measurement uncertainties associated with the emissions test results be included in the report. The measurement uncertainties given below are based on a 95.45% confidence level (based on a coverage factor (k=2))

The BTL measurement uncertainty as below table:

A. Radiated emissions test:

Test Site	Method	Measurement Frequency Range	Ant. H / V	U,(dB)
DG-CB03 (3m)	CISPR	30MHz ~ 200MHz	V	4.40
		30MHz ~ 200MHz	H	3.62
		200MHz ~ 1,000MHz	V	4.58
		200MHz ~ 1,000MHz	H	3.98

Note: Unless specifically mentioned, the uncertainty of measurement has not been taken into account to declare the compliance or non-compliance to the specification.

2.3 TEST ENVIRONMENT CONDITIONS

Test Item	Temperature	Humidity	Test Voltage	Tested By	Test Date
Radiated Emissions -30MHz to 1000MHz	24°C	56%	AC 120V/60Hz	Jensen Zhou	May 29, 2024

3. GENERAL INFORMATION

3.1 GENERAL DESCRIPTION OF EUT

Equipment	AX5400 Ceiling Mount Wi-Fi 6 Access Point
Brand Name	tp-link
Test Model	EAP670
Series Model	EAP673
Model Difference(s)	The difference of models only for marketing different (Adapter is not sold with EAP673), the other hardware was the same.
Power Source	1# DC voltage supplied from AC adapter. Model: T120200-2B4 2# Supplied from ETH(PoE) port.
Power Rating	1# INPUT: 100-240V~ 50/60Hz 0.8A OUTPUT: 12.0V  2.0A 2# PoE 48V
Operation Frequency Band(s)	UNII-1: 5150 MHz ~ 5250 MHz UNII-2A: 5250 MHz ~ 5350 MHz UNII-2C: 5470 MHz ~ 5725 MHz UNII-3: 5725 MHz ~ 5850 MHz
Modulation Type	IEEE 802.11a/n/ac: OFDM IEEE 802.11ax: OFDMA
Bit Rate of Transmitter	IEEE 802.11a: 54/48/36/24/18/12/9/6 Mbps IEEE 802.11n: up to 600 Mbps IEEE 802.11ac: up to 3466.7 Mbps IEEE 802.11ax: up to 4804 Mbps

Note:

- For a more detailed features description, please refer to the manufacturer's specifications or the user's manual.

2. Channel List:

IEEE 802.11a IEEE 802.11n(HT20) IEEE 802.11ac(VHT20) IEEE 802.11ax(HE20)		IEEE 802.11n(HT40) IEEE 802.11ac(VHT40) IEEE 802.11ax(HE40)		IEEE 802.11ac(VHT80) IEEE 802.11ax(HE80)	
UNII-1		UNII-1		UNII-1	
Channel	Frequency (MHz)	Channel	Frequency (MHz)	Channel	Frequency (MHz)
36	5180	38	5190	42	5210
40	5200	46	5230		
44	5220				
48	5240				

IEEE 802.11a IEEE 802.11n(HT20) IEEE 802.11ac(VHT20) IEEE 802.11ax(HE20)		IEEE 802.11n(HT40) IEEE 802.11ac(VHT40) IEEE 802.11ax(HE40)		IEEE 802.11ac(VHT80) IEEE 802.11ax(HE80)	
UNII-2A		UNII-2A		UNII-2A	
Channel	Frequency (MHz)	Channel	Frequency (MHz)	Channel	Frequency (MHz)
52	5260	54	5270	58	5290
56	5280	62	5310		
60	5300				
64	5320				

IEEE 802.11a IEEE 802.11n(HT20) IEEE 802.11ac(VHT20) IEEE 802.11ax(HE20)		IEEE 802.11n(HT40) IEEE 802.11ac(VHT40) IEEE 802.11ax(HE40)		IEEE 802.11ac(VHT80) IEEE 802.11ax(HE80)	
UNII-2C		UNII-2C		UNII-2C	
Channel	Frequency (MHz)	Channel	Frequency (MHz)	Channel	Frequency (MHz)
100	5500	102	5510	106	5530
104	5520	110	5550	122	5610
108	5540	118	5590	138	5690
112	5560	126	5630		
116	5580	134	5670		
120	5600	137	5710		
124	5620				
128	5640				
132	5660				
136	5680				
140	5700				
144	5720				

IEEE 802.11a IEEE 802.11n(HT20) IEEE 802.11ac(VHT20) IEEE 802.11ax(HE20)		IEEE 802.11n(HT40) IEEE 802.11ac(VHT40) IEEE 802.11ax(HE40)		IEEE 802.11ac(VHT80) IEEE 802.11ax(HE80)	
UNII-3		UNII-3		UNII-3	
Channel	Frequency (MHz)	Channel	Frequency (MHz)	Channel	Frequency (MHz)
149	5745	151	5755	155	5775
153	5765	159	5795		
157	5785				
161	5805				
165	5825				

IEEE 802.11ac(VHT160) IEEE 802.11ax(HE160)	
Channel	Frequency (MHz)
50	5250
114	5570

3. Table for Filed Antenna:

Antenna Type	Frequency Band (MHz)	Tx Paths	Number of spatial streams	Max Antenna Gain (dBi)	Beamforming Directional Gain(dBi)	CDD Directional Gain (dBi)	
						For Power	For PSD
Wi-Fi Antenna							
PIFA	2412 ~ 2462	2	1	3.00	6.01	3.00	6.01
	5150 ~ 5850	4	1	2.00	8.02	2.00	8.02

Remark:

1. The EUT supports Cyclic Delay Diversity (CDD) mode, and CDD signals are correlated.

If all antennas have the same gain, G_{ANT} , Directional gain = $G_{ANT} + \text{Array Gain}$, where Array Gain is as follows.

- For power spectral density (PSD) measurements on all devices,

$$\text{Array Gain} = 10 \log (N_{ANT} / N_{SS}) \text{ dB};$$

- For power measurements on IEEE 802.11 devices,

$$\text{Array Gain} = 0 \text{ dB for } N_{ANT} \leq 4;$$

2. The EUT also supports Beam Forming mode, and the Beam Forming support 802.11ac/ax, not include 802.11a/b/g/n. BF Directional gain = $G_{ANT} + 10 \log (N_{ANT})$.

3. All information of antenna were from the AUT report.

Test Mode	Tx Paths	CDD Mode	Beamforming Mode
802.11b/g/n (DTS)	2	√	X
802.11ax (DTS)	2	√	√
802.11a/n (NII)	4	√	X
802.11ac/ax (NII)	4	√	√

3.2 DESCRIPTION OF TEST MODES

The test system was pre-tested based on the consideration of all possible combinations of EUT operation mode.

Pretest Mode	Description
Mode 1	TX AX(HE20) Mode Channel 165

Following mode(s) was (were) found to be the worst case(s) and selected for the final test.

Radiated emissions test - Below 1GHz	
Final Test Mode	Description
Mode 1	TX AX(HE20) Mode Channel 165

Note: The adapter supplied and PoE supplied are evaluated Wall mounted (vertical) and desktop (horizontal), the desktop (horizontal) and adapter supplied is the worst case and recorded in the test report.

3.3 BLOCK DIAGRAM SHOWING THE CONFIGURATION OF SYSTEM TESTED

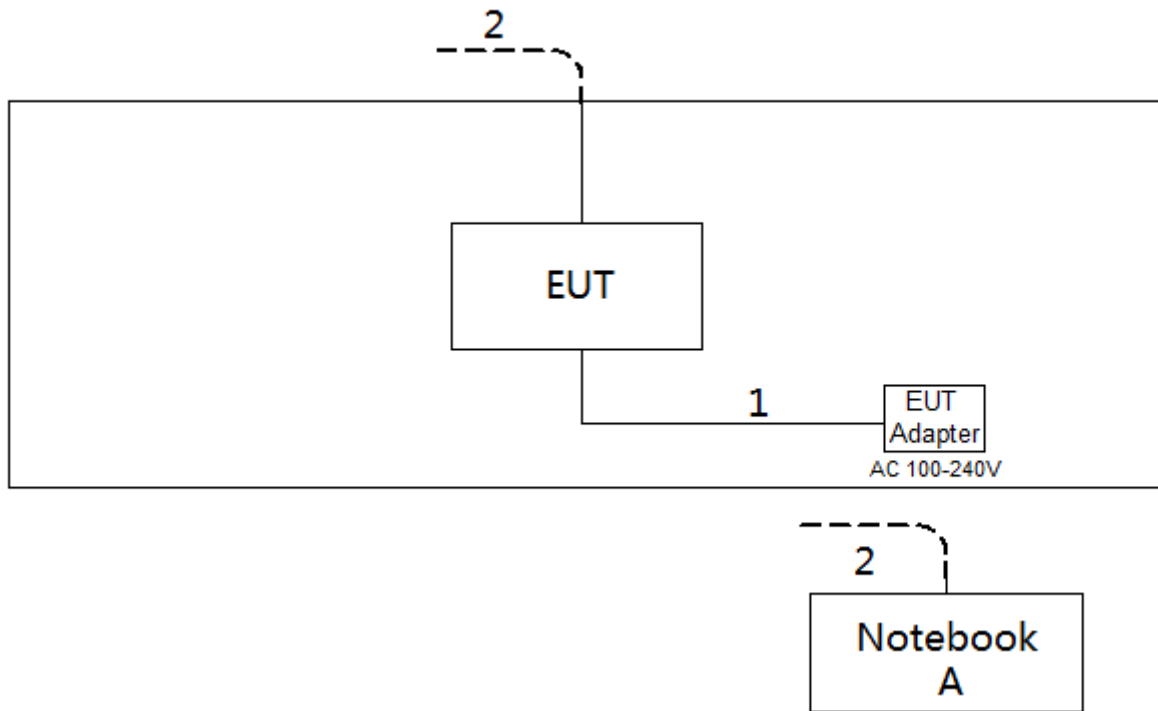

3.4 SUPPORT UNITS

Item	Equipment	Brand	Model No.	Series No.
A	Notebook	Honor	14SER5 3500	N/A

Item	Cable Type	Shielded Type	Ferrite Core	Length
1	DC Cable	NO	NO	1.5m
2	RJ45 Cable	NO	NO	10m

3.5 CUSTOMER INFORMATION DESCRIPTION

- 1) The antenna gain and beamforming gains are provided by the manufacturer.

4. RADIATED EMISSIONS

4.1 LIMIT

In case the emission fall within the restricted band specified on 15.205(a), then the 15.209(a) limit in the table below has to be followed.

LIMITS OF RADIATED EMISSIONS MEASUREMENT (30 MHz to 1000 MHz)

Frequency (MHz)	Field Strength (microvolts/meter)	Measurement Distance (meters)
30-88	100	3
88-216	150	3
216-960	200	3
Above 960	500	3

4.2 TEST PROCEDURE

- The measuring distance of 3 m shall be used for measurements. The EUT was placed on the top of a rotating table 0.8 meter above the ground at a 3 meter semi-anechoic chamber. The table was rotated 360 degrees to determine the position of the highest radiation.(below 1GHz)
- The height of the equipment or of the substitution antenna shall be 0.8m or 1.5m; the height of the test antenna shall vary between 1 m to 4 m. Both horizontal and vertical polarizations of the antenna are set to make the measurement.
- For each suspected emission, the EUT was arranged to its worst case and then the antenna was tuned to heights find the maximum reading (used Bore sight function).
- The initial step in collecting radiated emission data is a receiver peak detector mode pre-scanning the measurement frequency range. Significant peaks are then marked and then Quasi Peak detector mode re-measured.
- All readings are Peak unless otherwise stated QP in column of Note. Peak denotes that the Peak reading compliance with the QP Limits and then QP Mode measurement didn't perform. (below 1 GHz)
- For the actual test configuration, please refer to the related Item –EUT Test Photos.

The following table is the setting of the receiver:

Spectrum Parameters	Setting
Start ~ Stop Frequency	30 MHz~1000 MHz for RBW 100 kHz

Receiver Parameters	Setting
Start ~ Stop Frequency	30 MHz~1000 MHz for QP detector

4.3 DEVIATION FROM TEST STANDARD

No deviation.

4.4 TEST SETUP

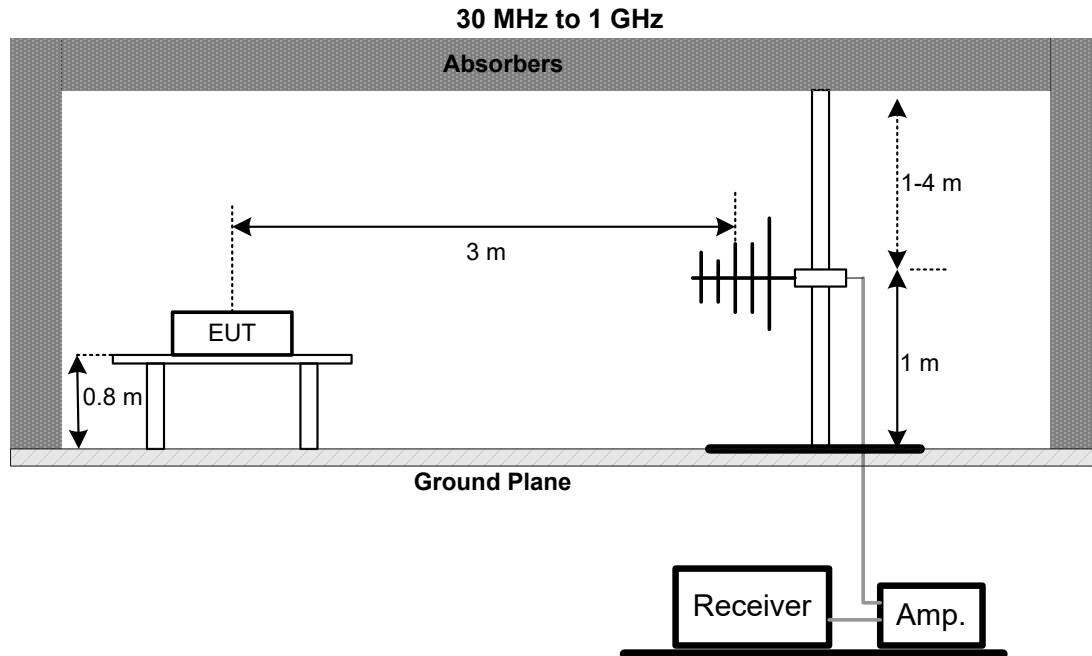

4.5 EUT OPERATING CONDITIONS

The EUT was programmed to be in continuously transmitting mode.

4.6 TEST RESULTS - 30 MHZ TO 1000 MHZ

Please refer to the APPENDIX A.

5. MEASUREMENT INSTRUMENTS LIST

Radiated Emissions - 30 MHz to 1 GHz					
Item	Kind of Equipment	Manufacturer	Type No.	Serial No.	Calibrated until
1	Trilog-Broadband Antenna	Schwarzbeck	VULB 9168	1462	Dec. 13, 2024
2	Attenuator	EMC INSTRUMENT	EMCI-N-6-06	AT-06009	Dec. 13, 2024
3	Preamplifier	EMC INSTRUMENT	EMC001330	980863	Apr. 07, 2025
4	Cable	RegalWay	LMR400-NMNM-12.5m	N/A	Jul. 04, 2024
5	Cable	RegalWay	LMR400-NMNM-3m	N/A	Jul. 04, 2024
6	Cable	RegalWay	LMR400-NMNM-0.5m	N/A	Jul. 04, 2024
7	Receiver	Agilent	N9038A	MY52130039	Dec. 22, 2024
8	Attenuator	Talent Microwave	TA10A2-S-18	N/A	N/A
9	Positioning Controller	MF	MF-7802	N/A	N/A
10	Measurement Software	Farad	EZ-EMC Ver.NB-03A1-01	N/A	N/A
11	966 Chamber room	CM	9*6*6	N/A	May 16, 2025

Remark "N/A" denotes no model name, serial no. or calibration specified.
 All calibration period of equipment list is one year.

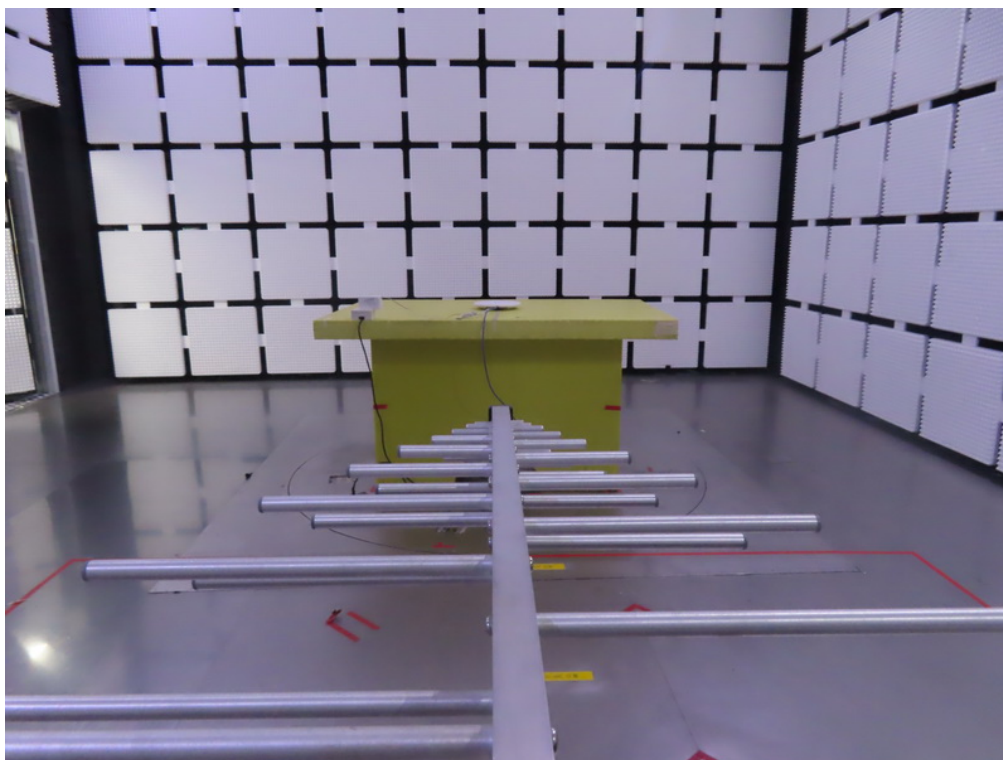
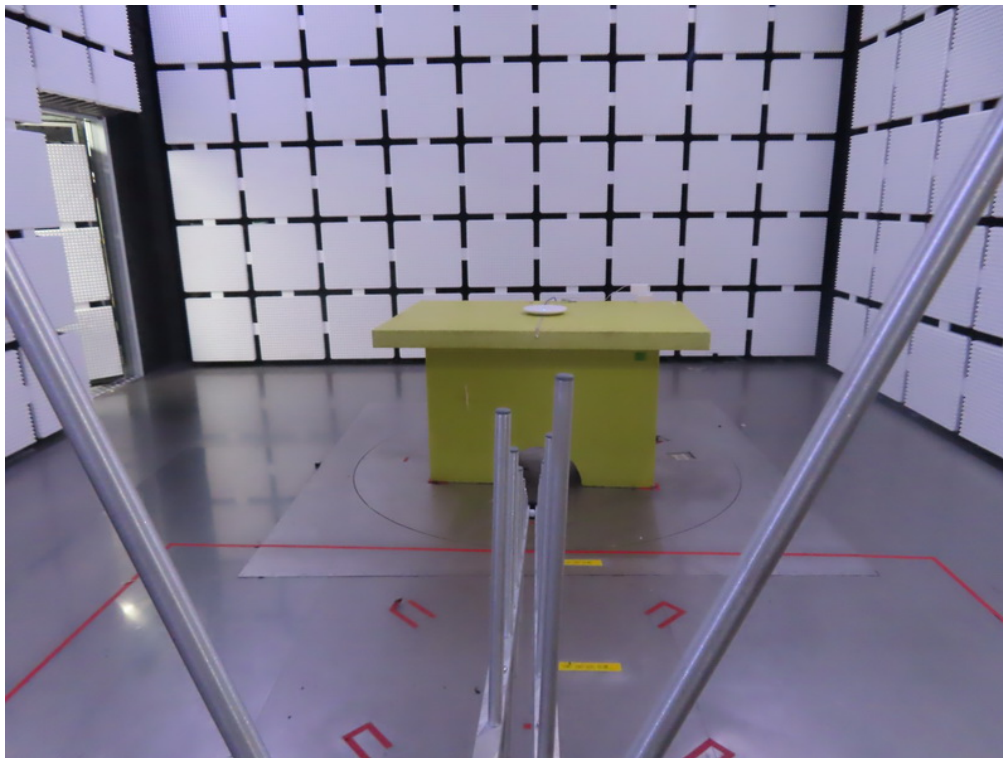
6. EUT TEST PHOTO**Radiated Emissions Test Photos****30 MHz to 1 GHz**

APPENDIX A - RADIATED EMISSION - 30 MHZ TO 1000 MHZ

Test Mode	TX AX(HE20) Mode Channel 165	Polarization	Vertical
-----------	------------------------------	--------------	----------

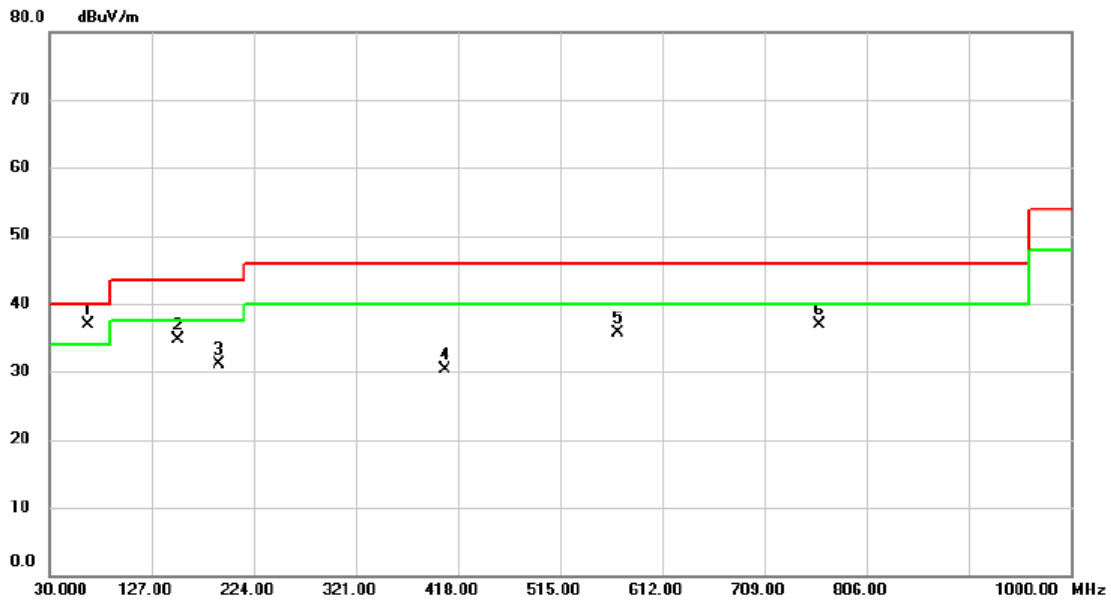

No.	Mk.	Freq. MHz	Reading Level dBuV	Correct Factor dB	Measure- ment dBuV/m	Limit dBuV/m	Margin dB	Detector	Comment
1	*	67.345	50.07	-13.10	36.97	40.00	-3.03	peak	
2		152.705	45.86	-11.07	34.79	43.50	-8.71	peak	
3		191.505	44.97	-13.94	31.03	43.50	-12.47	peak	
4		405.390	38.20	-7.84	30.36	46.00	-15.64	peak	
5		570.290	40.10	-4.40	35.70	46.00	-10.30	peak	
6		760.895	38.13	-1.16	36.97	46.00	-9.03	peak	

REMARKS:

- (1) Measurement Value = Reading Level + Correct Factor.
- (2) Margin Level = Measurement Value - Limit Value.

Test Mode	TX AX(HE20) Mode Channel 165	Polarization	Horizontal
-----------	------------------------------	--------------	------------

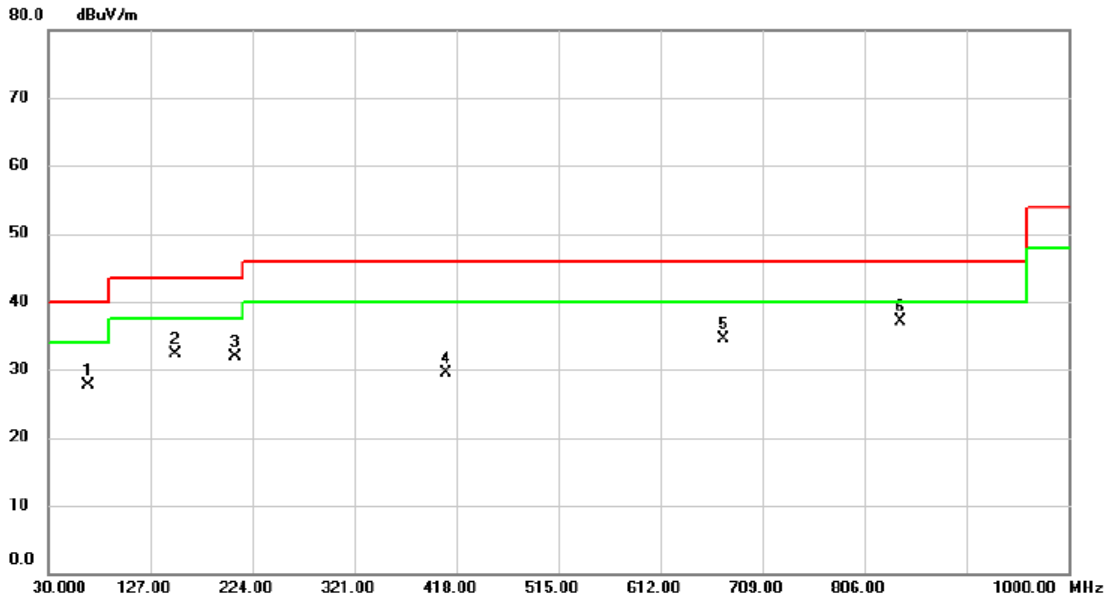

No. Mk.	Freq. MHz	Reading Level dBuV	Correct Factor dB	Measurement dBuV/m	Limit dBuV/m	Margin dB	Detector	Comment
1	68.315	40.94	-13.26	27.68	40.00	-12.32	peak	
2	150.765	43.45	-11.14	32.31	43.50	-11.19	peak	
3	207.995	46.22	-14.41	31.81	43.50	-11.69	peak	
4	408.785	37.20	-7.75	29.45	46.00	-16.55	peak	
5	672.140	37.03	-2.61	34.42	46.00	-11.58	peak	
6 *	839.950	37.82	-0.65	37.17	46.00	-8.83	peak	

REMARKS:

- (1) Measurement Value = Reading Level + Correct Factor.
- (2) Margin Level = Measurement Value - Limit Value

End of Test Report