

## DFS MEASUREMENT REPORT

---

**FCC ID** : 2AXJ4EAP670V2  
**Applicant** : TP-Link Corporation Limited  
**Application Type** : Certification  
**Product** : AX5400 Ceiling Mount Wi-Fi 6 Access Point  
**Model No.** : EAP670  
**Series Model No.** : EAP673  
**Brand Name** : tp-link  
**FCC Classification** : Unlicensed National Information Infrastructure (NII)  
**FCC Rule Part(s)** : Part 15 Subpart E - 15.407 Section (h)(2)  
**Type of Device** : Master Device  
**Received Date** : August 11, 2023  
**Test Date** : September 26, 2023 ~ October 17, 2023

**Tested By** : Peter Syu

( Peter Syu )

**Reviewed By** : Paddy Chen

( Paddy Chen )

**Approved By** : Chenz Ker

( Chenz Ker )



The test results relate only to the samples tested.

This equipment has been shown to be capable of compliance with the applicable technical standards as indicated in the measurement report and was tested in accordance with the measurement procedures specified in KDB 905462 D02v02. Test results reported herein relate only to the item(s) tested.

The test report shall not be reproduced except in full without the written approval of MRT Technology (Taiwan) Co., Ltd.

## Revision History

Report No.	Version	Description	Issue Date	Note
2308TW0107-U5	1.0	Original Report	2023-11-22	Valid

---

## CONTENTS

Description	Page
<b>Revision History</b> .....	<b>2</b>
<b>General Information</b> .....	<b>5</b>
<b>1. INTRODUCTION</b> .....	<b>6</b>
1.1. Scope .....	6
1.2. MRT Test Location .....	6
<b>2. PRODUCT INFORMATION</b> .....	<b>7</b>
2.1. Equipment Description.....	7
2.2. Product Specification Subjective to this Report.....	8
2.3. Operating Frequency and Channel List for this Report .....	9
2.4. Description of Available Antennas.....	10
2.5. Test Channels for this Report .....	10
2.6. Test Mode .....	11
2.7. Applied Standards .....	11
<b>3. DFS DETECTION THRESHOLDS AND RADAR TEST WAVEFORMS</b> .....	<b>12</b>
3.1. Applicability .....	12
3.2. DFS Devices Requirements.....	13
3.3. DFS Detection Threshold Values .....	14
3.4. Parameters of DFS Test Signals .....	15
3.5. Conducted Test Setup .....	18
<b>4. TEST EQUIPMENT CALIBRATION DATE</b> .....	<b>19</b>
<b>5. TEST RESULT</b> .....	<b>20</b>
5.1. Summary .....	20
5.2. Radar Waveform Calibration.....	21
5.2.1. Calibration Setup .....	21
5.2.2. Calibration Procedure .....	21
5.2.3. Calibration Result .....	22
5.2.4. Channel Loading Test Result .....	26
5.3. UNII Detection Bandwidth Measurement .....	29
5.3.1. Test Limit .....	29
5.3.2. Test Procedure .....	29
5.3.3. Test Result.....	30
5.4. Initial Channel Availability Check Time Measurement .....	40
5.4.1. Test Limit .....	40
5.4.2. Test Procedure .....	40
5.4.3. Test Result.....	41
5.5. Radar Burst at the Beginning of the Channel Availability Check Time Measurement ..	42
5.5.1. Test Limit .....	42

---

5.5.2. Test Procedure .....	42
5.5.3. Test Result.....	43
5.6. Radar Burst at the End of the Channel Availability Check Time Measurement.....	44
5.6.1. Test Limit .....	44
5.6.2. Test Procedure .....	44
5.6.3. Test Result.....	45
5.7. In-Service Monitoring for Channel Move Time, Channel Closing Transmission Time and Non-Occupancy Period Measurement.....	46
5.7.1. Test Limit .....	46
5.7.2. Test Procedure Used .....	46
5.7.3. Test Result.....	47
5.8. Statistical Performance Check Measurement .....	51
5.8.1. Test Limit .....	51
5.8.2. Test Procedure .....	51
5.8.3. Test Result.....	52
<b>6. CONCLUSION.....</b>	<b>280</b>
<b>Appendix A : Test Setup Photograph .....</b>	<b>281</b>
<b>Appendix B : EUT Photograph.....</b>	<b>281</b>
<b>Appendix C : Internal Photograph .....</b>	<b>281</b>

## General Information

<b>Applicant</b>	TP-Link Corporation Limited
<b>Applicant Address</b>	Room 901, 9/F., New East Ocean Centre, 9 Science Museum Road, Tsim Sha Tsui, Kowloon, Hongkong
<b>Manufacturer</b>	TP-Link Corporation Limited
<b>Manufacturer Address</b>	Room 901, 9/F. , New East Ocean Centre, 9 Science Museum Road, Tsim Sha Tsui, Kowloon, Hongkong
<b>Test Site</b>	MRT Technology (Taiwan) Co., Ltd
<b>Test Site Address</b>	No. 38, Fuxing Second Rd., Guishan Dist., Taoyuan City 333, Taiwan (R.O.C)
<b>MRT FCC Registration No.</b>	291082
<b>FCC Rule Part(s)</b>	Part 15.407

## Test Facility / Accreditations

1. MRT facility is a FCC registered (Reg. No. 291082) test facility with the site description report on file and is designated by the FCC as an Accredited Test Firm.
2. MRT facility is an IC registered (MRT Reg. No. 21723) test laboratory with the site description on file at Industry Canada.
3. MRT Lab is accredited to ISO 17025 by the Taiwan Accreditation Foundation (TAF Cert. No. 3261) in EMC, Telecommunications and Radio testing for FCC (Designation Number: TW3261), Industry Canada, EU and TELEC Rules.

# 1. INTRODUCTION

## 1.1. Scope

Measurement and determination of electromagnetic emissions (EMC) of radio frequency devices including intentional and/or unintentional radiators for compliance with the technical rules and regulations of the Federal Communications Commission and the Innovation, Science and Economic Development Canada and Certification and Engineering Bureau.

## 1.2. MRT Test Location

The map below shows the location of the MRT LABORATORY, its proximity to the Taoyuan City. These measurement tests were conducted at the MRT Technology (Taiwan) Co., Ltd. Facility located at No.38, Fuxing 2nd Rd., Guishan Dist., Taoyuan City 33377, Taiwan (R.O.C).

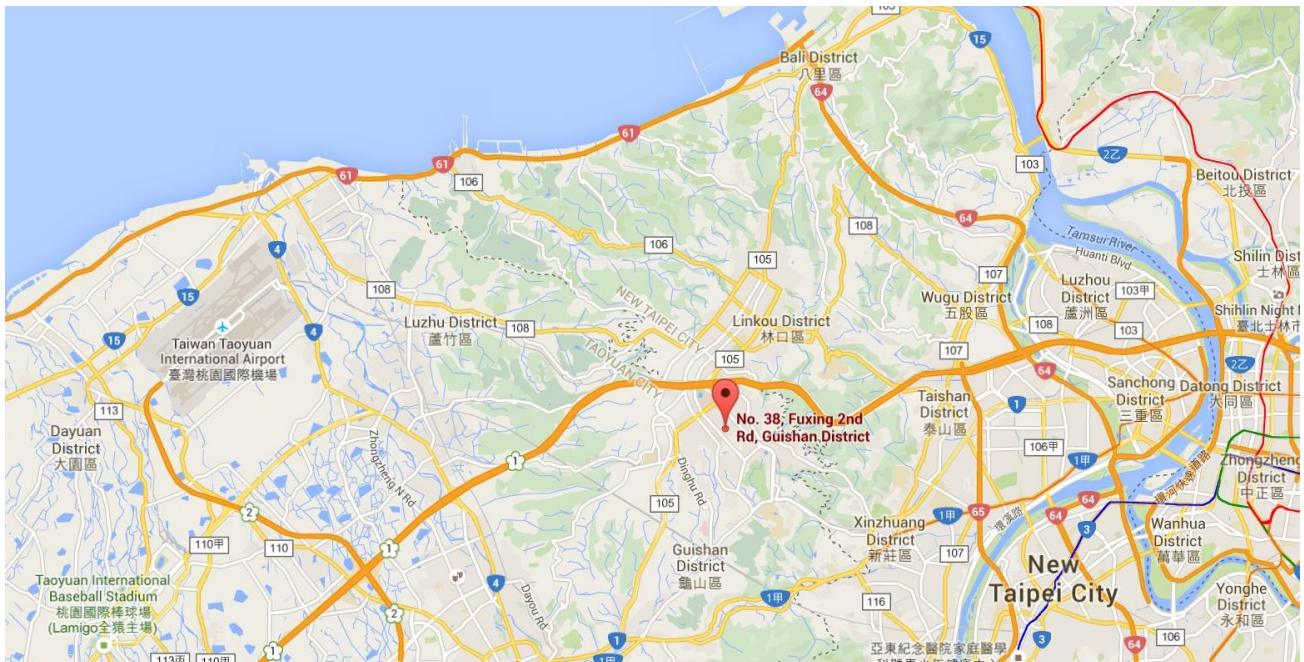

## 2. PRODUCT INFORMATION

### 2.1. Equipment Description

Product Name:	AX5400 Ceiling Mount Wi-Fi 6 Access Point
Model No.:	EAP670
Series Model No.	EAP673
Brand Name:	tp-link
Bluetooth Specification	Bluetooth Mode: V4.2
Wi-Fi Specification:	802.11a/b/g/n/ac/ax
EUT Identification No.:	#1-3 (DFS)
Accessory	
Adapter	Brand: tp-link M/N: T120200-2B4 Input: 100-240V~50/60Hz 0.8A Output: DC 12.0V, 2.0A Length: Non-shielded 1.5m

Note:

1. Model Difference: The difference of models only for marketing different (Adapter is not sold with EAP673), the other hardware was the same. (declared by the manufacturer)
2. The test was performed based on EAP670.

## 2.2. Product Specification Subjective to this Report

Frequency Range:	<p>For 802.11a/n-HT20/ac-VHT20/ax-HE20: 5260~5320 MHz, 5500~5720MHz</p> <p>For 802.11n-HT40/ac-VHT40/ax-HE40: 5270~5310 MHz,5510~5710MHz</p> <p>For 802.11ac-VHT80/ax-HE80: 5290MHz,5530MHz, 5610MHz, 5690MHz</p> <p>For 802.11ac-VHT160/ax-HE160: 5250MHz, 5570MHz</p>
Type of Modulation:	<p>802.11a/n/ac: OFDM,</p> <p>802.11ax: OFDMA</p>
TPC mechanism:	Support (Details refer to operational description)
Power-on cycle:	Requires 43.8 seconds to complete its power-on cycle
Uniform Spreading (For DFS Frequency Band):	For the 5250-5350MHz, 5470-5725 MHz bands, the Master device provides, on aggregate, uniform loading of the spectrum across all devices by selecting an operating channel among the available channels using a random algorithm.



### 2.3. Operating Frequency and Channel List for this Report

802.11a/n-HT20/ac-VHT20/ax-HE20

Channel	Frequency	Channel	Frequency	Channel	Frequency
52	5260 MHz	56	5280 MHz	60	5300 MHz
64	5320 MHz	100	5500 MHz	104	5520 MHz
108	5540 MHz	112	5560 MHz	116	5580 MHz
120	5600 MHz	124	5620 MHz	128	5640 MHz
132	5660 MHz	136	5680 MHz	140	5700 MHz
144	5720 MHz	--	--	--	--

802.11n-HT40/ac-VHT40/ax-HE40

Channel	Frequency	Channel	Frequency	Channel	Frequency
54	5270 MHz	62	5310 MHz	102	5510 MHz
110	5550 MHz	118	5590 MHz	126	5630 MHz
134	5670 MHz	142	5710 MHz	--	--

802.11ac-VHT80/ax-HE80

Channel	Frequency	Channel	Frequency	Channel	Frequency
58	5290 MHz	106	5530 MHz	122	5610 MHz
138	5690 MHz	--	--	--	--

802.11ac-VHT160/ax-HE160

Channel	Frequency	Channel	Frequency	Channel	Frequency
50	5250MHz	114	5570 MHz	--	--

## 2.4. Description of Available Antennas

Antenna Type	Frequency Band (MHz)	Tx Paths	Number of spatial streams	Max Antenna Gain (dBi)	Beamforming Directional Gain(dBi)	CDD Directional Gain (dBi)	
						For Power	For PSD
Wi-Fi Antenna							
PIFA	2412 ~ 2462	2	1	3.00	6.01	3.00	6.01
	5150 ~ 5850	4	1	2.00	8.02	2.00	8.02

Remark:

1. The EUT supports Cyclic Delay Diversity (CDD) mode, and CDD signals are correlated.

If all antennas have the same gain,  $G_{ANT}$ , Directional gain =  $G_{ANT} + \text{Array Gain}$ , where Array Gain is as follows.

- For power spectral density (PSD) measurements on all devices,

Array Gain =  $10 \log (N_{ANT} / N_{SS})$  dB;

- For power measurements on IEEE 802.11 devices,

Array Gain = 0 dB for  $N_{ANT} \leq 4$ ;

2. The EUT also supports Beam Forming mode, and the Beam Forming support 802.11ac/ax, not include 802.11a/b/g/n. BF Directional gain =  $G_{ANT} + 10 \log (N_{ANT})$ .

3. All information of antenna were from the AUT report.

Test Mode	Tx Paths	CDD Mode	Beamforming Mode
802.11b/g/n (DTS)	2	√	X
802.11ax (DTS)	2	√	√
802.11a/n (NII)	4	√	X
802.11ac/ax (NII)	4	√	√

## 2.5. Test Channels for this Report

Test Mode	Test Channel	Test Frequency
802.11ax-HE20	100	5500 MHz
802.11ax-HE40	102	5510 MHz
802.11ax-HE80	106	5530 MHz
802.11ax-HE160	50	5250 MHz
802.11ax-HE160	114	5570 MHz

## 2.6. Test Mode

Test Mode	Make the EUT communicate with notebook at DFS channel
-----------	---

## 2.7. Applied Standards

According to the specifications of the manufacturer, the EUT must comply with the requirements of the following standards:

- FCC Part15 Subpart E (Section 15.407 Section (h)(2))
- KDB 905462 D02v02
- KDB 905462 D04v01

### 3. DFS DETECTION THRESHOLDS AND RADAR TEST WAVEFORMS

#### 3.1. Applicability

The following table from FCC KDB 905462 D02 UNII DFS Compliance Procedures New Rules v02 lists the applicable requirements for the DFS testing.

Requirement	Operational Mode		
	Master	Client Without Radar Detection	Client With Radar Detection
Non-Occupancy Period	Yes	Not required	Yes
DFS Detection Threshold	Yes	Not required	Yes
Channel Availability Check Time	Yes	Not required	Not required
U-NII Detection Bandwidth	Yes	Not required	Yes

**Table 3-1: Applicability of DFS Requirements Prior to Use of a Channel**

Requirement	Operational Mode	
	Master Device or Client With Radar Detection	Client Without Radar Detection
DFS Detection Threshold	Yes	Not required
Channel Closing Transmission Time	Yes	Yes
Channel Move Time	Yes	Yes
U-NII Detection Bandwidth	Yes	Not required

Additional requirements for devices with multiple bandwidth modes	Master Device or Client with Radar Detection	Client Without Radar Detection
U-NII Detection Bandwidth and Statistical Performance Check	All BW modes must be tested	Not required
Channel Move Time and Channel Closing Transmission Time	Test using widest BW mode available	Test using the widest BW mode available for the link
All other tests	Any single BW mode	Not required

Note: Frequencies selected for statistical performance check should include several frequencies within the radar detection bandwidth and frequencies near the edge of the radar detection bandwidth. For 802.11 devices it is suggested to select frequencies in each of the bonded 20 MHz channels and the channel center frequency.

**Table 3-2: Applicability of DFS Requirements during normal operation**

### 3.2. DFS Devices Requirements

**Per FCC KDB 905462 D02 UNII DFS Compliance Procedures New Rules v02 the following are the requirements for Master Devices:**

- (a) The Master Device will use DFS in order to detect Radar Waveforms with received signal strength above the DFS Detection Threshold in the 5250 ~ 5350 MHz and 5470 ~ 5725 MHz bands. DFS is not required in the 5150 ~ 5250 MHz or 5725 ~ 5825 MHz bands.
- (b) Before initiating a network on a Channel, the Master Device will perform a Channel Availability Check for a specified time duration (Channel Availability Check Time) to ensure that there is no radar system operating on the Channel, using DFS described under subsection a) above.
- (c) The Master Device initiates a U-NII network by transmitting control signals that will enable other U-NII devices to Associate with the Master Device.
- (d) During normal operation, the Master Device will monitor the Channel (In-Service Monitoring) to ensure that there is no radar system operating on the Channel, using DFS described under a).
- (e) If the Master Device has detected a Radar Waveform during In-Service Monitoring as described under d), the Operating Channel of the U-NII network is no longer an Available Channel. The Master Device will instruct all associated Client Device(s) to stop transmitting on this Channel within the Channel Move Time. The transmissions during the Channel Move Time will be limited to the Channel Closing Transmission Time.
- (f) Once the Master Device has detected a Radar Waveform it will not utilize the Channel for the duration of the Non-Occupancy Period.
- (g) If the Master Device delegates the In-Service Monitoring to a Client Device, then the combination will be tested to the requirements described under d) through f) above.

**Channel Move Time and Channel Closing Transmission Time requirements are listed in the following table.**

Parameter	Value
Non-occupancy period	Minimum 30 minutes
Channel Availability Check Time	60 seconds
Channel Move Time	10 seconds See Note 1.
Channel Closing Transmission Time	200 milliseconds + an aggregate of 60 milliseconds over remaining 10 second period. See Notes 1 and 2.
U-NII Detection Bandwidth	Minimum 100% of the U-NII 99% transmission power bandwidth. See Note 3.
Note 1: Channel Move Time and the Channel Closing Transmission Time should be performed with Radar Type 0. The measurement timing begins at the end of the Radar Type 0 burst.	

Note 2: The Channel Closing Transmission Time is comprised of 200 milliseconds starting at the beginning of the Channel Move Time plus any additional intermittent control signals required to facilitate a Channel move (an aggregate of 60 milliseconds) during the remainder of the 10 second period. The aggregate duration of control signals will not count quiet periods in between transmissions.

Note 3: During the U-NII Detection Bandwidth detection test, radar type 0 should be used. For each frequency step the minimum percentage of detection is 90 percent. Measurements are performed with no data traffic.

**Table 3-3: DFS Response Requirements**

### 3.3. DFS Detection Threshold Values

The DFS detection thresholds are defined for Master devices and Client Devices with In-service monitoring. These detection thresholds are listed in the following table.

Maximum Transmit Power	Value (See Notes 1, 2, and 3)
EIRP $\geq$ 200 milliwatt	-64 dBm
EIRP < 200 milliwatt and power spectral density < 10 dBm/MHz	-62 dBm
EIRP < 200 milliwatt that do not meet the power spectral density requirement	-64 dBm

**Note 1:** This is the level at the input of the receiver assuming a 0 dBi receive antenna.

**Note 2:** Throughout these test procedures an additional 1 dB has been added to the amplitude of the test transmission waveforms to account for variations in measurement equipment. This will ensure that the test signal is at or above the detection threshold level to trigger a DFS response.

**Note 3:** EIRP is based on the highest antenna gain. For MIMO devices refer to KDB Publication 662911 D01.

**Table 3-4: Detection Thresholds for Master Devices and Client Devices with Radar Detection**

### 3.4. Parameters of DFS Test Signals

This section provides the parameters for required test waveforms, minimum percentage of successful detections, and the minimum number of trials that must be used for determining DFS conformance. Step intervals of 0.1 microsecond for Pulse Width, 1 microsecond for PRI, 1 MHz for chirp width and 1 for the number of pulses will be utilized for the random determination of specific test waveforms.

#### Short Pulse Radar Test Waveforms

Radar Type	Pulse Width (μsec)	PRI (μsec)	Number of Pulses	Minimum Percentage of Successful Detection	Minimum Number of Trials
0	1	1428	18	See Note 1	See Note 1
1	1	Test A: 15 unique PRI values randomly selected from the list of 23 PRI values in Table 3-6	$\text{Roundup} \left\{ \begin{array}{l} \left( \frac{1}{360} \right) \cdot \\ \left( \frac{19 \cdot 10^6}{\text{PRI}_{\mu\text{sec}}} \right) \end{array} \right\}$	60%	30
		Test B: 15 unique PRI values randomly selected within the range of 518-3066 μsec, with a minimum increment of 1 μsec, excluding PRI values selected in Test A			
2	1-5	150-230	23-29	60%	30
3	6-10	200-500	16-18	60%	30
4	11-20	200-500	12-16	60%	30
Aggregate (Radar Types 1-4)				80%	120
<b>Note 1:</b> Short Pulse Radar Type 0 should be used for the detection bandwidth test, channel move time, and channel closing time tests.					

**Table 3-5: Parameters for Short Pulse Radar Waveforms**

A minimum of 30 unique waveforms are required for each of the Short Pulse Radar Types 2 through 4. If more than 30 waveforms are used for Short Pulse Radar Types 2 through 4, then each additional waveform must also be unique and not repeated from the previous waveforms.

Pulse Repetition Frequency Number	Pulse Repetition Frequency (Pulses Per Second)	Pulse Repetition Interval (Microseconds)
1	1930.5	518
2	1858.7	538
3	1792.1	558
4	1730.1	578
5	1672.2	598
6	1618.1	618
7	1567.4	638
8	1519.8	658
9	1474.9	678
10	1432.7	698
11	1392.8	718
12	1355	738
13	1319.3	758
14	1285.3	778
15	1253.1	798
16	1222.5	818
17	1193.3	838
18	1165.6	858
19	1139	878
20	1113.6	898
21	1089.3	918
22	1066.1	938
23	326.2	3066

**Table 3-6: Pulse Repetition Intervals Values for Test A**



### Long Pulse Radar Test Waveform

Radar Type	Pulse Width (μsec)	Chirp Width (MHz)	PRI (μsec)	Number of Pulses per Burst	Number of Bursts	Minimum Percentage of Successful Detection	Minimum Number of Trials
5	50 - 100	5 - 20	1000 - 2000	1 - 3	8 - 20	80%	30

**Table 3-7: Parameters for Long Pulse Radar Waveforms**

The parameters for this waveform are randomly chosen. Thirty unique waveforms are required for the Long Pulse Radar Type waveforms. If more than 30 waveforms are used for the Long Pulse Radar Type waveforms, then each additional waveform must also be unique and not repeated from the previous waveforms.

### Frequency Hopping Radar Test Waveform

Radar Type	Pulse Width (μsec)	PRI (μsec)	Pulses Per Hop	Hopping Rate (kHz)	Hopping Sequence Length (msec)	Minimum Percentage of Successful Detection	Minimum Number of Trials
6	1	333	9	0.333	300	70%	30

**Table 3-8: Parameters for Frequency Hopping Radar Waveforms**

For the Frequency Hopping Radar Type, the same Burst parameters are used for each waveform. The hopping sequence is different for each waveform and a 100-length segment is selected from the hopping sequence defined by the following algorithm:

The first frequency in a hopping sequence is selected randomly from the group of 475 integer frequencies from 5250 – 5724MHz. Next, the frequency that was just chosen is removed from the group and a frequency is randomly selected from the remaining 474 frequencies in the group. This process continues until all 475 frequencies are chosen for the set. For selection of a random frequency, the frequencies remaining within the group are always treated as equally likely.

### 3.5. Conducted Test Setup

The FCC KDB 905462 D02 UNII DFS Compliance Procedures New Rules v02 describes a radiated test setup and a conducted test setup. The conducted test setup was used for this testing. Figure 3-1 shows the typical test setup.

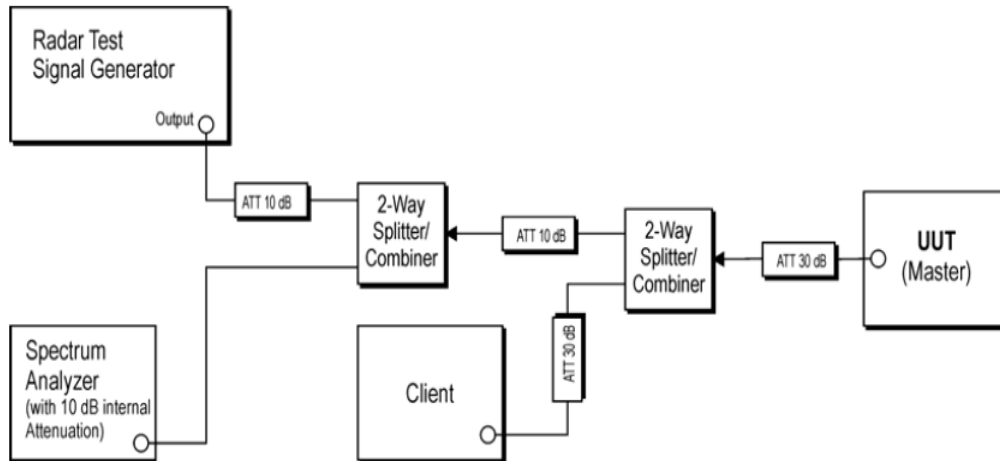

**Figure 3-1: Conducted Test Setup where UUT is a Master and Radar Test Waveforms are injected into the Masters**

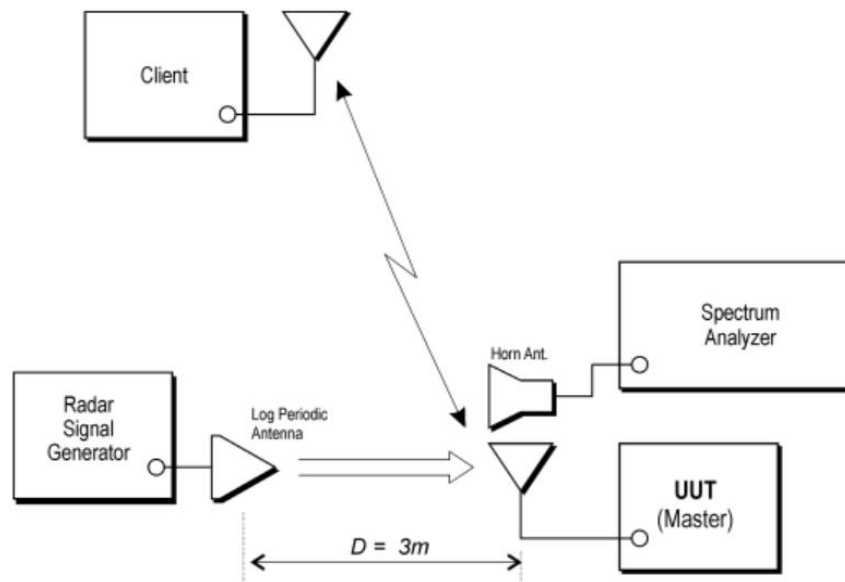

**Figure 3-2: Radiated Test Setup where UUT is a Master and Radar Test Waveforms are injected into the UUT**

## 4. TEST EQUIPMENT CALIBRATION DATE

### Dynamic Frequency Selection (DFS)

Instrument	Manufacturer	Type No.	Asset No.	Cali. Interval	Cali. Due Date
EXA Signal Analyzer	KEYSIGHT	N9010A	MRTTWA00012	1 year	2023/11/5
EXA Signal Analyzer	KEYSIGHT	N9010B	MRTTWA00074	1 year	2024/7/19
Vector Signal Generator	Keysight	N5182B	MRTTWA00010	1 year	2024/5/22
Combiner	WOKEN	0120A04208001S	MRTTWE00008	1 year	2024/6/15

### Client Information

Instrument	Manufacturer	Type No.	Certification Number
Wi-Fi Module	Intel	AX200NGW	FCC ID: PD9AX200NG

Software	Version	Manufacturer	Function
Pulse Building(N7607B)	V3.0.0	Keysight	Radar Signal Generation Software
DFS Tool	V6.7	Keysight	DFS Test Software

## 5. TEST RESULT

### 5.1. Summary

Parameter	Limit	Test Result	Reference
UNII Detection Bandwidth Measurement	Refer Table 3-3	Pass	Section 5.3
Initial Channel Availability Check Time	Refer Table 3-3	Pass	Section 5.4
Radar Burst at the Beginning of the Channel Availability Check Time	Refer Table 3-3	Pass	Section 5.5
Radar Burst at the End of the Channel Availability Check Time	Refer Table 3-3	Pass	Section 5.6
In-Service Monitoring for Channel Move Time, Channel Closing Transmission Time	Refer Table 3-3	Pass	Section 5.7
Non-Occupancy Period	Refer Table 3-3	Pass	Section 5.7
Statistical Performance Check	Refer Table 3-3	Pass	Section 5.8

**Note:** Determining compliance is based on the test results met the regulation limits or requirements declared by clients, and the test results don't take into account the value of measurement uncertainty.

## 5.2. Radar Waveform Calibration

### 5.2.1. Calibration Setup

The conducted test setup was used for this calibration testing. Figure 3-2 shows the typical test setup.

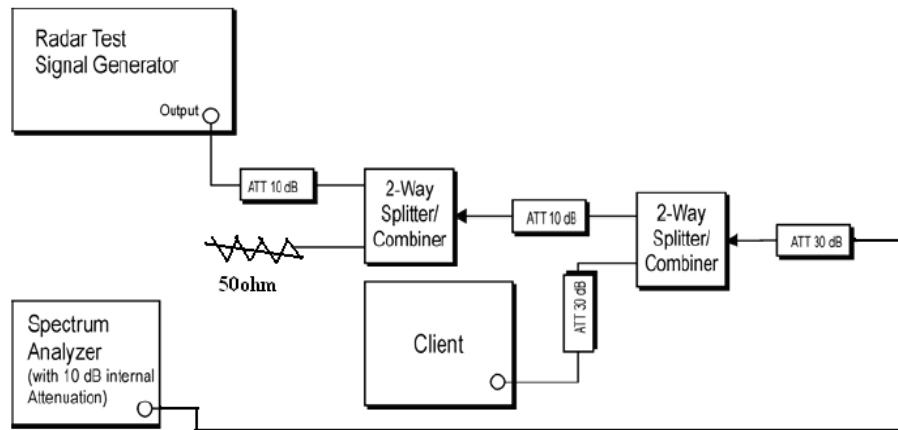

**Figure 3-2: Conducted Test Setup**

### 5.2.2. Calibration Procedure

The Interference Radar Detection Threshold Level is  $(-64\text{dBm}) + (0) [\text{dBi}] + 1 \text{ dB} = -63 \text{ dBm}$  that had been taken into account the output power range and antenna gain. The above equipment setup was used to calibrate the conducted Radar Waveform. A vector signal generator was utilized to establish the test signal level for each radar type. During this process there were replace 50ohm terminal form Master and Client device and no transmissions by either the Master or Client Device. The spectrum analyzer was switched to the zero span (Time Domain) at the frequency of the Radar Waveform generator. Peak detection was used. The spectrum analyzer resolution bandwidth (RBW) and video bandwidth (VBW) were set to at least 3MHz. The vector signal generator amplitude was set so that the power level measured at the spectrum analyzer was  $(-64\text{dBm}) + (0) [\text{dBi}] + 1 \text{ dB} = -63\text{dBm}$ . Capture the spectrum analyzer plots on short pulse radar types, long pulse radar type and hopping radar waveform.

### 5.2.3. Calibration Result

Product	AX5400 Ceiling Mount Wi-Fi 6 Access Point	Temperature	27°C
Test Engineer	Peter	Relative Humidity	65%
Test Site	SR5	Test Date	2023/09/26
Test Item	Radar Waveform Calibration-Master		

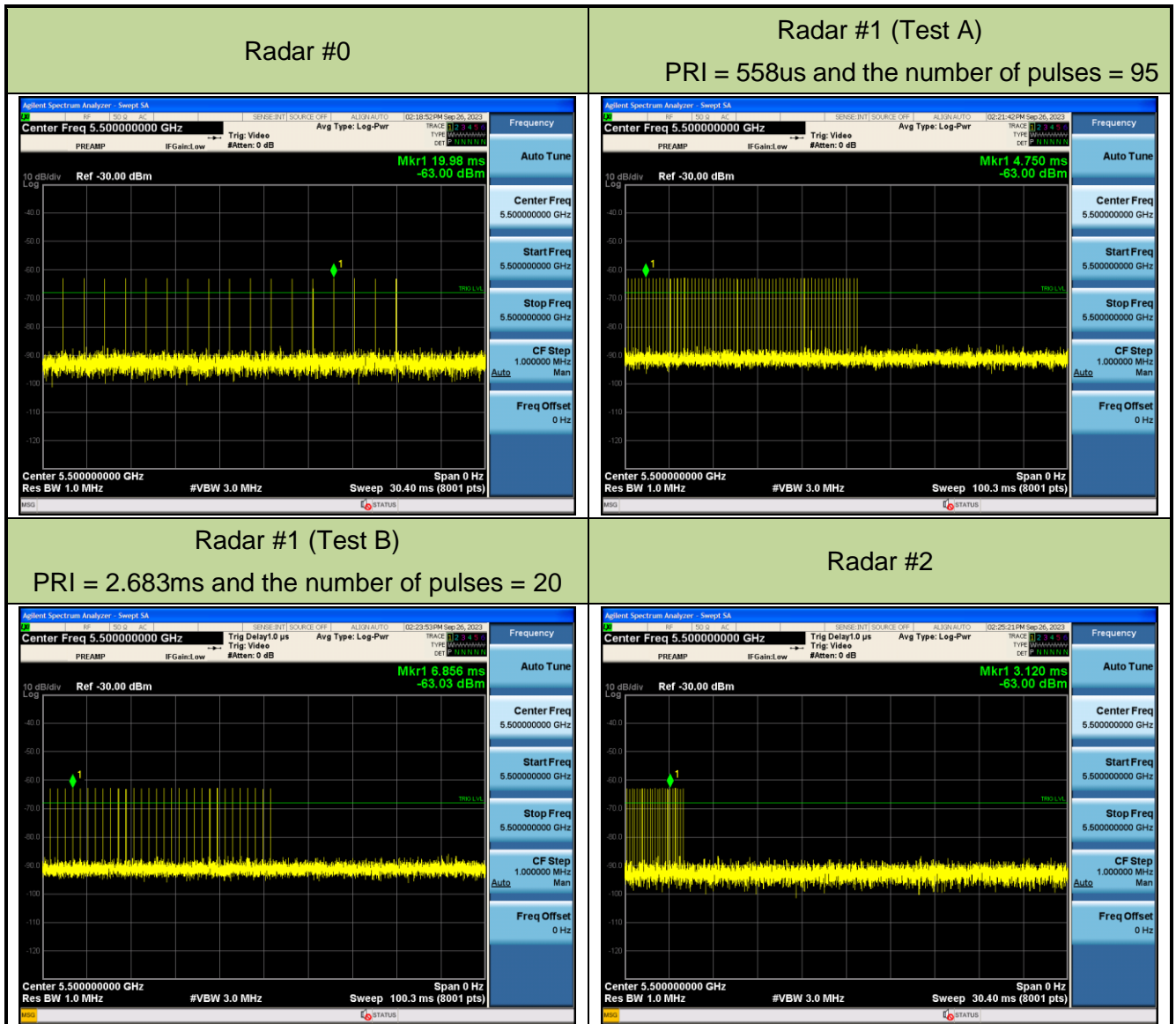

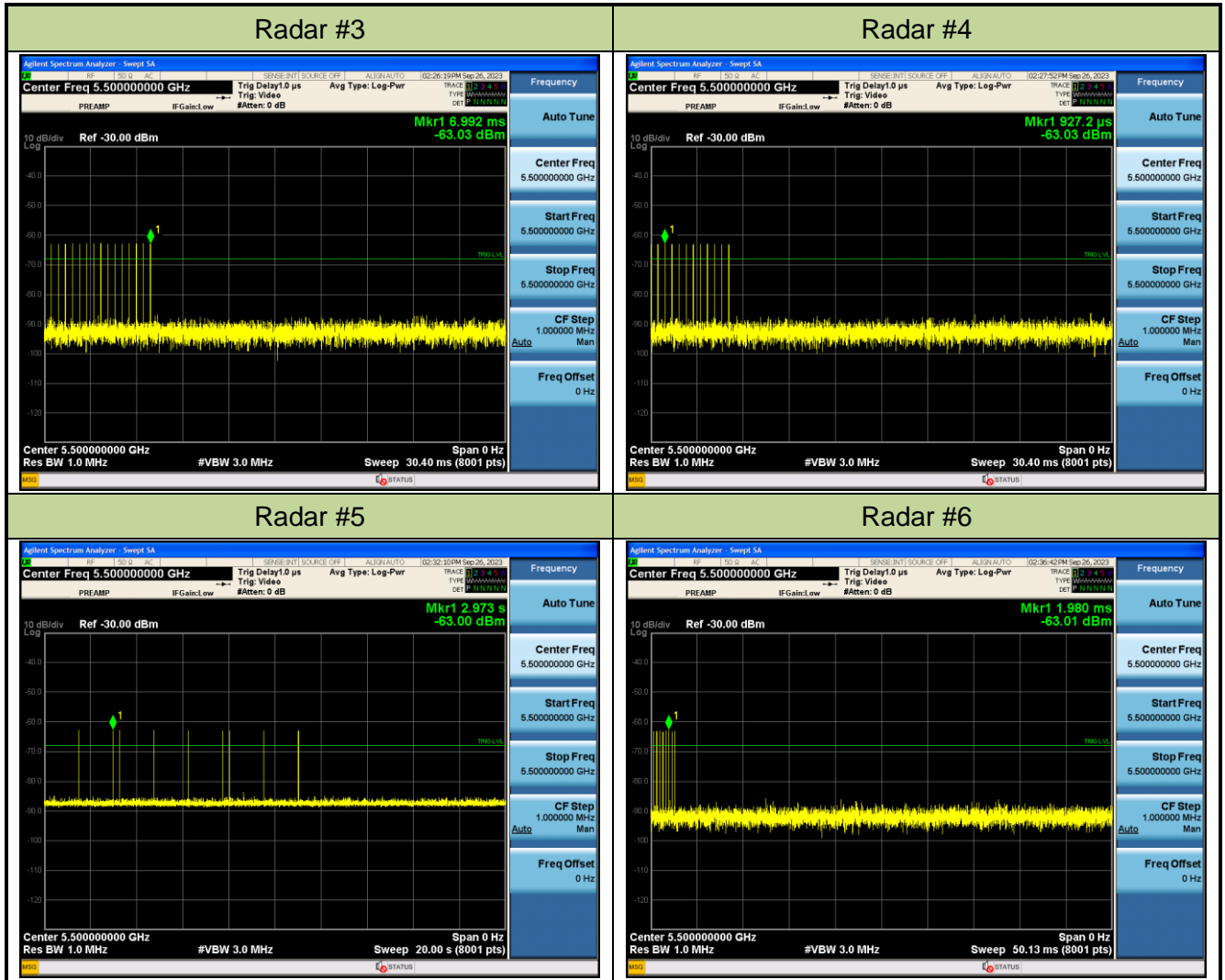

Product	AX5400 Ceiling Mount Wi-Fi 6 Access Point	Temperature	27°C
Test Engineer	Peter	Relative Humidity	65%
Test Site	SR5	Test Date	2023/10/17
Test Item	Radar Waveform Calibration-Mesh		

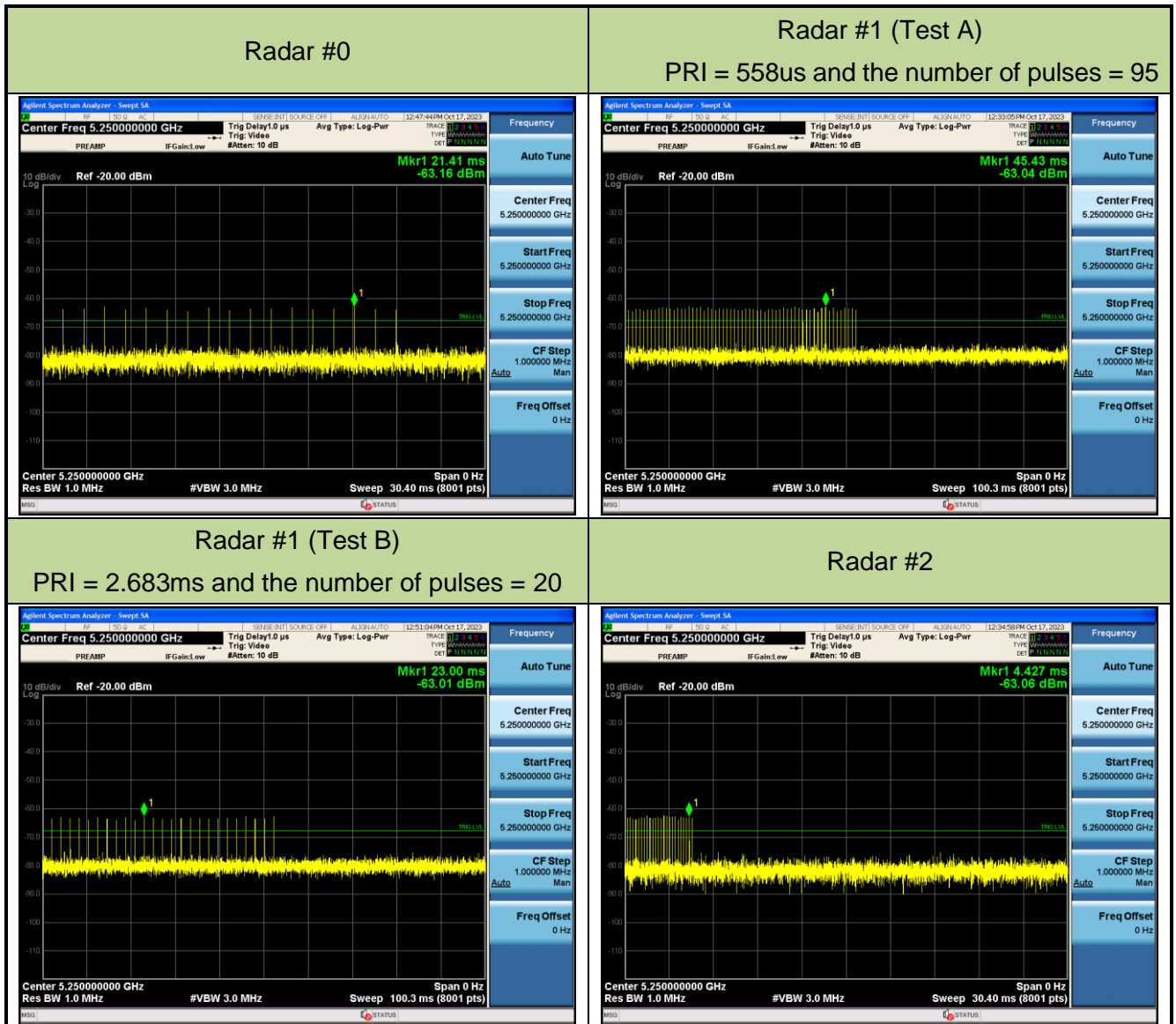



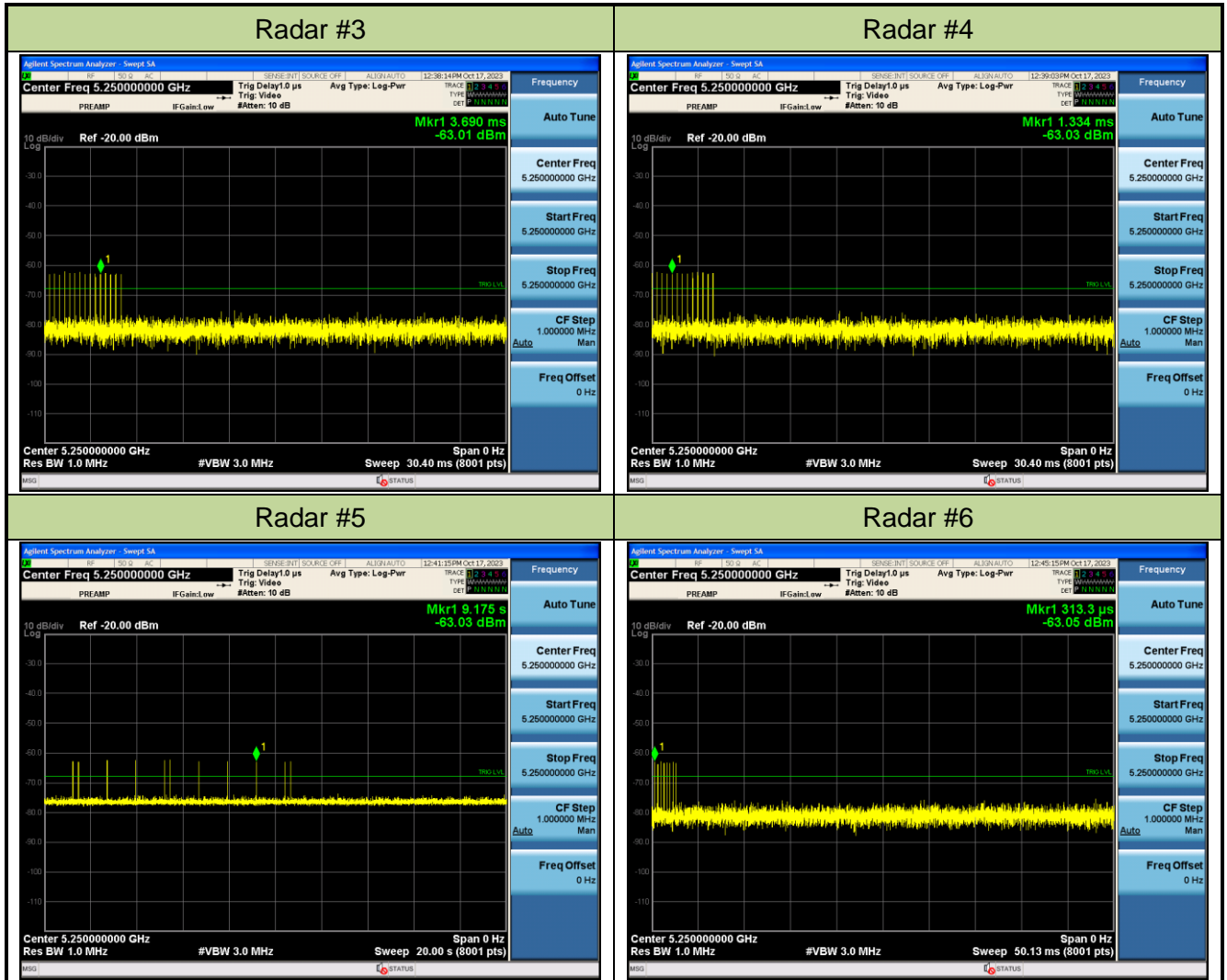

### 5.2.4. Channel Loading Test Result

Product	AX5400 Ceiling Mount Wi-Fi 6 Access Point	Temperature	27°C
Test Engineer	Peter	Relative Humidity	65%
Test Site	SR5	Test Date	2023/09/26
Test Item	Channel Loading-Master		

802.11ax-HE20 (5500MHz)

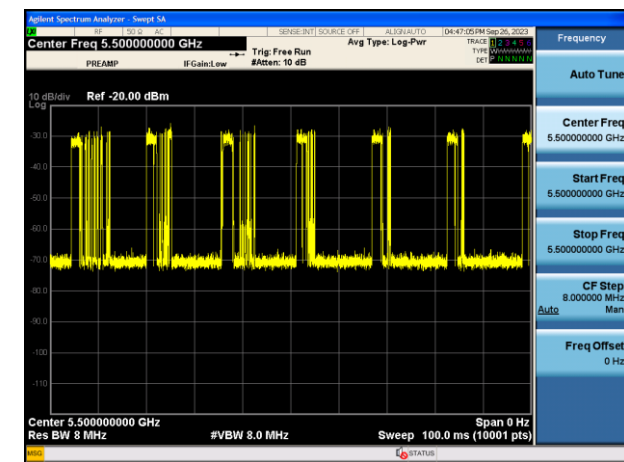

802.11ax-HE40 (5510MHz)

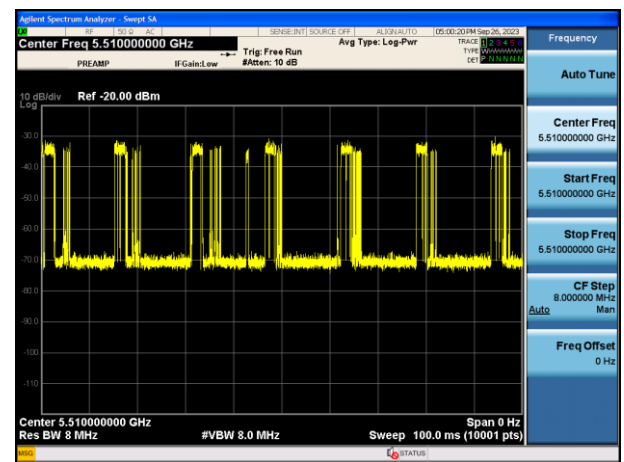

802.11ax-HE80 (5530MHz)

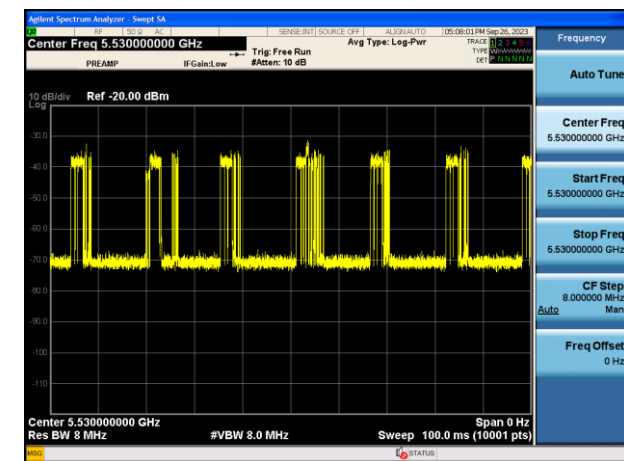

802.11ax-HE160 (5250MHz)

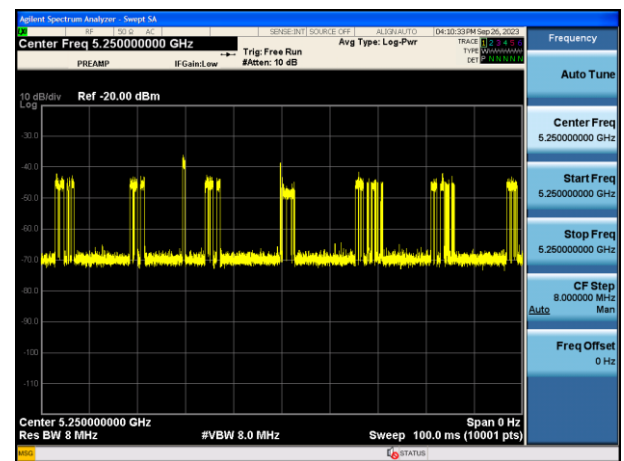

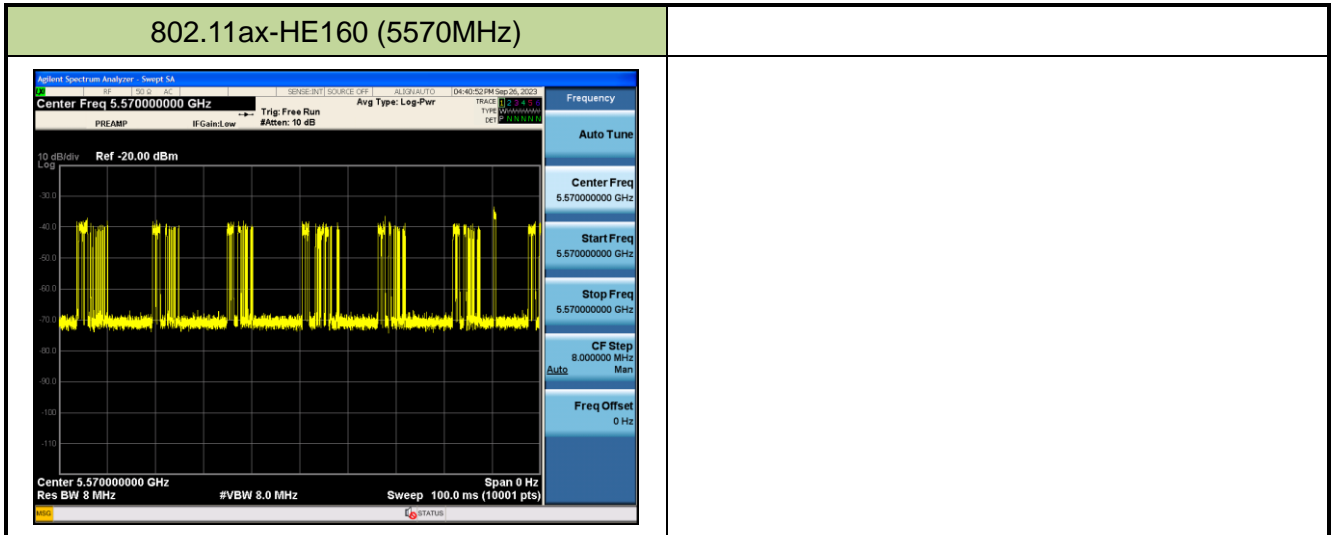

Test Mode	Test Frequency	Packet ratio	Requirement ratio	Test Result
802.11ax-HE20	5500 MHz	18.24%	≥ 17%	Pass
802.11ax-HE40	5510 MHz	18.33%	≥ 17%	Pass
802.11ax-HE80	5530 MHz	19.33%	≥ 17%	Pass
802.11ax-HE160	5250 MHz	17.18%	≥ 17%	Pass
802.11ax-HE160	5570 MHz	17.68%	≥ 17%	Pass

Note: System testing was performed with the designated iperf test file. This file is used by IP and Frame based systems for loading the test channel during the In-service compliance testing of the U-NII device. Packet ratio = Time On / (Time On + Off Time).

Product	AX5400 Ceiling Mount Wi-Fi 6 Access Point	Temperature	27°C
Test Engineer	Peter	Relative Humidity	65%
Test Site	SR5	Test Date	2023/10/17
Test Item	Channel Loading-Mesh		

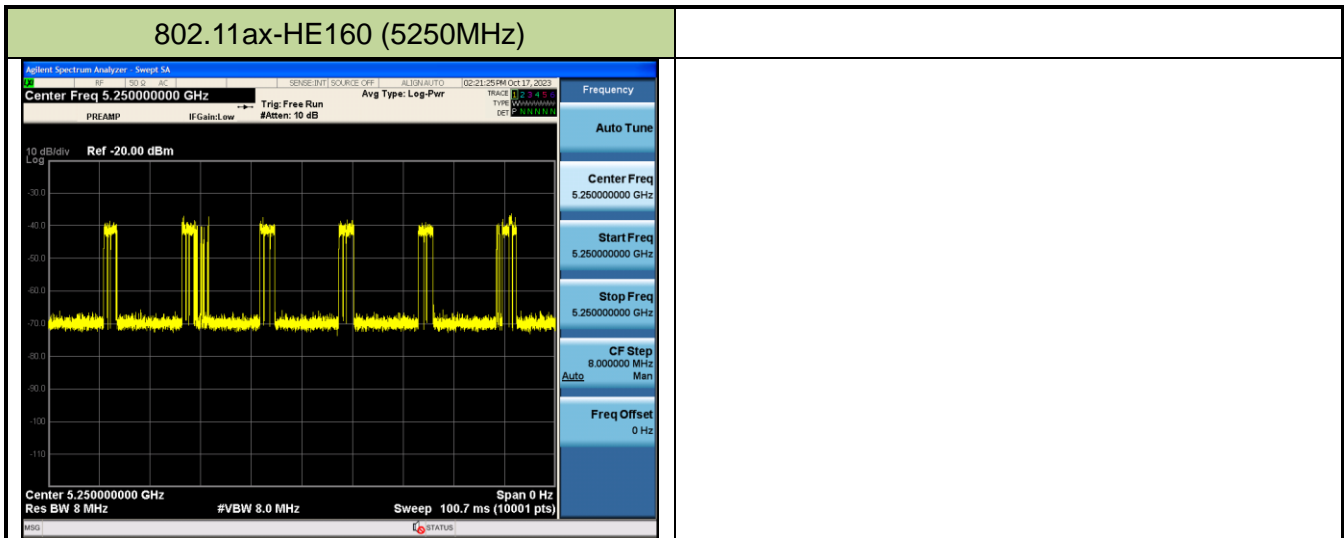

Test Mode	Test Frequency	Packet ratio	Requirement ratio	Test Result
802.11ax-HE160	5250 MHz	17.17%	≥ 17%	Pass

Note: System testing was performed with the designated iperf test file. This file is used by IP and Frame based systems for loading the test channel during the In-service compliance testing of the U-NII device. Packet ratio = Time On / (Time On + Off Time).

### 5.3. UNII Detection Bandwidth Measurement

#### 5.3.1. Test Limit

Minimum 100% of the UNII 99% transmission power bandwidth. During the U-NII Detection Bandwidth detection test, each frequency step the minimum percentage of detection is 90 percent. Measurements are performed with no data traffic.

#### 5.3.2. Test Procedure

1. Adjust the equipment to produce a single Burst of any one of the Short Pulse Radar Types 0-4 in Table 3-5 at the center frequency of the EUT Operating Channel at the specified DFS Detection Threshold level.
2. The generating equipment is configured as shown in the Conducted Test Setup above section 3.5.
3. The EUT is set up as a stand-alone device (no associated Client or Master, as appropriate) and no traffic. Frame based systems will be set to a talk/listen ratio reflecting the worst case (maximum) that is user configurable during this test.
4. Generate a single radar Burst, and note the response of the EUT. Repeat for a minimum of 10 trials. The EUT must detect the Radar Waveform using the specified U-NII Detection Bandwidth criterion shown in Table 3-5. In cases where the channel bandwidth may exceed past the DFS band edge on specific channels (i.e., 802.11ac or wideband frame based systems) select a channel that has the entire emission bandwidth within the DFS band. If this is not possible, test the detection BW to the DFS band edge.
5. Starting at the center frequency of the UUT operating Channel, increase the radar frequency in 5 MHz steps, repeating the above test sequence, until the detection rate falls below the U-NII Detection Bandwidth criterion specified in Table 3-3. Repeat this measurement in 1MHz steps at frequencies 5 MHz below where the detection rate begins to fall. Record the highest frequency (denote as FH) at which detection is greater than or equal to the U-NII Detection Bandwidth criterion. Recording the detection rate at frequencies above FH is not required to demonstrate compliance.
6. Starting at the center frequency of the EUT operating Channel, decrease the radar frequency in 1 MHz steps, repeating the above item 4 test sequence, until the detection rate falls below the U-NII Detection Bandwidth criterion. Record the lowest frequency (denote as FL) at which detection is greater than or equal to the U-NII Detection Bandwidth criterion. Recording the detection rate at frequencies below FL is not required to demonstrate compliance.
7. The U-NII Detection Bandwidth is calculated as follows: U-NII Detection Bandwidth = FH – FL
8. The U-NII Detection Bandwidth must be at least 100% of the EUT transmitter 99% power, otherwise, the EUT does not comply with DFS requirements.

### 5.3.3. Test Result

Product	AX5400 Ceiling Mount Wi-Fi 6 Access Point	Temperature	25 °C
Test Engineer	Jay	Relative Humidity	65 %
Test Site	SR5	Test Date	2023/9/28
Test Item	Detection Bandwidth (802.11ax-HE20 mode - 5500MHz) - Master		

Radar Frequency (MHz)	DFS Detection Trials (1=Detection, 0= No Detection)										Detection Rate (%)
	1	2	3	4	5	6	7	8	9	10	
5490	1	1	1	1	1	1	1	1	1	1	100%
5490.25 FL	1	1	1	1	1	1	1	1	1	1	100%
5491	1	1	1	1	1	1	1	1	1	1	100%
5492	1	1	1	1	1	1	1	1	1	1	100%
5493	1	1	1	1	1	1	1	1	1	1	100%
5494	1	1	1	1	1	1	1	1	1	1	100%
5495	1	1	1	1	1	1	1	1	1	1	100%
5500	1	1	1	1	1	1	1	1	1	1	100%
5505	1	1	1	1	1	1	1	1	1	1	100%
5506	1	1	1	1	1	1	1	1	1	1	100%
5507	1	1	1	1	1	1	1	1	1	1	100%
5508	1	1	1	1	1	1	1	1	1	1	100%
5509	1	1	1	1	1	1	1	1	1	1	100%
5509.75 FH	1	1	1	1	1	1	1	1	1	1	100%
5510	1	1	1	1	1	1	1	1	1	1	100%

Note 1: All NII channels for this device have identical Channel bandwidths. Therefore, all DFS testing was done at 5500MHz. The 99% channel bandwidth is 19.115 MHz. (See the 99% BW section of the RF report for further measurement details).

Note 2: Detection Bandwidth = FH - FL = 5509.5MHz – 5490.5MHz = 19.5 MHz

Note 3: NII Detection Bandwidth Min. Limit (MHz): 19.115MHz x 100% = 19.115 MHz.

Product	AX5400 Ceiling Mount Wi-Fi 6 Access Point	Temperature	25 °C
Test Engineer	Jay	Relative Humidity	65 %
Test Site	SR5	Test Date	2023/9/28
Test Item	Detection Bandwidth (802.11ax-HE40 mode - 5510MHz) - Master		

Radar Frequency (MHz)	DFS Detection Trials (1=Detection, 0= No Detection)										Detection Rate (%)
	1	2	3	4	5	6	7	8	9	10	
5490	1	1	1	1	1	1	1	1	1	1	100%
5491 FL	1	1	1	1	1	1	1	1	1	1	100%
5492	1	1	1	1	1	1	1	1	1	1	100%
5493	1	1	1	1	1	1	1	1	1	1	100%
5494	1	1	1	1	1	1	1	1	1	1	100%
5495	1	1	1	1	1	1	1	1	1	1	100%
5500	1	1	1	1	1	1	1	1	1	1	100%
5505	1	1	1	1	1	1	1	1	1	1	100%
5510	1	1	1	1	1	1	1	1	1	1	100%
5515	1	1	1	1	1	1	1	1	1	1	100%
5520	1	1	1	1	1	1	1	1	1	1	100%
5525	1	1	1	1	1	1	1	1	1	1	100%
5526	1	1	1	1	1	1	1	1	1	1	100%
5527	1	1	1	1	1	1	1	1	1	1	100%
5528	1	1	1	1	1	1	1	1	1	1	100%
5529 FH	1	1	1	1	1	1	1	1	1	1	100%
5530	1	1	1	1	1	1	1	1	1	1	100%

Note 1: All NII channels for this device have identical Channel bandwidths. Therefore, all DFS testing was done at 5510MHz. The 99% channel bandwidth is 37.654 MHz. (See the 99% BW section of the RF report for further measurement details).

Note 2: Detection Bandwidth = FH - FL = 5529MHz - 5491MHz = 38MHz.

Note 3: NII Detection Bandwidth Min. Limit (MHz): 37.654MHz x 100% =37.654 MHz.

Product	AX5400 Ceiling Mount Wi-Fi 6 Access Point	Temperature	25 °C
Test Engineer	Jay	Relative Humidity	65 %
Test Site	SR5	Test Date	2023/9/28
Test Item	Detection Bandwidth (802.11ax-HE80 mode - 5530MHz) - Master		

Radar Frequency (MHz)	DFS Detection Trials (1=Detection, 0= No Detection)										Detection Rate (%)
	1	2	3	4	5	6	7	8	9	10	
5490	1	1	1	1	1	1	1	1	1	1	100%
5491 FL	1	1	1	1	1	1	1	1	1	1	100%
5492	1	1	1	1	1	1	1	1	1	1	100%
5493	1	1	1	1	1	1	1	1	1	1	100%
5494	1	1	1	1	1	1	1	1	1	1	100%
5495	1	1	1	1	1	1	1	1	1	1	100%
5500	1	1	1	1	1	1	1	1	1	1	100%
5505	1	1	1	1	1	1	1	1	1	1	100%
5510	1	1	1	1	1	1	1	1	1	1	100%
5515	1	1	1	1	1	1	1	1	1	1	100%
5520	1	1	1	1	1	1	1	1	1	1	100%
5525	1	1	1	1	1	1	1	1	1	1	100%
5530	1	1	1	1	1	1	1	1	1	1	100%
5535	1	1	1	1	1	1	1	1	1	1	100%
5540	1	1	1	1	1	1	1	1	1	1	100%
5545	1	1	1	1	1	1	1	1	1	1	100%
5550	1	1	1	1	1	1	1	1	1	1	100%
5555	1	1	1	1	1	1	1	1	1	1	100%
5560	1	1	1	1	1	1	1	1	1	1	100%
5565	1	1	1	1	1	1	1	1	1	1	100%
5566	1	1	1	1	1	1	1	1	1	1	100%
5567	1	1	1	1	1	1	1	1	1	1	100%
5568	1	1	1	1	1	1	1	1	1	1	100%
5569 FH	1	1	1	1	1	1	1	1	1	1	100%
5570	1	1	1	1	1	1	1	1	1	1	100%

Note 1: All NII channels for this device have identical Channel bandwidths. Therefore, all DFS testing was done at 5530MHz. The 99% channel bandwidth is 77.254 MHz. (See the 99% BW section of the RF report for further measurement details).

Note 2: Detection Bandwidth = FH - FL = 5569MHz - 5491MHz = 78MHz.



Note 3: NII Detection Bandwidth Min. Limit (MHz):  $77.254\text{MHz} \times 100\% = 77.254 \text{ MHz}$ .

Product	AX5400 Ceiling Mount Wi-Fi 6 Access Point	Temperature	25 °C
Test Engineer	Jay	Relative Humidity	65 %
Test Site	SR5	Test Date	2023/9/28
Test Item	Detection Bandwidth (802.11ax-H160 mode - 5250MHz) - Master		

Radar Frequency (MHz)	DFS Detection Trials (1=Detection, 0= No Detection)										Detection Rate (%)
	1	2	3	4	5	6	7	8	9	10	
5249	1	1	1	1	1	1	1	1	1	1	100%
5250 FL	1	1	1	1	1	1	1	1	1	1	100%
5251	1	1	1	1	1	1	1	1	1	1	100%
5252	1	1	1	1	1	1	1	1	1	1	100%
5253	1	1	1	1	1	1	1	1	1	1	100%
5254	1	1	1	1	1	1	1	1	1	1	100%
5255	1	1	1	1	1	1	1	1	1	1	100%
5260	1	1	1	1	1	1	1	1	1	1	100%
5265	1	1	1	1	1	1	1	1	1	1	100%
5270	1	1	1	1	1	1	1	1	1	1	100%
5275	1	1	1	1	1	1	1	1	1	1	100%
5280	1	1	1	1	1	1	1	1	1	1	100%
5285	1	1	1	1	1	1	1	1	1	1	100%
5290	1	1	1	1	1	1	1	1	1	1	100%
5295	1	1	1	1	1	1	1	1	1	1	100%
5300	1	1	1	1	1	1	1	1	1	1	100%
5305	1	1	1	1	1	1	1	1	1	1	100%
5310	1	1	1	1	1	1	1	1	1	1	100%
5315	1	1	1	1	1	1	1	1	1	1	100%
5320	1	1	1	1	1	1	1	1	1	1	100%
5325	1	1	1	1	1	1	1	1	1	1	100%
5326	1	1	1	1	1	1	1	1	1	1	100%
5327	1	1	1	1	1	1	1	1	1	1	100%
5328FH	1	1	1	1	1	1	1	1	1	1	100%
5329	1	1	1	1	1	1	1	1	1	1	100%

Note 1: All NII channels for this device have identical Channel bandwidths. Therefore, all DFS testing was done at 5250MHz. The 99% channel bandwidth is 154.94 MHz. (See the 99% BW section of the RF report for further measurement details).

Note 2: Detection Bandwidth = FH - FL = 5328MHz - 5250MHz = 78MHz.

Note 3: NII Detection Bandwidth Min. Limit (MHz):  $154.94 \text{ MHz} \times 100\% / 2 = 77.47 \text{ MHz}$ .



Product	AX5400 Ceiling Mount Wi-Fi 6 Access Point	Temperature	25 °C
Test Engineer	Jay	Relative Humidity	65 %
Test Site	SR5	Test Date	2023/9/28
Test Item	Detection Bandwidth (802.11ax-HE160 mode - 5570MHz)- Master		

Radar Frequency (MHz)	DFS Detection Trials (1=Detection, 0= No Detection)										Detection Rate (%)
	1	2	3	4	5	6	7	8	9	10	
5490	1	1	1	1	1	1	1	1	1	1	100%
5491 FL	1	1	1	1	1	1	1	1	1	1	100%
5492	1	1	1	1	1	1	1	1	1	1	100%
5493	1	1	1	1	1	1	1	1	1	1	100%
5494	1	1	1	1	1	1	1	1	1	1	100%
5495	1	1	1	1	1	1	1	1	1	1	100%
5500	1	1	1	1	1	1	1	1	1	1	100%
5505	1	1	1	1	1	1	1	1	1	1	100%
5510	1	1	1	1	1	1	1	1	1	1	100%
5515	1	1	1	1	1	1	1	1	1	1	100%
5520	1	1	1	1	1	1	1	1	1	1	100%
5525	1	1	1	1	1	1	1	1	1	1	100%
5530	1	1	1	1	1	1	1	1	1	1	100%
5535	1	1	1	1	1	1	1	1	1	1	100%
5540	1	1	1	1	1	1	1	1	1	1	100%
5545	1	1	1	1	1	1	1	1	1	1	100%
5550	1	1	1	1	1	1	1	1	1	1	100%
5555	1	1	1	1	1	1	1	1	1	1	100%
5560	1	1	1	1	1	1	1	1	1	1	100%
5565	1	1	1	1	1	1	1	1	1	1	100%
5570	1	1	1	1	1	1	1	1	1	1	100%
5575	1	1	1	1	1	1	1	1	1	1	100%
5580	1	1	1	1	1	1	1	1	1	1	100%
5585	1	1	1	1	1	1	1	1	1	1	100%
5590	1	1	1	1	1	1	1	1	1	1	100%
5595	1	1	1	1	1	1	1	1	1	1	100%
5600	1	1	1	1	1	1	1	1	1	1	100%
5605	1	1	1	1	1	1	1	1	1	1	100%
5610	1	1	1	1	1	1	1	1	1	1	100%
5615	1	1	1	1	1	1	1	1	1	1	100%

5620	1	1	1	1	1	1	1	1	1	1	100%
5625	1	1	1	1	1	1	1	1	1	1	100%
5630	1	1	1	1	1	1	1	1	1	1	100%
5635	1	1	1	1	1	1	1	1	1	1	100%
5640	1	1	1	1	1	1	1	1	1	1	100%
5645	1	1	1	1	1	1	1	1	1	1	100%
5646	1	1	1	1	1	1	1	1	1	1	100%
5647	1	1	1	1	1	1	1	1	1	1	100%
5648	1	1	1	1	1	1	1	1	1	1	100%
5649 FH	1	1	1	1	1	1	1	1	1	1	100%
5650	1	1	1	1	1	1	1	1	1	1	100%

Note 1: All NII channels for this device have identical Channel bandwidths. Therefore, all DFS testing was done at 5570MHz. The 99% channel bandwidth is 155.25 MHz. (See the 99% BW section of the RF report for further measurement details).

Note 2: Detection Bandwidth = FH - FL = 5649MHz - 5491MHz = 158MHz.

Note 3: NII Detection Bandwidth Min. Limit (MHz): 155.25MHz x 100% =155.25 MHz.

Product	AX5400 Ceiling Mount Wi-Fi 6 Access Point	Temperature	25 °C
Test Engineer	Jay	Relative Humidity	65 %
Test Site	SR5	Test Date	2023/10/17
Test Item	Detection Bandwidth (802.11ax-H160 mode - 5250MHz) -MESH		

Radar Frequency (MHz)	DFS Detection Trials (1=Detection, 0= No Detection)										Detection Rate (%)
	1	2	3	4	5	6	7	8	9	10	
5249	1	1	1	1	1	1	1	1	1	1	100%
5250 FL	1	1	1	1	1	1	1	1	1	1	100%
5251	1	1	1	1	1	1	1	1	1	1	100%
5252	1	1	1	1	1	1	1	1	1	1	100%
5253	1	1	1	1	1	1	1	1	1	1	100%
5254	1	1	1	1	1	1	1	1	1	1	100%
5255	1	1	1	1	1	1	1	1	1	1	100%
5260	1	1	1	1	1	1	1	1	1	1	100%
5265	1	1	0	1	1	1	1	1	1	1	90%
5270	1	1	1	1	1	1	1	1	1	1	100%
5275	1	1	1	1	1	1	1	1	1	1	100%
5280	1	1	1	1	1	1	1	1	1	1	100%
5285	1	1	1	1	1	1	1	1	1	1	100%
5290	1	1	1	1	1	1	1	1	1	1	100%
5295	1	1	1	1	1	1	1	1	1	1	100%
5300	0	1	1	1	1	1	1	1	1	1	90%
5305	1	1	1	1	1	1	1	1	1	1	100%
5310	1	1	1	1	1	1	1	1	1	1	100%
5315	1	1	1	1	1	1	1	1	1	1	100%
5320	1	1	1	1	1	1	1	1	1	1	100%
5325	1	1	1	1	1	1	1	1	1	1	100%
5326	1	1	1	1	0	1	1	1	1	1	90%
5327	1	1	1	1	1	1	1	1	1	1	100%
5328FH	1	1	1	1	1	1	1	1	1	1	100%
5329	1	1	1	1	1	1	1	1	1	1	100%

Note 1: All NII channels for this device have identical Channel bandwidths. Therefore, all DFS testing was done at 5250MHz. The 99% channel bandwidth is 154.94MHz. (See the 99% BW section of the RF report for further measurement details).

Note 2: Detection Bandwidth = FH - FL = 5328MHz - 5250MHz = 78MHz.

Note 3: NII Detection Bandwidth Min. Limit (MHz):  $154.94\text{MHz} \times 100\% / 2 = 77.47\text{MHz}$ .

## **5.4. Initial Channel Availability Check Time Measurement**

### **5.4.1. Test Limit**

The EUT shall perform a Channel Availability Check to ensure that there is no radar operating on the channel. After power-up sequence, receive at least 1 minute on the intended operating frequency.

### **5.4.2. Test Procedure**

1. The U-NII devices will be powered on and be instructed to operate on the appropriate U-NII Channel that must incorporate DFS functions. At the same time the EUT is powered on, the spectrum analyzer will be set to zero span mode with a 3 MHz RBW and 3 MHz VBW on the Channel occupied by the radar (Chr) with a 2.5 minute sweep time. The spectrum analyzer's sweep will be started at the same time power is applied to the U-NII device.
2. The EUT should not transmit any beacon or data transmissions until at least 1 minute after the completion of the power-on cycle.
3. Confirm that the EUT initiates transmission on the channel. Measurement system showing its nominal noise floor is marker1.



### 5.4.3. Test Result

Product	AX5400 Ceiling Mount Wi-Fi 6 Access Point	Temperature	27°C
Test Engineer	Peter	Relative Humidity	65%
Test Site	SR5	Test Date	2023/09/26
Test Item	Initial Channel Availability Check Time (802.11ax-HE20 mode - 5500MHz)		

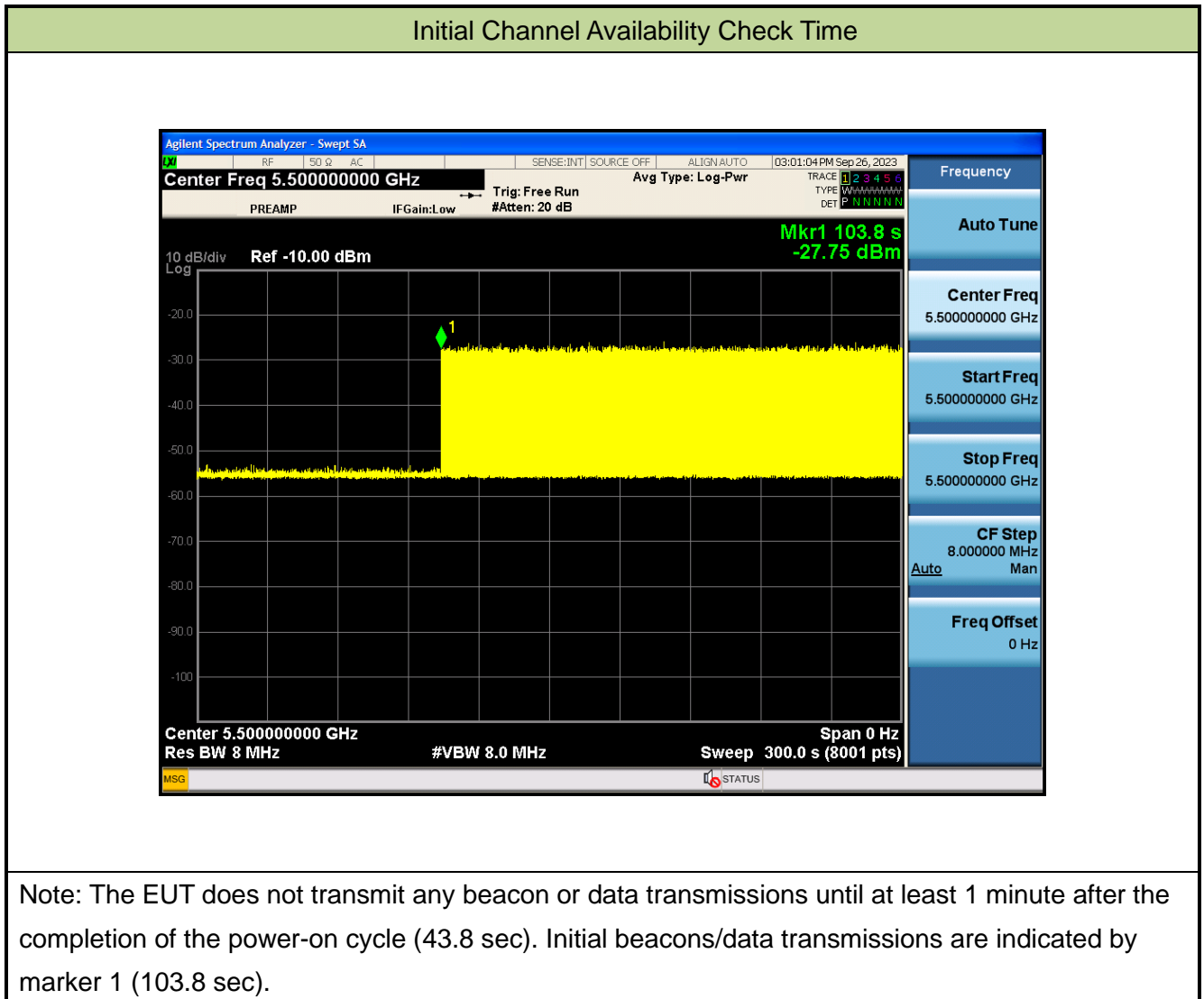

## **5.5. Radar Burst at the Beginning of the Channel Availability Check Time Measurement**

### **5.5.1. Test Limit**

In beginning of the Channel Availability Check (CAC) Time, radar is detected on this channel, select another intended channel and perform a CAC on that channel.

### **5.5.2. Test Procedure**

1. The steps below define the procedure to verify successful radar detection on the selected Channel during a period equal to the Channel Availability Check Time and avoidance of operation on that Channel when a radar Burst with a level equal to the DFS Detection Threshold + 1 dB occurs at the beginning of the Channel Availability Check Time.
2. The EUT is in completion power-up cycle (from T0 to T1). T1 denotes the instant when the EUT has completed its power-up sequence. The Channel Availability Check Time commences at instant T1 and will end no sooner than T1 + 60 seconds. A single Burst of one of Short Pulse Radar Types 0-4 at DFS Detection Threshold + 1 dB will commence within a 6 second window starting at T1.
3. Visual indication on the EUT of successful detection of the radar Burst will be recorded and reported. Observation of emissions will continue for 2.5 minutes after the radar Burst has been generated. Verify that during the 2.5 minutes measurement window no EUT transmissions occurred.

### 5.5.3. Test Result

Product	AX5400 Ceiling Mount Wi-Fi 6 Access Point	Temperature	27°C
Test Engineer	Peter	Relative Humidity	65%
Test Site	SR5	Test Date	2023/09/26
Test Item	Beginning of the Channel Availability Check Time (802.11ax-HE20 mode - 5500MHz)		

#### Beginning of the Channel Availability Check Time

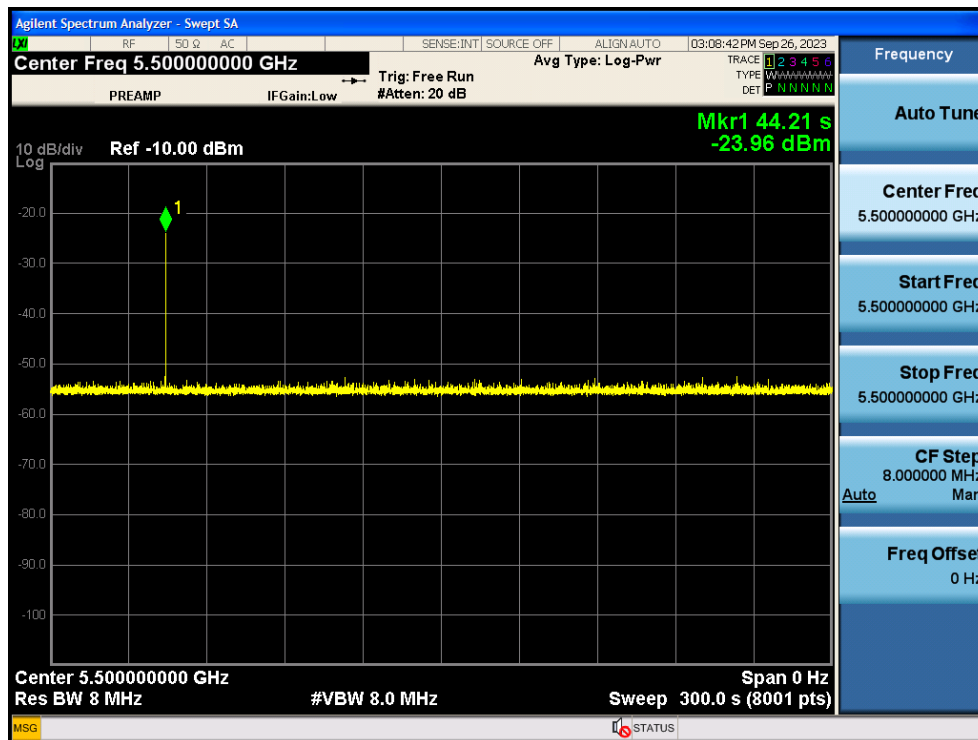

## **5.6. Radar Burst at the End of the Channel Availability Check Time Measurement**

### **5.6.1. Test Limit**

In the end of Channel Availability Check (CAC) Time, radar is detected on this channel, select another intended channel and perform a CAC on that channel.

### **5.6.2. Test Procedure**

1. The steps below define the procedure to verify successful radar detection on the selected Channel during a period equal to the Channel Availability Check Time and avoidance of operation on that Channel when a radar Burst with a level equal to the DFS Detection Threshold + 1 dB occurs at the beginning of the Channel Availability Check Time.
2. The EUT is powered on at T0. T1 denotes the instant when the EUT has completed its power-up sequence. The Channel Availability Check Time commences at instant T1 and will end no sooner than T1 + 60 seconds. A single Burst of one of Short Pulse Radar Types 0-4 at DFS Detection Threshold + 1 dB will commence within a 6 second window starting at T1+ 54 seconds.
3. Visual indication on the EUT of successful detection of the radar Burst will be recorded and reported. Observation of emissions will continue for 2.5 minutes after the radar Burst has been generated. Verify that during the 2.5 minutes measurement window no EUT transmissions occurred.

### 5.6.3. Test Result

Product	AX5400 Ceiling Mount Wi-Fi 6 Access Point	Temperature	27°C
Test Engineer	Peter	Relative Humidity	65%
Test Site	SR5	Test Date	2023/09/26
Test Item	End of the Channel Availability Check Time (802.11ax-HE20 mode - 5500MHz)		

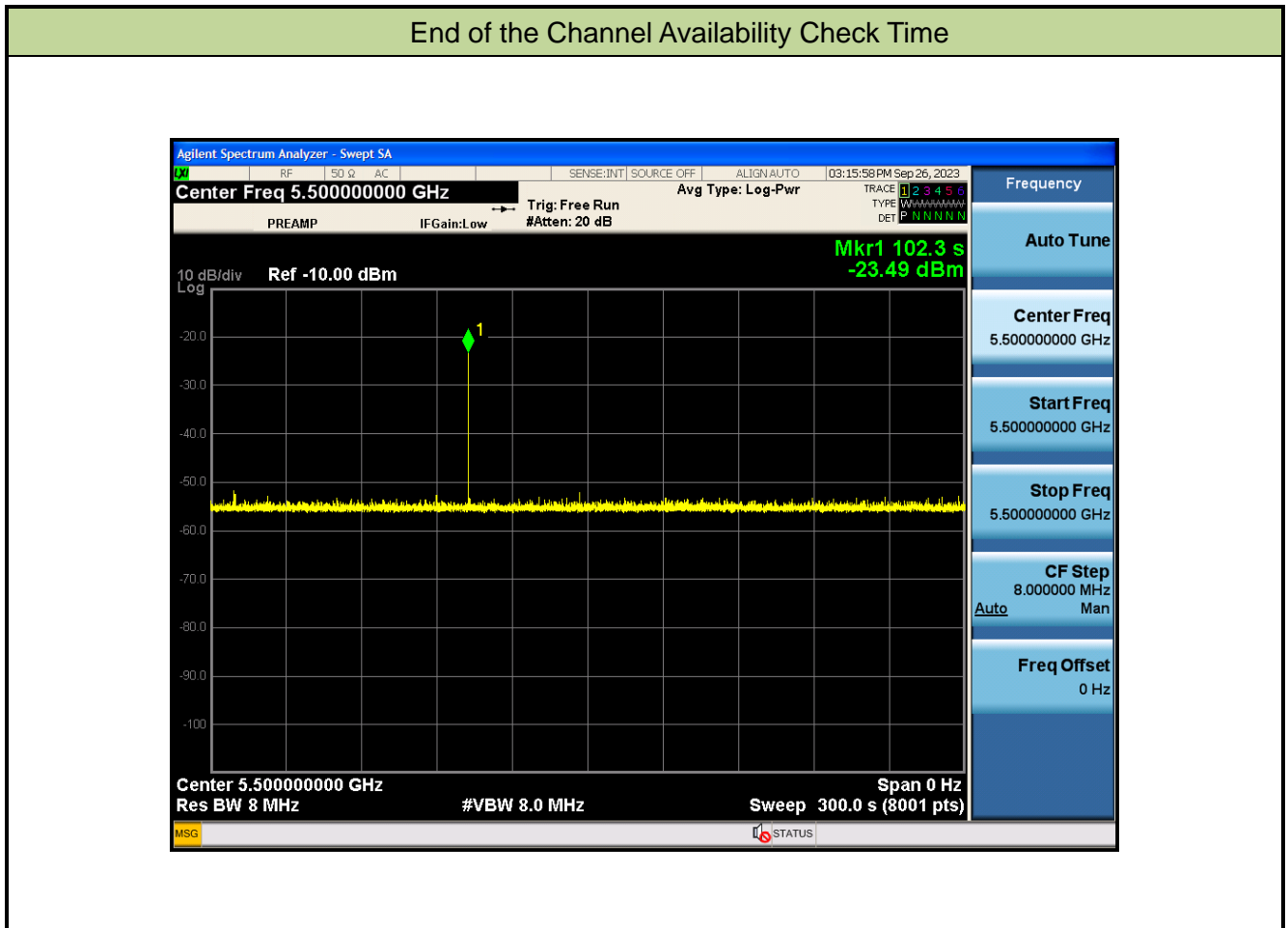

## **5.7. In-Service Monitoring for Channel Move Time, Channel Closing Transmission Time and Non-Occupancy Period Measurement**

### **5.7.1. Test Limit**

The EUT has In-Service Monitoring function to continuously monitor the radar signals. If the radar is detected, must leave the channel (Shutdown). The Channel Move Time to cease all transmissions on the current channel upon detection of a Radar Waveform above the DFS Detection Threshold within 10 sec. The total duration of Channel Closing Transmission Time is 260ms, consisting of data signals and the aggregate of control signals, by a U-NII device during the Channel Move Time. The Non-Occupancy Period time is 30 minute during which a Channel will not be utilized after a Radar Waveform is detected on that Channel.

### **5.7.2. Test Procedure Used**

1. The test should be performed with Radar Type 0. The measurement timing begins at the end of the Radar Type 0.
2. When the radar burst with a level equal to the DFS Detection Threshold + 1dB is generated on the Operating Channel of the U-NII device. A U-NII device operating as a Master Device will associate with the Client Device at Channel. Stream the MPEG test file from the Master Device to the Client Device on the selected Channel for the entire period of the test. At time T0 the Radar Waveform generator sends a Burst of pulses for each of the radar types at Detection Threshold + 1dB.
3. Observe the transmissions of the EUT at the end of the radar Burst on the Operating Channel. Measure and record the transmissions from the EUT during the observation time (Channel Move Time).
4. Measurement of the aggregate duration of the Channel Closing Transmission Time method. With the spectrum analyzer set to zero span tuned to the center frequency of the EUT operating channel at the radar simulated frequency, peak detection, and max hold, the dwell time per bin is given by:  $Dwell (1.5ms) = S (12 \text{ sec}) / B (8000)$ ; where Dwell is the dwell time per spectrum analyzer sampling bin, S is the sweep time and B is the number of spectrum analyzer sampling bins. An upper bound of the aggregate duration of the intermittent control signals of Channel Closing Transmission Time is calculated by:  $C = N \times Dwell$ ; where C is the Closing Time, N is the number of spectrum analyzer sampling bins showing a U-NII transmission and Dwell is the dwell time per bin.
5. Measure the EUT for more than 30 minutes following the channel close/move time to verify that the EUT does not resume any transmissions on this Channel.

### 5.7.3. Test Result

Product	AX5400 Ceiling Mount Wi-Fi 6 Access Point	Temperature	27°C
Test Engineer	Peter	Relative Humidity	65%
Test Site	SR5	Test Date	2023/09/26~2023/09/28
Test Item	Channel Move Time and Channel Closing Transmission Time (802.11ax-HE160 mode - 5250MHz)		

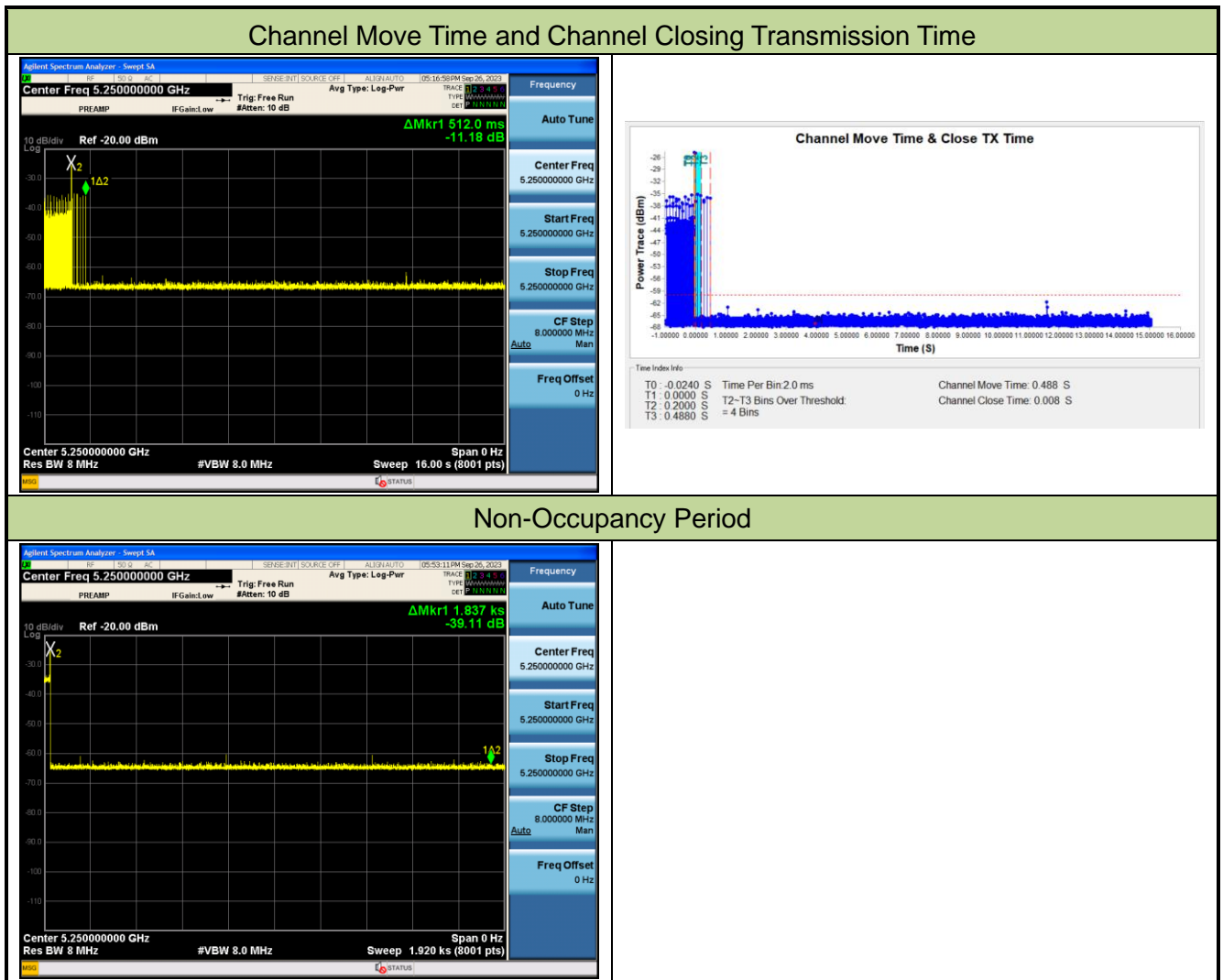

Parameter	Test Result	Limit
	Type 0	
Channel Move Time (s)	0.488s	<10s
Channel Closing Transmission Time (ms) (Note)	8ms	< 60ms
Non-Occupancy Period (min)	≥ 30min	≥ 30 min
<p>Note: The Channel Closing Transmission Time is comprised of 200 milliseconds starting at the beginning of the Channel Move Time plus any additional intermittent control signals required to facilitate a Channel move (an aggregate of 60 milliseconds) during the remainder of the 10 seconds period. The aggregate duration of control signals will not count quiet periods in between transmissions.</p>		



Product	AX5400 Ceiling Mount Wi-Fi 6 Access Point	Temperature	27°C
Test Engineer	Peter	Relative Humidity	65%
Test Site	SR5	Test Date	2023/09/26~2023/09/28
Test Item	Channel Move Time and Channel Closing Transmission Time (802.11ax-HE160 mode - 5570MHz)		

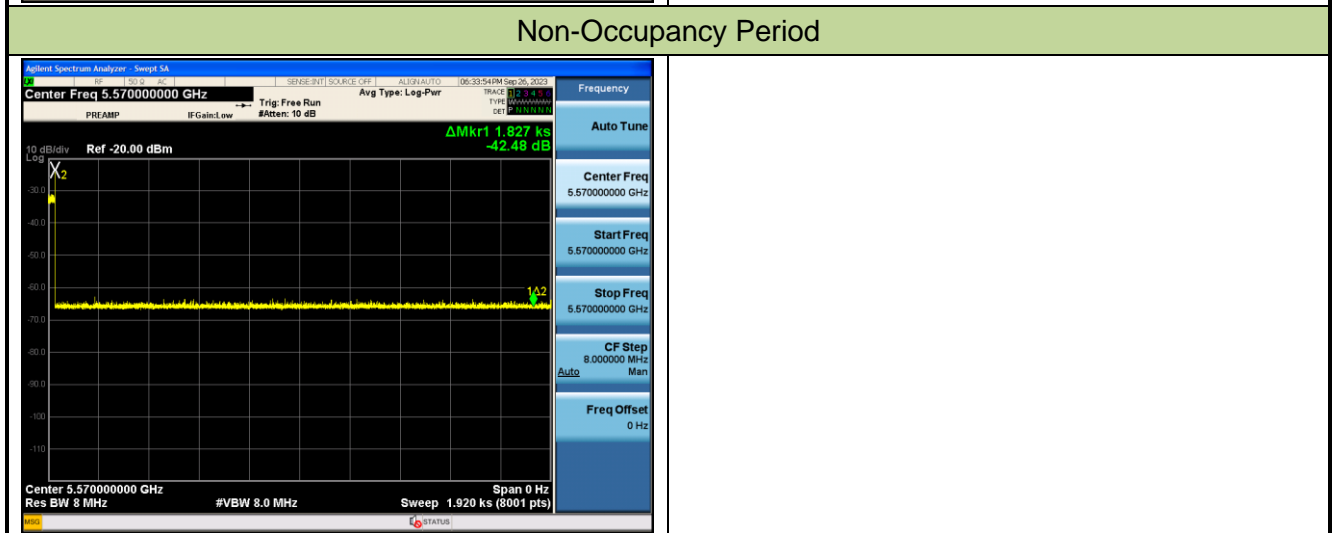
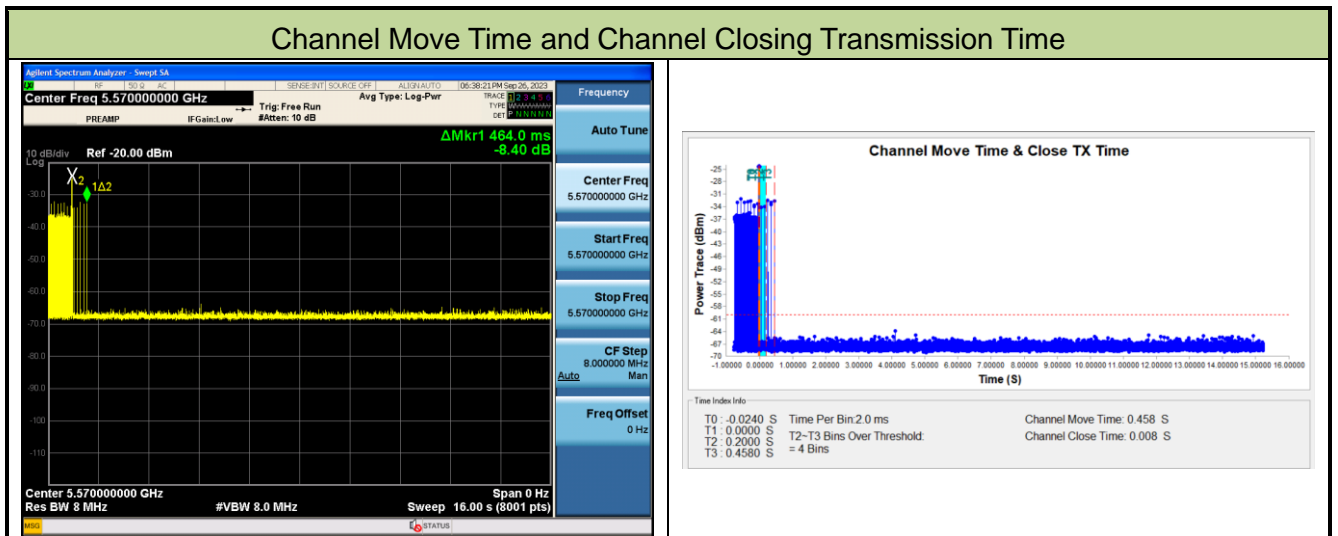

Parameter	Test Result	Limit
	Type 0	
Channel Move Time (s)	0.458s	<10s
Channel Closing Transmission Time (ms) (Note)	8ms	< 60ms
Non-Occupancy Period (min)	≥ 30min	≥ 30 min
<p>Note: The Channel Closing Transmission Time is comprised of 200 milliseconds starting at the beginning of the Channel Move Time plus any additional intermittent control signals required to facilitate a Channel move (an aggregate of 60 milliseconds) during the remainder of the 10 seconds period. The aggregate duration of control signals will not count quiet periods in between transmissions.</p>		

## 5.8. Statistical Performance Check Measurement

### 5.8.1. Test Limit

The minimum percentage of successful detection requirements found in below table when a radar burst with a level equal to the DFS Detection Threshold + 1dB is generated on the Operating Channel of the U-NII device (In- Service Monitoring).

Radar Type	Minimum Number of Trails	Detection Probability
0	30	Pd > 60%
1	30(15 of test A and 15 of test B)	Pd > 60%
2	30	Pd > 60%
3	30	Pd > 60%
4	30	Pd > 60%
Aggregate (Radar Types 1-4)	120	Pd > 80%
5	30	Pd > 80%
6	30	Pd > 70%

The percentage of successful detection is calculated by:

$(\text{Total Waveform Detections} / \text{Total Waveform Trails}) * 100 = \text{Probability of Detection Radar}$

Waveform In addition an aggregate minimum percentage of successful detection across all Short Pulse Radar Types 1-4 is required and is calculated as follows:  $(Pd1 + Pd2 + Pd3 + Pd4) / 4$ .

### 5.8.2. Test Procedure

1. Stream the MPEG test file from the Master Device to the Client Device on the test Channel for the entire period of the test.
2. At time T0 the Radar Waveform generator sends the individual waveform for each of the Radar Types 1-6, at levels equal to the DFS Detection Threshold + 1dB, on the Operating Channel.
3. Observe the transmissions of the EUT at the end of the Burst on the Operating Channel for duration greater than 10 seconds for Short Pulse Radar Types 0 to ensure detection occurs.
4. Observe the transmissions of the EUT at the end of the Burst on the Operating Channel for duration greater than 22 seconds for Long Pulse Radar Type 5 to ensure detection occurs.
5. The device can utilize a test mode to demonstrate when detection occurs to prevent the need to reset the device between trial runs.
6. The Minimum number of trails, minimum percentage of successful detection and the average minimum percentage of successful detection are found in below table.

### 5.8.3. Test Result

Product	AX5400 Ceiling Mount Wi-Fi 6 Access Point	Temperature	25 °C
Test Engineer	Jay	Relative Humidity	65 %
Test Site	SR5	Test Date	2023/10/2
Test Item	Radar Statistical Performance Check (802.11ax-HE20 – 5500MHz)-Master		

#### Radar Type 1-4 - Radar Statistical Performance

Trial	Frequency (MHz)	1=Detection, 0=No Detection			
		Radar Type 1	Radar Type 2	Radar Type 3	Radar Type 4
0	5490	1	1	1	1
1	5490	1	1	1	1
2	5491	1	1	1	0
3	5491	0	1	1	1
4	5492	1	1	0	1
5	5492	1	1	0	1
6	5493	1	0	1	1
7	5493	1	1	1	1
8	5494	1	1	0	1
9	5494	1	1	1	1
10	5495	1	1	1	1
11	5496	1	1	1	1
12	5497	1	1	1	1
13	5498	1	1	0	1
14	5499	1	1	1	1
15	5500	1	1	1	0
16	5501	1	0	0	1
17	5502	1	1	1	1
18	5503	1	1	1	1
19	5504	1	1	1	1
20	5505	1	1	0	0
21	5506	1	1	0	0
22	5507	1	1	1	0
23	5507	1	1	1	0
24	5508	1	0	1	0
25	5508	1	1	1	1
26	5509	1	1	1	1

Trial	Frequency	1=Detection, 0=No Detection			
	(MHz)	Radar Type 1	Radar Type 2	Radar Type 3	Radar Type 4
27	5509	1	1	0	1
28	5510	1	1	1	1
29	5510	1	1	1	1
Probability:		96.66%	90%	73.33%	76.66%
Type1-4		84.1625 % (>80%)			

## Radar Type 1 - Radar Waveform

	Trial Id	Radar Type	Pulse Width (us)	PRI (us)	Number of Pulses	Waveform Length (us)
Download	0	Type 1	1.0	798.0	67	53466.0
Download	1	Type 1	1.0	818.0	65	53170.0
Download	2	Type 1	1.0	578.0	92	53176.0
Download	3	Type 1	1.0	718.0	74	53132.0
Download	4	Type 1	1.0	938.0	57	53466.0
Download	5	Type 1	1.0	638.0	83	52954.0
Download	6	Type 1	1.0	538.0	99	53262.0
Download	7	Type 1	1.0	658.0	81	53298.0
Download	8	Type 1	1.0	518.0	102	52836.0
Download	9	Type 1	1.0	878.0	61	53558.0
Download	10	Type 1	1.0	918.0	58	53244.0
Download	11	Type 1	1.0	3066.0	18	55188.0
Download	12	Type 1	1.0	678.0	78	52884.0
Download	13	Type 1	1.0	598.0	89	53222.0
Download	14	Type 1	1.0	618.0	86	53148.0
Download	15	Type 1	1.0	900.0	59	53100.0
Download	16	Type 1	1.0	977.0	55	53735.0
Download	17	Type 1	1.0	1598.0	34	54332.0
Download	18	Type 1	1.0	1369.0	39	53391.0
Download	19	Type 1	1.0	847.0	63	53361.0
Download	20	Type 1	1.0	2496.0	22	54912.0
Download	21	Type 1	1.0	1889.0	28	52892.0
Download	22	Type 1	1.0	2877.0	19	54663.0
Download	23	Type 1	1.0	1559.0	34	53006.0
Download	24	Type 1	1.0	1965.0	27	53055.0
Download	25	Type 1	1.0	2895.0	19	55005.0
Download	26	Type 1	1.0	1722.0	31	53382.0
Download	27	Type 1	1.0	1271.0	42	53382.0
Download	28	Type 1	1.0	1237.0	43	53191.0
Download	29	Type 1	1.0	1934.0	28	54152.0

## Radar Type 2 - Radar Waveform

	Trial Id	Radar Type	Pulse Width (us)	PRI (us)	Number of Pulses	Waveform Length (us)
Download	0	Type 2	1.7	174.0	24	4176.0
Download	1	Type 2	3.8	176.0	27	4752.0
Download	2	Type 2	4.0	161.0	28	4508.0
Download	3	Type 2	4.3	226.0	28	6328.0
Download	4	Type 2	1.9	193.0	24	4632.0
Download	5	Type 2	1.1	230.0	23	5290.0
Download	6	Type 2	4.5	198.0	29	5742.0
Download	7	Type 2	2.9	227.0	26	5902.0
Download	8	Type 2	2.8	171.0	26	4446.0
Download	9	Type 2	3.6	221.0	27	5967.0
Download	10	Type 2	1.1	180.0	23	4140.0
Download	11	Type 2	1.3	189.0	23	4347.0
Download	12	Type 2	2.5	204.0	25	5100.0
Download	13	Type 2	4.5	203.0	29	5887.0
Download	14	Type 2	5.0	170.0	29	4930.0
Download	15	Type 2	3.1	201.0	26	5226.0
Download	16	Type 2	2.1	218.0	24	5232.0
Download	17	Type 2	2.6	208.0	25	5200.0
Download	18	Type 2	1.8	223.0	24	5352.0
Download	19	Type 2	1.2	220.0	23	5060.0
Download	20	Type 2	2.9	224.0	26	5824.0
Download	21	Type 2	4.0	160.0	28	4480.0
Download	22	Type 2	2.5	209.0	25	5225.0
Download	23	Type 2	1.0	205.0	23	4715.0
Download	24	Type 2	3.7	151.0	27	4077.0
Download	25	Type 2	2.5	186.0	25	4650.0
Download	26	Type 2	1.5	190.0	23	4370.0
Download	27	Type 2	1.3	185.0	23	4255.0
Download	28	Type 2	1.2	175.0	23	4025.0
Download	29	Type 2	1.7	216.0	24	5184.0

## Radar Type 3 - Radar Waveform

	<b>Trial Id</b>	<b>Radar Type</b>	<b>Pulse Width (us)</b>	<b>PRI (us)</b>	<b>Number of Pulses</b>	<b>Waveform Length (us)</b>
Download	0	Type 3	6.7	467.0	16	7472.0
Download	1	Type 3	8.8	304.0	18	5472.0
Download	2	Type 3	9.0	316.0	18	5688.0
Download	3	Type 3	9.3	439.0	18	7902.0
Download	4	Type 3	6.9	420.0	16	6720.0
Download	5	Type 3	6.1	249.0	16	3984.0
Download	6	Type 3	9.5	463.0	18	8334.0
Download	7	Type 3	7.9	258.0	17	4386.0
Download	8	Type 3	7.8	212.0	17	3604.0
Download	9	Type 3	8.6	236.0	17	4012.0
Download	10	Type 3	6.1	474.0	16	7584.0
Download	11	Type 3	6.3	461.0	16	7376.0
Download	12	Type 3	7.5	437.0	17	7429.0
Download	13	Type 3	9.5	287.0	18	5166.0
Download	14	Type 3	10.0	395.0	18	7110.0
Download	15	Type 3	8.1	322.0	17	5474.0
Download	16	Type 3	7.1	468.0	16	7488.0
Download	17	Type 3	7.6	255.0	17	4335.0
Download	18	Type 3	6.8	423.0	16	6768.0
Download	19	Type 3	6.2	456.0	16	7296.0
Download	20	Type 3	7.9	351.0	17	5967.0
Download	21	Type 3	9.0	411.0	18	7398.0
Download	22	Type 3	7.5	279.0	17	4743.0
Download	23	Type 3	6.0	431.0	16	6896.0
Download	24	Type 3	8.7	324.0	17	5508.0
Download	25	Type 3	7.5	419.0	17	7123.0
Download	26	Type 3	6.5	447.0	16	7152.0
Download	27	Type 3	6.3	481.0	16	7696.0
Download	28	Type 3	6.2	438.0	16	7008.0
Download	29	Type 3	6.7	270.0	16	4320.0



## Radar Type 4 - Radar Waveform

	Trial Id	Radar Type	Pulse Width (us)	PRI (us)	Number of Pulses	Waveform Length (us)
Download	0	Type 4	12.5	467.0	12	5604.0
Download	1	Type 4	17.2	304.0	15	4560.0
Download	2	Type 4	17.8	316.0	15	4740.0
Download	3	Type 4	18.5	439.0	16	7024.0
Download	4	Type 4	13.1	420.0	13	5460.0
Download	5	Type 4	11.3	249.0	12	2988.0
Download	6	Type 4	18.8	463.0	16	7408.0
Download	7	Type 4	15.3	258.0	14	3612.0
Download	8	Type 4	15.1	212.0	14	2968.0
Download	9	Type 4	16.9	236.0	15	3540.0
Download	10	Type 4	11.2	474.0	12	5688.0
Download	11	Type 4	11.7	461.0	12	5532.0
Download	12	Type 4	14.4	437.0	13	5681.0
Download	13	Type 4	18.9	287.0	16	4592.0
Download	14	Type 4	19.9	395.0	16	6320.0
Download	15	Type 4	15.7	322.0	14	4508.0
Download	16	Type 4	13.4	468.0	13	6084.0
Download	17	Type 4	14.5	255.0	13	3315.0
Download	18	Type 4	12.9	423.0	13	5499.0
Download	19	Type 4	11.5	456.0	12	5472.0
Download	20	Type 4	15.3	351.0	14	4914.0
Download	21	Type 4	17.8	411.0	15	6165.0
Download	22	Type 4	14.3	279.0	13	3627.0
Download	23	Type 4	11.1	431.0	12	5172.0
Download	24	Type 4	17.0	324.0	15	4860.0
Download	25	Type 4	14.5	419.0	13	5447.0
Download	26	Type 4	12.1	447.0	12	5364.0
Download	27	Type 4	11.7	481.0	12	5772.0
Download	28	Type 4	11.6	438.0	12	5256.0
Download	29	Type 4	12.7	270.0	12	3240.0



Radar Type 5 - Radar Statistical Performance

Trail #	Test Freq. (MHz)	1=Detection 0=No Detection	Trail #	Test Freq. (MHz)	1=Detection 0=No Detection
0	5490	1	15	5500	1
1	5490	0	16	5501	1
2	5491	0	17	5502	1
3	5491	0	18	5503	1
4	5492	1	19	5504	1
5	5492	0	20	5505	1
6	5493	0	21	5506	1
7	5493	1	22	5507	1
8	5494	1	23	5507	1
9	5494	1	24	5508	1
10	5495	1	25	5508	1
11	5496	1	26	5509	1
12	5497	1	27	5509	1
13	5498	1	28	5510	1
14	5499	1	29	5510	1
Detection Percentage (%)					83.33%

Type 5 Radar Waveform_0							
Burst ID	Burst Offset (us)	Pulse Width (us)	Chirp Width (MHz)	Number of Pulses per Burst	PRI-1 (us)	PRI-2 (us)	PRI-3 (us)
0	500001.0	58.7	7	1	1765.0	-	-
1	788858.0	84.3	7	3	1452.0	1398.0	1571.0
2	107934...	87.4	7	3	1358.0	1377.0	1111.0
3	173235.0	91.4	7	3	1554.0	1036.0	1662.0
4	464181.0	61.8	7	1	1828.0	-	-
5	754905.0	51.8	7	1	1621.0	-	-
6	104321...	93.4	7	3	1063.0	1317.0	1923.0
7	137661.0	73.8	7	2	1804.0	1156.0	-
8	427962.0	72.6	7	2	1935.0	1079.0	-
9	718561.0	82.5	7	2	1049.0	1478.0	-
Type 5 Radar Waveform_1							
Burst ID	Burst Offset (us)	Pulse Width (us)	Chirp Width (MHz)	Number of Pulses per Burst	PRI-1 (us)	PRI-2 (us)	PRI-3 (us)
0	630504.0	51.3	15	1	1713.0	-	-
1	63719.0	54.0	15	1	1485.0	-	-
2	244829.0	69.1	15	2	1043.0	1750.0	-
3	424983.0	93.8	15	3	1665.0	1844.0	1155.0
4	605585.0	99.1	15	3	1505.0	1825.0	1538.0
5	41253.0	76.0	15	2	1866.0	1508.0	-
6	222776.0	63.5	15	1	1889.0	-	-
7	403831.0	69.8	15	2	1024.0	1578.0	-
8	586300.0	60.9	15	1	1067.0	-	-
9	19004.0	52.9	15	1	1162.0	-	-
10	200185.0	73.7	15	2	1211.0	1581.0	-
11	380411.0	87.8	15	3	1516.0	1753.0	1473.0
12	562652.0	68.6	15	2	1029.0	1730.0	-
13	744707.0	50.9	15	1	1930.0	-	-
14	177818.0	83.0	15	2	1675.0	1303.0	-
15	359125.0	69.5	15	2	1296.0	1410.0	-

Type 5 Radar Waveform_2							
Burst ID	Burst Offset (us)	Pulse Width (us)	Chirp Width (MHz)	Number of Pulses per Burst	PRI-1 (us)	PRI-2 (us)	PRI-3 (us)
0	509264.0	56.4	16	1	1603.0	-	-
1	680130.0	53.9	16	1	1545.0	-	-
2	146533.0	53.5	16	1	1943.0	-	-
3	317593.0	59.4	16	1	1206.0	-	-
4	487066.0	78.5	16	2	1305.0	1969.0	-
5	655737.0	86.1	16	3	1355.0	1823.0	1948.0
6	125182.0	67.0	16	2	1788.0	1958.0	-
7	296065.0	74.5	16	2	1213.0	1124.0	-
8	466535.0	81.3	16	2	1215.0	1366.0	-
9	636980.0	81.5	16	2	1429.0	1293.0	-
10	104267.0	79.9	16	2	1345.0	1990.0	-
11	275181.0	50.5	16	1	1996.0	-	-
12	444173.0	88.4	16	3	1871.0	1121.0	1723.0
13	616638.0	65.7	16	1	1964.0	-	-
14	83142.0	93.0	16	3	1962.0	1265.0	1267.0
15	254505.0	63.6	16	1	1020.0	-	-
16	424165.0	78.1	16	2	1737.0	1422.0	-

Type 5 Radar Waveform_3							
Burst ID	Burst Offset (us)	Pulse Width (us)	Chirp Width (MHz)	Number of Pulses per Burst	PRI-1 (us)	PRI-2 (us)	PRI-3 (us)
0	561917.0	76.8	18	2	1105.0	1462.0	-
1	58856.0	72.6	18	2	1668.0	1188.0	-
2	219757.0	70.4	18	2	1321.0	1820.0	-
3	381519.0	57.0	18	1	1683.0	-	-
4	539847.0	88.6	18	3	1721.0	1611.0	1967.0
5	39100.0	55.0	18	1	1594.0	-	-
6	199396.0	93.3	18	3	1624.0	1678.0	1625.0
7	360062.0	86.7	18	3	1720.0	1540.0	1349.0
8	520177.0	86.7	18	3	1816.0	1617.0	1754.0
9	19237.0	57.7	18	1	1382.0	-	-
10	180157.0	78.1	18	2	1561.0	1416.0	-
11	341761.0	59.9	18	1	1734.0	-	-
12	502148.0	71.0	18	2	1677.0	1220.0	-
13	664532.0	65.7	18	1	1497.0	-	-
14	160058.0	86.4	18	3	1957.0	1088.0	1054.0
15	322202.0	58.3	18	1	1104.0	-	-
16	481097.0	92.3	18	3	1589.0	1800.0	1189.0
17	641560.0	95.4	18	3	1147.0	1801.0	1748.0

**Type 5 Radar Waveform\_4**

Burst ID	Burst Offset (us)	Pulse Width (us)	Chirp Width (MHz)	Number of Pulses per Burst	PRI-1 (us)	PRI-2 (us)	PRI-3 (us)
0	230026.0	89.4	8	3	1574.0	1736.0	1023.0
1	494090.0	70.2	8	2	1655.0	1500.0	-
2	759097.0	63.2	8	1	1445.0	-	-
3	102365...	53.9	8	1	1098.0	-	-
4	198005.0	65.2	8	1	1918.0	-	-
5	461089.0	87.1	8	3	1453.0	1658.0	1236.0
6	724508.0	94.6	8	3	1896.0	1154.0	1456.0
7	990596.0	62.4	8	1	1646.0	-	-
8	165301.0	67.6	8	2	1600.0	1439.0	-
9	428206.0	96.2	8	3	1629.0	1909.0	1879.0
10	693781.0	62.9	8	1	1793.0	-	-

**Type 5 Radar Waveform\_5**

Burst ID	Burst Offset (us)	Pulse Width (us)	Chirp Width (MHz)	Number of Pulses per Burst	PRI-1 (us)	PRI-2 (us)	PRI-3 (us)
0	131669...	81.4	5	2	1413.0	1565.0	-
1	182514.0	95.3	5	3	1774.0	1131.0	1995.0
2	546487.0	60.0	5	1	1160.0	-	-
3	909540.0	60.1	5	1	1922.0	-	-
4	127359...	59.6	5	1	1069.0	-	-
5	137882.0	91.8	5	3	1259.0	1810.0	1477.0
6	501010.0	78.4	5	2	1763.0	1487.0	-
7	865247.0	62.6	5	1	1122.0	-	-

Type 5 Radar Waveform_6							
Burst ID	Burst Offset (us)	Pulse Width (us)	Chirp Width (MHz)	Number of Pulses per Burst	PRI-1 (us)	PRI-2 (us)	PRI-3 (us)
0	516946.0	62.4	18	1	1000.0	-	-
1	39179.0	67.9	18	2	1925.0	1039.0	-
2	191187.0	99.0	18	3	1890.0	1228.0	1326.0
3	345057.0	60.3	18	1	1210.0	-	-
4	496341.0	72.7	18	2	1688.0	1548.0	-
5	20344.0	91.9	18	3	1988.0	1503.0	1201.0
6	172985.0	78.3	18	2	1309.0	1198.0	-
7	324992.0	88.9	18	3	1080.0	1399.0	1115.0
8	479203.0	64.5	18	1	1087.0	-	-
9	1625.0	60.3	18	1	1133.0	-	-
10	154419.0	65.8	18	1	1579.0	-	-
11	305517.0	93.5	18	3	1619.0	1682.0	1758.0
12	457252.0	92.2	18	3	1533.0	1842.0	1979.0
13	609099.0	96.2	18	3	1672.0	1744.0	1971.0
14	135269.0	70.3	18	2	1414.0	1692.0	-
15	288335.0	53.5	18	1	1706.0	-	-
16	439137.0	93.4	18	3	1870.0	1242.0	1395.0
17	594115.0	64.9	18	1	1438.0	-	-
18	116504.0	72.9	18	2	1239.0	1817.0	-

Type 5 Radar Waveform_7							
Burst ID	Burst Offset (us)	Pulse Width (us)	Chirp Width (MHz)	Number of Pulses per Burst	PRI-1 (us)	PRI-2 (us)	PRI-3 (us)
0	366038.0	57.3	12	1	1698.0	-	-
1	572552.0	83.3	12	2	1700.0	1427.0	-
2	780751.0	62.5	12	1	1952.0	-	-
3	132806.0	76.1	12	2	1612.0	1397.0	-
4	339391.0	87.5	12	3	1139.0	1901.0	1400.0
5	545977.0	97.1	12	3	1352.0	1798.0	1636.0
6	754249.0	73.8	12	2	1496.0	1536.0	-
7	107497.0	55.2	12	1	1357.0	-	-
8	314885.0	62.5	12	1	1811.0	-	-
9	521546.0	68.1	12	2	1251.0	1843.0	-
10	727998.0	99.9	12	3	1819.0	1057.0	1017.0
11	81932.0	61.3	12	1	1342.0	-	-
12	288728.0	73.9	12	2	1725.0	1872.0	-
13	496814.0	58.0	12	1	1747.0	-	-

**Type 5 Radar Waveform\_8**

Burst ID	Burst Offset (us)	Pulse Width (us)	Chirp Width (MHz)	Number of Pulses per Burst	PRI-1 (us)	PRI-2 (us)	PRI-3 (us)
0	755599.0	95.8	12	3	1465.0	1975.0	1904.0
1	60603.0	79.9	12	2	1764.0	1174.0	-
2	283803.0	77.4	12	2	1235.0	1584.0	-
3	506280.0	90.4	12	3	1114.0	1974.0	1027.0
4	731529.0	59.9	12	1	1126.0	-	-
5	33037.0	90.5	12	3	1275.0	1985.0	1845.0
6	256800.0	62.0	12	1	1062.0	-	-
7	478398.0	87.0	12	3	1463.0	1587.0	1887.0
8	701468.0	98.3	12	3	1586.0	1187.0	1651.0
9	5625.0	80.1	12	2	1277.0	1881.0	-
10	229189.0	52.1	12	1	1330.0	-	-
11	452740.0	51.7	12	1	1333.0	-	-
12	675900.0	52.7	12	1	1867.0	-	-

**Type 5 Radar Waveform\_9**

Burst ID	Burst Offset (us)	Pulse Width (us)	Chirp Width (MHz)	Number of Pulses per Burst	PRI-1 (us)	PRI-2 (us)	PRI-3 (us)
0	728602.0	70.7	15	2	1934.0	1731.0	-
1	163064.0	85.3	15	3	1179.0	1751.0	1711.0
2	344919.0	75.0	15	2	1034.0	1261.0	-
3	526501.0	56.4	15	1	1954.0	-	-
4	707567.0	66.7	15	2	1243.0	1090.0	-
5	140840.0	94.8	15	3	1224.0	1970.0	1214.0
6	322286.0	68.8	15	2	1701.0	1280.0	-
7	503381.0	71.0	15	2	1563.0	1537.0	-
8	684698.0	79.4	15	2	1525.0	1389.0	-
9	118479.0	100.0	15	3	1717.0	1498.0	1740.0
10	299495.0	91.9	15	3	1295.0	1037.0	1829.0
11	481809.0	61.5	15	1	1949.0	-	-
12	663548.0	63.2	15	1	1596.0	-	-
13	96313.0	99.0	15	3	1254.0	1919.0	1073.0
14	277029.0	86.6	15	3	1606.0	1849.0	1202.0
15	459655.0	65.8	15	1	1635.0	-	-

Type 5 Radar Waveform_10							
Burst ID	Burst Offset (us)	Pulse Width (us)	Chirp Width (MHz)	Number of Pulses per Burst	PRI-1 (us)	PRI-2 (us)	PRI-3 (us)
0	128199...	70.7	5	2	1897.0	1749.0	-
1	148716.0	64.6	5	1	1965.0	-	-
2	511400.0	99.0	5	3	1012.0	1045.0	1772.0
3	873819.0	91.9	5	3	1583.0	1466.0	1549.0
4	123645...	85.5	5	3	1420.0	1780.0	1459.0
5	103733.0	96.5	5	3	1530.0	1924.0	1835.0
6	467414.0	66.2	5	1	1550.0	-	-
7	828841.0	92.9	5	3	1929.0	1335.0	1883.0

Type 5 Radar Waveform_11							
Burst ID	Burst Offset (us)	Pulse Width (us)	Chirp Width (MHz)	Number of Pulses per Burst	PRI-1 (us)	PRI-2 (us)	PRI-3 (us)
0	106135...	63.1	6	1	1642.0	-	-
1	52533.0	83.5	6	3	1005.0	1981.0	1250.0
2	375121.0	74.5	6	2	1914.0	1474.0	-
3	698701.0	60.9	6	1	1430.0	-	-
4	102035...	70.4	6	2	1680.0	1542.0	-
5	12834.0	85.1	6	3	1048.0	1127.0	1393.0
6	335516.0	82.4	6	2	1605.0	1282.0	-
7	658234.0	74.0	6	2	1108.0	1691.0	-
8	979549.0	85.7	6	3	1486.0	1976.0	1212.0

Type 5 Radar Waveform_12							
Burst ID	Burst Offset (us)	Pulse Width (us)	Chirp Width (MHz)	Number of Pulses per Burst	PRI-1 (us)	PRI-2 (us)	PRI-3 (us)
0	975763.0	94.4	11	3	1385.0	1336.0	1376.0
1	221907.0	53.0	11	1	1805.0	-	-
2	463536.0	70.0	11	2	1248.0	1558.0	-
3	704621.0	87.6	11	3	1403.0	1170.0	1315.0
4	948913.0	61.7	11	1	1042.0	-	-
5	191927.0	83.2	11	2	1100.0	1535.0	-
6	434514.0	66.6	11	1	1038.0	-	-
7	676534.0	55.1	11	1	1423.0	-	-
8	915669.0	87.0	11	3	1789.0	1306.0	1643.0
9	162331.0	66.4	11	1	1409.0	-	-
10	404114.0	80.0	11	2	1319.0	1094.0	-
11	644572.0	85.6	11	3	1891.0	1291.0	1529.0



Type 5 Radar Waveform_13							
Burst ID	Burst Offset (us)	Pulse Width (us)	Chirp Width (MHz)	Number of Pulses per Burst	PRI-1 (us)	PRI-2 (us)	PRI-3 (us)
0	559643.0	78.9	18	2	1613.0	1263.0	-
1	83132.0	96.7	18	3	1627.0	1432.0	1986.0
2	235098.0	91.5	18	3	1472.0	1759.0	1784.0
3	388261.0	75.4	18	2	1274.0	1795.0	-
4	540400.0	71.1	18	2	1968.0	1444.0	-
5	64622.0	77.5	18	2	1588.0	1441.0	-
6	217521.0	65.4	18	1	1710.0	-	-
7	370455.0	53.1	18	1	1419.0	-	-
8	523206.0	59.9	18	1	1518.0	-	-
9	45893.0	67.3	18	2	1195.0	1168.0	-
10	198422.0	74.2	18	2	1386.0	1216.0	-
11	350921.0	69.0	18	2	1557.0	1132.0	-
12	503059.0	82.1	18	2	1987.0	1186.0	-
13	27020.0	93.3	18	3	1365.0	1032.0	1728.0
14	179613.0	83.3	18	2	1103.0	1568.0	-
15	331979.0	70.3	18	2	1699.0	1281.0	-
16	485741.0	57.9	18	1	1285.0	-	-
17	8305.0	50.6	18	1	1850.0	-	-
18	160375.0	94.3	18	3	1479.0	1218.0	1733.0

Type 5 Radar Waveform_14							
Burst ID	Burst Offset (us)	Pulse Width (us)	Chirp Width (MHz)	Number of Pulses per Burst	PRI-1 (us)	PRI-2 (us)	PRI-3 (us)
0	297680.0	67.5	20	2	1434.0	1117.0	-
1	441995.0	67.8	20	2	1567.0	1773.0	-
2	586834.0	75.9	20	2	1846.0	1362.0	-
3	134817.0	68.9	20	2	1237.0	1818.0	-
4	278690.0	96.0	20	3	1339.0	1796.0	1852.0
5	425629.0	66.6	20	1	1289.0	-	-
6	568519.0	78.3	20	2	1862.0	1856.0	-
7	117306.0	58.9	20	1	1412.0	-	-
8	261916.0	81.5	20	2	1113.0	1591.0	-
9	406632.0	82.4	20	2	1059.0	1861.0	-
10	550186.0	86.8	20	3	1797.0	1163.0	1320.0
11	98921.0	98.5	20	3	1268.0	1300.0	1868.0
12	244128.0	80.1	20	2	1086.0	1482.0	-
13	387268.0	86.3	20	3	1860.0	1407.0	1998.0
14	535106.0	57.2	20	1	1241.0	-	-
15	81010.0	84.3	20	3	1808.0	1873.0	1628.0
16	225534.0	86.8	20	3	1258.0	1302.0	1978.0
17	370865.0	83.0	20	2	1690.0	1378.0	-
18	514322.0	85.6	20	3	1327.0	1956.0	1311.0
19	63364.0	99.4	20	3	1112.0	1815.0	1262.0
Type 5 Radar Waveform_15							
Burst ID	Burst Offset (us)	Pulse Width (us)	Chirp Width (MHz)	Number of Pulses per Burst	PRI-1 (us)	PRI-2 (us)	PRI-3 (us)
0	298559.0	57.5	13	1	1379.0	-	-
1	505048.0	67.0	13	2	1551.0	1620.0	-
2	712288.0	70.9	13	2	1939.0	1083.0	-
3	65334.0	75.7	13	2	1332.0	1476.0	-
4	272524.0	77.1	13	2	1840.0	1010.0	-
5	479639.0	78.8	13	2	1371.0	1618.0	-
6	688000.0	51.0	13	1	1494.0	-	-
7	39859.0	55.4	13	1	1794.0	-	-
8	247001.0	68.5	13	2	1590.0	1266.0	-
9	453464.0	100.0	13	3	1484.0	1314.0	1428.0
10	660486.0	96.4	13	3	1363.0	1361.0	1292.0
11	14259.0	97.2	13	3	1694.0	1480.0	1446.0
12	221241.0	86.4	13	3	1447.0	1227.0	1102.0
13	428688.0	72.1	13	2	1184.0	1638.0	-

Type 5 Radar Waveform_16							
Burst ID	Burst Offset (us)	Pulse Width (us)	Chirp Width (MHz)	Number of Pulses per Burst	PRI-1 (us)	PRI-2 (us)	PRI-3 (us)
0	810996.0	62.4	9	1	1329.0	-	-
1	107330...	67.8	9	2	1364.0	1937.0	-
2	249825.0	53.0	9	1	1790.0	-	-
3	513186.0	77.8	9	2	1546.0	1906.0	-
4	776261.0	95.6	9	3	1145.0	1743.0	1499.0
5	104282...	58.8	9	1	1199.0	-	-
6	216805.0	92.8	9	3	1424.0	1408.0	1381.0
7	480761.0	68.5	9	2	1340.0	1972.0	-
8	743697.0	84.0	9	3	1607.0	1663.0	1270.0
9	100839...	70.8	9	2	1468.0	1760.0	-
10	184481.0	73.1	9	2	1869.0	1515.0	-
Type 5 Radar Waveform_17							
Burst ID	Burst Offset (us)	Pulse Width (us)	Chirp Width (MHz)	Number of Pulses per Burst	PRI-1 (us)	PRI-2 (us)	PRI-3 (us)
0	379027.0	68.8	11	2	1504.0	1973.0	-
1	601267.0	94.2	11	3	1920.0	1299.0	1467.0
2	826098.0	82.7	11	2	1003.0	1351.0	-
3	128582.0	74.8	11	2	1597.0	1457.0	-
4	352167.0	58.9	11	1	1874.0	-	-
5	573713.0	96.5	11	3	1838.0	1708.0	1328.0
6	796850.0	87.3	11	3	1405.0	1271.0	1687.0
7	101143.0	72.4	11	2	1200.0	1433.0	-
8	324788.0	51.3	11	1	1475.0	-	-
9	546355.0	86.8	11	3	1159.0	1652.0	1942.0
10	772173.0	50.4	11	1	1056.0	-	-
11	73442.0	97.0	11	3	1884.0	1876.0	1415.0
12	297241.0	50.1	11	1	1519.0	-	-

Type 5 Radar Waveform_18							
Burst ID	Burst Offset (us)	Pulse Width (us)	Chirp Width (MHz)	Number of Pulses per Burst	PRI-1 (us)	PRI-2 (us)	PRI-3 (us)
0	675668.0	91.9	8	3	1301.0	1337.0	1645.0
1	966684.0	67.2	8	2	1983.0	1040.0	-
2	60080.0	65.5	8	1	1671.0	-	-
3	350468.0	72.8	8	2	1489.0	1016.0	-
4	640208.0	90.5	8	3	1552.0	1180.0	1064.0
5	930430.0	81.6	8	2	1807.0	1853.0	-
6	24223.0	86.0	8	3	1312.0	1905.0	1278.0
7	314287.0	89.6	8	3	1152.0	1068.0	1832.0
8	605824.0	62.1	8	1	1119.0	-	-
9	896505.0	58.0	8	1	1234.0	-	-
Type 5 Radar Waveform_19							
Burst ID	Burst Offset (us)	Pulse Width (us)	Chirp Width (MHz)	Number of Pulses per Burst	PRI-1 (us)	PRI-2 (us)	PRI-3 (us)
0	148262...	73.8	5	2	1071.0	1915.0	-
1	348501.0	89.5	5	3	1294.0	1450.0	1025.0
2	712087.0	81.2	5	2	1144.0	1146.0	-
3	107622...	59.0	5	1	1041.0	-	-
4	143687...	87.5	5	3	1096.0	1941.0	1018.0
5	303833.0	76.7	5	2	1667.0	1947.0	-
6	667663.0	56.5	5	1	1573.0	-	-
7	102959...	89.0	5	3	1033.0	1391.0	1304.0
Type 5 Radar Waveform_20							
Burst ID	Burst Offset (us)	Pulse Width (us)	Chirp Width (MHz)	Number of Pulses per Burst	PRI-1 (us)	PRI-2 (us)	PRI-3 (us)
0	795066.0	83.1	12	2	1762.0	1058.0	-
1	148131.0	50.0	12	1	1739.0	-	-
2	355877.0	52.6	12	1	1055.0	-	-
3	563078.0	58.2	12	1	1704.0	-	-
4	768221.0	84.6	12	3	1226.0	1177.0	1886.0
5	122378.0	68.3	12	2	1269.0	1851.0	-
6	329595.0	80.6	12	2	1814.0	1074.0	-
7	537959.0	59.5	12	1	1009.0	-	-
8	745244.0	53.4	12	1	1417.0	-	-
9	97056.0	59.1	12	1	1431.0	-	-
10	304250.0	74.8	12	2	1002.0	1394.0	-
11	510244.0	85.0	12	3	1670.0	1755.0	1158.0
12	717553.0	85.3	12	3	1307.0	1560.0	1078.0
13	71512.0	61.9	12	1	1197.0	-	-

Type 5 Radar Waveform_21							
Burst ID	Burst Offset (us)	Pulse Width (us)	Chirp Width (MHz)	Number of Pulses per Burst	PRI-1 (us)	PRI-2 (us)	PRI-3 (us)
0	229509.0	70.8	17	2	1022.0	1015.0	-
1	400529.0	52.9	17	1	1483.0	-	-
2	569230.0	86.0	17	3	1524.0	1308.0	1287.0
3	37714.0	78.4	17	2	1821.0	1406.0	-
4	207532.0	93.3	17	3	1991.0	1966.0	1290.0
5	378491.0	70.0	17	2	1858.0	1471.0	-
6	548974.0	78.1	17	2	1507.0	1705.0	-
7	16774.0	52.4	17	1	1060.0	-	-
8	186482.0	84.8	17	3	1859.0	1839.0	1993.0
9	357118.0	83.5	17	3	1150.0	1492.0	1443.0
10	529488.0	56.7	17	1	1208.0	-	-
11	697766.0	86.2	17	3	1674.0	1125.0	1053.0
12	166571.0	58.8	17	1	1436.0	-	-
13	335823.0	85.4	17	3	1686.0	1509.0	1577.0
14	507436.0	77.7	17	2	1297.0	1298.0	-
15	676055.0	87.4	17	3	1649.0	1894.0	1075.0
16	145003.0	99.8	17	3	1185.0	1167.0	1616.0

Type 5 Radar Waveform_22							
Burst ID	Burst Offset (us)	Pulse Width (us)	Chirp Width (MHz)	Number of Pulses per Burst	PRI-1 (us)	PRI-2 (us)	PRI-3 (us)
0	447229.0	95.7	10	3	1353.0	1813.0	1028.0
1	688316.0	94.9	10	3	1735.0	1994.0	1084.0
2	929912.0	97.9	10	3	1354.0	1792.0	1418.0
3	176291.0	67.4	10	2	1348.0	1008.0	-
4	417300.0	96.9	10	3	1916.0	1425.0	1283.0
5	659121.0	97.6	10	3	1384.0	1050.0	1569.0
6	901006.0	83.6	10	3	1231.0	1219.0	1194.0
7	146470.0	82.6	10	2	1128.0	1346.0	-
8	387774.0	97.2	10	3	1142.0	1769.0	1173.0
9	629493.0	92.3	10	3	1181.0	1164.0	1458.0
10	871823.0	80.9	10	2	1222.0	1756.0	-
11	116586.0	78.1	10	2	1190.0	1999.0	-

Type 5 Radar Waveform_23							
Burst ID	Burst Offset (us)	Pulse Width (us)	Chirp Width (MHz)	Number of Pulses per Burst	PRI-1 (us)	PRI-2 (us)	PRI-3 (us)
0	538038.0	76.9	5	2	1564.0	1767.0	-
1	902167.0	64.7	5	1	1437.0	-	-
2	126430...	77.1	5	2	1046.0	1944.0	-
3	130381.0	72.7	5	2	1440.0	1374.0	-
4	494082.0	61.9	5	1	1035.0	-	-
5	856449.0	68.6	5	2	1205.0	1892.0	-
6	122012...	78.3	5	2	1047.0	1273.0	-
7	85626.0	73.1	5	2	1426.0	1863.0	-

Type 5 Radar Waveform_24							
Burst ID	Burst Offset (us)	Pulse Width (us)	Chirp Width (MHz)	Number of Pulses per Burst	PRI-1 (us)	PRI-2 (us)	PRI-3 (us)
0	224291.0	59.1	15	1	1718.0	-	-
1	404797.0	83.5	15	3	1070.0	1129.0	1318.0
2	585565.0	86.5	15	3	1176.0	1253.0	1442.0
3	20469.0	60.8	15	1	1209.0	-	-
4	201494.0	80.7	15	2	2000.0	1360.0	-
5	383735.0	65.2	15	1	1101.0	-	-
6	564279.0	69.1	15	2	1511.0	1030.0	-
7	746938.0	51.5	15	1	1161.0	-	-
8	178837.0	98.5	15	3	1061.0	1951.0	1812.0
9	361254.0	59.5	15	1	1325.0	-	-
10	540817.0	95.3	15	3	1284.0	1650.0	1169.0
11	723236.0	81.8	15	2	1460.0	1077.0	-
12	157347.0	66.0	15	1	1149.0	-	-
13	338866.0	59.3	15	1	1373.0	-	-
14	519043.0	79.2	15	2	1836.0	1534.0	-
15	698893.0	90.2	15	3	1455.0	1738.0	1490.0

Type 5 Radar Waveform_25							
Burst ID	Burst Offset (us)	Pulse Width (us)	Chirp Width (MHz)	Number of Pulses per Burst	PRI-1 (us)	PRI-2 (us)	PRI-3 (us)
0	165660.0	87.5	11	3	1343.0	1331.0	1313.0
1	388227.0	94.6	11	3	1448.0	1543.0	1803.0
2	611977.0	73.9	11	2	1722.0	1514.0	-
3	836637.0	55.4	11	1	1506.0	-	-
4	138508.0	52.3	11	1	1960.0	-	-
5	361157.0	95.8	11	3	1240.0	1380.0	1252.0
6	583572.0	96.1	11	3	1372.0	1411.0	1908.0
7	807375.0	77.8	11	2	1885.0	1593.0	-
8	110712.0	97.2	11	3	1021.0	1614.0	1633.0
9	334129.0	74.3	11	2	1582.0	1097.0	-
10	558353.0	57.9	11	1	1031.0	-	-
11	779576.0	68.8	11	2	1927.0	1936.0	-
12	83349.0	79.6	11	2	1857.0	1470.0	-
Type 5 Radar Waveform_26							
Burst ID	Burst Offset (us)	Pulse Width (us)	Chirp Width (MHz)	Number of Pulses per Burst	PRI-1 (us)	PRI-2 (us)	PRI-3 (us)
0	443672.0	63.4	7	1	1595.0	-	-
1	764888.0	97.0	7	3	1451.0	1660.0	1562.0
2	108877...	66.7	7	2	1116.0	1544.0	-
3	80701.0	99.5	7	3	1553.0	1526.0	1768.0
4	404035.0	64.3	7	1	1107.0	-	-
5	724735.0	90.7	7	3	1992.0	1626.0	1899.0
6	104983...	62.1	7	1	1630.0	-	-
7	41111.0	58.3	7	1	1676.0	-	-
8	363203.0	87.0	7	3	1726.0	1696.0	1464.0

**Type 5 Radar Waveform\_27**

Burst ID	Burst Offset (us)	Pulse Width (us)	Chirp Width (MHz)	Number of Pulses per Burst	PRI-1 (us)	PRI-2 (us)	PRI-3 (us)
0	685484.0	86.8	6	3	1673.0	1383.0	1653.0
1	100844...	81.7	6	2	1841.0	1911.0	-
2	1327.0	78.4	6	2	1900.0	1229.0	-
3	324073.0	82.1	6	2	1527.0	1072.0	-
4	645590.0	84.1	6	3	1893.0	1742.0	1491.0
5	968147.0	87.7	6	3	1247.0	1341.0	1955.0
6	129015...	97.0	6	3	1559.0	1685.0	1572.0
7	283759.0	99.1	6	3	1641.0	1727.0	1848.0
8	607681.0	62.0	6	1	1245.0	-	-

**Type 5 Radar Waveform\_28**

Burst ID	Burst Offset (us)	Pulse Width (us)	Chirp Width (MHz)	Number of Pulses per Burst	PRI-1 (us)	PRI-2 (us)	PRI-3 (us)
0	104641...	67.5	6	2	1193.0	1182.0	-
1	140782...	85.6	6	3	1221.0	1741.0	1338.0
2	274722.0	86.9	6	3	1580.0	1775.0	1809.0
3	637750.0	85.3	6	3	1082.0	1854.0	1095.0
4	100067...	67.3	6	2	1898.0	1977.0	-
5	136308...	94.8	6	3	1791.0	1350.0	1230.0
6	230397.0	72.9	6	2	1681.0	1323.0	-
7	593534.0	70.7	6	2	1709.0	1123.0	-

**Type 5 Radar Waveform\_29**

Burst ID	Burst Offset (us)	Pulse Width (us)	Chirp Width (MHz)	Number of Pulses per Burst	PRI-1 (us)	PRI-2 (us)	PRI-3 (us)
0	766096.0	63.3	8	1	1044.0	-	-
1	105361...	87.4	8	3	1945.0	1602.0	1203.0
2	148646.0	58.7	8	1	1556.0	-	-
3	439290.0	63.6	8	1	1598.0	-	-
4	730238.0	56.3	8	1	1110.0	-	-
5	102035...	57.2	8	1	1878.0	-	-
6	112833.0	50.3	8	1	1659.0	-	-
7	403062.0	71.9	8	2	1143.0	1724.0	-
8	692419.0	85.1	8	3	1404.0	1715.0	1449.0
9	985054.0	62.5	8	1	1276.0	-	-



## Radar Type 6 - Radar Statistical Performance

Trail #	1=Detection 0=No Detection	Trail #	1=Detection 0=No Detection
0	1	15	1
1	1	16	1
2	1	17	1
3	1	18	1
4	1	19	1
5	1	20	1
6	1	21	1
7	1	22	1
8	1	23	1
9	1	24	1
10	1	25	1
11	1	26	1
12	1	27	1
13	1	28	1
14	1	29	1
Detection Percentage (%)			100%

Type 6 Radar Waveform_0					
Frequency List (MHz)	0	1	2	3	4
0	5684	5647	5388	5528	5616
5	5491	5605	5502	5588	5683
10	5313	5430	5420	5521	5622
15	5292	5485	5489	5387	5265
20	5419	5271	5508	5386	5410
25	5494	5600	5471	5711	5584
30	5719	5342	5361	5308	5639
35	5397	5580	5664	5667	5349
40	5290	5541	5665	5322	5585
45	5501	5330	5264	5350	5718
50	5447	5378	5340	5445	5285
55	5389	5252	5368	5469	5713
60	5384	5516	5254	5689	5318
65	5416	5459	5607	5475	5514
70	5630	5542	5263	5379	5455
75	5411	5550	5617	5554	5708
80	5688	5619	5604	5258	5695
85	5559	5301	5690	5596	5537
90	5701	5448	5611	5658	5338
95	5525	5327	5413	5555	5546

Type 6 Radar Waveform_1					
Frequency List (MHz)	0	1	2	3	4
0	5464	5411	5324	5689	5458
5	5630	5530	5577	5276	5415
10	5719	5316	5461	5619	5643
15	5380	5612	5592	5432	5554
20	5427	5340	5449	5475	5383
25	5382	5549	5674	5437	5618
30	5286	5706	5318	5523	5595
35	5264	5293	5460	5442	5263
40	5604	5624	5603	5562	5582
45	5430	5310	5347	5311	5296
50	5712	5254	5516	5496	5374
55	5687	5574	5556	5423	5331
60	5581	5487	5379	5723	5285
65	5650	5298	5463	5666	5337
70	5541	5548	5538	5668	5260
75	5526	5677	5586	5376	5669
80	5299	5277	5289	5255	5462
85	5384	5361	5407	5588	5474
90	5681	5395	5482	5396	5670
95	5355	5580	5700	5295	5658

Type 6 Radar Waveform_2					
Frequency List (MHz)	0	1	2	3	4
0	5719	5650	5260	5278	5678
5	5672	5552	5652	5439	5622
10	5580	5502	5339	5664	5371
15	5264	5695	5477	5271	5338
20	5506	5487	5467	5356	5648
25	5401	5402	5541	5425	5692
30	5275	5263	5565	5415	5306
35	5384	5256	5595	5540	5707
40	5327	5579	5359	5668	5430
45	5369	5252	5599	5605	5547
50	5560	5510	5518	5269	5280
55	5521	5400	5458	5512	5544
60	5305	5555	5586	5596	5499
65	5412	5689	5607	5344	5620
70	5524	5293	5636	5697	5422
75	5551	5337	5405	5441	5352
80	5610	5365	5701	5324	5429
85	5542	5722	5272	5498	5419
90	5304	5372	5635	5723	5598
95	5274	5286	5564	5281	5589

Type 6 Radar Waveform_3					
Frequency List (MHz)	0	1	2	3	4
0	5499	5414	5671	5439	5520
5	5714	5477	5252	5505	5451
10	5484	5369	5543	5534	5685
15	5459	5391	5323	5425	5463
20	5346	5575	5428	5556	5329
25	5536	5350	5605	5645	5686
30	5467	5581	5707	5381	5717
35	5710	5445	5475	5624	5273
40	5663	5379	5412	5479	5470
45	5673	5666	5648	5513	5427
50	5305	5389	5481	5393	5598
55	5649	5711	5365	5457	5709
60	5694	5332	5641	5250	5387
65	5509	5542	5700	5361	5424
70	5622	5314	5510	5296	5336
75	5478	5595	5342	5565	5631
80	5328	5447	5661	5508	5415
85	5724	5330	5640	5287	5297
90	5593	5495	5567	5504	5453
95	5635	5316	5486	5690	5376

**Type 6 Radar Waveform\_4**

Frequency List (MHz)	0	1	2	3	4
0	5657	5653	5607	5600	5265
5	5378	5499	5327	5668	5658
10	5415	5633	5681	5254	5706
15	5547	5421	5329	5470	5655
20	5354	5266	5369	5645	5302
25	5677	5333	5274	5720	5509
30	5664	5596	5491	5433	5584
35	5566	5420	5426	5577	5693
40	5495	5320	5710	5670	5595
45	5628	5388	5358	5276	5260
50	5569	5649	5263	5534	5309
55	5663	5513	5303	5295	5399
60	5316	5335	5488	5523	5310
65	5256	5294	5425	5386	5496
70	5299	5660	5454	5554	5462
75	5708	5612	5580	5460	5442
80	5672	5478	5624	5525	5268
85	5482	5347	5411	5262	5646
90	5290	5701	5510	5390	5503
95	5270	5313	5610	5492	5485

**Type 6 Radar Waveform\_5**

Frequency List (MHz)	0	1	2	3	4
0	5437	5417	5543	5286	5582
5	5420	5424	5402	5356	5390
10	5346	5422	5722	5449	5252
15	5635	5548	5432	5515	5372
20	5265	5335	5407	5637	5275
25	5690	5529	5439	5475	5279
30	5551	5456	5621	5336	5643
35	5253	5626	5657	5691	5676
40	5491	5532	5578	5258	5667
45	5427	5608	5301	5446	5411
50	5541	5611	5270	5700	5352
55	5357	5631	5358	5617	5616
60	5710	5274	5327	5564	5712
65	5623	5636	5531	5724	5259
70	5466	5661	5606	5555	5579
75	5399	5509	5333	5513	5268
80	5485	5570	5698	5361	5638
85	5342	5646	5324	5310	5506
90	5605	5598	5419	5585	5391
95	5516	5302	5534	5520	5325

**Type 6 Radar Waveform\_6**

Frequency List (MHz)	0	1	2	3	4
0	5692	5656	5479	5447	5327
5	5462	5446	5477	5519	5694
10	5655	5308	5288	5547	5273
15	5723	5675	5535	5560	5564
20	5501	5348	5251	5578	5478
25	5642	5579	5313	5690	5345
30	5551	5417	5451	5290	5370
35	5487	5354	5502	5468	5283
40	5671	5618	5664	5356	5588
45	5384	5504	5464	5428	5276
50	5441	5575	5449	5571	5331
55	5529	5720	5456	5254	5657
60	5455	5559	5683	5652	5298
65	5409	5627	5565	5402	5358
70	5309	5472	5615	5605	5422
75	5609	5680	5525	5701	5537
80	5646	5263	5698	5473	5552
85	5667	5556	5619	5361	5562
90	5546	5380	5281	5287	5471
95	5503	5649	5548	5607	5467

**Type 6 Radar Waveform\_7**

Frequency List (MHz)	0	1	2	3	4
0	5472	5420	5415	5608	5644
5	5504	5371	5552	5585	5426
10	5586	5572	5329	5267	5294
15	5714	5327	5638	5508	5281
20	5667	5289	5718	5696	5369
25	5330	5370	5683	5347	5257
30	5709	5535	5669	5569	5271
35	5429	5461	5380	5507	5416
40	5307	5366	5609	5383	5661
45	5285	5568	5467	5465	5517
50	5693	5266	5622	5627	5381
55	5422	5637	5525	5521	5348
60	5594	5419	5602	5287	5385
65	5423	5273	5632	5688	5251
70	5687	5699	5551	5502	5431
75	5584	5250	5468	5652	5260
80	5592	5615	5549	5580	5333
85	5438	5506	5440	5603	5721
90	5625	5395	5444	5655	5651
95	5435	5362	5660	5353	5326

**Type 6 Radar Waveform\_8**

Frequency List (MHz)	0	1	2	3	4
0	5252	5659	5351	5294	5389
5	5643	5393	5627	5273	5633
10	5517	5361	5370	5462	5315
15	5327	5454	5266	5553	5473
20	5667	5261	5332	5669	5257
25	5279	5573	5312	5381	5299
30	5695	5492	5409	5343	5469
35	5568	5552	5651	5282	5330
40	5621	5449	5547	5623	5280
45	5592	5451	5550	5523	5580
50	5617	5323	5378	5716	5679
55	5366	5350	5479	5614	5545
60	5565	5714	5584	5594	5308
65	5466	5571	5581	5340	5618
70	5490	5537	5505	5434	5390
75	5611	5541	5328	5516	5281
80	5612	5452	5519	5510	5306
85	5557	5688	5326	5411	5631
90	5704	5289	5668	5346	5558
95	5429	5521	5657	5436	5339

**Type 6 Radar Waveform\_9**

Frequency List (MHz)	0	1	2	3	4
0	5410	5423	5287	5358	5706
5	5685	5318	5702	5436	5462
10	5351	5625	5411	5657	5336
15	5415	5484	5272	5598	5675
20	5427	5268	5324	5642	5523
25	5606	5301	5513	5438	5584
30	5449	5624	5495	5289	5610
35	5643	5447	5435	5341	5460
40	5532	5485	5388	5277	5521
45	5431	5633	5581	5526	5370
50	5493	5499	5429	5330	5502
55	5688	5538	5433	5329	5364
60	5536	5368	5274	5589	5609
65	5412	5297	5530	5663	5550
70	5413	5293	5465	5620	5605
75	5283	5712	5349	5425	5490
80	5614	5445	5512	5269	5452
85	5361	5356	5271	5511	5461
90	5621	5576	5637	5366	5586
95	5545	5553	5689	5719	5648

Type 6 Radar Waveform_10					
Frequency List (MHz)	0	1	2	3	4
0	5665	5662	5698	5519	5451
5	5252	5340	5302	5599	5669
10	5282	5414	5452	5377	5357
15	5503	5611	5375	5643	5479
20	5683	5496	5684	5413	5615
25	5411	5458	5407	5617	5449
30	5480	5473	5406	5364	5269
35	5584	5274	5259	5588	5255
40	5299	5712	5423	5531	5353
45	5716	5542	5579	5257	5369
50	5675	5419	5325	5632	5251
55	5387	5658	5507	5400	5439
60	5534	5355	5435	5358	5498
65	5602	5382	5305	5474	5634
70	5606	5608	5607	5688	5308
75	5394	5513	5595	5570	5553
80	5609	5575	5509	5464	5678
85	5416	5614	5562	5709	5344
90	5266	5468	5410	5702	5600
95	5668	5635	5442	5372	5385

Type 6 Radar Waveform_11					
Frequency List (MHz)	0	1	2	3	4
0	5445	5523	5634	5680	5293
5	5294	5265	5377	5665	5401
10	5591	5300	5493	5475	5378
15	5494	5263	5478	5671	5594
20	5662	5722	5405	5588	5677
25	5407	5610	5721	5483	5522
30	5459	5363	5482	5421	5307
35	5413	5447	5611	5644	5710
40	5320	5361	5296	5271	5282
45	5391	5324	5600	5632	5623
50	5376	5531	5605	5479	5439
55	5341	5709	5477	5381	5529
60	5604	5358	5304	5321	5428
65	5638	5689	5575	5277	5706
70	5592	5708	5456	5567	5267
75	5266	5633	5371	5576	5347
80	5561	5334	5676	5506	5659
85	5258	5617	5379	5514	5579
90	5516	5542	5431	5337	5253
95	5519	5655	5395	5349	5647

Type 6 Radar Waveform_12					
Frequency List (MHz)	0	1	2	3	4
0	5700	5287	5570	5366	5513
5	5433	5452	5353	5705	5522
10	5564	5631	5670	5399	5582
15	5390	5581	5636	5388	5602
20	5256	5663	5494	5561	5565
25	5259	5338	5350	5517	5661
30	5348	5320	5697	5552	5538
35	5407	5516	5655	5549	5403
40	5677	5536	5268	5686	5371
45	5658	5685	5409	5499	5455
50	5694	5349	5423	5530	5295
55	5424	5674	5352	5294	5659
60	5347	5377	5370	5555	5400
65	5675	5711	5683	5543	5701
70	5710	5278	5514	5557	5502
75	5671	5590	5365	5323	5503
80	5379	5258	5459	5439	5706
85	5447	5567	5633	5362	5596
90	5277	5610	5531	5358	5722
95	5529	5460	5465	5334	5319

Type 6 Radar Waveform_13					
Frequency List (MHz)	0	1	2	3	4
0	5383	5526	5506	5527	5355
5	5475	5687	5516	5437	5453
10	5353	5672	5390	5420	5670
15	5517	5684	5681	5580	5610
20	5422	5604	5486	5534	5356
25	5683	5541	5551	5703	5334
30	5277	5347	5325	5594	5629
35	5678	5669	5569	5388	5583
40	5615	5301	5362	5518	5351
45	5490	5619	5263	5674	5375
50	5631	5633	5308	5647	5270
55	5718	5724	5614	5493	5323
60	5312	5459	5466	5423	5485
65	5293	5345	5326	5613	5256
70	5262	5358	5472	5661	5714
75	5532	5519	5660	5582	5398
80	5657	5538	5279	5371	5529
85	5386	5500	5574	5636	5402
90	5412	5521	5406	5560	5286
95	5283	5395	5640	5290	5363



Type 6 Radar Waveform_14					
Frequeunc List (MHz)	0	1	2	3	4
0	5638	5290	5442	5688	5575
5	5517	5709	5602	5679	5644
10	5287	5617	5713	5585	5441
15	5283	5547	5690	5629	5297
20	5521	5491	5545	5507	5719
25	5535	5269	5655	5270	5698
30	5652	5596	5620	5258	5720
35	5571	5444	5483	5702	5666
40	5553	5359	5447	5331	5573
45	5677	5316	5561	5251	5332
50	5684	5397	5470	5689	5431
55	5581	5329	5312	5294	5624
60	5411	5255	5408	5714	5546
65	5275	5649	5466	5532	5636
70	5641	5647	5339	5381	5495
75	5619	5551	5421	5703	5616
80	5531	5319	5627	5693	5449
85	5497	5391	5539	5715	5462
90	5518	5280	5572	5654	5380
95	5451	5289	5342	5277	5274

Type 6 Radar Waveform_15					
Frequeunc List (MHz)	0	1	2	3	4
0	5418	5529	5378	5374	5417
5	5559	5634	5677	5270	5473
10	5693	5406	5279	5305	5462
15	5274	5674	5318	5489	5657
20	5583	5567	5480	5607	5387
25	5375	5284	5619	5409	5587
30	5666	5295	5273	5343	5397
35	5336	5367	5597	5638	5491
40	5684	5356	5689	5656	5260
45	5272	5351	5505	5508	5293
50	5536	5535	5422	5509	5643
55	5314	5562	5709	5282	5369
60	5699	5588	5298	5424	5342
65	5713	5633	5705	5471	5578
70	5520	5541	5371	5308	5332
75	5408	5285	5512	5586	5539
80	5557	5425	5710	5720	5526
85	5427	5616	5392	5286	5400
90	5428	5513	5675	5676	5653
95	5495	5304	5724	5315	5698

Type 6 Radar Waveform_16					
Frequency List (MHz)	0	1	2	3	4
0	5673	5293	5314	5535	5637
5	5698	5656	5277	5433	5680
10	5624	5292	5320	5403	5483
15	5362	5326	5421	5719	5681
20	5537	5251	5524	5453	5398
25	5336	5578	5388	5556	5451
30	5573	5623	5510	5522	5638
35	5439	5427	5275	5408	5477
40	5357	5429	5449	5353	5683
45	5669	5264	5696	5325	5713
50	5381	5684	5311	5672	5494
55	5480	5332	5489	5612	5328
60	5614	5602	5479	5301	5394
65	5632	5703	5570	5648	5508
70	5694	5620	5310	5716	5442
75	5457	5350	5392	5661	5417
80	5560	5664	5306	5496	5485
85	5330	5588	5577	5675	5313
90	5419	5395	5523	5455	5412
95	5411	5303	5399	5273	5707

Type 6 Radar Waveform_17					
Frequency List (MHz)	0	1	2	3	4
0	5453	5532	5250	5599	5479
5	5265	5581	5352	5596	5412
10	5458	5556	5361	5598	5504
15	5450	5524	5289	5495	5448
20	5417	5465	5648	5426	5286
25	5663	5306	5492	5590	5493
30	5462	5580	5296	5578	5615
35	5531	5525	5322	5316	5537
40	5367	5592	5350	5612	5649
45	5347	5279	5378	5503	5257
50	5385	5362	5317	5327	5520
55	5443	5622	5585	5256	5644
60	5343	5701	5393	5597	5660
65	5340	5586	5423	5702	5445
70	5326	5496	5560	5559	5337
75	5552	5613	5260	5391	5501
80	5345	5338	5522	5553	5374
85	5404	5301	5407	5540	5510
90	5309	5705	5406	5368	5444
95	5294	5313	5275	5519	5654

Type 6 Radar Waveform_18					
Frequency List (MHz)	0	1	2	3	4
0	5611	5296	5661	5285	5699
5	5307	5603	5427	5284	5619
10	5389	5345	5402	5318	5525
15	5538	5580	5627	5712	5687
20	5456	5583	5503	5262	5399
25	5552	5612	5509	5693	5624
30	5535	5351	5537	5368	5448
35	5656	5717	5706	5327	5678
40	5711	5630	5620	5305	5357
45	5444	5629	5430	5337	5431
50	5390	5608	5561	5413	5375
55	5615	5271	5708	5397	5517
60	5441	5556	5385	5334	5288
65	5595	5594	5546	5599	5550
70	5381	5701	5551	5688	5545
75	5302	5455	5426	5606	5540
80	5492	5565	5323	5388	5696
85	5655	5411	5617	5421	5582
90	5416	5539	5410	5516	5557
95	5477	5682	5587	5417	5366

Type 6 Radar Waveform_19					
Frequency List (MHz)	0	1	2	3	4
0	5391	5535	5597	5446	5444
5	5349	5625	5502	5447	5448
10	5698	5609	5540	5513	5546
15	5529	5610	5633	5282	5404
20	5464	5652	5254	5372	5440
25	5712	5322	5658	5674	5337
30	5494	5583	5697	5476	5381
35	5598	5356	5722	5469	5703
40	5621	5441	5373	5395	5484
45	5655	5387	5262	5438	5593
50	5324	5351	5707	5638	5430
55	5514	5596	5708	5462	5682
60	5320	5495	5635	5382	5651
65	5504	5720	5548	5479	5278
70	5414	5677	5449	5274	5521
75	5269	5675	5482	5369	5483
80	5385	5723	5594	5471	5334
85	5386	5536	5614	5704	5416
90	5318	5443	5574	5620	5461
95	5580	5566	5612	5615	5393

Type 6 Radar Waveform_20					
Frequency List (MHz)	0	1	2	3	4
0	5646	5299	5533	5607	5286
5	5488	5550	5577	5513	5655
10	5629	5398	5581	5708	5567
15	5617	5262	5261	5327	5596
20	5375	5343	5385	5345	5706
25	5316	5426	5692	5716	5701
30	5451	5323	5374	5674	5423
35	5413	5394	5606	5636	5405
40	5408	5559	5362	5438	5680
45	5589	5356	5537	5542	5263
50	5515	5650	5639	5512	5305
55	5422	5457	5401	5643	5275
60	5294	5508	5584	5618	5444
65	5574	5592	5543	5685	5317
70	5282	5551	5328	5254	5373
75	5549	5569	5320	5502	5521
80	5310	5546	5285	5626	5436
85	5434	5526	5490	5620	5519
90	5255	5325	5637	5688	5675
95	5478	5448	5338	5556	5605

Type 6 Radar Waveform_21					
Frequency List (MHz)	0	1	2	3	4
0	5426	5538	5469	5293	5506
5	5530	5572	5652	5676	5387
10	5560	5662	5622	5331	5588
15	5705	5389	5364	5372	5313
20	5383	5412	5423	5335	5318
25	5594	5265	5546	5251	5283
30	5590	5408	5623	5494	5562
35	5504	5287	5284	5550	5719
40	5491	5497	5505	5435	5609
45	5472	5679	5414	5493	5332
50	5614	5566	5264	5462	5384
55	5700	5259	5612	5276	5675
60	5451	5695	5601	5431	5344
65	5393	5610	5424	5338	5488
70	5486	5268	5651	5555	5518
75	5689	5463	5483	5298	5323
80	5519	5697	5282	5428	5626
85	5278	5621	5694	5541	5632
90	5559	5525	5289	5585	5271
95	5255	5526	5376	5427	5721

Type 6 Radar Waveform_22					
Frequency List (MHz)	0	1	2	3	4
0	5584	5302	5405	5454	5348
5	5572	5497	5252	5364	5691
10	5394	5548	5663	5526	5609
15	5318	5516	5467	5320	5505
20	5391	5578	5424	5291	5482
25	5592	5274	5256	5285	5422
30	5576	5365	5656	5300	5692
35	5701	5558	5437	5561	5574
40	5435	5270	5432	5538	5452
45	5287	5472	5546	5694	5393
50	5315	5617	5353	5328	5413
55	5688	5705	5473	5721	5329
60	5616	5640	5433	5257	5573
65	5642	5342	5646	5634	5254
70	5654	5404	5390	5334	5606
75	5464	5550	5386	5672	5279
80	5623	5529	5457	5338	5562
85	5495	5641	5355	5724	5531
90	5380	5722	5310	5510	5371
95	5406	5349	5356	5649	5554

Type 6 Radar Waveform_23					
Frequency List (MHz)	0	1	2	3	4
0	5364	5541	5341	5615	5568
5	5614	5519	5327	5527	5423
10	5325	5337	5704	5721	5630
15	5309	5643	5570	5365	5697
20	5302	5647	5305	5416	5264
25	5273	5477	5360	5319	5464
30	5465	5322	5396	5549	5512
35	5268	5308	5354	5687	5475
40	5397	5657	5373	5510	5526
45	5370	5432	5433	5599	5484
50	5269	5491	5668	5442	5583
55	5650	5601	5642	5420	5292
60	5692	5458	5306	5585	5362
65	5558	5368	5291	5466	5500
70	5569	5252	5715	5279	5253
75	5560	5250	5359	5357	5652
80	5542	5705	5543	5556	5453
85	5276	5440	5534	5517	5546
90	5414	5537	5260	5392	5591
95	5288	5452	5554	5408	5660

Type 6 Radar Waveform_24					
Frequency List (MHz)	0	1	2	3	4
0	5619	5305	5277	5679	5410
5	5278	5444	5402	5593	5630
10	5256	5601	5270	5441	5651
15	5397	5673	5576	5511	5310
20	5338	5343	5505	5712	5636
25	5393	5680	5464	5353	5506
30	5451	5279	5611	5701	5710
35	5407	5399	5722	5365	5389
40	5333	5362	5311	5275	5523
45	5299	5412	5453	5491	5652
50	5371	5620	5667	5719	5628
55	5309	5594	5314	5596	5610
60	5586	5663	5587	5471	5627
65	5669	5481	5465	5666	5715
70	5621	5676	5295	5372	5324
75	5323	5282	5577	5536	5684
80	5328	5477	5320	5482	5556
85	5337	5617	5420	5273	5635
90	5432	5376	5480	5625	5395
95	5500	5662	5373	5579	5640

Type 6 Radar Waveform_25					
Frequency List (MHz)	0	1	2	3	4
0	5399	5544	5688	5365	5630
5	5320	5466	5477	5281	5459
10	5565	5390	5311	5636	5672
15	5485	5325	5679	5455	5703
20	5318	5407	5284	5497	5685
25	5427	5720	5408	5568	5387
30	5645	5340	5711	5351	5475
35	5530	5546	5490	5518	5400
40	5647	5445	5724	5418	5520
45	5606	5392	5536	5549	5705
50	5496	5368	5295	5717	5607
55	5441	5405	5550	5634	5716
60	5572	5501	5307	5411	5286
65	5657	5508	5662	5553	5493
70	5309	5382	5329	5512	5643
75	5675	5597	5366	5504	5259
80	5666	5593	5306	5483	5648
85	5355	5335	5315	5540	5342
90	5360	5551	5435	5668	5269
95	5646	5706	5394	5610	5395

Type 6 Radar Waveform_26					
Frequency List (MHz)	0	1	2	3	4
0	5557	5405	5624	5526	5472
5	5362	5391	5552	5444	5666
10	5496	5654	5352	5259	5693
15	5573	5452	5307	5403	5420
20	5704	5700	5586	5658	5315
25	5669	5514	5294	5421	5687
30	5668	5469	5627	5350	5685
35	5581	5314	5293	5486	5528
40	5662	5517	5535	5372	5619
45	5510	5283	5523	5275	5544
50	5346	5331	5430	5385	5593
55	5407	5515	5602	5508	5273
60	5326	5333	5608	5454	5710
65	5596	5718	5457	5356	5565
70	5295	5653	5488	5505	5644
75	5717	5509	5485	5511	5679
80	5374	5470	5643	5645	5550
85	5713	5632	5503	5437	5703
90	5683	5434	5652	5276	5622
95	5412	5530	5640	5438	5603

Type 6 Radar Waveform_27					
Frequency List (MHz)	0	1	2	3	4
0	5337	5644	5560	5687	5692
5	5501	5413	5627	5607	5398
10	5427	5540	5490	5454	5714
15	5564	5579	5410	5448	5612
20	5712	5264	5641	5578	5631
25	5581	5521	5717	5455	5254
30	5690	5625	5684	5401	5548
35	5252	5672	5585	5446	5703
40	5325	5611	5503	5423	5514
45	5367	5255	5702	5568	5313
50	5626	5720	5397	5420	5253
55	5707	5306	5361	5705	5421
60	5479	5402	5491	5462	5262
65	5531	5400	5416	5659	5632
70	5550	5349	5634	5637	5378
75	5485	5502	5464	5516	5362
80	5555	5466	5288	5314	5630
85	5706	5642	5270	5713	5571
90	5563	5629	5556	5359	5686
95	5599	5658	5677	5633	5256

Type 6 Radar Waveform_28					
Frequency List (MHz)	0	1	2	3	4
0	5592	5408	5496	5373	5534
5	5543	5338	5702	5673	5261
10	5329	5531	5649	5260	5652
15	5706	5513	5493	5720	5333
20	5679	5667	5604	5469	5470
25	5445	5502	5489	5393	5579
30	5582	5424	5553	5368	5391
35	5385	5478	5599	5714	5639
40	5316	5441	5566	5608	5296
45	5710	5310	5626	5292	5675
50	5421	5448	5509	5454	5651
55	5494	5315	5420	5715	5450
60	5656	5504	5569	5357	5346
65	5617	5571	5285	5619	5437
70	5331	5364	5488	5351	5343
75	5423	5485	5698	5447	5443
80	5411	5701	5294	5562	5616
85	5413	5526	5724	5536	5510
90	5607	5409	5289	5664	5614
95	5418	5268	5446	5640	5464

Type 6 Radar Waveform_29					
Frequency List (MHz)	0	1	2	3	4
0	5372	5647	5432	5534	5279
5	5585	5360	5302	5361	5434
10	5667	5593	5572	5369	5281
15	5265	5261	5519	5441	5521
20	5631	5499	5620	5659	5577
25	5357	5322	5648	5606	5523
30	5435	5468	5539	5639	5327
35	5566	5530	5476	5274	5374
40	5628	5575	5399	5379	5331
45	5605	5700	5690	5393	5587
50	5345	5465	5378	5597	5695
55	5277	5498	5682	5269	5513
60	5437	5421	5660	5346	5449
65	5401	5280	5389	5440	5557
70	5607	5592	5414	5715	5403
75	5350	5491	5675	5319	5382
80	5505	5366	5428	5390	5636
85	5282	5255	5586	5404	5561
90	5380	5704	5454	5292	5300
95	5377	5560	5689	5595	5511





Product	AX5400 Ceiling Mount Wi-Fi 6 Access Point	Temperature	25 °C
Test Engineer	Jay	Relative Humidity	65 %
Test Site	SR5	Test Date	2023/10/2
Test Item	Radar Statistical Performance Check (802.11ax-HE40 mode – 5510MHz) -Master		

Radar Type 1-4 - Radar Statistical Performance

Trial	Frequency (MHz)	1=Detection, 0=No Detection			
		Radar Type 1	Radar Type 2	Radar Type 3	Radar Type 4
0	5491	0	1	1	1
1	5492	1	1	0	1
2	5493	1	1	0	0
3	5494	1	1	0	0
4	5495	1	1	1	1
5	5496	1	1	1	0
6	5497	1	1	0	0
7	5498	1	0	1	1
8	5499	1	1	1	1
9	5500	1	1	0	0
10	5501	1	1	1	0
11	5502	1	1	1	1
12	5504	1	1	1	1
13	5506	1	1	1	1
14	5508	1	1	1	1
15	5510	1	1	1	1
16	5512	1	1	1	1
17	5514	1	1	1	1
18	5516	1	1	1	1
19	5518	1	1	0	1
20	5520	1	1	1	1
21	5521	1	1	1	0
22	5522	1	1	1	1
23	5523	1	1	1	1
24	5524	1	1	1	0
25	5525	1	1	0	0
26	5526	1	1	1	1

Trial	Frequency	1=Detection, 0=No Detection			
	(MHz)	Radar Type 1	Radar Type 2	Radar Type 3	Radar Type 4
27	5527	1	1	1	1
28	5528	1	1	1	1
29	5529	1	1	0	1
Probability:		96.66%	96.66%	73.33%	70%
Type1-4		84.1625% (>80%)			