

RF MEASUREMENT REPORT

FCC ID : 2AXJ4EAP670V2
Applicant : TP-Link Corporation Limited
Application Type : Certification
Product : AX5400 Ceiling Mount Wi-Fi 6 Access Point
Model No. : EAP670
Series Model No. : EAP673
Brand Name : tp-link
FCC Classification : Unlicensed National Information Infrastructure (NII)
FCC Rule Part(s) : Part15 Subpart E (Section 15.407)
Received Date : August 11, 2023
Test Date : August 15, 2023 ~ August 18, 2023

Test By : Owen Tsai
(Owen Tsai)

Reviewed By : Paddy Chen
(Paddy Chen)

Approved By : Chenz Ker
(Chenz Ker)



The test results relate only to the samples tested.

This equipment has been shown to be capable of compliance with the applicable technical standards as indicated in the measurement report and was tested in accordance with the measurement procedures specified in KDB 789033 D02v02r01. Test results reported herein relate only to the item(s) tested.

The test report shall not be reproduced except in full without the written approval of MRT Technology (Taiwan) Co., Ltd.

Revision History

Report No.	Version	Description	Issue Date	Note
2308TW0107-U4	1.0	Original Report	2023-11-22	Valid

CONTENTS

Description	Page
General Information	6
1. INTRODUCTION	7
1.1. Scope	7
1.2. MRT Test Location	7
2. PRODUCT INFORMATION	8
2.1. Equipment Description.....	8
2.2. Product Specification Subjective to this Report.....	9
2.3. Working Frequencies for this report	10
2.4. Description of Available Antennas	11
2.5. Test Mode	12
2.6. Configuration of Test System.....	13
2.7. Test System Details.....	13
2.8. Description of Test Software	13
2.9. Applied Standards	14
2.10. Duty Cycle	14
2.11. Test Configuration	16
2.12. EMI Suppression Device(s)/Modifications	16
2.13. Labeling Requirements.....	16
3. DESCRIPTION OF TEST	17
3.1. Evaluation Procedure	17
3.2. AC Line Conducted Emissions	17
3.3. Radiated Emissions	18
4. ANTENNA REQUIREMENTS	19
5. TEST EQUIPMENT CALIBRATION DATE	20
6. MEASUREMENT UNCERTAINTY	22
7. TEST RESULT	23
7.1. Summary	23
7.2. 26dB Bandwidth Measurement.....	24
7.2.1. Test Limit	24
7.2.2. Test Procedure used.....	24
7.2.3. Test Setting.....	24
7.2.4. Test Setup	24
7.2.5. Test Result.....	25

7.3.	6dB Bandwidth Measurement.....	40
7.3.1.	Test Limit	40
7.3.2.	Test Procedure used.....	40
7.3.3.	Test Setting.....	40
7.3.4.	Test Setup	40
7.3.5.	TestResult.....	41
7.4.	Output Power Measurement.....	46
7.4.1.	Test Limit	46
7.4.2.	Test Procedure Used	46
7.4.3.	Test Setting.....	46
7.4.4.	Test Setup	46
7.4.5.	Test Result.....	47
7.5.	Transmit Power Control	53
7.5.1.	Test Limit	53
7.5.2.	Test Procedure Used	53
7.5.3.	Test Setting.....	53
7.5.4.	Test Setup	53
7.5.5.	Test Result.....	53
7.6.	Power Spectral Density Measurement.....	54
7.6.1.	Test Limit	54
7.6.2.	Test Procedure Used	54
7.6.3.	Test Setting.....	54
7.6.4.	Test Setup	55
7.6.5.	Test Result.....	56
7.7.	Frequency Stability Measurement.....	108
7.7.1.	Test Limit	108
7.7.2.	Test Limit	108
7.7.3.	Test Setup	109
7.7.4.	Test Result.....	109
7.8.	Radiated Spurious Emission Measurement	110
7.8.1.	Test Limit	110
7.8.2.	Test Procedure Used	110
7.8.3.	Test Setting.....	110
7.8.4.	Test Setup	112
7.8.5.	Test Result.....	113
7.9.	Radiated Restricted Band Edge Measurement	267
7.9.1.	Test Limit	267
7.9.2.	Test Procedure Used	268
7.9.3.	Test Setting.....	268

7.9.4. Test Setup	269
7.9.5. Test Result.....	270
7.10. AC Conducted Emissions Measurement.....	404
7.10.1. Test Limit	404
7.10.2. Test Setup	404
7.10.3. Test Result.....	405
8. CONCLUSION.....	409
Appendix A : Test Setup Photograph	410
Appendix B : EUT Photograph.....	410
Appendix C : Internal Photograph	410

General Information

Applicant	TP-Link Corporation Limited
Applicant Address	Room 901, 9/F., New East Ocean Centre, 9 Science Museum Road, Tsim Sha Tsui, Kowloon, Hongkong
Manufacturer	TP-Link Corporation Limited
Manufacturer Address	Room 901, 9/F. , New East Ocean Centre, 9 Science Museum Road, Tsim Sha Tsui, Kowloon, Hongkong
Test Site	MRT Technology (Taiwan) Co., Ltd
Test Site Address	No. 38, Fuxing Second Rd., Guishan Dist., Taoyuan City 333, Taiwan (R.O.C)
MRT FCC Registration No.	291082
FCC Rule Part(s)	Part 15.407

Test Facility / Accreditations

1. MRT facility is a FCC registered (Reg. No. 291082) test facility with the site description report on file and is designated by the FCC as an Accredited Test Firm.
2. MRT facility is an IC registered (MRT Reg. No. 21723) test laboratory with the site description on file at Industry Canada.
3. MRT Lab is accredited to ISO 17025 by the Taiwan Accreditation Foundation (TAF Cert. No. 3261) in EMC, Telecommunications and Radio testing for FCC (Designation Number: TW3261), Industry Canada, EU and TELEC Rules.

1. INTRODUCTION

1.1. Scope

Measurement and determination of electromagnetic emissions (EMC) of radio frequency devices including intentional and/or unintentional radiators for compliance with the technical rules and regulations of the Federal Communications Commission and the Innovation, Science and Economic Development Canada and Certification and Engineering Bureau.

1.2. MRT Test Location

The map below shows the location of the MRT LABORATORY, its proximity to the Taoyuan City. These measurement tests were conducted at the MRT Technology (Taiwan) Co., Ltd. Facility located at No.38, Fuxing 2nd Rd., Guishan Dist., Taoyuan City 33377, Taiwan (R.O.C).

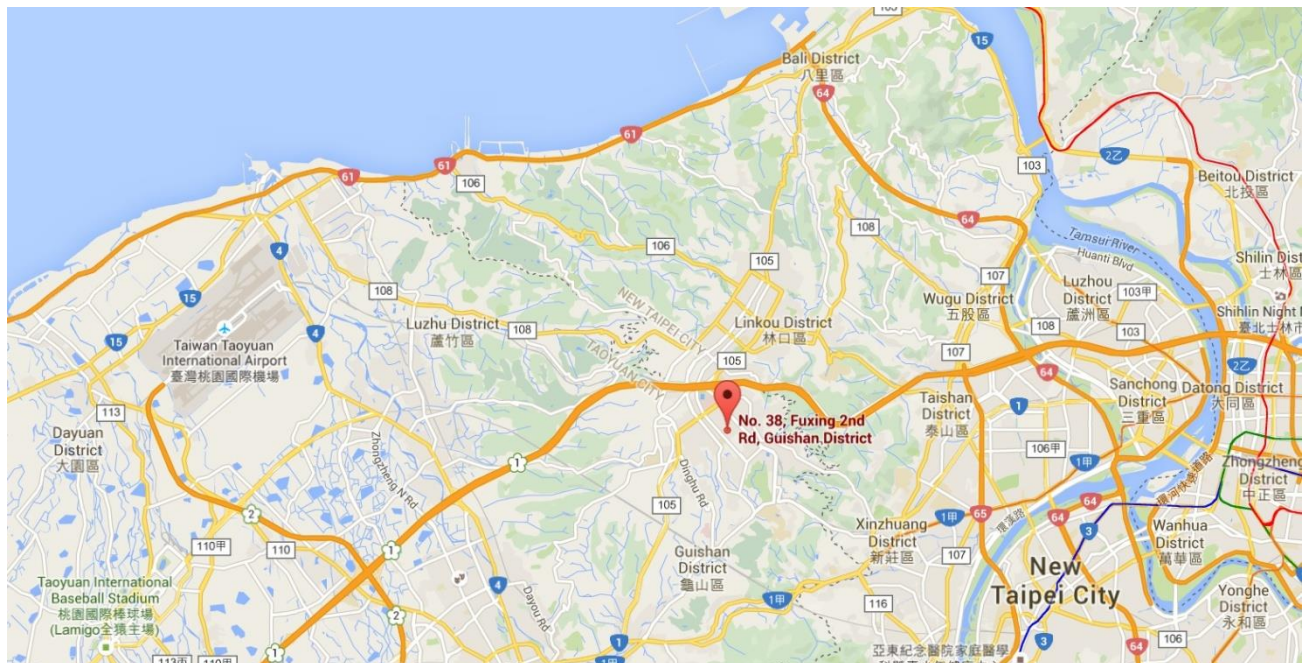

2. PRODUCT INFORMATION

2.1. Equipment Description

Product Name:	AX5400 Ceiling Mount Wi-Fi 6 Access Point
Model No.:	EAP670
Series Model No.	EAP673
Brand Name:	tp-link
Bluetooth Specification	Bluetooth Mode: V4.2
Wi-Fi Specification:	802.11a/b/g/n/ac/ax
EUTIdentificationNo.:	#1-1 (Conducted) #1-2 (Radiated)
Accessory	
Adapter	Brand: tp-link M/N: T120200-2B4 Input: 100-240V~50/60Hz 0.8A Output: DC 12.0V, 2.0A Length: Non-shielded 1.5m

Note:

1. Model Difference: The difference of models only for marketing different (Adapter is not sold with EAP673), the other hardware was the same. (declared by the manufacturer)
2. The test was performed based on EAP670.

2.2. Product Specification Subjective to this Report

Frequency Range:	For 802.11a/n-HT20/ac-VHT20/ax-HE20: 5180~5240MHz, 5260~5320MHz, 5500~5720MHz, 5745~5825MHz For 802.11n-HT40/ac-VHT40/ax-HE40: 5190~5230MHz, 5270~5310MHz, 5510~5710MHz, 5755~5795MHz For 802.11ac-VHT80/ax-HE80: 5210MHz, 5290MHz, 5530MHz, 5610 MHz, 5690MHz, 5775MHz For 802.11ac-VHT160/ax-HE160: 5250MHz, 5570MHz
Type of Modulation:	802.11a/n/ac: OFDM 802.11ax: OFDMA
Data Rate:	802.11a: 6/9/12/18/24/36/48/54Mbps 802.11n: up to 600Mbps 802.11ac: up to 3466.7Mbps 802.11ax: up to 4804Mbps

Note: For other features of this EUT, test report will be issued separately.

2.3. Working Frequencies for this report

802.11a/n-HT20/ac-VHT20/ax-HE20

Channel	Frequency	Channel	Frequency	Channel	Frequency
36	5180 MHz	40	5200 MHz	44	5220 MHz
48	5240 MHz	52	5260 MHz	56	5280 MHz
60	5300 MHz	64	5320 MHz	100	5500 MHz
104	5520 MHz	108	5540 MHz	112	5560 MHz
116	5580 MHz	120	5600 MHz	124	5620 MHz
128	5640 MHz	132	5660 MHz	136	5680 MHz
140	5700 MHz	144	5720 MHz	149	5745 MHz
153	5765 MHz	157	5785 MHz	161	5805 MHz
165	5825 MHz	--	--	--	--

802.11n-HT40/ac-VHT40/ax-HE40

Channel	Frequency	Channel	Frequency	Channel	Frequency
38	5190 MHz	46	5230 MHz	54	5270 MHz
62	5310 MHz	102	5510 MHz	110	5550MHz
118	5590 MHz	126	5630 MHz	134	5670 MHz
142	5710 MHz	151	5755 MHz	159	5795 MHz

802.11ac-VHT80/ax-HE80

Channel	Frequency	Channel	Frequency	Channel	Frequency
42	5210 MHz	58	5290 MHz	106	5530 MHz
122	5610 MHz	138	5690 MHz	155	5775 MHz

802.11ac-VHT160/ax-HE160

Channel	Frequency	Channel	Frequency	Channel	Frequency
50	5250MHz	114	5570 MHz	--	--

2.4. Description of Available Antennas

Antenna Type	Frequency Band (MHz)	Tx Paths	Number of spatial streams	Max Antenna Gain (dBi)	Beamforming Directional Gain(dBi)	CDD Directional Gain (dBi)	
						For Power	For PSD
Wi-Fi Antenna							
PIFA	2412 ~ 2462	2	1	3.00	6.01	3.00	6.01
	5150 ~ 5850	4	1	2.00	8.02	2.00	8.02

Remark:

1. The EUT supports Cyclic Delay Diversity (CDD) mode, and CDD signals are correlated.

If all antennas have the same gain, G_{ANT} , Directional gain = $G_{ANT} + \text{Array Gain}$, where Array Gain is as follows.

- For power spectral density (PSD) measurements on all devices,

$$\text{Array Gain} = 10 \log (N_{ANT} / N_{SS}) \text{ dB};$$

- For power measurements on IEEE 802.11 devices,

$$\text{Array Gain} = 0 \text{ dB for } N_{ANT} \leq 4;$$

2. The EUT also supports Beam Forming mode, and the Beam Forming support 802.11ac/ax, not include 802.11a/b/g/n. BF Directional gain = $G_{ANT} + 10 \log (N_{ANT})$.

3. All information of antenna were from the AUT report.

Test Mode	T _x Paths	CDD Mode	Beamforming Mode
802.11b/g/n (DTS)	2	√	X
802.11ax (DTS)	2	√	√
802.11a/n (NII)	4	√	X
802.11ac/ax (NII)	4	√	√

2.5. Test Mode

CDD Mode
Mode 1: Transmit by 802.11a_Nss=1 (6Mbps) (CDD mode)
Mode 2: Transmit by 802.11ac-VHT20_Nss=1 (MCS0) (CDD mode)
Mode 3: Transmit by 802.11ac-VHT40_Nss=1 (MCS0) (CDD mode)
Mode 4: Transmit by 802.11ac-VHT80_Nss=1 (MCS0) (CDD mode)
Mode 5: Transmit by 802.11ac-VHT160_Nss=1 (MCS0) (CDD mode)
Mode 6: Transmit by 802.11ax-HE20_Nss=1 (MCS0) (CDD mode)
Mode 7: Transmit by 802.11ax-HE40_Nss=1 (MCS0) (CDD mode)
Mode 8: Transmit by 802.11ax-HE80_Nss=1 (MCS0) (CDD mode)
Mode 9: Transmit by 802.11ax-HE160_Nss=1 (MCS0) (CDD mode)
Beamforming Mode
Mode 10: Transmit by 802.11ac-VHT20_Nss=1 (MCS0) (Beam-Forming mode)
Mode 11: Transmit by 802.11ac-VHT40_Nss=1 (MCS0) (Beam-Forming mode)
Mode 12: Transmit by 802.11ac-VHT80_Nss=1 (MCS0) (Beam-Forming mode)
Mode 13: Transmit by 802.11ac-VHT160_Nss=1 (MCS0) (Beam-Forming mode)
Mode 14: Transmit by 802.11ax-HE20_Nss=1 (MCS0) (Beam-Forming mode)
Mode 15: Transmit by 802.11ax-HE40_Nss=1 (MCS0) (Beam-Forming mode)
Mode 16: Transmit by 802.11ax-HE80_Nss=1 (MCS0) (Beam-Forming mode)
Mode 17: Transmit by 802.11ax-HE160_Nss=1 (MCS0) (Beam-Forming mode)
<p>Remark:</p> <ol style="list-style-type: none"> For Radiated emission, the modulation and the data rate picked for testing are determined by the Max. RF conducted power. This device supports 4 N_{SS} and power level of 4 N_{SS} is less than or equal to the power of 1 N_{SS}. The worst case is N_{SS}=1. Due to the same modulation between 802.11n and 802.11ac, so 802.11n-HT20 and HT40 are covered by 802.11ac-VHT20 and VHT40 in this report, meanwhile, power level for 802.11n-HT20 and HT40 will not be greater than 802.11ac-VHT20 and VHT40. Due to CDD mode was the worst mode, so all test items were evaluated in this report. The beamforming mode only evaluated the RF output power. EUT supports one configuration only in 802.11ax full RU mode.

2.6. Configuration of Test System

The device was tested per the guidance ANSI C63.10: 2013 was used to reference the appropriate EUT setup for radiated emissions testing and AC line conducted testing.

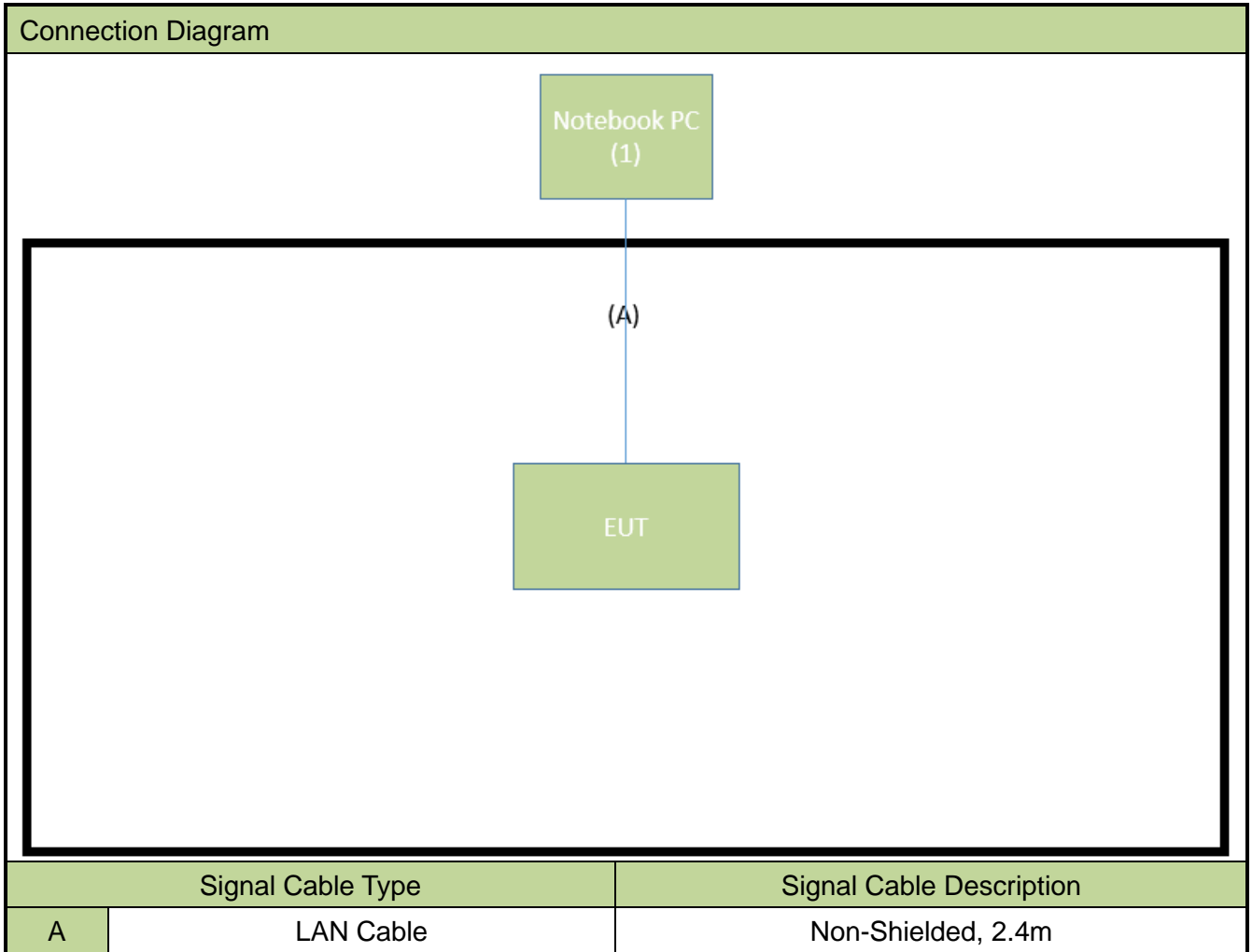

2.7. Test System Details

The types for all equipments, plus descriptions of all cables used in the tested system (including inserted cards) are:

No.	Product	Brand	Model No.	Serial No.	Power Cord
1	Notebook PC	Lenovo	20Y7-006KTW	N/A	Non-shielded, 0.8m

2.8. Description of Test Software

The test utility software used during testing was “QSPR”, the version is ver5.0-00188.

Note: Final power setting please refer to operational description.

2.9. Applied Standards

According to the specifications of the manufacturer, the EUT must comply with the requirements of the following standards:

- FCC Part 15.407
- KDB 789033 D02v02r01,
- KDB 662911 D01v02r01
- ANSI C63.10-2013

2.10. Duty Cycle

5GHz (NII) operation is possible in 20MHz, 40MHz, 80MHz and 160MHz channel bandwidths. The maximum achievable duty cycles for all modes were determined based on measurements performed on a spectrum analyzer in zero-span mode with RBW = 8MHz, VBW = 50MHz. The RBW and VBW were both greater than 50/T, where T is the minimum transmission duration, and the number of sweep points across T was greater than 100. The duty cycles are as follows:

Test Mode	Duty Cycle
802.11a	96.87%
802.11ac-VHT20	85.76%
802.11ac-VHT40	85.28%
802.11ac-VHT80	84.83%
802.11ac-VHT160	91.25%
802.11ax-HE20	85.81%
802.11ax-HE40	85.60%
802.11ax-HE80	86.04%
802.11ax-HE160	85.65%

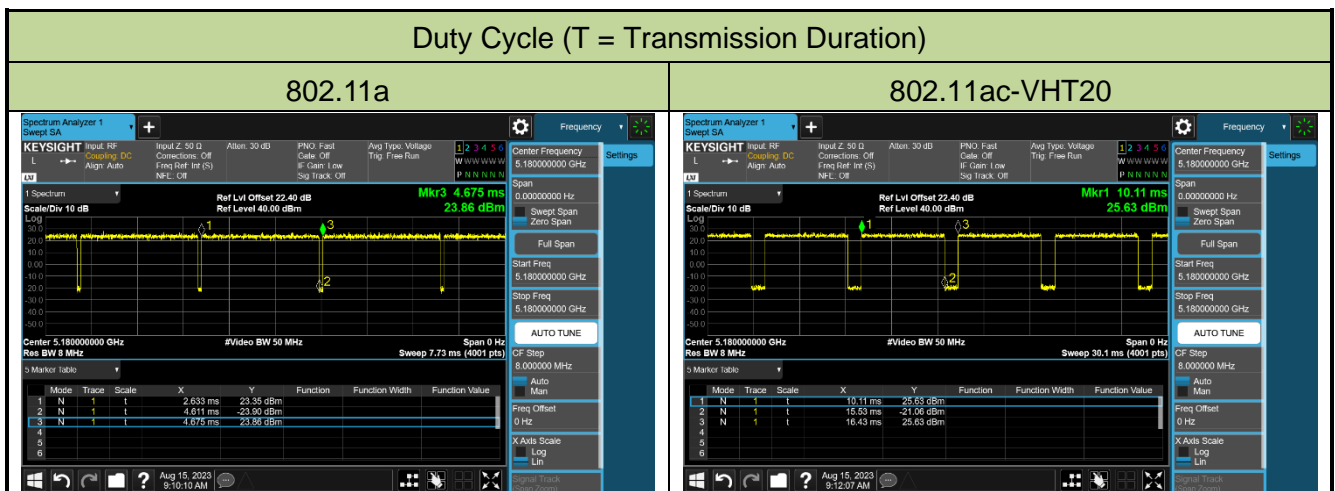

Duty Cycle (T = Transmission Duration)

802.11ac-VHT40

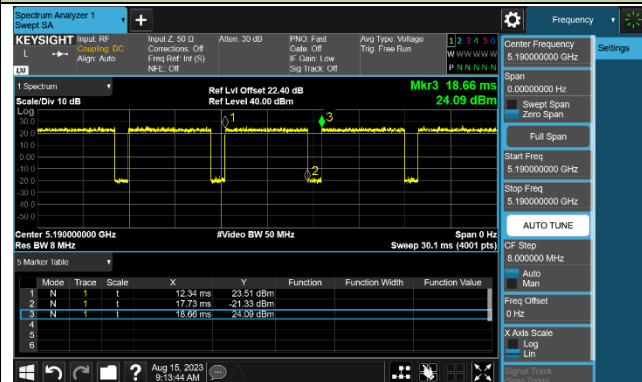

802.11ac-VHT80

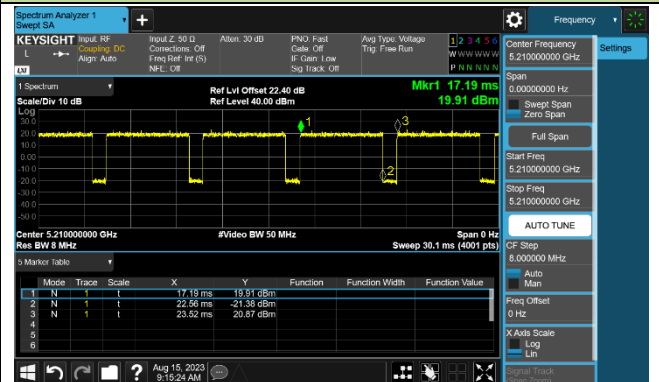

802.11ac-VHT160

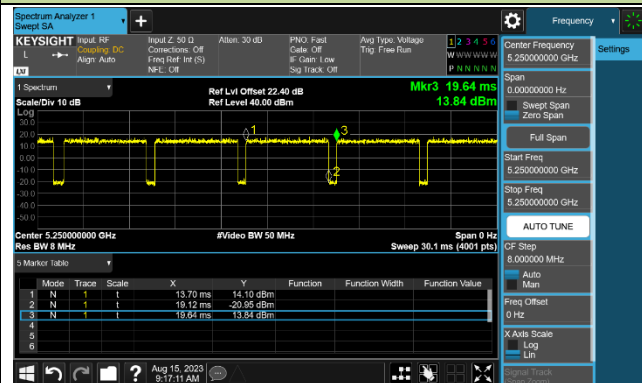

802.11ax-HE20

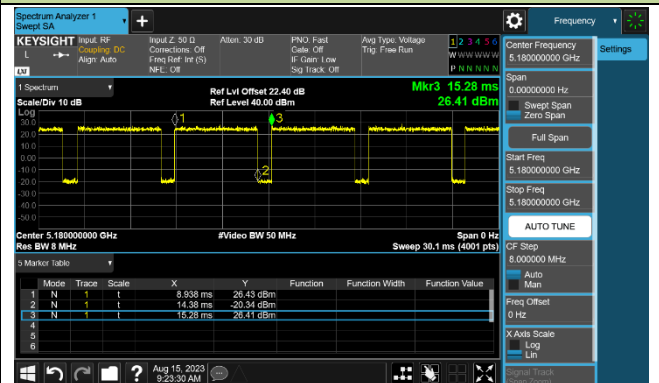

802.11ax-HE40

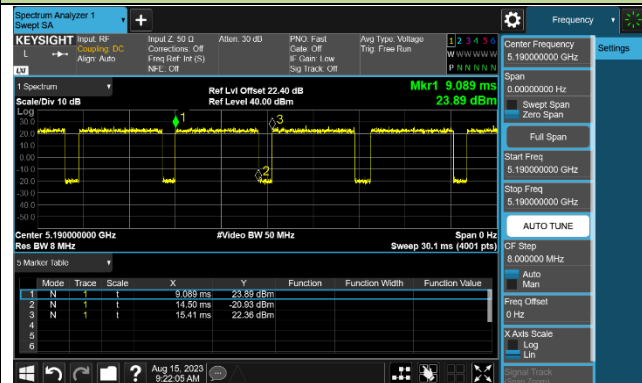

802.11ax-HE80

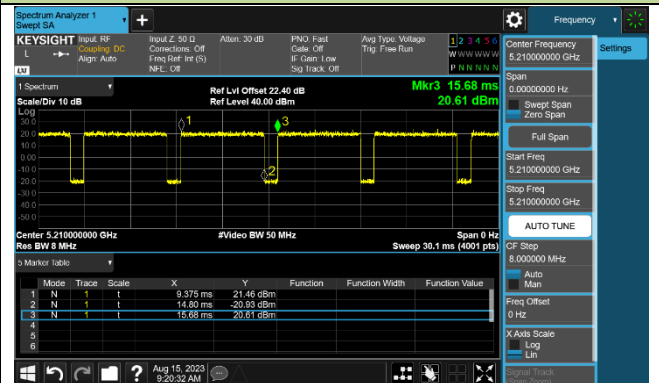

802.11ax-HE160

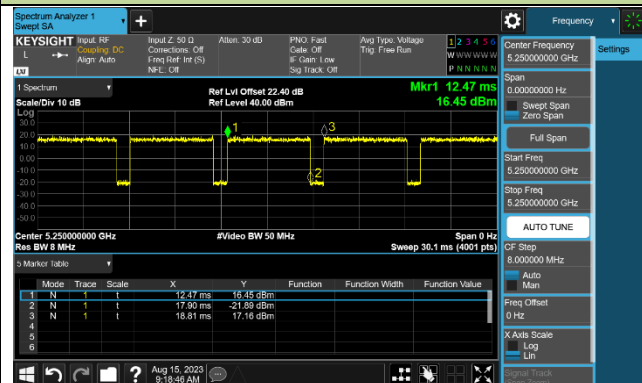

2.11. Test Configuration

The device was tested per the guidance of KDB 789033 D02v02r01. ANSI C63.10-2013 was used to reference the appropriate EUT setup for radiated spurious emissions testing and AC line conducted testing.

2.12. EMI Suppression Device(s)/Modifications

No EMI suppression device(s) were added and/or no modifications were made during testing.

2.13. Labeling Requirements

Per 2.1074 & 15.19; Docket 95-19

The label shall be permanently affixed at a conspicuous location on the device; instruction manual or pamphlet supplied to the user and be readily visible to the purchaser at the time of purchase.

However, when the device is so small wherein placement of the label with specified statement is not practical, only the FCC ID must be displayed on the device per Section 15.19(a)(5). Please see attachment for FCC ID label and label location.

3. DESCRIPTION OF TEST

3.1. Evaluation Procedure

The measurement procedures described in the American National Standard of Procedures for Compliance Testing of Unlicensed Wireless Devices (ANSI C63.10-2013), and the guidance provided in KDB 789033 D02v02r01 were used in the measurement.

3.2. AC Line Conducted Emissions

The line-conducted facility is located inside an 8'x4'x4' shielded enclosure. A 1m x 2m wooden table 80cm high is placed 40cm away from the vertical wall and 80cm away from the sidewall of the shielded room. Two 10kHz-30MHz, 50Ω/50uH Line-Impedance Stabilization Networks (LISNs) are bonded to the shielded room floor. Power to the LISNs is filtered by external high-current high-insertion loss power line filters. These filters attenuate ambient signal noise from entering the measurement lines. These filters are also bonded to the shielded enclosure.

The EUT is powered from one LISN and the support equipment is powered from the second LISN. All interconnecting cables more than 1 meter were shortened to a 1 meter length by non-inductive bundling (serpentine fashion) and draped over the back edge of the test table. All cables were at least 40cm above the horizontal reference ground-plane. Power cables for support equipment were routed down to the second LISN while ensuring that that cables were not draped over the second LISN.

Sufficient time for the EUT, support equipment, and test equipment was allowed in order for them to warm up to their normal operating condition. The RF output of the LISN was connected to the receiver and exploratory measurements were made to determine the frequencies producing the maximum emission from the EUT. The receiver was scanned from 150kHz to 30MHz. The detector function was set to peak mode for exploratory measurements while the bandwidth of the analyzer was set to 9kHz. The EUT, support equipment, and interconnecting cables were arranged and manipulated to maximize each emission. Each emission was also maximized by varying: power lines, the mode of operation or data exchange speed, or support equipment whichever determined the worst-case emission. Once the worst case emissions have been identified, the one EUT cable configuration/arrangement and mode of operation that produced these emissions are used for final measurements on the same test site. The analyzer is set to CISPR quasi-peak and average detectors with a 9kHz resolution bandwidth for final measurements.

An extension cord was used to connect to a single LISN which powered by EUT. The extension cord was calibrated with LISN, the impedance and insertion loss are compliance with the requirements as stated in ANSI C63.10-2013.

3.3. Radiated Emissions

The radiated test facilities consisted of an indoor 3 meter semi-anechoic chamber used for final measurements and exploratory measurements, when necessary. The measurement area is contained within the semi-anechoic chamber which is shielded from any ambient interference. For measurements above 1GHz absorbers are arranged on the floor between the turn table and the antenna mast in such a way so as to maximize the reduction of reflections. For measurements below 1GHz, the absorbers are removed. A MF Model 210SS turntable is used for radiated measurement. It is a continuously rotatable, remotecontrolled, metallic turntable and 2 meters (6.56 ft.) in diameter. The turn table is flush with the raised floor of the chamber in order to maintain its function as a ground plane. An 80cm high PVC support structure is placed on top of the turntable.

For all measurements, the spectrum was scanned through all EUT azimuths and from 1 to 4 meter receive antenna height using a broadband antenna from 30MHz up to the upper frequency shown in 15.33(b)(1) depending on the highest frequency generated or used in the device or on which the device operates or tunes. For frequencies above 1GHz, linearly polarized double ridge horn antennas were used. For frequencies below 30MHz, a calibrated loop antenna was used. When exploratory measurements were necessary, they were performed at 1 meter test distance inside the semi-anechoic chamber using broadband antennas, broadband amplifiers, and spectrum analyzers to determine the frequencies and modes producing the maximum emissions. Sufficient time for the EUT, support equipment, and test equipment was allowed in order for them to warm up to their normal operating condition. The test set-up for frequencies below 1GHz was placed on top of the 0.8 meter high, 1 x 1.5 meter table; and test set-up for frequencies 1-40GHz was placed on top of the 1.5 meter high, 1 x 1.5 meter table. The EUT, support equipment, and interconnecting cables were arranged and manipulated to maximize each emission. Appropriate precaution was taken to ensure that all emissions from the EUT were maximized and investigated. The system configuration, clock speed, mode of operation or video resolution, if applicable, turntable azimuth, and receive antenna height was noted for each frequency found.

Final measurements were made in the semi-anechoic chamber using calibrated, linearly polarized broadband and horn antennas. The test setup was configured to the setup that produced the worst case emissions. The spectrum analyzer was set to investigate all frequencies required for testing to compare the highest radiated disturbances with respect to the specified limits. The turntable containing the EUT was rotated through 360 degrees and the height of the receive antenna was varied 1 to 4 meters and stopped at the azimuth and height producing the maximum emission. Each emission was maximized by changing the orientation of the EUT through three orthogonal planes and changing the polarity of the receive antenna, whichever produced the worst-case emissions. According to 3dB Beam-Width of horn antenna, the horn antenna should be always directed to the EUT when rising height.

4. ANTENNA REQUIREMENTS

Excerpt from §15.203 of the FCC Rules/Regulations:

“An intentional radiator antenna shall be designed to ensure that no antenna other than that furnished by the responsible party can be used with the device. The use of a permanently attached antenna or of an antenna that uses a unique coupling to the intentional radiator shall be considered sufficient to comply with the provisions of this section.”

- The antenna of the device is **permanently attached**.
- There are no provisions for connection to an external antenna.

Conclusion:

The unit complies with the requirement of §15.203.

5. TEST EQUIPMENT CALIBRATION DATE

Conducted Emissions

Instrument	Manufacturer	Type No.	Asset No.	Cali. Interval	Cali. Due Date
Two-Line V-Network	R&S	ENV216	MRTTWA00019	1 year	2024/3/7
Two-Line V-Network	R&S	ENV216	MRTTWA00020	1 year	2024/4/17
EMI Test Receiver	R&S	ESR3	MRTTWA00045	1 year	2024/5/10
DIVA PLUS Funk-Wetterstation	TFA	35.1083	MRTTWA00050	1 year	2024/6/15

Radiated Emissions

Instrument	Manufacturer	Type No.	Asset No.	Cali. Interval	Cali. Due Date
Active Loop Antenna	SCHWARZBECK	FMZB 1519B	MRTTWA00002	1 year	2024/5/22
Broadband TRILOG Antenna	SCHWARZBECK	VULB 9162	MRTTWA00001	1 year	2023/12/21
Broadband Hornantenna	RFSPIN	DRH18-E	MRTTWA00087	1 year	2024/5/17
Broadband Preamplifier	EMC Instruments corporation	EMC118A45SE	MRTTWA00088	1 year	2024/5/17
Breitband Hornantenna	SCHWARZBECK	BBHA 9170	MRTTWA00004	1 year	2024/3/20
Broadband Amplifier	SCHWARZBECK	BBV 9721	MRTTWA00006	1 year	2024/3/27
EMI Test Receiver	R&S	ESR3	MRTTWA00009	1 year	2024/3/8
Signal Analyzer	R&S	FSVA3044	MRTTWA00092	1 year	2024/6/29
Antenna Cable	HUBERSUHNER	SF106	MRTTWE00034	1 year	2024/6/26
Cable	HUBERSUHNER	EMC105-NM-N M-3000	MRTTWE00035	1 year	2024/6/26
Temperature/Humidity Meter	TFA	35.1078.10.IT	MRTTWA00032	1 year	2024/6/4

Conducted Test Equipment

Instrument	Manufacturer	Type No.	Asset No.	Cali. Interval	Cali. Due Date
X-Series USB Peak and Average Power Sensor	KEYSIGHT	U2021XA	MRTTWA00014	1 year	2024/4/19
EXA Signal Analyzer	KEYSIGHT	N9010A	MRTTWA00012	1 year	2023/10/5
EXA Signal Analyzer	KEYSIGHT	N9010B	MRTTWA00074	1 year	2024/7/19
Attenuator	WTI	218FS-20	MRTTWE00026	1 year	2023/11/2
Attenuator	WTI	218FS-10	MRTTWE00027	1 year	2024/6/14
Temperature & Humidity Chamber	TEN BILLION	TTH-B3UP	MRTTWA00036	1 year	2024/6/11
DIVA PLUS Funk-Wetterstation	TFA	35.1083	MRTTWA00050	1 year	2024/6/15

Test Software

Software	Version	Function
e3	9.160520a	EMI Test Software

6. MEASUREMENT UNCERTAINTY

Where relevant, the following test uncertainty levels have been estimated for tests performed on the EUT as specified in CISPR 16-4-2. This uncertainty represents an expanded uncertainty expressed at approximately the 95% confidence level using a coverage factor of $k = 2$.

AC Conducted Emission Measurement
Measuring Uncertainty for a Level of Confidence of 95% ($U=2Uc(y)$): 150kHz~30MHz: $\pm 2.53\text{dB}$
Radiated Emission Measurement
Measuring Uncertainty for a Level of Confidence of 95% ($U=2Uc(y)$): 9kHz ~ 1GHz: $\pm 4.25\text{dB}$ 1GHz ~ 40GHz: $\pm 4.45\text{dB}$
Conducted Power (Carrier Power / Power Density)
Measuring Uncertainty for a Level of Confidence of 95% ($U=2Uc(y)$): $\pm 0.84\text{dB}$
Conducted Spurious Emission
Measuring Uncertainty for a Level of Confidence of 95% ($U=2Uc(y)$): $\pm 2.65\text{ dB}$
Occupied Bandwidth
Measuring Uncertainty for a Level of Confidence of 95% ($U=2Uc(y)$): $\pm 3.3\%$
Temp. / Humidity
Measuring Uncertainty for a Level of Confidence of 95% ($U=2Uc(y)$): $\pm 0.82^\circ\text{C} / \pm 3\%$
Frequency Error
Measuring Uncertainty for a Level of Confidence of 95% ($U=2Uc(y)$): $\pm 78.4\text{Hz}$

7. TEST RESULT

7.1. Summary

FCC Section(s)	Test Description	Test Limit	Test Condition	Test Result	Reference
15.407(a)	26dB Bandwidth	N/A	Conducted	Pass	Section 7.2
15.407(e)	6dB Bandwidth	$\geq 500\text{kHz}$		Pass	Section 7.3
15.407(a)(1)(ii), (2), (3)	Maximum Conducted Output Power	Refer to section 7.4		Pass	Section 7.4
15.407(h)(1)	Transmit Power Control	$\leq 24 \text{ dBm}$		Pass	Section 7.5
15.407(a)(1)(ii), (2), (3), (12)	Peak Power Spectral Density	Refer to section 7.6		Pass	Section 7.6
15.407(g)	Frequency Stability	N/A		Pass	Section 7.7
15.407(b)(1), (2), (3), (4)(i)	Undesirable Emissions	Refer to Section 7.8	Radiated	Pass	Section 7.8 & 7.9
15.205, 15.209 15.407(b)(8), (9), (10)	General Field Strength Limits (Restricted Bands and Radiated Emission Limits)	Emissions in restricted bands must meet the radiated limits detailed in 15.209		Pass	
15.207	AC Conducted Emissions 150kHz - 30MHz	< FCC 15.207 limits	Line Conducted	Pass	Section 7.10

Notes:

- 1) Determining compliance is based on the test results met the regulation limits or requirements declared by clients, and the test results don't take into account the value of measurement uncertainty.
- 2) The analyzer plots shown in this section were all taken with a correction table loaded into the analyzer. The correction table was used to account for the losses of the cables and attenuators used as part of the system to connect the EUT to the analyzer at all frequencies of interest.
- 3) For radiated emission test, every axis (X, Y, Z) was also verified. The test results shown in the following sections represent the worst-case emissions.

7.2. 26dB Bandwidth Measurement

7.2.1. Test Limit

N/A

7.2.2. Test Procedure used

KDB 789033 D02v02r01- Section C.1

7.2.3. Test Setting

1. The analyzers' automatic bandwidth measurement capability was used to perform the 26dB bandwidth measurement. The "X" dB bandwidth parameter was set to $X = 26$. The automatic bandwidth measurement function also has the capability of simultaneously measuring the 99% occupied bandwidth. The bandwidth measurement was not influenced by any intermediated power nulls in the fundamental emission.
2. RBW = approximately 1% of the emission bandwidth.
3. VBW $\geq 3 \times$ RBW.
4. Detector = Peak.
5. Trace mode = max hold.

7.2.4. Test Setup

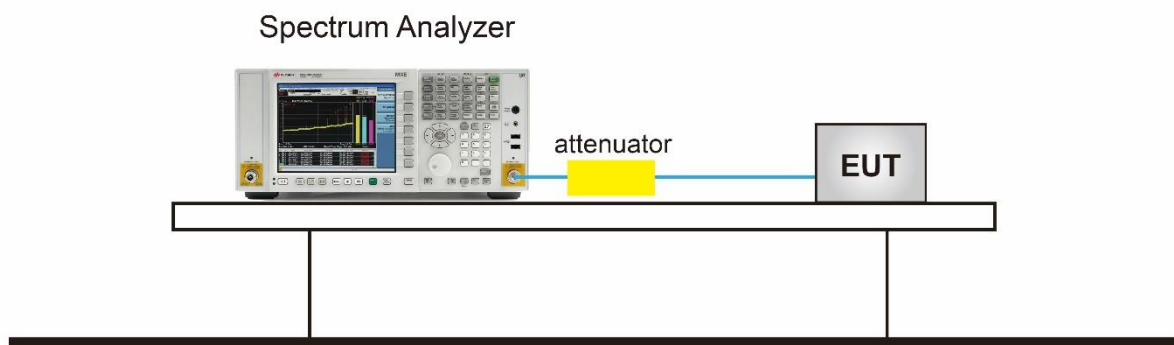

7.2.5. Test Result

Product	AX5400 Ceiling Mount Wi-Fi 6 Access Point	Test Engineer	Xuan Yu
Test Site	SR5	Test Date	2023/08/18

Test Mode	Data Rate/ MCS	Channel No.	Frequency (MHz)	26dB Bandwidth (MHz)	99% Bandwidth (MHz)
Ant 1					
802.11a	6Mbps	36	5180	19.970	16.514
802.11a	6Mbps	44	5220	20.340	16.533
802.11a	6Mbps	48	5240	19.980	16.519
802.11a	6Mbps	52	5260	19.320	16.534
802.11a	6Mbps	60	5300	19.430	16.516
802.11a	6Mbps	64	5320	19.640	16.498
802.11a	6Mbps	100	5500	18.920	16.515
802.11a	6Mbps	116	5580	19.330	16.499
802.11a	6Mbps	140	5700	19.260	16.518
802.11a	6Mbps	144	5720	19.950	16.524
802.11a	6Mbps	149	5745	23.030	16.748
802.11a	6Mbps	157	5785	24.820	16.703
802.11a	6Mbps	165	5825	22.130	16.618
802.11ac-VHT20	MCS0	36	5180	20.280	17.738
802.11ac-VHT20	MCS0	44	5220	20.680	17.771
802.11ac-VHT20	MCS0	48	5240	20.750	17.752
802.11ac-VHT20	MCS0	52	5260	20.340	17.750
802.11ac-VHT20	MCS0	60	5300	20.950	17.732
802.11ac-VHT20	MCS0	64	5320	20.300	17.749
802.11ac-VHT20	MCS0	100	5500	20.950	17.727
802.11ac-VHT20	MCS0	116	5580	21.220	17.753
802.11ac-VHT20	MCS0	140	5700	20.710	17.755
802.11ac-VHT20	MCS0	144	5720	20.440	17.772
802.11ac-VHT20	MCS0	149	5745	22.520	17.863
802.11ac-VHT20	MCS0	157	5785	21.680	17.822
802.11ac-VHT20	MCS0	165	5825	22.180	17.801

Test Mode	Data Rate/ MCS	Channel No.	Frequency (MHz)	26dB Bandwidth (MHz)	99% Bandwidth (MHz)
Ant 1					
802.11ac-VHT40	MCS0	38	5190	38.410	35.941
802.11ac-VHT40	MCS0	46	5230	39.230	36.027
802.11ac-VHT40	MCS0	54	5270	39.040	36.058
802.11ac-VHT40	MCS0	62	5310	39.100	36.046
802.11ac-VHT40	MCS0	102	5510	38.810	36.026
802.11ac-VHT40	MCS0	110	5550	38.970	35.971
802.11ac-VHT40	MCS0	134	5670	38.980	35.972
802.11ac-VHT40	MCS0	142	5710	39.240	35.992
802.11ac-VHT40	MCS0	151	5755	39.570	36.097
802.11ac-VHT40	MCS0	159	5795	39.960	36.070
802.11ac-VHT80	MCS0	42	5210	80.020	75.385
802.11ac-VHT80	MCS0	58	5290	80.640	75.441
802.11ac-VHT80	MCS0	106	5530	80.220	75.566
802.11ac-VHT80	MCS0	122	5610	81.070	75.405
802.11ac-VHT80	MCS0	138	5690	79.980	75.486
802.11ac-VHT80	MCS0	155	5775	88.370	75.701
802.11ac-VHT160	MCS0	50	5250	161.400	153.520
802.11ac-VHT160	MCS0	114	5570	161.400	153.610
802.11ax-HE20	MCS0	36	5180	20.570	19.046
802.11ax-HE20	MCS0	44	5220	21.590	19.121
802.11ax-HE20	MCS0	48	5240	21.460	19.018
802.11ax-HE20	MCS0	52	5260	20.940	19.047
802.11ax-HE20	MCS0	60	5300	21.360	19.034
802.11ax-HE20	MCS0	64	5320	21.290	19.055
802.11ax-HE20	MCS0	100	5500	21.230	19.115
802.11ax-HE20	MCS0	116	5580	21.410	19.021
802.11ax-HE20	MCS0	140	5700	21.150	19.052
802.11ax-HE20	MCS0	144	5720	20.750	19.075
802.11ax-HE20	MCS0	149	5745	22.830	19.090
802.11ax-HE20	MCS0	157	5785	23.540	19.110
802.11ax-HE20	MCS0	165	5825	21.490	19.075

Test Mode	Data Rate/ MCS	Channel No.	Frequency (MHz)	26dB Bandwidth (MHz)	99% Bandwidth (MHz)
Ant 1					
802.11ax-HE40	MCS0	38	5190	39.990	37.716
802.11ax-HE40	MCS0	46	5230	39.560	37.751
802.11ax-HE40	MCS0	54	5270	40.140	37.638
802.11ax-HE40	MCS0	62	5310	39.800	37.635
802.11ax-HE40	MCS0	102	5510	39.550	37.654
802.11ax-HE40	MCS0	110	5550	39.720	37.676
802.11ax-HE40	MCS0	134	5670	39.720	37.749
802.11ax-HE40	MCS0	142	5710	40.030	37.757
802.11ax-HE40	MCS0	151	5755	39.840	37.786
802.11ax-HE40	MCS0	159	5795	39.640	37.674
802.11ax-HE80	MCS0	42	5210	81.270	77.049
802.11ax-HE80	MCS0	58	5290	81.130	77.096
802.11ax-HE80	MCS0	106	5530	80.610	77.254
802.11ax-HE80	MCS0	122	5610	80.760	77.126
802.11ax-HE80	MCS0	138	5690	81.510	77.219
802.11ax-HE80	MCS0	155	5775	81.300	77.413
802.11ax-HE160	MCS0	50	5250	163.200	154.940
802.11ax-HE160	MCS0	114	5570	162.000	155.250

802.11a 26dB Bandwidth & 99% Bandwidth

Channel 36 (5180MHz)

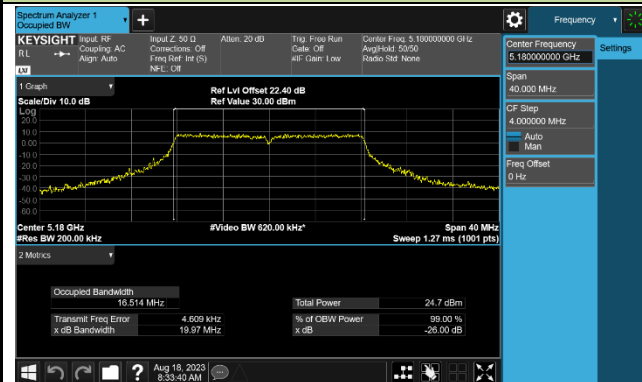

Channel 44 (5220MHz)

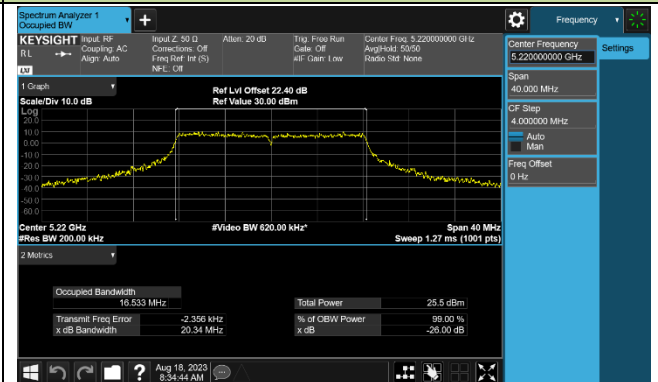

Channel 48 (5240MHz)

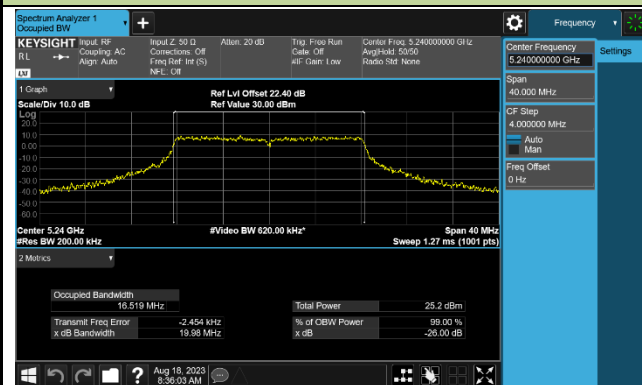

Channel 52 (5260MHz)

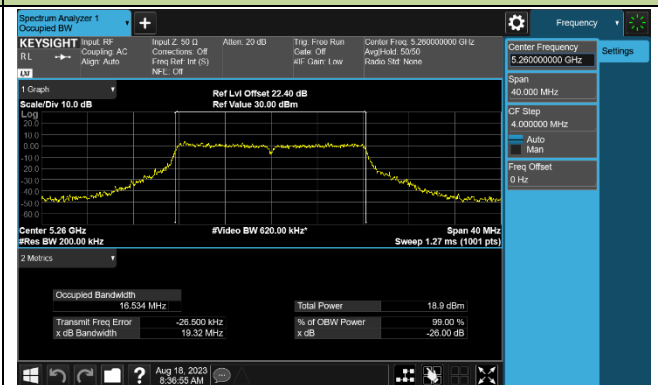

Channel 60 (5300MHz)

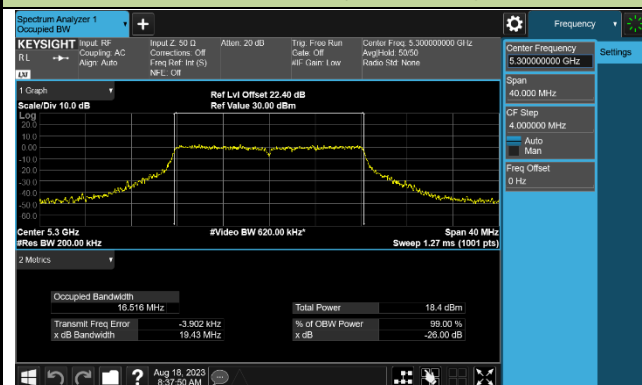

Channel 64 (5320MHz)

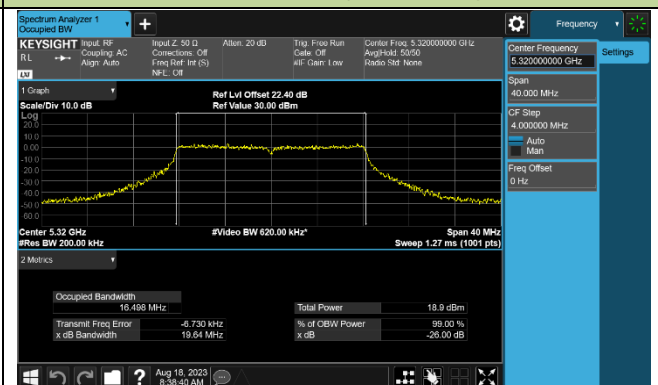

Channel 100 (5500MHz)

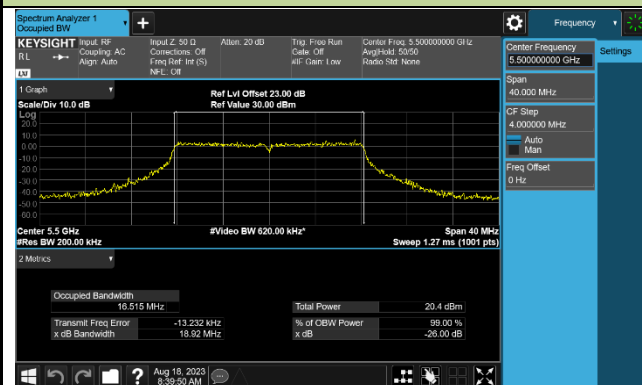

Channel 116 (5580MHz)

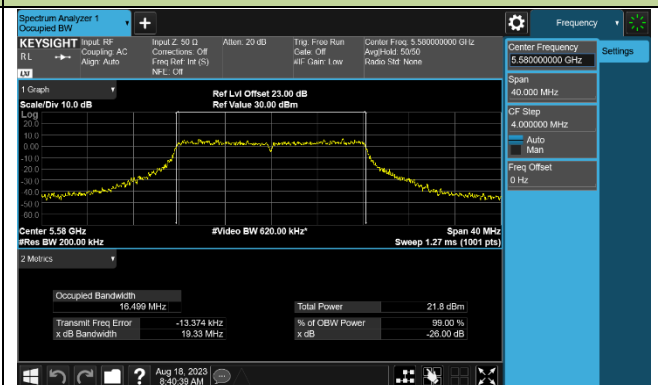

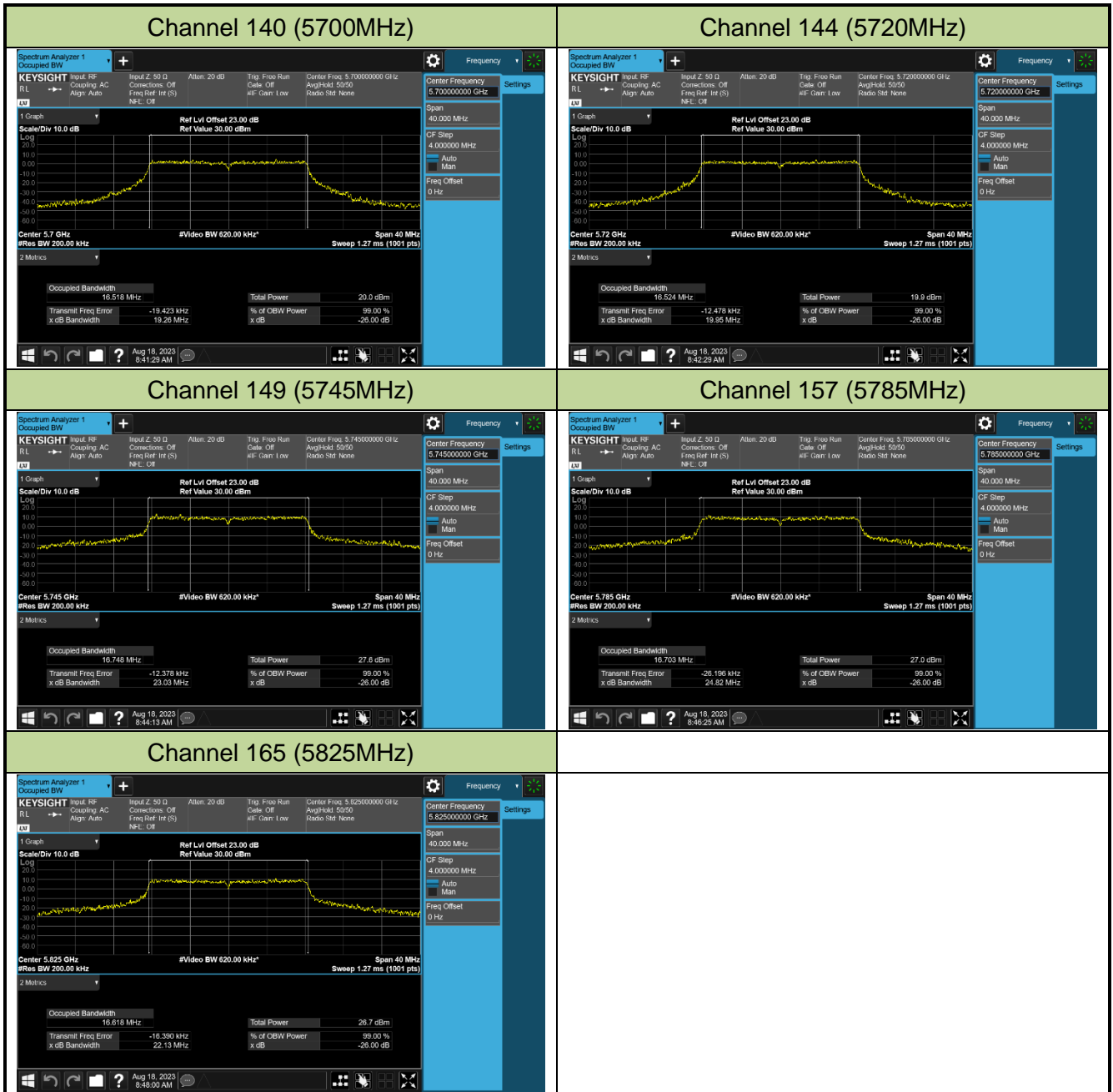

802.11ac-VHT20 26dB Bandwidth & 99% Bandwidth

Channel 36 (5180MHz)

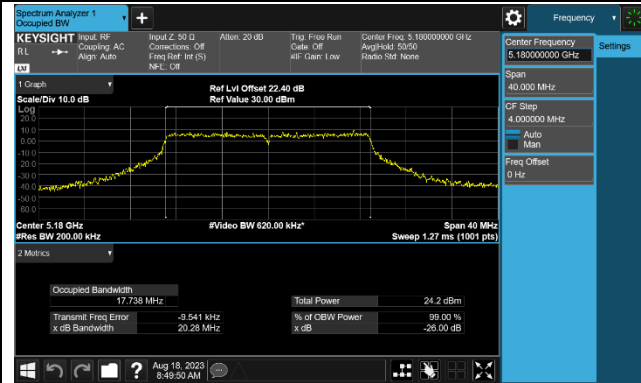

Channel 44 (5220MHz)

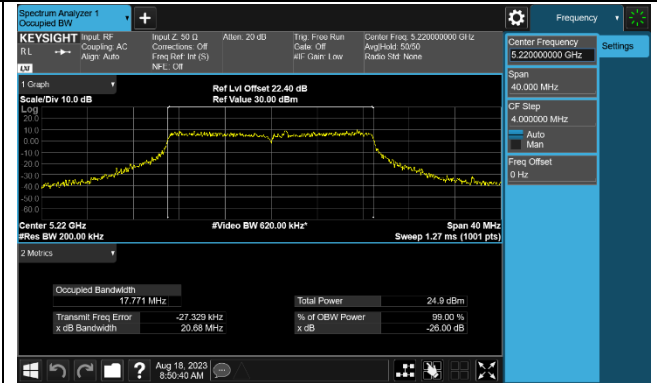

Channel 48 (5240MHz)

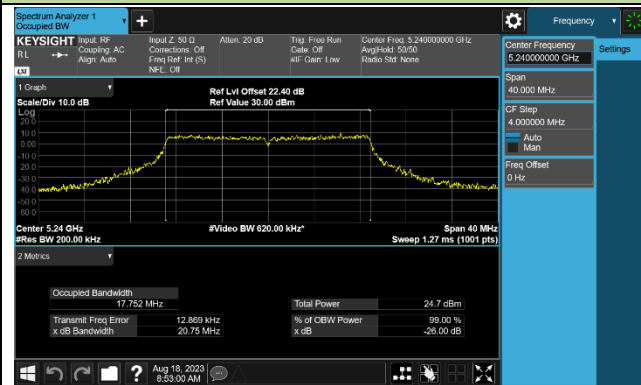

Channel 52 (5260MHz)

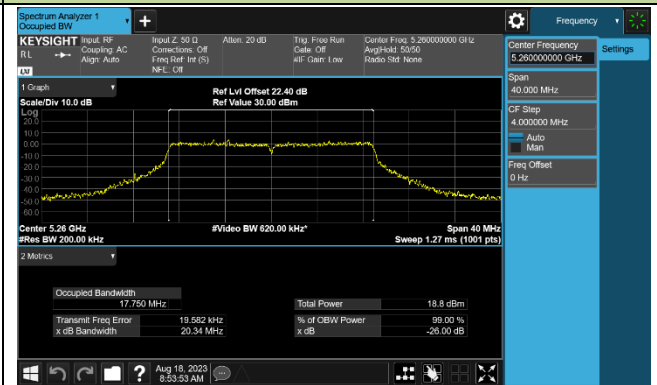

Channel 60 (5300MHz)

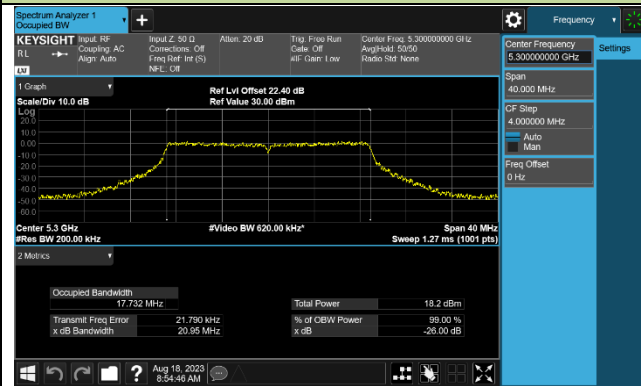

Channel 64 (5320MHz)

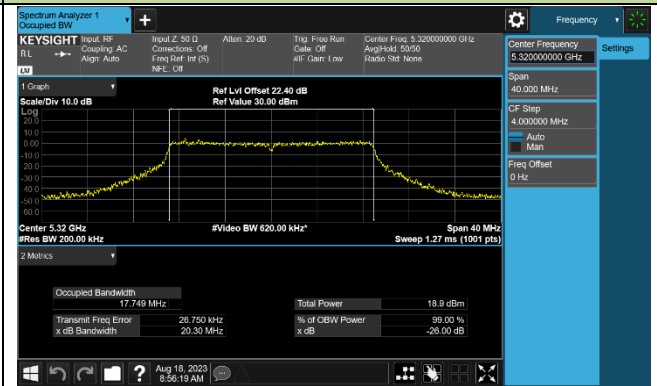

Channel 100 (5500MHz)

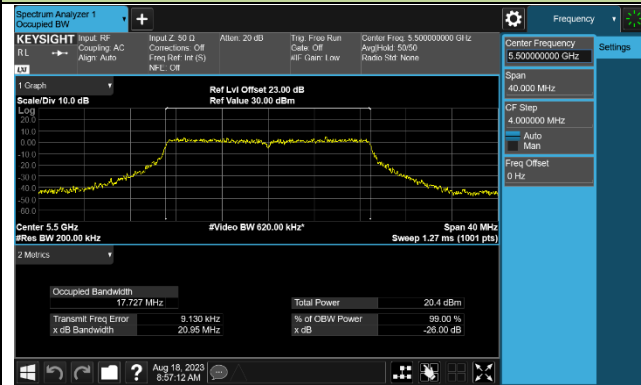

Channel 116 (5580MHz)

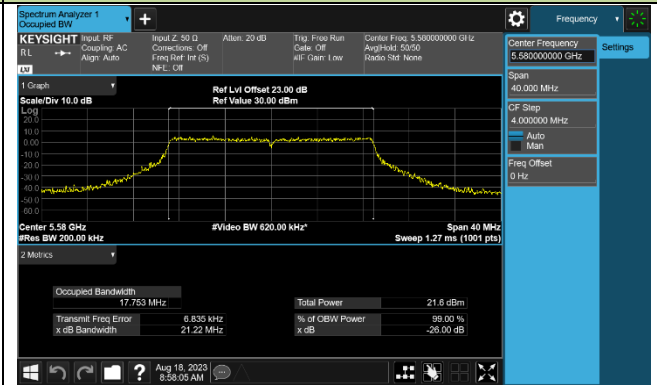

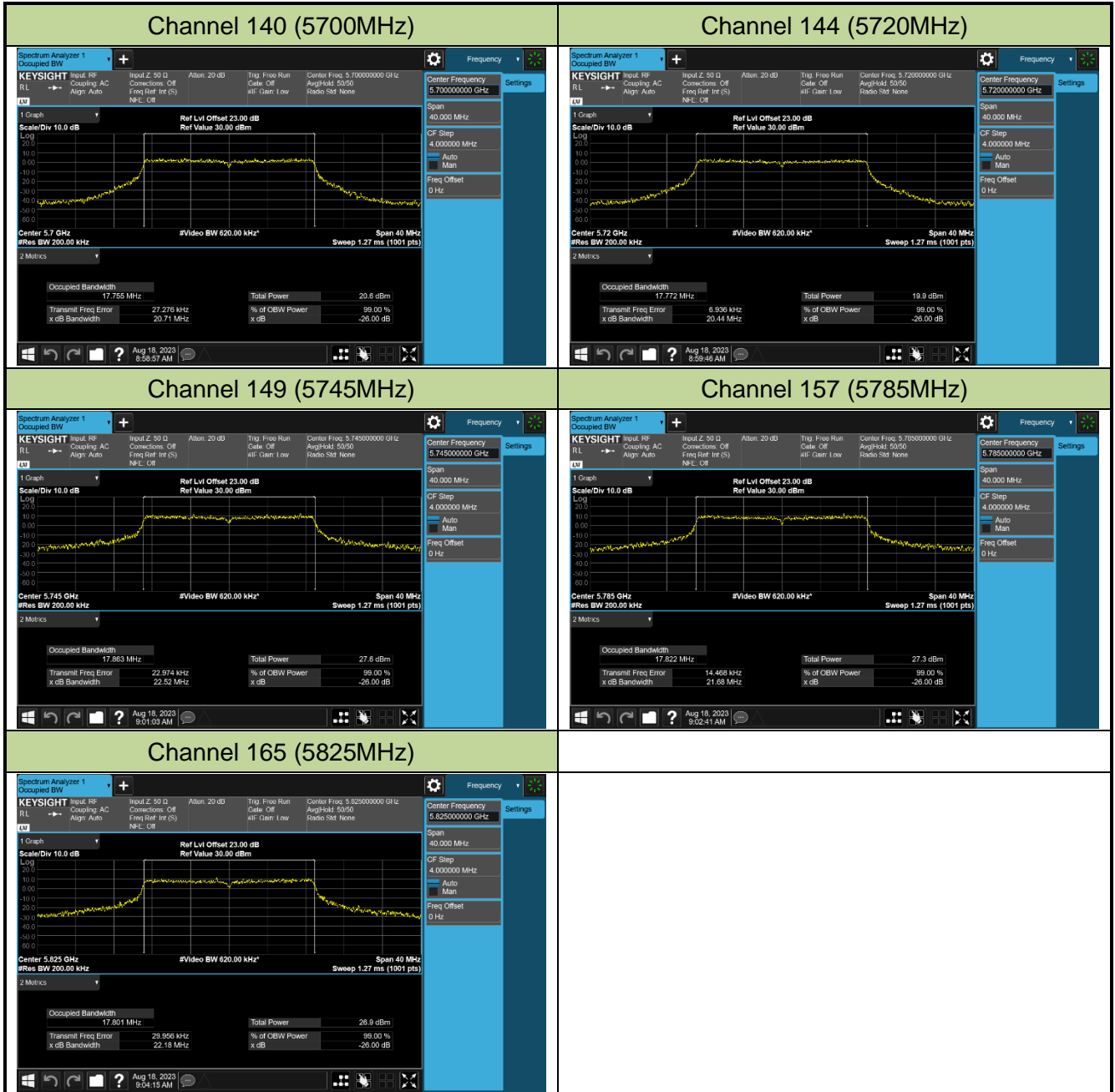

802.11ac-VHT40 26dB Bandwidth & 99% Bandwidth

Channel 38 (5190MHz)

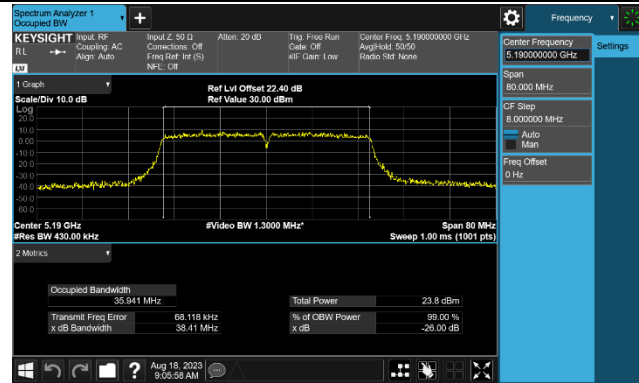

Channel 46 (5230MHz)

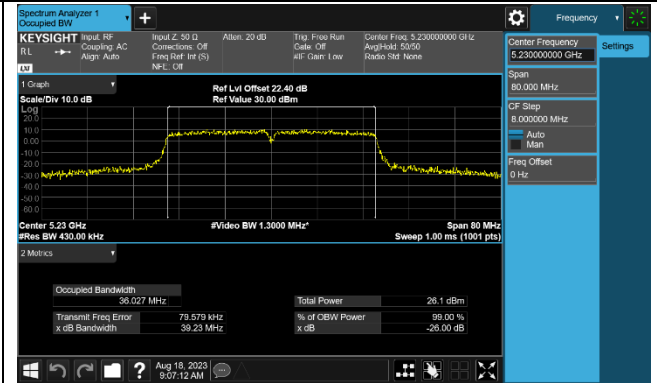

Channel 54 (5270MHz)

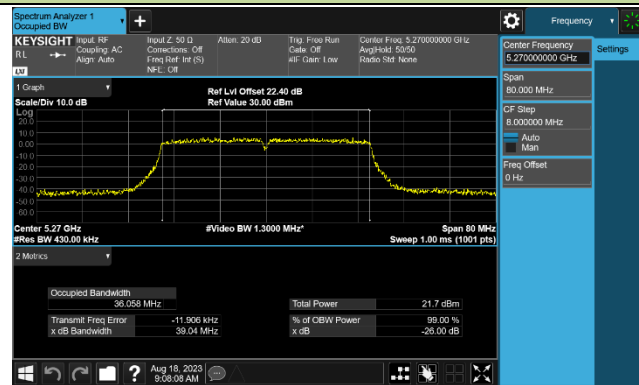

Channel 62 (5310MHz)

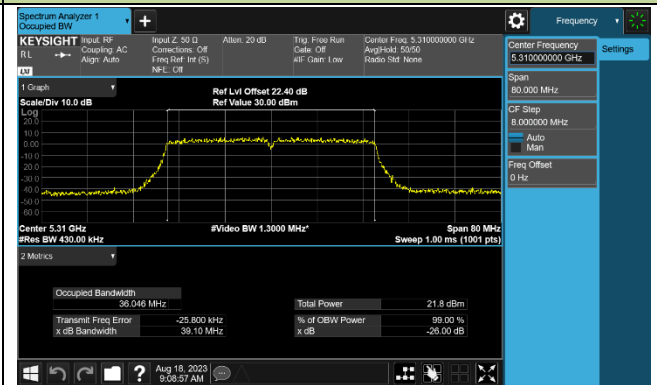

Channel 102 (5510MHz)

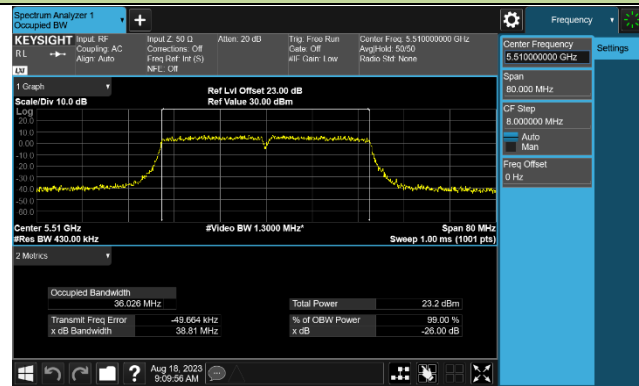

Channel 110 (5550MHz)

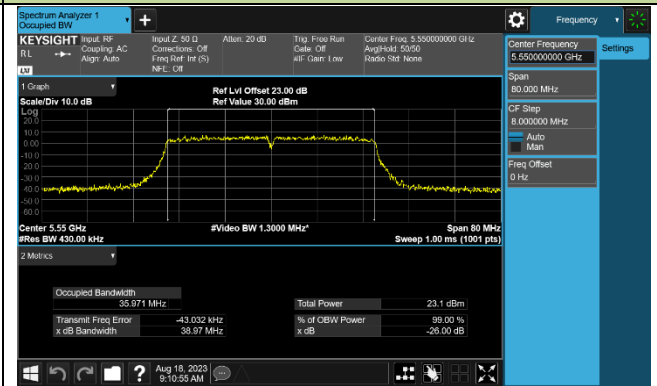

Channel 134 (5670MHz)

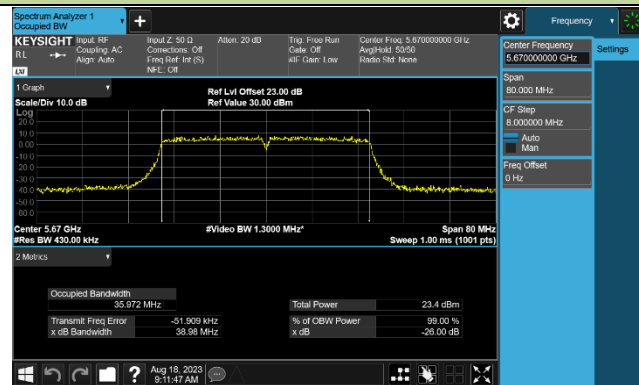

Channel 142 (5710MHz)

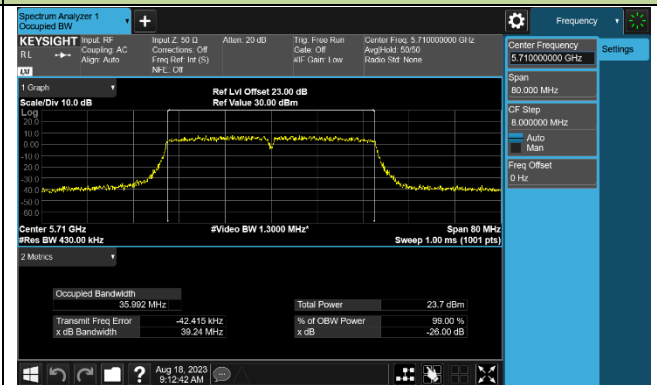

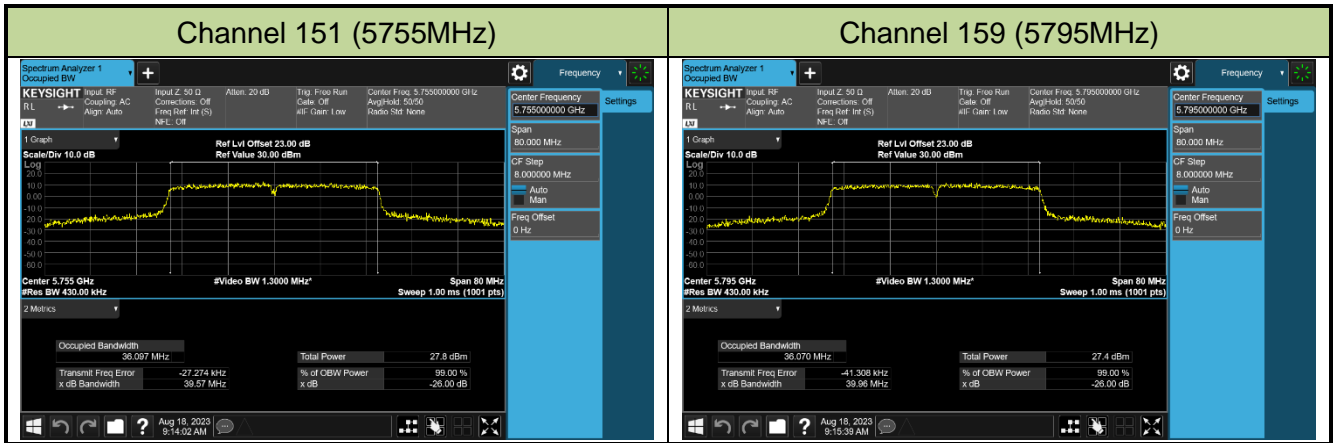

802.11ac-VHT80 26dB Bandwidth & 99% Bandwidth

Channel 42 (5210MHz)

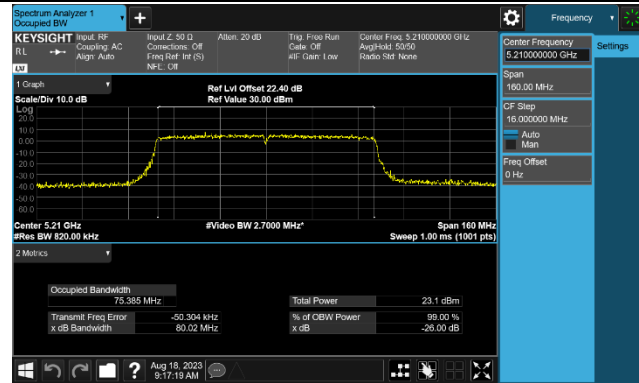

Channel 58 (5290MHz)

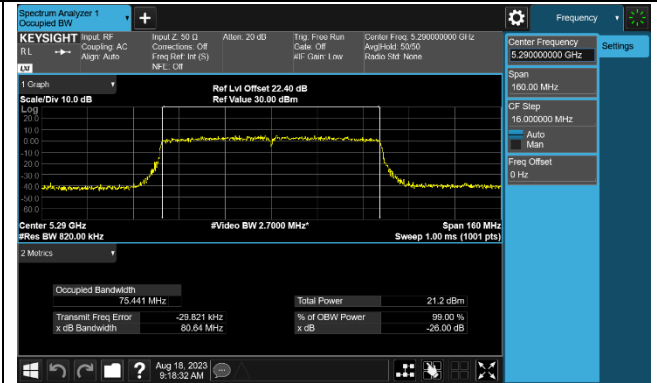

Channel 106 (5530MHz)

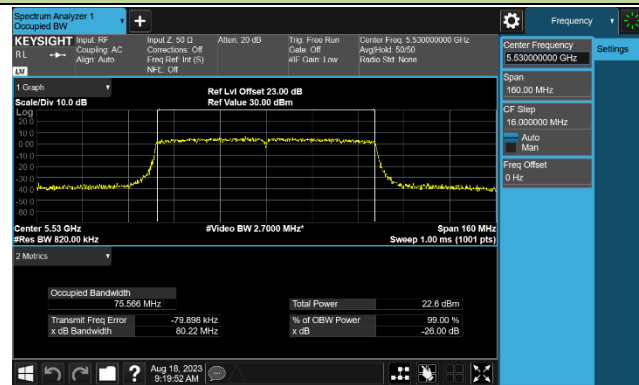

Channel 122 (5610MHz)

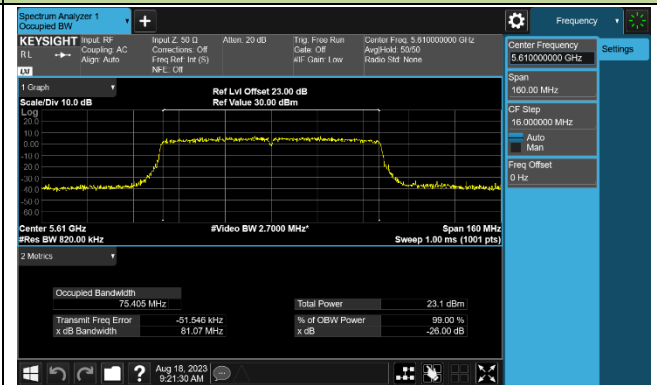

Channel 138 (5690MHz)

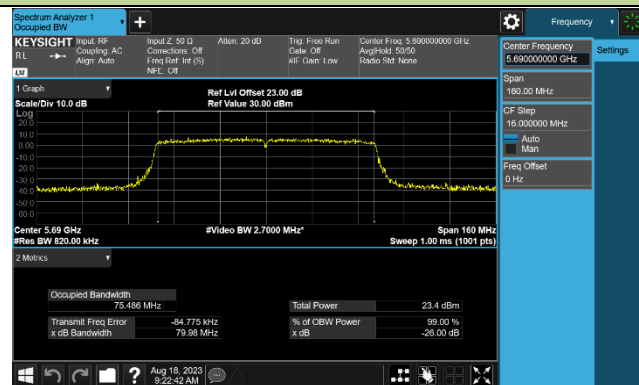

Channel 155 (5775MHz)

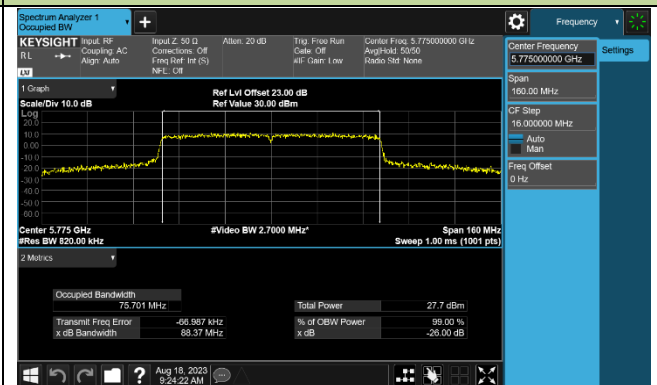

802.11ac-VHT160 26dB Bandwidth & 99% Bandwidth

Channel 50 (5250MHz)

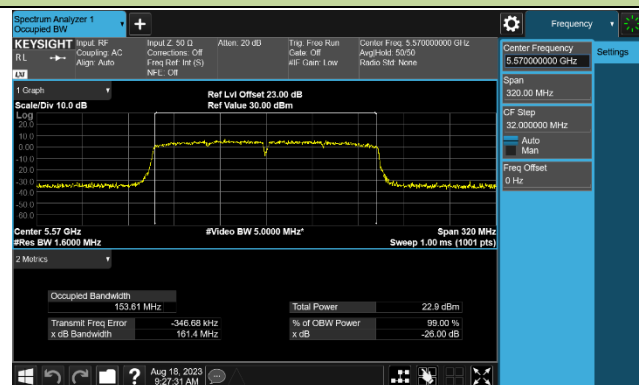

Channel 114 (5570MHz)

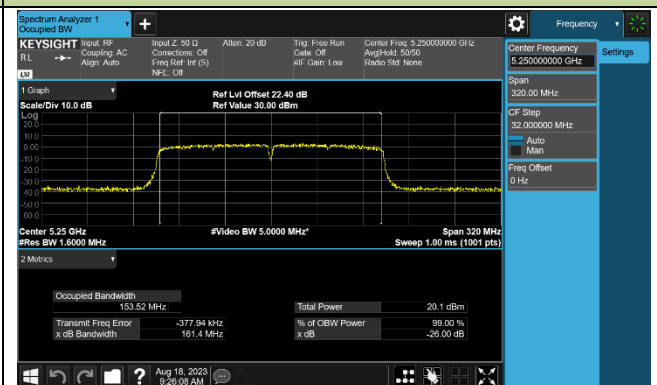

802.11ax-HE20 26dB Bandwidth & 99% Bandwidth

Channel 36 (5180MHz)

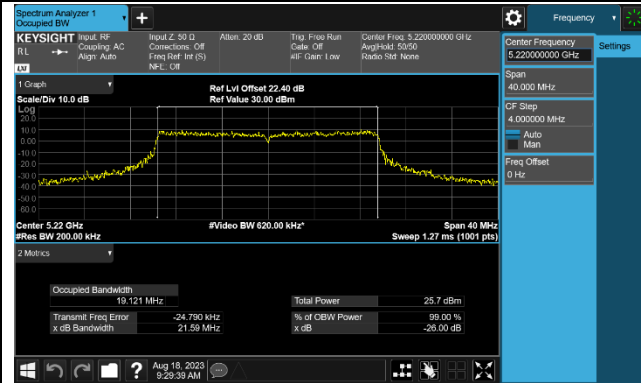

Channel 44 (5220MHz)

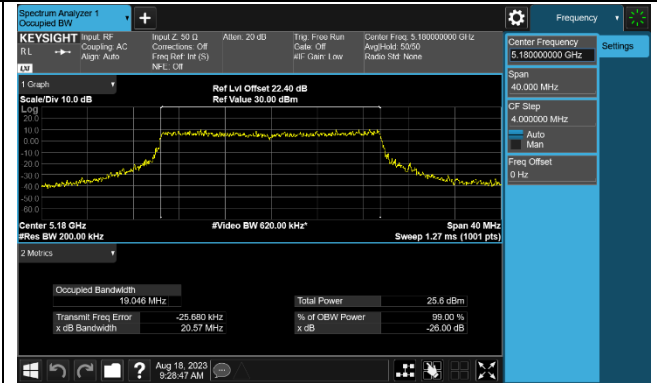

Channel 48 (5240MHz)

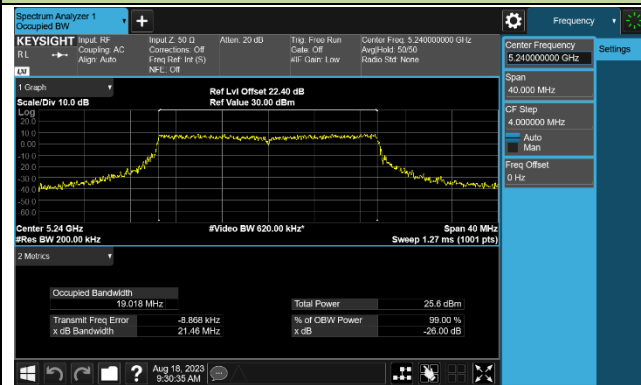

Channel 52 (5260MHz)

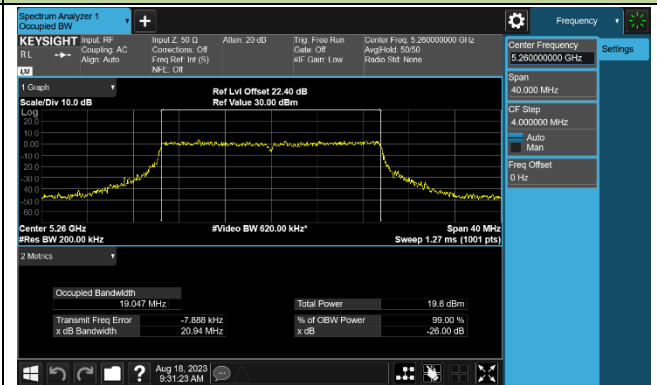

Channel 60 (5300MHz)

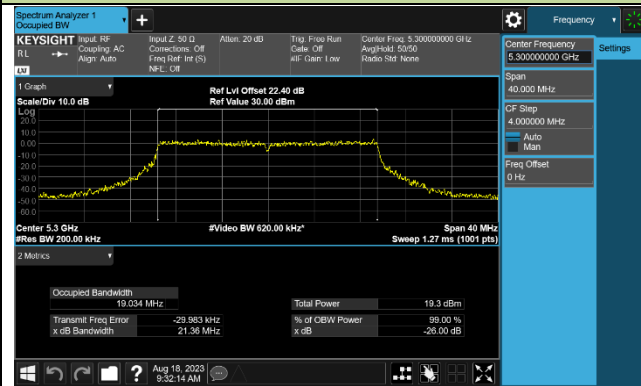

Channel 64 (5320MHz)

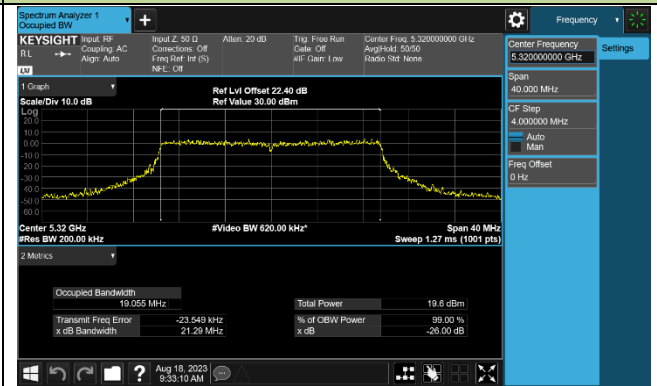

Channel 100 (5500MHz)

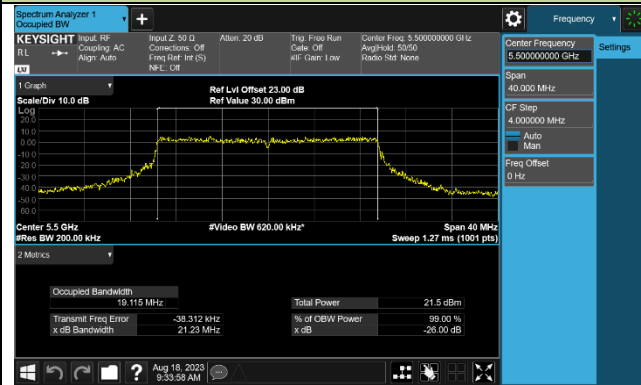

Channel 116 (5580MHz)

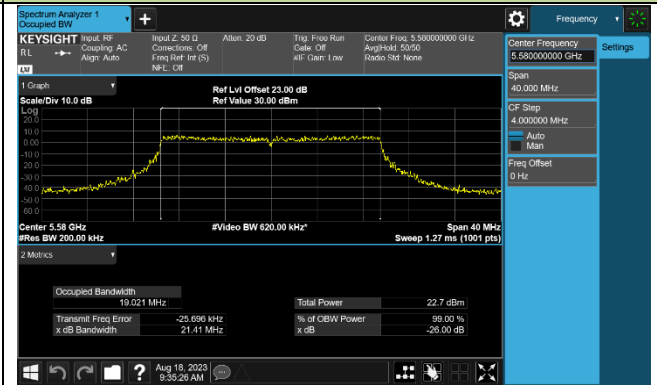

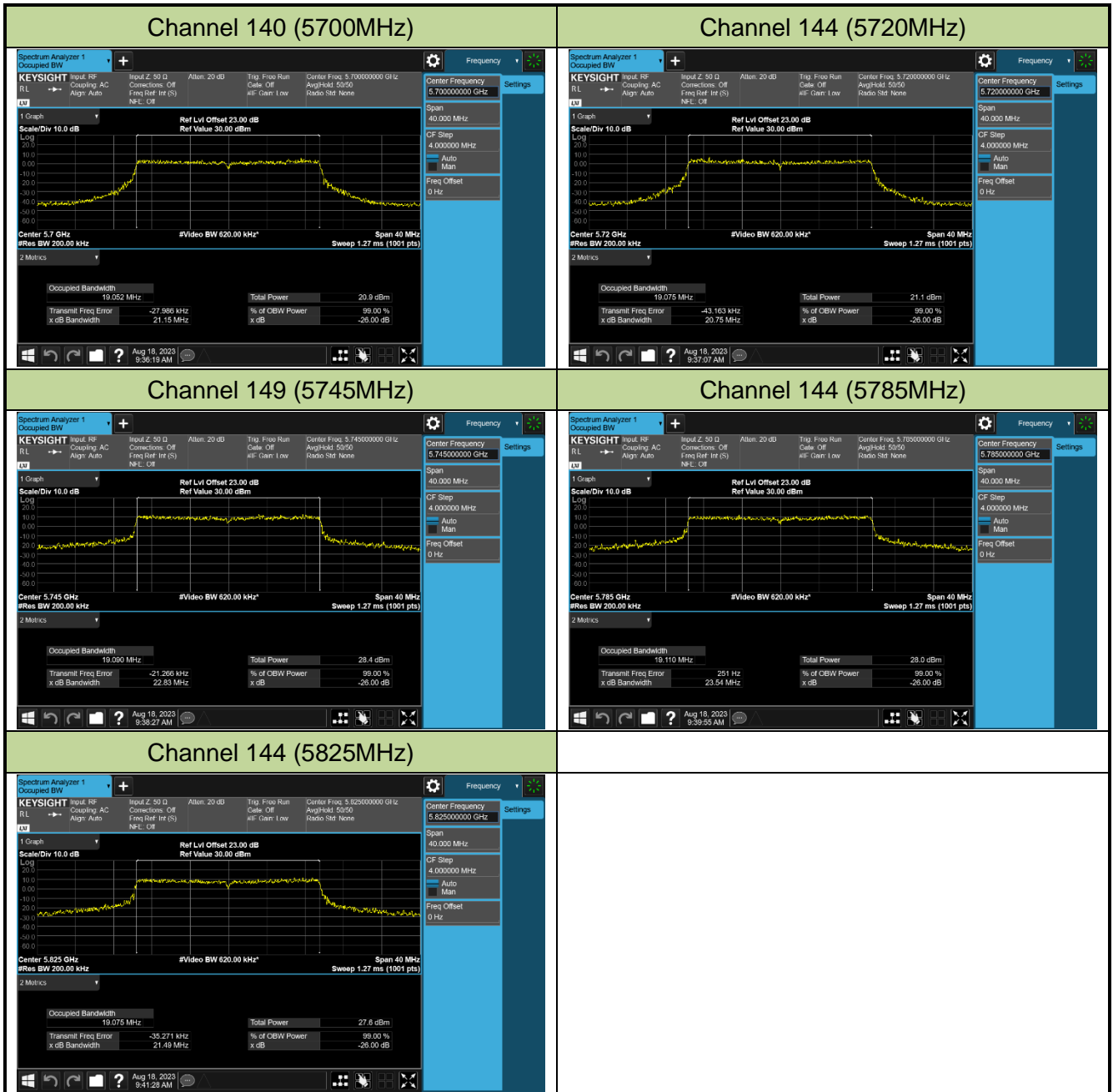

802.11ax-HE40 26dB Bandwidth & 99% Bandwidth

Channel 38 (5190MHz)

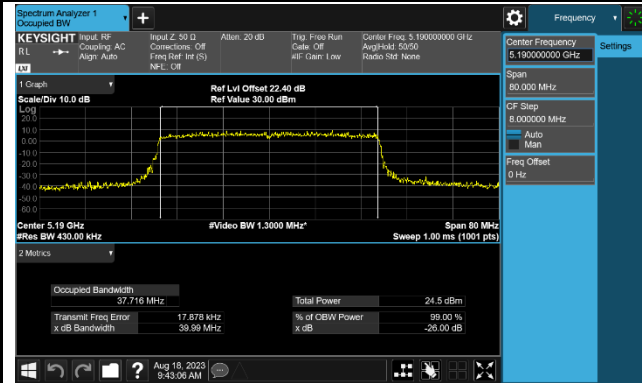

Channel 46 (5230MHz)

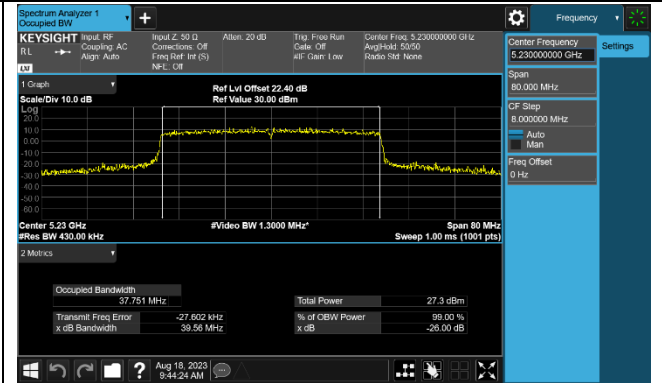

Channel 54 (5270MHz)

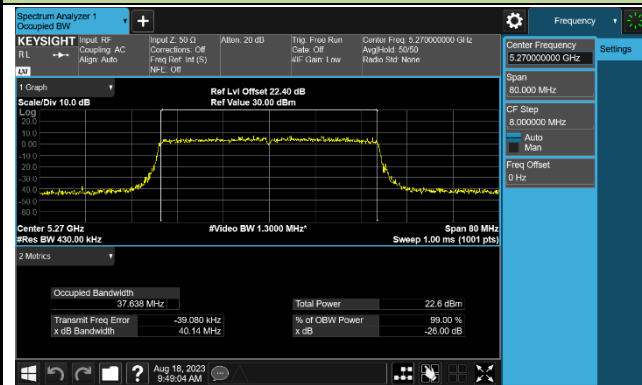

Channel 62 (5310MHz)

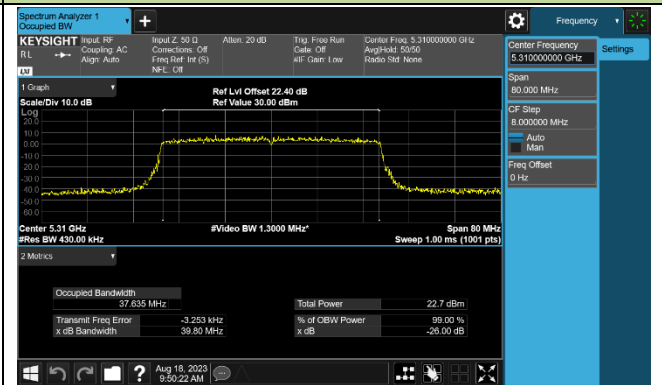

Channel 102 (5510MHz)

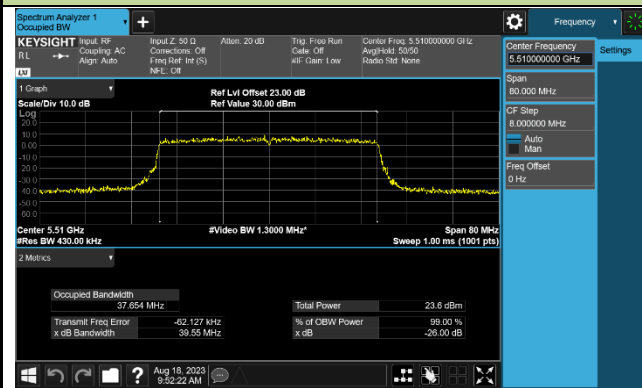

Channel 110 (5550MHz)

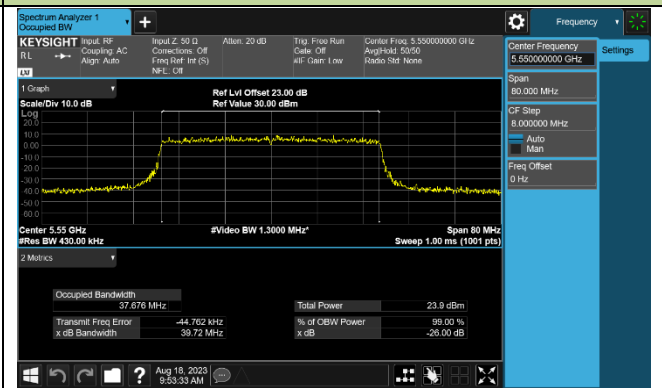

Channel 134 (5670MHz)

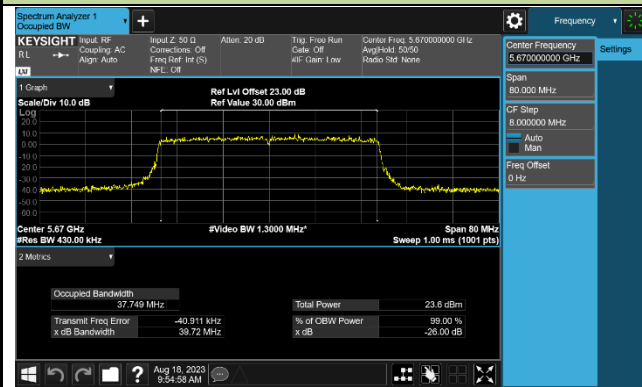

Channel 142 (5710MHz)

