

802.11ax-HE80 Power Spectral Density - Ant 0

Channel 42 (5210MHz)

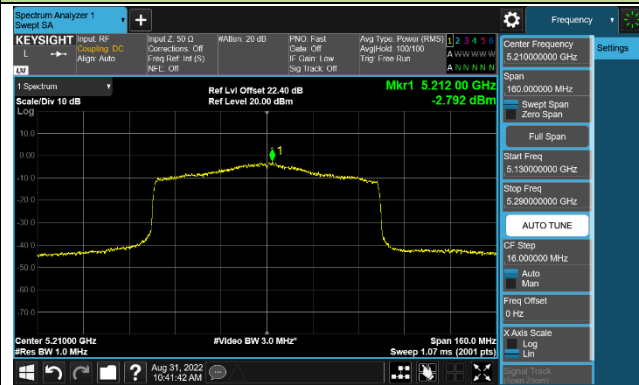

Channel 58 (5290MHz)

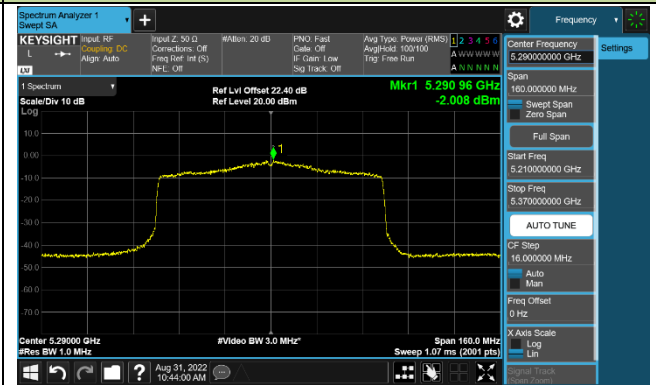

Channel 106 (5530MHz)

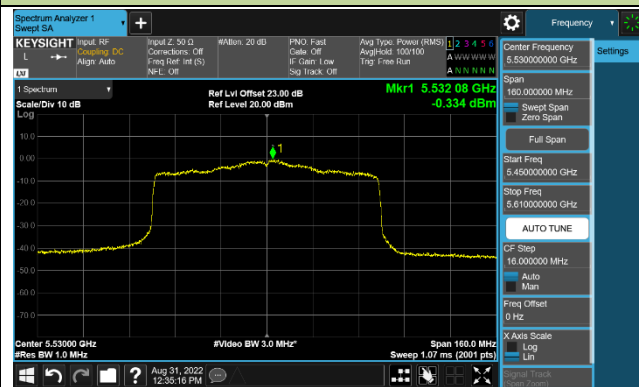

Channel 122 (5610MHz)

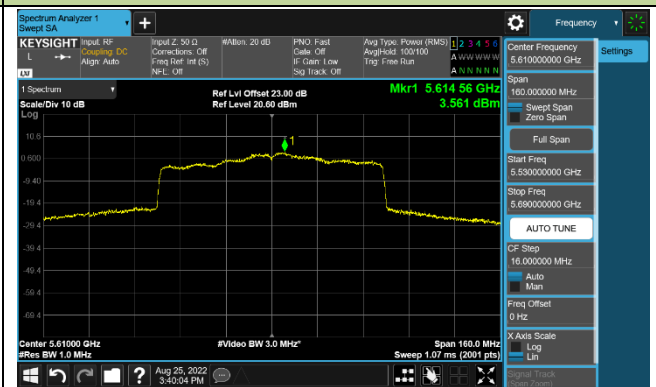

Channel 155 (5775MHz)



802.11ax-HE160 Power Spectral Density - Ant 0

Channel 50 (5250MHz)

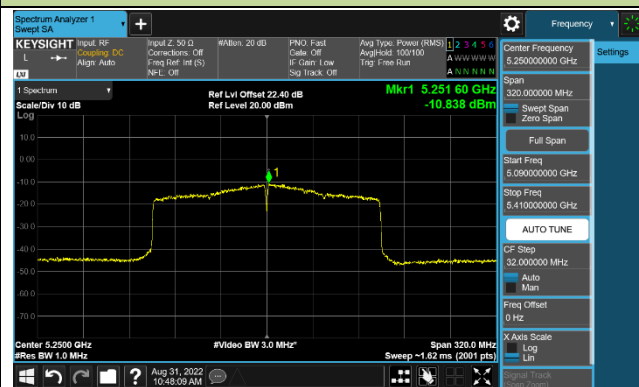

Channel 114 (5570MHz)

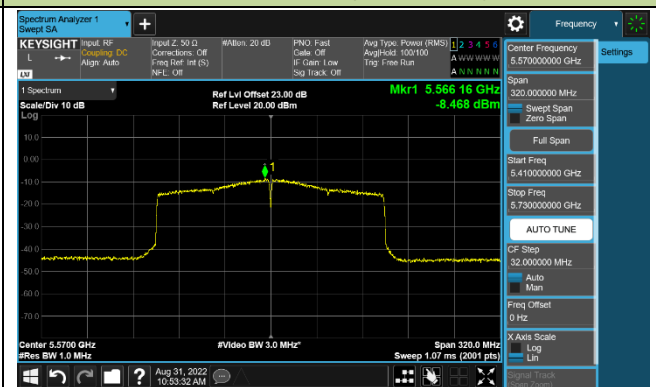

802.11a Power Spectral Density - Ant 1

Channel 36 (5180MHz)

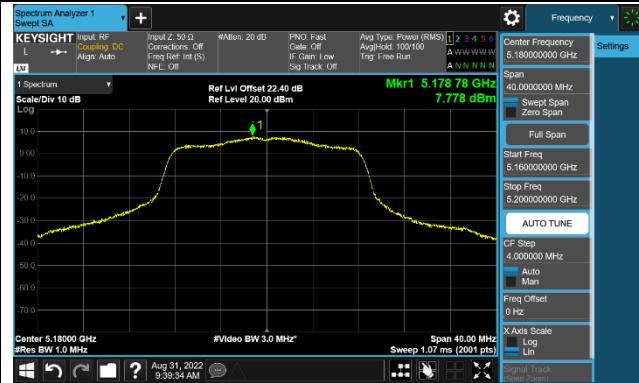

Channel 44 (5220MHz)

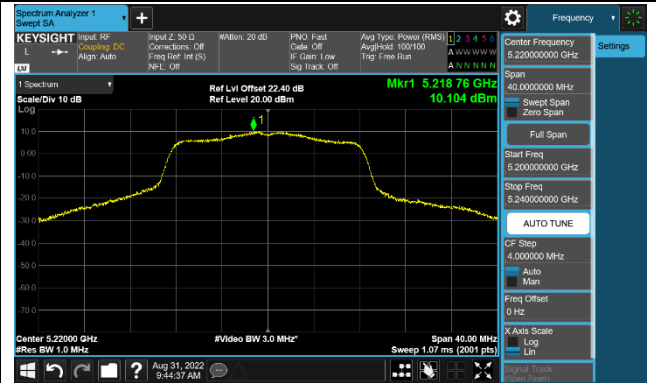

Channel 48 (5240MHz)

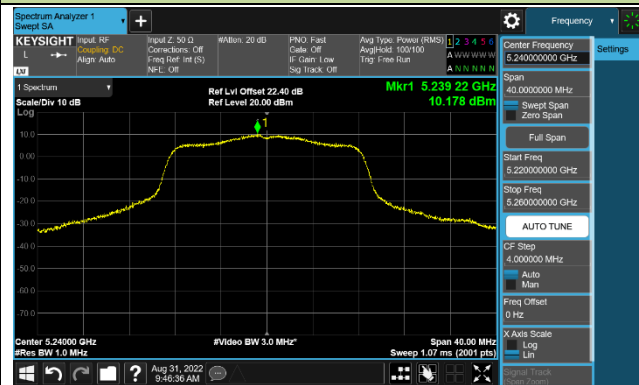

Channel 52 (5260MHz)

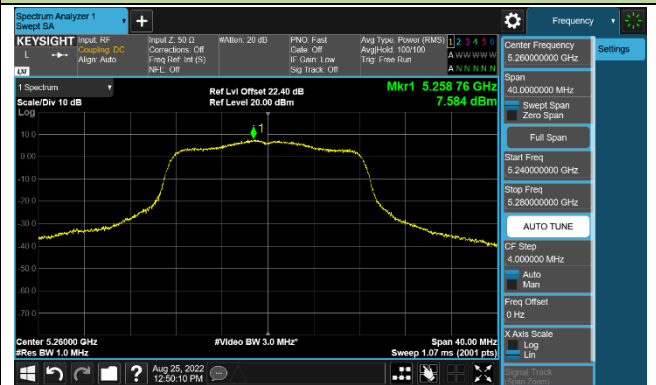

Channel 60 (5300MHz)

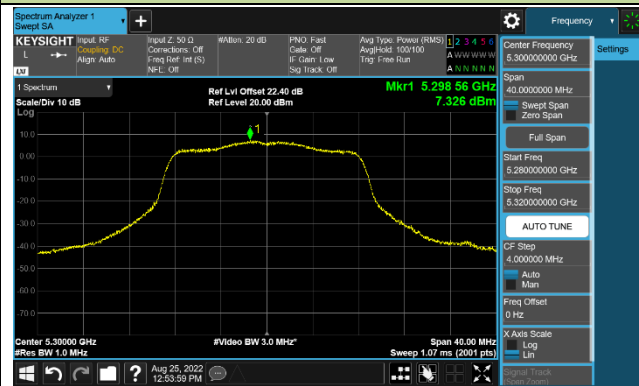

Channel 64 (5320MHz)

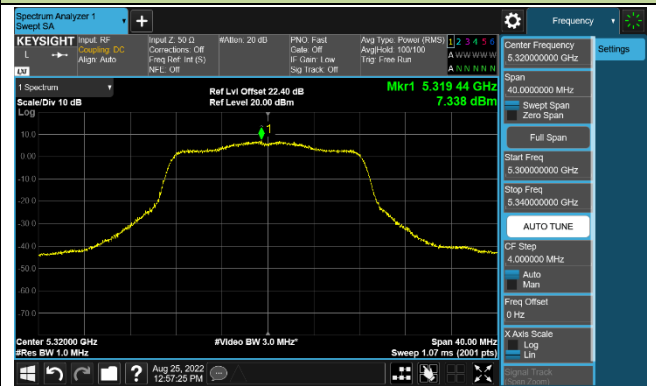

Channel 100 (5500MHz)

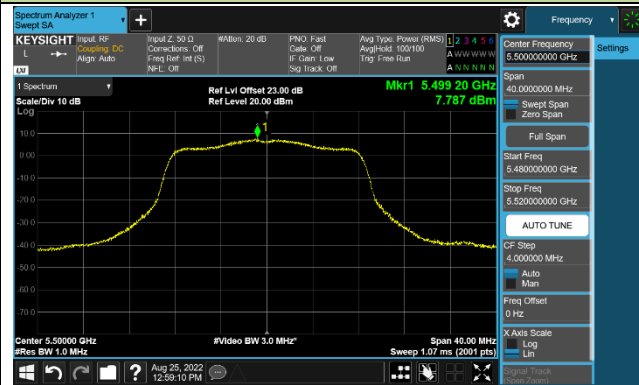

Channel 116 (5580MHz)

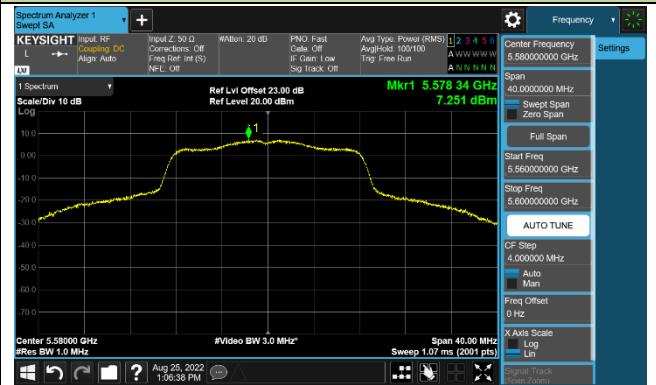

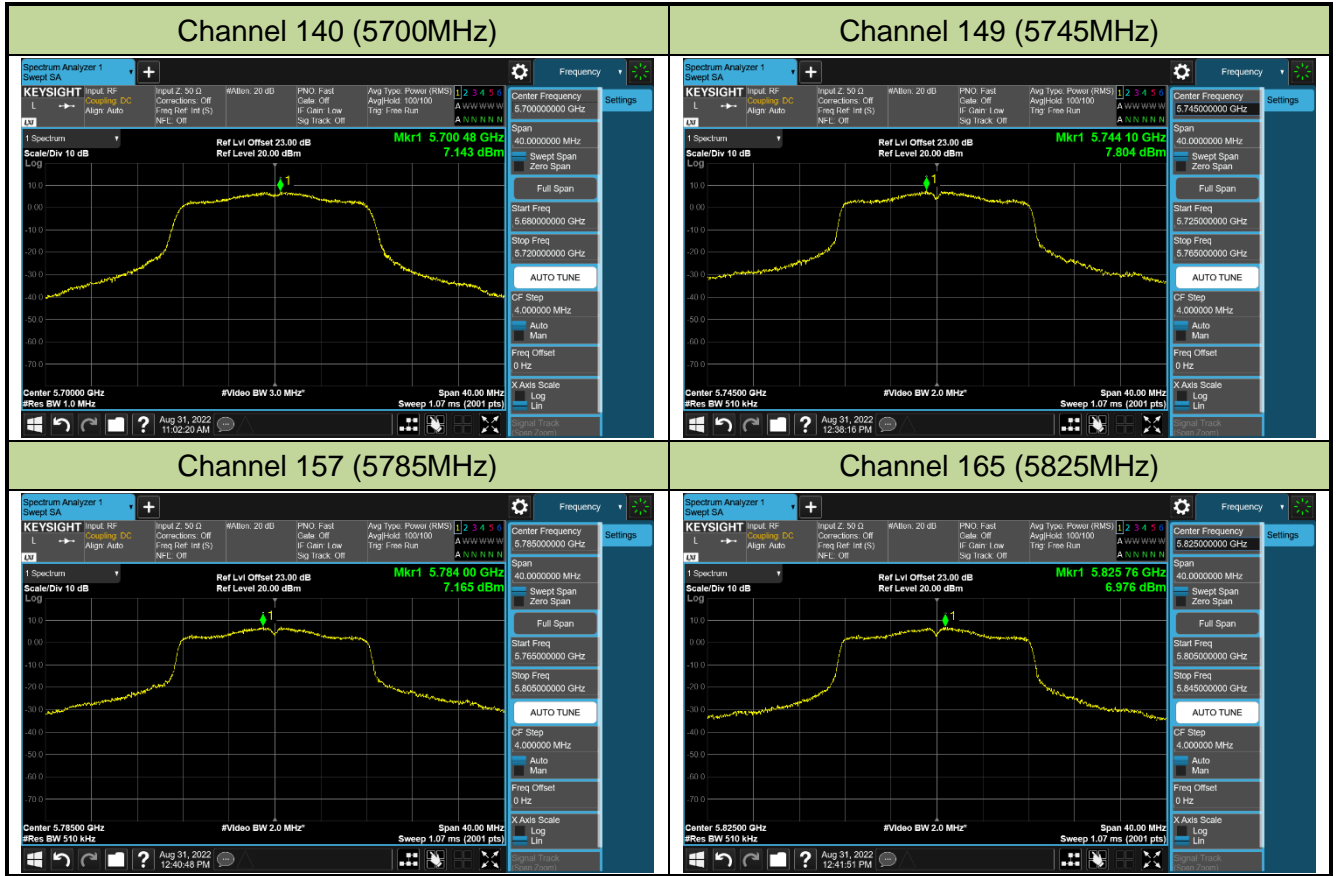

802.11ac-VHT20 Power Spectral Density - Ant 1

Channel 36 (5180MHz)

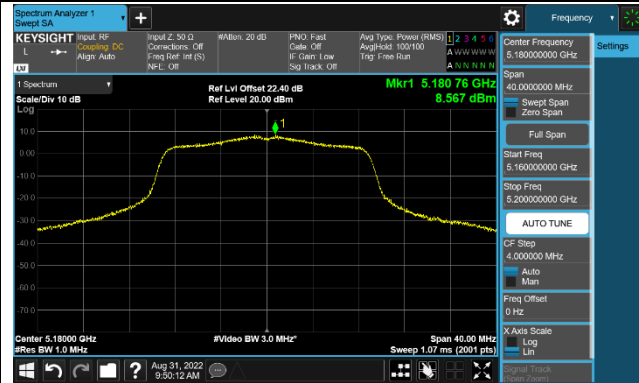

Channel 44 (5220MHz)

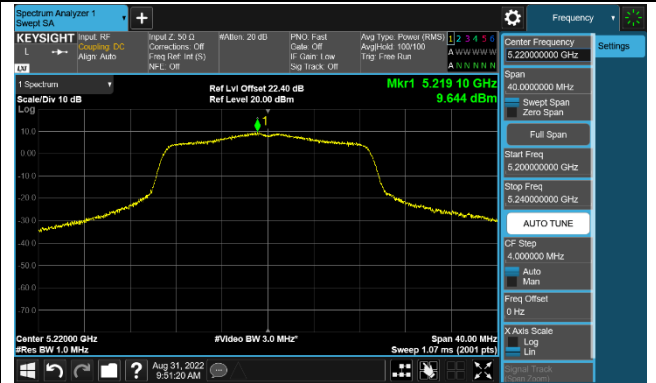

Channel 48 (5240MHz)

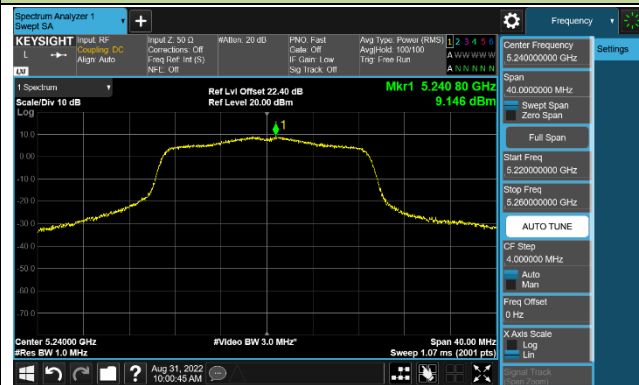

Channel 52 (5260MHz)

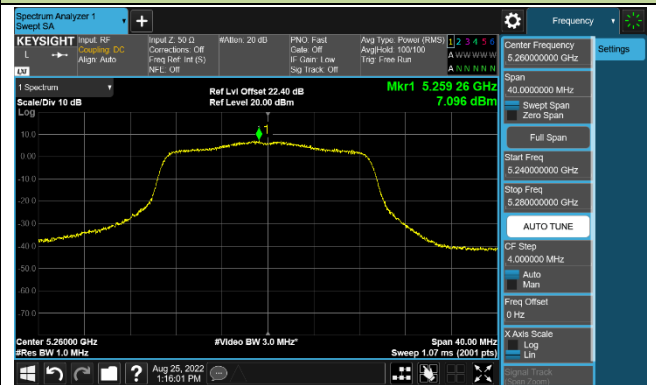

Channel 60 (5300MHz)

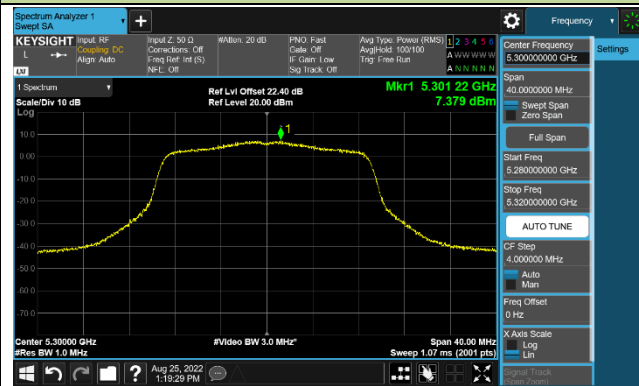

Channel 64 (5320MHz)

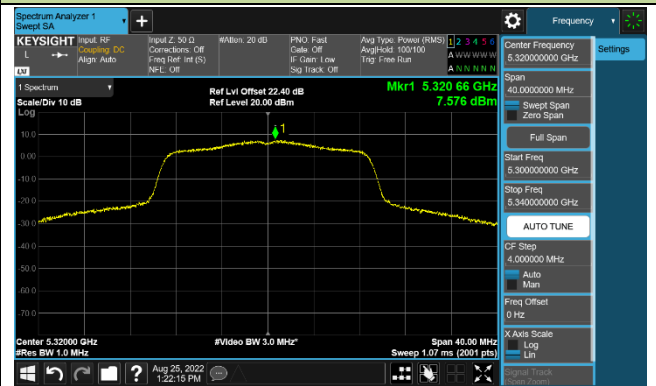

Channel 100 (5500MHz)

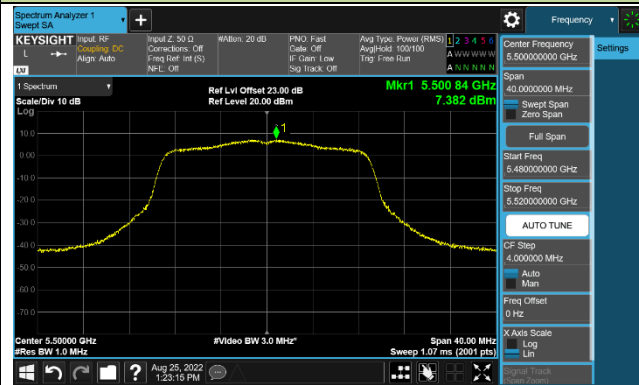

Channel 116 (5580MHz)

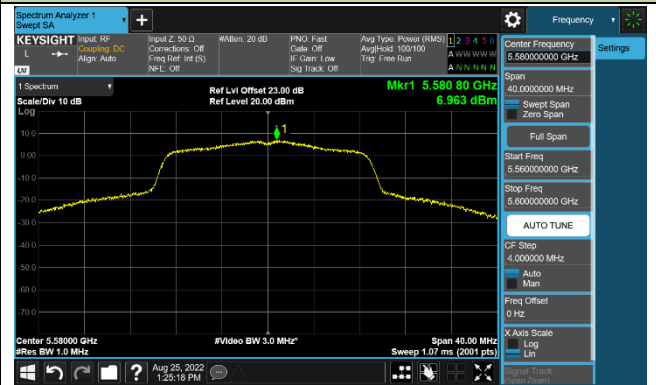

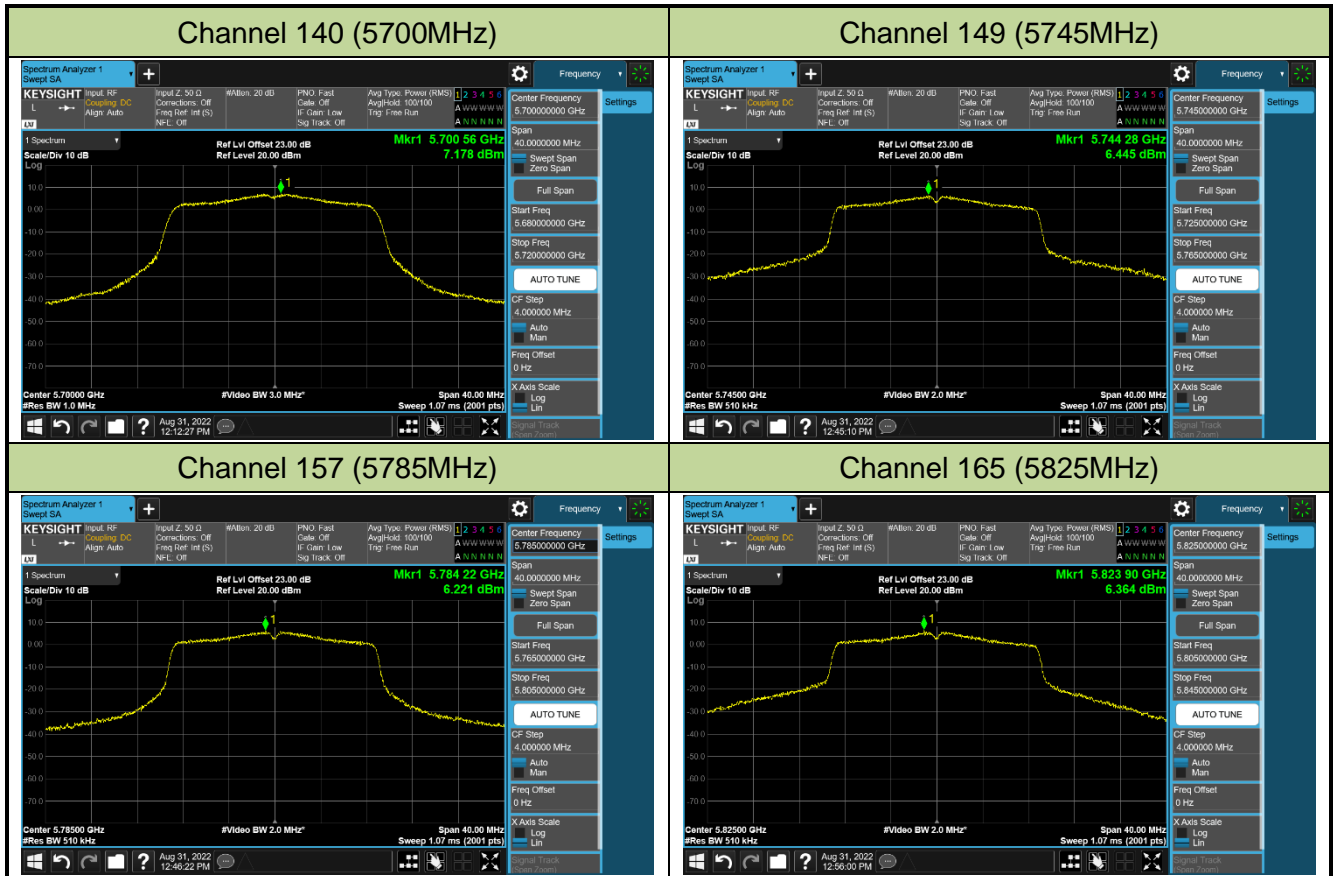

802.11ac-VHT40 Power Spectral Density - Ant 1

Channel 38 (5190MHz)

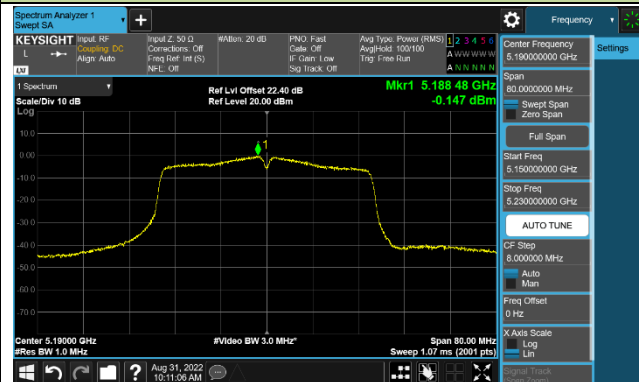

Channel 46 (5230MHz)

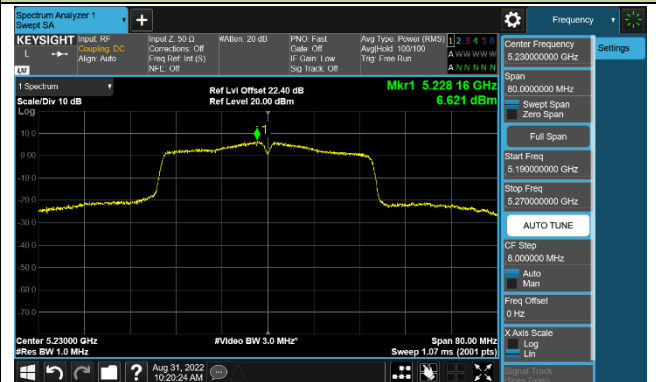

Channel 54 (5270MHz)

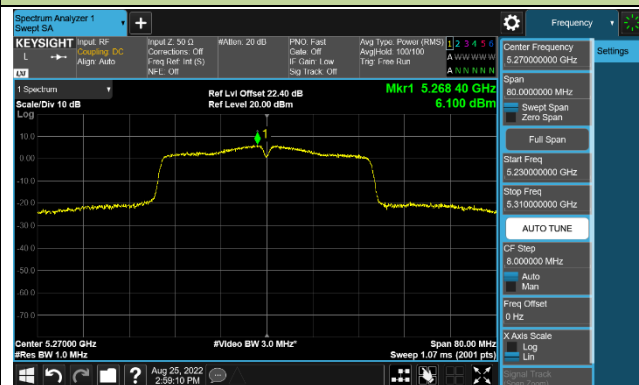

Channel 62 (5310MHz)

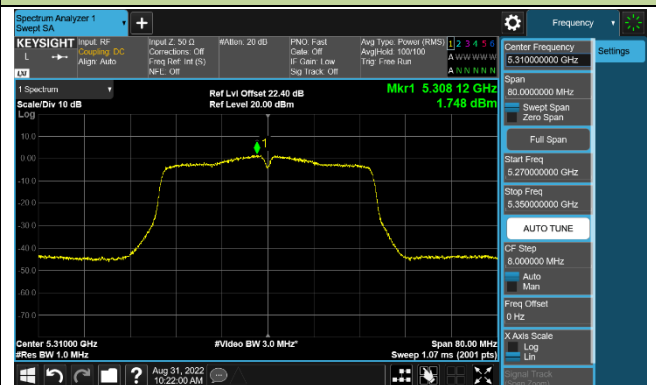

Channel 102 (5510MHz)

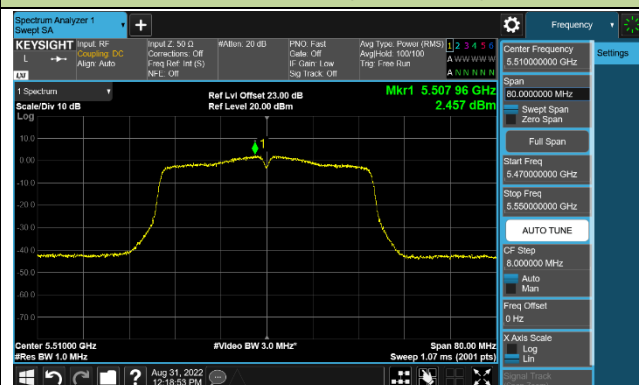

Channel 110 (5550MHz)

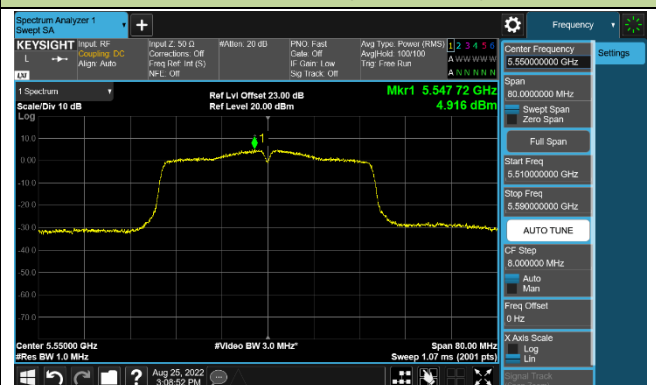

Channel 134 (5670MHz)

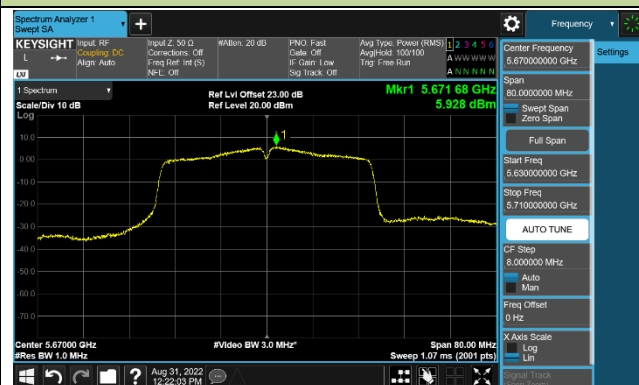

Channel 151 (5755MHz)

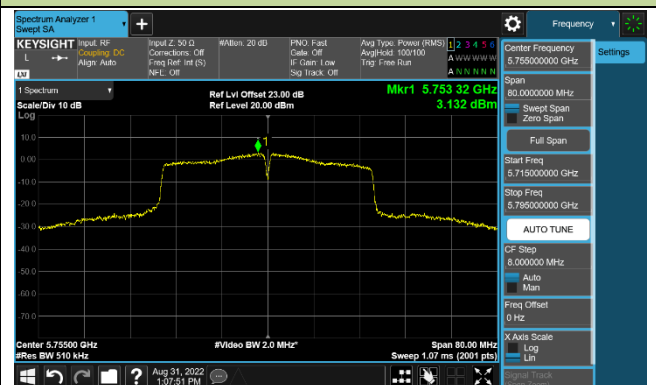



802.11ac-VHT80 Power Spectral Density - Ant 1

Channel 42 (5210MHz)

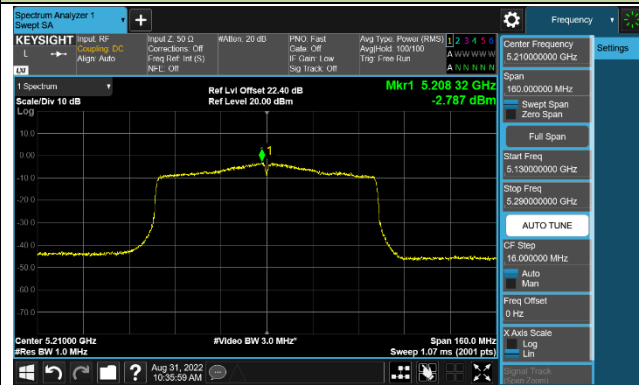

Channel 58 (5290MHz)

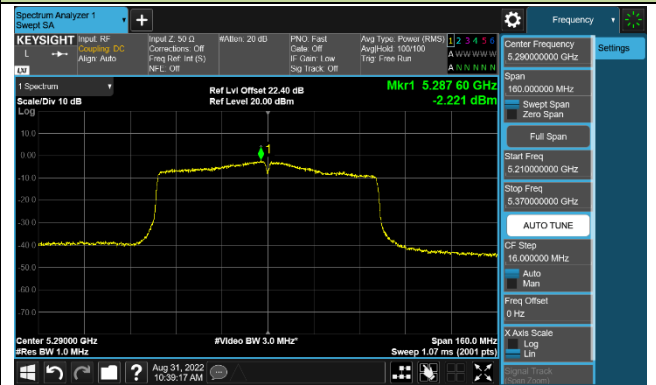

Channel 106 (5530MHz)

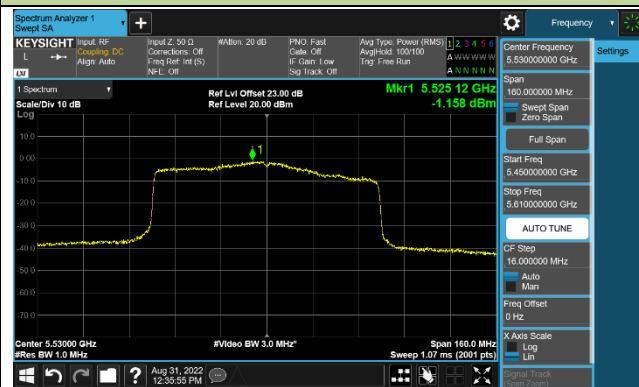

Channel 122 (5610MHz)

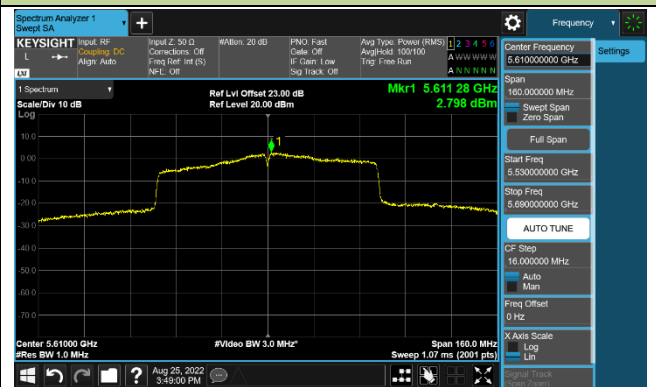

Channel 155 (5775MHz)

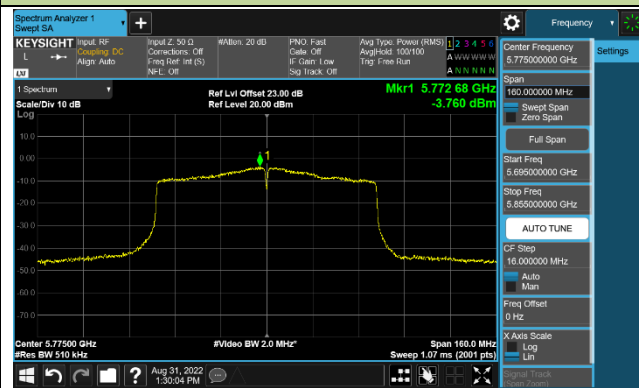

802.11ac-VHT160 Power Spectral Density - Ant 1

Channel 50 (5250MHz)

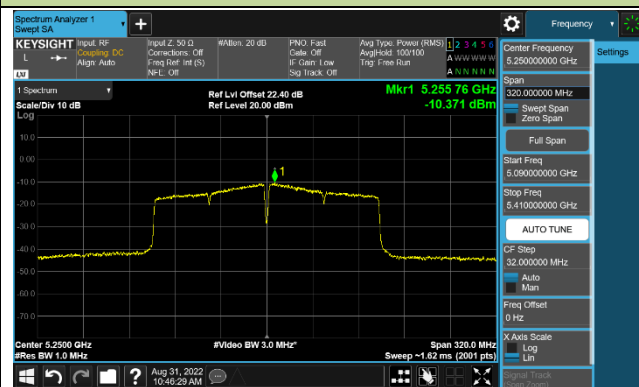

Channel 114 (5570MHz)

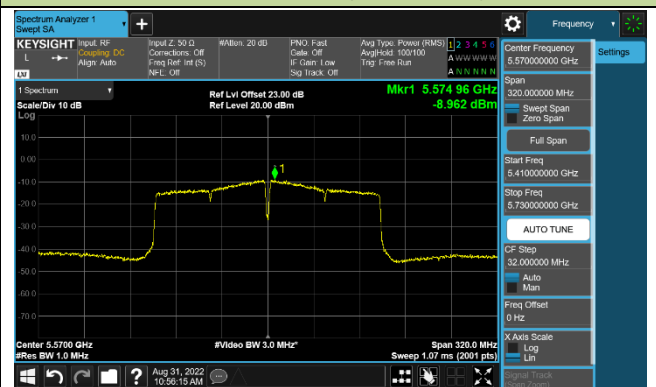

802.11ax-HE20 Power Spectral Density - Ant 1

Channel 36 (5180MHz)

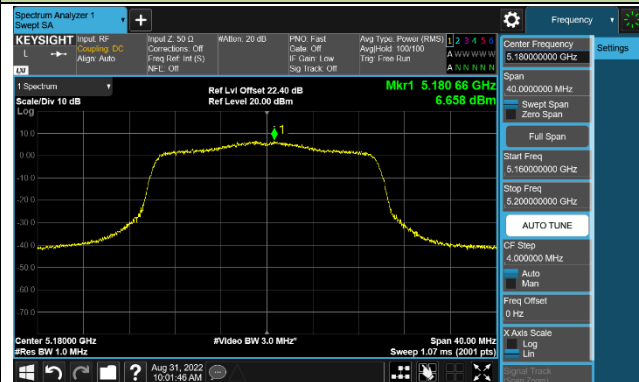

Channel 44 (5220MHz)

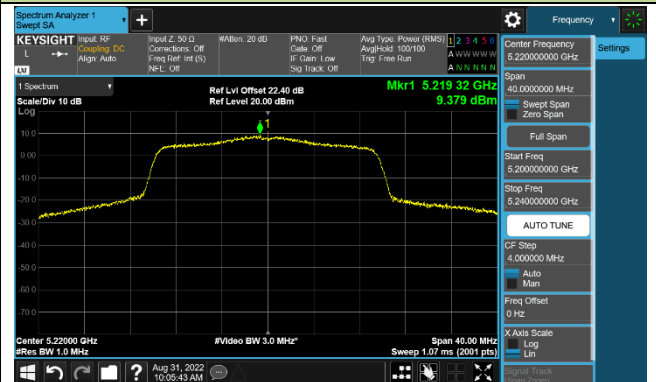

Channel 48 (5240MHz)

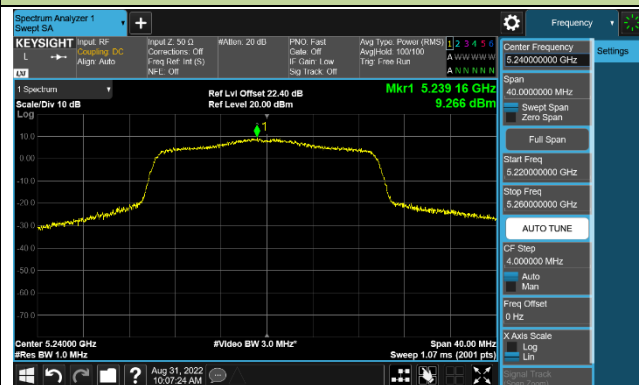

Channel 52 (5260MHz)

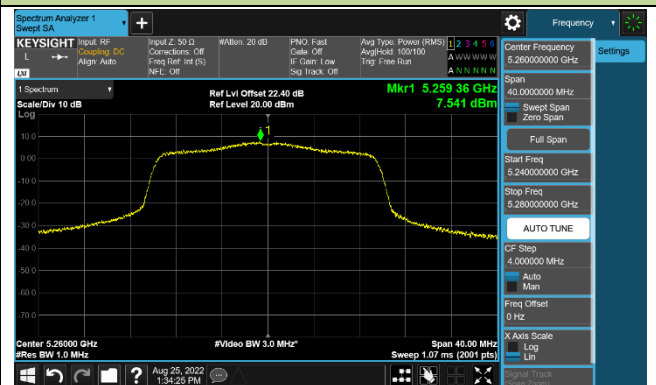

Channel 60 (5300MHz)

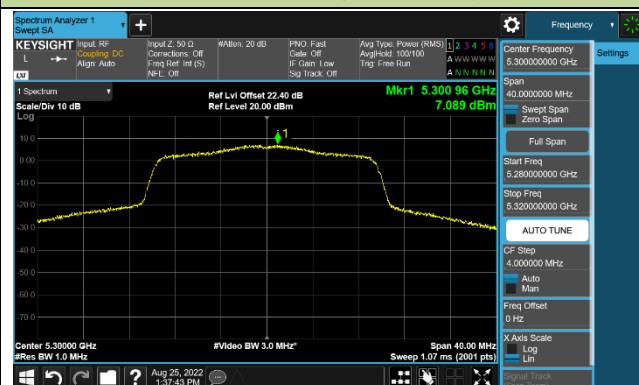

Channel 64 (5320MHz)

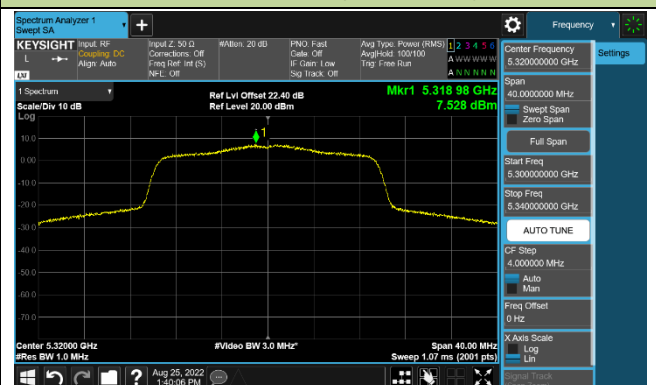

Channel 100 (5500MHz)

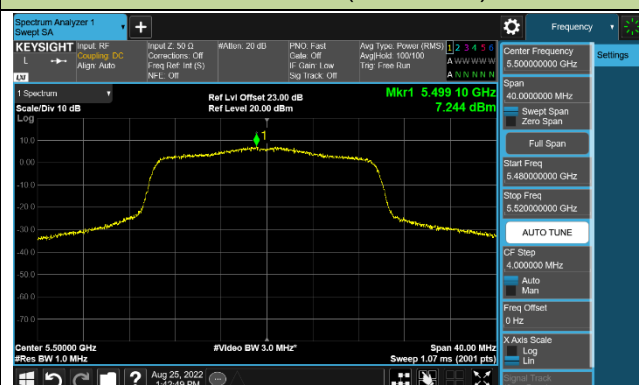

Channel 116 (5580MHz)

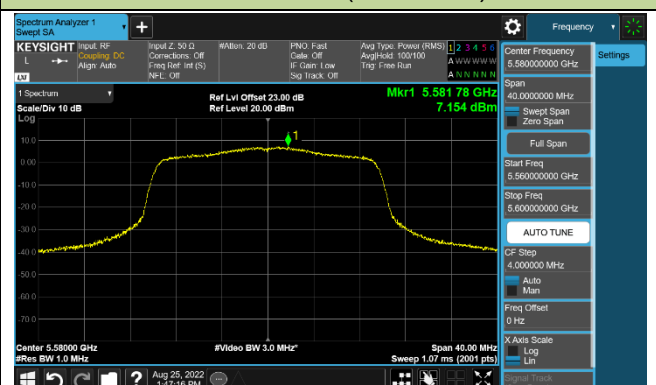

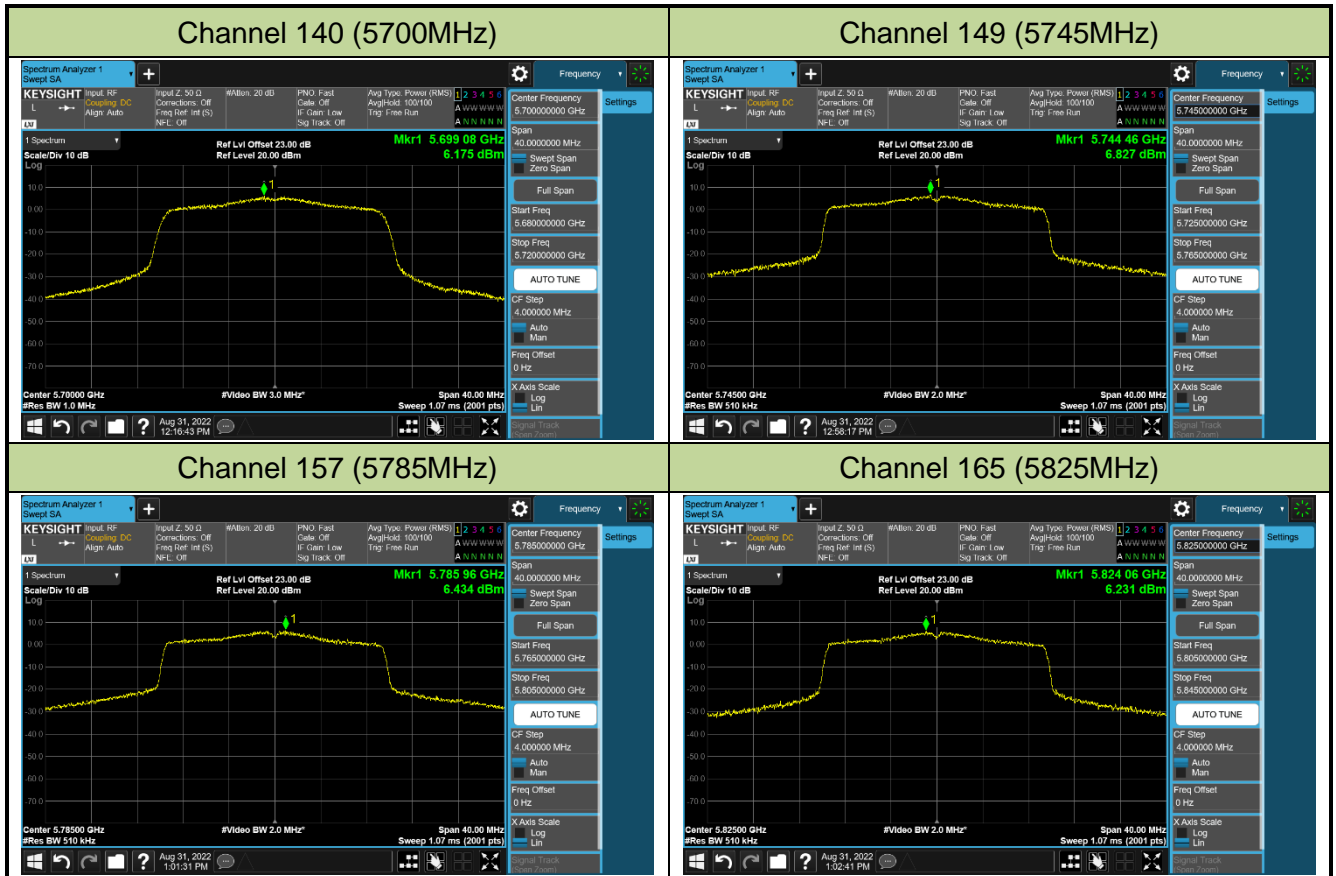

802.11ax-HE40 Power Spectral Density - Ant 1

Channel 38 (5190MHz)

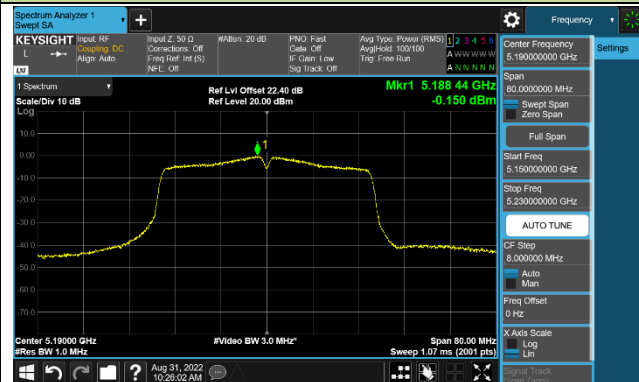

Channel 46 (5230MHz)

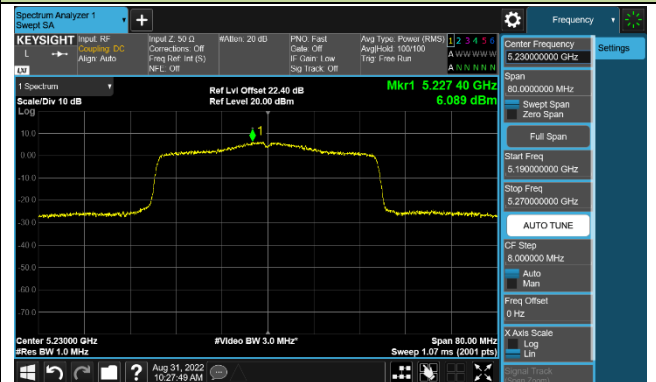

Channel 54 (5270MHz)

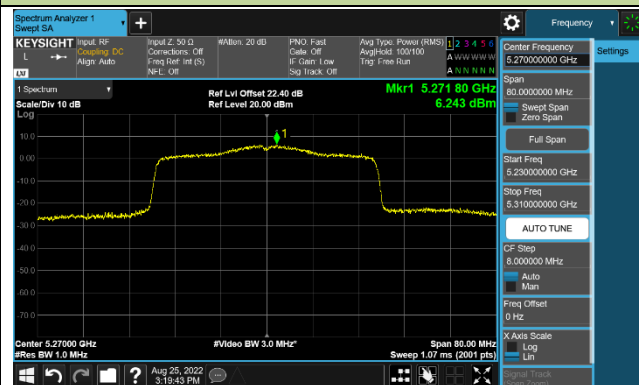

Channel 62 (5310MHz)

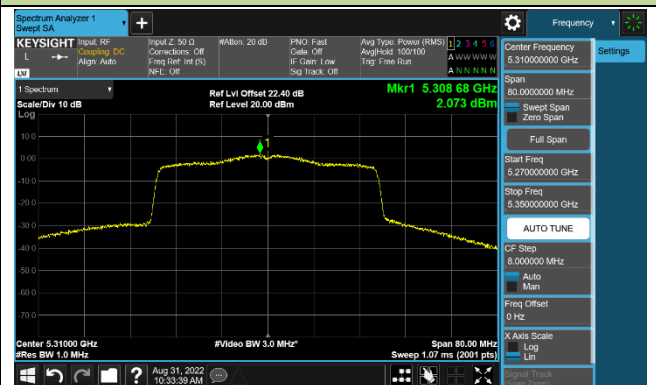

Channel 102 (5510MHz)

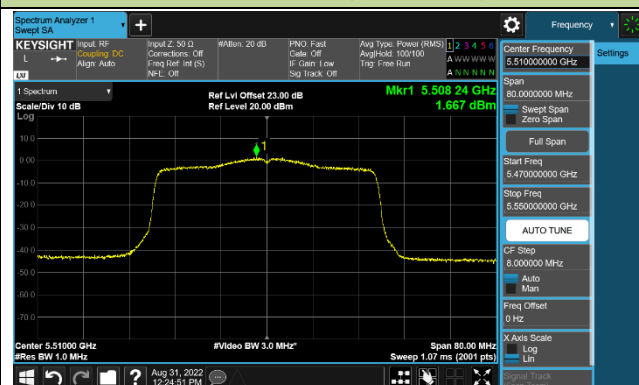

Channel 110 (5550MHz)

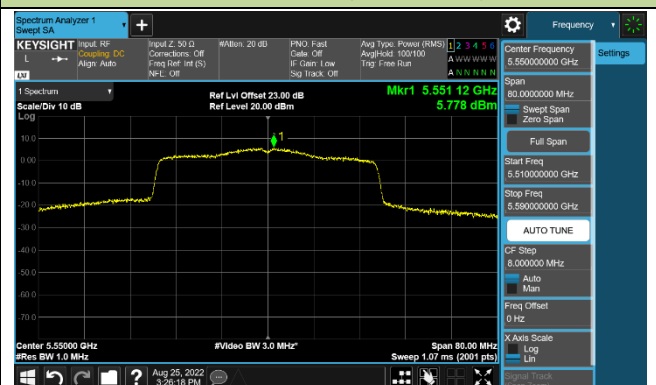

Channel 134 (5670MHz)

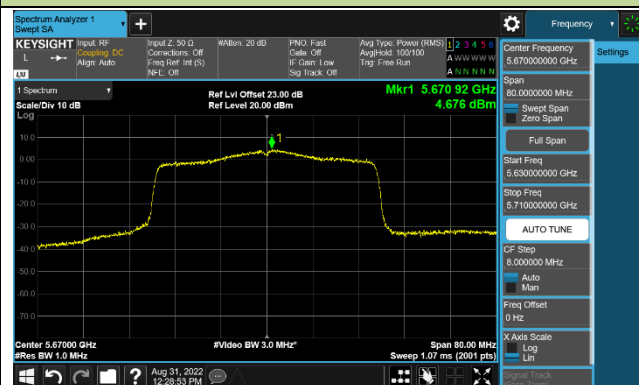

Channel 151 (5755MHz)

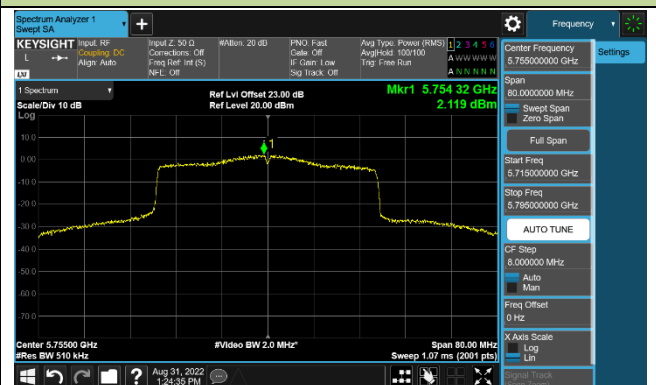



802.11ax-HE80 Power Spectral Density - Ant 1

Channel 42 (5210MHz)

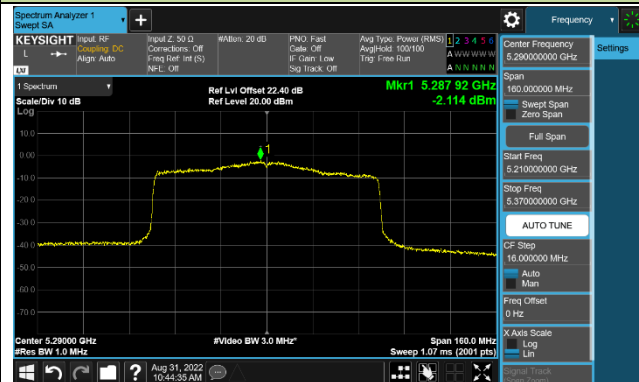

Channel 58 (5290MHz)

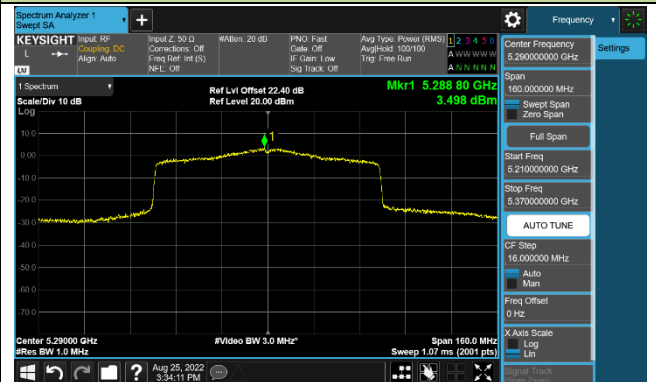

Channel 106 (5530MHz)

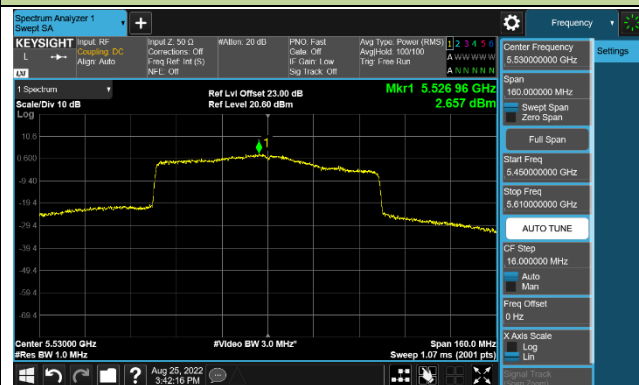

Channel 122 (5610MHz)

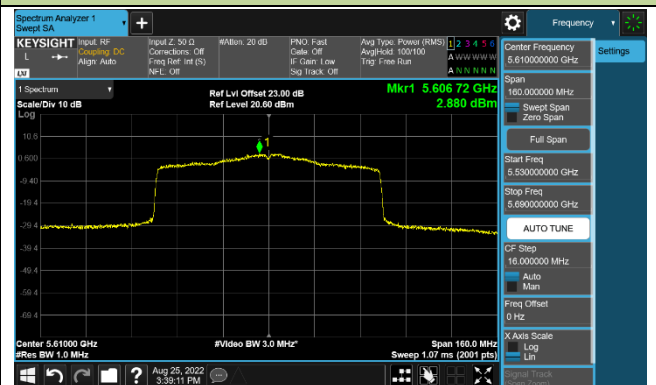

Channel 155 (5775MHz)

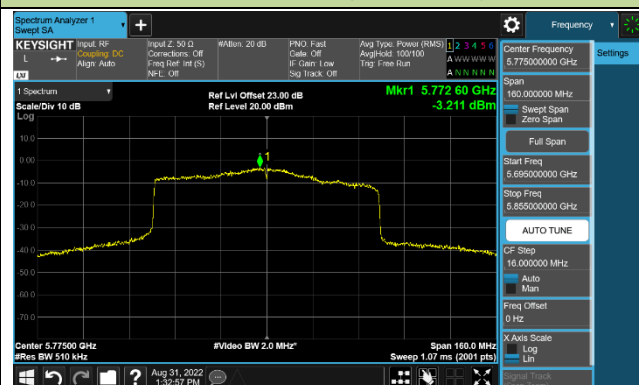

802.11ax-HE160 Power Spectral Density - Ant 1

Channel 50 (5250MHz)

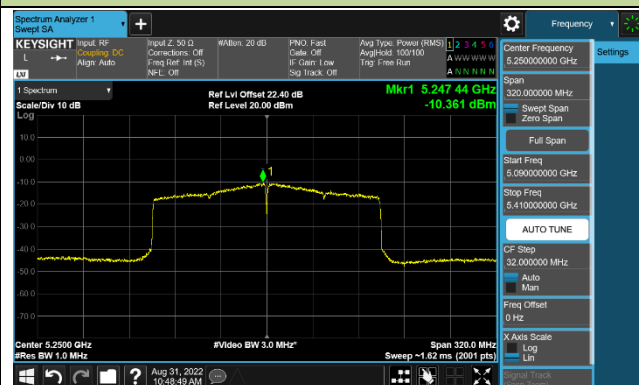

Channel 114 (5570MHz)

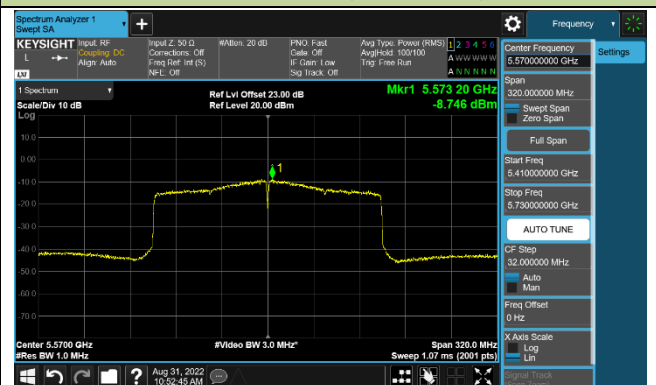

7.7. Frequency Stability Measurement

7.7.1. Test Limit

Manufactures of U-NII devices are responsible for ensuring frequency stability such that an emission is maintained within the band of operation under all conditions of normal operation as specified in the user's manual.

7.7.2. Test Limit

Frequency Stability Under Temperature Variations:

The equipment under test was connected to an external AC or DC power supply and input rated voltage. RF output was connected to a frequency counter or spectrum analyzer via feed through attenuators. The EUT was placed inside the temperature chamber. Set the spectrum analyzer RBW low enough to obtain the desired frequency resolution and measure EUT 20°C operating frequency as reference frequency. Turn EUT off and set the chamber temperature to highest. After the temperature stabilized for approximately 30 minutes recorded the frequency. Repeat step measure with 10°C decreased per stage until the lowest temperature reached.

Frequency Stability Under Voltage Variations:

Set chamber temperature to 20°C. Use a variable AC power supply / DC power source to power the EUT and set the voltage to rated voltage. Set the spectrum analyzer RBW low enough to obtain the desired frequency resolution and recorded the frequency.

Reduce the input voltage to specify extreme voltage variation ($\pm 15\%$) and endpoint, record the maximum frequency change.

7.7.3. Test Setup

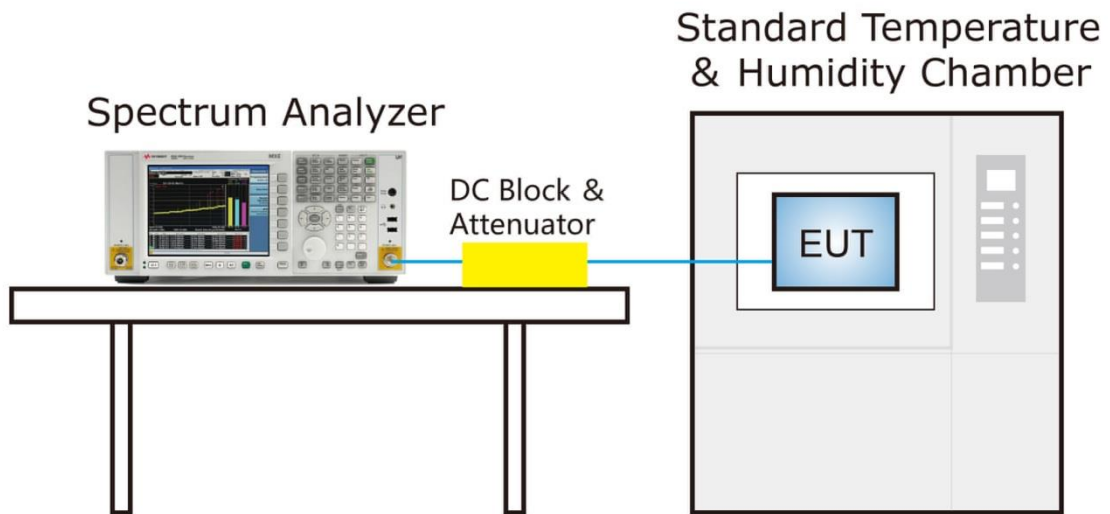

7.7.4. Test Result

Grantee ensure that the product meets e-CFR Title 47 section 15.407(g) and KDB 789033 D02v02r01 frequency stability such that the emissions are maintained within the band of operation under all conditions of normal operation as specified in the user's manual.

7.8. Radiated Spurious Emission Measurement

7.8.1. Test Limit

All out of band emissions appearing in a restricted band as specified in Section 15.205 of the Title 47CFR must not exceed the limits shown in Table per Section 15.209.

FCC Part 15 Subpart C Paragraph 15.209		
Frequency [MHz]	Field Strength [uV/m]	Measured Distance [Meters]
0.009 - 0.490	2400/F (kHz)	300
0.490 - 1.705	24000/F (kHz)	30
1.705 - 30	30	30
30 - 88	100	3
88 - 216	150	3
216 - 960	200	3
Above 960	500	3

7.8.2. Test Procedure Used

KDB 789033 D02v02r01- Section II) G

7.8.3. Test Setting

Table 1 - RBW as a function of frequency

Frequency	RBW
9 ~ 150 kHz	200 ~ 300 Hz
0.15 ~ 30 MHz	9 ~ 10 kHz
30 ~ 1000 MHz	100 ~ 120 kHz
>1000 MHz	1 MHz

Quasi-Peak Measurements below 1GHz

1. Analyzer center frequency was set to the frequency of the radiated spurious emission of interest
2. Span was set greater than 1MHz
3. RBW = as specified in Table 1
4. Detector = CISPR quasi-peak
5. Sweep time = auto couple
6. Trace was allowed to stabilize

Peak Measurements above 1GHz

1. Analyzer center frequency was set to the frequency of the radiated spurious emission of interest
2. RBW = 1MHz
3. VBW = 3MHz
4. Detector = peak
5. Sweep time = auto couple
6. Trace mode = max hold
7. Trace was allowed to stabilize

Average Measurements above 1GHz (Method VB)

1. Analyzer center frequency was set to the frequency of the radiated spurious emission of interest
2. RBW = 1MHz
3. VBW; If the EUT is configured to transmit with duty cycle $\geq 98\%$, set VBW = 10 Hz.
If the EUT duty cycle is $< 98\%$, set VBW $\geq 1/T$. T is the minimum transmission duration.
4. Detector = Peak
5. Sweep time = auto
6. Trace mode = max hold
7. Trace was allowed to stabilize

7.8.4. Test Setup

Below 1GHz Test Setup:

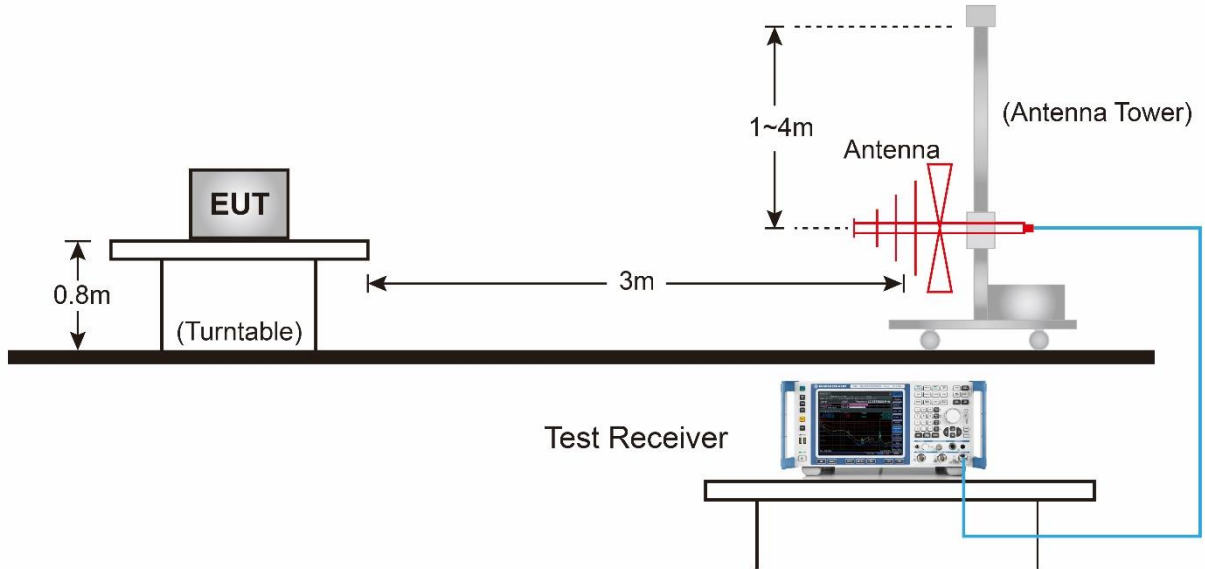

Above 1GHz Test Setup:

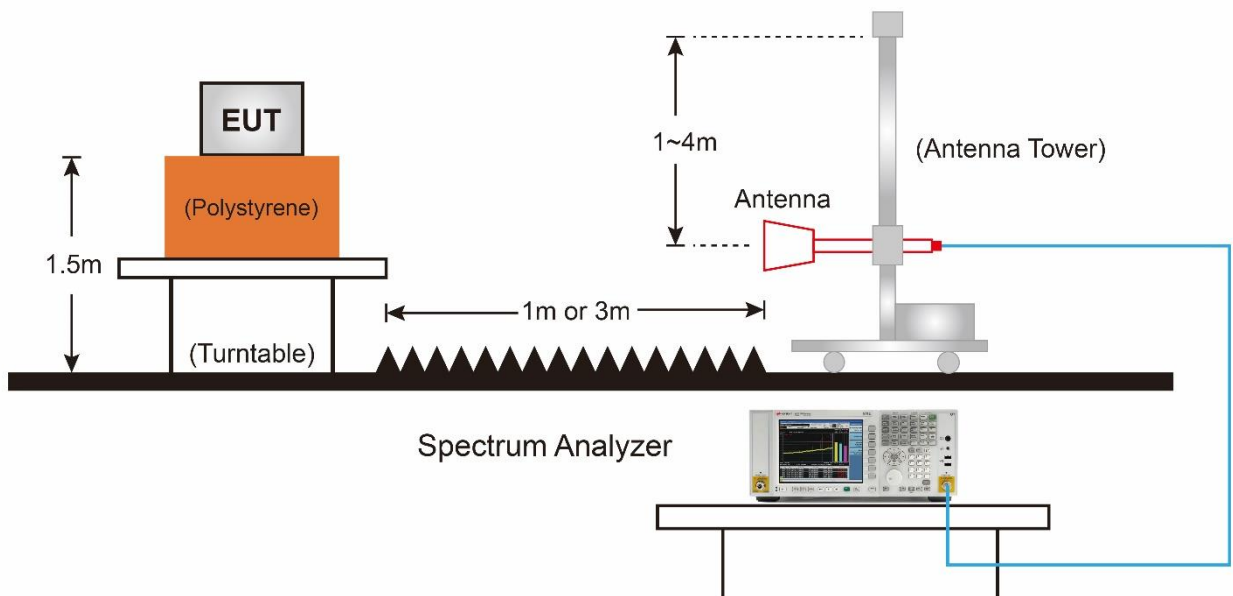

7.8.5. Test Result

EUT	AX3000 Wall Plate Wi-Fi 6 Access Point	Date of Test	2022-09-08
Factor	VULB 9162	Temp. / Humidity	22°C /63%
Polarity	Horizontal	Site / Test Engineer	AC2 / Ares
Test Mode	802.11ac-20MHz_TX_Band1_CH 44_ANT 0+1	Test Voltage	AC 120V/60Hz

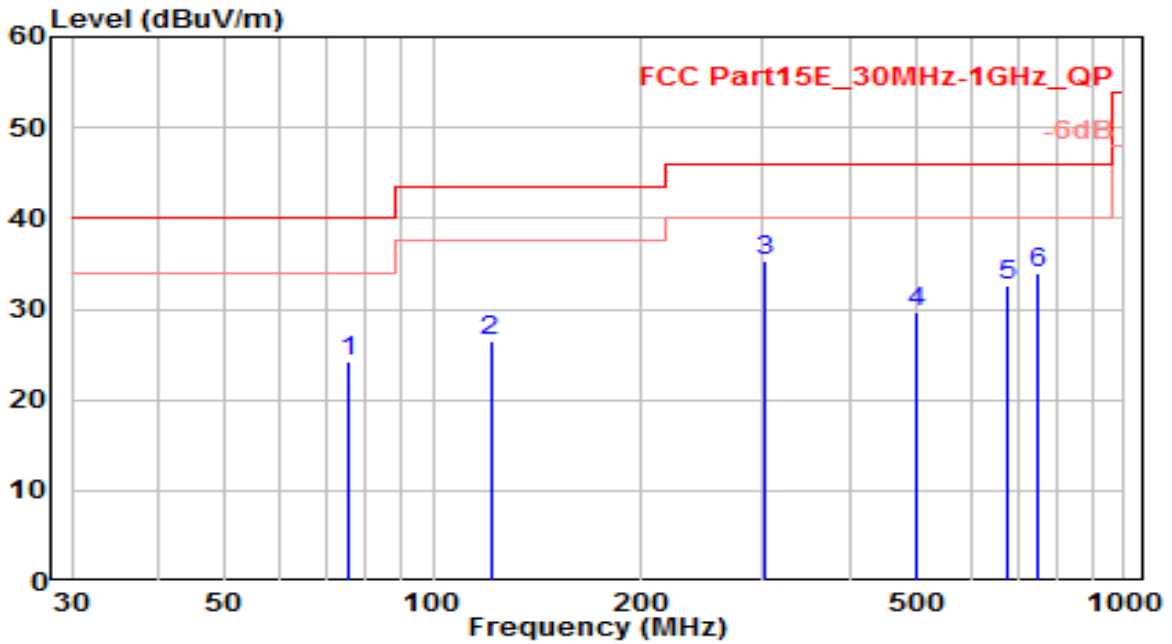

No	Frequency (MHz)	Reading (dBUV)	C.F (dB/m)	Measurement (dBUV/m)	Margin (dB)	Limit (dBUV/m)	Height (cm)	Angle (deg)	Remark (QP/PK/AV)
1	75.340	9.01	15.25	24.26	-15.74	40.00	100	45	QP
2	121.100	9.05	17.43	26.48	-17.02	43.50	100	105	QP
3	* 302.700	13.94	21.45	35.39	-10.61	46.00	100	5	QP
4	498.490	3.95	25.68	29.63	-16.37	46.00	100	275	QP
5	677.350	3.95	28.58	32.53	-13.47	46.00	100	30	QP
6	749.370	4.36	29.60	33.96	-12.04	46.00	100	30	QP

Note:

1. " *", means this data is the worst emission level.
2. C.F (Correction Factor) = Antenna Factor (dB)+ Cable Loss (dB).
3. Measurement (dBUV/m) = Reading(dBUV) + C.F (Correction Factor).
4. The emission levels of other frequencies are very lower than the limit and not show in test report.

EUT	AX3000 Wall Plate Wi-Fi 6 Access Point	Date of Test	2022-09-08
Factor	VULB 9162	Temp. / Humidity	22°C /63%
Polarity	Vertical	Site / Test Engineer	AC2 / Ares
Test Mode	802.11ac-20MHz_TX_Band1_CH 44_ANT 0+1	Test Voltage	AC 120V/60Hz

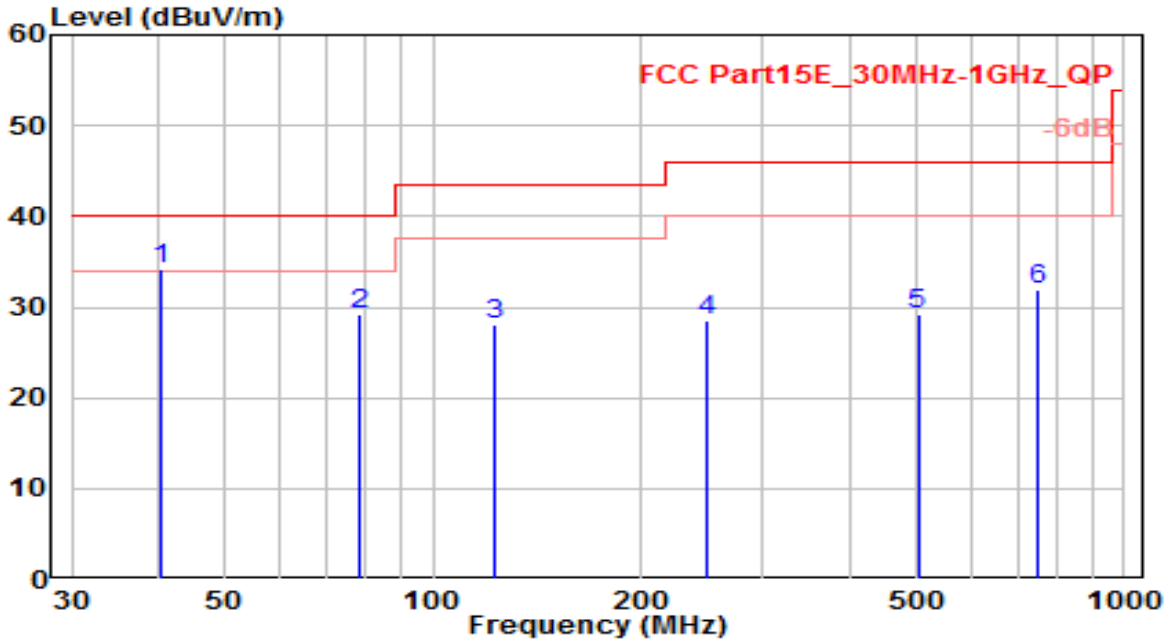

No	Frequency (MHz)	Reading (dBUV)	C.F (dB/m)	Measurement (dBUV/m)	Margin (dB)	Limit (dBUV/m)	Height (cm)	Angle (deg)	Remark (QP/PK/AV)
1	* 40.420	13.72	20.54	34.25	-5.75	40.00	100	180	QP
2	78.420	14.64	14.65	29.29	-10.71	40.00	100	55	QP
3	123.250	10.99	17.13	28.12	-15.38	43.50	100	300	QP
4	248.230	7.90	20.74	28.64	-17.36	46.00	100	260	QP
5	502.750	3.40	25.76	29.16	-16.84	46.00	100	205	QP
6	749.370	2.25	29.60	31.84	-14.16	46.00	100	360	QP

Note:

1. " *", means this data is the worst emission level.
2. C.F (Correction Factor) = Antenna Factor (dB)+ Cable Loss (dB).
3. Measurement (dBUV/m) = Reading(dBUV) + C.F (Correction Factor).
4. The emission levels of other frequencies are very lower than the limit and not show in test report.

EUT	AX3000 Wall Plate Wi-Fi 6 Access Point	Date of Test	2022-09-08
Factor	DRH18-E	Temp. / Humidity	22°C /63%
Polarity	Horizontal	Site / Test Engineer	AC2 / Ares
Test Mode	802.11a_TX_Band1_CH 36_ANT 0+1	Test Voltage	AC 120V/60Hz

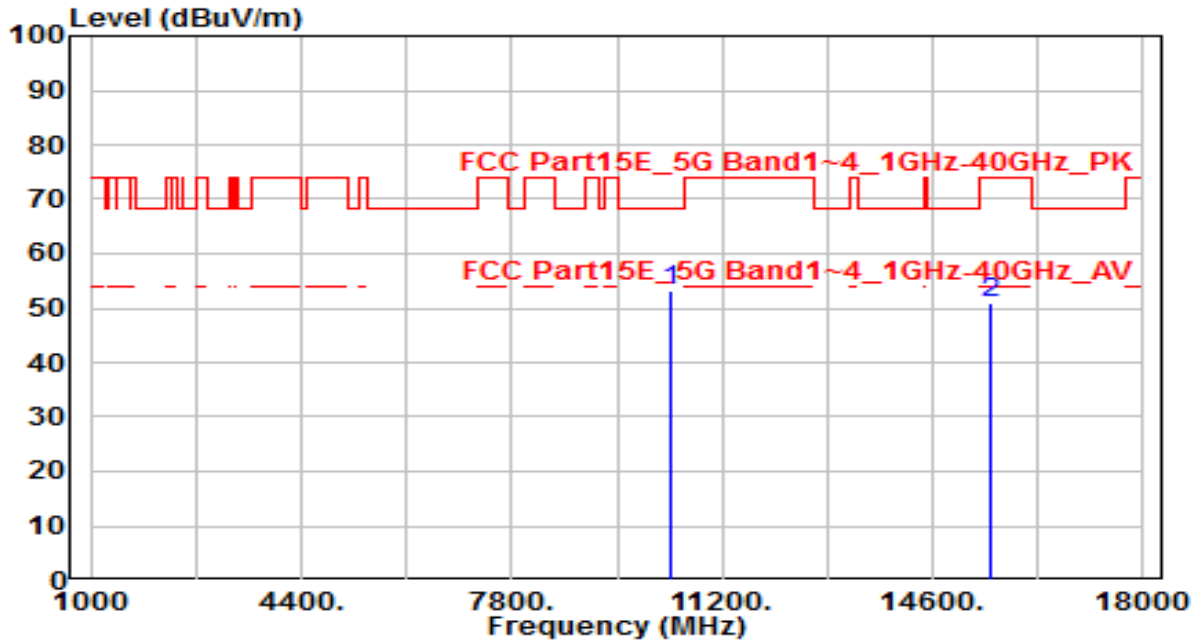

No	Frequency (MHz)	Reading (dBUV)	C.F (dB/m)	Measurement (dBUV/m)	Margin (dB)	Limit (dBUV/m)	Height (cm)	Angle (deg)	Remark (QP/PK/AV)
1	* 10360.000	47.73	5.29	53.03	-15.17	68.20	100	135	Peak
2	15540.000	44.41	6.41	50.81	-23.19	74.00	100	205	Peak

Note:

1. " *", means this data is the worst emission level.
2. C.F (Correction Factor) = Antenna Factor (dB)+ Cable Loss (dB) – Preamplifier(dB).
3. Measurement (dBUV/m) = Reading(dBUV) + C.F (Correction Factor).
4. The emission levels of other frequencies are very lower than the limit and not show in test report.

EUT	AX3000 Wall Plate Wi-Fi 6 Access Point	Date of Test	2022-09-08
Factor	DRH18-E	Temp. / Humidity	22°C /63%
Polarity	Vertical	Site / Test Engineer	AC2 / Ares
Test Mode	802.11a_TX_Band1_CH 36_ANT 0+1	Test Voltage	AC 120V/60Hz

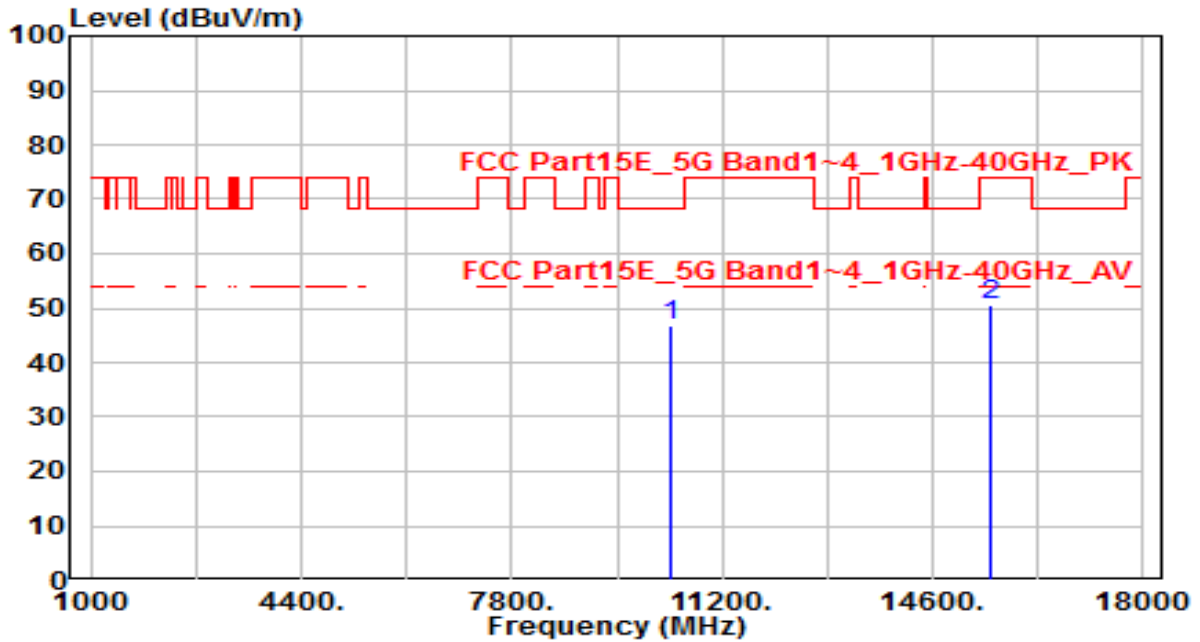

No	Frequency (MHz)	Reading (dBuV)	C.F (dB/m)	Measurement (dBuV/m)	Margin (dB)	Limit (dBuV/m)	Height (cm)	Angle (deg)	Remark (QP/PK/AV)
1	* 10360.000	41.61	5.29	46.90	-21.30	68.20	100	125	Peak
2	15540.000	44.17	6.41	50.57	-23.43	74.00	200	20	Peak

Note:

1. " *", means this data is the worst emission level.
2. C.F (Correction Factor) = Antenna Factor (dB)+ Cable Loss (dB) – Preamplifier(dB).
3. Measurement (dBuV/m) = Reading(dBuV) + C.F (Correction Factor).
4. The emission levels of other frequencies are very lower than the limit and not show in test report.

EUT	AX3000 Wall Plate Wi-Fi 6 Access Point	Date of Test	2022-09-08
Factor	DRH18-E	Temp. / Humidity	22°C /63%
Polarity	Horizontal	Site / Test Engineer	AC2 / Ares
Test Mode	802.11a_TX_Band1_CH 44_ANT 0+1	Test Voltage	AC 120V/60Hz

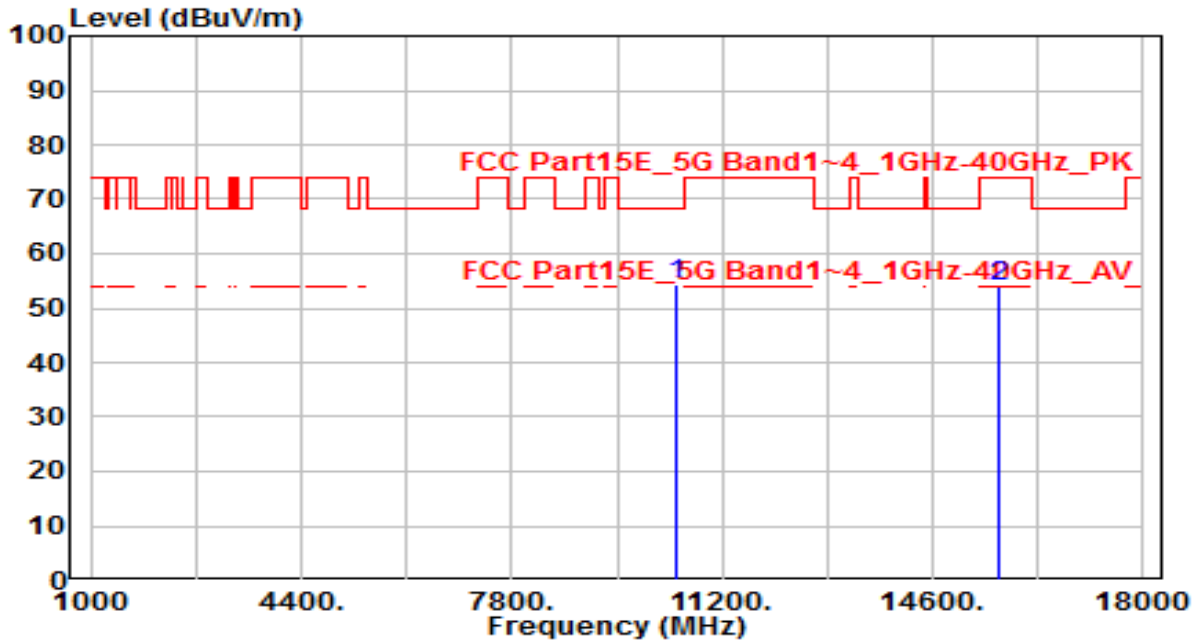

No	Frequency (MHz)	Reading (dBUV)	C.F (dB/m)	Measurement (dBUV/m)	Margin (dB)	Limit (dBUV/m)	Height (cm)	Angle (deg)	Remark (QP/PK/AV)
1	* 10440.000	49.11	5.28	54.39	-13.81	68.20	100	140	Peak
2	15660.000	47.24	6.56	53.79	-20.21	74.00	100	215	Peak

Note:

1. " *", means this data is the worst emission level.
2. C.F (Correction Factor) = Antenna Factor (dB)+ Cable Loss (dB) – Pre-amplifier(dB).
3. Measurement (dBUV/m) = Reading(dBUV) + C.F (Correction Factor).
4. The emission levels of other frequencies are very lower than the limit and not show in test report.

EUT	AX3000 Wall Plate Wi-Fi 6 Access Point	Date of Test	2022-09-08
Factor	DRH18-E	Temp. / Humidity	22°C /63%
Polarity	Vertical	Site / Test Engineer	AC2 / Ares
Test Mode	802.11a_TX_Band1_CH 44_ANT 0+1	Test Voltage	AC 120V/60Hz

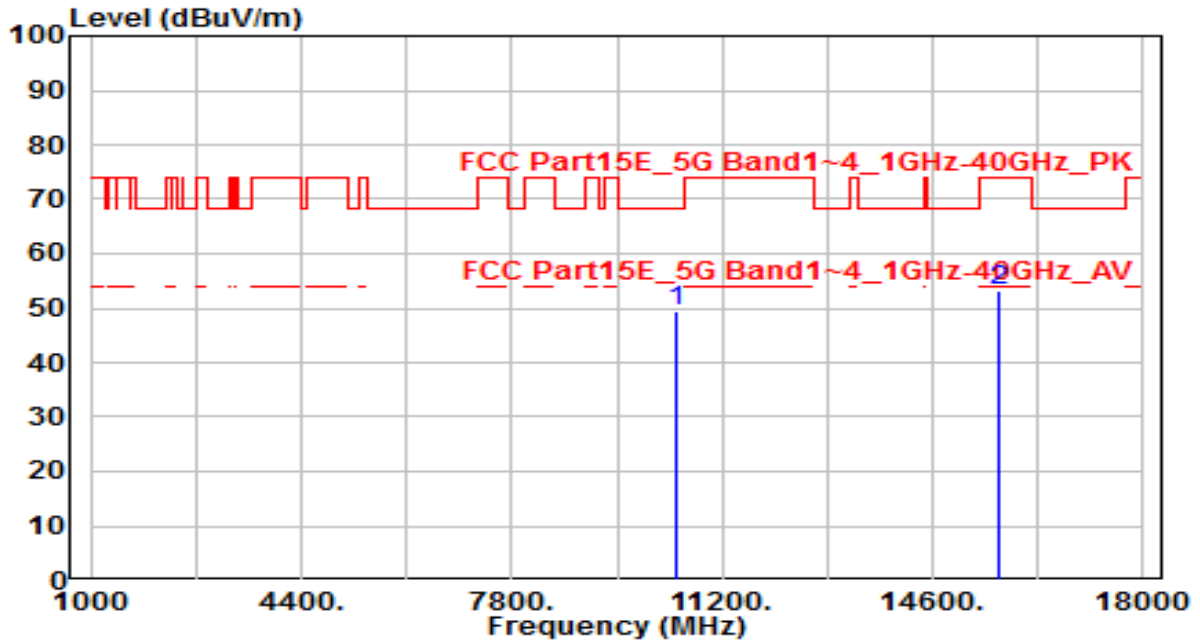

No	Frequency (MHz)	Reading (dBuV)	C.F (dB/m)	Measurement (dBuV/m)	Margin (dB)	Limit (dBuV/m)	Height (cm)	Angle (deg)	Remark (QP/PK/AV)
1	*	44.16	5.28	49.44	-18.76	68.20	100	205	Peak
2		46.75	6.56	53.31	-20.69	74.00	100	175	Peak

Note:

1. " *", means this data is the worst emission level.
2. C.F (Correction Factor) = Antenna Factor (dB)+ Cable Loss (dB) – Preamplifier(dB).
3. Measurement (dBuV/m) = Reading(dBuV) + C.F (Correction Factor).
4. The emission levels of other frequencies are very lower than the limit and not show in test report.

EUT	AX3000 Wall Plate Wi-Fi 6 Access Point	Date of Test	2022-09-08
Factor	DRH18-E	Temp. / Humidity	22°C /63%
Polarity	Horizontal	Site / Test Engineer	AC2 / Ares
Test Mode	802.11a_TX_Band1_CH 48_ANT 0+1	Test Voltage	AC 120V/60Hz

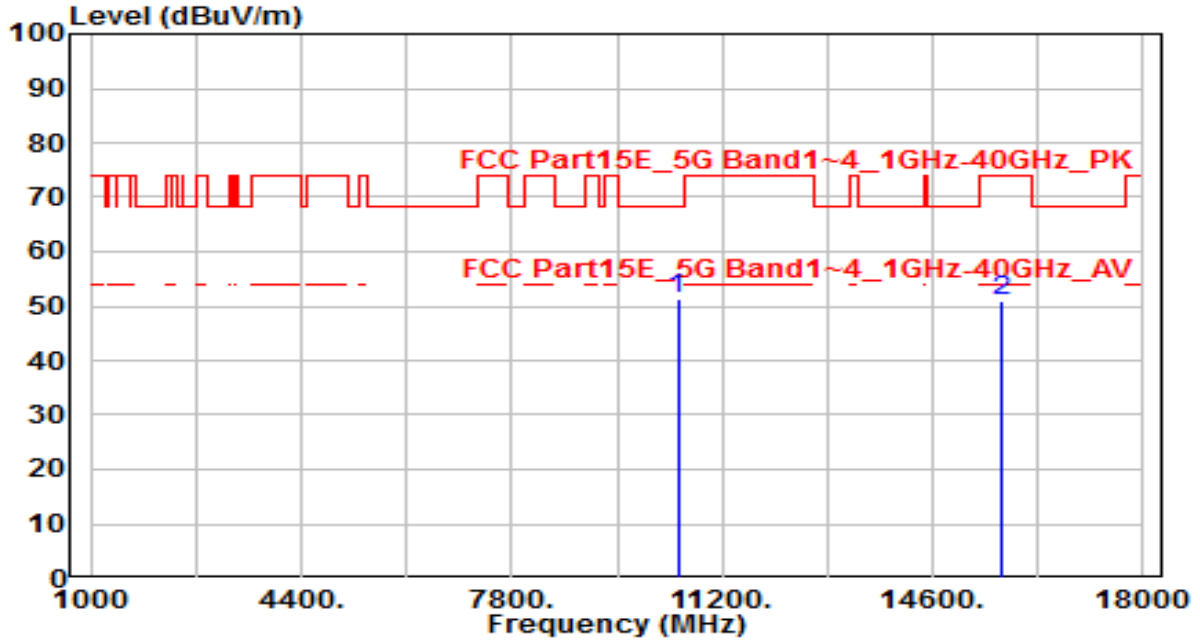

No	Frequency (MHz)	Reading (dBUV)	C.F (dB/m)	Measurement (dBUV/m)	Margin (dB)	Limit (dBUV/m)	Height (cm)	Angle (deg)	Remark (QP/PK/AV)
1	* 10480.000	46.06	5.26	51.32	-16.88	68.20	100	120	Peak
2	15720.000	44.42	6.69	51.11	-22.89	74.00	100	150	Peak

Note:

1. " *", means this data is the worst emission level.
2. C.F (Correction Factor) = Antenna Factor (dB)+ Cable Loss (dB) – Pre-amplifier(dB).
3. Measurement (dBUV/m) = Reading(dBUV) + C.F (Correction Factor).
4. The emission levels of other frequencies are very lower than the limit and not show in test report.

EUT	AX3000 Wall Plate Wi-Fi 6 Access Point	Date of Test	2022-09-08
Factor	DRH18-E	Temp. / Humidity	22°C /63%
Polarity	Vertical	Site / Test Engineer	AC2 / Ares
Test Mode	802.11a_TX_Band1_CH 48_ANT 0+1	Test Voltage	AC 120V/60Hz

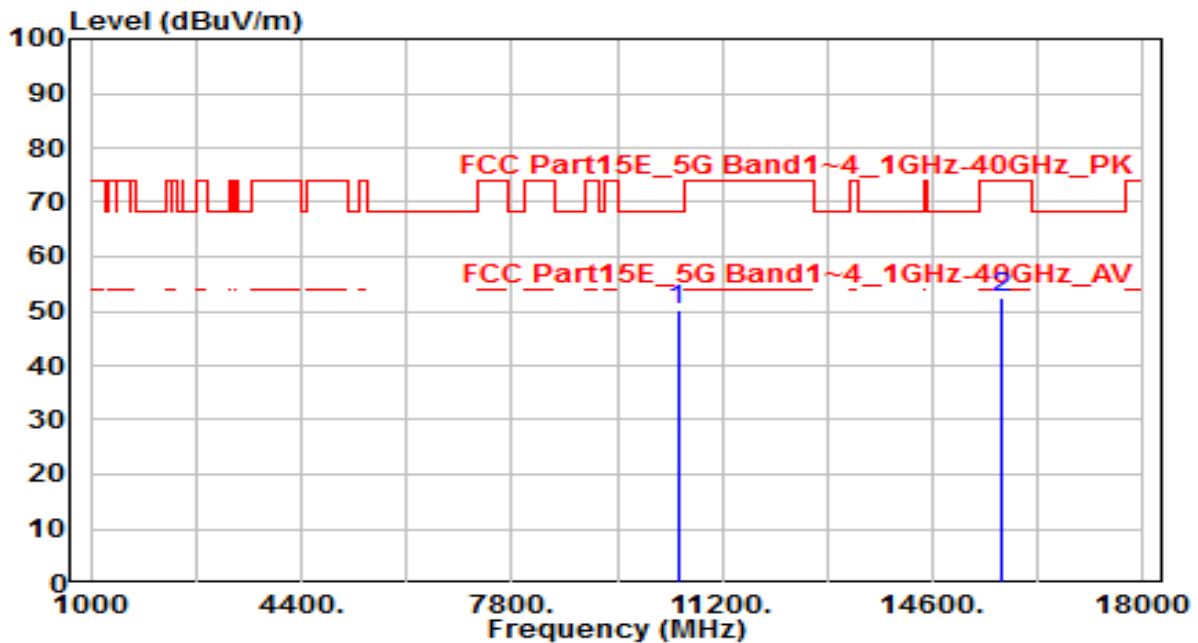

No	Frequency (MHz)	Reading (dBUV)	C.F (dB/m)	Measurement (dBUV/m)	Margin (dB)	Limit (dBUV/m)	Height (cm)	Angle (deg)	Remark (QP/PK/AV)
1	*	44.96	5.26	50.21	-17.99	68.20	100	205	Peak
2		45.78	6.69	52.48	-21.52	74.00	100	40	Peak

Note:

1. " *", means this data is the worst emission level.
2. C.F (Correction Factor) = Antenna Factor (dB)+ Cable Loss (dB) – Preamplifier(dB).
3. Measurement (dBUV/m) = Reading(dBUV) + C.F (Correction Factor).
4. The emission levels of other frequencies are very lower than the limit and not show in test report.

EUT	AX3000 Wall Plate Wi-Fi 6 Access Point	Date of Test	2022-09-08
Factor	DRH18-E	Temp. / Humidity	22°C /63%
Polarity	Horizontal	Site / Test Engineer	AC2 / Ares
Test Mode	802.11a_TX_Band2_CH 52_ANT 0+1	Test Voltage	AC 120V/60Hz

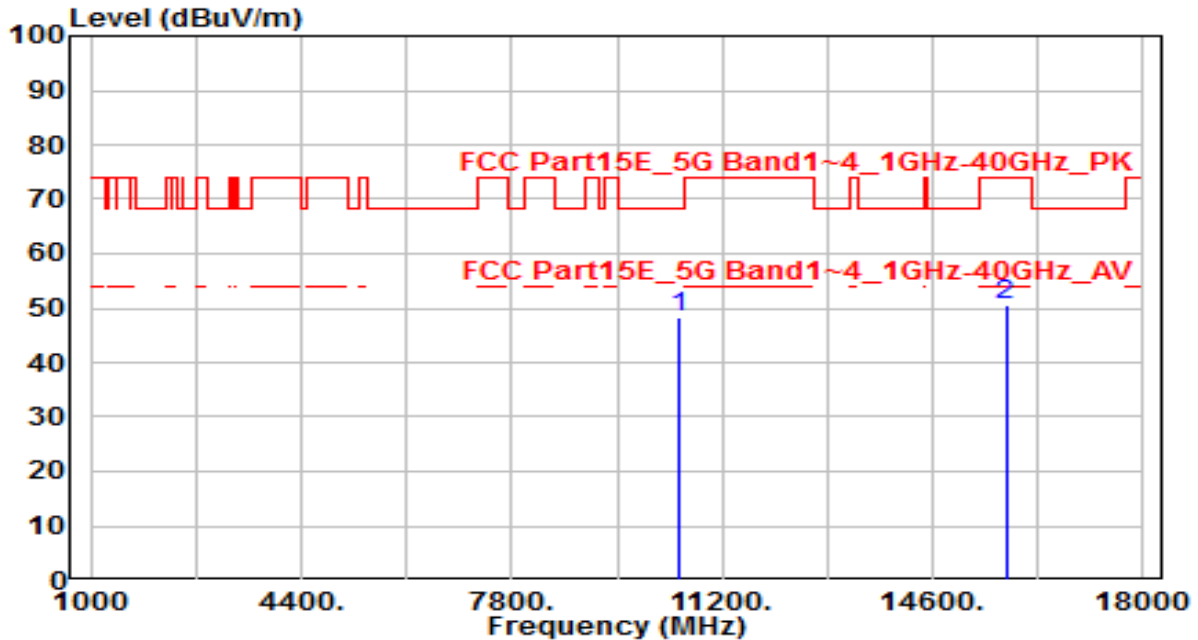

No	Frequency (MHz)	Reading (dBUV)	C.F (dB/m)	Measurement (dBUV/m)	Margin (dB)	Limit (dBUV/m)	Height (cm)	Angle (deg)	Remark (QP/PK/AV)
1	* 10520.000	42.87	5.25	48.12	-20.08	68.20	100	190	Peak
2	15780.000	43.55	6.83	50.38	-23.62	74.00	100	140	Peak

Note:

1. " *", means this data is the worst emission level.
2. C.F (Correction Factor) = Antenna Factor (dB)+ Cable Loss (dB) – Preamplifier(dB).
3. Measurement (dBUV/m) = Reading(dBUV) + C.F (Correction Factor).
4. The emission levels of other frequencies are very lower than the limit and not show in test report.

EUT	AX3000 Wall Plate Wi-Fi 6 Access Point	Date of Test	2022-09-08
Factor	DRH18-E	Temp. / Humidity	22°C /63%
Polarity	Vertical	Site / Test Engineer	AC2 / Ares
Test Mode	802.11a_TX_Band2_CH 52_ANT 0+1	Test Voltage	AC 120V/60Hz

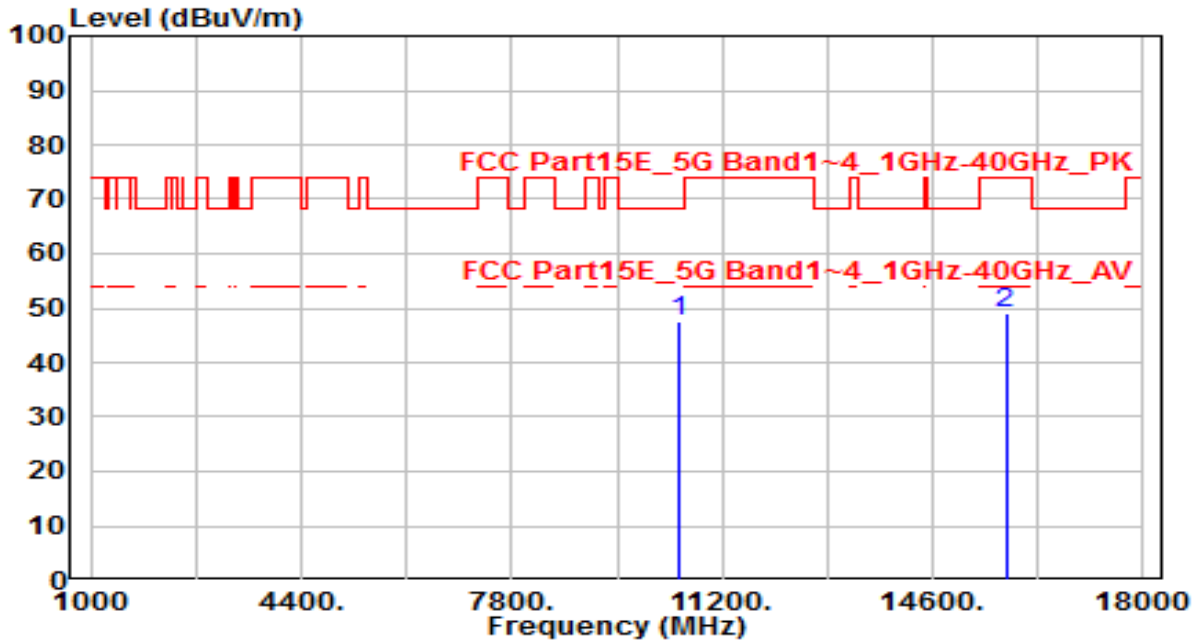

No	Frequency (MHz)	Reading (dBUV)	C.F (dB/m)	Measurement (dBUV/m)	Margin (dB)	Limit (dBUV/m)	Height (cm)	Angle (deg)	Remark (QP/PK/AV)
1	* 10520.000	42.17	5.25	47.42	-20.78	68.20	100	205	Peak
2	15780.000	42.41	6.83	49.24	-24.76	74.00	100	220	Peak

Note:

1. " *", means this data is the worst emission level.
2. C.F (Correction Factor) = Antenna Factor (dB)+ Cable Loss (dB) – Preamplifier(dB).
3. Measurement (dBUV/m) = Reading(dBUV) + C.F (Correction Factor).
4. The emission levels of other frequencies are very lower than the limit and not show in test report.

EUT	AX3000 Wall Plate Wi-Fi 6 Access Point	Date of Test	2022-09-08
Factor	DRH18-E	Temp. / Humidity	22°C /63%
Polarity	Horizontal	Site / Test Engineer	AC2 / Ares
Test Mode	802.11a_TX_Band2_CH 60_ANT 0+1	Test Voltage	AC 120V/60Hz

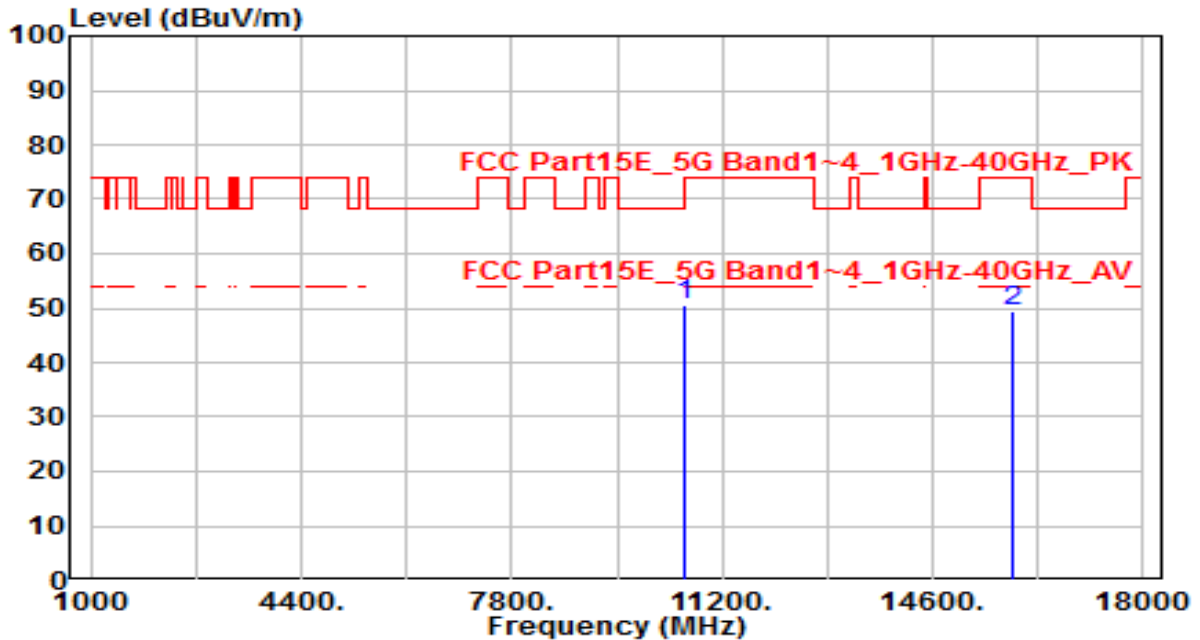

No	Frequency (MHz)	Reading (dBUV)	C.F (dB/m)	Measurement (dBUV/m)	Margin (dB)	Limit (dBUV/m)	Height (cm)	Angle (deg)	Remark (QP/PK/AV)
1	*	45.49	5.25	50.74	-17.46	68.20	100	135	Peak
2		42.65	6.95	49.60	-24.40	74.00	100	360	Peak

Note:

1. " *", means this data is the worst emission level.
2. C.F (Correction Factor) = Antenna Factor (dB)+ Cable Loss (dB) – Pre-amplifier(dB).
3. Measurement (dBUV/m) = Reading(dBUV) + C.F (Correction Factor).
4. The emission levels of other frequencies are very lower than the limit and not show in test report.

EUT	AX3000 Wall Plate Wi-Fi 6 Access Point	Date of Test	2022-09-08
Factor	DRH18-E	Temp. / Humidity	22°C /63%
Polarity	Vertical	Site / Test Engineer	AC2 / Ares
Test Mode	802.11a_TX_Band2_CH 60_ANT 0+1	Test Voltage	AC 120V/60Hz

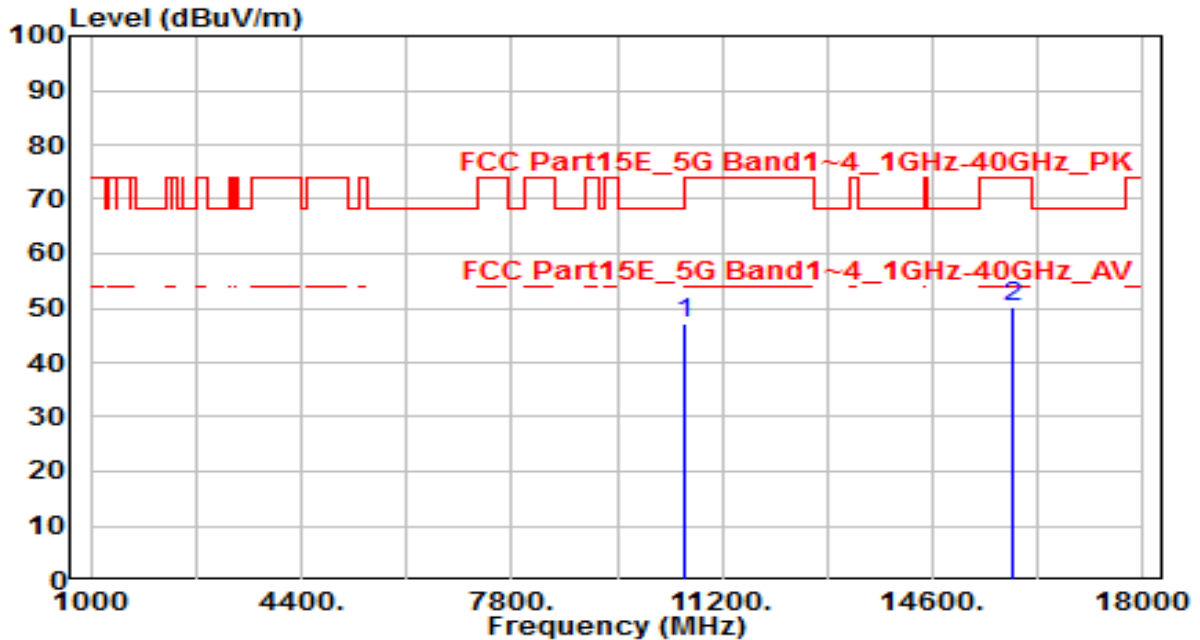

No	Frequency (MHz)	Reading (dBUV)	C.F (dB/m)	Measurement (dBUV/m)	Margin (dB)	Limit (dBUV/m)	Height (cm)	Angle (deg)	Remark (QP/PK/AV)
1	* 10600.000	41.81	5.25	47.07	-21.13	68.20	100	215	Peak
2	15900.000	43.05	6.95	50.00	-24.00	74.00	100	0	Peak

Note:

1. " *", means this data is the worst emission level.
2. C.F (Correction Factor) = Antenna Factor (dB)+ Cable Loss (dB) – Pre-amplifier(dB).
3. Measurement (dBUV/m) = Reading(dBUV) + C.F (Correction Factor).
4. The emission levels of other frequencies are very lower than the limit and not show in test report.

EUT	AX3000 Wall Plate Wi-Fi 6 Access Point	Date of Test	2022-09-08
Factor	DRH18-E	Temp. / Humidity	22°C /63%
Polarity	Horizontal	Site / Test Engineer	AC2 / Ares
Test Mode	802.11a_TX_Band2_CH 64_ANT 0+1	Test Voltage	AC 120V/60Hz

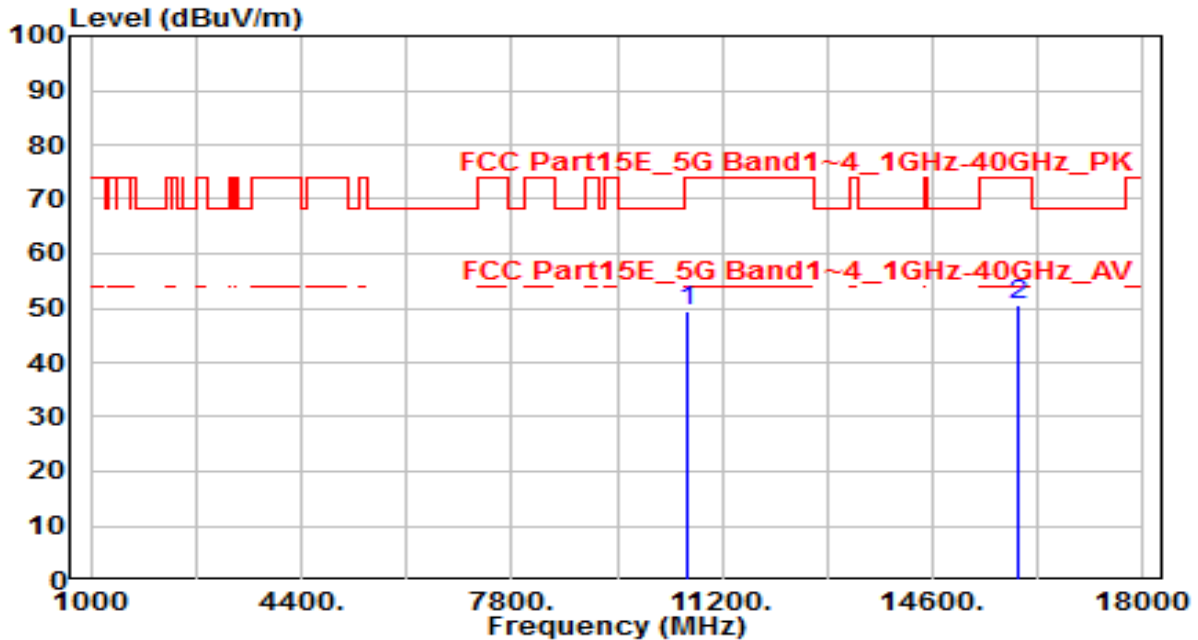

No	Frequency (MHz)	Reading (dBuV)	C.F (dB/m)	Measurement (dBuV/m)	Margin (dB)	Limit (dBuV/m)	Height (cm)	Angle (deg)	Remark (QP/PK/AV)
1	10640.000	44.30	5.27	49.57	-24.43	74.00	100	195	Peak
2	* 15960.000	43.38	7.00	50.38	-23.62	74.00	100	205	Peak

Note:

1. " *", means this data is the worst emission level.
2. C.F (Correction Factor) = Antenna Factor (dB)+ Cable Loss (dB) – Pre-amplifier(dB).
3. Measurement (dBuV/m) = Reading(dBuV) + C.F (Correction Factor).
4. The emission levels of other frequencies are very lower than the limit and not show in test report.

EUT	AX3000 Wall Plate Wi-Fi 6 Access Point	Date of Test	2022-09-08
Factor	DRH18-E	Temp. / Humidity	22°C /63%
Polarity	Vertical	Site / Test Engineer	AC2 / Ares
Test Mode	802.11a_TX_Band2_CH 64_ANT 0+1	Test Voltage	AC 120V/60Hz

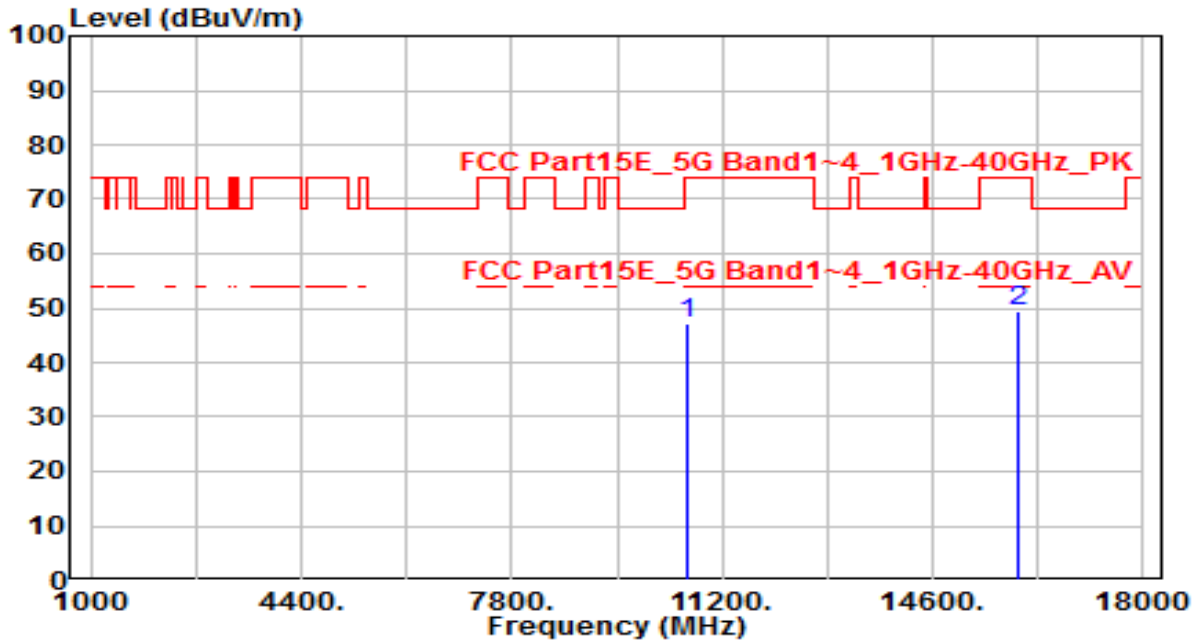

No	Frequency (MHz)	Reading (dBuV)	C.F (dB/m)	Measurement (dBuV/m)	Margin (dB)	Limit (dBuV/m)	Height (cm)	Angle (deg)	Remark (QP/PK/AV)
1	10640.000	41.73	5.27	47.00	-27.00	74.00	100	215	Peak
2	* 15960.000	42.31	7.00	49.31	-24.69	74.00	100	0	Peak

Note:

1. " *", means this data is the worst emission level.
2. C.F (Correction Factor) = Antenna Factor (dB)+ Cable Loss (dB) – Preamplifier(dB).
3. Measurement (dBuV/m) = Reading(dBuV) + C.F (Correction Factor).
4. The emission levels of other frequencies are very lower than the limit and not show in test report.

EUT	AX3000 Wall Plate Wi-Fi 6 Access Point	Date of Test	2022-09-08
Factor	DRH18-E	Temp. / Humidity	22°C /63%
Polarity	Horizontal	Site / Test Engineer	AC2 / Ares
Test Mode	802.11a_TX_Band3_CH 100_ANT 0+1	Test Voltage	AC 120V/60Hz

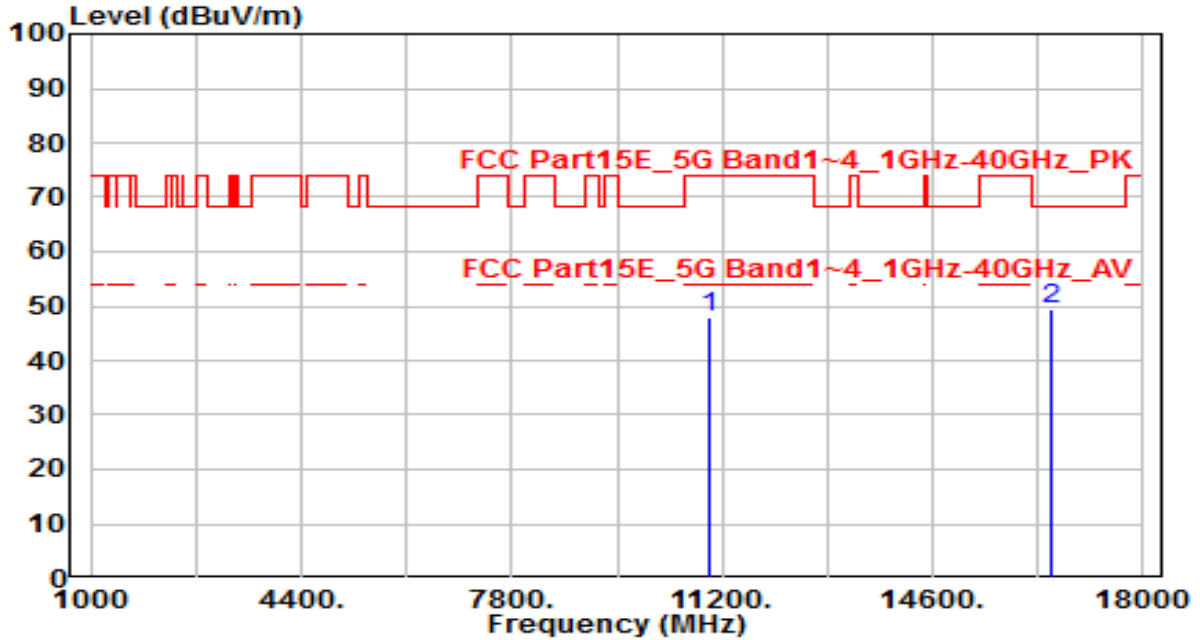

No	Frequency (MHz)	Reading (dBUV)	C.F (dB/m)	Measurement (dBUV/m)	Margin (dB)	Limit (dBUV/m)	Height (cm)	Angle (deg)	Remark (QP/PK/AV)
1	11000.000	42.55	5.56	48.11	-25.89	74.00	100	125	Peak
2	* 16500.000	42.12	7.34	49.47	-18.73	68.20	100	315	Peak

Note:

1. " *", means this data is the worst emission level.
2. C.F (Correction Factor) = Antenna Factor (dB)+ Cable Loss (dB) – Preamplifier(dB).
3. Measurement (dBUV/m) = Reading(dBUV) + C.F (Correction Factor).
4. The emission levels of other frequencies are very lower than the limit and not show in test report.

EUT	AX3000 Wall Plate Wi-Fi 6 Access Point	Date of Test	2022-09-08
Factor	DRH18-E	Temp. / Humidity	22°C /63%
Polarity	Vertical	Site / Test Engineer	AC2 / Ares
Test Mode	802.11a_TX_Band3_CH 100_ANT 0+1	Test Voltage	AC 120V/60Hz

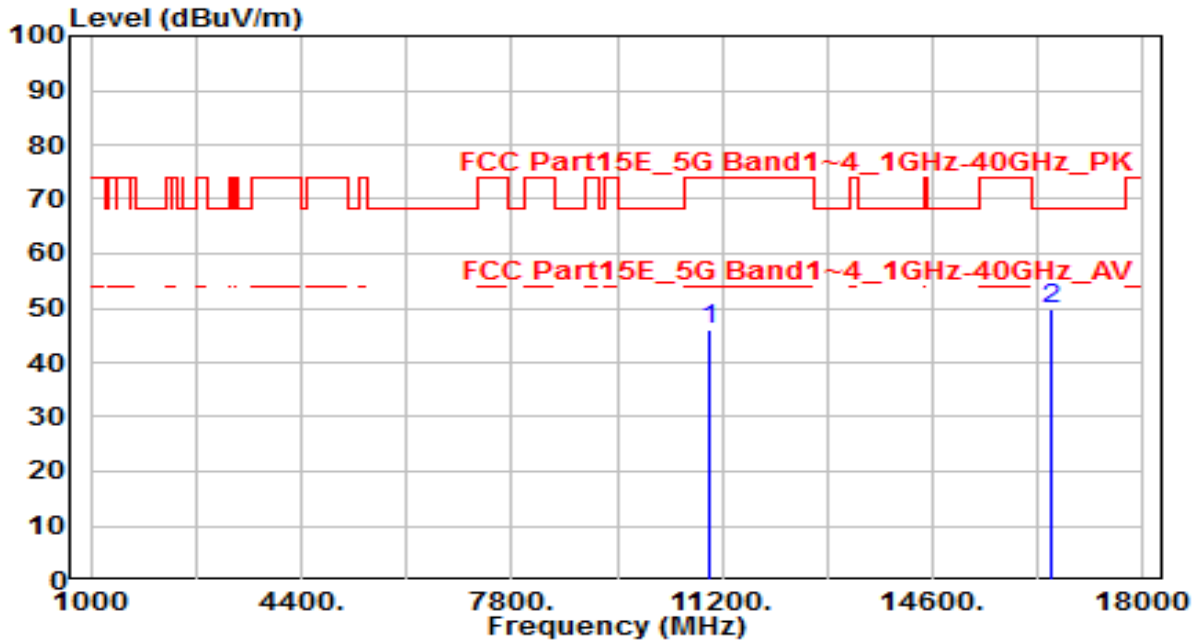

No	Frequency (MHz)	Reading (dBUV)	C.F (dB/m)	Measurement (dBUV/m)	Margin (dB)	Limit (dBUV/m)	Height (cm)	Angle (deg)	Remark (QP/PK/AV)
1	11000.000	40.29	5.56	45.85	-28.15	74.00	100	295	Peak
2	* 16500.000	42.58	7.34	49.93	-18.27	68.20	100	0	Peak

Note:

1. " *", means this data is the worst emission level.
2. C.F (Correction Factor) = Antenna Factor (dB)+ Cable Loss (dB) – Pre-amplifier(dB).
3. Measurement (dBUV/m) = Reading(dBUV) + C.F (Correction Factor).
4. The emission levels of other frequencies are very lower than the limit and not show in test report.

EUT	AX3000 Wall Plate Wi-Fi 6 Access Point	Date of Test	2022-09-08
Factor	DRH18-E	Temp. / Humidity	22°C /63%
Polarity	Horizontal	Site / Test Engineer	AC2 / Ares
Test Mode	802.11a_TX_Band3_CH 116_ANT 0+1	Test Voltage	AC 120V/60Hz

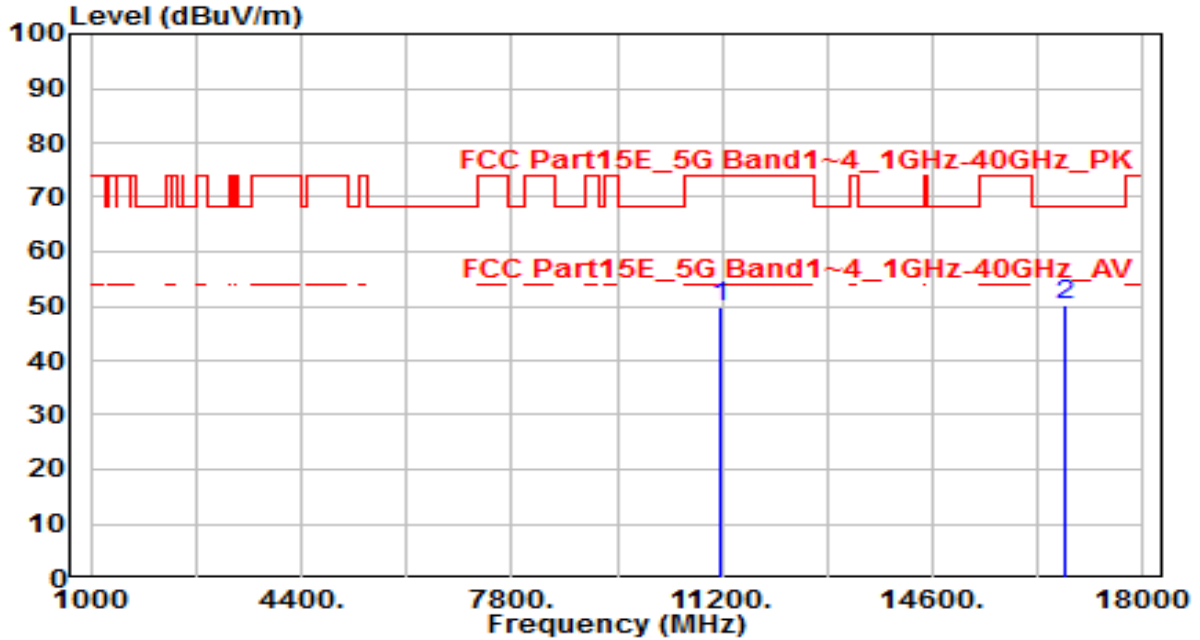

No	Frequency (MHz)	Reading (dBUV)	C.F (dB/m)	Measurement (dBUV/m)	Margin (dB)	Limit (dBUV/m)	Height (cm)	Angle (deg)	Remark (QP/PK/AV)
1	11160.000	43.95	5.73	49.68	-24.32	74.00	100	255	Peak
2	* 16740.000	42.66	7.72	50.38	-17.82	68.20	100	0	Peak

Note:

1. " *", means this data is the worst emission level.
2. C.F (Correction Factor) = Antenna Factor (dB)+ Cable Loss (dB) – Preamplifier(dB).
3. Measurement (dBUV/m) = Reading(dBUV) + C.F (Correction Factor).
4. The emission levels of other frequencies are very lower than the limit and not show in test report.

EUT	AX3000 Wall Plate Wi-Fi 6 Access Point	Date of Test	2022-09-08
Factor	DRH18-E	Temp. / Humidity	22°C /63%
Polarity	Vertical	Site / Test Engineer	AC2 / Ares
Test Mode	802.11a_TX_Band3_CH 116_ANT 0+1	Test Voltage	AC 120V/60Hz

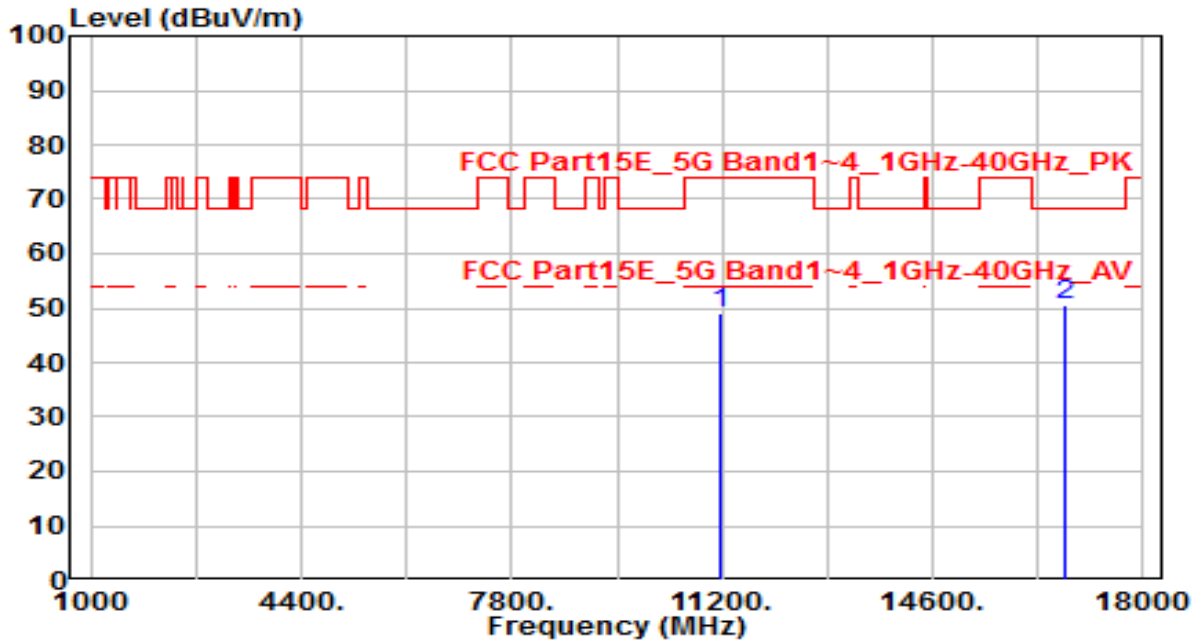

No	Frequency (MHz)	Reading (dBUV)	C.F (dB/m)	Measurement (dBUV/m)	Margin (dB)	Limit (dBUV/m)	Height (cm)	Angle (deg)	Remark (QP/PK/AV)
1	11160.000	43.42	5.73	49.15	-24.85	74.00	100	215	Peak
2	* 16740.000	42.84	7.72	50.55	-17.65	68.20	100	155	Peak

Note:

1. " *", means this data is the worst emission level.
2. C.F (Correction Factor) = Antenna Factor (dB)+ Cable Loss (dB) – Preamplifier(dB).
3. Measurement (dBUV/m) = Reading(dBUV) + C.F (Correction Factor).
4. The emission levels of other frequencies are very lower than the limit and not show in test report.

EUT	AX3000 Wall Plate Wi-Fi 6 Access Point	Date of Test	2022-09-08
Factor	DRH18-E	Temp. / Humidity	22°C /63%
Polarity	Horizontal	Site / Test Engineer	AC2 / Ares
Test Mode	802.11a_TX_Band3_CH 140_ANT 0+1	Test Voltage	AC 120V/60Hz

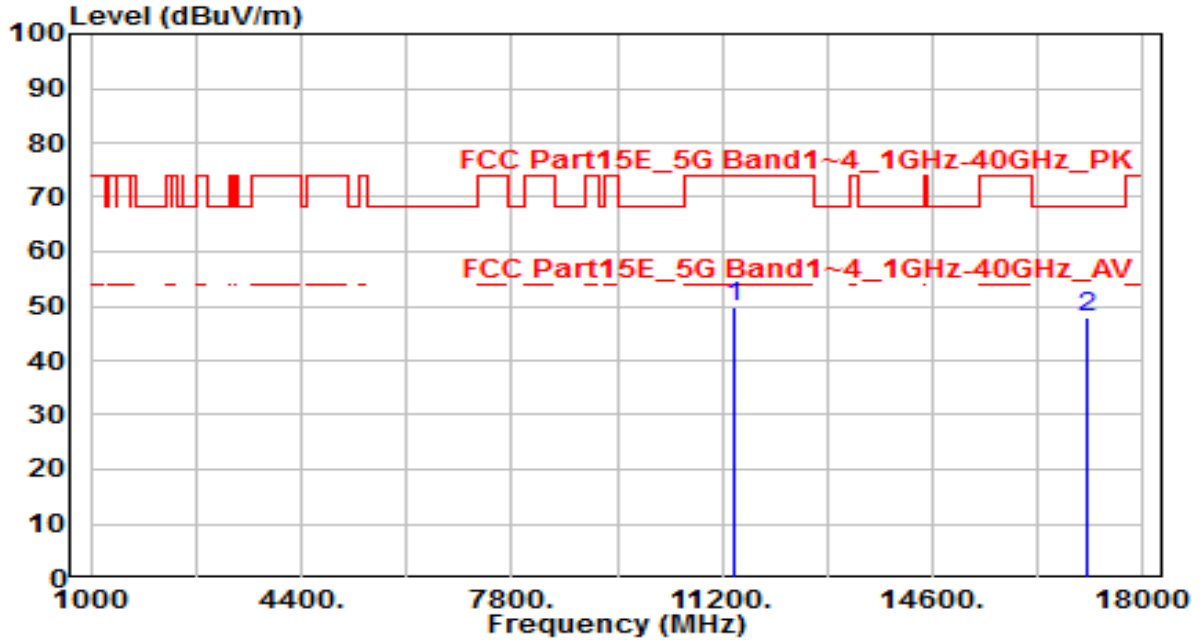

No	Frequency (MHz)	Reading (dBUV)	C.F (dB/m)	Measurement (dBUV/m)	Margin (dB)	Limit (dBUV/m)	Height (cm)	Angle (deg)	Remark (QP/PK/AV)
1	11400.000	43.80	5.98	49.78	-24.22	74.00	100	190	Peak
2	* 17100.000	41.88	6.16	48.04	-20.16	68.20	100	240	Peak

Note:

1. " *", means this data is the worst emission level.
2. C.F (Correction Factor) = Antenna Factor (dB)+ Cable Loss (dB) – Preamplifier(dB).
3. Measurement (dBUV/m) = Reading(dBUV) + C.F (Correction Factor).
4. The emission levels of other frequencies are very lower than the limit and not show in test report.

EUT	AX3000 Wall Plate Wi-Fi 6 Access Point	Date of Test	2022-09-08
Factor	DRH18-E	Temp. / Humidity	22°C /63%
Polarity	Vertical	Site / Test Engineer	AC2 / Ares
Test Mode	802.11a_TX_Band3_CH 140_ANT 0+1	Test Voltage	AC 120V/60Hz

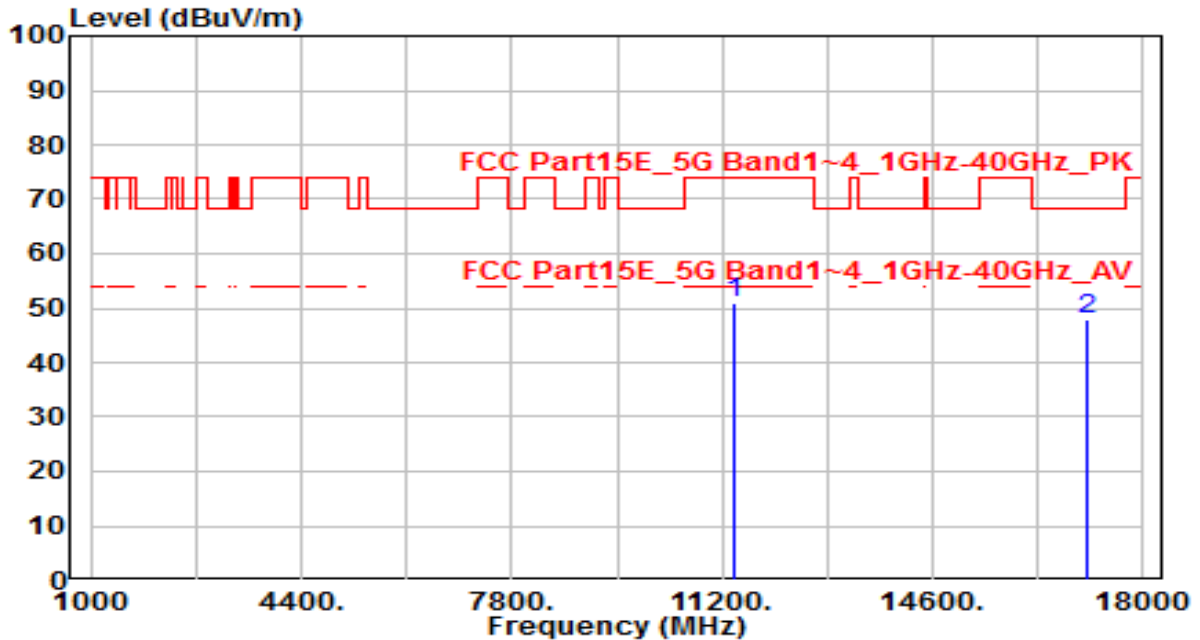

No	Frequency (MHz)	Reading (dBUV)	C.F (dB/m)	Measurement (dBUV/m)	Margin (dB)	Limit (dBUV/m)	Height (cm)	Angle (deg)	Remark (QP/PK/AV)
1	11400.000	45.12	5.98	51.10	-22.90	74.00	100	195	Peak
2	* 17100.000	41.79	6.16	47.96	-20.24	68.20	100	0	Peak

Note:

1. " *", means this data is the worst emission level.
2. C.F (Correction Factor) = Antenna Factor (dB)+ Cable Loss (dB) – Preamplifier(dB).
3. Measurement (dBUV/m) = Reading(dBUV) + C.F (Correction Factor).
4. The emission levels of other frequencies are very lower than the limit and not show in test report.

EUT	AX3000 Wall Plate Wi-Fi 6 Access Point	Date of Test	2022-09-08
Factor	DRH18-E	Temp. / Humidity	22°C /63%
Polarity	Horizontal	Site / Test Engineer	AC2 / Ares
Test Mode	802.11a_TX_Band4_CH 149_ANT 0+1	Test Voltage	AC 120V/60Hz

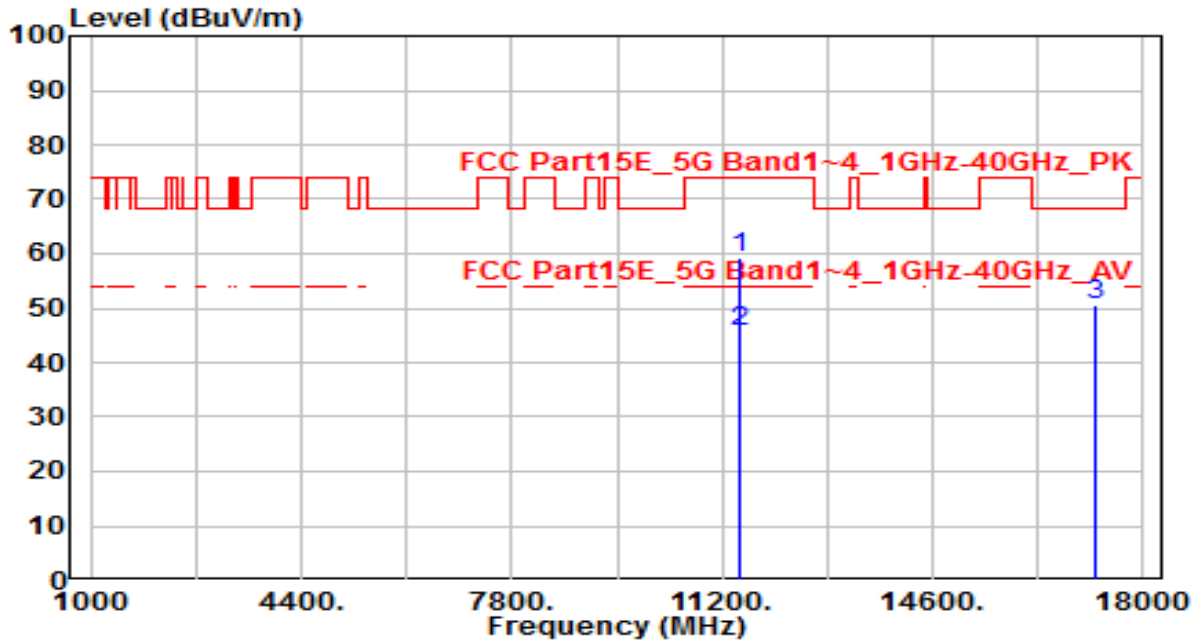

No	Frequency (MHz)	Reading (dBuV)	C.F (dB/m)	Measurement (dBuV/m)	Margin (dB)	Limit (dBuV/m)	Height (cm)	Angle (deg)	Remark (QP/PK/AV)
1	* 11490.000	53.39	5.94	59.33	-14.67	74.00	105	130	Peak
2	* 11490.000	39.90	5.94	45.84	-8.16	54.00	105	130	Average
3	17235.000	44.96	5.78	50.74	-17.46	68.20	100	225	Peak

Note:

1. " *", means this data is the worst emission level.
2. C.F (Correction Factor) = Antenna Factor (dB)+ Cable Loss (dB) – Preamplifier(dB).
3. Measurement (dBuV/m) = Reading(dBuV) + C.F (Correction Factor).
4. The emission levels of other frequencies are very lower than the limit and not show in test report.

EUT	AX3000 Wall Plate Wi-Fi 6 Access Point	Date of Test	2022-09-08
Factor	DRH18-E	Temp. / Humidity	22°C /63%
Polarity	Vertical	Site / Test Engineer	AC2 / Ares
Test Mode	802.11a_TX_Band4_CH 149_ANT 0+1	Test Voltage	AC 120V/60Hz

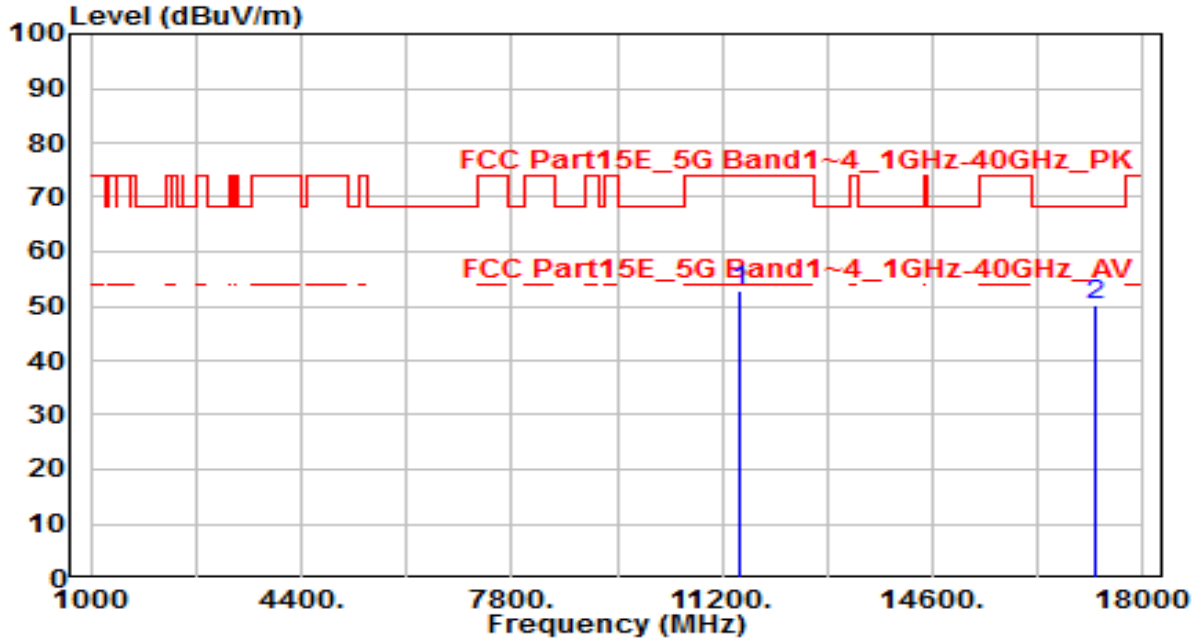

No	Frequency (MHz)	Reading (dBUV)	C.F (dB/m)	Measurement (dBUV/m)	Margin (dB)	Limit (dBUV/m)	Height (cm)	Angle (deg)	Remark (QP/PK/AV)
1	11490.000	46.88	5.94	52.82	-21.18	74.00	100	195	Peak
2	* 17235.000	44.34	5.78	50.12	-18.08	68.20	100	290	Peak

Note:

1. " *", means this data is the worst emission level.
2. C.F (Correction Factor) = Antenna Factor (dB)+ Cable Loss (dB) – Preamplifier(dB).
3. Measurement (dBUV/m) = Reading(dBUV) + C.F (Correction Factor).
4. The emission levels of other frequencies are very lower than the limit and not show in test report.

EUT	AX3000 Wall Plate Wi-Fi 6 Access Point	Date of Test	2022-09-08
Factor	DRH18-E	Temp. / Humidity	22°C /63%
Polarity	Horizontal	Site / Test Engineer	AC2 / Ares
Test Mode	802.11a_TX_Band4_CH 157_ANT 0+1	Test Voltage	AC 120V/60Hz

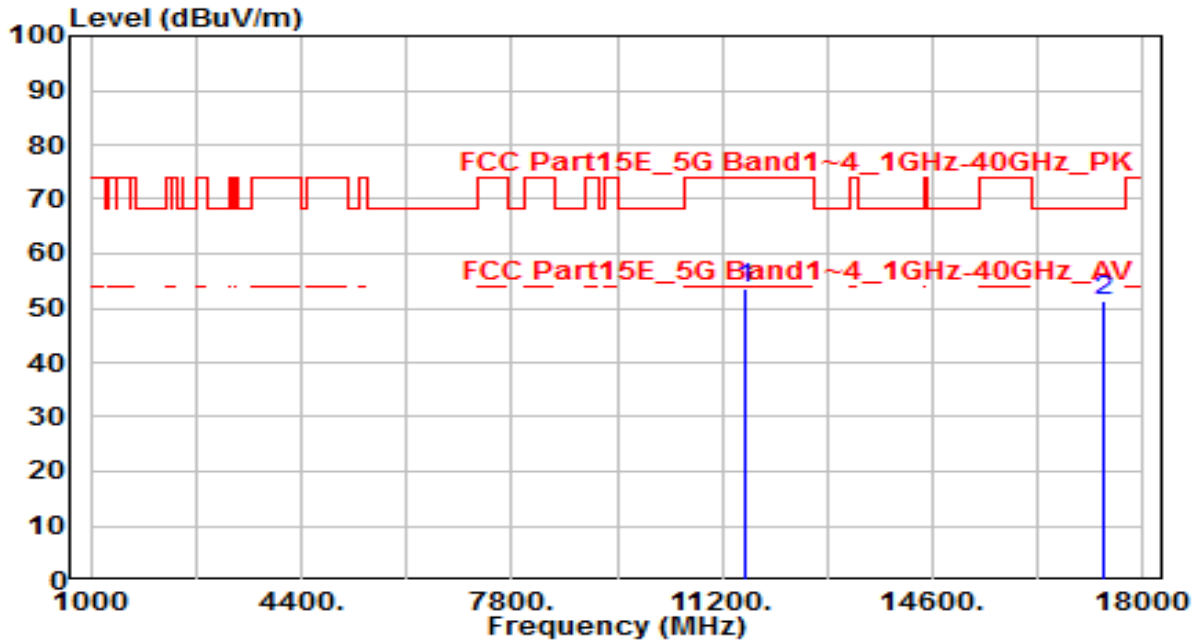

No	Frequency (MHz)	Reading (dBUV)	C.F (dB/m)	Measurement (dBUV/m)	Margin (dB)	Limit (dBUV/m)	Height (cm)	Angle (deg)	Remark (QP/PK/AV)
1	11570.000	47.73	5.91	53.64	-20.36	74.00	100	135	Peak
2	* 17355.000	45.76	5.54	51.30	-16.90	68.20	100	235	Peak

Note:

1. " *", means this data is the worst emission level.
2. C.F (Correction Factor) = Antenna Factor (dB)+ Cable Loss (dB) – Preamplifier(dB).
3. Measurement (dBUV/m) = Reading(dBUV) + C.F (Correction Factor).
4. The emission levels of other frequencies are very lower than the limit and not show in test report.

EUT	AX3000 Wall Plate Wi-Fi 6 Access Point	Date of Test	2022-09-08
Factor	DRH18-E	Temp. / Humidity	22°C /63%
Polarity	Vertical	Site / Test Engineer	AC2 / Ares
Test Mode	802.11a_TX_Band4_CH 157_ANT 0+1	Test Voltage	AC 120V/60Hz

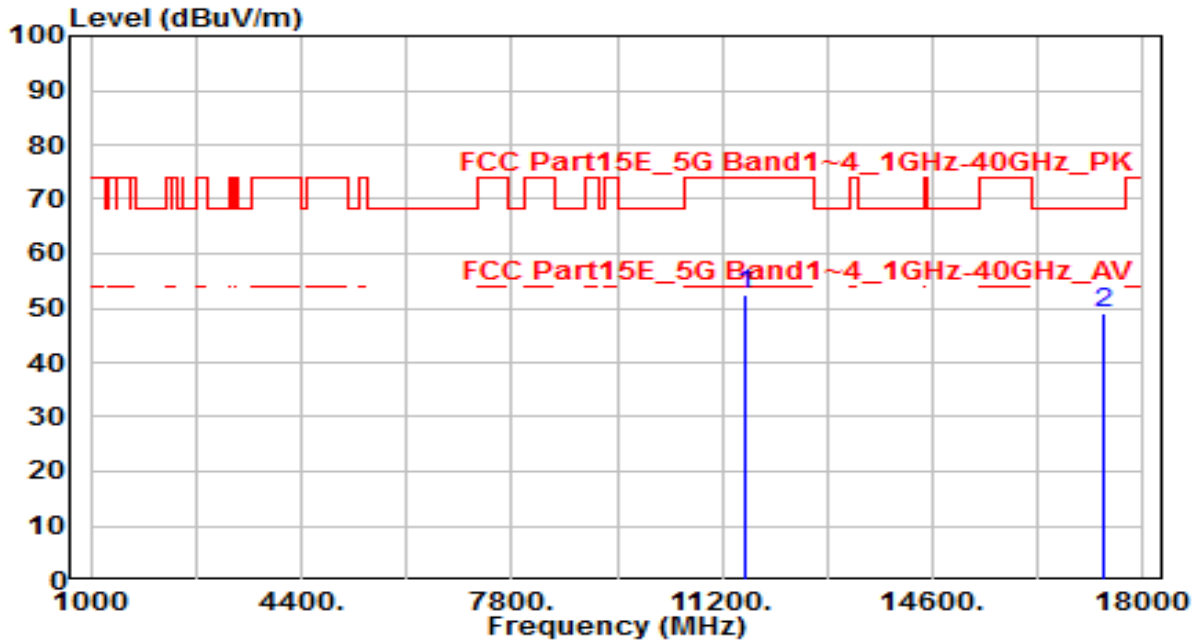

No	Frequency (MHz)	Reading (dBUV)	C.F (dB/m)	Measurement (dBUV/m)	Margin (dB)	Limit (dBUV/m)	Height (cm)	Angle (deg)	Remark (QP/PK/AV)
1	11570.000	46.40	5.91	52.31	-21.69	74.00	100	200	Peak
2	* 17355.000	43.34	5.54	48.88	-19.32	68.20	100	135	Peak

Note:

1. " *", means this data is the worst emission level.
2. C.F (Correction Factor) = Antenna Factor (dB)+ Cable Loss (dB) – Preamplifier(dB).
3. Measurement (dBUV/m) = Reading(dBUV) + C.F (Correction Factor).
4. The emission levels of other frequencies are very lower than the limit and not show in test report.

EUT	AX3000 Wall Plate Wi-Fi 6 Access Point	Date of Test	2022-09-08
Factor	DRH18-E	Temp. / Humidity	22°C /63%
Polarity	Horizontal	Site / Test Engineer	AC2 / Ares
Test Mode	802.11a_TX_Band4_CH 165_ANT 0+1	Test Voltage	AC 120V/60Hz

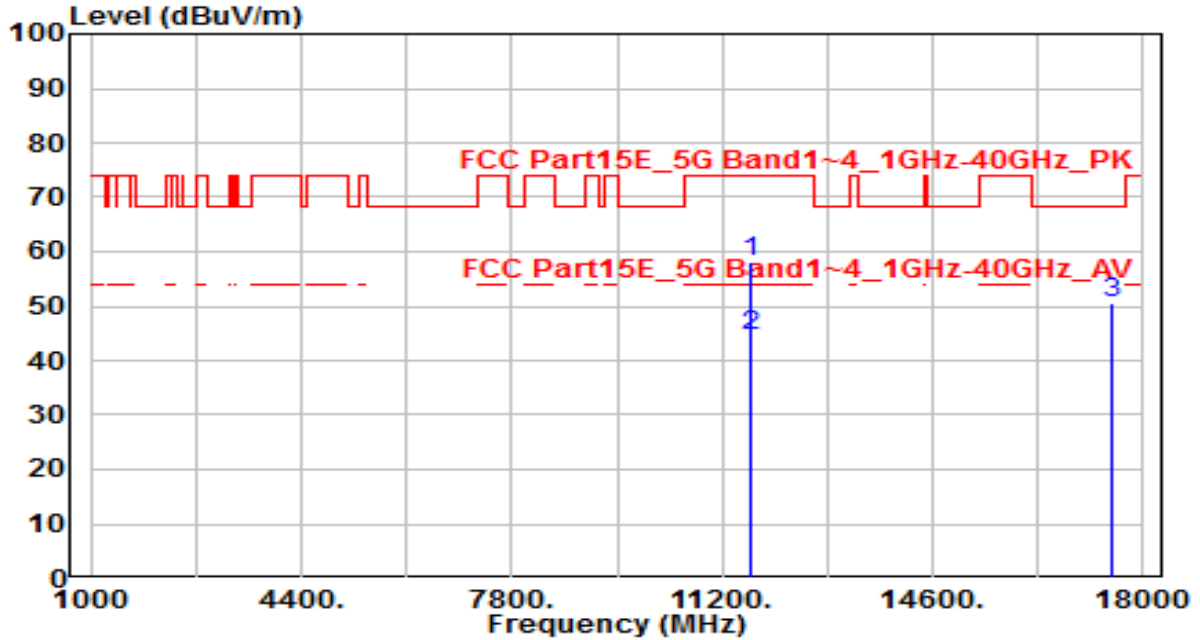

No	Frequency (MHz)	Reading (dBUV)	C.F (dB/m)	Measurement (dBUV/m)	Margin (dB)	Limit (dBUV/m)	Height (cm)	Angle (deg)	Remark (QP/PK/AV)
1	* 11650.000	52.33	5.86	58.19	-15.81	74.00	100	135	Peak
2	* 11650.000	38.68	5.86	44.54	-9.47	54.00	100	135	Average
3	17475.000	45.00	5.44	50.44	-17.76	68.20	100	235	Peak

Note:

1. " *", means this data is the worst emission level.
2. C.F (Correction Factor) = Antenna Factor (dB)+ Cable Loss (dB) – Preamplifier(dB).
3. Measurement (dBUV/m) = Reading(dBUV) + C.F (Correction Factor).
4. The emission levels of other frequencies are very lower than the limit and not show in test report.

EUT	AX3000 Wall Plate Wi-Fi 6 Access Point	Date of Test	2022-09-08
Factor	DRH18-E	Temp. / Humidity	22°C /63%
Polarity	Vertical	Site / Test Engineer	AC2 / Ares
Test Mode	802.11a_TX_Band4_CH 165_ANT 0+1	Test Voltage	AC 120V/60Hz

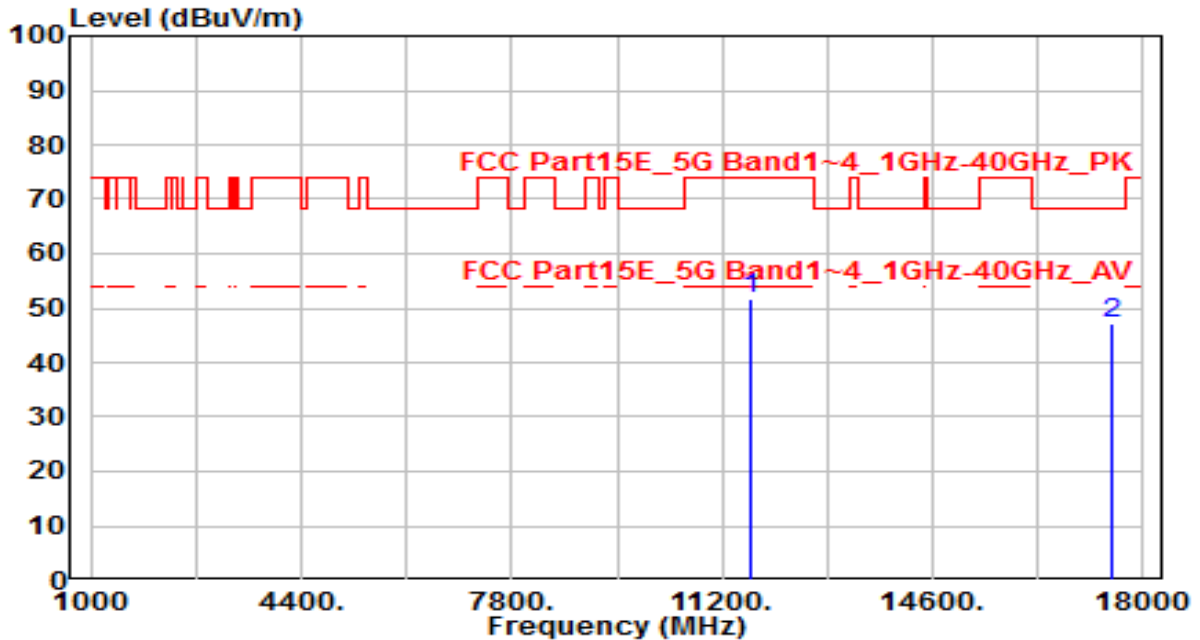

No	Frequency (MHz)	Reading (dBuV)	C.F (dB/m)	Measurement (dBuV/m)	Margin (dB)	Limit (dBuV/m)	Height (cm)	Angle (deg)	Remark (QP/PK/AV)
1	11650.000	45.69	5.86	51.55	-22.45	74.00	100	175	Peak
2	* 17475.000	41.78	5.44	47.22	-20.98	68.20	100	330	Peak

Note:

1. " *", means this data is the worst emission level.
2. C.F (Correction Factor) = Antenna Factor (dB)+ Cable Loss (dB) – Pre-amplifier(dB).
3. Measurement (dBuV/m) = Reading(dBuV) + C.F (Correction Factor).
4. The emission levels of other frequencies are very lower than the limit and not show in test report.