

7.6. Radiated Spurious Emission Measurement

7.6.1. Test Limit

All out of band emissions appearing in a restricted band as specified in Section 15.205 of the Title 47CFR must not exceed the limits shown in Table per Section 15.209.

FCC Part 15 Subpart C Paragraph 15.209		
Frequency [MHz]	Field Strength [Uv/m]	Measured Distance [Meters]
0.009 - 0.490	2400/F (kHz)	300
0.490 - 1.705	24000/F (kHz)	30
1.705 - 30	30	30
30 - 88	100	3
88 - 216	150	3
216 - 960	200	3
Above 960	500	3

7.6.2. Test Procedure Used

ANSI C63.10 - 2013 - Section 11.11 & 11.12

ANSI C63.10 - 2013 - Section 6.3 (General Requirements)

ANSI C63.10 - 2013 - Section 6.4 (Standard test method below 30MHz)

ANSI C63.10 - 2013 - Section 6.5 (Standard test method above 30MHz to 1GHz)

ANSI C63.10 - 2013 - Section 6.6 (Standard test method above 1GHz)

7.6.3. Test Setting

Table 1 - RBW as a function of frequency

Frequency	RBW
9 ~ 150 kHz	200 ~ 300 Hz
0.15 ~ 30 MHz	9 ~ 10 kHz
30 ~ 1000 MHz	100 ~ 120 kHz
> 1000MHz	1MHz

Quasi-Peak Measurements below 1GHz

1. Analyzer center frequency was set to the frequency of the radiated spurious emission of interest
2. Span was set greater than 1MHz
3. RBW = as specified in Table 1
4. Detector = CISPR quasi-peak
5. Sweep time = auto couple
6. Trace was allowed to stabilize

Peak Measurements above 1GHz

1. Analyzer center frequency was set to the frequency of the radiated spurious emission of interest
2. RBW = 1MHz
3. VBW = 3MHz
4. Detector = peak
5. Sweep time = auto couple
6. Trace mode = max hold
7. Trace was allowed to stabilize

Average Measurements above 1GHz (Method VB)

1. Analyzer center frequency was set to the frequency of the radiated spurious emission of interest
2. RBW = 1MHz
3. VBW; If the EUT is configured to transmit with duty cycle $\geq 98\%$, set VBW = 10 Hz.
If the EUT duty cycle is $< 98\%$, set VBW $\geq 1/T$. T is the minimum transmission duration.
4. Detector = Peak
5. Sweep time = auto
6. Trace mode = max hold
7. Trace was allowed to stabilize

7.6.4. Test Setup

Below 1GHz Test Setup:

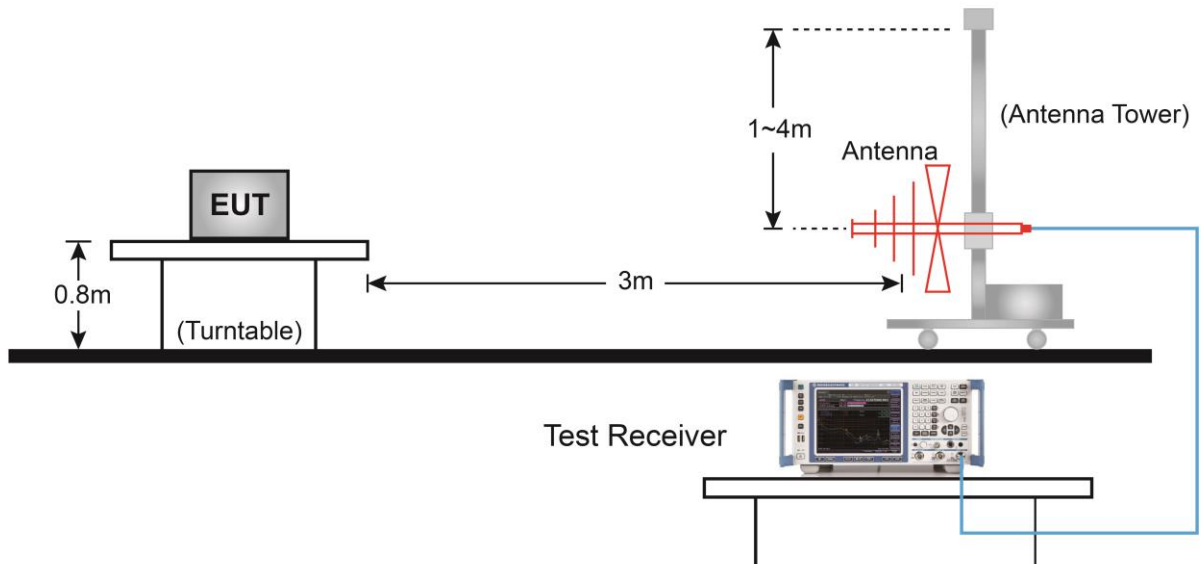

Above 1GHz Test Setup:

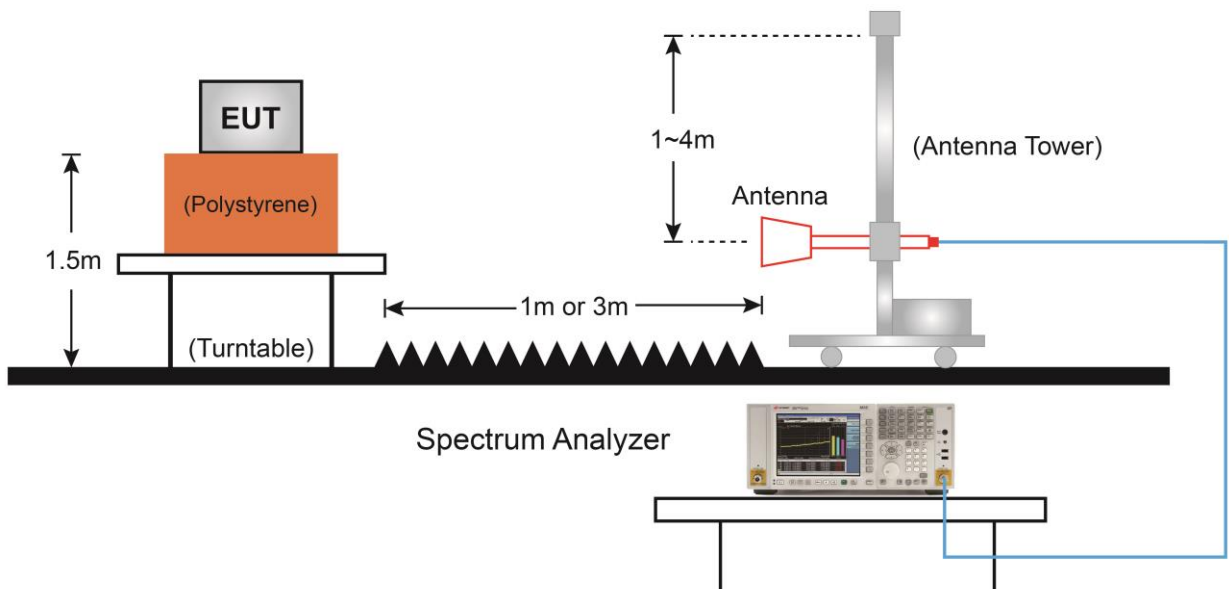

7.6.5. Test Result

EUT	AX3000 Ceiling Mount Wi-Fi 6 Access Point	Date of Test	2023-03-25
Factor	VULB 9162	Temp. / Humidity	22°C /63%
Polarity	Horizontal	Site / Test Engineer	AC2 / Xuan
Test Mode	802.11n-20MHz_TX_CH 6_ANT 0+1	Test Voltage	AC 120V/60Hz

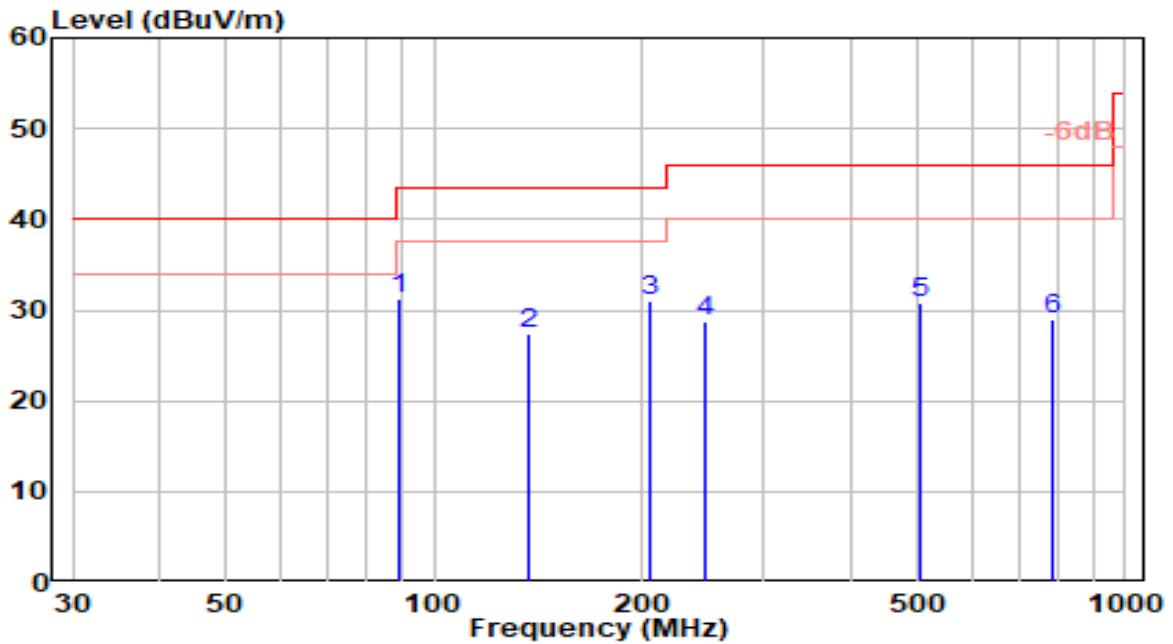

No	Frequency (MHz)	Reading (dBuV)	C.F (dB/m)	Measurement (dBuV/m)	Margin (dB)	Limit (dBuV/m)	Height (cm)	Angle (deg)	Remark (QP/PK/AV)
1	* 89.280	14.88	16.45	31.33	-12.17	43.50	150	260	QP
2	136.580	12.53	14.91	27.45	-16.05	43.50	100	276	QP
3	205.280	13.09	17.84	30.93	-12.57	43.50	150	284	QP
4	247.250	8.92	19.76	28.68	-17.32	46.00	100	334	QP
5	503.900	5.90	24.96	30.86	-15.14	46.00	150	268	QP
6	783.620	-0.11	29.12	29.01	-16.99	46.00	100	265	QP

Note:

1. " *", means this data is the worst emission level.
2. C.F (Correction Factor) = Antenna Factor (dB/m) + Cable Loss (dB).
3. Measurement (dBuV/m) = Reading(dBuV) + C.F (Correction Factor).
4. The emission levels of other frequencies are very lower than the limit and not show in test report.

EUT	AX3000 Ceiling Mount Wi-Fi 6 Access Point	Date of Test	2023-03-25
Factor	VULB 9162	Temp. / Humidity	22°C /63%
Polarity	Horizontal	Site / Test Engineer	AC2 / Xuan
Test Mode	802.11n-20MHz_TX_CH 6_ANT 0+1	Test Voltage	AC 120V/60Hz

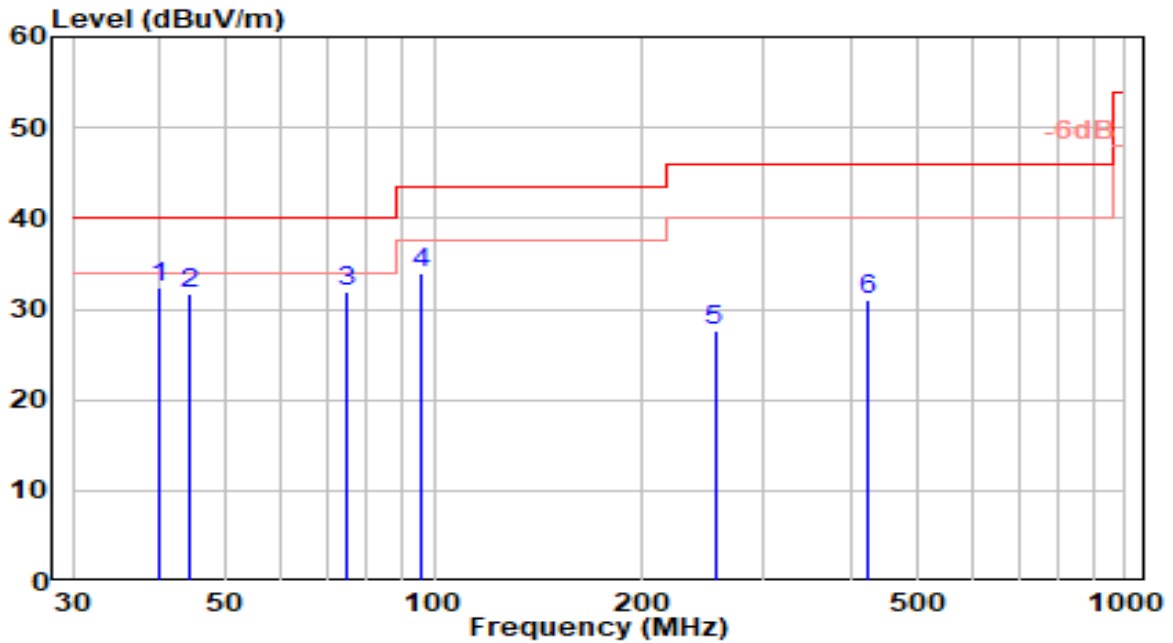

No	Frequency (MHz)	Reading (dBuV)	C.F (dB/m)	Measurement (dBuV/m)	Margin (dB)	Limit (dBuV/m)	Height (cm)	Angle (deg)	Remark (QP/PK/AV)	
1	*	40.170	12.97	19.33	32.30	-7.70	40.00	100	30	QP
2		44.390	11.54	20.26	31.80	-8.20	40.00	150	73	QP
3		74.880	17.45	14.51	31.96	-8.04	40.00	200	21	QP
4		95.920	16.18	17.71	33.89	-9.61	43.50	100	292	QP
5		254.790	7.67	19.93	27.60	-18.40	46.00	150	167	QP
6		423.080	7.77	23.29	31.07	-14.93	46.00	200	195	QP

Note:

1. " *", means this data is the worst emission level.
2. C.F (Correction Factor) = Antenna Factor (dB/m) + Cable Loss (dB).
3. Measurement (dBuV/m) = Reading(dBuV) + C.F (Correction Factor).
4. The emission levels of other frequencies are very lower than the limit and not show in test report.

EUT	AX3000 Ceiling Mount Wi-Fi 6 Access Point	Date of Test	2023-03-23
Factor	DRH18-E	Temp. / Humidity	22°C /63%
Polarity	Horizontal	Site / Test Engineer	AC2 / Marvin
Test Mode	802.11b_TX_CH 1_ANT 0+1	Test Voltage	AC 120V/60Hz

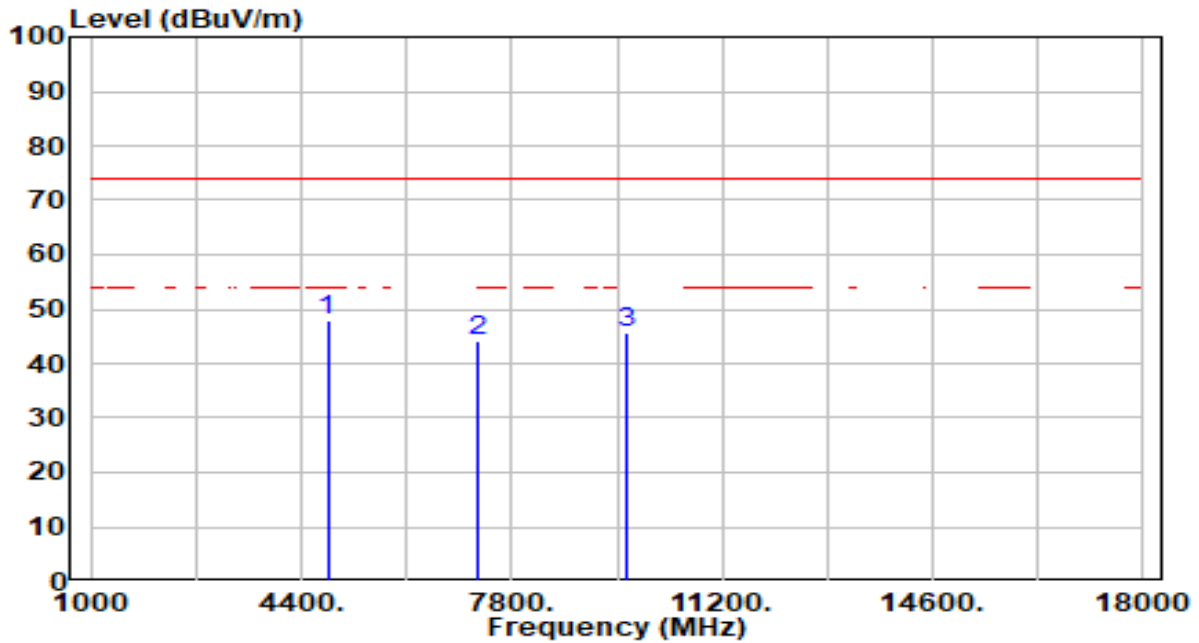

No	Frequency (MHz)	Reading (dBuV)	C.F (dB/m)	Measurement (dBuV/m)	Margin (dB)	Limit (dBuV/m)	Height (cm)	Angle (deg)	Remark (QP/PK/AV)
1	*	48.99	-1.23	47.77	-26.23	74.00	100	192	Peak
2		40.18	4.16	44.34	-29.66	74.00	100	85	Peak
3		42.25	3.29	45.54	-28.46	74.00	300	174	Peak

Note:

1. " *", means this data is the worst emission level.
2. C.F (Correction Factor) = Antenna Factor (dB/m) + Cable Loss (dB) – Preamplifier(dB).
3. Measurement (dBuV/m) = Reading(dBuV) + C.F (Correction Factor).
4. The emission levels of other frequencies are very lower than the limit and not show in test report.

EUT	AX3000 Ceiling Mount Wi-Fi 6 Access Point	Date of Test	2023-03-23
Factor	DRH18-E	Temp. / Humidity	22°C /63%
Polarity	Vertical	Site / Test Engineer	AC2 / Marvin
Test Mode	802.11b_TX_CH 1_ANT 0+1	Test Voltage	AC 120V/60Hz

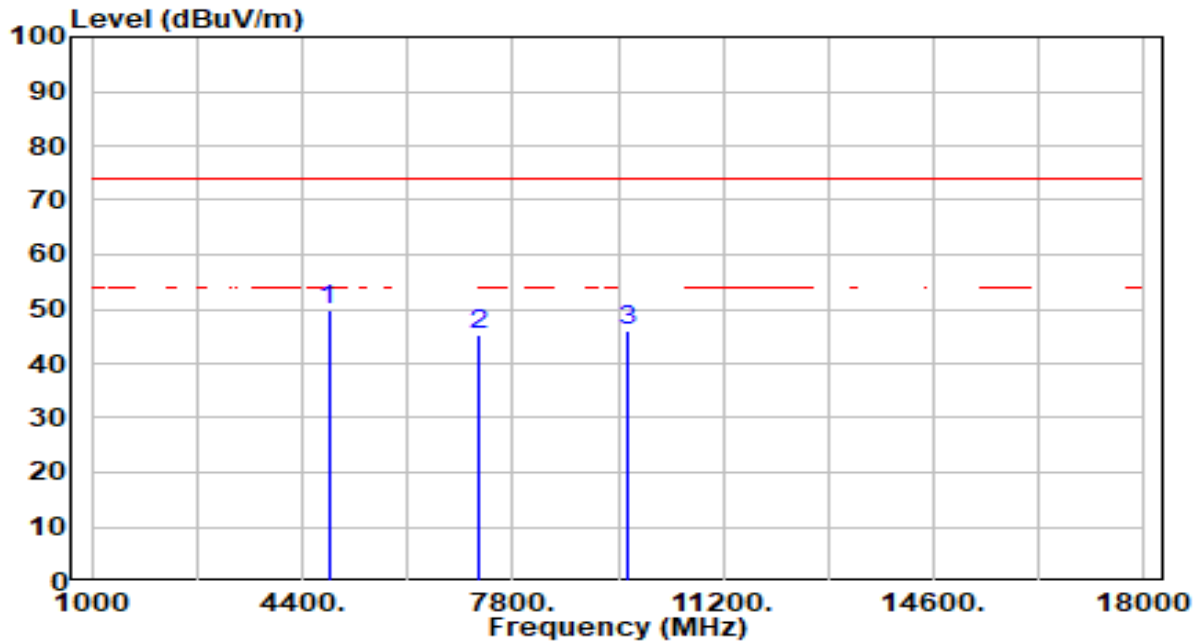

No	Frequency (MHz)	Reading (dBuV)	C.F (dB/m)	Measurement (dBuV/m)	Margin (dB)	Limit (dBuV/m)	Height (cm)	Angle (deg)	Remark (QP/PK/AV)	
1	*	4824.000	50.90	-1.23	49.67	-24.33	74.00	300	173	Peak
2		7236.000	41.28	4.16	45.44	-28.56	74.00	100	17	Peak
3		9648.000	42.66	3.29	45.95	-28.05	74.00	300	40	Peak

Note:

1. " *", means this data is the worst emission level.
2. C.F (Correction Factor) = Antenna Factor (dB/m) + Cable Loss (dB) – Preamplifier(dB).
3. Measurement (dBuV/m) = Reading(dBuV) + C.F (Correction Factor).
4. The emission levels of other frequencies are very lower than the limit and not show in test report.

EUT	AX3000 Ceiling Mount Wi-Fi 6 Access Point	Date of Test	2023-03-23
Factor	DRH18-E	Temp. / Humidity	22°C /63%
Polarity	Horizontal	Site / Test Engineer	AC2 / Marvin
Test Mode	802.11b_TX_CH 6_ANT 0+1	Test Voltage	AC 120V/60Hz

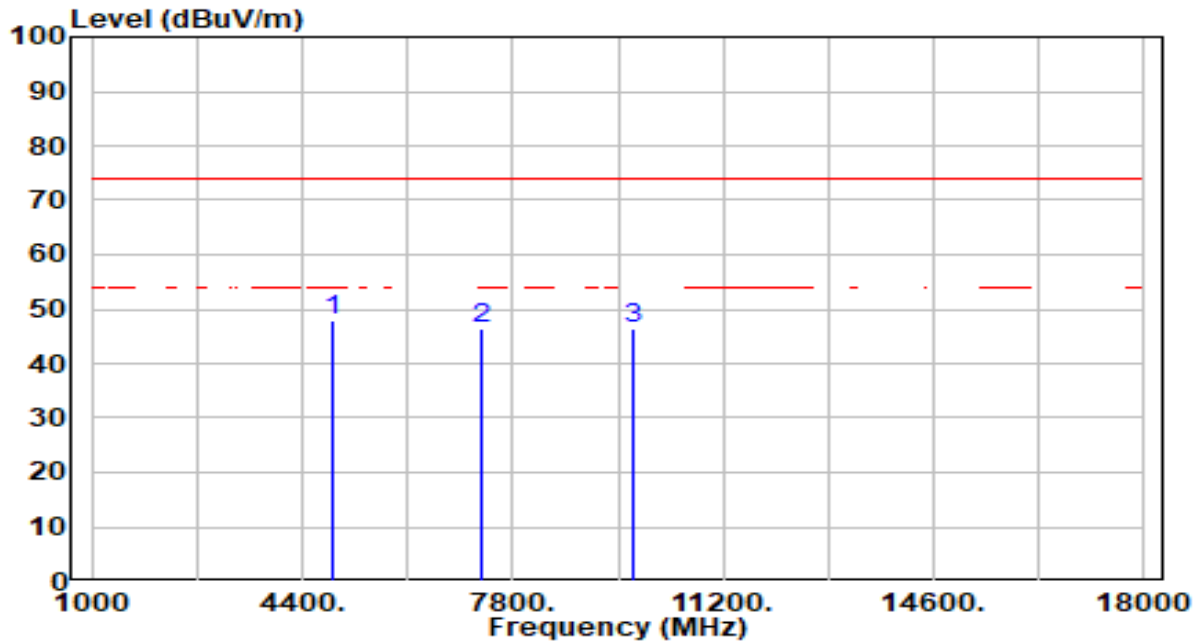

No	Frequency (MHz)	Reading (dBuV)	C.F (dB/m)	Measurement (dBuV/m)	Margin (dB)	Limit (dBuV/m)	Height (cm)	Angle (deg)	Remark (QP/PK/AV)
1	*	48.89	-1.13	47.76	-26.24	74.00	100	187	Peak
2		42.31	4.14	46.45	-27.55	74.00	100	115	Peak
3		43.02	3.33	46.35	-27.65	74.00	100	0	Peak

Note:

1. " *", means this data is the worst emission level.
2. C.F (Correction Factor) = Antenna Factor (dB/m) + Cable Loss (dB) – Preamplifier(dB).
3. Measurement (dBuV/m) = Reading(dBuV) + C.F (Correction Factor).
4. The emission levels of other frequencies are very lower than the limit and not show in test report.

EUT	AX3000 Ceiling Mount Wi-Fi 6 Access Point	Date of Test	2023-03-23
Factor	DRH18-E	Temp. / Humidity	22°C /63%
Polarity	Vertical	Site / Test Engineer	AC2 / Marvin
Test Mode	802.11b_TX_CH 6_ANT 0+1	Test Voltage	AC 120V/60Hz

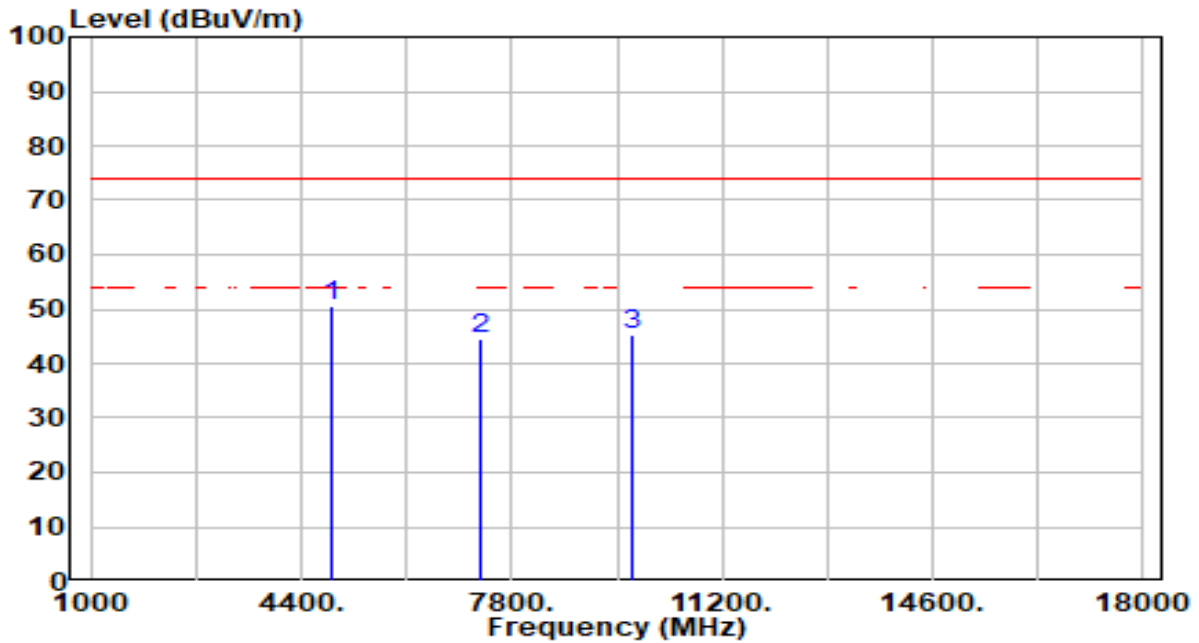

No	Frequency (MHz)	Reading (dBuV)	C.F (dB/m)	Measurement (dBuV/m)	Margin (dB)	Limit (dBuV/m)	Height (cm)	Angle (deg)	Remark (QP/PK/AV)	
1	*	4874.000	51.80	-1.13	50.68	-23.32	74.00	300	175	Peak
2		7311.000	40.24	4.14	44.38	-29.62	74.00	300	210	Peak
3		9748.000	42.04	3.33	45.37	-28.63	74.00	300	360	Peak

Note:

1. " *", means this data is the worst emission level.
2. C.F (Correction Factor) = Antenna Factor (dB/m) + Cable Loss (dB) – Preamplifier(dB).
3. Measurement (dBuV/m) = Reading(dBuV) + C.F (Correction Factor).
4. The emission levels of other frequencies are very lower than the limit and not show in test report.

EUT	AX3000 Ceiling Mount Wi-Fi 6 Access Point	Date of Test	2023-03-23
Factor	DRH18-E	Temp. / Humidity	22°C /63%
Polarity	Horizontal	Site / Test Engineer	AC2 / Marvin
Test Mode	802.11b_TX_CH 11_ANT 0+1	Test Voltage	AC 120V/60Hz

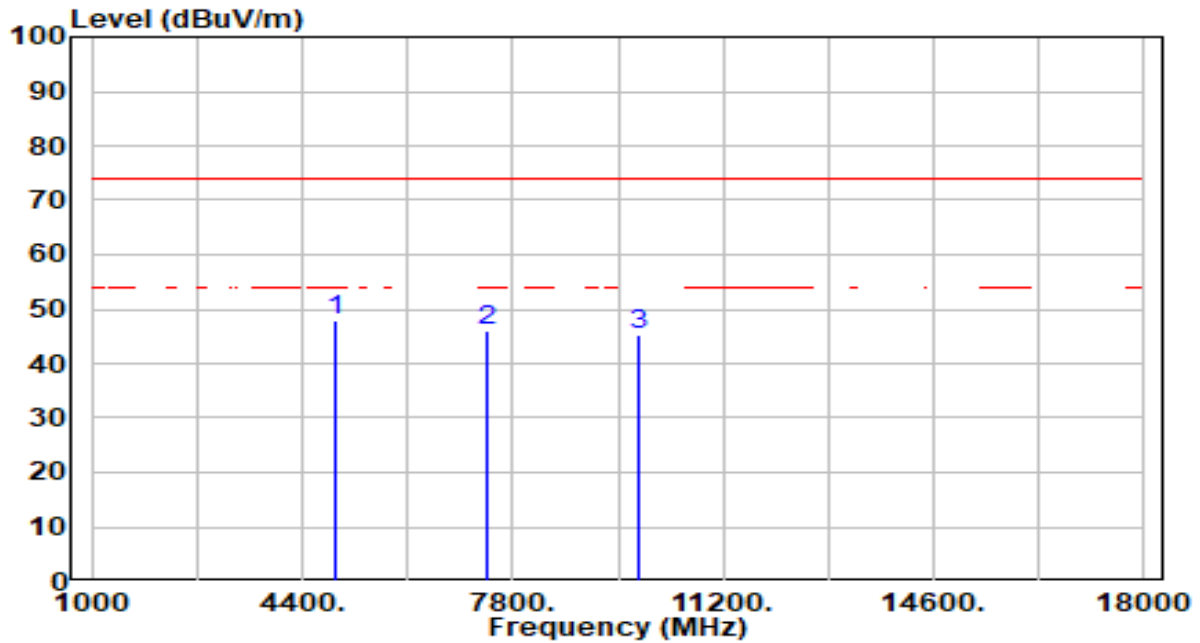

No	Frequency (MHz)	Reading (dBuV)	C.F (dB/m)	Measurement (dBuV/m)	Margin (dB)	Limit (dBuV/m)	Height (cm)	Angle (deg)	Remark (QP/PK/AV)
1	* 4924.000	49.04	-1.03	48.01	-25.99	74.00	100	189	Peak
2	7386.000	41.87	4.11	45.99	-28.01	74.00	100	107	Peak
3	9848.000	42.01	3.39	45.40	-28.60	74.00	100	129	Peak

Note:

1. " *", means this data is the worst emission level.
2. C.F (Correction Factor) = Antenna Factor (dB/m) + Cable Loss (dB) – Preamplifier(dB).
3. Measurement (dBuV/m) = Reading(dBuV) + C.F (Correction Factor).
4. The emission levels of other frequencies are very lower than the limit and not show in test report.

EUT	AX3000 Ceiling Mount Wi-Fi 6 Access Point	Date of Test	2023-03-23
Factor	DRH18-E	Temp. / Humidity	22°C /63%
Polarity	Vertical	Site / Test Engineer	AC2 / Marvin
Test Mode	802.11b_TX_CH 11_ANT 0+1	Test Voltage	AC 120V/60Hz

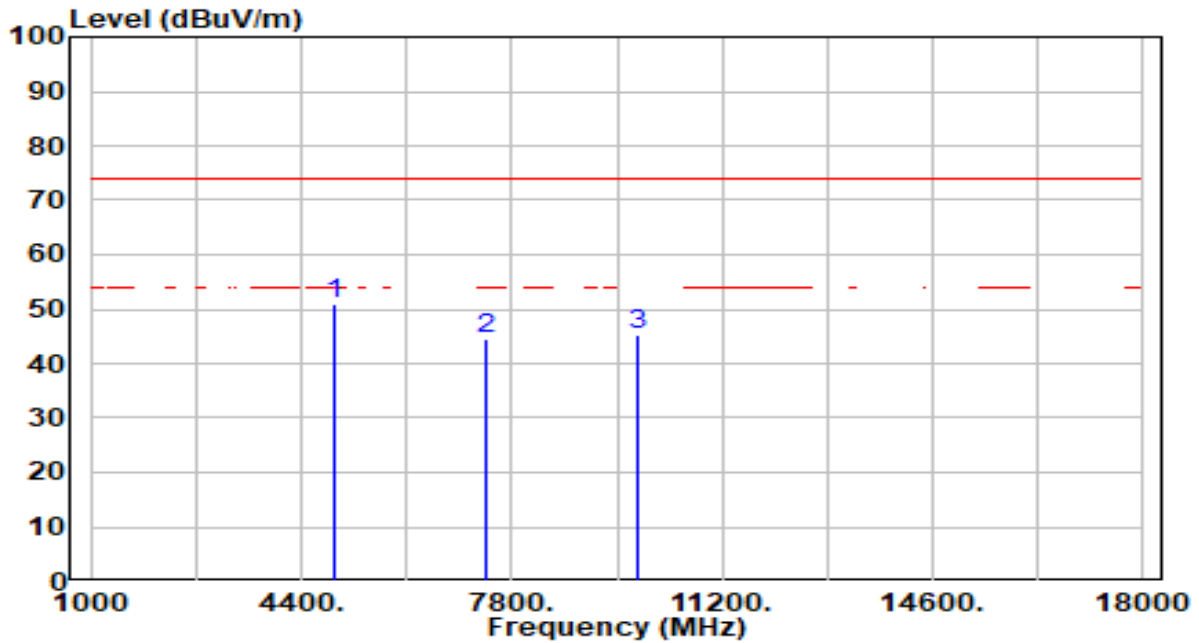

No	Frequency (MHz)	Reading (dBuV)	C.F (dB/m)	Measurement (dBuV/m)	Margin (dB)	Limit (dBuV/m)	Height (cm)	Angle (deg)	Remark (QP/PK/AV)	
1	*	4924.000	51.83	-1.03	50.80	-23.20	74.00	300	178	Peak
2		7386.000	40.58	4.11	44.69	-29.31	74.00	300	208	Peak
3		9848.000	41.77	3.39	45.16	-28.84	74.00	300	71	Peak

Note:

1. " *", means this data is the worst emission level.
2. C.F (Correction Factor) = Antenna Factor (dB/m) + Cable Loss (dB) – Preamplifier(dB).
3. Measurement (dBuV/m) = Reading(dBuV) + C.F (Correction Factor).
4. The emission levels of other frequencies are very lower than the limit and not show in test report.

EUT	AX3000 Ceiling Mount Wi-Fi 6 Access Point	Date of Test	2023-03-23
Factor	DRH18-E	Temp. / Humidity	22°C /63%
Polarity	Horizontal	Site / Test Engineer	AC2 / Marvin
Test Mode	802.11g_TX_CH 1_ANT 0+1	Test Voltage	AC 120V/60Hz

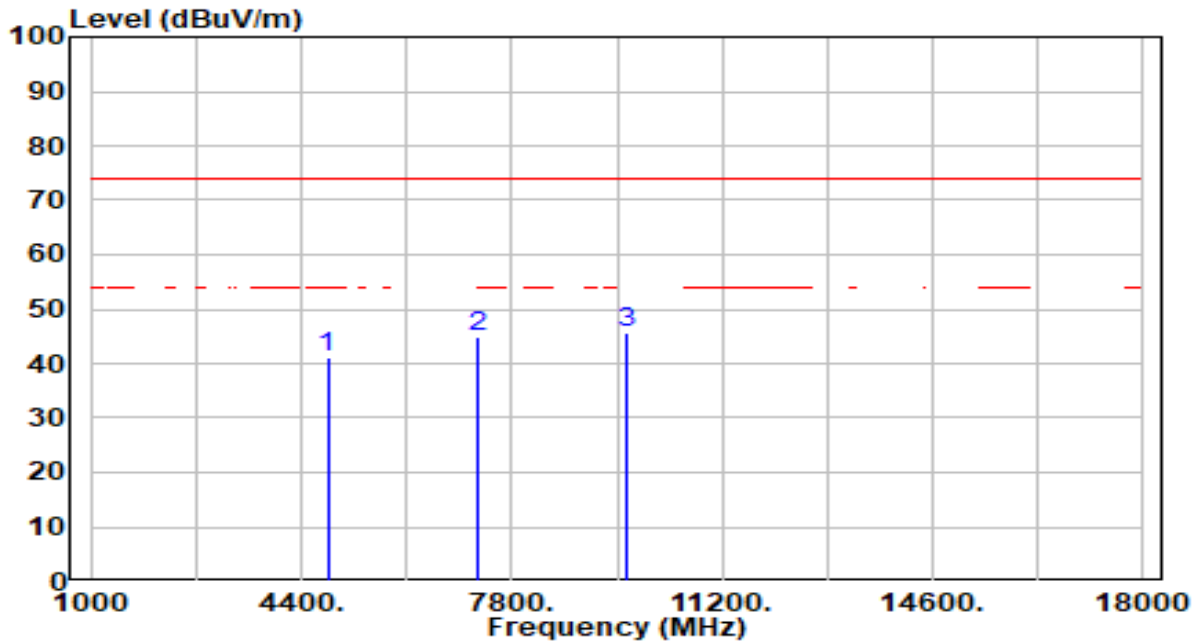

No	Frequency (MHz)	Reading (dBuV)	C.F (dB/m)	Measurement (dBuV/m)	Margin (dB)	Limit (dBuV/m)	Height (cm)	Angle (deg)	Remark (QP/PK/AV)
1	4824.000	42.36	-1.23	41.13	-32.87	74.00	100	211	Peak
2	7236.000	40.65	4.16	44.81	-29.19	74.00	100	1	Peak
3	* 9648.000	42.47	3.29	45.76	-28.24	74.00	100	184	Peak

Note:

1. " *", means this data is the worst emission level.
2. C.F (Correction Factor) = Antenna Factor (dB/m) + Cable Loss (dB) – Preamplifier(dB).
3. Measurement (dBuV/m) = Reading(dBuV) + C.F (Correction Factor).
4. The emission levels of other frequencies are very lower than the limit and not show in test report.

EUT	AX3000 Ceiling Mount Wi-Fi 6 Access Point	Date of Test	2023-03-23
Factor	DRH18-E	Temp. / Humidity	22°C /63%
Polarity	Vertical	Site / Test Engineer	AC2 / Marvin
Test Mode	802.11g_TX_CH 1_ANT 0+1	Test Voltage	AC 120V/60Hz

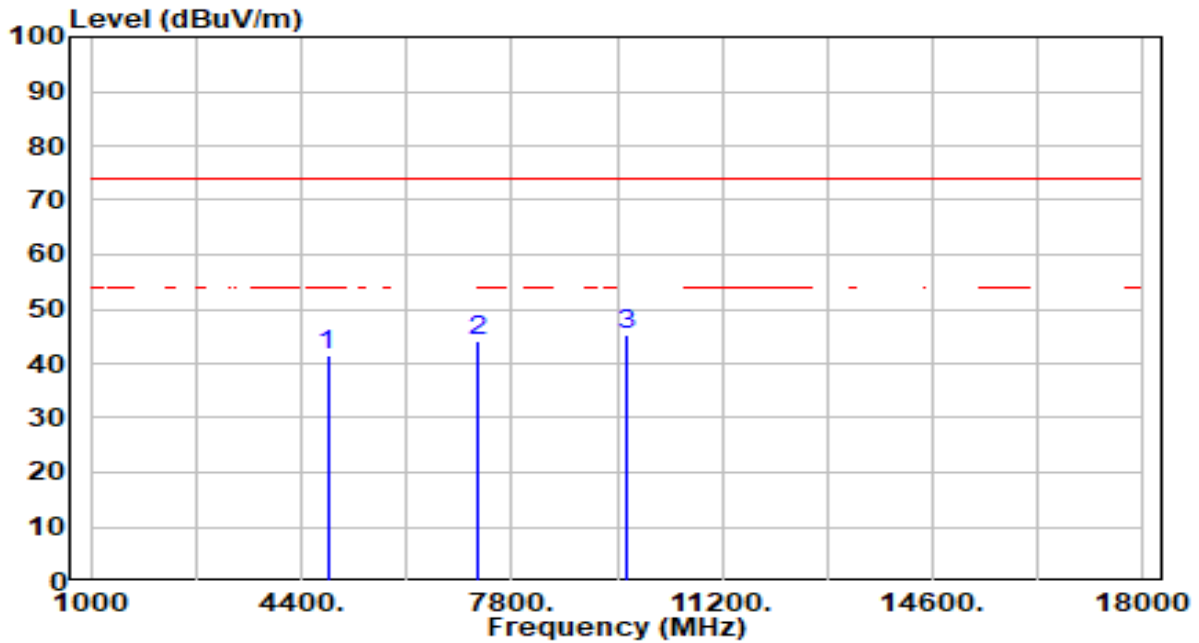

No	Frequency (MHz)	Reading (dBuV)	C.F (dB/m)	Measurement (dBuV/m)	Margin (dB)	Limit (dBuV/m)	Height (cm)	Angle (deg)	Remark (QP/PK/AV)
1	4824.000	42.92	-1.23	41.69	-32.31	74.00	300	193	Peak
2	7236.000	40.09	4.16	44.25	-29.75	74.00	300	347	Peak
3	* 9648.000	42.05	3.29	45.34	-28.66	74.00	300	69	Peak

Note:

1. " *", means this data is the worst emission level.
2. C.F (Correction Factor) = Antenna Factor (dB/m) + Cable Loss (dB) – Preamplifier(dB).
3. Measurement (dBuV/m) = Reading(dBuV) + C.F (Correction Factor).
4. The emission levels of other frequencies are very lower than the limit and not show in test report.

EUT	AX3000 Ceiling Mount Wi-Fi 6 Access Point	Date of Test	2023-03-23
Factor	DRH18-E	Temp. / Humidity	22°C /63%
Polarity	Horizontal	Site / Test Engineer	AC2 / Marvin
Test Mode	802.11g_TX_CH 6_ANT 0+1	Test Voltage	AC 120V/60Hz

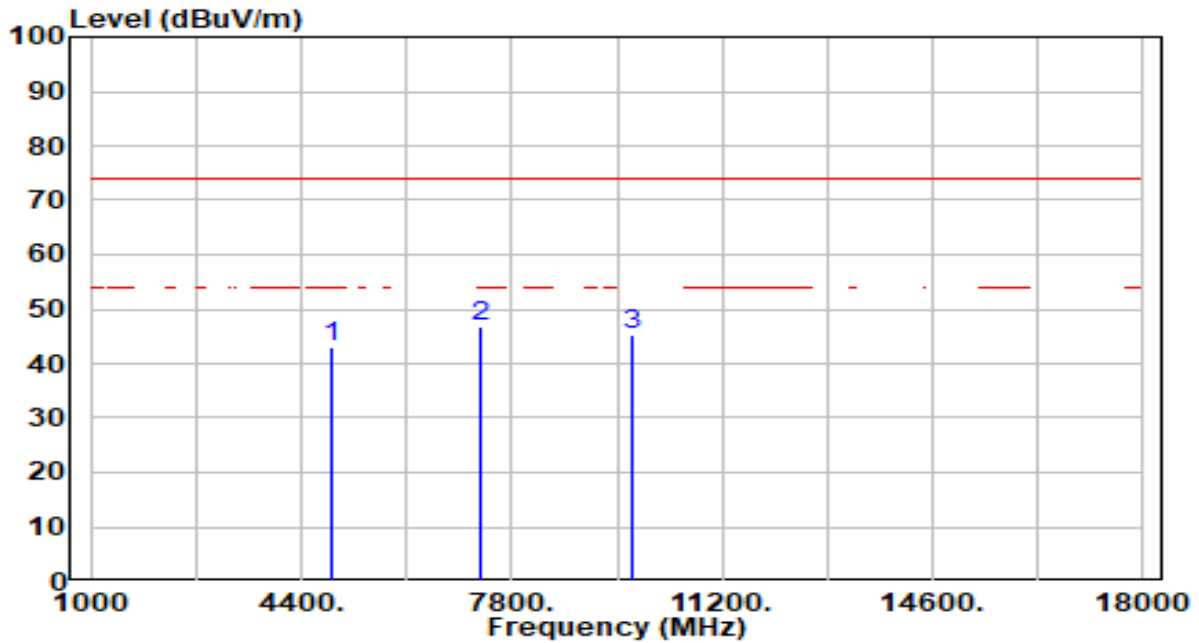

No	Frequency (MHz)	Reading (dBuV)	C.F (dB/m)	Measurement (dBuV/m)	Margin (dB)	Limit (dBuV/m)	Height (cm)	Angle (deg)	Remark (QP/PK/AV)
1	4874.000	44.12	-1.13	42.99	-31.01	74.00	100	187	Peak
2	* 7311.000	42.49	4.14	46.63	-27.37	74.00	100	124	Peak
3	9748.000	41.88	3.33	45.20	-28.80	74.00	100	73	Peak

Note:

1. " *", means this data is the worst emission level.
2. C.F (Correction Factor) = Antenna Factor (dB/m) + Cable Loss (dB) – Preamplifier(dB).
3. Measurement (dBuV/m) = Reading(dBuV) + C.F (Correction Factor).
4. The emission levels of other frequencies are very lower than the limit and not show in test report.

EUT	AX3000 Ceiling Mount Wi-Fi 6 Access Point	Date of Test	2023-03-23
Factor	DRH18-E	Temp. / Humidity	22°C /63%
Polarity	Vertical	Site / Test Engineer	AC2 / Marvin
Test Mode	802.11g_TX_CH 6_ANT 0+1	Test Voltage	AC 120V/60Hz

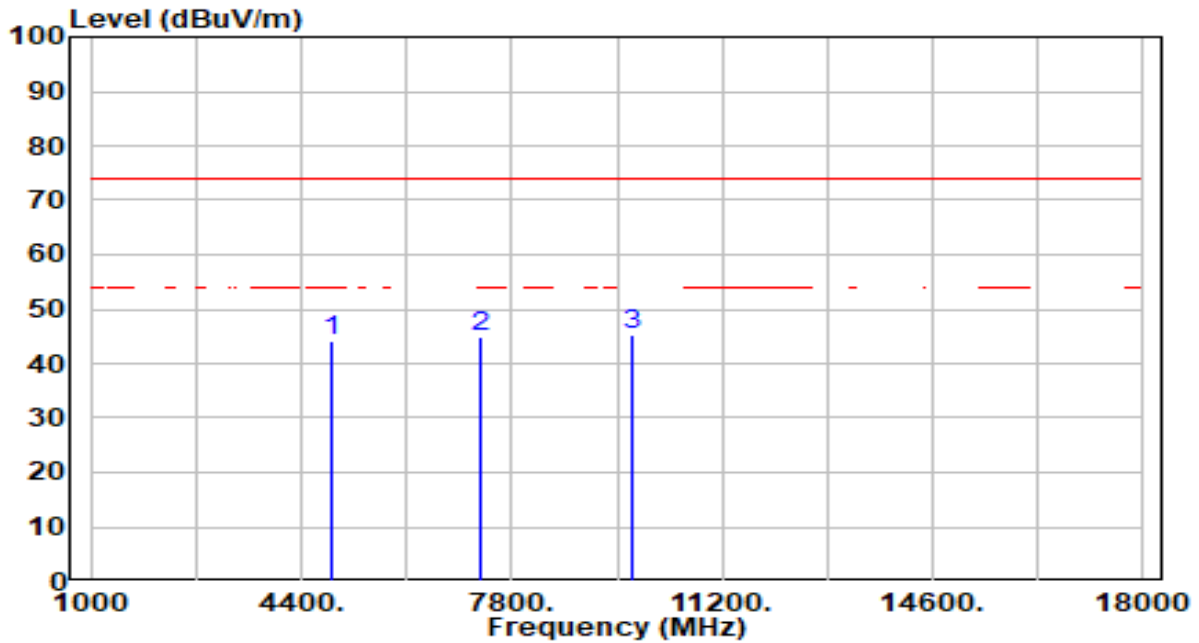

No	Frequency (MHz)	Reading (dBuV)	C.F (dB/m)	Measurement (dBuV/m)	Margin (dB)	Limit (dBuV/m)	Height (cm)	Angle (deg)	Remark (QP/PK/AV)
1	4874.000	45.30	-1.13	44.18	-29.82	74.00	300	167	Peak
2	7311.000	40.86	4.14	45.00	-29.00	74.00	300	316	Peak
3	* 9748.000	41.96	3.33	45.29	-28.71	74.00	300	131	Peak

Note:

1. " *", means this data is the worst emission level.
2. C.F (Correction Factor) = Antenna Factor (dB/m) + Cable Loss (dB) – Preamplifier(dB).
3. Measurement (dBuV/m) = Reading(dBuV) + C.F (Correction Factor).
4. The emission levels of other frequencies are very lower than the limit and not show in test report.

EUT	AX3000 Ceiling Mount Wi-Fi 6 Access Point	Date of Test	2023-03-23
Factor	DRH18-E	Temp. / Humidity	22°C /63%
Polarity	Horizontal	Site / Test Engineer	AC2 / Marvin
Test Mode	802.11g_TX_CH 11_ANT 0+1	Test Voltage	AC 120V/60Hz

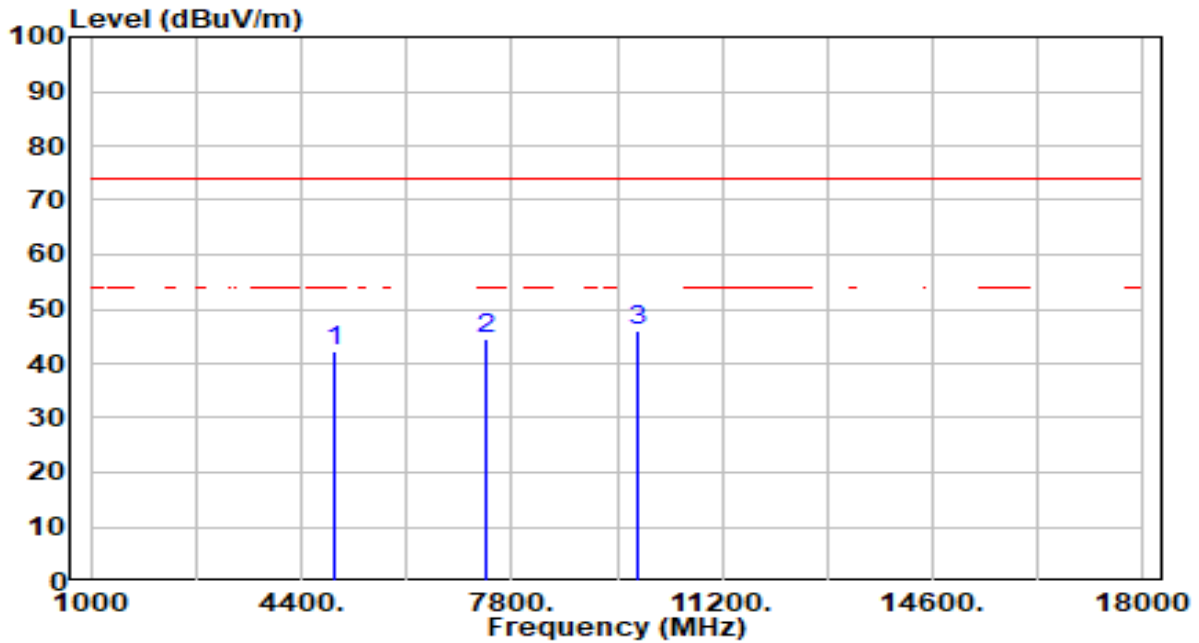

No	Frequency (MHz)	Reading (dBuV)	C.F (dB/m)	Measurement (dBuV/m)	Margin (dB)	Limit (dBuV/m)	Height (cm)	Angle (deg)	Remark (QP/PK/AV)
1	4924.000	43.23	-1.03	42.21	-31.79	74.00	100	185	Peak
2	7386.000	40.46	4.11	44.57	-29.43	74.00	100	112	Peak
3	* 9848.000	42.55	3.39	45.94	-28.06	74.00	100	0	Peak

Note:

1. " *", means this data is the worst emission level.
2. C.F (Correction Factor) = Antenna Factor (dB/m) + Cable Loss (dB) – Preamplifier(dB).
3. Measurement (dBuV/m) = Reading(dBuV) + C.F (Correction Factor).
4. The emission levels of other frequencies are very lower than the limit and not show in test report.

EUT	AX3000 Ceiling Mount Wi-Fi 6 Access Point	Date of Test	2023-03-23
Factor	DRH18-E	Temp. / Humidity	22°C /63%
Polarity	Vertical	Site / Test Engineer	AC2 / Marvin
Test Mode	802.11g_TX_CH 11_ANT 0+1	Test Voltage	AC 120V/60Hz

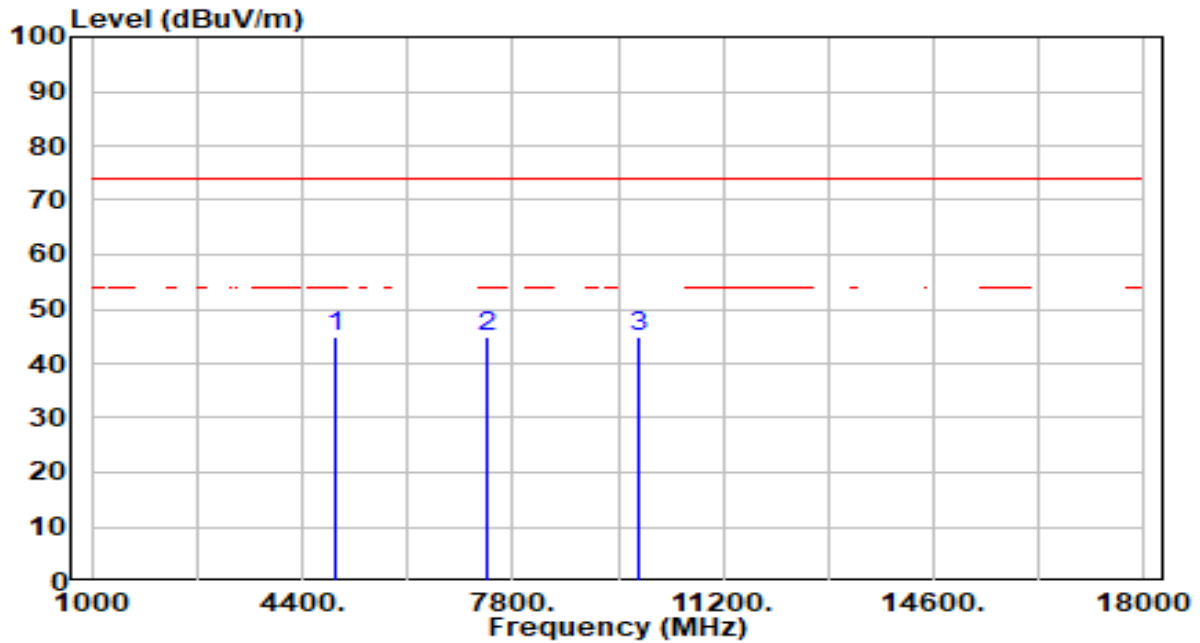

No	Frequency (MHz)	Reading (dBuV)	C.F (dB/m)	Measurement (dBuV/m)	Margin (dB)	Limit (dBuV/m)	Height (cm)	Angle (deg)	Remark (QP/PK/AV)
1	4924.000	45.84	-1.03	44.82	-29.18	74.00	300	164	Peak
2	* 7386.000	40.83	4.11	44.95	-29.05	74.00	300	202	Peak
3	9848.000	41.50	3.39	44.88	-29.12	74.00	300	67	Peak

Note:

1. " *", means this data is the worst emission level.
2. C.F (Correction Factor) = Antenna Factor (dB/m) + Cable Loss (dB) – Preamplifier(dB).
3. Measurement (dBuV/m) = Reading(dBuV) + C.F (Correction Factor).
4. The emission levels of other frequencies are very lower than the limit and not show in test report.

EUT	AX3000 Ceiling Mount Wi-Fi 6 Access Point	Date of Test	2023-03-23
Factor	DRH18-E	Temp. / Humidity	22°C /63%
Polarity	Horizontal	Site / Test Engineer	AC2 / Marvin
Test Mode	802.11n-20MHz_TX_CH 1_ANT 0+1	Test Voltage	AC 120V/60Hz

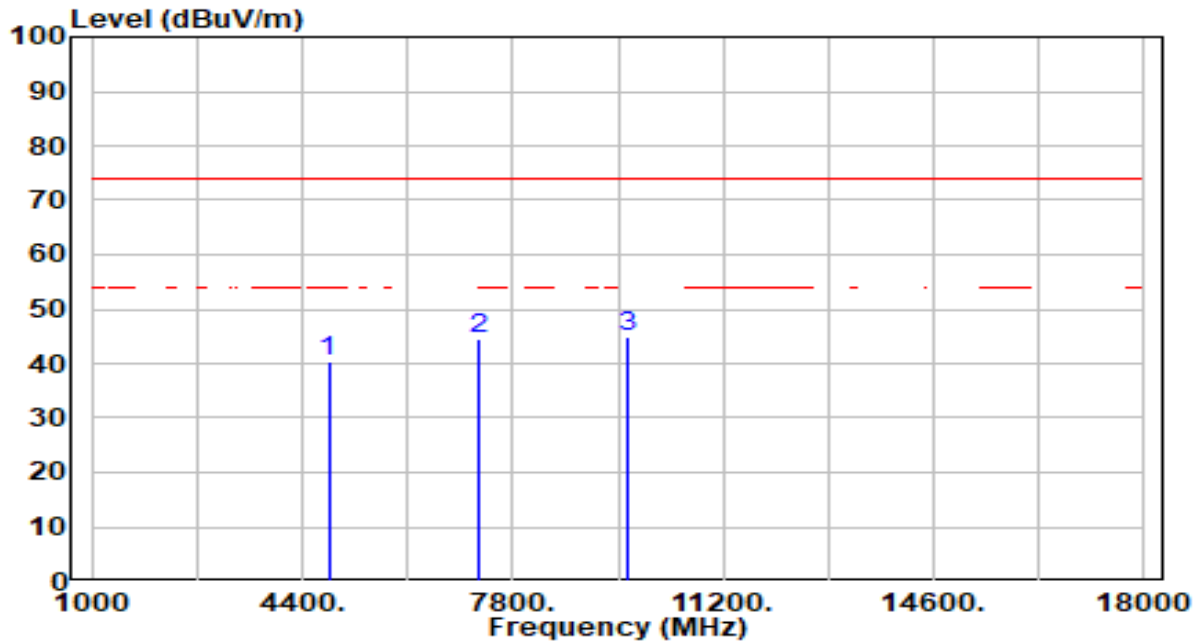

No	Frequency (MHz)	Reading (dBuV)	C.F (dB/m)	Measurement (dBuV/m)	Margin (dB)	Limit (dBuV/m)	Height (cm)	Angle (deg)	Remark (QP/PK/AV)
1	4824.000	41.67	-1.23	40.44	-33.56	74.00	100	197	Peak
2	7236.000	40.36	4.16	44.52	-29.48	74.00	100	85	Peak
3	* 9648.000	41.59	3.29	44.88	-29.12	74.00	100	0	Peak

Note:

1. " *", means this data is the worst emission level.
2. C.F (Correction Factor) = Antenna Factor (dB/m) + Cable Loss (dB) – Preamplifier(dB).
3. Measurement (dBuV/m) = Reading(dBuV) + C.F (Correction Factor).
4. The emission levels of other frequencies are very lower than the limit and not show in test report.

EUT	AX3000 Ceiling Mount Wi-Fi 6 Access Point	Date of Test	2023-03-23
Factor	DRH18-E	Temp. / Humidity	22°C /63%
Polarity	Vertical	Site / Test Engineer	AC2 / Marvin
Test Mode	802.11n-20MHz_TX_CH 1_ANT 0+1	Test Voltage	AC 120V/60Hz

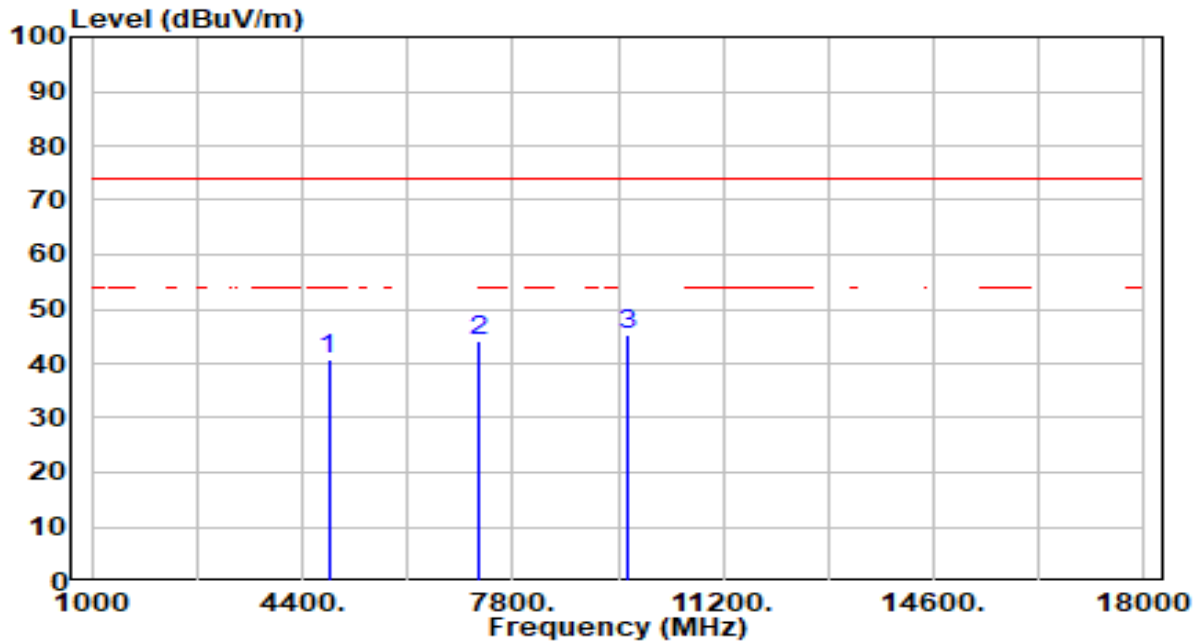

No	Frequency (MHz)	Reading (dBuV)	C.F (dB/m)	Measurement (dBuV/m)	Margin (dB)	Limit (dBuV/m)	Height (cm)	Angle (deg)	Remark (QP/PK/AV)
1	4824.000	42.11	-1.23	40.89	-33.11	74.00	300	190	Peak
2	7236.000	40.09	4.16	44.25	-29.75	74.00	300	149	Peak
3	* 9648.000	42.14	3.29	45.43	-28.57	74.00	300	296	Peak

Note:

1. " *", means this data is the worst emission level.
2. C.F (Correction Factor) = Antenna Factor (dB/m) + Cable Loss (dB) – Preamplifier(dB).
3. Measurement (dBuV/m) = Reading(dBuV) + C.F (Correction Factor).
4. The emission levels of other frequencies are very lower than the limit and not show in test report.

EUT	AX3000 Ceiling Mount Wi-Fi 6 Access Point	Date of Test	2023-03-23
Factor	DRH18-E	Temp. / Humidity	22°C /63%
Polarity	Horizontal	Site / Test Engineer	AC2 / Marvin
Test Mode	802.11n-20MHz_TX_CH 6_ANT 0+1	Test Voltage	AC 120V/60Hz

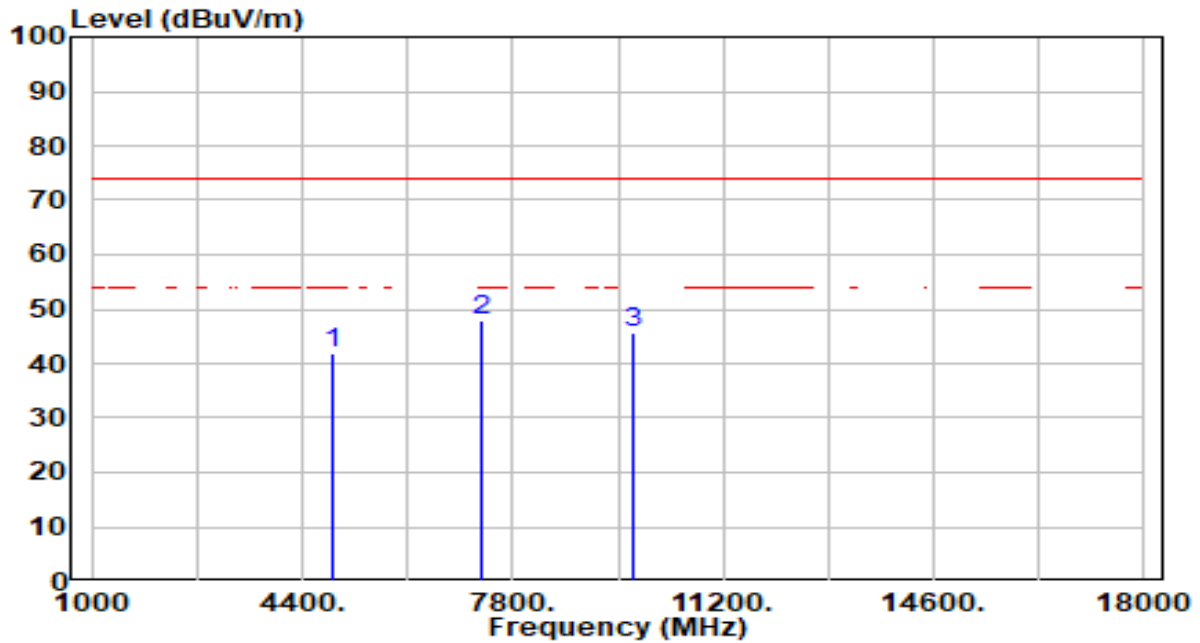

No	Frequency (MHz)	Reading (dBuV)	C.F (dB/m)	Measurement (dBuV/m)	Margin (dB)	Limit (dBuV/m)	Height (cm)	Angle (deg)	Remark (QP/PK/AV)
1	4874.000	42.92	-1.13	41.79	-32.21	74.00	100	181	Peak
2	* 7311.000	43.64	4.14	47.78	-26.22	74.00	100	138	Peak
3	9748.000	42.16	3.33	45.48	-28.52	74.00	100	88	Peak

Note:

1. " *", means this data is the worst emission level.
2. C.F (Correction Factor) = Antenna Factor (dB/m) + Cable Loss (dB) – Preamplifier(dB).
3. Measurement (dBuV/m) = Reading(dBuV) + C.F (Correction Factor).
4. The emission levels of other frequencies are very lower than the limit and not show in test report.

EUT	AX3000 Ceiling Mount Wi-Fi 6 Access Point	Date of Test	2023-03-23
Factor	DRH18-E	Temp. / Humidity	22°C /63%
Polarity	Vertical	Site / Test Engineer	AC2 / Marvin
Test Mode	802.11n-20MHz_TX_CH 6_ANT 0+1	Test Voltage	AC 120V/60Hz

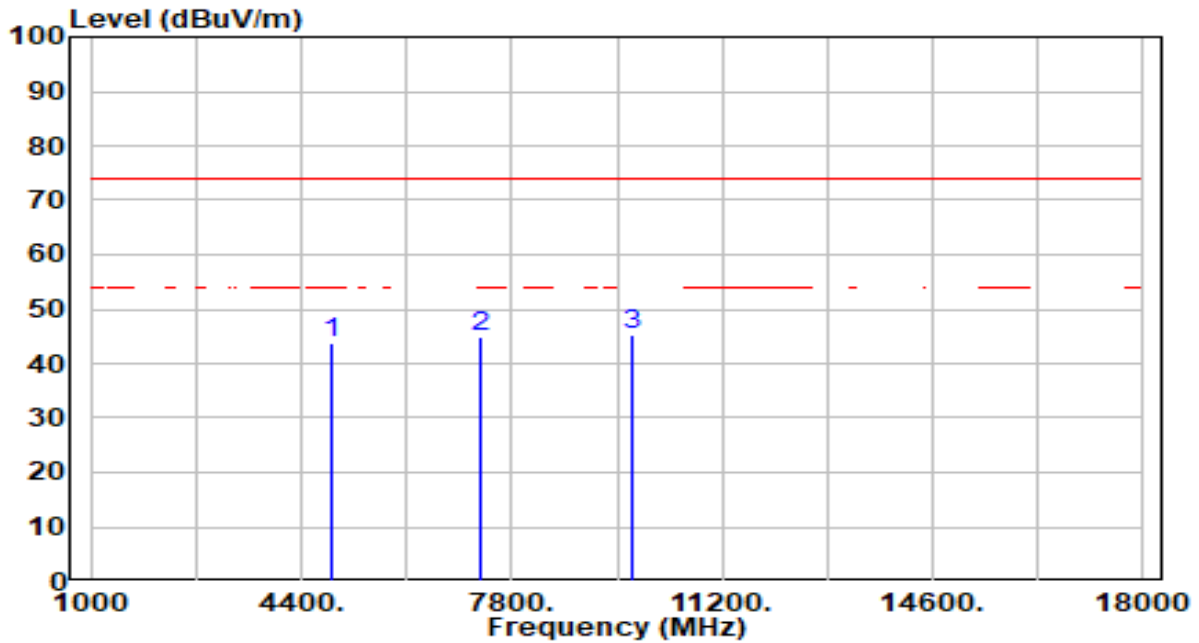

No	Frequency (MHz)	Reading (dBuV)	C.F (dB/m)	Measurement (dBuV/m)	Margin (dB)	Limit (dBuV/m)	Height (cm)	Angle (deg)	Remark (QP/PK/AV)
1	4874.000	44.78	-1.13	43.65	-30.35	74.00	300	172	Peak
2	7311.000	40.66	4.14	44.79	-29.21	74.00	300	198	Peak
3	* 9748.000	41.99	3.33	45.32	-28.68	74.00	300	51	Peak

Note:

1. " *", means this data is the worst emission level.
2. C.F (Correction Factor) = Antenna Factor (dB/m) + Cable Loss (dB) – Preamplifier(dB).
3. Measurement (dBuV/m) = Reading(dBuV) + C.F (Correction Factor).
4. The emission levels of other frequencies are very lower than the limit and not show in test report.

EUT	AX3000 Ceiling Mount Wi-Fi 6 Access Point	Date of Test	2023-03-23
Factor	DRH18-E	Temp. / Humidity	22°C /63%
Polarity	Horizontal	Site / Test Engineer	AC2 / Marvin
Test Mode	802.11n-20MHz_TX_CH 11_ANT 0+1	Test Voltage	AC 120V/60Hz

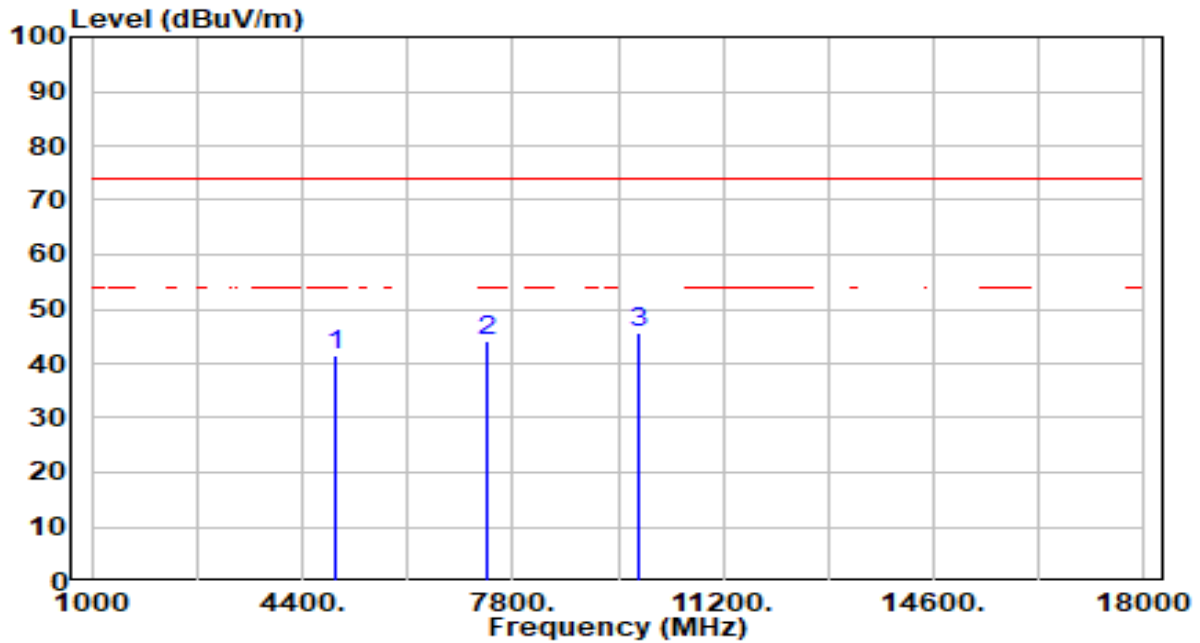

No	Frequency (MHz)	Reading (dBuV)	C.F (dB/m)	Measurement (dBuV/m)	Margin (dB)	Limit (dBuV/m)	Height (cm)	Angle (deg)	Remark (QP/PK/AV)
1	4924.000	42.69	-1.03	41.66	-32.34	74.00	100	182	Peak
2	7386.000	40.10	4.11	44.22	-29.78	74.00	100	141	Peak
3	* 9848.000	42.46	3.39	45.85	-28.15	74.00	100	217	Peak

Note:

1. " *", means this data is the worst emission level.
2. C.F (Correction Factor) = Antenna Factor (dB/m) + Cable Loss (dB) – Preamplifier(dB).
3. Measurement (dBuV/m) = Reading(dBuV) + C.F (Correction Factor).
4. The emission levels of other frequencies are very lower than the limit and not show in test report.

EUT	AX3000 Ceiling Mount Wi-Fi 6 Access Point	Date of Test	2023-03-23
Factor	DRH18-E	Temp. / Humidity	22°C /63%
Polarity	Vertical	Site / Test Engineer	AC2 / Marvin
Test Mode	802.11n-20MHz_TX_CH 11_ANT 0+1	Test Voltage	AC 120V/60Hz

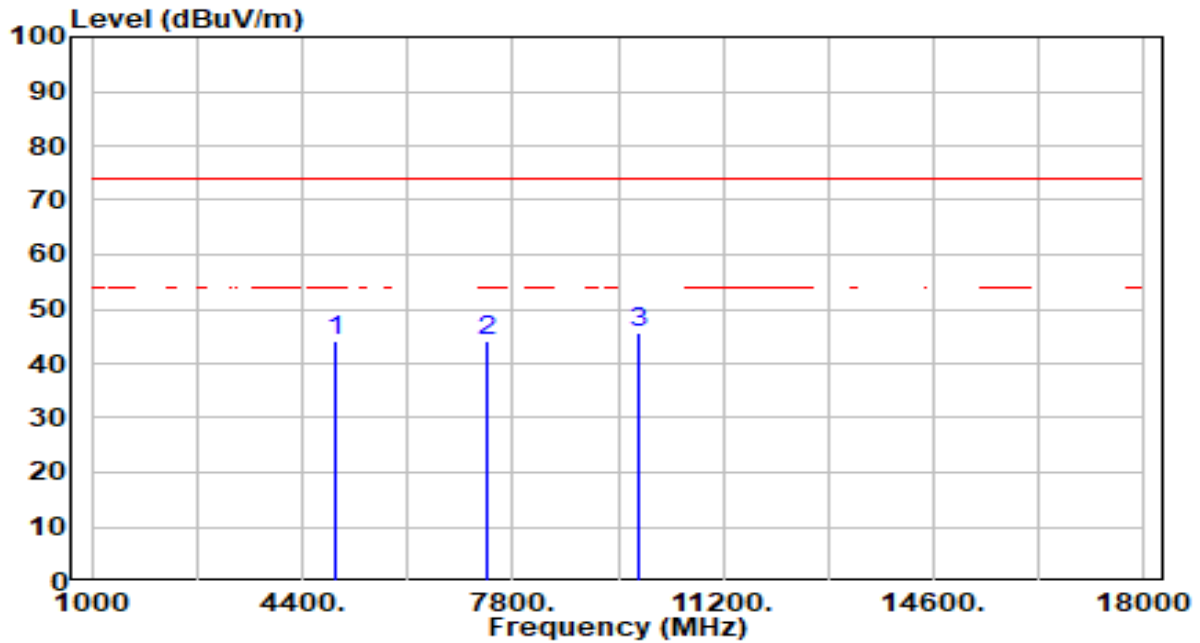

No	Frequency (MHz)	Reading (dBUV)	C.F (dB/m)	Measurement (dBUV/m)	Margin (dB)	Limit (dBUV/m)	Height (cm)	Angle (deg)	Remark (QP/PK/AV)
1	4924.000	45.17	-1.03	44.15	-29.85	74.00	300	169	Peak
2	7386.000	39.90	4.11	44.01	-29.99	74.00	300	48	Peak
3	* 9848.000	42.24	3.39	45.62	-28.38	74.00	300	140	Peak

Note:

1. " *", means this data is the worst emission level.
2. C.F (Correction Factor) = Antenna Factor (dB/m) + Cable Loss (dB) – Preamplifier(dB).
3. Measurement (dBUV/m) = Reading(dBUV) + C.F (Correction Factor).
4. The emission levels of other frequencies are very lower than the limit and not show in test report.

EUT	AX3000 Ceiling Mount Wi-Fi 6 Access Point	Date of Test	2023-03-23
Factor	DRH18-E	Temp. / Humidity	22°C /63%
Polarity	Horizontal	Site / Test Engineer	AC2 / Marvin
Test Mode	802.11n-40MHz_TX_CH 3_ANT 0+1	Test Voltage	AC 120V/60Hz

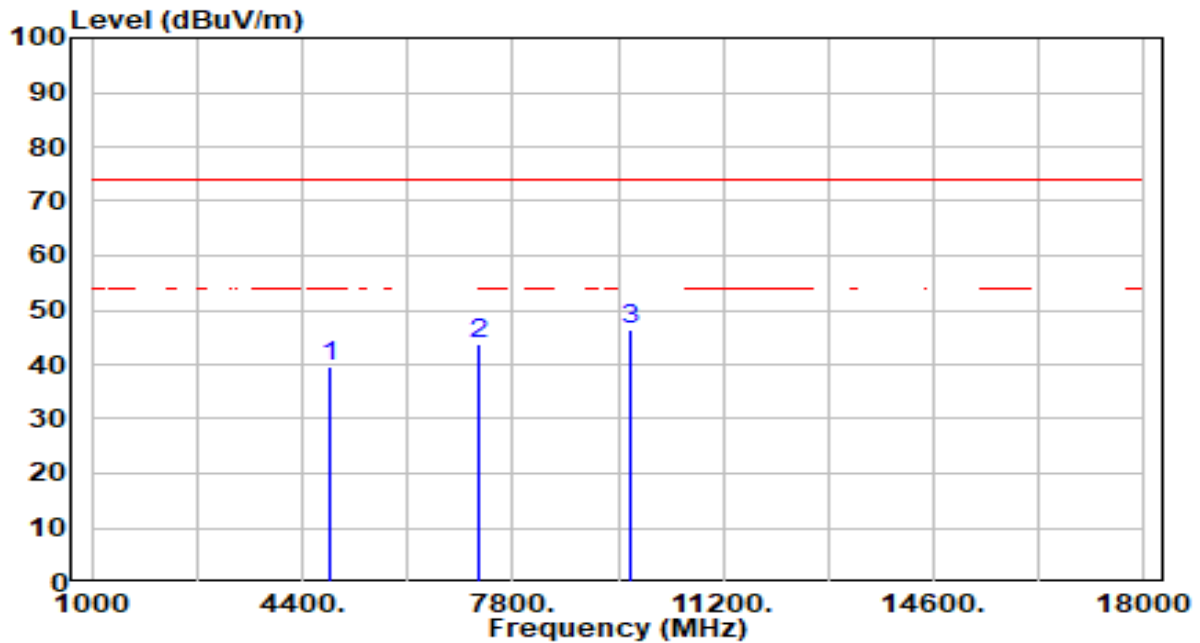

No	Frequency (MHz)	Reading (dBuV)	C.F (dB/m)	Measurement (dBuV/m)	Margin (dB)	Limit (dBuV/m)	Height (cm)	Angle (deg)	Remark (QP/PK/AV)
1	4844.000	40.76	-1.19	39.57	-34.43	74.00	100	171	Peak
2	7266.000	39.56	4.15	43.71	-30.29	74.00	100	162	Peak
3	* 9688.000	42.96	3.30	46.26	-27.74	74.00	100	150	Peak

Note:

1. " *", means this data is the worst emission level.
2. C.F (Correction Factor) = Antenna Factor (dB/m) + Cable Loss (dB) – Pre-amplifier(dB).
3. Measurement (dBuV/m) = Reading(dBuV) + C.F (Correction Factor).
4. The emission levels of other frequencies are very lower than the limit and not show in test report.

EUT	AX3000 Ceiling Mount Wi-Fi 6 Access Point	Date of Test	2023-03-23
Factor	DRH18-E	Temp. / Humidity	22°C /63%
Polarity	Vertical	Site / Test Engineer	AC2 / Marvin
Test Mode	802.11n-40MHz_TX_CH 3_ANT 0+1	Test Voltage	AC 120V/60Hz

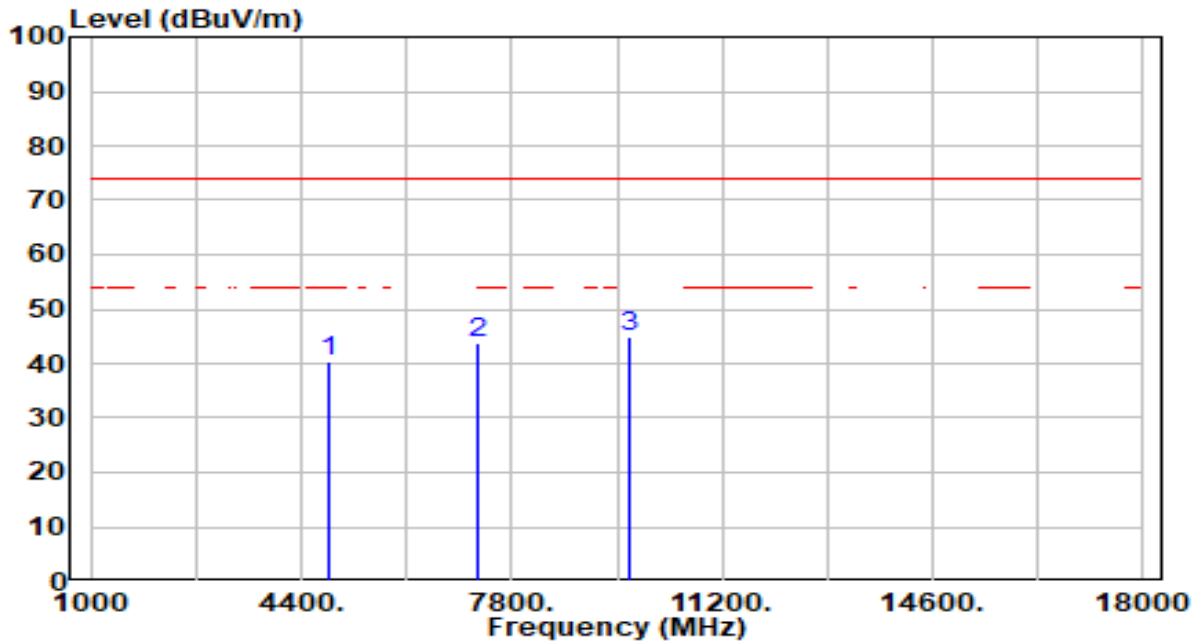

No	Frequency (MHz)	Reading (dBuV)	C.F (dB/m)	Measurement (dBuV/m)	Margin (dB)	Limit (dBuV/m)	Height (cm)	Angle (deg)	Remark (QP/PK/AV)
1	4844.000	41.56	-1.19	40.37	-33.63	74.00	300	163	Peak
2	7266.000	39.65	4.15	43.80	-30.20	74.00	300	154	Peak
3	* 9688.000	41.73	3.30	45.03	-28.97	74.00	300	128	Peak

Note:

1. " *", means this data is the worst emission level.
2. C.F (Correction Factor) = Antenna Factor (dB/m) + Cable Loss (dB) – Preamplifier(dB).
3. Measurement (dBuV/m) = Reading(dBuV) + C.F (Correction Factor).
4. The emission levels of other frequencies are very lower than the limit and not show in test report.

EUT	AX3000 Ceiling Mount Wi-Fi 6 Access Point	Date of Test	2023-03-23
Factor	DRH18-E	Temp. / Humidity	22°C /63%
Polarity	Horizontal	Site / Test Engineer	AC2 / Marvin
Test Mode	802.11n-40MHz_TX_CH 6_ANT 0+1	Test Voltage	AC 120V/60Hz

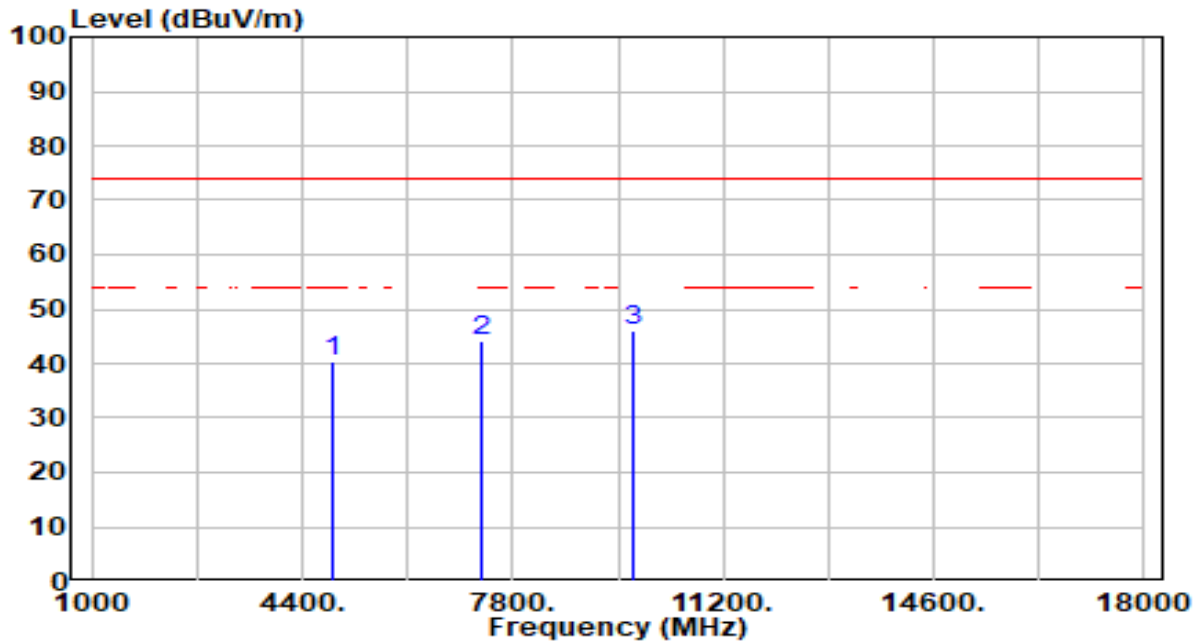

No	Frequency (MHz)	Reading (dBuV)	C.F (dB/m)	Measurement (dBuV/m)	Margin (dB)	Limit (dBuV/m)	Height (cm)	Angle (deg)	Remark (QP/PK/AV)
1	4874.000	41.41	-1.13	40.28	-33.72	74.00	100	38	Peak
2	7311.000	39.97	4.14	44.11	-29.89	74.00	100	167	Peak
3	* 9748.000	42.69	3.33	46.02	-27.98	74.00	100	311	Peak

Note:

1. " *", means this data is the worst emission level.
2. C.F (Correction Factor) = Antenna Factor (dB/m) + Cable Loss (dB) – Preamplifier(dB).
3. Measurement (dBuV/m) = Reading(dBuV) + C.F (Correction Factor).
4. The emission levels of other frequencies are very lower than the limit and not show in test report.

EUT	AX3000 Ceiling Mount Wi-Fi 6 Access Point	Date of Test	2023-03-23
Factor	DRH18-E	Temp. / Humidity	22°C /63%
Polarity	Vertical	Site / Test Engineer	AC2 / Marvin
Test Mode	802.11n-40MHz_TX_CH 6_ANT 0+1	Test Voltage	AC 120V/60Hz

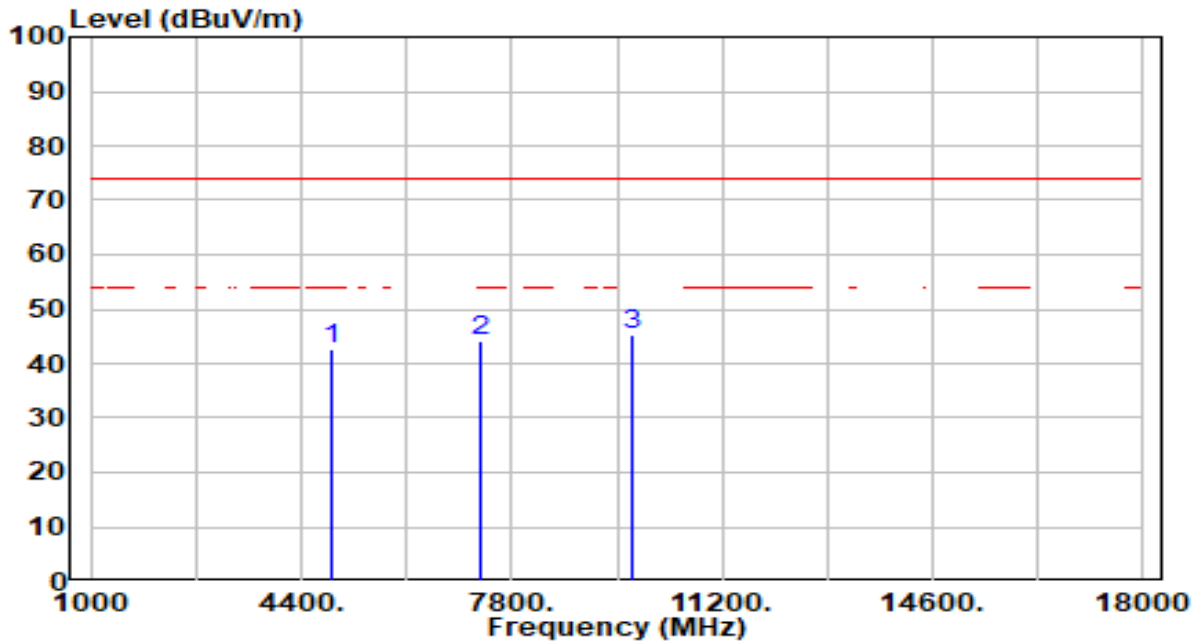

No	Frequency (MHz)	Reading (dBuV)	C.F (dB/m)	Measurement (dBuV/m)	Margin (dB)	Limit (dBuV/m)	Height (cm)	Angle (deg)	Remark (QP/PK/AV)
1	4874.000	43.88	-1.13	42.75	-31.25	74.00	300	178	Peak
2	7311.000	40.02	4.14	44.16	-29.84	74.00	300	204	Peak
3	* 9748.000	41.85	3.33	45.18	-28.82	74.00	300	360	Peak

Note:

1. " *", means this data is the worst emission level.
2. C.F (Correction Factor) = Antenna Factor (dB/m) + Cable Loss (dB) – Preamplifier(dB).
3. Measurement (dBuV/m) = Reading(dBuV) + C.F (Correction Factor).
4. The emission levels of other frequencies are very lower than the limit and not show in test report.

EUT	AX3000 Ceiling Mount Wi-Fi 6 Access Point	Date of Test	2023-03-23
Factor	DRH18-E	Temp. / Humidity	22°C /63%
Polarity	Horizontal	Site / Test Engineer	AC2 / Marvin
Test Mode	802.11n-40MHz_TX_CH 9_ANT 0+1	Test Voltage	AC 120V/60Hz

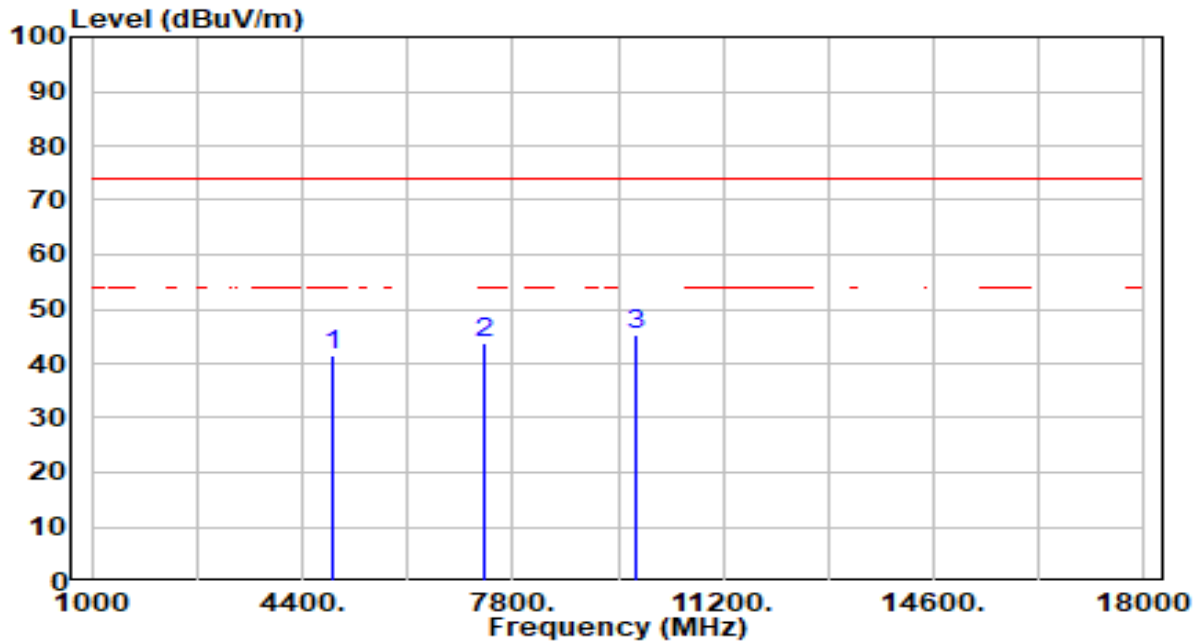

No	Frequency (MHz)	Reading (dBuV)	C.F (dB/m)	Measurement (dBuV/m)	Margin (dB)	Limit (dBuV/m)	Height (cm)	Angle (deg)	Remark (QP/PK/AV)
1	4904.000	42.71	-1.07	41.64	-32.36	74.00	100	170	Peak
2	7356.000	39.73	4.12	43.85	-30.15	74.00	100	132	Peak
3	* 9808.000	42.01	3.35	45.37	-28.63	74.00	100	126	Peak

Note:

1. " *", means this data is the worst emission level.
2. C.F (Correction Factor) = Antenna Factor (dB/m) + Cable Loss (dB) – Preamplifier(dB).
3. Measurement (dBuV/m) = Reading(dBuV) + C.F (Correction Factor).
4. The emission levels of other frequencies are very lower than the limit and not show in test report.

EUT	AX3000 Ceiling Mount Wi-Fi 6 Access Point	Date of Test	2023-03-23
Factor	DRH18-E	Temp. / Humidity	22°C /63%
Polarity	Vertical	Site / Test Engineer	AC2 / Marvin
Test Mode	802.11n-40MHz_TX_CH 9_ANT 0+1	Test Voltage	AC 120V/60Hz

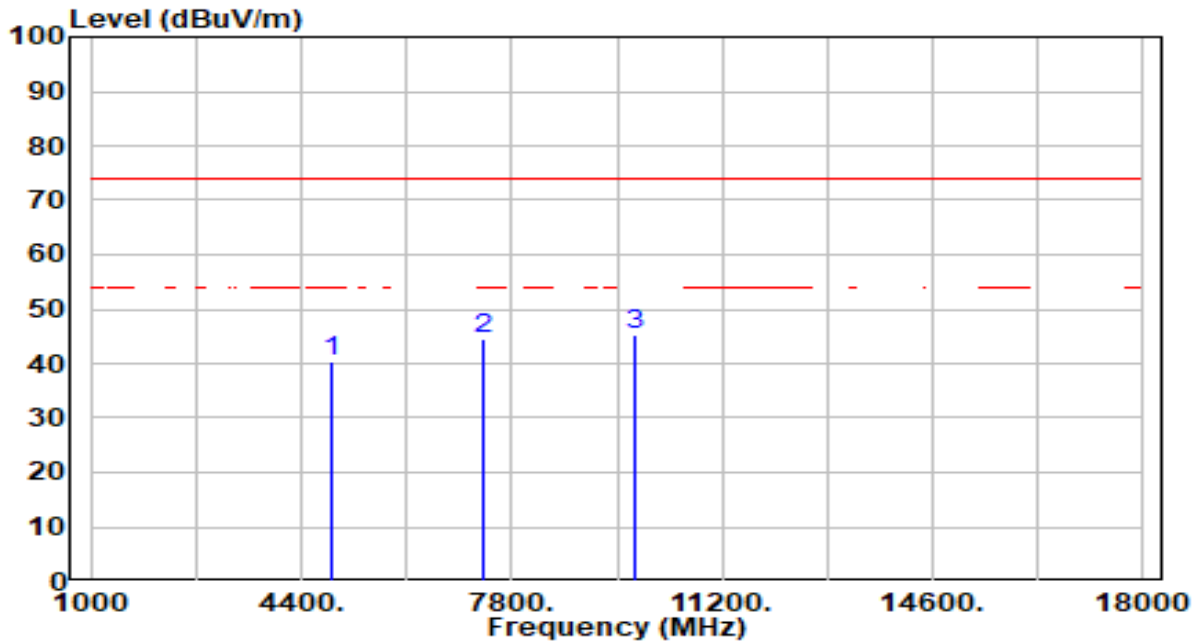

No	Frequency (MHz)	Reading (dBuV)	C.F (dB/m)	Measurement (dBuV/m)	Margin (dB)	Limit (dBuV/m)	Height (cm)	Angle (deg)	Remark (QP/PK/AV)
1	4904.000	41.42	-1.07	40.36	-33.64	74.00	300	166	Peak
2	7356.000	40.41	4.12	44.53	-29.47	74.00	300	334	Peak
3	* 9808.000	41.89	3.35	45.24	-28.76	74.00	300	278	Peak

Note:

1. " *", means this data is the worst emission level.
2. C.F (Correction Factor) = Antenna Factor (dB/m) + Cable Loss (dB) – Preamplifier(dB).
3. Measurement (dBuV/m) = Reading(dBuV) + C.F (Correction Factor).
4. The emission levels of other frequencies are very lower than the limit and not show in test report.

EUT	AX3000 Ceiling Mount Wi-Fi 6 Access Point	Date of Test	2023-03-23
Factor	DRH18-E	Temp. / Humidity	22°C /63%
Polarity	Horizontal	Site / Test Engineer	AC2 / Marvin
Test Mode	802.11ax-20MHz_TX_CH 1_ANT 0+1	Test Voltage	AC 120V/60Hz

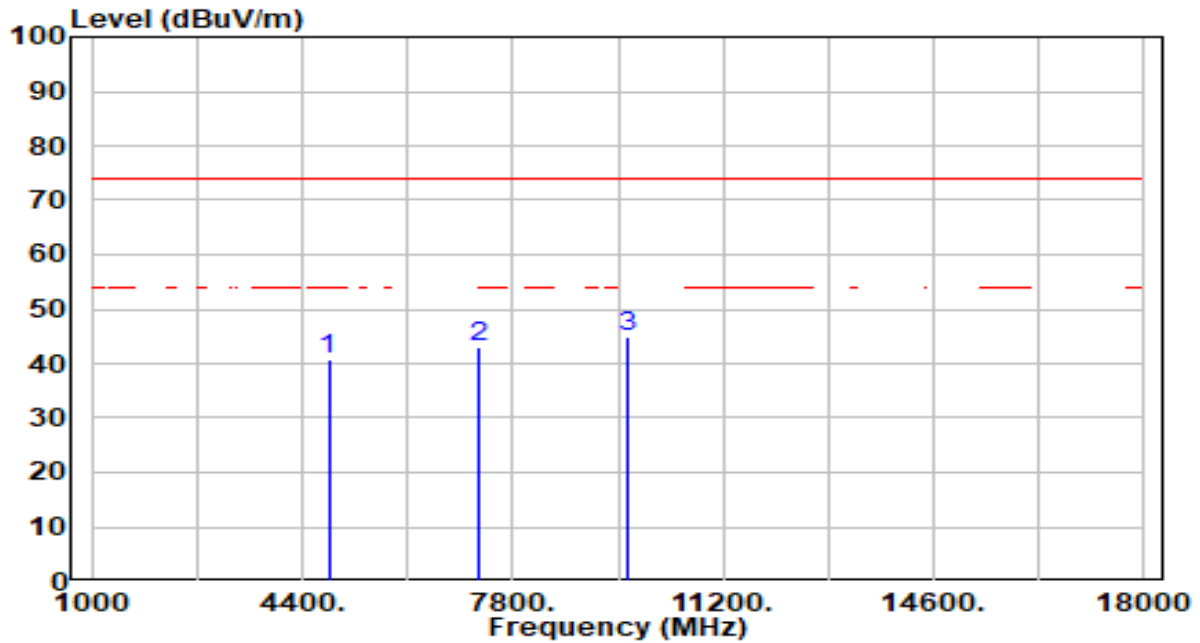

No	Frequency (MHz)	Reading (dBuV)	C.F (dB/m)	Measurement (dBuV/m)	Margin (dB)	Limit (dBuV/m)	Height (cm)	Angle (deg)	Remark (QP/PK/AV)
1	4824.000	41.92	-1.23	40.69	-33.31	74.00	100	268	Peak
2	7236.000	38.87	4.16	43.03	-30.97	74.00	100	209	Peak
3	* 9648.000	41.73	3.29	45.02	-28.98	74.00	100	144	Peak

Note:

1. " *", means this data is the worst emission level.
2. C.F (Correction Factor) = Antenna Factor (dB/m) + Cable Loss (dB) – Preamplifier(dB).
3. Measurement (dBuV/m) = Reading(dBuV) + C.F (Correction Factor).
4. The emission levels of other frequencies are very lower than the limit and not show in test report.

EUT	AX3000 Ceiling Mount Wi-Fi 6 Access Point	Date of Test	2023-03-23
Factor	DRH18-E	Temp. / Humidity	22°C /63%
Polarity	Vertical	Site / Test Engineer	AC2 / Marvin
Test Mode	802.11ax-20MHz_TX_CH 1_ANT 0+1	Test Voltage	AC 120V/60Hz

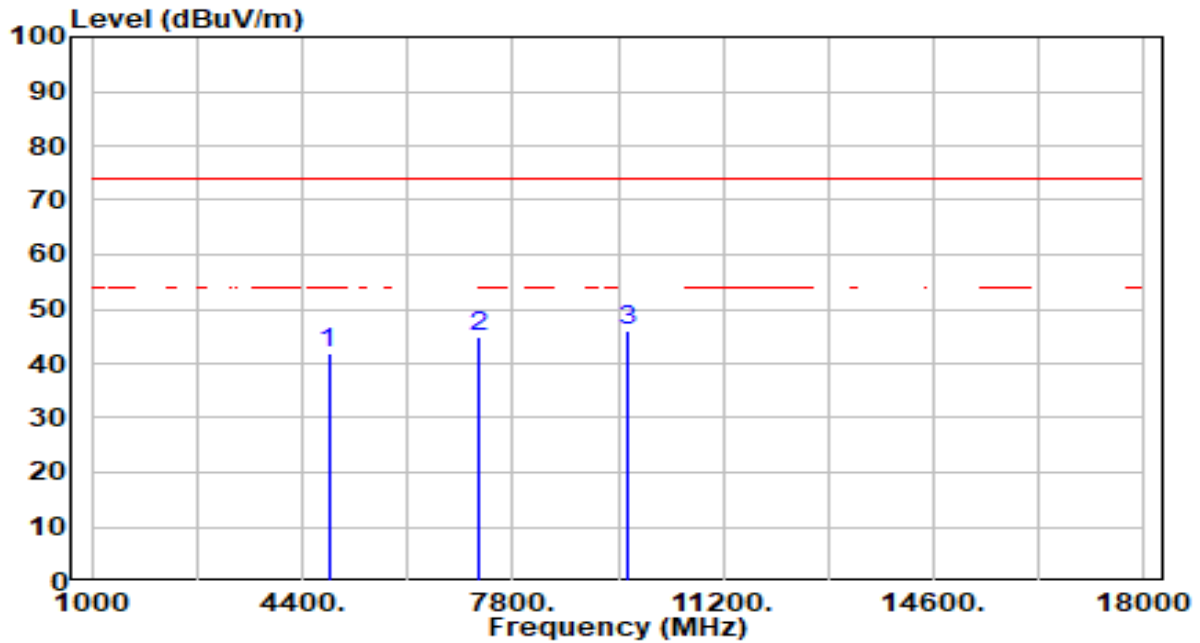

No	Frequency (MHz)	Reading (dBuV)	C.F (dB/m)	Measurement (dBuV/m)	Margin (dB)	Limit (dBuV/m)	Height (cm)	Angle (deg)	Remark (QP/PK/AV)
1	4824.000	43.23	-1.23	42.00	-32.00	74.00	300	175	Peak
2	7236.000	40.64	4.16	44.80	-29.20	74.00	300	207	Peak
3	* 9648.000	42.74	3.29	46.03	-27.97	74.00	300	110	Peak

Note:

1. " *", means this data is the worst emission level.
2. C.F (Correction Factor) = Antenna Factor (dB/m) + Cable Loss (dB) – Preamplifier(dB).
3. Measurement (dBuV/m) = Reading(dBuV) + C.F (Correction Factor).
4. The emission levels of other frequencies are very lower than the limit and not show in test report.

EUT	AX3000 Ceiling Mount Wi-Fi 6 Access Point	Date of Test	2023-03-23
Factor	DRH18-E	Temp. / Humidity	22°C /63%
Polarity	Horizontal	Site / Test Engineer	AC2 / Marvin
Test Mode	802.11ax-20MHz_TX_CH 6_ANT 0+1	Test Voltage	AC 120V/60Hz

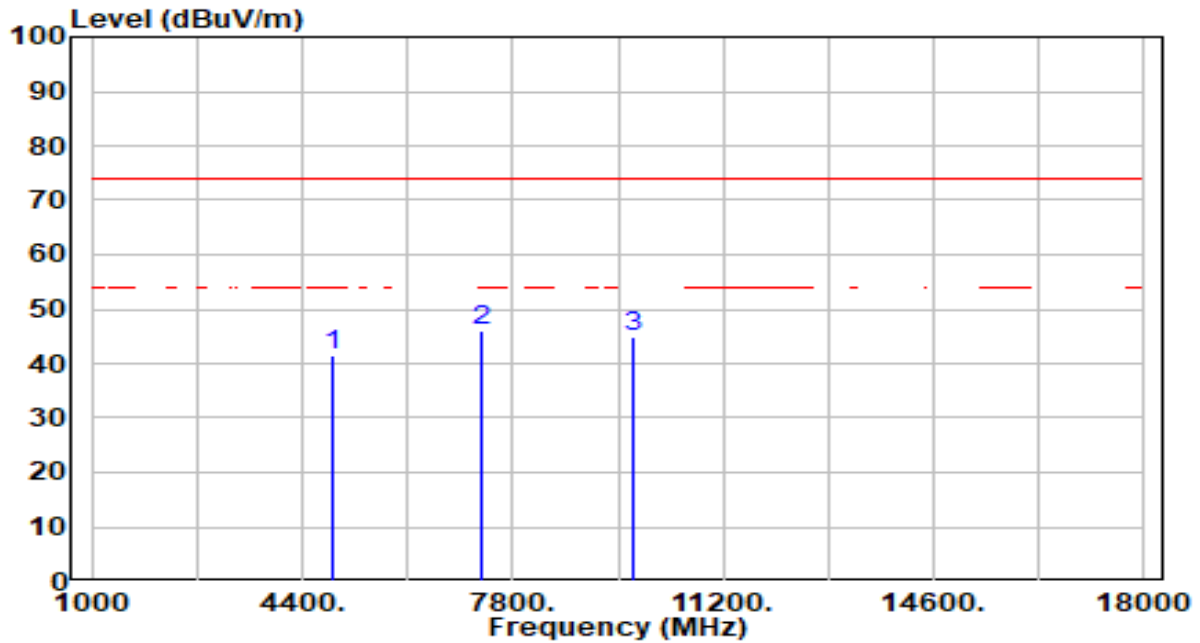

No	Frequency (MHz)	Reading (dBuV)	C.F (dB/m)	Measurement (dBuV/m)	Margin (dB)	Limit (dBuV/m)	Height (cm)	Angle (deg)	Remark (QP/PK/AV)
1	4874.000	42.68	-1.13	41.56	-32.44	74.00	100	190	Peak
2	* 7311.000	41.78	4.14	45.92	-28.08	74.00	100	137	Peak
3	9748.000	41.63	3.33	44.96	-29.04	74.00	100	131	Peak

Note:

1. " *", means this data is the worst emission level.
2. C.F (Correction Factor) = Antenna Factor (dB/m) + Cable Loss (dB) – Preamplifier(dB).
3. Measurement (dBuV/m) = Reading(dBuV) + C.F (Correction Factor).
4. The emission levels of other frequencies are very lower than the limit and not show in test report.

EUT	AX3000 Ceiling Mount Wi-Fi 6 Access Point	Date of Test	2023-03-23
Factor	DRH18-E	Temp. / Humidity	22°C /63%
Polarity	Vertical	Site / Test Engineer	AC2 / Marvin
Test Mode	802.11ax-20MHz_TX_CH 6_ANT 0+1	Test Voltage	AC 120V/60Hz

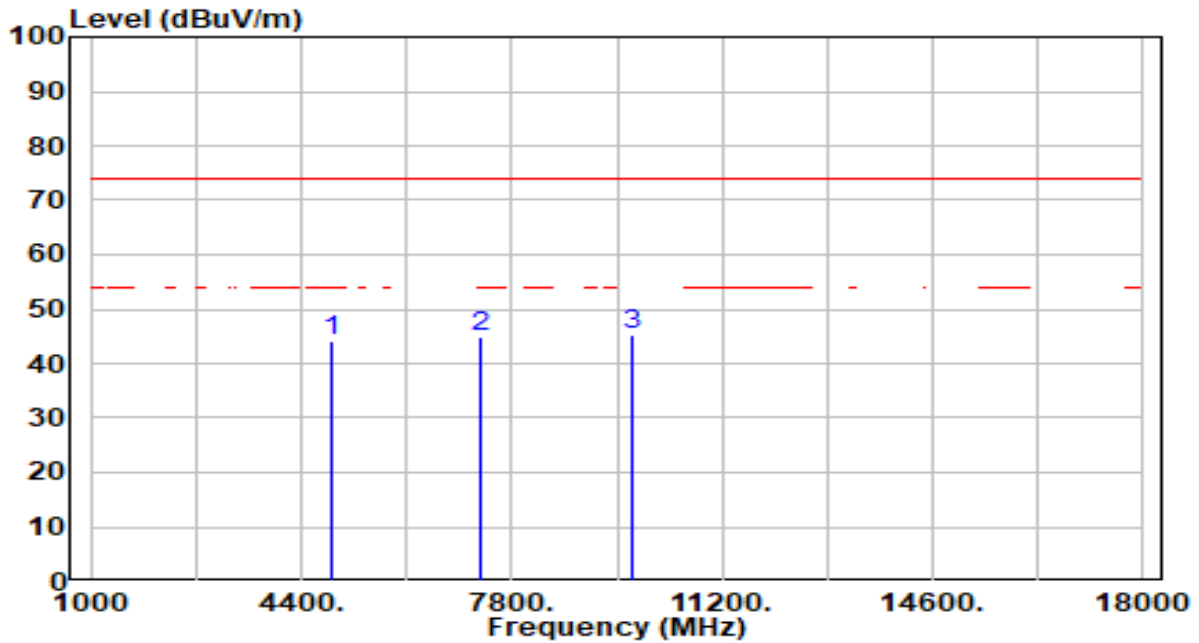

No	Frequency (MHz)	Reading (dBuV)	C.F (dB/m)	Measurement (dBuV/m)	Margin (dB)	Limit (dBuV/m)	Height (cm)	Angle (deg)	Remark (QP/PK/AV)
1	4874.000	45.20	-1.13	44.08	-29.92	74.00	300	163	Peak
2	7311.000	40.75	4.14	44.88	-29.12	74.00	300	192	Peak
3	* 9748.000	41.85	3.33	45.17	-28.83	74.00	300	55	Peak

Note:

1. " *", means this data is the worst emission level.
2. C.F (Correction Factor) = Antenna Factor (dB/m) + Cable Loss (dB) – Preamplifier(dB).
3. Measurement (dBuV/m) = Reading(dBuV) + C.F (Correction Factor).
4. The emission levels of other frequencies are very lower than the limit and not show in test report.

EUT	AX3000 Ceiling Mount Wi-Fi 6 Access Point	Date of Test	2023-03-23
Factor	DRH18-E	Temp. / Humidity	22°C /63%
Polarity	Horizontal	Site / Test Engineer	AC2 / Marvin
Test Mode	802.11ax-20MHz_TX_CH 11_ANT 0+1	Test Voltage	AC 120V/60Hz

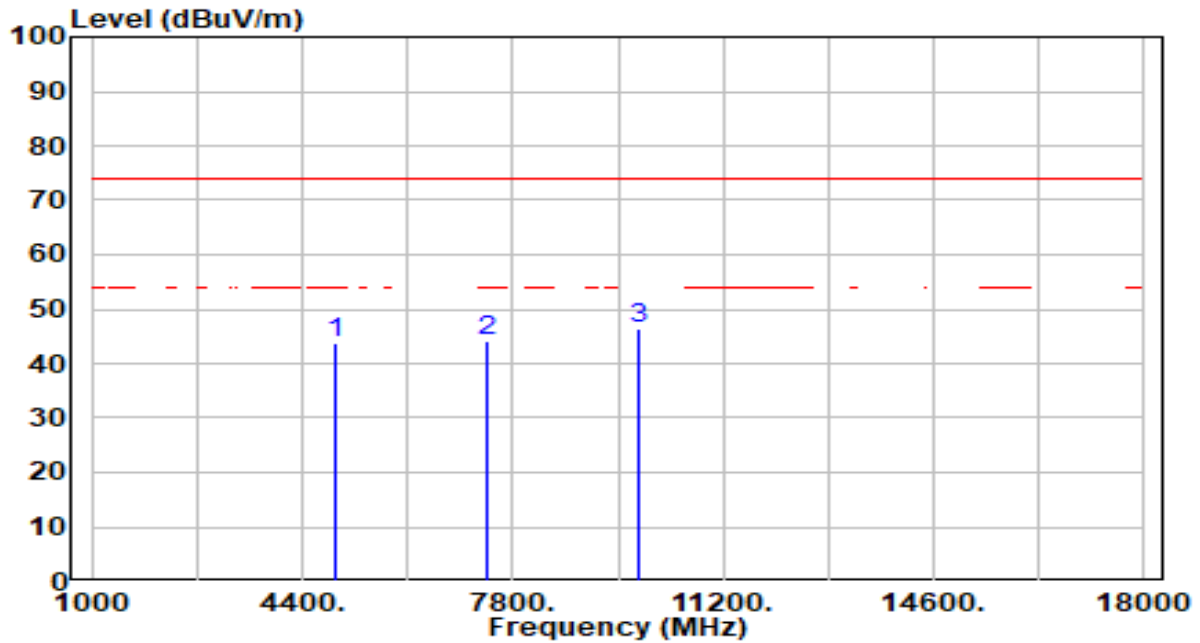

No	Frequency (MHz)	Reading (dBuV)	C.F (dB/m)	Measurement (dBuV/m)	Margin (dB)	Limit (dBuV/m)	Height (cm)	Angle (deg)	Remark (QP/PK/AV)
1	4924.000	44.81	-1.03	43.79	-30.21	74.00	100	180	Peak
2	7386.000	39.98	4.11	44.09	-29.91	74.00	100	312	Peak
3	* 9848.000	42.85	3.39	46.24	-27.76	74.00	100	235	Peak

Note:

1. " *", means this data is the worst emission level.
2. C.F (Correction Factor) = Antenna Factor (dB/m) + Cable Loss (dB) – Preamplifier(dB).
3. Measurement (dBuV/m) = Reading(dBuV) + C.F (Correction Factor).
4. The emission levels of other frequencies are very lower than the limit and not show in test report.

EUT	AX3000 Ceiling Mount Wi-Fi 6 Access Point	Date of Test	2023-03-23
Factor	DRH18-E	Temp. / Humidity	22°C /63%
Polarity	Vertical	Site / Test Engineer	AC2 / Marvin
Test Mode	802.11ax-20MHz_TX_CH 11_ANT 0+1	Test Voltage	AC 120V/60Hz

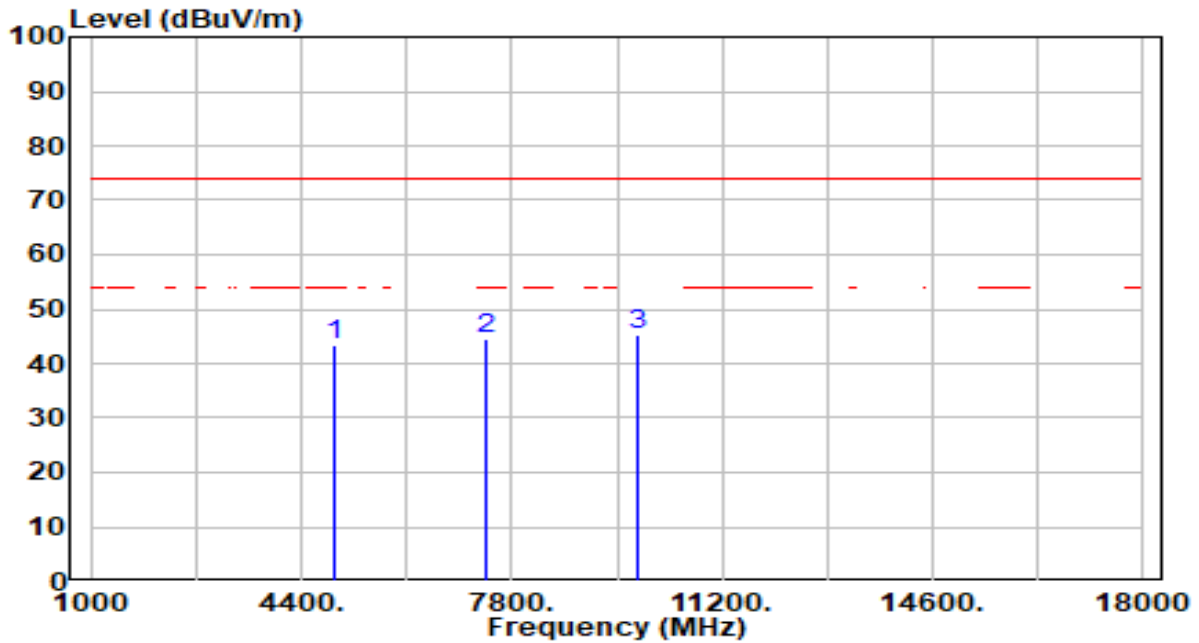

No	Frequency (MHz)	Reading (dBuV)	C.F (dB/m)	Measurement (dBuV/m)	Margin (dB)	Limit (dBuV/m)	Height (cm)	Angle (deg)	Remark (QP/PK/AV)
1	4924.000	44.57	-1.03	43.54	-30.46	74.00	300	175	Peak
2	7386.000	40.30	4.11	44.41	-29.59	74.00	300	38	Peak
3	* 9848.000	42.02	3.39	45.41	-28.59	74.00	300	46	Peak

Note:

1. " *", means this data is the worst emission level.
2. C.F (Correction Factor) = Antenna Factor (dB/m) + Cable Loss (dB) – Preamplifier(dB).
3. Measurement (dBuV/m) = Reading(dBuV) + C.F (Correction Factor).
4. The emission levels of other frequencies are very lower than the limit and not show in test report.

EUT	AX3000 Ceiling Mount Wi-Fi 6 Access Point	Date of Test	2023-03-23
Factor	DRH18-E	Temp. / Humidity	22°C /63%
Polarity	Horizontal	Site / Test Engineer	AC2 / Marvin
Test Mode	802.11ax-40MHz_TX_CH 3_ANT 0+1	Test Voltage	AC 120V/60Hz

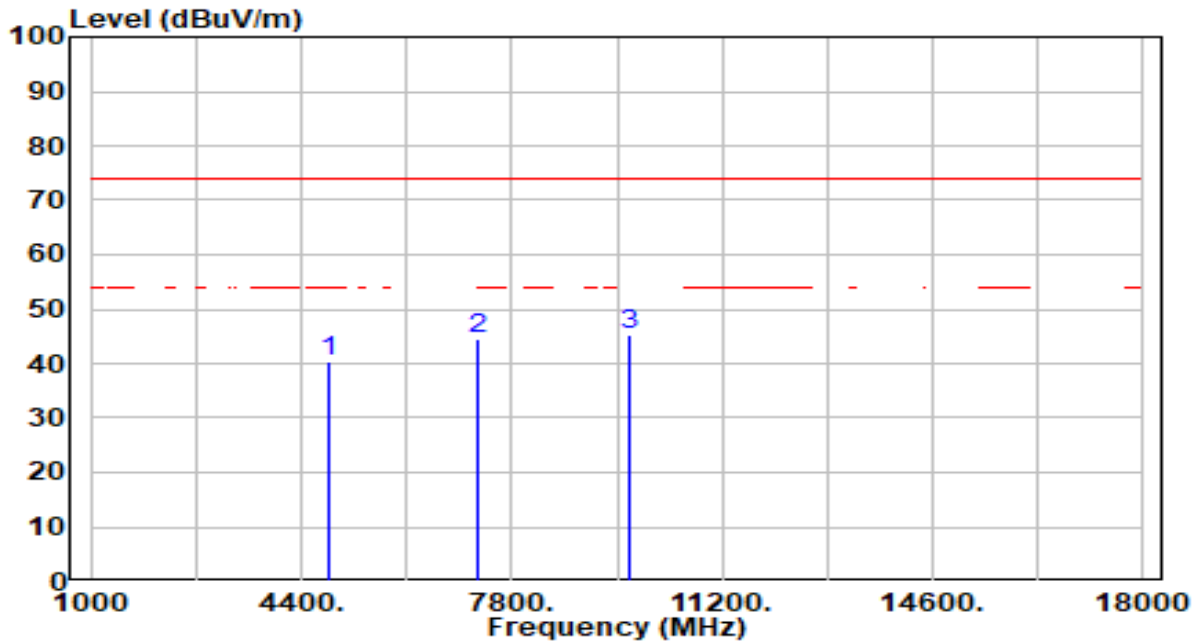

No	Frequency (MHz)	Reading (dBuV)	C.F (dB/m)	Measurement (dBuV/m)	Margin (dB)	Limit (dBuV/m)	Height (cm)	Angle (deg)	Remark (QP/PK/AV)
1	4844.000	41.74	-1.19	40.55	-33.45	74.00	100	175	Peak
2	7266.000	40.52	4.15	44.67	-29.33	74.00	100	32	Peak
3	* 9688.000	42.04	3.30	45.35	-28.65	74.00	100	181	Peak

Note:

1. " *", means this data is the worst emission level.
2. C.F (Correction Factor) = Antenna Factor (dB/m) + Cable Loss (dB) – Preamplifier(dB).
3. Measurement (dBuV/m) = Reading(dBuV) + C.F (Correction Factor).
4. The emission levels of other frequencies are very lower than the limit and not show in test report.

EUT	AX3000 Ceiling Mount Wi-Fi 6 Access Point	Date of Test	2023-03-23
Factor	DRH18-E	Temp. / Humidity	22°C /63%
Polarity	Vertical	Site / Test Engineer	AC2 / Marvin
Test Mode	802.11ax-40MHz_TX_CH 3_ANT 0+1	Test Voltage	AC 120V/60Hz

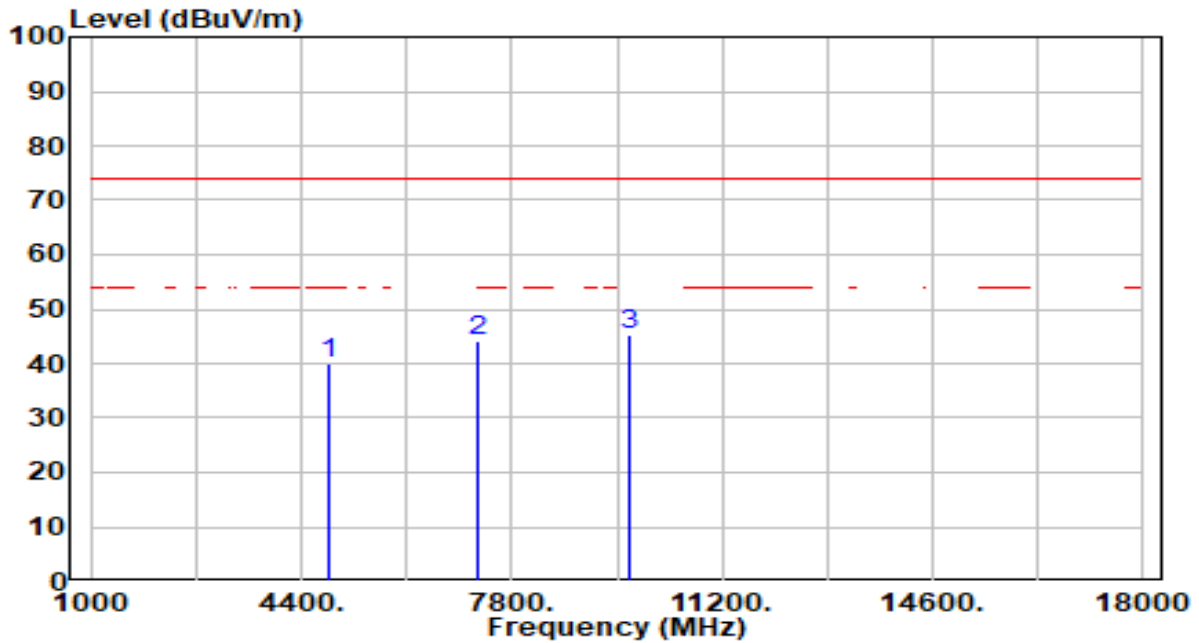

No	Frequency (MHz)	Reading (dBuV)	C.F (dB/m)	Measurement (dBuV/m)	Margin (dB)	Limit (dBuV/m)	Height (cm)	Angle (deg)	Remark (QP/PK/AV)
1	4844.000	41.19	-1.19	40.00	-34.00	74.00	300	114	Peak
2	7266.000	40.05	4.15	44.20	-29.80	74.00	300	294	Peak
3	* 9688.000	42.04	3.30	45.35	-28.65	74.00	300	339	Peak

Note:

1. " *", means this data is the worst emission level.
2. C.F (Correction Factor) = Antenna Factor (dB/m) + Cable Loss (dB) – Preamplifier(dB).
3. Measurement (dBuV/m) = Reading(dBuV) + C.F (Correction Factor).
4. The emission levels of other frequencies are very lower than the limit and not show in test report.

EUT	AX3000 Ceiling Mount Wi-Fi 6 Access Point	Date of Test	2023-03-23
Factor	DRH18-E	Temp. / Humidity	22°C /63%
Polarity	Horizontal	Site / Test Engineer	AC2 / Marvin
Test Mode	802.11ax-40MHz_TX_CH 6_ANT 0+1	Test Voltage	AC 120V/60Hz

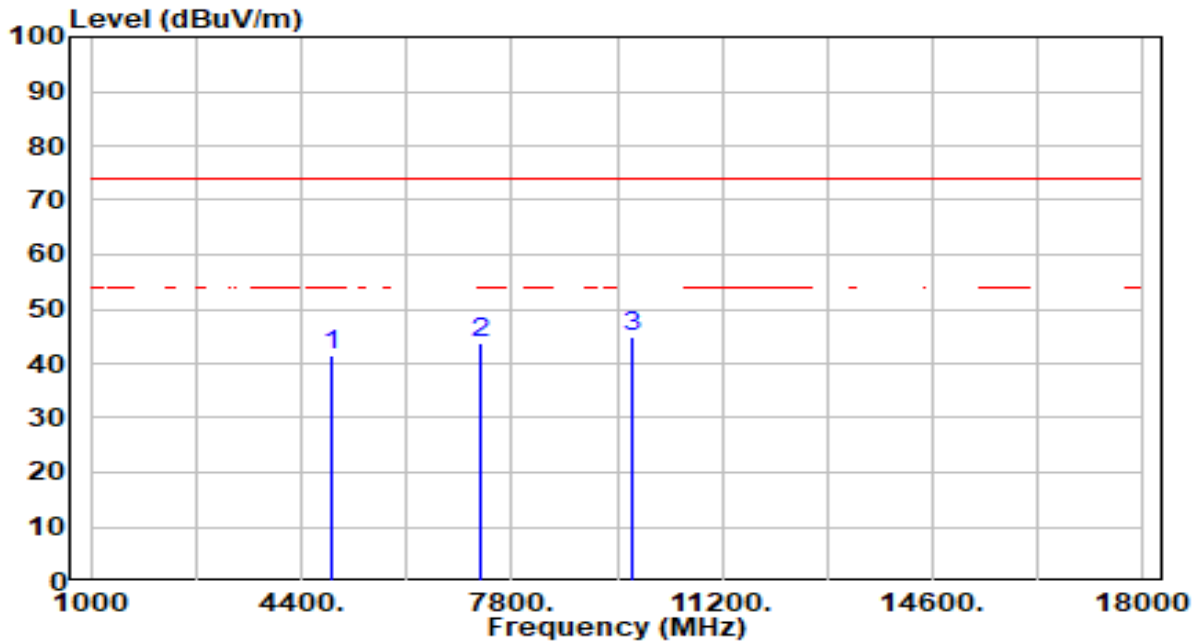

No	Frequency (MHz)	Reading (dBUV)	C.F (dB/m)	Measurement (dBUV/m)	Margin (dB)	Limit (dBUV/m)	Height (cm)	Angle (deg)	Remark (QP/PK/AV)
1	4874.000	42.77	-1.13	41.64	-32.36	74.00	100	187	Peak
2	7311.000	39.81	4.14	43.95	-30.05	74.00	100	1	Peak
3	* 9748.000	41.62	3.33	44.95	-29.05	74.00	100	29	Peak

Note:

1. " *", means this data is the worst emission level.
2. C.F (Correction Factor) = Antenna Factor (dB/m) + Cable Loss (dB) – Preamplifier(dB).
3. Measurement (dBUV/m) = Reading(dBUV) + C.F (Correction Factor).
4. The emission levels of other frequencies are very lower than the limit and not show in test report.

EUT	AX3000 Ceiling Mount Wi-Fi 6 Access Point	Date of Test	2023-03-23
Factor	DRH18-E	Temp. / Humidity	22°C /63%
Polarity	Vertical	Site / Test Engineer	AC2 / Marvin
Test Mode	802.11ax-40MHz_TX_CH 6_ANT 0+1	Test Voltage	AC 120V/60Hz

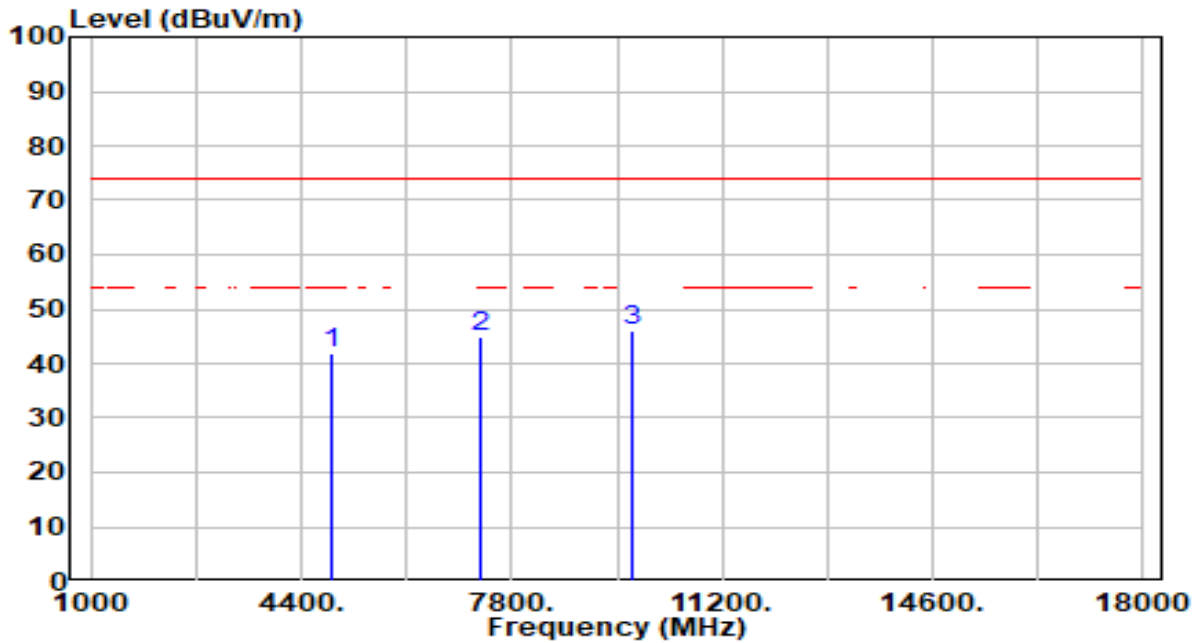

No	Frequency (MHz)	Reading (dBuV)	C.F (dB/m)	Measurement (dBuV/m)	Margin (dB)	Limit (dBuV/m)	Height (cm)	Angle (deg)	Remark (QP/PK/AV)
1	4874.000	43.10	-1.13	41.97	-32.03	74.00	300	176	Peak
2	7311.000	40.66	4.14	44.80	-29.20	74.00	300	120	Peak
3	* 9748.000	42.73	3.33	46.06	-27.94	74.00	300	208	Peak

Note:

1. " *", means this data is the worst emission level.
2. C.F (Correction Factor) = Antenna Factor (dB/m) + Cable Loss (dB) – Preamplifier(dB).
3. Measurement (dBuV/m) = Reading(dBuV) + C.F (Correction Factor).
4. The emission levels of other frequencies are very lower than the limit and not show in test report.

EUT	AX3000 Ceiling Mount Wi-Fi 6 Access Point	Date of Test	2023-03-23
Factor	DRH18-E	Temp. / Humidity	22°C /63%
Polarity	Horizontal	Site / Test Engineer	AC2 / Marvin
Test Mode	802.11ax-40MHz_TX_CH 9_ANT 0+1	Test Voltage	AC 120V/60Hz

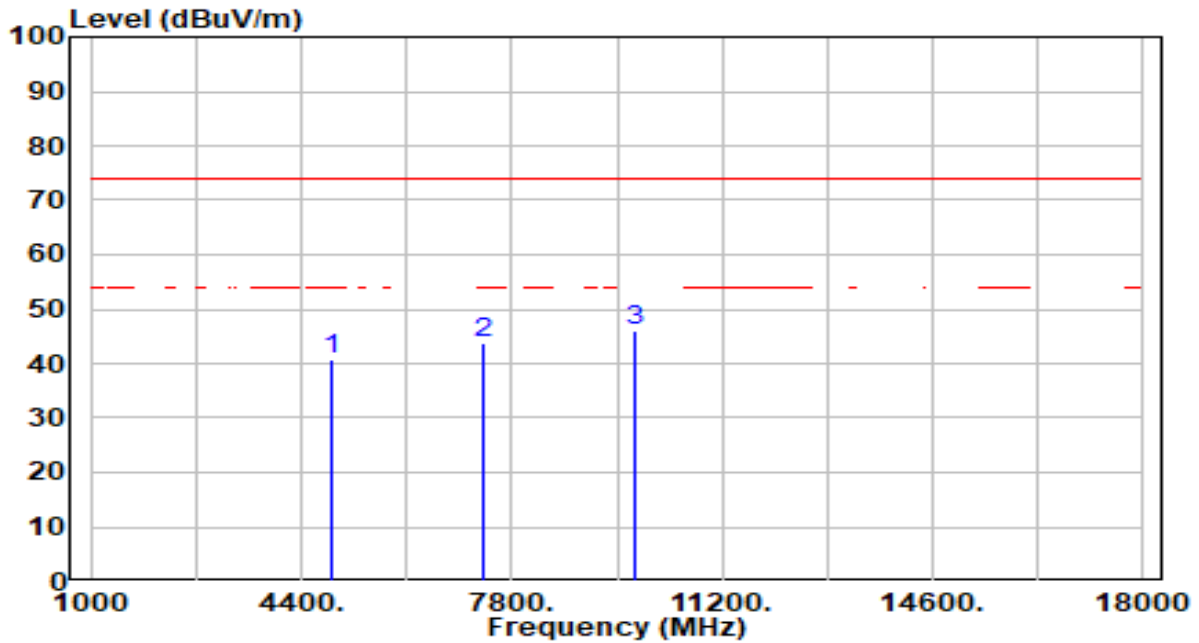

No	Frequency (MHz)	Reading (dBUV)	C.F (dB/m)	Measurement (dBUV/m)	Margin (dB)	Limit (dBUV/m)	Height (cm)	Angle (deg)	Remark (QP/PK/AV)
1	4904.000	41.92	-1.07	40.86	-33.14	74.00	100	245	Peak
2	7356.000	39.71	4.12	43.83	-30.17	74.00	100	82	Peak
3	* 9808.000	42.68	3.35	46.03	-27.97	74.00	100	230	Peak

Note:

1. " *", means this data is the worst emission level.
2. C.F (Correction Factor) = Antenna Factor (dB/m) + Cable Loss (dB) – Preamplifier(dB).
3. Measurement (dBUV/m) = Reading(dBUV) + C.F (Correction Factor).
4. The emission levels of other frequencies are very lower than the limit and not show in test report.

EUT	AX3000 Ceiling Mount Wi-Fi 6 Access Point	Date of Test	2023-03-23
Factor	DRH18-E	Temp. / Humidity	22°C /63%
Polarity	Vertical	Site / Test Engineer	AC2 / Marvin
Test Mode	802.11ax-40MHz_TX_CH 9_ANT 0+1	Test Voltage	AC 120V/60Hz

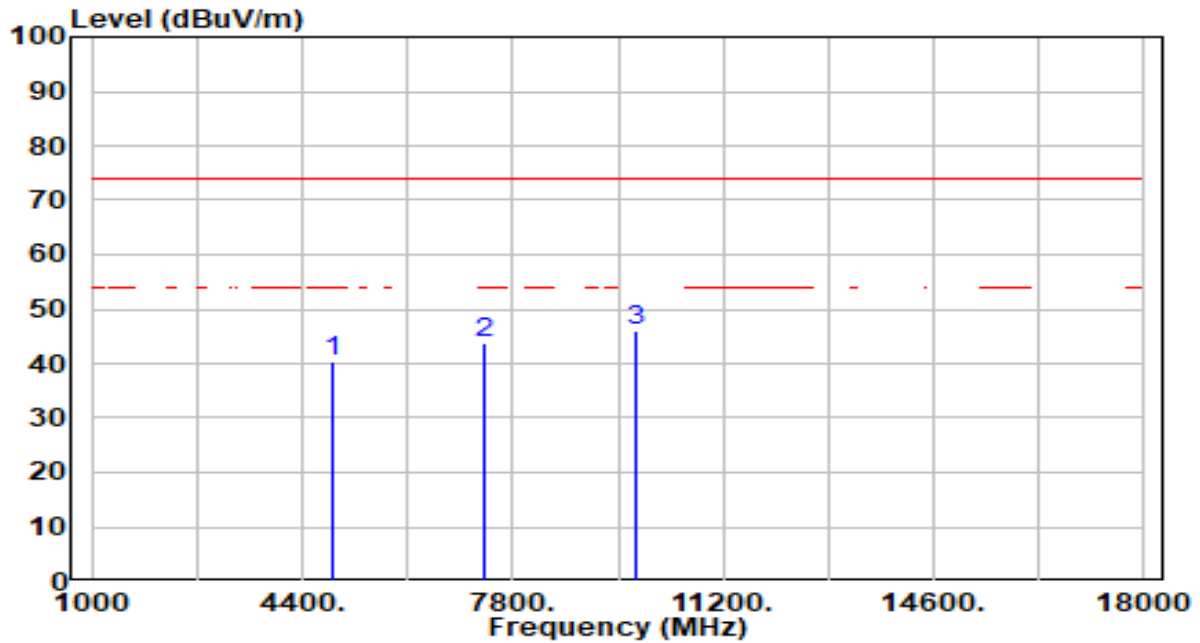

No	Frequency (MHz)	Reading (dBuV)	C.F (dB/m)	Measurement (dBuV/m)	Margin (dB)	Limit (dBuV/m)	Height (cm)	Angle (deg)	Remark (QP/PK/AV)
1	4904.000	41.58	-1.07	40.51	-33.49	74.00	300	184	Peak
2	7356.000	39.51	4.12	43.64	-30.36	74.00	300	228	Peak
3	* 9808.000	42.64	3.35	45.99	-28.01	74.00	300	243	Peak

Note:

1. " *", means this data is the worst emission level.
2. C.F (Correction Factor) = Antenna Factor (dB/m) + Cable Loss (dB) – Preamplifier(dB).
3. Measurement (dBuV/m) = Reading(dBuV) + C.F (Correction Factor).
4. The emission levels of other frequencies are very lower than the limit and not show in test report.

7.7. Radiated Restricted Band Edge Measurement

7.7.1. Test Limit

For 15.205 requirement:

Radiated emissions which fall in the restricted bands, as defined in Section 15.205(a) of FCC part 15, must also comply with the radiated emission limits specified in Section 15.209(a).

Frequency (MHz)	Frequency (MHz)	Frequency (MHz)	Frequency (GHz)
0.090 - 0.110	16.42 - 16.423	399.9 - 410	4.5 - 5.15
¹ 0.495 - 0.505	16.69475 - 16.69525	608 - 614	5.35 - 5.46
2.1735 - 2.1905	16.80425 - 16.80475	960 - 1240	7.25 - 7.75
4.125 - 4.128	25.5 - 25.67	1300 - 1427	8.025 - 8.5
4.17725 - 4.17775	37.5 - 38.25	1435 - 1626.5	9.0 - 9.2
4.20725 - 4.20775	73 - 74.6	1645.5 - 1646.5	9.3 - 9.5
6.215 - 6.218	74.8 - 75.2	1660 - 1710	10.6 - 12.7
6.26775 - 6.26825	108 - 121.94	1718.8 - 1722.2	13.25 - 13.4
6.31175 - 6.31225	123 - 138	2200 - 2300	14.47 - 14.5
8.291 - 8.294	149.9 - 150.05	2310 - 2390	15.35 - 16.2
8.362 - 8.366	156.52475 - 156.52525	2483.5 - 2500	17.7 - 21.4
8.37625 - 8.38675	156.7 - 156.9	2690 - 2900	22.01 - 23.12
8.41425 - 8.41475	162.0125 - 167.17	3260 - 3267	23.6 - 24.0
12.29 - 12.293	167.72 - 173.2	3332 - 3339	31.2 - 31.8
12.51975 - 12.52025	240 - 285	3345.8 - 3358	36.43 - 36.5
12.57675 - 12.57725	322 - 335.4	3600 - 4400	(²)
13.36 - 13.41	--	--	--

All out of band emissions appearing in a restricted band as specified in Section 15.205 of the Title 47CFR must not exceed the limits shown in Table per Section 15.209.

FCC Part 15 Subpart C Paragraph 15.209 Limits		
Frequency [MHz]	Field Strength [uV/m]	Measured Distance [Meters]
0.009 - 0.490	2400/F (kHz)	300
0.490 - 1.705	24000/F (kHz)	30
1.705 - 30	30	30
30 - 88	100	3
88 - 216	150	3
216 - 960	200	3
Above 960	500	3

7.7.2. Test Procedure Used

ANSI C63.10-2013 Section 6.3 (General Requirements)

ANSI C63.10-2013 Section 6.6 (Standard test method above 1GHz)

7.7.3. Test Setting

Peak Field Strength Measurements

1. Analyzer center frequency was set to the frequency of the radiated spurious emission of interest
2. RBW = 1MHz
3. VBW = 3MHz
4. Detector = peak
5. Sweep time = auto couple
6. Trace mode = max hold
7. Trace was allowed to stabilize

Average Measurements above 1GHz (Method VB)

1. Analyzer center frequency was set to the frequency of the radiated spurious emission of interest
2. RBW = 1MHz
3. VBW; If the EUT is configured to transmit with duty cycle $\geq 98\%$, set VBW = 10 Hz.

If the EUT duty cycle is $< 98\%$, set $VBW \geq 1/T$. T is the minimum transmission duration.

4. Detector = Peak
5. Sweep time = auto
6. Trace mode = max hold
7. Trace was allowed to stabilize

7.7.4.Test Setup

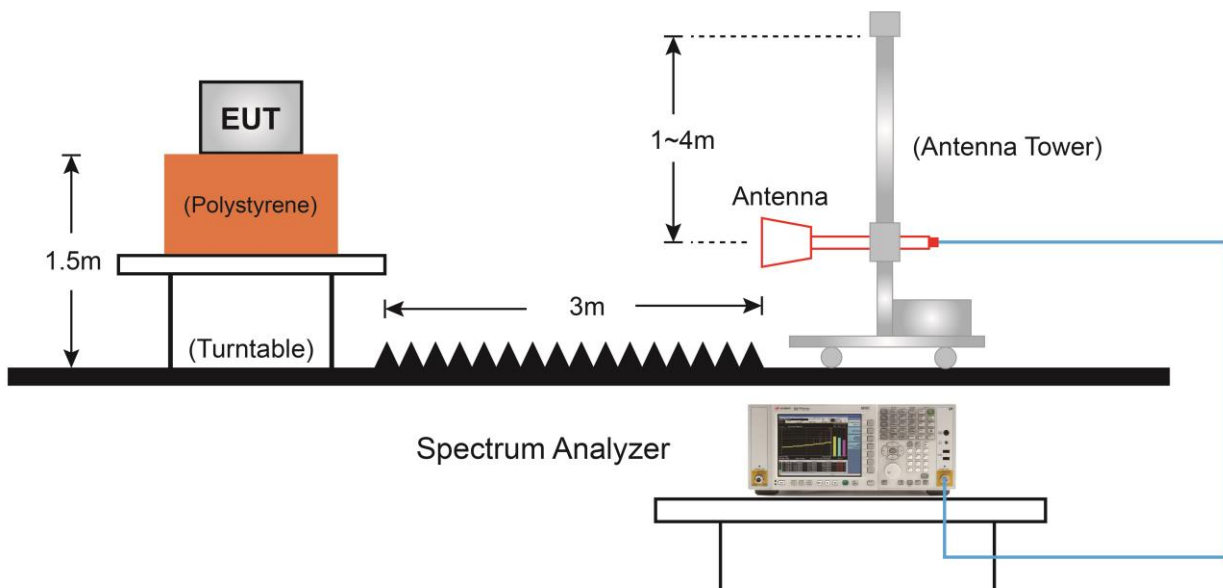

7.7.5. Test Result

EUT	AX3000 Ceiling Mount Wi-Fi 6 Access Point	Date of Test	2023-03-22
Factor	DRH18-E	Temp. / Humidity	22°C /63%
Polarity	Horizontal	Site / Test Engineer	AC2 / Marvin
Test Mode	802.11b_TX_CH 1_ANT 0+1	Test Voltage	AC 120V/60Hz

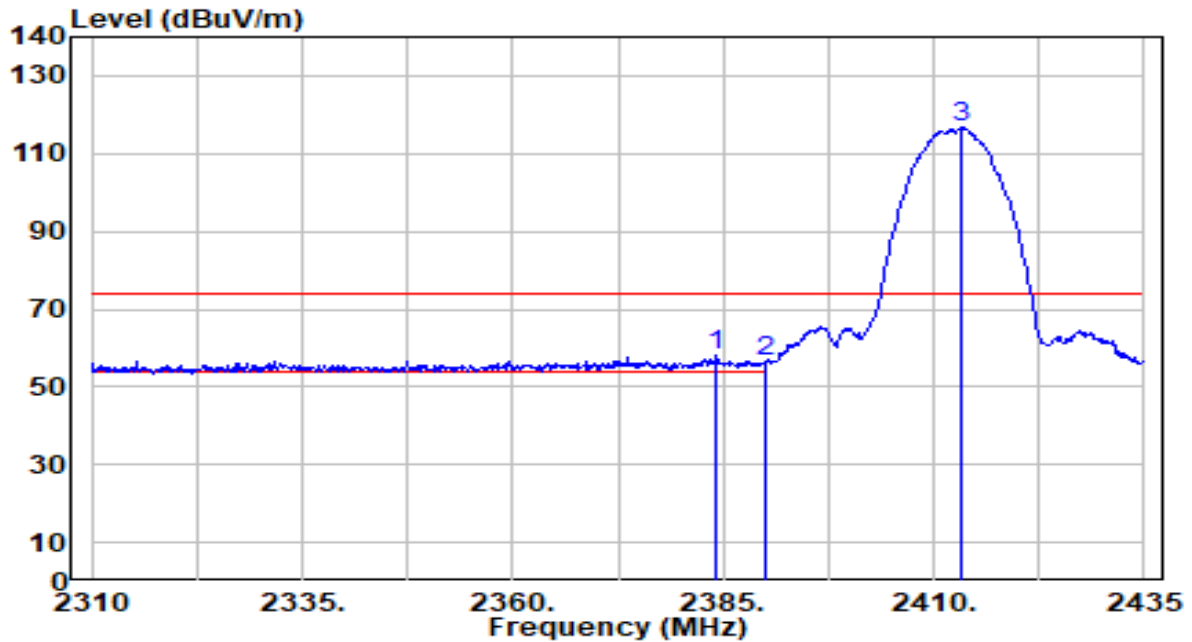

No	Frequency (MHz)	Reading (dBUV)	C.F (dB/m)	Measurement (dBUV/m)	Margin (dB)	Limit (dBUV/m)	Height (cm)	Angle (deg)	Remark (QP/PK/AV)
1	* 2384.125	28.00	29.99	57.99	-16.01	74.00	120	225	Peak
2	2390.000	26.47	29.99	56.47	-17.53	74.00	120	225	Peak
3	2413.375	86.61	30.05	116.66	N/A	N/A	120	225	Peak

Note:

1. " *", means this data is the worst emission level.
2. C.F (Correction Factor) = Antenna Factor (dB/m) + Cable Loss (dB).
3. Measurement (dBUV/m) = Reading(dBUV) + C.F (Correction Factor).
4. The emission levels of other frequencies are very lower than the limit and not show in test report.

EUT	AX3000 Ceiling Mount Wi-Fi 6 Access Point	Date of Test	2023-03-22
Factor	DRH18-E	Temp. / Humidity	22°C /63%
Polarity	Horizontal	Site / Test Engineer	AC2 / Marvin
Test Mode	802.11b_TX_CH 1_ANT 0+1	Test Voltage	AC 120V/60Hz

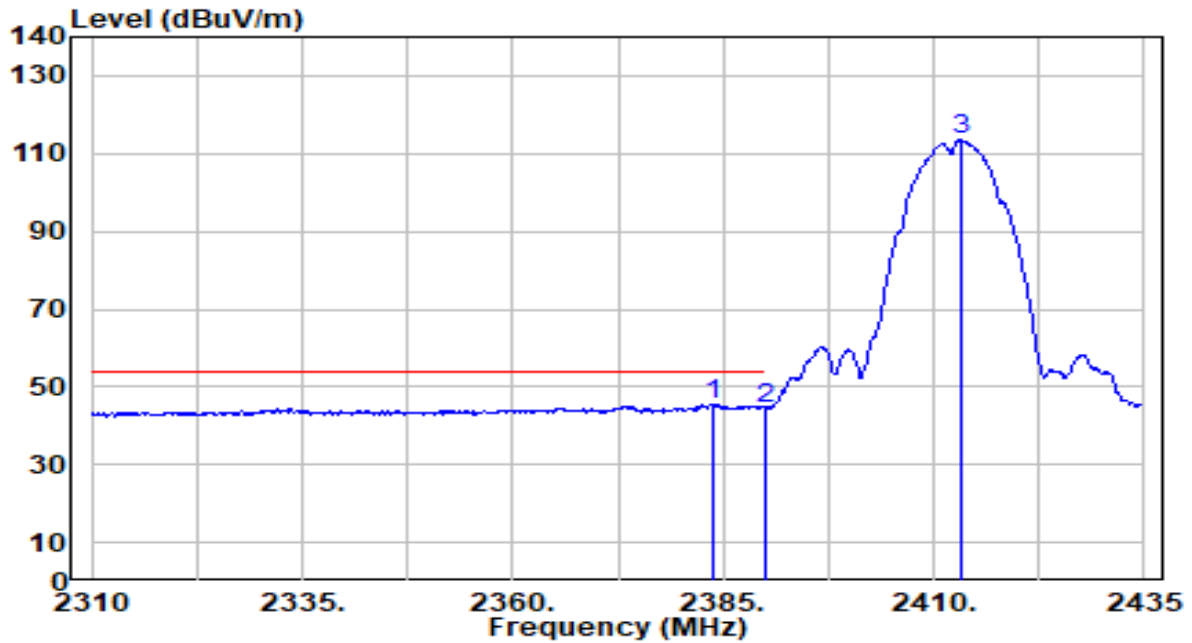

No	Frequency (MHz)	Reading (dBUV)	C.F (dB/m)	Measurement (dBUV/m)	Margin (dB)	Limit (dBUV/m)	Height (cm)	Angle (deg)	Remark (QP/PK/AV)	
1	*	2383.750	15.49	29.99	45.48	-8.52	54.00	120	225	Average
2		2390.000	14.40	29.99	44.40	-9.60	54.00	120	225	Average
3		2413.125	83.31	30.05	113.36	N/A	N/A	120	225	Average

Note:

1. " *", means this data is the worst emission level.
2. C.F (Correction Factor) = Antenna Factor (dB/m) + Cable Loss (dB).
3. Measurement (dBUV/m) = Reading(dBUV) + C.F (Correction Factor).
4. The emission levels of other frequencies are very lower than the limit and not show in test report.

EUT	AX3000 Ceiling Mount Wi-Fi 6 Access Point	Date of Test	2023-03-22
Factor	DRH18-E	Temp. / Humidity	22°C /63%
Polarity	Vertical	Site / Test Engineer	AC2 / Marvin
Test Mode	802.11b_TX_CH 1_ANT 0+1	Test Voltage	AC 120V/60Hz

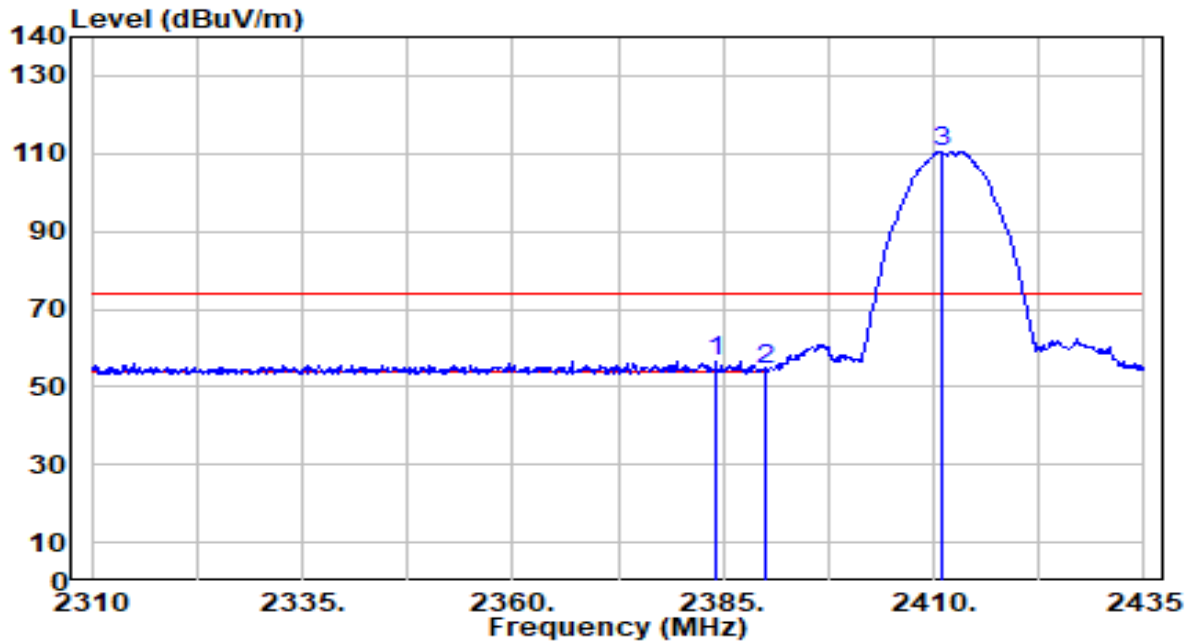

No	Frequency (MHz)	Reading (dBUV)	C.F (dB/m)	Measurement (dBUV/m)	Margin (dB)	Limit (dBUV/m)	Height (cm)	Angle (deg)	Remark (QP/PK/AV)
1	* 2384.125	26.73	29.99	56.72	-17.28	74.00	300	142	Peak
2	2390.000	24.34	29.99	54.34	-19.66	74.00	300	142	Peak
3	2410.875	80.42	30.04	110.46	N/A	N/A	300	142	Peak

Note:

1. " *", means this data is the worst emission level.
2. C.F (Correction Factor) = Antenna Factor (dB/m) + Cable Loss (dB).
3. Measurement (dBUV/m) = Reading(dBUV) + C.F (Correction Factor).
4. The emission levels of other frequencies are very lower than the limit and not show in test report.

EUT	AX3000 Ceiling Mount Wi-Fi 6 Access Point	Date of Test	2023-03-22
Factor	DRH18-E	Temp. / Humidity	22°C /63%
Polarity	Vertical	Site / Test Engineer	AC2 / Marvin
Test Mode	802.11b_TX_CH 1_ANT 0+1	Test Voltage	AC 120V/60Hz

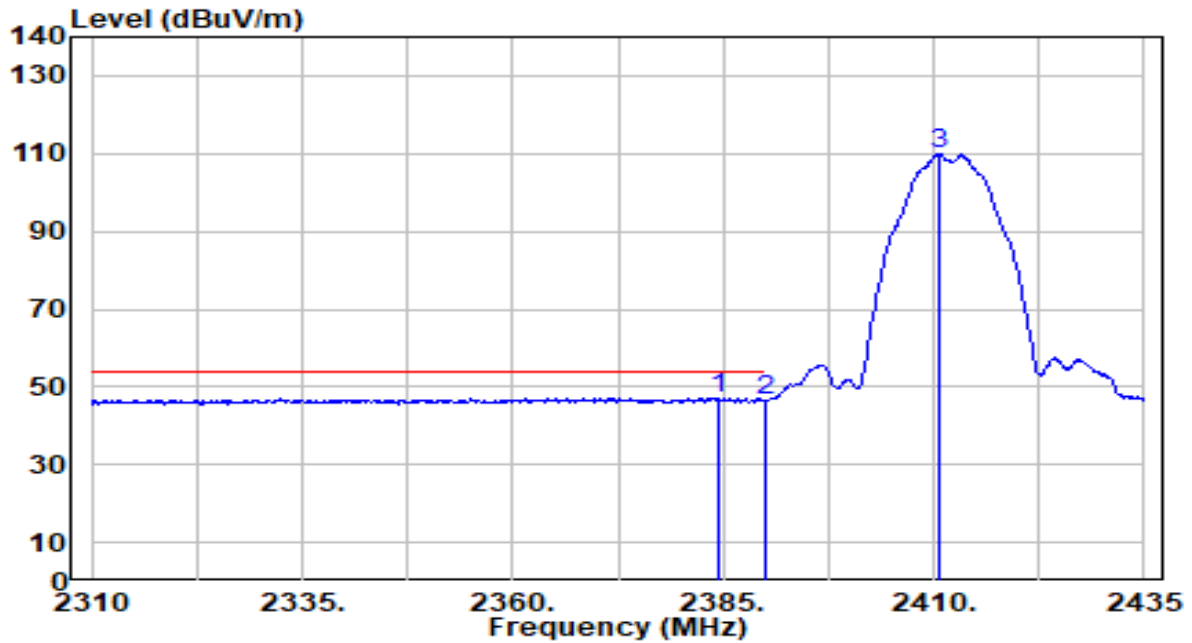

No	Frequency (MHz)	Reading (dBUV)	C.F (dB/m)	Measurement (dBUV/m)	Margin (dB)	Limit (dBUV/m)	Height (cm)	Angle (deg)	Remark (QP/PK/AV)	
1	*	2384.500	17.12	29.99	47.11	-6.89	54.00	300	142	Average
2		2390.000	16.63	29.99	46.62	-7.38	54.00	300	142	Average
3		2410.625	79.81	30.04	109.85	N/A	N/A	300	142	Average

Note:

1. " *", means this data is the worst emission level.
2. C.F (Correction Factor) = Antenna Factor (dB/m) + Cable Loss (dB).
3. Measurement (dBUV/m) = Reading(dBUV) + C.F (Correction Factor).
4. The emission levels of other frequencies are very lower than the limit and not show in test report.

EUT	AX3000 Ceiling Mount Wi-Fi 6 Access Point	Date of Test	2023-03-22
Factor	DRH18-E	Temp. / Humidity	22°C /63%
Polarity	Horizontal	Site / Test Engineer	AC2 / Marvin
Test Mode	802.11b_TX_CH 6_ANT 0+1	Test Voltage	AC 120V/60Hz

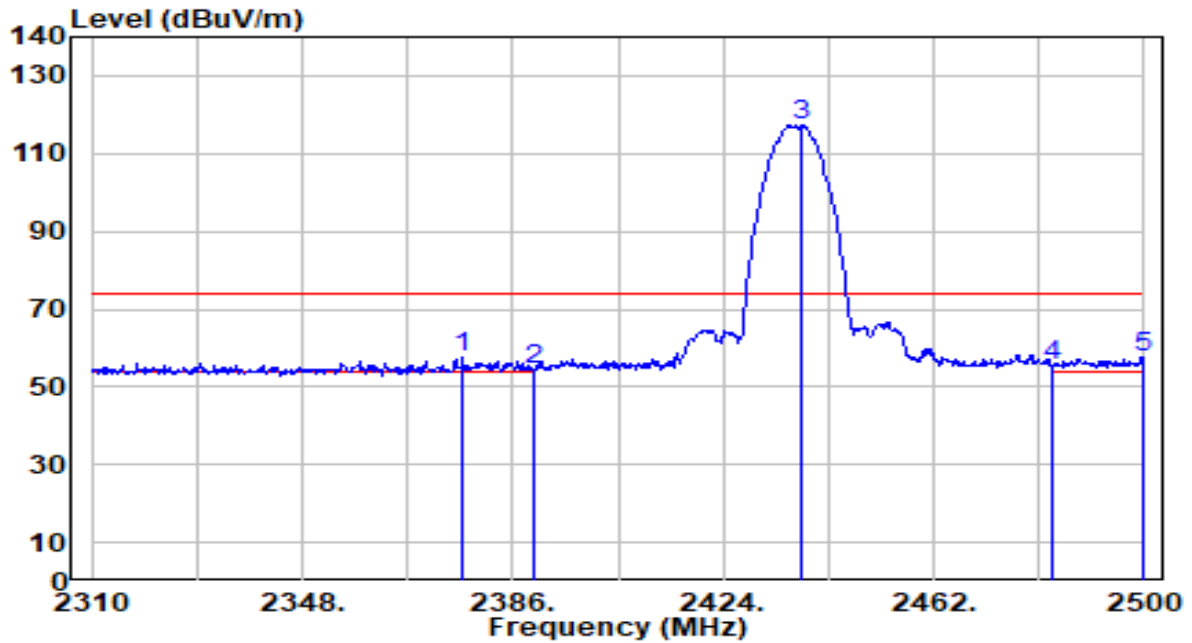

No	Frequency (MHz)	Reading (dBuV)	C.F (dB/m)	Measurement (dBuV/m)	Margin (dB)	Limit (dBuV/m)	Height (cm)	Angle (deg)	Remark (QP/PK/AV)
1	2377.070	27.50	29.98	57.48	-16.52	74.00	100	224	Peak
2	2390.000	24.39	29.99	54.39	-19.61	74.00	100	224	Peak
3	2438.250	87.23	30.13	117.37	N/A	N/A	100	224	Peak
4	2483.500	25.37	30.29	55.66	-18.34	74.00	100	224	Peak
5	* 2499.620	27.20	30.34	57.54	-16.46	74.00	100	224	Peak

Note:

1. " *", means this data is the worst emission level.
2. C.F (Correction Factor) = Antenna Factor (dB/m) + Cable Loss (dB).
3. Measurement (dBuV/m) = Reading(dBuV) + C.F (Correction Factor).
4. The emission levels of other frequencies are very lower than the limit and not show in test report.

EUT	AX3000 Ceiling Mount Wi-Fi 6 Access Point	Date of Test	2023-03-22
Factor	DRH18-E	Temp. / Humidity	22°C /63%
Polarity	Horizontal	Site / Test Engineer	AC2 / Marvin
Test Mode	802.11b_TX_CH 6_ANT 0+1	Test Voltage	AC 120V/60Hz

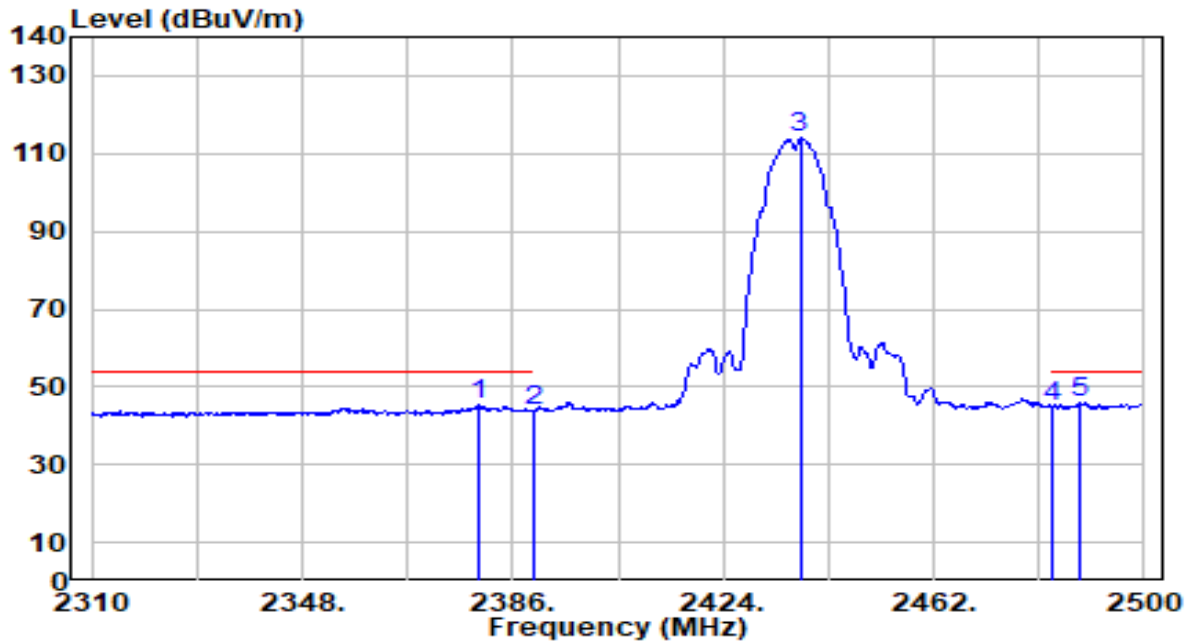

No	Frequency (MHz)	Reading (dBuV)	C.F (dB/m)	Measurement (dBuV/m)	Margin (dB)	Limit (dBuV/m)	Height (cm)	Angle (deg)	Remark (QP/PK/AV)
1	2380.110	15.23	29.98	45.21	-8.79	54.00	100	224	Average
2	2390.000	14.05	29.99	44.05	-9.95	54.00	100	224	Average
3	2437.870	83.90	30.13	114.03	N/A	N/A	100	224	Average
4	2483.500	14.43	30.29	44.72	-9.28	54.00	100	224	Average
5	* 2488.600	15.85	30.30	46.15	-7.85	54.00	100	224	Average

Note:

1. " *", means this data is the worst emission level.
2. C.F (Correction Factor) = Antenna Factor (dB/m) + Cable Loss (dB).
3. Measurement (dBuV/m) = Reading(dBuV) + C.F (Correction Factor).
4. The emission levels of other frequencies are very lower than the limit and not show in test report.

EUT	AX3000 Ceiling Mount Wi-Fi 6 Access Point	Date of Test	2023-03-22
Factor	DRH18-E	Temp. / Humidity	22°C /63%
Polarity	Vertical	Site / Test Engineer	AC2 / Marvin
Test Mode	802.11b_TX_CH 6_ANT 0+1	Test Voltage	AC 120V/60Hz

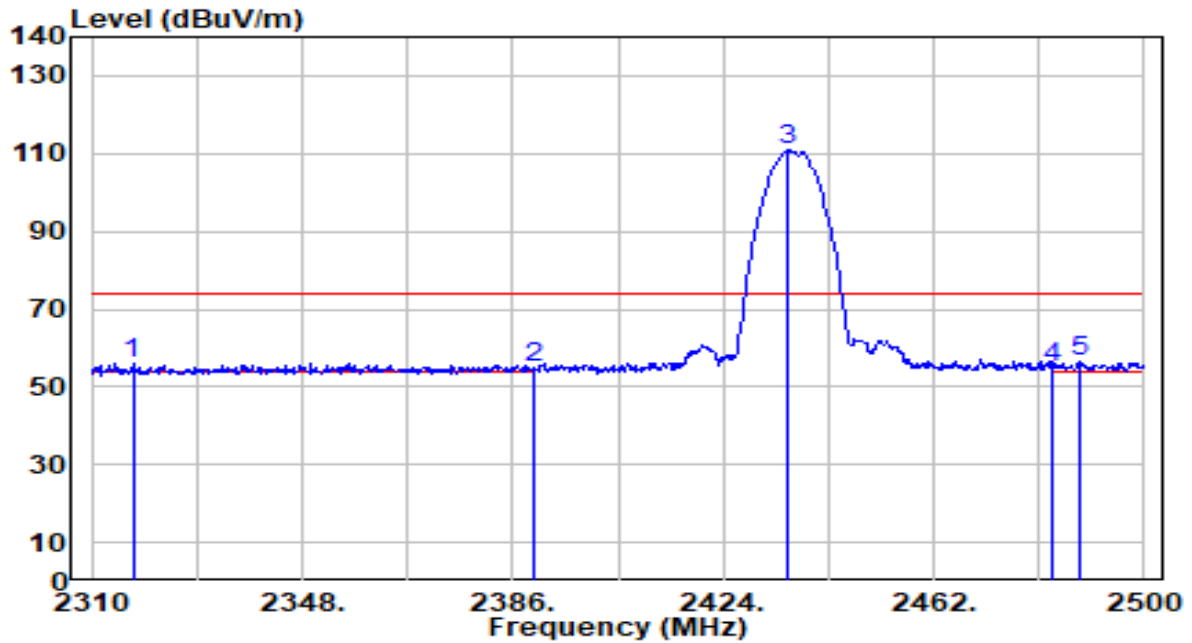

No	Frequency (MHz)	Reading (dBuV)	C.F (dB/m)	Measurement (dBuV/m)	Margin (dB)	Limit (dBuV/m)	Height (cm)	Angle (deg)	Remark (QP/PK/AV)
1	2317.410	25.93	29.90	55.83	-18.17	74.00	300	135	Peak
2	2390.000	24.73	29.99	54.73	-19.27	74.00	300	135	Peak
3	2435.780	80.88	30.13	111.00	N/A	N/A	300	135	Peak
4	2483.500	24.85	30.29	55.13	-18.87	74.00	300	135	Peak
5	* 2488.220	26.03	30.30	56.33	-17.67	74.00	300	135	Peak

Note:

1. " *", means this data is the worst emission level.
2. C.F (Correction Factor) = Antenna Factor (dB/m) + Cable Loss (dB).
3. Measurement (dBuV/m) = Reading(dBuV) + C.F (Correction Factor).
4. The emission levels of other frequencies are very lower than the limit and not show in test report.

EUT	AX3000 Ceiling Mount Wi-Fi 6 Access Point	Date of Test	2023-03-22
Factor	DRH18-E	Temp. / Humidity	22°C /63%
Polarity	Vertical	Site / Test Engineer	AC2 / Marvin
Test Mode	802.11b_TX_CH 6_ANT 0+1	Test Voltage	AC 120V/60Hz

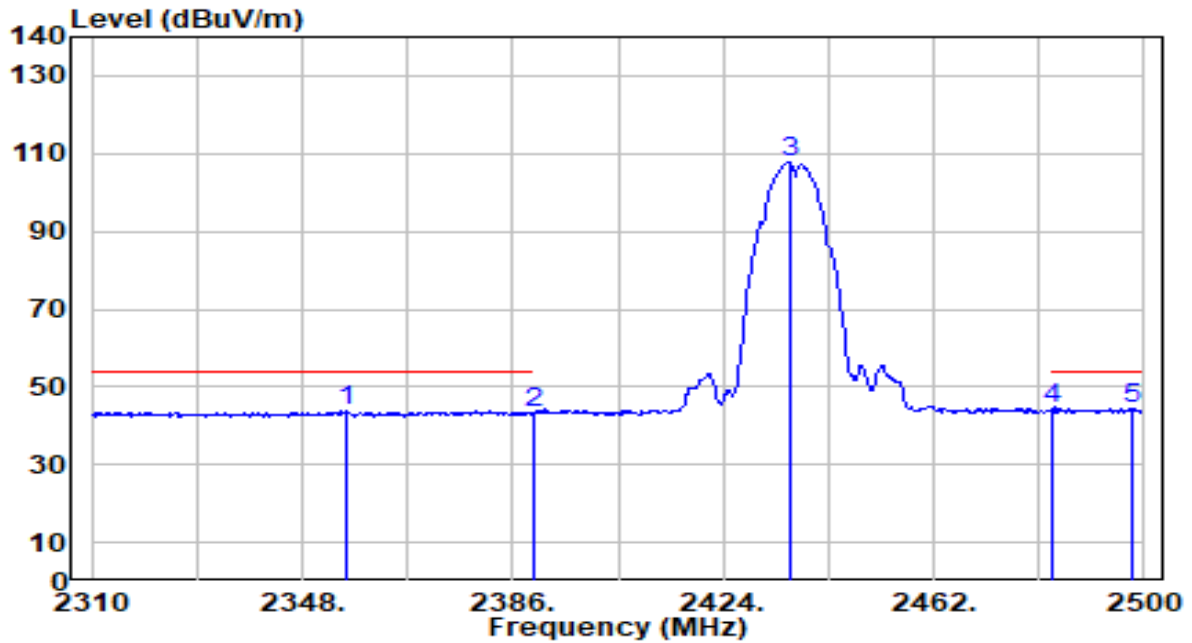

No	Frequency (MHz)	Reading (dBuV)	C.F (dB/m)	Measurement (dBuV/m)	Margin (dB)	Limit (dBuV/m)	Height (cm)	Angle (deg)	Remark (QP/PK/AV)
1	2355.790	13.86	29.95	43.81	-10.19	54.00	300	135	Average
2	2390.000	13.14	29.99	43.13	-10.87	54.00	300	135	Average
3	2435.970	77.70	30.13	107.83	N/A	N/A	300	135	Average
4	* 2483.500	14.13	30.29	44.42	-9.58	54.00	300	135	Average
5	2497.720	13.96	30.33	44.29	-9.71	54.00	300	135	Average

Note:

- " *", means this data is the worst emission level.
- C.F (Correction Factor) = Antenna Factor (dB/m) + Cable Loss (dB).
- Measurement (dBuV/m) = Reading(dBuV) + C.F (Correction Factor).
- The emission levels of other frequencies are very lower than the limit and not show in test report.

EUT	AX3000 Ceiling Mount Wi-Fi 6 Access Point	Date of Test	2023-03-22
Factor	DRH18-E	Temp. / Humidity	22°C /63%
Polarity	Horizontal	Site / Test Engineer	AC2 / Marvin
Test Mode	802.11b_TX_CH 11_ANT 0+1	Test Voltage	AC 120V/60Hz

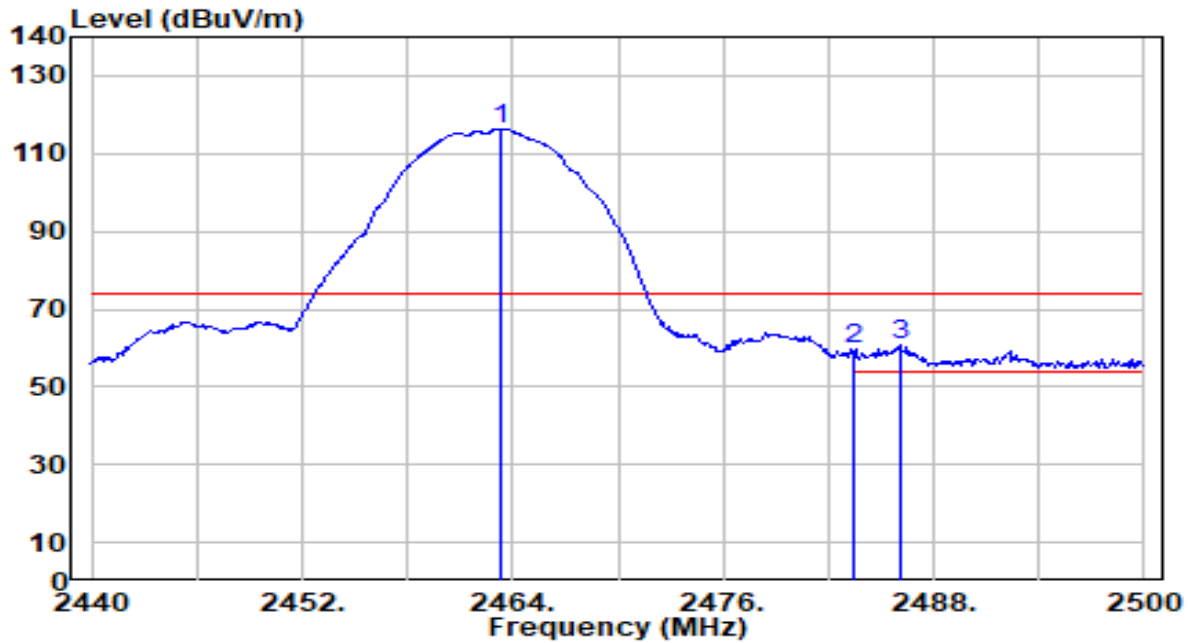

No	Frequency (MHz)	Reading (dBUV)	C.F (dB/m)	Measurement (dBUV/m)	Margin (dB)	Limit (dBUV/m)	Height (cm)	Angle (deg)	Remark (QP/PK/AV)
1	2463.280	86.23	30.22	116.45	N/A	N/A	113	128	Peak
2	2483.500	29.28	30.29	59.56	-14.44	74.00	113	128	Peak
3	* 2486.080	30.46	30.29	60.75	-13.25	74.00	113	128	Peak

Note:

1. " *", means this data is the worst emission level.
2. C.F (Correction Factor) = Antenna Factor (dB/m) + Cable Loss (dB).
3. Measurement (dBUV/m) = Reading(dBUV) + C.F (Correction Factor).
4. The emission levels of other frequencies are very lower than the limit and not show in test report.

EUT	AX3000 Ceiling Mount Wi-Fi 6 Access Point	Date of Test	2023-03-22
Factor	DRH18-E	Temp. / Humidity	22°C /63%
Polarity	Horizontal	Site / Test Engineer	AC2 / Marvin
Test Mode	802.11b_TX_CH 11_ANT 0+1	Test Voltage	AC 120V/60Hz

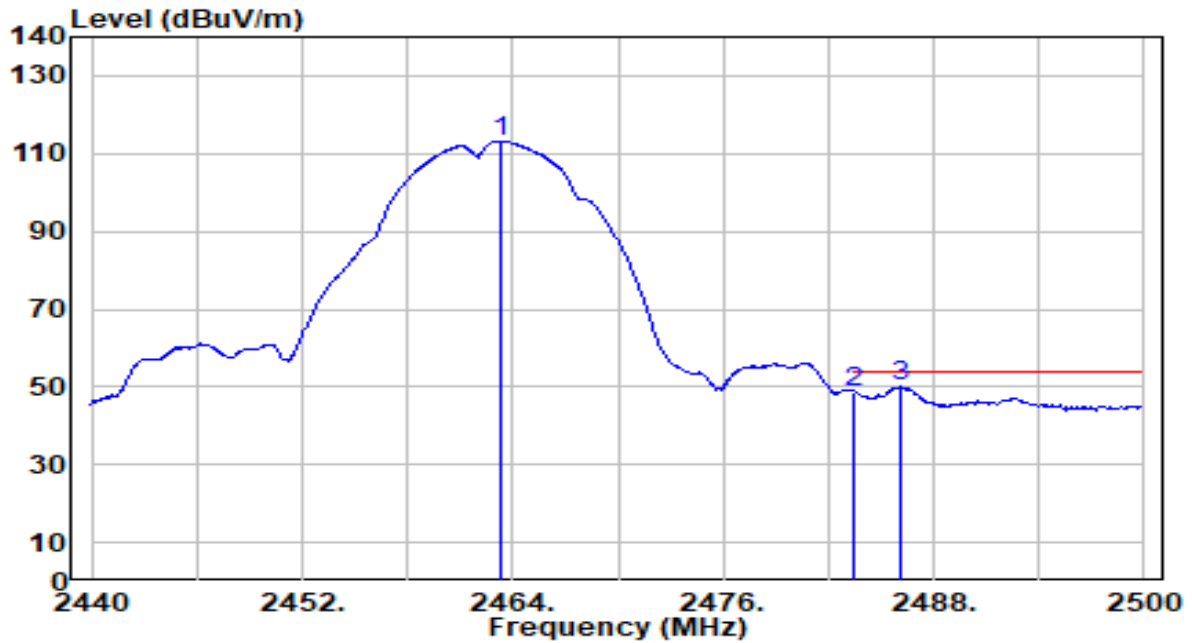

No	Frequency (MHz)	Reading (dBUV)	C.F (dB/m)	Measurement (dBUV/m)	Margin (dB)	Limit (dBUV/m)	Height (cm)	Angle (deg)	Remark (QP/PK/AV)
1	2463.280	83.02	30.22	113.24	N/A	N/A	113	128	Average
2	2483.500	18.39	30.29	48.68	-5.32	54.00	113	128	Average
3	* 2486.080	19.75	30.29	50.04	-3.96	54.00	113	128	Average

Note:

1. " *", means this data is the worst emission level.
2. C.F (Correction Factor) = Antenna Factor (dB/m) + Cable Loss (dB).
3. Measurement (dBUV/m) = Reading(dBUV) + C.F (Correction Factor).
4. The emission levels of other frequencies are very lower than the limit and not show in test report.

EUT	AX3000 Ceiling Mount Wi-Fi 6 Access Point	Date of Test	2023-03-22
Factor	DRH18-E	Temp. / Humidity	22°C /63%
Polarity	Vertical	Site / Test Engineer	AC2 / Marvin
Test Mode	802.11b_TX_CH 11_ANT 0+1	Test Voltage	AC 120V/60Hz

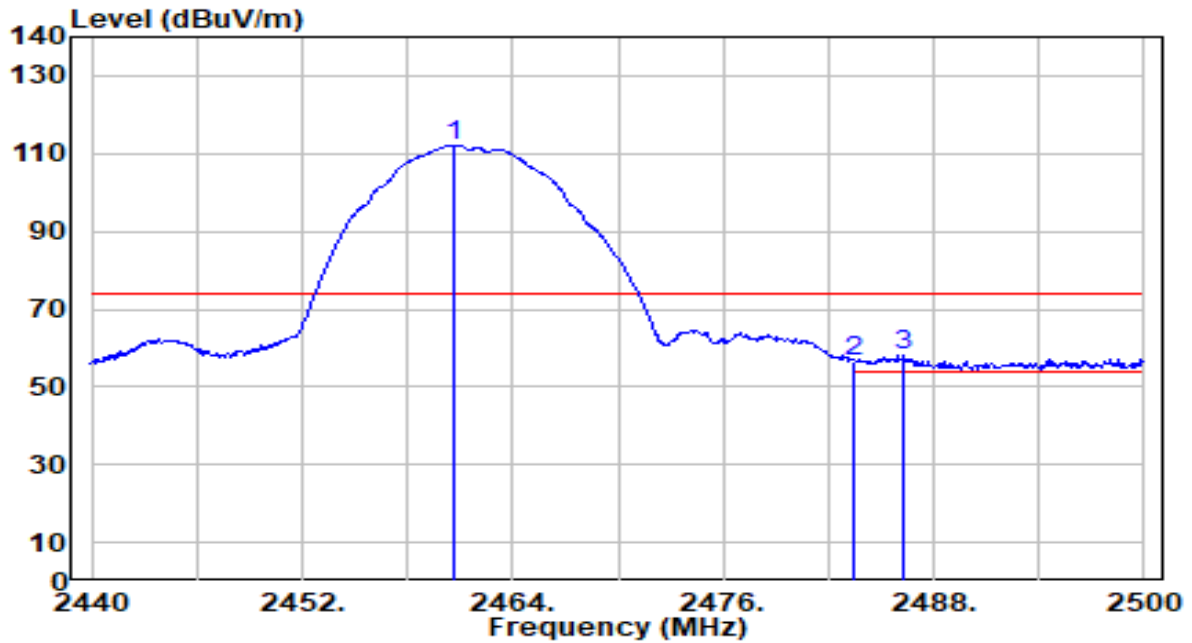

No	Frequency (MHz)	Reading (dBUV)	C.F (dB/m)	Measurement (dBUV/m)	Margin (dB)	Limit (dBUV/m)	Height (cm)	Angle (deg)	Remark (QP/PK/AV)
1	2460.720	82.05	30.21	112.26	N/A	N/A	300	180	Peak
2	2483.500	26.37	30.29	56.65	-17.35	74.00	300	180	Peak
3	* 2486.320	27.74	30.29	58.03	-15.97	74.00	300	180	Peak

Note:

1. " *", means this data is the worst emission level.
2. C.F (Correction Factor) = Antenna Factor (dB/m) + Cable Loss (dB).
3. Measurement (dBUV/m) = Reading(dBUV) + C.F (Correction Factor).
4. The emission levels of other frequencies are very lower than the limit and not show in test report.

EUT	AX3000 Ceiling Mount Wi-Fi 6 Access Point	Date of Test	2023-03-22
Factor	DRH18-E	Temp. / Humidity	22°C /63%
Polarity	Vertical	Site / Test Engineer	AC2 / Marvin
Test Mode	802.11b_TX_CH 11_ANT 0+1	Test Voltage	AC 120V/60Hz

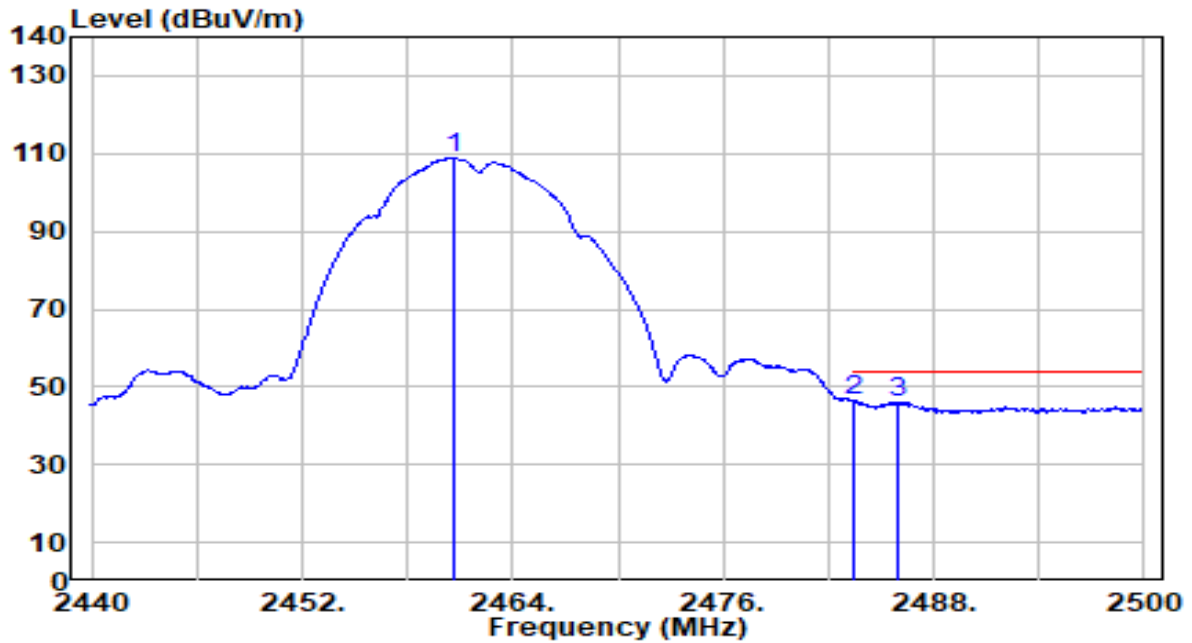

No	Frequency (MHz)	Reading (dBuV)	C.F (dB/m)	Measurement (dBuV/m)	Margin (dB)	Limit (dBuV/m)	Height (cm)	Angle (deg)	Remark (QP/PK/AV)
1	2460.640	78.68	30.21	108.89	N/A	N/A	300	180	Average
2	* 2483.500	15.98	30.29	46.26	-7.74	54.00	300	180	Average
3	2485.920	15.78	30.29	46.07	-7.93	54.00	300	180	Average

Note:

1. " *", means this data is the worst emission level.
2. C.F (Correction Factor) = Antenna Factor (dB/m) + Cable Loss (dB).
3. Measurement (dBuV/m) = Reading(dBuV) + C.F (Correction Factor).
4. The emission levels of other frequencies are very lower than the limit and not show in test report.

EUT	AX3000 Ceiling Mount Wi-Fi 6 Access Point	Date of Test	2023-03-22
Factor	DRH18-E	Temp. / Humidity	22°C /63%
Polarity	Horizontal	Site / Test Engineer	AC2 / Marvin
Test Mode	802.11g_TX_CH 1_ANT 0+1	Test Voltage	AC 120V/60Hz

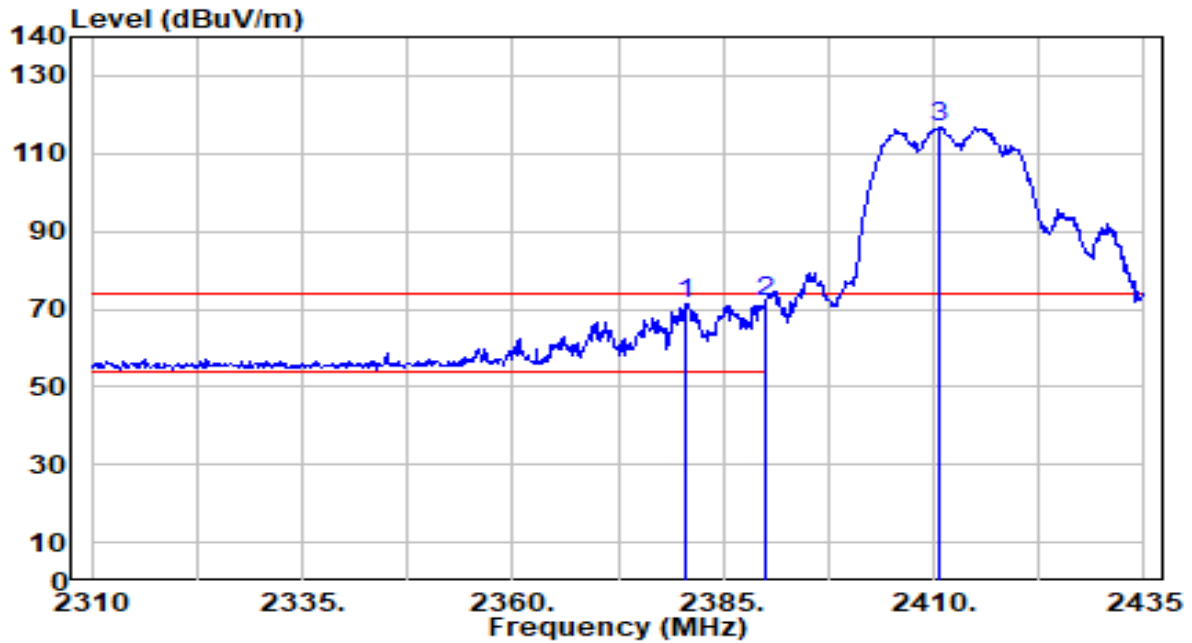

No	Frequency (MHz)	Reading (dBuV)	C.F (dB/m)	Measurement (dBuV/m)	Margin (dB)	Limit (dBuV/m)	Height (cm)	Angle (deg)	Remark (QP/PK/AV)
1	2380.625	41.48	29.98	71.47	-2.53	74.00	209	230	Peak
2	* 2390.000	41.89	29.99	71.88	-2.12	74.00	209	230	Peak
3	2410.750	86.83	30.04	116.88	N/A	N/A	209	230	Peak

Note:

1. " *", means this data is the worst emission level.
2. C.F (Correction Factor) = Antenna Factor (dB/m) + Cable Loss (dB).
3. Measurement (dBuV/m) = Reading(dBuV) + C.F (Correction Factor).
4. The emission levels of other frequencies are very lower than the limit and not show in test report.

EUT	AX3000 Ceiling Mount Wi-Fi 6 Access Point	Date of Test	2023-03-22
Factor	DRH18-E	Temp. / Humidity	22°C /63%
Polarity	Horizontal	Site / Test Engineer	AC2 / Marvin
Test Mode	802.11g_TX_CH 1_ANT 0+1	Test Voltage	AC 120V/60Hz

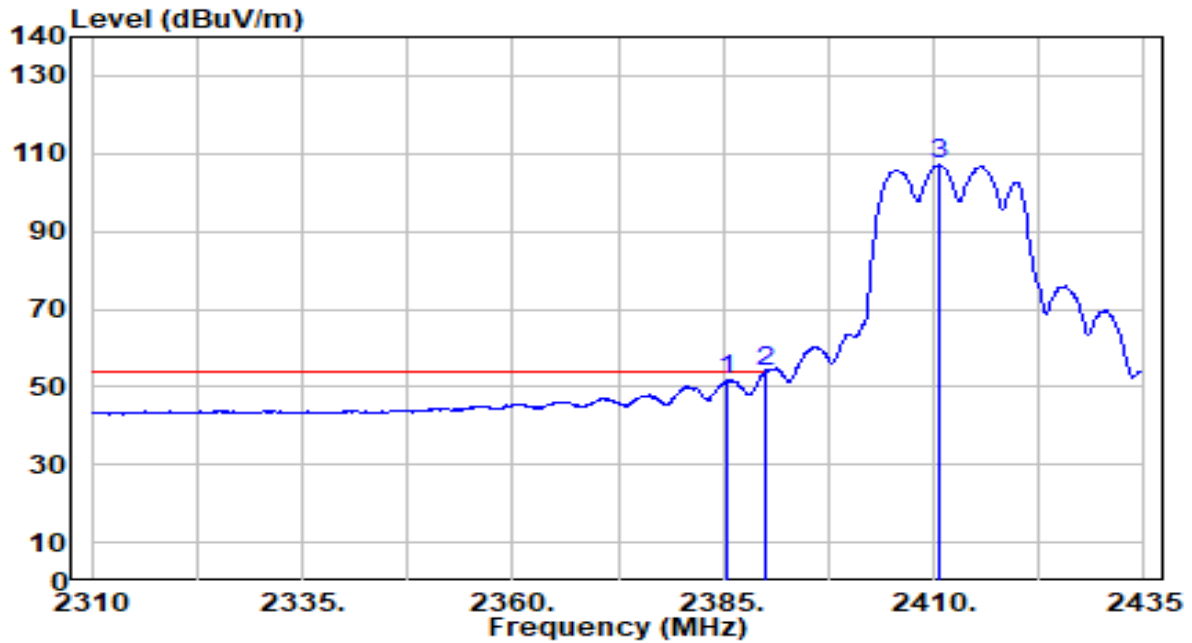

No	Frequency (MHz)	Reading (dBuV)	C.F (dB/m)	Measurement (dBuV/m)	Margin (dB)	Limit (dBuV/m)	Height (cm)	Angle (deg)	Remark (QP/PK/AV)
1	2385.500	21.73	29.99	51.72	-2.28	54.00	209	230	Average
2	* 2390.000	23.85	29.99	53.84	-0.16	54.00	209	230	Average
3	2410.500	77.01	30.04	107.06	N/A	N/A	209	230	Average

Note:

1. " *", means this data is the worst emission level.
2. C.F (Correction Factor) = Antenna Factor (dB/m) + Cable Loss (dB).
3. Measurement (dBuV/m) = Reading(dBuV) + C.F (Correction Factor).
4. The emission levels of other frequencies are very lower than the limit and not show in test report.

EUT	AX3000 Ceiling Mount Wi-Fi 6 Access Point	Date of Test	2023-03-22
Factor	DRH18-E	Temp. / Humidity	22°C /63%
Polarity	Vertical	Site / Test Engineer	AC2 / Marvin
Test Mode	802.11g_TX_CH 1_ANT 0+1	Test Voltage	AC 120V/60Hz

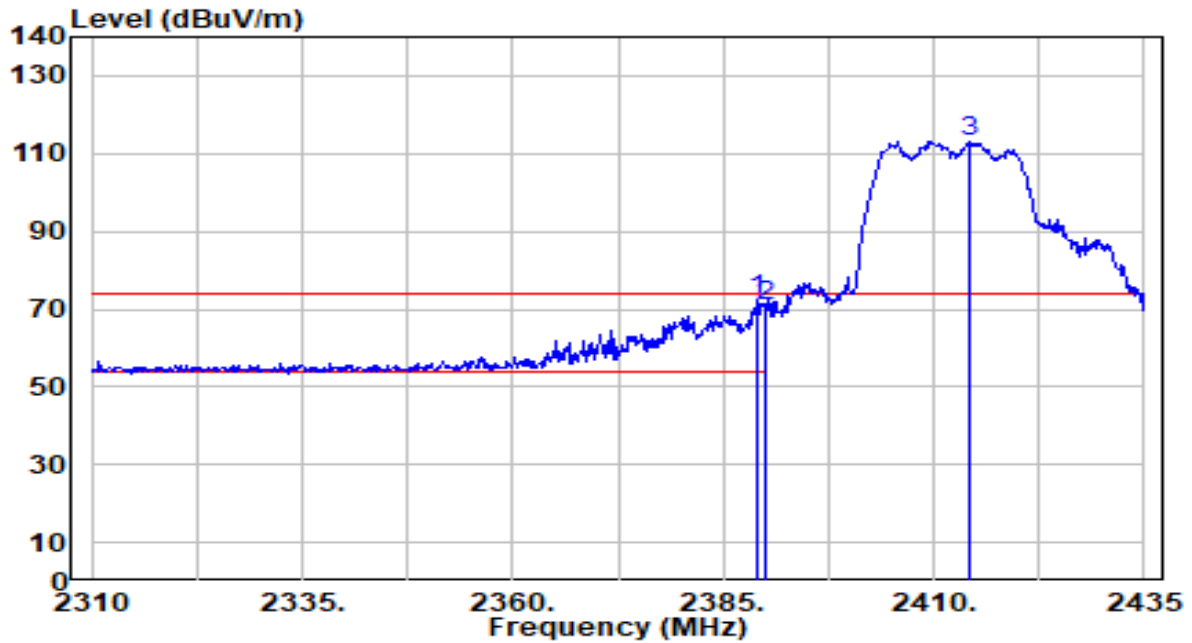

No	Frequency (MHz)	Reading (dBUV)	C.F (dB/m)	Measurement (dBUV/m)	Margin (dB)	Limit (dBUV/m)	Height (cm)	Angle (deg)	Remark (QP/PK/AV)	
1	*	2389.000	42.36	29.99	72.35	-1.65	74.00	353	180	Peak
2		2390.000	40.92	29.99	70.91	-3.09	74.00	353	180	Peak
3		2414.125	83.20	30.05	113.26	N/A	N/A	353	180	Peak

Note:

1. " *", means this data is the worst emission level.
2. C.F (Correction Factor) = Antenna Factor (dB/m) + Cable Loss (dB).
3. Measurement (dBUV/m) = Reading(dBUV) + C.F (Correction Factor).
4. The emission levels of other frequencies are very lower than the limit and not show in test report.

EUT	AX3000 Ceiling Mount Wi-Fi 6 Access Point	Date of Test	2023-03-22
Factor	DRH18-E	Temp. / Humidity	22°C /63%
Polarity	Vertical	Site / Test Engineer	AC2 / Marvin
Test Mode	802.11g_TX_CH 1_ANT 0+1	Test Voltage	AC 120V/60Hz

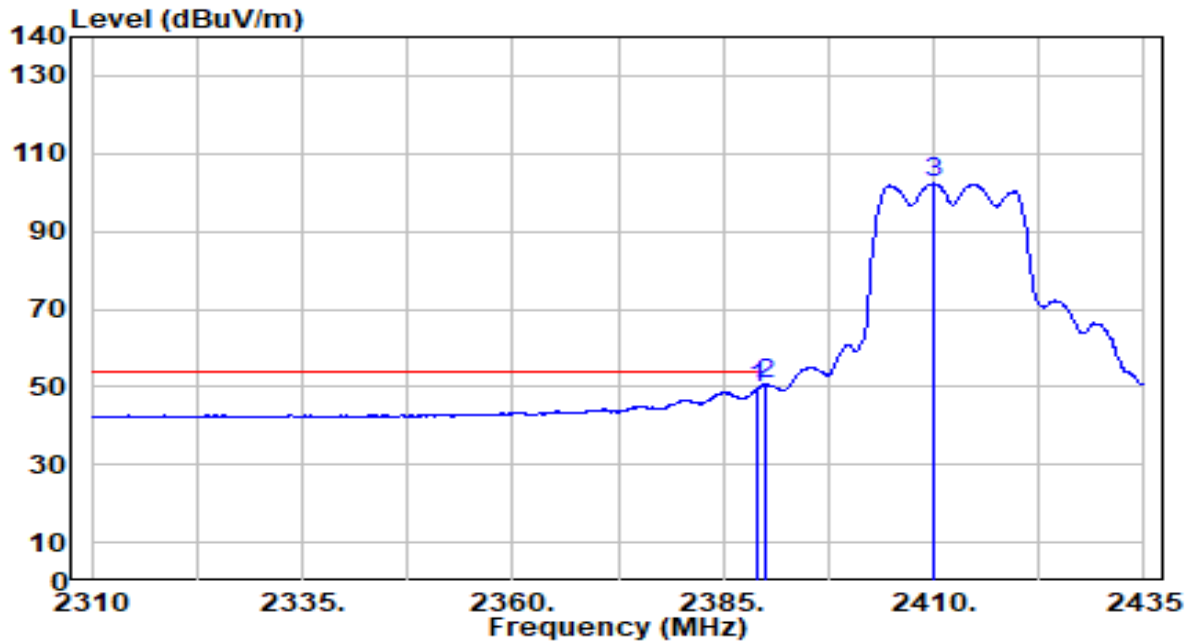

No	Frequency (MHz)	Reading (dBUV)	C.F (dB/m)	Measurement (dBUV/m)	Margin (dB)	Limit (dBUV/m)	Height (cm)	Angle (deg)	Remark (QP/PK/AV)
1	2389.000	19.58	29.99	49.58	-4.42	54.00	353	180	Average
2	* 2390.000	20.61	29.99	50.60	-3.40	54.00	353	180	Average
3	2409.875	72.27	30.04	102.31	N/A	N/A	353	180	Average

Note:

1. " *", means this data is the worst emission level.
2. C.F (Correction Factor) = Antenna Factor (dB/m) + Cable Loss (dB).
3. Measurement (dBUV/m) = Reading(dBUV) + C.F (Correction Factor).
4. The emission levels of other frequencies are very lower than the limit and not show in test report.

EUT	AX3000 Ceiling Mount Wi-Fi 6 Access Point	Date of Test	2023-03-22
Factor	DRH18-E	Temp. / Humidity	22°C /63%
Polarity	Horizontal	Site / Test Engineer	AC2 / Marvin
Test Mode	802.11g_TX_CH 6_ANT 0+1	Test Voltage	AC 120V/60Hz

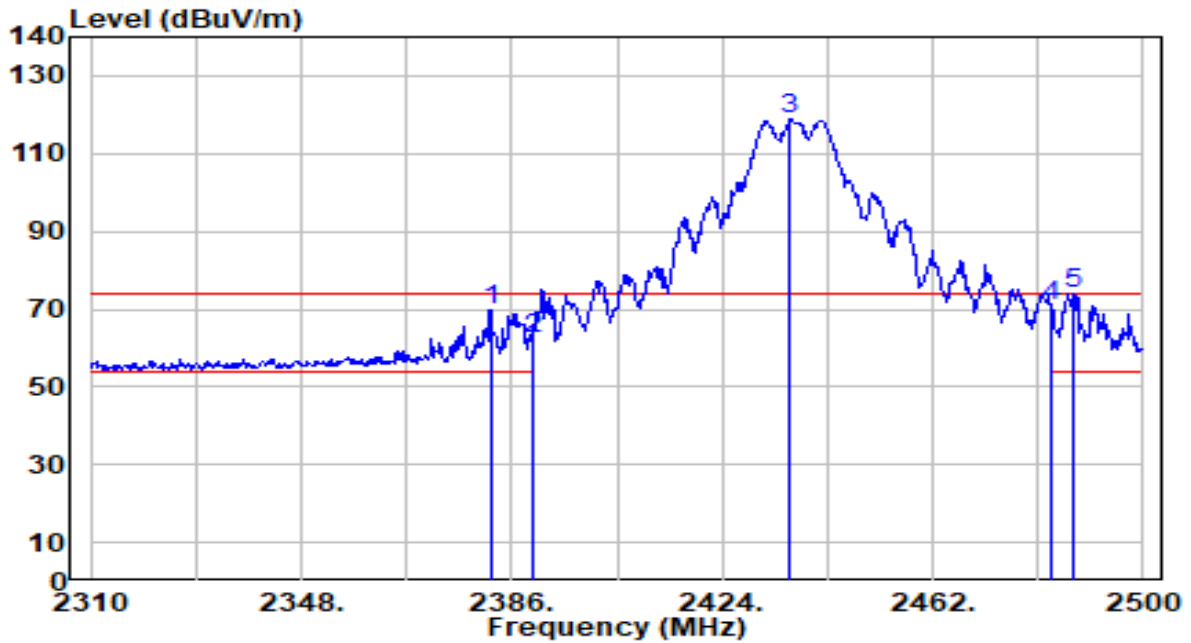

No	Frequency (MHz)	Reading (dBuV)	C.F (dB/m)	Measurement (dBuV/m)	Margin (dB)	Limit (dBuV/m)	Height (cm)	Angle (deg)	Remark (QP/PK/AV)
1	2382.200	40.00	29.98	69.99	-4.01	74.00	100	227	Peak
2	2390.000	32.54	29.99	62.53	-11.47	74.00	100	227	Peak
3	2436.350	88.59	30.13	118.72	N/A	N/A	100	227	Peak
4	2483.500	40.74	30.29	71.03	-2.97	74.00	100	227	Peak
5	* 2487.270	43.60	30.30	73.90	-0.10	74.00	100	227	Peak

Note:

1. " *", means this data is the worst emission level.
2. C.F (Correction Factor) = Antenna Factor (dB/m) + Cable Loss (dB).
3. Measurement (dBuV/m) = Reading(dBuV) + C.F (Correction Factor).
4. The emission levels of other frequencies are very lower than the limit and not show in test report.

EUT	AX3000 Ceiling Mount Wi-Fi 6 Access Point	Date of Test	2023-03-22
Factor	DRH18-E	Temp. / Humidity	22°C /63%
Polarity	Horizontal	Site / Test Engineer	AC2 / Marvin
Test Mode	802.11g_TX_CH 6_ANT 0+1	Test Voltage	AC 120V/60Hz

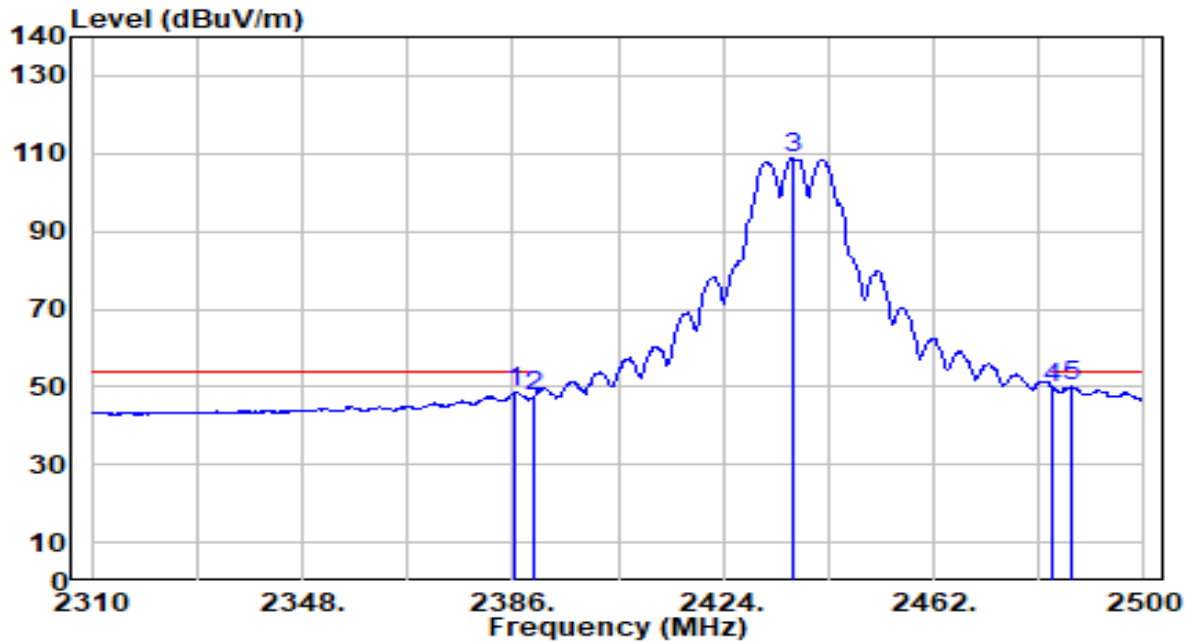

No	Frequency (MHz)	Reading (dBuV)	C.F (dB/m)	Measurement (dBuV/m)	Margin (dB)	Limit (dBuV/m)	Height (cm)	Angle (deg)	Remark (QP/PK/AV)
1	2386.380	18.60	29.99	48.59	-5.41	54.00	100	227	Average
2	2390.000	17.69	29.99	47.69	-6.31	54.00	100	227	Average
3	2436.540	78.84	30.13	108.97	N/A	N/A	100	227	Average
4	2483.500	19.46	30.29	49.75	-4.25	54.00	100	227	Average
5	* 2486.890	19.80	30.30	50.10	-3.90	54.00	100	227	Average

Note:

1. " *", means this data is the worst emission level.
2. C.F (Correction Factor) = Antenna Factor (dB/m) + Cable Loss (dB).
3. Measurement (dBuV/m) = Reading(dBuV) + C.F (Correction Factor).
4. The emission levels of other frequencies are very lower than the limit and not show in test report.

EUT	AX3000 Ceiling Mount Wi-Fi 6 Access Point	Date of Test	2023-03-22
Factor	DRH18-E	Temp. / Humidity	22°C /63%
Polarity	Vertical	Site / Test Engineer	AC2 / Marvin
Test Mode	802.11g_TX_CH 6_ANT 0+1	Test Voltage	AC 120V/60Hz

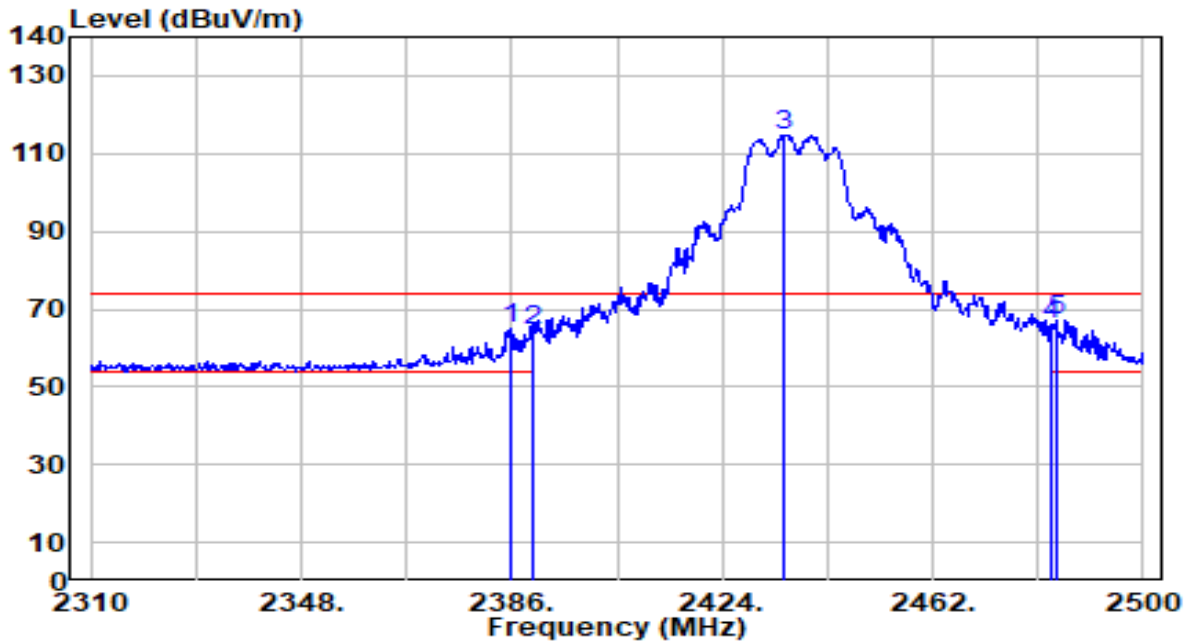

No	Frequency (MHz)	Reading (dBuV)	C.F (dB/m)	Measurement (dBuV/m)	Margin (dB)	Limit (dBuV/m)	Height (cm)	Angle (deg)	Remark (QP/PK/AV)
1	2386.000	34.74	29.99	64.72	-9.28	74.00	302	178	Peak
2	2390.000	34.35	29.99	64.34	-9.66	74.00	302	178	Peak
3	2435.210	84.74	30.12	114.87	N/A	N/A	302	178	Peak
4	2483.500	35.75	30.29	66.03	-7.97	74.00	302	178	Peak
5	* 2484.230	37.06	30.29	67.35	-6.65	74.00	302	178	Peak

Note:

1. " *", means this data is the worst emission level.
2. C.F (Correction Factor) = Antenna Factor (dB/m) + Cable Loss (dB).
3. Measurement (dBuV/m) = Reading(dBuV) + C.F (Correction Factor).
4. The emission levels of other frequencies are very lower than the limit and not show in test report.

EUT	AX3000 Ceiling Mount Wi-Fi 6 Access Point	Date of Test	2023-03-22
Factor	DRH18-E	Temp. / Humidity	22°C /63%
Polarity	Vertical	Site / Test Engineer	AC2 / Marvin
Test Mode	802.11g_TX_CH 6_ANT 0+1	Test Voltage	AC 120V/60Hz

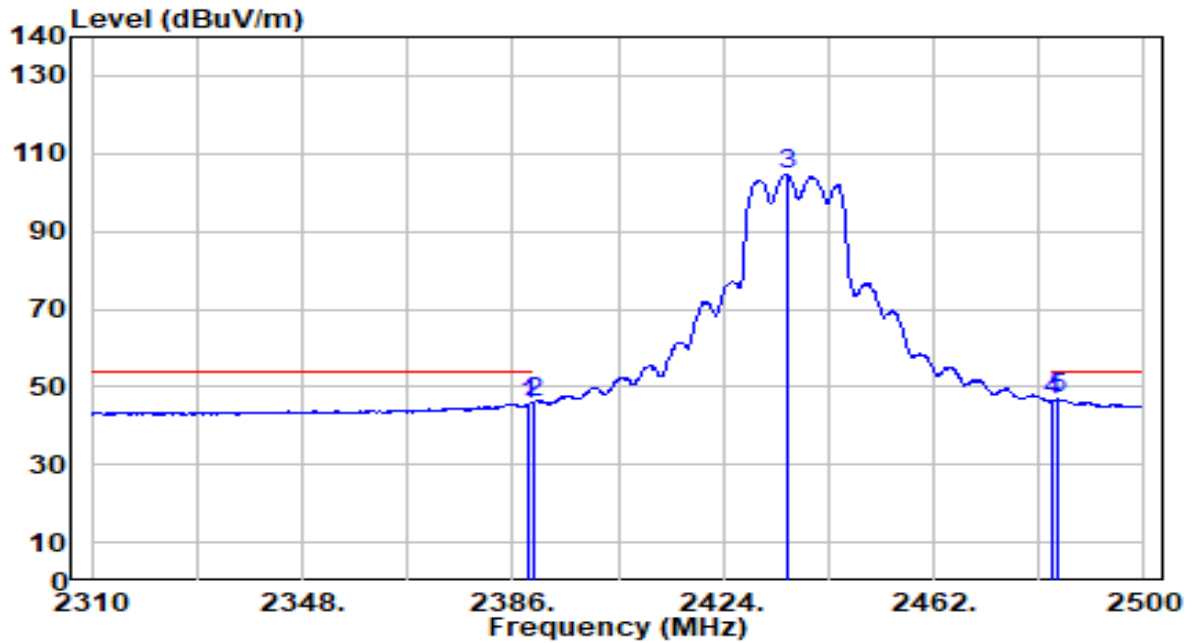

No	Frequency (MHz)	Reading (dBuV)	C.F (dB/m)	Measurement (dBuV/m)	Margin (dB)	Limit (dBuV/m)	Height (cm)	Angle (deg)	Remark (QP/PK/AV)
1	2389.040	15.63	29.99	45.62	-8.38	54.00	302	178	Average
2	2390.000	16.08	29.99	46.07	-7.93	54.00	302	178	Average
3	2435.400	74.57	30.13	104.69	N/A	N/A	302	178	Average
4	2483.500	16.15	30.29	46.44	-7.56	54.00	302	178	Average
5	* 2484.230	16.54	30.29	46.83	-7.17	54.00	302	178	Average

Note:

1. " *", means this data is the worst emission level.
2. C.F (Correction Factor) = Antenna Factor (dB/m) + Cable Loss (dB).
3. Measurement (dBuV/m) = Reading(dBuV) + C.F (Correction Factor).
4. The emission levels of other frequencies are very lower than the limit and not show in test report.

EUT	AX3000 Ceiling Mount Wi-Fi 6 Access Point	Date of Test	2023-03-22
Factor	DRH18-E	Temp. / Humidity	22°C /63%
Polarity	Horizontal	Site / Test Engineer	AC2 / Marvin
Test Mode	802.11g_TX_CH 11_ANT 0+1	Test Voltage	AC 120V/60Hz

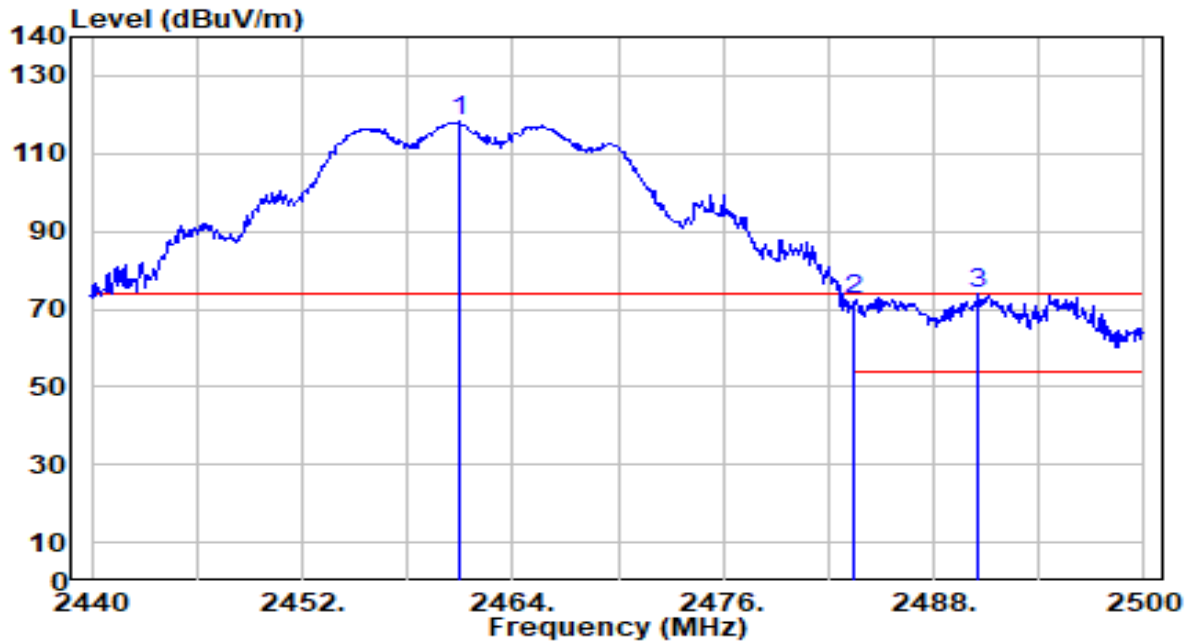

No	Frequency (MHz)	Reading (dBUV)	C.F (dB/m)	Measurement (dBUV/m)	Margin (dB)	Limit (dBUV/m)	Height (cm)	Angle (deg)	Remark (QP/PK/AV)
1	2460.960	87.92	30.21	118.13	N/A	N/A	258	230	Peak
2	2483.500	41.92	30.29	72.20	-1.80	74.00	258	230	Peak
3	* 2490.560	43.57	30.31	73.88	-0.12	74.00	258	230	Peak

Note:

1. " *", means this data is the worst emission level.
2. C.F (Correction Factor) = Antenna Factor (dB/m) + Cable Loss (dB).
3. Measurement (dBUV/m) = Reading(dBUV) + C.F (Correction Factor).
4. The emission levels of other frequencies are very lower than the limit and not show in test report.

EUT	AX3000 Ceiling Mount Wi-Fi 6 Access Point	Date of Test	2023-03-22
Factor	DRH18-E	Temp. / Humidity	22°C /63%
Polarity	Horizontal	Site / Test Engineer	AC2 / Marvin
Test Mode	802.11g_TX_CH 11_ANT 0+1	Test Voltage	AC 120V/60Hz

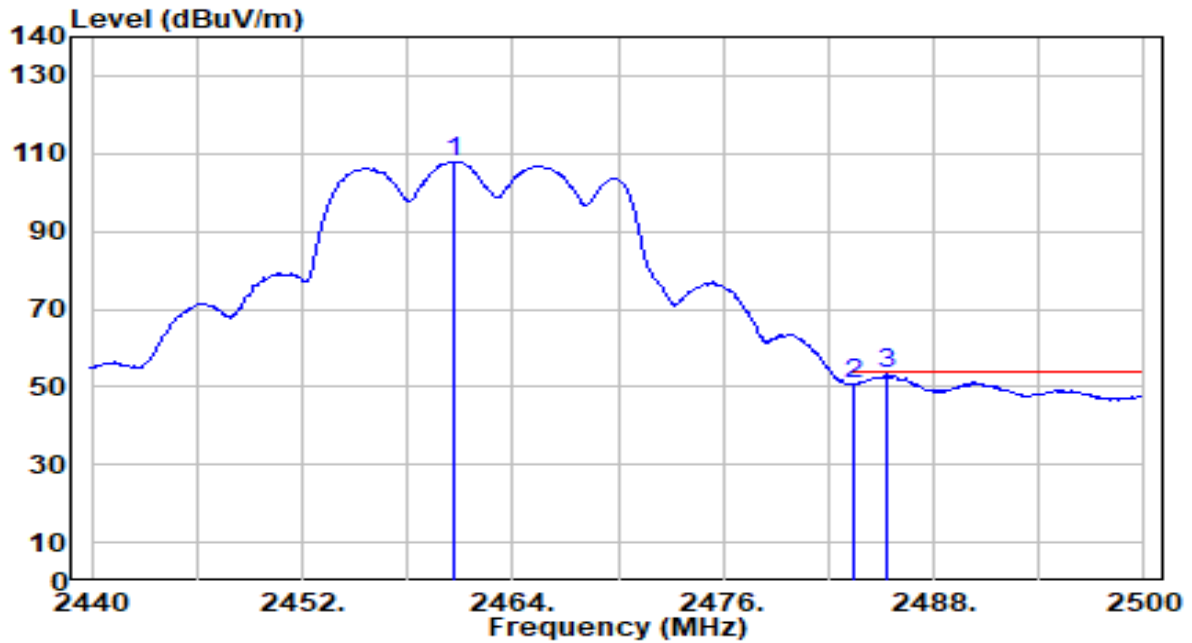

No	Frequency (MHz)	Reading (dBUV)	C.F (dB/m)	Measurement (dBUV/m)	Margin (dB)	Limit (dBUV/m)	Height (cm)	Angle (deg)	Remark (QP/PK/AV)
1	2460.720	77.70	30.21	107.91	N/A	N/A	258	230	Average
2	2483.500	20.38	30.29	50.67	-3.33	54.00	258	230	Average
3	* 2485.280	22.86	30.29	53.15	-0.85	54.00	258	230	Average

Note:

1. " *", means this data is the worst emission level.
2. C.F (Correction Factor) = Antenna Factor (dB/m) + Cable Loss (dB).
3. Measurement (dBUV/m) = Reading(dBUV) + C.F (Correction Factor).
4. The emission levels of other frequencies are very lower than the limit and not show in test report.

EUT	AX3000 Ceiling Mount Wi-Fi 6 Access Point	Date of Test	2023-03-22
Factor	DRH18-E	Temp. / Humidity	22°C /63%
Polarity	Vertical	Site / Test Engineer	AC2 / Marvin
Test Mode	802.11g_TX_CH 11_ANT 0+1	Test Voltage	AC 120V/60Hz

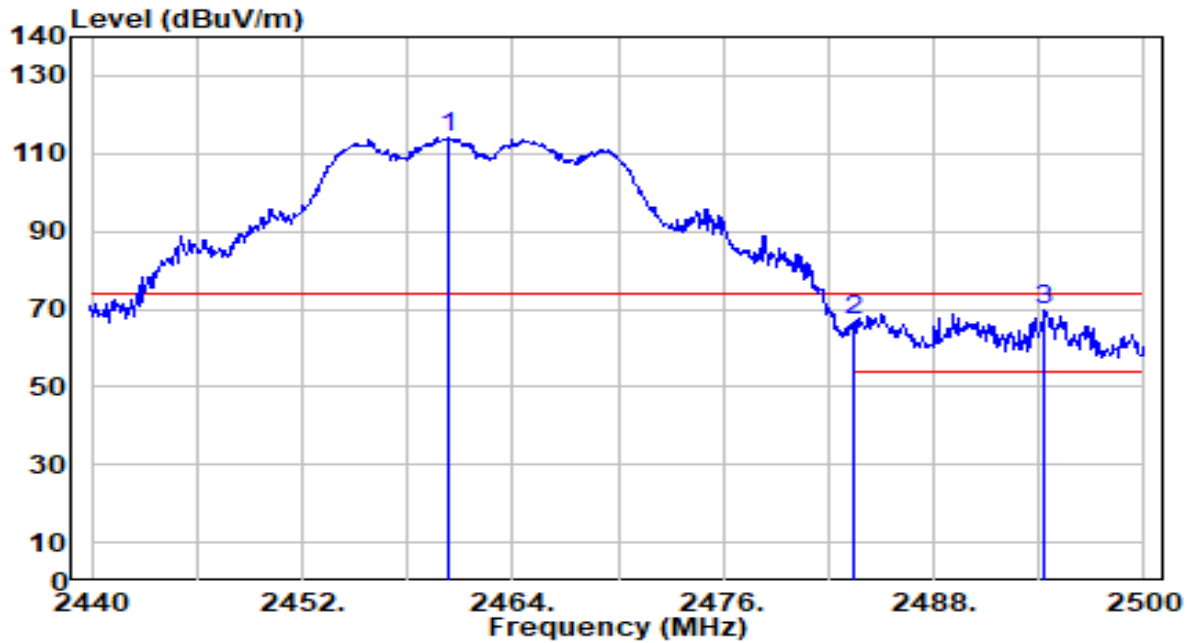

No	Frequency (MHz)	Reading (dBUV)	C.F (dB/m)	Measurement (dBUV/m)	Margin (dB)	Limit (dBUV/m)	Height (cm)	Angle (deg)	Remark (QP/PK/AV)
1	2460.400	84.14	30.21	114.35	N/A	N/A	332	181	Peak
2	2483.500	36.55	30.29	66.83	-7.17	74.00	332	181	Peak
3	* 2494.320	39.40	30.32	69.73	-4.27	74.00	332	181	Peak

Note:

1. " *", means this data is the worst emission level.
2. C.F (Correction Factor) = Antenna Factor (dB/m) + Cable Loss (dB).
3. Measurement (dBUV/m) = Reading(dBUV) + C.F (Correction Factor).
4. The emission levels of other frequencies are very lower than the limit and not show in test report.

EUT	AX3000 Ceiling Mount Wi-Fi 6 Access Point	Date of Test	2023-03-22
Factor	DRH18-E	Temp. / Humidity	22°C /63%
Polarity	Vertical	Site / Test Engineer	AC2 / Marvin
Test Mode	802.11g_TX_CH 11_ANT 0+1	Test Voltage	AC 120V/60Hz

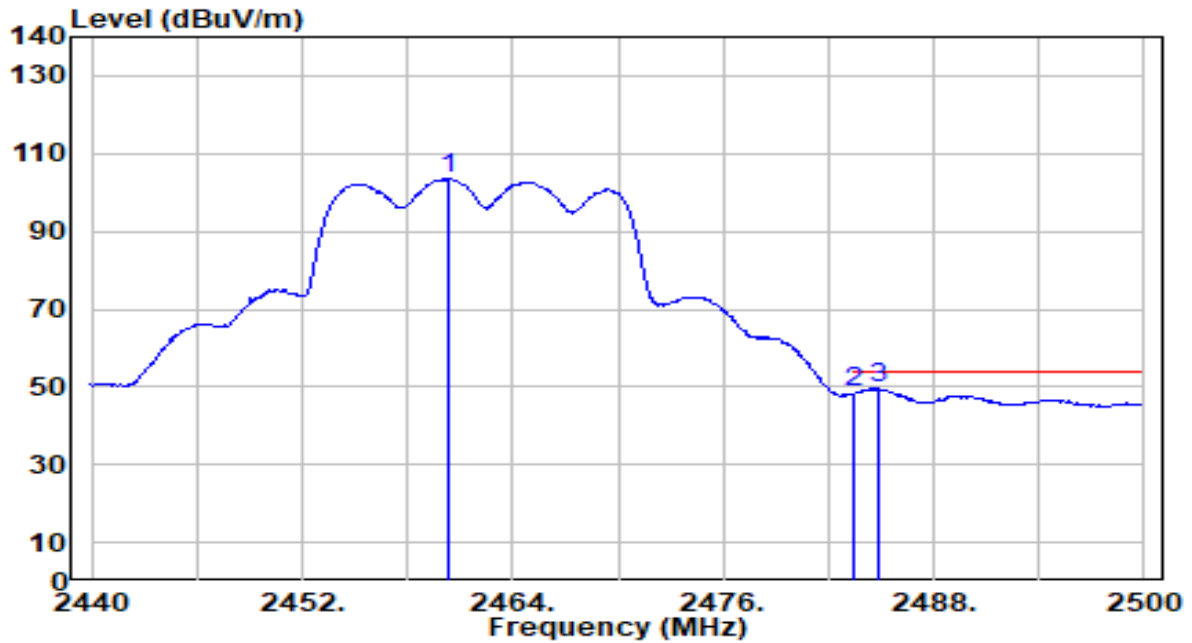

No	Frequency (MHz)	Reading (dBUV)	C.F (dB/m)	Measurement (dBUV/m)	Margin (dB)	Limit (dBUV/m)	Height (cm)	Angle (deg)	Remark (QP/PK/AV)
1	2460.320	73.17	30.21	103.38	N/A	N/A	332	181	Average
2	2483.500	18.12	30.29	48.40	-5.60	54.00	332	181	Average
3	* 2484.800	19.19	30.29	49.48	-4.52	54.00	332	181	Average

Note:

1. " *", means this data is the worst emission level.
2. C.F (Correction Factor) = Antenna Factor (dB/m) + Cable Loss (dB).
3. Measurement (dBUV/m) = Reading(dBUV) + C.F (Correction Factor).
4. The emission levels of other frequencies are very lower than the limit and not show in test report.

EUT	AX3000 Ceiling Mount Wi-Fi 6 Access Point	Date of Test	2023-03-22
Factor	DRH18-E	Temp. / Humidity	22°C /63%
Polarity	Horizontal	Site / Test Engineer	AC2 / Marvin
Test Mode	802.11n-20MHz_TX_CH 1_ANT 0+1	Test Voltage	AC 120V/60Hz

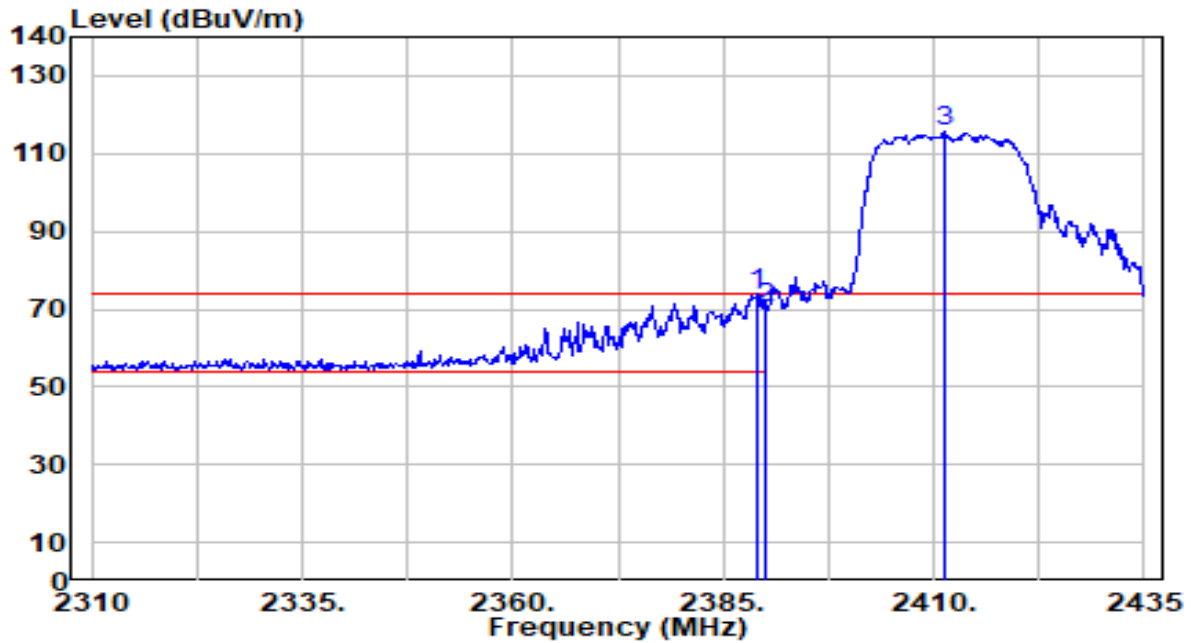

No	Frequency (MHz)	Reading (dBuV)	C.F (dB/m)	Measurement (dBuV/m)	Margin (dB)	Limit (dBuV/m)	Height (cm)	Angle (deg)	Remark (QP/PK/AV)	
1	*	2389.000	43.86	29.99	73.86	-0.14	74.00	209	230	Peak
2		2390.000	40.02	29.99	70.01	-3.99	74.00	209	230	Peak
3		2411.375	85.40	30.05	115.44	N/A	N/A	209	230	Peak

Note:

1. " *", means this data is the worst emission level.
2. C.F (Correction Factor) = Antenna Factor (dB/m) + Cable Loss (dB).
3. Measurement (dBuV/m) = Reading(dBuV) + C.F (Correction Factor).
4. The emission levels of other frequencies are very lower than the limit and not show in test report.

EUT	AX3000 Ceiling Mount Wi-Fi 6 Access Point	Date of Test	2023-03-22
Factor	DRH18-E	Temp. / Humidity	22°C /63%
Polarity	Horizontal	Site / Test Engineer	AC2 / Marvin
Test Mode	802.11n-20MHz_TX_CH 1_ANT 0+1	Test Voltage	AC 120V/60Hz

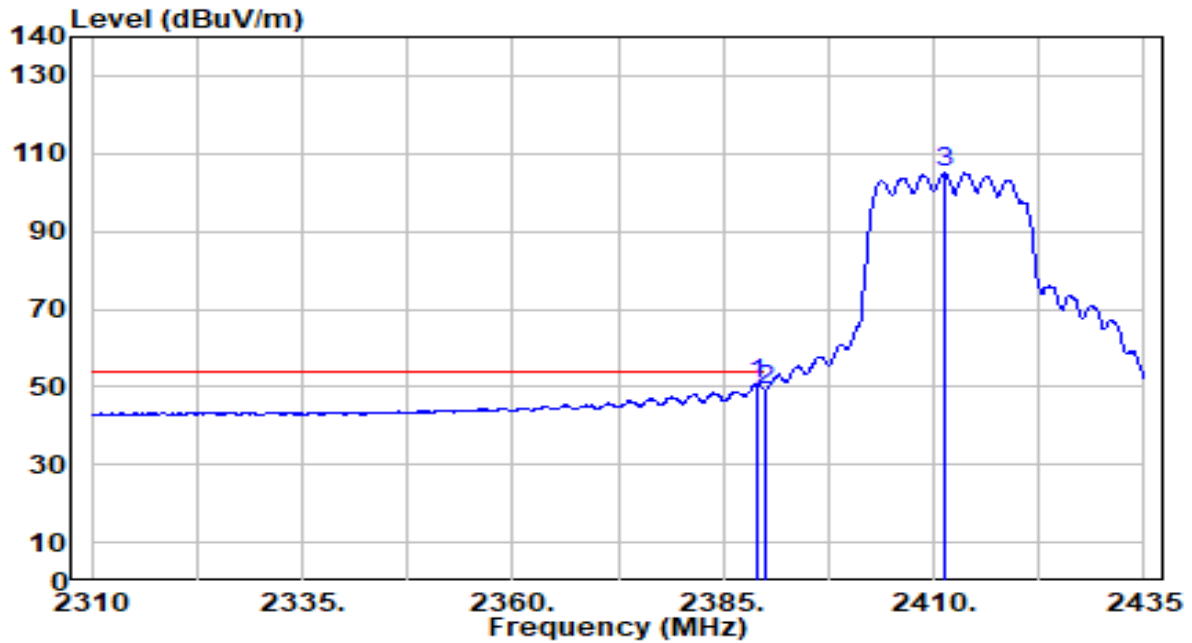

No	Frequency (MHz)	Reading (dBuV)	C.F (dB/m)	Measurement (dBuV/m)	Margin (dB)	Limit (dBuV/m)	Height (cm)	Angle (deg)	Remark (QP/PK/AV)
1	*	20.70	29.99	50.69	-3.31	54.00	209	230	Average
2		19.33	29.99	49.32	-4.68	54.00	209	230	Average
3		75.09	30.05	105.14	N/A	N/A	209	230	Average

Note:

1. " *", means this data is the worst emission level.
2. C.F (Correction Factor) = Antenna Factor (dB/m) + Cable Loss (dB).
3. Measurement (dBuV/m) = Reading(dBuV) + C.F (Correction Factor).
4. The emission levels of other frequencies are very lower than the limit and not show in test report.

EUT	AX3000 Ceiling Mount Wi-Fi 6 Access Point	Date of Test	2023-03-22
Factor	DRH18-E	Temp. / Humidity	22°C /63%
Polarity	Vertical	Site / Test Engineer	AC2 / Marvin
Test Mode	802.11n-20MHz_TX_CH 1_ANT 0+1	Test Voltage	AC 120V/60Hz

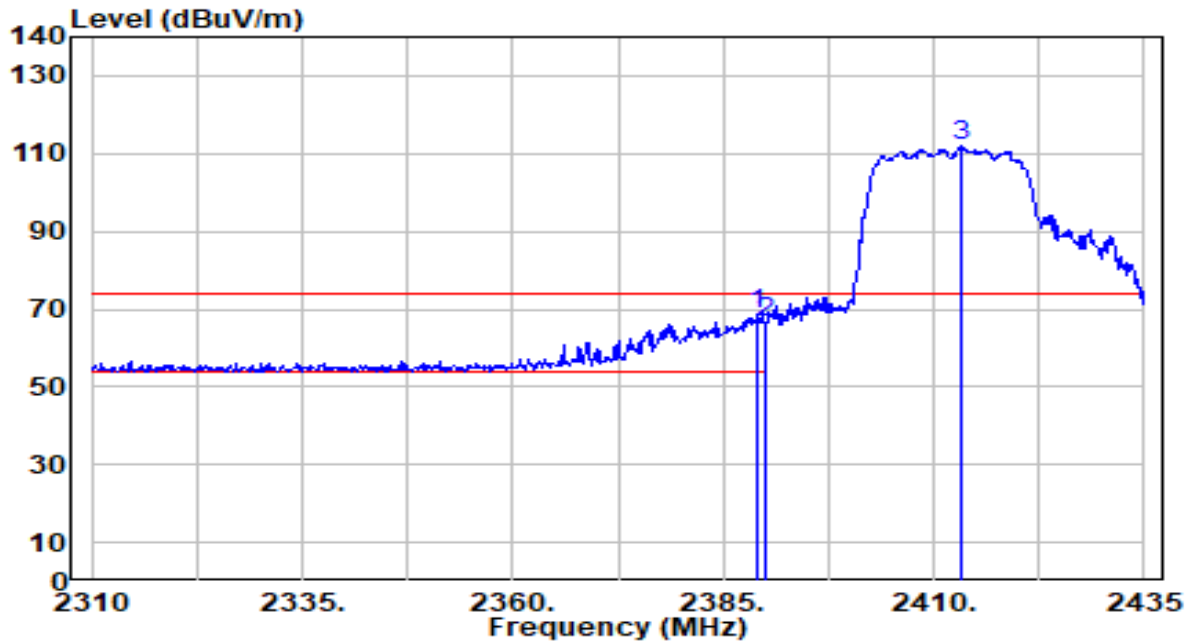

No	Frequency (MHz)	Reading (dBuV)	C.F (dB/m)	Measurement (dBuV/m)	Margin (dB)	Limit (dBuV/m)	Height (cm)	Angle (deg)	Remark (QP/PK/AV)	
1	*	2389.000	38.42	29.99	68.42	-5.58	74.00	348	178	Peak
2		2390.000	36.45	29.99	66.44	-7.56	74.00	348	178	Peak
3		2413.375	81.86	30.05	111.91	N/A	N/A	348	178	Peak

Note:

1. " *", means this data is the worst emission level.
2. C.F (Correction Factor) = Antenna Factor (dB/m) + Cable Loss (dB).
3. Measurement (dBuV/m) = Reading(dBuV) + C.F (Correction Factor).
4. The emission levels of other frequencies are very lower than the limit and not show in test report.

EUT	AX3000 Ceiling Mount Wi-Fi 6 Access Point	Date of Test	2023-03-22
Factor	DRH18-E	Temp. / Humidity	22°C /63%
Polarity	Vertical	Site / Test Engineer	AC2 / Marvin
Test Mode	802.11n-20MHz_TX_CH 1_ANT 0+1	Test Voltage	AC 120V/60Hz

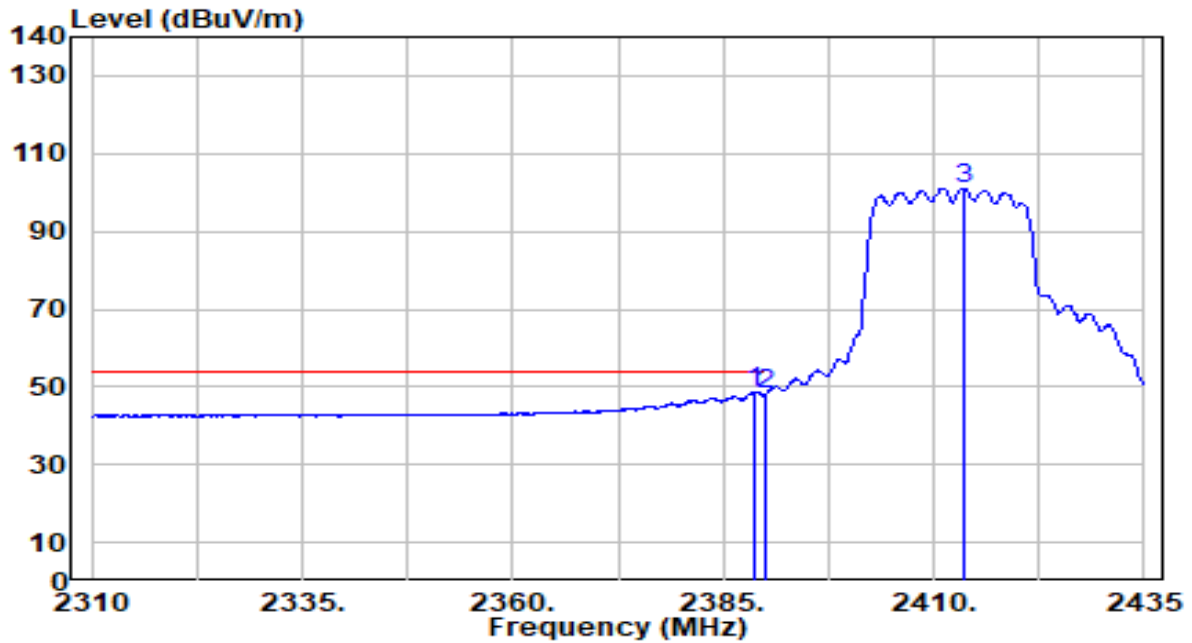

No	Frequency (MHz)	Reading (dBuV)	C.F (dB/m)	Measurement (dBuV/m)	Margin (dB)	Limit (dBuV/m)	Height (cm)	Angle (deg)	Remark (QP/PK/AV)	
1	*	2388.750	18.83	29.99	48.83	-5.17	54.00	348	178	Average
2		2390.000	17.87	29.99	47.87	-6.13	54.00	348	178	Average
3		2413.625	71.03	30.05	101.08	N/A	N/A	348	178	Average

Note:

1. " *", means this data is the worst emission level.
2. C.F (Correction Factor) = Antenna Factor (dB/m) + Cable Loss (dB).
3. Measurement (dBuV/m) = Reading(dBuV) + C.F (Correction Factor).
4. The emission levels of other frequencies are very lower than the limit and not show in test report.

EUT	AX3000 Ceiling Mount Wi-Fi 6 Access Point	Date of Test	2023-03-22
Factor	DRH18-E	Temp. / Humidity	22°C /63%
Polarity	Horizontal	Site / Test Engineer	AC2 / Marvin
Test Mode	802.11n-20MHz_TX_CH 6_ANT 0+1	Test Voltage	AC 120V/60Hz

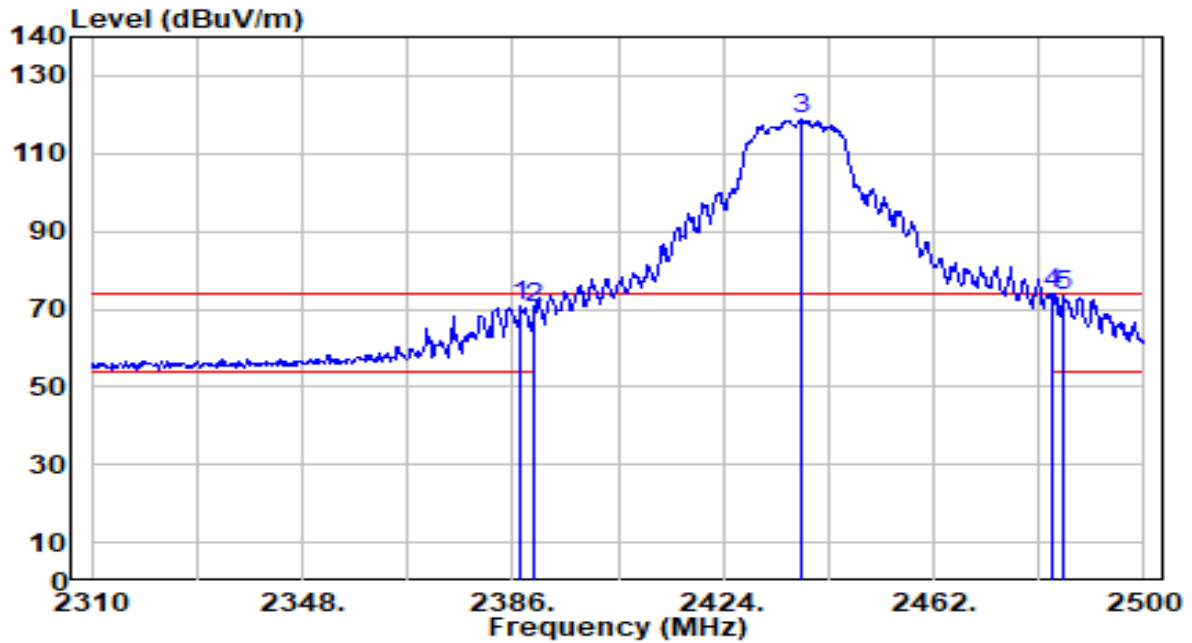

No	Frequency (MHz)	Reading (dBuV)	C.F (dB/m)	Measurement (dBuV/m)	Margin (dB)	Limit (dBuV/m)	Height (cm)	Angle (deg)	Remark (QP/PK/AV)
1	2387.520	40.68	29.99	70.67	-3.33	74.00	100	229	Peak
2	2390.000	40.09	29.99	70.09	-3.91	74.00	100	229	Peak
3	2438.060	88.77	30.13	118.90	N/A	N/A	100	229	Peak
4	* 2483.500	43.45	30.29	73.73	-0.27	74.00	100	229	Peak
5	2485.560	42.97	30.29	73.27	-0.73	74.00	100	229	Peak

Note:

1. " *", means this data is the worst emission level.
2. C.F (Correction Factor) = Antenna Factor (dB/m) + Cable Loss (dB).
3. Measurement (dBuV/m) = Reading(dBuV) + C.F (Correction Factor).
4. The emission levels of other frequencies are very lower than the limit and not show in test report.

EUT	AX3000 Ceiling Mount Wi-Fi 6 Access Point	Date of Test	2023-03-22
Factor	DRH18-E	Temp. / Humidity	22°C /63%
Polarity	Horizontal	Site / Test Engineer	AC2 / Marvin
Test Mode	802.11n-20MHz_TX_CH 6_ANT 0+1	Test Voltage	AC 120V/60Hz

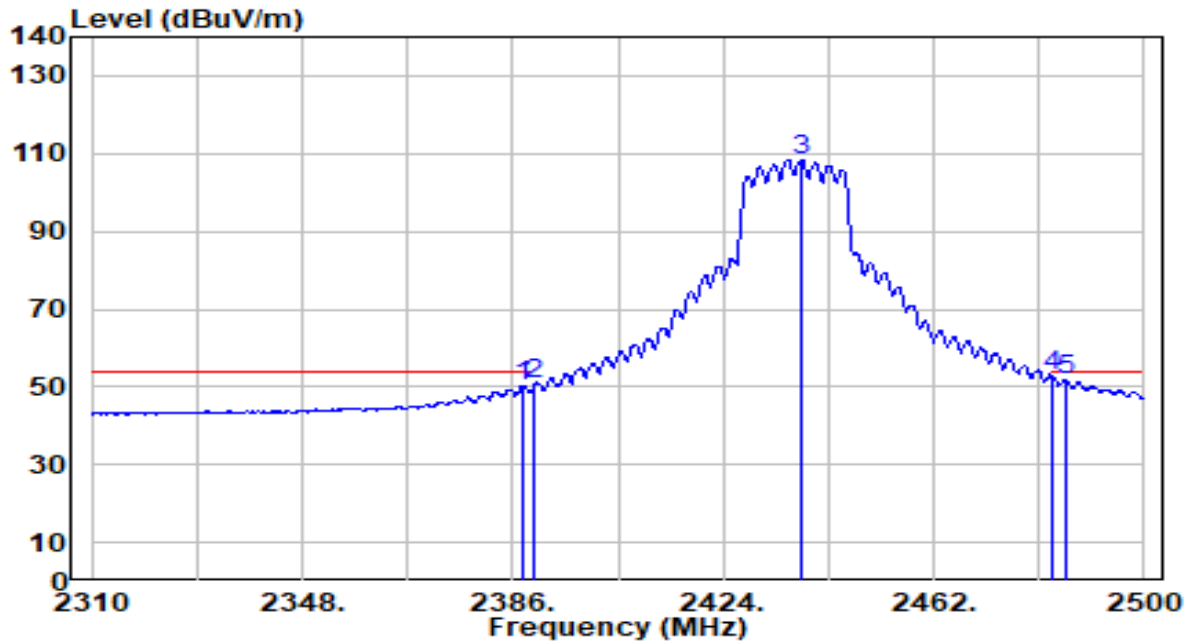

No	Frequency (MHz)	Reading (dBuV)	C.F (dB/m)	Measurement (dBuV/m)	Margin (dB)	Limit (dBuV/m)	Height (cm)	Angle (deg)	Remark (QP/PK/AV)
1	2387.710	20.31	29.99	50.30	-3.70	54.00	100	229	Average
2	2390.000	20.66	29.99	50.66	-3.34	54.00	100	229	Average
3	2438.250	78.40	30.13	108.54	N/A	N/A	100	229	Average
4	* 2483.500	22.51	30.29	52.80	-1.20	54.00	100	229	Average
5	2485.750	21.53	30.29	51.82	-2.18	54.00	100	229	Average

Note:

1. " *", means this data is the worst emission level.
2. C.F (Correction Factor) = Antenna Factor (dB/m) + Cable Loss (dB).
3. Measurement (dBuV/m) = Reading(dBuV) + C.F (Correction Factor).
4. The emission levels of other frequencies are very lower than the limit and not show in test report.

EUT	AX3000 Ceiling Mount Wi-Fi 6 Access Point	Date of Test	2023-03-22
Factor	DRH18-E	Temp. / Humidity	22°C /63%
Polarity	Vertical	Site / Test Engineer	AC2 / Marvin
Test Mode	802.11n-20MHz_TX_CH 6_ANT 0+1	Test Voltage	AC 120V/60Hz

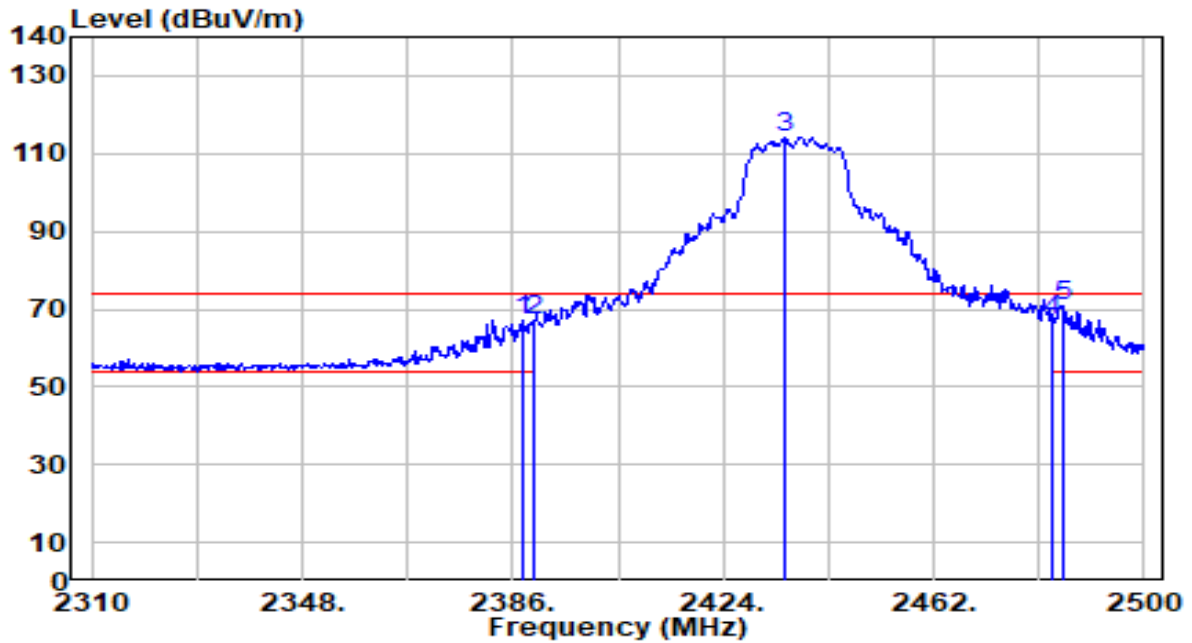

No	Frequency (MHz)	Reading (dBuV)	C.F (dB/m)	Measurement (dBuV/m)	Margin (dB)	Limit (dBuV/m)	Height (cm)	Angle (deg)	Remark (QP/PK/AV)
1	2387.710	36.90	29.99	66.89	-7.11	74.00	302	173	Peak
2	2390.000	36.89	29.99	66.88	-7.12	74.00	302	173	Peak
3	2435.020	84.03	30.12	114.16	N/A	N/A	302	173	Peak
4	2483.500	37.01	30.29	67.29	-6.71	74.00	302	173	Peak
5	* 2485.180	40.53	30.29	70.82	-3.18	74.00	302	173	Peak

Note:

1. " *", means this data is the worst emission level.
2. C.F (Correction Factor) = Antenna Factor (dB/m) + Cable Loss (dB).
3. Measurement (dBuV/m) = Reading(dBuV) + C.F (Correction Factor).
4. The emission levels of other frequencies are very lower than the limit and not show in test report.

EUT	AX3000 Ceiling Mount Wi-Fi 6 Access Point	Date of Test	2023-03-22
Factor	DRH18-E	Temp. / Humidity	22°C /63%
Polarity	Vertical	Site / Test Engineer	AC2 / Marvin
Test Mode	802.11n-20MHz_TX_CH 6_ANT 0+1	Test Voltage	AC 120V/60Hz

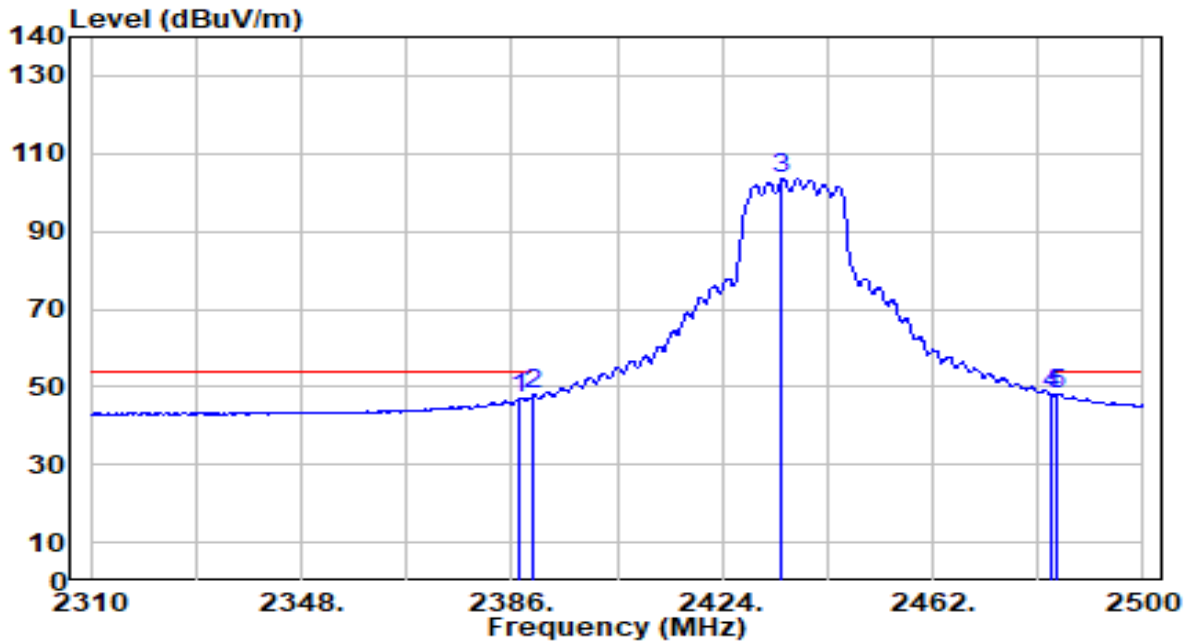

No	Frequency (MHz)	Reading (dBuV)	C.F (dB/m)	Measurement (dBuV/m)	Margin (dB)	Limit (dBuV/m)	Height (cm)	Angle (deg)	Remark (QP/PK/AV)
1	2387.140	17.02	29.99	47.01	-6.99	54.00	302	173	Average
2	2390.000	17.85	29.99	47.84	-6.16	54.00	302	173	Average
3	2434.830	73.31	30.12	103.43	N/A	N/A	302	173	Average
4	2483.500	17.58	30.29	47.86	-6.14	54.00	302	173	Average
5	* 2484.610	17.88	30.29	48.16	-5.84	54.00	302	173	Average

Note:

1. " *", means this data is the worst emission level.
2. C.F (Correction Factor) = Antenna Factor (dB/m) + Cable Loss (dB).
3. Measurement (dBuV/m) = Reading(dBuV) + C.F (Correction Factor).
4. The emission levels of other frequencies are very lower than the limit and not show in test report.

EUT	AX3000 Ceiling Mount Wi-Fi 6 Access Point	Date of Test	2023-03-22
Factor	DRH18-E	Temp. / Humidity	22°C /63%
Polarity	Horizontal	Site / Test Engineer	AC2 / Marvin
Test Mode	802.11n-20MHz_TX_CH 11_ANT 0+1	Test Voltage	AC 120V/60Hz

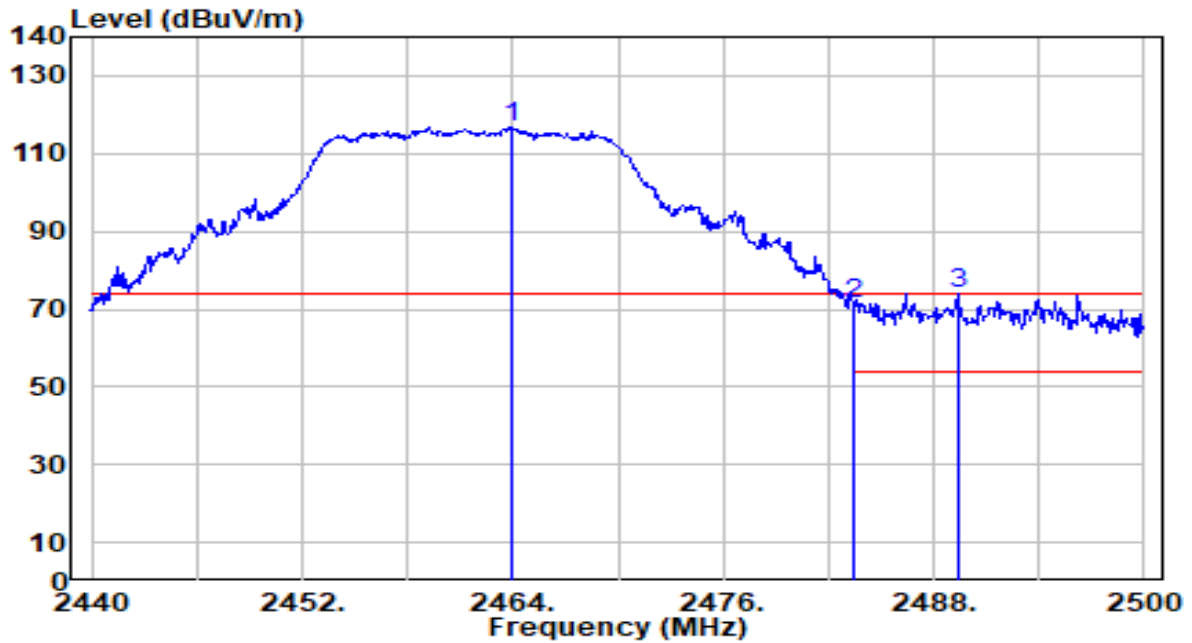

No	Frequency (MHz)	Reading (dBuV)	C.F (dB/m)	Measurement (dBuV/m)	Margin (dB)	Limit (dBuV/m)	Height (cm)	Angle (deg)	Remark (QP/PK/AV)
1	2463.920	86.54	30.22	116.76	N/A	N/A	203	230	Peak
2	2483.500	41.14	30.29	71.43	-2.57	74.00	203	230	Peak
3	* 2489.360	43.59	30.30	73.89	-0.11	74.00	203	230	Peak

Note:

1. " *", means this data is the worst emission level.
2. C.F (Correction Factor) = Antenna Factor (dB/m) + Cable Loss (dB).
3. Measurement (dBuV/m) = Reading(dBuV) + C.F (Correction Factor).
4. The emission levels of other frequencies are very lower than the limit and not show in test report.

EUT	AX3000 Ceiling Mount Wi-Fi 6 Access Point	Date of Test	2023-03-22
Factor	DRH18-E	Temp. / Humidity	22°C /63%
Polarity	Horizontal	Site / Test Engineer	AC2 / Marvin
Test Mode	802.11n-20MHz_TX_CH 11_ANT 0+1	Test Voltage	AC 120V/60Hz

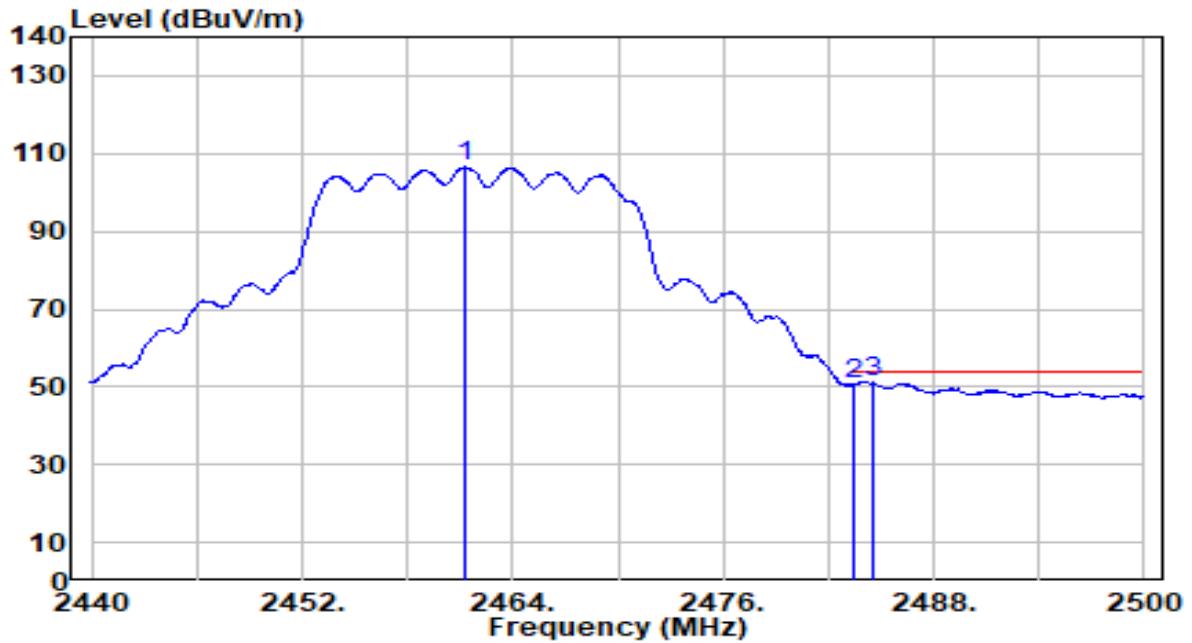

No	Frequency (MHz)	Reading (dBUV)	C.F (dB/m)	Measurement (dBUV/m)	Margin (dB)	Limit (dBUV/m)	Height (cm)	Angle (deg)	Remark (QP/PK/AV)
1	2461.280	76.27	30.21	106.48	N/A	N/A	203	230	Average
2	2483.500	20.29	30.29	50.58	-3.42	54.00	203	230	Average
3	* 2484.480	20.69	30.29	50.98	-3.02	54.00	203	230	Average

Note:

1. " *", means this data is the worst emission level.
2. C.F (Correction Factor) = Antenna Factor (dB/m) + Cable Loss (dB).
3. Measurement (dBUV/m) = Reading(dBUV) + C.F (Correction Factor).
4. The emission levels of other frequencies are very lower than the limit and not show in test report.

EUT	AX3000 Ceiling Mount Wi-Fi 6 Access Point	Date of Test	2023-03-22
Factor	DRH18-E	Temp. / Humidity	22°C /63%
Polarity	Vertical	Site / Test Engineer	AC2 / Marvin
Test Mode	802.11n-20MHz_TX_CH 11_ANT 0+1	Test Voltage	AC 120V/60Hz

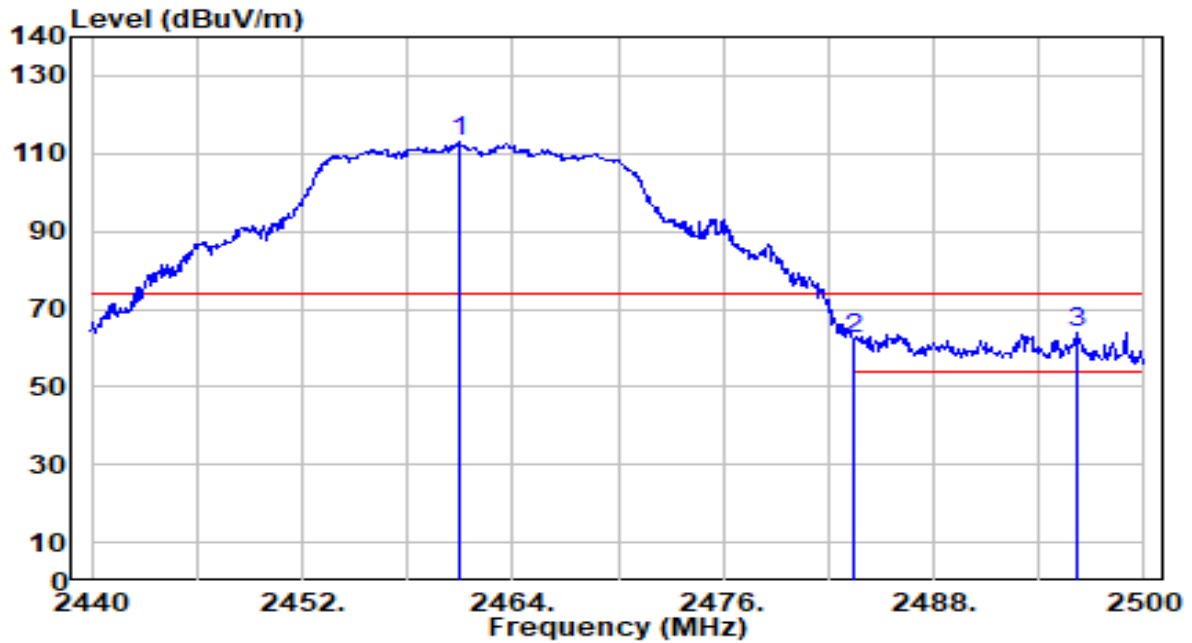

No	Frequency (MHz)	Reading (dBUV)	C.F (dB/m)	Measurement (dBUV/m)	Margin (dB)	Limit (dBUV/m)	Height (cm)	Angle (deg)	Remark (QP/PK/AV)
1	2460.960	82.92	30.21	113.13	N/A	N/A	331	180	Peak
2	2483.500	32.20	30.29	62.49	-11.51	74.00	331	180	Peak
3	* 2496.160	33.61	30.33	63.93	-10.07	74.00	331	180	Peak

Note:

1. " *", means this data is the worst emission level.
2. C.F (Correction Factor) = Antenna Factor (dB/m) + Cable Loss (dB).
3. Measurement (dBUV/m) = Reading(dBUV) + C.F (Correction Factor).
4. The emission levels of other frequencies are very lower than the limit and not show in test report.

EUT	AX3000 Ceiling Mount Wi-Fi 6 Access Point	Date of Test	2023-03-22
Factor	DRH18-E	Temp. / Humidity	22°C /63%
Polarity	Vertical	Site / Test Engineer	AC2 / Marvin
Test Mode	802.11n-20MHz_TX_CH 11_ANT 0+1	Test Voltage	AC 120V/60Hz

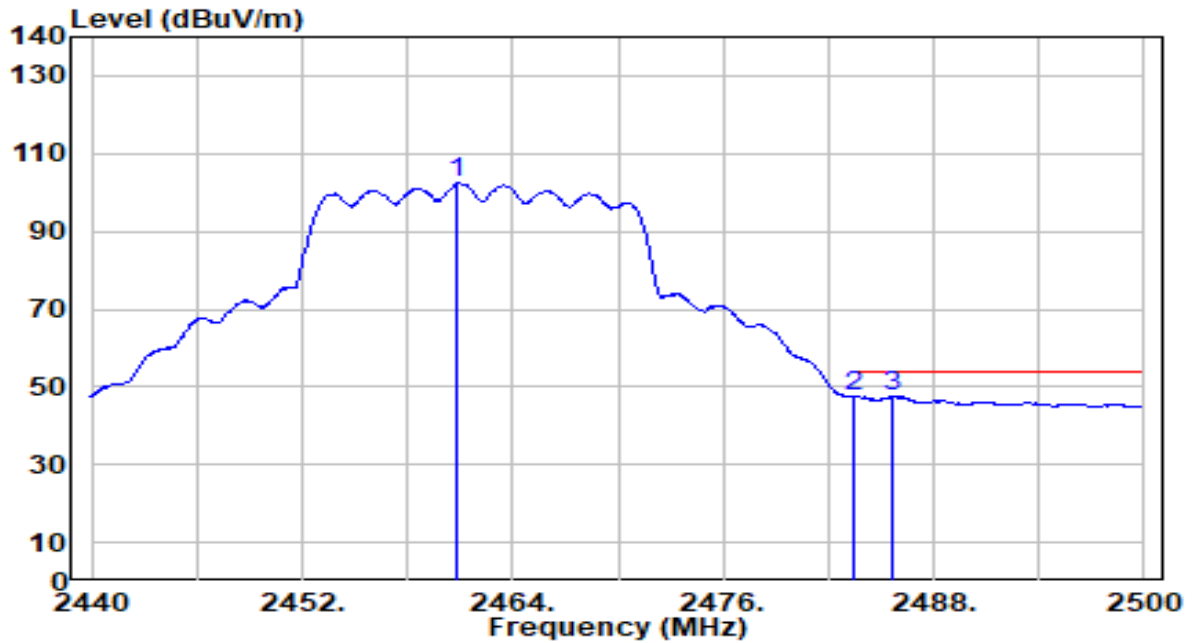

No	Frequency (MHz)	Reading (dBUV)	C.F (dB/m)	Measurement (dBUV/m)	Margin (dB)	Limit (dBUV/m)	Height (cm)	Angle (deg)	Remark (QP/PK/AV)
1	2460.880	72.12	30.21	102.33	N/A	N/A	331	180	Average
2	* 2483.500	17.18	30.29	47.46	-6.54	54.00	331	180	Average
3	2485.600	17.12	30.29	47.41	-6.59	54.00	331	180	Average

Note:

1. " *", means this data is the worst emission level.
2. C.F (Correction Factor) = Antenna Factor (dB/m) + Cable Loss (dB).
3. Measurement (dBUV/m) = Reading(dBUV) + C.F (Correction Factor).
4. The emission levels of other frequencies are very lower than the limit and not show in test report.

EUT	AX3000 Ceiling Mount Wi-Fi 6 Access Point	Date of Test	2023-03-22
Factor	DRH18-E	Temp. / Humidity	22°C /63%
Polarity	Horizontal	Site / Test Engineer	AC2 / Marvin
Test Mode	802.11n-40MHz_TX_CH 3_ANT 0+1	Test Voltage	AC 120V/60Hz

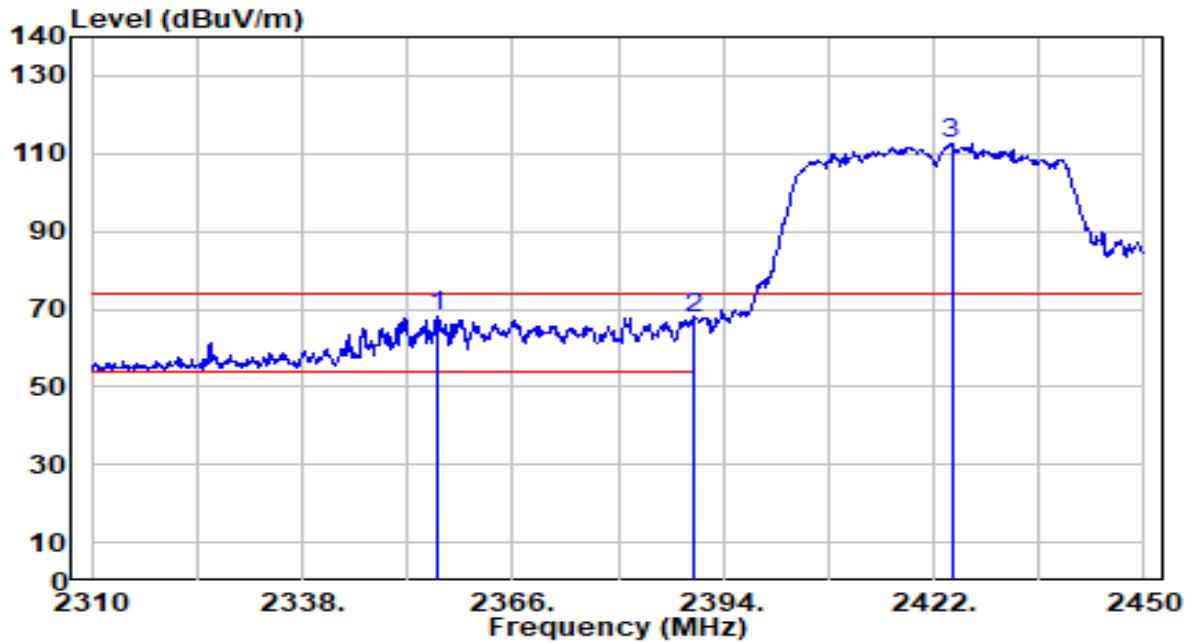

No	Frequency (MHz)	Reading (dBuV)	C.F (dB/m)	Measurement (dBuV/m)	Margin (dB)	Limit (dBuV/m)	Height (cm)	Angle (deg)	Remark (QP/PK/AV)	
1	*	2356.060	38.04	29.95	67.99	-6.01	74.00	200	231	Peak
2		2390.000	37.64	29.99	67.63	-6.37	74.00	200	231	Peak
3		2424.380	82.46	30.09	112.55	N/A	N/A	200	231	Peak

Note:

1. " *", means this data is the worst emission level.
2. C.F (Correction Factor) = Antenna Factor (dB/m) + Cable Loss (dB).
3. Measurement (dBuV/m) = Reading(dBuV) + C.F (Correction Factor).
4. The emission levels of other frequencies are very lower than the limit and not show in test report.

EUT	AX3000 Ceiling Mount Wi-Fi 6 Access Point	Date of Test	2023-03-22
Factor	DRH18-E	Temp. / Humidity	22°C /63%
Polarity	Horizontal	Site / Test Engineer	AC2 / Marvin
Test Mode	802.11n-40MHz_TX_CH 3_ANT 0+1	Test Voltage	AC 120V/60Hz

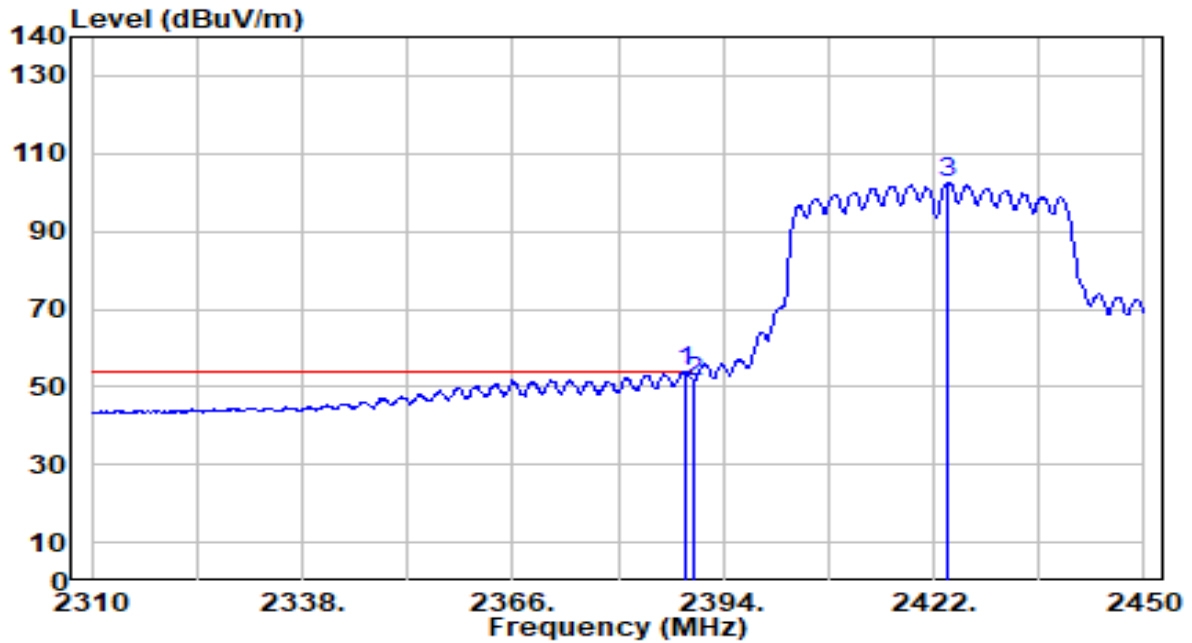

No	Frequency (MHz)	Reading (dBuV)	C.F (dB/m)	Measurement (dBuV/m)	Margin (dB)	Limit (dBuV/m)	Height (cm)	Angle (deg)	Remark (QP/PK/AV)
1	*	23.82	29.99	53.81	-0.19	54.00	200	231	Average
2		21.43	29.99	51.42	-2.58	54.00	200	231	Average
3		72.38	30.09	102.47	N/A	N/A	200	231	Average

Note:

1. " *", means this data is the worst emission level.
2. C.F (Correction Factor) = Antenna Factor (dB/m) + Cable Loss (dB).
3. Measurement (dBuV/m) = Reading(dBuV) + C.F (Correction Factor).
4. The emission levels of other frequencies are very lower than the limit and not show in test report.

EUT	AX3000 Ceiling Mount Wi-Fi 6 Access Point	Date of Test	2023-03-22
Factor	DRH18-E	Temp. / Humidity	22°C /63%
Polarity	Vertical	Site / Test Engineer	AC2 / Marvin
Test Mode	802.11n-40MHz_TX_CH 3_ANT 0+1	Test Voltage	AC 120V/60Hz

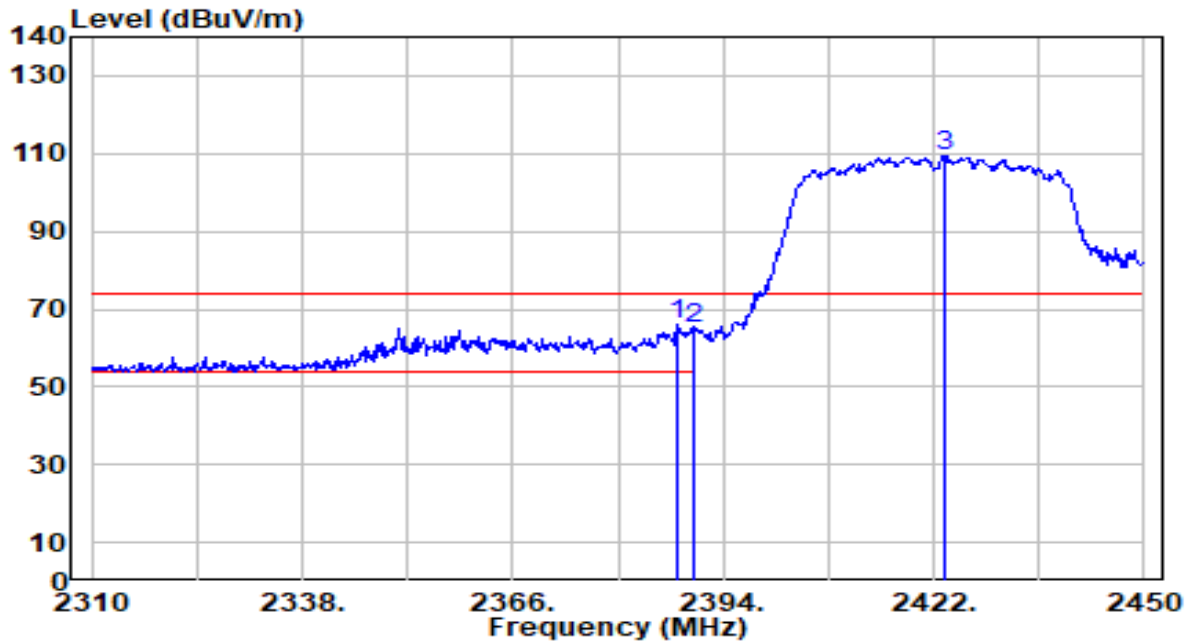

No	Frequency (MHz)	Reading (dBuV)	C.F (dB/m)	Measurement (dBuV/m)	Margin (dB)	Limit (dBuV/m)	Height (cm)	Angle (deg)	Remark (QP/PK/AV)	
1	*	2387.980	35.81	29.99	65.80	-8.20	74.00	348	180	Peak
2		2390.000	34.77	29.99	64.76	-9.24	74.00	348	180	Peak
3		2423.400	79.14	30.09	109.23	N/A	N/A	348	180	Peak

Note:

1. " *", means this data is the worst emission level.
2. C.F (Correction Factor) = Antenna Factor (dB/m) + Cable Loss (dB).
3. Measurement (dBuV/m) = Reading(dBuV) + C.F (Correction Factor).
4. The emission levels of other frequencies are very lower than the limit and not show in test report.

EUT	AX3000 Ceiling Mount Wi-Fi 6 Access Point	Date of Test	2023-03-22
Factor	DRH18-E	Temp. / Humidity	22°C /63%
Polarity	Vertical	Site / Test Engineer	AC2 / Marvin
Test Mode	802.11n-40MHz_TX_CH 3_ANT 0+1	Test Voltage	AC 120V/60Hz

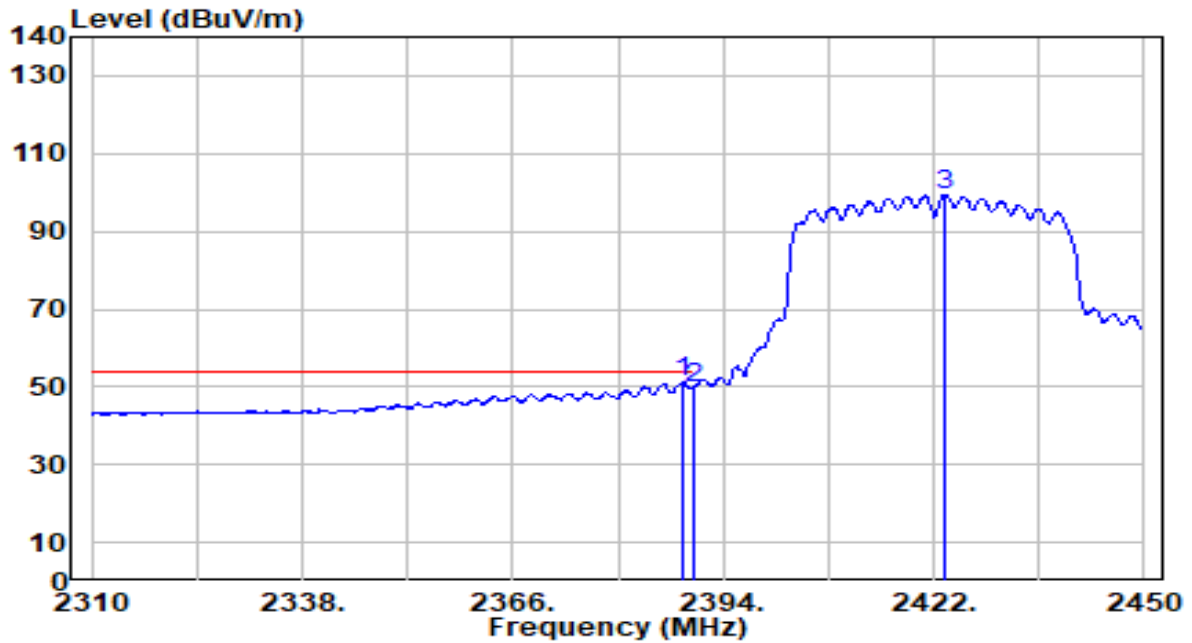

No	Frequency (MHz)	Reading (dBuV)	C.F (dB/m)	Measurement (dBuV/m)	Margin (dB)	Limit (dBuV/m)	Height (cm)	Angle (deg)	Remark (QP/PK/AV)	
1	*	2388.680	21.02	29.99	51.01	-2.99	54.00	348	180	Average
2		2390.000	19.92	29.99	49.92	-4.08	54.00	348	180	Average
3		2423.400	69.34	30.09	99.43	N/A	N/A	348	180	Average

Note:

1. " *", means this data is the worst emission level.
2. C.F (Correction Factor) = Antenna Factor (dB/m) + Cable Loss (dB).
3. Measurement (dBuV/m) = Reading(dBuV) + C.F (Correction Factor).
4. The emission levels of other frequencies are very lower than the limit and not show in test report.

EUT	AX3000 Ceiling Mount Wi-Fi 6 Access Point	Date of Test	2023-03-22
Factor	DRH18-E	Temp. / Humidity	22°C /63%
Polarity	Horizontal	Site / Test Engineer	AC2 / Marvin
Test Mode	802.11n-40MHz_TX_CH 6_ANT 0+1	Test Voltage	AC 120V/60Hz

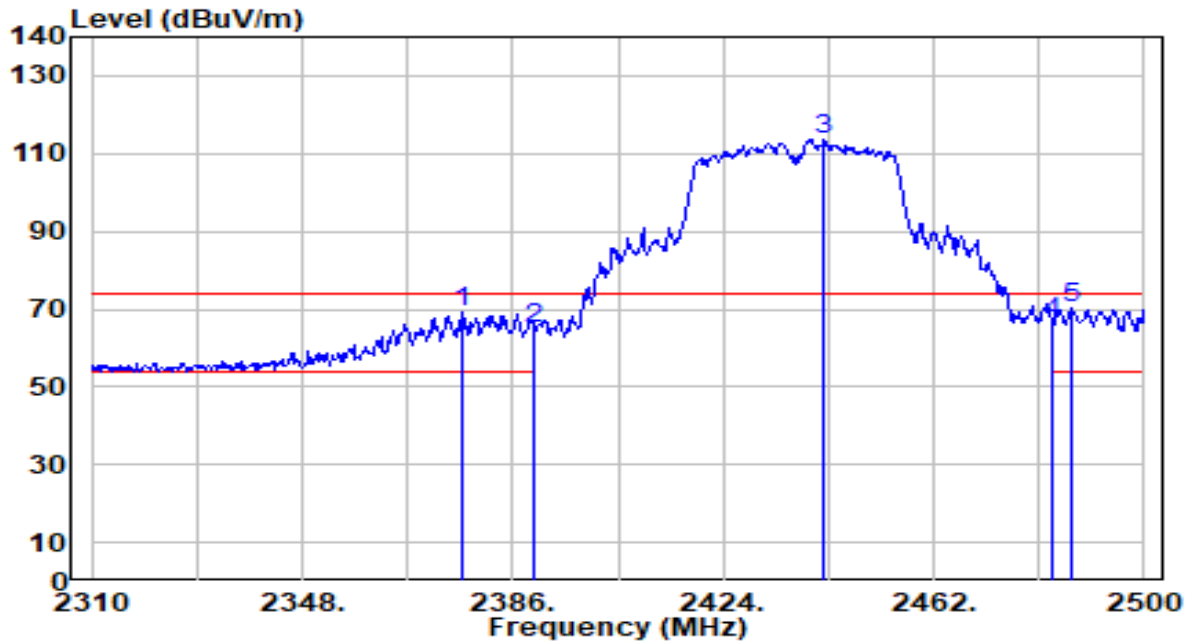

No	Frequency (MHz)	Reading (dBuV)	C.F (dB/m)	Measurement (dBuV/m)	Margin (dB)	Limit (dBuV/m)	Height (cm)	Angle (deg)	Remark (QP/PK/AV)
1	2377.070	39.07	29.98	69.04	-4.96	74.00	100	225	Peak
2	2390.000	34.94	29.99	64.93	-9.07	74.00	100	225	Peak
3	2442.050	83.50	30.15	113.65	N/A	N/A	100	225	Peak
4	2483.500	36.14	30.29	66.42	-7.58	74.00	100	225	Peak
5	* 2486.700	40.05	30.30	70.34	-3.66	74.00	100	225	Peak

Note:

1. " *", means this data is the worst emission level.
2. C.F (Correction Factor) = Antenna Factor (dB/m) + Cable Loss (dB).
3. Measurement (dBuV/m) = Reading(dBuV) + C.F (Correction Factor).
4. The emission levels of other frequencies are very lower than the limit and not show in test report.

EUT	AX3000 Ceiling Mount Wi-Fi 6 Access Point	Date of Test	2023-03-22
Factor	DRH18-E	Temp. / Humidity	22°C /63%
Polarity	Horizontal	Site / Test Engineer	AC2 / Marvin
Test Mode	802.11n-40MHz_TX_CH 6_ANT 0+1	Test Voltage	AC 120V/60Hz

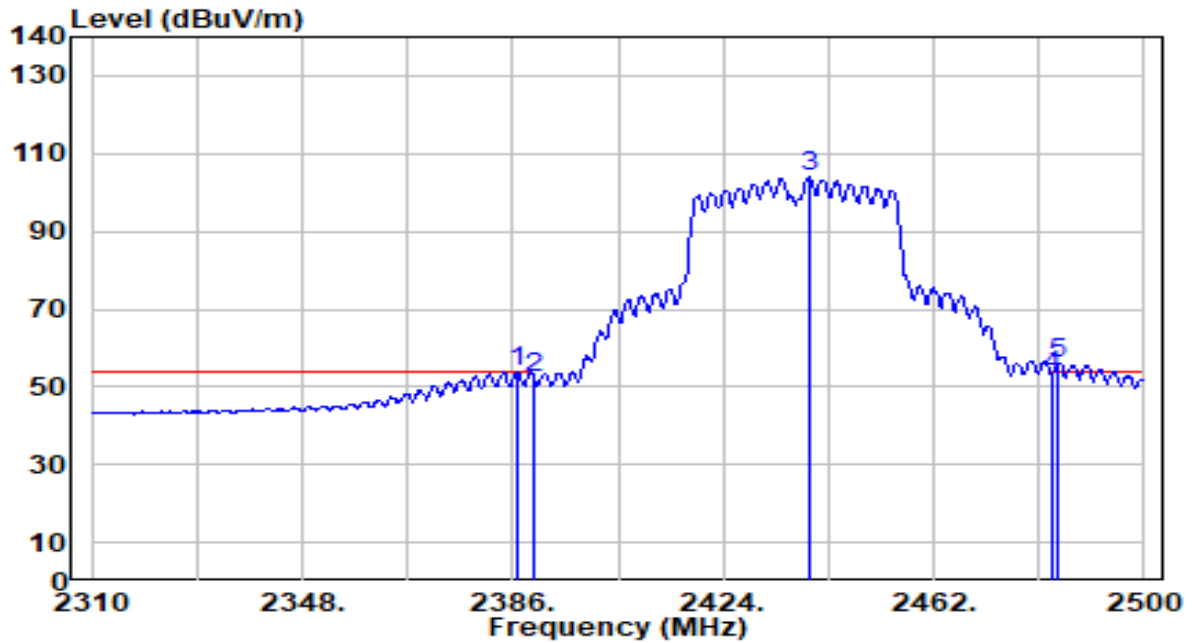

No	Frequency (MHz)	Reading (dBuV)	C.F (dB/m)	Measurement (dBuV/m)	Margin (dB)	Limit (dBuV/m)	Height (cm)	Angle (deg)	Remark (QP/PK/AV)	
1	*	2386.950	23.91	29.99	53.90	-0.10	54.00	100	225	Average
2		2390.000	22.16	29.99	52.16	-1.84	54.00	100	225	Average
3		2439.390	73.74	30.14	103.88	N/A	N/A	100	225	Average
4		2483.500	22.71	30.29	52.99	-1.01	54.00	100	225	Average
5		2484.610	25.67	30.29	55.96	1.96	54.00	100	225	Average

Note:

- "*" means this data is the worst emission level.
- C.F (Correction Factor) = Antenna Factor (dB/m) + Cable Loss (dB).
- Measurement (dBuV/m) = Reading(dBuV) + C.F (Correction Factor).
- The emission levels of other frequencies are very lower than the limit and not show in test report.

EUT	AX3000 Ceiling Mount Wi-Fi 6 Access Point	Date of Test	2023-03-22
Factor	DRH18-E	Temp. / Humidity	22°C /63%
Polarity	Vertical	Site / Test Engineer	AC2 / Marvin
Test Mode	802.11n-40MHz_TX_CH 6_ANT 0+1	Test Voltage	AC 120V/60Hz

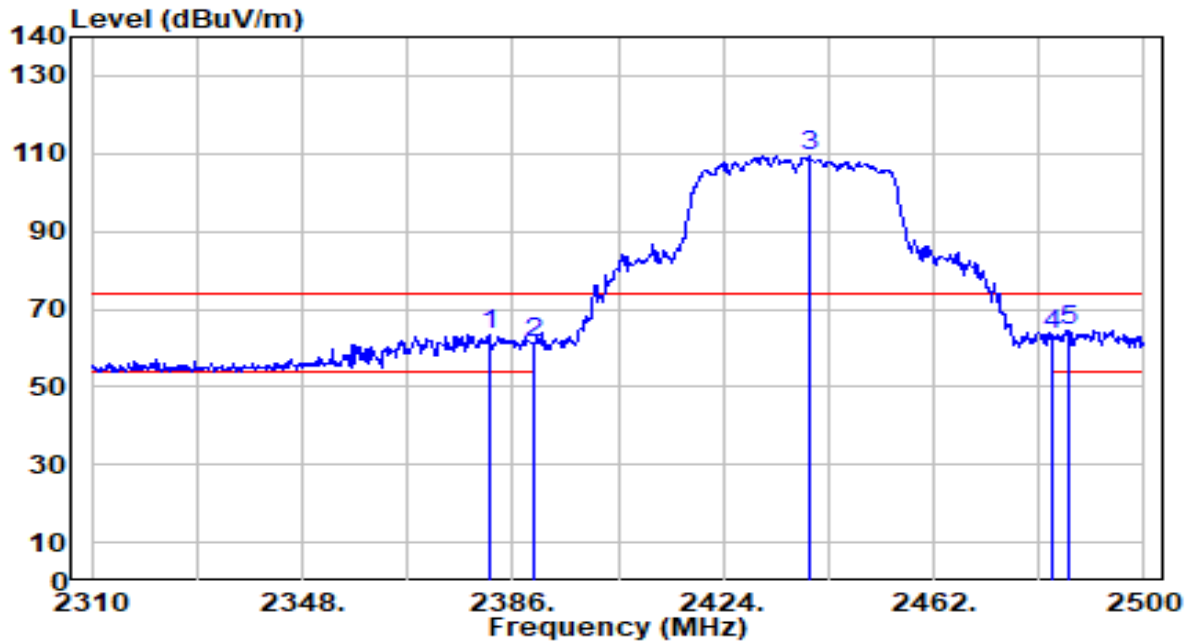

No	Frequency (MHz)	Reading (dBuV)	C.F (dB/m)	Measurement (dBuV/m)	Margin (dB)	Limit (dBuV/m)	Height (cm)	Angle (deg)	Remark (QP/PK/AV)
1	2381.820	33.50	29.98	63.48	-10.52	74.00	340	180	Peak
2	2390.000	31.13	29.99	61.13	-12.87	74.00	340	180	Peak
3	2439.770	79.33	30.14	109.47	N/A	N/A	340	180	Peak
4	2483.500	33.01	30.29	63.30	-10.70	74.00	340	180	Peak
5	* 2486.320	34.25	30.29	64.54	-9.46	74.00	340	180	Peak

Note:

1. " *", means this data is the worst emission level.
2. C.F (Correction Factor) = Antenna Factor (dB/m) + Cable Loss (dB).
3. Measurement (dBuV/m) = Reading(dBuV) + C.F (Correction Factor).
4. The emission levels of other frequencies are very lower than the limit and not show in test report.

EUT	AX3000 Ceiling Mount Wi-Fi 6 Access Point	Date of Test	2023-03-22
Factor	DRH18-E	Temp. / Humidity	22°C /63%
Polarity	Vertical	Site / Test Engineer	AC2 / Marvin
Test Mode	802.11n-40MHz_TX_CH 6_ANT 0+1	Test Voltage	AC 120V/60Hz

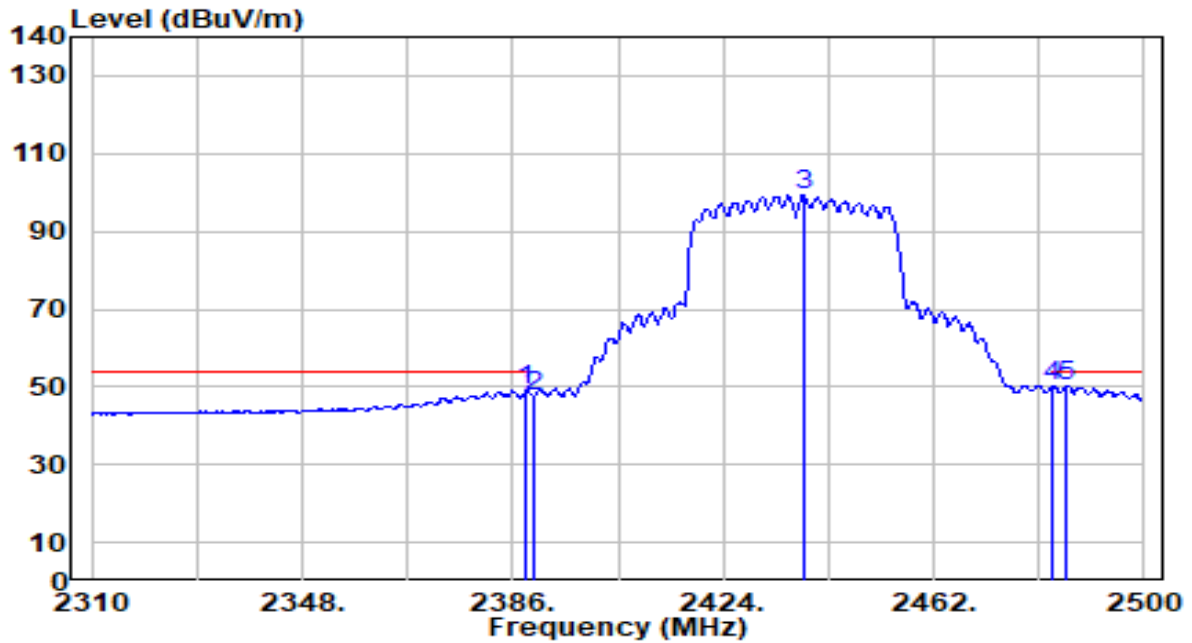

No	Frequency (MHz)	Reading (dBuV)	C.F (dB/m)	Measurement (dBuV/m)	Margin (dB)	Limit (dBuV/m)	Height (cm)	Angle (deg)	Remark (QP/PK/AV)
1	2388.280	19.26	29.99	49.25	-4.75	54.00	340	180	Average
2	2390.000	17.80	29.99	47.79	-6.21	54.00	340	180	Average
3	2438.440	69.01	30.14	99.14	N/A	N/A	340	180	Average
4	2483.500	19.75	30.29	50.03	-3.97	54.00	340	180	Average
5	* 2485.750	19.74	30.29	50.04	-3.96	54.00	340	180	Average

Note:

1. " *", means this data is the worst emission level.
2. C.F (Correction Factor) = Antenna Factor (dB/m) + Cable Loss (dB).
3. Measurement (dBuV/m) = Reading(dBuV) + C.F (Correction Factor).
4. The emission levels of other frequencies are very lower than the limit and not show in test report.

EUT	AX3000 Ceiling Mount Wi-Fi 6 Access Point	Date of Test	2023-03-22
Factor	DRH18-E	Temp. / Humidity	22°C /63%
Polarity	Horizontal	Site / Test Engineer	AC2 / Marvin
Test Mode	802.11n-40MHz_TX_CH 9_ANT 0+1	Test Voltage	AC 120V/60Hz

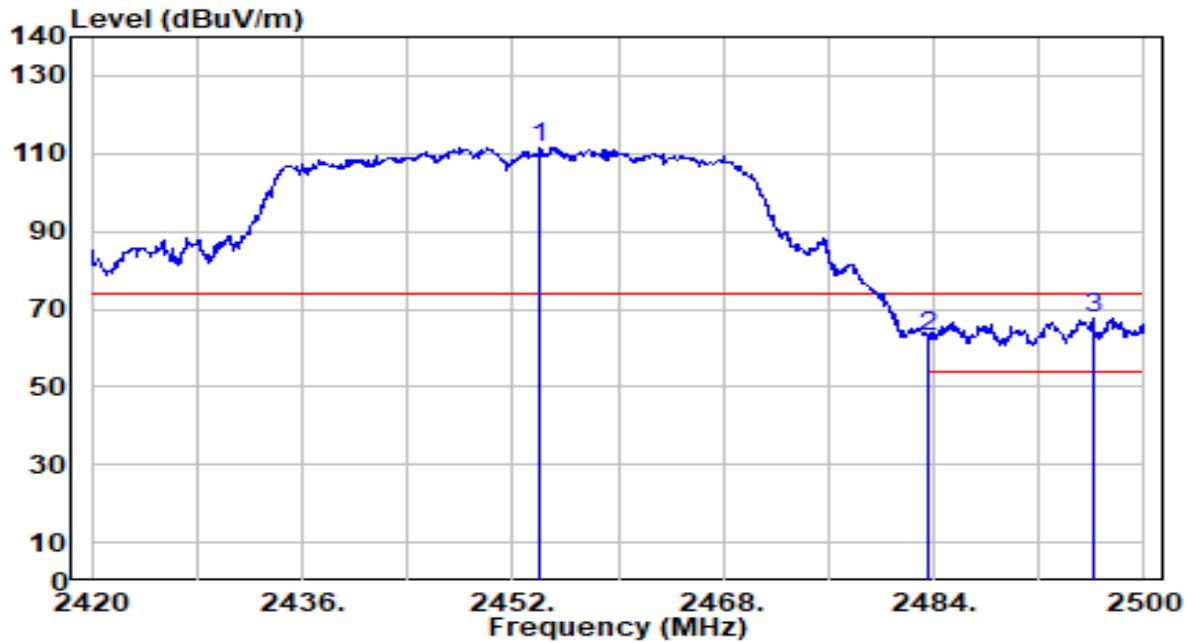

No	Frequency (MHz)	Reading (dBuV)	C.F (dB/m)	Measurement (dBuV/m)	Margin (dB)	Limit (dBuV/m)	Height (cm)	Angle (deg)	Remark (QP/PK/AV)
1	2454.080	81.52	30.19	111.71	N/A	N/A	208	230	Peak
2	2483.500	32.37	30.29	62.65	-11.35	74.00	208	230	Peak
3	* 2496.080	37.52	30.33	67.85	-6.15	74.00	208	230	Peak

Note:

1. " *", means this data is the worst emission level.
2. C.F (Correction Factor) = Antenna Factor (dB/m) + Cable Loss (dB).
3. Measurement (dBuV/m) = Reading(dBuV) + C.F (Correction Factor).
4. The emission levels of other frequencies are very lower than the limit and not show in test report.

EUT	AX3000 Ceiling Mount Wi-Fi 6 Access Point	Date of Test	2023-03-22
Factor	DRH18-E	Temp. / Humidity	22°C /63%
Polarity	Horizontal	Site / Test Engineer	AC2 / Marvin
Test Mode	802.11n-40MHz_TX_CH 9_ANT 0+1	Test Voltage	AC 120V/60Hz

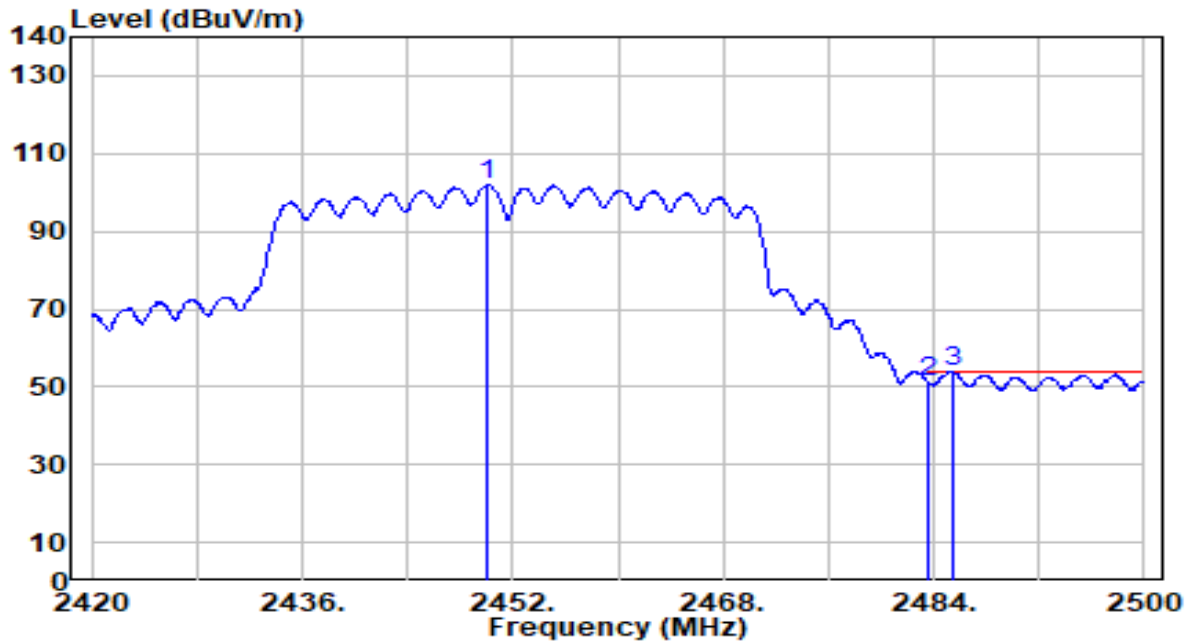

No	Frequency (MHz)	Reading (dBuV)	C.F (dB/m)	Measurement (dBuV/m)	Margin (dB)	Limit (dBuV/m)	Height (cm)	Angle (deg)	Remark (QP/PK/AV)
1	2450.080	71.79	30.17	101.97	N/A	N/A	208	230	Average
2	2483.500	20.91	30.29	51.20	-2.80	54.00	208	230	Average
3	* 2485.520	23.60	30.29	53.90	-0.10	54.00	208	230	Average

Note:

1. " *", means this data is the worst emission level.
2. C.F (Correction Factor) = Antenna Factor (dB/m) + Cable Loss (dB).
3. Measurement (dBuV/m) = Reading(dBuV) + C.F (Correction Factor).
4. The emission levels of other frequencies are very lower than the limit and not show in test report.

EUT	AX3000 Ceiling Mount Wi-Fi 6 Access Point	Date of Test	2023-03-22
Factor	DRH18-E	Temp. / Humidity	22°C /63%
Polarity	Vertical	Site / Test Engineer	AC2 / Marvin
Test Mode	802.11n-40MHz_TX_CH 9_ANT 0+1	Test Voltage	AC 120V/60Hz

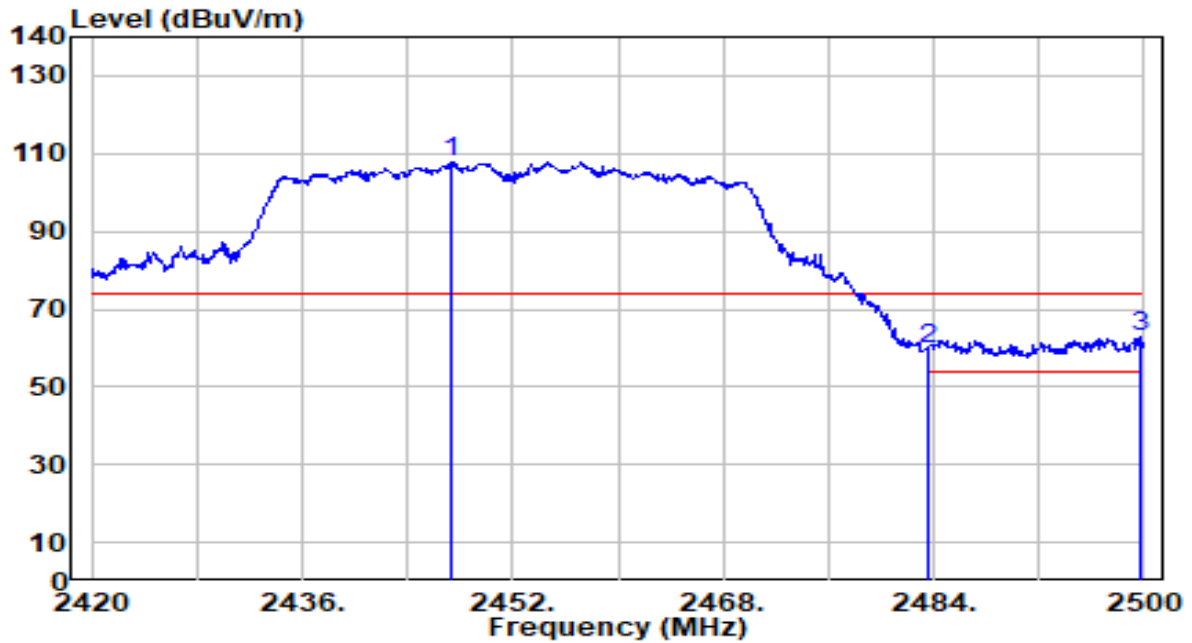

No	Frequency (MHz)	Reading (dBuV)	C.F (dB/m)	Measurement (dBuV/m)	Margin (dB)	Limit (dBuV/m)	Height (cm)	Angle (deg)	Remark (QP/PK/AV)
1	2447.280	77.80	30.16	107.96	N/A	N/A	340	180	Peak
2	2483.500	29.28	30.29	59.56	-14.44	74.00	340	180	Peak
3	* 2499.760	32.37	30.34	62.71	-11.29	74.00	340	180	Peak

Note:

1. " *", means this data is the worst emission level.
2. C.F (Correction Factor) = Antenna Factor (dB/m) + Cable Loss (dB).
3. Measurement (dBuV/m) = Reading(dBuV) + C.F (Correction Factor).
4. The emission levels of other frequencies are very lower than the limit and not show in test report.

EUT	AX3000 Ceiling Mount Wi-Fi 6 Access Point	Date of Test	2023-03-22
Factor	DRH18-E	Temp. / Humidity	22°C /63%
Polarity	Vertical	Site / Test Engineer	AC2 / Marvin
Test Mode	802.11n-40MHz_TX_CH 9_ANT 0+1	Test Voltage	AC 120V/60Hz

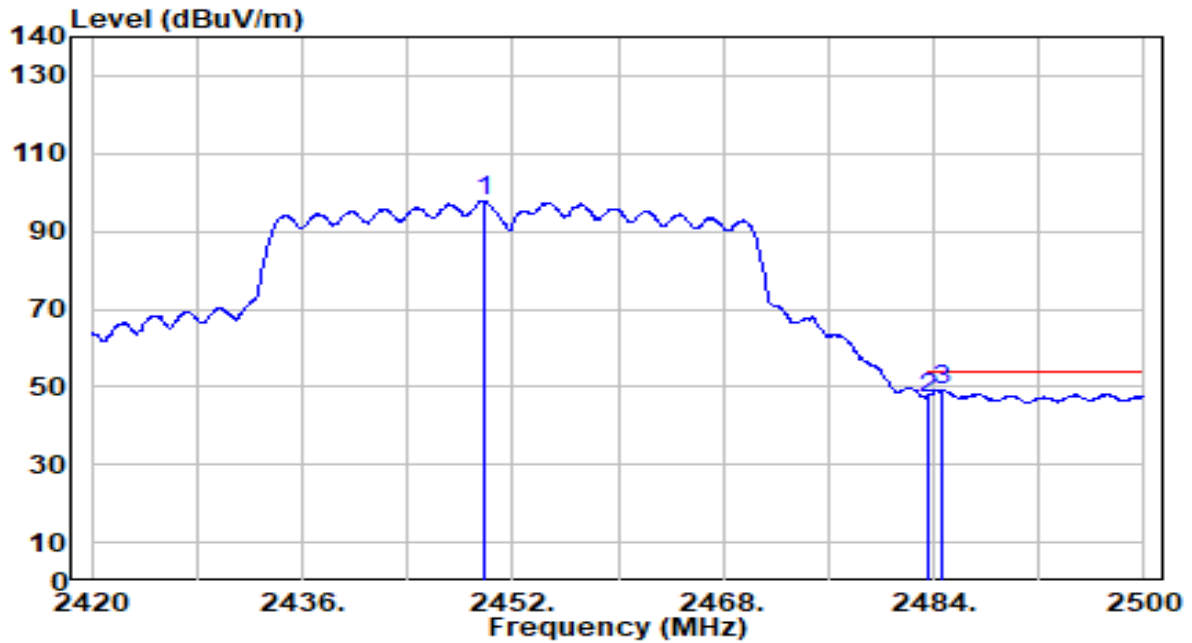

No	Frequency (MHz)	Reading (dBuV)	C.F (dB/m)	Measurement (dBuV/m)	Margin (dB)	Limit (dBuV/m)	Height (cm)	Angle (deg)	Remark (QP/PK/AV)
1	2449.920	67.50	30.17	97.67	N/A	N/A	340	180	Average
2	2483.500	16.97	30.29	47.26	-6.74	54.00	340	180	Average
3	* 2484.640	18.92	30.29	49.21	-4.79	54.00	340	180	Average

Note:

1. " *", means this data is the worst emission level.
2. C.F (Correction Factor) = Antenna Factor (dB/m) + Cable Loss (dB).
3. Measurement (dBuV/m) = Reading(dBuV) + C.F (Correction Factor).
4. The emission levels of other frequencies are very lower than the limit and not show in test report.

EUT	AX3000 Ceiling Mount Wi-Fi 6 Access Point	Date of Test	2023-03-22
Factor	DRH18-E	Temp. / Humidity	22°C /63%
Polarity	Horizontal	Site / Test Engineer	AC2 / Marvin
Test Mode	802.11ax-20MHz_TX_CH 1_ANT 0+1	Test Voltage	AC 120V/60Hz

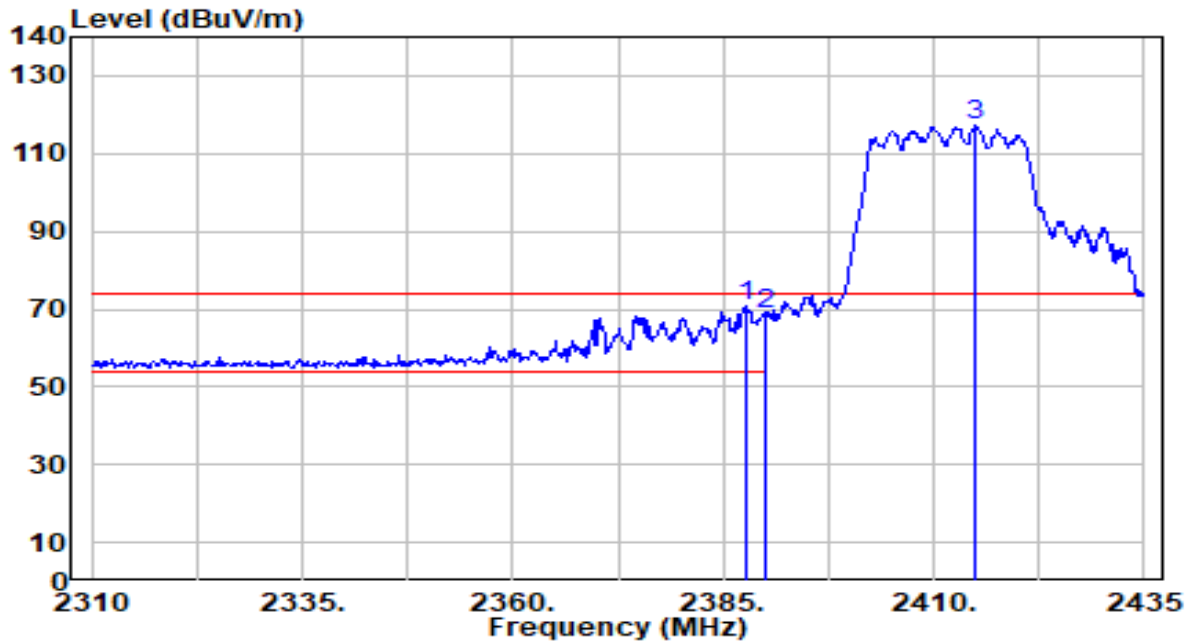

No	Frequency (MHz)	Reading (dBUV)	C.F (dB/m)	Measurement (dBUV/m)	Margin (dB)	Limit (dBUV/m)	Height (cm)	Angle (deg)	Remark (QP/PK/AV)	
1	*	2387.625	40.59	29.99	70.59	-3.41	74.00	210	230	Peak
2		2390.000	38.60	29.99	68.59	-5.41	74.00	210	230	Peak
3		2415.000	87.14	30.06	117.20	N/A	N/A	210	230	Peak

Note:

1. " *", means this data is the worst emission level.
2. C.F (Correction Factor) = Antenna Factor (dB/m) + Cable Loss (dB).
3. Measurement (dBUV/m) = Reading(dBUV) + C.F (Correction Factor).
4. The emission levels of other frequencies are very lower than the limit and not show in test report.

EUT	AX3000 Ceiling Mount Wi-Fi 6 Access Point	Date of Test	2023-03-22
Factor	DRH18-E	Temp. / Humidity	22°C /63%
Polarity	Horizontal	Site / Test Engineer	AC2 / Marvin
Test Mode	802.11ax-20MHz_TX_CH 1_ANT 0+1	Test Voltage	AC 120V/60Hz

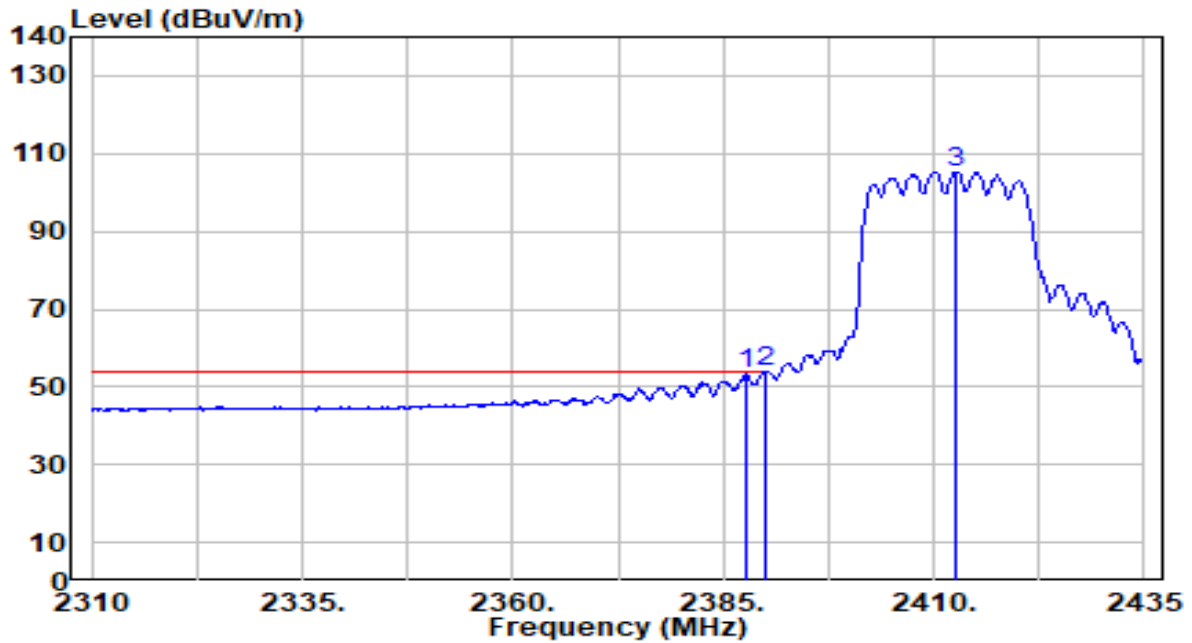

No	Frequency (MHz)	Reading (dBUV)	C.F (dB/m)	Measurement (dBUV/m)	Margin (dB)	Limit (dBUV/m)	Height (cm)	Angle (deg)	Remark (QP/PK/AV)
1	2387.750	23.22	29.99	53.21	-0.79	54.00	210	230	Average
2	* 2390.000	23.81	29.99	53.81	-0.19	54.00	210	230	Average
3	2412.750	75.34	30.05	105.39	N/A	N/A	210	230	Average

Note:

1. " *", means this data is the worst emission level.
2. C.F (Correction Factor) = Antenna Factor (dB/m) + Cable Loss (dB).
3. Measurement (dBUV/m) = Reading(dBUV) + C.F (Correction Factor).
4. The emission levels of other frequencies are very lower than the limit and not show in test report.

EUT	AX3000 Ceiling Mount Wi-Fi 6 Access Point	Date of Test	2023-03-22
Factor	DRH18-E	Temp. / Humidity	22°C /63%
Polarity	Vertical	Site / Test Engineer	AC2 / Marvin
Test Mode	802.11ax-20MHz_TX_CH 1_ANT 0+1	Test Voltage	AC 120V/60Hz

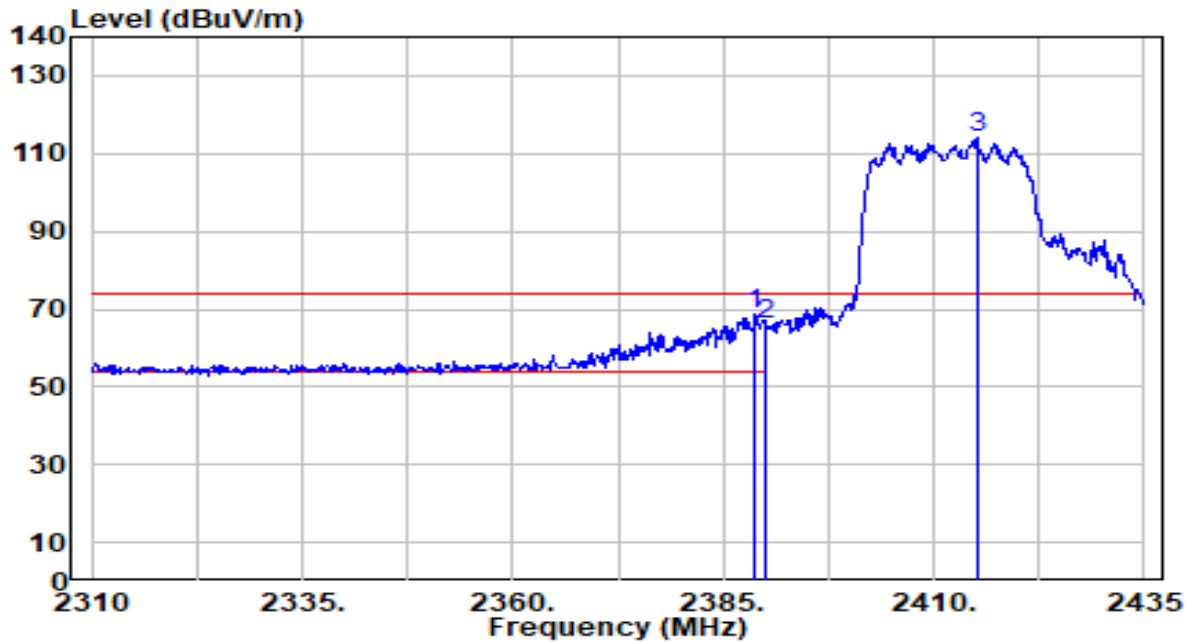

No	Frequency (MHz)	Reading (dBUV)	C.F (dB/m)	Measurement (dBUV/m)	Margin (dB)	Limit (dBUV/m)	Height (cm)	Angle (deg)	Remark (QP/PK/AV)	
1	*	2388.750	38.83	29.99	68.82	-5.18	74.00	351	178	Peak
2		2390.000	36.03	29.99	66.02	-7.98	74.00	351	178	Peak
3		2415.125	83.80	30.06	113.86	39.86	74.00	351	178	Peak

Note:

1. " *", means this data is the worst emission level.
2. C.F (Correction Factor) = Antenna Factor (dB/m) + Cable Loss (dB).
3. Measurement (dBUV/m) = Reading(dBUV) + C.F (Correction Factor).
4. The emission levels of other frequencies are very lower than the limit and not show in test report.

EUT	AX3000 Ceiling Mount Wi-Fi 6 Access Point	Date of Test	2023-03-22
Factor	DRH18-E	Temp. / Humidity	22°C /63%
Polarity	Vertical	Site / Test Engineer	AC2 / Marvin
Test Mode	802.11ax-20MHz_TX_CH 1_ANT 0+1	Test Voltage	AC 120V/60Hz

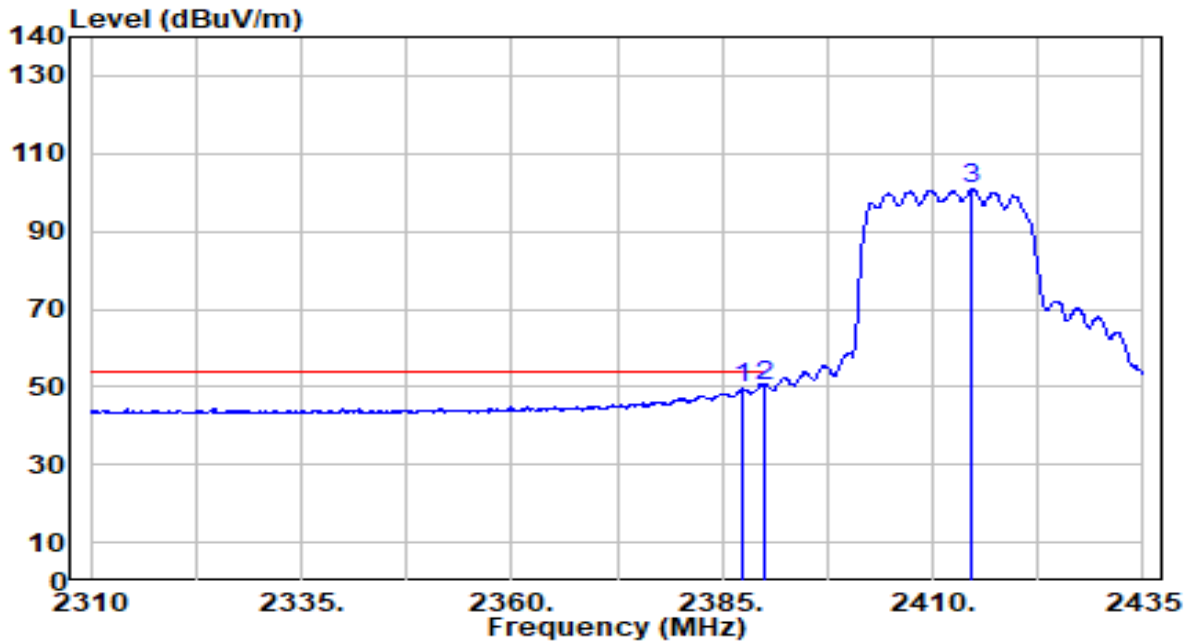

No	Frequency (MHz)	Reading (dBUV)	C.F (dB/m)	Measurement (dBUV/m)	Margin (dB)	Limit (dBUV/m)	Height (cm)	Angle (deg)	Remark (QP/PK/AV)
1	2387.250	19.43	29.99	49.42	-4.58	54.00	351	178	Average
2	* 2390.000	20.44	29.99	50.43	-3.57	54.00	351	178	Average
3	2414.625	70.84	30.06	100.90	N/A	N/A	351	178	Average

Note:

1. " *", means this data is the worst emission level.
2. C.F (Correction Factor) = Antenna Factor (dB/m) + Cable Loss (dB).
3. Measurement (dBUV/m) = Reading(dBUV) + C.F (Correction Factor).
4. The emission levels of other frequencies are very lower than the limit and not show in test report.

EUT	AX3000 Ceiling Mount Wi-Fi 6 Access Point	Date of Test	2023-03-22
Factor	DRH18-E	Temp. / Humidity	22°C /63%
Polarity	Horizontal	Site / Test Engineer	AC2 / Marvin
Test Mode	802.11ax-20MHz_TX_CH 6_ANT 0+1	Test Voltage	AC 120V/60Hz

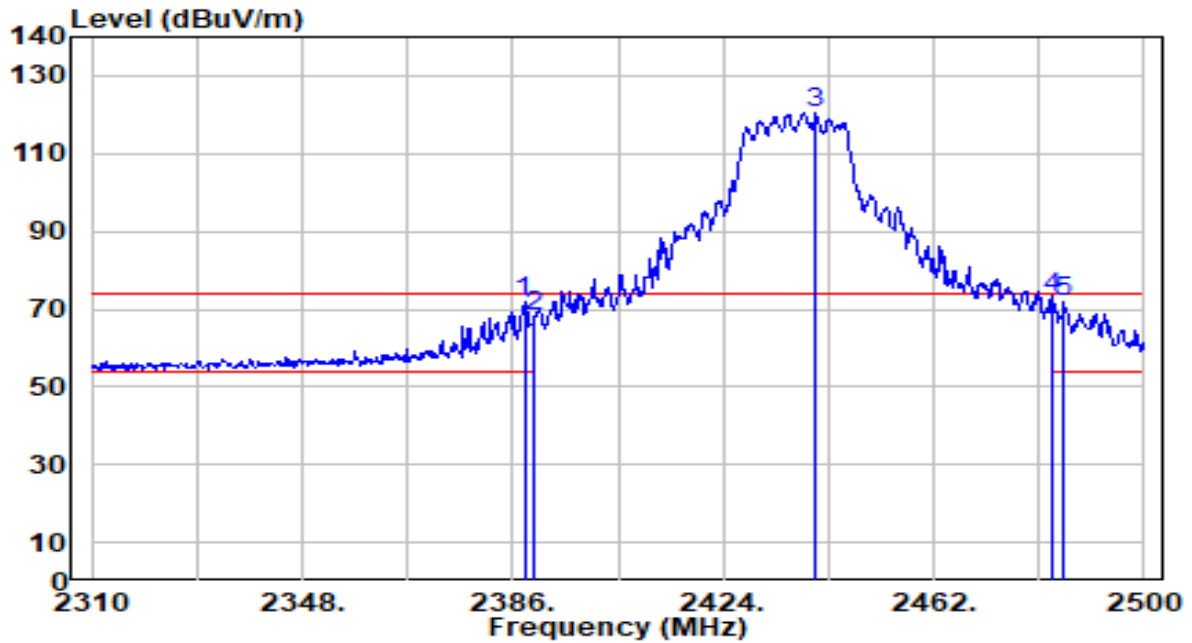

No	Frequency (MHz)	Reading (dBuV)	C.F (dB/m)	Measurement (dBuV/m)	Margin (dB)	Limit (dBuV/m)	Height (cm)	Angle (deg)	Remark (QP/PK/AV)
1	2388.090	41.84	29.99	71.83	-2.17	74.00	100	224	Peak
2	2390.000	37.97	29.99	67.96	-6.04	74.00	100	224	Peak
3	2440.720	90.34	30.14	120.48	N/A	N/A	100	224	Peak
4	* 2483.500	42.53	30.29	72.82	-1.18	74.00	100	224	Peak
5	2485.370	41.65	30.29	71.94	-2.06	74.00	100	224	Peak

Note:

1. " *", means this data is the worst emission level.
2. C.F (Correction Factor) = Antenna Factor (dB/m) + Cable Loss (dB).
3. Measurement (dBuV/m) = Reading(dBuV) + C.F (Correction Factor).
4. The emission levels of other frequencies are very lower than the limit and not show in test report.

EUT	AX3000 Ceiling Mount Wi-Fi 6 Access Point	Date of Test	2023-03-22
Factor	DRH18-E	Temp. / Humidity	22°C /63%
Polarity	Horizontal	Site / Test Engineer	AC2 / Marvin
Test Mode	802.11ax-20MHz_TX_CH 6_ANT 0+1	Test Voltage	AC 120V/60Hz

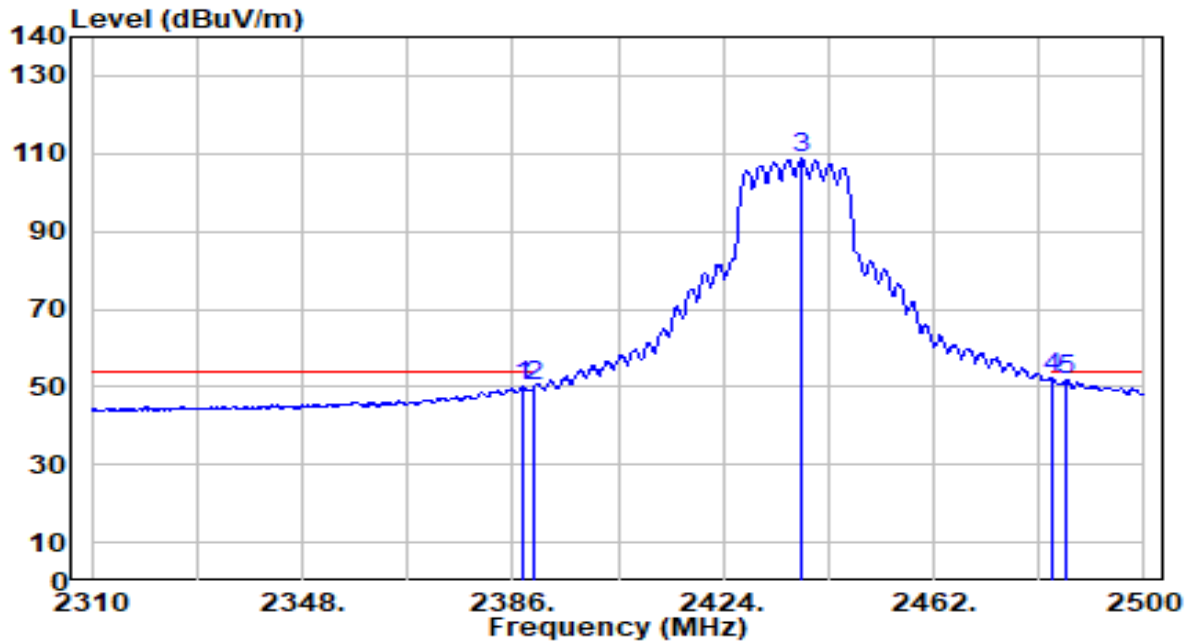

No	Frequency (MHz)	Reading (dBuV)	C.F (dB/m)	Measurement (dBuV/m)	Margin (dB)	Limit (dBuV/m)	Height (cm)	Angle (deg)	Remark (QP/PK/AV)
1	2387.900	20.01	29.99	50.00	-4.00	54.00	100	224	Average
2	2390.000	20.03	29.99	50.02	-3.98	54.00	100	224	Average
3	2438.060	78.73	30.13	108.87	N/A	N/A	100	224	Average
4	* 2483.500	21.80	30.29	52.09	-1.91	54.00	100	224	Average
5	2486.130	21.71	30.29	52.00	-2.00	54.00	100	224	Average

Note:

1. " *", means this data is the worst emission level.
2. C.F (Correction Factor) = Antenna Factor (dB/m) + Cable Loss (dB).
3. Measurement (dBuV/m) = Reading(dBuV) + C.F (Correction Factor).
4. The emission levels of other frequencies are very lower than the limit and not show in test report.

EUT	AX3000 Ceiling Mount Wi-Fi 6 Access Point	Date of Test	2023-03-22
Factor	DRH18-E	Temp. / Humidity	22°C /63%
Polarity	Vertical	Site / Test Engineer	AC2 / Marvin
Test Mode	802.11ax-20MHz_TX_CH 6_ANT 0+1	Test Voltage	AC 120V/60Hz

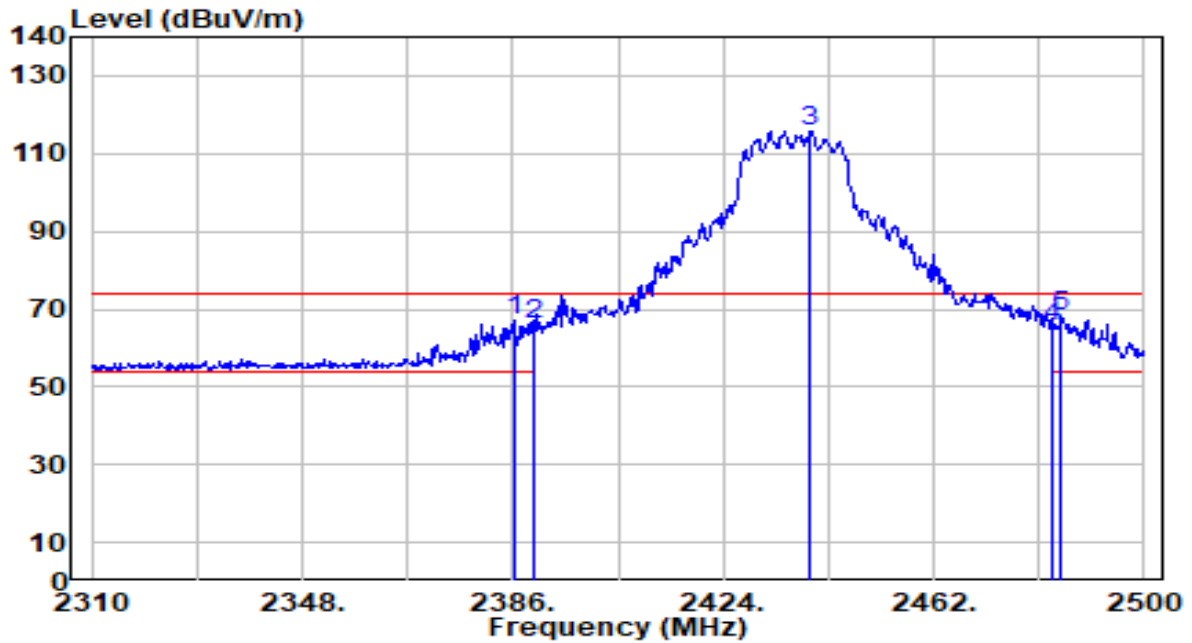

No	Frequency (MHz)	Reading (dBuV)	C.F (dB/m)	Measurement (dBuV/m)	Margin (dB)	Limit (dBuV/m)	Height (cm)	Angle (deg)	Remark (QP/PK/AV)
1	2386.190	36.85	29.99	66.84	-7.16	74.00	300	180	Peak
2	2390.000	35.82	29.99	65.81	-8.19	74.00	300	180	Peak
3	2439.770	85.71	30.14	115.85	N/A	N/A	300	180	Peak
4	2483.500	35.05	30.29	65.33	-8.67	74.00	300	180	Peak
5	* 2484.990	37.72	30.29	68.01	-5.99	74.00	300	180	Peak

Note:

1. " *", means this data is the worst emission level.
2. C.F (Correction Factor) = Antenna Factor (dB/m) + Cable Loss (dB).
3. Measurement (dBuV/m) = Reading(dBuV) + C.F (Correction Factor).
4. The emission levels of other frequencies are very lower than the limit and not show in test report.

EUT	AX3000 Ceiling Mount Wi-Fi 6 Access Point	Date of Test	2023-03-22
Factor	DRH18-E	Temp. / Humidity	22°C /63%
Polarity	Vertical	Site / Test Engineer	AC2 / Marvin
Test Mode	802.11ax-20MHz_TX_CH 6_ANT 0+1	Test Voltage	AC 120V/60Hz

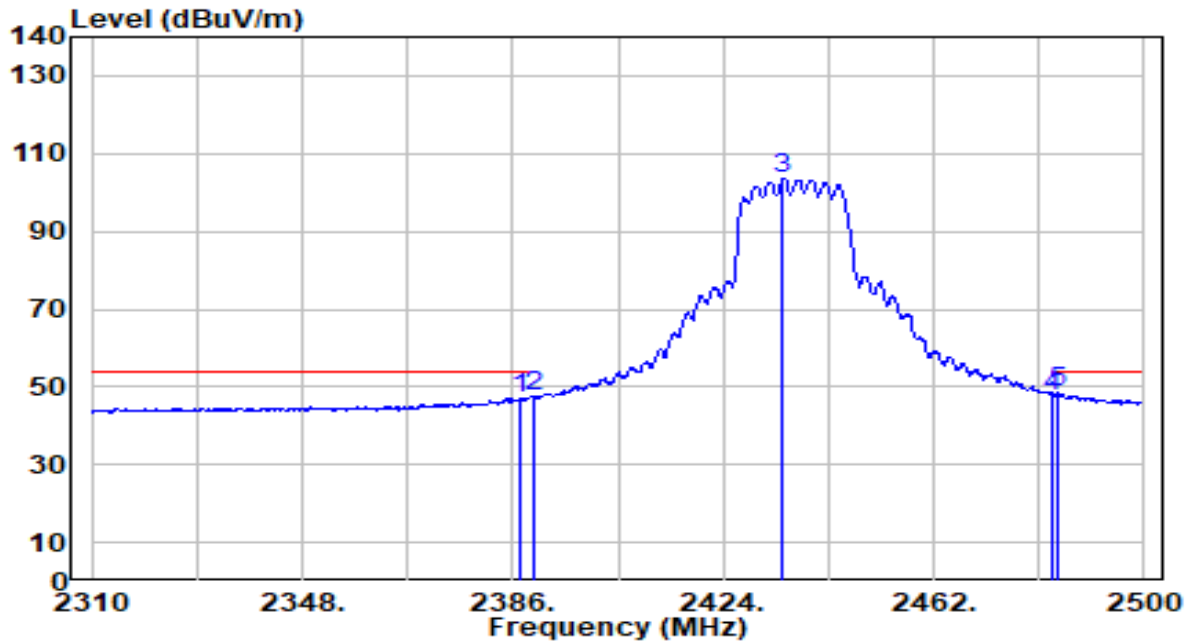

No	Frequency (MHz)	Reading (dBuV)	C.F (dB/m)	Measurement (dBuV/m)	Margin (dB)	Limit (dBuV/m)	Height (cm)	Angle (deg)	Remark (QP/PK/AV)
1	2387.330	17.29	29.99	47.28	-6.72	54.00	300	180	Average
2	2390.000	17.65	29.99	47.64	-6.36	54.00	300	180	Average
3	2434.830	73.37	30.12	103.49	N/A	N/A	300	180	Average
4	2483.500	17.49	30.29	47.78	-6.22	54.00	300	180	Average
5	* 2484.420	18.32	30.29	48.61	-5.39	54.00	300	180	Average

Note:

1. " *", means this data is the worst emission level.
2. C.F (Correction Factor) = Antenna Factor (dB/m) + Cable Loss (dB).
3. Measurement (dBuV/m) = Reading(dBuV) + C.F (Correction Factor).
4. The emission levels of other frequencies are very lower than the limit and not show in test report.

EUT	AX3000 Ceiling Mount Wi-Fi 6 Access Point	Date of Test	2023-03-22
Factor	DRH18-E	Temp. / Humidity	22°C /63%
Polarity	Horizontal	Site / Test Engineer	AC2 / Marvin
Test Mode	802.11ax-20MHz_TX_CH 11_ANT 0+1	Test Voltage	AC 120V/60Hz

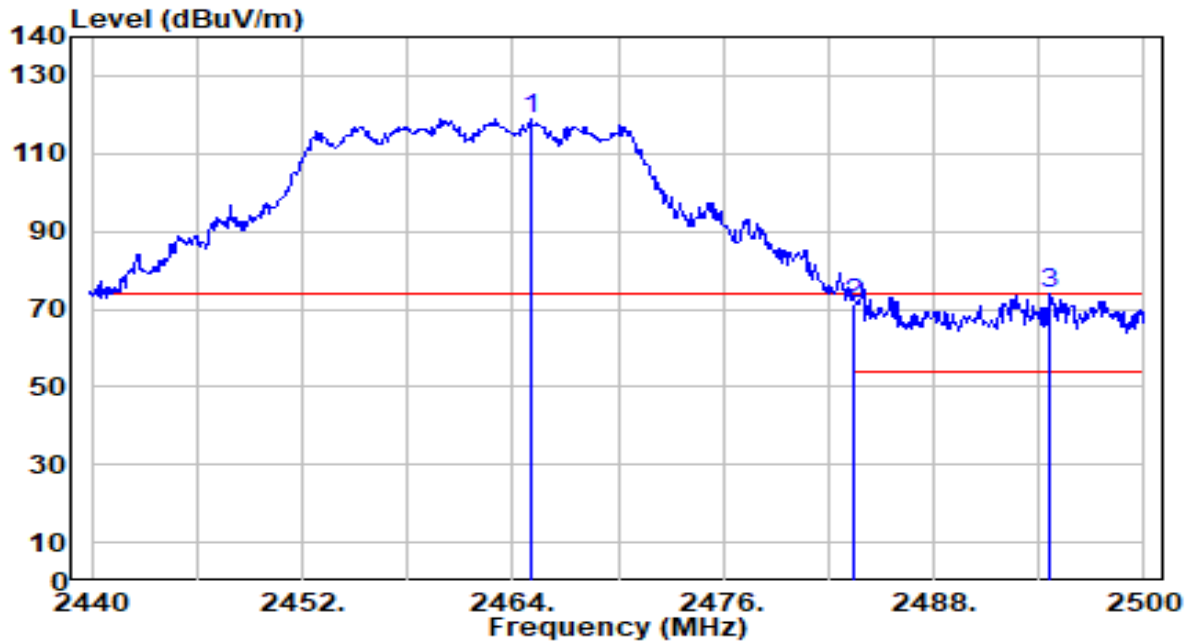

No	Frequency (MHz)	Reading (dBuV)	C.F (dB/m)	Measurement (dBuV/m)	Margin (dB)	Limit (dBuV/m)	Height (cm)	Angle (deg)	Remark (QP/PK/AV)
1	2465.040	88.75	30.22	118.97	N/A	N/A	205	230	Peak
2	2483.500	41.22	30.29	71.51	-2.49	74.00	205	230	Peak
3	* 2494.640	43.57	30.32	73.89	-0.11	74.00	205	230	Peak

Note:

1. " *", means this data is the worst emission level.
2. C.F (Correction Factor) = Antenna Factor (dB/m) + Cable Loss (dB).
3. Measurement (dBuV/m) = Reading(dBuV) + C.F (Correction Factor).
4. The emission levels of other frequencies are very lower than the limit and not show in test report.

EUT	AX3000 Ceiling Mount Wi-Fi 6 Access Point	Date of Test	2023-03-22
Factor	DRH18-E	Temp. / Humidity	22°C /63%
Polarity	Horizontal	Site / Test Engineer	AC2 / Marvin
Test Mode	802.11ax-20MHz_TX_CH 11_ANT 0+1	Test Voltage	AC 120V/60Hz

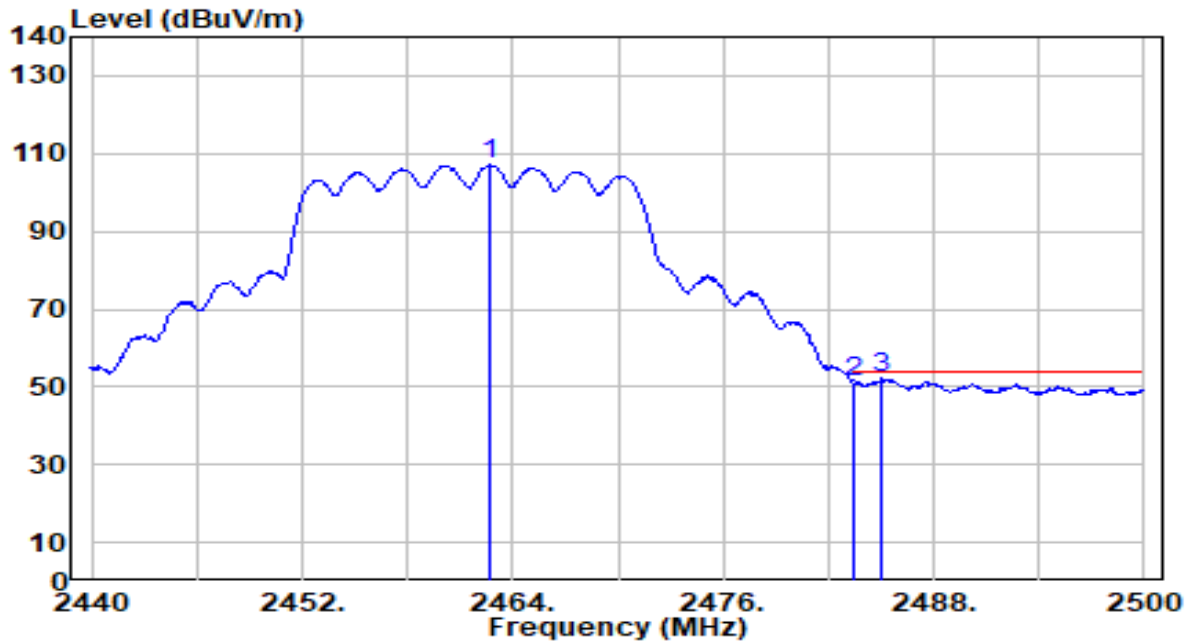

No	Frequency (MHz)	Reading (dBuV)	C.F (dB/m)	Measurement (dBuV/m)	Margin (dB)	Limit (dBuV/m)	Height (cm)	Angle (deg)	Remark (QP/PK/AV)
1	2462.640	76.77	30.22	106.99	N/A	N/A	205	230	Average
2	2483.500	20.90	30.29	51.19	-2.81	54.00	205	230	Average
3	* 2485.040	21.76	30.29	52.05	-1.95	54.00	205	230	Average

Note:

1. " *", means this data is the worst emission level.
2. C.F (Correction Factor) = Antenna Factor (dB/m) + Cable Loss (dB).
3. Measurement (dBuV/m) = Reading(dBuV) + C.F (Correction Factor).
4. The emission levels of other frequencies are very lower than the limit and not show in test report.

EUT	AX3000 Ceiling Mount Wi-Fi 6 Access Point	Date of Test	2023-03-22
Factor	DRH18-E	Temp. / Humidity	22°C /63%
Polarity	Vertical	Site / Test Engineer	AC2 / Marvin
Test Mode	802.11ax-20MHz_TX_CH 11_ANT 0+1	Test Voltage	AC 120V/60Hz

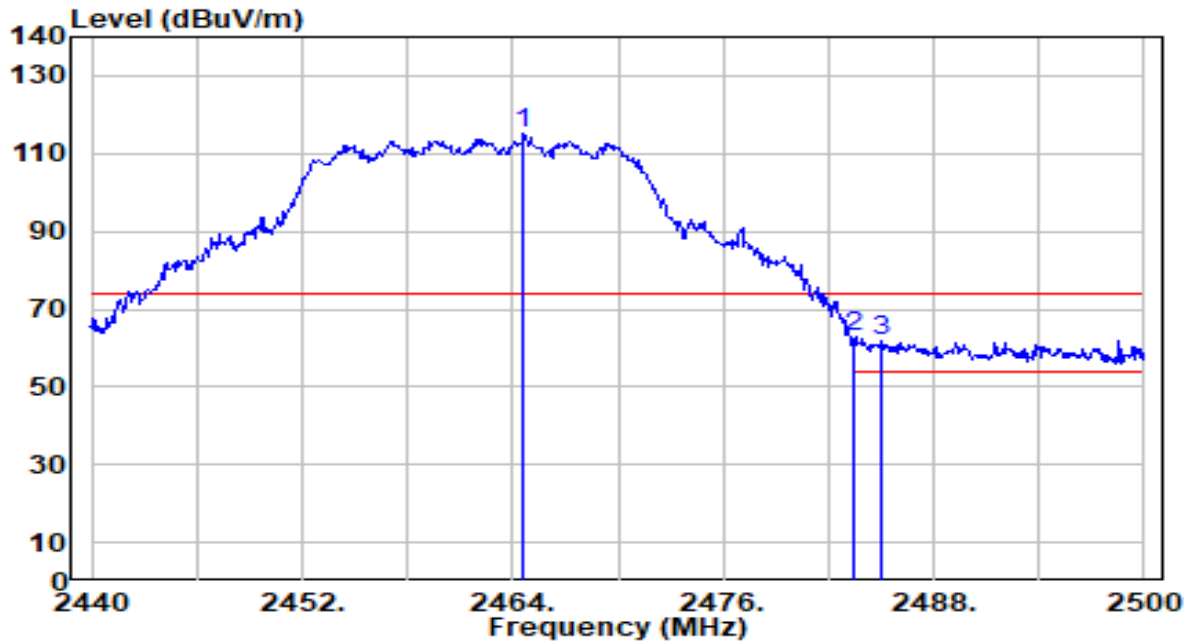

No	Frequency (MHz)	Reading (dBuV)	C.F (dB/m)	Measurement (dBuV/m)	Margin (dB)	Limit (dBuV/m)	Height (cm)	Angle (deg)	Remark (QP/PK/AV)
1	2464.640	84.77	30.22	114.99	N/A	N/A	379	180	Peak
2	* 2483.500	32.42	30.29	62.70	-11.30	74.00	379	180	Peak
3	2485.040	31.46	30.29	61.75	-12.25	74.00	379	180	Peak

Note:

1. " *", means this data is the worst emission level.
2. C.F (Correction Factor) = Antenna Factor (dB/m) + Cable Loss (dB).
3. Measurement (dBuV/m) = Reading(dBuV) + C.F (Correction Factor).
4. The emission levels of other frequencies are very lower than the limit and not show in test report.

EUT	AX3000 Ceiling Mount Wi-Fi 6 Access Point	Date of Test	2023-03-22
Factor	DRH18-E	Temp. / Humidity	22°C /63%
Polarity	Vertical	Site / Test Engineer	AC2 / Marvin
Test Mode	802.11ax-20MHz_TX_CH 11_ANT 0+1	Test Voltage	AC 120V/60Hz

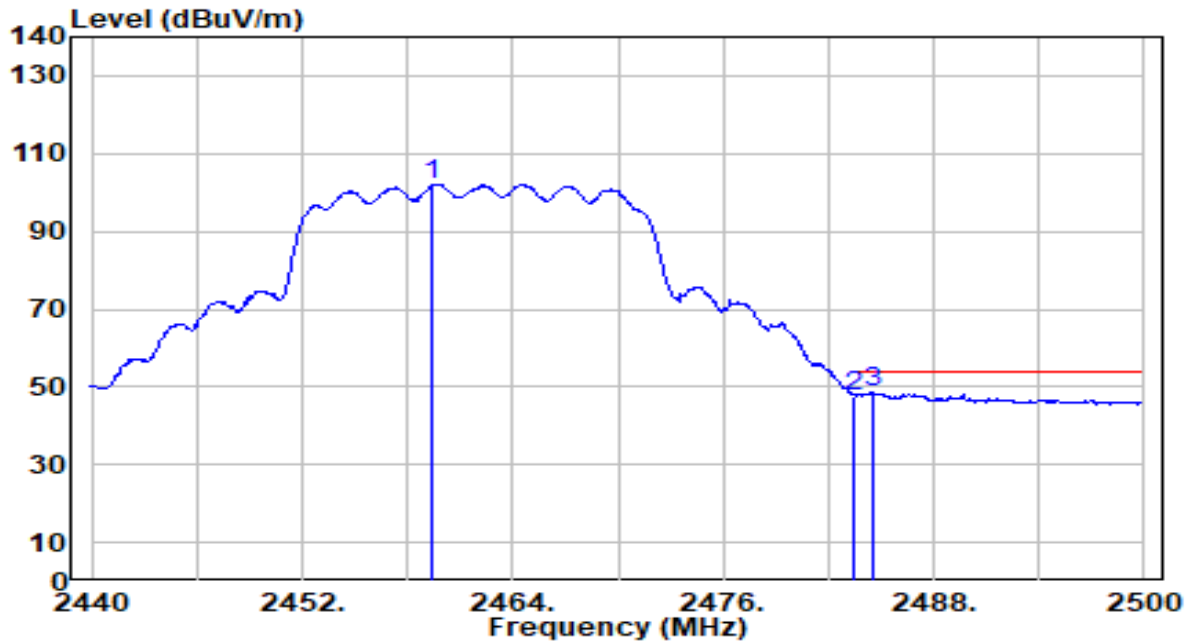

No	Frequency (MHz)	Reading (dBuV)	C.F (dB/m)	Measurement (dBuV/m)	Margin (dB)	Limit (dBuV/m)	Height (cm)	Angle (deg)	Remark (QP/PK/AV)
1	2459.440	71.92	30.21	102.12	N/A	N/A	379	180	Average
2	2483.500	17.46	30.29	47.75	-6.25	54.00	379	180	Average
3	* 2484.560	18.09	30.29	48.38	-5.62	54.00	379	180	Average

Note:

1. " *", means this data is the worst emission level.
2. C.F (Correction Factor) = Antenna Factor (dB/m) + Cable Loss (dB).
3. Measurement (dBuV/m) = Reading(dBuV) + C.F (Correction Factor).
4. The emission levels of other frequencies are very lower than the limit and not show in test report.

EUT	AX3000 Ceiling Mount Wi-Fi 6 Access Point	Date of Test	2023-03-22
Factor	DRH18-E	Temp. / Humidity	22°C /63%
Polarity	Horizontal	Site / Test Engineer	AC2 / Marvin
Test Mode	802.11ax-40MHz_TX_CH 3_ANT 0+1	Test Voltage	AC 120V/60Hz

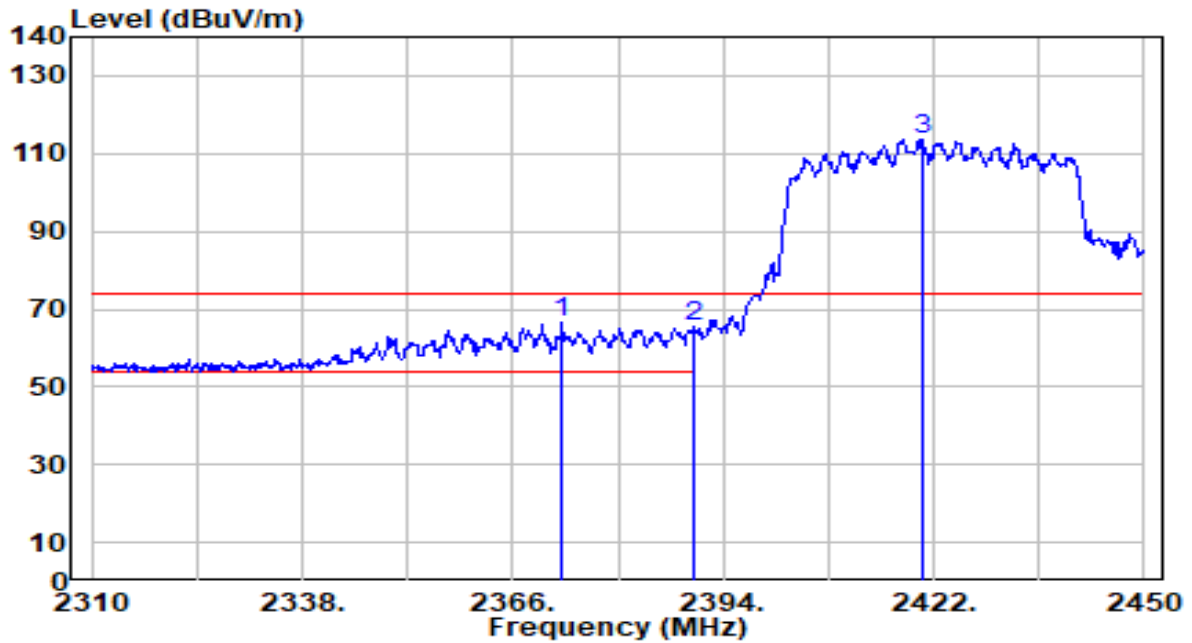

No	Frequency (MHz)	Reading (dBUV)	C.F (dB/m)	Measurement (dBUV/m)	Margin (dB)	Limit (dBUV/m)	Height (cm)	Angle (deg)	Remark (QP/PK/AV)	
1	*	2372.580	36.67	29.97	66.64	-7.36	74.00	200	231	Peak
2		2390.000	35.62	29.99	65.62	-8.38	74.00	200	231	Peak
3		2420.460	83.62	30.08	113.70	N/A	N/A	200	231	Peak

Note:

1. " *", means this data is the worst emission level.
2. C.F (Correction Factor) = Antenna Factor (dB/m) + Cable Loss (dB).
3. Measurement (dBUV/m) = Reading(dBUV) + C.F (Correction Factor).
4. The emission levels of other frequencies are very lower than the limit and not show in test report.

EUT	AX3000 Ceiling Mount Wi-Fi 6 Access Point	Date of Test	2023-03-22
Factor	DRH18-E	Temp. / Humidity	22°C /63%
Polarity	Horizontal	Site / Test Engineer	AC2 / Marvin
Test Mode	802.11ax-40MHz_TX_CH 3_ANT 0+1	Test Voltage	AC 120V/60Hz

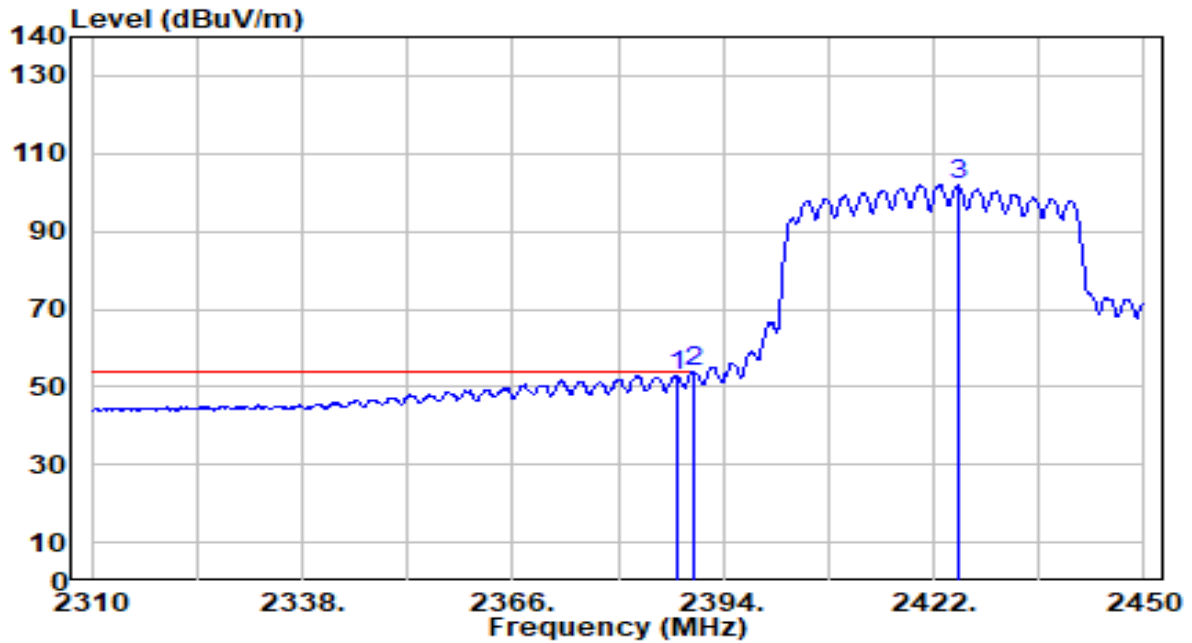

No	Frequency (MHz)	Reading (dBuV)	C.F (dB/m)	Measurement (dBuV/m)	Margin (dB)	Limit (dBuV/m)	Height (cm)	Angle (deg)	Remark (QP/PK/AV)
1	2387.840	22.67	29.99	52.66	-1.34	54.00	200	231	Average
2	* 2390.000	23.90	29.99	53.90	-0.10	54.00	200	231	Average
3	2425.220	71.80	30.09	101.89	N/A	N/A	200	231	Average

Note:

1. " *", means this data is the worst emission level.
2. C.F (Correction Factor) = Antenna Factor (dB/m) + Cable Loss (dB).
3. Measurement (dBuV/m) = Reading(dBuV) + C.F (Correction Factor).
4. The emission levels of other frequencies are very lower than the limit and not show in test report.

EUT	AX3000 Ceiling Mount Wi-Fi 6 Access Point	Date of Test	2023-03-22
Factor	DRH18-E	Temp. / Humidity	22°C /63%
Polarity	Vertical	Site / Test Engineer	AC2 / Marvin
Test Mode	802.11ax-40MHz_TX_CH 3_ANT 0+1	Test Voltage	AC 120V/60Hz

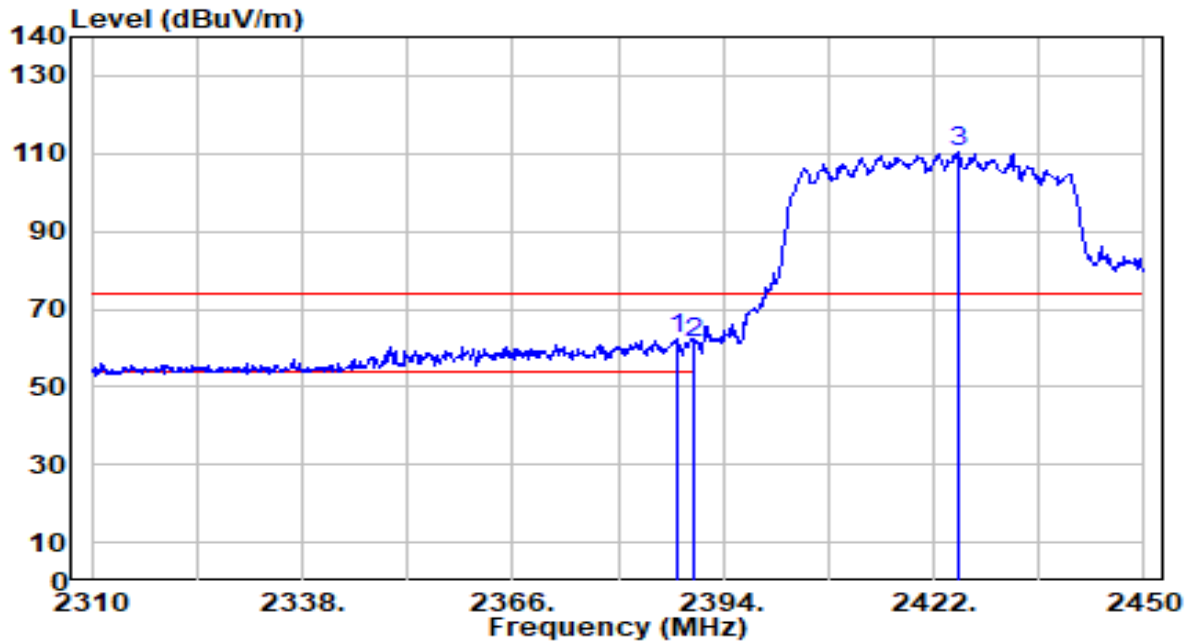

No	Frequency (MHz)	Reading (dBUV)	C.F (dB/m)	Measurement (dBUV/m)	Margin (dB)	Limit (dBUV/m)	Height (cm)	Angle (deg)	Remark (QP/PK/AV)	
1	*	2387.980	32.40	29.99	62.39	-11.61	74.00	346	178	Peak
2		2390.000	31.05	29.99	61.05	-12.95	74.00	346	178	Peak
3		2425.360	80.21	30.09	110.30	N/A	N/A	346	178	Peak

Note:

1. " *", means this data is the worst emission level.
2. C.F (Correction Factor) = Antenna Factor (dB/m) + Cable Loss (dB).
3. Measurement (dBUV/m) = Reading(dBUV) + C.F (Correction Factor).
4. The emission levels of other frequencies are very lower than the limit and not show in test report.

EUT	AX3000 Ceiling Mount Wi-Fi 6 Access Point	Date of Test	2023-03-22
Factor	DRH18-E	Temp. / Humidity	22°C /63%
Polarity	Vertical	Site / Test Engineer	AC2 / Marvin
Test Mode	802.11ax-40MHz_TX_CH 3_ANT 0+1	Test Voltage	AC 120V/60Hz

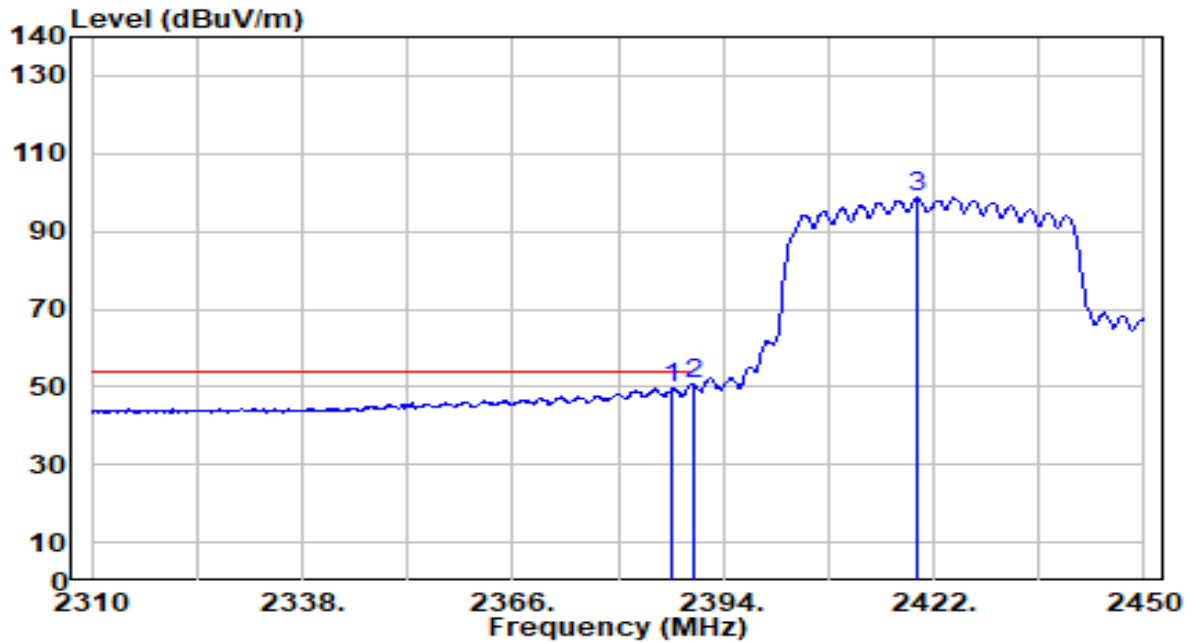

No	Frequency (MHz)	Reading (dBUV)	C.F (dB/m)	Measurement (dBUV/m)	Margin (dB)	Limit (dBUV/m)	Height (cm)	Angle (deg)	Remark (QP/PK/AV)
1	2387.280	19.87	29.99	49.86	-4.14	54.00	346	178	Average
2	* 2390.000	20.82	29.99	50.81	-3.19	54.00	346	178	Average
3	2419.760	68.52	30.07	98.59	N/A	N/A	346	178	Average

Note:

1. " *", means this data is the worst emission level.
2. C.F (Correction Factor) = Antenna Factor (dB/m) + Cable Loss (dB).
3. Measurement (dBUV/m) = Reading(dBUV) + C.F (Correction Factor).
4. The emission levels of other frequencies are very lower than the limit and not show in test report.

EUT	AX3000 Ceiling Mount Wi-Fi 6 Access Point	Date of Test	2023-03-22
Factor	DRH18-E	Temp. / Humidity	22°C /63%
Polarity	Horizontal	Site / Test Engineer	AC2 / Marvin
Test Mode	802.11ax-40MHz_TX_CH 6_ANT 0+1	Test Voltage	AC 120V/60Hz

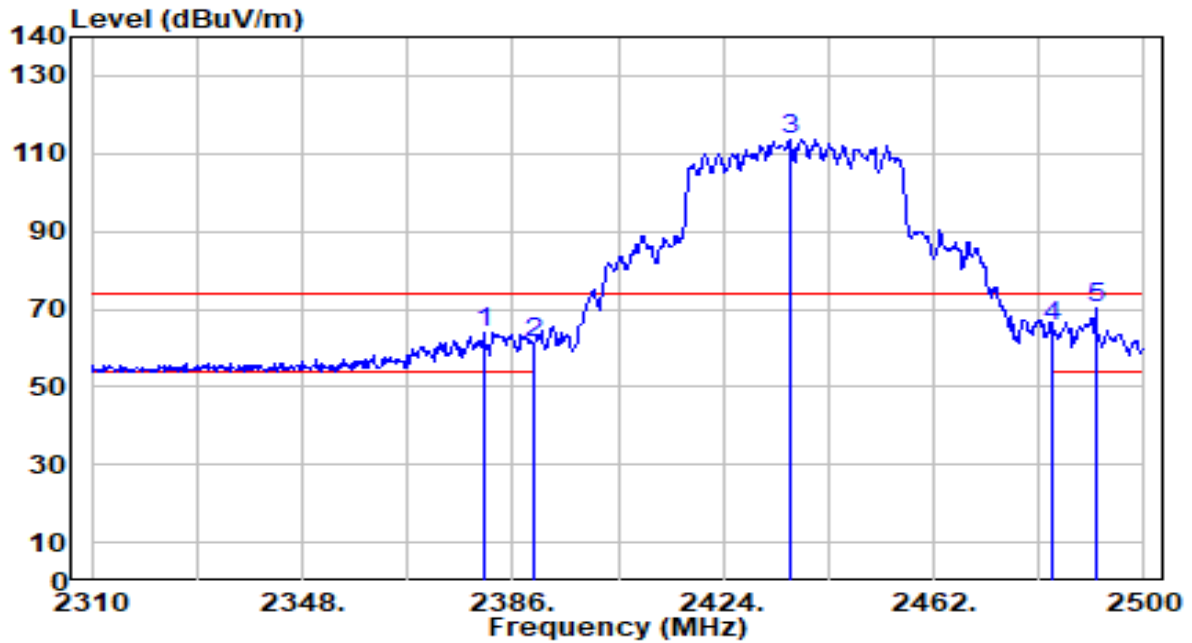

No	Frequency (MHz)	Reading (dBuV)	C.F (dB/m)	Measurement (dBuV/m)	Margin (dB)	Limit (dBuV/m)	Height (cm)	Angle (deg)	Remark (QP/PK/AV)
1	2380.870	34.04	29.98	64.02	-9.98	74.00	100	224	Peak
2	2390.000	31.55	29.99	61.55	-12.45	74.00	100	224	Peak
3	2435.970	83.58	30.13	113.71	N/A	N/A	100	224	Peak
4	2483.500	35.21	30.29	65.50	-8.50	74.00	100	224	Peak
5	* 2491.260	39.97	30.31	70.28	-3.72	74.00	100	224	Peak

Note:

1. " *", means this data is the worst emission level.
2. C.F (Correction Factor) = Antenna Factor (dB/m) + Cable Loss (dB).
3. Measurement (dBuV/m) = Reading(dBuV) + C.F (Correction Factor).
4. The emission levels of other frequencies are very lower than the limit and not show in test report.

EUT	AX3000 Ceiling Mount Wi-Fi 6 Access Point	Date of Test	2023-03-22
Factor	DRH18-E	Temp. / Humidity	22°C /63%
Polarity	Horizontal	Site / Test Engineer	AC2 / Marvin
Test Mode	802.11ax-40MHz_TX_CH 6_ANT 0+1	Test Voltage	AC 120V/60Hz

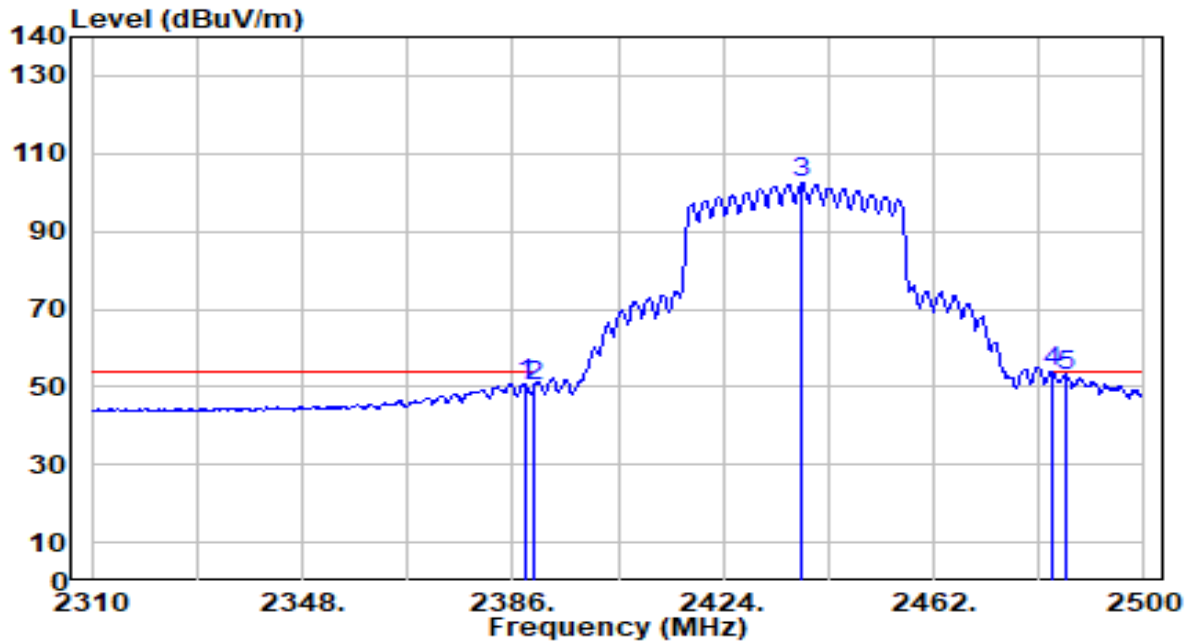

No	Frequency (MHz)	Reading (dBuV)	C.F (dB/m)	Measurement (dBuV/m)	Margin (dB)	Limit (dBuV/m)	Height (cm)	Angle (deg)	Remark (QP/PK/AV)
1	2388.280	20.86	29.99	50.86	-3.14	54.00	100	224	Average
2	2390.000	20.05	29.99	50.04	-3.96	54.00	100	224	Average
3	2438.250	72.44	30.13	102.57	N/A	N/A	100	224	Average
4	* 2483.500	23.62	30.29	53.90	-0.10	54.00	100	224	Average
5	2485.940	22.78	30.29	53.07	-0.93	54.00	100	224	Average

Note:

1. " *", means this data is the worst emission level.
2. C.F (Correction Factor) = Antenna Factor (dB/m) + Cable Loss (dB).
3. Measurement (dBuV/m) = Reading(dBuV) + C.F (Correction Factor).
4. The emission levels of other frequencies are very lower than the limit and not show in test report.

EUT	AX3000 Ceiling Mount Wi-Fi 6 Access Point	Date of Test	2023-03-22
Factor	DRH18-E	Temp. / Humidity	22°C /63%
Polarity	Vertical	Site / Test Engineer	AC2 / Marvin
Test Mode	802.11ax-40MHz_TX_CH 6_ANT 0+1	Test Voltage	AC 120V/60Hz

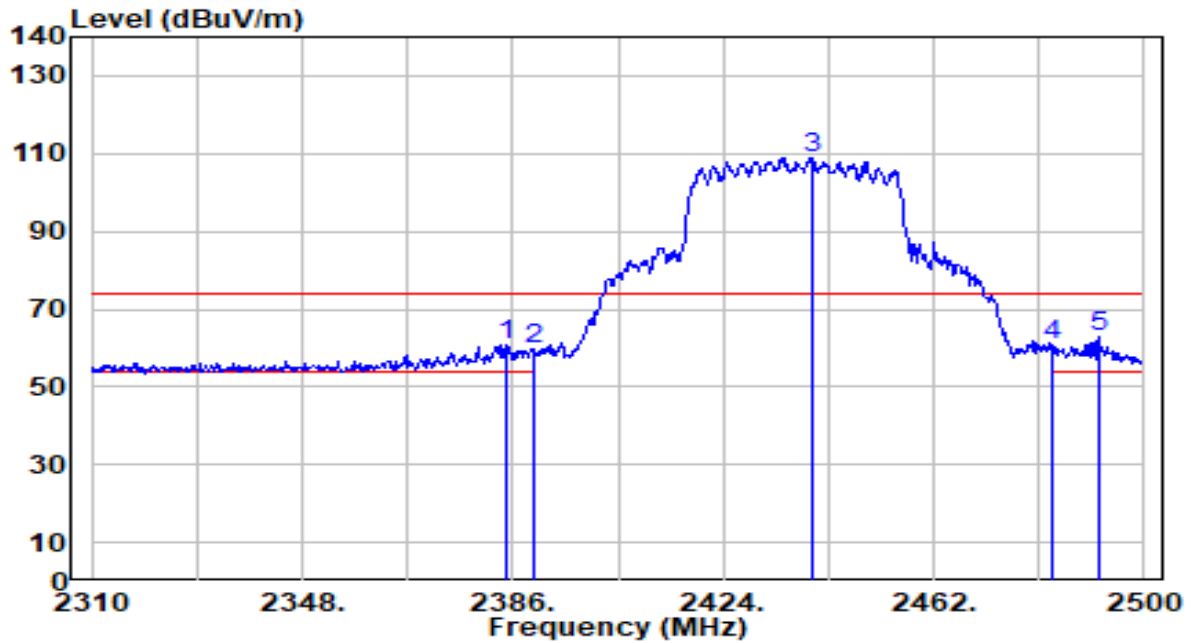

No	Frequency (MHz)	Reading (dBuV)	C.F (dB/m)	Measurement (dBuV/m)	Margin (dB)	Limit (dBuV/m)	Height (cm)	Angle (deg)	Remark (QP/PK/AV)
1	2384.670	30.72	29.99	60.70	-13.30	74.00	342	180	Peak
2	2390.000	29.55	29.99	59.55	-14.45	74.00	342	180	Peak
3	2439.960	78.92	30.14	109.06	N/A	N/A	342	180	Peak
4	2483.500	30.35	30.29	60.63	-13.37	74.00	342	180	Peak
5	* 2491.640	32.43	30.31	62.74	-11.26	74.00	342	180	Peak

Note:

1. " *", means this data is the worst emission level.
2. C.F (Correction Factor) = Antenna Factor (dB/m) + Cable Loss (dB).
3. Measurement (dBuV/m) = Reading(dBuV) + C.F (Correction Factor).
4. The emission levels of other frequencies are very lower than the limit and not show in test report.

EUT	AX3000 Ceiling Mount Wi-Fi 6 Access Point	Date of Test	2023-03-22
Factor	DRH18-E	Temp. / Humidity	22°C /63%
Polarity	Vertical	Site / Test Engineer	AC2 / Marvin
Test Mode	802.11ax-40MHz_TX_CH 6_ANT 0+1	Test Voltage	AC 120V/60Hz

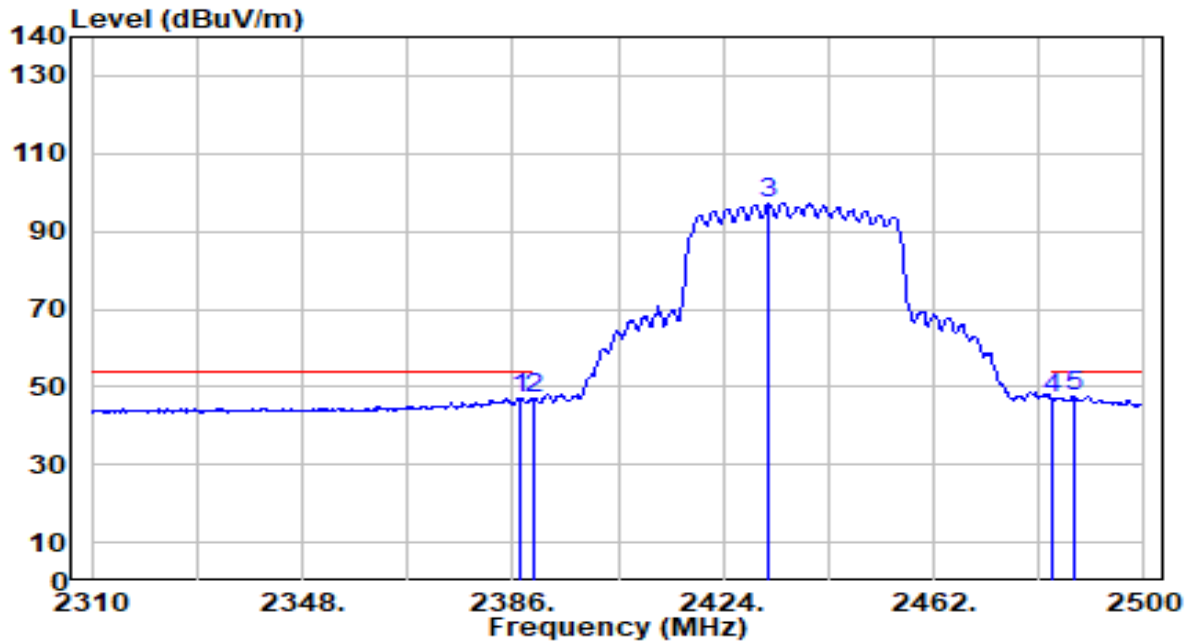

No	Frequency (MHz)	Reading (dBuV)	C.F (dB/m)	Measurement (dBuV/m)	Margin (dB)	Limit (dBuV/m)	Height (cm)	Angle (deg)	Remark (QP/PK/AV)
1	2387.140	17.06	29.99	47.05	-6.95	54.00	342	180	Average
2	2390.000	17.21	29.99	47.20	-6.80	54.00	342	180	Average
3	2431.980	67.20	30.11	97.31	N/A	N/A	342	180	Average
4	2483.500	16.71	30.29	47.00	-7.00	54.00	342	180	Average
5	* 2487.460	17.38	30.30	47.68	-6.32	54.00	342	180	Average

Note:

1. " *", means this data is the worst emission level.
2. C.F (Correction Factor) = Antenna Factor (dB/m) + Cable Loss (dB).
3. Measurement (dBuV/m) = Reading(dBuV) + C.F (Correction Factor).
4. The emission levels of other frequencies are very lower than the limit and not show in test report.

EUT	AX3000 Ceiling Mount Wi-Fi 6 Access Point	Date of Test	2023-03-22
Factor	DRH18-E	Temp. / Humidity	22°C /63%
Polarity	Horizontal	Site / Test Engineer	AC2 / Marvin
Test Mode	802.11ax-40MHz_TX_CH 9_ANT 0+1	Test Voltage	AC 120V/60Hz

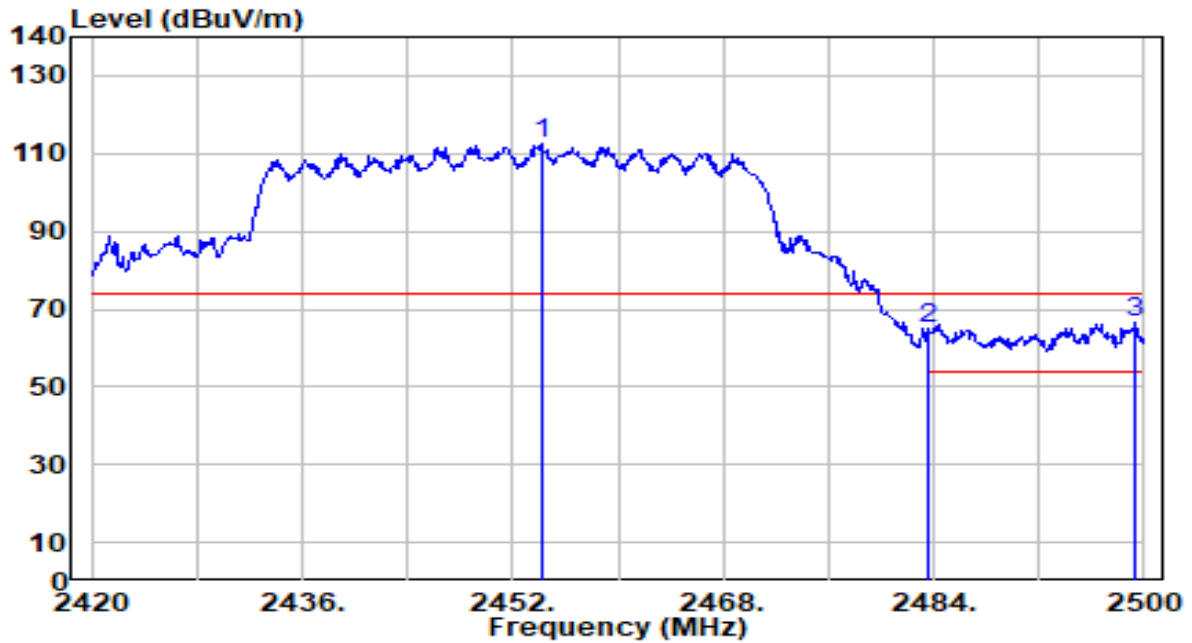

No	Frequency (MHz)	Reading (dBUV)	C.F (dB/m)	Measurement (dBUV/m)	Margin (dB)	Limit (dBUV/m)	Height (cm)	Angle (deg)	Remark (QP/PK/AV)
1	2454.240	82.59	30.19	112.77	N/A	N/A	200	230	Peak
2	2483.500	34.79	30.29	65.07	-8.93	74.00	200	230	Peak
3	* 2499.280	36.24	30.34	66.57	-7.43	74.00	200	230	Peak

Note:

1. " *", means this data is the worst emission level.
2. C.F (Correction Factor) = Antenna Factor (dB/m) + Cable Loss (dB).
3. Measurement (dBUV/m) = Reading(dBUV) + C.F (Correction Factor).
4. The emission levels of other frequencies are very lower than the limit and not show in test report.

EUT	AX3000 Ceiling Mount Wi-Fi 6 Access Point	Date of Test	2023-03-22
Factor	DRH18-E	Temp. / Humidity	22°C /63%
Polarity	Horizontal	Site / Test Engineer	AC2 / Marvin
Test Mode	802.11ax-40MHz_TX_CH 9_ANT 0+1	Test Voltage	AC 120V/60Hz

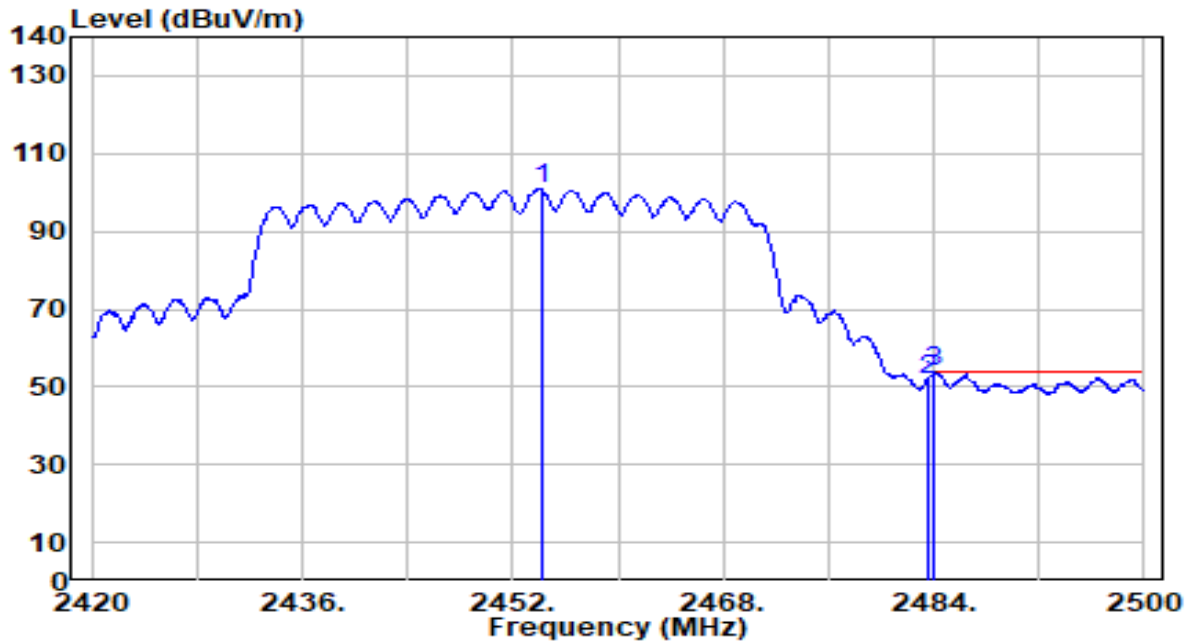

No	Frequency (MHz)	Reading (dBUV)	C.F (dB/m)	Measurement (dBUV/m)	Margin (dB)	Limit (dBUV/m)	Height (cm)	Angle (deg)	Remark (QP/PK/AV)
1	2454.160	70.59	30.19	100.77	N/A	N/A	200	230	Average
2	2483.500	21.73	30.29	52.01	-1.99	54.00	200	230	Average
3	* 2484.000	23.58	30.29	53.87	-0.13	54.00	200	230	Average

Note:

1. " *", means this data is the worst emission level.
2. C.F (Correction Factor) = Antenna Factor (dB/m) + Cable Loss (dB).
3. Measurement (dBUV/m) = Reading(dBUV) + C.F (Correction Factor).
4. The emission levels of other frequencies are very lower than the limit and not show in test report.

EUT	AX3000 Ceiling Mount Wi-Fi 6 Access Point	Date of Test	2023-03-22
Factor	DRH18-E	Temp. / Humidity	22°C /63%
Polarity	Vertical	Site / Test Engineer	AC2 / Marvin
Test Mode	802.11ax-40MHz_TX_CH 9_ANT 0+1	Test Voltage	AC 120V/60Hz

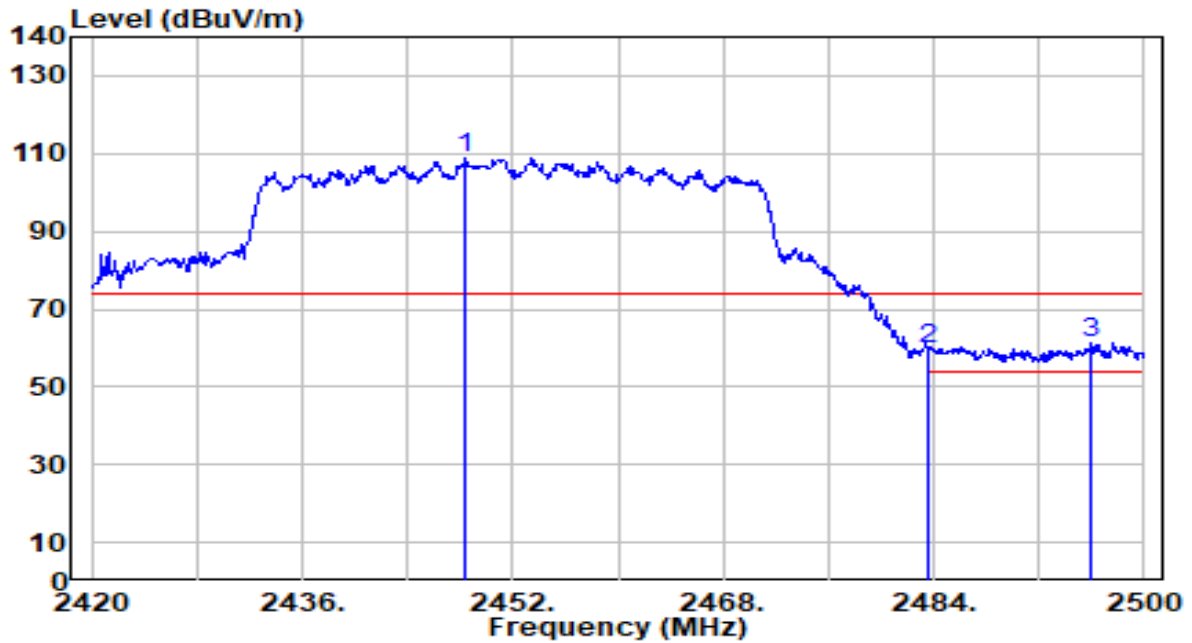

No	Frequency (MHz)	Reading (dBuV)	C.F (dB/m)	Measurement (dBuV/m)	Margin (dB)	Limit (dBuV/m)	Height (cm)	Angle (deg)	Remark (QP/PK/AV)
1	2448.400	78.71	30.17	108.88	N/A	N/A	337	180	Peak
2	2483.500	29.45	30.29	59.74	-14.26	74.00	337	180	Peak
3	* 2496.000	31.10	30.33	61.43	-12.57	74.00	337	180	Peak

Note:

1. " *", means this data is the worst emission level.
2. C.F (Correction Factor) = Antenna Factor (dB/m) + Cable Loss (dB).
3. Measurement (dBuV/m) = Reading(dBuV) + C.F (Correction Factor).
4. The emission levels of other frequencies are very lower than the limit and not show in test report.

EUT	AX3000 Ceiling Mount Wi-Fi 6 Access Point	Date of Test	2023-03-22
Factor	DRH18-E	Temp. / Humidity	22°C /63%
Polarity	Vertical	Site / Test Engineer	AC2 / Marvin
Test Mode	802.11ax-40MHz_TX_CH 9_ANT 0+1	Test Voltage	AC 120V/60Hz

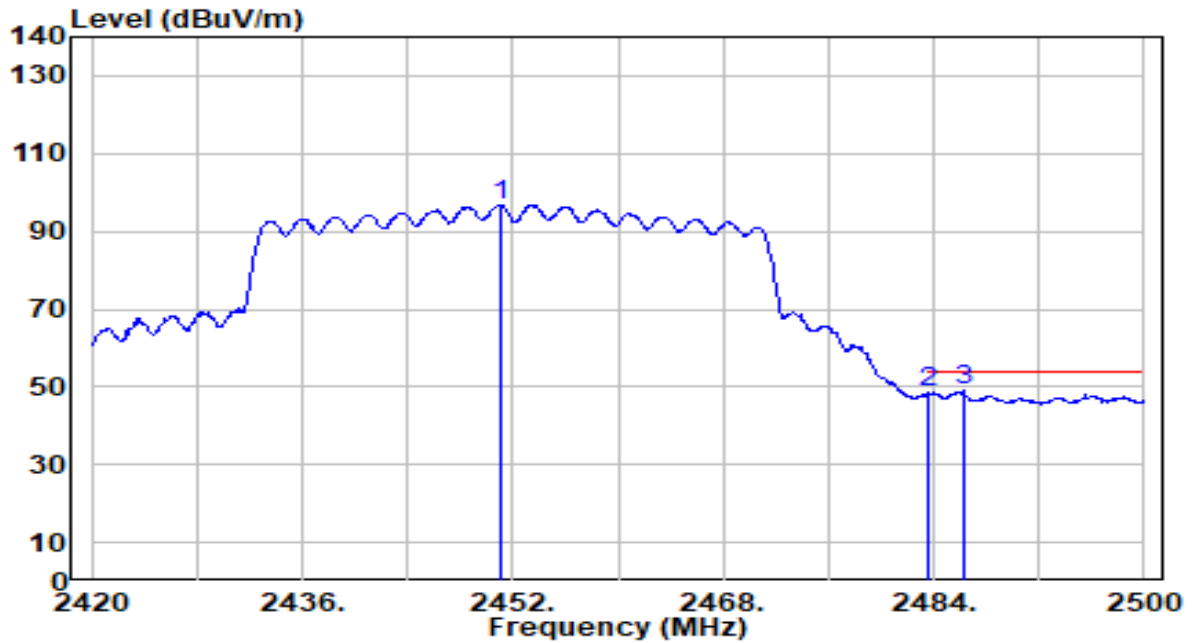

No	Frequency (MHz)	Reading (dBuV)	C.F (dB/m)	Measurement (dBuV/m)	Margin (dB)	Limit (dBuV/m)	Height (cm)	Angle (deg)	Remark (QP/PK/AV)
1	2451.120	66.70	30.18	96.88	N/A	N/A	337	180	Average
2	2483.500	18.24	30.29	48.52	-5.48	54.00	337	180	Average
3	* 2486.320	18.77	30.29	49.07	-4.93	54.00	337	180	Average

Note:

1. " *", means this data is the worst emission level.
2. C.F (Correction Factor) = Antenna Factor (dB/m) + Cable Loss (dB).
3. Measurement (dBuV/m) = Reading(dBuV) + C.F (Correction Factor).
4. The emission levels of other frequencies are very lower than the limit and not show in test report.

7.8. AC Conducted Emissions Measurement

7.8.1. Test Limit

FCC Part 15 Subpart C Paragraph 15.207 Limits		
Frequency (MHz)	QP (dBuV)	AV (dBuV)
0.15 - 0.50	66 - 56	56 - 46
0.50 - 5.0	56	46
5.0 - 30	60	50

Note 1: The lower limit shall apply at the transition frequencies.

Note 2: The limit decreases linearly with the logarithm of the frequency in the range 0.15MHz to 0.5MHz.

7.8.2. Test Setup

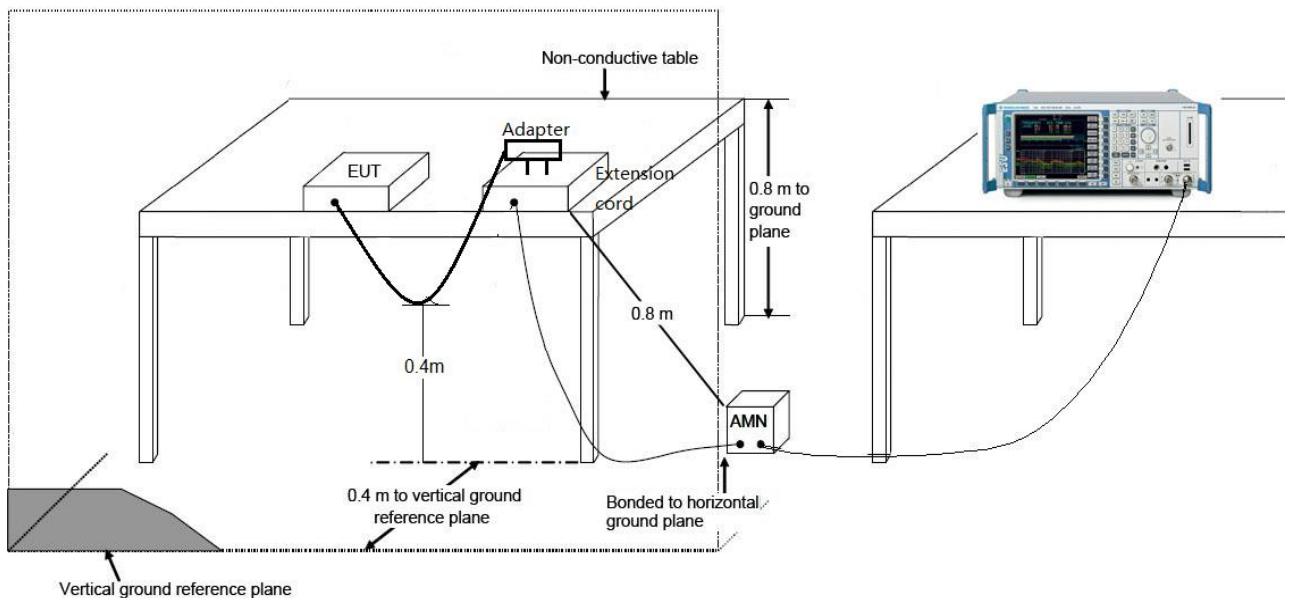

7.8.3. Test Result

EUT	AX3000 Ceiling Mount Wi-Fi 6 Access Point	Date of Test	2023-03-30
Factor	CE_ENV216-L1 (Filter ON)	Temp. / Humidity	23.7°C /61%
Polarity	Line1	Site / Test Engineer	SR2 / Amber
Test Mode	802.11n-20MHz_TX_CH 6_ANT 0+1	Test Voltage	AC 120V/60Hz

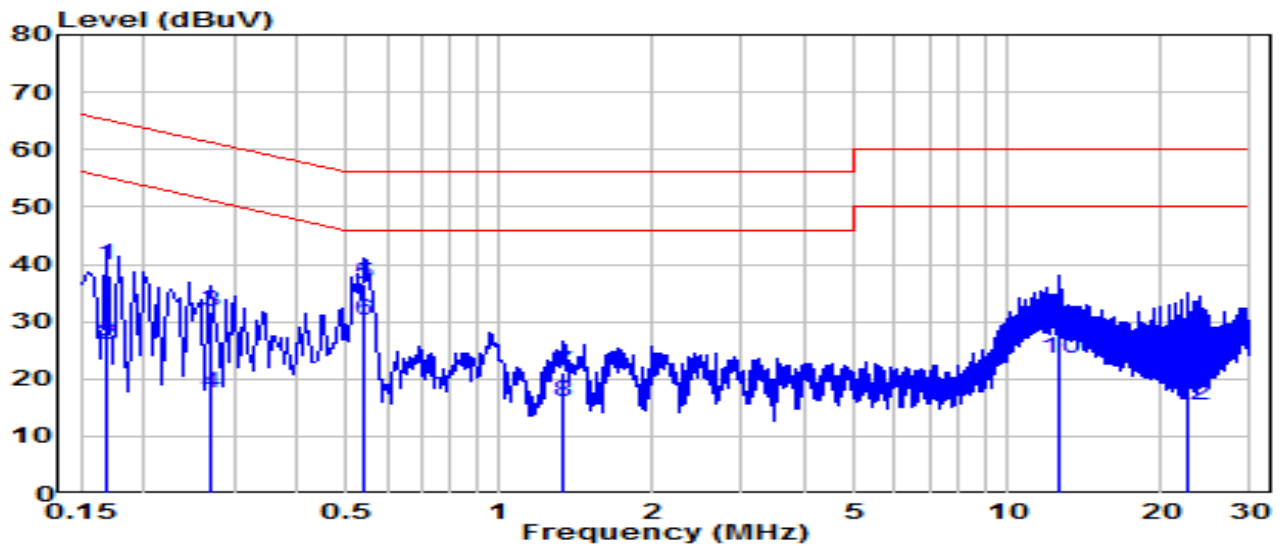

No	Frequency (MHz)	Reading (dBuV)	C.F (dB)	Measurement (dBuV)	Margin (dB)	Limit (dBuV)	Remark (QP/PK/AV)
1	0.168	30.24	9.62	39.86	-25.20	65.06	QP
2	0.168	16.35	9.62	25.97	-29.09	55.06	Average
3	0.271	21.93	9.63	31.56	-29.51	61.07	QP
4	0.271	7.73	9.63	17.36	-33.71	51.07	Average
5	* 0.541	26.87	9.64	36.51	-19.49	56.00	QP
6	* 0.541	20.50	9.64	30.14	-15.86	46.00	Average
7	1.338	11.54	9.68	21.21	-34.79	56.00	QP
8	1.338	6.35	9.68	16.03	-29.97	46.00	Average
9	12.587	19.41	9.88	29.28	-30.72	60.00	QP
10	12.587	13.64	9.88	23.52	-26.48	50.00	Average
11	22.711	16.03	9.92	25.95	-34.05	60.00	QP
12	22.711	5.60	9.92	15.52	-34.48	50.00	Average

Note:

1. " *", means this data is the worst emission level.
2. C.F (Correction Factor) = LISN Factor (dB)+ Cable Loss (dB).
3. Measurement (dBuV) = Reading(dBuV) + C.F (Correction Factor).

EUT	AX3000 Ceiling Mount Wi-Fi 6 Access Point	Date of Test	2023-03-30
Factor	CE_ENV216-N (Filter ON)	Temp. / Humidity	23.7°C /61%
Polarity	Neutral	Site / Test Engineer	SR2 / Amber
Test Mode	802.11n-20MHz_TX_CH 6_ANT 0+1	Test Voltage	AC 120V/60Hz

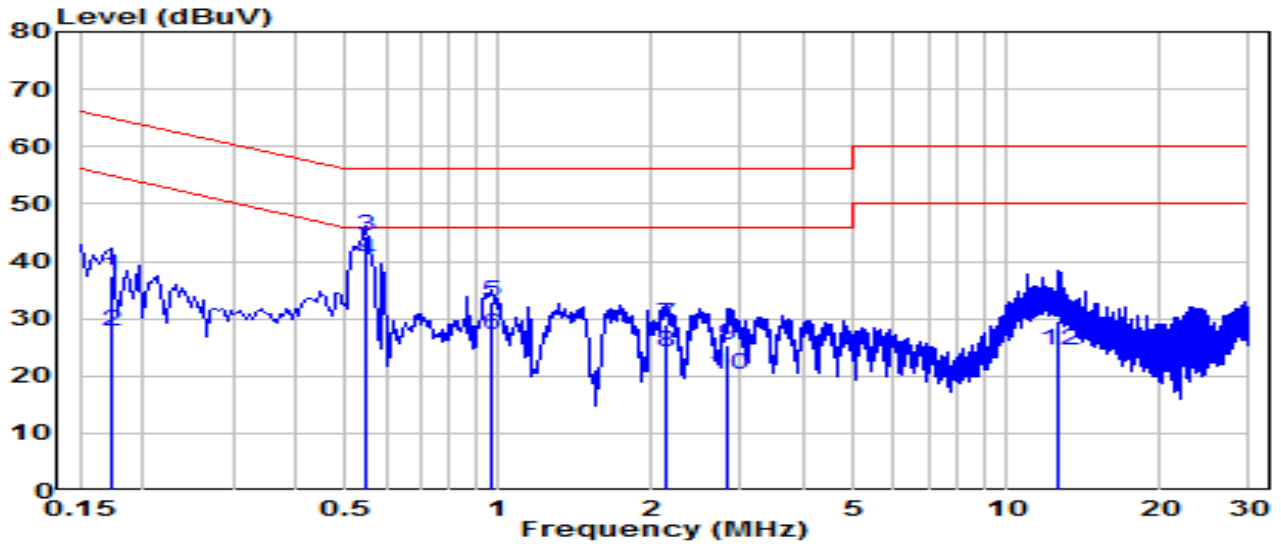

No	Frequency (MHz)	Reading (dBuV)	C.F (dB)	Measurement (dBuV)	Margin (dB)	Limit (dBuV)	Remark (QP/PK/AV)
1	0.172	27.96	9.62	37.58	-27.26	64.84	QP
2	0.172	18.05	9.62	27.67	-27.17	54.84	Average
3	* 0.546	34.80	9.64	44.45	-11.55	56.00	QP
4	* 0.546	30.43	9.64	40.08	-5.92	46.00	Average
5	0.969	23.15	9.67	32.82	-23.18	56.00	QP
6	0.969	17.53	9.67	27.20	-18.80	46.00	Average
7	2.134	19.37	9.69	29.06	-26.94	56.00	QP
8	2.134	14.44	9.69	24.14	-21.86	46.00	Average
9	2.809	15.65	9.71	25.35	-30.65	56.00	QP
10	2.809	10.43	9.71	20.14	-25.86	46.00	Average
11	12.609	19.67	9.90	29.57	-30.43	60.00	QP
12	12.609	14.50	9.90	24.40	-25.60	50.00	Average

Note:

1. " *", means this data is the worst emission level.
2. C.F (Correction Factor) = LISN Factor (dB)+ Cable Loss (dB).
3. Measurement (dBuV) = Reading(dBuV) + C.F (Correction Factor).

EUT	AX3000 Ceiling Mount Wi-Fi 6 Access Point	Date of Test	2023-03-30
Factor	CE_ENV216-L1 (Filter ON)	Temp. / Humidity	23.7°C /61%
Polarity	Line1	Site / Test Engineer	SR2 / Amber
Test Mode	802.11n-20MHz_TX_CH 6_ANT 0+1	Test Voltage	AC 240V/60Hz

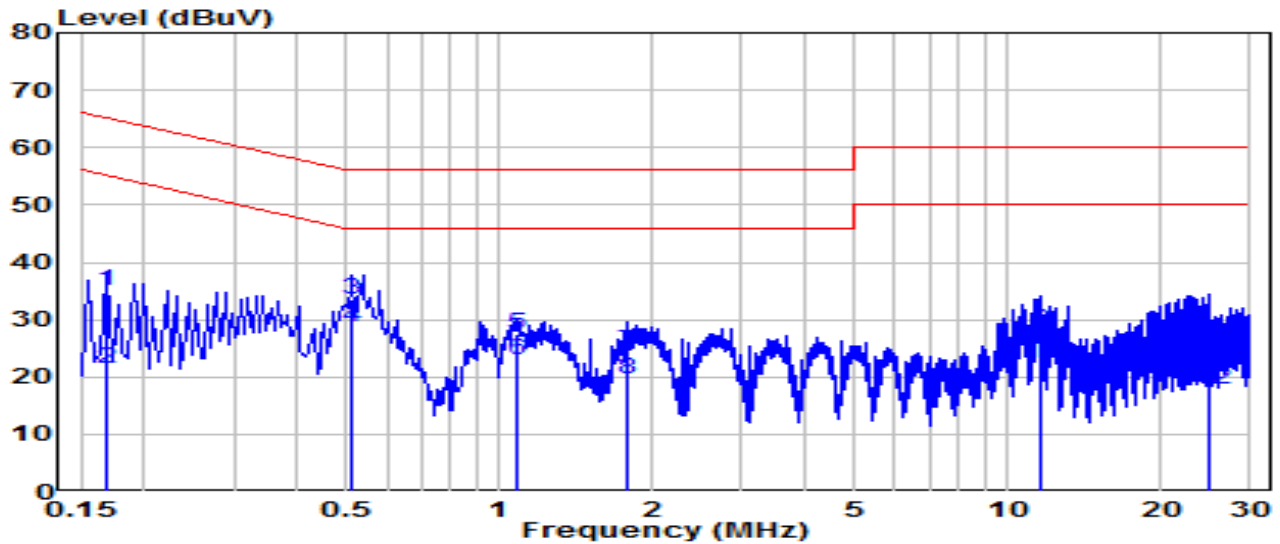

No	Frequency (MHz)	Reading (dBuV)	C.F (dB)	Measurement (dBuV)	Margin (dB)	Limit (dBuV)	Remark (QP/PK/AV)
1	0.168	25.44	9.62	35.06	-30.00	65.06	QP
2	0.168	11.90	9.62	21.52	-33.54	55.06	Average
3	* 0.514	24.00	9.64	33.64	-22.36	56.00	QP
4	* 0.514	18.91	9.64	28.55	-17.45	46.00	Average
5	1.081	17.82	9.67	27.49	-28.51	56.00	QP
6	1.081	13.18	9.67	22.85	-23.15	46.00	Average
7	1.779	14.86	9.69	24.54	-31.46	56.00	QP
8	1.779	9.96	9.69	19.65	-26.35	46.00	Average
9	11.606	18.35	9.87	28.22	-31.78	60.00	QP
10	11.606	12.48	9.87	22.35	-27.65	50.00	Average
11	25.046	15.08	9.91	24.99	-35.01	60.00	QP
12	25.046	7.97	9.91	17.88	-32.12	50.00	Average

Note:

- "*" means this data is the worst emission level.
- C.F (Correction Factor) = LISN Factor (dB)+ Cable Loss (dB).
- Measurement (dBuV) = Reading(dBuV) + C.F (Correction Factor).

EUT	AX3000 Ceiling Mount Wi-Fi 6 Access Point	Date of Test	2023-03-30
Factor	CE_ENV216-N (Filter ON)	Temp. / Humidity	23.7°C /61%
Polarity	Neutral	Site / Test Engineer	SR2 / Amber
Test Mode	802.11n-20MHz_TX_CH 6_ANT 0+1	Test Voltage	AC 240V/60Hz

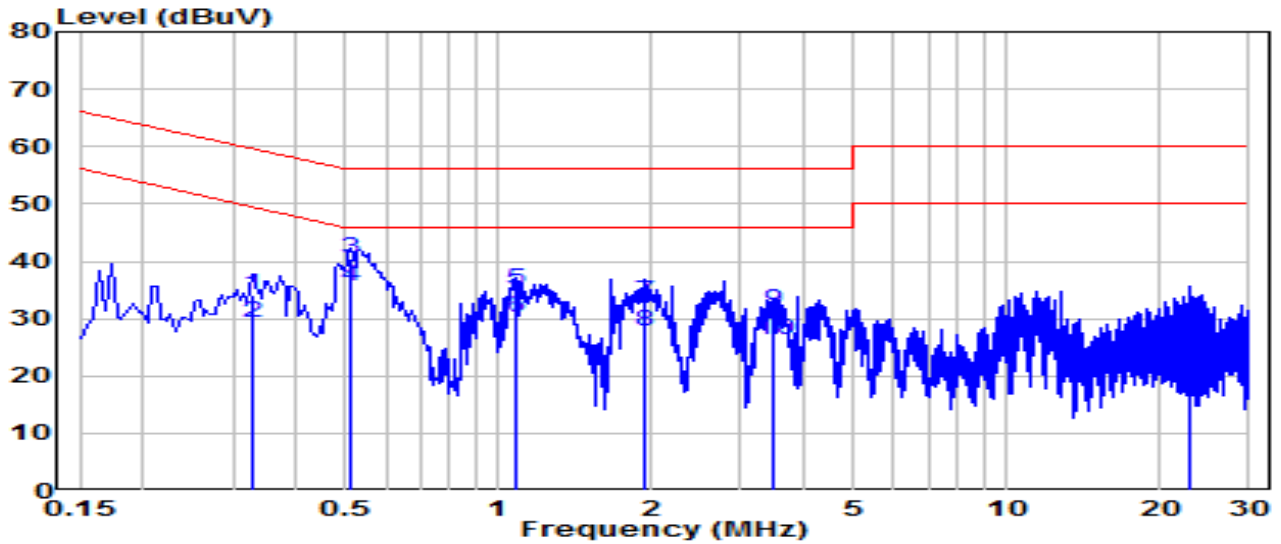

No	Frequency (MHz)	Reading (dBuV)	C.F (dB)	Measurement (dBuV)	Margin (dB)	Limit (dBuV)	Remark (QP/PK/AV)
1	0.330	24.54	9.63	34.17	-25.28	59.45	QP
2	0.330	19.65	9.63	29.28	-20.17	49.45	Average
3	* 0.514	30.81	9.64	40.46	-15.54	56.00	QP
4	* 0.514	26.09	9.64	35.73	-10.27	46.00	Average
5	1.077	25.47	9.67	35.14	-20.86	56.00	QP
6	1.077	20.43	9.67	30.11	-15.89	46.00	Average
7	1.950	23.30	9.69	32.99	-23.01	56.00	QP
8	1.950	18.02	9.69	27.71	-18.29	46.00	Average
9	3.480	21.57	9.72	31.29	-24.71	56.00	QP
10	3.480	16.47	9.72	26.19	-19.81	46.00	Average
11	23.071	18.42	10.01	28.43	-31.57	60.00	QP
12	23.071	7.00	10.01	17.01	-32.99	50.00	Average

Note:

1. " *", means this data is the worst emission level.
2. C.F (Correction Factor) = LISN Factor (dB)+ Cable Loss (dB).
3. Measurement (dBuV) = Reading(dBuV) + C.F (Correction Factor).

8. CONCLUSION

The data collected relate only the item(s) tested and show that the device is compliance with Part 15C of the FCC Rules.

————— The End —————

Appendix A : Test Setup Photograph

Refer to “2303TW0117-UT” file.

Appendix B : External Photograph

Refer to “2303TW0117-UE” file.

Appendix C : Internal Photograph

Refer to “2303TW0117-UI” file.

————— The End —————