

FCC Radio Test Report

FCC ID: 2AXJ4EAP620HDV3

This report concerns: Original Grant

Project No. : 2111C164
Equipment : AX1800 Ceiling Mount Wi-Fi 6 Access Point
Brand Name : tp-link
Test Model : EAP620 HD
Series Model : N/A
Applicant : TP-Link Corporation Limited
Address : Room 901, 9/F. , New East Ocean Centre, 9 Science Museum Road, Tsim Sha Tsui, Kowloon, Hong Kong
Manufacturer : TP-Link Corporation Limited
Address : Room 901, 9/F. , New East Ocean Centre, 9 Science Museum Road, Tsim Sha Tsui, Kowloon, Hong Kong
Date of Receipt : Dec. 20, 2021
Date of Test : Dec. 22, 2021 ~ Jan. 24, 2022
Issued Date : Feb. 08, 2022
Report Version : R00
Test Sample : Engineering Sample No.: DG2021122114 for conducted and radiated emissions-9kHz to 30 MHz, DG2021122113 for radiated.
Standard(s) : FCC CFR Title 47, Part 15, Subpart E
FCC KDB 789033 D02 General UNII Test Procedures New Rules v02r01
FCC KDB 662911 D01 Multiple Transmitter Output v02r01
ANSI C63.10-2013

The above equipment has been tested and found compliance with the requirement of the relative standards by BTL Inc.



Prepared by : Antony Liang



Approved by : Chay Cai



TESTING CERT #5123.02

Add: No. 3 Jinshagang 1st Rd. Shixia, Dalang Town Dongguan City, Guangdong 523792

People's Republic of China

Tel: +86-769-8318-3000

Web: www.newbtl.com

Declaration

BTL represents to the client that testing is done in accordance with standard procedures as applicable and that test instruments used has been calibrated with standards traceable to international standard(s) and/or national standard(s).

BTL's reports apply only to the specific samples tested under conditions. It is manufacture's responsibility to ensure that additional production units of this model are manufactured with the identical electrical and mechanical components. **BTL** shall have no liability for any declarations, inferences or generalizations drawn by the client or others from **BTL** issued reports.

The report must not be used by the client to claim product certification, approval, or endorsement by NVLAP, NIST, A2LA, or any agency of the U.S. Government.

This report is the confidential property of the client. As a mutual protection to the clients, the public and ourselves, the test report shall not be reproduced, except in full, without our written approval.

BTL's laboratory quality assurance procedures are in compliance with the **ISO/IEC 17025** requirements, and accredited by the conformity assessment authorities listed in this test report.

BTL is not responsible for the sampling stage, so the results only apply to the sample as received.

The information, data and test plan are provided by manufacturer which may affect the validity of results, so it is manufacturer's responsibility to ensure that the apparatus meets the essential requirements of applied standards and in all the possible configurations as representative of its intended use.

Limitation

For the use of the authority's logo is limited unless the Test Standard(s)/Scope(s)/Item(s) mentioned in this test report is (are) included in the conformity assessment authorities acceptance respective.

Please note that the measurement uncertainty is provided for informational purpose only and are not use in determining the Pass/Fail results.

Table of Contents	Page
REPORT ISSUED HISTORY	6
1 . SUMMARY OF TEST RESULTS	7
1.1 TEST FACILITY	8
1.2 MEASUREMENT UNCERTAINTY	8
1.3 TEST ENVIRONMENT CONDITIONS	9
2 . GENERAL INFORMATION	10
2.1 GENERAL DESCRIPTION OF EUT	10
2.2 TEST MODES	13
2.3 PARAMETERS OF TEST SOFTWARE	16
2.4 DUTY CYCLE	17
2.5 BLOCK DIAGRAM SHOWING THE CONFIGURATION OF SYSTEM TESTED	20
2.6 SUPPORT UNITS	20
3 . AC POWER LINE CONDUCTED EMISSIONS	21
3.1 LIMIT	21
3.2 TEST PROCEDURE	21
3.3 DEVIATION FROM TEST STANDARD	21
3.4 TEST SETUP	22
3.5 EUT OPERATION CONDITIONS	22
3.6 TEST RESULTS	22
4 . RADIATED EMISSIONS	23
4.1 LIMIT	23
4.2 TEST PROCEDURE	24
4.3 DEVIATION FROM TEST STANDARD	25
4.4 TEST SETUP	25
4.5 EUT OPERATION CONDITIONS	26
4.6 TEST RESULTS - 9 KHZ TO 30 MHZ	26
4.7 TEST RESULTS - 30 MHZ TO 1000 MHZ	26
4.8 TEST RESULTS - ABOVE 1000 MHZ	26
5 . BANDWIDTH	27
5.1 LIMIT	27
5.2 TEST PROCEDURE	27
5.3 DEVIATION FROM STANDARD	27
5.4 TEST SETUP	27

Table of Contents	Page
5.5 EUT OPERATION CONDITIONS	27
5.6 TEST RESULTS	27
6 . MAXIMUM OUTPUT POWER	28
6.1 LIMIT	28
6.2 TEST PROCEDURE	28
6.3 DEVIATION FROM STANDARD	28
6.4 TEST SETUP	28
6.5 EUT OPERATION CONDITIONS	28
6.6 TEST RESULTS	28
7 . POWER SPECTRAL DENSITY	29
7.1 LIMIT	29
7.2 TEST PROCEDURE	29
7.3 DEVIATION FROM STANDARD	29
7.4 TEST SETUP	30
7.5 EUT OPERATION CONDITIONS	30
7.6 TEST RESULTS	30
8 . FREQUENCY STABILITY	31
8.1 LIMIT	31
8.2 TEST PROCEDURE	31
8.3 DEVIATION FROM STANDARD	31
8.4 TEST SETUP	31
8.5 EUT OPERATION CONDITIONS	31
8.6 TEST RESULTS	31
9 . MEASUREMENT INSTRUMENTS LIST	32
10 . EUT TEST PHOTOS	34
APPENDIX A - AC POWER LINE CONDUCTED EMISSIONS	39
APPENDIX B - RADIATED EMISSION - 9 KHZ TO 30 MHZ	42
APPENDIX C - RADIATED EMISSION - 30 MHZ TO 1000 MHZ	47
APPENDIX D - RADIATED EMISSION - ABOVE 1000 MHZ	50
APPENDIX E - BANDWIDTH	171
APPENDIX F - MAXIMUM OUTPUT POWER	186
APPENDIX G - POWER SPECTRAL DENSITY	213

Table of Contents**Page****APPENDIX H - FREQUENCY STABILITY****234**

REPORT ISSUED HISTORY

Report Version	Description	Issued Date
R00	Original Issue.	Feb. 08, 2022

1. SUMMARY OF TEST RESULTS

Test procedures according to the technical standard(s):

FCC CFR Title 47, Part 15, Subpart E				
Standard(s) Section	Test Item	Test Result	Judgment	Remark
15.207 15.407(b)	AC Power Line Conducted Emissions	APPENDIX A	PASS	-----
15.407(b) 15.205(a) 15.209(a)	Radiated Emissions	APPENDIX B APPENDIX C APPENDIX D	PASS	-----
15.407(a) 15.407(e)	Bandwidth	APPENDIX E	PASS	-----
15.407(a)	Maximum Output Power	APPENDIX F	PASS	-----
15.407(a)	Power Spectral Density	APPENDIX G	PASS	-----
15.407(g)	Frequency Stability	APPENDIX H	PASS	-----
15.203	Antenna Requirements	-----	PASS	NOTE (2)
15.407(c)	Automatically Discontinue Transmission	-----	PASS	NOTE (3)

Note:

- (1) "N/A" denotes test is not applicable in this test report.
- (2) The device what use a permanently attached antenna were considered sufficient to comply with the provisions of 15.203.
- (3) During no any information transmission, the EUT can automatically discontinue transmission and become standby mode for power saving. the EUT can detect the controlling signal of ACK message transmitting from remote device and verify whether it shall resend or discontinue transmission.
- (4) For UNII-1 this device was functioned as a
 - Outdoor access point device
 - Indoor access point device
 - Fixed point-to-point access points device
 - Client device

1.1 TEST FACILITY

The test facilities used to collect the test data in this report is at the location of No. 3 Jinshagang 1st Rd. Shixia, Dalang Town Dongguan City, Guangdong 523792 People's Republic of China.

BTL's Registration Number for FCC: 357015

BTL's Designation Number for FCC: CN1240

1.2 MEASUREMENT UNCERTAINTY

ISO/IEC 17025 requires that an estimate of the measurement uncertainties associated with the emissions test results be included in the report. The measurement uncertainties given below are based on a 95% confidence level (based on a coverage factor (k=2))

The BTL measurement uncertainty as below table:

A. AC power line conducted emissions test:

Test Site	Method	Measurement Frequency Range	U,(dB)
DG-C02	CISPR	150kHz ~ 30MHz	2.60

B. Radiated emissions test:

Test Site	Method	Measurement Frequency Range	U,(dB)
DG-CB01	CISPR	9kHz ~ 30MHz	2.36

Test Site	Method	Measurement Frequency Range	Ant. H / V	U,(dB)
DG-CB03 (3m)	CISPR	30MHz ~ 200MHz	V	4.36
		30MHz ~ 200MHz	H	3.32
		200MHz ~ 1,000MHz	V	4.08
		200MHz ~ 1,000MHz	H	3.96

Test Site	Method	Measurement Frequency Range	U,(dB)
DG-CB03 (3m)	CISPR	1GHz ~ 6GHz	3.80
		6GHz ~ 18GHz	4.82

Test Site	Method	Measurement Frequency Range	U,(dB)
DG-CB03 (1m)	CISPR	18 ~ 26.5 GHz	3.62
		26.5 ~ 40 GHz	4.00

C. Other Measurement test:

Test Item	Uncertainty
Bandwidth	±3.8 %
Maximum Output Power	±0.95 dB
Power Spectral Density	±0.86 dB
Frequency Stability	±0.16 dB
Temperature	±0.08 °C
Humidity	±1.5%

Note: Unless specifically mentioned, the uncertainty of measurement has not been taken into account to declare the compliance or non-compliance to the specification.

1.3 TEST ENVIRONMENT CONDITIONS

Test Item	Temperature	Humidity	Test Voltage	Tested By
AC Power Line Conducted Emissions	23°C	60%	AC 120V/60Hz	Aries Tang
Radiated Emissions-9kHz to 30MHz	20°C	53%	AC 120V/60Hz	Torocat Yuan
Radiated Emissions-30MHz to 1000MHz	27°C	62%	AC 120V/60Hz	Jakyri Wen
Radiated Emissions-Above 1000 MHz	27°C	62%	AC 120V/60Hz	Jakyri Wen
Bandwidth	21°C	43%	AC120V/60Hz	Jesse Wang
Maximum Output Power	19.4°C-23.2°C	46%-48.8%	AC120V/60Hz	Longdage Feng
Power Spectral Density	21°C	43%	AC120V/60Hz	Jesse Wang
Frequency Stability	Normal & Extreme	43%	Normal & Extreme	Jesse Wang

2. GENERAL INFORMATION

2.1 GENERAL DESCRIPTION OF EUT

Equipment	AX1800 Ceiling Mount Wi-Fi 6 Access Point
Brand Name	tp-link
Test Model	EAP620 HD
Series Model	N/A
Model Difference(s)	N/A
Power Source	1# DC Voltage supplied from AC adapter. Model:T120150-2B1 2# Supplied from PoE.
Power Rating	1# I/P:100-240V~ 50/60Hz 0.6A O/P:12V \equiv 1.5A 2# 802.3at PoE: 42.5-57V \equiv 0.6A
Operation Frequency Band(s)	UNII-1: 5150 MHz ~ 5250 MHz UNII-3: 5725 MHz ~ 5850 MHz
Modulation Type	IEEE 802.11a/n/ac: OFDM IEEE 802.11ax: OFDMA
Bit Rate of Transmitter	IEEE 802.11a: 54/48/36/24/18/12/9/6 Mbps IEEE 802.11n: up to 300 Mbps IEEE 802.11ac: up to 866.7 Mbps IEEE 802.11ax: up to 1201 Mbps
Maximum Output Power UNII-1 Non Beamforming	IEEE 802.11ac(VHT20): 25.43 dBm (0.3491 W)
Maximum Output Power UNII-3 Non Beamforming	IEEE 802.11ac(VHT40): 25.40 dBm (0.3467 W)
Maximum Output Power UNII-1 Beamforming	IEEE 802.11ax(HE20): 24.89 dBm (0.3083 W)
Maximum Output Power UNII-3 Beamforming	IEEE 802.11ac(VHT20): 24.97 dBm (0.3141 W)

Note:

1. For a more detailed features description, please refer to the manufacturer's specifications or the user's manual.

2. Channel List:

IEEE 802.11a IEEE 802.11n(HT20) IEEE 802.11ac(VHT20) IEEE 802.11ax(HE20)		IEEE 802.11n(HT40) IEEE 802.11ac(VHT40) IEEE 802.11ax(HE40)		IEEE 802.11ac(VHT80) IEEE 802.11ax(HE80)	
UNII-1		UNII-1		UNII-1	
Channel	Frequency (MHz)	Channel	Frequency (MHz)	Channel	Frequency (MHz)
36	5180	38	5190	42	5210
40	5200	46	5230		
44	5220				
48	5240				

IEEE 802.11a IEEE 802.11n(HT20) IEEE 802.11ac(VHT20) IEEE 802.11ax(HE20)		IEEE 802.11n(HT40) IEEE 802.11ac(VHT40) IEEE 802.11ax(HE40)		IEEE 802.11ac(VHT80) IEEE 802.11ax(HE80)	
UNII-3		UNII-3		UNII-3	
Channel	Frequency (MHz)	Channel	Frequency (MHz)	Channel	Frequency (MHz)
149	5745	151	5755	155	5775
153	5765	159	5795		
157	5785				
161	5805				
165	5825				

3. Antenna Specification:

Ant.	Brand	Model Name	Antenna Type	Connector	Gain (dBi)
1	tp-link	N/A	PIFA	N/A	3
2	tp-link	N/A	PIFA	N/A	3

Note:

- 1) This EUT supports CDD, and all antennas have the same gain, Directional gain = $G_{ANT} + \text{Array Gain}$. For power measurements, Array Gain=0dB ($N_{ANT} \leq 4$), so the Directional gain=3. For power spectral density measurements, $N_{ANT}=2$, $N_{SS} = 1$. So the Directional gain= $G_{ANT} + \text{Array Gain} = G_{ANT} + 10\log(N_{ANT}/N_{SS})\text{dBi} = 3 + 10\log(2/1)\text{dBi} = 6.01$. Then, the UNII-1 power spectral density limit is $17 - (6.01 - 6) = 16.99$, the UNII-3 power spectral density limit is $30 - (6.01 - 6) = 29.99$.
- 2) Beamforming Gain: 3dB. Then Directional gain=3+3=6.
- 3) The antenna gain and beamforming gain are provided by the manufacturer.

4. Table for Antenna Configuration:
For Non Beamforming:

Operating Mode	TX Mode	2TX
IEEE 802.11a		V(Ant. 1 + Ant. 2)
IEEE 802.11n(HT20)		V(Ant. 1 + Ant. 2)
IEEE 802.11n(HT40)		V(Ant. 1 + Ant. 2)
IEEE 802.11ac(VHT20)		V(Ant. 1 + Ant. 2)
IEEE 802.11ac(VHT40)		V(Ant. 1 + Ant. 2)
IEEE 802.11ac(VHT80)		V(Ant. 1 + Ant. 2)
IEEE 802.11ax(HE20)		V(Ant. 1 + Ant. 2)
IEEE 802.11ax(HE40)		V(Ant. 1 + Ant. 2)
IEEE 802.11ax(HE80)		V(Ant. 1 + Ant. 2)

For Beamforming:

Operating Mode	TX Mode	2TX
IEEE 802.11n(HT20)		V(Ant. 1 + Ant. 2)
IEEE 802.11n(HT40)		V(Ant. 1 + Ant. 2)
IEEE 802.11ac(VHT20)		V(Ant. 1 + Ant. 2)
IEEE 802.11ac(VHT40)		V(Ant. 1 + Ant. 2)
IEEE 802.11ac(VHT80)		V(Ant. 1 + Ant. 2)
IEEE 802.11ax(HE20)		V(Ant. 1 + Ant. 2)
IEEE 802.11ax(HE40)		V(Ant. 1 + Ant. 2)
IEEE 802.11ax(HE80)		V(Ant. 1 + Ant. 2)

2.2 TEST MODES

The test system was pre-tested based on the consideration of all possible combinations of EUT operation mode.

Pretest Mode	Description
Mode 1	TX A Mode Channel 36/40/48 (UNII-1)
Mode 2	TX AC(VHT20) Mode Channel 36/40/48 (UNII-1)
Mode 3	TX AC(VHT40) Mode Channel 38/46 (UNII-1)
Mode 4	TX AC(VHT80) Mode Channel 42 (UNII-1)
Mode 5	TX AX(HE20) Mode Channel 36/40/48 (UNII-1)
Mode 6	TX AX(HE40) Mode Channel 38/46 (UNII-1)
Mode 7	TX AX(HE80) Mode Channel 42 (UNII-1)
Mode 8	TX A Mode Channel 149/157/165 (UNII-3)
Mode 9	TX AC(VHT20) Mode Channel 149/157/165 (UNII-3)
Mode 10	TX AC(VHT40) Mode Channel 151/159 (UNII-3)
Mode 11	TX AC(VHT80) Mode Channel 155 (UNII-3)
Mode 12	TX AX(HE20) Mode Channel 149/157/165 (UNII-3)
Mode 13	TX AX(HE40) Mode Channel 151/159 (UNII-3)
Mode 14	TX AX(HE80) Mode Channel 155 (UNII-3)
Mode 15	TX AC(VHT20) Mode Channel 48 (UNII-1)

Following mode(s) was (were) found to be the worst case(s) and selected for the final test.

AC power line conducted emissions test	
Final Test Mode	Description
Mode 15	TX AC(VHT20) Mode Channel 48 (UNII-1)

Radiated Emissions Test - Below 1GHz	
Final Test Mode	Description
Mode 15	TX AC(VHT20) Mode Channel 48 (UNII-1)

Radiated Emissions Test - Above 1GHz_Non Beamforming	
Final Test Mode	Description
Mode 1	TX A Mode Channel 36/40/48 (UNII-1)
Mode 2	TX AC(VHT20) Mode Channel 36/40/48 (UNII-1)
Mode 3	TX AC(VHT40) Mode Channel 38/46 (UNII-1)
Mode 4	TX AC(VHT80) Mode Channel 42 (UNII-1)
Mode 5	TX AX(HE20) Mode Channel 36/40/48 (UNII-1)
Mode 6	TX AX(HE40) Mode Channel 38/46 (UNII-1)
Mode 7	TX AX(HE80) Mode Channel 42 (UNII-1)
Mode 8	TX A Mode Channel 149/157/165 (UNII-3)
Mode 9	TX AC(VHT20) Mode Channel 149/157/165 (UNII-3)
Mode 10	TX AC(VHT40) Mode Channel 151/159 (UNII-3)
Mode 11	TX AC(VHT80) Mode Channel 155 (UNII-3)
Mode 12	TX AX(HE20) Mode Channel 149/157/165 (UNII-3)
Mode 13	TX AX(HE40) Mode Channel 151/159 (UNII-3)
Mode 14	TX AX(HE80) Mode Channel 155 (UNII-3)

Maximum Output Power Test_Non Beamforming	
Final Test Mode	Description
Mode 1	TX A Mode Channel 36/40/48 (UNII-1)
Mode 2	TX AC(VHT20) Mode Channel 36/40/48 (UNII-1)
Mode 3	TX AC(VHT40) Mode Channel 38/46 (UNII-1)
Mode 4	TX AC(VHT80) Mode Channel 42 (UNII-1)
Mode 5	TX AX(HE20) Mode Channel 36/40/48 (UNII-1)
Mode 6	TX AX(HE40) Mode Channel 38/46 (UNII-1)
Mode 7	TX AX(HE80) Mode Channel 42 (UNII-1)
Mode 8	TX A Mode Channel 149/157/165 (UNII-3)
Mode 9	TX AC(VHT20) Mode Channel 149/157/165 (UNII-3)
Mode 10	TX AC(VHT40) Mode Channel 151/159 (UNII-3)
Mode 11	TX AC(VHT80) Mode Channel 155 (UNII-3)
Mode 12	TX AX(HE20) Mode Channel 149/157/165 (UNII-3)
Mode 13	TX AX(HE40) Mode Channel 151/159 (UNII-3)
Mode 14	TX AX(HE80) Mode Channel 155 (UNII-3)

Maximum Output Power Test_Beamforming	
Final Test Mode	Description
Mode 2	TX AC(VHT20) Mode Channel 36/40/48 (UNII-1)
Mode 3	TX AC(VHT40) Mode Channel 38/46 (UNII-1)
Mode 4	TX AC(VHT80) Mode Channel 42 (UNII-1)
Mode 5	TX AX(HE20) Mode Channel 36/40/48 (UNII-1)
Mode 6	TX AX(HE40) Mode Channel 38/46 (UNII-1)
Mode 7	TX AX(HE80) Mode Channel 42 (UNII-1)
Mode 9	TX AC(VHT20) Mode Channel 149/157/165 (UNII-3)
Mode 10	TX AC(VHT40) Mode Channel 151/159 (UNII-3)
Mode 11	TX AC(VHT80) Mode Channel 155 (UNII-3)
Mode 12	TX AX(HE20) Mode Channel 149/157/165 (UNII-3)
Mode 13	TX AX(HE40) Mode Channel 151/159 (UNII-3)
Mode 14	TX AX(HE80) Mode Channel 155 (UNII-3)

Other Conducted Test_Non Beamforming	
Final Test Mode	Description
Mode 1	TX A Mode Channel 36/40/48 (UNII-1)
Mode 2	TX AC(VHT20) Mode Channel 36/40/48 (UNII-1)
Mode 3	TX AC(VHT40) Mode Channel 38/46 (UNII-1)
Mode 4	TX AC(VHT80) Mode Channel 42 (UNII-1)
Mode 5	TX AX(HE20) Mode Channel 36/40/48 (UNII-1)
Mode 6	TX AX(HE40) Mode Channel 38/46 (UNII-1)
Mode 7	TX AX(HE80) Mode Channel 42 (UNII-1)
Mode 8	TX A Mode Channel 149/157/165 (UNII-3)
Mode 9	TX AC(VHT20) Mode Channel 149/157/165 (UNII-3)
Mode 10	TX AC(VHT40) Mode Channel 151/159 (UNII-3)
Mode 11	TX AC(VHT80) Mode Channel 155 (UNII-3)
Mode 12	TX AX(HE20) Mode Channel 149/157/165 (UNII-3)
Mode 13	TX AX(HE40) Mode Channel 151/159 (UNII-3)
Mode 14	TX AX(HE80) Mode Channel 155 (UNII-3)

Note:

- (1) For AC power line conducted emissions and radiated emission below 1 GHz test, the TX AC(VHT20) Mode Channel 48 (UNII-1) is found to be the worst case and recorded.
- (2) For radiated emission above 1 GHz test, the spurious points of 1GHz~26.5GHz and 26.5GHz~40GHz have been pre-tested and in this report only recorded the worst case. The remaining spurious points are all below the limit value of 20dB.
- (3) All the bit rate of transmitter have been tested and found the lowest rate is found to be the worst case and recorded.
- (4) VHT20/VHT40 covers HT20/HT40, due to same modulation. The power setting for 802.11n HT20 and HT40 are the same or lower than 802.11ac VHT20 and VHT40.
- (5) The measurements for Output Power are tested, the Non Beamforming and Beamforming are recorded in the report. The worst case is Non Beamforming and only the worst case is documented for other test items.
- (6) IEEE 802.11ax mode only supports full RU, so only the full RU is evaluated and measured inside report.
- (7) For radiated emission below 1 GHz test, Adapter Supply and PoE Supply are tested, the worst case is Adapter Supply and recorded.
- (8) For radiated emission test, every axis (X, Y, Z) are verified. The test results shown in the following sections represent the worst case emissions.

2.3 PARAMETERS OF TEST SOFTWARE

Test Software Version	QSPR v 5.0-00188
-----------------------	------------------

2.4 DUTY CYCLE

If duty cycle is $\geq 98\%$, duty factor is not required.

If duty cycle is $< 98\%$, duty factor shall be considered.

The output power = measured power + duty factor.

The power spectral density = measured power spectral density + duty factor.

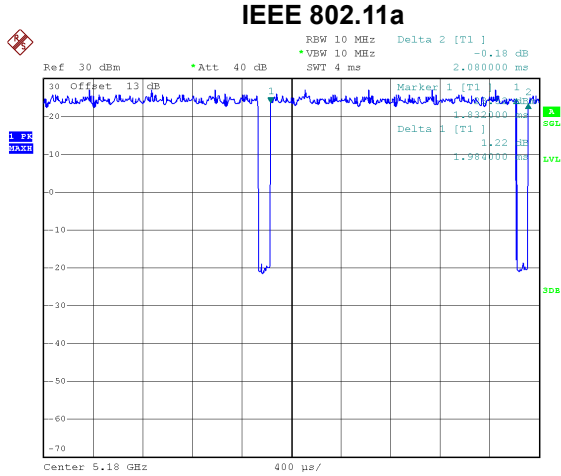

Date: 30.DEC.2021 18:36:36

Duty cycle = $1.984 \text{ ms} / 2.080 \text{ ms} = 95.38\%$
 Duty Factor = $10 \log(1 / \text{Duty cycle}) = 0.21$

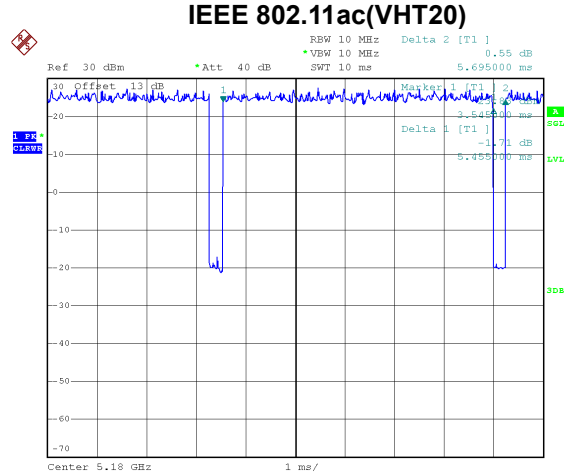

Date: 30.DEC.2021 18:45:48

Duty cycle = $5.455 \text{ ms} / 5.695 \text{ ms} = 95.79\%$
 Duty Factor = $10 \log(1 / \text{Duty cycle}) = 0.19$

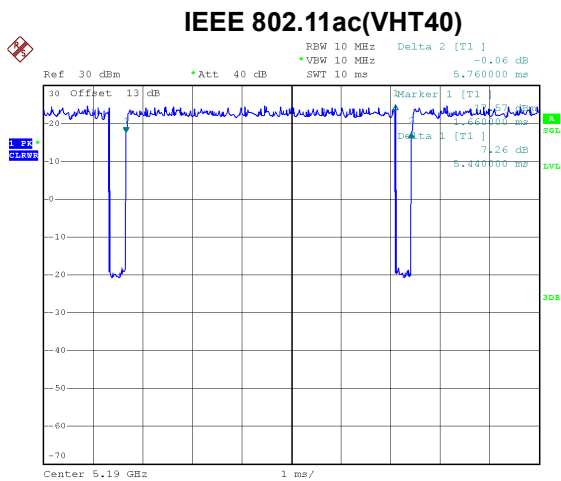

Date: 30.DEC.2021 18:46:54

Duty cycle = $5.440 \text{ ms} / 5.760 \text{ ms} = 94.44\%$
 Duty Factor = $10 \log(1 / \text{Duty cycle}) = 0.25$

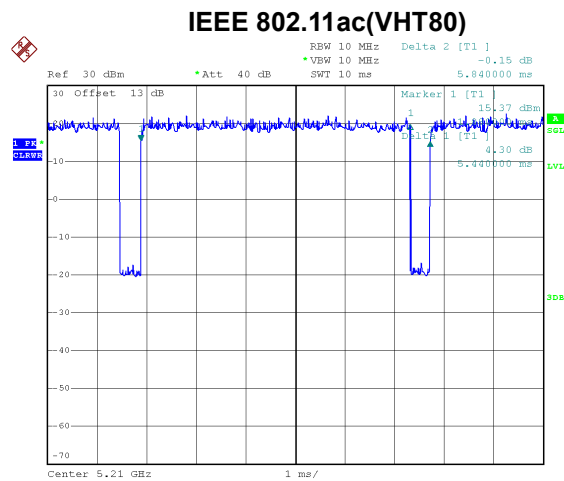

Date: 30.DEC.2021 18:47:50

Duty cycle = $5.440 \text{ ms} / 5.840 \text{ ms} = 93.15\%$
 Duty Factor = $10 \log(1 / \text{Duty cycle}) = 0.31$

IEEE 802.11ax(HE20)

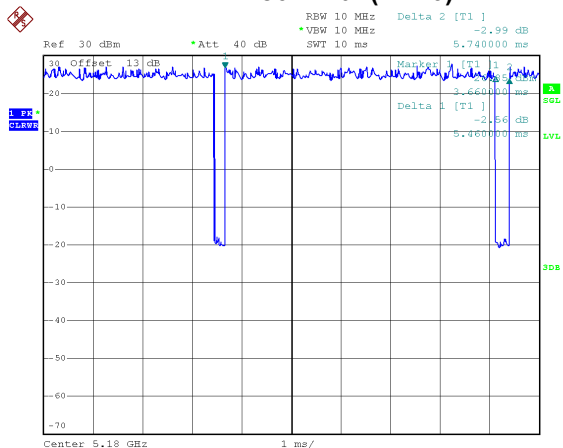

Date: 30.DEC.2021 18:48:39

Duty cycle = 5.460 ms / 5.740 ms = 95.12%
 Duty Factor = 10 log(1 / Duty cycle) = 0.22

IEEE 802.11ax(HE40)

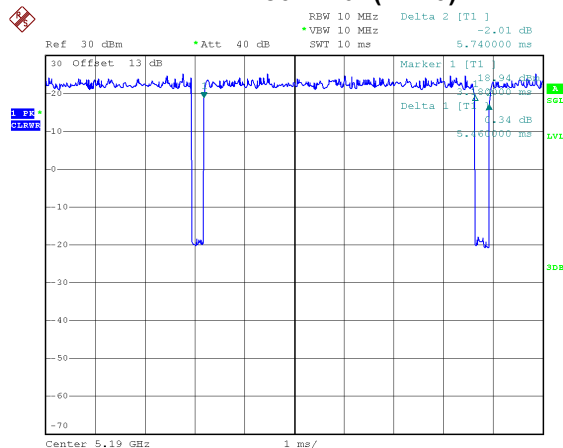

Date: 30.DEC.2021 18:49:22

Duty cycle = 5.460 ms / 5.740 ms = 95.12%
 Duty Factor = 10 log(1 / Duty cycle) = 0.22

IEEE 802.11ax(HE80)

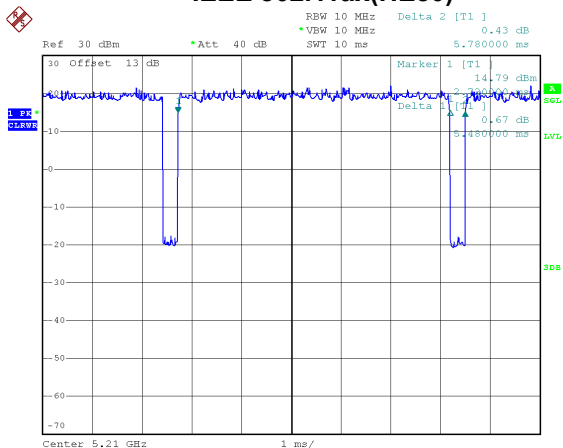

Date: 30.DEC.2021 18:50:11

Duty cycle = 5.480 ms / 5.780 ms = 94.81%
 Duty Factor = 10 log(1 / Duty cycle) = 0.23

NOTE:

For IEEE 802.11a:

For radiated emissions frequency above 1 GHz, the resolution bandwidth of test receiver/spectrum analyzer is 1 MHz and the video bandwidth is 504 Hz (Duty cycle < 98%).

For IEEE 802.11n(HT20):

For radiated emissions frequency above 1 GHz, the resolution bandwidth of test receiver/spectrum analyzer is 1 MHz and the video bandwidth is 1 kHz (Duty cycle < 98%).

For IEEE 802.11n(HT40):

For radiated emissions frequency above 1 GHz, the resolution bandwidth of test receiver/spectrum analyzer is 1 MHz and the video bandwidth is 2 kHz (Duty cycle < 98%).

For IEEE 802.11ac(VHT20):

For radiated emissions frequency above 1 GHz, the resolution bandwidth of test receiver/spectrum analyzer is 1 MHz and the video bandwidth is 183 Hz (Duty cycle < 98%).

For IEEE 802.11ac(VHT40):

For radiated emissions frequency above 1 GHz, the resolution bandwidth of test receiver/spectrum analyzer is 1 MHz and the video bandwidth is 184 Hz (Duty cycle < 98%).

For IEEE 802.11ac(VHT80):

For radiated emissions frequency above 1 GHz, the resolution bandwidth of test receiver/spectrum analyzer is 1 MHz and the video bandwidth is 184 Hz (Duty cycle < 98%).

For IEEE 802.11ax(HE20):

For radiated emissions frequency above 1 GHz, the resolution bandwidth of test receiver/spectrum analyzer is 1 MHz and the video bandwidth is 183 Hz (Duty cycle < 98%).

For IEEE 802.11ax(HE40):

For radiated emissions frequency above 1 GHz, the resolution bandwidth of test receiver/spectrum analyzer is 1 MHz and the video bandwidth is 183 Hz (Duty cycle < 98%).

For IEEE 802.11ax(HE80):

For radiated emissions frequency above 1 GHz, the resolution bandwidth of test receiver/spectrum analyzer is 1 MHz and the video bandwidth is 182 Hz (Duty cycle < 98%).

2.5 BLOCK DIAGRAM SHOWING THE CONFIGURATION OF SYSTEM TESTED

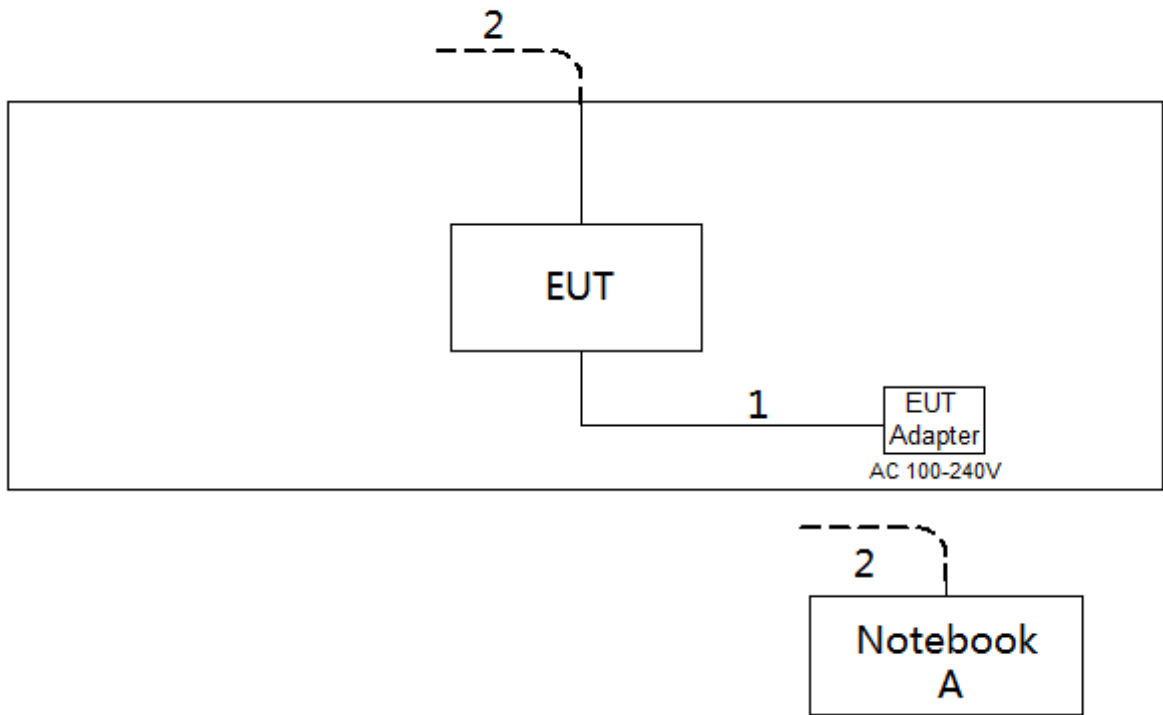

2.6 SUPPORT UNITS

Item	Equipment	Brand	Model No.	Series No.
A	Notebook	Dell	Inspiron 15-7559	N/A

Item	Cable Type	Shielded Type	Ferrite Core	Length
1	DC Cable	NO	NO	1.5m
2	RJ45 Cable	NO	NO	10m

3. AC POWER LINE CONDUCTED EMISSIONS

3.1 LIMIT

Frequency (MHz)	Limit (dB μ V)	
	Quasi-peak	Average
0.15 - 0.5	66 to 56*	56 to 46*
0.5 - 5.0	56	46
5.0 - 30.0	60	50

NOTE:

- (1) The tighter limit applies at the band edges.
- (2) The limit of " * " marked band means the limitation decreases linearly with the logarithm of the frequency in the range.

3.2 TEST PROCEDURE

- a. The EUT was placed 0.8 meters from the horizontal ground plane with EUT being connected to the power mains through a line impedance stabilization network (LISN). All other support equipment powered from additional LISN(s). The LISN provide 50 Ohm/ 50uH of coupling impedance for the measuring instrument.
- b. Interconnecting cables that hang closer than 40 cm to the ground plane shall be folded back and forth in the center forming a bundle 30 to 40 cm long.
- c. I/O cables that are not connected to a peripheral shall be bundled in the center. The end of the cable may be terminated, if required, using the correct terminating impedance. The overall length shall not exceed 1 m.
- d. LISN at least 80 cm from nearest part of EUT chassis.
- e. For the actual test configuration, please refer to the related Item -EUT Test Photos.

The following table is the setting of the receiver:

Receiver Parameter	Setting
Start Frequency	0.15 MHz
Stop Frequency	30 MHz
IF Bandwidth	9 kHz

3.3 DEVIATION FROM TEST STANDARD

No deviation

3.4 TEST SETUP

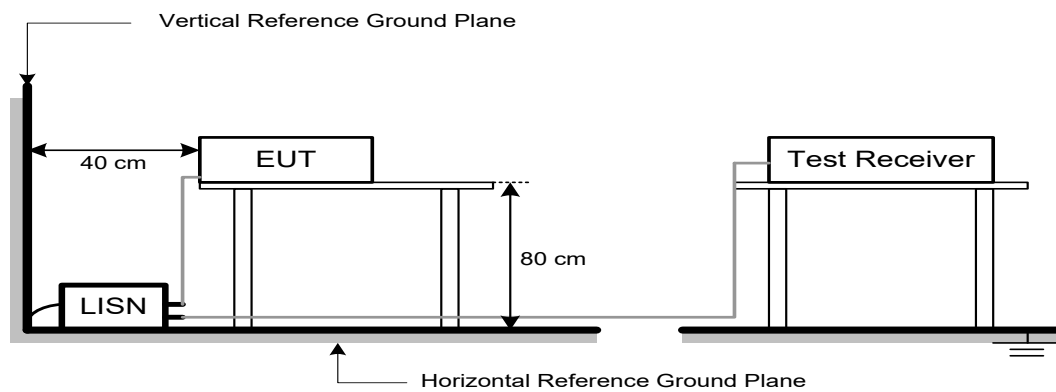

3.5 EUT OPERATION CONDITIONS

The EUT was configured for testing in a typical fashion (as a customer would normally use it). The EUT has been programmed to continuously transmit during test. This operating condition was tested and used to collect the included data.

The EUT was programmed to be in continuously transmitting/TX mode.

3.6 TEST RESULTS

Please refer to the APPENDIX A.

4. RADIATED EMISSIONS

4.1 LIMIT

In case the emission fall within the restricted band specified on 15.205(a), then the 15.209(a) limit in the table below has to be followed.

LIMITS OF RADIATED EMISSIONS MEASUREMENT (9 kHz to 1000 MHz)

Frequency (MHz)	Field Strength (microvolts/meter)	Measurement Distance (meters)
0.009-0.490	2400/F(kHz)	300
0.490-1.705	24000/F(kHz)	30
1.705-30.0	30	30
30-88	100	3
88-216	150	3
216-960	200	3
Above 960	500	3

LIMITS OF UNWANTED EMISSION OUT OF THE RESTRICTED BANDS (Above 1000 MHz)

Frequency (MHz)	EIRP Limit (dBm/MHz)	Equivalent Field Strength at 3m (dBμV/m)
5150-5250	-27	68.2
5725-5850 NOTE (2)	-27	68.2
	10	105.2
	15.6	110.8
	27	122.2

NOTE:

- (1) The following formula is used to convert the equipment isotropic radiated power (eirp) to field strength:

$$E = \frac{1000000\sqrt{30P}}{3} \mu\text{V/m, where P is the eirp (Watts)}$$

- (2) According to 15.407(b)(4)(i), all emissions shall be limited to a level of -27 dBm/MHz at 75 MHz or more above or below the band edge increasing linearly to 10 dBm/MHz at 25 MHz above or below the band edge, and from 25 MHz above or below the band edge increasing linearly to a level of 15.6 dBm/MHz at 5 MHz above or below the band edge, and from 5 MHz above or below the band edge increasing linearly to a level of 27 dBm/MHz at the band edge.

4.2 TEST PROCEDURE

- a. The measuring distance of 3 m shall be used for measurements. The EUT was placed on the top of a rotating table 0.8 meter above the ground at a 3 meter semi-anechoic chamber. The table was rotated 360 degrees to determine the position of the highest radiation.(below 1GHz)
- b. The measuring distance of 3 m shall be used for measurements. The EUT was placed on the top of a rotating table 1.5 meter above the ground at a 3 meter semi-anechoic chamber. The table was rotated 360 degrees to determine the position of the highest radiation.(above 1GHz)
- c. The height of the equipment or of the substitution antenna shall be 0.8m or 1.5m; the height of the test antenna shall vary between 1 m to 4 m. Both horizontal and vertical polarizations of the antenna are set to make the measurement.
- d. For each suspected emission, the EUT was arranged to its worst case and then the antenna was tuned to heights find the maximum reading (used Bore sight function).
- e. The receiver system was set to peak and average detect function and specified bandwidth with maximum hold mode when the test frequency is above 1 GHz.
- f. The initial step in collecting radiated emission data is a receiver peak detector mode pre-scanning the measurement frequency range. Significant peaks are then marked and then Quasi Peak detector mode re-measured.
- g. All readings are Peak unless otherwise stated QP in column of Note. Peak denotes that the Peak reading compliance with the QP Limits and then QP Mode measurement didn't perform. (below 1 GHz)
- h. All readings are Peak Mode value unless otherwise stated AVG in column of Note. If the Peak Mode Measured value compliance with the Peak Limits and lower than AVG Limits, the EUT shall be deemed to meet both Peak & AVG Limits and then only Peak Mode was measured, but AVG Mode didn't perform. (above 1 GHz)
- i. For the actual test configuration, please refer to the related Item –EUT Test Photos.

The following table is the setting of the receiver:

Spectrum Parameters	Setting
Start ~ Stop Frequency	9 kHz~150 kHz for RBW 200 Hz
Start ~ Stop Frequency	0.15 MHz~30 MHz for RBW 9 kHz
Start ~ Stop Frequency	30 MHz~1000 MHz for RBW 100 kHz

Spectrum Parameters	Setting
Start Frequency	1000 MHz
Stop Frequency	10th carrier harmonic or 40 GHz, whichever is lower
RBW / VBW (Emission in restricted band)	1 MHz / 3 MHz for PK value 1 MHz / 1/T Hz for AVG value

Receiver Parameters	Setting
Start ~ Stop Frequency	9 kHz~90 kHz for PK/AVG detector
Start ~ Stop Frequency	90 kHz~110 kHz for QP detector
Start ~ Stop Frequency	110 kHz~490 kHz for PK/AVG detector
Start ~ Stop Frequency	490 kHz~30 MHz for QP detector
Start ~ Stop Frequency	30 MHz~1000 MHz for QP detector
Start ~ Stop Frequency	1 GHz~40 GHz for PK/AVG detector

4.3 DEVIATION FROM TEST STANDARD

No deviation.

4.4 TEST SETUP

9 kHz to 30 MHz

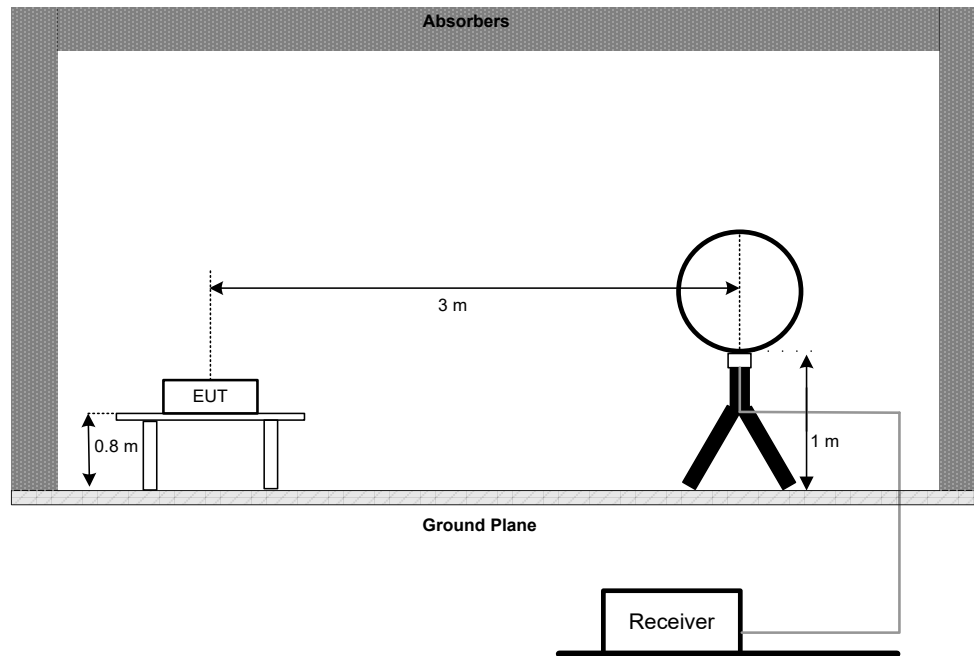

30 MHz to 1 GHz

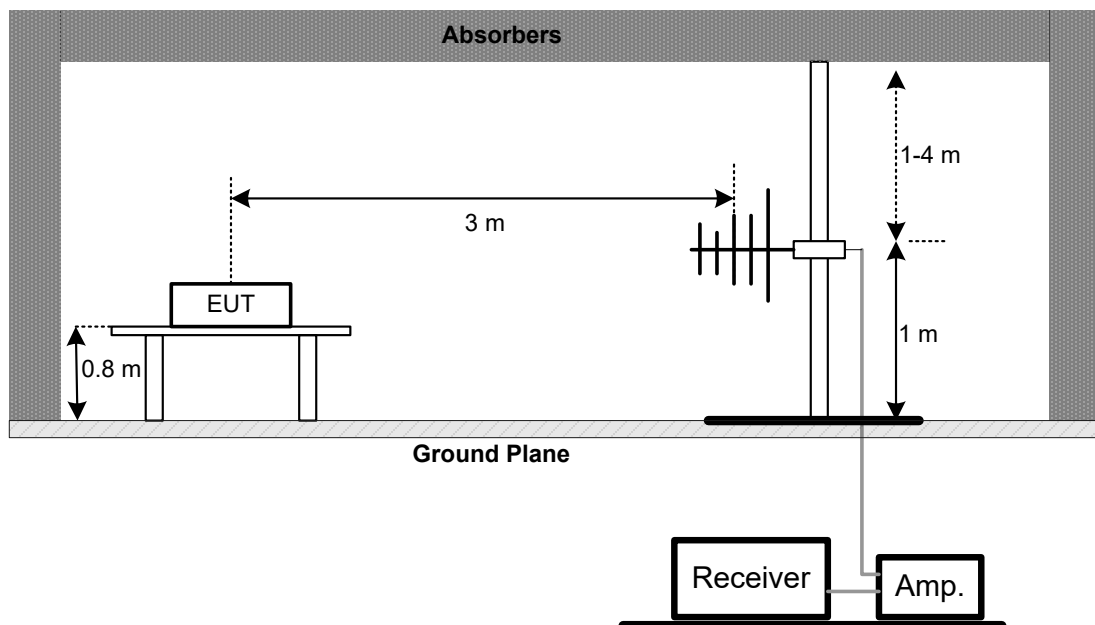

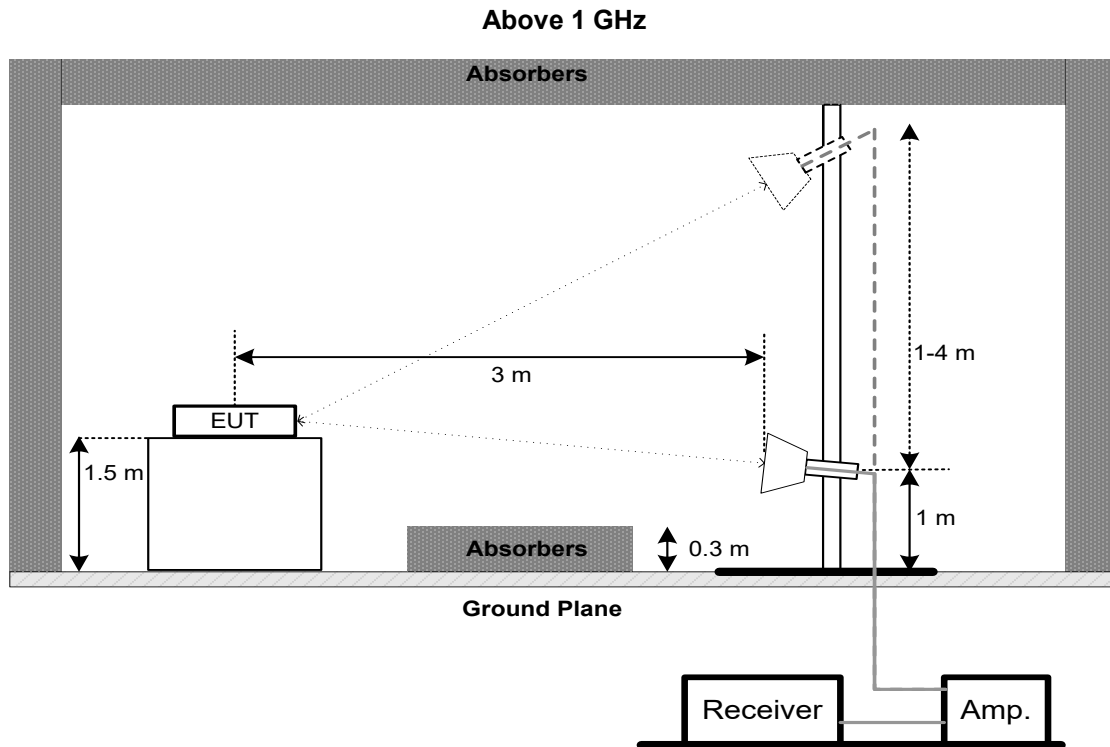

4.5 EUT OPERATION CONDITIONS

The EUT tested system was configured as the statements of 3.5 unless otherwise a special operating condition is specified in the follows during the testing.

4.6 TEST RESULTS - 9 KHZ TO 30 MHZ

Please refer to the APPENDIX B.

Remark:

- (1) Distance extrapolation factor = $40 \log (\text{specific distance} / \text{test distance})$ (dB).
- (2) Limit line = specific limits (dBuV) + distance extrapolation factor.

4.7 TEST RESULTS - 30 MHZ TO 1000 MHZ

Please refer to the APPENDIX C.

4.8 TEST RESULTS - ABOVE 1000 MHZ

Please refer to the APPENDIX D.

Remark:

- (1) No limit: This is fundamental signal, the judgment is not applicable.
For fundamental signal judgment was referred to Peak output test.

5. BANDWIDTH

5.1 LIMIT

Section	Test Item	Limit	Frequency Range (MHz)
FCC 15.407(a)	26 dB Bandwidth	-	5150-5250
FCC 15.407(e)	6 dB Bandwidth	Minimum 500 kHz	5725-5850

5.2 TEST PROCEDURE

a. The EUT was directly connected to the spectrum analyzer and antenna output port as show in the block diagram below

b. Spectrum Setting:

For UNII-1:

Spectrum Parameter	Setting
Span Frequency	> 26 dB Bandwidth
RBW	Appromixately 1% of the emission bandwidth
VBW	> RBW
Detector	Peak
Trace	Max Hold
Sweep Time	Auto

For UNII-3:

Spectrum Parameter	Setting
Span Frequency	> 6 dB Bandwidth
RBW	100 kHz
VBW	300 kHz
Detector	Peak
Trace	Max Hold
Sweep Time	Auto

c. Measured the spectrum width with power higher than 26 dB / 6 dB below carrier.

5.3 DEVIATION FROM STANDARD

No deviation.

5.4 TEST SETUP



5.5 EUT OPERATION CONDITIONS

The EUT was programmed to be in continuously transmitting mode.

5.6 TEST RESULTS

Please refer to the APPENDIX E.

6. MAXIMUM OUTPUT POWER

6.1 LIMIT

Section	Test Item	Limit	Frequency Range (MHz)
FCC 15.407(a)	Maximum Output Power	AP device: 1 Watt (30 dBm) Client device: 250 mW (23.98 dBm)	5150-5250
		1 Watt (30dBm)	5725-5850

Note:

- a. For an indoor access point operating in the band 5.15-5.25 GHz, the maximum conducted output power over the frequency band of operation shall not exceed 1 W provided the maximum antenna gain does not exceed 6 dBi. In addition, the maximum power spectral density shall not exceed 17 dBm in any 1 megahertz band. If transmitting antennas of directional gain greater than 6 dBi are used, both the maximum conducted output power and the maximum power spectral density shall be reduced by the amount in dB that the directional gain of the antenna exceeds 6 dBi.

6.2 TEST PROCEDURE

- a. The EUT was directly connected to the power meter and antenna output port as show in the block diagram below.
- b. Test test was performed in accordance with method of FCC KDB 789033 D02 General UNII Test Procedures New Rules v02r01.

6.3 DEVIATION FROM STANDARD

No deviation.

6.4 TEST SETUP

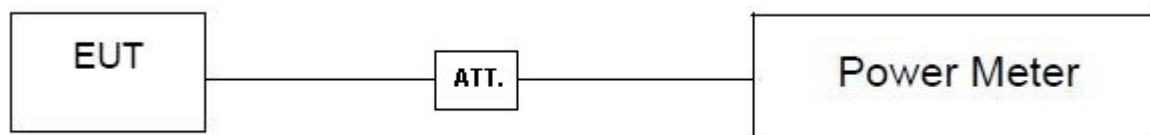

6.5 EUT OPERATION CONDITIONS

The EUT was programmed to be in continuously transmitting mode.

6.6 TEST RESULTS

Please refer to the APPENDIX F.

7. POWER SPECTRAL DENSITY

7.1 LIMIT

Section	Test Item	Limit	Frequency Range (MHz)
FCC 15.407(a)	Power Spectral Density	AP device: 17 dBm/MHz Client device: 11 dBm/MHz	5150-5250
		30 dBm/500 kHz	5725-5850

7.2 TEST PROCEDURE

- The EUT was directly connected to the spectrum analyzer and antenna output port as show in the block diagram below.
- Spectrum Setting:

For UNII-1:

Spectrum Parameter	Setting
Span Frequency	Encompass the entire emissions bandwidth (EBW) of the signal
RBW	1 MHz.
VBW	3 MHz.
Detector	RMS
Trace average	100 trace
Sweep Time	Auto

For UNII-3:

Spectrum Parameter	Setting
Span Frequency	Encompass the entire emissions bandwidth (EBW) of the signal
RBW	100 kHz.
VBW	300 kHz.
Detector	RMS
Trace average	100 trace
Sweep Time	Auto

Note:

- For UNII-3, according to KDB publication 789033 D02 General UNII Test Procedures New Rules v02r01, section II.F.5., it is acceptable to set RBW at 100kHz and VBW at 300kHz if the spectrum analyzer does not have 500 kHz RBW. Then, add $10 \log (500 \text{ kHz}/100 \text{ kHz})$ to the measured result, i.e. 7 dB.
- During the test of U-NII 3 PSD, the measurement result with RBW=100kHz has been added 7 dB by compensating offset. For example, the cable loss is 13 dB, and the final offset is $13 + 7 = 20 \text{ dB}$ when RBW=100kHz is used.

7.3 DEVIATION FROM STANDARD

No deviation.

7.4 TEST SETUP



7.5 EUT OPERATION CONDITIONS

The EUT was programmed to be in continuously transmitting mode.

7.6 TEST RESULTS

Please refer to the APPENDIX G.

8. FREQUENCY STABILITY

8.1 LIMIT

Section	Test Item	Limit	Frequency Range (MHz)
FCC 15.407(g)	Frequency Stability	An emission is maintained within the band of operation under all conditions of normal operation as specified in the users manual.	5150-5250
			5725-5850

8.2 TEST PROCEDURE

- a. The EUT was directly connected to the spectrum analyzer and antenna output port as show in the block diagram below.
- b. Spectrum Setting:

Spectrum Parameter	Setting
Span Frequency	Entire absence of modulation emissions bandwidth
RBW	10 kHz
VBW	10 kHz
Detector	Peak
Trace	Max Hold
Sweep Time	Auto

- c. The test extreme voltage is to change the primary supply voltage from 85 to 115 percent of the nominal value.
- d. User manual temperature is 0°C~40°C.

8.3 DEVIATION FROM STANDARD

No deviation.

8.4 TEST SETUP

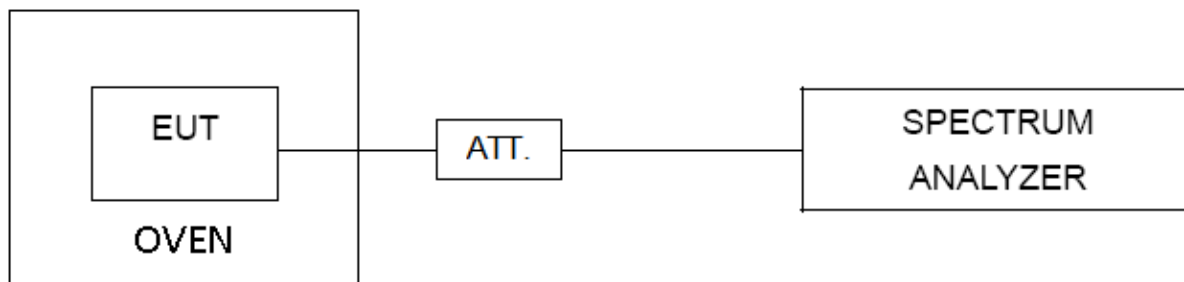

8.5 EUT OPERATION CONDITIONS

The EUT was programmed to be in continuously transmitting mode.

8.6 TEST RESULTS

Please refer to the APPENDIX H.

9. MEASUREMENT INSTRUMENTS LIST

AC Power Line Conducted Emissions					
Item	Kind of Equipment	Manufacturer	Type No.	Serial No.	Calibrated until
1	EMI Test Receiver	R&S	ESCI	100382	Jan. 22, 2023
2	LISN	EMCO	3816/2	52765	Jan. 23, 2023
3	TWO-LINE V-NETWORK	R&S	ENV216	101447	Jan. 23, 2023
4	50Ω Terminator	SHX	TF5-3	15041305	Feb. 27, 2022
5	Measurement Software	Farad	EZ-EMC Ver.NB-03A1-01	N/A	N/A
6	Cable	N/A	RG223	12m	Mar. 09, 2022
7	643 Shield Room	ETS	6*4*3	N/A	N/A

Radiated Emissions - 9 kHz to 30 MHz					
Item	Kind of Equipment	Manufacturer	Type No.	Serial No.	Calibrated until
1	MXE EMI Receiver	Keysight	N9038A	MY56400091	Jan. 22, 2023
2*	Active Loop Antenna	R&S	HFH2-Z2	830749/020	Aug. 23, 2024
3	Cable	N/A	RG 213/U(9kHz~1GHz)	N/A	May 27, 2022
4	Measurement Software	Farad	EZ-EMC Ver.NB-03A1-01	N/A	N/A
5	966 Chamber Room	ETS	9*6*6	N/A	Jul. 17, 2022

Radiated Emissions - 30 MHz to 1 GHz					
Item	Kind of Equipment	Manufacturer	Type No.	Serial No.	Calibrated until
1	Antenna	Schwarzbeck	VULB9160	9160-3232	Mar. 15, 2022
2	Amplifier	HP	8447D	2944A08742	Jan. 22, 2023
3	Cable	emci	LMR-400	N/A	Nov. 30, 2022
4	Controller	CT	SC100	N/A	N/A
5	Controller	MF	MF-7802	MF780208416	N/A
6	Measurement Software	Farad	EZ-EMC Ver.NB-03A1-01	N/A	N/A
7	Receiver	Agilent	N9038A	MY52130039	Jan. 22, 2023
8	966 Chamber Room	RM	9*6*6	N/A	Jul. 24, 2022

Radiated Emissions - Above 1 GHz					
Item	Kind of Equipment	Manufacturer	Type No.	Serial No.	Calibrated until
1	Double Ridged Horn Antenna	ARA	DRG-118A	16554	Apr. 21, 2022
2	Broad-Band Horn Antenna	Schwarzbeck	BBHA 9170	9170319	Jun. 30, 2022
3	Amplifier	Agilent	8449B	3008A02584	Jul. 10, 2022
4	Controller	CT	SC100	N/A	N/A
5	Controller	MF	MF-7802	MF780208416	N/A
6	Receiver	Agilent	N9038A	MY52130039	Jan. 22, 2023
7	EXA Spectrum Analyzer	Keysight	N9010A	MY56480488	Jan. 22, 2023
8	Low Noise Amplifier	CONNPHY	CLN-18G40G-4330-K	619413	Jul. 16, 2022
9	Cable	N/A	A81-SMAMSMAM-12.5M	N/A	Oct. 15, 2022
10	Cable	Talent microwave	A40-2.92M2.92M-2.5M	N/A	Nov. 30, 2022
11*	Band Reject Filter	Micro-Tronics	BRC50703-01	7	Feb. 27, 2024
12*	Band Reject Filter	Micro-Tronics	BRC50705-01	10	Feb. 27, 2024
13	Measurement Software	Farad	EZ-EMC Ver.NB-03A1-01	N/A	N/A
14	966 Chamber Room	RM	9*6*6	N/A	Jul. 24, 2022

Bandwidth & Power Spectral Density					
Item	Kind of Equipment	Manufacturer	Type No.	Serial No.	Calibrated until
1	Spectrum Analyzer	R&S	FSP40	100185	Jul. 10, 2022
2	Attenuator	WOKEN	6SM3502	VAS1214NL	Feb. 07, 2022
3	RF Cable	Tongkaichuan	N/A	N/A	N/A
4	DC Block	Mini	N/A	N/A	N/A

Maximum Output Power					
Item	Kind of Equipment	Manufacturer	Type No.	Serial No.	Calibrated until
1	Peak Power Analyzer	Keysight	8990B	MY51000506	Jul. 10, 2022
2	Wideband power sensor	Keysight	N1923A	MY58310004	Jul. 10, 2022
3	Attenuator	WOKEN	6SM3502	VAS1214NL	Feb. 07, 2022
4	RF Cable	Tongkaichuan	N/A	N/A	N/A

Frequency Stability					
Item	Kind of Equipment	Manufacturer	Type No.	Serial No.	Calibrated until
1	Spectrum Analyzer	R&S	FSP40	100185	Jul. 10, 2022
2	Precision Oven Tester	CEPREI	CEEC-M64T-40	15-008	Jan. 22, 2023
3	Attenuator	WOKEN	6SM3502	VAS1214NL	Feb. 07, 2022
4	RF Cable	Tongkaichuan	N/A	N/A	N/A
5	DC Block	Mini	N/A	N/A	N/A

Remark: "N/A" denotes no model name, serial no. or calibration specified.

"*" calibration period of equipment list is three year.

Except * item, all calibration period of equipment list is one year.

10. EUT TEST PHOTOS**AC Power Line Conducted Emissions Test Photos**

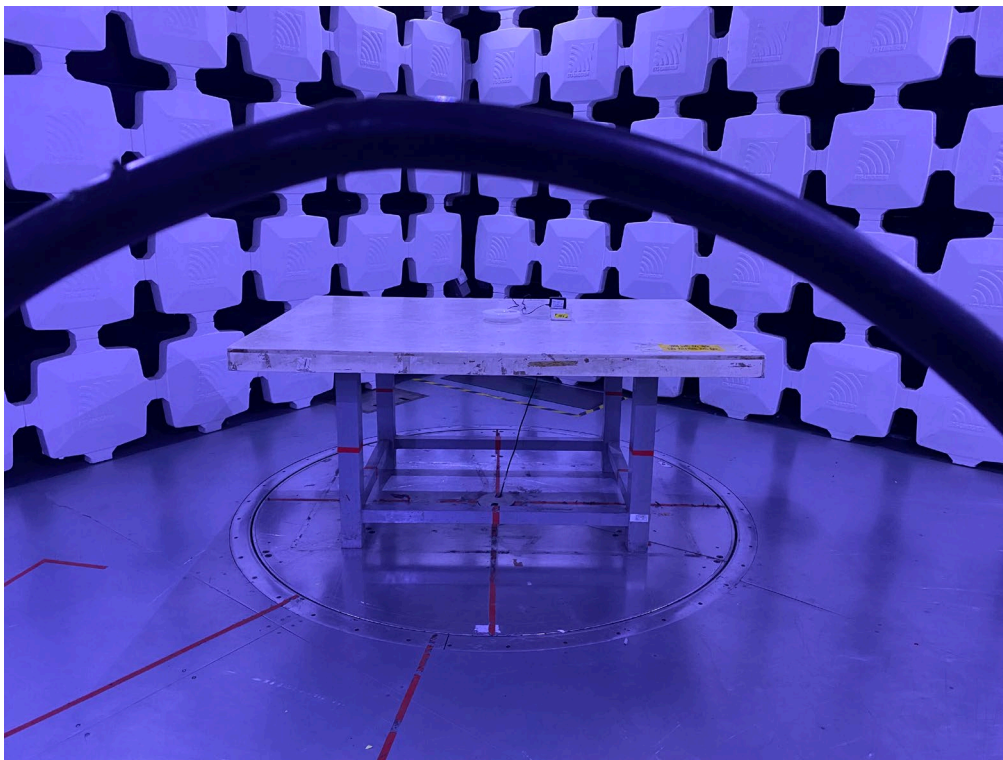
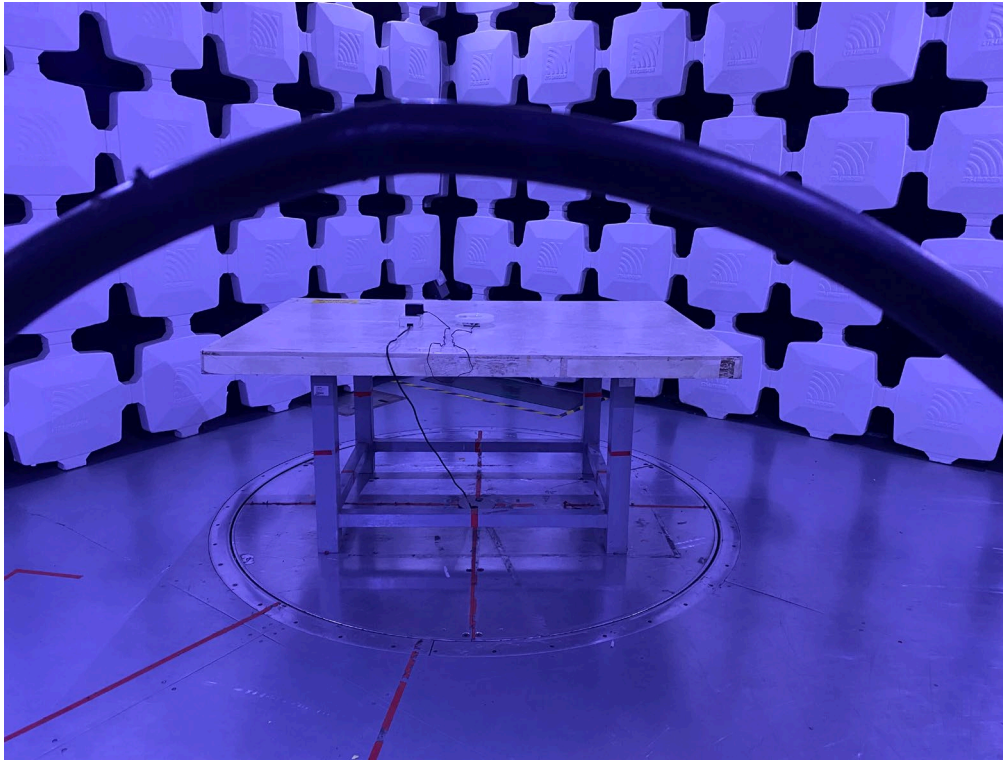
Radiated Emissions Test Photos**9 kHz to 30 MHz**

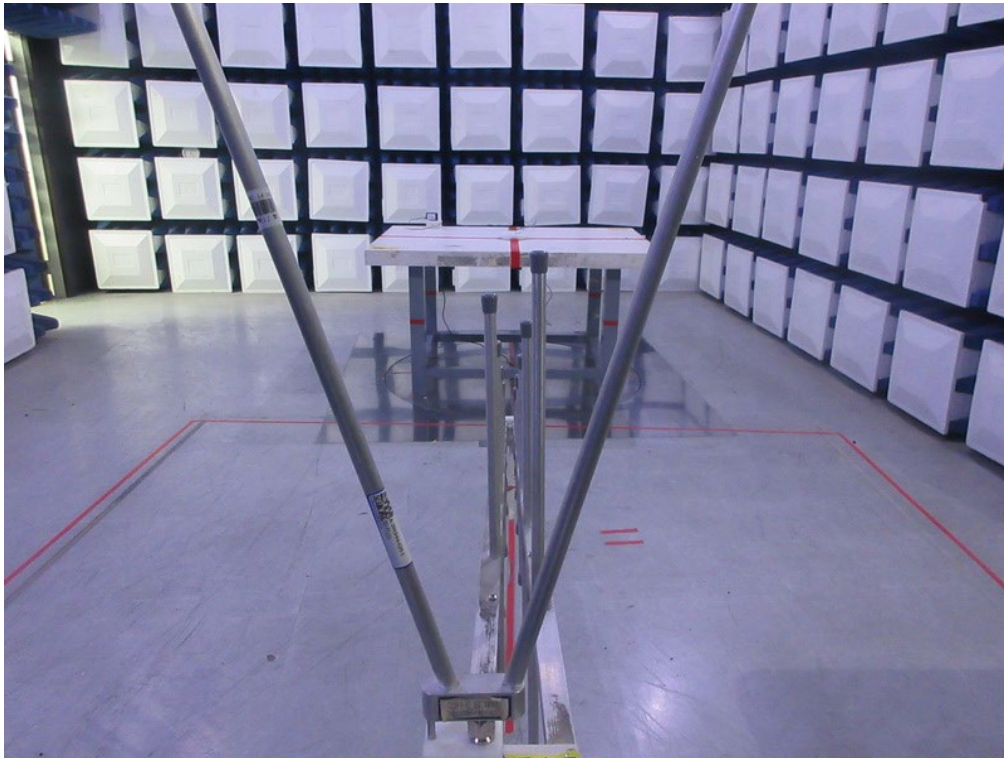
Radiated Emissions Test Photos**30 MHz to 1 GHz**

Radiated Emissions Test Photos**Above 1 GHz**

Conducted Test Photos

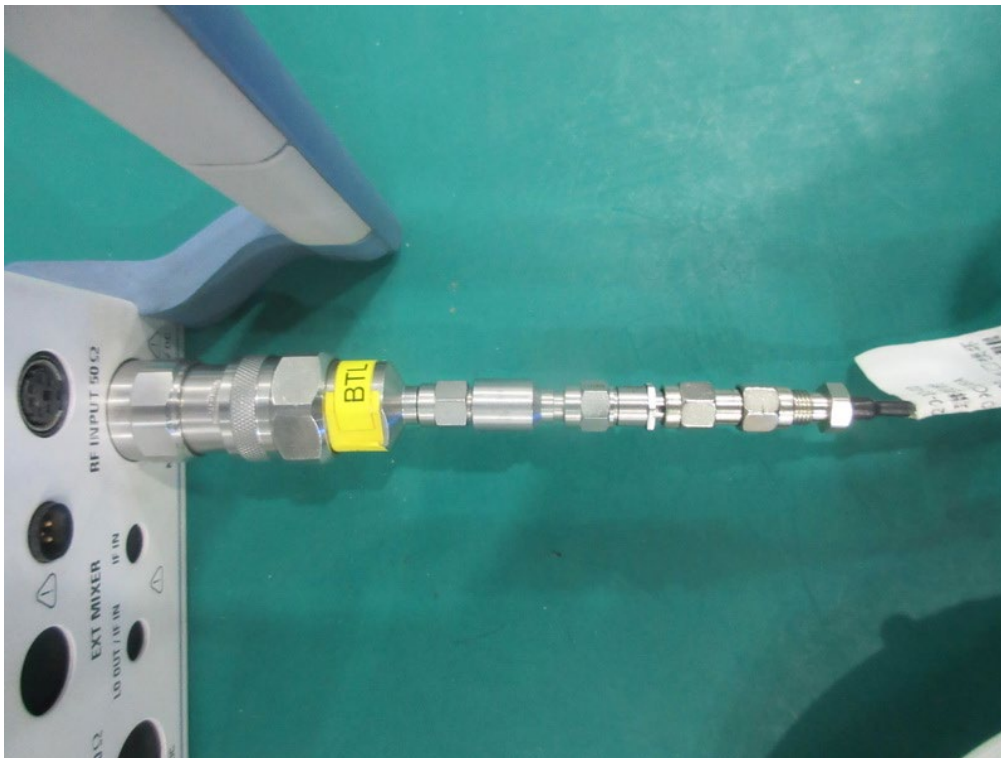

APPENDIX A - AC POWER LINE CONDUCTED EMISSIONS

Test Mode	TX AC(VHT20) Mode Channel 48 (UNII-1)	Phase	Line
-----------	---------------------------------------	-------	------

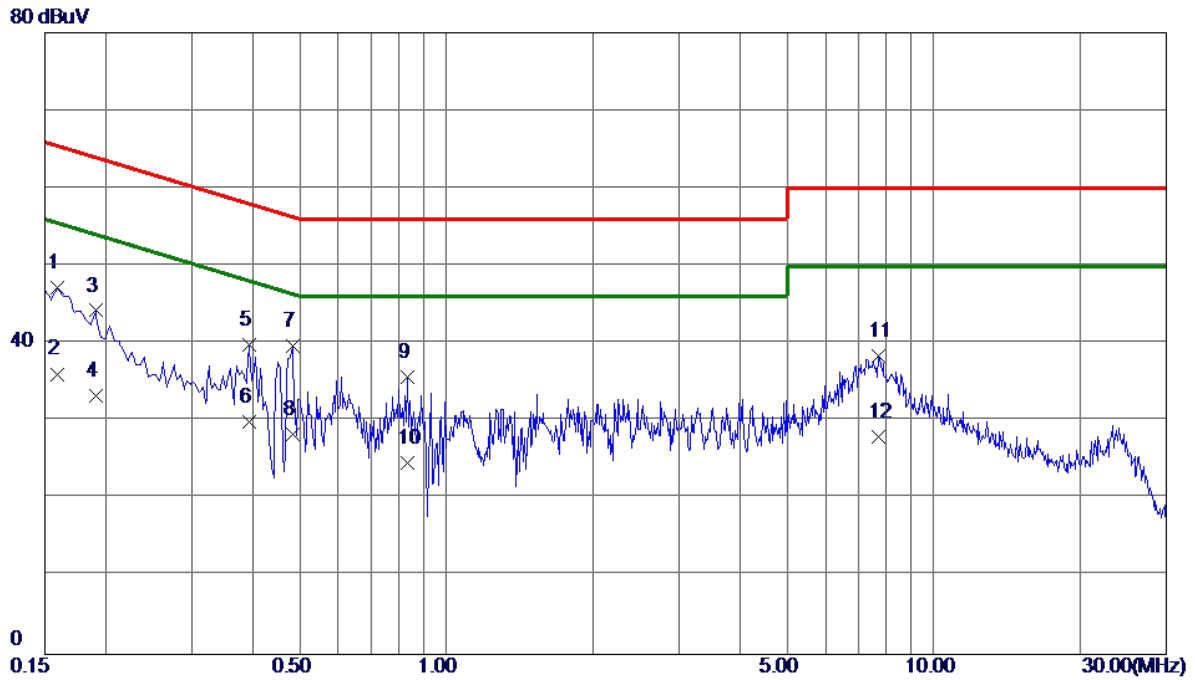

No.	Freq. MHz	Reading Level dBuV	Correct Factor dB	Measurement dBuV	Limit dBuV	Margin dB	Detector	Comment
1	0.1590	37.39	9.78	47.17	65.52	-18.35	QP	
2	0.1590	26.30	9.78	36.08	55.52	-19.44	AVG	
3	0.1905	34.43	9.81	44.24	64.01	-19.77	QP	
4	0.1905	23.40	9.81	33.21	54.01	-20.80	AVG	
5	0.3930	30.01	9.85	39.86	58.00	-18.14	QP	
6	0.3930	20.11	9.85	29.96	48.00	-18.04	AVG	
7 *	0.4830	29.84	9.86	39.70	56.29	-16.59	QP	
8	0.4830	18.40	9.86	28.26	46.29	-18.03	AVG	
9	0.8340	25.64	9.97	35.61	56.00	-20.39	QP	
10	0.8340	14.60	9.97	24.57	46.00	-21.43	AVG	
11	7.6965	28.00	10.44	38.44	60.00	-21.56	QP	
12	7.6965	17.50	10.44	27.94	50.00	-22.06	AVG	

REMARKS:

- (1) Measurement Value = Reading Level + Correct Factor.
- (2) Margin Level = Measurement Value - Limit Value.
- (3) The test result has included the cable loss.

Test Mode	TX AC(VHT20) Mode Channel 48 (UNII-1)	Phase	Neutral
-----------	---------------------------------------	-------	---------

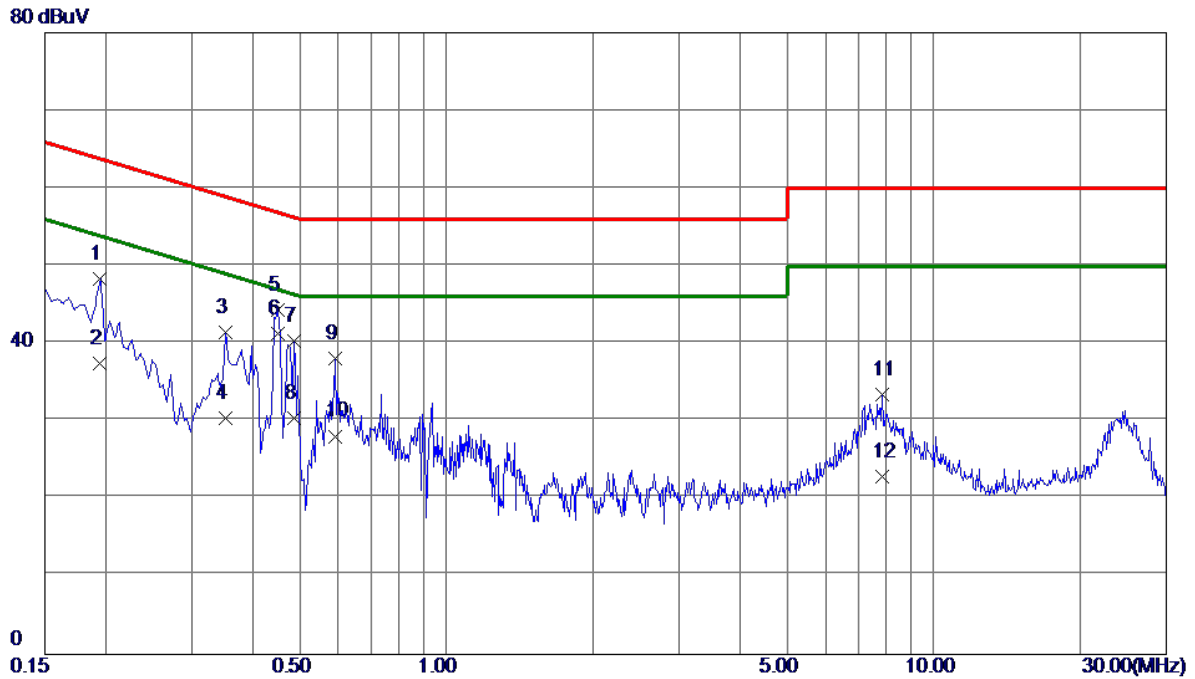

No.	Freq. MHz	Reading Level dBuV	Correct Factor dB	Measurement dBuV	Limit dBuV	Margin dB	Detector	Comment
1	0.1949	38.45	9.85	48.30	63.83	-15.53	QP	
2	0.1949	27.60	9.85	37.45	53.83	-16.38	AVG	
3	0.3525	31.51	9.91	41.42	58.90	-17.48	QP	
4	0.3525	20.50	9.91	30.41	48.90	-18.49	AVG	
5	0.4515	34.43	9.93	44.36	56.85	-12.49	QP	
6 *	0.4515	31.41	9.93	41.34	46.85	-5.51	AVG	
7	0.4875	30.32	9.94	40.26	56.21	-15.95	QP	
8	0.4875	20.40	9.94	30.34	46.21	-15.87	AVG	
9	0.5910	28.12	9.98	38.10	56.00	-17.90	QP	
10	0.5910	18.10	9.98	28.08	46.00	-17.92	AVG	
11	7.8315	22.93	10.50	33.43	60.00	-26.57	QP	
12	7.8315	12.40	10.50	22.90	50.00	-27.10	AVG	

REMARKS:

- (1) Measurement Value = Reading Level + Correct Factor.
- (2) Margin Level = Measurement Value - Limit Value.
- (3) The test result has included the cable loss.

APPENDIX B - RADIATED EMISSION - 9 KHZ TO 30 MHZ

Test Mode	TX AC(VHT20) Mode Channel 48 (UNII-1)	Polarization	Ant 0°
-----------	---------------------------------------	--------------	--------

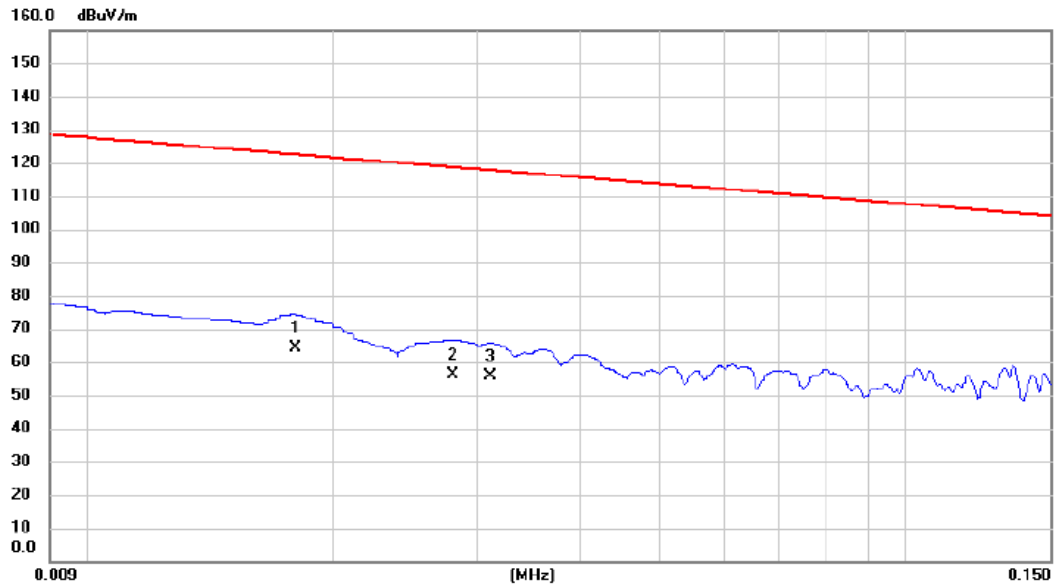

No.	Mk.	Freq. MHz	Reading Level dBuV	Correct Factor dB	Measure- ment dBuV/m	Limit dBuV/m	Margin dB	Detector	Comment
1	*	0.0180	49.35	14.92	64.27	122.50	-58.23	AVG	
2		0.0280	42.28	14.11	56.39	118.66	-62.27	AVG	
3		0.0311	41.66	14.03	55.69	117.75	-62.06	AVG	

REMARKS:

- (1) Measurement Value = Reading Level + Correct Factor.
- (2) Margin Level = Measurement Value - Limit Value.

Test Mode	TX AC(VHT20) Mode Channel 48 (UNII-1)	Polarization	Ant 0°
-----------	---------------------------------------	--------------	--------

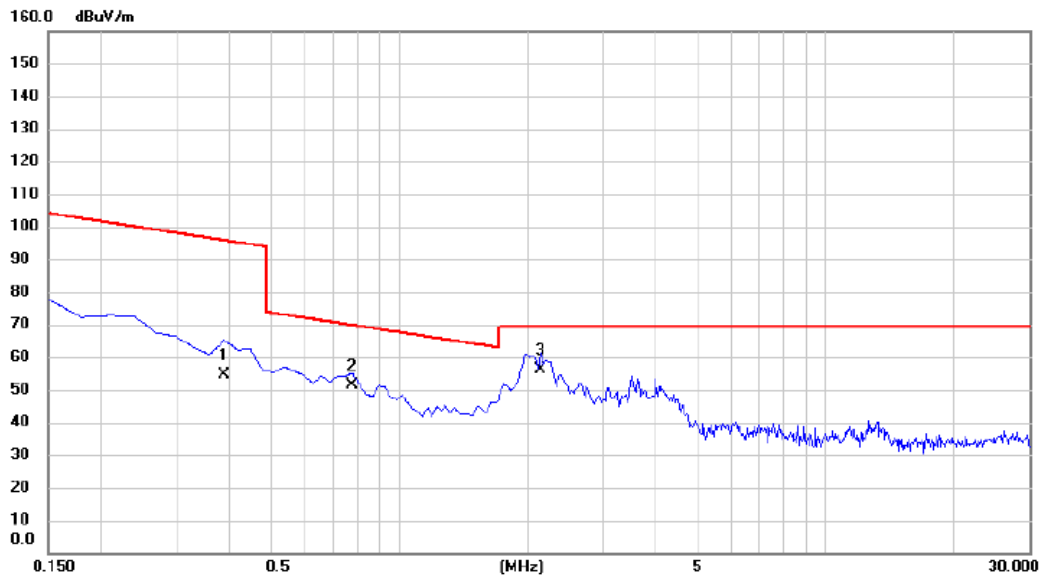

No. Mk.	Freq. MHz	Reading Level dBuV	Correct Factor dB	Measure- ment dBuV/m	Limit dBuV/m	Margin dB	Detector	Comment
1	0.3888	41.32	13.47	54.79	95.81	-41.02	AVG	
2	0.7768	38.33	13.05	51.38	69.80	-18.42	QP	
3 *	2.1500	44.29	12.03	56.32	69.54	-13.22	QP	

REMARKS:

- (1) Measurement Value = Reading Level + Correct Factor.
- (2) Margin Level = Measurement Value - Limit Value.

Test Mode	TX AC(VHT20) Mode Channel 48 (UNII-1)	Polarization	Ant 90°
-----------	---------------------------------------	--------------	---------

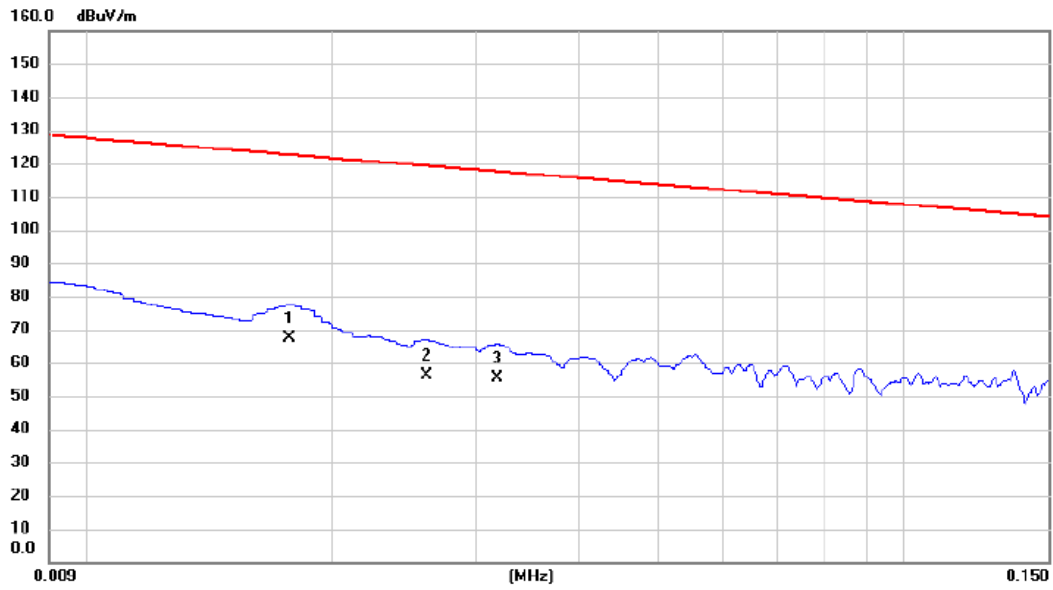

No.	Mk.	Freq. MHz	Reading Level dBuV	Correct Factor dB	Measure- ment dBuV/m	Limit dBuV/m	Margin dB	Detector	Comment
1	*	0.0177	52.21	15.01	67.22	122.65	-55.43	AVG	
2		0.0261	42.23	14.15	56.38	119.27	-62.89	AVG	
3		0.0318	41.29	14.02	55.31	117.56	-62.25	AVG	

REMARKS:

- (1) Measurement Value = Reading Level + Correct Factor.
- (2) Margin Level = Measurement Value - Limit Value.

Test Mode	TX AC(VHT20) Mode Channel 48 (UNII-1)	Polarization	Ant 90°
-----------	---------------------------------------	--------------	---------



No. Mk.	Freq. MHz	Reading Level dBuV	Correct Factor dB	Measurement dBuV/m	Limit dBuV/m	Margin dB	Detector	Comment
1	0.4485	40.39	13.40	53.79	94.57	-40.78	AVG	
2	0.7470	40.29	13.08	53.37	70.14	-16.77	QP	
3 *	2.0604	45.21	12.07	57.28	69.54	-12.26	QP	

REMARKS:

- (1) Measurement Value = Reading Level + Correct Factor.
- (2) Margin Level = Measurement Value - Limit Value.

APPENDIX C - RADIATED EMISSION - 30 MHZ TO 1000 MHZ

Test Mode	TX AC(VHT20) Mode Channel 48 (UNII-1)	Polarization	Vertical
-----------	---------------------------------------	--------------	----------

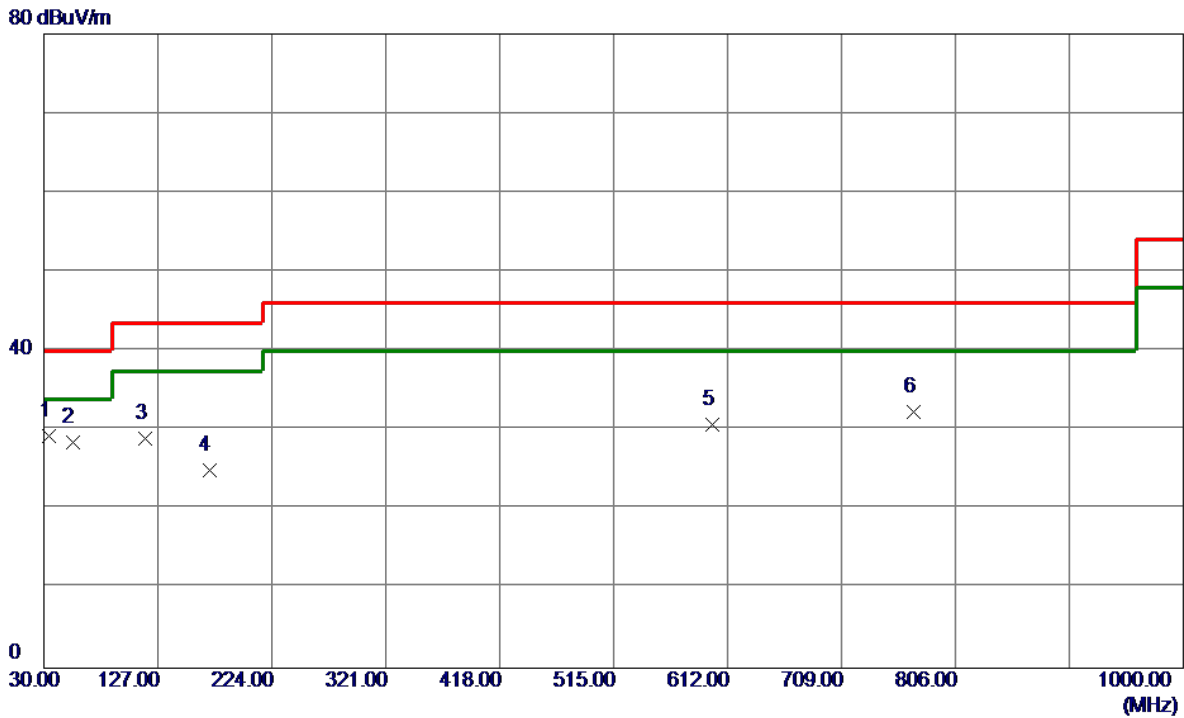

No.	Freq. MHz	Reading Level dBuV/m	Correct Factor dB	Measure ment dBuV/m	Limit dBuV/m	Margin dB	Detector	Comment
1 *	33.8800	44.43	-15.08	29.35	40.00	-10.65	Peak	
2	54.2500	42.53	-14.10	28.43	40.00	-11.57	Peak	
3	116.3300	43.49	-14.48	29.01	43.50	-14.49	Peak	
4	170.6500	37.63	-12.65	24.98	43.50	-18.52	Peak	
5	599.3900	35.23	-4.57	30.66	46.00	-15.34	Peak	
6	770.1100	33.75	-1.44	32.31	46.00	-13.69	Peak	

REMARKS:

- (1) Measurement Value = Reading Level + Correct Factor.
- (2) Margin Level = Measurement Value - Limit Value.

Test Mode	TX AC(VHT20) Mode Channel 48 (UNII-1)	Polarization	Horizontal
-----------	---------------------------------------	--------------	------------

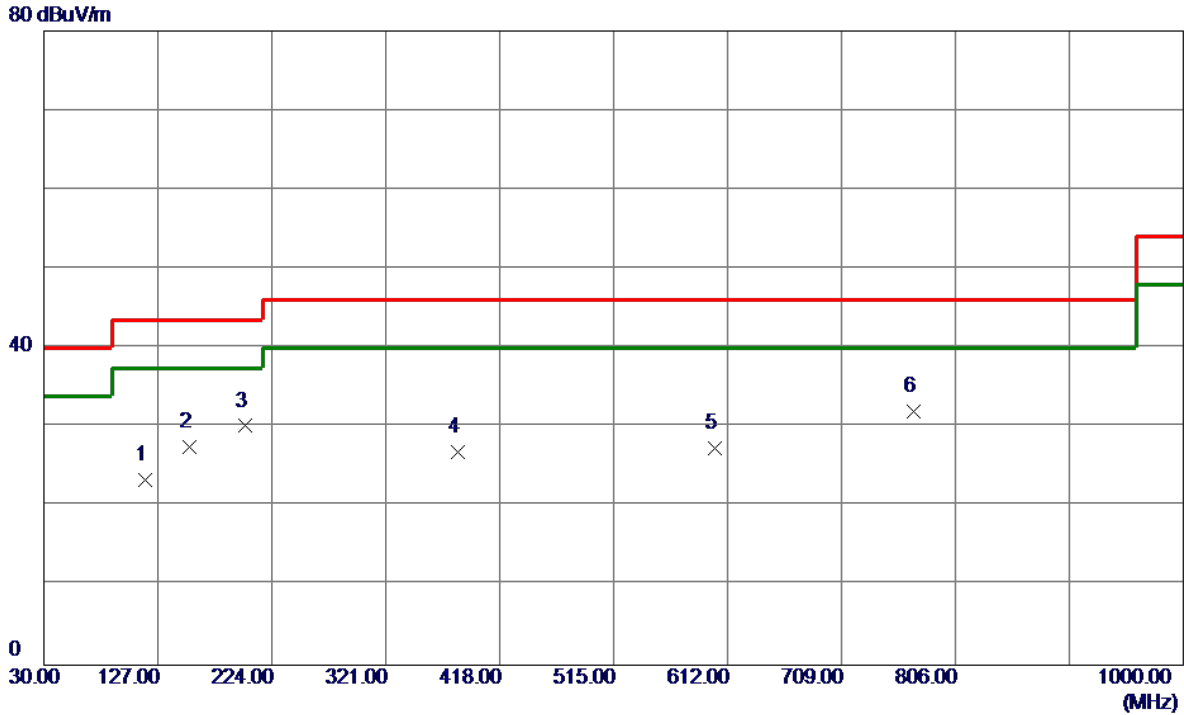

No.	Freq. MHz	Reading Level dBuV/m	Correct Factor dB	Measure ment dBuV/m	Limit dBuV/m	Margin dB	Detector	Comment
1	116.3300	37.84	-14.48	23.36	43.50	-20.14	Peak	
2	154.1600	39.99	-12.52	27.47	43.50	-16.03	Peak	
3 *	201.6900	45.54	-15.38	30.16	43.50	-13.34	Peak	
4	382.1099	36.08	-9.20	26.88	46.00	-19.12	Peak	
5	601.3300	31.85	-4.53	27.32	46.00	-18.68	Peak	
6	770.1100	33.40	-1.44	31.96	46.00	-14.04	Peak	

REMARKS:

- (1) Measurement Value = Reading Level + Correct Factor.
- (2) Margin Level = Measurement Value - Limit Value.

APPENDIX D - RADIATED EMISSION - ABOVE 1000 MHZ

Test Mode	UNII-1_TX A Mode 5180 MHz	Polarization	Vertical
-----------	---------------------------	--------------	----------

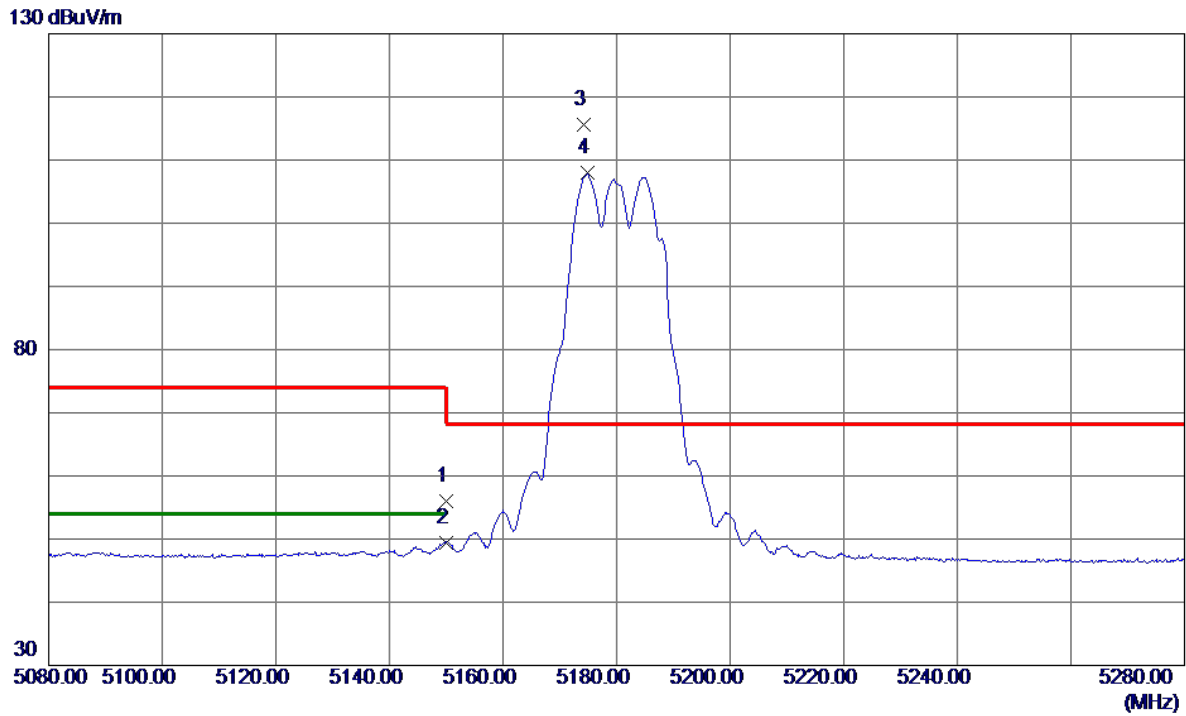

No.	Freq. MHz	Reading Level dBuV/m	Correct Factor dB	Measure ment dBuV/m	Limit dBuV/m	Margin dB	Detector	Comment
1	5150.0000	37.94	18.05	55.99	74.00	-18.01	Peak	
2	5150.0000	31.31	18.05	49.36	54.00	-4.64	AVG	
3 *	5174.3000	97.53	18.12	115.65	68.20	47.45	Peak	No Limit
4	5174.9000	89.78	18.12	107.90	999.00	-891.10	AVG	No Limit

REMARKS:

- (1) Measurement Value = Reading Level + Correct Factor.
- (2) Margin Level = Measurement Value - Limit Value.

Test Mode	UNII-1_TX A Mode 5180 MHz	Polarization	Vertical
-----------	---------------------------	--------------	----------

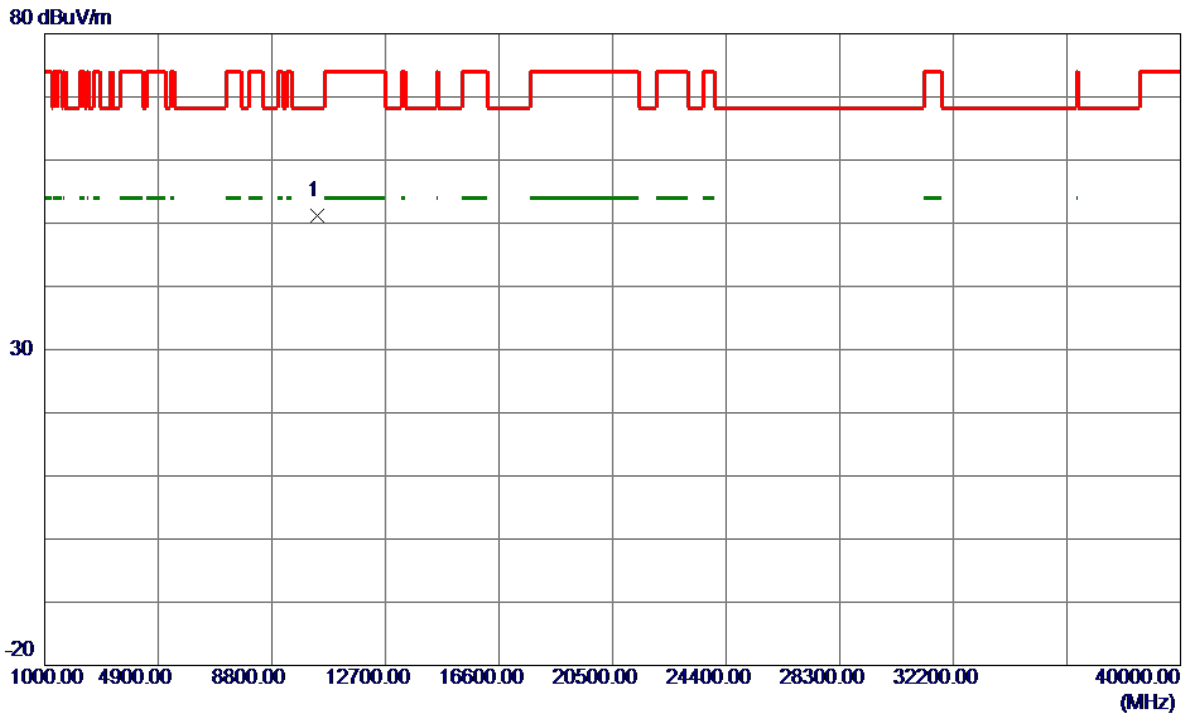

No.	Freq. MHz	Reading Level dBuV/m	Correct Factor dB	Measure ment dBuV/m	Limit dBuV/m	Margin dB	Detector	Comment
1 *	10359.9650	35.10	16.08	51.18	68.20	-17.02	Peak	

REMARKS:

- (1) Measurement Value = Reading Level + Correct Factor.
- (2) Margin Level = Measurement Value - Limit Value.

Test Mode	UNII-1_TX A Mode 5180 MHz	Polarization	Horizontal
-----------	---------------------------	--------------	------------

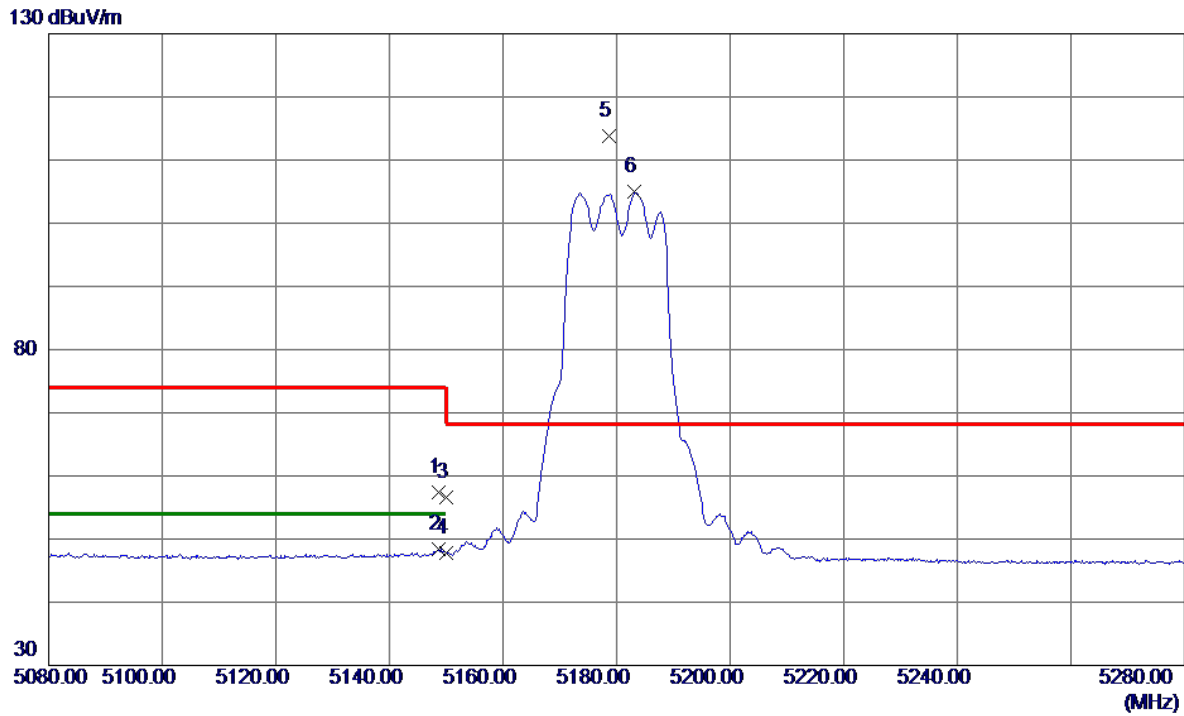

No.	Freq. MHz	Reading Level dBuV/m	Correct Factor dB	Measure ment dBuV/m	Limit dBuV/m	Margin dB	Detector	Comment
1	5148.6000	39.35	18.04	57.39	74.00	-16.61	Peak	
2	5148.6000	30.32	18.04	48.36	54.00	-5.64	AVG	
3	5150.0000	38.54	18.05	56.59	74.00	-17.41	Peak	
4	5150.0000	29.82	18.05	47.87	54.00	-6.13	AVG	
5 *	5178.6000	95.59	18.13	113.72	68.20	45.52	Peak	No Limit
6	5183.2000	86.83	18.15	104.98	999.00	-894.02	AVG	No Limit

REMARKS:

- (1) Measurement Value = Reading Level + Correct Factor.
- (2) Margin Level = Measurement Value - Limit Value.

Test Mode	UNII-1_TX A Mode 5180 MHz	Polarization	Horizontal
-----------	---------------------------	--------------	------------

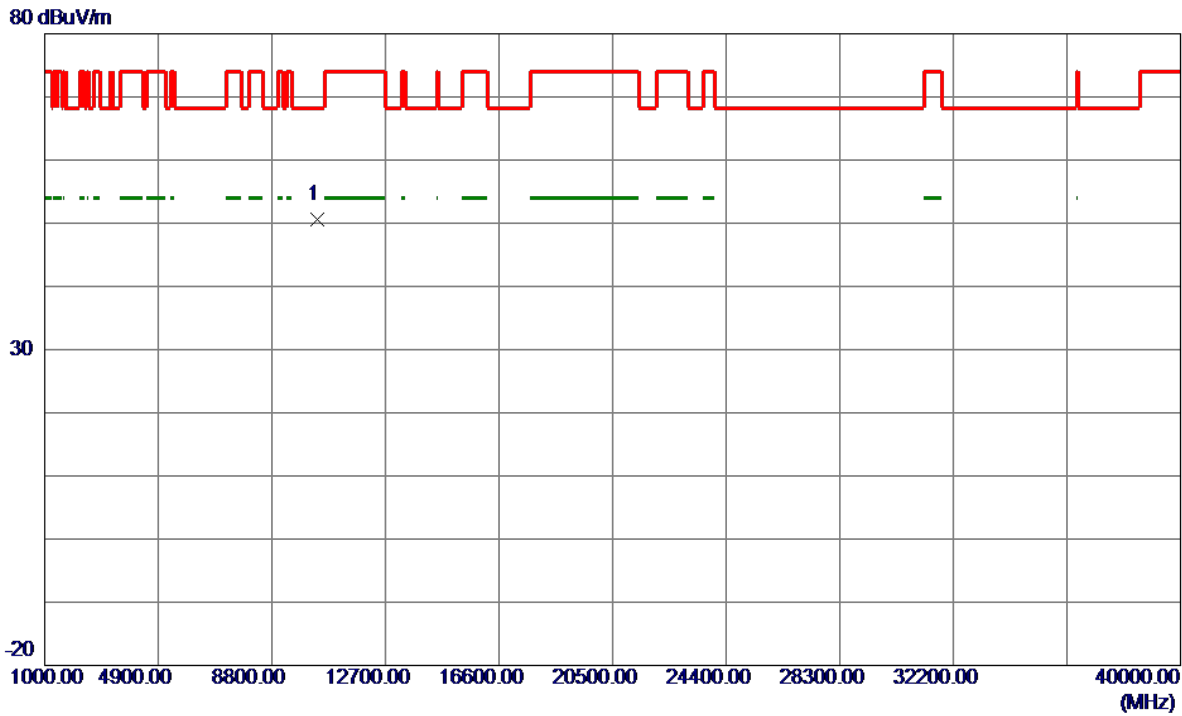

No.	Freq. MHz	Reading Level dBuV/m	Correct Factor dB	Measure ment dBuV/m	Limit dBuV/m	Margin dB	Detector	Comment
1 *	10359.3370	34.59	16.08	50.67	68.20	-17.53	Peak	

REMARKS:

- (1) Measurement Value = Reading Level + Correct Factor.
- (2) Margin Level = Measurement Value - Limit Value.

Test Mode	UNII-1_TX A Mode 5200 MHz	Polarization	Vertical
-----------	---------------------------	--------------	----------

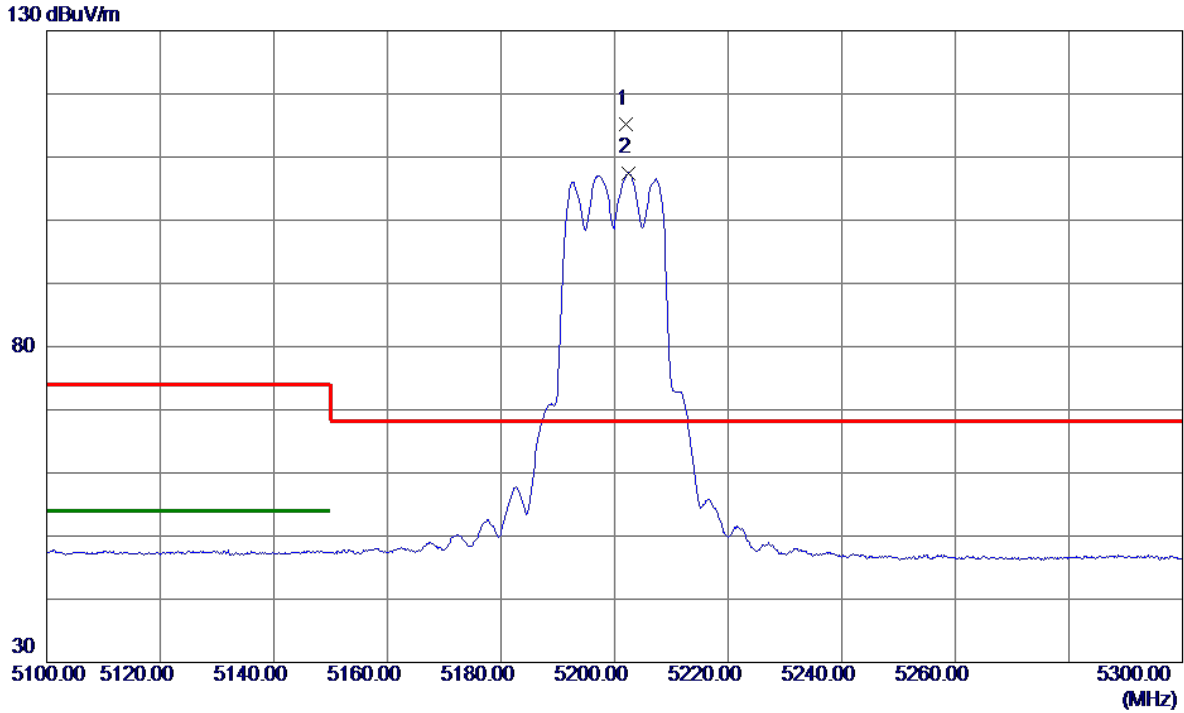

No.	Freq. MHz	Reading Level dBuV/m	Correct Factor dB	Measure ment dBuV/m	Limit dBuV/m	Margin dB	Detector	Comment
1 *	5202.1000	97.02	18.21	115.23	68.20	47.03	Peak	No Limit
2	5202.4000	89.29	18.21	107.50	999.00	-891.50	AVG	No Limit

REMARKS:

- (1) Measurement Value = Reading Level + Correct Factor.
- (2) Margin Level = Measurement Value - Limit Value.

Test Mode	UNII-1_TX A Mode 5200 MHz	Polarization	Vertical
-----------	---------------------------	--------------	----------



No.	Freq. MHz	Reading Level dBuV/m	Correct Factor dB	Measure ment dBuV/m	Limit dBuV/m	Margin dB	Detector	Comment
1 *	10399.7360	35.36	16.13	51.49	68.20	-16.71	Peak	

REMARKS:

- (1) Measurement Value = Reading Level + Correct Factor.
- (2) Margin Level = Measurement Value - Limit Value.

Test Mode	UNII-1_TX A Mode 5200 MHz	Polarization	Horizontal
-----------	---------------------------	--------------	------------

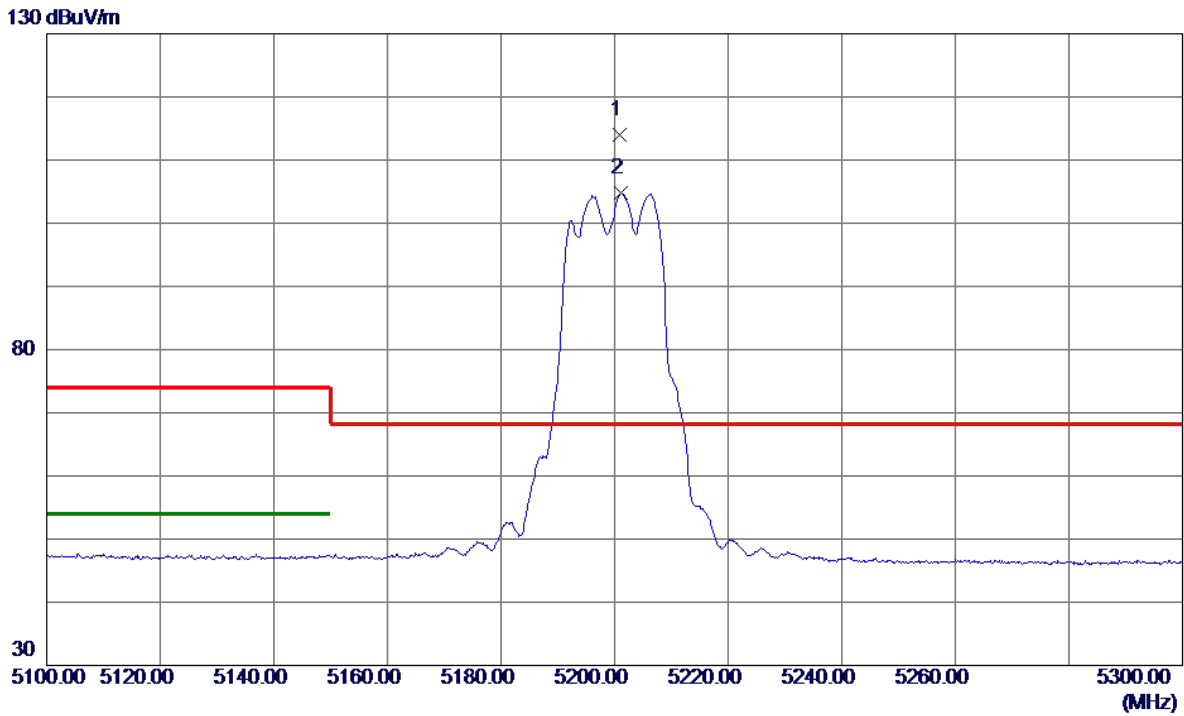

No.	Freq. MHz	Reading Level dBuV/m	Correct Factor dB	Measure ment dBuV/m	Limit dBuV/m	Margin dB	Detector	Comment
1 *	5200.9000	95.78	18.20	113.98	68.20	45.78	Peak	No Limit
2	5201.1000	86.58	18.20	104.78	999.00	-894.22	AVG	No Limit

REMARKS:

- (1) Measurement Value = Reading Level + Correct Factor.
- (2) Margin Level = Measurement Value - Limit Value.

Test Mode	UNII-1_TX A Mode 5200 MHz	Polarization	Horizontal
-----------	---------------------------	--------------	------------



No.	Freq. MHz	Reading Level dBuV/m	Correct Factor dB	Measure ment dBuV/m	Limit dBuV/m	Margin dB	Detector	Comment
1 *	10399.8660	33.43	16.13	49.56	68.20	-18.64	Peak	

REMARKS:

- (1) Measurement Value = Reading Level + Correct Factor.
- (2) Margin Level = Measurement Value - Limit Value.

Test Mode	UNII-1_TX A Mode 5240 MHz	Polarization	Vertical
-----------	---------------------------	--------------	----------

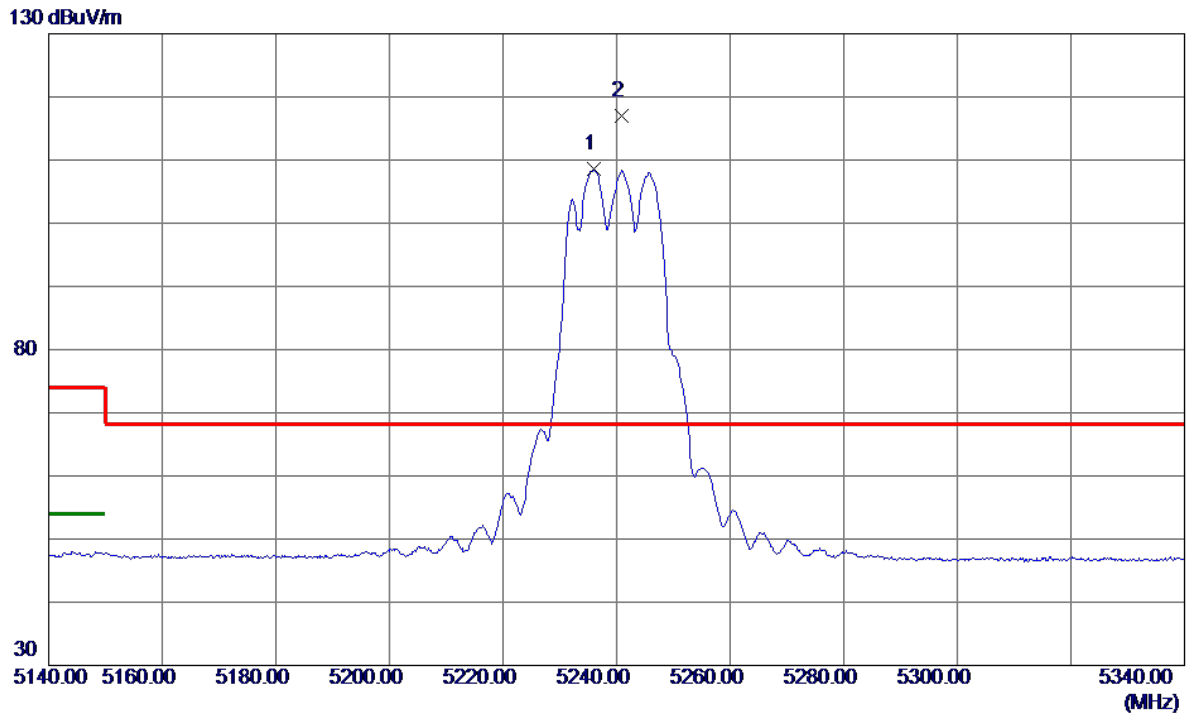

No.	Freq. MHz	Reading Level dBuV/m	Correct Factor dB	Measure ment dBuV/m	Limit dBuV/m	Margin dB	Detector	Comment
1	5236.0000	90.24	18.31	108.55	999.00	-890.45	AVG	No Limit
2 *	5240.8000	98.62	18.33	116.95	68.20	48.75	Peak	No Limit

REMARKS:

- (1) Measurement Value = Reading Level + Correct Factor.
- (2) Margin Level = Measurement Value - Limit Value.

Test Mode	UNII-1_TX A Mode 5240 MHz	Polarization	Vertical
-----------	---------------------------	--------------	----------

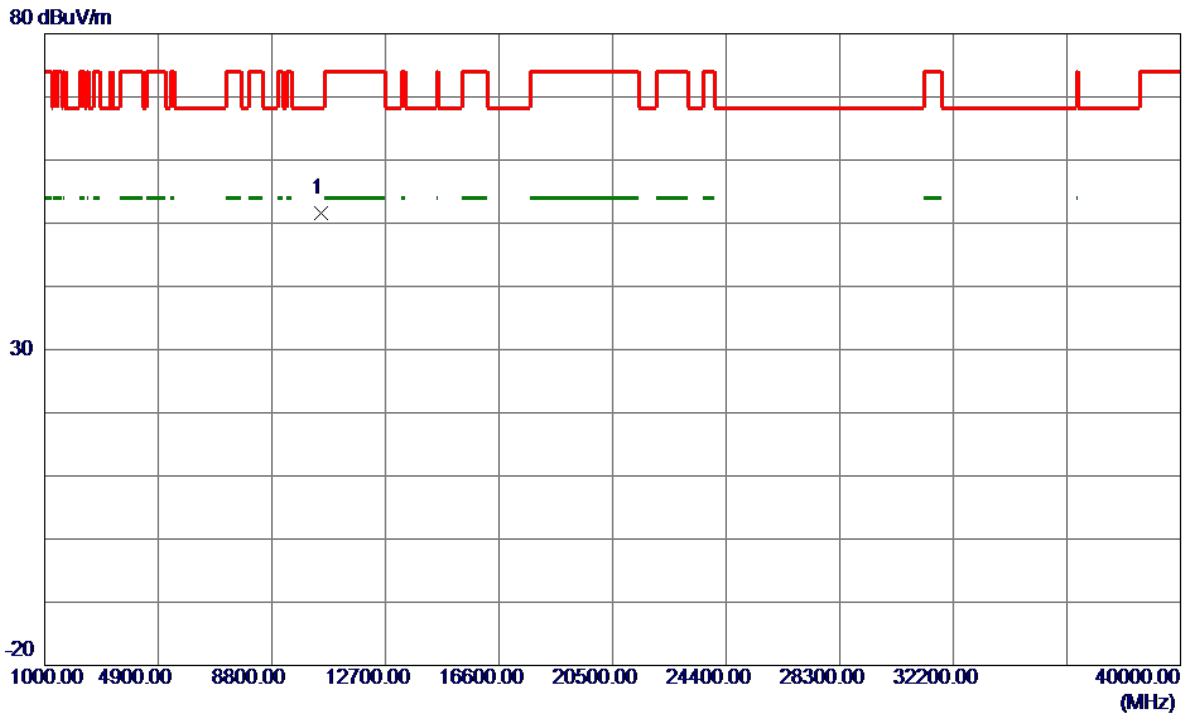

No.	Freq. MHz	Reading Level dBuV/m	Correct Factor dB	Measure ment dBuV/m	Limit dBuV/m	Margin dB	Detector	Comment
1 *	10479.8580	35.36	16.24	51.60	68.20	-16.60	Peak	

REMARKS:

- (1) Measurement Value = Reading Level + Correct Factor.
- (2) Margin Level = Measurement Value - Limit Value.

Test Mode	UNII-1_TX A Mode 5240 MHz	Polarization	Horizontal
-----------	---------------------------	--------------	------------

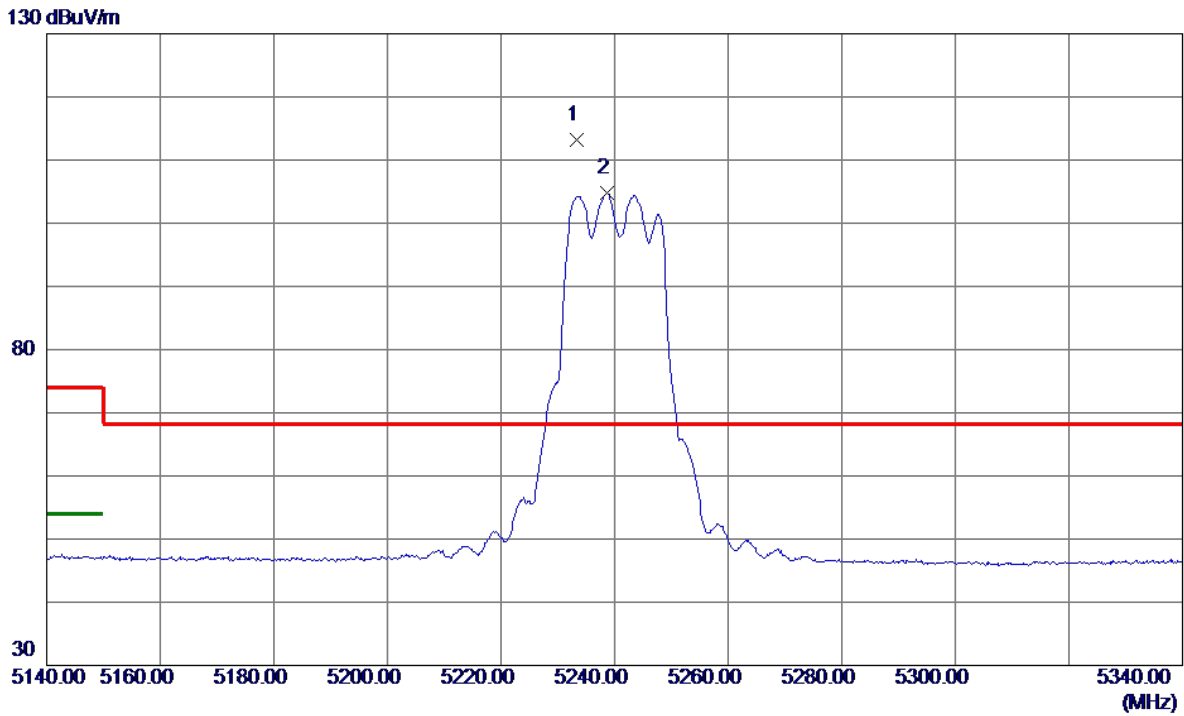

No.	Freq. MHz	Reading Level dBuV/m	Correct Factor dB	Measure ment dBuV/m	Limit dBuV/m	Margin dB	Detector	Comment
1 *	5233.4000	94.84	18.30	113.14	68.20	44.94	Peak	No Limit
2	5238.7000	86.52	18.32	104.84	999.00	-894.16	AVG	No Limit

REMARKS:

- (1) Measurement Value = Reading Level + Correct Factor.
- (2) Margin Level = Measurement Value - Limit Value.

Test Mode	UNII-1_TX A Mode 5240 MHz	Polarization	Horizontal
-----------	---------------------------	--------------	------------

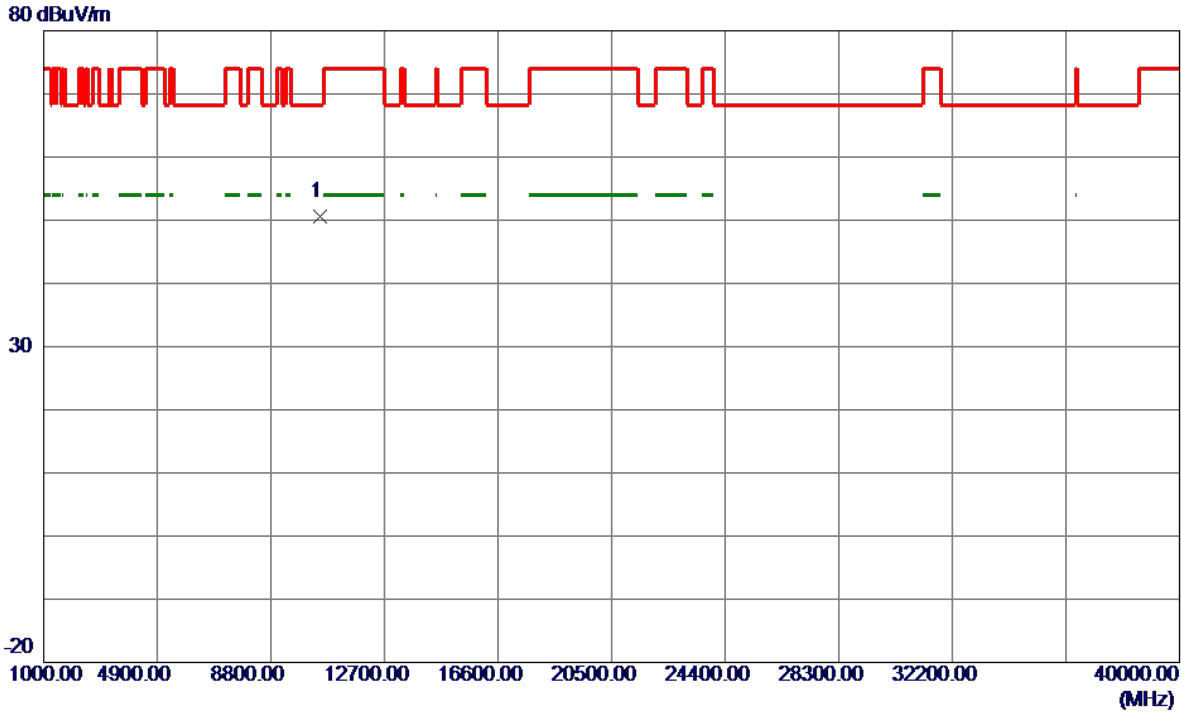

No.	Freq. MHz	Reading Level dBuV/m	Correct Factor dB	Measure ment dBuV/m	Limit dBuV/m	Margin dB	Detector	Comment
1 *	10480.8090	34.27	16.24	50.51	68.20	-17.69	Peak	

REMARKS:

- (1) Measurement Value = Reading Level + Correct Factor.
- (2) Margin Level = Measurement Value - Limit Value.

Test Mode	UNII-1_TX AC(VHT20) Mode 5180 MHz	Polarization	Vertical
-----------	-----------------------------------	--------------	----------

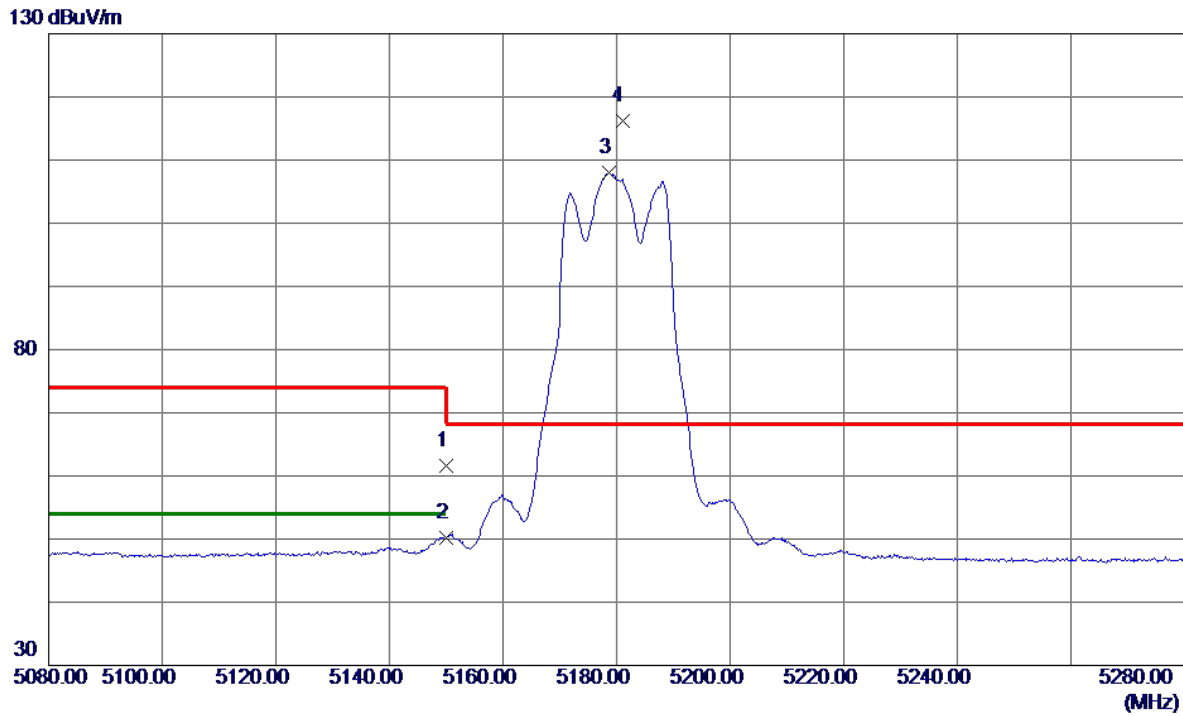

No.	Freq. MHz	Reading Level dBuV/m	Correct Factor dB	Measure ment dBuV/m	Limit dBuV/m	Margin dB	Detector	Comment
1	5150.0000	43.64	18.05	61.69	74.00	-12.31	Peak	
2	5150.0000	32.08	18.05	50.13	54.00	-3.87	AVG	
3	5178.6000	89.78	18.13	107.91	999.00	-891.09	AVG	No Limit
4 *	5181.0000	98.07	18.14	116.21	68.20	48.01	Peak	No Limit

REMARKS:

- (1) Measurement Value = Reading Level + Correct Factor.
- (2) Margin Level = Measurement Value - Limit Value.

Test Mode	UNII-1_TX AC(VHT20) Mode 5180 MHz	Polarization	Vertical
-----------	-----------------------------------	--------------	----------

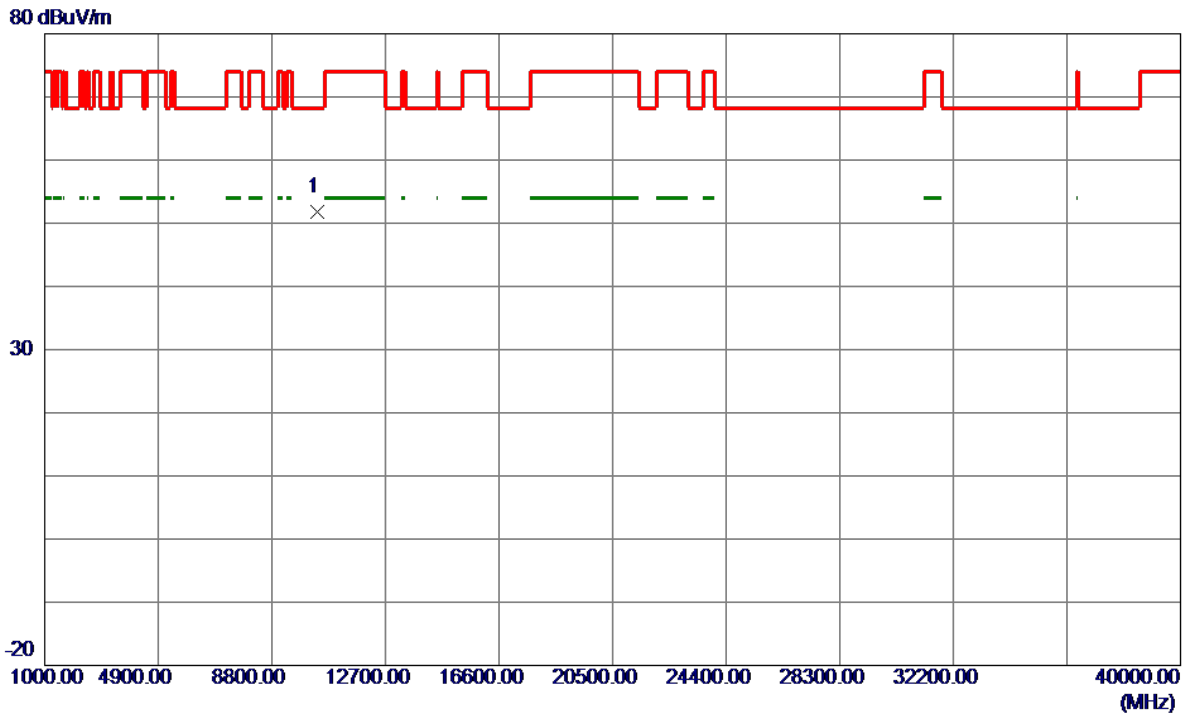

No.	Freq. MHz	Reading Level dBuV/m	Correct Factor dB	Measure ment dBuV/m	Limit dBuV/m	Margin dB	Detector	Comment
1 *	10360.0470	35.75	16.08	51.83	68.20	-16.37	Peak	

REMARKS:

- (1) Measurement Value = Reading Level + Correct Factor.
- (2) Margin Level = Measurement Value - Limit Value.

Test Mode	UNII-1_TX AC(VHT20) Mode 5180 MHz	Polarization	Horizontal
-----------	-----------------------------------	--------------	------------

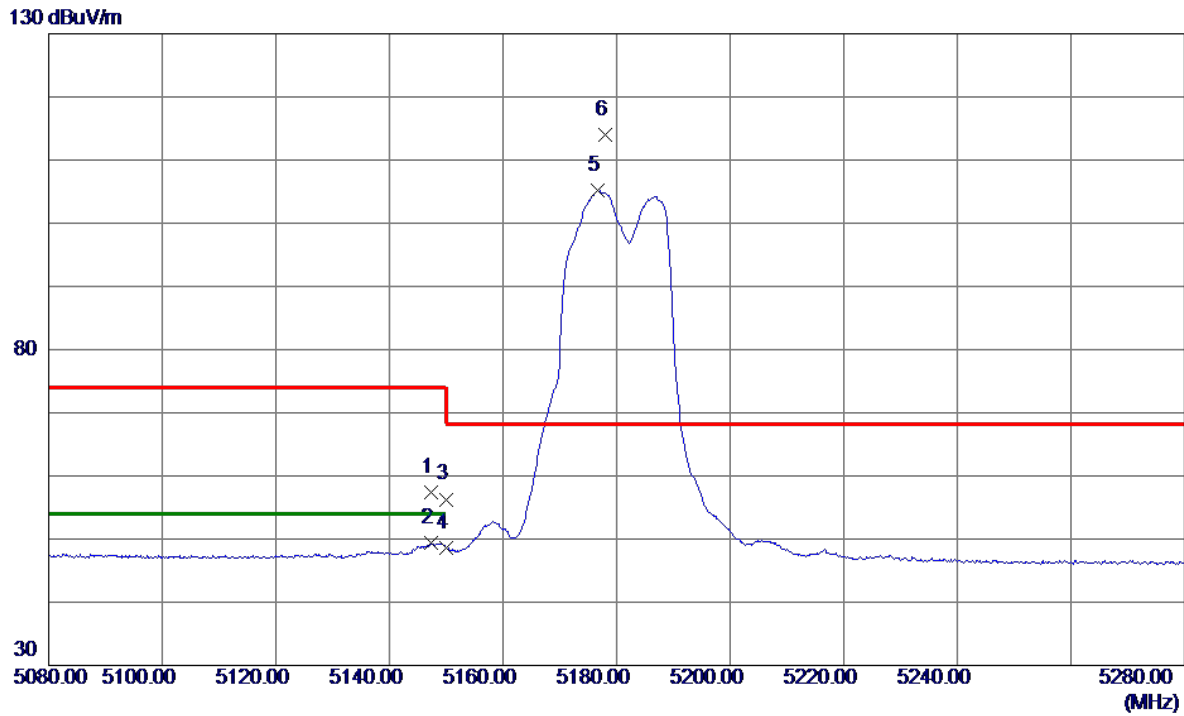

No.	Freq. MHz	Reading Level dBuV/m	Correct Factor dB	Measure ment dBuV/m	Limit dBuV/m	Margin dB	Detector	Comment
1	5147.3000	39.32	18.04	57.36	74.00	-16.64	Peak	
2	5147.3000	31.34	18.04	49.38	54.00	-4.62	AVG	
3	5150.0000	38.25	18.05	56.30	74.00	-17.70	Peak	
4	5150.0000	30.57	18.05	48.62	54.00	-5.38	AVG	
5	5176.7000	87.03	18.13	105.16	999.00	-893.84	AVG	No Limit
6 *	5178.1000	95.81	18.13	113.94	68.20	45.74	Peak	No Limit

REMARKS:

- (1) Measurement Value = Reading Level + Correct Factor.
- (2) Margin Level = Measurement Value - Limit Value.

Test Mode	UNII-1_TX AC(VHT20) Mode 5180 MHz	Polarization	Horizontal
-----------	-----------------------------------	--------------	------------



No.	Freq. MHz	Reading Level dBuV/m	Correct Factor dB	Measure ment dBuV/m	Limit dBuV/m	Margin dB	Detector	Comment
1 *	10359.4450	34.46	16.08	50.54	68.20	-17.66	Peak	

REMARKS:

- (1) Measurement Value = Reading Level + Correct Factor.
- (2) Margin Level = Measurement Value - Limit Value.

Test Mode	UNII-1_TX AC(VHT20) Mode 5200 MHz	Polarization	Vertical
-----------	-----------------------------------	--------------	----------

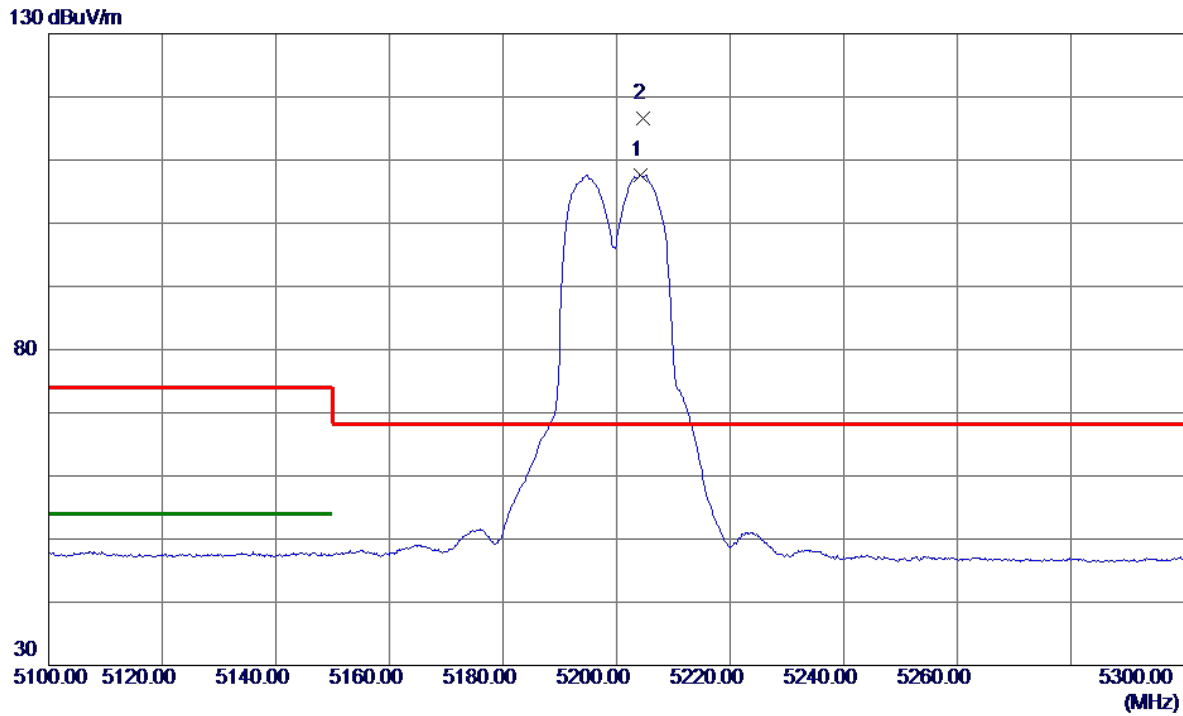

No.	Freq. MHz	Reading Level dBuV/m	Correct Factor dB	Measure ment dBuV/m	Limit dBuV/m	Margin dB	Detector	Comment
1	5204.2000	89.42	18.21	107.63	999.00	-891.37	AVG	No Limit
2 *	5204.7000	98.35	18.21	116.56	68.20	48.36	Peak	No Limit

REMARKS:

- (1) Measurement Value = Reading Level + Correct Factor.
- (2) Margin Level = Measurement Value - Limit Value.

Test Mode	UNII-1_TX AC(VHT20) Mode 5200 MHz	Polarization	Vertical
-----------	-----------------------------------	--------------	----------

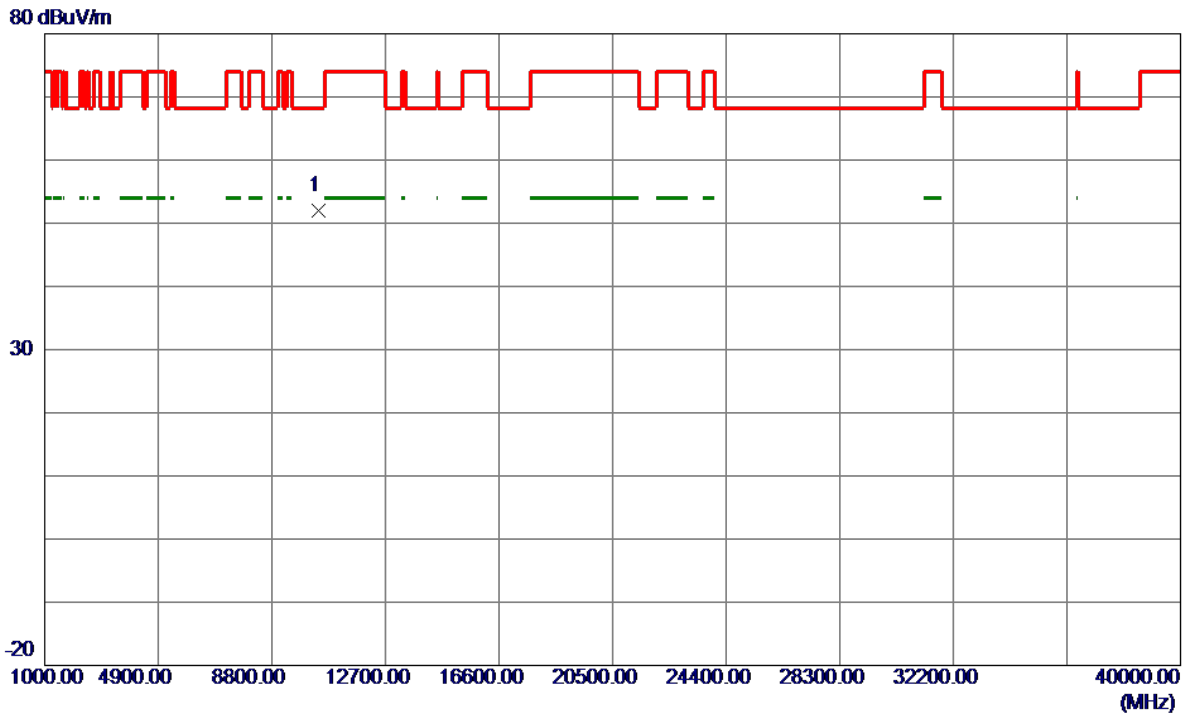

No.	Freq. MHz	Reading Level dBuV/m	Correct Factor dB	Measure ment dBuV/m	Limit dBuV/m	Margin dB	Detector	Comment
1 *	10399.4250	35.86	16.13	51.99	68.20	-16.21	Peak	

REMARKS:

- (1) Measurement Value = Reading Level + Correct Factor.
- (2) Margin Level = Measurement Value - Limit Value.

Test Mode	UNII-1_TX AC(VHT20) Mode 5200 MHz	Polarization	Horizontal
-----------	-----------------------------------	--------------	------------

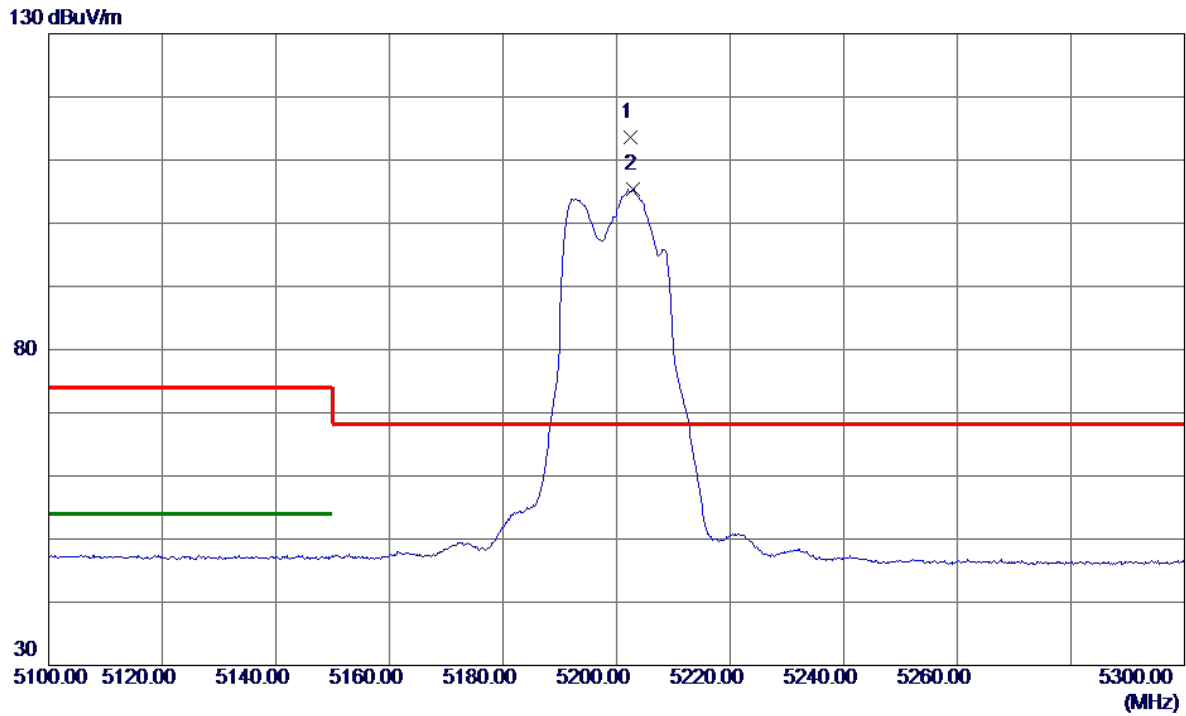

No.	Freq. MHz	Reading Level dBuV/m	Correct Factor dB	Measure ment dBuV/m	Limit dBuV/m	Margin dB	Detector	Comment
1 *	5202.5000	95.32	18.21	113.53	68.20	45.33	Peak	No Limit
2	5203.0000	87.19	18.21	105.40	999.00	-893.60	AVG	No Limit

REMARKS:

- (1) Measurement Value = Reading Level + Correct Factor.
- (2) Margin Level = Measurement Value - Limit Value.

Test Mode	UNII-1_TX AC(VHT20) Mode 5200 MHz	Polarization	Horizontal
-----------	-----------------------------------	--------------	------------



No.	Freq. MHz	Reading Level dBuV/m	Correct Factor dB	Measure ment dBuV/m	Limit dBuV/m	Margin dB	Detector	Comment
1 *	10400.8230	35.01	16.13	51.14	68.20	-17.06	Peak	

REMARKS:

- (1) Measurement Value = Reading Level + Correct Factor.
- (2) Margin Level = Measurement Value - Limit Value.

Test Mode	UNII-1_TX AC(VHT20) Mode 5240 MHz	Polarization	Vertical
-----------	-----------------------------------	--------------	----------

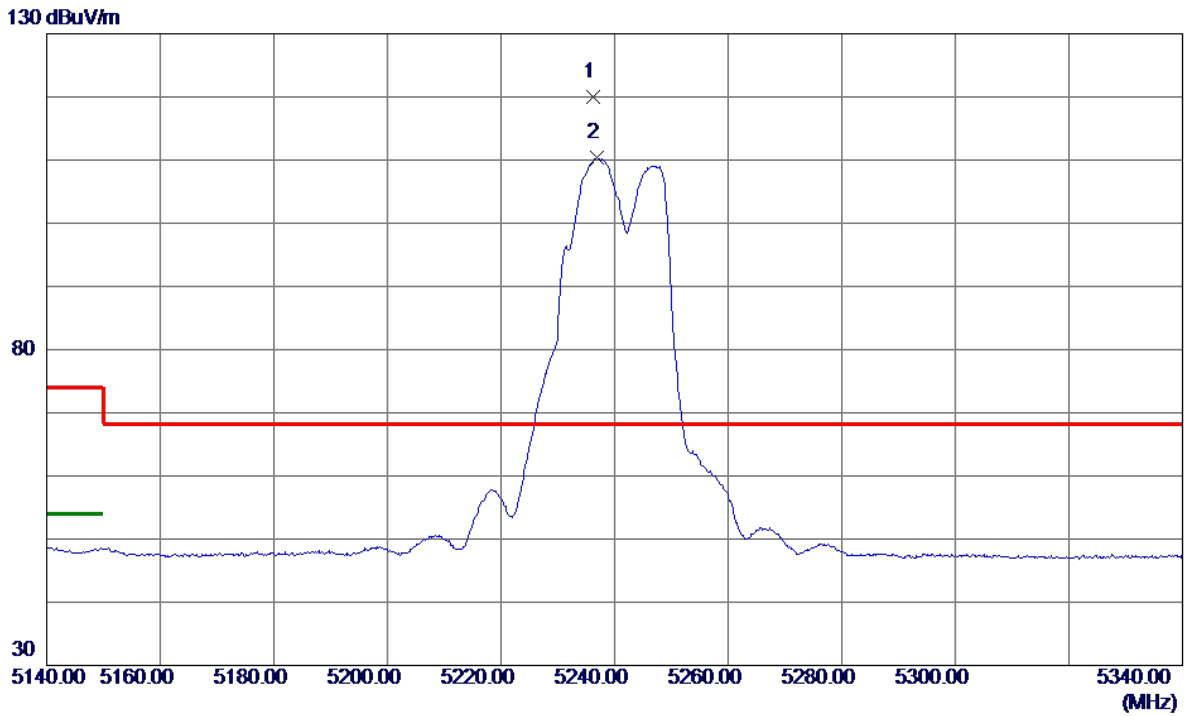

No.	Freq. MHz	Reading Level dBuV/m	Correct Factor dB	Measure ment dBuV/m	Limit dBuV/m	Margin dB	Detector	Comment
1 *	5236.2000	101.62	18.31	119.93	68.20	51.73	Peak	No Limit
2	5236.8000	92.13	18.31	110.44	999.00	-888.56	AVG	No Limit

REMARKS:

- (1) Measurement Value = Reading Level + Correct Factor.
- (2) Margin Level = Measurement Value - Limit Value.

Test Mode	UNII-1_TX AC(VHT20) Mode 5240 MHz	Polarization	Vertical
-----------	-----------------------------------	--------------	----------

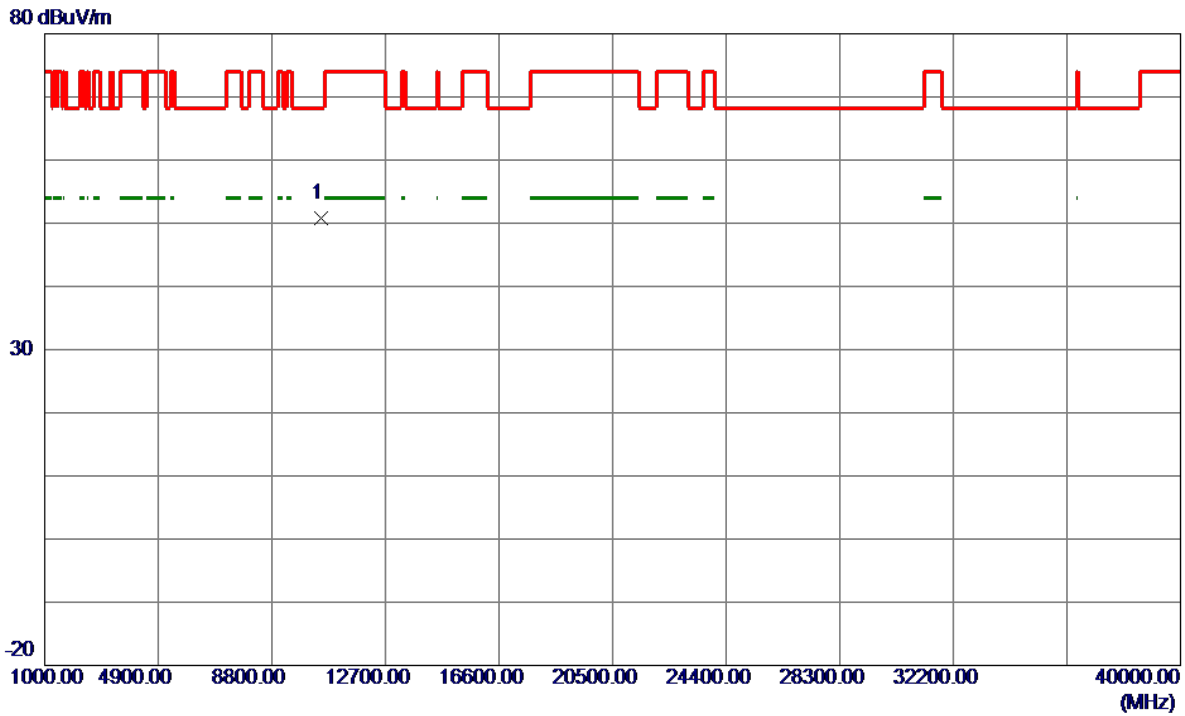

No.	Freq. MHz	Reading Level dBuV/m	Correct Factor dB	Measure ment dBuV/m	Limit dBuV/m	Margin dB	Detector	Comment
1 *	10479.7080	34.56	16.24	50.80	68.20	-17.40	Peak	

REMARKS:

- (1) Measurement Value = Reading Level + Correct Factor.
- (2) Margin Level = Measurement Value - Limit Value.

Test Mode	UNII-1_TX AC(VHT20) Mode 5240 MHz	Polarization	Horizontal
-----------	-----------------------------------	--------------	------------

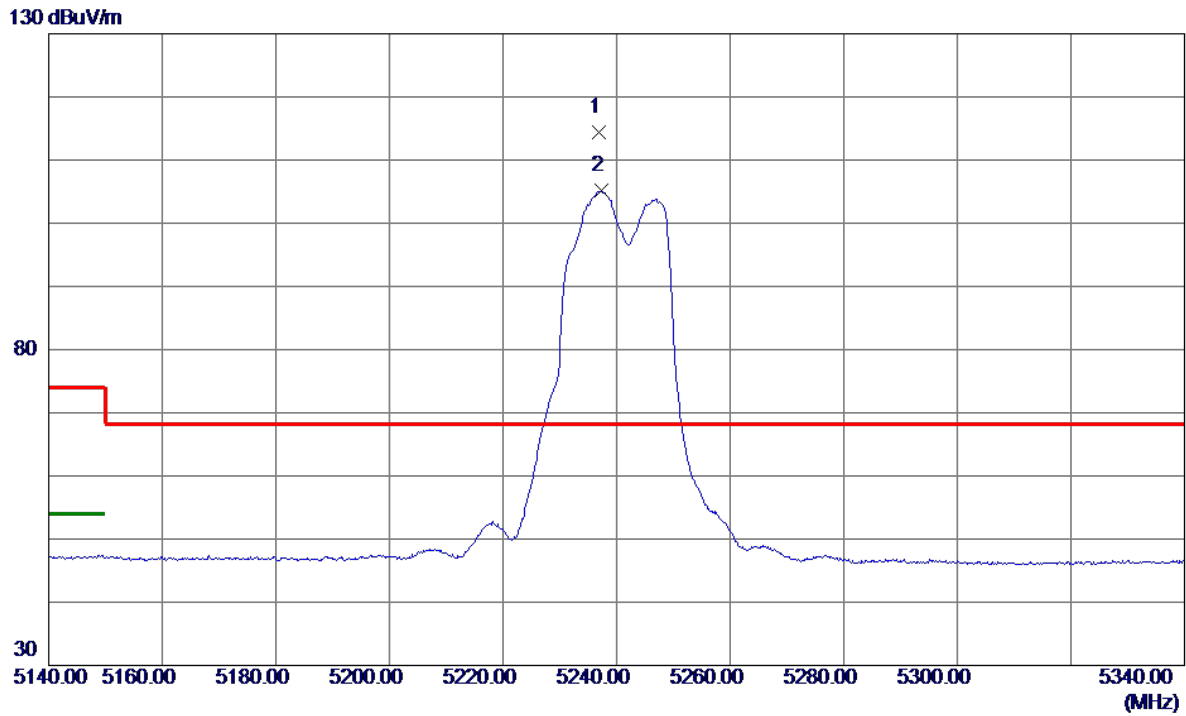

No.	Freq. MHz	Reading Level dBuV/m	Correct Factor dB	Measure ment dBuV/m	Limit dBuV/m	Margin dB	Detector	Comment
1 *	5236.9000	96.16	18.31	114.47	68.20	46.27	Peak	No Limit
2	5237.3000	86.89	18.31	105.20	999.00	-893.80	AVG	No Limit

REMARKS:

- (1) Measurement Value = Reading Level + Correct Factor.
- (2) Margin Level = Measurement Value - Limit Value.

Test Mode	UNII-1_TX AC(VHT20) Mode 5240 MHz	Polarization	Horizontal
-----------	-----------------------------------	--------------	------------



No.	Freq. MHz	Reading Level dBuV/m	Correct Factor dB	Measure ment dBuV/m	Limit dBuV/m	Margin dB	Detector	Comment
1 *	10479.6540	33.50	16.24	49.74	68.20	-18.46	Peak	

REMARKS:

- (1) Measurement Value = Reading Level + Correct Factor.
- (2) Margin Level = Measurement Value - Limit Value.

Test Mode	UNII-1_TX AC(VHT40) Mode 5190 MHz	Polarization	Vertical
-----------	-----------------------------------	--------------	----------

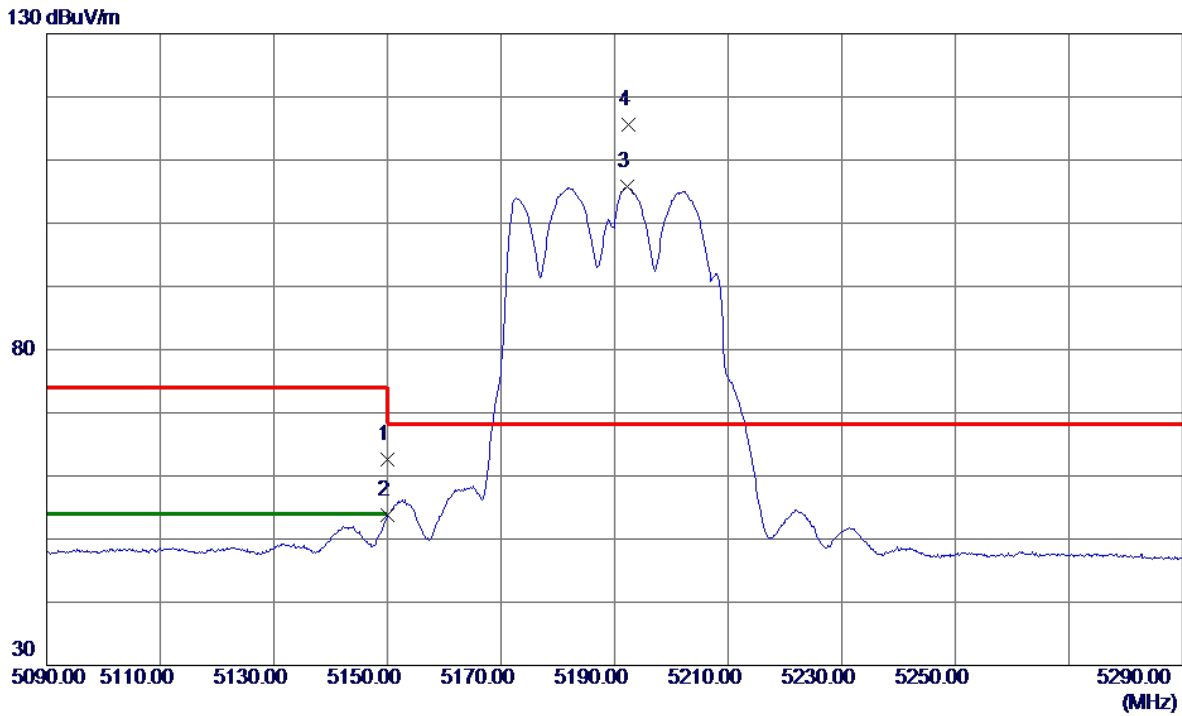

No.	Freq. MHz	Reading Level dBuV/m	Correct Factor dB	Measure ment dBuV/m	Limit dBuV/m	Margin dB	Detector	Comment
1	5150.0000	44.54	18.05	62.59	74.00	-11.41	Peak	
2	5150.0000	35.78	18.05	53.83	54.00	-0.17	AVG	
3	5192.2000	87.63	18.18	105.81	999.00	-893.19	AVG	No Limit
4 *	5192.4000	97.40	18.18	115.58	68.20	47.38	Peak	No Limit

REMARKS:

- (1) Measurement Value = Reading Level + Correct Factor.
- (2) Margin Level = Measurement Value - Limit Value.

Test Mode	UNII-1_TX AC(VHT40) Mode 5190 MHz	Polarization	Vertical
-----------	-----------------------------------	--------------	----------

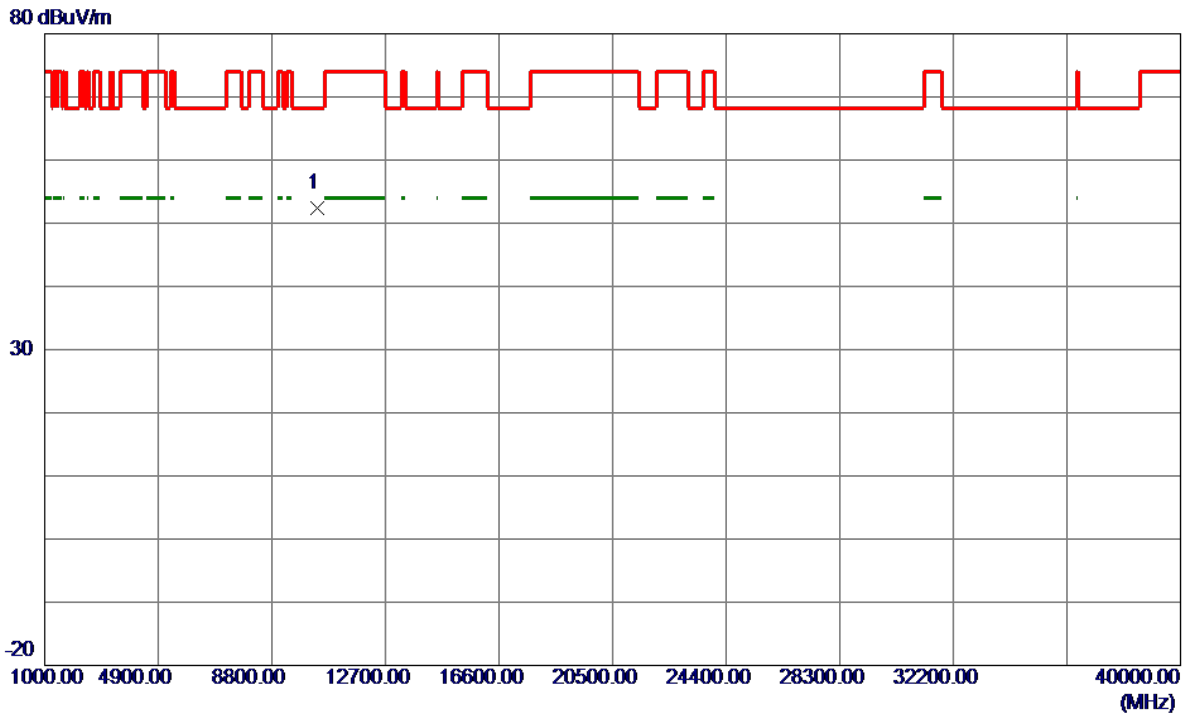

No.	Freq. MHz	Reading Level dBuV/m	Correct Factor dB	Measure ment dBuV/m	Limit dBuV/m	Margin dB	Detector	Comment
1 *	10380.2590	36.34	16.10	52.44	68.20	-15.76	Peak	

REMARKS:

- (1) Measurement Value = Reading Level + Correct Factor.
- (2) Margin Level = Measurement Value - Limit Value.

Test Mode	UNII-1_TX AC(VHT40) Mode 5190 MHz	Polarization	Horizontal
-----------	-----------------------------------	--------------	------------

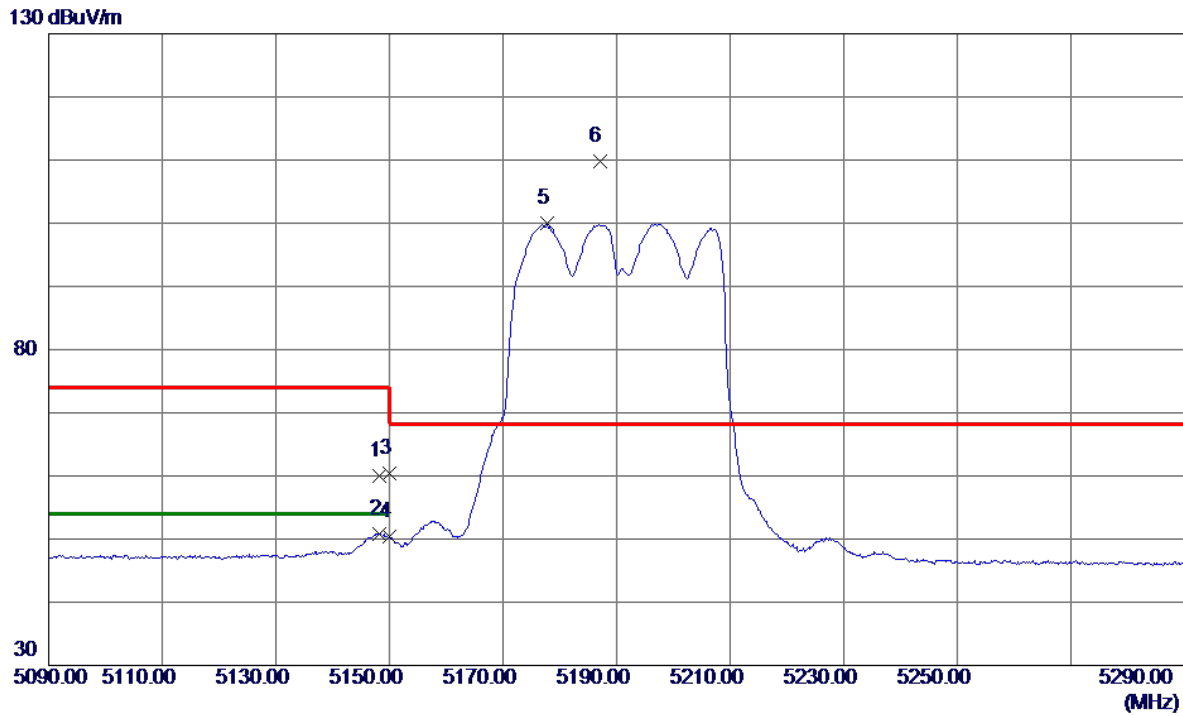

No.	Freq. MHz	Reading Level dBuV/m	Correct Factor dB	Measure ment dBuV/m	Limit dBuV/m	Margin dB	Detector	Comment
1	5148.2000	41.92	18.04	59.96	74.00	-14.04	Peak	
2	5148.2000	32.81	18.04	50.85	54.00	-3.15	AVG	
3	5150.0000	42.28	18.05	60.33	74.00	-13.67	Peak	
4	5150.0000	32.34	18.05	50.39	54.00	-3.61	AVG	
5	5177.8000	81.80	18.13	99.93	999.00	-899.07	AVG	No Limit
6 *	5187.0000	91.65	18.16	109.81	68.20	41.61	Peak	No Limit

REMARKS:

- (1) Measurement Value = Reading Level + Correct Factor.
- (2) Margin Level = Measurement Value - Limit Value.

Test Mode	UNII-1_TX AC(VHT40) Mode 5190 MHz	Polarization	Horizontal
-----------	-----------------------------------	--------------	------------

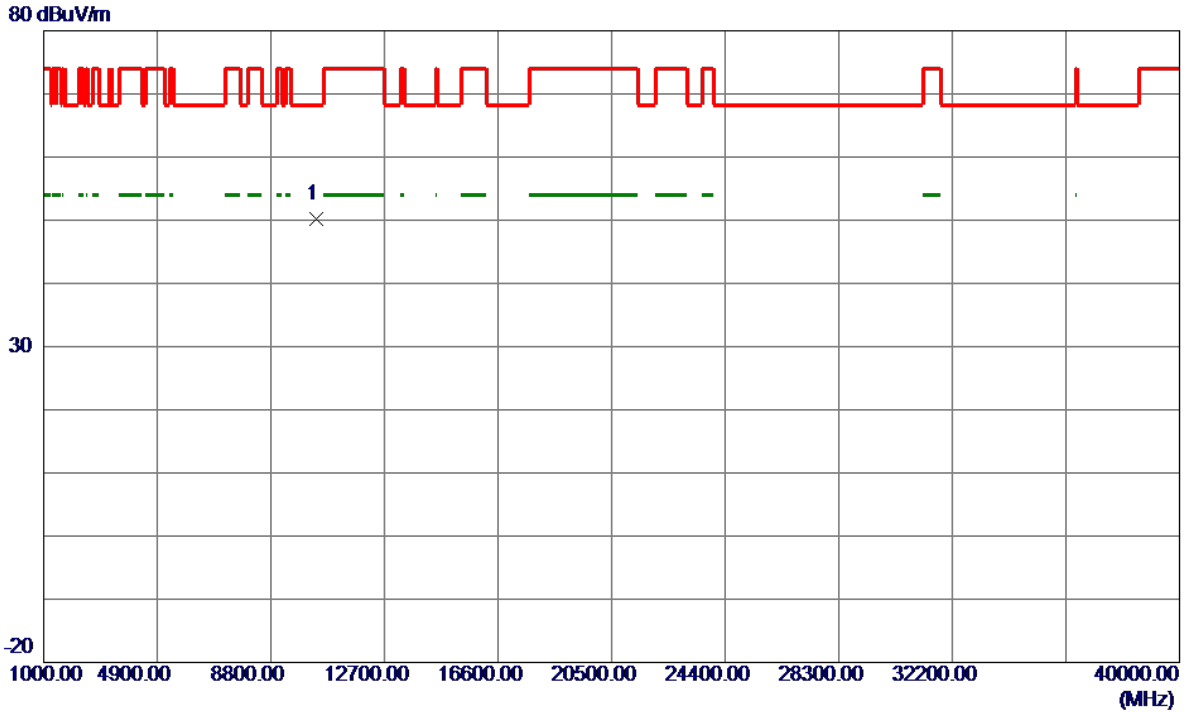

No.	Freq. MHz	Reading Level dBuV/m	Correct Factor dB	Measure ment dBuV/m	Limit dBuV/m	Margin dB	Detector	Comment
1 *	10380.6170	34.00	16.11	50.11	68.20	-18.09	Peak	

REMARKS:

- (1) Measurement Value = Reading Level + Correct Factor.
- (2) Margin Level = Measurement Value - Limit Value.

Test Mode	UNII-1_TX AC(VHT40) Mode 5230 MHz	Polarization	Vertical
-----------	-----------------------------------	--------------	----------

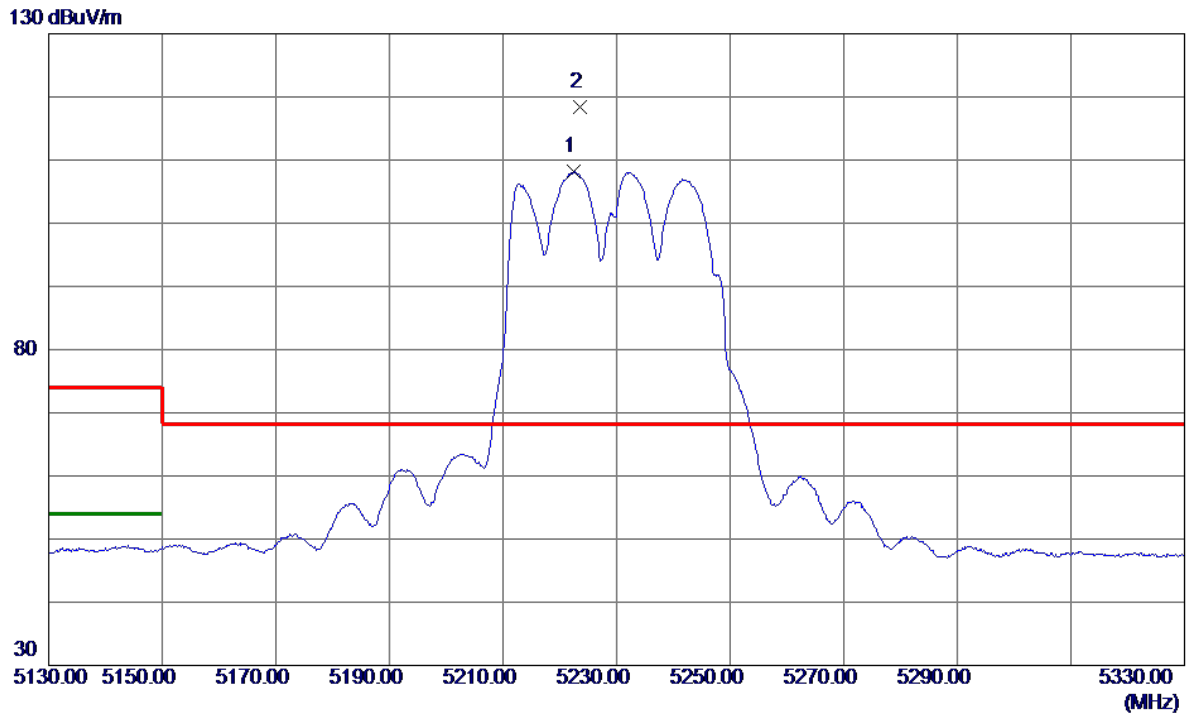

No.	Freq. MHz	Reading Level dBuV/m	Correct Factor dB	Measure ment dBuV/m	Limit dBuV/m	Margin dB	Detector	Comment
1	5222.5000	90.02	18.27	108.29	999.00	-890.71	AVG	No Limit
2 *	5223.6000	100.05	18.27	118.32	68.20	50.12	Peak	No Limit

REMARKS:

- (1) Measurement Value = Reading Level + Correct Factor.
- (2) Margin Level = Measurement Value - Limit Value.

Test Mode	UNII-1_TX AC(VHT40) Mode 5230 MHz	Polarization	Vertical
-----------	-----------------------------------	--------------	----------

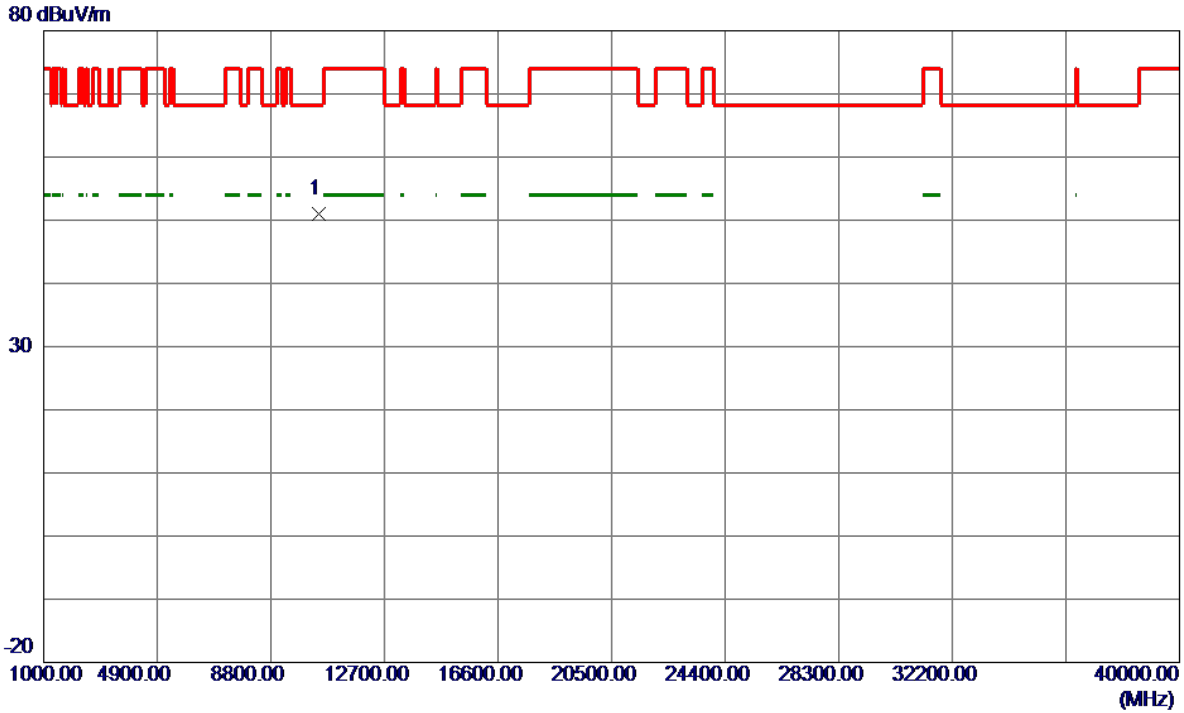

No.	Freq. MHz	Reading Level dBuV/m	Correct Factor dB	Measure ment dBuV/m	Limit dBuV/m	Margin dB	Detector	Comment
1 *	10459.9670	34.87	16.21	51.08	68.20	-17.12	Peak	

REMARKS:

- (1) Measurement Value = Reading Level + Correct Factor.
- (2) Margin Level = Measurement Value - Limit Value.

Test Mode	UNII-1_TX AC(VHT40) Mode 5230 MHz	Polarization	Horizontal
-----------	-----------------------------------	--------------	------------

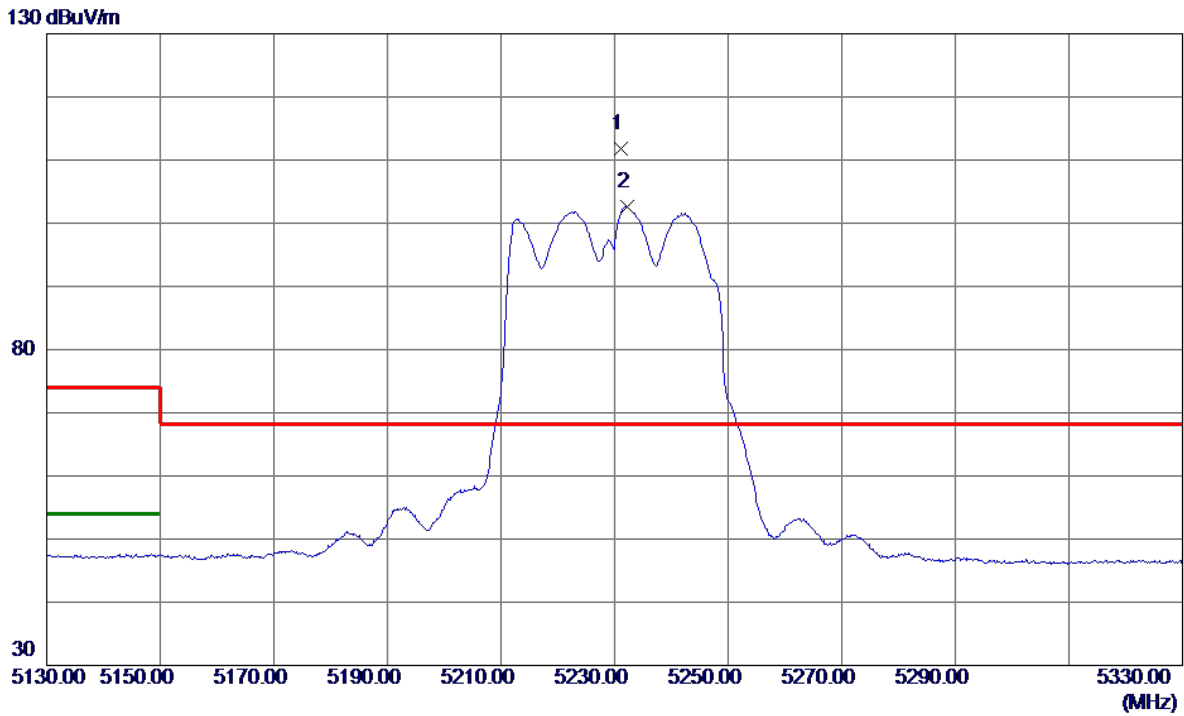

No.	Freq. MHz	Reading Level dBuV/m	Correct Factor dB	Measure ment dBuV/m	Limit dBuV/m	Margin dB	Detector	Comment
1 *	5231.2000	93.46	18.30	111.76	68.20	43.56	Peak	No Limit
2	5232.2000	84.34	18.30	102.64	999.00	-896.36	AVG	No Limit

REMARKS:

- (1) Measurement Value = Reading Level + Correct Factor.
- (2) Margin Level = Measurement Value - Limit Value.

Test Mode	UNII-1_TX AC(VHT40) Mode 5230 MHz	Polarization	Horizontal
-----------	-----------------------------------	--------------	------------

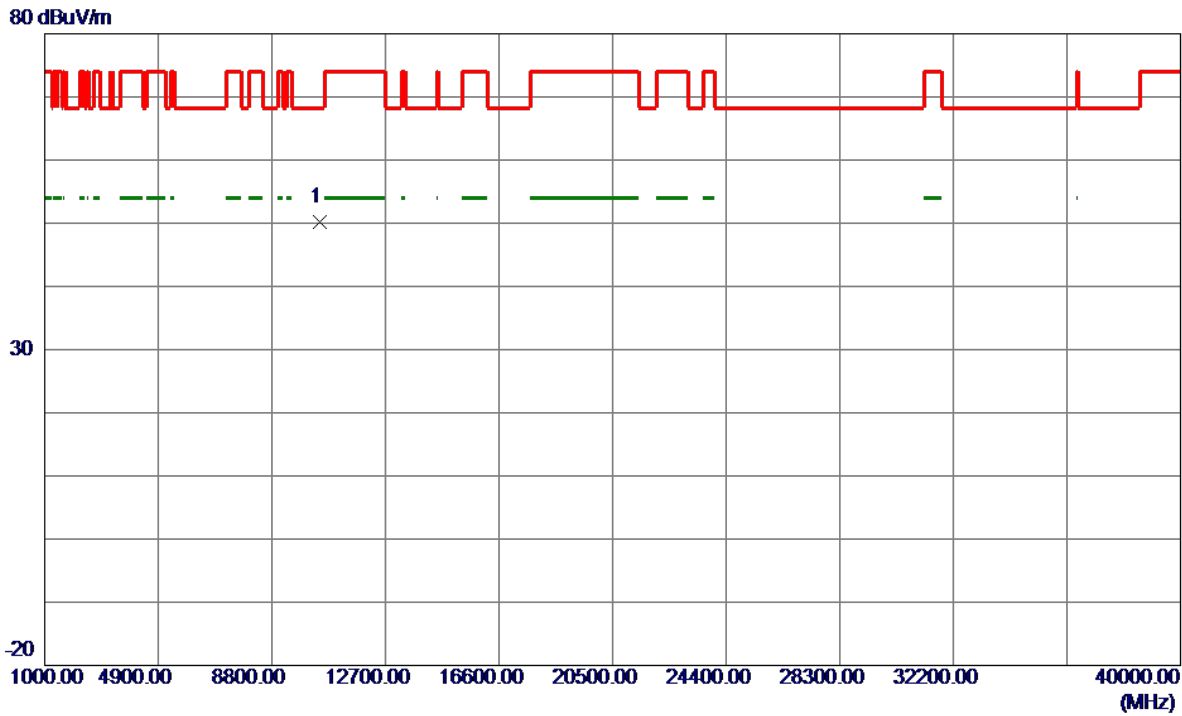

No.	Freq. MHz	Reading Level dBuV/m	Correct Factor dB	Measure ment dBuV/m	Limit dBuV/m	Margin dB	Detector	Comment
1 *	10460.3110	33.91	16.22	50.13	68.20	-18.07	Peak	

REMARKS:

- (1) Measurement Value = Reading Level + Correct Factor.
- (2) Margin Level = Measurement Value - Limit Value.

Test Mode	UNII-1_TX AC(VHT80) Mode 5210 MHz	Polarization	Vertical
-----------	-----------------------------------	--------------	----------

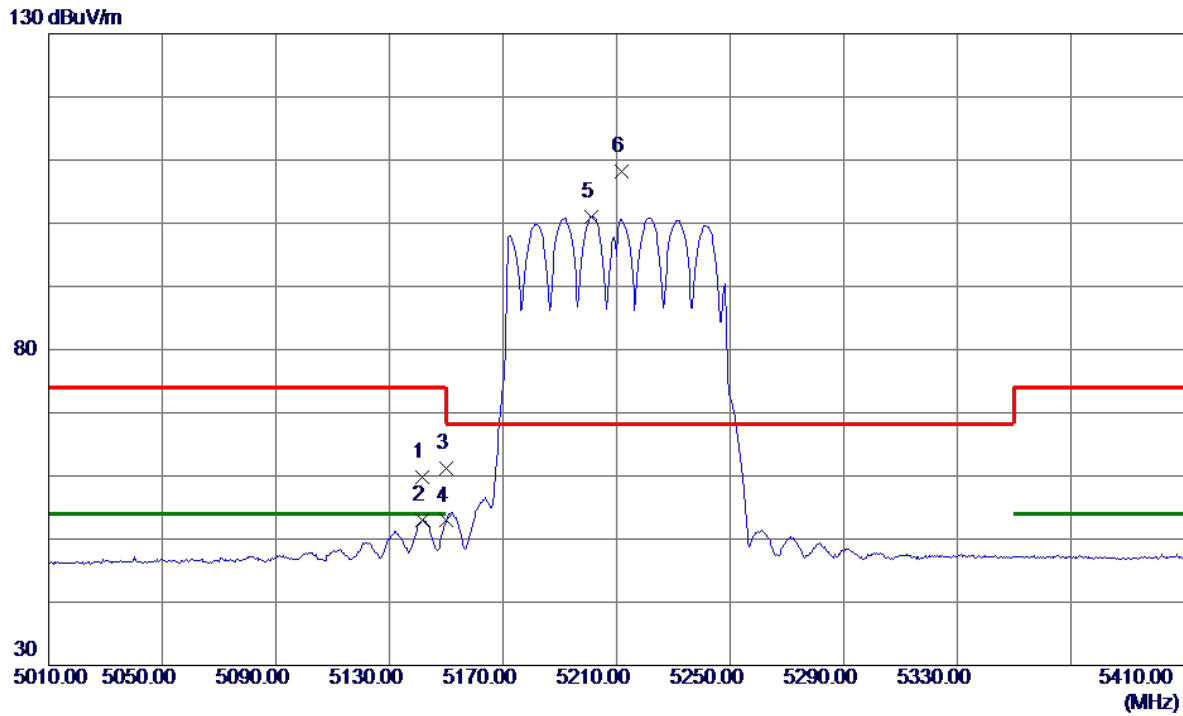

No.	Freq. MHz	Reading Level dBuV/m	Correct Factor dB	Measure ment dBuV/m	Limit dBuV/m	Margin dB	Detector	Comment
1	5141.6000	43.56	16.27	59.83	74.00	-14.17	Peak	
2	5141.6000	36.76	16.27	53.03	54.00	-0.97	AVG	
3	5150.0000	44.92	16.28	61.20	74.00	-12.80	Peak	
4	5150.0000	36.62	16.28	52.90	54.00	-1.10	AVG	
5	5201.2000	84.74	16.34	101.08	999.00	-897.92	AVG	No Limit
6 *	5211.6000	91.79	16.35	108.14	68.20	39.94	Peak	No Limit

REMARKS:

- (1) Measurement Value = Reading Level + Correct Factor.
- (2) Margin Level = Measurement Value - Limit Value.

Test Mode	UNII-1_TX AC(VHT80) Mode 5210 MHz	Polarization	Vertical
-----------	-----------------------------------	--------------	----------

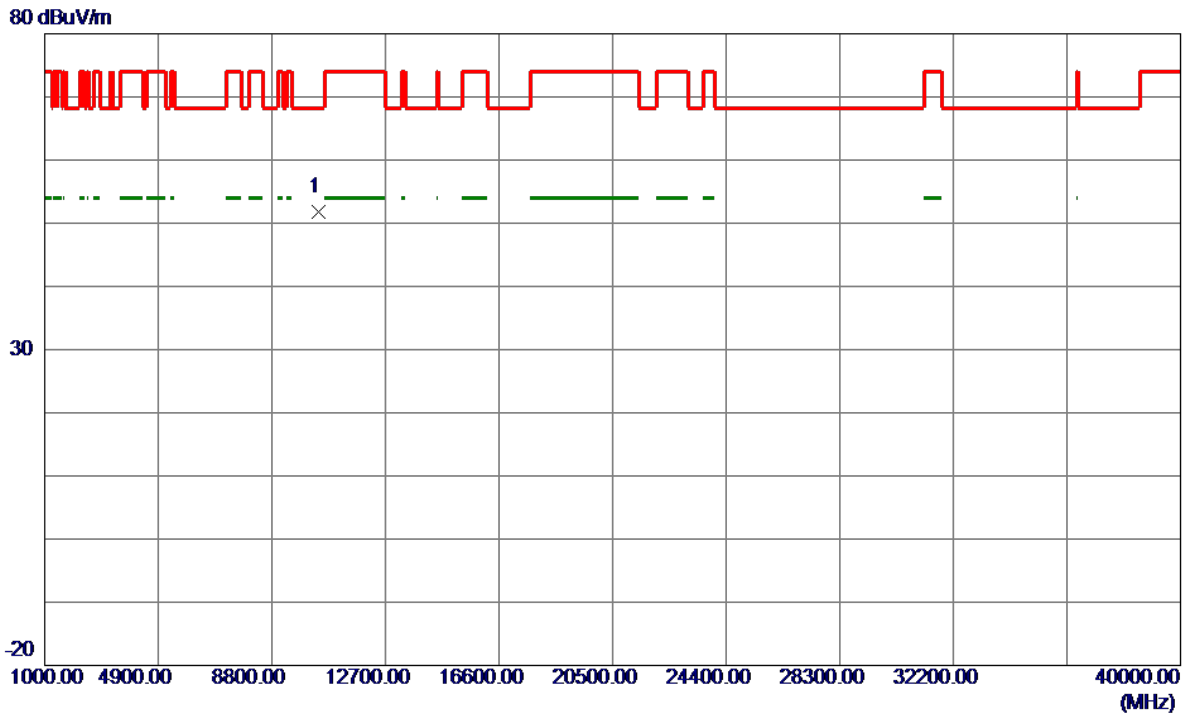

No.	Freq. MHz	Reading Level dBuV/m	Correct Factor dB	Measure ment dBuV/m	Limit dBuV/m	Margin dB	Detector	Comment
1 *	10420.0519	35.61	16.16	51.77	68.20	-16.43	Peak	

REMARKS:

- (1) Measurement Value = Reading Level + Correct Factor.
- (2) Margin Level = Measurement Value - Limit Value.

Test Mode	UNII-1_TX AC(VHT80) Mode 5210 MHz	Polarization	Horizontal
-----------	-----------------------------------	--------------	------------

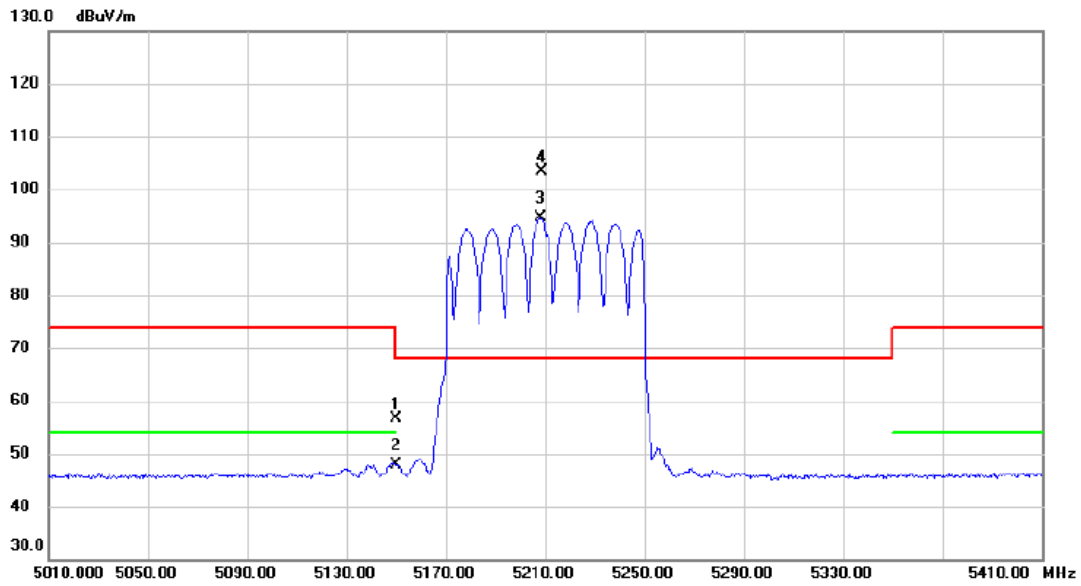

No.	Mk.	Freq. MHz	Reading Level dBuV	Correct Factor dB	Measure- ment dBuV/m	Limit dBuV/m	Margin dB	Detector	Comment
1		5150.000	40.38	16.28	56.66	74.00	-17.34	peak	
2		5150.000	31.67	16.28	47.95	54.00	-6.05	AVG	
3	X	5208.400	78.16	16.35	94.51	68.20	26.31	AVG	No Limit
4	*	5208.800	87.02	16.35	103.37	68.20	35.17	peak	No Limit

REMARKS:

- (1) Measurement Value = Reading Level + Correct Factor.
- (2) Margin Level = Measurement Value - Limit Value.

Test Mode	UNII-1_TX AC(VHT80) Mode 5210 MHz	Polarization	Horizontal
-----------	-----------------------------------	--------------	------------

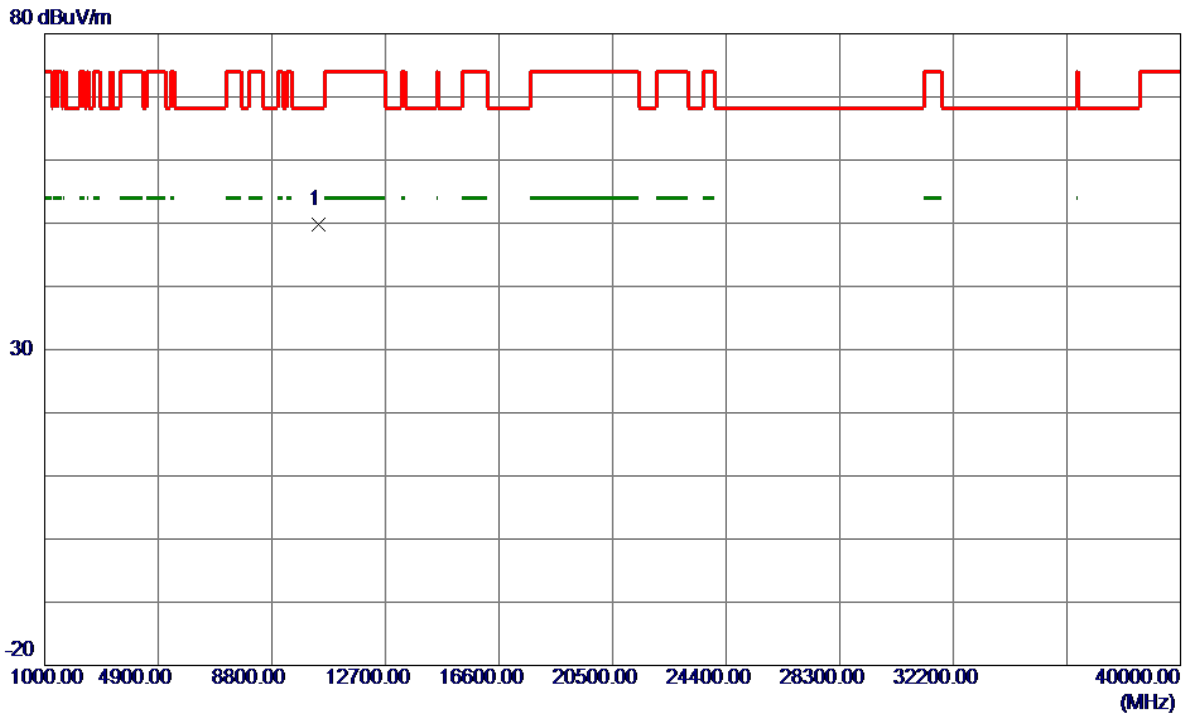

No.	Freq. MHz	Reading Level dBuV/m	Correct Factor dB	Measure ment dBuV/m	Limit dBuV/m	Margin dB	Detector	Comment
1 *	10419.4870	33.68	16.16	49.84	68.20	-18.36	Peak	

REMARKS:

- (1) Measurement Value = Reading Level + Correct Factor.
- (2) Margin Level = Measurement Value - Limit Value.

Test Mode	UNII-1_TX AX(HE20) Mode 5180 MHz	Polarization	Vertical
-----------	----------------------------------	--------------	----------

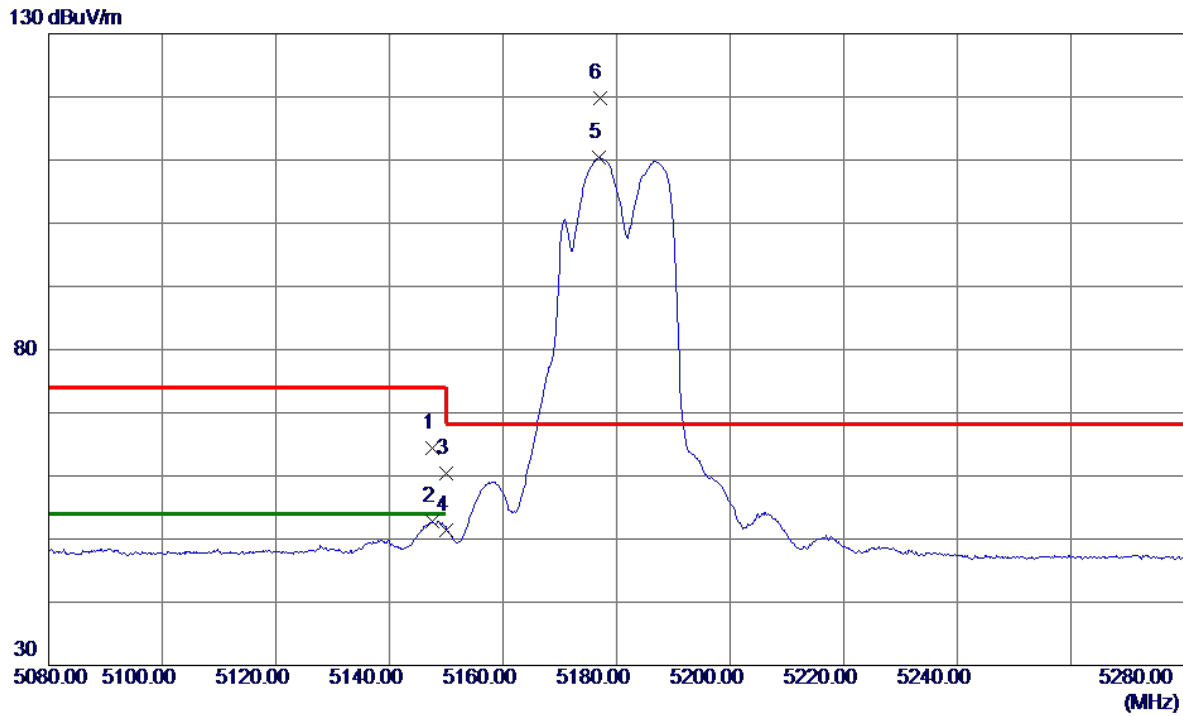

No.	Freq. MHz	Reading Level dBuV/m	Correct Factor dB	Measure ment dBuV/m	Limit dBuV/m	Margin dB	Detector	Comment
1	5147.5000	46.31	18.04	64.35	74.00	-9.65	Peak	
2	5147.5000	34.79	18.04	52.83	54.00	-1.17	AVG	
3	5150.0000	42.42	18.05	60.47	74.00	-13.53	Peak	
4	5150.0000	33.43	18.05	51.48	54.00	-2.52	AVG	
5	5176.9000	92.24	18.13	110.37	999.00	-888.63	AVG	No Limit
6 *	5177.0000	101.62	18.13	119.75	68.20	51.55	Peak	No Limit

REMARKS:

- (1) Measurement Value = Reading Level + Correct Factor.
- (2) Margin Level = Measurement Value - Limit Value.

Test Mode	UNII-1_TX AX(HE20) Mode 5180 MHz	Polarization	Vertical
-----------	----------------------------------	--------------	----------

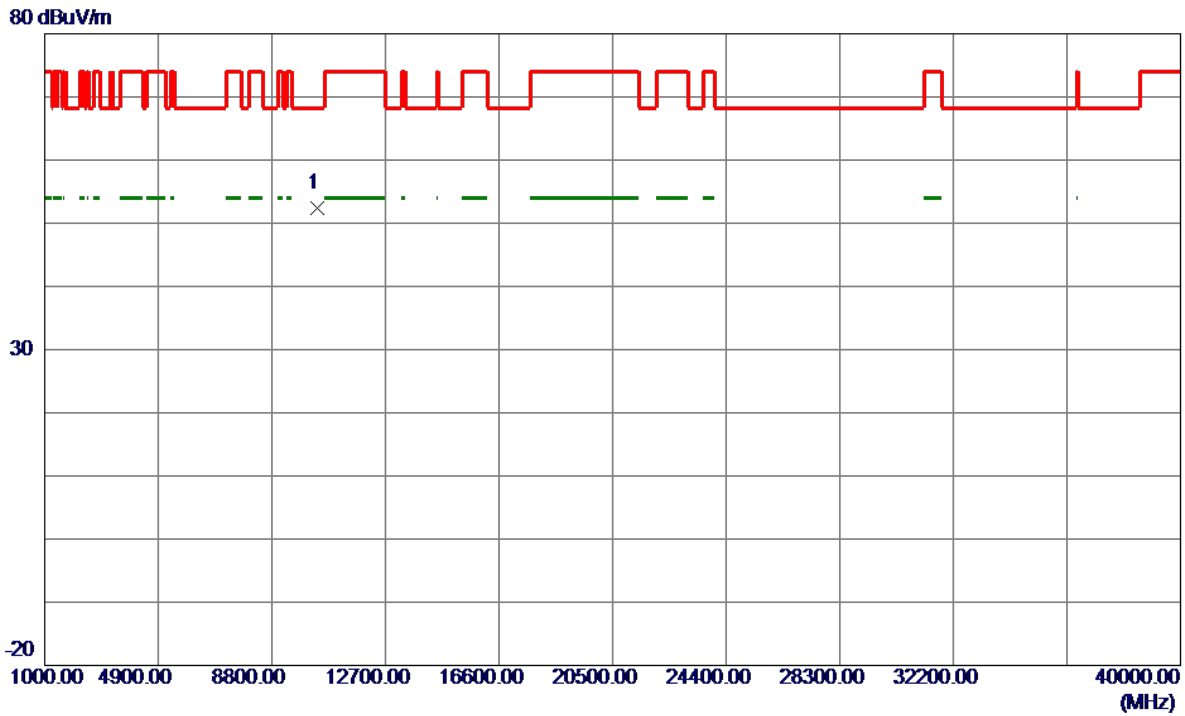

No.	Freq. MHz	Reading Level dBuV/m	Correct Factor dB	Measure ment dBuV/m	Limit dBuV/m	Margin dB	Detector	Comment
1 *	10359.8360	36.25	16.08	52.33	68.20	-15.87	Peak	

REMARKS:

- (1) Measurement Value = Reading Level + Correct Factor.
- (2) Margin Level = Measurement Value - Limit Value.

Test Mode	UNII-1_TX AX(HE20) Mode 5180 MHz	Polarization	Horizontal
-----------	----------------------------------	--------------	------------

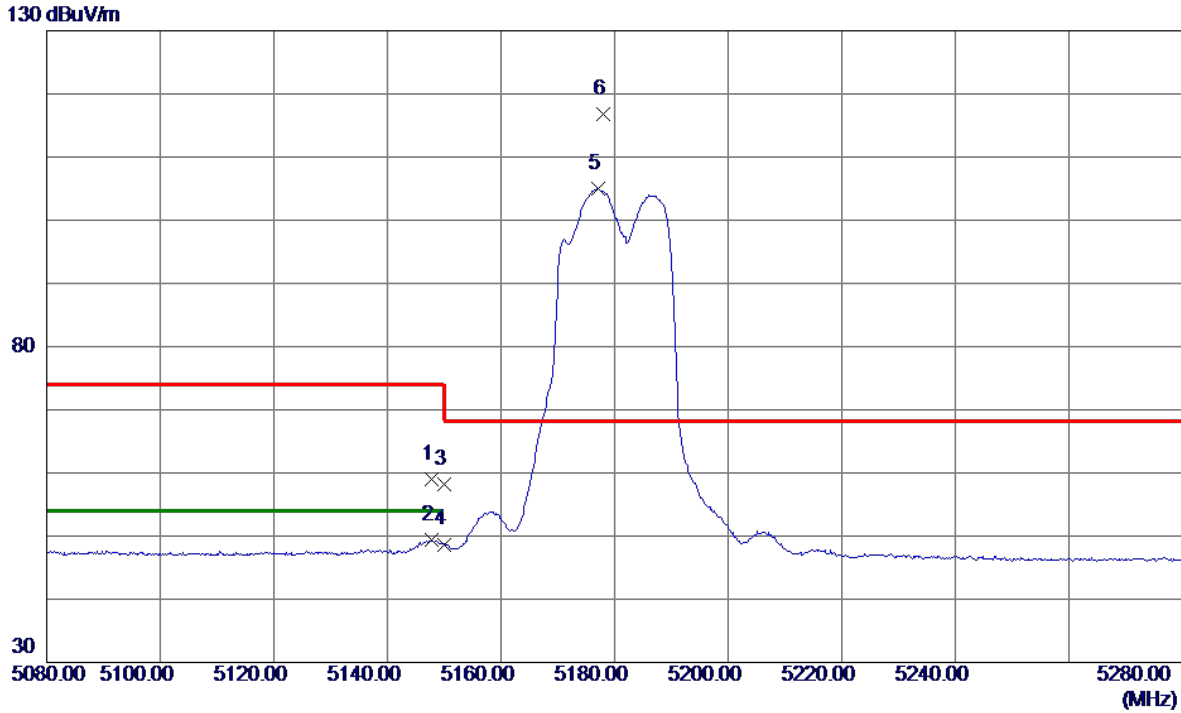

No.	Freq. MHz	Reading Level dBuV/m	Correct Factor dB	Measure ment dBuV/m	Limit dBuV/m	Margin dB	Detector	Comment
1	5147.7000	40.90	18.04	58.94	74.00	-15.06	Peak	
2	5147.7000	31.36	18.04	49.40	54.00	-4.60	AVG	
3	5150.0000	40.15	18.05	58.20	74.00	-15.80	Peak	
4	5150.0000	30.65	18.05	48.70	54.00	-5.30	AVG	
5	5177.1000	86.92	18.13	105.05	999.00	-893.95	AVG	No Limit
6 *	5177.9000	98.72	18.13	116.85	68.20	48.65	Peak	No Limit

REMARKS:

- (1) Measurement Value = Reading Level + Correct Factor.
- (2) Margin Level = Measurement Value - Limit Value.

Test Mode	UNII-1_TX AX(HE20) Mode 5180 MHz	Polarization	Horizontal
-----------	----------------------------------	--------------	------------

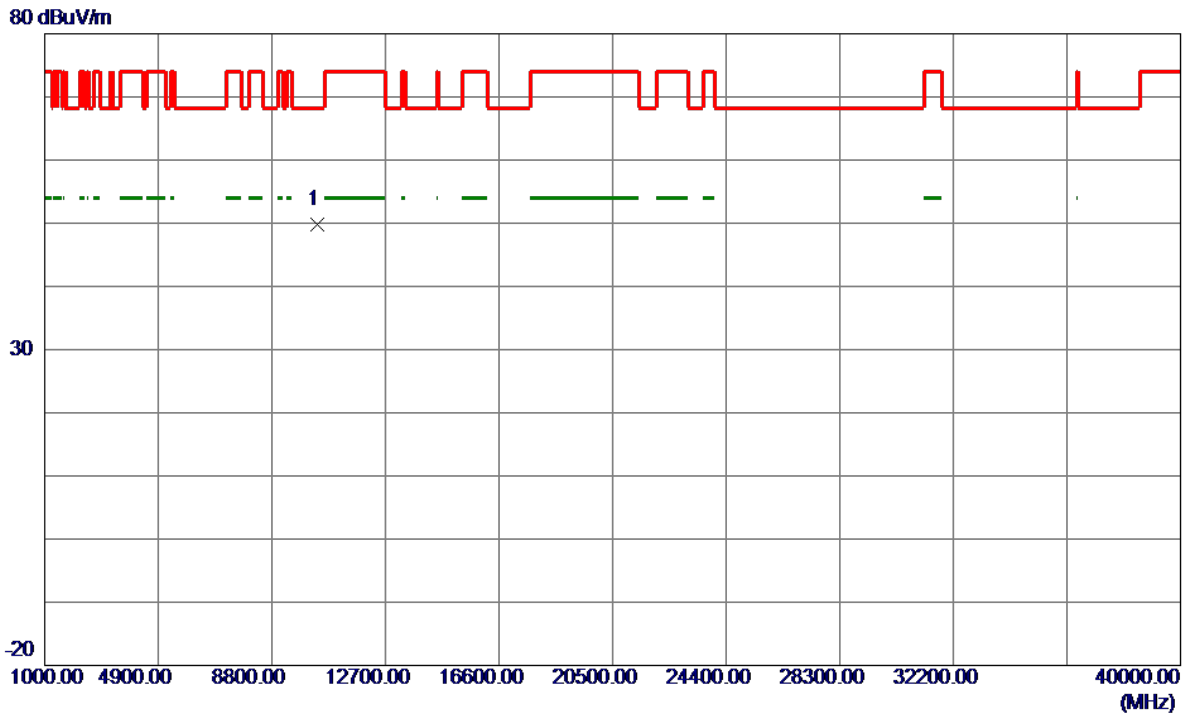

No.	Freq. MHz	Reading Level dBuV/m	Correct Factor dB	Measure ment dBuV/m	Limit dBuV/m	Margin dB	Detector	Comment
1 *	10359.9450	33.63	16.08	49.71	68.20	-18.49	Peak	

REMARKS:

- (1) Measurement Value = Reading Level + Correct Factor.
- (2) Margin Level = Measurement Value - Limit Value.

Test Mode	UNII-1_TX AX(HE20) Mode 5200 MHz	Polarization	Vertical
-----------	----------------------------------	--------------	----------

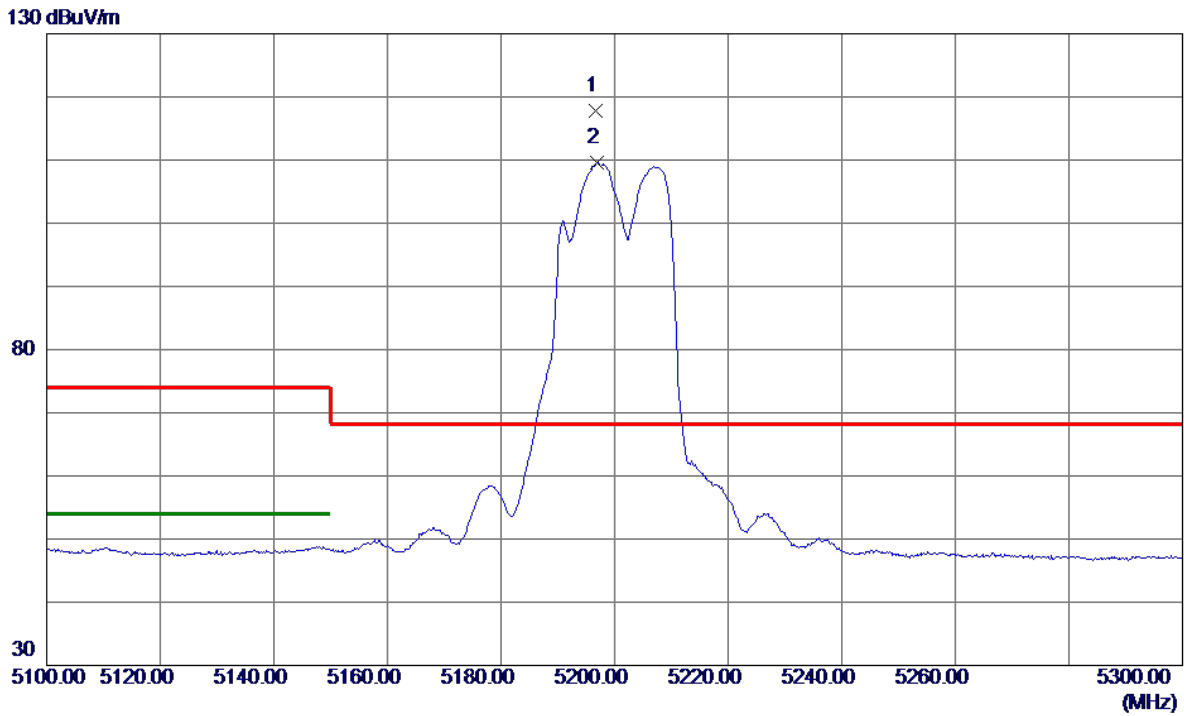

No.	Freq. MHz	Reading Level dBuV/m	Correct Factor dB	Measure ment dBuV/m	Limit dBuV/m	Margin dB	Detector	Comment
1 *	5196.6000	99.65	18.19	117.84	68.20	49.64	Peak	No Limit
2	5196.9000	91.35	18.19	109.54	999.00	-889.46	AVG	No Limit

REMARKS:

- (1) Measurement Value = Reading Level + Correct Factor.
- (2) Margin Level = Measurement Value - Limit Value.

Test Mode	UNII-1_TX AX(HE20) Mode 5200 MHz	Polarization	Vertical
-----------	----------------------------------	--------------	----------



No.	Freq. MHz	Reading Level dBuV/m	Correct Factor dB	Measure ment dBuV/m	Limit dBuV/m	Margin dB	Detector	Comment
1 *	10399.7720	35.44	16.13	51.57	68.20	-16.63	Peak	

REMARKS:

- (1) Measurement Value = Reading Level + Correct Factor.
- (2) Margin Level = Measurement Value - Limit Value.

Test Mode	UNII-1_TX AX(HE20) Mode 5200 MHz	Polarization	Horizontal
-----------	----------------------------------	--------------	------------

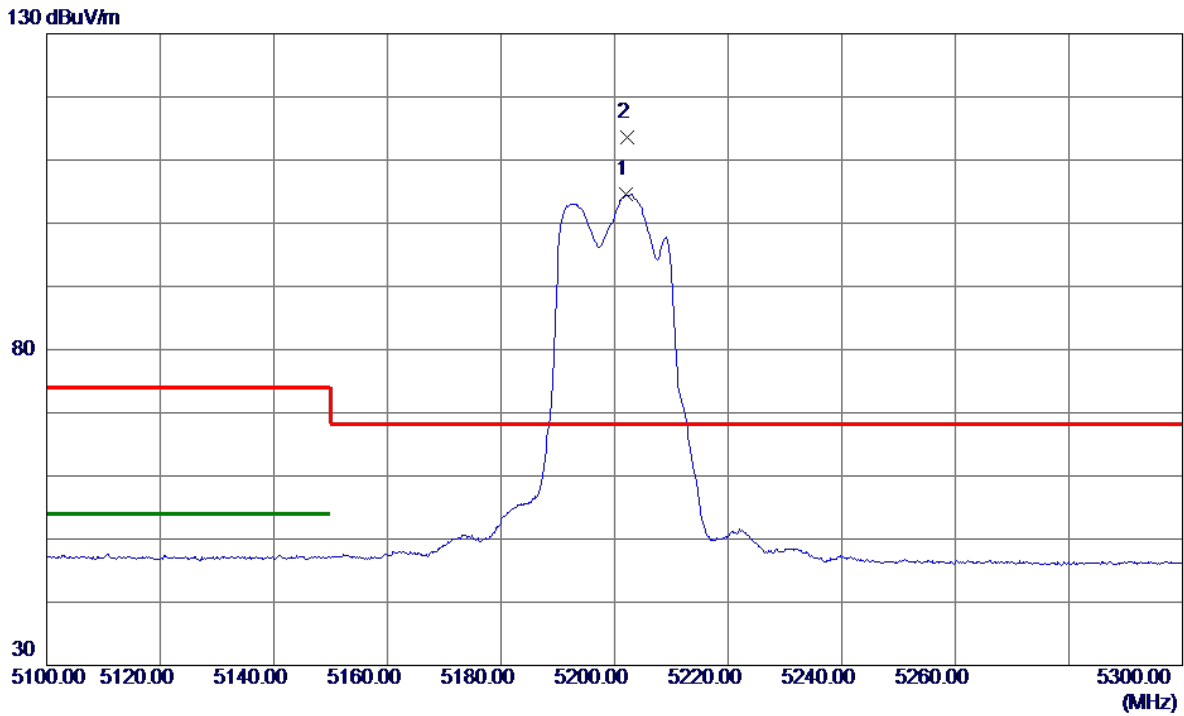

No.	Freq. MHz	Reading Level dBuV/m	Correct Factor dB	Measure ment dBuV/m	Limit dBuV/m	Margin dB	Detector	Comment
1	5202.0000	86.47	18.21	104.68	999.00	-894.32	AVG	No Limit
2 *	5202.3000	95.39	18.21	113.60	68.20	45.40	Peak	No Limit

REMARKS:

- (1) Measurement Value = Reading Level + Correct Factor.
- (2) Margin Level = Measurement Value - Limit Value.

Test Mode	UNII-1_TX AX(HE20) Mode 5200 MHz	Polarization	Horizontal
-----------	----------------------------------	--------------	------------

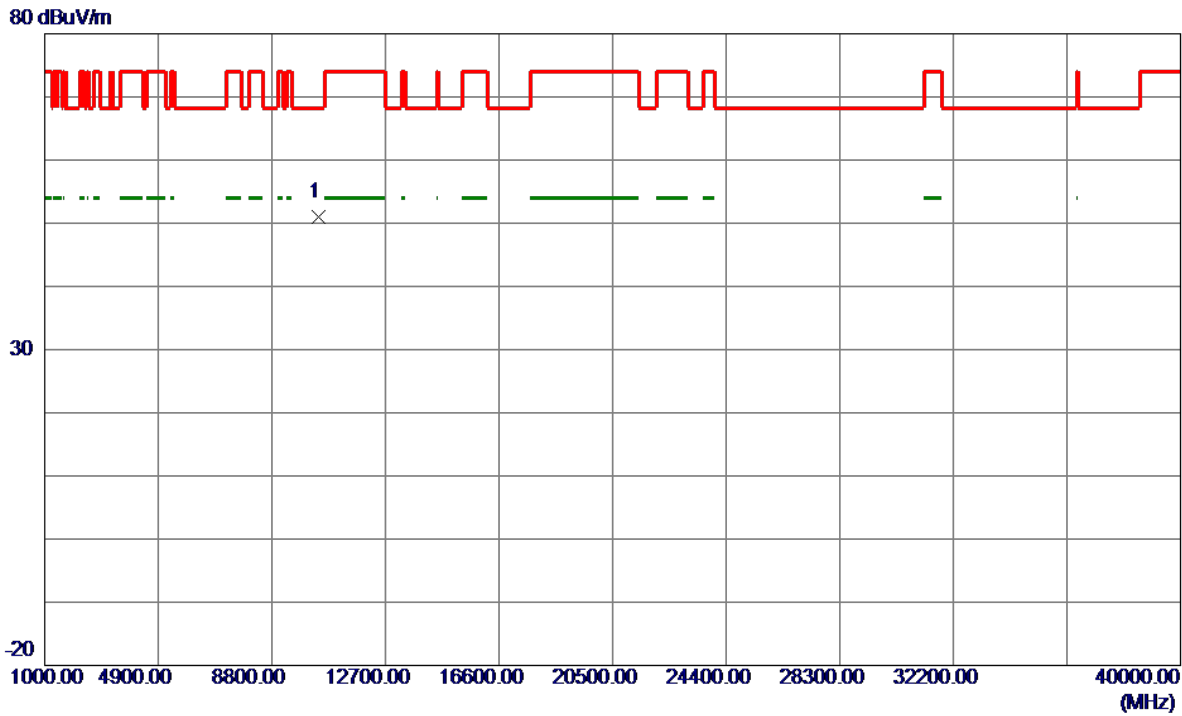

No.	Freq. MHz	Reading Level dBuV/m	Correct Factor dB	Measure ment dBuV/m	Limit dBuV/m	Margin dB	Detector	Comment
1 *	10399.8460	34.87	16.13	51.00	68.20	-17.20	Peak	

REMARKS:

- (1) Measurement Value = Reading Level + Correct Factor.
- (2) Margin Level = Measurement Value - Limit Value.

Test Mode	UNII-1_TX AX(HE20) Mode 5240 MHz	Polarization	Vertical
-----------	----------------------------------	--------------	----------

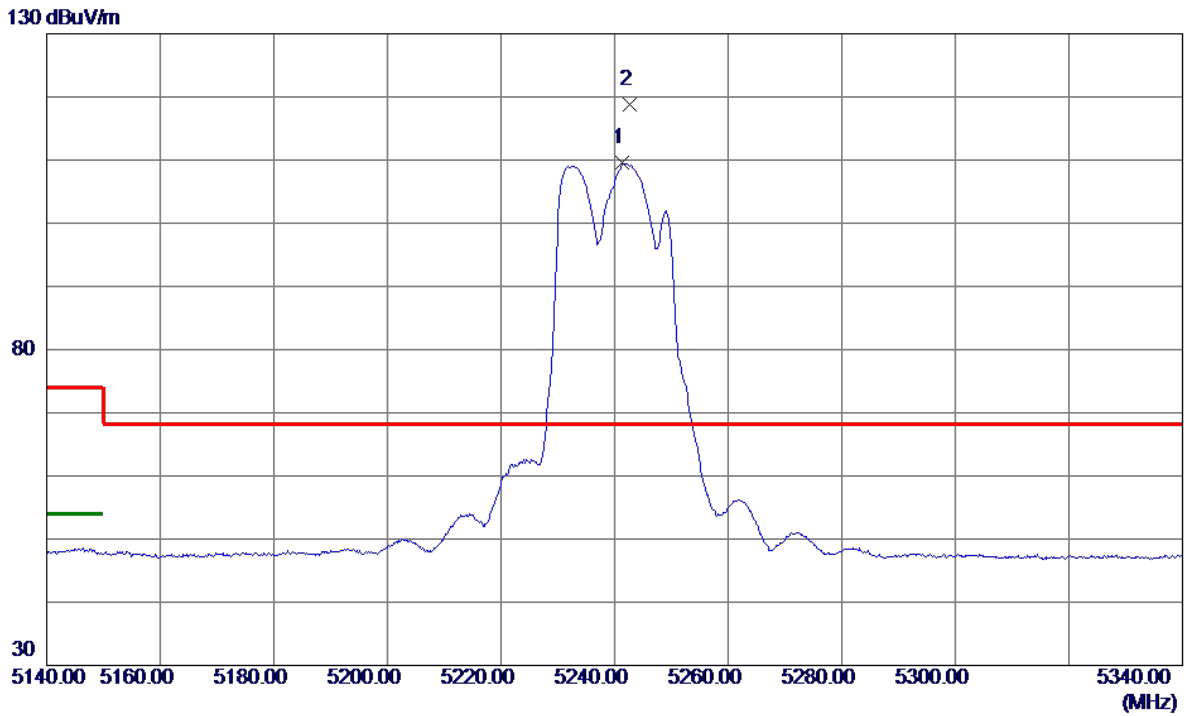

No.	Freq. MHz	Reading Level dBuV/m	Correct Factor dB	Measure ment dBuV/m	Limit dBuV/m	Margin dB	Detector	Comment
1	5241.4000	91.27	18.33	109.60	999.00	-889.40	AVG	No Limit
2 *	5242.6000	100.48	18.33	118.81	68.20	50.61	Peak	No Limit

REMARKS:

- (1) Measurement Value = Reading Level + Correct Factor.
- (2) Margin Level = Measurement Value - Limit Value.

Test Mode	UNII-1_TX AX(HE20) Mode 5240 MHz	Polarization	Vertical
-----------	----------------------------------	--------------	----------

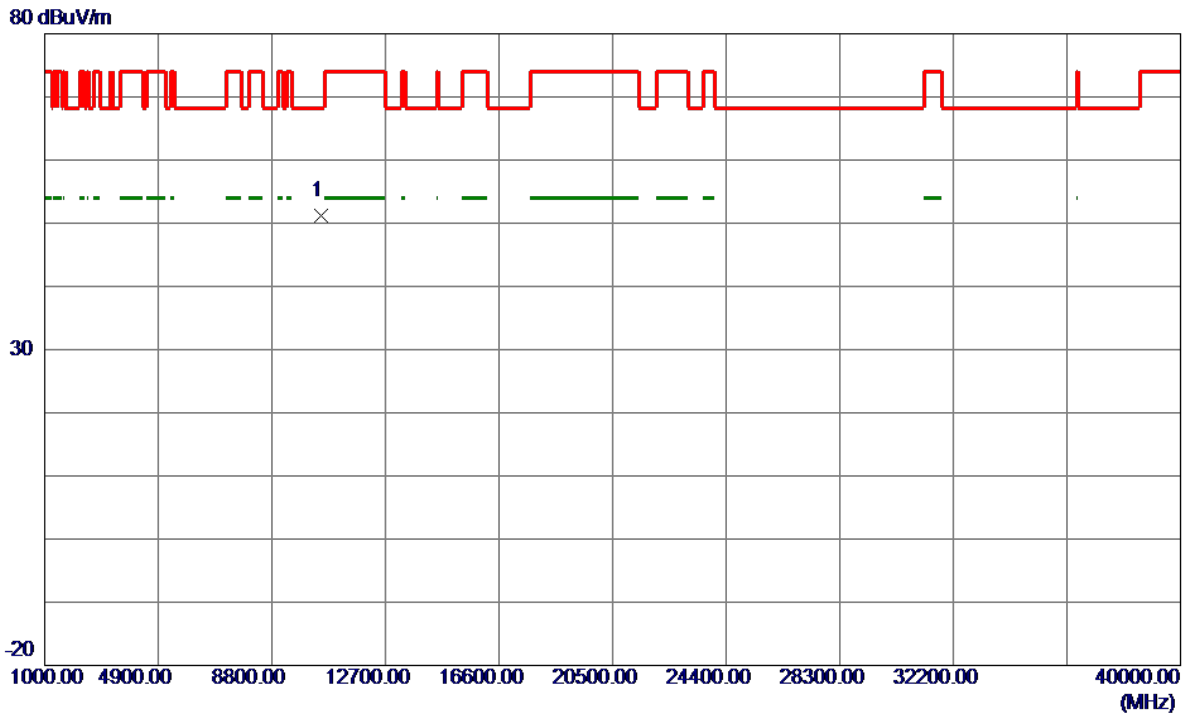

No.	Freq. MHz	Reading Level dBuV/m	Correct Factor dB	Measure ment dBuV/m	Limit dBuV/m	Margin dB	Detector	Comment
1 *	10479.8910	34.92	16.24	51.16	68.20	-17.04	Peak	

REMARKS:

- (1) Measurement Value = Reading Level + Correct Factor.
- (2) Margin Level = Measurement Value - Limit Value.

Test Mode	UNII-1_TX AX(HE20) Mode 5240 MHz	Polarization	Horizontal
-----------	----------------------------------	--------------	------------

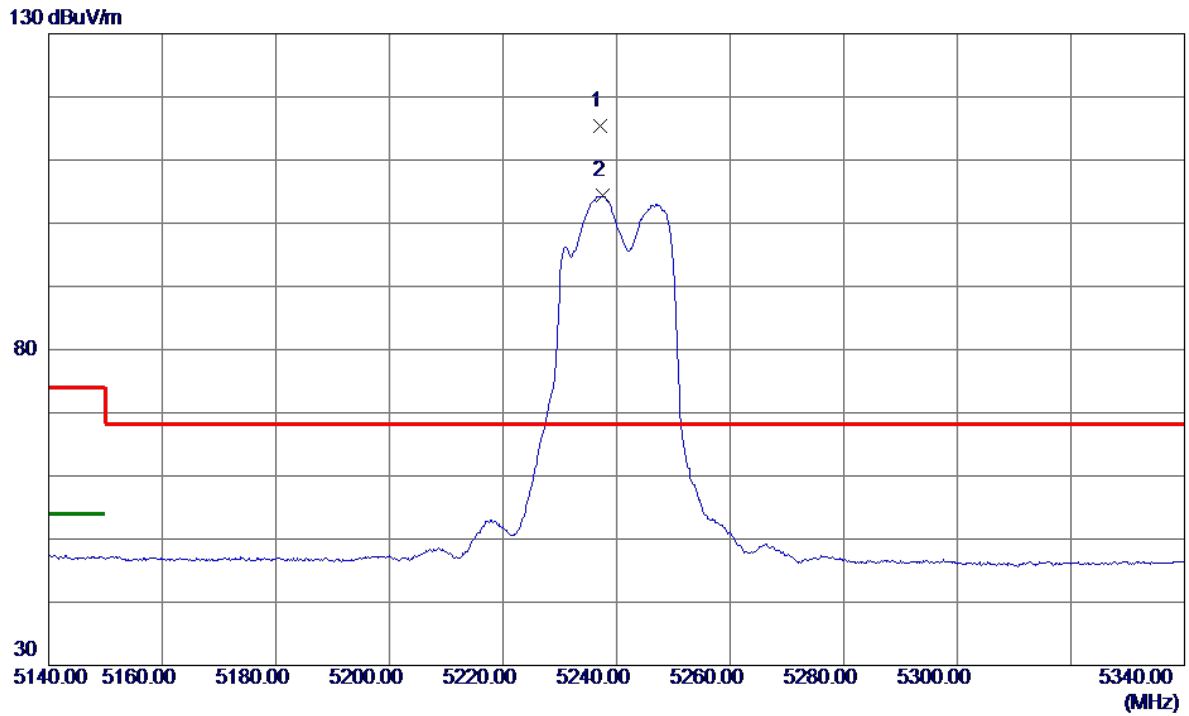

No.	Freq. MHz	Reading Level dBuV/m	Correct Factor dB	Measure ment dBuV/m	Limit dBuV/m	Margin dB	Detector	Comment
1 *	5237.2000	97.18	18.31	115.49	68.20	47.29	Peak	No Limit
2	5237.5000	86.01	18.32	104.33	999.00	-894.67	AVG	No Limit

REMARKS:

- (1) Measurement Value = Reading Level + Correct Factor.
- (2) Margin Level = Measurement Value - Limit Value.

Test Mode	UNII-1_TX AX(HE20) Mode 5240 MHz	Polarization	Horizontal
-----------	----------------------------------	--------------	------------



No.	Freq. MHz	Reading Level dBuV/m	Correct Factor dB	Measure ment dBuV/m	Limit dBuV/m	Margin dB	Detector	Comment
1 *	10479.8910	34.71	16.24	50.95	68.20	-17.25	Peak	

REMARKS:

- (1) Measurement Value = Reading Level + Correct Factor.
- (2) Margin Level = Measurement Value - Limit Value.

Test Mode	UNII-1_TX AX(HE40) Mode 5190 MHz	Polarization	Vertical
-----------	----------------------------------	--------------	----------

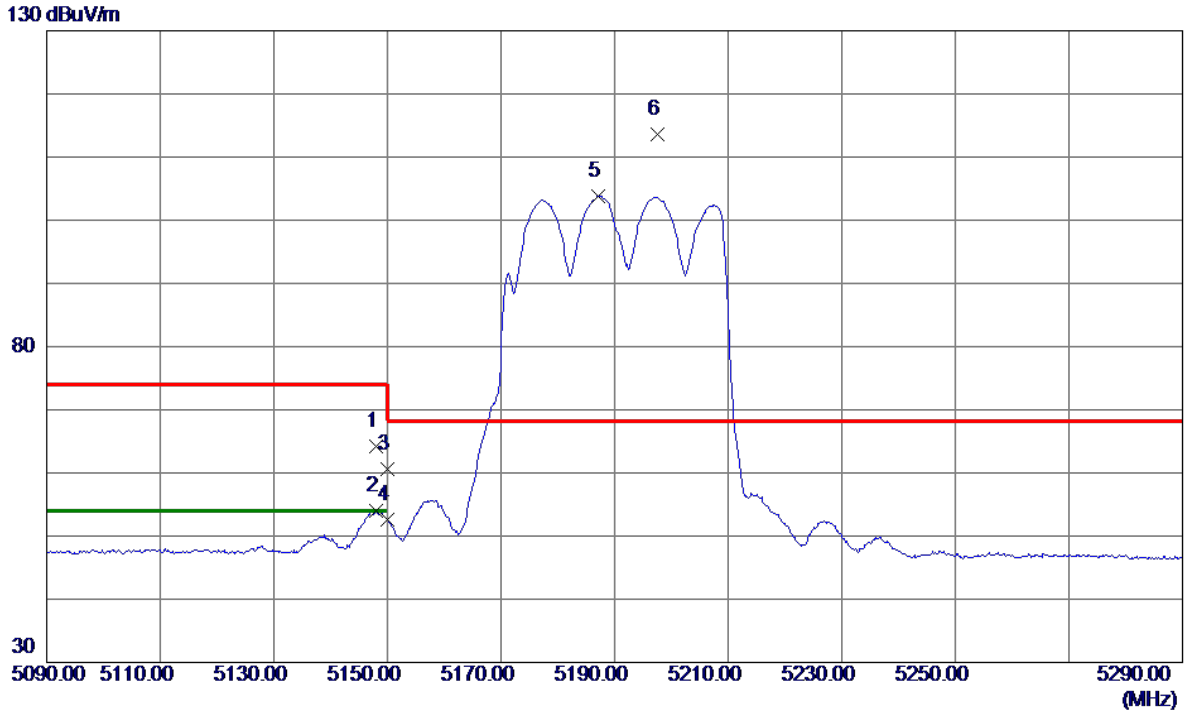

No.	Freq. MHz	Reading Level dBuV/m	Correct Factor dB	Measure ment dBuV/m	Limit dBuV/m	Margin dB	Detector	Comment
1	5147.9000	46.25	18.04	64.29	74.00	-9.71	Peak	
2	5147.9000	35.88	18.04	53.92	54.00	-0.08	AVG	
3	5150.0000	42.52	18.05	60.57	74.00	-13.43	Peak	
4	5150.0000	34.61	18.05	52.66	54.00	-1.34	AVG	
5	5187.1000	85.71	18.16	103.87	999.00	-895.13	AVG	No Limit
6 *	5197.5000	95.42	18.19	113.61	68.20	45.41	Peak	No Limit

REMARKS:

- (1) Measurement Value = Reading Level + Correct Factor.
- (2) Margin Level = Measurement Value - Limit Value.

Test Mode	UNII-1_TX AX(HE40) Mode 5190 MHz	Polarization	Vertical
-----------	----------------------------------	--------------	----------

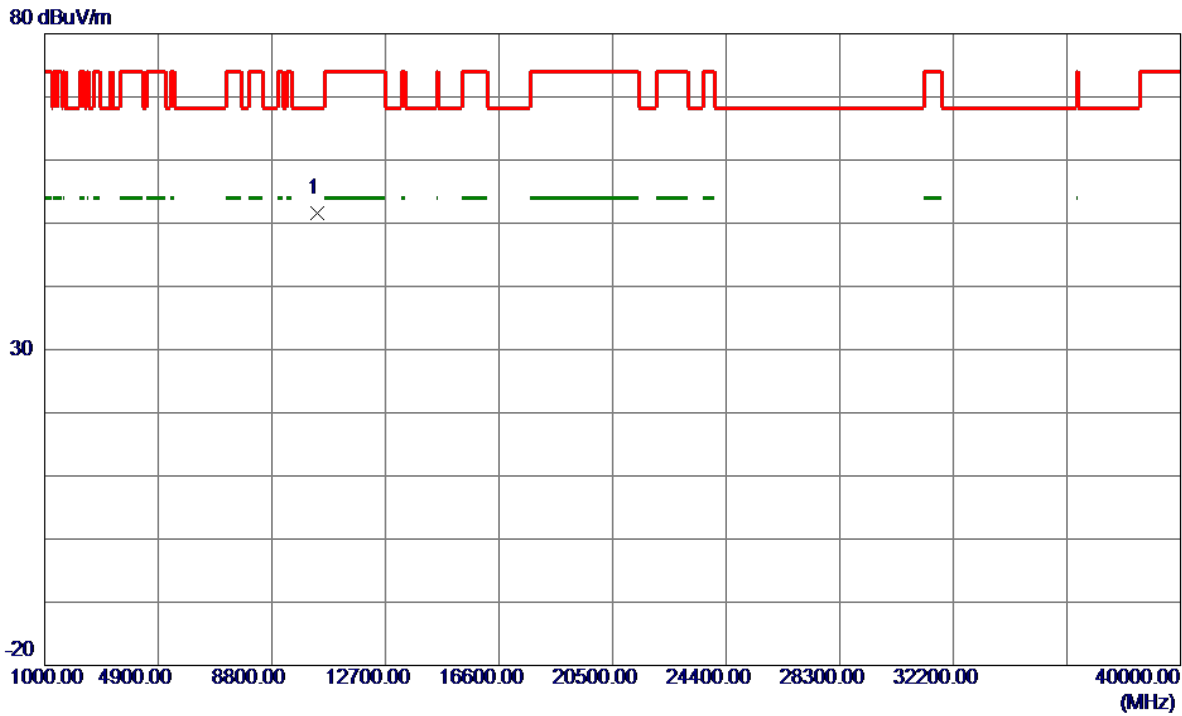

No.	Freq. MHz	Reading Level dBuV/m	Correct Factor dB	Measure ment dBuV/m	Limit dBuV/m	Margin dB	Detector	Comment
1 *	10379.9020	35.48	16.10	51.58	68.20	-16.62	Peak	

REMARKS:

- (1) Measurement Value = Reading Level + Correct Factor.
- (2) Margin Level = Measurement Value - Limit Value.

Test Mode	UNII-1_TX AX(HE40) Mode 5190 MHz	Polarization	Horizontal
-----------	----------------------------------	--------------	------------

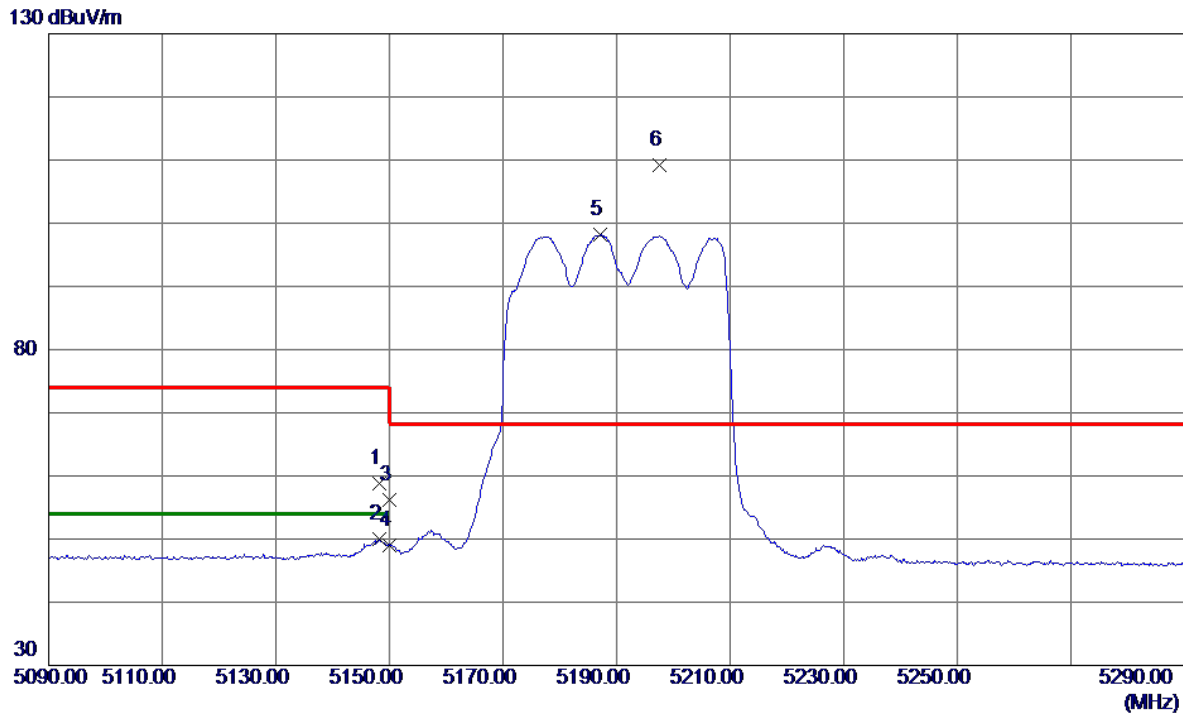

No.	Freq. MHz	Reading Level dBuV/m	Correct Factor dB	Measure ment dBuV/m	Limit dBuV/m	Margin dB	Detector	Comment
1	5148.3000	40.83	18.04	58.87	74.00	-15.13	Peak	
2	5148.3000	31.94	18.04	49.98	54.00	-4.02	AVG	
3	5150.0000	38.23	18.05	56.28	74.00	-17.72	Peak	
4	5150.0000	30.97	18.05	49.02	54.00	-4.98	AVG	
5	5187.2000	79.95	18.16	98.11	999.00	-900.89	AVG	No Limit
6 *	5197.5000	90.92	18.19	109.11	68.20	40.91	Peak	No Limit

REMARKS:

- (1) Measurement Value = Reading Level + Correct Factor.
- (2) Margin Level = Measurement Value - Limit Value.

Test Mode	UNII-1_TX AX(HE40) Mode 5190 MHz	Polarization	Horizontal
-----------	----------------------------------	--------------	------------

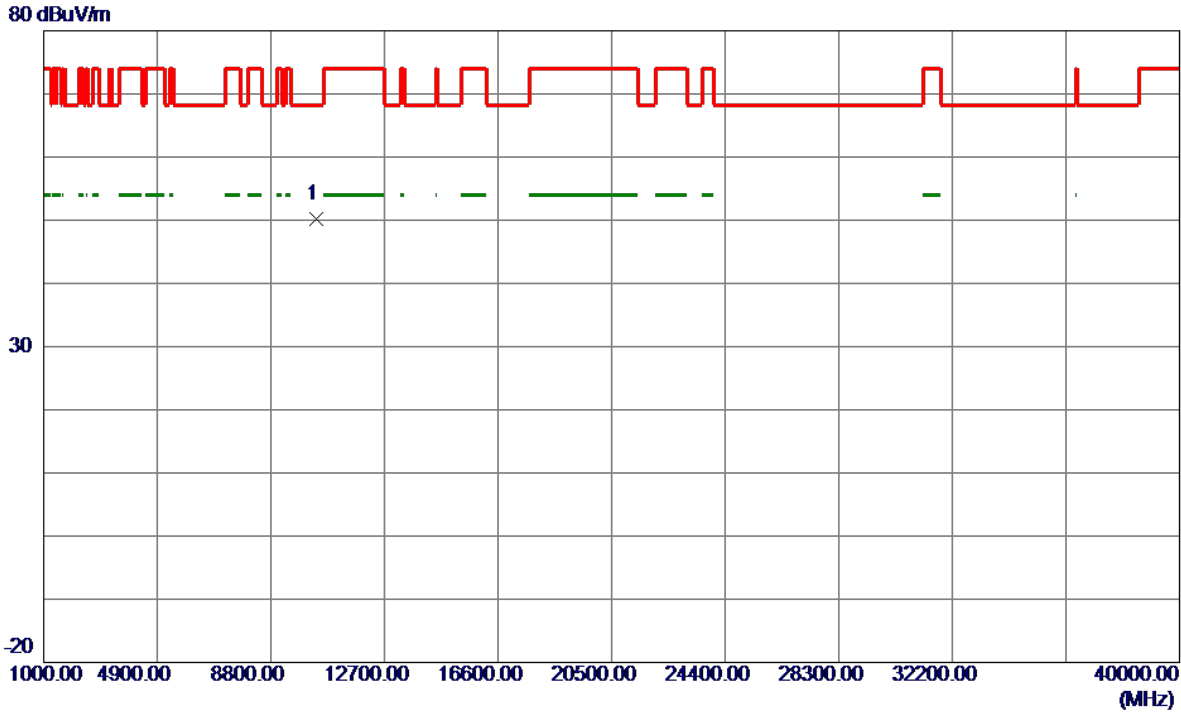

No.	Freq. MHz	Reading Level dBuV/m	Correct Factor dB	Measure ment dBuV/m	Limit dBuV/m	Margin dB	Detector	Comment
1 *	10380.4930	34.02	16.11	50.13	68.20	-18.07	Peak	

REMARKS:

- (1) Measurement Value = Reading Level + Correct Factor.
- (2) Margin Level = Measurement Value - Limit Value.

Test Mode	UNII-1_TX AX(HE40) Mode 5230 MHz	Polarization	Vertical
-----------	----------------------------------	--------------	----------

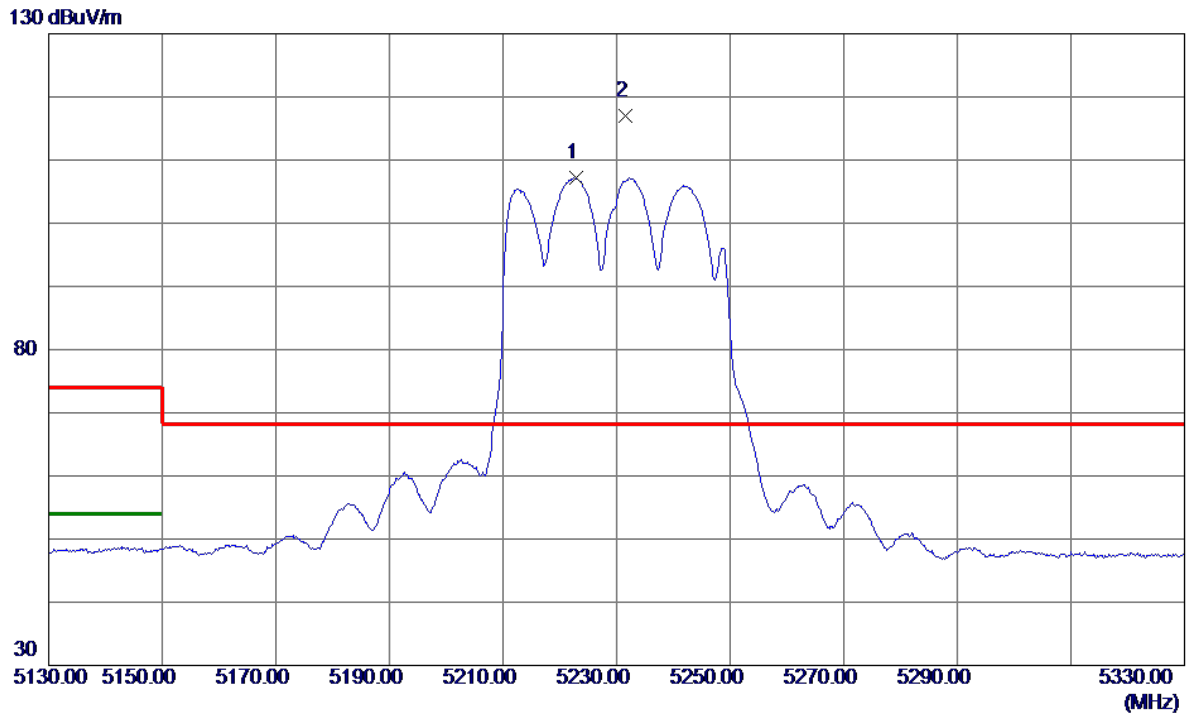

No.	Freq. MHz	Reading Level dBuV/m	Correct Factor dB	Measure ment dBuV/m	Limit dBuV/m	Margin dB	Detector	Comment
1	5222.9000	88.84	18.27	107.11	999.00	-891.89	AVG	No Limit
2 *	5231.6000	98.73	18.30	117.03	68.20	48.83	Peak	No Limit

REMARKS:

- (1) Measurement Value = Reading Level + Correct Factor.
- (2) Margin Level = Measurement Value - Limit Value.

Test Mode	UNII-1_TX AX(HE40) Mode 5230 MHz	Polarization	Vertical
-----------	----------------------------------	--------------	----------

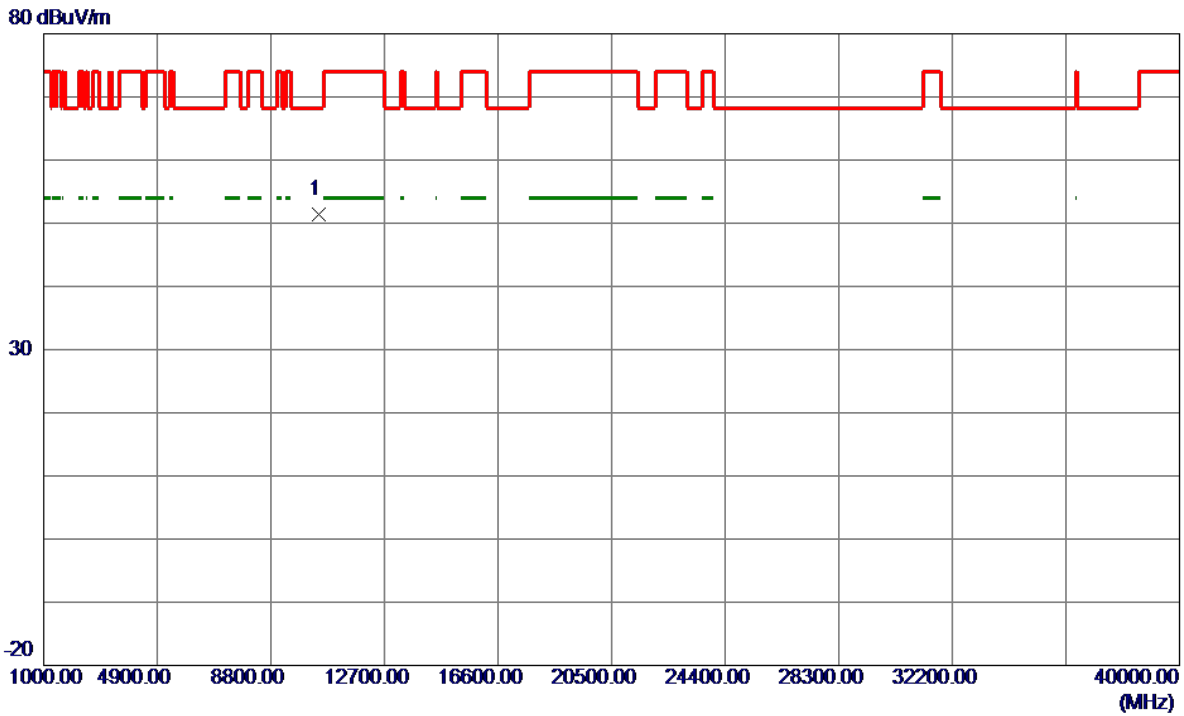

No.	Freq. MHz	Reading Level dBuV/m	Correct Factor dB	Measure ment dBuV/m	Limit dBuV/m	Margin dB	Detector	Comment
1 *	10459.8190	35.18	16.21	51.39	68.20	-16.81	Peak	

REMARKS:

- (1) Measurement Value = Reading Level + Correct Factor.
- (2) Margin Level = Measurement Value - Limit Value.

Test Mode	UNII-1_TX AX(HE40) Mode 5230 MHz	Polarization	Horizontal
-----------	----------------------------------	--------------	------------

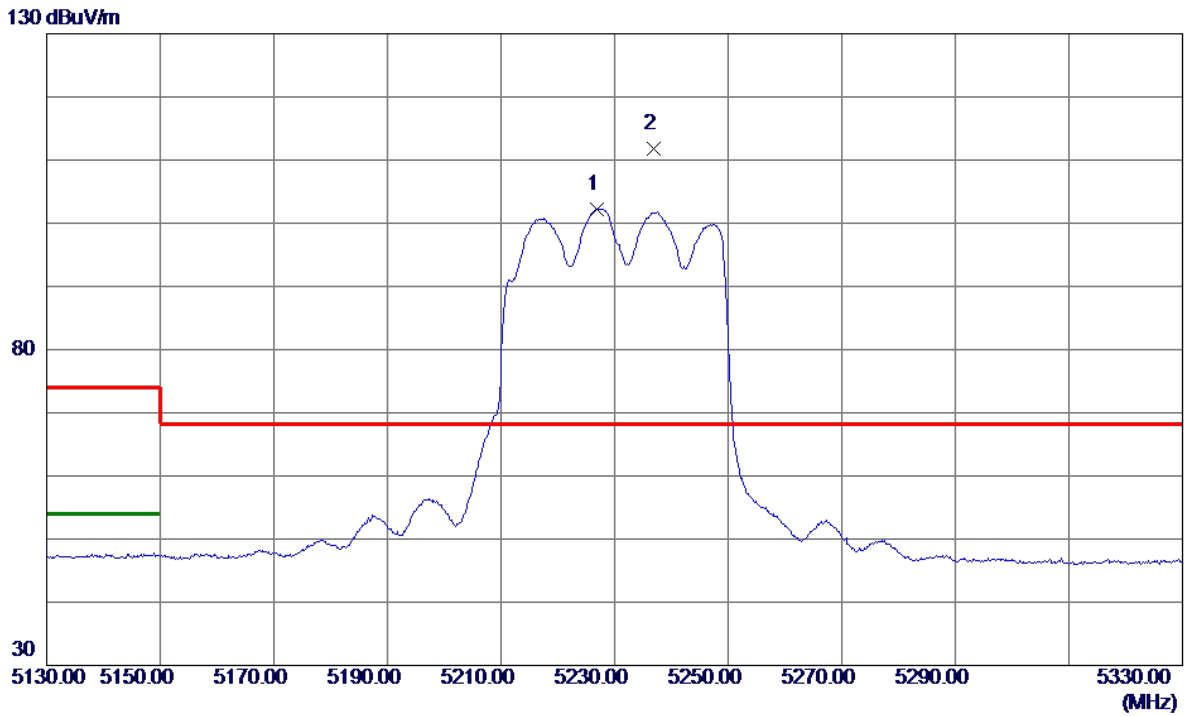

No.	Freq. MHz	Reading Level dBuV/m	Correct Factor dB	Measure ment dBuV/m	Limit dBuV/m	Margin dB	Detector	Comment
1	5226.9000	83.97	18.28	102.25	999.00	-896.75	AVG	No Limit
2 *	5236.9000	93.51	18.31	111.82	68.20	43.62	Peak	No Limit

REMARKS:

- (1) Measurement Value = Reading Level + Correct Factor.
- (2) Margin Level = Measurement Value - Limit Value.

Test Mode	UNII-1_TX AX(HE40) Mode 5230 MHz	Polarization	Horizontal
-----------	----------------------------------	--------------	------------



No.	Freq. MHz	Reading Level dBuV/m	Correct Factor dB	Measure ment dBuV/m	Limit dBuV/m	Margin dB	Detector	Comment
1 *	10459.6190	34.65	16.21	50.86	68.20	-17.34	Peak	

REMARKS:

- (1) Measurement Value = Reading Level + Correct Factor.
- (2) Margin Level = Measurement Value - Limit Value.

Test Mode	UNII-1_TX AX(HE80) Mode 5210 MHz	Polarization	Vertical
-----------	----------------------------------	--------------	----------

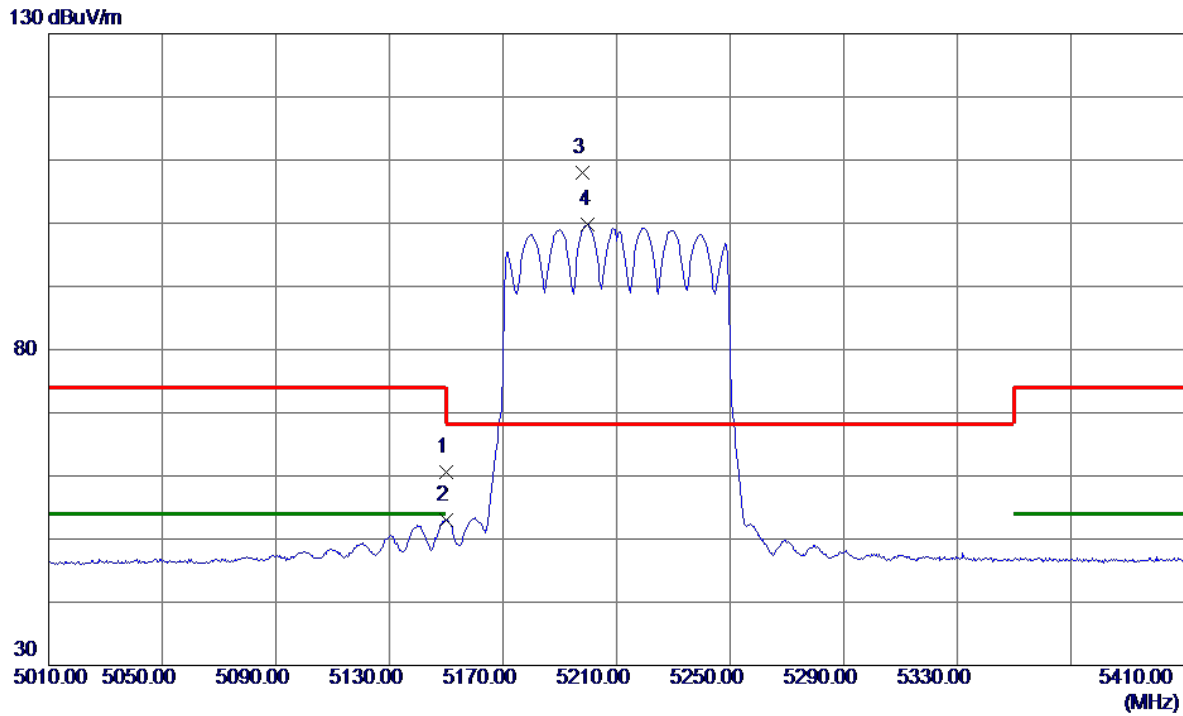

No.	Freq. MHz	Reading Level dBuV/m	Correct Factor dB	Measure ment dBuV/m	Limit dBuV/m	Margin dB	Detector	Comment
1	5150.0000	44.37	16.28	60.65	74.00	-13.35	Peak	
2	5150.0000	36.77	16.28	53.05	54.00	-0.95	AVG	
3 *	5198.0000	91.64	16.34	107.98	68.20	39.78	Peak	No Limit
4	5200.0000	83.39	16.34	99.73	999.00	-899.27	AVG	No Limit

REMARKS:

- (1) Measurement Value = Reading Level + Correct Factor.
- (2) Margin Level = Measurement Value - Limit Value.

Test Mode	UNII-1_TX AX(HE80) Mode 5210 MHz	Polarization	Vertical
-----------	----------------------------------	--------------	----------

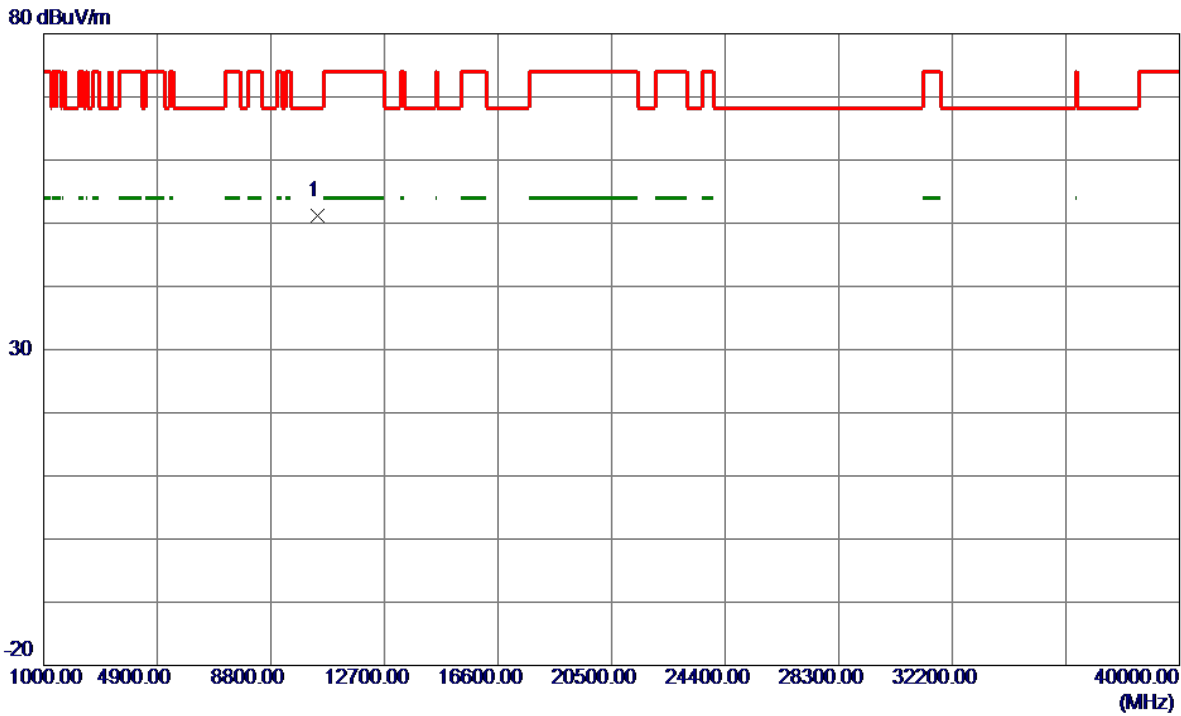

No.	Freq. MHz	Reading Level dBuV/m	Correct Factor dB	Measure ment dBuV/m	Limit dBuV/m	Margin dB	Detector	Comment
1 *	10419.2890	35.12	16.16	51.28	68.20	-16.92	Peak	

REMARKS:

- (1) Measurement Value = Reading Level + Correct Factor.
- (2) Margin Level = Measurement Value - Limit Value.

Test Mode	UNII-1_TX AX(HE80) Mode 5210 MHz	Polarization	Horizontal
-----------	----------------------------------	--------------	------------

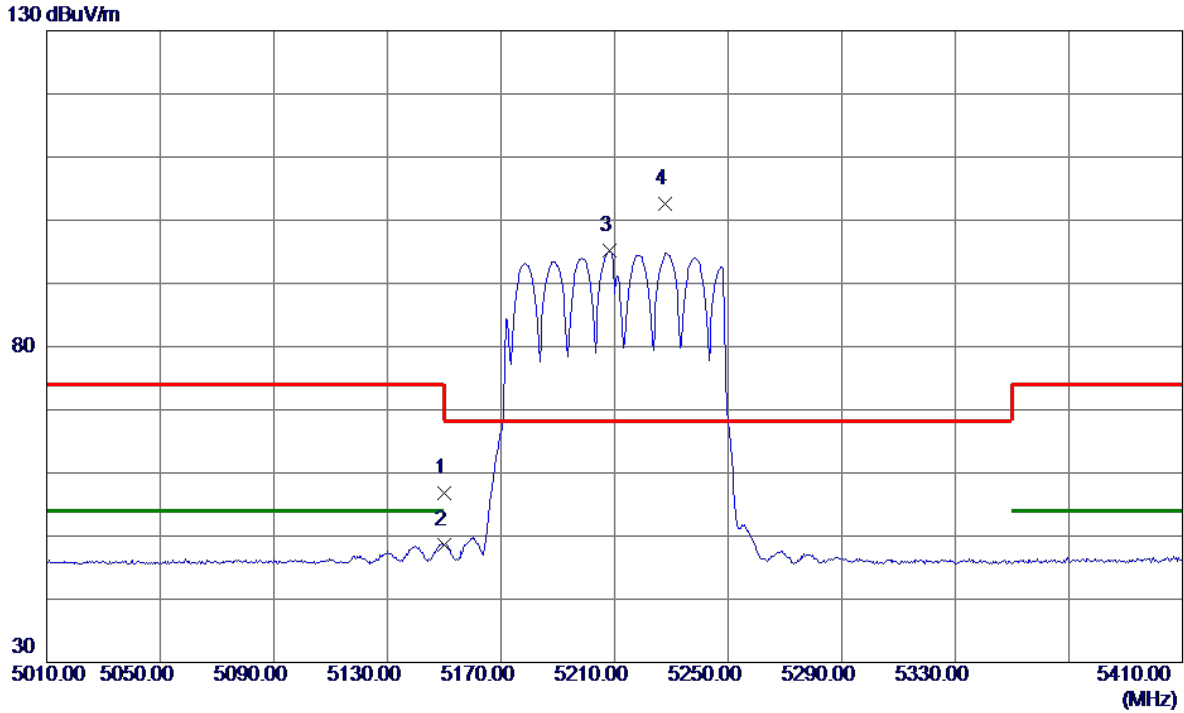

No.	Freq. MHz	Reading Level dBuV/m	Correct Factor dB	Measure ment dBuV/m	Limit dBuV/m	Margin dB	Detector	Comment
1	5150.0000	40.60	16.28	56.88	74.00	-17.12	Peak	
2	5150.0000	32.27	16.28	48.55	54.00	-5.45	AVG	
3	5208.4000	78.79	16.35	95.14	999.00	-903.86	AVG	No Limit
4 *	5227.6000	86.24	16.37	102.61	68.20	34.41	Peak	No Limit

REMARKS:

- (1) Measurement Value = Reading Level + Correct Factor.
- (2) Margin Level = Measurement Value - Limit Value.

Test Mode	UNII-1_TX AX(HE80) Mode 5210 MHz	Polarization	Horizontal
-----------	----------------------------------	--------------	------------



No.	Freq. MHz	Reading Level dBuV/m	Correct Factor dB	Measure ment dBuV/m	Limit dBuV/m	Margin dB	Detector	Comment
1 *	10419.8090	33.54	16.16	49.70	68.20	-18.50	Peak	

REMARKS:

- (1) Measurement Value = Reading Level + Correct Factor.
- (2) Margin Level = Measurement Value - Limit Value.

Test Mode	UNII-3_TX A Mode 5745 MHz	Polarization	Vertical
-----------	---------------------------	--------------	----------

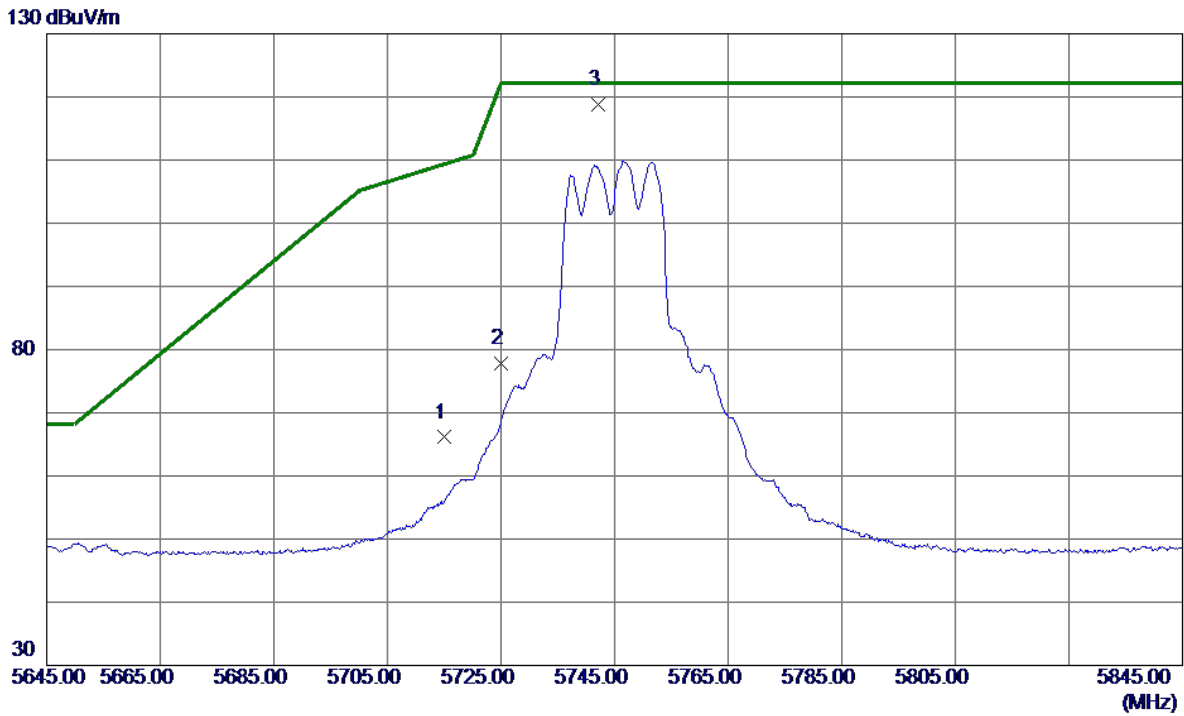

No.	Freq. MHz	Reading Level dBuV/m	Correct Factor dB	Measure ment dBuV/m	Limit dBuV/m	Margin dB	Detector	Comment
1	5715.0000	46.38	19.72	66.10	109.40	-43.30	Peak	
2	5725.0000	58.00	19.75	77.75	122.20	-44.45	Peak	
3 *	5742.2000	98.95	19.80	118.75	122.20	-3.45	Peak	No Limit

REMARKS:

- (1) Measurement Value = Reading Level + Correct Factor.
- (2) Margin Level = Measurement Value - Limit Value.

Test Mode	UNII-3_TX A Mode 5745 MHz	Polarization	Vertical
-----------	---------------------------	--------------	----------



No.	Freq. MHz	Reading Level dBuV/m	Correct Factor dB	Measure ment dBuV/m	Limit dBuV/m	Margin dB	Detector	Comment
1 *	11490.0370	20.37	17.36	37.73	54.00	-16.27	AVG	
2	11490.6780	33.92	17.36	51.28	74.00	-22.72	Peak	

REMARKS:

- (1) Measurement Value = Reading Level + Correct Factor.
- (2) Margin Level = Measurement Value - Limit Value.

Test Mode	UNII-3_TX A Mode 5745 MHz	Polarization	Horizontal
-----------	---------------------------	--------------	------------

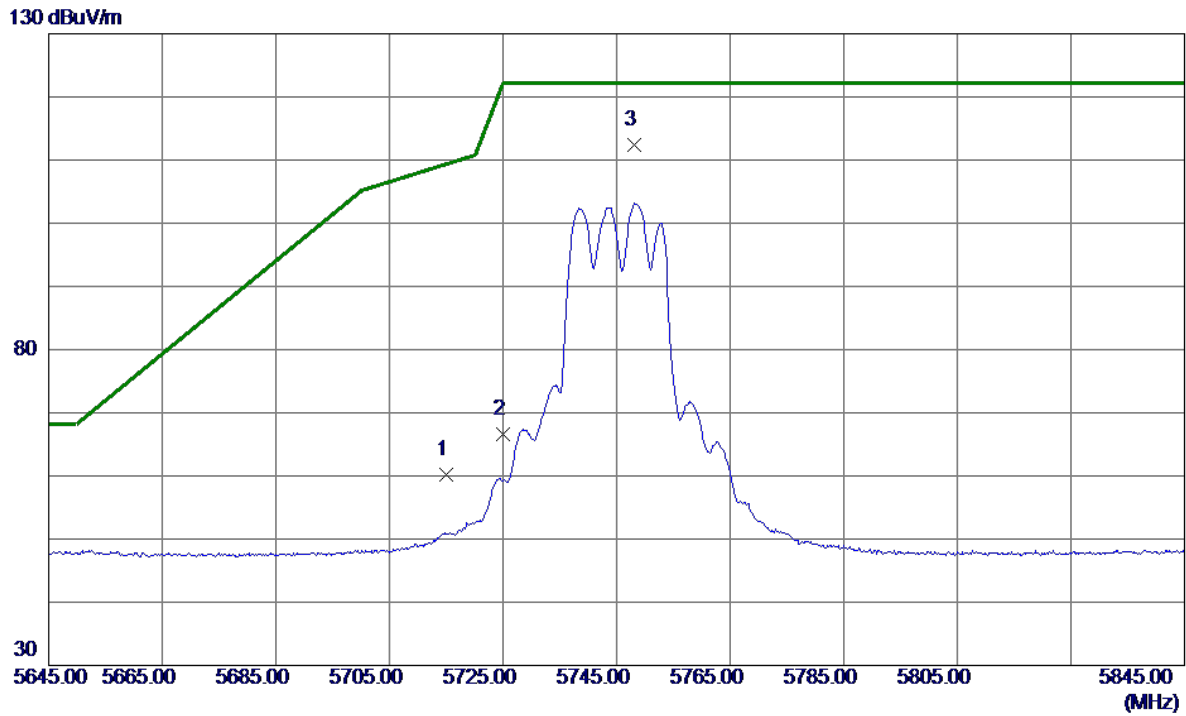

No.	Freq. MHz	Reading Level dBuV/m	Correct Factor dB	Measure ment dBuV/m	Limit dBuV/m	Margin dB	Detector	Comment
1	5715.0000	40.52	19.72	60.24	109.40	-49.16	Peak	
2	5725.0000	46.81	19.75	66.56	122.20	-55.64	Peak	
3 *	5748.1000	92.65	19.82	112.47	122.20	-9.73	Peak	No Limit

REMARKS:

- (1) Measurement Value = Reading Level + Correct Factor.
- (2) Margin Level = Measurement Value - Limit Value.

Test Mode	UNII-3_TX A Mode 5745 MHz	Polarization	Horizontal
-----------	---------------------------	--------------	------------

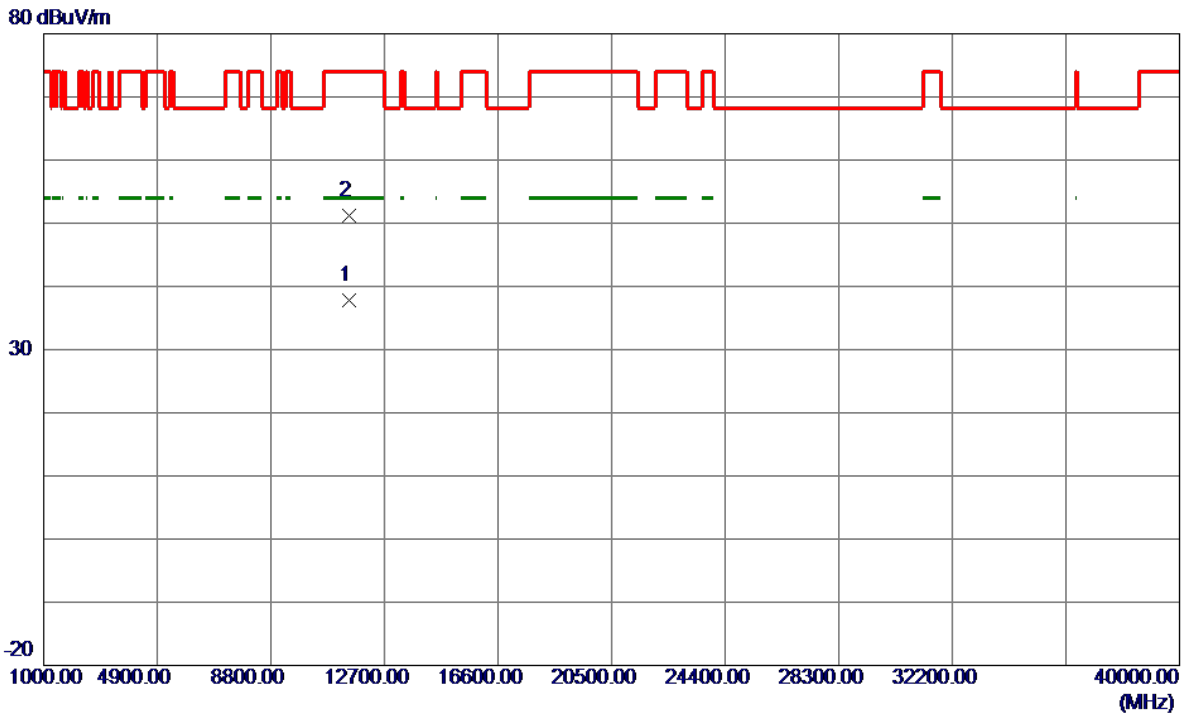

No.	Freq. MHz	Reading Level dBuV/m	Correct Factor dB	Measure ment dBuV/m	Limit dBuV/m	Margin dB	Detector	Comment
1 *	11489.0000	20.42	17.36	37.78	54.00	-16.22	AVG	
2	11490.6720	33.82	17.36	51.18	74.00	-22.82	Peak	

REMARKS:

- (1) Measurement Value = Reading Level + Correct Factor.
- (2) Margin Level = Measurement Value - Limit Value.

Test Mode	UNII-3_TX A Mode 5785 MHz	Polarization	Vertical
-----------	---------------------------	--------------	----------

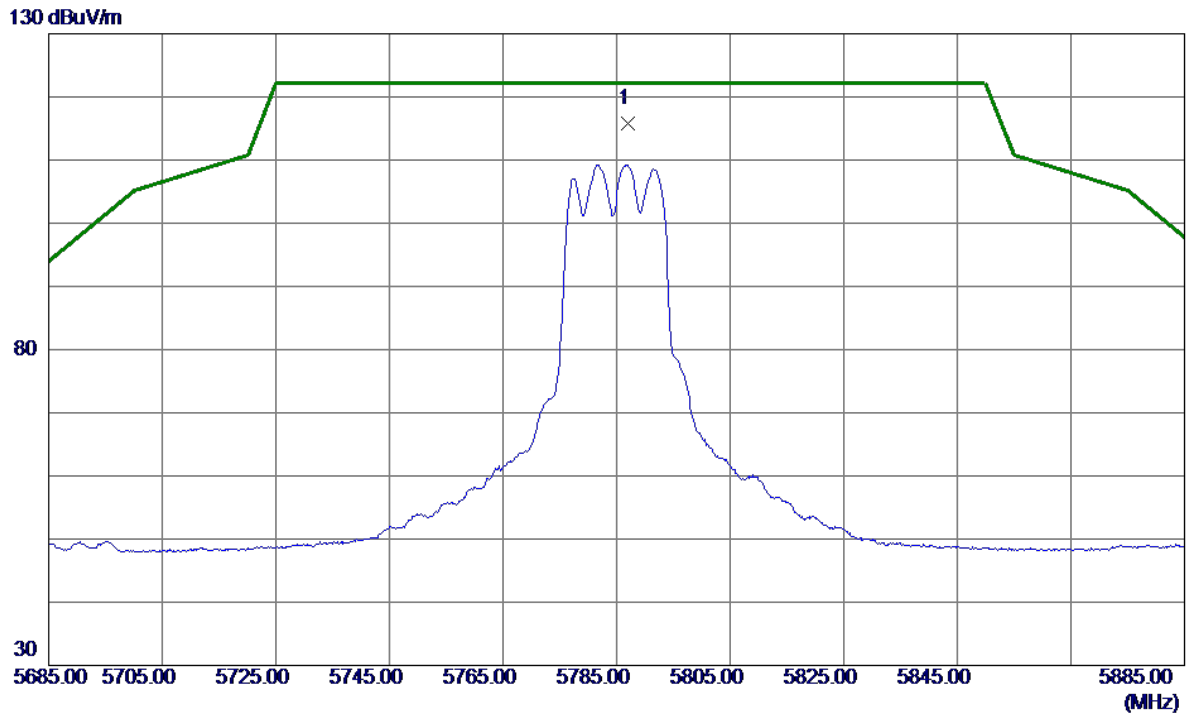

No.	Freq. MHz	Reading Level dBuV/m	Correct Factor dB	Measure ment dBuV/m	Limit dBuV/m	Margin dB	Detector	Comment
1 *	5786.9000	95.97	19.92	115.89	122.20	-6.31	Peak	No Limit

REMARKS:

- (1) Measurement Value = Reading Level + Correct Factor.
- (2) Margin Level = Measurement Value - Limit Value.

Test Mode	UNII-3_TX A Mode 5785 MHz	Polarization	Vertical
-----------	---------------------------	--------------	----------

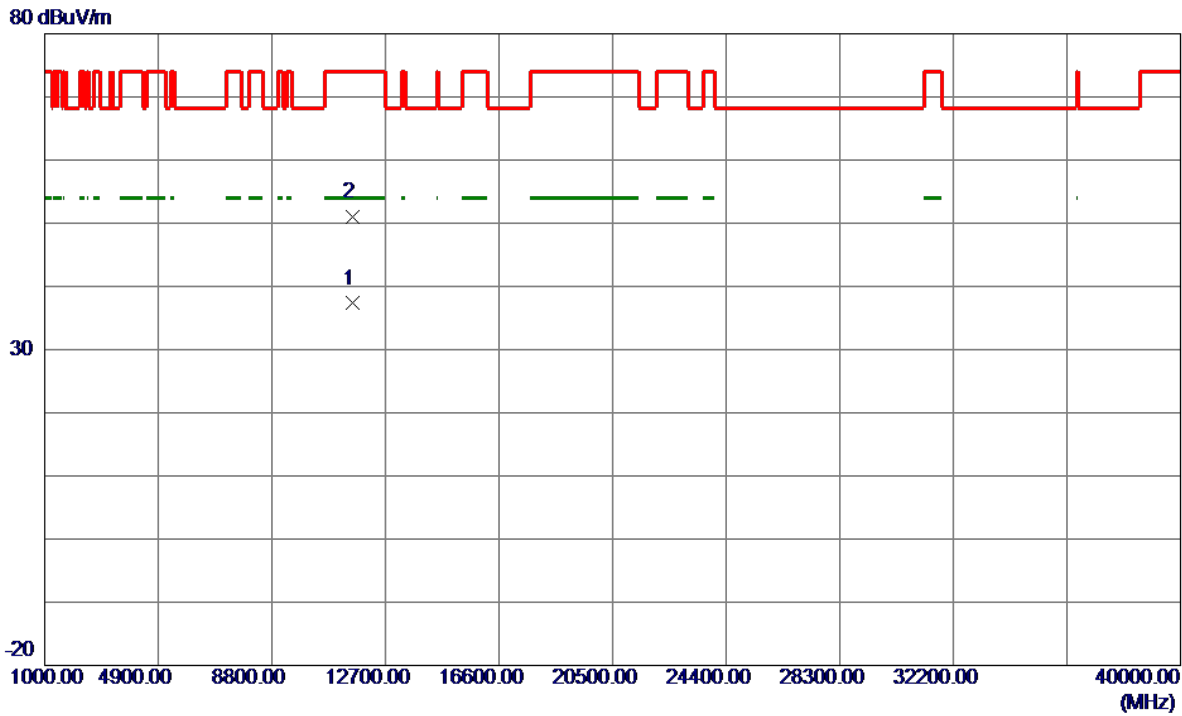

No.	Freq. MHz	Reading Level dBuV/m	Correct Factor dB	Measure ment dBuV/m	Limit dBuV/m	Margin dB	Detector	Comment
1 *	11570.5480	19.90	17.40	37.30	54.00	-16.70	AVG	
2	11570.6800	33.51	17.40	50.91	74.00	-23.09	Peak	

REMARKS:

- (1) Measurement Value = Reading Level + Correct Factor.
- (2) Margin Level = Measurement Value - Limit Value.

Test Mode	UNII-3_TX A Mode 5785 MHz	Polarization	Horizontal
-----------	---------------------------	--------------	------------

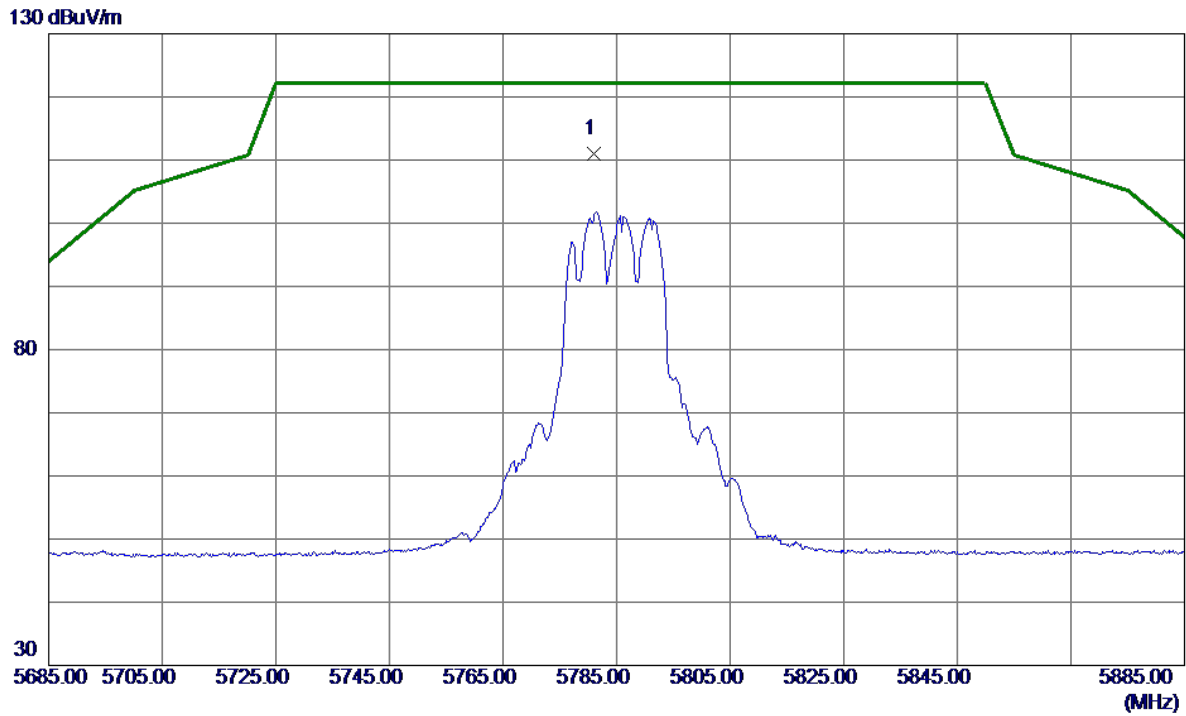

No.	Freq. MHz	Reading Level dBuV/m	Correct Factor dB	Measure ment dBuV/m	Limit dBuV/m	Margin dB	Detector	Comment
1 *	5781.0000	91.05	19.91	110.96	122.20	-11.24	Peak	No Limit

REMARKS:

- (1) Measurement Value = Reading Level + Correct Factor.
- (2) Margin Level = Measurement Value - Limit Value.

Test Mode	UNII-3_TX A Mode 5785 MHz	Polarization	Horizontal
-----------	---------------------------	--------------	------------

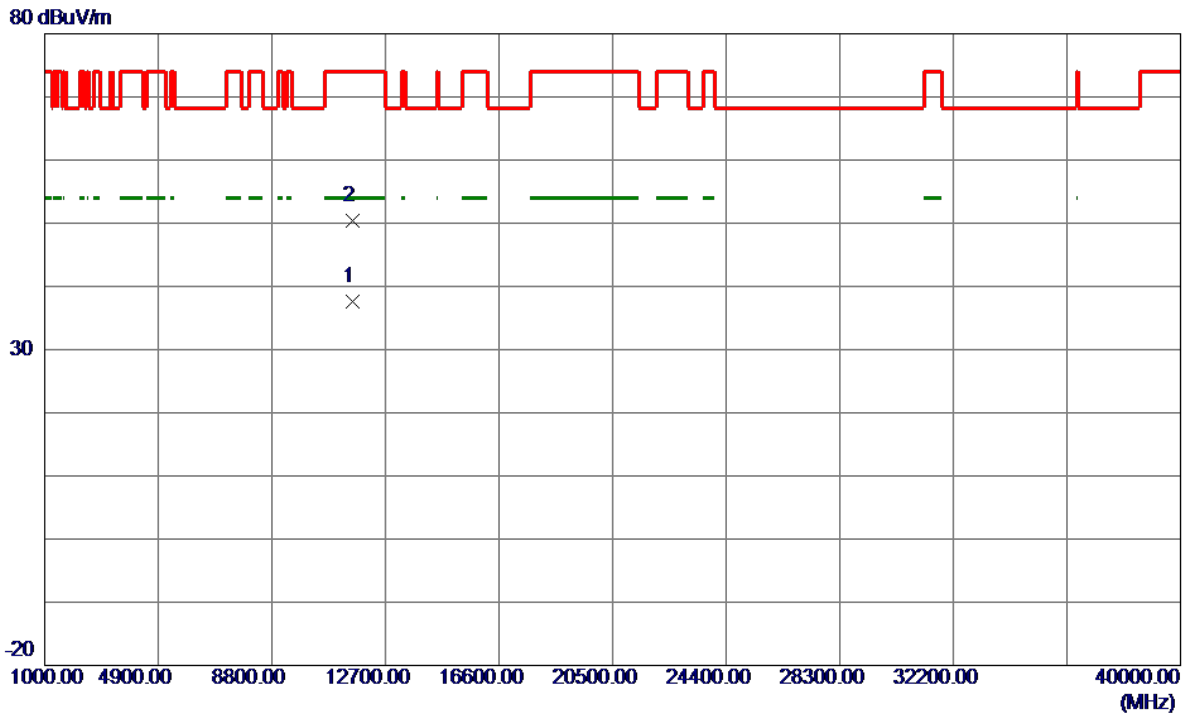

No.	Freq. MHz	Reading Level dBuV/m	Correct Factor dB	Measure ment dBuV/m	Limit dBuV/m	Margin dB	Detector	Comment
1 *	11569.0620	20.11	17.40	37.51	54.00	-16.49	AVG	
2	11569.6410	32.97	17.40	50.37	74.00	-23.63	Peak	

REMARKS:

- (1) Measurement Value = Reading Level + Correct Factor.
- (2) Margin Level = Measurement Value - Limit Value.

Test Mode	UNII-3_TX A Mode 5825 MHz	Polarization	Vertical
-----------	---------------------------	--------------	----------

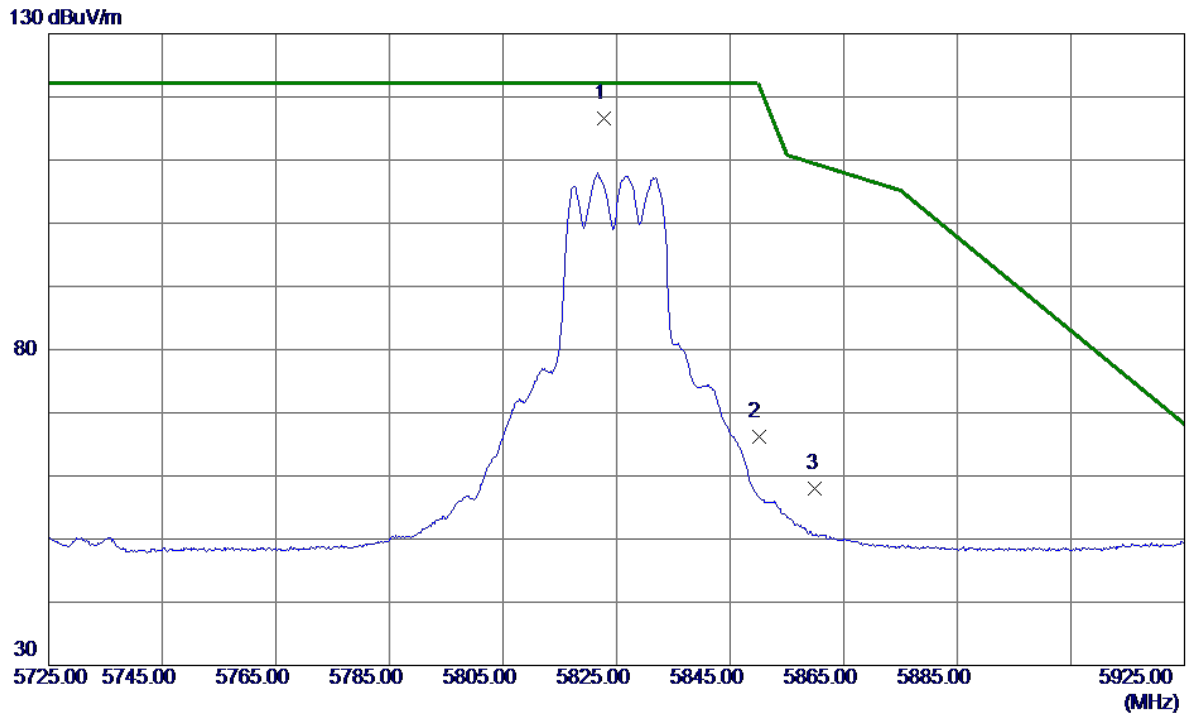

No.	Freq. MHz	Reading Level dBuV/m	Correct Factor dB	Measure ment dBuV/m	Limit dBuV/m	Margin dB	Detector	Comment
1 *	5822.8000	96.65	20.02	116.67	122.20	-5.53	Peak	No Limit
2	5850.0000	46.01	20.10	66.11	122.20	-56.09	Peak	
3	5860.0000	37.96	20.13	58.09	109.40	-51.31	Peak	

REMARKS:

- (1) Measurement Value = Reading Level + Correct Factor.
- (2) Margin Level = Measurement Value - Limit Value.

Test Mode	UNII-3_TX A Mode 5825 MHz	Polarization	Vertical
-----------	---------------------------	--------------	----------

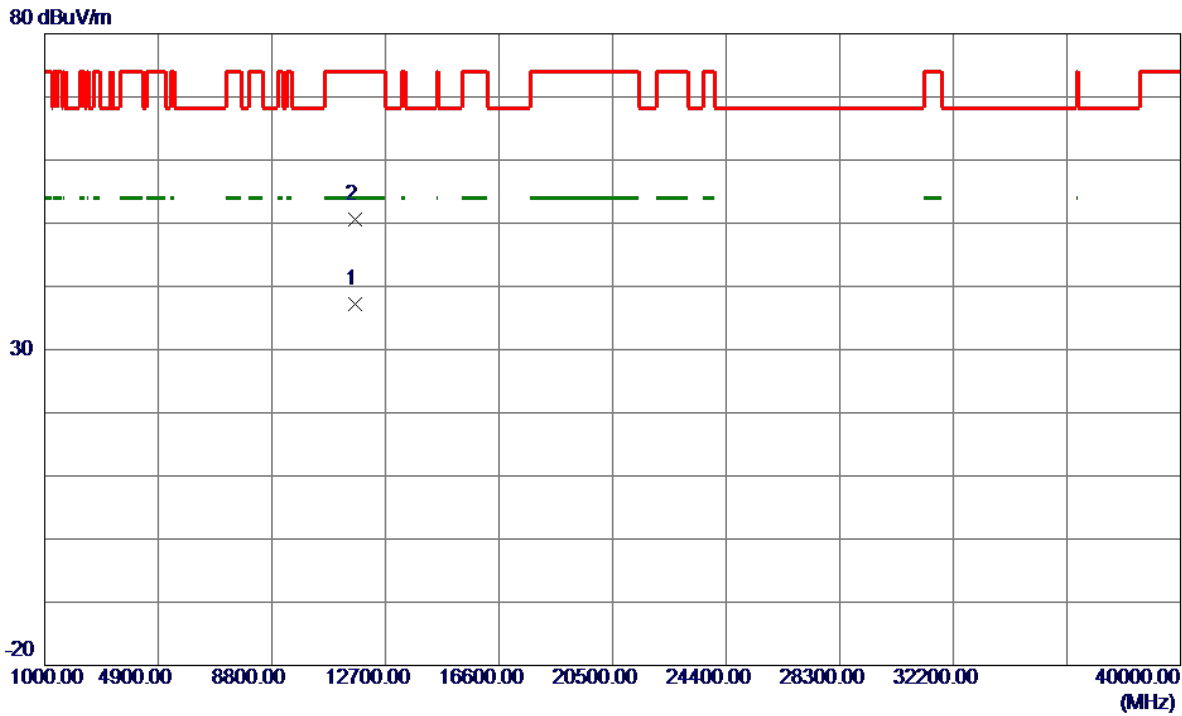

No.	Freq. MHz	Reading Level dBuV/m	Correct Factor dB	Measure ment dBuV/m	Limit dBuV/m	Margin dB	Detector	Comment
1 *	11649.8610	19.80	17.42	37.22	54.00	-16.78	AVG	
2	11650.2360	33.14	17.43	50.57	74.00	-23.43	Peak	

REMARKS:

- (1) Measurement Value = Reading Level + Correct Factor.
- (2) Margin Level = Measurement Value - Limit Value.

Test Mode	UNII-3_TX A Mode 5825 MHz	Polarization	Horizontal
-----------	---------------------------	--------------	------------

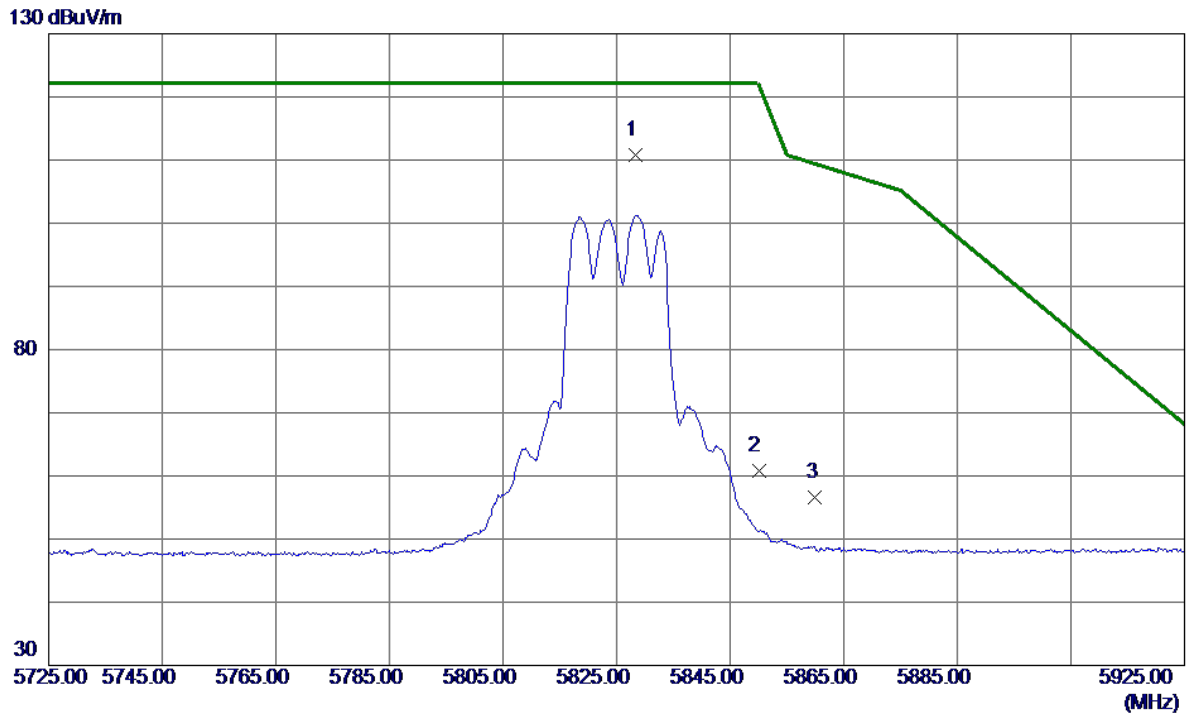

No.	Freq. MHz	Reading Level dBuV/m	Correct Factor dB	Measure ment dBuV/m	Limit dBuV/m	Margin dB	Detector	Comment
1 *	5828.3000	90.68	20.04	110.72	122.20	-11.48	Peak	No Limit
2	5850.0000	40.66	20.10	60.76	122.20	-61.44	Peak	
3	5860.0000	36.54	20.13	56.67	109.40	-52.73	Peak	

REMARKS:

- (1) Measurement Value = Reading Level + Correct Factor.
- (2) Margin Level = Measurement Value - Limit Value.

Test Mode	UNII-3_TX A Mode 5825 MHz	Polarization	Horizontal
-----------	---------------------------	--------------	------------

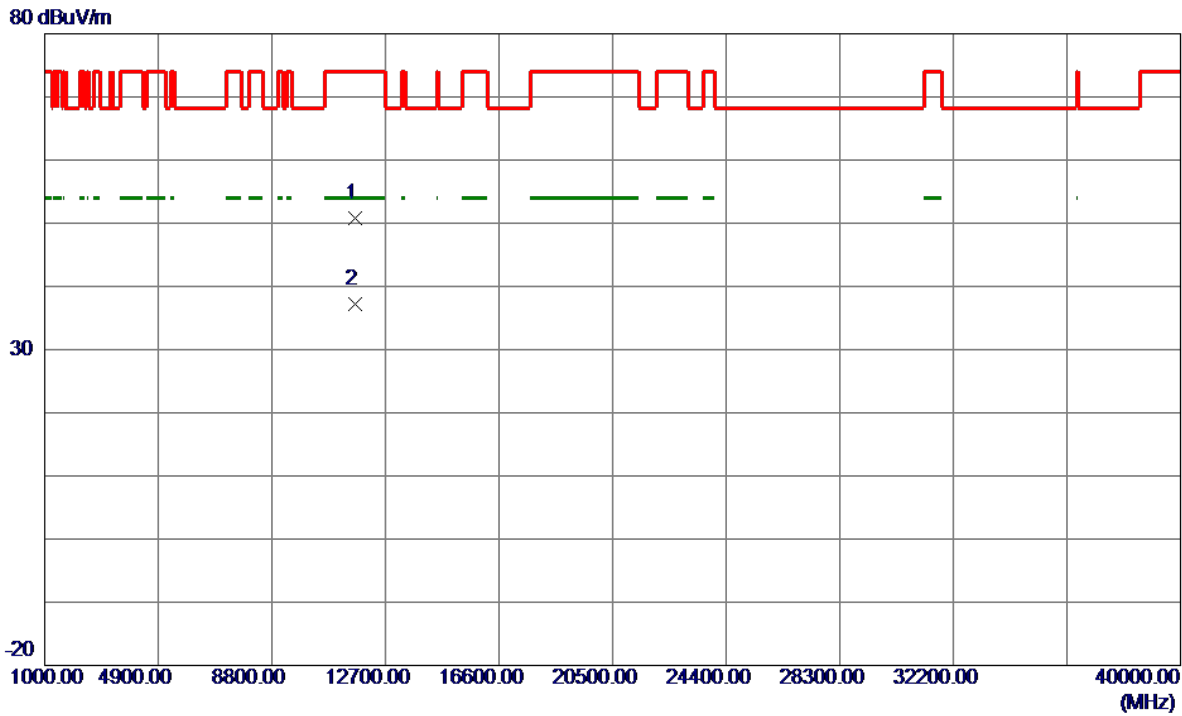

No.	Freq. MHz	Reading Level dBuV/m	Correct Factor dB	Measure ment dBuV/m	Limit dBuV/m	Margin dB	Detector	Comment
1	11649.1310	33.47	17.42	50.89	74.00	-23.11	Peak	
2 *	11650.6280	19.83	17.43	37.26	54.00	-16.74	AVG	

REMARKS:

- (1) Measurement Value = Reading Level + Correct Factor.
- (2) Margin Level = Measurement Value - Limit Value.

Test Mode	UNII-3_TX AC(VHT20) Mode 5745 MHz	Polarization	Vertical
-----------	-----------------------------------	--------------	----------

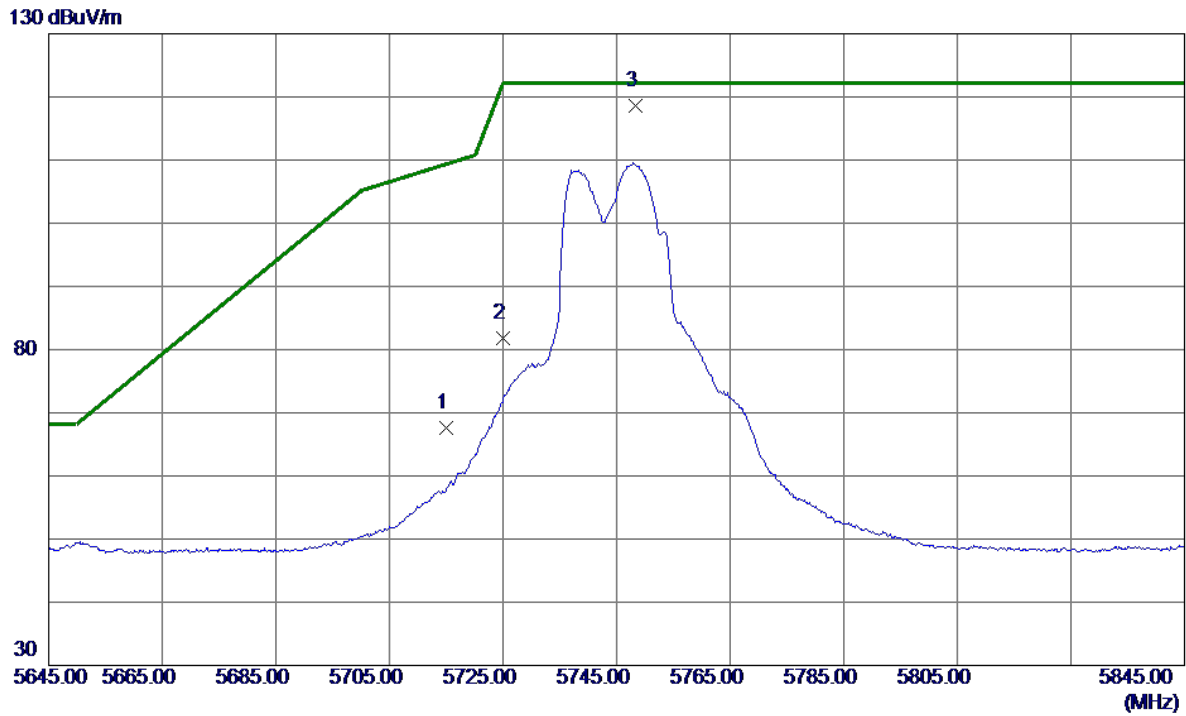

No.	Freq. MHz	Reading Level dBuV/m	Correct Factor dB	Measure ment dBuV/m	Limit dBuV/m	Margin dB	Detector	Comment
1	5715.0000	47.86	19.72	67.58	109.40	-41.82	Peak	
2	5725.0000	62.06	19.75	81.81	122.20	-40.39	Peak	
3 *	5748.3000	98.69	19.82	118.51	122.20	-3.69	Peak	No Limit

REMARKS:

- (1) Measurement Value = Reading Level + Correct Factor.
- (2) Margin Level = Measurement Value - Limit Value.

Test Mode	UNII-3_TX AC(VHT20) Mode 5745 MHz	Polarization	Vertical
-----------	-----------------------------------	--------------	----------

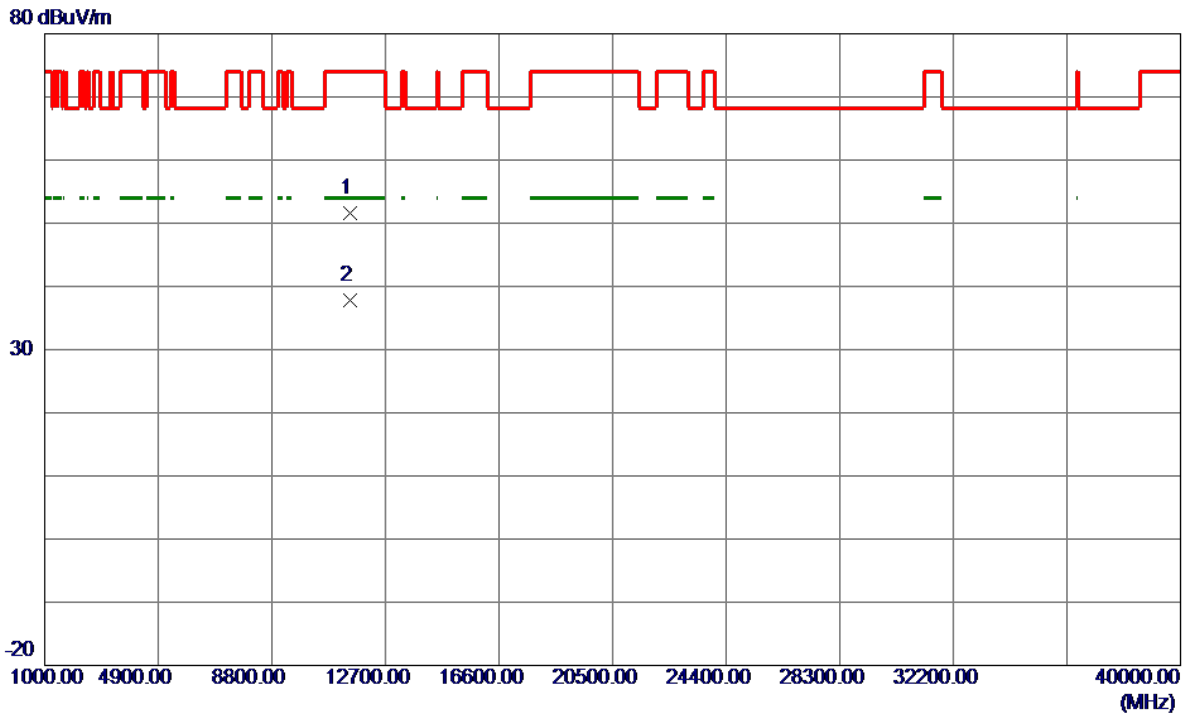

No.	Freq. MHz	Reading Level dBuV/m	Correct Factor dB	Measure ment dBuV/m	Limit dBuV/m	Margin dB	Detector	Comment
1	11490.3280	34.29	17.36	51.65	74.00	-22.35	Peak	
2 *	11490.7859	20.37	17.36	37.73	54.00	-16.27	AVG	

REMARKS:

- (1) Measurement Value = Reading Level + Correct Factor.
- (2) Margin Level = Measurement Value - Limit Value.

Test Mode	UNII-3_TX AC(VHT20) Mode 5745 MHz	Polarization	Horizontal
-----------	-----------------------------------	--------------	------------

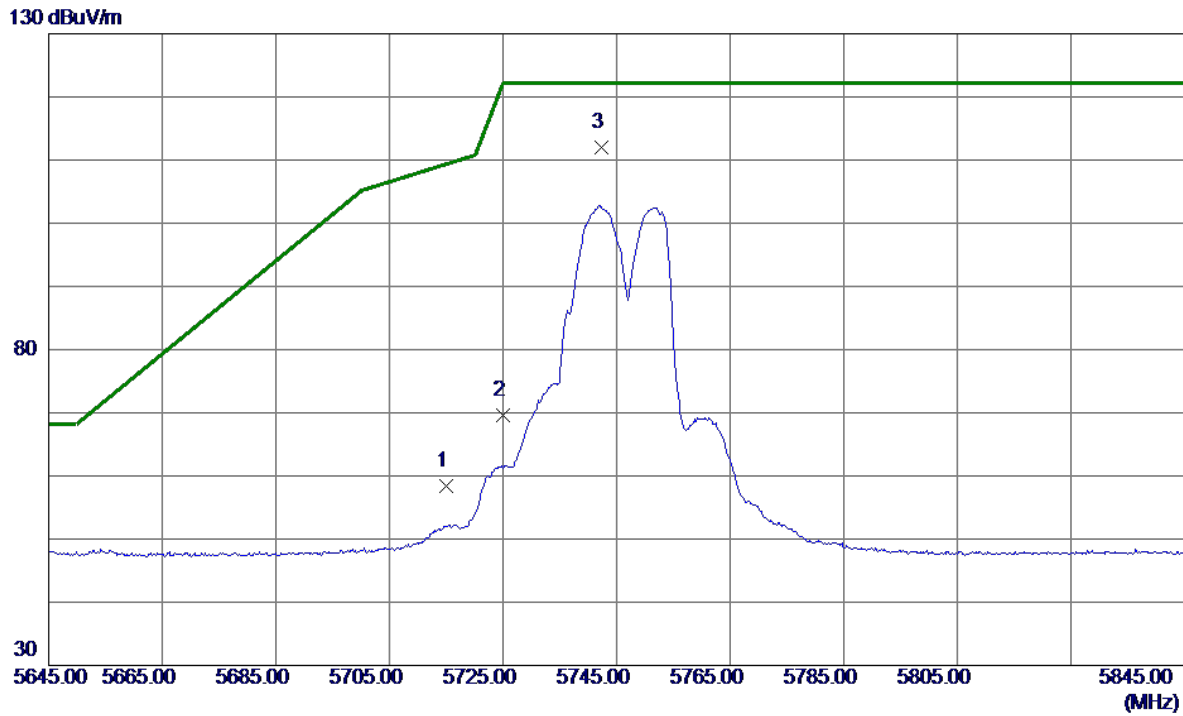

No.	Freq. MHz	Reading Level dBuV/m	Correct Factor dB	Measure ment dBuV/m	Limit dBuV/m	Margin dB	Detector	Comment
1	5715.0000	38.73	19.72	58.45	109.40	-50.95	Peak	
2	5725.0000	49.93	19.75	69.68	122.20	-52.52	Peak	
3 *	5742.4000	92.24	19.80	112.04	122.20	-10.16	Peak	No Limit

REMARKS:

- (1) Measurement Value = Reading Level + Correct Factor.
- (2) Margin Level = Measurement Value - Limit Value.

Test Mode	UNII-3_TX AC(VHT20) Mode 5745 MHz	Polarization	Horizontal
-----------	-----------------------------------	--------------	------------

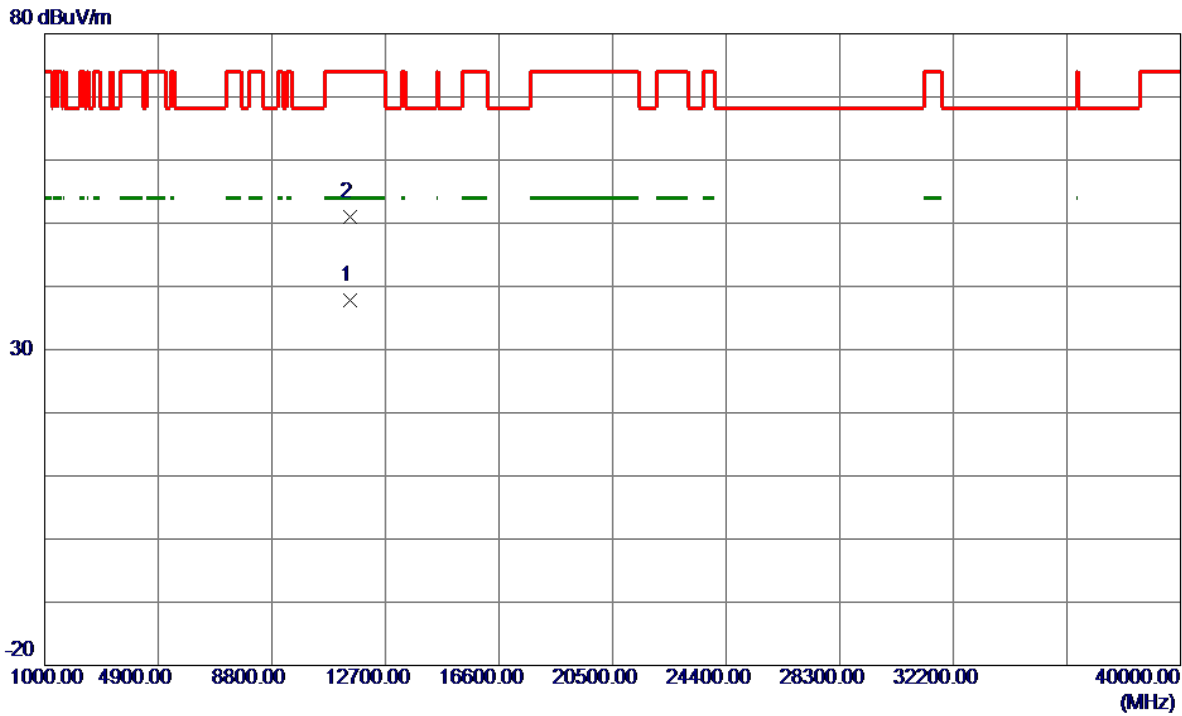

No.	Freq. MHz	Reading Level dBuV/m	Correct Factor dB	Measure ment dBuV/m	Limit dBuV/m	Margin dB	Detector	Comment
1 *	11489.9150	20.36	17.36	37.72	54.00	-16.28	AVG	
2	11490.5990	33.55	17.36	50.91	74.00	-23.09	Peak	

REMARKS:

- (1) Measurement Value = Reading Level + Correct Factor.
- (2) Margin Level = Measurement Value - Limit Value.

Test Mode	UNII-3_TX AC(VHT20) Mode 5785 MHz	Polarization	Vertical
-----------	-----------------------------------	--------------	----------

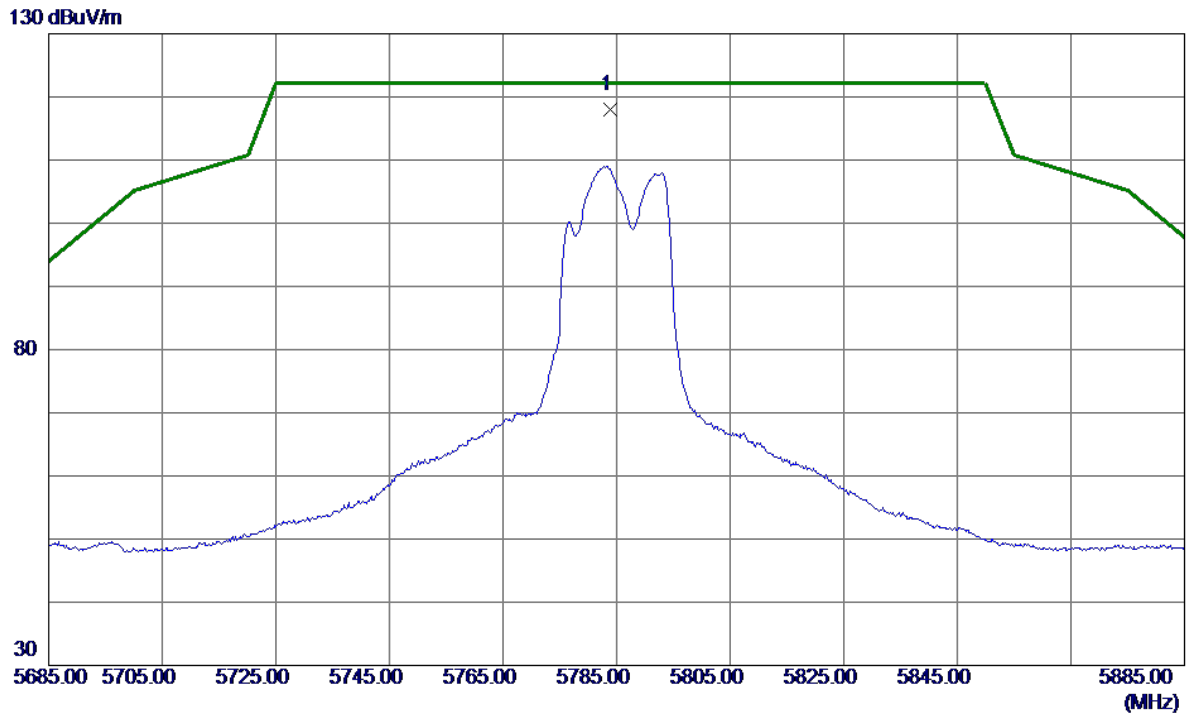

No.	Freq. MHz	Reading Level dBuV/m	Correct Factor dB	Measure ment dBuV/m	Limit dBuV/m	Margin dB	Detector	Comment
1 *	5783.9000	98.02	19.92	117.94	122.20	-4.26	Peak	No Limit

REMARKS:

- (1) Measurement Value = Reading Level + Correct Factor.
- (2) Margin Level = Measurement Value - Limit Value.

Test Mode	UNII-3_TX AC(VHT20) Mode 5785 MHz	Polarization	Vertical
-----------	-----------------------------------	--------------	----------

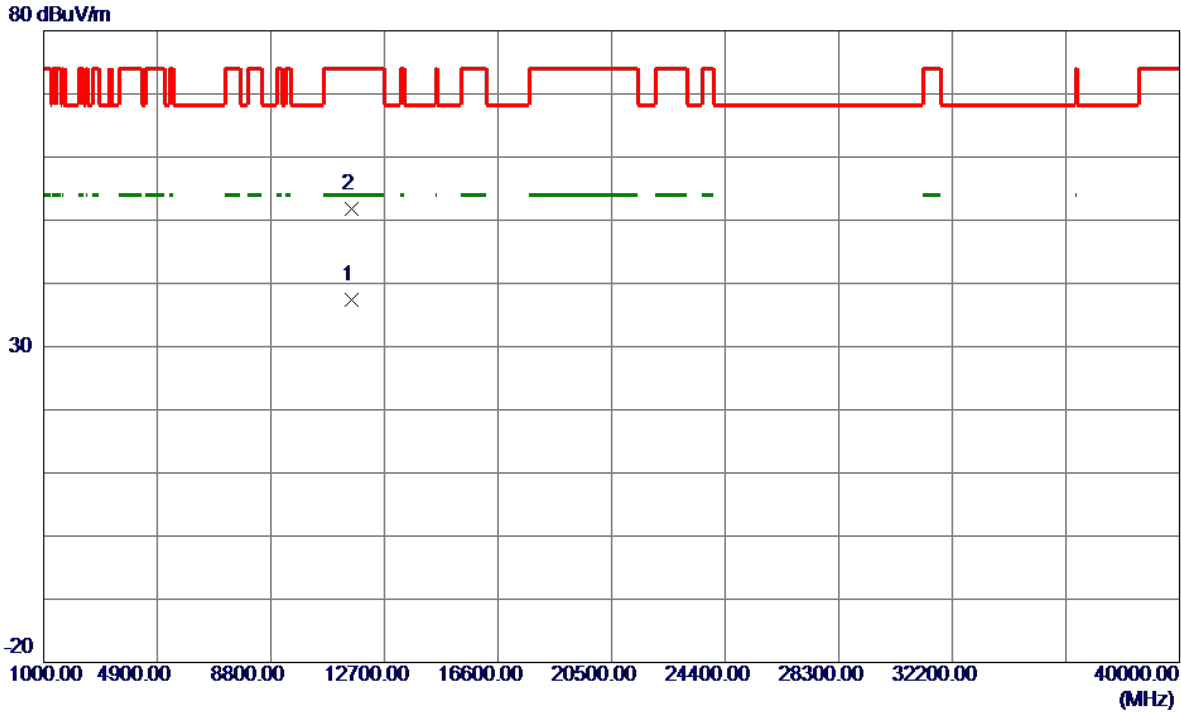

No.	Freq. MHz	Reading Level dBuV/m	Correct Factor dB	Measure ment dBuV/m	Limit dBuV/m	Margin dB	Detector	Comment
1 *	11570.1769	19.93	17.40	37.33	54.00	-16.67	AVG	
2	11570.2960	34.35	17.40	51.75	74.00	-22.25	Peak	

REMARKS:

- (1) Measurement Value = Reading Level + Correct Factor.
- (2) Margin Level = Measurement Value - Limit Value.

Test Mode	UNII-3_TX AC(VHT20) Mode 5785 MHz	Polarization	Horizontal
-----------	-----------------------------------	--------------	------------

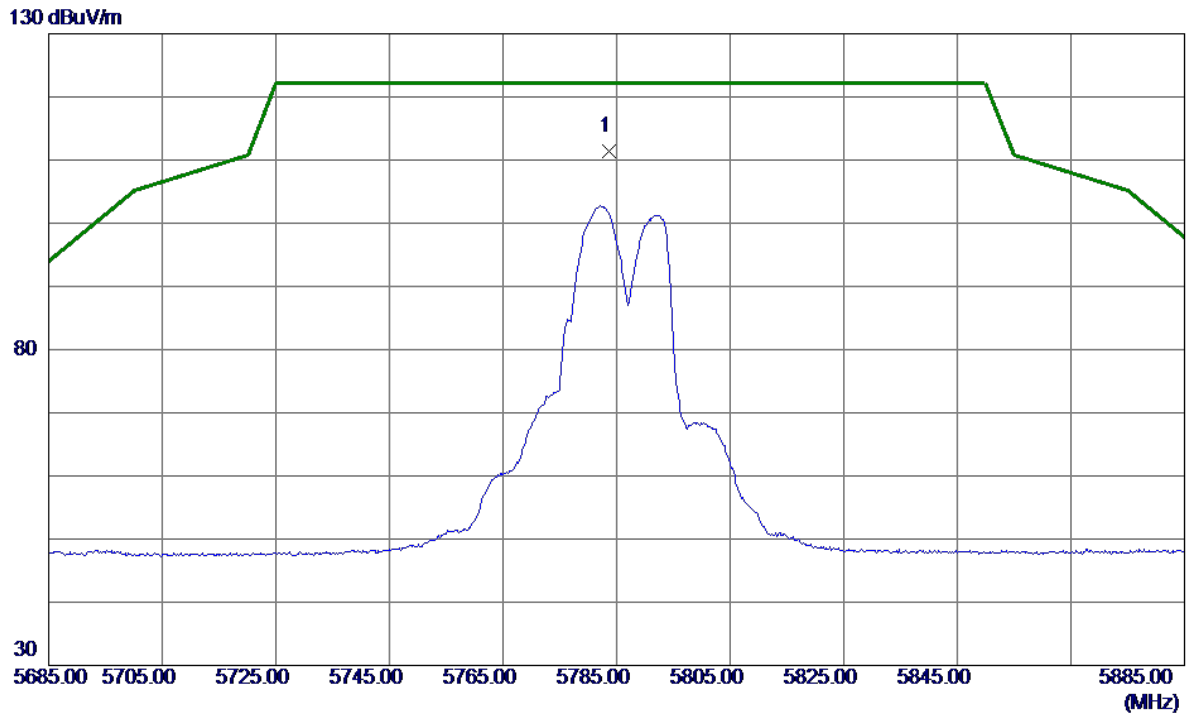

No.	Freq. MHz	Reading Level dBuV/m	Correct Factor dB	Measure ment dBuV/m	Limit dBuV/m	Margin dB	Detector	Comment
1 *	5783.6000	91.49	19.92	111.41	122.20	-10.79	Peak	No Limit

REMARKS:

- (1) Measurement Value = Reading Level + Correct Factor.
- (2) Margin Level = Measurement Value - Limit Value.

Test Mode	UNII-3_TX AC(VHT20) Mode 5785 MHz	Polarization	Horizontal
-----------	-----------------------------------	--------------	------------

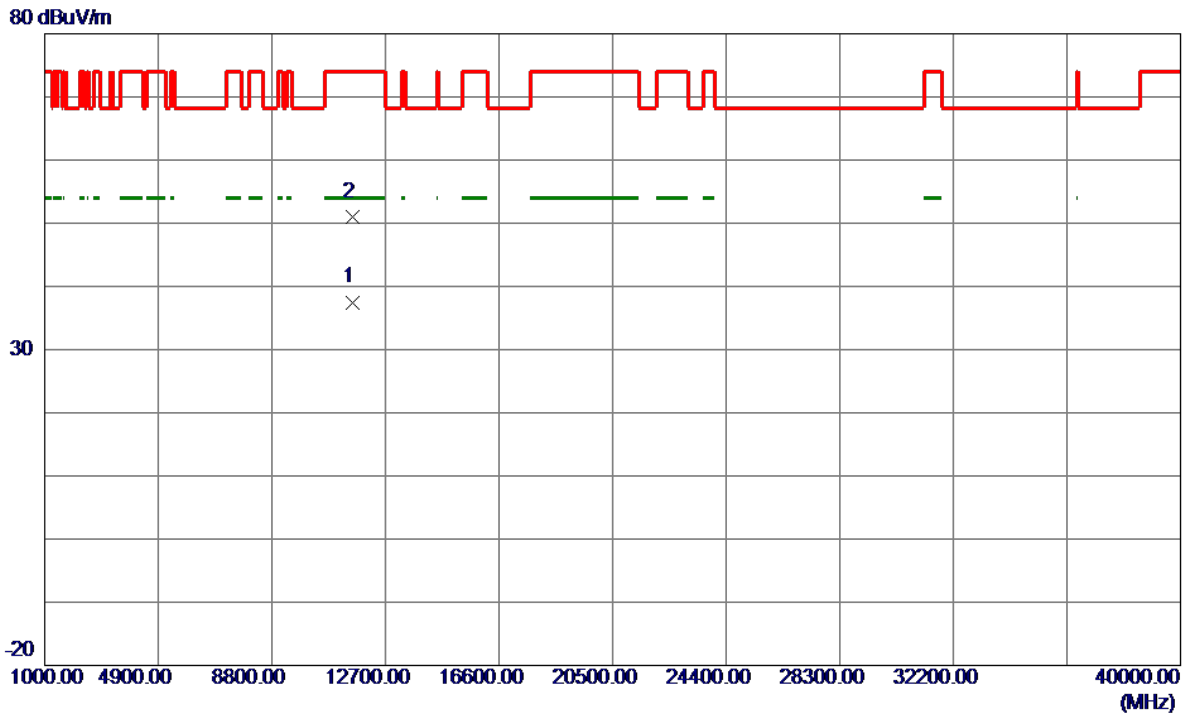

No.	Freq. MHz	Reading Level dBuV/m	Correct Factor dB	Measure ment dBuV/m	Limit dBuV/m	Margin dB	Detector	Comment
1 *	11569.1960	20.10	17.40	37.50	54.00	-16.50	AVG	
2	11570.3150	33.54	17.40	50.94	74.00	-23.06	Peak	

REMARKS:

- (1) Measurement Value = Reading Level + Correct Factor.
- (2) Margin Level = Measurement Value - Limit Value.

Test Mode	UNII-3_TX AC(VHT20) Mode 5825 MHz	Polarization	Vertical
-----------	-----------------------------------	--------------	----------

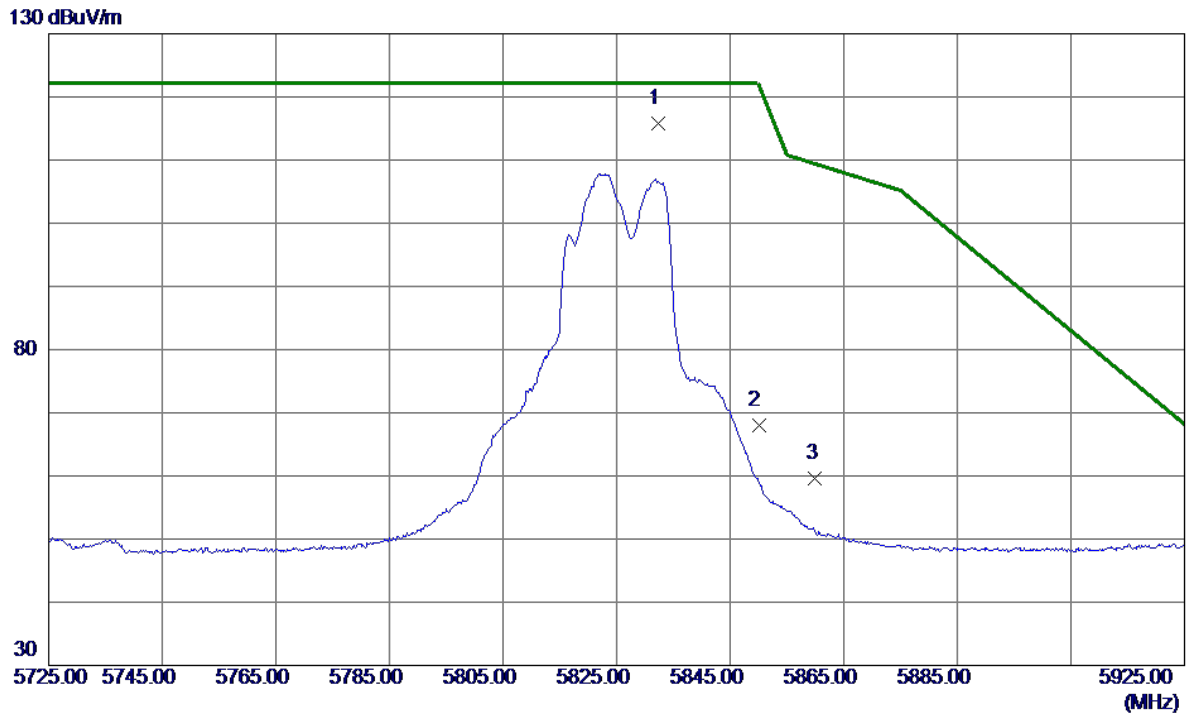

No.	Freq. MHz	Reading Level dBuV/m	Correct Factor dB	Measure ment dBuV/m	Limit dBuV/m	Margin dB	Detector	Comment
1 *	5832.4000	95.81	20.05	115.86	122.20	-6.34	Peak	No Limit
2	5850.0000	47.83	20.10	67.93	122.20	-54.27	Peak	
3	5860.0000	39.53	20.13	59.66	109.40	-49.74	Peak	

REMARKS:

- (1) Measurement Value = Reading Level + Correct Factor.
- (2) Margin Level = Measurement Value - Limit Value.

Test Mode	UNII-3_TX AC(VHT20) Mode 5825 MHz	Polarization	Vertical
-----------	-----------------------------------	--------------	----------

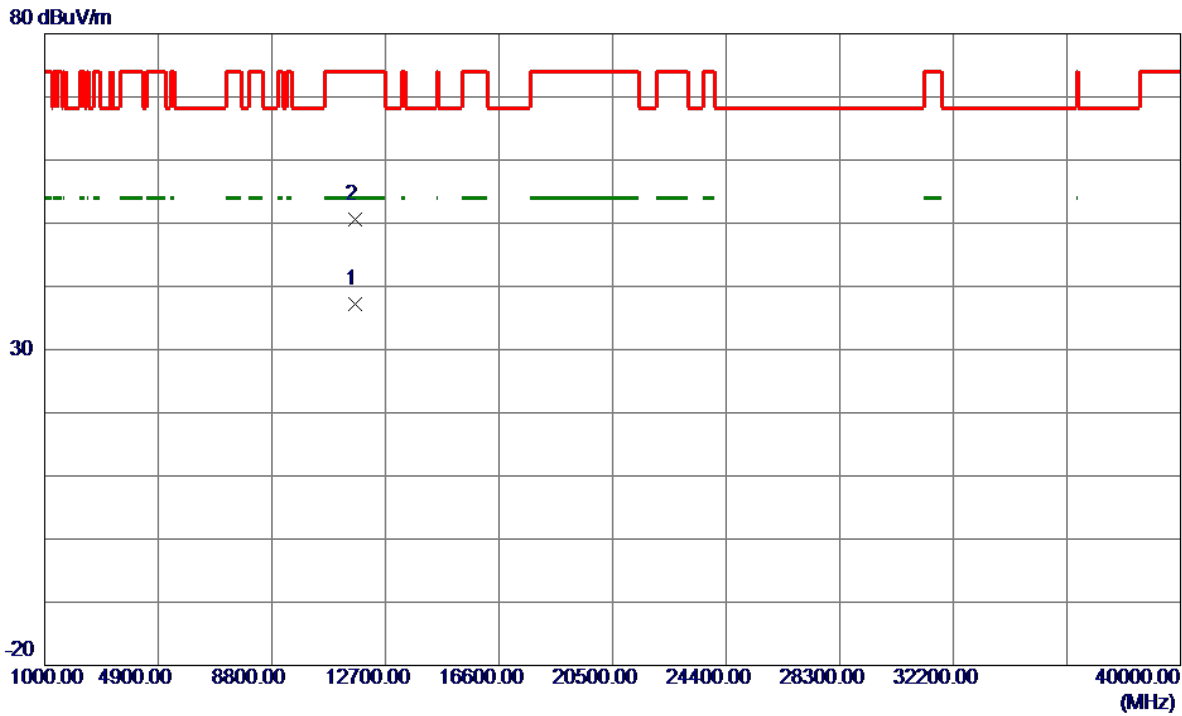

No.	Freq. MHz	Reading Level dBuV/m	Correct Factor dB	Measure ment dBuV/m	Limit dBuV/m	Margin dB	Detector	Comment
1 *	11650.0960	19.86	17.42	37.28	54.00	-16.72	AVG	
2	11650.1560	33.22	17.42	50.64	74.00	-23.36	Peak	

REMARKS:

- (1) Measurement Value = Reading Level + Correct Factor.
- (2) Margin Level = Measurement Value - Limit Value.

Test Mode	UNII-3_TX AC(VHT20) Mode 5825 MHz	Polarization	Horizontal
-----------	-----------------------------------	--------------	------------

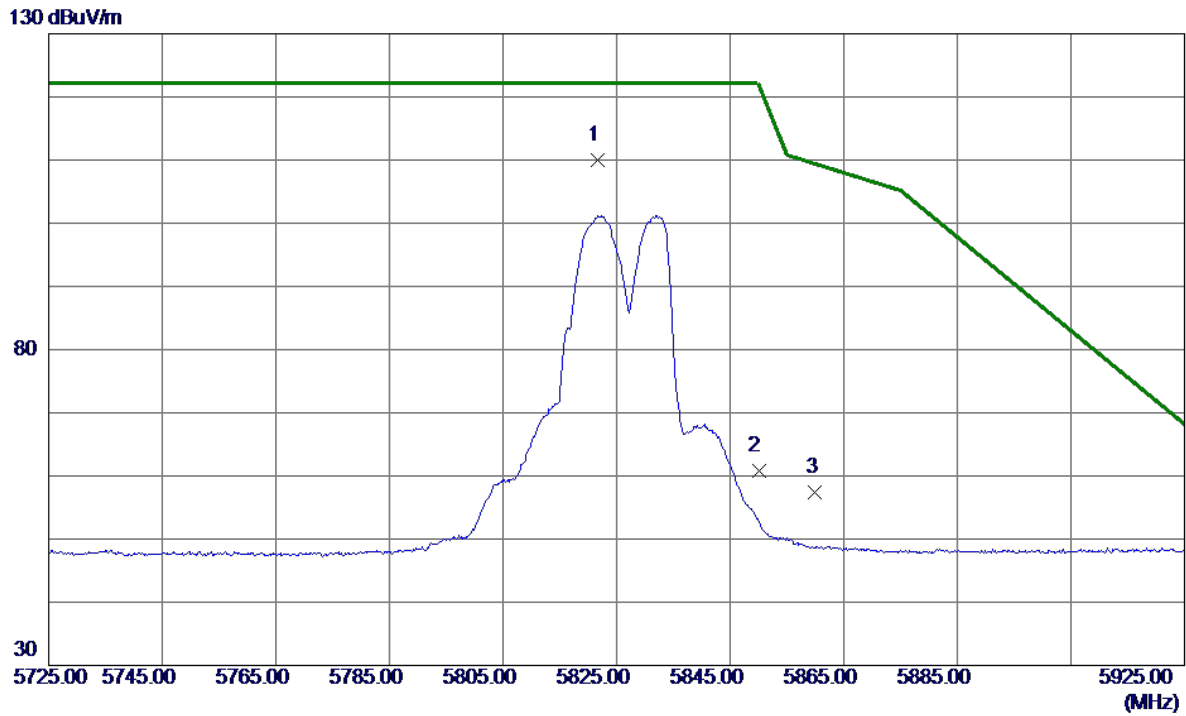

No.	Freq. MHz	Reading Level dBuV/m	Correct Factor dB	Measure ment dBuV/m	Limit dBuV/m	Margin dB	Detector	Comment
1 *	5821.6000	90.00	20.02	110.02	122.20	-12.18	Peak	No Limit
2	5850.0000	40.75	20.10	60.85	122.20	-61.35	Peak	
3	5860.0000	37.20	20.13	57.33	109.40	-52.07	Peak	

REMARKS:

- (1) Measurement Value = Reading Level + Correct Factor.
- (2) Margin Level = Measurement Value - Limit Value.

Test Mode	UNII-3_TX AC(VHT20) Mode 5825 MHz	Polarization	Horizontal
-----------	-----------------------------------	--------------	------------

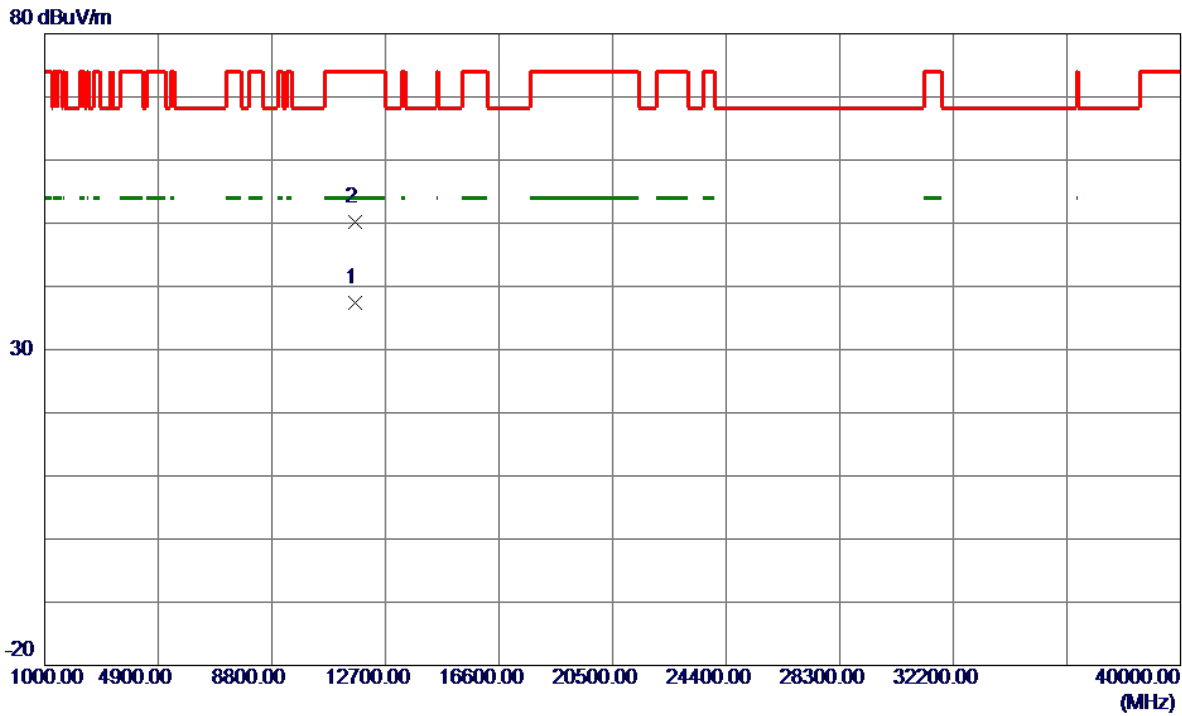

No.	Freq. MHz	Reading Level dBuV/m	Correct Factor dB	Measure ment dBuV/m	Limit dBuV/m	Margin dB	Detector	Comment
1 *	11649.4509	19.93	17.42	37.35	54.00	-16.65	AVG	
2	11650.9870	32.84	17.43	50.27	74.00	-23.73	Peak	

REMARKS:

- (1) Measurement Value = Reading Level + Correct Factor.
- (2) Margin Level = Measurement Value - Limit Value.

Test Mode	UNII-3_TX AC(VHT40) Mode 5755 MHz	Polarization	Vertical
-----------	-----------------------------------	--------------	----------

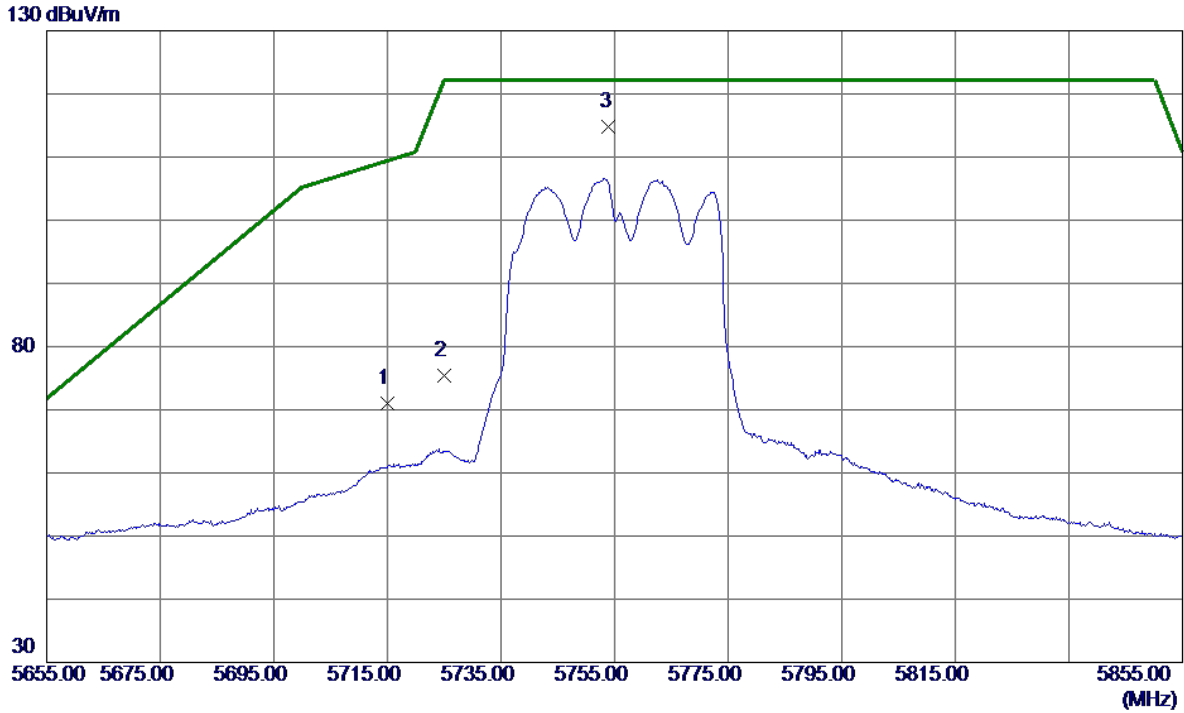

No.	Freq. MHz	Reading Level dBuV/m	Correct Factor dB	Measure ment dBuV/m	Limit dBuV/m	Margin dB	Detector	Comment
1	5715.0000	51.33	19.72	71.05	109.40	-38.35	Peak	
2	5725.0000	55.57	19.75	75.32	122.20	-46.88	Peak	
3 *	5754.0000	95.00	19.83	114.83	122.20	-7.37	Peak	No Limit

REMARKS:

- (1) Measurement Value = Reading Level + Correct Factor.
- (2) Margin Level = Measurement Value - Limit Value.

Test Mode	UNII-3_TX AC(VHT40) Mode 5755 MHz	Polarization	Vertical
-----------	-----------------------------------	--------------	----------

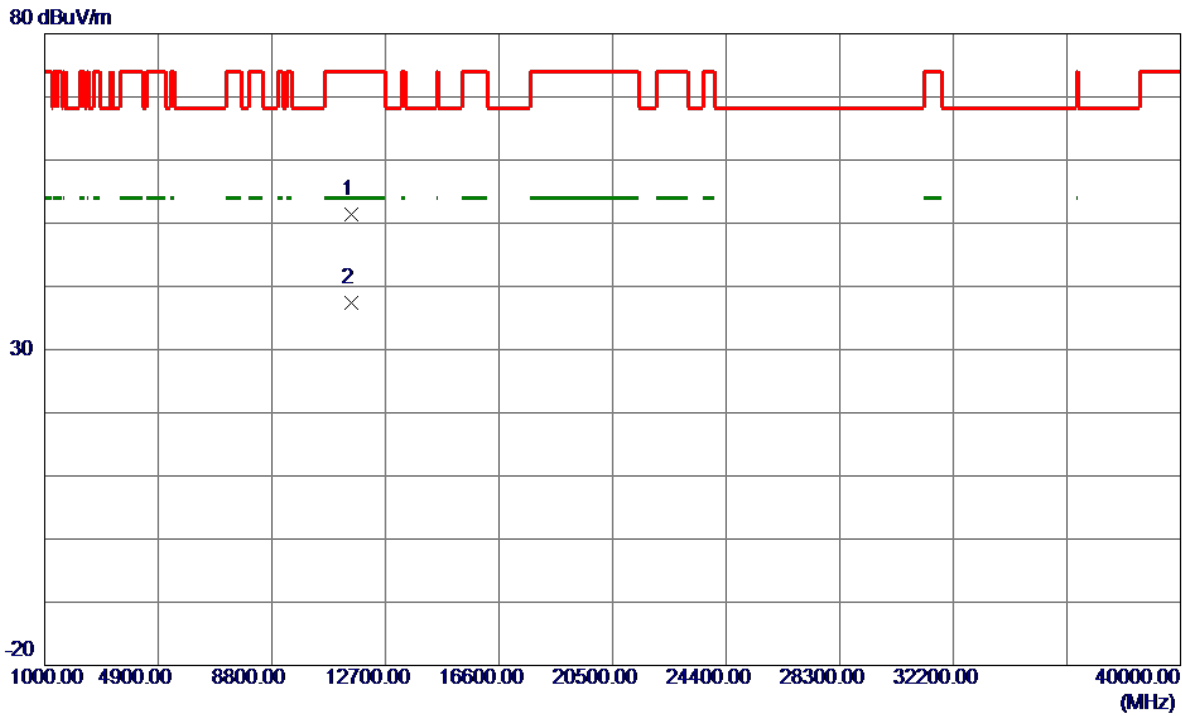

No.	Freq. MHz	Reading Level dBuV/m	Correct Factor dB	Measure ment dBuV/m	Limit dBuV/m	Margin dB	Detector	Comment
1	11510.5060	34.09	17.38	51.47	74.00	-22.53	Peak	
2 *	11510.6750	19.98	17.38	37.36	54.00	-16.64	AVG	

REMARKS:

- (1) Measurement Value = Reading Level + Correct Factor.
- (2) Margin Level = Measurement Value - Limit Value.

Test Mode	UNII-3_TX AC(VHT40) Mode 5755 MHz	Polarization	Horizontal
-----------	-----------------------------------	--------------	------------

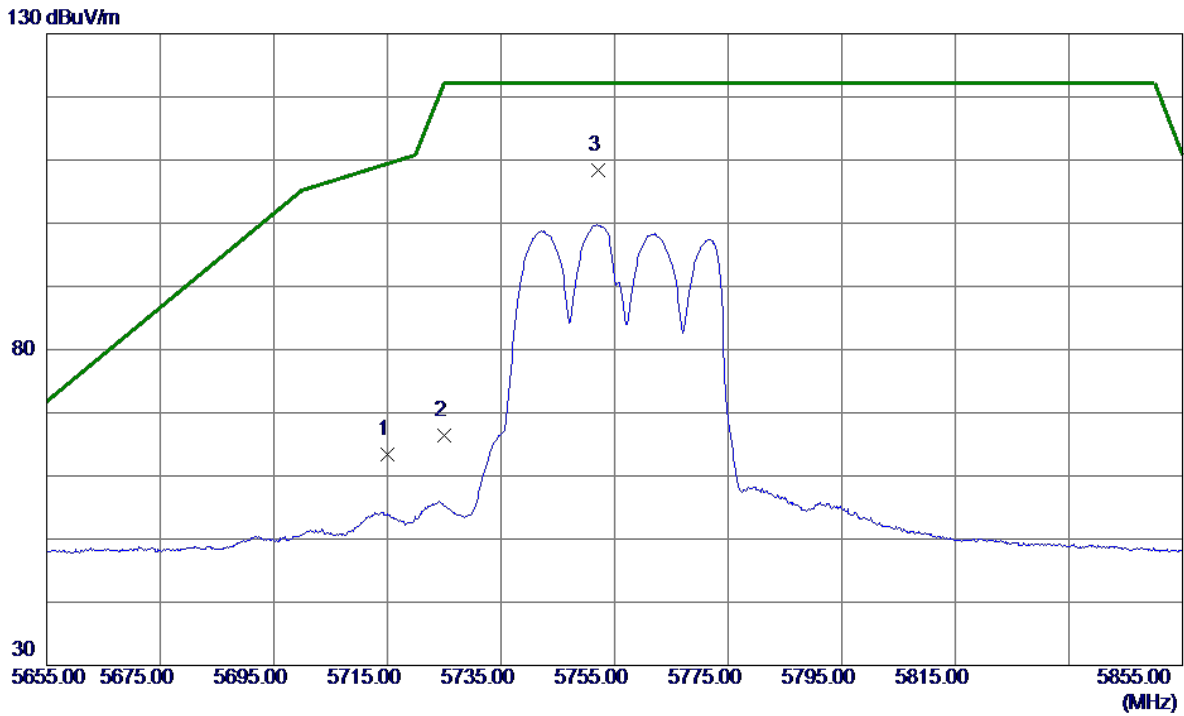

No.	Freq. MHz	Reading Level dBuV/m	Correct Factor dB	Measure ment dBuV/m	Limit dBuV/m	Margin dB	Detector	Comment
1	5715.0000	43.61	19.72	63.33	109.40	-46.07	Peak	
2	5725.0000	46.71	19.75	66.46	122.20	-55.74	Peak	
3 *	5752.2000	88.58	19.83	108.41	122.20	-13.79	Peak	No Limit

REMARKS:

- (1) Measurement Value = Reading Level + Correct Factor.
- (2) Margin Level = Measurement Value - Limit Value.

Test Mode	UNII-3_TX AC(VHT40) Mode 5755 MHz	Polarization	Horizontal
-----------	-----------------------------------	--------------	------------

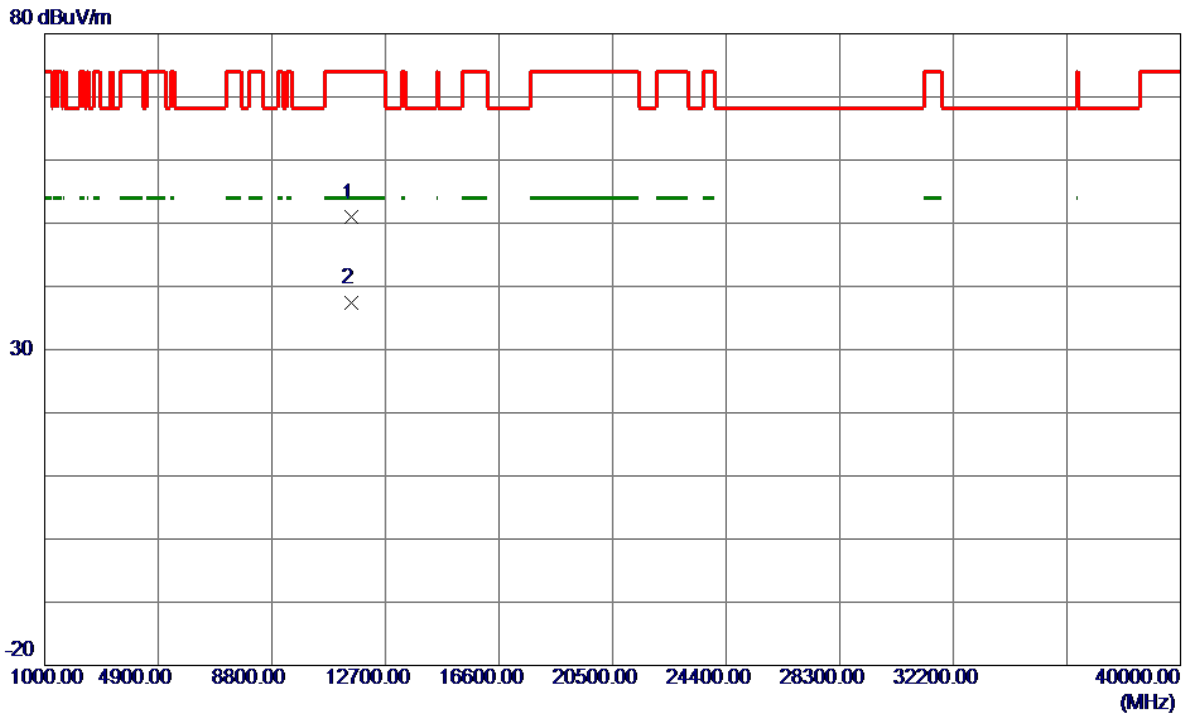

No.	Freq. MHz	Reading Level dBuV/m	Correct Factor dB	Measure ment dBuV/m	Limit dBuV/m	Margin dB	Detector	Comment
1	11510.3230	33.52	17.38	50.90	74.00	-23.10	Peak	
2 *	11510.7730	20.04	17.38	37.42	54.00	-16.58	AVG	

REMARKS:

- (1) Measurement Value = Reading Level + Correct Factor.
- (2) Margin Level = Measurement Value - Limit Value.

Test Mode	UNII-3_TX AC(VHT40) Mode 5795 MHz	Polarization	Vertical
-----------	-----------------------------------	--------------	----------

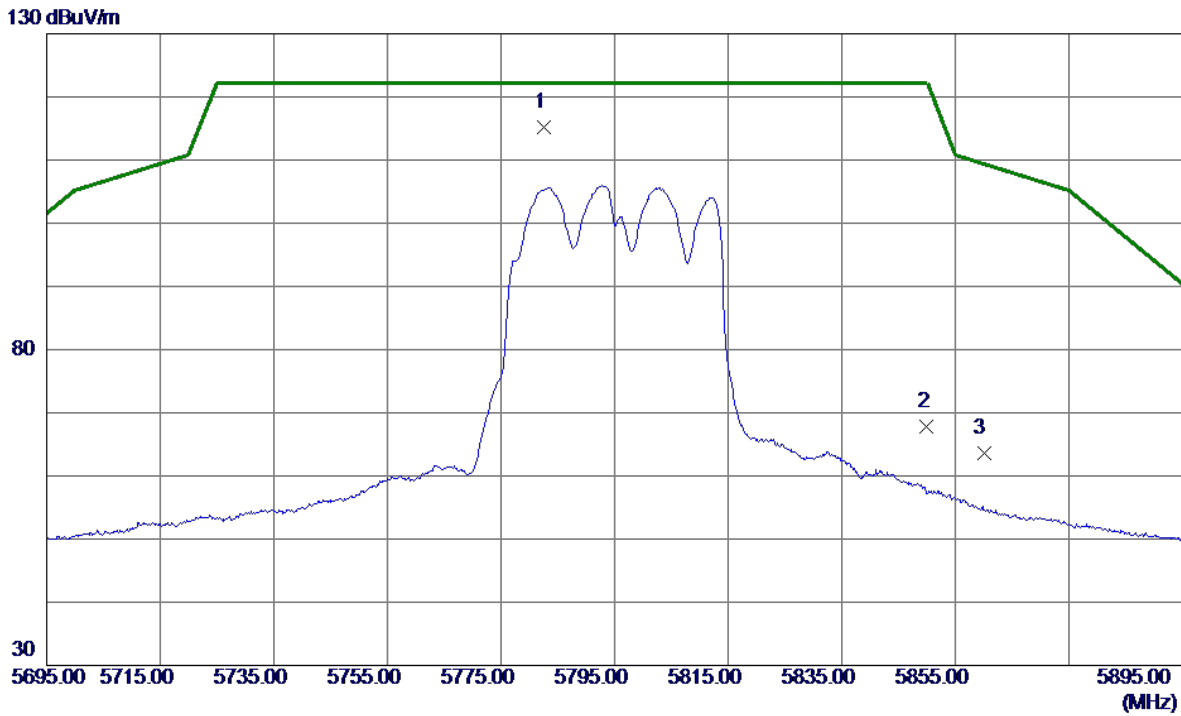

No.	Freq. MHz	Reading Level dBuV/m	Correct Factor dB	Measure ment dBuV/m	Limit dBuV/m	Margin dB	Detector	Comment
1 *	5782.5000	95.32	19.91	115.23	122.20	-6.97	Peak	No Limit
2	5850.0000	47.72	20.10	67.82	122.20	-54.38	Peak	
3	5860.0000	43.55	20.13	63.68	109.40	-45.72	Peak	

REMARKS:

- (1) Measurement Value = Reading Level + Correct Factor.
- (2) Margin Level = Measurement Value - Limit Value.

Test Mode	UNII-3_TX AC(VHT40) Mode 5795 MHz	Polarization	Vertical
-----------	-----------------------------------	--------------	----------

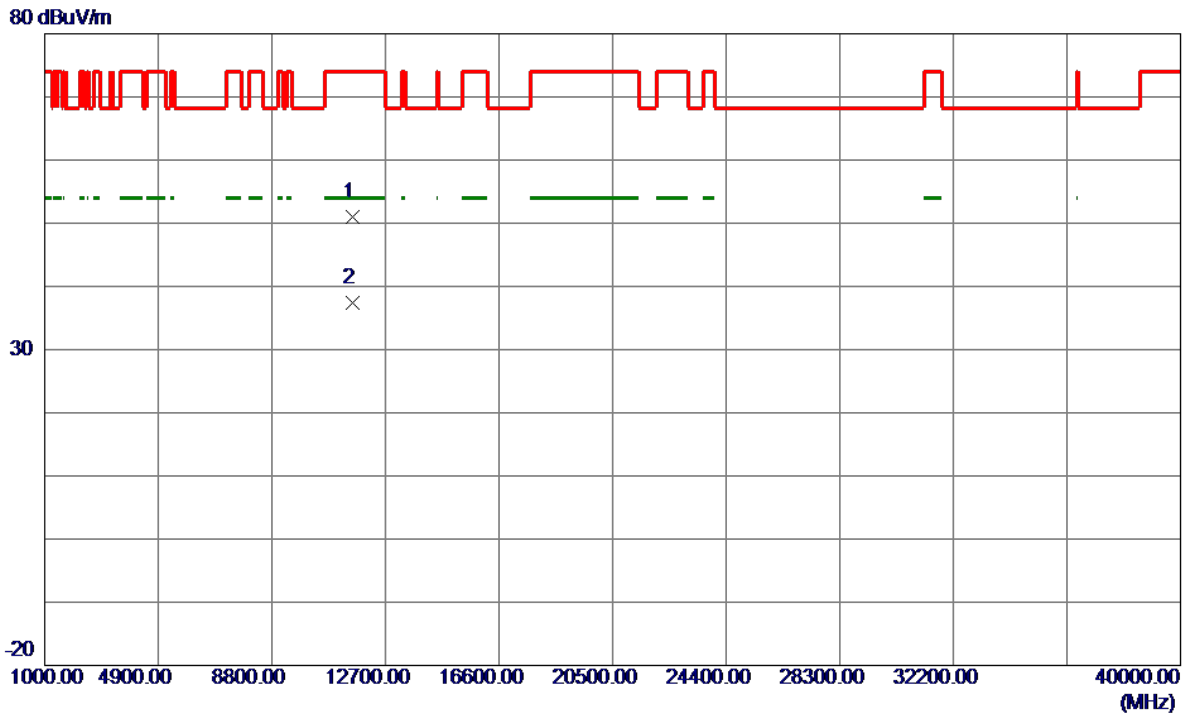

No.	Freq. MHz	Reading Level dBuV/m	Correct Factor dB	Measure ment dBuV/m	Limit dBuV/m	Margin dB	Detector	Comment
1	11589.0759	33.53	17.41	50.94	74.00	-23.06	Peak	
2 *	11589.2000	20.07	17.41	37.48	54.00	-16.52	AVG	

REMARKS:

- (1) Measurement Value = Reading Level + Correct Factor.
- (2) Margin Level = Measurement Value - Limit Value.

Test Mode	UNII-3_TX AC(VHT40) Mode 5795 MHz	Polarization	Horizontal
-----------	-----------------------------------	--------------	------------

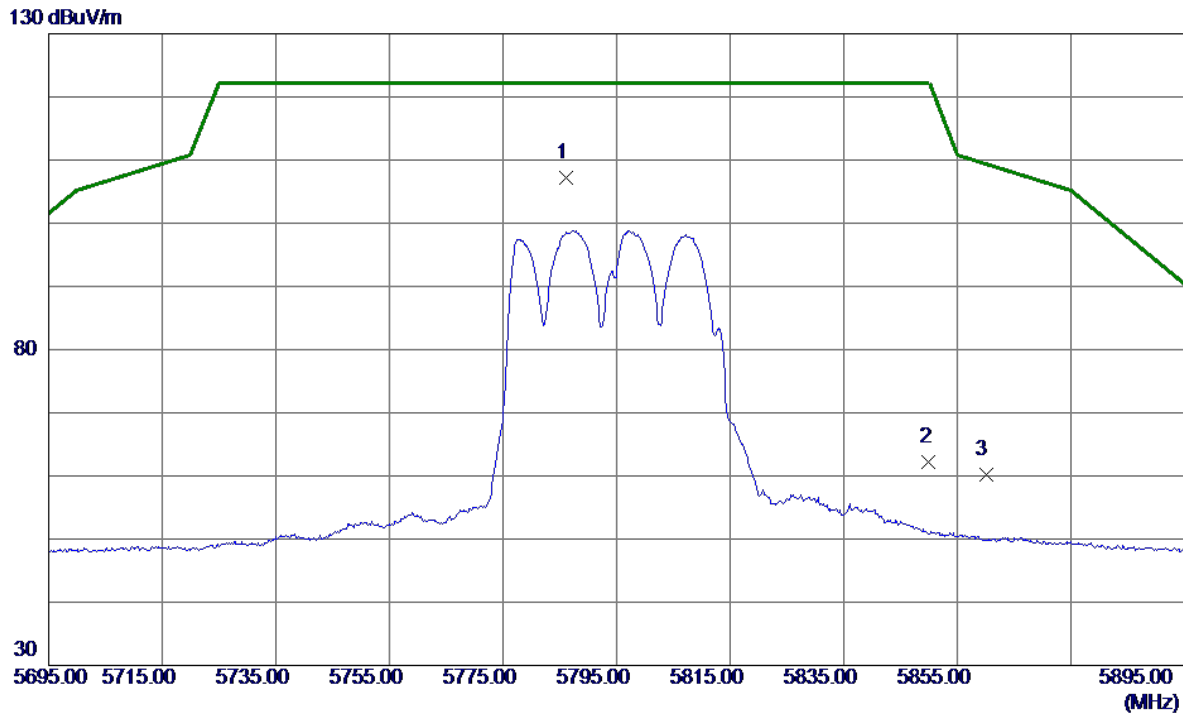

No.	Freq. MHz	Reading Level dBuV/m	Correct Factor dB	Measure ment dBuV/m	Limit dBuV/m	Margin dB	Detector	Comment
1 *	5786.1000	87.33	19.92	107.25	122.20	-14.95	Peak	No Limit
2	5850.0000	42.05	20.10	62.15	122.20	-60.05	Peak	
3	5860.0000	40.13	20.13	60.26	109.40	-49.14	Peak	

REMARKS:

- (1) Measurement Value = Reading Level + Correct Factor.
- (2) Margin Level = Measurement Value - Limit Value.

Test Mode	UNII-3_TX AC(VHT40) Mode 5795 MHz	Polarization	Horizontal
-----------	-----------------------------------	--------------	------------



No.	Freq. MHz	Reading Level dBuV/m	Correct Factor dB	Measure ment dBuV/m	Limit dBuV/m	Margin dB	Detector	Comment
1	11589.0510	33.89	17.41	51.30	74.00	-22.70	Peak	
2 *	11589.1230	20.09	17.41	37.50	54.00	-16.50	AVG	

REMARKS:

- (1) Measurement Value = Reading Level + Correct Factor.
- (2) Margin Level = Measurement Value - Limit Value.

Test Mode	UNII-3_TX AC(VHT80) Mode 5775 MHz	Polarization	Vertical
-----------	-----------------------------------	--------------	----------

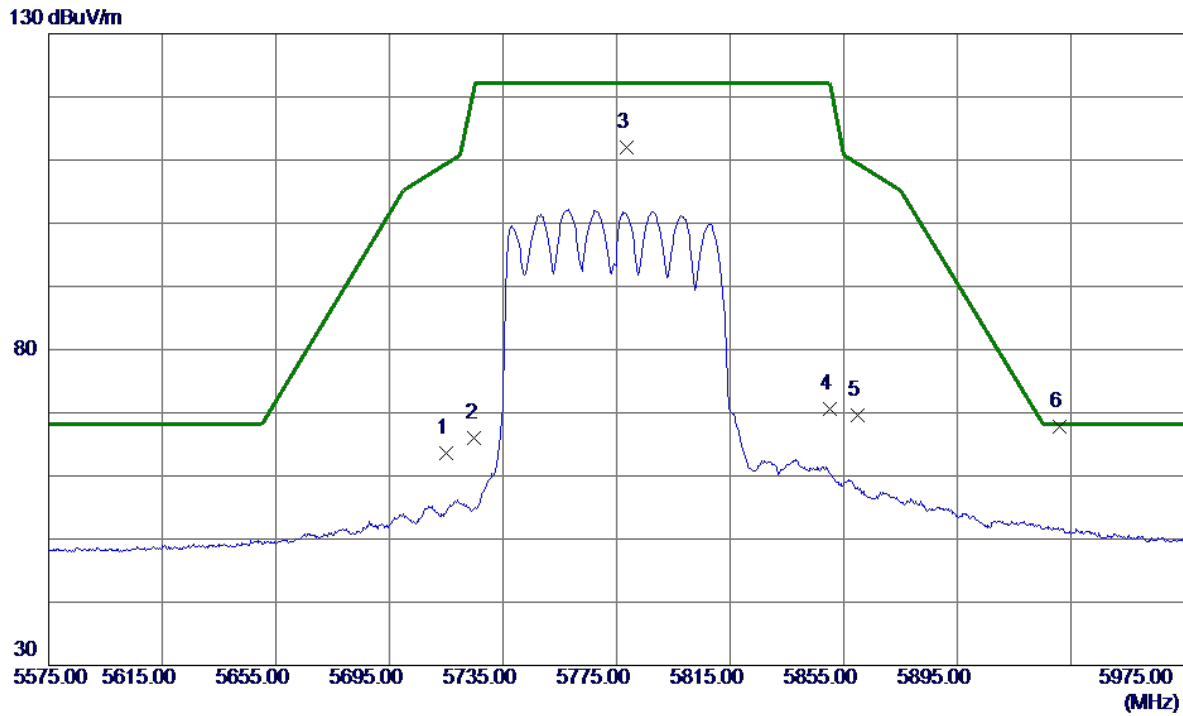

No.	Freq. MHz	Reading Level dBuV/m	Correct Factor dB	Measure ment dBuV/m	Limit dBuV/m	Margin dB	Detector	Comment
1	5715.0000	43.88	19.72	63.60	109.40	-45.80	Peak	
2	5725.0000	46.22	19.75	65.97	122.20	-56.23	Peak	
3	5778.4000	92.10	19.90	112.00	122.20	-10.20	Peak	No Limit
4	5850.0000	50.44	20.10	70.54	122.20	-51.66	Peak	
5	5860.0000	49.48	20.13	69.61	109.40	-39.79	Peak	
6 *	5931.0000	47.46	20.33	67.79	68.20	-0.41	Peak	

REMARKS:

- (1) Measurement Value = Reading Level + Correct Factor.
- (2) Margin Level = Measurement Value - Limit Value.

Test Mode	UNII-3_TX AC(VHT80) Mode 5775 MHz	Polarization	Vertical
-----------	-----------------------------------	--------------	----------

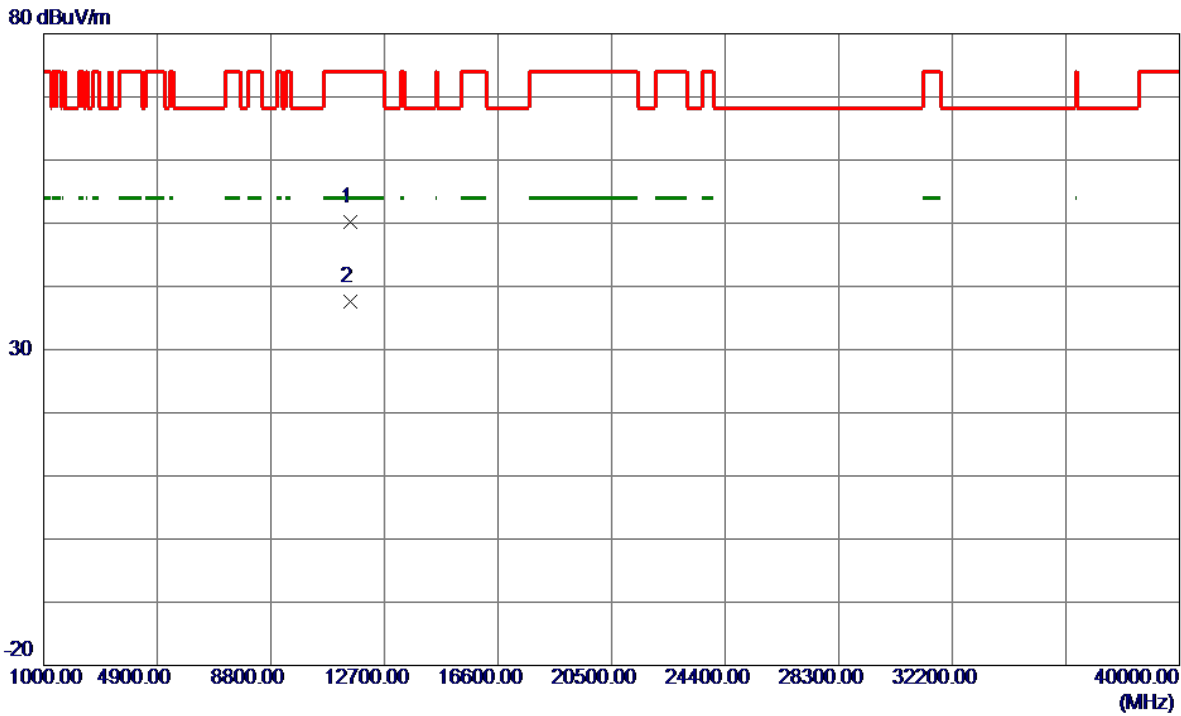

No.	Freq. MHz	Reading Level dBuV/m	Correct Factor dB	Measure ment dBuV/m	Limit dBuV/m	Margin dB	Detector	Comment
1	11549.1880	32.84	17.39	50.23	74.00	-23.77	Peak	
2 *	11549.6550	20.17	17.39	37.56	54.00	-16.44	AVG	

REMARKS:

- (1) Measurement Value = Reading Level + Correct Factor.
- (2) Margin Level = Measurement Value - Limit Value.

Test Mode	UNII-3_TX AC(VHT80) Mode 5775 MHz	Polarization	Horizontal
-----------	-----------------------------------	--------------	------------

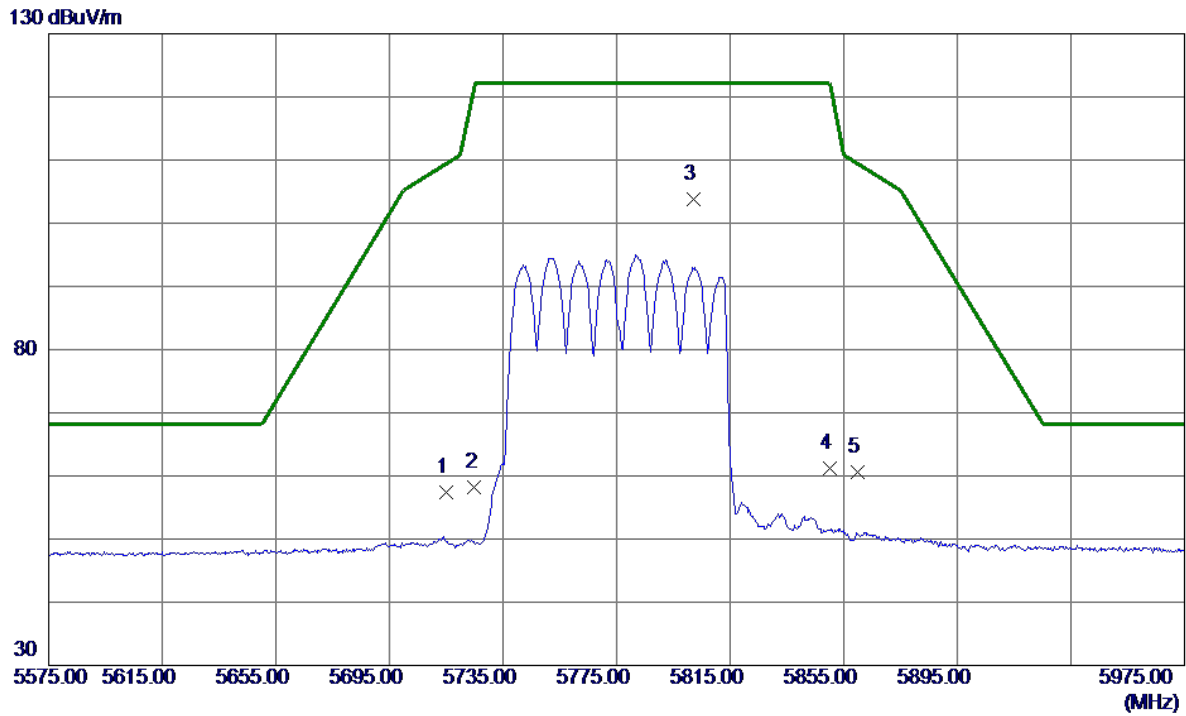

No.	Freq. MHz	Reading Level dBuV/m	Correct Factor dB	Measure ment dBuV/m	Limit dBuV/m	Margin dB	Detector	Comment
1	5715.0000	37.64	19.72	57.36	109.40	-52.04	Peak	
2	5725.0000	38.51	19.75	58.26	122.20	-63.94	Peak	
3 *	5802.2000	83.89	19.97	103.86	122.20	-18.34	Peak	No Limit
4	5850.0000	41.17	20.10	61.27	122.20	-60.93	Peak	
5	5860.0000	40.53	20.13	60.66	109.40	-48.74	Peak	

REMARKS:

- (1) Measurement Value = Reading Level + Correct Factor.
- (2) Margin Level = Measurement Value - Limit Value.

Test Mode	UNII-3_TX AC(VHT80) Mode 5775 MHz	Polarization	Horizontal
-----------	-----------------------------------	--------------	------------

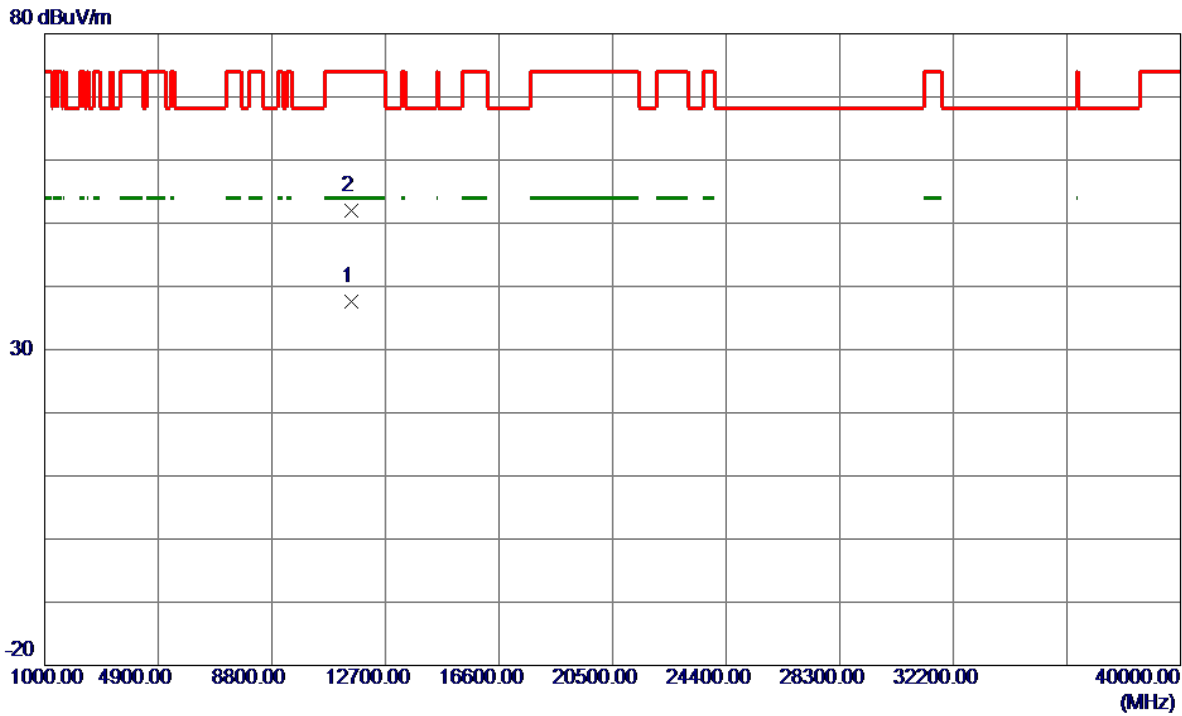

No.	Freq. MHz	Reading Level dBuV/m	Correct Factor dB	Measure ment dBuV/m	Limit dBuV/m	Margin dB	Detector	Comment
1 *	11550.3740	20.29	17.40	37.69	54.00	-16.31	AVG	
2	11550.5860	34.61	17.40	52.01	74.00	-21.99	Peak	

REMARKS:

- (1) Measurement Value = Reading Level + Correct Factor.
- (2) Margin Level = Measurement Value - Limit Value.

Test Mode	UNII-3_TX AX(HE20) Mode 5745 MHz	Polarization	Vertical
-----------	----------------------------------	--------------	----------

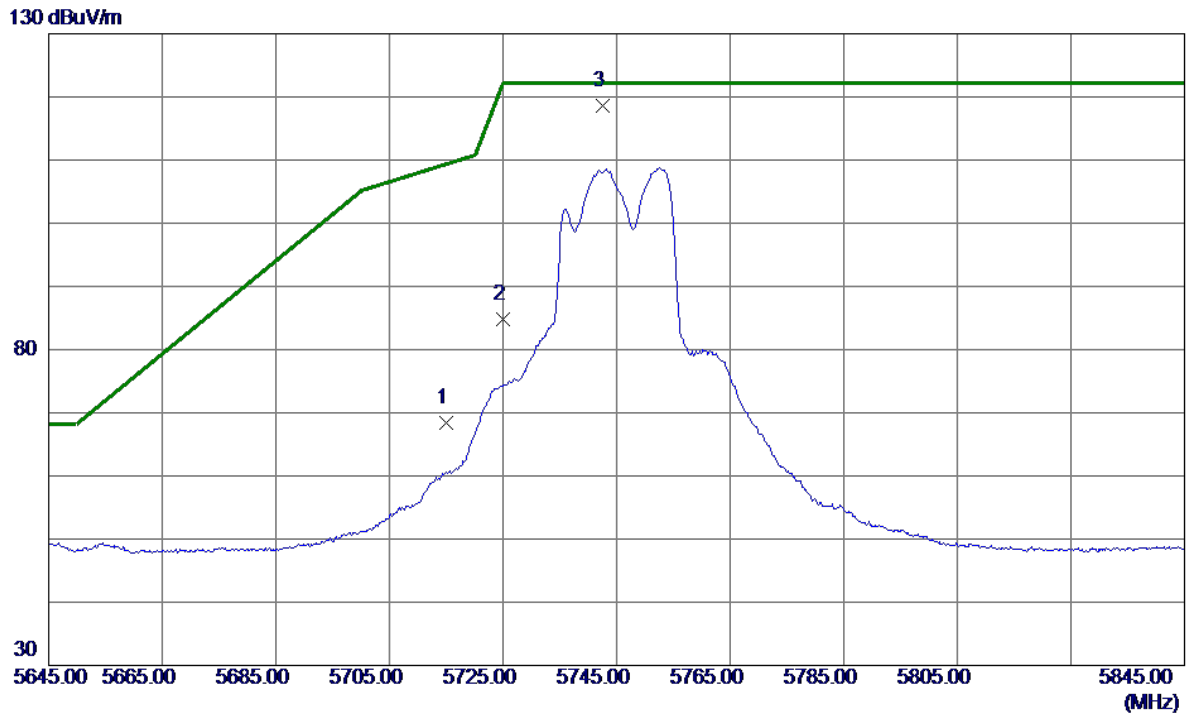

No.	Freq. MHz	Reading Level dBuV/m	Correct Factor dB	Measure ment dBuV/m	Limit dBuV/m	Margin dB	Detector	Comment
1	5715.0000	48.73	19.72	68.45	109.40	-40.95	Peak	
2	5725.0000	65.07	19.75	84.82	122.20	-37.38	Peak	
3 *	5742.5000	98.81	19.80	118.61	122.20	-3.59	Peak	No Limit

REMARKS:

- (1) Measurement Value = Reading Level + Correct Factor.
- (2) Margin Level = Measurement Value - Limit Value.

Test Mode	UNII-3_TX AX(HE20) Mode 5745 MHz	Polarization	Vertical
-----------	----------------------------------	--------------	----------

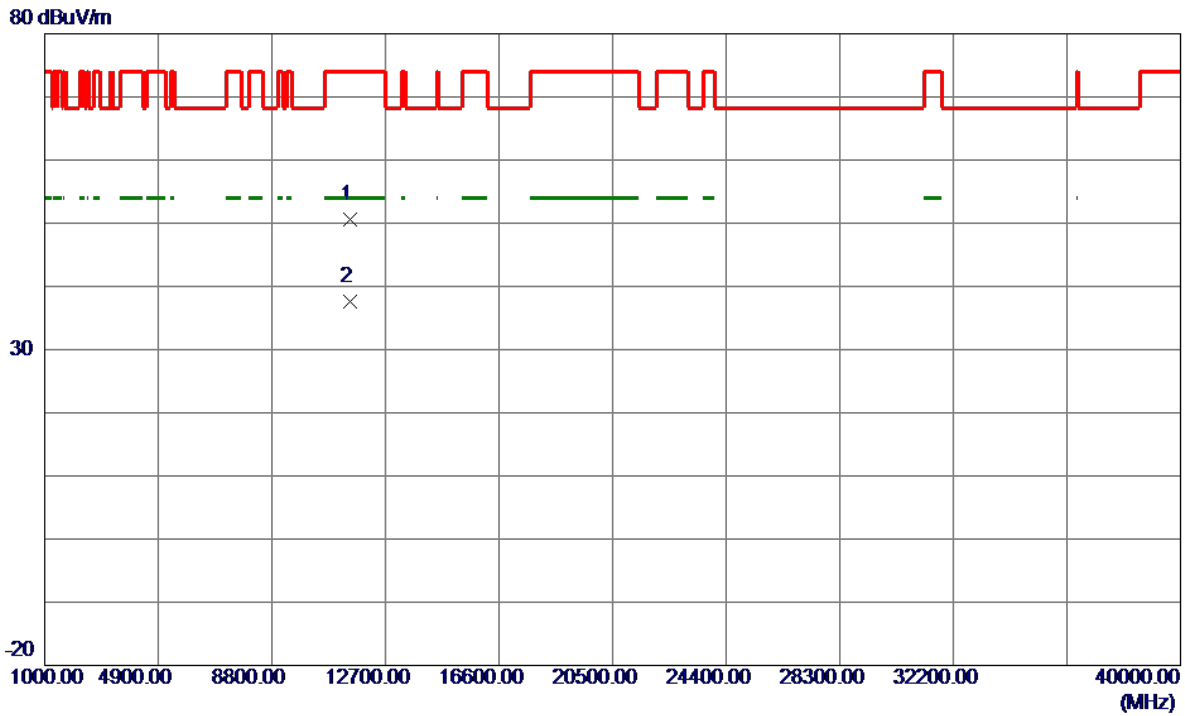

No.	Freq. MHz	Reading Level dBuV/m	Correct Factor dB	Measure ment dBuV/m	Limit dBuV/m	Margin dB	Detector	Comment
1	11489.2699	33.33	17.36	50.69	74.00	-23.31	Peak	
2 *	11490.3940	20.32	17.36	37.68	54.00	-16.32	AVG	

REMARKS:

- (1) Measurement Value = Reading Level + Correct Factor.
- (2) Margin Level = Measurement Value - Limit Value.

Test Mode	UNII-3_TX AX(HE20) Mode 5745 MHz	Polarization	Horizontal
-----------	----------------------------------	--------------	------------

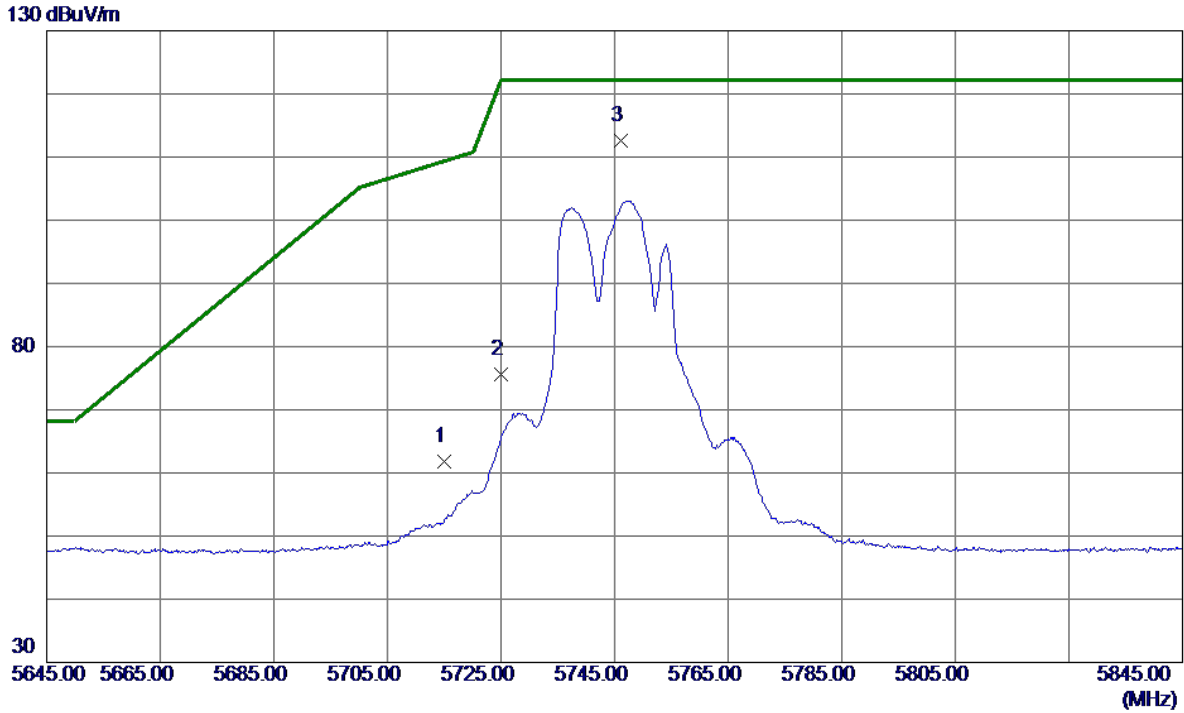

No.	Freq. MHz	Reading Level dBuV/m	Correct Factor dB	Measure ment dBuV/m	Limit dBuV/m	Margin dB	Detector	Comment
1	5715.0000	42.09	19.72	61.81	109.40	-47.59	Peak	
2	5725.0000	55.81	19.75	75.56	122.20	-46.64	Peak	
3 *	5746.2000	92.83	19.81	112.64	122.20	-9.56	Peak	No Limit

REMARKS:

- (1) Measurement Value = Reading Level + Correct Factor.
- (2) Margin Level = Measurement Value - Limit Value.

Test Mode	UNII-3_TX AX(HE20) Mode 5745 MHz	Polarization	Horizontal
-----------	----------------------------------	--------------	------------

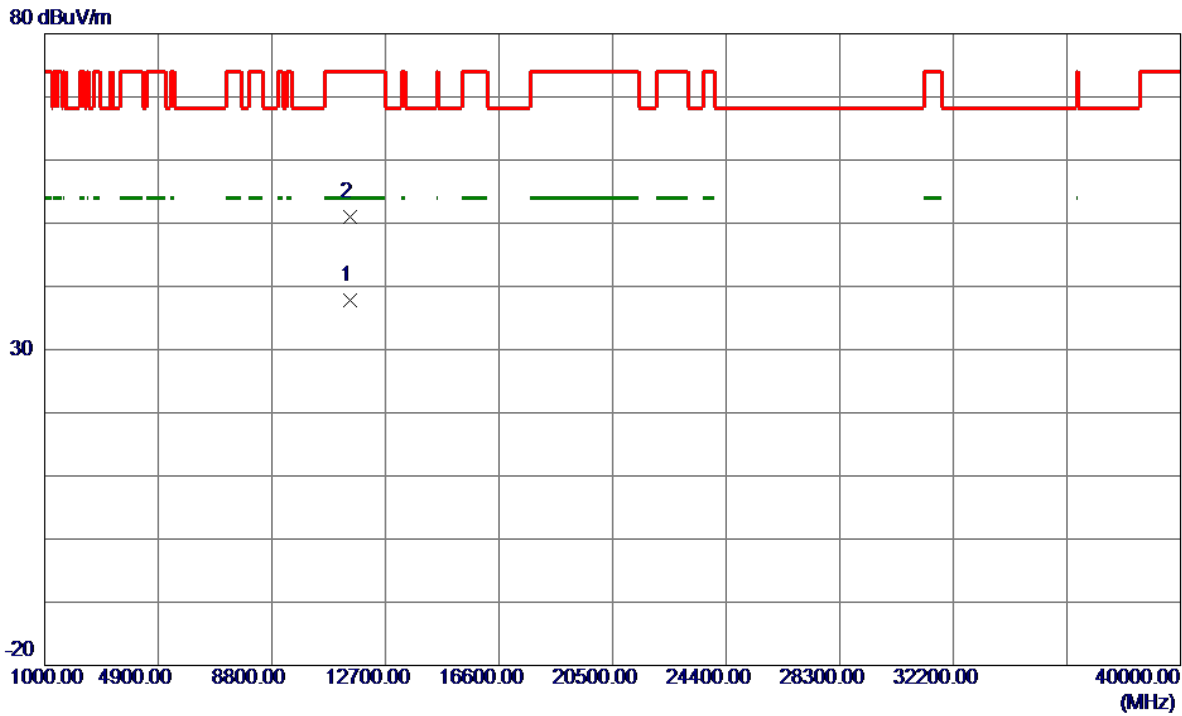

No.	Freq. MHz	Reading Level dBuV/m	Correct Factor dB	Measure ment dBuV/m	Limit dBuV/m	Margin dB	Detector	Comment
1 *	11489.4730	20.51	17.36	37.87	54.00	-16.13	AVG	
2	11490.2750	33.66	17.36	51.02	74.00	-22.98	Peak	

REMARKS:

- (1) Measurement Value = Reading Level + Correct Factor.
- (2) Margin Level = Measurement Value - Limit Value.

Test Mode	UNII-3_TX AX(HE20) Mode 5785 MHz	Polarization	Vertical
-----------	----------------------------------	--------------	----------

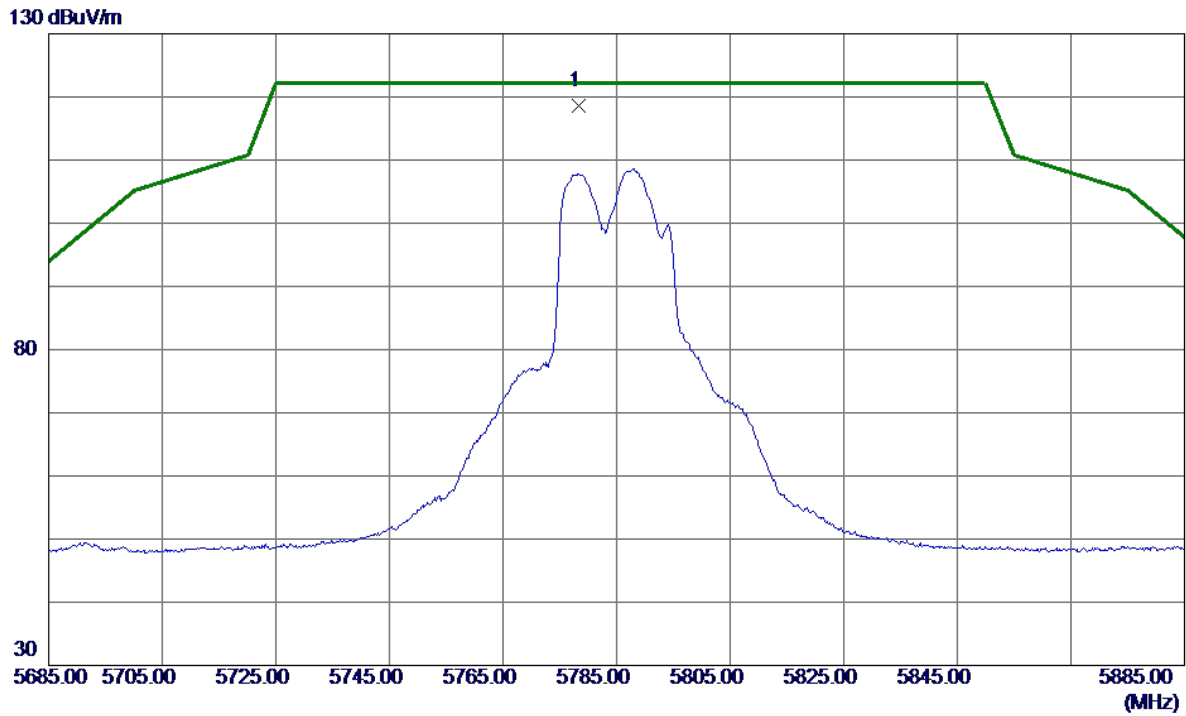

No.	Freq. MHz	Reading Level dBuV/m	Correct Factor dB	Measure ment dBuV/m	Limit dBuV/m	Margin dB	Detector	Comment
1 *	5778.4000	98.64	19.90	118.54	122.20	-3.66	Peak	No Limit

REMARKS:

- (1) Measurement Value = Reading Level + Correct Factor.
- (2) Margin Level = Measurement Value - Limit Value.

Test Mode	UNII-3_TX AX(HE20) Mode 5785 MHz	Polarization	Vertical
-----------	----------------------------------	--------------	----------

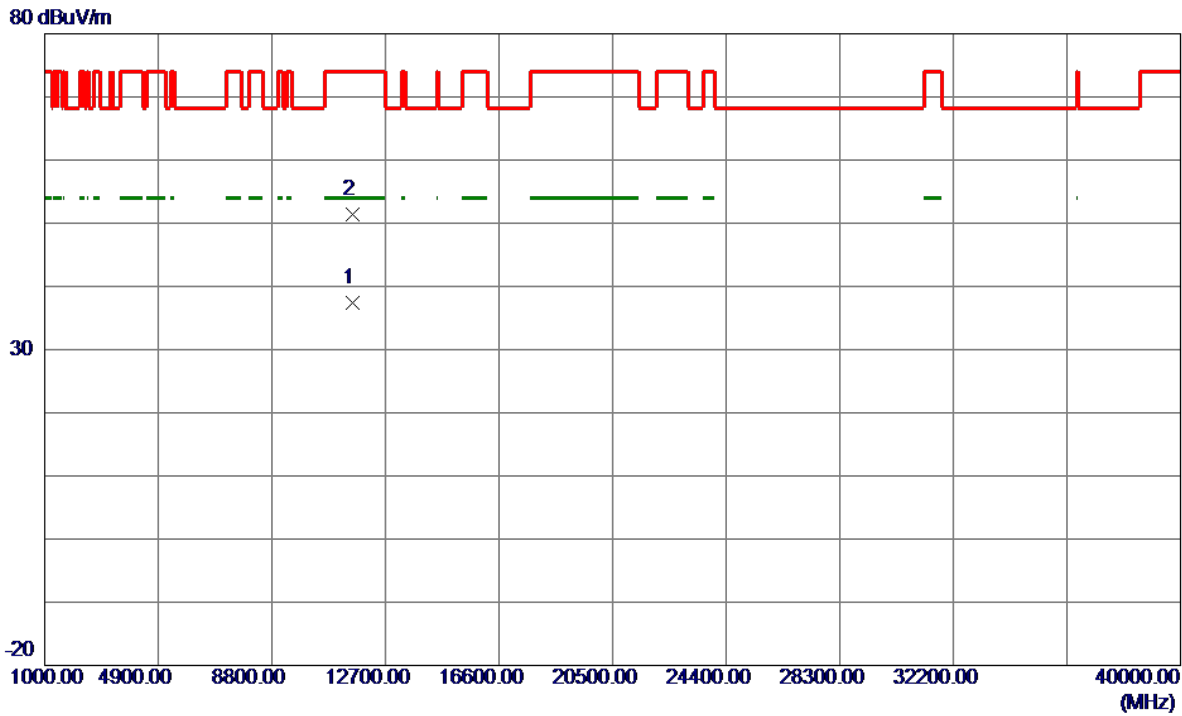

No.	Freq. MHz	Reading Level dBuV/m	Correct Factor dB	Measure ment dBuV/m	Limit dBuV/m	Margin dB	Detector	Comment
1 *	11570.5290	20.05	17.40	37.45	54.00	-16.55	AVG	
2	11570.7080	34.09	17.40	51.49	74.00	-22.51	Peak	

REMARKS:

- (1) Measurement Value = Reading Level + Correct Factor.
- (2) Margin Level = Measurement Value - Limit Value.

Test Mode	UNII-3_TX AX(HE20) Mode 5785 MHz	Polarization	Horizontal
-----------	----------------------------------	--------------	------------

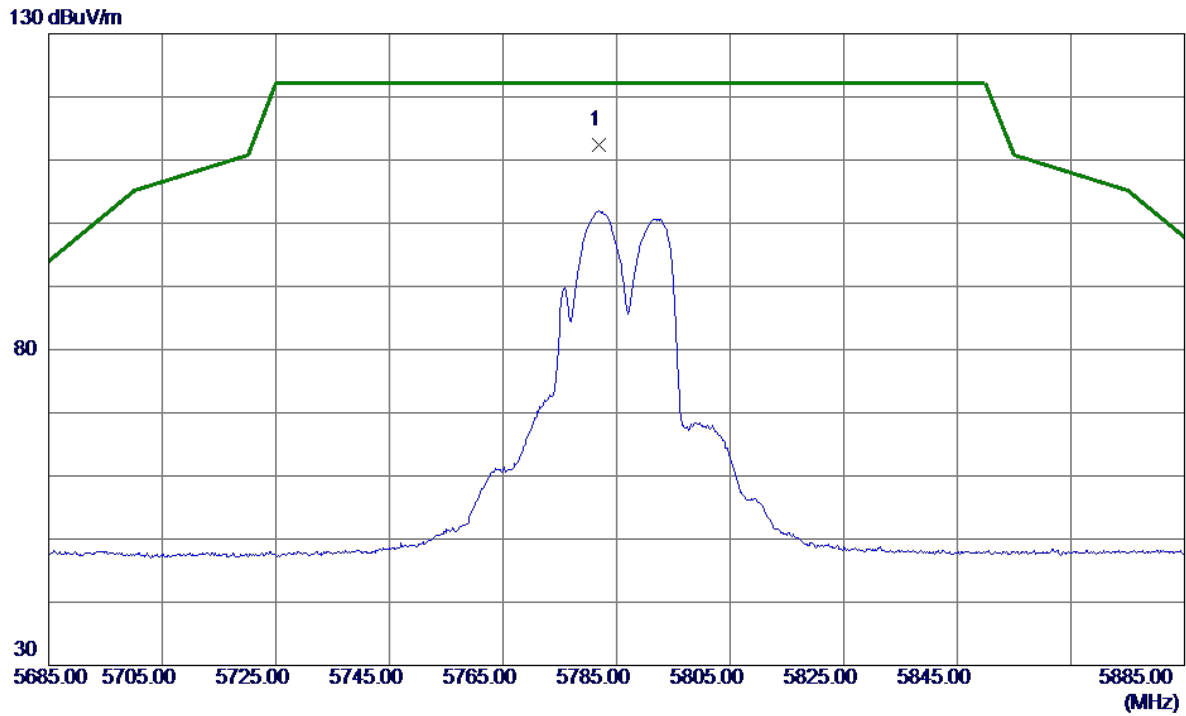

No.	Freq. MHz	Reading Level dBuV/m	Correct Factor dB	Measure ment dBuV/m	Limit dBuV/m	Margin dB	Detector	Comment
1 *	5781.8000	92.56	19.91	112.47	122.20	-9.73	Peak	No Limit

REMARKS:

- (1) Measurement Value = Reading Level + Correct Factor.
- (2) Margin Level = Measurement Value - Limit Value.

Test Mode	UNII-3_TX AX(HE20) Mode 5785 MHz	Polarization	Horizontal
-----------	----------------------------------	--------------	------------



No.	Freq. MHz	Reading Level dBuV/m	Correct Factor dB	Measure ment dBuV/m	Limit dBuV/m	Margin dB	Detector	Comment
1 *	11570.0519	20.04	17.40	37.44	54.00	-16.56	AVG	
2	11570.4520	33.87	17.40	51.27	74.00	-22.73	Peak	

REMARKS:

- (1) Measurement Value = Reading Level + Correct Factor.
- (2) Margin Level = Measurement Value - Limit Value.

Test Mode	UNII-3_TX AX(HE20) Mode 5825 MHz	Polarization	Vertical
-----------	----------------------------------	--------------	----------

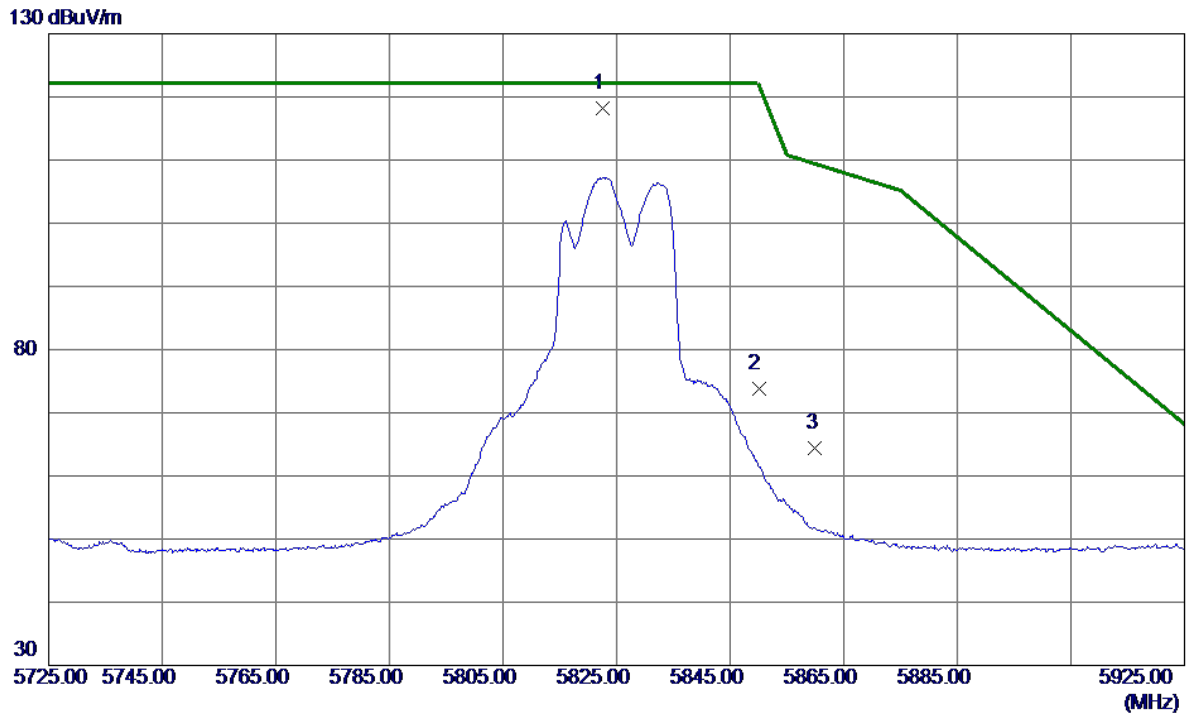

No.	Freq. MHz	Reading Level dBuV/m	Correct Factor dB	Measure ment dBuV/m	Limit dBuV/m	Margin dB	Detector	Comment
1 *	5822.6000	98.14	20.02	118.16	122.20	-4.04	Peak	No Limit
2	5850.0000	53.62	20.10	73.72	122.20	-48.48	Peak	
3	5860.0000	44.35	20.13	64.48	109.40	-44.92	Peak	

REMARKS:

- (1) Measurement Value = Reading Level + Correct Factor.
- (2) Margin Level = Measurement Value - Limit Value.

Test Mode	UNII-3_TX AX(HE20) Mode 5825 MHz	Polarization	Vertical
-----------	----------------------------------	--------------	----------

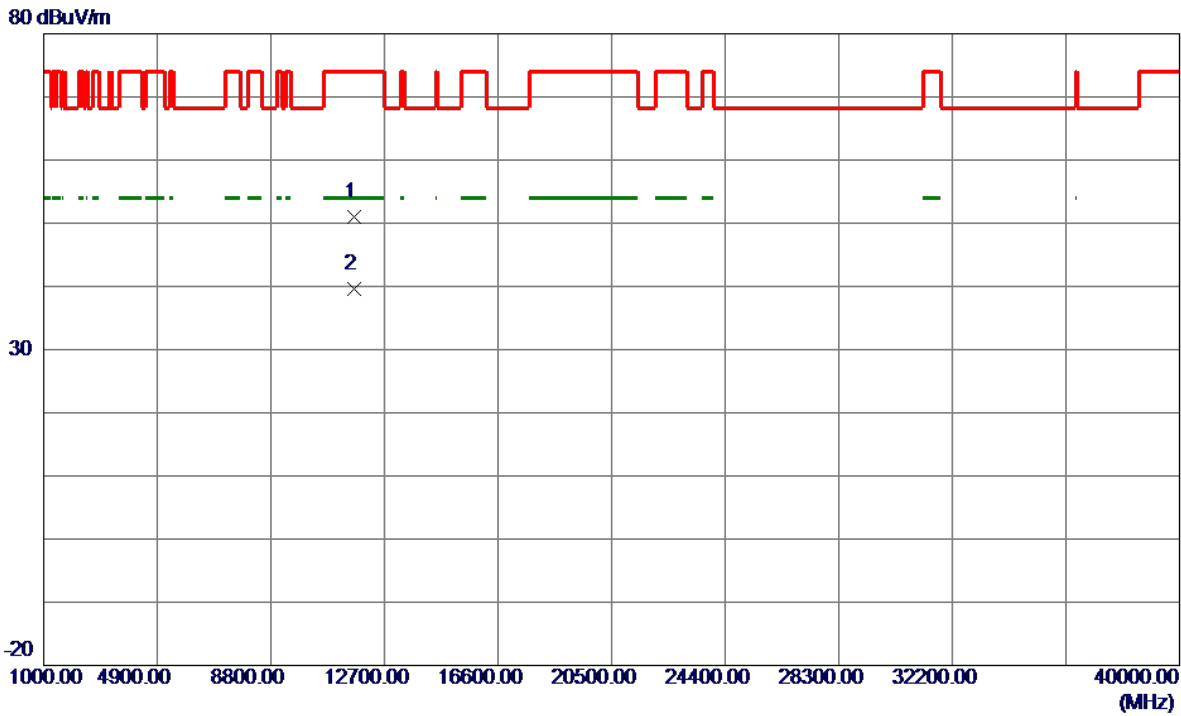

No.	Freq. MHz	Reading Level dBuV/m	Correct Factor dB	Measure ment dBuV/m	Limit dBuV/m	Margin dB	Detector	Comment
1	11649.1240	33.57	17.42	50.99	74.00	-23.01	Peak	
2 *	11649.1240	22.17	17.42	39.59	54.00	-14.41	AVG	

REMARKS:

- (1) Measurement Value = Reading Level + Correct Factor.
- (2) Margin Level = Measurement Value - Limit Value.

Test Mode	UNII-3_TX AX(HE20) Mode 5825 MHz	Polarization	Horizontal
-----------	----------------------------------	--------------	------------

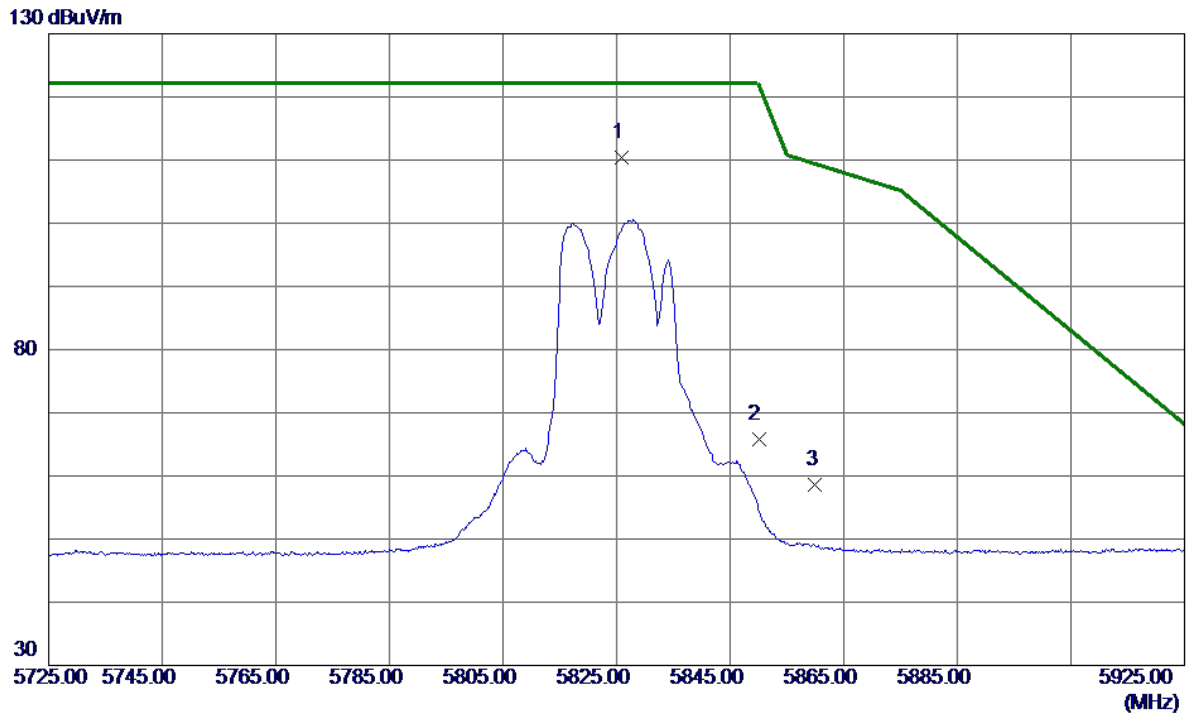

No.	Freq. MHz	Reading Level dBuV/m	Correct Factor dB	Measure ment dBuV/m	Limit dBuV/m	Margin dB	Detector	Comment
1 *	5825.9000	90.35	20.03	110.38	122.20	-11.82	Peak	No Limit
2	5850.0000	45.64	20.10	65.74	122.20	-56.46	Peak	
3	5860.0000	38.53	20.13	58.66	109.40	-50.74	Peak	

REMARKS:

- (1) Measurement Value = Reading Level + Correct Factor.
- (2) Margin Level = Measurement Value - Limit Value.

Test Mode	UNII-3_TX AX(HE20) Mode 5825 MHz	Polarization	Horizontal
-----------	----------------------------------	--------------	------------

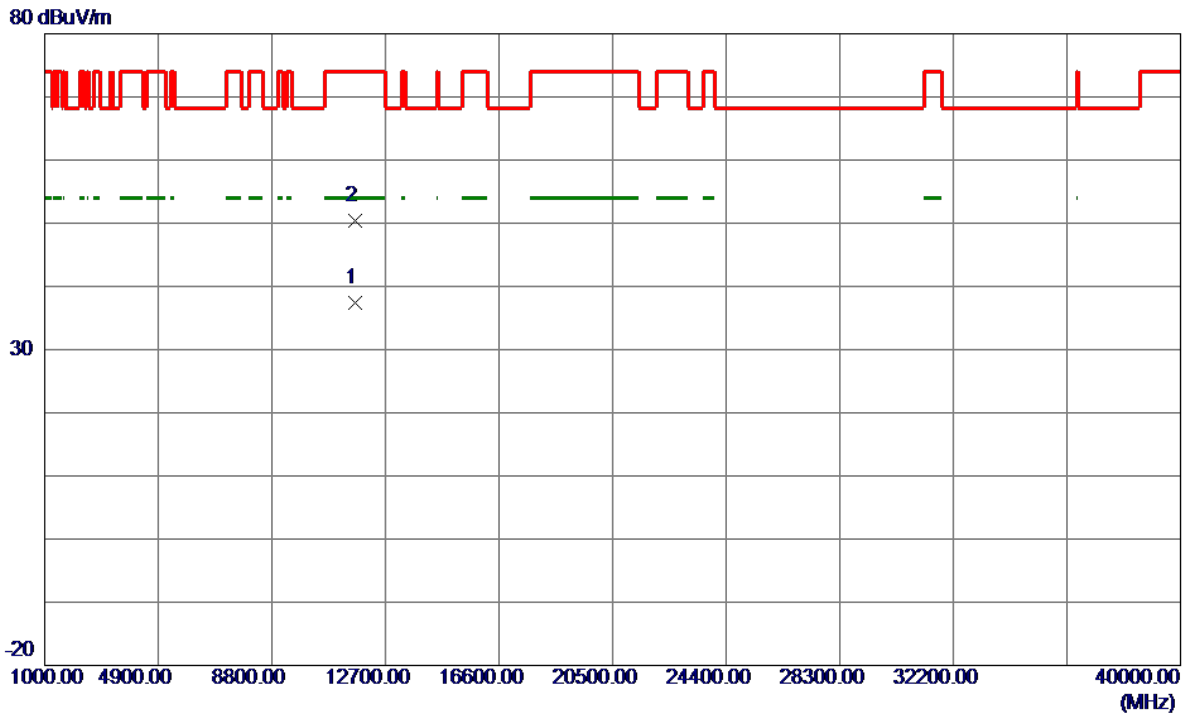

No.	Freq. MHz	Reading Level dBuV/m	Correct Factor dB	Measure ment dBuV/m	Limit dBuV/m	Margin dB	Detector	Comment
1 *	11650.3520	19.94	17.43	37.37	54.00	-16.63	AVG	
2	11650.9930	33.04	17.43	50.47	74.00	-23.53	Peak	

REMARKS:

- (1) Measurement Value = Reading Level + Correct Factor.
- (2) Margin Level = Measurement Value - Limit Value.

Test Mode	UNII-3_TX AX(HE40) Mode 5755 MHz	Polarization	Vertical
-----------	----------------------------------	--------------	----------

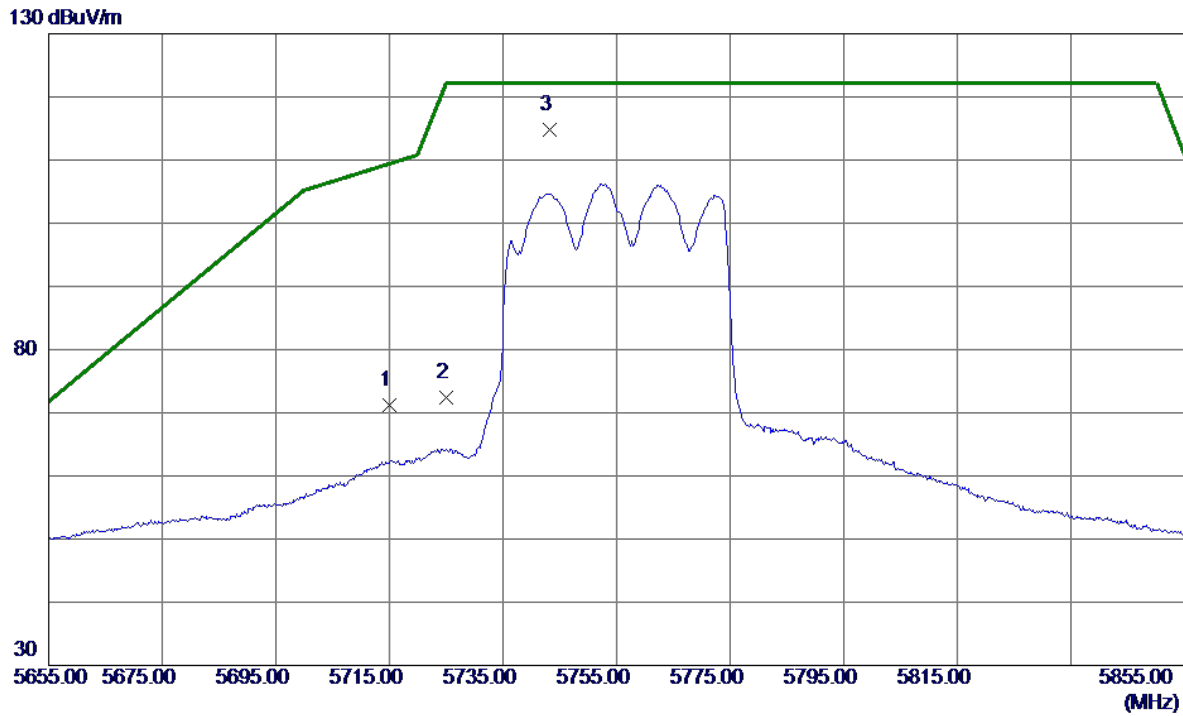

No.	Freq. MHz	Reading Level dBuV/m	Correct Factor dB	Measure ment dBuV/m	Limit dBuV/m	Margin dB	Detector	Comment
1	5715.0000	51.49	19.72	71.21	109.40	-38.19	Peak	
2	5725.0000	52.56	19.75	72.31	122.20	-49.89	Peak	
3 *	5743.3000	95.09	19.80	114.89	122.20	-7.31	Peak	No Limit

REMARKS:

- (1) Measurement Value = Reading Level + Correct Factor.
- (2) Margin Level = Measurement Value - Limit Value.

Test Mode	UNII-3_TX AX(HE40) Mode 5755 MHz	Polarization	Vertical
-----------	----------------------------------	--------------	----------

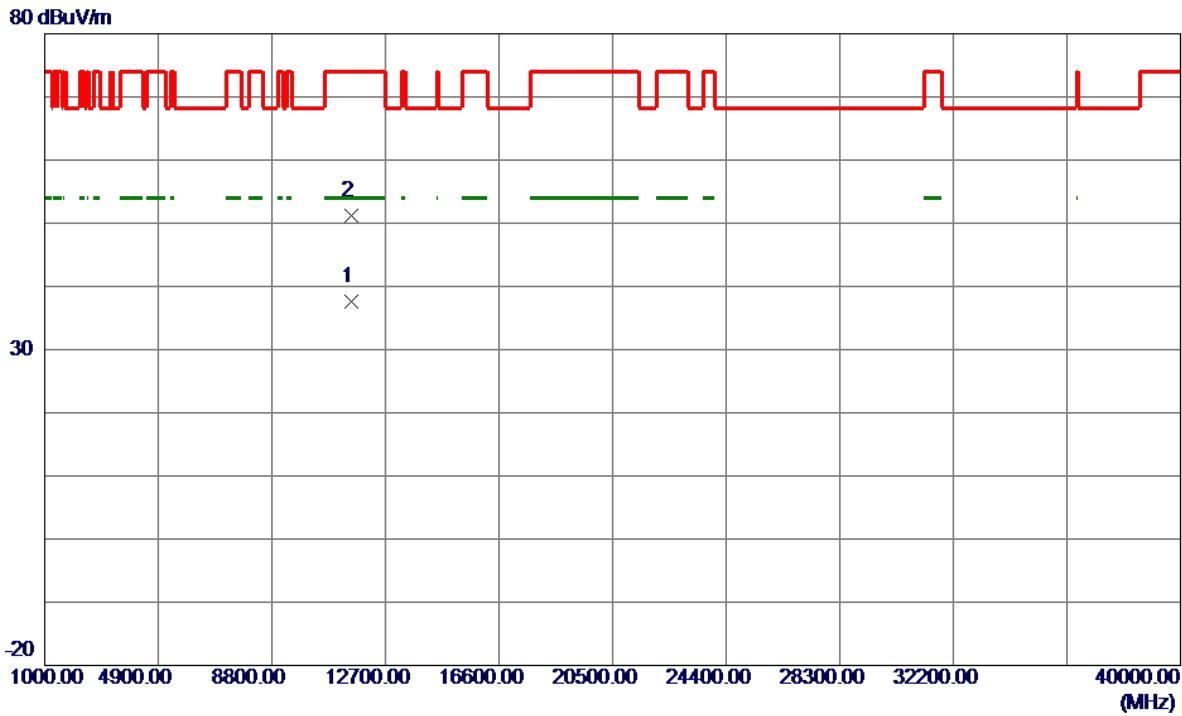

No.	Freq. MHz	Reading Level dBuV/m	Correct Factor dB	Measure ment dBuV/m	Limit dBuV/m	Margin dB	Detector	Comment
1 *	11510.5890	20.19	17.38	37.57	54.00	-16.43	AVG	
2	11510.8080	33.78	17.38	51.16	74.00	-22.84	Peak	

REMARKS:

- (1) Measurement Value = Reading Level + Correct Factor.
- (2) Margin Level = Measurement Value - Limit Value.

Test Mode	UNII-3_TX AX(HE40) Mode 5755 MHz	Polarization	Horizontal
-----------	----------------------------------	--------------	------------

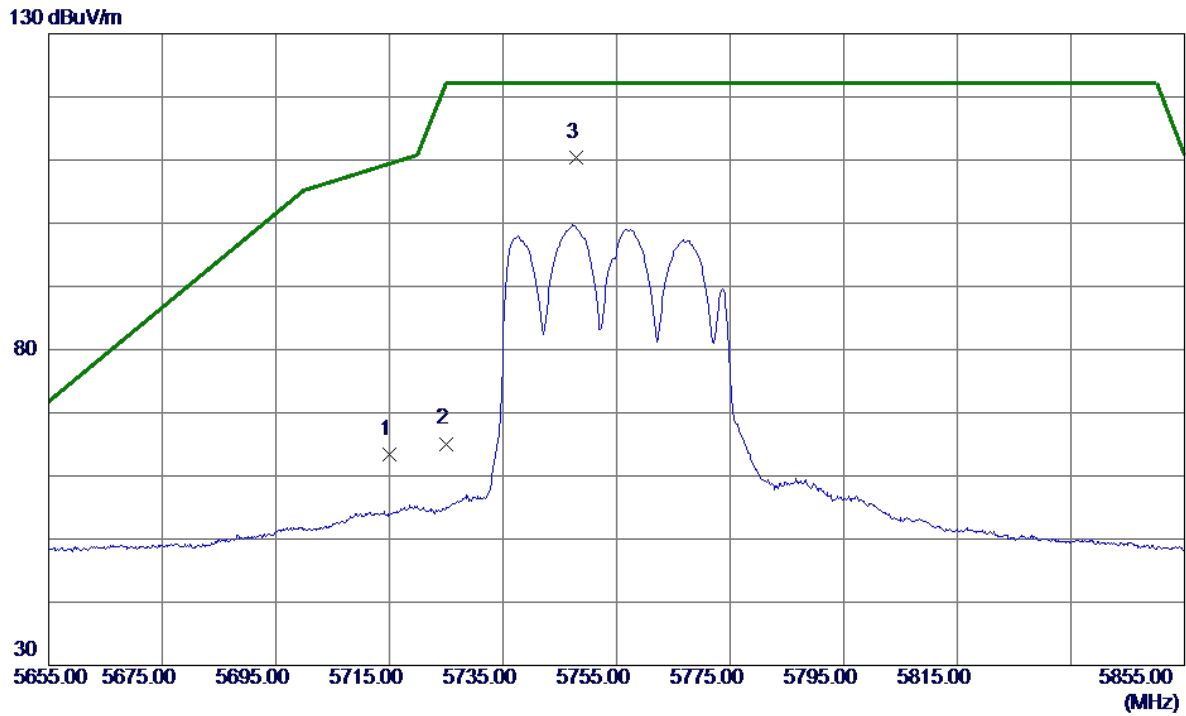

No.	Freq. MHz	Reading Level dBuV/m	Correct Factor dB	Measure ment dBuV/m	Limit dBuV/m	Margin dB	Detector	Comment
1	5715.0000	43.72	19.72	63.44	109.40	-45.96	Peak	
2	5725.0000	45.35	19.75	65.10	122.20	-57.10	Peak	
3 *	5747.8000	90.57	19.82	110.39	122.20	-11.81	Peak	No Limit

REMARKS:

- (1) Measurement Value = Reading Level + Correct Factor.
- (2) Margin Level = Measurement Value - Limit Value.

Test Mode	UNII-3_TX AX(HE40) Mode 5755 MHz	Polarization	Horizontal
-----------	----------------------------------	--------------	------------

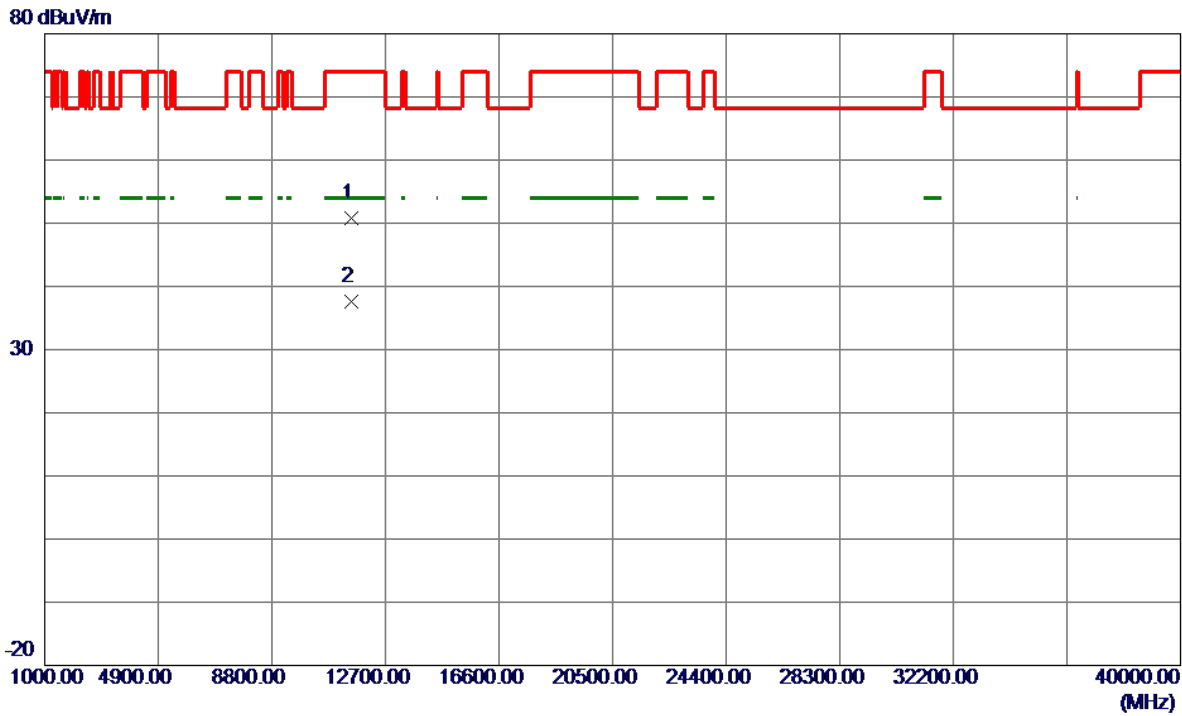

No.	Freq. MHz	Reading Level dBuV/m	Correct Factor dB	Measure ment dBuV/m	Limit dBuV/m	Margin dB	Detector	Comment
1	11509.2140	33.40	17.38	50.78	74.00	-23.22	Peak	
2 *	11509.7900	20.23	17.38	37.61	54.00	-16.39	AVG	

REMARKS:

- (1) Measurement Value = Reading Level + Correct Factor.
- (2) Margin Level = Measurement Value - Limit Value.

Test Mode	UNII-3_TX AX(HE40) Mode 5795 MHz	Polarization	Vertical
-----------	----------------------------------	--------------	----------

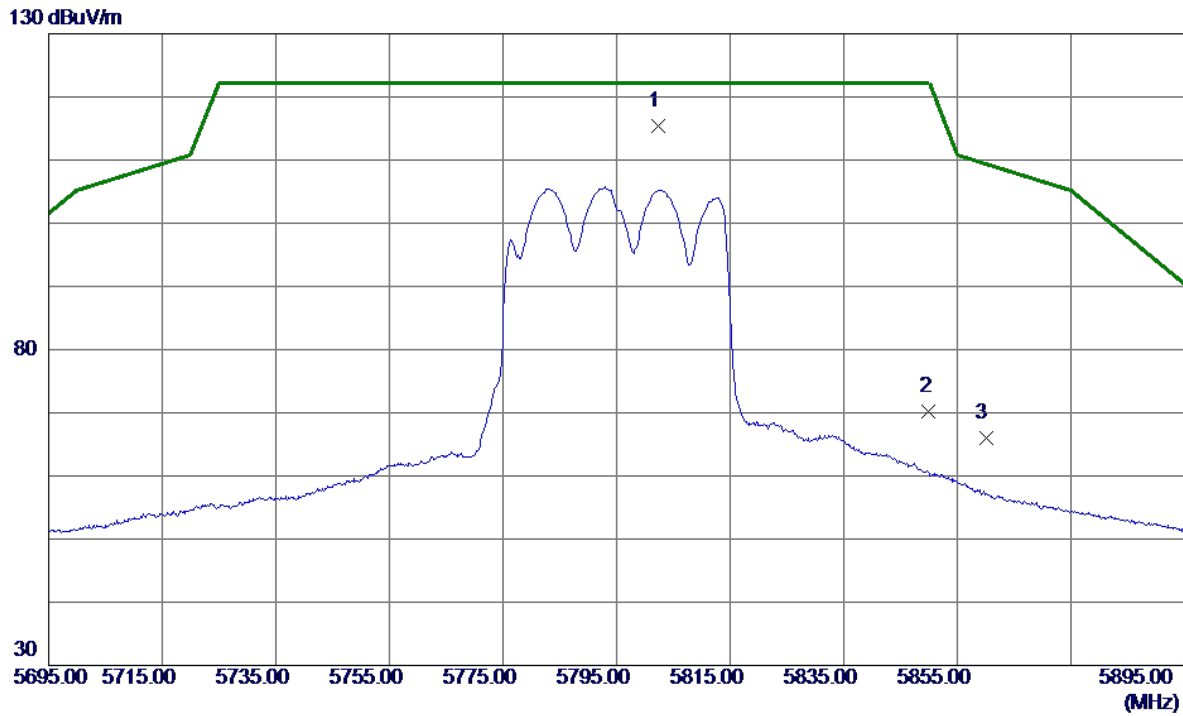

No.	Freq. MHz	Reading Level dBuV/m	Correct Factor dB	Measure ment dBuV/m	Limit dBuV/m	Margin dB	Detector	Comment
1 *	5802.4000	95.51	19.97	115.48	122.20	-6.72	Peak	No Limit
2	5850.0000	50.05	20.10	70.15	122.20	-52.05	Peak	
3	5860.0000	45.78	20.13	65.91	109.40	-43.49	Peak	

REMARKS:

- (1) Measurement Value = Reading Level + Correct Factor.
- (2) Margin Level = Measurement Value - Limit Value.

Test Mode	UNII-3_TX AX(HE40) Mode 5795 MHz	Polarization	Vertical
-----------	----------------------------------	--------------	----------

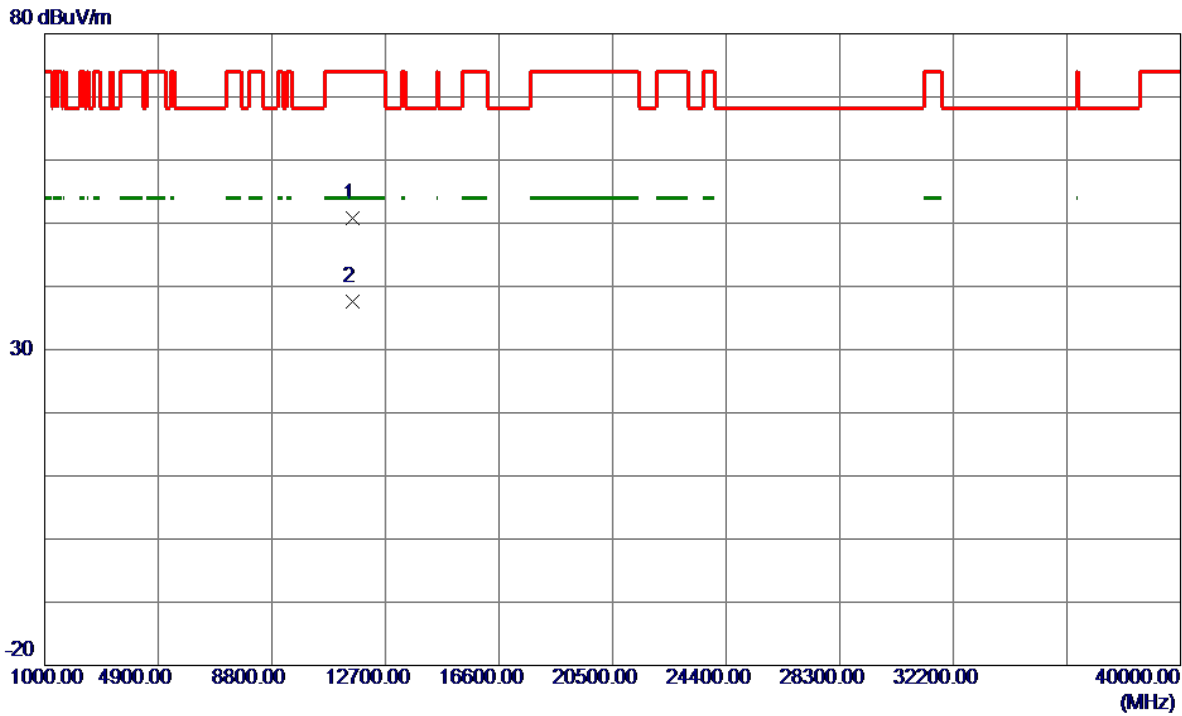

No.	Freq. MHz	Reading Level dBuV/m	Correct Factor dB	Measure ment dBuV/m	Limit dBuV/m	Margin dB	Detector	Comment
1	11589.3090	33.48	17.41	50.89	74.00	-23.11	Peak	
2 *	11590.7270	20.13	17.41	37.54	54.00	-16.46	AVG	

REMARKS:

- (1) Measurement Value = Reading Level + Correct Factor.
- (2) Margin Level = Measurement Value - Limit Value.

Test Mode	UNII-3_TX AX(HE40) Mode 5795 MHz	Polarization	Horizontal
-----------	----------------------------------	--------------	------------

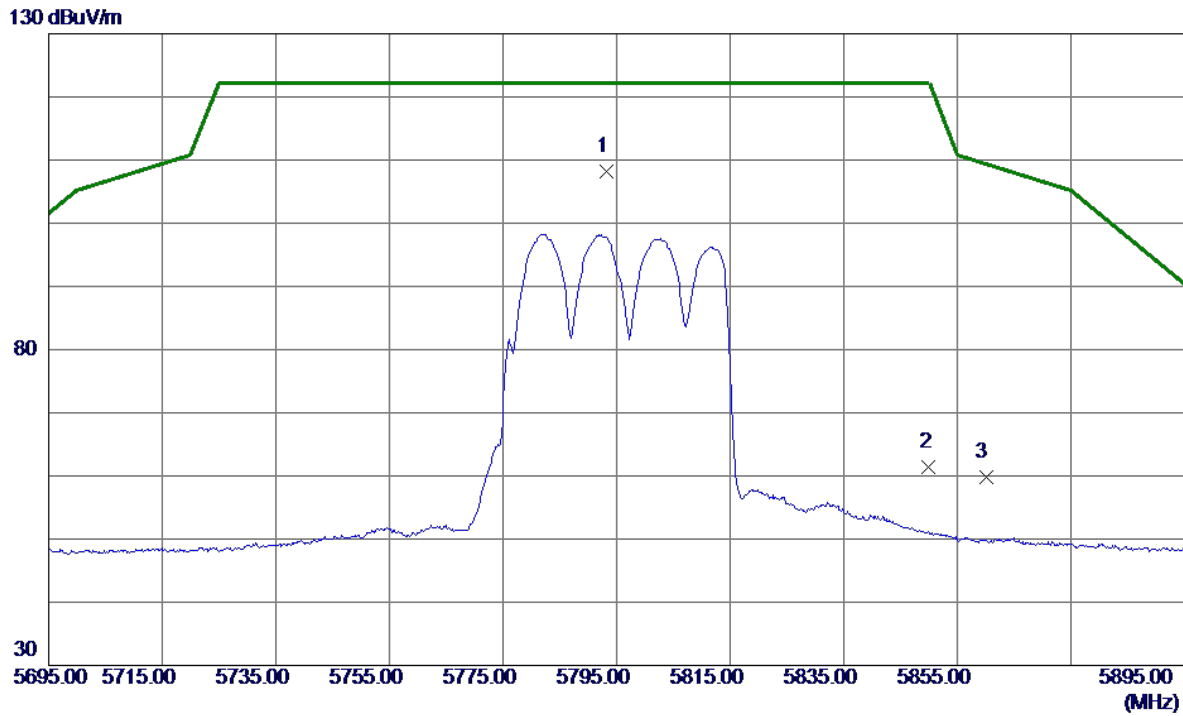

No.	Freq. MHz	Reading Level dBuV/m	Correct Factor dB	Measure ment dBuV/m	Limit dBuV/m	Margin dB	Detector	Comment
1 *	5793.3000	88.19	19.94	108.13	122.20	-14.07	Peak	No Limit
2	5850.0000	41.31	20.10	61.41	122.20	-60.79	Peak	
3	5860.0000	39.63	20.13	59.76	109.40	-49.64	Peak	

REMARKS:

- (1) Measurement Value = Reading Level + Correct Factor.
- (2) Margin Level = Measurement Value - Limit Value.

Test Mode	UNII-3_TX AX(HE40) Mode 5795 MHz	Polarization	Horizontal
-----------	----------------------------------	--------------	------------

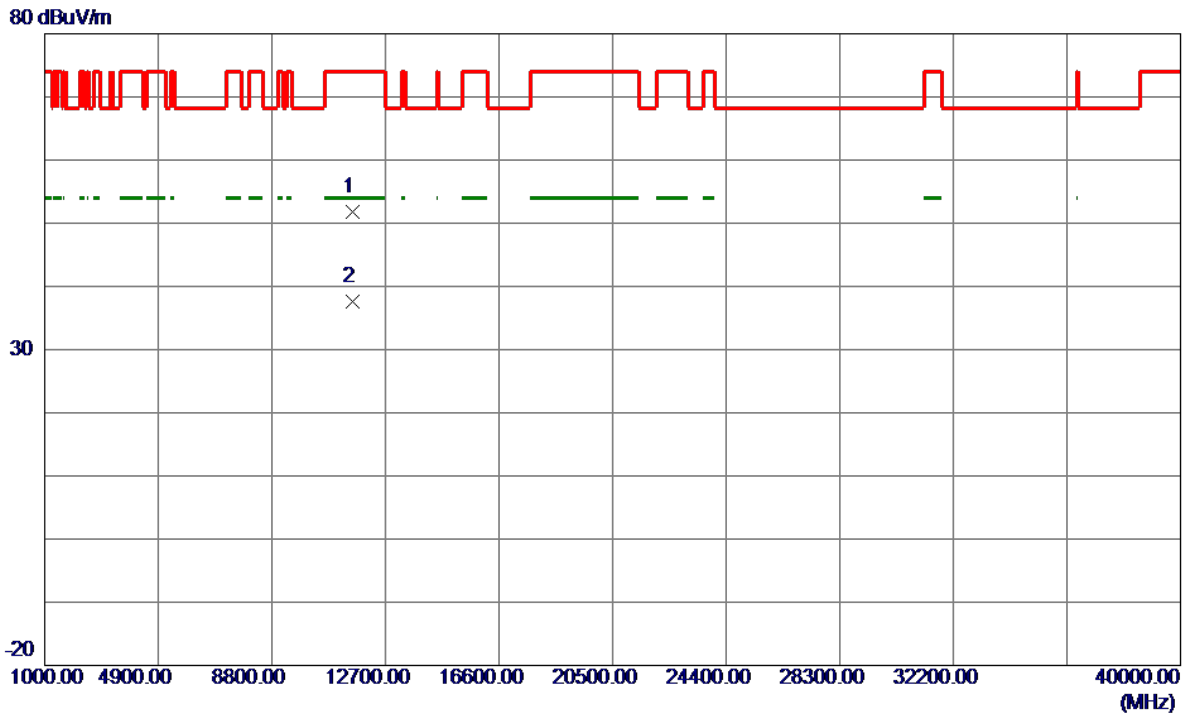

No.	Freq. MHz	Reading Level dBuV/m	Correct Factor dB	Measure ment dBuV/m	Limit dBuV/m	Margin dB	Detector	Comment
1	11589.0030	34.37	17.41	51.78	74.00	-22.22	Peak	
2 *	11590.0439	20.18	17.41	37.59	54.00	-16.41	AVG	

REMARKS:

- (1) Measurement Value = Reading Level + Correct Factor.
- (2) Margin Level = Measurement Value - Limit Value.

Test Mode	UNII-3_TX AX(HE80) Mode 5775 MHz	Polarization	Vertical
-----------	----------------------------------	--------------	----------

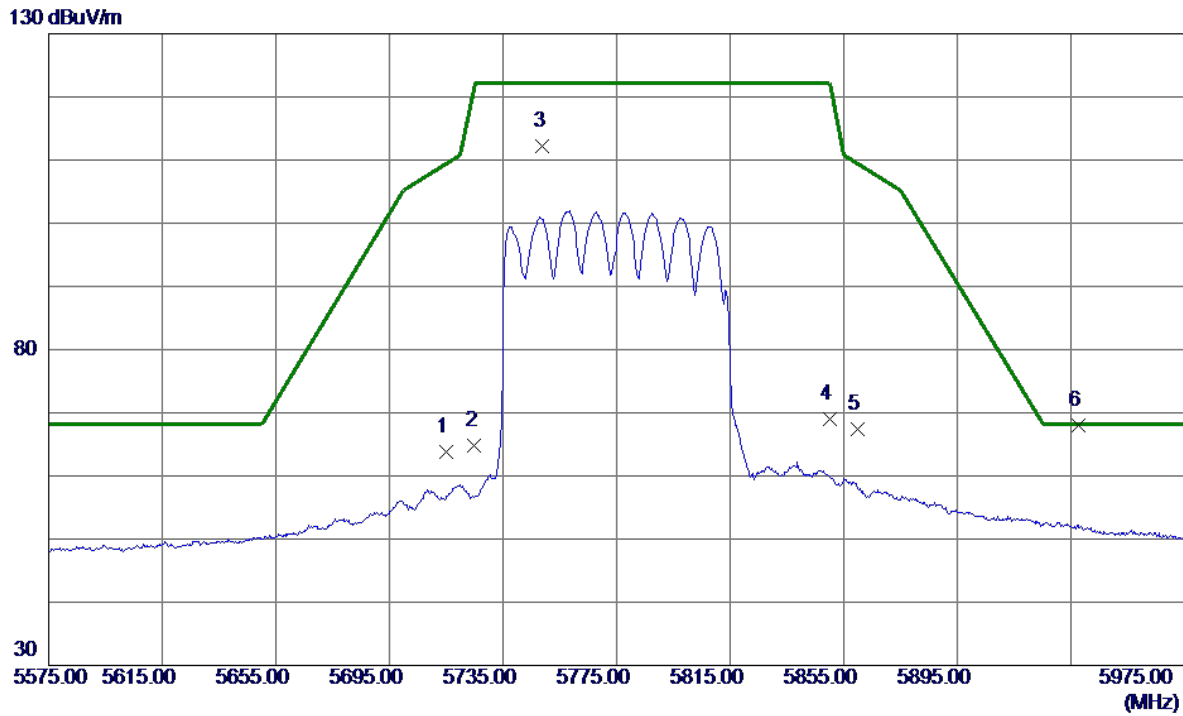

No.	Freq. MHz	Reading Level dBuV/m	Correct Factor dB	Measure ment dBuV/m	Limit dBuV/m	Margin dB	Detector	Comment
1	5715.0000	44.10	19.72	63.82	109.40	-45.58	Peak	
2	5725.0000	45.02	19.75	64.77	122.20	-57.43	Peak	
3	5749.0000	92.46	19.82	112.28	122.20	-9.92	Peak	No Limit
4	5850.0000	48.91	20.10	69.01	122.20	-53.19	Peak	
5	5860.0000	47.29	20.13	67.42	109.40	-41.98	Peak	
6 *	5937.8000	47.56	20.35	67.91	68.20	-0.29	Peak	

REMARKS:

- (1) Measurement Value = Reading Level + Correct Factor.
- (2) Margin Level = Measurement Value - Limit Value.

Test Mode	UNII-3_TX AX(HE80) Mode 5775 MHz	Polarization	Vertical
-----------	----------------------------------	--------------	----------

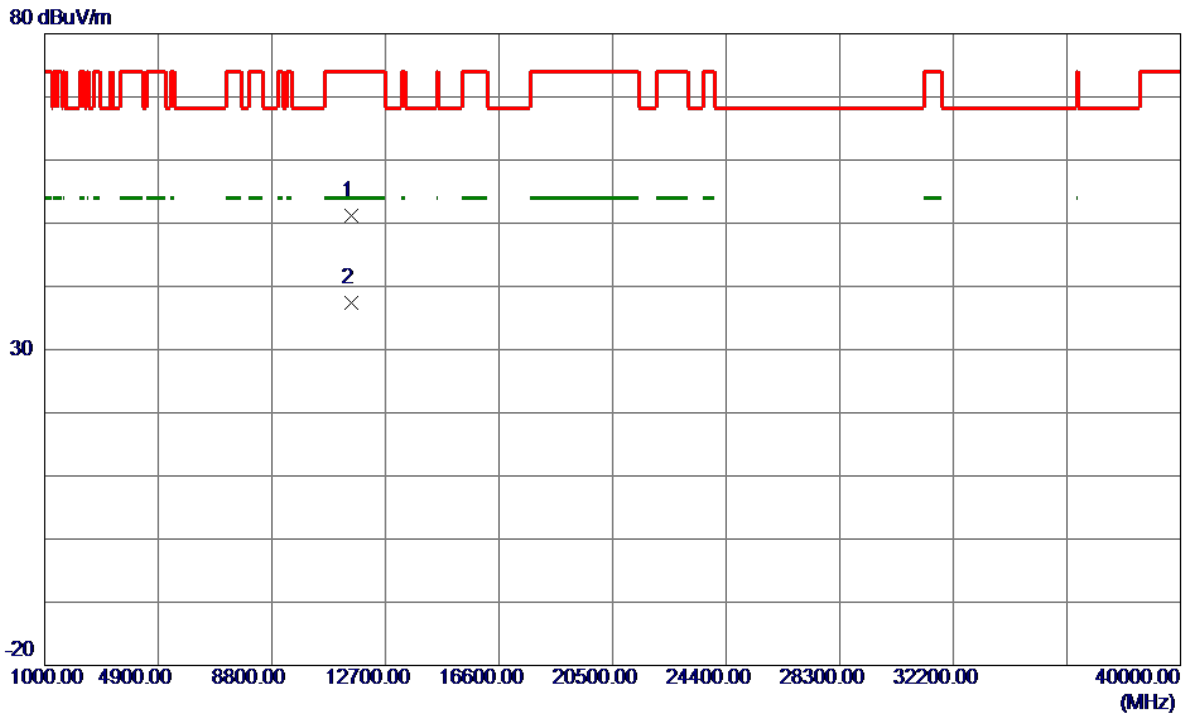

No.	Freq. MHz	Reading Level dBuV/m	Correct Factor dB	Measure ment dBuV/m	Limit dBuV/m	Margin dB	Detector	Comment
1	11550.3800	33.75	17.40	51.15	74.00	-22.85	Peak	
2 *	11550.7800	20.06	17.40	37.46	54.00	-16.54	AVG	

REMARKS:

- (1) Measurement Value = Reading Level + Correct Factor.
- (2) Margin Level = Measurement Value - Limit Value.

Test Mode	UNII-3_TX AX(HE80) Mode 5775 MHz	Polarization	Horizontal
-----------	----------------------------------	--------------	------------

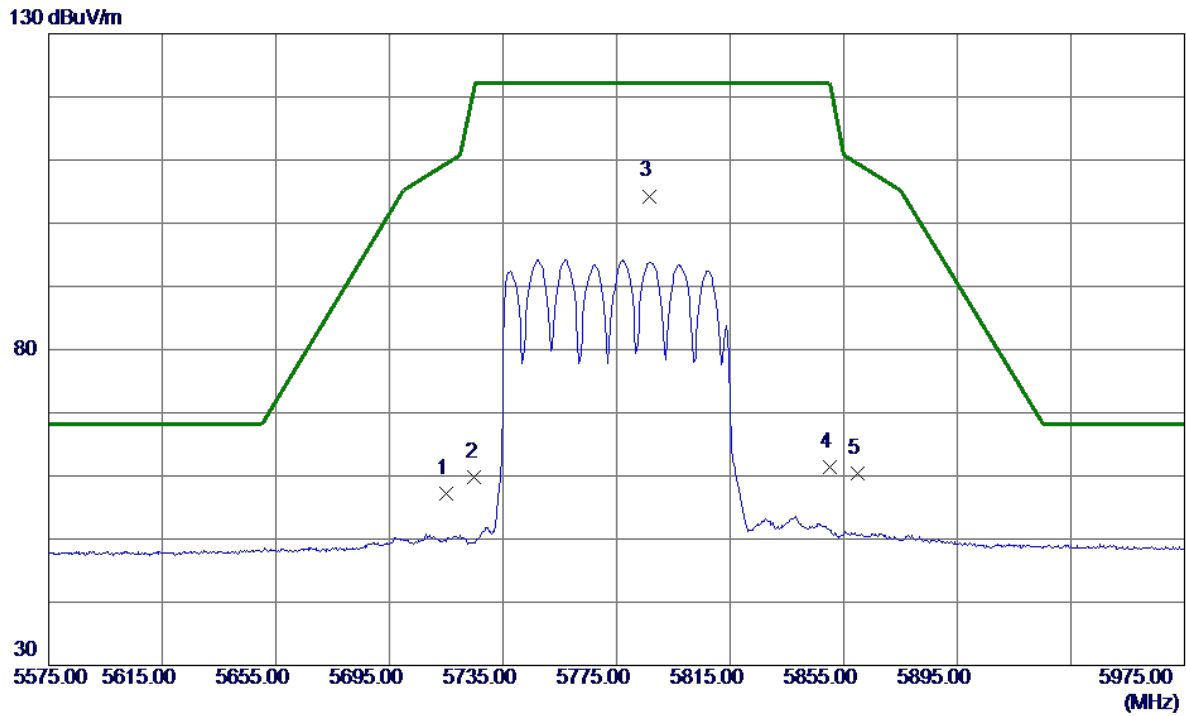

No.	Freq. MHz	Reading Level dBuV/m	Correct Factor dB	Measure ment dBuV/m	Limit dBuV/m	Margin dB	Detector	Comment
1	5715.0000	37.57	19.72	57.29	109.40	-52.11	Peak	
2	5725.0000	39.97	19.75	59.72	122.20	-62.48	Peak	
3 *	5786.4000	84.38	19.92	104.30	122.20	-17.90	Peak	No Limit
4	5850.0000	41.27	20.10	61.37	122.20	-60.83	Peak	
5	5860.0000	40.33	20.13	60.46	109.40	-48.94	Peak	

REMARKS:

- (1) Measurement Value = Reading Level + Correct Factor.
- (2) Margin Level = Measurement Value - Limit Value.

Test Mode	UNII-3_TX AX(HE80) Mode 5775 MHz	Polarization	Horizontal
-----------	----------------------------------	--------------	------------

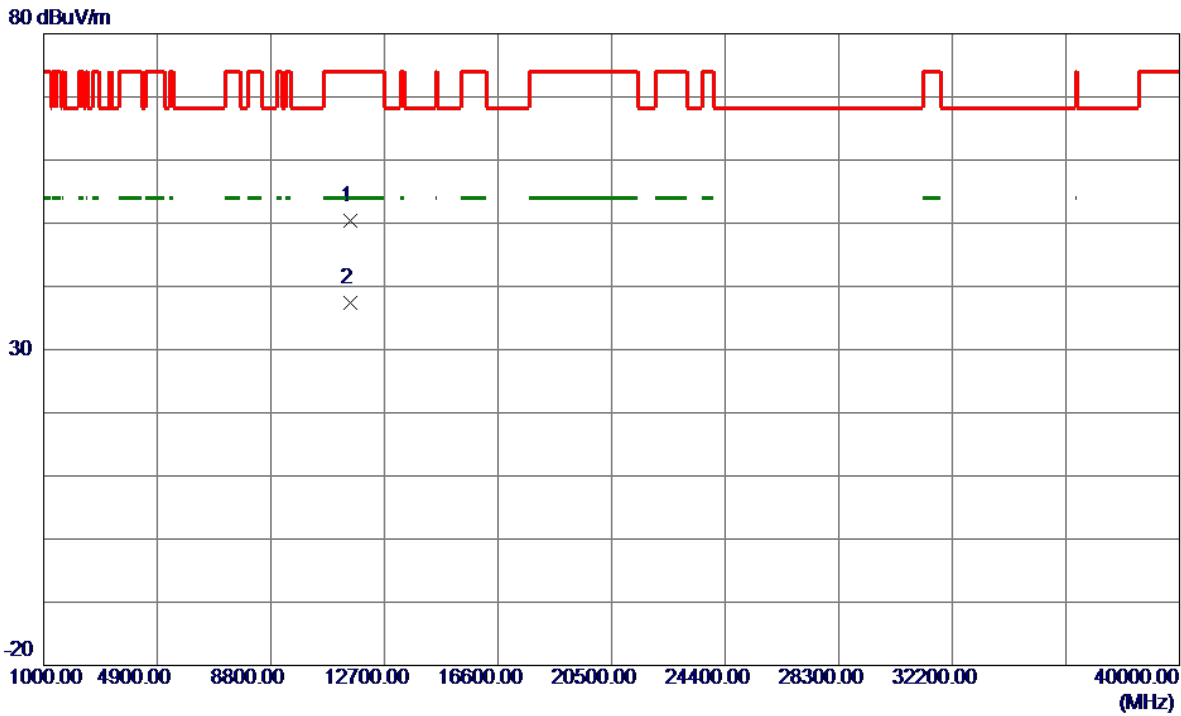

No.	Freq. MHz	Reading Level dBuV/m	Correct Factor dB	Measure ment dBuV/m	Limit dBuV/m	Margin dB	Detector	Comment
1	11550.0730	33.06	17.39	50.45	74.00	-23.55	Peak	
2 *	11550.4200	20.08	17.40	37.48	54.00	-16.52	AVG	

REMARKS:

- (1) Measurement Value = Reading Level + Correct Factor.
- (2) Margin Level = Measurement Value - Limit Value.

APPENDIX E - BANDWIDTH

Test Mode	UNII-1_TX A Mode
-----------	------------------

Channel	Frequency (MHz)	26 dB Bandwidth (MHz)	99 % Occupied Bandwidth (MHz)
36	5180	20.95	16.80
40	5200	20.55	16.80
48	5240	20.60	16.80

CH36

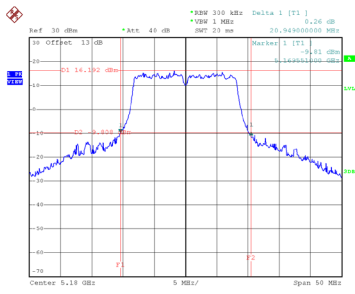

Date: 30.DEC.2021 17:02:16

CH40 26 dB Bandwidth

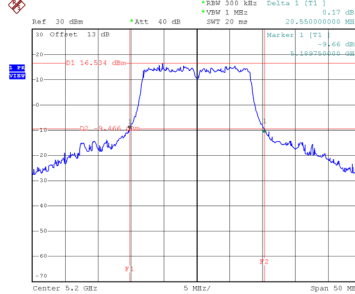

Date: 30.DEC.2021 17:03:00

CH48

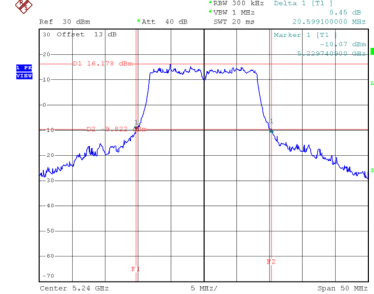

Date: 30.DEC.2021 17:04:51

99 % Occupied Bandwidth

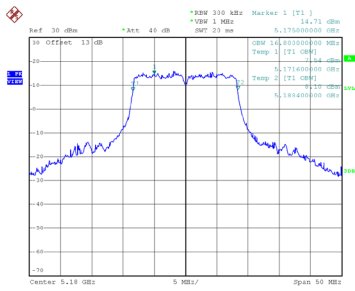

Date: 30.DEC.2021 17:01:51

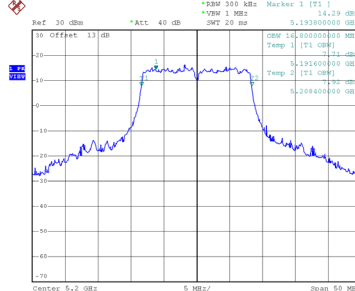

Date: 30.DEC.2021 17:02:35

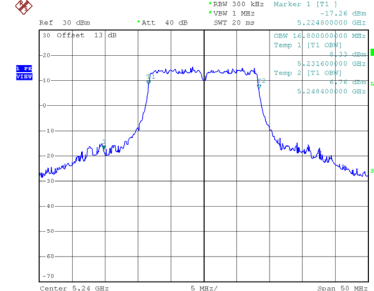

Date: 30.DEC.2021 17:04:24

Test Mode UNII-1_TX AC(VHT20) Mode

Channel	Frequency (MHz)	26 dB Bandwidth (MHz)	99 % Occupied Bandwidth (MHz)
36	5180	21.55	17.70
40	5200	21.30	17.80
48	5240	21.50	17.70

CH36

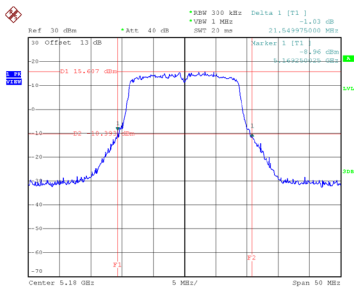

Date: 30.DEC.2021 17:08:38

CH40 26 dB Bandwidth

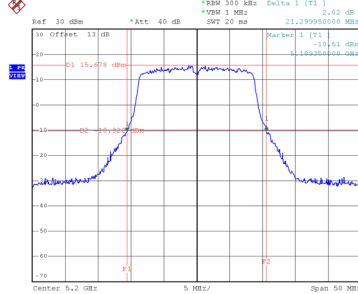

Date: 30.DEC.2021 17:09:24

CH48

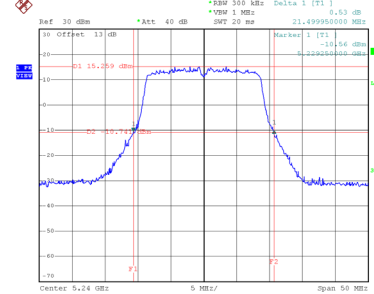

Date: 30.DEC.2021 17:10:08

99 % Occupied Bandwidth

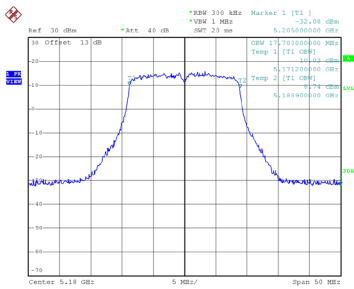

Date: 30.DEC.2021 17:08:12

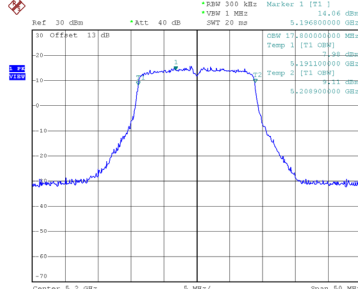

Date: 30.DEC.2021 17:09:58

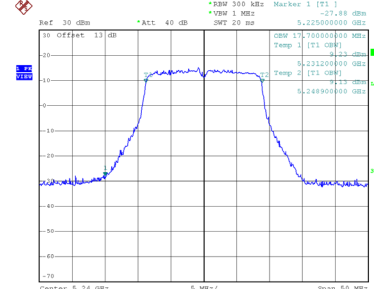

Date: 30.DEC.2021 17:09:43

Test Mode	UNII-1_TX AC(VHT40) Mode
-----------	--------------------------

Channel	Frequency (MHz)	26 dB Bandwidth (MHz)	99 % Occupied Bandwidth (MHz)
38	5190	40.40	36.40
46	5230	41.19	36.40

CH38

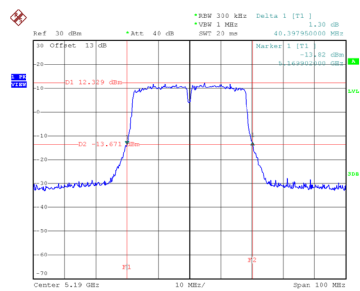

Date: 30.DEC.2021 17:13:24

CH46

26 dB Bandwidth

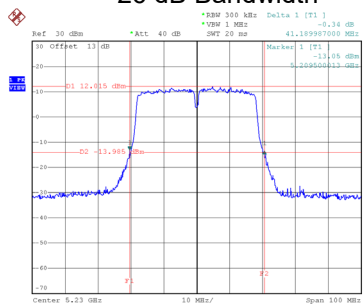

Date: 30.DEC.2021 17:14:09

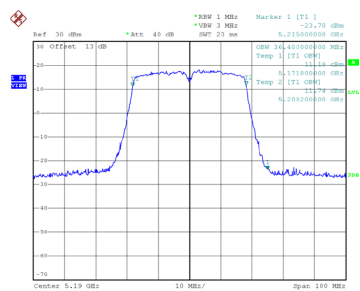

Date: 30.DEC.2021 17:12:57

99 % Occupied Bandwidth

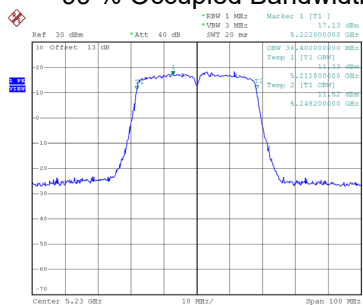

Date: 30.DEC.2021 17:13:42