

# FCC Radio Test Report

## FCC ID: 2AXJ4EAP620HDV2

This report concerns: **Original Grant**

**Project No.** : 2102C267  
**Equipment** : AX1800 Ceiling Mount Wi-Fi 6 Access Point  
**Brand Name** : tp-link  
**Test Model** : EAP620 HD  
**Series Model** : N/A  
**Applicant** : TP-Link Corporation Limited  
**Address** : Room 901, 9/F. , New East Ocean Centre, 9 Science Museum Road,  
Tsim Sha Tsui, Kowloon, Hong Kong  
**Manufacturer** : TP-Link Corporation Limited  
**Address** : Room 901, 9/F. , New East Ocean Centre, 9 Science Museum Road,  
Tsim Sha Tsui, Kowloon, Hong Kong  
**Date of Receipt** : Feb. 10, 2021  
**Date of Test** : Feb. 25, 2021 ~ Mar. 24, 2021  
**Issued Date** : Apr. 08, 2021  
**Report Version** : R00  
**Test Sample** : Engineering Sample No.: DG20210225114 for conducted,  
DG2021030351 for radiated.  
**Standard(s)** : FCC Part15, Subpart E(15.407)  
ANSI C63.10-2013  
FCC KDB 789033 D02 General UNII Test Procedures New Rules v02r01  
FCC KDB 662911 D01 Multiple Transmitter Output v02r01

The above equipment has been tested and found compliance with the requirement of the relative standards by BTL Inc.



Prepared by : Chella Zheng



Approved by : Ethan Ma



Certificate #5123.02

Add: No.3, Jinshagang 1st Road, Shixia, Dalang Town, Dongguan, Guangdong, China.

Tel: +86-769-8318-3000

Web: www.newbtl.com

**Declaration**

**BTL** represents to the client that testing is done in accordance with standard procedures as applicable and that test instruments used has been calibrated with standards traceable to international standard(s) and/or national standard(s).

**BTL's** reports apply only to the specific samples tested under conditions. It is manufacture's responsibility to ensure that additional production units of this model are manufactured with the identical electrical and mechanical components. **BTL** shall have no liability for any declarations, inferences or generalizations drawn by the client or others from **BTL** issued reports.

The report must not be used by the client to claim product certification, approval, or endorsement by NVLAP, NIST, A2LA, or any agency of the U.S. Government.

This report is the confidential property of the client. As a mutual protection to the clients, the public and ourselves, the test report shall not be reproduced, except in full, without our written approval.

**BTL's** laboratory quality assurance procedures are in compliance with the **ISO/IEC 17025** requirements, and accredited by the conformity assessment authorities listed in this test report.

**BTL** is not responsible for the sampling stage, so the results only apply to the sample as received.

The information, data and test plan are provided by manufacturer which may affect the validity of results, so it is manufacturer's responsibility to ensure that the apparatus meets the essential requirements of applied standards and in all the possible configurations as representative of its intended use.

**Limitation**

For the use of the authority's logo is limited unless the Test Standard(s)/Scope(s)/Item(s) mentioned in this test report is (are) included in the conformity assessment authorities acceptance respective.

Please note that the measurement uncertainty is provided for informational purpose only and are not use in determining the Pass/Fail results.

<b>Table of Contents</b>	<b>Page</b>
<b>REPORT ISSUED HISTORY</b>	<b>6</b>
<b>1 . SUMMARY OF TEST RESULTS</b>	<b>7</b>
1.1 TEST FACILITY	8
1.2 MEASUREMENT UNCERTAINTY	8
1.3 TEST ENVIRONMENT CONDITIONS	9
<b>2 . GENERAL INFORMATION</b>	<b>10</b>
2.1 GENERAL DESCRIPTION OF EUT	10
2.2 TEST MODES	13
2.3 PARAMETERS OF TEST SOFTWARE	16
2.4 DUTY CYCLE	17
2.5 BLOCK DIAGRAM SHOWING THE CONFIGURATION OF SYSTEM TESTED	19
2.6 SUPPORT UNITS	19
<b>3 . AC POWER LINE CONDUCTED EMISSIONS TEST</b>	<b>20</b>
3.1 LIMIT	20
3.2 TEST PROCEDURE	20
3.3 DEVIATION FROM TEST STANDARD	20
3.4 TEST SETUP	21
3.5 EUT OPERATION CONDITIONS	21
3.6 TEST RESULTS	21
<b>4 . RADIATED EMISSIONS TEST</b>	<b>22</b>
4.1 LIMIT	22
4.2 TEST PROCEDURE	23
4.3 DEVIATION FROM TEST STANDARD	23
4.4 TEST SETUP	24
4.5 EUT OPERATION CONDITIONS	25
4.6 TEST RESULTS - 9 KHZ to 30 MHZ	25
4.7 TEST RESULTS - 30 MHz TO 1000 MHz	25
4.8 TEST RESULTS - ABOVE 1000 MHz	25
<b>5 . BANDWIDTH TEST</b>	<b>26</b>
5.1 LIMIT	26
5.2 TEST PROCEDURE	26
5.3 DEVIATION FROM STANDARD	26
5.4 TEST SETUP	26

<b>Table of Contents</b>	<b>Page</b>
5.5 EUT OPERATION CONDITIONS	26
5.6 TEST RESULTS	26
<b>6 . MAXIMUM OUTPUT POWER TEST</b>	<b>27</b>
6.1 LIMIT	27
6.2 TEST PROCEDURE	27
6.3 DEVIATION FROM STANDARD	27
6.4 TEST SETUP	27
6.5 EUT OPERATION CONDITIONS	27
6.6 TEST RESULTS	27
<b>7 . POWER SPECTRAL DENSITY TEST</b>	<b>28</b>
7.1 LIMIT	28
7.2 TEST PROCEDURE	28
7.3 DEVIATION FROM STANDARD	28
7.4 TEST SETUP	29
7.5 EUT OPERATION CONDITIONS	29
7.6 TEST RESULTS	29
<b>8 . FREQUENCY STABILITY MEASUREMENT</b>	<b>30</b>
8.1 LIMIT	30
8.2 TEST PROCEDURE	30
8.3 DEVIATION FROM STANDARD	30
8.4 TEST SETUP	30
8.5 EUT OPERATION CONDITIONS	30
8.6 TEST RESULTS	30
<b>9 . MEASUREMENT INSTRUMENTS LIST</b>	<b>31</b>
<b>10 . EUT TEST PHOTOS</b>	<b>33</b>
<b>APPENDIX A - AC POWER LINE CONDUCTED EMISSIONS</b>	<b>38</b>
<b>APPENDIX B - RADIATED EMISSION - 9 KHZ TO 30 MHZ</b>	<b>41</b>
<b>APPENDIX C - RADIATED EMISSION - 30 MHZ TO 1 GHZ</b>	<b>46</b>
<b>APPENDIX D - RADIATED EMISSION - ABOVE 1000 MHZ</b>	<b>49</b>
<b>APPENDIX E - BANDWIDTH</b>	<b>170</b>
<b>APPENDIX F - MAXIMUM OUTPUT POWER</b>	<b>185</b>
<b>APPENDIX G - POWER SPECTRAL DENSITY</b>	<b>212</b>

<b>Table of Contents</b>	<b>Page</b>
<b>APPENDIX H - FREQUENCY STABILITY</b>	<b>233</b>

**REPORT ISSUED HISTORY**

Report Version	Description	Issued Date
R00	Original Issue.	Apr. 08, 2021

## 1. SUMMARY OF TEST RESULTS

Test procedures according to the technical standard(s):

FCC Part15, Subpart E(15.407)				
Standard(s) Section	Test Item	Test Result	Judgment	Remark
15.207 15.407(b)	AC Power Line Conducted Emissions	APPENDIX A	PASS	-----
15.407(b) 15.205(a) 15.209(a)	Radiated Emissions	APPENDIX B APPENDIX C APPENDIX D	PASS	-----
15.407(a) 15.407(e)	Spectrum Bandwidth	APPENDIX E	PASS	-----
15.407(a)	Maximum Output Power	APPENDIX F	PASS	-----
15.407(a)	Power Spectral Density	APPENDIX G	PASS	-----
15.407(g)	Frequency Stability	APPENDIX H	PASS	-----
15.203	Antenna Requirements	-----	PASS	NOTE (2)
15.407(c)	Automatically Discontinue Transmission	-----	PASS	NOTE (3)

**Note:**

- (1) "N/A" denotes test is not applicable in this test report.
- (2) The device what use a permanently attached antenna were considered sufficient to comply with the provisions of 15.203.
- (3) During no any information transmission, the EUT can automatically discontinue transmission and become standby mode for power saving. the EUT can detect the controlling signal of ACK message transmitting from remote device and verify whether it shall resend or discontinue transmission.
- (4) For UNII-1 this device was functioned as a  
 Access point device     Client device

## 1.1 TEST FACILITY

The test facilities used to collect the test data in this report is at the location of No.3,Jinshagang 1st Road, Shixia, Dalang Town, Dongguan, Guangdong, China.

BTL's Test Firm Registration Number for FCC: 357015

BTL's Designation Number for FCC: CN1240

## 1.2 MEASUREMENT UNCERTAINTY

ISO/IEC 17025 requires that an estimate of the measurement uncertainties associated with the emissions test results be included in the report. The measurement uncertainties given below are based on a 95% confidence level (based on a coverage factor (k=2))

The BTL measurement uncertainty as below table:

### A. AC power line conducted emissions test:

Test Site	Method	Measurement Frequency Range	U, (dB)
DG-C02	CISPR	150kHz ~ 30MHz	2.68

### B. Radiated emissions test:

Test Site	Method	Measurement Frequency Range	Ant. H / V	U, (dB)
DG-CB03	CISPR	9kHz ~ 30MHz	-	3.02
		30MHz ~ 200MHz	V	4.26
		30MHz ~ 200MHz	H	3.38
		200MHz ~ 1,000MHz	V	3.98
		200MHz ~ 1,000MHz	H	3.94
		1GHz ~ 6GHz	-	3.96
		6GHz ~ 18GHz	-	5.24
		18GHz ~ 26.5GHz	-	3.62
		26.5GHz ~ 40GHz	-	4.00

### C. Other Measurement test:

Test Item	Uncertainty
Bandwidth	±3.8 %
Maximum Output Power	±0.95 dB
Power Spectral Density	±0.86 dB
Frequency Stability	±0.16 dB
Temperature	±0.08 °C
Humidity	±1.5%

Note: Unless specifically mentioned, the uncertainty of measurement has not been taken into account to declare the compliance or non-compliance to the specification.



**1.3 TEST ENVIRONMENT CONDITIONS**

Test Item	Temperature	Humidity	Test Voltage	Tested By
AC Power Line Conducted Emissions	25°C	53%	AC 120V/60Hz	Gerry Zhao
Radiated Emissions-9K-30MHz	25°C	60%	AC 120V/60Hz	Hayden Chen
Radiated Emissions-30 MHz to 1GHz	26°C	52%	AC 120V/60Hz	Hayden Chen
Radiated Emissions-Above 1000 MHz	24°C	60%	AC 120V/60Hz	Hayden Chen
Spectrum Bandwidth	24°C	40%	AC 120V/60Hz	Jesse Wang
Maximum Output Power	24°C	40%	AC 120V/60Hz	Evan Yang
Power Spectral Density	24°C	40%	AC 120V/60Hz	Jesse Wang
Frequency Stability	Normal & Extreme	40%	Normal & Extreme	Jesse Wang

## 2. GENERAL INFORMATION

### 2.1 GENERAL DESCRIPTION OF EUT

Equipment	AX1800 Ceiling Mount Wi-Fi 6 Access Point
Brand Name	tp-link
Test Model	EAP620 HD
Series Model	N/A
Model Difference(s)	N/A
HVIN	EAP620 HDV2
Power Source	1# DC voltage supplied from AC adapter. Model: T120100-2B1 2# PoE supplied. (Supports Unit)
Power Rating	1# I/P: 100-240V ~50/60Hz 0.3A O/P: 12V $\overline{=}$ 1A 2# 802.3at PoE: 42.5-57V $\overline{=}$ 0.6A
Operation Frequency Band(s)	UNII-1: 5150 MHz~5250 MHz UNII-3: 5725 MHz~5850 MHz
Modulation Type	IEEE 802.11a/n/ac: OFDM IEEE 802.11ax: OFDMA
Bit Rate of Transmitter	IEEE 802.11a: 54/48/36/24/18/12/9/6 Mbps IEEE 802.11n: up to 300 Mbps IEEE 802.11ac: up to 866.7 Mbps IEEE 802.11ax: up to 1201 Mbps
Maximum Output Power _UNII-1 Non Beamforming	IEEE 802.11a: 25.63 dBm (0.3656 W) IEEE 802.11ac (VHT20): 25.46 dBm (0.3516 W) IEEE 802.11ac (VHT40): 25.47 dBm (0.3524 W) IEEE 802.11ac (VHT80): 25.28 dBm (0.3373 W) IEEE 802.11ax (HE20): 25.45 dBm (0.3508 W) IEEE 802.11ax (HE40): 25.20 dBm (0.3311 W) IEEE 802.11ax (HE80): 24.38 dBm (0.2742 W)
Maximum Output Power _UNII-3 Non Beamforming	IEEE 802.11a: 25.65 dBm (0.3673 W) IEEE 802.11ac (VHT20): 25.51 dBm (0.3556 W) IEEE 802.11ac (VHT40): 25.47 dBm (0.3524 W) IEEE 802.11ac (VHT80): 25.31 dBm (0.3396 W) IEEE 802.11ax (HE20): 25.38 dBm (0.3451 W) IEEE 802.11ax (HE40): 25.49 dBm (0.3540 W) IEEE 802.11ax (HE80): 25.13 dBm (0.3258 W)
Maximum Output Power _UNII-1 Beamforming	IEEE 802.11ac (VHT20): 24.66 dBm (0.2924 W) IEEE 802.11ac (VHT40): 24.66 dBm (0.2924 W) IEEE 802.11ac (VHT80): 23.49 dBm (0.2234 W) IEEE 802.11ax (HE20): 24.64 dBm (0.2911 W) IEEE 802.11ax (HE40): 24.39 dBm (0.2748 W) IEEE 802.11ax (HE80): 23.57 dBm (0.2275 W)
Maximum Output Power _UNII-3 Beamforming	IEEE 802.11ac (VHT20): 24.75 dBm (0.2985 W) IEEE 802.11ac (VHT40): 24.73 dBm (0.2972 W) IEEE 802.11ac (VHT80): 24.51 dBm (0.2825 W) IEEE 802.11ax (HE20): 24.57 dBm (0.2864 W) IEEE 802.11ax (HE40): 24.69 dBm (0.2944 W) IEEE 802.11ax (HE80): 24.33 dBm (0.2710 W)

**Note:**

1. For a more detailed features description, please refer to the manufacturer's specifications or the user's manual.

**2. Channel List:**

IEEE 802.11a IEEE 802.11n (HT20) IEEE 802.11ac (VHT20) IEEE 802.11ax (HE20)		IEEE 802.11n (HT40) IEEE 802.11ac (VHT40) IEEE 802.11ax (HE40)		IEEE 802.11ac (VHT80) IEEE 802.11ax (HE80)	
UNII-1		UNII-1		UNII-1	
Channel	Frequency (MHz)	Channel	Frequency (MHz)	Channel	Frequency (MHz)
36	5180	38	5190	42	5210
40	5200	46	5230		
44	5220				
48	5240				

IEEE 802.11a IEEE 802.11n (HT20) IEEE 802.11ac (VHT20) IEEE 802.11ax (HE20)		IEEE 802.11n (HT40) IEEE 802.11ac (VHT40) IEEE 802.11ax (HE40)		IEEE 802.11ac (VHT80) IEEE 802.11ax (HE80)	
UNII-3		UNII-3		UNII-3	
Channel	Frequency (MHz)	Channel	Frequency (MHz)	Channel	Frequency (MHz)
149	5745	151	5755	155	5775
153	5765	159	5795		
157	5785				
161	5805				
165	5825				

**3. RU Configuration:**

IEEE 802.11ax (HE20)	Resource Unit	242 Tone(20M)
	Specific Resource Unit	61
IEEE 802.11ax (HE40)	Resource Unit	484 Tone(40M)
	Specific Resource Unit	65
IEEE 802.11ax (HE80)	Resource Unit	996 Tone(80M)
	Specific Resource Unit	67

Note: IEEE 802.11ax mode only supports the highest tone, so the highest tone was evaluated and measured inside report.

**4. Antenna Specification:**

Ant.	Brand	P/N	Antenna Type	Connector	Gain (dBi)
1	tp-link	EAP1800(EU)1.0	PIFA	I-PEX	3
2	tp-link	EAP1800(EU)1.0	PIFA	I-PEX	3

**Note:**

- This EUT supports CDD, and all antennas have the same gain, Directional gain =  $G_{ANT} + \text{Array Gain}$ . For power measurements, Array Gain=0dB ( $N_{ANT} \leq 4$ ), so the Directional gain=3. For power spectral density measurements,  $N_{ANT}=2$ ,  $N_{SS} = 1$ . So the Directional gain= $G_{ANT} + \text{Array Gain} = G_{ANT} + 10\log(N_{ANT}/N_{SS})\text{dBi} = 3 + 10\log(2/1)\text{dBi} = 6.01$ . Then, the UNII-1 power spectral density limit is  $17 - (6.01 - 6) = 16.99$ , the UNII-3 power spectral density limit is  $30 - (6.01 - 6) = 29.99$ .
- Beamforming Gain: 3dB. So Directional gain=3+3=6.
- The antenna gain and beamforming gain are provided by the manufacturer.

## 5. Table for Antenna Configuration:

For Non Beamforming:

Operating Mode	TX Mode	2TX
IEEE 802.11a		V (Ant. 1 + Ant. 2)
IEEE 802.11n(HT20)		V (Ant. 1 + Ant. 2)
IEEE 802.11n(HT40)		V (Ant. 1 + Ant. 2)
IEEE 802.11ac (VHT20)		V (Ant. 1 + Ant. 2)
IEEE 802.11ac (VHT40)		V (Ant. 1 + Ant. 2)
IEEE 802.11ac (VHT80)		V (Ant. 1 + Ant. 2)
IEEE 802.11ax (HE20)		V (Ant. 1 + Ant. 2)
IEEE 802.11ax (HE40)		V (Ant. 1 + Ant. 2)
IEEE 802.11ax (HE80)		V (Ant. 1 + Ant. 2)

For Beamforming:

Operating Mode	TX Mode	2TX
IEEE 802.11ac (VHT20)		V (Ant. 1 + Ant. 2)
IEEE 802.11ac (VHT40)		V (Ant. 1 + Ant. 2)
IEEE 802.11ac (VHT80)		V (Ant. 1 + Ant. 2)
IEEE 802.11ax (HE20)		V (Ant. 1 + Ant. 2)
IEEE 802.11ax (HE40)		V (Ant. 1 + Ant. 2)
IEEE 802.11ax (HE80)		V (Ant. 1 + Ant. 2)

## 2.2 TEST MODES

The test system was pre-tested based on the consideration of all possible combinations of EUT operation mode.

Pretest Mode	Description
Mode 1	TX A Mode / CH36, CH40, CH48 (UNII-1)
Mode 2	TX AC (VHT20) Mode / CH36, CH40, CH48 (UNII-1)
Mode 3	TX AC (VHT40) Mode / CH38, CH46 (UNII-1)
Mode 4	TX AC (VHT80) Mode / CH42 (UNII-1)
Mode 5	TX AX (HE20) Mode / CH36, CH40, CH48 (UNII-1)
Mode 6	TX AX (HE40) Mode / CH38, CH46 (UNII-1)
Mode 7	TX AX (HE80) Mode / CH42 (UNII-1)
Mode 8	TX A Mode / CH149,CH157,CH165 (UNII-3)
Mode 9	TX AC (VHT20) Mode / CH149,CH157,CH165 (UNII-3)
Mode 10	TX AC (VHT40) Mode / CH151,CH159 (UNII-3)
Mode 11	TX AC (VHT80) Mode / CH155 (UNII-3)
Mode 12	TX AX (HE20) Mode / CH149,CH157,CH165 (UNII-3)
Mode 13	TX AX (HE40) Mode / CH151,CH159 (UNII-3)
Mode 14	TX AX (HE80) Mode / CH155 (UNII-3)
Mode 15	TX A Mode / CH149 (UNII-3)

Following mode(s) was (were) found to be the worst case(s) and selected for the final test.

<b>AC power line conducted emissions test</b>	
Final Test Mode	Description
Mode 15	TX A Mode / CH149 (UNII-3)

<b>Radiated emissions test - Below 1GHz</b>	
Final Test Mode	Description
Mode 15	TX A Mode / CH149 (UNII-3)

Radiated emissions test - Above 1GHz_Non Beamforming	
Final Test Mode	Description
Mode 1	TX A Mode / CH36, CH40, CH48 (UNII-1)
Mode 2	TX AC (VHT20) Mode / CH36, CH40, CH48 (UNII-1)
Mode 3	TX AC (VHT40) Mode / CH38, CH46 (UNII-1)
Mode 4	TX AC (VHT80) Mode / CH42 (UNII-1)
Mode 5	TX AX (HE20) Mode / CH36, CH40, CH48 (UNII-1)
Mode 6	TX AX (HE40) Mode / CH38, CH46 (UNII-1)
Mode 7	TX AX (HE80) Mode / CH42 (UNII-1)
Mode 8	TX A Mode / CH149,CH157,CH165 (UNII-3)
Mode 9	TX AC (VHT20) Mode / CH149,CH157,CH165 (UNII-3)
Mode 10	TX AC (VHT40) Mode / CH151,CH159 (UNII-3)
Mode 11	TX AC (VHT80) Mode / CH155 (UNII-3)
Mode 12	TX AX (HE20) Mode / CH149,CH157,CH165 (UNII-3)
Mode 13	TX AX (HE40) Mode / CH151,CH159 (UNII-3)
Mode 14	TX AX (HE80) Mode / CH155 (UNII-3)

Maximum Output Power test_Non Beamforming	
Final Test Mode	Description
Mode 1	TX A Mode / CH36, CH40, CH48 (UNII-1)
Mode 2	TX AC (VHT20) Mode / CH36, CH40, CH48 (UNII-1)
Mode 3	TX AC (VHT40) Mode / CH38, CH46 (UNII-1)
Mode 4	TX AC (VHT80) Mode / CH42 (UNII-1)
Mode 5	TX AX (HE20) Mode / CH36, CH40, CH48 (UNII-1)
Mode 6	TX AX (HE40) Mode / CH38, CH46 (UNII-1)
Mode 7	TX AX (HE80) Mode / CH42 (UNII-1)
Mode 8	TX A Mode / CH149,CH157,CH165 (UNII-3)
Mode 9	TX AC (VHT20) Mode / CH149,CH157,CH165 (UNII-3)
Mode 10	TX AC (VHT40) Mode / CH151,CH159 (UNII-3)
Mode 11	TX AC (VHT80) Mode / CH155 (UNII-3)
Mode 12	TX AX (HE20) Mode / CH149,CH157,CH165 (UNII-3)
Mode 13	TX AX (HE40) Mode / CH151,CH159 (UNII-3)
Mode 14	TX AX (HE80) Mode / CH155 (UNII-3)

Maximum Output Power test_Beamforming	
Final Test Mode	Description
Mode 2	TX AC (VHT20) Mode / CH36, CH40, CH48 (UNII-1)
Mode 3	TX AC (VHT40) Mode / CH38, CH46 (UNII-1)
Mode 4	TX AC (VHT80) Mode / CH42 (UNII-1)
Mode 5	TX AX (HE20) Mode / CH36, CH40, CH48 (UNII-1)
Mode 6	TX AX (HE40) Mode / CH38, CH46 (UNII-1)
Mode 7	TX AX (HE80) Mode / CH42 (UNII-1)
Mode 9	TX AC (VHT20) Mode / CH149,CH157,CH165 (UNII-3)
Mode 10	TX AC (VHT40) Mode / CH151,CH159 (UNII-3)
Mode 11	TX AC (VHT80) Mode / CH155 (UNII-3)
Mode 12	TX AX (HE20) Mode / CH149,CH157,CH165 (UNII-3)
Mode 13	TX AX (HE40) Mode / CH151,CH159 (UNII-3)
Mode 14	TX AX (HE80) Mode / CH155 (UNII-3)

Other Conducted test_Non Beamforming	
Final Test Mode	Description
Mode 1	TX A Mode / CH36, CH40, CH48 (UNII-1)
Mode 2	TX AC (VHT20) Mode / CH36, CH40, CH48 (UNII-1)
Mode 3	TX AC (VHT40) Mode / CH38, CH46 (UNII-1)
Mode 4	TX AC (VHT80) Mode / CH42 (UNII-1)
Mode 5	TX AX (HE20) Mode / CH36, CH40, CH48 (UNII-1)
Mode 6	TX AX (HE40) Mode / CH38, CH46 (UNII-1)
Mode 7	TX AX (HE80) Mode / CH42 (UNII-1)
Mode 8	TX A Mode / CH149,CH157,CH165 (UNII-3)
Mode 9	TX AC (VHT20) Mode / CH149,CH157,CH165 (UNII-3)
Mode 10	TX AC (VHT40) Mode / CH151,CH159 (UNII-3)
Mode 11	TX AC (VHT80) Mode / CH155 (UNII-3)
Mode 12	TX AX (HE20) Mode / CH149,CH157,CH165 (UNII-3)
Mode 13	TX AX (HE40) Mode / CH151,CH159 (UNII-3)
Mode 14	TX AX (HE80) Mode / CH155 (UNII-3)

**Note:**

- (1) For radiated emission below 1 GHz test, the IEEE 802.11a channel 149 is found to be the worst case and recorded.
- (2) For radiated emission above 1 GHz test, 1GHz~26.5GHz and 26.5GHz~40GHz have been pre-tested and in this report only recorded the worst case. The remaining spurious points are all below the limit value of 20dB.
- (3) All the bit rate of transmitter have been tested and found the lowest rate is found to be the worst case and recorded.
- (4) The measurements for Output Power are tested, the Non Beamforming and Beamforming are recorded in the report. The worst case is Non Beamforming and only the worst case is documented for other test items.
- (5) For AC power line conducted emissions and radiated emissions below 1 GHz test, all adapters had been pre-tested and in this report only recorded the worst case.
- (6) VHT20/VHT40 covers HT20/HT40, due to same modulation. The power setting for 802.11n HT20 and HT40 are the same or lower than 802.11ac VHT20 and VHT40.

**2.3 PARAMETERS OF TEST SOFTWARE**

Test Software	QDART-Connectivity1.0-00075.exe
---------------	---------------------------------



## 2.4 DUTY CYCLE

If duty cycle is  $\geq 98\%$ , duty factor is not required.

If duty cycle is  $< 98\%$ , duty factor shall be considered.

The output power = measured power + duty factor.

The power spectral density = measured power spectral density + duty factor.

**IEEE 802.11a**

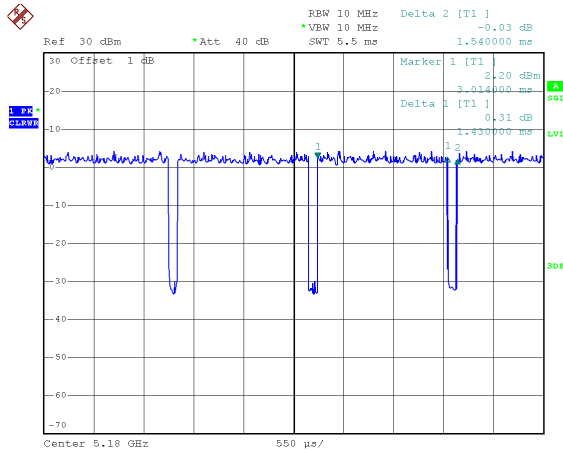

Date: 26.FEB.2021 10:38:35

Duty cycle = 1.430 ms / 1.540 ms = 92.86%  
 Duty Factor =  $10 \log(1 / \text{Duty cycle}) = 0.32$

**IEEE 802.11ac (VHT20)**

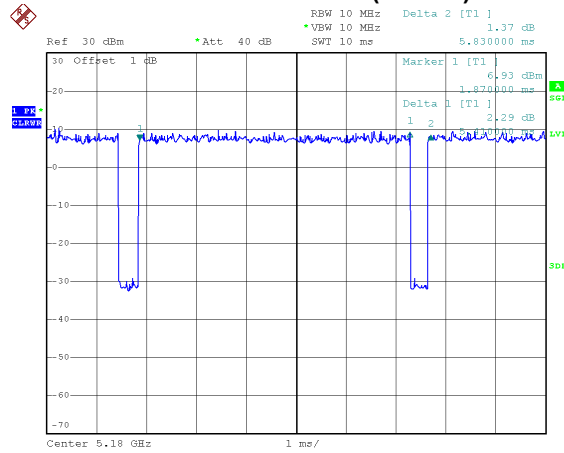

Date: 26.FEB.2021 10:47:13

Duty cycle = 5.410 ms / 5.830 ms = 92.80%  
 Duty Factor =  $10 \log(1 / \text{Duty cycle}) = 0.32$

**IEEE 802.11ac (VHT40)**

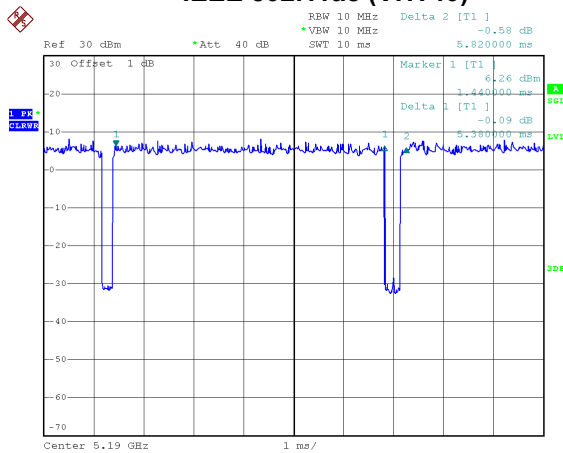

Date: 26.FEB.2021 10:49:20

Duty cycle = 5.380 ms / 5.820 ms = 92.44%  
 Duty Factor =  $10 \log(1 / \text{Duty cycle}) = 0.34$

**IEEE 802.11ac (VHT80)**

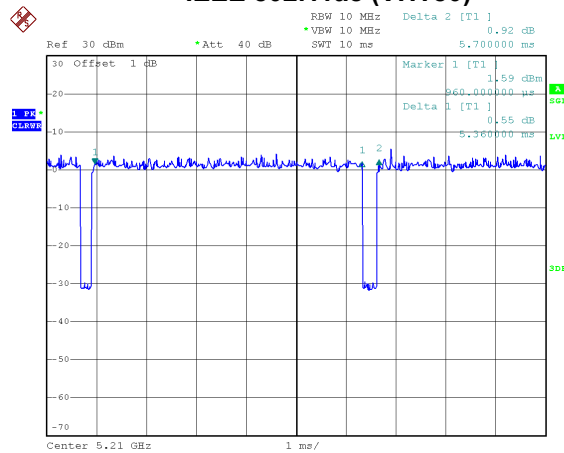

Date: 26.FEB.2021 10:50:45

Duty cycle = 5.360 ms / 5.700 ms = 94.04%  
 Duty Factor =  $10 \log(1 / \text{Duty cycle}) = 0.27$

### IEEE 802.11ax (HE20)

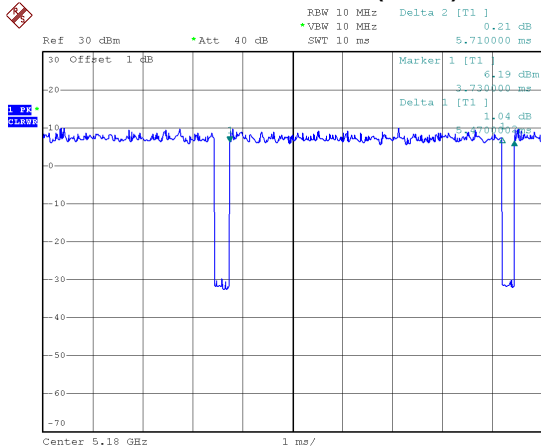

Date: 26.FEB.2021 10:59:18

Duty cycle = 5.470 ms / 5.710 ms = 95.80%  
 Duty Factor = 10 log(1 / Duty cycle) = 0.19

### IEEE 802.11ax (HE40)

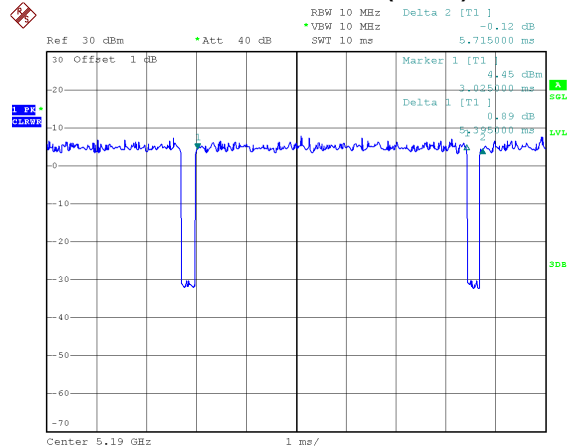

Date: 26.FEB.2021 11:01:17

Duty cycle = 5.395 ms / 5.715 ms = 94.40%  
 Duty Factor = 10 log(1 / Duty cycle) = 0.25

### IEEE 802.11ax (HE80)

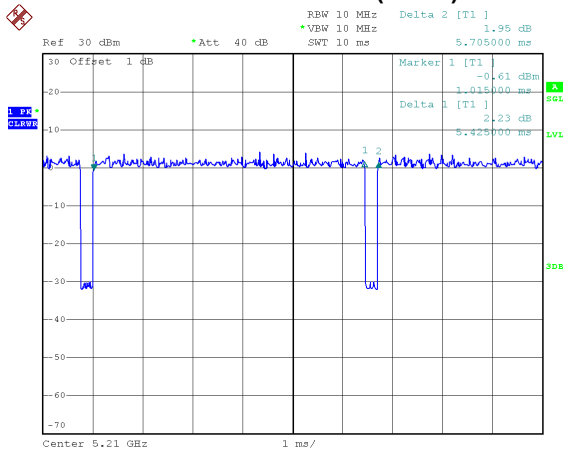

Date: 26.FEB.2021 11:02:38

Duty cycle = 5.425 ms / 5.705 ms = 95.09%  
 Duty Factor = 10 log(1 / Duty cycle) = 0.22

#### NOTE:

For IEEE 802.11a, IEEE 802.11n (HT20), IEEE 802.11ac (VHT20) and IEEE 802.11ax (HE20):  
 For radiated emissions frequency above 1 GHz, the resolution bandwidth of test receiver/spectrum analyzer is 1 MHz and the video bandwidth is 1 kHz (Duty cycle < 98%).  
 For IEEE 802.11n (HT40), IEEE 802.11ac (VHT40) and IEEE 802.11ax (HE40):  
 For radiated emissions frequency above 1 GHz, the resolution bandwidth of test receiver/spectrum analyzer is 1 MHz and the video bandwidth is 2 kHz (Duty cycle < 98%).  
 For IEEE 802.11ac (VHT80) and IEEE 802.11ax (HE80):  
 For radiated emissions frequency above 1 GHz, the resolution bandwidth of test receiver/spectrum analyzer is 1 MHz and the video bandwidth is 3 kHz (Duty cycle < 98%).

## 2.5 BLOCK DIAGRAM SHOWING THE CONFIGURATION OF SYSTEM TESTED

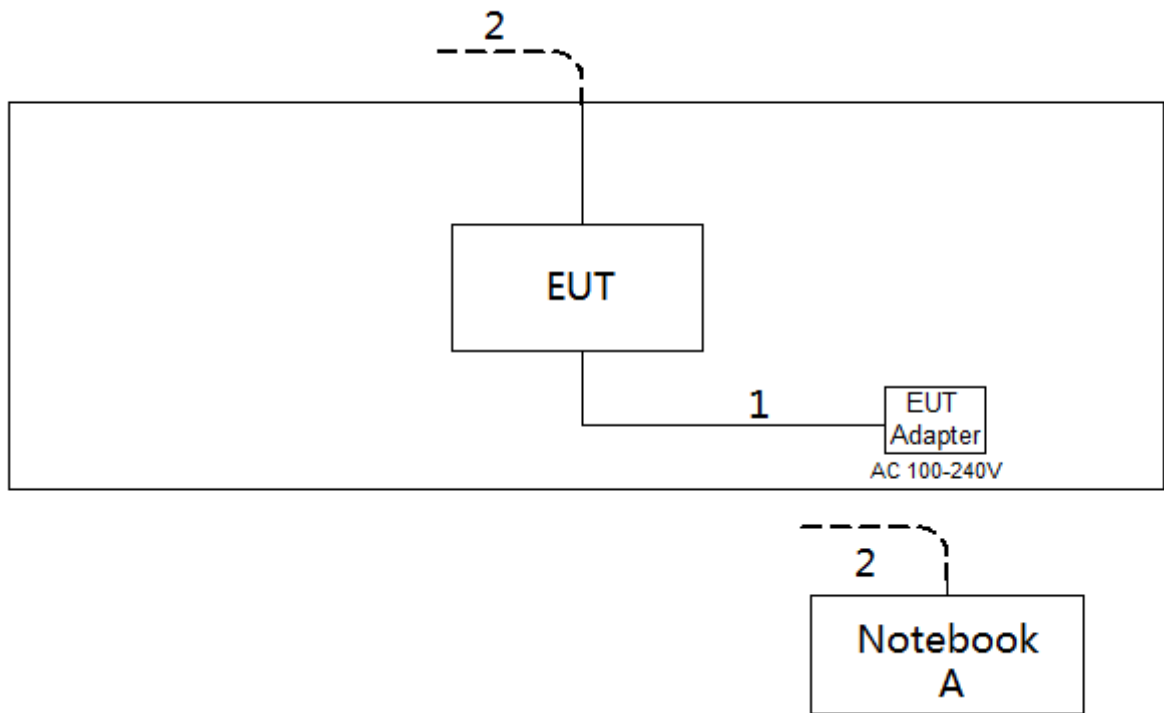

## 2.6 SUPPORT UNITS

Item	Equipment	Brand	Model No.	Series No.
A	Notebook	Dell	Inspiron 15-7559	N/A

Item	Cable Type	Shielded Type	Ferrite Core	Length
1	DC Cable	NO	NO	1.5m
2	RJ45 Cable	NO	NO	10m

### 3. AC POWER LINE CONDUCTED EMISSIONS TEST

#### 3.1 LIMIT

Frequency (MHz)	Limit (dB $\mu$ V)	
	Quasi-peak	Average
0.15 - 0.5	66 to 56*	56 to 46*
0.5 - 5.0	56	46
5.0 - 30.0	60	50

**NOTE:**

- (1) The tighter limit applies at the band edges.
- (2) The limit of " \* " marked band means the limitation decreases linearly with the logarithm of the frequency in the range.

The following table is the setting of the receiver

Receiver Parameter	Setting
Attenuation	10 dB
Start Frequency	0.15 MHz
Stop Frequency	30 MHz
IF Bandwidth	9 KHz

#### 3.2 TEST PROCEDURE

- a. The EUT was placed 0.8 meters from the horizontal ground plane with EUT being connected to the power mains through a line impedance stabilization network (LISN). All other support equipment powered from additional LISN(s). The LISN provide 50 Ohm/ 50uH of coupling impedance for the measuring instrument.
- b. Interconnecting cables that hang closer than 40 cm to the ground plane shall be folded back and forth in the center forming a bundle 30 to 40 cm long.
- c. I/O cables that are not connected to a peripheral shall be bundled in the center. The end of the cable may be terminated, if required, using the correct terminating impedance. The overall length shall not exceed 1 m.
- d. LISN at least 80 cm from nearest part of EUT chassis.
- e. For the actual test configuration, please refer to the related Item -EUT Test Photos.

#### 3.3 DEVIATION FROM TEST STANDARD

No deviation

### 3.4 TEST SETUP

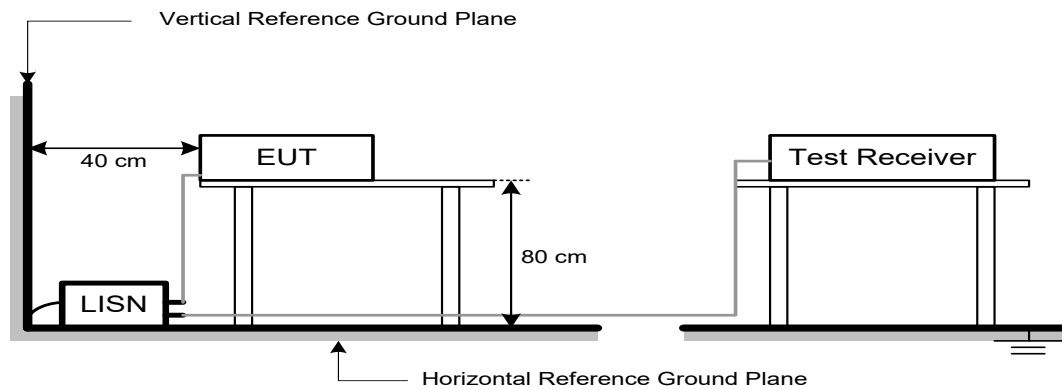

### 3.5 EUT OPERATION CONDITIONS

The EUT was configured for testing in a typical fashion (as a customer would normally use it). The EUT has been programmed to continuously transmit during test. This operating condition was tested and used to collect the included data.

The EUT was programmed to be in continuously transmitting/TX mode.

### 3.6 TEST RESULTS

Please refer to the APPENDIX A.

#### 4. RADIATED EMISSIONS TEST

##### 4.1 LIMIT

In case the emission fall within the restricted band specified on 15.205(a), then the 15.209(a) limit in the table below has to be followed.

##### LIMITS OF RADIATED EMISSIONS MEASUREMENT (9 kHz to 1000 MHz)

Frequency (MHz)	Field Strength (microvolts/meter)	Measurement Distance (meters)
0.009-0.490	2400/F(kHz)	300
0.490-1.705	24000/F(kHz)	30
1.705-30.0	30	30
30-88	100	3
88-216	150	3
216-960	200	3
Above 960	500	3

##### LIMITS OF UNWANTED EMISSION OUT OF THE RESTRICTED BANDS

Frequency (MHz)	EIRP Limit (dBm/MHz)	Equivalent Field Strength at 3m (dBμV/m)
5150-5250	-27	68.3
5250-5350	-27	68.3
5470-5725	-27	68.3
5725-5850	-27 NOTE (2)	68.3
	10 NOTE (2)	105.3
	15.6 NOTE (2)	110.9
	27 NOTE (2)	122.3

##### NOTE:

(1) The following formula is used to convert the equipment isotropic radiated power (eirp) to field strength:

$$E = \frac{1000000\sqrt{30P}}{3} \mu\text{V/m, where P is the eirp (Watts)}$$

(2) According to 15.407(b)(4)(i), all emissions shall be limited to a level of -27 dBm/MHz at 75 MHz or more above or below the band edge increasing linearly to 10 dBm/MHz at 25 MHz above or below the band edge, and from 25 MHz above or below the band edge increasing linearly to a level of 15.6 dBm/MHz at 5 MHz above or below the band edge, and from 5 MHz above or below the band edge increasing linearly to a level of 27 dBm/MHz at the band edge.

## 4.2 TEST PROCEDURE

- a. The measuring distance of 3 m shall be used for measurements. The EUT was placed on the top of a rotating table 0.8 meter above the ground at a 3 meter semi-anechoic chamber. The table was rotated 360 degrees to determine the position of the highest radiation.(below 1GHz)
- b. The measuring distance of 3 m shall be used for measurements. The EUT was placed on the top of a rotating table 1.5 meter above the ground at a 3 meter semi-anechoic chamber. The table was rotated 360 degrees to determine the position of the highest radiation.(above 1GHz)
- c. The height of the equipment or of the substitution antenna shall be 0.8m or 1.5m; the height of the test antenna shall vary between 1 m to 4 m. Both horizontal and vertical polarizations of the antenna are set to make the measurement.
- d. For each suspected emission, the EUT was arranged to its worst case and then the antenna was tuned to heights find the maximum reading (used Bore sight function).
- e. The receiver system was set to peak and average detect function and specified bandwidth with maximum hold mode when the test frequency is above 1 GHz.
- f. The initial step in collecting radiated emission data is a receiver peak detector mode pre-scanning the measurement frequency range. Significant peaks are then marked and then Quasi Peak detector mode re-measured.
- g. All readings are Peak unless otherwise stated QP in column of Note. Peak denotes that the Peak reading compliance with the QP Limits and then QP Mode measurement didn't perform.  
(below 1 GHz)
- h. All readings are Peak Mode value unless otherwise stated AVG in column of Note. If the Peak Mode Measured value compliance with the Peak Limits and lower than AVG Limits, the EUT shall be deemed to meet both Peak & AVG Limits and then only Peak Mode was measured, but AVG Mode didn't perform. (above 1 GHz)
- i. For the actual test configuration, please refer to the related Item –EUT Test Photos.

## 4.3 DEVIATION FROM TEST STANDARD

No deviation

**4.4 TEST SETUP**

**9 kHz to 30 MHz**

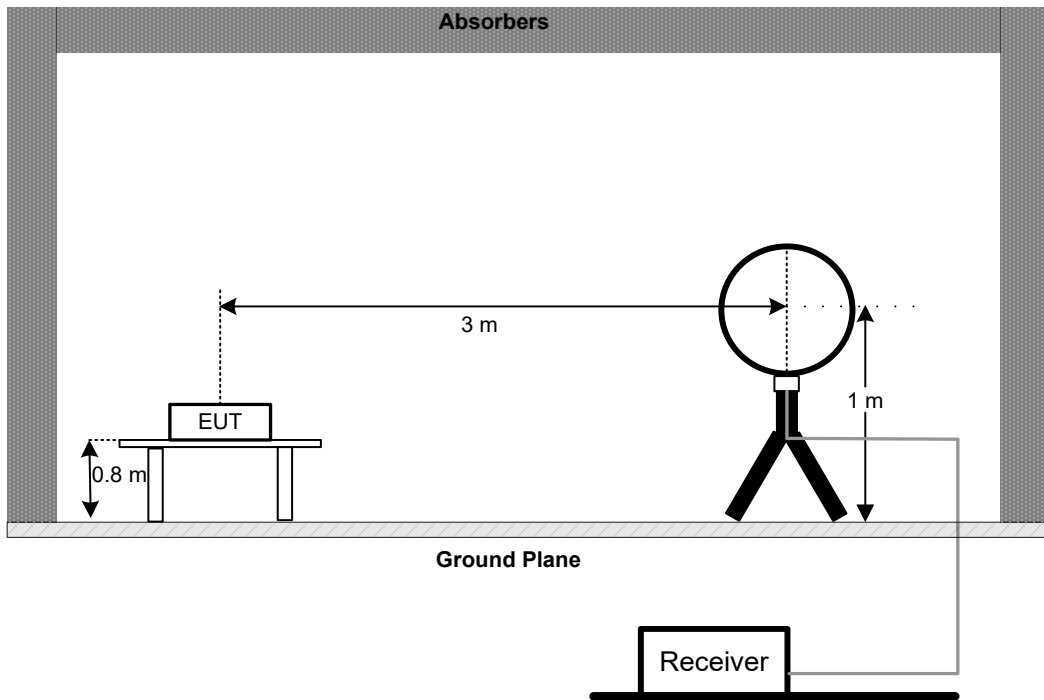

**30 MHz to 1 GHz**

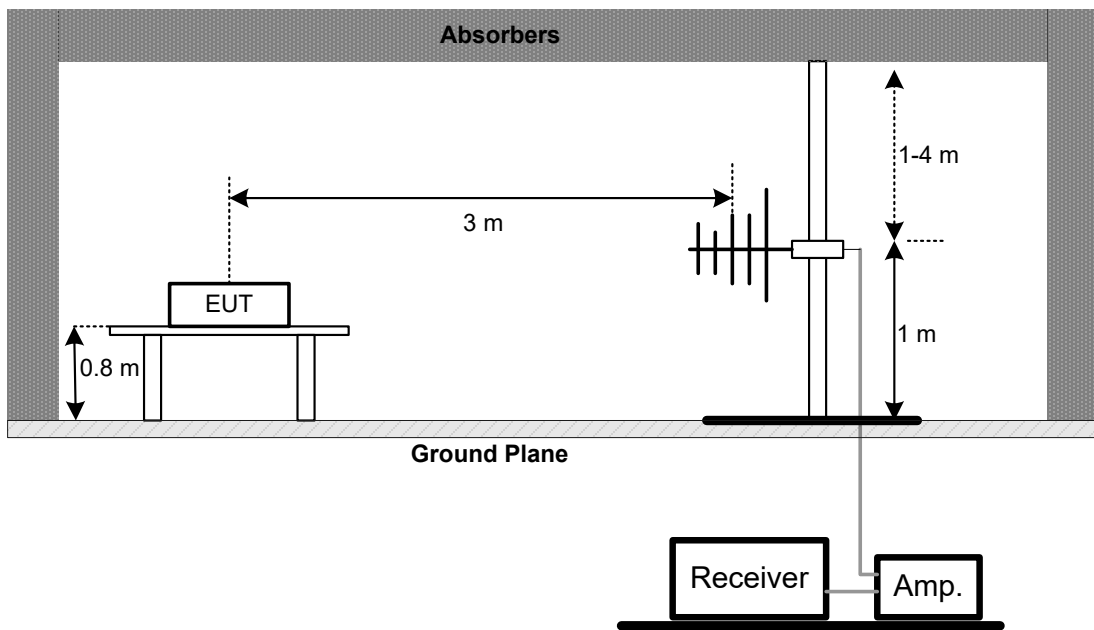



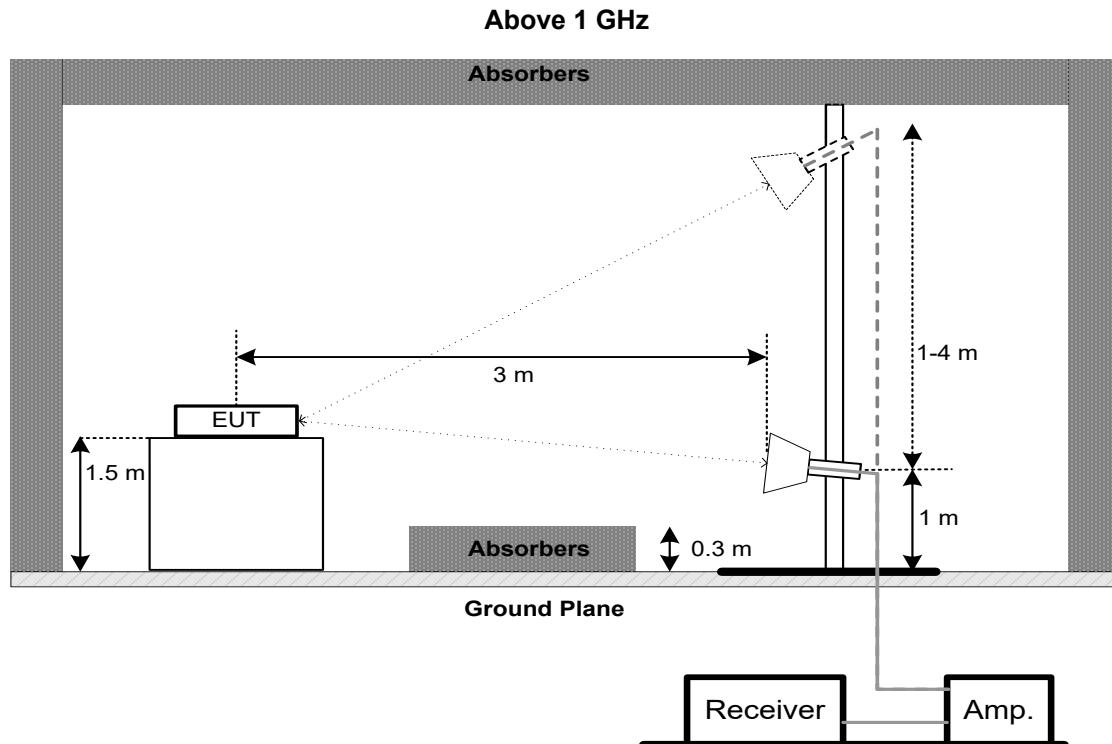

#### 4.5 EUT OPERATION CONDITIONS

The EUT tested system was configured as the statements of 3.5 unless otherwise a special operating condition is specified in the follows during the testing.

#### 4.6 TEST RESULTS - 9 KHZ to 30 MHZ

Please refer to the APPENDIX B

Remark:

- (1) Distance extrapolation factor =  $40 \log (\text{specific distance} / \text{test distance})$  (dB).
- (2) Limit line = specific limits (dBuV) + distance extrapolation factor.

#### 4.7 TEST RESULTS - 30 MHz TO 1000 MHz

Please refer to the APPENDIX C.

#### 4.8 TEST RESULTS - ABOVE 1000 MHz

Please refer to the APPENDIX D.

Remark:

- (1) No limit: This is fundamental signal, the judgment is not applicable.  
For fundamental signal judgment was referred to Peak output test.

## 5. BANDWIDTH TEST

### 5.1 LIMIT

FCC Part15, Subpart E (15.407)			
Section	Test Item	Limit	Frequency Range (MHz)
15.407(a)	26 dB Bandwidth	-	5150-5250
15.407(e)	6 dB Bandwidth	Minimum 500 kHz	5725-5850

### 5.2 TEST PROCEDURE

- The EUT was directly connected to the spectrum analyzer and antenna output port as show in the block diagram below
- Spectrum Setting:

For UNII-1:

Spectrum Parameter	Setting
Attenuation	Auto
Span Frequency	> 26 dB Bandwidth
RBW	300 kHz (Bandwidth 20 MHz and Bandwidth 40 MHz) 1 MHz (Bandwidth 80 MHz)
VBW	1 MHz (Bandwidth 20 MHz and Bandwidth 40 MHz) 3 MHz (Bandwidth 80 MHz)
Detector	Peak
Trace	Max Hold
Sweep Time	Auto

For UNII-3:

Spectrum Parameter	Setting
Attenuation	Auto
Span Frequency	6 dB Bandwidth
RBW	100 kHz
VBW	300 kHz
Detector	Peak
Trace	Max Hold
Sweep Time	Auto

- Measured the spectrum width with power higher than 26 dB / 6 dB below carrier

### 5.3 DEVIATION FROM STANDARD

No deviation.

### 5.4 TEST SETUP



### 5.5 EUT OPERATION CONDITIONS

The EUT was programmed to be in continuously transmitting mode.

### 5.6 TEST RESULTS

Please refer to the APPENDIX E.

## 6. MAXIMUM OUTPUT POWER TEST

### 6.1 LIMIT

FCC Part15, Subpart E (15.407)			
Section	Test Item	Limit	Frequency Range (MHz)
15.407(a)	Maximum Output Power	AP device: 1 Watt (30 dBm) Client device: 250 mW (24 dBm)	5150-5250
		1 Watt (30dBm)	5725-5850

Note:

- a. For an indoor access point operating in the band 5.15-5.25 GHz, the maximum conducted output power over the frequency band of operation shall not exceed 1 W provided the maximum antenna gain does not exceed 6 dBi. In addition, the maximum power spectral density shall not exceed 17 dBm in any 1 megahertz band. If transmitting antennas of directional gain greater than 6 dBi are used, both the maximum conducted output power and the maximum power spectral density shall be reduced by the amount in dB that the directional gain of the antenna exceeds 6 dBi.

### 6.2 TEST PROCEDURE

- a. The EUT was directly connected to the power meter and antenna output port as show in the block diagram below.
- b. Test test was performed in accordance with method of FCC KDB 789033 D02 General UNII Test Procedures New Rules v02r01.

### 6.3 DEVIATION FROM STANDARD

No deviation.

### 6.4 TEST SETUP



### 6.5 EUT OPERATION CONDITIONS

The EUT was programmed to be in continuously transmitting mode.

### 6.6 TEST RESULTS

Please refer to the APPENDIX F.

## 7. POWER SPECTRAL DENSITY TEST

### 7.1 LIMIT

FCC Part15, Subpart E (15.407)			
Section	Test Item	Limit	Frequency Range (MHz)
15.407(a)	Power Spectral Density	AP device: 17 dBm/MHz Client device: 11 dBm/MHz	5150-5250
		30 dBm/500 kHz	5725-5850

### 7.2 TEST PROCEDURE

- a. The EUT was directly connected to the spectrum analyzer and antenna output port as show in the block diagram below.
- b. Spectrum Setting

For UNII-1:

Spectrum Parameter	Setting
Span Frequency	Encompass the entire emissions bandwidth (EBW) of the signal
RBW	1 MHz.
VBW	3 MHz.
Detector	RMS
Trace average	100 trace
Sweep Time	Auto

For UNII-3:

Spectrum Parameter	Setting
Span Frequency	Encompass the entire emissions bandwidth (EBW) of the signal
RBW	100 kHz.
VBW	300 kHz.
Detector	RMS
Trace average	100 trace
Sweep Time	Auto

Note:

1. For UNII-3, according to KDB publication 789033 D02 General UNII Test Procedures New Rules v02r01, section II.F.5., it is acceptable to set RBW at 100kHz and VBW at 300kHz if the spectrum analyzer does not have 500 kHz RBW. Then, add  $10 \log (500 \text{ kHz}/100 \text{ kHz})$  to the measured result, i.e. 7 dB.
2. During the test of U-NII 3 PSD, the measurement result with RBW=100kHz has been added 7 dB by compensating offset. For example, the cable loss is 12 dB, and the final offset is  $12 + 7 = 19$  dB when RBW=100kHz is used.

### 7.3 DEVIATION FROM STANDARD

No deviation.

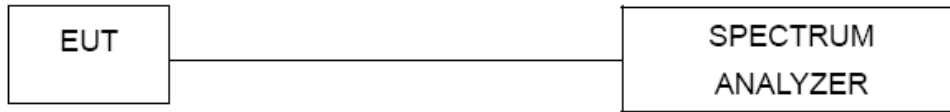
**7.4 TEST SETUP****7.5 EUT OPERATION CONDITIONS**

The EUT was programmed to be in continuously transmitting mode.

**7.6 TEST RESULTS**

Please refer to the APPENDIX G.

## 8. FREQUENCY STABILITY MEASUREMENT

### 8.1 LIMIT

FCC Part15, Subpart E (15.407)			
Section	Test Item	Limit	Frequency Range (MHz)
15.407(g)	Frequency Stability	An emission is maintained within the band of operation under all conditions of normal operation as specified in the users manual.	5150-5250
			5725-5850

### 8.2 TEST PROCEDURE

- The EUT was directly connected to the spectrum analyzer and antenna output port as show in the block diagram below.
- Spectrum Setting:

Spectrum Parameter	Setting
Attenuation	Auto
Span Frequency	Entire absence of modulation emissions bandwidth
RBW	10 kHz
VBW	10 kHz
Sweep Time	Auto

- The test extreme voltage is to change the primary supply voltage from 85 to 115 percent of the nominal value.
- User manual temperature is 0°C~40°C.

### 8.3 DEVIATION FROM STANDARD

No deviation.

### 8.4 TEST SETUP

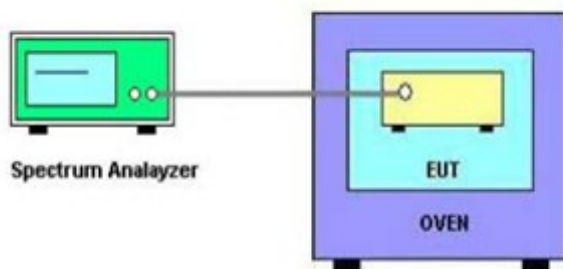

### 8.5 EUT OPERATION CONDITIONS

The EUT was programmed to be in continuously transmitting mode.

### 8.6 TEST RESULTS

Please refer to the APPENDIX H.

**9. MEASUREMENT INSTRUMENTS LIST**

AC Power Line Conducted Emissions					
Item	Kind of Equipment	Manufacturer	Type No.	Serial No.	Calibrated until
1	EMI Test Receiver	R&S	ESCI	100382	Feb. 28, 2022
2	LISN	EMCO	3816/2	52765	Feb. 27, 2022
3	TWO-LINE V-NETWORK	R&S	ENV216	101447	Feb. 27, 2022
4	50Ω Terminator	SHX	TF5-3	15041305	Feb. 27, 2022
5	Measurement Software	Farad	EZ-EMC Ver.NB-03A1-01	N/A	N/A
6	Cable	N/A	RG223	12m	Mar. 09, 2022
7	643 Shield Room	ETS	6*4*3m	N/A	N/A

Radiated Emissions - 9 kHz to 30 MHz					
Item	Kind of Equipment	Manufacturer	Type No.	Serial No.	Calibrated until
1	Antenna	EM	EM-6876-1	230	Apr. 16, 2021
2	Cable	N/A	RG 213/U	N/A	May 29, 2021
3	EMI Test Receiver	R&S	ESCI	100895	Feb. 27, 2022
4	Measurement Software	Farad	EZ-EMC Ver.NB-03A1-01	N/A	N/A
5	966 Chambe Room	RM	9*6*6m	N/A	Jul. 25, 2021

Radiated Emissions - 30 MHz to 1 GHz					
Item	Kind of Equipment	Manufacturer	Type No.	Serial No.	Calibrated until
1	Trilog-Broadband Antenna	Schwarzbeck	VULB9168	586	Nov. 27, 2021
2	Amplifier	HP	8447D	2944A08742	Feb. 28, 2022
3	Receiver	Agilent	N9038A	MY52130039	Jul. 25, 2021
4	Cable	emci	LMR-400(30MHz-1 GHz)(8m+5m)	N/A	May 22, 2021
5	Controller	CT	SC100	N/A	N/A
6	Controller	MF	MF-7802	MF780208416	N/A
7	Measurement Software	Farad	EZ-EMC Ver.NB-03A1-01	N/A	N/A
8	966 Chambe Room	RM	9*6*6m	N/A	Jul. 25, 2021

Radiated Emissions - Above 1 GHz					
Item	Kind of Equipment	Manufacturer	Type No.	Serial No.	Calibrated until
1	Double Ridged Guide Antenna	ETS	3115	75789	May 12, 2021
2	Broad-Band Horn Antenna	Schwarzbeck	BBHA 9170	9170319	Jul. 07, 2021
3	Amplifier	Agilent	8449B	3008A02584	Jul. 25, 2021
4	Microwave Preamplifier With Adaptor	EMC INSTRUMENT	EMC2654045	980039 & HA01	Feb. 28, 2022
5	Receiver	Agilent	N9038A	MY52130039	Jul. 25, 2021
6	Controller	CT	SC100	N/A	N/A
7	Controller	MF	MF-7802	MF780208416	N/A
8	Cable	N/A	EMC104-SM-SM-6000	N/A	Oct. 16, 2021
9	Measurement Software	Farad	EZ-EMC Ver.NB-03A1-01	N/A	N/A
10	Band Reject Filter	Micro-Tronics	BRC50705-01	10	Feb. 27, 2022
11	Band Reject Filter	Micro-Tronics	BRC50703-01	7	Feb. 27, 2022
12	966 Chambe Room	RM	9*6*6m	N/A	Jul. 25, 2021

Bandwidth					
Item	Kind of Equipment	Manufacturer	Type No.	Serial No.	Calibrated until
1	Spectrum Analyzer	R&S	FSP40	100185	Jul. 25, 2021
2	RF Cable	Tongkaichuan	N/A	N/A	N/A
3	DC Block	Mini	N/A	N/A	N/A
4	Attenuator	WOKEN	6SM3502	VAS1214NL	Feb. 07, 2022

Power Spectral Density					
Item	Kind of Equipment	Manufacturer	Type No.	Serial No.	Calibrated until
1	EXA Spectrum Analyzer	Agilent	N9010A	MY50520044	Feb. 28, 2022
2	RF Cable	Tongkaichuan	N/A	N/A	N/A
3	DC Block	Mini	N/A	N/A	N/A
4	Attenuator	WOKEN	6SM3502	VAS1214NL	Feb. 07, 2022

Maximum Output Power					
Item	Kind of Equipment	Manufacturer	Type No.	Serial No.	Calibrated until
1	Peak Power Analyzer	Keysight	8990B	MY51000506	Aug. 07, 2021
2	Wideband power sensor	Keysight	N1923A	MY58310004	Jul. 25, 2021
3	Attenuator	WOKEN	6SM3502	VAS1214NL	Feb. 07, 2022
4	RF Cable	Tongkaichuan	N/A	N/A	N/A

Frequency Stability					
Item	Kind of Equipment	Manufacturer	Type No.	Serial No.	Calibrated until
1	Spectrum Analyzer	R&S	FSP40	100185	Jul. 25, 2021
2	Precision Oven Tester	CEPREI	CEEC-M64T-40	15-008	Feb. 27, 2022
3	RF Cable	Tongkaichuan	N/A	N/A	N/A
4	DC Block	Mini	N/A	N/A	N/A
5	Attenuator	WOKEN	6SM3502	VAS1214NL	Feb. 07, 2022

Remark: "N/A" denotes no model name, serial no. or calibration specified.

All calibration period of equipment list is one year.



**10. EUT TEST PHOTOS****AC Power Line Conducted Emissions Test Photos**

**Radiated Emissions Test Photos**

**9 kHz to 30 MHz**



**Radiated Emissions Test Photos**

**30 MHz to 1 GHz**

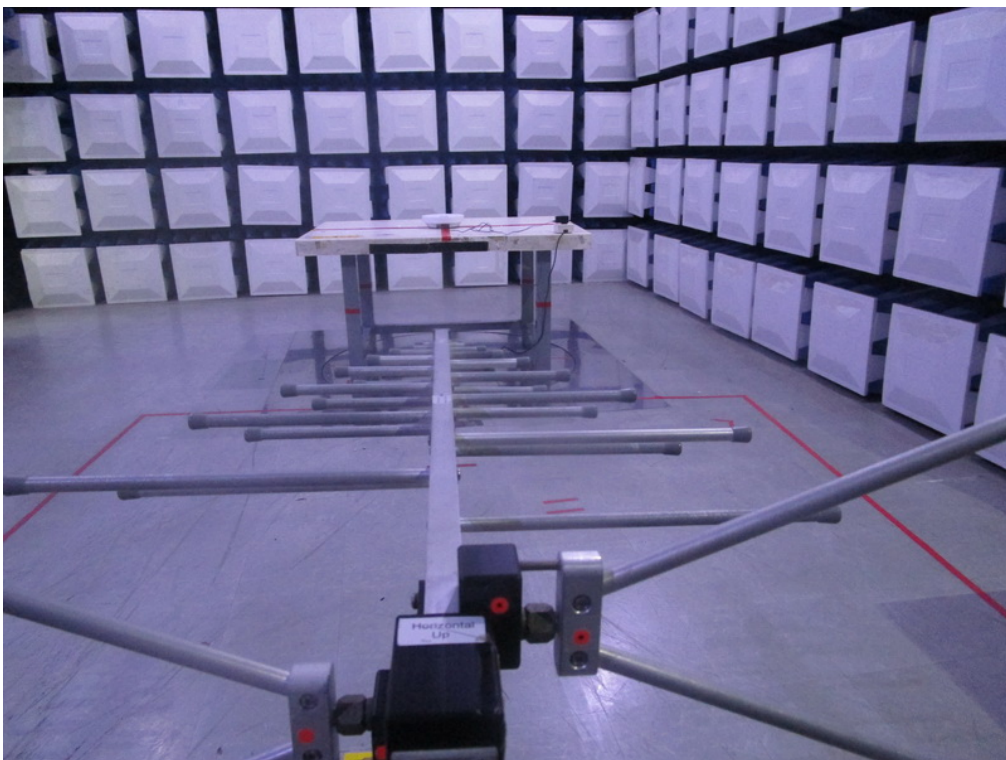
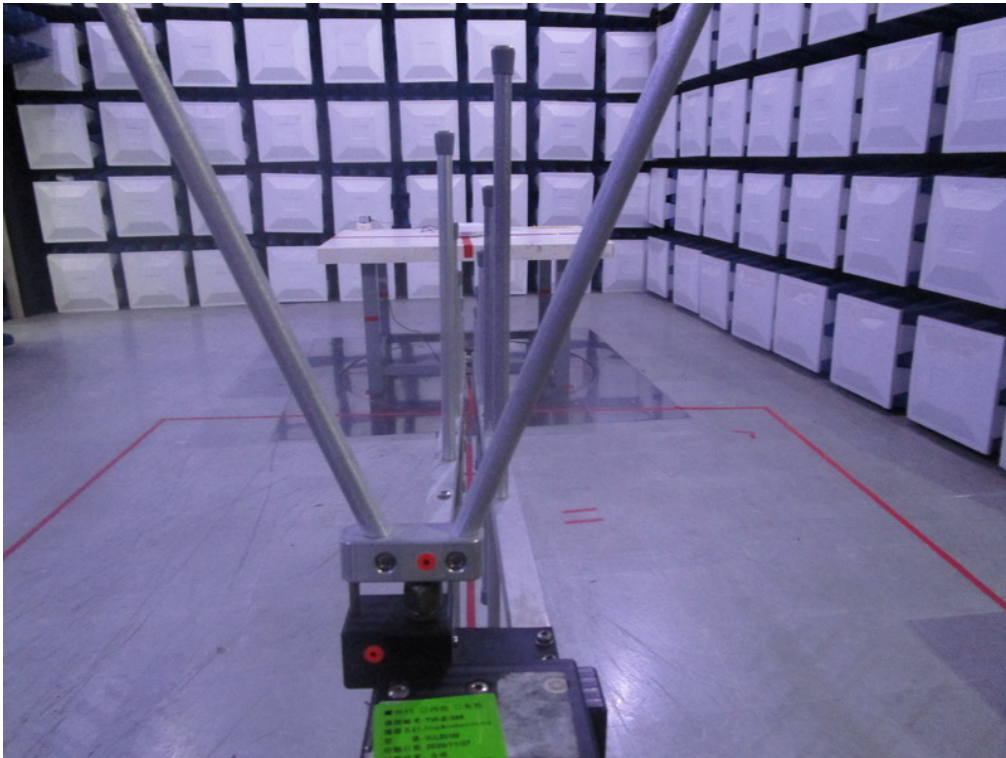

**Radiated Emissions Test Photos**

**Above 1 GHz**

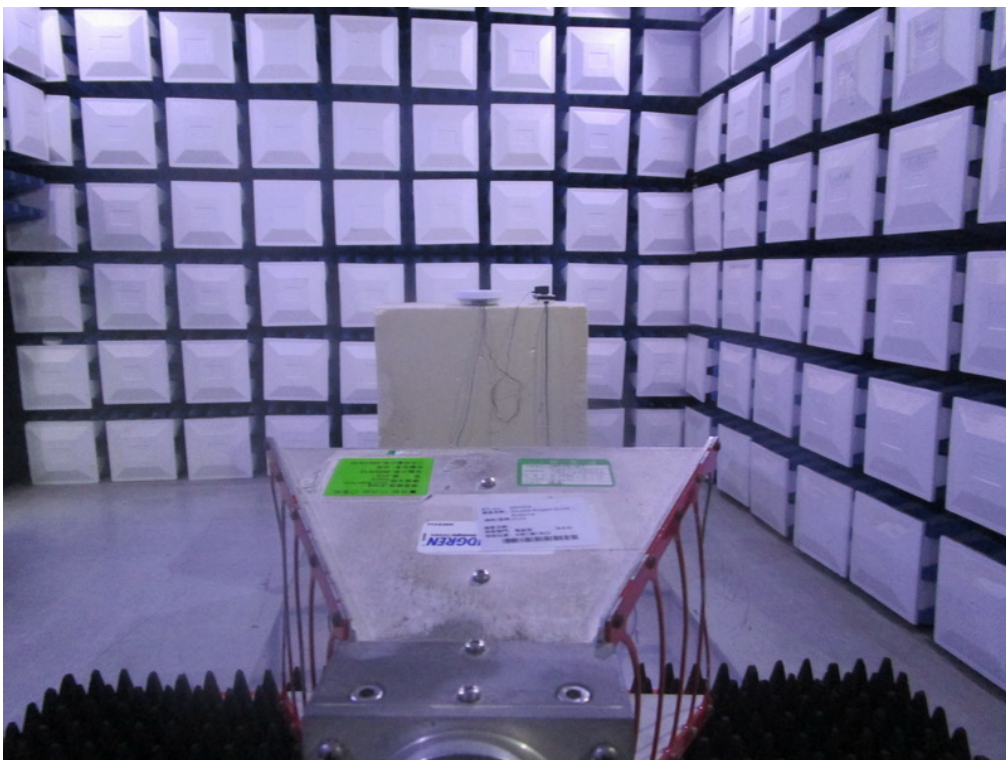
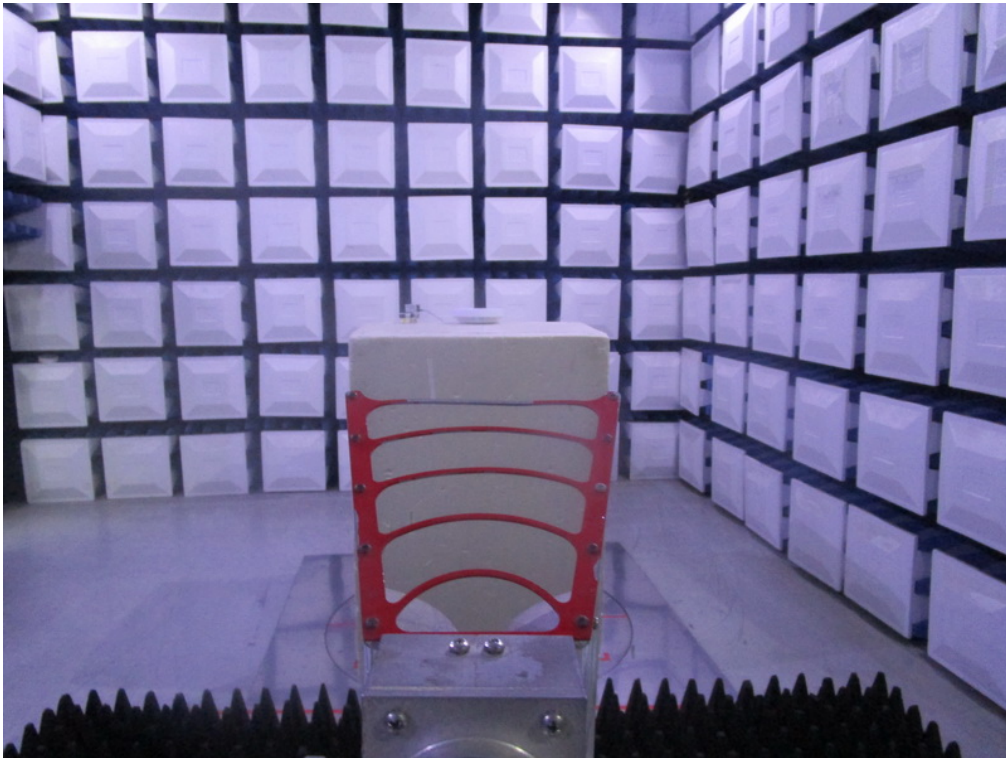

**Conducted Test Photos**

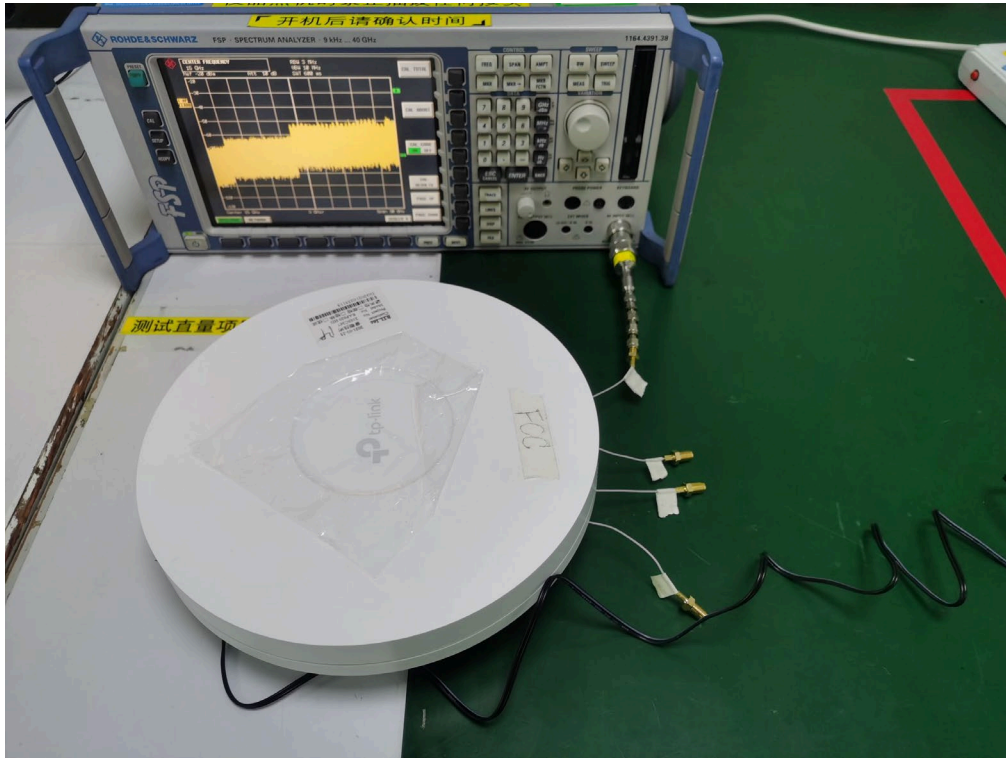

## **APPENDIX A - AC POWER LINE CONDUCTED EMISSIONS**

Test Mode: TX A MODE CHANNEL 149

Line

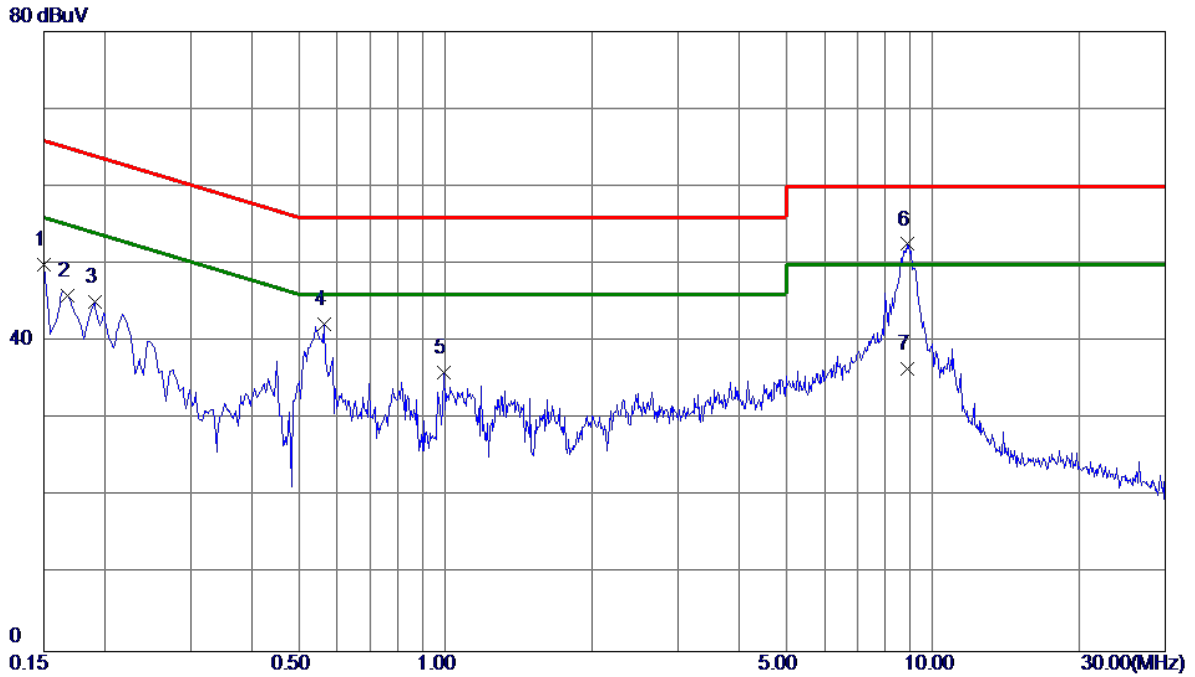

No.	Freq. MHz	Reading Level dBuV	Correct Factor dB	Measure ment dBuV	Limit dBuV	Margin dB	Detector	Comment
1	0.1500	40.30	9.67	49.97	66.00	-16.03	Peak	
2	0.1680	36.14	9.80	45.94	65.06	-19.12	Peak	
3	0.1905	35.30	9.88	45.18	64.01	-18.83	Peak	
4	0.5639	32.25	9.94	42.19	56.00	-13.81	Peak	
5	0.9915	26.04	9.98	36.02	56.00	-19.98	Peak	
6 *	8.8935	41.99	10.57	52.56	60.00	-7.44	Peak	
7	8.8935	25.90	10.57	36.47	50.00	-13.53	AVG	

REMARKS:

- (1) Measurement Value = Reading Level + Correct Factor.
- (2) Margin Level = Measurement Value - Limit Value.
- (3) The test result has included the cable loss.

Test Mode: TX A MODE CHANNEL 149

Neutral

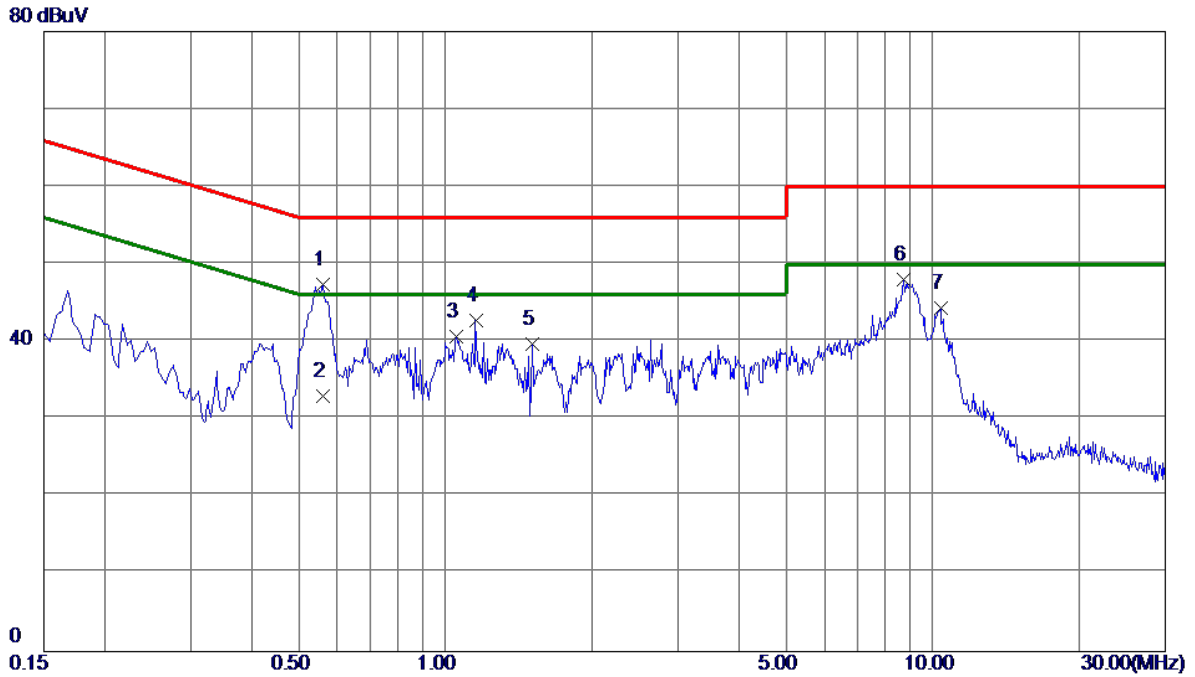

No.	Freq. MHz	Reading Level dBuV	Correct Factor dB	Measurement dBuV	Limit dBuV	Margin dB	Detector	Comment
1 *	0.5595	37.28	10.15	47.43	56.00	-8.57	Peak	
2	0.5595	22.80	10.15	32.95	46.00	-13.05	AVG	
3	1.0500	30.33	10.28	40.61	56.00	-15.39	Peak	
4	1.1535	32.40	10.29	42.69	56.00	-13.31	Peak	
5	1.5045	29.40	10.33	39.73	56.00	-16.27	Peak	
6	8.7180	37.03	10.91	47.94	60.00	-12.06	Peak	
7	10.3875	33.32	11.02	44.34	60.00	-15.66	Peak	

REMARKS:

- (1) Measurement Value = Reading Level + Correct Factor.
- (2) Margin Level = Measurement Value - Limit Value.
- (3) The test result has included the cable loss.



**APPENDIX B - RADIATED EMISSION - 9 KHZ TO 30 MHZ**

Test Mode: TX A MODE CHANNEL 149

0°

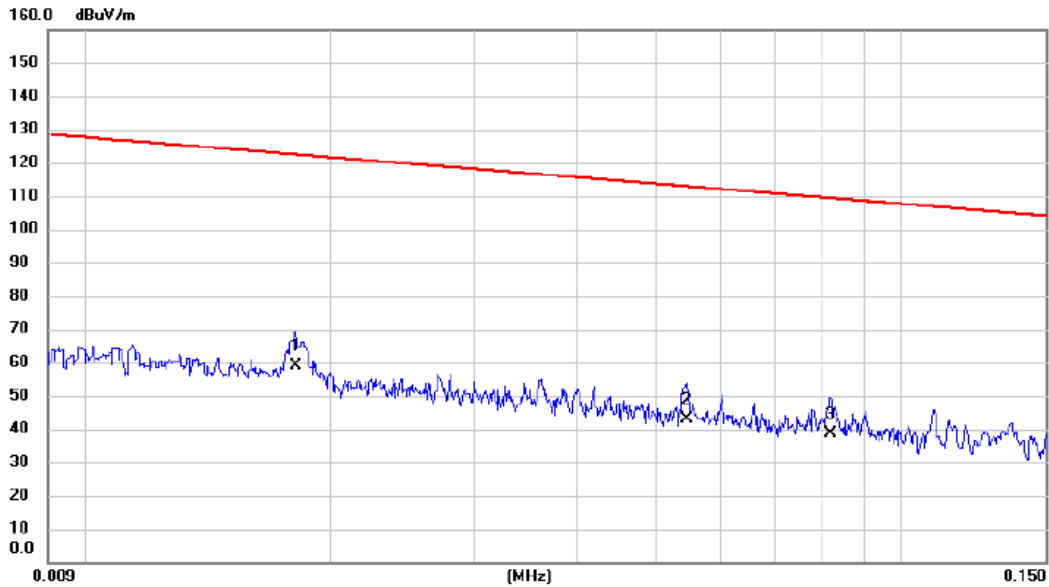

No.	Mk.	Freq. MHz	Reading Level dBuV	Correct Factor dB	Measure- ment dBuV/m	Limit dBuV/m	Margin dB	Detector	Comment
1	*	0.0181	45.23	13.81	59.04	122.45	-63.41	AVG	
2		0.0546	30.69	12.45	43.14	112.86	-69.72	AVG	
3		0.0817	25.88	12.61	38.49	109.36	-70.87	AVG	

REMARKS:

- (1) Measurement Value = Reading Level + Correct Factor.
- (2) Margin Level = Measurement Value - Limit Value.
- (3) The test result has included the cable loss.

Test Mode: TX A MODE CHANNEL 149

0°

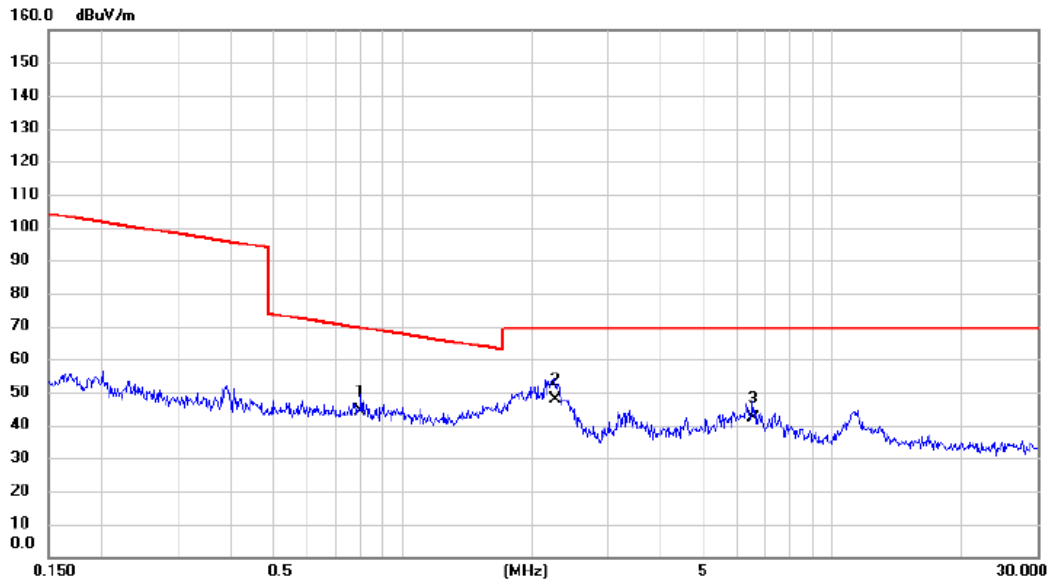

No.	Mk.	Freq. MHz	Reading Level dBuV	Correct Factor dB	Measure- ment dBuV/m	Limit dBuV/m	Margin dB	Detector	Comment
1		0.8002	32.28	11.88	44.16	69.54	-25.38	QP	
2	*	2.2606	36.76	11.17	47.93	69.54	-21.61	QP	
3		6.5227	30.91	11.21	42.12	69.54	-27.42	QP	

REMARKS:

- (1) Measurement Value = Reading Level + Correct Factor.
- (2) Margin Level = Measurement Value - Limit Value.
- (3) The test result has included the cable loss.

Test Mode: TX A MODE CHANNEL 149

90°

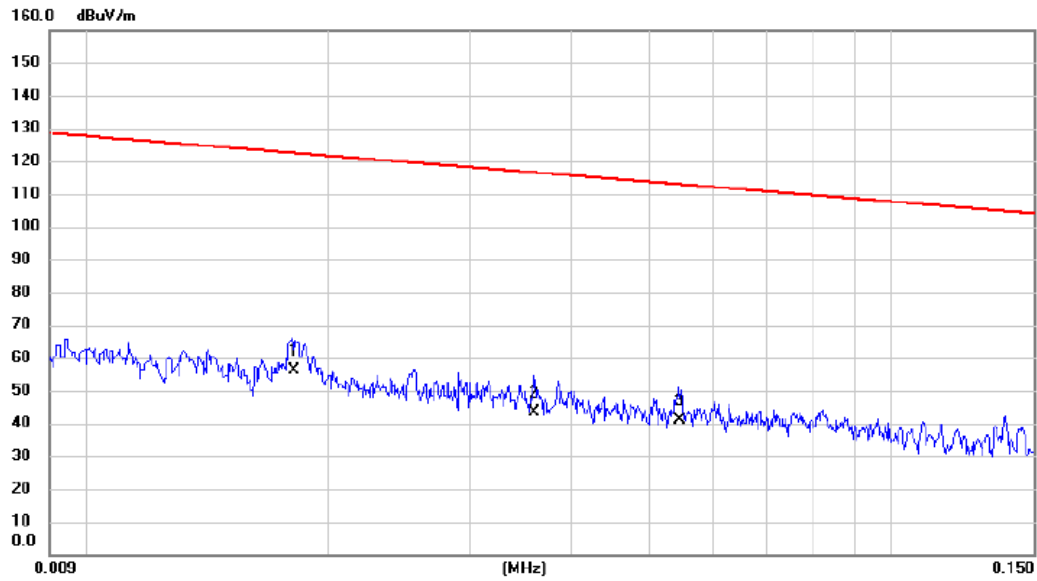

No.	Mk.	Freq.	Reading Level	Correct Factor	Measurement	Limit	Margin	Detector	Comment
		MHz	dBuV	dB	dBuV/m	dBuV/m	dB		
1	*	0.0181	42.51	13.81	56.32	122.45	-66.13	AVG	
2		0.0360	30.79	12.79	43.58	116.48	-72.90	AVG	
3		0.0545	28.53	12.45	40.98	112.88	-71.90	AVG	

REMARKS:

- (1) Measurement Value = Reading Level + Correct Factor.
- (2) Margin Level = Measurement Value - Limit Value.
- (3) The test result has included the cable loss.

Test Mode: TX A MODE CHANNEL 149

90°

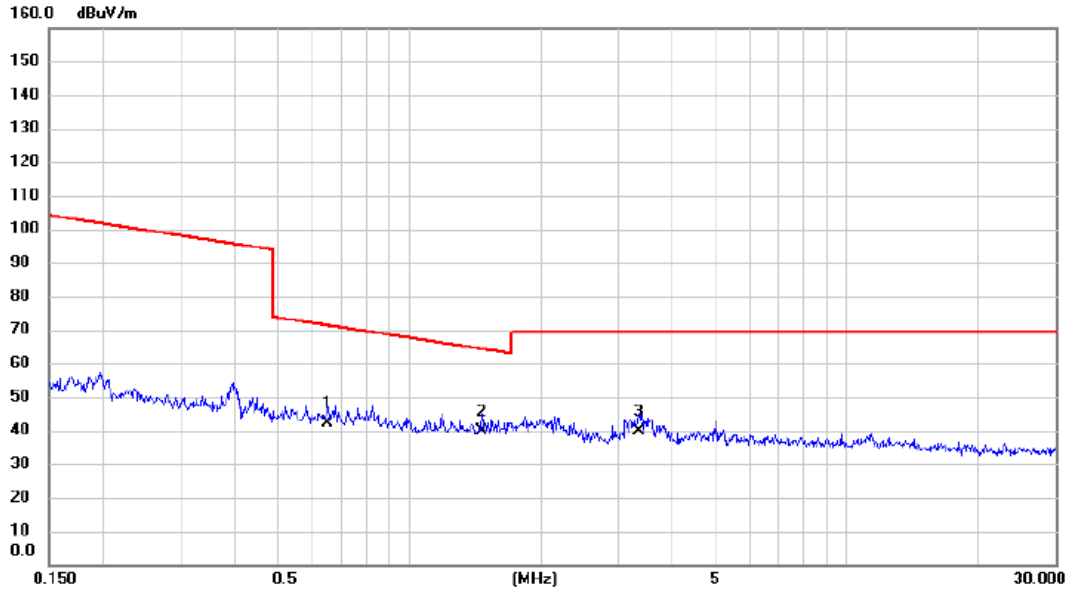

No.	Mk.	Freq. MHz	Reading Level dBuV	Correct Factor dB	Measure- ment dBuV/m	Limit dBuV/m	Margin dB	Detector	Comment
1		0.6508	30.11	11.95	42.06	71.34	-29.28	QP	
2	*	1.4640	28.26	11.57	39.83	64.29	-24.46	QP	
3		3.3458	28.96	10.85	39.81	69.54	-29.73	QP	

**REMARKS:**

- (1) Measurement Value = Reading Level + Correct Factor.
- (2) Margin Level = Measurement Value - Limit Value.
- (3) The test result has included the cable loss.

## **APPENDIX C - RADIATED EMISSION - 30 MHZ TO 1 GHZ**

Test Mode: TX A MODE CHANNEL 149

### Vertical

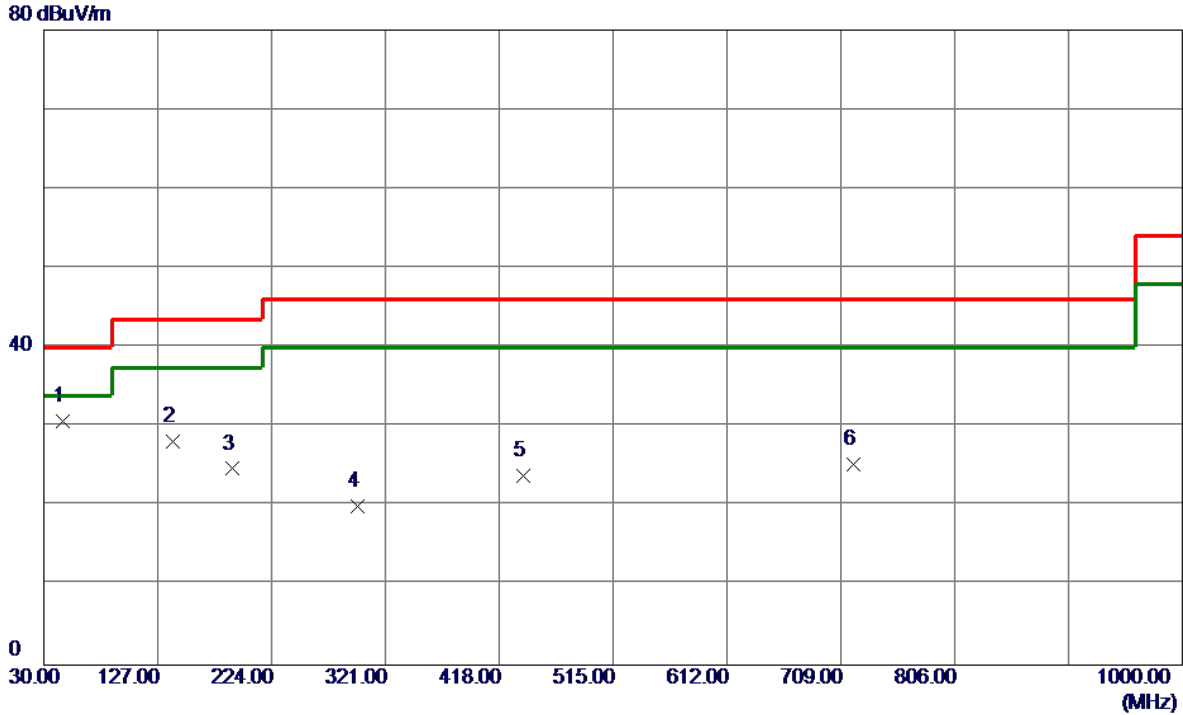

No.	Freq. MHz	Reading Level dBuV/m	Correct Factor dB	Measure ment dBuV/m	Limit dBuV/m	Margin dB	Detector	Comment
1 *	46.4900	44.63	-13.97	30.66	40.00	-9.34	Peak	
2	139.6100	40.71	-12.56	28.15	43.50	-15.35	Peak	
3	190.0500	38.82	-14.10	24.72	43.50	-18.78	Peak	
4	297.7200	31.06	-11.11	19.95	46.00	-26.05	Peak	
5	438.3700	31.79	-7.95	23.84	46.00	-22.16	Peak	
6	719.6700	28.75	-3.43	25.32	46.00	-20.68	Peak	

**REMARKS:**

- (1) Measurement Value = Reading Level + Correct Factor.
- (2) Margin Level = Measurement Value - Limit Value.

Test Mode: TX A MODE CHANNEL 149

### Horizontal

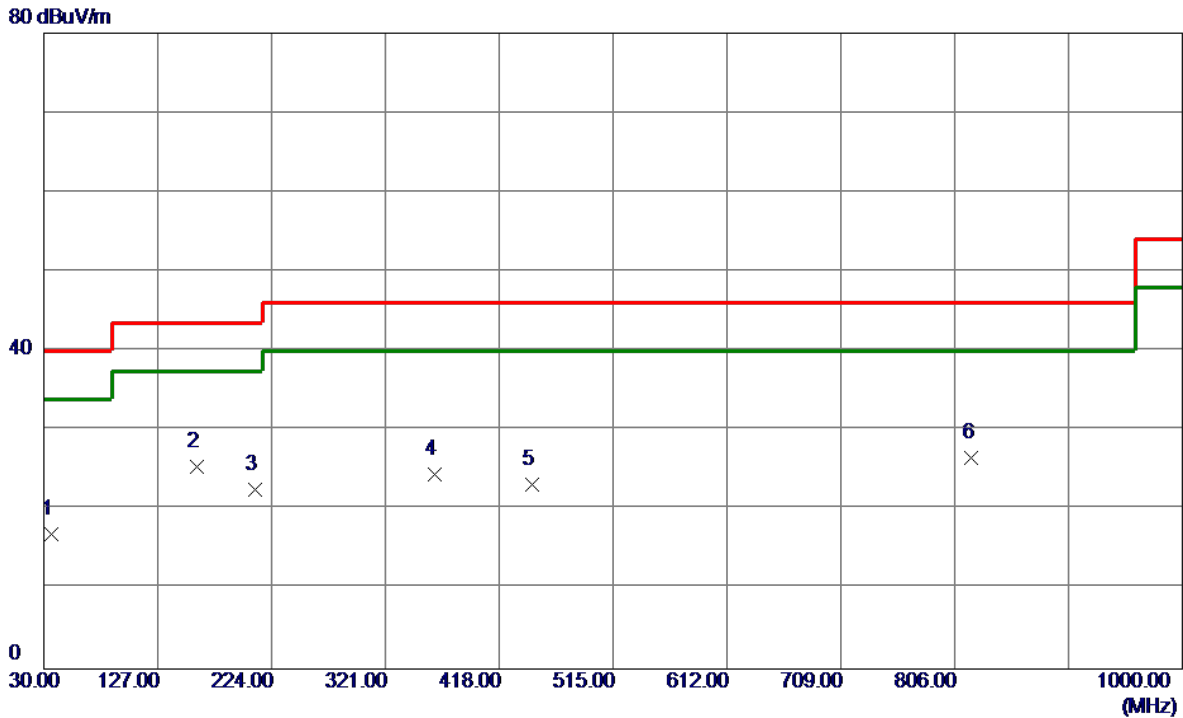

No.	Freq. MHz	Reading Level dBuV/m	Correct Factor dB	Measure ment dBuV/m	Limit dBuV/m	Margin dB	Detector	Comment
1	36.7900	31.29	-14.28	17.01	40.00	-22.99	Peak	
2 *	159.9800	36.15	-10.67	25.48	43.50	-18.02	Peak	
3	210.4200	37.68	-15.18	22.50	43.50	-21.00	Peak	
4	362.7100	34.34	-9.90	24.44	46.00	-21.56	Peak	
5	446.1300	30.87	-7.74	23.13	46.00	-22.87	Peak	
6	820.5500	28.77	-2.21	26.56	46.00	-19.44	Peak	

**REMARKS:**

- (1) Measurement Value = Reading Level + Correct Factor.
- (2) Margin Level = Measurement Value - Limit Value.



## **APPENDIX D - RADIATED EMISSION - ABOVE 1000 MHZ**

Orthogonal Axis	X
Test Mode	UNII-1_TX A Mode 5180 MHz

### Vertical

130 dBuV/m

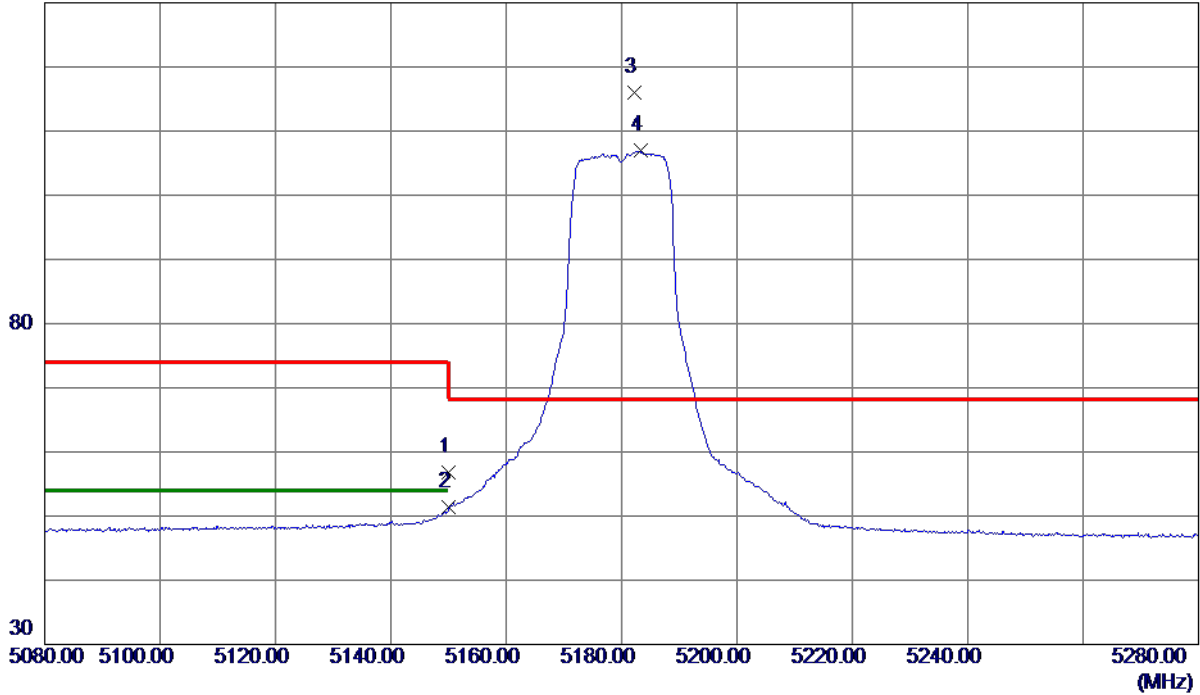

No.	Freq. MHz	Reading Level dBuV/m	Correct Factor dB	Measure ment dBuV/m	Limit dBuV/m	Margin dB	Detector	Comment
1	5150.0000	37.62	19.25	56.87	74.00	-17.13	Peak	
2	5150.0000	32.13	19.25	51.38	54.00	-2.62	AVG	
3 *	5182.3000	96.77	19.32	116.09	68.20	47.89	Peak	No Limit
4	5183.3000	87.58	19.32	106.90	999.00	-892.10	AVG	No Limit

**REMARKS:**

- (1) Measurement Value = Reading Level + Correct Factor.
- (2) Margin Level = Measurement Value - Limit Value.

Orthogonal Axis	X
Test Mode	UNII-1_TX A Mode 5180 MHz

### Vertical

80 dBuV/m

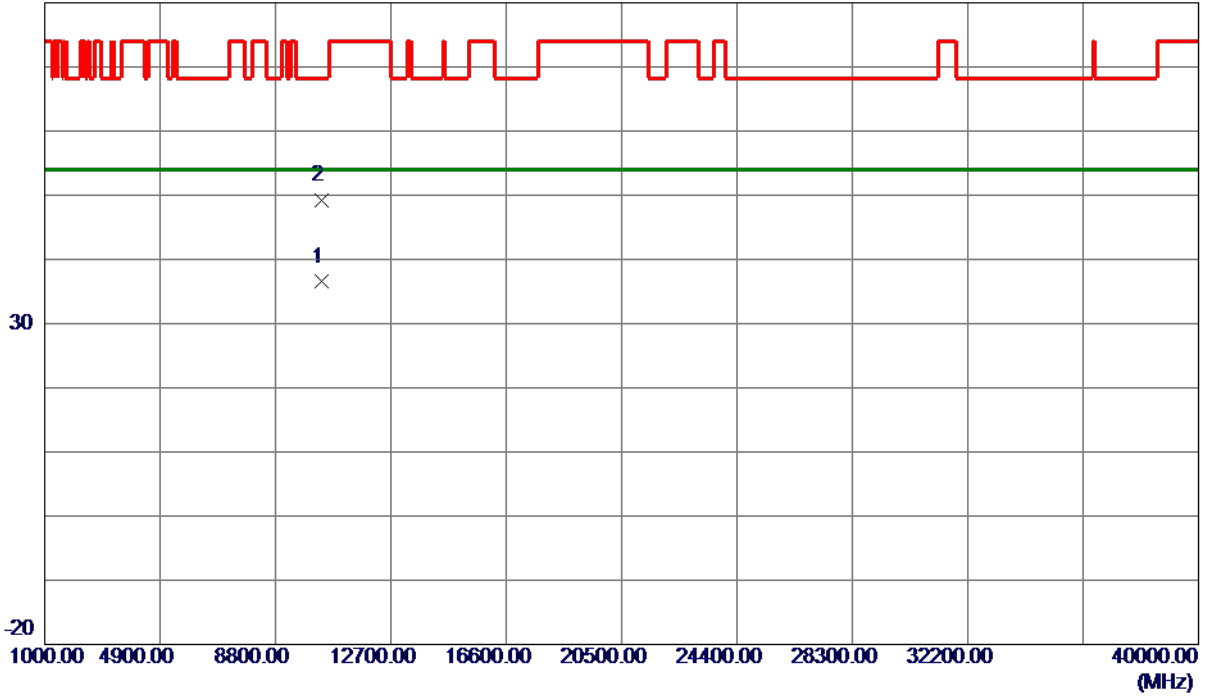

No.	Freq. MHz	Reading Level dBuV/m	Correct Factor dB	Measure ment dBuV/m	Limit dBuV/m	Margin dB	Detector	Comment
1 *	10360.2670	21.41	15.09	36.50	54.00	-17.50	AVG	
2	10360.8370	34.03	15.09	49.12	68.30	-19.18	Peak	

**REMARKS:**

- (1) Measurement Value = Reading Level + Correct Factor.
- (2) Margin Level = Measurement Value - Limit Value.

Orthogonal Axis	X
Test Mode	UNII-1_TX A Mode 5180 MHz

### Horizontal

130 dBuV/m

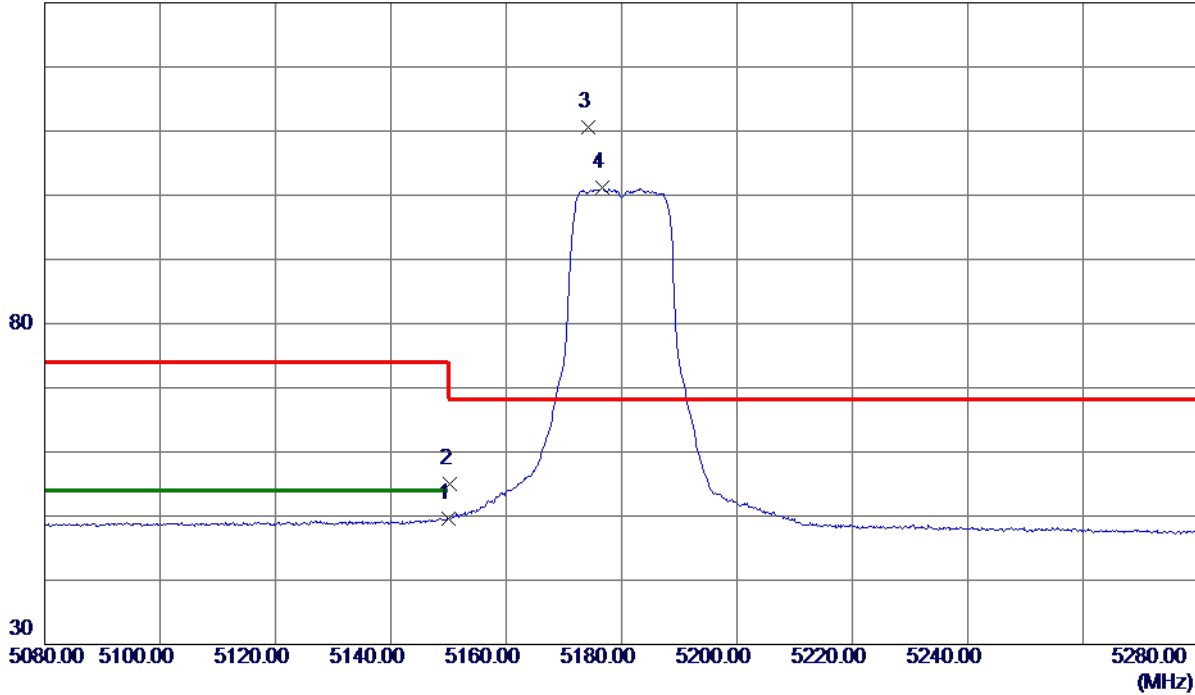

No.	Freq. MHz	Reading Level dBuV/m	Correct Factor dB	Measure ment dBuV/m	Limit dBuV/m	Margin dB	Detector	Comment
1	5150.0000	30.41	19.25	49.66	54.00	-4.34	AVG	
2	5150.2000	35.81	19.25	55.06	68.20	-13.14	Peak	
3 *	5174.3000	91.28	19.30	110.58	68.20	42.38	Peak	No Limit
4	5176.6000	81.80	19.31	101.11	999.00	-897.89	AVG	No Limit

**REMARKS:**

- (1) Measurement Value = Reading Level + Correct Factor.
- (2) Margin Level = Measurement Value - Limit Value.

Orthogonal Axis	X
Test Mode	UNII-1_TX A Mode 5180 MHz

### Horizontal

80 dBuV/m

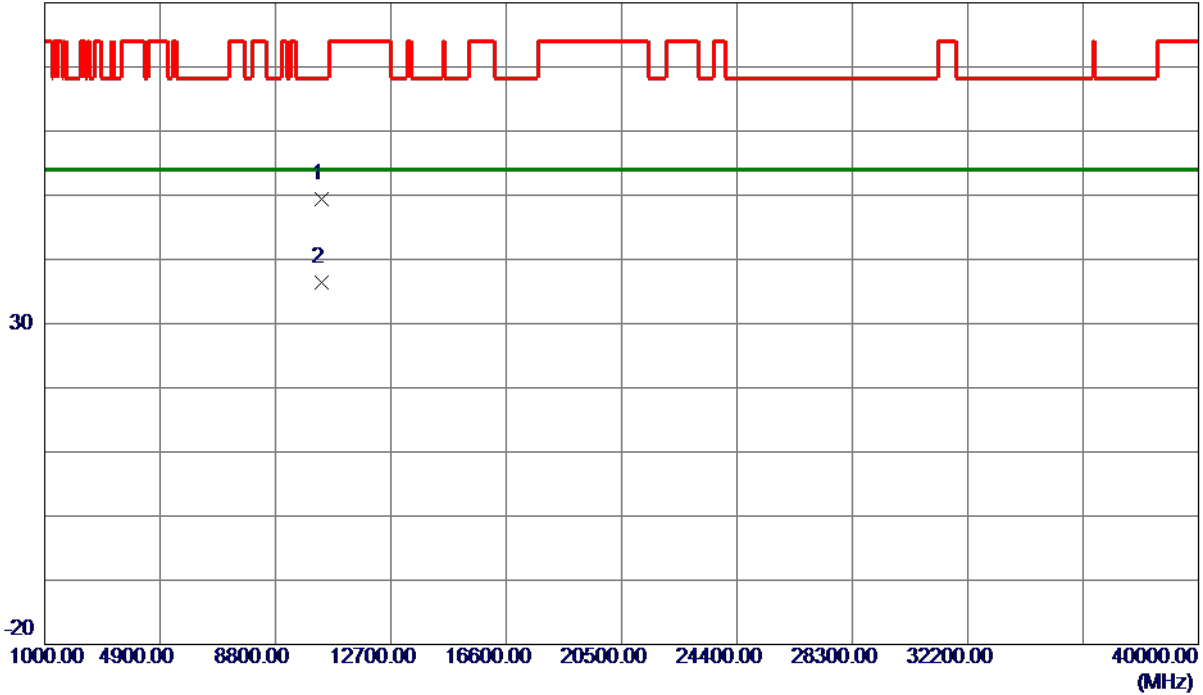

No.	Freq. MHz	Reading Level dBuV/m	Correct Factor dB	Measure ment dBuV/m	Limit dBuV/m	Margin dB	Detector	Comment
1	10360.1700	34.35	15.09	49.44	68.30	-18.86	Peak	
2 *	10360.2280	21.39	15.09	36.48	54.00	-17.52	AVG	

**REMARKS:**

- (1) Measurement Value = Reading Level + Correct Factor.
- (2) Margin Level = Measurement Value - Limit Value.

Orthogonal Axis	X
Test Mode	UNII-1_TX A Mode 5200 MHz

### Vertical

130 dBuV/m

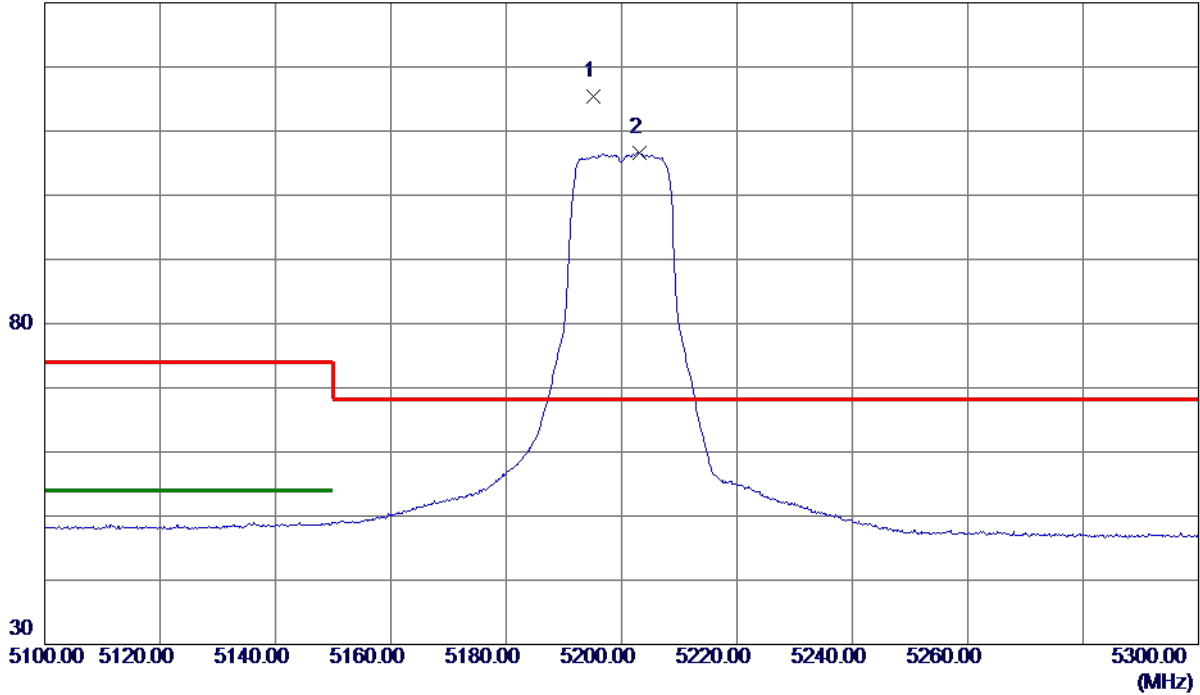

No.	Freq. MHz	Reading Level dBuV/m	Correct Factor dB	Measure ment dBuV/m	Limit dBuV/m	Margin dB	Detector	Comment
1 *	5195.2000	95.96	19.35	115.31	68.20	47.11	Peak	No Limit
2	5203.2000	87.30	19.37	106.67	999.00	-892.33	AVG	No Limit

**REMARKS:**

- (1) Measurement Value = Reading Level + Correct Factor.
- (2) Margin Level = Measurement Value - Limit Value.

Orthogonal Axis	X
Test Mode	UNII-1_TX A Mode 5200 MHz

### Vertical

80 dBuV/m

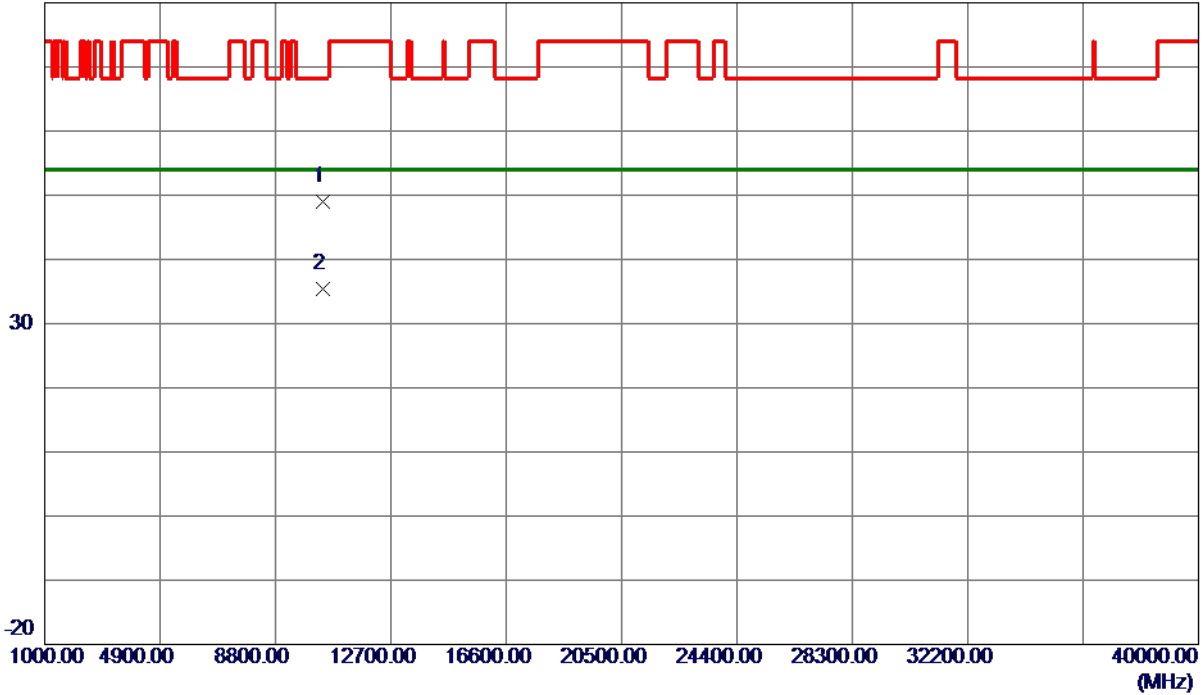

No.	Freq. MHz	Reading Level dBuV/m	Correct Factor dB	Measure ment dBuV/m	Limit dBuV/m	Margin dB	Detector	Comment
1	10397.5450	33.80	15.15	48.95	68.30	-19.35	Peak	
2 *	10399.2250	20.33	15.15	35.48	54.00	-18.52	AVG	

**REMARKS:**

- (1) Measurement Value = Reading Level + Correct Factor.
- (2) Margin Level = Measurement Value - Limit Value.

Orthogonal Axis	X
Test Mode	UNII-1_TX A Mode 5200 MHz

### Horizontal

130 dBuV/m

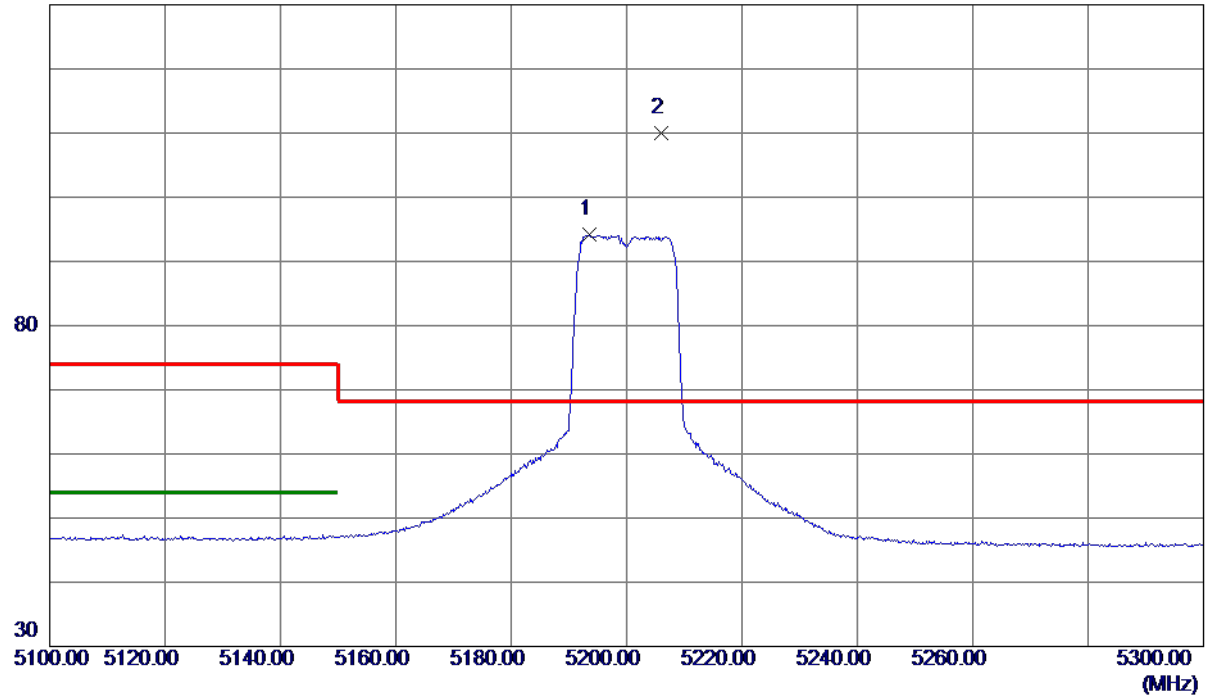

No.	Freq. MHz	Reading Level dBuV/m	Correct Factor dB	Measure ment dBuV/m	Limit dBuV/m	Margin dB	Detector	Comment
1	5193.5000	76.33	17.80	94.13	999.00	-904.87	AVG	No Limit
2 *	5205.9000	92.14	17.83	109.97	68.20	41.77	Peak	No Limit

**REMARKS:**

- (1) Measurement Value = Reading Level + Correct Factor.
- (2) Margin Level = Measurement Value - Limit Value.



Orthogonal Axis	X
Test Mode	UNII-1_TX A Mode 5200 MHz

### Horizontal

80 dBuV/m

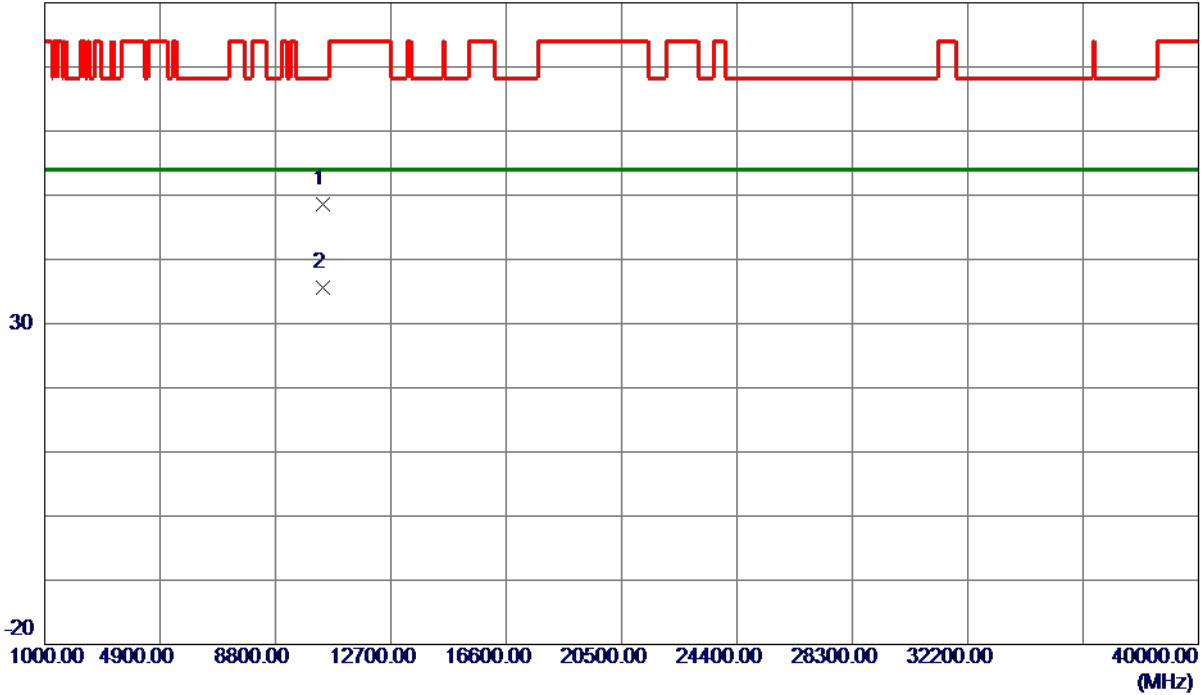

No.	Freq. MHz	Reading Level dBuV/m	Correct Factor dB	Measure ment dBuV/m	Limit dBuV/m	Margin dB	Detector	Comment
1	10400.3099	33.43	15.16	48.59	68.30	-19.71	Peak	
2 *	10402.3720	20.53	15.16	35.69	54.00	-18.31	AVG	

**REMARKS:**

- (1) Measurement Value = Reading Level + Correct Factor.
- (2) Margin Level = Measurement Value - Limit Value.

Orthogonal Axis	X
Test Mode	UNII-1_TX A Mode 5240 MHz

**Vertical**

130 dBuV/m

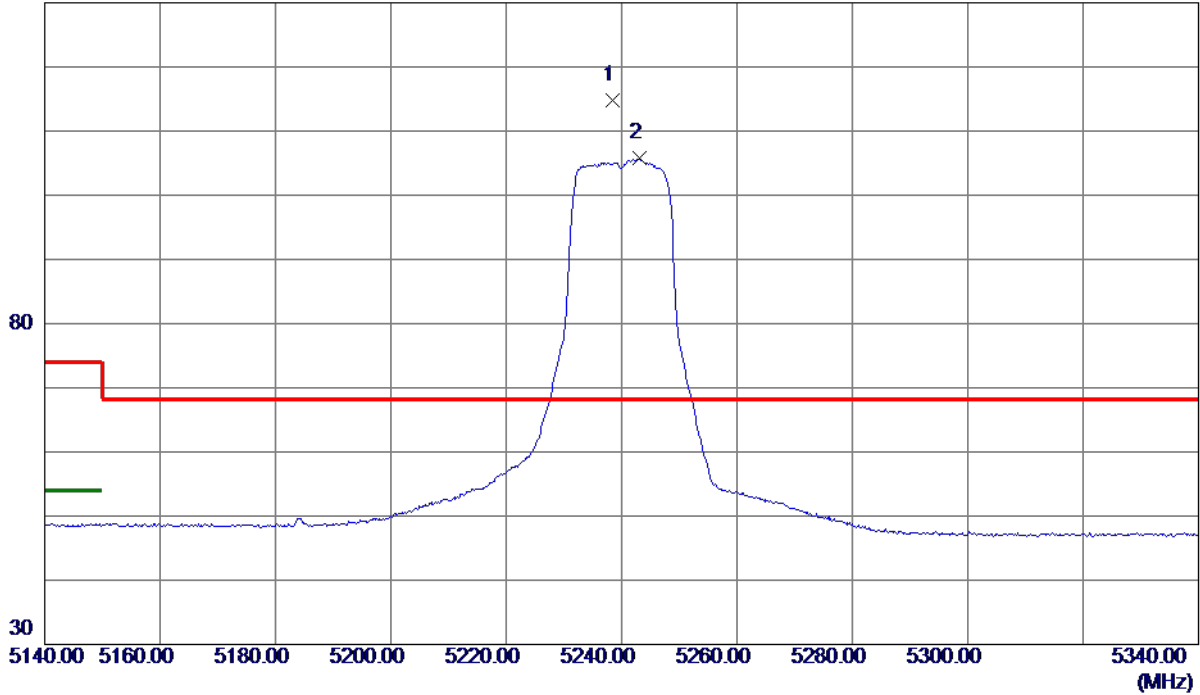

No.	Freq. MHz	Reading Level dBuV/m	Correct Factor dB	Measure ment dBuV/m	Limit dBuV/m	Margin dB	Detector	Comment
1 *	5238.5000	95.35	19.46	114.81	68.20	46.61	Peak	No Limit
2	5243.1000	86.26	19.47	105.73	999.00	-893.27	AVG	No Limit

**REMARKS:**

- (1) Measurement Value = Reading Level + Correct Factor.
- (2) Margin Level = Measurement Value - Limit Value.

Orthogonal Axis	X
Test Mode	UNII-1_TX A Mode 5240 MHz

### Vertical

80 dBuV/m

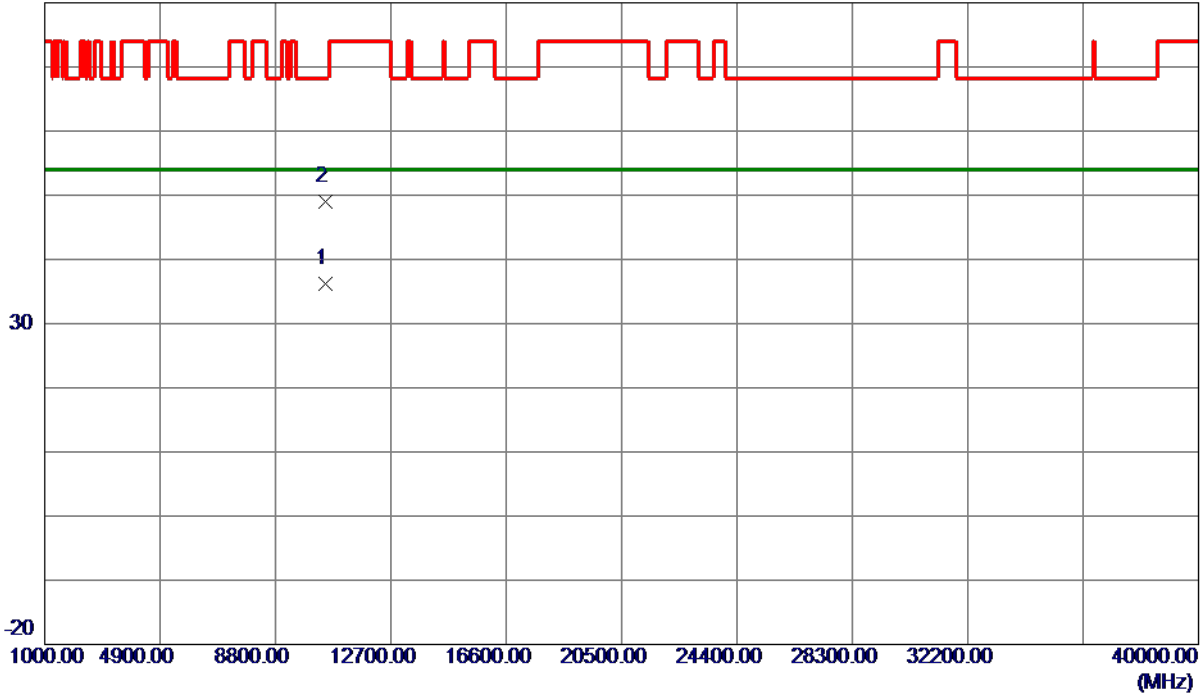

No.	Freq. MHz	Reading Level dBuV/m	Correct Factor dB	Measure ment dBuV/m	Limit dBuV/m	Margin dB	Detector	Comment
1 *	10479.3300	20.83	15.29	36.12	54.00	-17.88	AVG	
2	10481.9500	33.61	15.30	48.91	68.30	-19.39	Peak	

**REMARKS:**

- (1) Measurement Value = Reading Level + Correct Factor.
- (2) Margin Level = Measurement Value - Limit Value.

Orthogonal Axis	X
Test Mode	UNII-1_TX A Mode 5240 MHz

### Horizontal

130 dBuV/m

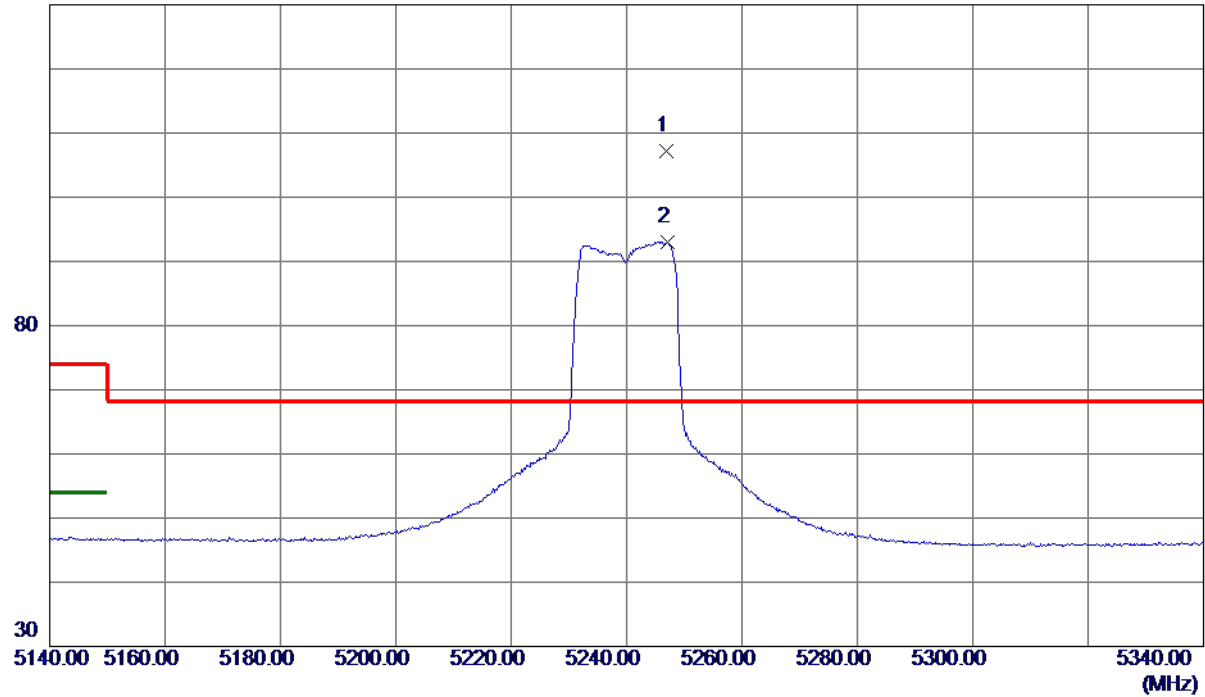

No.	Freq. MHz	Reading Level dBuV/m	Correct Factor dB	Measure ment dBuV/m	Limit dBuV/m	Margin dB	Detector	Comment
1 *	5246.8000	89.21	17.94	107.15	68.20	38.95	Peak	No Limit
2	5247.2000	75.09	17.94	93.03	999.00	-905.97	AVG	No Limit

**REMARKS:**

- (1) Measurement Value = Reading Level + Correct Factor.
- (2) Margin Level = Measurement Value - Limit Value.

Orthogonal Axis	X
Test Mode	UNII-1_TX A Mode 5240 MHz

### Horizontal

80 dBuV/m

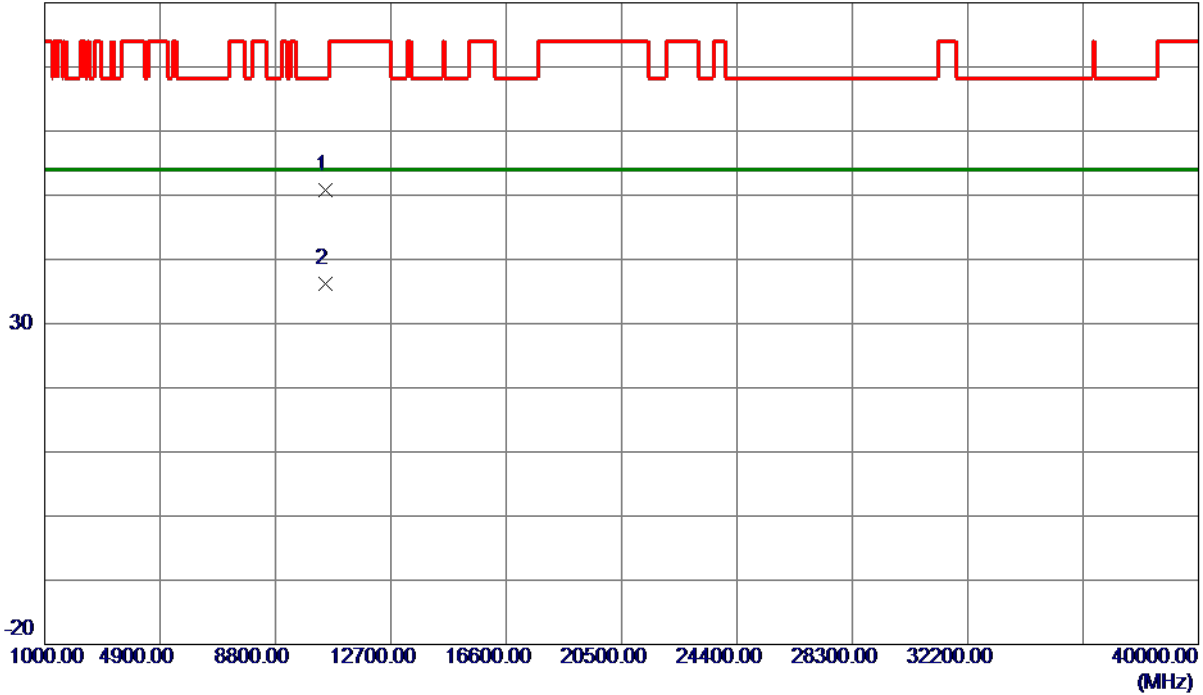

No.	Freq. MHz	Reading Level dBuV/m	Correct Factor dB	Measure ment dBuV/m	Limit dBuV/m	Margin dB	Detector	Comment
1 *	10478.6570	35.59	15.29	50.88	68.30	-17.42	Peak	
2	10480.0150	20.92	15.30	36.22	54.00	-17.78	AVG	

**REMARKS:**

- (1) Measurement Value = Reading Level + Correct Factor.
- (2) Margin Level = Measurement Value - Limit Value.

Orthogonal Axis	X
Test Mode	UNII-3_TX A Mode 5745 MHz

### Vertical

130 dBuV/m

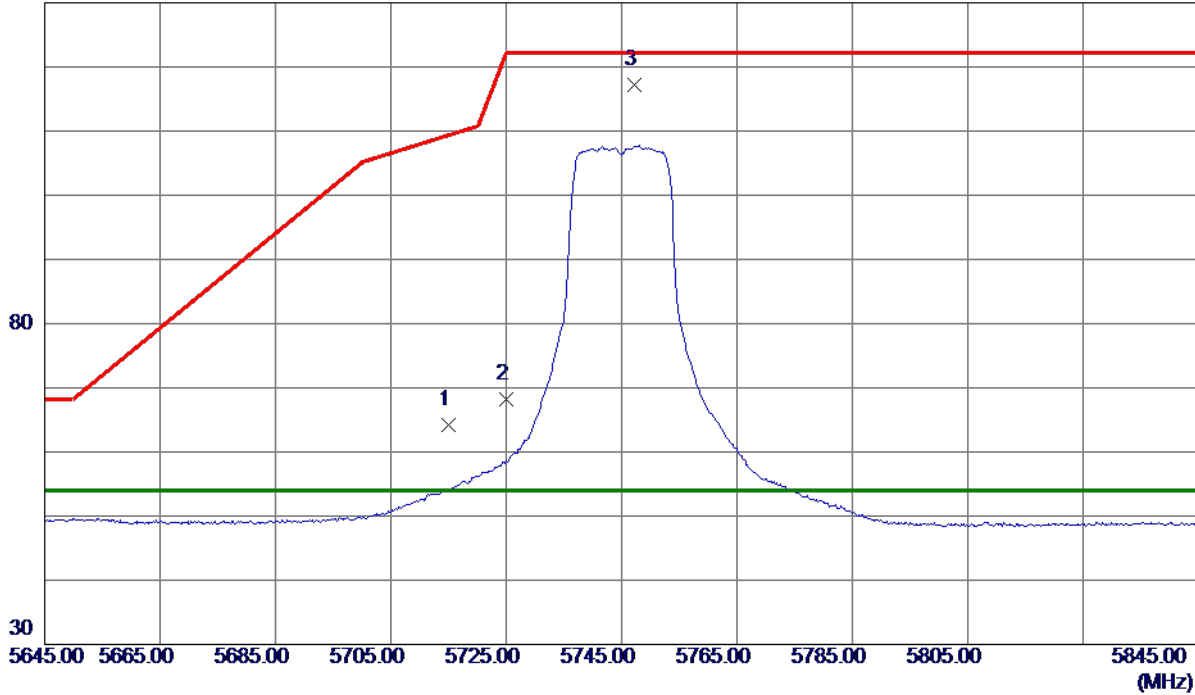

No.	Freq. MHz	Reading Level dBuV/m	Correct Factor dB	Measure ment dBuV/m	Limit dBuV/m	Margin dB	Detector	Comment
1	5715.0000	43.38	20.87	64.25	109.40	-45.15	Peak	
2	5725.0000	47.32	20.91	68.23	122.20	-53.97	Peak	
3 *	5747.3000	96.24	20.99	117.23	122.20	-4.97	Peak	No Limit

**REMARKS:**

- (1) Measurement Value = Reading Level + Correct Factor.
- (2) Margin Level = Measurement Value - Limit Value.

Orthogonal Axis	X
Test Mode	UNII-3_TX A Mode 5745 MHz

### Vertical

80 dBuV/m

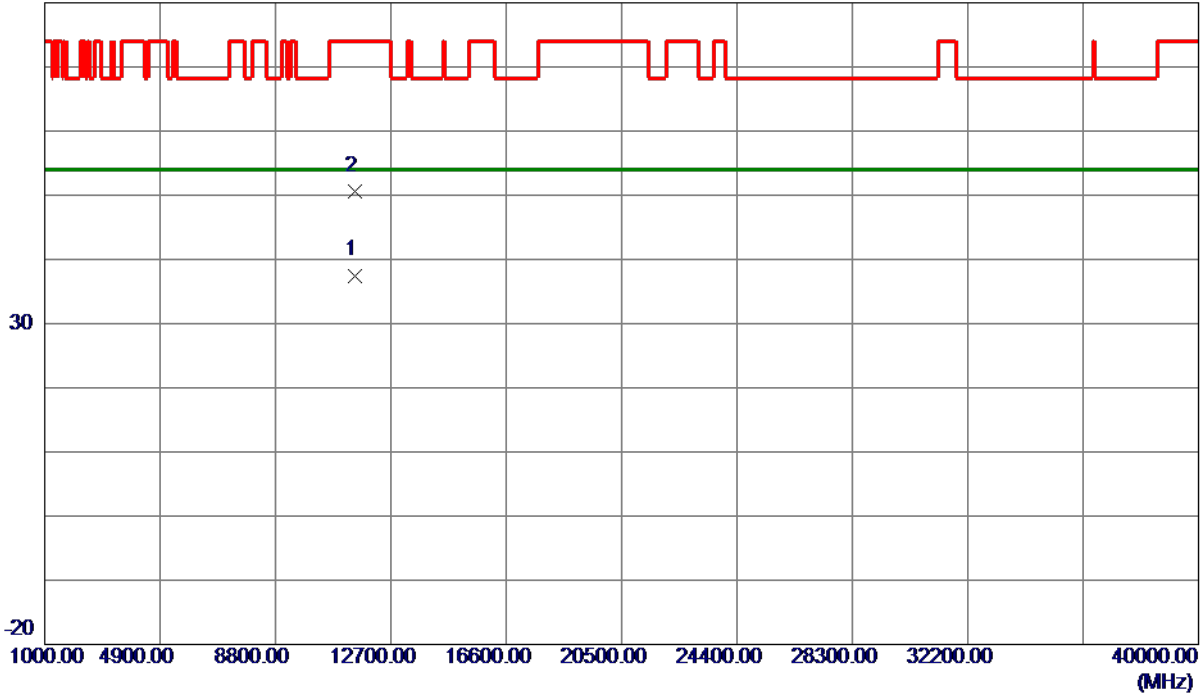

No.	Freq. MHz	Reading Level dBuV/m	Correct Factor dB	Measure ment dBuV/m	Limit dBuV/m	Margin dB	Detector	Comment
1 *	11487.9200	20.41	17.09	37.50	54.00	-16.50	AVG	
2	11491.8130	33.59	17.10	50.69	74.00	-23.31	Peak	

**REMARKS:**

- (1) Measurement Value = Reading Level + Correct Factor.
- (2) Margin Level = Measurement Value - Limit Value.

Orthogonal Axis	X
Test Mode	UNII-3_TX A Mode 5745 MHz

### Horizontal

130 dBuV/m

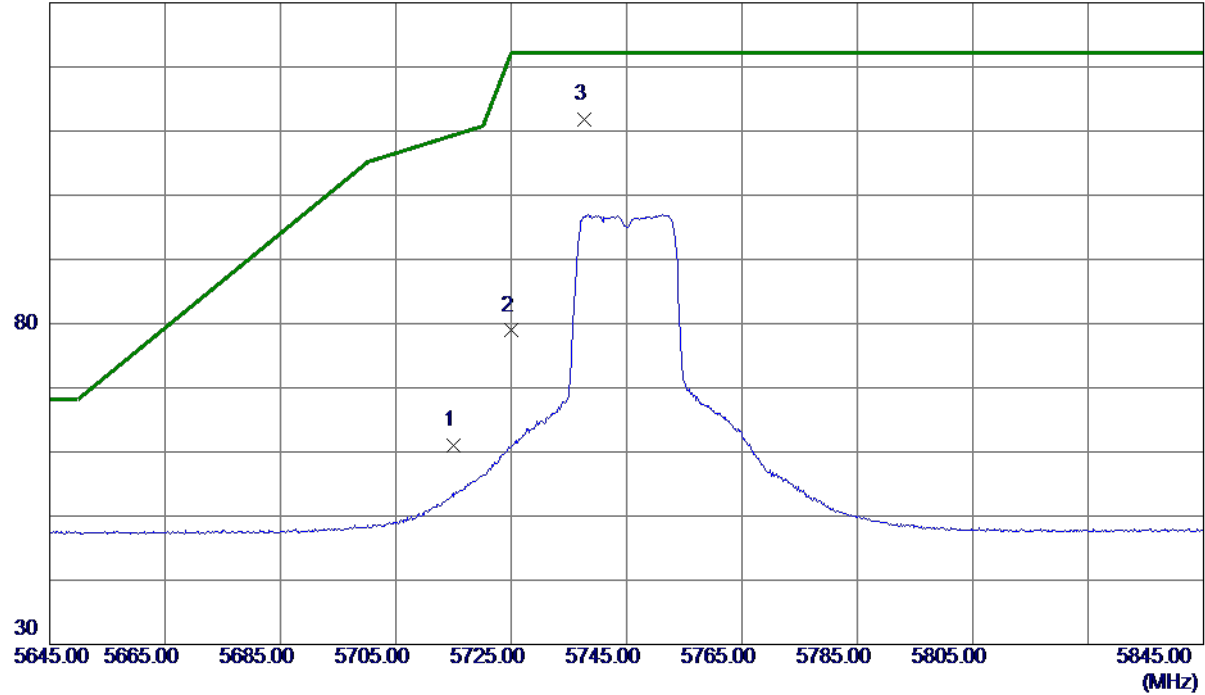

No.	Freq. MHz	Reading Level dBuV/m	Correct Factor dB	Measure ment dBuV/m	Limit dBuV/m	Margin dB	Detector	Comment
1	5715.0000	41.72	19.31	61.03	109.40	-48.37	Peak	
2	5725.0000	59.56	19.34	78.90	122.20	-43.30	Peak	
3 *	5737.6000	92.34	19.38	111.72	122.20	-10.48	Peak	No Limit

**REMARKS:**

- (1) Measurement Value = Reading Level + Correct Factor.
- (2) Margin Level = Measurement Value - Limit Value.



Orthogonal Axis	X
Test Mode	UNII-3_TX A Mode 5745 MHz

### Horizontal

80 dBuV/m

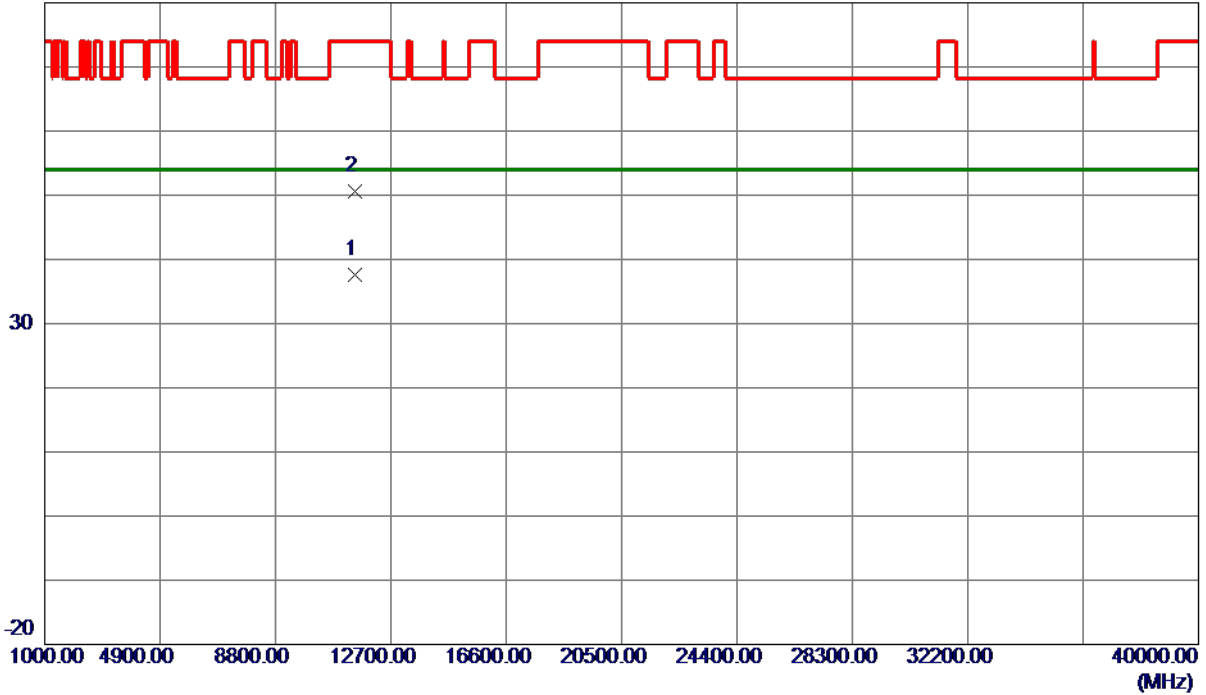

No.	Freq. MHz	Reading Level dBuV/m	Correct Factor dB	Measure ment dBuV/m	Limit dBuV/m	Margin dB	Detector	Comment
1 *	11488.7220	20.52	17.09	37.61	54.00	-16.39	AVG	
2	11488.7820	33.52	17.09	50.61	74.00	-23.39	Peak	

**REMARKS:**

- (1) Measurement Value = Reading Level + Correct Factor.
- (2) Margin Level = Measurement Value - Limit Value.

Orthogonal Axis	X
Test Mode	UNII-3_TX A Mode 5785 MHz

### Vertical

130 dBuV/m

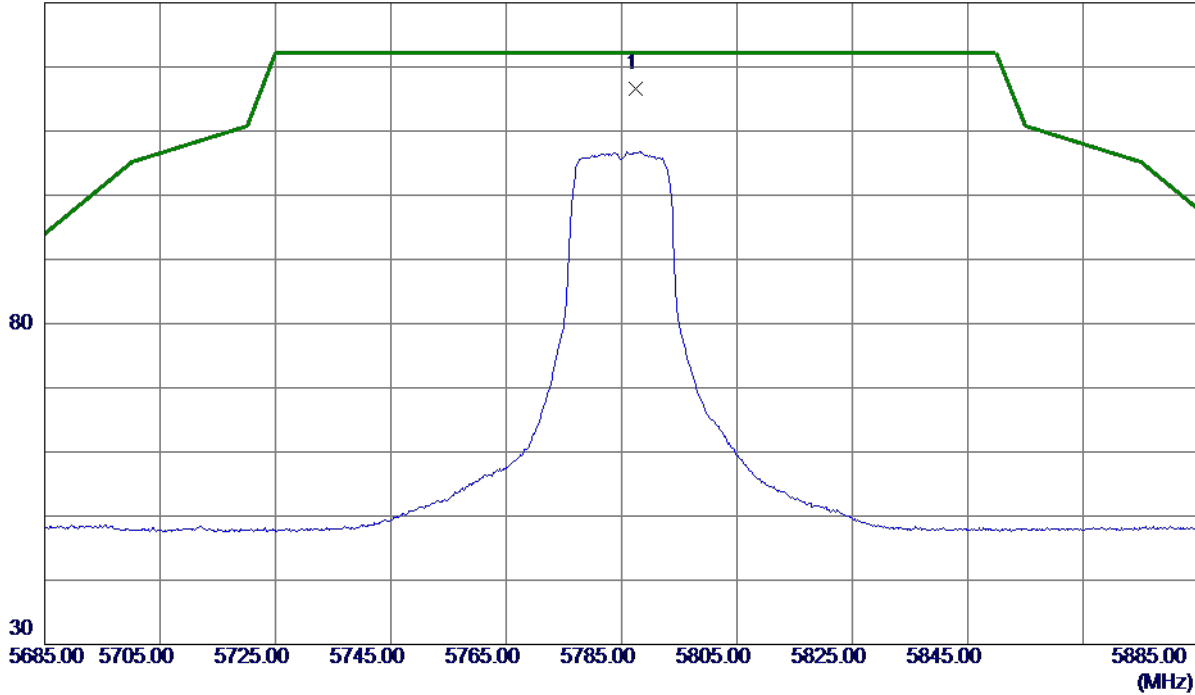

No.	Freq. MHz	Reading Level dBuV/m	Correct Factor dB	Measure ment dBuV/m	Limit dBuV/m	Margin dB	Detector	Comment
1 *	5787.4000	95.45	21.14	116.59	122.20	-5.61	Peak	No Limit

**REMARKS:**

- (1) Measurement Value = Reading Level + Correct Factor.
- (2) Margin Level = Measurement Value - Limit Value.

Orthogonal Axis	X
Test Mode	UNII-3_TX A Mode 5785 MHz

### Vertical

80 dBuV/m

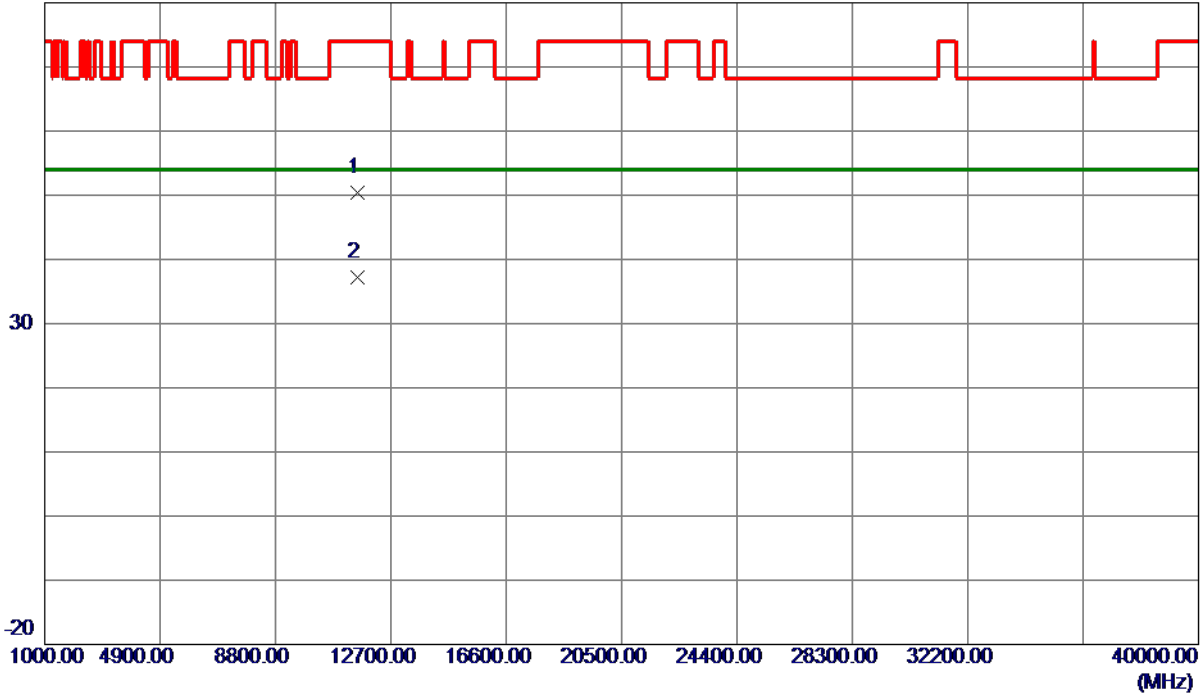

No.	Freq. MHz	Reading Level dBuV/m	Correct Factor dB	Measure ment dBuV/m	Limit dBuV/m	Margin dB	Detector	Comment
1	11571.3370	33.23	17.22	50.45	74.00	-23.55	Peak	
2 *	11572.1350	20.03	17.22	37.25	54.00	-16.75	AVG	

**REMARKS:**

- (1) Measurement Value = Reading Level + Correct Factor.
- (2) Margin Level = Measurement Value - Limit Value.

Orthogonal Axis	X
Test Mode	UNII-3_TX A Mode 5785 MHz

### Horizontal

130 dBuV/m

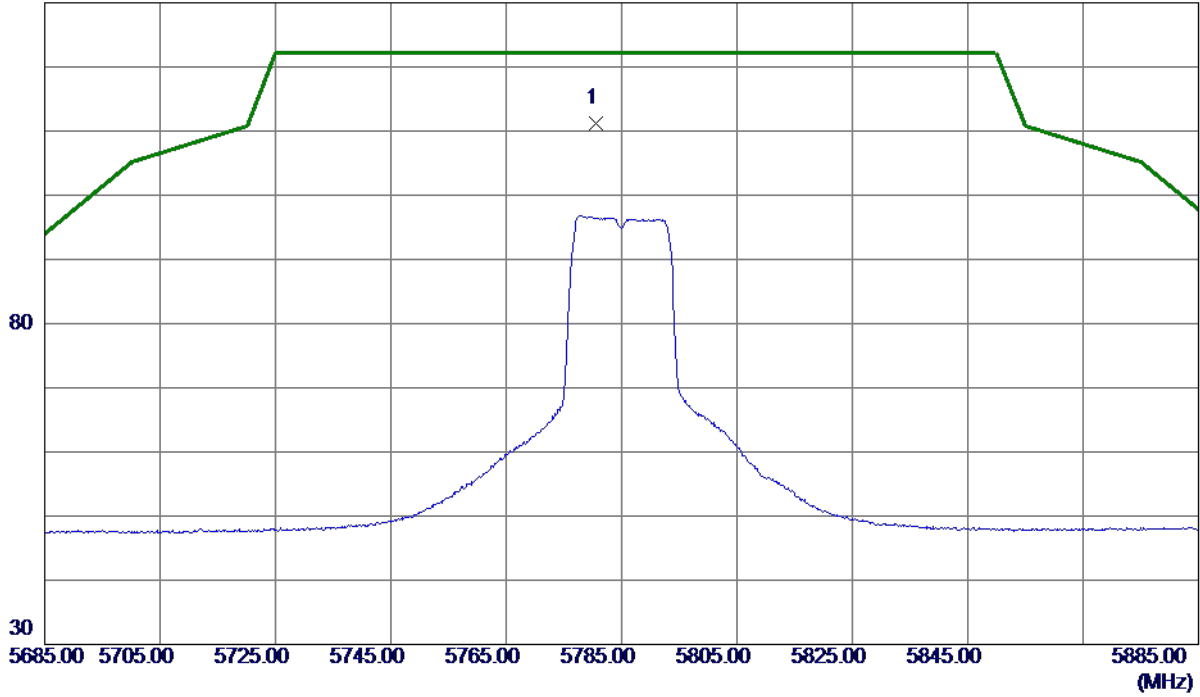

No.	Freq. MHz	Reading Level dBuV/m	Correct Factor dB	Measure ment dBuV/m	Limit dBuV/m	Margin dB	Detector	Comment
1 *	5780.5000	91.75	19.52	111.27	122.20	-10.93	Peak	No Limit

**REMARKS:**

- (1) Measurement Value = Reading Level + Correct Factor.
- (2) Margin Level = Measurement Value - Limit Value.

Orthogonal Axis	X
Test Mode	UNII-3_TX A Mode 5785 MHz

### Horizontal

80 dBuV/m

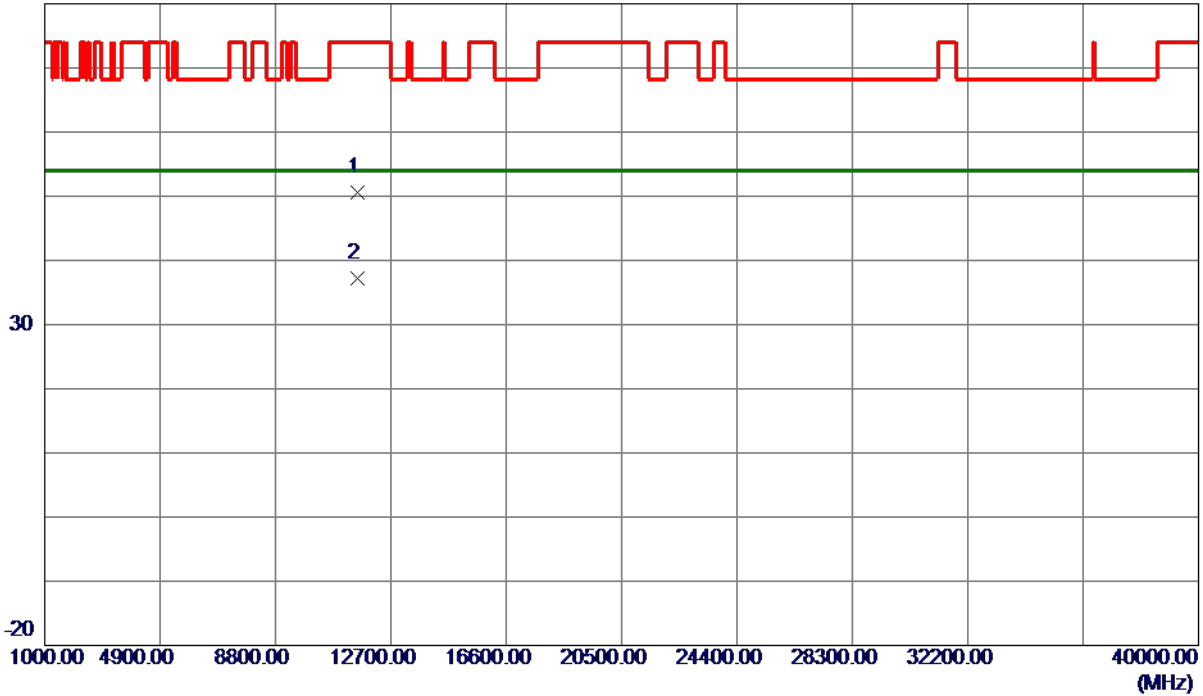

No.	Freq. MHz	Reading Level dBuV/m	Correct Factor dB	Measure ment dBuV/m	Limit dBuV/m	Margin dB	Detector	Comment
1	11568.3080	33.33	17.22	50.55	74.00	-23.45	Peak	
2 *	11570.0250	19.98	17.22	37.20	54.00	-16.80	AVG	

**REMARKS:**

- (1) Measurement Value = Reading Level + Correct Factor.
- (2) Margin Level = Measurement Value - Limit Value.

Orthogonal Axis	X
Test Mode	UNII-3_TX A Mode 5825 MHz

### Vertical

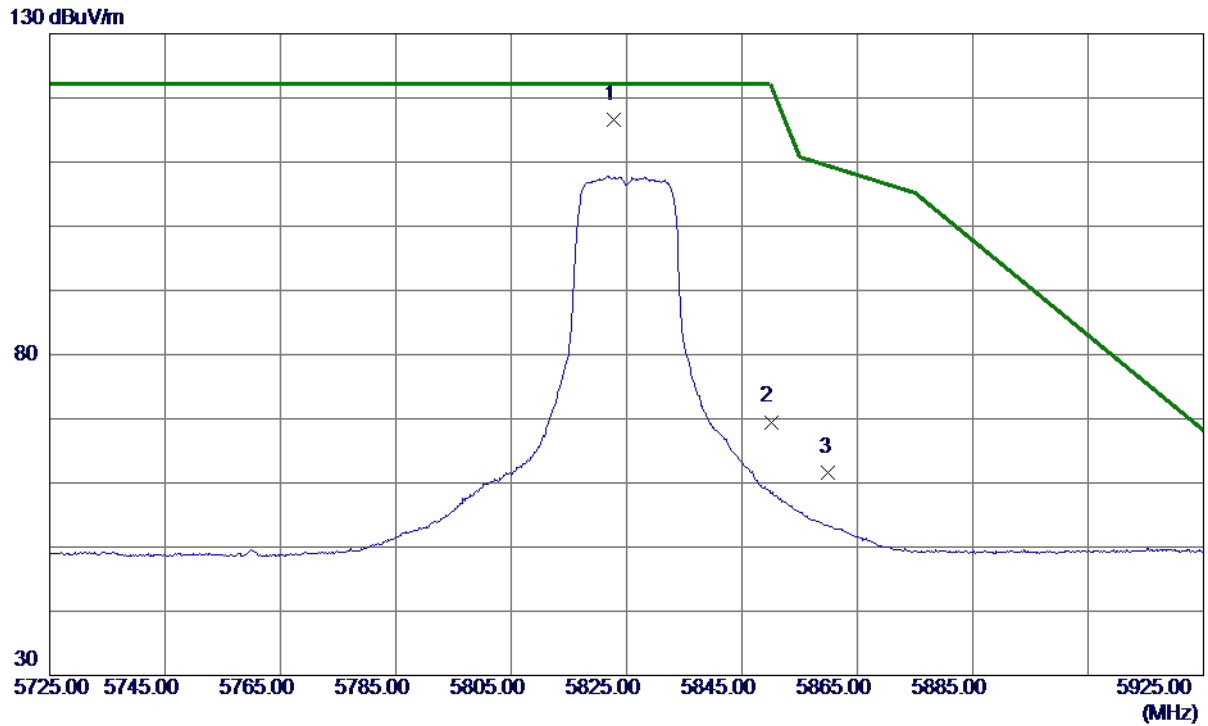

No.	Freq. MHz	Reading Level dBuV/m	Correct Factor dB	Measure ment dBuV/m	Limit dBuV/m	Margin dB	Detector	Comment
1 *	5822.7000	95.33	21.27	116.60	122.20	-5.60	Peak	No Limit
2	5850.0000	48.13	21.37	69.50	122.20	-52.70	Peak	
3	5860.0000	40.15	21.41	61.56	109.40	-47.84	Peak	

**REMARKS:**

- (1) Measurement Value = Reading Level + Correct Factor.
- (2) Margin Level = Measurement Value - Limit Value.

Orthogonal Axis	X
Test Mode	UNII-3_TX A Mode 5825 MHz

### Vertical

80 dBuV/m

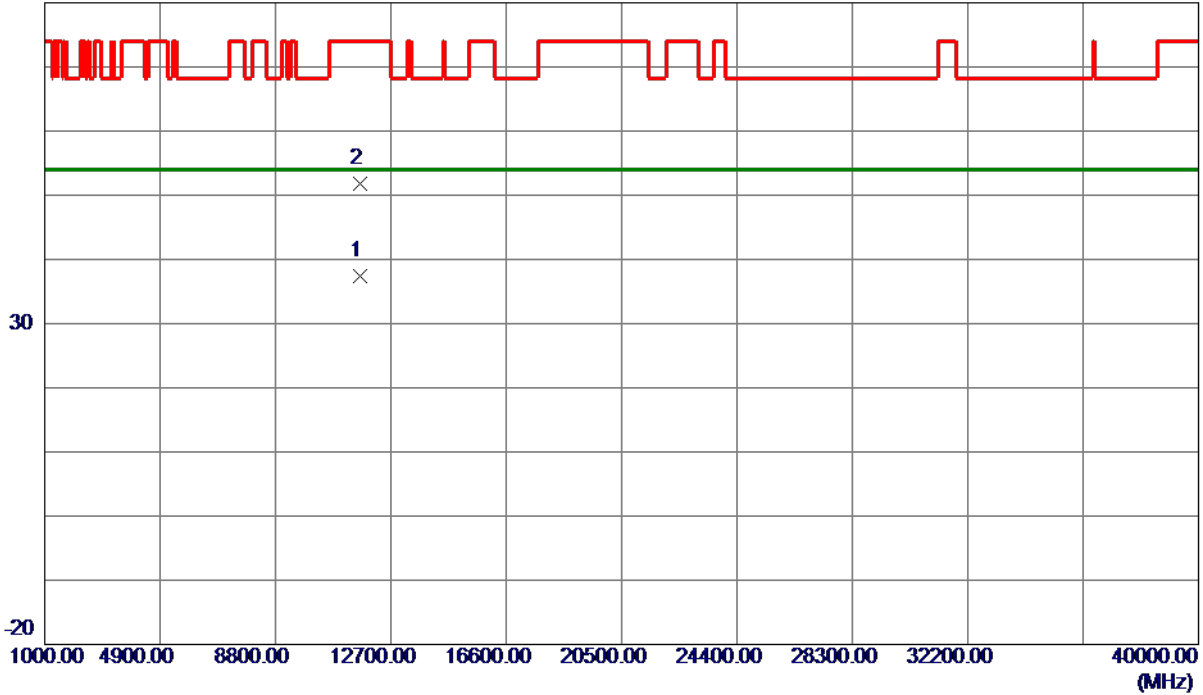

No.	Freq. MHz	Reading Level dBuV/m	Correct Factor dB	Measure ment dBuV/m	Limit dBuV/m	Margin dB	Detector	Comment
1 *	11648.8350	19.98	17.33	37.31	54.00	-16.69	AVG	
2	11649.9970	34.38	17.33	51.71	74.00	-22.29	Peak	

**REMARKS:**

- (1) Measurement Value = Reading Level + Correct Factor.
- (2) Margin Level = Measurement Value - Limit Value.

Orthogonal Axis	X
Test Mode	UNII-3_TX A Mode 5825 MHz

### Horizontal

130 dBuV/m

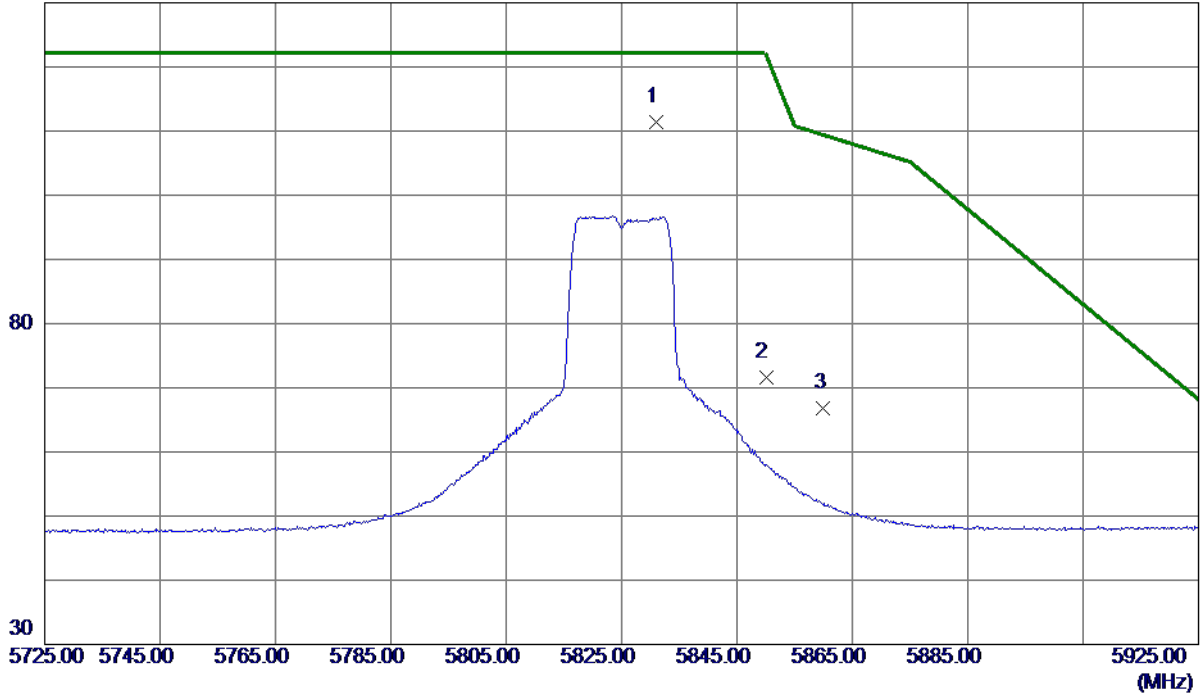

No.	Freq. MHz	Reading Level dBuV/m	Correct Factor dB	Measure ment dBuV/m	Limit dBuV/m	Margin dB	Detector	Comment
1 *	5831.0000	91.71	19.67	111.38	122.20	-10.82	Peak	No Limit
2	5850.0000	51.90	19.73	71.63	122.20	-50.57	Peak	
3	5860.0000	46.97	19.76	66.73	109.40	-42.67	Peak	

**REMARKS:**

- (1) Measurement Value = Reading Level + Correct Factor.
- (2) Margin Level = Measurement Value - Limit Value.



Orthogonal Axis	X
Test Mode	UNII-3_TX A Mode 5825 MHz

### Horizontal

80 dBuV/m

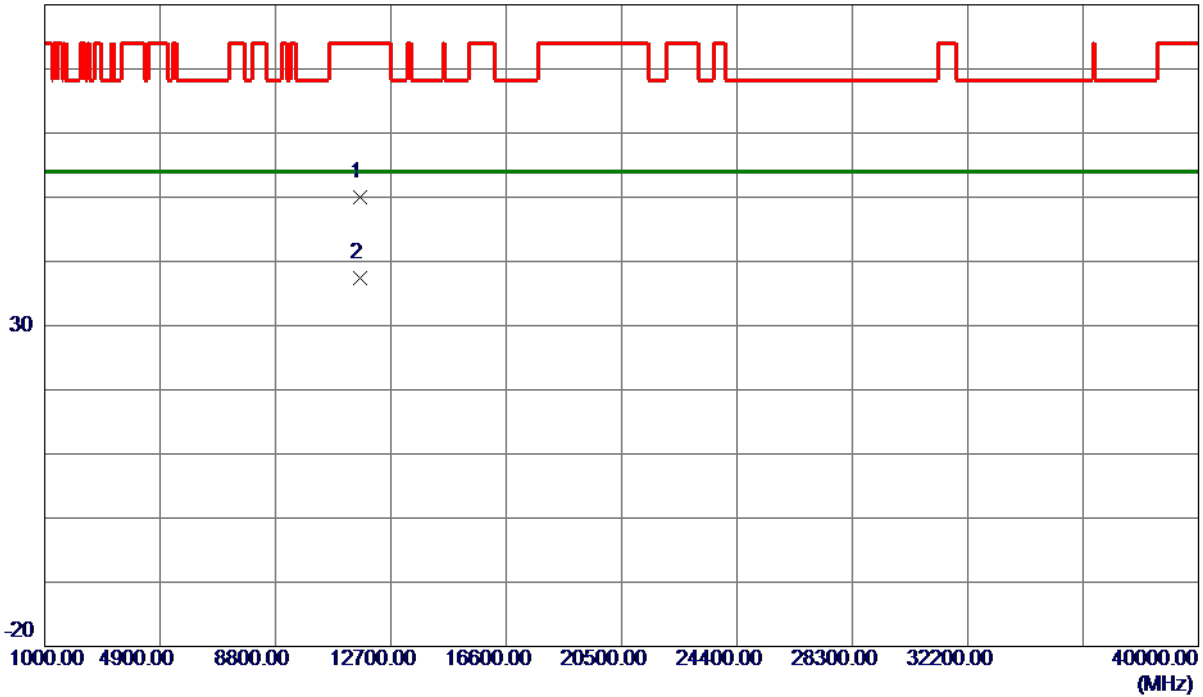

No.	Freq. MHz	Reading Level dBuV/m	Correct Factor dB	Measure ment dBuV/m	Limit dBuV/m	Margin dB	Detector	Comment
1	11648.1750	32.72	17.33	50.05	74.00	-23.95	Peak	
2 *	11650.6980	19.99	17.33	37.32	54.00	-16.68	AVG	

**REMARKS:**

- (1) Measurement Value = Reading Level + Correct Factor.
- (2) Margin Level = Measurement Value - Limit Value.

Orthogonal Axis	X
Test Mode	UNII-1_TX AC (VHT20) Mode 5180 MHz

### Vertical

130 dBuV/m

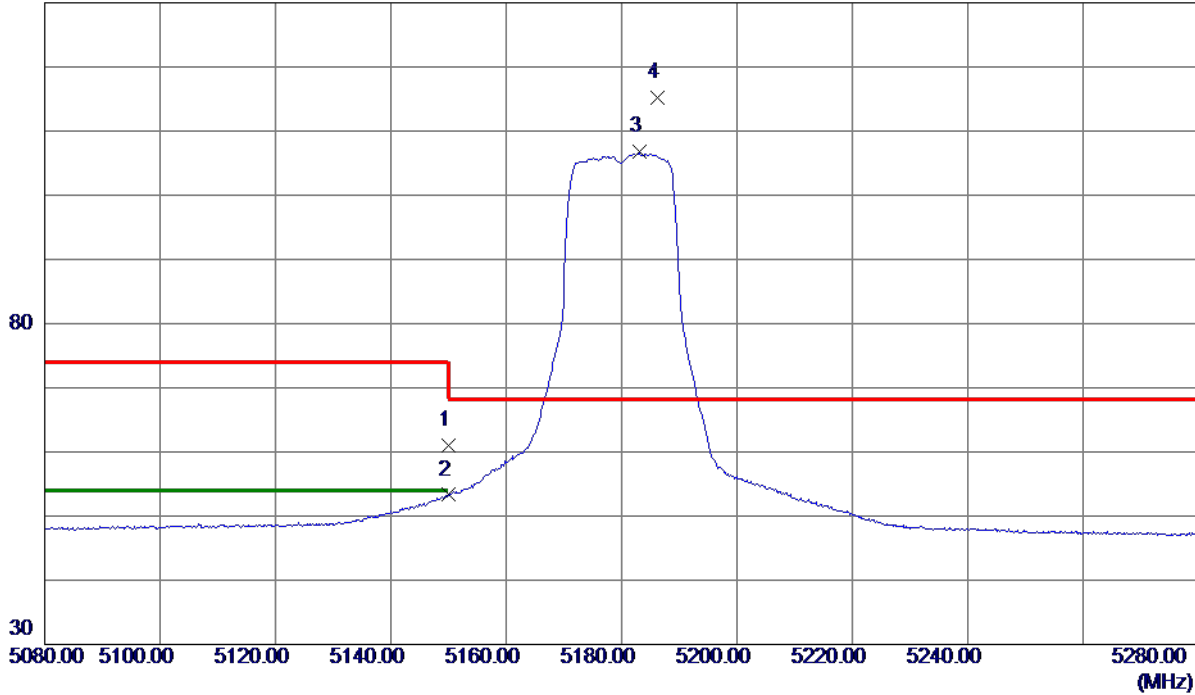

No.	Freq. MHz	Reading Level dBuV/m	Correct Factor dB	Measure ment dBuV/m	Limit dBuV/m	Margin dB	Detector	Comment
1	5150.0000	41.80	19.25	61.05	74.00	-12.95	Peak	
2	5150.0000	34.05	19.25	53.30	54.00	-0.70	AVG	
3	5183.1000	87.45	19.32	106.77	999.00	-892.23	AVG	No Limit
4 *	5186.3000	95.93	19.33	115.26	68.20	47.06	Peak	No Limit

**REMARKS:**

- (1) Measurement Value = Reading Level + Correct Factor.
- (2) Margin Level = Measurement Value - Limit Value.

Orthogonal Axis	X
Test Mode	UNII-1_TX AC (VHT20) Mode 5180 MHz

### Vertical

80 dBuV/m

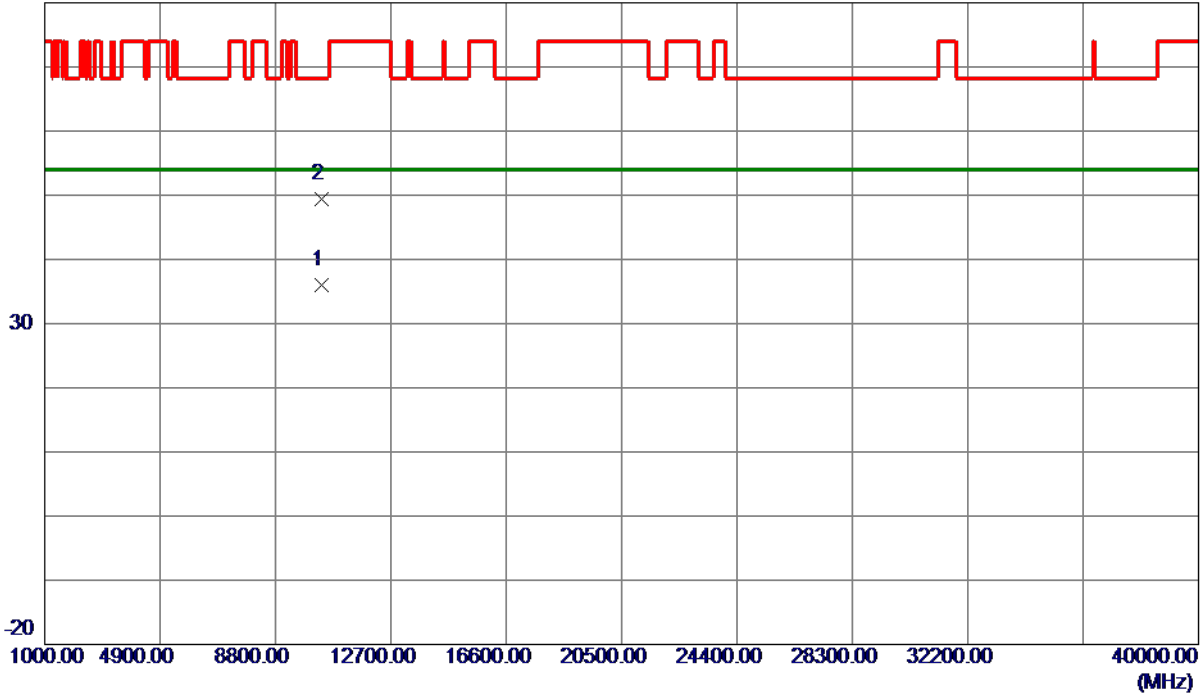

No.	Freq. MHz	Reading Level dBuV/m	Correct Factor dB	Measure ment dBuV/m	Limit dBuV/m	Margin dB	Detector	Comment
1 *	10358.2370	20.91	15.08	35.99	54.00	-18.01	AVG	
2	10360.5320	34.32	15.09	49.41	68.30	-18.89	Peak	

**REMARKS:**

- (1) Measurement Value = Reading Level + Correct Factor.
- (2) Margin Level = Measurement Value - Limit Value.

Orthogonal Axis	X
Test Mode	UNII-1_TX AC (VHT20) Mode 5180 MHz

### Horizontal

130 dBuV/m

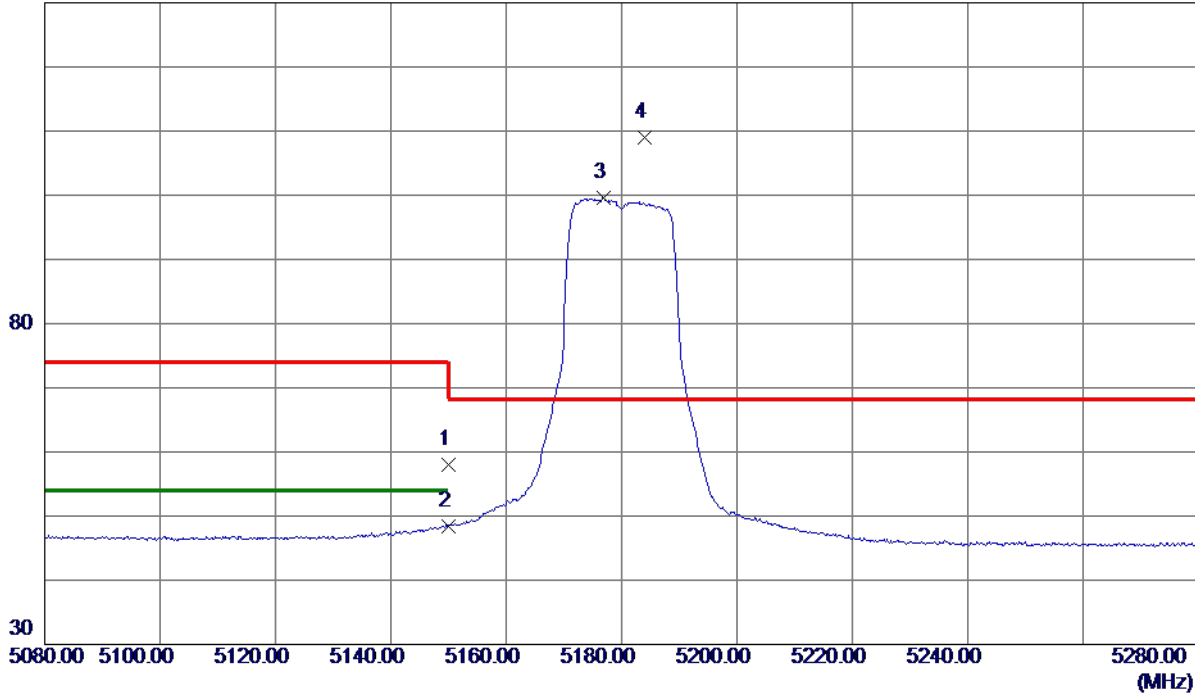

No.	Freq. MHz	Reading Level dBuV/m	Correct Factor dB	Measure ment dBuV/m	Limit dBuV/m	Margin dB	Detector	Comment
1	5150.0000	40.29	17.68	57.97	74.00	-16.03	Peak	
2	5150.0000	30.79	17.68	48.47	54.00	-5.53	AVG	
3	5176.8000	81.79	17.75	99.54	999.00	-899.46	AVG	No Limit
4 *	5183.9000	91.28	17.77	109.05	68.20	40.85	Peak	No Limit

**REMARKS:**

- (1) Measurement Value = Reading Level + Correct Factor.
- (2) Margin Level = Measurement Value - Limit Value.

Orthogonal Axis	X
Test Mode	UNII-1_TX AC (VHT20) Mode 5180 MHz

### Horizontal

80 dBuV/m

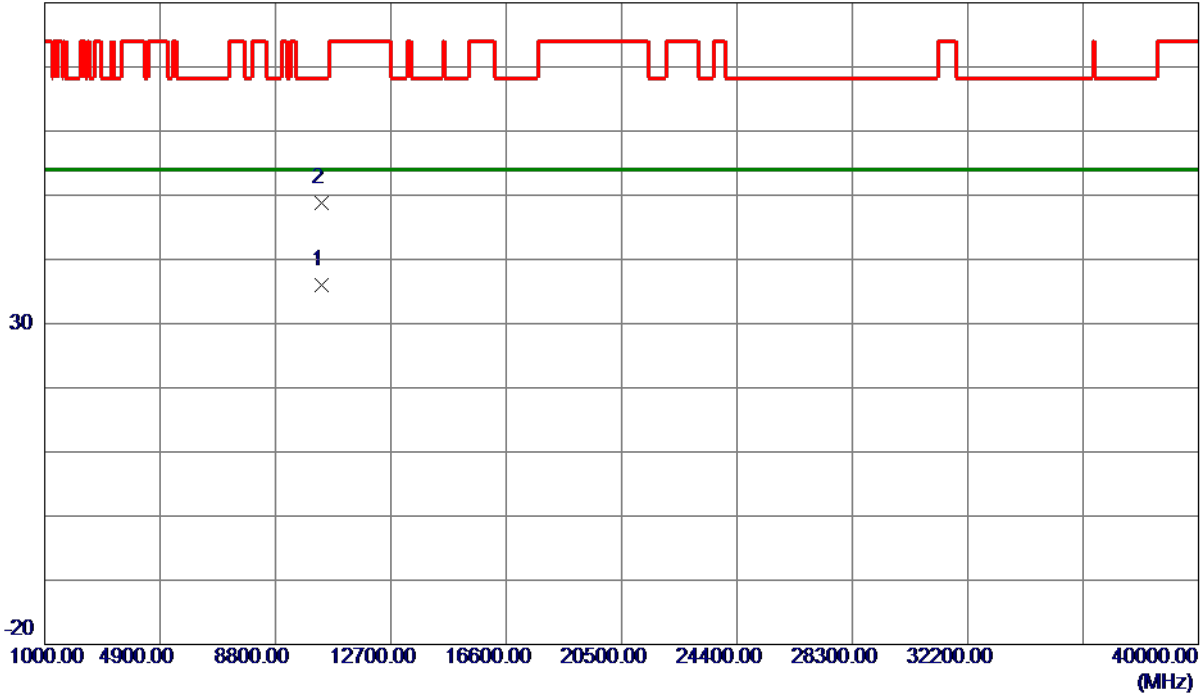

No.	Freq. MHz	Reading Level dBuV/m	Correct Factor dB	Measure ment dBuV/m	Limit dBuV/m	Margin dB	Detector	Comment
1 *	10358.4269	20.95	15.08	36.03	54.00	-17.97	AVG	
2	10359.6100	33.78	15.09	48.87	68.30	-19.43	Peak	

**REMARKS:**

- (1) Measurement Value = Reading Level + Correct Factor.
- (2) Margin Level = Measurement Value - Limit Value.

Orthogonal Axis	X
Test Mode	UNII-1_TX AC (VHT20) Mode 5200 MHz

**Vertical**

130 dBuV/m

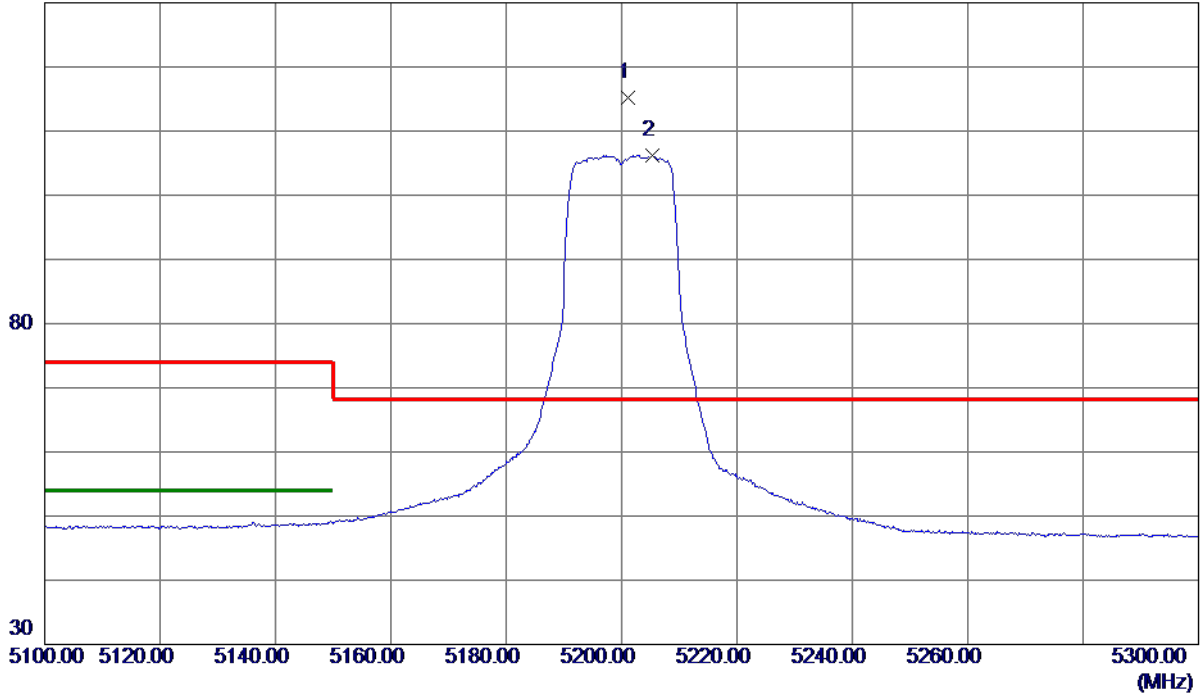

No.	Freq. MHz	Reading Level dBuV/m	Correct Factor dB	Measure ment dBuV/m	Limit dBuV/m	Margin dB	Detector	Comment
1 *	5201.1000	95.91	19.37	115.28	68.20	47.08	Peak	No Limit
2	5205.3000	86.86	19.38	106.24	999.00	-892.76	AVG	No Limit

**REMARKS:**

- (1) Measurement Value = Reading Level + Correct Factor.
- (2) Margin Level = Measurement Value - Limit Value.

Orthogonal Axis	X
Test Mode	UNII-1_TX AC (VHT20) Mode 5200 MHz

### Vertical

80 dBuV/m

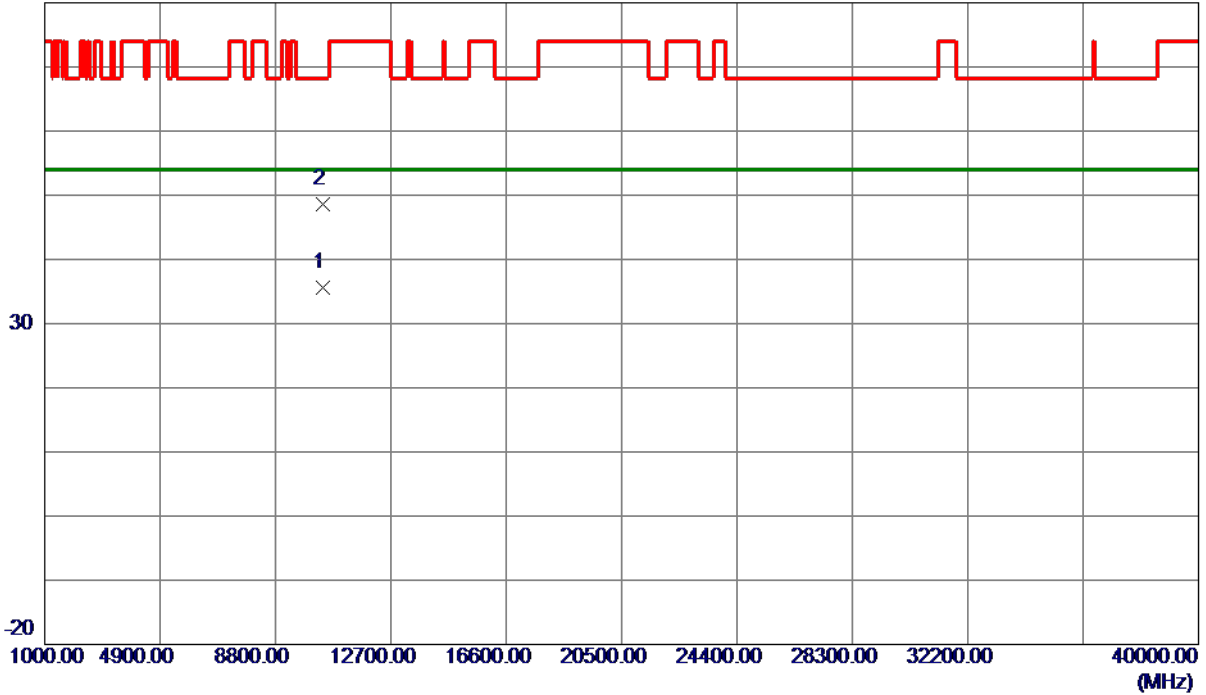

No.	Freq. MHz	Reading Level dBuV/m	Correct Factor dB	Measure ment dBuV/m	Limit dBuV/m	Margin dB	Detector	Comment
1 *	10400.0770	20.50	15.16	35.66	54.00	-18.34	AVG	
2	10401.4100	33.50	15.16	48.66	68.30	-19.64	Peak	

**REMARKS:**

- (1) Measurement Value = Reading Level + Correct Factor.
- (2) Margin Level = Measurement Value - Limit Value.

Orthogonal Axis	X
Test Mode	UNII-1_TX AC (VHT20) Mode 5200 MHz

### Horizontal

130 dBuV/m

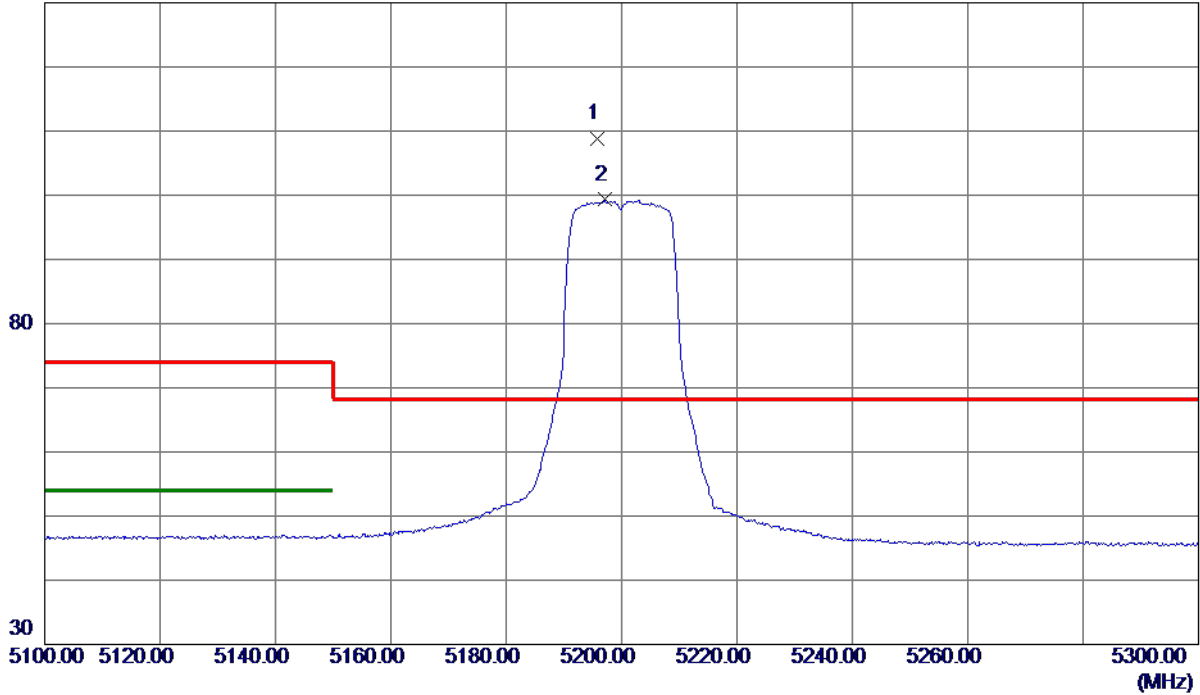

No.	Freq. MHz	Reading Level dBuV/m	Correct Factor dB	Measure ment dBuV/m	Limit dBuV/m	Margin dB	Detector	Comment
1 *	5195.8000	90.95	17.80	108.75	68.20	40.55	Peak	No Limit
2	5197.1000	81.49	17.81	99.30	999.00	-899.70	AVG	No Limit

**REMARKS:**

- (1) Measurement Value = Reading Level + Correct Factor.
- (2) Margin Level = Measurement Value - Limit Value.



Orthogonal Axis	X
Test Mode	UNII-1_TX AC (VHT20) Mode 5200 MHz

### Horizontal

80 dBuV/m

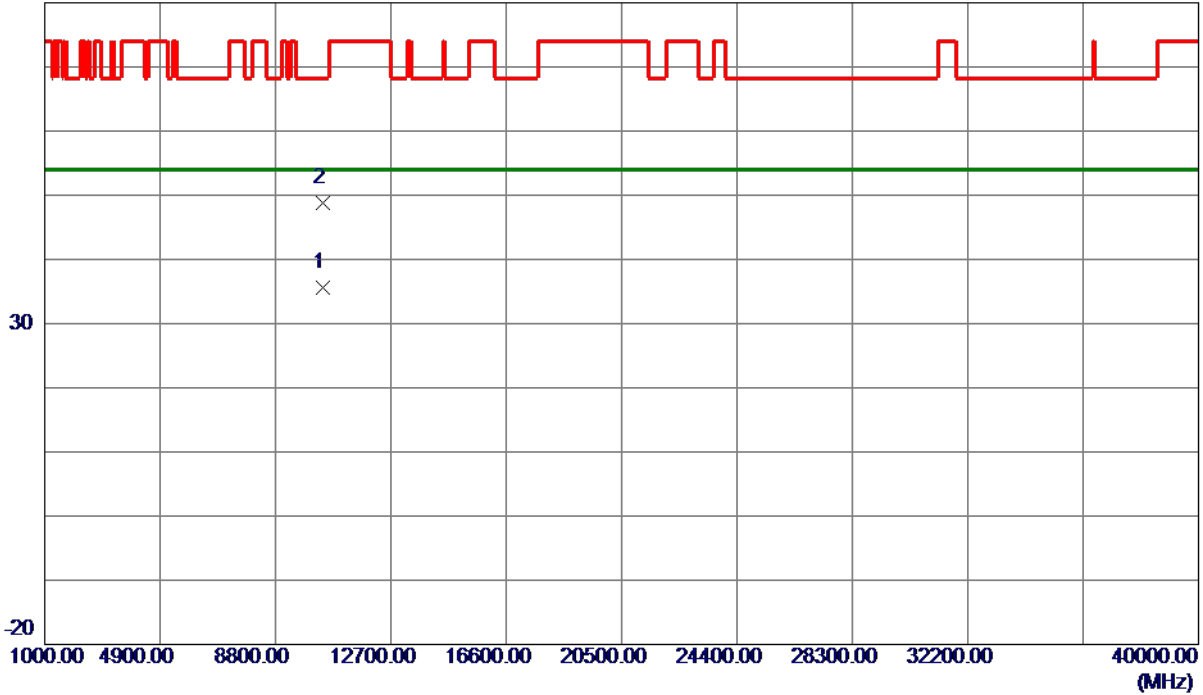

No.	Freq. MHz	Reading Level dBuV/m	Correct Factor dB	Measure ment dBuV/m	Limit dBuV/m	Margin dB	Detector	Comment
1 *	10400.5150	20.51	15.16	35.67	54.00	-18.33	AVG	
2	10402.4250	33.65	15.16	48.81	68.30	-19.49	Peak	

**REMARKS:**

- (1) Measurement Value = Reading Level + Correct Factor.
- (2) Margin Level = Measurement Value - Limit Value.

Orthogonal Axis	X
Test Mode	UNII-1_TX AC (VHT20) Mode 5240 MHz

### Vertical

130 dBuV/m

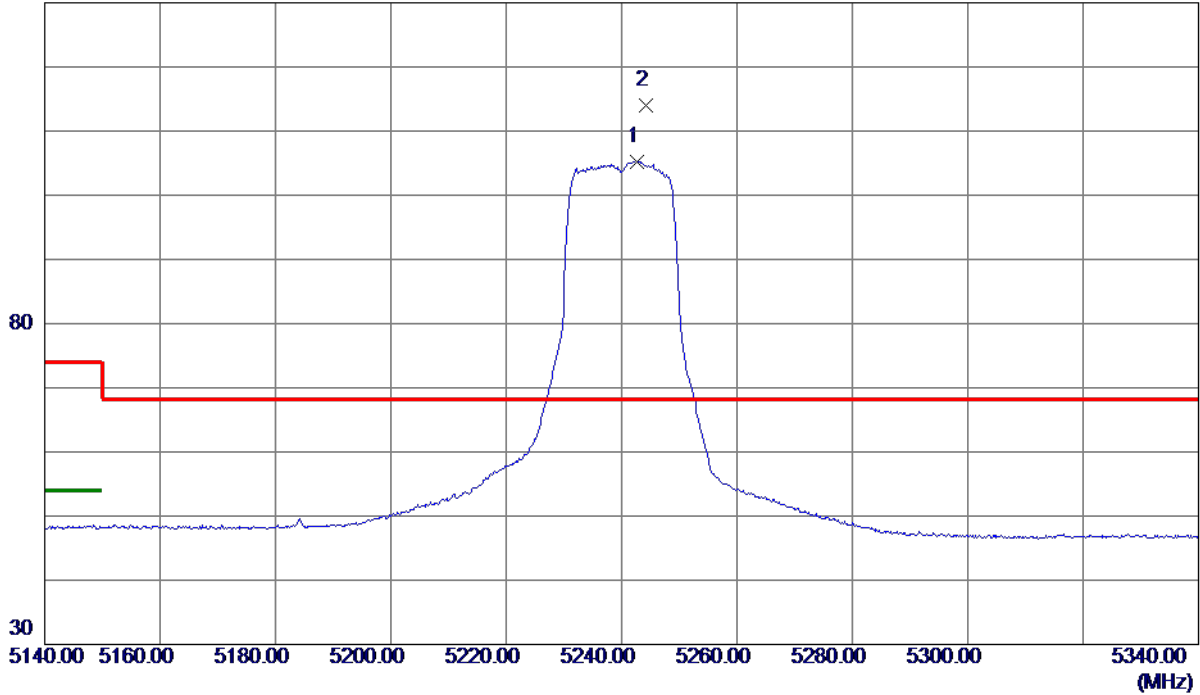

No.	Freq. MHz	Reading Level dBuV/m	Correct Factor dB	Measure ment dBuV/m	Limit dBuV/m	Margin dB	Detector	Comment
1	5242.7000	85.82	19.47	105.29	999.00	-893.71	AVG	No Limit
2 *	5244.2000	94.58	19.47	114.05	68.20	45.85	Peak	No Limit

**REMARKS:**

- (1) Measurement Value = Reading Level + Correct Factor.
- (2) Margin Level = Measurement Value - Limit Value.

Orthogonal Axis	X
Test Mode	UNII-1_TX AC (VHT20) Mode 5240 MHz

### Vertical

80 dBuV/m

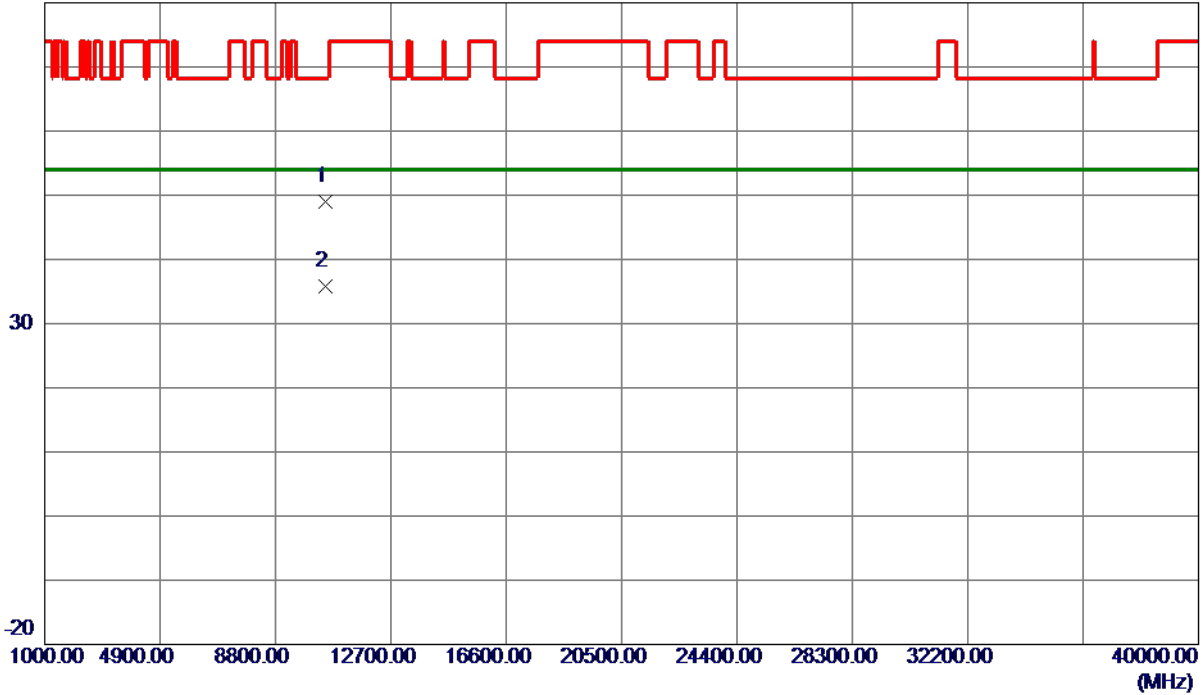

No.	Freq. MHz	Reading Level dBuV/m	Correct Factor dB	Measure ment dBuV/m	Limit dBuV/m	Margin dB	Detector	Comment
1	10478.9700	33.71	15.29	49.00	68.30	-19.30	Peak	
2 *	10481.9150	20.52	15.30	35.82	54.00	-18.18	AVG	

**REMARKS:**

- (1) Measurement Value = Reading Level + Correct Factor.
- (2) Margin Level = Measurement Value - Limit Value.

Orthogonal Axis	X
Test Mode	UNII-1_TX AC (VHT20) Mode 5240 MHz

### Horizontal

130 dBuV/m

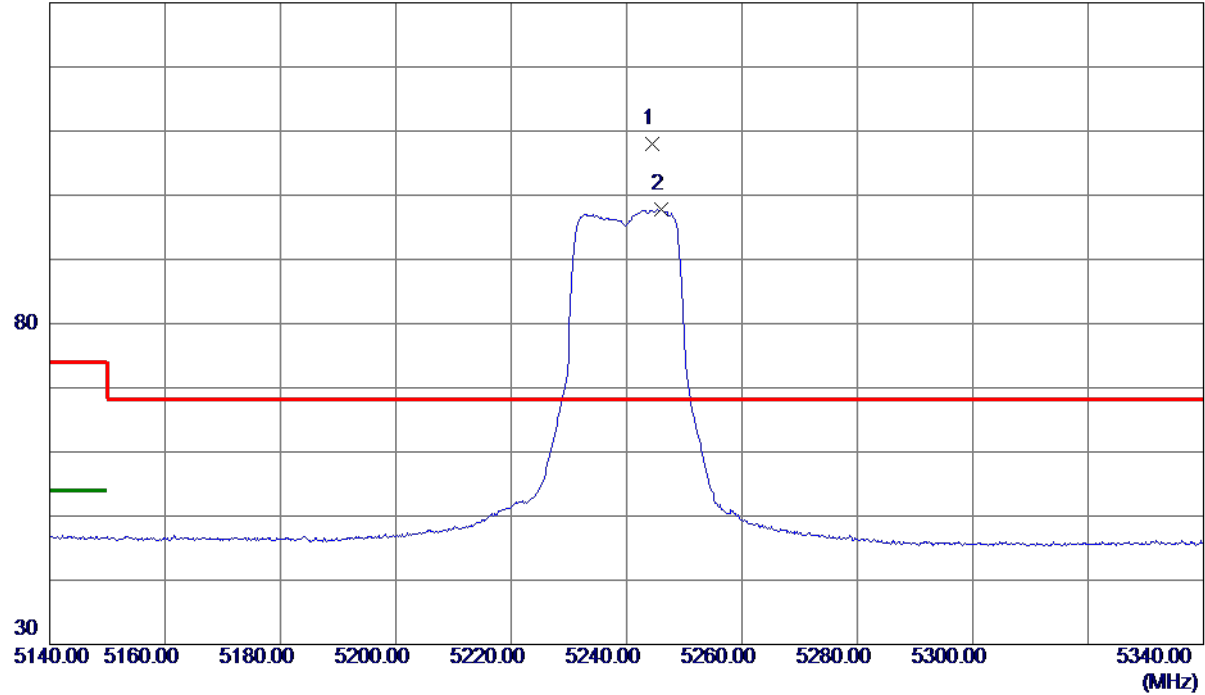

No.	Freq. MHz	Reading Level dBuV/m	Correct Factor dB	Measure ment dBuV/m	Limit dBuV/m	Margin dB	Detector	Comment
1 *	5244.4000	90.14	17.94	108.08	68.20	39.88	Peak	No Limit
2	5245.9000	79.92	17.94	97.86	999.00	-901.14	AVG	No Limit

**REMARKS:**

- (1) Measurement Value = Reading Level + Correct Factor.
- (2) Margin Level = Measurement Value - Limit Value.

Orthogonal Axis	X
Test Mode	UNII-1_TX AC (VHT20) Mode 5240 MHz

### Horizontal

80 dBuV/m

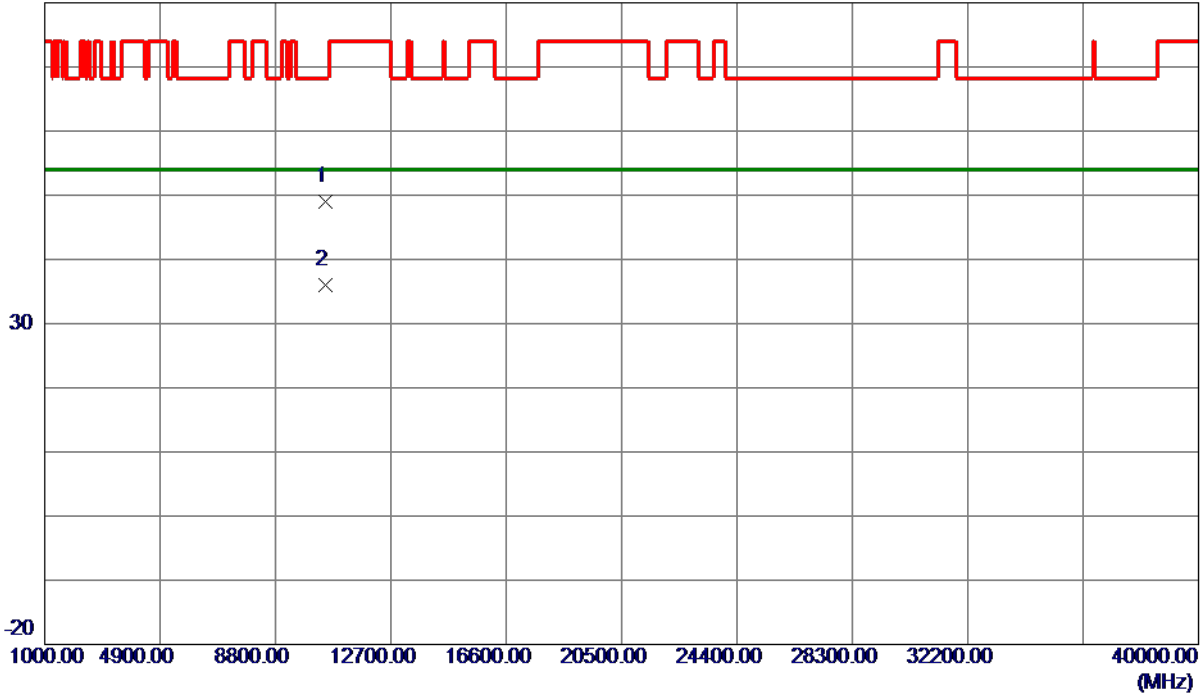

No.	Freq. MHz	Reading Level dBuV/m	Correct Factor dB	Measure ment dBuV/m	Limit dBuV/m	Margin dB	Detector	Comment
1	10480.1080	33.62	15.30	48.92	68.30	-19.38	Peak	
2 *	10480.9230	20.68	15.30	35.98	54.00	-18.02	AVG	

**REMARKS:**

- (1) Measurement Value = Reading Level + Correct Factor.
- (2) Margin Level = Measurement Value - Limit Value.

Orthogonal Axis	X
Test Mode	UNII-1_TX AC (VHT40) Mode 5190 MHz

### Vertical

130 dBuV/m

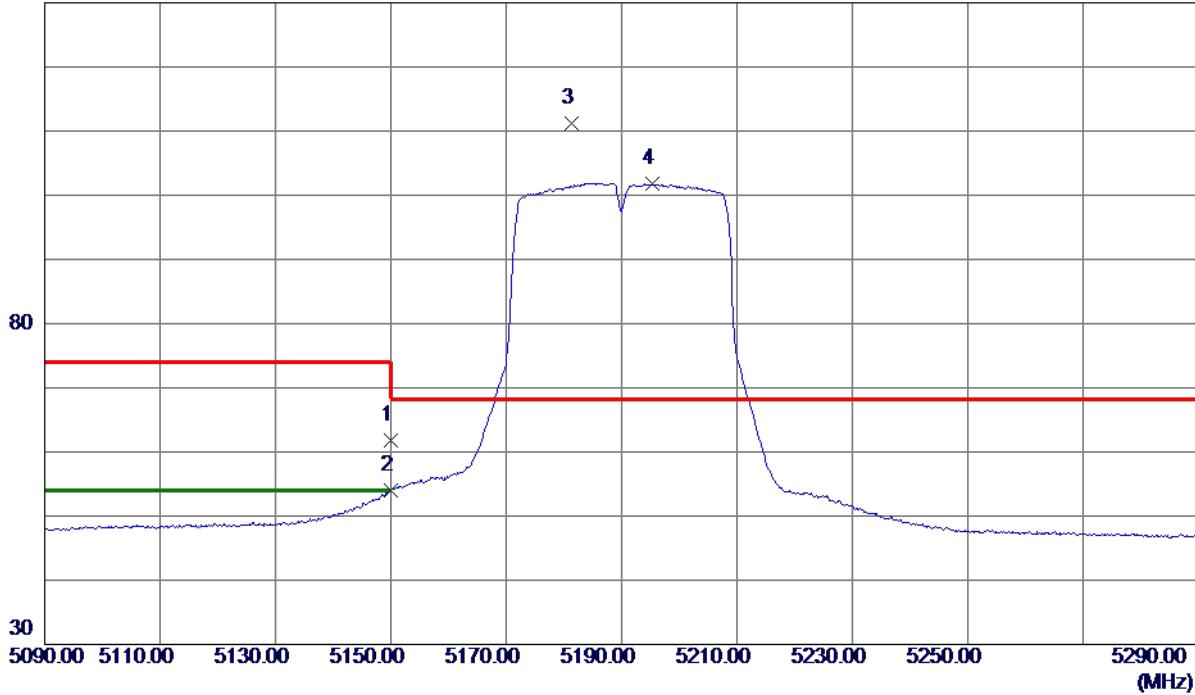

No.	Freq. MHz	Reading Level dBuV/m	Correct Factor dB	Measure ment dBuV/m	Limit dBuV/m	Margin dB	Detector	Comment
1	5150.0000	42.51	19.25	61.76	74.00	-12.24	Peak	
2	5150.0000	34.66	19.25	53.91	54.00	-0.09	AVG	
3 *	5181.4000	91.88	19.32	111.20	68.20	43.00	Peak	No Limit
4	5195.4000	82.52	19.35	101.87	999.00	-897.13	AVG	No Limit

**REMARKS:**

- (1) Measurement Value = Reading Level + Correct Factor.
- (2) Margin Level = Measurement Value - Limit Value.

Orthogonal Axis	X
Test Mode	UNII-1_TX AC (VHT40) Mode 5190 MHz

### Vertical

80 dBuV/m



No.	Freq. MHz	Reading Level dBuV/m	Correct Factor dB	Measure ment dBuV/m	Limit dBuV/m	Margin dB	Detector	Comment
1 *	10377.9450	20.66	15.12	35.78	54.00	-18.22	AVG	
2	10379.3099	34.94	15.12	50.06	68.30	-18.24	Peak	

**REMARKS:**

- (1) Measurement Value = Reading Level + Correct Factor.
- (2) Margin Level = Measurement Value - Limit Value.

Orthogonal Axis	X
Test Mode	UNII-1_TX AC (VHT40) Mode 5190 MHz

### Horizontal

130 dBuV/m

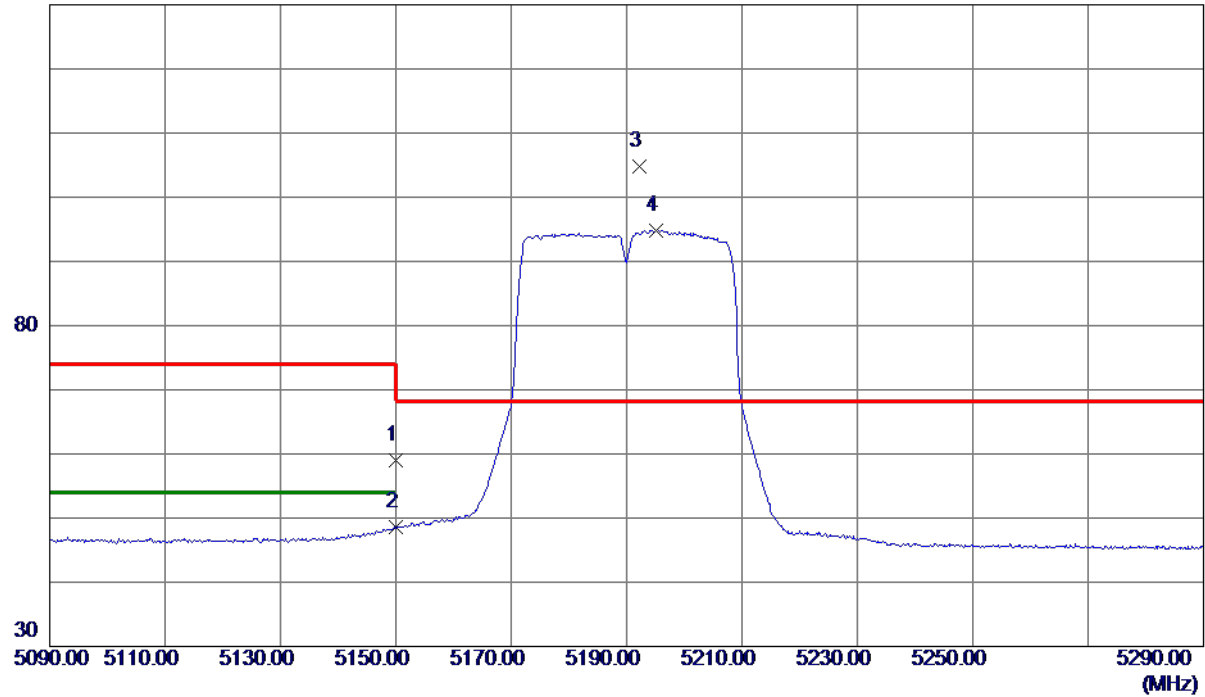

No.	Freq. MHz	Reading Level dBuV/m	Correct Factor dB	Measure ment dBuV/m	Limit dBuV/m	Margin dB	Detector	Comment
1	5150.0000	41.26	17.68	58.94	74.00	-15.06	Peak	
2	5150.0000	30.84	17.68	48.52	54.00	-5.48	AVG	
3 *	5192.3000	86.98	17.79	104.77	68.20	36.57	Peak	No Limit
4	5195.2000	77.03	17.80	94.83	999.00	-904.17	AVG	No Limit

**REMARKS:**

- (1) Measurement Value = Reading Level + Correct Factor.
- (2) Margin Level = Measurement Value - Limit Value.



Orthogonal Axis	X
Test Mode	UNII-1_TX AC (VHT40) Mode 5190 MHz

### Horizontal

80 dBuV/m

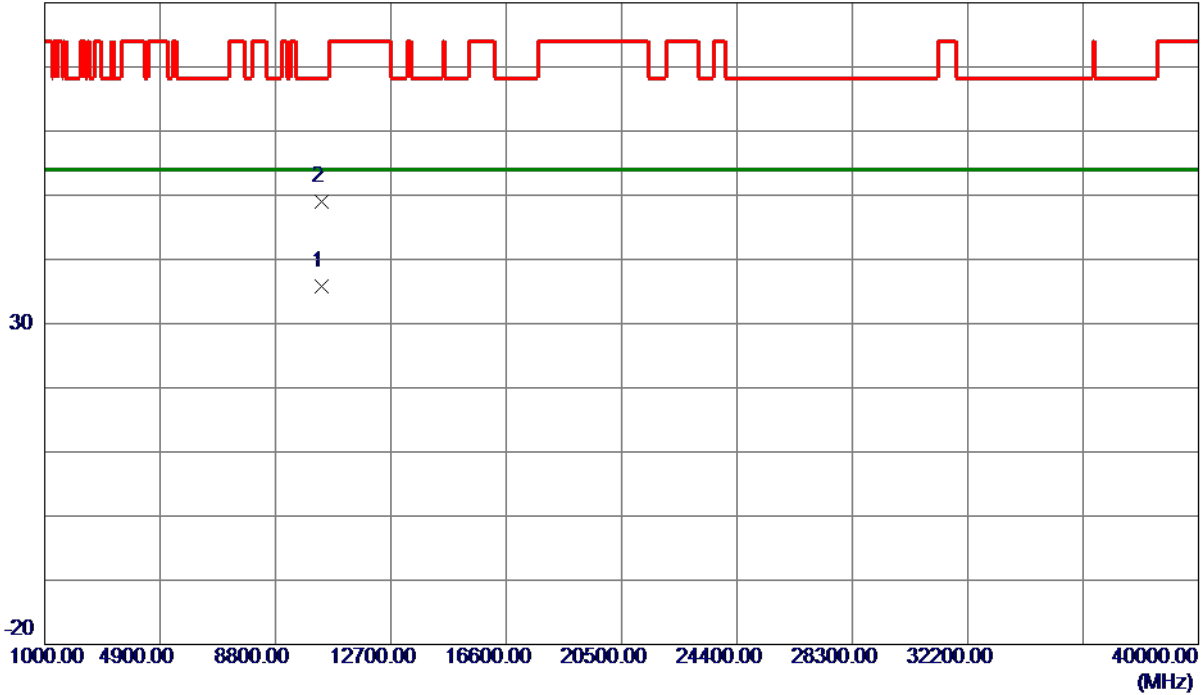

No.	Freq. MHz	Reading Level dBuV/m	Correct Factor dB	Measure ment dBuV/m	Limit dBuV/m	Margin dB	Detector	Comment
1 *	10377.7250	20.67	15.12	35.79	54.00	-18.21	AVG	
2	10379.2980	33.93	15.12	49.05	68.30	-19.25	Peak	

**REMARKS:**

- (1) Measurement Value = Reading Level + Correct Factor.
- (2) Margin Level = Measurement Value - Limit Value.

Orthogonal Axis	X
Test Mode	UNII-1_TX AC (VHT40) Mode 5230 MHz

### Vertical

130 dBuV/m

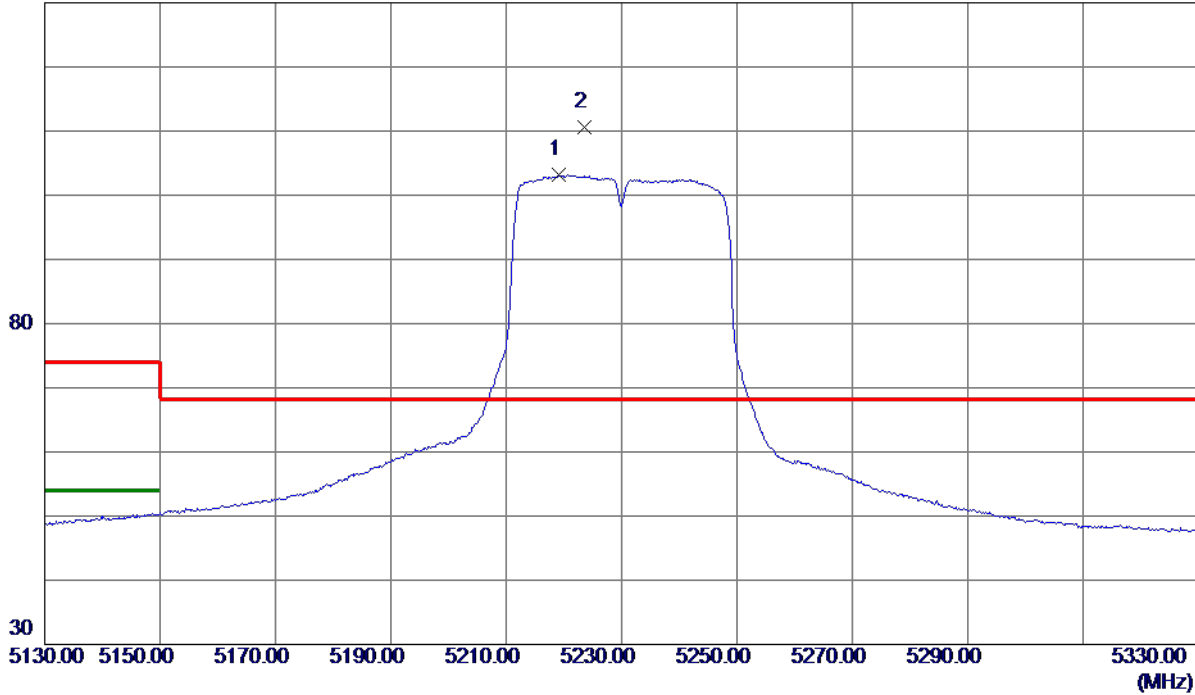

No.	Freq. MHz	Reading Level dBuV/m	Correct Factor dB	Measure ment dBuV/m	Limit dBuV/m	Margin dB	Detector	Comment
1	5219.1000	83.77	19.41	103.18	999.00	-895.82	AVG	No Limit
2 *	5223.5000	91.13	19.42	110.55	68.20	42.35	Peak	No Limit

**REMARKS:**

- (1) Measurement Value = Reading Level + Correct Factor.
- (2) Margin Level = Measurement Value - Limit Value.

Orthogonal Axis	X
Test Mode	UNII-1_TX AC (VHT40) Mode 5230 MHz

### Vertical

80 dBuV/m

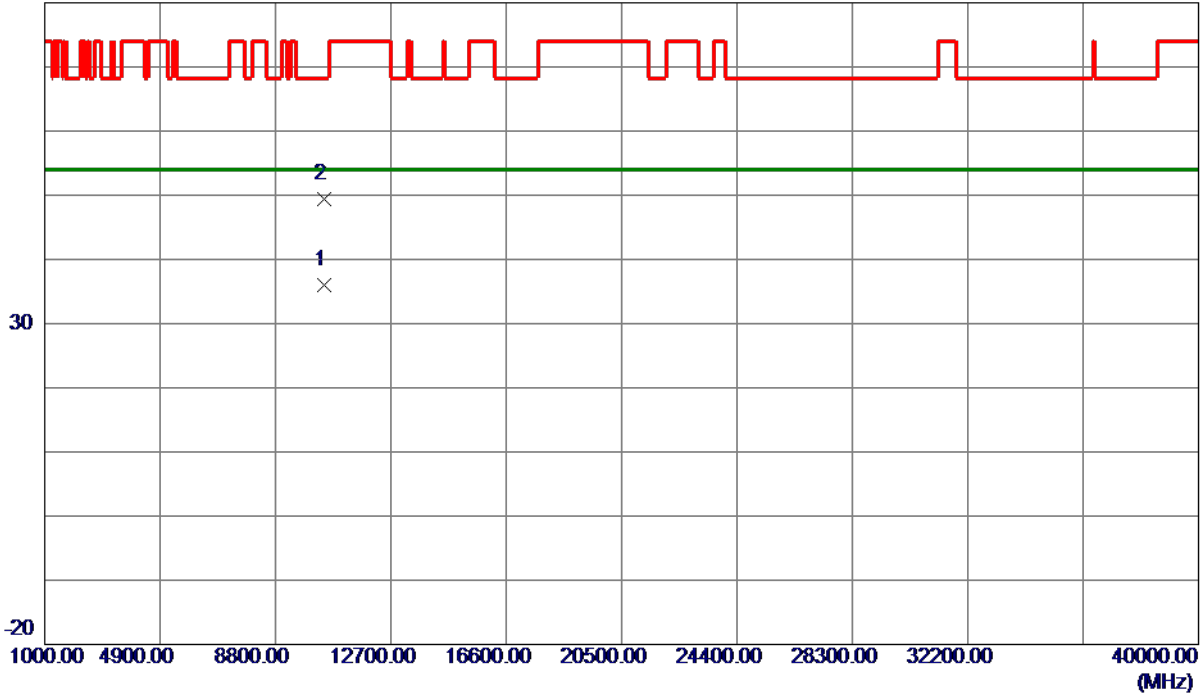

No.	Freq. MHz	Reading Level dBuV/m	Correct Factor dB	Measure ment dBuV/m	Limit dBuV/m	Margin dB	Detector	Comment
1 *	10458.0000	20.68	15.26	35.94	54.00	-18.06	AVG	
2	10458.2750	34.08	15.26	49.34	68.30	-18.96	Peak	

**REMARKS:**

- (1) Measurement Value = Reading Level + Correct Factor.
- (2) Margin Level = Measurement Value - Limit Value.

Orthogonal Axis	X
Test Mode	UNII-1_TX AC (VHT40) Mode 5230 MHz

### Horizontal

130 dBuV/m

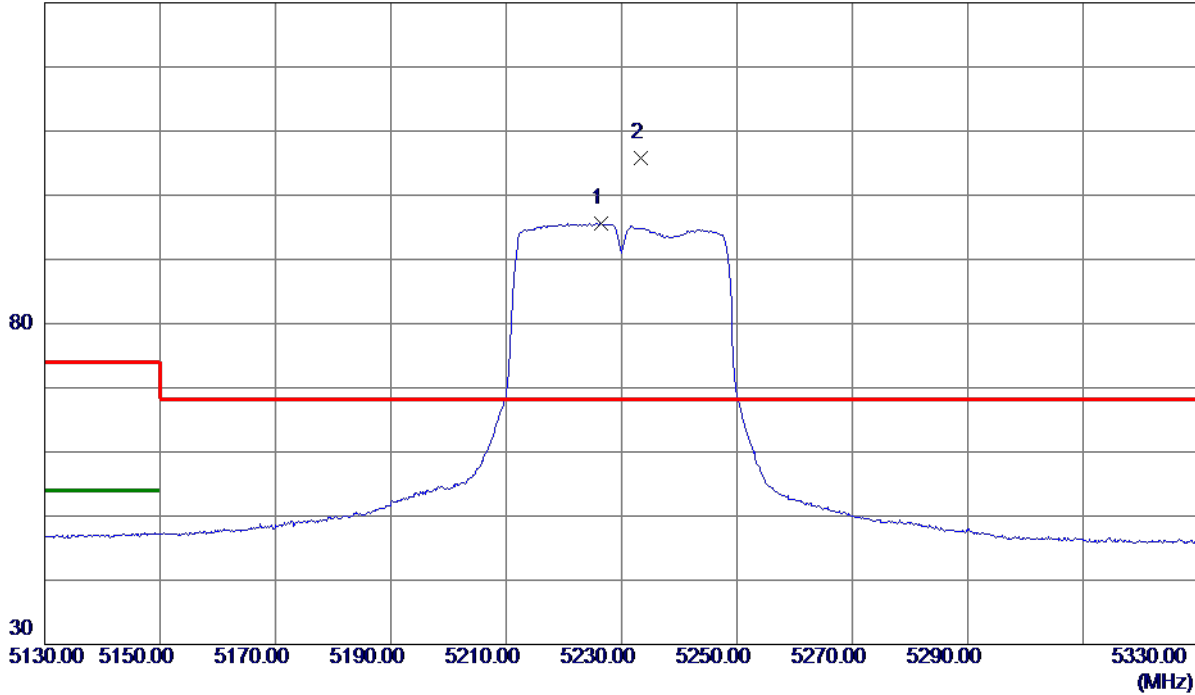

No.	Freq. MHz	Reading Level dBuV/m	Correct Factor dB	Measure ment dBuV/m	Limit dBuV/m	Margin dB	Detector	Comment
1	5226.4000	77.74	17.89	95.63	999.00	-903.37	AVG	No Limit
2 *	5233.4000	87.91	17.91	105.82	68.20	37.62	Peak	No Limit

**REMARKS:**

- (1) Measurement Value = Reading Level + Correct Factor.
- (2) Margin Level = Measurement Value - Limit Value.

Orthogonal Axis	X
Test Mode	UNII-1_TX AC (VHT40) Mode 5230 MHz

### Horizontal

80 dBuV/m

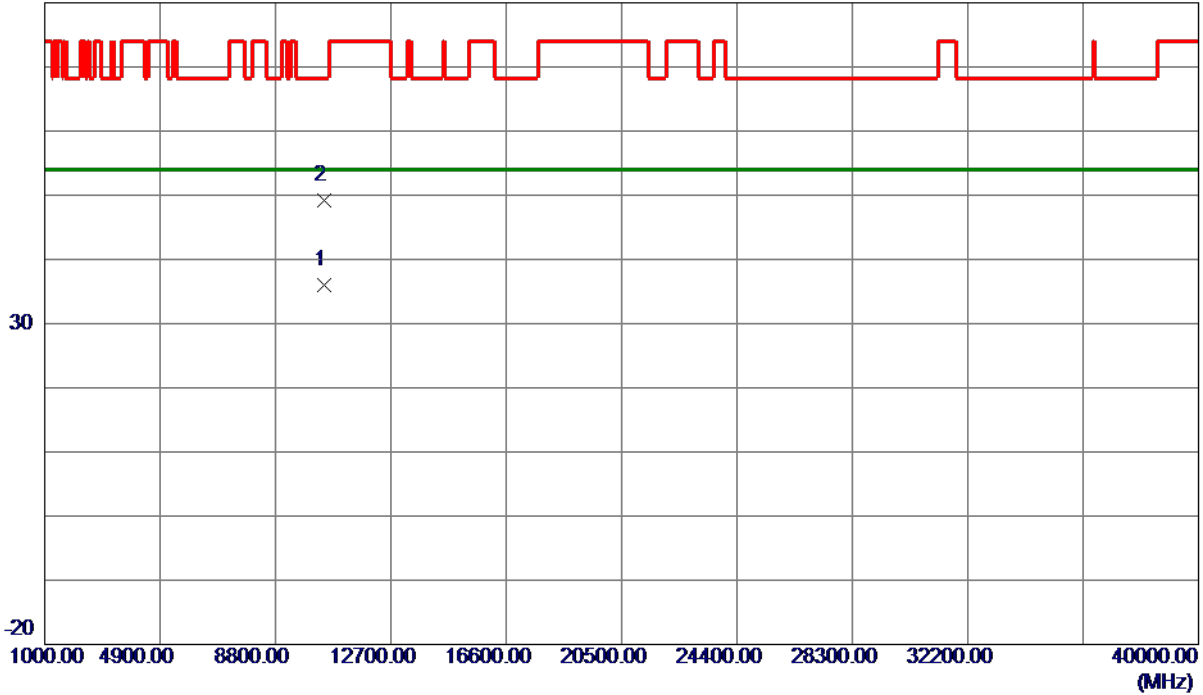

No.	Freq. MHz	Reading Level dBuV/m	Correct Factor dB	Measure ment dBuV/m	Limit dBuV/m	Margin dB	Detector	Comment
1 *	10460.1120	20.75	15.26	36.01	54.00	-17.99	AVG	
2	10462.4200	33.91	15.26	49.17	68.30	-19.13	Peak	

**REMARKS:**

- (1) Measurement Value = Reading Level + Correct Factor.
- (2) Margin Level = Measurement Value - Limit Value.

Orthogonal Axis	X
Test Mode	UNII-1_TX AC (VHT80) Mode 5210 MHz

### Vertical

130 dBuV/m

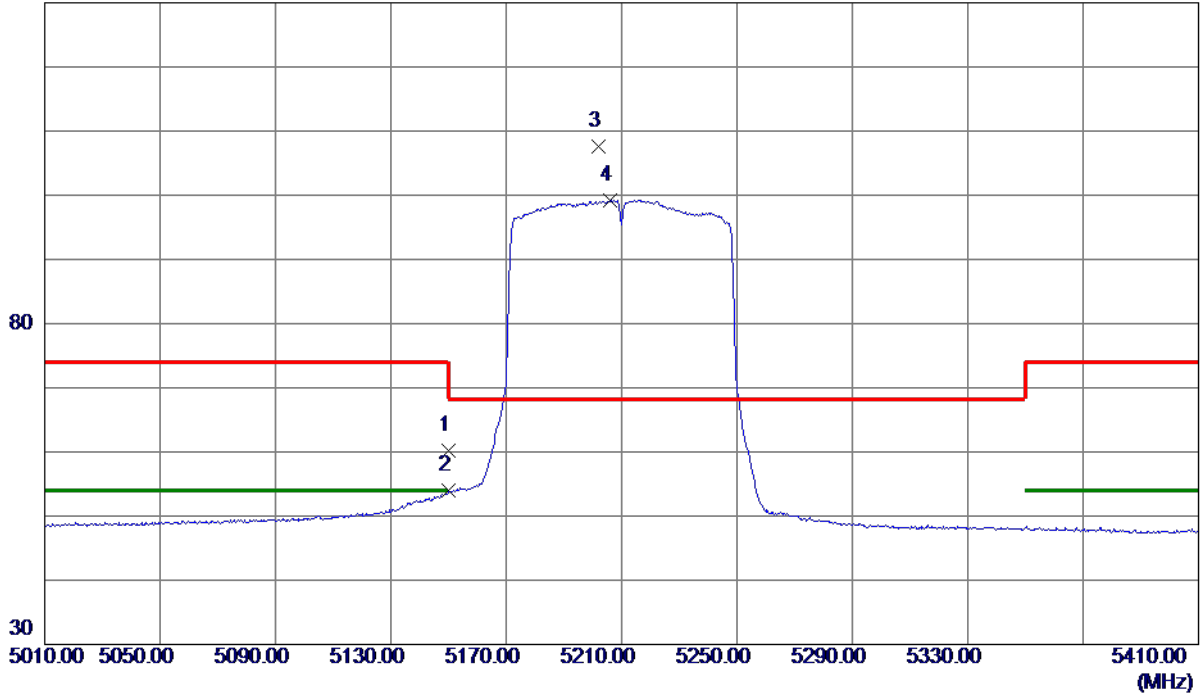

No.	Freq. MHz	Reading Level dBuV/m	Correct Factor dB	Measure ment dBuV/m	Limit dBuV/m	Margin dB	Detector	Comment
1	5150.0000	41.01	19.25	60.26	74.00	-13.74	Peak	
2	5150.0000	34.74	19.25	53.99	54.00	-0.01	AVG	
3 *	5202.2000	88.28	19.37	107.65	68.20	39.45	Peak	No Limit
4	5206.0000	79.91	19.38	99.29	999.00	-899.71	AVG	No Limit

**REMARKS:**

- (1) Measurement Value = Reading Level + Correct Factor.
- (2) Margin Level = Measurement Value - Limit Value.

Orthogonal Axis	X
Test Mode	UNII-1_TX AC (VHT80) Mode 5210 MHz

### Vertical

80 dBuV/m

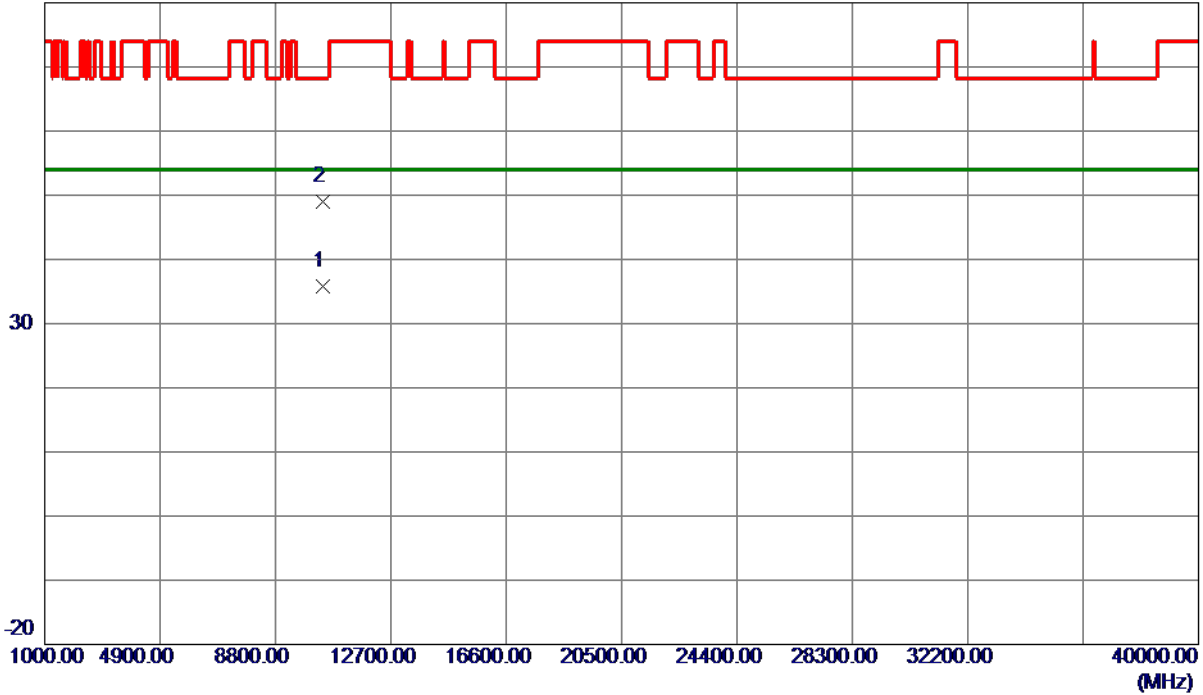

No.	Freq. MHz	Reading Level dBuV/m	Correct Factor dB	Measure ment dBuV/m	Limit dBuV/m	Margin dB	Detector	Comment
1 *	10418.3250	20.69	15.19	35.88	54.00	-18.12	AVG	
2	10419.9150	33.78	15.19	48.97	68.30	-19.33	Peak	

**REMARKS:**

- (1) Measurement Value = Reading Level + Correct Factor.
- (2) Margin Level = Measurement Value - Limit Value.

Orthogonal Axis	X
Test Mode	UNII-1_TX AC (VHT80) Mode 5210 MHz

### Horizontal

130 dBuV/m

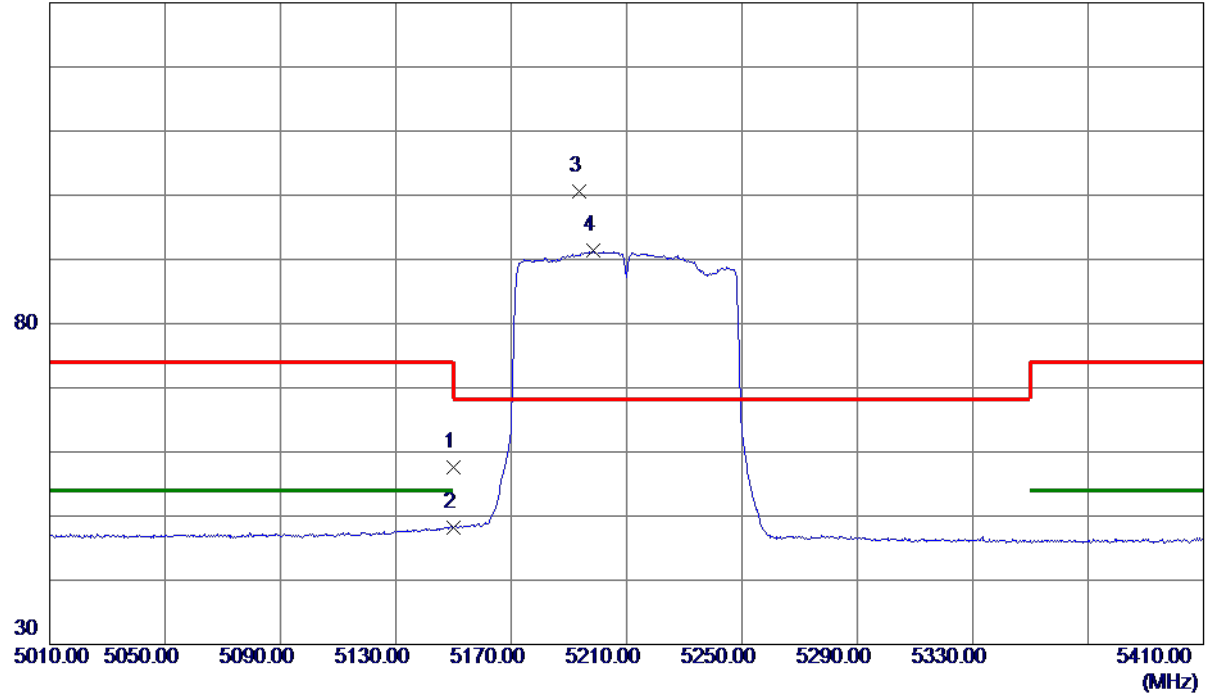

No.	Freq. MHz	Reading Level dBuV/m	Correct Factor dB	Measure ment dBuV/m	Limit dBuV/m	Margin dB	Detector	Comment
1	5150.0000	39.92	17.68	57.60	74.00	-16.40	Peak	
2	5150.0000	30.56	17.68	48.24	54.00	-5.76	AVG	
3 *	5193.4000	82.74	17.80	100.54	68.20	32.34	Peak	No Limit
4	5198.4000	73.59	17.81	91.40	999.00	-907.60	AVG	No Limit

**REMARKS:**

- (1) Measurement Value = Reading Level + Correct Factor.
- (2) Margin Level = Measurement Value - Limit Value.



Orthogonal Axis	X
Test Mode	UNII-1_TX AC (VHT80) Mode 5210 MHz

### Horizontal

80 dBuV/m

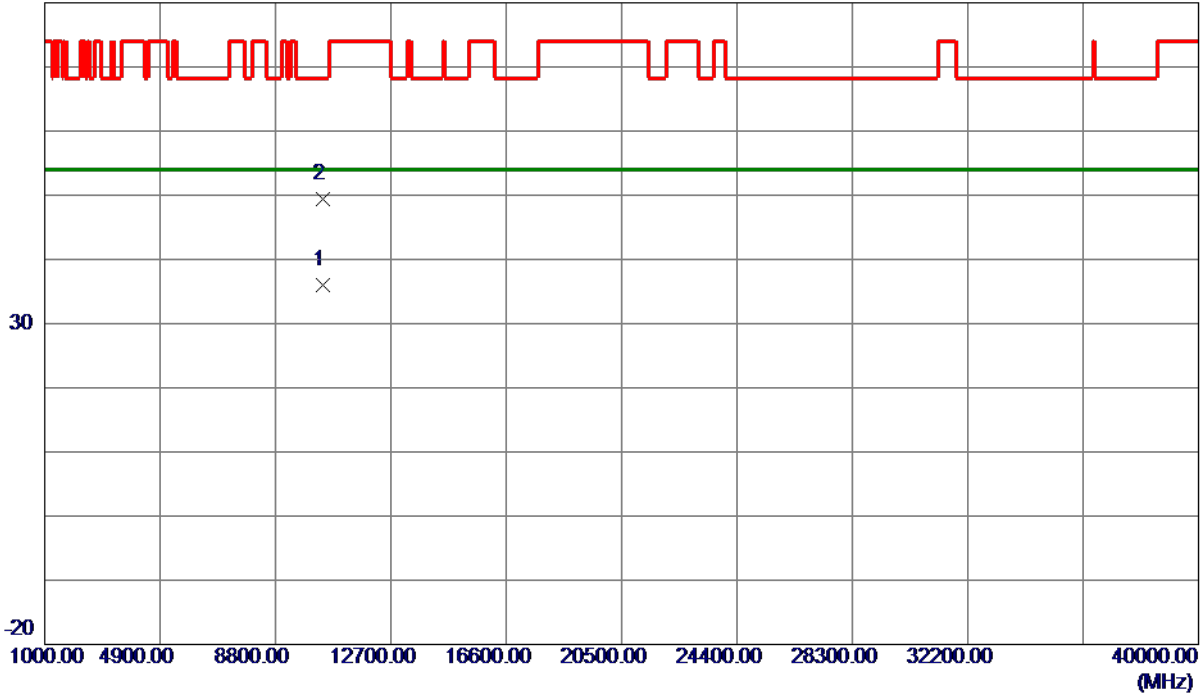

No.	Freq. MHz	Reading Level dBuV/m	Correct Factor dB	Measure ment dBuV/m	Limit dBuV/m	Margin dB	Detector	Comment
1 *	10421.3820	20.88	15.19	36.07	54.00	-17.93	AVG	
2	10421.5830	34.27	15.19	49.46	68.30	-18.84	Peak	

**REMARKS:**

- (1) Measurement Value = Reading Level + Correct Factor.
- (2) Margin Level = Measurement Value - Limit Value.

Orthogonal Axis	X
Test Mode	UNII-3_TX AC (VHT20) Mode 5745 MHz

**Vertical**

130 dBuV/m

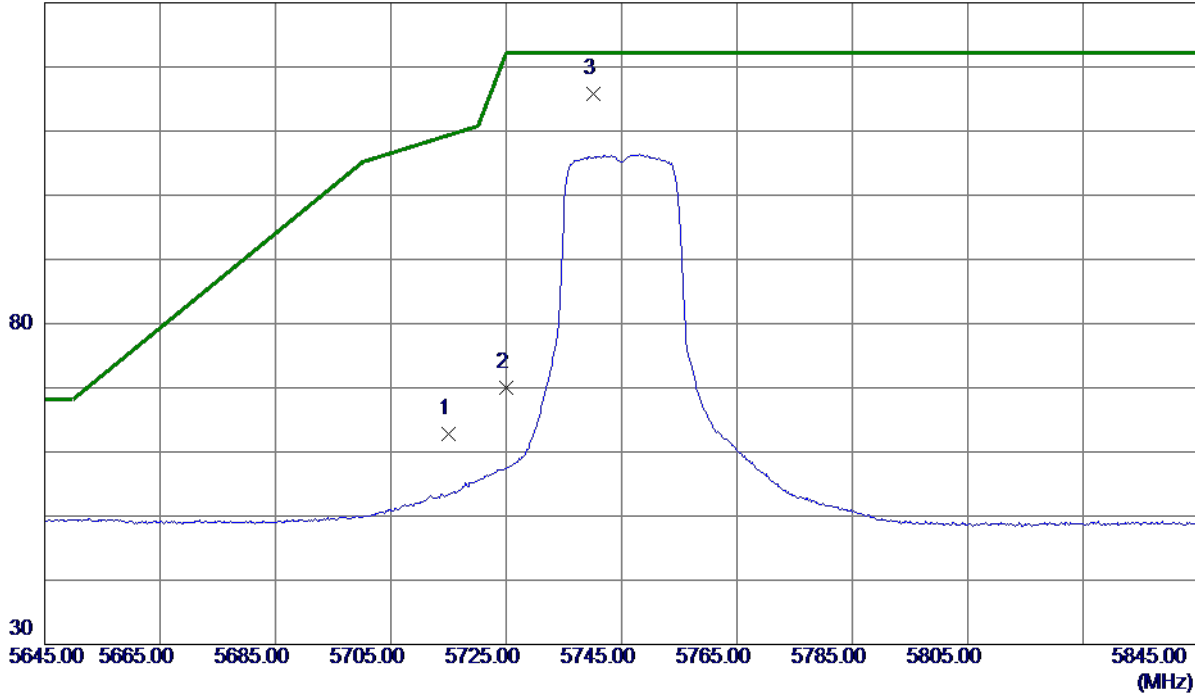

No.	Freq. MHz	Reading Level dBuV/m	Correct Factor dB	Measure ment dBuV/m	Limit dBuV/m	Margin dB	Detector	Comment
1	5715.0000	41.86	20.87	62.73	109.40	-46.67	Peak	
2	5725.0000	49.13	20.91	70.04	122.20	-52.16	Peak	
3 *	5740.2000	94.92	20.97	115.89	122.20	-6.31	Peak	No Limit

**REMARKS:**

- (1) Measurement Value = Reading Level + Correct Factor.
- (2) Margin Level = Measurement Value - Limit Value.

Orthogonal Axis	X
Test Mode	UNII-3_TX AC (VHT20) Mode 5745 MHz

### Vertical

80 dBuV/m

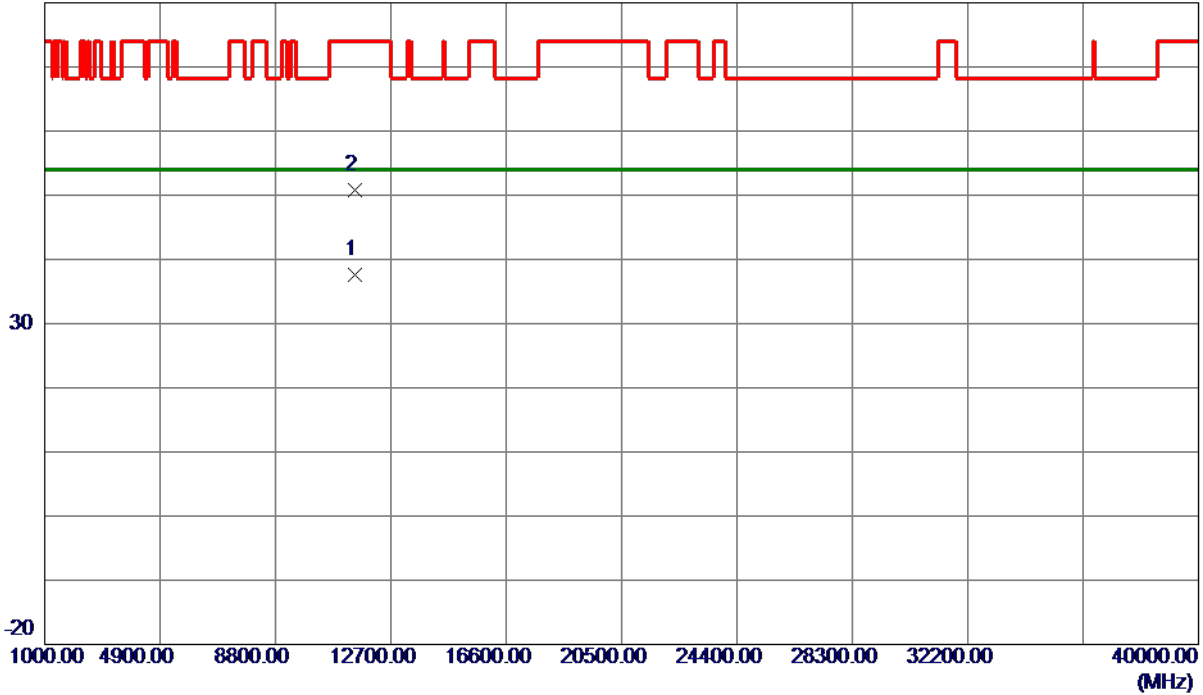

No.	Freq. MHz	Reading Level dBuV/m	Correct Factor dB	Measure ment dBuV/m	Limit dBuV/m	Margin dB	Detector	Comment
1 *	11488.4450	20.56	17.09	37.65	54.00	-16.35	AVG	
2	11489.6650	33.66	17.09	50.75	74.00	-23.25	Peak	

**REMARKS:**

- (1) Measurement Value = Reading Level + Correct Factor.
- (2) Margin Level = Measurement Value - Limit Value.

Orthogonal Axis	X
Test Mode	UNII-3_TX AC (VHT20) Mode 5745 MHz

### Horizontal

130 dBuV/m

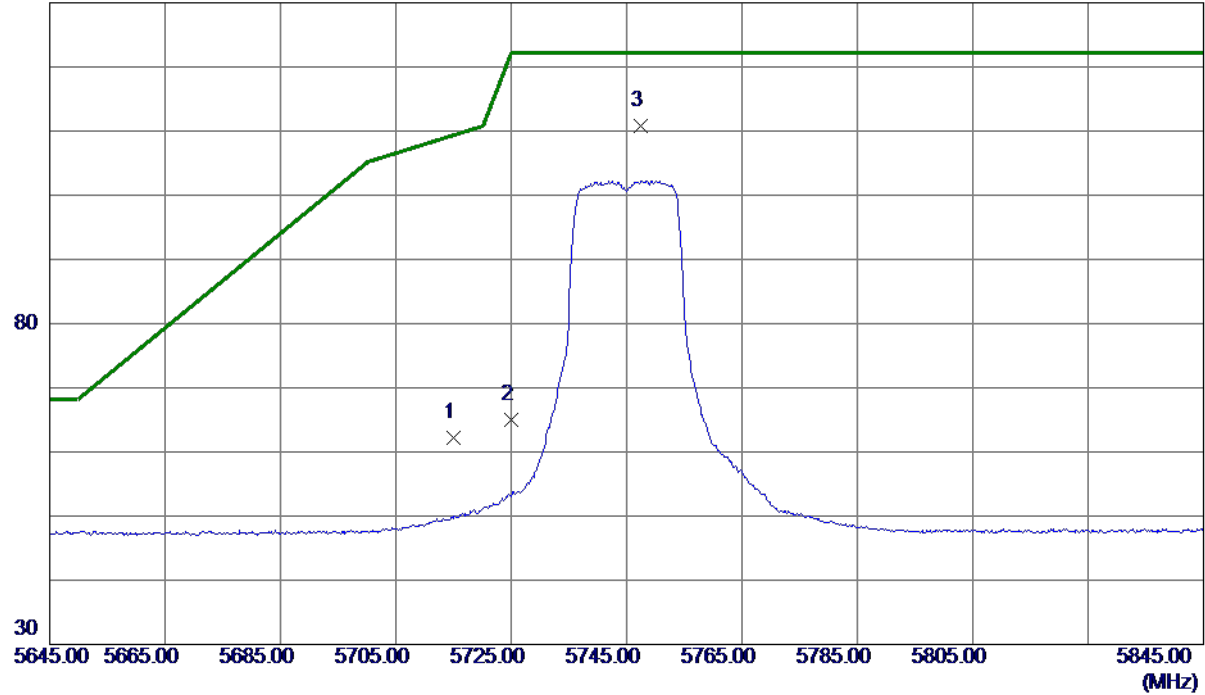

No.	Freq. MHz	Reading Level dBuV/m	Correct Factor dB	Measure ment dBuV/m	Limit dBuV/m	Margin dB	Detector	Comment
1	5715.0000	42.96	19.31	62.27	109.40	-47.13	Peak	
2	5725.0000	45.69	19.34	65.03	122.20	-57.17	Peak	
3 *	5747.5000	91.44	19.41	110.85	122.20	-11.35	Peak	No Limit

**REMARKS:**

- (1) Measurement Value = Reading Level + Correct Factor.
- (2) Margin Level = Measurement Value - Limit Value.

Orthogonal Axis	X
Test Mode	UNII-3_TX AC (VHT20) Mode 5745 MHz

### Horizontal

80 dBuV/m

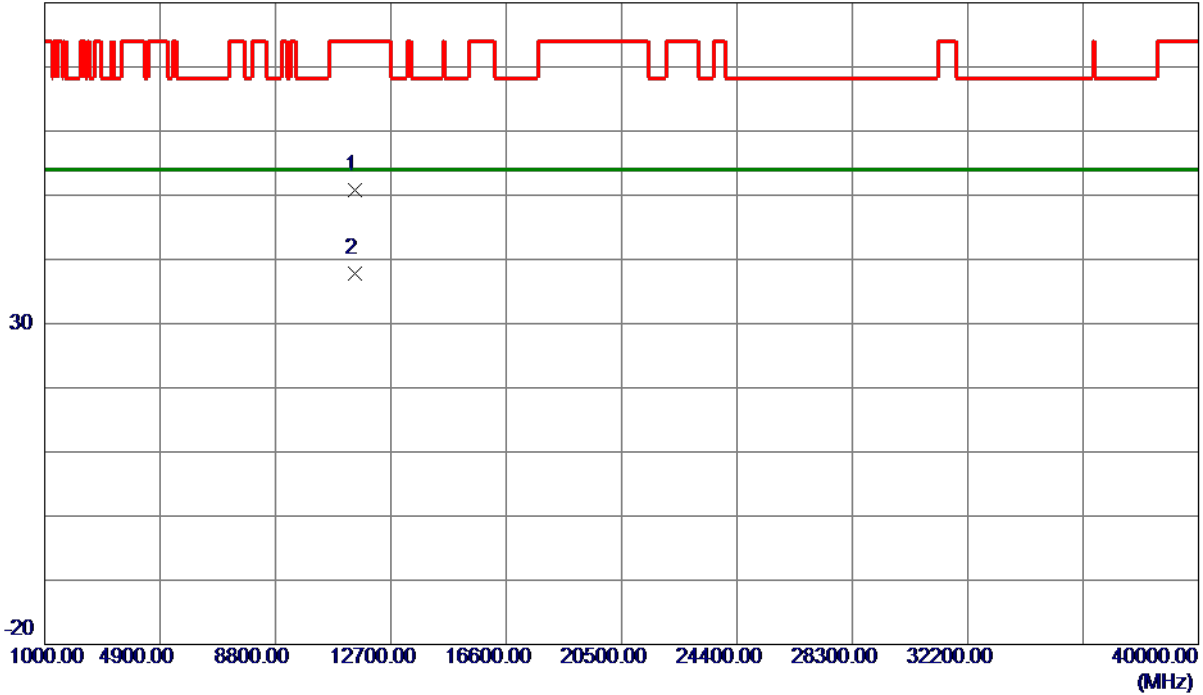

No.	Freq. MHz	Reading Level dBuV/m	Correct Factor dB	Measure ment dBuV/m	Limit dBuV/m	Margin dB	Detector	Comment
1	11487.8150	33.69	17.09	50.78	74.00	-23.22	Peak	
2 *	11491.7750	20.72	17.10	37.82	54.00	-16.18	AVG	

**REMARKS:**

- (1) Measurement Value = Reading Level + Correct Factor.
- (2) Margin Level = Measurement Value - Limit Value.

Orthogonal Axis	X
Test Mode	UNII-3_TX AC (VHT20) Mode 5785 MHz

**Vertical**

130 dBuV/m

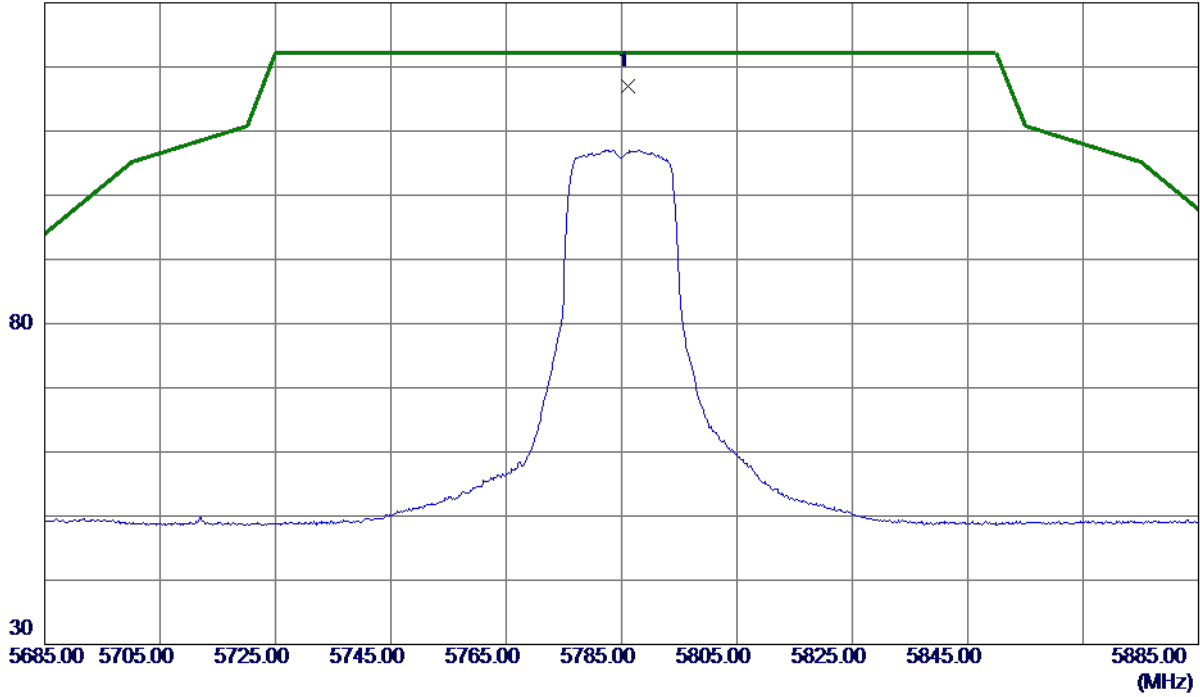

No.	Freq. MHz	Reading Level dBuV/m	Correct Factor dB	Measure ment dBuV/m	Limit dBuV/m	Margin dB	Detector	Comment
1 *	5786.2000	95.88	21.14	117.02	122.20	-5.18	Peak	No Limit

**REMARKS:**

- (1) Measurement Value = Reading Level + Correct Factor.
- (2) Margin Level = Measurement Value - Limit Value.

Orthogonal Axis	X
Test Mode	UNII-3_TX AC (VHT20) Mode 5785 MHz

### Vertical

80 dBuV/m

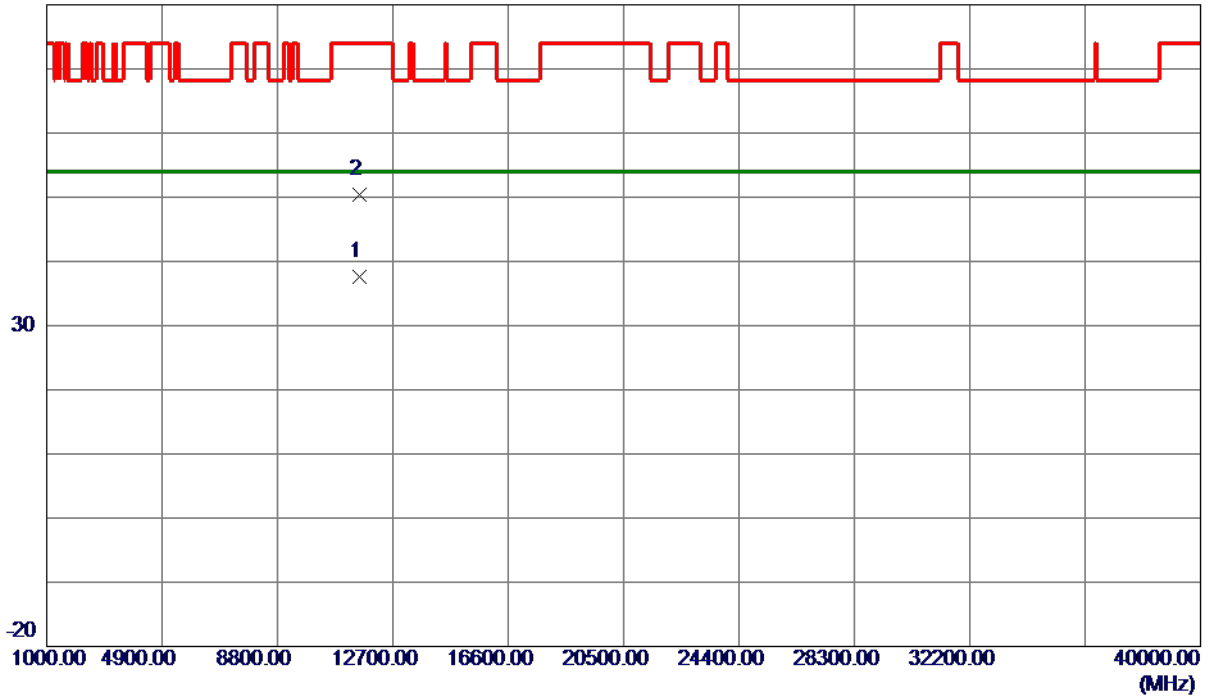

No.	Freq. MHz	Reading Level dBuV/m	Correct Factor dB	Measure ment dBuV/m	Limit dBuV/m	Margin dB	Detector	Comment
1 *	11567.8920	20.30	17.22	37.52	54.00	-16.48	AVG	
2	11571.1350	33.16	17.22	50.38	74.00	-23.62	Peak	

**REMARKS:**

- (1) Measurement Value = Reading Level + Correct Factor.
- (2) Margin Level = Measurement Value - Limit Value.

Orthogonal Axis	X
Test Mode	UNII-3_TX AC (VHT20) Mode 5785 MHz

### Horizontal

130 dBuV/m

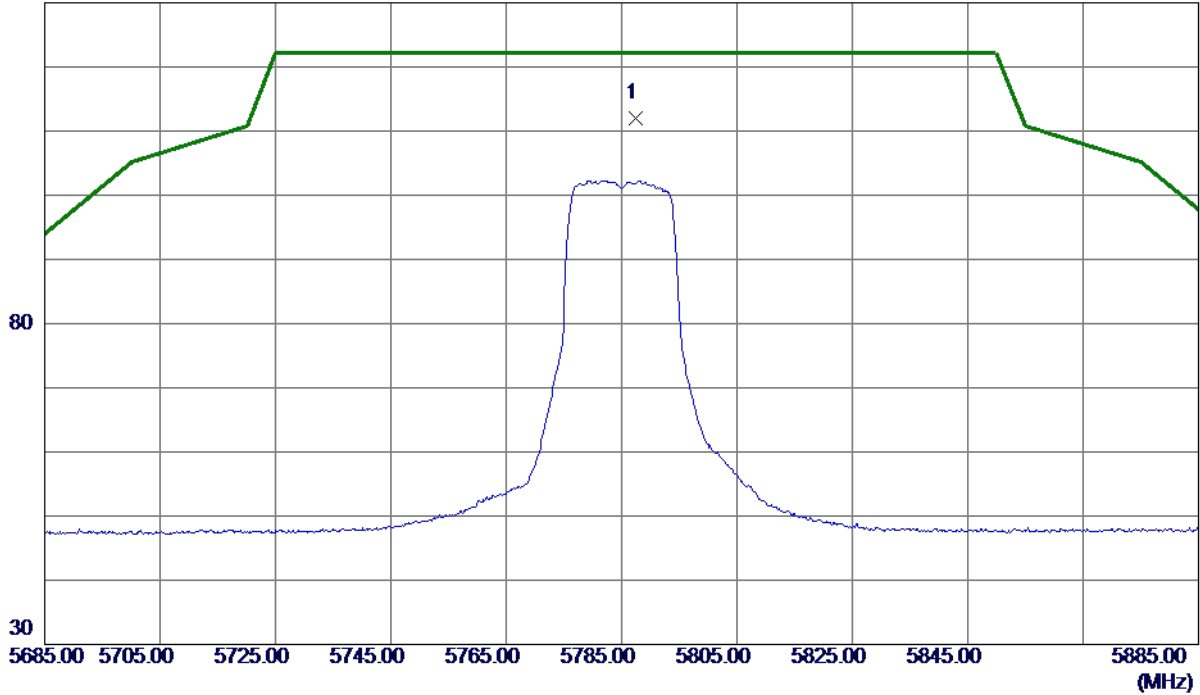

No.	Freq. MHz	Reading Level dBuV/m	Correct Factor dB	Measure ment dBuV/m	Limit dBuV/m	Margin dB	Detector	Comment
1 *	5787.5000	92.49	19.54	112.03	122.20	-10.17	Peak	No Limit

**REMARKS:**

- (1) Measurement Value = Reading Level + Correct Factor.
- (2) Margin Level = Measurement Value - Limit Value.



Orthogonal Axis	X
Test Mode	UNII-3_TX AC (VHT20) Mode 5785 MHz

### Horizontal

80 dBuV/m

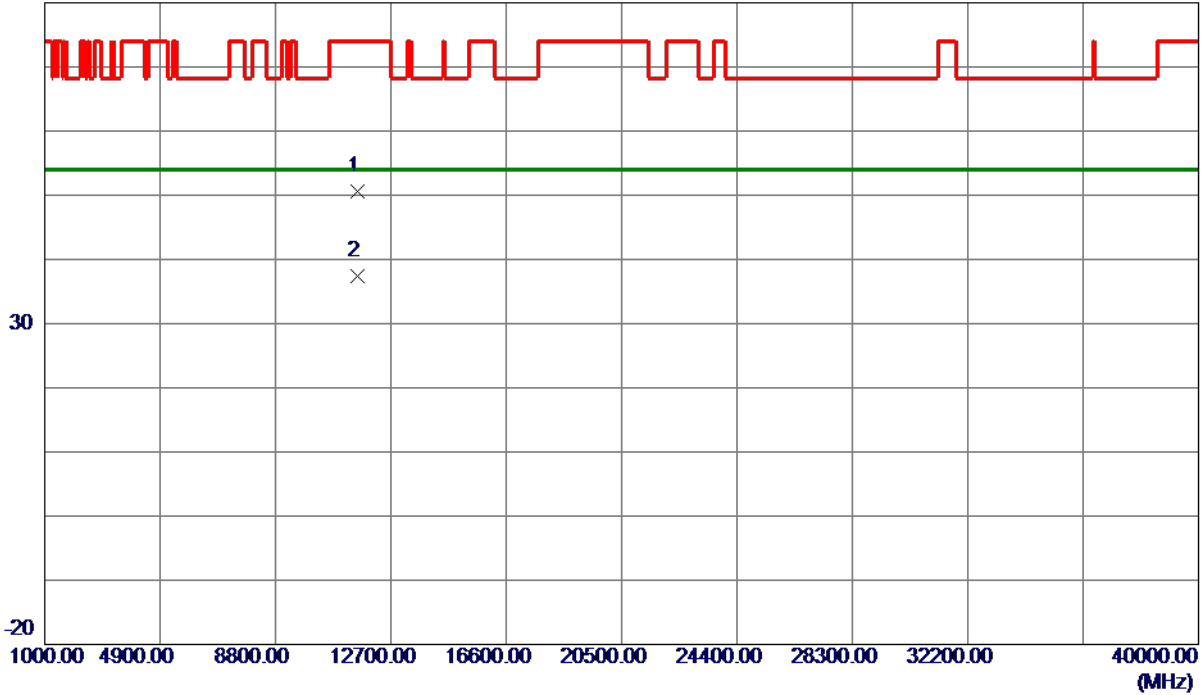

No.	Freq. MHz	Reading Level dBuV/m	Correct Factor dB	Measure ment dBuV/m	Limit dBuV/m	Margin dB	Detector	Comment
1	11569.3019	33.42	17.22	50.64	74.00	-23.36	Peak	
2 *	11569.8530	20.11	17.22	37.33	54.00	-16.67	AVG	

**REMARKS:**

- (1) Measurement Value = Reading Level + Correct Factor.
- (2) Margin Level = Measurement Value - Limit Value.

Orthogonal Axis	X
Test Mode	UNII-3_TX AC (VHT20) Mode 5825 MHz

**Vertical**

130 dBuV/m

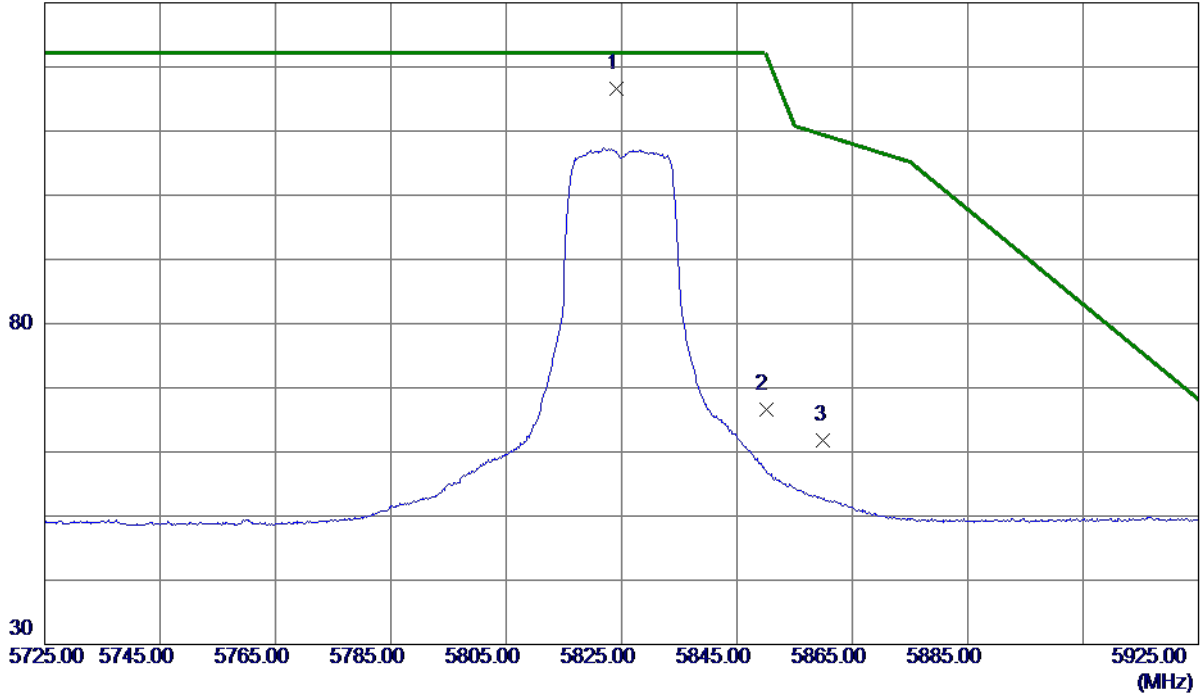

No.	Freq. MHz	Reading Level dBuV/m	Correct Factor dB	Measure ment dBuV/m	Limit dBuV/m	Margin dB	Detector	Comment
1 *	5824.2000	95.38	21.28	116.66	122.20	-5.54	Peak	No Limit
2	5850.0000	45.28	21.37	66.65	122.20	-55.55	Peak	
3	5860.0000	40.37	21.41	61.78	109.40	-47.62	Peak	

**REMARKS:**

- (1) Measurement Value = Reading Level + Correct Factor.
- (2) Margin Level = Measurement Value - Limit Value.

Orthogonal Axis	X
Test Mode	UNII-3_TX AC (VHT20) Mode 5825 MHz

### Vertical

80 dBuV/m

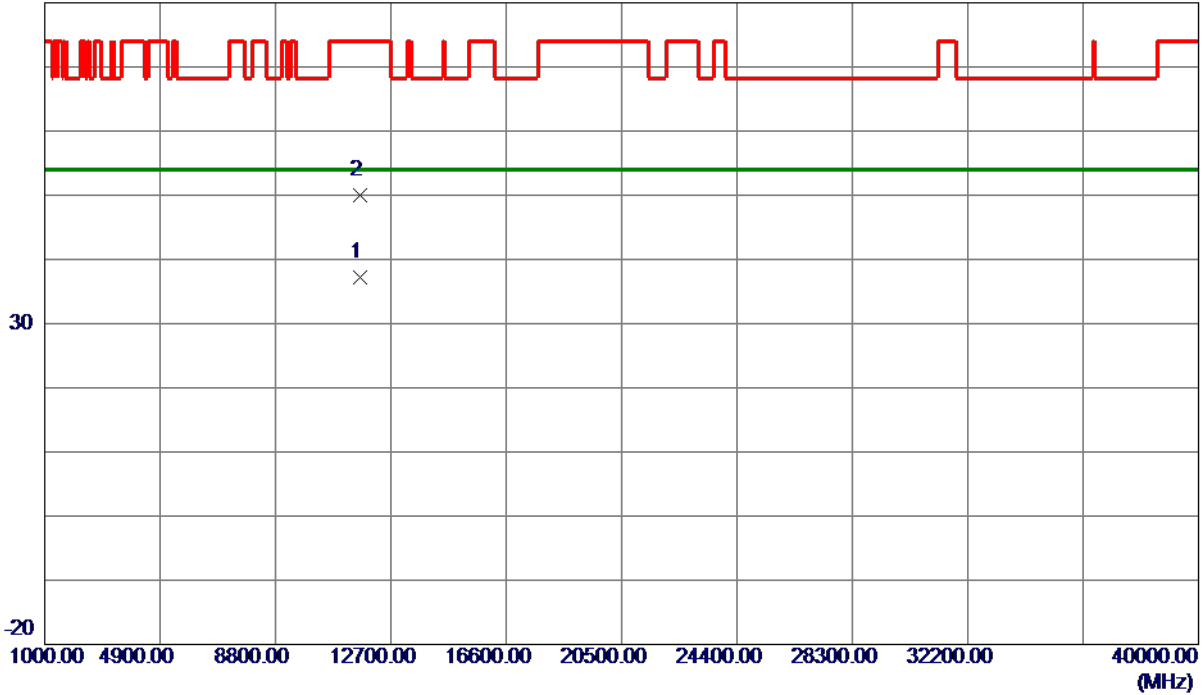

No.	Freq. MHz	Reading Level dBuV/m	Correct Factor dB	Measure ment dBuV/m	Limit dBuV/m	Margin dB	Detector	Comment
1 *	11650.1280	19.91	17.33	37.24	54.00	-16.76	AVG	
2	11651.9420	32.61	17.34	49.95	74.00	-24.05	Peak	

**REMARKS:**

- (1) Measurement Value = Reading Level + Correct Factor.
- (2) Margin Level = Measurement Value - Limit Value.

Orthogonal Axis	X
Test Mode	UNII-3_TX AC (VHT20) Mode 5825 MHz

### Horizontal

130 dBuV/m

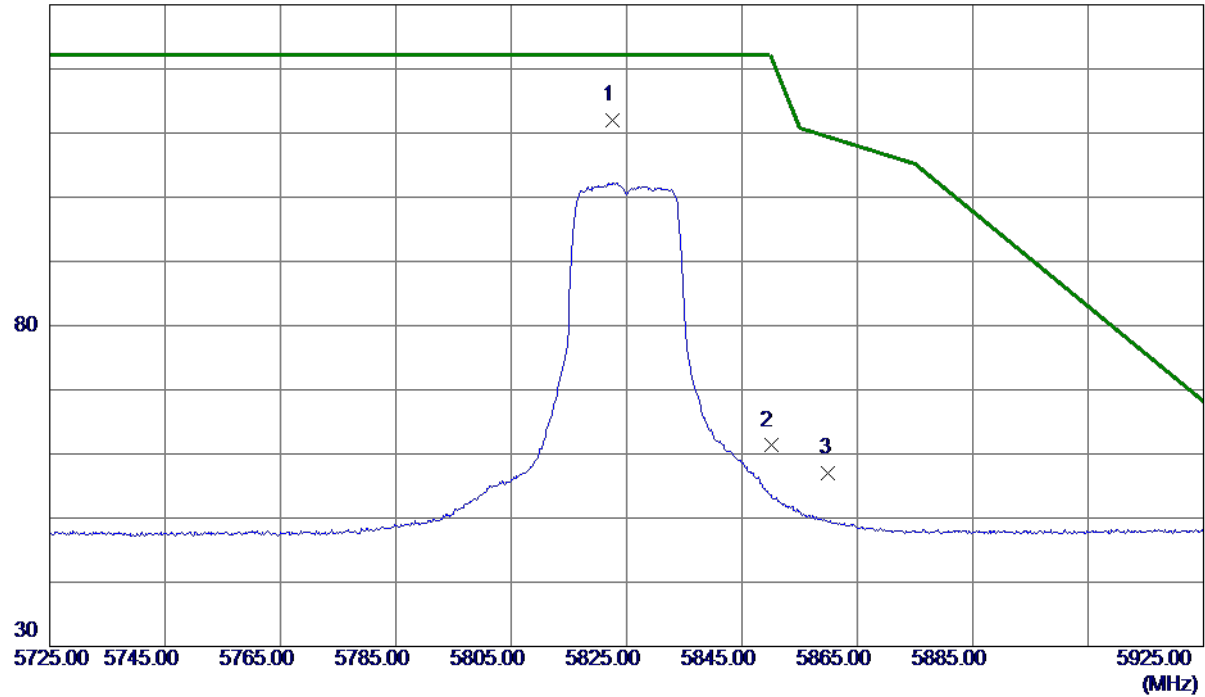

No.	Freq. MHz	Reading Level dBuV/m	Correct Factor dB	Measure ment dBuV/m	Limit dBuV/m	Margin dB	Detector	Comment
1 *	5822.6000	92.42	19.65	112.07	122.20	-10.13	Peak	No Limit
2	5850.0000	41.57	19.73	61.30	122.20	-60.90	Peak	
3	5860.0000	37.20	19.76	56.96	109.40	-52.44	Peak	

**REMARKS:**

- (1) Measurement Value = Reading Level + Correct Factor.
- (2) Margin Level = Measurement Value - Limit Value.

Orthogonal Axis	X
Test Mode	UNII-3_TX AC (VHT20) Mode 5825 MHz

### Horizontal

80 dBuV/m

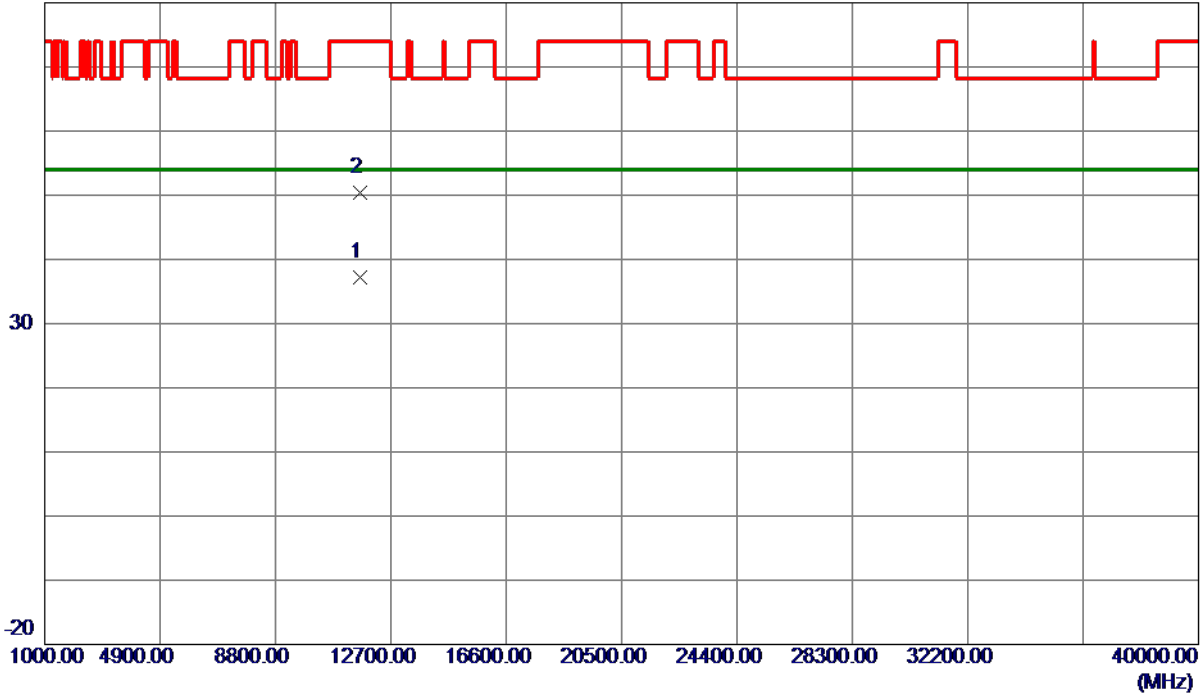

No.	Freq. MHz	Reading Level dBuV/m	Correct Factor dB	Measure ment dBuV/m	Limit dBuV/m	Margin dB	Detector	Comment
1 *	11648.6280	19.93	17.33	37.26	54.00	-16.74	AVG	
2	11651.2370	33.05	17.33	50.38	74.00	-23.62	Peak	

**REMARKS:**

- (1) Measurement Value = Reading Level + Correct Factor.
- (2) Margin Level = Measurement Value - Limit Value.

Orthogonal Axis	X
Test Mode	UNII-3_TX AC (VHT40) Mode 5755 MHz

**Vertical**

130 dBuV/m

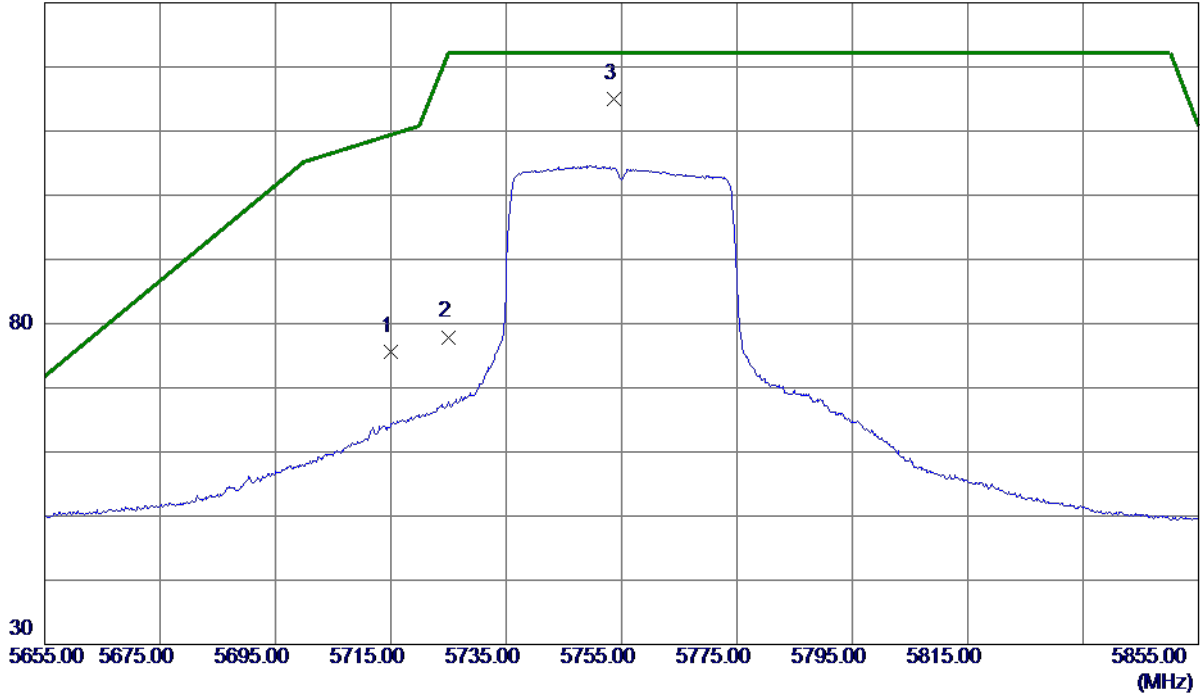

No.	Freq. MHz	Reading Level dBuV/m	Correct Factor dB	Measure ment dBuV/m	Limit dBuV/m	Margin dB	Detector	Comment
1	5715.0000	54.66	20.87	75.53	109.40	-33.87	Peak	
2	5725.0000	56.99	20.91	77.90	122.20	-44.30	Peak	
3 *	5753.7000	94.08	21.02	115.10	122.20	-7.10	Peak	No Limit

**REMARKS:**

- (1) Measurement Value = Reading Level + Correct Factor.
- (2) Margin Level = Measurement Value - Limit Value.

Orthogonal Axis	X
Test Mode	UNII-3_TX AC (VHT40) Mode 5755 MHz

### Vertical

80 dBuV/m

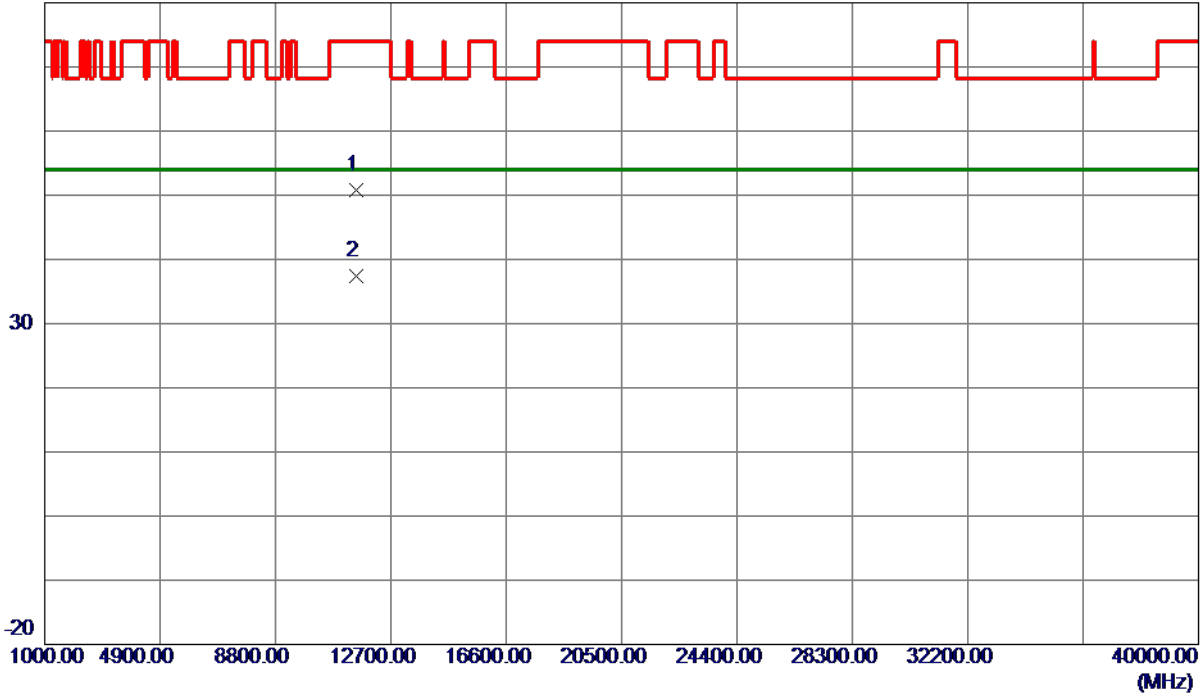

No.	Freq. MHz	Reading Level dBuV/m	Correct Factor dB	Measure ment dBuV/m	Limit dBuV/m	Margin dB	Detector	Comment
1	11510.0050	33.76	17.13	50.89	74.00	-23.11	Peak	
2 *	11510.4029	20.35	17.13	37.48	54.00	-16.52	AVG	

**REMARKS:**

- (1) Measurement Value = Reading Level + Correct Factor.
- (2) Margin Level = Measurement Value - Limit Value.

Orthogonal Axis	X
Test Mode	UNII-3_TX AC (VHT40) Mode 5755 MHz

### Horizontal

130 dBuV/m

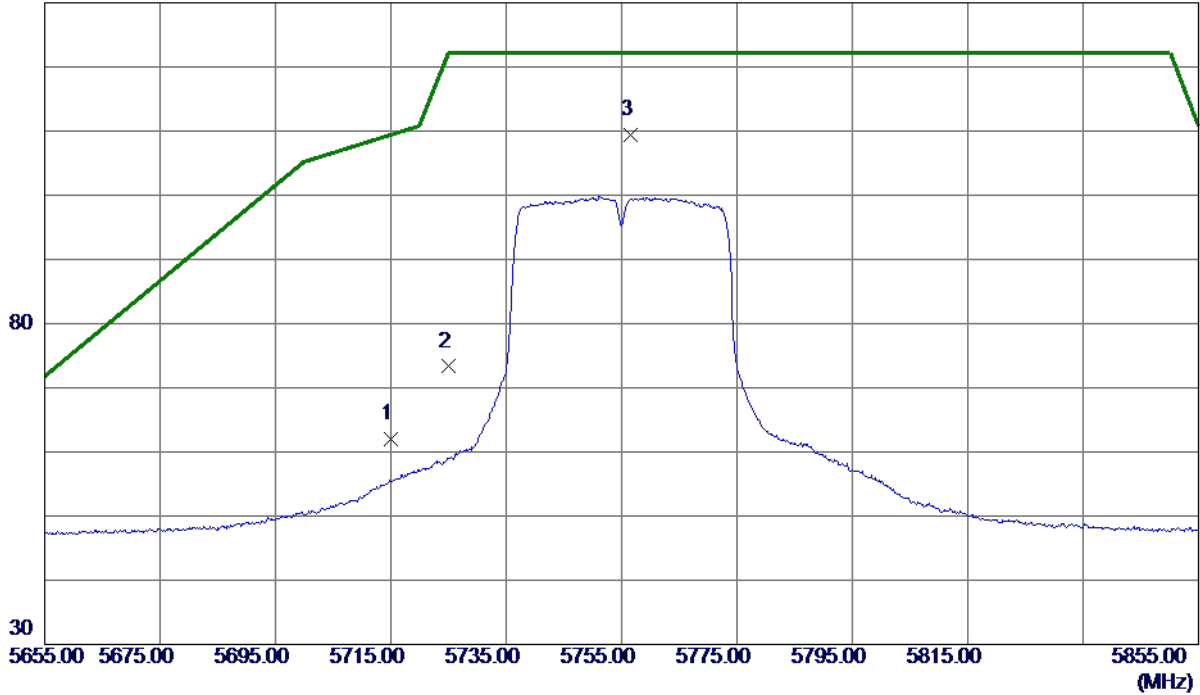

No.	Freq. MHz	Reading Level dBuV/m	Correct Factor dB	Measure ment dBuV/m	Limit dBuV/m	Margin dB	Detector	Comment
1	5715.0000	42.68	19.31	61.99	109.40	-47.41	Peak	
2	5725.0000	53.96	19.34	73.30	122.20	-48.90	Peak	
3 *	5756.5000	89.88	19.44	109.32	122.20	-12.88	Peak	No Limit

**REMARKS:**

- (1) Measurement Value = Reading Level + Correct Factor.
- (2) Margin Level = Measurement Value - Limit Value.



Orthogonal Axis	X
Test Mode	UNII-3_TX AC (VHT40) Mode 5755 MHz

### Horizontal

80 dBuV/m

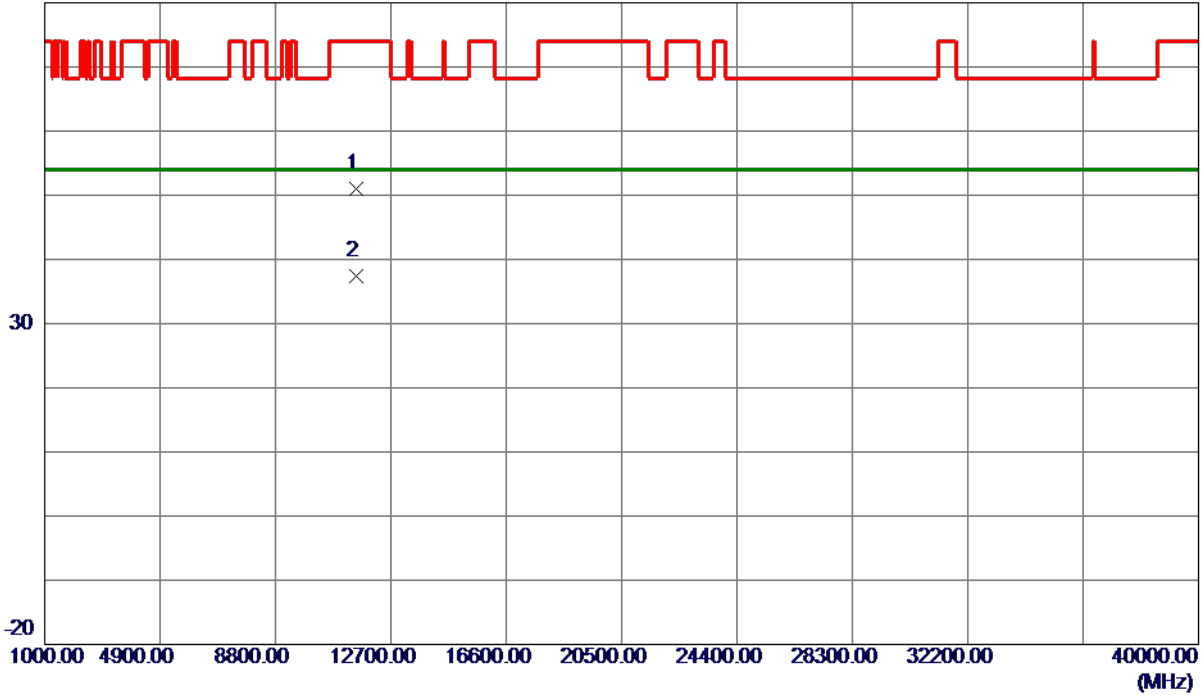

No.	Freq. MHz	Reading Level dBuV/m	Correct Factor dB	Measure ment dBuV/m	Limit dBuV/m	Margin dB	Detector	Comment
1	11511.4029	33.91	17.14	51.05	74.00	-22.95	Peak	
2 *	11511.4720	20.27	17.14	37.41	54.00	-16.59	AVG	

**REMARKS:**

- (1) Measurement Value = Reading Level + Correct Factor.
- (2) Margin Level = Measurement Value - Limit Value.

Orthogonal Axis	X
Test Mode	UNII-3_TX AC (VHT40) Mode 5795 MHz

### Vertical

130 dBuV/m

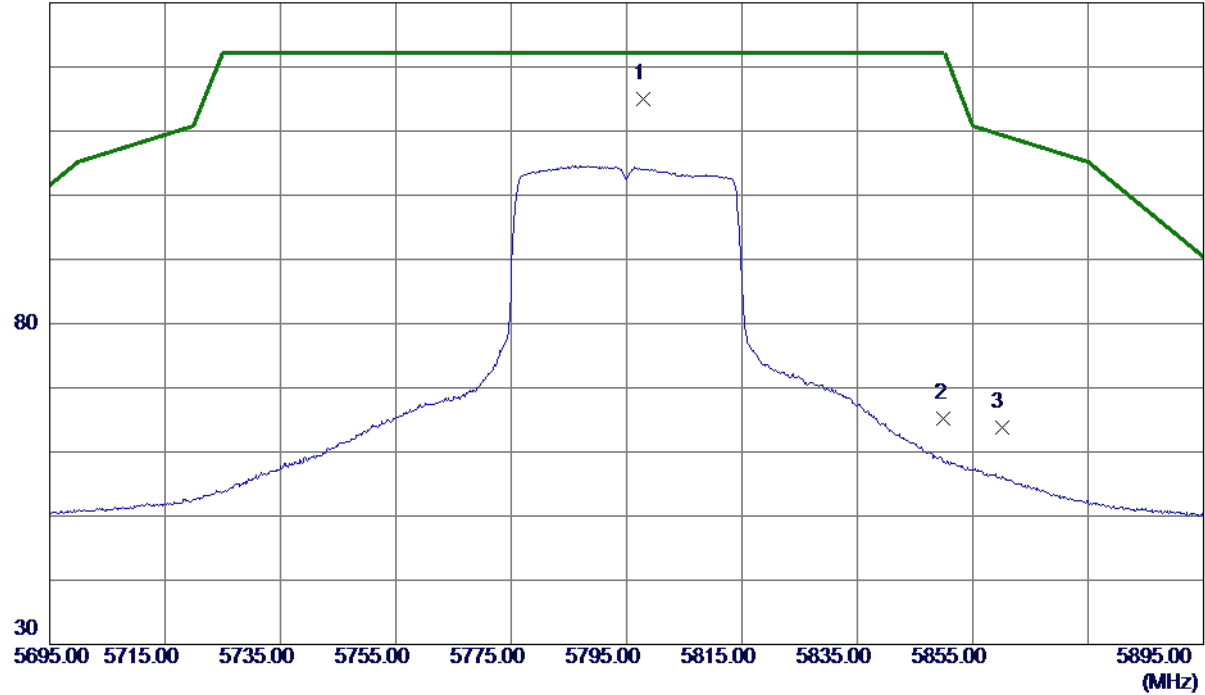

No.	Freq. MHz	Reading Level dBuV/m	Correct Factor dB	Measure ment dBuV/m	Limit dBuV/m	Margin dB	Detector	Comment
1 *	5797.8000	93.85	21.18	115.03	122.20	-7.17	Peak	No Limit
2	5850.0000	43.81	21.37	65.18	122.20	-57.02	Peak	
3	5860.0000	42.35	21.41	63.76	109.40	-45.64	Peak	

**REMARKS:**

- (1) Measurement Value = Reading Level + Correct Factor.
- (2) Margin Level = Measurement Value - Limit Value.

Orthogonal Axis	X
Test Mode	UNII-3_TX AC (VHT40) Mode 5795 MHz

### Vertical

80 dBuV/m

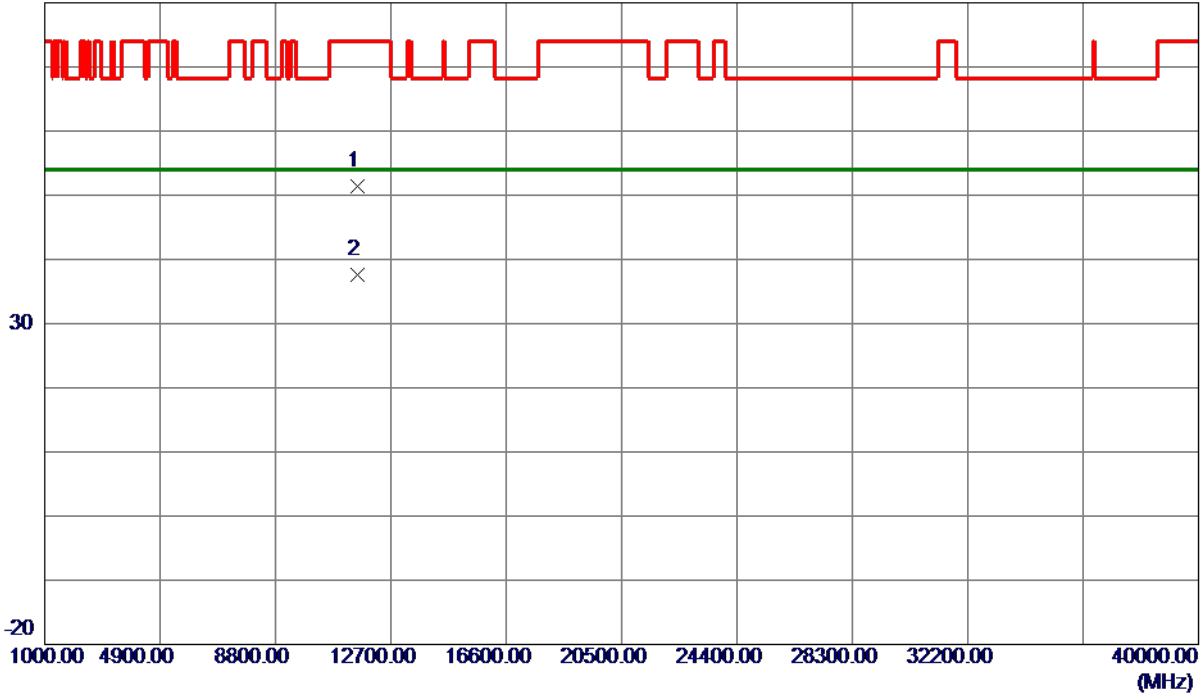

No.	Freq. MHz	Reading Level dBuV/m	Correct Factor dB	Measure ment dBuV/m	Limit dBuV/m	Margin dB	Detector	Comment
1	11588.7500	34.24	17.25	51.49	74.00	-22.51	Peak	
2 *	11590.5350	20.36	17.25	37.61	54.00	-16.39	AVG	

**REMARKS:**

- (1) Measurement Value = Reading Level + Correct Factor.
- (2) Margin Level = Measurement Value - Limit Value.

Orthogonal Axis	X
Test Mode	UNII-3_TX AC (VHT40) Mode 5795 MHz

### Horizontal

130 dBuV/m

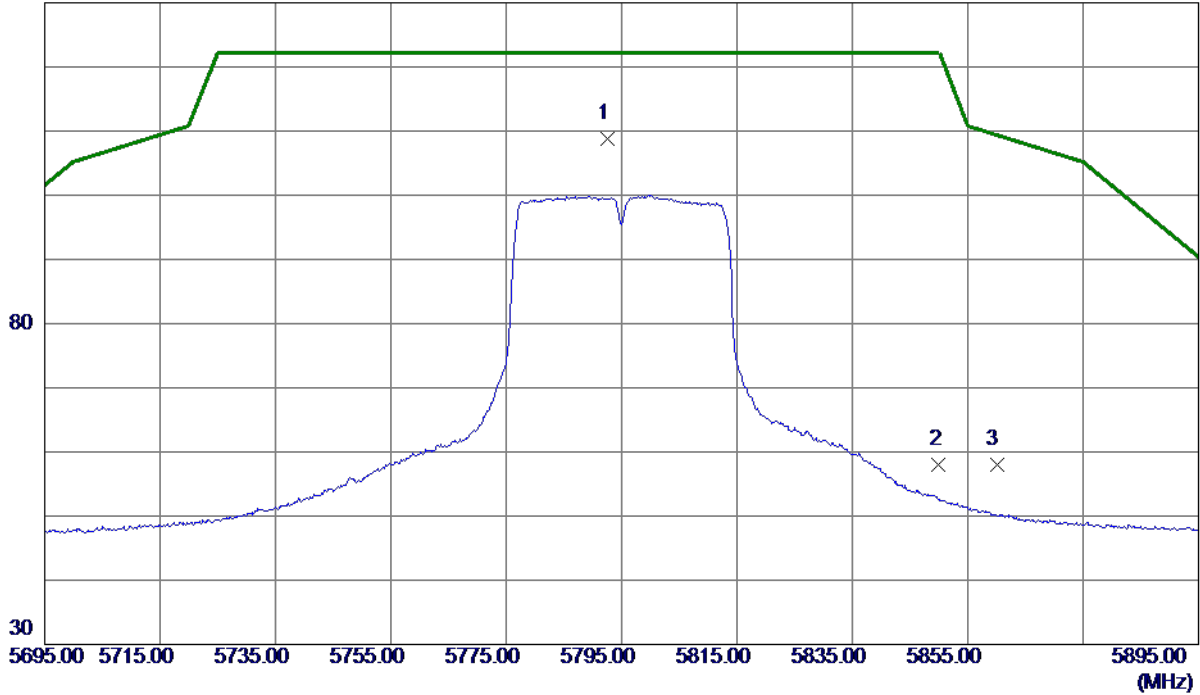

No.	Freq. MHz	Reading Level dBuV/m	Correct Factor dB	Measure ment dBuV/m	Limit dBuV/m	Margin dB	Detector	Comment
1 *	5792.6000	89.28	19.55	108.83	122.20	-13.37	Peak	No Limit
2	5850.0000	38.31	19.73	58.04	122.20	-64.16	Peak	
3	5860.0000	38.33	19.76	58.09	109.40	-51.31	Peak	

**REMARKS:**

- (1) Measurement Value = Reading Level + Correct Factor.
- (2) Margin Level = Measurement Value - Limit Value.

Orthogonal Axis	X
Test Mode	UNII-3_TX AC (VHT40) Mode 5795 MHz

### Horizontal

80 dBuV/m

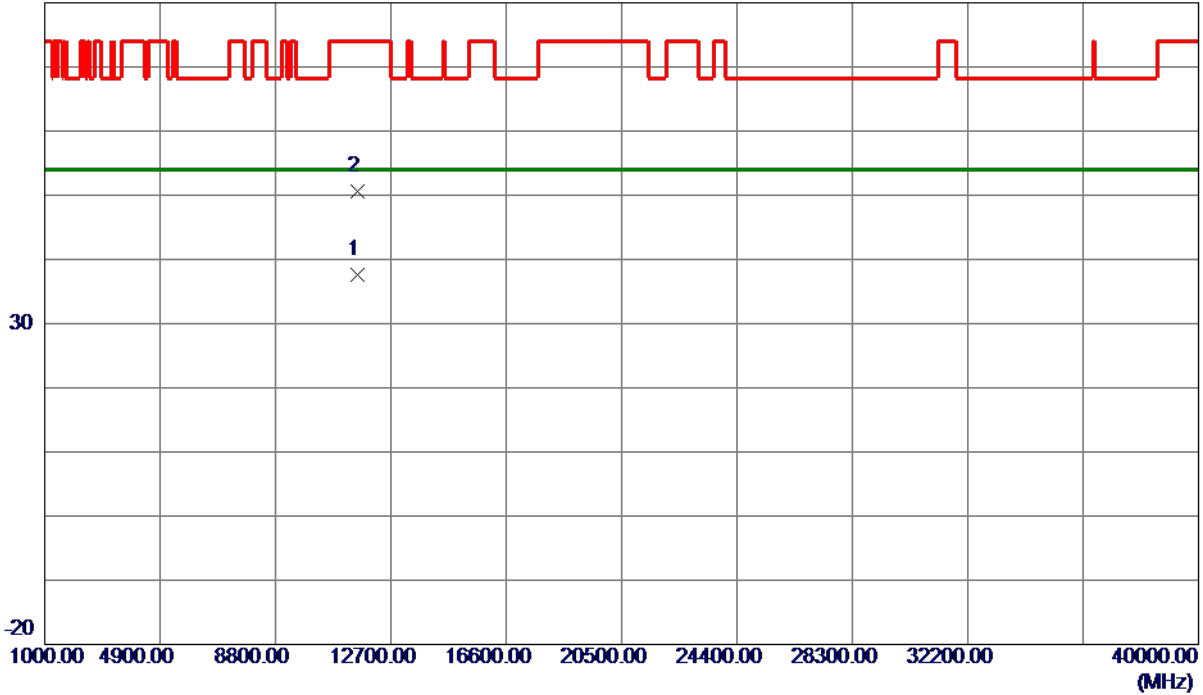

No.	Freq. MHz	Reading Level dBuV/m	Correct Factor dB	Measure ment dBuV/m	Limit dBuV/m	Margin dB	Detector	Comment
1 *	11587.8620	20.36	17.24	37.60	54.00	-16.40	AVG	
2	11588.5500	33.38	17.25	50.63	74.00	-23.37	Peak	

**REMARKS:**

- (1) Measurement Value = Reading Level + Correct Factor.
- (2) Margin Level = Measurement Value - Limit Value.

Orthogonal Axis	X
Test Mode	UNII-3_TX AC (VHT80) Mode 5775 MHz

### Vertical

130 dBuV/m

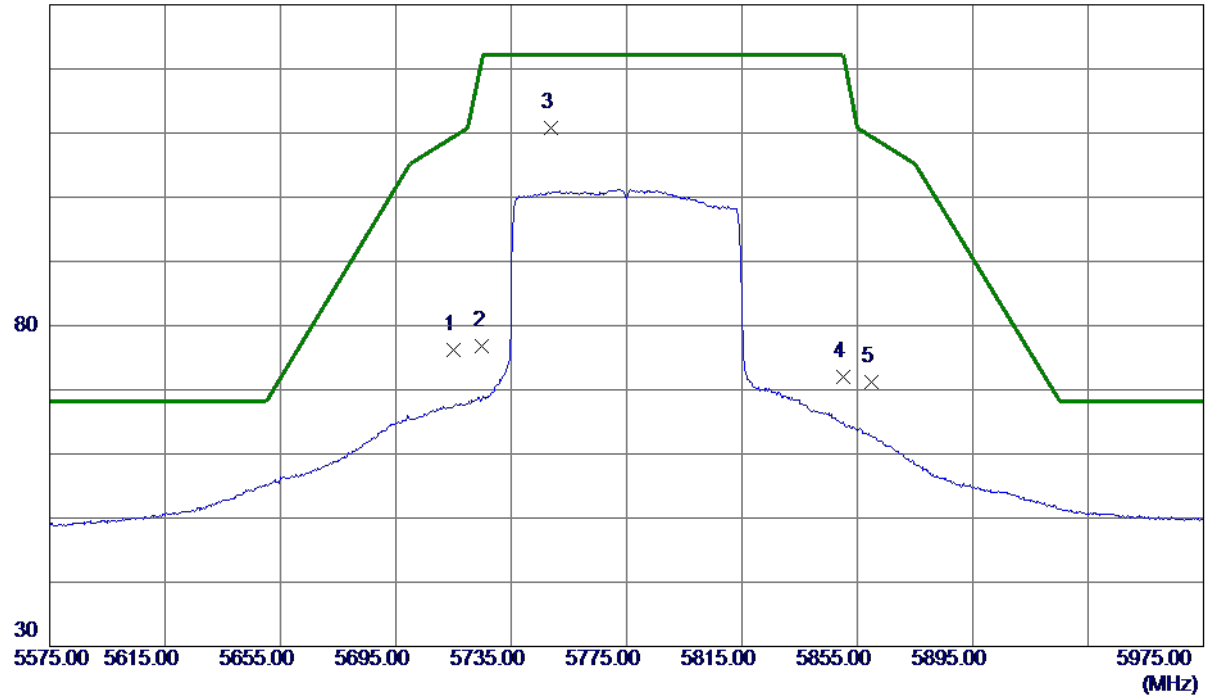

No.	Freq. MHz	Reading Level dBuV/m	Correct Factor dB	Measure ment dBuV/m	Limit dBuV/m	Margin dB	Detector	Comment
1	5715.0000	55.37	20.87	76.24	109.40	-33.16	Peak	
2	5725.0000	55.97	20.91	76.88	122.20	-45.32	Peak	
3 *	5748.6000	89.71	21.00	110.71	122.20	-11.49	Peak	No Limit
4	5850.0000	50.68	21.37	72.05	122.20	-50.15	Peak	
5	5860.0000	49.74	21.41	71.15	109.40	-38.25	Peak	

**REMARKS:**

- (1) Measurement Value = Reading Level + Correct Factor.
- (2) Margin Level = Measurement Value - Limit Value.

Orthogonal Axis	X
Test Mode	UNII-3_TX AC (VHT80) Mode 5775 MHz

### Vertical

80 dBuV/m

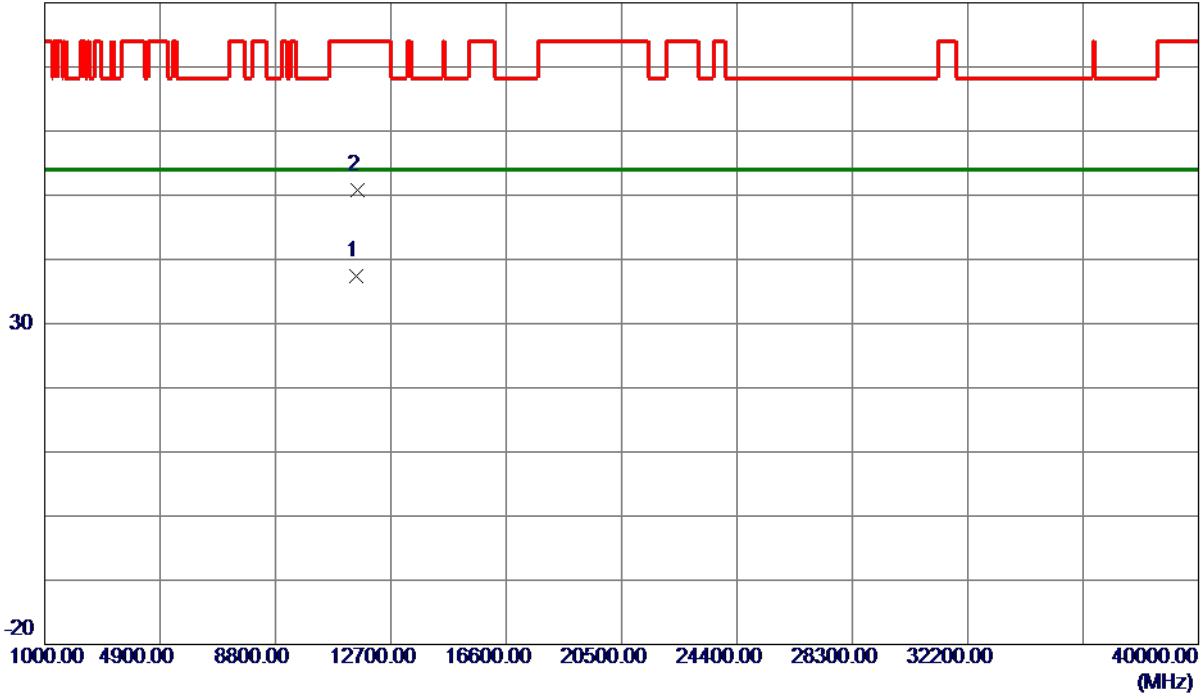

No.	Freq. MHz	Reading Level dBuV/m	Correct Factor dB	Measure ment dBuV/m	Limit dBuV/m	Margin dB	Detector	Comment
1 *	11548.4830	20.25	17.19	37.44	54.00	-16.56	AVG	
2	11551.7699	33.61	17.19	50.80	74.00	-23.20	Peak	

**REMARKS:**

- (1) Measurement Value = Reading Level + Correct Factor.
- (2) Margin Level = Measurement Value - Limit Value.

Orthogonal Axis	X
Test Mode	UNII-3_TX AC (VHT80) Mode 5775 MHz

### Horizontal

130 dBuV/m

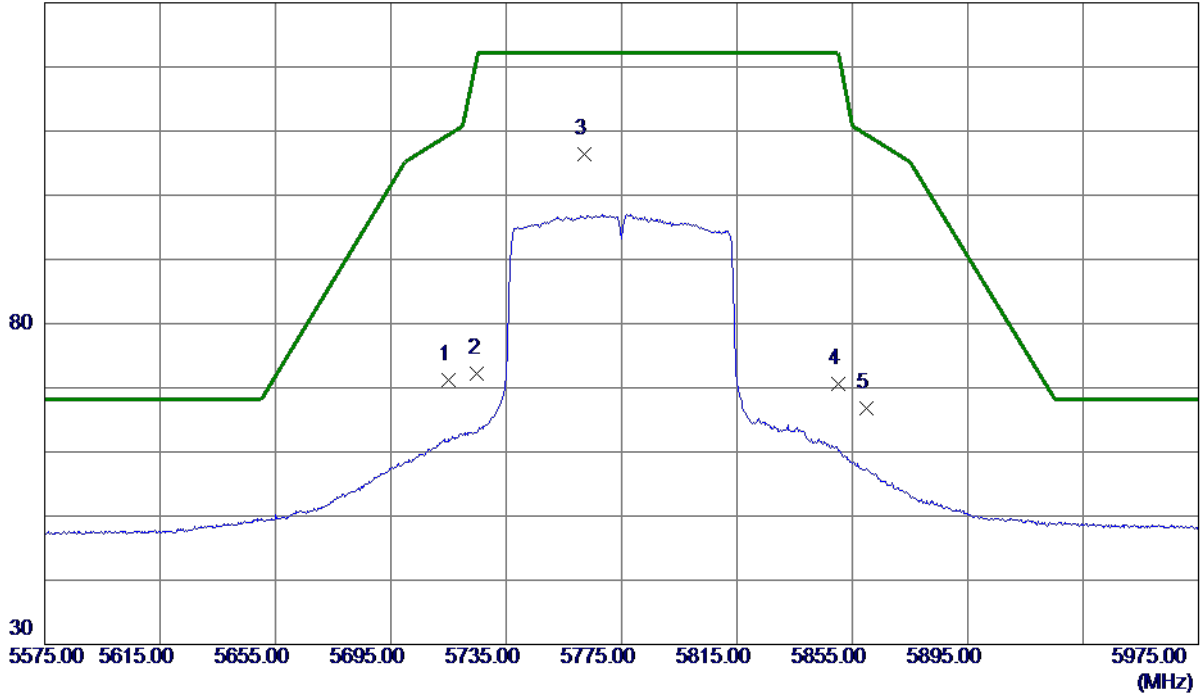

No.	Freq. MHz	Reading Level dBuV/m	Correct Factor dB	Measure ment dBuV/m	Limit dBuV/m	Margin dB	Detector	Comment
1	5715.0000	51.94	19.31	71.25	109.40	-38.15	Peak	
2	5725.0000	52.84	19.34	72.18	122.20	-50.02	Peak	
3 *	5762.2000	86.97	19.46	106.43	122.20	-15.77	Peak	No Limit
4	5850.0000	50.80	19.73	70.53	122.20	-51.67	Peak	
5	5860.0000	47.08	19.76	66.84	109.40	-42.56	Peak	

**REMARKS:**

- (1) Measurement Value = Reading Level + Correct Factor.
- (2) Margin Level = Measurement Value - Limit Value.



Orthogonal Axis	X
Test Mode	UNII-3_TX AC (VHT80) Mode 5775 MHz

### Horizontal

80 dBuV/m

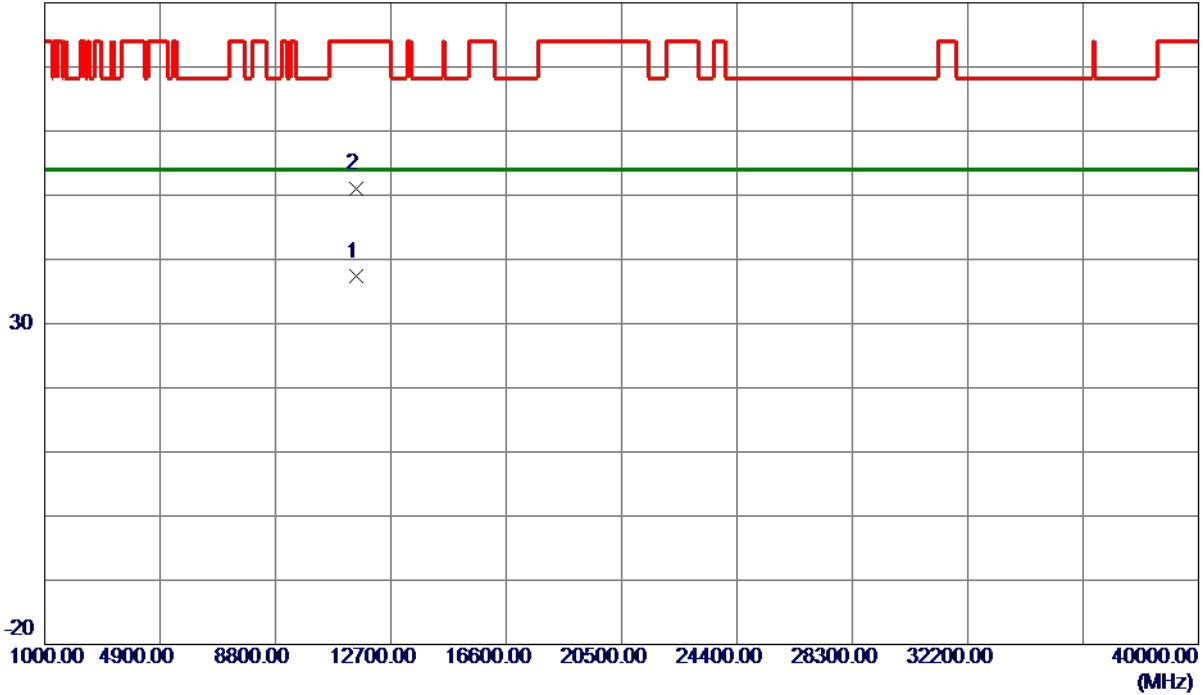

No.	Freq. MHz	Reading Level dBuV/m	Correct Factor dB	Measure ment dBuV/m	Limit dBuV/m	Margin dB	Detector	Comment
1 *	11548.3650	20.11	17.19	37.30	54.00	-16.70	AVG	
2	11551.3620	33.83	17.19	51.02	74.00	-22.98	Peak	

**REMARKS:**

- (1) Measurement Value = Reading Level + Correct Factor.
- (2) Margin Level = Measurement Value - Limit Value.

Orthogonal Axis	X
Test Mode	UNII-1_TX AX (HE20) Mode 5180 MHz

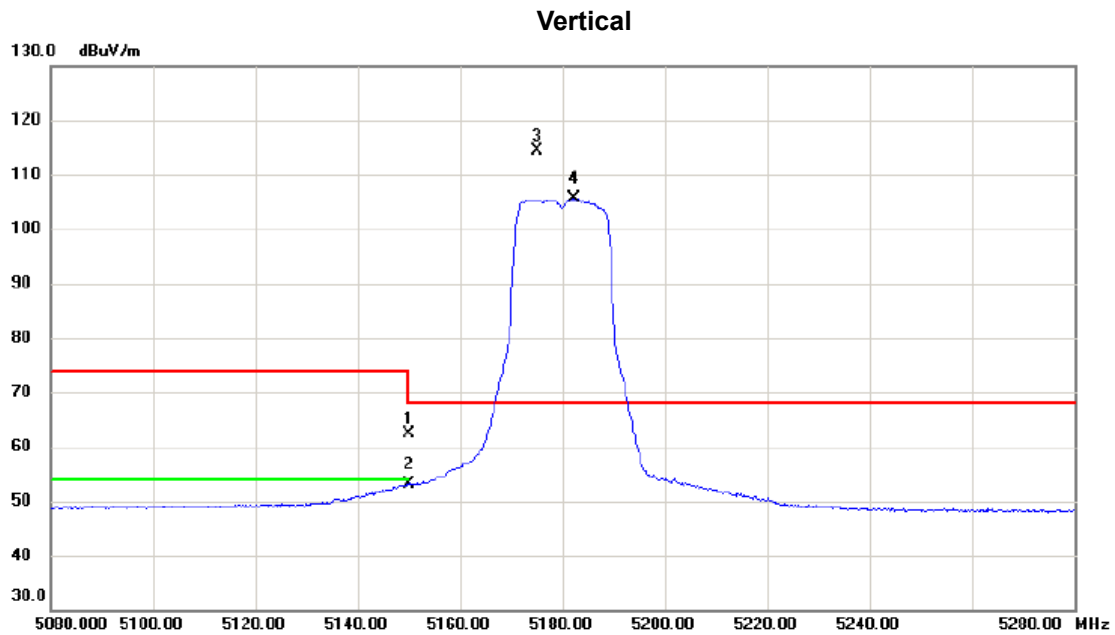

No.	Mk.	Freq. MHz	Reading Level dBuV	Correct Factor dB	Measure- ment dBuV/m	Limit dBuV/m	Margin dB	Detector	Comment
1		5150.000	43.21	19.25	62.46	74.00	-11.54	peak	
2		5150.000	33.85	19.25	53.10	54.00	-0.90	AVG	
3	*	5175.100	95.16	19.31	114.47	68.20	46.27	peak	No Limit
4	X	5182.200	86.27	19.32	105.59	68.20	37.39	AVG	No Limit

**REMARKS:**

- (1) Measurement Value = Reading Level + Correct Factor.
- (2) Margin Level = Measurement Value - Limit Value.

Orthogonal Axis	X
Test Mode	UNII-1_TX AX (HE20) Mode 5180 MHz

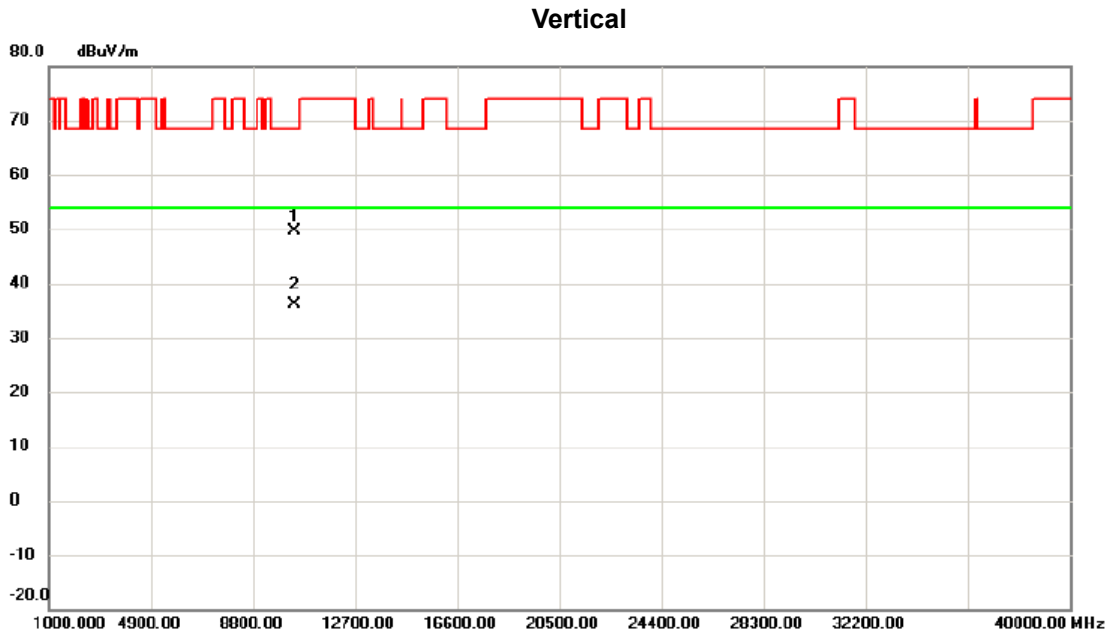

No.	Mk.	Freq.	Reading Level	Correct Factor	Measurement	Limit	Margin	Detector	Comment
		MHz	dBuV	dB	dBuV/m	dBuV/m	dB		
1		10360.743	34.50	15.09	49.59	68.30	-18.71	peak	
2	*	10361.765	21.09	15.09	36.18	54.00	-17.82	AVG	

**REMARKS:**

- (1) Measurement Value = Reading Level + Correct Factor.
- (2) Margin Level = Measurement Value - Limit Value.

Orthogonal Axis	X
Test Mode	UNII-1_TX AX (HE20) Mode 5180 MHz

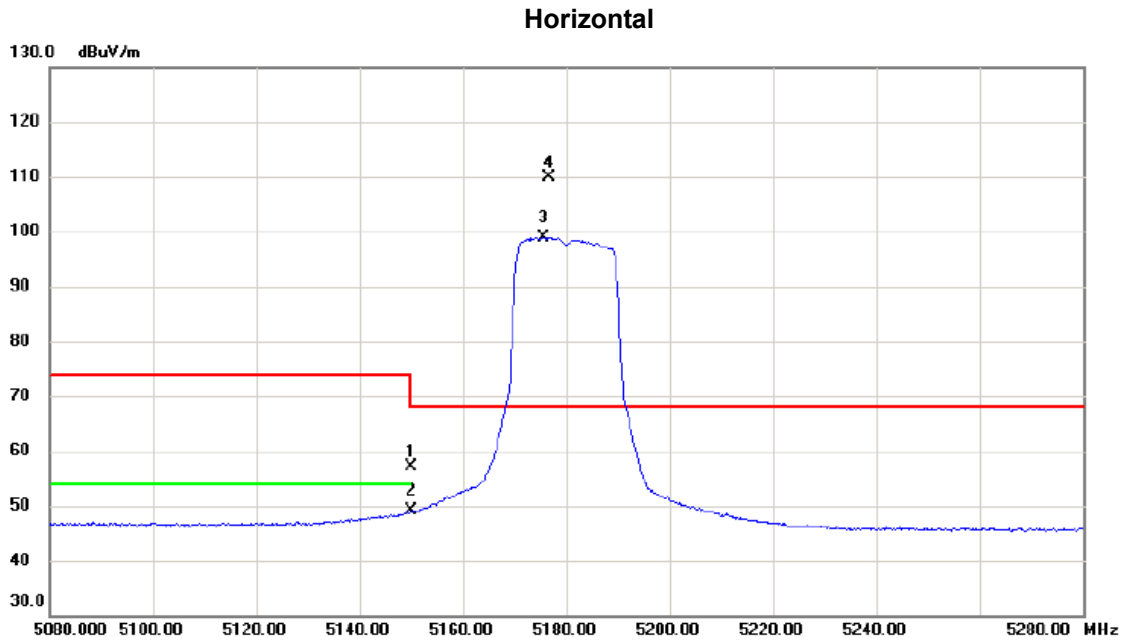

No.	Mk.	Freq. MHz	Reading Level dBuV	Correct Factor dB	Measure- ment dBuV/m	Limit dBuV/m	Margin dB	Detector	Comment
1		5150.000	39.57	17.68	57.25	74.00	-16.75	peak	
2		5150.000	31.48	17.68	49.16	54.00	-4.84	AVG	
3	X	5175.600	81.15	17.75	98.90	68.20	30.70	AVG	No Limit
4	*	5176.700	92.20	17.75	109.95	68.20	41.75	peak	No Limit

**REMARKS:**

- (1) Measurement Value = Reading Level + Correct Factor.
- (2) Margin Level = Measurement Value - Limit Value.

Orthogonal Axis	X
Test Mode	UNII-1_TX AX (HE20) Mode 5180 MHz

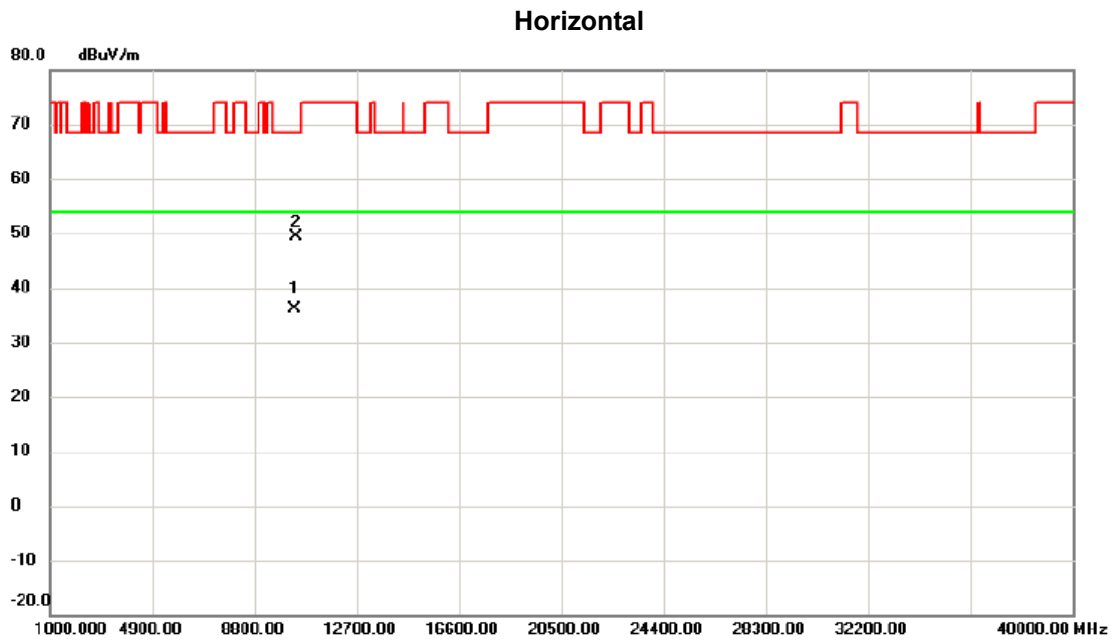

No.	Mk.	Freq. MHz	Reading Level dBuV	Correct Factor dB	Measure- ment dBuV/m	Limit dBuV/m	Margin dB	Detector	Comment
1	*	10358.097	20.95	15.09	36.04	54.00	-17.96	AVG	
2		10360.055	34.17	15.09	49.26	68.30	-19.04	peak	

REMARKS:

- (1) Measurement Value = Reading Level + Correct Factor.
- (2) Margin Level = Measurement Value - Limit Value.

Orthogonal Axis	X
Test Mode	UNII-1_TX AX (HE20) Mode 5200 MHz

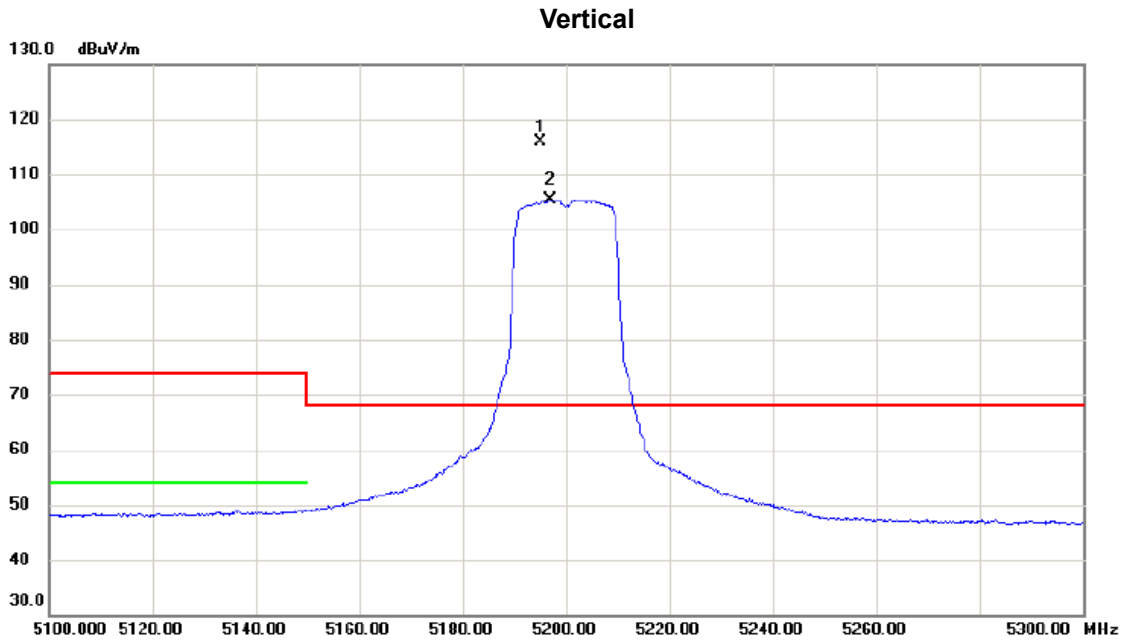

No.	Mk.	Freq. MHz	Reading Level dBuV	Correct Factor dB	Measure- ment dBuV/m	Limit dBuV/m	Margin dB	Detector	Comment
1	*	5195.000	96.43	19.36	115.79	68.20	47.59	peak	No Limit
2	X	5197.000	86.10	19.36	105.46	68.20	37.26	AVG	No Limit

**REMARKS:**

- (1) Measurement Value = Reading Level + Correct Factor.
- (2) Margin Level = Measurement Value - Limit Value.

Orthogonal Axis	X
Test Mode	UNII-1_TX AX (HE20) Mode 5200 MHz

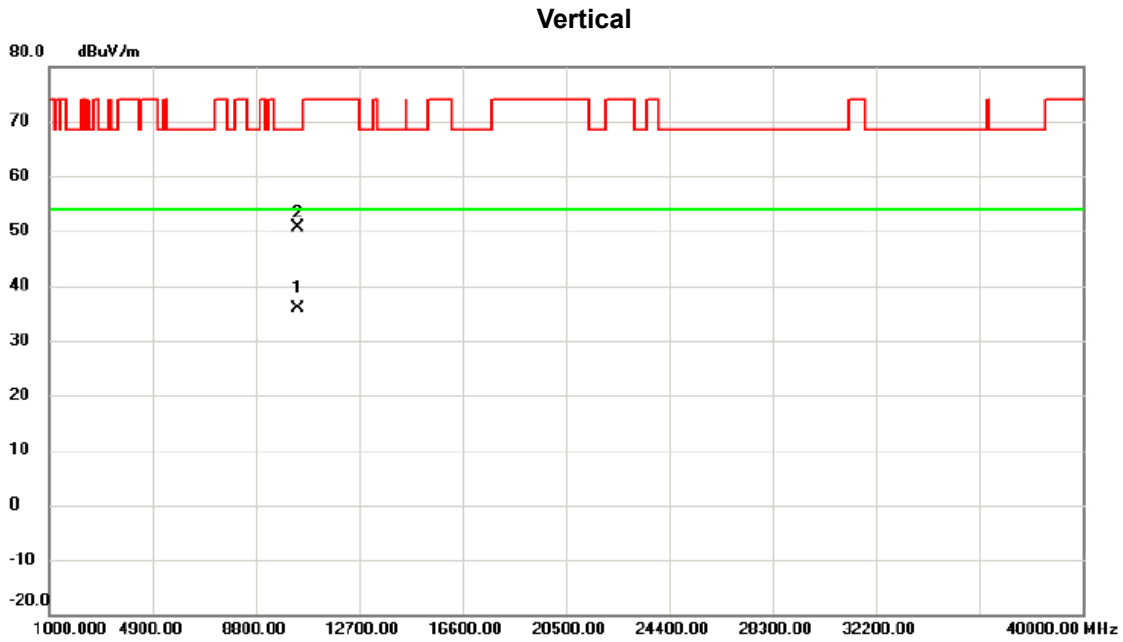

No.	Mk.	Freq.	Reading Level	Correct Factor	Measurement	Limit	Margin	Detector	Comment
		MHz	dBuV	dB	dBuV/m	dBuV/m	dB		
1		10400.032	20.75	15.16	35.91	54.00	-18.09	AVG	
2	*	10400.265	35.48	15.16	50.64	68.30	-17.66	peak	

REMARKS:

- (1) Measurement Value = Reading Level + Correct Factor.
- (2) Margin Level = Measurement Value - Limit Value.

Orthogonal Axis	X
Test Mode	UNII-1_TX AX (HE20) Mode 5200 MHz

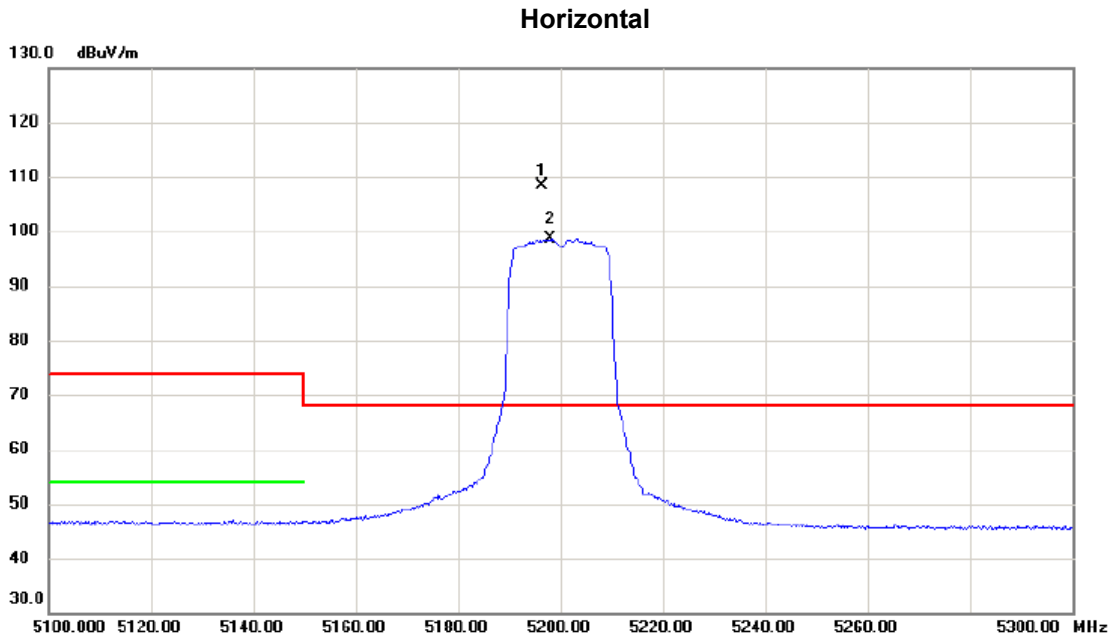

No.	Mk.	Freq. MHz	Reading Level dBuV	Correct Factor dB	Measure- ment dBuV/m	Limit dBuV/m	Margin dB	Detector	Comment
1	*	5196.400	90.59	17.81	108.40	68.20	40.20	peak	No Limit
2	X	5198.000	80.88	17.81	98.69	68.20	30.49	AVG	No Limit

**REMARKS:**

- (1) Measurement Value = Reading Level + Correct Factor.
- (2) Margin Level = Measurement Value - Limit Value.



Orthogonal Axis	X
Test Mode	UNII-1_TX AX (HE20) Mode 5200 MHz

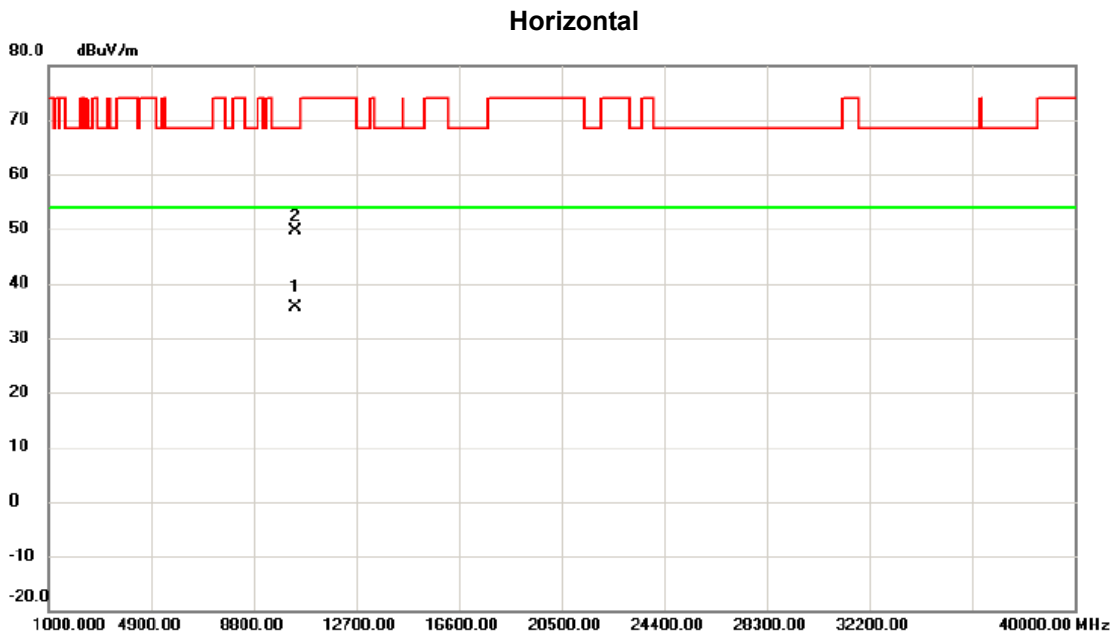

No.	Mk.	Freq. MHz	Reading Level dBuV	Correct Factor dB	Measure- ment dBuV/m	Limit dBuV/m	Margin dB	Detector	Comment
1	*	10398.025	20.54	15.15	35.69	54.00	-18.31	AVG	
2		10399.458	34.37	15.16	49.53	68.30	-18.77	peak	

**REMARKS:**

- (1) Measurement Value = Reading Level + Correct Factor.
- (2) Margin Level = Measurement Value - Limit Value.

Orthogonal Axis	X
Test Mode	UNII-1_TX AX (HE20) Mode 5240 MHz

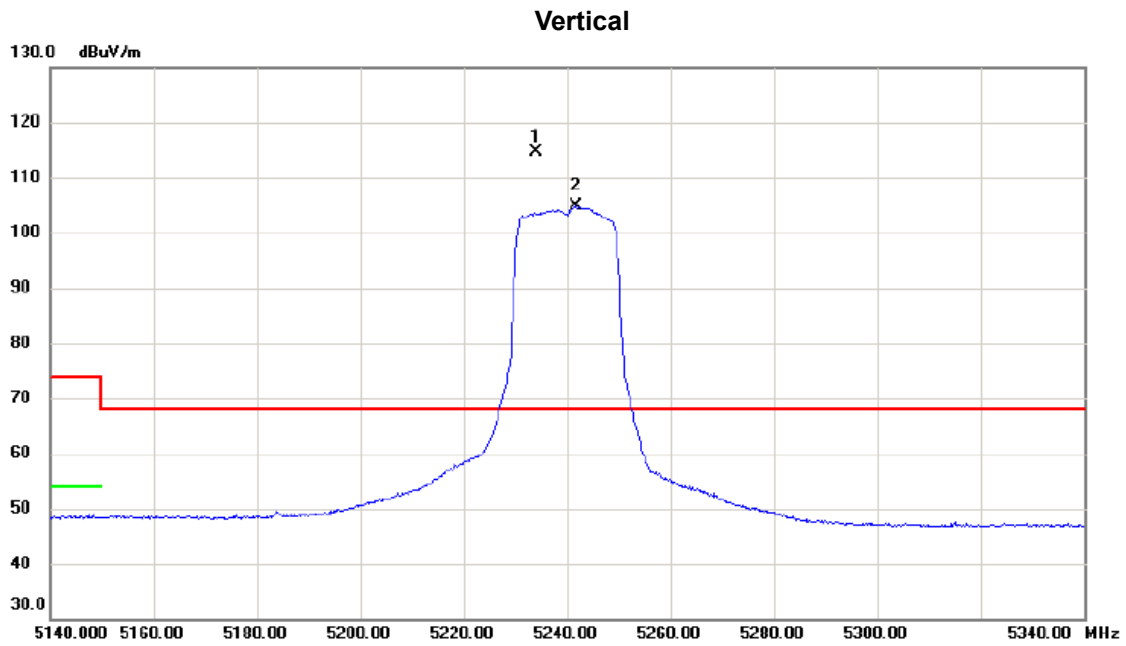

No.	Mk.	Freq. MHz	Reading Level dBuV	Correct Factor dB	Measure- ment dBuV/m	Limit dBuV/m	Margin dB	Detector	Comment
1	*	5234.000	95.29	19.44	114.73	68.20	46.53	peak	No Limit
2	X	5241.600	85.31	19.46	104.77	68.20	36.57	AVG	No Limit

**REMARKS:**

- (1) Measurement Value = Reading Level + Correct Factor.
- (2) Margin Level = Measurement Value - Limit Value.

Orthogonal Axis	X
Test Mode	UNII-1_TX AX (HE20) Mode 5240 MHz

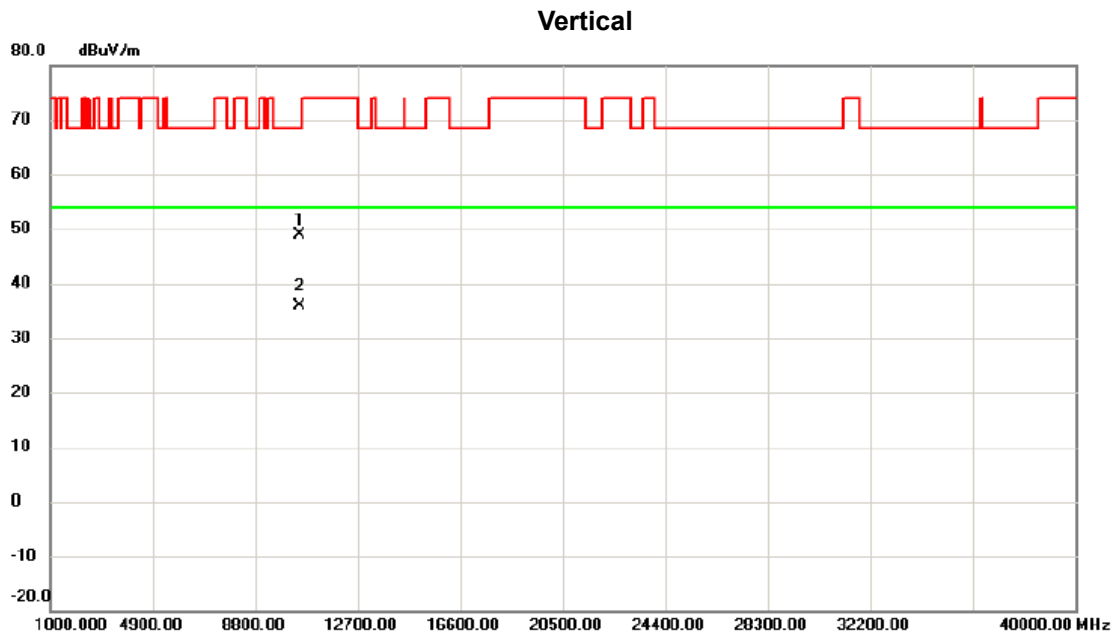

No.	Mk.	Freq. MHz	Reading Level dBuV	Correct Factor dB	Measure- ment dBuV/m	Limit dBuV/m	Margin dB	Detector	Comment
1		10478.585	33.65	15.29	48.94	68.30	-19.36	peak	
2	*	10479.565	20.68	15.29	35.97	54.00	-18.03	AVG	

REMARKS:

- (1) Measurement Value = Reading Level + Correct Factor.
- (2) Margin Level = Measurement Value - Limit Value.

Orthogonal Axis	X
Test Mode	UNII-1_TX AX (HE20) Mode 5240 MHz

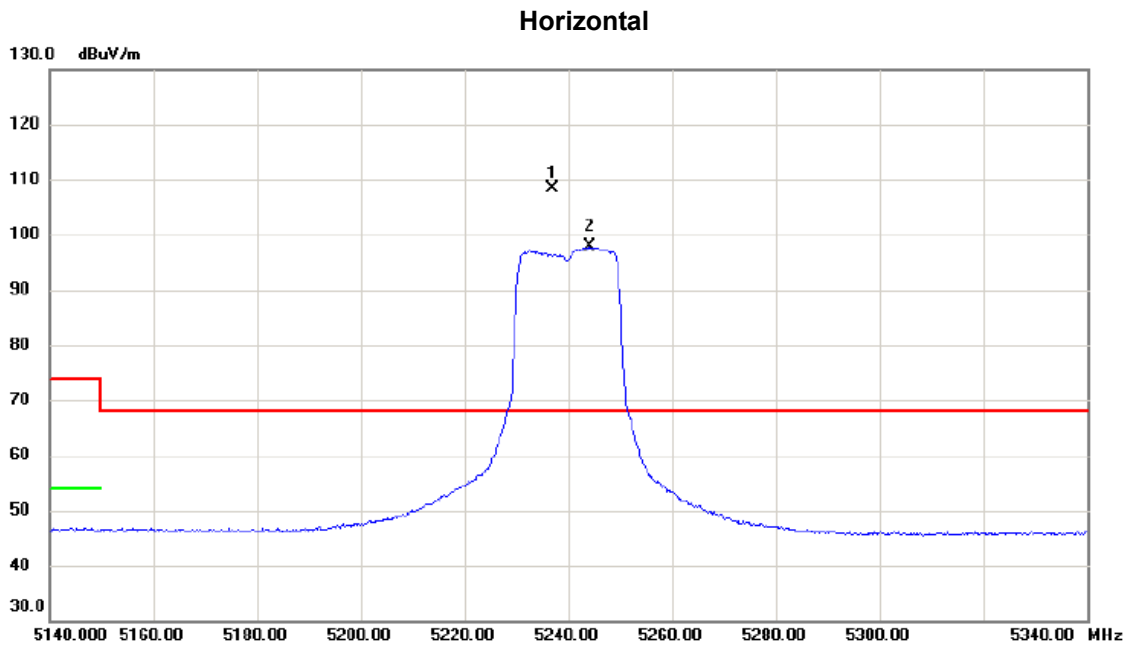

No.	Mk.	Freq. MHz	Reading Level dBuV	Correct Factor dB	Measure- ment dBuV/m	Limit dBuV/m	Margin dB	Detector	Comment
1	*	5237.000	90.50	17.92	108.42	68.20	40.22	peak	No Limit
2	X	5244.200	79.89	17.93	97.82	68.20	29.62	AVG	No Limit

**REMARKS:**

- (1) Measurement Value = Reading Level + Correct Factor.
- (2) Margin Level = Measurement Value - Limit Value.

Orthogonal Axis	X
Test Mode	UNII-1_TX AX (HE20) Mode 5240 MHz

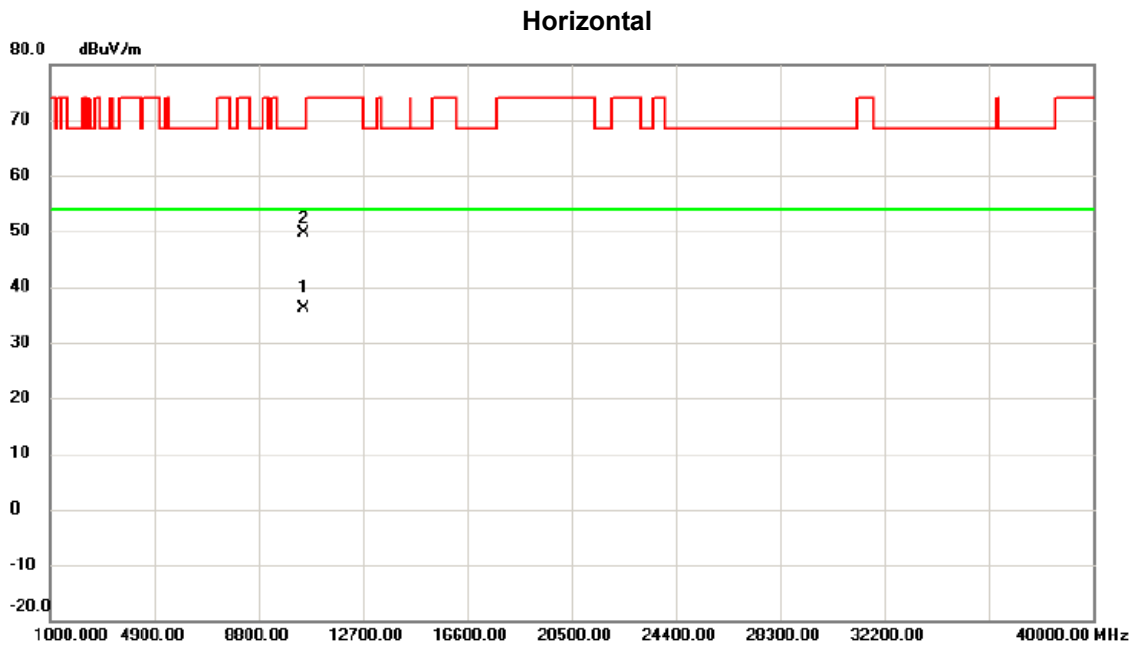

No.	Mk.	Freq. MHz	Reading Level dBuV	Correct Factor dB	Measure- ment dBuV/m	Limit dBuV/m	Margin dB	Detector	Comment
1	*	10479.288	20.75	15.29	36.04	54.00	-17.96	AVG	
2		10480.860	34.23	15.29	49.52	68.30	-18.78	peak	

**REMARKS:**

- (1) Measurement Value = Reading Level + Correct Factor.
- (2) Margin Level = Measurement Value - Limit Value.

Orthogonal Axis	X
Test Mode	UNII-1_TX AX (HE40) Mode 5190 MHz

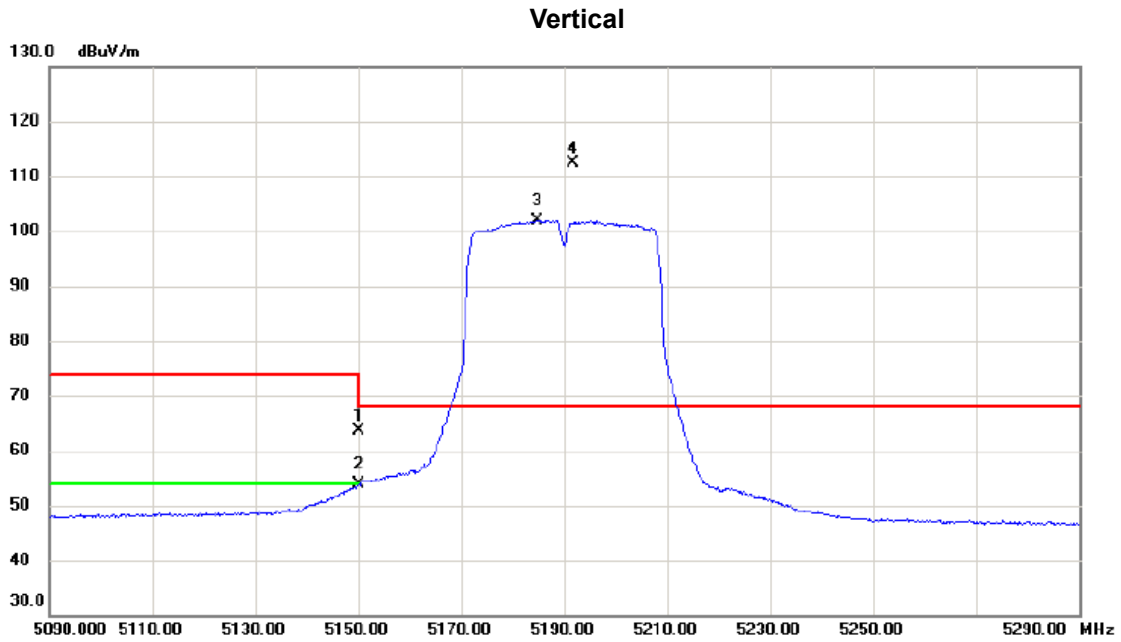

No.	Mk.	Freq. MHz	Reading Level dBuV	Correct Factor dB	Measure- ment dBuV/m	Limit dBuV/m	Margin dB	Detector	Comment
1		5150.000	44.41	19.25	63.66	74.00	-10.34	peak	
2		5150.000	34.54	19.25	53.79	54.00	-0.21	AVG	
3	X	5184.800	82.59	19.32	101.91	68.20	33.71	AVG	No Limit
4	*	5191.800	93.13	19.34	112.47	68.20	44.27	peak	No Limit

**REMARKS:**

- (1) Measurement Value = Reading Level + Correct Factor.
- (2) Margin Level = Measurement Value - Limit Value.

Orthogonal Axis	X
Test Mode	UNII-1_TX AX (HE40) Mode 5190 MHz

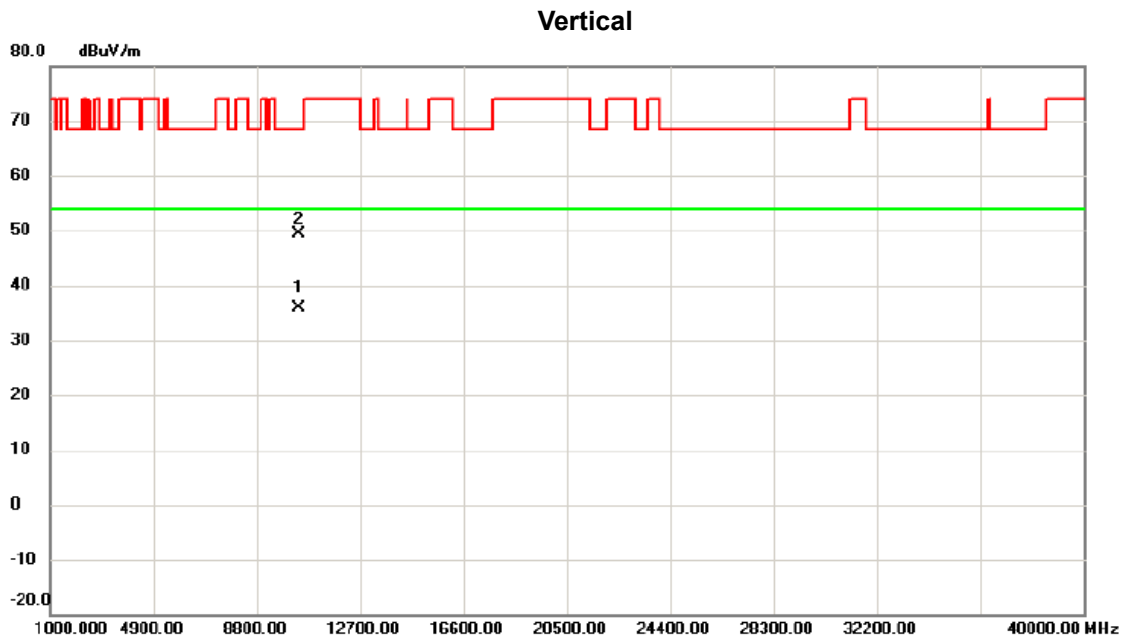

No.	Mk.	Freq. MHz	Reading Level dBuV	Correct Factor dB	Measure- ment dBuV/m	Limit dBuV/m	Margin dB	Detector	Comment
1	*	10380.837	20.88	15.11	35.99	54.00	-18.01	AVG	
2		10382.138	34.29	15.12	49.41	68.30	-18.89	peak	

REMARKS:

- (1) Measurement Value = Reading Level + Correct Factor.
- (2) Margin Level = Measurement Value - Limit Value.

Orthogonal Axis	X
Test Mode	UNII-1_TX AX (HE40) Mode 5190 MHz

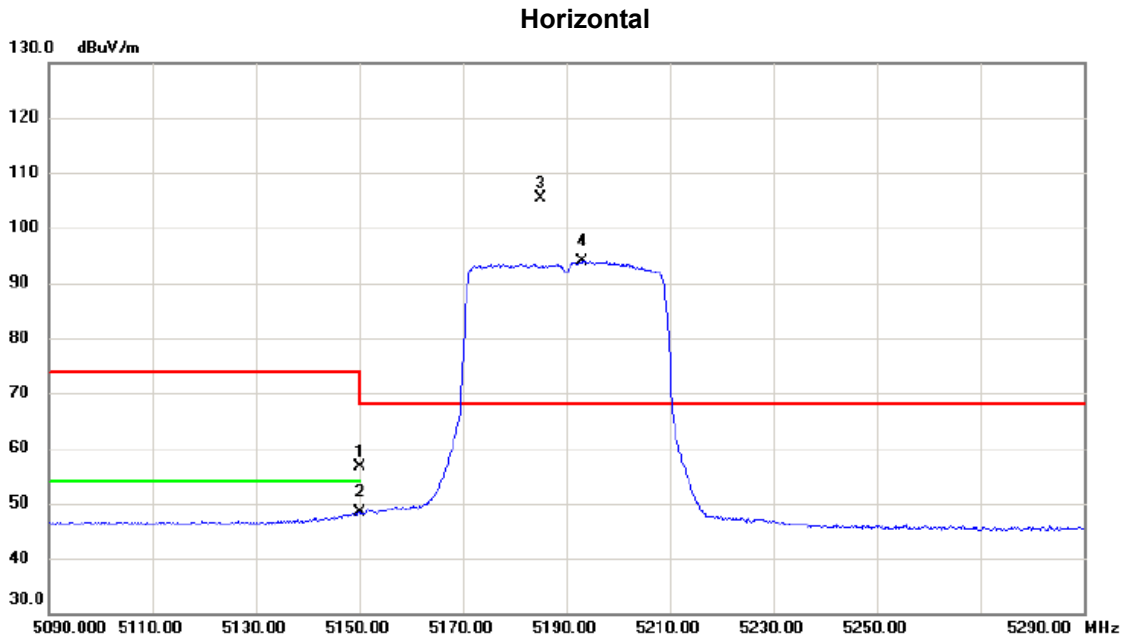

No.	Mk.	Freq.	Reading Level	Correct Factor	Measurement	Limit	Margin		
		MHz	dBuV	dB	dBuV/m	dBuV/m	dB	Detector	Comment
1		5150.000	39.05	17.68	56.73	74.00	-17.27	peak	
2		5150.000	30.61	17.68	48.29	54.00	-5.71	AVG	
3	*	5185.200	87.58	17.78	105.36	68.20	37.16	peak	No Limit
4	X	5193.200	76.05	17.79	93.84	68.20	25.64	AVG	No Limit

**REMARKS:**

- (1) Measurement Value = Reading Level + Correct Factor.
- (2) Margin Level = Measurement Value - Limit Value.



Orthogonal Axis	X
Test Mode	UNII-1_TX AX (HE40) Mode 5190 MHz

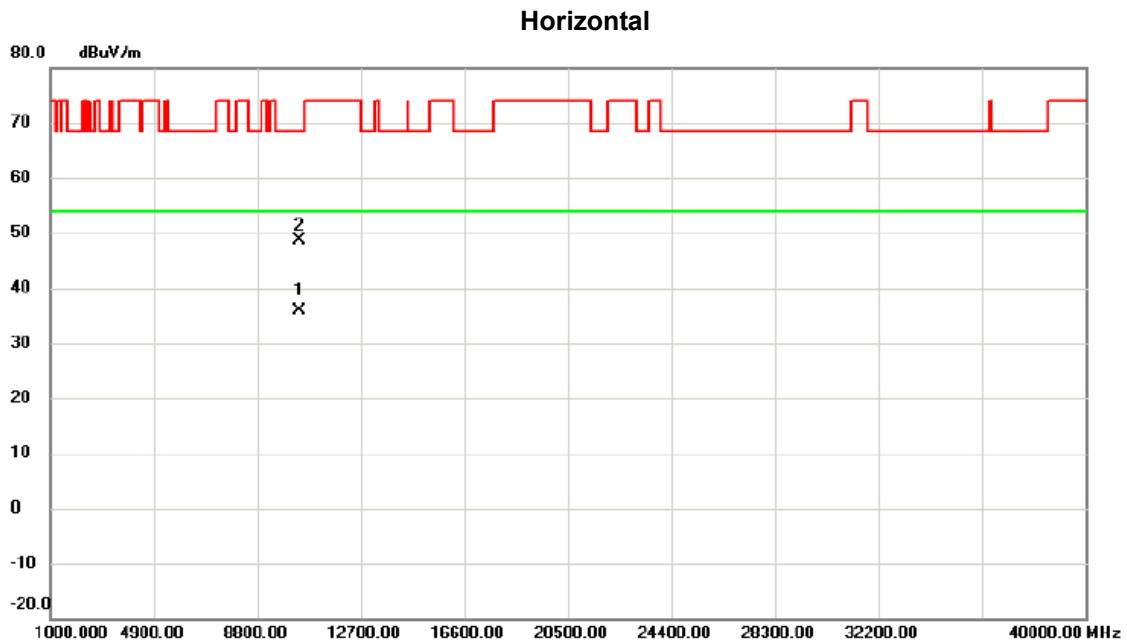

No.	Mk.	Freq. MHz	Reading Level dBuV	Correct Factor dB	Measure- ment dBuV/m	Limit dBuV/m	Margin dB	Detector	Comment
1	*	10378.202	20.89	15.11	36.00	54.00	-18.00	AVG	
2		10381.770	33.41	15.12	48.53	68.30	-19.77	peak	

**REMARKS:**

- (1) Measurement Value = Reading Level + Correct Factor.
- (2) Margin Level = Measurement Value - Limit Value.

Orthogonal Axis	X
Test Mode	UNII-1_TX AX (HE40) Mode 5230 MHz

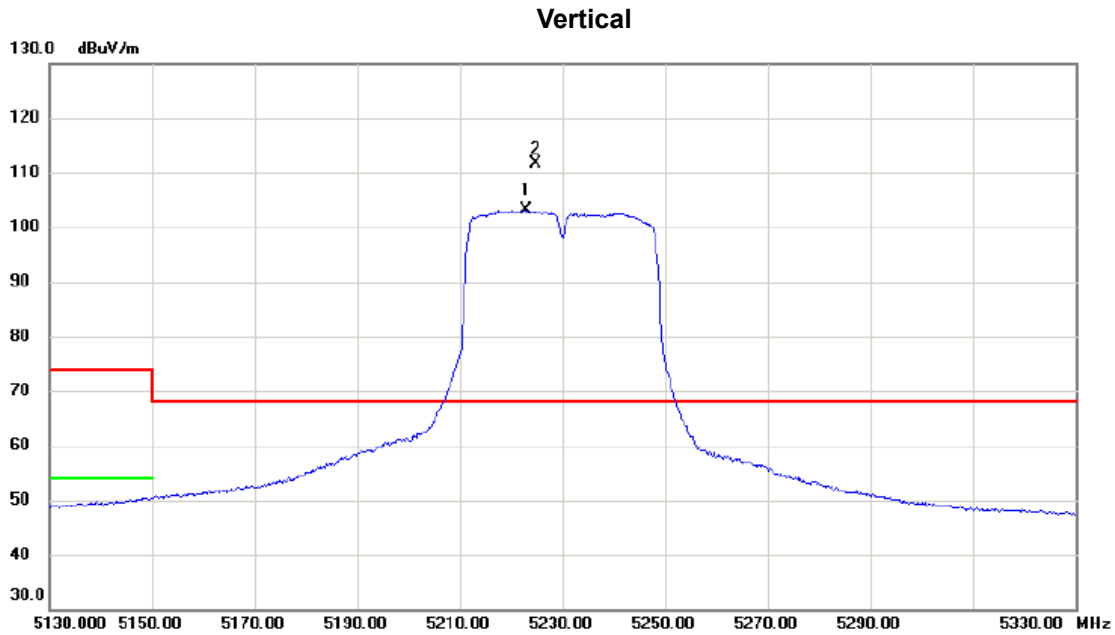

No.	Mk.	Freq.	Reading Level	Correct Factor	Measurement	Limit	Margin		
		MHz	dBuV	dB	dBuV/m	dBuV/m	dB	Detector	Comment
1	X	5222.800	83.69	19.41	103.10	68.20	34.90	AVG	No Limit
2	*	5224.700	92.30	19.42	111.72	68.20	43.52	peak	No Limit

**REMARKS:**

- (1) Measurement Value = Reading Level + Correct Factor.
- (2) Margin Level = Measurement Value - Limit Value.

Orthogonal Axis	X
Test Mode	UNII-1_TX AX (HE40) Mode 5230 MHz

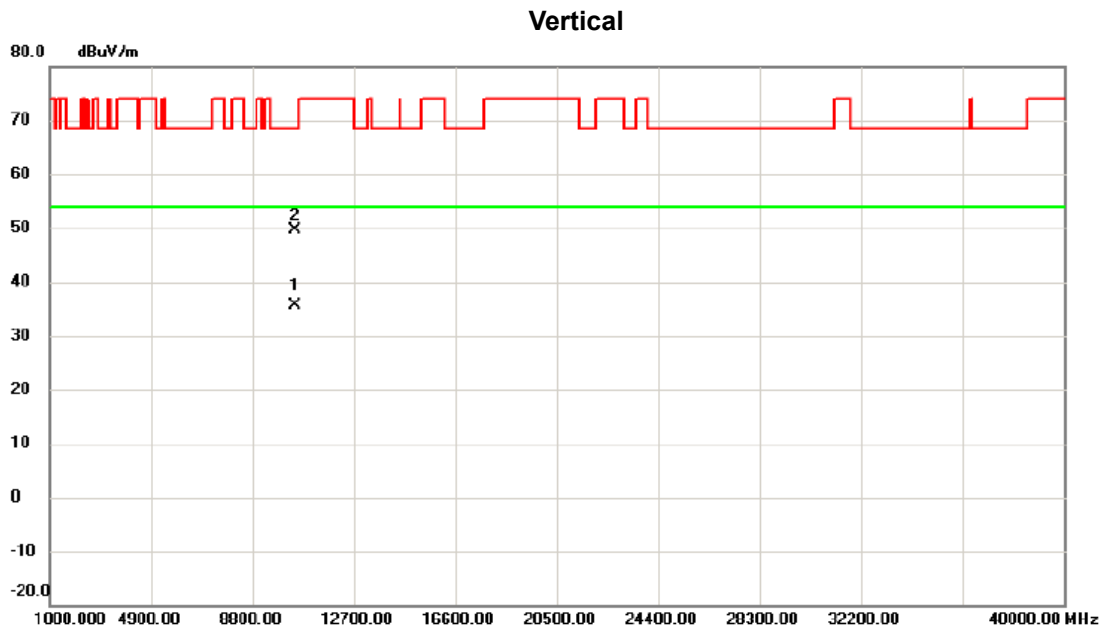

No. Mk.	Freq. MHz	Reading Level dBuV	Correct Factor dB	Measure- ment dBuV/m	Limit dBuV/m	Margin dB	Detector	Comment
1 *	10458.017	20.44	15.26	35.70	54.00	-18.30	AVG	
2	10458.122	34.42	15.26	49.68	68.30	-18.62	peak	

**REMARKS:**

- (1) Measurement Value = Reading Level + Correct Factor.
- (2) Margin Level = Measurement Value - Limit Value.

Orthogonal Axis	X
Test Mode	UNII-1_TX AX (HE40) Mode 5230 MHz

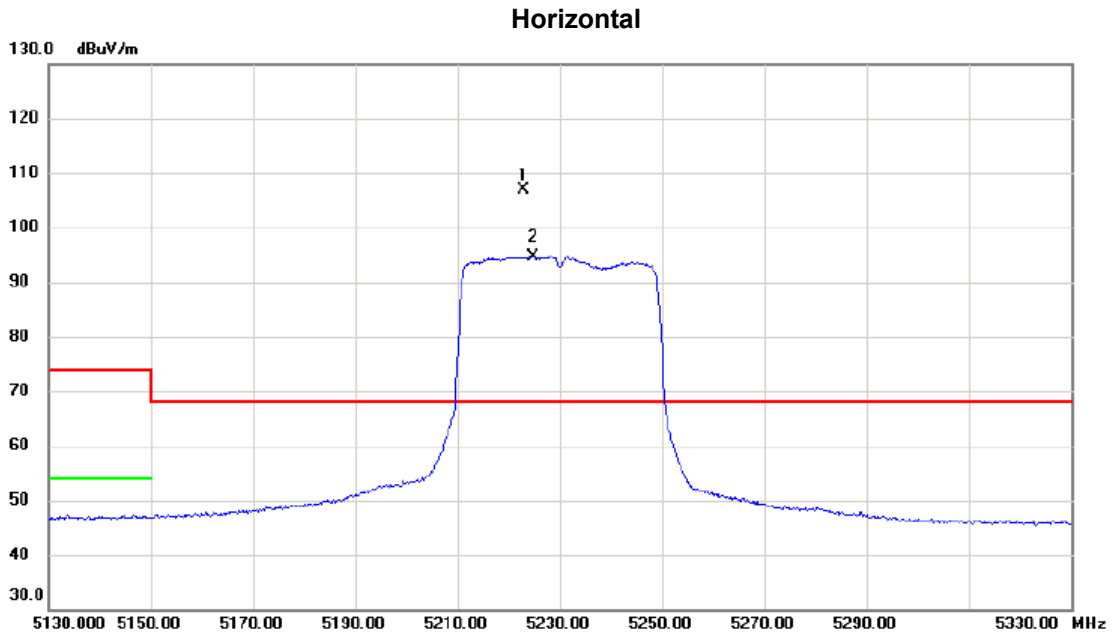

No.	Mk.	Freq.	Reading Level	Correct Factor	Measurement	Limit	Margin		
		MHz	dBuV	dB	dBuV/m	dBuV/m	dB	Detector	Comment
1	*	5222.900	88.92	17.87	106.79	68.20	38.59	peak	No Limit
2	X	5224.800	76.85	17.88	94.73	68.20	26.53	AVG	No Limit

**REMARKS:**

- (1) Measurement Value = Reading Level + Correct Factor.
- (2) Margin Level = Measurement Value - Limit Value.

Orthogonal Axis	X
Test Mode	UNII-1_TX AX (HE40) Mode 5230 MHz

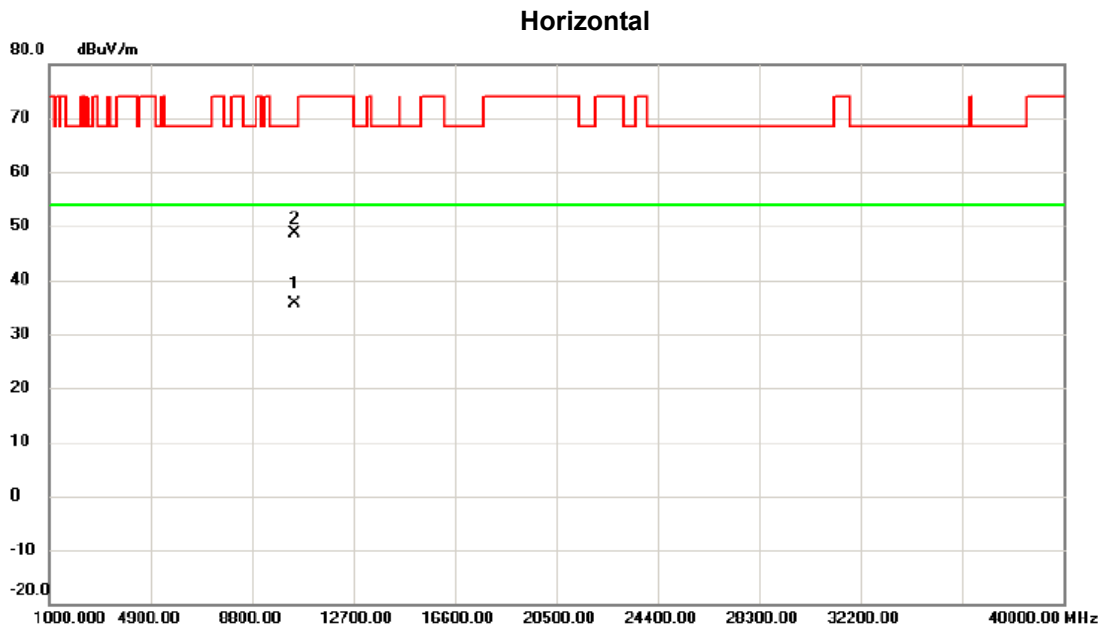

No.	Mk.	Freq. MHz	Reading Level dBuV	Correct Factor dB	Measure- ment dBuV/m	Limit dBuV/m	Margin dB	Detector	Comment
1	*	10457.618	20.41	15.26	35.67	54.00	-18.33	AVG	
2		10458.830	33.39	15.26	48.65	68.30	-19.65	peak	

**REMARKS:**

- (1) Measurement Value = Reading Level + Correct Factor.
- (2) Margin Level = Measurement Value - Limit Value.

Orthogonal Axis	X
Test Mode	UNII-1_TX AX (HE80) Mode 5210 MHz

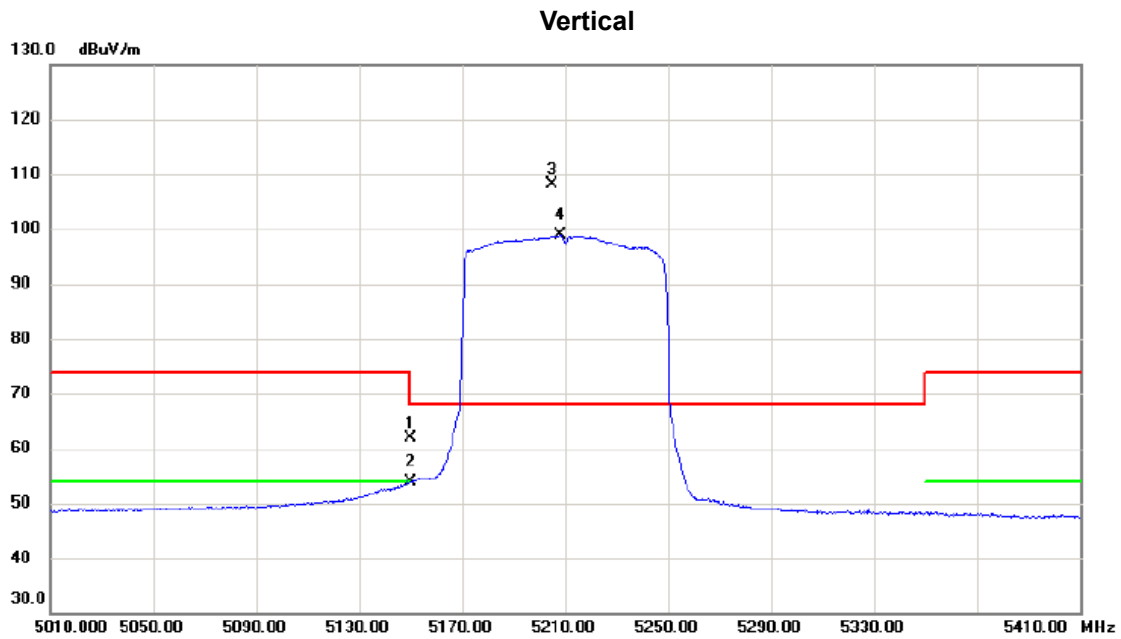

No.	Mk.	Freq. MHz	Reading Level dBuV	Correct Factor dB	Measure- ment dBuV/m	Limit dBuV/m	Margin dB	Detector	Comment
1		5150.000	42.60	19.25	61.85	74.00	-12.15	peak	
2		5150.000	34.64	19.25	53.89	54.00	-0.11	AVG	
3	*	5204.800	88.77	19.37	108.14	68.20	39.94	peak	No Limit
4	X	5208.400	79.53	19.39	98.92	68.20	30.72	AVG	No Limit

**REMARKS:**

- (1) Measurement Value = Reading Level + Correct Factor.
- (2) Margin Level = Measurement Value - Limit Value.

Orthogonal Axis	X
Test Mode	UNII-1_TX AX (HE80) Mode 5210 MHz

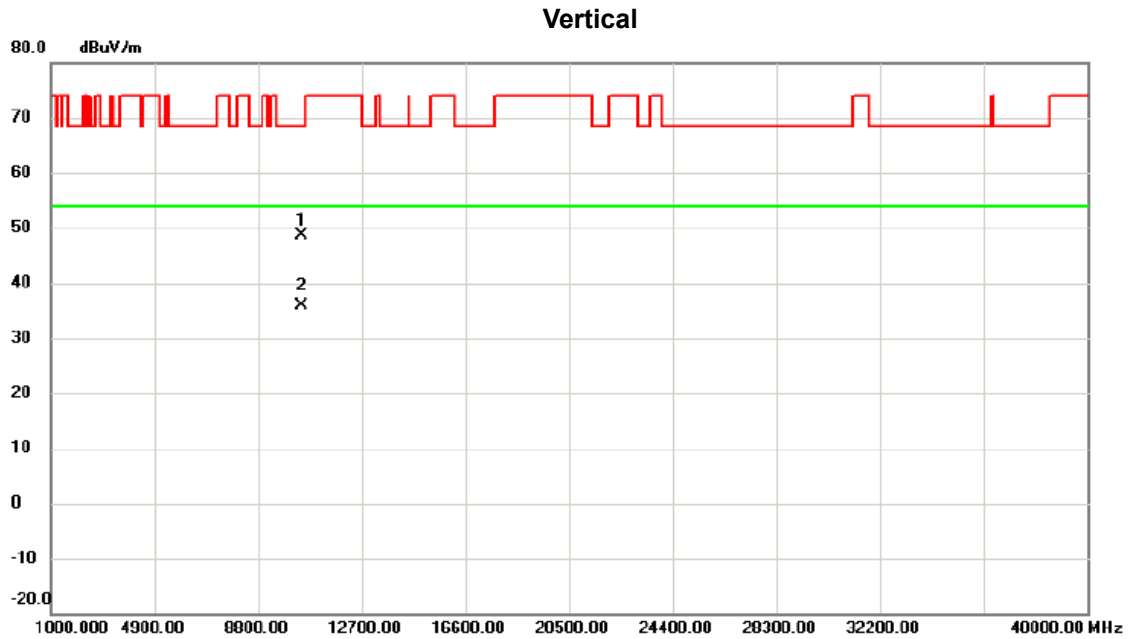

No.	Mk.	Freq. MHz	Reading Level dBuV	Correct Factor dB	Measure- ment dBuV/m	Limit dBuV/m	Margin dB	Detector	Comment
1		10420.550	33.48	15.20	48.68	68.30	-19.62	peak	
2	*	10422.212	20.68	15.20	35.88	54.00	-18.12	AVG	

**REMARKS:**

- (1) Measurement Value = Reading Level + Correct Factor.
- (2) Margin Level = Measurement Value - Limit Value.

Orthogonal Axis	X
Test Mode	UNII-1_TX AX (HE80) Mode 5210 MHz

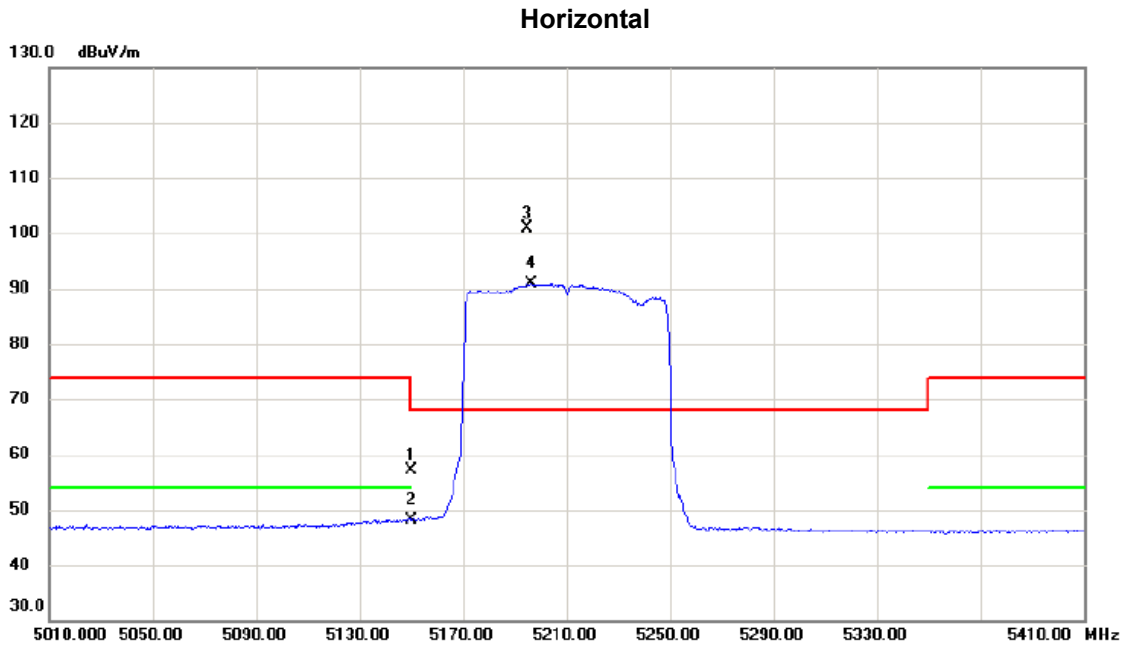

No.	Mk.	Freq. MHz	Reading Level dBuV	Correct Factor dB	Measure- ment dBuV/m	Limit dBuV/m	Margin dB	Detector	Comment
1		5150.000	39.48	17.68	57.16	74.00	-16.84	peak	
2		5150.000	30.43	17.68	48.11	54.00	-5.89	AVG	
3	*	5194.600	82.99	17.79	100.78	68.20	32.58	peak	No Limit
4	X	5196.400	73.02	17.81	90.83	68.20	22.63	AVG	No Limit

**REMARKS:**

- (1) Measurement Value = Reading Level + Correct Factor.
- (2) Margin Level = Measurement Value - Limit Value.



Orthogonal Axis	X
Test Mode	UNII-1_TX AX (HE80) Mode 5210 MHz

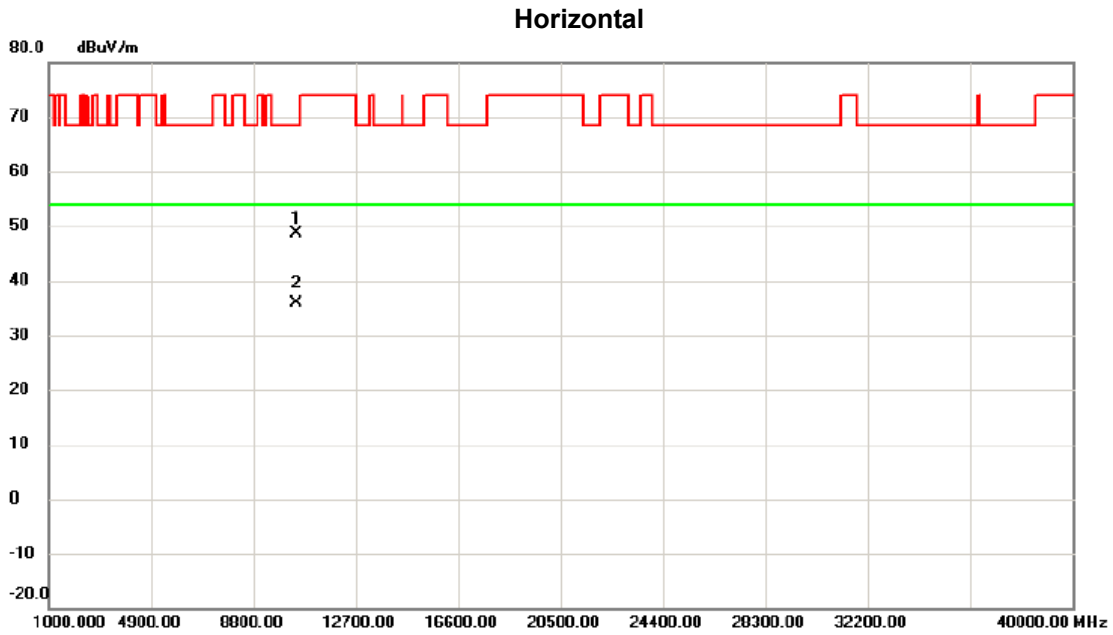

No.	Mk.	Freq. MHz	Reading Level dBuV	Correct Factor dB	Measure- ment dBuV/m	Limit dBuV/m	Margin dB	Detector	Comment
1		10417.840	33.53	15.19	48.72	68.30	-19.58	peak	
2	*	10422.425	20.75	15.20	35.95	54.00	-18.05	AVG	

**REMARKS:**

- (1) Measurement Value = Reading Level + Correct Factor.
- (2) Margin Level = Measurement Value - Limit Value.

Orthogonal Axis	X
Test Mode	UNII-3_TX AX (HE20) Mode 5745 MHz

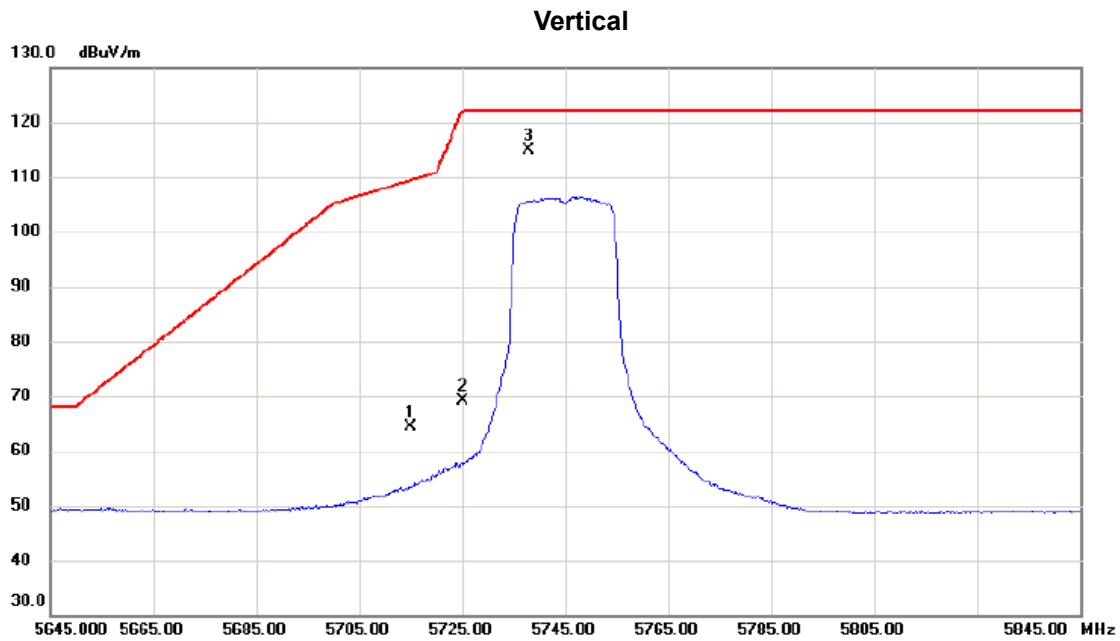

No. Mk.	Freq. MHz	Reading Level dBuV	Correct Factor dB	Measurement dBuV/m	Limit dBuV/m	Margin dB	Detector	Comment
1	5715.000	43.44	20.88	64.32	109.40	-45.08	peak	
2	5725.000	48.20	20.91	69.11	122.20	-53.09	peak	
3 *	5738.000	93.92	20.96	114.88	122.20	-7.32	peak	No Limit

**REMARKS:**

- (1) Measurement Value = Reading Level + Correct Factor.
- (2) Margin Level = Measurement Value - Limit Value.

Orthogonal Axis	X
Test Mode	UNII-3_TX AX (HE20) Mode 5745 MHz

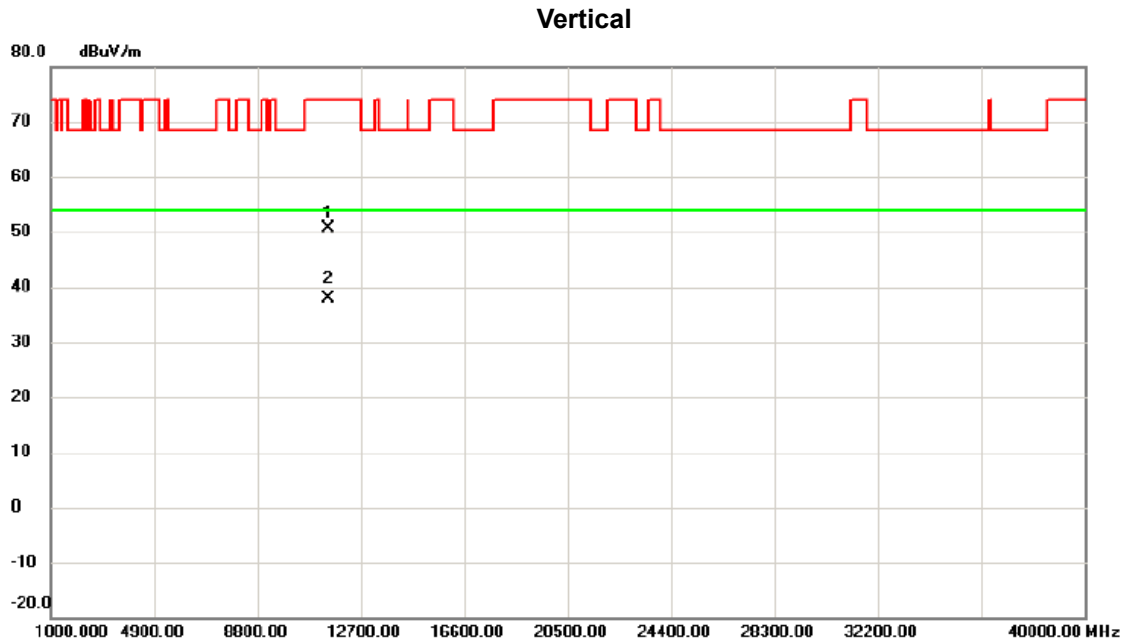

No.	Mk.	Freq.	Reading Level	Correct Factor	Measurement	Limit	Margin	Detector	Comment
		MHz	dBuV	dB	dBuV/m	dBuV/m	dB		
1		11488.175	33.48	17.09	50.57	74.00	-23.43	peak	
2	*	11491.548	20.68	17.10	37.78	54.00	-16.22	AVG	

**REMARKS:**

- (1) Measurement Value = Reading Level + Correct Factor.
- (2) Margin Level = Measurement Value - Limit Value.

Orthogonal Axis	X
Test Mode	UNII-3_TX AX (HE20) Mode 5745 MHz

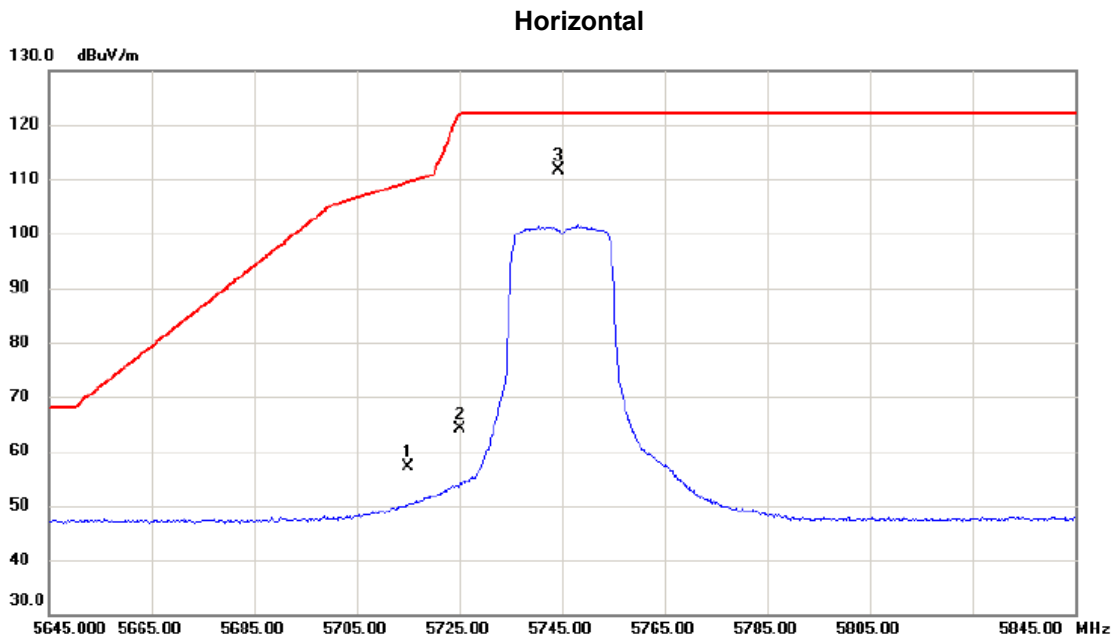

No.	Mk.	Freq. MHz	Reading Level dBuV	Correct Factor dB	Measure- ment dBuV/m	Limit dBuV/m	Margin dB	Detector	Comment
1		5715.000	37.72	19.32	57.04	109.40	-52.36	peak	
2		5725.000	44.74	19.35	64.09	122.20	-58.11	peak	
3	*	5744.300	92.26	19.41	111.67	122.20	-10.53	peak	No Limit

**REMARKS:**

- (1) Measurement Value = Reading Level + Correct Factor.
- (2) Margin Level = Measurement Value - Limit Value.

Orthogonal Axis	X
Test Mode	UNII-3_TX AX (HE20) Mode 5745 MHz

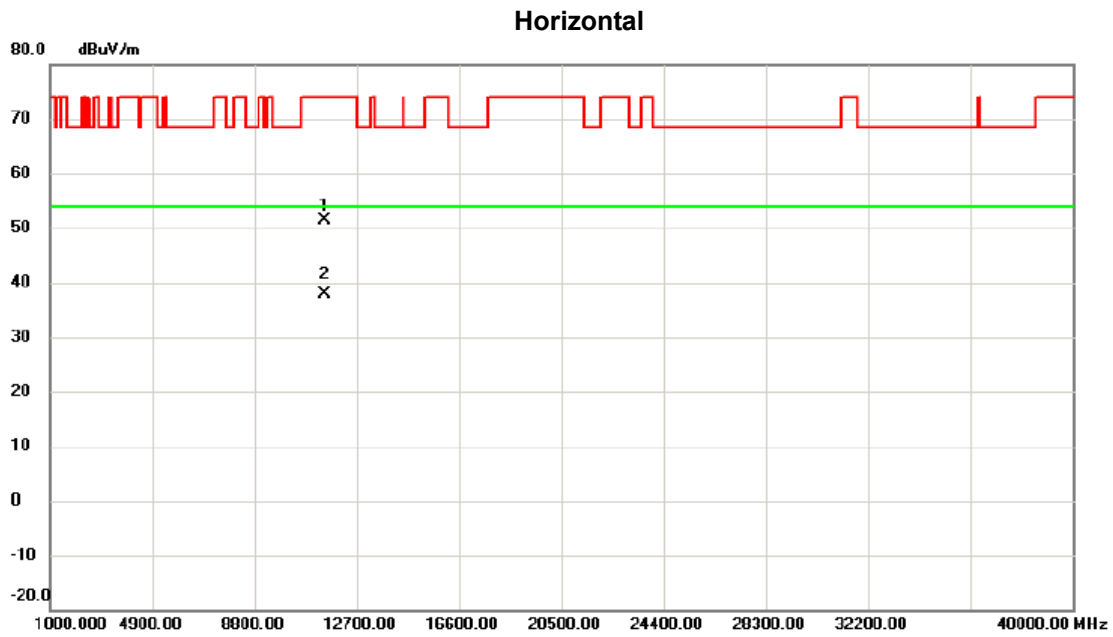

No.	Mk.	Freq.	Reading Level	Correct Factor	Measurement	Limit	Margin	Detector	Comment
		MHz	dBuV	dB	dBuV/m	dBuV/m	dB		
1		11488.010	34.38	17.09	51.47	74.00	-22.53	peak	
2	*	11489.045	20.79	17.09	37.88	54.00	-16.12	AVG	

**REMARKS:**

- (1) Measurement Value = Reading Level + Correct Factor.
- (2) Margin Level = Measurement Value - Limit Value.

Orthogonal Axis	X
Test Mode	UNII-3_TX AX (HE20) Mode 5785 MHz

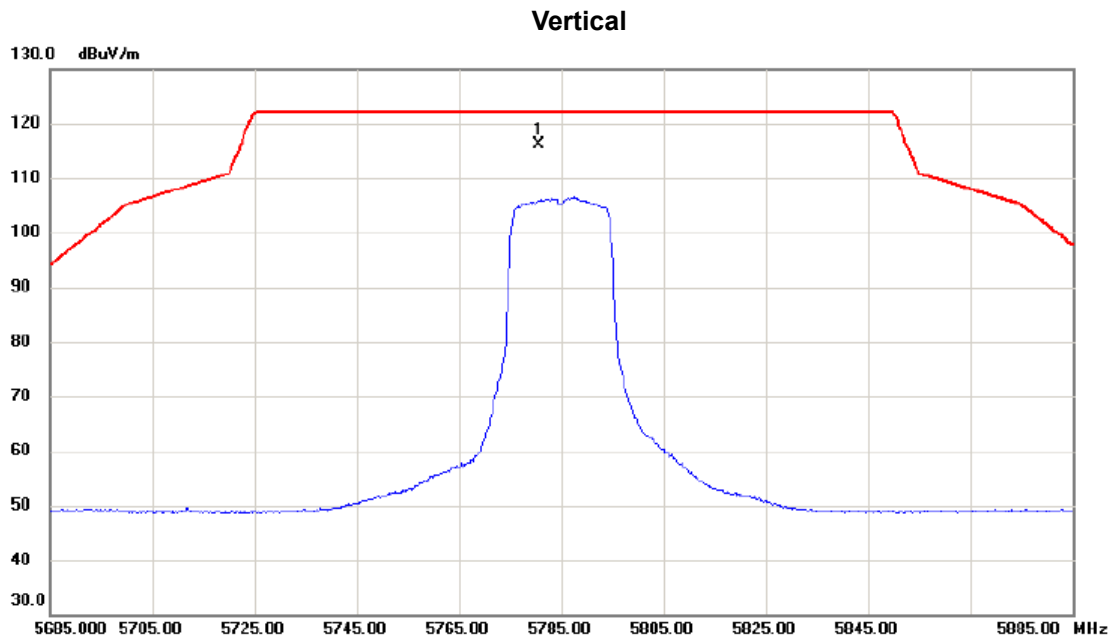

No. Mk.	Freq. MHz	Reading Level dBuV	Correct Factor dB	Measure- ment dBuV/m	Limit dBuV/m	Margin dB	Detector	Comment
1 *	5780.500	95.06	21.11	116.17	122.20	-6.03	peak	No Limit

**REMARKS:**

- (1) Measurement Value = Reading Level + Correct Factor.
- (2) Margin Level = Measurement Value - Limit Value.

Orthogonal Axis	X
Test Mode	UNII-3_TX AX (HE20) Mode 5785 MHz

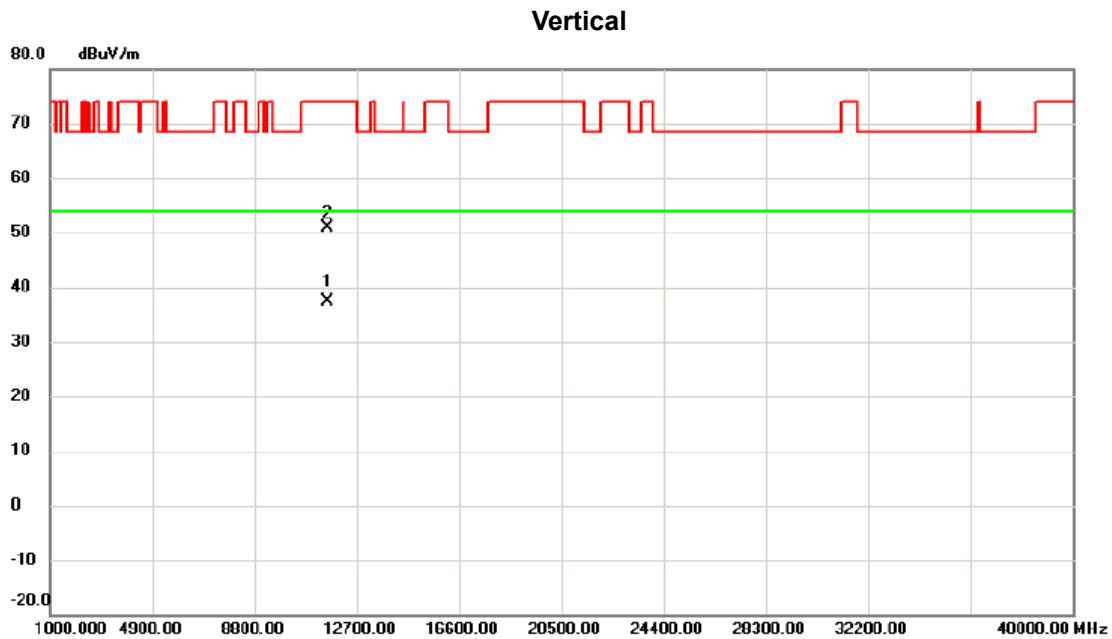

No. Mk.	Freq. MHz	Reading Level dBuV	Correct Factor dB	Measure- ment dBuV/m	Limit dBuV/m	Margin dB	Detector	Comment
1 *	11570.278	20.24	17.22	37.46	54.00	-16.54	AVG	
2	11572.050	33.59	17.22	50.81	74.00	-23.19	peak	

**REMARKS:**

- (1) Measurement Value = Reading Level + Correct Factor.
- (2) Margin Level = Measurement Value - Limit Value.

Orthogonal Axis	X
Test Mode	UNII-3_TX AX (HE20) Mode 5785 MHz

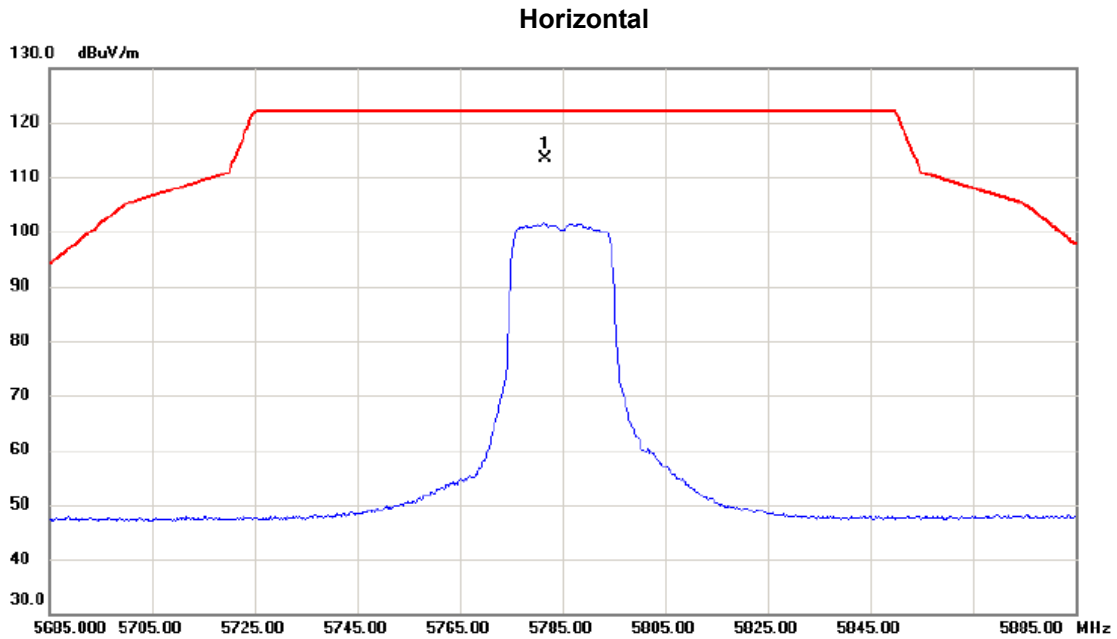

No. Mk.	Freq. MHz	Reading Level dBuV	Correct Factor dB	Measurement dBuV/m	Limit dBuV/m	Margin dB	Detector	Comment
1 *	5781.600	93.85	19.53	113.38	122.20	-8.82	peak	No Limit

**REMARKS:**

- (1) Measurement Value = Reading Level + Correct Factor.
- (2) Margin Level = Measurement Value - Limit Value.



Orthogonal Axis	X
Test Mode	UNII-3_TX AX (HE20) Mode 5785 MHz

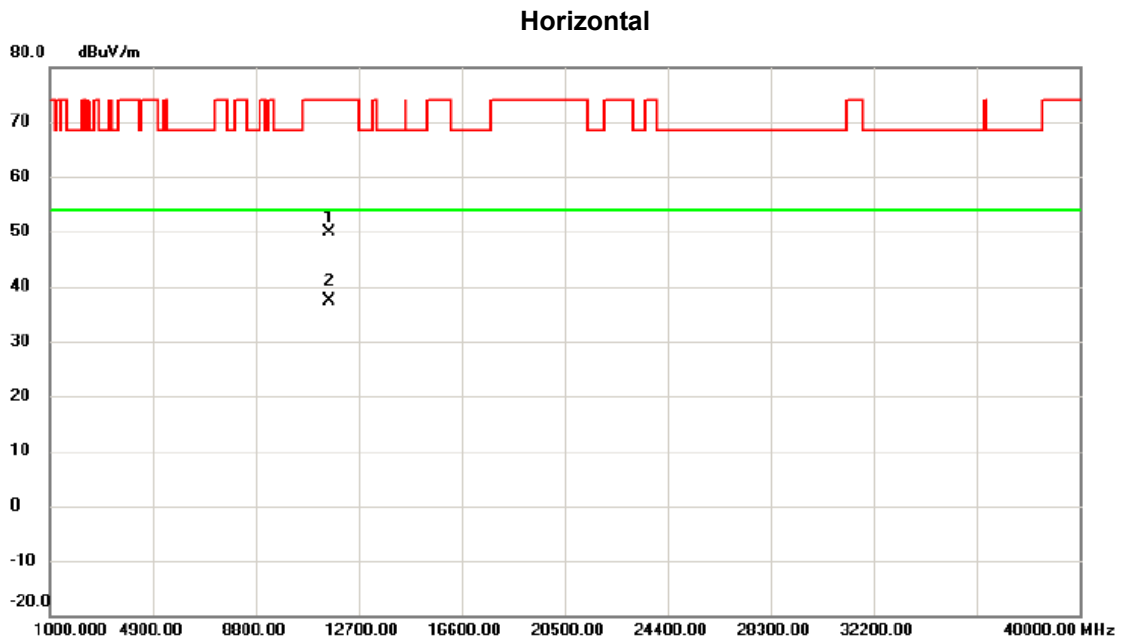

No. Mk.	Freq. MHz	Reading Level dBuV	Correct Factor dB	Measurement dBuV/m	Limit dBuV/m	Margin dB	Detector	Comment
1	11569.985	32.71	17.22	49.93	74.00	-24.07	peak	
2 *	11570.767	20.16	17.22	37.38	54.00	-16.62	AVG	

**REMARKS:**

- (1) Measurement Value = Reading Level + Correct Factor.
- (2) Margin Level = Measurement Value - Limit Value.

Orthogonal Axis	X
Test Mode	UNII-3_TX AX (HE20) Mode 5825 MHz

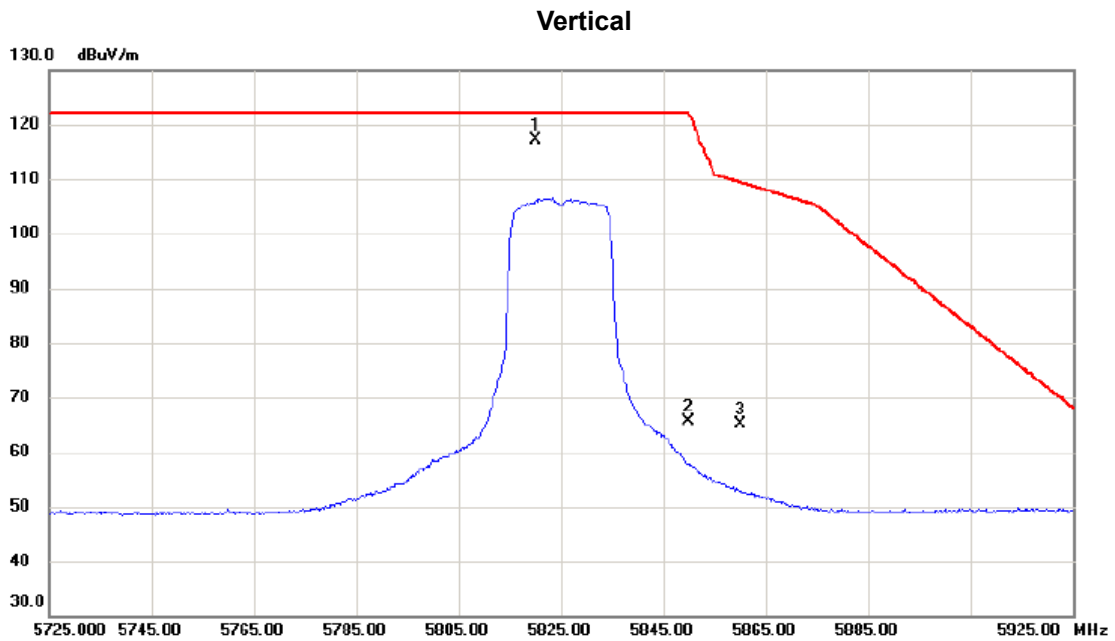

No.	Mk.	Freq. MHz	Reading Level dBuV	Correct Factor dB	Measure- ment dBuV/m	Limit dBuV/m	Margin dB	Detector	Comment
1	*	5820.200	95.81	21.26	117.07	122.20	-5.13	peak	No Limit
2		5850.000	44.30	21.37	65.67	122.20	-56.53	peak	
3		5860.000	43.67	21.40	65.07	109.40	-44.33	peak	

**REMARKS:**

- (1) Measurement Value = Reading Level + Correct Factor.
- (2) Margin Level = Measurement Value - Limit Value.

Orthogonal Axis	X
Test Mode	UNII-3_TX AX (HE20) Mode 5825 MHz

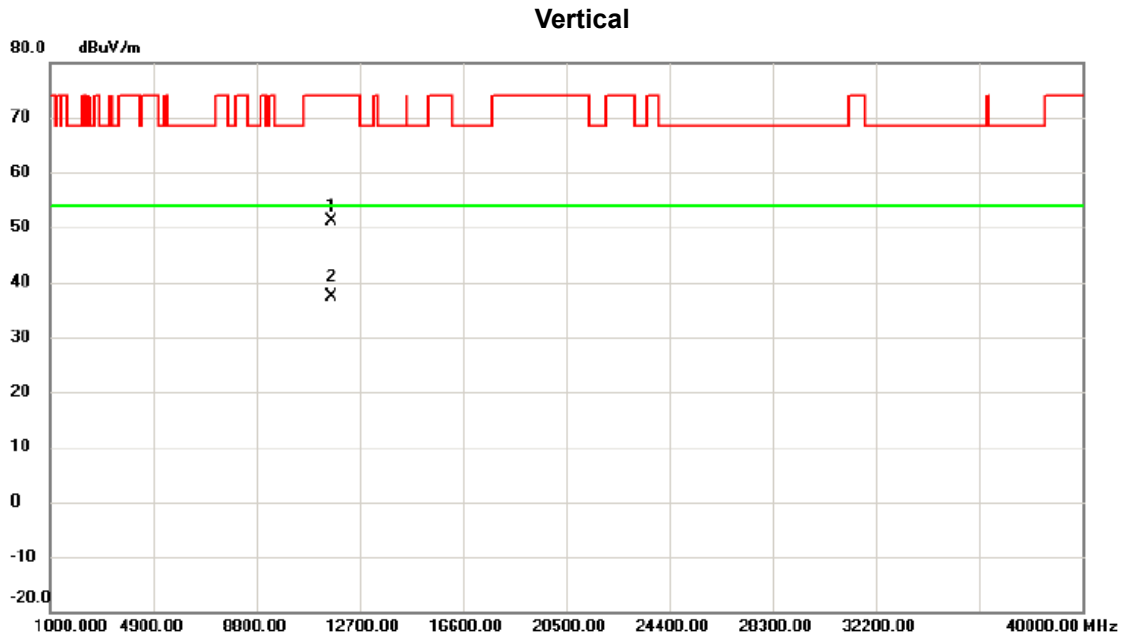

No.	Mk.	Freq. MHz	Reading Level dBuV	Correct Factor dB	Measure- ment dBuV/m	Limit dBuV/m	Margin dB	Detector	Comment
1		11648.300	33.79	17.33	51.12	74.00	-22.88	peak	
2	*	11649.272	20.09	17.33	37.42	54.00	-16.58	AVG	

**REMARKS:**

- (1) Measurement Value = Reading Level + Correct Factor.
- (2) Margin Level = Measurement Value - Limit Value.

Orthogonal Axis	X
Test Mode	UNII-3_TX AX (HE20) Mode 5825 MHz

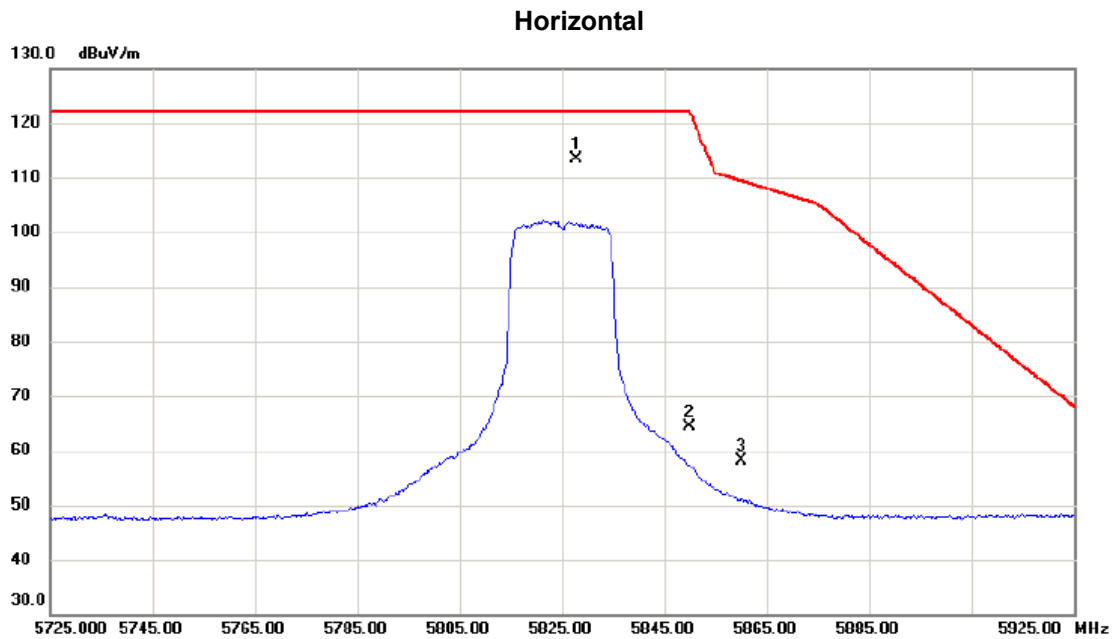

No. Mk.	Freq. MHz	Reading Level dBuV	Correct Factor dB	Measurement dBuV/m	Limit dBuV/m	Margin dB	Detector	Comment
1 *	5827.700	93.64	19.67	113.31	122.20	-8.89	peak	No Limit
2	5850.000	44.54	19.73	64.27	122.20	-57.93	peak	
3	5860.000	38.27	19.76	58.03	109.40	-51.37	peak	

**REMARKS:**

- (1) Measurement Value = Reading Level + Correct Factor.
- (2) Margin Level = Measurement Value - Limit Value.

Orthogonal Axis	X
Test Mode	UNII-3_TX AX (HE20) Mode 5825 MHz

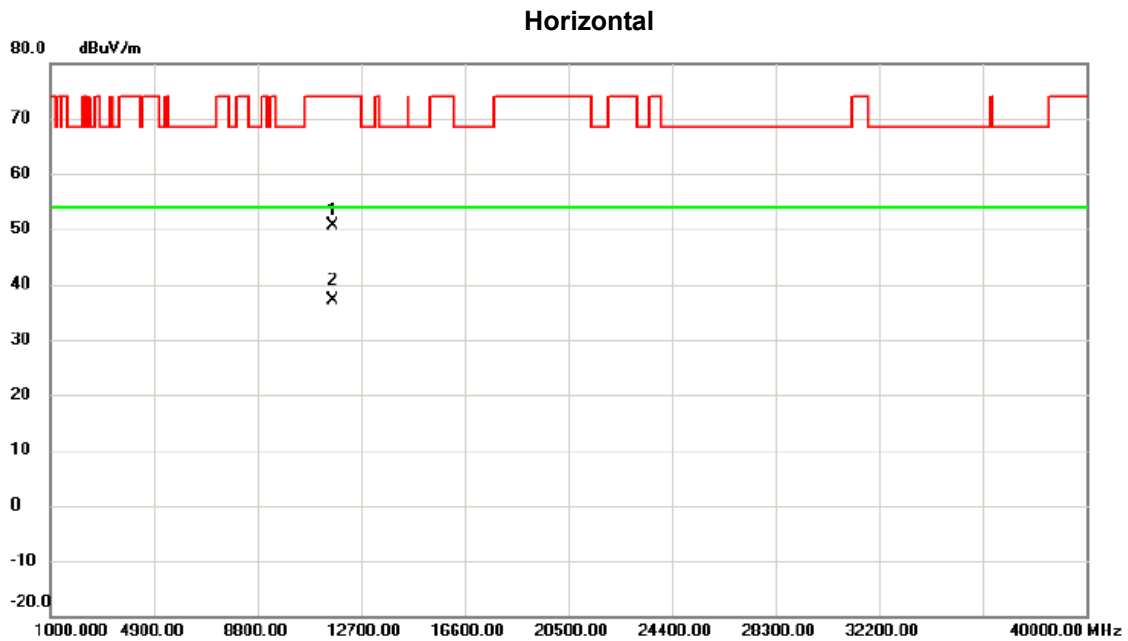

No.	Mk.	Freq. MHz	Reading Level dBuV	Correct Factor dB	Measure- ment dBuV/m	Limit dBuV/m	Margin dB	Detector	Comment
1		11648.405	33.40	17.33	50.73	74.00	-23.27	peak	
2	*	11648.720	19.89	17.33	37.22	54.00	-16.78	AVG	

**REMARKS:**

- (1) Measurement Value = Reading Level + Correct Factor.
- (2) Margin Level = Measurement Value - Limit Value.

Orthogonal Axis	X
Test Mode	UNII-3_TX AX (HE40) Mode 5755 MHz

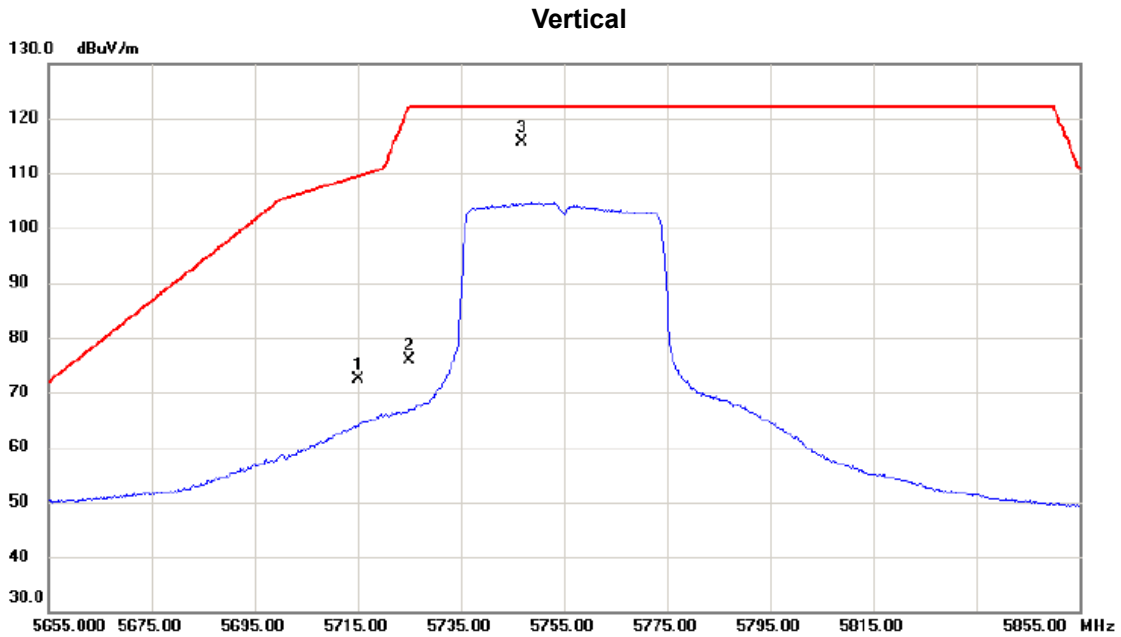

No.	Mk.	Freq.	Reading Level	Correct Factor	Measurement	Limit	Margin	Detector	Comment
		MHz	dBuV	dB	dBuV/m	dBuV/m	dB		
1		5715.000	51.49	20.88	72.37	109.40	-37.03	peak	
2		5725.000	54.93	20.91	75.84	122.20	-46.36	peak	
3	*	5746.800	94.52	20.99	115.51	122.20	-6.69	peak	No Limit

**REMARKS:**

- (1) Measurement Value = Reading Level + Correct Factor.
- (2) Margin Level = Measurement Value - Limit Value.

Orthogonal Axis	X
Test Mode	UNII-3_TX AX (HE40) Mode 5755 MHz

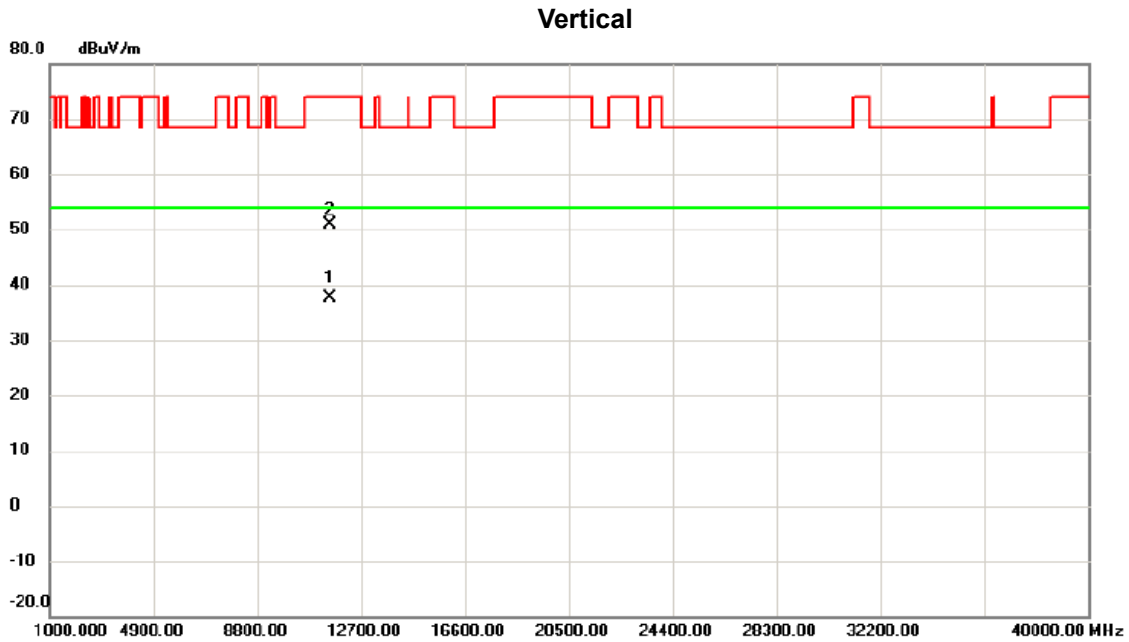

No.	Mk.	Freq. MHz	Reading Level dBuV	Correct Factor dB	Measure- ment dBuV/m	Limit dBuV/m	Margin dB	Detector	Comment
1	*	11509.635	20.56	17.13	37.69	54.00	-16.31	AVG	
2		11510.843	33.69	17.13	50.82	74.00	-23.18	peak	

REMARKS:

- (1) Measurement Value = Reading Level + Correct Factor.
- (2) Margin Level = Measurement Value - Limit Value.

Orthogonal Axis	X
Test Mode	UNII-3_TX AX (HE40) Mode 5755 MHz

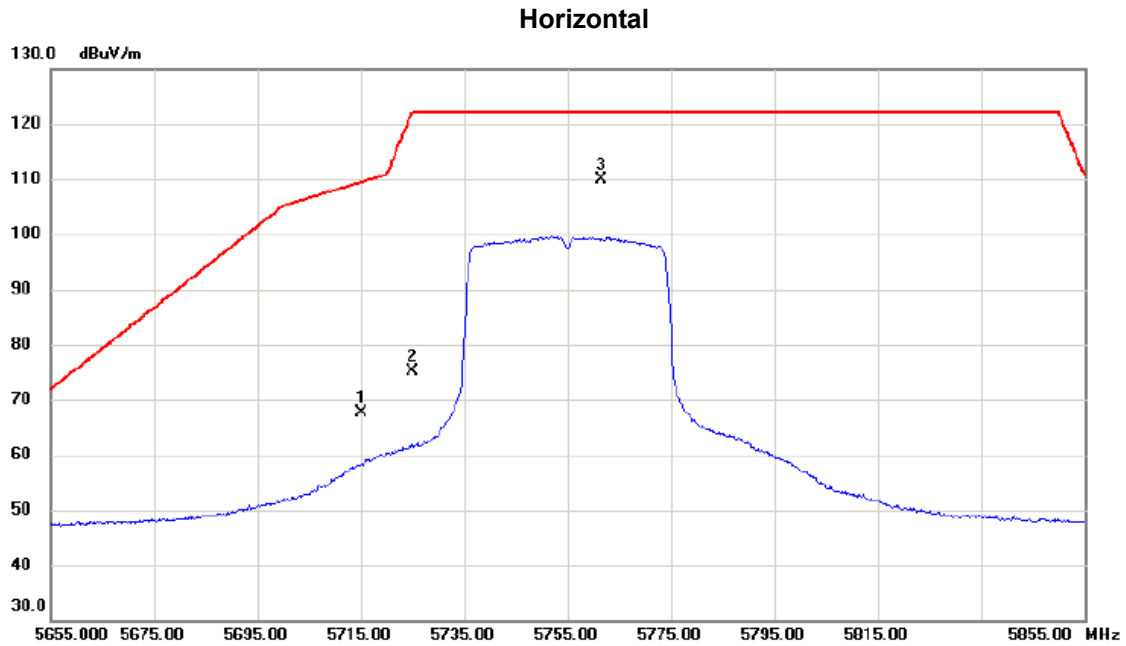

No.	Mk.	Freq. MHz	Reading Level dBuV	Correct Factor dB	Measure- ment dBuV/m	Limit dBuV/m	Margin dB	Detector	Comment
1		5715.000	48.37	19.32	67.69	109.40	-41.71	peak	
2		5725.000	55.75	19.35	75.10	122.20	-47.10	peak	
3	*	5761.600	90.52	19.46	109.98	122.20	-12.22	peak	No Limit

REMARKS:  
 (1) Measurement Value = Reading Level + Correct Factor.  
 (2) Margin Level = Measurement Value - Limit Value.



Orthogonal Axis	X
Test Mode	UNII-3_TX AX (HE40) Mode 5755 MHz

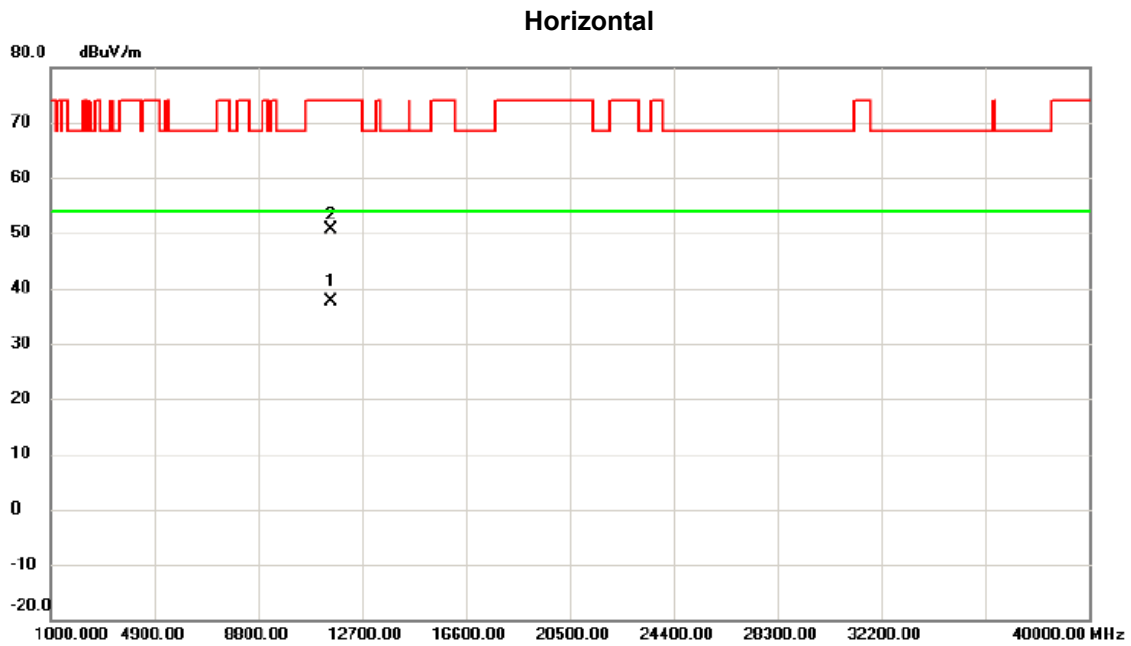

No.	Mk.	Freq. MHz	Reading Level dBuV	Correct Factor dB	Measure- ment dBuV/m	Limit dBuV/m	Margin dB	Detector	Comment
1	*	11508.275	20.56	17.13	37.69	54.00	-16.31	AVG	
2		11512.245	33.38	17.13	50.51	74.00	-23.49	peak	

**REMARKS:**

- (1) Measurement Value = Reading Level + Correct Factor.
- (2) Margin Level = Measurement Value - Limit Value.

Orthogonal Axis	X
Test Mode	UNII-3_TX AX (HE40) Mode 5795 MHz

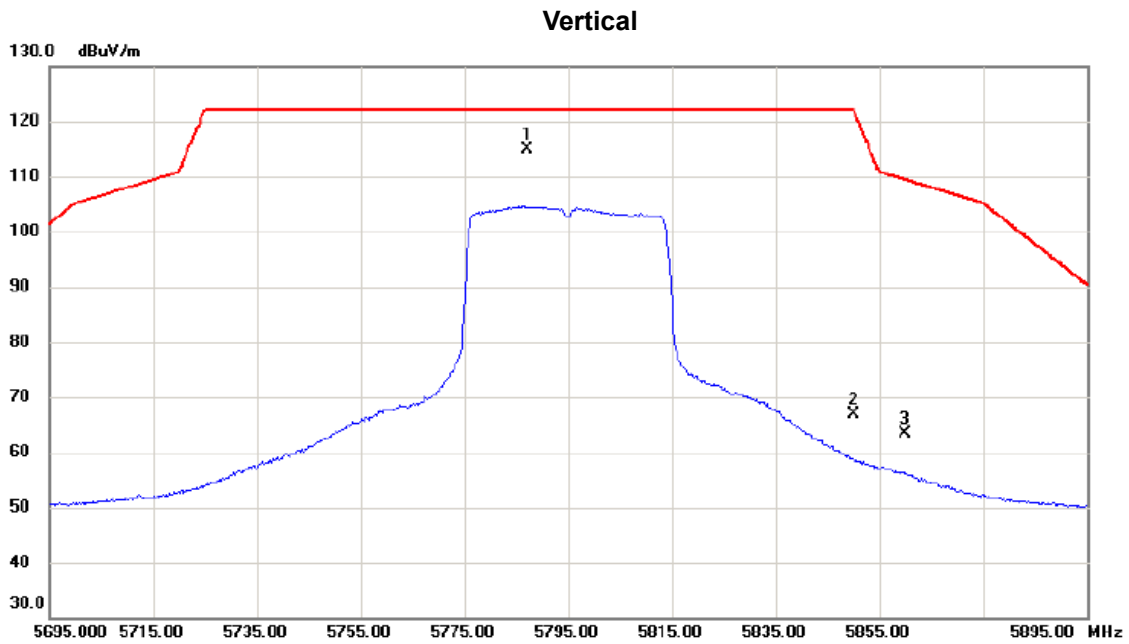

No.	Mk.	Freq. MHz	Reading Level dBuV	Correct Factor dB	Measure- ment dBuV/m	Limit dBuV/m	Margin dB	Detector	Comment
1	*	5787.000	93.68	21.14	114.82	122.20	-7.38	peak	No Limit
2		5850.000	45.56	21.37	66.93	122.20	-55.27	peak	
3		5860.000	41.99	21.40	63.39	109.40	-46.01	peak	

**REMARKS:**

- (1) Measurement Value = Reading Level + Correct Factor.
- (2) Margin Level = Measurement Value - Limit Value.

Orthogonal Axis	X
Test Mode	UNII-3_TX AX (HE40) Mode 5795 MHz

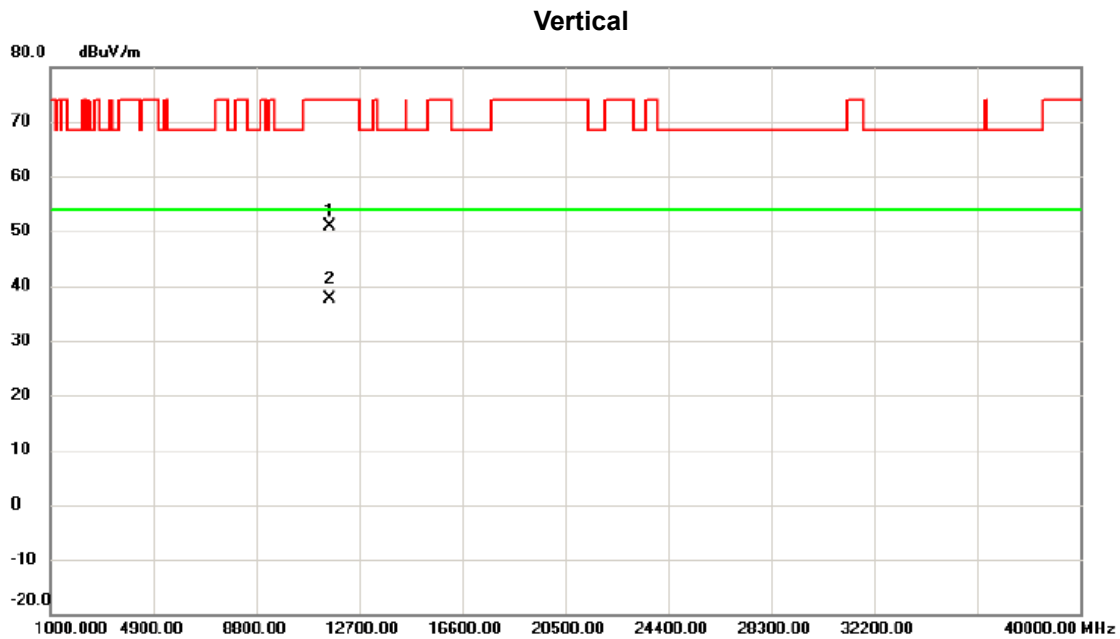

No.	Mk.	Freq. MHz	Reading Level dBuV	Correct Factor dB	Measure- ment dBuV/m	Limit dBuV/m	Margin dB	Detector	Comment
1		11590.212	33.56	17.25	50.81	74.00	-23.19	peak	
2	*	11591.905	20.27	17.25	37.52	54.00	-16.48	AVG	

**REMARKS:**

- (1) Measurement Value = Reading Level + Correct Factor.
- (2) Margin Level = Measurement Value - Limit Value.

Orthogonal Axis	X
Test Mode	UNII-3_TX AX (HE40) Mode 5795 MHz

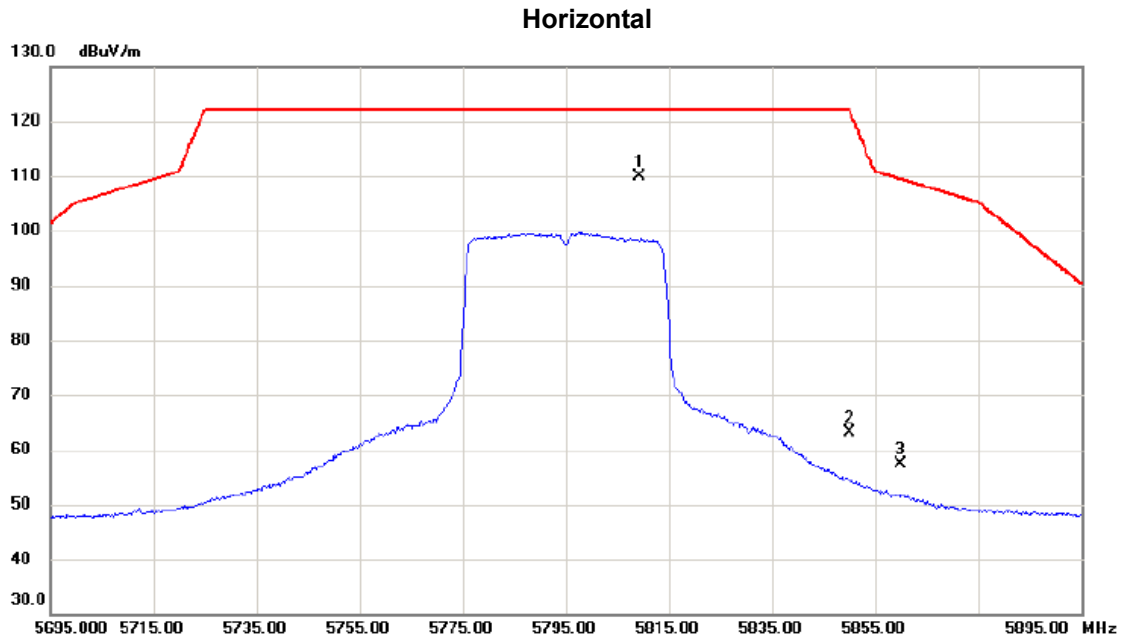

No.	Mk.	Freq. MHz	Reading Level dBuV	Correct Factor dB	Measurement dBuV/m	Limit dBuV/m	Margin dB	Detector	Comment
1	*	5809.300	90.18	19.60	109.78	122.20	-12.42	peak	No Limit
2		5850.000	43.50	19.73	63.23	122.20	-58.97	peak	
3		5860.000	37.61	19.76	57.37	109.40	-52.03	peak	

**REMARKS:**

- (1) Measurement Value = Reading Level + Correct Factor.
- (2) Margin Level = Measurement Value - Limit Value.

Orthogonal Axis	X
Test Mode	UNII-3_TX AX (HE40) Mode 5795 MHz

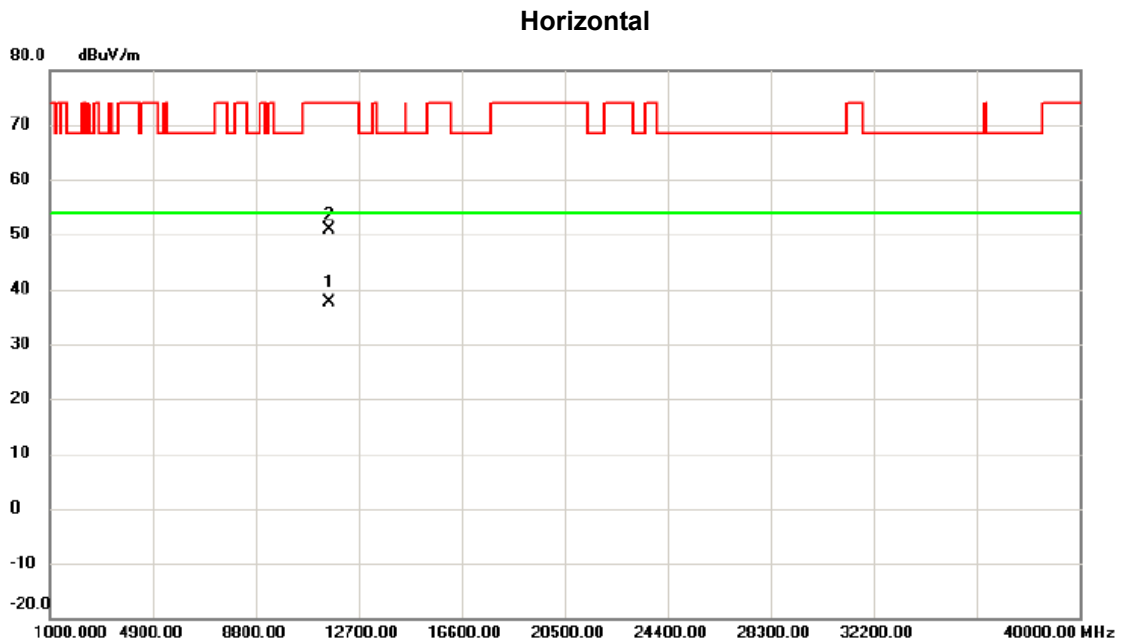

No.	Mk.	Freq. MHz	Reading Level dBuV	Correct Factor dB	Measure- ment dBuV/m	Limit dBuV/m	Margin dB	Detector	Comment
1	*	11587.772	20.35	17.25	37.60	54.00	-16.40	AVG	
2		11588.167	33.63	17.25	50.88	74.00	-23.12	peak	

**REMARKS:**

- (1) Measurement Value = Reading Level + Correct Factor.
- (2) Margin Level = Measurement Value - Limit Value.

Orthogonal Axis	X
Test Mode	UNII-3_TX AX (HE80) Mode 5775 MHz

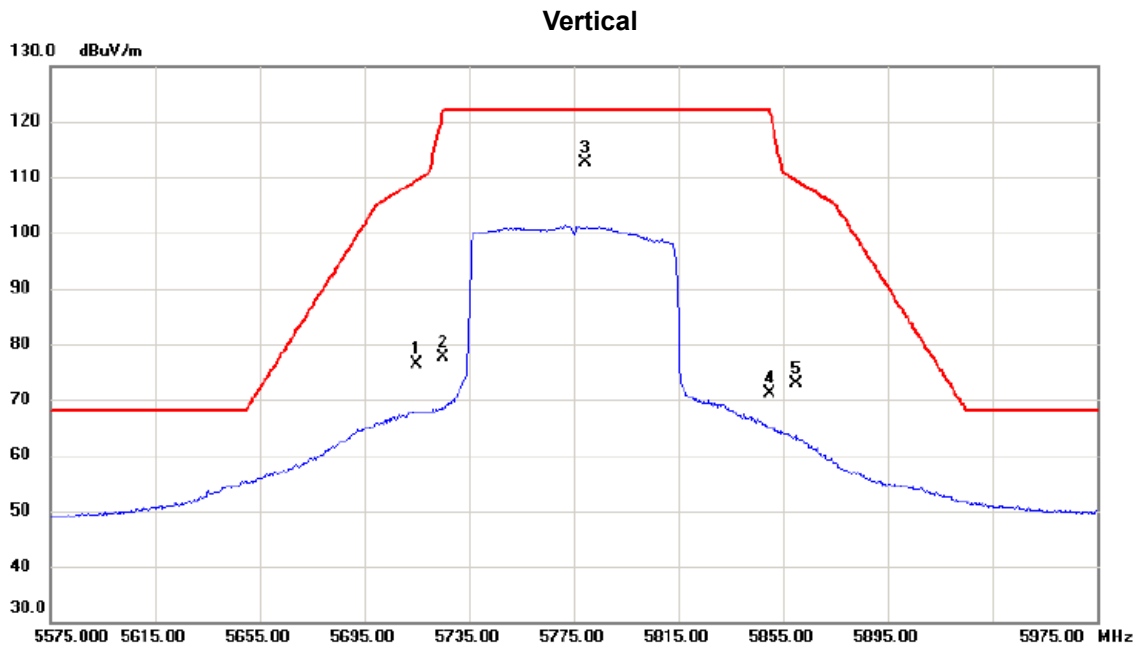

No.	Mk.	Freq. MHz	Reading Level dBuV	Correct Factor dB	Measure- ment dBuV/m	Limit dBuV/m	Margin dB	Detector	Comment
1		5715.000	55.45	20.88	76.33	109.40	-33.07	peak	
2		5725.000	56.84	20.91	77.75	122.20	-44.45	peak	
3	*	5779.400	91.45	21.11	112.56	122.20	-9.64	peak	No Limit
4		5850.000	49.85	21.37	71.22	122.20	-50.98	peak	
5		5860.000	51.59	21.40	72.99	109.40	-36.41	peak	

**REMARKS:**

- (1) Measurement Value = Reading Level + Correct Factor.
- (2) Margin Level = Measurement Value - Limit Value.

Orthogonal Axis	X
Test Mode	UNII-3_TX AX (HE80) Mode 5775 MHz

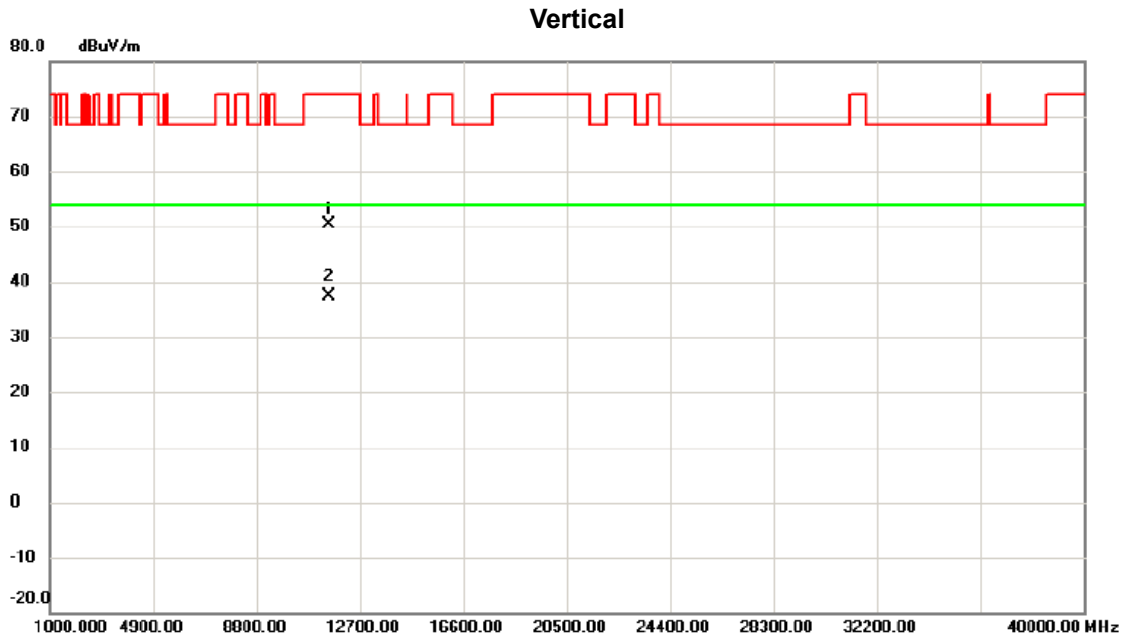

No.	Mk.	Freq. MHz	Reading Level dBuV	Correct Factor dB	Measure- ment dBuV/m	Limit dBuV/m	Margin dB	Detector	Comment
1		11548.960	33.32	17.18	50.50	74.00	-23.50	peak	
2	*	11549.165	20.15	17.19	37.34	54.00	-16.66	AVG	

**REMARKS:**

- (1) Measurement Value = Reading Level + Correct Factor.
- (2) Margin Level = Measurement Value - Limit Value.

Orthogonal Axis	X
Test Mode	UNII-3_TX AX (HE80) Mode 5775 MHz

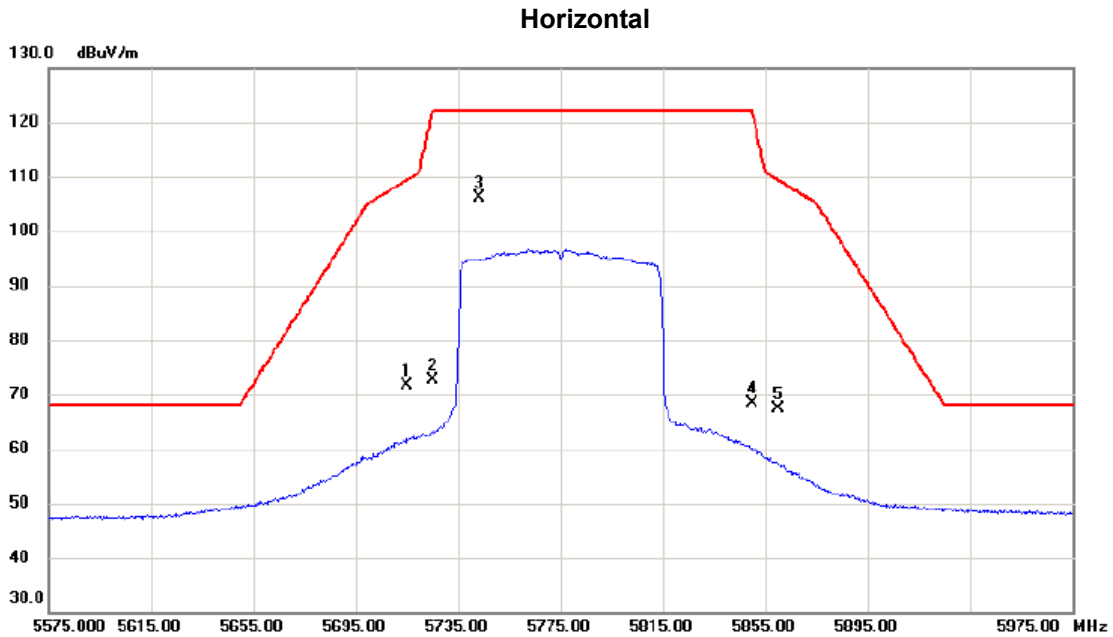

No.	Mk.	Freq. MHz	Reading Level dBuV	Correct Factor dB	Measure- ment dBuV/m	Limit dBuV/m	Margin dB	Detector	Comment
1		5715.000	52.21	19.32	71.53	109.40	-37.87	peak	
2		5725.000	53.33	19.35	72.68	122.20	-49.52	peak	
3	*	5743.400	86.72	19.40	106.12	122.20	-16.08	peak	No Limit
4		5850.000	48.57	19.73	68.30	122.20	-53.90	peak	
5		5860.000	47.56	19.76	67.32	109.40	-42.08	peak	

REMARKS:

- (1) Measurement Value = Reading Level + Correct Factor.
- (2) Margin Level = Measurement Value - Limit Value.



Orthogonal Axis	X
Test Mode	UNII-3_TX AX (HE80) Mode 5775 MHz

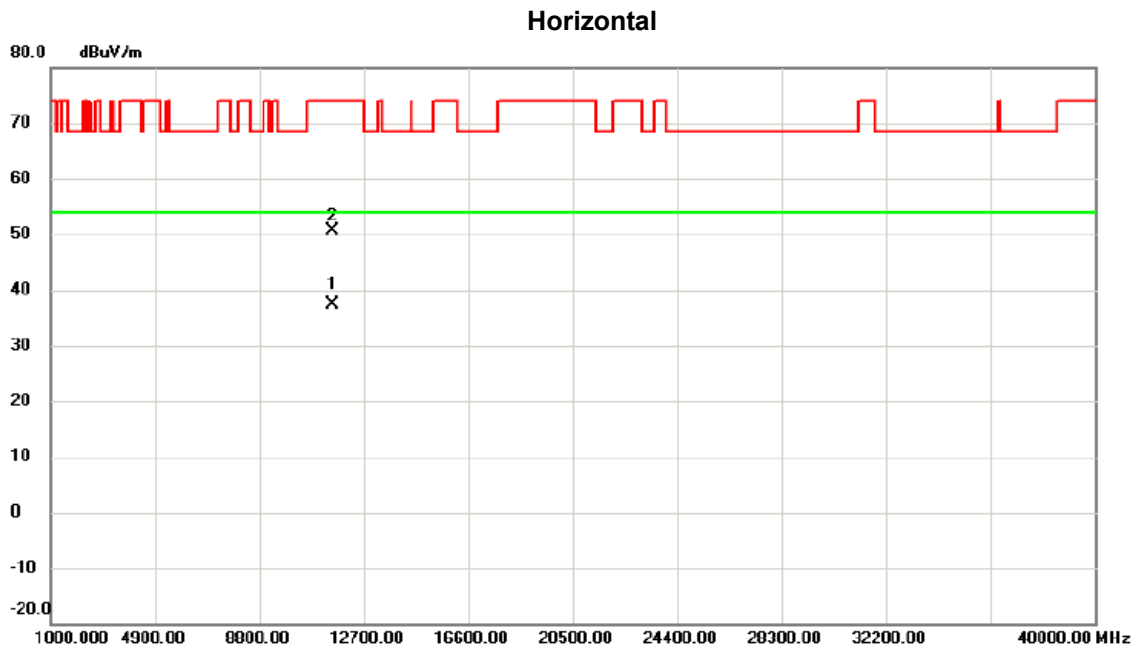

No.	Mk.	Freq. MHz	Reading Level dBuV	Correct Factor dB	Measure- ment dBuV/m	Limit dBuV/m	Margin dB	Detector	Comment
1	*	11547.750	20.10	17.18	37.28	54.00	-16.72	AVG	
2		11551.990	33.44	17.20	50.64	74.00	-23.36	peak	

**REMARKS:**

(1) Measurement Value = Reading Level + Correct Factor.

(2) Margin Level = Measurement Value - Limit Value.

## APPENDIX E - BANDWIDTH

Test Mode	UNII-1_TX A Mode
-----------	------------------

Channel	Frequency (MHz)	26 dB Bandwidth (MHz)	99 % Emission Bandwidth (MHz)
36	5180	21.29	16.60
40	5200	21.49	16.60
48	5240	21.09	16.60

**CH36**

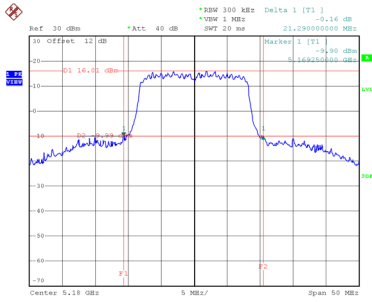

Date: 3.MAR.2021 14:29:03

**CH40**  
26 dB Bandwidth

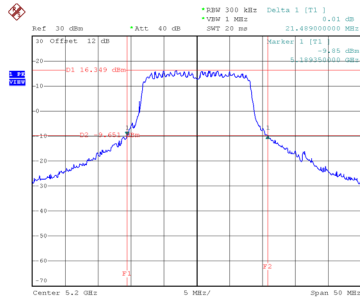

Date: 3.MAR.2021 14:41:25

**CH48**

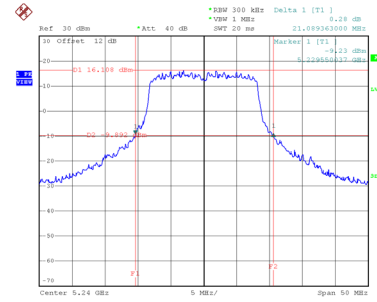

Date: 3.MAR.2021 14:43:25

**99 % Emission Bandwidth**

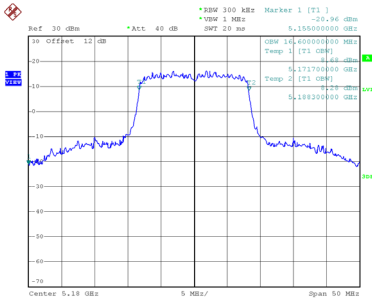

Date: 3.MAR.2021 14:28:17

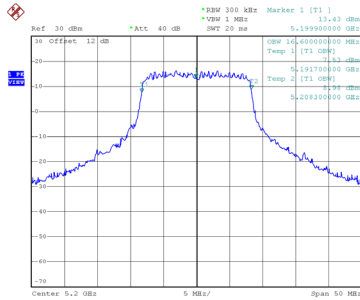

Date: 3.MAR.2021 14:40:59

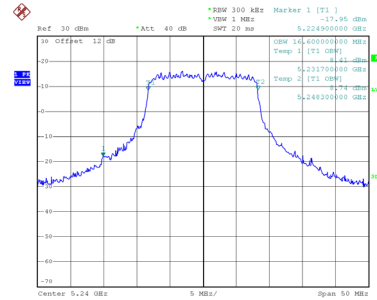

Date: 3.MAR.2021 14:42:59