

RF MEASUREMENT REPORT

FCC ID : 2AXJ4EAP211BRG
Applicant : TP-Link Corporation Limited
Application Type : Certification
Product : 5GHz 867Mbps Indoor/Outdoor Access Point
Model No. : EAP211-Bridge
Brand Name : tp-link
FCC Classification : Unlicensed National Information Infrastructure (NII)
FCC Rule Part(s) : Part15 Subpart E (Section 15.407)
Received Date : August 15, 2023
Test Date : August 18, 2023 ~ September 5, 2023
Test By : Owen Tsai
(Owen Tsai)
Reviewed By : Paddy Chen
(Paddy Chen)
Approved By : Chenz Ker
(Chenz Ker)



The test results relate only to the samples tested.

This equipment has been shown to be capable of compliance with the applicable technical standards as indicated in the measurement report and was tested in accordance with the measurement procedures specified in KDB 789033 D02v02r01. Test results reported herein relate only to the item(s) tested.

The test report shall not be reproduced except in full without the written approval of MRT Technology (Taiwan) Co., Ltd.

Revision History

Report No.	Version	Description	Issue Date	Note
2308TW0108-U2	1.0	Original Report	2023-10-27	Valid

CONTENTS

Description	Page
General Information	6
1. INTRODUCTION	7
1.1. Scope	7
1.2. MRT Test Location	7
2. PRODUCT INFORMATION	8
2.1. Equipment Description.....	8
2.2. Product Specification Subjective to this Report.....	8
2.3. Working Frequencies for this report	9
2.4. Description of Available Antennas	9
2.5. Test Mode	10
2.6. Configuration of Test System.....	11
2.7. Test System Details.....	11
2.8. Description of Test Software	12
2.9. Applied Standards	12
2.10. Duty Cycle	13
2.11. Test Configuration	14
2.12. EMI Suppression Device(s)/Modifications	14
2.13. Labeling Requirements.....	14
3. DESCRIPTION OF TEST	15
3.1. Evaluation Procedure	15
3.2. AC Line Conducted Emissions	15
3.3. Radiated Emissions	16
4. ANTENNA REQUIREMENTS	17
5. TEST EQUIPMENT CALIBRATION DATE	18
6. MEASUREMENT UNCERTAINTY	19
7. TEST RESULT	20
7.1. Summary	20
7.2. 26dB Bandwidth Measurement.....	21
7.2.1. Test Limit	21
7.2.2. Test Procedure used.....	21
7.2.3. Test Setting.....	21
7.2.4. Test Setup	21
7.2.5. Test Result.....	22

7.3.	6dB Bandwidth Measurement.....	26
7.3.1.	Test Limit	26
7.3.2.	Test Procedure used.....	26
7.3.3.	Test Setting.....	26
7.3.4.	Test Setup	26
7.3.5.	TestResult.....	27
7.4.	Output Power Measurement	30
7.4.1.	Test Limit	30
7.4.2.	Test Procedure Used	30
7.4.3.	Test Setting.....	30
7.4.4.	Test Setup	30
7.4.5.	Test Result.....	31
7.5.	Power Spectral Density Measurement	34
7.5.1.	Test Limit	34
7.5.2.	Test Procedure Used	34
7.5.3.	Test Setting.....	34
7.5.4.	Test Setup	35
7.5.5.	Test Result.....	36
7.6.	Frequency Stability Measurement.....	44
7.6.1.	Test Limit	44
7.6.2.	Test Limit	44
7.6.3.	Test Setup	45
7.6.4.	Test Result.....	45
7.7.	Radiated Spurious Emission Measurement	46
7.7.1.	Test Limit	46
7.7.2.	Test Procedure Used	46
7.7.3.	Test Setting.....	46
7.7.4.	Test Setup	48
7.7.5.	Test Result.....	49
7.8.	Radiated Restricted Band Edge Measurement	89
7.8.1.	Test Limit	89
7.8.2.	Test Procedure Used	90
7.8.3.	Test Setting.....	90
7.8.4.	Test Setup	91
7.8.5.	Test Result.....	92
7.9.	AC Conducted Emissions Measurement.....	122
7.9.1.	Test Limit	122
7.9.2.	Test Setup	122
7.9.3.	Test Result.....	123

8. CONCLUSION.....	127
Appendix A : Test Setup Photograph	128
Appendix B : EUT Photograph.....	128
Appendix C : Internal Photograph	128

General Information

Applicant	TP-Link Corporation Limited
Applicant Address	Room 901, 9/F., New East Ocean Centre, 9 Science Museum Road, Tsim Sha Tsui, Kowloon, Hongkong
Manufacturer	TP-Link Corporation Limited
Manufacturer Address	Room 901, 9/F., New East Ocean Centre, 9 Science Museum Road, Tsim Sha Tsui, Kowloon, Hongkong
Test Site	MRT Technology (Taiwan) Co., Ltd
Test Site Address	No. 38, Fuxing Second Rd., Guishan Dist., Taoyuan City 333, Taiwan (R.O.C)
MRT FCC Registration No.	291082
FCC Rule Part(s)	Part 15.407

Test Facility / Accreditations

1. MRT facility is a FCC registered (Reg. No. 291082) test facility with the site description report on file and is designated by the FCC as an Accredited Test Firm.
2. MRT facility is an IC registered (MRT Reg. No. 21723) test laboratory with the site description on file at Industry Canada.
3. MRT Lab is accredited to ISO 17025 by the Taiwan Accreditation Foundation (TAF Cert. No. 3261) in EMC, Telecommunications and Radio testing for FCC (Designation Number: TW3261), Industry Canada, EU and TELEC Rules.

1. INTRODUCTION

1.1. Scope

Measurement and determination of electromagnetic emissions (EMC) of radio frequency devices including intentional and/or unintentional radiators for compliance with the technical rules and regulations of the Federal Communications Commission and the Innovation, Science and Economic Development Canada and Certification and Engineering Bureau.

1.2. MRT Test Location

The map below shows the location of the MRT LABORATORY, its proximity to the Taoyuan City. These measurement tests were conducted at the MRT Technology (Taiwan) Co., Ltd. Facility located at No.38, Fuxing 2nd Rd., Guishan Dist., Taoyuan City 33377, Taiwan (R.O.C).

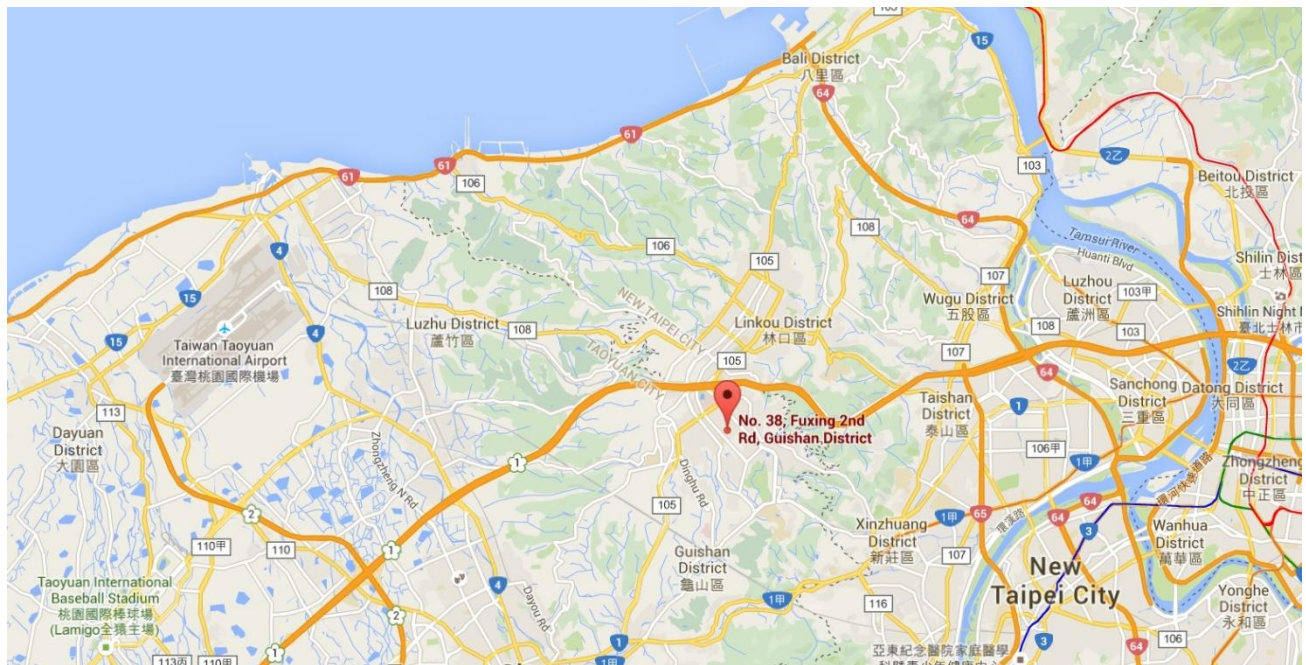

2. PRODUCT INFORMATION

2.1. Equipment Description

Product Name:	5GHz 867Mbps Indoor/Outdoor Access Point
Model No.:	EAP211-Bridge
Brand Name:	tp-link
Wi-Fi Specification:	802.11a/n/ac
EUT Identification No.:	#1-1 (Conducted) #1-2 (Radiated)
Accessory	
PoE Adapter	BRAND: tp-link MODEL: TL-POE2412G INPUT: 100 - 240V ~ 50/60Hz 0.4A. OUTPUT: DC 24.0V 0.5A 12.0W

2.2. Product Specification Subjective to this Report

Frequency Range:	For 802.11a/n-HT20/ac-VHT20: 5180~5240MHz, 5745~5825MHz For 802.11n-HT40/ac-VHT40: 5190~5230MHz, 5755~5795MHz For 802.11ac-VHT80: 5210MHz, 5775MHz
Type of Modulation:	802.11a/n/ac: OFDM
Data Rate	802.11a: 6/9/12/18/24/36/48/54Mbps 802.11n: up to 300Mbps 802.11ac: up to 866.7Mbps

Note: For other features of this EUT, test report will be issued separately.

2.3. Working Frequencies for this report

802.11a/n-HT20/ac-VHT20

Channel	Frequency	Channel	Frequency	Channel	Frequency
36	5180 MHz	40	5200 MHz	44	5220 MHz
48	5240 MHz	149	5745 MHz	153	5765 MHz
157	5785 MHz	161	5805 MHz	165	5825 MHz

802.11n-HT40/ac-VHT40

Channel	Frequency	Channel	Frequency	Channel	Frequency
38	5190 MHz	46	5230 MHz	151	5755 MHz
159	5795 MHz	N/A	N/A	N/A	N/A

802.11ac-VHT80

Channel	Frequency	Channel	Frequency	Channel	Frequency
42	5210 MHz	155	5775 MHz	N/A	N/A

2.4. Description of Available Antennas

Antenna Type	Frequency Band (MHz)	Tx Paths	Number of spatial streams	Max. Antenna Gain (dBi)	Beamforming Directional Gain (dBi)	CDD Directional Gain (dBi)	
						For Power	For PSD
Dipole	5150 ~ 5250	2	1	2.98	5.99	2.98	5.99
	5725 ~ 5850	2	1	3.50	6.51	3.50	6.51
Antenna Gain (at any elevation angle above 30 degrees)							
Dipole	5150 ~ 5250	2	1	2.13	5.14	2.13	5.14

Remark:

- The EUT supports Cyclic Delay Diversity (CDD) mode, and CDD signals are correlated.

If all antennas have the same gain, G_{ANT} , Directional gain = $G_{ANT} + \text{Array Gain}$, where Array Gain is as follows.

- For power spectral density (PSD) measurements on all devices,

$$\text{Array Gain} = 10 \log (N_{ANT} / N_{SS}) \text{ dB};$$

- For power measurements on IEEE 802.11 devices,

$$\text{Array Gain} = 0 \text{ dB for } N_{ANT} \leq 4;$$

- The EUT also supports Beam Forming mode, and the Beam Forming support 802.11ac/ax, not include 802.11a/n. BF Directional gain = $G_{ANT} + 10 \log (N_{ANT})$.

3. The information as above is from the AUT report.

Test Mode	T _x Paths	CDD Mode	Beamforming Mode
802.11a/n (NII)	2	√	X
802.11ac (NII)	2	√	√

2.5. Test Mode

CDD Mode
Mode 1: Transmit by 802.11a_Nss=1 (6Mbps) (CDD mode)
Mode 2: Transmit by 802.11ac-VHT20_Nss=1 (MCS0) (CDD mode)
Mode 3: Transmit by 802.11ac-VHT40_Nss=1 (MCS0) (CDD mode)
Mode 4: Transmit by 802.11ac-VHT80_Nss=1 (MCS0) (CDD mode)
Beamforming Mode
Mode 5: Transmit by 802.11ac-VHT20_Nss=1 (MCS0) (Beam-Forming mode)
Mode 6: Transmit by 802.11ac-VHT40_Nss=1 (MCS0) (Beam-Forming mode)
Mode 7: Transmit by 802.11ac-VHT80_Nss=1 (MCS0) (Beam-Forming mode)
Remark:
1. For Radiated emission, the modulation and the data rate picked for testing are determined by the Max. RF conducted power.
2. This device supports 2 N _{SS} and power level of 2 N _{SS} is less than or equal to the power of 1 N _{SS} . The worst case is N _{SS} =1.
3. Due to the same modulation between 802.11n and 802.11ac, so 802.11n-HT20 and HT40 are covered by 802.11ac-VHT20 and VHT40 in this report, meanwhile, power level for 802.11n-HT20 and HT40 will not be greater than 802.11ac-VHT20 and VHT40.
4. Due to CDD mode was the worst mode, so all test items were evaluated in this report. The beamforming mode only evaluated the RF output power.

2.6. Configuration of Test System

The device was tested per the guidance ANSI C63.10: 2013 was used to reference the appropriate EUT setup for radiated emissions testing and AC line conducted testing.

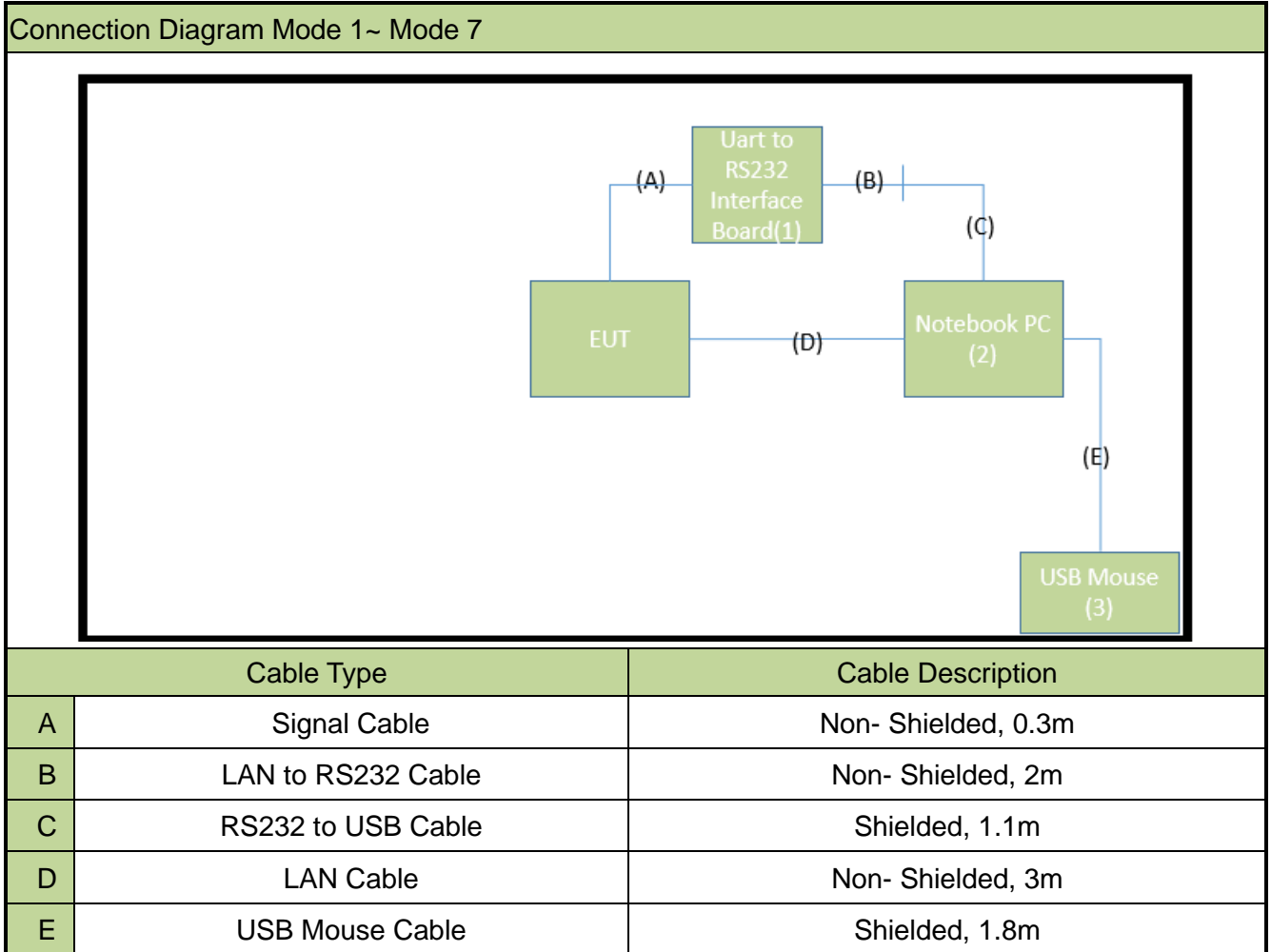

2.7. Test System Details

The types for all equipments, plus descriptions of all cables used in the tested system (including inserted cards) are:

Mode 1~ Mode 7:

	Product	Manufacturer	Model No.	Serial No.	Power Cord
1	Uart to RS232 Interface Board	TP-Link	10558	N/A	N/A
2	Notebook PC	HP	HP 240 G9	N/A	Non-shielded, 0.8m
3	USB Mouse	Logitech	M90	N/A	N/A

2.8. Description of Test Software

The test utility software used during testing was “QSPR”, the version is ver3.0-00268.

Note: Final power setting please refer to operational description.

2.9. Applied Standards

According to the specifications of the manufacturer, the EUT must comply with the requirements of the following standards:

- FCC Part 15.247
- KDB 789033 D02v02r01,
- KDB 662911 D01v02r01
- ANSI C63.10-2013

2.10. Duty Cycle

5GHz (NII) operation is possible in 20MHz, 40MHz, 80MHz and 160MHz channel bandwidths. The maximum achievable duty cycles for all modes were determined based on measurements performed on a spectrum analyzer in zero-span mode with RBW = 8MHz, VBW = 50MHz. The RBW and VBW were both greater than 50/T, where T is the minimum transmission duration, and the number of sweep points across T was greater than 100. The duty cycles are as follows:

Test Mode	Duty Cycle
802.11a	97.11%
802.11ac-VHT20	98.56%
802.11ac-VHT40	96.50%
802.11ac-VHT80	92.02%

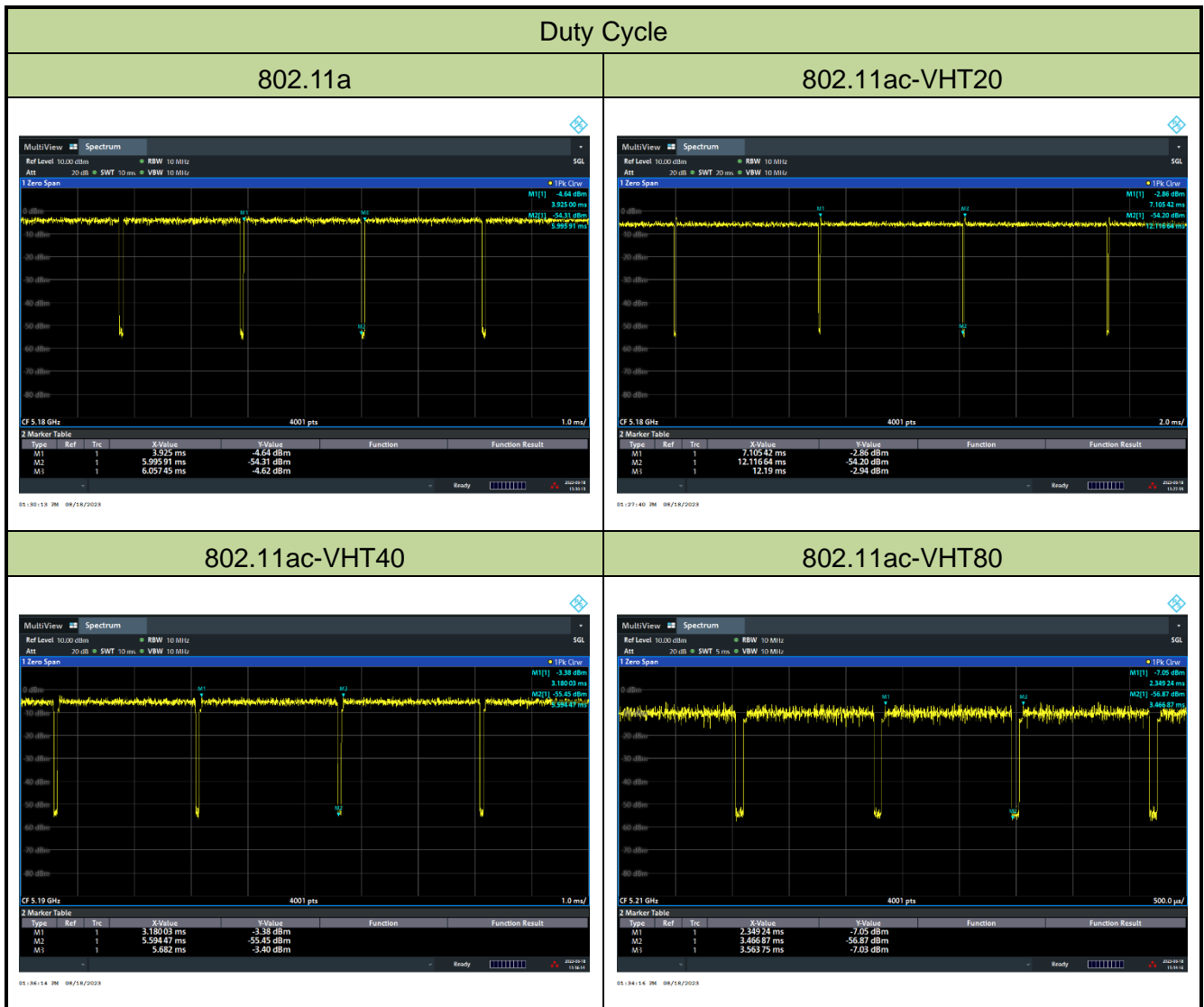

2.11. Test Configuration

The device was tested per the guidance of KDB 789033 D02v02r01. ANSI C63.10-2013 was used to reference the appropriate EUT setup for radiated spurious emissions testing and AC line conducted testing.

2.12. EMI Suppression Device(s)/Modifications

No EMI suppression device(s) were added and/or no modifications were made during testing.

2.13. Labeling Requirements

Per 2.1074 & 15.19; Docket 95-19

The label shall be permanently affixed at a conspicuous location on the device; instruction manual or pamphlets supplied to the user and be readily visible to the purchaser at the time of purchase.

However, when the device is so small wherein placement of the label with specified statement is not practical, only the FCC ID must be displayed on the device per Section 15.19(a)(5). Please see attachment for FCC ID label and label location.

3. DESCRIPTION OF TEST

3.1. Evaluation Procedure

The measurement procedures described in the American National Standard of Procedures for Compliance Testing of Unlicensed Wireless Devices (ANSI C63.10-2013), and the guidance provided in KDB 789033 D02v02r01 were used in the measurement.

3.2. AC Line Conducted Emissions

The line-conducted facility is located inside an 8'x4'x4' shielded enclosure. A 1m x 2m wooden table 80cm high is placed 40cm away from the vertical wall and 80cm away from the sidewall of the shielded room. Two 10kHz-30MHz, 50Ω/50uH Line-Impedance Stabilization Networks (LISNs) are bonded to the shielded room floor. Power to the LISNs is filtered by external high-current high-insertion loss power line filters. These filters attenuate ambient signal noise from entering the measurement lines. These filters are also bonded to the shielded enclosure.

The EUT is powered from one LISN and the support equipment is powered from the second LISN. All interconnecting cables more than 1 meter were shortened to a 1 meter length by non-inductive bundling (serpentine fashion) and draped over the back edge of the test table. All cables were at least 40cm above the horizontal reference ground-plane. Power cables for support equipment were routed down to the second LISN while ensuring that that cables were not draped over the second LISN.

Sufficient time for the EUT, support equipment, and test equipment was allowed in order for them to warm up to their normal operating condition. The RF output of the LISN was connected to the receiver and exploratory measurements were made to determine the frequencies producing the maximum emission from the EUT. The receiver was scanned from 150kHz to 30MHz. The detector function was set to peak mode for exploratory measurements while the bandwidth of the analyzer was set to 9kHz. The EUT, support equipment, and interconnecting cables were arranged and manipulated to maximize each emission. Each emission was also maximized by varying: power lines, the mode of operation or data exchange speed, or support equipment whichever determined the worst-case emission. Once the worst case emissions have been identified, the one EUT cable configuration/arrangement and mode of operation that produced these emissions are used for final measurements on the same test site. The analyzer is set to CISPR quasi-peak and average detectors with a 9kHz resolution bandwidth for final measurements.

An extension cord was used to connect to a single LISN which powered by EUT. The extension cord was calibrated with LISN, the impedance and insertion loss are compliance with the requirements as stated in ANSI C63.10-2013.

3.3. Radiated Emissions

The radiated test facilities consisted of an indoor 3 meter semi-anechoic chamber used for final measurements and exploratory measurements, when necessary. The measurement area is contained within the semi-anechoic chamber which is shielded from any ambient interference. For measurements above 1GHz absorbers are arranged on the floor between the turn table and the antenna mast in such a way so as to maximize the reduction of reflections. For measurements below 1GHz, the absorbers are removed. A MF Model 210SS turntable is used for radiated measurement. It is a continuously rotatable, remotecontrolled, metallic turntable and 2 meters (6.56 ft.) in diameter. The turn table is flush with the raised floor of the chamber in order to maintain its function as a ground plane. An 80cm high PVC support structure is placed on top of the turntable.

For all measurements, the spectrum was scanned through all EUT azimuths and from 1 to 4 meter receive antenna height using a broadband antenna from 30MHz up to the upper frequency shown in 15.33(b)(1) depending on the highest frequency generated or used in the device or on which the device operates or tunes. For frequencies above 1GHz, linearly polarized double ridge horn antennas were used. For frequencies below 30MHz, a calibrated loop antenna was used. When exploratory measurements were necessary, they were performed at 1 meter test distance inside the semi-anechoic chamber using broadband antennas, broadband amplifiers, and spectrum analyzers to determine the frequencies and modes producing the maximum emissions. Sufficient time for the EUT, support equipment, and test equipment was allowed in order for them to warm up to their normal operating condition. The test set-up for frequencies below 1GHz was placed on top of the 0.8 meter high, 1 x 1.5 meter table; and test set-up for frequencies 1-40GHz was placed on top of the 1.5 meter high, 1 x 1.5 meter table. The EUT, support equipment, and interconnecting cables were arranged and manipulated to maximize each emission. Appropriate precaution was taken to ensure that all emissions from the EUT were maximized and investigated. The system configuration, clock speed, mode of operation or video resolution, if applicable, turntable azimuth, and receive antenna height was noted for each frequency found.

Final measurements were made in the semi-anechoic chamber using calibrated, linearly polarized broadband and horn antennas. The test setup was configured to the setup that produced the worst case emissions. The spectrum analyzer was set to investigate all frequencies required for testing to compare the highest radiated disturbances with respect to the specified limits. The turntable containing the EUT was rotated through 360 degrees and the height of the receive antenna was varied 1 to 4 meters and stopped at the azimuth and height producing the maximum emission. Each emission was maximized by changing the orientation of the EUT through three orthogonal planes and changing the polarity of the receive antenna, whichever produced the worst-case emissions. According to 3dB Beam-Width of horn antenna, the horn antenna should be always directed to the EUT when rising height.

4. ANTENNA REQUIREMENTS

Excerpt from §15.203 of the FCC Rules/Regulations:

“An intentional radiator antenna shall be designed to ensure that no antenna other than that furnished by the responsible party can be used with the device. The use of a permanently attached antenna or of an antenna that uses a unique coupling to the intentional radiator shall be considered sufficient to comply with the provisions of this section.”

- The antenna of the device is **permanently attached**.
- There are no provisions for connection to an external antenna.

Conclusion:

The unit complies with the requirement of §15.203.

5. TEST EQUIPMENT CALIBRATION DATE

Conducted Emissions

Instrument	Manufacturer	Type No.	Asset No.	Cali. Interval	Cali. Due Date
Two-Line V-Network	R&S	ENV216	MRTTWA00019	1 year	2024/3/7
Two-Line V-Network	R&S	ENV216	MRTTWA00020	1 year	2024/4/17
EMI Test Receiver	R&S	ESR3	MRTTWA00045	1 year	2024/5/10
Temperature/Humidity Meter	TFA	35.1078.10.IT	MRTTWA00050	1 year	2024/6/15

Radiated Emissions

Instrument	Manufacturer	Type No.	Asset No.	Cali. Interval	Cali. Due Date
Active Loop Antenna	SCHWARZBECK	FMZB 1519B	MRTTWA00002	1 year	2024/5/22
Broadband TRILOG Antenna	SCHWARZBECK	VULB 9162	MRTTWA00001	1 year	2023/12/21
Broadband Hornantenna	RFSPIN	DRH18-E	MRTTWA00087	1 year	2024/5/17
Broadband Preamplifier	EMC Instruments corporation	EMC118A45SE	MRTTWA00088	1 year	2024/5/17
Breitband Hornantenna	SCHWARZBECK	BBHA 9170	MRTTWA00004	1 year	2024/3/20
Broadband Amplifier	SCHWARZBECK	BBV 9721	MRTTWA00006	1 year	2024/3/27
EMI Test Receiver	R&S	ESR3	MRTTWA00009	1 year	2024/3/8
Signal Analyzer	R&S	FSVA3044	MRTTWA00092	1 year	2024/6/29
Antenna Cable	HUBERSUHNER	SF106	MRTTWE00034	1 year	2024/6/26
Cable	HUBERSUHNER	EMC105-NM-N M-3000	MRTTWE00035	1 year	2024/6/26
Temperature/Humidity Meter	TFA	35.1078.10.IT	MRTTWA00032	1 year	2024/6/4

Conducted Test Equipment

Instrument	Manufacturer	Type No.	Asset No.	Cali. Interval	Cali. Due Date
X-Series USB Peak and Average Power Sensor	KEYSIGHT	U2021XA	MRTTWA00014	1 year	2024/4/19
EXA Signal Analyzer	KEYSIGHT	N9010A	MRTTWA00012	1 year	2023/10/5
EXA Signal Analyzer	KEYSIGHT	N9010B	MRTTWA00074	1 year	2024/7/19
Temperature & Humidity Chamber	TEN BILLION	TTH-B3UP	MRTTWA00036	1 year	2024/6/11
DIVA PLUS Funk-Wetterstation	TFA	35.1083	MRTTWA00050	1 year	2024/6/15

Software	Version	Function
e3	9.160520a	EMI Test Software

6. MEASUREMENT UNCERTAINTY

Where relevant, the following test uncertainty levels have been estimated for tests performed on the EUT as specified in CISPR 16-4-2. This uncertainty represents an expanded uncertainty expressed at approximately the 95% confidence level using a coverage factor of $k = 2$.

AC Conducted Emission Measurement
Measuring Uncertainty for a Level of Confidence of 95% ($U=2Uc(y)$): 150kHz~30MHz: $\pm 2.53\text{dB}$
Radiated Emission Measurement
Measuring Uncertainty for a Level of Confidence of 95% ($U=2Uc(y)$): 9kHz ~ 1GHz: $\pm 4.25\text{dB}$ 1GHz ~ 40GHz: $\pm 4.45\text{dB}$
Conducted Power (Carrier Power / Power Density)
Measuring Uncertainty for a Level of Confidence of 95% ($U=2Uc(y)$): $\pm 0.84\text{dB}$
Conducted Spurious Emission
Measuring Uncertainty for a Level of Confidence of 95% ($U=2Uc(y)$): $\pm 2.65\text{ dB}$
Occupied Bandwidth
Measuring Uncertainty for a Level of Confidence of 95% ($U=2Uc(y)$): $\pm 3.3\%$
Temp. / Humidity
Measuring Uncertainty for a Level of Confidence of 95% ($U=2Uc(y)$): $\pm 0.82^\circ\text{C} / \pm 3\%$
Frequency Error
Measuring Uncertainty for a Level of Confidence of 95% ($U=2Uc(y)$): $\pm 78.4\text{Hz}$

7. TEST RESULT

7.1. Summary

FCC Section(s)	Test Description	Test Limit	Test Condition	Test Result	Reference
15.407(a)	26dB Bandwidth	N/A	Conducted	Pass	Section 7.2
15.407(e)	6dB Bandwidth	$\geq 500\text{kHz}$		Pass	Section 7.3
15.407(a)(1)(ii), (3)	Maximum Conducted Output Power	Refer to section 7.4		Pass	Section 7.4
15.407(a)(1)(ii), (3), (12)	Peak Power Spectral Density	Refer to section 7.5		Pass	Section 7.5
15.407(g)	Frequency Stability	N/A		Pass	Section 7.6
15.407(b)(1), (4)(i)	Undesirable Emissions	Refer to Section 7.7	Radiated	Pass	Section 7.7 & 7.8
15.205, 15.209 15.407(b)(8), (9), (10)	General Field Strength Limits (Restricted Bands and Radiated Emission Limits)	Emissions in restricted bands must meet the radiated limits detailed in 15.209		Pass	
15.207	AC Conducted Emissions 150kHz - 30MHz	< FCC 15.207 limits	Line Conducted	Pass	Section 7.9

Notes:

- Determining compliance is based on the test results met the regulation limits or requirements declared by clients, and the test results don't take into account the value of measurement uncertainty.
- The analyzer plots shown in this section were all taken with a correction table loaded into the analyzer. The correction table was used to account for the losses of the cables and attenuators used as part of the system to connect the EUT to the analyzer at all frequencies of interest.
- When applicable, for radiated emission test, every axis (X, Y, Z) was also verified. The test results shown in the following sections represent the worst-case emissions.

7.2. 26dB Bandwidth Measurement

7.2.1. Test Limit

N/A

7.2.2. Test Procedure used

KDB 789033 D02v02r01- Section C.1

7.2.3. Test Setting

1. The analyzers' automatic bandwidth measurement capability was used to perform the 26dB bandwidth measurement. The "X" dB bandwidth parameter was set to $X = 26$. The automatic bandwidth measurement function also has the capability of simultaneously measuring the 99% occupied bandwidth. The bandwidth measurement was not influenced by any intermediated power nulls in the fundamental emission.
2. RBW = approximately 1% of the emission bandwidth.
3. VBW $\geq 3 \times$ RBW.
4. Detector = Peak.
5. Trace mode = max hold.

7.2.4. Test Setup

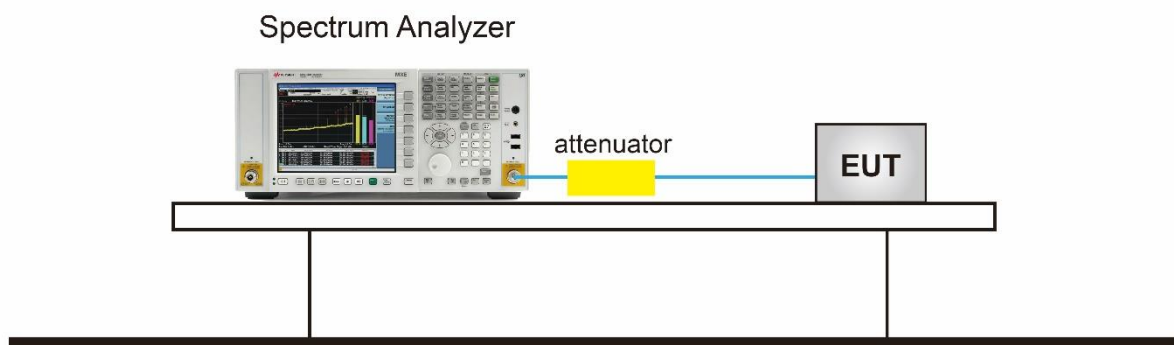

7.2.5. Test Result

Product	5GHz 867Mbps Indoor/Outdoor Access Point	Test Engineer	Xuan
Test Site	SR6	Test Date	2023/8/23

Test Mode	Data Rate/ MCS	Channel No.	Frequency (MHz)	26dB Bandwidth (MHz)	99% Bandwidth (MHz)
Ant 1					
802.11a	6Mbps	36	5180	18.95	16.426
802.11a	6Mbps	44	5220	19.42	16.400
802.11a	6Mbps	48	5240	18.92	16.438
802.11a	6Mbps	149	5745	19.28	16.456
802.11a	6Mbps	157	5785	20.07	16.457
802.11a	6Mbps	165	5825	20.53	16.475
802.11ac-VHT20	MCS0	36	5180	19.80	17.615
802.11ac-VHT20	MCS0	44	5220	19.55	17.638
802.11ac-VHT20	MCS0	48	5240	20.02	17.643
802.11ac-VHT20	MCS0	149	5745	19.81	17.655
802.11ac-VHT20	MCS0	157	5785	21.46	17.684
802.11ac-VHT20	MCS0	165	5825	20.50	17.659
802.11ac-VHT40	MCS0	38	5190	38.87	35.854
802.11ac-VHT40	MCS0	46	5230	38.52	35.795
802.11ac-VHT40	MCS0	151	5755	39.64	36.006
802.11ac-VHT40	MCS0	159	5795	46.43	36.014
802.11ac-VHT80	MCS0	42	5210	81.94	75.933
802.11ac-VHT80	MCS0	155	5775	102.40	76.076

802.11a 26dB Bandwidth & 99% Bandwidth

Channel 36 (5180MHz)

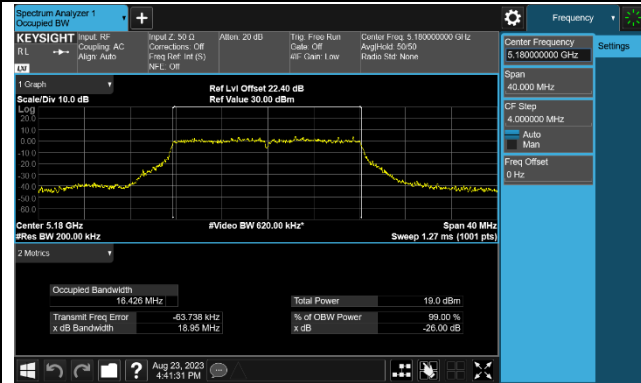

Channel 44 (5220MHz)

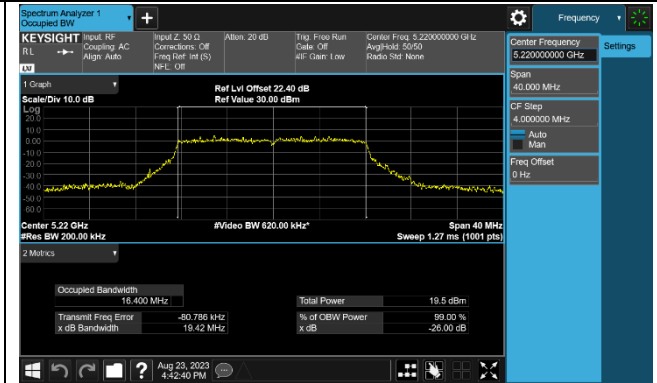

Channel 48 (5240MHz)

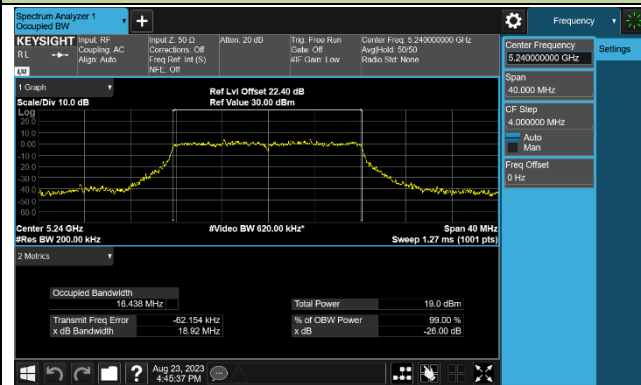

Channel 149 (5745MHz)

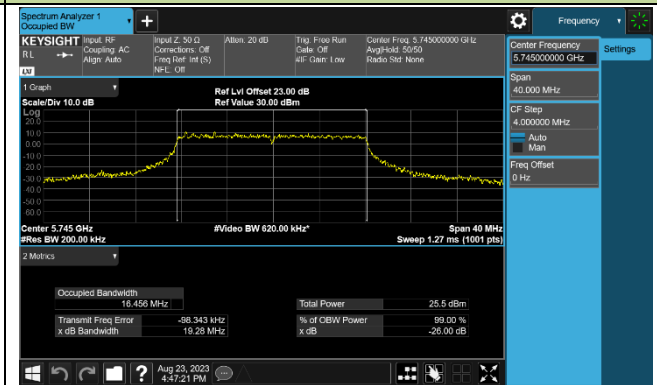

Channel 157 (5785MHz)

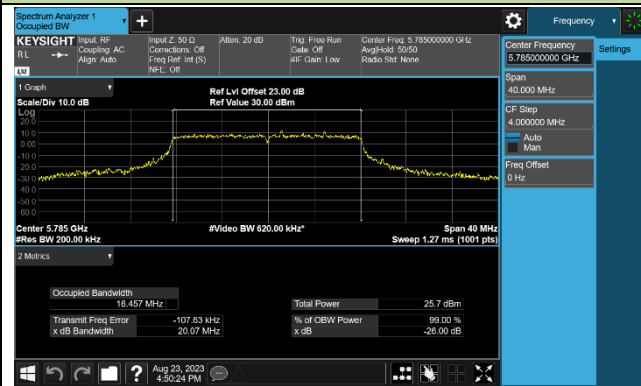

Channel 165 (5825MHz)

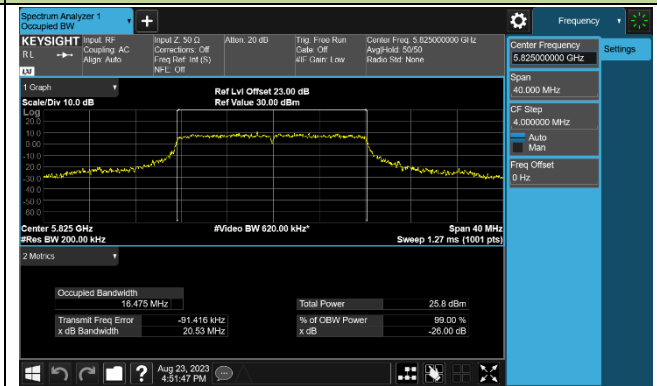

802.11ac-VHT20 26dB Bandwidth & 99% Bandwidth

Channel 36 (5180MHz)

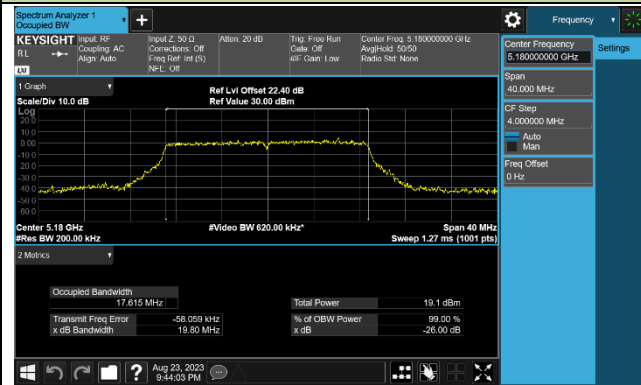

Channel 44 (5220MHz)

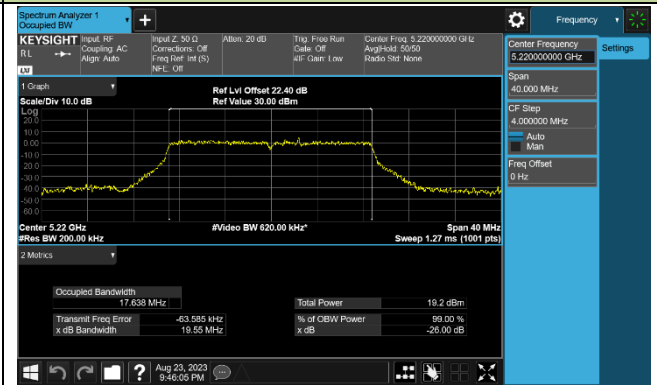

Channel 48 (5240MHz)

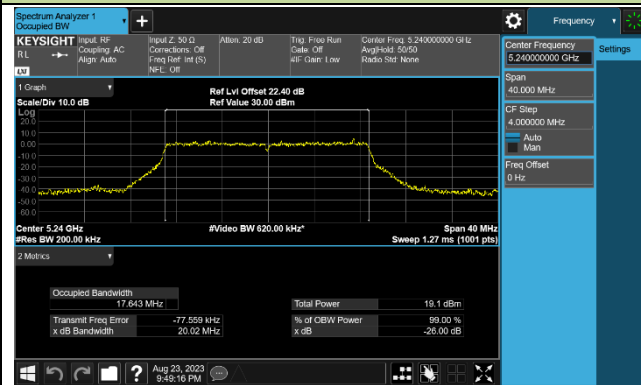

Channel 149 (5745MHz)

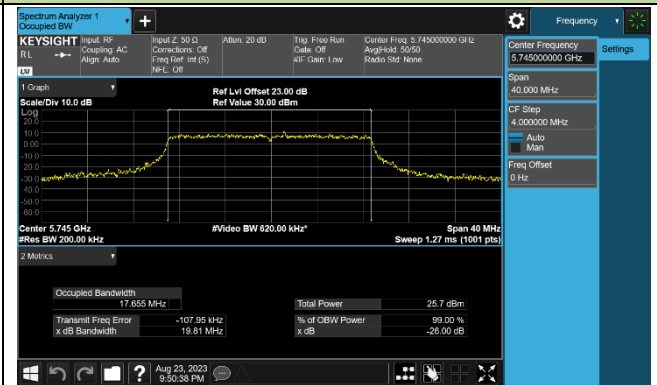

Channel 157 (5785MHz)

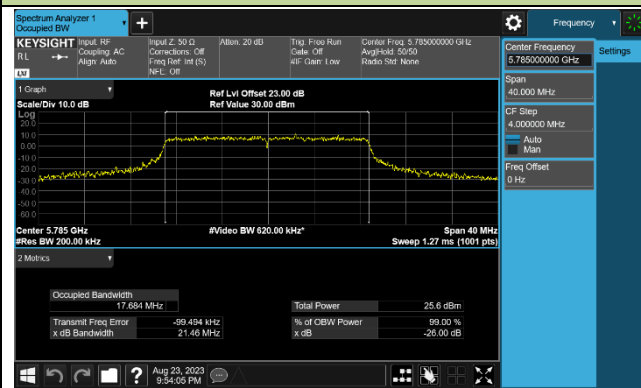

Channel 165 (5825MHz)

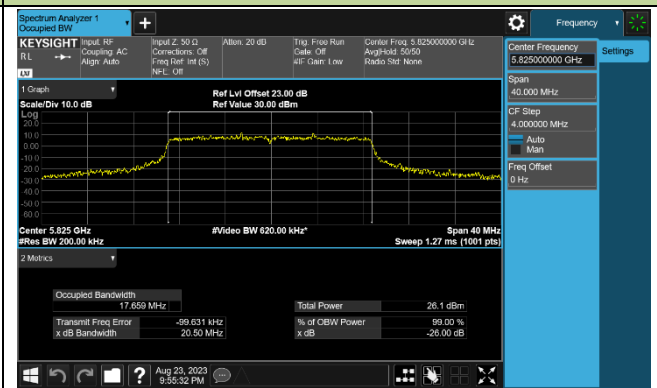

802.11ac-VHT40 26dB Bandwidth & 99% Bandwidth

Channel 38 (5190MHz)



Channel 46 (5230MHz)

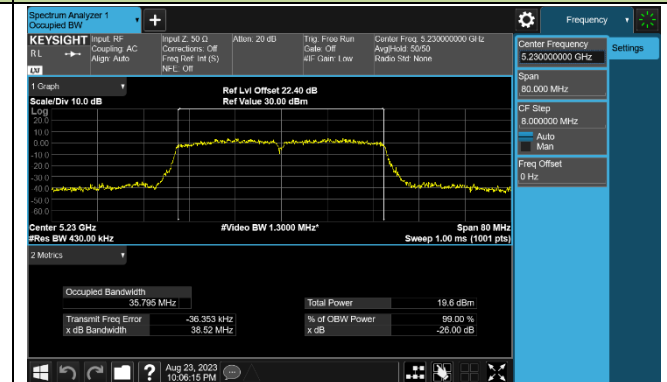

Channel 151 (5755MHz)

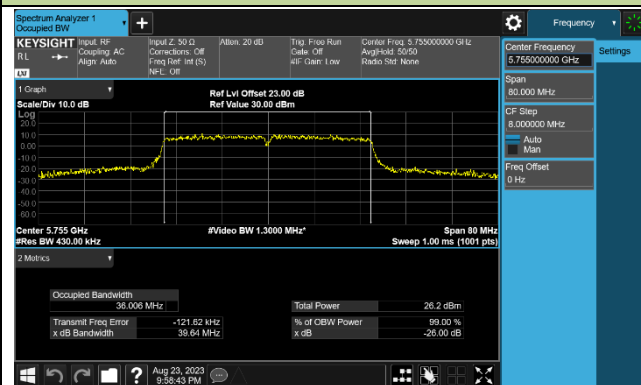

Channel 159 (5795MHz)

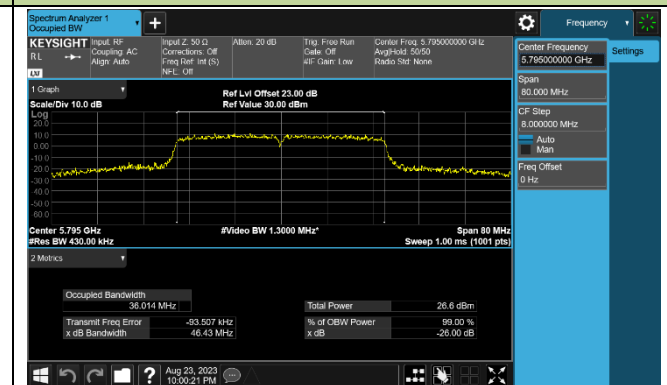

802.11ac-VHT80 26dB Bandwidth & 99% Bandwidth

Channel 42 (5210MHz)

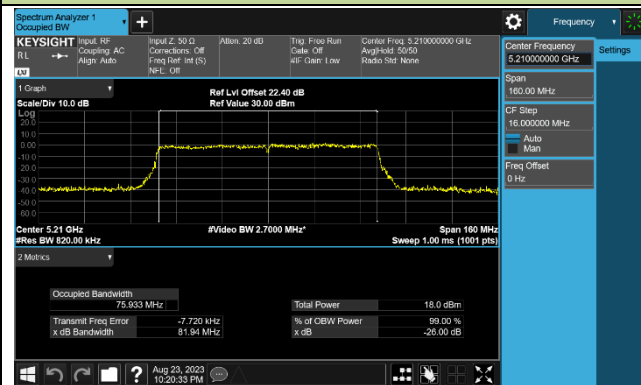

Channel 155 (5775MHz)

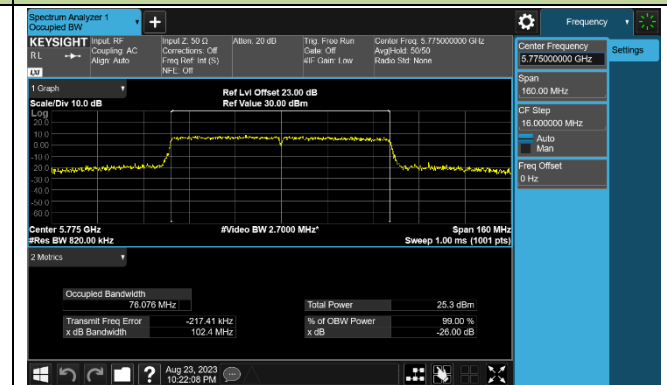

7.3. 6dB Bandwidth Measurement

7.3.1. Test Limit

The minimum 6dB bandwidth shall be at least 500 kHz.

7.3.2. Test Procedure used

KDB 789033 D02v02r01- Section C.2

7.3.3. Test Setting

1. Set center frequency to the nominal EUT channel center frequency.
2. RBW = 100 kHz.
3. VBW $3 \times$ RBW.
4. Detector = Peak.
5. Trace mode = max hold.
6. Sweep = auto couple.
7. Allow the trace to stabilize.
8. Measure the maximum width of the emission that is constrained by the frequencies associated with the two outermost amplitude points (upper and lower frequencies) that are attenuated by 6 dB relative to the maximum level measured in the fundamental emission.

7.3.4. Test Setup

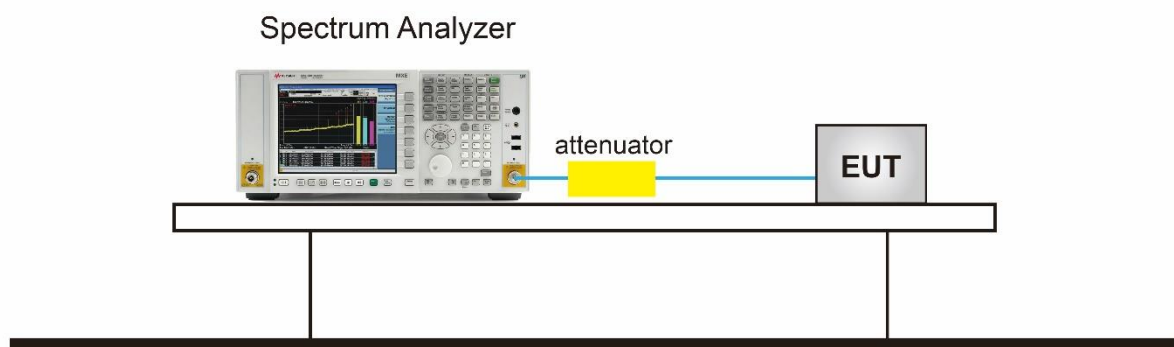

7.3.5.TestResult

Product	5GHz 867Mbps Indoor/Outdoor Access Point	Test Engineer	Xuan
Test Site	SR6	Test Date	2023/8/23

Test Mode	Data Rate/MCS	Channel No.	Frequency (MHz)	6dB Bandwidth (MHz)	Limit (MHz)	Result
Ant 1						
802.11a	6Mbps	149	5745	16.35	≥ 0.5	Pass
802.11a	6Mbps	157	5785	16.32	≥ 0.5	Pass
802.11a	6Mbps	165	5825	16.34	≥ 0.5	Pass
802.11ac-VHT20	MCS0	149	5745	17.20	≥ 0.5	Pass
802.11ac-VHT20	MCS0	157	5785	17.59	≥ 0.5	Pass
802.11ac-VHT20	MCS0	165	5825	16.30	≥ 0.5	Pass
802.11ac-VHT40	MCS0	151	5755	35.90	≥ 0.5	Pass
802.11ac-VHT40	MCS0	159	5795	35.32	≥ 0.5	Pass
802.11ac-VHT80	MCS0	155	5775	75.96	≥ 0.5	Pass

802.11a 6dB Bandwidth

Channel 149 (5745MHz)

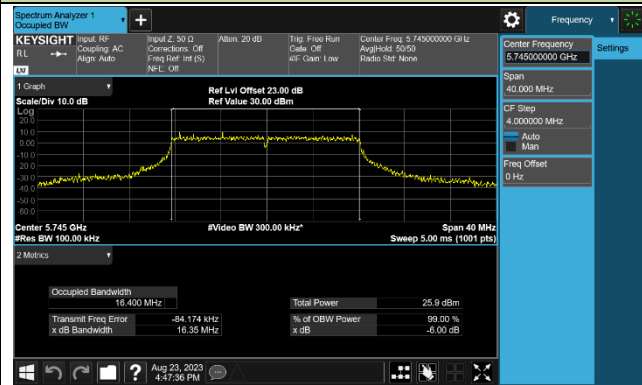

Channel 157 (5785MHz)

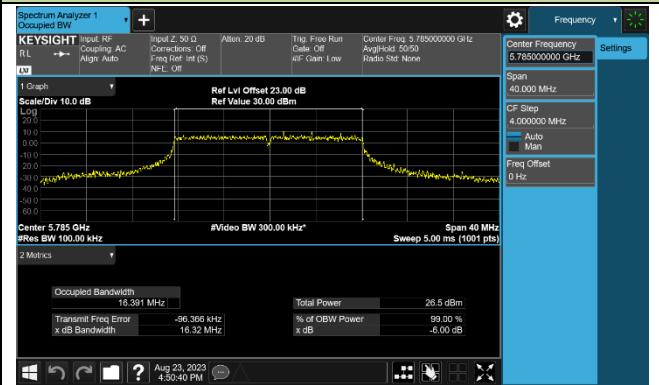

Channel 165 (5825MHz)

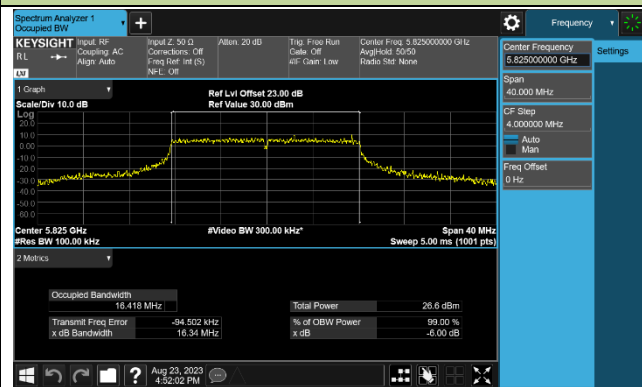

802.11ac-VHT20 6dB Bandwidth

Channel 149 (5745MHz)

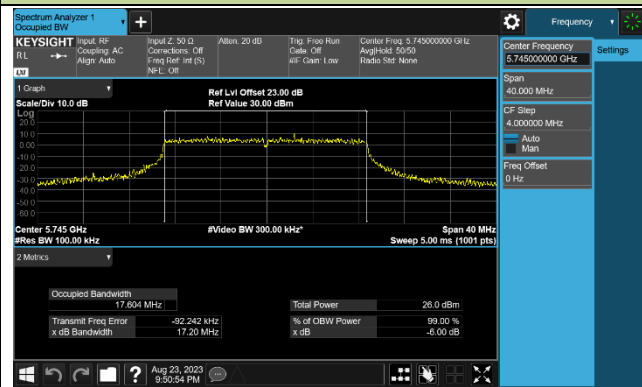

Channel 157 (5785MHz)

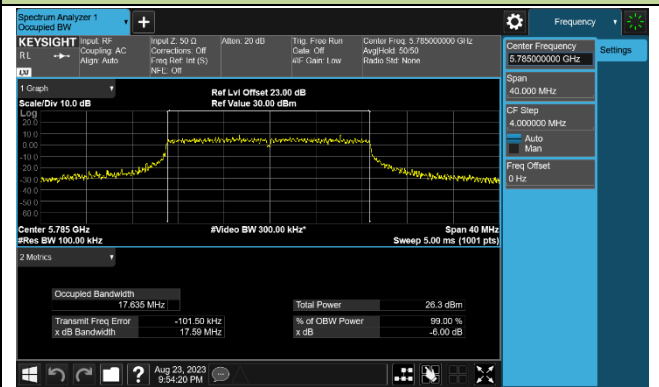

Channel 165 (5825MHz)

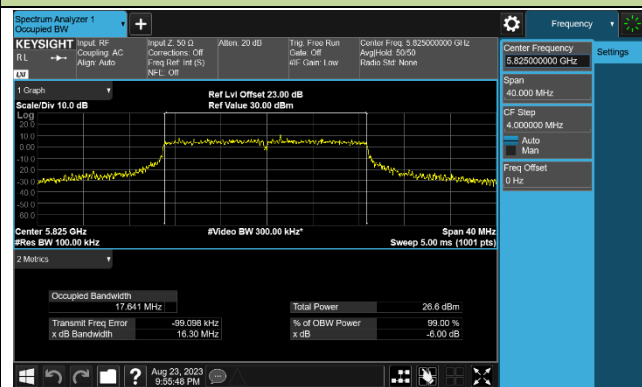

802.11ac-VHT40 6dB Bandwidth

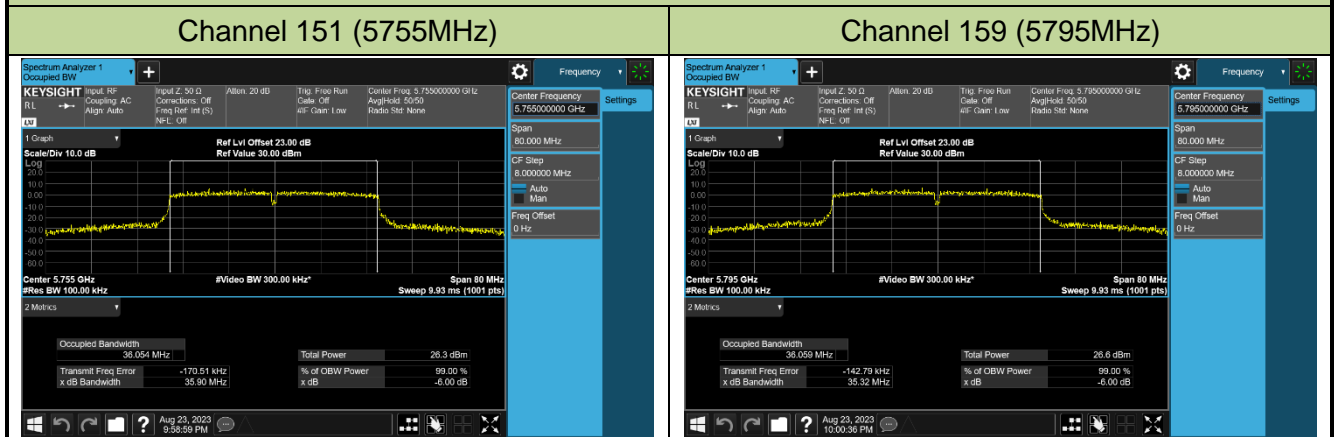

802.11ac-VHT80 6dB Bandwidth

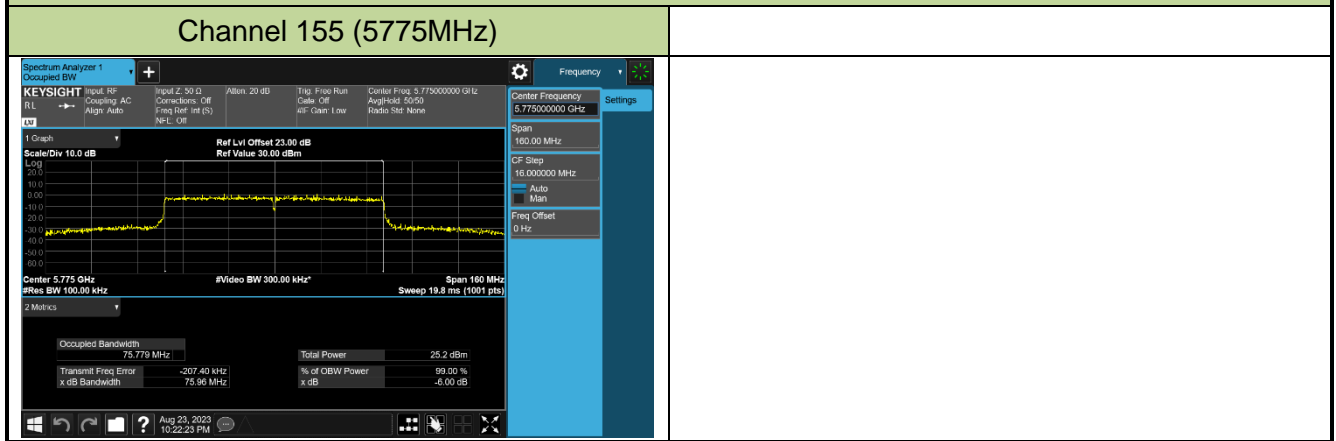

7.4. Output Power Measurement

7.4.1. Test Limit

For the band 5.15-5.25 GHz, the maximum conducted output power over the frequency band of operation shall not exceed 1 W provided the maximum antenna gain does not exceed 6 dBi.

For an outdoor access point operating in the band 5.15-5.25 GHz, the maximum e.i.r.p. at any elevation angle above 30 degrees as measured from the horizon must not exceed 125 mW (21 dBm).

For the band 5.725-5.85 GHz, the maximum conducted output power over the frequency band of operation shall not exceed 1 W (30dBm).

If transmitting antennas of directional gain greater than 6dBi are used, the maximum conducted output power shall be reduced by the amount in dB that the directional gain of the antenna exceeds 6dBi.

7.4.2. Test Procedure Used

KDB 789033D02v02r01- Section E)3)b) Method PM-G

7.4.3. Test Setting

Average power measurements were performed only when the EUT was transmitting at its maximum power control level using a broadband power meter with a pulse sensor. The power meter implemented triggering and gating capabilities which were set up such that power measurements were recorded only during the ON time of the transmitter.

7.4.4. Test Setup

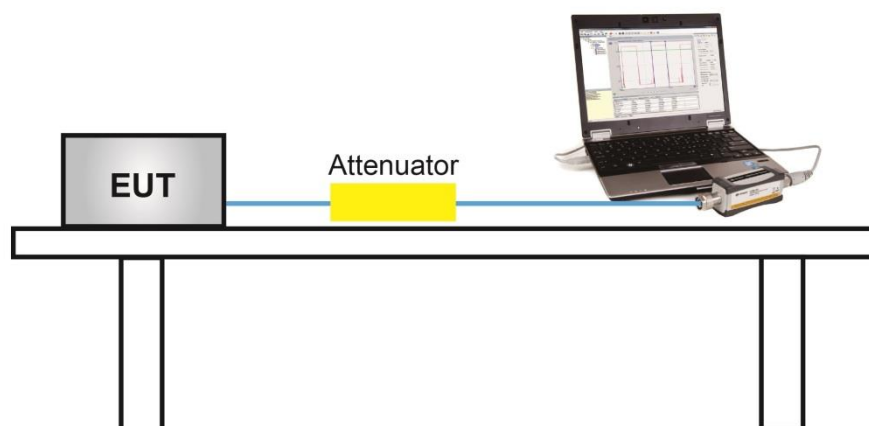

7.4.5. Test Result

Product	5GHz 867Mbps Indoor/Outdoor Access Point	Test Engineer	Xuan
Test Site	SR6	Test Date	2023/8/23
Test Mode	CDD Mode		

Test Mode	Data Rate/ MCS	Channel No.	Freq. (MHz)	Ant 0 Average Power (dBm)	Ant 1 Average Power (dBm)	Total Average Power (dBm)	Power Limit (dBm)	Result
11a	6Mbps	36	5180	15.13	15.46	18.31	≤ 30.00	Pass
11a	6Mbps	44	5220	15.57	15.92	18.76	≤ 30.00	Pass
11a	6Mbps	48	5240	15.26	15.60	18.44	≤ 30.00	Pass
11a	6Mbps	149	5745	22.49	22.26	25.39	≤ 30.00	Pass
11a	6Mbps	157	5785	22.63	22.25	25.45	≤ 30.00	Pass
11a	6Mbps	165	5825	22.52	22.45	25.50	≤ 30.00	Pass
11ac-VHT20	MCS0	36	5180	15.56	15.91	18.75	≤ 30.00	Pass
11ac-VHT20	MCS0	44	5220	15.43	15.89	18.68	≤ 30.00	Pass
11ac-VHT20	MCS0	48	5240	15.46	15.81	18.65	≤ 30.00	Pass
11ac-VHT20	MCS0	149	5745	22.45	22.30	25.39	≤ 30.00	Pass
11ac-VHT20	MCS0	157	5785	22.66	22.56	25.62	≤ 30.00	Pass
11ac-VHT20	MCS0	165	5825	22.11	22.41	25.27	≤ 30.00	Pass
11ac-VHT40	MCS0	38	5190	14.95	15.35	18.16	≤ 30.00	Pass
11ac-VHT40	MCS0	46	5230	15.54	15.94	18.75	≤ 30.00	Pass
11ac-VHT40	MCS0	151	5755	22.52	22.47	25.51	≤ 30.00	Pass
11ac-VHT40	MCS0	159	5795	22.48	22.33	25.42	≤ 30.00	Pass
11ac-VHT80	MCS0	42	5210	15.38	15.18	18.29	≤ 30.00	Pass
11ac-VHT80	MCS0	155	5775	22.37	22.18	25.29	≤ 30.00	Pass

Note: The Total Average Power (dBm) = $10 \cdot \log \{10^{(\text{Ant 0 Average Power} / 10)} + 10^{(\text{Ant 1 Average Power} / 10)}\}$.

Product	5GHz 867Mbps Indoor/Outdoor Access Point	Test Engineer	Xuan
Test Site	SR6	Test Date	2023/8/23
Test Mode	Beamforming Mode		

Test Mode	Data Rate/ MCS	Channel No.	Freq. (MHz)	Ant 0 Average Power (dBm)	Ant 1 Average Power (dBm)	Total Average Power (dBm)	Power Limit (dBm)	Result
11ac-VHT20	MCS0	36	5180	15.56	15.91	18.75	≤ 30.00	Pass
11ac-VHT20	MCS0	44	5220	15.43	15.89	18.68	≤ 30.00	Pass
11ac-VHT20	MCS0	48	5240	15.46	15.81	18.65	≤ 30.00	Pass
11ac-VHT20	MCS0	149	5745	22.45	22.30	25.39	≤ 29.49	Pass
11ac-VHT20	MCS0	157	5785	22.66	22.56	25.62	≤ 29.49	Pass
11ac-VHT20	MCS0	165	5825	22.11	22.41	25.27	≤ 29.49	Pass
11ac-VHT40	MCS0	38	5190	14.95	15.35	18.16	≤ 30.00	Pass
11ac-VHT40	MCS0	46	5230	15.54	15.94	18.75	≤ 30.00	Pass
11ac-VHT40	MCS0	151	5755	22.52	22.47	25.51	≤ 29.49	Pass
11ac-VHT40	MCS0	159	5795	22.48	22.33	25.42	≤ 29.49	Pass
11ac-VHT80	MCS0	42	5210	15.38	15.18	18.29	≤ 30.00	Pass
11ac-VHT80	MCS0	155	5775	22.37	22.18	25.29	≤ 29.49	Pass

Note 1:

The Total Average Power (dBm) = $10 \cdot \log \{10^{(\text{Ant 0 Average Power} / 10)} + 10^{(\text{Ant 1 Average Power} / 10)}\}$.

Note 2:

For 5725 - 5850MHz Band: Average Power Limit (dBm) = 30 - (6.51 - 6) = 29.49dBm.

Product	5GHz 867Mbps Indoor/Outdoor Access Point	Test Engineer	Xuan
Test Site	SR6	Test Date	2023/8/23

Test Mode	Data Rate/ MCS	Channel No.	Freq. (MHz)	Average Power (dBm)		Total Average Power (dBm)	EIRP (dBm)	EIRP Limit (dBm)	Result
				Ant 0	Ant 1				
EIRP at any elevation angle above 30 degrees (CDD mode)									
11a	6Mbps	36	5180	15.13	15.46	18.31	20.44	≤ 21.00	Pass
11a	6Mbps	44	5220	15.57	15.92	18.76	20.89	≤ 21.00	Pass
11a	6Mbps	48	5240	15.26	15.60	18.44	20.57	≤ 21.00	Pass
11ac-VHT20	MCS0	36	5180	15.56	15.91	18.75	20.88	≤ 21.00	Pass
11ac-VHT20	MCS0	44	5220	15.43	15.89	18.68	20.81	≤ 21.00	Pass
11ac-VHT20	MCS0	48	5240	15.46	15.81	18.65	20.78	≤ 21.00	Pass
11ac-VHT40	MCS0	38	5190	14.95	15.35	18.16	20.29	≤ 21.00	Pass
11ac-VHT40	MCS0	46	5230	15.54	15.94	18.75	20.88	≤ 21.00	Pass
11ac-VHT80	MCS0	42	5210	15.38	15.18	18.29	20.42	≤ 21.00	Pass
EIRP at any elevation angle above 30 degrees (Beamforming mode)									
11ac-VHT20	MCS0	36	5180	12.73	12.47	15.61	20.75	≤ 21.00	Pass
11ac-VHT20	MCS0	44	5220	12.73	12.49	15.62	20.76	≤ 21.00	Pass
11ac-VHT20	MCS0	48	5240	12.70	12.69	15.71	20.85	≤ 21.00	Pass
11ac-VHT40	MCS0	38	5190	12.63	12.47	15.56	20.70	≤ 21.00	Pass
11ac-VHT40	MCS0	46	5230	12.65	12.22	15.45	20.59	≤ 21.00	Pass
11ac-VHT80	MCS0	42	5210	12.46	12.28	15.38	20.52	≤ 21.00	Pass

Note 1: The Total Average Power (dBm) = $10 \cdot \log \{10^{(\text{Ant 0 Average Power} / 10)} + 10^{(\text{Ant 1 Average Power} / 10)}\}$.

Note 2: EIRP (dBm) = Total Average Power (dBm) + Directional Gain (dBi)

7.5. Power Spectral Density Measurement

7.5.1. Test Limit

For the band 5.15-5.25 GHz, the maximum power spectral density shall not exceed 17 dBm in any 1 megahertz band.

For the band 5.725-5.85 GHz, the maximum power spectral density shall not exceed 30 dBm in any 500-kHz band.

If transmitting antennas of directional gain greater than 6dBi are used, the peak power spectral density shall be reduced by the amount in dB that the directional gain of the antenna exceeds 6dBi.

7.5.2. Test Procedure Used

KDB 789033 D02v02r01-SectionF

7.5.3. Test Setting

1. Analyzer was set to the center frequency of the UNII channel under investigation
2. Span was set to encompass the entire 26dB EBW of the signal.
3. RBW = 1MHz, if measurement bandwidth of Maximum PSD is specified in 500 kHz,
RBW = 510 kHz
4. VBW = 3MHz
5. Number of sweep points $\geq 2 \times (\text{span} / \text{RBW})$
6. Detector = power averaging (Average)
7. Sweep time = auto
8. Trigger = free run
9. Use the peak search function on the instrument to find the peak of the spectrum and record its value.
10. Add $10 \cdot \log(1/x)$, where x is the duty cycle, to the measured power in order to compute the average power during the actual transmission times (because the measurement represents an average over both the on and off times of the transmission). For example, add $10 \cdot \log(1/0.25) = 6$ dB if the duty cycle is 25 percent.

7.5.4. Test Setup

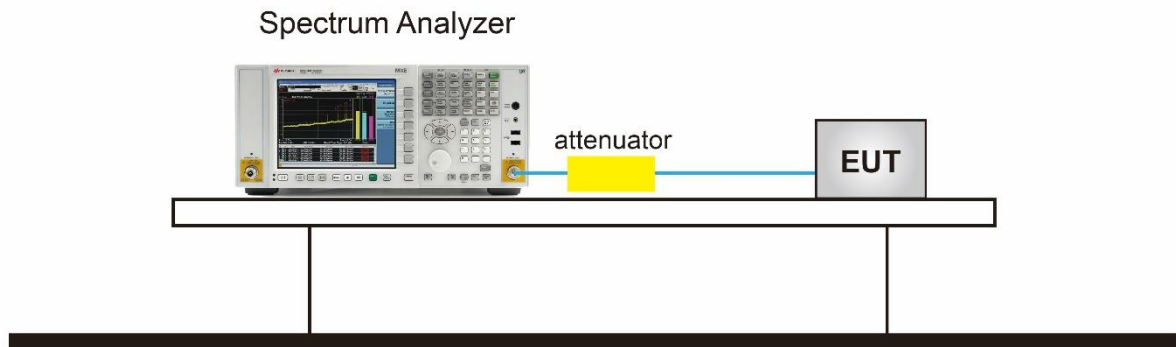

7.5.5. Test Result

Product	5GHz 867Mbps Indoor/Outdoor Access Point	Test Engineer	Xuan
Test Site	SR6	Test Date	2023/8/23
Mode	Power Spectral Density (U-NII- 1) CDD Mode		

Test Mode	Data Rate /MCS	Ch. No.	Freq. (MHz)	Ant 0 PSD (dBm/MHz)	Ant 1 PSD (dBm/MHz)	Duty Cycle (%)	Total PSD (dBm/MHz)	PSD Limit (dBm/MHz)	Result
11a	6Mbps	36	5180	3.776	3.788	97.11%	6.920	≤ 17.00	Pass
11a	6Mbps	44	5220	3.731	4.046	97.11%	7.029	≤ 17.00	Pass
11a	6Mbps	48	5240	3.917	3.722	97.11%	6.958	≤ 17.00	Pass
11ac-VHT20	MCS0	36	5180	4.017	3.869	98.56%	7.017	≤ 17.00	Pass
11ac-VHT20	MCS0	44	5220	3.087	3.618	98.56%	6.434	≤ 17.00	Pass
11ac-VHT20	MCS0	48	5240	3.127	2.896	98.56%	6.086	≤ 17.00	Pass
11ac-VHT40	MCS0	38	5190	0.066	-0.027	96.50%	3.185	≤ 17.00	Pass
11ac-VHT40	MCS0	46	5230	1.138	1.627	96.50%	4.554	≤ 17.00	Pass
11ac-VHT80	MCS0	42	5210	-2.679	-3.235	92.02%	0.423	≤ 17.00	Pass

Note 1: When EUT duty cycle ≥ 98%, the total PSD (dBm/MHz) = $10 \cdot \log \{10^{(\text{Ant 0 PSD}/10)} + 10^{(\text{Ant 1 PSD}/10)}\}$ (dBm/MHz).

When EUT duty cycle < 98%, the total PSD (dBm/MHz) = $10 \cdot \log \{10^{(\text{Ant 0 PSD}/10)} + 10^{(\text{Ant 1 PSD}/10)}\} + 10 \cdot \log (1/\text{Duty Cycle})$ (dBm/MHz).

Product	5GHz 867Mbps Indoor/Outdoor Access Point	Test Engineer	Xuan
Test Site	SR6	Test Date	2023/8/23
Test Item	Power Spectral Density (U-NII-3) CDD Mode		

Test Mode	Data Rate/ MCS	Ch. No.	Freq. (MHz)	Ant 0 PSD (dBm/510 KHz)	Ant 1 PSD (dBm/510 KHz)	Duty Cycle (%)	Total PSD (dBm/ 510kHz)	Limit (dBm/ 500kHz)	Result
11a	6Mbps	149	5745	6.932	6.898	97.11%	10.053	≤ 29.49	Pass
11a	6Mbps	157	5785	8.029	7.403	97.11%	10.865	≤ 29.49	Pass
11a	6Mbps	165	5825	7.245	7.765	97.11%	10.650	≤ 29.49	Pass
11ac-VHT20	MCS0	149	5745	7.089	7.062	98.56%	10.149	≤ 29.49	Pass
11ac-VHT20	MCS0	157	5785	7.018	7.119	98.56%	10.142	≤ 29.49	Pass
11ac-VHT20	MCS0	165	5825	7.477	7.799	98.56%	10.714	≤ 29.49	Pass
11ac-VHT40	MCS0	151	5755	4.714	4.593	96.50%	7.819	≤ 29.49	Pass
11ac-VHT40	MCS0	159	5795	4.957	5.442	96.50%	8.371	≤ 29.49	Pass
11ac-VHT80	MCS0	155	5775	1.471	0.508	92.02%	4.388	≤ 29.49	Pass

Note 1: When EUT duty cycle ≥ 98%,

the total PSD (dBm/500kHz) = $10 \cdot \log \{10^{(\text{Ant 0 PSD}/10)} + 10^{(\text{Ant 1 PSD}/10)}\}$ (dBm/510kHz).

When EUT duty cycle < 98%, the total PSD (dBm/510kHz) = $10 \cdot \log \{10^{(\text{Ant 0 PSD}/10)} + 10^{(\text{Ant 1 PSD}/10)}\}$ (dBm/510kHz) + $10 \cdot \log (1/\text{Duty Cycle})$.

Note 2: PSD Limit (dBm/500kHz) = 30 - (6.51 - 6) = 29.49 (dBm/500kHz).

802.11a Power Spectral Density - Ant 0

Channel 36 (5180MHz)



Channel 44 (5220MHz)

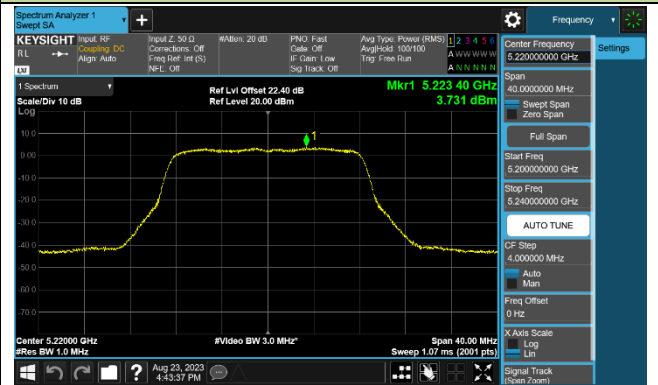

Channel 48 (5240MHz)

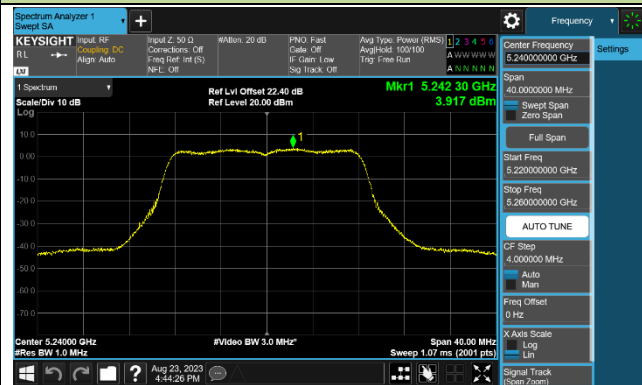

Channel 149 (5745MHz)

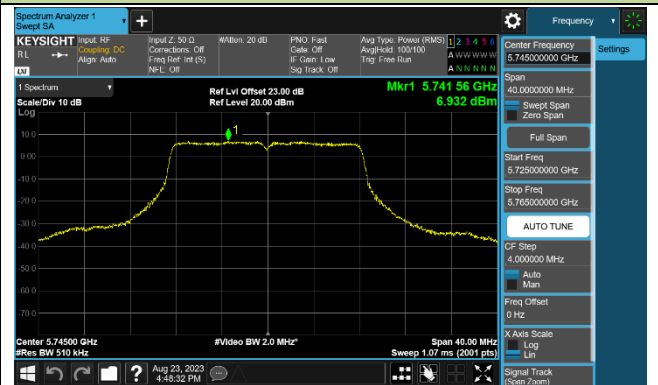

Channel 157 (5785MHz)

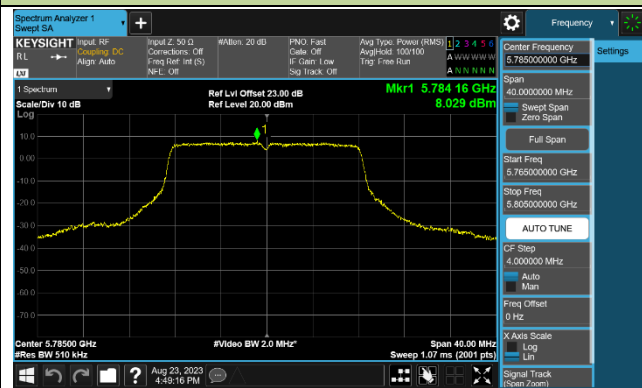

Channel 165 (5825MHz)

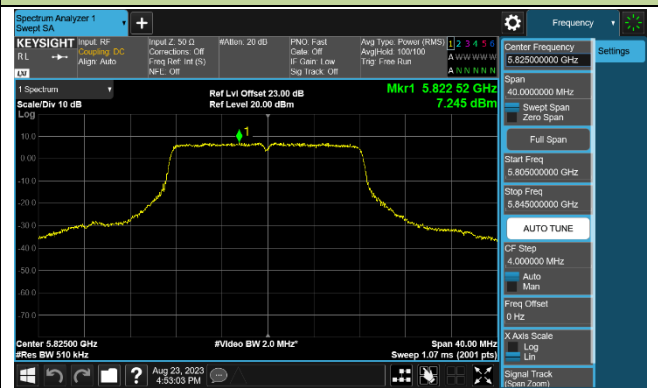

802.11ac-VHT20 Power Spectral Density - Ant 0

Channel 36 (5180MHz)

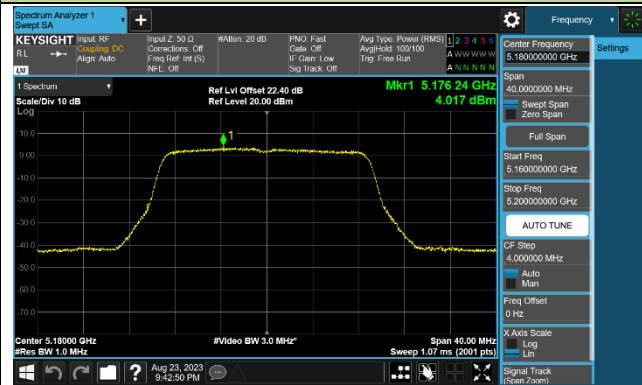

Channel 44 (5220MHz)

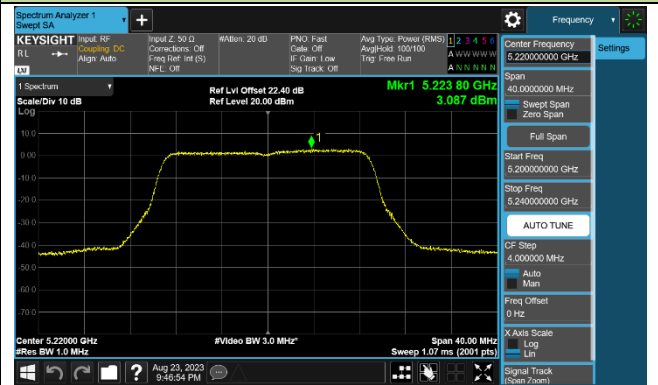

Channel 48 (5240MHz)

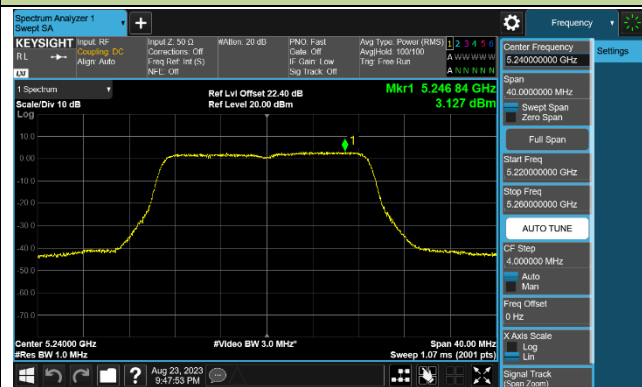

Channel 149 (5745MHz)

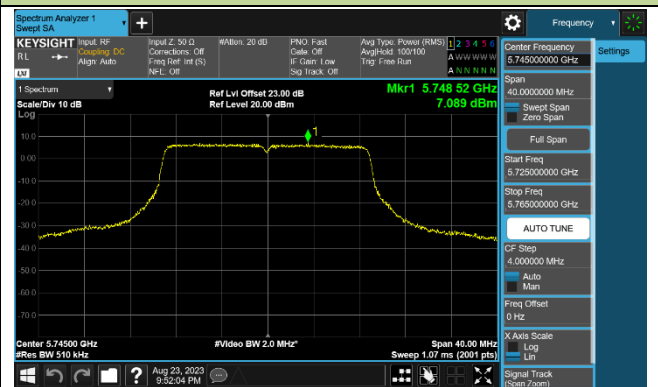

Channel 157 (5785MHz)

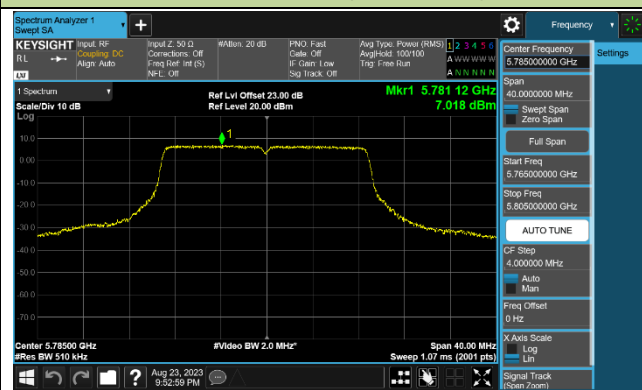

Channel 165 (5825MHz)

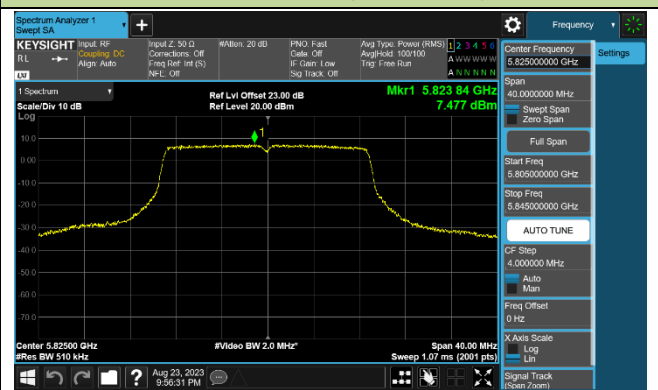

802.11ac-VHT40 Power Spectral Density - Ant 0

Channel 38 (5190MHz)

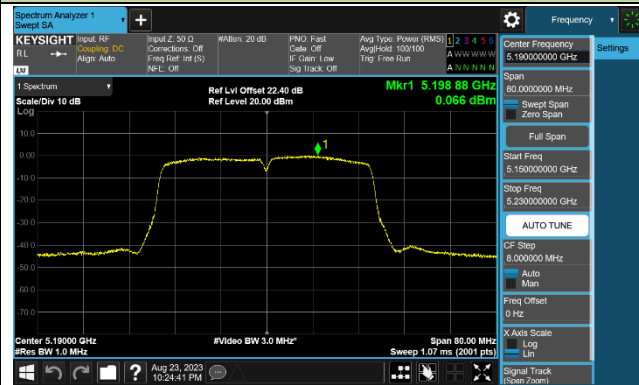

Channel 46 (5230MHz)

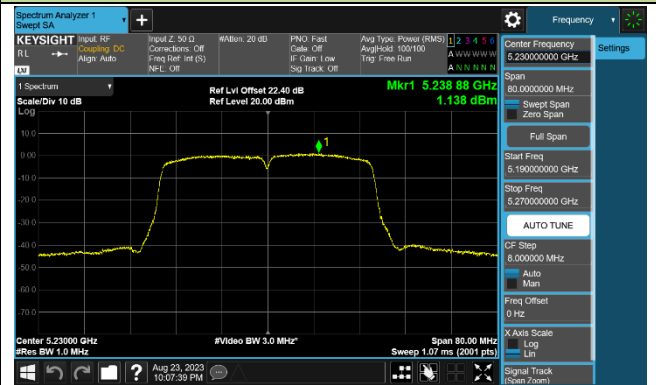

Channel 151 (5755MHz)

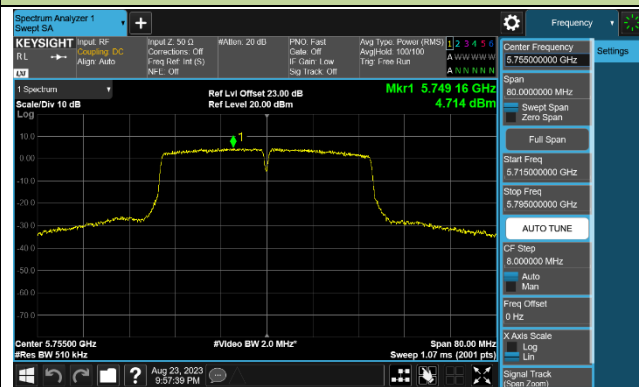

Channel 159 (5795MHz)

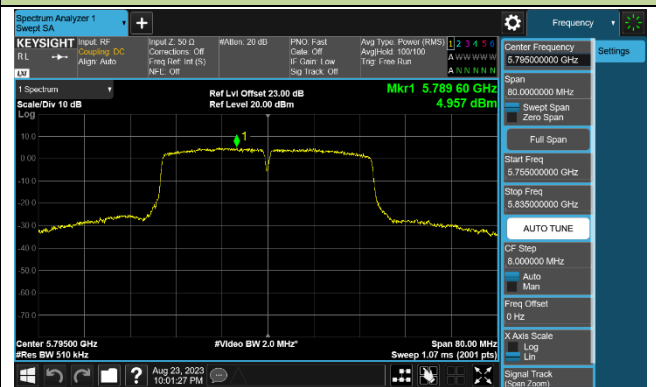

802.11ac-VHT80 Power Spectral Density - Ant 0

Channel 42 (5210MHz)

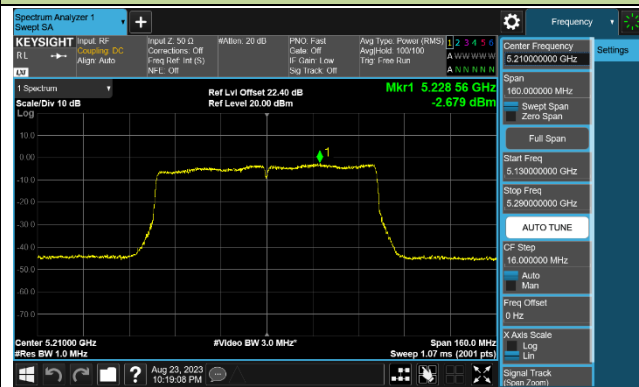

Channel 155 (5775MHz)

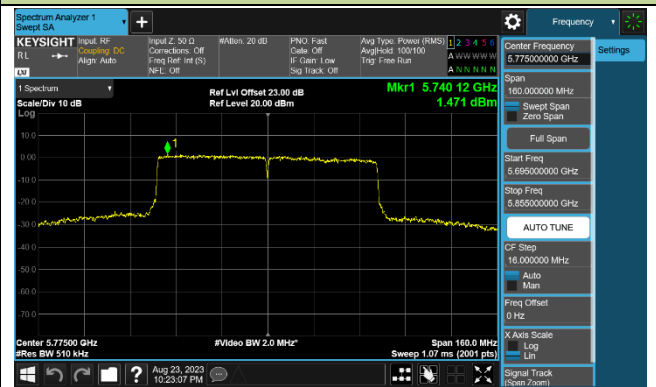

802.11a Power Spectral Density - Ant 1

Channel 36 (5180MHz)

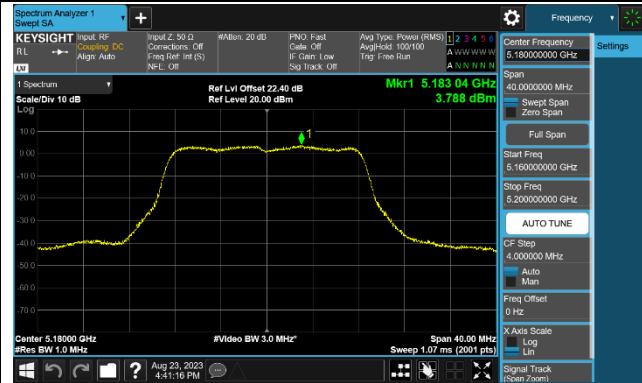

Channel 44 (5220MHz)

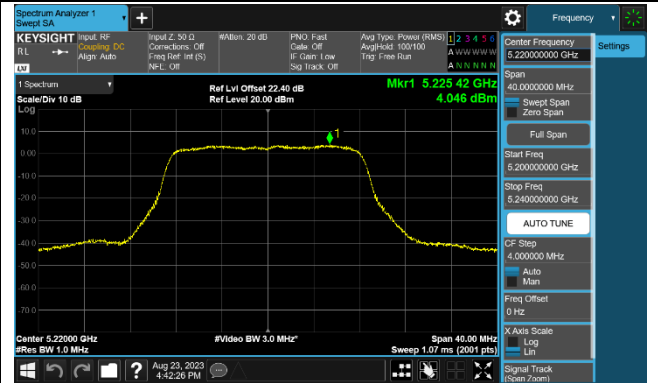

Channel 48 (5240MHz)

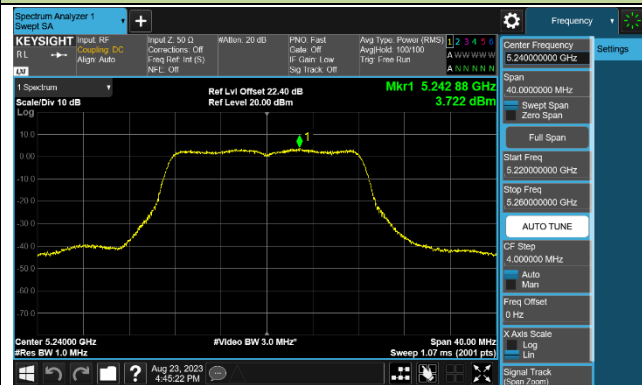

Channel 149 (5745MHz)

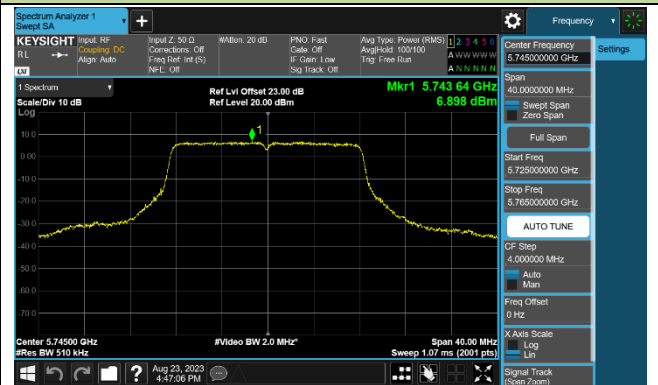

Channel 157 (5785MHz)

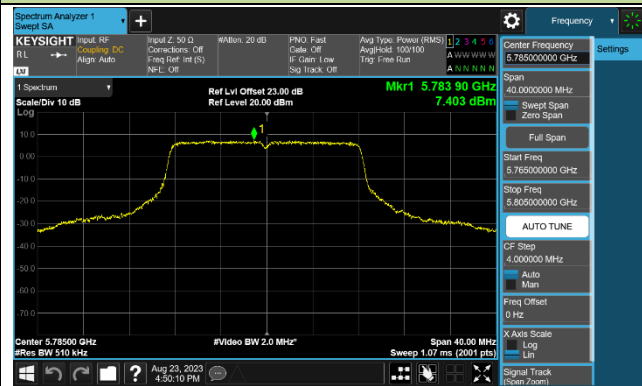

Channel 165 (5825MHz)

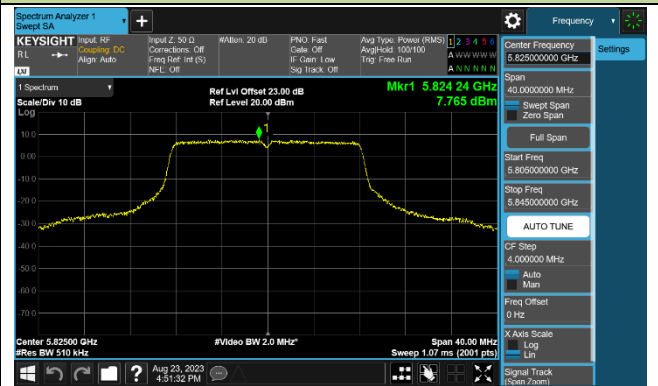

802.11ac-VHT20 Power Spectral Density - Ant 1

Channel 36 (5180MHz)

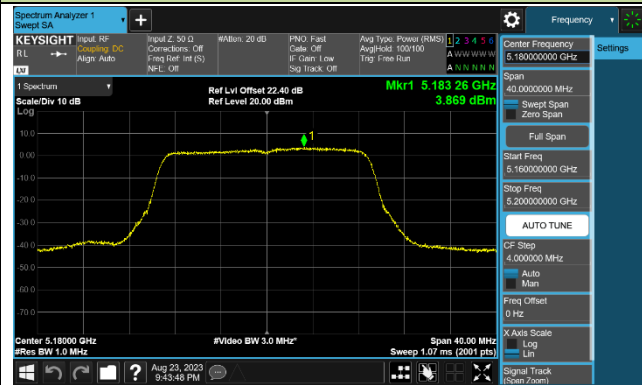

Channel 44 (5220MHz)

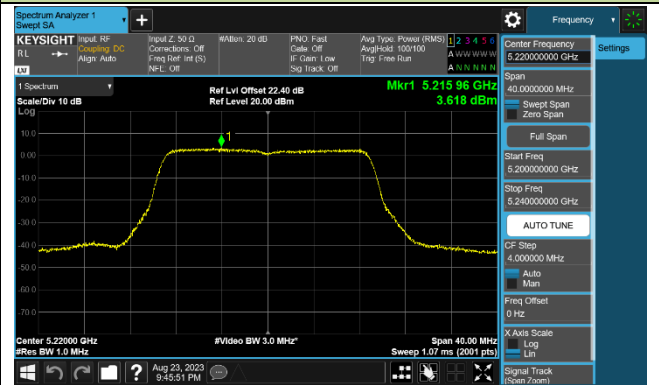

Channel 48 (5240MHz)

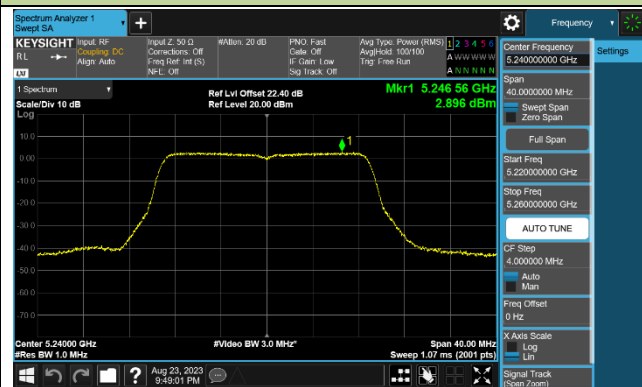

Channel 149 (5745MHz)

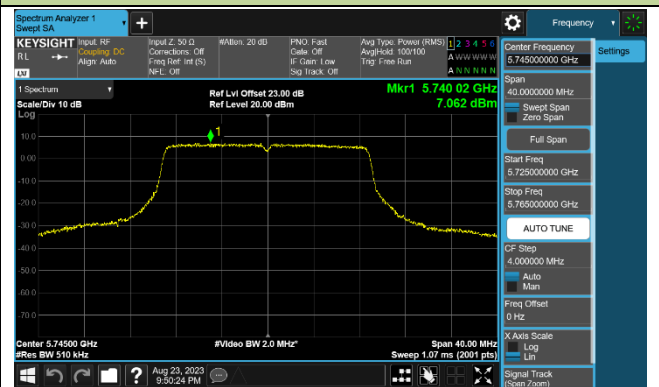

Channel 157 (5785MHz)

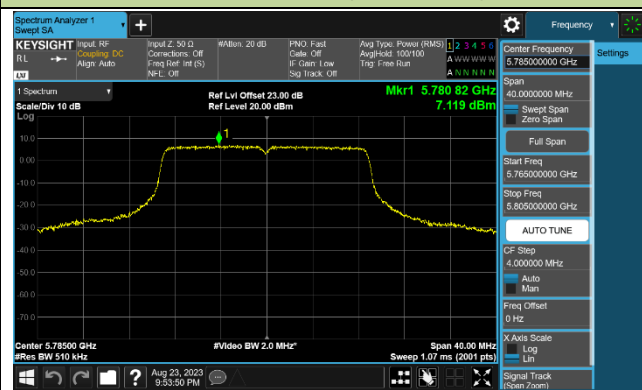

Channel 165 (5825MHz)

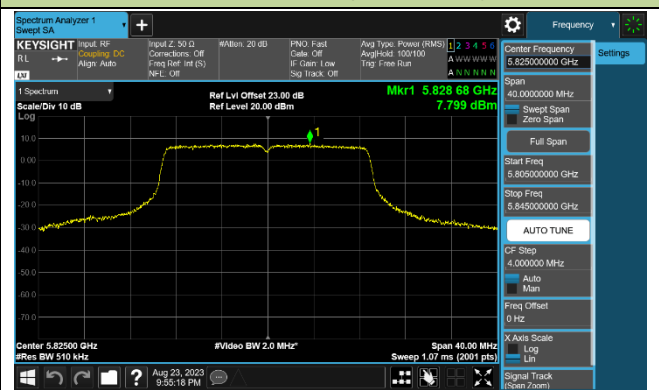

802.11ac-VHT40 Power Spectral Density - Ant 1

Channel 38 (5190MHz)

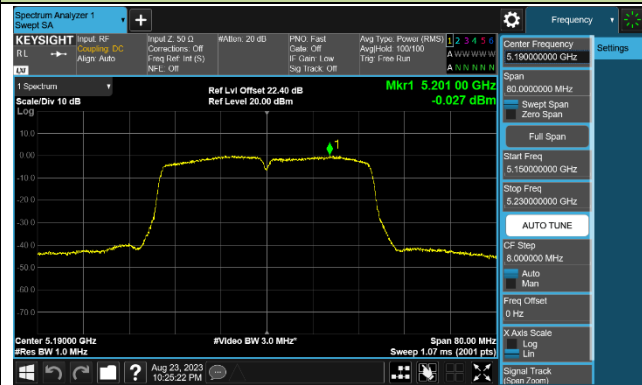

Channel 46 (5230MHz)

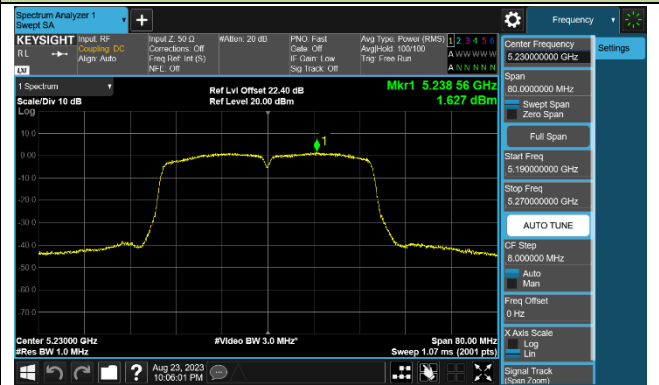

Channel 151 (5755MHz)

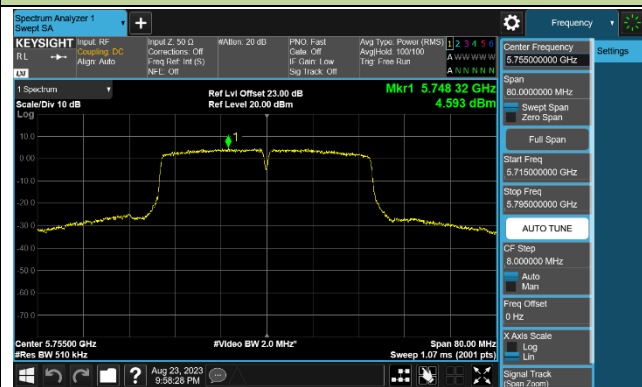

Channel 159 (5795MHz)

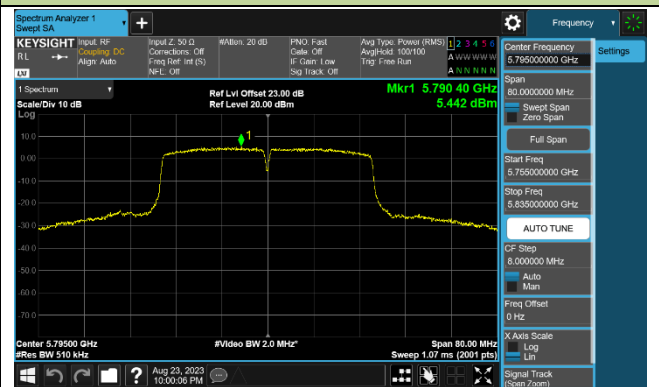

802.11ac-VHT80 Power Spectral Density - Ant 1

Channel 42 (5210MHz)

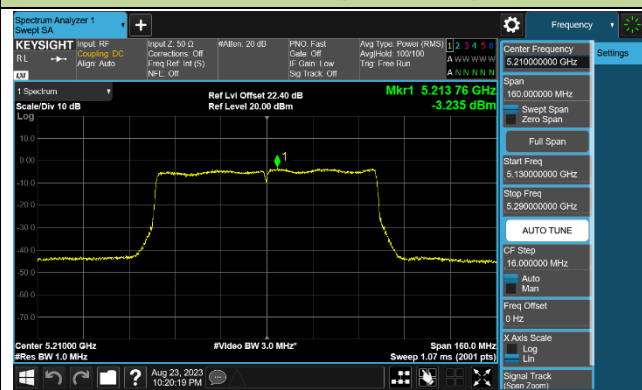

Channel 155 (5775MHz)

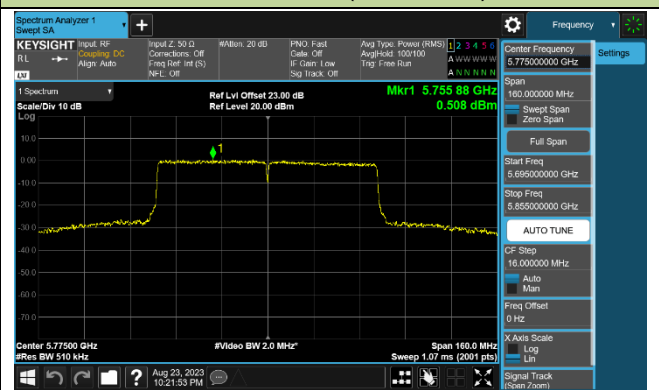

7.6. Frequency Stability Measurement

7.6.1. Test Limit

Manufactures of U-NII devices are responsible for ensuring frequency stability such that an emission is maintained within the band of operation under all conditions of normal operation as specified in the user's manual.

The transmitter center frequency tolerance shall be ± 20 ppm maximum for the 5GHz band (IEEE 802.11 specification).

7.6.2. Test Limit

Frequency Stability Under Temperature Variations:

The equipment under test was connected to an external AC or DC power supply and input rated voltage. RF output was connected to a frequency counter or spectrum analyzer via feed through attenuators. The EUT was placed inside the temperature chamber. Set the spectrum analyzer RBW low enough to obtain the desired frequency resolution and measure EUT 20°C operating frequency as reference frequency. Turn EUT off and set the chamber temperature to highest. After the temperature stabilized for approximately 30 minutes recorded the frequency. Repeat step measure with 10°C decreased per stage until the lowest temperature reached.

Frequency Stability Under Voltage Variations:

Set chamber temperature to 20°C. Use a variable AC power supply / DC power source to power the EUT and set the voltage to rated voltage. Set the spectrum analyzer RBW low enough to obtain the desired frequency resolution and recorded the frequency.

Reduce the input voltage to specify extreme voltage variation ($\pm 15\%$) and endpoint, record the maximum frequency change.

7.6.3. Test Setup

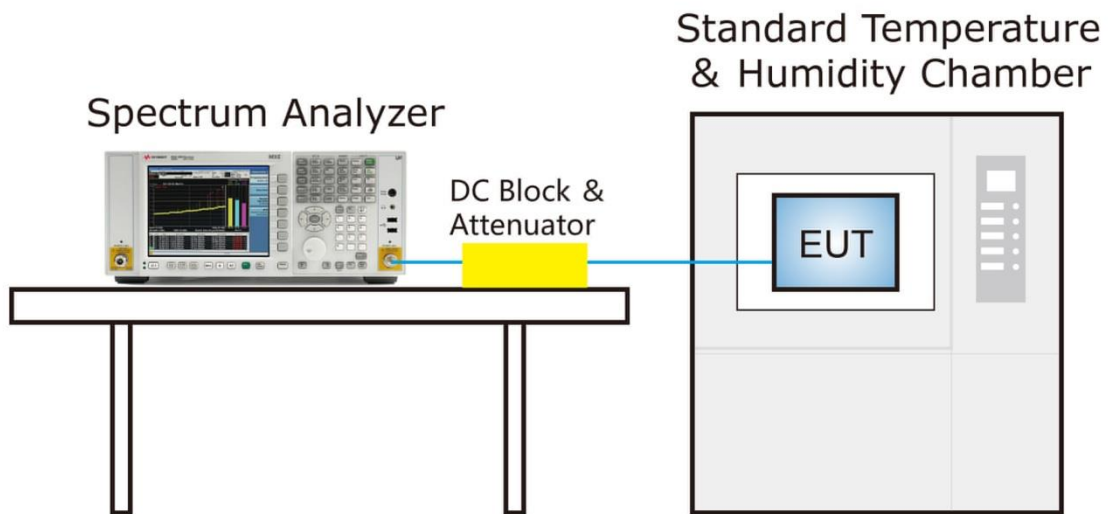

7.6.4. Test Result

Grantee ensure that the product meets e-CFR Title 47 section 15.407(g) and KDB 789033 D02v02r01 frequency stability such that the emissions are maintained within the band of operation under all conditions of normal operation as specified in the user's manual.

7.7. Radiated Spurious Emission Measurement

7.7.1. Test Limit

All out of band emissions appearing in a restricted band as specified in Section 15.205 of the Title 47CFR must not exceed the limits shown in Table per Section 15.209.

FCC Part 15 Subpart C Paragraph 15.209		
Frequency [MHz]	Field Strength [uV/m]	Measured Distance [Meters]
0.009 - 0.490	2400/F (kHz)	300
0.490 - 1.705	24000/F (kHz)	30
1.705 - 30	30	30
30 - 88	100	3
88 - 216	150	3
216 - 960	200	3
Above 960	500	3

7.7.2. Test Procedure Used

KDB 789033 D02v02r01- Section G

7.7.3. Test Setting

Table 1 - RBW as a function of frequency

Frequency	RBW
9 ~ 150 kHz	200 ~ 300 Hz
0.15 ~ 30 MHz	9 ~ 10 kHz
30 ~ 1000 MHz	100 ~ 120 kHz
>1000 MHz	1 MHz

Quasi-Peak Measurements below 1GHz

1. Analyzer center frequency was set to the frequency of the radiated spurious emission of interest
2. Span was set greater than 1MHz
3. RBW = as specified in Table 1
4. Detector = CISPR quasi-peak
5. Sweep time = auto couple
6. Trace was allowed to stabilize

Peak Measurements above 1GHz

1. Analyzer center frequency was set to the frequency of the radiated spurious emission of interest
2. RBW = 1MHz
3. VBW = 3MHz
4. Detector = peak
5. Sweep time = auto couple
6. Trace mode = max hold
7. Trace was allowed to stabilize

Average Measurements above 1GHz (Method VB)

1. Analyzer center frequency was set to the frequency of the radiated spurious emission of interest
2. RBW = 1MHz
3. VBW; If the EUT is configured to transmit with duty cycle $\geq 98\%$, set VBW = 10 Hz.
If the EUT duty cycle is $< 98\%$, set VBW $\geq 1/T$. T is the minimum transmission duration.
4. Detector = Peak
5. Sweep time = auto
6. Trace mode = max hold
7. Trace was allowed to stabilize

7.7.4. Test Setup

Below 1GHz Test Setup:

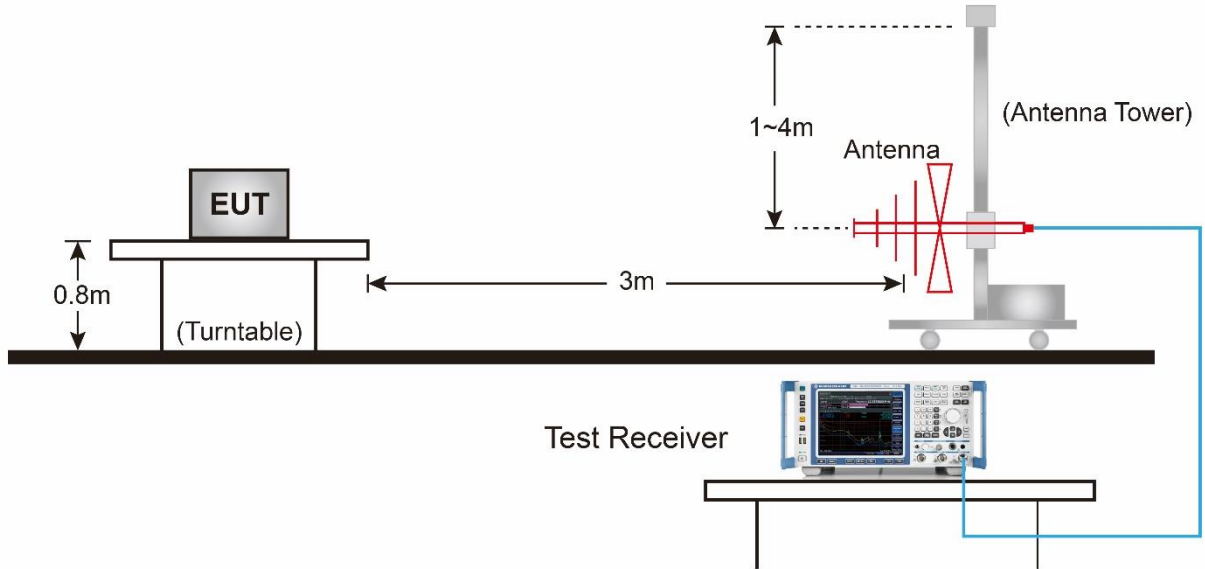

Above 1GHz Test Setup:

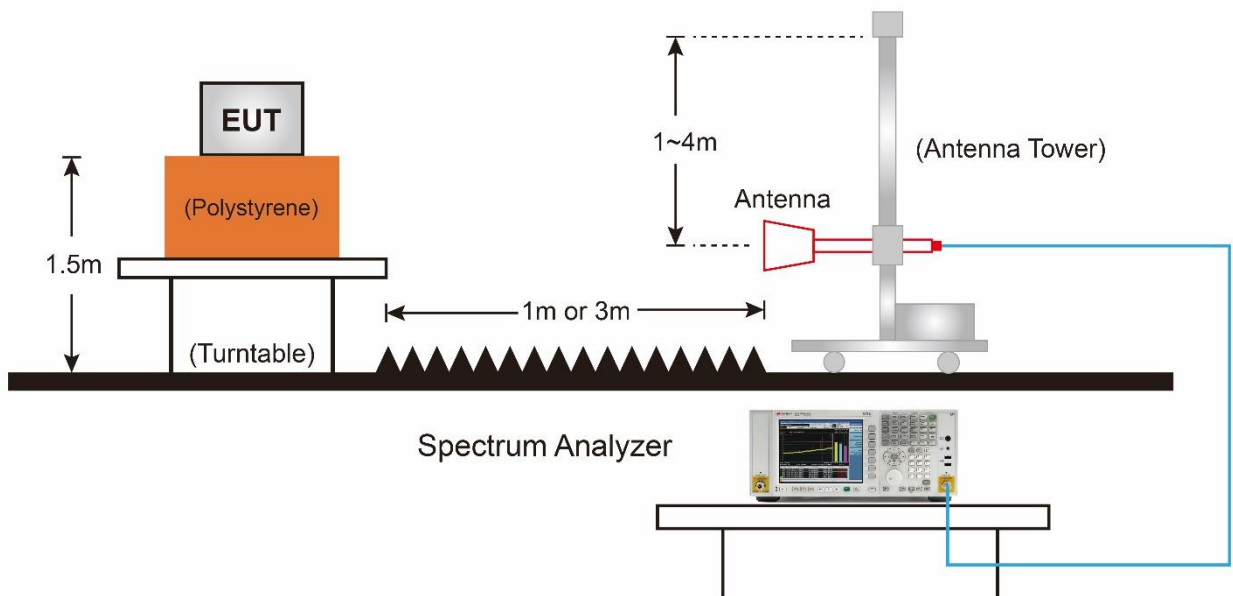

7.7.5. Test Result

EUT	5GHz 867Mbps Indoor/Outdoor Access Point	Date of Test	2023-08-21
Factor	VULB 9162	Temp. / Humidity	21°C /63%
Polarity	Horizontal	Site / Test Engineer	AC2 / Stanley
Test Mode	802.11ac-20MHz_TX_Band1_CH 44_ANT 0+1	Test Voltage	AC 120V/60Hz

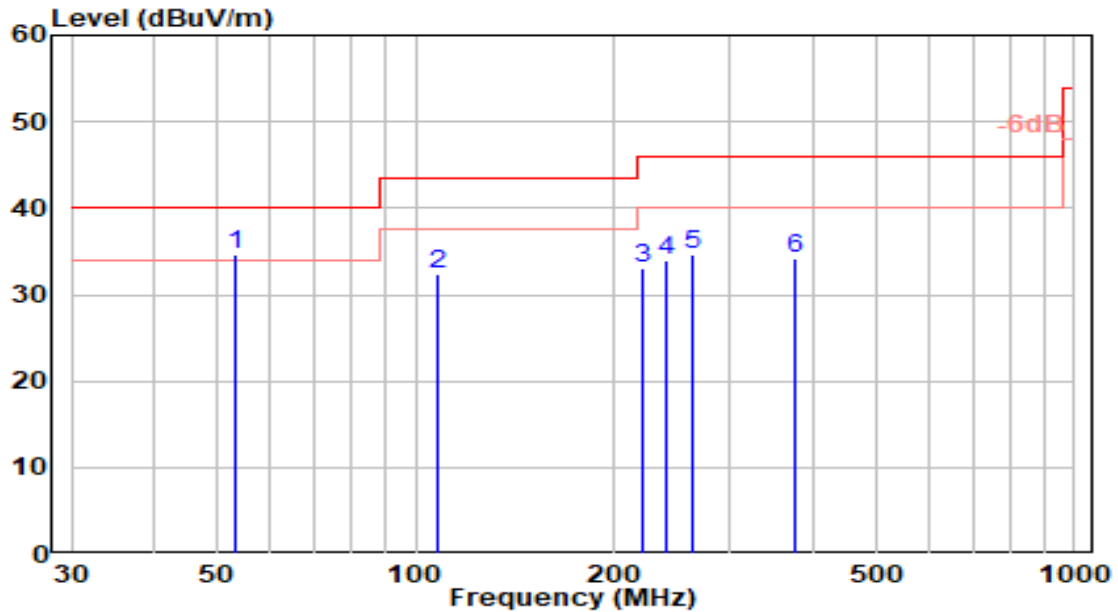

No	Frequency (MHz)	Reading (dBUV)	C.F (dB/m)	Measurement (dBUV/m)	Margin (dB)	Limit (dBUV/m)	Height (cm)	Angle (deg)	Remark (QP/PK/AV)	
1	*	53.280	14.53	20.18	34.71	-5.29	40.00	200	0	QP
2		107.600	14.33	18.15	32.49	-11.01	43.50	200	253	QP
3		221.090	14.67	18.39	33.06	-12.94	46.00	100	298	QP
4		239.520	14.59	19.43	34.02	-11.98	46.00	100	257	QP
5		263.770	14.64	19.96	34.61	-11.39	46.00	150	210	QP
6		375.320	11.41	22.71	34.12	-11.88	46.00	100	360	QP

Note:

1. " *", means this data is the worst emission level.
2. C.F (Correction Factor) = Antenna Factor (dB/m) + Cable Loss (dB).
3. Measurement (dBUV/m) = Reading(dBUV) + C.F (Correction Factor).
4. The emission levels of other frequencies are very lower than the limit and not show in test report.

EUT	5GHz 867Mbps Indoor/Outdoor Access Point	Date of Test	2023-08-21
Factor	VULB 9162	Temp. / Humidity	21°C /63%
Polarity	Vertical	Site / Test Engineer	AC2 / Stanley
Test Mode	802.11ac-20MHz_TX_Band1_CH 44_ANT 0+1	Test Voltage	AC 120V/60Hz

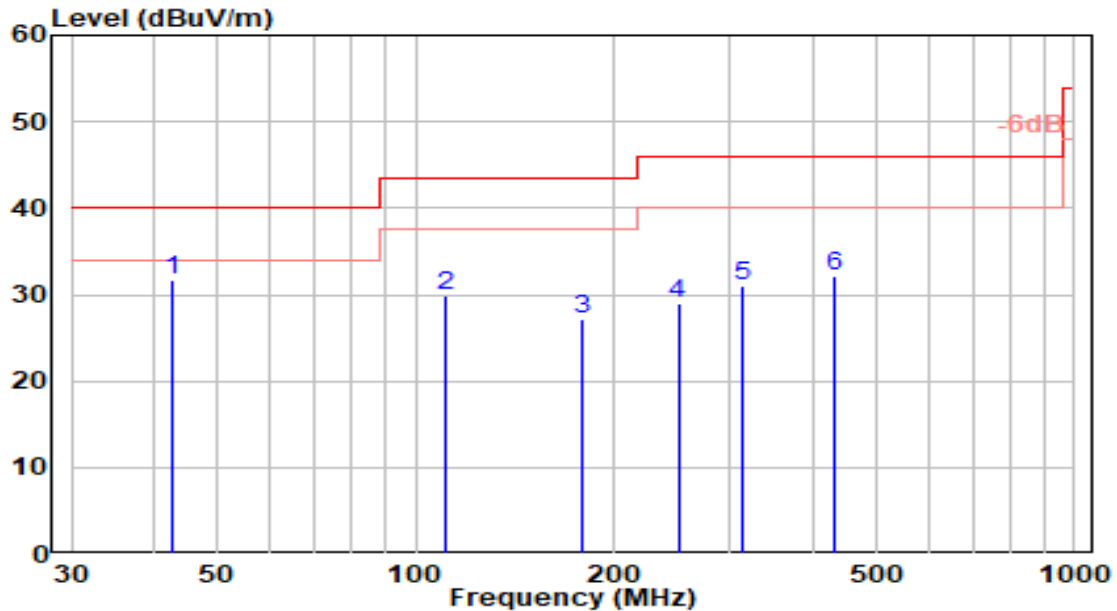

No	Frequency (MHz)	Reading (dBuV)	C.F (dB/m)	Measurement (dBuV/m)	Margin (dB)	Limit (dBuV/m)	Height (cm)	Angle (deg)	Remark (QP/PK/AV)	
1	*	42.610	11.74	19.87	31.60	-8.40	40.00	100	80	QP
2		110.510	11.80	18.00	29.79	-13.71	43.50	100	214	QP
3		178.410	10.91	16.19	27.10	-16.40	43.50	100	356	QP
4		250.190	9.04	19.87	28.92	-17.08	46.00	100	342	QP
5		312.270	10.19	20.93	31.13	-14.87	46.00	150	360	QP
6		431.580	8.89	23.37	32.26	-13.74	46.00	100	283	QP

Note:

- " *", means this data is the worst emission level.
- C.F (Correction Factor) = Antenna Factor (dB/m) + Cable Loss (dB).
- Measurement (dBuV/m) = Reading(dBuV) + C.F (Correction Factor).
- The emission levels of other frequencies are very lower than the limit and not show in test report.

EUT	5GHz 867Mbps Indoor/Outdoor Access Point	Date of Test	2023-08-19
Factor	DRH18-E	Temp. / Humidity	23°C /62%
Polarity	Horizontal	Site / Test Engineer	AC2 / Marvin
Test Mode	802.11a_TX_Band1_CH 36_ANT 0+1	Test Voltage	AC 120V/60Hz

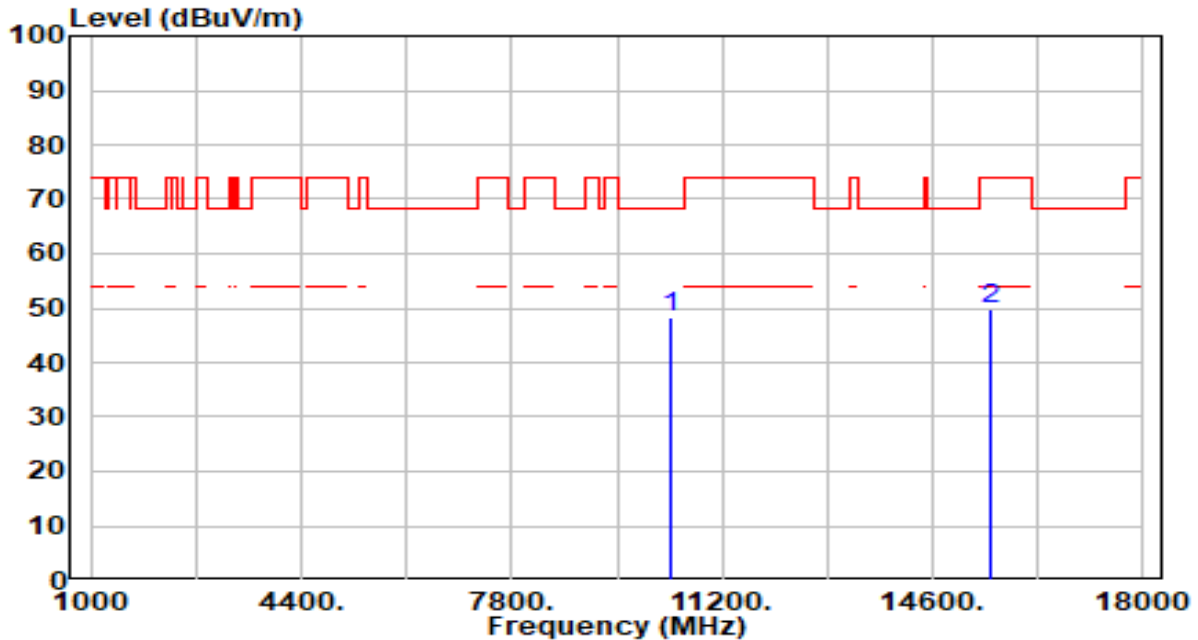

No	Frequency (MHz)	Reading (dBuV)	C.F (dB/m)	Measurement (dBuV/m)	Margin (dB)	Limit (dBuV/m)	Height (cm)	Angle (deg)	Remark (QP/PK/AV)	
1	*	10360.000	45.30	2.81	48.11	-20.09	68.20	200	191	Peak
2		15540.000	45.30	4.52	49.83	-24.17	74.00	100	98	Peak

Note:

1. " *", means this data is the worst emission level.
2. C.F (Correction Factor) = Antenna Factor (dB/m)+ Cable Loss (dB) – Preamplifier(dB).
3. Measurement (dBuV/m) = Reading(dBuV) + C.F (Correction Factor).
4. The emission levels of other frequencies are very lower than the limit and not show in test report.

EUT	5GHz 867Mbps Indoor/Outdoor Access Point	Date of Test	2023-08-19
Factor	DRH18-E	Temp. / Humidity	23°C /62%
Polarity	Vertical	Site / Test Engineer	AC2 / Marvin
Test Mode	802.11a_TX_Band1_CH 36_ANT 0+1	Test Voltage	AC 120V/60Hz

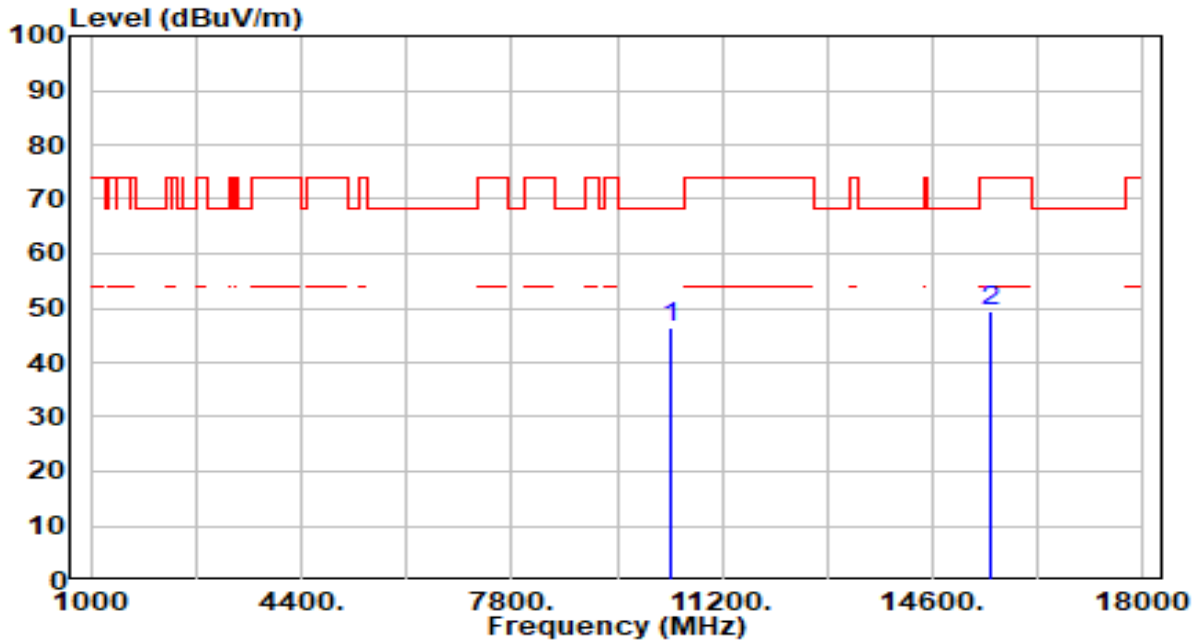

No	Frequency (MHz)	Reading (dBuV)	C.F (dB/m)	Measurement (dBuV/m)	Margin (dB)	Limit (dBuV/m)	Height (cm)	Angle (deg)	Remark (QP/PK/AV)
1	*	43.55	2.81	46.36	-21.84	68.20	100	176	Peak
2		44.90	4.52	49.42	-24.58	74.00	200	157	Peak

Note:

1. " *", means this data is the worst emission level.
2. C.F (Correction Factor) = Antenna Factor (dB/m)+ Cable Loss (dB) – Preamplifier(dB).
3. Measurement (dBuV/m) = Reading(dBuV) + C.F (Correction Factor).
4. The emission levels of other frequencies are very lower than the limit and not show in test report.

EUT	5GHz 867Mbps Indoor/Outdoor Access Point	Date of Test	2023-08-19
Factor	DRH18-E	Temp. / Humidity	23°C /62%
Polarity	Horizontal	Site / Test Engineer	AC2 / Marvin
Test Mode	802.11a_TX_Band1_CH 44_ANT 0+1	Test Voltage	AC 120V/60Hz

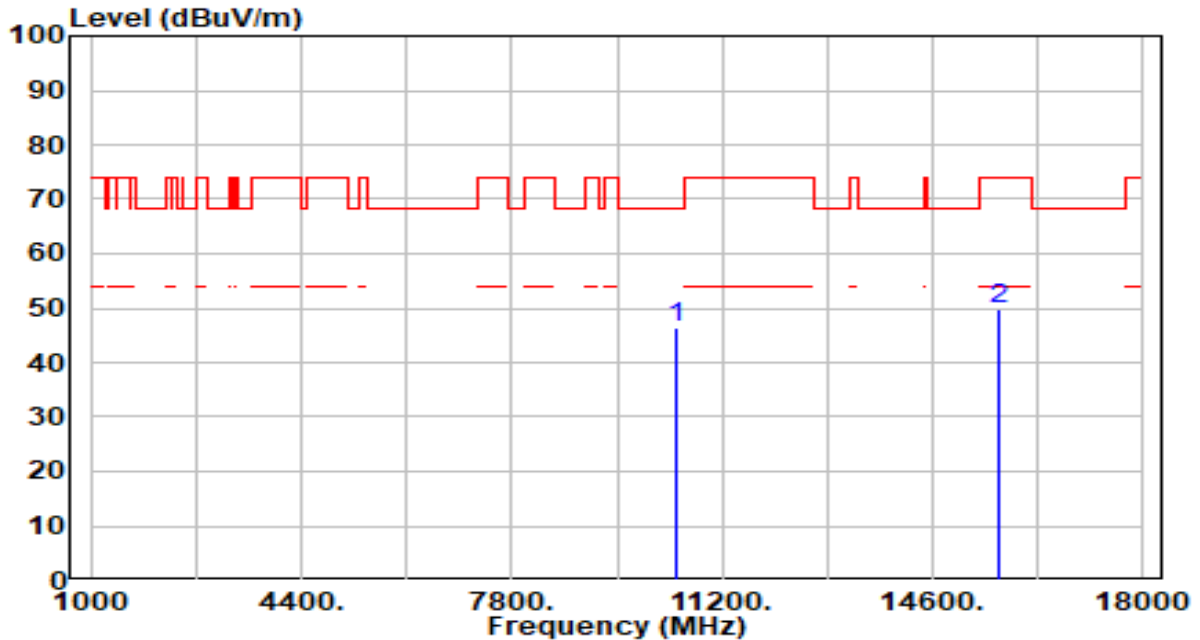

No	Frequency (MHz)	Reading (dBuV)	C.F (dB/m)	Measurement (dBuV/m)	Margin (dB)	Limit (dBuV/m)	Height (cm)	Angle (deg)	Remark (QP/PK/AV)
1	* 10440.000	43.57	2.72	46.29	-21.91	68.20	200	16	Peak
2	15660.000	44.97	4.67	49.64	-24.36	74.00	200	318	Peak

Note:

1. " *", means this data is the worst emission level.
2. C.F (Correction Factor) = Antenna Factor (dB/m)+ Cable Loss (dB) – Preamplifier(dB).
3. Measurement (dBuV/m) = Reading(dBuV) + C.F (Correction Factor).
4. The emission levels of other frequencies are very lower than the limit and not show in test report.

EUT	5GHz 867Mbps Indoor/Outdoor Access Point	Date of Test	2023-08-19
Factor	DRH18-E	Temp. / Humidity	23°C /62%
Polarity	Vertical	Site / Test Engineer	AC2 / Marvin
Test Mode	802.11a_TX_Band1_CH 44_ANT 0+1	Test Voltage	AC 120V/60Hz

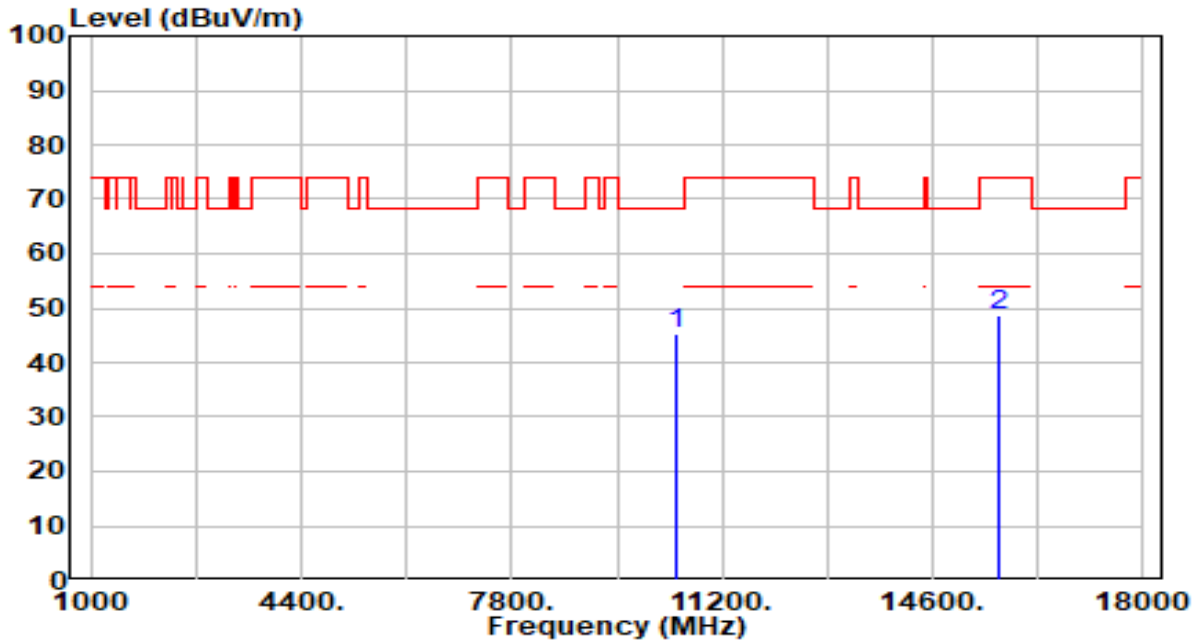

No	Frequency (MHz)	Reading (dBuV)	C.F (dB/m)	Measurement (dBuV/m)	Margin (dB)	Limit (dBuV/m)	Height (cm)	Angle (deg)	Remark (QP/PK/AV)
1	* 10440.000	42.59	2.72	45.32	-22.88	68.20	200	1	Peak
2	15660.000	43.99	4.67	48.66	-25.34	74.00	200	342	Peak

Note:

1. " *", means this data is the worst emission level.
2. C.F (Correction Factor) = Antenna Factor (dB/m)+ Cable Loss (dB) – Preamplifier(dB).
3. Measurement (dBuV/m) = Reading(dBuV) + C.F (Correction Factor).
4. The emission levels of other frequencies are very lower than the limit and not show in test report.

EUT	5GHz 867Mbps Indoor/Outdoor Access Point	Date of Test	2023-08-19
Factor	DRH18-E	Temp. / Humidity	23°C /62%
Polarity	Horizontal	Site / Test Engineer	AC2 / Marvin
Test Mode	802.11a_TX_Band1_CH 48_ANT 0+1	Test Voltage	AC 120V/60Hz

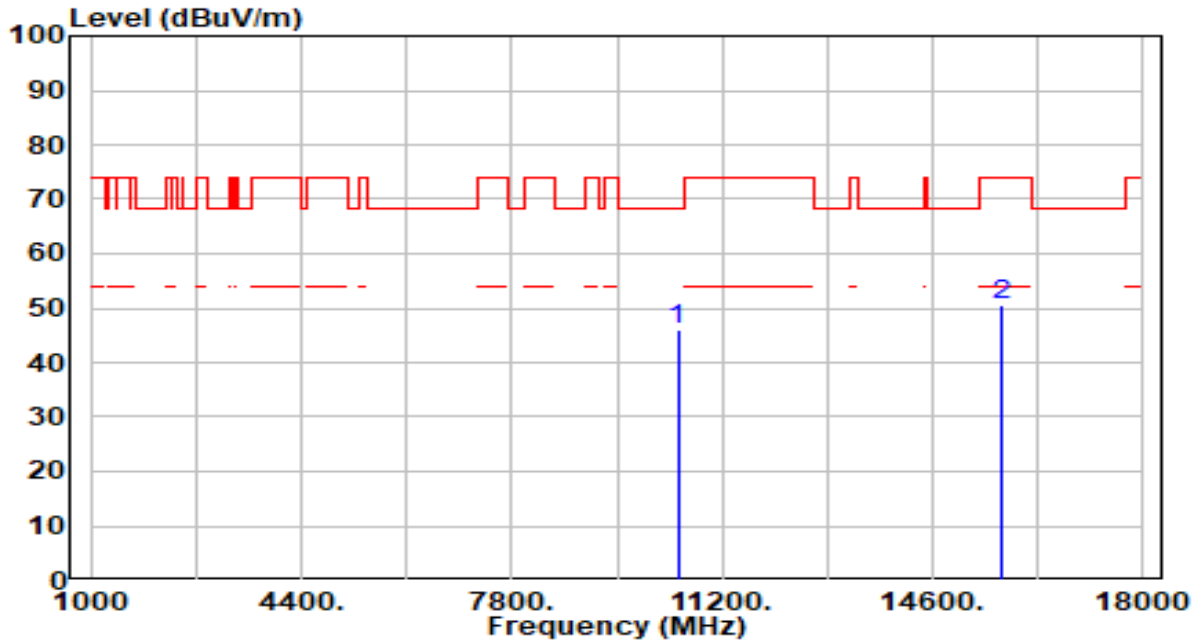

No	Frequency (MHz)	Reading (dBuV)	C.F (dB/m)	Measurement (dBuV/m)	Margin (dB)	Limit (dBuV/m)	Height (cm)	Angle (deg)	Remark (QP/PK/AV)
1	* 10480.000	43.24	2.68	45.92	-22.28	68.20	200	360	Peak
2	15720.000	45.92	4.84	50.75	-23.25	74.00	200	283	Peak

Note:

1. " *", means this data is the worst emission level.
2. C.F (Correction Factor) = Antenna Factor (dB/m)+ Cable Loss (dB) – Preamplifier(dB).
3. Measurement (dBuV/m) = Reading(dBuV) + C.F (Correction Factor).
4. The emission levels of other frequencies are very lower than the limit and not show in test report.

EUT	5GHz 867Mbps Indoor/Outdoor Access Point	Date of Test	2023-08-19
Factor	DRH18-E	Temp. / Humidity	23°C /62%
Polarity	Vertical	Site / Test Engineer	AC2 / Marvin
Test Mode	802.11a_TX_Band1_CH 48_ANT 0+1	Test Voltage	AC 120V/60Hz

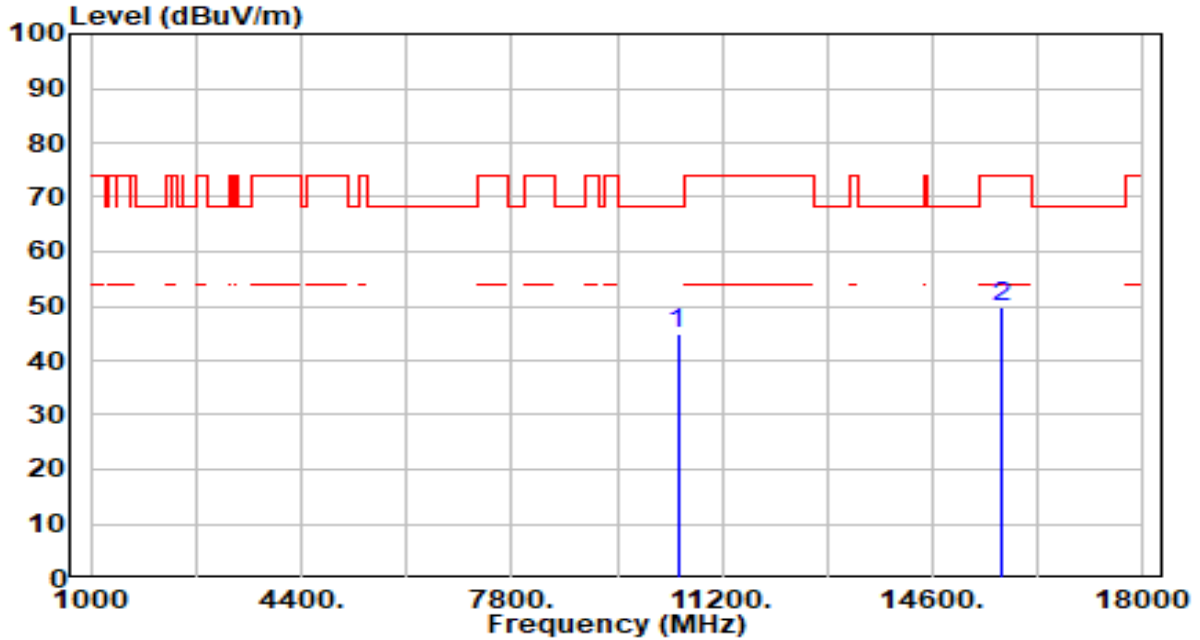

No	Frequency (MHz)	Reading (dBuV)	C.F (dB/m)	Measurement (dBuV/m)	Margin (dB)	Limit (dBuV/m)	Height (cm)	Angle (deg)	Remark (QP/PK/AV)
1	* 10480.000	42.09	2.68	44.77	-23.43	68.20	200	189	Peak
2	15720.000	45.05	4.84	49.88	-24.12	74.00	200	38	Peak

Note:

1. " *", means this data is the worst emission level.
2. C.F (Correction Factor) = Antenna Factor (dB/m)+ Cable Loss (dB) – Preamplifier(dB).
3. Measurement (dBuV/m) = Reading(dBuV) + C.F (Correction Factor).
4. The emission levels of other frequencies are very lower than the limit and not show in test report.

EUT	5GHz 867Mbps Indoor/Outdoor Access Point	Date of Test	2023-08-19
Factor	DRH18-E	Temp. / Humidity	23°C /62%
Polarity	Horizontal	Site / Test Engineer	AC2 / Marvin
Test Mode	802.11a_TX_Band4_CH 149_ANT 0+1	Test Voltage	AC 120V/60Hz

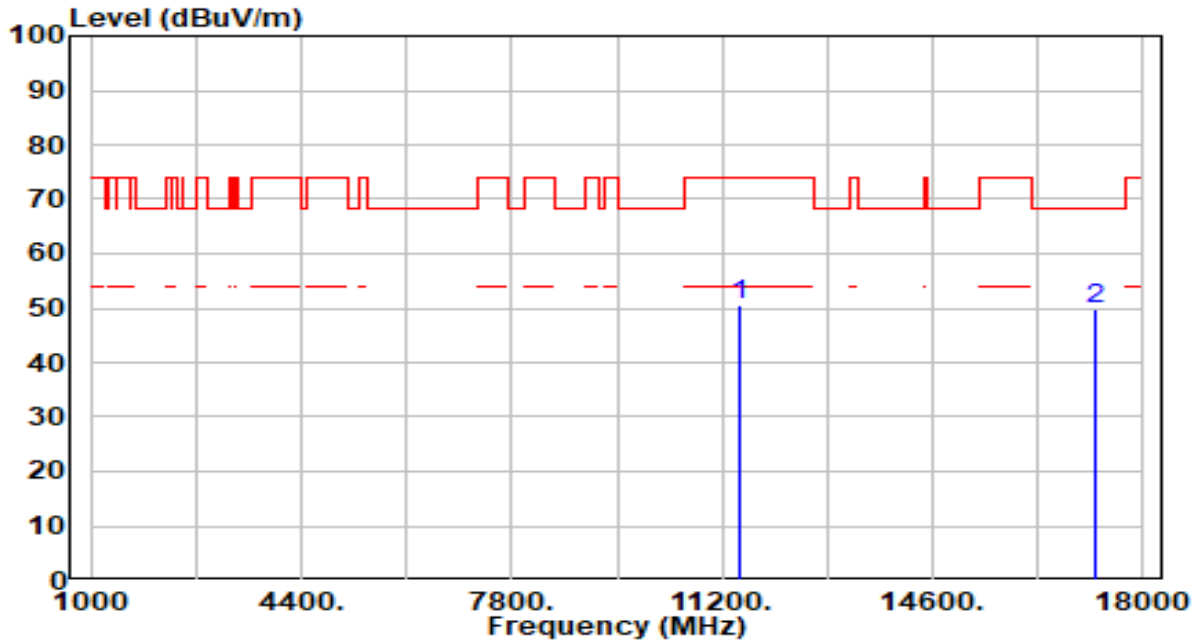

No	Frequency (MHz)	Reading (dBUV)	C.F (dB/m)	Measurement (dBUV/m)	Margin (dB)	Limit (dBUV/m)	Height (cm)	Angle (deg)	Remark (QP/PK/AV)
1	11490.000	47.06	3.57	50.62	-23.38	74.00	200	360	Peak
2	* 17235.000	45.44	4.45	49.89	-18.31	68.20	200	37	Peak

Note:

1. " *", means this data is the worst emission level.
2. C.F (Correction Factor) = Antenna Factor (dB/m)+ Cable Loss (dB) – Preamplifier(dB).
3. Measurement (dBUV/m) = Reading(dBUV) + C.F (Correction Factor).
4. The emission levels of other frequencies are very lower than the limit and not show in test report.