

FCC Radio Test Report

FCC ID: 2AXJ4EAP115V42

This report concerns: Original Grant

Project No. : 2205C171
Equipment : 300Mbps Wireless N Ceiling Mount Access Point
Brand Name : tp-link
Test Model : EAP115
Series Model : N/A
Applicant : TP-Link Corporation Limited
Address : Room 901, 9/F. , New East Ocean Centre, 9 Science Museum Road,
Tsim Sha Tsui, Kowloon, Hong Kong
Manufacturer : TP-Link Corporation Limited
Address : Room 901, 9/F. , New East Ocean Centre, 9 Science Museum Road,
Tsim Sha Tsui, Kowloon, Hong Kong
Date of Receipt : May 31, 2022
Date of Test : Jun. 01, 2022 ~ Jun. 13, 2022
Issued Date : Jun. 24, 2022
Report Version : R00
Test Sample : Engineering Sample No.: DG2022060123 for conducted,
DG2022060122 for radiated.
Standard(s) : FCC CFR Title 47, Part 15, Subpart C
FCC KDB 558074 D01 15.247 Meas Guidance v05r02
FCC KDB 662911 D01 Multiple Transmitter Output v02r01
ANSI C63.10-2013

The above equipment has been tested and found compliance with the requirement of the relative standards by BTL Inc.



Prepared by : Sheldon Ou

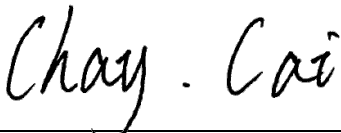

Approved by : Chay Cai



TESTING CERT #5123.02

Add: No. 3 Jinshagang 1st Rd. Shixia, Dalang Town Dongguan City, Guangdong 523792

People's Republic of China

Tel: +86-769-8318-3000

Web: www.newbtl.com

Declaration

BTL represents to the client that testing is done in accordance with standard procedures as applicable and that test instruments used has been calibrated with standards traceable to international standard(s) and/or national standard(s).

BTL's reports apply only to the specific samples tested under conditions. It is manufacture's responsibility to ensure that additional production units of this model are manufactured with the identical electrical and mechanical components. **BTL** shall have no liability for any declarations, inferences or generalizations drawn by the client or others from **BTL** issued reports.

The report must not be used by the client to claim product certification, approval, or endorsement by NVLAP, NIST, A2LA, or any agency of the U.S. Government.

This report is the confidential property of the client. As a mutual protection to the clients, the public and ourselves, the test report shall not be reproduced, except in full, without our written approval.

BTL's laboratory quality assurance procedures are in compliance with the **ISO/IEC 17025** requirements, and accredited by the conformity assessment authorities listed in this test report.

BTL is not responsible for the sampling stage, so the results only apply to the sample as received.

The information, data and test plan are provided by manufacturer which may affect the validity of results, so it is manufacturer's responsibility to ensure that the apparatus meets the essential requirements of applied standards and in all the possible configurations as representative of its intended use.

Limitation

For the use of the authority's logo is limited unless the Test Standard(s)/Scope(s)/Item(s) mentioned in this test report is (are) included in the conformity assessment authorities acceptance respective.

Please note that the measurement uncertainty is provided for informational purpose only and are not use in determining the Pass/Fail results.

Table of Contents	Page
REPORT ISSUED HISTORY	6
1 . SUMMARY OF TEST RESULTS	7
1.1 TEST FACILITY	8
1.2 MEASUREMENT UNCERTAINTY	8
1.3 TEST ENVIRONMENT CONDITIONS	9
2 . GENERAL INFORMATION	10
2.1 GENERAL DESCRIPTION OF EUT	10
2.2 DESCRIPTION OF TEST MODES	12
2.3 PARAMETERS OF TEST SOFTWARE	13
2.4 DUTY CYCLE	14
2.5 BLOCK DIAGRAM SHOWING THE CONFIGURATION OF SYSTEM TESTED	16
2.6 SUPPORT UNITS	16
3 . AC POWER LINE CONDUCTED EMISSIONS	17
3.1 LIMIT	17
3.2 TEST PROCEDURE	17
3.3 DEVIATION FROM TEST STANDARD	17
3.4 TEST SETUP	18
3.5 EUT OPERATION CONDITIONS	18
3.6 TEST RESULTS	18
4 . RADIATED EMISSIONS	19
4.1 LIMIT	19
4.2 TEST PROCEDURE	20
4.3 DEVIATION FROM TEST STANDARD	21
4.4 TEST SETUP	21
4.5 EUT OPERATION CONDITIONS	22
4.6 TEST RESULTS - 9 KHZ TO 30 MHZ	22
4.7 TEST RESULTS - 30 MHZ TO 1000 MHZ	22
4.8 TEST RESULTS - ABOVE 1000 MHZ	22
5 . BANDWIDTH	23
5.1 LIMIT	23
5.2 TEST PROCEDURE	23
5.3 DEVIATION FROM STANDARD	23
5.4 TEST SETUP	23

Table of Contents	Page
5.5 EUT OPERATION CONDITIONS	23
5.6 TEST RESULTS	23
6 . MAXIMUM AVERAGE OUTPUT POWER	24
6.1 LIMIT	24
6.2 TEST PROCEDURE	24
6.3 DEVIATION FROM STANDARD	24
6.4 TEST SETUP	24
6.5 EUT OPERATION CONDITIONS	24
6.6 TEST RESULTS	24
7 . CONDUCTED SPURIOUS EMISSIONS	25
7.1 LIMIT	25
7.2 TEST PROCEDURE	25
7.3 DEVIATION FROM STANDARD	25
7.4 TEST SETUP	25
7.5 EUT OPERATION CONDITIONS	25
7.6 TEST RESULTS	25
8 . POWER SPECTRAL DENSITY	26
8.1 LIMIT	26
8.2 TEST PROCEDURE	26
8.3 DEVIATION FROM STANDARD	26
8.4 TEST SETUP	26
8.5 EUT OPERATION CONDITIONS	26
8.6 TEST RESULTS	26
9 . MEASUREMENT INSTRUMENTS LIST	27
10 . EUT TEST PHOTO	29
APPENDIX A - AC POWER LINE CONDUCTED EMISSIONS	34
APPENDIX B - RADIATED EMISSION - 9 KHZ TO 30 MHZ	37
APPENDIX C - RADIATED EMISSION - 30 MHZ TO 1000 MHZ	42
APPENDIX D - RADIATED EMISSION- ABOVE 1000 MHZ	45
APPENDIX E - BANDWIDTH	86
APPENDIX F - MAXIMUM AVERAGE OUTPUT POWER	91
APPENDIX G - CONDUCTED SPURIOUS EMISSIONS	96

Table of Contents**Page****APPENDIX H - POWER SPECTRAL DENSITY****113**

REPORT ISSUED HISTORY

Report No.	Version	Description	Issued Date	Note
BTL-FCCP-1-2205C171	R00	Original Report	Jun. 24, 2022	Valid

1. SUMMARY OF TEST RESULTS

Test procedures according to the technical standard(s):

FCC CFR Title 47, Part 15, Subpart C				
Standard(s) Section	Test Item	Test Result	Judgment	Remark
15.207	AC Power Line Conducted Emissions	APPENDIX A	PASS	-----
15.247(d) 15.205(a) 15.209(a)	Radiated Emissions	APPENDIX B APPENDIX C APPENDIX D	PASS	-----
15.247(a)(2)	Bandwidth	APPENDIX E	PASS	-----
15.247(b)(3)	Maximum Average Output Power	APPENDIX F	PASS	-----
15.247(d)	Conducted Spurious Emissions	APPENDIX G	PASS	-----
15.247(e)	Power Spectral Density	APPENDIX H	PASS	-----
15.203	Antenna Requirement	-----	PASS	Note(2)

Note:

- (1) "N/A" denotes test is not applicable in this test report.
- (2) The device what use a permanently attached antenna were considered sufficient to comply with the provisions of 15.203.

1.1 TEST FACILITY

The test facilities used to collect the test data in this report is at the location of No. 3 Jinshagang 1st Rd. Shixia, Dalang Town Dongguan City, Guangdong 523792 People's Republic of China.

BTL's Registration Number for FCC: 357015

BTL's Designation Number for FCC: CN1240

1.2 MEASUREMENT UNCERTAINTY

ISO/IEC 17025 requires that an estimate of the measurement uncertainties associated with the emissions test results be included in the report. The measurement uncertainties given below are based on a 95% confidence level (based on a coverage factor (k=2))

The BTL measurement uncertainty as below table:

A. AC power line conducted emissions test:

Test Site	Method	Measurement Frequency Range	U,(dB)
DG-C02	CISPR	150kHz ~ 30MHz	2.60

B. Radiated emissions test:

Test Site	Method	Measurement Frequency Range	U,(dB)
DG-CB01	CISPR	9kHz ~ 30MHz	2.36

Test Site	Method	Measurement Frequency Range	Ant. H / V	U,(dB)
DG-CB03 (3m)	CISPR	30MHz ~ 200MHz	V	4.36
		30MHz ~ 200MHz	H	3.32
		200MHz ~ 1,000MHz	V	4.08
		200MHz ~ 1,000MHz	H	3.96

Test Site	Method	Measurement Frequency Range	U,(dB)
DG-CB03 (3m)	CISPR	1GHz ~ 6GHz	3.80
		6GHz ~ 18GHz	4.82

Test Site	Method	Measurement Frequency Range	U,(dB)
DG-CB03 (1m)	CISPR	18 ~ 26.5 GHz	3.62
		26.5 ~ 40 GHz	4.00

C. Other Measurement:

Test Item	Uncertainty
Bandwidth	±3.8 %
Maximum Output Power	±0.95 dB
Conducted Spurious Emission	±2.71 dB
Power Spectral Density	±0.86 dB
Temperature	±0.08 °C
Humidity	±1.5%

Note: Unless specifically mentioned, the uncertainty of measurement has not been taken into account to declare the compliance or non-compliance to the specification.

1.3 TEST ENVIRONMENT CONDITIONS

Test Item	Temperature	Humidity	Test Voltage	Tested By
AC Power Line Conducted Emissions	26°C	58%	AC 120V/60Hz	Jeter Wang
Radiated Emissions-9kHz to 30 MHz	24°C	58%	AC 120V/60Hz	Rod Tang
Radiated Emissions-30MHz to 1000MHz	25°C	59%	AC 120V/60Hz	Meers Zhang
Radiated Emissions-Above 1000MHz	25°C	59%	AC 120V/60Hz	Meers Zhang
Bandwidth	24°C	58%	AC120V/50Hz	Nicole Chen
Maximum Average Output Power	23.5-24.1°C	62.1-66.8%	AC120V/50Hz	Complex Qin
Conducted Spurious Emissions	24°C	58%	AC120V/50Hz	Nicole Chen
Power Spectral Density	24°C	58%	AC120V/50Hz	Nicole Chen

2. GENERAL INFORMATION

2.1 GENERAL DESCRIPTION OF EUT

Equipment	300Mbps Wireless N Ceiling Mount Access Point
Brand Name	tp-link
Test Model	EAP115
Series Model	N/A
Model Difference(s)	N/A
Power Source	1# DC voltage supplied from AC adapter. Model: T090060-2B1 2# Supplied from PoE.
Power Rating	1# I/P: 100-240V~ 50/60Hz 0.3A O/P: 9V \approx 0.6A 2# PoE: 36-57V \approx 0.1A 802.3af
Operation Frequency	2412 MHz ~ 2462 MHz
Modulation Type	IEEE 802.11b: DSSS IEEE 802.11g: OFDM IEEE 802.11n: OFDM
Bit Rate of Transmitter	IEEE 802.11b: 11/5.5/2/1 Mbps IEEE 802.11g: 54/48/36/24/18/12/9/6 Mbps IEEE 802.11n: up to 300 Mbps
Maximum Average Output Power	IEEE 802.11b: 22.16 dBm (0.1644 W)

Note:

1. For a more detailed features description, please refer to the manufacturer's specifications or the user's manual.

2. Channel List:

CH01 - CH11 for IEEE 802.11b, IEEE 802.11g, IEEE 802.11n(HT20)							
CH03 - CH09 for IEEE 802.11n(HT40)							
Channel	Frequency (MHz)	Channel	Frequency (MHz)	Channel	Frequency (MHz)	Channel	Frequency (MHz)
01	2412	04	2427	07	2442	10	2457
02	2417	05	2432	08	2447	11	2462
03	2422	06	2437	09	2452		

3. Antenna Specification:

Ant.	Brand	P/N	Antenna Type	Connector	Gain (dBi)
1	tp-link	Antenna_ EAP115(EU&US)4.20	PIFA	N/A	3.21
2	tp-link	Antenna_ EAP115(EU&US)4.20	PIFA	N/A	3.21

Note:

1) This EUT supports CDD, and all antennas have the same gain, Directional gain = $G_{ANT} + \text{Array Gain}$. For power measurements, Array Gain=0dB ($N_{ANT} \leq 4$), so the Directional gain=3.21.

For power spectral density measurements, $N_{ANT}=2$, $N_{SS} = 1$.

So the Directional gain= $G_{ANT} + \text{Array Gain} = G_{ANT} + 10\log(N_{ANT}/N_{SS})\text{dBi} = 3.21 + 10\log(2/1)\text{dBi} = 6.22$.

Then, the power spectral density limit is $8 - (6.22 - 6) = 7.78$.

2) The antenna gain is provided by the manufacturer.

4. Table for Antenna Configuration:

Operating Mode	TX Mode	2TX
IEEE 802.11b		V(Ant. 1 + Ant. 2)
IEEE 802.11g		V(Ant. 1 + Ant. 2)
IEEE 802.11n(HT20)		V(Ant. 1 + Ant. 2)
IEEE 802.11n(HT40)		V(Ant. 1 + Ant. 2)

2.2 DESCRIPTION OF TEST MODES

The test system was pre-tested based on the consideration of all possible combinations of EUT operation mode.

Pretest Mode	Description
Mode 1	TX B Mode Channel 01/06/11
Mode 2	TX G Mode Channel 01/06/11
Mode 3	TX N(HT20) Mode Channel 01/06/11
Mode 4	TX N(HT40) Mode Channel 03/06/09
Mode 7	TX B Mode Channel 11
Mode 8	TX B Mode Channel 01/02/06/10/11
Mode 9	TX G Mode Channel 01/02/06/10/11
Mode 10	TX N(HT20) Mode Channel 01/02/06/10/11
Mode 11	TX N(HT40) Mode Channel 03/04/06/08/09

Following mode(s) was (were) found to be the worst case(s) and selected for the final test.

AC power line conducted emissions test	
Final Test Mode	Description
Mode 7	TX B Mode Channel 11

Radiated emissions test - Below 1GHz	
Final Test Mode	Description
Mode 7	TX B Mode Channel 11

Radiated emissions test- Above 1GHz	
Final Test Mode	Description
Mode 8	TX B Mode Channel 01/02/06/10/11
Mode 9	TX G Mode Channel 01/02/06/10/11
Mode 10	TX N(HT20) Mode Channel 01/02/06/10/11
Mode 11	TX N(HT40) Mode Channel 03/04/06/08/09

Conducted test	
Final Test Mode	Description
Mode 1	TX B Mode Channel 01/06/11
Mode 2	TX G Mode Channel 01/06/11
Mode 3	TX N(HT20) Mode Channel 01/06/11
Mode 4	TX N(HT40) Mode Channel 03/06/09

NOTE:

- (1) All the bit rate of transmitter have been tested and found the lowest rate is found to be the worst case and recorded.
- (2) For AC power line conducted emissions and radiated emission below 1 GHz test, the TX B Mode Channel 11 is found to be the worst case and recorded.
- (3) For radiated emission above 1 GHz test, the spurious points of 1GHz~26.5GHz have been pre-tested and in this report only recorded the worst case. The remaining spurious points are all below the limit value of 20dB.
- (4) For radiated emission above 1 GHz test, the polarization of Vertical and Horizontal are evaluated, the worst case is Horizontal for Band edge, Vertical for Harmonic. In this report only recorded the worst case.
- (5) For radiated emission below 1GHz test, Adapter Supply and PoE Supply are evaluated, the worst case is Adapter Supply and recorded.

2.3 PARAMETERS OF TEST SOFTWARE

Test Software Version	Cart		
	2412	2437	2462
Frequency (MHz)			
IEEE 802.11b	18	18	19
IEEE 802.11g	14	18	15.5
IEEE 802.11n(HT20)	14	19	15
Frequency (MHz)	2422	2437	2452
IEEE 802.11n(HT40)	11.5	16	12.5

2.4 DUTY CYCLE

If duty cycle is $\geq 98\%$, duty factor is not required.
 If duty cycle is $< 98\%$, duty factor shall be considered.
 The output power = measured power + duty factor.

IEEE 802.11b

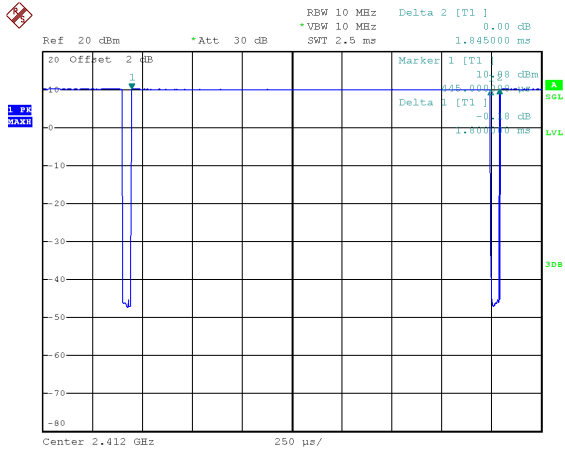

Date: 5.JUN.2022 11:50:43

Duty cycle = $1.800 \text{ ms} / 1.845 \text{ ms} = 97.56\%$
 Duty Factor = $10 \log(1/\text{Duty cycle}) = 0.11$

IEEE 802.11g

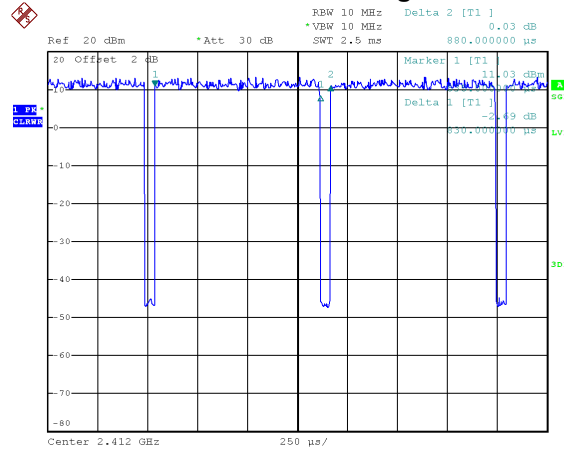

Date: 5.JUN.2022 11:51:11

Duty cycle = $0.830 \text{ ms} / 0.880 \text{ ms} = 94.32\%$
 Duty Factor = $10 \log(1/\text{Duty cycle}) = 0.25$

IEEE 802.11n(HT20)

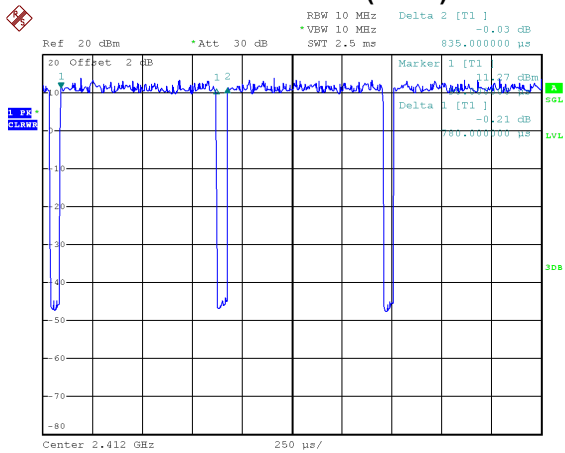

Date: 5.JUN.2022 11:51:44

Duty cycle = $0.780 \text{ ms} / 0.835 \text{ ms} = 93.41\%$
 Duty Factor = $10 \log(1/\text{Duty cycle}) = 0.30$

IEEE 802.11n(HT40)

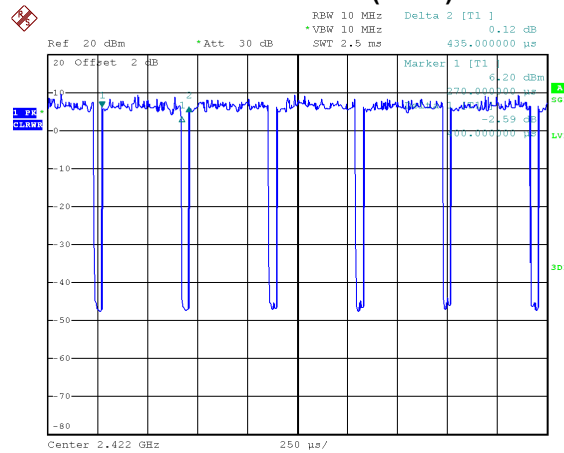

Date: 5.JUN.2022 11:52:06

Duty cycle = $0.400 \text{ ms} / 0.435 \text{ ms} = 91.95\%$
 Duty Factor = $10 \log(1/\text{Duty cycle}) = 0.36$

NOTE:

For IEEE 802.11b:

For radiated emissions frequency above 1 GHz, the resolution bandwidth of test receiver/spectrum analyzer is 1 MHz and the video bandwidth is 556 Hz.

For IEEE 802.11g:

For radiated emissions frequency above 1 GHz, the resolution bandwidth of test receiver/spectrum analyzer is 1 MHz and the video bandwidth is 1205 Hz.

For IEEE 802.11n(HT20):

For radiated emissions frequency above 1 GHz, the resolution bandwidth of test receiver/spectrum analyzer is 1 MHz and the video bandwidth is 1282 Hz.

For IEEE 802.11n(HT40):

For radiated emissions frequency above 1 GHz, the resolution bandwidth of test receiver/spectrum analyzer is 1 MHz and the video bandwidth is 2500 Hz.

2.5 BLOCK DIAGRAM SHOWING THE CONFIGURATION OF SYSTEM TESTED

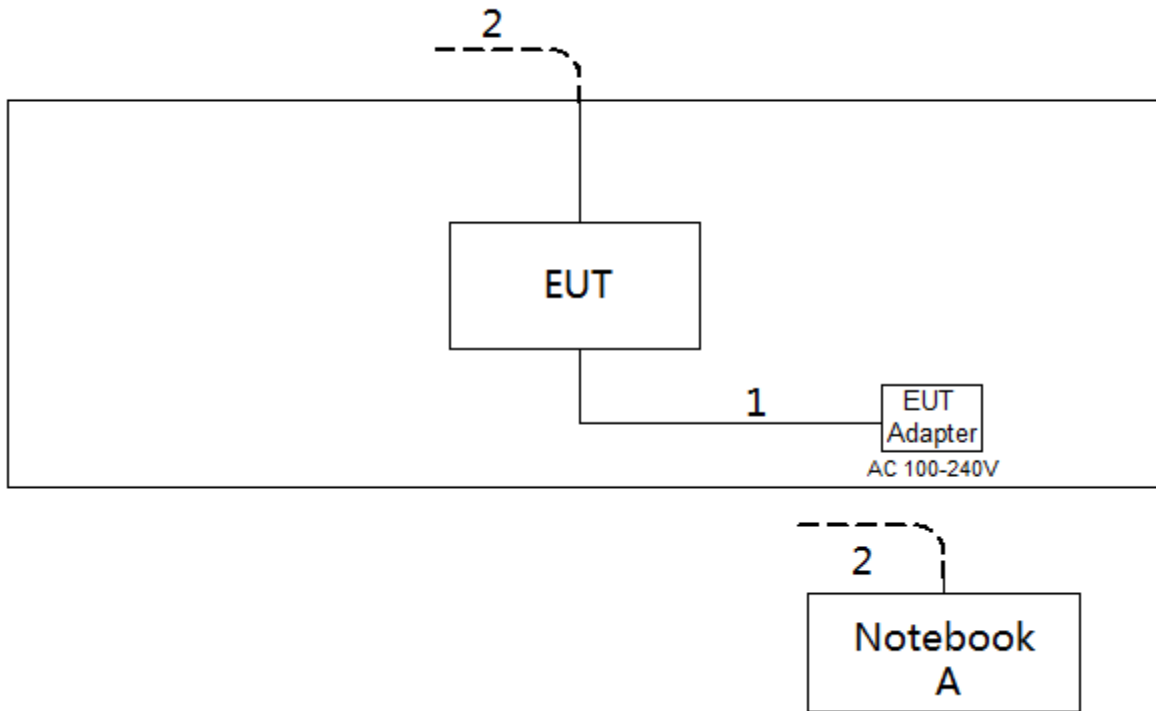

2.6 SUPPORT UNITS

Item	Equipment	Brand	Model No.	Series No.
A	Notebook	Dell	Inspiron 15-7559	N/A

Item	Cable Type	Shielded Type	Ferrite Core	Length
1	DC Cable	NO	NO	1.5m
2	RJ45 Cable	NO	NO	10m

3. AC POWER LINE CONDUCTED EMISSIONS

3.1 LIMIT

Frequency of Emission (MHz)	Limit (dB μ V)	
	Quasi-peak	Average
0.15 - 0.5	66 to 56*	56 to 46*
0.5 - 5.0	56	46
5.0 - 30.0	60	50

NOTE:

- (1) The tighter limit applies at the band edges.
- (2) The limit of "*" marked band means the limitation decreases linearly with the logarithm of the frequency in the range.

3.2 TEST PROCEDURE

- a. The EUT was placed 0.8 meters from the horizontal ground plane with EUT being connected to the power mains through a line impedance stabilization network (LISN). All other support equipment powered from additional LISN(s). The LISN provide 50 Ohm/ 50uH of coupling impedance for the measuring instrument.
- b. Interconnecting cables that hang closer than 40 cm to the ground plane shall be folded back and forth in the center forming a bundle 30 to 40 cm long.
- c. I/O cables that are not connected to a peripheral shall be bundled in the center. The end of the cable may be terminated, if required, using the correct terminating impedance. The overall length shall not exceed 1 m.
- d. LISN at least 80 cm from nearest part of EUT chassis.
- e. For the actual test configuration, please refer to the related Item -EUT Test Photos.

The following table is the setting of the receiver:

Receiver Parameters	Setting
Start Frequency	0.15 MHz
Stop Frequency	30 MHz
IF Bandwidth	9 kHz

3.3 DEVIATION FROM TEST STANDARD

No deviation.

3.4 TEST SETUP

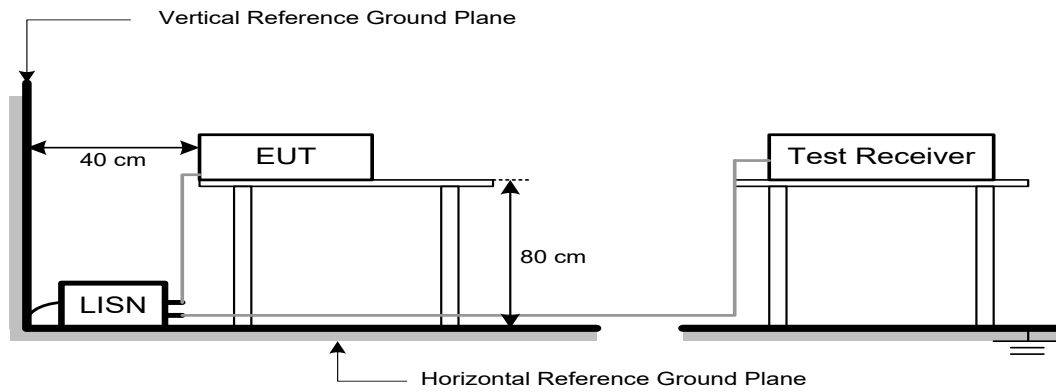

3.5 EUT OPERATION CONDITIONS

EUT was programmed to be in continuously transmitting mode.

3.6 TEST RESULTS

Please refer to the APPENDIX A.

4. RADIATED EMISSIONS

4.1 LIMIT

In case the emission fall within the restricted band specified on 15.205(a), then the 15.209(a) limit in the table below has to be followed.

LIMITS OF RADIATED EMISSION MEASUREMENT (9 kHz-1000 MHz)

Frequency (MHz)	Field Strength (microvolts/meter)	Measurement Distance (meters)
0.009-0.490	2400/F(kHz)	300
0.490-1.705	24000/F(kHz)	30
1.705-30.0	30	30
30-88	100	3
88-216	150	3
216-960	200	3
Above 960	500	3

LIMITS OF RADIATED EMISSION MEASUREMENT (Above 1000 MHz)

Frequency (MHz)	(dBuV/m at 3 m)	
	Peak	Average
Above 1000	74	54

NOTE:

- (1) The limit for radiated test was performed according to FCC CFR Title 47, Part 15, Subpart C.
- (2) The tighter limit applies at the band edges.
- (3) Emission level (dBuV/m)=20log Emission level (uV/m).

4.2 TEST PROCEDURE

- a. The measuring distance of 3 m shall be used for measurements. The EUT was placed on the top of a rotating table 0.8 meter above the ground at a 3 meter semi-anechoic chamber. The table was rotated 360 degrees to determine the position of the highest radiation.(below 1 GHz)
- b. The measuring distance of 3 m shall be used for measurements. The EUT was placed on the top of a rotating table 1.5 meter above the ground at a 3 meter semi-anechoic chamber. The table was rotated 360 degrees to determine the position of the highest radiation.(above 1 GHz)
- c. The height of the equipment or of the substitution antenna shall be 0.8m or 1.5m; the height of the test antenna shall vary between 1 m to 4 m. Both horizontal and vertical polarizations of the antenna are set to make the measurement.
- d. For each suspected emission, the EUT was arranged to its worst case and then the antenna was tuned to heights find the maximum reading (used Bore sight function).
- e. The receiver system was set to peak and average detect function and specified bandwidth with maximum hold mode when the test frequency is above 1 GHz.
- f. The initial step in collecting radiated emission data is a receiver peak detector mode pre-scanning the measurement frequency range. Significant peaks are then marked and then Quasi Peak detector mode re-measured.
- g. All readings are Peak unless otherwise stated QP in column of Note. Peak denotes that the Peak reading compliance with the QP Limits and then QP Mode measurement didn't perform.
(below 1 GHz)
- h. All readings are Peak Mode value unless otherwise stated AVG in column of Note. If the Peak Mode Measured value compliance with the Peak Limits and lower than AVG Limits, the EUT shall be deemed to meet both Peak & AVG Limits and then only Peak Mode was measured, but AVG Mode didn't perform. (above 1 GHz)
- i. For the actual test configuration, please refer to the related Item -EUT Test Photos.

The following table is the setting of the receiver:

Spectrum Parameters	Setting
Start ~ Stop Frequency	9 kHz~150 kHz for RBW 200 Hz
Start ~ Stop Frequency	0.15 MHz~30 MHz for RBW 9 kHz
Start ~ Stop Frequency	30 MHz~1000 MHz for RBW 100 kHz

Spectrum Parameters	Setting
Start Frequency	1000 MHz
Stop Frequency	10th carrier harmonic
RBW / VBW (Emission in restricted band)	1 MHz / 3 MHz for PK value 1 MHz / 1/T Hz for AVG value

Receiver Parameters	Setting
Start ~ Stop Frequency	9 kHz~90 kHz for PK/AVG detector
Start ~ Stop Frequency	90 kHz~110 kHz for QP detector
Start ~ Stop Frequency	110 kHz~490 kHz for PK/AVG detector
Start ~ Stop Frequency	490 kHz~30 MHz for QP detector
Start ~ Stop Frequency	30 MHz~1000 MHz for QP detector
Start ~ Stop Frequency	1 GHz~26.5 GHz for PK/AVG detector

4.3 DEVIATION FROM TEST STANDARD

No deviation.

4.4 TEST SETUP

9 kHz to 30 MHz

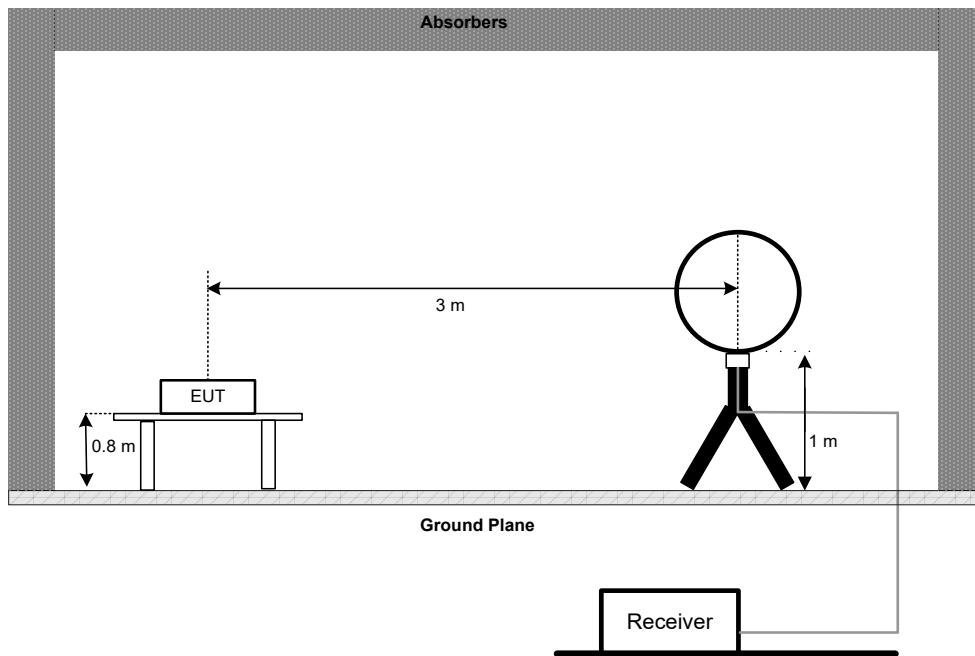

30 MHz to 1 GHz

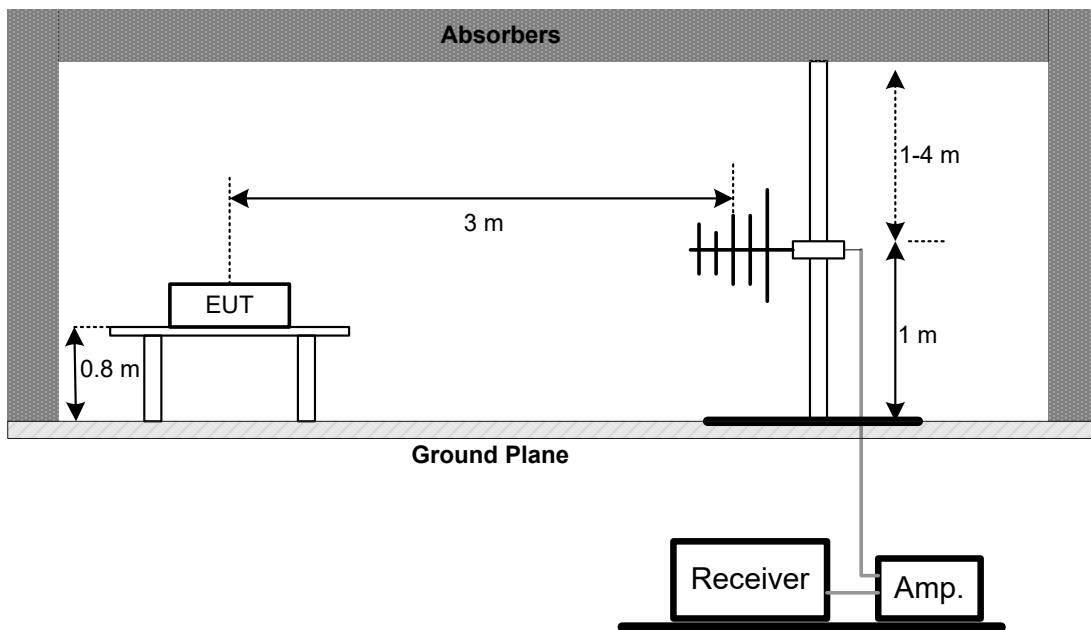

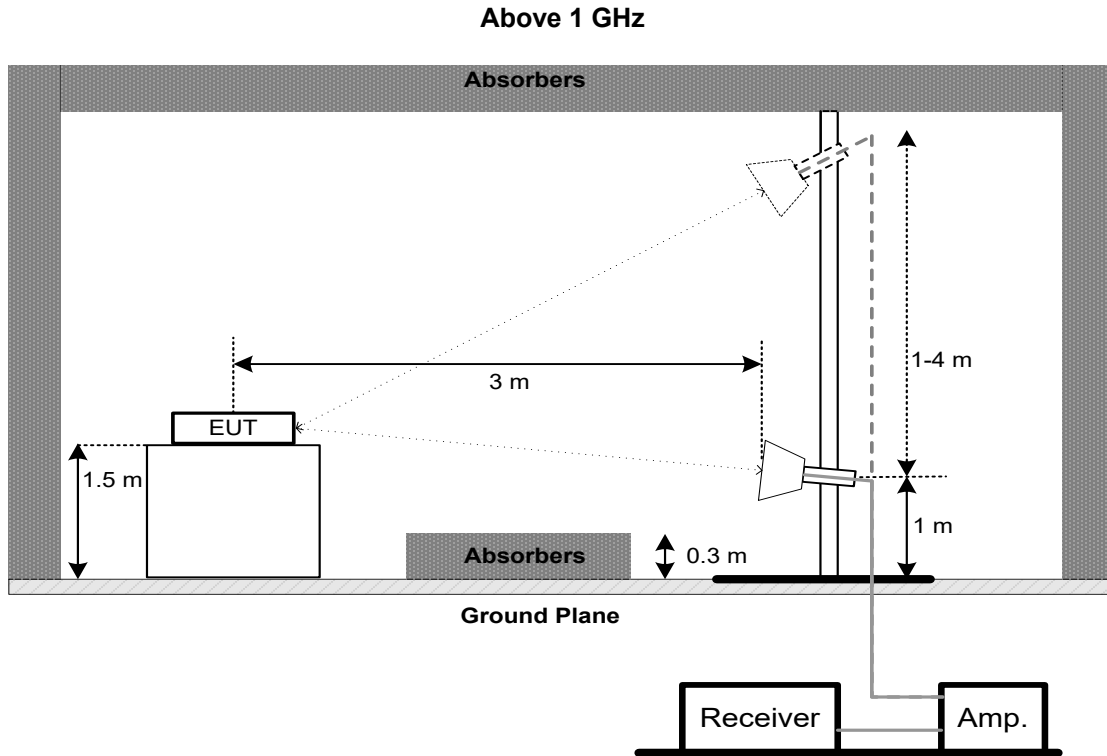

4.5 EUT OPERATION CONDITIONS

The EUT was programmed to be in continuously transmitting mode.

4.6 TEST RESULTS - 9 KHZ TO 30 MHZ

Please refer to the APPENDIX B.

Remark:

- (1) Distance extrapolation factor = $40 \log (\text{specific distance} / \text{test distance})$ (dB).
- (2) Limit line = specific limits (dBuV) + distance extrapolation factor.

4.7 TEST RESULTS - 30 MHZ TO 1000 MHZ

Please refer to the APPENDIX C.

4.8 TEST RESULTS - ABOVE 1000 MHZ

Please refer to the APPENDIX D.

Remark:

- (1) No limit: This is fundamental signal, the judgment is not applicable.
For fundamental signal judgment was referred to Peak output test.

5. BANDWIDTH

5.1 LIMIT

Section	Test Item	Limit
FCC 15.247(a)(2)	6 dB Bandwidth	Minimum 500 kHz
	99% Emission Bandwidth	-

5.2 TEST PROCEDURE

- The EUT was directly connected to the spectrum analyzer and antenna output port as show in the block diagram below.
- The following table is the setting of the spectrum analyzer:

For 6 dB Bandwidth:

Spectrum Parameters	Setting
Span Frequency	> Measurement Bandwidth
RBW	100 kHz
VBW	300 kHz
Detector	Peak
Trace	Max Hold
Sweep Time	Auto

For 99% Emission Bandwidth:

Spectrum Parameters	Setting
Span Frequency	Between 1.5 times and 5.0 times the OBW
RBW	300 kHz For 20MHz 1 MHz For 40MHz
VBW	1 MHz For 20MHz 3 MHz For 40MHz
Detector	Peak
Trace	Max Hold
Sweep Time	Auto

5.3 DEVIATION FROM STANDARD

No deviation.

5.4 TEST SETUP



5.5 EUT OPERATION CONDITIONS

The EUT was programmed to be in continuously transmitting mode.

5.6 TEST RESULTS

Please refer to the APPENDIX E.

6. MAXIMUM AVERAGE OUTPUT POWER

6.1 LIMIT

Section	Test Item	Limit
FCC 15.247(b)(3)	Maximum Average Output Power	1.0000 Watt or 30.00 dBm

6.2 TEST PROCEDURE

- The EUT was directly connected to the peak power analyzer and antenna output port as show in the block diagram below.
- The maximum conducted output power was performed in accordance with method 11.9.2.3.1 of ANSI C63.10-2013 and FCC KDB 662911 D01 v02r01 Multiple Transmitter Output.

6.3 DEVIATION FROM STANDARD

No deviation.

6.4 TEST SETUP

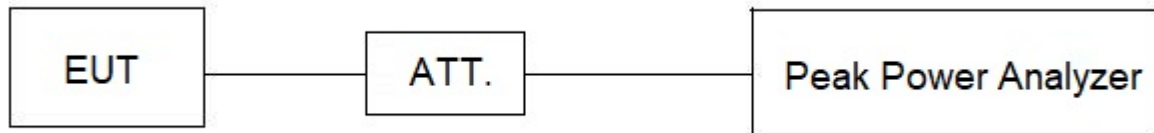

6.5 EUT OPERATION CONDITIONS

The EUT was programmed to be in continuously transmitting mode.

6.6 TEST RESULTS

Please refer to the APPENDIX F.

7. CONDUCTED SPURIOUS EMISSIONS

7.1 LIMIT

In any 100 kHz bandwidth outside the frequency band in which the spread spectrum or digitally modulated intentional radiator is operating, the radio frequency power that is produced by the intentional radiator shall be at least 20 dB below that in the 100 kHz bandwidth within the band that contains the highest level of the desired power, based on either an RF conducted or a radiated measurement, provided the transmitter demonstrates compliance with the peak Output Power limits. If the transmitter complies with the Output Power limits based on the use of RMS averaging over a time interval, as permitted under paragraph (b)(3) of this section, the attenuation required under this paragraph shall be 30 dB instead of 20 dB. Attenuation below the general limits specified in Section 15.209(a) is not required.

7.2 TEST PROCEDURE

- a. The EUT was directly connected to the spectrum analyzer and antenna output port as show in the block diagram below.
- b. The following table is the setting of the spectrum analyzer:

For Reference Level:

Spectrum Parameters	Setting
Span Frequency	≥ 1.5 times the bandwidth.
RBW	100 kHz
VBW	300 kHz
Detector	Peak
Trace	Max Hold
Sweep Time	Auto

For Emission Level:

Spectrum Parameters	Setting
Start Frequency	30 MHz
Stop Frequency	26.5 GHz
RBW	100 kHz
VBW	300 kHz
Detector	Peak
Trace	Max Hold
Sweep Time	Auto

7.3 DEVIATION FROM STANDARD

No deviation.

7.4 TEST SETUP



7.5 EUT OPERATION CONDITIONS

The EUT was programmed to be in continuously transmitting mode.

7.6 TEST RESULTS

Please refer to the APPENDIX G.

8. POWER SPECTRAL DENSITY

8.1 LIMIT

Section	Test Item	Limit
FCC 15.247(e)	Power Spectral Density	8 dBm (in any 3 kHz)

8.2 TEST PROCEDURE

- a. The EUT was directly connected to the spectrum analyzer and antenna output port as show in the block diagram below.
- b. The following table is the setting of the spectrum analyzer:

Spectrum Parameters	Setting
Span Frequency	25 MHz (20 MHz) / 60 MHz (40 MHz)
RBW	3 kHz
VBW	10 kHz
Detector	Peak
Trace	Max Hold
Sweep Time	Auto

8.3 DEVIATION FROM STANDARD

No deviation.

8.4 TEST SETUP

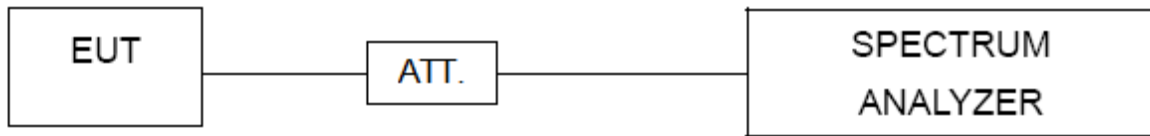

8.5 EUT OPERATION CONDITIONS

The EUT was programmed to be in continuously transmitting mode.

8.6 TEST RESULTS

Please refer to the APPENDIX H.

9. MEASUREMENT INSTRUMENTS LIST

AC Power Line Conducted Emissions					
Item	Kind of Equipment	Manufacturer	Type No.	Serial No.	Calibrated until
1	EMI Test Receiver	R&S	ESCI	100382	Jan. 22, 2023
2	LISN	EMCO	3816/2	52765	Jan. 23, 2023
3	TWO-LINE V-NETWORK	R&S	ENV216	101447	Jan. 23, 2023
4	50Ω Terminator	SHX	TF5-3	15041305	N/A
5	Measurement Software	Farad	EZ-EMC Ver.NB-03A1-01	N/A	N/A
6	Cable	N/A	RG223	12m	Mar. 08, 2023
7	643 Shield Room	ETS	6*4*3	N/A	N/A

Radiated Emissions - 9 kHz to 30 MHz					
Item	Kind of Equipment	Manufacturer	Type No.	Serial No.	Calibrated until
1	MXE EMI Receiver	Keysight	N9038A	MY56400091	Jan. 22, 2023
2*	Active Loop Antenna	R&S	HFH2-Z2	830749/020	Aug. 23, 2024
3	Cable	N/A	RG 213/U(9kHz~1GHz)	N/A	Jul. 09, 2022
4	Measurement Software	Farad	EZ-EMC Ver.NB-03A1-01	N/A	N/A
5	966 Chamber Room	ETS	9*6*6	N/A	Jul. 17, 2022

Radiated Emissions - 30 MHz to 1 GHz					
Item	Kind of Equipment	Manufacturer	Type No.	Serial No.	Calibrated until
1	Antenna	Schwarzbeck	VULB9160	9160-3232	Mar. 03, 2023
2	Amplifier	HP	8447D	2944A08742	Jan. 22, 2023
3	Cable	emci	LMR-400	N/A	Nov. 30, 2022
4	Controller	CT	SC100	N/A	N/A
5	Controller	MF	MF-7802	MF780208416	N/A
6	Receiver	Agilent	N9038A	MY52130039	Jan. 22, 2023
7	Measurement Software	Farad	EZ-EMC Ver.NB-03A1-01	N/A	N/A
8	966 Chamber Room	RM	9*6*6	N/A	Jul. 24, 2022

Radiated Emissions - Above 1 GHz					
Item	Kind of Equipment	Manufacturer	Type No.	Serial No.	Calibrated until
1	Double Ridged Horn Antenna	ARA	DRG-118A	16554	Apr. 18, 2023
2	Broad-Band Horn Antenna	Schwarzbeck	BBHA 9170	9170319	Jun. 30, 2022
3	Amplifier	Agilent	8449B	3008A02584	Jul. 10, 2022
4	Controller	CT	SC100	N/A	N/A
5	Controller	MF	MF-7802	MF780208416	N/A
6	Receiver	Agilent	N9038A	MY52130039	Jan. 22, 2023
7	EXA Spectrum Analyzer	Keysight	N9010A	MY56480488	Jan. 22, 2023
8	Low Noise Amplifier	CONNPHY	CLN-18G40G-4330-K	619413	Jul. 16, 2022
9	Cable	Talent microwave	A81-SMAMSMAM-12.5M	N/A	Oct. 15, 2022
10	Cable	Talent microwave	A40-2.92M2.92M-2.5M	N/A	Nov. 30, 2022
11	Filter	STI	STI15-9912	N/A	Jul. 10, 2022
12	Measurement Software	Farad	EZ-EMC Ver.NB-03A1-01	N/A	N/A
13	966 Chamber Room	RM	9*6*6	N/A	Jul. 24, 2022

Bandwidth & Conducted Spurious Emissions & Power Spectral Density					
Item	Kind of Equipment	Manufacturer	Type No.	Serial No.	Calibrated until
1	Spectrum Analyzer	R&S	FSP40	100185	Jul. 10, 2022
2	Attenuator	WOKEN	6SM3502	VAS1214NL	N/A
3	RF Cable	Tongkaichuan	N/A	N/A	N/A
4	DC Block	Mini	N/A	N/A	N/A

Maximum Average Output Power					
Item	Kind of Equipment	Manufacturer	Type No.	Serial No.	Calibrated until
1	Peak Power Analyzer	Keysight	8990B	MY51000506	Jul. 10, 2022
2	Wideband power sensor	Keysight	N1923A	MY58310004	Jul. 10, 2022
3	Attenuator	WOKEN	6SM3502	VAS1214NL	N/A
4	RF Cable	Tongkaichuan	N/A	N/A	N/A

Remark: "N/A" denotes no model name, serial no. or calibration specified.
 "*" calibration period of equipment list is three year.
 Except * item, all calibration period of equipment list is one year.

10. EUT TEST PHOTO**AC Power Line Conducted Emissions Test Photos**

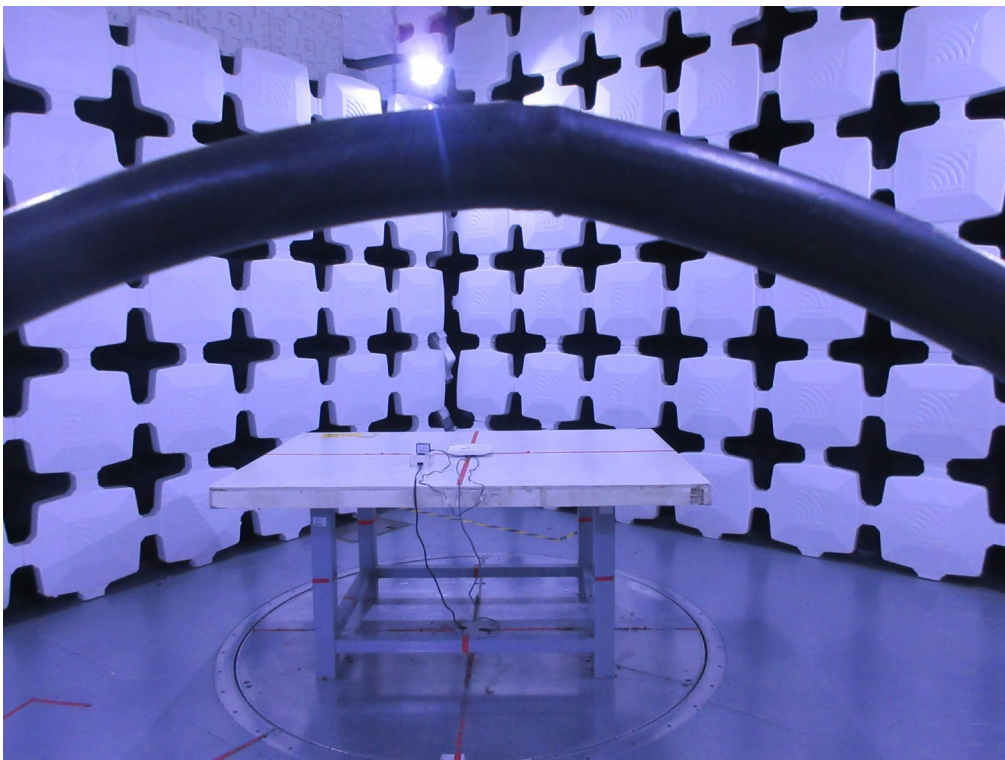
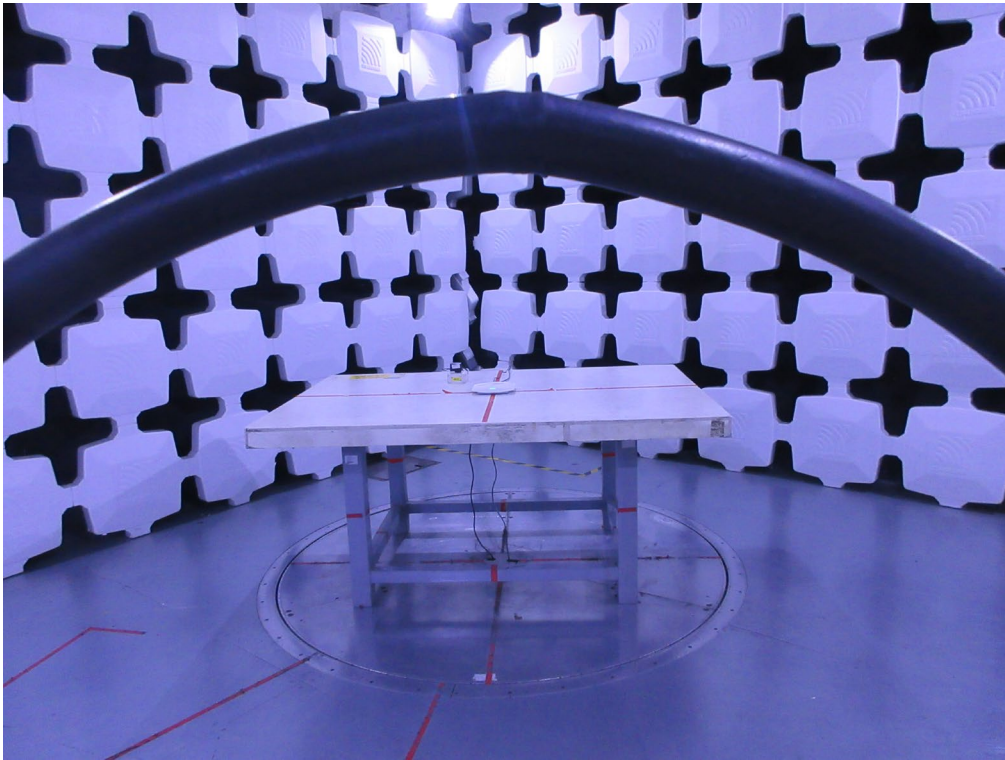
Radiated Emissions Test Photos**9 kHz to 30 MHz**

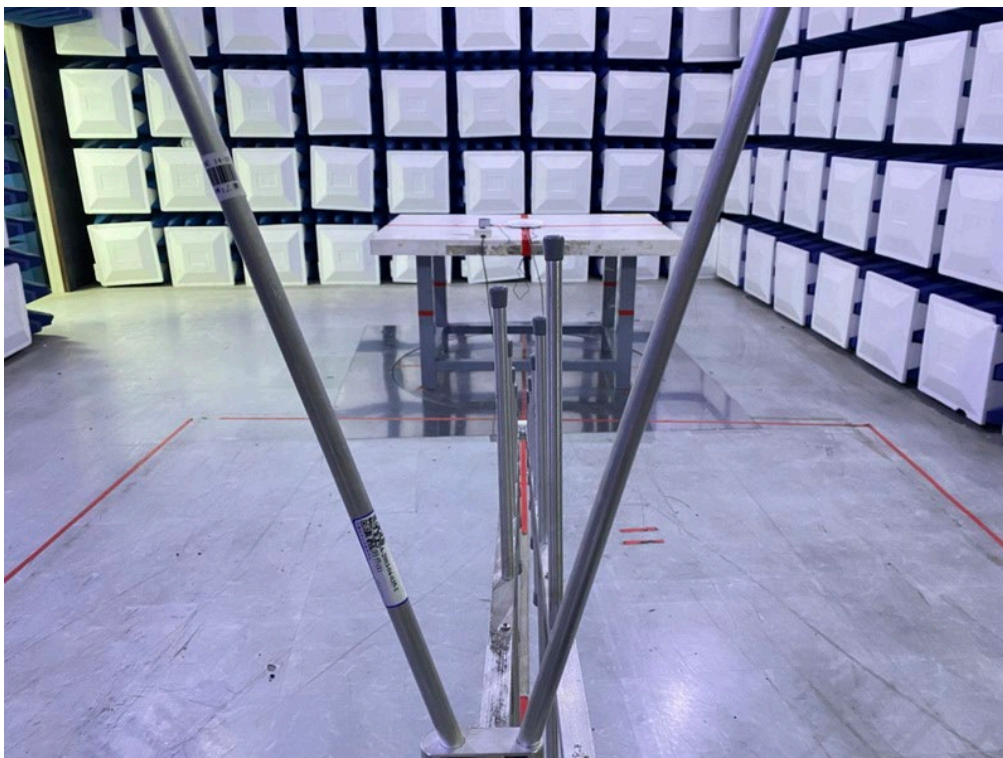
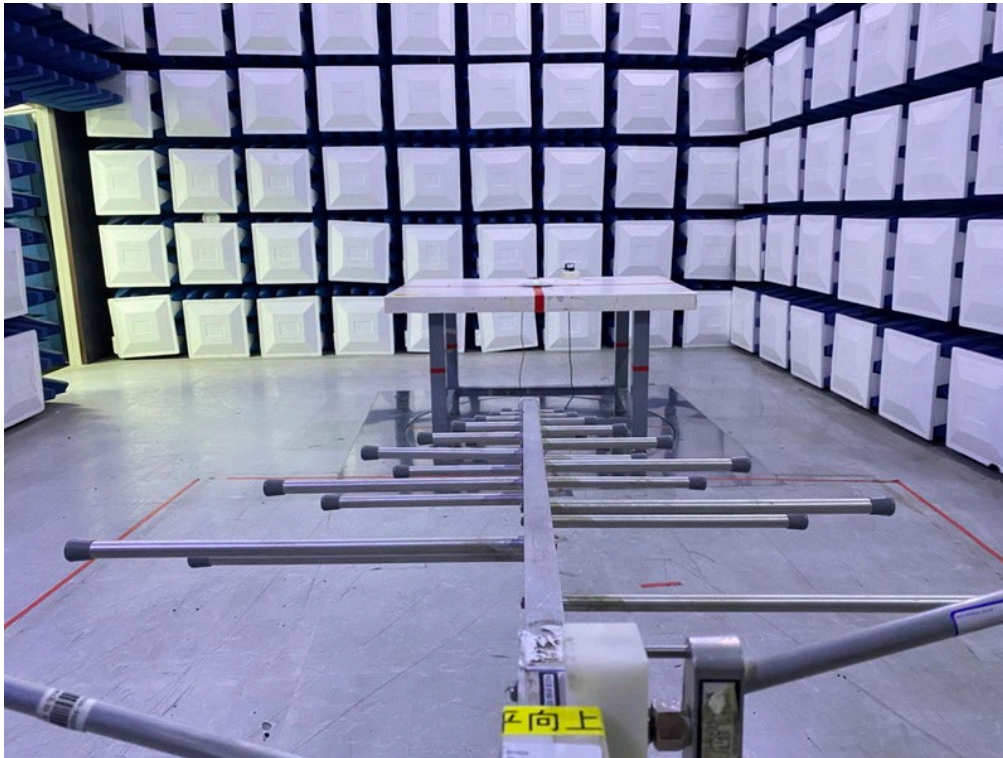
Radiated Emissions Test Photos**30 MHz to 1 GHz**

Radiated Emissions Test Photos

Above 1 GHz

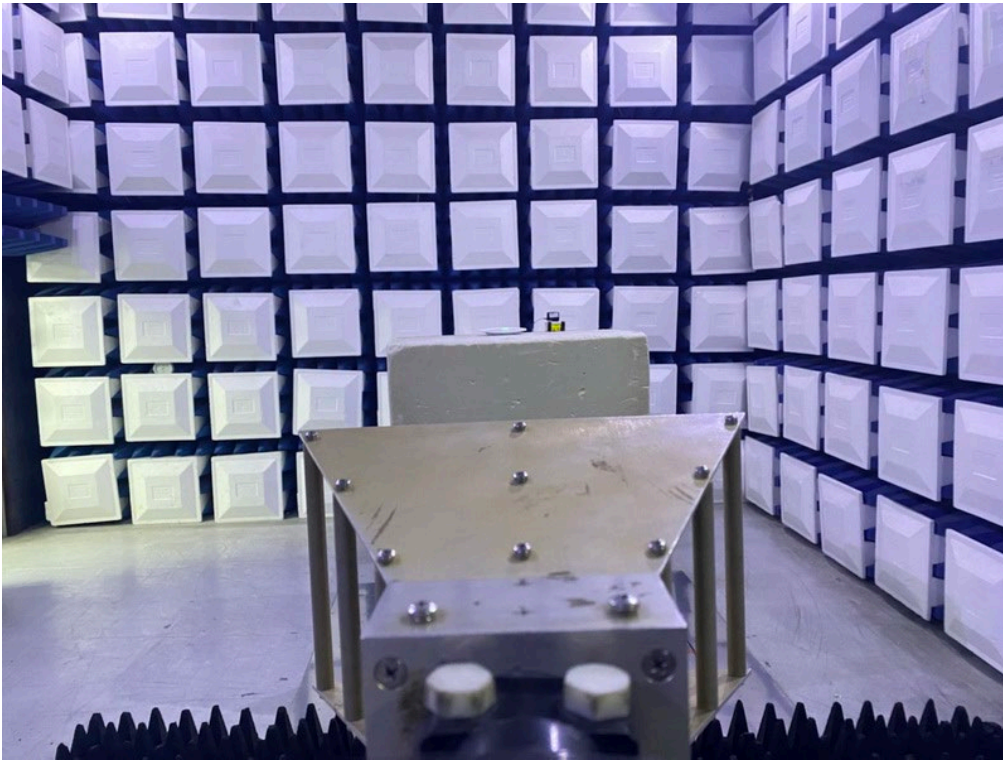

Conducted Test Photos

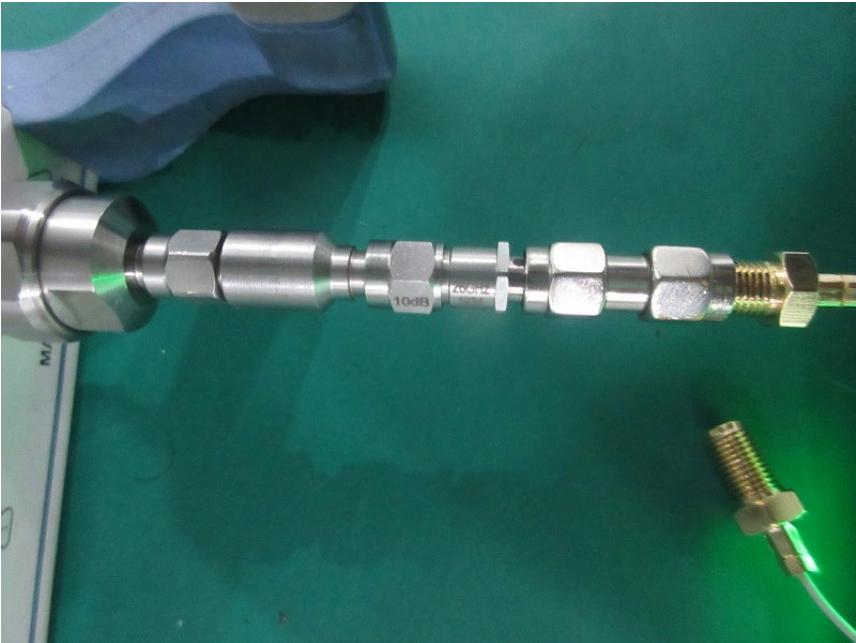
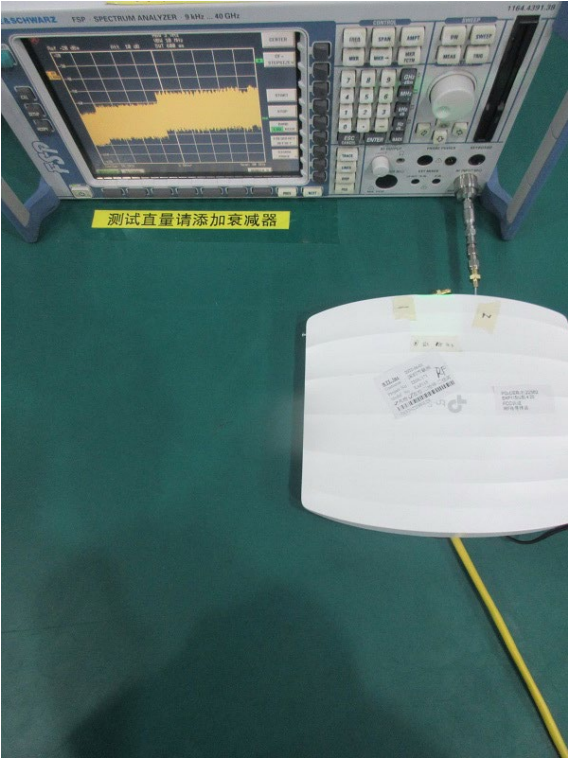

APPENDIX A - AC POWER LINE CONDUCTED EMISSIONS

Test Mode	TX B Mode Channel 11	Phase	Line
-----------	----------------------	-------	------

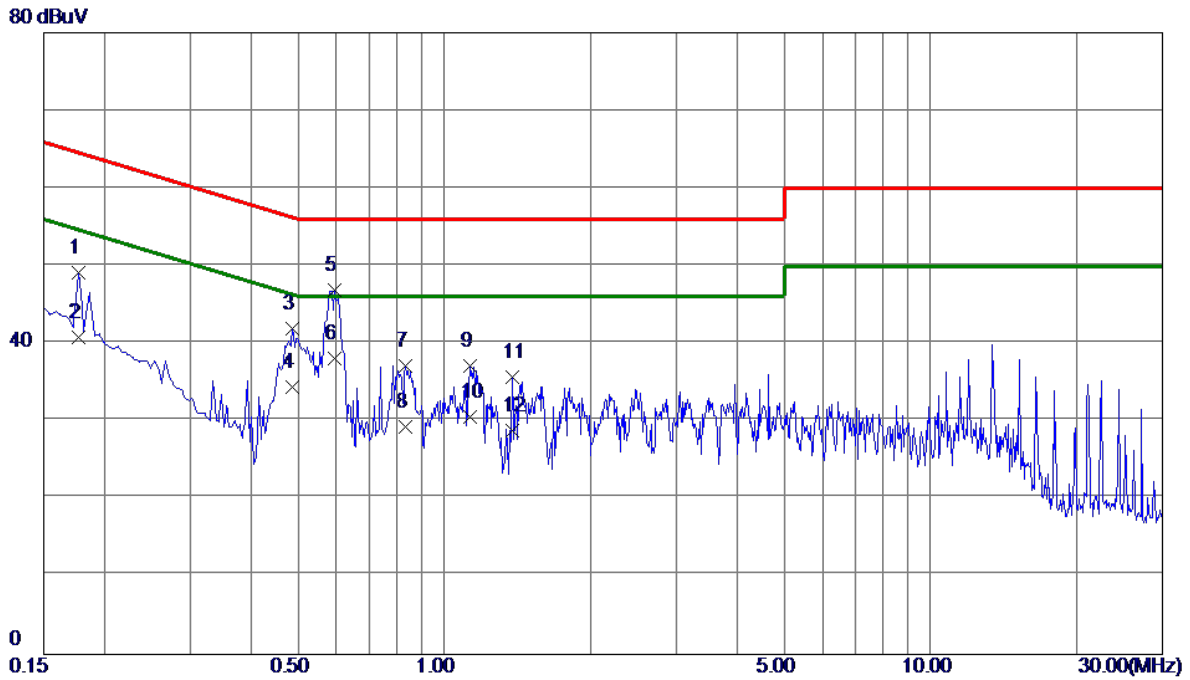

No.	Freq. MHz	Reading Level dBuV	Correct Factor dB	Measure ment dBuV	Limit dBuV	Margin dB	Detector	Comment
1	0.1770	39.46	9.68	49.14	64.63	-15.49	QP	
2	0.1770	31.19	9.68	40.87	54.63	-13.76	AVG	
3	0.4875	32.14	9.76	41.90	56.21	-14.31	QP	
4	0.4875	24.60	9.76	34.36	46.21	-11.85	AVG	
5	0.5955	37.04	9.79	46.83	56.00	-9.17	QP	
6 *	0.5955	28.30	9.79	38.09	46.00	-7.91	AVG	
7	0.8340	27.31	9.80	37.11	56.00	-18.89	QP	
8	0.8340	19.50	9.80	29.30	46.00	-16.70	AVG	
9	1.1310	27.26	9.84	37.10	56.00	-18.90	QP	
10	1.1310	20.70	9.84	30.54	46.00	-15.46	AVG	
11	1.3785	25.89	9.85	35.74	56.00	-20.26	QP	
12	1.3785	18.89	9.85	28.74	46.00	-17.26	AVG	

REMARKS:

- (1) Measurement Value = Reading Level + Correct Factor.
- (2) Margin Level = Measurement Value - Limit Value.

Test Mode	TX B Mode Channel 11	Phase	Neutral
-----------	----------------------	-------	---------

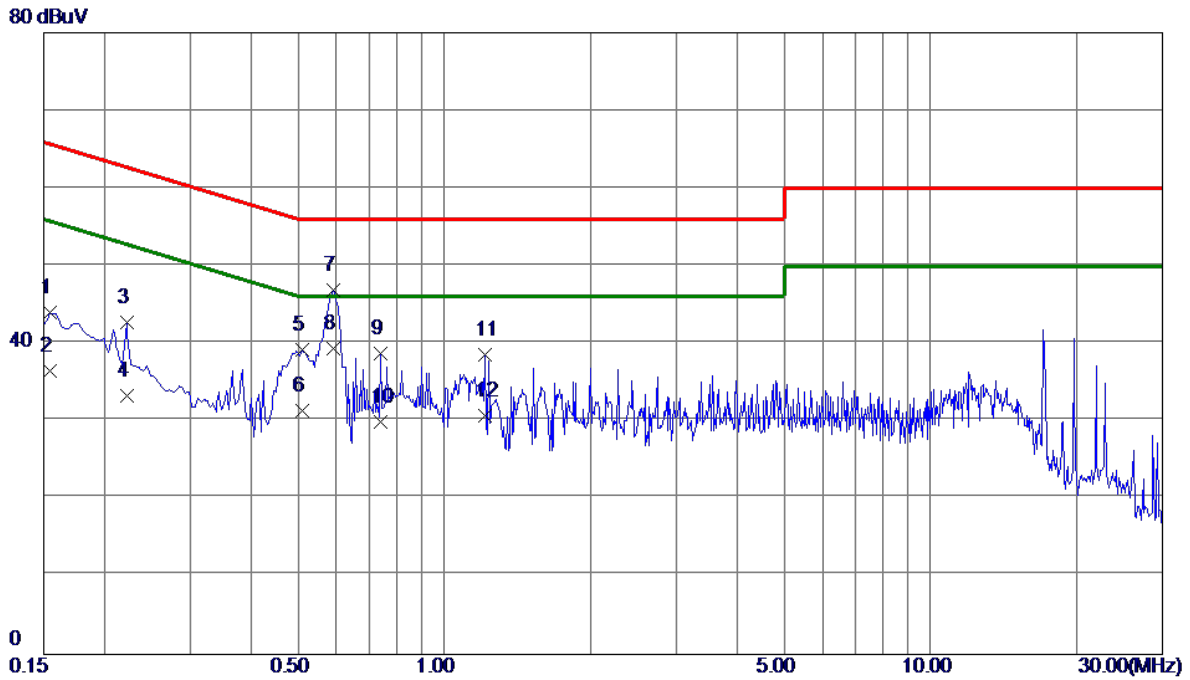

No.	Freq. MHz	Reading Level dBuV	Correct Factor dB	Measure ment dBuV	Limit dBuV	Margin dB	Detector	Comment
1	0.1545	34.22	9.71	43.93	65.75	-21.82	QP	
2	0.1545	26.70	9.71	36.41	55.75	-19.34	AVG	
3	0.2220	32.94	9.74	42.68	62.74	-20.06	QP	
4	0.2220	23.59	9.74	33.33	52.74	-19.41	AVG	
5	0.5100	29.43	9.79	39.22	56.00	-16.78	QP	
6	0.5100	21.50	9.79	31.29	46.00	-14.71	AVG	
7	0.5910	37.07	9.82	46.89	56.00	-9.11	QP	
8 *	0.5910	29.60	9.82	39.42	46.00	-6.58	AVG	
9	0.7395	28.88	9.83	38.71	56.00	-17.29	QP	
10	0.7395	20.10	9.83	29.93	46.00	-16.07	AVG	
11	1.2120	28.67	9.87	38.54	56.00	-17.46	QP	
12	1.2120	20.90	9.87	30.77	46.00	-15.23	AVG	

REMARKS:

- (1) Measurement Value = Reading Level + Correct Factor.
- (2) Margin Level = Measurement Value - Limit Value.

APPENDIX B - RADIATED EMISSION - 9 KHZ TO 30 MHZ

Test Mode	TX B Mode Channel 11	Polarization	Ant 0°
-----------	----------------------	--------------	--------

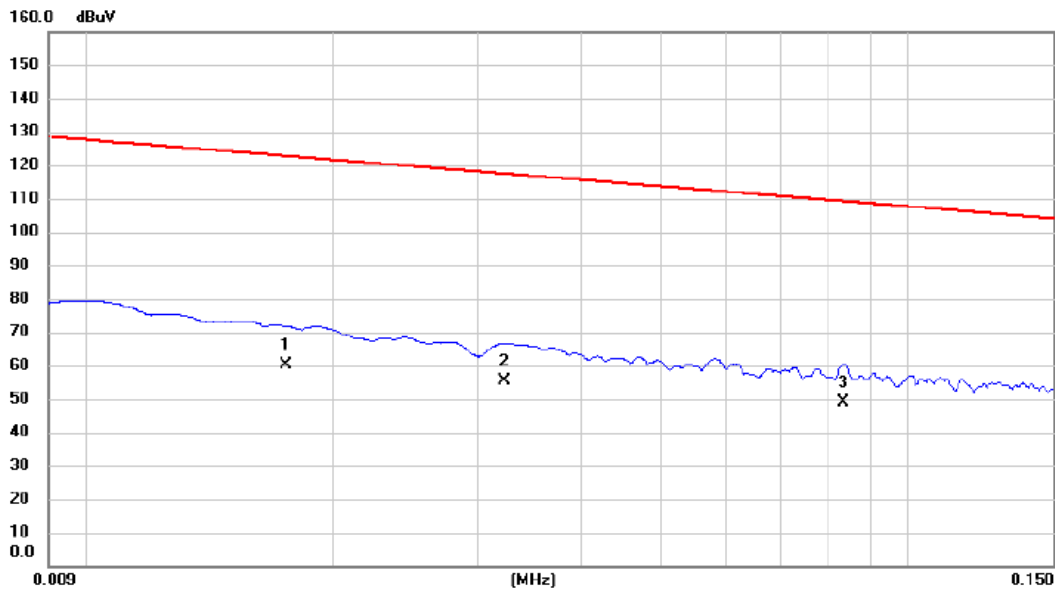

No.	Mk.	Freq. MHz	Reading Level dBuV	Correct Factor dB	Measure- ment dBuV	Limit dBuV	Margin dB	Detector	Antenna Height cm	Table Degree	Comment
1		0.0175	45.26	15.08	60.34	122.74	-62.40	AVG			
2		0.0323	41.35	14.01	55.36	117.42	-62.06	AVG			
3	*	0.0834	35.28	13.64	48.92	109.18	-60.26	AVG			

REMARKS:

- (1) Measurement Value = Reading Level + Correct Factor.
- (2) Margin Level = Measurement Value - Limit Value.

Test Mode	TX B Mode Channel 11	Polarization	Ant 0°
-----------	----------------------	--------------	--------

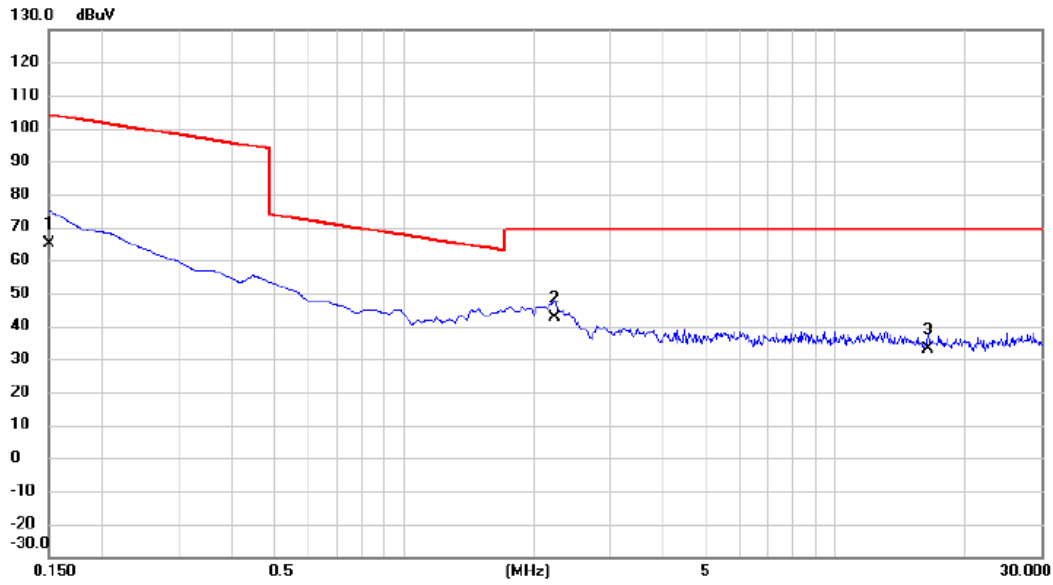

No.	Mk.	Freq. MHz	Reading Level dBuV	Correct Factor dB	Measure- ment dBuV	Limit dBuV	Margin dB	Detector	Antenna Height cm	Table Degree	Comment
1		0.1500	51.23	13.83	65.06	104.09	-39.03	AVG			
2	*	2.2395	30.26	12.39	42.65	69.54	-26.89	QP			
3		16.4481	20.45	12.44	32.89	69.54	-36.65	QP			

REMARKS:

- (1) Measurement Value = Reading Level + Correct Factor.
- (2) Margin Level = Measurement Value - Limit Value.

Test Mode	TX B Mode Channel 11	Polarization	Ant 90°
-----------	----------------------	--------------	---------

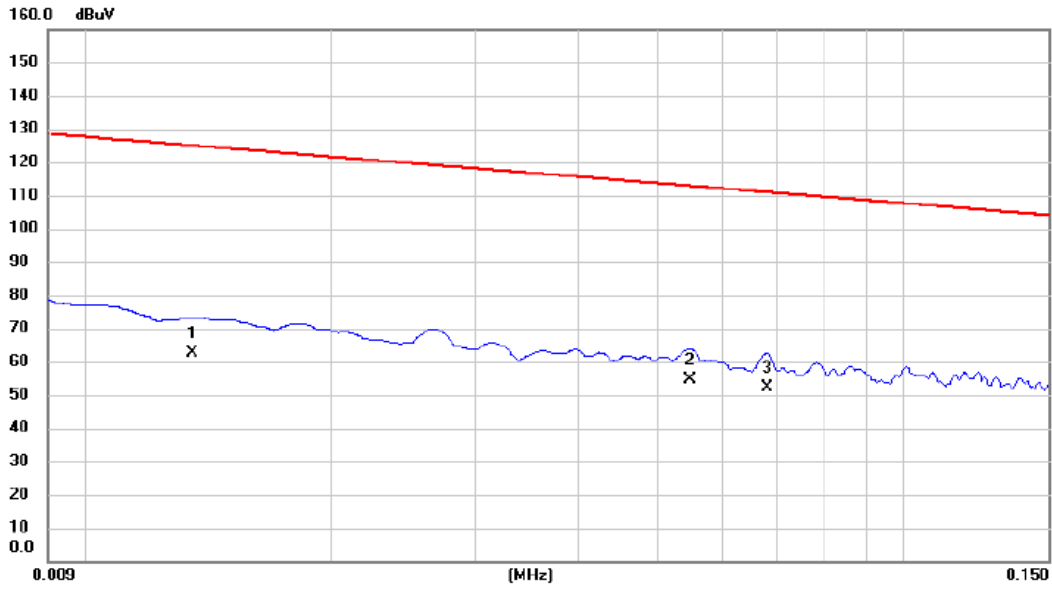

No.	Mk.	Freq. MHz	Reading Level dBuV	Correct Factor dB	Measure- ment dBuV	Limit dBuV	Margin dB	Detector	Antenna Height cm	Table Degree	Comment
1		0.0135	46.29	16.33	62.62	125.00	-62.38	AVG			
2	*	0.0548	40.92	13.60	54.52	112.83	-58.31	AVG			
3		0.0680	38.57	13.61	52.18	110.95	-58.77	AVG			

REMARKS:

(1) Measurement Value = Reading Level + Correct Factor.

(2) Margin Level = Measurement Value - Limit Value.

Test Mode	TX B Mode Channel 11	Polarization	Ant 90°
-----------	----------------------	--------------	---------

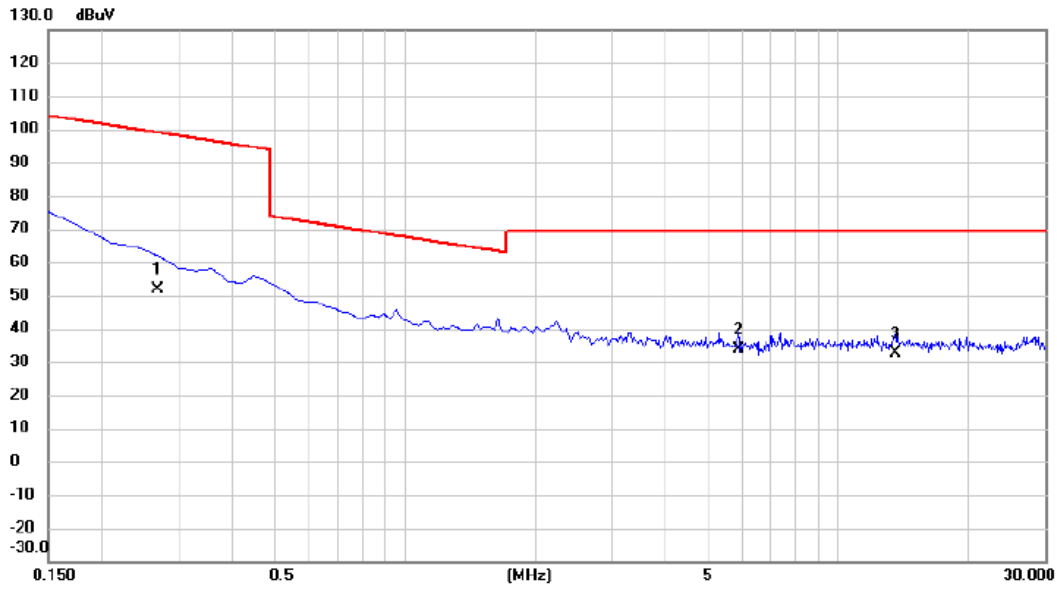

No.	Mk.	Freq. MHz	Reading Level dBuV	Correct Factor dB	Measure- ment dBuV	Limit dBuV	Margin dB	Detector	Antenna Height cm	Table Degree	Comment
1		0.2694	37.96	13.85	51.81	99.00	-47.19	AVG			
2	*	5.8812	21.43	12.34	33.77	69.54	-35.77	QP			
3		13.5526	20.55	12.22	32.77	69.54	-36.77	QP			

REMARKS:

- (1) Measurement Value = Reading Level + Correct Factor.
- (2) Margin Level = Measurement Value - Limit Value.

APPENDIX C - RADIATED EMISSION - 30 MHZ TO 1000 MHZ

Test Mode	TX B Mode Channel 11	Polarization	Vertical
-----------	----------------------	--------------	----------

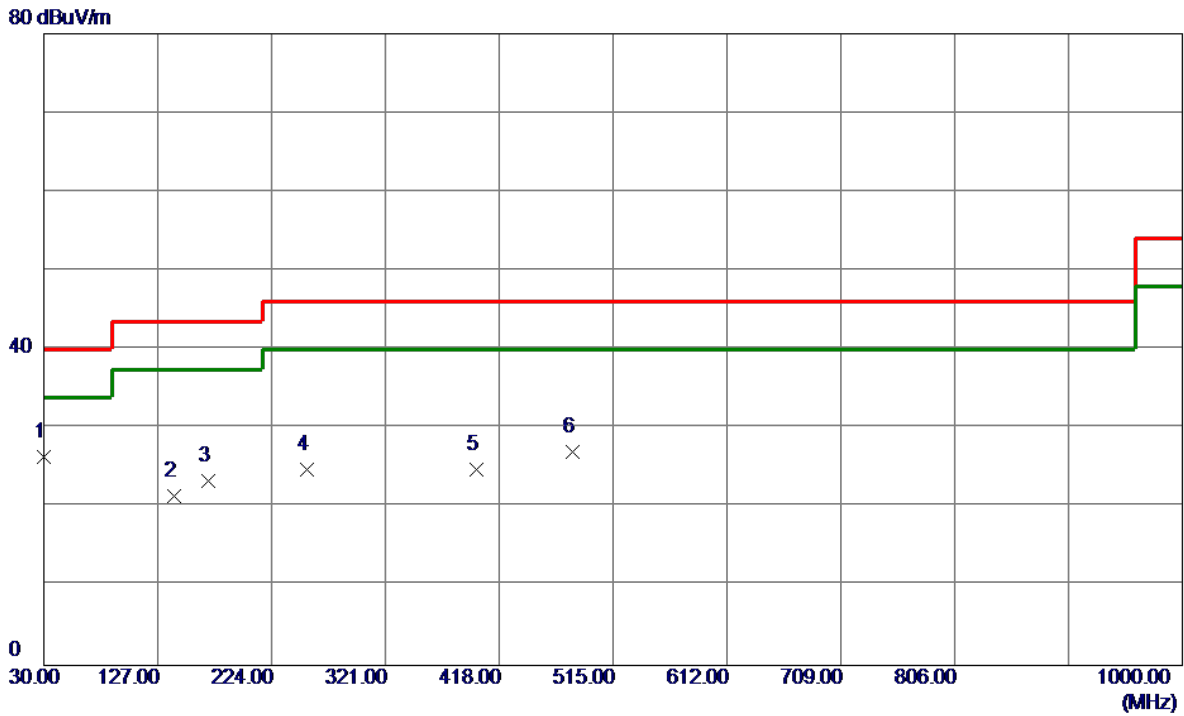

No.	Freq. MHz	Reading Level dBuV/m	Correct Factor dB	Measure ment dBuV/m	Limit dBuV/m	Margin dB	Detector	Comment
1 *	30.0000	42.40	-16.07	26.33	40.00	-13.67	Peak	
2	140.5800	34.40	-13.02	21.38	43.50	-22.12	Peak	
3	169.6799	36.33	-12.99	23.34	43.50	-20.16	Peak	
4	254.0700	37.85	-13.07	24.78	46.00	-21.22	Peak	
5	398.6000	33.81	-8.99	24.82	46.00	-21.18	Peak	
6	480.0800	34.10	-7.12	26.98	46.00	-19.02	Peak	

REMARKS:

- (1) Measurement Value = Reading Level + Correct Factor.
- (2) Margin Level = Measurement Value - Limit Value.

Test Mode	TX B Mode Channel 11	Polarization	Horizontal
-----------	----------------------	--------------	------------

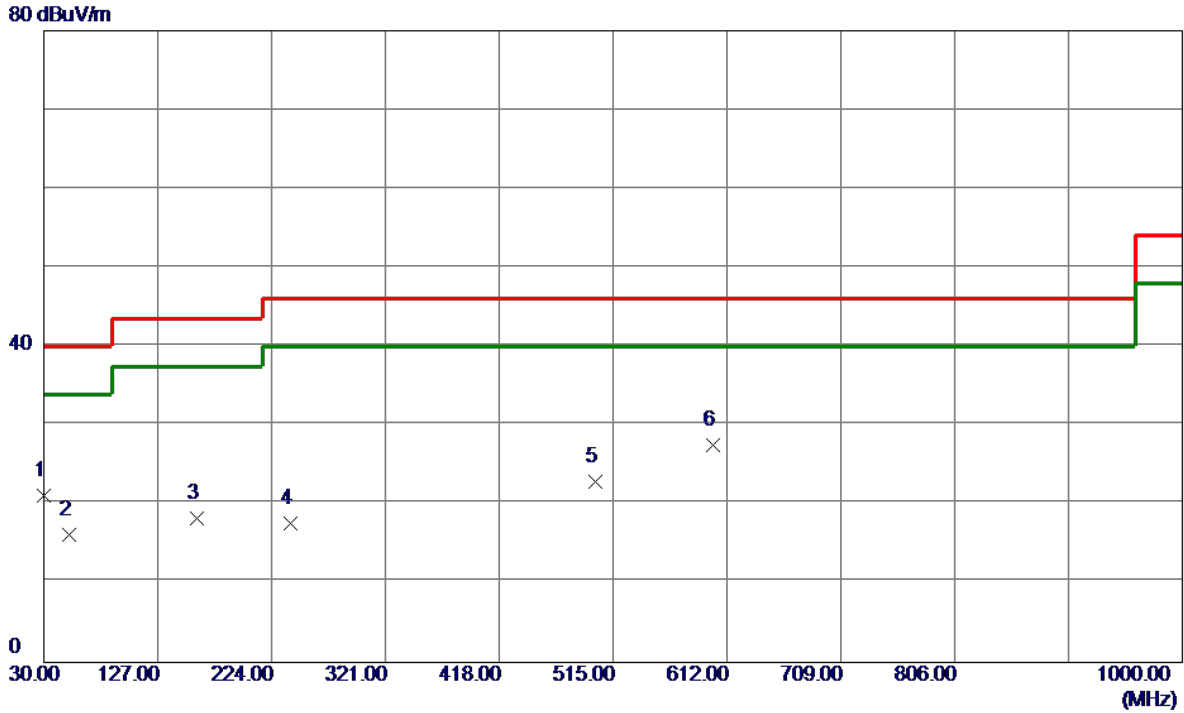

No.	Freq. MHz	Reading Level dBuV/m	Correct Factor dB	Measure ment dBuV/m	Limit dBuV/m	Margin dB	Detector	Comment
1	30.0000	37.12	-16.07	21.05	40.00	-18.95	Peak	
2	51.3400	30.47	-14.26	16.21	40.00	-23.79	Peak	
3	159.9800	31.03	-12.72	18.31	43.50	-25.19	Peak	
4	240.4900	31.06	-13.52	17.54	46.00	-28.46	Peak	
5	499.4800	29.70	-6.88	22.82	46.00	-23.18	Peak	
6 *	600.3600	32.31	-4.78	27.53	46.00	-18.47	Peak	

REMARKS:

- (1) Measurement Value = Reading Level + Correct Factor.
- (2) Margin Level = Measurement Value - Limit Value.

APPENDIX D - RADIATED EMISSION- ABOVE 1000 MHZ

Test Mode	TX B Mode 2412 MHz	Polarization	Vertical
-----------	--------------------	--------------	----------



No.	Freq. MHz	Reading Level dBuV/m	Correct Factor dB	Measure ment dBuV/m	Limit dBuV/m	Margin dB	Detector	Comment
1	4823.8600	45.39	4.56	49.95	74.00	-24.05	Peak	
2 *	4824.0000	41.48	4.56	46.04	54.00	-7.96	AVG	

REMARKS:

- (1) Measurement Value = Reading Level + Correct Factor.
- (2) Margin Level = Measurement Value - Limit Value.

Test Mode	TX B Mode 2412 MHz	Polarization	Horizontal
-----------	--------------------	--------------	------------

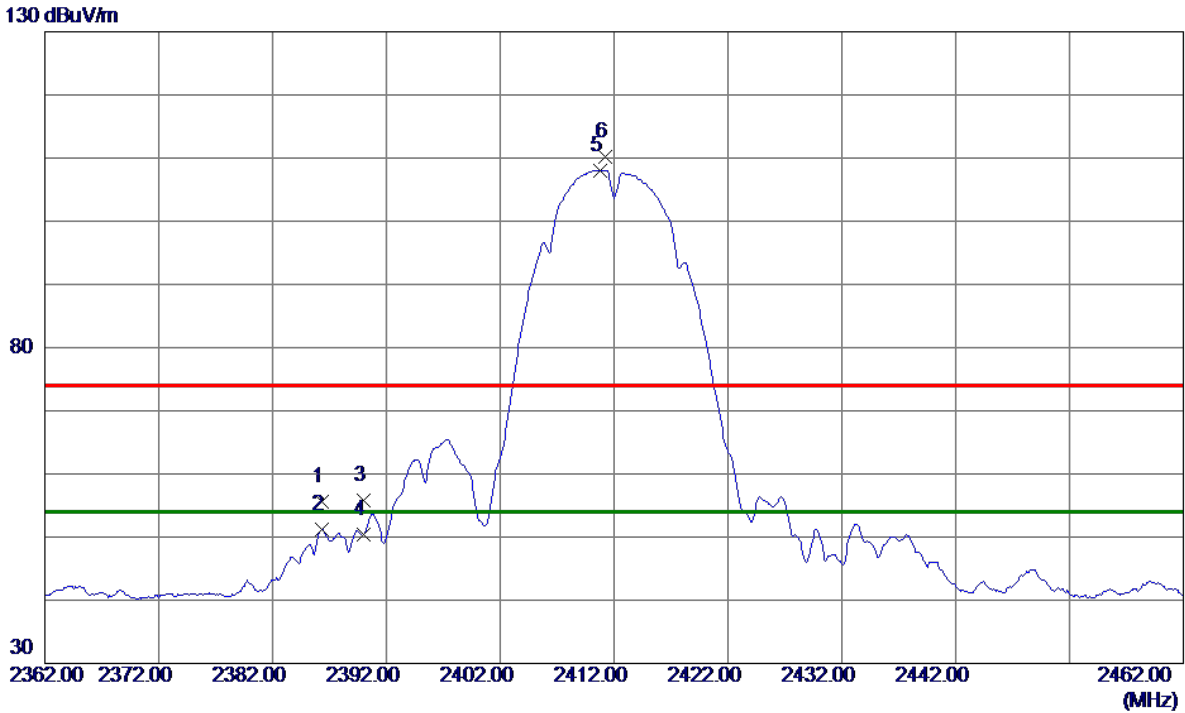

No.	Freq. MHz	Reading Level dBuV/m	Correct Factor dB	Measure ment dBuV/m	Limit dBuV/m	Margin dB	Detector	Comment
1	2386.3000	47.58	7.97	55.55	74.00	-18.45	Peak	
2	2386.3000	43.30	7.97	51.27	54.00	-2.73	AVG	
3	2390.0000	47.81	7.98	55.79	74.00	-18.21	Peak	
4	2390.0000	42.44	7.98	50.42	54.00	-3.58	AVG	
5 *	2410.8000	100.08	8.01	108.09	54.00	54.09	AVG	No Limit
6	2411.2000	102.26	8.01	110.27	74.00	36.27	Peak	No Limit

REMARKS:

- (1) Measurement Value = Reading Level + Correct Factor.
- (2) Margin Level = Measurement Value - Limit Value.

Test Mode	TX B Mode 2417 MHz	Polarization	Vertical
-----------	--------------------	--------------	----------

80 dBuV/m

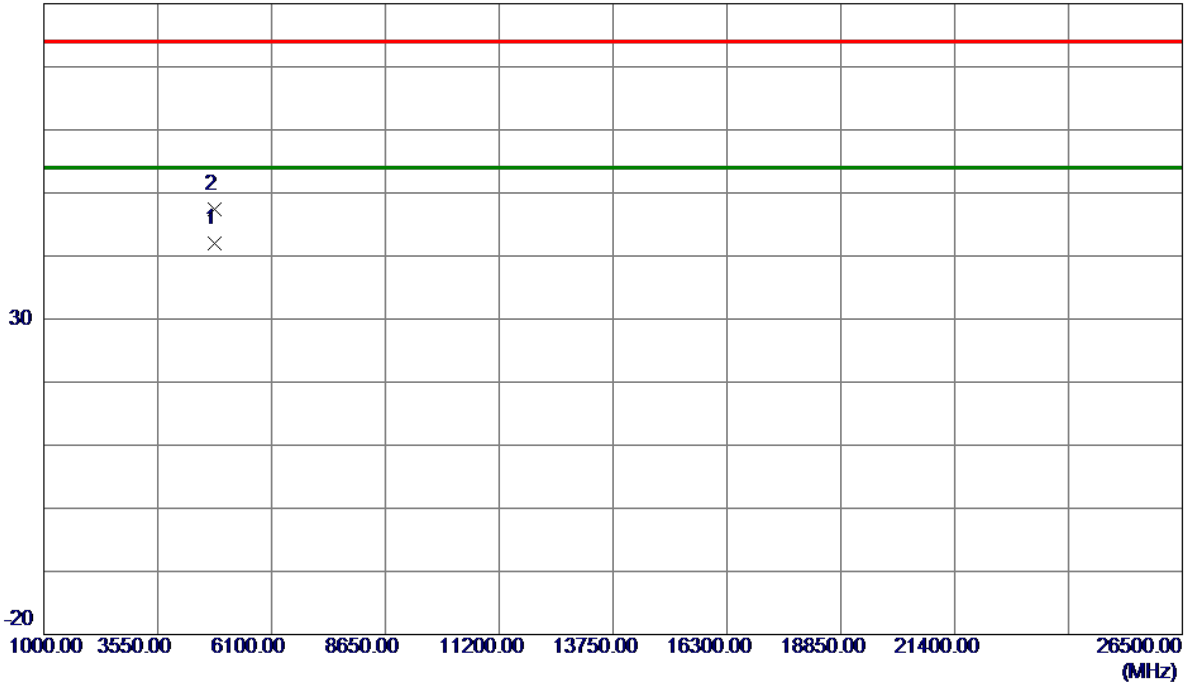

No.	Freq. MHz	Reading Level dBuV/m	Correct Factor dB	Measure ment dBuV/m	Limit dBuV/m	Margin dB	Detector	Comment
1 *	4833.9300	37.42	4.60	42.02	54.00	-11.98	AVG	
2	4834.0800	42.80	4.60	47.40	74.00	-26.60	Peak	

REMARKS:

- (1) Measurement Value = Reading Level + Correct Factor.
- (2) Margin Level = Measurement Value - Limit Value.

Test Mode	TX B Mode 2417 MHz	Polarization	Horizontal
-----------	--------------------	--------------	------------

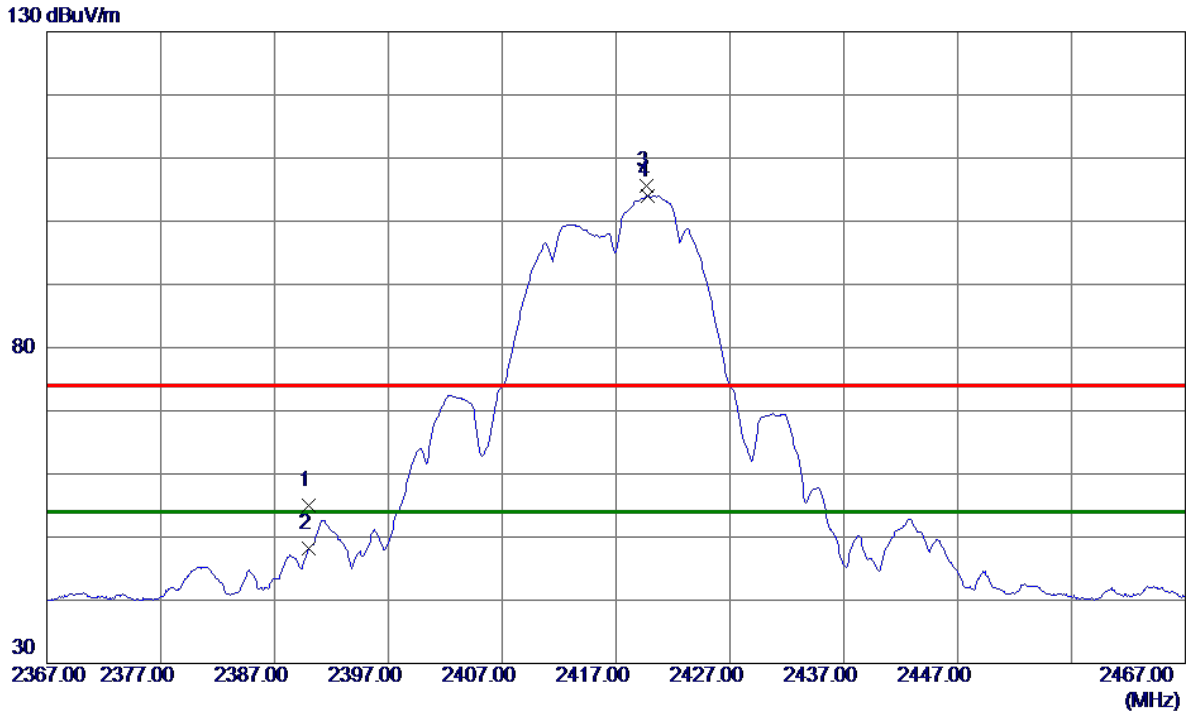

No.	Freq. MHz	Reading Level dBuV/m	Correct Factor dB	Measure ment dBuV/m	Limit dBuV/m	Margin dB	Detector	Comment
1	2390.0000	47.01	7.98	54.99	74.00	-19.01	Peak	
2	2390.0000	40.23	7.98	48.21	54.00	-5.79	AVG	
3	2419.7000	97.64	8.03	105.67	74.00	31.67	Peak	No Limit
4 *	2419.8000	95.97	8.03	104.00	54.00	50.00	AVG	No Limit

REMARKS:

- (1) Measurement Value = Reading Level + Correct Factor.
- (2) Margin Level = Measurement Value - Limit Value.

Test Mode	TX B Mode 2437 MHz	Polarization	Vertical
-----------	--------------------	--------------	----------

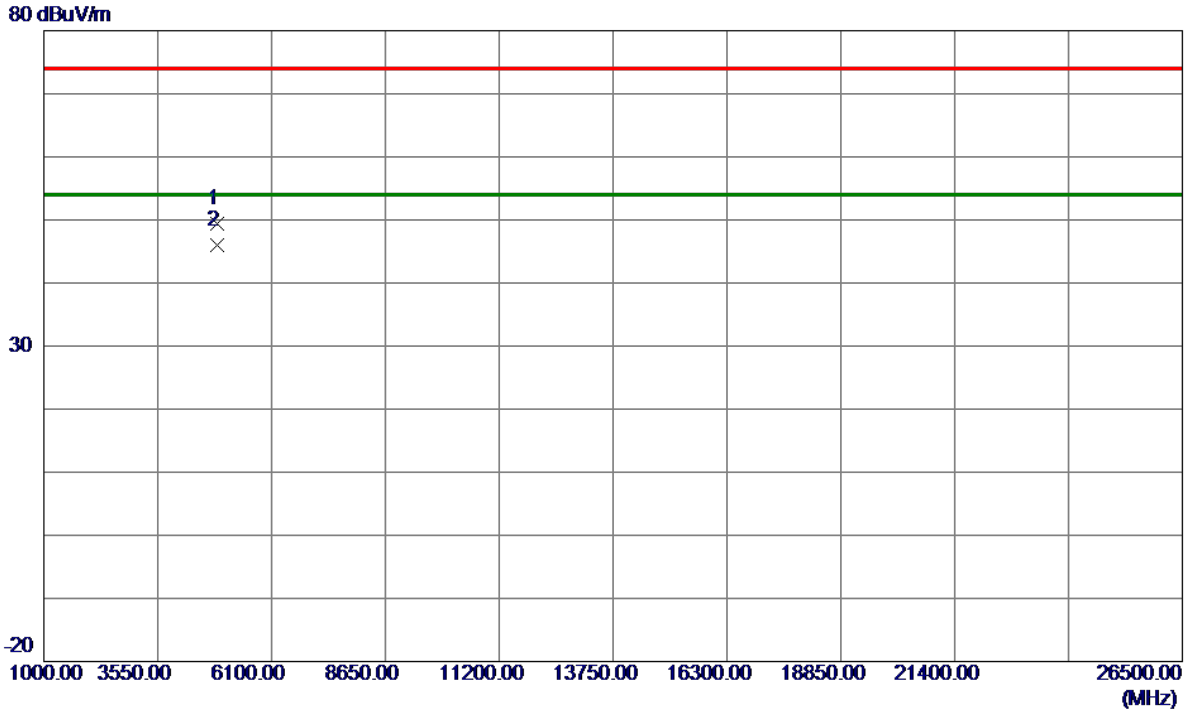

No.	Freq. MHz	Reading Level dBuV/m	Correct Factor dB	Measure ment dBuV/m	Limit dBuV/m	Margin dB	Detector	Comment
1	4873.9100	44.61	4.77	49.38	74.00	-24.62	Peak	
2 *	4874.0150	41.28	4.77	46.05	54.00	-7.95	AVG	

REMARKS:

- (1) Measurement Value = Reading Level + Correct Factor.
- (2) Margin Level = Measurement Value - Limit Value.

Test Mode	TX B Mode 2437 MHz	Polarization	Horizontal
-----------	--------------------	--------------	------------

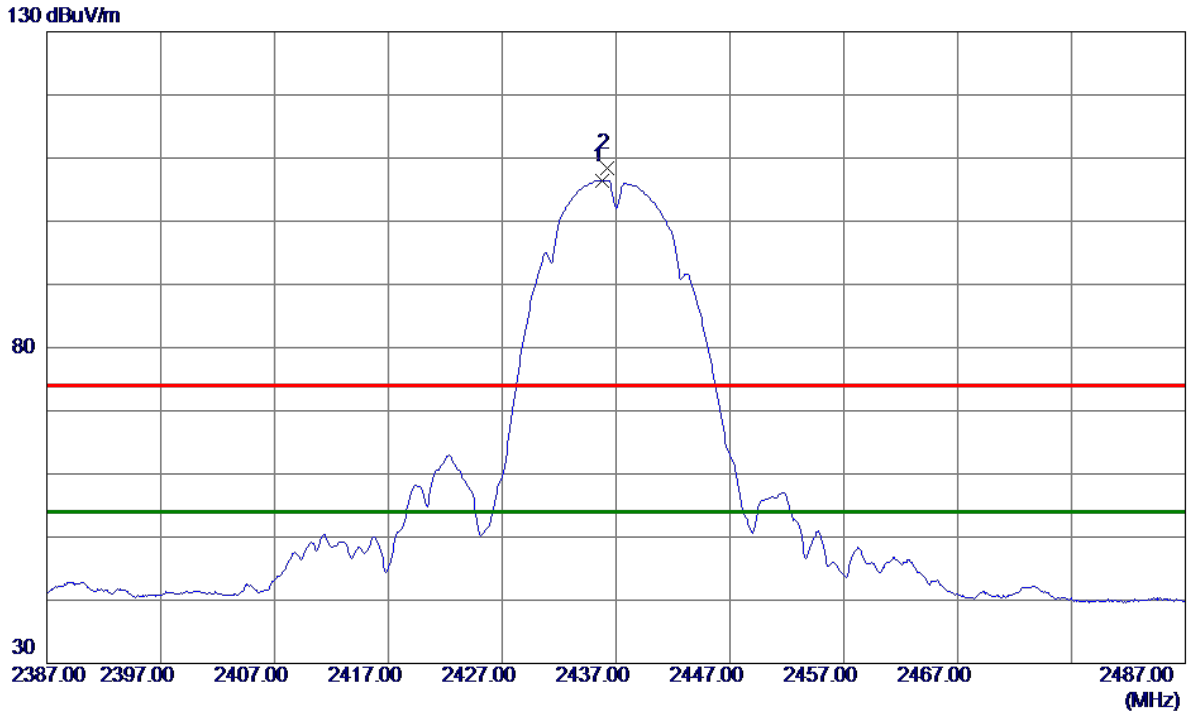

No.	Freq. MHz	Reading Level dBuV/m	Correct Factor dB	Measure ment dBuV/m	Limit dBuV/m	Margin dB	Detector	Comment
1 *	2435.8000	98.43	8.06	106.49	54.00	52.49	AVG	No Limit
2	2436.2000	100.33	8.06	108.39	74.00	34.39	Peak	No Limit

REMARKS:

- (1) Measurement Value = Reading Level + Correct Factor.
- (2) Margin Level = Measurement Value - Limit Value.

Test Mode	TX B Mode 2457 MHz	Polarization	Vertical
-----------	--------------------	--------------	----------

80 dBuV/m

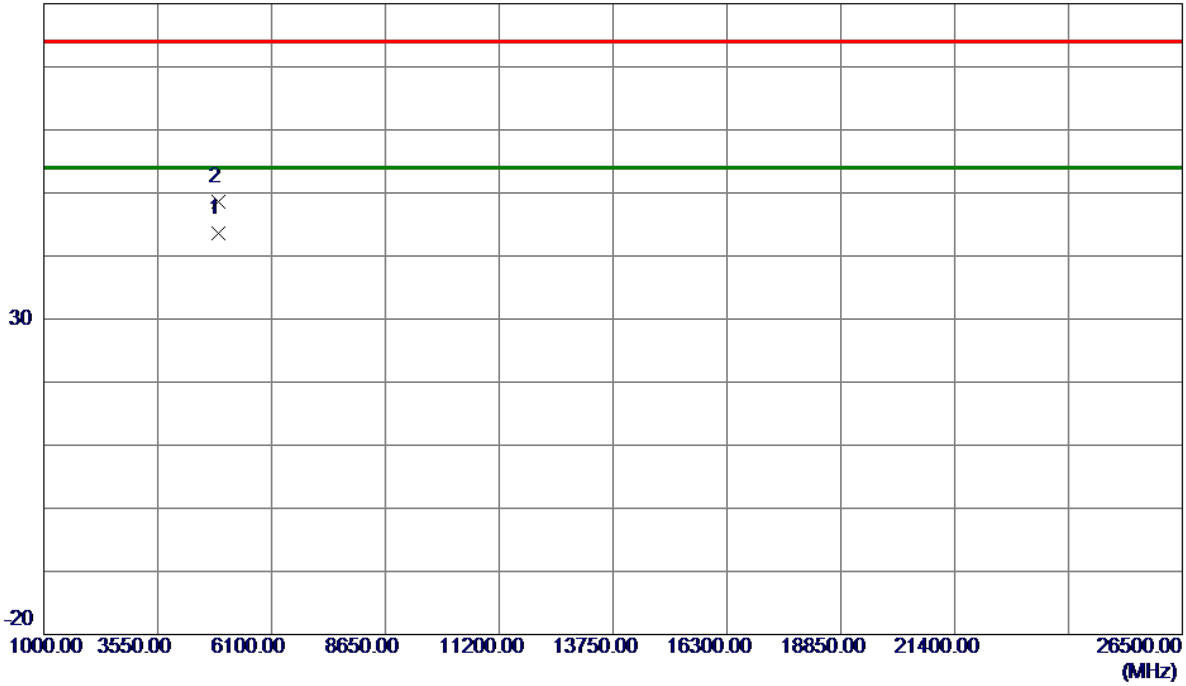

No.	Freq. MHz	Reading Level dBuV/m	Correct Factor dB	Measure ment dBuV/m	Limit dBuV/m	Margin dB	Detector	Comment
1 *	4914.0150	38.66	4.93	43.59	54.00	-10.41	AVG	
2	4914.0600	43.58	4.94	48.52	74.00	-25.48	Peak	

REMARKS:

- (1) Measurement Value = Reading Level + Correct Factor.
- (2) Margin Level = Measurement Value - Limit Value.

Test Mode	TX B Mode 2457 MHz	Polarization	Horizontal
-----------	--------------------	--------------	------------

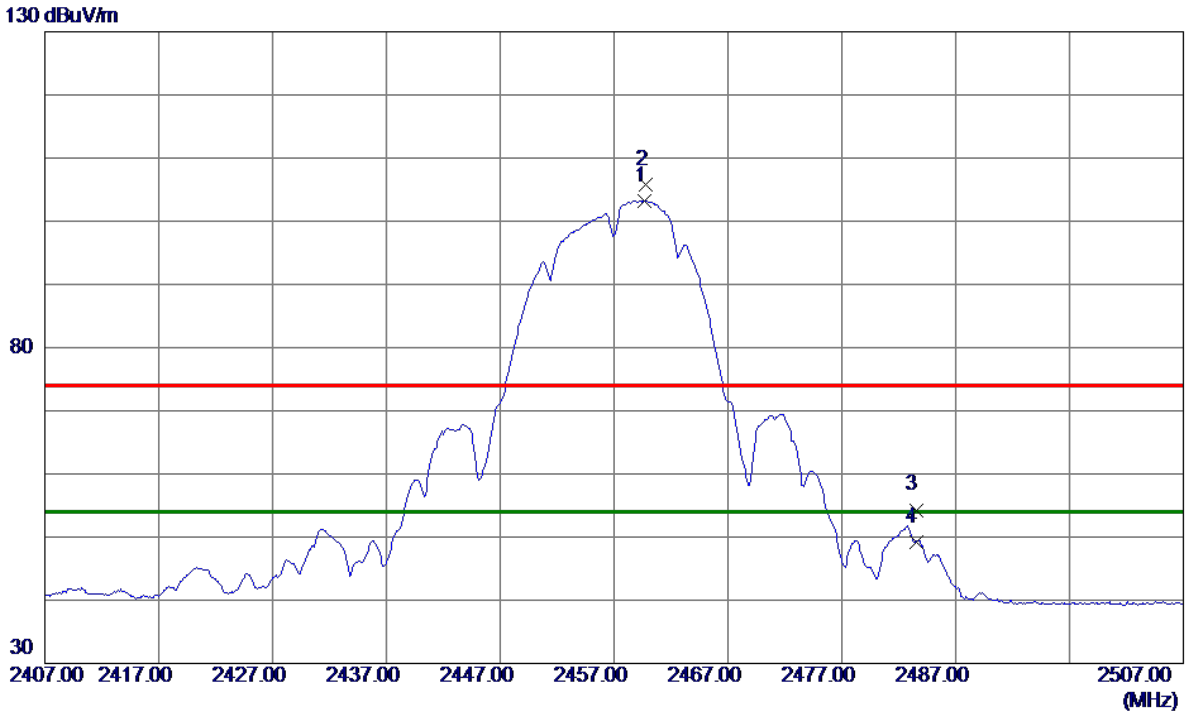

No.	Freq. MHz	Reading Level dBuV/m	Correct Factor dB	Measure ment dBuV/m	Limit dBuV/m	Margin dB	Detector	Comment
1 *	2459.7000	95.19	8.10	103.29	54.00	49.29	AVG	No Limit
2	2459.8000	97.64	8.10	105.74	74.00	31.74	Peak	No Limit
3	2483.5000	46.16	8.14	54.30	74.00	-19.70	Peak	
4	2483.5000	41.02	8.14	49.16	54.00	-4.84	AVG	

REMARKS:

- (1) Measurement Value = Reading Level + Correct Factor.
- (2) Margin Level = Measurement Value - Limit Value.

Test Mode	TX B Mode 2462 MHz	Polarization	Vertical
-----------	--------------------	--------------	----------

80 dBuV/m

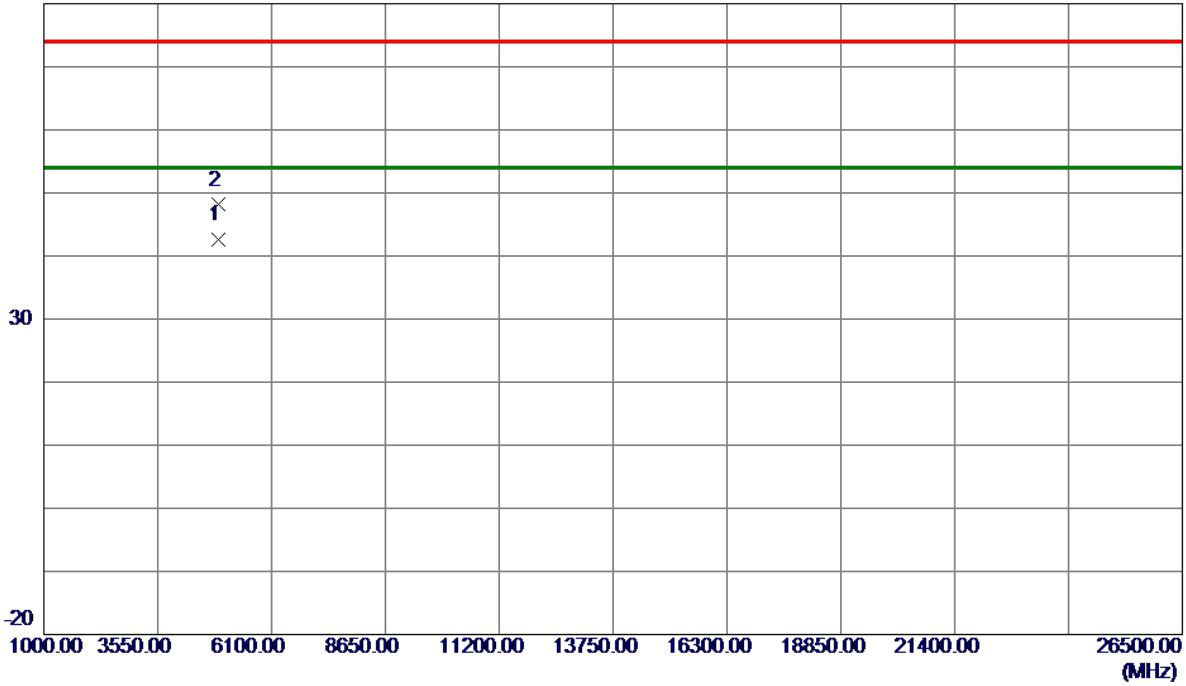

No.	Freq. MHz	Reading Level dBuV/m	Correct Factor dB	Measure ment dBuV/m	Limit dBuV/m	Margin dB	Detector	Comment
1 *	4923.9550	37.66	4.98	42.64	54.00	-11.36	AVG	
2	4923.9850	43.12	4.98	48.10	74.00	-25.90	Peak	

REMARKS:

- (1) Measurement Value = Reading Level + Correct Factor.
- (2) Margin Level = Measurement Value - Limit Value.

Test Mode	TX B Mode 2462 MHz	Polarization	Horizontal
-----------	--------------------	--------------	------------

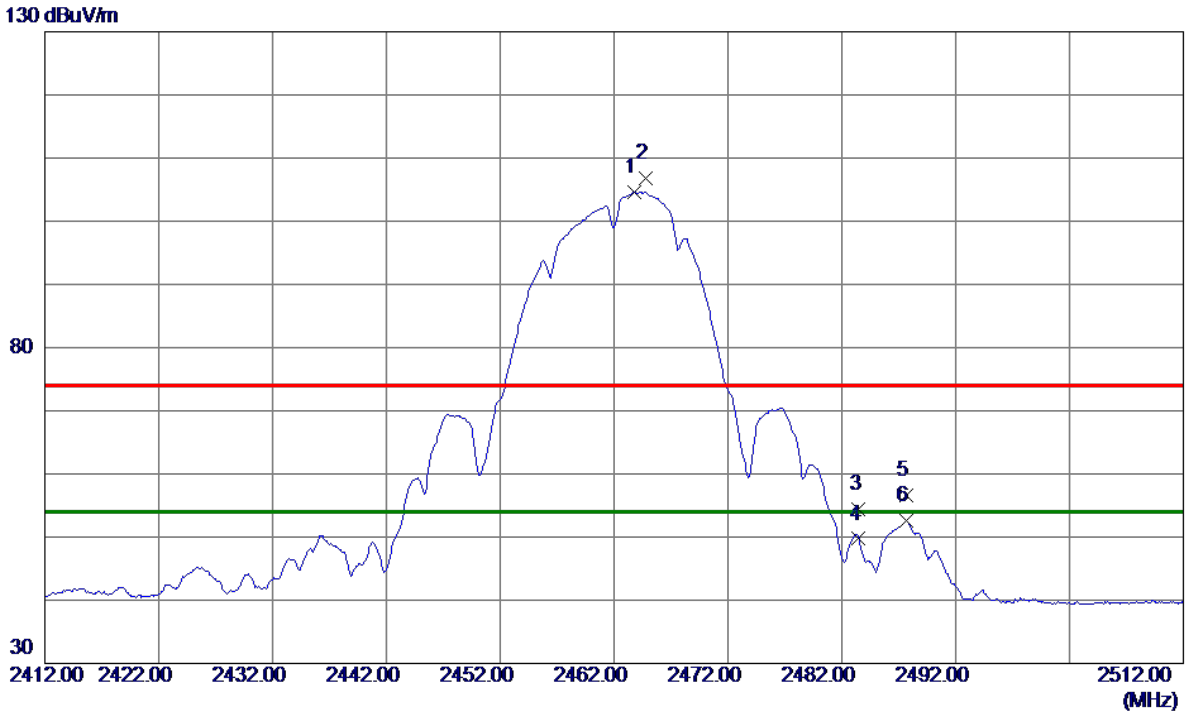

No.	Freq. MHz	Reading Level dBuV/m	Correct Factor dB	Measure ment dBuV/m	Limit dBuV/m	Margin dB	Detector	Comment
1 *	2463.8000	96.57	8.10	104.67	54.00	50.67	AVG	No Limit
2	2464.8000	98.71	8.10	106.81	74.00	32.81	Peak	No Limit
3	2483.5000	46.27	8.14	54.41	74.00	-19.59	Peak	
4	2483.5000	41.56	8.14	49.70	54.00	-4.30	AVG	
5	2487.7000	48.47	8.14	56.61	74.00	-17.39	Peak	
6	2487.7000	44.38	8.14	52.52	54.00	-1.48	AVG	

REMARKS:

- (1) Measurement Value = Reading Level + Correct Factor.
- (2) Margin Level = Measurement Value - Limit Value.

Test Mode	TX G Mode 2412 MHz	Polarization	Vertical
-----------	--------------------	--------------	----------

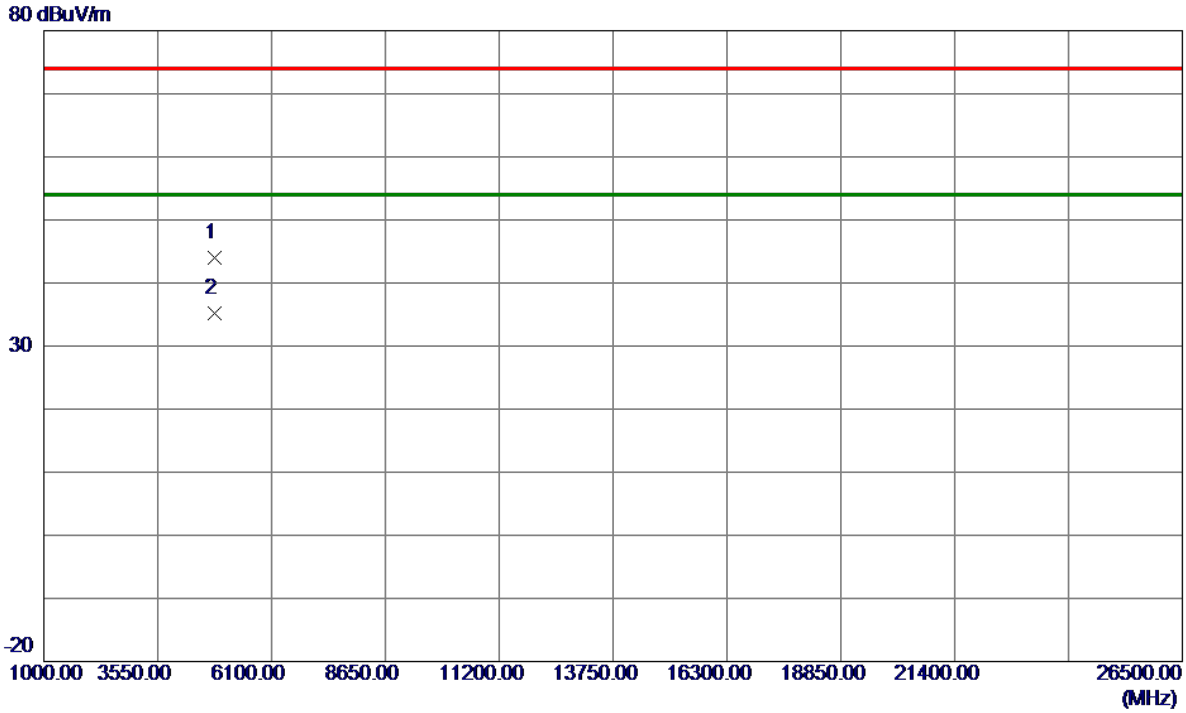

No.	Freq. MHz	Reading Level dBuV/m	Correct Factor dB	Measure ment dBuV/m	Limit dBuV/m	Margin dB	Detector	Comment
1	4824.0000	39.53	4.56	44.09	74.00	-29.91	Peak	
2 *	4824.0000	30.64	4.56	35.20	54.00	-18.80	AVG	

REMARKS:

- (1) Measurement Value = Reading Level + Correct Factor.
- (2) Margin Level = Measurement Value - Limit Value.

Test Mode	TX G Mode 2412 MHz	Polarization	Horizontal
-----------	--------------------	--------------	------------

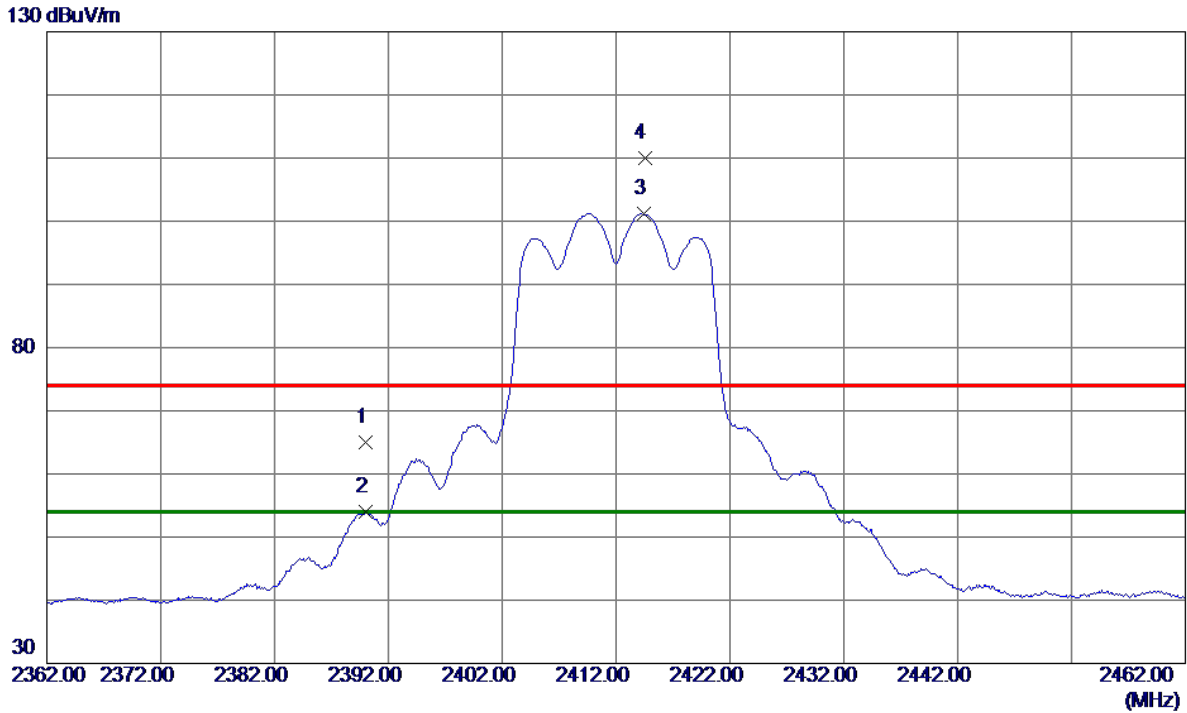

No.	Freq. MHz	Reading Level dBuV/m	Correct Factor dB	Measure ment dBuV/m	Limit dBuV/m	Margin dB	Detector	Comment
1	2390.0000	57.10	7.98	65.08	74.00	-8.92	Peak	
2	2390.0000	45.95	7.98	53.93	54.00	-0.07	AVG	
3 *	2414.4000	93.24	8.02	101.26	54.00	47.26	AVG	No Limit
4	2414.5000	101.93	8.02	109.95	74.00	35.95	Peak	No Limit

REMARKS:

- (1) Measurement Value = Reading Level + Correct Factor.
- (2) Margin Level = Measurement Value - Limit Value.

Test Mode	TX G Mode 2417 MHz	Polarization	Vertical
-----------	--------------------	--------------	----------

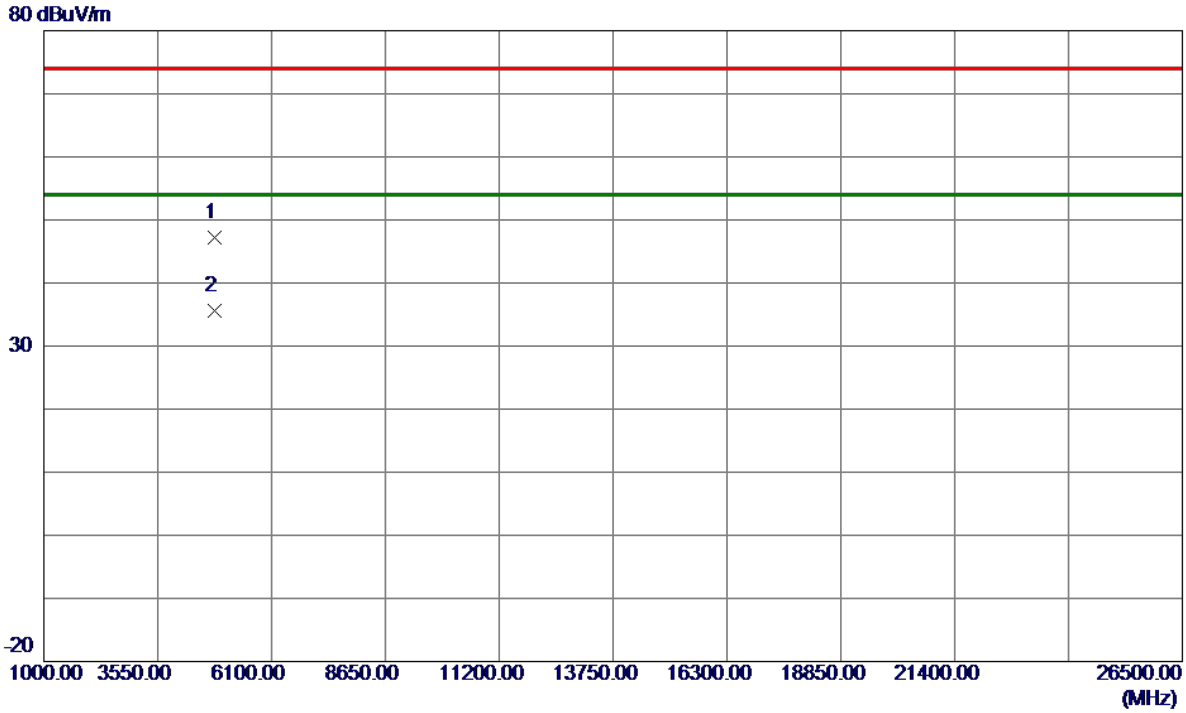

No.	Freq. MHz	Reading Level dBuV/m	Correct Factor dB	Measure ment dBuV/m	Limit dBuV/m	Margin dB	Detector	Comment
1	4833.4750	42.52	4.60	47.12	74.00	-26.88	Peak	
2 *	4833.9400	31.01	4.60	35.61	54.00	-18.39	AVG	

REMARKS:

- (1) Measurement Value = Reading Level + Correct Factor.
- (2) Margin Level = Measurement Value - Limit Value.

Test Mode	TX G Mode 2417 MHz	Polarization	Horizontal
-----------	--------------------	--------------	------------

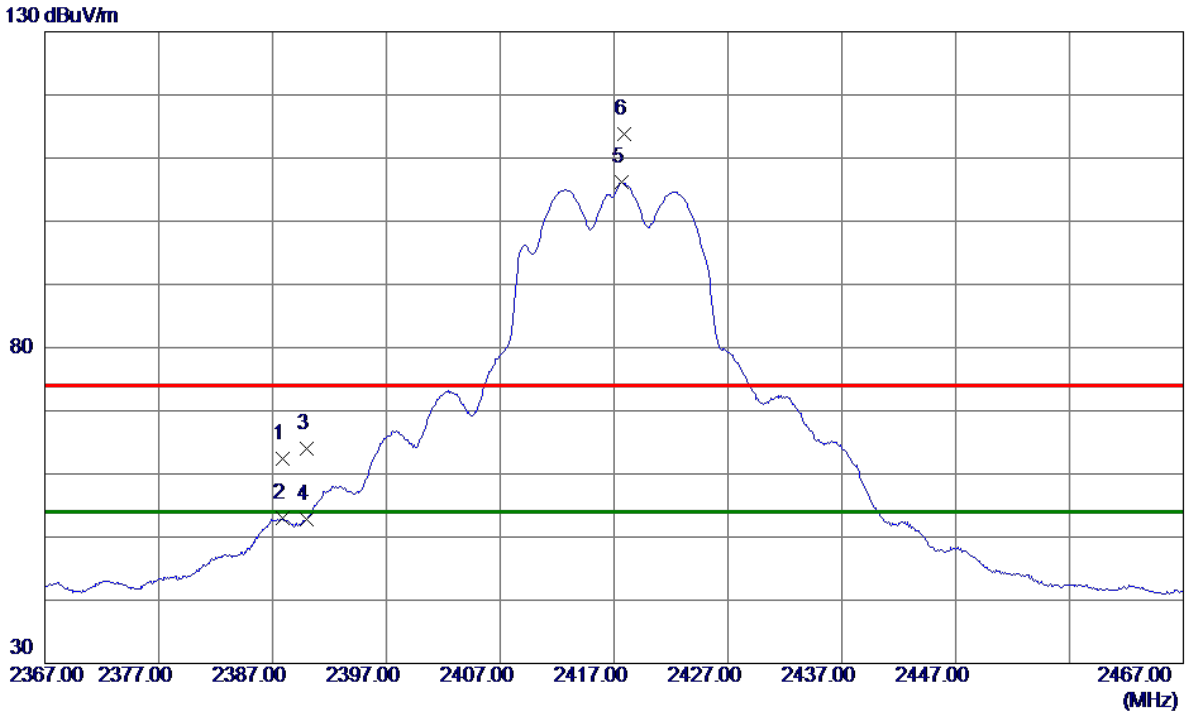

No.	Freq. MHz	Reading Level dBuV/m	Correct Factor dB	Measure ment dBuV/m	Limit dBuV/m	Margin dB	Detector	Comment
1	2387.9000	54.46	7.97	62.43	74.00	-11.57	Peak	
2	2387.9000	45.12	7.97	53.09	54.00	-0.91	AVG	
3	2390.0000	56.00	7.98	63.98	74.00	-10.02	Peak	
4	2390.0000	44.91	7.98	52.89	54.00	-1.11	AVG	
5 *	2417.7000	98.24	8.02	106.26	54.00	52.26	AVG	No Limit
6	2417.9000	105.80	8.02	113.82	74.00	39.82	Peak	No Limit

REMARKS:

- (1) Measurement Value = Reading Level + Correct Factor.
- (2) Margin Level = Measurement Value - Limit Value.

Test Mode	TX G Mode 2437 MHz	Polarization	Vertical
-----------	--------------------	--------------	----------

80 dBuV/m

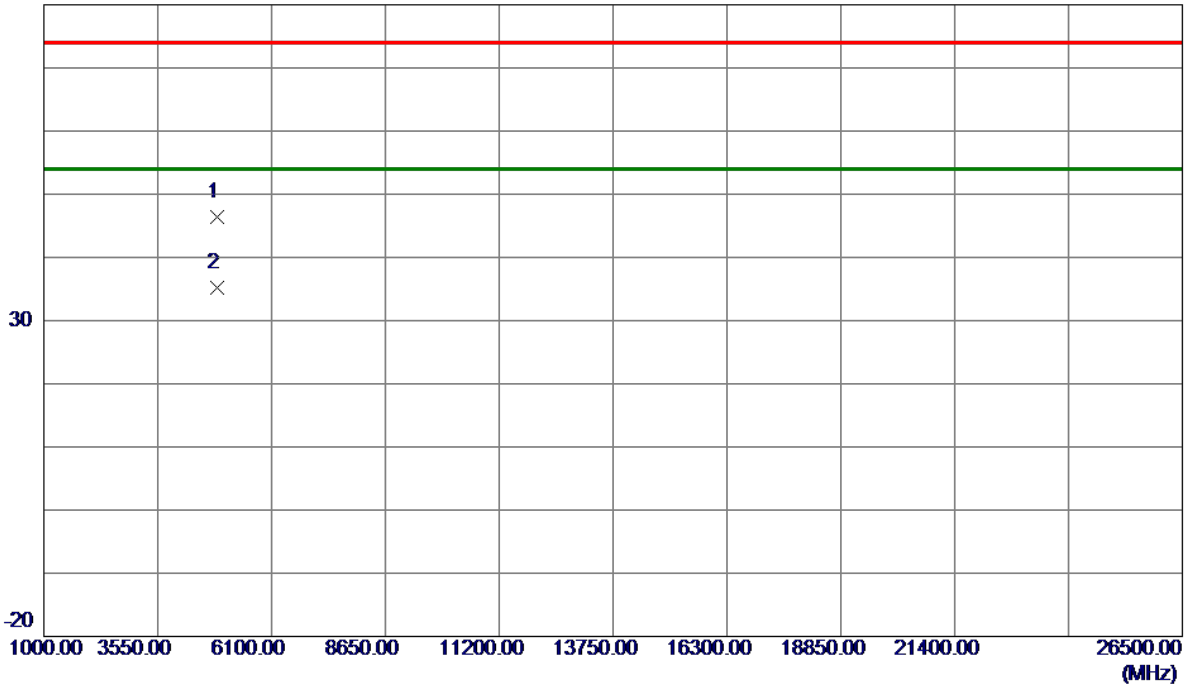

No.	Freq. MHz	Reading Level dBuV/m	Correct Factor dB	Measure ment dBuV/m	Limit dBuV/m	Margin dB	Detector	Comment
1	4873.4150	41.70	4.77	46.47	74.00	-27.53	Peak	
2 *	4874.3300	30.39	4.77	35.16	54.00	-18.84	AVG	

REMARKS:

- (1) Measurement Value = Reading Level + Correct Factor.
- (2) Margin Level = Measurement Value - Limit Value.

Test Mode	TX G Mode 2437 MHz	Polarization	Horizontal
-----------	--------------------	--------------	------------

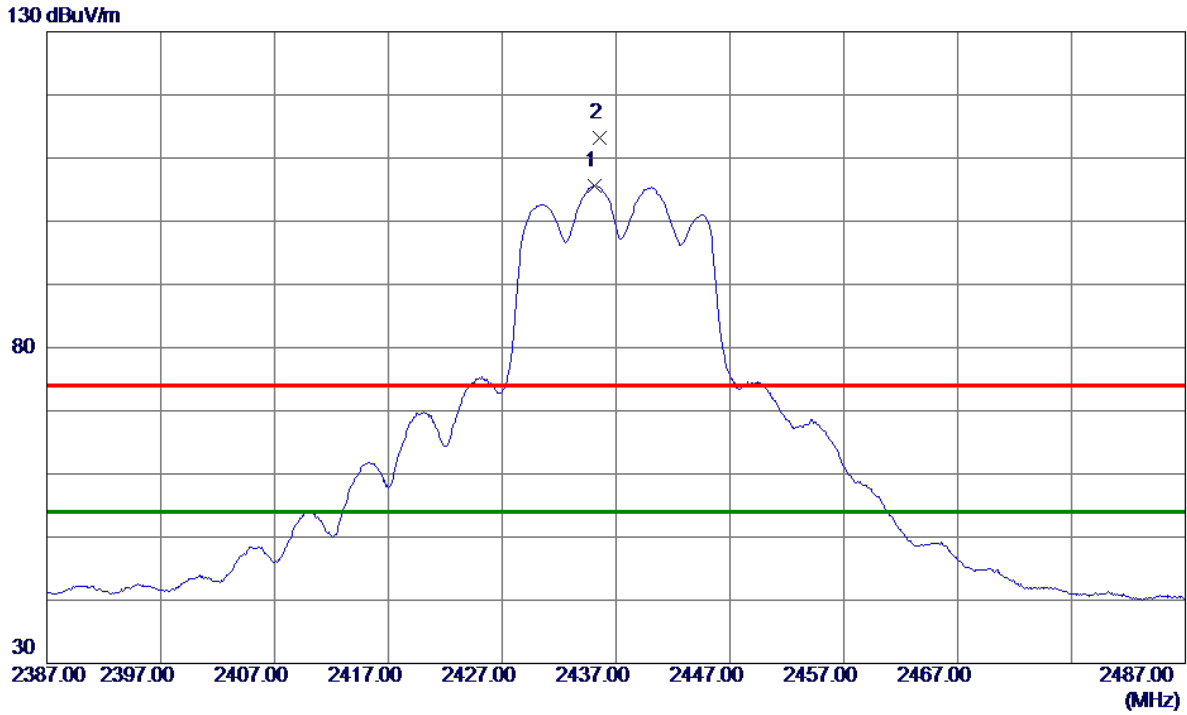

No.	Freq. MHz	Reading Level dBuV/m	Correct Factor dB	Measure ment dBuV/m	Limit dBuV/m	Margin dB	Detector	Comment
1 *	2435.1000	97.54	8.05	105.59	54.00	51.59	AVG	No Limit
2	2435.6000	105.17	8.05	113.22	74.00	39.22	Peak	No Limit

REMARKS:

- (1) Measurement Value = Reading Level + Correct Factor.
- (2) Margin Level = Measurement Value - Limit Value.

Test Mode	TX G Mode 2457 MHz	Polarization	Vertical
-----------	--------------------	--------------	----------

80 dBuV/m

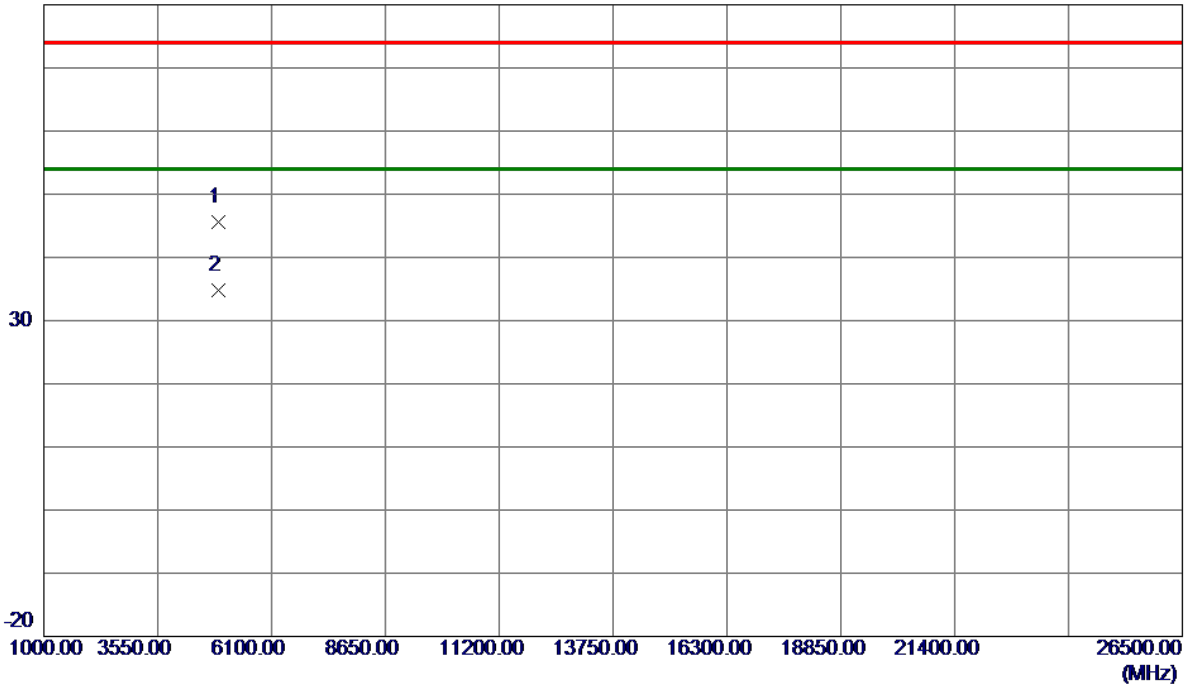

No.	Freq. MHz	Reading Level dBuV/m	Correct Factor dB	Measure ment dBuV/m	Limit dBuV/m	Margin dB	Detector	Comment
1	4914.0550	40.59	4.94	45.53	74.00	-28.47	Peak	
2 *	4914.2599	29.91	4.94	34.85	54.00	-19.15	AVG	

REMARKS:

- (1) Measurement Value = Reading Level + Correct Factor.
- (2) Margin Level = Measurement Value - Limit Value.

Test Mode	TX G Mode 2457 MHz	Polarization	Horizontal
-----------	--------------------	--------------	------------

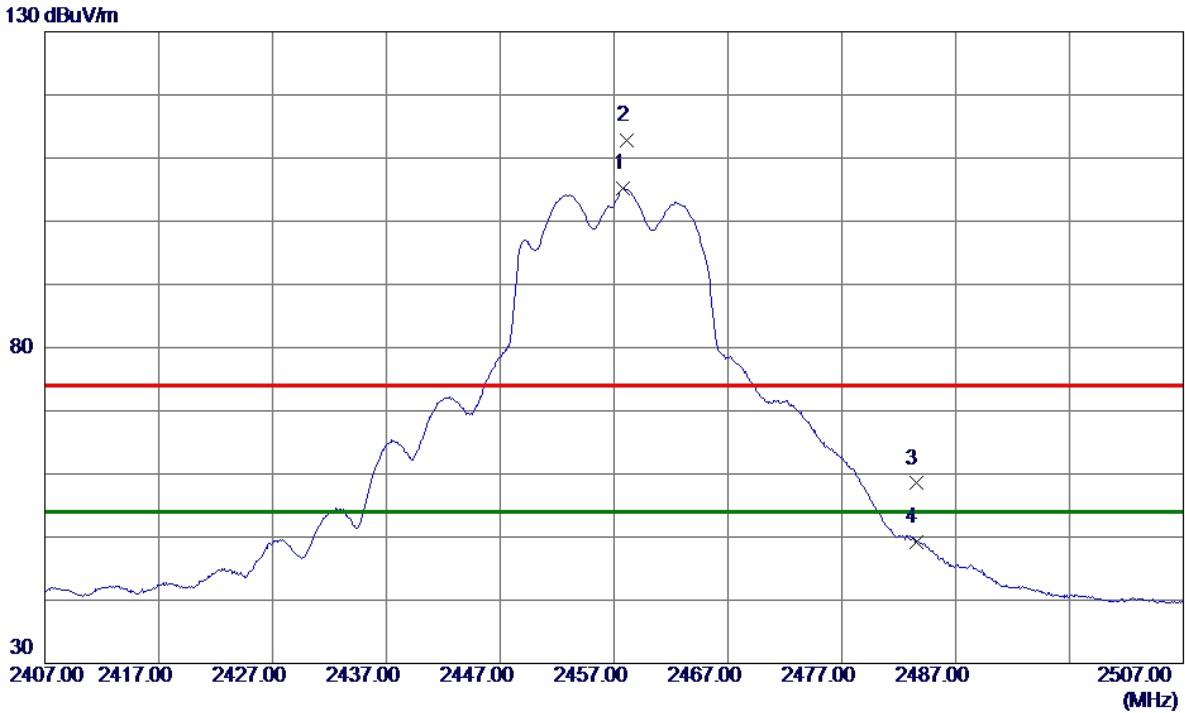

No.	Freq. MHz	Reading Level dBuV/m	Correct Factor dB	Measure ment dBuV/m	Limit dBuV/m	Margin dB	Detector	Comment
1 *	2457.8000	97.11	8.09	105.20	54.00	51.20	AVG	No Limit
2	2458.1000	104.69	8.09	112.78	74.00	38.78	Peak	No Limit
3	2483.5000	50.36	8.14	58.50	74.00	-15.50	Peak	
4	2483.5000	41.12	8.14	49.26	54.00	-4.74	AVG	

REMARKS:

- (1) Measurement Value = Reading Level + Correct Factor.
- (2) Margin Level = Measurement Value - Limit Value.

Test Mode	TX G Mode 2462 MHz	Polarization	Vertical
-----------	--------------------	--------------	----------

80 dBuV/m

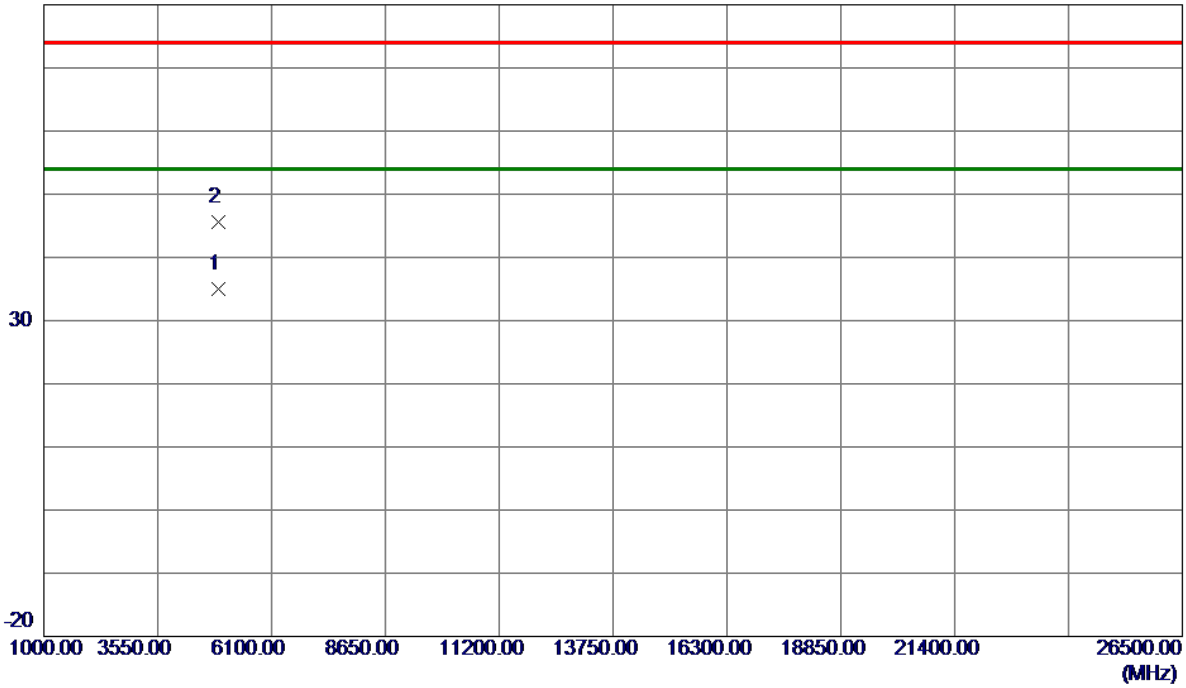

No.	Freq. MHz	Reading Level dBuV/m	Correct Factor dB	Measure ment dBuV/m	Limit dBuV/m	Margin dB	Detector	Comment
1 *	4923.6000	30.05	4.97	35.02	54.00	-18.98	AVG	
2	4923.7350	40.59	4.98	45.57	74.00	-28.43	Peak	

REMARKS:

- (1) Measurement Value = Reading Level + Correct Factor.
- (2) Margin Level = Measurement Value - Limit Value.

Test Mode	TX G Mode 2462 MHz	Polarization	Horizontal
-----------	--------------------	--------------	------------

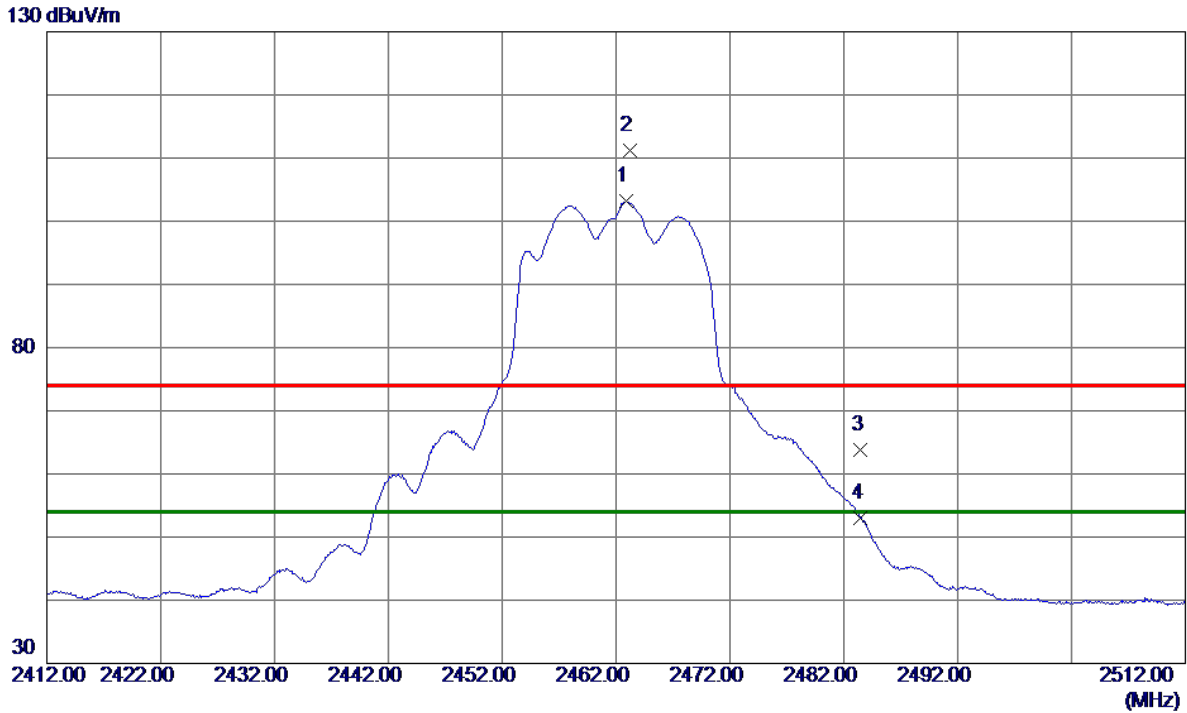

No.	Freq. MHz	Reading Level dBuV/m	Correct Factor dB	Measure ment dBuV/m	Limit dBuV/m	Margin dB	Detector	Comment
1 *	2462.9000	95.14	8.10	103.24	54.00	49.24	AVG	No Limit
2	2463.2000	103.07	8.10	111.17	74.00	37.17	Peak	No Limit
3	2483.5000	55.59	8.14	63.73	74.00	-10.27	Peak	
4	2483.5000	44.82	8.14	52.96	54.00	-1.04	AVG	

REMARKS:

- (1) Measurement Value = Reading Level + Correct Factor.
- (2) Margin Level = Measurement Value - Limit Value.

Test Mode	TX N(HT20) Mode 2412 MHz	Polarization	Vertical
-----------	--------------------------	--------------	----------

80 dBuV/m

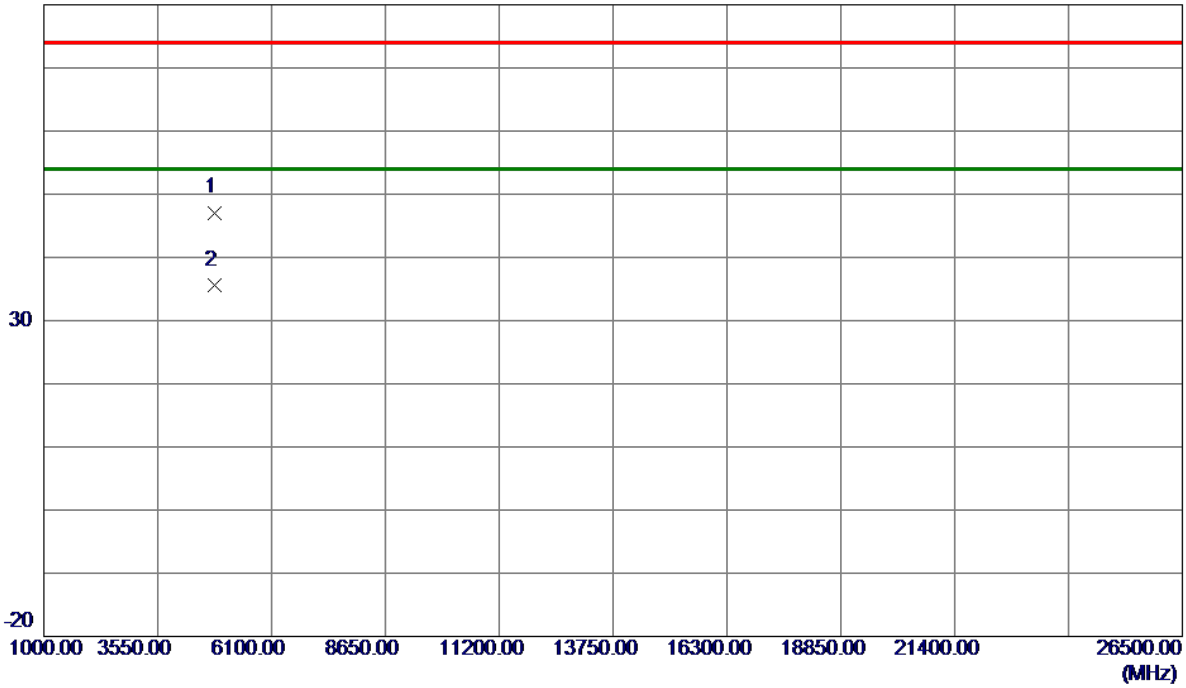

No.	Freq. MHz	Reading Level dBuV/m	Correct Factor dB	Measure ment dBuV/m	Limit dBuV/m	Margin dB	Detector	Comment
1	4824.1400	42.54	4.56	47.10	74.00	-26.90	Peak	
2 *	4824.8950	31.09	4.57	35.66	54.00	-18.34	AVG	

REMARKS:

- (1) Measurement Value = Reading Level + Correct Factor.
- (2) Margin Level = Measurement Value - Limit Value.

Test Mode	TX N(HT20) Mode 2412 MHz	Polarization	Horizontal
-----------	--------------------------	--------------	------------

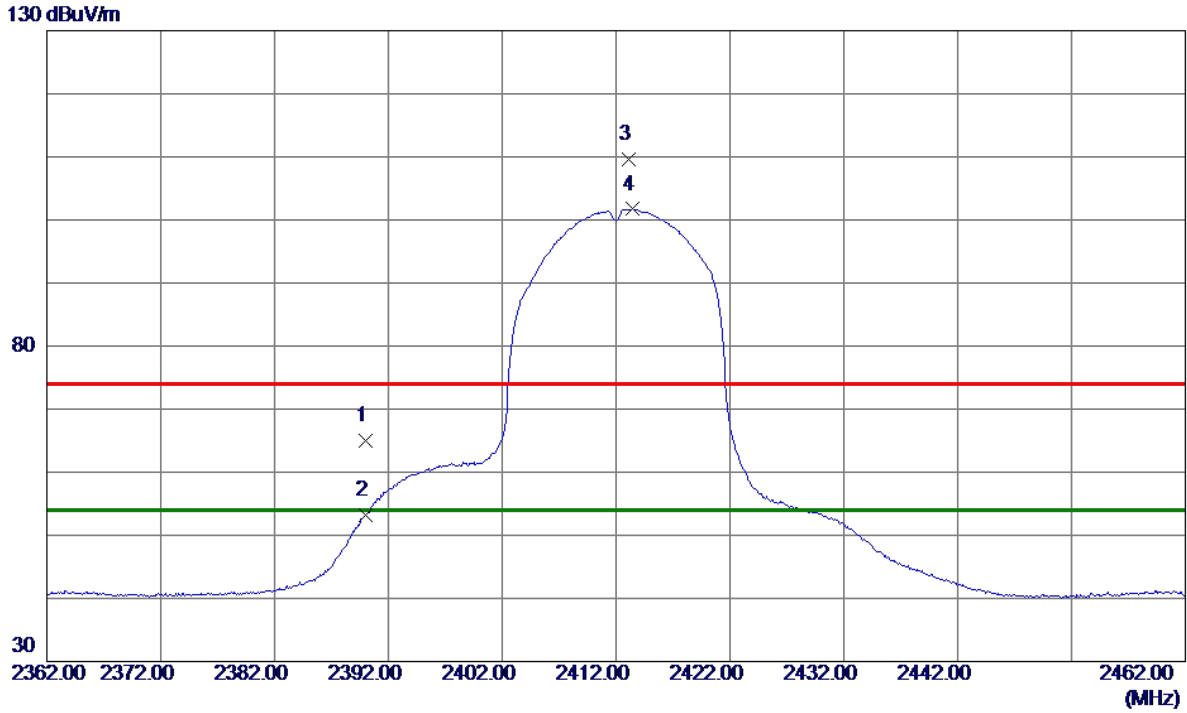

No.	Freq. MHz	Reading Level dBuV/m	Correct Factor dB	Measure ment dBuV/m	Limit dBuV/m	Margin dB	Detector	Comment
1	2390.0000	57.07	7.98	65.05	74.00	-8.95	Peak	
2	2390.0000	45.25	7.98	53.23	54.00	-0.77	AVG	
3	2413.1000	101.55	8.02	109.57	74.00	35.57	Peak	No Limit
4 *	2413.4000	93.68	8.02	101.70	54.00	47.70	AVG	No Limit

REMARKS:

- (1) Measurement Value = Reading Level + Correct Factor.
- (2) Margin Level = Measurement Value - Limit Value.

Test Mode	TX N(HT20) Mode 2417 MHz	Polarization	Vertical
-----------	--------------------------	--------------	----------

80 dBuV/m

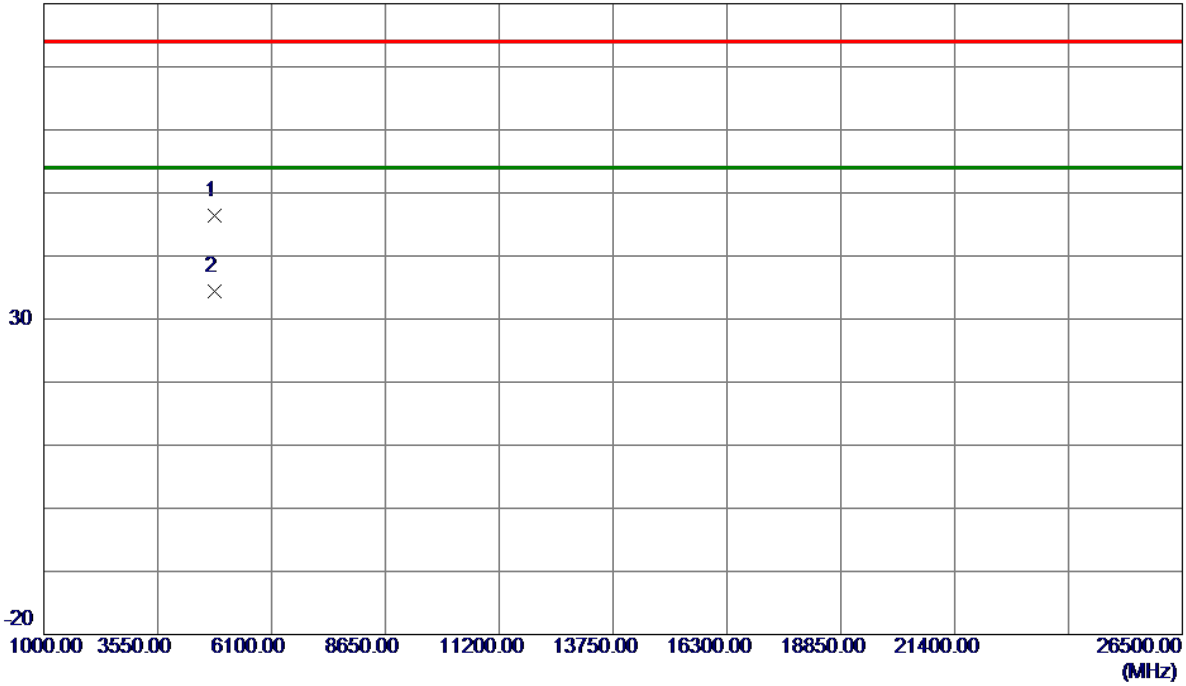

No.	Freq. MHz	Reading Level dBuV/m	Correct Factor dB	Measure ment dBuV/m	Limit dBuV/m	Margin dB	Detector	Comment
1	4834.0000	41.73	4.60	46.33	74.00	-27.67	Peak	
2 *	4834.0000	29.83	4.60	34.43	54.00	-19.57	AVG	

REMARKS:

- (1) Measurement Value = Reading Level + Correct Factor.
- (2) Margin Level = Measurement Value - Limit Value.

Test Mode	TX N(HT20) Mode 2417 MHz	Polarization	Horizontal
-----------	--------------------------	--------------	------------

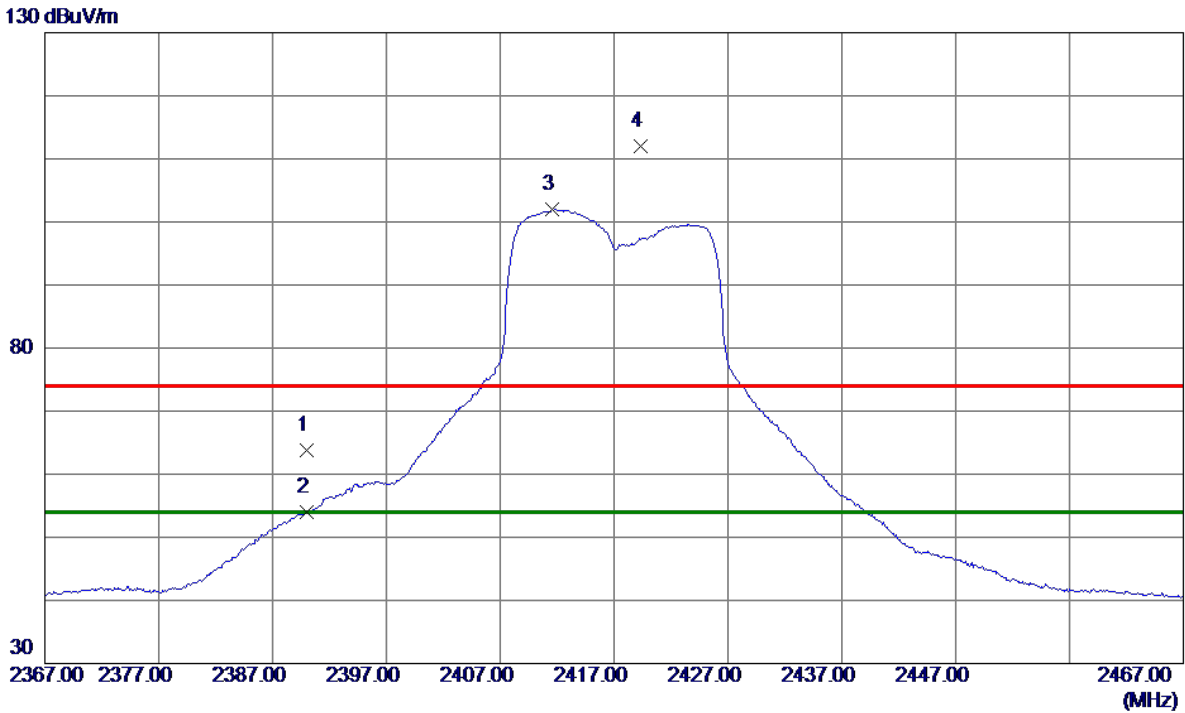

No.	Freq. MHz	Reading Level dBuV/m	Correct Factor dB	Measure ment dBuV/m	Limit dBuV/m	Margin dB	Detector	Comment
1	2390.0000	55.74	7.98	63.72	74.00	-10.28	Peak	
2	2390.0000	45.96	7.98	53.94	54.00	-0.06	AVG	
3 *	2411.6000	94.01	8.01	102.02	54.00	48.02	AVG	No Limit
4	2419.3000	103.96	8.03	111.99	74.00	37.99	Peak	No Limit

REMARKS:

- (1) Measurement Value = Reading Level + Correct Factor.
- (2) Margin Level = Measurement Value - Limit Value.

Test Mode	TX N(HT20) Mode 2437 MHz	Polarization	Vertical
-----------	--------------------------	--------------	----------

80 dBuV/m

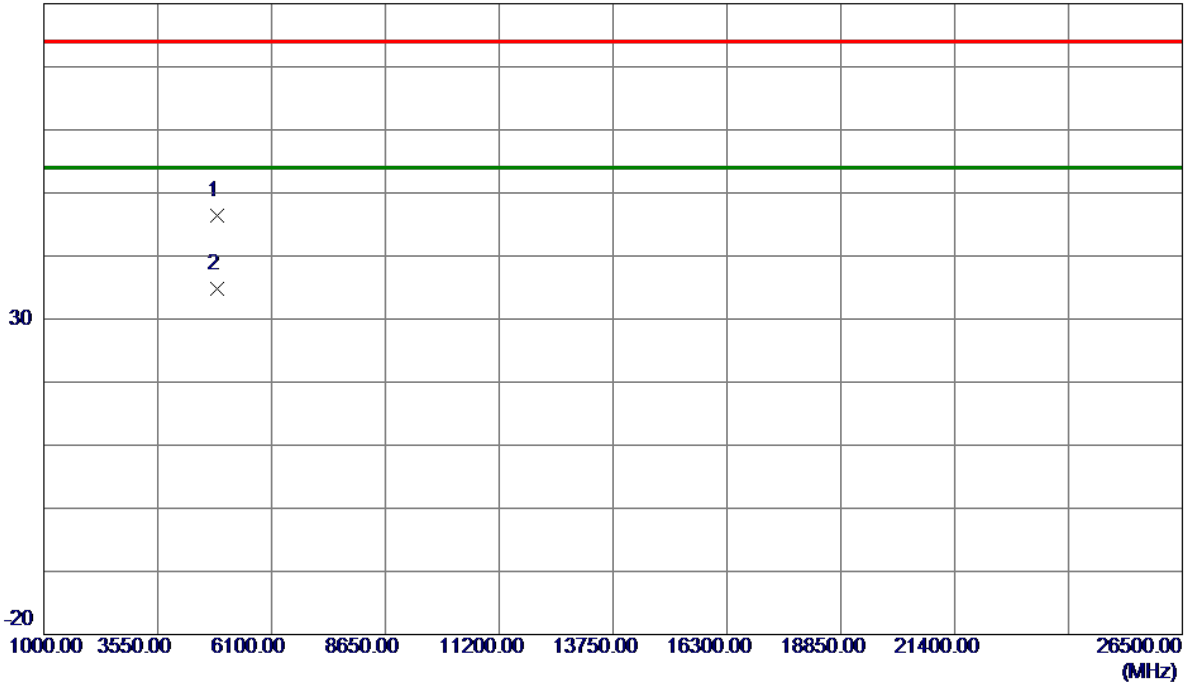

No.	Freq. MHz	Reading Level dBuV/m	Correct Factor dB	Measure ment dBuV/m	Limit dBuV/m	Margin dB	Detector	Comment
1	4874.0000	41.57	4.77	46.34	74.00	-27.66	Peak	
2 *	4874.0000	30.02	4.77	34.79	54.00	-19.21	AVG	

REMARKS:

- (1) Measurement Value = Reading Level + Correct Factor.
- (2) Margin Level = Measurement Value - Limit Value.

Test Mode	TX N(HT20) Mode 2437 MHz	Polarization	Horizontal
-----------	--------------------------	--------------	------------

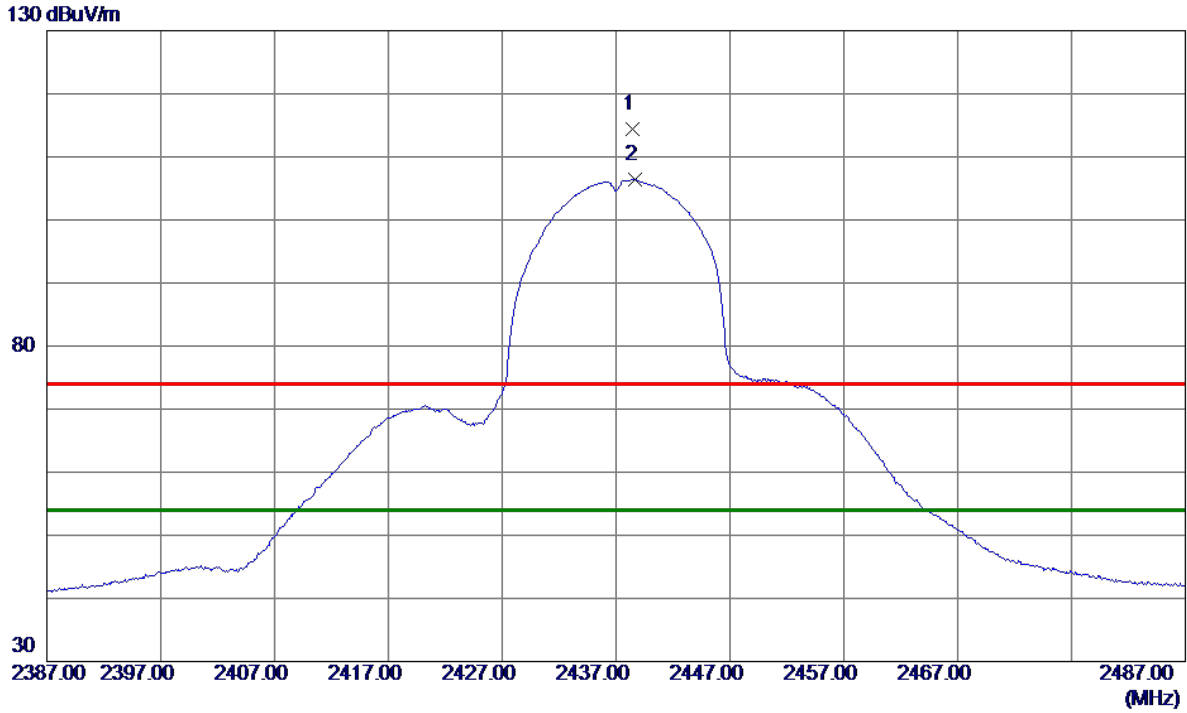

No.	Freq. MHz	Reading Level dBuV/m	Correct Factor dB	Measure ment dBuV/m	Limit dBuV/m	Margin dB	Detector	Comment
1	2438.4000	106.30	8.06	114.36	74.00	40.36	Peak	No Limit
2 *	2438.7000	98.31	8.06	106.37	54.00	52.37	AVG	No Limit

REMARKS:

- (1) Measurement Value = Reading Level + Correct Factor.
- (2) Margin Level = Measurement Value - Limit Value.

Test Mode	TX N(HT20) Mode 2457 MHz	Polarization	Vertical
-----------	--------------------------	--------------	----------

80 dBuV/m

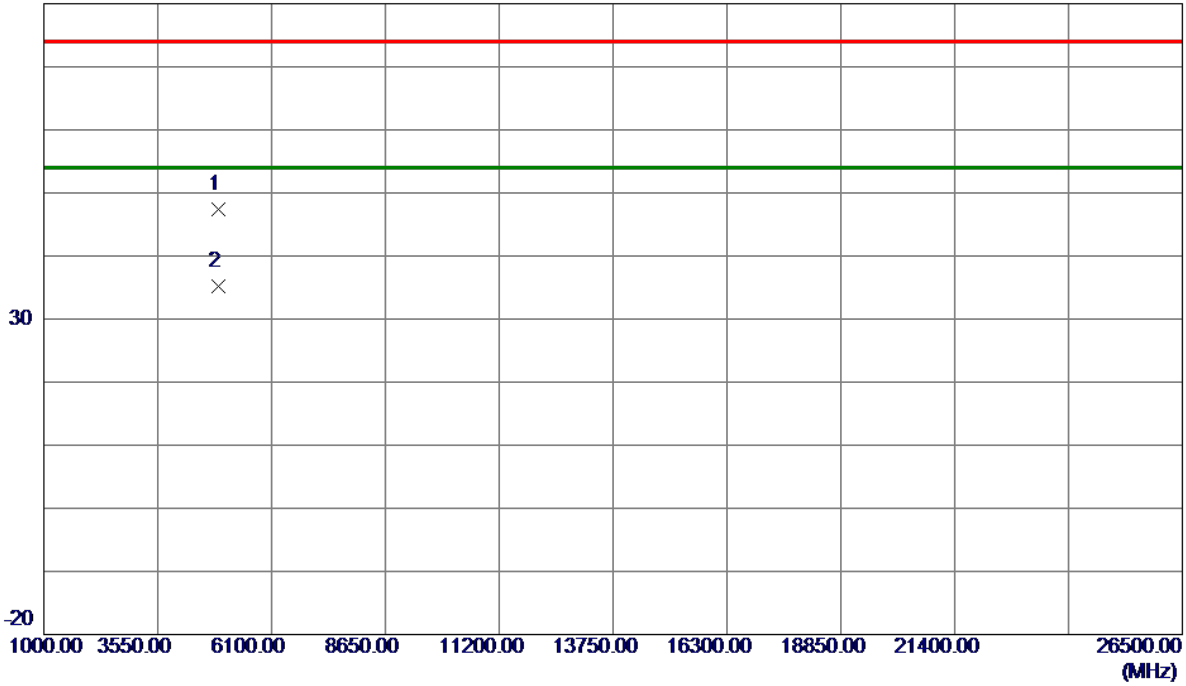

No.	Freq. MHz	Reading Level dBuV/m	Correct Factor dB	Measure ment dBuV/m	Limit dBuV/m	Margin dB	Detector	Comment
1	4914.0000	42.56	4.93	47.49	74.00	-26.51	Peak	
2 *	4914.0000	30.34	4.93	35.27	54.00	-18.73	AVG	

REMARKS:

- (1) Measurement Value = Reading Level + Correct Factor.
- (2) Margin Level = Measurement Value - Limit Value.

Test Mode	TX N(HT20) Mode 2457 MHz	Polarization	Horizontal
-----------	--------------------------	--------------	------------

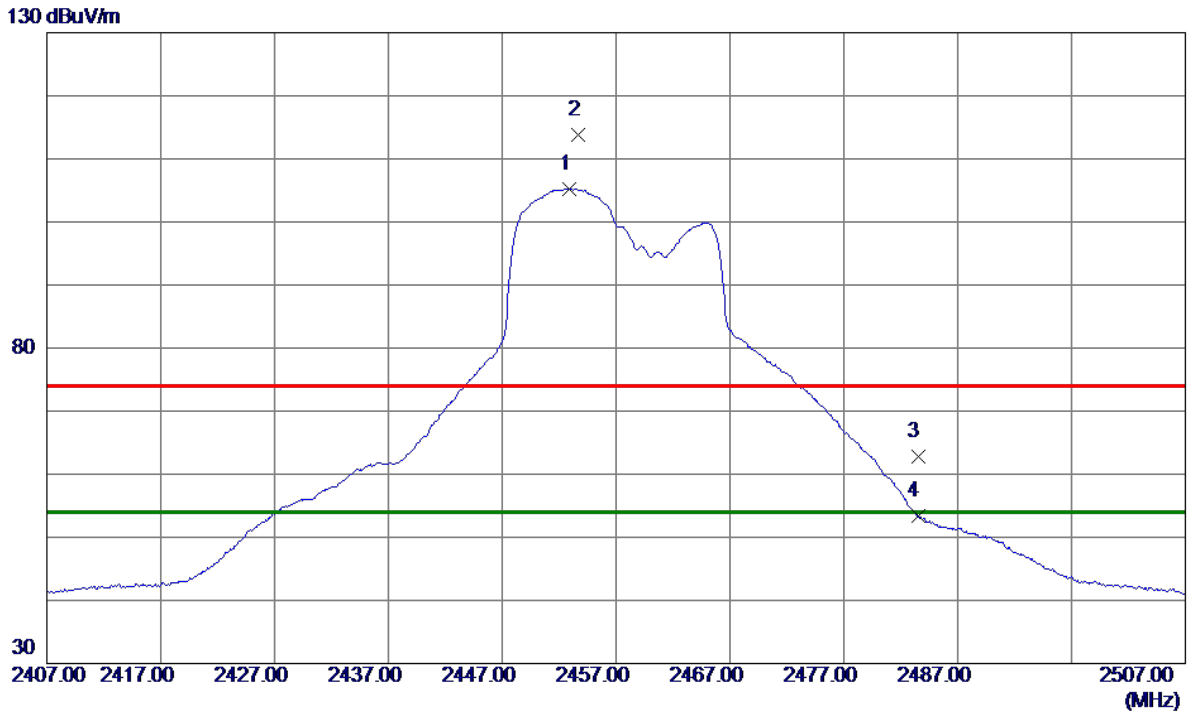

No.	Freq. MHz	Reading Level dBuV/m	Correct Factor dB	Measure ment dBuV/m	Limit dBuV/m	Margin dB	Detector	Comment
1 *	2452.9000	97.14	8.08	105.22	54.00	51.22	AVG	No Limit
2	2453.7000	105.69	8.09	113.78	74.00	39.78	Peak	No Limit
3	2483.5000	54.70	8.14	62.84	74.00	-11.16	Peak	
4	2483.5000	45.17	8.14	53.31	54.00	-0.69	AVG	

REMARKS:

- (1) Measurement Value = Reading Level + Correct Factor.
- (2) Margin Level = Measurement Value - Limit Value.

Test Mode	TX N(HT20) Mode 2462 MHz	Polarization	Vertical
-----------	--------------------------	--------------	----------

80 dBuV/m

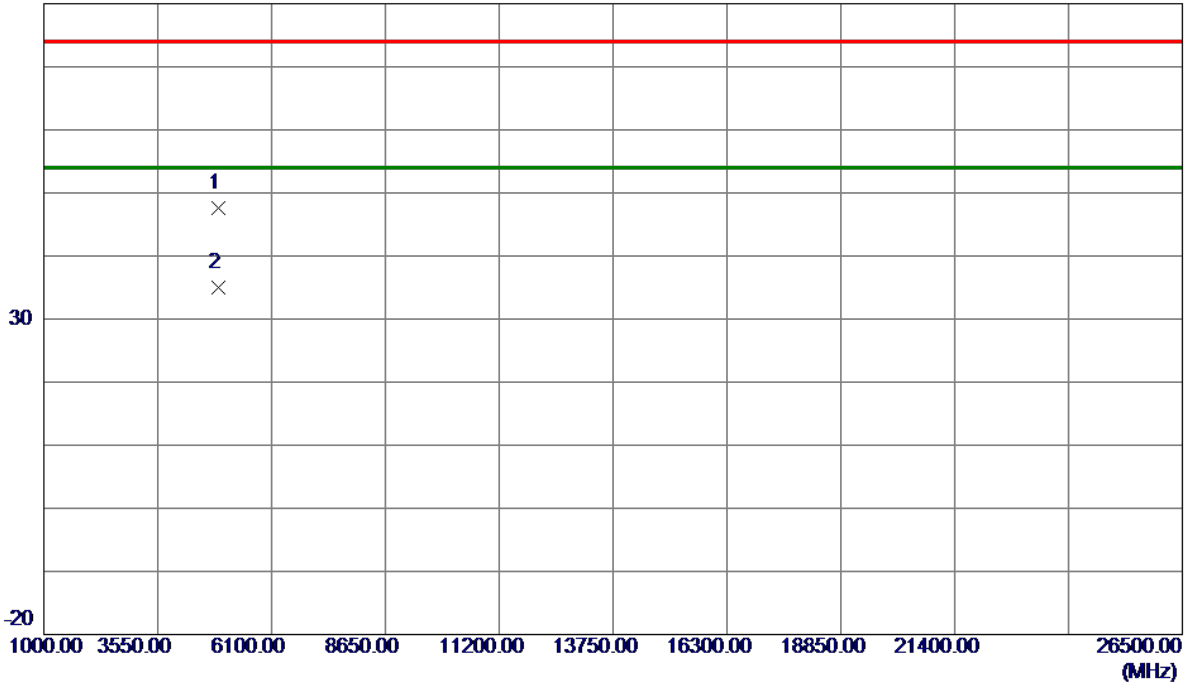

No.	Freq. MHz	Reading Level dBuV/m	Correct Factor dB	Measure ment dBuV/m	Limit dBuV/m	Margin dB	Detector	Comment
1	4924.0000	42.53	4.98	47.51	74.00	-26.49	Peak	
2 *	4924.0000	30.11	4.98	35.09	54.00	-18.91	AVG	

REMARKS:

- (1) Measurement Value = Reading Level + Correct Factor.
- (2) Margin Level = Measurement Value - Limit Value.

Test Mode	TX N(HT20) Mode 2462 MHz	Polarization	Horizontal
-----------	--------------------------	--------------	------------

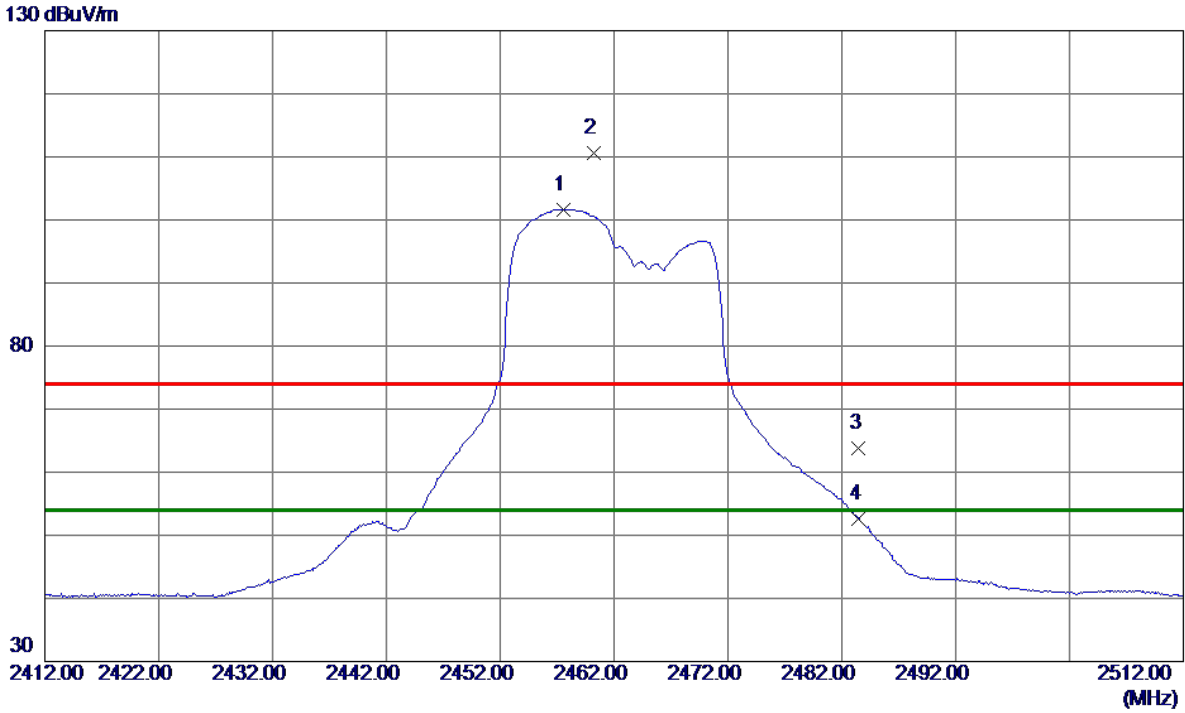

No.	Freq. MHz	Reading Level dBuV/m	Correct Factor dB	Measure ment dBuV/m	Limit dBuV/m	Margin dB	Detector	Comment
1 *	2457.6000	93.55	8.09	101.64	54.00	47.64	AVG	No Limit
2	2460.2000	102.52	8.10	110.62	74.00	36.62	Peak	No Limit
3	2483.5000	55.64	8.14	63.78	74.00	-10.22	Peak	
4	2483.5000	44.55	8.14	52.69	54.00	-1.31	AVG	

REMARKS:

- (1) Measurement Value = Reading Level + Correct Factor.
- (2) Margin Level = Measurement Value - Limit Value.

Test Mode	TX N(HT40) Mode 2422 MHz	Polarization	Vertical
-----------	--------------------------	--------------	----------

80 dBuV/m

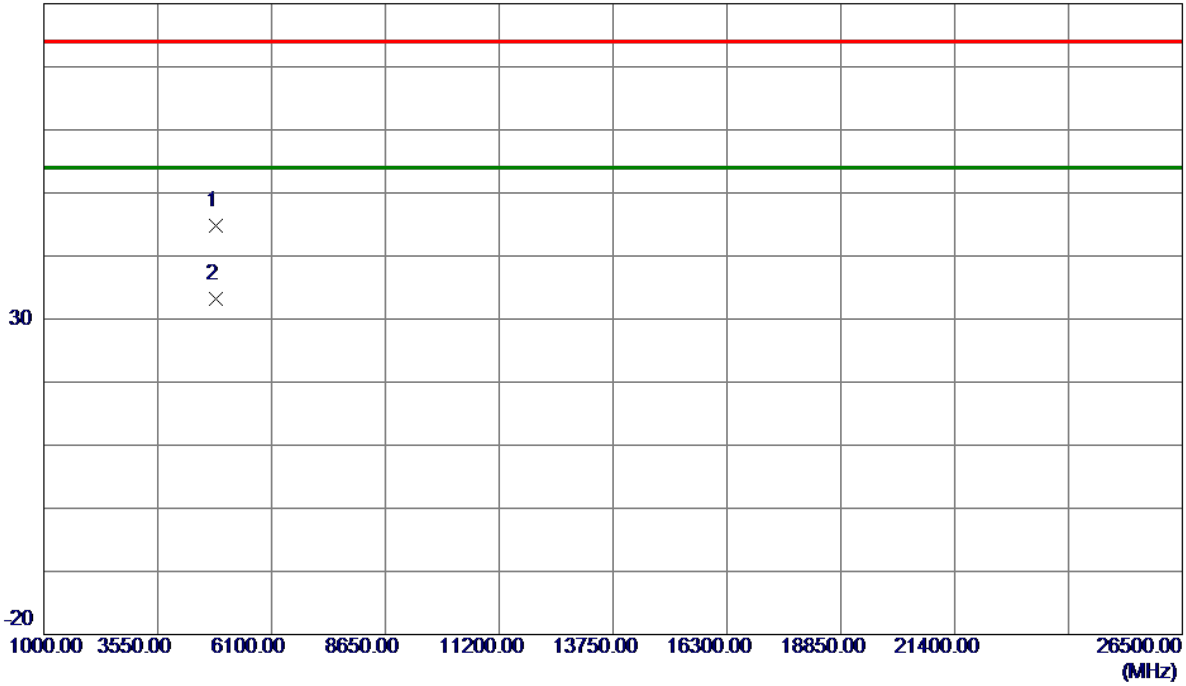

No.	Freq. MHz	Reading Level dBuV/m	Correct Factor dB	Measure ment dBuV/m	Limit dBuV/m	Margin dB	Detector	Comment
1	4842.5800	40.19	4.64	44.83	74.00	-29.17	Peak	
2 *	4845.2850	28.61	4.65	33.26	54.00	-20.74	AVG	

REMARKS:

- (1) Measurement Value = Reading Level + Correct Factor.
- (2) Margin Level = Measurement Value - Limit Value.

Test Mode	TX N(HT40) Mode 2422 MHz	Polarization	Horizontal
-----------	--------------------------	--------------	------------

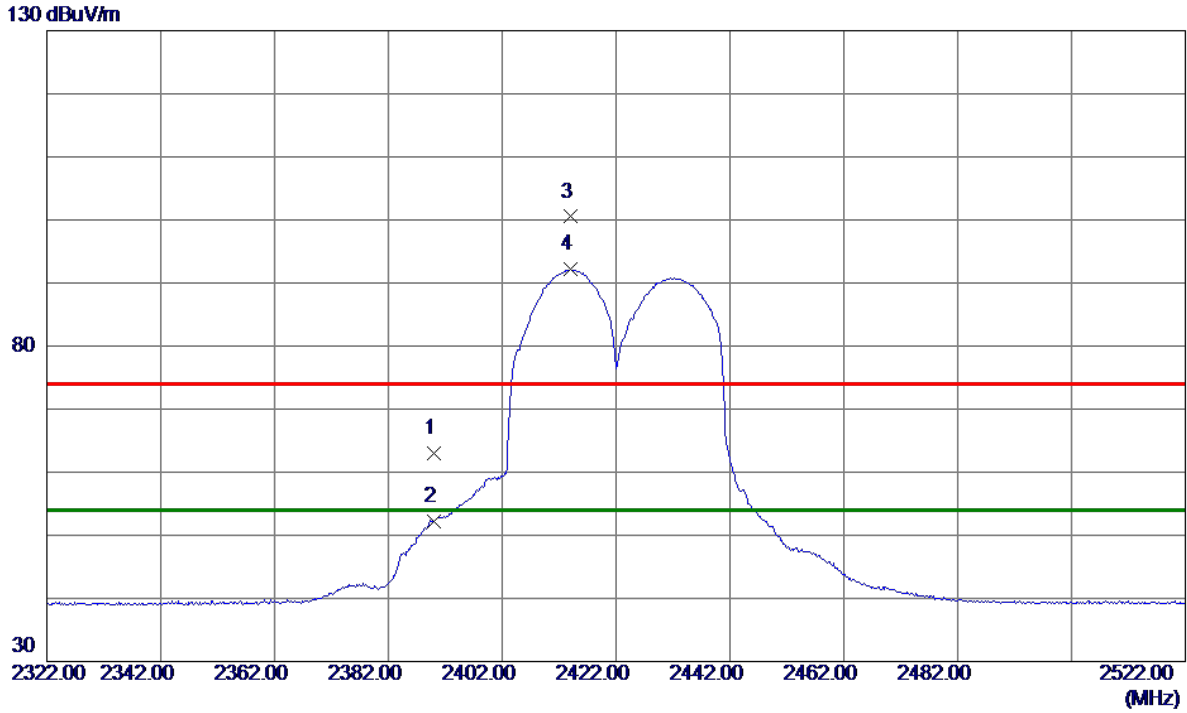

No.	Freq. MHz	Reading Level dBuV/m	Correct Factor dB	Measure ment dBuV/m	Limit dBuV/m	Margin dB	Detector	Comment
1	2390.0000	54.94	7.98	62.92	74.00	-11.08	Peak	
2	2390.0000	44.27	7.98	52.25	54.00	-1.75	AVG	
3	2414.0000	92.48	8.02	100.50	74.00	26.50	Peak	No Limit
4 *	2414.0000	84.23	8.02	92.25	54.00	38.25	AVG	No Limit

REMARKS:

(1) Measurement Value = Reading Level + Correct Factor.

(2) Margin Level = Measurement Value - Limit Value.

Test Mode	TX N(HT40) Mode 2427 MHz	Polarization	Vertical
-----------	--------------------------	--------------	----------

80 dBuV/m

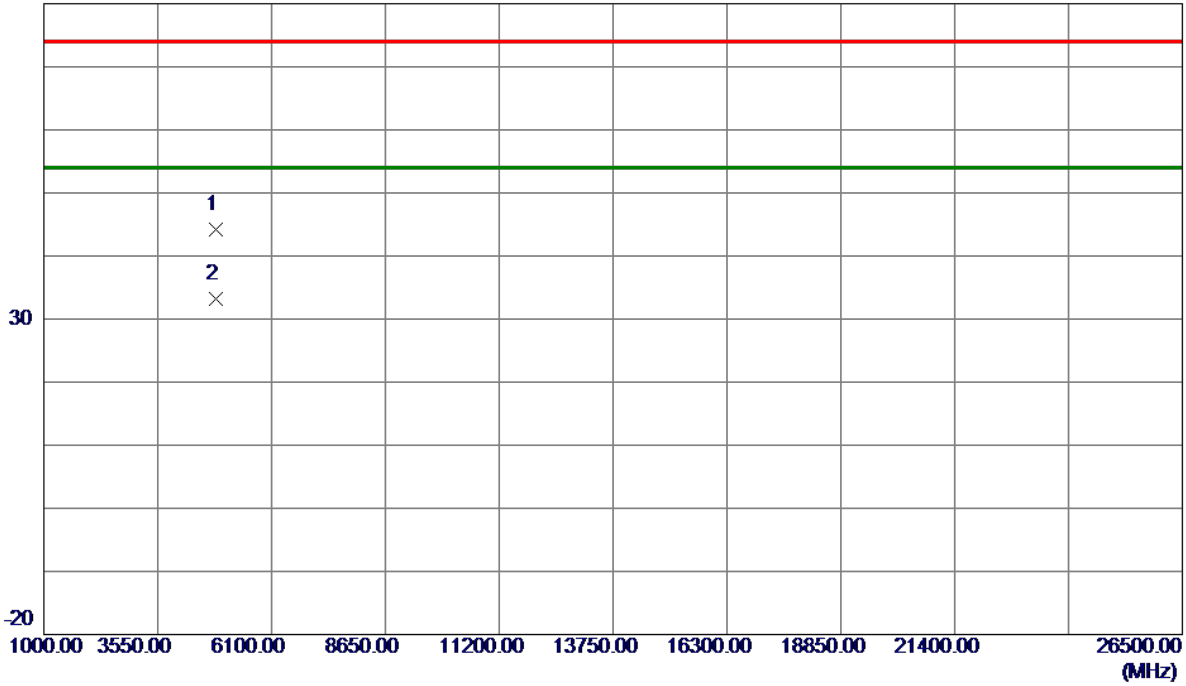

No.	Freq. MHz	Reading Level dBuV/m	Correct Factor dB	Measure ment dBuV/m	Limit dBuV/m	Margin dB	Detector	Comment
1	4853.7850	39.57	4.69	44.26	74.00	-29.74	Peak	
2 *	4855.1250	28.54	4.69	33.23	54.00	-20.77	AVG	

REMARKS:

- (1) Measurement Value = Reading Level + Correct Factor.
- (2) Margin Level = Measurement Value - Limit Value.

Test Mode	TX N(HT40) Mode 2427 MHz	Polarization	Horizontal
-----------	--------------------------	--------------	------------

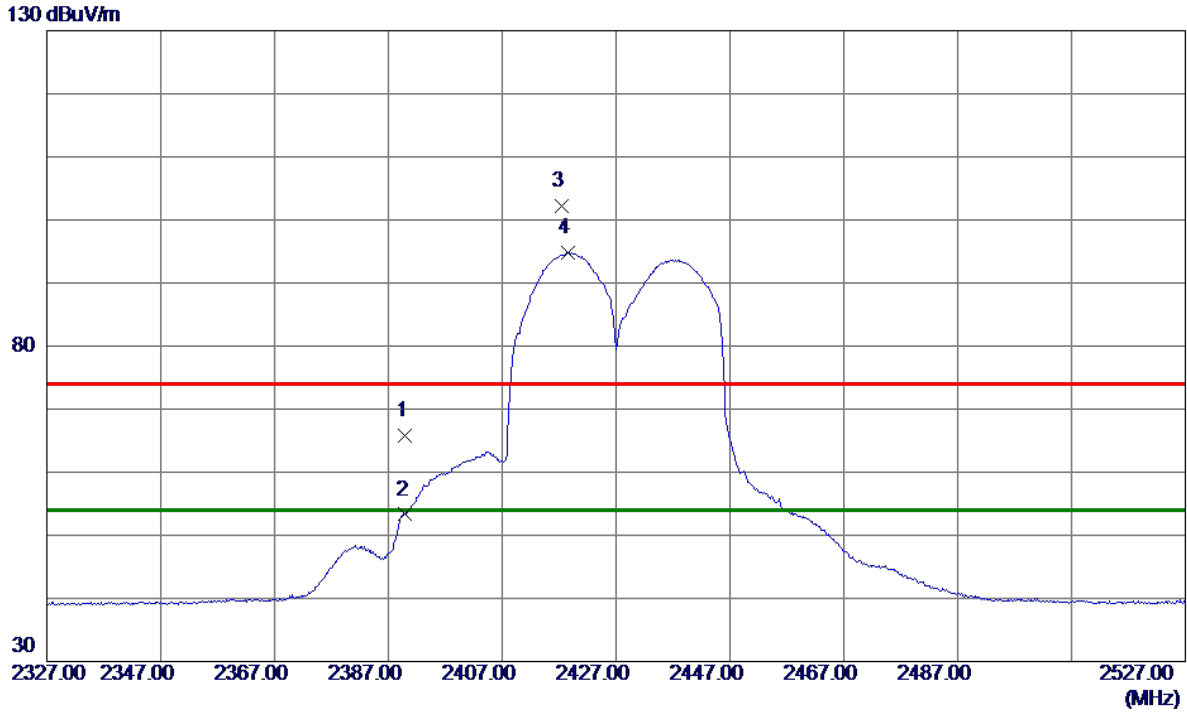

No.	Freq. MHz	Reading Level dBuV/m	Correct Factor dB	Measure ment dBuV/m	Limit dBuV/m	Margin dB	Detector	Comment
1	2390.0000	57.87	7.98	65.85	74.00	-8.15	Peak	
2	2390.0000	45.32	7.98	53.30	54.00	-0.70	AVG	
3	2417.4000	94.27	8.02	102.29	74.00	28.29	Peak	No Limit
4 *	2418.6000	86.73	8.03	94.76	54.00	40.76	AVG	No Limit

REMARKS:

- (1) Measurement Value = Reading Level + Correct Factor.
- (2) Margin Level = Measurement Value - Limit Value.

Test Mode	TX N(HT40) Mode 2437 MHz	Polarization	Vertical
-----------	--------------------------	--------------	----------

80 dBuV/m

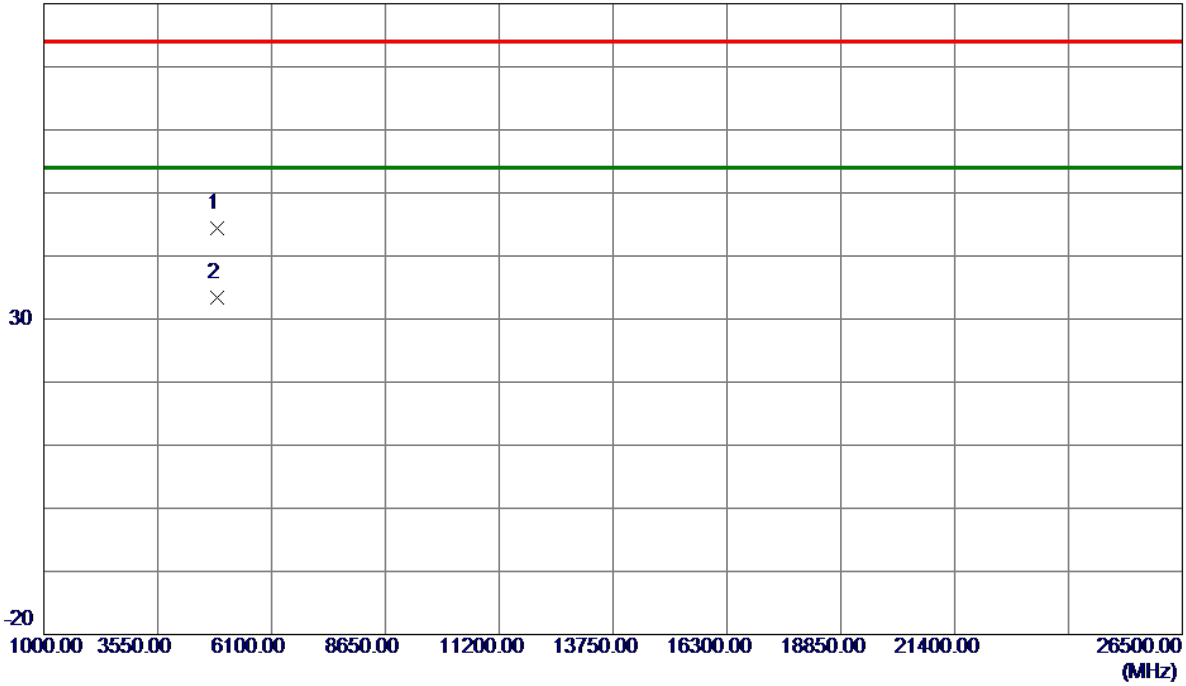

No.	Freq. MHz	Reading Level dBuV/m	Correct Factor dB	Measure ment dBuV/m	Limit dBuV/m	Margin dB	Detector	Comment
1	4871.6200	39.69	4.76	44.45	74.00	-29.55	Peak	
2 *	4871.7200	28.59	4.76	33.35	54.00	-20.65	AVG	

REMARKS:

- (1) Measurement Value = Reading Level + Correct Factor.
- (2) Margin Level = Measurement Value - Limit Value.

Test Mode	TX N(HT40) Mode 2437 MHz	Polarization	Horizontal
-----------	--------------------------	--------------	------------

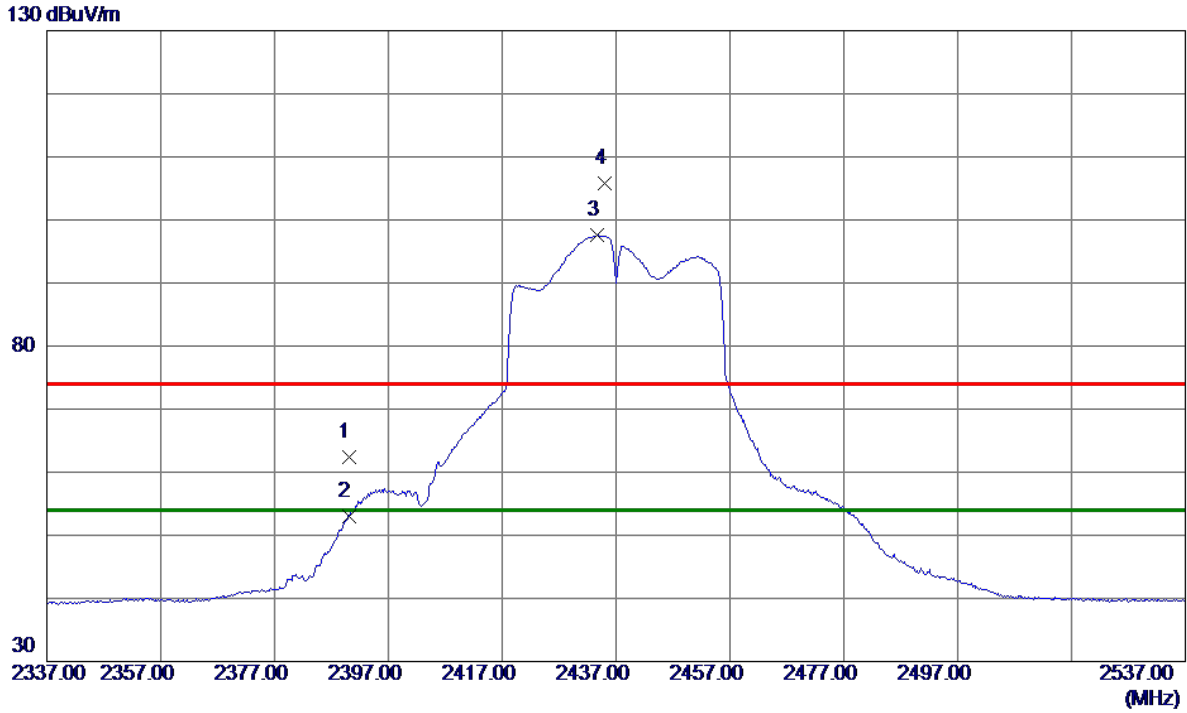

No.	Freq. MHz	Reading Level dBuV/m	Correct Factor dB	Measure ment dBuV/m	Limit dBuV/m	Margin dB	Detector	Comment
1	2390.0000	54.35	7.98	62.33	74.00	-11.67	Peak	
2	2390.0000	44.95	7.98	52.93	54.00	-1.07	AVG	
3 *	2433.6000	89.49	8.05	97.54	54.00	43.54	AVG	No Limit
4	2435.0000	97.78	8.05	105.83	74.00	31.83	Peak	No Limit

REMARKS:

(1) Measurement Value = Reading Level + Correct Factor.

(2) Margin Level = Measurement Value - Limit Value.

Test Mode	TX N(HT40) Mode 2447 MHz	Polarization	Vertical
-----------	--------------------------	--------------	----------

80 dBuV/m

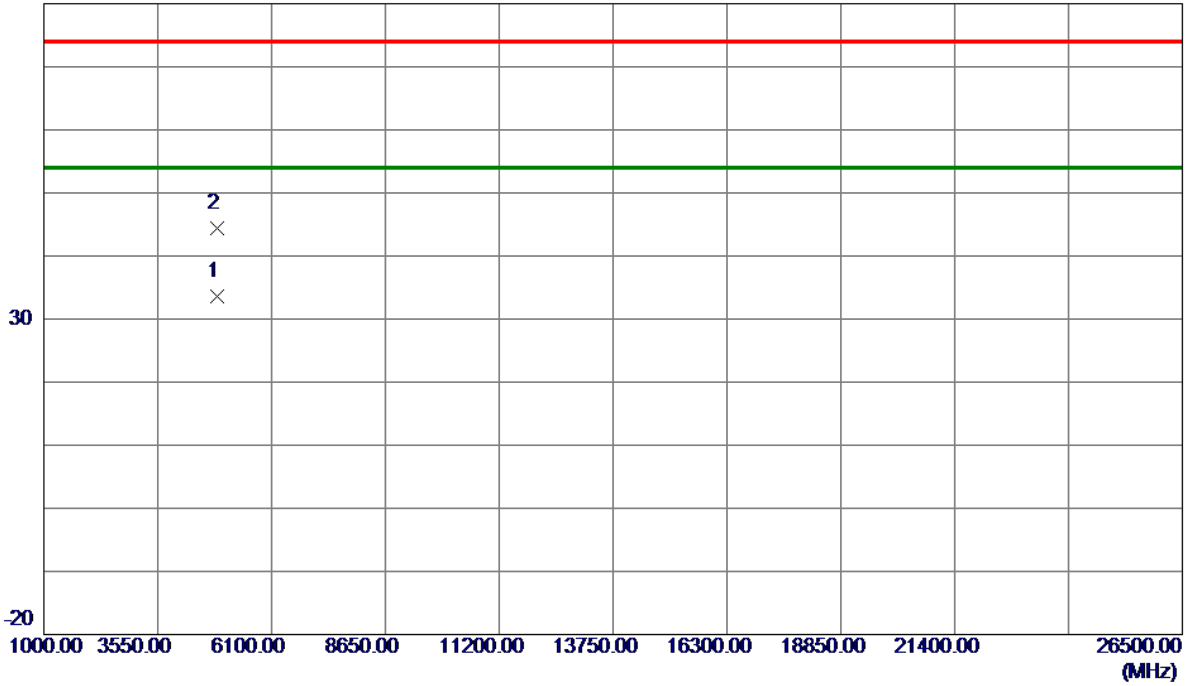

No.	Freq. MHz	Reading Level dBuV/m	Correct Factor dB	Measure ment dBuV/m	Limit dBuV/m	Margin dB	Detector	Comment
1 *	4892.1349	28.68	4.84	33.52	54.00	-20.48	AVG	
2	4893.2500	39.48	4.85	44.33	74.00	-29.67	Peak	

REMARKS:

- (1) Measurement Value = Reading Level + Correct Factor.
- (2) Margin Level = Measurement Value - Limit Value.

Test Mode	TX N(HT40) Mode 2447 MHz	Polarization	Horizontal
-----------	--------------------------	--------------	------------

130 dBuV/m

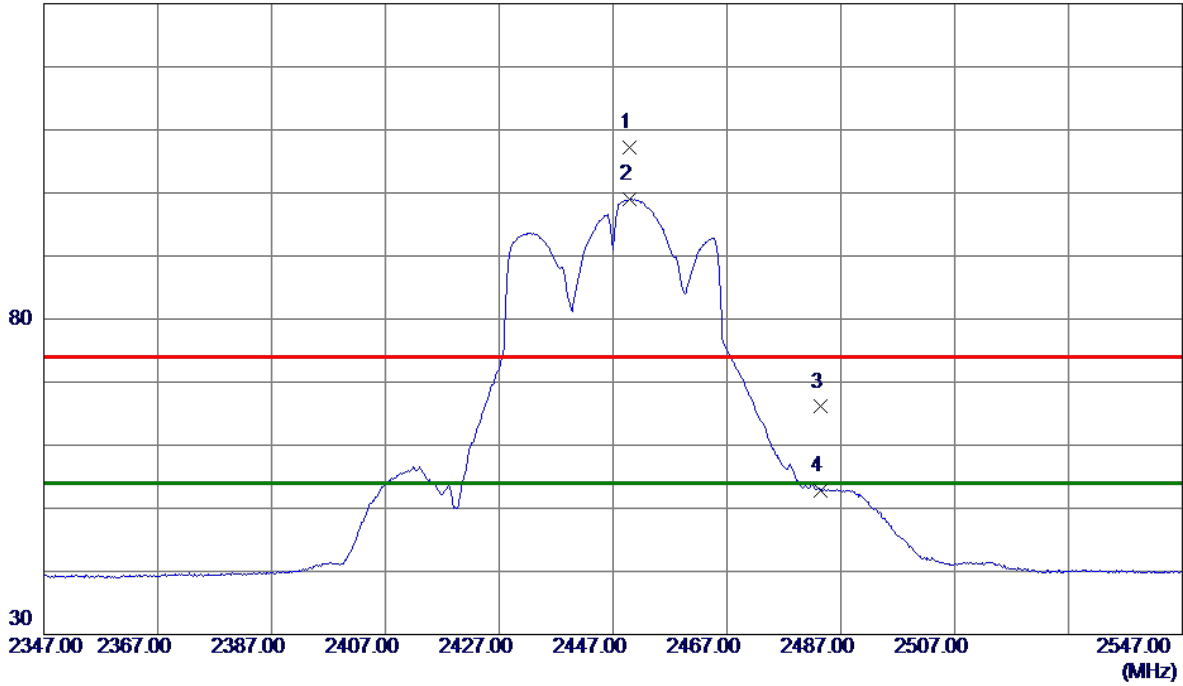

No.	Freq. MHz	Reading Level dBuV/m	Correct Factor dB	Measure ment dBuV/m	Limit dBuV/m	Margin dB	Detector	Comment
1	2449.8000	99.03	8.08	107.11	74.00	33.11	Peak	No Limit
2 *	2449.8000	90.87	8.08	98.95	54.00	44.95	AVG	No Limit
3	2483.5000	57.96	8.14	66.10	74.00	-7.90	Peak	
4	2483.5000	44.65	8.14	52.79	54.00	-1.21	AVG	

REMARKS:

- (1) Measurement Value = Reading Level + Correct Factor.
- (2) Margin Level = Measurement Value - Limit Value.

Test Mode	TX N(HT40) Mode 2452 MHz	Polarization	Vertical
-----------	--------------------------	--------------	----------

80 dBuV/m

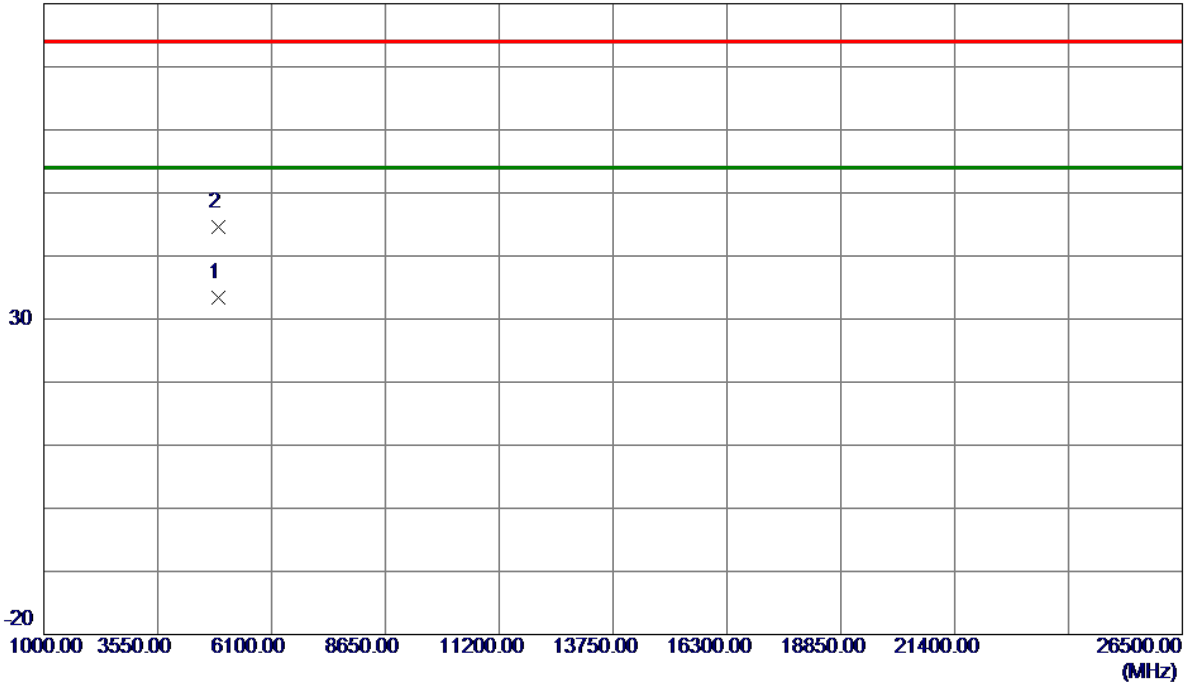

No.	Freq. MHz	Reading Level dBuV/m	Correct Factor dB	Measure ment dBuV/m	Limit dBuV/m	Margin dB	Detector	Comment
1 *	4901.9300	28.50	4.89	33.39	54.00	-20.61	AVG	
2	4903.3550	39.63	4.89	44.52	74.00	-29.48	Peak	

REMARKS:

- (1) Measurement Value = Reading Level + Correct Factor.
- (2) Margin Level = Measurement Value - Limit Value.

Test Mode	TX N(HT40) Mode 2452 MHz	Polarization	Horizontal
-----------	--------------------------	--------------	------------

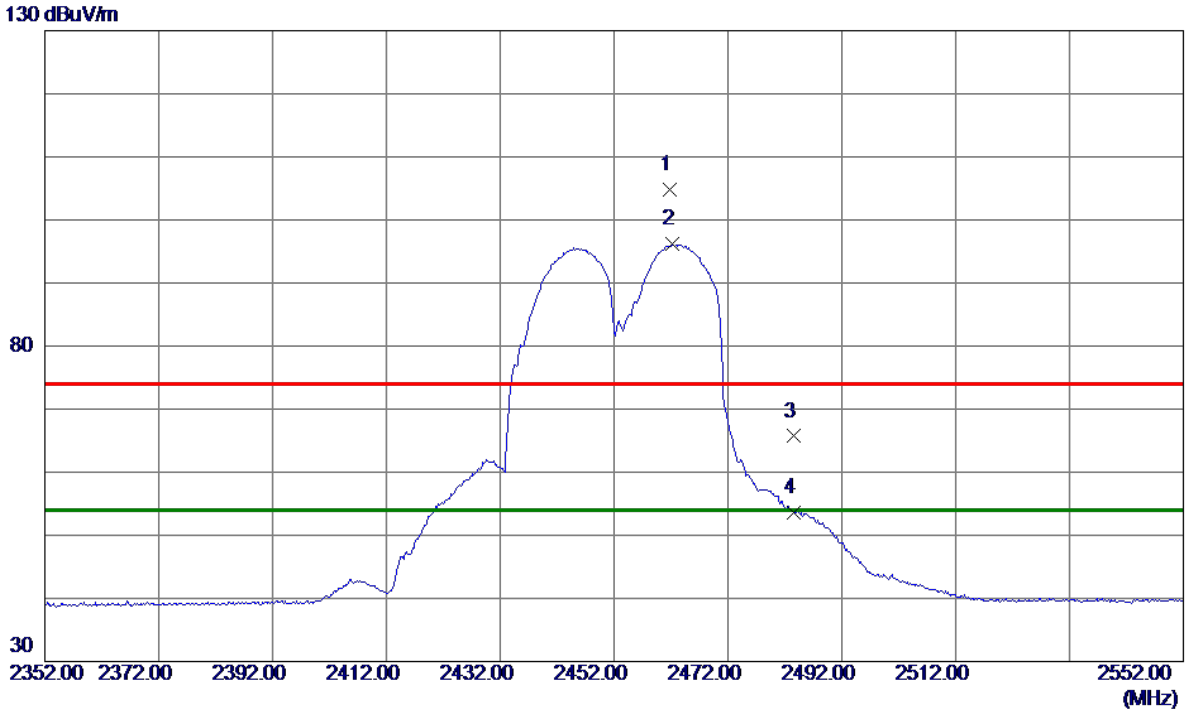

No.	Freq. MHz	Reading Level dBuV/m	Correct Factor dB	Measure ment dBuV/m	Limit dBuV/m	Margin dB	Detector	Comment
1	2461.8000	96.63	8.10	104.73	74.00	30.73	Peak	No Limit
2 *	2462.2000	88.02	8.10	96.12	54.00	42.12	AVG	No Limit
3	2483.5000	57.56	8.14	65.70	74.00	-8.30	Peak	
4	2483.5000	45.48	8.14	53.62	54.00	-0.38	AVG	

REMARKS:

- (1) Measurement Value = Reading Level + Correct Factor.
- (2) Margin Level = Measurement Value - Limit Value.

APPENDIX E - BANDWIDTH

Test Mode TX B Mode

Channel	Frequency (MHz)	6 dB Bandwidth (MHz)	99 % Occupied Bandwidth (MHz)	6 dB Bandwidth Min. Limit (MHz)	Result
01	2412	9.100	13.200	0.5	Complies
06	2437	9.590	13.920	0.5	Complies
11	2462	9.610	13.600	0.5	Complies

CH01

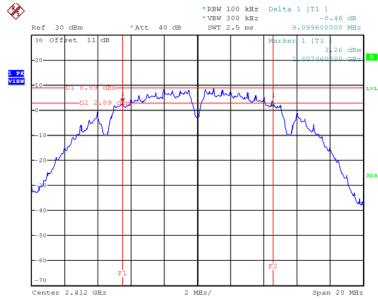

Date: 5.JUN.2022 11:54:44

CH06

6 dB Bandwidth

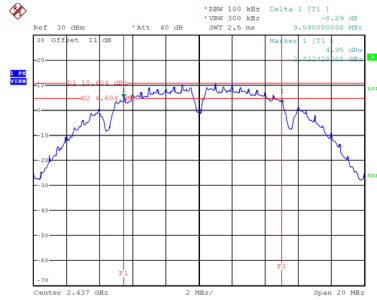

Date: 5.JUN.2022 11:55:38

CH11

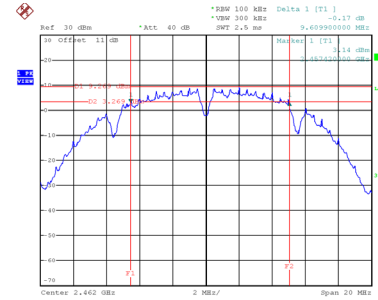

Date: 5.JUN.2022 11:57:05

99 % Occupied Bandwidth

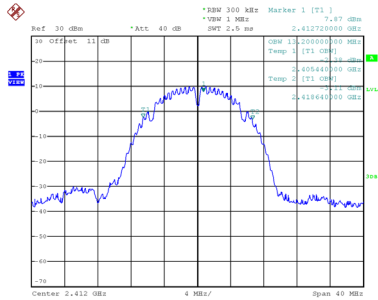

Date: 5.JUN.2022 11:54:51

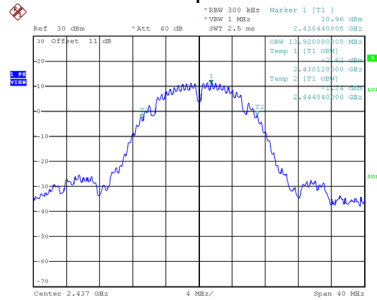

Date: 5.JUN.2022 11:55:45

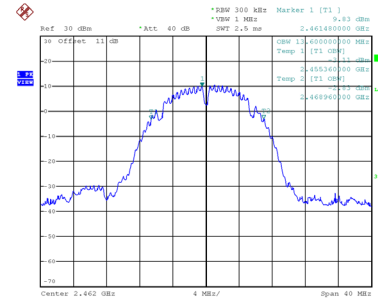

Date: 5.JUN.2022 11:57:12

Test Mode	TX G Mode
-----------	-----------

Channel	Frequency (MHz)	6 dB Bandwidth (MHz)	99 % Occupied Bandwidth (MHz)	6 dB Bandwidth Min. Limit (MHz)	Result
01	2412	13.940	16.240	0.5	Complies
06	2437	15.080	16.320	0.5	Complies
11	2462	15.100	16.320	0.5	Complies

CH01

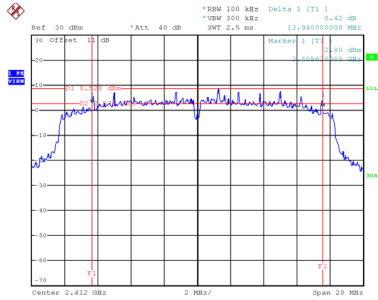

Date: 5.JUN.2022 11:57:52

CH06

6 dB Bandwidth

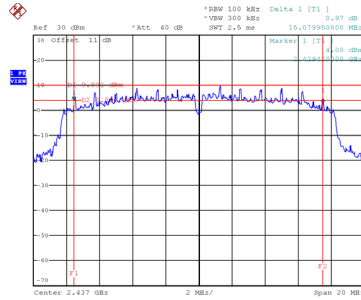

Date: 5.JUN.2022 12:11:02

CH11

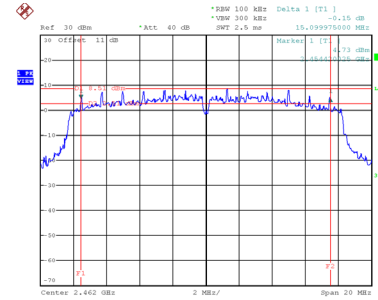

Date: 5.JUN.2022 12:11:40

99 % Occupied Bandwidth

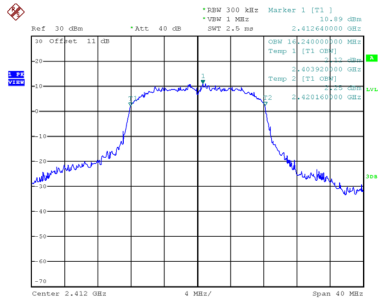

Date: 5.JUN.2022 11:57:58

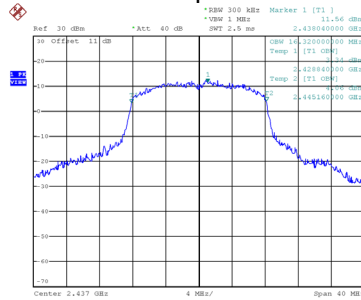

Date: 5.JUN.2022 12:11:09

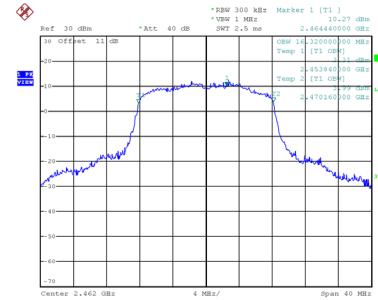

Date: 5.JUN.2022 12:11:47

Test Mode	TX N(HT20) Mode
-----------	-----------------

Channel	Frequency (MHz)	6 dB Bandwidth (MHz)	99 % Occupied Bandwidth (MHz)	6 dB Bandwidth Min. Limit (MHz)	Result
01	2412	15.140	17.520	0.5	Complies
06	2437	15.120	17.360	0.5	Complies
11	2462	15.100	17.520	0.5	Complies

CH01

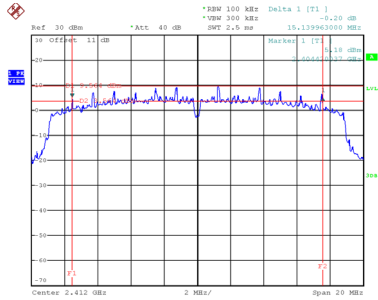

Date: 5.JUN.2022 12:12:07

CH06

6 dB Bandwidth

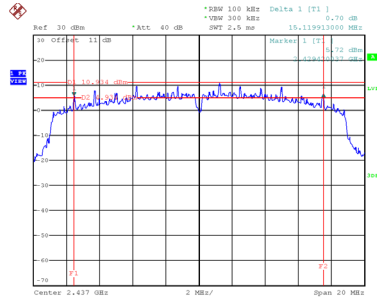

Date: 5.JUN.2022 12:12:50

CH11

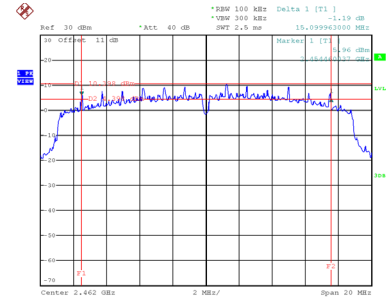

Date: 5.JUN.2022 12:13:18

99 % Occupied Bandwidth

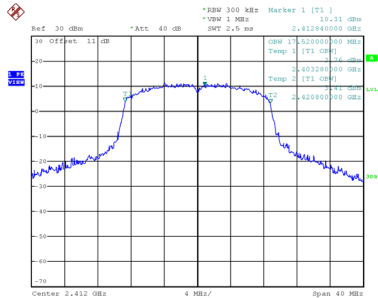

Date: 5.JUN.2022 12:12:13

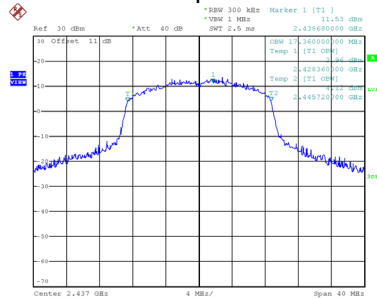

Date: 5.JUN.2022 12:12:57

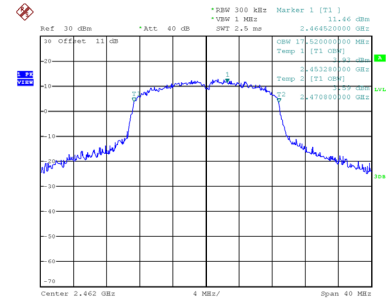

Date: 5.JUN.2022 12:13:24

Test Mode	TX N(HT40) Mode
-----------	-----------------

Channel	Frequency (MHz)	6 dB Bandwidth (MHz)	99 % Occupied Bandwidth (MHz)	6 dB Bandwidth Min. Limit (MHz)	Result
03	2422	32.720	36.480	0.5	Complies
06	2437	33.920	36.480	0.5	Complies
09	2452	32.720	36.480	0.5	Complies

CH03

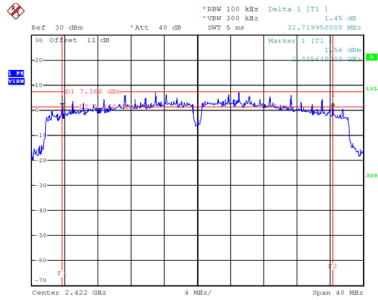

Date: 5.JUN.2022 12:21:20

CH06

6 dB Bandwidth

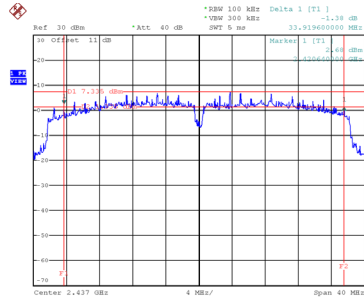

Date: 5.JUN.2022 12:22:16

CH09

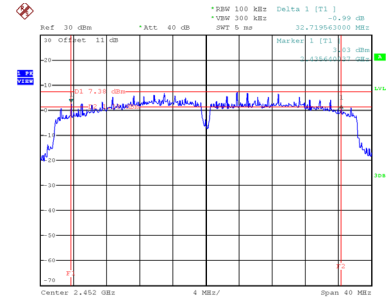

Date: 5.JUN.2022 12:22:52

99 % Occupied Bandwidth

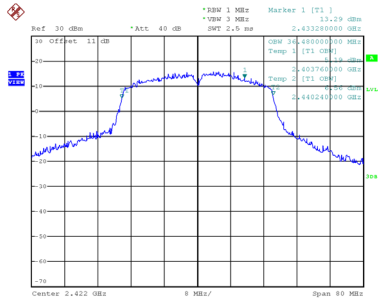

Date: 5.JUN.2022 12:21:27

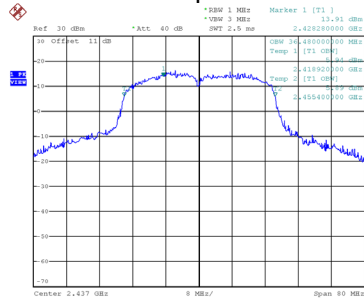

Date: 5.JUN.2022 12:22:23

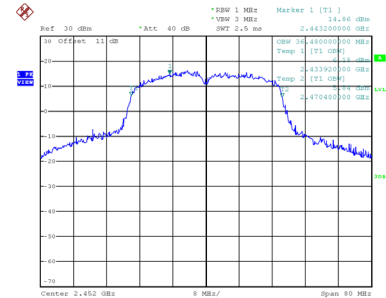

Date: 5.JUN.2022 12:22:59

APPENDIX F - MAXIMUM AVERAGE OUTPUT POWER

Test Mode	TX B Mode_Ant. 1
-----------	------------------

Channel	Frequency (MHz)	Average Output Power (dBm)	Duty Factor	Average Output Power + Duty Factor (dBm)	Max. Limit (dBm)	Max. Limit (W)	Result
01	2412	17.97	0.11	18.08	30.00	1.0000	Complies
06	2437	19.02	0.11	19.13	30.00	1.0000	Complies
11	2462	19.23	0.11	19.34	30.00	1.0000	Complies

Test Mode	TX B Mode_Ant. 2
-----------	------------------

Channel	Frequency (MHz)	Average Output Power (dBm)	Duty Factor	Average Output Power + Duty Factor (dBm)	Max. Limit (dBm)	Max. Limit (W)	Result
01	2412	18.81	0.11	18.92	30.00	1.0000	Complies
06	2437	18.48	0.11	18.59	30.00	1.0000	Complies
11	2462	18.85	0.11	18.96	30.00	1.0000	Complies

Test Mode	TX B Mode_Total
-----------	-----------------

Channel	Frequency (MHz)	Average Output Power (dBm)	Max. Limit (dBm)	Max. Limit (W)	Result
01	2412	21.53	30.00	1.0000	Complies
06	2437	21.88	30.00	1.0000	Complies
11	2462	22.16	30.00	1.0000	Complies

Test Mode	TX G Mode_Ant. 1
-----------	------------------

Channel	Frequency (MHz)	Average Output Power (dBm)	Duty Factor	Average Output Power + Duty Factor (dBm)	Max. Limit (dBm)	Max. Limit (W)	Result
01	2412	13.23	0.25	13.48	30.00	1.0000	Complies
06	2437	18.61	0.25	18.86	30.00	1.0000	Complies
11	2462	16.07	0.25	16.32	30.00	1.0000	Complies

Test Mode	TX G Mode_Ant. 2
-----------	------------------

Channel	Frequency (MHz)	Average Output Power (dBm)	Duty Factor	Average Output Power + Duty Factor (dBm)	Max. Limit (dBm)	Max. Limit (W)	Result
01	2412	14.34	0.25	14.59	30.00	1.0000	Complies
06	2437	17.93	0.25	18.18	30.00	1.0000	Complies
11	2462	15.81	0.25	16.06	30.00	1.0000	Complies

Test Mode	TX G Mode_Total
-----------	-----------------

Channel	Frequency (MHz)	Average Output Power (dBm)	Max. Limit (dBm)	Max. Limit (W)	Result
01	2412	17.08	30.00	1.0000	Complies
06	2437	21.55	30.00	1.0000	Complies
11	2462	19.21	30.00	1.0000	Complies

Test Mode	TX N(HT20) Mode_Ant. 1
-----------	------------------------

Channel	Frequency (MHz)	Average Output Power (dBm)	Duty Factor	Average Output Power + Duty Factor (dBm)	Max. Limit (dBm)	Max. Limit (W)	Result
01	2412	12.76	0.30	13.06	30.00	1.0000	Complies
06	2437	18.99	0.30	19.29	30.00	1.0000	Complies
11	2462	15.28	0.30	15.58	30.00	1.0000	Complies

Test Mode	TX N(HT20) Mode_Ant. 2
-----------	------------------------

Channel	Frequency (MHz)	Average Output Power (dBm)	Duty Factor	Average Output Power + Duty Factor (dBm)	Max. Limit (dBm)	Max. Limit (W)	Result
01	2412	13.88	0.30	14.18	30.00	1.0000	Complies
06	2437	18.58	0.30	18.88	30.00	1.0000	Complies
11	2462	14.75	0.30	15.05	30.00	1.0000	Complies

Test Mode	TX N(HT20) Mode_Total
-----------	-----------------------

Channel	Frequency (MHz)	Average Output Power (dBm)	Max. Limit (dBm)	Max. Limit (W)	Result
01	2412	16.66	30.00	1.0000	Complies
06	2437	22.10	30.00	1.0000	Complies
11	2462	18.33	30.00	1.0000	Complies

Test Mode	TX N(HT40) Mode_Ant. 1
-----------	------------------------

Channel	Frequency (MHz)	Average Output Power (dBm)	Duty Factor	Average Output Power + Duty Factor (dBm)	Max. Limit (dBm)	Max. Limit (W)	Result
03	2422	10.11	0.36	10.47	30.00	1.0000	Complies
06	2437	15.82	0.36	16.18	30.00	1.0000	Complies
09	2452	11.85	0.36	12.21	30.00	1.0000	Complies

Test Mode	TX N(HT40) Mode_Ant. 2
-----------	------------------------

Channel	Frequency (MHz)	Average Output Power (dBm)	Duty Factor	Average Output Power + Duty Factor (dBm)	Max. Limit (dBm)	Max. Limit (W)	Result
03	2422	11.13	0.36	11.49	30.00	1.0000	Complies
06	2437	16.26	0.36	16.62	30.00	1.0000	Complies
09	2452	12.44	0.36	12.80	30.00	1.0000	Complies

Test Mode	TX N(HT40) Mode_Total
-----------	-----------------------

Channel	Frequency (MHz)	Average Output Power (dBm)	Max. Limit (dBm)	Max. Limit (W)	Result
03	2422	14.02	30.00	1.0000	Complies
06	2437	19.42	30.00	1.0000	Complies
09	2452	15.53	30.00	1.0000	Complies

APPENDIX G - CONDUCTED SPURIOUS EMISSIONS

Test Mode TX B Mode_Ant. 1

Reference Level-CH01

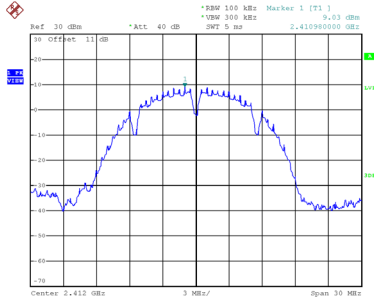

Date: 5.JUN.2022 13:50:18

Reference Level-CH06

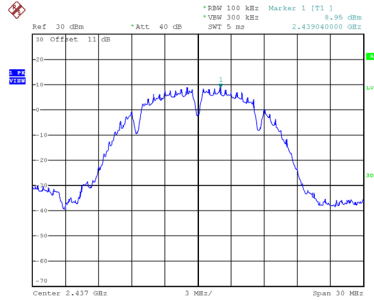

Date: 5.JUN.2022 13:50:44

Reference Level-CH11

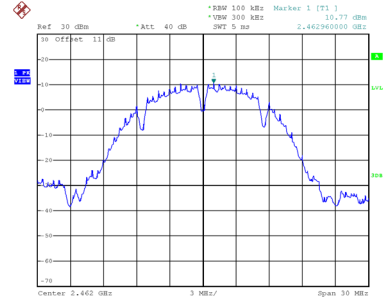

Date: 5.JUN.2022 13:51:04

Bandedge-CH01

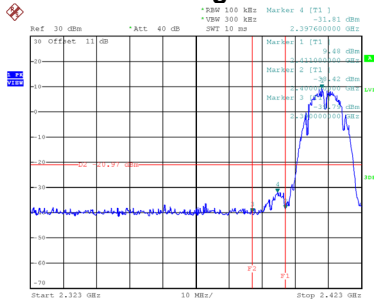

Date: 5.JUN.2022 14:31:14

Bandedge-CH11

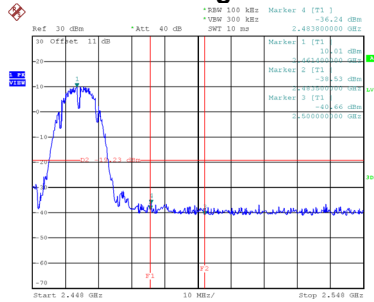

Date: 5.JUN.2022 14:32:56

CH01 – 10th Harmonic of the fundamental frequency

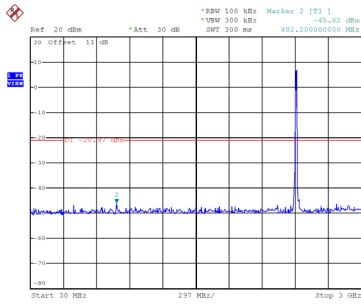

Date: 5.JUN.2022 15:36:37

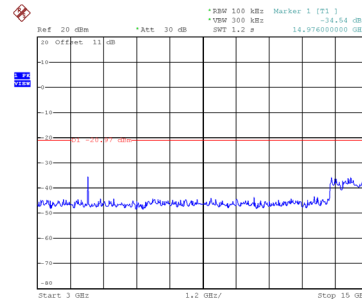

Date: 5.JUN.2022 15:37:22

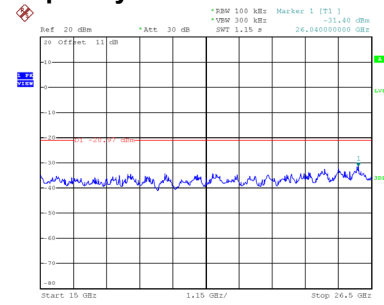

Date: 5.JUN.2022 15:37:30

CH06 – 10th Harmonic of the fundamental frequency

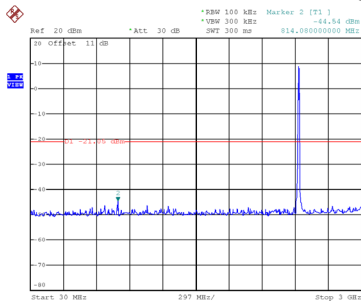

Date: 5.JUN.2022 15:37:58

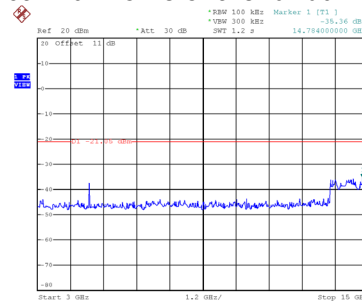

Date: 5.JUN.2022 15:38:06

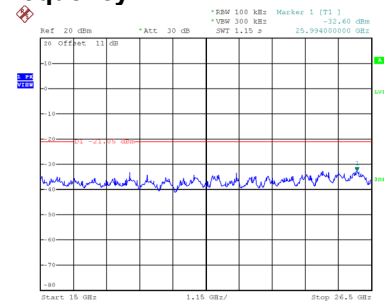

Date: 5.JUN.2022 15:38:14

CH11 – 10th Harmonic of the fundamental frequency

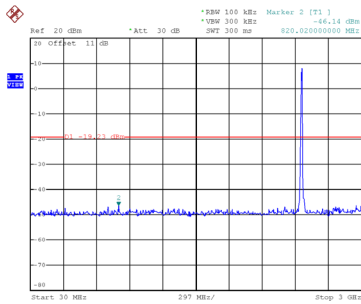

Date: 5.JUN.2022 15:38:40

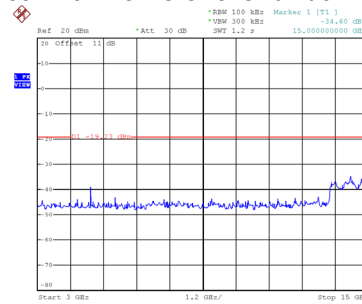

Date: 5.JUN.2022 15:38:48

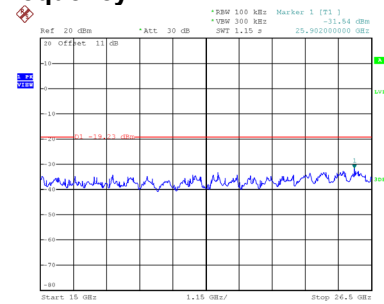

Date: 5.JUN.2022 15:38:56

Test Mode TX B Mode_Ant. 2

Reference Level-CH01

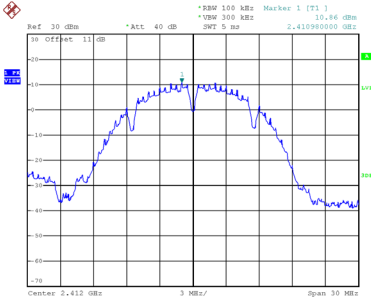

Date: 5.JUN.2022 13:40:36

Reference Level-CH06

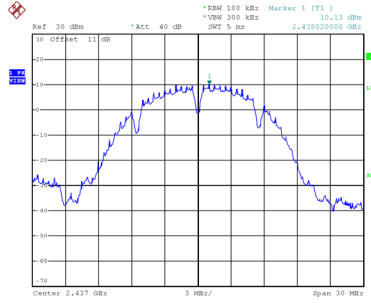

Date: 5.JUN.2022 13:41:03

Reference Level-CH11

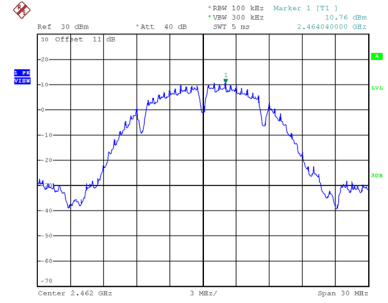

Date: 5.JUN.2022 13:41:26

Bandedge-CH01

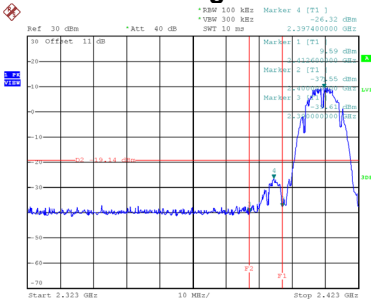

Date: 5.JUN.2022 14:06:19

Bandedge-CH11

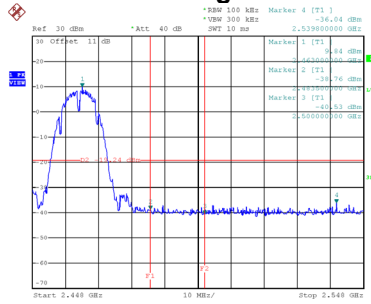

Date: 5.JUN.2022 14:07:53