

RF MEASUREMENT REPORT

FCC ID : 2AXJ4D230V1
Applicant : TP-Link Corporation Limited
Application Type : Certification
Product : Tapo Video Doorbell Camera
Model No. : Tapo D230
Brand Name : tp-link
FCC Classification : Digital Transmission System (DTS)
FCC Rule Part(s) : Part15 Subpart C (Section 15.247)
Received Date : March 25, 2024
Test Date : April 10, 2024~May 23, 2024

Tested By : Owen Tsai
(Owen Tsai)

Reviewed By : Paddy Chen
(Paddy Chen)

Approved By : Chenz Ker
(Chenz Ker)



The test results only relate to the tested sample.

This equipment has been shown to be capable of compliance with the applicable technical standards as indicated in the measurement report and was tested in accordance with the measurement procedures specified in ANSI C63.10. Test results reported herein relate only to the item(s) tested.

The test report shall not be reproduced except in full without the written approval of MRT Technology (Taiwan) Co., Ltd.

Revision History

Report No.	Version	Description	Issue Date	Note
2403TW0115-U3	1.0	Original Report	2024-06-07	Valid

Note: Tapo D230 (FCC ID: 2AXJ4D230V1) is a variant device based on Tapo D230 (FCC ID: 2AXJ4D230) to replace the 2.4g WIFI chip and the layout of Main Board and add some spot check verified data according to KDB 484596 D01v02r02 and the difference between the FCC IDs.

CONTENTS

Description	Page
§2.1033 General Information	5
1. INTRODUCTION	6
1.1. Scope.....	6
1.2. MRT Test Location.....	6
2. PRODUCT INFORMATION	7
2.1. Equipment Description	7
2.2. Product Specification Subjective to this Standard.....	7
2.3. Test Mode.....	8
2.4. Configuration of Test System.....	8
2.5. Test System Details	8
2.6. Operation Frequency / Channel List.....	9
2.7. Test Software.....	9
2.8. EMI Suppression Device(s)/Modifications	9
2.9. Labeling Requirements	9
3. DESCRIPTION of TEST	10
3.1. Evaluation Procedure.....	10
3.2. AC Line Conducted Emissions	10
3.3. Radiated Emissions	11
4. ANTENNA REQUIREMENTS.....	12
5. TEST EQUIPMENT CALIBRATION DATE.....	13
6. MEASUREMENT UNCERTAINTY.....	14
7. TEST RESULT	15
7.1. Summary.....	15
7.2. 6dB Bandwidth Measurement	16
7.2.1. Test Limit.....	16
7.2.2. Test Procedure used	16
7.2.3. Test Setting	16
7.2.4. Test Setup	16
7.2.5. Test Result	17
7.3. Output Power Measurement.....	18
7.3.1. Test Limit.....	18
7.3.2. Test Procedure Used.....	18
7.3.3. Test Setting	18
7.3.4. Test Setup	18
7.3.5. Test Result of Output Power	19
7.4. Power Spectral Density Measurement	20
7.4.1. Test Limit.....	20
7.4.2. Test Procedure Used.....	20
7.4.3. Test Setting	20
7.4.4. Test Setup	20

7.4.5.	Test Result	21
7.5.	Out-of-Band Spurious Emissions Emissions Measurement	22
7.5.1.	Test Limit	22
7.5.2.	Test Procedure Used	22
7.5.3.	Test Setting	22
7.5.4.	Test Setup	22
7.5.5.	Test Result	23
7.6.	Radiated Spurious Emission Measurement	24
7.6.1.	Test Limit	24
7.6.2.	Test Procedure Used	24
7.6.3.	Test Setting	24
7.6.4.	Test Setup	26
7.6.5.	Test Result	28
7.7.	Radiated Restricted Band Edge Measurement	32
7.7.1.	Test Limit	32
7.7.2.	Test Procedure Used	32
7.7.3.	Test Setting	32
7.7.4.	Test Setup	34
7.7.5.	Test Result	35
7.8.	AC Conducted Emissions Measurement	37
7.8.1.	Test Limit	37
7.8.2.	Test Setup	37
7.8.3.	Test Result	38
8.	CONCLUSION	42
	Appendix A : Test Setup Photograph	43
	Appendix B : External Photograph	43
	Appendix C : Internal Photograph	43

§2.1033 General Information

Applicant	TP-Link Corporation Limited
Applicant Address	Room 901, 9/F., New East Ocean Centre, 9 Science Museum Road, Tsim Sha Tsui, Kowloon, Hongkong
Manufacturer	TP-Link Corporation Limited
Manufacturer Address	Room 901, 9/F., New East Ocean Centre, 9 Science Museum Road, Tsim Sha Tsui, Kowloon, Hongkong
Test Site	MRT Technology (Taiwan) Co., Ltd
Test Site Address	No. 38, Fuxing Second Rd., Guishan Dist., Taoyuan City 333, Taiwan (R.O.C)
MRT FCC Registration No.	291082
FCC Rule Part(s)	Part 15.247

Test Facility / Accreditations

1. MRT facility is a FCC registered (Reg. No. 291082) test facility with the site description report on file and is designated by the FCC as an Accredited Test Firm.
2. MRT facility is an IC registered (MRT Reg. No. 21723) test laboratory with the site description on file at Industry Canada.
3. MRT Lab is accredited to ISO 17025 by the Taiwan Accreditation Foundation (TAF Cert. No. 3261) in EMC, Telecommunications and Radio testing for FCC (Designation Number: TW3261), Industry Canada, EU and TELEC Rules.

1. INTRODUCTION

1.1. Scope

Measurement and determination of electromagnetic emissions (EMC) of radio frequency devices including intentional and/or unintentional radiators for compliance with the technical rules and regulations of the Federal Communications Commission and the Industry Canada Certification and Engineering Bureau.

1.2. MRT Test Location

The map below shows the location of the MRT LABORATORY, its proximity to the Taoyuan City. These measurement tests were conducted at the MRT Technology (Taiwan) Co., Ltd. Facility located at No.38, Fuxing 2nd Rd., Guishan Dist., Taoyuan City 33377, Taiwan (R.O.C).

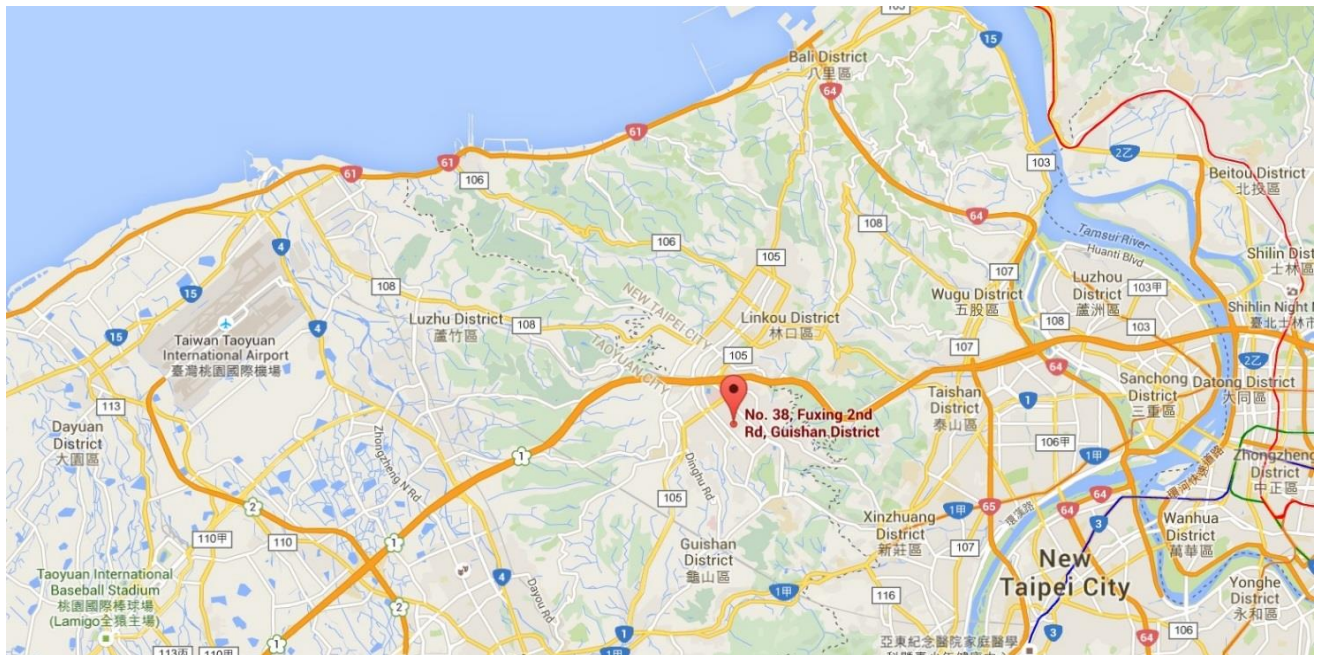

2. PRODUCT INFORMATION

2.1. Equipment Description

Product Name	Tapo Video Doorbell Camera
Model No.	Tapo D230
Brand Name	tp-link
EUT Identification No.:	#1-1 (Conducted) #1-2 (Radiated)
Radio Specification:	WLAN: 802.11b/g/n (1TX / 1RX) WPAN: Sub 1G
Accessory	
Adapter	Brand: Dongguan Aohai Technology Co., Ltd Model No: A8-501000 Input: AC 100-240V~0.2A, 50-60Hz Output: DC 5V, 1A
Micro USB Cable	Brand: AUFU HANRICO ELECTRONICS CO., LTD Model No: 26ATP00214 Length: 0.5m (Shielded)
Battery	Brand: TP-Link Corporation Limited Model No: Tapo A100

2.2. Product Specification Subjective to this Standard

Operating Frequency	920.9 MHz, 921.7MHz, 922.3MHz
Type of modulation	GFSK
Data Rate	50kbps
Antenna Type:	IFA
Antenna Gain:	-6.5dBi

2.3. Test Mode

Test Mode	Mode 1: Transmit
-----------	------------------

Note: Regarding to the operation frequency, the lowest, middle and highest frequency are selected to perform the test.

2.4. Configuration of Test System

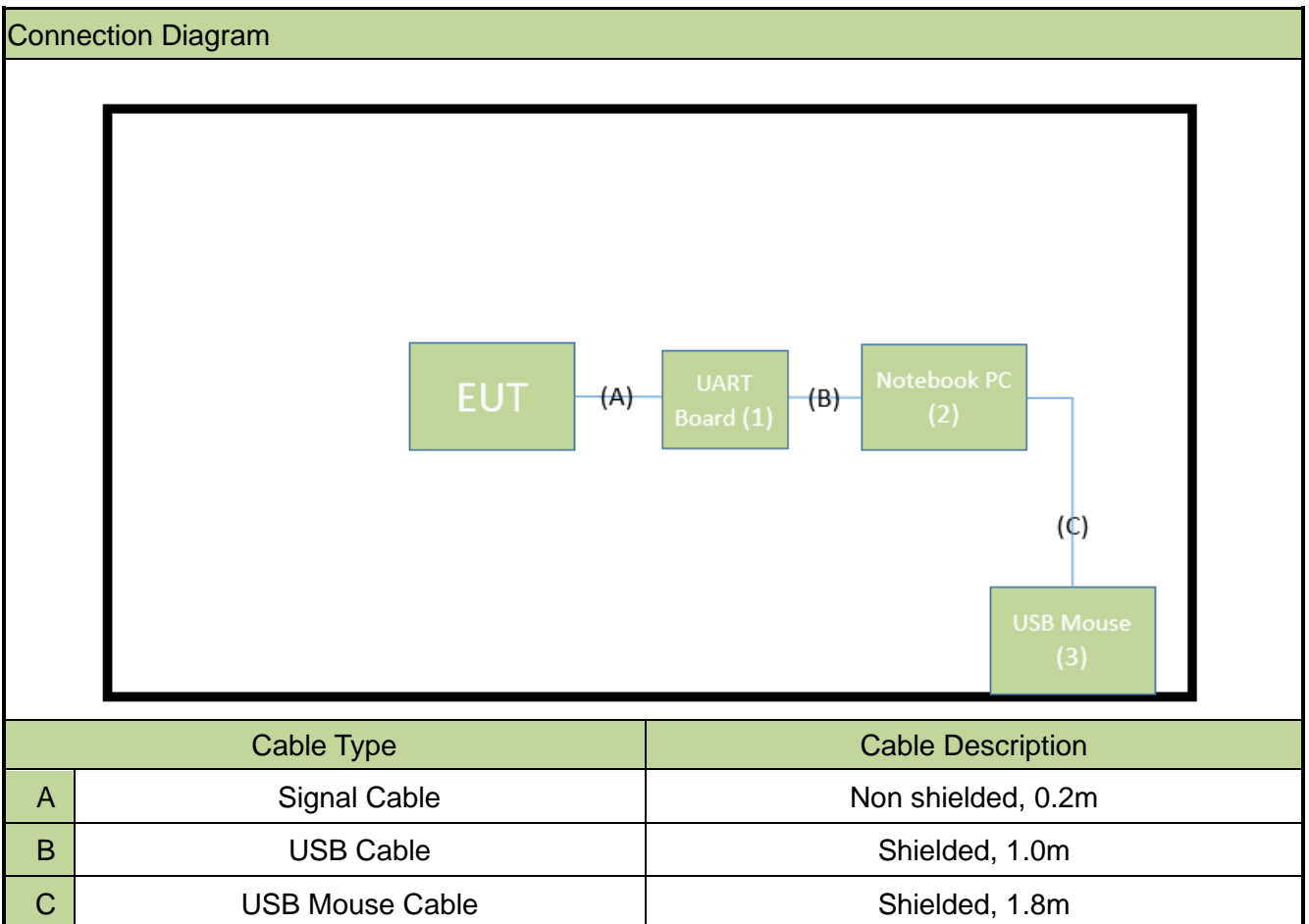

2.5. Test System Details

The types for all equipments, plus descriptions of all cables used in the tested system (including inserted cards) are:

	Product	Manufacturer	Model No.	Serial No.	Power Cord
1	UART Board	GZUt	CH340	N/A	N/A
2	Notebook PC	Lenovo	T450	N/A	Non-Shielded, 0.8m
3	USB Mouse	Logitech	M90	N/A	N/A

2.6. Operation Frequency / Channel List

Channel	Frequency
1	920.9 MHz
2	921.7 MHz
3	922.3 MHz

Total Time (T _{on}) (ms)	The duration of one cycle (ms)	Duty Cycle (ms)	Average Factor (dB)
9.75	100	0.10	20.22

Note 1: Duty Cycle = Total Time (T_{on}) / 100ms.

Note 2: Average Factor = 20*Log*(1/Duty Cycle).

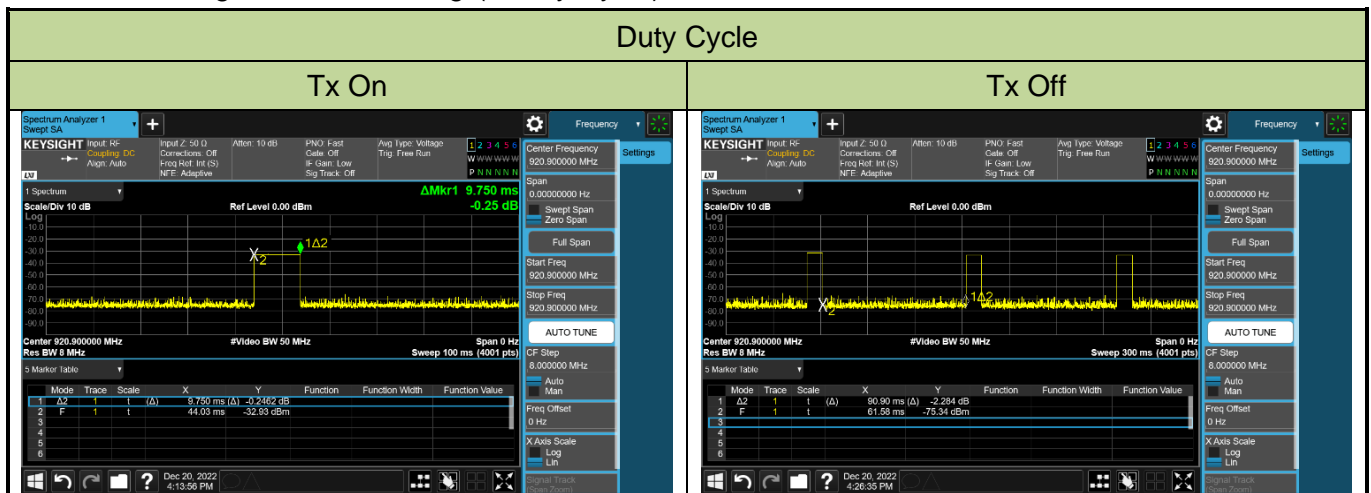

2.7. Test Software

The test utility software used during testing was “Tera Term”, the version is ver4.98

2.8. EMI Suppression Device(s)/Modifications

No EMI suppression device(s) were added and/or no modifications were made during testing.

2.9. Labeling Requirements

Per 2.1074 & 15.19; Docket 95-19

The label shall be permanently affixed at a conspicuous location on the device; instruction manual or pamphlet supplied to the user and be readily visible to the purchaser at the time of purchase.

However, when the device is so small wherein placement of the label with specified statement is not practical, only the FCC ID must be displayed on the device per Section 15.19(a)(5). Please see attachment for FCC ID label and label location.

3. DESCRIPTION of TEST

3.1. Evaluation Procedure

The measurement procedures described in the American National Standard for Testing Unlicensed Wireless Devices (ANSI C63.10-2013), and the guidance provided in KDB 558074 D01v05 were used in the measurement of the device.

3.2. AC Line Conducted Emissions

The line-conducted facility is located inside an 9'x4'x3' shielded enclosure. A 1m x 2m wooden table 80cm high is placed 40cm away from the vertical wall and 80cm away from the sidewall of the shielded room. Two 10kHz-30MHz, 50Ω/50uH Line-Impedance Stabilization Networks (LISNs) are bonded to the shielded room floor. Power to the LISNs is filtered by external high-current high-insertion loss power line filters. These filters attenuate ambient signal noise from entering the measurement lines. These filters are also bonded to the shielded enclosure.

The EUT is powered from one LISN and the support equipment is powered from the second LISN. All interconnecting cables more than 1 meter were shortened to a 1 meter length by non-inductive bundling (serpentine fashion) and draped over the back edge of the test table. All cables were at least 40cm above the horizontal reference ground-plane. Power cables for support equipment were routed down to the second LISN while ensuring that that cables were not draped over the second LISN.

Sufficient time for the EUT, support equipment, and test equipment was allowed in order for them to warm up to their normal operating condition. The RF output of the LISN was connected to the receiver and exploratory measurements were made to determine the frequencies producing the maximum emission from the EUT. The receiver was scanned from 150kHz to 30MHz. The detector function was set to peak mode for exploratory measurements while the bandwidth of the analyzer was set to 9kHz. The EUT, support equipment, and interconnecting cables were arranged and manipulated to maximize each emission. Each emission was also maximized by varying: power lines, the mode of operation or data exchange speed, or support equipment which determined the worst-case emission. Once the worst case emissions have been identified, the one EUT cable configuration/arrangement and mode of operation that produced these emissions are used for final measurements on the same test site. The analyzer is set to CISPR quasi-peak and average detectors with a 9kHz resolution bandwidth for final measurements.

An extension cord was used to connect to a single LISN which powered by EUT. The extension cord was calibrated with LISN, the impedance and insertion loss are compliance with the requirements as stated in ANSI C63.10-2013.

3.3. Radiated Emissions

The radiated test facilities consisted of an indoor 3 meter semi-anechoic chamber used for final measurements and exploratory measurements, when necessary. The measurement area is contained within the semi-anechoic chamber which is shielded from any ambient interference. For measurements above 1GHz absorbers are arranged on the floor between the turn table and the antenna mast in such a way so as to maximize the reduction of reflections. For measurements below 1GHz, the absorbers are removed. A MF Model 210SS turntable is used for radiated measurement. It is a continuously rotatable, remote controlled, metallic turntable and 2 meters (6.56 ft.) in diameter. The turn table is flush with the raised floor of the chamber in order to maintain its function as a ground plane. An 80cm high PVC support structure is placed on top of the turntable.

For all measurements, the spectrum was scanned through all EUT azimuths and from 1 to 4 meter receive antenna height using a broadband antenna from 30MHz up to the upper frequency shown in 15.33(b)(1) depending on the highest frequency generated or used in the device or on which the device operates or tunes. For frequencies above 1GHz, linearly polarized double ridge horn antennas were used. For frequencies below 30MHz, a calibrated loop antenna was used. When exploratory measurements were necessary, they were performed at 1 meter test distance inside the semi-anechoic chamber using broadband antennas, broadband amplifiers, and spectrum analyzers to determine the frequencies and modes producing the maximum emissions. Sufficient time for the EUT, support equipment, and test equipment was allowed in order for them to warm up to their normal operating condition. The test set-up for frequencies below 1GHz was placed on top of the 0.8 meter high, 1 x 1.5 meter table; and test set-up for frequencies 1-40GHz was placed on top of the 1.5 meter high, 1 x 1.5 meter table. The EUT, support equipment, and interconnecting cables were arranged and manipulated to maximize each emission. Appropriate precaution was taken to ensure that all emissions from the EUT were maximized and investigated. The system configuration, clock speed, mode of operation or video resolution, if applicable, turntable azimuth, and receive antenna height was noted for each frequency found.

Final measurements were made in the semi-anechoic chamber using calibrated, linearly polarized broadband and horn antennas. The test setup was configured to the setup that produced the worst case emissions. The spectrum analyzer was set to investigate all frequencies required for testing to compare the highest radiated disturbances with respect to the specified limits. The turntable containing the EUT was rotated through 360 degrees and the height of the receive antenna was varied 1 to 4 meters and stopped at the azimuth and height producing the maximum emission. Each emission was maximized by changing the orientation of the EUT through three orthogonal planes and changing the polarity of the receive antenna, which produced the worst-case emissions. According to 3dB Beam-Width of horn antenna, the horn antenna should be always directed to the EUT when rising height.

4. ANTENNA REQUIREMENTS

Excerpt from §15.203 of the FCC Rules/Regulations:

“An intentional radiator antenna shall be designed to ensure that no antenna other than that furnished by the responsible party can be used with the device. The use of a permanently attached antenna or of an antenna that uses a unique coupling to the intentional radiator shall be considered sufficient to comply with the provisions of this section.”

- The antenna of the device is permanently attached.
- There are no provisions for connection to an external antenna.

Conclusion:

The EUT unit complies with the requirement of §15.203.

5. TEST EQUIPMENT CALIBRATION DATE

Radiated Emissions

Instrument	Manufacturer	Type No.	Asset No.	Cali. Interval	Cali. Due Date
Active Loop Antenna	SCHWARZBECK	FMZB 1519B	MRTTWA00002	1 year	2025/5/7
Broadband TRILOG Antenna	SCHWARZBECK	VULB 9162	MRTTWA00001	1 year	2024/10/31
Broadband Hornantenna	RFSPIN	DRH18-E	MRTTWA00087	1 year	2024/8/17
Broadband Preamplifier	EMC Instruments corporation	EMC118A45SE	MRTTWA00088	1 year	2024/8/17
Breitband Hornantenna	SCHWARZBECK	BBHA 9170	MRTTWA00004	1 year	2025/3/26
Broadband Amplifier	SCHWARZBECK	BBV 9721	MRTTWA00006	1 year	2025/3/21
EMI Test Receiver	R&S	ESR3	MRTTWA00009	1 year	2025/3/5
Signal Analyzer	R&S	FSVA3044	MRTTWA00092	1 year	2024/6/29
Antenna Cable	HUBERSUHNER	SF106	MRTTWE00034	1 year	2024/6/26
Cable	HUBERSUHNER	EMC105-NM-NM-3000	MRTTWE00035	1 year	2024/6/26
Temperature/Humidity Meter	TFA	35.1078.10.IT	MRTTWA00032	1 year	2024/6/4

Conducted Test Equipment

Instrument	Manufacturer	Type No.	Asset No.	Cali. Interval	Cali. Due Date
EXA Signal Analyzer	KEYSIGHT	N9010A	MRTTWA00012	1 year	2024/10/17
EXA Signal Analyzer	KEYSIGHT	N9010B	MRTTWA00074	1 year	2024/7/19
USB Wideband Power Sensor	KEYSIGHT	U2021XA	MRTTWA00015	1 year	2025/3/12

Software	Version	Function
e3	9.160520a	EMI Test Software

6. MEASUREMENT UNCERTAINTY

Where relevant, the following test uncertainty levels have been estimated for tests performed on the EUT as specified in CISPR 16-4-2. This uncertainty represents an expanded uncertainty expressed at approximately the 95% confidence level using a coverage factor of $k = 2$.

Conducted Emission- Power Line
Measuring Uncertainty for a Level of Confidence of 95% ($U=2Uc(y)$): 0.15MHz~30MHz: $\pm 2.53\text{dB}$
Radiated Spurious Emission
Measuring Uncertainty for a Level of Confidence of 95% ($U=2Uc(y)$): 9kHz~30MHz: $\pm 3.92\text{dB}$ 30MHz~1GHz: $\pm 4.25\text{dB}$ 1GHz~18GHz: $\pm 4.40\text{dB}$ 18GHz~40GHz: $\pm 4.45\text{dB}$
Frequency Error
Measuring Uncertainty for a Level of Confidence of 95% ($U=2Uc(y)$): $\pm 78.4\text{Hz}$
Conducted Power
Measuring Uncertainty for a Level of Confidence of 95% ($U=2Uc(y)$): $\pm 0.84\text{dB}$
Conducted Spurious Emission
Measuring Uncertainty for a Level of Confidence of 95% ($U=2Uc(y)$): $\pm 2.65\text{ dB}$
Occupied Bandwidth
Measuring Uncertainty for a Level of Confidence of 95% ($U=2Uc(y)$): $\pm 3.3\%$
Temp. / Humidity
Measuring Uncertainty for a Level of Confidence of 95% ($U=2Uc(y)$): $\pm 0.82^\circ\text{C}/ \pm 3\%$
DC Voltage
Measuring Uncertainty for a Level of Confidence of 95% ($U=2Uc(y)$): $\pm 0.3\%$

7. TEST RESULT

7.1. Summary

FCC Section(s)	Test Description	Test Condition	Data Referencing	Test Result	Note
15.247(a)(2)	6dB Bandwidth	Conducted	Y	Pass	Refer to the original report: 2212TW0107-U2
15.247(b)(3)	Output Power		Y	Pass	Refer to the original report: 2212TW0107-U2 and the spot check data in section 7.3 of this report
15.247(e)	Power Spectral Density		Y	Pass	Refer to the original report: 2212TW0107-U2
15.247(d)	Band Edge / Out-of-Band Emissions		Y	Pass	Refer to the original report: 2212TW0107-U2
15.205 15.209	General Field Strength Limits (Restricted Bands and Radiated Emission Limits)	Radiated	Y	Pass	Refer to the original report: 2212TW0107-U2 and the spot check data in section 7.6 & 7.7 of this report
15.207	AC Conducted Emissions 150kHz - 30MHz	Line Conducted	N	Pass	Section 7.8

Notes:

- 1) Determining compliance is based on the test results met the regulation limits or requirements declared by clients, and the test results don't take into account the value of measurement uncertainty.
- 2) For radiated emission test, every axis (X, Y, Z) was also verified. The test results shown in the following sections represent the worst case emissions.
- 3) The analyzer plots shown in this section were all taken with a correction table loaded into the analyzer. The correction table was used to account for the losses of the cables and attenuators used as part of the system to connect the EUT to the analyzer at all frequencies of interest.

7.2. 6dB Bandwidth Measurement

7.2.1. Test Limit

The minimum 6dB bandwidth shall be at least 500 kHz.

7.2.2. Test Procedure used

ANSI C63.10-2013 Section 11.8

7.2.3. Test Setting

1. The Spectrum's automatic bandwidth measurement capability was used to perform the 6dB bandwidth measurement. The "X" dB bandwidth parameter was set to $X = 6$. The bandwidth measurement was not influenced by any intermediate power nulls in the fundamental emission.
2. Set RBW = 100 kHz
3. $VBW \geq 3 \times RBW$
4. Detector = Peak
5. Trace mode = max hold
6. Sweep = auto couple
7. Allow the trace was allowed to stabilize

7.2.4. Test Setup

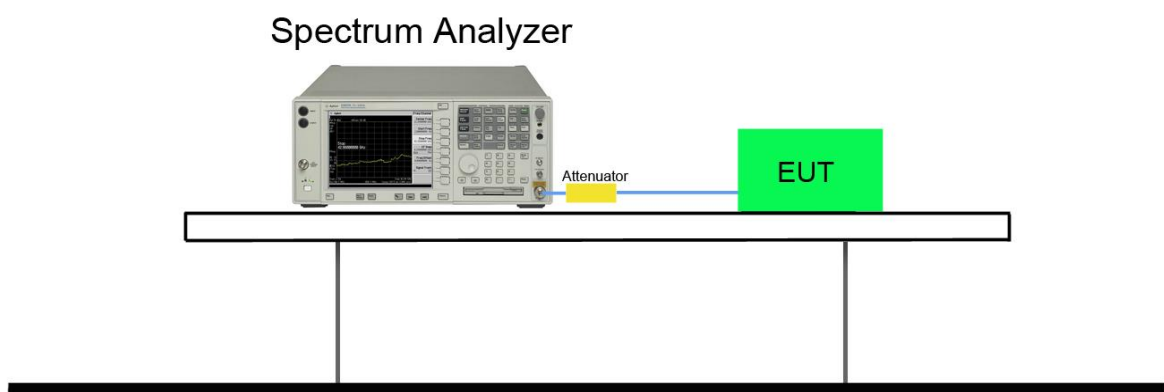

7.2.5. Test Result

Test Mode	Frequency (MHz)	6dB Bandwidth (KHz)	Limit (KHz)	Result
SUB 1G_TX	921.7	551.00	≥ 500	Pass

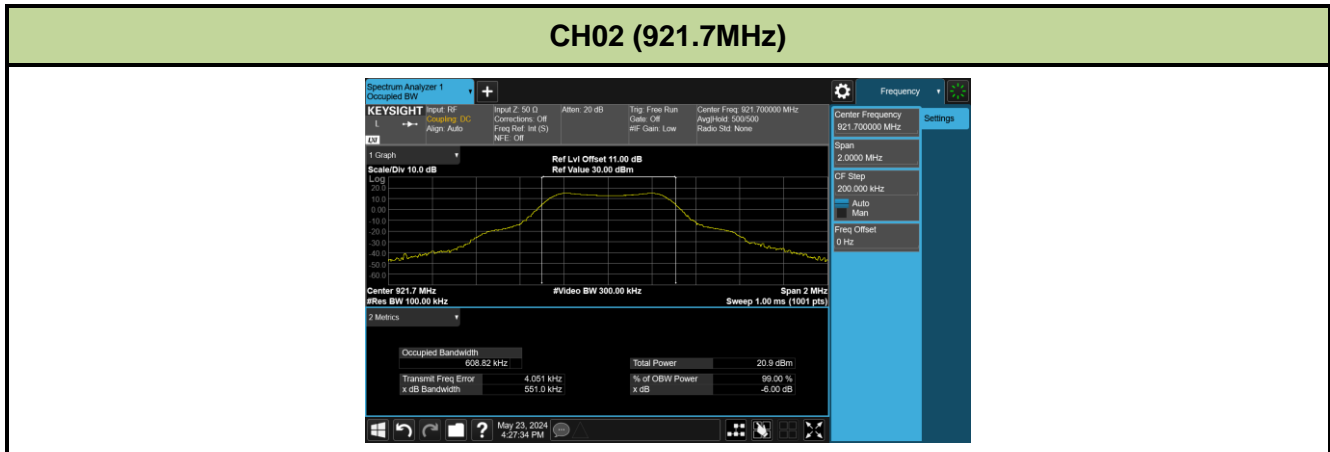

7.3. Output Power Measurement

7.3.1. Test Limit

The maximum out power shall be less 1 Watt (30dBm).

7.3.2. Test Procedure Used

ANSI C63.10-2013 Section 11.9.1.3

ANSI C63.10-2013 Section 11.9.2.3

7.3.3. Test Setting

Peak Power Measurement

The maximum peak conducted output power may be measured using a broadband peak RF power meter. The power meter shall have a video bandwidth that is greater than or equal to the DTS bandwidth and shall utilize a fast-responding diode detector.

Average Power Measurement

Average power measurements were performed only when the EUT was transmitting at its maximum power control level using a broadband power meter with a pulse sensor. The power meter implemented triggering and gating capabilities which were set up such that power measurements were recorded only during the ON time of the transmitter. The trace was averaged over 100 traces to obtain the final measured average power.

7.3.4. Test Setup

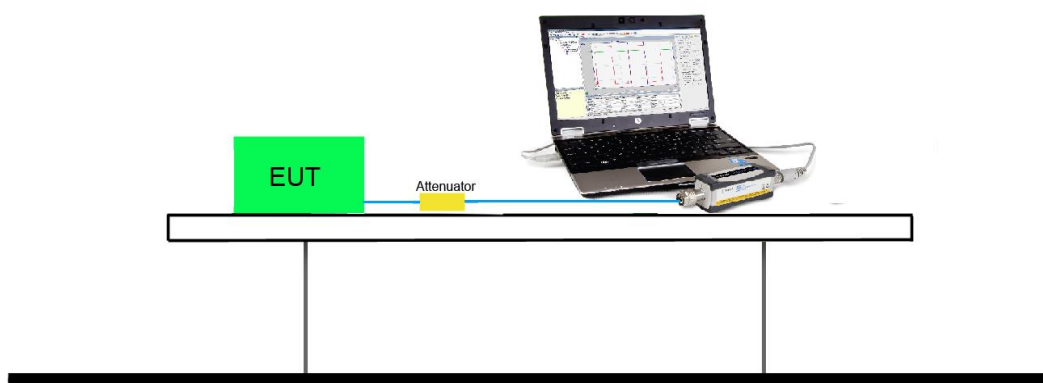

7.3.5. Test Result

Test Mode	Frequency (MHz)	Average Power (dBm)	Peak Power (dBm)	Power Limit (dBm)
SUB 1G_TX	920.9	15.33	15.48	< 30
	921.7	15.36	15.52	< 30
	922.3	15.37	15.53	< 30

Note: Output power =Reading value on power meter + cable loss.

7.4. Power Spectral Density Measurement

7.4.1. Test Limit

The maximum permissible power spectral density is 8dBm in any 3 kHz band.

7.4.2. Test Procedure Used

ANSI C63.10-2013 Section 11.10.2

7.4.3. Test Setting

This procedure shall be used if maximum peak conducted output power was used to demonstrate compliance, and is optional if the maximum conducted (average) output power was used to demonstrate compliance.

- a) Set analyzer center frequency to DTS channel center frequency.
- b) Set the span to 1.5 times the DTS bandwidth.
- c) Set the RBW to: 3 kHz.
- d) Set the VBW $\geq 3^*$ RBW.
- e) Detector = peak.
- f) Sweep time = auto couple.
- g) Trace mode = max hold.
- h) Allow trace to fully stabilize.
- i) Use the peak marker function to determine the maximum amplitude level within the RBW.

7.4.4. Test Setup

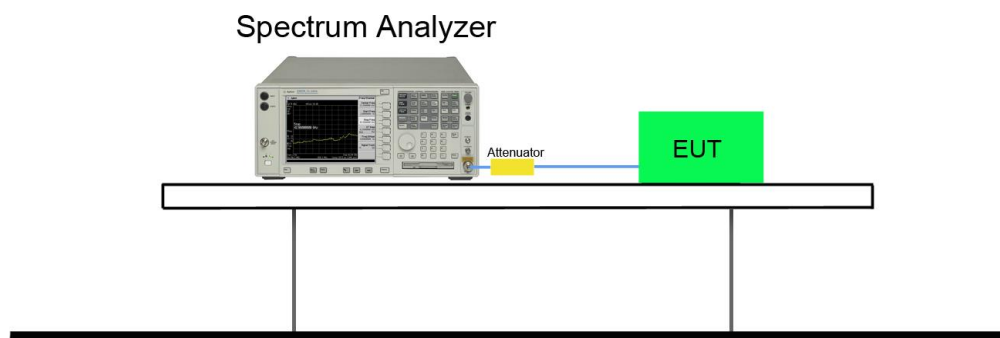

7.4.5. Test Result

Test Mode	Frequency (MHz)	PSD (dBm/3kHz)	Limit (dBm/3kHz)	Result
SUB 1G_TX	921.7	6.08	≤ 8	Pass

CH02 (921.7MHz)

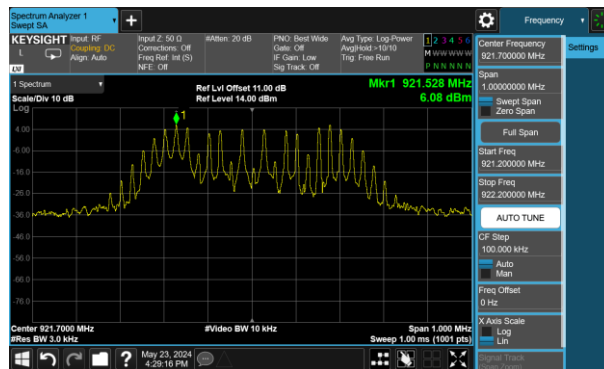

7.5. Out-of-Band Spurious Emissions Emissions Measurement

7.5.1. Test Limit

In any 100 kHz bandwidth outside the frequency band in which the spread spectrum or digitally modulated intentional radiator is operating, the radio frequency power that is produced by the intentional radiator shall be at least 20 dB below that in the 100 kHz bandwidth within the band that contains the highest level of the desired power, based on RF conducted measurement, provided the transmitter demonstrates compliance with the peak conducted power limits.

7.5.2. Test Procedure Used

ANSI C63.10-2013 Section 11.11

7.5.3. Test Setting

- (a) Set instrument center frequency to DTS channel center frequency
- (b) Set the span to ≥ 1.5 times the DTS bandwidth
- (c) Set the RBW = 100 kHz
- (d) Set the VBW $\geq 3 \times$ RBW
- (e) Detector = peak
- (f) Sweep time = auto couple
- (g) Trace mode = max hold
- (h) Allow trace to fully stabilize

7.5.4. Test Setup

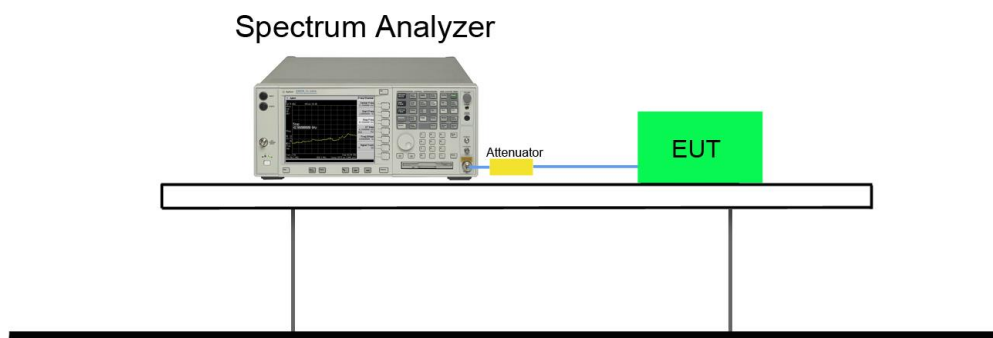

7.5.5. Test Result

Test Mode	Frequency (MHz)	Limit	Result
SUB 1G_TX	921.7	20dBc	Pass

CH02 (921.7MHz)	CH02 (921.7MHz)
<p>Center Frequency: 921.500000 MHz Span: 5.00000000 MHz Mkr3 922.420 MHz -33.31 dBm</p>	<p>Center Frequency: 970.000000 MHz Span: 970.000000 MHz Mkr1 995.49 MHz -56.75 dBm</p>
CH02 (921.7MHz)	
<p>Center Frequency: 6.500000000 GHz Span: 9.000000000 GHz Mkr1 1.84291 GHz -50.22 dBm</p>	

7.6. Radiated Spurious Emission Measurement

7.6.1. Test Limit

All out of band emissions appearing in a restricted band as specified in Section 15.205 of the Title 47 CFR must not exceed the limits shown in Table per Section 15.209.

FCC Part 15 Subpart C Paragraph 15.209		
Frequency [MHz]	Field Strength [V/m]	Measured Distance [Meters]
0.009 - 0.490	2400/F (kHz)	300
0.490 - 1.705	24000/F (kHz)	30
1.705 - 30	30	30
30 - 88	100	3
88 - 216	150	3
216 - 960	200	3
Above 960	500	3

7.6.2. Test Procedure Used

ANSI C63.10 - 2013 - Section 11.11 & 11.12

ANSI C63.10 - 2013 - Section 6.3 (General Requirements)

ANSI C63.10 - 2013 - Section 6.4 (Standard test method below 30MHz)

ANSI C63.10 - 2013 - Section 6.5 (Standard test method above 30MHz to 1GHz)

ANSI C63.10 - 2013 - Section 6.6 (Standard test method above 1GHz)

7.6.3. Test Setting

Peak Field Strength Measurements

1. Analyzer center frequency was set to the frequency of the radiated spurious emission of interest
2. RBW = as specified in Table 1
3. VBW = 3MHz

4. Detector = peak
5. Sweep time = auto couple
6. Trace mode = max hold
7. Trace was allowed to stabilize

Table 1 - RBW as a function of frequency

Frequency	RBW
9 ~ 150 kHz	200 ~ 300 Hz
0.15 ~ 30 MHz	9 ~ 10 kHz
30 ~ 1000 MHz	100 ~ 120 kHz
> 1000 MHz	1 MHz

Average Field Strength Measurements

1. Analyzer center frequency was set to the frequency of the radiated spurious emission of interest
2. RBW = 1MHz
3. VBW \geq 1/T
4. De As an alternative, the instrument may be set to linear detector mode. Ensure that video filtering is applied in linear voltage domain (rather than in a log or dB domain). Some instruments require linear display mode in order to accomplish this. Others have a setting for Average-VBW Type, which can be set to "Voltage" regardless of the display mode
5. Detector = Peak
6. Sweep time = auto
7. Trace mode = max hold
8. Allow max hold to run for at least 50 times (1/duty cycle) traces

7.6.4. Test Setup

9kHz ~ 30MHz Test Setup:

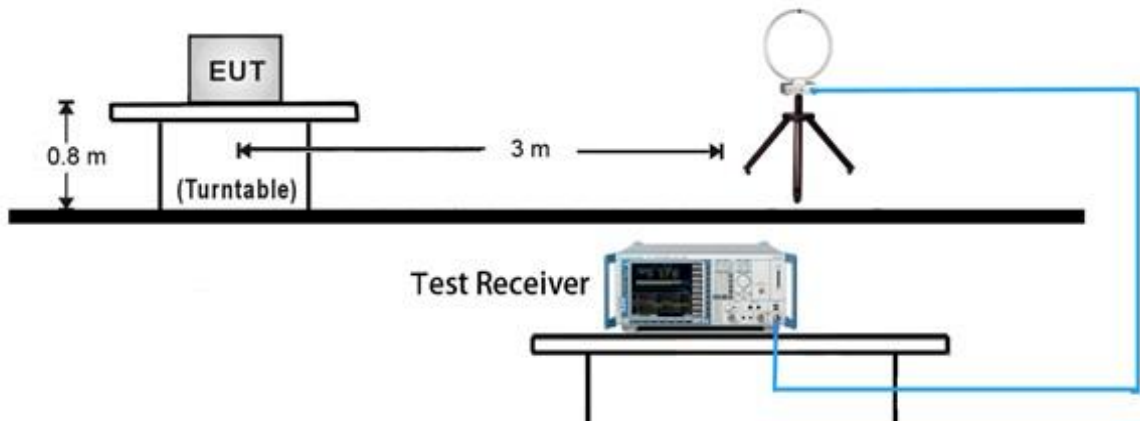

30MHz ~ 1GHz Test Setup:

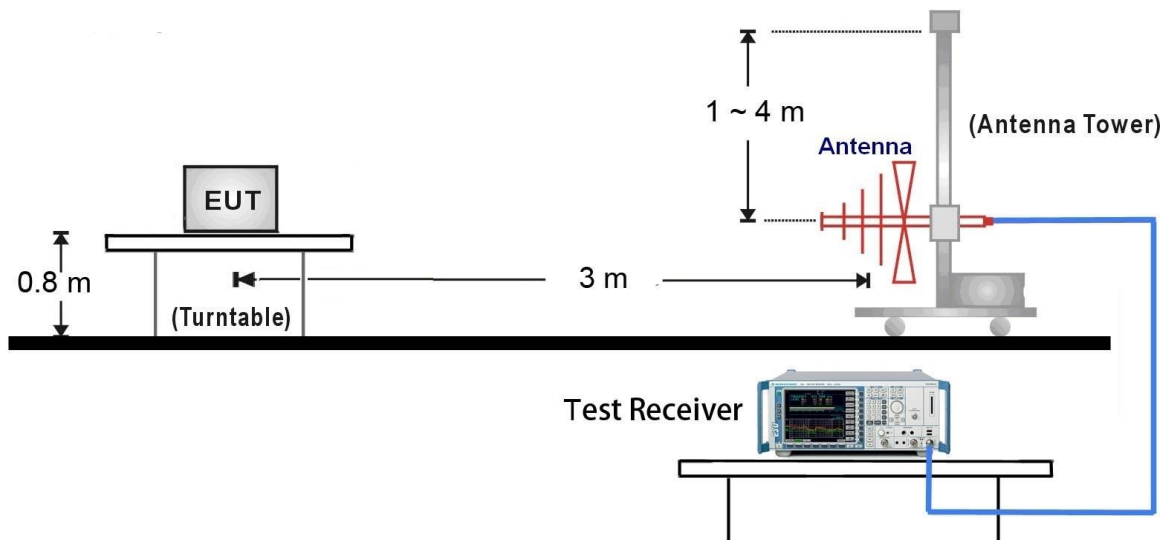

1GHz ~ 18GHz Test Setup:

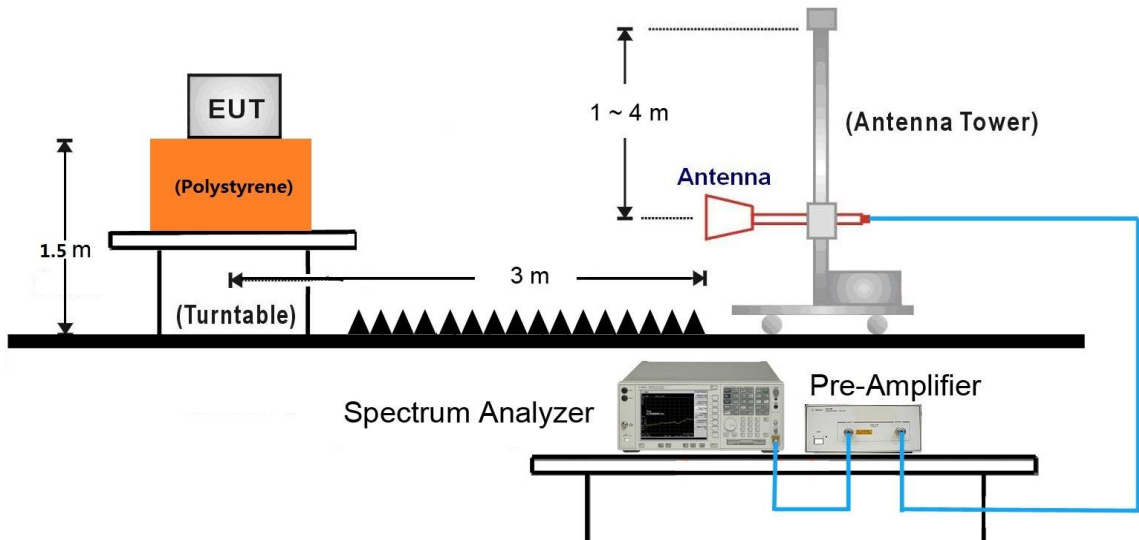

18GHz ~25GHz Test Setup:

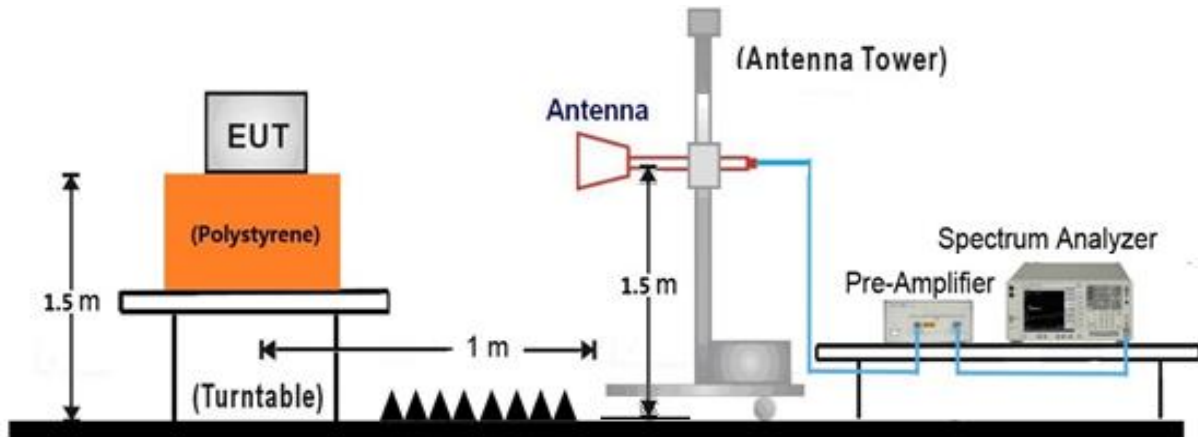

7.6.5. Test Result

EUT	Tapo Video Doorbell Camera	Date of Test	2024-05-15
Factor	VULB 9162	Temp. / Humidity	23°C /62%
Polarity	Horizontal	Site / Test Engineer	AC2 / Stanley
Test Mode	SUB 1G_TX_921.7MHz	Test Voltage	By Battery

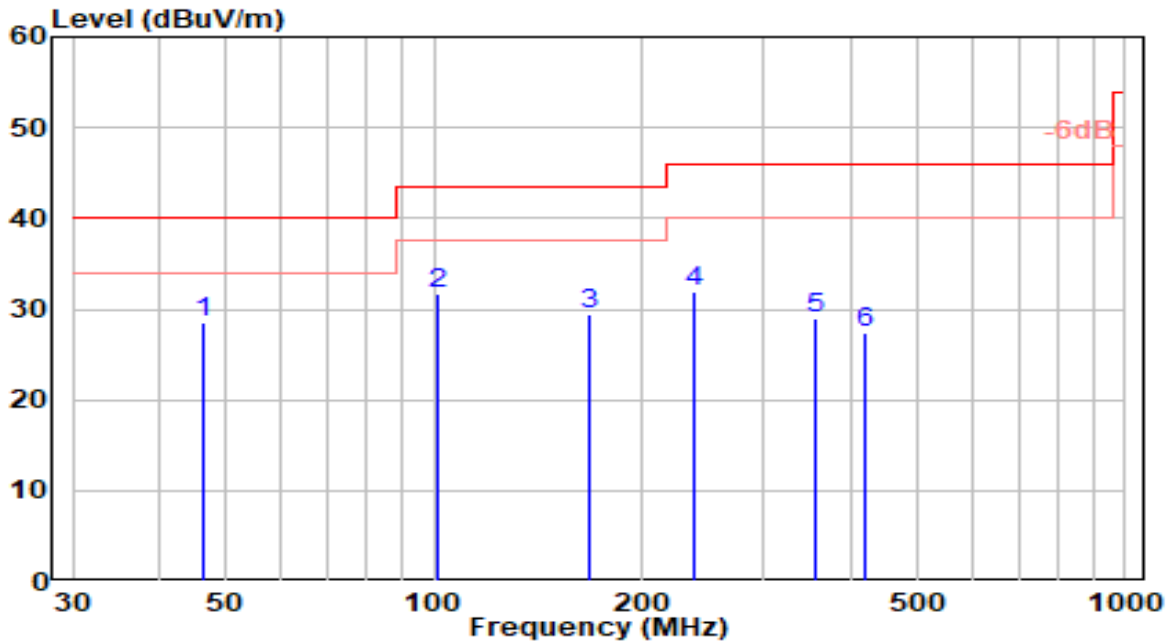

No	Frequency (MHz)	Reading (dBUV)	C.F (dB/m)	Measurement (dBUV/m)	Margin (dB)	Limit (dBUV/m)	Height (cm)	Angle (deg)	Remark (QP/PK/AV)
1	* 46.490	7.93	20.51	28.44	-11.56	40.00	100	236	QP
2	100.810	13.32	18.32	31.63	-11.87	43.50	100	255	QP
3	167.740	13.71	15.74	29.45	-14.05	43.50	100	292	QP
4	238.550	12.69	19.31	32.00	-14.00	46.00	100	312	QP
5	354.950	6.37	22.55	28.92	-17.08	46.00	100	258	QP
6	420.910	3.83	23.53	27.36	-18.64	46.00	100	311	QP

Note:

- "*" means this data is the worst emission level.
- C.F (Correction Factor) = Antenna Factor (dB/m) + Cable Loss (dB).
- Measurement (dBUV/m) = Reading(dBUV) + C.F (Correction Factor).
- The emission levels of other frequencies are very lower than the limit and not show in test report.

EUT	Tapo Video Doorbell Camera	Date of Test	2024-05-15
Factor	VULB 9162	Temp. / Humidity	23°C /62%
Polarity	Vertical	Site / Test Engineer	AC2 / Stanley
Test Mode	SUB 1G_TX_921.7MHz	Test Voltage	By Battery

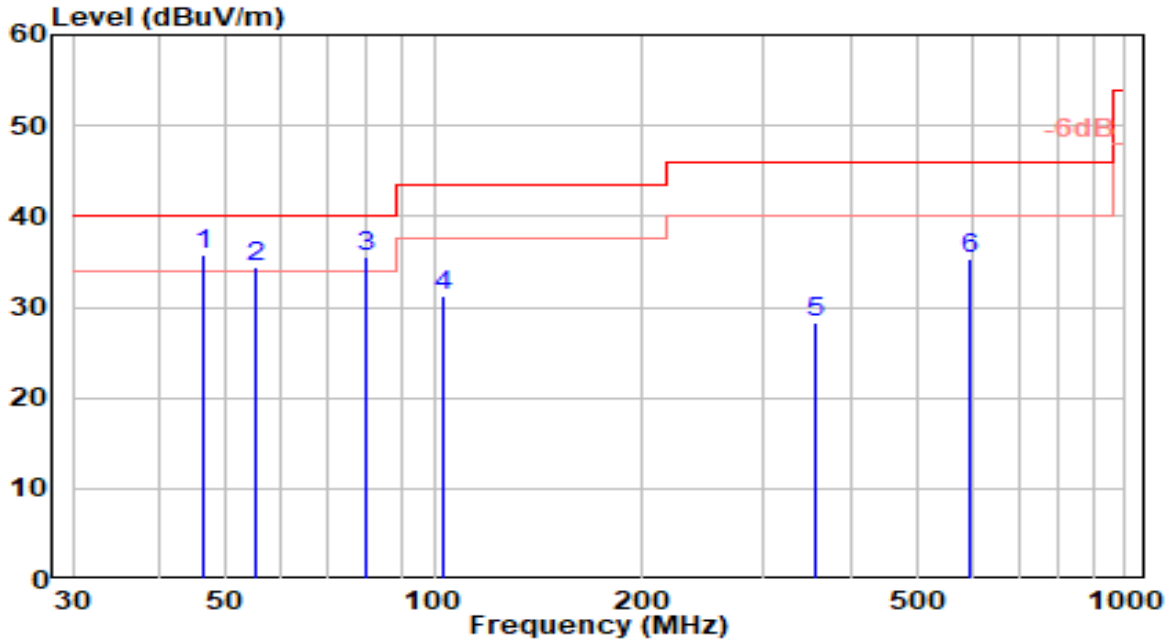

No	Frequency (MHz)	Reading (dBuV)	C.F (dB/m)	Measurement (dBuV/m)	Margin (dB)	Limit (dBuV/m)	Height (cm)	Angle (deg)	Remark (QP/PK/AV)
1	* 46.490	15.24	20.51	35.75	-4.25	40.00	100	0	QP
2	55.220	14.64	19.81	34.46	-5.54	40.00	100	317	QP
3	79.470	21.58	13.92	35.51	-4.49	40.00	100	280	QP
4	102.750	12.95	18.33	31.28	-12.22	43.50	100	264	QP
5	355.920	5.79	22.57	28.35	-17.65	46.00	100	350	QP
6	598.420	8.39	26.97	35.36	-10.64	46.00	100	192	QP

Note:

1. " *", means this data is the worst emission level.
2. C.F (Correction Factor) = Antenna Factor (dB/m) + Cable Loss (dB).
3. Measurement (dBuV/m) = Reading(dBuV) + C.F (Correction Factor).
4. The emission levels of other frequencies are very lower than the limit and not show in test report.

EUT	Tapo Video Doorbell Camera	Date of Test	2024-05-14
Factor	DRH18-E	Temp. / Humidity	23°C /62%
Polarity	Horizontal	Site / Test Engineer	AC2 / Stanley
Test Mode	SUB 1G_TX_921.7MHz	Test Voltage	By Battery

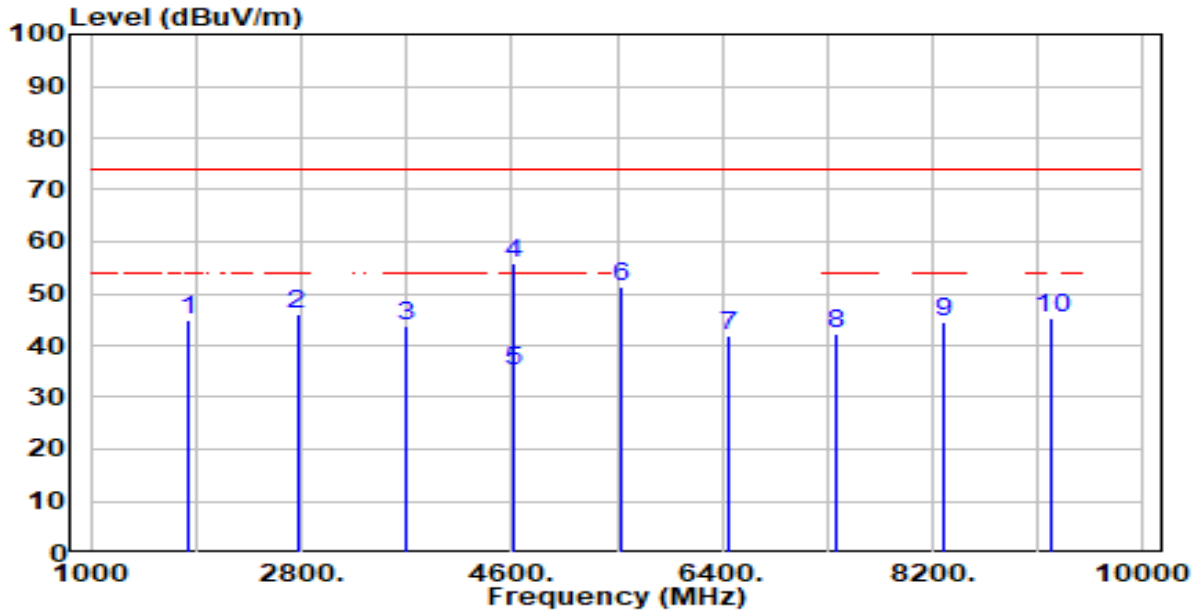

No	Frequency (MHz)	Reading (dBuV)	C.F (dB/m)	Measurement (dBuV/m)	Margin (dB)	Limit (dBuV/m)	Height (cm)	Angle (deg)	Remark (QP/PK/AV)
1	1843.400	65.51	-20.58	44.93	-29.07	74.00	300	20	Peak
2	2765.100	63.24	-17.21	46.03	-27.97	74.00	228	0	Peak
3	3686.800	58.37	-14.77	43.60	-30.40	74.00	200	97	Peak
4	* 4608.500	68.13	-12.14	55.99	-18.01	74.00	200	253	Peak
5	* 4608.500	N/A	N/A	35.77	-18.23	54.00	200	253	Average
6	5530.200	62.30	-11.12	51.19	-22.81	74.00	300	39	Peak
7	6451.900	48.94	-7.16	41.78	-32.22	74.00	100	25	Peak
8	7373.600	47.88	-5.69	42.19	-31.81	74.00	300	173	Peak
9	8295.300	49.83	-5.32	44.51	-29.49	74.00	100	360	Peak
10	9217.000	50.46	-5.28	45.17	-28.83	74.00	300	25	Peak

Note:

- " *", means this data is the worst emission level.
- C.F (Correction Factor) = Antenna Factor (dB/m) + Cable Loss (dB) – Preamplifier(dB).
- Measurement (dBuV/m) = Reading(dBuV) + C.F (Correction Factor).
- The emission levels of other frequencies are very lower than the limit and not show in test report.
- Average factor (20Log(1/Duty Cycle)) is 20.22dB.
- Average Measurement = Peak Measurement - Average factor.

EUT	Tapo Video Doorbell Camera	Date of Test	2024-05-14
Factor	DRH18-E	Temp. / Humidity	23°C /62%
Polarity	Vertical	Site / Test Engineer	AC2 / Stanley
Test Mode	SUB 1G_TX_921.7MHz	Test Voltage	By Battery

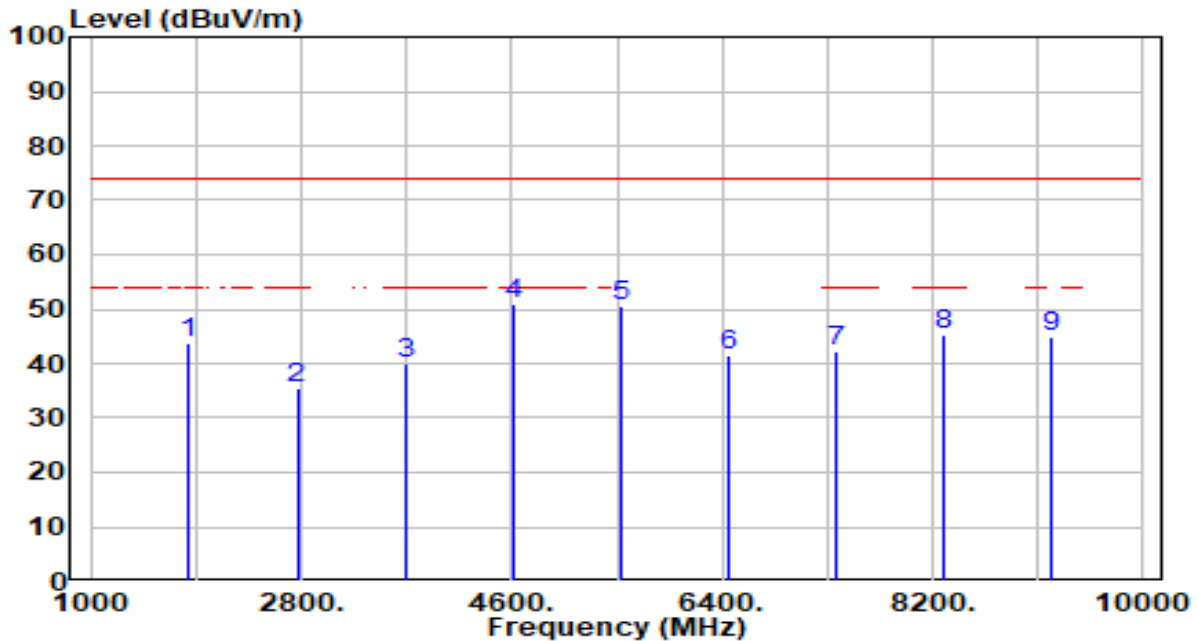

No	Frequency (MHz)	Reading (dBuV)	C.F (dB/m)	Measurement (dBuV/m)	Margin (dB)	Limit (dBuV/m)	Height (cm)	Angle (deg)	Remark (QP/PK/AV)
1	1843.400	64.53	-20.58	43.95	-30.05	74.00	300	360	Peak
2	2765.100	52.84	-17.21	35.63	-38.37	74.00	100	253	Peak
3	3686.800	54.61	-14.77	39.84	-34.16	74.00	300	360	Peak
4	* 4608.500	62.99	-12.14	50.85	-23.15	74.00	300	360	Peak
5	5530.200	61.78	-11.12	50.66	-23.34	74.00	300	360	Peak
6	6451.900	48.61	-7.16	41.46	-32.54	74.00	100	324	Peak
7	7373.600	47.78	-5.69	42.09	-31.91	74.00	292	0	Peak
8	8295.300	50.43	-5.32	45.11	-28.89	74.00	278	0	Peak
9	9217.000	50.27	-5.28	44.98	-29.02	74.00	300	317	Peak

Note:

- " *", means this data is the worst emission level.
- C.F (Correction Factor) = Antenna Factor (dB/m) + Cable Loss (dB) – Preamplifier(dB).
- Measurement (dBuV/m) = Reading(dBuV) + C.F (Correction Factor).
- The emission levels of other frequencies are very lower than the limit and not show in test report.

7.7. Radiated Restricted Band Edge Measurement

7.7.1. Test Limit

All out of band emissions appearing in a restricted band as specified in Section 15.205 of the Title 47 CFR must not exceed the limits shown in Table per Section 15.209.

FCC Part 15 Subpart C Paragraph 15.209		
Frequency [MHz]	Field Strength [V/m]	Measured Distance [Meters]
0.009 - 0.490	2400/F (kHz)	300
0.490 - 1.705	24000/F (kHz)	30
1.705 – 30	30	30
30 – 88	100	3
88 – 216	150	3
216 – 960	200	3
Above 960	500	3

7.7.2. Test Procedure Used

ANSI C63.10-2013 Section 6.3 & 6.6 & 11.13

7.7.3. Test Setting

Peak Field Strength Measurements

1. Analyzer center frequency was set to the frequency of the radiated spurious emission of interest
2. RBW = as specified in Table 1
3. VBW = 3 * RBW
4. Detector = peak
5. Sweep time = auto couple
6. Trace mode = max hold
7. Trace was allowed to stabilize

Table 1 - RBW as a function of frequency

Frequency	RBW
9 ~ 150 kHz	200 ~ 300 Hz
0.15 ~ 30 MHz	9 ~ 10 kHz
30 ~ 1000 MHz	100 ~ 120 kHz
> 1000 MHz	1 MHz

Average Field Strength Measurements

1. Analyzer center frequency was set to the frequency of the radiated spurious emission of interest
2. RBW = 1MHz
3. VBW $\geq 1/T$
4. De As an alternative, the instrument may be set to linear detector mode. Ensure that video filtering is applied in linear voltage domain (rather than in a log or dB domain). Some instruments require linear display mode in order to accomplish this. Others have a setting for Average-VBW Type, which can be set to "Voltage" regardless of the display mode
5. Detector = Peak
6. Sweep time = auto
7. Trace mode = max hold
8. Allow max hold to run for at least 50 times (1/duty cycle) traces

7.7.4. Test Setup

30MHz ~ 1GHz Test Setup:

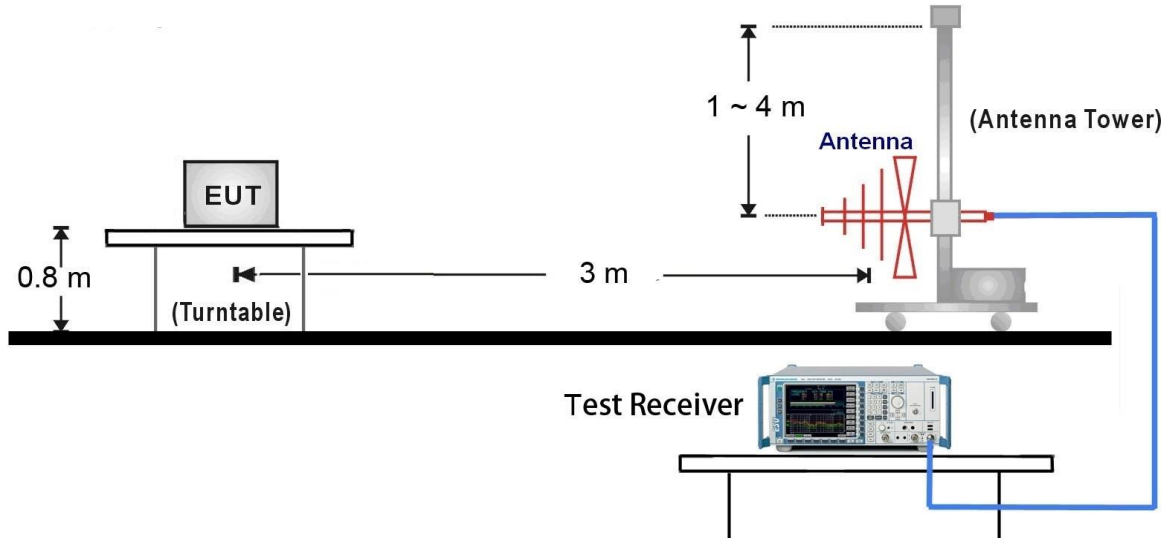

7.7.5. Test Result

EUT	Tapo Video Doorbell Camera	Date of Test	2024-05-15
Factor	VULB 9162	Temp. / Humidity	23°C /62%
Polarity	Horizontal	Site / Test Engineer	AC2 / Stanley
Test Mode	SUB 1G_TX_921.7MHz	Test Voltage	By Battery

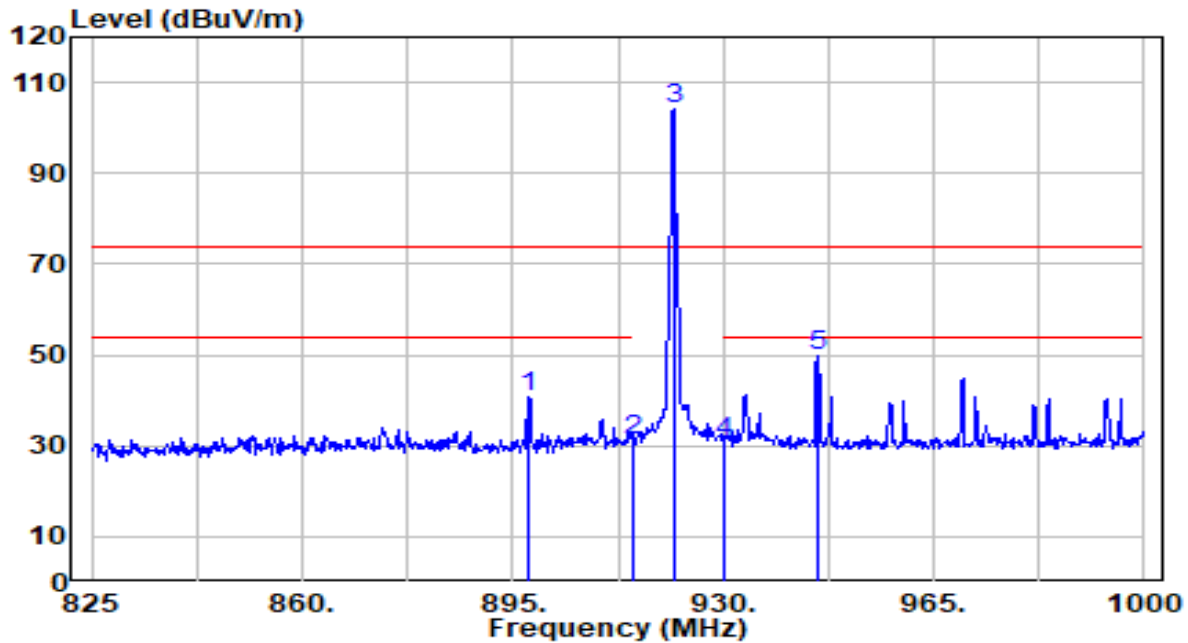

No	Frequency (MHz)	Reading (dBuV)	C.F (dB/m)	Measurement (dBuV/m)	Margin (dB)	Limit (dBuV/m)	Height (cm)	Angle (deg)	Remark (QP/PK/AV)
1	897.450	10.04	30.69	40.74	-33.26	74.00	200	312	Peak
2	915.000	0.26	30.77	31.03	-42.97	74.00	200	312	Peak
3	921.950	73.26	30.80	104.06	N/A	N/A	200	312	Peak
4	* 930.000	0.15	30.84	30.99	-43.01	74.00	200	312	Peak
5	945.575	19.03	30.91	49.94	-24.06	74.00	200	312	Peak

Note:

1. " *", means this data is the worst emission level.
2. C.F (Correction Factor) = Antenna Factor (dB/m) + Cable Loss (dB) – Preamplifier(dB).
3. Measurement (dBuV/m) = Reading(dBuV) + C.F (Correction Factor).
4. The emission levels of other frequencies are very lower than the limit and not show in test report.

EUT	Tapo Video Doorbell Camera	Date of Test	2024-05-15
Factor	VULB 9162	Temp. / Humidity	23°C /62%
Polarity	Vertical	Site / Test Engineer	AC2 / Stanley
Test Mode	SUB 1G_TX_921.7MHz	Test Voltage	By Battery

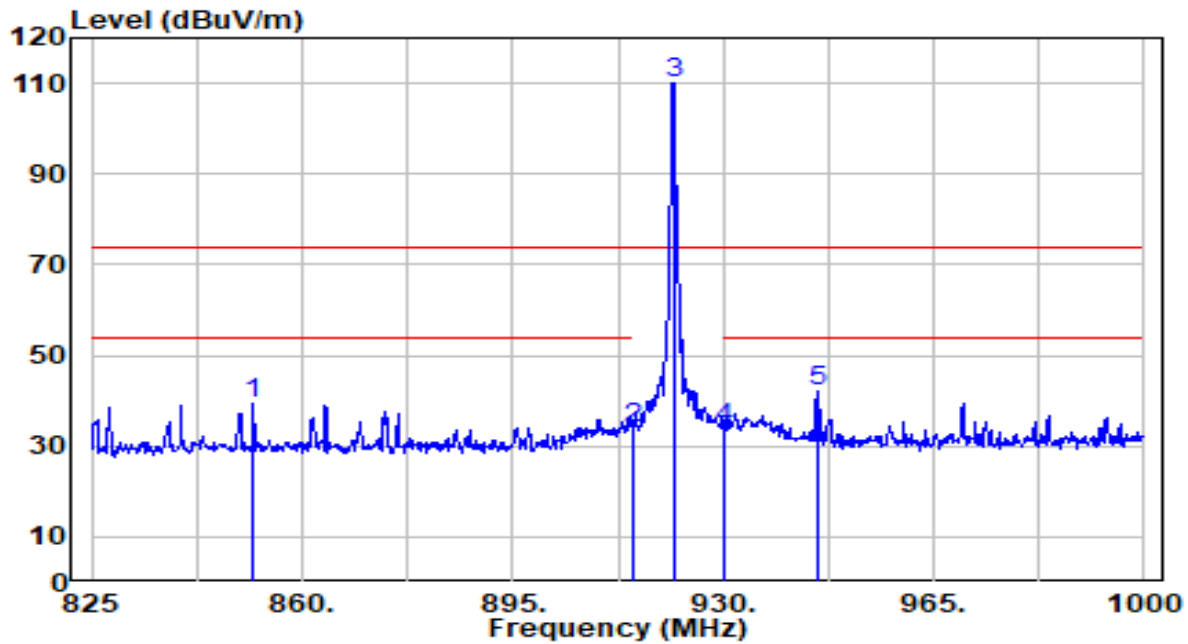

No	Frequency (MHz)	Reading (dBuV)	C.F (dB/m)	Measurement (dBuV/m)	Margin (dB)	Limit (dBuV/m)	Height (cm)	Angle (deg)	Remark (QP/PK/AV)
1	851.950	8.96	30.58	39.54	-34.46	74.00	100	349	Peak
2	* 915.000	3.29	30.77	34.06	-39.94	74.00	100	349	Peak
3	921.950	79.16	30.80	109.97	N/A	N/A	100	349	Peak
4	930.000	3.34	30.84	34.18	-39.82	74.00	100	349	Peak
5	945.925	11.20	30.91	42.11	-31.89	74.00	100	349	Peak

Note:

- "*" means this data is the worst emission level.
- C.F (Correction Factor) = Antenna Factor (dB/m) + Cable Loss (dB) – Preamplifier(dB).
- Measurement (dBuV/m) = Reading(dBuV) + C.F (Correction Factor).
- The emission levels of other frequencies are very lower than the limit and not show in test report.

7.8. AC Conducted Emissions Measurement

7.8.1. Test Limit

FCC Part 15 Subpart C Paragraph 15.207 / RSS-Gen Limits		
Frequency (MHz)	QP (dB μ V)	Average (dB μ V)
0.15 - 0.50	66 - 56	56 - 46
0.50 - 5.0	56	46
5.0 - 30	60	50

Note 1: The lower limit shall apply at the transition frequencies.

Note 2: The limit decreases linearly with the logarithm of the frequency in the range 0.15MHz to 0.5MHz.

7.8.2. Test Setup

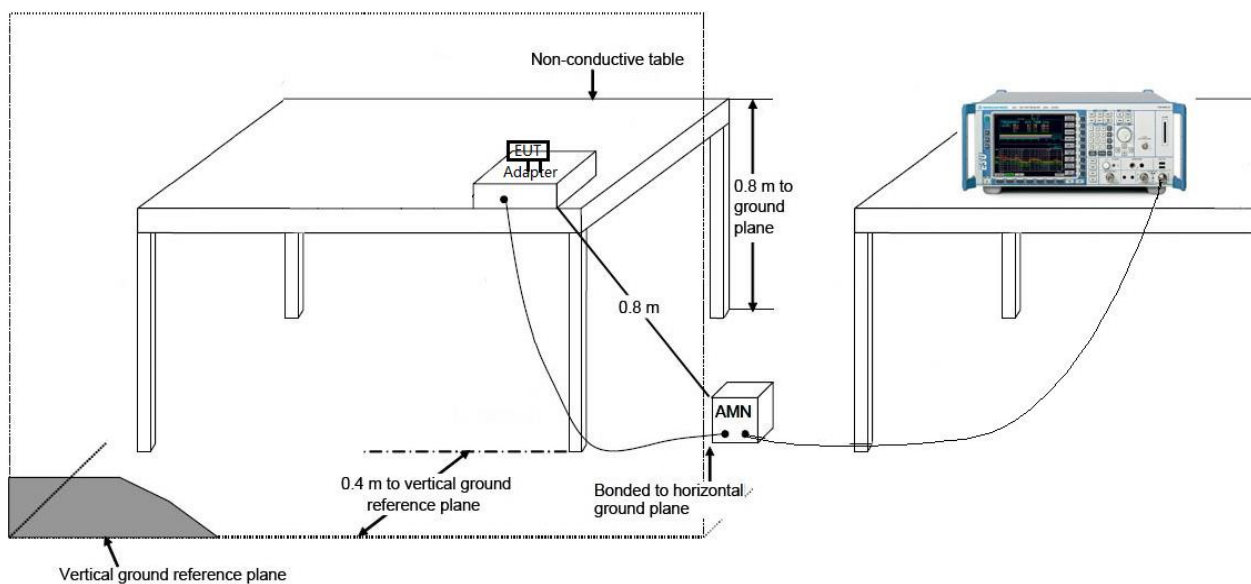

7.8.3. Test Result

EUT	Tapo Video Doorbell Camera	Date of Test	2024-05-21
Factor	CE_ENV216-L1 (Filter ON)	Temp. / Humidity	22.8°C /47%
Polarity	Line1	Site / Test Engineer	SR2 / Bob
Test Mode	SUB 1G_TX_921.7MHz	Test Voltage	AC 120V/60Hz

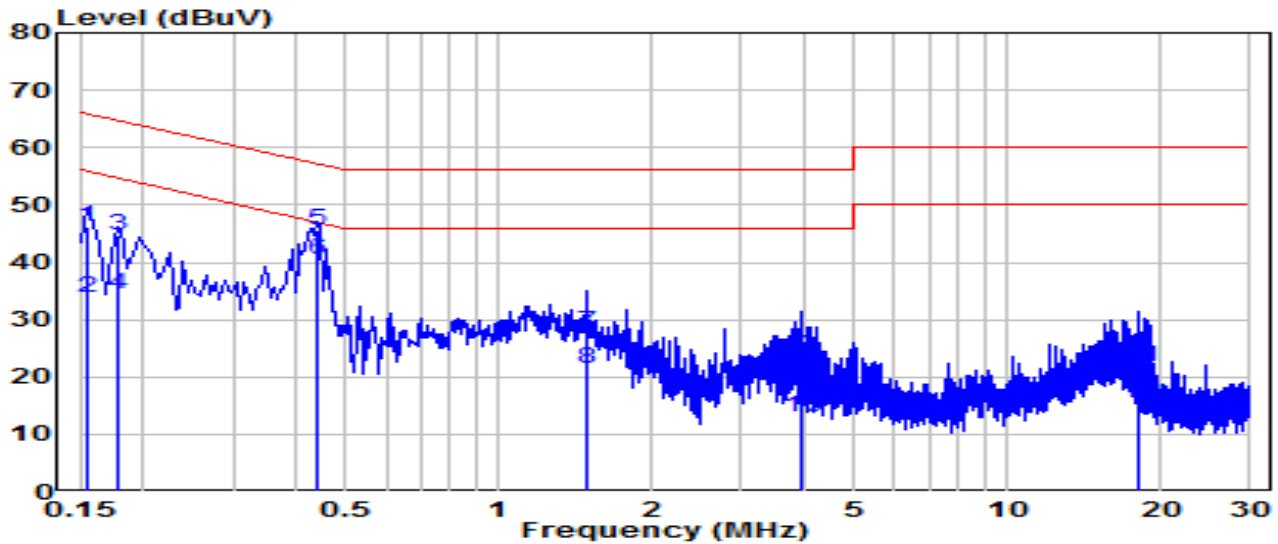

No	Frequency (MHz)	Reading (dBuV)	C.F (dB)	Measurement (dBuV)	Margin (dB)	Limit (dBuV)	Remark (QP/PK/AV)
1	0.154	36.60	9.63	46.23	-19.52	65.75	QP
2	0.154	24.28	9.63	33.91	-21.85	55.75	Average
3	0.177	35.15	9.63	44.78	-19.85	64.63	QP
4	0.177	24.69	9.63	34.32	-20.30	54.63	Average
5	* 0.438	36.07	9.65	45.72	-11.38	57.10	QP
6	* 0.438	30.89	9.65	40.54	-6.56	47.10	Average
7	1.491	17.99	9.69	27.68	-28.32	56.00	QP
8	1.491	11.76	9.69	21.45	-24.55	46.00	Average
9	3.943	13.68	9.73	23.41	-32.59	56.00	QP
10	3.943	3.16	9.73	12.89	-33.11	46.00	Average
11	18.157	11.84	9.93	21.76	-38.24	60.00	QP
12	18.157	5.42	9.93	15.34	-34.66	50.00	Average

Note:

1. " *", means this data is the worst emission level.
2. C.F (Correction Factor) = LISN Factor (dB)+ Cable Loss (dB).
3. Measurement (dBuV) = Reading(dBuV) + C.F (Correction Factor).

EUT	Tapo Video Doorbell Camera	Date of Test	2024-05-21
Factor	CE_ENV216-N (Filter ON)	Temp. / Humidity	22.8°C /47%
Polarity	Neutral	Site / Test Engineer	SR2 / Bob
Test Mode	SUB 1G_TX_921.7MHz	Test Voltage	AC 120V/60Hz

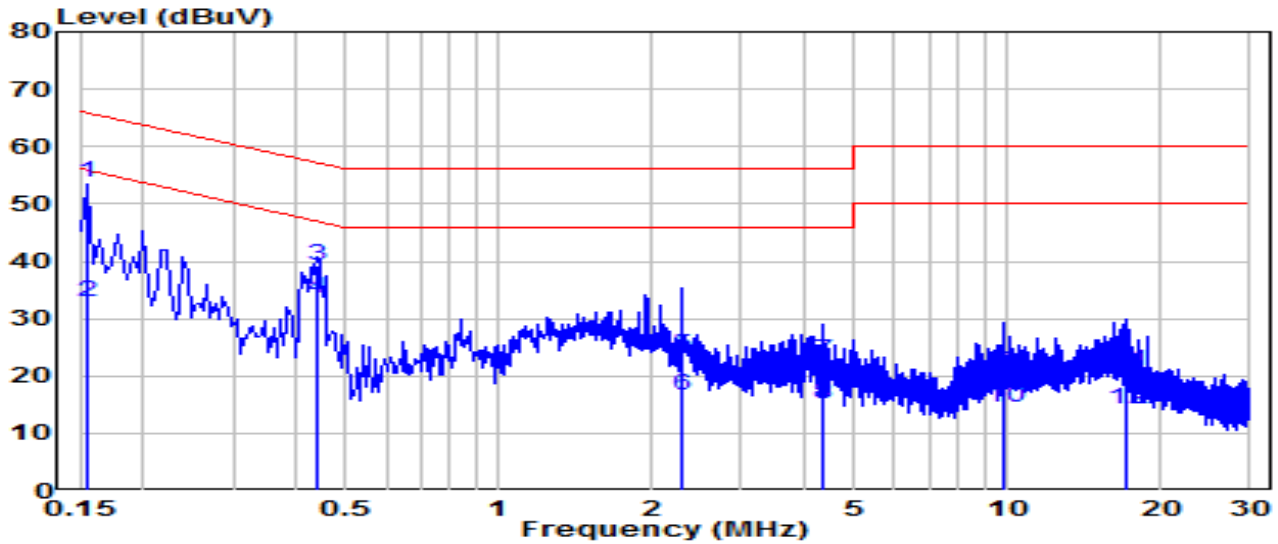

No		Frequency (MHz)	Reading (dBuV)	C.F (dB)	Measurement (dBuV)	Margin (dB)	Limit (dBuV)	Remark (QP/PK/AV)
1	*	0.154	44.26	9.63	53.89	-11.87	65.75	QP
2	*	0.154	23.16	9.63	32.79	-22.97	55.75	Average
3		0.438	29.63	9.65	39.28	-17.82	57.10	QP
4		0.438	23.75	9.65	33.40	-13.70	47.10	Average
5		2.296	13.74	9.71	23.46	-32.54	56.00	QP
6		2.296	6.80	9.71	16.51	-29.49	46.00	Average
7		4.353	12.80	9.75	22.55	-33.45	56.00	QP
8		4.353	5.40	9.75	15.14	-30.86	46.00	Average
9		9.797	10.78	9.88	20.66	-39.34	60.00	QP
10		9.797	4.50	9.88	14.39	-35.61	50.00	Average
11		17.212	10.88	9.97	20.84	-39.16	60.00	QP
12		17.212	4.18	9.97	14.15	-35.85	50.00	Average

Note:

1. " *", means this data is the worst emission level.
2. C.F (Correction Factor) = LISN Factor (dB)+ Cable Loss (dB).
3. Measurement (dBuV) = Reading(dBuV) + C.F (Correction Factor).

EUT	Tapo Video Doorbell Camera	Date of Test	2024-05-21
Factor	CE_ENV216-L1 (Filter ON)	Temp. / Humidity	22.8°C /47%
Polarity	Line1	Site / Test Engineer	SR2 / Bob
Test Mode	SUB 1G_TX_921.7MHz	Test Voltage	AC 240V/60Hz

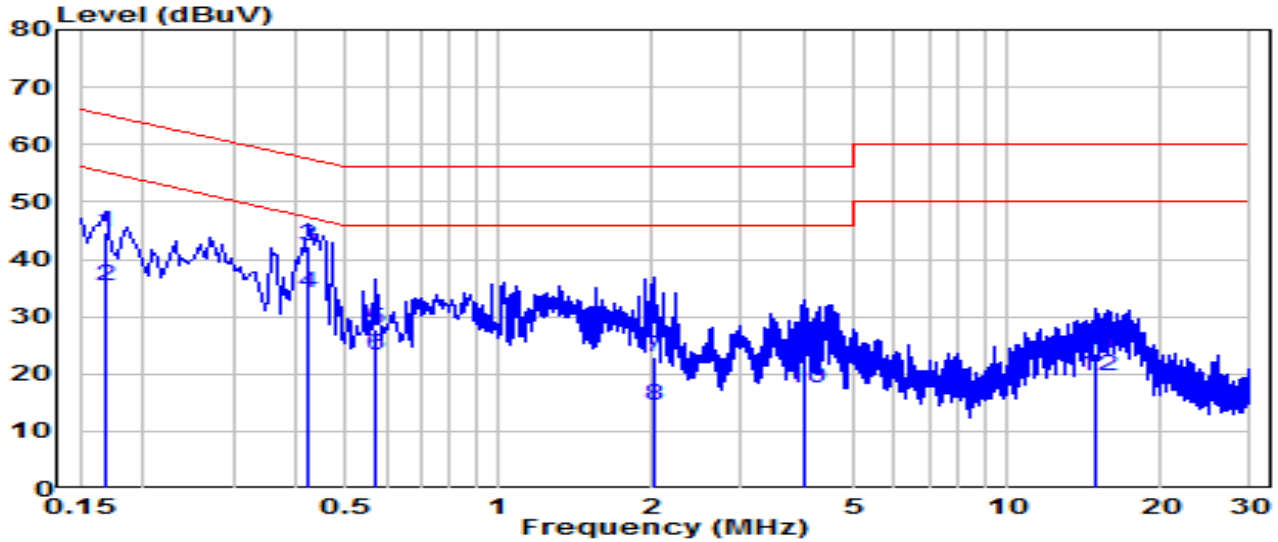

No	Frequency (MHz)	Reading (dBuV)	C.F (dB)	Measurement (dBuV)	Margin (dB)	Limit (dBuV)	Remark (QP/PK/AV)
1	0.168	35.12	9.63	44.75	-20.31	65.06	QP
2	0.168	25.61	9.63	35.24	-19.81	55.06	Average
3	* 0.420	32.57	9.65	42.22	-15.23	57.45	QP
4	* 0.420	24.36	9.65	34.01	-13.44	47.45	Average
5	0.568	18.13	9.66	27.78	-28.22	56.00	QP
6	0.568	13.61	9.66	23.27	-22.73	46.00	Average
7	2.026	13.32	9.70	23.02	-32.98	56.00	QP
8	2.026	4.81	9.70	14.51	-31.49	46.00	Average
9	4.015	15.15	9.73	24.88	-31.12	56.00	QP
10	4.015	7.76	9.73	17.49	-28.51	46.00	Average
11	14.994	13.53	9.90	23.43	-36.57	60.00	QP
12	14.994	9.70	9.90	19.60	-30.40	50.00	Average

Note:

1. " *", means this data is the worst emission level.
2. C.F (Correction Factor) = LISN Factor (dB)+ Cable Loss (dB).
3. Measurement (dBuV) = Reading(dBuV) + C.F (Correction Factor).

EUT	Tapo Video Doorbell Camera	Date of Test	2024-05-21
Factor	CE_ENV216-N (Filter ON)	Temp. / Humidity	22.8°C /47%
Polarity	Neutral	Site / Test Engineer	SR2 / Bob
Test Mode	SUB 1G_TX_921.7MHz	Test Voltage	AC 240V/60Hz

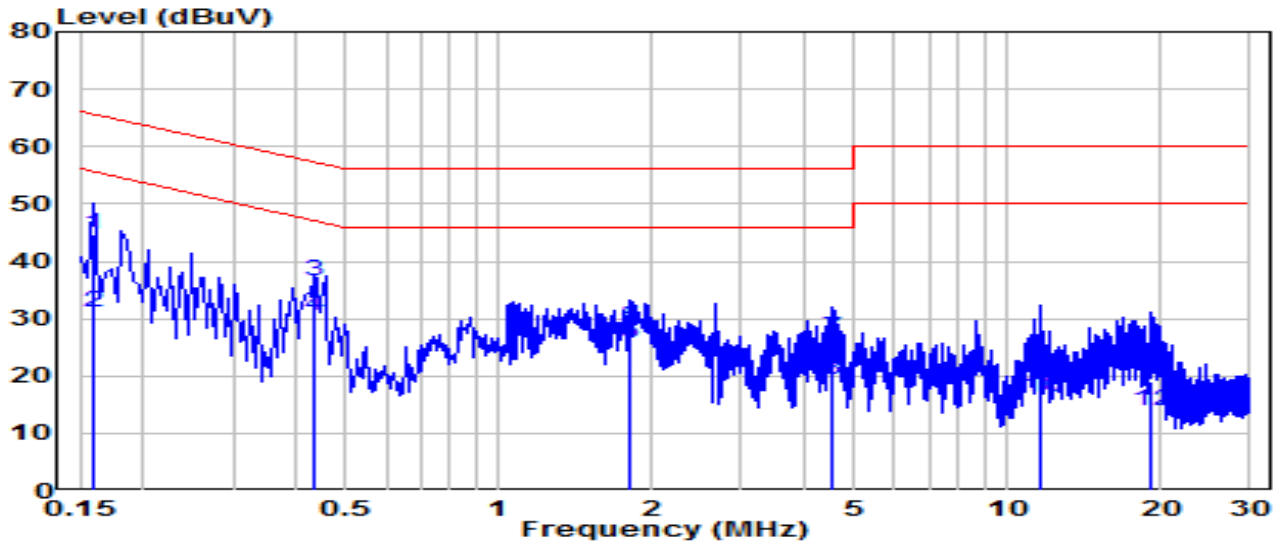

No	Frequency (MHz)	Reading (dBuV)	C.F (dB)	Measurement (dBuV)	Margin (dB)	Limit (dBuV)	Remark (QP/PK/AV)
1	0.159	34.99	9.63	44.62	-20.90	65.52	QP
2	0.159	21.35	9.63	30.98	-24.53	55.52	Average
3	* 0.433	26.90	9.65	36.55	-20.64	57.19	QP
4	* 0.433	20.99	9.65	30.63	-16.55	47.19	Average
5	1.810	18.64	9.70	28.34	-27.66	56.00	QP
6	1.810	15.85	9.70	25.56	-20.44	46.00	Average
7	4.537	16.81	9.75	26.56	-29.44	56.00	QP
8	4.537	9.59	9.75	19.34	-26.66	46.00	Average
9	11.552	11.15	9.91	21.06	-38.94	60.00	QP
10	11.552	6.52	9.91	16.42	-33.58	50.00	Average
11	19.246	9.01	9.99	19.00	-41.00	60.00	QP
12	19.246	3.97	9.99	13.96	-36.04	50.00	Average

Note:

- " *", means this data is the worst emission level.
- C.F (Correction Factor) = LISN Factor (dB)+ Cable Loss (dB).
- Measurement (dBuV) = Reading(dBuV) + C.F (Correction Factor).

8. CONCLUSION

The data collected relate only the item(s) tested and show that the device is in compliance with Part 15C of the FCC Rules.

Appendix A : Test Setup Photograph

Refer to “2403TW0115-UT” file.

Appendix B : External Photograph

Refer to “2403TW0115-UE” file.

Appendix C : Internal Photograph

Refer to “2403TW0115-UI” file.

————— The End —————