



User Guide

Video Doorbell Camera Kit

Contents

| | |
|------------------------------------|----|
| About This Guide | 1 |
| Introduction | 2 |
| Appearance - Doorbell | 3 |
| Appearance - Hub | 4 |
| Charge the Battery | 7 |
| Insert the Battery | 8 |
| Set Up Your Hub and Doorbell | 9 |
| Install a microSD Card | 11 |
| Install Your Doorbell | 12 |
| Authentication | 14 |

About This Guide

This guide provides a brief introduction to the Video Doorbell Camera Kit and the Tapo app, as well as regulatory information.

Please note that features available in Tapo may vary by model and software version. Tapo availability may also vary by region. All images, steps, and descriptions in this guide are only examples and may not reflect your actual Tapo Doorbell experience.

Conventions

In this guide, the following convention is used:

| Convention | Description |
|------------------|--|
| Blue | Key information appears in blue, including management page text such as menus, items, buttons and so on. |
| <u>Underline</u> | Hyperlinks are in blue and underlined. You can click to redirect to a website. |
| 📌Note: | Ignoring this type of note might result in a malfunction or damage to the device. |

More Info

- Specifications can be found on the product page at <https://www.tapo.com>.
- Our Technical Support and troubleshooting information can be found at <https://www.tapo.com/support/>.

Introduction

With Tapo Video Doorbell Camera Kit, you always know who's there. Its rechargeable and removable battery with a low-power protocol extends your usage. No wires means you can place the doorbell wherever you like. The doorbell is equipped with the starlight sensor and the spotlights, catching more colors. The highly-sensitive starlight sensor captures higher-quality images even in low-light conditions. The integrated spotlights help enhance your security view with vivid colors even at night.

- **2K 5MP Video** – Provides higher-quality security views with 2K 5MP resolution.
- **Head-to-Toe View** – Compared with the traditional 16:9 aspect ratio, Tapo D230's 4:3 aspect ratio captures more field of view.
- **Smart AI Detection and Notification** – Smart AI identifies people, pets, and packages, notifying users as needed.
- **180-Day Battery Life[^]** – The rechargeable and removable battery with a low-power protocol extends your usage.
[^]180-day battery life is based on TP-Link's laboratory testing with 10-20 triggered events per day. Actual battery life may vary based on device settings, use, and environmental factors.
- **Wire-Free Placement** – No wires means you can place the doorbell wherever you want.
- **Color Night Vision** – Reveals high-fidelity details and color at night with the starlight sensor.
- **Quick Response** – Responds to your deliveries without saying a word with customizable responses through the Tapo app.
- **Flexible Storage Choices** – Saves recorded videos on the hub-installed microSD card* (up to 256 GB) or by using Tapo Care** cloud storage services.
*microSD card needs to be purchased separately.
**Subscribe for cloud storage at <https://www.tapo.com/tapocare/>.
- **Hub as Indoor Chime** – Chooses from a variety of ringtones to replace a traditional wired chime.
- **Motion Detection** – Gets instant notifications when your camera detects motion.
- **IP64 Water & Dust Resistant**– Helps Tapo doorbell performs well even in harsh environments with rain and dust.
- **Two-Way Audio** – Communicates with others with the built-in microphone and speaker.

Appearance - Doorbell

Front

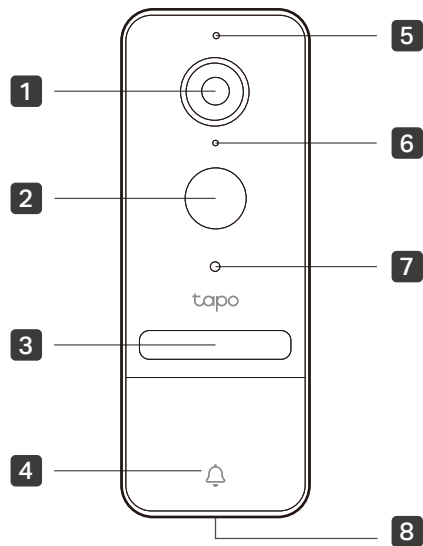

1 Lens

2 Motion Sensor

3 Spotlight

4 Ring Button

5 Microphone

6 Status LED
Indicates the status of your doorbell.

7 Light Sensor

8 Speaker

Back

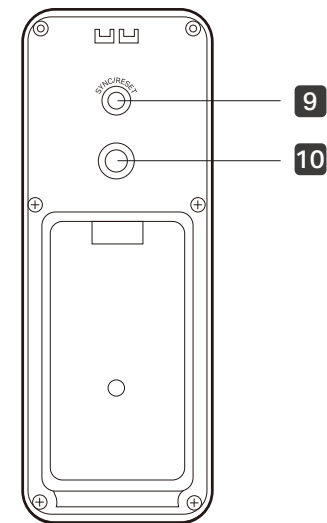

9 SYNC/RESET Button

- Press for 1s: Pair with the hub
- Press and hold for about 5s: Reset the doorbell

10 Anti-Theft Button

When the Anti-Theft Alarm is enabled on the Tapo app, an alarm will trigger once the doorbell is removed.

- Press and hold for 5s: Pause the alarm (Continues to alarm when released)
- Press and hold buttons **9** + **10** simultaneously for 10s: Disable the anti-theft alarm feature

Appearance - Hub

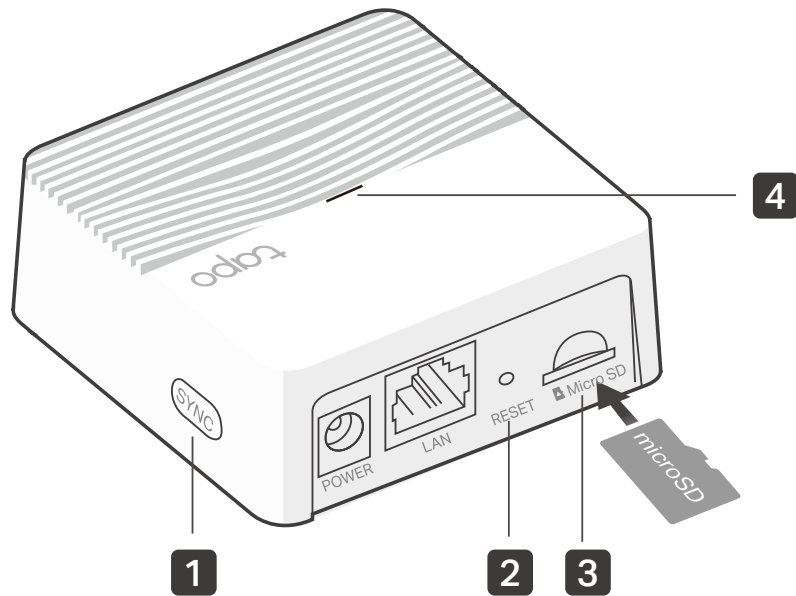

1 SYNC

Press to pair with the camera, or silence the hub when it rings.

2 RESET

Press and hold for about 5 seconds until the hub LED quickly blinks red to reset the hub.

3 microSD Card Slot

Insert a microSD card to record camera videos locally. Initialize the microSD card within the Tapo app first.

↑microSD card not included.

4 Status LED

Indicate the status of your hub.

Hub Status LED

| | |
|------------------------|------------------------|
| Solid red | Starting up |
| Blinking red and green | Ready for setup |
| Solid amber | Connected to router |
| Solid green | Connected to the cloud |
| Blinking green slowly | Pairing |
| Blinking red quickly | Hub resetting |
| Blinking green quickly | Hub updating |

Doorbell Status LED

| | |
|----------------------------|------------------------|
| Solid Red | Starting up |
| Blinking red and green | Ready for pairing |
| Blinking green slowly | Pairing |
| Solid amber | Connected to the hub |
| Solid green | Connected to the cloud |
| Blinking red quickly | Doorbell resetting |
| Blinking green quickly | Doorbell updating |
| Blinking red once a minute | Low battery |
| Blinking red slowly | Offline |

Charge the Battery

Connect the battery to a power source.

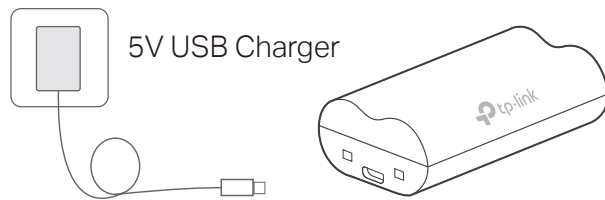

- **Charging:** Solid amber
- **Fully charged:** Solid green

Notes:

1. Charge the battery before use. This will take about 5~6 hours.
2. If you want to use the doorbell while charging the battery, we recommend purchasing another battery for your convenience.

Insert the Battery

1. Use a pin to detach the doorbell.

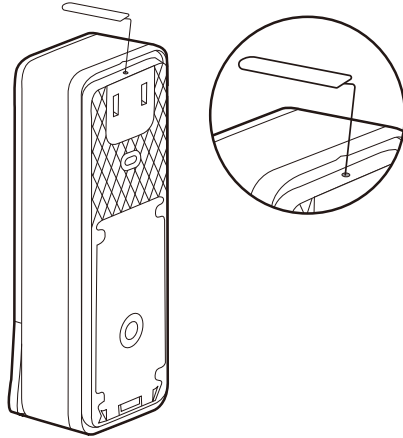

2. Insert the charged battery.

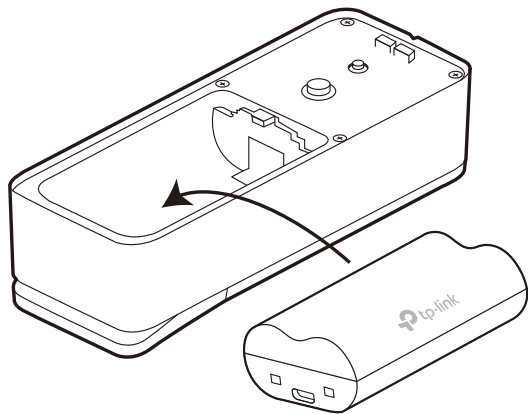

Set Up Your Hub and Doorbell

Follow the steps below to get started with your new hub and camera.

Step 1. Download Tapo App

Get the Tapo app from the App Store or Google Play, or by scanning the QR code below.



OR



Step 2. Log In

Open the app, and log in with your TP-Link ID. If you don't have an account, create one first.

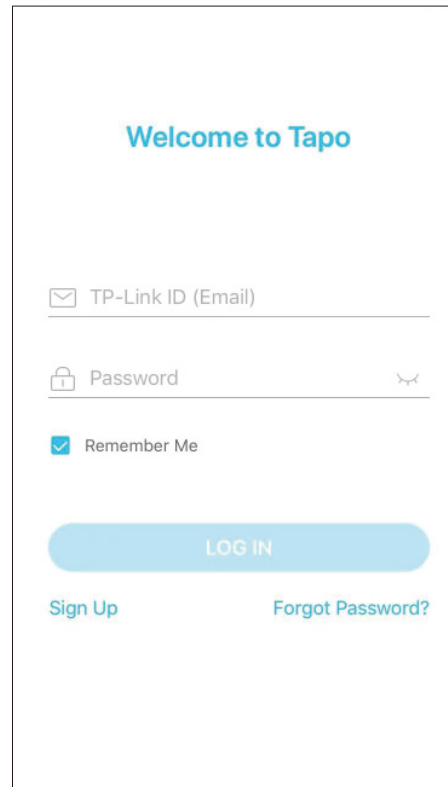

Step 3. Add Your Hub First

Tap the ⊕ button in the app and select your model. Follow app instructions to set up your hub.

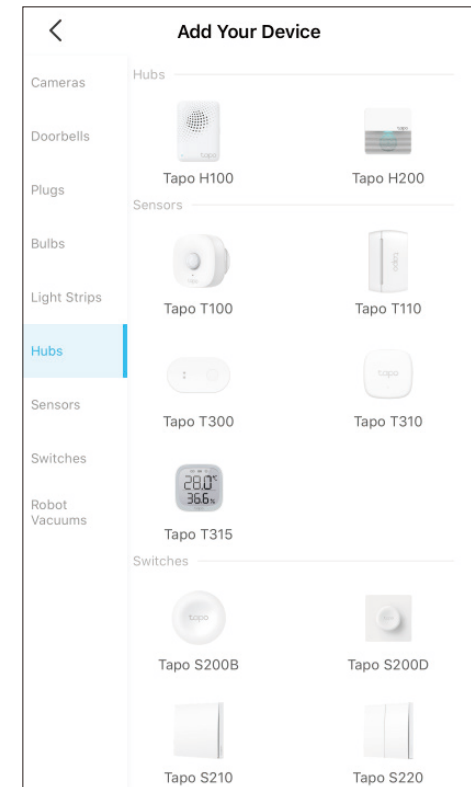

Step 4. Add Your Doorbell

Tap the ⊕ button in the app and select your model.
Follow app instructions to set up your doorbell.

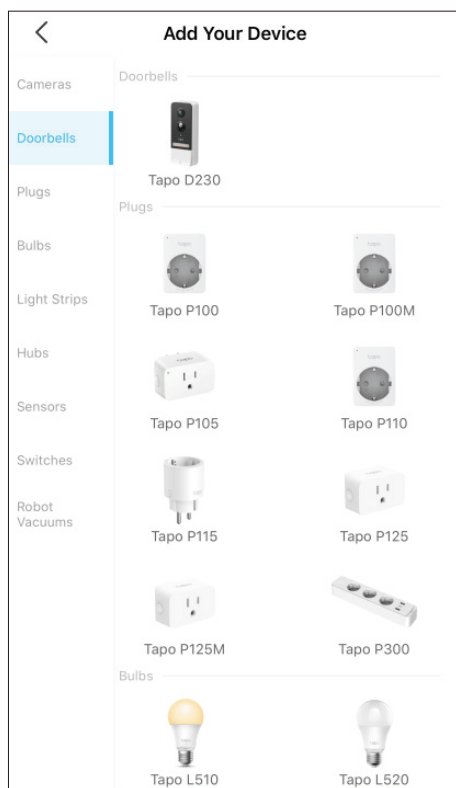

Install a microSD Card

If you want the camera to record videos locally, insert a microSD card to your hub.

Initialize the microSD card within the Tapo app.

You can go to [Camera Settings](#) > [microSD Card](#) in the Tapo app to check the card status or format your card.

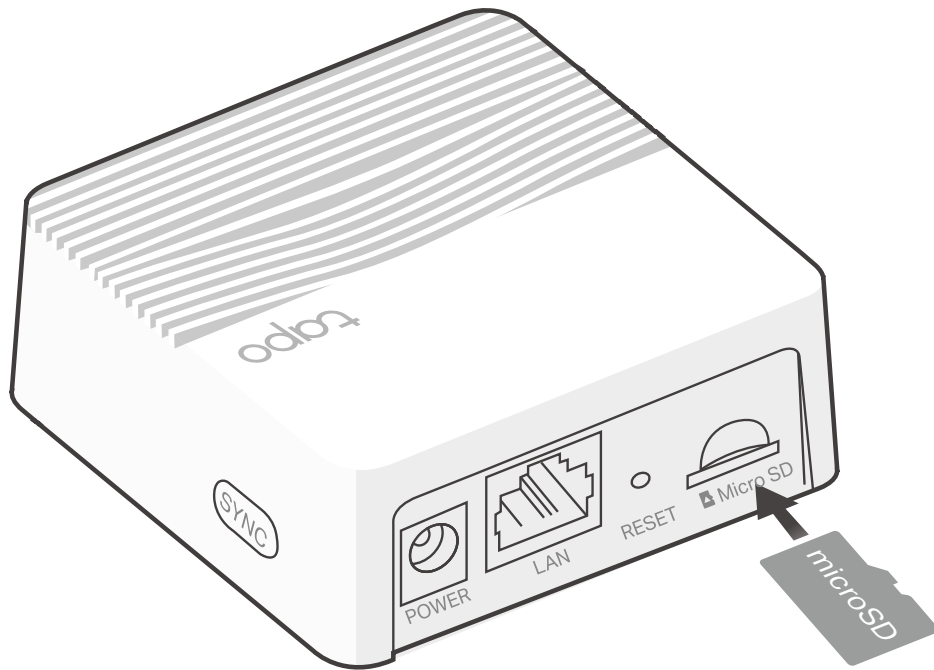

Install Your Doorbell

When you finish adding your doorbell in the Tapo app, you can stick your doorbell to a clean wall with the included adhesive, or mount it on a wall with the provided mounting template and screws.

Option 1. Stick to a clean wall

1. Attach the included adhesive to the back of the bracket.

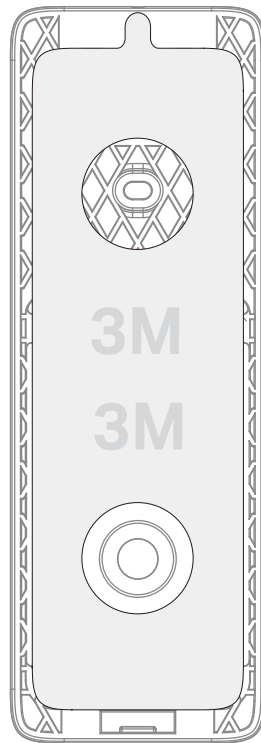

2. Stick the bracket with adhesive to a clean wall. Then attach the doorbell to the bracket.

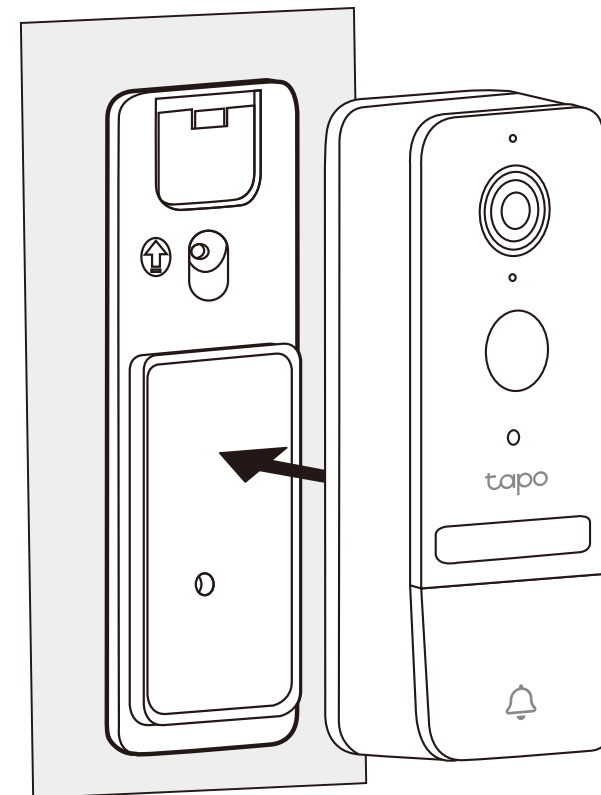

Option 2. Mount to the wall

1. Stick the mounting template to the desired mounting place. Drill two holes according to the template.

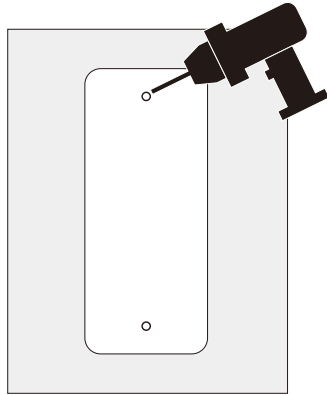

2. Insert two anchors into the holes and use the screws to affix the bracket over the anchors. Then attach the doorbell to the bracket.

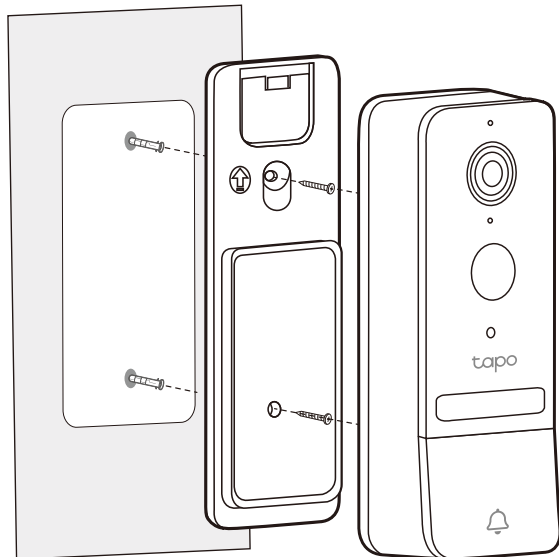

(Optional) Use 15° Mounting Wedge to Adjust Angle

To adjust the viewing angle of the doorbell, you can use the 15° mounting wedge within the package.

1. After drilling holes, insert two anchors into the holes.
2. Place the bracket above the wedge.
3. Use the screws to affix the wedge and bracket over the anchors.
4. Attach the doorbell to the bracket.

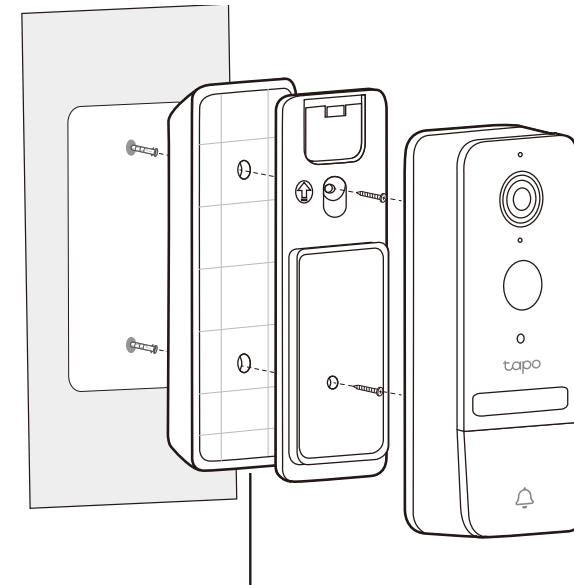

Wedge

(You can flip 180° to find the appropriate angle.)

Size of Screws

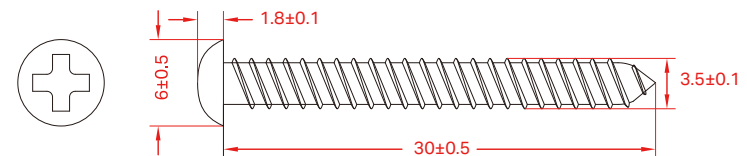

Authentication

FCC compliance information statement



Product Name: Video Doorbell Camera Kit

Model Number: Tapo D230

| Component Name | Model |
|----------------|-------------|
| AC ADAPTER | T090085-2B1 |
| USB ADAPTER | A8-501000 |

Responsible Party:

TP-Link USA Corporation

Address: 10 Mauchly, Irvine, CA 926181

Website: <http://www.tp-link.com/us/>

Tel: +1 626 333 0234

Fax: +1 909 527 6804

E-mail: sales.usa@tp-link.com

This equipment has been tested and found to comply with the limits for a Class B digital device, pursuant to part 15 of the FCC Rules. These limits are designed to provide reasonable protection against harmful interference in a residential installation. This equipment generates, uses and can radiate radio frequency energy and, if not installed and used in accordance with the instructions, may cause harmful interference to radio communications. However, there is no guarantee that interference will not occur in a particular installation. If this equipment does cause harmful interference to radio or television reception, which can be determined by turning the equipment off and on, the user is encouraged to try to correct the interference by one or more of the following measures:

- Reorient or relocate the receiving antenna.
- Increase the separation between the equipment and receiver.
- Connect the equipment into an outlet on a circuit different from that to which the receiver is connected.
- Consult the dealer or an experienced radio/ TV technician for help.

This device complies with part 15 of the FCC Rules. Operation is subject to the following two conditions:

1. This device may not cause harmful interference.
2. This device must accept any interference received, including interference that may cause undesired operation.

Any changes or modifications not expressly approved by the party responsible for compliance could void the user's authority to operate the equipment.

Note: The manufacturer is not responsible for any radio or TV interference caused by unauthorized modifications to this equipment. Such modifications could void the user's authority to operate the equipment.

FCC RF Radiation Exposure Statement

This equipment complies with FCC RF radiation exposure limits set forth for an uncontrolled environment. This device and its antenna must not be co-located or operating in conjunction with any other antenna or transmitter.

"To comply with FCC RF exposure compliance requirements, this grant is applicable to only Mobile Configurations. The antennas used for this transmitter must be installed to provide a separation distance of at least 20 cm from all persons and must not be co-located or operating in conjunction with any other antenna or transmitter."

We, **TP-Link USA Corporation**, has determined that the equipment shown as above has been shown to comply with the applicable technical standards, FCC part 15. There is no unauthorized change is made in the equipment and the equipment is properly maintained and operated.

Issue Date: 2023-01-03

FCC compliance information statement

Product Name: AC ADAPTER

Model Number: T090085-2B1

Product Name: USB ADAPTER

Model Number: A8-501000

Responsible Party:

TP-Link USA Corporation

Address: 10 Mauchly, Irvine, CA 926181

Website: <http://www.tp-link.com/us/>

Tel: +1 626 333 0234

Fax: +1 909 527 6804

E-mail: sales.usa@tp-link.com

This equipment has been tested and found to comply with the limits for a Class B digital device, pursuant to part 15 of the FCC Rules. These limits are designed to provide reasonable protection against harmful interference in a residential installation. This equipment generates, uses and can radiate radio frequency energy and, if not installed and used in accordance with the instructions, may cause harmful interference to radio communications. However, there is no guarantee that interference will not occur in a particular installation. If this equipment does cause harmful interference to radio or television reception, which can be determined by turning the equipment off and on, the user is encouraged to try to correct the interference by one or more of the following measures:

- Increase the separation between the equipment and receiver.
- Connect the equipment into an outlet on a circuit different from that to which the receiver is connected.
- Consult the dealer or an experienced radio/ TV technician for help.

This device complies with part 15 of the FCC Rules. Operation is subject to the following two conditions:

1. This device may not cause harmful interference.
2. This device must accept any interference received, including interference that may cause undesired operation.

Any changes or modifications not expressly approved by the party responsible for compliance could void the user's authority to operate the equipment.

We, **TP-Link USA Corporation**, has determined that the equipment shown as above has been shown to comply with the applicable technical standards, FCC part 15. There is no unauthorized change is made in the equipment and the equipment is properly maintained and operated.

Issue Date: 2032-01-03

CE Mark Warning



This is a class B product. In a domestic environment, this product may cause radio interference, in which case the user may be required to take adequate measures.

OPERATING FREQUENCY (the maximum transmitted power)

2412MHz—2472MHz (20dBm)

EU Declaration of Conformity

TP-Link hereby declares that the device is in compliance with the essential requirements and other relevant provisions of directives 2014/53/EU, 2009/125/EC, 2011/65/EU and (EU)2015/863.

The original EU declaration of conformity may be found at <https://www.tapo.com/en/support/ce/>

RF Exposure Information

This device meets the EU requirements (2014/53/EU Article 3.1a) on the limitation of exposure of the general public to electromagnetic fields by way of health protection.

The device complies with RF specifications when the device used at 20 cm from your body.



UK Declaration of Conformity

TP-Link hereby declares that the device is in compliance with the essential requirements and other relevant provisions of the Radio Equipment Regulations 2017.

The original UK declaration of conformity may be found at <https://www.tapo.com/support/ukca/>

Canadian Compliance Statement

This device contains licence-exempt transmitter(s)/receiver(s) that comply with Innovation, Science and Economic Development Canada's licence-exempt RSS(s). Operation is subject to the following two conditions:

1. This device may not cause interference.

2. This device must accept any interference, including interference that may cause undesired operation of the device.

L'émetteur/récepteur exempt de licence contenu dans le présent appareil est conforme aux CNR d'Innovation, Sciences et Développement économique Canada applicables aux appareils radio exempts de licence. L'exploitation est autorisée aux deux conditions suivantes :

1. l'appareil ne doit pas produire de brouillage;
2. l'utilisateur de l'appareil doit accepter tout brouillage radioélectrique subi, même si le brouillage est susceptible d'en compromettre le fonctionnement

Radiation Exposure Statement:

This equipment complies with IC radiation exposure limits set forth for an uncontrolled environment. This equipment should be installed and operated with minimum distance 20cm between the radiator & your body.

Déclaration d'exposition aux radiations:

Cet équipement est conforme aux limites d'exposition aux rayonnements IC établies pour un environnement non contrôlé. Cet équipement doit être installé et utilisé avec un minimum de 20 cm de distance entre la source de rayonnement et votre corps.

Industry Canada Statement

CAN ICES-3 (B)/NMB-3(B)

Korea Warning Statements:

당해 무선설비는 운용중 전파혼신 가능성이 있음.

NCC Notice

注意!

取得審驗證明之低功率射頻器材，非經核准，公司、商號或使用者均不得擅自變更頻率、加大功率或變更原設計之特性及功能。

低功率射頻器材之使用不得影響飛航安全及干擾合法通信；經發現有干擾現象時，應立即停用，並改善至無干擾時方得繼續使用。

前述合法通信，指依電信管理法規定作業之無線電通信。

低功率射頻器材須忍受合法通信或工業、科學及醫療用電波輻射性電機設備之干擾。

BSMI Notice

安全諮詢及注意事項

- 請使用原裝電源供應器或只能按照本產品注明的電源類型使用本產品。
- 清潔本產品之前請先拔掉電源線。請勿使用液體、噴霧清潔劑或濕布進行清潔。
- 注意防潮，請勿將水或其他液體潑灑到本產品上。
- 插槽與開口供通風使用，以確保本產品的操作可靠並防止過熱，請勿堵塞或覆蓋開口。
- 請勿將本產品置放於靠近熱源的地方。除非有正常的通風，否則不可放在密閉位置中。
- 請不要私自打開機殼，不要嘗試自行維修本產品，請由授權的專業人士進行此項工作。

限用物質含有情況標示聲明書

| | | | | | | |
|--------------------------------|--|----------------------|----------------------|---|---|---|
| 設備名稱：Video Doorbell Camera Kit | | | | 型號（型式）：Tapo D230S1 | | |
| Equipment name | | | | Type designation (Type) | | |
| 單元 Unit | 限用物質及其化學符號 Restricted substances and its chemical symbols | | | | | |
| | 鉛 Lead (Pb) | 汞 Mercury (Hg) | 鎘 Cadmium (Cd) | 六價鉻 Hexavalent chromium (Cr ⁺⁶) | 多溴聯苯 Polybrominated biphenyls (PBB) | 多溴二苯醚 Polybrominated diphenyl ethers (PBDE) |
| PCB | ○ | ○ | ○ | ○ | ○ | ○ |
| 外殼 | ○ | ○ | ○ | ○ | ○ | ○ |
| 電源供應器 | — | ○ | ○ | ○ | ○ | ○ |
| 其他及其 配件 | — | ○ | ○ | ○ | ○ | ○ |

備考 1. “超出 0.1 wt %” 及 “超出 0.01 wt %” 係指限用物質之百分比含量超出百分比含量基準值

Note 1: “Exceeding 0.1 wt %” and “exceeding 0.01 wt %” indicate that the percentage content of the restricted substance exceeds the reference percentage value of presence condition.

備考 2. “○” 係指該項限用物質之百分比含量未超出百分比含量基準值。

Note 2: “○” indicates that the percentage content of the restricted substance does not exceed the percentage of reference value of presence.

備考 3. “—” 係指該項限用物質為排除項目。

Note 3: The “—” indicates that the restricted substance corresponds to the exemption.



Продукт сертифіковано згідно с правилами системи УкрСЕПРО на відповідність вимогам нормативних документів та вимогам, що передбачені чинними законодавчими актами України.



Safety Information

- Do not use damaged charger or USB cable to charge the device.
- Do not use any other chargers than those recommended.
- Do not use the device where wireless devices are not allowed.
- Adapter shall be easily accessible.
- Use only power supplies which are provided by manufacturer and in the original packing of this product. If you have any questions, please don't hesitate to contact us.
- Keep the device away from fire or hot environments. DO NOT immerse in water or any other liquid.
- Do not disassemble, repair or modify the product.
- Do not place near automatically controlled devices such as fire alarms. Radio waves emitted from this product may cause such devices to malfunction resulting in an accident.

- Observe restrictions on using wireless products in fuel depots, chemical plants or when blasting operations are in progress.
- Do not use liquid to clean the product. Only use a dry cloth.
- Never put metal objects inside the product. If a metal object enters the product turn off the circuit breaker and contact an authorised electrician.
- This product is not intended to be used when providing medical care. Consult the manufacturer of any personal medical devices, such as pacemakers or hearing aids to determine if they are adequately shielded from external RF (radio frequency) energy.
- Do not use this product in health care facilities. Hospitals or health care facilities may be using equipment that could be sensitive to external RF energy.
- Do not place heavy objects on top of the product.
- When you leave the product unused for a long time unplug the product from the power outlet.
- This product may interfere with other electronic products such as TV, radios, personal computers, phones or other wireless devices.
- Always follow the local waste and recycle laws when you get rid of the used battery.
- Do not use the product if the casing has been broken. Danger of electric shock.
- Never touch the product with wet hands.
- The mounting height should not be higher than 2 meters.

CAUTION!





Risk of fire or explosion
if the battery is replaced by an incorrect type

CAUTION!

Avoid replacement of a battery with an incorrect type that can defeat a safeguard.
Avoid disposal of a battery into fire or a hot oven, or mechanically crushing or cutting of a battery, that can result in an explosion.
Do not leave a battery in an extremely high temperature surrounding environment that can result in an explosion or the leakage of flammable liquid or gas; Do not leave a battery subjected to extremely low air pressure that may result in an explosion or the leakage of flammable liquid or gas.

Please read and follow the above safety information when operating the device. We cannot guarantee that no accidents or damage will occur due to improper use of the device. Please use this product with care and operate at your own risk.

Explanation of the symbols on the product label

| Symbol | Explanation |
|---|--|
|  | DC voltage |
|  | Caution |
|  | Operator's manual |
|  | Indoor use only |
|  | <p>RECYCLING</p> <p>This product bears the selective sorting symbol for Waste electrical and electronic equipment (WEEE). This means that this product must be handled pursuant to European directive 2012/19/EU in order to be recycled or dismantled to minimize its impact on the environment.</p> <p>User has the choice to give his product to a competent recycling organization or to the retailer when he buys a new electrical or electronic equipment.</p> |