

**CFR 47 FCC PART 15 SUBPART C
ISED RSS-247 ISSUE 2**

TEST REPORT

For

Tapo Wired Video Doorbell

MODEL NUMBER: Tapo D130

REPORT NUMBER: 4790817791-1-RF-1

ISSUE DATE: May 15, 2023

**FCC ID:2AXJ4D130
IC:26583-D130**

Prepared for

TP-Link Corporation Limited

**Room 901, 9/F. , New East Ocean Centre, 9 Science Museum Road, Tsim Sha Tsui,
Kowloon, Hong Kong**

Prepared by

UL Verification Services (Guangzhou) Co., Ltd, Song Shan Lake Branch

**Building 10, Innovation Technology Park, No. 1, Li Bin Road, Song Shan Lake Hi-
Tech Development Zone Dongguan, 523808, People's Republic of China**

Tel: +86 769 22038881

Fax: +86 769 33244054

Website: www.ul.com

Revision History

Rev.	Issue Date	Revisions	Revised By
V0	May 15, 2023	Initial Issue	

Summary of Test Results

Test Item	Clause	Limit/Requirement	Result
Antenna Requirement	N/A	FCC Part 15.203/15.247 (c) RSS-GEN Clause 6.8	Pass
AC Power Line Conducted Emission	ANSI C63.10-2013, Clause 6.2	FCC Part 15.207 RSS-GEN Clause 8.8	Pass
Conducted Output Power	ANSI C63.10-2013, Clause 11.9.1.3	FCC Part 15.247 (b)(3) RSS-247 Clause 5.4 (d)	Pass
6dB Bandwidth and 99% Occupied Bandwidth	ANSI C63.10-2013, Clause 11.8.1	FCC Part 15.247 (a)(2) RSS-247 Clause 5.2 (a) ISED RSS-Gen Clause 6.7	Pass
Power Spectral Density	ANSI C63.10-2013, Clause 11.10.2	FCC Part 15.247 (e) RSS-247 Clause 5.2 (b)	Pass
Conducted Band edge and spurious emission	ANSI C63.10-2013, Clause 11.11	FCC Part 15.247(d) RSS-247 Clause 5.5	Pass
Radiated Band edge and Spurious Emission	ANSI C63.10-2013, Clause 11.12 & Clause 11.13	FCC Part 15.247 (d) FCC Part 15.205/15.209 RSS-247 Clause 5.5 RSS-GEN Clause 8.9	Pass
Duty Cycle	ANSI C63.10-2013, Clause 11.6	None; for reporting purposes only.	Pass

*This test report is only published to and used by the applicant, and it is not for evidence purpose in China.

*The measurement result for the sample received is <Pass> according to <CFR 47 FCC PART 15 SUBPART C><ISED RSS-247 ISSUE 2> when <Accuracy Method> decision rule is applied.

CONTENTS

1. ATTESTATION OF TEST RESULTS	6
2. TEST METHODOLOGY	7
3. FACILITIES AND ACCREDITATION	7
4. CALIBRATION AND UNCERTAINTY	8
4.1. <i>MEASURING INSTRUMENT CALIBRATION</i>	8
4.2. <i>MEASUREMENT UNCERTAINTY</i>	8
5. EQUIPMENT UNDER TEST	9
5.1. <i>DESCRIPTION OF EUT</i>	9
5.2. <i>CHANNEL LIST</i>	9
5.3. <i>MAXIMUM EIRP</i>	9
5.4. <i>TEST CHANNEL CONFIGURATION</i>	9
5.5. <i>THE WORSE CASE POWER SETTING PARAMETER</i>	10
5.6. <i>WORST-CASE CONFIGURATIONS</i>	11
5.7. <i>DESCRIPTION OF AVAILABLE ANTENNAS</i>	12
5.8. <i>SUPPORT UNITS FOR SYSTEM TEST</i>	13
6. MEASURING EQUIPMENT AND SOFTWARE USED	14
7. ANTENNA PORT TEST RESULTS	17
7.1. <i>CONDUCTED OUTPUT POWER</i>	17
7.2. <i>6DB BANDWIDTH AND 99% OCCUPIED BANDWIDTH</i>	18
7.3. <i>POWER SPECTRAL DENSITY</i>	20
7.4. <i>CONDUCTED BAND EDGE AND SPURIOUS EMISSION</i>	22
7.5. <i>DUTY CYCLE</i>	24
8. RADIATED TEST RESULTS	25
8.1. <i>RESTRICTED BANDEDGE</i>	33
8.2. <i>SPURIOUS EMISSIONS(1 GHZ~3 GHZ)</i>	51
8.3. <i>SPURIOUS EMISSIONS(3 GHZ~18 GHZ)</i>	57
8.4. <i>SPURIOUS EMISSIONS(9 KHZ~30 MHZ)</i>	81
8.5. <i>SPURIOUS EMISSIONS(18 GHZ~26 GHZ)</i>	84
8.6. <i>SPURIOUS EMISSIONS(30 MHZ~1 GHZ)</i>	86
9. ANTENNA REQUIREMENT	88
10. AC POWER LINE CONDUCTED EMISSION	89

11.	TEST DATA	93
11.1.	<i>APPENDIX A: DTS BANDWIDTH</i>	<i>93</i>
11.1.1.	Test Result	93
11.1.2.	Test Graphs	94
11.2.	<i>APPENDIX B: OCCUPIED CHANNEL BANDWIDTH</i>	<i>104</i>
11.2.1.	Test Result	104
11.2.2.	Test Graphs	105
11.3.	<i>APPENDIX C: MAXIMUM CONDUCTED OUTPUT POWER</i>	<i>115</i>
11.3.1.	Test Result	115
11.4.	<i>APPENDIX D: MAXIMUM POWER SPECTRAL DENSITY</i>	<i>116</i>
11.4.1.	Test Result	116
11.4.2.	Test Graphs	117
11.5.	<i>APPENDIX E: BAND EDGE MEASUREMENTS</i>	<i>127</i>
11.5.1.	Test Result	127
11.5.2.	Test Graphs	128
11.6.	<i>APPENDIX F: CONDUCTED SPURIOUS EMISSION</i>	<i>136</i>
11.6.1.	Test Result	136
11.6.2.	Test Graphs	138
11.7.	<i>APPENDIX G: DUTY CYCLE</i>	<i>169</i>
11.7.1.	Test Result	169
11.7.2.	Test Graphs	170

1. ATTESTATION OF TEST RESULTS

Applicant Information

Company Name: TP-Link Corporation Limited
Address: Room 901, 9/F. , New East Ocean Centre, 9 Science Museum Road, Tsim Sha Tsui, Kowloon, Hong Kong

Manufacturer Information

Company Name: TP-Link Corporation Limited
Address: Room 901, 9/F. , New East Ocean Centre, 9 Science Museum Road, Tsim Sha Tsui, Kowloon, Hong Kong

EUT Information

EUT Name: Tapo Wired Video Doorbell
Model: Tapo D130
Brand: tp-link
Sample Received Date: April 17, 2023
Sample Status: Normal
Sample ID: 5991614
Date of Tested: April 17, 2023 to May 15, 2023

APPLICABLE STANDARDS	
STANDARD	TEST RESULTS
CFR 47 FCC PART 15 SUBPART C ISED RSS-247 ISSUE 2	Pass

Prepared By:



Fanny Huang
Engineer Project Associate

Checked By:

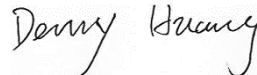

Denny Huang
Senior Project Engineer

Approved By:



Stephen Guo
Operations Manager

2. TEST METHODOLOGY

All tests were performed in accordance with the standard CFR 47 FCC PART 15 SUBPART C ISED RSS-247 ISSUE 2, KDB 558074 D01 15.247 Meas Guidance v05r02, KDB 414788 D01 Radiated Test Site v01r01, KDB 662911 D01 Multiple Transmitter Output v02r01, CFR 47 FCC Part 2, ANSI C63.10-2013 and ISED RSS-GEN Issue 5

3. FACILITIES AND ACCREDITATION

<p>Accreditation Certificate</p>	<p>A2LA (Certificate No.: 4102.01) UL Verification Services (Guangzhou) Co., Ltd. Song Shan Lake Branch. has been assessed and proved to be in compliance with A2LA.</p> <p>FCC (FCC Designation No.: CN1187) UL Verification Services (Guangzhou) Co., Ltd. Song Shan Lake Branch. Has been recognized to perform compliance testing on equipment subject to the Commission's Declaration of Conformity (DoC) and Certification rules</p> <p>ISED (Company No.: 21320) UL Verification Services (Guangzhou) Co., Ltd. Song Shan Lake Branch. has been registered and fully described in a report filed with ISED. The Company Number is 21320 and the test lab Conformity Assessment Body Identifier (CABID) is CN0046.</p> <p>VCCI (Registration No.: G-20019, R-20004, C-20012 and T-20011) UL Verification Services (Guangzhou) Co., Ltd. Song Shan Lake Branch. has been assessed and proved to be in compliance with VCCI, the Membership No. is 3793. Facility Name: Chamber D, the VCCI registration No. is G-20019 and R-20004 Shielding Room B , the VCCI registration No. is C-20012 and T-20011</p>
----------------------------------	----------------------------------------------------------------------------------------------------------------------------------------------------------------------------------------------------------------------------------------------------------------------------------------------------------------------------------------------------------------------------------------------------------------------------------------------------------------------------------------------------------------------------------------------------------------------------------------------------------------------------------------------------------------------------------------------------------------------------------------------------------------------------------------------------------------------------------------------------------------------------------------------------------------------------------------------------------------------------------------------------------------------------------------------------------------------------------------------------------------------------------------------------------------------------------------------------------------------------------------

Note 1:

All tests measurement facilities use to collect the measurement data are located at Building 10, Innovation Technology Park, No. 1, Li Bin Road, Song Shan Lake Hi-Tech Development Zone Dongguan, 523808, People’s Republic of China.

Note 2:

The test anechoic chamber in UL Verification Services (Guangzhou) Co., Ltd. Song Shan Lake Branch had been calibrated and compared to the open field sites and the test anechoic chamber is shown to be equivalent to or worst case from the open field site.

Note 3:

For below 30 MHz, lab had performed measurements at test anechoic chamber and comparing to measurements obtained on an open field site. And these measurements below 30 MHz had been correlated to measurements performed on an OFS.

4. CALIBRATION AND UNCERTAINTY

4.1. MEASURING INSTRUMENT CALIBRATION

The measuring equipment utilized to perform the tests documented in this report has been calibrated in accordance with the manufacturer's recommendations and is traceable to recognized national standards.

4.2. MEASUREMENT UNCERTAINTY

Where relevant, the following measurement uncertainty levels have been estimated for tests performed on the apparatus:

Test Item	Uncertainty
Conduction emission	3.62 dB
Radiated Emission (Included Fundamental Emission) (9 kHz ~ 30 MHz)	2.2 dB
Radiated Emission (Included Fundamental Emission) (30 MHz ~ 1 GHz)	4.00 dB
Radiated Emission (Included Fundamental Emission) (1 GHz to 26 GHz)	5.78 dB (1 GHz ~ 18 GHz)
	5.23 dB (18 GHz ~ 26 GHz)
Duty Cycle	±0.028%
DTS and 99% Occupied Bandwidth	±0.0196%
Maximum Conducted Output Power	±0.686 dB
Maximum Power Spectral Density Level	±0.743 dB
Conducted Band-edge Compliance	±1.328 dB
Conducted Unwanted Emissions In Non-restricted Frequency Bands	±0.746 dB (9 kHz ~ 1 GHz)
	±1.328dB (1 GHz ~ 26 GHz)
Note: This uncertainty represents an expanded uncertainty expressed at approximately the 95% confidence level using a coverage factor of k=2.	

5. EQUIPMENT UNDER TEST

5.1. DESCRIPTION OF EUT

EUT Name	Tapo Wired Video Doorbell
Model	Tapo D130
Frequency Range:	2412 MHz to 2462 MHz
Radio Technology:	IEEE802.11b/g/n HT20
Type of Modulation:	IEEE 802.11b: DSSS(CCK, DQPSK, DBPSK) IEEE 802.11g/n: OFDM(64-QAM, 16-QAM, QPSK, BPSK)
Normal Test Voltage:	AC 120 V, 60 Hz

5.2. CHANNEL LIST

Channel List for 802.11b/g/n (20 MHz)							
Channel	Frequency (MHz)	Channel	Frequency (MHz)	Channel	Frequency (MHz)	Channel	Frequency (MHz)
1	2412	4	2427	7	2442	10	2457
2	2417	5	2432	8	2447	11	2462
3	2422	6	2437	9	2452	/	/

5.3. MAXIMUM EIRP

IEEE Std. 802.11	Frequency (MHz)	Channel Number	Maximum Conducted AVG Output Power (dBm)	Maximum AVG EIRP (dBm)
b	2412 ~ 2462	1-11[11]	24.46	26.39
g	2412 ~ 2462	1-11[11]	25.91	27.84
n HT20	2412 ~ 2462	1-11[11]	25.92	27.85

5.4. TEST CHANNEL CONFIGURATION

IEEE Std. 802.11	Test Channel Number	Frequency
b	CH 1(Low Channel), CH 6(MID Channel), CH 11(High Channel)	2412 MHz, 2437 MHz, 2462 MHz
g	CH 1(Low Channel), CH 6(MID Channel), CH 11(High Channel)	2412 MHz, 2437 MHz, 2462 MHz
n HT20	CH 1(Low Channel), CH 6(MID Channel), CH 11(High Channel)	2412 MHz, 2437 MHz, 2462 MHz

5.5. THE WORSE CASE POWER SETTING PARAMETER

The Worse Case Power Setting Parameter under 2400 ~ 2483.5MHz Band											
Test Software		MP Tool									
Modulation Mode	Transmit Antenna Number	Test Software Setting Value									
		NCB: 20MHz					NCB: 40MHz				
		CH1	CH2	CH6	CH10	CH11	CH3	CH4	CH6	CH8	CH9
802.11b	1	44	44	44	45	45	NA				
	2	44	44	44	45	45					
802.11g	1	54	54	54	55	54					
	2	54	54	54	55	54					
802.11n HT20	1	52	54	54	55	51					
	2	52	54	54	55	51					

5.6. WORST-CASE CONFIGURATIONS

The EUT was tested in the following configuration(s):

Controlled in test mode using a software application on the EUT supplied by customer. The application was used to enable a continuous transmission and to select the mode, test channels, bandwidth, data rates as required.

Test channels referring to section 5.4.

Maximum power setting referring to section 5.5.

Worst-case data rates as provided by the client were:

802.11b mode: 1 Mbps

802.11g mode: 6 Mbps

802.11n HT20 mode: MCS0

802.11b/g/n HT20 support SISO and MIMO mode.

802.11b/g SISO mode, Antenna 1 and Antenna 2 has the same power setting, so only Antenna 1 worst case test data were recorded in the report.

802.11n SISO mode and MIMO mode have the same power setting, so only the worst case power mode(MIMO) will be record in the report.

The EUT has 2 separate antennas which correspond to 2 separate antenna ports. Core 1 and Core 2 correspond to antenna 1 and antenna 2 respectively.

The measured additional path loss was included in any path loss calculations for all RF cable used during tested.

Conducted output power, power spectral density tests separately on each port with all supported SISO & MIMO port combinations.

Conducted bandedge and spurious emissions tests were performed with SISO mode, as this port was found to have the worst case in terms of power settings amongst all supported possible SISO & MIMO port combinations.

Radiated emissions tests were performed with the MIMO modes. These were found to be the worst modulation scheme with regards to emissions after preliminary investigations and, as this mode emits the highest conducted output power level, it was deemed to be the worst case.

The EUT support Cyclic Shift Diversity(CDD), Space Time Coding(STBC), Spartial Division Multiplexing(SDM) modes. They use the same conducted power per chain in any given mode, so we only chose the worst case mode CDD for final testing.

5.7. DESCRIPTION OF AVAILABLE ANTENNAS

Antenna	Frequency (MHz)	Antenna Type	MAX Antenna Gain (dBi)
1	2412-2462	IFA antenna	1.93
2	2412-2462	IFA antenna	1.86

The EUT support Cyclic Shift Diversity(CDD) mode.

MIMO output power port and MIMO PSD port summing were performed in accordance with KDB 662911 D01. For the CDD results the Directional Gain was calculated in accordance with the following method.

For output power measurements:

Directional gain= $G_{ANT} + \text{Array Gain} = 1.93 \text{ dBi}$

G_{ANT} : equal to the gain of the antenna having the highest gain

Array Gain = 0 dB (i.e., no array gain) for $N_{ANT} \leq 4$

For power spectral density (PSD) measurements:

Directional gain= $G_{ANT} + \text{Array Gain} = 4.94 \text{ dBi}$

Array Gain = $10 \log(N_{ANT}/N_{SS}) \text{ dB}$.

N_{ANT} : number of transmit antennas

N_{SS} : number of spatial streams, The worst case directional gain will occur when $N_{SS} = 1$

Test Mode	Transmit and Receive Mode	Description
IEEE 802.11b	<input checked="" type="checkbox"/> 2TX, 2RX	ANT 1 and ANT 2 can be used as transmitting/receiving antenna.
IEEE 802.11g	<input checked="" type="checkbox"/> 2TX, 2RX	ANT 1 and ANT 2 can be used as transmitting/receiving antenna.
IEEE 802.11n HT20	<input checked="" type="checkbox"/> 2TX, 2RX	ANT 1 and ANT 2 can be used as transmitting/receiving antenna.

Note: The value of the antenna gain was declared by customer.

5.8. SUPPORT UNITS FOR SYSTEM TEST

SUPPORT EQUIPMENT

Item	Equipment	Brand Name	Model Name	Remarks
1	PC	Lenovo	E42-80	/
2	AC Power Adapter	/	KJS-4825	INPUT: AC220V. 50Hz OUTPUT: 24V, 1000mA

I/O CABLES

Cable No	Port	Connector Type	Cable Type	Cable Length(m)	Remarks
1	USB	/	/	1.0	/

ACCESSORIES

Item	Accessory	Brand Name	Model Name	Description
1	/	/	/	/

TEST SETUP

The EUT can work in engineering mode with a software through a Laptop.

SETUP DIAGRAM FOR TESTS

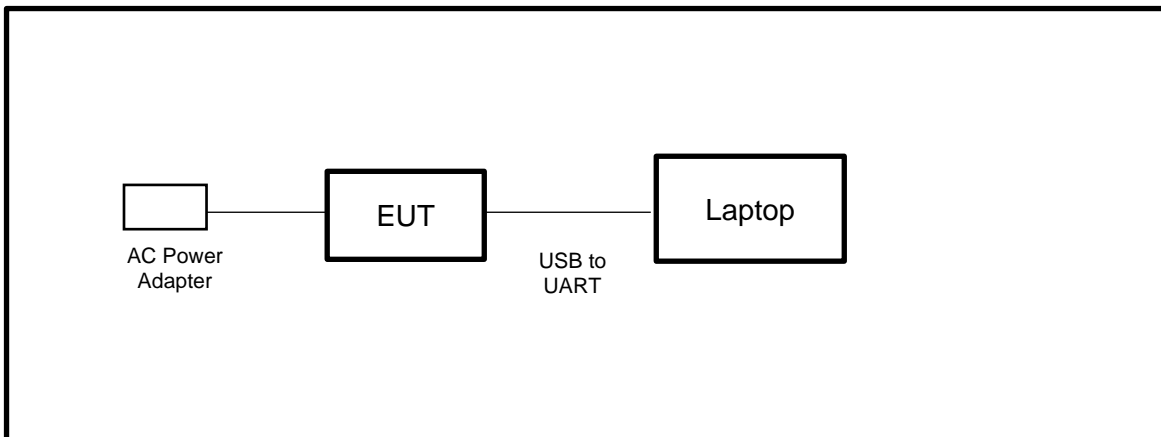

6. MEASURING EQUIPMENT AND SOFTWARE USED

R&S TS 8997 Test System					
Equipment	Manufacturer	Model No.	Serial No.	Last Cal.	Due. Date
Power sensor, Power Meter	R&S	OSP120	100921	Mar.31,2023	Mar.30,2024
Vector Signal Generator	R&S	SMBV100A	261637	Oct.17, 2022	Oct.16, 2023
Signal Generator	R&S	SMB100A	178553	Oct.17, 2022	Oct.16, 2023
Signal Analyzer	R&S	FSV40	101118	Oct.17, 2022	Oct.16, 2023
Software					
Description	Manufacturer	Name		Version	
For R&S TS 8997 Test System	Rohde & Schwarz	EMC 32		10.60.10	
Tonsend RF Test System					
Equipment	Manufacturer	Model No.	Serial No.	Last Cal.	Due. Date
Wideband Radio Communication Tester	R&S	CMW500	155523	Oct.17, 2022	Oct.16, 2023
Wireless Connectivity Tester	R&S	CMW270	1201.0002N75-102	Sep.28, 2022	Sep.27, 2023
PXA Signal Analyzer	Keysight	N9030A	MY55410512	Oct.17, 2022	Oct.16, 2023
MXG Vector Signal Generator	Keysight	N5182B	MY56200284	Oct.17, 2022	Oct.16, 2023
MXG Vector Signal Generator	Keysight	N5172B	MY56200301	Oct.17, 2022	Oct.16, 2023
DC power supply	Keysight	E3642A	MY55159130	Oct.17, 2022	Oct.16, 2023
Temperature & Humidity Chamber	SANMOOD	SG-80-CC-2	2088	Oct.17, 2022	Oct.16, 2023
Attenuator	Aglient	8495B	2814a12853	Oct.18, 2022	Oct.17, 2023
RF Control Unit	Tonscend	JS0806-2	23B80620666	April 18,2023	April 17,2024
Software					
Description	Manufacturer	Name		Version	
Tonsend SRD Test System	Tonsend	JS1120-3 RF Test System		V3.2.22	

Conducted Emissions					
Equipment	Manufacturer	Model No.	Serial No.	Last Cal.	Due Date
EMI Test Receiver	R&S	ESR3	101961	Oct.17, 2022	Oct.16, 2023
Two-Line V-Network	R&S	ENV216	101983	Oct.17, 2022	Oct.16, 2023
Artificial Mains Networks	Schwarzbeck	NSLK 8126	8126465	Oct.17, 2022	Oct.16, 2023
Software					
Description			Manufacturer	Name	Version
Test Software for Conducted Emissions			Farad	EZ-EMC	Ver. UL-3A1

Radiated Emissions					
Equipment	Manufacturer	Model No.	Serial No.	Last Cal.	Due Date
MXE EMI Receiver	KESIGHT	N9038A	MY56400036	Oct.17, 2022	Oct.16, 2023
Hybrid Log Periodic Antenna	TDK	HLP-3003C	130959	Aug.02, 2021	Aug.01, 2024
Preamplifier	HP	8447D	2944A09099	Oct.17, 2022	Oct.16, 2023
EMI Measurement Receiver	R&S	ESR26	101377	Oct.17, 2022	Oct.16, 2023
Horn Antenna	TDK	HRN-0118	130940	July 20, 2021	July 19, 2024
Preamplifier	TDK	PA-02-0118	TRS-305-00067	Oct.17, 2022	Oct.16, 2023
Horn Antenna	Schwarzbeck	BBHA9170	697	July 20, 2021	July 19, 2024
Preamplifier	TDK	PA-02-2	TRS-307-00003	Oct.17, 2022	Oct.16, 2023
Preamplifier	TDK	PA-02-3	TRS-308-00002	Oct.17, 2022	Oct.16, 2023
Loop antenna	Schwarzbeck	1519B	00008	Dec.14, 2021	Dec.13, 2024
Preamplifier	TDK	PA-02-001-3000	TRS-302-00050	Oct.17, 2022	Oct.16, 2023
Preamplifier	Mini-Circuits	ZX60-83LN-S+	SUP01202035	Oct.17, 2022	Oct.16, 2023
High Pass Filter	Wi	WHKX10-2700-3000-18000-40SS	23	/	/
Highpass Filter	Wainwright	WHKX10-5850-6500-1800-40SS	4	/	/
Band Reject Filter	Wainwright	WRCJV12-5695-5725-5850-5880-40SS	4	/	/

Band Reject Filter	Wainwright	WRCJV20-5120-5150-5350-5380-60SS	2	/	/
Band Reject Filter	Wainwright	WRCJV20-5440-5470-5725-5755-60SS	1	/	/
Band Reject Filter	Wainwright	WRCJV8-2350-2400-2483.5-2533.5-40SS	4	/	/
Band Reject Filter	Wainwright	WRCD5-1879-1879.85-1880.15-1881-40SS	1	/	/
Notch Filter	Wainwright	WHJ10-882-980-7000-40SS	1	/	/
Software					
Description			Manufacturer	Name	Version
Test Software for Radiated Emissions			Farad	EZ-EMC	Ver. UL-3A1

Other Instrument					
Equipment	Manufacturer	Model No.	Serial No.	Last Cal.	Due Date
Temperature humidity probe	OMEGA	ITHX-SD-5	18470007	Oct.22, 2022	Oct.21, 2023
Barometer	Yiyi	Baro	N/A	Oct.24, 2022	Oct.23, 2023
Attenuator	Agilent	8495B	2814a12853	Oct.18, 2022	Oct.17, 2023

7. ANTENNA PORT TEST RESULTS

7.1. CONDUCTED OUTPUT POWER

LIMITS

CFR 47 FCC Part15 (15.247) Subpart C ISED RSS-247 ISSUE 2			
Section	Test Item	Limit	Frequency Range (MHz)
CFR 47 FCC 15.247(b)(3) ISED RSS-247 5.4 (d)	AVG Output Power	1 watt or 30 dBm	2400-2483.5

TEST PROCEDURE

Refer to ANSI C63.10-2013 clause 11.9.2.3.1.

Connect the EUT to a low loss RF cable from the antenna port to the power sensor (video bandwidth is greater than the occupied bandwidth).

Measure peak emission level, the indicated level is the average output power, after any corrections for external attenuators and cables.

The test result in dBm by adding $[10 \log (1 / D)]$, where D is the duty cycle.

TEST SETUP

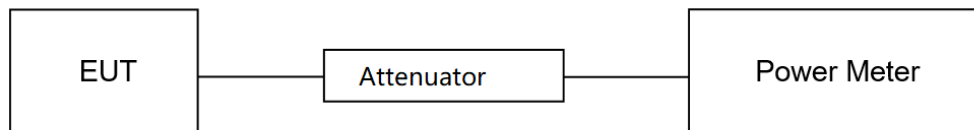

TEST ENVIRONMENT

Temperature	25.8°C	Relative Humidity	64.9%
Atmosphere Pressure	101kPa	Test Voltage	AC 120 V, 60 Hz

TEST DATE / ENGINEER

Test Date	April 28, 2023	Test By	Johnson Liu
-----------	----------------	---------	-------------

TEST RESULTS

Please refer to section "Test Data" - Appendix C

7.2. 6DB BANDWIDTH AND 99% OCCUPIED BANDWIDTH

LIMITS

CFR 47 FCC Part15 (15.247) Subpart C ISED RSS-247 ISSUE 2			
Section	Test Item	Limit	Frequency Range (MHz)
CFR 47 FCC 15.247(a)(2) ISED RSS-247 5.2 (a)	6 dB Bandwidth	≥ 500 kHz	2400-2483.5
ISED RSS-Gen Clause 6.7	99 % Occupied Bandwidth	For reporting purposes only.	2400-2483.5

TEST PROCEDURE

Refer to ANSI C63.10-2013 clause 11.8 for DTS bandwidth and clause 6.9 for Occupied Bandwidth.

Connect the EUT to the spectrum analyser and use the following settings:

Center Frequency	The center frequency of the channel under test
Frequency Span	For 6 dB Bandwidth: Enough to capture all products of the modulation carrier emission For 99 % Occupied Bandwidth: Between 1.5 times and 5.0 times the OBW
Detector	Peak
RBW	For 6 dB Bandwidth: 100 kHz For 99 % Occupied Bandwidth: 1 % to 5 % of the occupied bandwidth
VBW	For 6 dB Bandwidth: ≥3 × RBW For 99 % Occupied Bandwidth: ≥3 × RBW
Trace	Max hold
Sweep	Auto couple

a) Use the 99 % power bandwidth function of the instrument, allow the trace to stabilize and report the measured bandwidth.

b) Allow the trace to stabilize and measure the maximum width of the emission that is constrained by the frequencies associated with the two outermost amplitude points (upper and lower frequencies) that are attenuated by 6 dB relative to the maximum level measured in the fundamental emission.

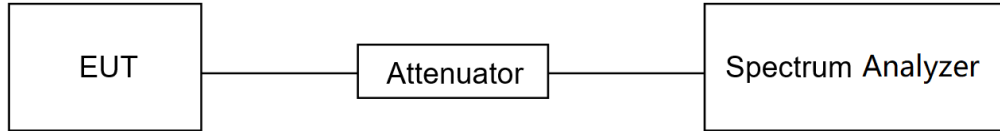
TEST SETUP**TEST ENVIRONMENT**

Temperature	25.8°C	Relative Humidity	64.9%
Atmosphere Pressure	101kPa	Test Voltage	AC 120 V, 60 Hz

TEST DATE / ENGINEER

Test Date	April 28, 2023	Test By	Johnson Liu
-----------	----------------	---------	-------------

TEST RESULTS

Please refer to section "Test Data" - Appendix A&B

7.3. POWER SPECTRAL DENSITY

LIMITS

CFR 47 FCC Part15 (15.247) Subpart C ISED RSS-247 ISSUE 2			
Section	Test Item	Limit	Frequency Range (MHz)
CFR 47 FCC §15.247 (e) ISED RSS-247 5.2 (b)	Power Spectral Density	8 dBm in any 3 kHz band	2400-2483.5

TEST PROCEDURE

Refer to ANSI C63.10-2013 clause 11.10.5.

Connect the EUT to the spectrum analyser and use the following settings:

Center Frequency	The center frequency of the channel under test
Detector	power averaging (rms)
RBW	$3 \text{ kHz} \leq \text{RBW} \leq 100 \text{ kHz}$
VBW	$\geq 3 \times \text{RBW}$
Span	1.5 x OBW bandwidth
Trace	Average
Sweep time	Auto couple

Allow trace to fully stabilize and use the peak marker function to determine the maximum amplitude level within the RBW.

If measured value exceeds limit, reduce RBW (no less than 3 kHz) and repeat.

TEST SETUP

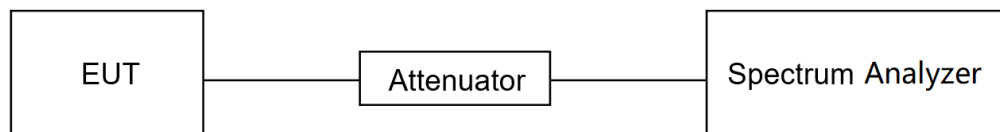

TEST ENVIRONMENT

Temperature	25.8°C	Relative Humidity	64.9%
Atmosphere Pressure	101kPa	Test Voltage	AC 120 V, 60 Hz

TEST DATE / ENGINEER

Test Date	April 28, 2023	Test By	Johnson Liu
-----------	----------------	---------	-------------

TEST RESULTS

Please refer to section "Test Data" - Appendix D

7.4. CONDUCTED BAND EDGE AND SPURIOUS EMISSION

LIMITS

CFR 47 FCC Part15 (15.247) Subpart C ISED RSS-247 ISSUE 2		
Section	Test Item	Limit
CFR 47 FCC §15.247 (d) ISED RSS-247 5.5	Conducted Bandedge and Spurious Emissions	at least 30 dB below that in the 100 kHz bandwidth within the band that contains the highest level of the desired power

TEST PROCEDURE

Refer to ANSI C63.10-2013 clause 11.11 and 11.13.

Connect the EUT to the spectrum analyser and use the following settings for reference level measurement:

Center Frequency	The center frequency of the channel under test
Detector	Peak
RBW	100 kHz
VBW	$\geq 3 \times \text{RBW}$
Span	1.5 x DTS bandwidth
Trace	Max hold
Sweep time	Auto couple.

Allow trace to fully stabilize and use the peak marker function to determine the maximum PSD level.

Change the settings for emission level measurement:

Span	Set the center frequency and span to encompass frequency range to be measured
Detector	Peak
RBW	100 kHz
VBW	$\geq 3 \times \text{RBW}$
measurement points	$\geq \text{span}/\text{RBW}$
Trace	Max hold
Sweep time	Auto couple.

Allow trace to fully stabilize and use the peak marker function to determine the maximum PSD level. Ensure that the amplitude of all unwanted emissions outside of the authorized frequency band (excluding restricted frequency bands) is attenuated by at least the minimum requirements specified in 11.11.

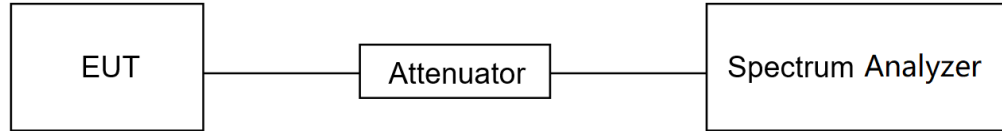
TEST SETUP**TEST ENVIRONMENT**

Temperature	25.8°C	Relative Humidity	64.9%
Atmosphere Pressure	101kPa	Test Voltage	AC 120 V, 60 Hz

TEST DATE / ENGINEER

Test Date	April 28, 2023	Test By	Johnson Liu
-----------	----------------	---------	-------------

TEST RESULTS

Please refer to section "Test Data" - Appendix E&F

7.5. DUTY CYCLE

LIMITS

None; for reporting purposes only.

TEST PROCEDURE

Refer to ANSI C63.10-2013 clause 11.6 Zero – Span Spectrum Analyzer method.

TEST SETUP

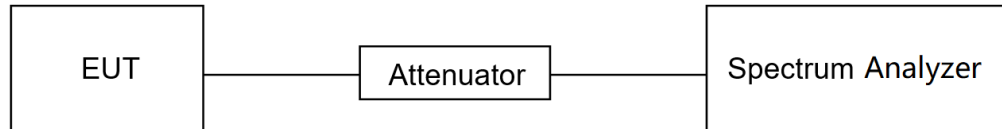

TEST ENVIRONMENT

Temperature	25.8°C	Relative Humidity	64.9%
Atmosphere Pressure	101kPa	Test Voltage	AC 120 V, 60 Hz

TEST DATE / ENGINEER

Test Date	April 28, 2023	Test By	Johnson Liu
-----------	----------------	---------	-------------

TEST RESULTS

Please refer to section "Test Data" - Appendix G

8. RADIATED TEST RESULTS

LIMITS

Please refer to CFR 47 FCC §15.205 and §15.209.

Please refer to ISED RSS-GEN Clause 8.9 and Clause 8.10.

Radiation Disturbance Test Limit for FCC (Class B) (9 kHz ~ 1 GHz)

Emissions radiated outside of the specified frequency bands above 30 MHz			
Frequency Range (MHz)	Field Strength Limit (uV/m) at 3 m	Field Strength Limit (dBuV/m) at 3 m	
		Quasi-Peak	
30 - 88	100	40	
88 - 216	150	43.5	
216 - 960	200	46	
Above 960	500	54	
Above 1000	500	Peak	Average
		74	54

FCC Emissions radiated outside of the specified frequency bands below 30 MHz		
Frequency (MHz)	Field strength (microvolts/meter)	Measurement distance (meters)
0.009-0.490	2400/F(kHz)	300
0.490-1.705	24000/F(kHz)	30
1.705-30.0	30	30

ISED General field strength limits at frequencies below 30 MHz

Table 6 – General field strength limits at frequencies below 30 MHz		
Frequency	Magnetic field strength (H-Field) (uA/m)	Measurement distance (m)
9 - 490 kHz ^{Note 1}	6.37/F (F in kHz)	300
490 - 1705 kHz	63.7/F (F in kHz)	30
1.705 - 30 MHz	0.08	30

Note 1: The emission limits for the ranges 9-90 kHz and 110-490 kHz are based on measurements employing a linear average detector.

ISED Restricted bands please refer to ISED RSS-GEN Clause 8.10

Table 7 – Restricted frequency bands ^{Note 1}		
MHz	MHz	GHz
0.090 - 0.110	149.9 - 150.05	9.0 - 9.2
0.495 - 0.505	156.52475 - 156.52525	9.3 - 9.5
2.1735 - 2.1905	156.7 - 156.9	10.6 - 12.7
3.020 - 3.026	162.0125 - 167.17	13.25 - 13.4
4.125 - 4.128	167.72 - 173.2	14.47 - 14.5
4.17725 - 4.17775	240 - 285	15.35 - 16.2
4.20725 - 4.20775	322 - 335.4	17.7 - 21.4
5.677 - 5.683	399.9 - 410	22.01 - 23.12
6.215 - 6.218	608 - 614	23.6 - 24.0
6.26775 - 6.26825	960 - 1427	31.2 - 31.8
6.31175 - 6.31225	1435 - 1626.5	36.43 - 36.5
8.291 - 8.294	1645.5 - 1646.5	Above 38.6
8.362 - 8.366	1660 - 1710	
8.37625 - 8.38675	1718.8 - 1722.2	
8.41425 - 8.41475	2200 - 2300	
12.29 - 12.293	2310 - 2390	
12.51975 - 12.52025	2483.5 - 2500	
12.57675 - 12.57725	2655 - 2900	
13.36 - 13.41	3260 - 3267	
16.42 - 16.423	3332 - 3339	
16.69475 - 16.69525	3345.8 - 3358	
16.80425 - 16.80475	3500 - 4400	
25.5 - 25.67	4500 - 5150	
37.5 - 38.25	5350 - 5460	
73 - 74.6	7250 - 7750	
74.8 - 75.2	8025 - 8500	
108 - 138		

Note 1: Certain frequency bands listed in table 7 and in bands above 38.6 GHz are designated for licence-exempt applications. These frequency bands and the requirements that apply to related devices are set out in the 200 and 300 series of RSSs.

FCC Restricted bands of operation refer to FCC §15.205 (a):

MHz	MHz	MHz	GHz
0.090-0.110	16.42-16.423	399.9-410	4.5-5.15
¹ 0.495-0.505	16.69475-16.69525	608-614	5.35-5.46
2.1735-2.1905	16.80425-16.80475	960-1240	7.25-7.75
4.125-4.128	25.5-25.67	1300-1427	8.025-8.5
4.17725-4.17775	37.5-38.25	1435-1626.5	9.0-9.2
4.20725-4.20775	73-74.6	1645.5-1646.5	9.3-9.5
6.215-6.218	74.8-75.2	1660-1710	10.6-12.7
6.26775-6.26825	108-121.94	1718.8-1722.2	13.25-13.4
6.31175-6.31225	123-138	2200-2300	14.47-14.5
8.291-8.294	149.9-150.05	2310-2390	15.35-16.2
8.362-8.366	156.52475-156.52525	2483.5-2500	17.7-21.4
8.37625-8.38675	156.7-156.9	2690-2900	22.01-23.12
8.41425-8.41475	162.0125-167.17	3260-3267	23.6-24.0
12.29-12.293	167.72-173.2	3332-3339	31.2-31.8
12.51975-12.52025	240-285	3345.8-3358	36.43-36.5
12.57675-12.57725	322-335.4	3600-4400	(²)
13.36-13.41			

Note: ¹Until February 1, 1999, this restricted band shall be 0.490-0.510 MHz.

²Above 38.6c

TEST PROCEDURE

Below 30 MHz

The setting of the spectrum analyser

RBW	200 Hz (From 9 kHz to 0.15 MHz)/ 9 kHz (From 0.15 MHz to 30 MHz)
VBW	200 Hz (From 9 kHz to 0.15 MHz)/ 9 kHz (From 0.15 MHz to 30 MHz)
Sweep	Auto

1. The testing follows the guidelines in ANSI C63.10-2013 clause 6.4.
2. The EUT was arranged to its worst case and then turntable (from 0 degree to 360 degrees) to find the maximum reading. A pre-amp and a high pass filter are used for the test in order to get better signal level. Both Horizontal, Face-on and Face-off polarizations of the antenna are set to make the measurement.
3. The EUT was placed on a turntable with 80 cm above ground.
4. The EUT was set 3 meters from the interference receiving antenna, which was mounted on the top of a 1 m height antenna tower.
5. The radiated emission limits are based on measurements employing a CISPR quasi-peak detector except for the frequency bands 9-90 kHz, 110-490 kHz and above 1000 MHz Radiated emission limits in these three bands are based on measurements employing an average detector.
6. For measurement below 1 GHz, the initial step in collecting conducted emission data is a spectrum analyzer peak detector mode pre-scanning the measurement frequency range. Significant peaks are then marked and then Quasi Peak and average detector mode re-measured. If the emission level of the EUT measured by the peak detector is 3 dB lower than the applicable limit, the peak emission level will be reported. Otherwise, the emission measurement will be repeated using the quasi-peak and average detector and reported.
7. Although these tests were performed other than open field site, adequate comparison measurements were confirmed against 30m open field site. Therefore sufficient tests were made to demonstrate that the alternative site produces results that correlate with the ones of tests made in an open field site based on KDB 414788.
8. The limits in CFR 47, Part 15, Subpart C, paragraph 15.209 (a), are identical to those in RSS-GEN Section 8.9, Table 6, since the measurements are performed in terms of magnetic field strength and converted to electric field strength levels (as reported in the table) using the free space impedance of 377Ω . For example, the measurement frequency X KHz resulted in a level of Y dBuV/m, which is equivalent to $Y-51.5 = Z$ dBuA/m, which has the same margin, W dB, to the corresponding RSS-GEN Table 6 limit as it has to be 15.209(a) limit.

Below 1 GHz and above 30 MHz

The setting of the spectrum analyser

RBW	120 kHz
VBW	300 kHz
Sweep	Auto

Detector	Peak/QP
Trace	Max hold

1. The testing follows the guidelines in ANSI C63.10-2013 clause 6.5.
2. The EUT was arranged to its worst case and then tune the antenna tower (from 1 m to 4 m) and turntable (from 0 degree to 360 degrees) to find the maximum reading. A pre-amp and a high pass filter are used for the test in order to get better signal level. Both horizontal and vertical polarizations of the antenna are set to make the measurement.
3. The EUT was placed on a turntable with 80 cm above ground.
4. The EUT was set 3 meters from the interference receiving antenna, which was mounted on the top of a variable height antenna tower.
5. For measurement below 1 GHz, the initial step in collecting conducted emission data is a spectrum analyzer peak detector mode pre-scanning the measurement frequency range. Significant peaks are then marked and then Quasi Peak detector mode re-measured. If the emission level of the EUT measured by the peak detector is 3 dB lower than the applicable limit, the peak emission level will be reported. Otherwise, the emission measurement will be repeated using the quasi-peak detector and reported.

Above 1G

The setting of the spectrum analyser

RBW	1 MHz
VBW	PEAK: 3 MHz AVG: see note 6
Sweep	Auto
Detector	Peak
Trace	Max hold

1. The testing follows the guidelines in ANSI C63.10-2013 clause 6.6.
2. The EUT was arranged to its worst case and then tune the antenna tower (from 1 m to 4 m) and turntable (from 0 degree to 360 degrees) to find the maximum reading. A pre-amp and a high pass filter are used for the test in order to get better signal level. Both horizontal and vertical polarizations of the antenna are set to make the measurement.
3. The EUT was placed on a turntable with 1.5 m above ground.
4. The EUT was set 3 meters from the interference receiving antenna, which was mounted on the top of a variable height antenna tower.
5. For measurement above 1 GHz, the emission measurement will be measured by the peak detector. This peak level, once corrected, must comply with the limit specified in Section 15.209.
6. For measurements above 1 GHz the resolution bandwidth is set to 1 MHz, then the video bandwidth is set to 3 MHz for peak measurements and 1 MHz resolution bandwidth with 1/T video bandwidth with peak detector for average measurements. For the Duty Cycle please refer to clause 7.5.ON TIME AND DUTY CYCLE.

X axis, Y axis, Z axis positions:

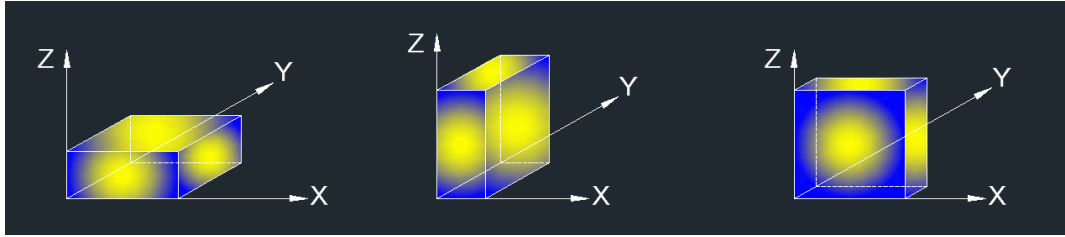

Note 1: For all radiated test, EUT in each of three orthogonal axis emissions had been tested, but only the worst case (X axis) data recorded in the report.

For Band edge:

Note:

1. Measurement = Reading Level + Correct Factor.
2. If the peak values are less than the average limit of 54 dBuV/m, the average result is deemed to comply with average limit.
3. Peak: Peak detector.
4. AVG: $VBW=1/T_{on}$, where: T_{on} is the transmitting duration.
5. For the transmitting duration, please refer to clause 7.5.
6. Only the worst data was recorded, if it complies with the limit, the other emissions deemed to comply with the limit.
7. Horizontal and Vertical have been tested, only the worst data was recorded in the report.
8. All modes, channels and antennas have been tested, only the worst data was recorded in the report.

For Radiate Spurious emission 1GHz-3GHz:

Note:

1. Measurement = Reading Level + Correct Factor.
2. If the Peak values are less than the Average limit of 54 dBuV/m, the Average result is deemed to comply with Average limit.
3. Peak: Peak detector.
4. AVG: $VBW=1/T_{on}$, where: T_{on} is the transmitting duration.
5. For the transmitting duration, please refer to clause 7.5.
6. Filter losses were only considered in the spurious frequency bands and the authorized band was not corrected for Band reject filter losses.
7. Proper operation of the transmitter prior to adding the filter to the measurement chain.
8. All modes, channels and antennas have been tested, only the worst data was recorded in the report.

For Radiate Spurious emission 3GHz-18GHz:

Note:

1. Peak Result = Reading Level + Correct Factor.
2. If the Peak values are less than the Average limit of 54 dBuV/m, the Average result is deemed to comply with Average limit.
3. Peak: Peak detector.
4. AVG: $VBW=1/Ton$, where: Ton is the transmitting duration.
5. For the transmitting duration, please refer to clause 7.5.
6. Filter losses were only considered in the spurious frequency bands and the authorized band was not corrected for High Pass Filter losses.
7. Proper operation of the transmitter prior to adding the filter to the measurement chain.
8. All modes, channels and antennas have been tested, only the worst data was recorded in the report.

For Radiate Spurious emission 9kHz-30MHz:

Note:

1. Measurement = Reading Level + Correct Factor.
($\text{dBuA/m} = \text{dBuV/m} - 20\text{Log}_{10}[120\pi] = \text{dBuV/m} - 51.5$).
2. If the Peak values are less than the QP limit, the QP result is deemed to comply with QP limit.
3. All 3 polarizations (Horizontal, Face-on and Face-off) of the loop antenna had been tested, but only the worst data recorded in the report.
4. All modes, channels and antennas have been tested, only the worst data was recorded in the report.

For Radiate Spurious emission 18GHz-26GHz:

Note:

1. Measurement = Reading Level + Correct Factor.
2. If the Peak values are less than the Average limit of 54 dBuV/m, the Average result is deemed to comply with Average limit.
3. Peak: Peak detector.
4. All modes, channels and antennas have been tested, only the worst data was recorded in the report.

For Radiate Spurious emission 30MHz-1GHz:

Note:

1. Result Level = Read Level + Correct Factor.
2. If the Peak values are less than the QP limit, the QP result is deemed to comply with QP limit.
3. Test setup: RBW: 120 kHz, VBW: 300 kHz, Sweep time: auto.
4. All modes, channels and antennas have been tested, only the worst data was recorded in the report.

TEST SETUP

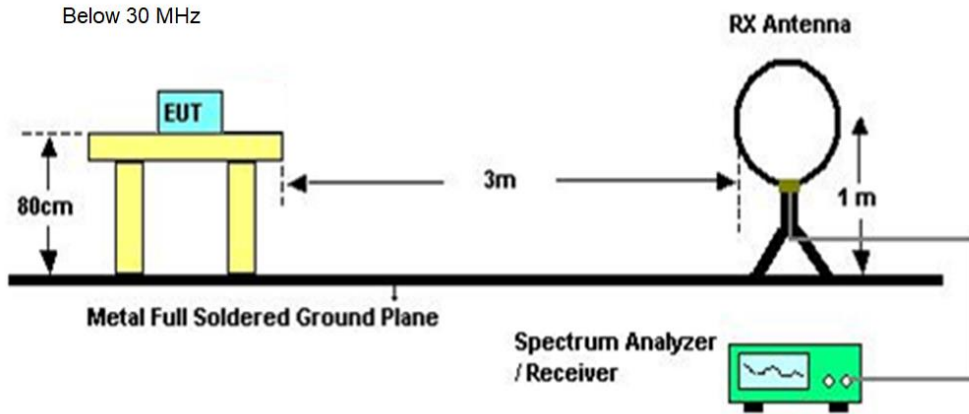

Below 1 GHz and above 30 MHz

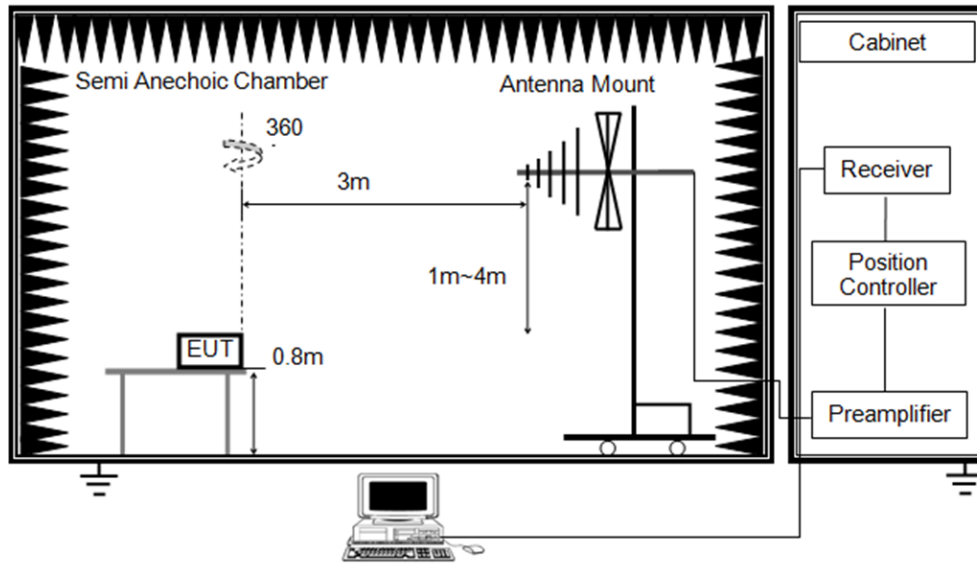

Above 1 GHz

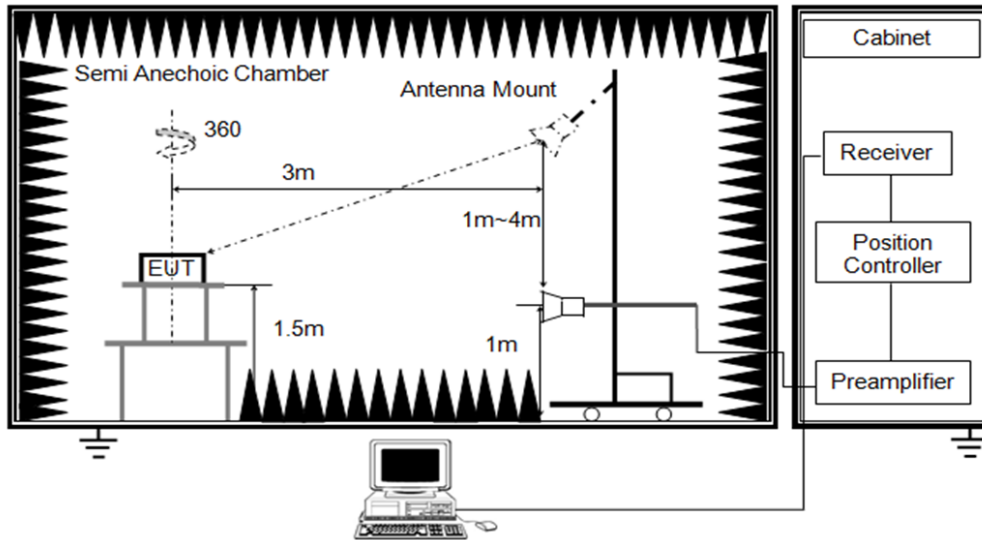

TEST ENVIRONMENT

Temperature	25.3°C	Relative Humidity	66%
Atmosphere Pressure	101kPa	Test Voltage	AC 120 V, 60 Hz

TEST DATE / ENGINEER

Test Date	May 9, 2023	Test By	Rex Huang
-----------	-------------	---------	-----------

TEST RESULTS

8.1. RESTRICTED BANDEDGE

Test Mode:	802.11b PK	Channel:	2412
Polarity:	Horizontal	Test Voltage:	AC 120 V, 60 Hz

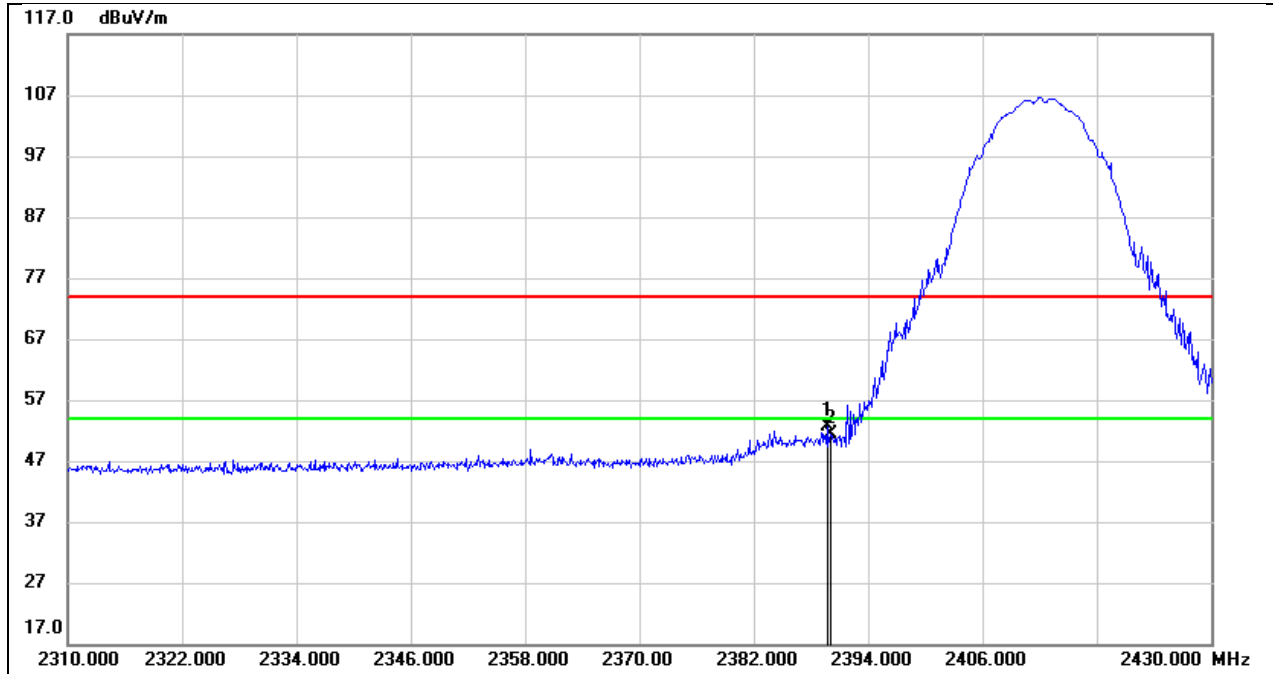

No.	Frequency (MHz)	Reading (dBuV)	Correct (dB/m)	Result (dBuV/m)	Limit (dBuV/m)	Margin (dB)	Remark
1	2389.680	20.40	32.16	52.56	74.00	-21.44	peak
2	2390.000	19.10	32.16	51.26	74.00	-22.74	peak

Test Mode:	802.11b PK	Channel:	2412
Polarity:	Vertical	Test Voltage:	AC 120 V, 60 HZ

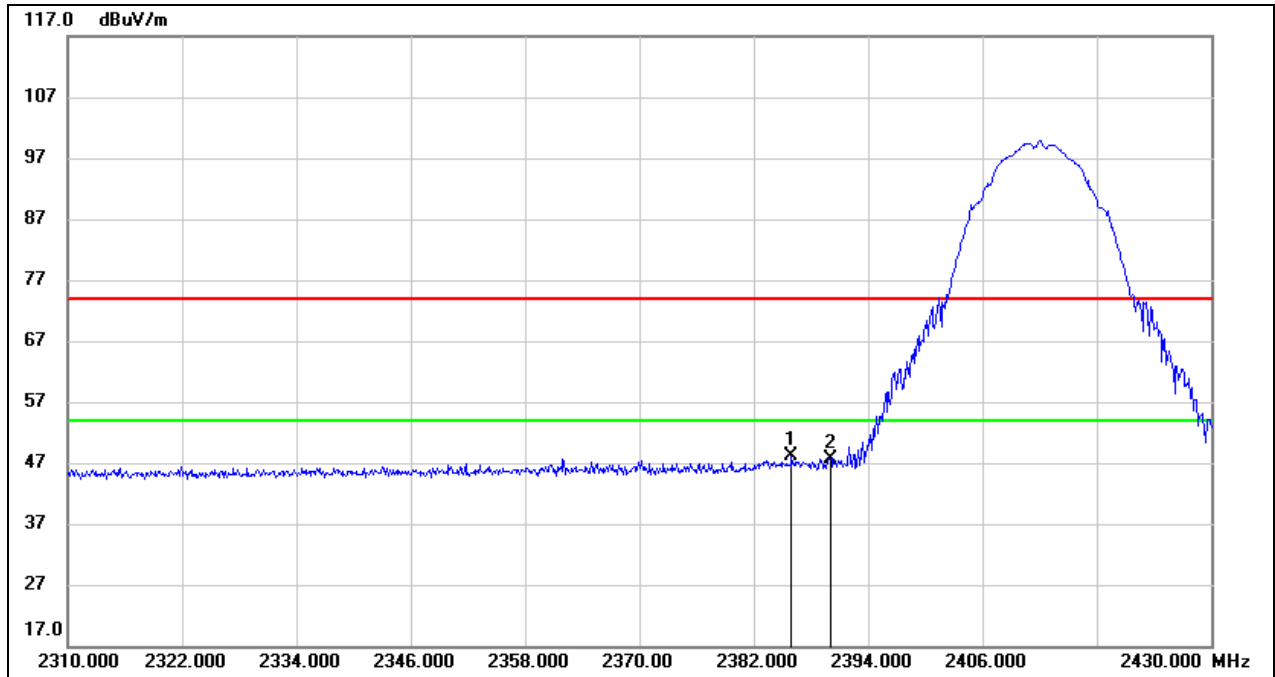

No.	Frequency (MHz)	Reading (dBuV)	Correct (dB/m)	Result (dBuV/m)	Limit (dBuV/m)	Margin (dB)	Remark
1	2385.960	15.99	32.14	48.13	74.00	-25.87	peak
2	2390.000	15.46	32.16	47.62	74.00	-26.38	peak

Test Mode:	802.11b PK	Channel:	2462
Polarity:	Horizontal	Test Voltage:	AC 120 V, 60 HZ

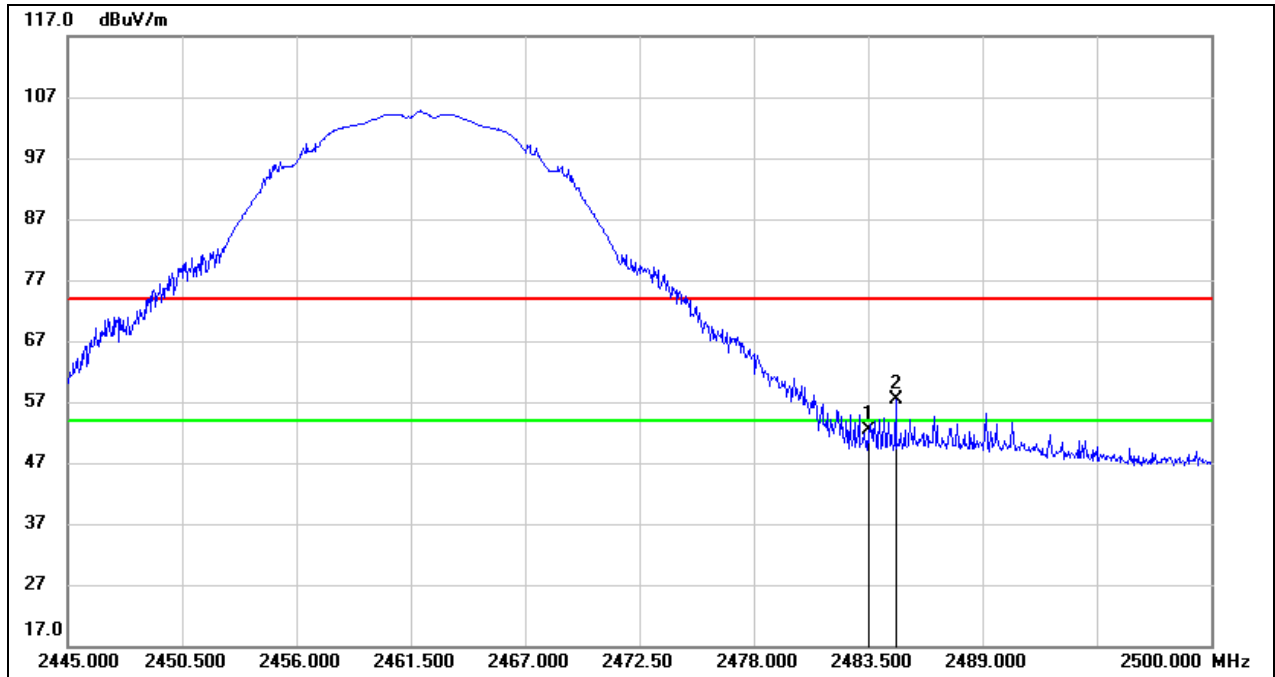

No.	Frequency (MHz)	Reading (dBuV)	Correct (dB/m)	Result (dBuV/m)	Limit (dBuV/m)	Margin (dB)	Remark
1	2483.500	19.95	32.44	52.39	74.00	-21.61	peak
2	2484.820	25.05	32.44	57.49	74.00	-16.51	peak

Test Mode:	802.11b AV	Channel:	2462
Polarity:	Horizontal	Test Voltage:	AC 120 V, 60 HZ

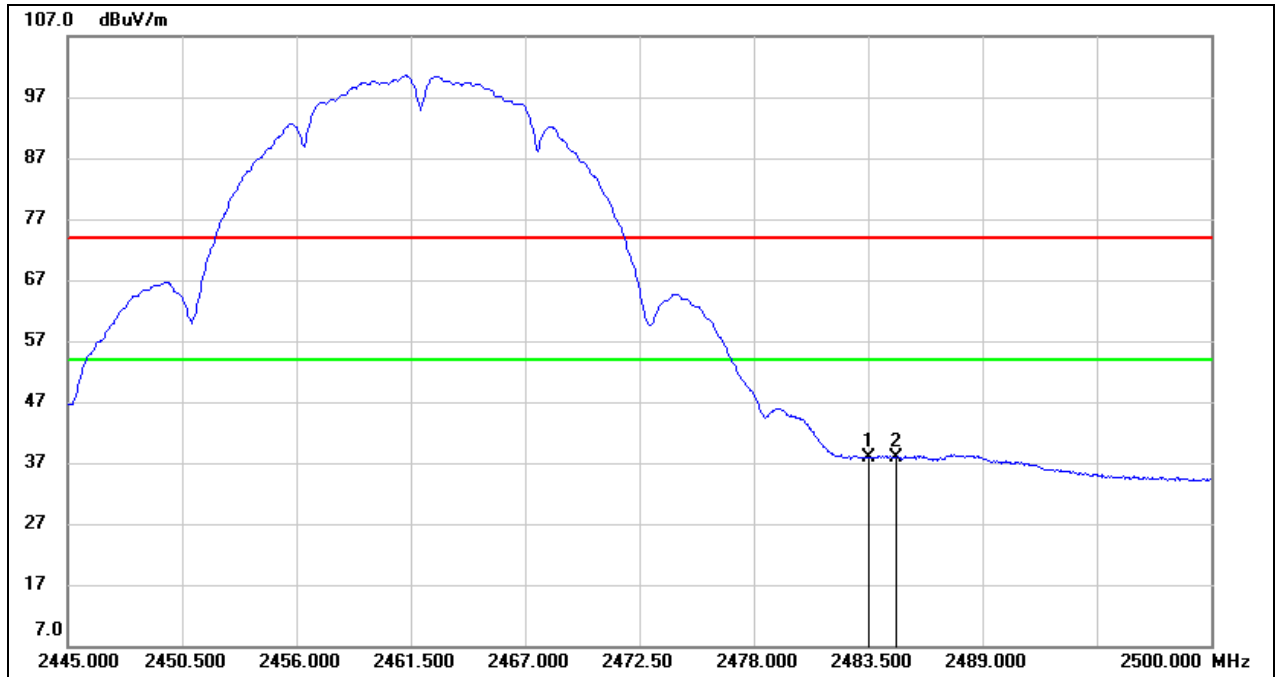

No.	Frequency (MHz)	Reading (dBuV)	Correct (dB/m)	Result (dBuV/m)	Limit (dBuV/m)	Margin (dB)	Remark
1	2483.500	5.42	32.44	37.86	54.00	-16.14	AVG
2	2484.820	5.35	32.44	37.79	54.00	-16.21	AVG

Test Mode:	802.11g PK	Channel:	2412
Polarity:	Horizontal	Test Voltage:	AC 120 V, 60 HZ

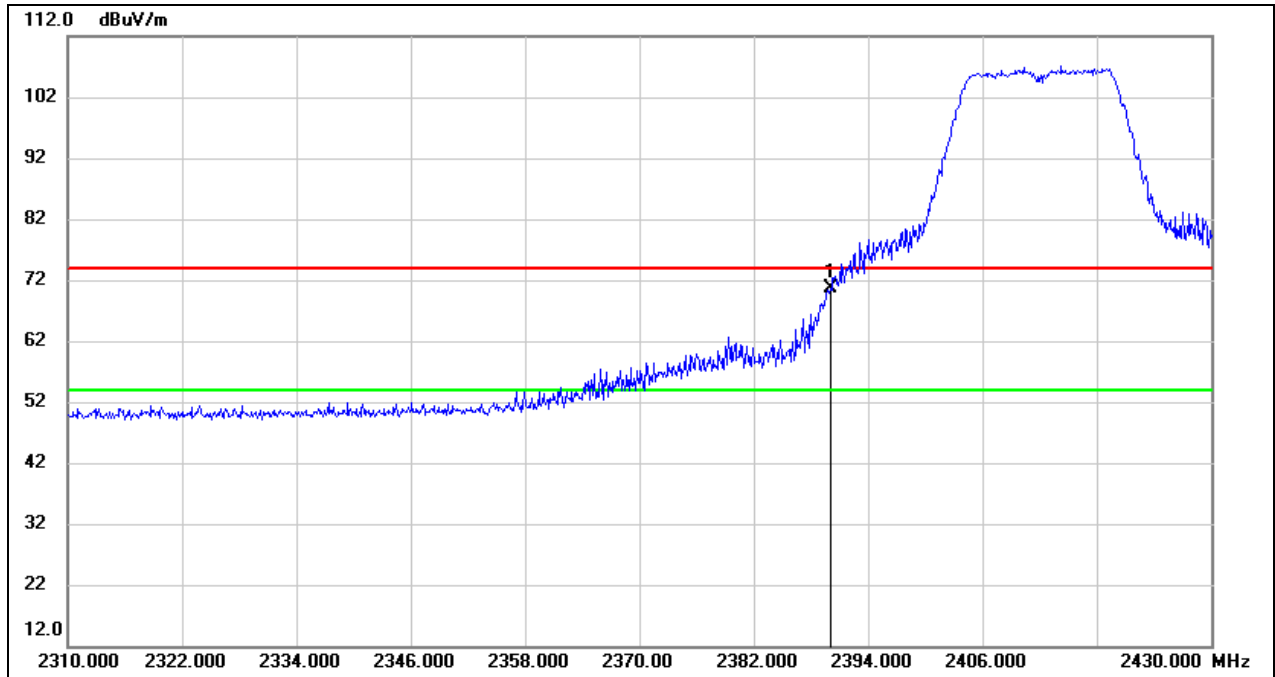

No.	Frequency (MHz)	Reading (dBuV)	Correct (dB/m)	Result (dBuV/m)	Limit (dBuV/m)	Margin (dB)	Remark
1	2390.000	38.35	32.16	70.51	74.00	-3.49	peak

Test Mode:	802.11g AV	Channel:	2412
Polarity:	Horizontal	Test Voltage:	AC 120 V, 60 HZ

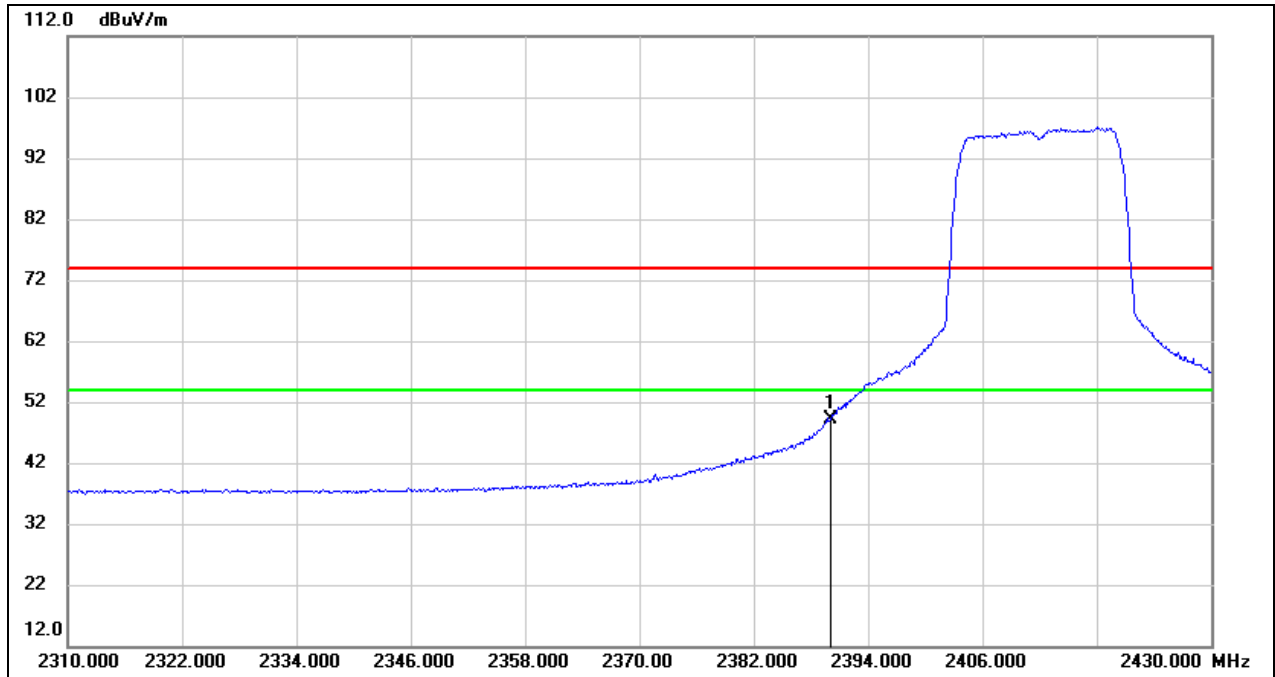

No.	Frequency (MHz)	Reading (dBuV)	Correct (dB/m)	Result (dBuV/m)	Limit (dBuV/m)	Margin (dB)	Remark
1	2390.000	17.05	32.16	49.21	54.00	-4.79	AVG

Test Mode:	802.11g PK	Channel:	2457
Polarity:	Horizontal	Test Voltage:	AC 120 V, 60 HZ

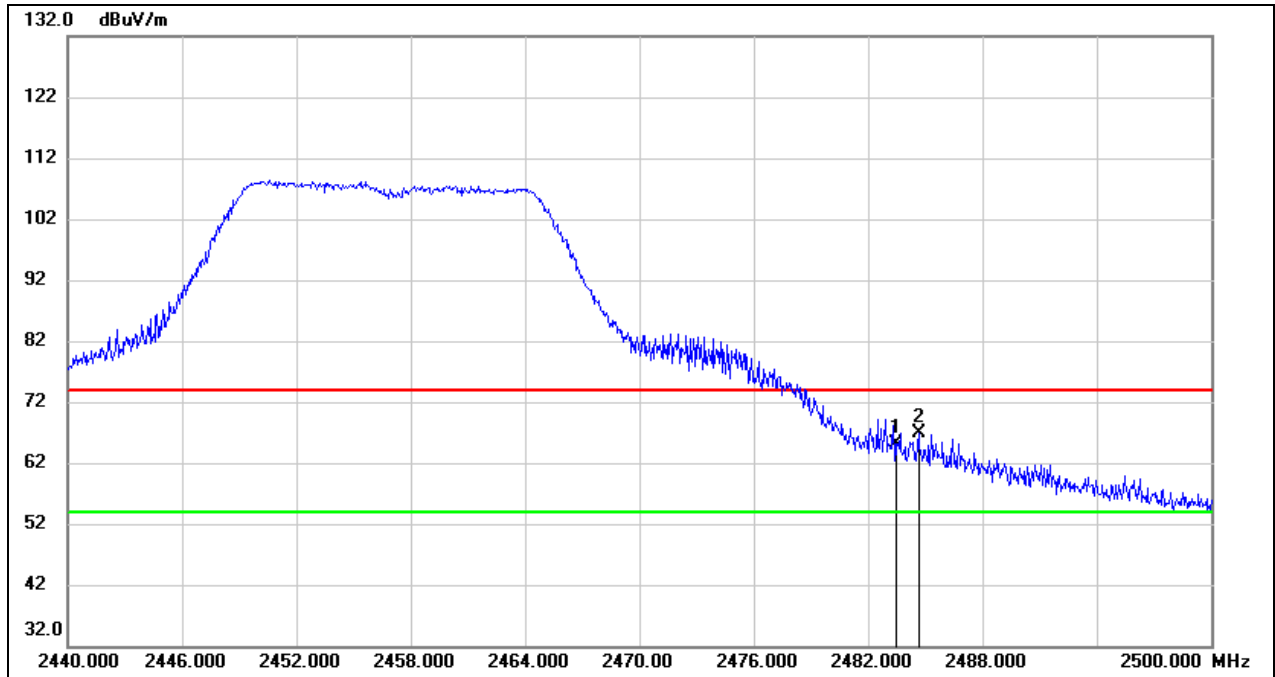

No.	Frequency (MHz)	Reading (dBuV)	Correct (dB/m)	Result (dBuV/m)	Limit (dBuV/m)	Margin (dB)	Remark
1	2483.500	32.62	32.44	65.06	74.00	-8.94	peak
2	2484.640	34.35	32.44	66.79	74.00	-7.21	peak

Test Mode:	802.11g AV	Channel:	2457
Polarity:	Horizontal	Test Voltage:	AC 120 V, 60 HZ

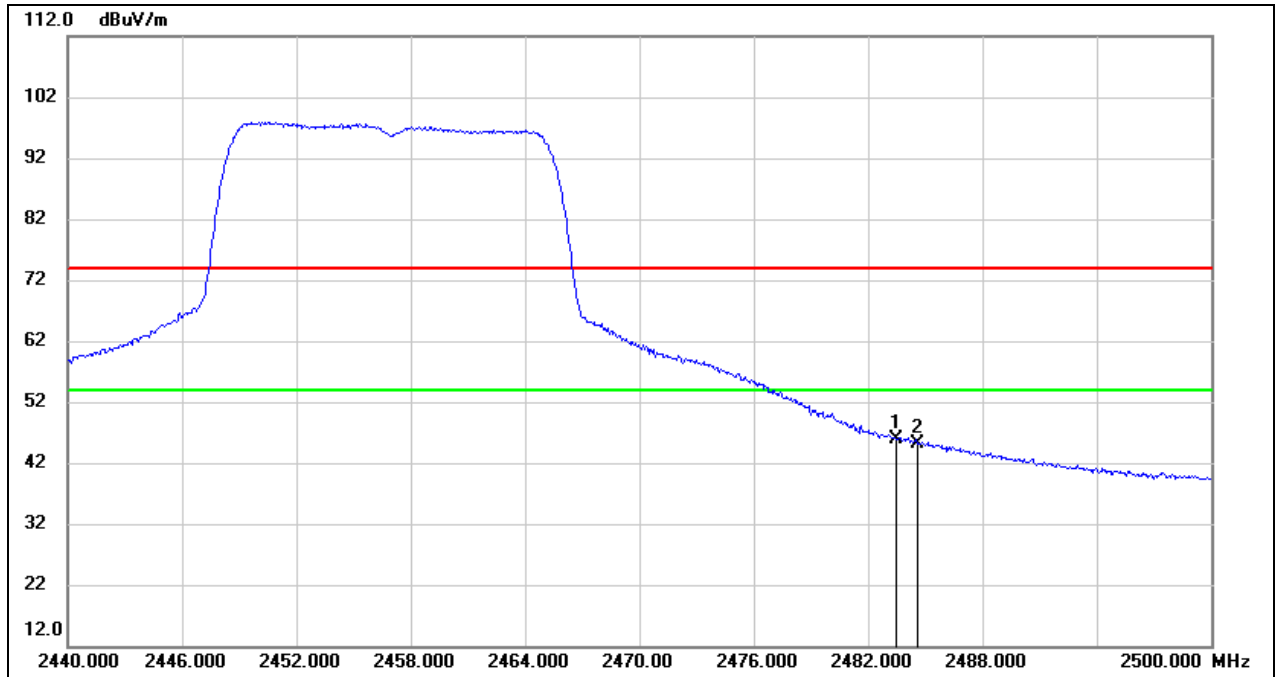

No.	Frequency (MHz)	Reading (dBuV)	Correct (dB/m)	Result (dBuV/m)	Limit (dBuV/m)	Margin (dB)	Remark
1	2483.500	13.56	32.44	46.00	54.00	-8.00	AVG
2	2484.640	12.74	32.44	45.18	54.00	-8.82	AVG

Test Mode:	802.11g PK	Channel:	2462
Polarity:	Horizontal	Test Voltage:	AC 120 V, 60 HZ

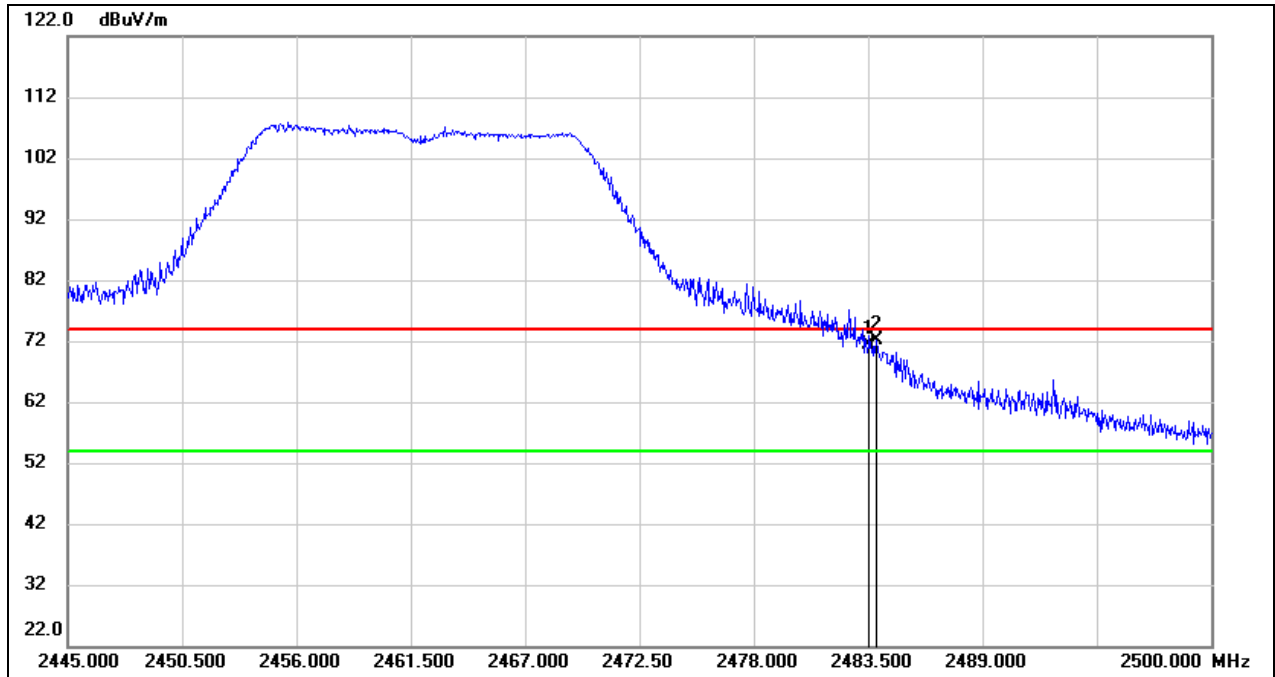

No.	Frequency (MHz)	Reading (dBuV)	Correct (dB/m)	Result (dBuV/m)	Limit (dBuV/m)	Margin (dB)	Remark
1	2483.500	38.98	32.44	71.42	74.00	-2.58	peak
2	2483.885	39.59	32.44	72.03	74.00	-1.97	peak

Test Mode:	802.11g AV	Channel:	2462
Polarity:	Horizontal	Test Voltage:	AC 120 V, 60 HZ

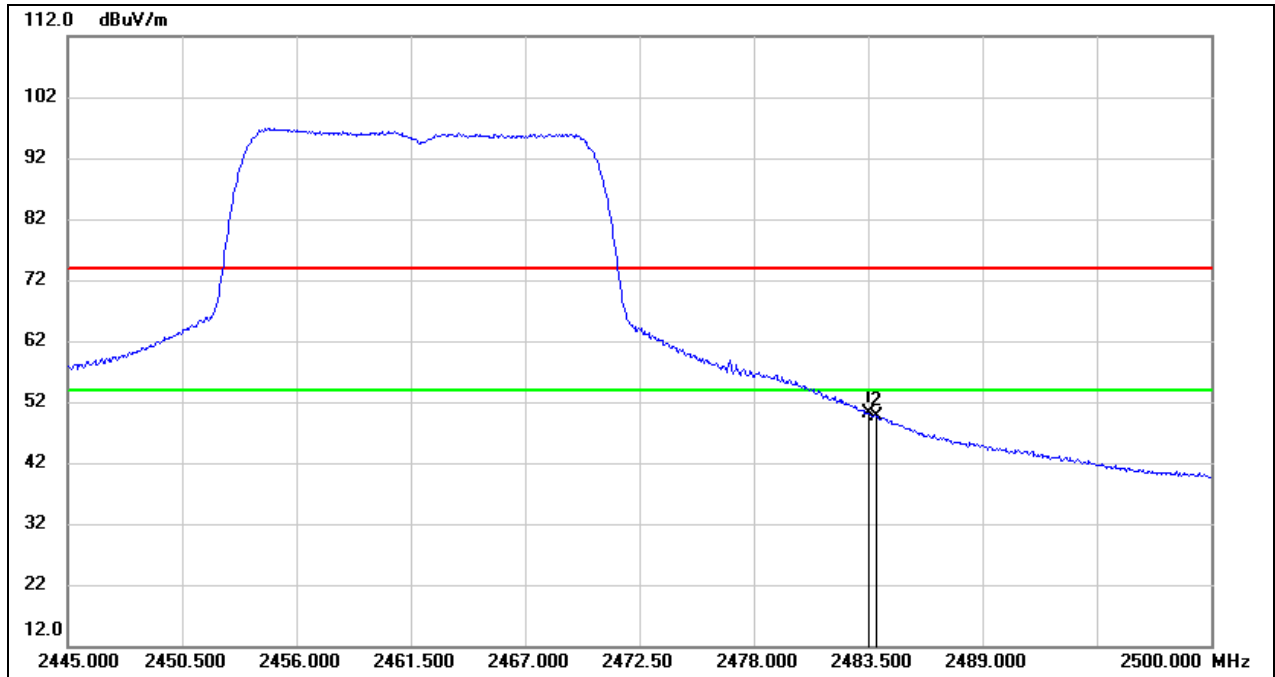

No.	Frequency (MHz)	Reading (dBuV)	Correct (dB/m)	Result (dBuV/m)	Limit (dBuV/m)	Margin (dB)	Remark
1	2483.500	17.78	32.44	50.22	54.00	-3.78	AVG
2	2483.885	17.27	32.44	49.71	54.00	-4.29	AVG

Test Mode:	802.11n HT20 PK	Channel:	2412
Polarity:	Horizontal	Test Voltage:	AC 120 V, 60 HZ

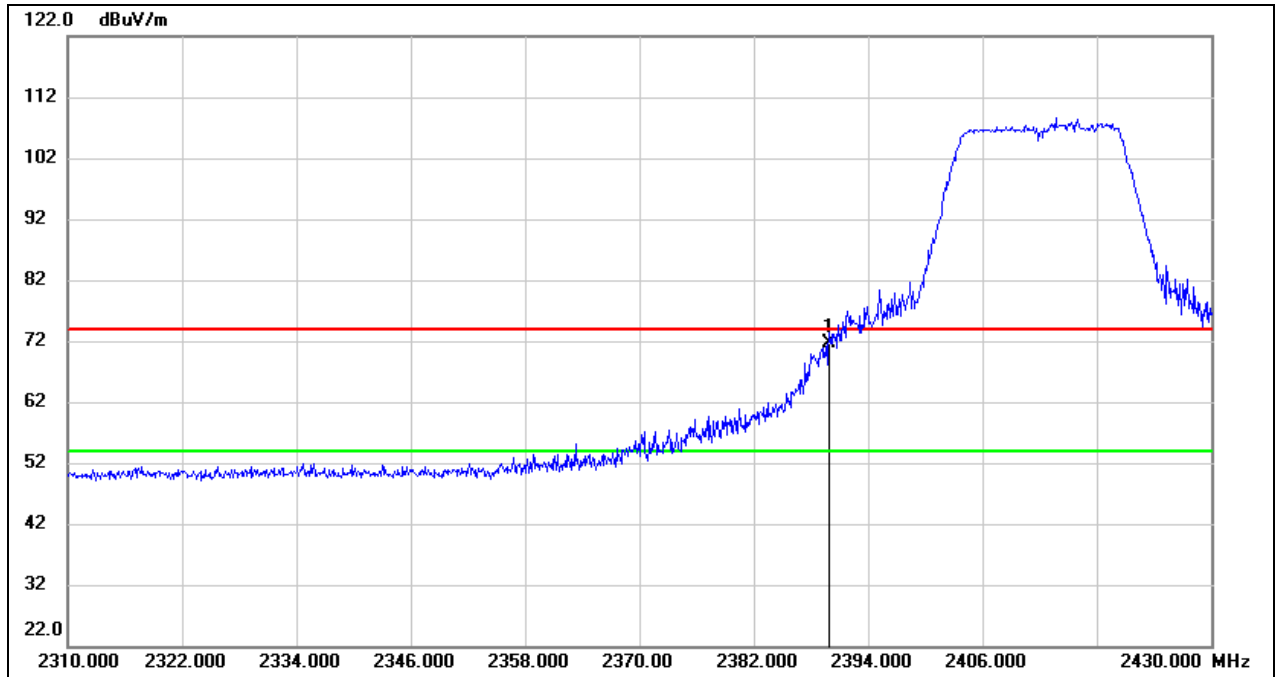

No.	Frequency (MHz)	Reading (dBuV)	Correct (dB/m)	Result (dBuV/m)	Limit (dBuV/m)	Margin (dB)	Remark
1	2390.000	39.47	32.16	71.63	74.00	-2.37	peak

Test Mode:	802.11n HT20 AV	Channel:	2412
Polarity:	Horizontal	Test Voltage:	AC 120 V, 60 HZ

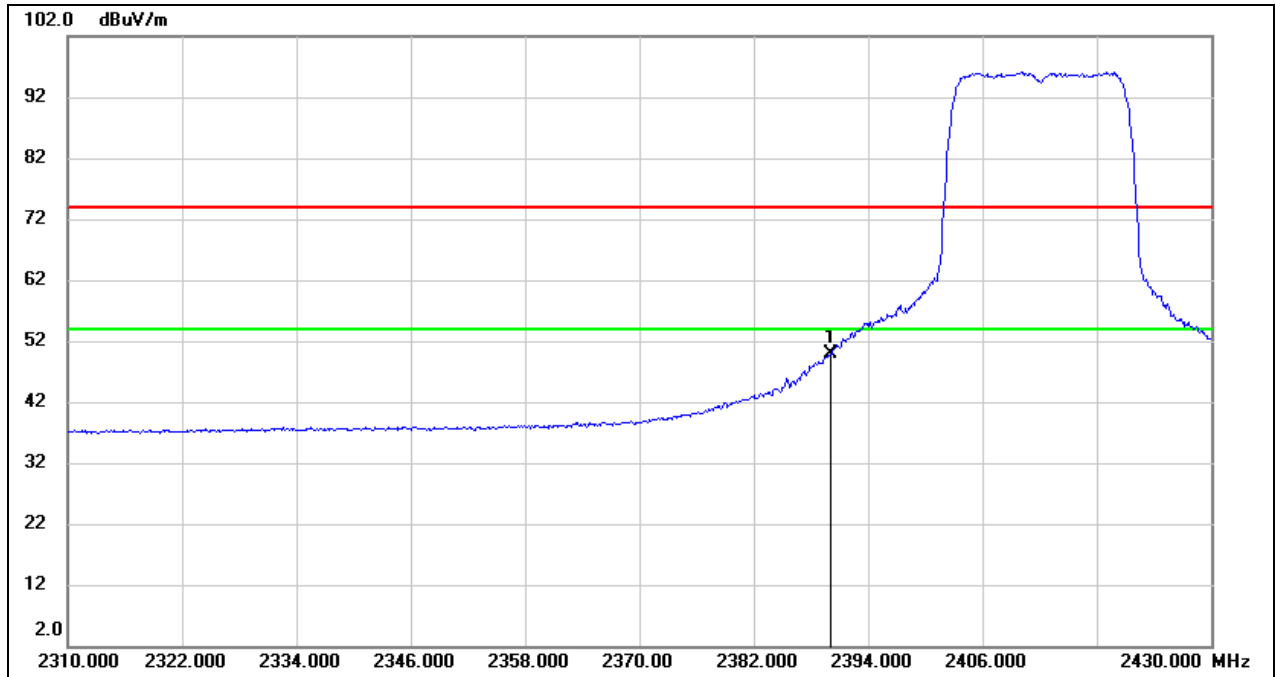

No.	Frequency (MHz)	Reading (dBuV)	Correct (dB/m)	Result (dBuV/m)	Limit (dBuV/m)	Margin (dB)	Remark
1	2390.000	17.64	32.16	49.80	54.00	-4.20	AVG

Test Mode:	802.11n HT20 PK	Channel:	2417
Polarity:	Horizontal	Test Voltage:	AC 120 V, 60 HZ

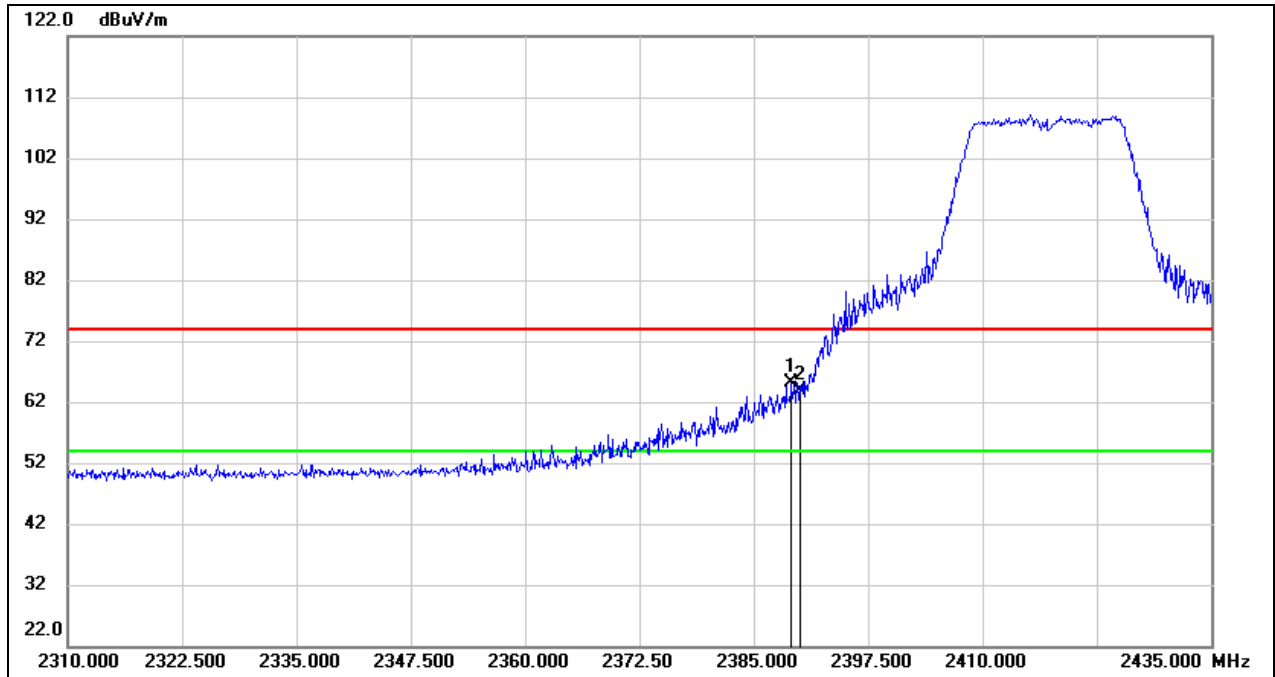

No.	Frequency (MHz)	Reading (dBuV)	Correct (dB/m)	Result (dBuV/m)	Limit (dBuV/m)	Margin (dB)	Remark
1	2389.125	33.02	32.16	65.18	74.00	-8.82	peak
2	2390.000	31.60	32.16	63.76	74.00	-10.24	peak

Test Mode:	802.11n HT20 AV	Channel:	2417
Polarity:	Horizontal	Test Voltage:	AC 120 V, 60 HZ

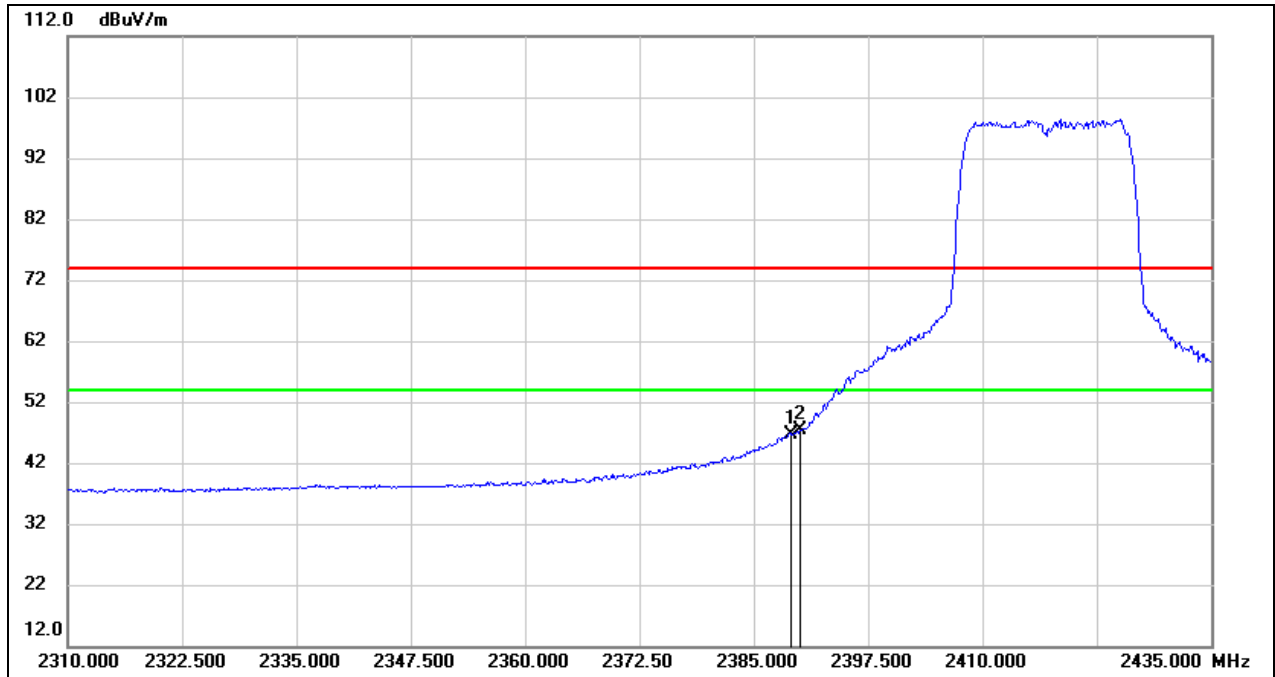

No.	Frequency (MHz)	Reading (dBuV)	Correct (dB/m)	Result (dBuV/m)	Limit (dBuV/m)	Margin (dB)	Remark
1	2389.125	14.36	32.16	46.52	54.00	-7.48	AVG
2	2390.000	15.34	32.16	47.50	54.00	-6.50	AVG

Test Mode:	802.11n HT20 PK	Channel:	2457
Polarity:	Horizontal	Test Voltage:	AC 120 V, 60 HZ

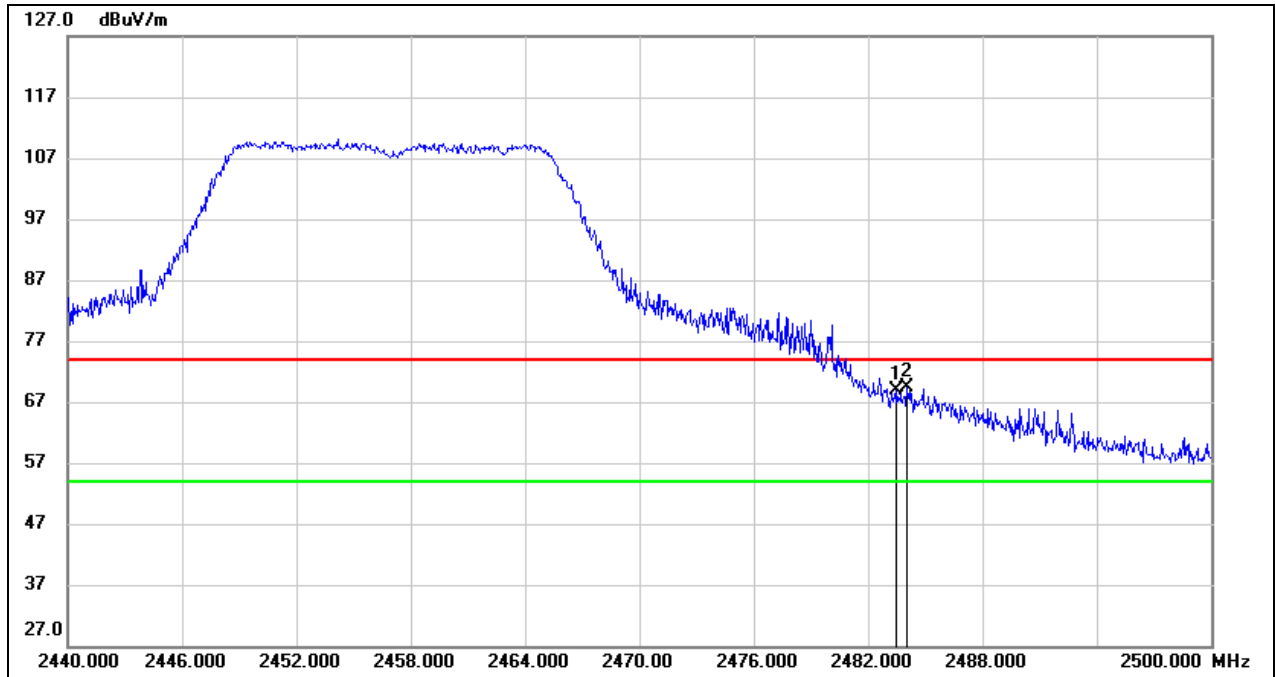

No.	Frequency (MHz)	Reading (dBuV)	Correct (dB/m)	Result (dBuV/m)	Limit (dBuV/m)	Margin (dB)	Remark
1	2483.500	36.39	32.44	68.83	74.00	-5.17	peak
2	2484.040	36.99	32.44	69.43	74.00	-4.57	peak

Test Mode:	802.11n HT20 AV	Channel:	2457
Polarity:	Horizontal	Test Voltage:	AC 120 V, 60 HZ

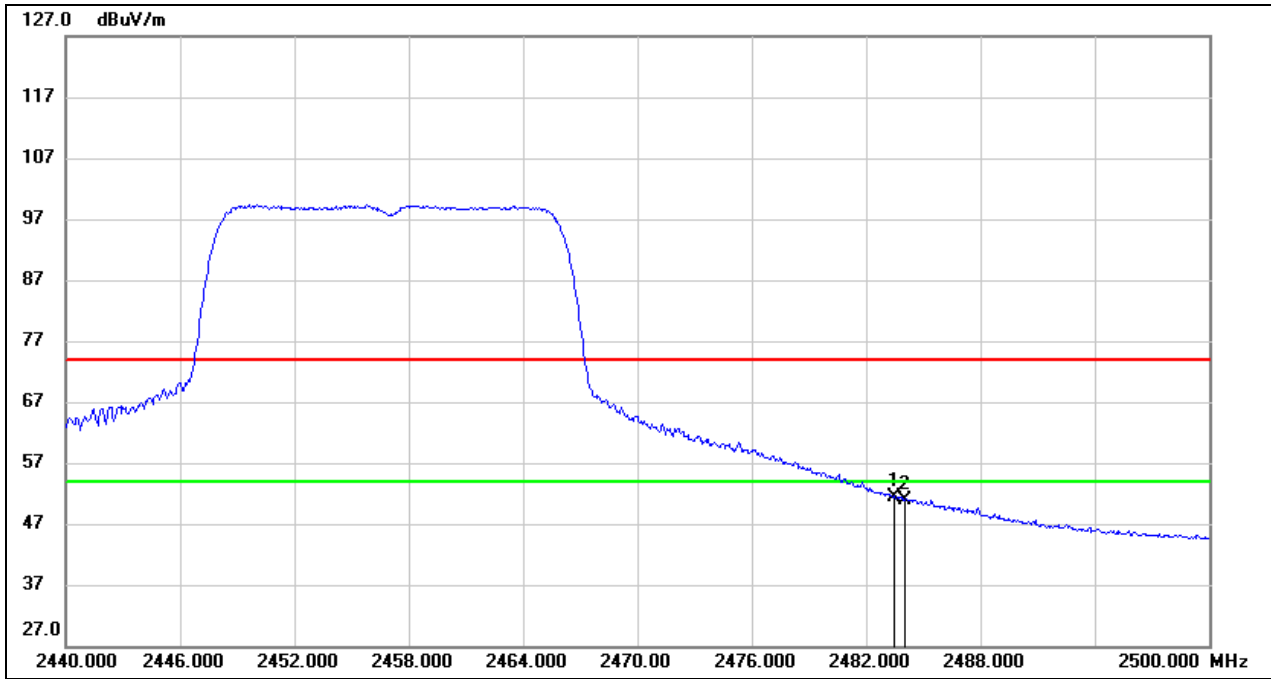

No.	Frequency (MHz)	Reading (dBuV)	Correct (dB/m)	Result (dBuV/m)	Limit (dBuV/m)	Margin (dB)	Remark
1	2483.500	18.85	32.44	51.29	54.00	-2.71	AVG
2	2484.040	18.52	32.44	50.96	54.00	-3.04	AVG

Test Mode:	802.11n HT20 PK	Channel:	2462
Polarity:	Horizontal	Test Voltage:	AC 120 V, 60 HZ

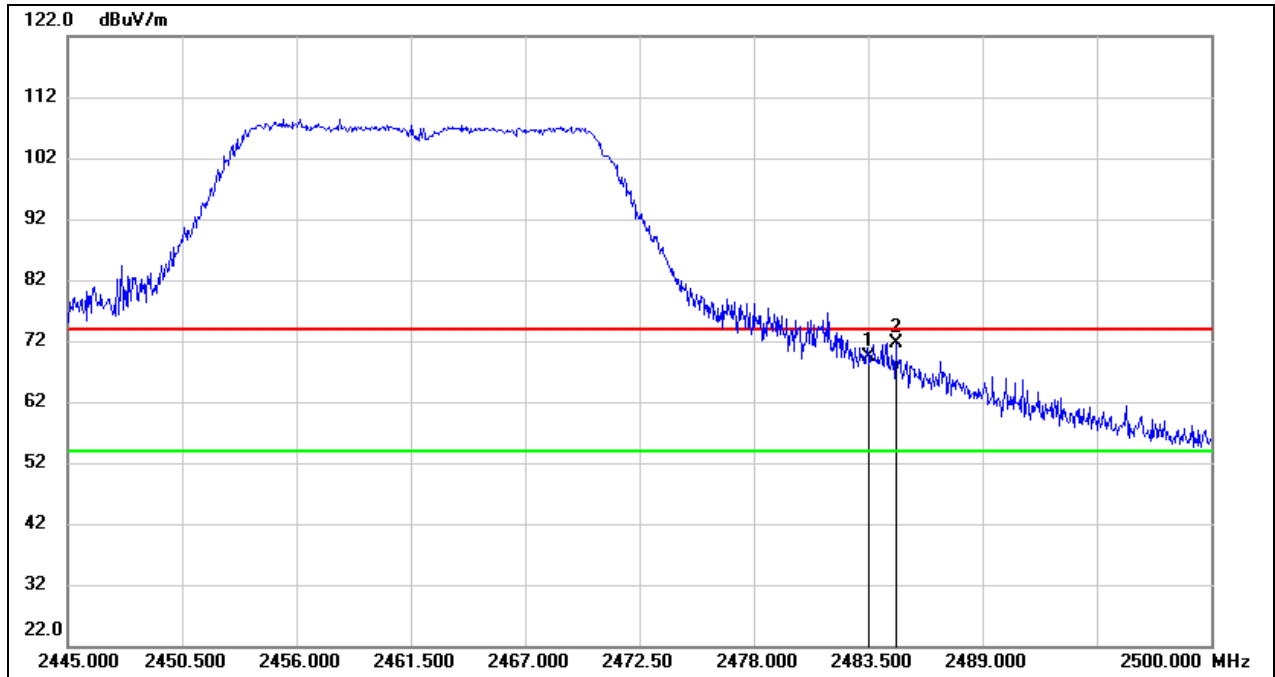

No.	Frequency (MHz)	Reading (dBuV)	Correct (dB/m)	Result (dBuV/m)	Limit (dBuV/m)	Margin (dB)	Remark
1	2483.500	37.05	32.44	69.49	74.00	-4.51	peak
2	2484.820	39.17	32.44	71.61	74.00	-2.39	peak

Test Mode:	802.11n HT20 AV	Channel:	2462
Polarity:	Horizontal	Test Voltage:	AC 120 V, 60 HZ

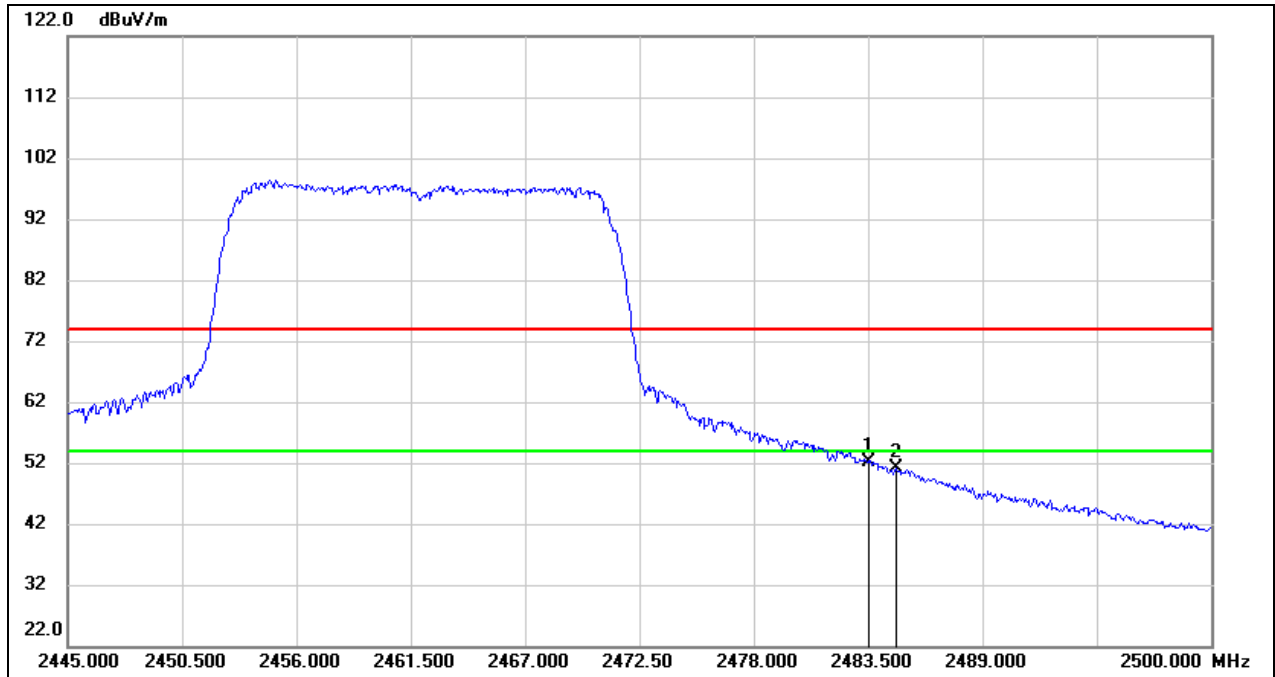

No.	Frequency (MHz)	Reading (dBuV)	Correct (dB/m)	Result (dBuV/m)	Limit (dBuV/m)	Margin (dB)	Remark
1	2483.500	19.80	32.44	52.24	54.00	-1.76	AVG
2	2484.820	18.67	32.44	51.11	54.00	-2.89	AVG

8.2. SPURIOUS EMISSIONS(1 GHZ~3 GHZ)

Test Mode:	802.11b	Channel:	2412
Polarity:	Horizontal	Test Voltage:	AC 120 V, 60 HZ

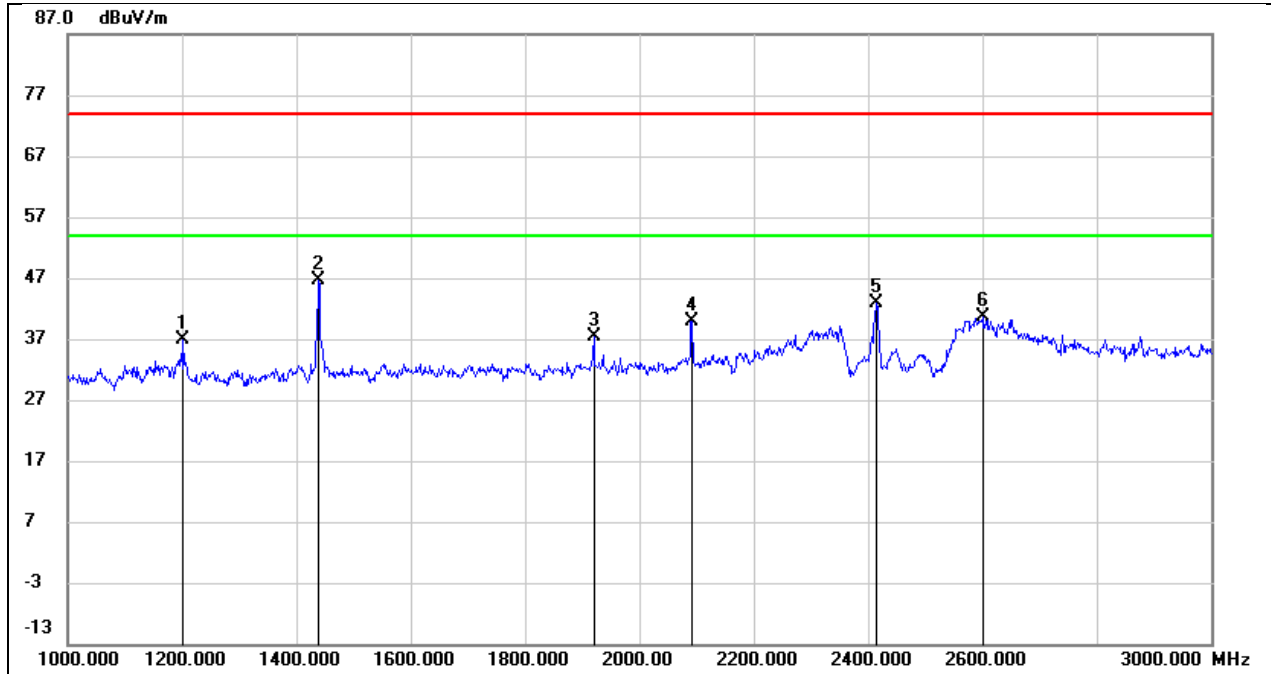

No.	Frequency (MHz)	Reading (dBuV)	Correct (dB/m)	Result (dBuV/m)	Limit (dBuV/m)	Margin (dB)	Remark
1	1202.000	51.05	-14.09	36.96	74.00	-37.04	peak
2	1438.000	59.70	-13.00	46.70	74.00	-27.30	peak
3	1920.000	48.65	-11.32	37.33	74.00	-36.67	peak
4	2092.000	50.44	-10.59	39.85	74.00	-34.15	peak
5	2412.000	51.76	-8.93	42.83	/	/	fundamental
6	2600.000	48.77	-8.19	40.58	74.00	-33.42	peak

Test Mode:	802.11b	Channel:	2412
Polarity:	Vertical	Test Voltage:	AC 120 V, 60 HZ

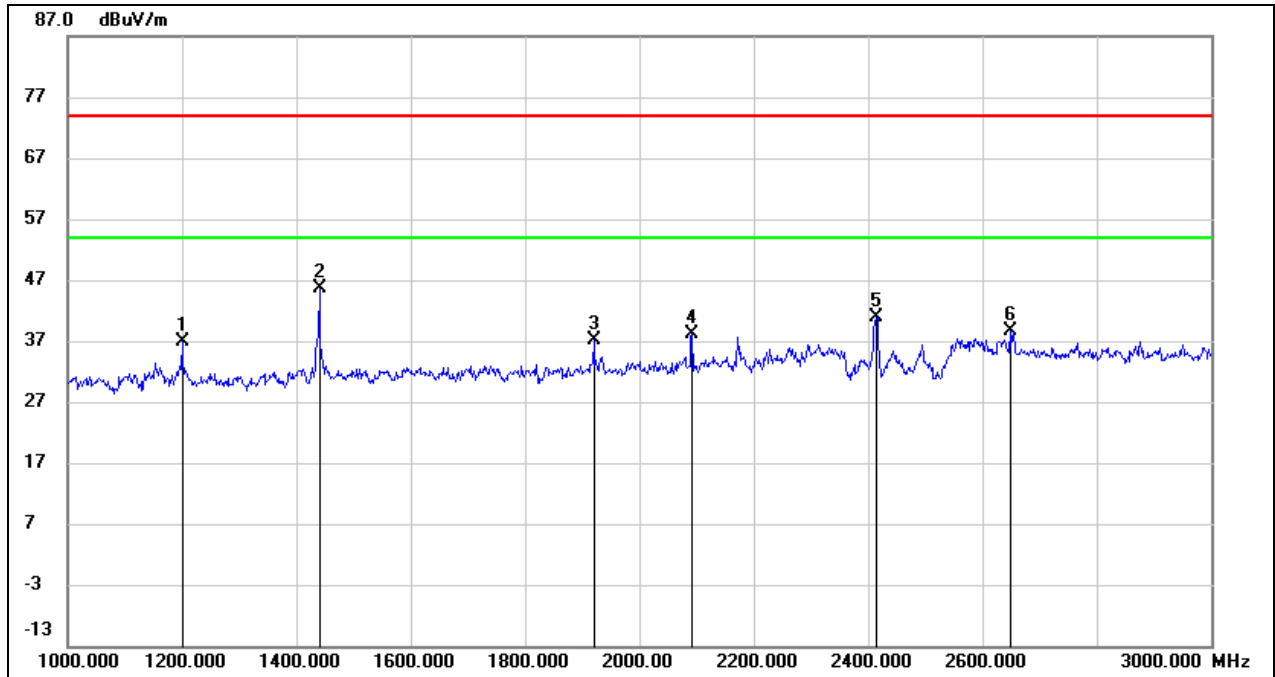

No.	Frequency (MHz)	Reading (dBuV)	Correct (dB/m)	Result (dBuV/m)	Limit (dBuV/m)	Margin (dB)	Remark
1	1200.000	50.87	-14.10	36.77	74.00	-37.23	peak
2	1440.000	58.56	-12.98	45.58	74.00	-28.42	peak
3	1920.000	48.43	-11.32	37.11	74.00	-36.89	peak
4	2092.000	48.82	-10.59	38.23	74.00	-35.77	peak
5	2412.000	49.85	-8.93	40.92	/	/	fundamental
6	2648.000	46.72	-8.04	38.68	74.00	-35.32	peak

Test Mode:	802.11b	Channel:	2437
Polarity:	Horizontal	Test Voltage:	AC 120 V, 60 HZ

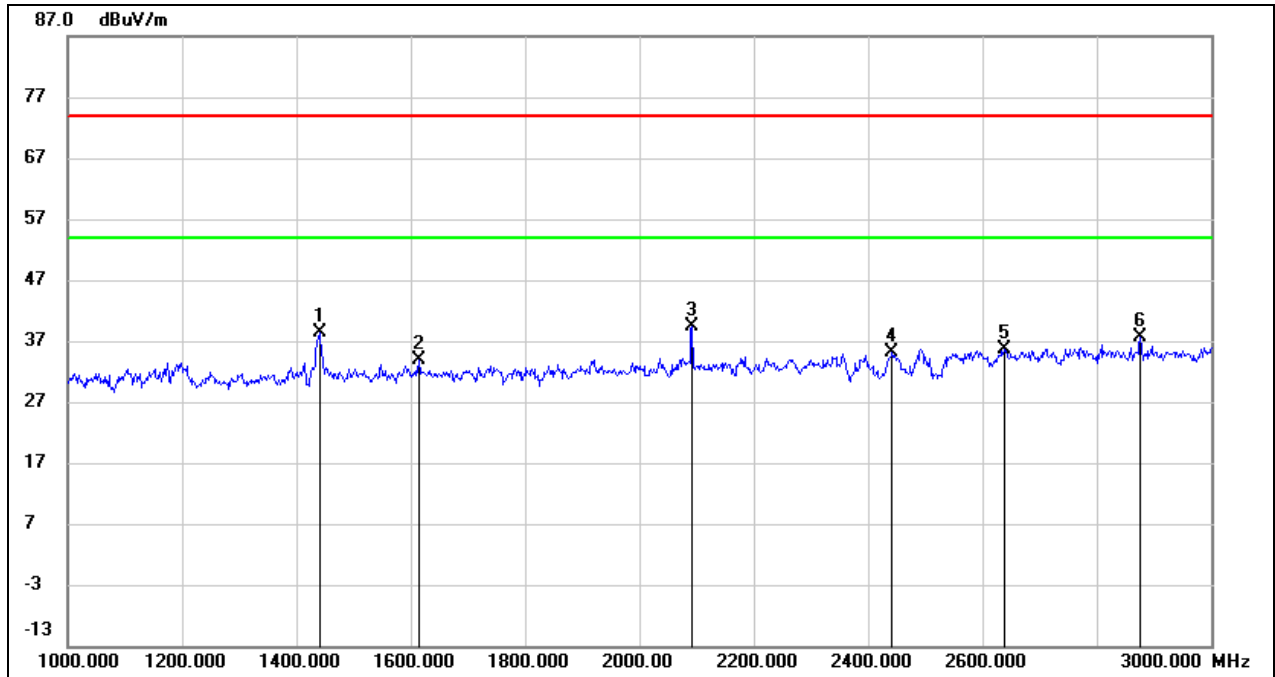

No.	Frequency (MHz)	Reading (dBuV)	Correct (dB/m)	Result (dBuV/m)	Limit (dBuV/m)	Margin (dB)	Remark
1	1440.000	51.26	-12.98	38.28	74.00	-35.72	peak
2	1614.000	46.11	-12.34	33.77	74.00	-40.23	peak
3	2092.000	50.01	-10.59	39.42	74.00	-34.58	peak
4	2437.000	43.92	-8.79	35.13	/	/	fundamental
5	2638.000	43.60	-8.07	35.53	74.00	-38.47	peak
6	2876.000	44.87	-7.35	37.52	74.00	-36.48	peak

Test Mode:	802.11b	Channel:	2437
Polarity:	Vertical	Test Voltage:	AC 120 V, 60 HZ

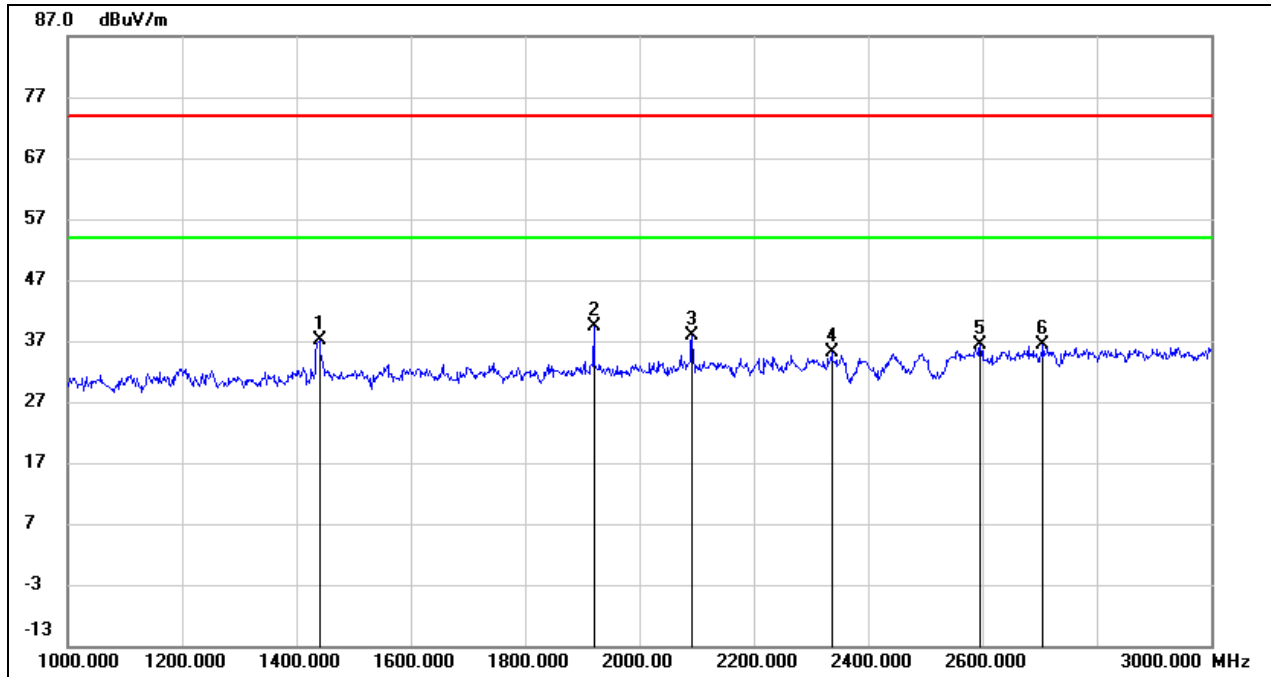

No.	Frequency (MHz)	Reading (dBuV)	Correct (dB/m)	Result (dBuV/m)	Limit (dBuV/m)	Margin (dB)	Remark
1	1440.000	50.17	-12.98	37.19	74.00	-36.81	peak
2	1920.000	50.62	-11.32	39.30	74.00	-34.70	peak
3	2092.000	48.43	-10.59	37.84	74.00	-36.16	peak
4	2336.000	44.38	-9.33	35.05	74.00	-38.95	peak
5	2596.000	44.56	-8.20	36.36	74.00	-37.64	peak
6	2706.000	44.26	-7.87	36.39	74.00	-37.61	peak

Test Mode:	802.11b	Channel:	2462
Polarity:	Horizontal	Test Voltage:	AC 120 V, 60 HZ

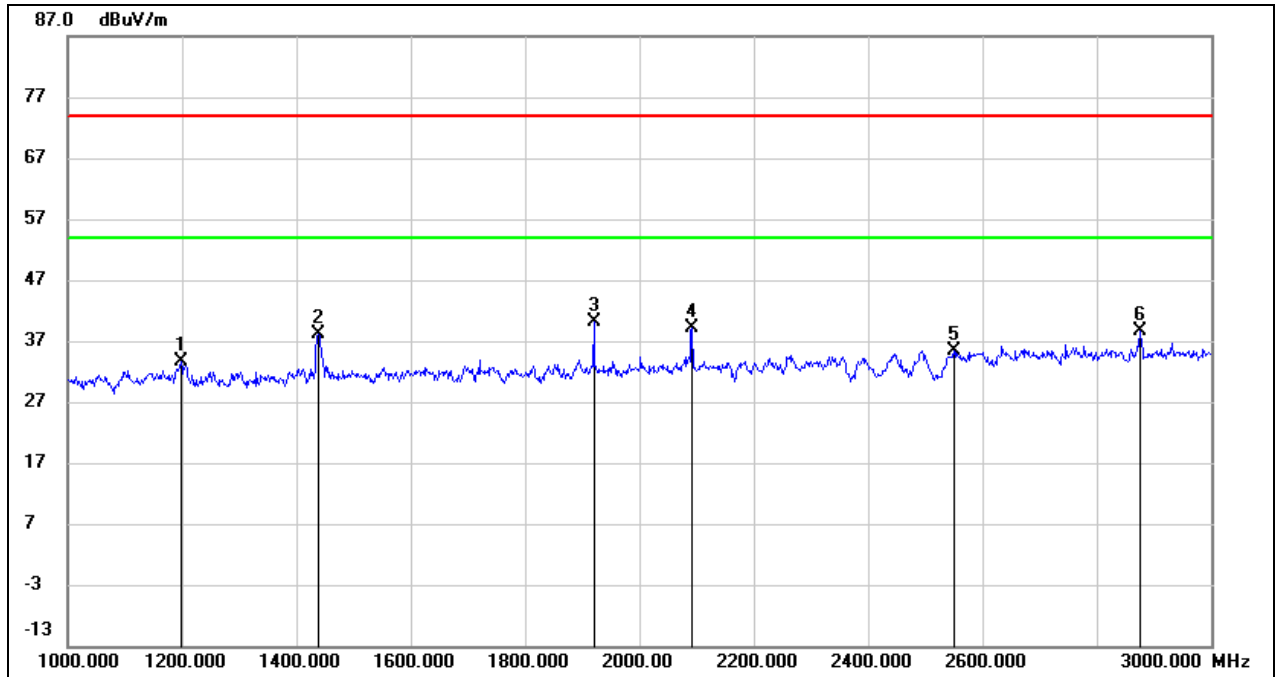

No.	Frequency (MHz)	Reading (dBuV)	Correct (dB/m)	Result (dBuV/m)	Limit (dBuV/m)	Margin (dB)	Remark
1	1198.000	47.71	-14.11	33.60	74.00	-40.40	peak
2	1438.000	51.01	-13.00	38.01	74.00	-35.99	peak
3	1920.000	51.55	-11.32	40.23	74.00	-33.77	peak
4	2092.000	49.80	-10.59	39.21	74.00	-34.79	peak
5	2550.000	43.65	-8.33	35.32	74.00	-38.68	peak
6	2876.000	46.08	-7.35	38.73	74.00	-35.27	peak

Test Mode:	802.11b	Channel:	2462
Polarity:	Vertical	Test Voltage:	AC 120 V, 60 HZ

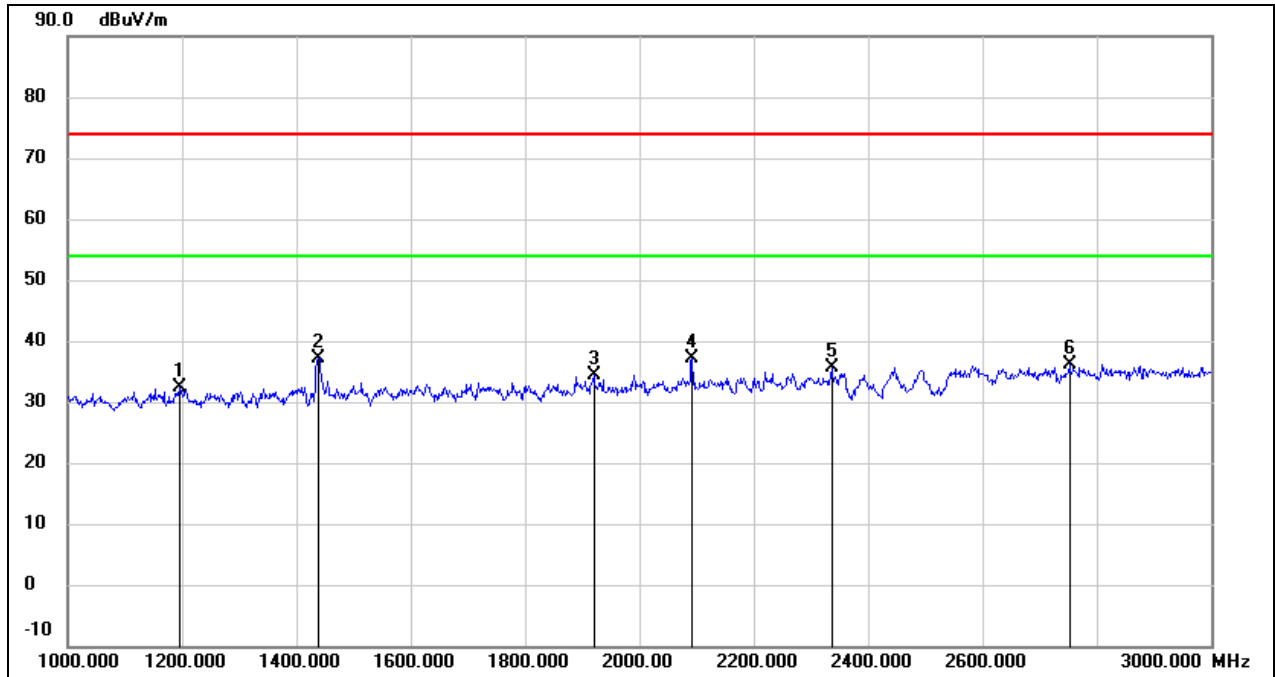

No.	Frequency (MHz)	Reading (dBuV)	Correct (dB/m)	Result (dBuV/m)	Limit (dBuV/m)	Margin (dB)	Remark
1	1196.000	46.43	-14.12	32.31	74.00	-41.69	peak
2	1438.000	50.11	-13.00	37.11	74.00	-36.89	peak
3	1920.000	45.64	-11.32	34.32	74.00	-39.68	peak
4	2092.000	47.62	-10.59	37.03	74.00	-36.97	peak
5	2336.000	45.07	-9.33	35.74	74.00	-38.26	peak
6	2752.000	43.80	-7.73	36.07	74.00	-37.93	peak

8.3. SPURIOUS EMISSIONS(3 GHZ~18 GHZ)

Test Mode:	802.11b	Channel:	2412
Polarity:	Horizontal	Test Voltage:	AC 120 V, 60 HZ

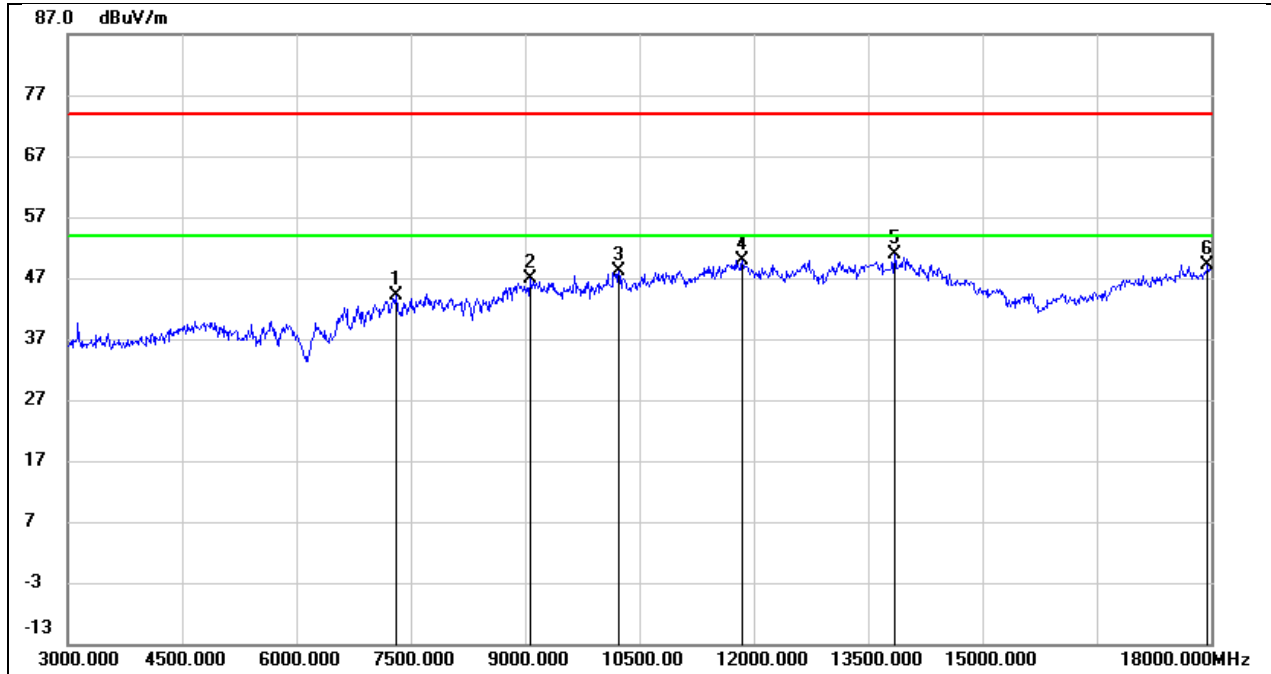

No.	Frequency (MHz)	Reading (dBuV)	Correct (dB/m)	Result (dBuV/m)	Limit (dBuV/m)	Margin (dB)	Remark
1	7305.000	37.68	6.47	44.15	74.00	-29.85	peak
2	9060.000	36.27	10.51	46.78	74.00	-27.22	peak
3	10230.000	35.56	12.46	48.02	74.00	-25.98	peak
4	11850.000	32.44	17.56	50.00	74.00	-24.00	peak
5	13845.000	29.16	21.62	50.78	74.00	-23.22	peak
6	17955.000	23.70	25.42	49.12	74.00	-24.88	peak

Test Mode:	802.11b	Channel:	2412
Polarity:	Vertical	Test Voltage:	AC 120 V, 60 HZ

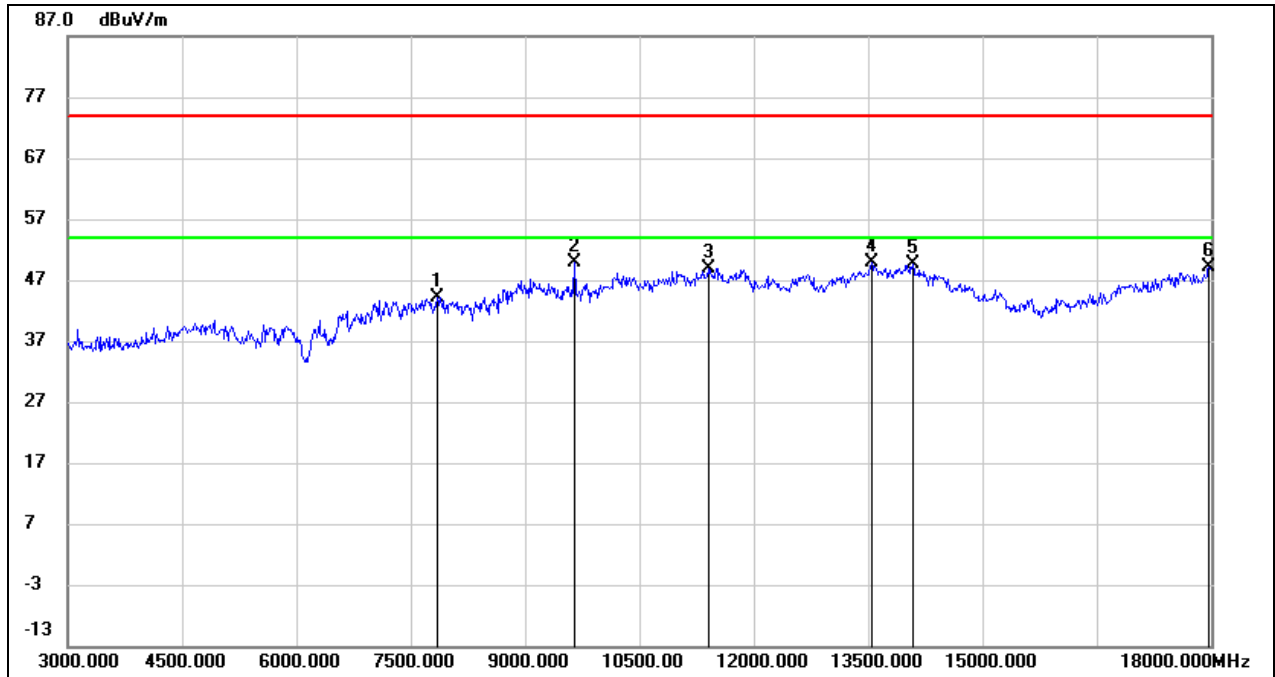

No.	Frequency (MHz)	Reading (dBuV)	Correct (dB/m)	Result (dBuV/m)	Limit (dBuV/m)	Margin (dB)	Remark
1	7845.000	37.91	6.32	44.23	74.00	-29.77	peak
2	9645.000	38.79	11.08	49.87	74.00	-24.13	peak
3	11400.000	32.68	16.23	48.91	74.00	-25.09	peak
4	13545.000	28.86	20.99	49.85	74.00	-24.15	peak
5	14085.000	27.90	21.61	49.51	74.00	-24.49	peak
6	17970.000	23.58	25.51	49.09	74.00	-24.91	peak

Test Mode:	802.11b	Channel:	2437
Polarity:	Horizontal	Test Voltage:	AC 120 V, 60 HZ

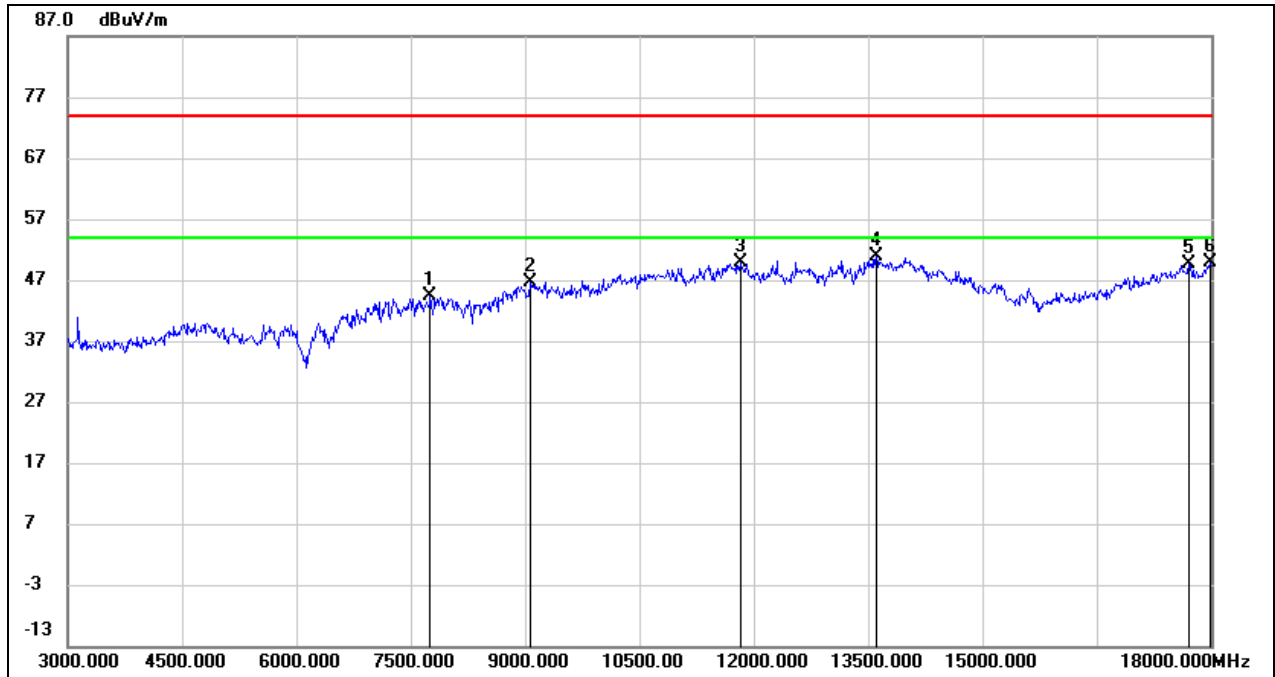

No.	Frequency (MHz)	Reading (dBuV)	Correct (dB/m)	Result (dBuV/m)	Limit (dBuV/m)	Margin (dB)	Remark
1	7755.000	38.03	6.31	44.34	74.00	-29.66	peak
2	9075.000	36.09	10.52	46.61	74.00	-27.39	peak
3	11820.000	32.33	17.47	49.80	74.00	-24.20	peak
4	13605.000	29.66	21.12	50.78	74.00	-23.22	peak
5	17700.000	25.81	23.91	49.72	74.00	-24.28	peak
6	17985.000	24.17	25.60	49.77	74.00	-24.23	peak

Test Mode:	802.11b	Channel:	2437
Polarity:	Vertical	Test Voltage:	AC 120 V, 60 HZ

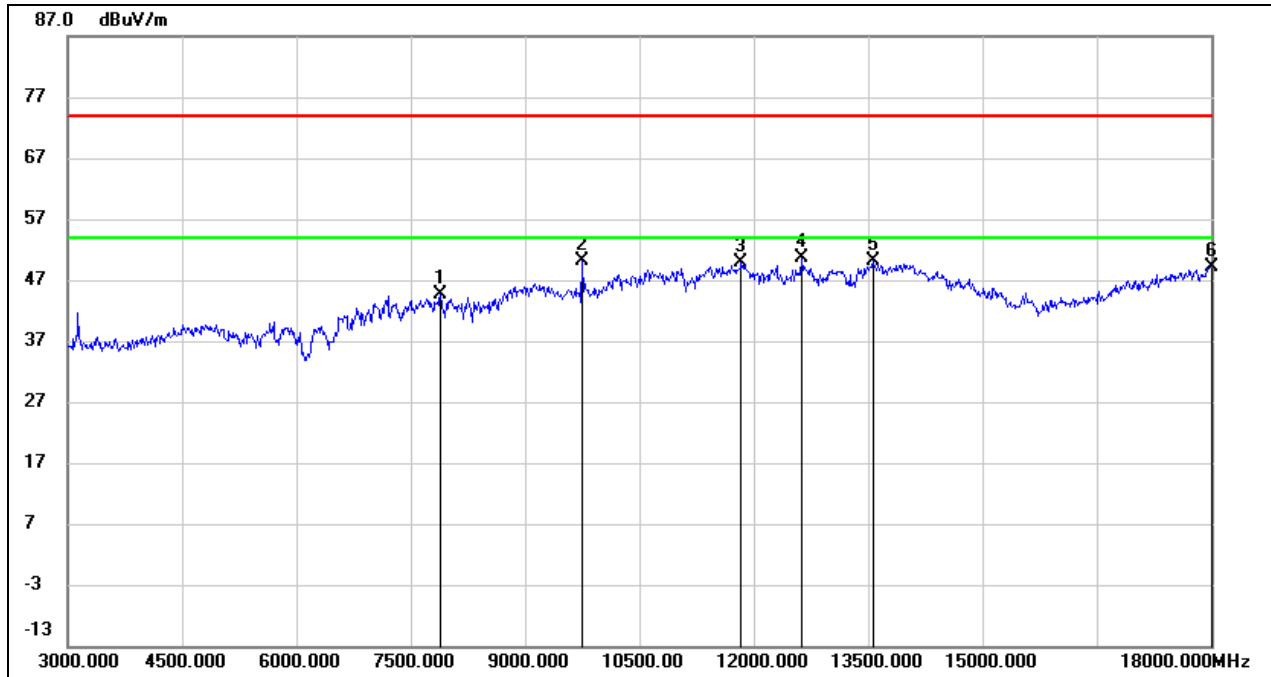

No.	Frequency (MHz)	Reading (dBuV)	Correct (dB/m)	Result (dBuV/m)	Limit (dBuV/m)	Margin (dB)	Remark
1	7890.000	38.30	6.31	44.61	74.00	-29.39	peak
2	9750.000	38.88	11.35	50.23	74.00	-23.77	peak
3	11835.000	32.40	17.51	49.91	74.00	-24.09	peak
4	12630.000	32.76	17.89	50.65	74.00	-23.35	peak
5	13560.000	29.09	21.04	50.13	74.00	-23.87	peak
6	18000.000	23.53	25.69	49.22	74.00	-24.78	peak

Test Mode:	802.11b	Channel:	2462
Polarity:	Horizontal	Test Voltage:	AC 120 V, 60 HZ

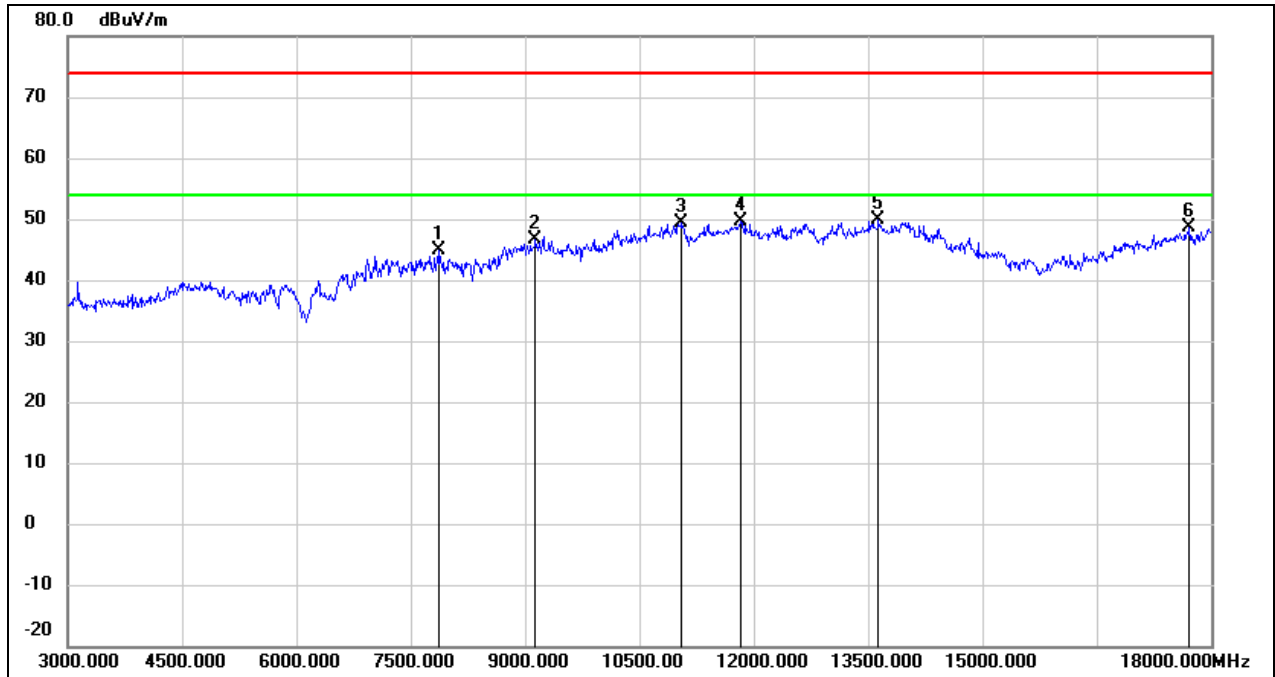

No.	Frequency (MHz)	Reading (dBuV)	Correct (dB/m)	Result (dBuV/m)	Limit (dBuV/m)	Margin (dB)	Remark
1	7875.000	38.59	6.31	44.90	74.00	-29.10	peak
2	9135.000	36.09	10.55	46.64	74.00	-27.36	peak
3	11055.000	34.30	14.96	49.26	74.00	-24.74	peak
4	11835.000	32.04	17.51	49.55	74.00	-24.45	peak
5	13635.000	28.76	21.19	49.95	74.00	-24.05	peak
6	17715.000	24.56	24.00	48.56	74.00	-25.44	peak

Test Mode:	802.11b	Channel:	2462
Polarity:	Vertical	Test Voltage:	AC 120 V, 60 HZ

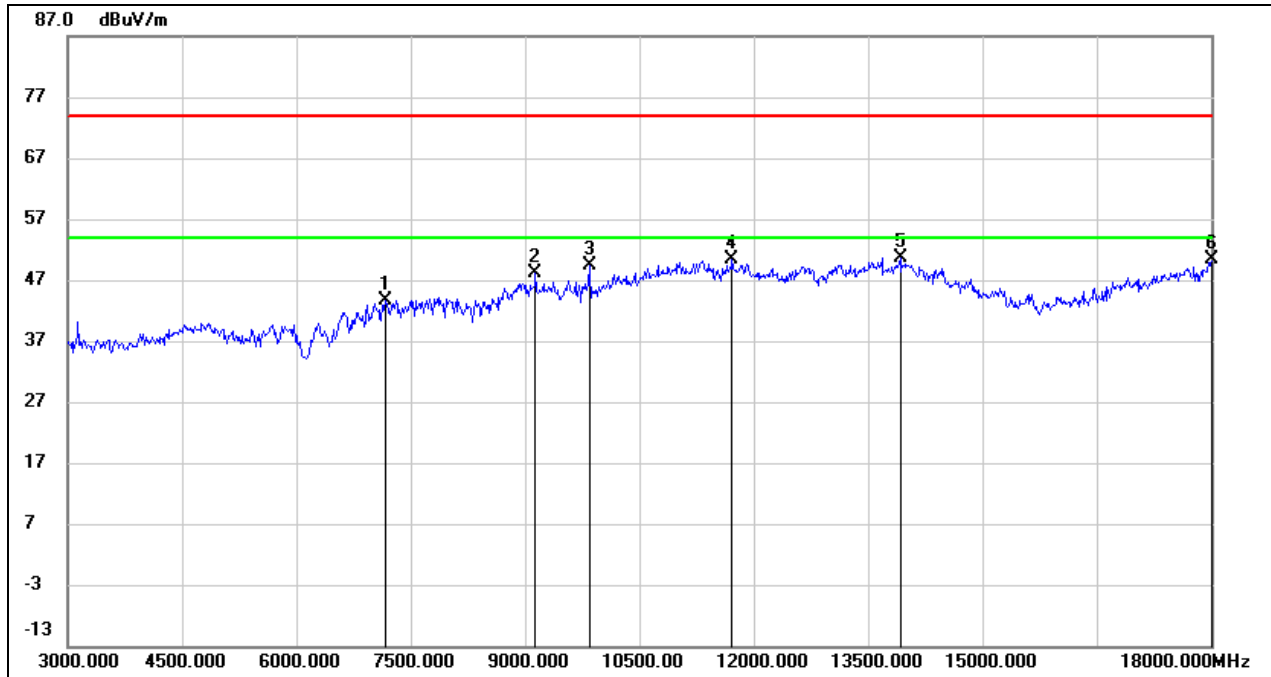

No.	Frequency (MHz)	Reading (dBuV)	Correct (dB/m)	Result (dBuV/m)	Limit (dBuV/m)	Margin (dB)	Remark
1	7170.000	37.17	6.56	43.73	74.00	-30.27	peak
2	9135.000	37.58	10.55	48.13	74.00	-25.87	peak
3	9840.000	37.68	11.59	49.27	74.00	-24.73	peak
4	11715.000	33.07	17.19	50.26	74.00	-23.74	peak
5	13920.000	28.88	21.79	50.67	74.00	-23.33	peak
6	18000.000	24.67	25.69	50.36	74.00	-23.64	peak

Test Mode:	802.11g	Channel:	2412
Polarity:	Horizontal	Test Voltage:	AC 120 V, 60 HZ

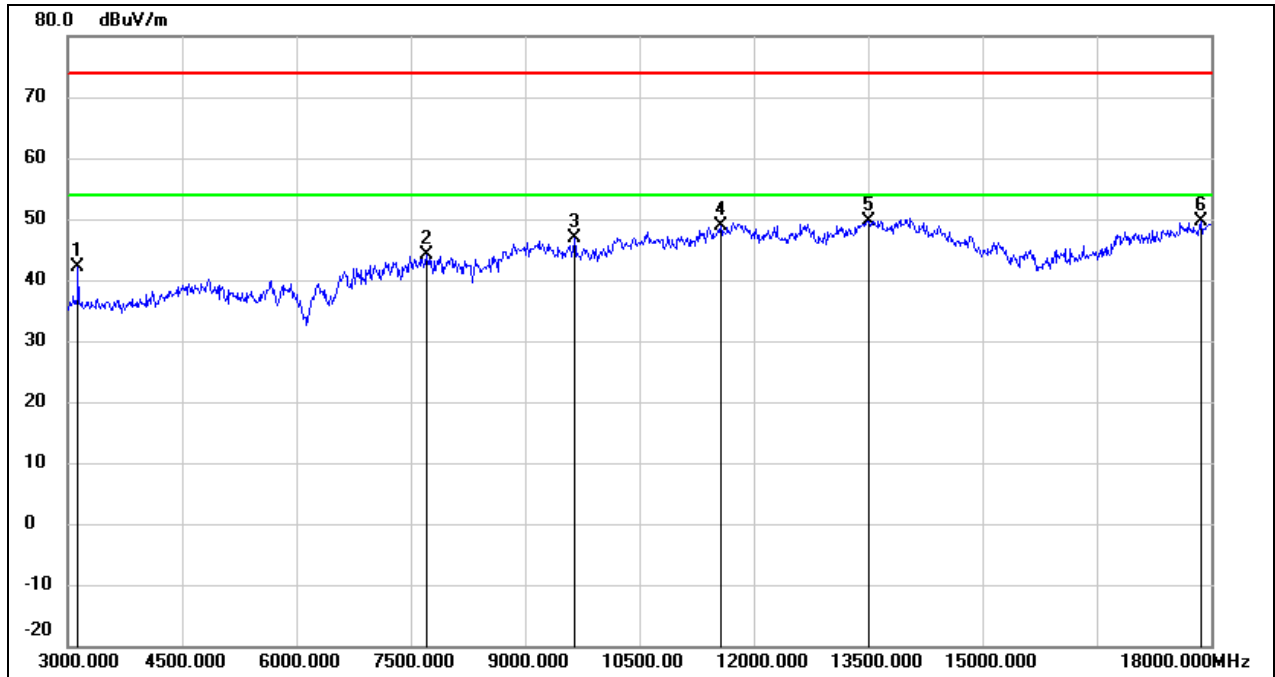

No.	Frequency (MHz)	Reading (dBuV)	Correct (dB/m)	Result (dBuV/m)	Limit (dBuV/m)	Margin (dB)	Remark
1	3135.000	47.17	-5.16	42.01	74.00	-31.99	peak
2	7710.000	37.75	6.33	44.08	74.00	-29.92	peak
3	9645.000	35.70	11.08	46.78	74.00	-27.22	peak
4	11565.000	32.13	16.77	48.90	74.00	-25.10	peak
5	13500.000	28.80	20.90	49.70	74.00	-24.30	peak
6	17865.000	24.65	24.89	49.54	74.00	-24.46	peak

Test Mode:	802.11g	Channel:	2412
Polarity:	Vertical	Test Voltage:	AC 120 V, 60 HZ

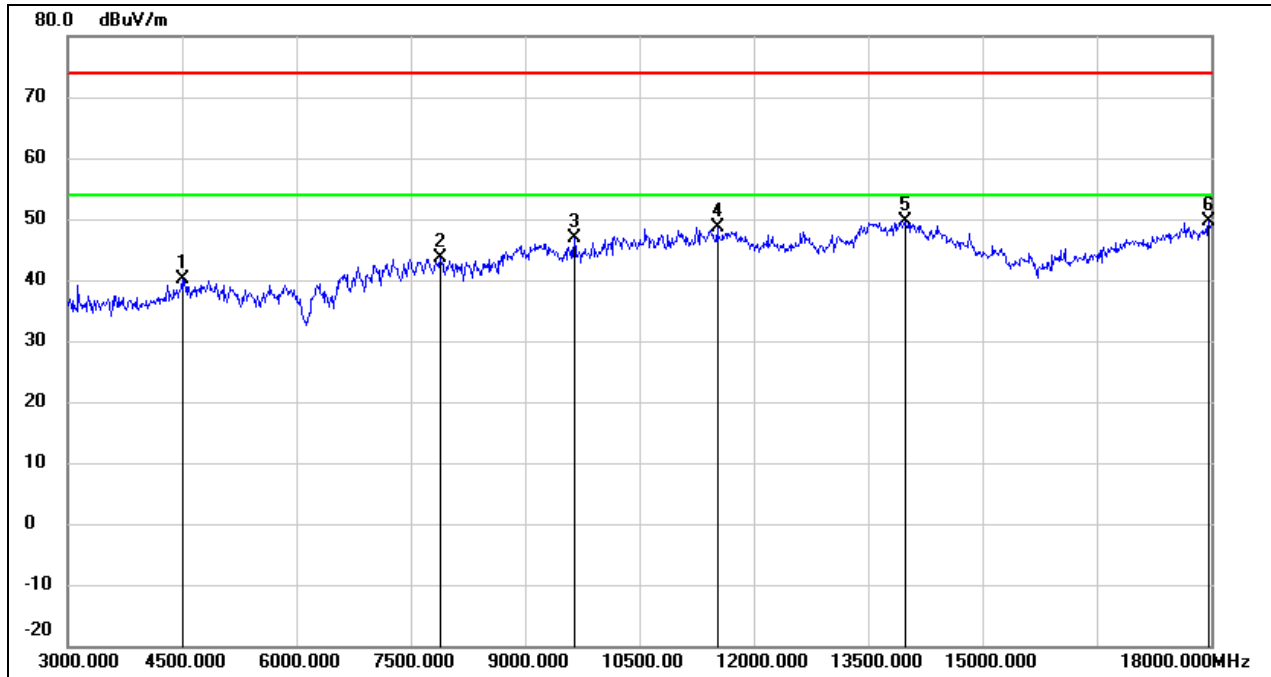

No.	Frequency (MHz)	Reading (dBuV)	Correct (dB/m)	Result (dBuV/m)	Limit (dBuV/m)	Margin (dB)	Remark
1	4500.000	41.51	-1.46	40.05	74.00	-33.95	peak
2	7890.000	37.21	6.31	43.52	74.00	-30.48	peak
3	9645.000	35.79	11.08	46.87	74.00	-27.13	peak
4	11520.000	32.08	16.65	48.73	74.00	-25.27	peak
5	13995.000	27.76	21.95	49.71	74.00	-24.29	peak
6	17970.000	24.10	25.51	49.61	74.00	-24.39	peak

Test Mode:	802.11g	Channel:	2437
Polarity:	Horizontal	Test Voltage:	AC 120 V, 60 HZ

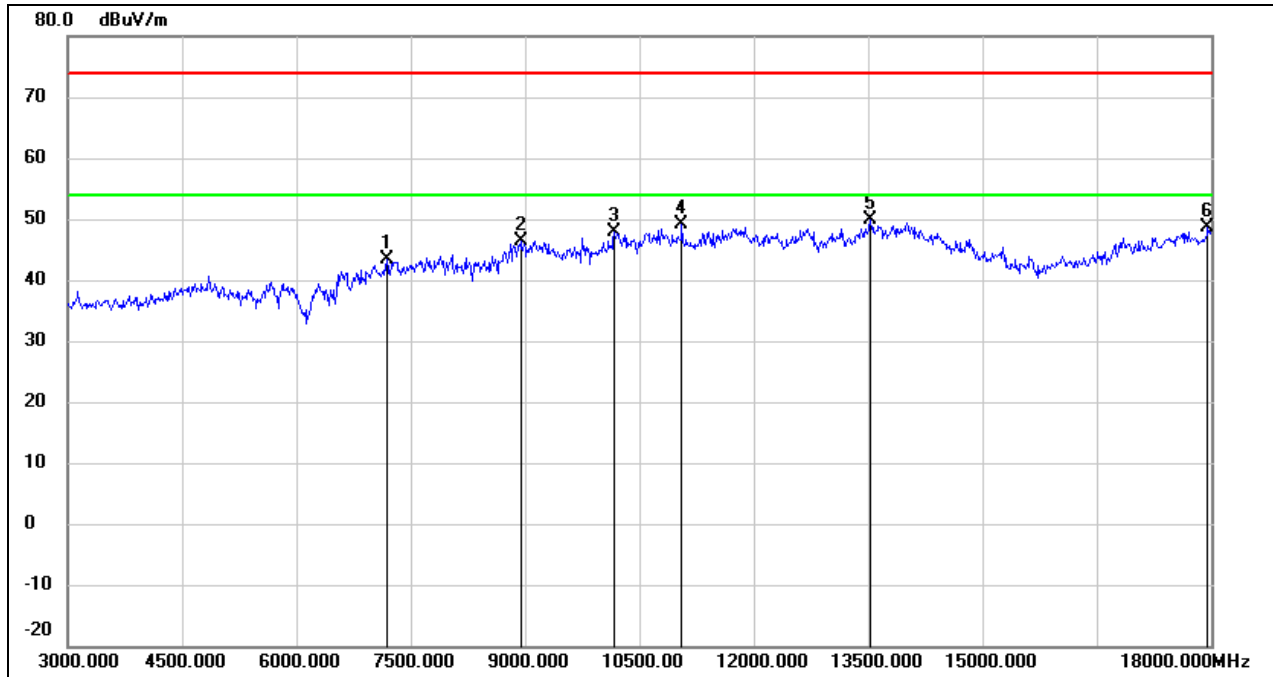

No.	Frequency (MHz)	Reading (dBuV)	Correct (dB/m)	Result (dBuV/m)	Limit (dBuV/m)	Margin (dB)	Remark
1	7185.000	36.88	6.55	43.43	74.00	-30.57	peak
2	8940.000	36.41	10.04	46.45	74.00	-27.55	peak
3	10170.000	35.48	12.34	47.82	74.00	-26.18	peak
4	11055.000	34.07	14.96	49.03	74.00	-24.97	peak
5	13530.000	28.93	20.96	49.89	74.00	-24.11	peak
6	17955.000	23.14	25.42	48.56	74.00	-25.44	peak

Test Mode:	802.11g	Channel:	2437
Polarity:	Vertical	Test Voltage:	AC 120 V, 60 HZ

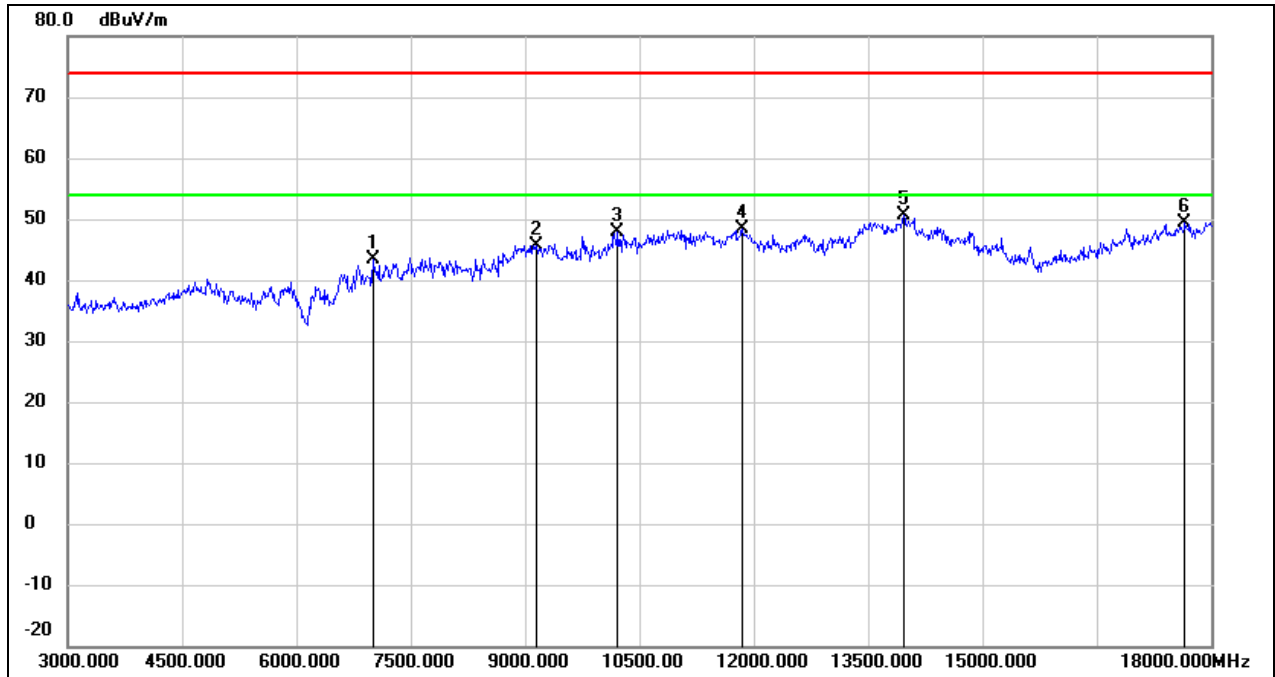

No.	Frequency (MHz)	Reading (dBuV)	Correct (dB/m)	Result (dBuV/m)	Limit (dBuV/m)	Margin (dB)	Remark
1	7005.000	36.60	6.69	43.29	74.00	-30.71	peak
2	9150.000	35.19	10.54	45.73	74.00	-28.27	peak
3	10215.000	35.34	12.43	47.77	74.00	-26.23	peak
4	11850.000	30.79	17.56	48.35	74.00	-25.65	peak
5	13965.000	28.64	21.89	50.53	74.00	-23.47	peak
6	17655.000	25.82	23.64	49.46	74.00	-24.54	peak

Test Mode:	802.11g	Channel:	2457
Polarity:	Horizontal	Test Voltage:	AC 120 V, 60 HZ

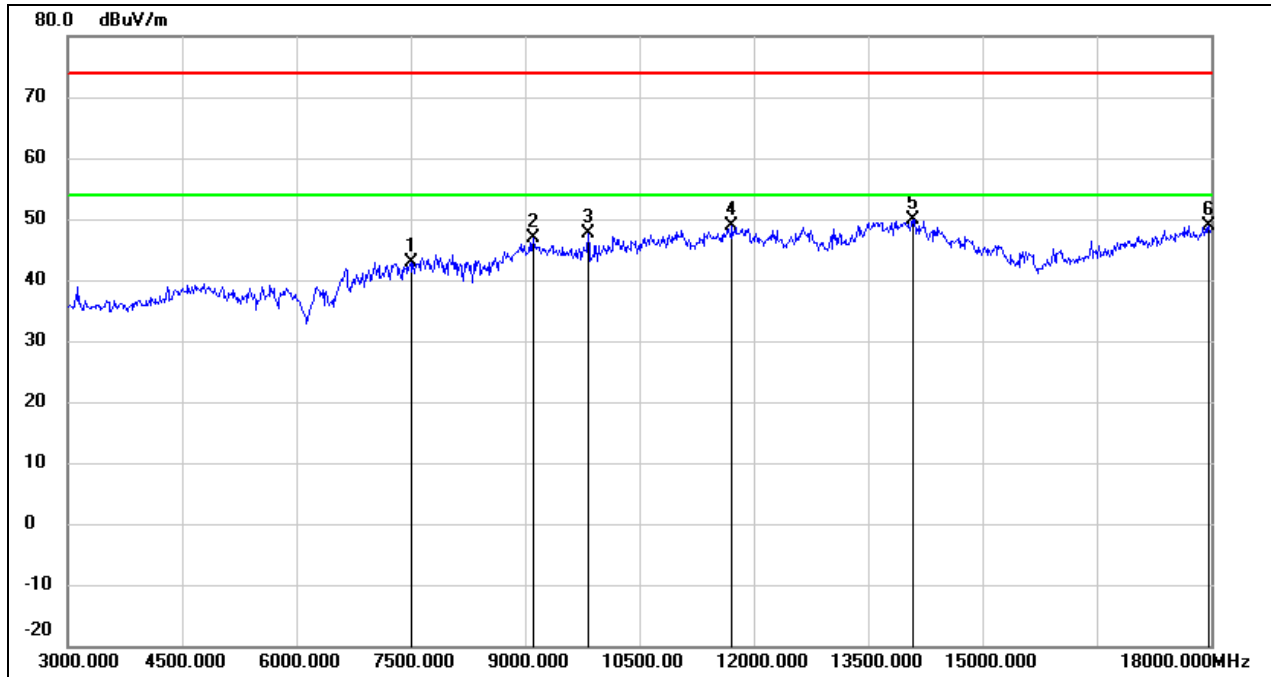

No.	Frequency (MHz)	Reading (dBuV)	Correct (dB/m)	Result (dBuV/m)	Limit (dBuV/m)	Margin (dB)	Remark
1	7500.000	36.50	6.33	42.83	74.00	-31.17	peak
2	9105.000	36.39	10.53	46.92	74.00	-27.08	peak
3	9825.000	35.98	11.56	47.54	74.00	-26.46	peak
4	11715.000	31.71	17.19	48.90	74.00	-25.10	peak
5	14085.000	28.37	21.61	49.98	74.00	-24.02	peak
6	17970.000	23.36	25.51	48.87	74.00	-25.13	peak

Test Mode:	802.11g	Channel:	2457
Polarity:	Vertical	Test Voltage:	AC 120 V, 60 HZ

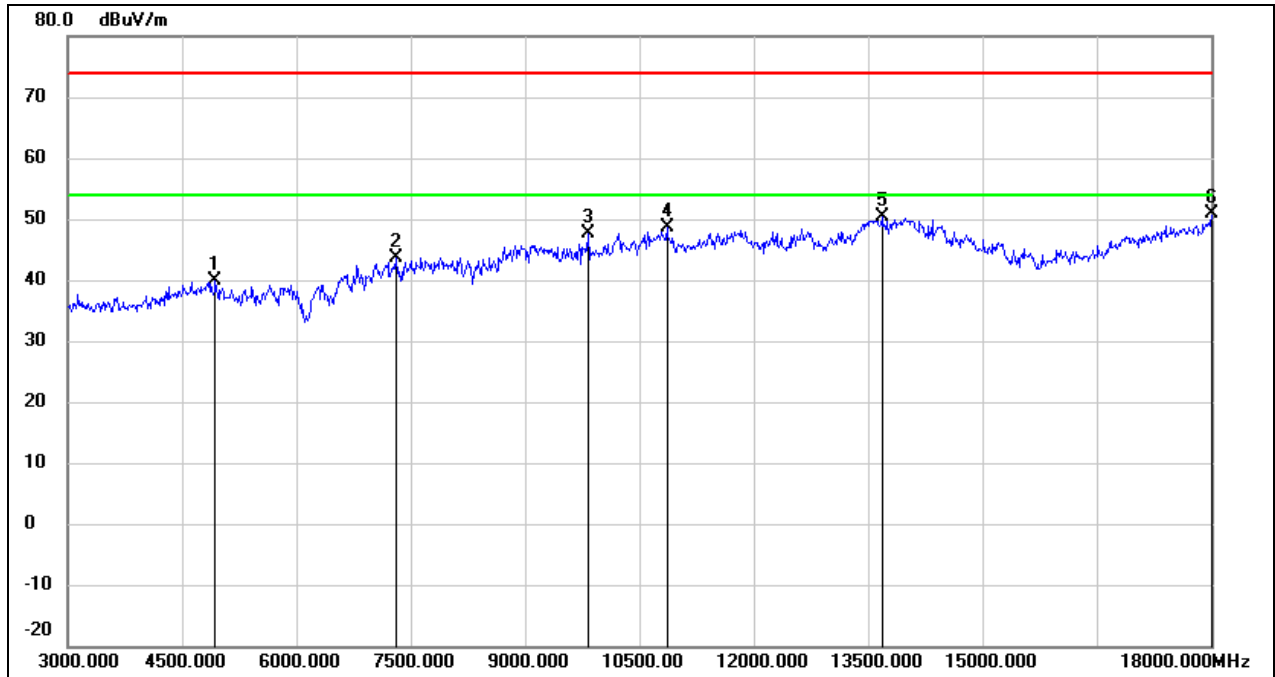

No.	Frequency (MHz)	Reading (dBuV)	Correct (dB/m)	Result (dBuV/m)	Limit (dBuV/m)	Margin (dB)	Remark
1	4935.000	39.70	0.20	39.90	74.00	-34.10	peak
2	7305.000	37.18	6.47	43.65	74.00	-30.35	peak
3	9825.000	36.04	11.56	47.60	74.00	-26.40	peak
4	10860.000	34.29	14.27	48.56	74.00	-25.44	peak
5	13680.000	29.18	21.29	50.47	74.00	-23.53	peak
6	18000.000	25.17	25.69	50.86	74.00	-23.14	peak

Test Mode:	802.11g	Channel:	2462
Polarity:	Horizontal	Test Voltage:	AC 120 V, 60 HZ

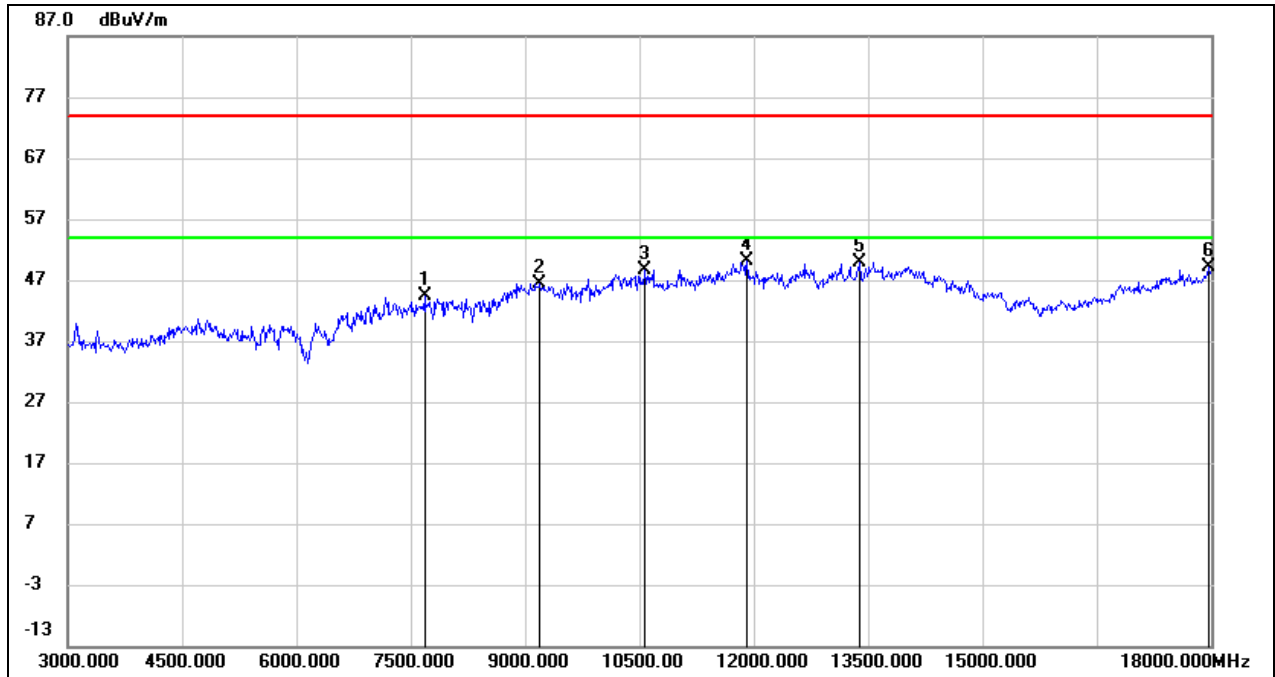

No.	Frequency (MHz)	Reading (dBuV)	Correct (dB/m)	Result (dBuV/m)	Limit (dBuV/m)	Margin (dB)	Remark
1	7680.000	38.16	6.32	44.48	74.00	-29.52	peak
2	9195.000	35.86	10.56	46.42	74.00	-27.58	peak
3	10575.000	35.43	13.25	48.68	74.00	-25.32	peak
4	11910.000	32.35	17.72	50.07	74.00	-23.93	peak
5	13395.000	29.45	20.44	49.89	74.00	-24.11	peak
6	17970.000	23.51	25.51	49.02	74.00	-24.98	peak

Test Mode:	802.11g	Channel:	2462
Polarity:	Vertical	Test Voltage:	AC 120 V, 60 HZ

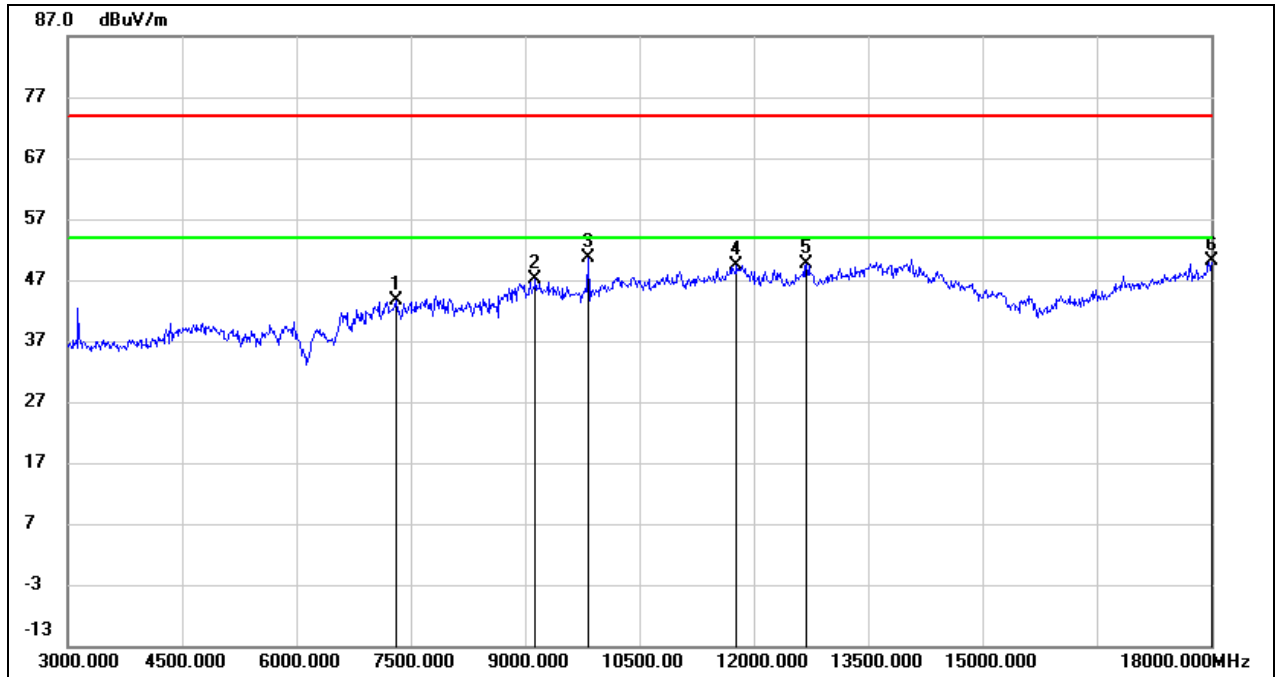

No.	Frequency (MHz)	Reading (dBuV)	Correct (dB/m)	Result (dBuV/m)	Limit (dBuV/m)	Margin (dB)	Remark
1	7305.000	37.24	6.47	43.71	74.00	-30.29	peak
2	9135.000	36.56	10.55	47.11	74.00	-26.89	peak
3	9825.000	39.01	11.56	50.57	74.00	-23.43	peak
4	11775.000	31.97	17.35	49.32	74.00	-24.68	peak
5	12690.000	31.58	18.02	49.60	74.00	-24.40	peak
6	18000.000	24.36	25.69	50.05	74.00	-23.95	peak

Test Mode:	802.11n HT20	Channel:	2412
Polarity:	Horizontal	Test Voltage:	AC 120 V, 60 HZ

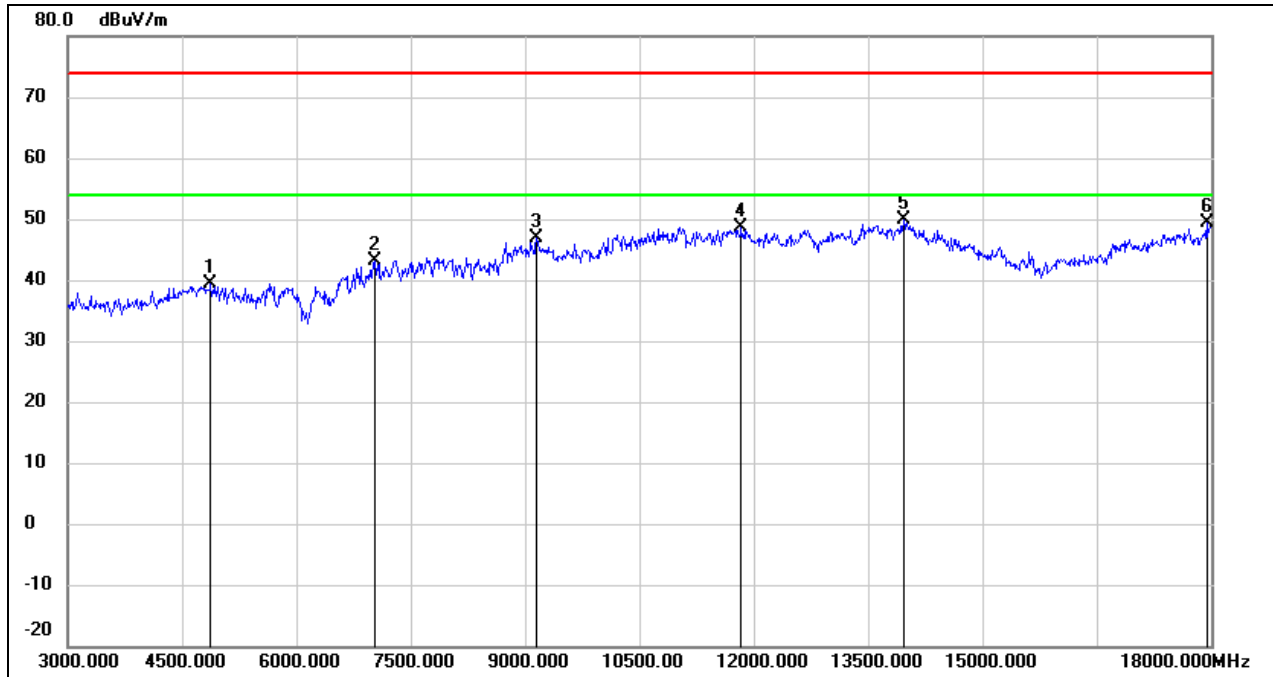

No.	Frequency (MHz)	Reading (dBuV)	Correct (dB/m)	Result (dBuV/m)	Limit (dBuV/m)	Margin (dB)	Remark
1	4875.000	39.48	-0.03	39.45	74.00	-34.55	peak
2	7035.000	36.56	6.67	43.23	74.00	-30.77	peak
3	9150.000	36.31	10.54	46.85	74.00	-27.15	peak
4	11835.000	31.10	17.51	48.61	74.00	-25.39	peak
5	13965.000	27.87	21.89	49.76	74.00	-24.24	peak
6	17940.000	24.07	25.34	49.41	74.00	-24.59	peak

Test Mode:	802.11n HT20	Channel:	2412
Polarity:	Vertical	Test Voltage:	AC 120 V, 60 HZ

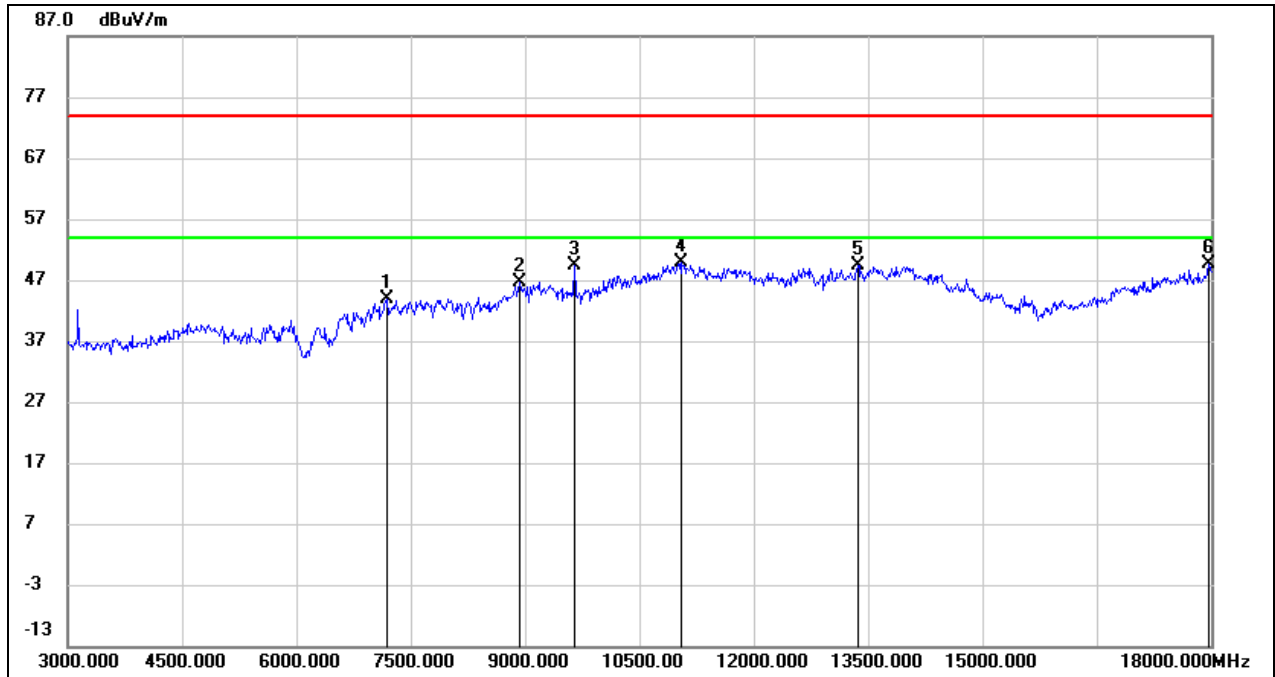

No.	Frequency (MHz)	Reading (dBuV)	Correct (dB/m)	Result (dBuV/m)	Limit (dBuV/m)	Margin (dB)	Remark
1	7185.000	37.26	6.55	43.81	74.00	-30.19	peak
2	8925.000	36.62	9.94	46.56	74.00	-27.44	peak
3	9645.000	38.25	11.08	49.33	74.00	-24.67	peak
4	11055.000	34.97	14.96	49.93	74.00	-24.07	peak
5	13365.000	29.18	20.31	49.49	74.00	-24.51	peak
6	17970.000	24.09	25.51	49.60	74.00	-24.40	peak

Test Mode:	802.11n HT20	Channel:	2417
Polarity:	Horizontal	Test Voltage:	AC 120 V, 60 HZ

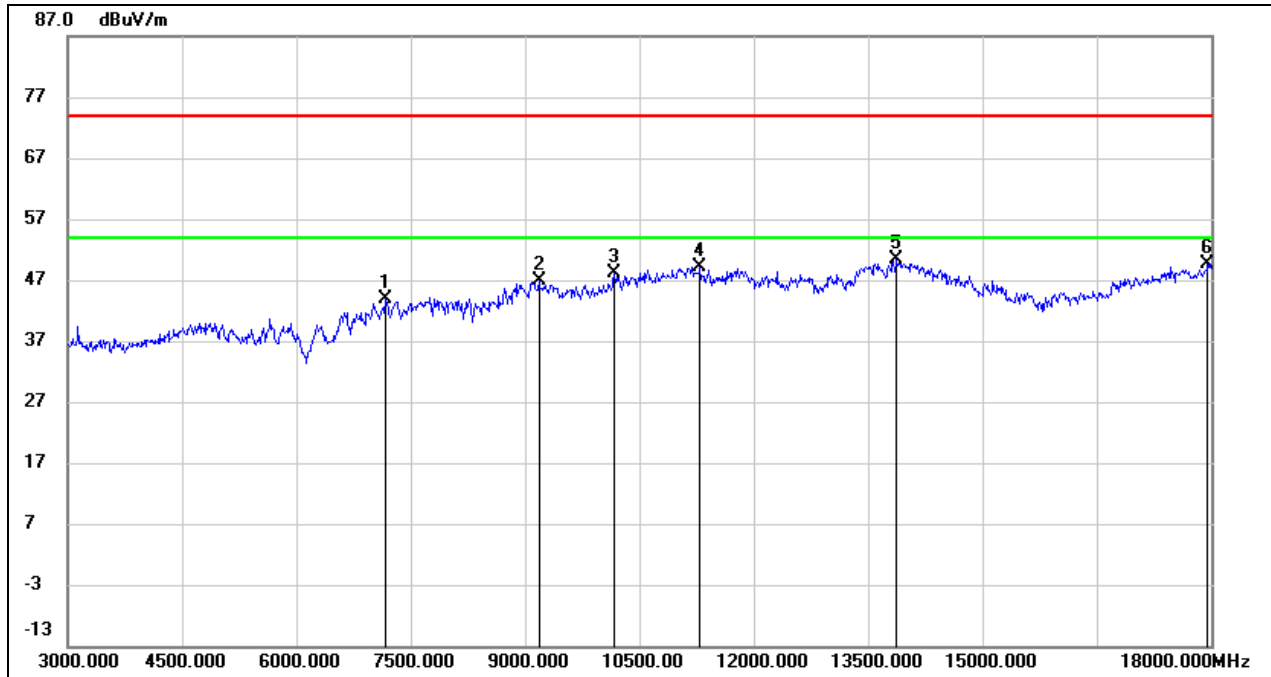

No.	Frequency (MHz)	Reading (dBuV)	Correct (dB/m)	Result (dBuV/m)	Limit (dBuV/m)	Margin (dB)	Remark
1	7170.000	37.28	6.56	43.84	74.00	-30.16	peak
2	9180.000	36.23	10.56	46.79	74.00	-27.21	peak
3	10170.000	35.88	12.34	48.22	74.00	-25.78	peak
4	11295.000	33.29	15.85	49.14	74.00	-24.86	peak
5	13875.000	28.58	21.70	50.28	74.00	-23.72	peak
6	17955.000	24.09	25.42	49.51	74.00	-24.49	peak

Test Mode:	802.11n HT20	Channel:	2417
Polarity:	Vertical	Test Voltage:	AC 120 V, 60 HZ

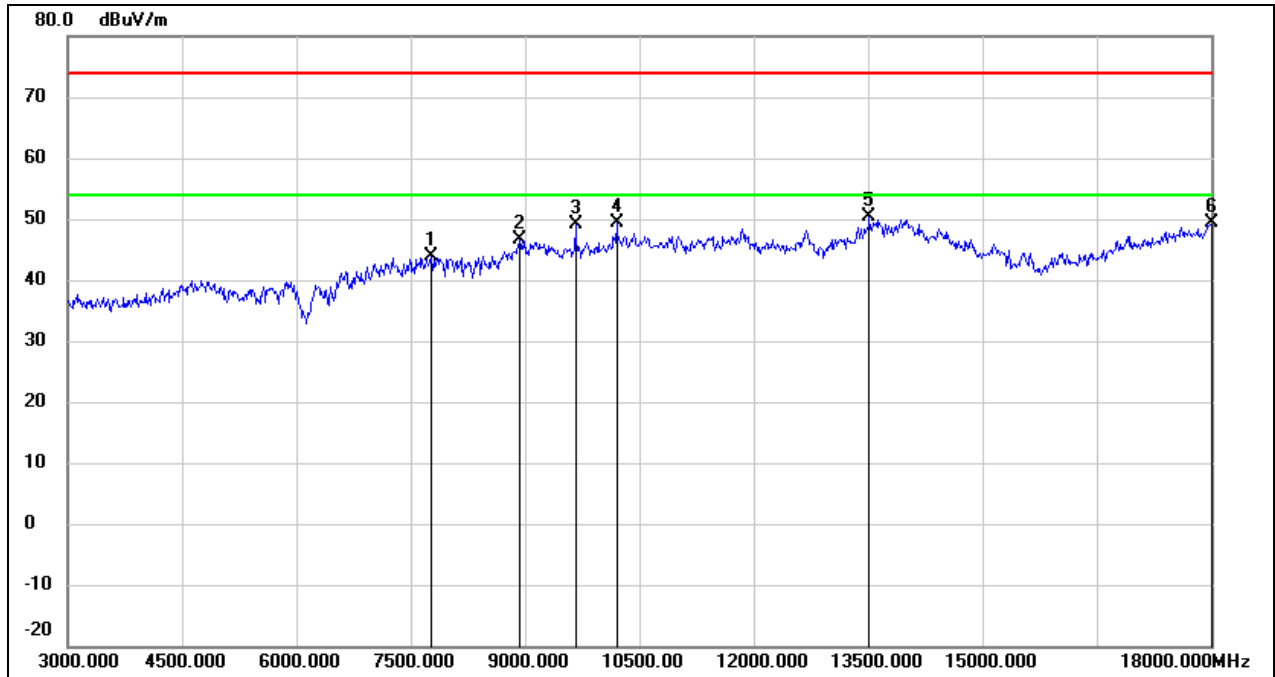

No.	Frequency (MHz)	Reading (dBuV)	Correct (dB/m)	Result (dBuV/m)	Limit (dBuV/m)	Margin (dB)	Remark
1	7770.000	37.62	6.31	43.93	74.00	-30.07	peak
2	8925.000	36.65	9.94	46.59	74.00	-27.41	peak
3	9660.000	38.02	11.11	49.13	74.00	-24.87	peak
4	10200.000	36.97	12.40	49.37	74.00	-24.63	peak
5	13515.000	29.40	20.93	50.33	74.00	-23.67	peak
6	18000.000	23.61	25.69	49.30	74.00	-24.70	peak

Test Mode:	802.11n HT20	Channel:	2437
Polarity:	Horizontal	Test Voltage:	AC 120 V, 60 HZ

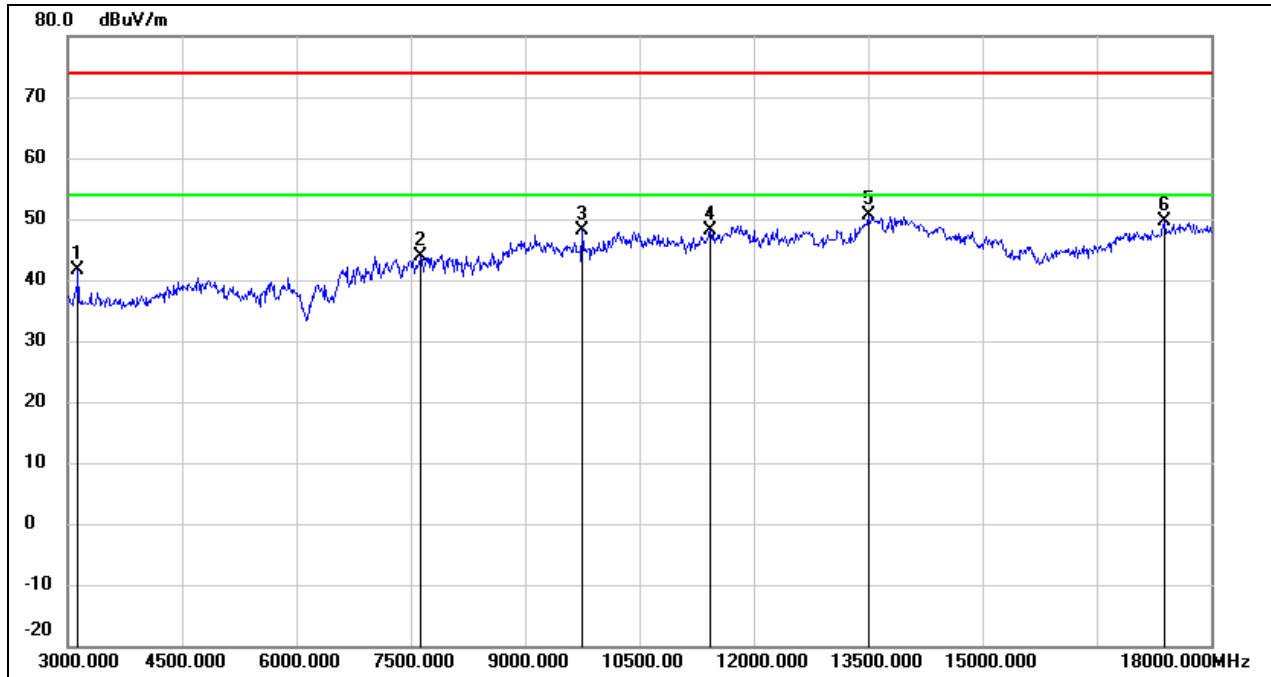

No.	Frequency (MHz)	Reading (dBuV)	Correct (dB/m)	Result (dBuV/m)	Limit (dBuV/m)	Margin (dB)	Remark
1	3135.000	46.82	-5.16	41.66	74.00	-32.34	peak
2	7635.000	37.63	6.33	43.96	74.00	-30.04	peak
3	9750.000	36.70	11.35	48.05	74.00	-25.95	peak
4	11430.000	31.80	16.34	48.14	74.00	-25.86	peak
5	13500.000	29.73	20.90	50.63	74.00	-23.37	peak
6	17385.000	27.31	22.31	49.62	74.00	-24.38	peak

Test Mode:	802.11n HT20	Channel:	2437
Polarity:	Vertical	Test Voltage:	AC 120 V, 60 HZ

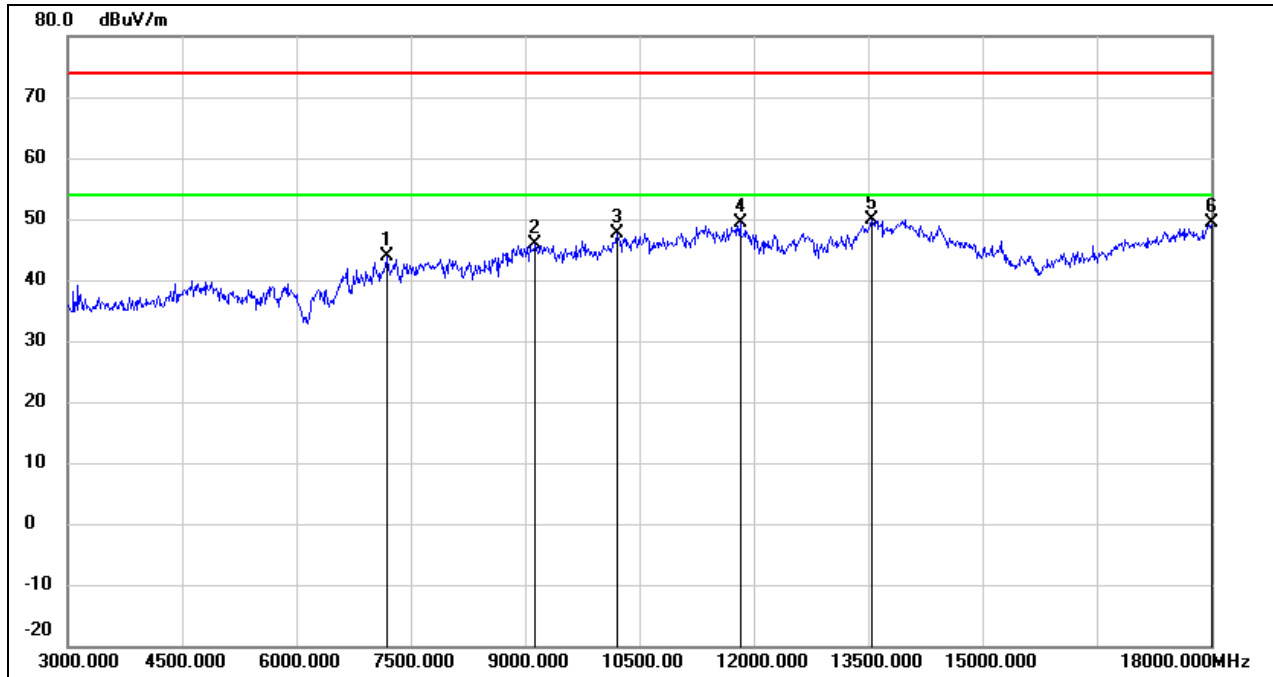

No.	Frequency (MHz)	Reading (dBuV)	Correct (dB/m)	Result (dBuV/m)	Limit (dBuV/m)	Margin (dB)	Remark
1	7185.000	37.25	6.55	43.80	74.00	-30.20	peak
2	9135.000	35.23	10.55	45.78	74.00	-28.22	peak
3	10200.000	35.27	12.40	47.67	74.00	-26.33	peak
4	11820.000	31.81	17.47	49.28	74.00	-24.72	peak
5	13545.000	28.89	20.99	49.88	74.00	-24.12	peak
6	18000.000	23.64	25.69	49.33	74.00	-24.67	peak

Test Mode:	802.11n HT20	Channel:	2457
Polarity:	Horizontal	Test Voltage:	AC 120 V, 60 HZ

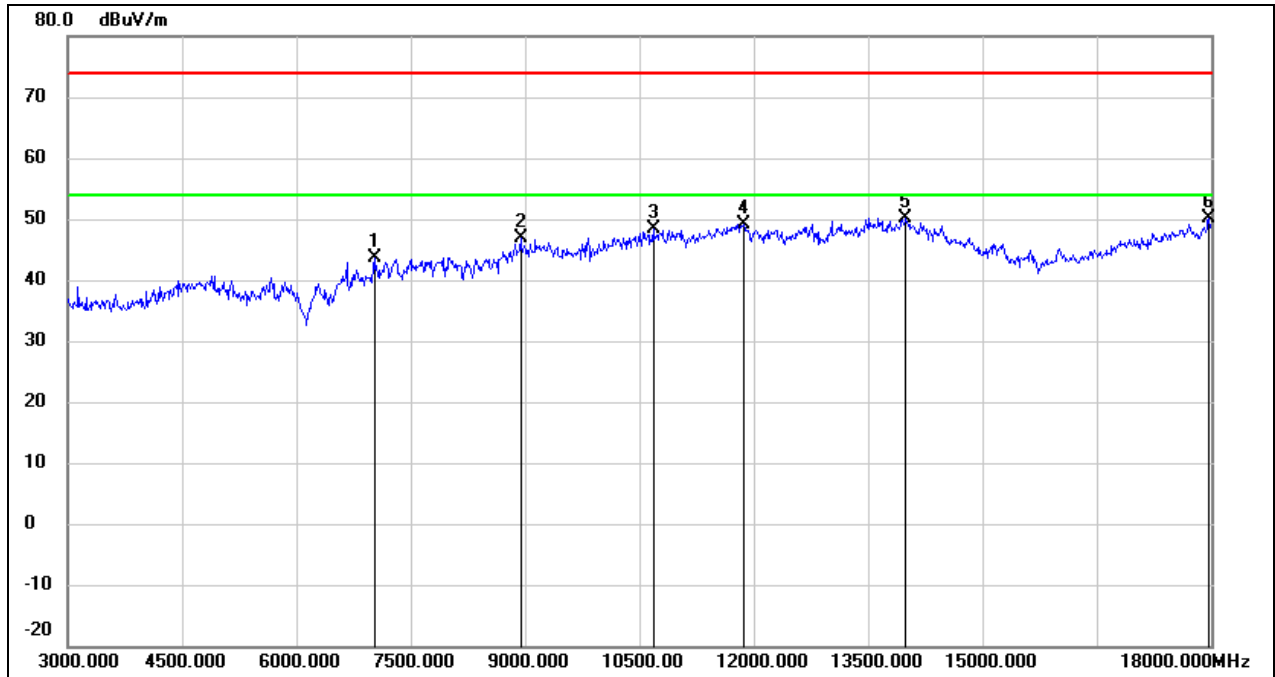

No.	Frequency (MHz)	Reading (dBuV)	Correct (dB/m)	Result (dBuV/m)	Limit (dBuV/m)	Margin (dB)	Remark
1	7020.000	36.84	6.67	43.51	74.00	-30.49	peak
2	8940.000	36.72	10.04	46.76	74.00	-27.24	peak
3	10680.000	34.81	13.62	48.43	74.00	-25.57	peak
4	11865.000	31.50	17.59	49.09	74.00	-24.91	peak
5	13995.000	28.12	21.95	50.07	74.00	-23.93	peak
6	17970.000	24.51	25.51	50.02	74.00	-23.98	peak

Test Mode:	802.11n HT20	Channel:	2457
Polarity:	Vertical	Test Voltage:	AC 120 V, 60 HZ

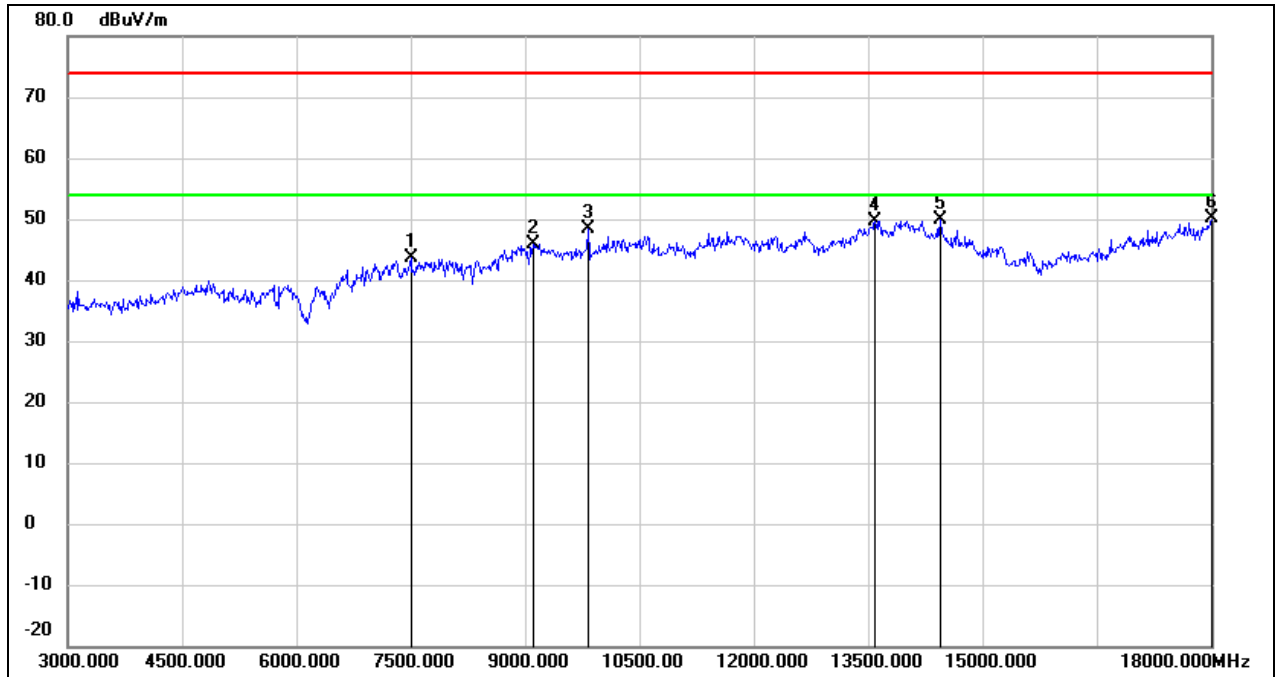

No.	Frequency (MHz)	Reading (dBuV)	Correct (dB/m)	Result (dBuV/m)	Limit (dBuV/m)	Margin (dB)	Remark
1	7500.000	37.35	6.33	43.68	74.00	-30.32	peak
2	9105.000	35.23	10.53	45.76	74.00	-28.24	peak
3	9825.000	36.87	11.56	48.43	74.00	-25.57	peak
4	13590.000	28.51	21.09	49.60	74.00	-24.40	peak
5	14445.000	29.66	20.14	49.80	74.00	-24.20	peak
6	18000.000	24.49	25.69	50.18	74.00	-23.82	peak

Test Mode:	802.11n HT20	Channel:	2462
Polarity:	Horizontal	Test Voltage:	AC 120 V, 60 HZ

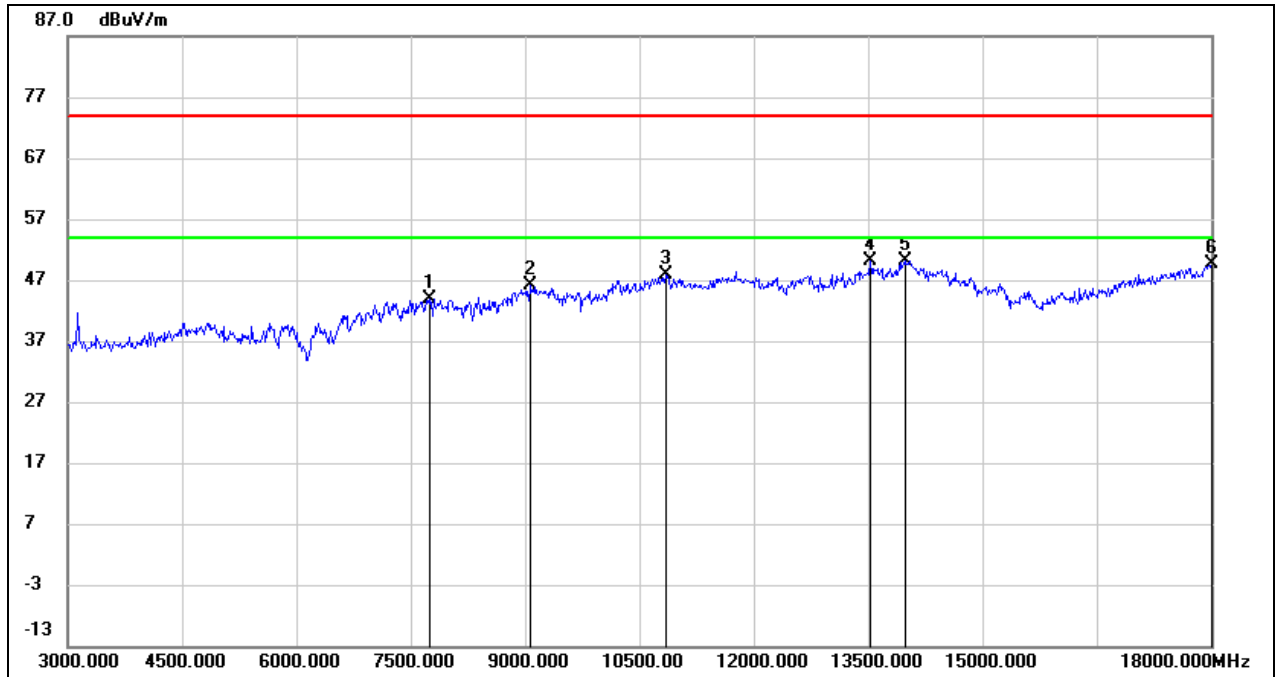

No.	Frequency (MHz)	Reading (dBuV)	Correct (dB/m)	Result (dBuV/m)	Limit (dBuV/m)	Margin (dB)	Remark
1	7740.000	37.47	6.32	43.79	74.00	-30.21	peak
2	9075.000	35.50	10.52	46.02	74.00	-27.98	peak
3	10845.000	33.70	14.21	47.91	74.00	-26.09	peak
4	13530.000	29.16	20.96	50.12	74.00	-23.88	peak
5	13980.000	28.23	21.92	50.15	74.00	-23.85	peak
6	18000.000	23.94	25.69	49.63	74.00	-24.37	peak

Test Mode:	802.11n HT20	Channel:	2462
Polarity:	Vertical	Test Voltage:	AC 120 V, 60 HZ

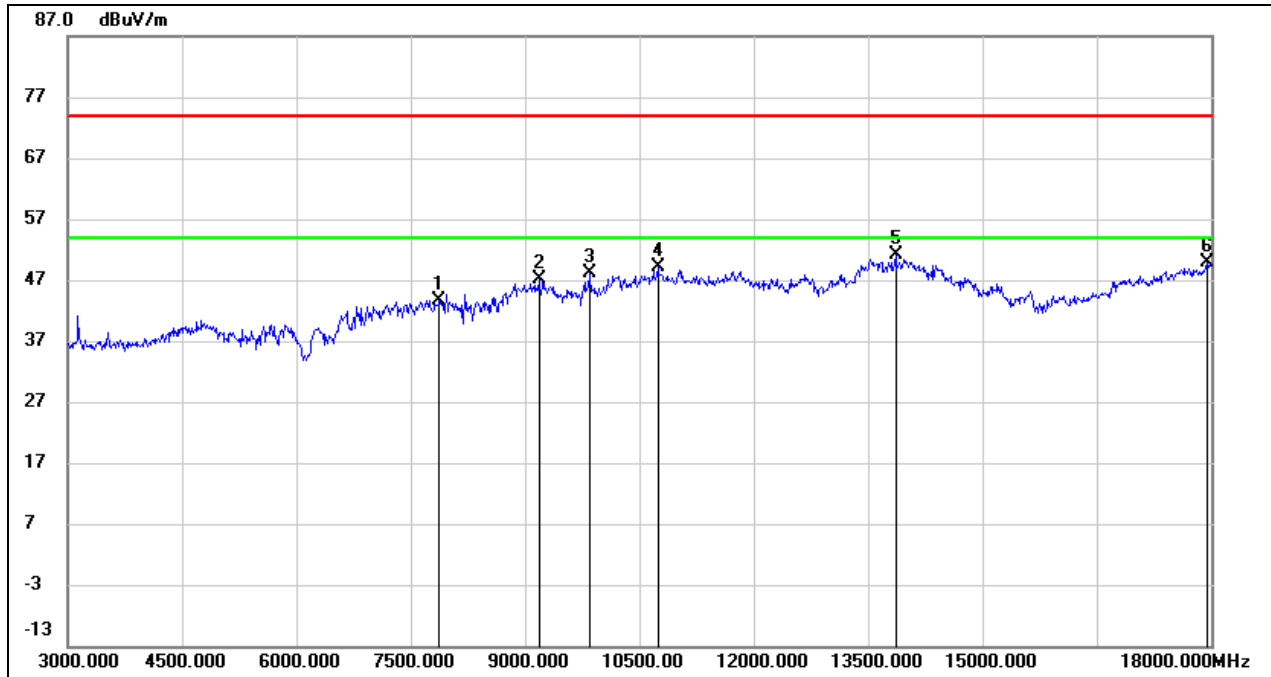

No.	Frequency (MHz)	Reading (dBuV)	Correct (dB/m)	Result (dBuV/m)	Limit (dBuV/m)	Margin (dB)	Remark
1	7875.000	37.41	6.31	43.72	74.00	-30.28	peak
2	9180.000	36.62	10.56	47.18	74.00	-26.82	peak
3	9840.000	36.62	11.59	48.21	74.00	-25.79	peak
4	10740.000	35.35	13.85	49.20	74.00	-24.80	peak
5	13860.000	29.47	21.67	51.14	74.00	-22.86	peak
6	17940.000	24.58	25.34	49.92	74.00	-24.08	peak

8.4. SPURIOUS EMISSIONS(9 KHZ~30 MHZ)

Test Mode:	802.11b	Channel:	2412
Polarity:	FACE ON	Test Voltage:	DC 5V

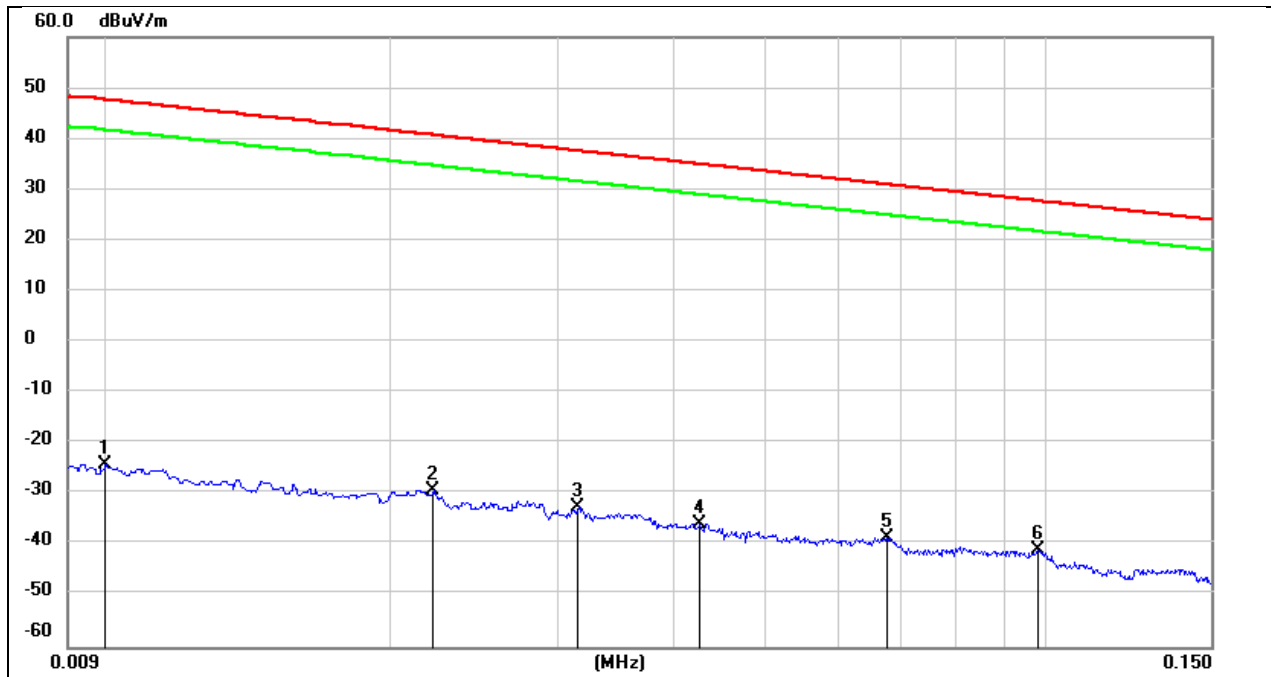

No.	Frequency (MHz)	Reading (dBuV)	Correct (dB/m)	FCC Result (dBuV/m)	FCC Limit (dBuV/m)	ISED Result (dBuA/m)	ISED Limit (dBuA/m)	Margin (dB)	Remark
1	0.0100	77.22	-101.40	-24.18	47.60	-75.68	-3.90	-71.78	peak
2	0.0221	72.13	-101.35	-29.22	40.71	-80.72	-10.79	-69.93	peak
3	0.0316	68.74	-101.40	-32.66	37.61	-84.16	-13.89	-70.27	peak
4	0.0427	65.64	-101.45	-35.81	34.99	-87.31	-16.51	-70.80	peak
5	0.0675	63.14	-101.56	-38.42	31.02	-89.92	-20.48	-69.44	peak
6	0.0981	60.77	-101.78	-41.01	27.77	-92.51	-23.73	-68.78	peak

Test Mode:	802.11b	Channel:	2412
Polarity:	FACE ON	Test Voltage:	DC 5V

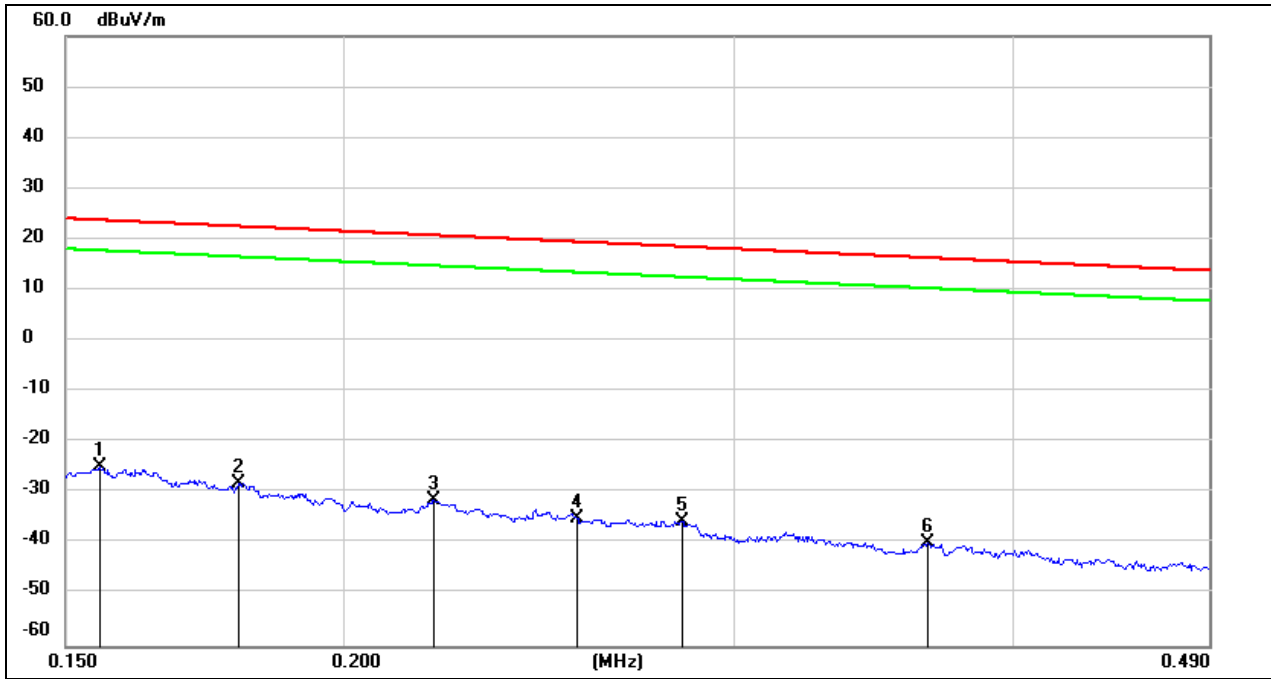

No.	Frequency (MHz)	Reading (dBuV)	Correct (dB/m)	FCC Result (dBuV/m)	FCC Limit (dBuV/m)	ISED Result (dBuA/m)	ISED Limit (dBuA/m)	Margin (dB)	Remark
1	0.1554	76.77	-101.65	-24.88	23.77	-76.38	-27.73	-48.65	peak
2	0.1794	73.77	-101.68	-27.91	22.53	-79.41	-28.97	-50.44	peak
3	0.2197	70.27	-101.75	-31.48	20.76	-82.98	-30.74	-52.24	peak
4	0.2545	66.90	-101.80	-34.90	19.49	-86.40	-32.01	-54.39	peak
5	0.2837	66.22	-101.83	-35.61	18.54	-87.11	-32.96	-54.15	peak
6	0.3662	62.08	-101.93	-39.85	16.33	-91.35	-35.17	-56.18	peak

Test Mode:	802.11b	Channel:	2412
Polarity:	FACE ON	Test Voltage:	DC 5V

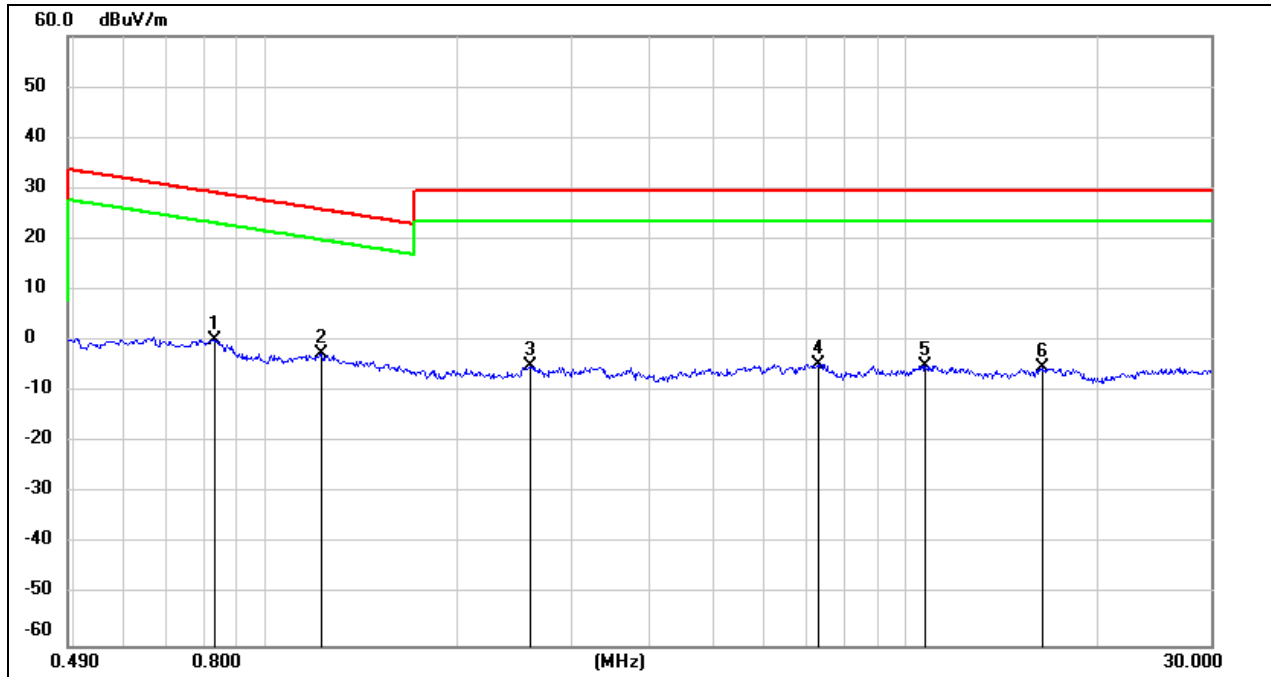

No.	Frequency (MHz)	Reading (dBuV)	Correct (dB/m)	FCC Result (dBuV/m)	FCC Limit (dBuV/m)	ISED Result (dBuA/m)	ISED Limit (dBuA/m)	Margin (dB)	Remark
1	0.8296	62.44	-62.17	0.27	29.23	-51.23	-22.27	-28.96	peak
2	1.2214	59.62	-62.16	-2.54	25.87	-54.04	-25.63	-28.41	peak
3	2.5935	56.61	-61.68	-5.07	29.54	-56.57	-21.96	-34.61	peak
4	7.3361	56.58	-61.17	-4.59	29.54	-56.09	-21.96	-34.13	peak
5	10.7299	55.98	-60.83	-4.85	29.54	-56.35	-21.96	-34.39	peak
6	16.3959	55.67	-60.96	-5.29	29.54	-56.79	-21.96	-34.83	peak

8.5. SPURIOUS EMISSIONS(18 GHZ~26 GHZ)

Test Mode:	802.11b	Channel:	2412
Polarity:	Horizontal	Test Voltage:	DC 5V

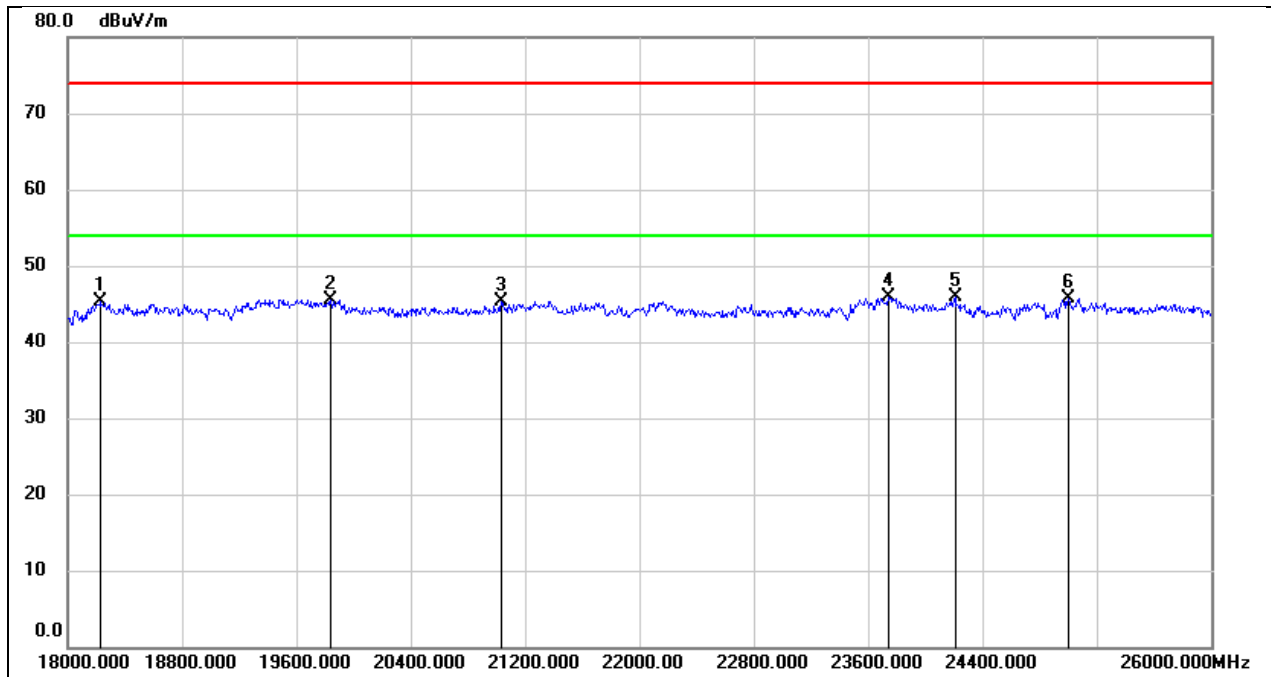

No.	Frequency (MHz)	Reading (dBuV)	Correct (dB/m)	Result (dBuV/m)	Limit (dBuV/m)	Margin (dB)	Remark
1	18232.000	50.75	-5.54	45.21	74.00	-28.79	peak
2	19840.000	50.82	-5.32	45.50	74.00	-28.50	peak
3	21032.000	50.15	-4.87	45.28	74.00	-28.72	peak
4	23744.000	49.15	-3.20	45.95	74.00	-28.05	peak
5	24208.000	48.71	-2.81	45.90	74.00	-28.10	peak
6	25000.000	47.86	-2.10	45.76	74.00	-28.24	peak

Test Mode:	802.11b	Channel:	2412
Polarity:	Vertical	Test Voltage:	DC 5V

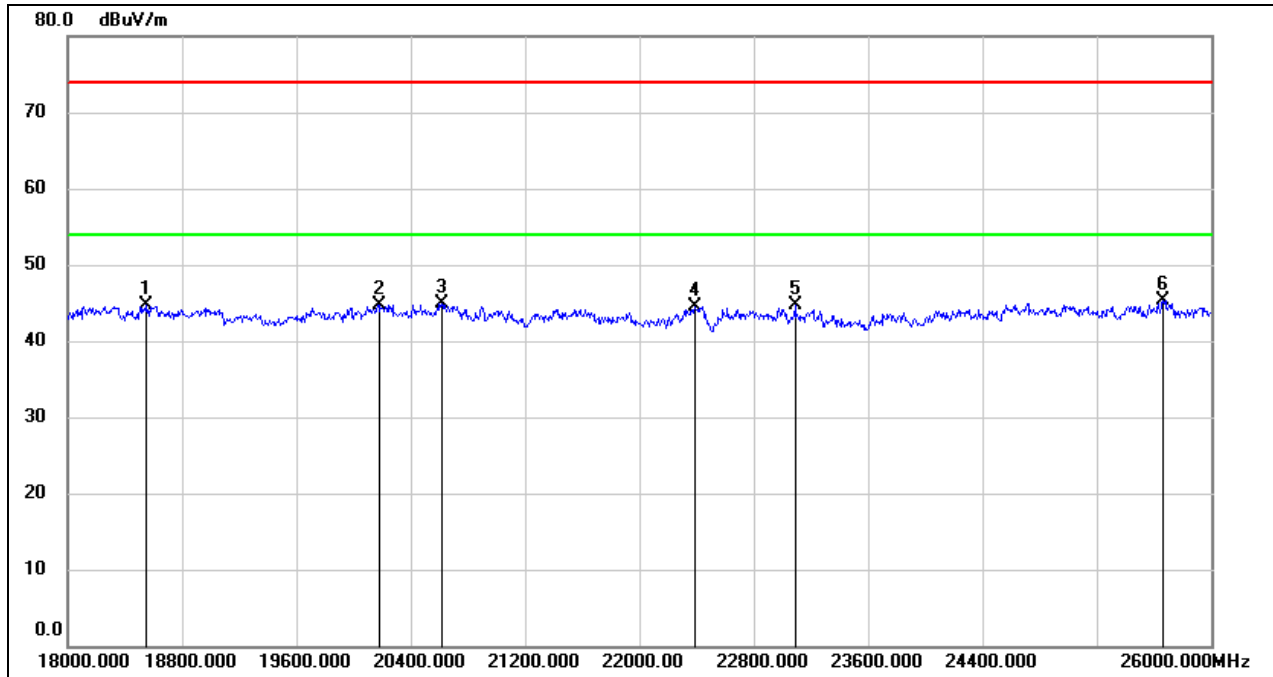

No.	Frequency (MHz)	Reading (dBuV)	Correct (dB/m)	Result (dBuV/m)	Limit (dBuV/m)	Margin (dB)	Remark
1	18552.000	50.04	-5.28	44.76	74.00	-29.24	peak
2	20176.000	50.21	-5.56	44.65	74.00	-29.35	peak
3	20616.000	50.13	-5.24	44.89	74.00	-29.11	peak
4	22392.000	48.61	-4.02	44.59	74.00	-29.41	peak
5	23088.000	48.02	-3.41	44.61	74.00	-29.39	peak
6	25664.000	46.39	-1.01	45.38	74.00	-28.62	peak

8.6. SPURIOUS EMISSIONS(30 MHZ~1 GHZ)

Test Mode:	802.11b	Channel:	2412
Polarity:	Horizontal	Test Voltage:	AC 120 V, 60 HZ

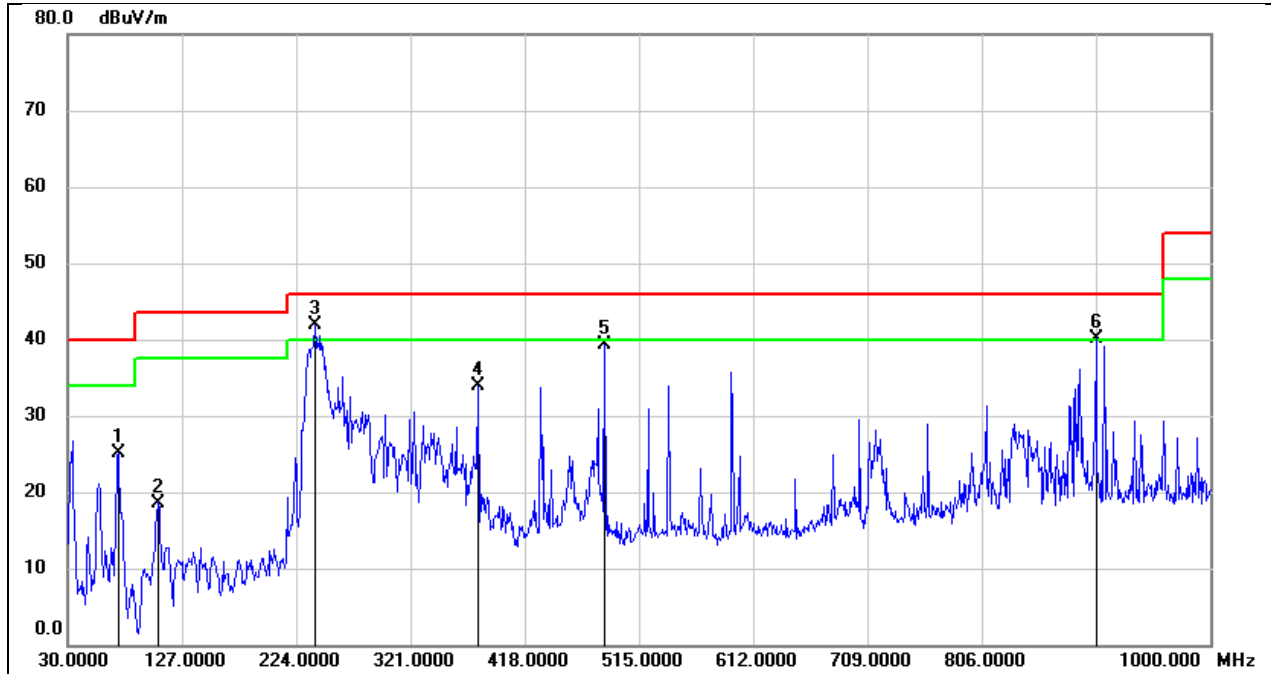

No.	Frequency (MHz)	Reading (dBuV)	Correct (dB/m)	Result (dBuV/m)	Limit (dBuV/m)	Margin (dB)	Remark
1	72.6800	45.97	-20.96	25.01	40.00	-14.99	QP
2	106.6300	39.21	-20.61	18.60	43.50	-24.90	QP
3	239.5200	60.35	-18.40	41.95	46.00	-4.05	QP
4	378.2300	46.81	-12.89	33.92	46.00	-12.08	QP
5	485.9000	50.26	-10.98	39.28	46.00	-6.72	QP
6	903.0000	44.83	-4.78	40.05	46.00	-5.95	QP

Test Mode:	802.11b	Channel:	2412
Polarity:	Vertical	Test Voltage:	AC 120 V, 60 HZ

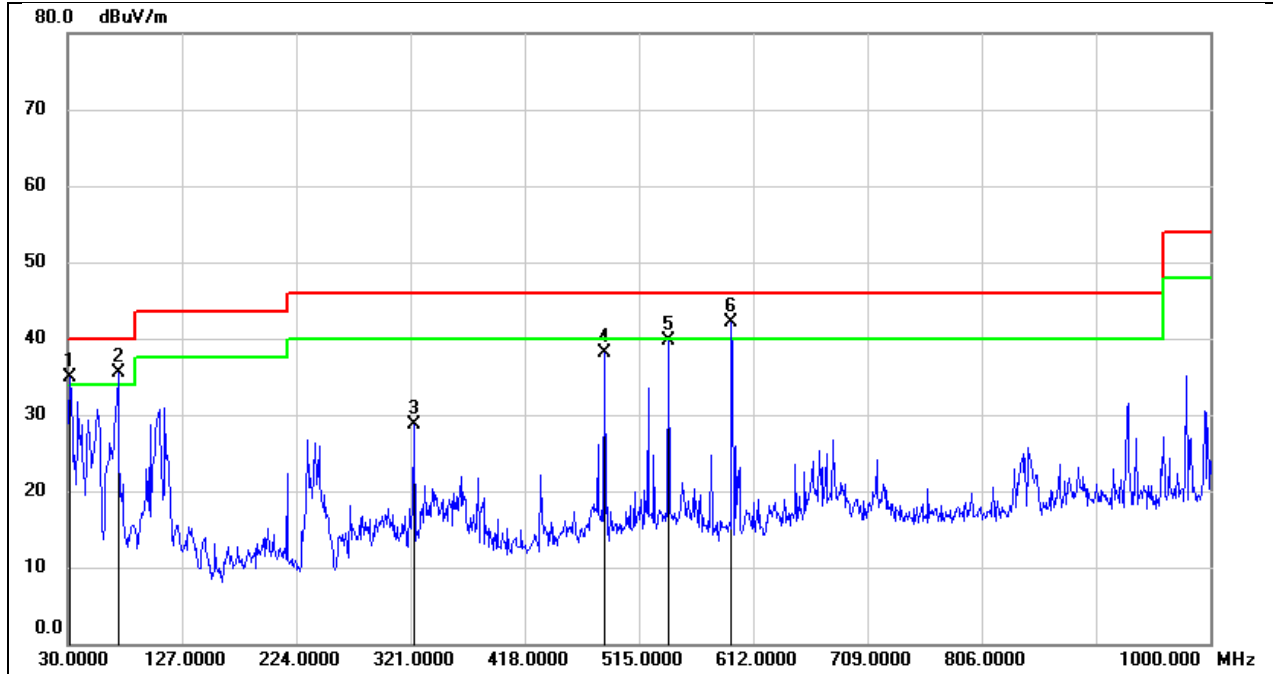

No.	Frequency (MHz)	Reading (dBuV)	Correct (dB/m)	Result (dBuV/m)	Limit (dBuV/m)	Margin (dB)	Remark
1	31.9400	53.53	-18.55	34.98	40.00	-5.02	QP
2	72.6800	56.40	-20.96	35.44	40.00	-4.56	QP
3	323.9100	42.70	-14.09	28.61	46.00	-17.39	QP
4	485.9000	49.06	-10.98	38.08	46.00	-7.92	QP
5	540.2199	50.13	-10.37	39.76	46.00	-6.24	QP
6	593.5700	51.50	-9.46	42.04	46.00	-3.96	QP

9. ANTENNA REQUIREMENT

REQUIREMENT

Please refer to FCC part 15.203

An intentional radiator shall be designed to ensure that no antenna other than that furnished by the responsible party shall be used with the device. The use of a permanently attached antenna or of an antenna that uses a unique coupling to the intentional radiator shall be considered sufficient to comply with the provisions of this section. The manufacturer may design the unit so that a broken antenna can be replaced by the user, but the use of a standard antenna jack or electrical connector is prohibited.

Please refer to FCC part 15.247(b)(4)

The conducted output power limit specified in paragraph (b) of this section is based on the use of antennas with directional gains that do not exceed 6 dBi. Except as shown in paragraph (c) of this section, if transmitting antennas of directional gain greater than 6 dBi are used, the conducted output power from the intentional radiator shall be reduced below the stated values in paragraphs (b)(1), (b)(2), and (b)(3) of this section, as appropriate, by the amount in dB that the directional gain of the antenna exceeds 6 dBi.

DESCRIPTION

Pass

10. AC POWER LINE CONDUCTED EMISSION

LIMITS

Please refer to CFR 47 FCC §15.207 (a) and ISED RSS-Gen Clause 8.8

FREQUENCY (MHz)	Quasi-peak	Average
0.15 -0.5	66 - 56 *	56 - 46 *
0.50 -5.0	56.00	46.00
5.0 -30.0	60.00	50.00

TEST PROCEDURE

The EUT is put on a table of non-conducting material that is 80 cm high. The vertical conducting wall of shielding is located 40 cm to the rear of the EUT. The power line of the EUT is connected to the AC mains through a Artificial Mains Network (A.M.N.). A EMI Measurement Receiver (R&S Test Receiver ESR3) is used to test the emissions from both sides of AC line. According to the requirements in Section 6.2 of ANSI C63.10-2013. Conducted emissions from the EUT measured in the frequency range between 0.15 MHz and 30 MHz using CISPR Quasi-Peak and average detector mode. The bandwidth of EMI test receiver is set at 9 kHz.

The arrangement of the equipment is installed to meet the standards and operating in a manner, which tends to maximize its emission characteristics in a normal application.

TEST SETUP

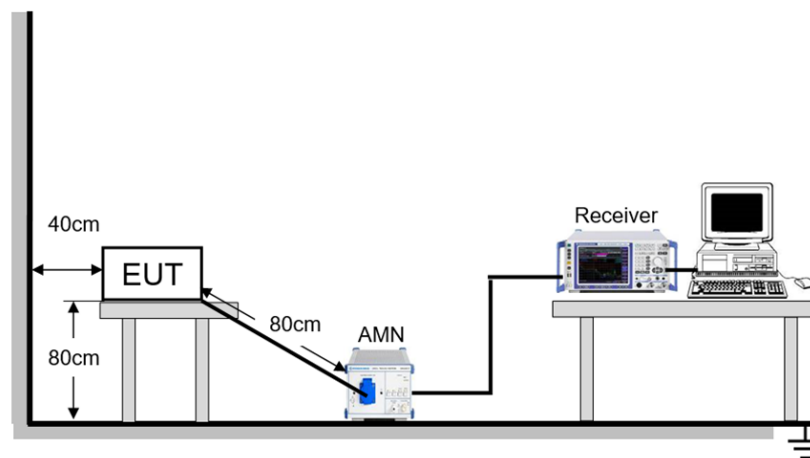

TEST ENVIRONMENT

Temperature	24.2°C	Relative Humidity	55%
Atmosphere Pressure	101kPa	Test Voltage	AC 120 V, 60 Hz

TEST DATE / ENGINEER

Test Date	May 12, 2023	Test By	Wite Chen
-----------	--------------	---------	-----------

TEST RESULTS

Test Mode:	802.11b	Channel:	2412
Line:	Line	Test Voltage:	AC 120V_60Hz

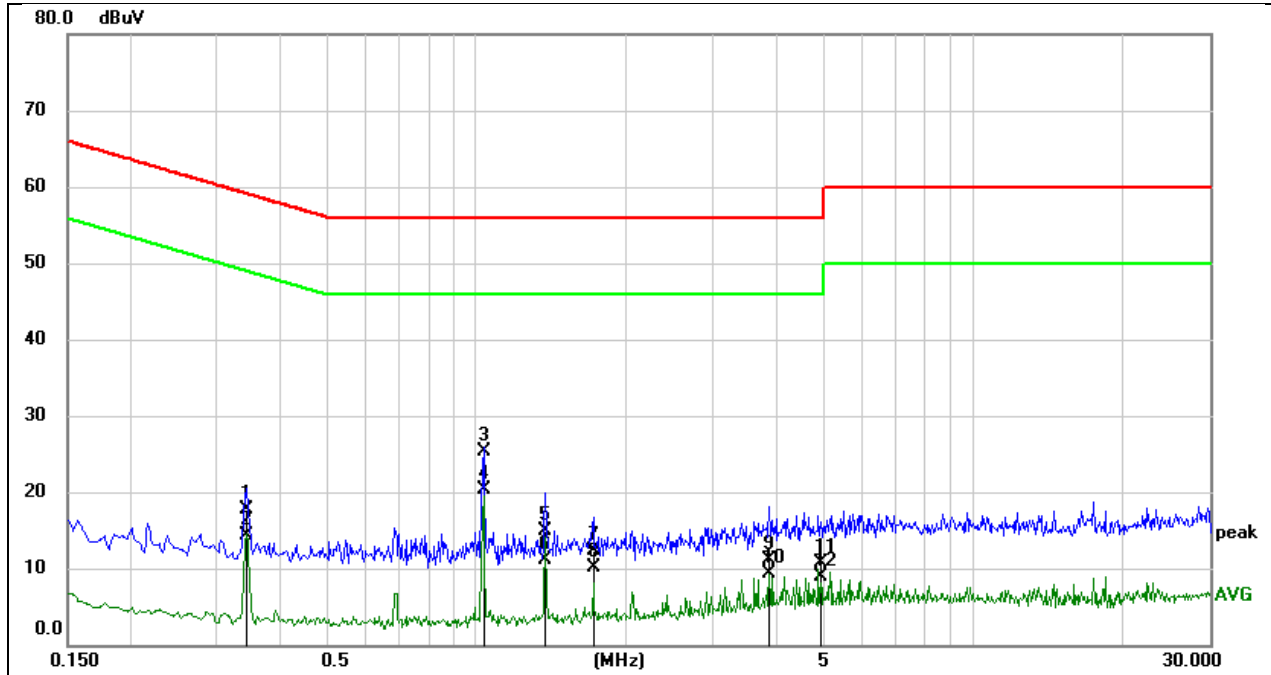

No.	Frequency (MHz)	Reading (dBuV)	Correct (dB)	Result (dBuV)	Limit (dBuV)	Margin (dB)	Remark
1	0.3440	8.03	9.59	17.62	59.11	-41.49	QP
2	0.3440	4.72	9.59	14.31	49.11	-34.80	AVG
3	1.0320	15.71	9.61	25.32	56.00	-30.68	QP
4	1.0320	10.66	9.61	20.27	46.00	-25.73	AVG
5	1.3757	5.25	9.61	14.86	56.00	-41.14	QP
6	1.3757	1.54	9.61	11.15	46.00	-34.85	AVG
7	1.7196	2.74	9.62	12.36	56.00	-43.64	QP
8	1.7196	0.58	9.62	10.20	46.00	-35.80	AVG
9	3.8947	1.50	9.69	11.19	56.00	-44.81	QP
10	3.8947	-0.43	9.69	9.26	46.00	-36.74	AVG
11	4.9510	0.98	9.72	10.70	56.00	-45.30	QP
12	4.9510	-0.90	9.72	8.82	46.00	-37.18	AVG

Note:

1. Result = Reading + Correct Factor.
2. If QP Result complies with AV limit, AV Result is deemed to comply with AV limit.
3. Test setup: RBW: 200 Hz (9 kHz ~ 150 kHz), 9 kHz (150 kHz ~ 30 MHz).
4. Step size: 80 Hz (0.009 MHz ~ 0.15 MHz), 4 kHz (0.15 MHz ~ 30 MHz), Scan time: auto.

Note: All the modes have been tested, only the worst data was recorded in the report.

Test Mode:	802.11b	Channel:	2412
Line:	Neutral	Test Voltage:	AC 120V_60Hz

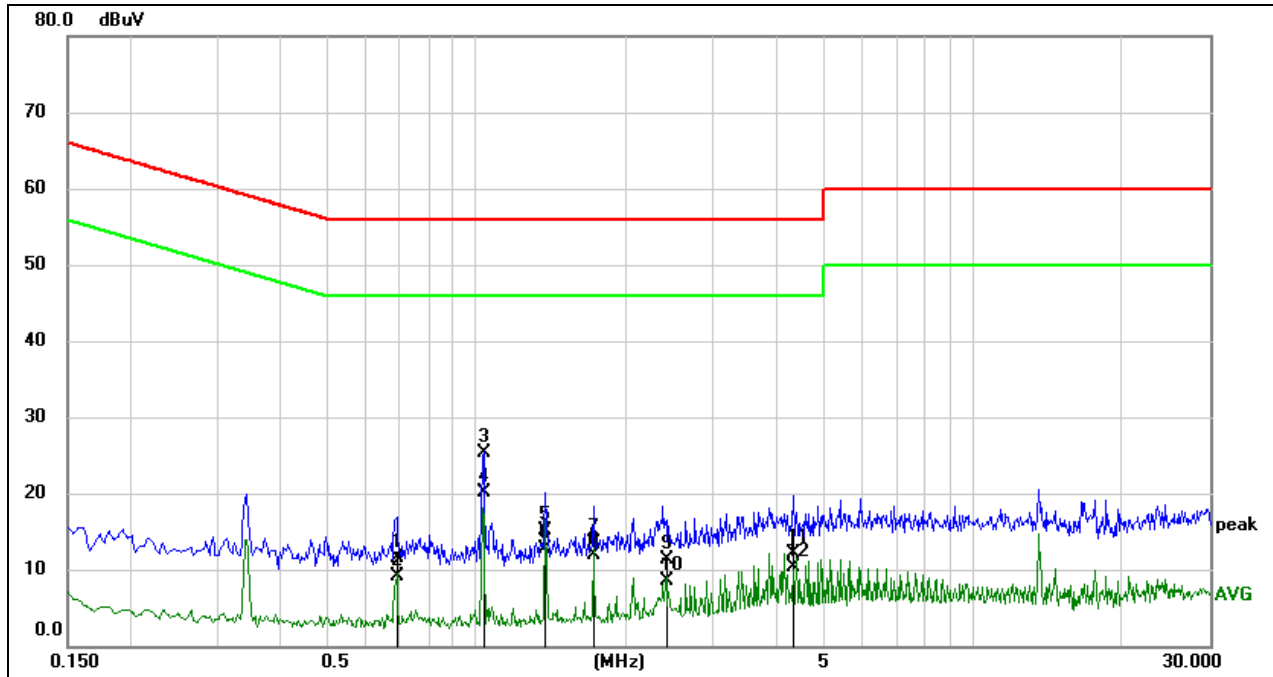

No.	Frequency (MHz)	Reading (dBuV)	Correct (dB)	Result (dBuV)	Limit (dBuV)	Margin (dB)	Remark
1	0.6892	1.85	9.60	11.45	56.00	-44.55	QP
2	0.6892	-0.58	9.60	9.02	46.00	-36.98	AVG
3	1.0327	15.64	9.61	25.25	56.00	-30.75	QP
4	1.0327	10.40	9.61	20.01	46.00	-25.99	AVG
5	1.3767	5.59	9.61	15.20	56.00	-40.80	QP
6	1.3767	3.17	9.61	12.78	46.00	-33.22	AVG
7	1.7211	3.81	9.62	13.43	56.00	-42.57	QP
8	1.7211	2.29	9.62	11.91	46.00	-34.09	AVG
9	2.4097	1.73	9.65	11.38	56.00	-44.62	QP
10	2.4097	-1.09	9.65	8.56	46.00	-37.44	AVG
11	4.3568	2.38	9.70	12.08	56.00	-43.92	QP
12	4.3568	0.59	9.70	10.29	46.00	-35.71	AVG

Note:

1. Result = Reading + Correct Factor.
2. If QP Result complies with AV limit, AV Result is deemed to comply with AV limit.
3. Test setup: RBW: 200 Hz (9 kHz ~ 150 kHz), 9 kHz (150 kHz ~ 30 MHz).
4. Step size: 80 Hz (0.009 MHz ~ 0.15 MHz), 4 kHz (0.15 MHz ~ 30 MHz), Scan time: auto.

Note: All the modes have been tested, only the worst data was recorded in the report.

11. TEST DATA

11.1. APPENDIX A: DTS BANDWIDTH

11.1.1. Test Result

Test Mode	Antenna	Channel	DTS BW [MHz]	FL[MHz]	FH[MHz]	Limit[MHz]	Verdict
11B-CDD	Ant1	2412	9.60	2406.92	2416.52	0.5	PASS
	Ant2	2412	10.12	2406.92	2417.04	0.5	PASS
	Ant1	2417	10.00	2412.00	2422.00	0.5	PASS
	Ant2	2417	9.52	2412.48	2422.00	0.5	PASS
	Ant1	2437	10.04	2431.96	2442.00	0.5	PASS
	Ant2	2437	9.52	2432.00	2441.52	0.5	PASS
	Ant1	2457	10.08	2451.96	2462.04	0.5	PASS
	Ant2	2457	10.08	2451.96	2462.04	0.5	PASS
11G-CDD	Ant1	2462	10.04	2456.96	2467.00	0.5	PASS
	Ant2	2462	10.04	2457.00	2467.04	0.5	PASS
	Ant1	2412	16.32	2403.84	2420.16	0.5	PASS
	Ant2	2412	16.36	2403.84	2420.20	0.5	PASS
	Ant1	2417	16.32	2408.84	2425.16	0.5	PASS
	Ant2	2417	16.36	2408.80	2425.16	0.5	PASS
	Ant1	2437	16.36	2428.80	2445.16	0.5	PASS
	Ant2	2437	16.36	2428.80	2445.16	0.5	PASS
11N20MIMO	Ant1	2457	16.36	2448.80	2465.16	0.5	PASS
	Ant2	2457	16.36	2448.80	2465.16	0.5	PASS
	Ant1	2462	16.36	2453.80	2470.16	0.5	PASS
	Ant2	2462	16.32	2453.84	2470.16	0.5	PASS
	Ant1	2412	17.72	2403.16	2420.88	0.5	PASS
	Ant2	2412	17.60	2403.20	2420.80	0.5	PASS
	Ant1	2417	17.56	2408.20	2425.76	0.5	PASS
	Ant2	2417	17.60	2408.20	2425.80	0.5	PASS
11N20MIMO	Ant1	2437	17.60	2428.20	2445.80	0.5	PASS
	Ant2	2437	17.76	2428.12	2445.88	0.5	PASS
	Ant1	2457	17.60	2448.20	2465.80	0.5	PASS
	Ant2	2457	17.60	2448.20	2465.80	0.5	PASS
	Ant1	2462	17.60	2453.20	2470.80	0.5	PASS
	Ant2	2462	17.76	2453.12	2470.88	0.5	PASS

11.1.2. Test Graphs

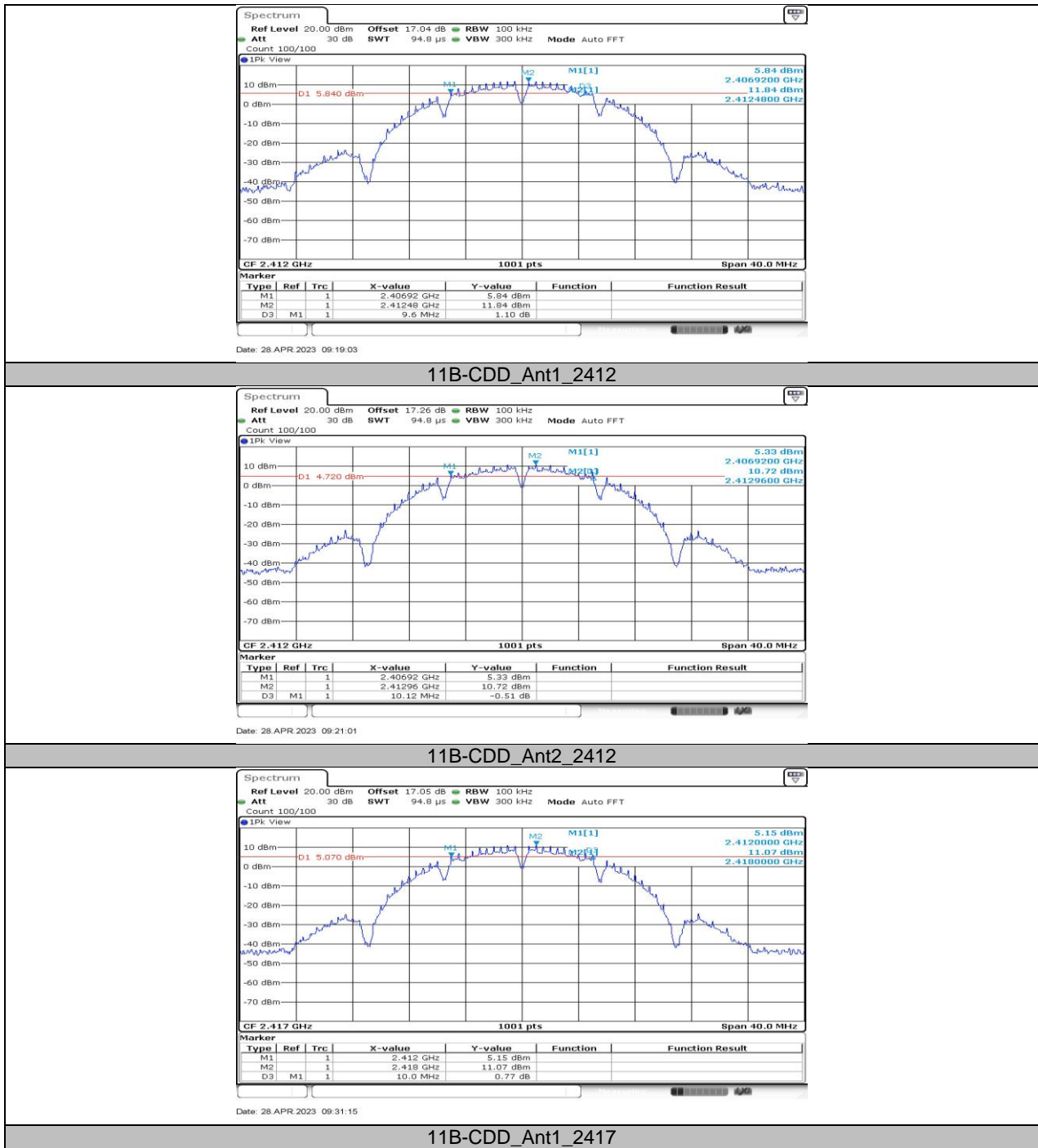

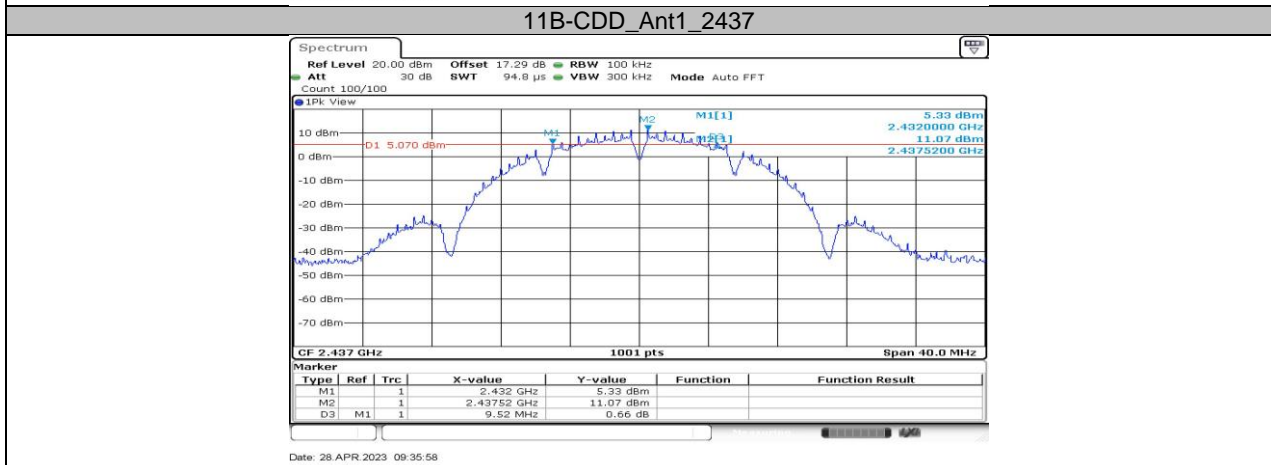
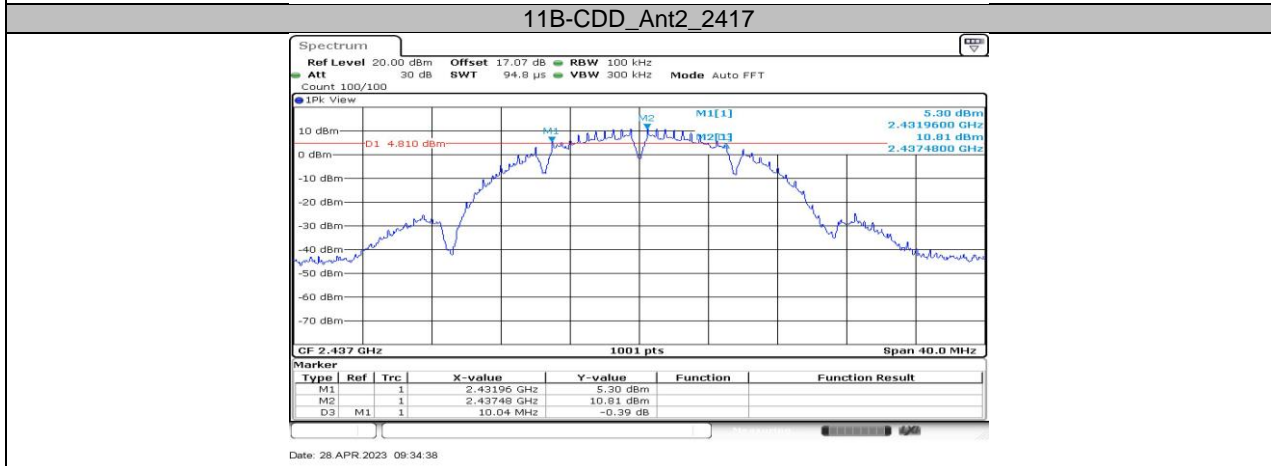
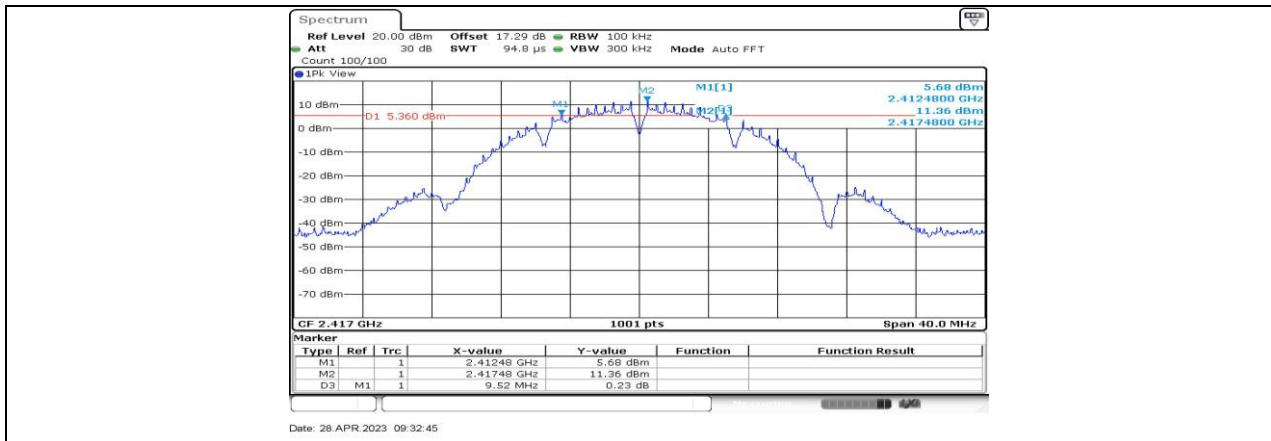

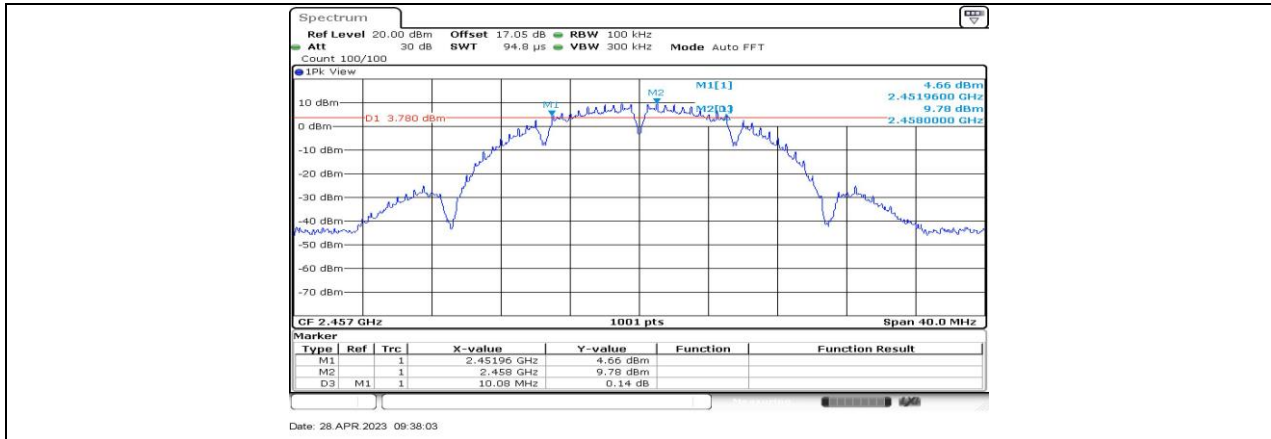

11B-CDD_Ant1_2457

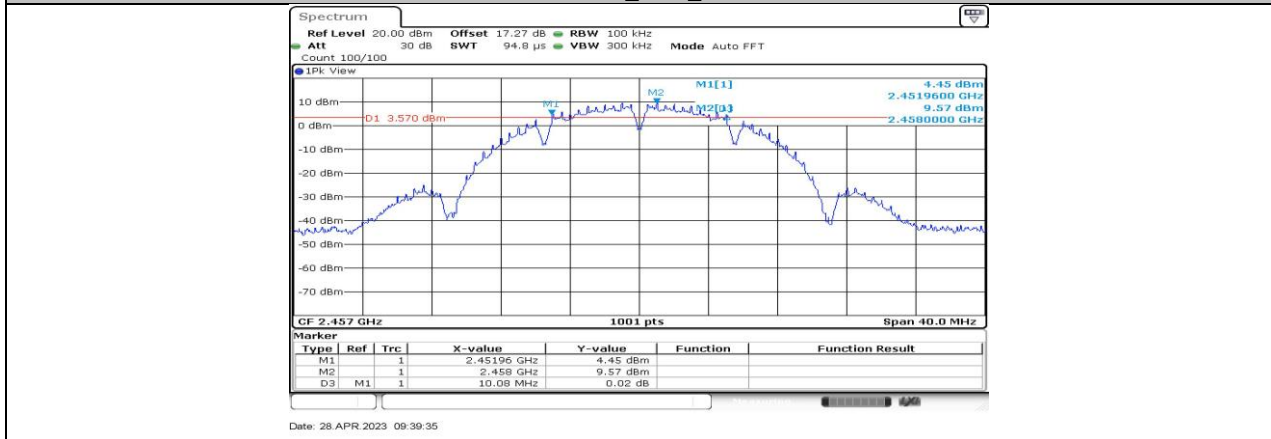

11B-CDD_Ant2_2457

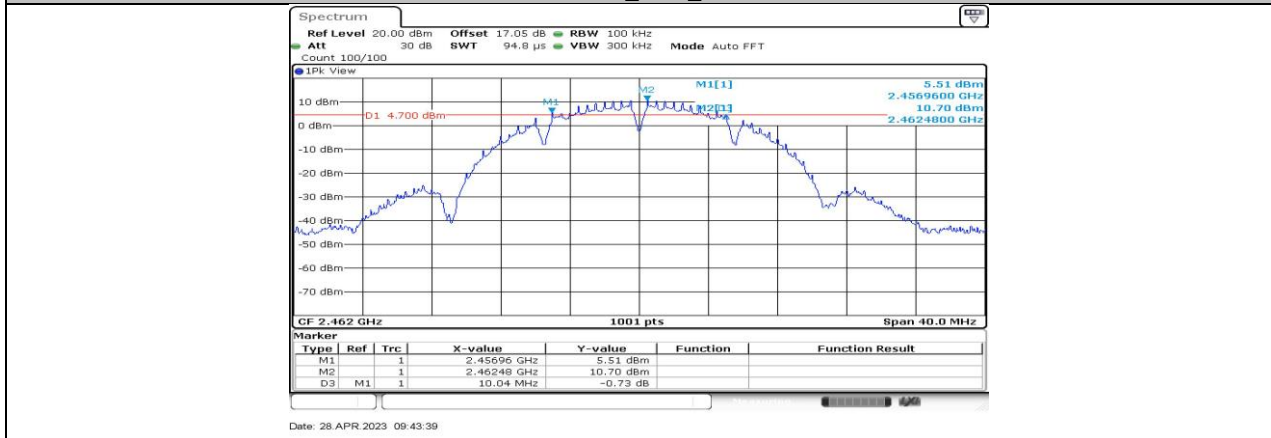

11B-CDD_Ant1_2462

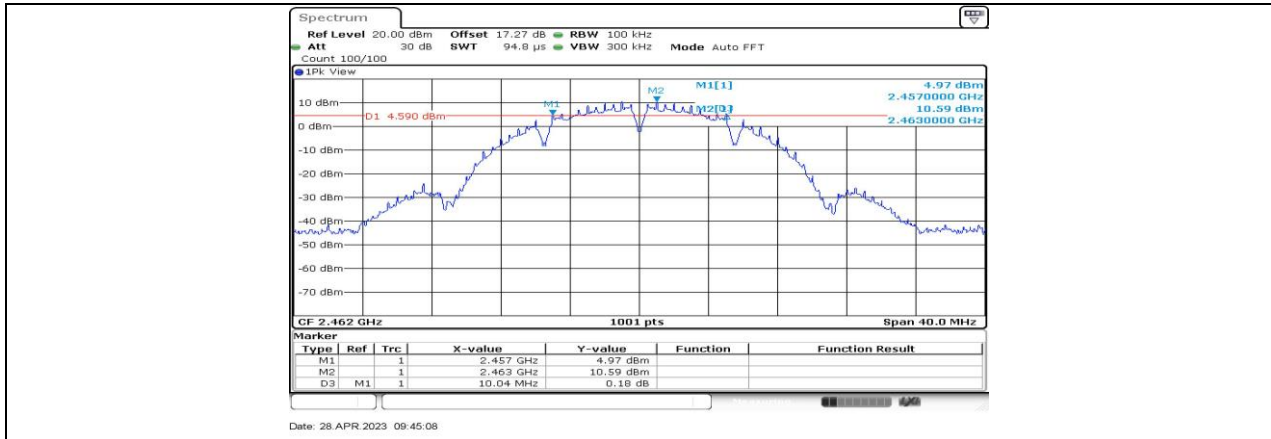

Date: 28 APR 2023 09:45:08

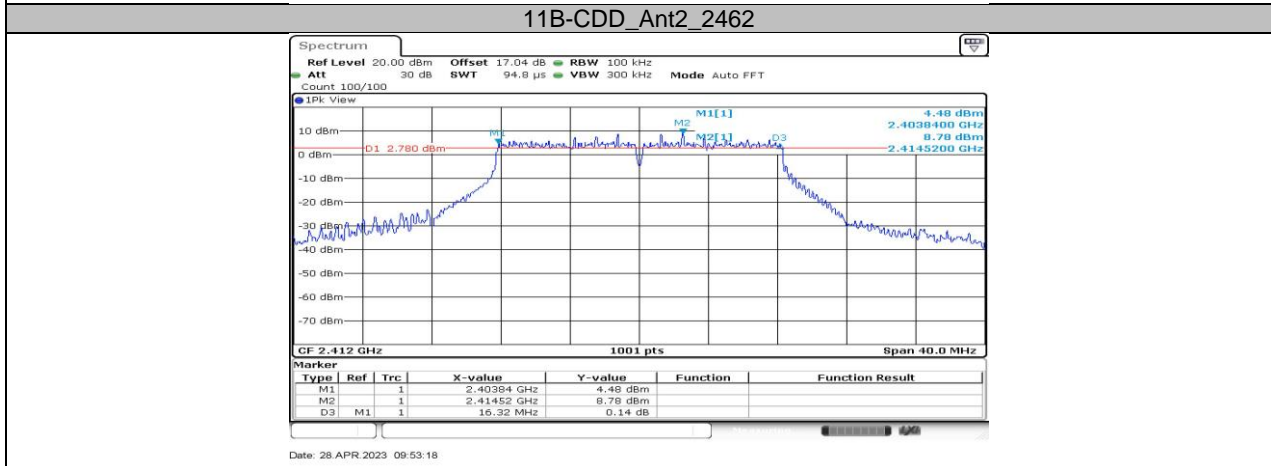

Date: 28 APR 2023 09:53:18

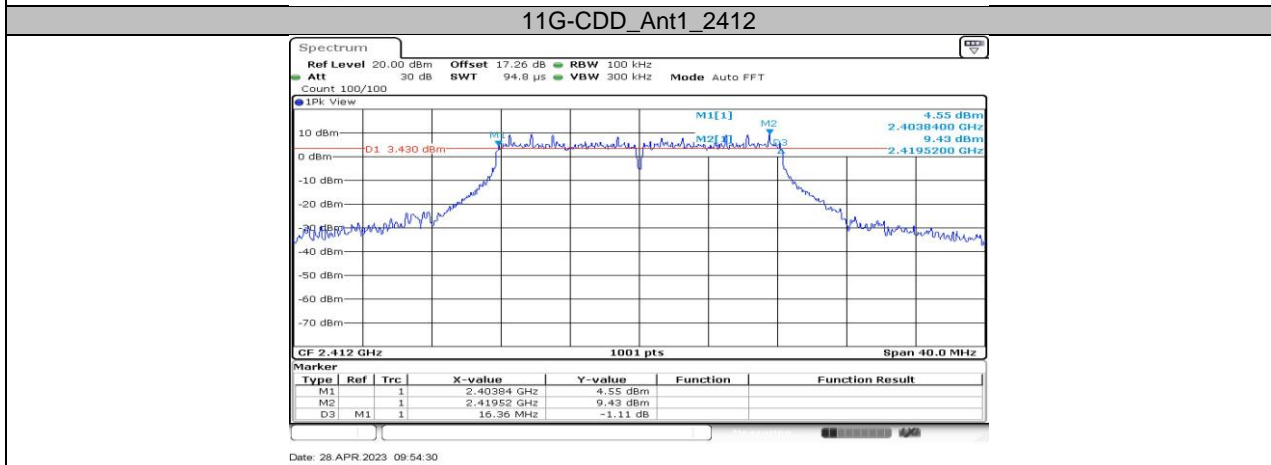

Date: 28 APR 2023 09:54:30

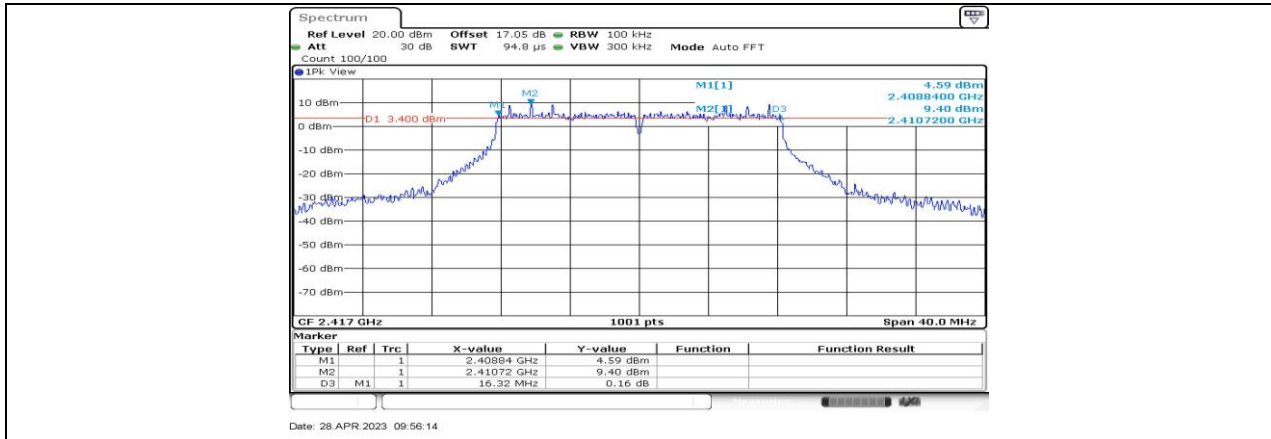

11G-CDD_Ant1_2417

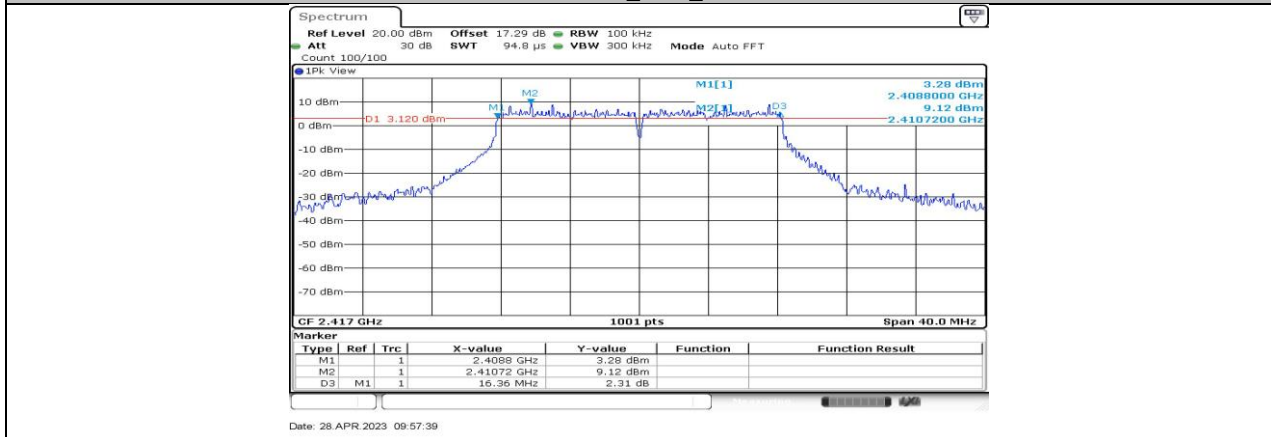

11G-CDD_Ant2_2417

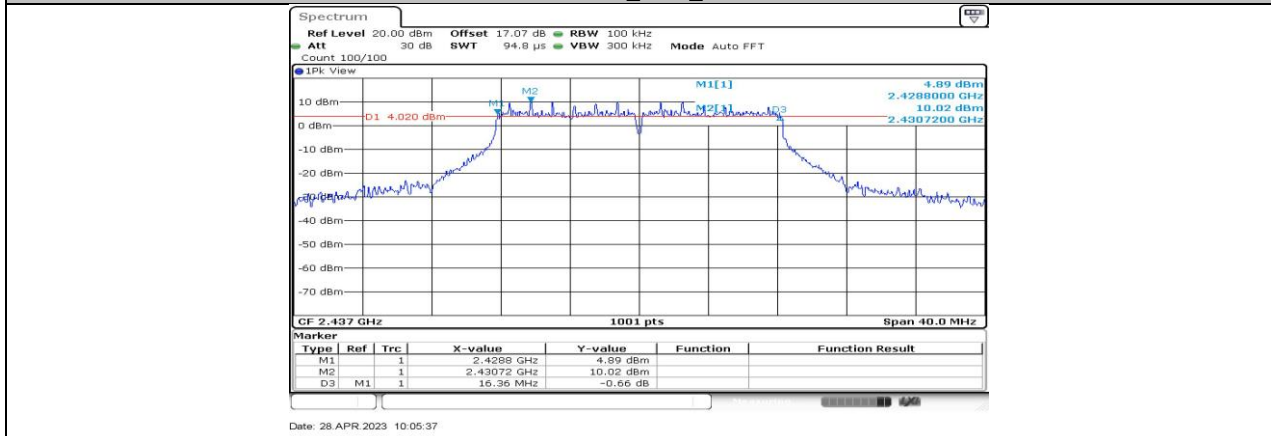

11G-CDD_Ant1_2437

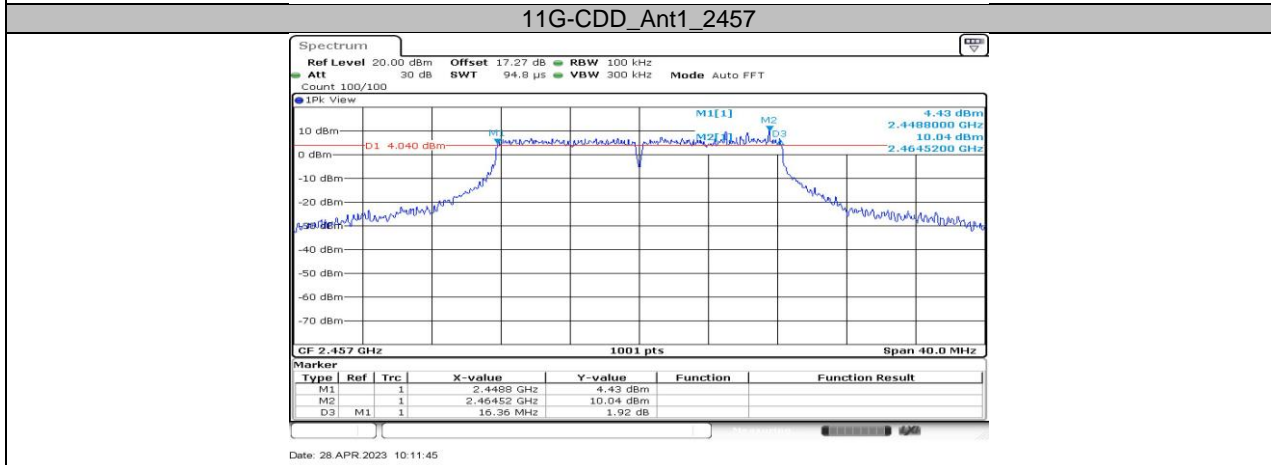
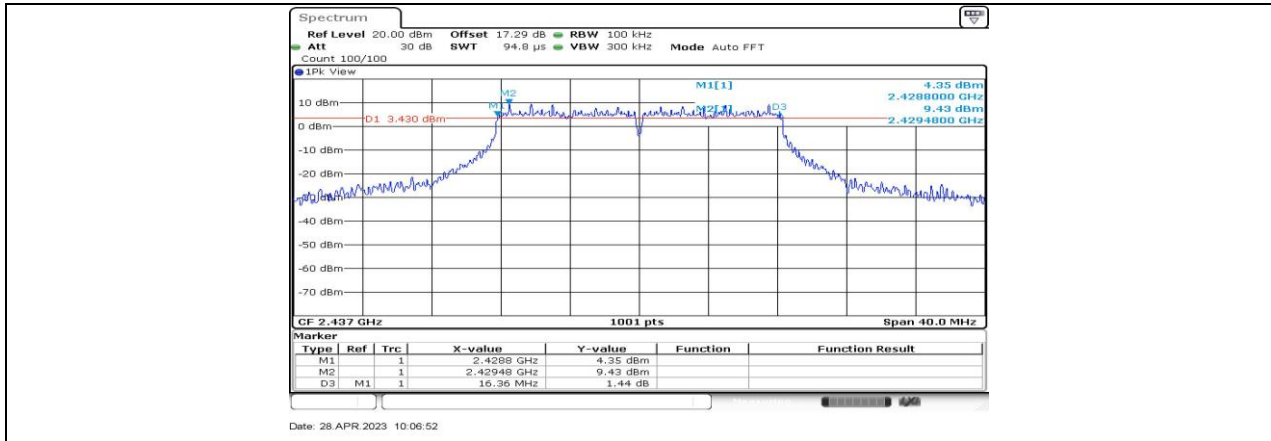

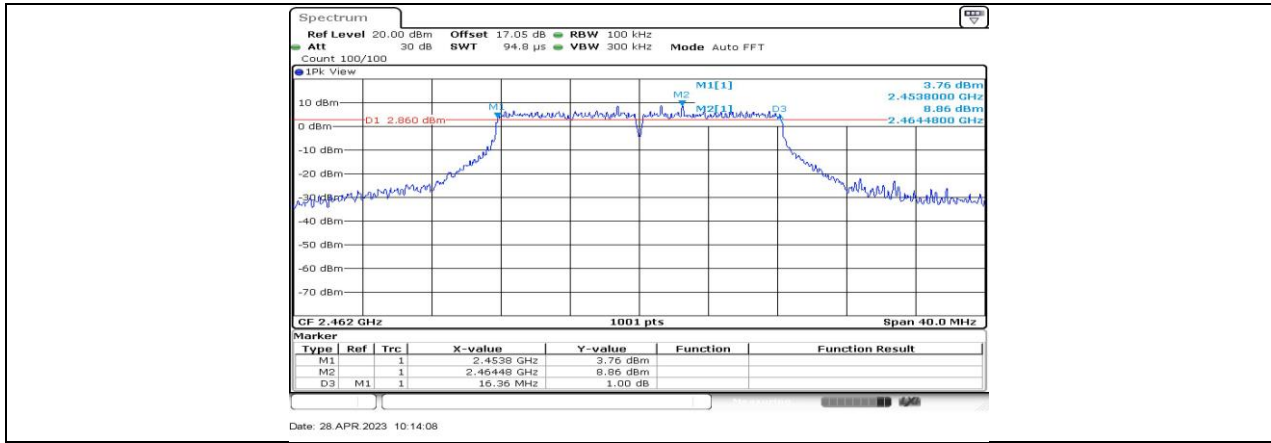

11G-CDD_Ant1_2462

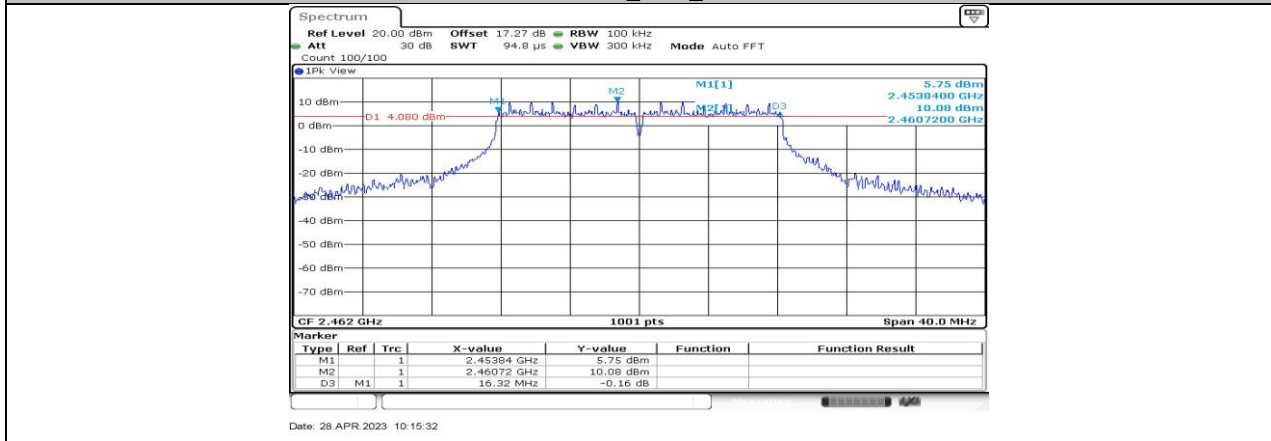

11G-CDD_Ant2_2462

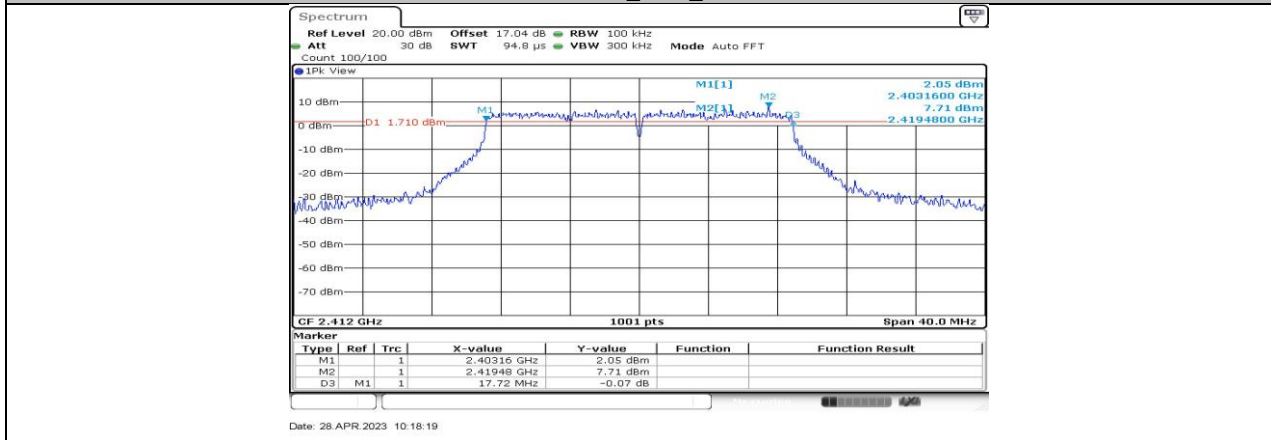

11N20MIMO_Ant1_2412

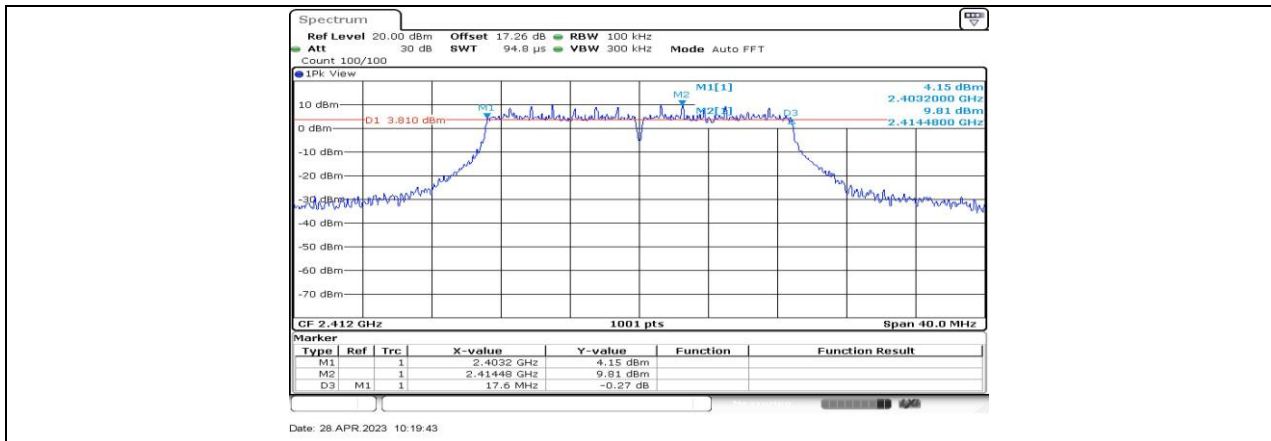

11N20MIMO_Ant2_2412

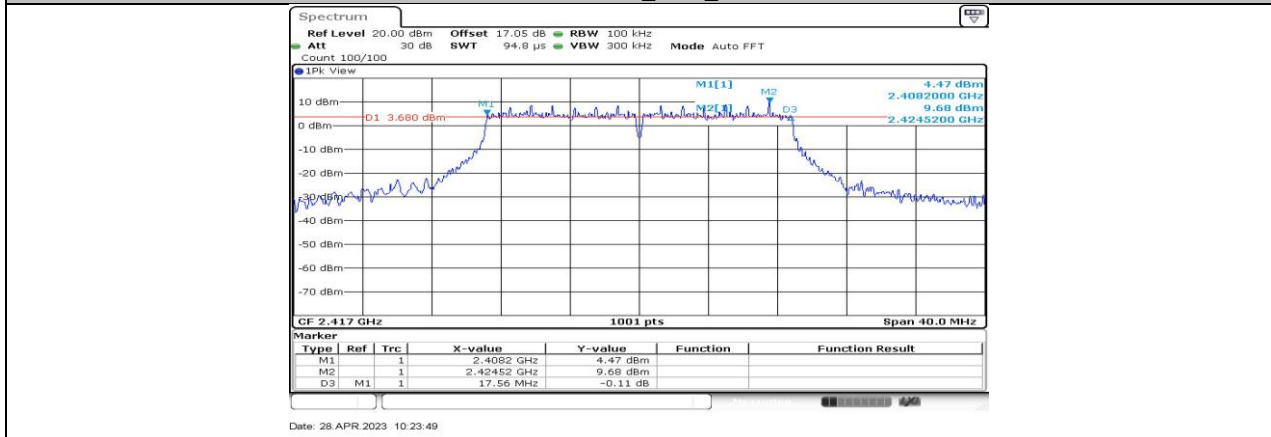

11N20MIMO_Ant1_2417

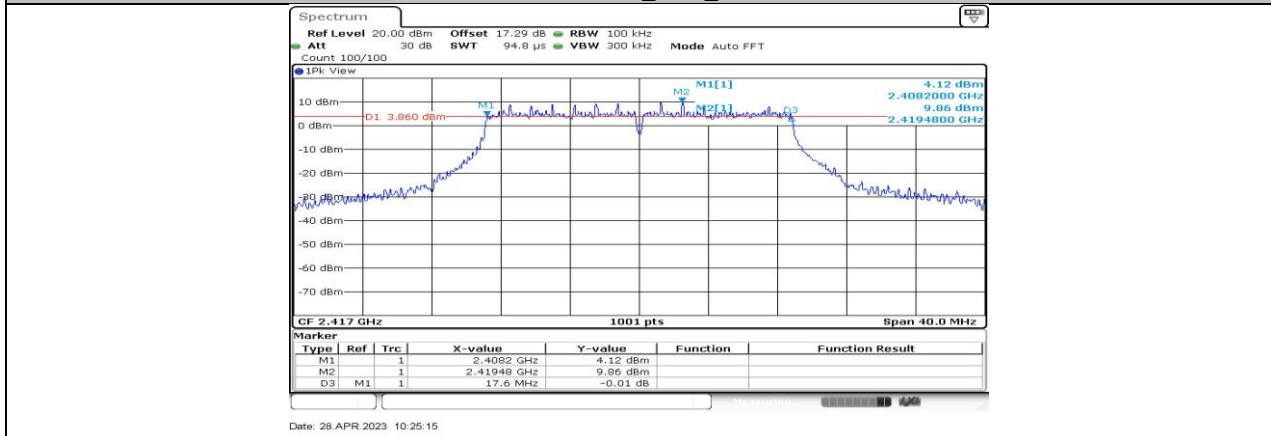

11N20MIMO_Ant2_2417

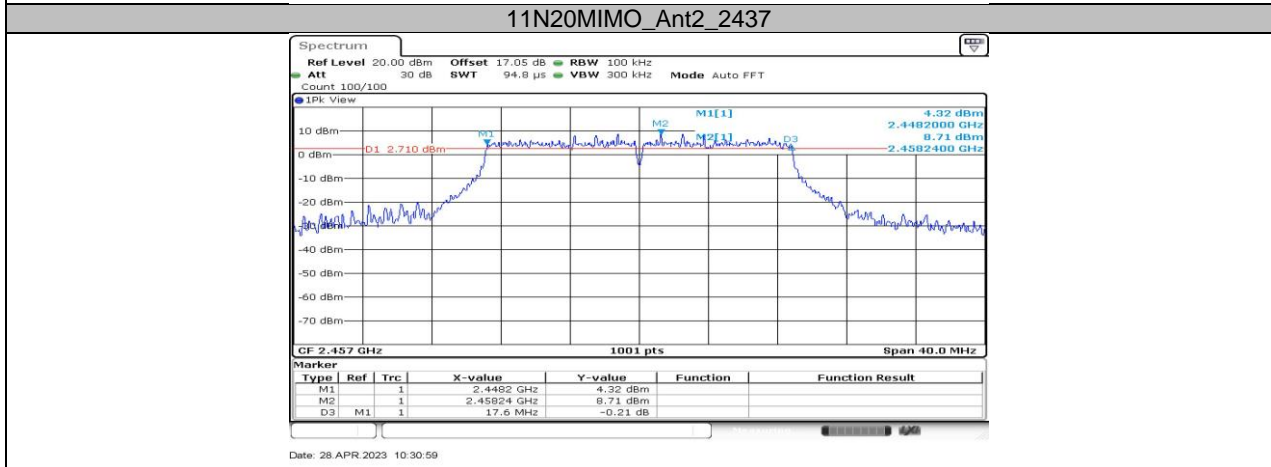
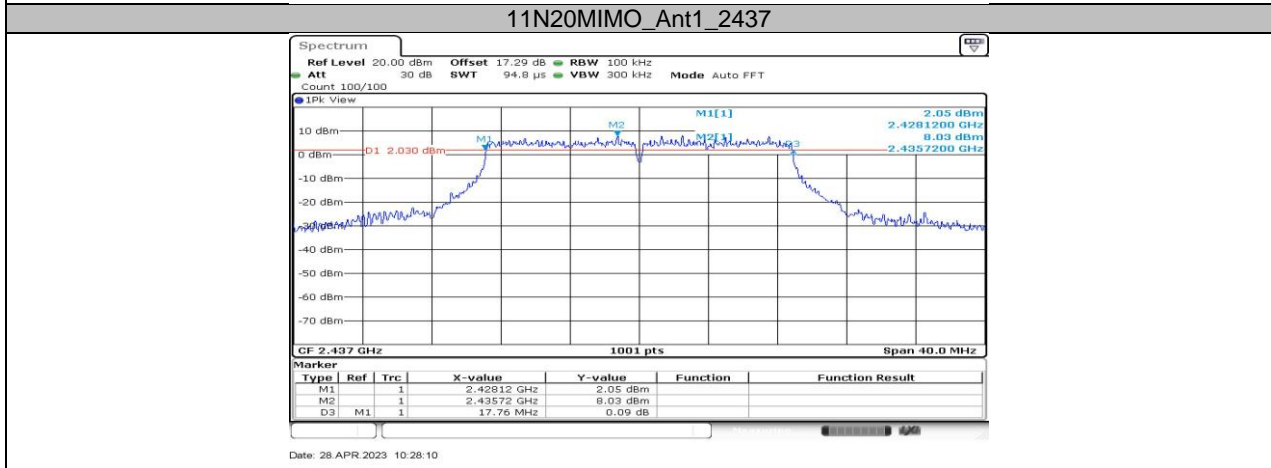
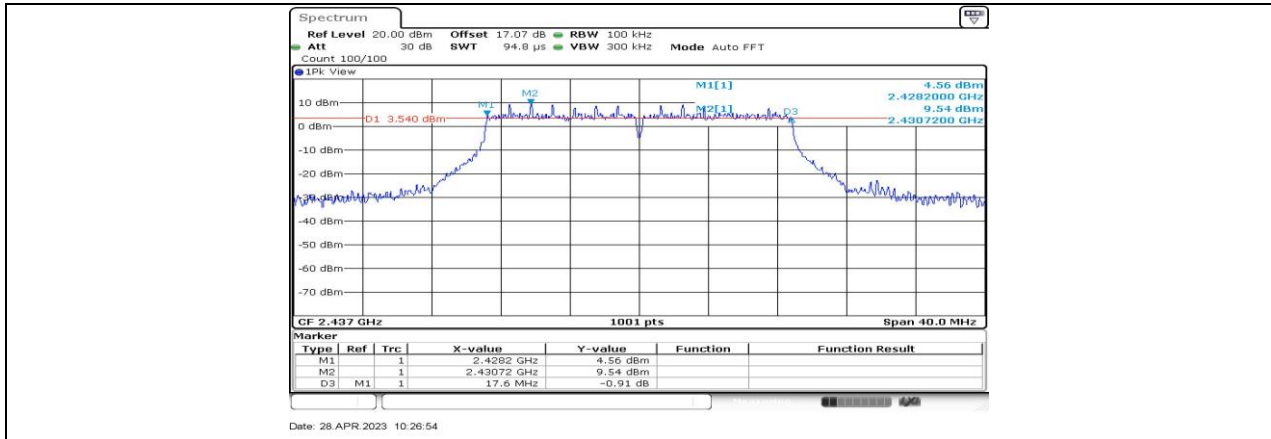

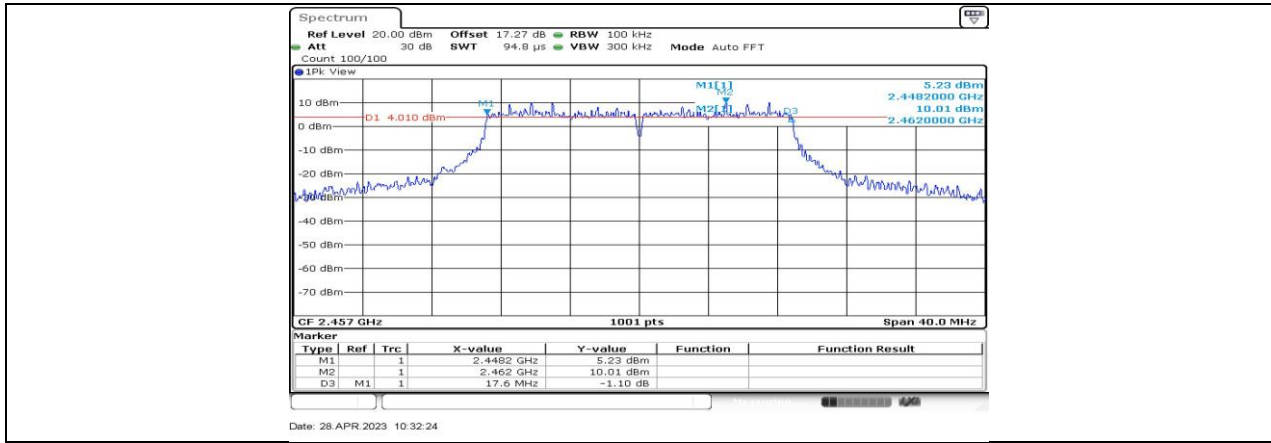

11N20MIMO_Ant2_2457

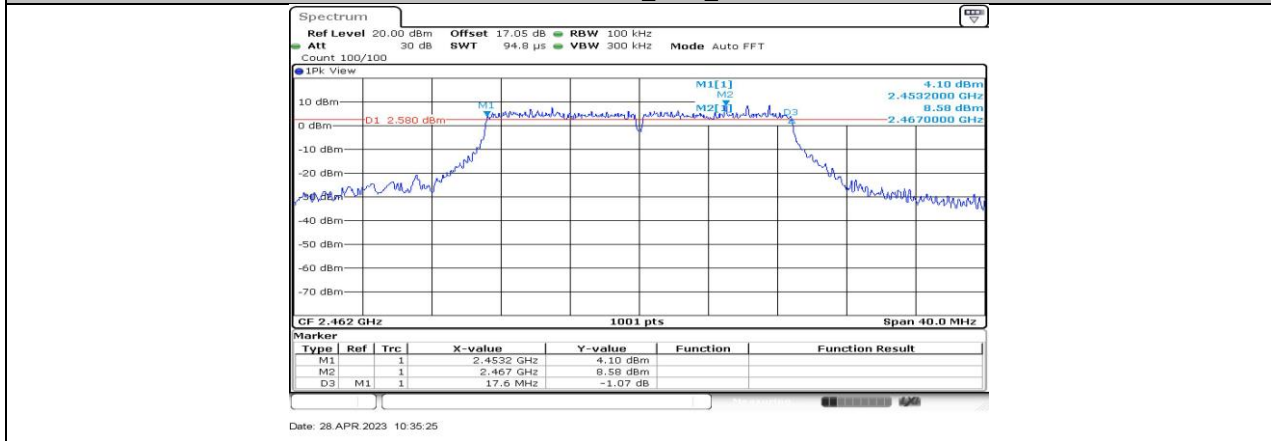

11N20MIMO_Ant1_2462

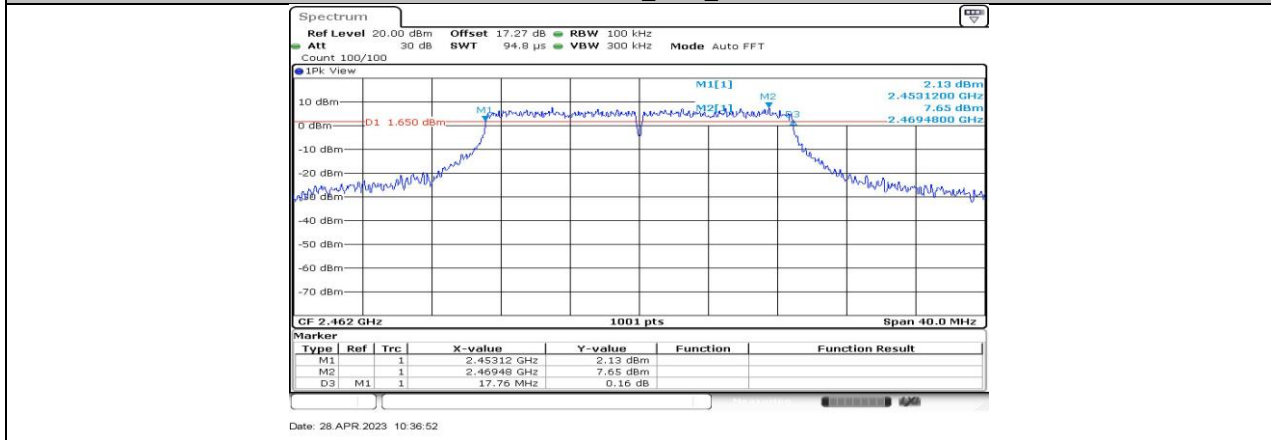

11N20MIMO_Ant2_2462

11.2. APPENDIX B: OCCUPIED CHANNEL BANDWIDTH

11.2.1. Test Result

Test Mode	Antenna	Channel	OCB [MHz]	FL[MHz]	FH[MHz]	Verdict
11B-CDD	Ant1	2412	15.225	2404.3676	2419.5924	PASS
	Ant2	2412	15.185	2404.4076	2419.5924	PASS
	Ant1	2417	15.185	2409.4076	2424.5924	PASS
	Ant2	2417	15.145	2409.4476	2424.5924	PASS
	Ant1	2437	15.225	2429.4076	2444.6324	PASS
	Ant2	2437	15.225	2429.4076	2444.6324	PASS
	Ant1	2457	15.225	2449.4076	2464.6324	PASS
	Ant2	2457	15.225	2449.4076	2464.6324	PASS
	Ant1	2462	15.225	2454.4076	2469.6324	PASS
	Ant2	2462	15.185	2454.4076	2469.5924	PASS
11G-CDD	Ant1	2412	17.862	2403.0490	2420.9111	PASS
	Ant2	2412	17.622	2403.2488	2420.8711	PASS
	Ant1	2417	17.902	2408.0490	2425.9510	PASS
	Ant2	2417	17.662	2408.2088	2425.8711	PASS
	Ant1	2437	17.862	2428.0490	2445.9111	PASS
	Ant2	2437	17.742	2428.1289	2445.8711	PASS
	Ant1	2457	17.902	2448.0889	2465.9910	PASS
	Ant2	2457	17.822	2448.0889	2465.9111	PASS
	Ant1	2462	17.902	2453.0490	2470.9510	PASS
	Ant2	2462	17.822	2453.0490	2470.8711	PASS
11N20MIMO	Ant1	2412	18.741	2402.6094	2421.3506	PASS
	Ant2	2412	18.701	2402.6893	2421.3906	PASS
	Ant1	2417	18.701	2407.6494	2426.3506	PASS
	Ant2	2417	18.741	2407.6494	2426.3906	PASS
	Ant1	2437	18.701	2427.6494	2446.3506	PASS
	Ant2	2437	18.781	2427.6094	2446.3906	PASS
	Ant1	2457	18.821	2447.5694	2466.3906	PASS
	Ant2	2457	18.861	2447.5694	2466.4306	PASS
	Ant1	2462	18.781	2452.6494	2471.4306	PASS
	Ant2	2462	18.901	2452.5694	2471.4705	PASS

11.2.2. Test Graphs

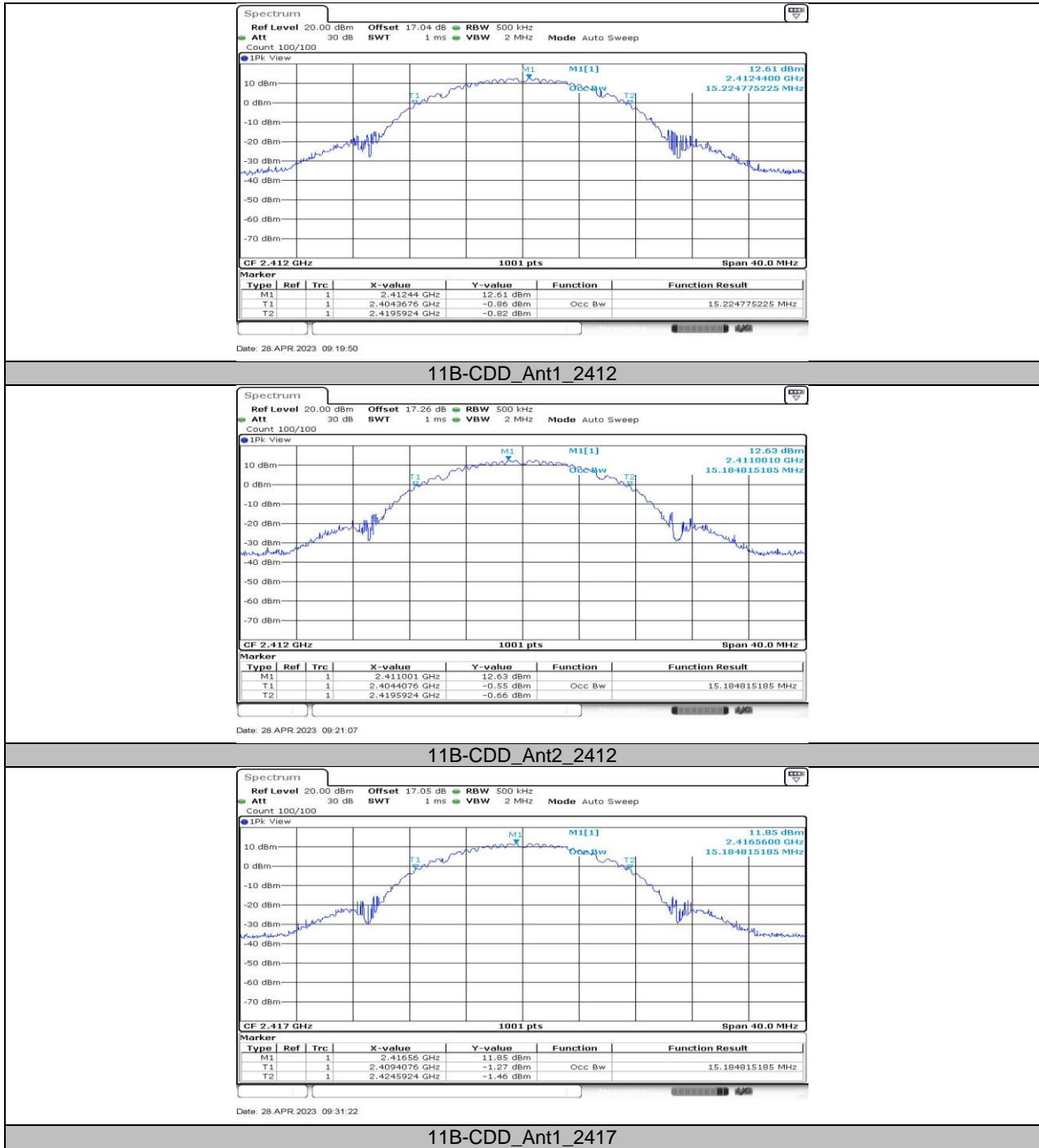

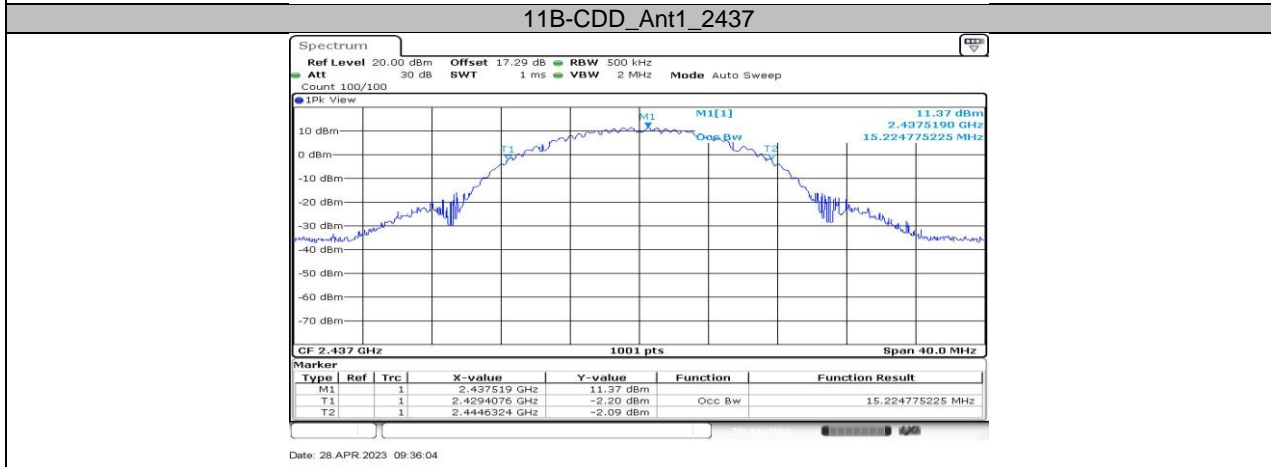
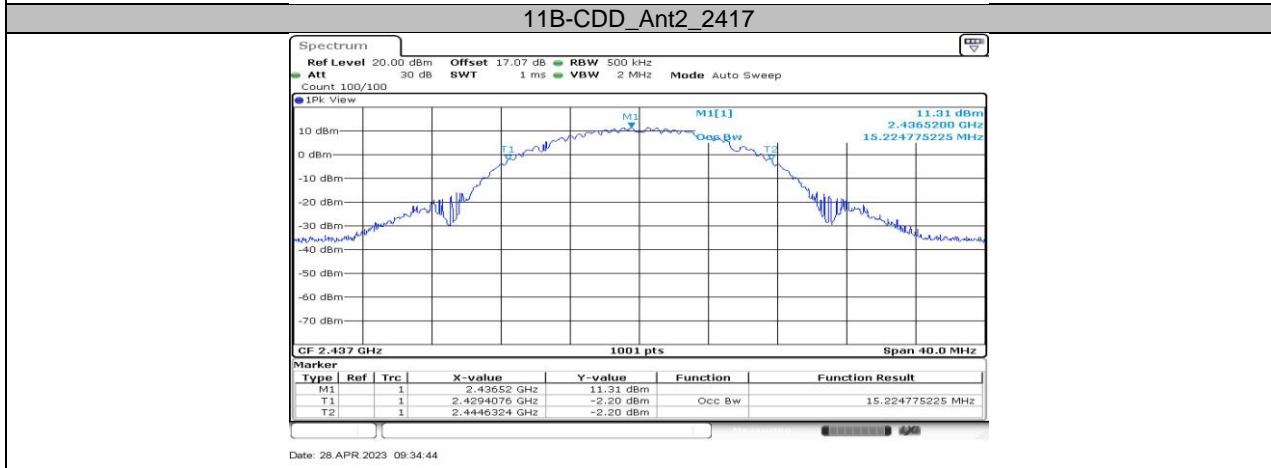
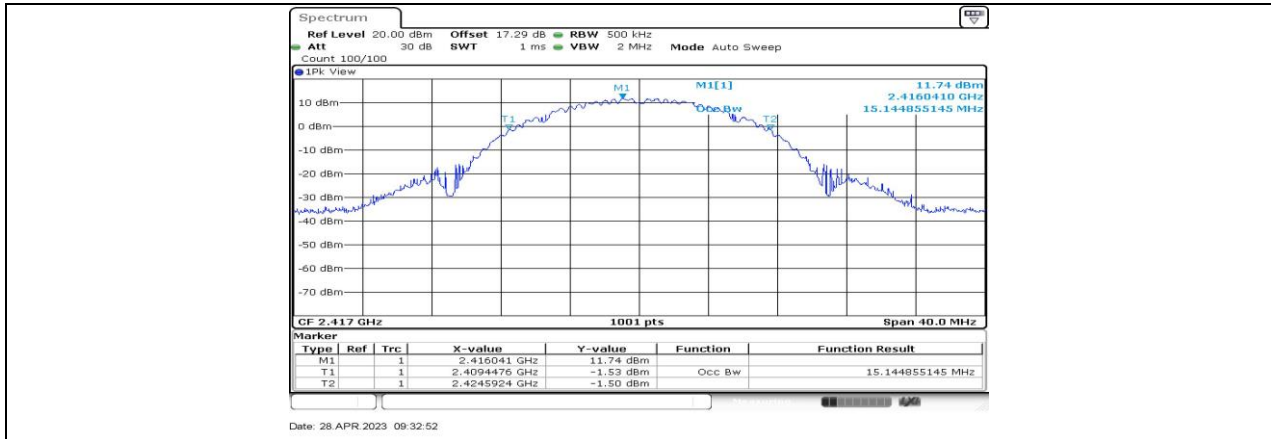

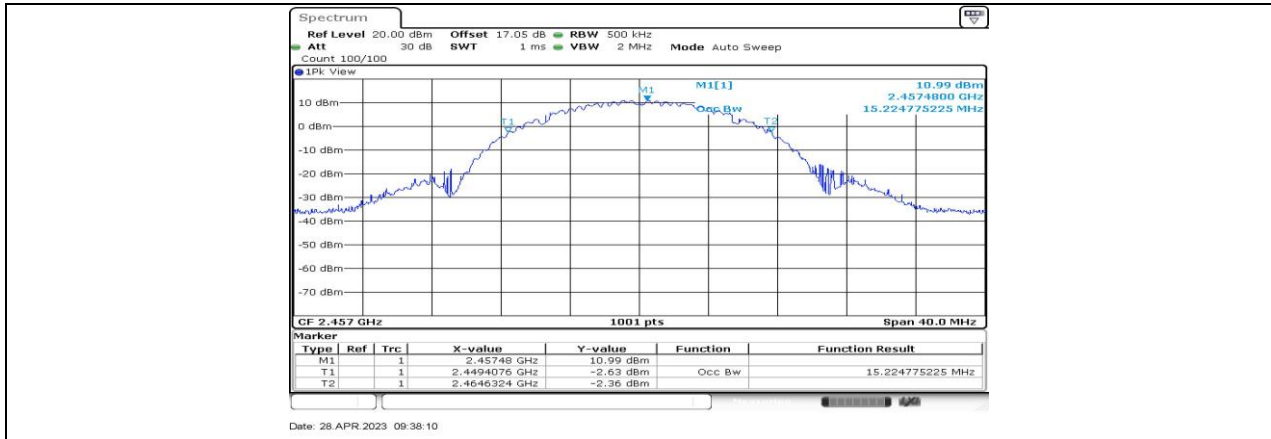

11B-CDD_Ant1_2457

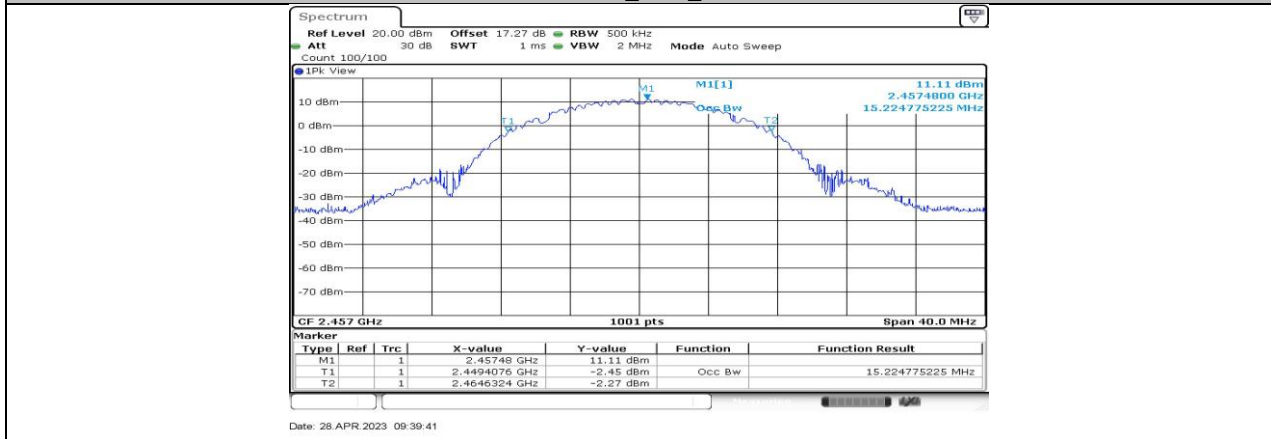

11B-CDD_Ant2_2457

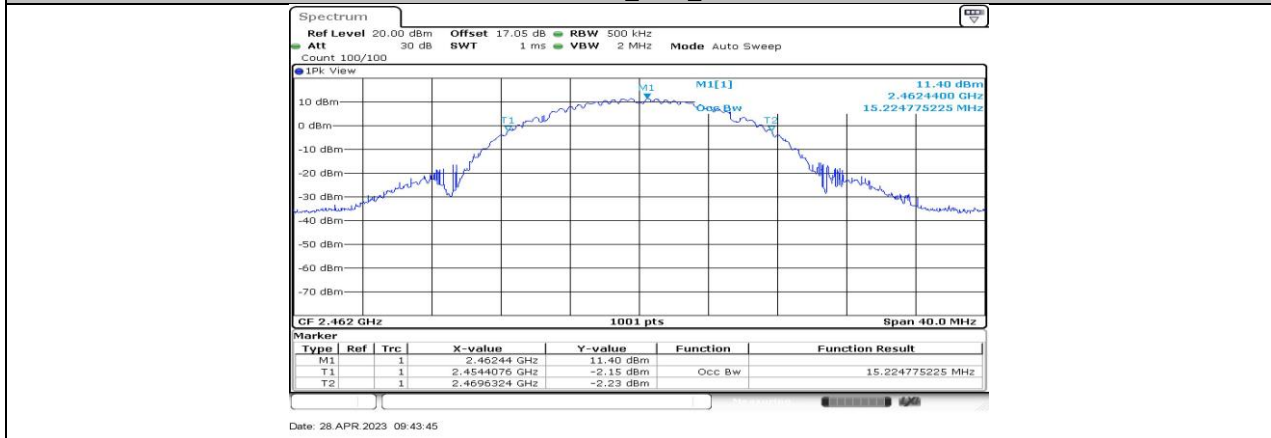

11B-CDD_Ant1_2462