

## RF MEASUREMENT REPORT

---

**FCC ID** : 2AXJ4C510W  
**Applicant** : TP-Link Corporation Limited  
**Application Type** : Certification  
**Product** : Outdoor Pan/Tilt Security Wi-Fi Camera  
**Model No.** : Tapo C510W  
**Brand Name** : tp-link  
**FCC Classification** : Digital Transmission System (DTS)  
**FCC Rule Part(s)** : Part15 Subpart C (Section 15.247)  
**Received Date** : May 5, 2023  
**Test Date** : May 10, 2023~June 05, 2023

**Tested By** : Owen Tsai  
( Owen Tsai )

**Reviewed By** : Paddy Chen  
( Paddy Chen )

**Approved By** : Chenz Ker  
( Chenz Ker )



The test results relate only to the samples tested.

This equipment has been shown to be capable of compliance with the applicable technical standards as indicated in the measurement report and was tested in accordance with the measurement procedures specified in ANSI C63.10-2013. Test results reported herein relate only to the item(s) tested.

The test report shall not be reproduced except in full without the written approval of MRT Technology (Taiwan) Co., Ltd.

---

## Revision History

Report No.	Version	Description	Issue Date	Note
2305TW0104-U2	1.0	Original Report	2023-06-14	Valid

---

## CONTENTS

Description	Page
<b>1. INTRODUCTION</b> .....	<b>6</b>
1.1. Scope .....	6
1.2. MRT Test Location .....	6
<b>2. PRODUCT INFORMATION</b> .....	<b>7</b>
2.1. Feature of Equipment under Test .....	7
2.2. Product Specification Subjective to this Report.....	7
2.3. Working Frequencies for this report .....	8
2.4. Test Mode.....	8
2.5. Configuration of Test System.....	9
2.6. Test System Details.....	9
2.7. Description of Test Software .....	9
2.8. Applied Standards .....	10
2.9. Duty Cycle .....	10
2.10. Test Configuration .....	11
2.11. EMI Suppression Device(s)/Modifications.....	11
2.12. Labeling Requirements.....	11
<b>3. DESCRIPTION of TEST</b> .....	<b>12</b>
3.1. Evaluation Procedure .....	12
3.2. AC Line Conducted Emissions.....	12
3.3. Radiated Emissions .....	13
<b>4. ANTENNA REQUIREMENTS</b> .....	<b>14</b>
<b>5. TEST EQUIPMENT CALIBRATION DATE</b> .....	<b>15</b>
<b>6. MEASUREMENT UNCERTAINTY</b> .....	<b>16</b>
<b>7. TEST RESULT</b> .....	<b>17</b>
7.1. Summary .....	17
7.2. 6dB Bandwidth Measurement.....	18
7.2.1. Test Limit.....	18
7.2.2. Test Procedure used.....	18
7.2.3. Test Setting .....	18
7.2.4. Test Setup .....	18
7.2.5. Test Result .....	19
7.3. Output Power Measurement .....	23
7.3.1. Test Limit.....	23
7.3.2. Test Procedure Used.....	23
7.3.3. Test Setting .....	23
7.3.4. Test Setup .....	23

---

7.3.5. Test Result .....	24
7.4. Power Spectral Density Measurement .....	25
7.4.1. Test Limit .....	25
7.4.2. Test Procedure Used .....	25
7.4.3. Test Setting .....	25
7.4.4. Test Setup .....	26
7.4.5. Test Result .....	27
7.5. Conducted Band Edge and Out-of-Band Emissions.....	31
7.5.1. Test Limit .....	31
7.5.2. Test Procedure Used .....	31
7.5.3. Test Setting .....	31
7.5.4. Test Setup .....	32
7.5.5. Test Result .....	33
7.6. Radiated Spurious Emission Measurement .....	37
7.6.1. Test Limit .....	37
7.6.2. Test Procedure Used .....	37
7.6.3. Test Setting .....	37
7.6.4. Test Setup .....	39
7.6.5. Test Result .....	40
7.7. Radiated Restricted Band Edge Measurement .....	60
7.7.1. Test Limit .....	60
7.7.2. Test Procedure Used .....	61
7.7.3. Test Setting .....	61
7.7.4. Test Setup .....	62
7.7.5. Test Result .....	63
7.8. AC Conducted Emissions Measurement.....	99
7.8.1. Test Limit .....	99
7.8.2. Test Setup .....	99
7.8.3. Test Result .....	100
<b>8. CONCLUSION .....</b>	<b>104</b>
<b>Appendix A : Test Setup Photograph .....</b>	<b>105</b>
<b>Appendix B : External Photograph.....</b>	<b>105</b>
<b>Appendix C : Internal Photograph.....</b>	<b>105</b>

## General Information

<b>Applicant</b>	TP-Link Corporation Limited
<b>Applicant Address</b>	Room 901, 9/F., New East Ocean Centre, 9 Science Museum Road, Tsim Sha Tsui, Kowloon, Hongkong
<b>Manufacturer</b>	TP-Link Corporation Limited
<b>Manufacturer Address</b>	Room 901, 9/F., New East Ocean Centre, 9 Science Museum Road, Tsim Sha Tsui, Kowloon, Hongkong
<b>Test Site</b>	MRT Technology (Taiwan) Co., Ltd
<b>Test Site Address</b>	No. 38, Fuxing Second Rd., Guishan Dist., Taoyuan City 333, Taiwan (R.O.C)
<b>MRT FCC Registration No.</b>	291082
<b>FCC Rule Part(s)</b>	Part 15.247

## Test Facility / Accreditations

1. MRT facility is a FCC registered (Reg. No. 291082) test facility with the site description report on file and is designated by the FCC as an Accredited Test Firm.
2. MRT facility is an IC registered (MRT Reg. No. 21723) test laboratory with the site description on file at Industry Canada.
3. MRT Lab is accredited to ISO 17025 by the Taiwan Accreditation Foundation (TAF Cert. No. 3261) in EMC, Telecommunications and Radio testing for FCC (Designation Number: TW3261), Industry Canada, EU and TELEC Rules.

# 1. INTRODUCTION

## 1.1. Scope

Measurement and determination of electromagnetic emissions (EMC) of radio frequency devices including intentional and/or unintentional radiators for compliance with the technical rules and regulations of the Federal Communications Commission and the Innovation, Science and Economic Development Canada and Certification and Engineering Bureau.

## 1.2. MRT Test Location

The map below shows the location of the MRT LABORATORY, its proximity to the Taoyuan City. These measurement tests were conducted at the MRT Technology (Taiwan) Co., Ltd. Facility located at No.38, Fuxing 2nd Rd., Guishan Dist., Taoyuan City 33377, Taiwan (R.O.C).

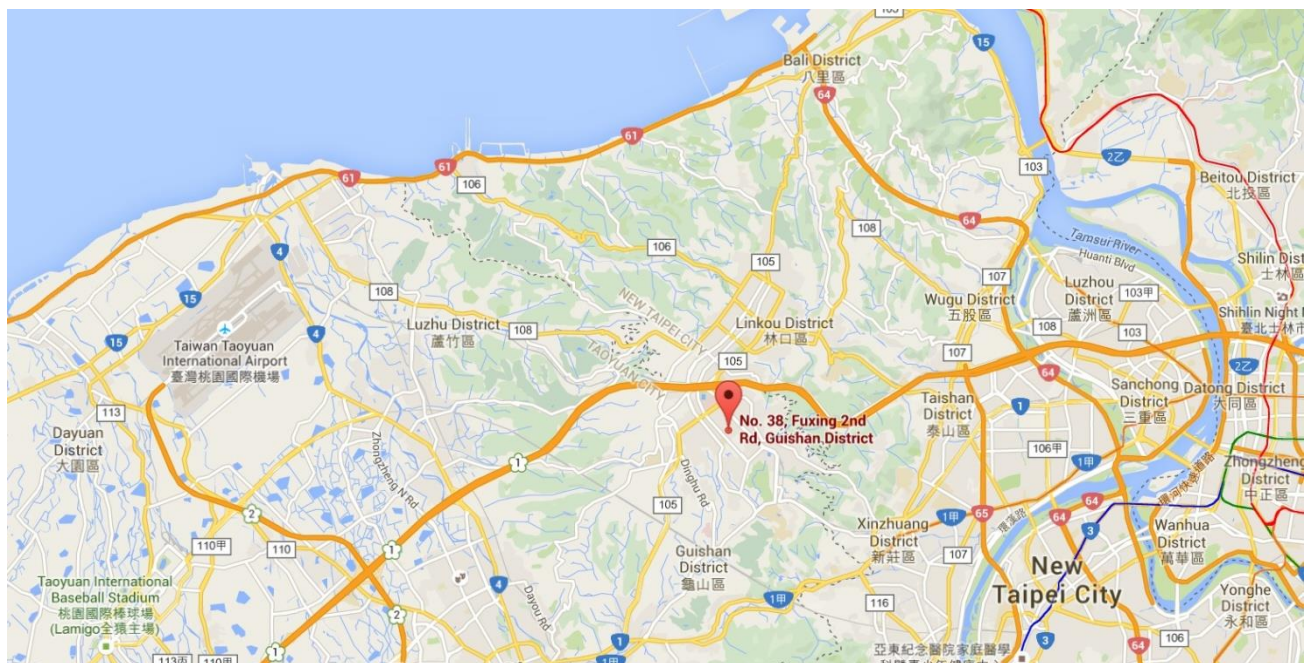

## 2. PRODUCT INFORMATION

### 2.1. Feature of Equipment under Test

Product Name:	Outdoor Pan/Tilt Security Wi-Fi Camera
Model No.:	Tapo C510W
Brand Name:	tp-link
Wi-Fi Specification:	802.11b/g/n
EUT Identification No.:	#1-1 (Conducted) #1-2 (Radiated)
Accessory	
Adapter	BRAND: tp-link MODEL: T120100-2B1 INPUT: 100 - 240V ~ 50/60Hz 0.3A. OUTPUT: DC 12.0V /1A

### 2.2. Product Specification Subjective to this Report

Frequency Range:	802.11b/g/n-HT20: 2412 ~ 2462MHz
Channel Number:	802.11b/g/n-HT20: 11
Type of Modulation:	802.11b: DSSS 802.11g/n: OFDM
Data Rate:	802.11b: 1/2/5.5/11Mbps 802.11g: 6/9/12/18/24/36/48/54Mbps 802.11n: up to 72.2Mbps
Antenna Type:	Dipole antenna
Antenna Gain:	2.0dBi

### 2.3. Working Frequencies for this report

802.11b/g/n-HT20

Channel	Frequency	Channel	Frequency	Channel	Frequency
01	2412 MHz	02	2417 MHz	03	2422 MHz
04	2427 MHz	05	2432 MHz	06	2437 MHz
07	2442 MHz	08	2447 MHz	09	2452 MHz
10	2457 MHz	11	2462 MHz	--	--

### 2.4. Test Mode

Mode 1: Transmit by 802.11b (1Mbps)

Mode 2: Transmit by 802.11g (6Mbps)

Mode 3: Transmit by 802.11n-HT20 (MCS0)

Note:

1. For Radiated emission, the modulation and the data rate picked for testing are determined by the Max. RF conducted power.
2. As Designated by manufacturer, the lowest data rate was the worst condition, so all the tests were done with lowest data rate.



## 2.5. Configuration of Test System

The device was tested per the guidance ANSI C63.10: 2013 was used to reference the appropriate EUT setup for radiated emissions testing and AC line conducted testing.

Connection Diagram

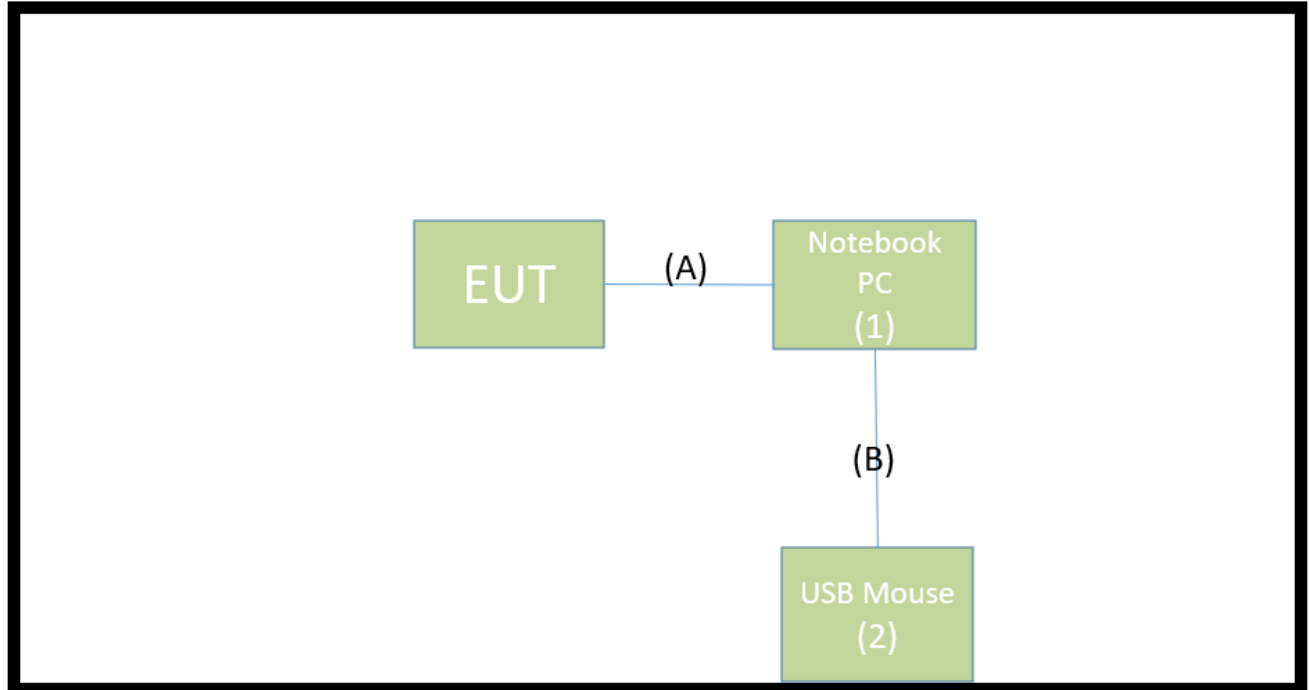

	Cable Type	Cable Description
A	USB Cable	Shielded, 1.0m
B	USB Mouse Cable	Shielded, 1.8m

## 2.6. Test System Details

The types for all equipments, plus descriptions of all cables used in the tested system (including inserted cards) are:

	Product	Manufacturer	Model No.	Serial No.	Power Cord
1	Notebook PC	Lenovo	T450	N/A	Non-Shielded, 0.8m
2	USB Mouse	Logitech	M90	N/A	N/A

## 2.7. Description of Test Software

The test utility software used during testing was “RTL11n\_8188FTV\_USB”, the version is ver1.25.

Note: Final power setting please refer to operational description.

## 2.8. Applied Standards

According to the specifications of the manufacturer, the EUT must comply with the requirements of the following standards:

- FCC Part 15.247
- KDB 558074 D01v05r02
- ANSI C63.10-2013

## 2.9. Duty Cycle

2.4GHz WLAN (DTS) operation is possible in 20MHz and 40MHz channel bandwidths. The maximum achievable duty cycles for all modes were determined based on measurements performed on a spectrum analyzer in zero-span mode with RBW = 8MHz, VBW = 50MHz. The RBW and VBW were both greater than 50/T, where T is the minimum transmission duration, and the number of sweep points across T was greater than 100. The duty cycles are as follows:

Test Mode	Duty Cycle
802.11b	99.27%
802.11g	91.72%
802.11n-HT20	90.61%

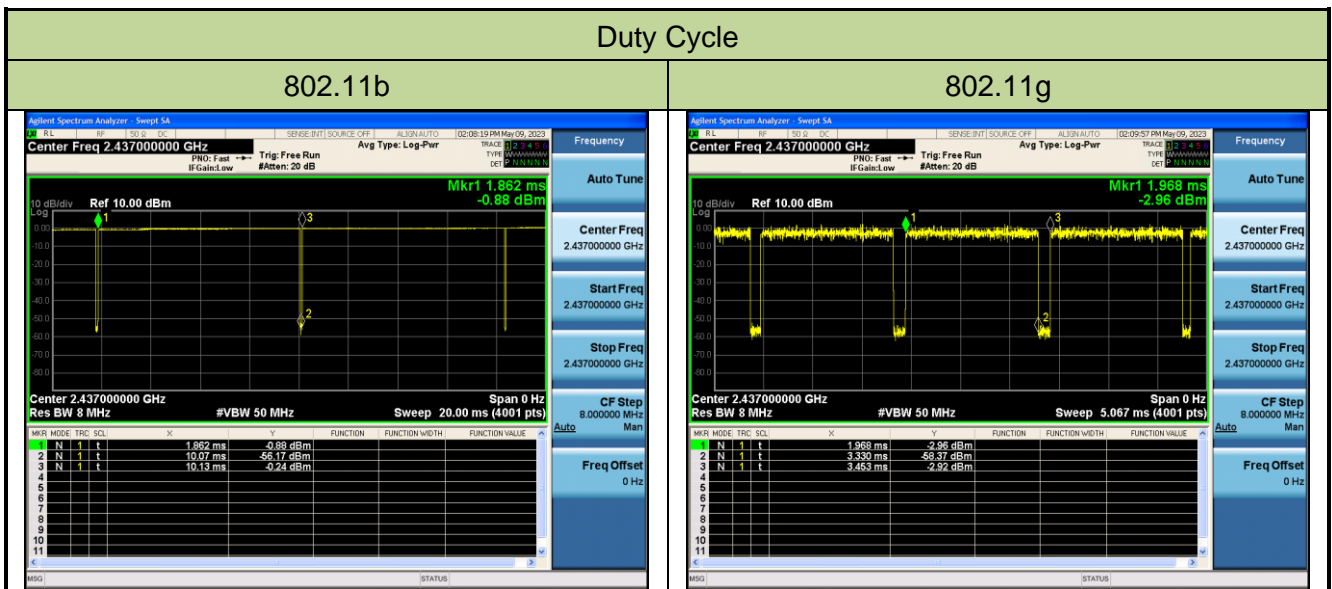

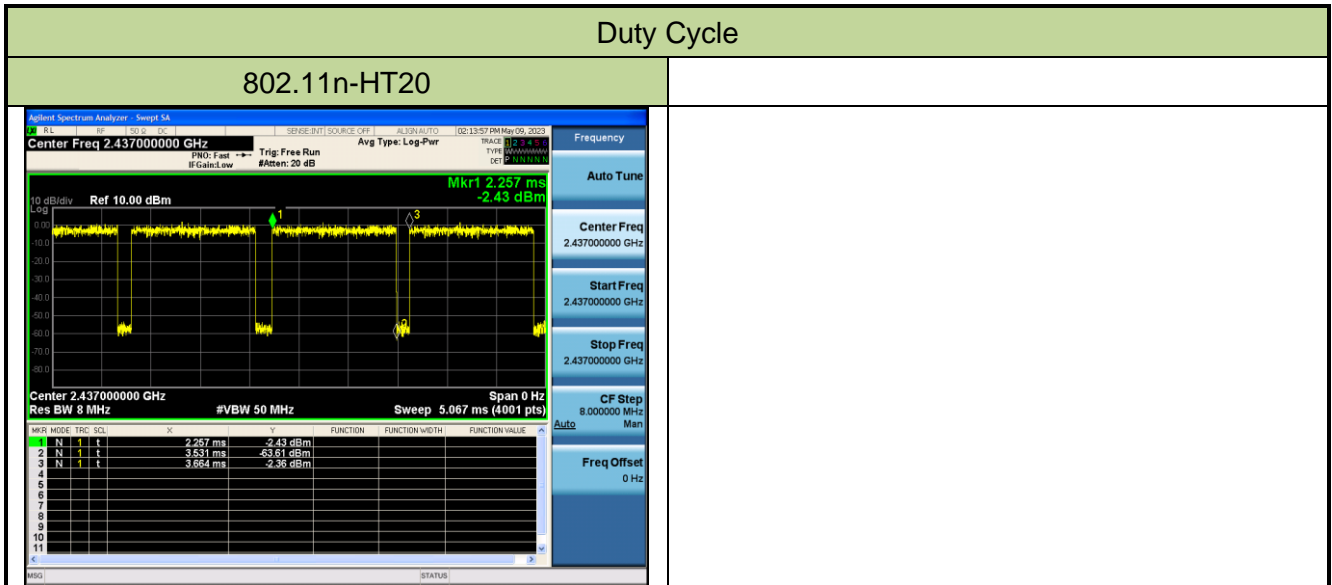

## 2.10. Test Configuration

The device was tested per the guidance of ANSI C63.10-2013. ANSI C63.10-2013 was used to reference the appropriate EUT setup for radiated spurious emissions testing and AC line conducted testing.

## 2.11. EMI Suppression Device(s)/Modifications

No EMI suppression device(s) were added and/or no modifications were made during testing.

## 2.12. Labeling Requirements

Per 2.1074 & 15.19; Docket 95-19

The label shall be permanently affixed at a conspicuous location on the device; instruction manual or pamphlet supplied to the user and be readily visible to the purchaser at the time of purchase. However, when the device is so small wherein placement of the label with specified statement is not practical, only the FCC ID must be displayed on the device per Section 15.19(a)(5). Please see attachment for FCC ID label and label location.

### **3. DESCRIPTION of TEST**

#### **3.1. Evaluation Procedure**

The measurement procedures described in the American National Standard of Procedures for Compliance Testing of Unlicensed Wireless Devices (ANSI C63.10-2013), and the guidance was used in the measurement.

#### **3.2. AC Line Conducted Emissions**

The line-conducted facility is located inside an 8'x4'x4' shielded enclosure. A 1m x 2m wooden table 80cm high is placed 40cm away from the vertical wall and 80cm away from the sidewall of the shielded room. Two 10kHz-30MHz, 50Ω/50uH Line-Impedance Stabilization Networks (LISNs) are bonded to the shielded room floor. Power to the LISNs is filtered by external high-current high-insertion loss power line filters. These filters attenuate ambient signal noise from entering the measurement lines. These filters are also bonded to the shielded enclosure.

The EUT is powered from one LISN and the support equipment is powered from the second LISN. All interconnecting cables more than 1 meter were shortened to a 1 meter length by non-inductive bundling (serpentine fashion) and draped over the back edge of the test table. All cables were at least 40cm above the horizontal reference ground-plane. Power cables for support equipment were routed down to the second LISN while ensuring that that cables were not draped over the second LISN.

Sufficient time for the EUT, support equipment, and test equipment was allowed in order for them to warm up to their normal operating condition. The RF output of the LISN was connected to the receiver and exploratory measurements were made to determine the frequencies producing the maximum emission from the EUT. The receiver was scanned from 150kHz to 30MHz. The detector function was set to peak mode for exploratory measurements while the bandwidth of the analyzer was set to 9kHz. The EUT, support equipment, and interconnecting cables were arranged and manipulated to maximize each emission. Each emission was also maximized by varying power lines, the mode of operation or data exchange speed, or support equipment whichever determined the worst-case emission. Once the worst-case emissions have been identified, the one EUT cable configuration/arrangement and mode of operation that produced these emissions are used for final measurements on the same test site. The analyzer is set to CISPR quasi-peak and average detectors with a 9kHz resolution bandwidth for final measurements.

An extension cord was used to connect to a single LISN which powered by EUT. The extension cord was calibrated with LISN, the impedance and insertion loss are compliance with the requirements as stated in ANSI C63.10-2013.

### 3.3. Radiated Emissions

The radiated test facilities consisted of an indoor 3 meter semi-anechoic chamber used for final measurements and exploratory measurements, when necessary. The measurement area is contained within the semi-anechoic chamber which is shielded from any ambient interference. For measurements above 1GHz absorbers are arranged on the floor between the turn table and the antenna mast in such a way so as to maximize the reduction of reflections. For measurements below 1GHz, the absorbers are removed. A MF Model 210SS turntable is used for radiated measurement. It is a continuously rotatable, remote controlled, metallic turntable and 2 meters (6.56 ft.) in diameter. The turn table is flush with the raised floor of the chamber in order to maintain its function as a ground plane. An 80cm high PVC support structure is placed on top of the turntable.

For all measurements, the spectrum was scanned through all EUT azimuths and from 1 to 4 meter receive antenna height using a broadband antenna from 30MHz up to the upper frequency shown in 15.33(b)(1) depending on the highest frequency generated or used in the device or on which the device operates or tunes. For frequencies above 1GHz, linearly polarized double ridge horn antennas were used. For frequencies below 30MHz, a calibrated loop antenna was used. When exploratory measurements were necessary, they were performed at 1 meter test distance inside the semi-anechoic chamber using broadband antennas, broadband amplifiers, and spectrum analyzers to determine the frequencies and modes producing the maximum emissions. Sufficient time for the EUT, support equipment, and test equipment was allowed in order for them to warm up to their normal operating condition. The test set-up for frequencies below 1GHz was placed on top of the 0.8 meter high, 1 x 1.5 meter table; and test set-up for frequencies 1-40GHz was placed on top of the 1.5 meter high, 1 x 1.5 meter table. The EUT, support equipment, and interconnecting cables were arranged and manipulated to maximize each emission. Appropriate precaution was taken to ensure that all emissions from the EUT were maximized and investigated. The system configuration, clock speed, mode of operation or video resolution, if applicable, turntable azimuth, and receive antenna height was noted for each frequency found.

Final measurements were made in the semi-anechoic chamber using calibrated, linearly polarized broadband and horn antennas. The test setup was configured to the setup that produced the worst case emissions. The spectrum analyzer was set to investigate all frequencies required for testing to compare the highest radiated disturbances with respect to the specified limits. The turntable containing the EUT was rotated through 360 degrees and the height of the receive antenna was varied 1 to 4 meters and stopped at the azimuth and height producing the maximum emission. Each emission was maximized by changing the orientation of the EUT through three orthogonal planes and changing the polarity of the receive antenna, whichever produced the worst-case emissions. According to 3dB Beam-Width of horn antenna, the horn antenna should be always directed to the EUT when rising height.

## 4. ANTENNA REQUIREMENTS

### **Excerpt from §15.203 of the FCC Rules/Regulations:**

“An intentional radiator antenna shall be designed to ensure that no antenna other than that furnished by the responsible party can be used with the device. The use of a permanently attached antenna or of an antenna that uses a unique coupling to the intentional radiator shall be considered sufficient to comply with the provisions of this section.”

- The antenna of the device is **permanently attached**.
- There are no provisions for connection to an external antenna.

### **Conclusion:**

The unit complies with the requirement of §15.203.

## 5. TEST EQUIPMENT CALIBRATION DATE

### Conducted Emissions

Instrument	Manufacturer	Type No.	Asset No.	Cali. Interval	Cali. Due Date
Two-Line V-Network	R&S	ENV216	MRTTWA00019	1 year	2024/3/7
Two-Line V-Network	R&S	ENV216	MRTTWA00020	1 year	2024/4/20
EMI Test Receiver	R&S	ESR3	MRTTWA00045	1 year	2024/5/10

### Radiated Emissions

Instrument	Manufacturer	Type No.	Asset No.	Cali. Interval	Cali. Due Date
Broadband TRILOG Antenna	SCHWARZBECK	VULB 9162	MRTTWA00001	1 year	2023/12/21
Active Loop Antenna	SCHWARZBECK	FMZB 1519B	MRTTWA00002	1 year	2024/5/23
Broadband Hornantenna	SCHWARZBECK	BBHA 9120D	MRTTWA00003	1 year	2024/3/24
Breitband Hornantenna	SCHWARZBECK	BBHA 9170	MRTTWA00004	1 year	2024/3/20
Broadband Preamplifier	SCHWARZBECK	BBV 9718	MRTTWA00005	1 year	2024/3/24
Broadband Amplifier	SCHWARZBECK	BBV 9721	MRTTWA00006	1 year	2024/3/27
Signal Analyzer	R&S	FSV40	MRTTWA00007	1 year	2024/3/14
EMI Test Receiver	R&S	ESR3	MRTTWA00009	1 year	2024/3/8
EXA Signal Analyzer	KEYSIGHT	N9010A	MRTTWA00012	1 year	2023/10/5
Antenna Cable	HUBERSUHNER	SF106	MRTTWE00010	1 year	2023/6/14
Temperature/Humidity Meter	TFA	35.1078.10.IT	MRTTWA00032	1 year	2023/6/5

### Conducted Test Equipment

Instrument	Manufacturer	Type No.	Asset No.	Cali. Interval	Cali. Due Date
X-Series USB Peak and Average Power Sensor	KEYSIGHT	U2021XA	MRTTWA00014	1 year	2024/4/19
EXA Signal Analyzer	KEYSIGHT	N9010A	MRTTWA00012	1 year	2023/10/5
EXA Signal Analyzer	KEYSIGHT	N9010B	MRTTWA00074	1 year	2023/7/19
Attenuator	WTI	218FS-20	MRTTWE00026	1 year	2023/11/2
Attenuator	WTI	218FS-10	MRTTWE00027	1 year	2023/6/15
Attenuator	WTI	218FS-06	MRTTWE00028	1 year	2023/6/15
Temperature & Humidity Chamber	TEN BILLION	TTH-B3UP	MRTTWA00036	1 year	2023/6/14
DIVA PLUS Funk-Wetterstation	TFA	35.1083	MRTTWA00050	1 year	2023/6/16

Software	Version	Function
e3	9.160520a	EMI Test Software

## 6. MEASUREMENT UNCERTAINTY

Where relevant, the following test uncertainty levels have been estimated for tests performed on the EUT as specified in CISPR 16-4-2. This uncertainty represents an expanded uncertainty expressed at approximately the 95% confidence level using a coverage factor of  $k = 2$ .

<b>AC Conducted Emission Measurement</b>
Measuring Uncertainty for a Level of Confidence of 95% ( $U=2Uc(y)$ ): 150kHz~30MHz: $\pm 2.53\text{dB}$
<b>Radiated Emission Measurement</b>
Measuring Uncertainty for a Level of Confidence of 95% ( $U=2Uc(y)$ ): 9kHz ~ 1GHz: $\pm 4.25\text{dB}$ 1GHz ~ 40GHz: $\pm 4.45\text{dB}$
<b>Conducted Power (Carrier Power / Power Density)</b>
Measuring Uncertainty for a Level of Confidence of 95% ( $U=2Uc(y)$ ): $\pm 0.84\text{dB}$
<b>Conducted Spurious Emission</b>
Measuring Uncertainty for a Level of Confidence of 95% ( $U=2Uc(y)$ ): $\pm 2.65\text{ dB}$
<b>Occupied Bandwidth</b>
Measuring Uncertainty for a Level of Confidence of 95% ( $U=2Uc(y)$ ): $\pm 3.3\%$
<b>Temp. / Humidity</b>
Measuring Uncertainty for a Level of Confidence of 95% ( $U=2Uc(y)$ ): $\pm 0.82^\circ\text{C} / \pm 3\%$



## 7. TEST RESULT

### 7.1. Summary

FCC Section(s)	Test Description	Test Limit	Test Condition	Test Result	Reference
15.247(a)(2)	6dB Bandwidth	$\geq 500\text{kHz}$	Conducted	Pass	Section 7.2
15.247(b)(3)	Output Power	$\leq 30\text{dBm}$		Pass	Section 7.3
15.247(e)	Power Spectral Density	$\leq 8\text{dBm}/3\text{kHz}$		Pass	Section 7.4
15.247(d)	Band Edge / Out-of-Band Emissions	$\geq 30\text{dBc}$ (Average)		Pass	Section 7.5
15.205 15.209	General Field Strength Limits (Restricted Bands and Radiated Emission Limits)	Emissions in restricted bands must meet the radiated limits detailed in 15.209	Radiated	Pass	Section 7.6 & 7.7
15.207	AC Conducted Emissions 150kHz - 30MHz	< FCC 15.207 limits	Line Conducted	Pass	Section 7.8

**Notes:**

- 1) Determining compliance is based on the test results met the regulation limits or requirements declared by clients, and the test results don't take into account the value of measurement uncertainty.
- 2) The analyzer plots shown in this section were all taken with a correction table loaded into the analyzer. The correction table was used to account for the losses of the cables and attenuators used as part of the system to connect the EUT to the analyzer at all frequencies of interest.
- 3) For radiated emission test, every axis (X, Y, Z) was also verified. The test results shown in the following sections represent the worst-case emissions.

## 7.2. 6dB Bandwidth Measurement

### 7.2.1. Test Limit

The minimum 6dB bandwidth shall be at least 500 kHz.

### 7.2.2. Test Procedure used

ANSI C63.10 - 2013 Section 11.8

### 7.2.3. Test Setting

1. The Spectrum's automatic bandwidth measurement capability was used to perform the 6dB bandwidth measurement. The "X" dB bandwidth parameter was set to  $X = 6$ . The bandwidth measurement was not influenced by any intermediate power nulls in the fundamental emission.
2. Set RBW = 100 kHz
3.  $VBW \geq 3 \times RBW$
4. Detector = Peak
5. Trace mode = max hold
6. Sweep = auto couple
7. Allow the trace was allowed to stabilize

### 7.2.4. Test Setup

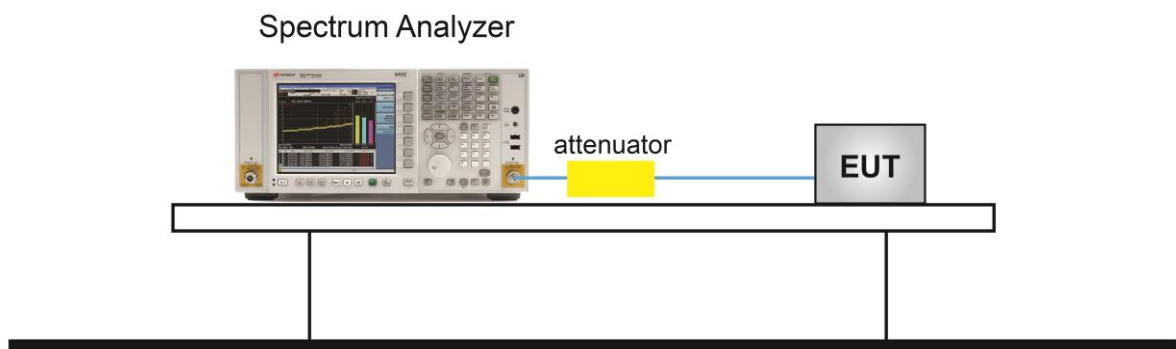

### 7.2.5. Test Result

Product	Outdoor Pan/Tilt Security Wi-Fi Camera	Temperature	25°C
Test Engineer	Marvin	Relative Humidity	54%
Test Site	SR6	Test Date	2023/05/15

Test Mode	Data Rate / MCS	Channel No.	Frequency (MHz)	6dB Bandwidth (MHz)	Limit (MHz)	Result
802.11b	1Mbps	01	2412	8.574	≥ 0.5	Pass
802.11b	1Mbps	06	2437	8.072	≥ 0.5	Pass
802.11b	1Mbps	11	2462	9.534	≥ 0.5	Pass
802.11g	6Mbps	01	2412	16.370	≥ 0.5	Pass
802.11g	6Mbps	06	2437	16.370	≥ 0.5	Pass
802.11g	6Mbps	11	2462	16.370	≥ 0.5	Pass
802.11n-HT20	MCS0	01	2412	17.580	≥ 0.5	Pass
802.11n-HT20	MCS0	06	2437	17.580	≥ 0.5	Pass
802.11n-HT20	MCS0	11	2462	17.580	≥ 0.5	Pass

802.11b 6dB Bandwidth

Channel 01 (2412MHz)

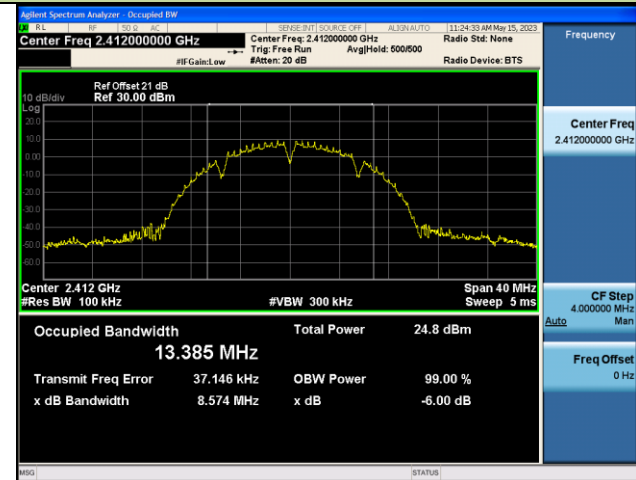

Channel 06 (2437MHz)

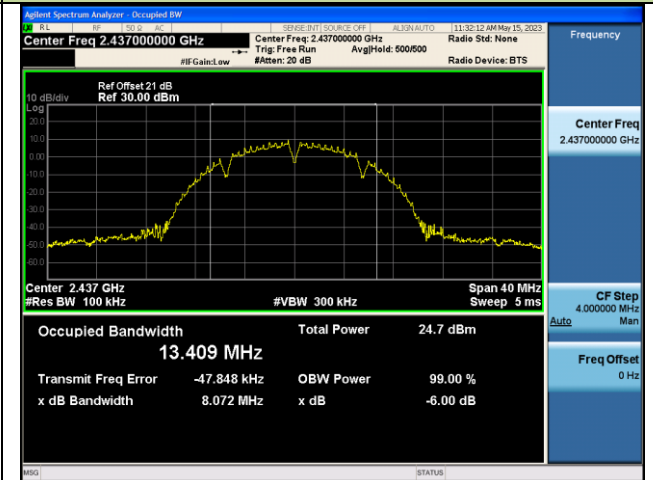

Channel 11 (2462MHz)

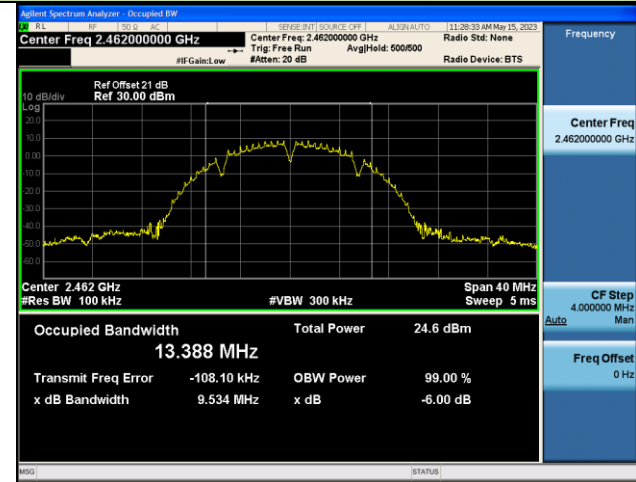

## 802.11g 6dB Bandwidth

## Channel 01 (2412MHz)

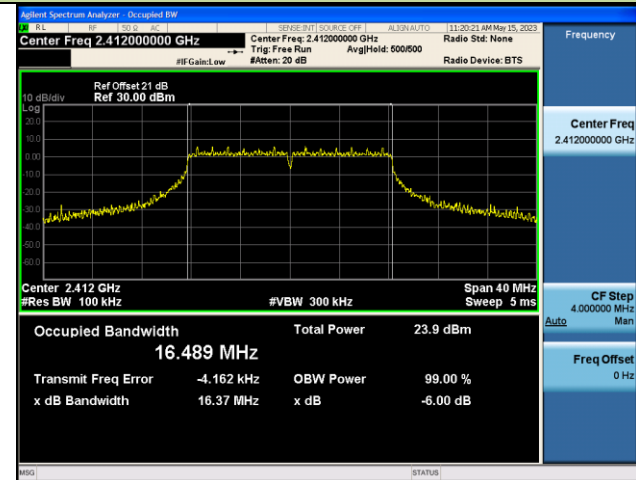

## Channel 06 (2437MHz)

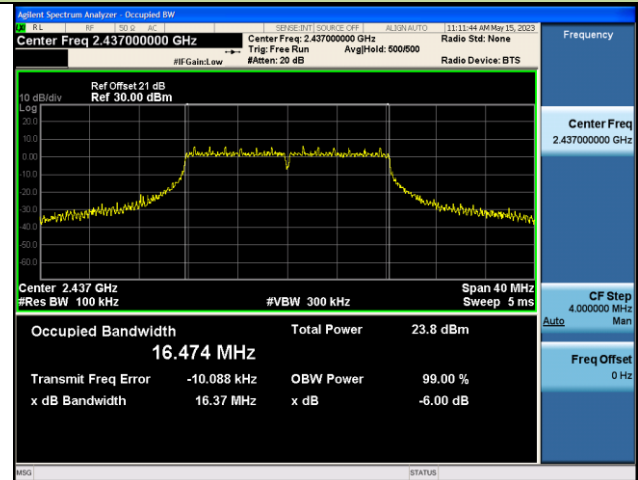

## Channel 11 (2462MHz)

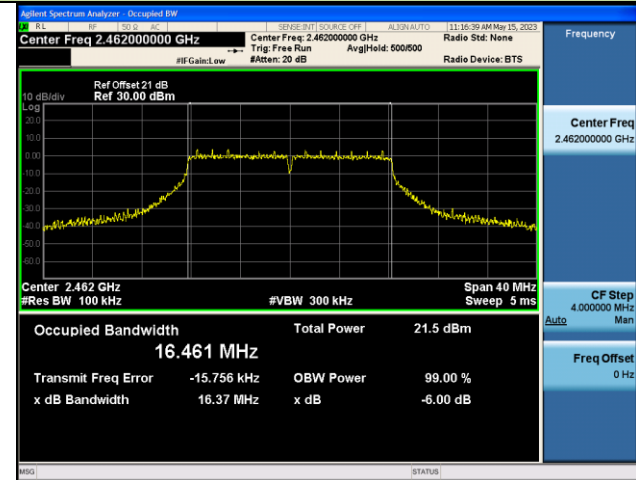

## 802.11n-HT20 6dB Bandwidth - Ant 0

## Channel 01 (2412MHz)

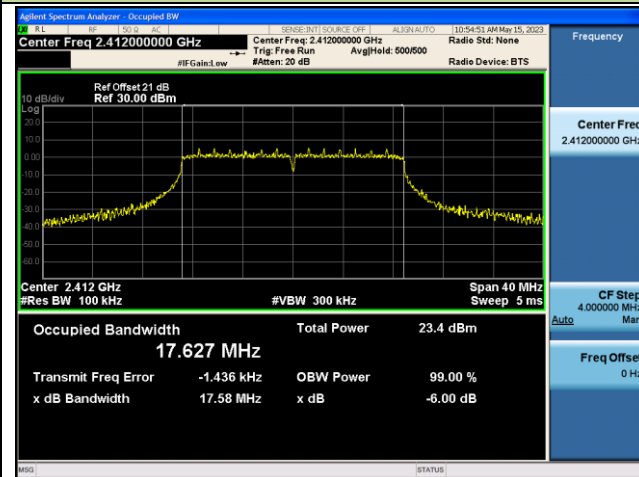

## Channel 06 (2437MHz)

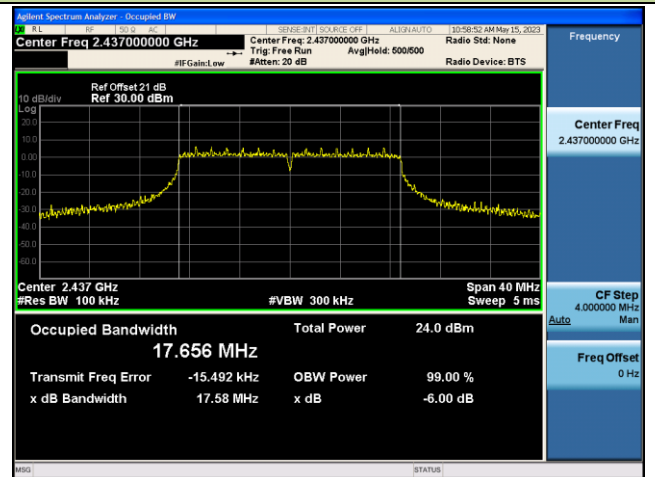

## Channel 11 (2462MHz)

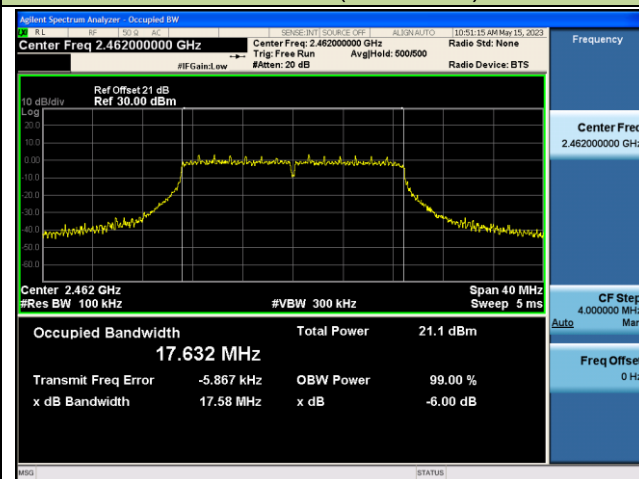

## 7.3. Output Power Measurement

### 7.3.1. Test Limit

The maximum output power shall be less 1 Watt (30dBm).

The conducted output power limit specified in paragraph FCC Part 15.247(b) of this section is based on the use of antennas with directional gains that do not exceed 6 dBi. If transmitting antennas of directional gain greater than 6 dBi are used, the conducted output power from the intentional radiator shall be reduced below the stated values in paragraphs FCC Part 15.247(b)(3) of this section, as appropriate, by the amount in dB that the directional gain of the antenna exceeds 6 dBi.

### 7.3.2. Test Procedure Used

ANSI C63.10 - 2013 Section 11.9.2.3.2

### 7.3.3. Test Setting

#### Average Power Measurement

Average power measurements were performed only when the EUT was transmitting at its maximum power control level using a broadband power meter with a pulse sensor. The power meter implemented triggering and gating capabilities which were set up such that power measurements were recorded only during the ON time of the transmitter.

### 7.3.4. Test Setup

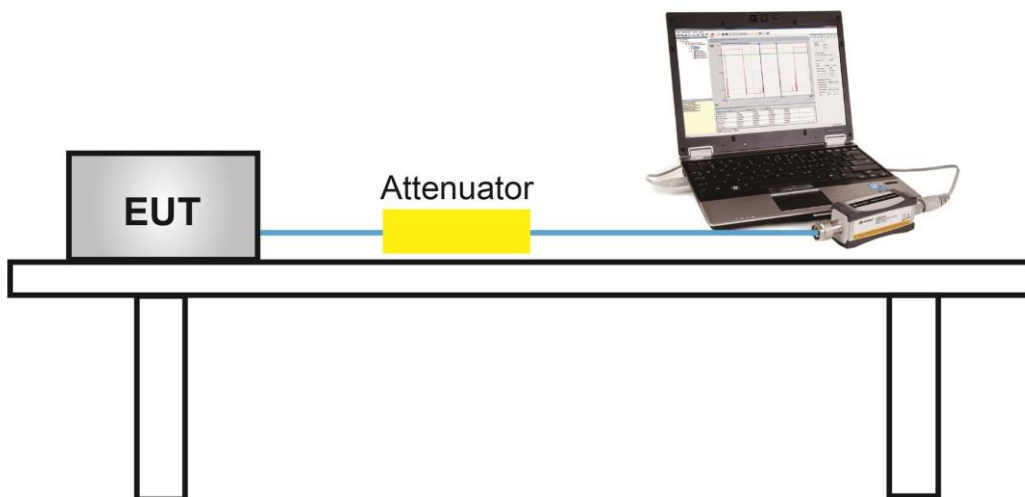

### 7.3.5. Test Result

Product	Outdoor Pan/Tilt Security Wi-Fi Camera	Temperature	25°C
Test Engineer	Marvin	Relative Humidity	54%
Test Site	SR6	Test Date	2023/05/12

Test Mode	Data Rate/ MCS	Channel No.	Freq. (MHz)	Average Power (dBm)	Limit (dBm)	Result
802.11b	1Mbps	01	2412	18.43	≤ 30.00	Pass
802.11b	1Mbps	06	2437	18.31	≤ 30.00	Pass
802.11b	1Mbps	11	2462	18.40	≤ 30.00	Pass
802.11g	6Mbps	01	2412	17.85	≤ 30.00	Pass
802.11g	6Mbps	06	2437	18.12	≤ 30.00	Pass
802.11g	6Mbps	11	2462	15.47	≤ 30.00	Pass
802.11n-HT20	MCS0	01	2412	17.01	≤ 30.00	Pass
802.11n-HT20	MCS0	06	2437	18.19	≤ 30.00	Pass
802.11n-HT20	MCS0	11	2462	15.36	≤ 30.00	Pass



## **7.4. Power Spectral Density Measurement**

### **7.4.1. Test Limit**

The maximum permissible power spectral density is 8dBm in any 3 kHz band.

The same method of determining the conducted output power shall be used to determine the power spectral density.

### **7.4.2. Test Procedure Used**

ANSI C63.10 - 2013 Section 11.10.5

### **7.4.3. Test Setting**

1. Measure the duty cycle (x) of the transmitter output signal.
2. Set instrument center frequency to DTS channel center frequency.
3. Set span to at least 1.5 times the OBW.
4. RBW = 10 kHz.
5. VBW = 30 kHz.
6. Detector = RMS.
7. Ensure that the number of measurement points in the sweep  $\geq 2 \times \text{span}/\text{RBW}$ .
8. Sweep time = auto couple.
9. Don't use sweep triggering. Allow sweep to "free run".
10. Employ trace averaging (RMS) mode over a minimum of 100 traces.
11. Use the peak marker function to determine the maximum amplitude level.
12. Add  $10 \log (1/x)$ , where x is the duty cycle measured in step (a), to the measured PSD to compute the average PSD during the actual transmission time.

### 7.4.4. Test Setup

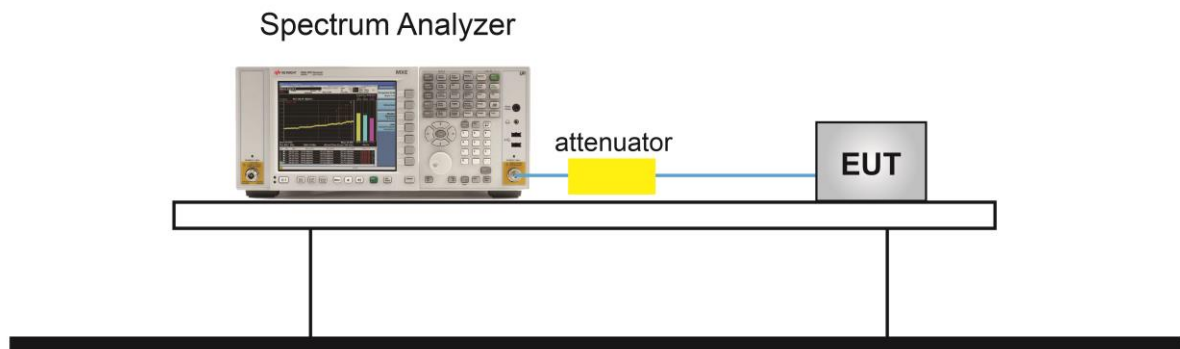

### 7.4.5. Test Result

Product	Outdoor Pan/Tilt Security Wi-Fi Camera	Temperature	25°C
Test Engineer	Marvin	Relative Humidity	54%
Test Site	SR6	Test Date	2023/05/15

Test Mode	Data Rate/ MCS	Channel No.	Freq. (MHz)	PSD (dBm/ 10kHz)	Duty Cycle (%)	Total PSD (dBm/ 10kHz)	Limit (dBm/ 3kHz)	Result
802.11b	1Mbps	01	2412	-7.185	99.27	-7.153	≤ 8.00	Pass
802.11b	1Mbps	06	2437	-7.694	99.27	-7.662	≤ 8.00	Pass
802.11b	1Mbps	11	2462	-7.589	99.27	-7.557	≤ 8.00	Pass
802.11g	6Mbps	01	2412	-10.966	91.72	-10.591	≤ 8.00	Pass
802.11g	6Mbps	06	2437	-10.839	91.72	-10.464	≤ 8.00	Pass
802.11g	6Mbps	11	2462	-12.665	91.72	-12.290	≤ 8.00	Pass
802.11n-HT20	MCS0	01	2412	-10.673	90.61	-10.245	≤ 8.00	Pass
802.11n-HT20	MCS0	06	2437	-10.874	90.61	-10.446	≤ 8.00	Pass
802.11n-HT20	MCS0	11	2462	-13.098	90.61	-12.670	≤ 8.00	Pass

Note: Total AVGPDS = PSD + 10\*log (1/Duty Cycle).

## 802.11b AVGPDS - Ant 0

## Channel 01 (2412MHz)

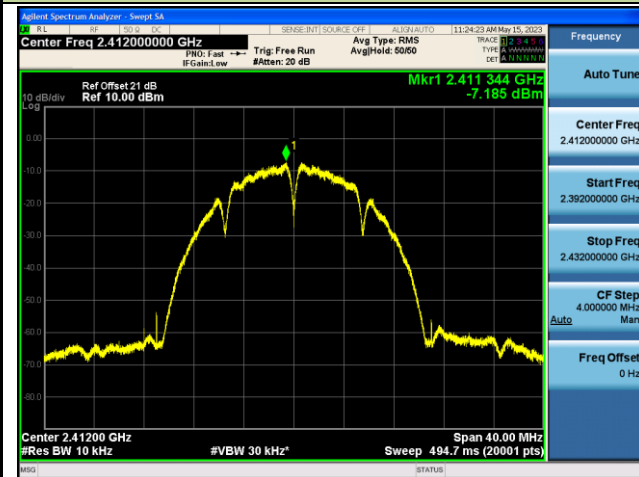

## Channel 06 (2437MHz)

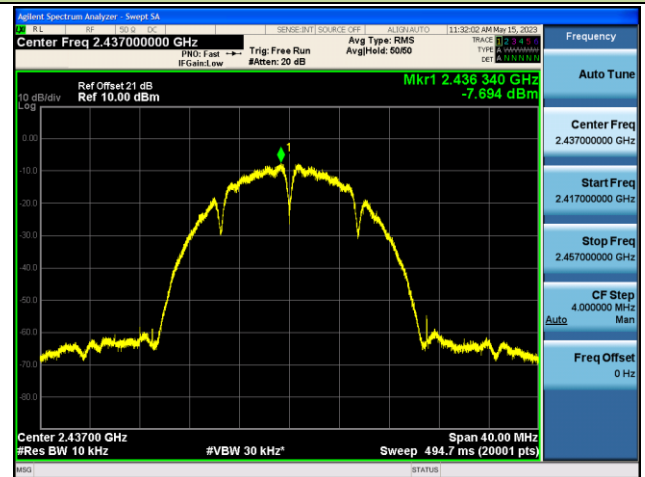

## Channel 11 (2462MHz)

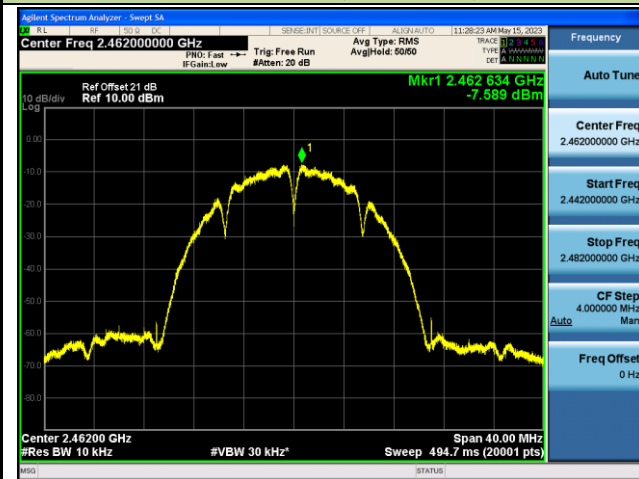

## 802.11g AVGPDS - Ant 0

## Channel 01 (2412MHz)

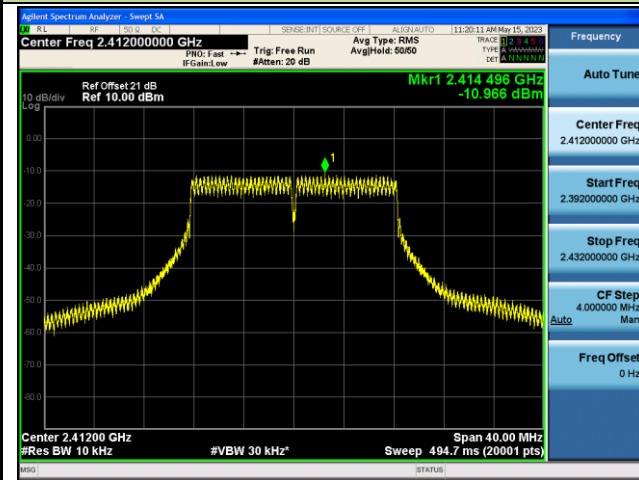

## Channel 06 (2437MHz)

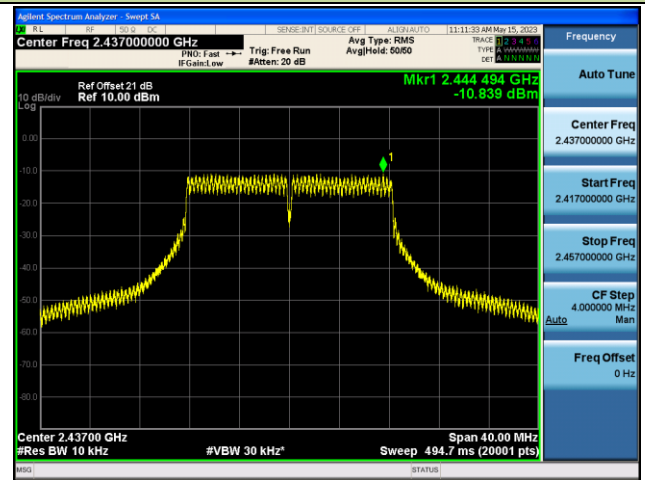

## Channel 11 (2462MHz)

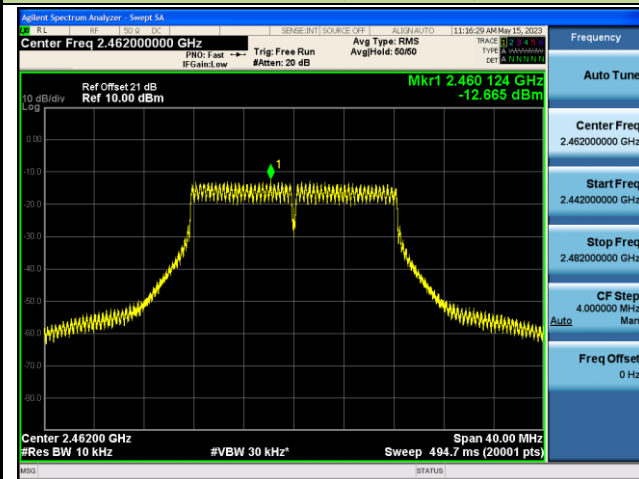

802.11n-HT20 AVGPDS - Ant 0

Channel 01 (2412MHz)

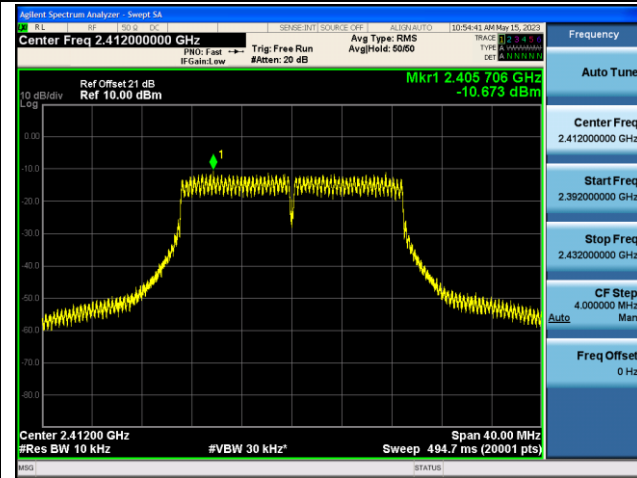

Channel 06 (2437MHz)

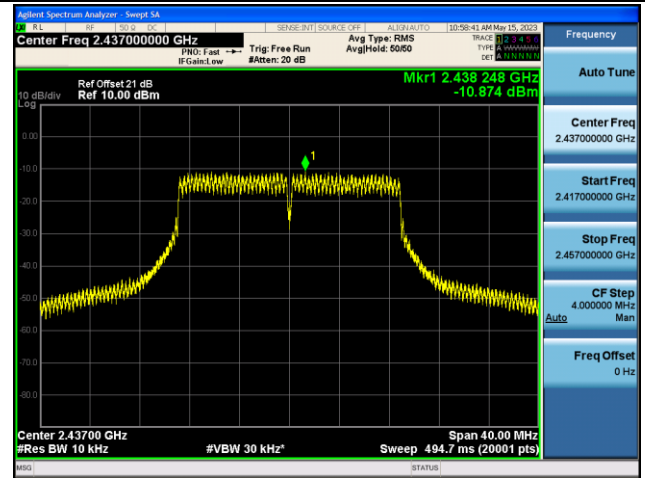

Channel 11 (2462MHz)

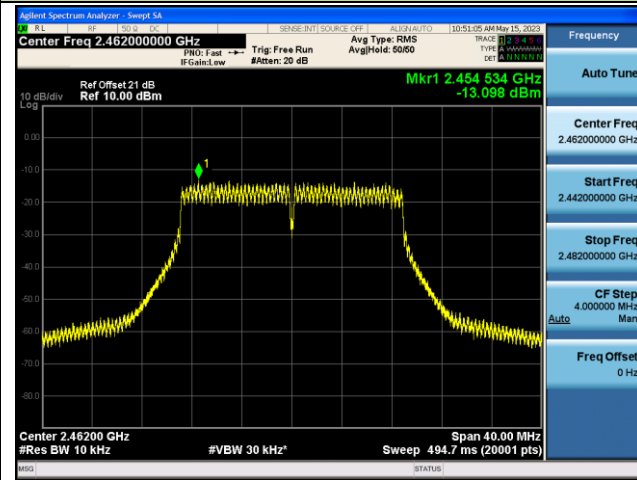

## **7.5. Conducted Band Edge and Out-of-Band Emissions**

### **7.5.1. Test Limit**

The limit for out-of-band spurious emissions at the band edge is 30dB below the fundamental emission level, as determined from the in-band power measurement of the DTS channel performed in a 100 kHz bandwidth per the PSD procedure.

### **7.5.2. Test Procedure Used**

ANSI C63.10 - 2013 Section 11.11

### **7.5.3. Test Setting**

#### **Reference level measurement**

1. Set instrument center frequency to DTS channel center frequency
2. Set the span to  $\geq 1.5$  times the DTS bandwidth
3. Set the RBW = 100 kHz
4. Set the VBW  $\geq 3 \times$  RBW
5. Detector = peak
6. Sweep time = auto couple
7. Trace mode = max hold
8. Allow trace to fully stabilize

#### **Emission level measurement**

1. Set the center frequency and span to encompass frequency range to be measured
2. RBW = 100kHz
3. VBW = 300kHz
4. Detector = Peak
5. Trace mode = max hold
6. Sweep time = auto couple
7. The trace was allowed to stabilize

### 7.5.4. Test Setup

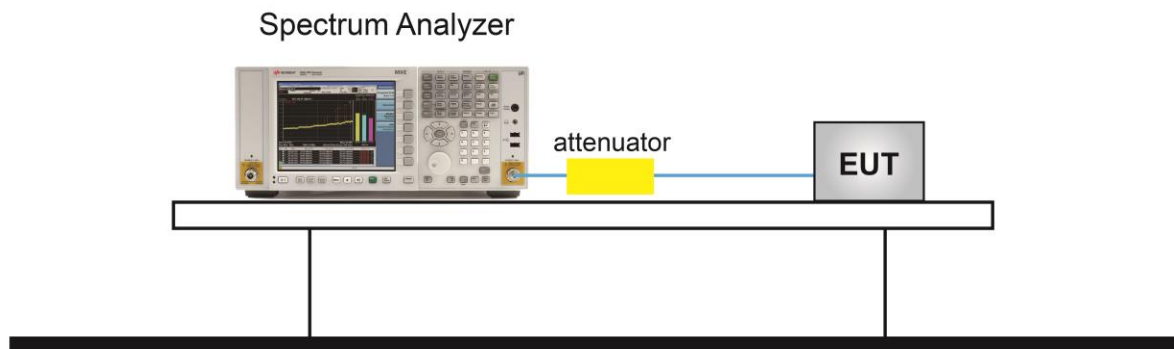



### 7.5.5. Test Result

Product	Outdoor Pan/Tilt Security Wi-Fi Camera	Temperature	25°C
Test Engineer	Marvin	Relative Humidity	54%
Test Site	SR6	Test Date	2023/05/15

Test Mode	Data Rate / MCS	Channel No.	Frequency (MHz)	Limit (dBc)	Result
802.11b	1Mbps	01	2412	30	Pass
802.11b	1Mbps	06	2437	30	Pass
802.11b	1Mbps	11	2462	30	Pass
802.11g	6Mbps	01	2412	30	Pass
802.11g	6Mbps	06	2437	30	Pass
802.11g	6Mbps	11	2462	30	Pass
802.11n-HT20	MCS0	01	2412	30	Pass
802.11n-HT20	MCS0	06	2437	30	Pass
802.11n-HT20	MCS0	11	2462	30	Pass



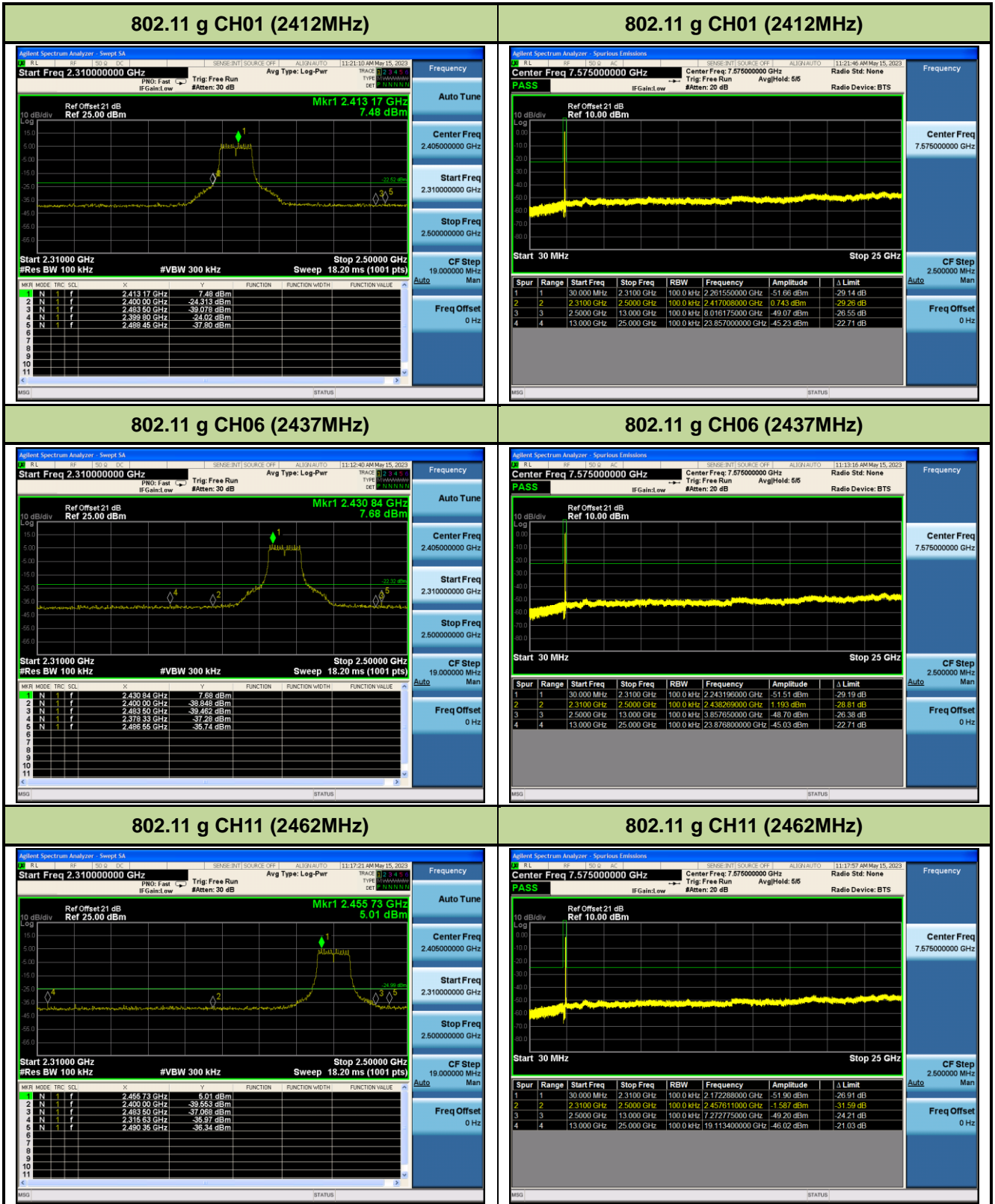

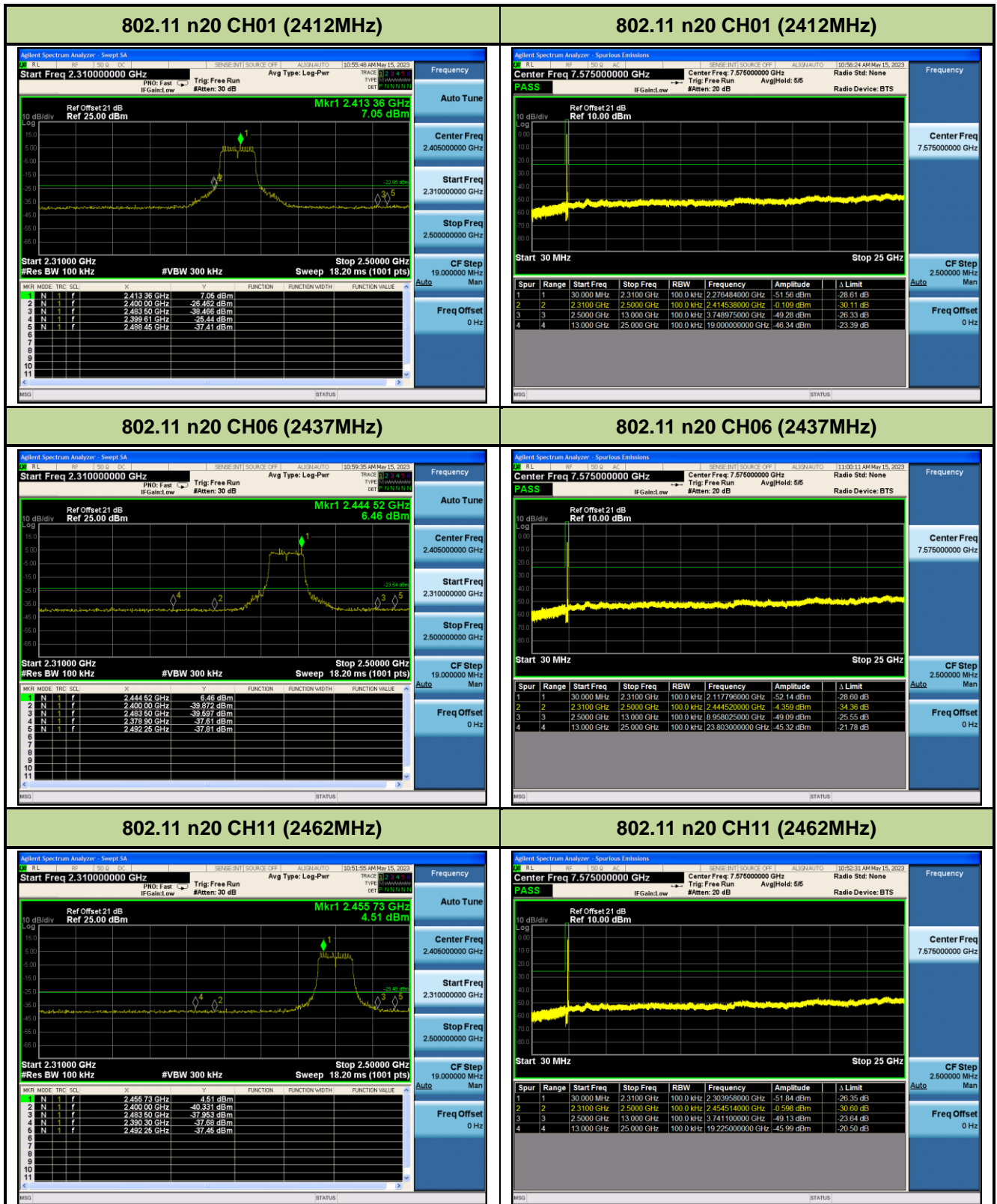

## 7.6. Radiated Spurious Emission Measurement

### 7.6.1. Test Limit

All out of band emissions appearing in a restricted band as specified in Section 15.205 of the Title 47CFR must not exceed the limits shown in Table per Section 15.209.

FCC Part 15 Subpart C Paragraph 15.209		
Frequency [MHz]	Field Strength [Uv/m]	Measured Distance [Meters]
0.009 - 0.490	2400/F (kHz)	300
0.490 - 1.705	24000/F (kHz)	30
1.705 - 30	30	30
30 - 88	100	3
88 - 216	150	3
216 - 960	200	3
Above 960	500	3

### 7.6.2. Test Procedure Used

ANSI C63.10 - 2013 Section 11.11 & 11.12

ANSI C63.10 - 2013 Section 6.3 (General Requirements)

ANSI C63.10 - 2013 Section 6.4 (Standard test method below 30MHz)

ANSI C63.10 - 2013 Section 6.5 (Standard test method above 30MHz to 1GHz)

ANSI C63.10 - 2013 Section 6.6 (Standard test method above 1GHz)

### 7.6.3. Test Setting

**Table 1 - RBW as a function of frequency**

Frequency	RBW
9 ~ 150 kHz	200 ~ 300 Hz
0.15 ~ 30 MHz	9 ~ 10 kHz
30 ~ 1000 MHz	100 ~ 120 kHz
> 1000MHz	1MHz

**Quasi-Peak Measurements below 1GHz**

1. Analyzer center frequency was set to the frequency of the radiated spurious emission of interest
2. Span was set greater than 1MHz
3. RBW = as specified in Table 1
4. Detector = CISPR quasi-peak
5. Sweep time = auto couple
6. Trace was allowed to stabilize

**Peak Measurements above 1GHz**

1. Analyzer center frequency was set to the frequency of the radiated spurious emission of interest
2. RBW = 1MHz
3. VBW = 3MHz
4. Detector = peak
5. Sweep time = auto couple
6. Trace mode = max hold
7. Trace was allowed to stabilize

**Average Measurements above 1GHz (Method VB)**

1. Analyzer center frequency was set to the frequency of the radiated spurious emission of interest
2. RBW = 1MHz
3. VBW; If the EUT is configured to transmit with duty cycle  $\geq 98\%$ , set VBW = 10 Hz.  
If the EUT duty cycle is  $< 98\%$ , set VBW  $\geq 1/T$ . T is the minimum transmission duration.
4. Detector = Peak
5. Sweep time = auto
6. Trace mode = max hold
7. Trace was allowed to stabilize

### 7.6.4. Test Setup

#### Below 1GHz Test Setup:

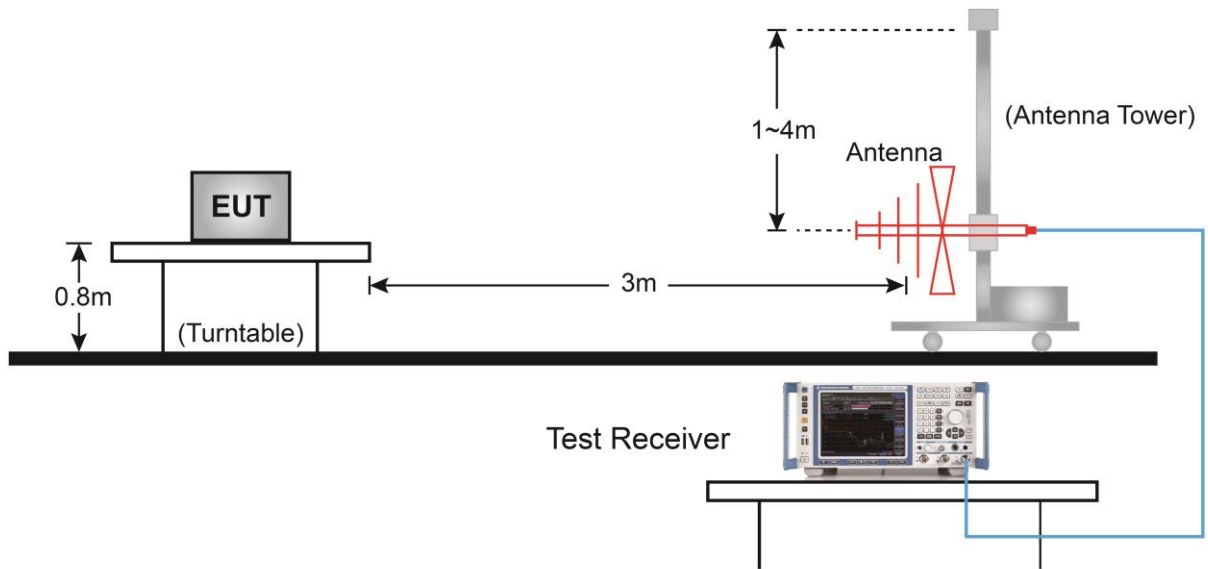

#### Above 1GHz Test Setup:

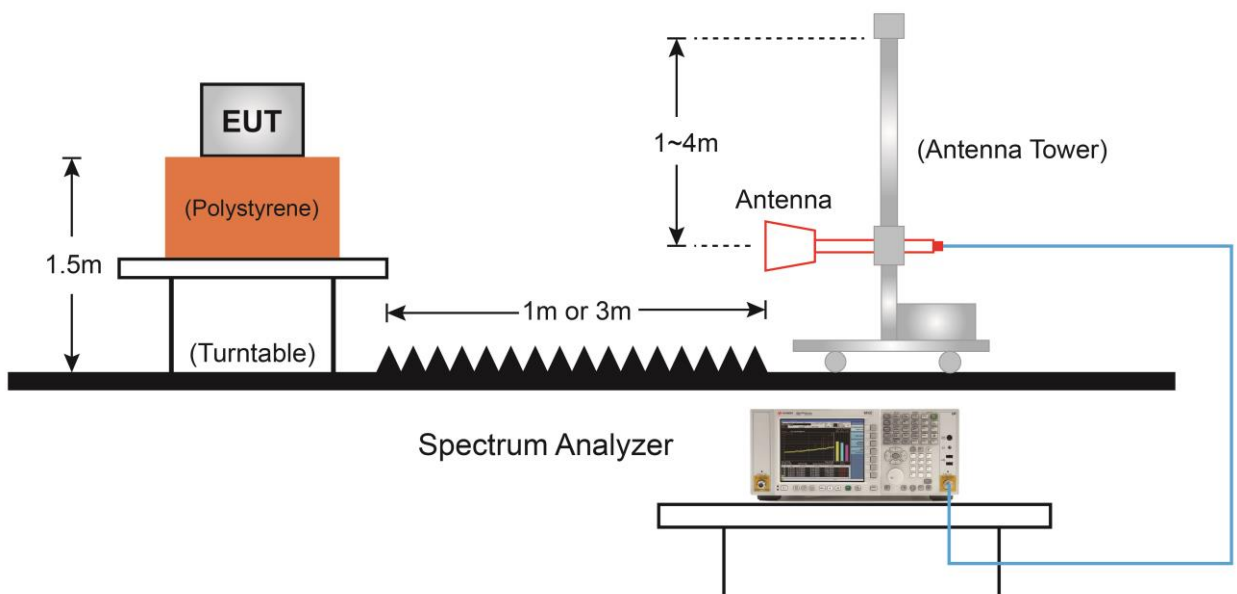



### 7.6.5. Test Result

EUT	Outdoor Pan/Tilt Security Wi-Fi Camera	Date of Test	2023-05-11
Factor	VULB 9162	Temp. / Humidity	24°C /59%
Polarity	Horizontal	Site / Test Engineer	AC1 / Todd
Test Mode	802.11n-20MHz_TX_CH 6_ANT 0	Test Voltage	AC 120V/60Hz

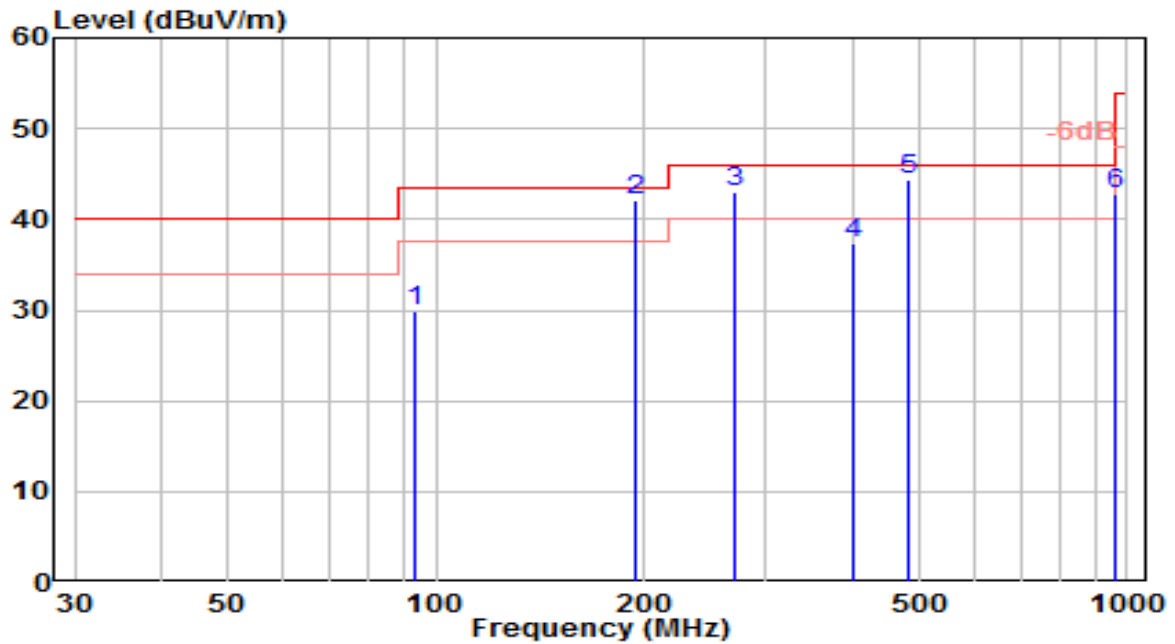

No	Frequency (MHz)	Reading (dBuV)	C.F (dB/m)	Measurement (dBuV/m)	Margin (dB)	Limit (dBuV/m)	Height (cm)	Angle (deg)	Remark (QP/PK/AV)
1	93.415	12.33	17.60	29.94	-13.56	43.50	100	70	QP
2	* 194.394	24.10	18.11	42.20	-1.30	43.50	100	280	QP
3	271.258	22.64	20.42	43.06	-2.94	46.00	100	40	QP
4	402.674	13.52	23.78	37.30	-8.70	46.00	100	310	QP
5	481.939	19.33	25.04	44.37	-1.63	46.00	100	65	QP
6	958.556	10.64	32.04	42.68	-3.32	46.00	100	10	QP

Note:

1. " \*", means this data is the worst emission level.
2. C.F (Correction Factor) = Antenna Factor (dB/m)+ Cable Loss (dB).
3. Measurement (dBuV/m) = Reading(dBuV) + C.F (Correction Factor).
4. The emission levels of other frequencies are very lower than the limit and not show in test report.



EUT	Outdoor Pan/Tilt Security Wi-Fi Camera	Date of Test	2023-05-11
Factor	VULB 9162	Temp. / Humidity	24°C /59%
Polarity	Vertical	Site / Test Engineer	AC1 / Todd
Test Mode	802.11n-20MHz_TX_CH 6_ANT 0	Test Voltage	AC 120V/60Hz

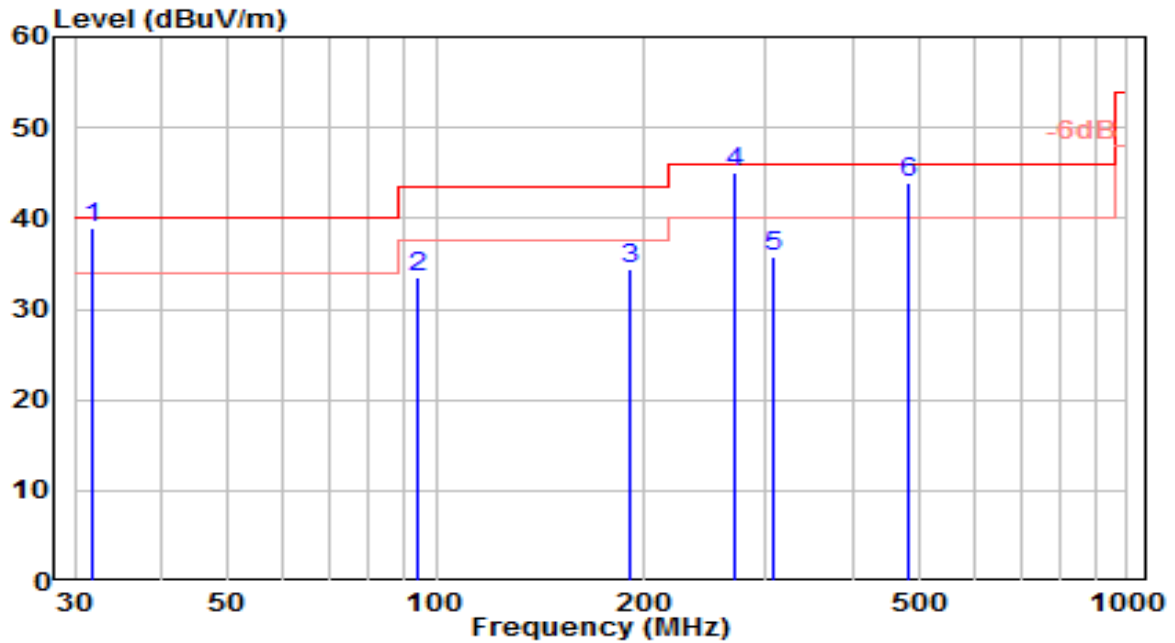

No	Frequency (MHz)	Reading (dBuV)	C.F (dB/m)	Measurement (dBuV/m)	Margin (dB)	Limit (dBuV/m)	Height (cm)	Angle (deg)	Remark (QP/PK/AV)
1	31.765	21.91	17.06	38.97	-1.03	40.00	100	290	QP
2	93.938	15.77	17.69	33.47	-10.03	43.50	100	100	QP
3	190.326	16.55	17.93	34.48	-9.02	43.50	100	155	QP
4	* 271.246	24.71	20.42	45.13	-0.87	46.00	100	65	QP
5	306.707	14.59	21.26	35.85	-10.15	46.00	100	80	QP
6	481.902	18.80	25.04	43.84	-2.16	46.00	100	295	QP

Note:

1. " \*", means this data is the worst emission level.
2. C.F (Correction Factor) = Antenna Factor (dB/m)+ Cable Loss (dB).
3. Measurement (dBuV/m) = Reading(dBuV) + C.F (Correction Factor).
4. The emission levels of other frequencies are very lower than the limit and not show in test report.

EUT	Outdoor Pan/Tilt Security Wi-Fi Camera	Date of Test	2023-05-13
Factor	BBHA 9120D	Temp. / Humidity	24°C /59%
Polarity	Horizontal	Site / Test Engineer	AC1 / Todd
Test Mode	802.11b_TX_CH 1_ANT 0	Test Voltage	AC 120V/60Hz

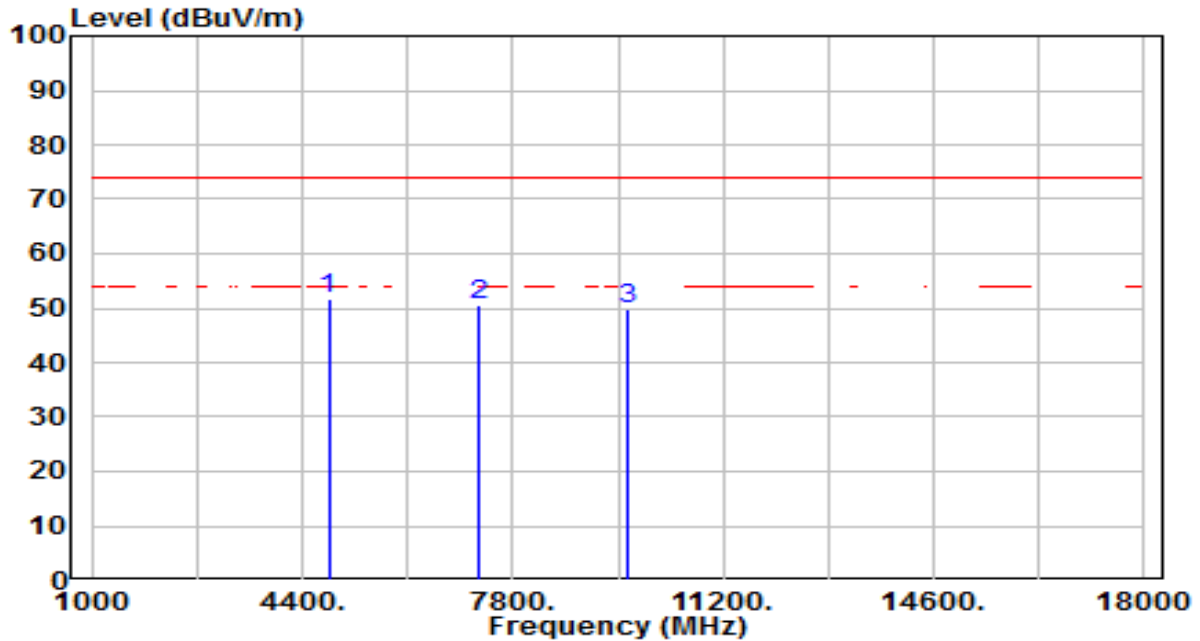

No	Frequency (MHz)	Reading (dBuV)	C.F (dB/m)	Measurement (dBuV/m)	Margin (dB)	Limit (dBuV/m)	Height (cm)	Angle (deg)	Remark (QP/PK/AV)
1	* 4824.000	47.65	3.91	51.57	-22.43	74.00	150	360	Peak
2	7236.000	38.62	11.94	50.56	-23.44	74.00	150	360	Peak
3	9648.000	33.89	15.79	49.68	-24.32	74.00	150	360	Peak

Note:

- "\*" means this data is the worst emission level.
- C.F (Correction Factor) = Antenna Factor (dB/m)+ Cable Loss (dB) – Pre-amplifier(dB).
- Measurement (dBuV/m) = Reading(dBuV) + C.F (Correction Factor).
- The emission levels of other frequencies are very lower than the limit and not show in test report.

EUT	Outdoor Pan/Tilt Security Wi-Fi Camera	Date of Test	2023-05-13
Factor	BBHA 9120D	Temp. / Humidity	24°C /59%
Polarity	Vertical	Site / Test Engineer	AC1 / Todd
Test Mode	802.11b_TX_CH 1_ANT 0	Test Voltage	AC 120V/60Hz

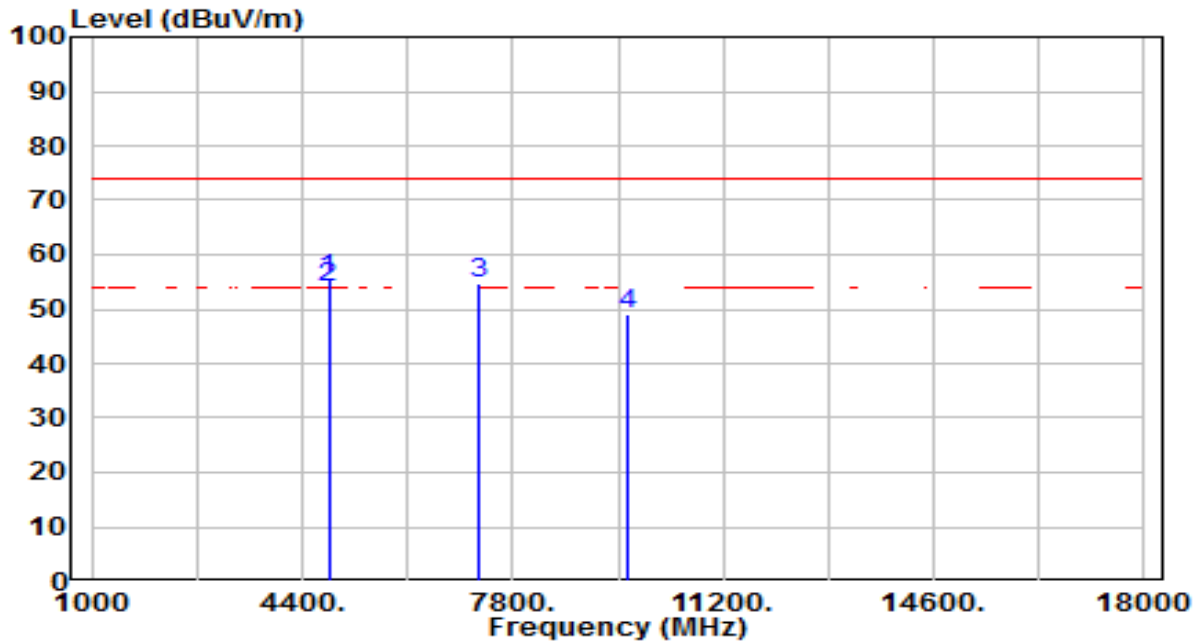

No	Frequency (MHz)	Reading (dBuV)	C.F (dB/m)	Measurement (dBuV/m)	Margin (dB)	Limit (dBuV/m)	Height (cm)	Angle (deg)	Remark (QP/PK/AV)	
1	*	4824.000	51.62	3.91	55.54	-18.46	74.00	200	94	Peak
2	*	4824.000	49.90	3.91	53.81	-0.19	54.00	200	94	Average
3		7236.000	42.85	11.94	54.78	-19.22	74.00	150	360	Peak
4		9648.000	33.27	15.79	49.06	-24.94	74.00	150	360	Peak

Note:

1. " \*", means this data is the worst emission level.
2. C.F (Correction Factor) = Antenna Factor (dB/m)+ Cable Loss (dB) – Pre-amplifier(dB).
3. Measurement (dBuV/m) = Reading(dBuV) + C.F (Correction Factor).
4. The emission levels of other frequencies are very lower than the limit and not show in test report.

EUT	Outdoor Pan/Tilt Security Wi-Fi Camera	Date of Test	2023-05-13
Factor	BBHA 9120D	Temp. / Humidity	24°C /59%
Polarity	Horizontal	Site / Test Engineer	AC1 / Todd
Test Mode	802.11b_TX_CH 6_ANT 0	Test Voltage	AC 120V/60Hz

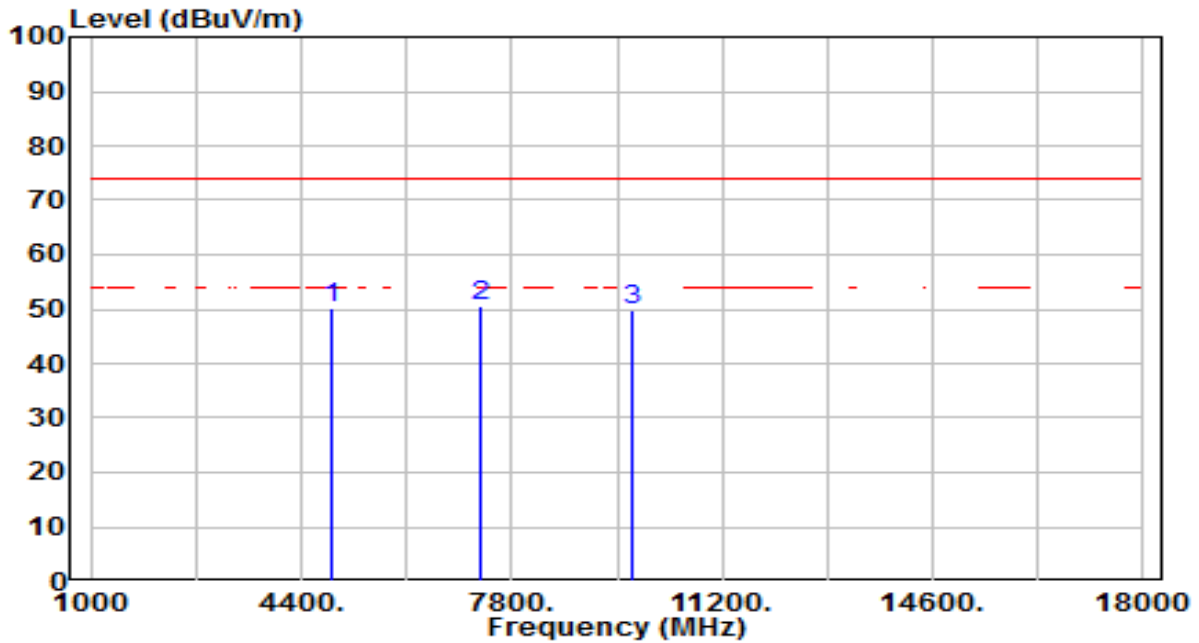

No	Frequency (MHz)	Reading (dBuV)	C.F (dB/m)	Measurement (dBuV/m)	Margin (dB)	Limit (dBuV/m)	Height (cm)	Angle (deg)	Remark (QP/PK/AV)
1	4874.000	46.34	4.02	50.36	-23.64	74.00	150	360	Peak
2	* 7311.000	38.39	12.20	50.59	-23.41	74.00	150	360	Peak
3	9748.000	33.64	16.01	49.65	-24.35	74.00	150	360	Peak

Note:

1. " \*", means this data is the worst emission level.
2. C.F (Correction Factor) = Antenna Factor (dB/m)+ Cable Loss (dB) – Preamplifier(dB).
3. Measurement (dBuV/m) = Reading(dBuV) + C.F (Correction Factor).
4. The emission levels of other frequencies are very lower than the limit and not show in test report.

EUT	Outdoor Pan/Tilt Security Wi-Fi Camera	Date of Test	2023-05-13
Factor	BBHA 9120D	Temp. / Humidity	24°C /59%
Polarity	Vertical	Site / Test Engineer	AC1 / Todd
Test Mode	802.11b_TX_CH 6_ANT 0	Test Voltage	AC 120V/60Hz

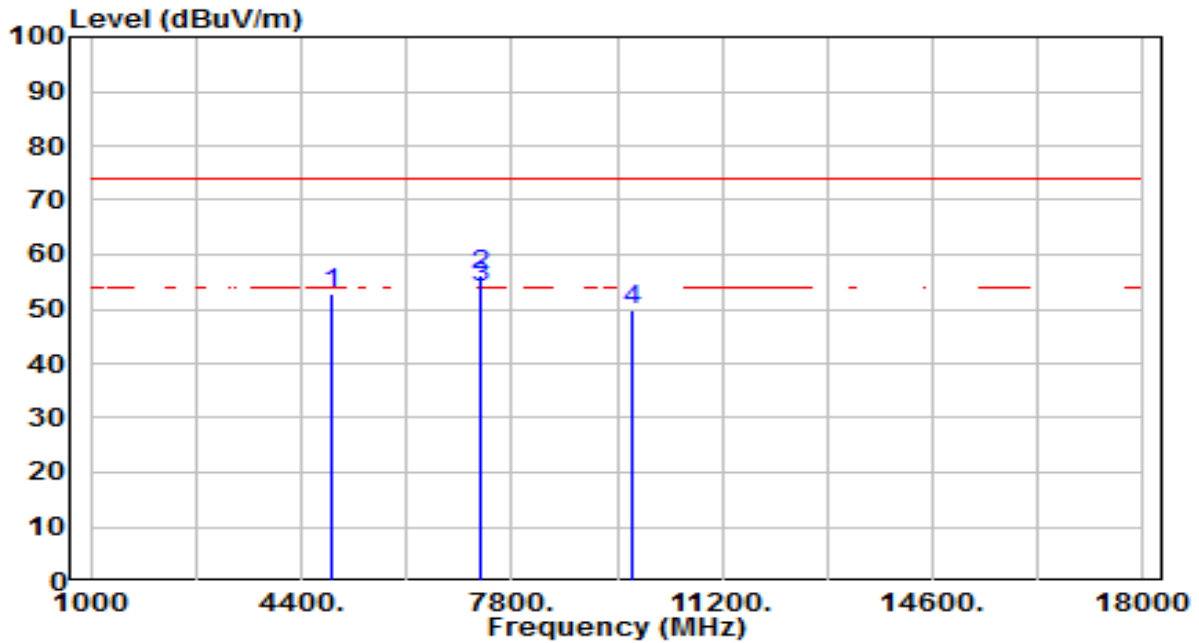

No	Frequency (MHz)	Reading (dBuV)	C.F (dB/m)	Measurement (dBuV/m)	Margin (dB)	Limit (dBuV/m)	Height (cm)	Angle (deg)	Remark (QP/PK/AV)
1	4874.000	48.96	4.02	52.98	-21.02	74.00	150	360	Peak
2	* 7311.000	44.14	12.20	56.35	-17.65	74.00	100	220	Peak
3	* 7311.000	41.70	12.20	53.90	-0.10	54.00	100	220	Average
4	9748.000	33.98	16.01	49.99	-24.01	74.00	150	360	Peak

Note:

- "\*" means this data is the worst emission level.
- C.F (Correction Factor) = Antenna Factor (dB/m)+ Cable Loss (dB) – Pre-amplifier(dB).
- Measurement (dBuV/m) = Reading(dBuV) + C.F (Correction Factor).
- The emission levels of other frequencies are very lower than the limit and not show in test report.

EUT	Outdoor Pan/Tilt Security Wi-Fi Camera	Date of Test	2023-05-13
Factor	BBHA 9120D	Temp. / Humidity	24°C /59%
Polarity	Horizontal	Site / Test Engineer	AC1 / Todd
Test Mode	802.11b_TX_CH 11_ANT 0	Test Voltage	AC 120V/60Hz

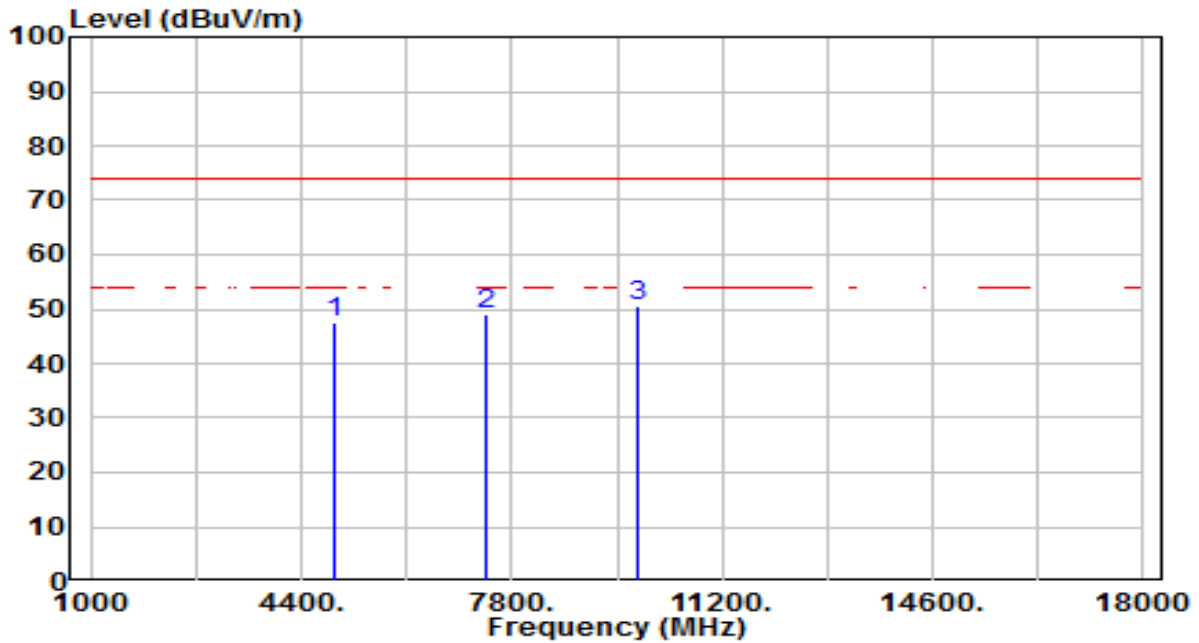

No	Frequency (MHz)	Reading (dBuV)	C.F (dB/m)	Measurement (dBuV/m)	Margin (dB)	Limit (dBuV/m)	Height (cm)	Angle (deg)	Remark (QP/PK/AV)
1	4924.000	43.30	4.13	47.43	-26.57	74.00	150	360	Peak
2	7386.000	36.65	12.46	49.11	-24.89	74.00	150	360	Peak
3	* 9848.000	34.30	16.23	50.53	-23.47	74.00	150	360	Peak

Note:

1. " \*", means this data is the worst emission level.
2. C.F (Correction Factor) = Antenna Factor (dB/m)+ Cable Loss (dB) – Pre-amplifier(dB).
3. Measurement (dBuV/m) = Reading(dBuV) + C.F (Correction Factor).
4. The emission levels of other frequencies are very lower than the limit and not show in test report.

EUT	Outdoor Pan/Tilt Security Wi-Fi Camera	Date of Test	2023-05-13
Factor	BBHA 9120D	Temp. / Humidity	24°C /59%
Polarity	Vertical	Site / Test Engineer	AC1 / Todd
Test Mode	802.11b_TX_CH 11_ANT 0	Test Voltage	AC 120V/60Hz

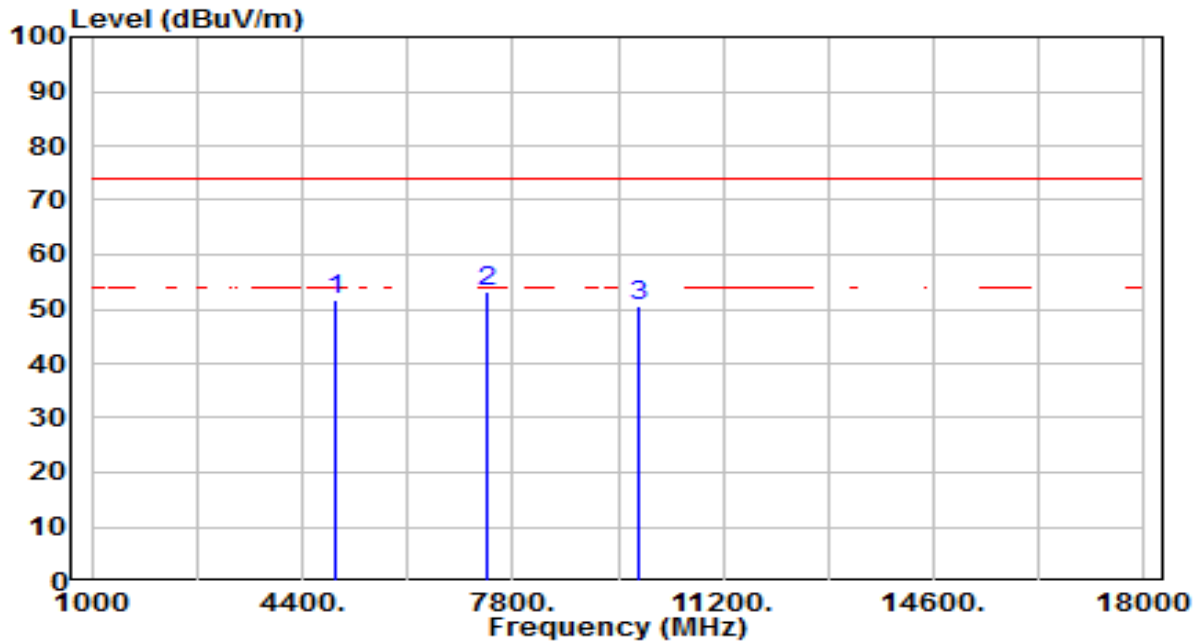

No	Frequency (MHz)	Reading (dBuV)	C.F (dB/m)	Measurement (dBuV/m)	Margin (dB)	Limit (dBuV/m)	Height (cm)	Angle (deg)	Remark (QP/PK/AV)
1	4924.000	47.59	4.13	51.72	-22.28	74.00	150	360	Peak
2	* 7386.000	40.85	12.46	53.32	-20.68	74.00	150	360	Peak
3	9848.000	34.51	16.23	50.74	-23.26	74.00	150	360	Peak

Note:

1. " \*", means this data is the worst emission level.
2. C.F (Correction Factor) = Antenna Factor (dB/m)+ Cable Loss (dB) – Preamplifier(dB).
3. Measurement (dBuV/m) = Reading(dBuV) + C.F (Correction Factor).
4. The emission levels of other frequencies are very lower than the limit and not show in test report.

EUT	Outdoor Pan/Tilt Security Wi-Fi Camera	Date of Test	2023-05-13
Factor	BBHA 9120D	Temp. / Humidity	24°C /59%
Polarity	Horizontal	Site / Test Engineer	AC1 / Todd
Test Mode	802.11g_TX_CH 1_ANT 0	Test Voltage	AC 120V/60Hz

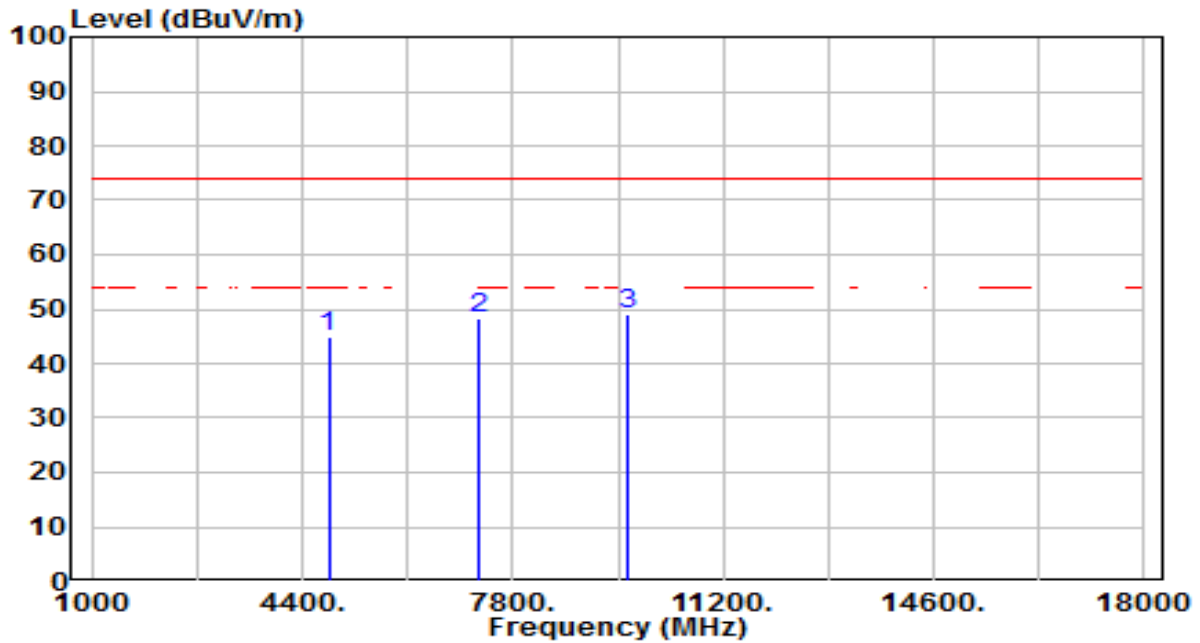

No	Frequency (MHz)	Reading (dBuV)	C.F (dB/m)	Measurement (dBuV/m)	Margin (dB)	Limit (dBuV/m)	Height (cm)	Angle (deg)	Remark (QP/PK/AV)
1	4824.000	40.89	3.91	44.80	-29.20	74.00	150	360	Peak
2	7236.000	36.28	11.94	48.22	-25.78	74.00	150	360	Peak
3	* 9648.000	33.11	15.79	48.90	-25.10	74.00	150	360	Peak

Note:

1. " \*", means this data is the worst emission level.
2. C.F (Correction Factor) = Antenna Factor (dB/m)+ Cable Loss (dB) – Pre-amplifier(dB).
3. Measurement (dBuV/m) = Reading(dBuV) + C.F (Correction Factor).
4. The emission levels of other frequencies are very lower than the limit and not show in test report.



EUT	Outdoor Pan/Tilt Security Wi-Fi Camera	Date of Test	2023-05-13
Factor	BBHA 9120D	Temp. / Humidity	24°C /59%
Polarity	Vertical	Site / Test Engineer	AC1 / Todd
Test Mode	802.11g_TX_CH 1_ANT 0	Test Voltage	AC 120V/60Hz

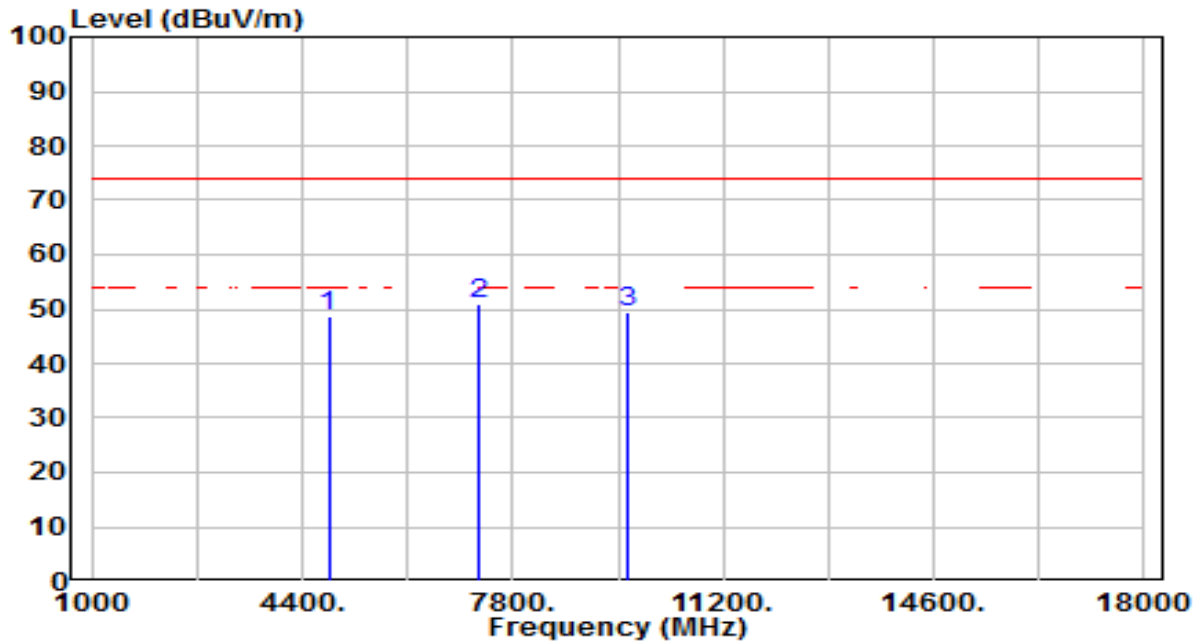

No	Frequency (MHz)	Reading (dBuV)	C.F (dB/m)	Measurement (dBuV/m)	Margin (dB)	Limit (dBuV/m)	Height (cm)	Angle (deg)	Remark (QP/PK/AV)
1	4824.000	44.81	3.91	48.72	-25.28	74.00	150	360	Peak
2	* 7236.000	39.03	11.94	50.97	-23.03	74.00	150	360	Peak
3	9648.000	33.74	15.79	49.53	-24.47	74.00	150	360	Peak

Note:

1. " \*", means this data is the worst emission level.
2. C.F (Correction Factor) = Antenna Factor (dB/m)+ Cable Loss (dB) – Pre-amplifier(dB).
3. Measurement (dBuV/m) = Reading(dBuV) + C.F (Correction Factor).
4. The emission levels of other frequencies are very lower than the limit and not show in test report.

EUT	Outdoor Pan/Tilt Security Wi-Fi Camera	Date of Test	2023-05-13
Factor	BBHA 9120D	Temp. / Humidity	24°C /59%
Polarity	Horizontal	Site / Test Engineer	AC1 / Todd
Test Mode	802.11g_TX_CH 6_ANT 0	Test Voltage	AC 120V/60Hz

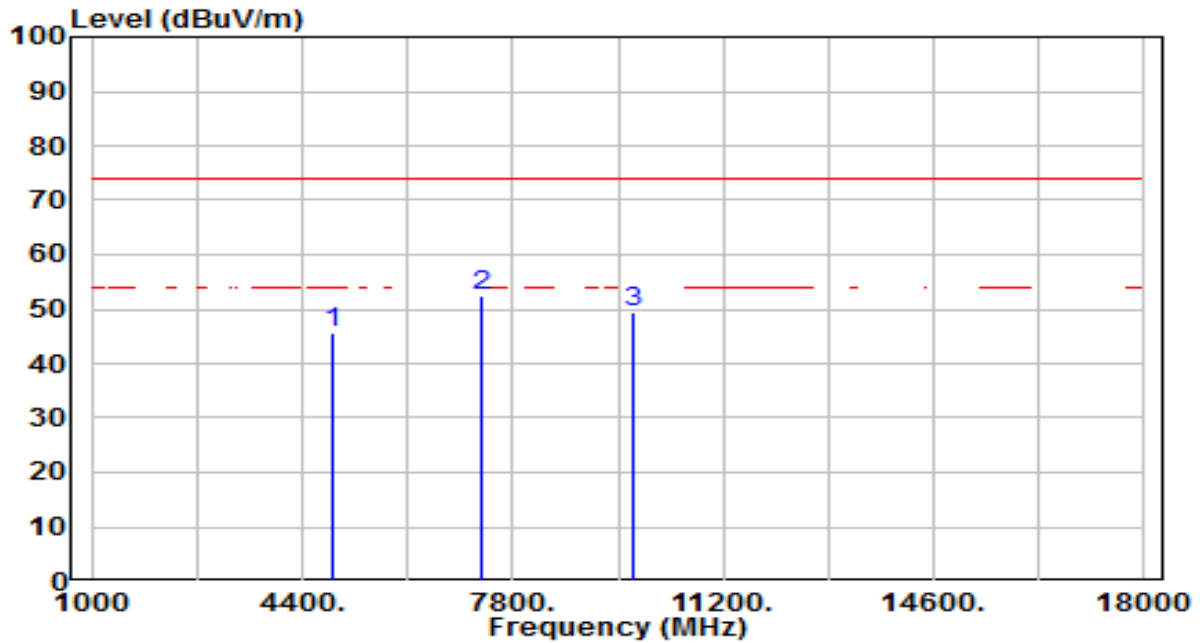

No	Frequency (MHz)	Reading (dBuV)	C.F (dB/m)	Measurement (dBuV/m)	Margin (dB)	Limit (dBuV/m)	Height (cm)	Angle (deg)	Remark (QP/PK/AV)
1	4874.000	41.48	4.02	45.50	-28.50	74.00	150	360	Peak
2	* 7311.000	40.34	12.20	52.54	-21.46	74.00	150	360	Peak
3	9748.000	33.58	16.01	49.59	-24.41	74.00	150	360	Peak

Note:

1. " \*", means this data is the worst emission level.
2. C.F (Correction Factor) = Antenna Factor (dB/m)+ Cable Loss (dB) – Preamplifier(dB).
3. Measurement (dBuV/m) = Reading(dBuV) + C.F (Correction Factor).
4. The emission levels of other frequencies are very lower than the limit and not show in test report.

EUT	Outdoor Pan/Tilt Security Wi-Fi Camera	Date of Test	2023-05-13
Factor	BBHA 9120D	Temp. / Humidity	24°C /59%
Polarity	Vertical	Site / Test Engineer	AC1 / Todd
Test Mode	802.11g_TX_CH 6_ANT 0	Test Voltage	AC 120V/60Hz

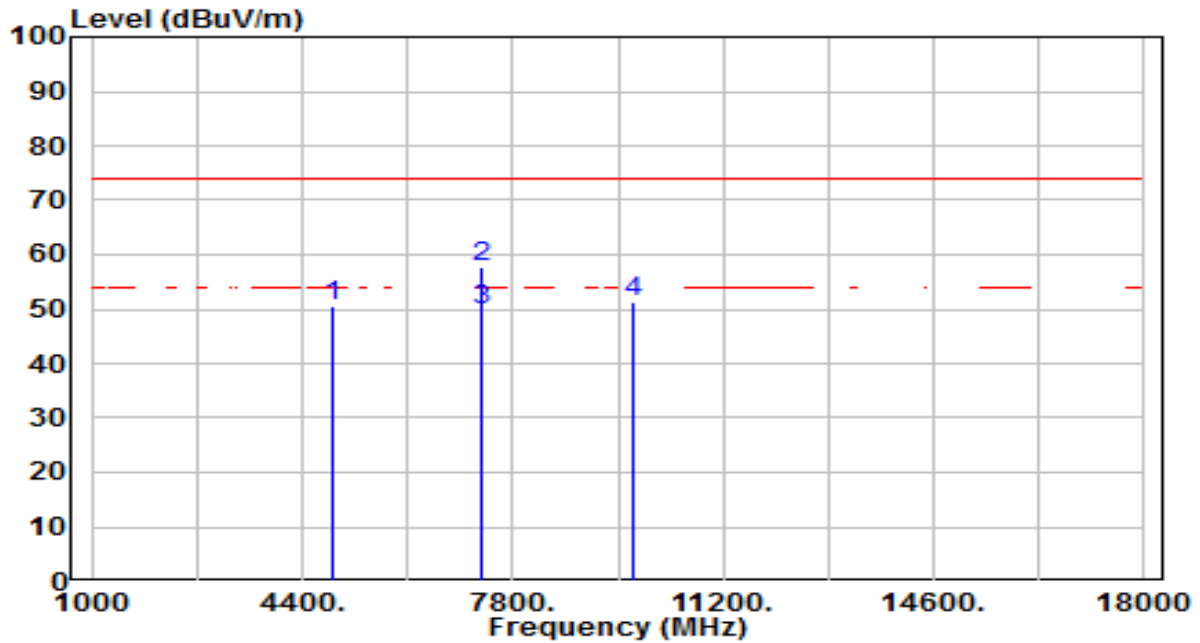

No	Frequency (MHz)	Reading (dBuV)	C.F (dB/m)	Measurement (dBuV/m)	Margin (dB)	Limit (dBuV/m)	Height (cm)	Angle (deg)	Remark (QP/PK/AV)
1	4874.000	46.55	4.02	50.57	-23.43	74.00	150	360	Peak
2	* 7311.000	45.63	12.20	57.83	-16.17	74.00	102	226	Peak
3	* 7311.000	37.44	12.20	49.64	-4.36	54.00	102	226	Average
4	9748.000	35.33	16.01	51.34	-22.66	74.00	150	360	Peak

Note:

- "\*" means this data is the worst emission level.
- C.F (Correction Factor) = Antenna Factor (dB/m)+ Cable Loss (dB) – Preamplifier(dB).
- Measurement (dBuV/m) = Reading(dBuV) + C.F (Correction Factor).
- The emission levels of other frequencies are very lower than the limit and not show in test report.

EUT	Outdoor Pan/Tilt Security Wi-Fi Camera	Date of Test	2023-05-13
Factor	BBHA 9120D	Temp. / Humidity	24°C /59%
Polarity	Horizontal	Site / Test Engineer	AC1 / Todd
Test Mode	802.11g_TX_CH 11_ANT 0	Test Voltage	AC 120V/60Hz

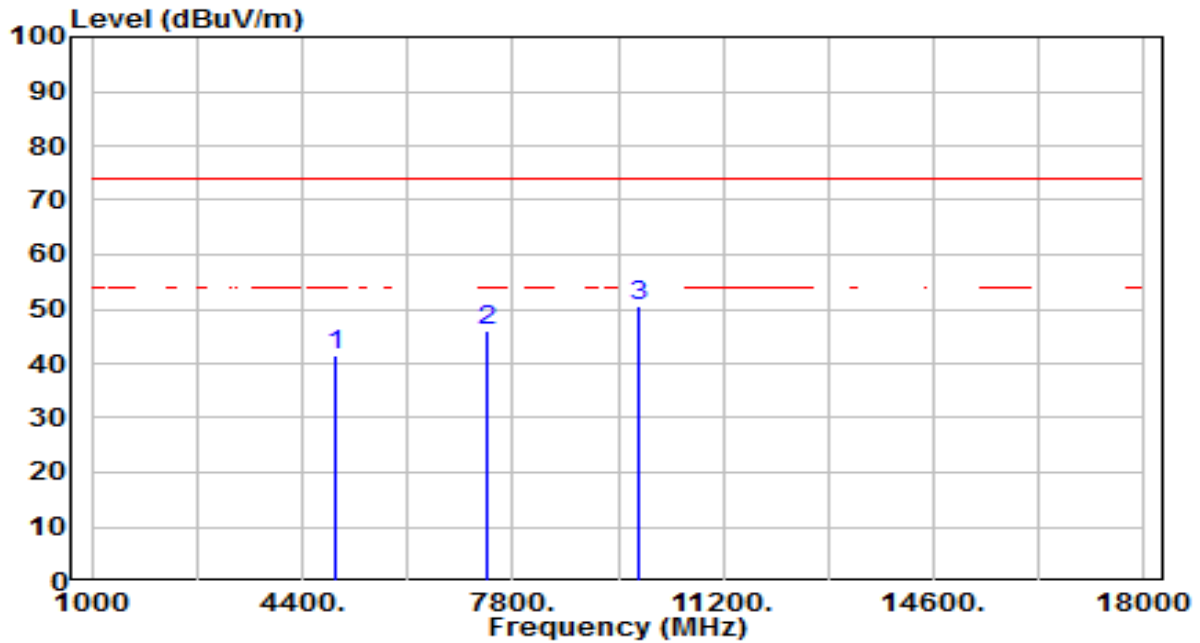

No	Frequency (MHz)	Reading (dBuV)	C.F (dB/m)	Measurement (dBuV/m)	Margin (dB)	Limit (dBuV/m)	Height (cm)	Angle (deg)	Remark (QP/PK/AV)
1	4924.000	37.32	4.13	41.44	-32.56	74.00	150	360	Peak
2	7386.000	33.50	12.46	45.96	-28.04	74.00	150	360	Peak
3	* 9848.000	34.34	16.23	50.56	-23.44	74.00	150	360	Peak

Note:

1. " \*", means this data is the worst emission level.
2. C.F (Correction Factor) = Antenna Factor (dB/m)+ Cable Loss (dB) – Preamplifier(dB).
3. Measurement (dBuV/m) = Reading(dBuV) + C.F (Correction Factor).
4. The emission levels of other frequencies are very lower than the limit and not show in test report.

EUT	Outdoor Pan/Tilt Security Wi-Fi Camera	Date of Test	2023-05-13
Factor	BBHA 9120D	Temp. / Humidity	24°C /59%
Polarity	Vertical	Site / Test Engineer	AC1 / Todd
Test Mode	802.11g_TX_CH 11_ANT 0	Test Voltage	AC 120V/60Hz

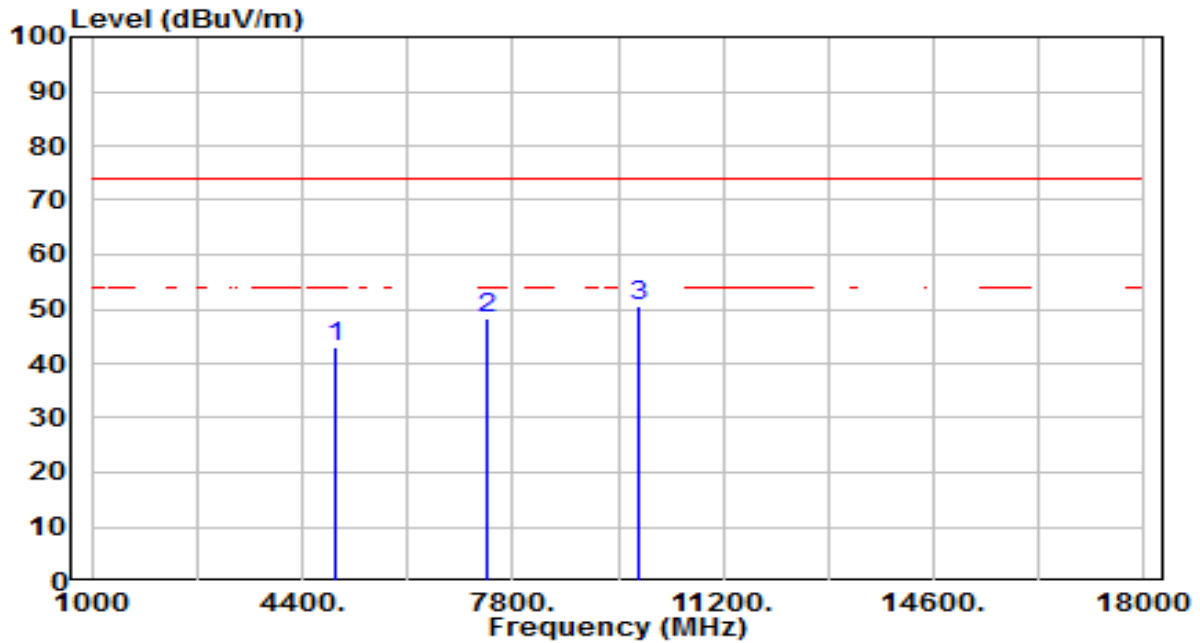

No	Frequency (MHz)	Reading (dBuV)	C.F (dB/m)	Measurement (dBuV/m)	Margin (dB)	Limit (dBuV/m)	Height (cm)	Angle (deg)	Remark (QP/PK/AV)
1	4924.000	38.87	4.13	43.00	-31.00	74.00	150	360	Peak
2	7386.000	35.79	12.46	48.25	-25.75	74.00	150	360	Peak
3	* 9848.000	34.30	16.23	50.53	-23.47	74.00	150	360	Peak

Note:

1. " \*", means this data is the worst emission level.
2. C.F (Correction Factor) = Antenna Factor (dB/m)+ Cable Loss (dB) – Preamplifier(dB).
3. Measurement (dBuV/m) = Reading(dBuV) + C.F (Correction Factor).
4. The emission levels of other frequencies are very lower than the limit and not show in test report.

EUT	Outdoor Pan/Tilt Security Wi-Fi Camera	Date of Test	2023-05-13
Factor	BBHA 9120D	Temp. / Humidity	24°C /59%
Polarity	Horizontal	Site / Test Engineer	AC1 / Todd
Test Mode	802.11n-20MHz_TX_CH 1_ANT 0	Test Voltage	AC 120V/60Hz

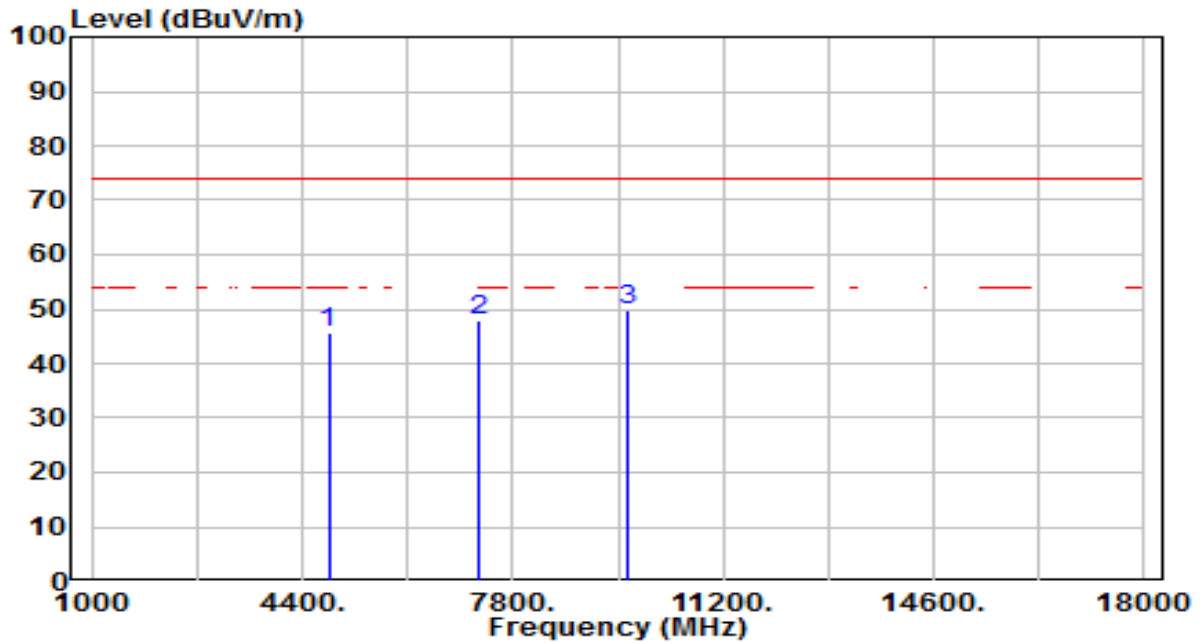

No	Frequency (MHz)	Reading (dBuV)	C.F (dB/m)	Measurement (dBuV/m)	Margin (dB)	Limit (dBuV/m)	Height (cm)	Angle (deg)	Remark (QP/PK/AV)
1	4824.000	41.66	3.91	45.58	-28.42	74.00	150	360	Peak
2	7236.000	35.92	11.94	47.86	-26.14	74.00	150	360	Peak
3	* 9648.000	33.87	15.79	49.66	-24.34	74.00	150	360	Peak

Note:

1. " \*", means this data is the worst emission level.
2. C.F (Correction Factor) = Antenna Factor (dB/m)+ Cable Loss (dB) – Preamplifier(dB).
3. Measurement (dBuV/m) = Reading(dBuV) + C.F (Correction Factor).
4. The emission levels of other frequencies are very lower than the limit and not show in test report.

EUT	Outdoor Pan/Tilt Security Wi-Fi Camera	Date of Test	2023-05-13
Factor	BBHA 9120D	Temp. / Humidity	24°C /59%
Polarity	Vertical	Site / Test Engineer	AC1 / Todd
Test Mode	802.11n-20MHz_TX_CH 1_ANT 0	Test Voltage	AC 120V/60Hz

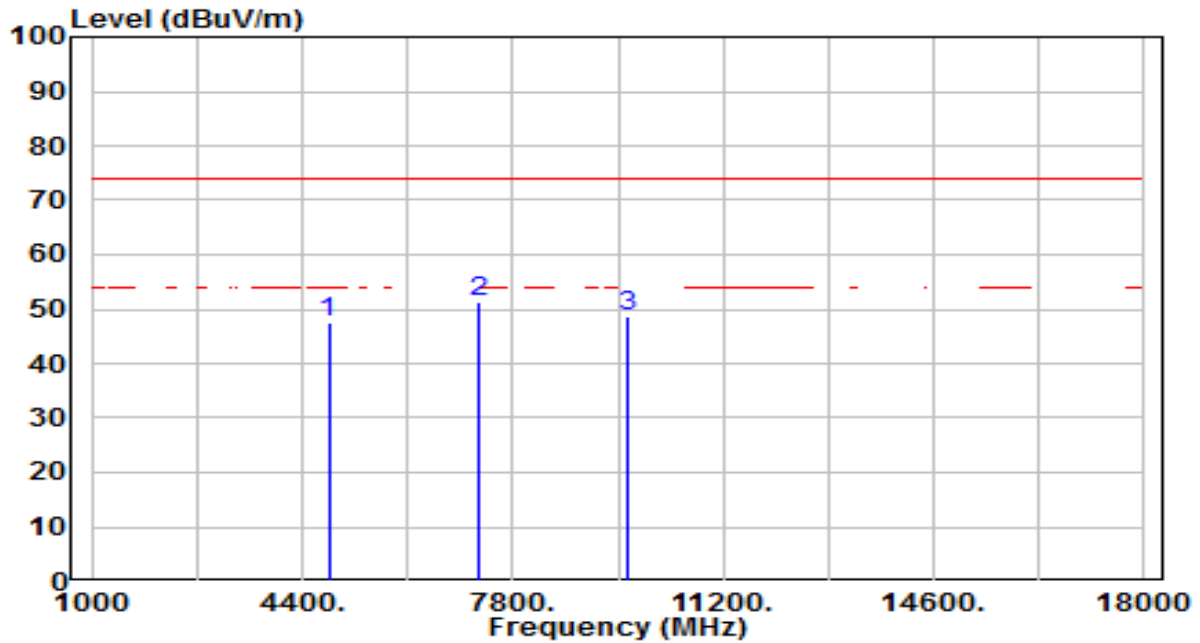

No	Frequency (MHz)	Reading (dBuV)	C.F (dB/m)	Measurement (dBuV/m)	Margin (dB)	Limit (dBuV/m)	Height (cm)	Angle (deg)	Remark (QP/PK/AV)
1	4824.000	43.46	3.91	47.37	-26.63	74.00	150	360	Peak
2	* 7236.000	39.25	11.94	51.19	-22.81	74.00	150	360	Peak
3	9648.000	33.06	15.79	48.85	-25.15	74.00	150	360	Peak

Note:

1. " \*", means this data is the worst emission level.
2. C.F (Correction Factor) = Antenna Factor (dB/m)+ Cable Loss (dB) – Pre-amplifier(dB).
3. Measurement (dBuV/m) = Reading(dBuV) + C.F (Correction Factor).
4. The emission levels of other frequencies are very lower than the limit and not show in test report.

EUT	Outdoor Pan/Tilt Security Wi-Fi Camera	Date of Test	2023-05-13
Factor	BBHA 9120D	Temp. / Humidity	24°C /59%
Polarity	Horizontal	Site / Test Engineer	AC1 / Todd
Test Mode	802.11n-20MHz_TX_CH 6_ANT 0	Test Voltage	AC 120V/60Hz

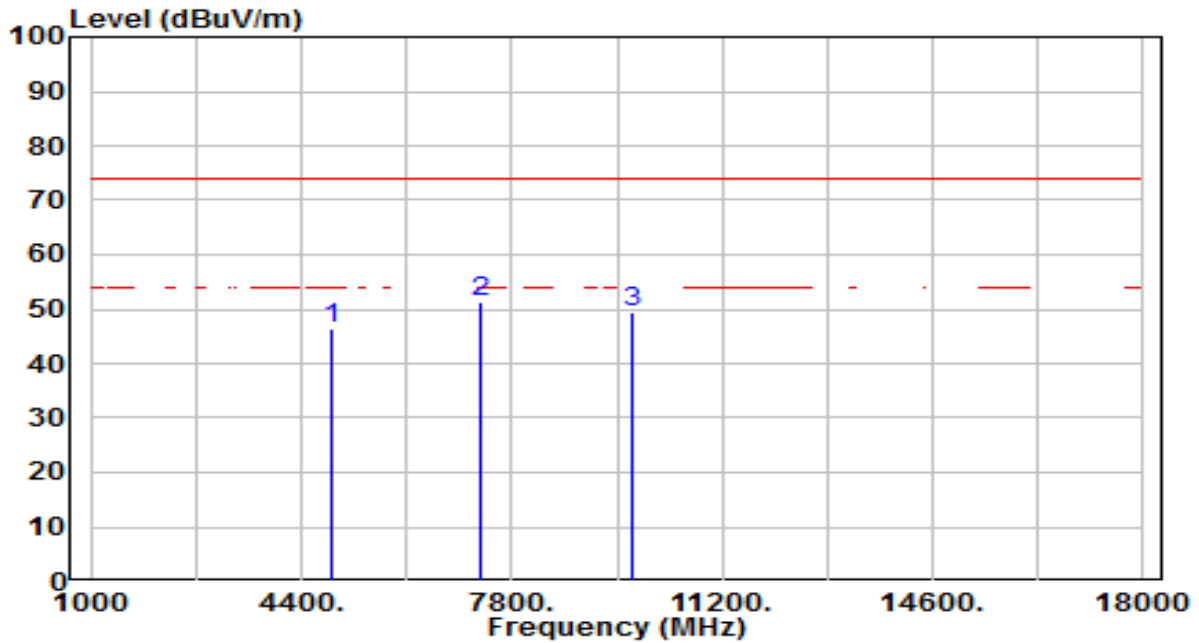

No	Frequency (MHz)	Reading (dBuV)	C.F (dB/m)	Measurement (dBuV/m)	Margin (dB)	Limit (dBuV/m)	Height (cm)	Angle (deg)	Remark (QP/PK/AV)
1	4874.000	42.37	4.02	46.39	-27.61	74.00	150	360	Peak
2	* 7311.000	39.29	12.20	51.49	-22.51	74.00	150	360	Peak
3	9748.000	33.48	16.01	49.49	-24.51	74.00	150	360	Peak

Note:

1. " \*", means this data is the worst emission level.
2. C.F (Correction Factor) = Antenna Factor (dB/m)+ Cable Loss (dB) – Pre-amplifier(dB).
3. Measurement (dBuV/m) = Reading(dBuV) + C.F (Correction Factor).
4. The emission levels of other frequencies are very lower than the limit and not show in test report.



EUT	Outdoor Pan/Tilt Security Wi-Fi Camera	Date of Test	2023-05-13
Factor	BBHA 9120D	Temp. / Humidity	24°C /59%
Polarity	Vertical	Site / Test Engineer	AC1 / Todd
Test Mode	802.11n-20MHz_TX_CH 6_ANT 0	Test Voltage	AC 120V/60Hz

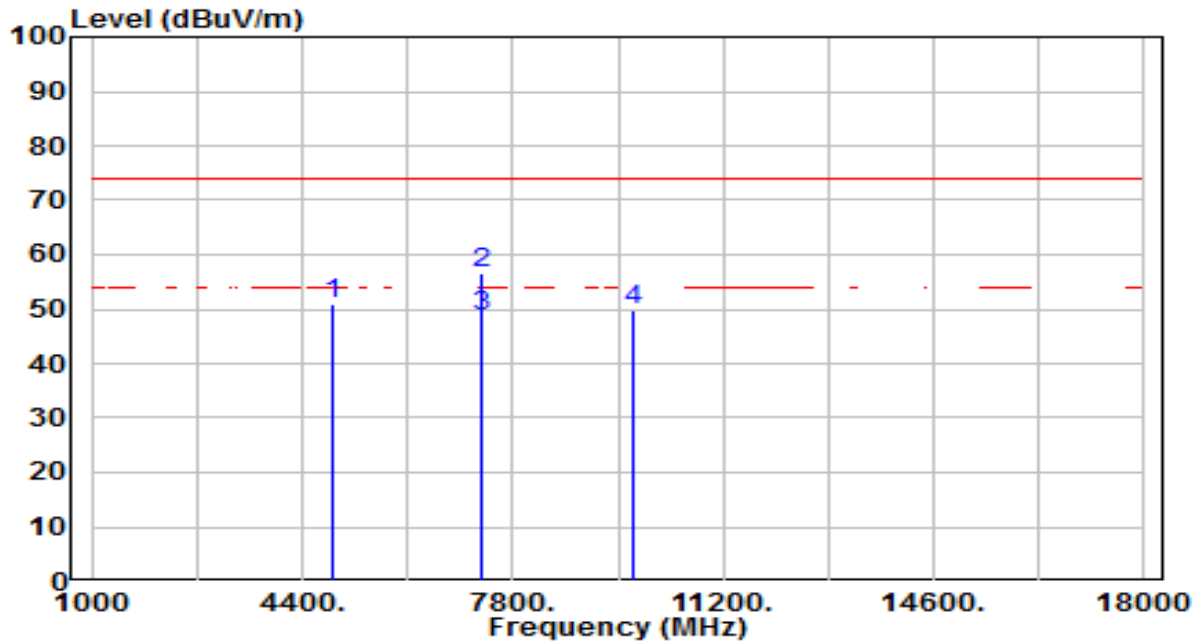

No	Frequency (MHz)	Reading (dBuV)	C.F (dB/m)	Measurement (dBuV/m)	Margin (dB)	Limit (dBuV/m)	Height (cm)	Angle (deg)	Remark (QP/PK/AV)
1	4874.000	46.93	4.02	50.95	-23.05	74.00	150	360	Peak
2	* 7311.000	44.42	12.20	56.62	-17.38	74.00	101	227	Peak
3	* 7311.000	36.57	12.20	48.77	-5.23	54.00	101	227	Average
4	9748.000	33.73	16.01	49.74	-24.26	74.00	150	360	Peak

Note:

- "\*" means this data is the worst emission level.
- C.F (Correction Factor) = Antenna Factor (dB/m)+ Cable Loss (dB) – Pre-amplifier(dB).
- Measurement (dBuV/m) = Reading(dBuV) + C.F (Correction Factor).
- The emission levels of other frequencies are very lower than the limit and not show in test report.

EUT	Outdoor Pan/Tilt Security Wi-Fi Camera	Date of Test	2023-05-13
Factor	BBHA 9120D	Temp. / Humidity	24°C /59%
Polarity	Horizontal	Site / Test Engineer	AC1 / Todd
Test Mode	802.11n-20MHz_TX_CH 11_ANT 0	Test Voltage	AC 120V/60Hz

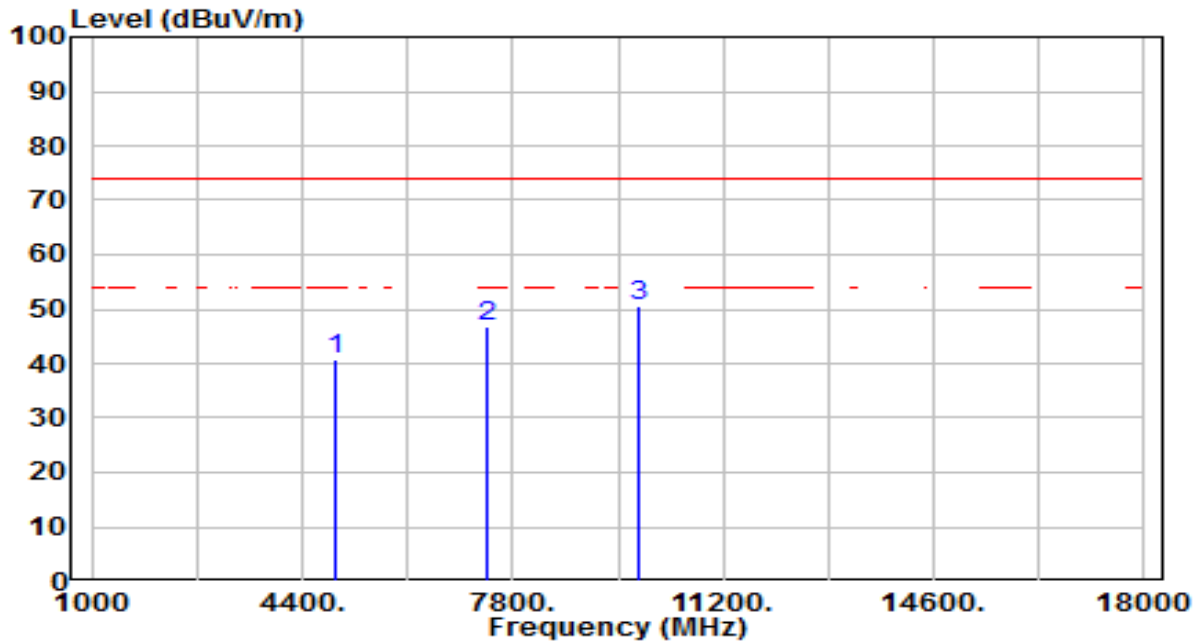

No	Frequency (MHz)	Reading (dBuV)	C.F (dB/m)	Measurement (dBuV/m)	Margin (dB)	Limit (dBuV/m)	Height (cm)	Angle (deg)	Remark (QP/PK/AV)
1	4924.000	36.63	4.13	40.76	-33.24	74.00	150	360	Peak
2	7386.000	34.42	12.46	46.89	-27.11	74.00	150	360	Peak
3	* 9848.000	34.39	16.23	50.62	-23.38	74.00	150	360	Peak

Note:

1. " \*", means this data is the worst emission level.
2. C.F (Correction Factor) = Antenna Factor (dB/m)+ Cable Loss (dB) – Pre-amplifier(dB).
3. Measurement (dBuV/m) = Reading(dBuV) + C.F (Correction Factor).
4. The emission levels of other frequencies are very lower than the limit and not show in test report.

EUT	Outdoor Pan/Tilt Security Wi-Fi Camera	Date of Test	2023-05-13
Factor	BBHA 9120D	Temp. / Humidity	24°C /59%
Polarity	Vertical	Site / Test Engineer	AC1 / Todd
Test Mode	802.11n-20MHz_TX_CH 11_ANT 0	Test Voltage	AC 120V/60Hz

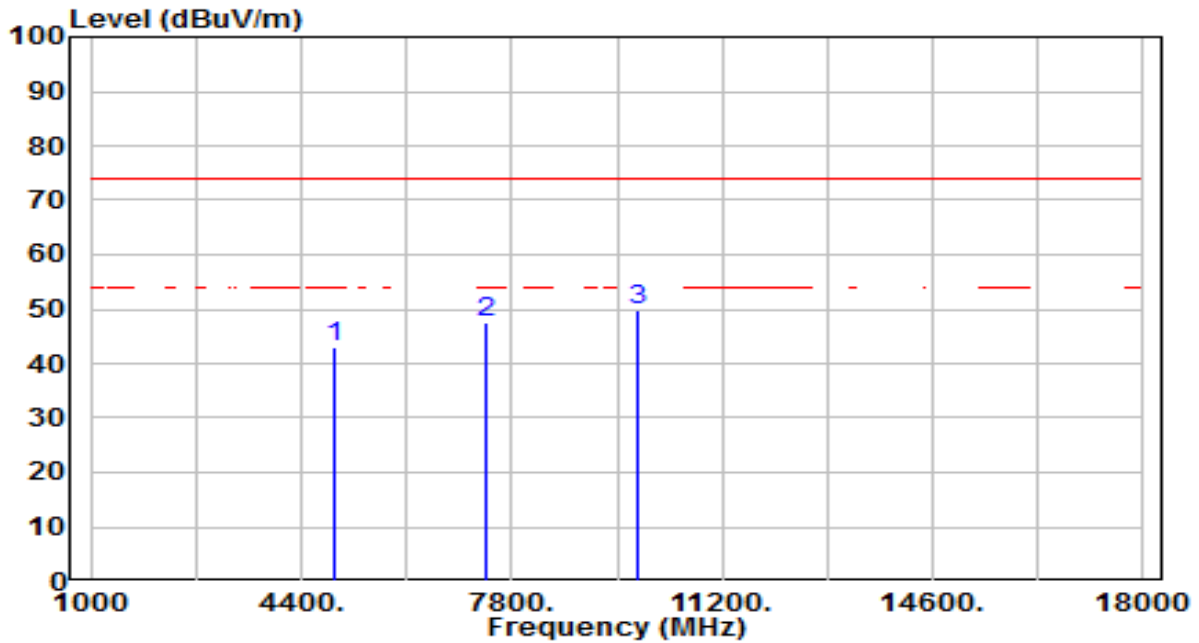

No	Frequency (MHz)	Reading (dBuV)	C.F (dB/m)	Measurement (dBuV/m)	Margin (dB)	Limit (dBuV/m)	Height (cm)	Angle (deg)	Remark (QP/PK/AV)
1	4924.000	38.98	4.13	43.11	-30.89	74.00	150	360	Peak
2	7386.000	35.09	12.46	47.56	-26.44	74.00	150	360	Peak
3	* 9848.000	33.68	16.23	49.91	-24.09	74.00	150	360	Peak

Note:

1. " \*", means this data is the worst emission level.
2. C.F (Correction Factor) = Antenna Factor (dB/m)+ Cable Loss (dB) – Pre-amplifier(dB).
3. Measurement (dBuV/m) = Reading(dBuV) + C.F (Correction Factor).
4. The emission levels of other frequencies are very lower than the limit and not show in test report.

## 7.7. Radiated Restricted Band Edge Measurement

### 7.7.1. Test Limit

**For 15.205 requirement:**

Radiated emissions which fall in the restricted bands, as defined in Section 15.205(a) of FCC part 15, must also comply with the radiated emission limits specified in Section 15.209(a).

Frequency (MHz)	Frequency (MHz)	Frequency (MHz)	Frequency (GHz)
0.090 - 0.110	16.42 - 16.423	399.9 - 410	4.5 - 5.15
<sup>1</sup> 0.495 - 0.505	16.69475 - 16.69525	608 - 614	5.35 - 5.46
2.1735 - 2.1905	16.80425 - 16.80475	960 - 1240	7.25 - 7.75
4.125 - 4.128	25.5 - 25.67	1300 - 1427	8.025 - 8.5
4.17725 - 4.17775	37.5 - 38.25	1435 - 1626.5	9.0 - 9.2
4.20725 - 4.20775	73 - 74.6	1645.5 - 1646.5	9.3 - 9.5
6.215 - 6.218	74.8 - 75.2	1660 - 1710	10.6 - 12.7
6.26775 - 6.26825	108 - 121.94	1718.8 - 1722.2	13.25 - 13.4
6.31175 - 6.31225	123 - 138	2200 - 2300	14.47 - 14.5
8.291 - 8.294	149.9 - 150.05	2310 - 2390	15.35 - 16.2
8.362 - 8.366	156.52475 - 156.52525	2483.5 - 2500	17.7 - 21.4
8.37625 - 8.38675	156.7 - 156.9	2690 - 2900	22.01 - 23.12
8.41425 - 8.41475	162.0125 - 167.17	3260 - 3267	23.6 - 24.0
12.29 - 12.293	167.72 - 173.2	3332 - 3339	31.2 - 31.8
12.51975 - 12.52025	240 - 285	3345.8 - 3358	36.43 - 36.5
12.57675 - 12.57725	322 - 335.4	3600 - 4400	( <sup>2</sup> )
13.36 - 13.41	--	--	--

All out of band emissions appearing in a restricted band as specified in Section 15.205 of the Title 47CFR must not exceed the limits shown in Table per Section 15.209.

FCC Part 15 Subpart C Paragraph 15.209 Limits		
Frequency [MHz]	Field Strength [uV/m]	Measured Distance [Meters]
0.009 - 0.490	2400/F (kHz)	300
0.490 - 1.705	24000/F (kHz)	30
1.705 - 30	30	30
30 - 88	100	3
88 - 216	150	3
216 - 960	200	3
Above 960	500	3

### 7.7.2. Test Procedure Used

ANSI C63.10 - 2013 Section 6.3 (General Requirements)

ANSI C63.10 - 2013 Section 6.6 (Standard test method above 1GHz)

### 7.7.3. Test Setting

#### Peak Field Strength Measurements

1. Analyzer center frequency was set to the frequency of the radiated spurious emission of interest
2. RBW = 1MHz
3. VBW = 3MHz
4. Detector = peak
5. Sweep time = auto couple
6. Trace mode = max hold
7. Trace was allowed to stabilize

### Average Measurements above 1GHz (Method VB)

1. Analyzer center frequency was set to the frequency of the radiated spurious emission of interest
2. RBW = 1MHz
3. VBW; If the EUT is configured to transmit with duty cycle  $\geq 98\%$ , set VBW = 10 Hz.

If the EUT duty cycle is  $< 98\%$ , set  $VBW \geq 1/T$ . T is the minimum transmission duration.

4. Detector = Peak
5. Sweep time = auto
6. Trace mode = max hold
7. Trace was allowed to stabilize

#### 7.7.4. Test Setup

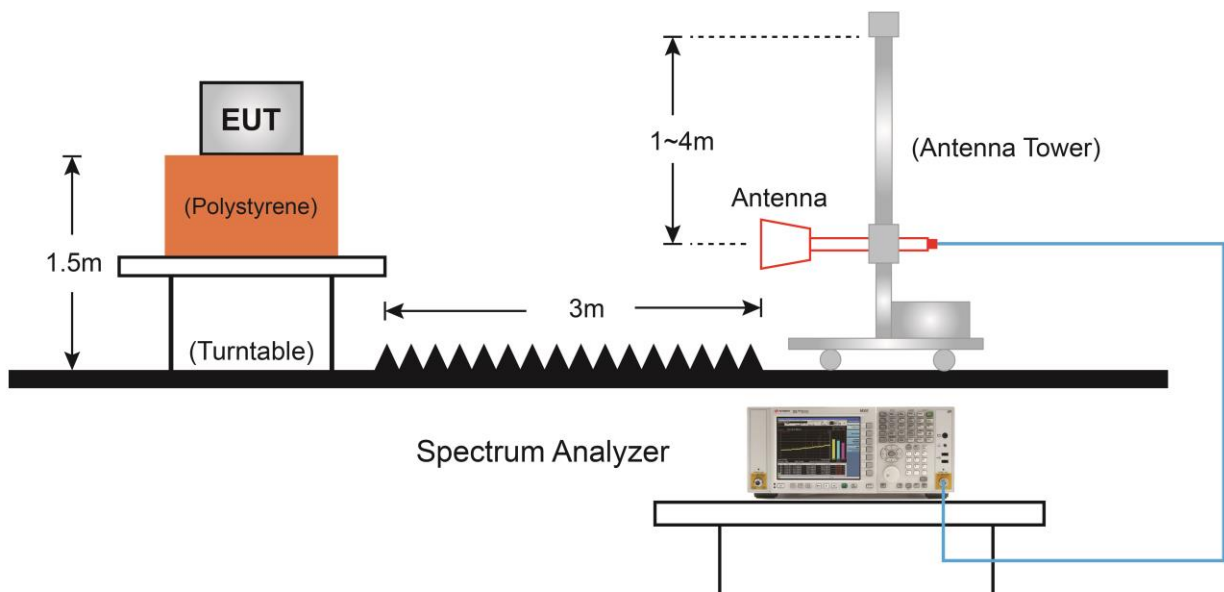

### 7.7.5. Test Result

EUT	Outdoor Pan/Tilt Security Wi-Fi Camera	Date of Test	2023-05-13
Factor	BBHA 9120D	Temp. / Humidity	24°C /59%
Polarity	Horizontal	Site / Test Engineer	AC1 / Todd
Test Mode	802.11b_TX_CH 1_ANT 0	Test Voltage	AC 120V/60Hz

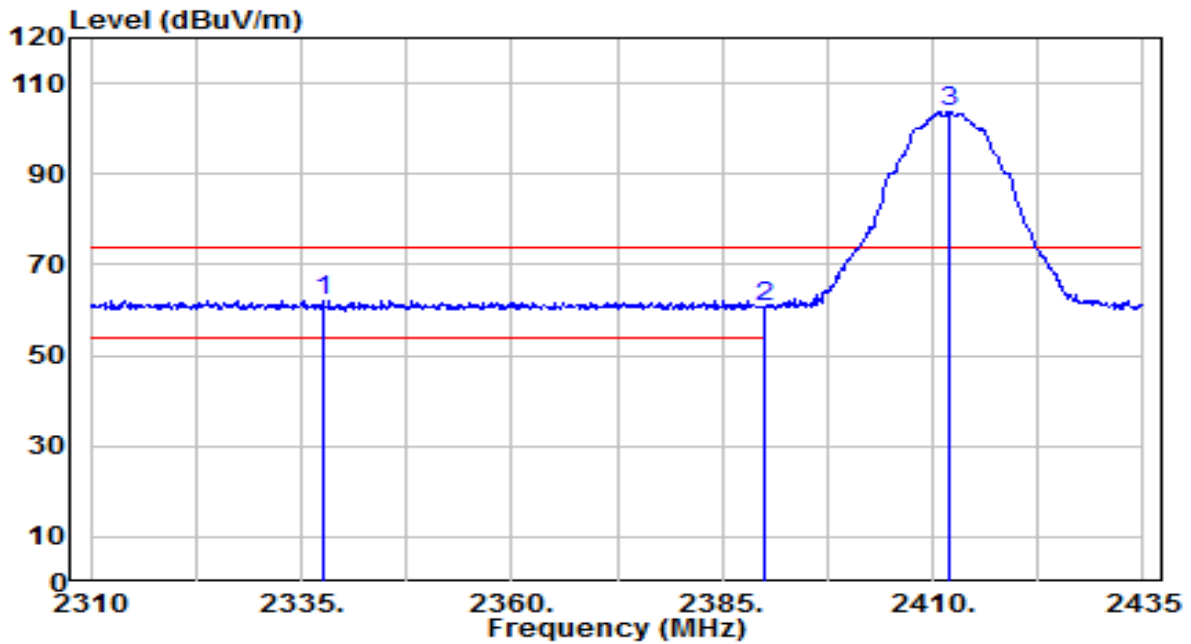

No	Frequency (MHz)	Reading (dBuV)	C.F (dB/m)	Measurement (dBuV/m)	Margin (dB)	Limit (dBuV/m)	Height (cm)	Angle (deg)	Remark (QP/PK/AV)
1	* 2337.500	30.21	32.00	62.21	-11.79	74.00	140	105	Peak
2	2390.000	28.57	32.18	60.76	-13.24	74.00	140	105	Peak
3	2412.000	71.59	32.26	103.85	N/A	N/A	140	105	Peak

Note:

1. " \*", means this data is the worst emission level.
2. C.F (Correction Factor) = Antenna Factor (dB/m)+ Cable Loss (dB).
3. Measurement (dBuV/m) = Reading(dBuV) + C.F (Correction Factor).
4. The emission levels of other frequencies are very lower than the limit and not show in test report.

EUT	Outdoor Pan/Tilt Security Wi-Fi Camera	Date of Test	2023-05-13
Factor	BBHA 9120D	Temp. / Humidity	24°C /59%
Polarity	Horizontal	Site / Test Engineer	AC1 / Todd
Test Mode	802.11b_TX_CH 1_ANT 0	Test Voltage	AC 120V/60Hz

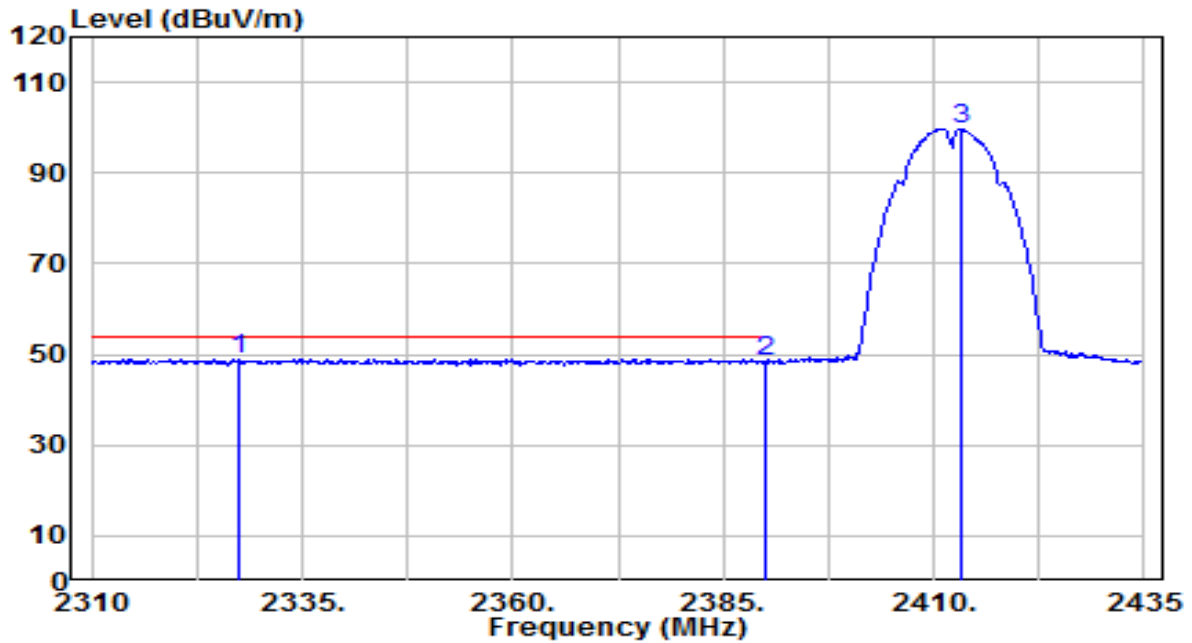

No	Frequency (MHz)	Reading (dBUV)	C.F (dB/m)	Measurement (dBUV/m)	Margin (dB)	Limit (dBUV/m)	Height (cm)	Angle (deg)	Remark (QP/PK/AV)	
1	*	2327.375	16.98	31.96	48.94	-5.06	54.00	140	105	Average
2		2390.000	16.28	32.18	48.47	-5.53	54.00	140	105	Average
3		2413.125	67.53	32.27	99.80	N/A	N/A	140	105	Average

Note:

1. " \*", means this data is the worst emission level.
2. C.F (Correction Factor) = Antenna Factor (dB/m)+ Cable Loss (dB).
3. Measurement (dBUV/m) = Reading(dBUV) + C.F (Correction Factor).
4. The emission levels of other frequencies are very lower than the limit and not show in test report.



EUT	Outdoor Pan/Tilt Security Wi-Fi Camera	Date of Test	2023-05-13
Factor	BBHA 9120D	Temp. / Humidity	24°C /59%
Polarity	Vertical	Site / Test Engineer	AC1 / Todd
Test Mode	802.11b_TX_CH 1_ANT 0	Test Voltage	AC 120V/60Hz

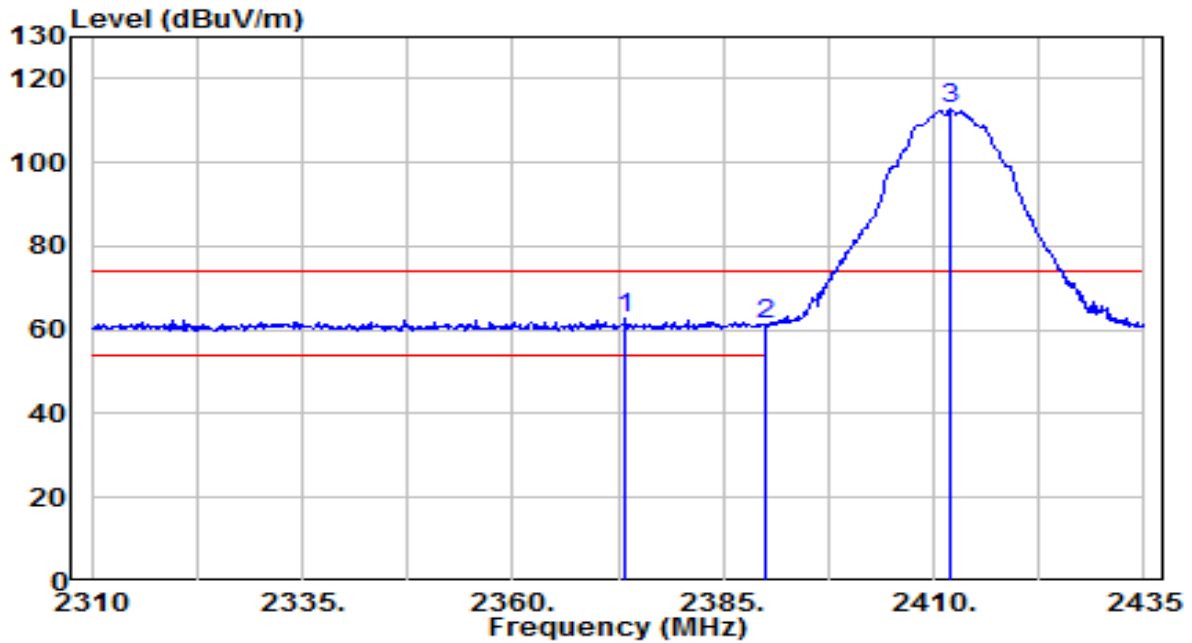

No	Frequency (MHz)	Reading (dBuV)	C.F (dB/m)	Measurement (dBuV/m)	Margin (dB)	Limit (dBuV/m)	Height (cm)	Angle (deg)	Remark (QP/PK/AV)	
1	*	2373.375	30.88	32.12	63.00	-11.00	74.00	115	110	Peak
2		2390.000	29.31	32.18	61.49	-12.51	74.00	115	110	Peak
3		2412.000	80.37	32.26	112.63	N/A	N/A	115	110	Peak

Note:

1. " \*", means this data is the worst emission level.
2. C.F (Correction Factor) = Antenna Factor (dB/m)+ Cable Loss (dB).
3. Measurement (dBuV/m) = Reading(dBuV) + C.F (Correction Factor).
4. The emission levels of other frequencies are very lower than the limit and not show in test report.

EUT	Outdoor Pan/Tilt Security Wi-Fi Camera	Date of Test	2023-05-13
Factor	BBHA 9120D	Temp. / Humidity	24°C /59%
Polarity	Vertical	Site / Test Engineer	AC1 / Todd
Test Mode	802.11b_TX_CH 1_ANT 0	Test Voltage	AC 120V/60Hz

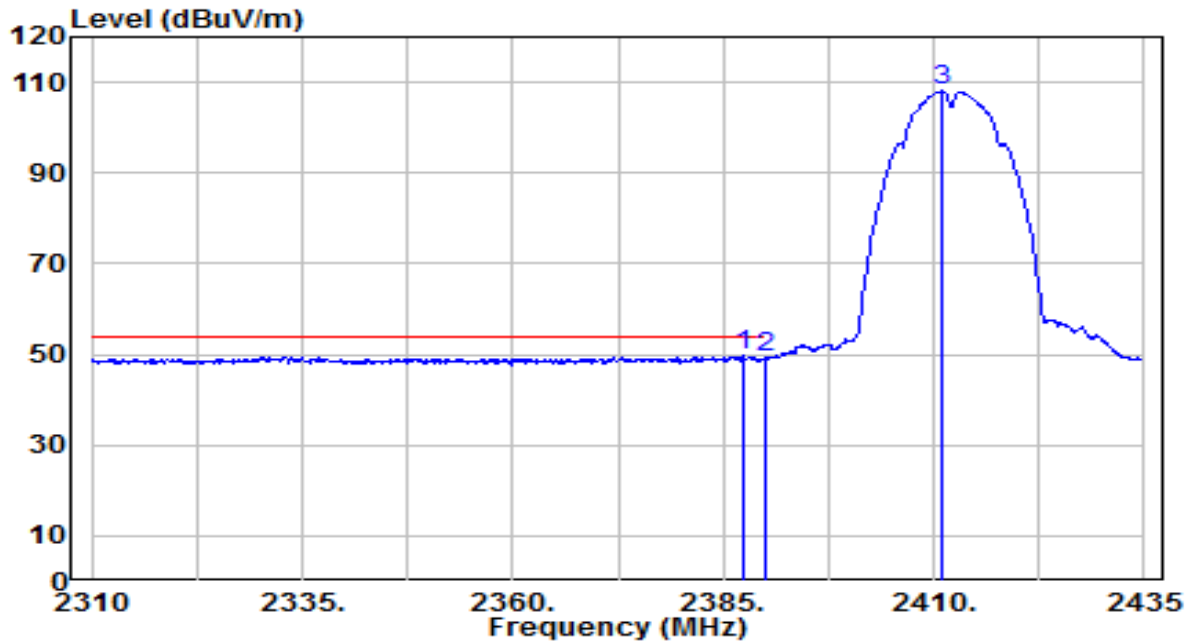

No	Frequency (MHz)	Reading (dBUV)	C.F (dB/m)	Measurement (dBUV/m)	Margin (dB)	Limit (dBUV/m)	Height (cm)	Angle (deg)	Remark (QP/PK/AV)	
1	*	2387.375	17.42	32.17	49.59	-4.41	54.00	115	110	Average
2		2390.000	17.29	32.18	49.48	-4.52	54.00	115	110	Average
3		2411.125	75.75	32.26	108.01	N/A	N/A	115	110	Average

Note:

1. " \*", means this data is the worst emission level.
2. C.F (Correction Factor) = Antenna Factor (dB/m)+ Cable Loss (dB).
3. Measurement (dBUV/m) = Reading(dBUV) + C.F (Correction Factor).
4. The emission levels of other frequencies are very lower than the limit and not show in test report.

EUT	Outdoor Pan/Tilt Security Wi-Fi Camera	Date of Test	2023-05-13
Factor	BBHA 9120D	Temp. / Humidity	24°C /59%
Polarity	Horizontal	Site / Test Engineer	AC1 / Todd
Test Mode	802.11b_TX_CH 6_ANT 0	Test Voltage	AC 120V/60Hz

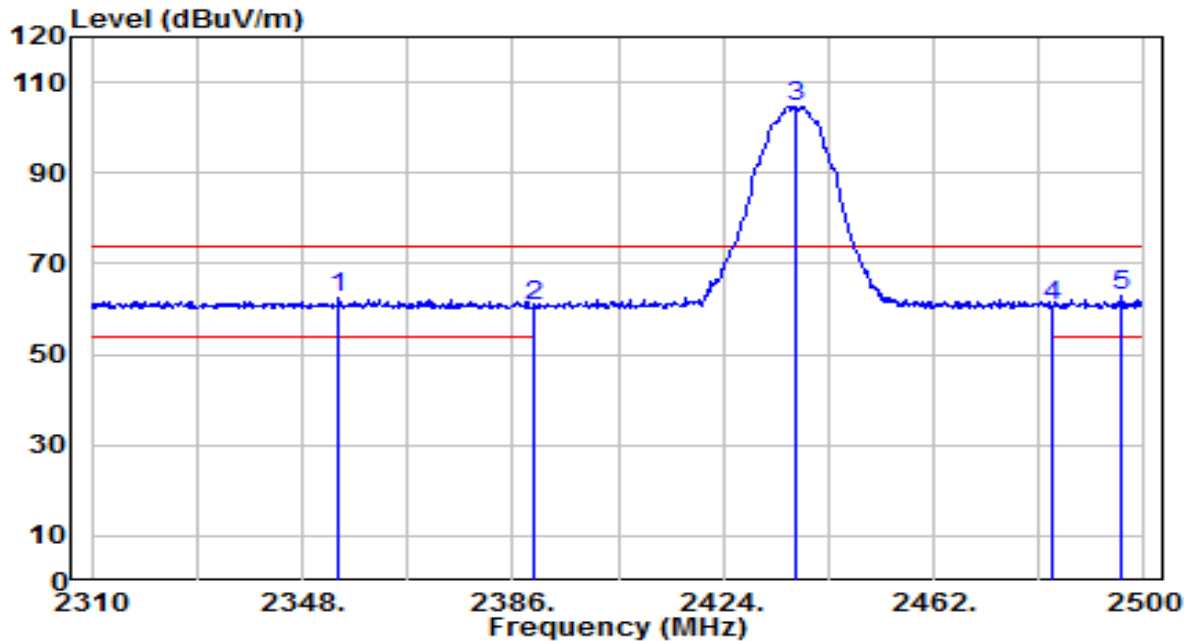

No	Frequency (MHz)	Reading (dBuV)	C.F (dB/m)	Measurement (dBuV/m)	Margin (dB)	Limit (dBuV/m)	Height (cm)	Angle (deg)	Remark (QP/PK/AV)
1	2354.460	30.33	32.06	62.38	-11.62	74.00	120	110	Peak
2	2390.000	28.37	32.18	60.55	-13.45	74.00	120	110	Peak
3	2436.920	72.44	32.35	104.79	N/A	N/A	120	110	Peak
4	2483.500	28.31	32.52	60.83	-13.17	74.00	120	110	Peak
5	* 2495.630	30.17	32.56	62.74	-11.26	74.00	120	110	Peak

Note:

1. " \*", means this data is the worst emission level.
2. C.F (Correction Factor) = Antenna Factor (dB/m)+ Cable Loss (dB).
3. Measurement (dBuV/m) = Reading(dBuV) + C.F (Correction Factor).
4. The emission levels of other frequencies are very lower than the limit and not show in test report.

EUT	Outdoor Pan/Tilt Security Wi-Fi Camera	Date of Test	2023-05-13
Factor	BBHA 9120D	Temp. / Humidity	24°C /59%
Polarity	Horizontal	Site / Test Engineer	AC1 / Todd
Test Mode	802.11b_TX_CH 6_ANT 0	Test Voltage	AC 120V/60Hz

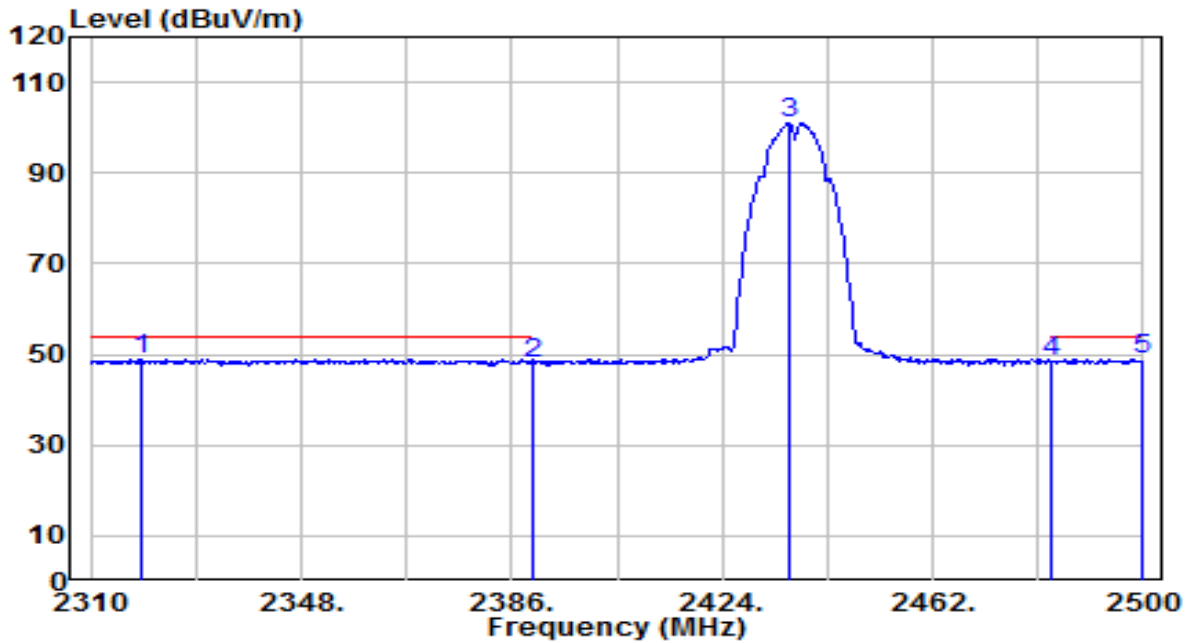

No	Frequency (MHz)	Reading (dBuV)	C.F (dB/m)	Measurement (dBuV/m)	Margin (dB)	Limit (dBuV/m)	Height (cm)	Angle (deg)	Remark (QP/PK/AV)
1	2319.120	17.00	31.93	48.93	-5.07	54.00	120	110	Average
2	2390.000	15.91	32.18	48.09	-5.91	54.00	120	110	Average
3	2435.970	68.59	32.35	100.94	N/A	N/A	120	110	Average
4	2483.500	16.16	32.52	48.68	-5.32	54.00	120	110	Average
5	* 2500.000	16.48	32.58	49.06	-4.94	54.00	120	110	Average

Note:

- " \*", means this data is the worst emission level.
- C.F (Correction Factor) = Antenna Factor (dB/m)+ Cable Loss (dB).
- Measurement (dBuV/m) = Reading(dBuV) + C.F (Correction Factor).
- The emission levels of other frequencies are very lower than the limit and not show in test report.

EUT	Outdoor Pan/Tilt Security Wi-Fi Camera	Date of Test	2023-05-13
Factor	BBHA 9120D	Temp. / Humidity	24°C /59%
Polarity	Vertical	Site / Test Engineer	AC1 / Todd
Test Mode	802.11b_TX_CH 6_ANT 0	Test Voltage	AC 120V/60Hz

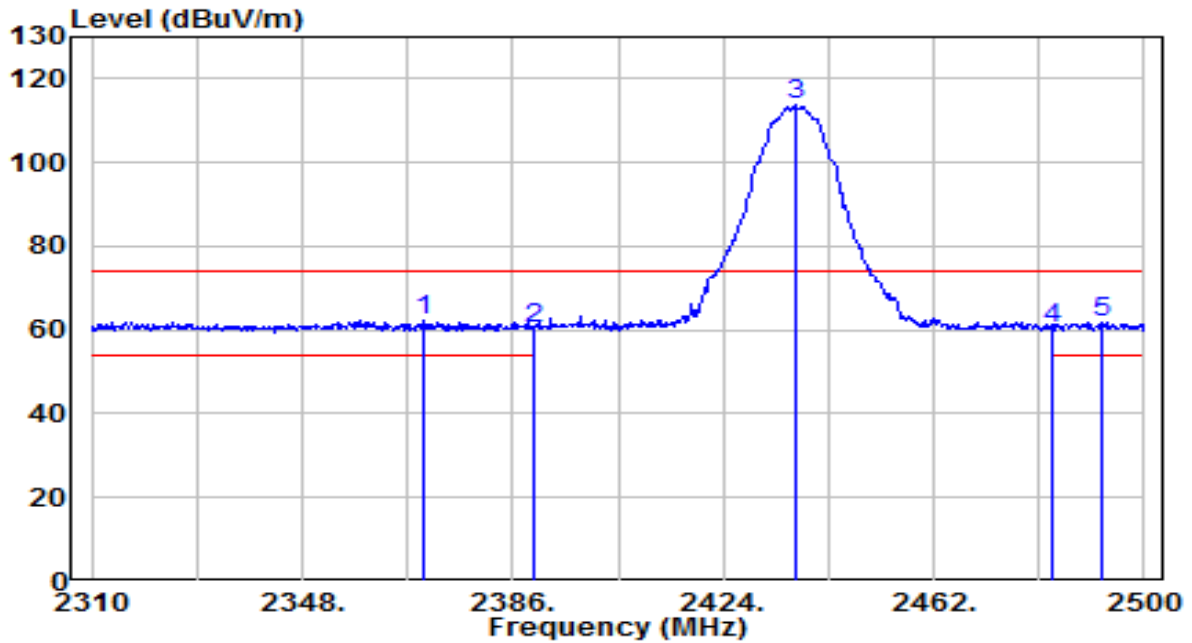

No	Frequency (MHz)	Reading (dBuV)	C.F (dB/m)	Measurement (dBuV/m)	Margin (dB)	Limit (dBuV/m)	Height (cm)	Angle (deg)	Remark (QP/PK/AV)
1	* 2369.850	30.20	32.11	62.31	-11.69	74.00	190	115	Peak
2	2390.000	28.24	32.18	60.43	-13.57	74.00	190	115	Peak
3	2436.920	81.24	32.35	113.59	N/A	N/A	190	115	Peak
4	2483.500	27.68	32.52	60.20	-13.80	74.00	190	115	Peak
5	2492.590	29.42	32.55	61.98	-12.02	74.00	190	115	Peak

Note:

1. " \*", means this data is the worst emission level.
2. C.F (Correction Factor) = Antenna Factor (dB/m)+ Cable Loss (dB).
3. Measurement (dBuV/m) = Reading(dBuV) + C.F (Correction Factor).
4. The emission levels of other frequencies are very lower than the limit and not show in test report.

EUT	Outdoor Pan/Tilt Security Wi-Fi Camera	Date of Test	2023-05-13
Factor	BBHA 9120D	Temp. / Humidity	24°C /59%
Polarity	Vertical	Site / Test Engineer	AC1 / Todd
Test Mode	802.11b_TX_CH 6_ANT 0	Test Voltage	AC 120V/60Hz

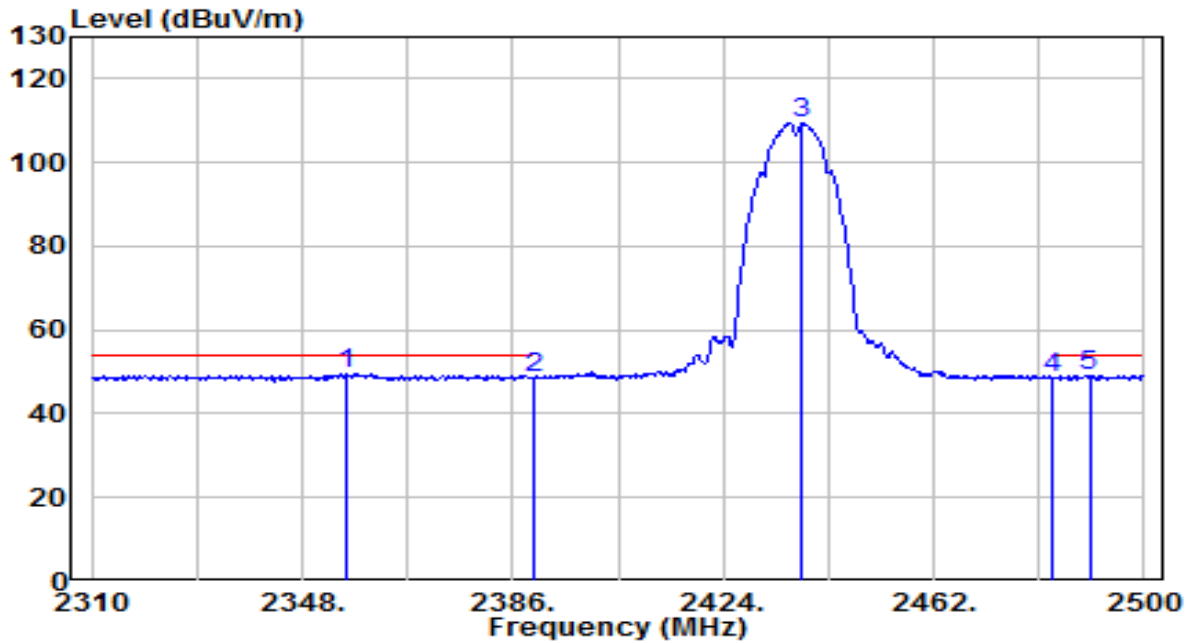

No	Frequency (MHz)	Reading (dBuV)	C.F (dB/m)	Measurement (dBuV/m)	Margin (dB)	Limit (dBuV/m)	Height (cm)	Angle (deg)	Remark (QP/PK/AV)
1	* 2356.170	17.66	32.06	49.72	-4.28	54.00	190	115	Average
2	2390.000	16.38	32.18	48.56	-5.44	54.00	190	115	Average
3	2438.060	77.05	32.36	109.41	N/A	N/A	190	115	Average
4	2483.500	16.03	32.52	48.56	-5.44	54.00	190	115	Average
5	2490.120	16.73	32.54	49.27	-4.73	54.00	190	115	Average

Note:

- " \*", means this data is the worst emission level.
- C.F (Correction Factor) = Antenna Factor (dB/m)+ Cable Loss (dB).
- Measurement (dBuV/m) = Reading(dBuV) + C.F (Correction Factor).
- The emission levels of other frequencies are very lower than the limit and not show in test report.

EUT	Outdoor Pan/Tilt Security Wi-Fi Camera	Date of Test	2023-05-13
Factor	BBHA 9120D	Temp. / Humidity	24°C /59%
Polarity	Horizontal	Site / Test Engineer	AC1 / Todd
Test Mode	802.11b_TX_CH 11_ANT 0	Test Voltage	AC 120V/60Hz

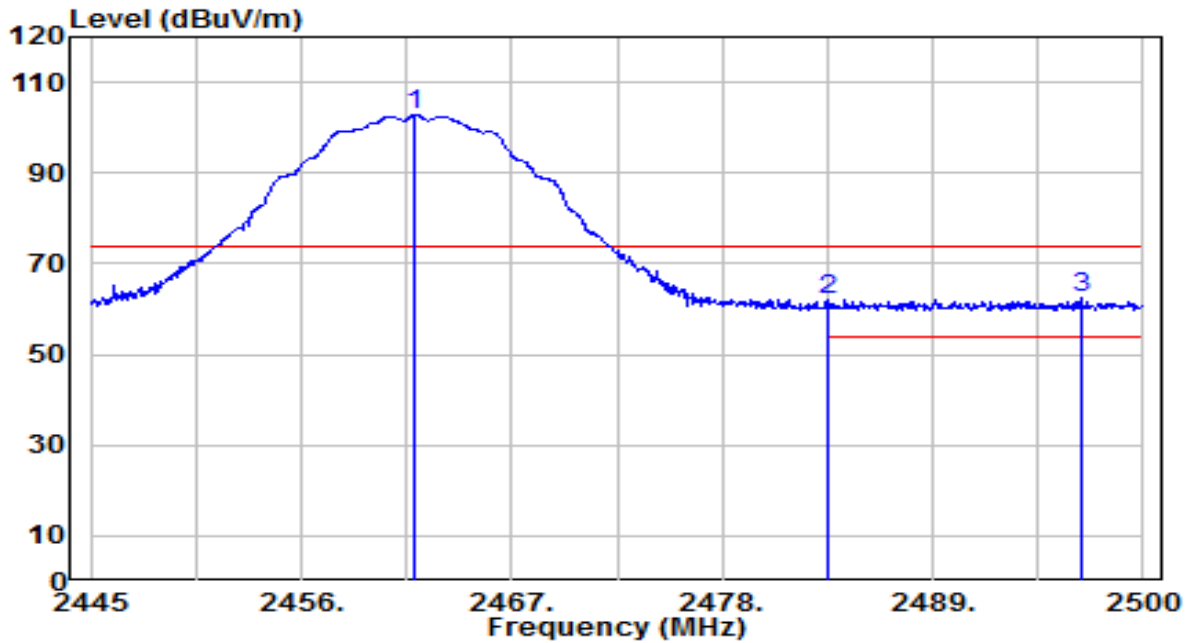

No	Frequency (MHz)	Reading (dBuV)	C.F (dB/m)	Measurement (dBuV/m)	Margin (dB)	Limit (dBuV/m)	Height (cm)	Angle (deg)	Remark (QP/PK/AV)
1	2461.885	70.37	32.44	102.81	N/A	N/A	130	110	Peak
2	2483.500	29.42	32.52	61.94	-12.06	74.00	130	110	Peak
3	* 2496.755	29.75	32.57	62.32	-11.68	74.00	130	110	Peak

Note:

1. " \*", means this data is the worst emission level.
2. C.F (Correction Factor) = Antenna Factor (dB/m)+ Cable Loss (dB).
3. Measurement (dBuV/m) = Reading(dBuV) + C.F (Correction Factor).
4. The emission levels of other frequencies are very lower than the limit and not show in test report.

EUT	Outdoor Pan/Tilt Security Wi-Fi Camera	Date of Test	2023-05-13
Factor	BBHA 9120D	Temp. / Humidity	24°C /59%
Polarity	Horizontal	Site / Test Engineer	AC1 / Todd
Test Mode	802.11b_TX_CH 11_ANT 0	Test Voltage	AC 120V/60Hz

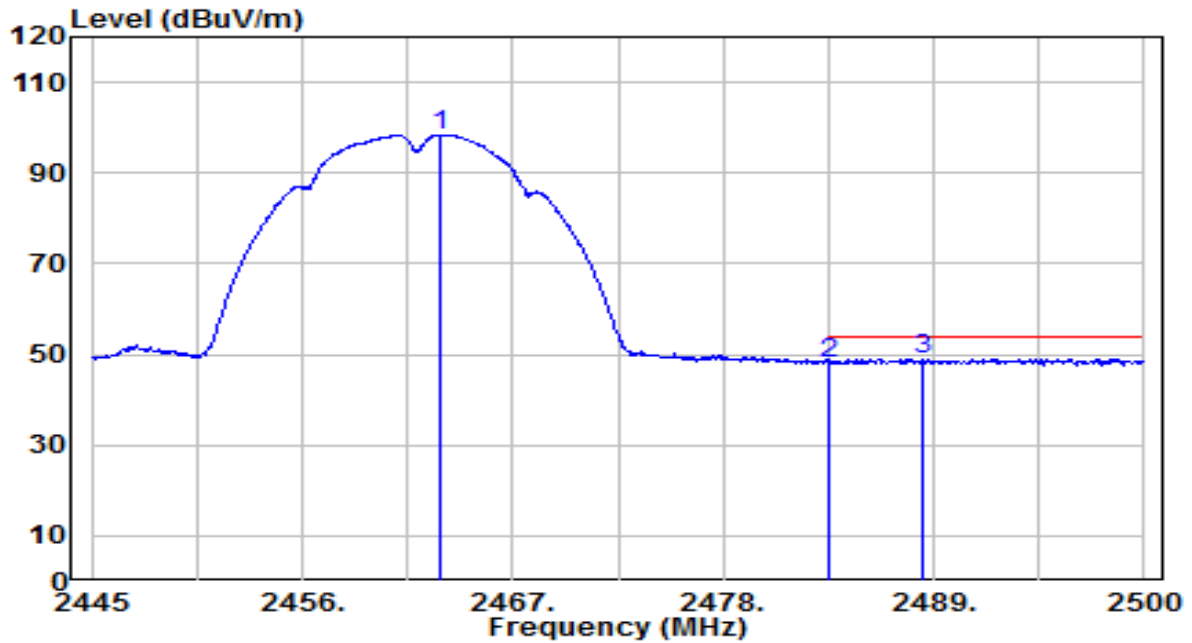

No	Frequency (MHz)	Reading (dBUV)	C.F (dB/m)	Measurement (dBUV/m)	Margin (dB)	Limit (dBUV/m)	Height (cm)	Angle (deg)	Remark (QP/PK/AV)
1	2463.260	66.02	32.45	98.47	N/A	N/A	130	110	Average
2	2483.500	15.70	32.52	48.23	-5.77	54.00	130	110	Average
3	* 2488.450	16.52	32.54	49.06	-4.94	54.00	130	110	Average

Note:

1. " \*", means this data is the worst emission level.
2. C.F (Correction Factor) = Antenna Factor (dB/m)+ Cable Loss (dB).
3. Measurement (dBUV/m) = Reading(dBUV) + C.F (Correction Factor).
4. The emission levels of other frequencies are very lower than the limit and not show in test report.



EUT	Outdoor Pan/Tilt Security Wi-Fi Camera	Date of Test	2023-05-13
Factor	BBHA 9120D	Temp. / Humidity	24°C /59%
Polarity	Vertical	Site / Test Engineer	AC1 / Todd
Test Mode	802.11b_TX_CH 11_ANT 0	Test Voltage	AC 120V/60Hz

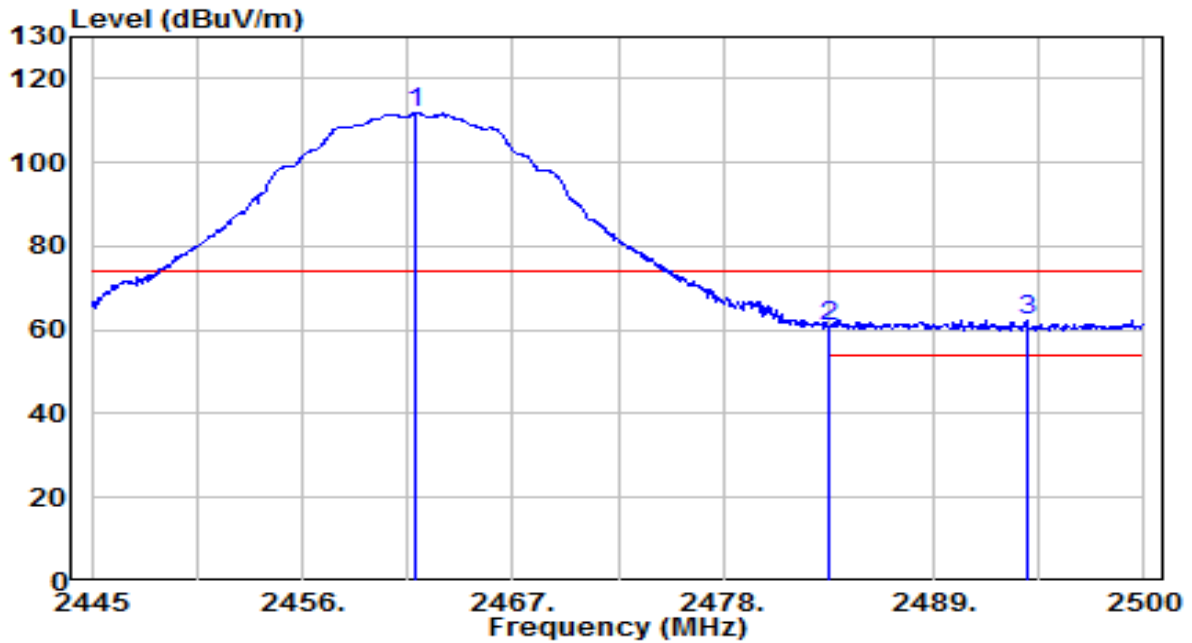

No	Frequency (MHz)	Reading (dBuV)	C.F (dB/m)	Measurement (dBuV/m)	Margin (dB)	Limit (dBuV/m)	Height (cm)	Angle (deg)	Remark (QP/PK/AV)
1	2461.940	79.53	32.44	111.97	N/A	N/A	145	115	Peak
2	2483.500	28.26	32.52	60.78	-13.22	74.00	145	115	Peak
3	* 2493.840	29.86	32.56	62.42	-11.58	74.00	145	115	Peak

Note:

1. " \*", means this data is the worst emission level.
2. C.F (Correction Factor) = Antenna Factor (dB/m)+ Cable Loss (dB).
3. Measurement (dBuV/m) = Reading(dBuV) + C.F (Correction Factor).
4. The emission levels of other frequencies are very lower than the limit and not show in test report.

EUT	Outdoor Pan/Tilt Security Wi-Fi Camera	Date of Test	2023-05-13
Factor	BBHA 9120D	Temp. / Humidity	24°C /59%
Polarity	Vertical	Site / Test Engineer	AC1 / Todd
Test Mode	802.11b_TX_CH 11_ANT 0	Test Voltage	AC 120V/60Hz

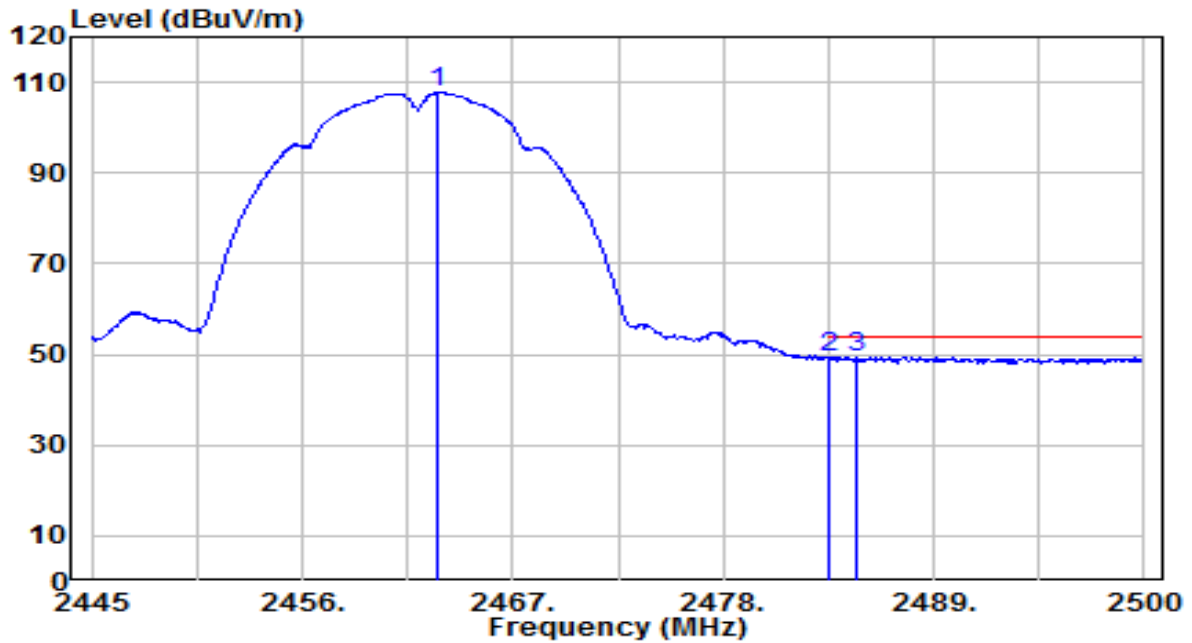

No	Frequency (MHz)	Reading (dBUV)	C.F (dB/m)	Measurement (dBUV/m)	Margin (dB)	Limit (dBUV/m)	Height (cm)	Angle (deg)	Remark (QP/PK/AV)
1	2463.040	75.25	32.45	107.70	N/A	N/A	145	115	Average
2	2483.500	16.78	32.52	49.30	-4.70	54.00	145	115	Average
3	* 2484.930	16.93	32.53	49.46	-4.54	54.00	145	115	Average

Note:

1. " \*", means this data is the worst emission level.
2. C.F (Correction Factor) = Antenna Factor (dB/m)+ Cable Loss (dB).
3. Measurement (dBUV/m) = Reading(dBUV) + C.F (Correction Factor).
4. The emission levels of other frequencies are very lower than the limit and not show in test report.

EUT	Outdoor Pan/Tilt Security Wi-Fi Camera	Date of Test	2023-05-13
Factor	BBHA 9120D	Temp. / Humidity	24°C /59%
Polarity	Horizontal	Site / Test Engineer	AC1 / Todd
Test Mode	802.11g_TX_CH 1_ANT 0	Test Voltage	AC 120V/60Hz

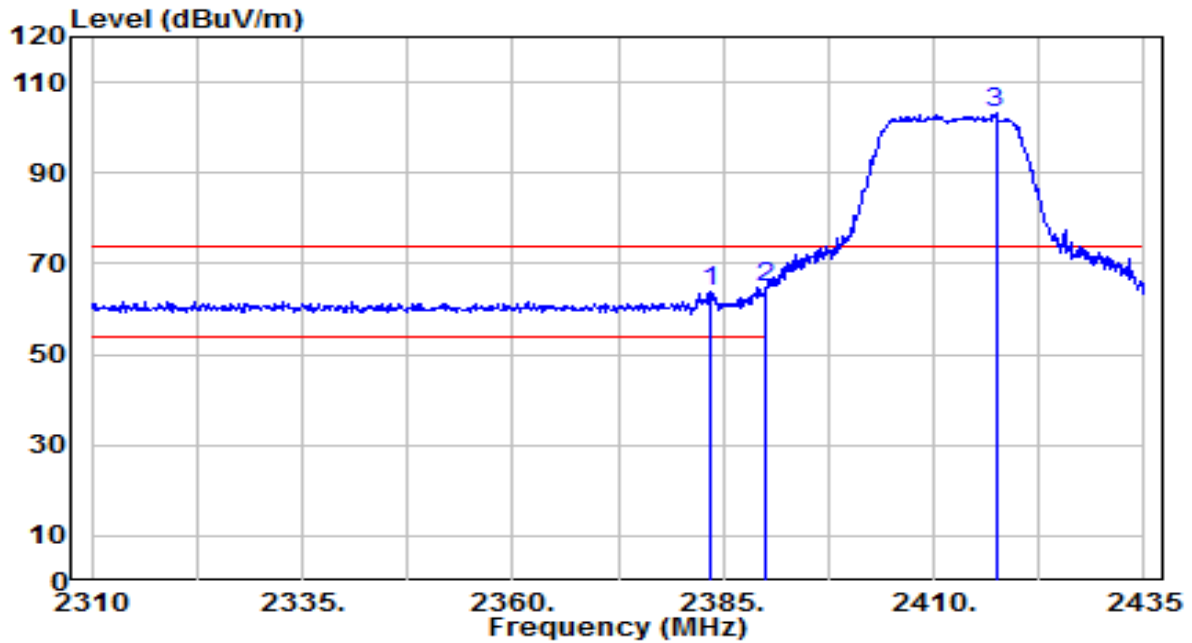

No	Frequency (MHz)	Reading (dBuV)	C.F (dB/m)	Measurement (dBuV/m)	Margin (dB)	Limit (dBuV/m)	Height (cm)	Angle (deg)	Remark (QP/PK/AV)
1	2383.375	31.49	32.16	63.65	-10.35	74.00	140	105	Peak
2	* 2390.000	32.73	32.18	64.91	-9.09	74.00	140	105	Peak
3	2417.375	70.80	32.28	103.08	N/A	N/A	140	105	Peak

Note:

1. " \*", means this data is the worst emission level.
2. C.F (Correction Factor) = Antenna Factor (dB/m)+ Cable Loss (dB).
3. Measurement (dBuV/m) = Reading(dBuV) + C.F (Correction Factor).
4. The emission levels of other frequencies are very lower than the limit and not show in test report.

EUT	Outdoor Pan/Tilt Security Wi-Fi Camera	Date of Test	2023-05-13
Factor	BBHA 9120D	Temp. / Humidity	24°C /59%
Polarity	Horizontal	Site / Test Engineer	AC1 / Todd
Test Mode	802.11g_TX_CH 1_ANT 0	Test Voltage	AC 120V/60Hz

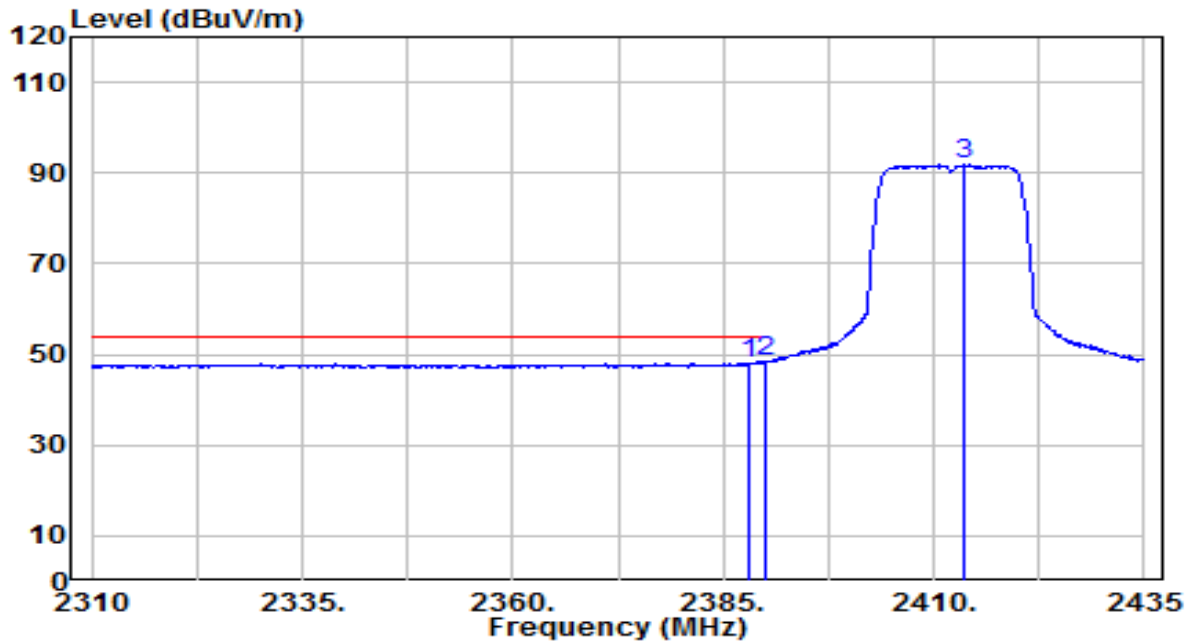

No	Frequency (MHz)	Reading (dBuV)	C.F (dB/m)	Measurement (dBuV/m)	Margin (dB)	Limit (dBuV/m)	Height (cm)	Angle (deg)	Remark (QP/PK/AV)
1	2388.000	15.80	32.18	47.97	-6.03	54.00	140	105	Average
2	* 2390.000	16.28	32.18	48.46	-5.54	54.00	140	105	Average
3	2413.500	59.57	32.27	91.84	N/A	N/A	140	105	Average

Note:

1. " \*", means this data is the worst emission level.
2. C.F (Correction Factor) = Antenna Factor (dB/m)+ Cable Loss (dB).
3. Measurement (dBuV/m) = Reading(dBuV) + C.F (Correction Factor).
4. The emission levels of other frequencies are very lower than the limit and not show in test report.

EUT	Outdoor Pan/Tilt Security Wi-Fi Camera	Date of Test	2023-05-13
Factor	BBHA 9120D	Temp. / Humidity	24°C /59%
Polarity	Vertical	Site / Test Engineer	AC1 / Todd
Test Mode	802.11g_TX_CH 1_ANT 0	Test Voltage	AC 120V/60Hz

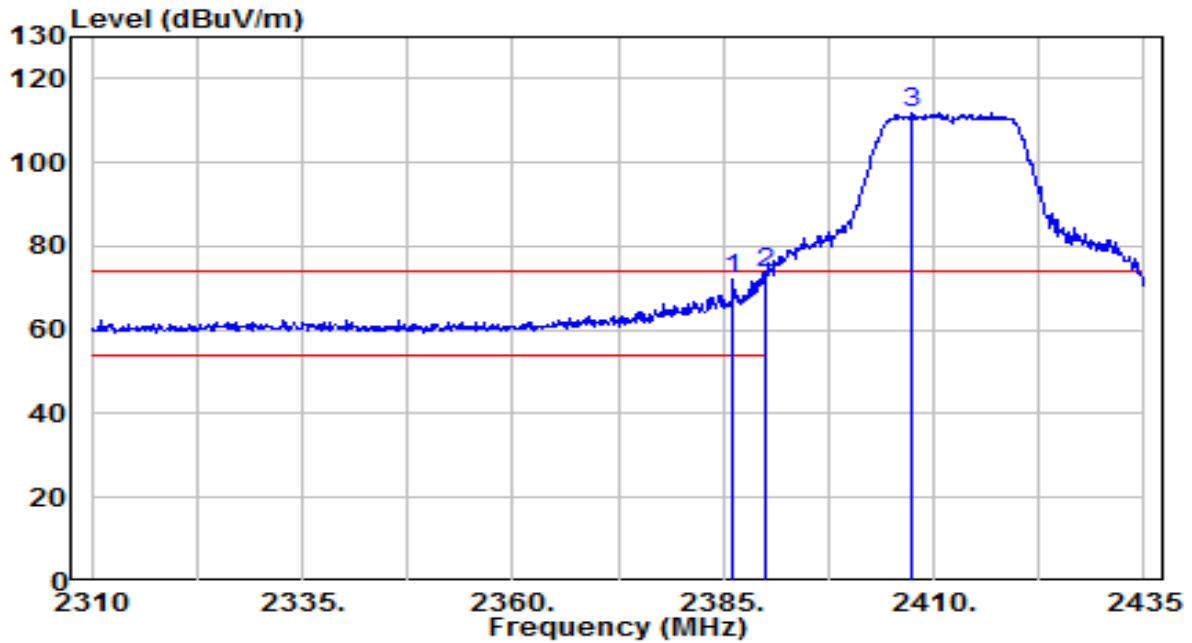

No	Frequency (MHz)	Reading (dBuV)	C.F (dB/m)	Measurement (dBuV/m)	Margin (dB)	Limit (dBuV/m)	Height (cm)	Angle (deg)	Remark (QP/PK/AV)
1	2386.250	39.75	32.17	71.92	-2.08	74.00	115	110	Peak
2	* 2390.000	41.43	32.18	73.62	-0.38	74.00	115	110	Peak
3	2407.375	79.59	32.25	111.83	N/A	N/A	115	110	Peak

Note:

1. " \*", means this data is the worst emission level.
2. C.F (Correction Factor) = Antenna Factor (dB/m)+ Cable Loss (dB).
3. Measurement (dBuV/m) = Reading(dBuV) + C.F (Correction Factor).
4. The emission levels of other frequencies are very lower than the limit and not show in test report.

EUT	Outdoor Pan/Tilt Security Wi-Fi Camera	Date of Test	2023-05-13
Factor	BBHA 9120D	Temp. / Humidity	24°C /59%
Polarity	Vertical	Site / Test Engineer	AC1 / Todd
Test Mode	802.11g_TX_CH 1_ANT 0	Test Voltage	AC 120V/60Hz

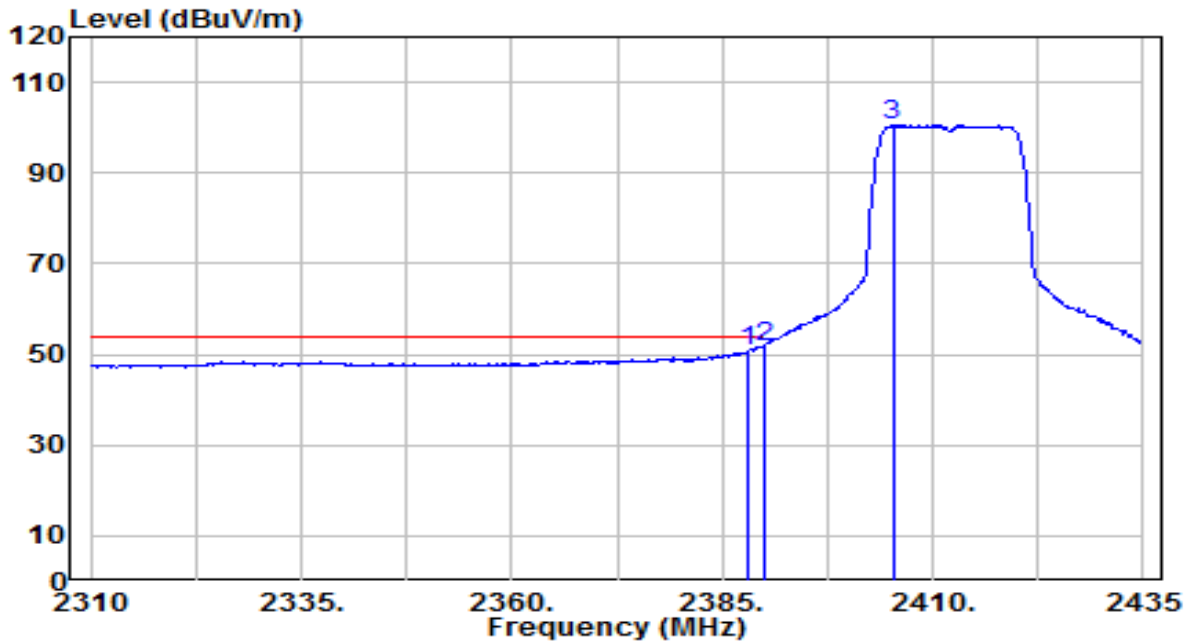

No	Frequency (MHz)	Reading (dBUV)	C.F (dB/m)	Measurement (dBUV/m)	Margin (dB)	Limit (dBUV/m)	Height (cm)	Angle (deg)	Remark (QP/PK/AV)
1	2388.000	18.36	32.18	50.54	-3.46	54.00	115	110	Average
2	* 2390.000	19.59	32.18	51.77	-2.23	54.00	115	110	Average
3	2405.250	68.45	32.24	100.69	N/A	N/A	115	110	Average

Note:

1. " \*", means this data is the worst emission level.
2. C.F (Correction Factor) = Antenna Factor (dB/m)+ Cable Loss (dB).
3. Measurement (dBUV/m) = Reading(dBUV) + C.F (Correction Factor).
4. The emission levels of other frequencies are very lower than the limit and not show in test report.

EUT	Outdoor Pan/Tilt Security Wi-Fi Camera	Date of Test	2023-05-13
Factor	BBHA 9120D	Temp. / Humidity	24°C /59%
Polarity	Horizontal	Site / Test Engineer	AC1 / Todd
Test Mode	802.11g_TX_CH 6_ANT 0	Test Voltage	AC 120V/60Hz

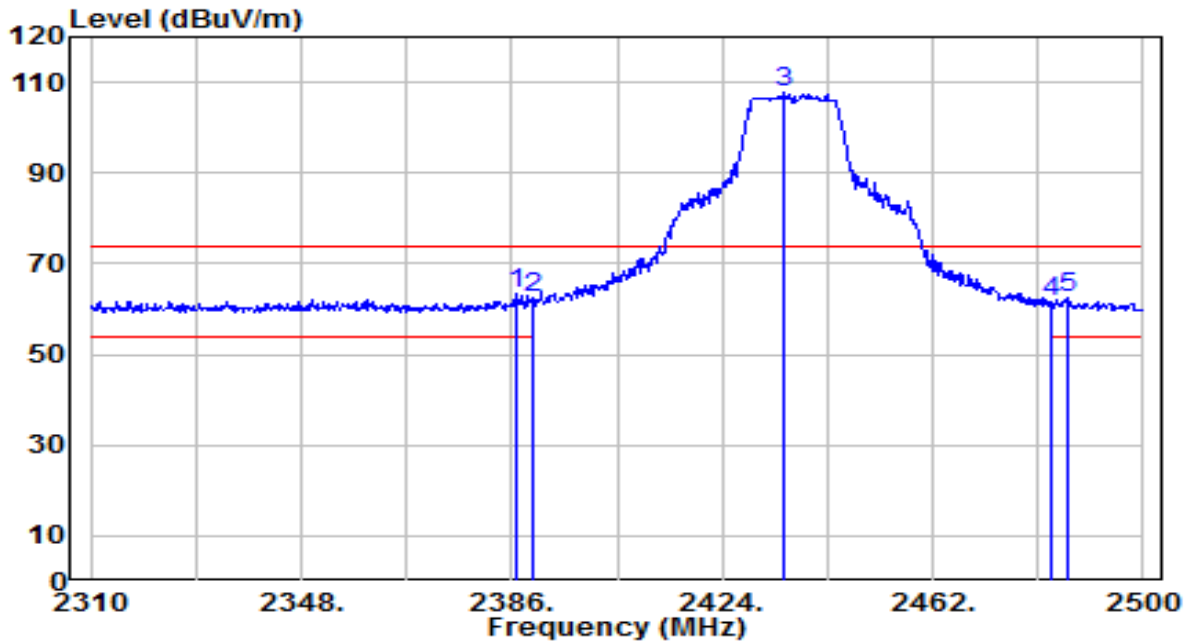

No	Frequency (MHz)	Reading (dBUV)	C.F (dB/m)	Measurement (dBUV/m)	Margin (dB)	Limit (dBUV/m)	Height (cm)	Angle (deg)	Remark (QP/PK/AV)
1	* 2386.950	31.00	32.17	63.17	-10.83	74.00	120	110	Peak
2	2390.000	30.13	32.18	62.32	-11.68	74.00	120	110	Peak
3	2435.020	75.65	32.35	107.99	N/A	N/A	120	110	Peak
4	2483.500	28.95	32.52	61.47	-12.53	74.00	120	110	Peak
5	2486.510	30.04	32.53	62.57	-11.43	74.00	120	110	Peak

Note:

1. " \*", means this data is the worst emission level.
2. C.F (Correction Factor) = Antenna Factor (dB/m)+ Cable Loss (dB).
3. Measurement (dBUV/m) = Reading(dBUV) + C.F (Correction Factor).
4. The emission levels of other frequencies are very lower than the limit and not show in test report.

EUT	Outdoor Pan/Tilt Security Wi-Fi Camera	Date of Test	2023-05-13
Factor	BBHA 9120D	Temp. / Humidity	24°C /59%
Polarity	Horizontal	Site / Test Engineer	AC1 / Todd
Test Mode	802.11g_TX_CH 6_ANT 0	Test Voltage	AC 120V/60Hz

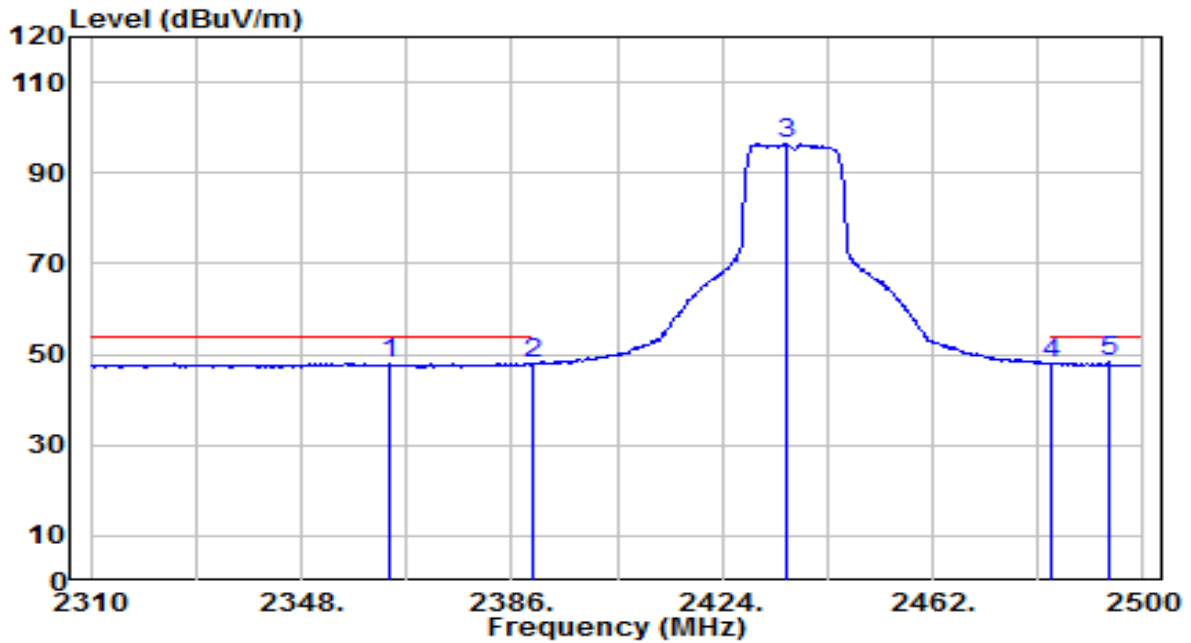

No	Frequency (MHz)	Reading (dBuV)	C.F (dB/m)	Measurement (dBuV/m)	Margin (dB)	Limit (dBuV/m)	Height (cm)	Angle (deg)	Remark (QP/PK/AV)
1	2363.770	15.94	32.09	48.03	-5.97	54.00	120	110	Average
2	2390.000	15.72	32.18	47.90	-6.10	54.00	120	110	Average
3	2435.590	64.13	32.35	96.48	N/A	N/A	120	110	Average
4	2483.500	15.38	32.52	47.90	-6.10	54.00	120	110	Average
5	* 2493.730	15.69	32.56	48.25	-5.75	54.00	120	110	Average

Note:

1. " \*", means this data is the worst emission level.
2. C.F (Correction Factor) = Antenna Factor (dB/m)+ Cable Loss (dB).
3. Measurement (dBuV/m) = Reading(dBuV) + C.F (Correction Factor).
4. The emission levels of other frequencies are very lower than the limit and not show in test report.



EUT	Outdoor Pan/Tilt Security Wi-Fi Camera	Date of Test	2023-05-13
Factor	BBHA 9120D	Temp. / Humidity	24°C /59%
Polarity	Vertical	Site / Test Engineer	AC1 / Todd
Test Mode	802.11g_TX_CH 6_ANT 0	Test Voltage	AC 120V/60Hz

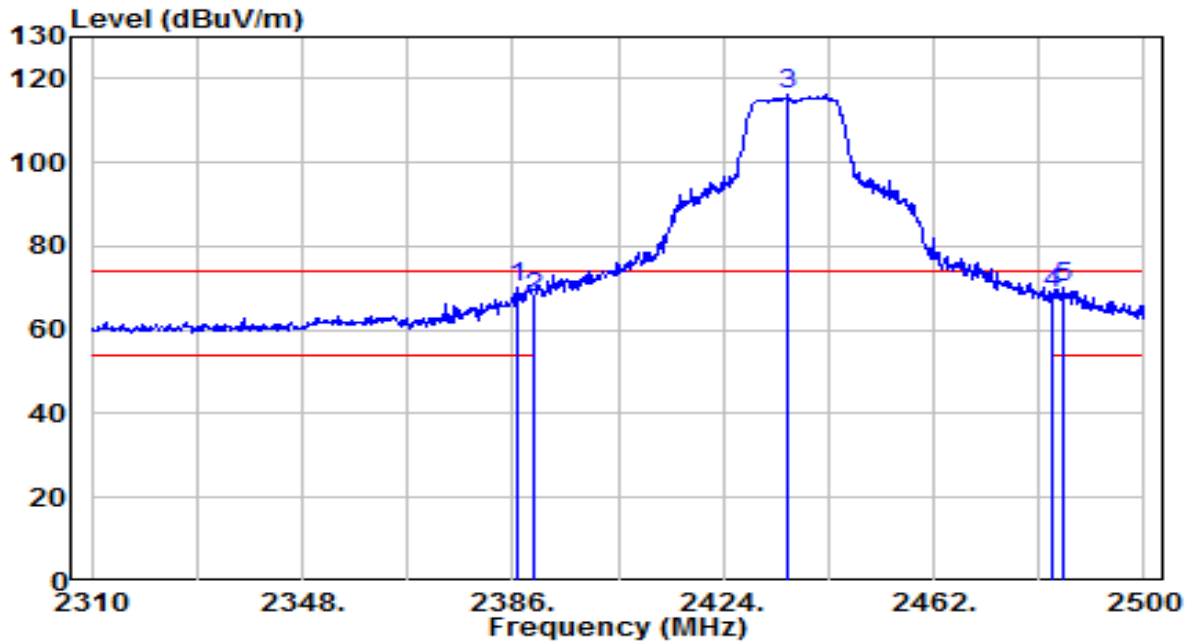

No	Frequency (MHz)	Reading (dBuV)	C.F (dB/m)	Measurement (dBuV/m)	Margin (dB)	Limit (dBuV/m)	Height (cm)	Angle (deg)	Remark (QP/PK/AV)
1	* 2386.950	38.17	32.17	70.34	-3.66	74.00	190	115	Peak
2	2390.000	35.75	32.18	67.94	-6.06	74.00	190	115	Peak
3	2435.780	83.81	32.35	116.16	N/A	N/A	190	115	Peak
4	2483.500	36.11	32.52	68.63	-5.37	74.00	190	115	Peak
5	2485.180	37.47	32.53	70.00	-4.00	74.00	190	115	Peak

Note:

1. " \*", means this data is the worst emission level.
2. C.F (Correction Factor) = Antenna Factor (dB/m)+ Cable Loss (dB).
3. Measurement (dBuV/m) = Reading(dBuV) + C.F (Correction Factor).
4. The emission levels of other frequencies are very lower than the limit and not show in test report.

EUT	Outdoor Pan/Tilt Security Wi-Fi Camera	Date of Test	2023-05-13
Factor	BBHA 9120D	Temp. / Humidity	24°C /59%
Polarity	Vertical	Site / Test Engineer	AC1 / Todd
Test Mode	802.11g_TX_CH 6_ANT 0	Test Voltage	AC 120V/60Hz

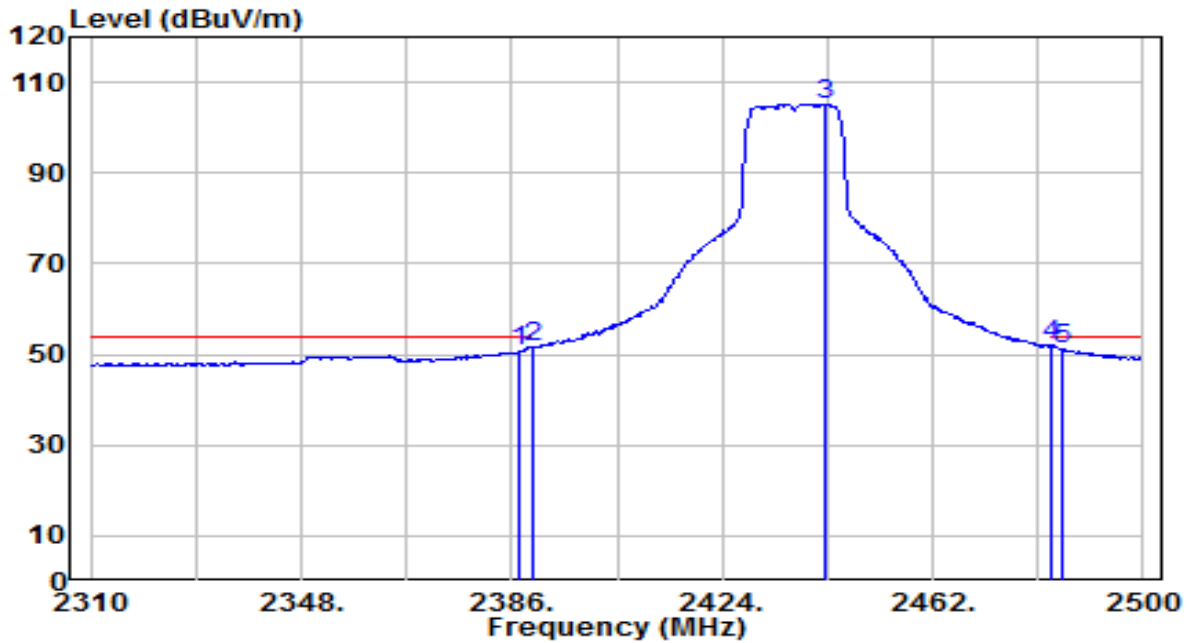

No	Frequency (MHz)	Reading (dBuV)	C.F (dB/m)	Measurement (dBuV/m)	Margin (dB)	Limit (dBuV/m)	Height (cm)	Angle (deg)	Remark (QP/PK/AV)
1	2387.520	18.65	32.18	50.83	-3.17	54.00	190	115	Average
2	2390.000	19.45	32.18	51.63	-2.37	54.00	190	115	Average
3	2442.620	72.90	32.37	105.28	N/A	N/A	190	115	Average
4	* 2483.500	19.58	32.52	52.10	-1.90	54.00	190	115	Average
5	2485.180	18.77	32.53	51.29	-2.71	54.00	190	115	Average

Note:

1. " \*", means this data is the worst emission level.
2. C.F (Correction Factor) = Antenna Factor (dB/m)+ Cable Loss (dB).
3. Measurement (dBuV/m) = Reading(dBuV) + C.F (Correction Factor).
4. The emission levels of other frequencies are very lower than the limit and not show in test report.

EUT	Outdoor Pan/Tilt Security Wi-Fi Camera	Date of Test	2023-05-13
Factor	BBHA 9120D	Temp. / Humidity	24°C /59%
Polarity	Horizontal	Site / Test Engineer	AC1 / Todd
Test Mode	802.11g_TX_CH 11_ANT 0	Test Voltage	AC 120V/60Hz

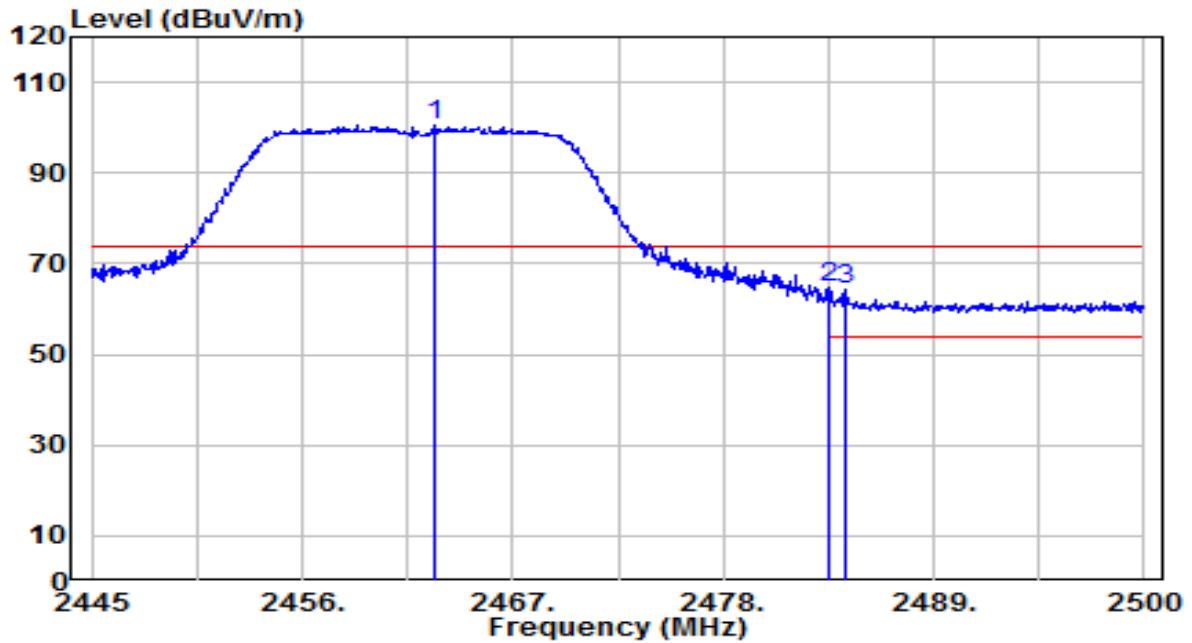

No	Frequency (MHz)	Reading (dBuV)	C.F (dB/m)	Measurement (dBuV/m)	Margin (dB)	Limit (dBuV/m)	Height (cm)	Angle (deg)	Remark (QP/PK/AV)
1	2462.875	68.16	32.45	100.60	N/A	N/A	130	110	Peak
2	* 2483.500	32.21	32.52	64.73	-9.27	74.00	130	110	Peak
3	2484.325	31.76	32.52	64.28	-9.72	74.00	130	110	Peak

Note:

1. " \*", means this data is the worst emission level.
2. C.F (Correction Factor) = Antenna Factor (dB/m)+ Cable Loss (dB).
3. Measurement (dBuV/m) = Reading(dBuV) + C.F (Correction Factor).
4. The emission levels of other frequencies are very lower than the limit and not show in test report.

EUT	Outdoor Pan/Tilt Security Wi-Fi Camera	Date of Test	2023-05-13
Factor	BBHA 9120D	Temp. / Humidity	24°C /59%
Polarity	Horizontal	Site / Test Engineer	AC1 / Todd
Test Mode	802.11g_TX_CH 11_ANT 0	Test Voltage	AC 120V/60Hz

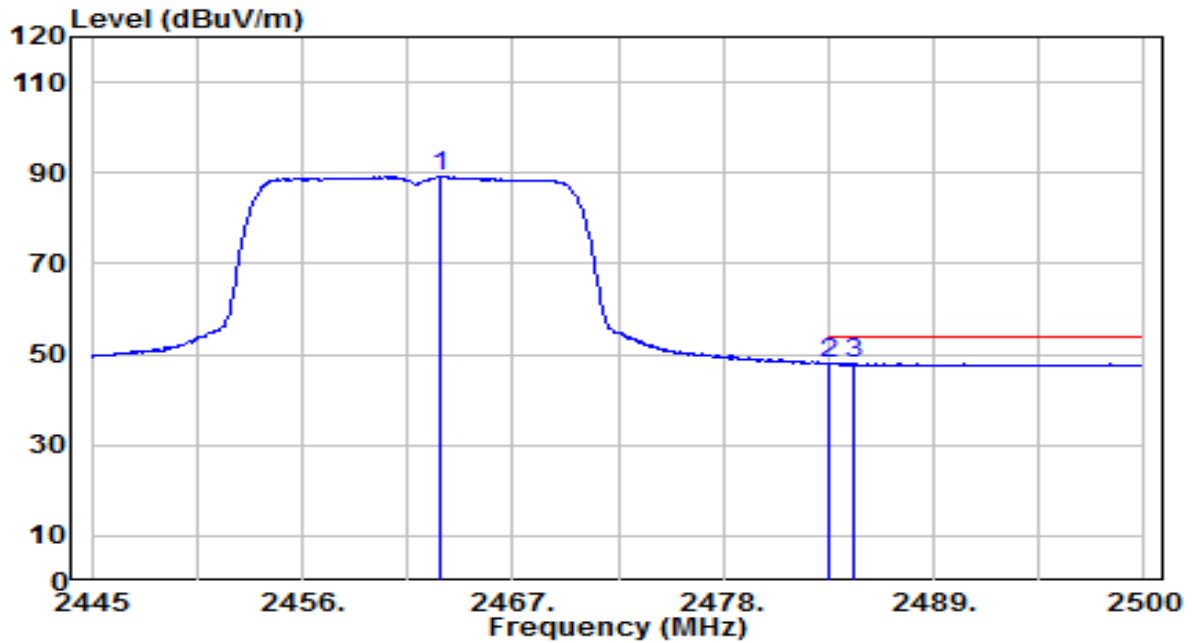

No	Frequency (MHz)	Reading (dBUV)	C.F (dB/m)	Measurement (dBUV/m)	Margin (dB)	Limit (dBUV/m)	Height (cm)	Angle (deg)	Remark (QP/PK/AV)
1	2463.150	56.82	32.45	89.27	N/A	N/A	130	110	Average
2	2483.500	15.50	32.52	48.03	-5.97	54.00	130	110	Average
3	* 2484.875	15.51	32.53	48.04	-5.96	54.00	130	110	Average

Note:

1. " \*", means this data is the worst emission level.
2. C.F (Correction Factor) = Antenna Factor (dB/m)+ Cable Loss (dB).
3. Measurement (dBUV/m) = Reading(dBUV) + C.F (Correction Factor).
4. The emission levels of other frequencies are very lower than the limit and not show in test report.

EUT	Outdoor Pan/Tilt Security Wi-Fi Camera	Date of Test	2023-05-13
Factor	BBHA 9120D	Temp. / Humidity	24°C /59%
Polarity	Vertical	Site / Test Engineer	AC1 / Todd
Test Mode	802.11g_TX_CH 11_ANT 0	Test Voltage	AC 120V/60Hz

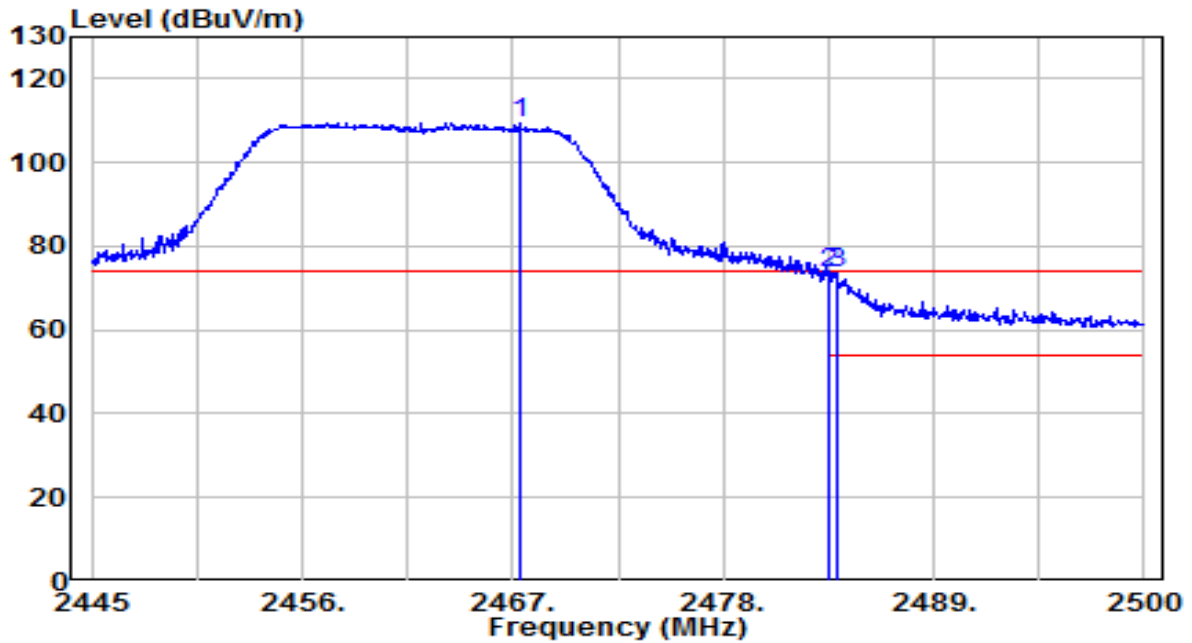

No	Frequency (MHz)	Reading (dBuV)	C.F (dB/m)	Measurement (dBuV/m)	Margin (dB)	Limit (dBuV/m)	Height (cm)	Angle (deg)	Remark (QP/PK/AV)
1	2467.385	77.07	32.46	109.53	N/A	N/A	145	115	Peak
2	* 2483.500	41.29	32.52	73.81	-0.19	74.00	145	115	Peak
3	2483.940	41.19	32.52	73.71	-0.29	74.00	145	115	Peak

Note:

1. " \*", means this data is the worst emission level.
2. C.F (Correction Factor) = Antenna Factor (dB/m)+ Cable Loss (dB).
3. Measurement (dBuV/m) = Reading(dBuV) + C.F (Correction Factor).
4. The emission levels of other frequencies are very lower than the limit and not show in test report.

EUT	Outdoor Pan/Tilt Security Wi-Fi Camera	Date of Test	2023-05-13
Factor	BBHA 9120D	Temp. / Humidity	24°C /59%
Polarity	Vertical	Site / Test Engineer	AC1 / Todd
Test Mode	802.11g_TX_CH 11_ANT 0	Test Voltage	AC 120V/60Hz

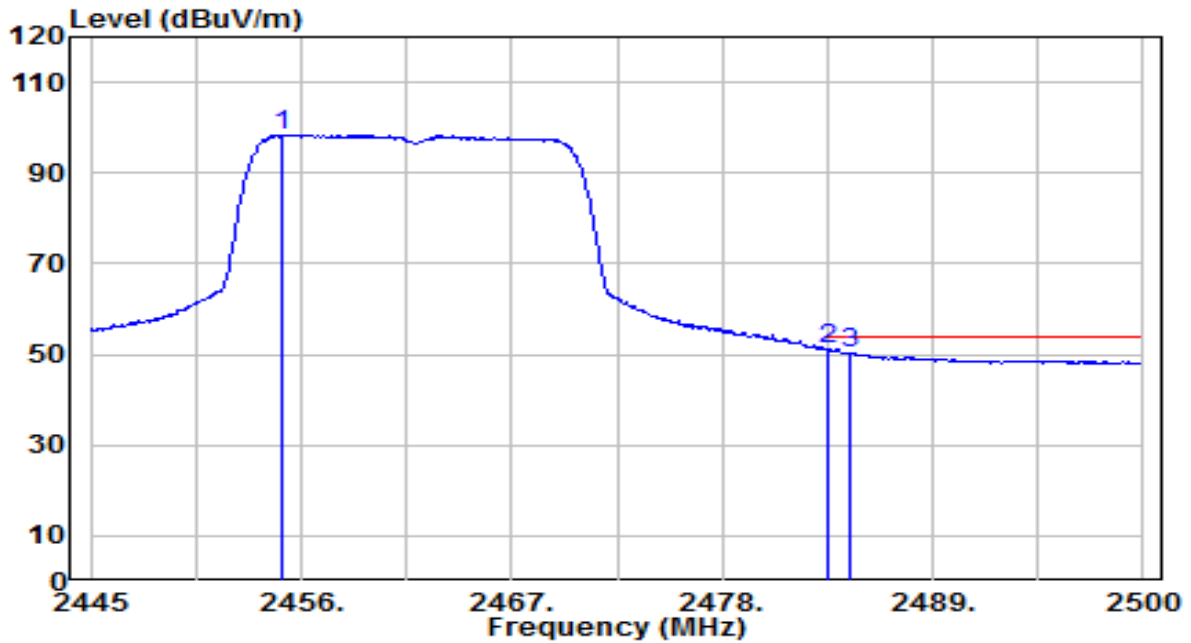

No	Frequency (MHz)	Reading (dBuV)	C.F (dB/m)	Measurement (dBuV/m)	Margin (dB)	Limit (dBuV/m)	Height (cm)	Angle (deg)	Remark (QP/PK/AV)
1	2454.955	66.00	32.42	98.42	N/A	N/A	145	115	Average
2	* 2483.500	18.54	32.52	51.06	-2.94	54.00	145	115	Average
3	2484.710	17.87	32.52	50.40	-3.60	54.00	145	115	Average

Note:

1. " \*", means this data is the worst emission level.
2. C.F (Correction Factor) = Antenna Factor (dB/m)+ Cable Loss (dB).
3. Measurement (dBuV/m) = Reading(dBuV) + C.F (Correction Factor).
4. The emission levels of other frequencies are very lower than the limit and not show in test report.

EUT	Outdoor Pan/Tilt Security Wi-Fi Camera	Date of Test	2023-05-13
Factor	BBHA 9120D	Temp. / Humidity	24°C /59%
Polarity	Horizontal	Site / Test Engineer	AC1 / Todd
Test Mode	802.11n-20MHz_TX_CH 1_ANT 0	Test Voltage	AC 120V/60Hz

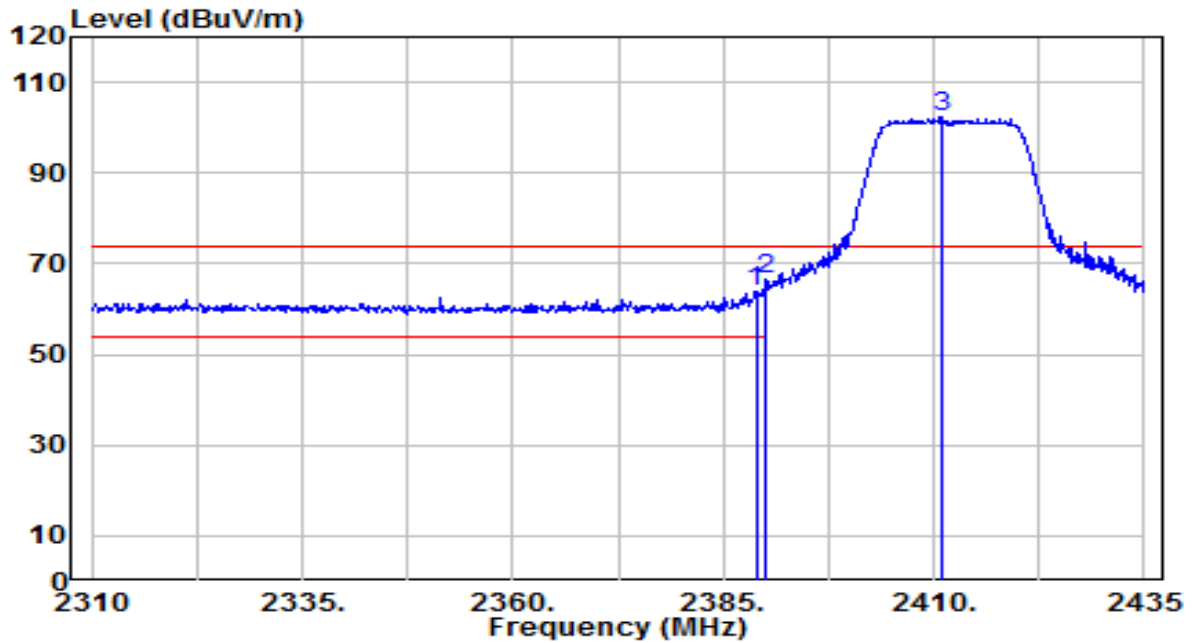

No	Frequency (MHz)	Reading (dBuV)	C.F (dB/m)	Measurement (dBuV/m)	Margin (dB)	Limit (dBuV/m)	Height (cm)	Angle (deg)	Remark (QP/PK/AV)
1	2388.875	31.85	32.18	64.03	-9.97	74.00	140	105	Peak
2	* 2390.000	34.16	32.18	66.35	-7.65	74.00	140	105	Peak
3	2410.875	70.06	32.26	102.32	N/A	N/A	140	105	Peak

Note:

1. " \*", means this data is the worst emission level.
2. C.F (Correction Factor) = Antenna Factor (dB/m)+ Cable Loss (dB).
3. Measurement (dBuV/m) = Reading(dBuV) + C.F (Correction Factor).
4. The emission levels of other frequencies are very lower than the limit and not show in test report.

EUT	Outdoor Pan/Tilt Security Wi-Fi Camera	Date of Test	2023-05-13
Factor	BBHA 9120D	Temp. / Humidity	24°C /59%
Polarity	Horizontal	Site / Test Engineer	AC1 / Todd
Test Mode	802.11n-20MHz_TX_CH 1_ANT 0	Test Voltage	AC 120V/60Hz

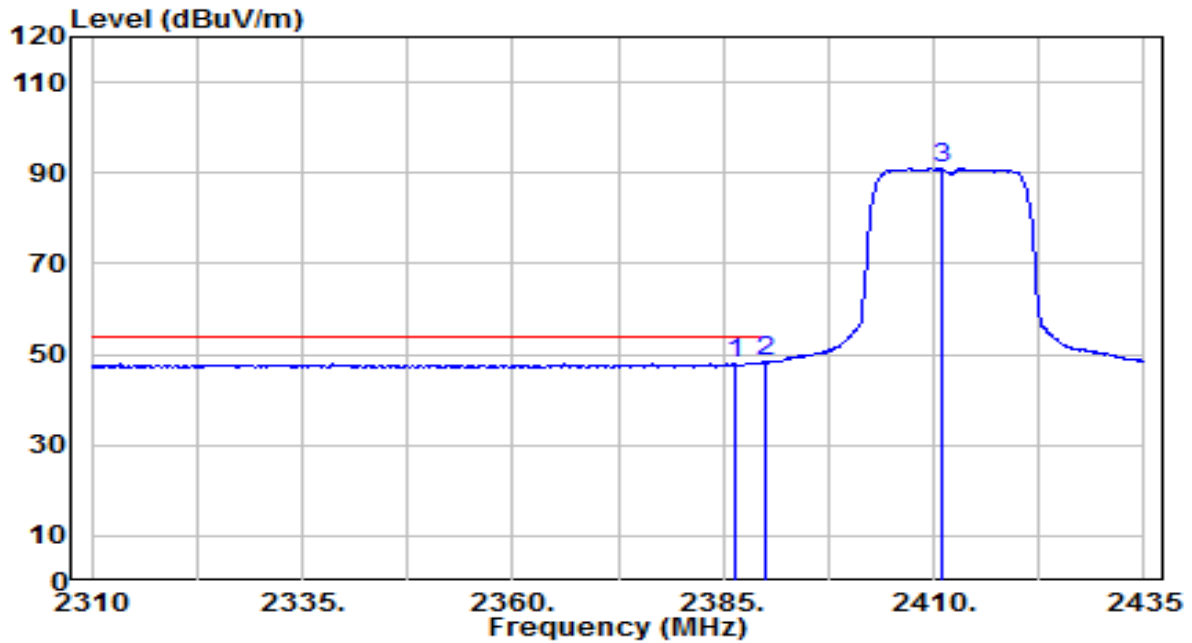

No	Frequency (MHz)	Reading (dBuV)	C.F (dB/m)	Measurement (dBuV/m)	Margin (dB)	Limit (dBuV/m)	Height (cm)	Angle (deg)	Remark (QP/PK/AV)
1	2386.500	15.72	32.17	47.89	-6.11	54.00	140	105	Average
2	* 2390.000	16.07	32.18	48.26	-5.74	54.00	140	105	Average
3	2411.125	58.84	32.26	91.10	N/A	N/A	140	105	Average

Note:

1. " \*", means this data is the worst emission level.
2. C.F (Correction Factor) = Antenna Factor (dB/m)+ Cable Loss (dB).
3. Measurement (dBuV/m) = Reading(dBuV) + C.F (Correction Factor).
4. The emission levels of other frequencies are very lower than the limit and not show in test report.



EUT	Outdoor Pan/Tilt Security Wi-Fi Camera	Date of Test	2023-05-13
Factor	BBHA 9120D	Temp. / Humidity	24°C /59%
Polarity	Vertical	Site / Test Engineer	AC1 / Todd
Test Mode	802.11n-20MHz_TX_CH 1_ANT 0	Test Voltage	AC 120V/60Hz

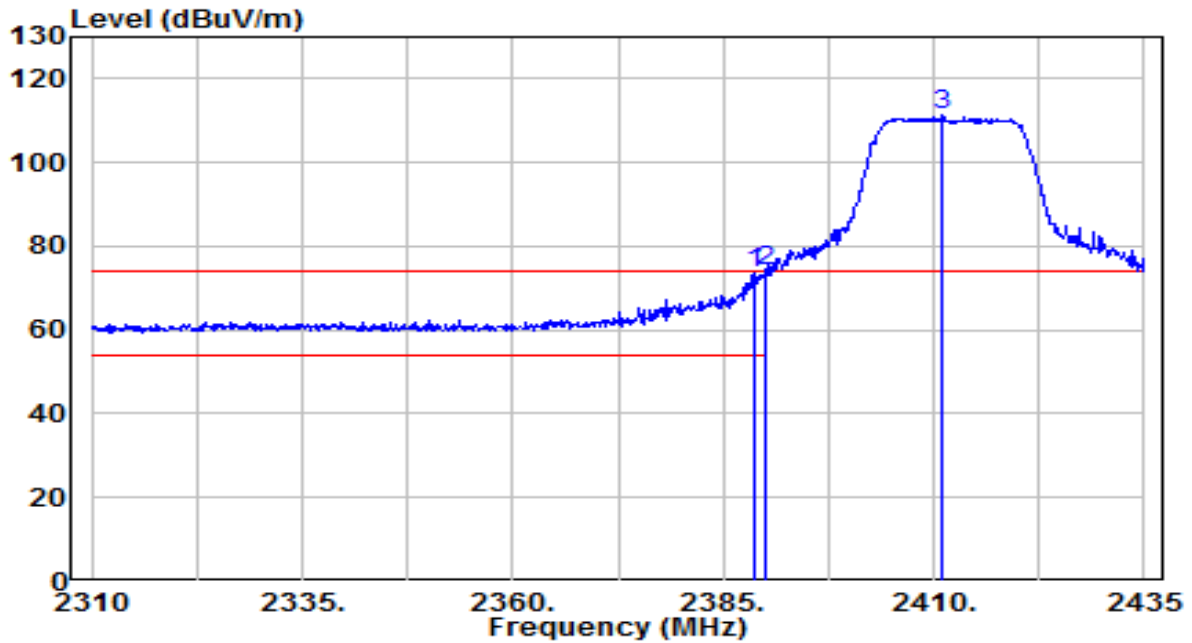

No	Frequency (MHz)	Reading (dBuV)	C.F (dB/m)	Measurement (dBuV/m)	Margin (dB)	Limit (dBuV/m)	Height (cm)	Angle (deg)	Remark (QP/PK/AV)
1	2388.625	41.16	32.18	73.34	-0.66	74.00	115	110	Peak
2	* 2390.000	41.70	32.18	73.88	-0.12	74.00	115	110	Peak
3	2411.000	79.01	32.26	111.27	N/A	N/A	115	110	Peak

Note:

1. " \*", means this data is the worst emission level.
2. C.F (Correction Factor) = Antenna Factor (dB/m)+ Cable Loss (dB).
3. Measurement (dBuV/m) = Reading(dBuV) + C.F (Correction Factor).
4. The emission levels of other frequencies are very lower than the limit and not show in test report.

EUT	Outdoor Pan/Tilt Security Wi-Fi Camera	Date of Test	2023-05-13
Factor	BBHA 9120D	Temp. / Humidity	24°C /59%
Polarity	Vertical	Site / Test Engineer	AC1 / Todd
Test Mode	802.11n-20MHz_TX_CH 1_ANT 0	Test Voltage	AC 120V/60Hz

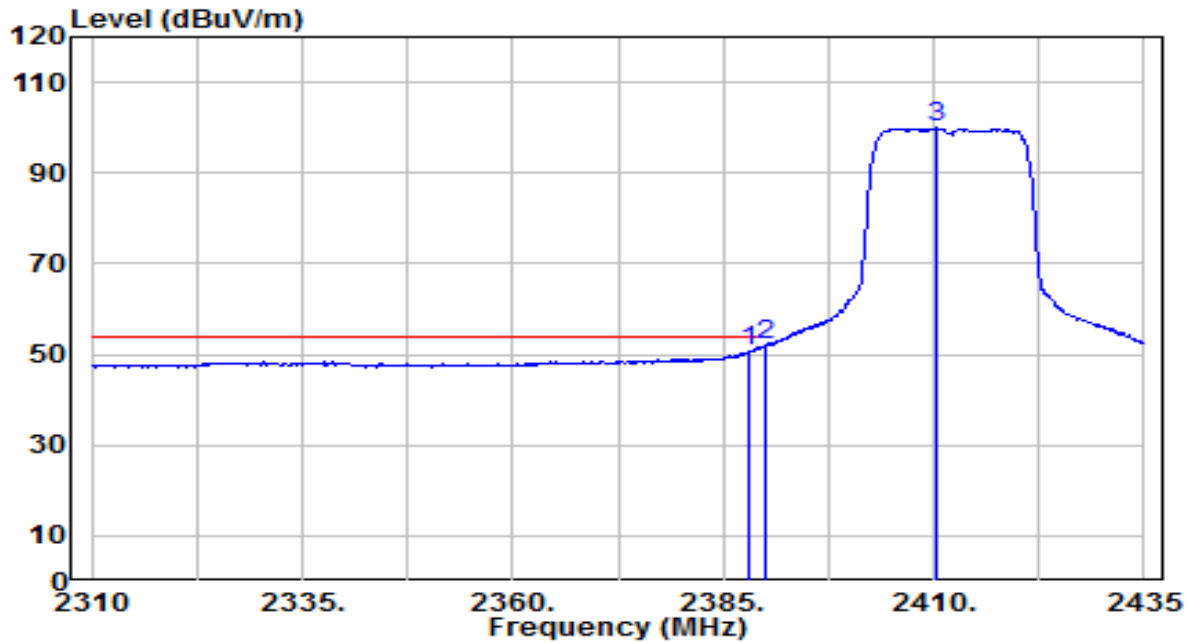

No	Frequency (MHz)	Reading (dBUV)	C.F (dB/m)	Measurement (dBUV/m)	Margin (dB)	Limit (dBUV/m)	Height (cm)	Angle (deg)	Remark (QP/PK/AV)
1	2388.000	18.32	32.18	50.49	-3.51	54.00	115	110	Average
2	* 2390.000	19.74	32.18	51.92	-2.08	54.00	115	110	Average
3	2410.375	67.60	32.26	99.86	N/A	N/A	115	110	Average

Note:

1. " \*", means this data is the worst emission level.
2. C.F (Correction Factor) = Antenna Factor (dB/m)+ Cable Loss (dB).
3. Measurement (dBUV/m) = Reading(dBUV) + C.F (Correction Factor).
4. The emission levels of other frequencies are very lower than the limit and not show in test report.

EUT	Outdoor Pan/Tilt Security Wi-Fi Camera	Date of Test	2023-05-13
Factor	BBHA 9120D	Temp. / Humidity	24°C /59%
Polarity	Horizontal	Site / Test Engineer	AC1 / Todd
Test Mode	802.11n-20MHz_TX_CH 6_ANT 0	Test Voltage	AC 120V/60Hz

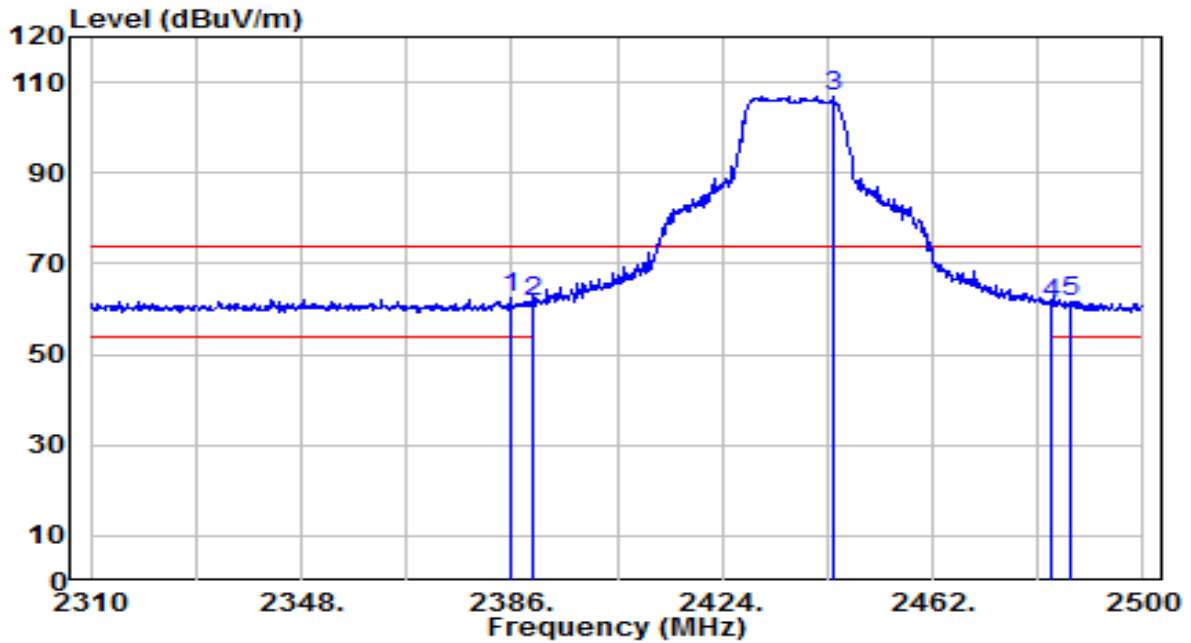

No	Frequency (MHz)	Reading (dBuV)	C.F (dB/m)	Measurement (dBuV/m)	Margin (dB)	Limit (dBuV/m)	Height (cm)	Angle (deg)	Remark (QP/PK/AV)	
1	*	2385.620	30.15	32.17	62.32	-11.69	74.00	120	110	Peak
2		2390.000	29.26	32.18	61.44	-12.56	74.00	120	110	Peak
3		2443.950	74.37	32.38	106.74	N/A	N/A	120	110	Peak
4		2483.500	28.62	32.52	61.14	-12.86	74.00	120	110	Peak
5		2486.890	29.23	32.53	61.77	-12.23	74.00	120	110	Peak

Note:

1. " \*", means this data is the worst emission level.
2. C.F (Correction Factor) = Antenna Factor (dB/m)+ Cable Loss (dB).
3. Measurement (dBuV/m) = Reading(dBuV) + C.F (Correction Factor).
4. The emission levels of other frequencies are very lower than the limit and not show in test report.

EUT	Outdoor Pan/Tilt Security Wi-Fi Camera	Date of Test	2023-05-13
Factor	BBHA 9120D	Temp. / Humidity	24°C /59%
Polarity	Horizontal	Site / Test Engineer	AC1 / Todd
Test Mode	802.11n-20MHz_TX_CH 6_ANT 0	Test Voltage	AC 120V/60Hz

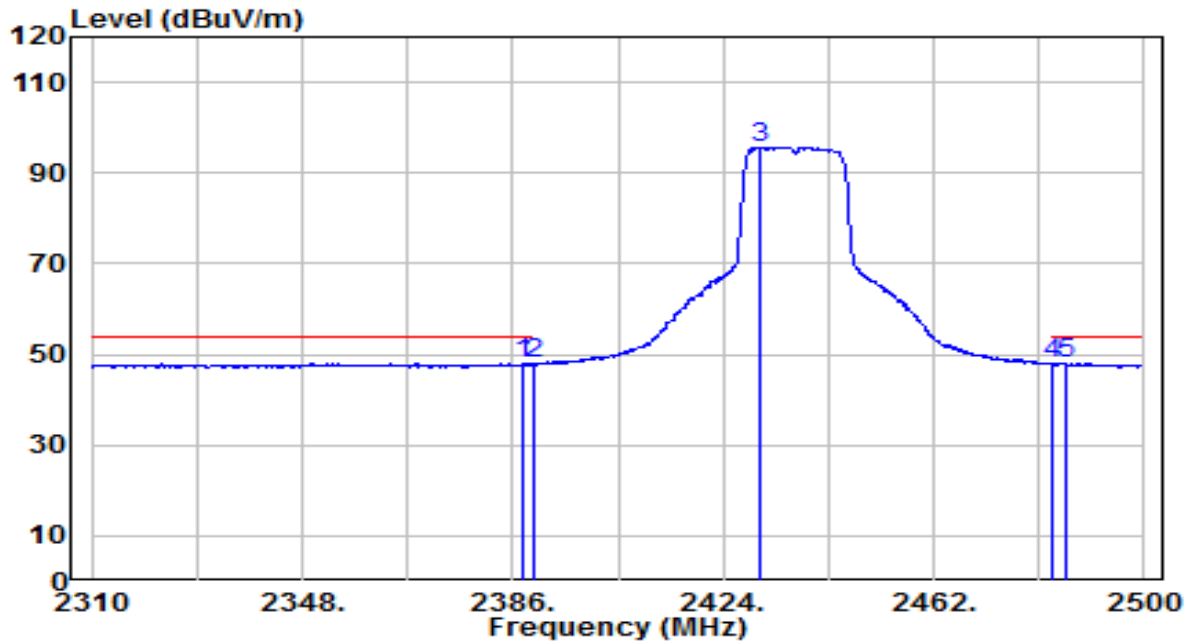

No	Frequency (MHz)	Reading (dBuV)	C.F (dB/m)	Measurement (dBuV/m)	Margin (dB)	Limit (dBuV/m)	Height (cm)	Angle (deg)	Remark (QP/PK/AV)
1	2387.710	15.88	32.18	48.05	-5.95	54.00	120	110	Average
2	2390.000	15.73	32.18	47.92	-6.08	54.00	120	110	Average
3	2430.460	63.44	32.33	95.77	N/A	N/A	120	110	Average
4	* 2483.500	15.61	32.52	48.13	-5.87	54.00	120	110	Average
5	2485.940	15.56	32.53	48.08	-5.92	54.00	120	110	Average

Note:

- "\*" means this data is the worst emission level.
- C.F (Correction Factor) = Antenna Factor (dB/m)+ Cable Loss (dB).
- Measurement (dBuV/m) = Reading(dBuV) + C.F (Correction Factor).
- The emission levels of other frequencies are very lower than the limit and not show in test report.

EUT	Outdoor Pan/Tilt Security Wi-Fi Camera	Date of Test	2023-05-13
Factor	BBHA 9120D	Temp. / Humidity	24°C /59%
Polarity	Vertical	Site / Test Engineer	AC1 / Todd
Test Mode	802.11n-20MHz_TX_CH 6_ANT 0	Test Voltage	AC 120V/60Hz

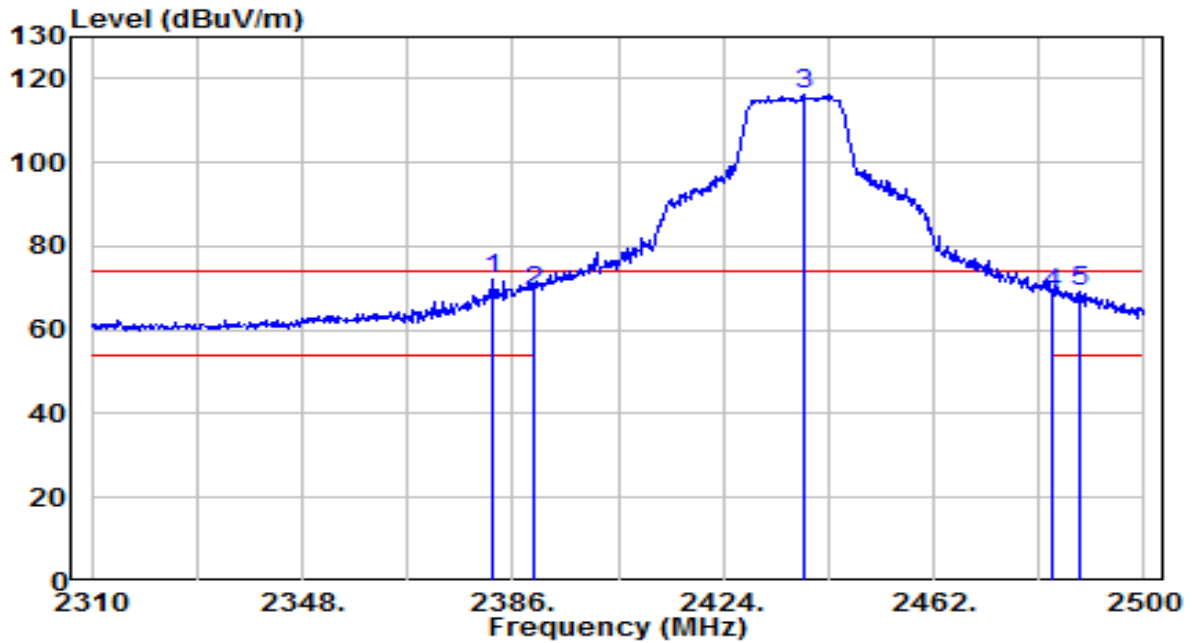

No	Frequency (MHz)	Reading (dBuV)	C.F (dB/m)	Measurement (dBuV/m)	Margin (dB)	Limit (dBuV/m)	Height (cm)	Angle (deg)	Remark (QP/PK/AV)
1	* 2382.200	40.05	32.16	72.20	-1.80	74.00	190	115	Peak
2	2390.000	37.23	32.18	69.41	-4.59	74.00	190	115	Peak
3	2438.820	84.15	32.36	116.51	N/A	N/A	190	115	Peak
4	2483.500	36.24	32.52	68.76	-5.24	74.00	190	115	Peak
5	2488.410	36.51	32.54	69.05	-4.95	74.00	190	115	Peak

Note:

1. " \*", means this data is the worst emission level.
2. C.F (Correction Factor) = Antenna Factor (dB/m)+ Cable Loss (dB).
3. Measurement (dBuV/m) = Reading(dBuV) + C.F (Correction Factor).
4. The emission levels of other frequencies are very lower than the limit and not show in test report.

EUT	Outdoor Pan/Tilt Security Wi-Fi Camera	Date of Test	2023-05-13
Factor	BBHA 9120D	Temp. / Humidity	24°C /59%
Polarity	Vertical	Site / Test Engineer	AC1 / Todd
Test Mode	802.11n-20MHz_TX_CH 6_ANT 0	Test Voltage	AC 120V/60Hz

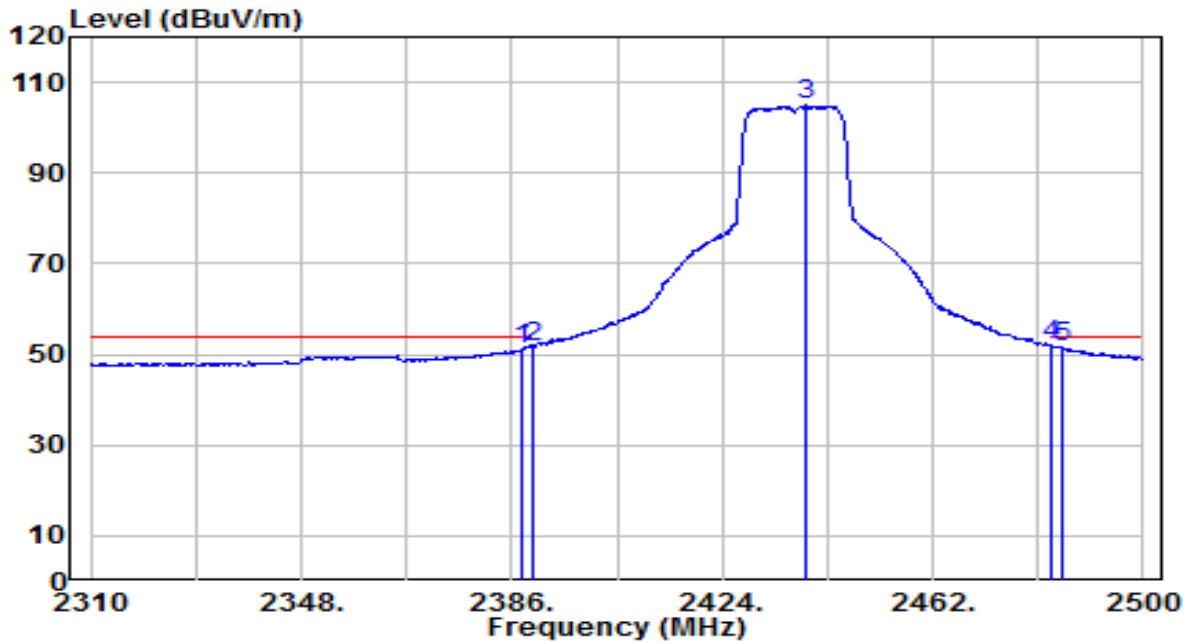

No	Frequency (MHz)	Reading (dBuV)	C.F (dB/m)	Measurement (dBuV/m)	Margin (dB)	Limit (dBuV/m)	Height (cm)	Angle (deg)	Remark (QP/PK/AV)
1	2387.900	18.77	32.18	50.95	-3.05	54.00	190	115	Average
2	2390.000	19.60	32.18	51.78	-2.22	54.00	190	115	Average
3	2439.200	72.52	32.36	104.88	N/A	N/A	190	115	Average
4	* 2483.500	19.34	32.52	51.86	-2.14	54.00	190	115	Average
5	2485.180	19.16	32.53	51.69	-2.31	54.00	190	115	Average

Note:

1. " \*", means this data is the worst emission level.
2. C.F (Correction Factor) = Antenna Factor (dB/m)+ Cable Loss (dB).
3. Measurement (dBuV/m) = Reading(dBuV) + C.F (Correction Factor).
4. The emission levels of other frequencies are very lower than the limit and not show in test report.

EUT	Outdoor Pan/Tilt Security Wi-Fi Camera	Date of Test	2023-05-13
Factor	BBHA 9120D	Temp. / Humidity	24°C /59%
Polarity	Horizontal	Site / Test Engineer	AC1 / Todd
Test Mode	802.11n-20MHz_TX_CH 11_ANT 0	Test Voltage	AC 120V/60Hz

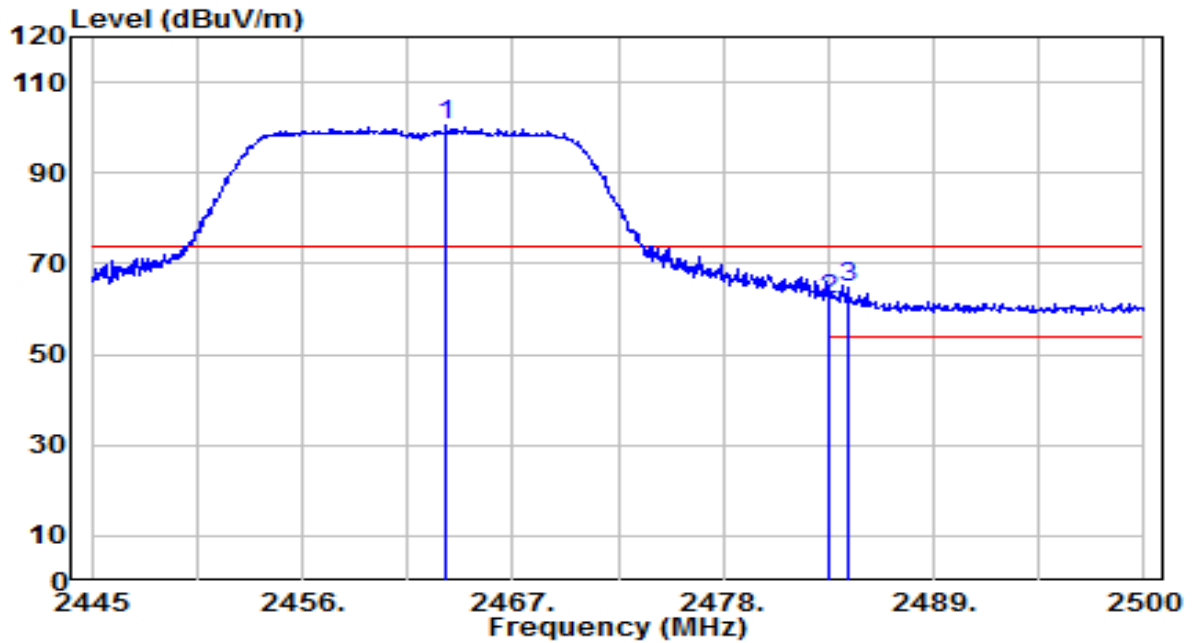

No	Frequency (MHz)	Reading (dBUV)	C.F (dB/m)	Measurement (dBUV/m)	Margin (dB)	Limit (dBUV/m)	Height (cm)	Angle (deg)	Remark (QP/PK/AV)
1	2463.535	67.96	32.45	100.41	N/A	N/A	130	110	Peak
2	2483.500	29.72	32.52	62.24	-11.76	74.00	130	110	Peak
3	* 2484.490	32.29	32.52	64.82	-9.18	74.00	130	110	Peak

Note:

1. " \*", means this data is the worst emission level.
2. C.F (Correction Factor) = Antenna Factor (dB/m)+ Cable Loss (dB).
3. Measurement (dBUV/m) = Reading(dBUV) + C.F (Correction Factor).
4. The emission levels of other frequencies are very lower than the limit and not show in test report.

EUT	Outdoor Pan/Tilt Security Wi-Fi Camera	Date of Test	2023-05-13
Factor	BBHA 9120D	Temp. / Humidity	24°C /59%
Polarity	Horizontal	Site / Test Engineer	AC1 / Todd
Test Mode	802.11n-20MHz_TX_CH 11_ANT 0	Test Voltage	AC 120V/60Hz

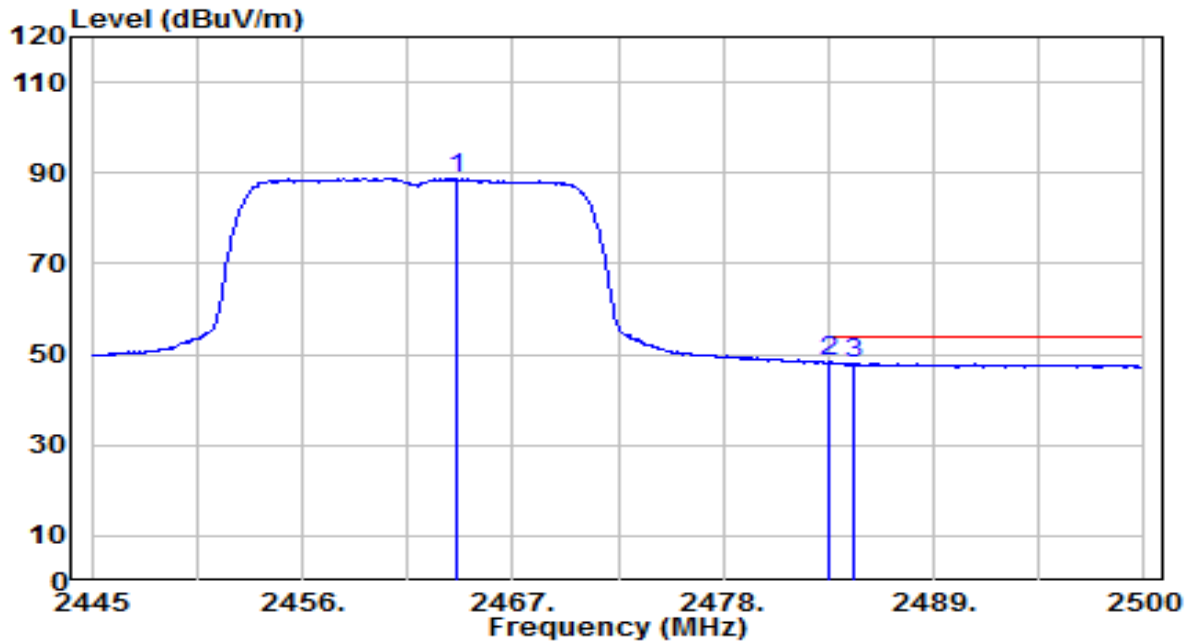

No	Frequency (MHz)	Reading (dBUV)	C.F (dB/m)	Measurement (dBUV/m)	Margin (dB)	Limit (dBUV/m)	Height (cm)	Angle (deg)	Remark (QP/PK/AV)
1	2464.085	56.34	32.45	88.79	N/A	N/A	130	110	Average
2	* 2483.500	15.76	32.52	48.28	-5.72	54.00	130	110	Average
3	2484.765	15.51	32.53	48.03	-5.97	54.00	130	110	Average

Note:

1. " \*", means this data is the worst emission level.
2. C.F (Correction Factor) = Antenna Factor (dB/m)+ Cable Loss (dB).
3. Measurement (dBUV/m) = Reading(dBUV) + C.F (Correction Factor).
4. The emission levels of other frequencies are very lower than the limit and not show in test report.



EUT	Outdoor Pan/Tilt Security Wi-Fi Camera	Date of Test	2023-05-13
Factor	BBHA 9120D	Temp. / Humidity	24°C /59%
Polarity	Vertical	Site / Test Engineer	AC1 / Todd
Test Mode	802.11n-20MHz_TX_CH 11_ANT 0	Test Voltage	AC 120V/60Hz

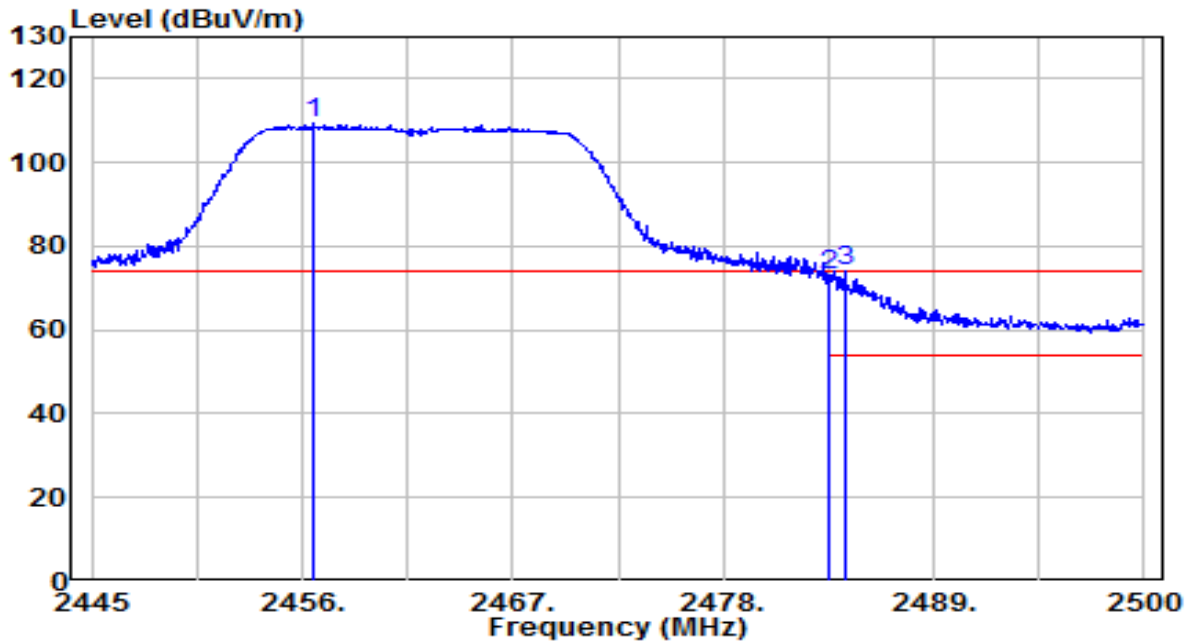

No	Frequency (MHz)	Reading (dBuV)	C.F (dB/m)	Measurement (dBuV/m)	Margin (dB)	Limit (dBuV/m)	Height (cm)	Angle (deg)	Remark (QP/PK/AV)
1	2456.605	77.00	32.42	109.42	N/A	N/A	145	115	Peak
2	2483.500	40.70	32.52	73.22	-0.78	74.00	145	115	Peak
3	* 2484.325	41.32	32.52	73.84	-0.16	74.00	145	115	Peak

Note:

1. " \*", means this data is the worst emission level.
2. C.F (Correction Factor) = Antenna Factor (dB/m)+ Cable Loss (dB).
3. Measurement (dBuV/m) = Reading(dBuV) + C.F (Correction Factor).
4. The emission levels of other frequencies are very lower than the limit and not show in test report.

EUT	Outdoor Pan/Tilt Security Wi-Fi Camera	Date of Test	2023-05-13
Factor	BBHA 9120D	Temp. / Humidity	24°C /59%
Polarity	Vertical	Site / Test Engineer	AC1 / Todd
Test Mode	802.11n-20MHz_TX_CH 11_ANT 0	Test Voltage	AC 120V/60Hz

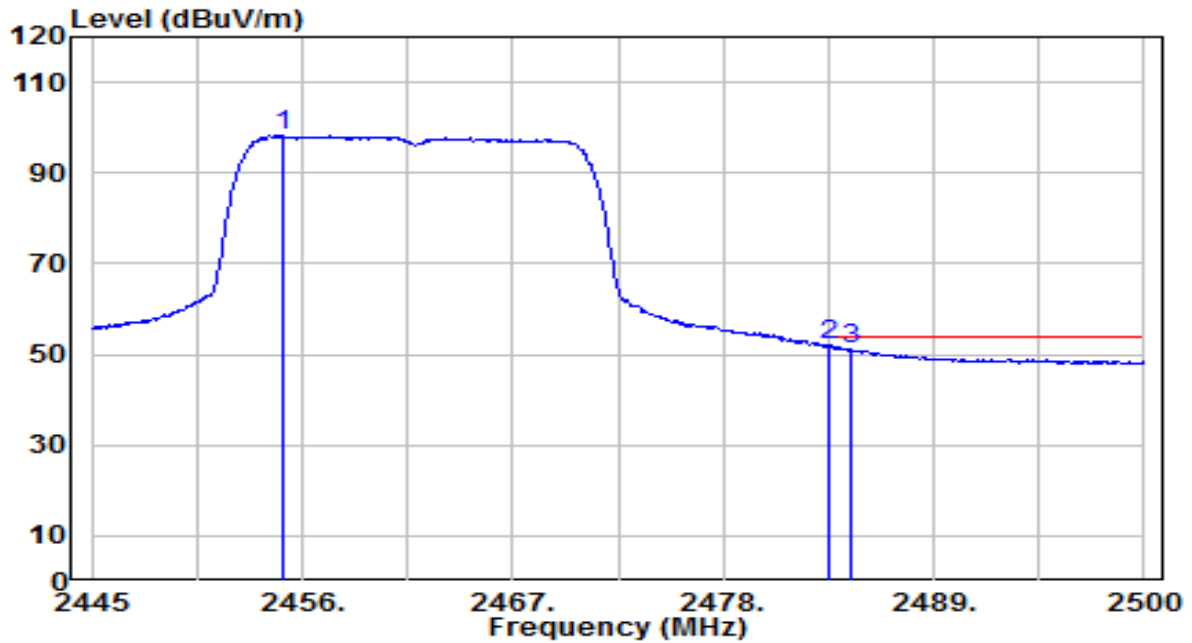

No	Frequency (MHz)	Reading (dBuV)	C.F (dB/m)	Measurement (dBuV/m)	Margin (dB)	Limit (dBuV/m)	Height (cm)	Angle (deg)	Remark (QP/PK/AV)
1	2454.955	65.77	32.42	98.19	N/A	N/A	145	115	Average
2	* 2483.500	19.38	32.52	51.90	-2.10	54.00	145	115	Average
3	2484.710	18.64	32.52	51.17	-2.83	54.00	145	115	Average

Note:

1. " \*", means this data is the worst emission level.
2. C.F (Correction Factor) = Antenna Factor (dB/m)+ Cable Loss (dB).
3. Measurement (dBuV/m) = Reading(dBuV) + C.F (Correction Factor).
4. The emission levels of other frequencies are very lower than the limit and not show in test report.

## 7.8. AC Conducted Emissions Measurement

### 7.8.1. Test Limit

FCC Part 15 Subpart C Paragraph 15.207 Limits		
Frequency (MHz)	QP (dBuV)	AV (dBuV)
0.15 - 0.50	66 - 56	56 - 46
0.50 - 5.0	56	46
5.0 - 30	60	50

Note 1: The lower limit shall apply at the transition frequencies.

Note 2: The limit decreases linearly with the logarithm of the frequency in the range 0.15MHz to 0.5MHz.

### 7.8.2. Test Setup

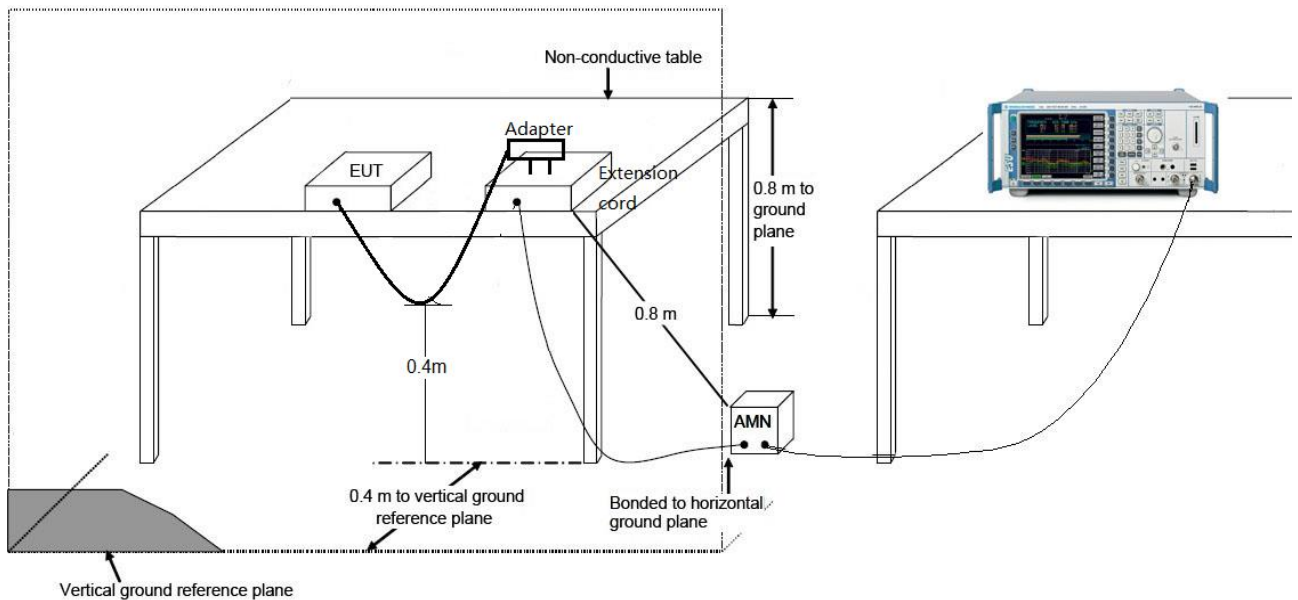

### 7.8.3. Test Result

EUT	Outdoor Pan/Tilt Security Wi-Fi Camera	Date of Test	2023-05-10
Factor	CE_ENV216-L1 (Filter ON)	Temp. / Humidity	23.7°C /57%
Polarity	Line1	Site / Test Engineer	SR2 / Bob
Test Mode	802.11n-20MHz_TX_CH 6_ANT 0	Test Voltage	AC 120V/60Hz

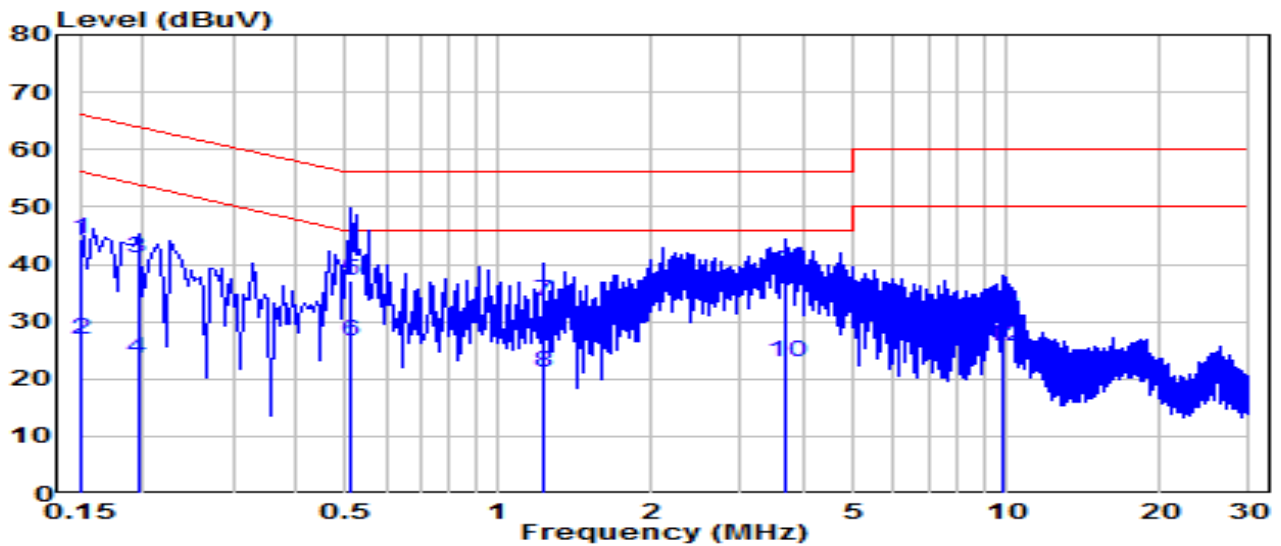

No	Frequency (MHz)	Reading (dBUV)	C.F (dB)	Measurement (dBUV)	Margin (dB)	Limit (dBUV)	Remark (QP/PK/AV)
1	0.150	34.65	9.62	44.27	-21.73	66.00	QP
2	0.150	17.39	9.62	27.01	-28.99	56.00	Average
3	0.195	31.54	9.62	41.16	-22.66	63.82	QP
4	0.195	13.82	9.62	23.45	-30.38	53.82	Average
5	0.510	27.61	9.64	37.25	-18.75	56.00	QP
6	0.510	17.06	9.64	26.71	-19.29	46.00	Average
7	1.225	23.92	9.67	33.60	-22.40	56.00	QP
8	1.225	11.38	9.67	21.05	-24.95	46.00	Average
9	*	3.682	9.72	38.66	-17.34	56.00	QP
10	*	3.682	9.72	22.96	-23.04	46.00	Average
11	9.851	20.49	9.86	30.35	-29.65	60.00	QP
12	9.851	15.69	9.86	25.54	-24.46	50.00	Average

Note:

1. " \*", means this data is the worst emission level.
2. C.F (Correction Factor) = LISN Factor (dB)+ Cable Loss (dB).
3. Measurement (dBUV) = Reading(dBUV) + C.F (Correction Factor).

EUT	Outdoor Pan/Tilt Security Wi-Fi Camera	Date of Test	2023-05-10
Factor	CE_ENV216-N (Filter ON)	Temp. / Humidity	23.7°C /57%
Polarity	Neutral	Site / Test Engineer	SR2 / Bob
Test Mode	802.11n-20MHz_TX_CH 6_ANT 0	Test Voltage	AC 120V/60Hz

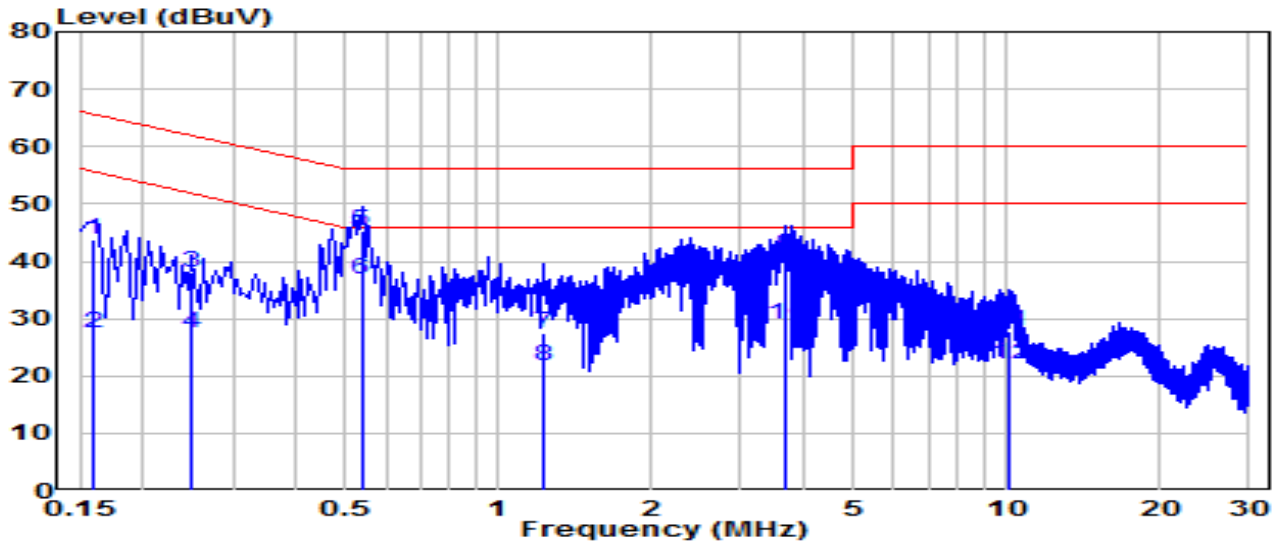

No	Frequency (MHz)	Reading (dBuV)	C.F (dB)	Measurement (dBuV)	Margin (dB)	Limit (dBuV)	Remark (QP/PK/AV)
1	0.159	34.29	9.62	43.91	-21.61	65.52	QP
2	0.159	17.76	9.62	27.38	-28.14	55.52	Average
3	0.249	28.37	9.63	38.00	-23.80	61.79	QP
4	0.249	17.77	9.63	27.39	-24.40	51.79	Average
5 *	0.537	35.58	9.64	45.22	-10.78	56.00	QP
6 *	0.537	27.27	9.64	36.91	-9.09	46.00	Average
7	1.230	17.81	9.67	27.49	-28.51	56.00	QP
8	1.230	11.95	9.67	21.63	-24.37	46.00	Average
9	3.673	31.27	9.72	40.99	-15.01	56.00	QP
10	3.673	19.31	9.72	29.03	-16.97	46.00	Average
11	10.063	18.02	9.87	27.89	-32.11	60.00	QP
12	10.063	12.09	9.87	21.96	-28.04	50.00	Average

Note:

1. " \*", means this data is the worst emission level.
2. C.F (Correction Factor) = LISN Factor (dB)+ Cable Loss (dB).
3. Measurement (dBuV) = Reading(dBuV) + C.F (Correction Factor).

EUT	Outdoor Pan/Tilt Security Wi-Fi Camera	Date of Test	2023-05-10
Factor	CE_ENV216-L1 (Filter ON)	Temp. / Humidity	23.7°C /57%
Polarity	Line1	Site / Test Engineer	SR2 / Bob
Test Mode	802.11n-20MHz_TX_CH 6_ANT 0	Test Voltage	AC 240V/60Hz

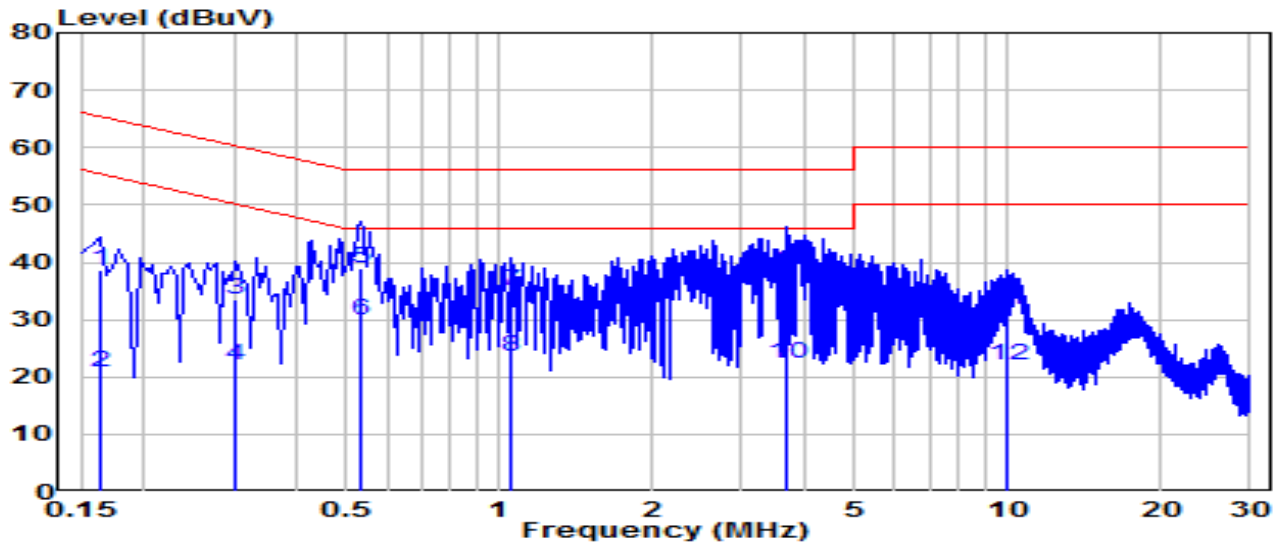

No	Frequency (MHz)	Reading (dBUV)	C.F (dB)	Measurement (dBUV)	Margin (dB)	Limit (dBUV)	Remark (QP/PK/AV)
1	0.163	29.01	9.62	38.63	-26.65	65.28	QP
2	0.163	11.13	9.62	20.75	-34.54	55.28	Average
3	0.303	23.86	9.63	33.49	-26.67	60.16	QP
4	0.303	12.49	9.63	22.12	-28.04	50.16	Average
5	* 0.532	29.18	9.64	38.82	-17.18	56.00	QP
6	* 0.532	20.30	9.64	29.95	-16.05	46.00	Average
7	1.059	25.37	9.67	35.04	-20.96	56.00	QP
8	1.059	13.88	9.67	23.55	-22.45	46.00	Average
9	3.696	28.55	9.72	38.28	-17.72	56.00	QP
10	3.696	12.51	9.72	22.23	-23.77	46.00	Average
11	9.914	21.77	9.86	31.63	-28.37	60.00	QP
12	9.914	12.30	9.86	22.16	-27.84	50.00	Average

Note:

- "\*" means this data is the worst emission level.
- C.F (Correction Factor) = LISN Factor (dB)+ Cable Loss (dB).
- Measurement (dBUV) = Reading(dBUV) + C.F (Correction Factor).

EUT	Outdoor Pan/Tilt Security Wi-Fi Camera	Date of Test	2023-05-10
Factor	CE_ENV216-N (Filter ON)	Temp. / Humidity	23.7°C /57%
Polarity	Neutral	Site / Test Engineer	SR2 / Bob
Test Mode	802.11n-20MHz_TX_CH 6_ANT 0	Test Voltage	AC 240V/60Hz

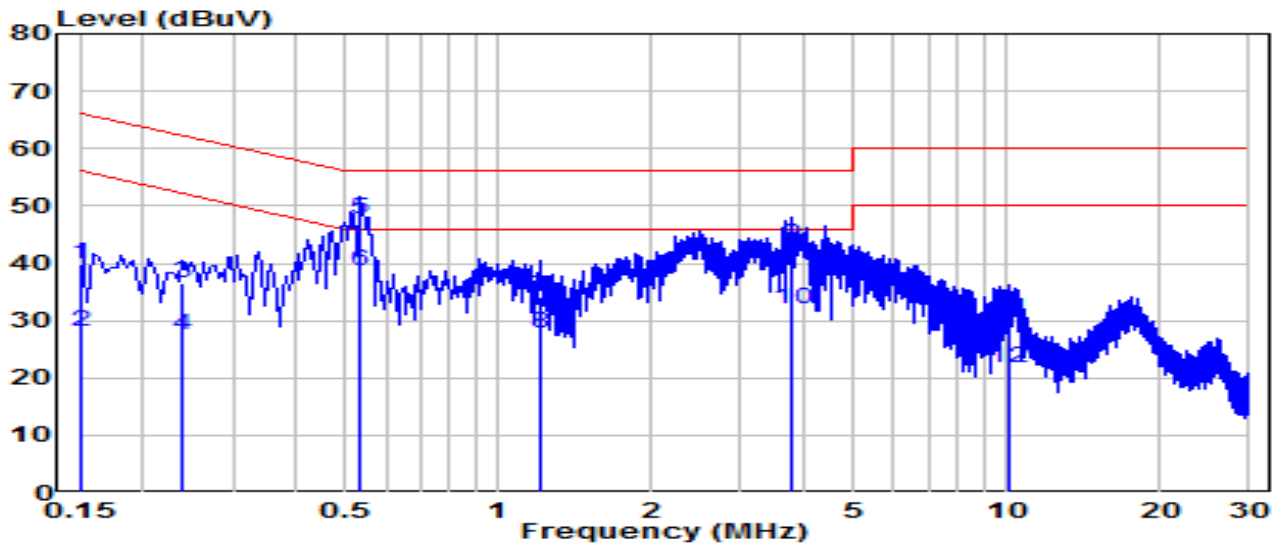

No	Frequency (MHz)	Reading (dBuV)	C.F (dB)	Measurement (dBuV)	Margin (dB)	Limit (dBuV)	Remark (QP/PK/AV)
1	0.150	30.29	9.62	39.91	-26.09	66.00	QP
2	0.150	18.41	9.62	28.03	-27.97	56.00	Average
3	0.240	26.79	9.63	36.42	-25.68	62.10	QP
4	0.240	17.86	9.63	27.48	-24.61	52.10	Average
5	* 0.532	37.94	9.64	47.58	-8.42	56.00	QP
6	* 0.532	29.12	9.64	38.76	-7.24	46.00	Average
7	1.212	24.30	9.67	33.97	-22.03	56.00	QP
8	1.212	18.00	9.67	27.68	-18.32	46.00	Average
9	3.763	33.34	9.73	43.07	-12.93	56.00	QP
10	3.763	22.15	9.73	31.87	-14.13	46.00	Average
11	10.045	20.25	9.87	30.12	-29.88	60.00	QP
12	10.045	11.97	9.87	21.85	-28.15	50.00	Average

Note:

1. " \*", means this data is the worst emission level.
2. C.F (Correction Factor) = LISN Factor (dB)+ Cable Loss (dB).
3. Measurement (dBuV) = Reading(dBuV) + C.F (Correction Factor).

## 8. CONCLUSION

The data collected relate only the item(s) tested and show that the device is compliance with Part 15C of the FCC Rules.



## **Appendix A : Test Setup Photograph**

Refer to “2305TW0104-UT” file.

## **Appendix B : External Photograph**

Refer to “2305TW0104-UE” file.

## **Appendix C : Internal Photograph**

Refer to “2305TW0104-UI” file.

————— The End —————