

Product Name: Smart Wire-Free Security Camera	Report No: FCC022022-5385RF1
Product Model: Tapo C400	Security Classification: Open
Version: V1.0	Total Page:80

TIRT Testing Report



Prepared By:	Checked By:	Approved By:	
Stone Tang	Randy Lv	Daniel Chen	
<i>Stone Tang</i>	<i>Randy Lv</i>	<i>Daniel Chen</i>	

FCC Radio Test Report

FCC ID: 2AXJ4C400

This report concerns: Original Grant

Project No. : 022022-5385
Equipment : Smart Wire-Free Security Camera
Brand Name : tp-link
Test Model : Tapo C400
Series Model : N/A
Applicant : TP-Link Corporation Limited
Address : Room 901, 9/F. , New East Ocean Centre, 9 Science Museum Road,
Tsim Sha Tsui, Kowloon, Hong Kong
Manufacturer : TP-Link Corporation Limited
Address : Room 901, 9/F. , New East Ocean Centre, 9 Science Museum Road,
Tsim Sha Tsui, Kowloon, Hong Kong
Date of Test : 2022.09.05-2022.10.12
Issued Date : 2022.10.20
Report Version : V1.0
Test Sample : Engineering Sample No.: 20220713018147
Standard(s) : FCC CFR Title 47, Part 15, Subpart C
FCC KDB 558074 D01 15.247 Meas Guidance v05r02
ANSI C63.10-2013

- The test result referred exclusively to the presented test model /sample.
- Without written approval of TIRT Inc. the test report shall not reproduced except in full.

Add: Plant 3,Gongjindianzi,Shatian, Kengzi Street, Pingshan District, Shenzhen,
Guangdong, China

TEL: +86-0755-27087573

Table of Contents	Page
REPORT ISSUED HISTORY	6
1 . SUMMARY OF TEST RESULTS	7
1.1 TEST LOCATION	8
1.2 MEASUREMENT UNCERTAINTY	8
1.3 TEST ENVIRONMENT CONDITIONS	8
2 . GENERAL INFORMATION	9
2.1 GENERAL DESCRIPTION OF EUT	9
2.2 DESCRIPTION OF TEST MODES	10
2.3 PARAMETERS OF TEST SOFTWARE	11
2.4 DUTY CYCLE	12
2.5 BLOCK DIAGRAM SHOWING THE CONFIGURATION OF SYSTEM TESTED	13
2.6 SUPPORT UNITS	13
3 . AC POWER LINE CONDUCTED EMISSIONS	14
3.1 LIMIT	14
3.2 TEST PROCEDURE	14
3.3 DEVIATION FROM TEST STANDARD	14
3.4 TEST SETUP	15
3.5 EUT OPERATION CONDITIONS	15
3.6 TEST RESULTS	15
4 . RADIATED EMISSIONS	16
4.1 LIMIT	16
4.2 TEST PROCEDURE	17
4.3 DEVIATION FROM TEST STANDARD	18
4.4 TEST SETUP	18
4.5 EUT OPERATION CONDITIONS	19
4.6 TEST RESULTS - 9 KHZ TO 30 MHZ	19
4.7 TEST RESULTS - 30 MHZ TO 1000 MHZ	19
4.8 TEST RESULTS - ABOVE 1000 MHZ	19
5 . BANDWIDTH	20
5.1 LIMIT	20
5.2 TEST PROCEDURE	20
5.3 DEVIATION FROM STANDARD	20
5.4 TEST SETUP	20

Table of Contents	Page
5.5 EUT OPERATION CONDITIONS	20
5.6 TEST RESULTS	20
6 . MAXIMUM OUTPUT POWER & E.I.R.P.	21
6.1 LIMIT	21
6.2 TEST PROCEDURE	21
6.3 DEVIATION FROM STANDARD	21
6.4 TEST SETUP	21
6.5 EUT OPERATION CONDITIONS	21
6.6 TEST RESULTS	21
7 . CONDUCTED SPURIOUS EMISSIONS	22
7.1 LIMIT	22
7.2 TEST PROCEDURE	22
7.3 DEVIATION FROM STANDARD	22
7.4 TEST SETUP	22
7.5 EUT OPERATION CONDITIONS	22
7.6 TEST RESULTS	22
8 . POWER SPECTRAL DENSITY	23
8.1 LIMIT	23
8.2 TEST PROCEDURE	23
8.3 DEVIATION FROM STANDARD	23
8.4 TEST SETUP	23
8.5 EUT OPERATION CONDITIONS	23
8.6 TEST RESULTS	23
9 . MEASUREMENT INSTRUMENTS LIST	24
10 . EUT TEST PHOTO	25
APPENDIX A - AC POWER LINE CONDUCTED EMISSIONS	27
APPENDIX B - RADIATED EMISSION - 9 KHZ TO 30 MHZ	30
APPENDIX C - RADIATED EMISSION - 30 MHZ TO 1000 MHZ	31
APPENDIX D - RADIATED EMISSION- ABOVE 1000 MHZ	34
APPENDIX E - BANDWIDTH	65
APPENDIX F - MAXIMUM AVERAGE OUTPUT POWER	69
APPENDIX G - CONDUCTED SPURIOUS EMISSIONS	71

Table of Contents

Page

APPENDIX H - POWER SPECTRAL DENSITY

78

REPORT ISSUED HISTORY

Report No.	Version	Description	Issued Date	Note
FCC022022-5385RF1	V1.0	Original Report.	2022.10.20	Valid

1. SUMMARY OF TEST RESULTS

Test procedures according to the technical standard(s):

FCC CFR Title 47, Part 15, Subpart C				
Standard(s) Section	Test Item	Test Result	Judgment	Remark
15.207	AC Power Line Conducted Emissions	APPENDIX A	PASS	-----
15.247(d) 15.205(a) 15.209(a)	Radiated Emissions	APPENDIX B APPENDIX C APPENDIX D	PASS	-----
15.247(a)(2)	Bandwidth	APPENDIX E	PASS	-----
15.247(b)(3)	Maximum Output Power	APPENDIX F	PASS	-----
15.247(d)	Conducted Spurious Emissions	APPENDIX G	PASS	-----
15.247(e)	Power Spectral Density	APPENDIX H	PASS	-----
15.203	Antenna Requirement	-----	PASS	Note(2)

Note:

- (1) "N/A" denotes test is not applicable in this test report.
- (2) The device what use a permanently attached antenna were considered sufficient to comply with the provisions of 15.203.

1.1 TEST LOCATION

Company:	Shenzhen Branch of Beijing TIRT Technology Service Co.,Ltd
Address:	Plant 3,Gongjindianzi,Shatian, Kengzi Street, Pingshan District, Shenzhen, Guangdong, China
CNAS Registration Number:	CNAS L14158
A2LA Registration Number	6049.01
Telephone:	+86-0755-27087573

1.2 MEASUREMENT UNCERTAINTY

ISO/IEC 17025 requires that an estimate of the measurement uncertainties associated with the emissions test results be included in the report. The measurement uncertainties given below are based on a 95% confidence level (based on a coverage factor (k=2))

The TIRT measurement uncertainty as below table:

Parameter	Uncertainty
Occupied Channel Bandwidth	±142.12kHz
RF power conducted	±0.74dB
RF power radiated	±3.25dB
Spurious emissions, conducted	±1.78dB
Spurious emissions, radiated (30MHz~1GHz)	±4.6dB
Spurious emissions, radiated (1GHz ~ 18GHz)	±4.9dB
Conduction Emissions(150kHz~30MHz)	±3.1dB
Humidity	±4.6%
Temperature	±0.7°C
Time	±1.25%

Note: Unless specifically mentioned, the uncertainty of measurement has not been taken into account to declare the compliance or non-compliance to the specification.

1.3 TEST ENVIRONMENT CONDITIONS

Test Item	Temperature	Humidity	Test Voltage	Tested By
AC Power Line Conducted Emissions	26°C	56%	AC 120V/60Hz	Stone Tang
Radiated Emissions-9kHz to 30 MHz	25°C	55%	AC 120V/60Hz	Stone Tang
Radiated Emissions-30MHz to 1000MHz	23°C	53%	AC 120V/60Hz	Stone Tang
Radiated Emissions-Above 1000MHz	23°C	53%	AC 120V/60Hz	Stone Tang
Bandwidth	23°C	54%	AC 120V/60Hz	Stone Tang
Maximum Output Power	23°C	54%	AC 120V/60Hz	Stone Tang
Conducted Spurious Emissions	23°C	54%	AC 120V/60Hz	Stone Tang
Power Spectral Density	23°C	54%	AC 120V/60Hz	Stone Tang

2. GENERAL INFORMATION

2.1 GENERAL DESCRIPTION OF EUT

Equipment	Smart Wire-Free Security Camera
Brand Name	tp-link
Test Model	Tapo C400
Series Model	N/A
Model Difference(s)	N/A
Software Version	N/A
Hardware Version	N/A
Power Source	1# DC Voltage supplied from AC adapter. Model: A8-501000 2# Battery supplied. Model: Tapo A100
Power Rating	1# I/P: 100-240V~ 50/60Hz 0.2A; O/P: DC5V 1A 2# DC 3.7V, 5200mAh
Operation Frequency	2412 MHz ~ 2462 MHz
Modulation Type	IEEE 802.11b: DSSS IEEE 802.11g: OFDM IEEE 802.11n: OFDM
Bit Rate of Transmitter	IEEE 802.11b: 11/5.5/2/1 Mbps IEEE 802.11g: 54/48/36/24/18/12/9/6 Mbps IEEE 802.11n: up to 72.2 Mbps
Maximum Output Power	IEEE 802.11b: 19.82 dBm (0.0959 W)

Note:

- For a more detailed features description, please refer to the manufacturer's specifications or the user's manual.

2. Channel List:

CH01 - CH11 for IEEE 802.11b, IEEE 802.11g, IEEE 802.11n(HT20)							
Channel	Frequency (MHz)	Channel	Frequency (MHz)	Channel	Frequency (MHz)	Channel	Frequency (MHz)
01	2412	04	2427	07	2442	10	2457
02	2417	05	2432	08	2447	11	2462
03	2422	06	2437	09	2452		

3. Antenna Specification:

Ant.	Brand	Model Name	Antenna Type	Connector	Gain (dBi)
1	tp-link	N/A	Internal	N/A	0

Note:

- The antenna gain is provided by the manufacturer.

2.2 DESCRIPTION OF TEST MODES

The test system was pre-tested based on the consideration of all possible combinations of EUT operation mode.

Pretest Mode	Description
Mode 1	TX B Mode Channel 01/06/11
Mode 2	TX G Mode Channel 01/06/11
Mode 3	TX N(HT20) Mode Channel 01/06/11
Mode 4	TX G Mode Channel 06
Mode 5	TX B Mode Channel 01/02/06/10/11
Mode 6	TX G Mode Channel 01/02/06/10/11
Mode 7	TX N(HT20) Mode Channel 01/02/06/10/11

Following mode(s) was (were) found to be the worst case(s) and selected for the final test.

AC power line conducted emissions test	
Final Test Mode	Description
Mode 4	TX G Mode Channel 06

Radiated emissions test - Below 1GHz	
Final Test Mode	Description
Mode 4	TX G Mode Channel 06

Radiated emissions test- Above 1GHz	
Final Test Mode	Description
Mode 5	TX B Mode Channel 01/02/06/10/11
Mode 6	TX G Mode Channel 01/02/06/10/11
Mode 7	TX N(HT20) Mode Channel 01/02/06/10/11

Conducted test	
Final Test Mode	Description
Mode 1	TX B Mode Channel 01/06/11
Mode 2	TX G Mode Channel 01/06/11
Mode 3	TX N(HT20) Mode Channel 01/06/11

NOTE:

(1) All the bit rate of transmitter have been tested and found the lowest rate is found to be the worst case and recorded.

- (2) For AC power line conducted emissions and radiated emission below 1 GHz test, the IEEE 802.11b channel 11 is found to be the worst case and recorded.
- (3) For radiated emission above 1 GHz test, the spurious points of 1GHz~26.5GHz have been pre-tested and in this report only recorded the worst case. The remaining spurious points are all below the limit value of 20dB.
- (4) For radiated emission above 1 GHz test, the polarization of Vertical and Horizontal are evaluated, the worst case is Vertical and recorded.

2.3 PARAMETERS OF TEST SOFTWARE

Test Software Version	1.0.0 Build 220812 Rel.55891		
Frequency (MHz)	2412	2437	2462
IEEE 802.11b	21	21	23
IEEE 802.11g	1F	24	26
IEEE 802.11n(HT20)	1F	26	28

2.4 DUTY CYCLE

If duty cycle is $\geq 98\%$, duty factor is not required.
 If duty cycle is $< 98\%$, duty factor shall be considered.
 The output power = measured power + duty factor.

IEEE 802.11b

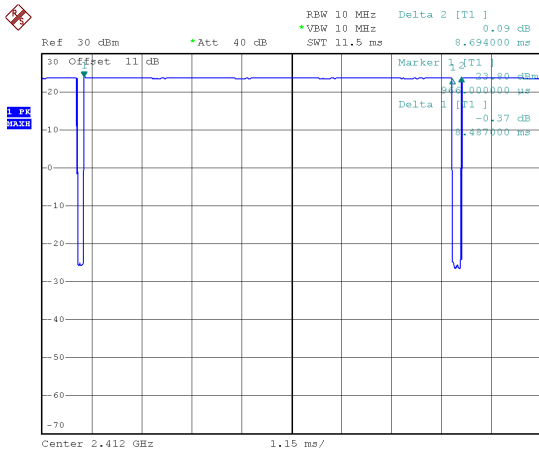

Date: 8.SEP.2022 15:43:28

Duty cycle = $8.487 \text{ ms} / 8.694 \text{ ms} = 97.62\%$
 Duty Factor = $10 \log(1/\text{Duty cycle}) = 0.10$

IEEE 802.11g

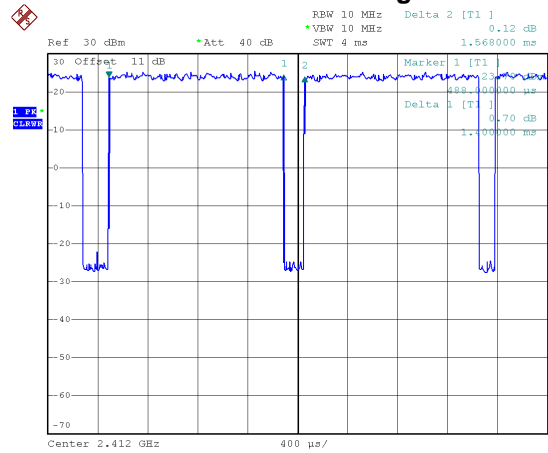

Date: 8.SEP.2022 15:44:01

Duty cycle = $1.400 \text{ ms} / 1.568 \text{ ms} = 89.29\%$
 Duty Factor = $10 \log(1/\text{Duty cycle}) = 0.49$

IEEE 802.11n(HT20)

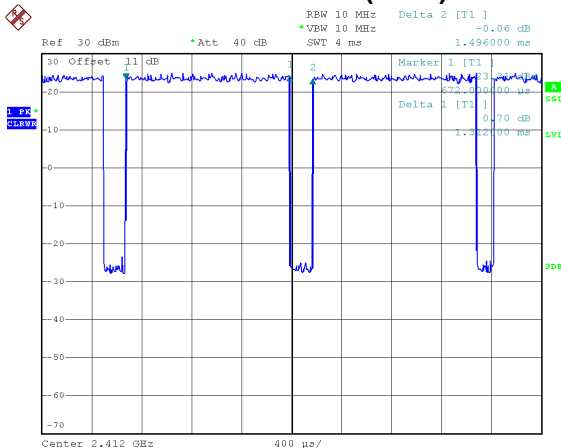

Date: 8.SEP.2022 15:44:28

Duty cycle = $1.312 \text{ ms} / 1.496 \text{ ms} = 87.70\%$
 Duty Factor = $10 \log(1/\text{Duty cycle}) = 0.57$

NOTE:

For IEEE 802.11b:

For radiated emissions frequency above 1 GHz, the resolution bandwidth of test receiver/spectrum analyzer is 1 MHz and the video bandwidth is 118Hz.

For IEEE 802.11g:

For radiated emissions frequency above 1 GHz, the resolution bandwidth of test receiver/spectrum analyzer is 1 MHz and the video bandwidth is 714Hz.

For IEEE 802.11n(HT20):

For radiated emissions frequency above 1 GHz, the resolution bandwidth of test receiver/spectrum analyzer is 1 MHz and the video bandwidth is 762Hz.

(Remark: The video bandwidth of the spectrum analyzer was set to 1kHz during the test.)

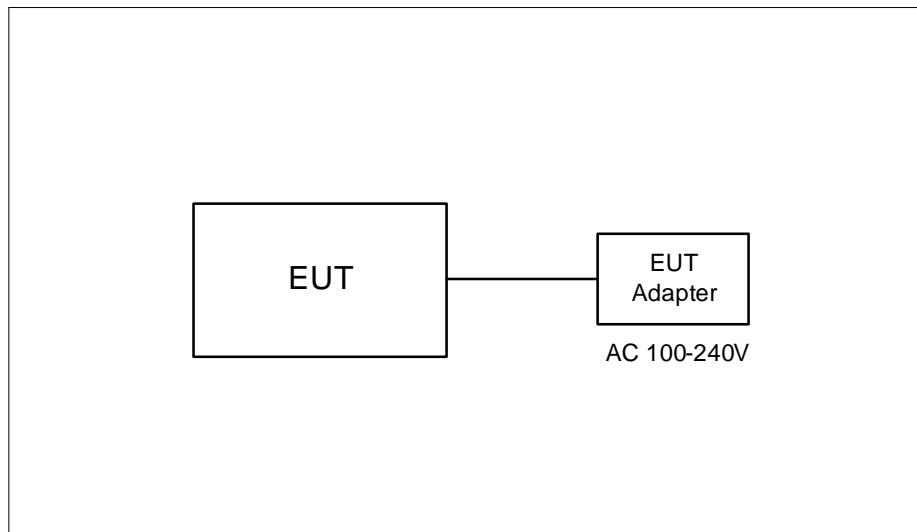
2.5 BLOCK DIAGRAM SHOWING THE CONFIGURATION OF SYSTEM TESTED**2.6 SUPPORT UNITS**

Support Equipment				
Item	Cable Type	Shielded Type	Ferrite Core	Length
1	DC Cable	NO	NO	0.5m

3. AC POWER LINE CONDUCTED EMISSIONS

3.1 LIMIT

Frequency of Emission (MHz)	Limit (dBµV)	
	Quasi-peak	Average
0.15 - 0.5	66 to 56*	56 to 46*
0.5 - 5.0	56	46
5.0 - 30.0	60	50

NOTE:

- (1) The tighter limit applies at the band edges.
- (2) The limit of " * " marked band means the limitation decreases linearly with the logarithm of the frequency in the range.

3.2 TEST PROCEDURE

- a. The EUT was placed 0.8 meters from the horizontal ground plane with EUT being connected to the power mains through a line impedance stabilization network (LISN). All other support equipment powered from additional LISN(s). The LISN provide 50 Ohm/ 50uH of coupling impedance for the measuring instrument.
- b. Interconnecting cables that hang closer than 40 cm to the ground plane shall be folded back and forth in the center forming a bundle 30 to 40 cm long.
- c. I/O cables that are not connected to a peripheral shall be bundled in the center. The end of the cable may be terminated, if required, using the correct terminating impedance. The overall length shall not exceed 1 m.
- d. LISN at least 80 cm from nearest part of EUT chassis.
- e. For the actual test configuration, please refer to the related Item -EUT Test Photos.

The following table is the setting of the receiver:

Receiver Parameters	Setting
Start Frequency	0.15 MHz
Stop Frequency	30 MHz
IF Bandwidth	9 kHz

3.3 DEVIATION FROM TEST STANDARD

No deviation.

3.4 TEST SETUP

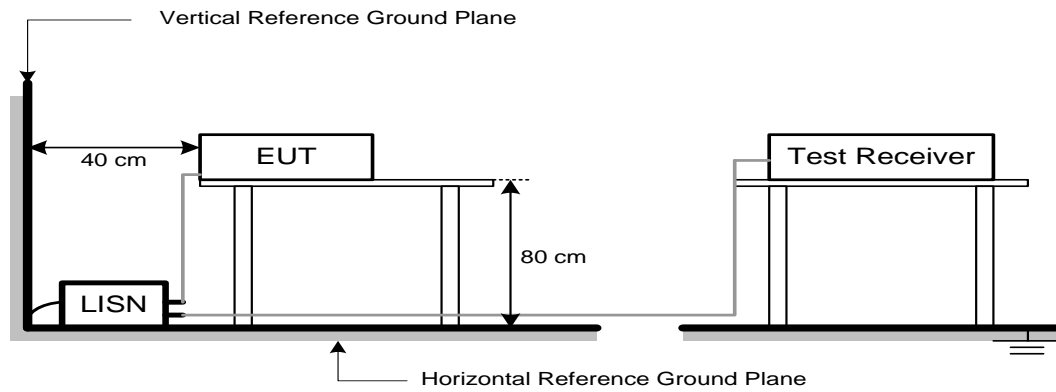

3.5 EUT OPERATION CONDITIONS

EUT was programmed to be in continuously transmitting mode.

3.6 TEST RESULTS

Please refer to the APPENDIX A.

4. RADIATED EMISSIONS

4.1 LIMIT

In case the emission fall within the restricted band specified on 15.205(a) , then the 15.209(a) and limit in the table below has to be followed.

LIMITS OF RADIATED EMISSION MEASUREMENT (9 kHz-1000 MHz)

Frequency (MHz)	Field Strength (microvolts/meter)	Measurement Distance (meters)
0.009-0.490	2400/F(kHz)	300
0.490-1.705	24000/F(kHz)	30
1.705-30.0	30	30
30-88	100	3
88-216	150	3
216-960	200	3
Above 960	500	3

LIMITS OF RADIATED EMISSION MEASUREMENT (Above 1000 MHz)

Frequency (MHz)	(dBuV/m at 3 m)	
	Peak	Average
Above 1000	74	54

NOTE:

- (1) The limit for radiated test was performed according to FCC CFR Title 47, Part 15, Subpart C.
- (2) The tighter limit applies at the band edges.
- (3) Emission level (dBuV/m)=20log Emission level (uV/m).

4.2 TEST PROCEDURE

- a. The measuring distance of 3 m shall be used for measurements. The EUT was placed on the top of a rotating table 0.8 meter above the ground at a 3 meter semi-anechoic chamber. The table was rotated 360 degrees to determine the position of the highest radiation. (below 1 GHz)
- b. The measuring distance of 3 m shall be used for measurements. The EUT was placed on the top of a rotating table 1.5 meter above the ground at a 3 meter semi-anechoic chamber. The table was rotated 360 degrees to determine the position of the highest radiation. (above 1 GHz)
- c. The height of the equipment or of the substitution antenna shall be 0.8m or 1.5m; the height of the test antenna shall vary between 1 m to 4 m. Both horizontal and vertical polarizations of the antenna are set to make the measurement.
- d. For each suspected emission, the EUT was arranged to its worst case and then the antenna was tuned to heights find the maximum reading (used Bore sight function).
- e. The receiver system was set to peak and average detect function and specified bandwidth with maximum hold mode when the test frequency is above 1 GHz.
- f. The initial step in collecting radiated emission data is a receiver peak detector mode pre-scanning the measurement frequency range. Significant peaks are then marked and then Quasi Peak detector mode re-measured.
- g. All readings are Peak unless otherwise stated QP in column of Note. Peak denotes that the Peak reading compliance with the QP Limits and then QP Mode measurement didn't perform. (below 1 GHz)
- h. All readings are Peak Mode value unless otherwise stated AVG in column of Note. If the Peak Mode Measured value compliance with the Peak Limits and lower than AVG Limits, the EUT shall be deemed to meet both Peak & AVG Limits and then only Peak Mode was measured, but AVG Mode didn't perform. (above 1 GHz)
- i. For the actual test configuration, please refer to the related Item -EUT Test Photos.

The following table is the setting of the receiver:

Spectrum Parameters	Setting
Start ~ Stop Frequency	9 kHz~150 kHz for RBW 200 Hz
Start ~ Stop Frequency	0.15 MHz~30 MHz for RBW 9 kHz
Start ~ Stop Frequency	30 MHz~1000 MHz for RBW 100 kHz

Spectrum Parameters	Setting
Start Frequency	1000 MHz
Stop Frequency	10th carrier harmonic
RBW / VBW (Emission in restricted band)	1 MHz / 3 MHz for PK value 1 MHz / 1/T Hz for AVG value

Receiver Parameters	Setting
Start ~ Stop Frequency	9 kHz~90 kHz for PK/AVG detector
Start ~ Stop Frequency	90 kHz~110 kHz for QP detector
Start ~ Stop Frequency	110 kHz~490 kHz for PK/AVG detector
Start ~ Stop Frequency	490 kHz~30 MHz for QP detector
Start ~ Stop Frequency	30 MHz~1000 MHz for QP detector
Start ~ Stop Frequency	1 GHz~26.5 GHz for PK/AVG detector

4.3 DEVIATION FROM TEST STANDARD

No deviation.

4.4 TEST SETUP

9 kHz to 30 MHz

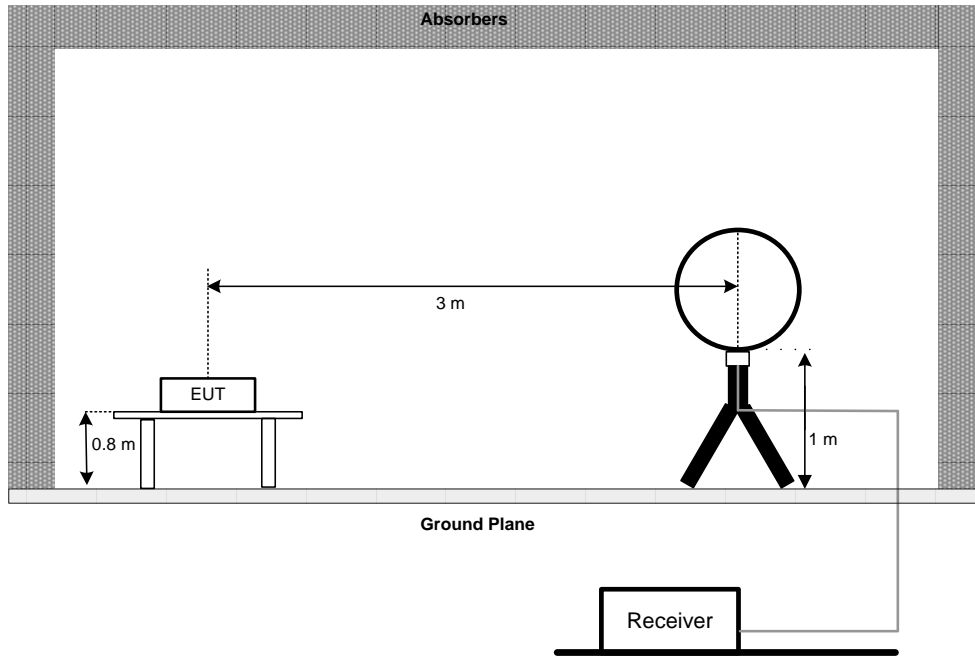

30 MHz to 1 GHz

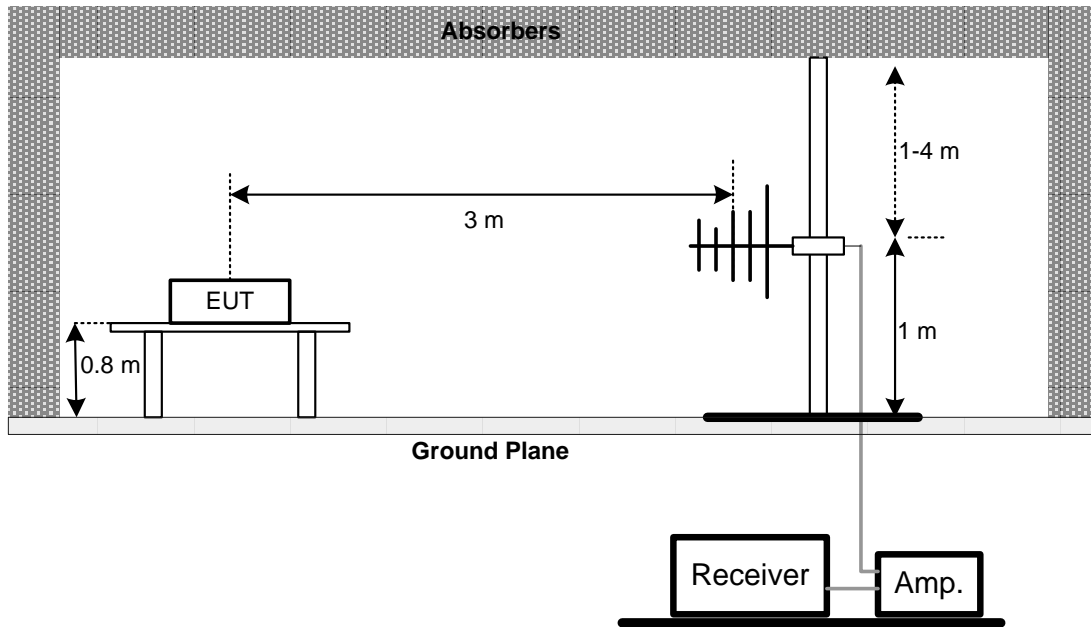

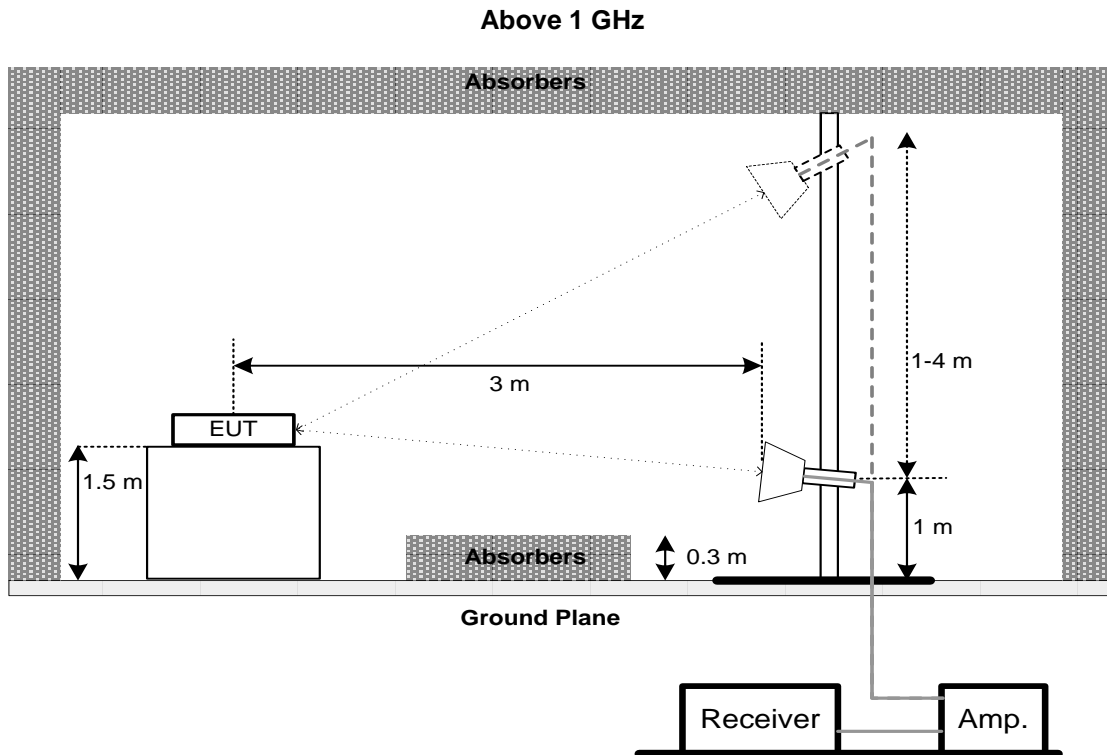

4.5 EUT OPERATION CONDITIONS

The EUT was programmed to be in continuously transmitting mode.

4.6 TEST RESULTS - 9 KHZ TO 30 MHZ

Please refer to the APPENDIX B.

Remark:

- (1) Distance extrapolation factor = $40 \log (\text{specific distance} / \text{test distance})$ (dB).
- (2) Limit line = specific limits (dBuV) + distance extrapolation factor.

4.7 TEST RESULTS - 30 MHZ TO 1000 MHZ

Please refer to the APPENDIX C.

4.8 TEST RESULTS - ABOVE 1000 MHZ

Please refer to the APPENDIX D.

Remark:

- (1) No limit: This is fundamental signal, the judgment is not applicable.
For fundamental signal judgment was referred to Peak output test.

5. BANDWIDTH

5.1 LIMIT

Section	Test Item	Limit
FCC 15.247(a)(2)	6 dB Bandwidth	Minimum 500 kHz
	99% Emission Bandwidth	-

5.2 TEST PROCEDURE

- The EUT was directly connected to the spectrum analyzer and antenna output port as show in the block diagram below.
- The following table is the setting of the spectrum analyzer:

For 6 dB Bandwidth:

Spectrum Parameters	Setting
Span Frequency	> Measurement Bandwidth
RBW	100 kHz
VBW	300 kHz
Detector	Peak
Trace	Max Hold
Sweep Time	Auto

For 99% Emission Bandwidth:

Spectrum Parameters	Setting
Span Frequency	Between 1.5 times and 5.0 times the OBW
RBW	300 kHz
VBW	1 MHz
Detector	Peak
Trace	Max Hold
Sweep Time	Auto

5.3 DEVIATION FROM STANDARD

No deviation.

5.4 TEST SETUP



5.5 EUT OPERATION CONDITIONS

The EUT was programmed to be in continuously transmitting mode.

5.6 TEST RESULTS

Please refer to the APPENDIX E.

6. MAXIMUM OUTPUT POWER & E.I.R.P.

6.1 LIMIT

Section	Test Item	Limit
FCC 15.247(b)(3)	Maximum Output Power	1.0000 Watt or 30.00 dBm

6.2 TEST PROCEDURE

- a. The EUT was directly connected to the peak power analyzer and antenna output port as show in the block diagram below.
- b. The maximum conducted output power was performed in accordance with method 11.9.2.3.1 (for AVG power) of ANSI C63.10-2013 and FCC KDB 662911 D01 v02r01 Multiple Transmitter Output.

6.3 DEVIATION FROM STANDARD

No deviation.

6.4 TEST SETUP

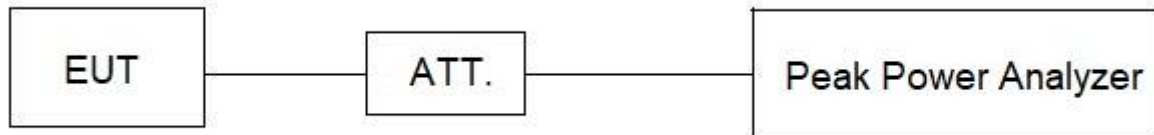

6.5 EUT OPERATION CONDITIONS

The EUT was programmed to be in continuously transmitting mode.

6.6 TEST RESULTS

Please refer to the APPENDIX F.

7. CONDUCTED SPURIOUS EMISSIONS

7.1 LIMIT

In any 100 kHz bandwidth outside the frequency band in which the spread spectrum or digitally modulated intentional radiator is operating, the radio frequency power that is produced by the intentional radiator shall be at least 20 dB below that in the 100 kHz bandwidth within the band that contains the highest level of the desired power, based on either an RF conducted or a radiated measurement, provided the transmitter demonstrates compliance with the peak Output Power limits. If the transmitter complies with the Output Power limits based on the use of RMS averaging over a time interval, as permitted under paragraph (b)(3) of this section, the attenuation required under this paragraph shall be 30 dB instead of 20 dB. Attenuation below the general limits specified in Section 15.209(a) is not required.

7.2 TEST PROCEDURE

- a. The EUT was directly connected to the spectrum analyzer and antenna output port as show in the block diagram below.
- b. The following table is the setting of the spectrum analyzer:

For Emission Level:

Spectrum Parameters	Setting
Start Frequency	30 MHz
Stop Frequency	26.5 GHz
RBW	100 kHz
VBW	300 kHz
Detector	Peak
Trace	Max Hold
Sweep Time	Auto

For Reference Level:

Spectrum Parameters	Setting
Span Frequency	≥ 1.5 times the bandwidth
RBW	100 kHz
VBW	300 kHz
Detector	Peak
Trace	Max Hold
Sweep Time	Auto

7.3 DEVIATION FROM STANDARD

No deviation.

7.4 TEST SETUP



7.5 EUT OPERATION CONDITIONS

The EUT was programmed to be in continuously transmitting mode.

7.6 TEST RESULTS

Please refer to the APPENDIX G.

8. POWER SPECTRAL DENSITY

8.1 LIMIT

Section	Test Item	Limit
FCC 15.247(e)	Power Spectral Density	8 dBm (in any 3 kHz)

8.2 TEST PROCEDURE

- a. The EUT was directly connected to the spectrum analyzer and antenna output port as show in the block diagram below.
- b. The following table is the setting of the spectrum analyzer:

Spectrum Parameters	Setting
Span Frequency	25 MHz
RBW	3 kHz
VBW	10 kHz
Detector	Peak
Trace	Max Hold
Sweep Time	Auto

8.3 DEVIATION FROM STANDARD

No deviation.

8.4 TEST SETUP



8.5 EUT OPERATION CONDITIONS

The EUT was programmed to be in continuously transmitting mode.

8.6 TEST RESULTS

Please refer to the APPENDIX H.

9. MEASUREMENT INSTRUMENTS LIST

No.	Equipment	Manufacturer	Type No.	Serial No.	Calibrated until
1	EMI Receiver	Rohde&Schwarz	ESCI	1166.5950.03	2022/11/09
2	AMN	Rohde&Schwarz	ENV216	3560.6550.05	2022/11/09
3	AMN	Schwarzbeck	NSLK8127	#829	2022/11/09
4	ECSI RF IN RF Cable	Rohde&Schwarz	RP-X1	N/A	2022/11/09
5	ECSI RF IN RF Cable	Rohde&Schwarz	Sapre sm	N/A	2022/11/09
6	EMI Receiver	Rohde&Schwarz	ESR7	102013	2022/11/09
7	Spectrum analyzer	Rohde&Schwarz	FSV30	103741	2022/11/09
8	Spectrum analyzer	KEYSIGHT	N9010A-44	MY51440158	2022/11/09
9	Integral Antenna	Schwarzbeck	VULB 9163	VULB 9163-361	2022/11/20
10	Integral Antenna	Schwarzbeck	BBHA 9120D	BBHA 9120D 1201	2022/11/20
11	Integral Antenna	Schwarzbeck	BBHA 9170	9170#685	2022/11/20
12	Preamplifier	Schwarzbeck	BBV9745	#78	2022/11/09
13	Preamplifier	Schwarzbeck	BBV9721	9721-019	2022/11/09
14	Preamplifier	RF System/UK	TRLA-0101 80G50B	22062101	2023/07/20
15	ECSI RF IN RF Cable	Rohde&Schwarz	AP-X1	N/A	2022/11/09
16	ECSI RF IN RF Cable	HAOXUN	Z-108	N/A	2022/11/09
17	RF Cable	ZDECL	ZT40-2.92J -2.92J-6M	18124358	2023/07/20
18	Spectrum Analyzer	Agilent	N9010A	MY51440158	2022/11/09
19	Spectrum Analyzer	Agilent	N9010A	MY52221119	2022/11/09
20	EMI Receiver	Rohde&Schwarz	ESU	100184	2023/07/20
21	Temp&Humidity Recorder	Anymetre	JR900	N/A	2022/11/03
22	Temp&Humidity Chamber	ETOMA	NTH1100-3 0A	16080628	2022/11/03
23	Filter	STI	STI15-9845	N/A	N/A
24	Filter	STI	5.1G	N/A	N/A
25	Filter	STI	STI15-9845	N/A	N/A
26	Testing Software	EZ-EMC	TW-03A2	N/A	N/A

Remark: "N/A" denotes no model name, serial no. or calibration specified.

"**" calibration period of equipment list is three year.

Except * item, all calibration period of equipment list is one year.

10. EUT TEST PHOTO

AC Power Line Conducted Emissions Test Photos



Radiated Emissions Test Photos

30 MHz to 1 GHz

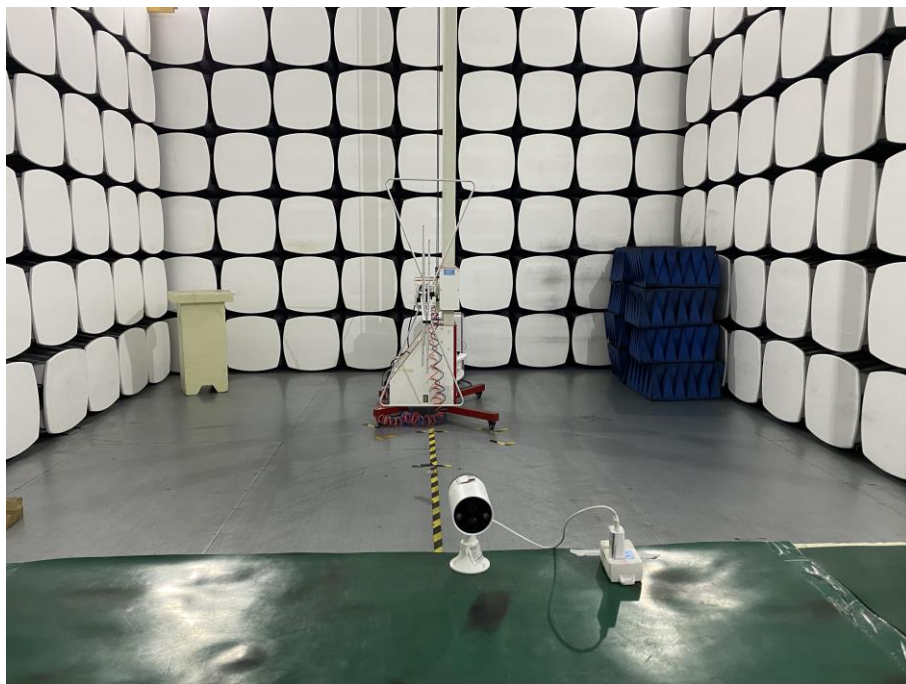

Radiated Emissions Test Photos

Above 1 GHz

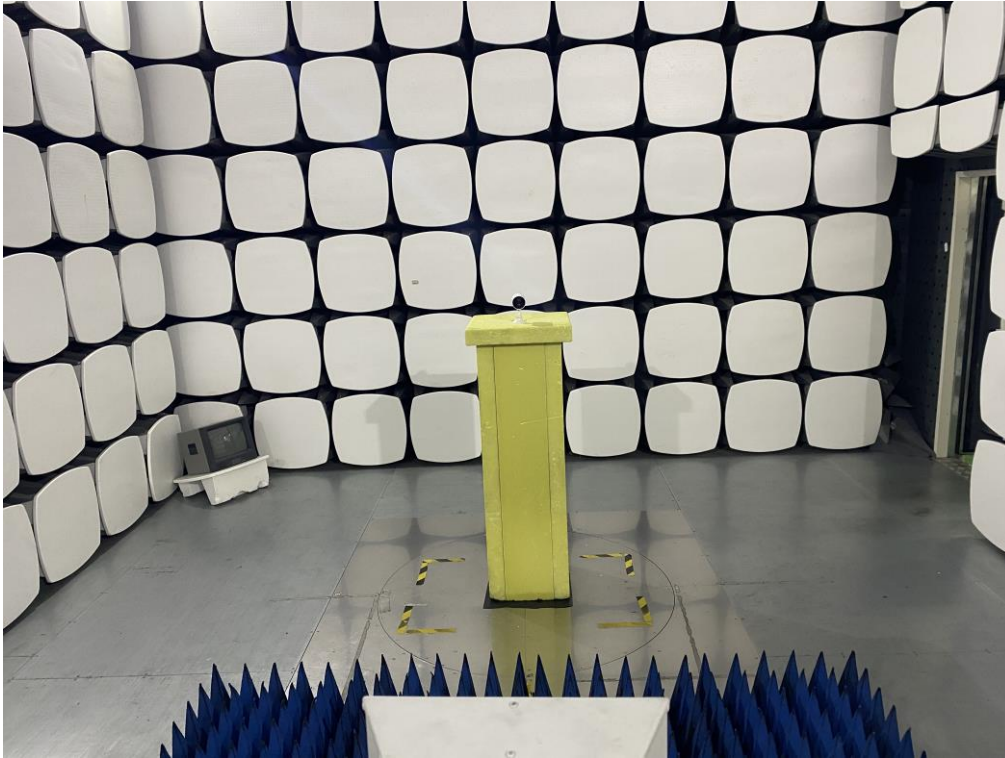

Conducted Test Photos



APPENDIX A - AC POWER LINE CONDUCTED EMISSIONS

Test Mode	TX G Mode Channel 06	Phase	Line
-----------	----------------------	-------	------

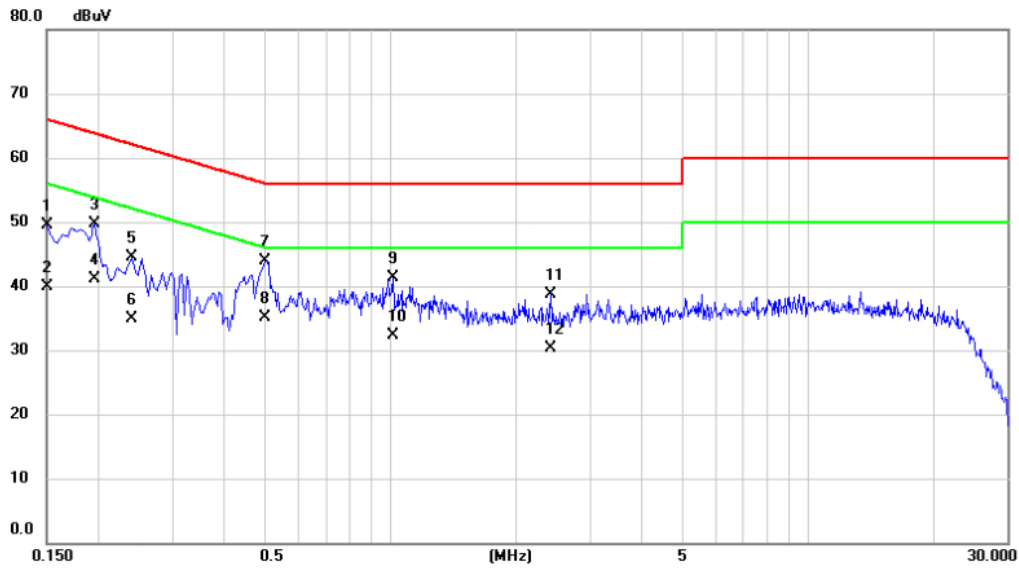

No.	Mk.	Freq.	Reading Level	Correct Factor	Measurement	Limit	Margin	Detector	Comment
		MHz	dBuV	dB	dBuV	dBuV	dB		
1		0.1500	39.88	9.65	49.53	66.00	-16.47	QP	
2		0.1500	30.20	9.65	39.85	56.00	-16.15	AVG	
3		0.1950	40.09	9.68	49.77	63.82	-14.05	QP	
4		0.1950	31.50	9.68	41.18	53.82	-12.64	AVG	
5		0.2400	34.89	9.70	44.59	62.10	-17.51	QP	
6		0.2400	25.30	9.70	35.00	52.10	-17.10	AVG	
7		0.5010	34.20	9.76	43.96	56.00	-12.04	QP	
8	*	0.5010	25.40	9.76	35.16	46.00	-10.84	AVG	
9		1.0140	31.40	9.82	41.22	56.00	-14.78	QP	
10		1.0140	22.50	9.82	32.32	46.00	-13.68	AVG	
11		2.4180	28.87	9.93	38.80	56.00	-17.20	QP	
12		2.4180	20.40	9.93	30.33	46.00	-15.67	AVG	

REMARKS:

- (1) Measurement Value = Reading Level + Correct Factor.
- (2) Margin Level = Measurement Value - Limit Value.
- (3) The test result has included the cable loss.

Test Mode	TX G Mode Channel 06	Phase	Neutral
-----------	----------------------	-------	---------

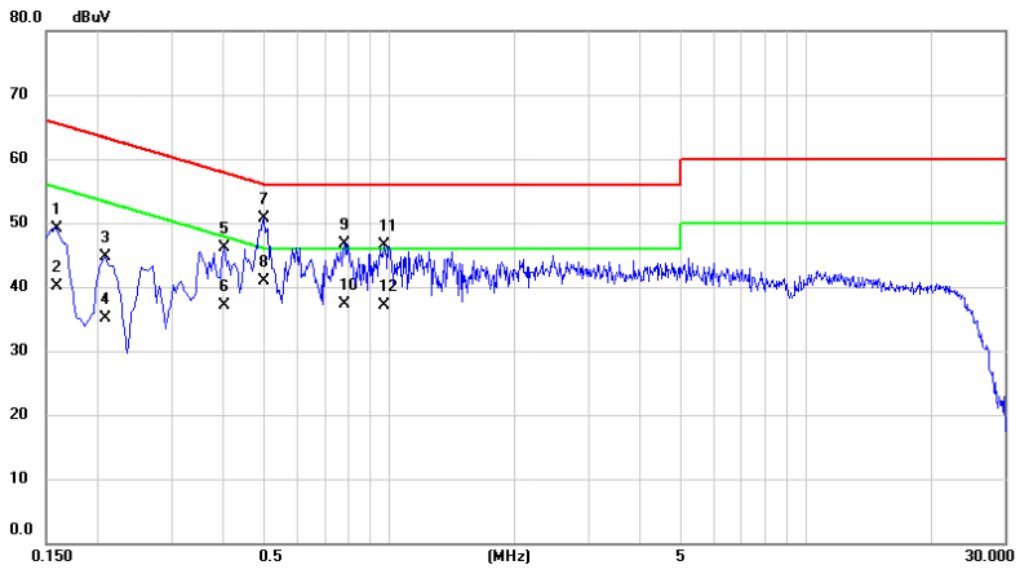

No.	Mk.	Freq. MHz	Reading Level dBuV	Correct Factor dB	Measure- ment dBuV	Limit dBuV	Margin dB	Detector	Comment
1		0.1590	39.43	9.70	49.13	65.52	-16.39	QP	
2		0.1590	30.50	9.70	40.20	55.52	-15.32	AVG	
3		0.2085	34.90	9.72	44.62	63.26	-18.64	QP	
4		0.2085	25.30	9.72	35.02	53.26	-18.24	AVG	
5		0.4020	36.24	9.78	46.02	57.81	-11.79	QP	
6		0.4020	27.40	9.78	37.18	47.81	-10.63	AVG	
7		0.5010	40.97	9.79	50.76	56.00	-5.24	QP	
8	*	0.5010	31.20	9.79	40.99	46.00	-5.01	AVG	
9		0.7800	36.97	9.82	46.79	56.00	-9.21	QP	
10		0.7800	27.40	9.82	37.22	46.00	-8.78	AVG	
11		0.9690	36.65	9.85	46.50	56.00	-9.50	QP	
12		0.9690	27.30	9.85	37.15	46.00	-8.85	AVG	

REMARKS:

- (1) Measurement Value = Reading Level + Correct Factor.
- (2) Margin Level = Measurement Value - Limit Value.
- (3) The test result has included the cable loss.

APPENDIX B - RADIATED EMISSION - 9 KHZ TO 30 MHZ

Radiated emission: 9KHz-30MHz

The low frequency, which started from 9 kHz to 30MHz, was pre-scanned and the result which was 20dB lower than the limit line was not reported.

There is a comparison data of both open-field test site and semi-Anechoic chamber, and the result came out very similar.

APPENDIX C - RADIATED EMISSION - 30 MHZ TO 1000 MHZ

Test Mode	TX G Mode Channel 06	Polarization	Vertical
-----------	----------------------	--------------	----------

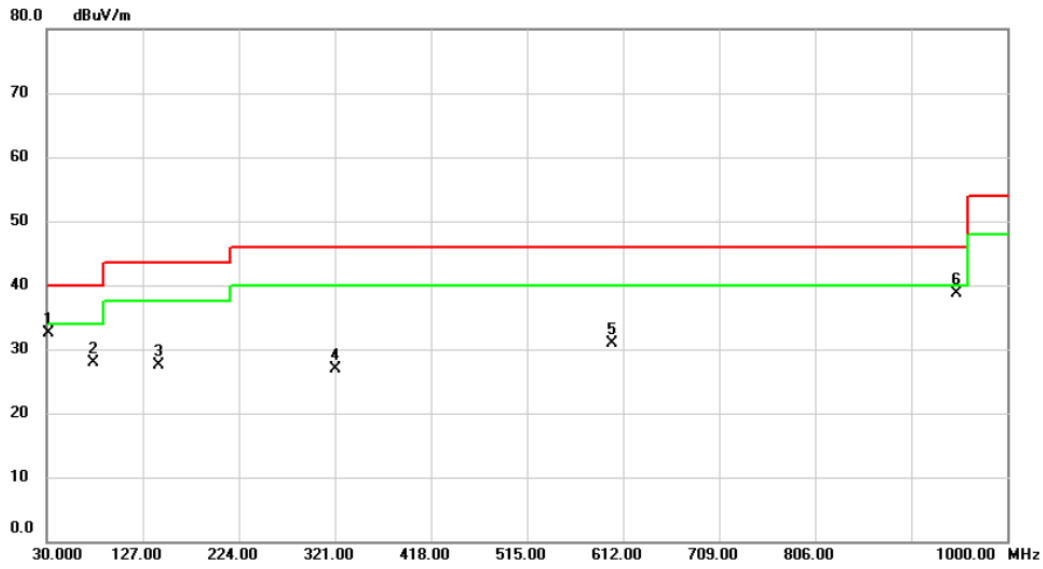

No.	Mk.	Freq. MHz	Reading Level dBuV	Correct Factor dB	Measure- ment dBuV/m	Limit dBuV/m	Margin dB	Detector	Comment
1		31.9400	48.34	-15.74	32.60	40.00	-7.40	peak	
2		77.5300	45.84	-17.92	27.92	40.00	-12.08	peak	
3		143.4900	40.52	-12.93	27.59	43.50	-15.91	peak	
4		321.0000	37.77	-10.83	26.94	46.00	-19.06	peak	
5		600.3600	35.72	-4.79	30.93	46.00	-15.07	peak	
6	*	948.5900	37.55	1.17	38.72	46.00	-7.28	peak	

REMARKS:

(1) Measurement Value = Reading Level + Correct Factor.

(2) Margin Level = Measurement Value - Limit Value.

Test Mode	TX G Mode Channel 06	Polarization	Horizontal
-----------	----------------------	--------------	------------

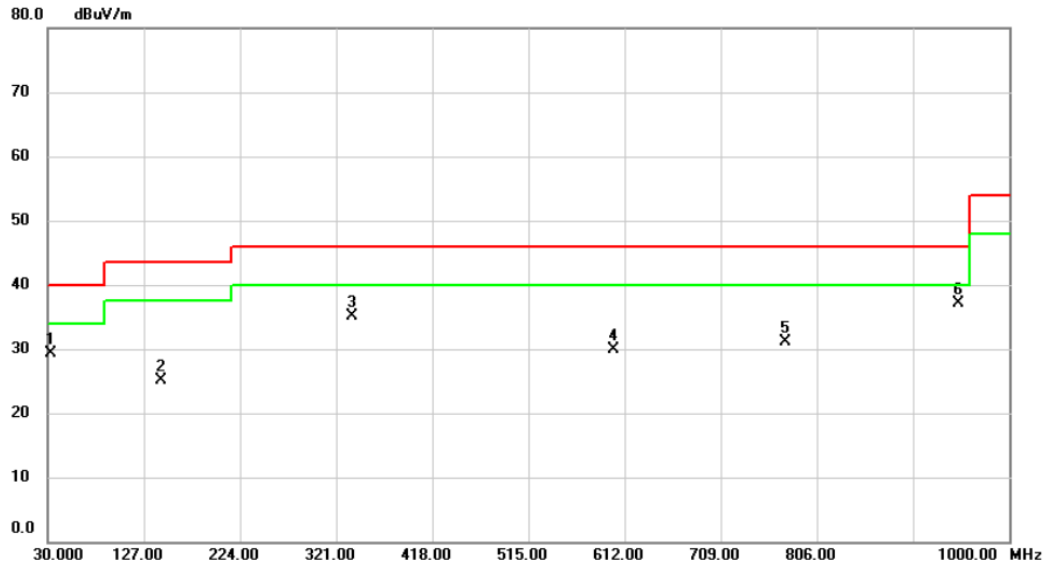

No. Mk.	Freq. MHz	Reading Level dBuV	Correct Factor dB	Measurement dBuV/m	Limit dBuV/m	Margin dB	Detector	Comment
1	32.9100	44.99	-15.62	29.37	40.00	-10.63	peak	
2	144.4600	37.97	-12.89	25.08	43.50	-18.42	peak	
3	336.5200	45.59	-10.50	35.09	46.00	-10.91	peak	
4	600.3600	34.79	-4.79	30.00	46.00	-16.00	peak	
5	773.9900	32.87	-1.67	31.20	46.00	-14.80	peak	
6 *	948.5900	35.95	1.17	37.12	46.00	-8.88	peak	

REMARKS:

(1) Measurement Value = Reading Level + Correct Factor.

(2) Margin Level = Measurement Value - Limit Value.

APPENDIX D - RADIATED EMISSION- ABOVE 1000 MHZ

Test Mode	TX B Mode 2412 MHz	Polarization	Horizontal
-----------	--------------------	--------------	------------

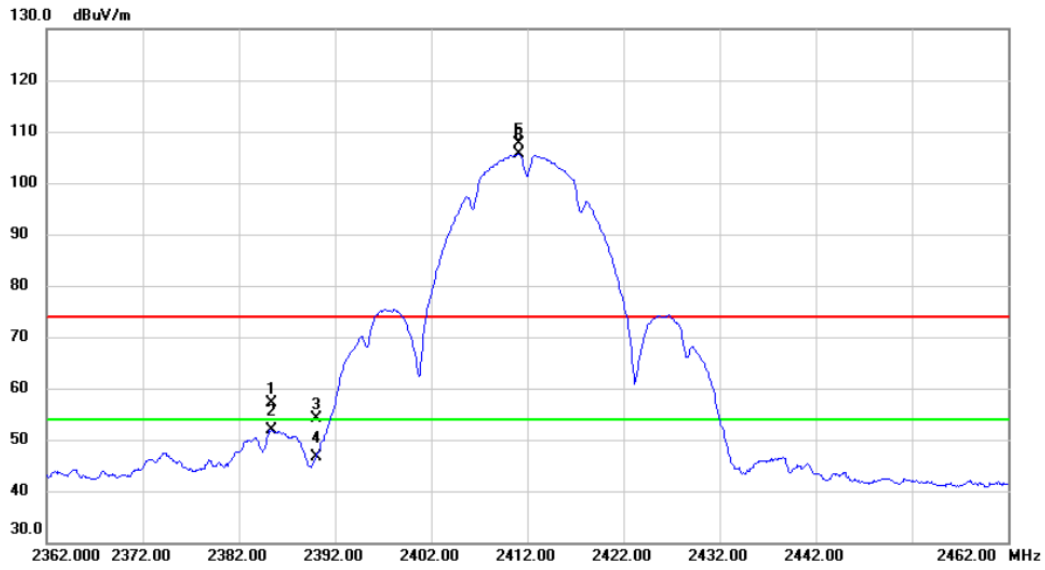

No.	Mk.	Freq. MHz	Reading Level dBuV	Correct Factor dB	Measure- ment dBuV/m	Limit dBuV/m	Margin dB	Detector	Comment
1		2385.400	47.18	9.86	57.04	74.00	-16.96	peak	
2		2385.400	42.01	9.86	51.87	54.00	-2.13	AVG	
3		2390.000	44.31	9.88	54.19	74.00	-19.81	peak	
4		2390.000	36.66	9.88	46.54	54.00	-7.46	AVG	
5	X	2411.100	97.69	9.91	107.60	74.00	33.60	peak	No Limit
6	*	2411.200	95.83	9.92	105.75	54.00	51.75	AVG	No Limit

REMARKS:

- (1) Measurement Value = Reading Level + Correct Factor.
 (2) Margin Level = Measurement Value - Limit Value.

Test Mode	TX B Mode 2412 MHz	Polarization	Vertical
-----------	--------------------	--------------	----------

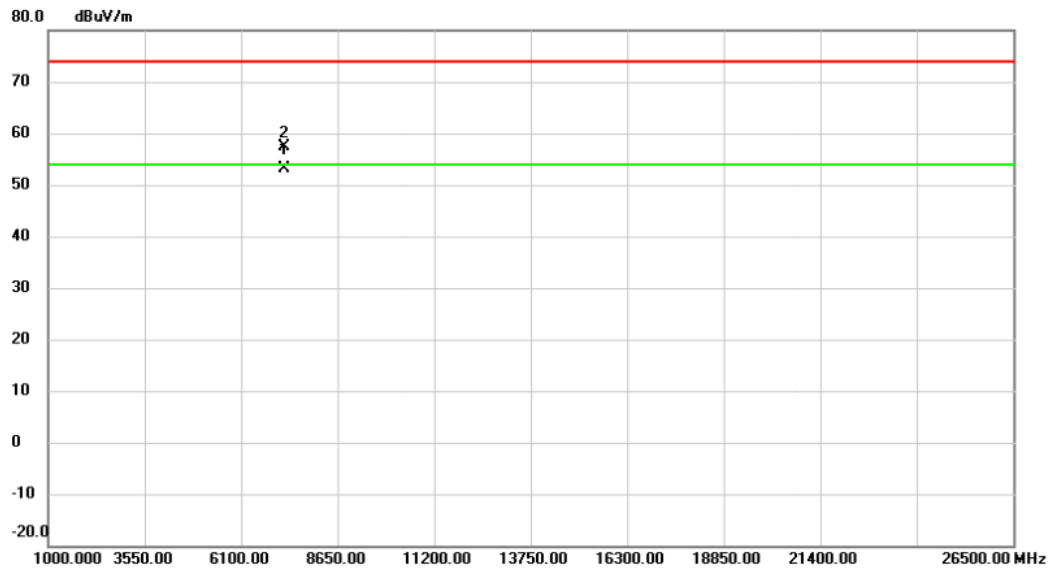

No.	Mk.	Freq. MHz	Reading Level dBuV	Correct Factor dB	Measure- ment dBuV/m	Limit dBuV/m	Margin dB	Detector	Comment
1	*	7235.150	38.75	14.42	53.17	54.00	-0.83	AVG	
2		7235.840	42.84	14.42	57.26	74.00	-16.74	peak	

REMARKS:

- (1) Measurement Value = Reading Level + Correct Factor.
 (2) Margin Level = Measurement Value - Limit Value.

Test Mode	TX B Mode 2417 MHz	Polarization	Horizontal
-----------	--------------------	--------------	------------

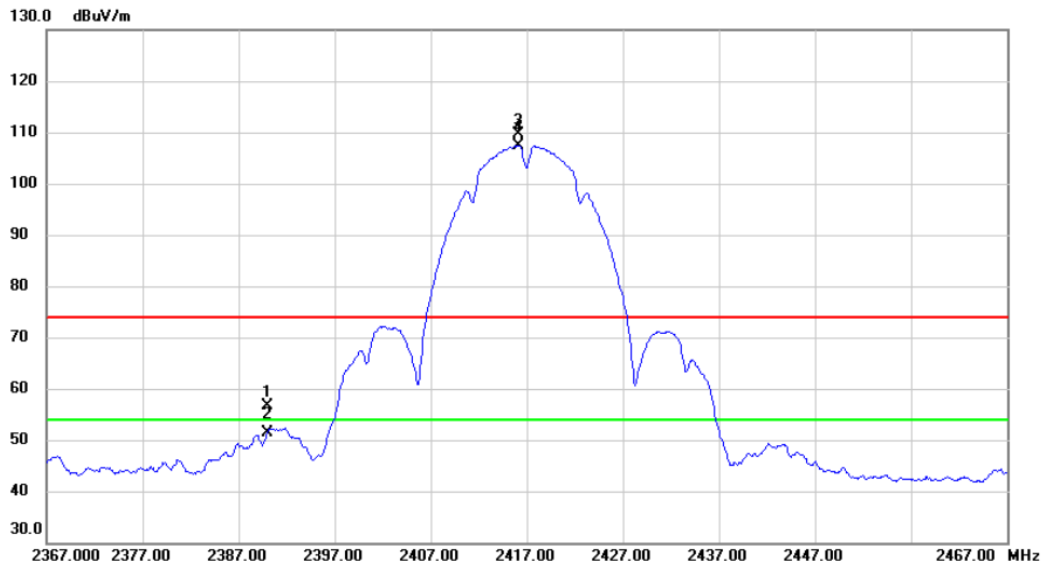

No.	Mk.	Freq. MHz	Reading Level dBuV	Correct Factor dB	Measure- ment dBuV/m	Limit dBuV/m	Margin dB	Detector	Comment
1		2390.000	46.76	9.88	56.64	74.00	-17.36	peak	
2		2390.000	41.56	9.88	51.44	54.00	-2.56	AVG	
3	X	2416.100	99.71	9.93	109.64	74.00	35.64	peak	No Limit
4	*	2416.100	97.53	9.93	107.46	54.00	53.46	AVG	No Limit

REMARKS:

- (1) Measurement Value = Reading Level + Correct Factor.
 (2) Margin Level = Measurement Value - Limit Value.

Test Mode	TX B Mode 2417 MHz	Polarization	Vertical
-----------	--------------------	--------------	----------

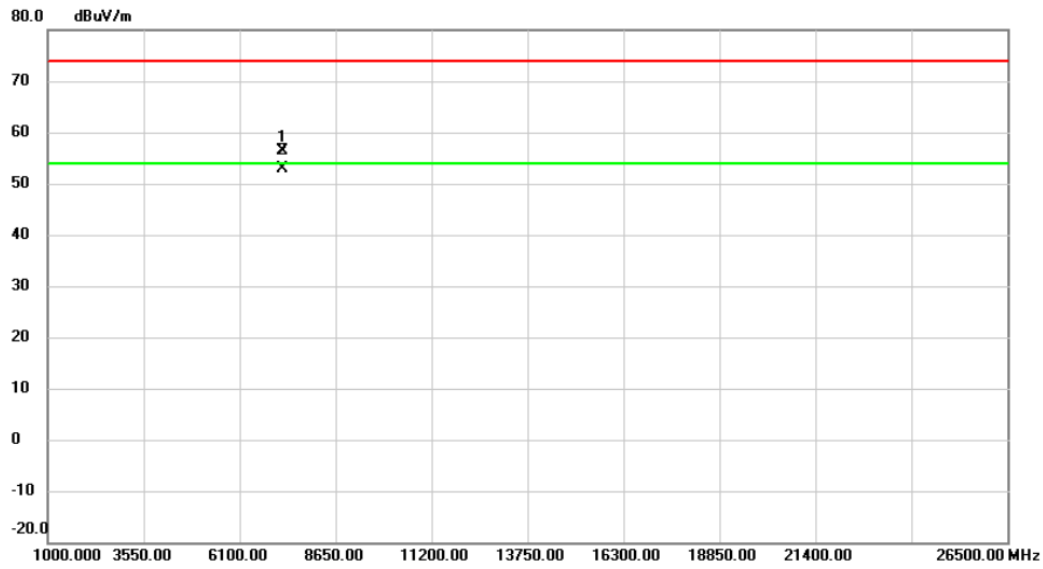

No.	Mk.	Freq. MHz	Reading Level dBuV	Correct Factor dB	Measure- ment dBuV/m	Limit dBuV/m	Margin dB	Detector	Comment
1		7251.260	42.03	14.44	56.47	74.00	-17.53	peak	
2	*	7251.740	38.52	14.44	52.96	54.00	-1.04	AVG	

REMARKS:

- (1) Measurement Value = Reading Level + Correct Factor.
 (2) Margin Level = Measurement Value - Limit Value.

Test Mode	TX B Mode 2437 MHz	Polarization	Horizontal
-----------	--------------------	--------------	------------

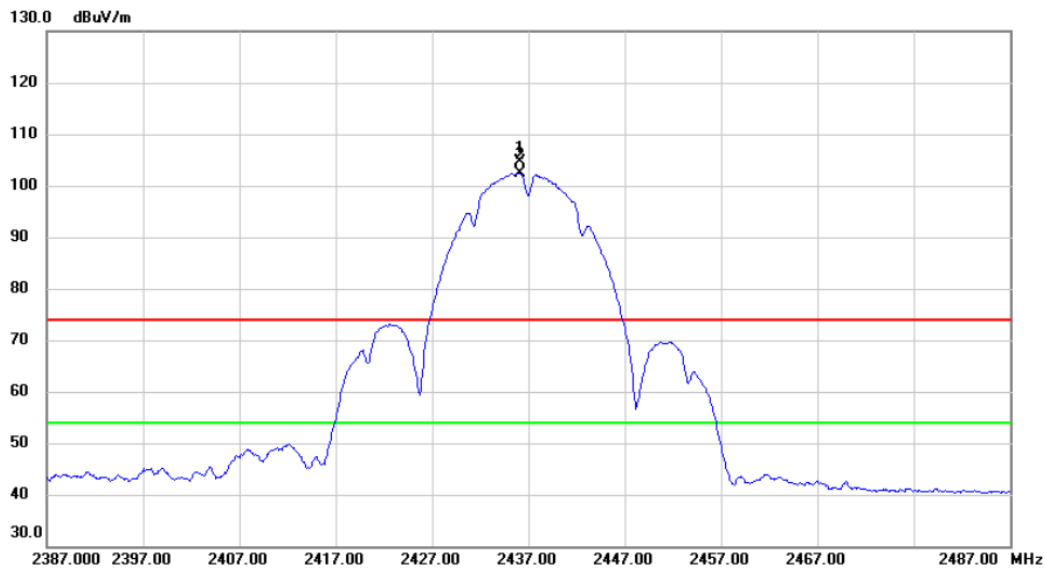

No.	Mk.	Freq.	Reading Level	Correct Factor	Measurement	Limit	Margin		
		MHz	dBuV	dB	dBuV/m	dBuV/m	dB	Detector	Comment
1	X	2436.100	94.62	9.97	104.59	74.00	30.59	peak	No Limit
2	*	2436.200	92.47	9.97	102.44	54.00	48.44	AVG	No Limit

REMARKS:

- (1) Measurement Value = Reading Level + Correct Factor.
- (2) Margin Level = Measurement Value - Limit Value.

Test Mode	TX B Mode 2437 MHz	Polarization	Vertical
-----------	--------------------	--------------	----------

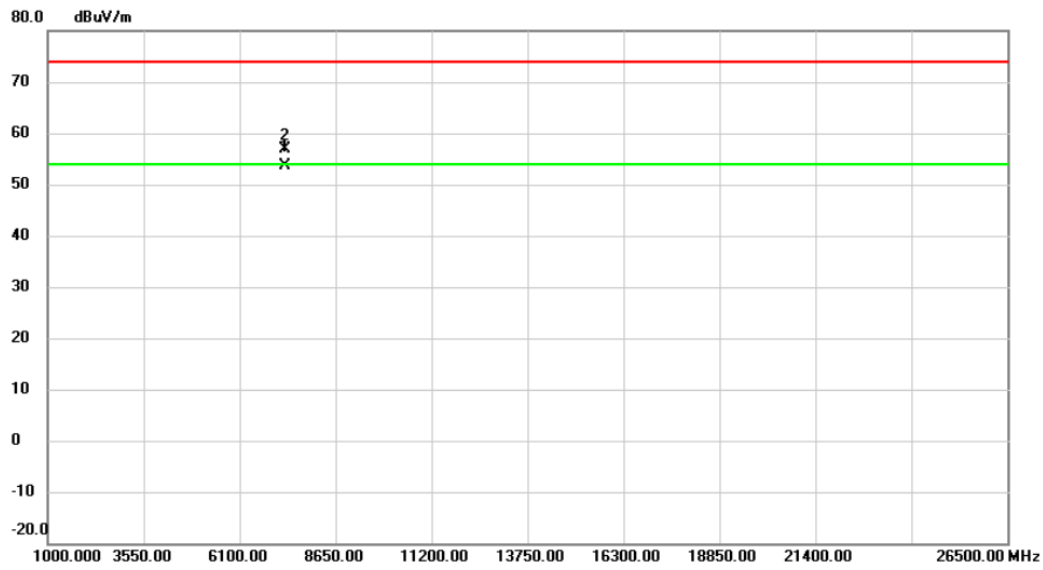

No.	Mk.	Freq. MHz	Reading Level dBuV	Correct Factor dB	Measure- ment dBuV/m	Limit dBuV/m	Margin dB	Detector	Comment
1	*	7310.060	39.08	14.47	53.55	54.00	-0.45	AVG	
2		7310.300	42.29	14.47	56.76	74.00	-17.24	peak	

REMARKS:

- (1) Measurement Value = Reading Level + Correct Factor.
 (2) Margin Level = Measurement Value - Limit Value.

Test Mode	TX B Mode 2457 MHz	Polarization	Horizontal
-----------	--------------------	--------------	------------

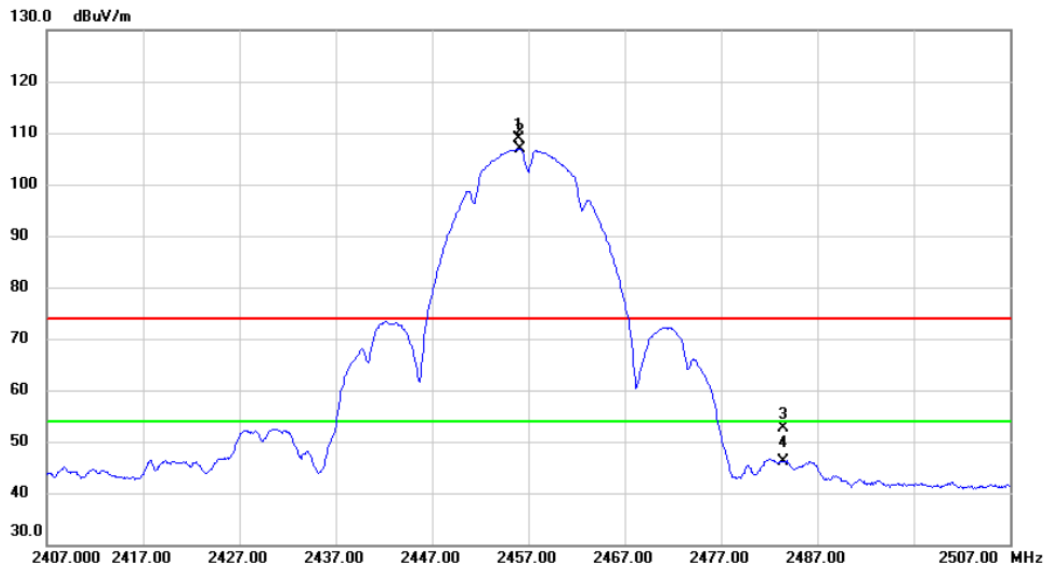

No.	Mk.	Freq. MHz	Reading Level dBuV	Correct Factor dB	Measure- ment dBuV/m	Limit dBuV/m	Margin dB	Detector	Comment
1	X	2456.000	98.95	10.01	108.96	74.00	34.96	peak	No Limit
2	*	2456.200	96.91	10.01	106.92	54.00	52.92	AVG	No Limit
3		2483.500	42.49	10.07	52.56	74.00	-21.44	peak	
4		2483.500	35.99	10.07	46.06	54.00	-7.94	AVG	

REMARKS:

- (1) Measurement Value = Reading Level + Correct Factor.
 (2) Margin Level = Measurement Value - Limit Value.

Test Mode	TX B Mode 2457 MHz	Polarization	Vertical
-----------	--------------------	--------------	----------

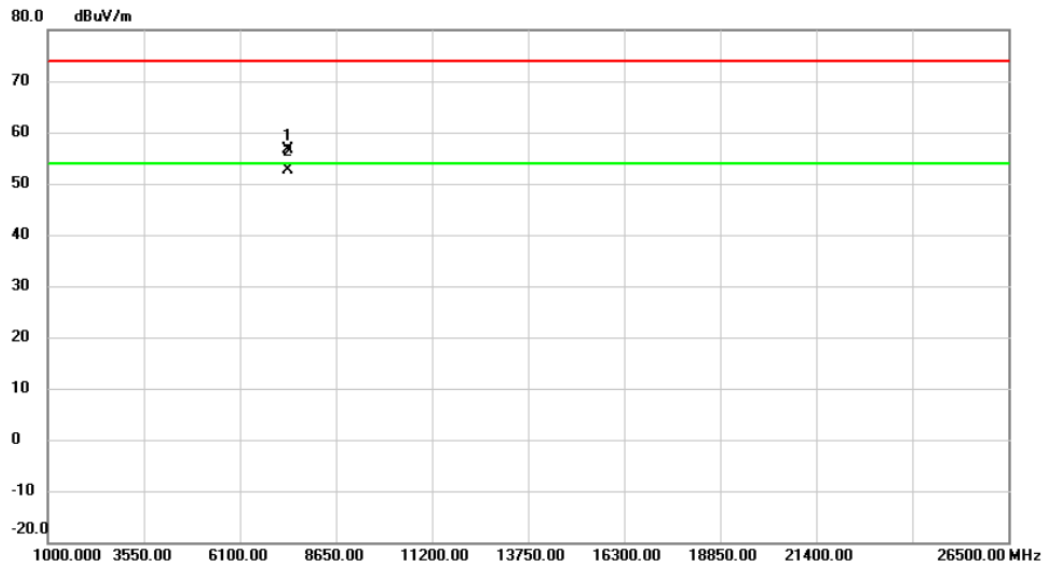

No.	Mk.	Freq.	Reading Level	Correct Factor	Measurement	Limit	Margin	Detector	Comment
		MHz	dBuV	dB	dBuV/m	dBuV/m	dB		
1		7363.640	42.10	14.49	56.59	74.00	-17.41	peak	
2	*	7371.700	38.04	14.49	52.53	54.00	-1.47	AVG	

REMARKS:

- (1) Measurement Value = Reading Level + Correct Factor.
 (2) Margin Level = Measurement Value - Limit Value.

Test Mode	TX B Mode 2462 MHz	Polarization	Horizontal
-----------	--------------------	--------------	------------

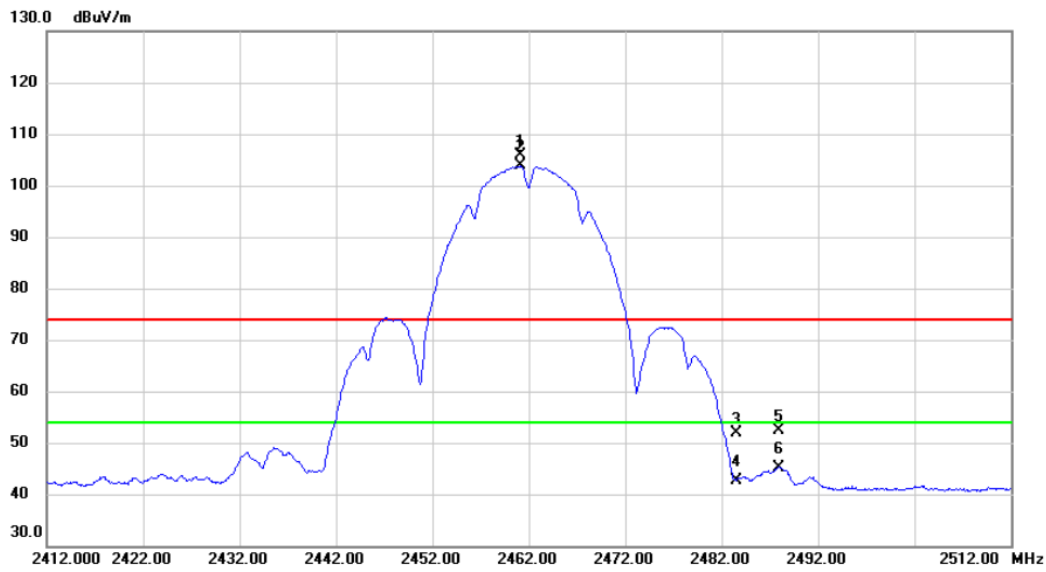

No.	Mk.	Freq. MHz	Reading Level dBuV	Correct Factor dB	Measure- ment dBuV/m	Limit dBuV/m	Margin dB	Detector	Comment
1	X	2461.200	95.88	10.02	105.90	74.00	31.90	peak	No Limit
2	*	2461.200	93.78	10.02	103.80	54.00	49.80	AVG	No Limit
3		2483.500	41.78	10.07	51.85	74.00	-22.15	peak	
4		2483.500	32.63	10.07	42.70	54.00	-11.30	AVG	
5		2487.900	42.26	10.07	52.33	74.00	-21.67	peak	
6		2487.900	35.18	10.07	45.25	54.00	-8.75	AVG	

REMARKS:

- (1) Measurement Value = Reading Level + Correct Factor.
 (2) Margin Level = Measurement Value - Limit Value.

Test Mode	TX B Mode 2462 MHz	Polarization	Vertical
-----------	--------------------	--------------	----------

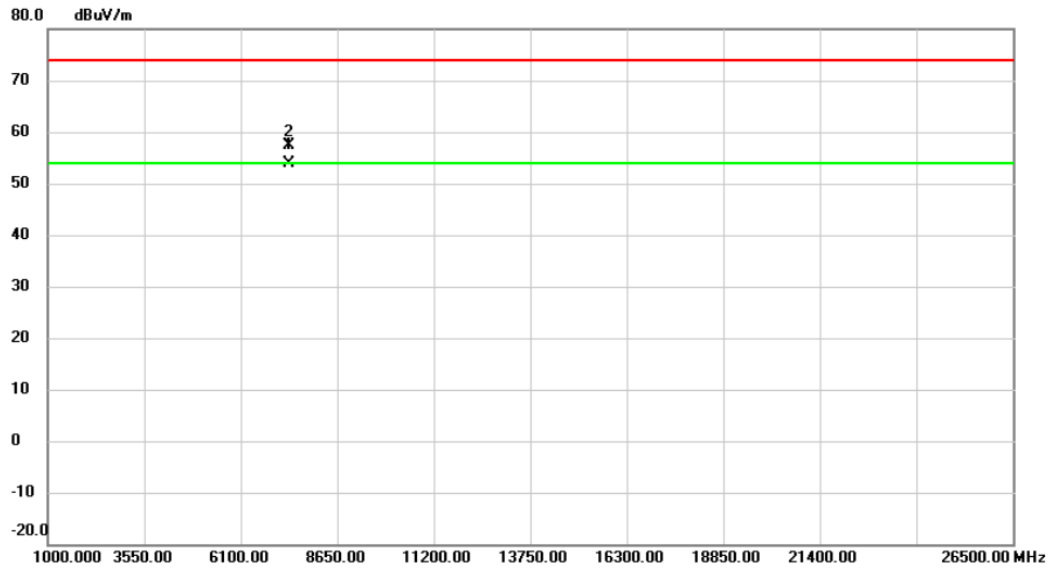

No. Mk.	Freq. MHz	Reading Level dBuV	Correct Factor dB	Measurement dBuV/m	Limit dBuV/m	Margin dB	Detector	Comment
1 *	7385.070	39.33	14.50	53.83	54.00	-0.17	AVG	
2	7386.800	42.99	14.50	57.49	74.00	-16.51	peak	

REMARKS:

- (1) Measurement Value = Reading Level + Correct Factor.
- (2) Margin Level = Measurement Value - Limit Value.

Test Mode	TX G Mode 2412 MHz	Polarization	Horizontal
-----------	--------------------	--------------	------------

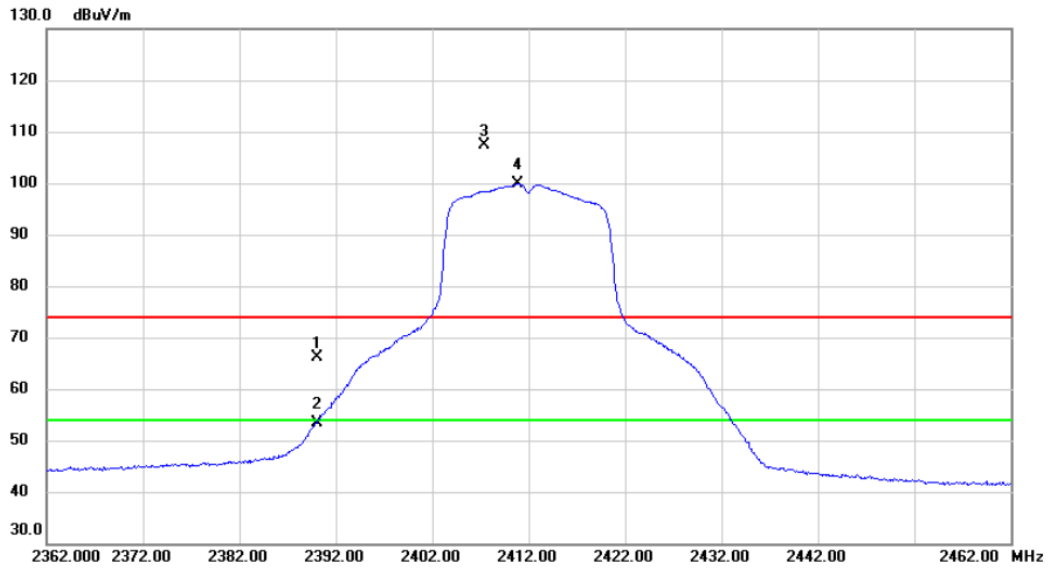

No.	Mk.	Freq.	Reading Level	Correct Factor	Measurement	Limit	Margin	Detector	Comment
		MHz	dBuV	dB	dBuV/m	dBuV/m	dB		
1		2390.000	56.27	9.88	66.15	74.00	-7.85	peak	
2		2390.000	43.43	9.88	53.31	54.00	-0.69	AVG	
3	X	2407.400	97.58	9.90	107.48	74.00	33.48	peak	No Limit
4	*	2410.900	89.92	9.91	99.83	54.00	45.83	AVG	No Limit

REMARKS:

- (1) Measurement Value = Reading Level + Correct Factor.
- (2) Margin Level = Measurement Value - Limit Value.

Test Mode	TX G Mode 2412 MHz	Polarization	Vertical
-----------	--------------------	--------------	----------

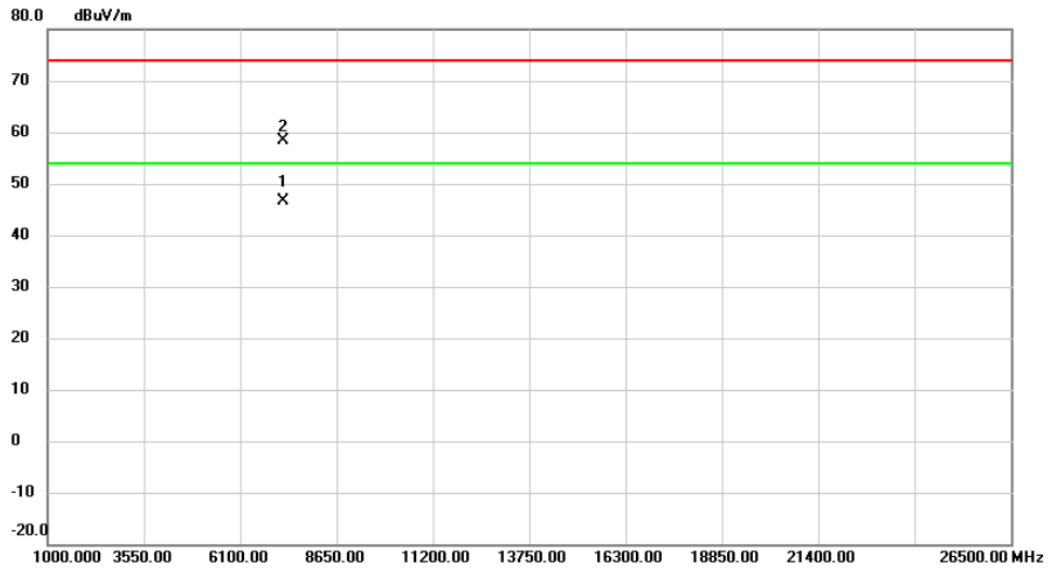

No.	Mk.	Freq.	Reading Level	Correct Factor	Measurement	Limit	Margin	Detector	Comment
		MHz	dBuV	dB	dBuV/m	dBuV/m	dB		
1	*	7235.010	32.15	14.42	46.57	54.00	-7.43	AVG	
2		7235.650	44.04	14.42	58.46	74.00	-15.54	peak	

REMARKS:

- (1) Measurement Value = Reading Level + Correct Factor.
 (2) Margin Level = Measurement Value - Limit Value.

Test Mode	TX G Mode 2417 MHz	Polarization	Horizontal
-----------	--------------------	--------------	------------

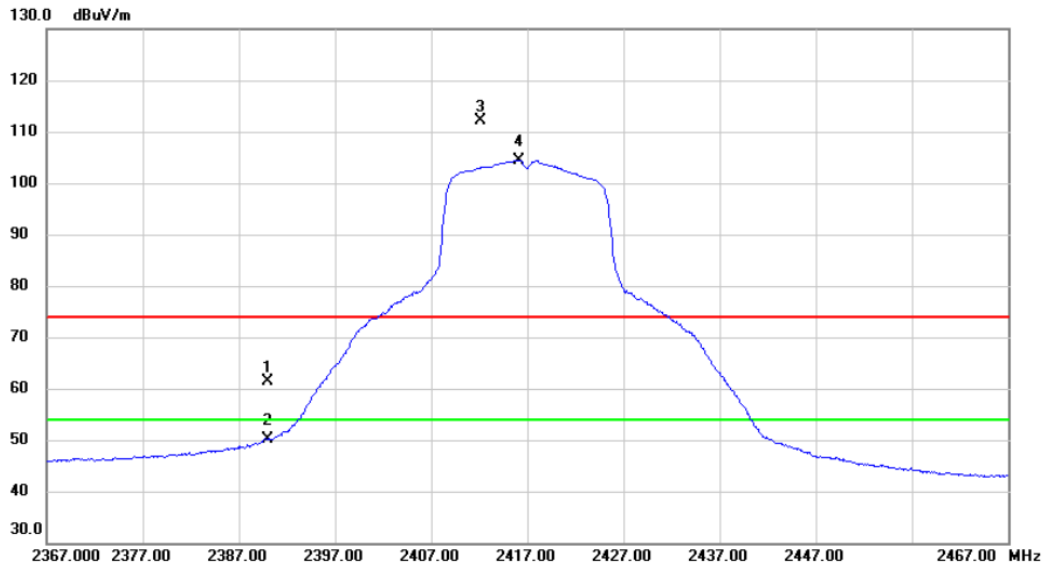

No.	Mk.	Freq. MHz	Reading Level dBuV	Correct Factor dB	Measure- ment dBuV/m	Limit dBuV/m	Margin dB	Detector	Comment
1		2390.000	51.44	9.88	61.32	74.00	-12.68	peak	
2		2390.000	40.14	9.88	50.02	54.00	-3.98	AVG	
3	X	2412.200	102.1	9.92	112.11	74.00	38.11	peak	No Limit
4	*	2416.100	94.54	9.93	104.47	54.00	50.47	AVG	No Limit

REMARKS:

- (1) Measurement Value = Reading Level + Correct Factor.
- (2) Margin Level = Measurement Value - Limit Value.

Test Mode	TX G Mode 2417 MHz	Polarization	Vertical
-----------	--------------------	--------------	----------

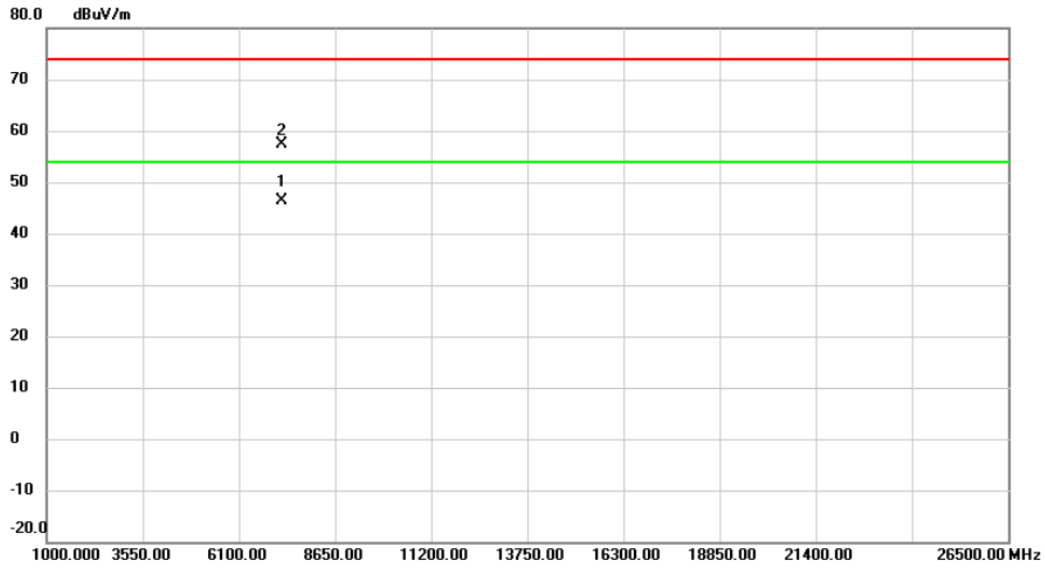

No.	Mk.	Freq. MHz	Reading Level dBuV	Correct Factor dB	Measure- ment dBuV/m	Limit dBuV/m	Margin dB	Detector	Comment
1	*	7250.080	31.97	14.44	46.41	54.00	-7.59	AVG	
2		7251.920	42.89	14.44	57.33	74.00	-16.67	peak	

REMARKS:

- (1) Measurement Value = Reading Level + Correct Factor.
- (2) Margin Level = Measurement Value - Limit Value.

Test Mode	TX G Mode 2437 MHz	Polarization	Horizontal
-----------	--------------------	--------------	------------

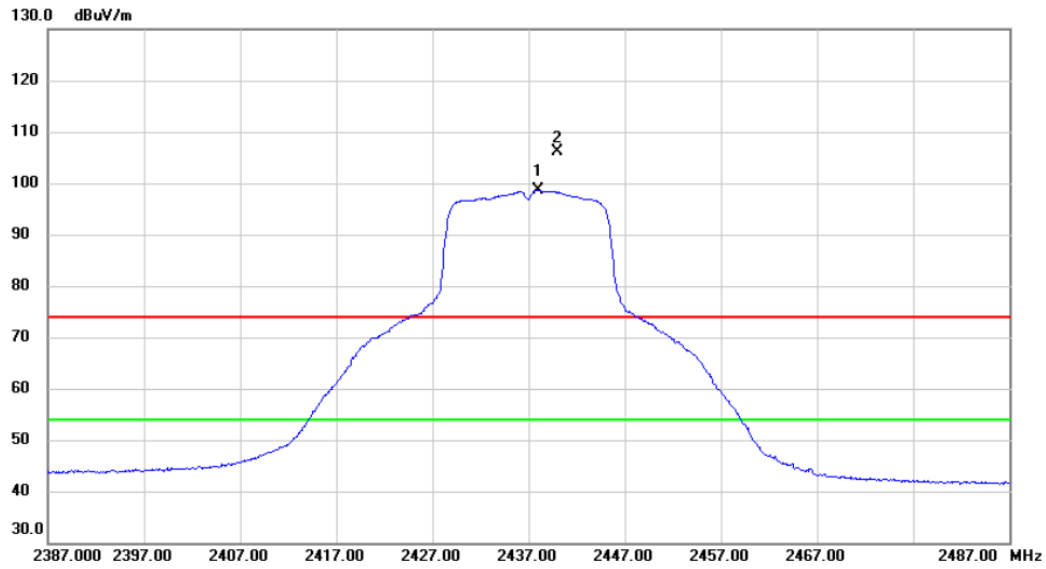

No.	Mk.	Freq.	Reading Level	Correct Factor	Measurement	Limit	Margin		
		MHz	dBuV	dB	dBuV/m	dBuV/m	dB	Detector	Comment
1	*	2438.000	88.73	9.98	98.71	54.00	44.71	AVG	No Limit
2	X	2440.000	96.23	9.98	106.21	74.00	32.21	peak	No Limit

REMARKS:

- (1) Measurement Value = Reading Level + Correct Factor.
- (2) Margin Level = Measurement Value - Limit Value.

Test Mode	TX G Mode 2437 MHz	Polarization	Vertical
-----------	--------------------	--------------	----------

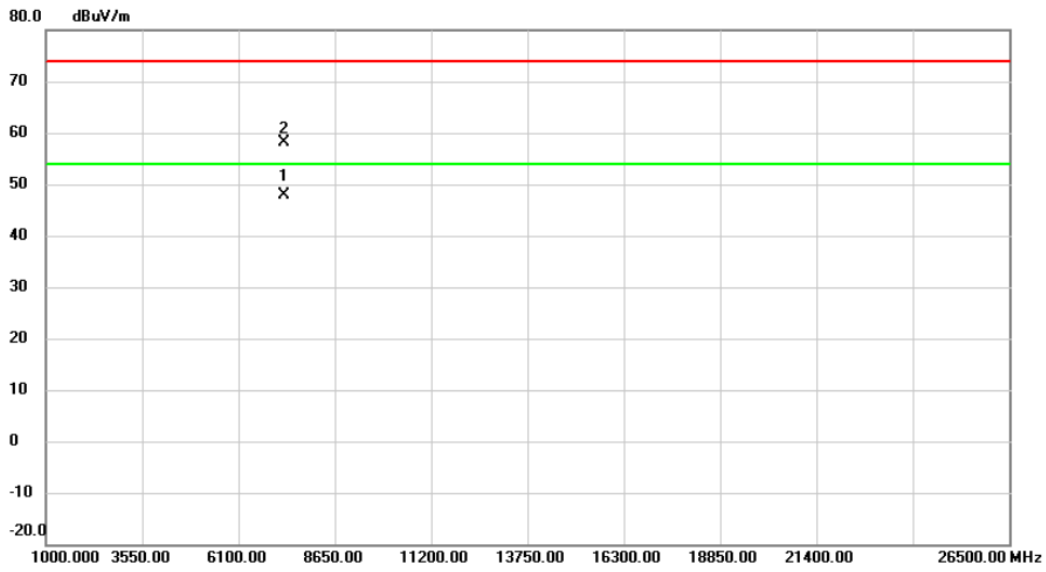

No.	Mk.	Freq. MHz	Reading Level dBuV	Correct Factor dB	Measure- ment dBuV/m	Limit dBuV/m	Margin dB	Detector	Comment
1	*	7310.810	33.38	14.47	47.85	54.00	-6.15	AVG	
2		7310.970	43.74	14.47	58.21	74.00	-15.79	peak	

REMARKS:

- (1) Measurement Value = Reading Level + Correct Factor.
 (2) Margin Level = Measurement Value - Limit Value.

Test Mode	TX G Mode 2457 MHz	Polarization	Horizontal
-----------	--------------------	--------------	------------

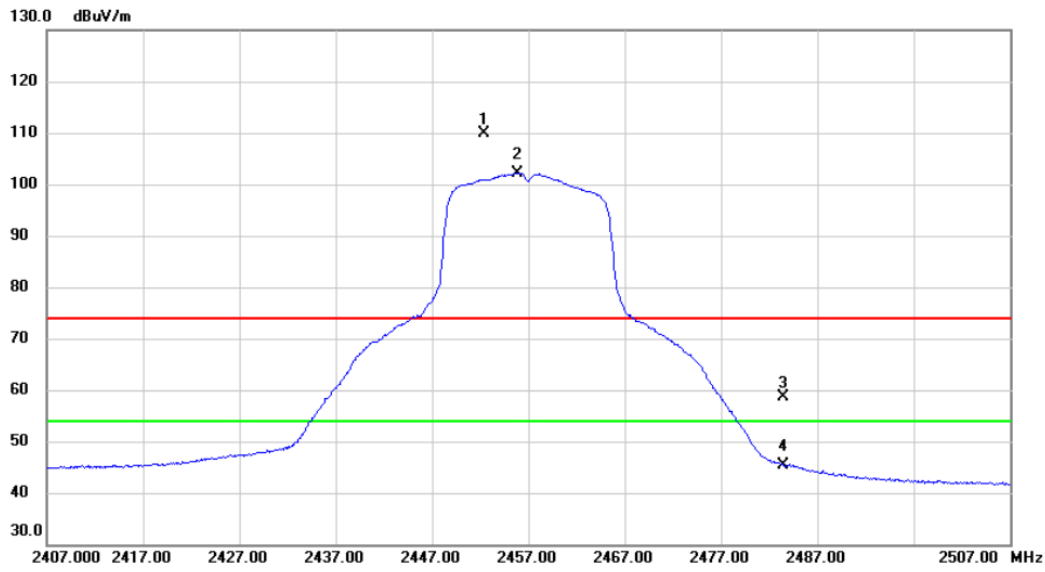

No.	Mk.	Freq. MHz	Reading Level dBuV	Correct Factor dB	Measure- ment dBuV/m	Limit dBuV/m	Margin dB	Detector	Comment
1	X	2452.400	99.88	10.00	109.88	74.00	35.88	peak	No Limit
2	*	2455.900	92.23	10.01	102.24	54.00	48.24	AVG	No Limit
3		2483.500	48.60	10.07	58.67	74.00	-15.33	peak	
4		2483.500	35.25	10.07	45.32	54.00	-8.68	AVG	

REMARKS:

- (1) Measurement Value = Reading Level + Correct Factor.
 (2) Margin Level = Measurement Value - Limit Value.

Test Mode	TX G Mode 2457 MHz	Polarization	Vertical
-----------	--------------------	--------------	----------

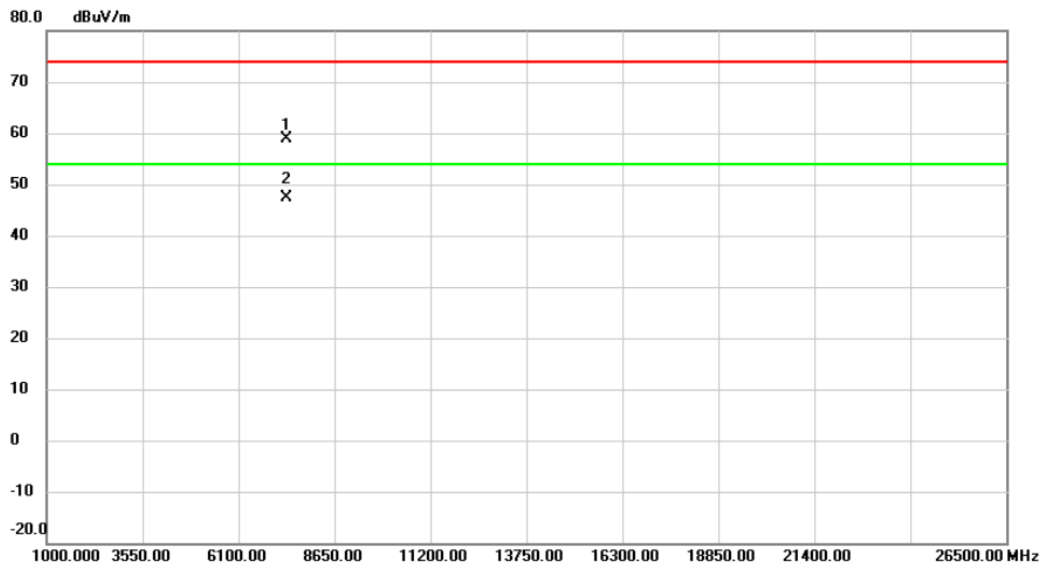

No.	Mk.	Freq.	Reading Level	Correct Factor	Measurement	Limit	Margin	Detector	Comment
		MHz	dBuV	dB	dBuV/m	dBuV/m	dB		
1		7374.320	44.46	14.49	58.95	74.00	-15.05	peak	
2	*	7380.060	32.86	14.50	47.36	54.00	-6.64	AVG	

REMARKS:

- (1) Measurement Value = Reading Level + Correct Factor.
 (2) Margin Level = Measurement Value - Limit Value.

Test Mode	TX G Mode 2462 MHz	Polarization	Horizontal
-----------	--------------------	--------------	------------

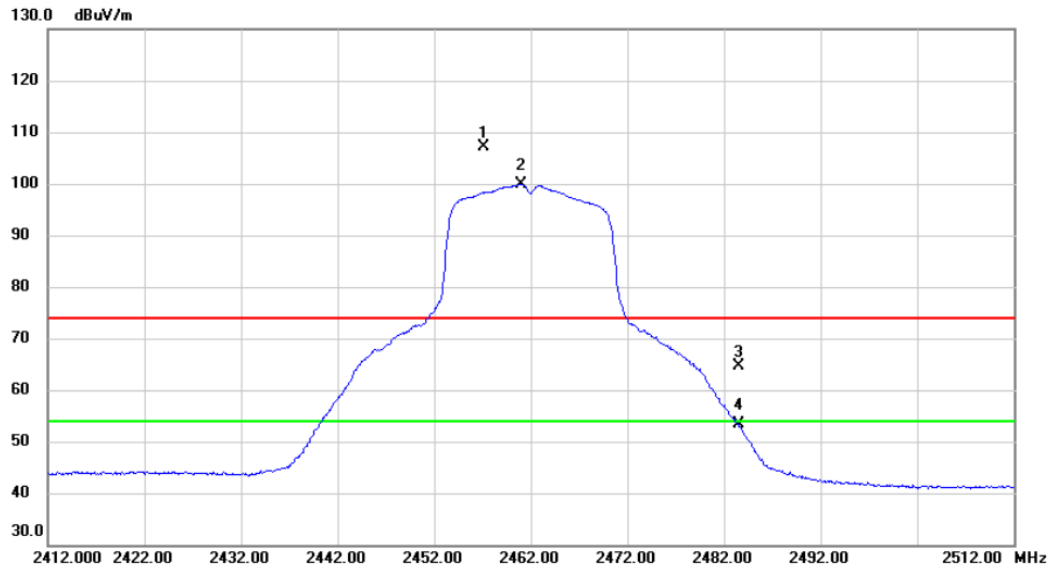

No.	Mk.	Freq. MHz	Reading Level dBuV	Correct Factor dB	Measure- ment dBuV/m	Limit dBuV/m	Margin dB	Detector	Comment
1	X	2457.200	97.02	10.01	107.03	74.00	33.03	peak	No Limit
2	*	2461.000	89.84	10.02	99.86	54.00	45.86	AVG	No Limit
3		2483.500	54.62	10.07	64.69	74.00	-9.31	peak	
4		2483.500	43.23	10.07	53.30	54.00	-0.70	AVG	

REMARKS:

- (1) Measurement Value = Reading Level + Correct Factor.
 (2) Margin Level = Measurement Value - Limit Value.

Test Mode	TX G Mode 2462 MHz	Polarization	Vertical
-----------	--------------------	--------------	----------

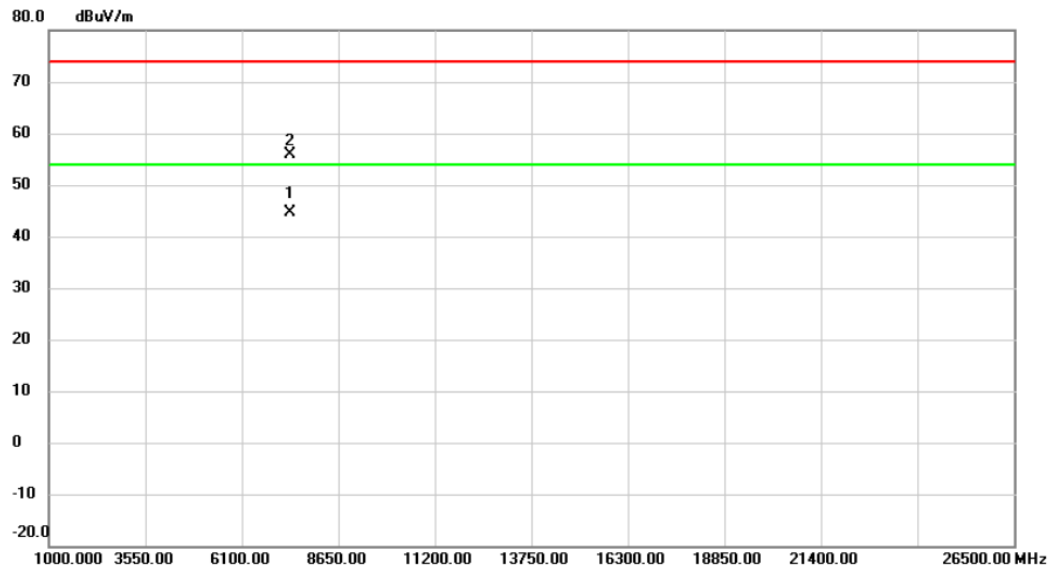

No.	Mk.	Freq.	Reading Level	Correct Factor	Measurement	Limit	Margin	Detector	Comment
		MHz	dBuV	dB	dBuV/m	dBuV/m	dB		
1	*	7385.330	30.16	14.50	44.66	54.00	-9.34	AVG	
2		7389.760	41.30	14.50	55.80	74.00	-18.20	peak	

REMARKS:

- (1) Measurement Value = Reading Level + Correct Factor.
 (2) Margin Level = Measurement Value - Limit Value.

Test Mode	TX N(HT20) Mode 2412 MHz	Polarization	Horizontal
-----------	--------------------------	--------------	------------

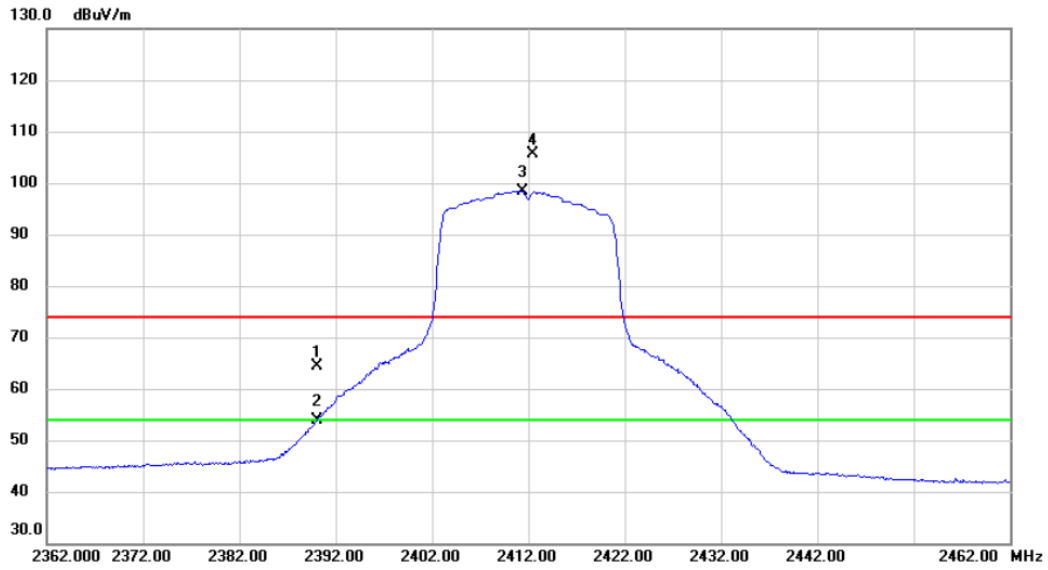

No.	Mk.	Freq. MHz	Reading Level dBuV	Correct Factor dB	Measure- ment dBuV/m	Limit dBuV/m	Margin dB	Detector	Comment
1		2390.000	54.45	9.88	64.33	74.00	-9.67	peak	
2		2390.000	44.00	9.88	53.88	54.00	-0.12	AVG	
3	*	2411.400	88.53	9.92	98.45	54.00	44.45	AVG	No Limit
4	X	2412.500	95.70	9.92	105.62	74.00	31.62	peak	No Limit

REMARKS:

- (1) Measurement Value = Reading Level + Correct Factor.
 (2) Margin Level = Measurement Value - Limit Value.

Test Mode	TX N(HT20) Mode 2412 MHz	Polarization	Vertical
-----------	--------------------------	--------------	----------

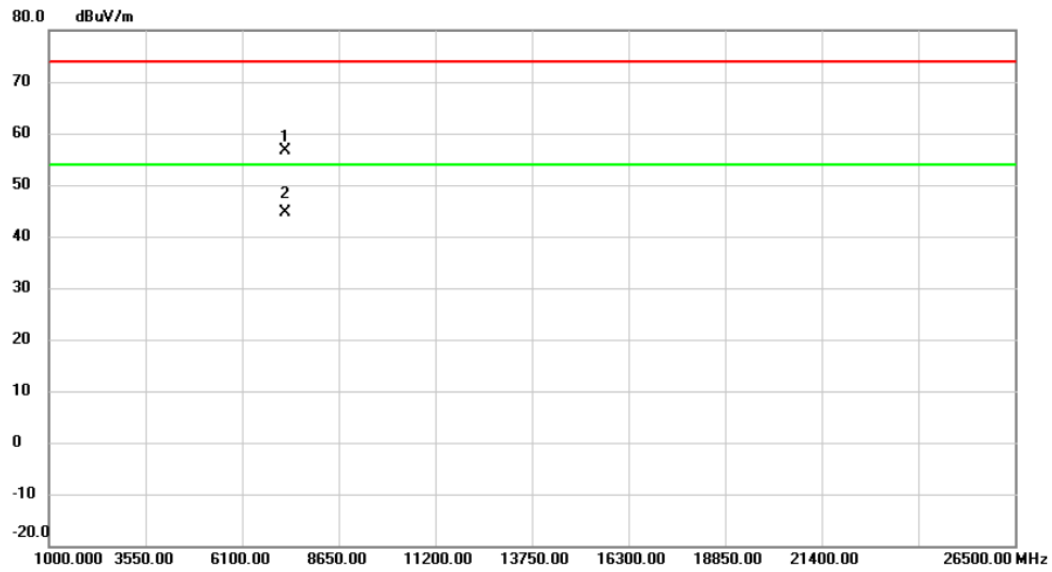

No.	Mk.	Freq. MHz	Reading Level dBuV	Correct Factor dB	Measure- ment dBuV/m	Limit dBuV/m	Margin dB	Detector	Comment
1		7232.770	42.11	14.42	56.53	74.00	-17.47	peak	
2	*	7235.940	30.23	14.42	44.65	54.00	-9.35	AVG	

REMARKS:

- (1) Measurement Value = Reading Level + Correct Factor.
 (2) Margin Level = Measurement Value - Limit Value.

Test Mode	TX N(HT20) Mode 2417 MHz	Polarization	Horizontal
-----------	--------------------------	--------------	------------

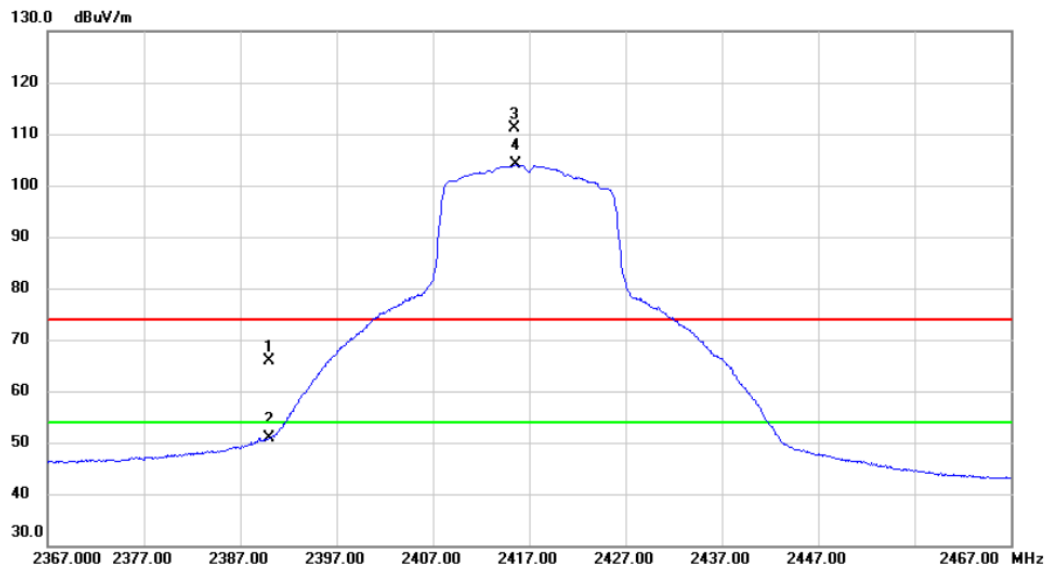

No. Mk.	Freq. MHz	Reading Level dBuV	Correct Factor dB	Measure- ment dBuV/m	Limit dBuV/m	Margin dB	Detector	Comment
1	2390.000	56.07	9.88	65.95	74.00	-8.05	peak	
2	2390.000	40.91	9.88	50.79	54.00	-3.21	AVG	
3 X	2415.500	101.2	9.93	111.19	74.00	37.19	peak	No Limit
4 *	2415.600	94.08	9.93	104.01	54.00	50.01	AVG	No Limit

REMARKS:

- (1) Measurement Value = Reading Level + Correct Factor.
 (2) Margin Level = Measurement Value - Limit Value.

Test Mode	TX N(HT20) Mode 2417 MHz	Polarization	Vertical
-----------	--------------------------	--------------	----------

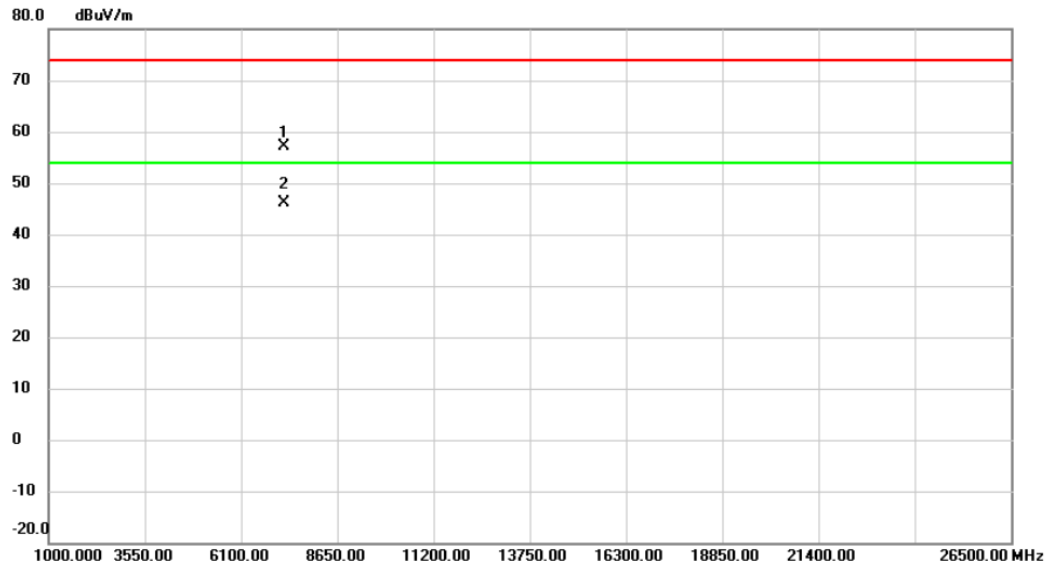

No. Mk.	Freq. MHz	Reading Level dBuV	Correct Factor dB	Measurement dBuV/m	Limit dBuV/m	Margin dB	Detector	Comment
1	7250.660	42.73	14.44	57.17	74.00	-16.83	peak	
2 *	7251.640	31.77	14.44	46.21	54.00	-7.79	AVG	

REMARKS:

- (1) Measurement Value = Reading Level + Correct Factor.
- (2) Margin Level = Measurement Value - Limit Value.

Test Mode	TX N(HT20) Mode 2437 MHz	Polarization	Horizontal
-----------	--------------------------	--------------	------------

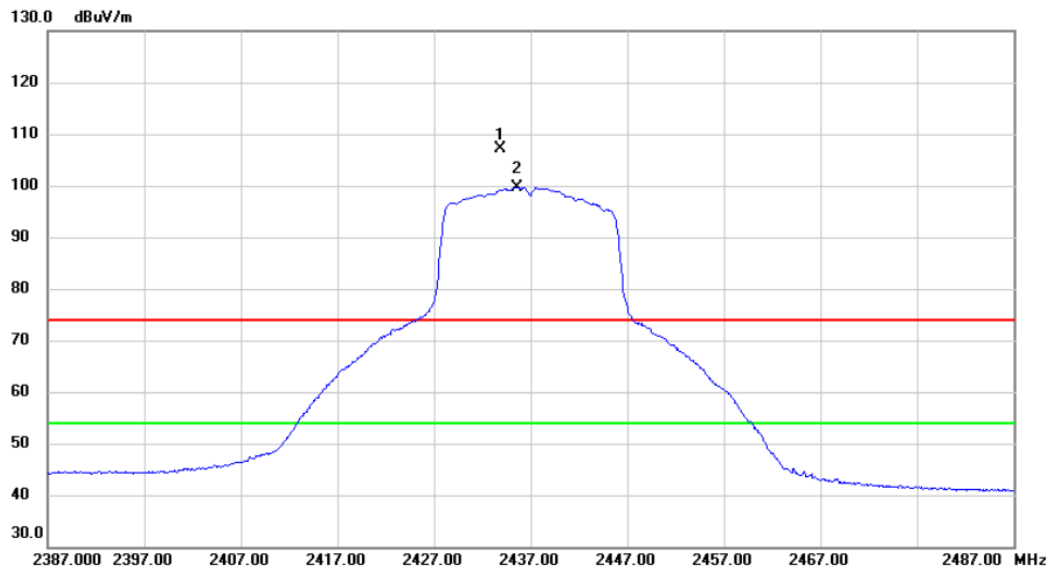

No.	Mk.	Freq.	Reading Level	Correct Factor	Measurement	Limit	Margin	Detector	Comment
		MHz	dBuV	dB	dBuV/m	dBuV/m	dB		
1	X	2433.900	97.26	9.97	107.23	74.00	33.23	peak	No Limit
2	*	2435.600	89.72	9.97	99.69	54.00	45.69	AVG	No Limit

REMARKS:

- (1) Measurement Value = Reading Level + Correct Factor.
 (2) Margin Level = Measurement Value - Limit Value.

Test Mode	TX N(HT20) Mode 2437 MHz	Polarization	Vertical
-----------	--------------------------	--------------	----------

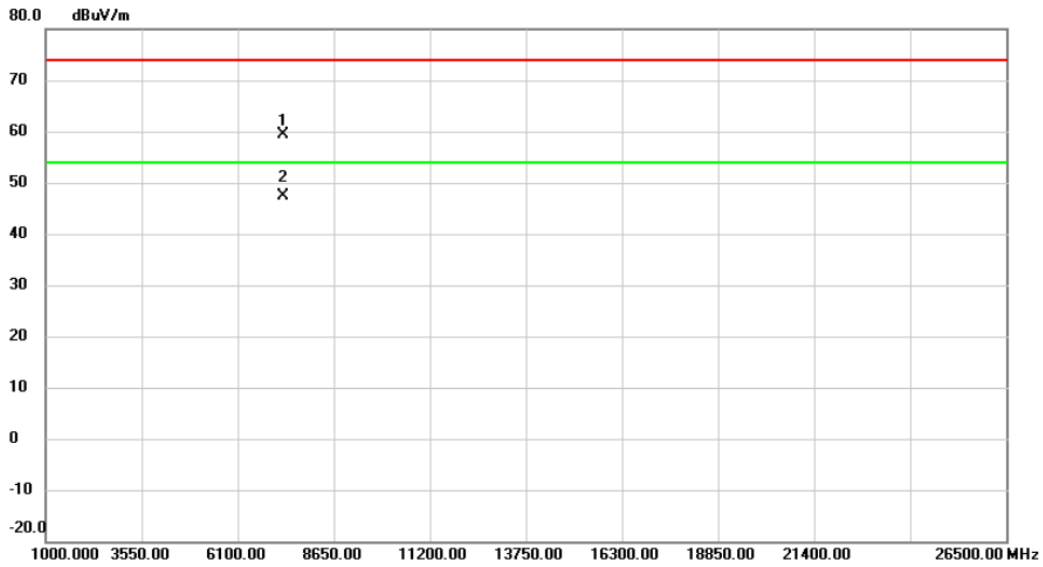

No.	Mk.	Freq.	Reading Level	Correct Factor	Measurement	Limit	Margin	Detector	Comment
		MHz	dBuV	dB	dBuV/m	dBuV/m	dB		
1		7307.730	44.89	14.46	59.35	74.00	-14.65	peak	
2	*	7310.210	32.80	14.47	47.27	54.00	-6.73	AVG	

REMARKS:

- (1) Measurement Value = Reading Level + Correct Factor.
 (2) Margin Level = Measurement Value - Limit Value.

Test Mode	TX N(HT20) Mode 2457 MHz	Polarization	Horizontal
-----------	--------------------------	--------------	------------

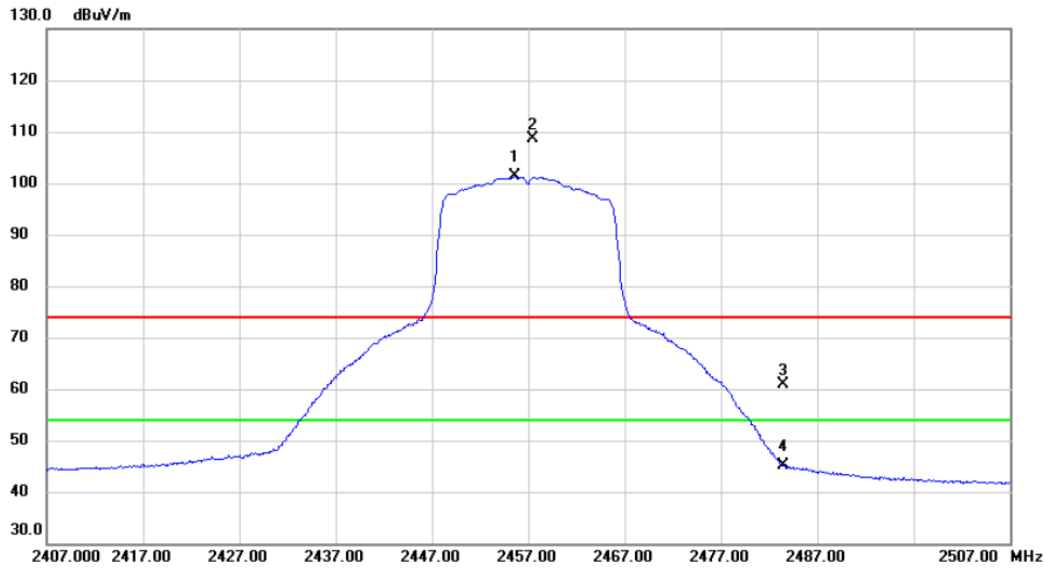

No.	Mk.	Freq. MHz	Reading Level dBuV	Correct Factor dB	Measure- ment dBuV/m	Limit dBuV/m	Margin dB	Detector	Comment
1	*	2455.600	91.29	10.01	101.30	54.00	47.30	AVG	No Limit
2	X	2457.400	98.53	10.01	108.54	74.00	34.54	peak	No Limit
3		2483.500	50.88	10.07	60.95	74.00	-13.05	peak	
4		2483.500	35.06	10.07	45.13	54.00	-8.87	AVG	

REMARKS:

- (1) Measurement Value = Reading Level + Correct Factor.
- (2) Margin Level = Measurement Value - Limit Value.

Test Mode	TX N(HT20) Mode 2457 MHz	Polarization	Vertical
-----------	--------------------------	--------------	----------

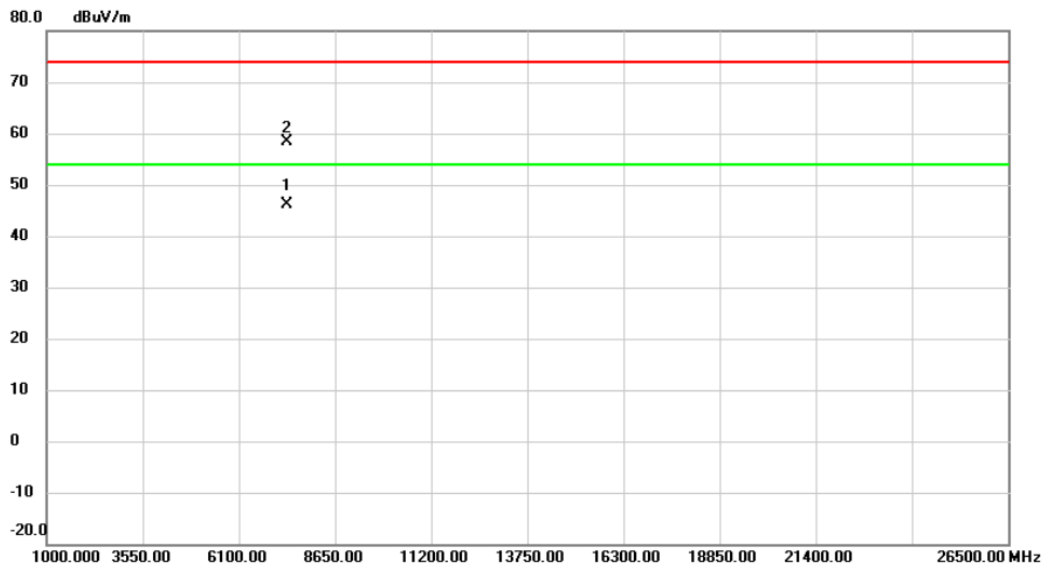

No.	Mk.	Freq. MHz	Reading Level dBuV	Correct Factor dB	Measure- ment dBuV/m	Limit dBuV/m	Margin dB	Detector	Comment
1	*	7362.340	31.68	14.49	46.17	54.00	-7.83	AVG	
2		7375.200	43.95	14.50	58.45	74.00	-15.55	peak	

REMARKS:

- (1) Measurement Value = Reading Level + Correct Factor.
 (2) Margin Level = Measurement Value - Limit Value.

Test Mode	TX N(HT20) Mode 2462 MHz	Polarization	Horizontal
-----------	--------------------------	--------------	------------

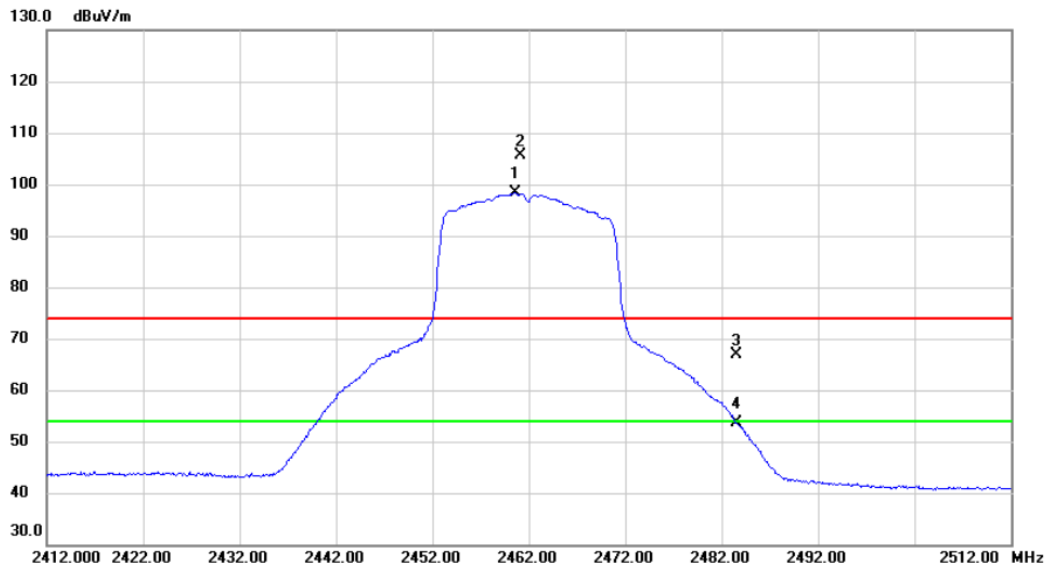

No.	Mk.	Freq. MHz	Reading Level dBuV	Correct Factor dB	Measure- ment dBuV/m	Limit dBuV/m	Margin dB	Detector	Comment
1	*	2460.600	88.38	10.02	98.40	54.00	44.40	AVG	No Limit
2	X	2461.200	95.53	10.02	105.55	74.00	31.55	peak	No Limit
3		2483.500	56.74	10.07	66.81	74.00	-7.19	peak	
4		2483.500	43.53	10.07	53.60	54.00	-0.40	AVG	

REMARKS:

- (1) Measurement Value = Reading Level + Correct Factor.
- (2) Margin Level = Measurement Value - Limit Value.

Test Mode	TX N(HT20) Mode 2462 MHz	Polarization	Vertical
-----------	--------------------------	--------------	----------

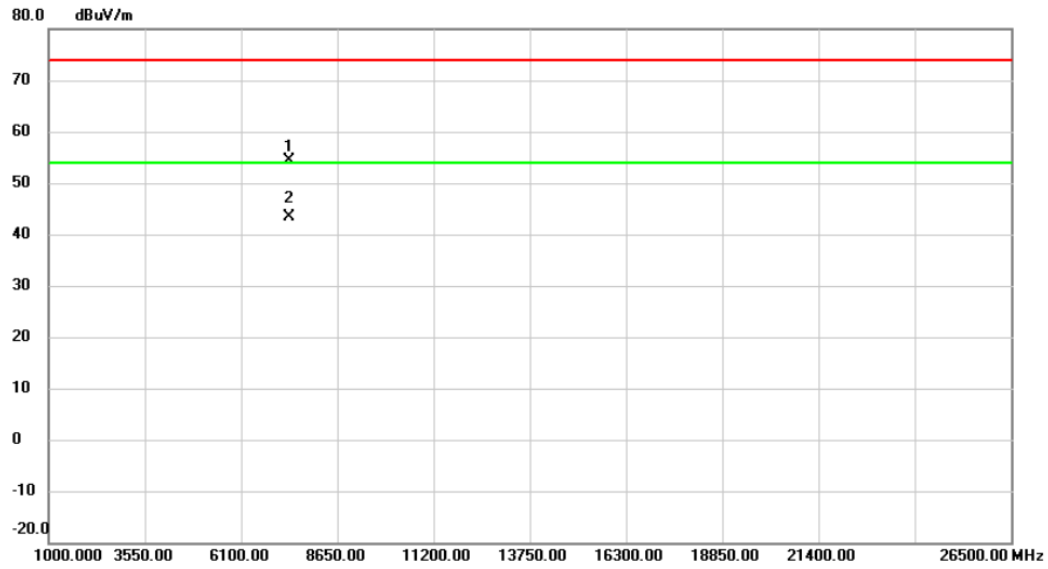

No.	Mk.	Freq. MHz	Reading Level dBuV	Correct Factor dB	Measure- ment dBuV/m	Limit dBuV/m	Margin dB	Detector	Comment
1		7383.070	39.93	14.50	54.43	74.00	-19.57	peak	
2	*	7385.470	28.77	14.50	43.27	54.00	-10.73	AVG	

REMARKS:

- (1) Measurement Value = Reading Level + Correct Factor.
 (2) Margin Level = Measurement Value - Limit Value.

APPENDIX E - BANDWIDTH

Test Mode	TX B Mode
-----------	-----------

Channel	Frequency (MHz)	6 dB Bandwidth (MHz)	99 % Occupied Bandwidth (MHz)	6 dB Bandwidth Min. Limit (MHz)	Result
01	2412	10.100	15.040	0.5	Complies
06	2437	10.100	14.880	0.5	Complies
11	2462	10.070	14.880	0.5	Complies

CH01

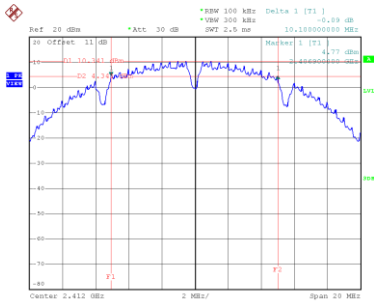

Date: 8.SEP.2022 13:56:18

CH06

6 dB Bandwidth

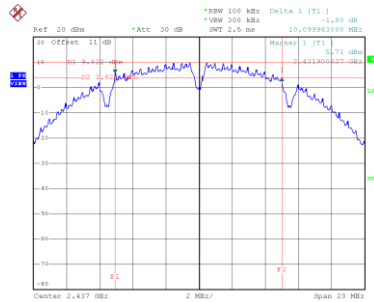

Date: 8.SEP.2022 13:58:09

CH11

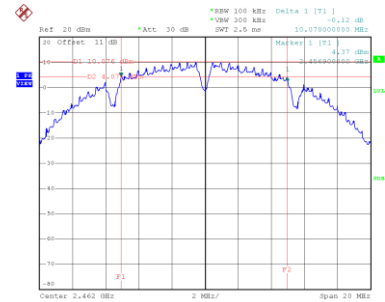

Date: 8.SEP.2022 13:59:31

99 % Occupied Bandwidth

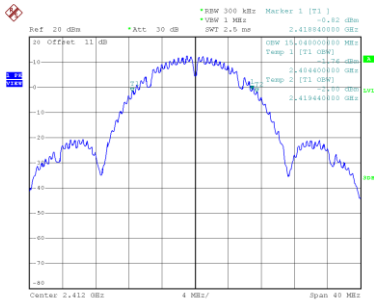

Date: 8.SEP.2022 13:56:27

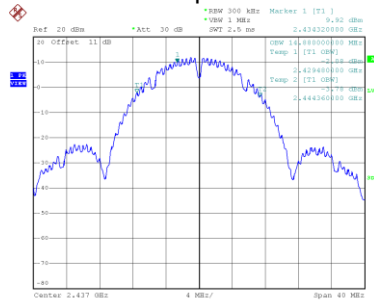

Date: 8.SEP.2022 13:58:17

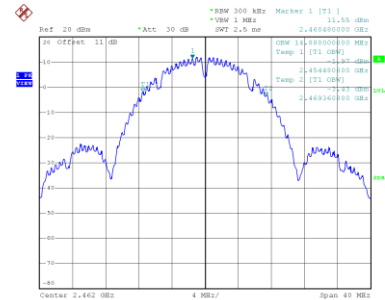

Date: 8.SEP.2022 13:59:39

Test Mode	TX G Mode
-----------	-----------

Channel	Frequency (MHz)	6 dB Bandwidth (MHz)	99 % Occupied Bandwidth (MHz)	6 dB Bandwidth Min. Limit (MHz)	Result
01	2412	15.140	18.160	0.5	Complies
06	2437	14.438	17.120	0.5	Complies
11	2462	15.100	17.120	0.5	Complies

CH01

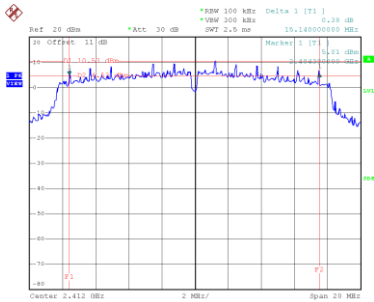

Date: 8.SEP.2022 14:01:18

CH06

6 dB Bandwidth

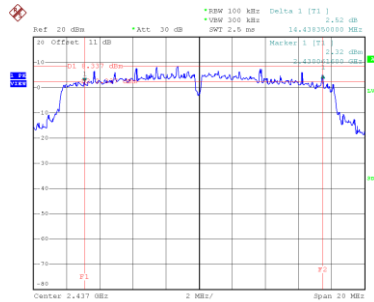

Date: 8.SEP.2022 14:37:34

CH11

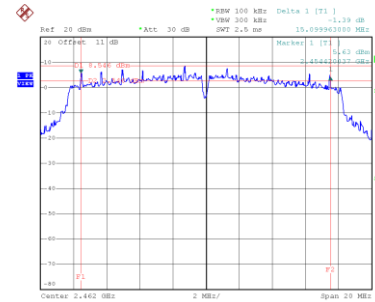

Date: 8.SEP.2022 14:03:33

99 % Occupied Bandwidth

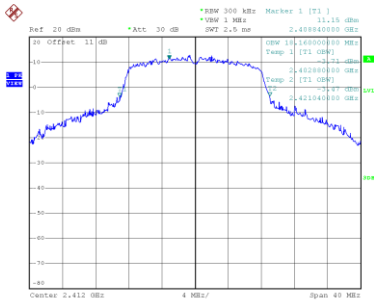

Date: 8.SEP.2022 14:01:27

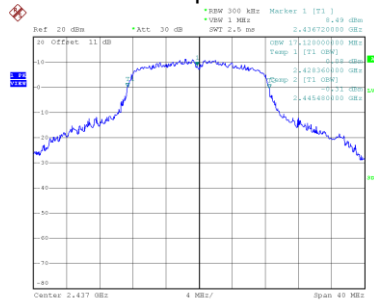

Date: 8.SEP.2022 14:02:52

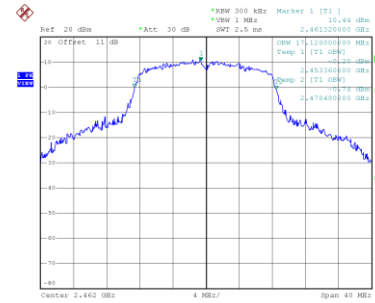

Date: 8.SEP.2022 14:03:41

Test Mode	TX N(HT20) Mode
-----------	-----------------

Channel	Frequency (MHz)	6 dB Bandwidth (MHz)	99 % Occupied Bandwidth (MHz)	6 dB Bandwidth Min. Limit (MHz)	Result
01	2412	15.180	18.560	0.5	Complies
06	2437	15.140	18.160	0.5	Complies
11	2462	15.100	18.000	0.5	Complies

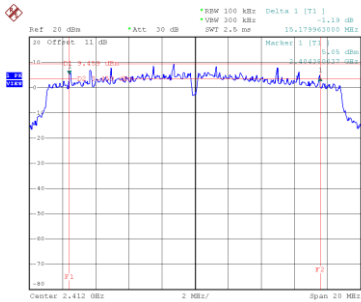
CH01

Date: 8.SEP.2022 14:04:58

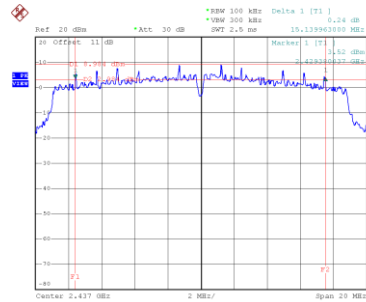
CH06
6 dB Bandwidth

Date: 8.SEP.2022 14:05:46

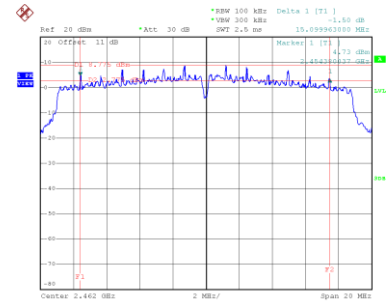
CH11

Date: 8.SEP.2022 14:06:35

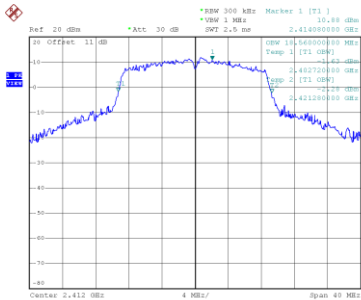
99 % Occupied Bandwidth

Date: 8.SEP.2022 14:05:06

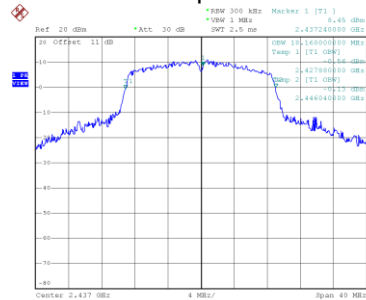

Date: 8.SEP.2022 14:05:54

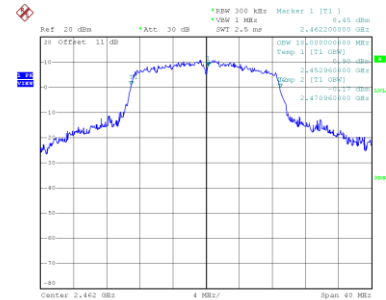

Date: 8.SEP.2022 14:06:43

APPENDIX F - MAXIMUM AVERAGE OUTPUT POWER

Test Mode	TX B Mode
-----------	-----------

Channel	Frequency (MHz)	Output Power (dBm)	Duty Factor	Output Power + Duty Factor (dBm)	Max. Limit (dBm)	Max. Limit (W)	Result
01	2412	18.73	0.10	18.83	30.00	1.0000	Complies
06	2437	18.79	0.10	18.89	30.00	1.0000	Complies
11	2462	19.43	0.10	19.53	30.00	1.0000	Complies

Test Mode	TX G Mode
-----------	-----------

Channel	Frequency (MHz)	Output Power (dBm)	Duty Factor	Output Power + Duty Factor (dBm)	Max. Limit (dBm)	Max. Limit (W)	Result
01	2412	18.03	0.49	18.52	30.00	1.0000	Complies
06	2437	19.33	0.49	19.82	30.00	1.0000	Complies
11	2462	19.07	0.49	19.56	30.00	1.0000	Complies

Test Mode	TX N(HT20) Mode
-----------	-----------------

Channel	Frequency (MHz)	Output Power (dBm)	Duty Factor	Output Power + Duty Factor (dBm)	Max. Limit (dBm)	Max. Limit (W)	Result
01	2412	17.06	0.57	17.63	30.00	1.0000	Complies
06	2437	19.13	0.57	19.70	30.00	1.0000	Complies
11	2462	19.01	0.57	19.58	30.00	1.0000	Complies

APPENDIX G - CONDUCTED SPURIOUS EMISSIONS

Test Mode TX B Mode

Reference Level-CH01

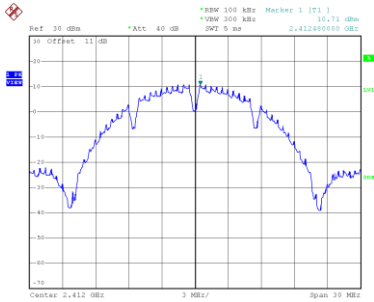

Date: 8.SEP.2022 14:47:52

Reference Level -CH06

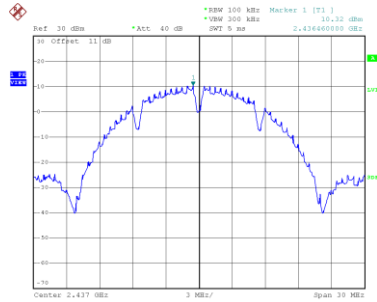

Date: 8.SEP.2022 14:48:26

Reference Level -CH11

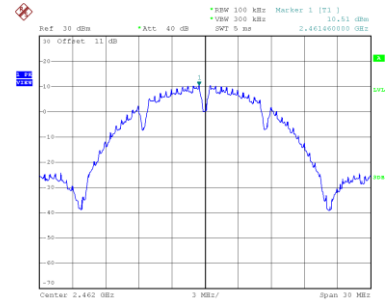

Date: 8.SEP.2022 14:48:57

Bandedge-CH01

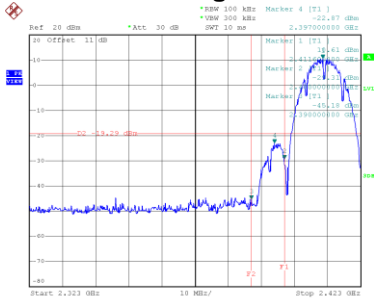

Date: 8.SEP.2022 14:52:25

Bandedge-CH11

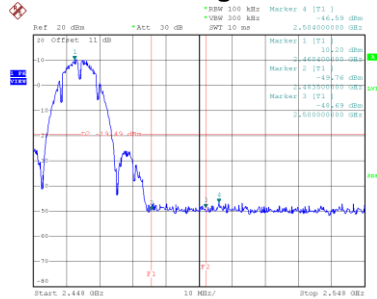

Date: 8.SEP.2022 15:00:28

CH01 – 10th Harmonic of the fundamental frequency

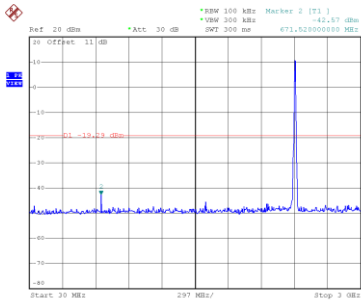

Date: 8.SEP.2022 14:53:29

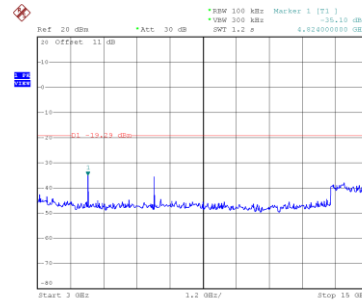

Date: 8.SEP.2022 14:53:38

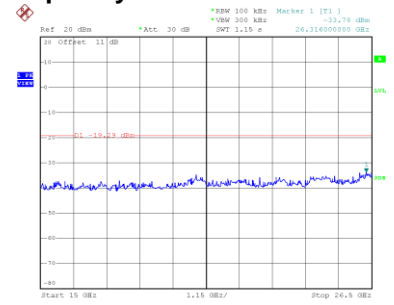

Date: 8.SEP.2022 14:53:47

CH06 – 10th Harmonic of the fundamental frequency

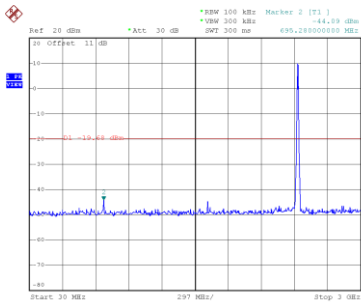

Date: 8.SEP.2022 14:56:10

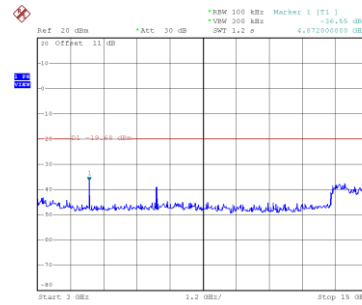

Date: 8.SEP.2022 14:56:20

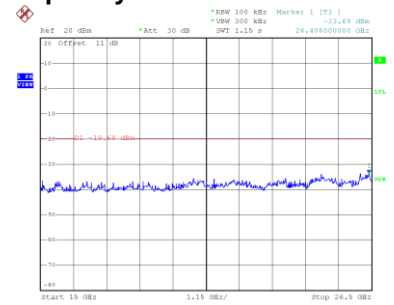

Date: 8.SEP.2022 14:56:29

CH11 – 10th Harmonic of the fundamental frequency

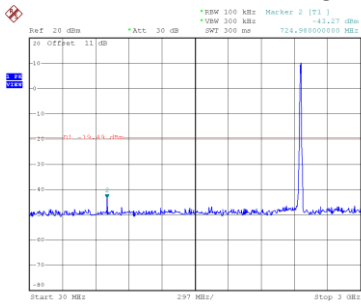

Date: 8.SEP.2022 15:01:22

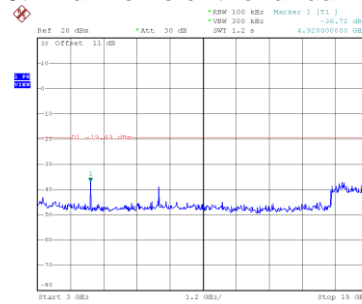

Date: 8.SEP.2022 15:01:31

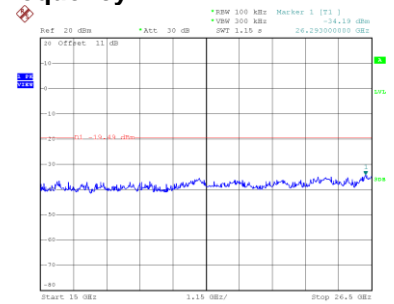

Date: 8.SEP.2022 15:01:40

Test Mode TX G Mode

Reference Level-CH01

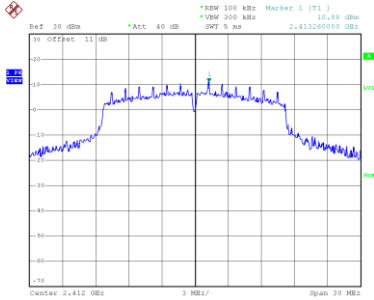

Date: 8.SEP.2022 15:05:06

Reference Level -CH06

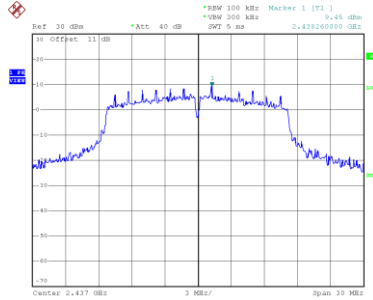

Date: 8.SEP.2022 15:05:17

Reference Level -CH11

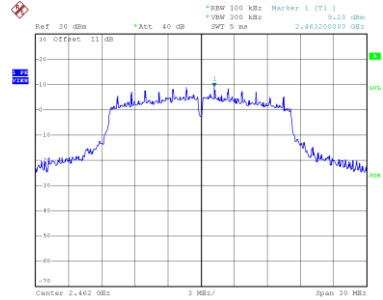

Date: 8.SEP.2022 15:07:09

Bandedge-CH01

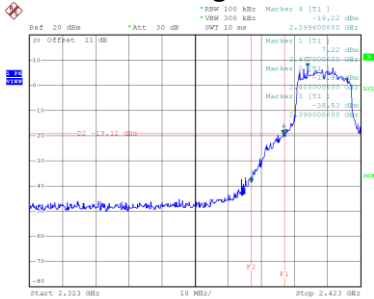

Date: 8.SEP.2022 15:23:41

Bandedge-CH11

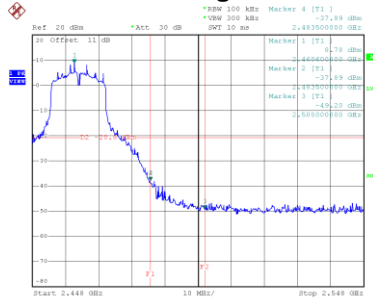

Date: 8.SEP.2022 15:28:42

CH01 – 10th Harmonic of the fundamental frequency

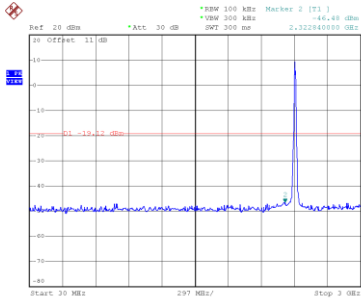

Date: 8.SEP.2022 15:24:32

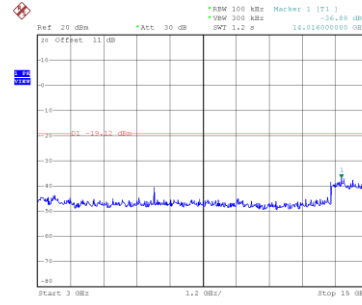

Date: 8.SEP.2022 15:24:41

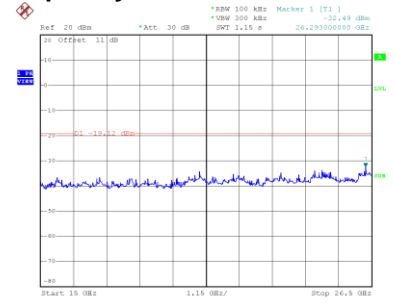

Date: 8.SEP.2022 15:24:50

CH06 – 10th Harmonic of the fundamental frequency

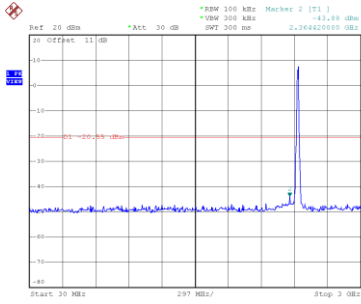

Date: 8.SEP.2022 15:27:16

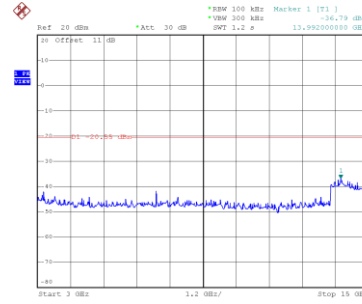

Date: 8.SEP.2022 15:27:45

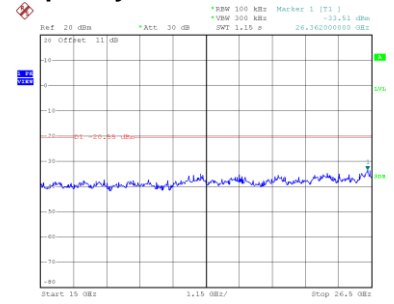

Date: 8.SEP.2022 15:27:54

CH11 – 10th Harmonic of the fundamental frequency

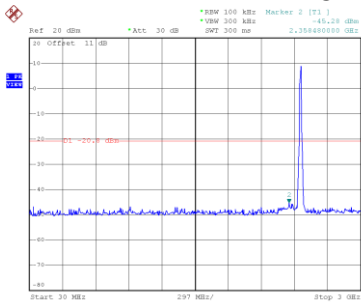

Date: 8.SEP.2022 15:29:24

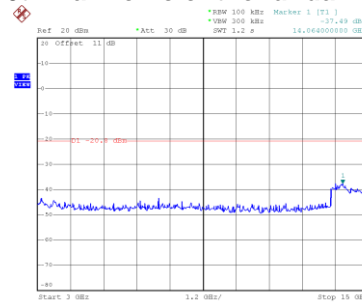

Date: 8.SEP.2022 15:29:34

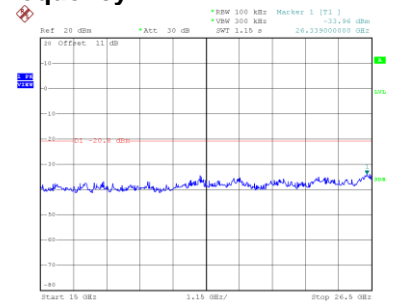

Date: 8.SEP.2022 15:29:43

Test Mode TX N(HT20) Mode

Reference Level-CH01

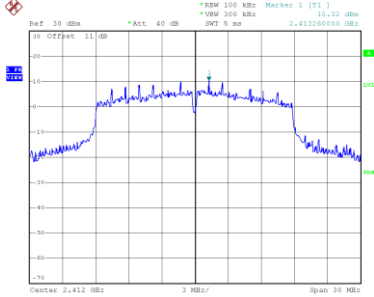

Date: 8.SEP.2022 15:08:54

Reference Level -CH06

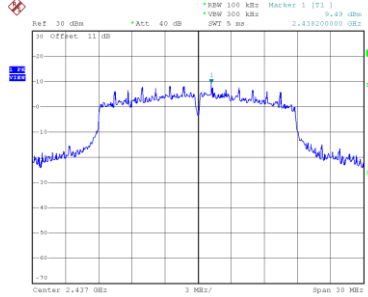

Date: 8.SEP.2022 15:09:33

Reference Level -CH11

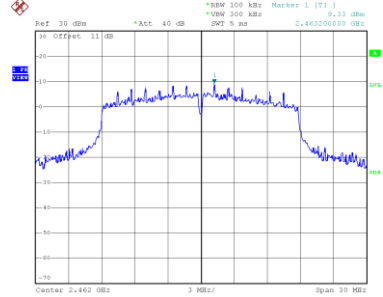

Date: 8.SEP.2022 15:09:58

Bandedge-CH01

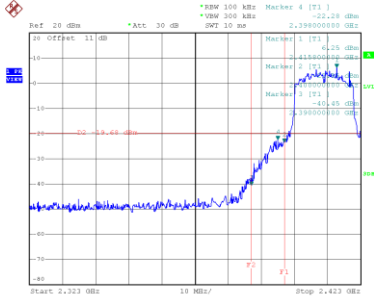

Date: 8.SEP.2022 15:13:03

Bandedge-CH11

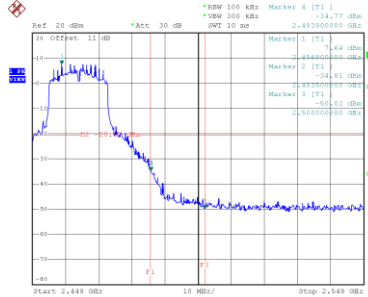

Date: 8.SEP.2022 15:14:25

CH01 – 10th Harmonic of the fundamental frequency

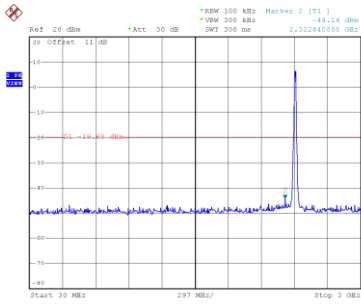

Date: 8.SEP.2022 15:36:10

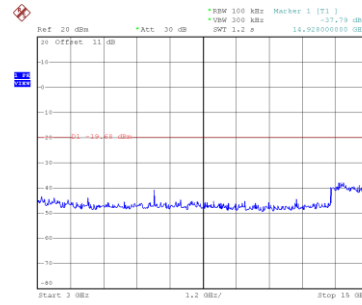

Date: 8.SEP.2022 15:36:20

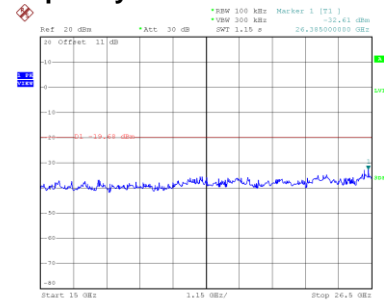

Date: 8.SEP.2022 15:36:29

CH06 – 10th Harmonic of the fundamental frequency

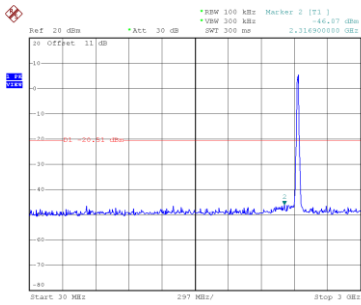

Date: 8.SEP.2022 15:38:50

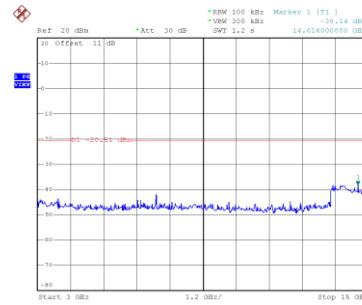

Date: 8.SEP.2022 15:39:08

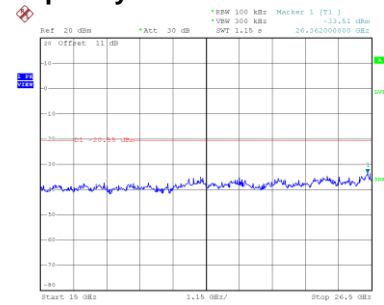

Date: 8.SEP.2022 15:39:54

CH11 – 10th Harmonic of the fundamental frequency

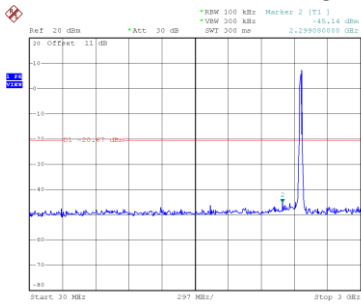

Date: 8.SEP.2022 15:41:24

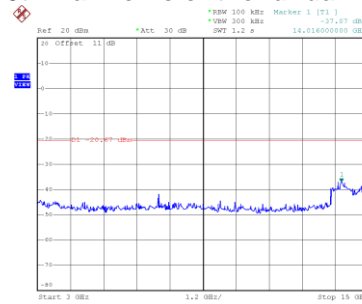

Date: 8.SEP.2022 15:41:34

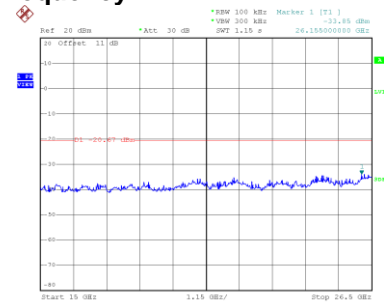

Date: 8.SEP.2022 15:41:43

APPENDIX H - POWER SPECTRAL DENSITY

Test Mode	TX B Mode
-----------	-----------

Channel	Frequency (MHz)	Power Spectral Density (dBm/3kHz)	Max. Limit (dBm/3kHz)	Result
01	2412	-4.95	8	Complies
06	2437	-4.69	8	Complies
11	2462	-5.32	8	Complies

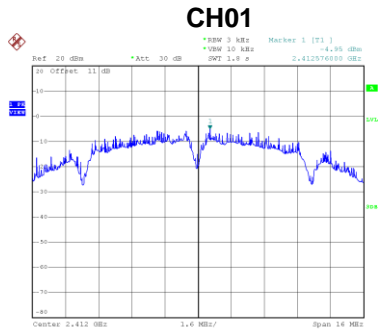

Date: 8.8EP.2022 14:31:49

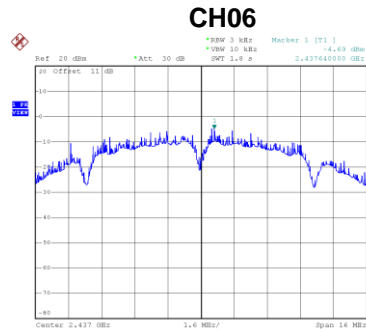

Date: 8.8EP.2022 14:33:01

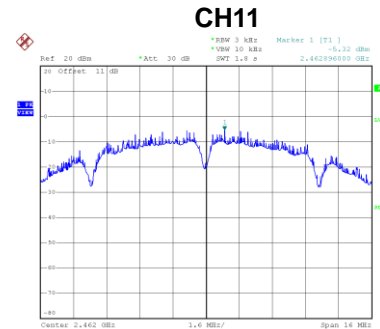

Date: 8.8EP.2022 14:34:55

Test Mode	TX G Mode
-----------	-----------

Channel	Frequency (MHz)	Power Spectral Density (dBm/3kHz)	Max. Limit (dBm/3kHz)	Result
01	2412	-6.03	8	Complies
06	2437	-8.32	8	Complies
11	2462	-8.48	8	Complies

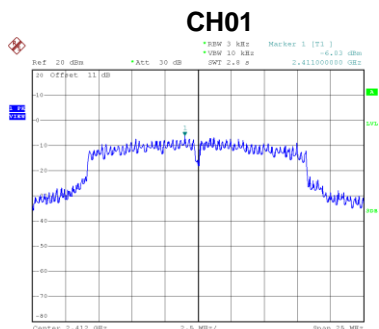

Date: 8.8EP.2022 14:38:26

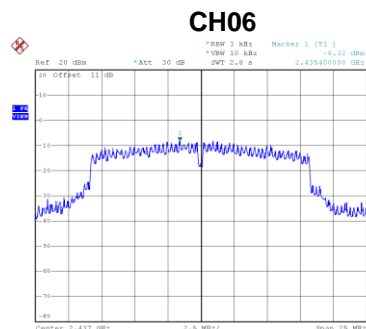

Date: 8.8EP.2022 14:38:55

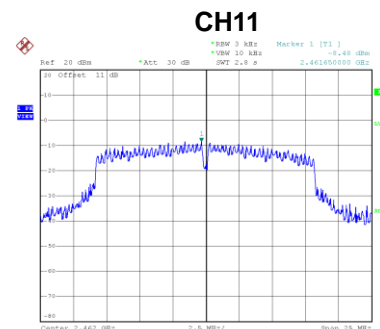

Date: 8.8EP.2022 14:39:56

Test Mode	TX N(HT20) Mode
-----------	-----------------

Channel	Frequency (MHz)	Power Spectral Density (dBm/3kHz)	Max. Limit (dBm/3kHz)	Result
01	2412	-6.07	8	Complies
06	2437	-6.87	8	Complies
11	2462	-6.42	8	Complies

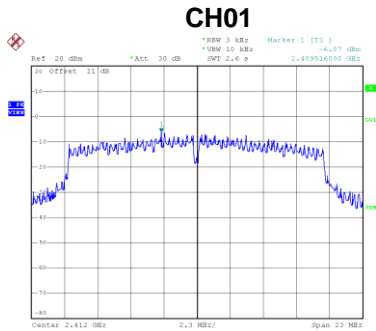

Date: 8.SEP.2022 14:43:31

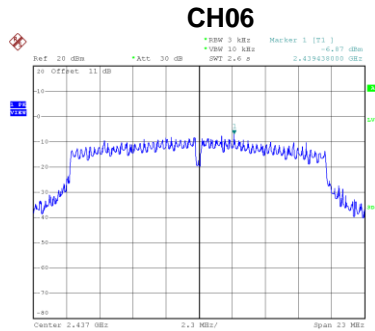

Date: 8.SEP.2022 14:43:58

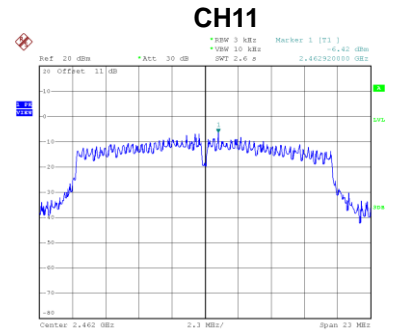

Date: 8.SEP.2022 14:44:23

End of Test Report