

RF MEASUREMENT REPORT

FCC ID : 2AXJ4C340W
Applicant : TP-Link Corporation Limited
Application Type : Certification
Product : 4MP Outdoor Full-Color Wi-Fi Bullet Network Camera
Model No. : VIGI C340-W
Brand Name : tp-link
FCC Classification : Digital Transmission System (DTS)
FCC Rule Part(s) : Part15 Subpart C (Section 15.247)
Received Date : May 24, 2022
Test Date : June 22, 2022~July 24, 2023

Tested By : Kaunaz Lee
(Kaunaz Lee)
Reviewed By : Paddy Chen
(Paddy Chen)
Approved By : Chenz Ker
(Chenz Ker)



The test results relate only to the samples tested.

This equipment has been shown to be capable of compliance with the applicable technical standards as indicated in the measurement report and was tested in accordance with the measurement procedures specified in ANSI C63.10-2013. Test results reported herein relate only to the item(s) tested.

The test report shall not be reproduced except in full without the written approval of MRT Technology (Taiwan) Co., Ltd.

Revision History

| Report No. | Version | Description | Issue Date | Note |
|---------------|---------|-----------------|------------|-------|
| 2307TW0114-U2 | 1.0 | Original Report | 2023-08-16 | Valid |
| | | | | |

CONTENTS

| Description | Page |
|--|-----------|
| 1. INTRODUCTION | 6 |
| 1.1. Scope | 6 |
| 1.2. MRT Test Location | 6 |
| 2. PRODUCT INFORMATION | 7 |
| 2.1. Feature of Equipment under Test | 7 |
| 2.2. Product Specification Subjective to this Report | 7 |
| 2.3. Working Frequencies for this report | 8 |
| 2.4. Description of Available Antennas | 8 |
| 2.5. Test Mode | 9 |
| 2.6. Configuration of Test System | 9 |
| 2.7. Test System Details | 10 |
| 2.8. Description of Test Software | 10 |
| 2.9. Applied Standards | 10 |
| 2.10. Duty Cycle | 11 |
| 2.11. Test Configuration | 12 |
| 2.12. EMI Suppression Device(s)/Modifications | 12 |
| 2.13. Labeling Requirements | 12 |
| 3. DESCRIPTION of TEST | 13 |
| 3.1. Evaluation Procedure | 13 |
| 3.2. AC Line Conducted Emissions | 13 |
| 3.3. Radiated Emissions | 14 |
| 4. ANTENNA REQUIREMENTS | 15 |
| 5. TEST EQUIPMENT CALIBRATION DATE | 16 |
| 6. MEASUREMENT UNCERTAINTY | 18 |
| 7. TEST RESULT | 19 |
| 7.1. Summary | 19 |
| 7.2. 6dB Bandwidth Measurement | 20 |
| 7.2.1. Test Limit | 20 |
| 7.2.2. Test Procedure used | 20 |
| 7.2.3. Test Setting | 20 |
| 7.2.4. Test Setup | 20 |
| 7.2.5. Test Result | 21 |
| 7.3. Output Power Measurement | 24 |
| 7.3.1. Test Limit | 24 |
| 7.3.2. Test Procedure Used | 24 |
| 7.3.3. Test Setting | 24 |

| | |
|---|------------|
| 7.3.4. Test Setup | 24 |
| 7.3.5. Test Result | 25 |
| 7.4. Power Spectral Density Measurement | 26 |
| 7.4.1. Test Limit | 26 |
| 7.4.2. Test Procedure Used | 26 |
| 7.4.3. Test Setting | 26 |
| 7.4.4. Test Setup | 27 |
| 7.4.5. Test Result | 28 |
| 7.5. Conducted Band Edge and Out-of-Band Emissions..... | 33 |
| 7.5.1. Test Limit | 33 |
| 7.5.2. Test Procedure Used | 33 |
| 7.5.3. Test Setting | 33 |
| 7.5.4. Test Setup | 34 |
| 7.5.5. Test Result | 35 |
| 7.6. Radiated Spurious Emission Measurement | 47 |
| 7.6.1. Test Limit | 47 |
| 7.6.2. Test Procedure Used | 47 |
| 7.6.3. Test Setting | 47 |
| 7.6.4. Test Setup | 49 |
| 7.6.5. Test Result | 50 |
| 7.7. Radiated Restricted Band Edge Measurement | 76 |
| 7.7.1. Test Limit | 76 |
| 7.7.2. Test Procedure Used | 77 |
| 7.7.3. Test Setting | 77 |
| 7.7.4. Test Setup | 78 |
| 7.7.5. Test Result | 79 |
| 7.8. AC Conducted Emissions Measurement..... | 127 |
| 7.8.1. Test Limit | 127 |
| 7.8.2. Test Setup | 127 |
| 7.8.3. Test Result | 128 |
| 8. CONCLUSION | 132 |
| Appendix A : Test Setup Photograph | 133 |
| Appendix B : External Photograph..... | 133 |
| Appendix C : Internal Photograph..... | 133 |

General Information

| | |
|---------------------------------|---|
| Applicant | TP-Link Corporation Limited |
| Applicant Address | Room 901, 9/F., New East Ocean Centre, 9 Science Museum Road, Tsim Sha Tsui, Kowloon, Hongkong |
| Manufacturer | TP-Link Corporation Limited |
| Manufacturer Address | Room 901, 9/F. , New East Ocean Centre, 9 Science Museum Road, Tsim Sha Tsui, Kowloon, Hongkong |
| Test Site | MRT Technology (Taiwan) Co., Ltd |
| Test Site Address | No. 38, Fuxing Second Rd., Guishan Dist., Taoyuan City 333, Taiwan (R.O.C) |
| MRT FCC Registration No. | 291082 |
| FCC Rule Part(s) | Part 15.247 |

Test Facility / Accreditations

1. MRT facility is a FCC registered (Reg. No. 291082) test facility with the site description report on file and is designated by the FCC as an Accredited Test Firm.
2. MRT facility is an IC registered (MRT Reg. No. 21723) test laboratory with the site description on file at Industry Canada.
3. MRT Lab is accredited to ISO 17025 by the Taiwan Accreditation Foundation (TAF Cert. No. 3261) in EMC, Telecommunications and Radio testing for FCC (Designation Number: TW3261), Industry Canada, EU and TELEC Rules.

1. INTRODUCTION

1.1. Scope

Measurement and determination of electromagnetic emissions (EMC) of radio frequency devices including intentional and/or unintentional radiators for compliance with the technical rules and regulations of the Federal Communications Commission and the Innovation, Science and Economic Development Canada and Certification and Engineering Bureau.

1.2. MRT Test Location

The map below shows the location of the MRT LABORATORY, its proximity to the Taoyuan City. These measurement tests were conducted at the MRT Technology (Taiwan) Co., Ltd. Facility located at No.38, Fuxing 2nd Rd., Guishan Dist., Taoyuan City 33377, Taiwan (R.O.C).

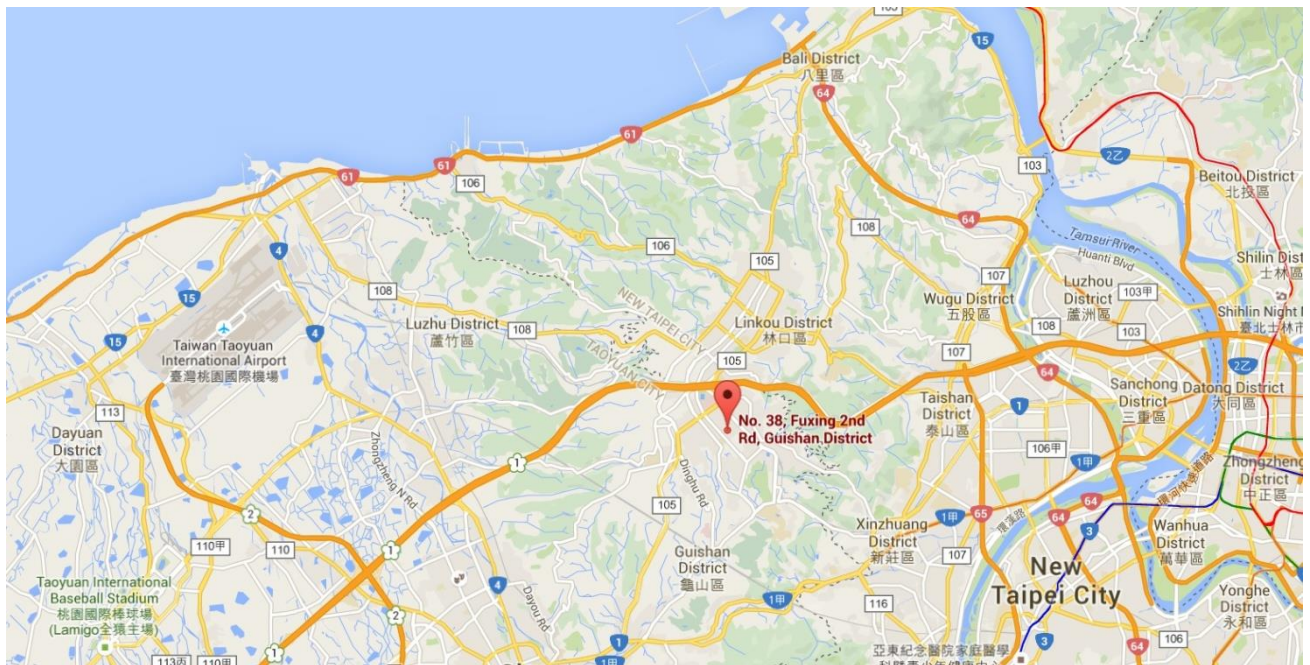

2. PRODUCT INFORMATION

2.1. Feature of Equipment under Test

| | |
|-------------------------|--|
| Product Name: | 4MP Outdoor Full-Color Wi-Fi Bullet Network Camera |
| Model No.: | VIGI C340-W |
| Brand Name: | tp-link |
| Wi-Fi Specification: | 802.11a/b/g/n |
| EUT Identification No.: | #1-1 (Conducted) #1-2 (Radiated) |
| Accessory | |
| Power Adapter | Brand: tp-link Model: T090085-2B1 Input: 100 - 240V ~ 50/60Hz 0.3A Output: 9V=0.85A Cable Out: Non-shielding, 1.5m |

2.2. Product Specification Subjective to this Report

| | |
|---------------------|---|
| Frequency Range: | 802.11b/g/n-HT20: 2412 ~ 2462MHz 802.11n-HT40: 2422 ~ 2452MHz |
| Channel Number: | 802.11b/g/n-HT20: 11 802.11n-HT40: 7 |
| Type of Modulation: | 802.11b: DSSS 802.11g/n: OFDM |
| Data Rate: | 802.11b: 1/2/5.5/11Mbps 802.11g: 6/9/12/18/24/36/48/54Mbps 802.11n: up to 300Mbps |

Note: For other features of this EUT, test report will be issued separately.

2.3. Working Frequencies for this report

802.11b/g/n-HT20

| Channel | Frequency | Channel | Frequency | Channel | Frequency |
|---------|-----------|---------|-----------|---------|-----------|
| 01 | 2412 MHz | 02 | 2417 MHz | 03 | 2422 MHz |
| 04 | 2427 MHz | 05 | 2432 MHz | 06 | 2437 MHz |
| 07 | 2442 MHz | 08 | 2447 MHz | 09 | 2452 MHz |
| 10 | 2457 MHz | 11 | 2462 MHz | -- | -- |

802.11n-HT40

| Channel | Frequency | Channel | Frequency | Channel | Frequency |
|---------|-----------|---------|-----------|---------|-----------|
| 03 | 2422 MHz | 04 | 2427 MHz | 05 | 2432 MHz |
| 06 | 2437 MHz | 07 | 2442 MHz | 08 | 2447 MHz |
| 09 | 2452 MHz | -- | -- | -- | -- |

2.4. Description of Available Antennas

| Antenna Type | Frequency Band (MHz) | Mode | T _x Paths | Max Antenna Gain (dBi) | CDD Directional Gain (dBi) | |
|--------------|----------------------|-----------|----------------------|------------------------|----------------------------|---------|
| | | | | | For Power | For PSD |
| Dipole | 2412 ~ 2462 | 802.11b | 1 | 2 | -- | -- |
| | | 802.11g/n | 2 | 2 | 2 | 5.01 |

Note:

1. For 802.11b, the EUT supports SISO mode only at Ant 0.
2. For 802.11g/n, the EUT supports Cyclic Delay Diversity (CDD) mode and CDD signals are correlated.

If all antennas have the same gain, G_{ANT} , Directional gain = G_{ANT} + Array Gain, where Array Gain is as follows.

- For power spectral density (PSD) measurements on all devices,

$$\text{Array Gain} = 10 \log (N_{ANT} / N_{SS}) \text{ dB};$$

- For power measurements on IEEE 802.11 devices,

$$\text{Array Gain} = 0 \text{ dB for } N_{ANT} \leq 4;$$

2.5. Test Mode

| |
|--|
| Mode 1: Transmit by 802.11b (1Mbps) with Ant 0 |
| Mode 2: Transmit by 802.11g_ N _{SS} =1 (6Mbps) (CDD mode) |
| Mode 3: Transmit by 802.11n-HT20_ N _{SS} =1 (MCS0) (CDD mode) |
| Mode 4: Transmit by 802.11n-HT40_ N _{SS} =1 (MCS0) (CDD mode) |
| Remark: |
| 1. For Radiated emission, the modulation and the data rate picked for testing are determined by the Max. RF conducted power. |
| 2. This device supports 2 N _{SS} and power level of 2 N _{SS} is less than or equal to the power of 1 N _{SS} . The worst case is N _{SS} =1. |

2.6. Configuration of Test System

The device was tested per the guidance ANSI C63.10: 2013 was used to reference the appropriate EUT setup for radiated emissions testing and AC line conducted testing.

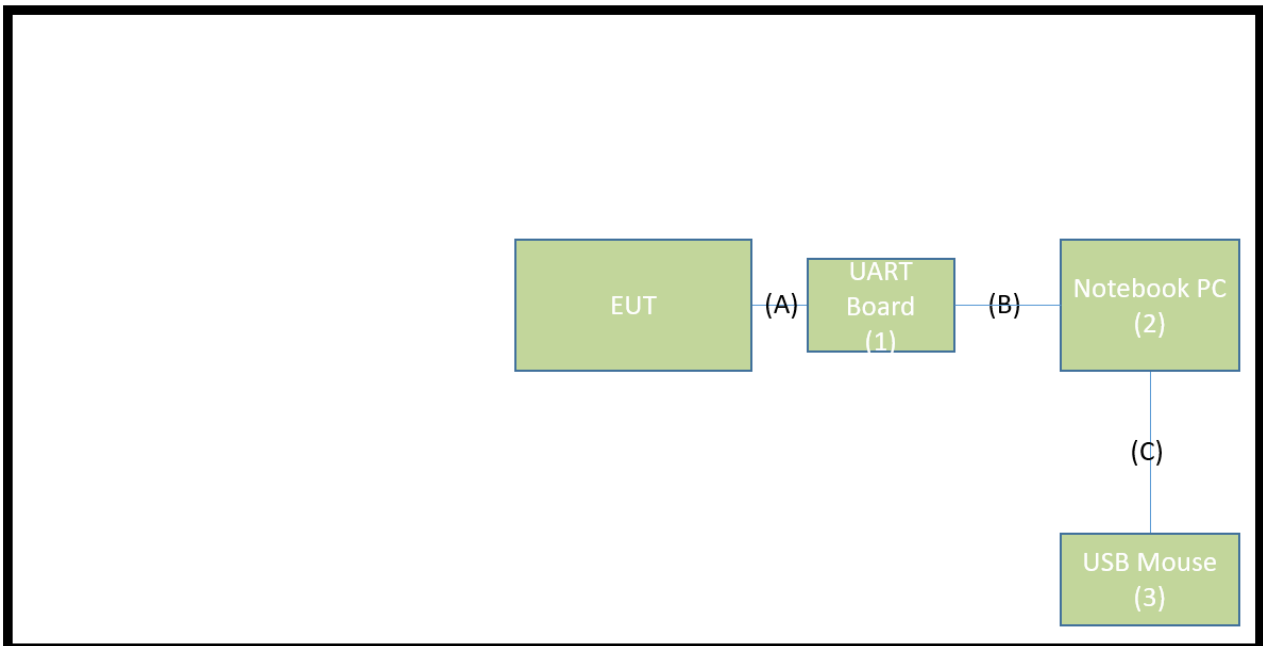
| Connection Diagram | | |
|--|----------------------------|--------------------|
|  <pre> graph LR EUT[EUT] --- A["(A)"] --- UART["UART Board (1)"] UART --- B["(B)"] --- PC["Notebook PC (2)"] PC --- C["(C)"] --- Mouse["USB Mouse (3)"] </pre> | | |
| Cable Type | Cable Description | |
| A | Signal Cable (Dupont Line) | Non-shielded, 0.3m |
| B | RS232 to LAN Cable | Non-shielded, 2.0m |
| C | USB Mouse Cable | Shielded, 1.8m |

2.7. Test System Details

The types for all equipments, plus descriptions of all cables used in the tested system (including inserted cards) are:

| | Product | Brand | Model No. | Serial No. | Power Cord |
|---|-------------|----------|------------|------------|--------------------|
| 1 | UART Board | tp-link | RS-232 1.0 | N/A | N/A |
| 2 | Notebook PC | Lenovo | T450 | N/A | Non-Shielded, 0.8m |
| 3 | USB Mouse | Logitech | M90 | N/A | N/A |

2.8. Description of Test Software

The test utility software used during testing was “Tera Term version 4.98”.

Note: Final power setting please refer to operational description.

2.9. Applied Standards

According to the specifications of the manufacturer, the EUT must comply with the requirements of the following standards:

- FCC Part 15.247
- KDB 558074 D01v05r02
- KDB 662911 D01v02r01
- ANSI C63.10-2013

2.10. Duty Cycle

2.4GHz WLAN (DTS) operation is possible in 20MHz and 40MHz channel bandwidths. The maximum achievable duty cycles for all modes were determined based on measurements performed on a spectrum analyzer in zero-span mode with RBW = 10MHz, VBW = 10MHz. The RBW and VBW were both greater than 50/T, where T is the minimum transmission duration, and the number of sweep points across T was greater than 100. The duty cycles are as follows:

| Test Mode | Duty Cycle |
|--------------|------------|
| 802.11b | 99.16% |
| 802.11g | 94.80% |
| 802.11n-HT20 | 94.18% |
| 802.11n-HT40 | 84.05% |

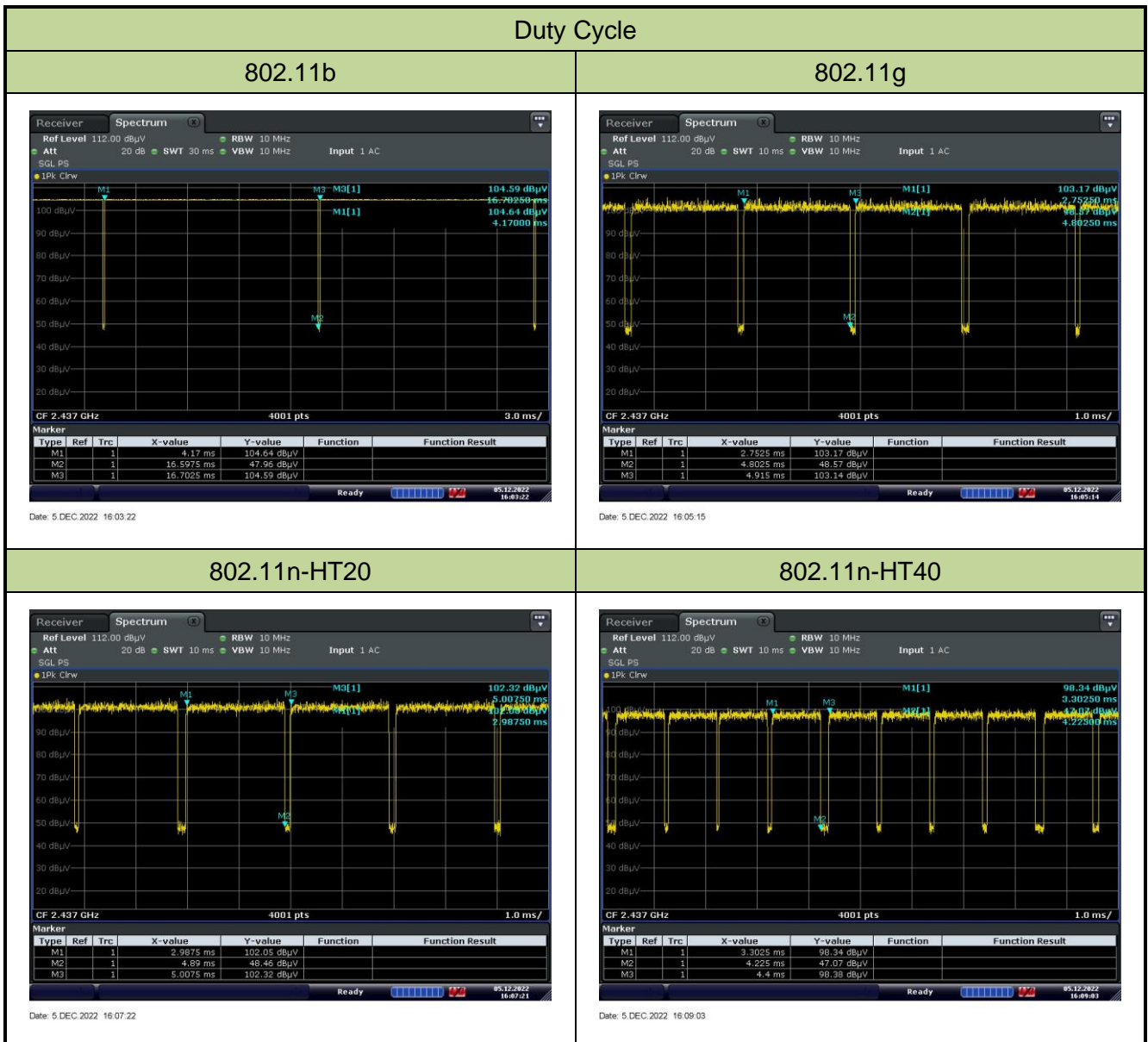

2.11. Test Configuration

The device was tested per the guidance of ANSI C63.10-2013. ANSI C63.10-2013 was used to reference the appropriate EUT setup for radiated spurious emissions testing and AC line conducted testing.

2.12. EMI Suppression Device(s)/Modifications

No EMI suppression device(s) were added and/or no modifications were made during testing.

2.13. Labeling Requirements

Per 2.1074 & 15.19; Docket 95-19

The label shall be permanently affixed at a conspicuous location on the device; instruction manual or pamphlet supplied to the user and be readily visible to the purchaser at the time of purchase. However, when the device is so small wherein placement of the label with specified statement is not practical, only the FCC ID must be displayed on the device per Section 15.19(a)(5). Please see attachment for FCC ID label and label location.

3. DESCRIPTION of TEST

3.1. Evaluation Procedure

The measurement procedures described in the American National Standard of Procedures for Compliance Testing of Unlicensed Wireless Devices (ANSI C63.10-2013), and the guidance was used in the measurement.

3.2. AC Line Conducted Emissions

The line-conducted facility is located inside an 8'x4'x4' shielded enclosure. A 1m x 2m wooden table 80cm high is placed 40cm away from the vertical wall and 80cm away from the sidewall of the shielded room. Two 10kHz-30MHz, 50Ω/50uH Line-Impedance Stabilization Networks (LISNs) are bonded to the shielded room floor. Power to the LISNs is filtered by external high-current high-insertion loss power line filters. These filters attenuate ambient signal noise from entering the measurement lines. These filters are also bonded to the shielded enclosure.

The EUT is powered from one LISN and the support equipment is powered from the second LISN. All interconnecting cables more than 1 meter were shortened to a 1 meter length by non-inductive bundling (serpentine fashion) and draped over the back edge of the test table. All cables were at least 40cm above the horizontal reference ground-plane. Power cables for support equipment were routed down to the second LISN while ensuring that that cables were not draped over the second LISN.

Sufficient time for the EUT, support equipment, and test equipment was allowed in order for them to warm up to their normal operating condition. The RF output of the LISN was connected to the receiver and exploratory measurements were made to determine the frequencies producing the maximum emission from the EUT. The receiver was scanned from 150kHz to 30MHz. The detector function was set to peak mode for exploratory measurements while the bandwidth of the analyzer was set to 9kHz. The EUT, support equipment, and interconnecting cables were arranged and manipulated to maximize each emission. Each emission was also maximized by varying power lines, the mode of operation or data exchange speed, or support equipment whichever determined the worst-case emission. Once the worst-case emissions have been identified, the one EUT cable configuration/arrangement and mode of operation that produced these emissions are used for final measurements on the same test site. The analyzer is set to CISPR quasi-peak and average detectors with a 9kHz resolution bandwidth for final measurements.

An extension cord was used to connect to a single LISN which powered by EUT. The extension cord was calibrated with LISN, the impedance and insertion loss are compliance with the requirements as stated in ANSI C63.10-2013.

3.3. Radiated Emissions

The radiated test facilities consisted of an indoor 3 meter semi-anechoic chamber used for final measurements and exploratory measurements, when necessary. The measurement area is contained within the semi-anechoic chamber which is shielded from any ambient interference. For measurements above 1GHz absorbers are arranged on the floor between the turn table and the antenna mast in such a way so as to maximize the reduction of reflections. For measurements below 1GHz, the absorbers are removed. A MF Model 210SS turntable is used for radiated measurement. It is a continuously rotatable, remote controlled, metallic turntable and 2 meters (6.56 ft.) in diameter. The turn table is flush with the raised floor of the chamber in order to maintain its function as a ground plane. An 80cm high PVC support structure is placed on top of the turntable.

For all measurements, the spectrum was scanned through all EUT azimuths and from 1 to 4 meter receive antenna height using a broadband antenna from 30MHz up to the upper frequency shown in 15.33(b)(1) depending on the highest frequency generated or used in the device or on which the device operates or tunes. For frequencies above 1GHz, linearly polarized double ridge horn antennas were used. For frequencies below 30MHz, a calibrated loop antenna was used. When exploratory measurements were necessary, they were performed at 1 meter test distance inside the semi-anechoic chamber using broadband antennas, broadband amplifiers, and spectrum analyzers to determine the frequencies and modes producing the maximum emissions. Sufficient time for the EUT, support equipment, and test equipment was allowed in order for them to warm up to their normal operating condition. The test set-up for frequencies below 1GHz was placed on top of the 0.8 meter high, 1 x 1.5 meter table; and test set-up for frequencies 1-40GHz was placed on top of the 1.5 meter high, 1 x 1.5 meter table. The EUT, support equipment, and interconnecting cables were arranged and manipulated to maximize each emission. Appropriate precaution was taken to ensure that all emissions from the EUT were maximized and investigated. The system configuration, clock speed, mode of operation or video resolution, if applicable, turntable azimuth, and receive antenna height was noted for each frequency found.

Final measurements were made in the semi-anechoic chamber using calibrated, linearly polarized broadband and horn antennas. The test setup was configured to the setup that produced the worst case emissions. The spectrum analyzer was set to investigate all frequencies required for testing to compare the highest radiated disturbances with respect to the specified limits. The turntable containing the EUT was rotated through 360 degrees and the height of the receive antenna was varied 1 to 4 meters and stopped at the azimuth and height producing the maximum emission. Each emission was maximized by changing the orientation of the EUT through three orthogonal planes and changing the polarity of the receive antenna, whichever produced the worst-case emissions. According to 3dB Beam-Width of horn antenna, the horn antenna should be always directed to the EUT when rising height.

4. ANTENNA REQUIREMENTS

Excerpt from §15.203 of the FCC Rules/Regulations:

“An intentional radiator antenna shall be designed to ensure that no antenna other than that furnished by the responsible party can be used with the device. The use of a permanently attached antenna or of an antenna that uses a unique coupling to the intentional radiator shall be considered sufficient to comply with the provisions of this section.”

- The antenna of the device is **permanently attached**.
- There are no provisions for connection to an external antenna.

Conclusion:

The unit complies with the requirement of §15.203.

5. TEST EQUIPMENT CALIBRATION DATE

Conducted Emissions

| Instrument | Manufacturer | Type No. | Asset No. | Cali. Interval | Cali. Due Date |
|--------------------|--------------|----------|-------------|----------------|----------------|
| Two-Line V-Network | R&S | ENV216 | MRTTWA00019 | 1 year | 2024/3/7 |
| Two-Line V-Network | R&S | ENV216 | MRTTWA00020 | 1 year | 2024/4/17 |
| EMI Test Receiver | R&S | ESR3 | MRTTWA00045 | 1 year | 2024/5/10 |

Radiated Emissions

| Instrument | Manufacturer | Type No. | Asset No. | Cali. Interval | Cali. Due Date |
|----------------------------|--------------|---------------------------|-------------|----------------|----------------|
| Active Loop Antenna | SCHWARZBECK | FMZB 1519B | MRTTWA00002 | 1 year | 2024/5/22 |
| Broadband TRILOG Antenna | SCHWARZBECK | VULB 9162 | MRTTWA00001 | 1 year | 2024/12/21 |
| Broadband Hornantenna | SCHWARZBECK | BBHA 9120D | MRTTWA00003 | 1 year | 2024/3/24 |
| Broadband Preamplifier | SCHWARZBECK | BBV 9718 | MRTTWA00005 | 1 year | 2024/3/24 |
| Breitband Hornantenna | SCHWARZBECK | BBHA 9170 | MRTTWA00004 | 1 year | 2024/3/20 |
| Broadband Amplifier | SCHWARZBECK | BBV 9721 | MRTTWA00006 | 1 year | 2024/3/27 |
| EMI Test Receiver | R&S | ESR3 | MRTTWA00009 | 1 year | 2024/3/8 |
| Signal Analyzer | R&S | FSV40 | MRTTWA00007 | 1 year | 2024/3/14 |
| Antenna Cable | HUBERSUHNER | SF106 | MRTTWE00010 | 1 year | 2024/6/13 |
| Cable | Rosnol | K1K50-UP02 64-K1K50-4M | MRTTWE00012 | 1 year | 2024/6/18 |
| Temperature/Humidity Meter | TFA | 35.1078.10.IT | MRTTWA00032 | 1 year | 2024/6/4 |

Conducted Test Equipment

| Instrument | Manufacturer | Type No. | Asset No. | Cali. Interval | Cali. Due Date |
|--|--------------|----------|-------------|----------------|----------------|
| X-Series USB Peak and Average Power Sensor | KEYSIGHT | U2021XA | MRTTWA00014 | 1 year | 2024/4/19 |
| EXA Signal Analyzer | KEYSIGHT | N9010A | MRTTWA00012 | 1 year | 2023/10/5 |
| EXA Signal Analyzer | KEYSIGHT | N9010B | MRTTWA00074 | 1 year | 2024/7/19 |
| Attenuator | WTI | 218FS-20 | MRTTWE00026 | 1 year | 2023/11/2 |
| Attenuator | WTI | 218FS-10 | MRTTWE00027 | 1 year | 2024/6/14 |
| Attenuator | WTI | 218FS-06 | MRTTWE00028 | 1 year | 2024/6/14 |
| Temperature & Humidity Chamber | TEN BILLION | TTH-B3UP | MRTTWA00036 | 1 year | 2024/6/11 |
| DIVA PLUS Funk-Wetterstation | TFA | 35.1083 | MRTTWA00050 | 1 year | 2024/6/15 |

| Software | Version | Function |
|----------|-----------|-------------------|
| e3 | 9.160520a | EMI Test Software |

6. MEASUREMENT UNCERTAINTY

Where relevant, the following test uncertainty levels have been estimated for tests performed on the EUT as specified in CISPR 16-4-2. This uncertainty represents an expanded uncertainty expressed at approximately the 95% confidence level using a coverage factor of $k = 2$.

| |
|---|
| AC Conducted Emission Measurement |
| Measuring Uncertainty for a Level of Confidence of 95% ($U=2Uc(y)$): 150kHz~30MHz: $\pm 2.53\text{dB}$ |
| Radiated Emission Measurement |
| Measuring Uncertainty for a Level of Confidence of 95% ($U=2Uc(y)$): 9kHz ~ 1GHz: $\pm 4.25\text{dB}$ 1GHz ~ 40GHz: $\pm 4.45\text{dB}$ |
| Conducted Power (Carrier Power / Power Density) |
| Measuring Uncertainty for a Level of Confidence of 95% ($U=2Uc(y)$): $\pm 0.84\text{dB}$ |
| Conducted Spurious Emission |
| Measuring Uncertainty for a Level of Confidence of 95% ($U=2Uc(y)$): $\pm 2.65\text{ dB}$ |
| Occupied Bandwidth |
| Measuring Uncertainty for a Level of Confidence of 95% ($U=2Uc(y)$): $\pm 3.3\%$ |
| Temp. / Humidity |
| Measuring Uncertainty for a Level of Confidence of 95% ($U=2Uc(y)$): $\pm 0.82^\circ\text{C} / \pm 3\%$ |

7. TEST RESULT

7.1. Summary

| FCC Section(s) | Test Description | Test Limit | Test Condition | Test Result | Reference |
|------------------|---|--|----------------|-------------|-------------------|
| 15.247(a)(2) | 6dB Bandwidth | $\geq 500\text{kHz}$ | Conducted | Pass | Section 7.2 |
| 15.247(b)(3) | Output Power | $\leq 30\text{dBm}$ | | Pass | Section 7.3 |
| 15.247(e) | Power Spectral Density | $\leq 8\text{dBm}/3\text{kHz}$ | | Pass | Section 7.4 |
| 15.247(d) | Band Edge / Out-of-Band Emissions | $\geq 30\text{dBc}$ (Average) | | Pass | Section 7.5 |
| 15.205 15.209 | General Field Strength Limits (Restricted Bands and Radiated Emission Limits) | Emissions in restricted bands must meet the radiated limits detailed in 15.209 | Radiated | Pass | Section 7.6 & 7.7 |
| 15.207 | AC Conducted Emissions 150kHz - 30MHz | $< \text{FCC } 15.207 \text{ limits}$ | Line Conducted | Pass | Section 7.8 |

Notes:

- 1) Determining compliance is based on the test results met the regulation limits or requirements declared by clients, and the test results don't take into account the value of measurement uncertainty.
- 2) The analyzer plots shown in this section were all taken with a correction table loaded into the analyzer. The correction table was used to account for the losses of the cables and attenuators used as part of the system to connect the EUT to the analyzer at all frequencies of interest.
- 3) For radiated emission test, every axis (X, Y, Z) was also verified. The test results shown in the following sections represent the worst-case emissions.
- 4) All items' test data except the AC Conducted Emissions are from the previous report (report No.: 2212TW0110-U1), since the new sample was changed the CPU and adapter based on the previous sample, but the changes have no effect on the RF parameters, so only AC Conducted Emissions is retested.

7.2. 6dB Bandwidth Measurement

7.2.1. Test Limit

The minimum 6dB bandwidth shall be at least 500 kHz.

7.2.2. Test Procedure used

ANSI C63.10 - 2013 Section 11.8

7.2.3. Test Setting

1. The Spectrum's automatic bandwidth measurement capability was used to perform the 6dB bandwidth measurement. The "X" dB bandwidth parameter was set to $X = 6$. The bandwidth measurement was not influenced by any intermediate power nulls in the fundamental emission.
2. Set RBW = 100 kHz
3. $VBW \geq 3 \times RBW$
4. Detector = Peak
5. Trace mode = max hold
6. Sweep = auto couple
7. Allow the trace was allowed to stabilize

7.2.4. Test Setup

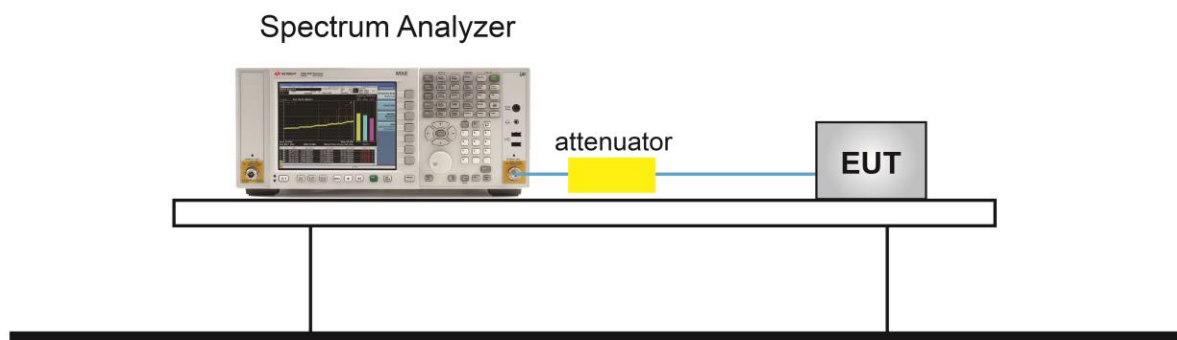

7.2.5. Test Result

| | | | |
|---------------|---|-------------------|-------------------------|
| Product | 4MP Outdoor Full-Color Wi-Fi Bullet Network Camera | Temperature | 25°C |
| Test Engineer | Jay | Relative Humidity | 54% |
| Test Site | SR5 | Test Date | 2022/06/25 ~ 2022/12/07 |

| Test Mode | Data Rate / MCS | Channel No. | Frequency (MHz) | 6dB Bandwidth (MHz) | Limit (MHz) | Result |
|--------------|--------------------|-------------|--------------------|------------------------|----------------|--------|
| Ant 0 | | | | | | |
| 802.11b | 1Mbps | 01 | 2412 | 10.040 | ≥ 0.5 | Pass |
| 802.11b | 1Mbps | 06 | 2437 | 10.020 | ≥ 0.5 | Pass |
| 802.11b | 1Mbps | 11 | 2462 | 9.079 | ≥ 0.5 | Pass |
| 802.11g | 6Mbps | 01 | 2412 | 16.400 | ≥ 0.5 | Pass |
| 802.11g | 6Mbps | 06 | 2437 | 16.420 | ≥ 0.5 | Pass |
| 802.11g | 6Mbps | 11 | 2462 | 16.390 | ≥ 0.5 | Pass |
| 802.11n-HT20 | MCS0 | 01 | 2412 | 17.620 | ≥ 0.5 | Pass |
| 802.11n-HT20 | MCS0 | 06 | 2437 | 17.640 | ≥ 0.5 | Pass |
| 802.11n-HT20 | MCS0 | 11 | 2462 | 17.610 | ≥ 0.5 | Pass |
| 802.11n-HT40 | MCS0 | 03 | 2422 | 36.310 | ≥ 0.5 | Pass |
| 802.11n-HT40 | MCS0 | 06 | 2437 | 36.320 | ≥ 0.5 | Pass |
| 802.11n-HT40 | MCS0 | 09 | 2452 | 36.310 | ≥ 0.5 | Pass |

802.11b 6dB Bandwidth - Ant 0

Channel 01 (2412MHz)

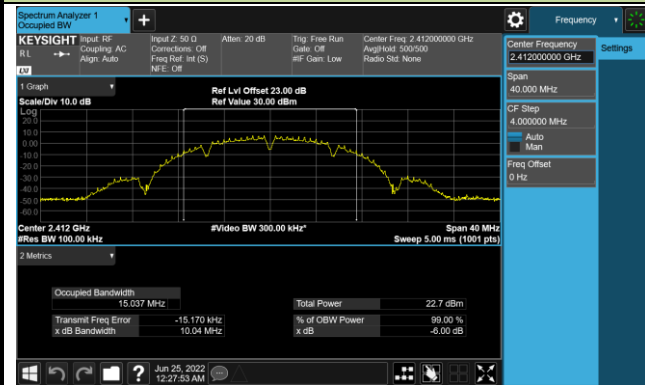

Channel 06 (2437MHz)

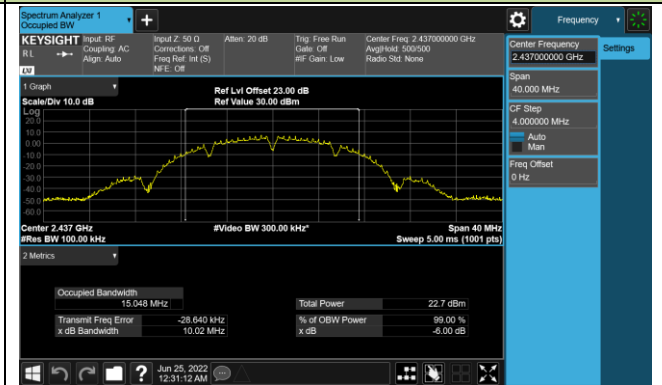

Channel 11 (2462MHz)



802.11g 6dB Bandwidth - Ant 0

Channel 01 (2412MHz)

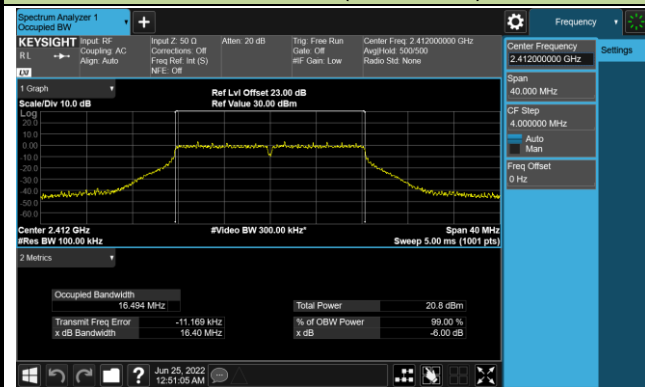

Channel 06 (2437MHz)

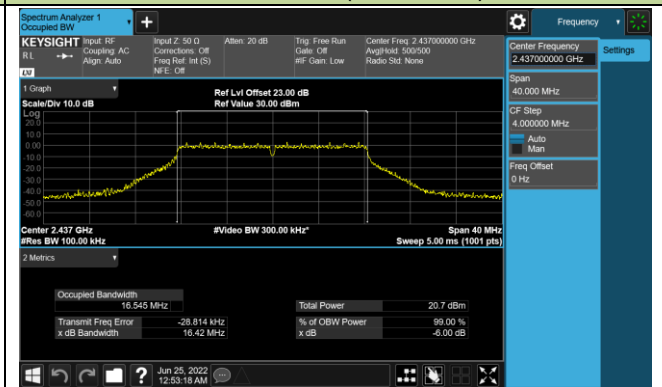

Channel 11 (2462MHz)

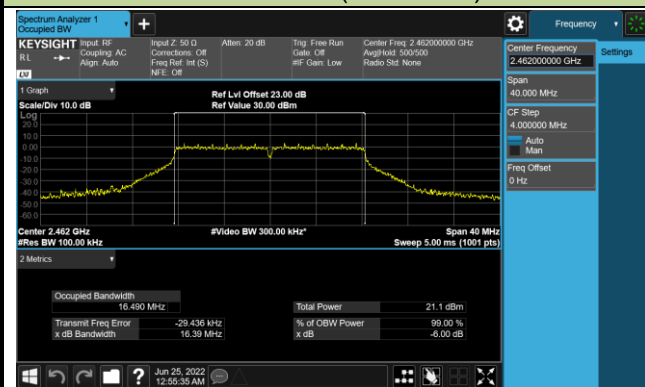

802.11n-HT20 6dB Bandwidth - Ant 0

Channel 01 (2412MHz)

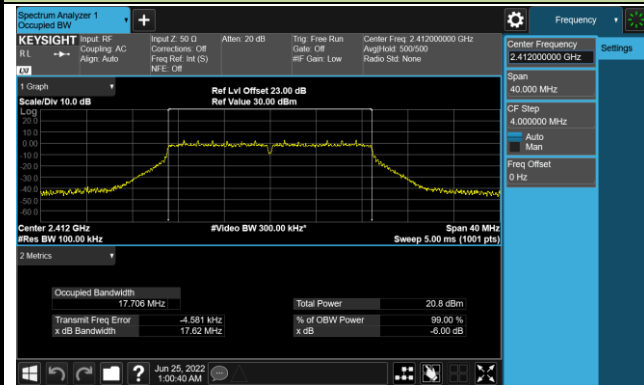

Channel 06 (2437MHz)

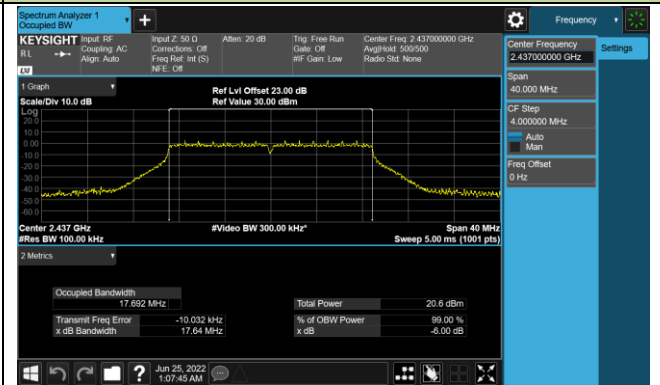

Channel 11 (2462MHz)

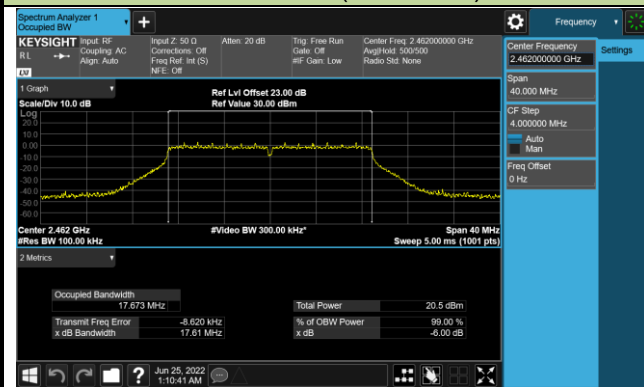

802.11n-HT40 6dB Bandwidth - Ant 0

Channel 03 (2422MHz)

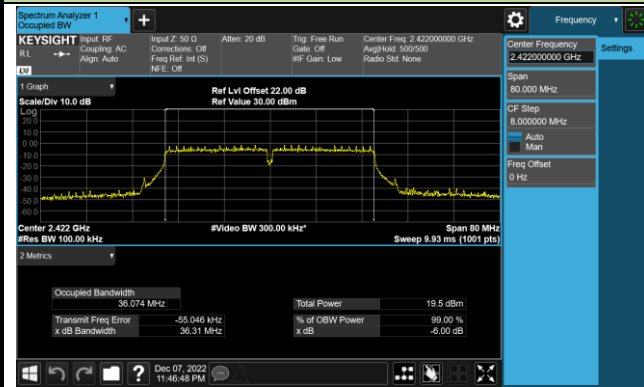

Channel 06 (2437MHz)

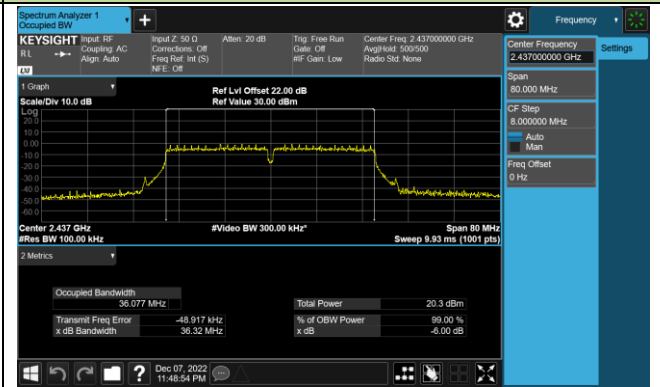

Channel 09 (2452MHz)

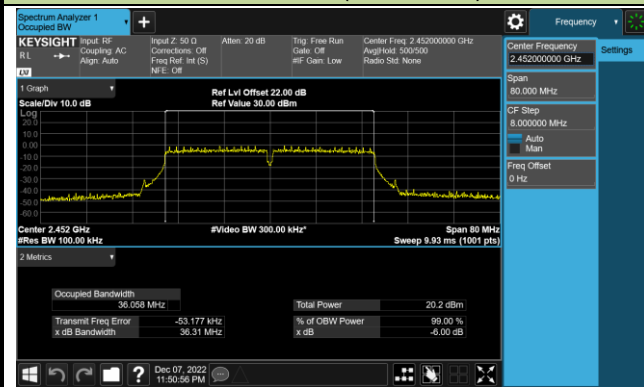

7.3. Output Power Measurement

7.3.1. Test Limit

The maximum output power shall be less 1 Watt (30dBm).

The conducted output power limit specified in paragraph FCC Part 15.247(b) of this section is based on the use of antennas with directional gains that do not exceed 6 dBi. If transmitting antennas of directional gain greater than 6 dBi are used, the conducted output power from the intentional radiator shall be reduced below the stated values in paragraphs FCC Part 15.247(b)(3) of this section, as appropriate, by the amount in dB that the directional gain of the antenna exceeds 6 dBi.

7.3.2. Test Procedure Used

ANSI C63.10 - 2013 Section 11.9.2.3.2

7.3.3. Test Setting

Average Power Measurement

Average power measurements were performed only when the EUT was transmitting at its maximum power control level using a broadband power meter with a pulse sensor. The power meter implemented triggering and gating capabilities which were set up such that power measurements were recorded only during the ON time of the transmitter.

7.3.4. Test Setup

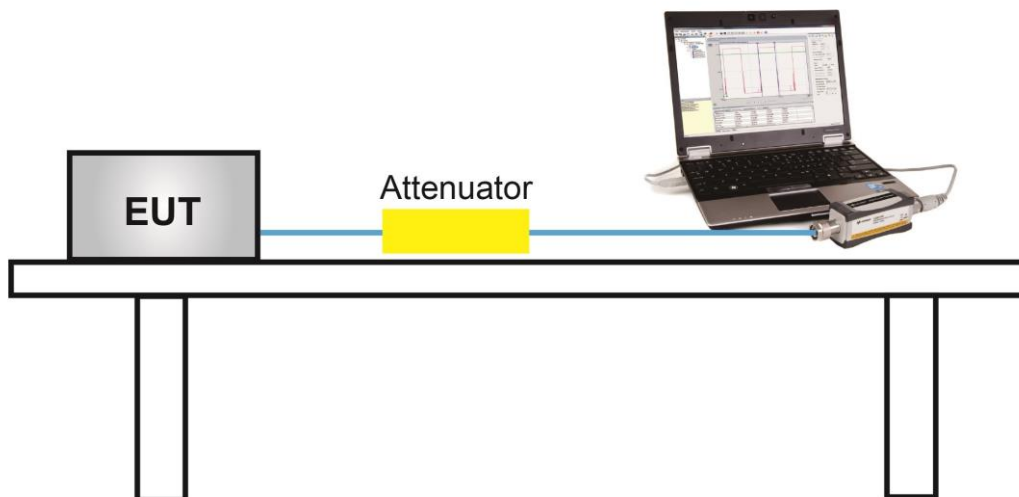

7.3.5. Test Result

| | | | |
|---------------|--|-------------------|------------|
| Product | 4MP Outdoor Full-Color Wi-Fi Bullet Network Camera | Temperature | 25°C |
| Test Engineer | Jay | Relative Humidity | 54% |
| Test Site | SR5 | Test Date | 2022/06/22 |

| Test Mode | Data Rate/ MCS | Channel No. | Freq. (MHz) | Ant 0 Average Power (dBm) | Ant 1 Average Power (dBm) | Total Average Power (dBm) | Limit (dBm) | Result |
|--------------|-------------------|----------------|----------------|---------------------------------|---------------------------------|---------------------------------|----------------|--------|
| SISO Mode | | | | | | | | |
| 802.11b | 1Mbps | 01 | 2412 | 15.14 | -- | -- | ≤ 30.00 | Pass |
| 802.11b | 1Mbps | 06 | 2437 | 15.47 | -- | -- | ≤ 30.00 | Pass |
| 802.11b | 1Mbps | 11 | 2462 | 15.19 | -- | -- | ≤ 30.00 | Pass |
| CDD Mode | | | | | | | | |
| 802.11g | 6Mbps | 01 | 2412 | 15.06 | 15.14 | 18.11 | ≤ 30.00 | Pass |
| 802.11g | 6Mbps | 06 | 2437 | 15.18 | 15.31 | 18.26 | ≤ 30.00 | Pass |
| 802.11g | 6Mbps | 11 | 2462 | 15.41 | 15.23 | 18.33 | ≤ 30.00 | Pass |
| 802.11n-HT20 | MCS0 | 01 | 2412 | 15.11 | 15.33 | 18.23 | ≤ 30.00 | Pass |
| 802.11n-HT20 | MCS0 | 06 | 2437 | 15.06 | 15.49 | 18.29 | ≤ 30.00 | Pass |
| 802.11n-HT20 | MCS0 | 11 | 2462 | 15.35 | 15.21 | 18.29 | ≤ 30.00 | Pass |
| 802.11n-HT40 | MCS0 | 03 | 2422 | 14.10 | 14.24 | 17.18 | ≤ 30.00 | Pass |
| 802.11n-HT40 | MCS0 | 06 | 2437 | 15.07 | 15.14 | 18.12 | ≤ 30.00 | Pass |
| 802.11n-HT40 | MCS0 | 09 | 2452 | 14.74 | 15.08 | 17.92 | ≤ 30.00 | Pass |

Note: Total Average Power (dBm) = $10 \cdot \log \{10^{(\text{Ant 0 Average Power} / 10)} + 10^{(\text{Ant 1 Average Power} / 10)}\}$

7.4. Power Spectral Density Measurement

7.4.1. Test Limit

The maximum permissible power spectral density is 8dBm in any 3 kHz band.

The same method of determining the conducted output power shall be used to determine the power spectral density.

7.4.2. Test Procedure Used

ANSI C63.10 - 2013 Section 11.10.5

7.4.3. Test Setting

1. Measure the duty cycle (x) of the transmitter output signal.
2. Set instrument center frequency to DTS channel center frequency.
3. Set span to at least 1.5 times the OBW.
4. RBW = 10 kHz.
5. VBW = 30 kHz.
6. Detector = RMS.
7. Ensure that the number of measurement points in the sweep $\geq 2 \times \text{span}/\text{RBW}$.
8. Sweep time = auto couple.
9. Don't use sweep triggering. Allow sweep to "free run".
10. Employ trace averaging (RMS) mode over a minimum of 100 traces.
11. Use the peak marker function to determine the maximum amplitude level.
12. Add $10 \log (1/x)$, where x is the duty cycle measured in step (a), to the measured PSD to compute the average PSD during the actual transmission time.

7.4.4. Test Setup

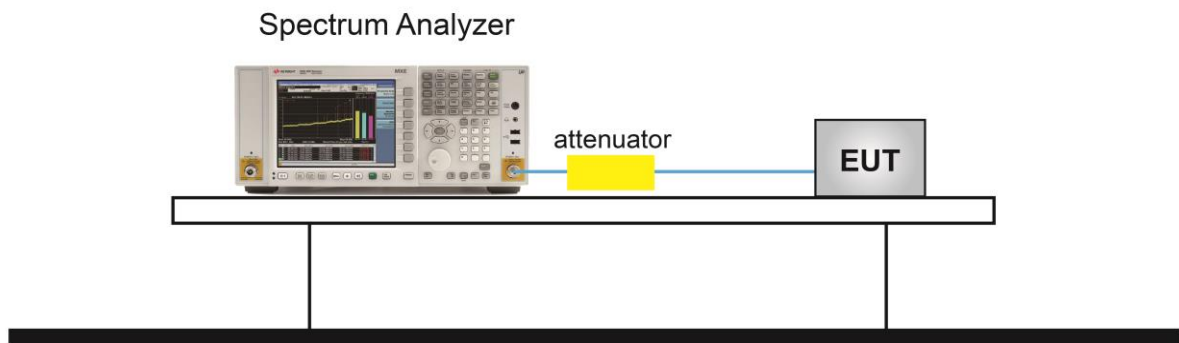

7.4.5. Test Result

| | | | |
|---------------|--|-------------------|------------------------|
| Product | 4MP Outdoor Full-Color Wi-Fi Bullet Network Camera | Temperature | 25°C |
| Test Engineer | Jay | Relative Humidity | 54% |
| Test Site | SR5 | Test Date | 2022/6/25 ~ 2022/12/07 |

| Test Mode | Data Rate/MCS | Channel No. | Freq. (MHz) | PSD (dBm/10kHz) | Duty Cycle (%) | Final PSD (dBm/10kHz) | Limit (dBm/3kHz) | Result |
|-----------|---------------|-------------|-------------|-----------------|----------------|-----------------------|------------------|--------|
| 802.11b | 1Mbps | 01 | 2412 | -10.060 | 99.16% | -10.060 | ≤ 8.00 | Pass |
| 802.11b | 1Mbps | 06 | 2437 | -10.211 | 99.16% | -10.211 | ≤ 8.00 | Pass |
| 802.11b | 1Mbps | 11 | 2462 | -10.838 | 99.16% | -10.838 | ≤ 8.00 | Pass |

Note: For 802.11b, When EUT duty cycle ≥ 98%, Final AVGPSSD = AVGPSSD.

| Test Mode | Data Rate/MCS | Channel No. | Freq. (MHz) | Ant 0 PSD (dBm/10kHz) | Ant 1 PSD (dBm/10kHz) | Duty Cycle (%) | Total PSD (dBm/10kHz) | Limit (dBm/3kHz) | Result |
|--------------|---------------|-------------|-------------|-----------------------|-----------------------|----------------|-----------------------|------------------|--------|
| 802.11g | 6Mbps | 01 | 2412 | -12.147 | -12.023 | 94.80% | -8.842 | ≤ 8.00 | Pass |
| 802.11g | 6Mbps | 06 | 2437 | -12.073 | -12.700 | 94.80% | -9.133 | ≤ 8.00 | Pass |
| 802.11g | 6Mbps | 11 | 2462 | -12.017 | -12.793 | 94.80% | -9.145 | ≤ 8.00 | Pass |
| 802.11n-HT20 | MCS0 | 01 | 2412 | -13.103 | -12.266 | 94.18% | -9.394 | ≤ 8.00 | Pass |
| 802.11n-HT20 | MCS0 | 06 | 2437 | -13.575 | -12.602 | 94.18% | -9.791 | ≤ 8.00 | Pass |
| 802.11n-HT20 | MCS0 | 11 | 2462 | -13.760 | -11.700 | 94.18% | -9.338 | ≤ 8.00 | Pass |
| 802.11n-HT40 | MCS0 | 03 | 2422 | -15.777 | -16.176 | 84.05% | -12.207 | ≤ 8.00 | Pass |
| 802.11n-HT40 | MCS0 | 06 | 2437 | -15.018 | -15.475 | 84.05% | -11.476 | ≤ 8.00 | Pass |
| 802.11n-HT40 | MCS0 | 09 | 2452 | -16.055 | -16.029 | 84.05% | -12.277 | ≤ 8.00 | Pass |

Note: For 802.11g/n, When EUT duty cycle < 98%, Total AVGPSSD = $10 \cdot \log \{ 10^{(\text{Ant 0 AVGPSSD}/10)} + 10^{(\text{Ant 1 AVGPSSD}/10)} \} + 10 \cdot \log (1/\text{Duty Cycle})$.

802.11b AVGPSD - Ant 0

Channel 01 (2412MHz)



Channel 06 (2437MHz)

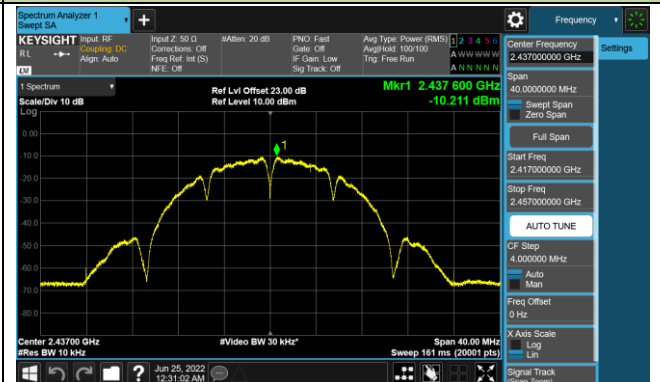

Channel 11 (2462MHz)

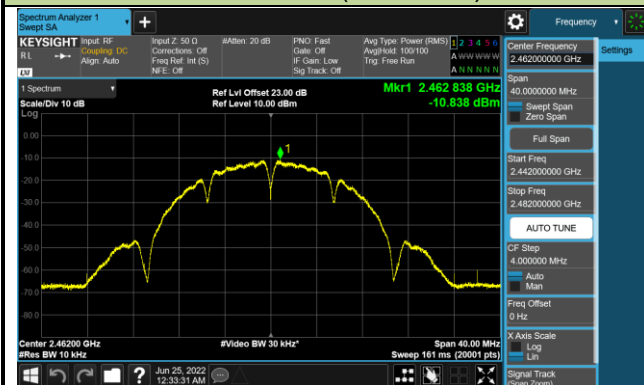

802.11g AVGPSD - Ant 0

Channel 01 (2412MHz)

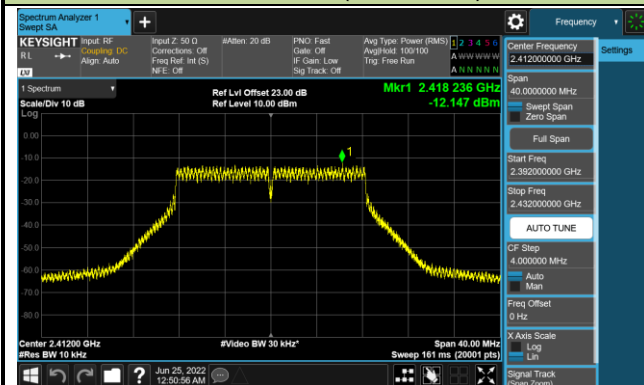

Channel 06 (2437MHz)

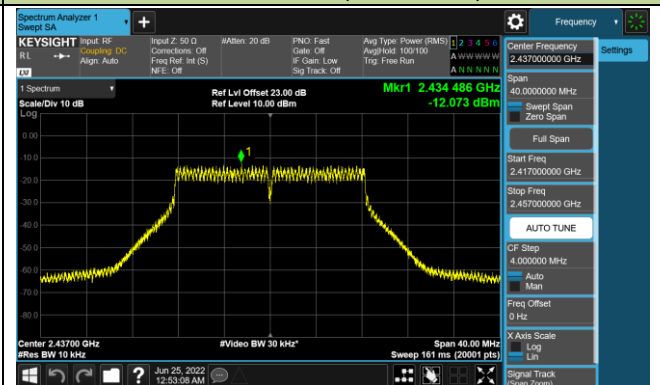

Channel 11 (2462MHz)

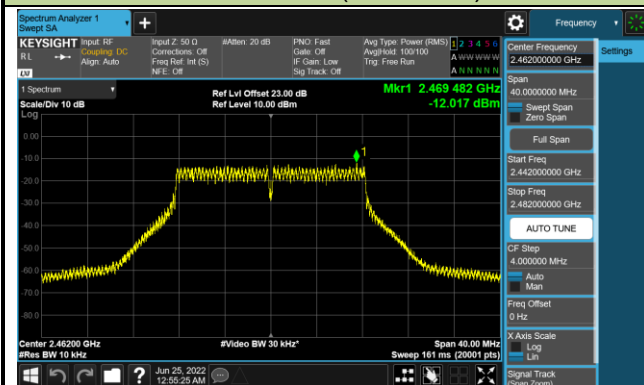

802.11n-HT20 AVGPDS - Ant 0 - CDD Mode

Channel 01 (2412MHz)

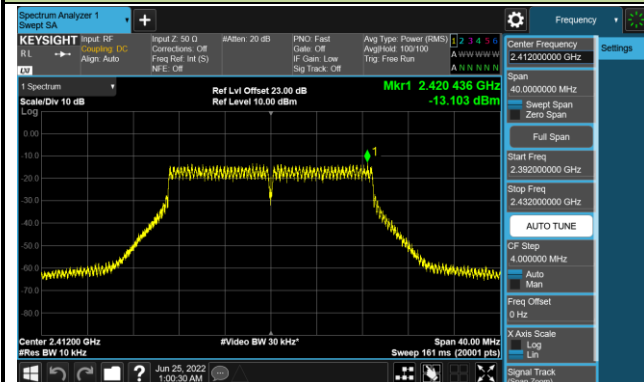

Channel 06 (2437MHz)

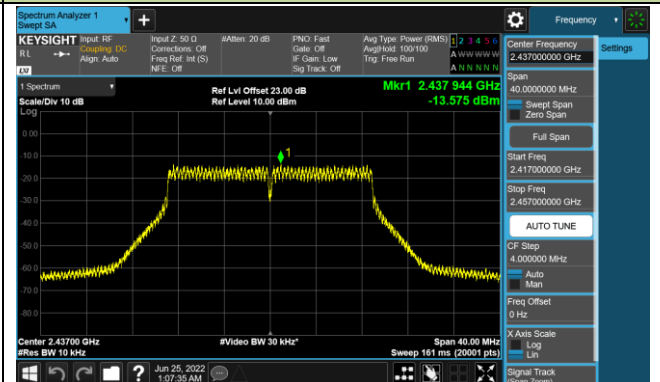

Channel 11 (2462MHz)

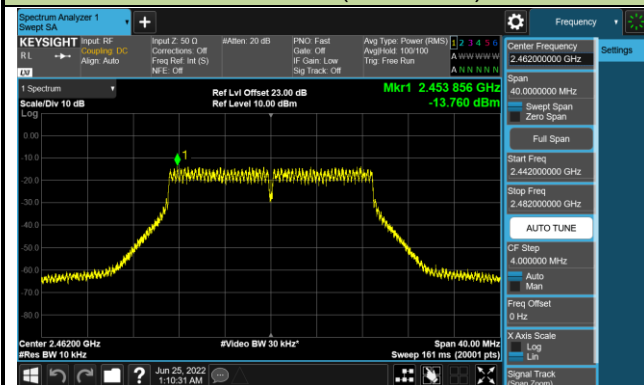

802.11n-HT40 AVGPDS - Ant 0 - CDD Mode

Channel 03 (2422MHz)

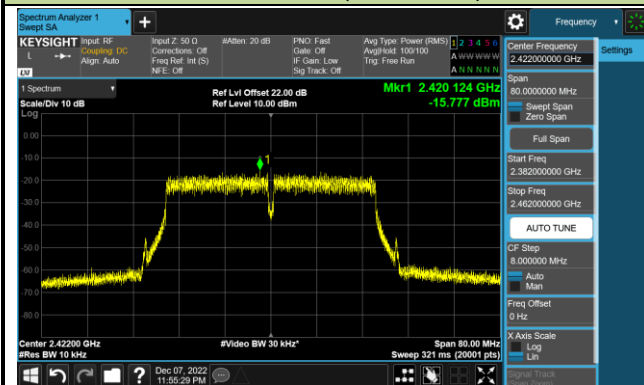

Channel 06 (2437MHz)

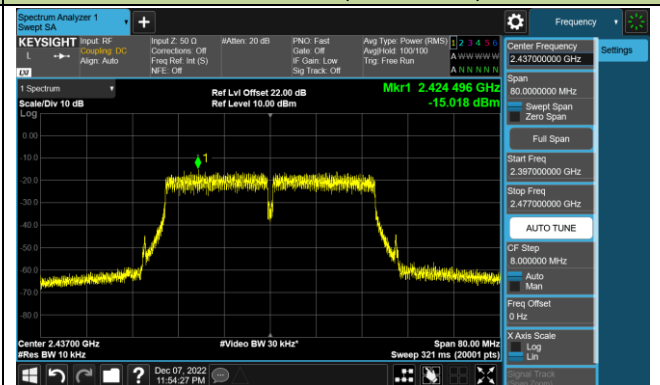

Channel 09 (2452MHz)



802.11g AVGPSD - Ant 1

Channel 01 (2412MHz)

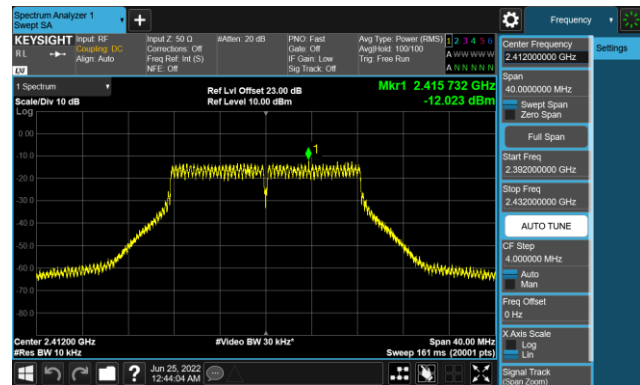

Channel 06 (2437MHz)

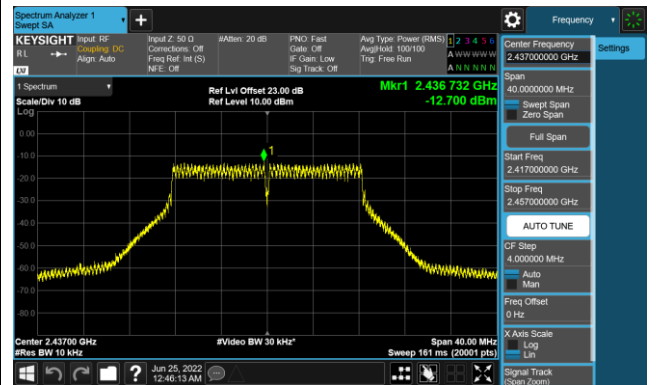

Channel 11 (2462MHz)

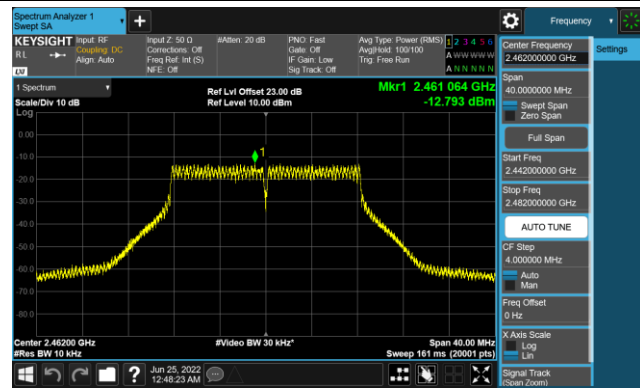

802.11n-HT20 AVGPSD - Ant 1 - CDD Mode

Channel 01 (2412MHz)

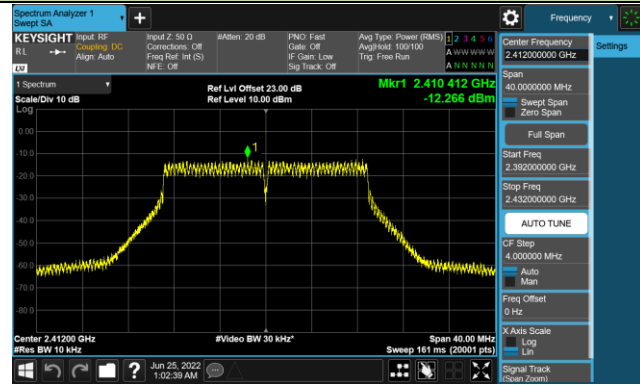

Channel 06 (2437MHz)

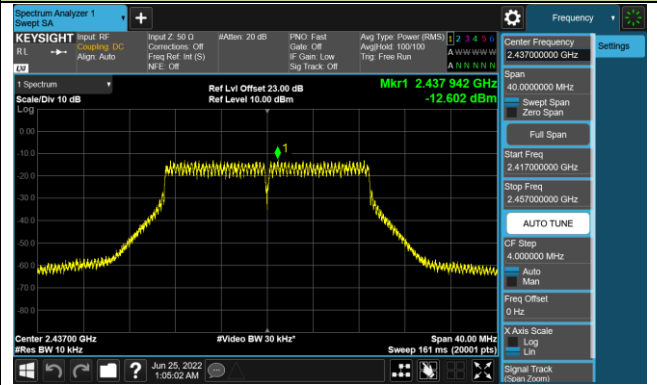

Channel 11 (2462MHz)

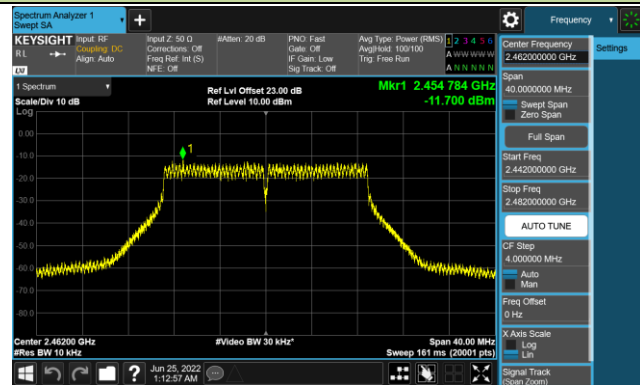

802.11n-HT40 AVGPDS - Ant 1 - CDD Mode

Channel 03 (2422MHz)



Channel 06 (2437MHz)

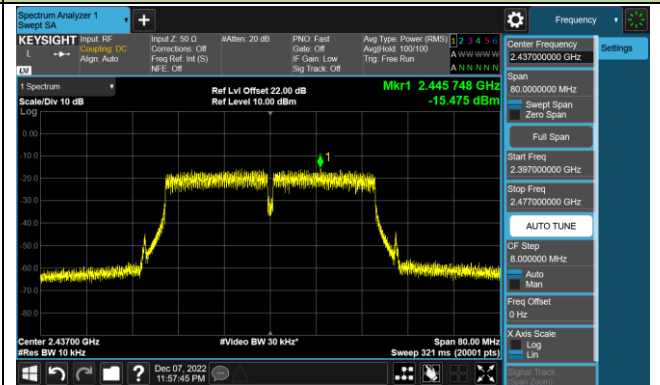

Channel 09 (2452MHz)

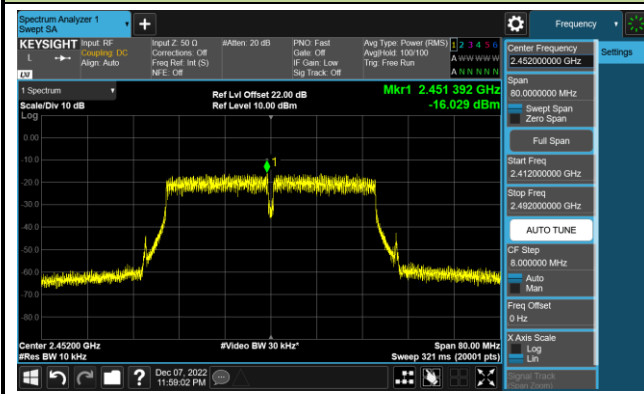

7.5. Conducted Band Edge and Out-of-Band Emissions

7.5.1. Test Limit

The limit for out-of-band spurious emissions at the band edge is 30dB below the fundamental emission level, as determined from the in-band power measurement of the DTS channel performed in a 100 kHz bandwidth per the PSD procedure.

7.5.2. Test Procedure Used

ANSI C63.10 - 2013 Section 11.11

7.5.3. Test Setting

Reference level measurement

1. Set instrument center frequency to DTS channel center frequency
2. Set the span to ≥ 1.5 times the DTS bandwidth
3. Set the RBW = 100 kHz
4. Set the VBW $\geq 3 \times$ RBW
5. Detector = peak
6. Sweep time = auto couple
7. Trace mode = max hold
8. Allow trace to fully stabilize

Emission level measurement

1. Set the center frequency and span to encompass frequency range to be measured
2. RBW = 100kHz
3. VBW = 300kHz
4. Detector = Peak
5. Trace mode = max hold
6. Sweep time = auto couple
7. The trace was allowed to stabilize

7.5.4. Test Setup

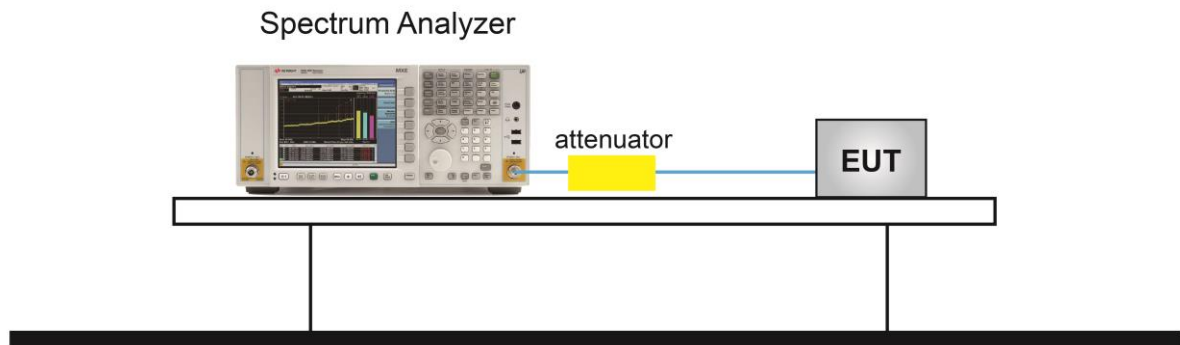

7.5.5. Test Result

| | | | |
|---------------|---|-------------------|------------------------|
| Product | 4MP Outdoor Full-Color Wi-Fi Bullet Network Camera | Temperature | 25°C |
| Test Engineer | Jay | Relative Humidity | 54% |
| Test Site | SR5 | Test Date | 2022/6/25 ~ 2022/12/07 |

| Test Mode | Data Rate / MCS | Channel No. | Frequency (MHz) | Limit (dBc) | Result |
|--------------|--------------------|-------------|--------------------|----------------|--------|
| 802.11b | 1Mbps | 01 | 2412 | 30 | Pass |
| 802.11b | 1Mbps | 06 | 2437 | 30 | Pass |
| 802.11b | 1Mbps | 11 | 2462 | 30 | Pass |
| 802.11g | 6Mbps | 01 | 2412 | 30 | Pass |
| 802.11g | 6Mbps | 06 | 2437 | 30 | Pass |
| 802.11g | 6Mbps | 11 | 2462 | 30 | Pass |
| 802.11n-HT20 | MCS0 | 01 | 2412 | 30 | Pass |
| 802.11n-HT20 | MCS0 | 06 | 2437 | 30 | Pass |
| 802.11n-HT20 | MCS0 | 11 | 2462 | 30 | Pass |
| 802.11n-HT40 | MCS0 | 03 | 2422 | 30 | Pass |
| 802.11n-HT40 | MCS0 | 06 | 2437 | 30 | Pass |
| 802.11n-HT40 | MCS0 | 09 | 2452 | 30 | Pass |

Antenna 0

802.11 b CH01 (2412MHz)

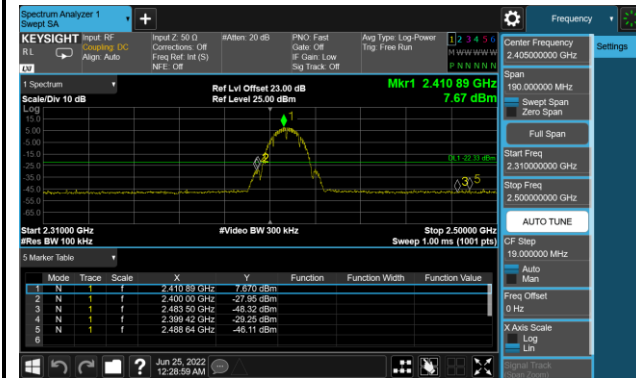

802.11 b CH01 (2412MHz)

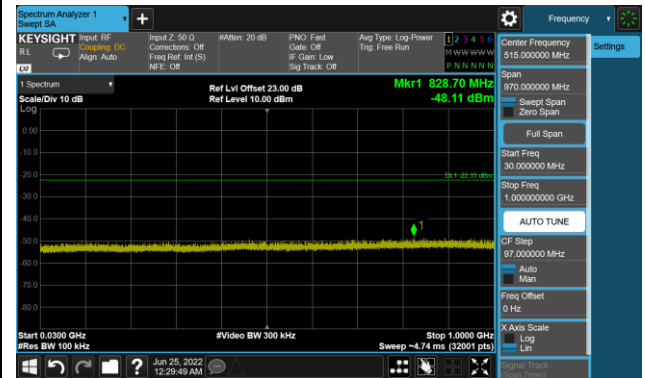

802.11 b CH01 (2412MHz)

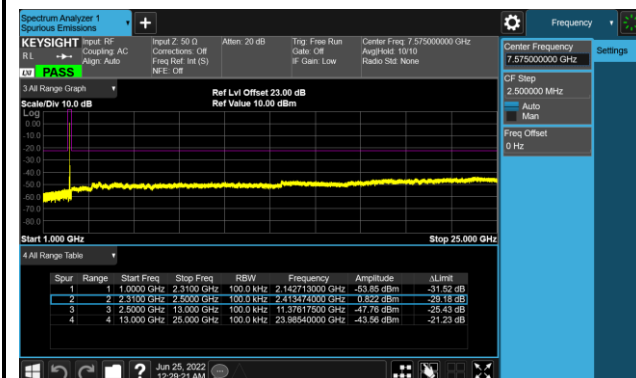

802.11 b CH06 (2437MHz)

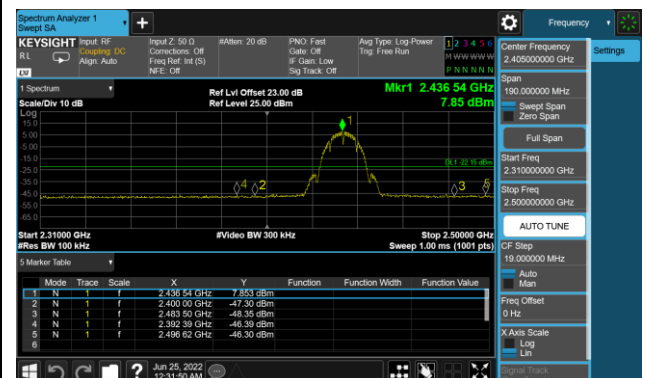

802.11 b CH06 (2437MHz)

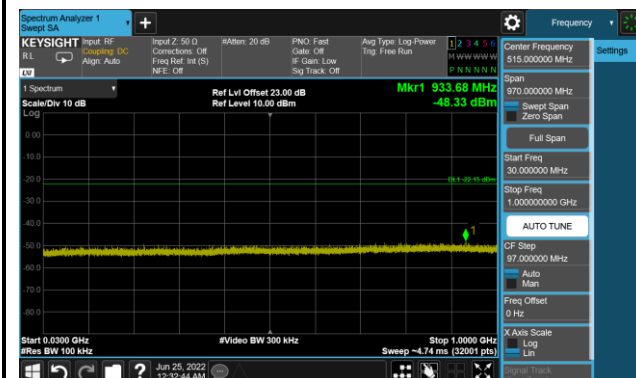

802.11 b CH06 (2437MHz)

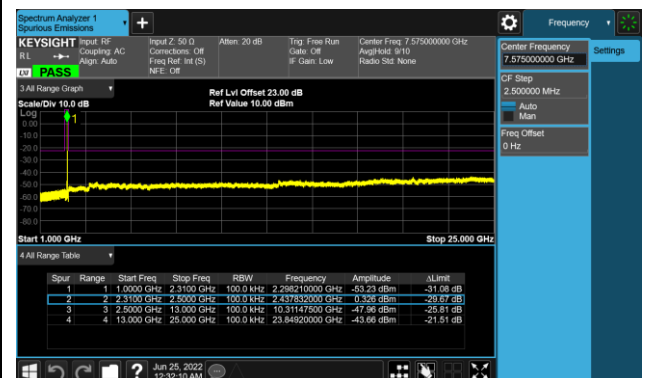

802.11 b CH11 (2462MHz)

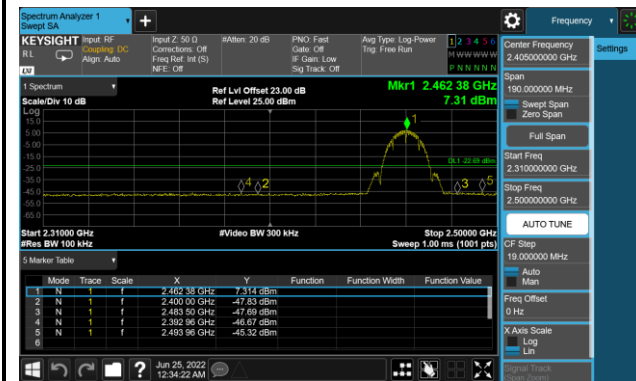

802.11 b CH11 (2462MHz)

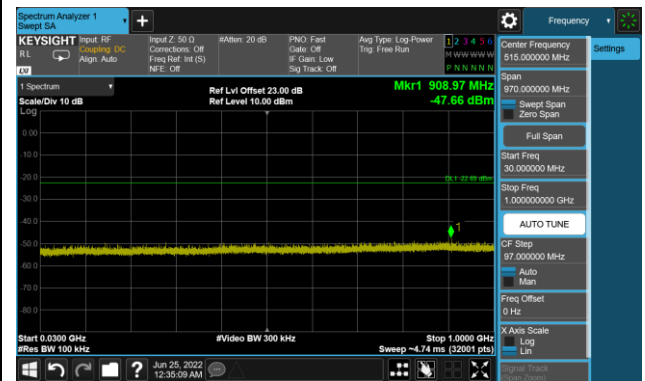

802.11 b CH11 (2462MHz)

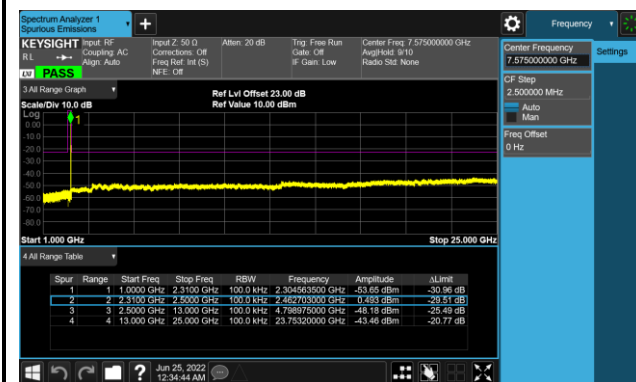

802.11 g CH01 (2412MHz)

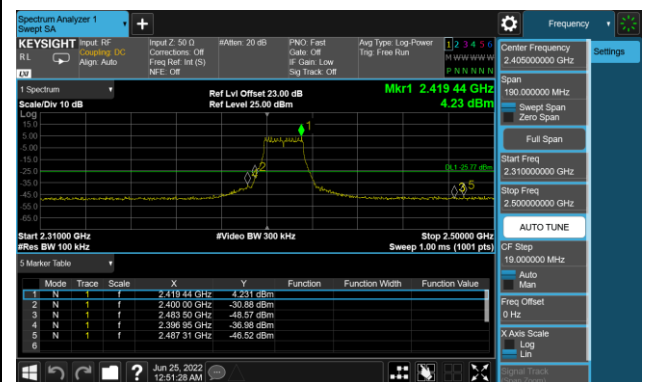

802.11 g CH01 (2412MHz)

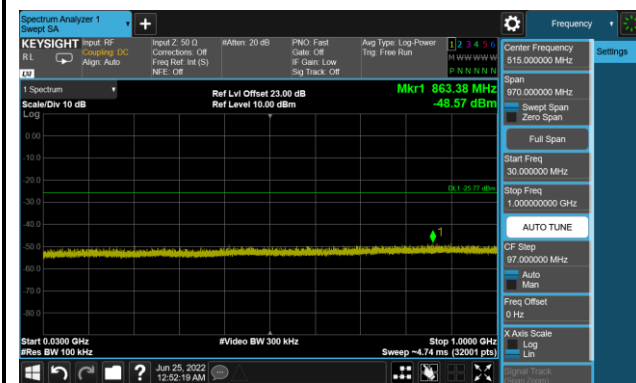

802.11 g CH01 (2412MHz)

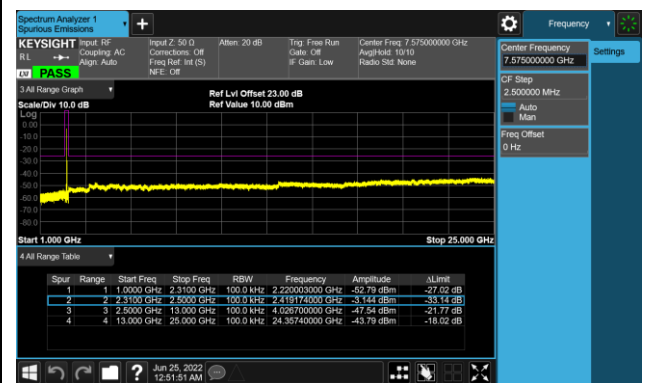

802.11 g CH06 (2437MHz)



802.11 g CH06 (2437MHz)



802.11 g CH06 (2437MHz)

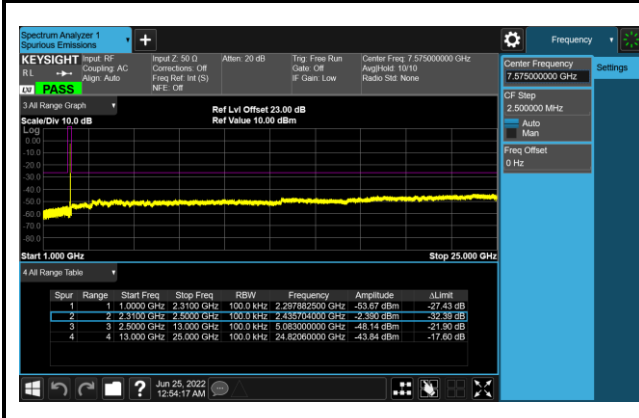

802.11 g CH11 (2462MHz)

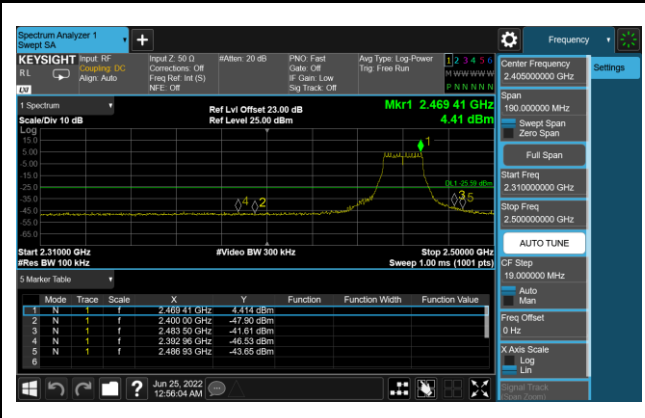

802.11 g CH11 (2462MHz)



802.11 g CH11 (2462MHz)

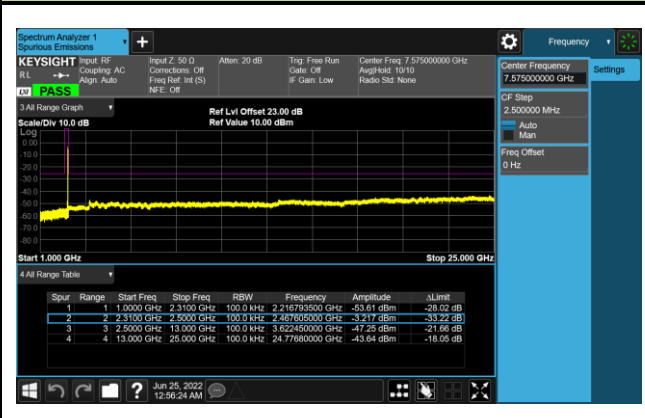

802.11 n20 CH01 (2412MHz)

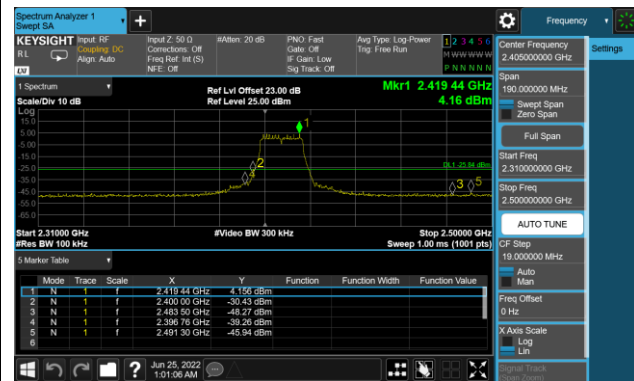

802.11 n20 CH01 (2412MHz)

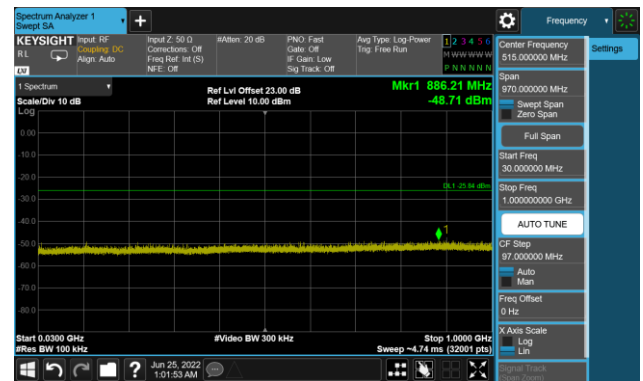

802.11 n20 CH01 (2412MHz)

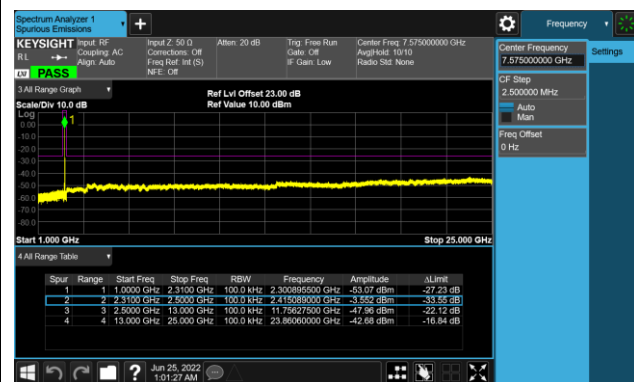

802.11 n20 CH06 (2437MHz)

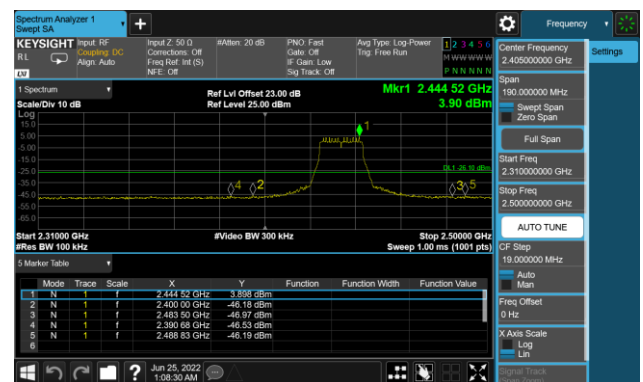

802.11 n20 CH06 (2437MHz)

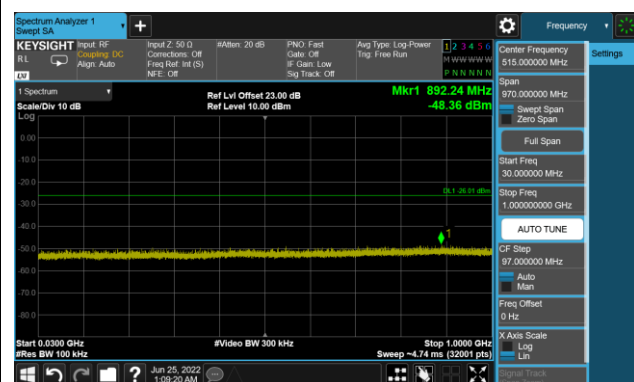

802.11 n20 CH06 (2437MHz)

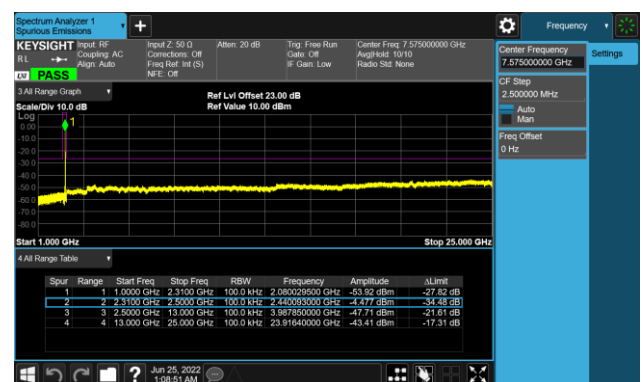

802.11 n20 CH11 (2462MHz)



802.11 n20 CH11 (2462MHz)



802.11 n20 CH11 (2462MHz)

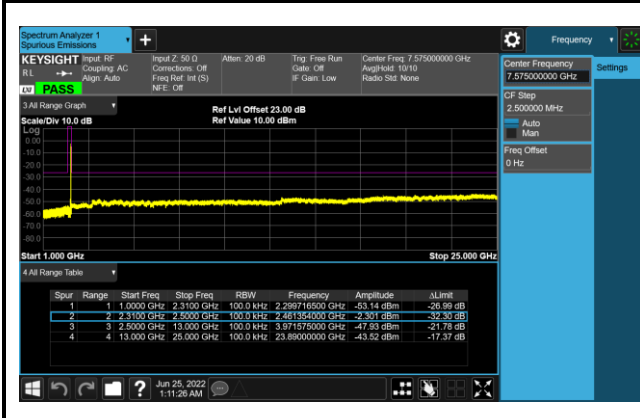

802.11 n40 CH03 (2422MHz)

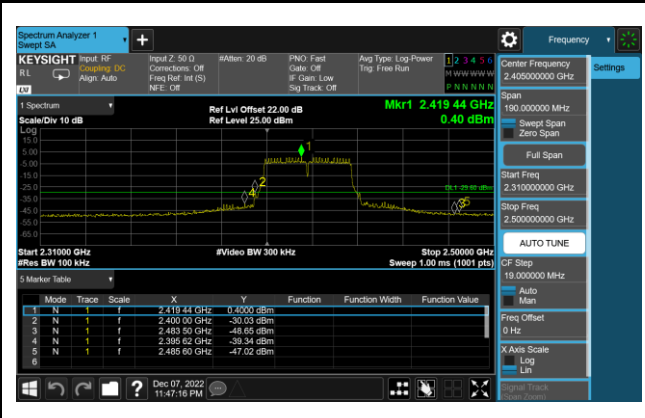

802.11 n40 CH03 (2422MHz)

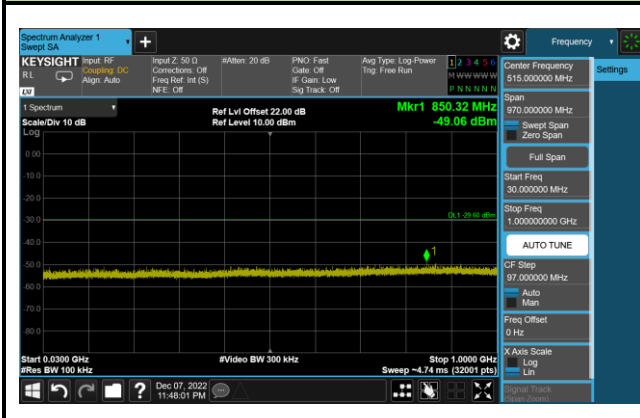

802.11 n40 CH03 (2422MHz)

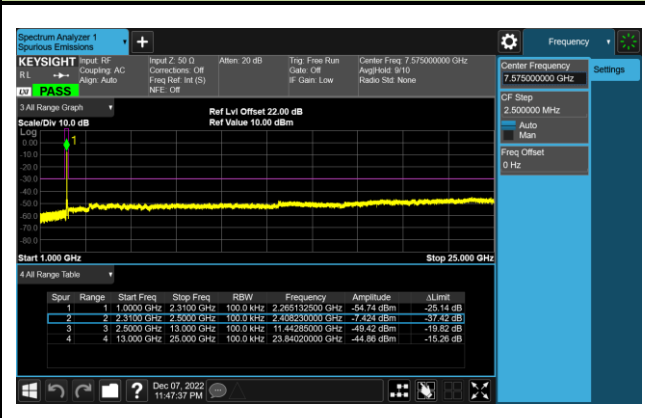

802.11 n40 CH06 (2437MHz)

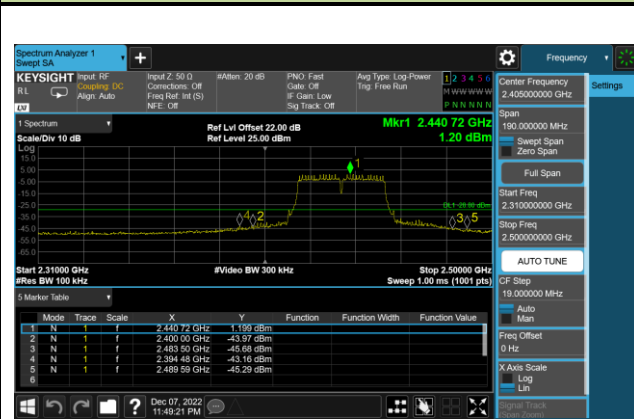

802.11 n40 CH06 (2437MHz)



802.11 n40 CH06 (2437MHz)

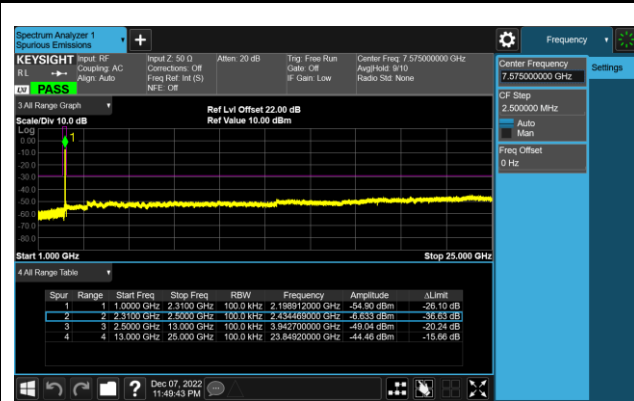

802.11 n40 CH09 (2452MHz)

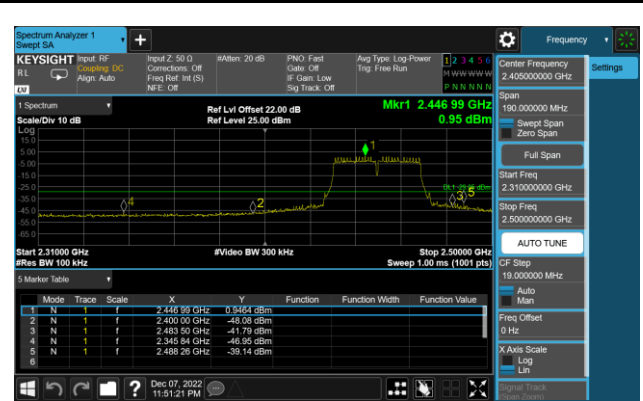

802.11 n40 CH09 (2452MHz)

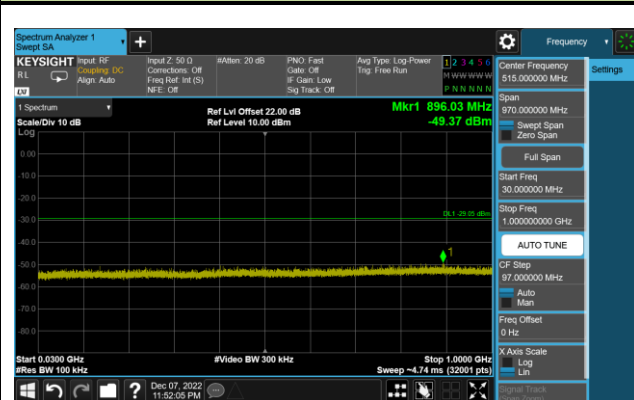

802.11 n40 CH09 (2452MHz)

