

RF MEASUREMENT REPORT

FCC ID : 2AXJ4C24V2
Applicant : TP-Link Corporation Limited
Application Type : Certification
Product : AC750 Dual Band Wi-Fi Router
Model No. : Archer C24
Brand Name : tp-link
FCC Classification : Unlicensed National Information Infrastructure (NII)
FCC Rule Part(s) : Part15 Subpart E (Section 15.407)
Received Date : March 30, 2023
Test Date : April 14, 2023 ~ May 3, 2023

Test By : Owen Tsai
(Owen Tsai)

Reviewed By : Paddy Chen
(Paddy Chen)

Approved By : Chenz Ker
(Chenz Ker)



The test results relate only to the samples tested.

This equipment has been shown to be capable of compliance with the applicable technical standards as indicated in the measurement report and was tested in accordance with the measurement procedures specified in KDB 789033 D02v02r01. Test results reported herein relate only to the item(s) tested.

The test report shall not be reproduced except in full without the written approval of MRT Technology (Taiwan) Co., Ltd.

Revision History

Report No.	Version	Description	Issue Date	Note
2304TW0106-U2	1.0	Original Report	2023-05-29	Valid

CONTENTS

Description	Page
General Information	6
1. INTRODUCTION	7
1.1. Scope	7
1.2. MRT Test Location	7
2. PRODUCT INFORMATION	8
2.1. Feature of Equipment under Test	8
2.2. Product Specification Subjective to this Report.....	8
2.3. Working Frequencies for this report	9
2.4. Description of Available Antennas.....	9
2.5. Test Mode	10
2.6. Configuration of Test System.....	10
2.7. Test System Details.....	11
2.8. Description of Test Software	11
2.9. Applied Standards	11
2.10. Duty Cycle	12
2.11. Test Configuration	13
2.12. EMI Suppression Device(s)/Modifications.....	13
2.13. Labeling Requirements.....	13
3. DESCRIPTION OF TEST	14
3.1. Evaluation Procedure	14
3.2. AC Line Conducted Emissions	14
3.3. Radiated Emissions	15
4. ANTENNA REQUIREMENTS	16
5. TEST EQUIPMENT CALIBRATION DATE	17
6. MEASUREMENT UNCERTAINTY	18
7. TEST RESULT	19
7.1. Summary	19
7.2. 26dB Bandwidth Measurement.....	20
7.2.1. Test Limit	20
7.2.2. Test Procedure used.....	20
7.2.3. Test Setting.....	20
7.2.4. Test Setup	20
7.2.5. Test Result.....	21
7.3. 6dB Bandwidth Measurement.....	25
7.3.1. Test Limit	25
7.3.2. Test Procedure used.....	25

7.3.3. Test Setting.....	25
7.3.4. Test Setup	25
7.3.5. TestResult.....	26
7.4. Output Power Measurement.....	29
7.4.1. Test Limit	29
7.4.2. Test Procedure Used	29
7.4.3. Test Setting.....	29
7.4.4. Test Setup	29
7.4.5. Test Result.....	30
7.5. Power Spectral Density Measurement.....	31
7.5.1. Test Limit	31
7.5.2. Test Procedure Used	31
7.5.3. Test Setting.....	31
7.5.4. Test Setup	32
7.5.5. Test Result.....	33
7.6. Frequency Stability Measurement.....	38
7.6.1. Test Limit	38
7.6.2. Test Limit	38
7.6.3. Test Setup	39
7.6.4. Test Result.....	39
7.7. Radiated Spurious Emission Measurement	40
7.7.1. Test Limit	40
7.7.2. Test Procedure Used	40
7.7.3. Test Setting.....	40
7.7.4. Test Setup	42
7.7.5. Test Result.....	43
7.8. Radiated Restricted Band Edge Measurement	83
7.8.1. Test Limit	83
7.8.2. Test Procedure Used	84
7.8.3. Test Setting.....	84
7.8.4. Test Setup	85
7.8.5. Test Result.....	86
7.9. AC Conducted Emissions Measurement.....	116
7.9.1. Test Limit	116
7.9.2. Test Procedure	116
7.9.3. Test Setup	117
7.9.4. Test Result.....	118
8. CONCLUSION.....	122
Appendix A : Test Setup Photograph	123

Appendix B : EUT Photograph..... 123
Appendix C : Internal Photograph 123

General Information

Applicant	TP-Link Corporation Limited
Applicant Address	Room 901, 9/F., New East Ocean Centre, 9 Science Museum Road, Tsim Sha Tsui, Kowloon, Hongkong
Manufacturer	TP-Link Corporation Limited
Manufacturer Address	Room 901, 9/F., New East Ocean Centre, 9 Science Museum Road, Tsim Sha Tsui, Kowloon, Hongkong
Test Site	MRT Technology (Taiwan) Co., Ltd
Test Site Address	No. 38, Fuxing Second Rd., Guishan Dist., Taoyuan City 333, Taiwan (R.O.C)
MRT FCC Registration No.	291082
FCC Rule Part(s)	Part 15.407

Test Facility / Accreditations

1. MRT facility is a FCC registered (Reg. No. 291082) test facility with the site description report on file and is designated by the FCC as an Accredited Test Firm.
2. MRT facility is an IC registered (MRT Reg. No. 21723) test laboratory with the site description on file at Industry Canada.
3. MRT Lab is accredited to ISO 17025 by the Taiwan Accreditation Foundation (TAF Cert. No. 3261) in EMC, Telecommunications and Radio testing for FCC (Designation Number: TW3261), Industry Canada, EU and TELEC Rules.

1. INTRODUCTION

1.1. Scope

Measurement and determination of electromagnetic emissions (EMC) of radio frequency devices including intentional and/or unintentional radiators for compliance with the technical rules and regulations of the Federal Communications Commission and the Innovation, Science and Economic Development Canada and Certification and Engineering Bureau.

1.2. MRT Test Location

The map below shows the location of the MRT LABORATORY, its proximity to the Taoyuan City. These measurement tests were conducted at the MRT Technology (Taiwan) Co., Ltd. Facility located at No.38, Fuxing 2nd Rd., Guishan Dist., Taoyuan City 33377, Taiwan (R.O.C).

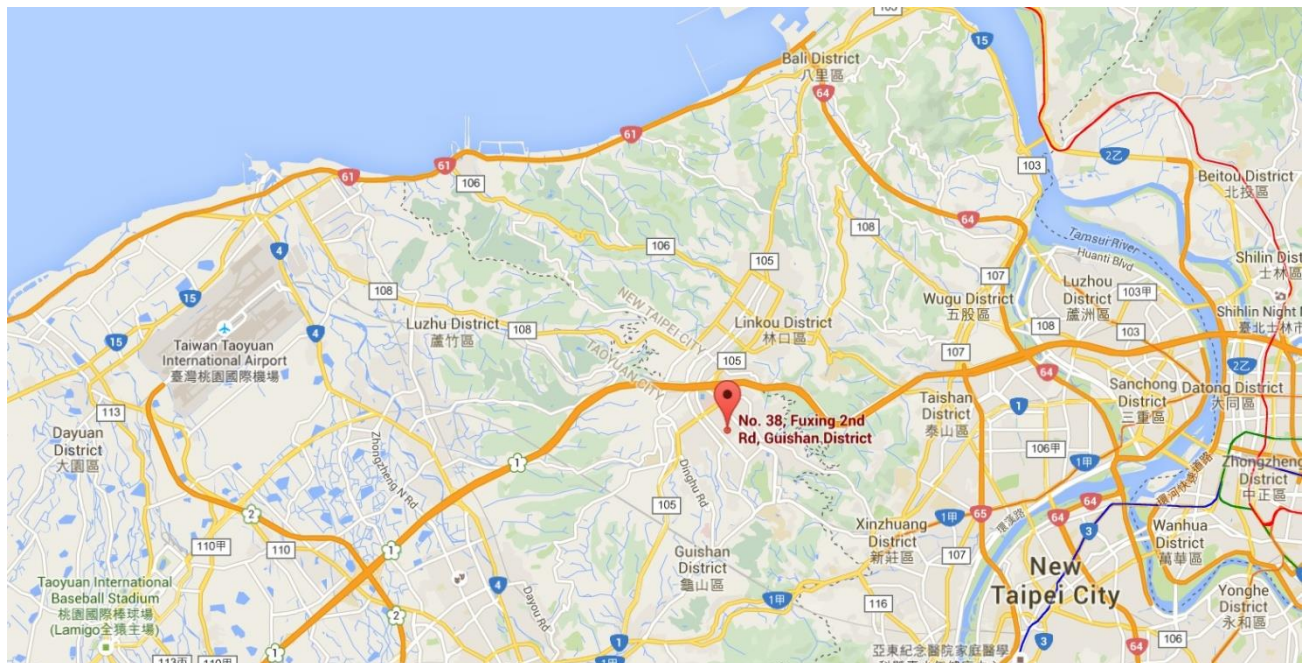

2. PRODUCT INFORMATION

2.1. Feature of Equipment under Test

Product Name:	AC750 Dual Band Wi-Fi Router
Model No.:	Archer C24
Brand Name:	tp-link
Wi-Fi Specification:	802.11a/b/g/n/ac
EUT Identification No.:	C24V2(US)#1-1 (Conducted) C24V2(US)#1-2 (Radiated)
Accessory	
Adapter	BRAND: tp-link MODEL: T090060-2B1 INPUT: 100 - 240V ~ 50/60Hz 0.3A. OUTPUT: DC 9V 0.6A Cable Out: Non-shielding, 1.5m

2.2. Product Specification Subjective to this Report

Frequency Range:	For 802.11a/n-HT20/ac-VHT20: 5180~5240MHz, 5745~5825MHz For 802.11n-HT40/ac-VHT40: 5190~5230MHz, 5755~5795MHz For 802.11ac-VHT80: 5210MHz, 5775MHz
Type of Modulation:	802.11a/n/ac: OFDM
Data Rate:	802.11a: 6/9/12/18/24/36/48/54Mbps 802.11n: up to 150Mbps 802.11ac: up to 433.3Mbps

Note: For other features of this EUT, test report will be issued separately.

2.3. Working Frequencies for this report

802.11a/n-HT20/ac-VHT20

Channel	Frequency	Channel	Frequency	Channel	Frequency
36	5180 MHz	40	5200 MHz	44	5220 MHz
48	5240 MHz	149	5745 MHz	153	5765 MHz
157	5785 MHz	161	5805 MHz	165	5825 MHz

802.11n-HT40/ac-VHT40

Channel	Frequency	Channel	Frequency	Channel	Frequency
38	5190 MHz	46	5230 MHz	151	5755 MHz
159	5795 MHz	N/A	N/A	N/A	N/A

802.11ac-VHT80

Channel	Frequency	Channel	Frequency	Channel	Frequency
42	5210 MHz	155	5775 MHz	N/A	N/A

2.4. Description of Available Antennas

Antenna Type	Frequency Band (MHz)	T _x Paths	Max Antenna Gain (dBi)	CDD Directional Gain (dBi)	
				For Power	For PSD
Dipole Antenna	2412 ~ 2462	2	1.10	1.10	4.11
	5150 ~ 5250	1	1.80	--	--
	5725 ~ 5850	1	2.00	--	--

Note:

1. The EUT supports SISO Mode for Wi-Fi 5GHz and Cyclic Delay Diversity (CDD) mode for Wi-Fi 2.4GHz, For CDD transmissions, directional gain is calculated as follows, $N_{ANT} = 2$, $N_{SS} = 1$.

If all antennas have the same gain, G_{ANT} , Directional gain = $G_{ANT} + \text{Array Gain}$, where Array Gain is as follows.

- For power spectral density (PSD) measurements on all devices,

$$\text{Array Gain} = 10 \log (N_{ANT} / N_{SS}) \text{ dB};$$

- For power measurements on IEEE 802.11 devices,

$$\text{Array Gain} = 0 \text{ dB for } N_{ANT} \leq 4;$$

2. The information as above is from the antenna specifications.

2.5. Test Mode

Mode 1: Transmit by 802.11a (6Mbps) (SISO mode)
Mode 2: Transmit by 802.11ac-VHT20 (MCS0) (SISO mode)
Mode 3: Transmit by 802.11ac-VHT40 (MCS0) (SISO mode)
Mode 4: Transmit by 802.11ac-VHT80 (MCS0) (SISO mode)
Note:
1. For Radiated emission, the modulation and the data rate picked for testing are determined by the Max. RF conducted power.
2. As Designated by manufacturer, the lowest data rate was the worst condition, so all the tests were done with lowest data rate.

2.6. Configuration of Test System

The device was tested per the guidance ANSI C63.10: 2013 was used to reference the appropriate EUT setup for radiated emissions testing and AC line conducted testing.

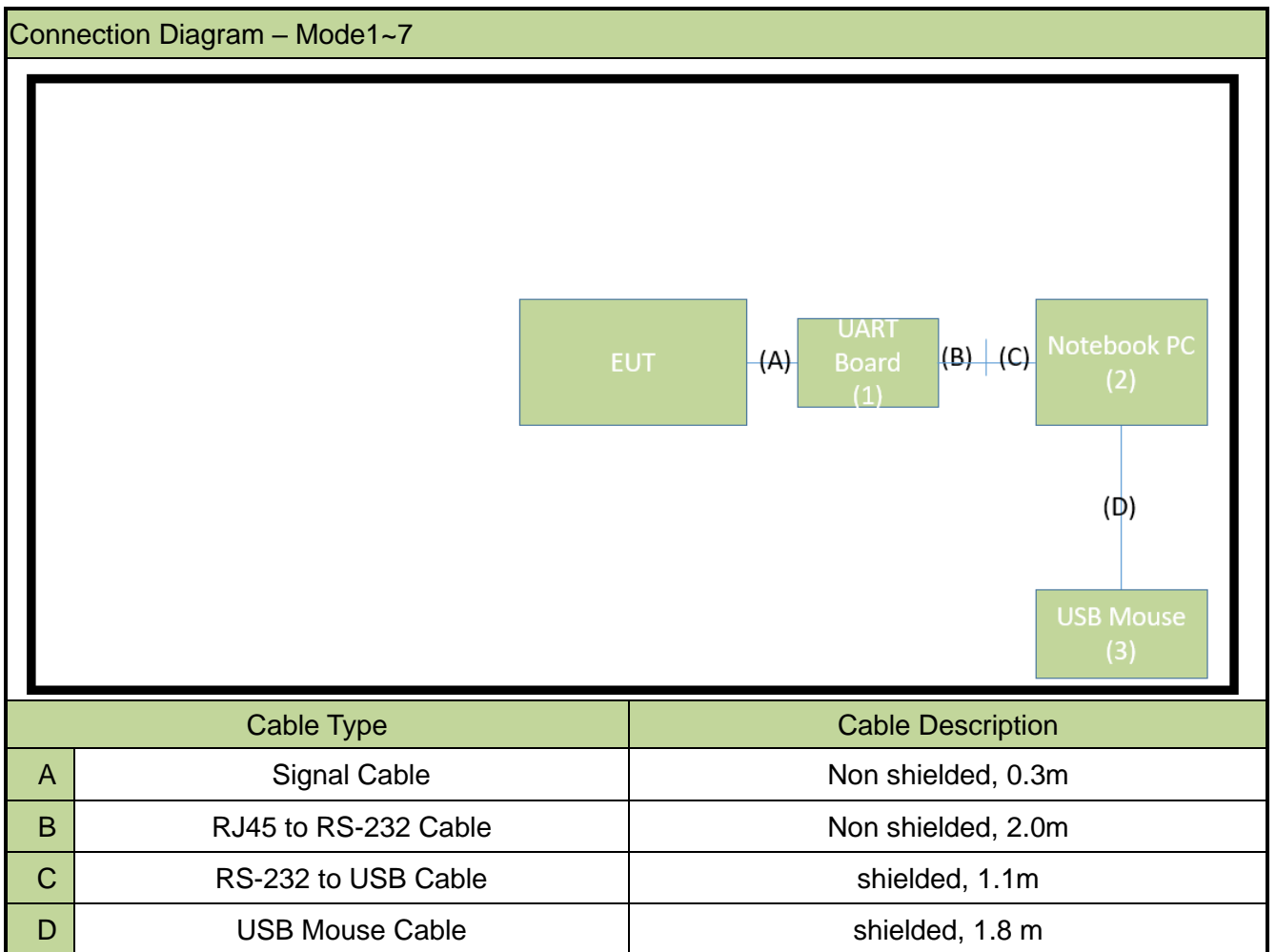

2.7. Test System Details

The types for all equipments, plus descriptions of all cables used in the tested system (including inserted cards) are:

	Product	Manufacturer	Model No.	Serial No.	Power Cord
1	UART Board	tp-link	RS232 Interface board	N/A	N/A
2	Notebook PC	Lenovo	20Y7-006KTW	N/A	Non-Shielded, 0.8m
3	USB Mouse	Logitech	M90	N/A	N/A

2.8. Description of Test Software

The test utility software used during testing was “Tera Term”, the version is ver4.98.

Note: Final power setting please refer to operational description.

2.9. Applied Standards

According to the specifications of the manufacturer, the EUT must comply with the requirements of the following standards:

- FCC Part 15.247
- KDB 789033 D02v02r01,
- KDB 662911 D01v02r01
- ANSI C63.10-2013

2.10. Duty Cycle

5GHz (NII) operation is possible in 20MHz, 40MHz and 80MHz channel bandwidths. The maximum achievable duty cycles for all modes were determined based on measurements performed on a spectrum analyzer in zero-span mode with RBW = 8MHz, VBW = 50MHz. The RBW and VBW were both greater than 50/T, where T is the minimum transmission duration, and the number of sweep points across T was greater than 100. The duty cycles are as follows:

Test Mode	Duty Cycle
802.11a	67.78%
802.11ac-VHT20	93.96%
802.11ac-VHT40	94.14%
802.11ac-VHT80	87.26%

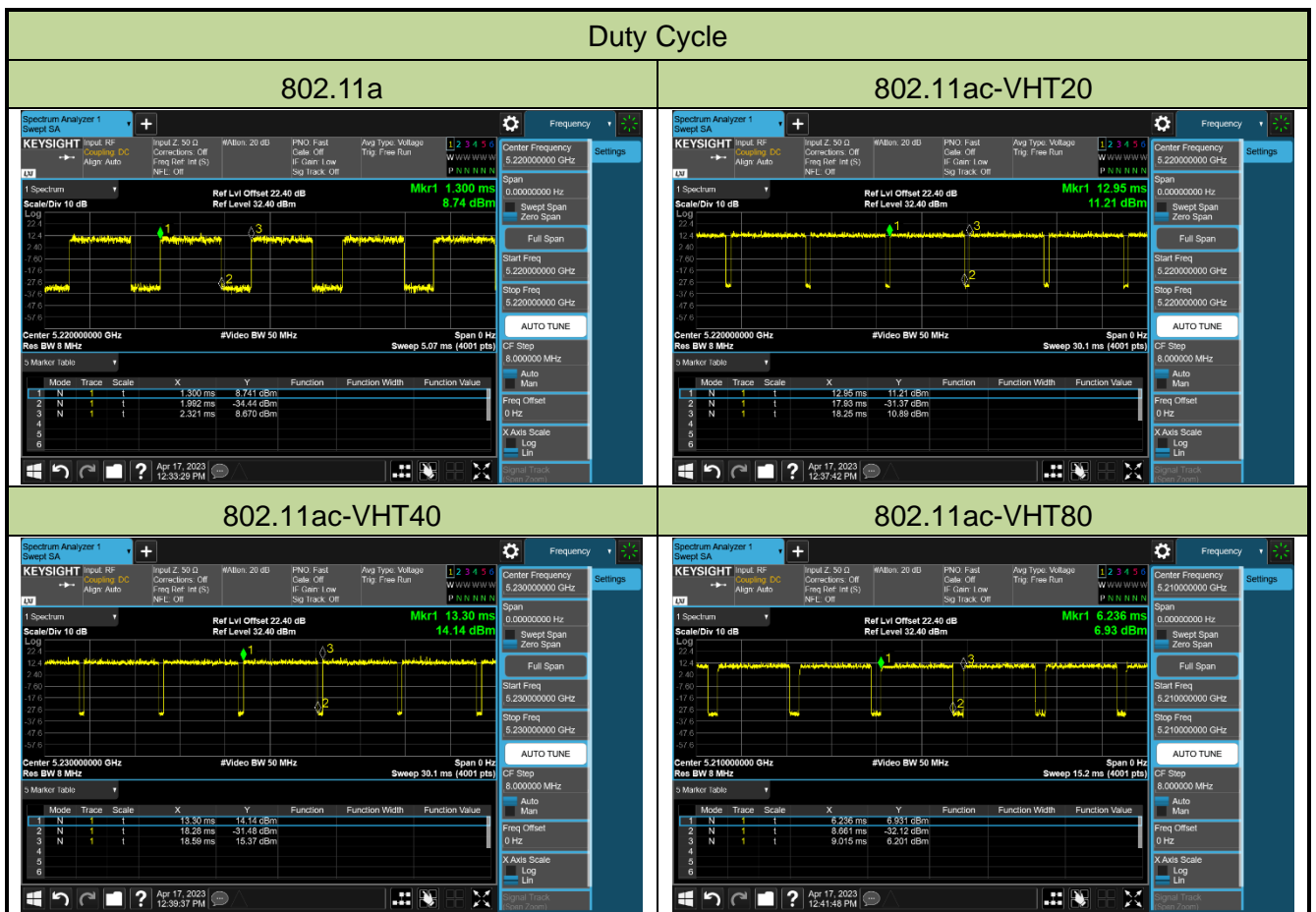

2.11. Test Configuration

The device was tested per the guidance of KDB 789033 D02v02r01. ANSI C63.10-2013 was used to reference the appropriate EUT setup for radiated spurious emissions testing and AC line conducted testing.

2.12. EMI Suppression Device(s)/Modifications

No EMI suppression device(s) were added and/or no modifications were made during testing.

2.13. Labeling Requirements

Per 2.1074 & 15.19; Docket 95-19

The label shall be permanently affixed at a conspicuous location on the device; instruction manual or pamphlet supplied to the user and be readily visible to the purchaser at the time of purchase.

However, when the device is so small wherein placement of the label with specified statement is not practical, only the FCC ID must be displayed on the device per Section 15.19(a)(5). Please see attachment for FCC ID label and label location.

3. DESCRIPTION OF TEST

3.1. Evaluation Procedure

The measurement procedures described in the American National Standard of Procedures for Compliance Testing of Unlicensed Wireless Devices (ANSI C63.10-2013), and the guidance provided in KDB 789033 D02v02r01 were used in the measurement.

3.2. AC Line Conducted Emissions

The line-conducted facility is located inside an 8'x4'x4' shielded enclosure. A 1m x 2m wooden table 80cm high is placed 40cm away from the vertical wall and 80cm away from the sidewall of the shielded room. Two 10kHz-30MHz, 50Ω/50uH Line-Impedance Stabilization Networks (LISNs) are bonded to the shielded room floor. Power to the LISNs is filtered by external high-current high-insertion loss power line filters. These filters attenuate ambient signal noise from entering the measurement lines. These filters are also bonded to the shielded enclosure.

The EUT is powered from one LISN and the support equipment is powered from the second LISN. All interconnecting cables more than 1 meter were shortened to a 1 meter length by non-inductive bundling (serpentine fashion) and draped over the back edge of the test table. All cables were at least 40cm above the horizontal reference ground-plane. Power cables for support equipment were routed down to the second LISN while ensuring that that cables were not draped over the second LISN.

Sufficient time for the EUT, support equipment, and test equipment was allowed in order for them to warm up to their normal operating condition. The RF output of the LISN was connected to the receiver and exploratory measurements were made to determine the frequencies producing the maximum emission from the EUT. The receiver was scanned from 150kHz to 30MHz. The detector function was set to peak mode for exploratory measurements while the bandwidth of the analyzer was set to 9kHz. The EUT, support equipment, and interconnecting cables were arranged and manipulated to maximize each emission. Each emission was also maximized by varying: power lines, the mode of operation or data exchange speed, or support equipment whichever determined the worst-case emission. Once the worst case emissions have been identified, the one EUT cable configuration/arrangement and mode of operation that produced these emissions are used for final measurements on the same test site. The analyzer is set to CISPR quasi-peak and average detectors with a 9kHz resolution bandwidth for final measurements.

An extension cord was used to connect to a single LISN which powered by EUT. The extension cord was calibrated with LISN, the impedance and insertion loss are compliance with the requirements as stated in ANSI C63.10-2013.

3.3. Radiated Emissions

The radiated test facilities consisted of an indoor 3 meter semi-anechoic chamber used for final measurements and exploratory measurements, when necessary. The measurement area is contained within the semi-anechoic chamber which is shielded from any ambient interference. For measurements above 1GHz absorbers are arranged on the floor between the turn table and the antenna mast in such a way so as to maximize the reduction of reflections. For measurements below 1GHz, the absorbers are removed. A MF Model 210SS turntable is used for radiated measurement. It is a continuously rotatable, remote controlled, metallic turntable and 2 meters (6.56 ft.) in diameter. The turn table is flush with the raised floor of the chamber in order to maintain its function as a ground plane. An 80cm high PVC support structure is placed on top of the turntable.

For all measurements, the spectrum was scanned through all EUT azimuths and from 1 to 4 meter receive antenna height using a broadband antenna from 30MHz up to the upper frequency shown in 15.33(b)(1) depending on the highest frequency generated or used in the device or on which the device operates or tunes. For frequencies above 1GHz, linearly polarized double ridge horn antennas were used. For frequencies below 30MHz, a calibrated loop antenna was used. When exploratory measurements were necessary, they were performed at 1 meter test distance inside the semi-anechoic chamber using broadband antennas, broadband amplifiers, and spectrum analyzers to determine the frequencies and modes producing the maximum emissions. Sufficient time for the EUT, support equipment, and test equipment was allowed in order for them to warm up to their normal operating condition. The test set-up for frequencies below 1GHz was placed on top of the 0.8 meter high, 1 x 1.5 meter table; and test set-up for frequencies 1-40GHz was placed on top of the 1.5 meter high, 1 x 1.5 meter table. The EUT, support equipment, and interconnecting cables were arranged and manipulated to maximize each emission. Appropriate precaution was taken to ensure that all emissions from the EUT were maximized and investigated. The system configuration, clock speed, mode of operation or video resolution, if applicable, turntable azimuth, and receive antenna height was noted for each frequency found.

Final measurements were made in the semi-anechoic chamber using calibrated, linearly polarized broadband and horn antennas. The test setup was configured to the setup that produced the worst case emissions. The spectrum analyzer was set to investigate all frequencies required for testing to compare the highest radiated disturbances with respect to the specified limits. The turntable containing the EUT was rotated through 360 degrees and the height of the receive antenna was varied 1 to 4 meters and stopped at the azimuth and height producing the maximum emission. Each emission was maximized by changing the orientation of the EUT through three orthogonal planes and changing the polarity of the receive antenna, whichever produced the worst-case emissions. According to 3dB Beam-Width of horn antenna, the horn antenna should be always directed to the EUT when rising height.

4. ANTENNA REQUIREMENTS

Excerpt from §15.203 of the FCC Rules/Regulations:

“An intentional radiator antenna shall be designed to ensure that no antenna other than that furnished by the responsible party can be used with the device. The use of a permanently attached antenna or of an antenna that uses a unique coupling to the intentional radiator shall be considered sufficient to comply with the provisions of this section.”

- The antenna of the device is **permanently attached**.
- There are no provisions for connection to an external antenna.

Conclusion:

The unit complies with the requirement of §15.203.

5. TEST EQUIPMENT CALIBRATION DATE

Conducted Emissions

Instrument	Manufacturer	Type No.	Asset No.	Cali. Interval	Cali. Due Date
Two-Line V-Network	R&S	ENV216	MRTTWA00019	1 year	2024/3/7
Two-Line V-Network	R&S	ENV216	MRTTWA00020	1 year	2024/4/17
EMI Test Receiver	R&S	ESR3	MRTTWA00045	1 year	2023/5/9

Radiated Emissions

Instrument	Manufacturer	Type No.	Asset No.	Cali. Interval	Cali. Due Date
Broadband TRILOG Antenna	SCHWARZBECK	VULB 9162	MRTTWA00001	1 year	2023/12/21
EMI Test Receiver	R&S	ESR3	MRTTWA00009	1 year	2024/3/8
Signal Analyzer	R&S	FSVA3044	MRTTWA00092	1 year	2023/6/23
Active Loop Antenna	Schwarzbeck	FMZB 1519B	MRTTWA00002	1 year	2023/5/24
Broadband Hornantenna	RFSPIN	DRH18-E	MRTTWA00087	1 year	2023/5/10
Breitband Hornantenna	Schwarzbeck	BBHA 9170	MRTTWA00004	1 year	2024/3/20
Broadband Preampfier	EMC Instruments corporation	EMC118A45SE	MRTTWA00088	1 year	2023/5/9
Broadband Preampfier	SCHWARZBECK	BBV 9718	MRTTWA00005	1 year	2024/3/27
Cable	HUBERSUHNER	SF106	MRTTWE00034	1 year	2023/6/27

Conducted Test Equipment

Instrument	Manufacturer	Type No.	Asset No.	Cali. Interval	Cali. Due Date
X-Series USB Peak and Average Power Sensor	KEYSIGHT	U2021XA	MRTTWA00014	1 year	2024/4/19
EXA Signal Analyzer	KEYSIGHT	N9010A	MRTTWA00012	1 year	2023/10/5
EXA Signal Analyzer	KEYSIGHT	N9010B	MRTTWA00074	1 year	2023/7/19
Attenuator	WTI	218FS-20	MRTTWE00026	1 year	2023/11/2
Attenuator	WTI	218FS-10	MRTTWE00027	1 year	2023/6/15
Temperature & Humidity Chamber	TEN BILLION	TTH-B3UP	MRTTWA00036	1 year	2023/6/14
DIVA PLUS Funk-Wetterstation	TFA	35.1083	MRTTWA00050	1 year	2023/6/16

Software	Version	Function
e3	9.160520a	EMI Test Software

6. MEASUREMENT UNCERTAINTY

Where relevant, the following test uncertainty levels have been estimated for tests performed on the EUT as specified in CISPR 16-4-2. This uncertainty represents an expanded uncertainty expressed at approximately the 95% confidence level using a coverage factor of $k = 2$.

AC Conducted Emission Measurement
Measuring Uncertainty for a Level of Confidence of 95% ($U=2Uc(y)$): 150kHz~30MHz: $\pm 2.53\text{dB}$
Radiated Emission Measurement
Measuring Uncertainty for a Level of Confidence of 95% ($U=2Uc(y)$): 9kHz ~ 1GHz: $\pm 4.25\text{dB}$ 1GHz ~ 40GHz: $\pm 4.45\text{dB}$
Conducted Power (Carrier Power / Power Density)
Measuring Uncertainty for a Level of Confidence of 95% ($U=2Uc(y)$): $\pm 0.84\text{dB}$
Conducted Spurious Emission
Measuring Uncertainty for a Level of Confidence of 95% ($U=2Uc(y)$): $\pm 2.65\text{ dB}$
Occupied Bandwidth
Measuring Uncertainty for a Level of Confidence of 95% ($U=2Uc(y)$): $\pm 3.3\%$
Temp. / Humidity
Measuring Uncertainty for a Level of Confidence of 95% ($U=2Uc(y)$): $\pm 0.82^\circ\text{C} / \pm 3\%$
Frequency Error
Measuring Uncertainty for a Level of Confidence of 95% ($U=2Uc(y)$): $\pm 78.4\text{Hz}$

7. TEST RESULT

7.1. Summary

FCC Section(s)	Test Description	Test Limit	Test Condition	Test Result	Reference
15.407(a)	26dB Bandwidth	N/A	Conducted	Pass	Section 7.2
15.407(e)	6dB Bandwidth	$\geq 500\text{kHz}$		Pass	Section 7.3
15.407(a)(1)(ii), (3)	Maximum Conducted Output Power	Refer to section 7.4		Pass	Section 7.4
15.407(a)(1)(ii), (3), (12)	Peak Power Spectral Density	Refer to section 7.5		Pass	Section 7.5
15.407(g)	Frequency Stability	N/A		Pass	Section 7.6
15.407(b)(1), (4)(i)	Undesirable Emissions	Refer to Section 7.7	Radiated	Pass	Section 7.7 & 7.8
15.205, 15.209 15.407(b)(8), (9), (10)	General Field Strength Limits (Restricted Bands and Radiated Emission Limits)	Emissions in restricted bands must meet the radiated limits detailed in 15.209		Pass	
15.207	AC Conducted Emissions 150kHz - 30MHz	< FCC 15.207 limits	Line Conducted	Pass	Section 7.9

Notes:

- Determining compliance is based on the test results met the regulation limits or requirements declared by clients, and the test results don't take into account the value of measurement uncertainty.
- The analyzer plots shown in this section were all taken with a correction table loaded into the analyzer. The correction table was used to account for the losses of the cables and attenuators used as part of the system to connect the EUT to the analyzer at all frequencies of interest.
- For radiated emission test, every axis (X, Y, Z) was also verified. The test results shown in the following sections represent the worst-case emissions.

7.2. 26dB Bandwidth Measurement

7.2.1. Test Limit

N/A

7.2.2. Test Procedure used

KDB 789033 D02v02r01- Section II)C.1

7.2.3. Test Setting

1. The analyzers' automatic bandwidth measurement capability was used to perform the 26dB bandwidth measurement. The "X" dB bandwidth parameter was set to $X = 26$. The automatic bandwidth measurement function also has the capability of simultaneously measuring the 99% occupied bandwidth. The bandwidth measurement was not influenced by any intermediated power nulls in the fundamental emission.
2. RBW = approximately 1% of the emission bandwidth.
3. VBW $\geq 3 \times$ RBW.
4. Detector = Peak.
5. Trace mode = max hold.

7.2.4. Test Setup

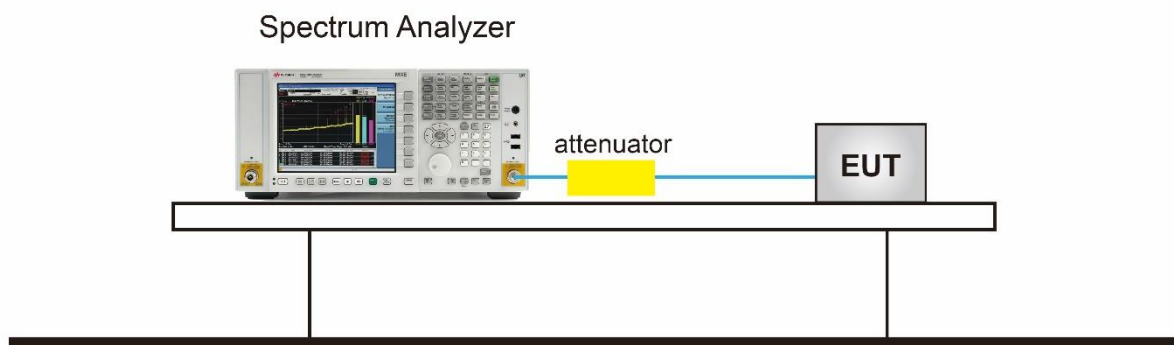

7.2.5. Test Result

Product	AC750 Dual Band Wi-Fi Router	Test Engineer	Xuan
Test Site	SR6	Test Date	2023/4/19

Test Mode	Data Rate/ MCS	Channel No.	Frequency (MHz)	26dB Bandwidth (MHz)	99% Bandwidth (MHz)
802.11a	6Mbps	36	5180	20.510	16.409
802.11a	6Mbps	44	5220	20.200	16.415
802.11a	6Mbps	48	5240	20.640	16.465
802.11a	6Mbps	149	5745	34.080	18.785
802.11a	6Mbps	157	5785	31.830	18.965
802.11a	6Mbps	165	5825	31.740	19.252
802.11ac-VHT20	MCS0	36	5180	31.280	17.935
802.11ac-VHT20	MCS0	44	5220	27.680	17.906
802.11ac-VHT20	MCS0	48	5240	28.180	17.877
802.11ac-VHT20	MCS0	149	5745	21.150	17.653
802.11ac-VHT20	MCS0	157	5785	25.230	17.727
802.11ac-VHT20	MCS0	165	5825	24.500	17.706
802.11ac-VHT40	MCS0	38	5190	39.870	36.049
802.11ac-VHT40	MCS0	46	5230	56.400	36.355
802.11ac-VHT40	MCS0	151	5755	40.830	36.071
802.11ac-VHT40	MCS0	159	5795	41.880	36.182
802.11ac-VHT80	MCS0	42	5210	81.060	75.439
802.11ac-VHT80	MCS0	155	5775	116.500	75.770

80.211a 26dB Bandwidth & 99% Bandwidth

Channel 36 (5180MHz)

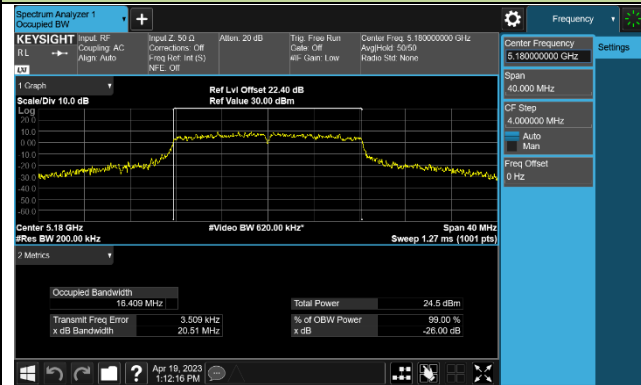

Channel 44 (5220MHz)

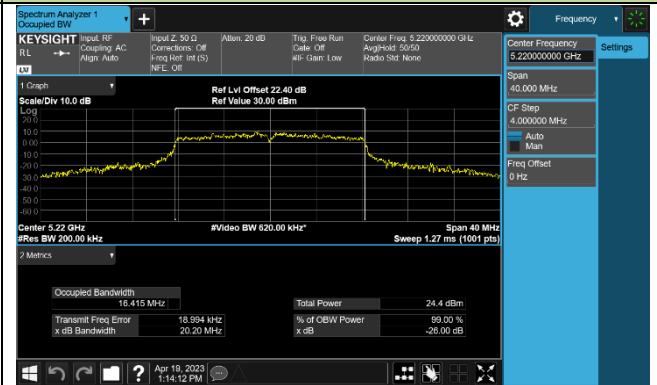

Channel 48 (5240MHz)

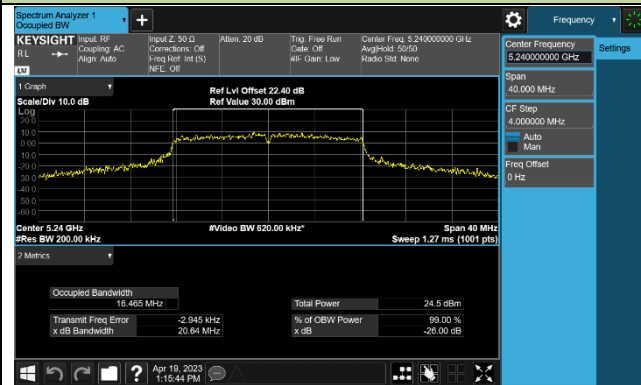

Channel 149 (5745MHz)

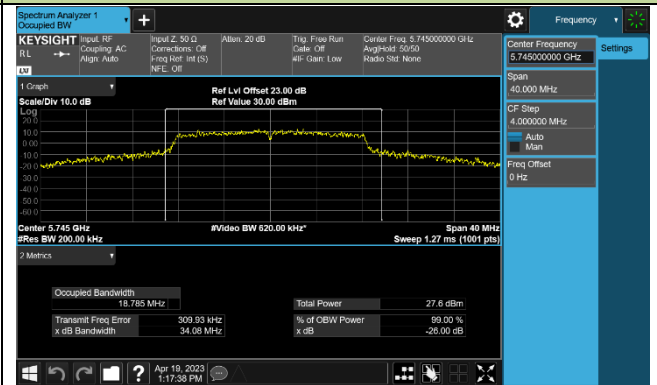

Channel 157 (5785MHz)

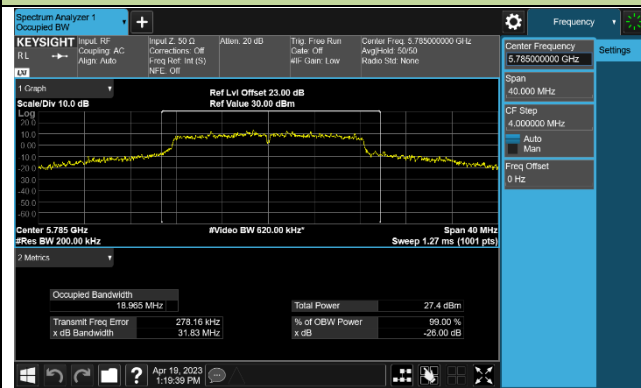

Channel 165 (5825MHz)

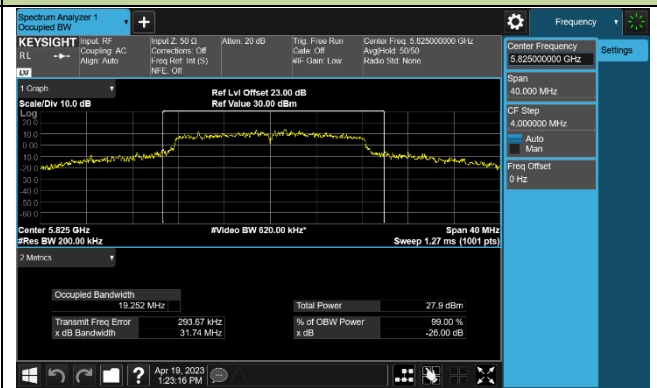

802.11ac-VHT20 26dB Bandwidth & 99% Bandwidth

Channel 36 (5180MHz)

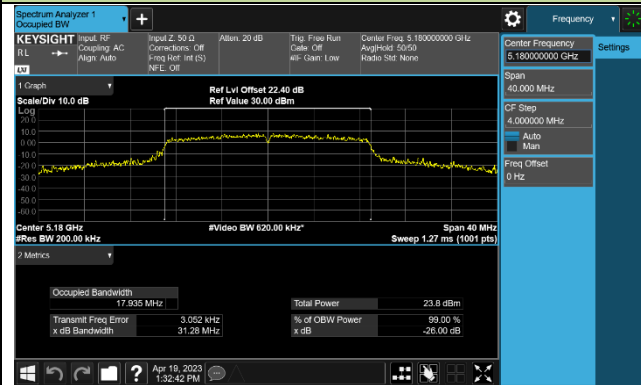

Channel 44 (5220MHz)

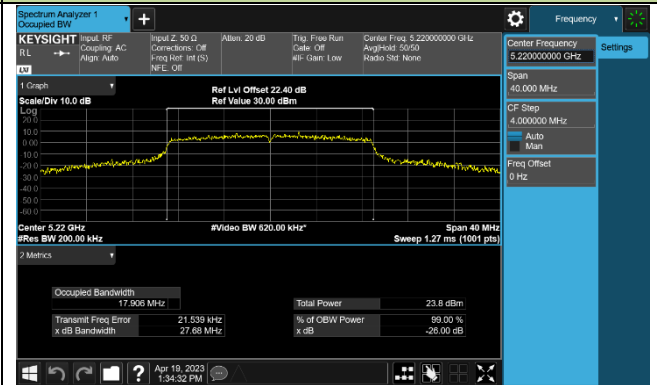

Channel 48 (5240MHz)

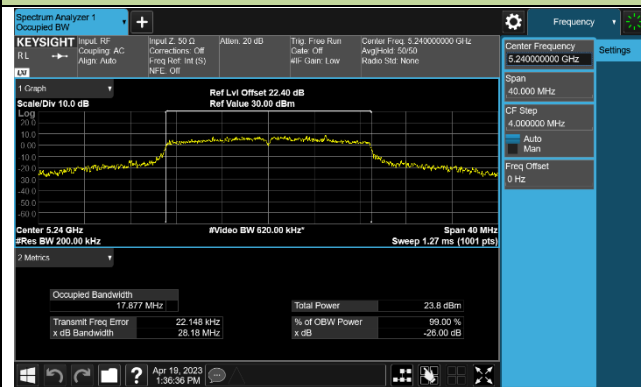

Channel 149 (5745MHz)

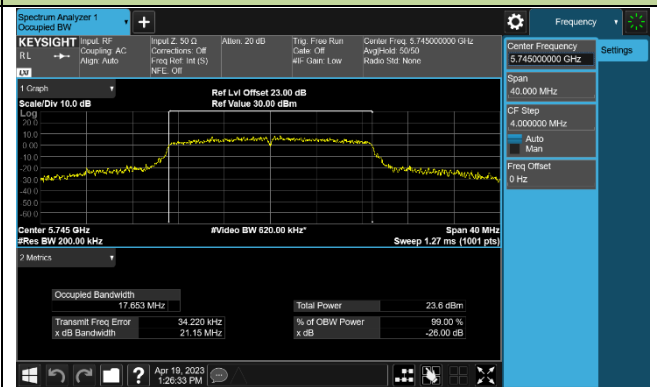

Channel 157 (5785MHz)

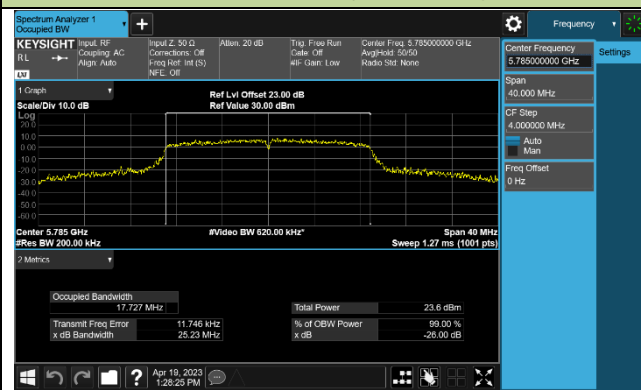

Channel 165 (5825MHz)

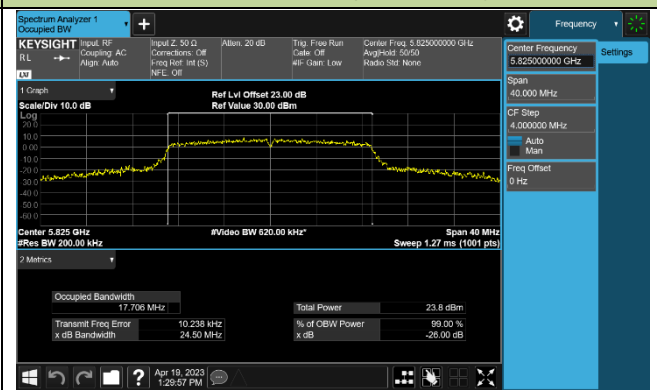

802.11ac-VHT40 26dB Bandwidth & 99% Bandwidth

Channel 38 (5190MHz)

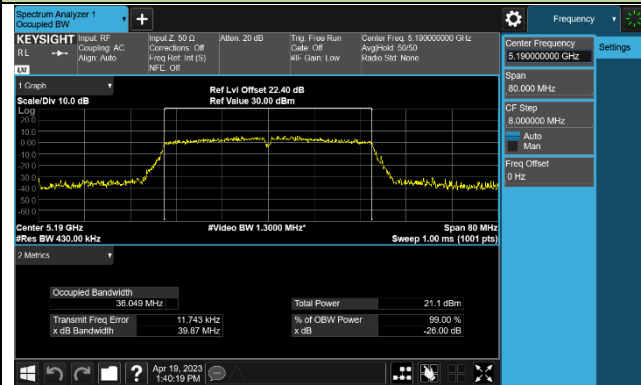

Channel 46 (5230MHz)

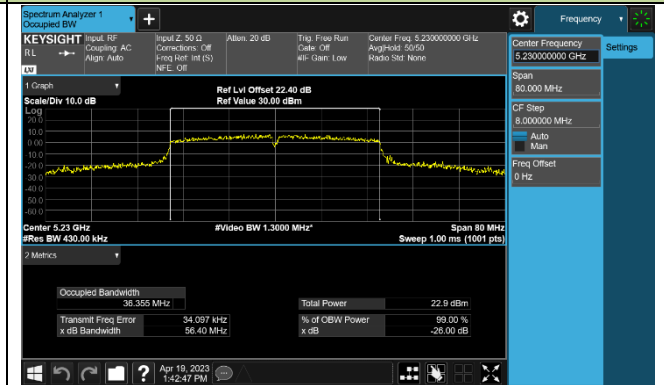

Channel 151 (5755MHz)

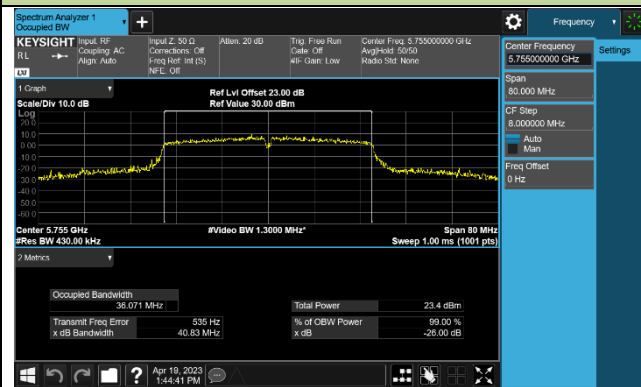

Channel 159 (5795MHz)

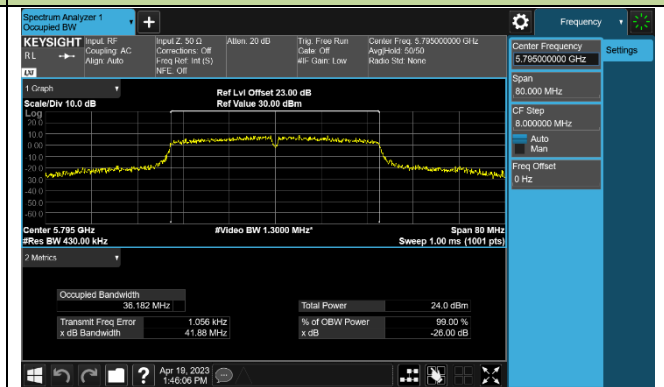

802.11ac-VHT80 26dB Bandwidth & 99% Bandwidth

Channel 42 (5210MHz)

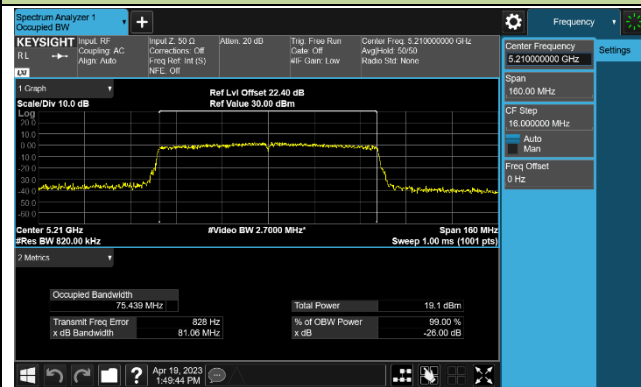

Channel 155 (5775MHz)

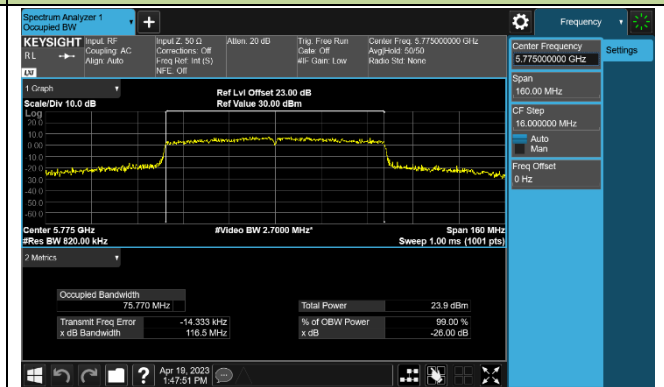

7.3. 6dB Bandwidth Measurement

7.3.1. Test Limit

The minimum 6dB bandwidth shall be at least 500 kHz.

7.3.2. Test Procedure used

KDB 789033 D02v02r01- Section II)C.2

7.3.3. Test Setting

1. Set center frequency to the nominal EUT channel center frequency.
2. RBW = 100 kHz.
3. VBW $3 \times$ RBW.
4. Detector = Peak.
5. Trace mode = max hold.
6. Sweep = auto couple.
7. Allow the trace to stabilize.
8. Measure the maximum width of the emission that is constrained by the frequencies associated with the two outermost amplitude points (upper and lower frequencies) that are attenuated by 6 dB relative to the maximum level measured in the fundamental emission.

7.3.4. Test Setup

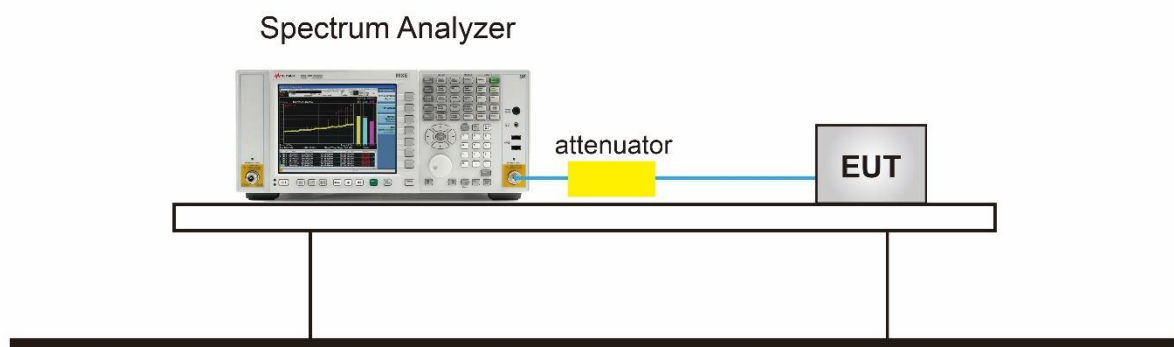

7.3.5.TestResult

Product	AC750 Dual Band Wi-Fi Router	Test Engineer	Xuan
Test Site	SR6	Test Date	2023/4/19

Test Mode	Data Rate/ MCS	Channel No.	Frequency (MHz)	6dB Bandwidth (MHz)	Limit (MHz)	Result
802.11a	6Mbps	149	5745	15.960	≥ 0.5	Pass
802.11a	6Mbps	157	5785	16.290	≥ 0.5	Pass
802.11a	6Mbps	165	5825	14.190	≥ 0.5	Pass
802.11ac-VHT20	MCS0	149	5745	17.540	≥ 0.5	Pass
802.11ac-VHT20	MCS0	157	5785	17.560	≥ 0.5	Pass
802.11ac-VHT20	MCS0	165	5825	17.570	≥ 0.5	Pass
802.11ac-VHT40	MCS0	151	5755	36.270	≥ 0.5	Pass
802.11ac-VHT40	MCS0	159	5795	33.150	≥ 0.5	Pass
802.11ac-VHT80	MCS0	155	5775	74.000	≥ 0.5	Pass

802.11a 6dB Bandwidth

Channel 149 (5745MHz)

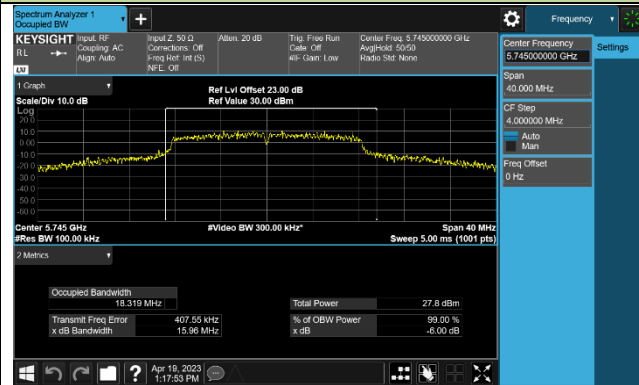

Channel 157 (5785MHz)

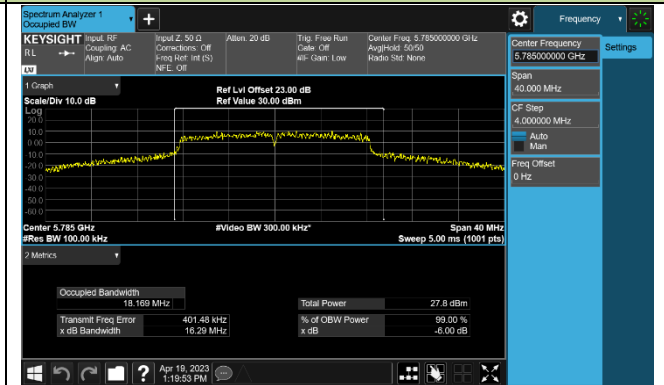

Channel 165 (5825MHz)

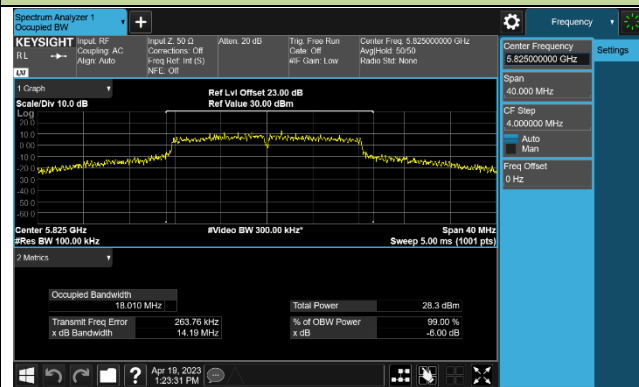

802.11ac-VHT20 6dB Bandwidth

Channel 149 (5745MHz)

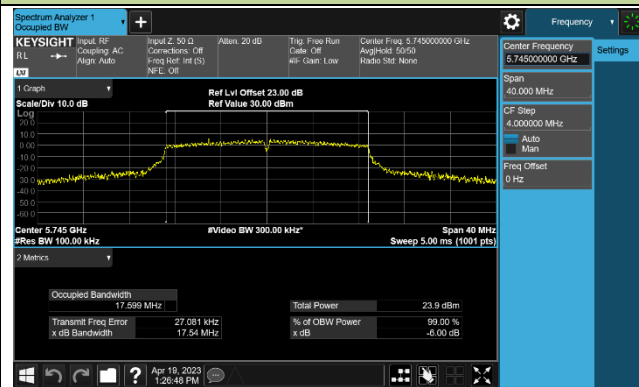

Channel 157 (5785MHz)

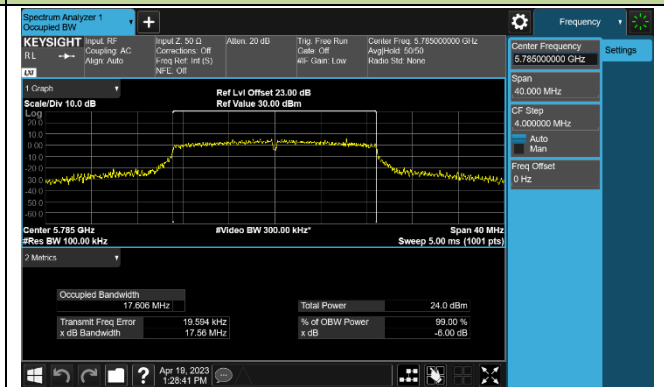

Channel 165 (5825MHz)

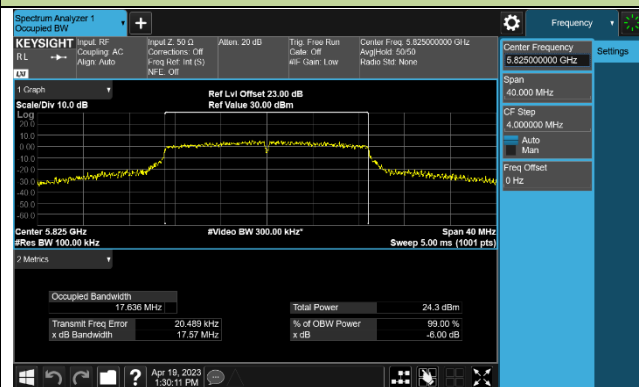

802.11ac-VHT40 6dB Bandwidth

Channel 151 (5755MHz)

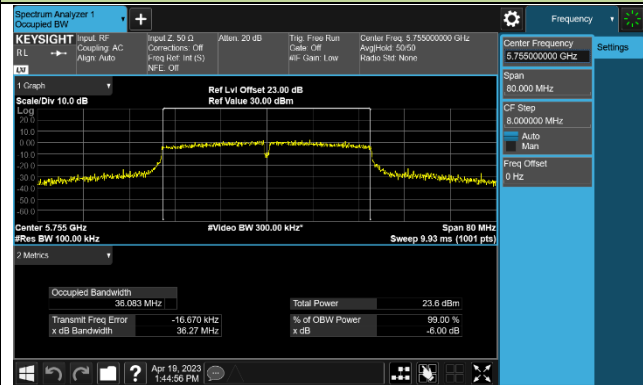

Channel 159 (5795MHz)

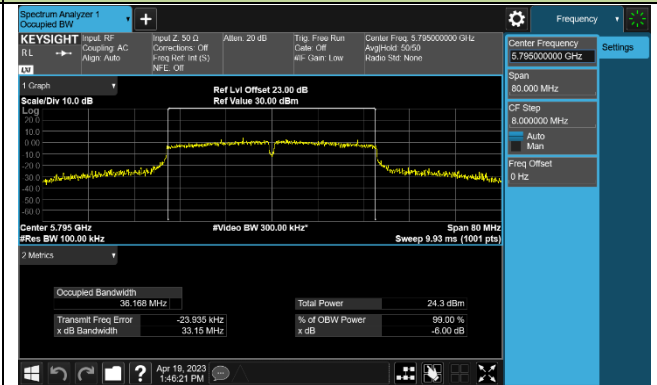

802.11ac-VHT80 6dB Bandwidth

Channel 155 (5775MHz)

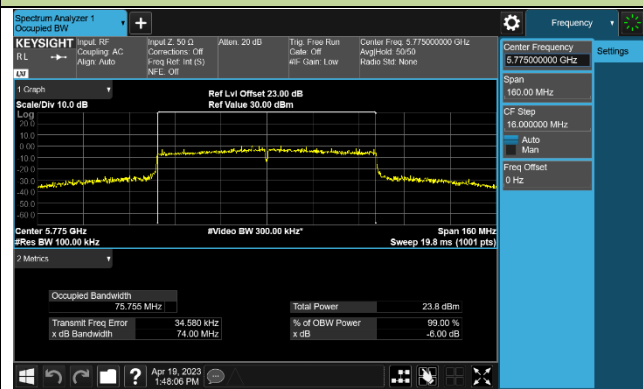

7.4. Output Power Measurement

7.4.1. Test Limit

For the band 5.15-5.25 GHz, the maximum conducted output power over the frequency band of operation shall not exceed 1 W provided the maximum antenna gain does not exceed 6 dBi.

For the band 5.725-5.85 GHz, the maximum conducted output power over the frequency band of operation shall not exceed 1 W (30dBm).

If transmitting antennas of directional gain greater than 6dBi are used, the maximum conducted output power shall be reduced by the amount in dB that the directional gain of the antenna exceeds 6dBi.

7.4.2. Test Procedure Used

KDB 789033D02v02r01- Section II)E)3)b) Method PM-G

7.4.3. Test Setting

Average power measurements were performed only when the EUT was transmitting at its maximum power control level using a broadband power meter with a pulse sensor. The power meter implemented triggering and gating capabilities which were set up such that power measurements were recorded only during the ON time of the transmitter.

7.4.4. Test Setup

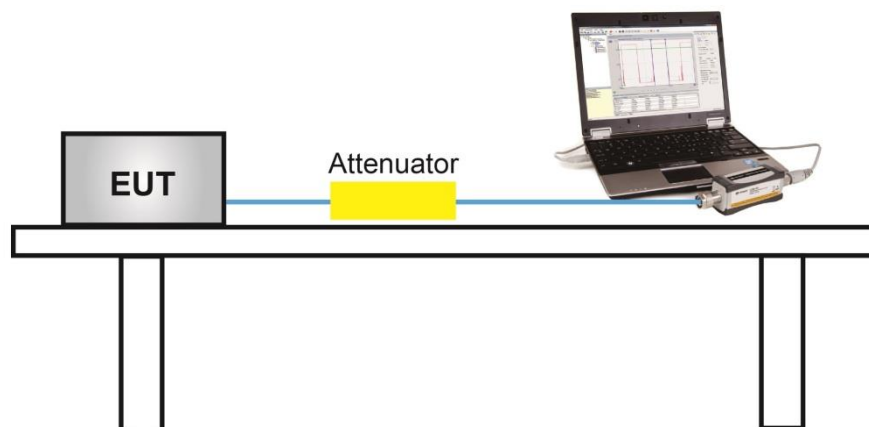

7.4.5. Test Result

Product	AC750 Dual Band Wi-Fi Router	Test Engineer	Xuan
Test Site	SR6	Test Date	2023/4/14~2023/4/17
Test Mode	SISO mode		

Test Mode	Data Rate/ MCS	Channel No.	Freq. (MHz)	Average Power (dBm)	Power Limit (dBm)	Result
11a	6Mbps	36	5180	20.09	≤ 30.00	Pass
11a	6Mbps	44	5220	20.22	≤ 30.00	Pass
11a	6Mbps	48	5240	20.51	≤ 30.00	Pass
11a	6Mbps	149	5745	20.27	≤ 30.00	Pass
11a	6Mbps	157	5785	20.38	≤ 30.00	Pass
11a	6Mbps	165	5825	20.26	≤ 30.00	Pass
11ac-VHT20	MCS0	36	5180	20.06	≤ 30.00	Pass
11ac-VHT20	MCS0	44	5220	20.15	≤ 30.00	Pass
11ac-VHT20	MCS0	48	5240	20.20	≤ 30.00	Pass
11ac-VHT20	MCS0	149	5745	20.17	≤ 30.00	Pass
11ac-VHT20	MCS0	157	5785	20.34	≤ 30.00	Pass
11ac-VHT20	MCS0	165	5825	20.24	≤ 30.00	Pass
11ac-VHT40	MCS0	38	5190	17.72	≤ 30.00	Pass
11ac-VHT40	MCS0	46	5230	20.17	≤ 30.00	Pass
11ac-VHT40	MCS0	151	5755	20.12	≤ 30.00	Pass
11ac-VHT40	MCS0	159	5795	20.22	≤ 30.00	Pass
11ac-VHT80	MCS0	42	5210	16.20	≤ 30.00	Pass
11ac-VHT80	MCS0	155	5775	20.58	≤ 30.00	Pass

7.5. Power Spectral Density Measurement

7.5.1. Test Limit

For the band 5.15-5.25 GHz, the maximum power spectral density shall not exceed 17 dBm in any 1 megahertz band.

For the band 5.725-5.85 GHz, the maximum power spectral density shall not exceed 30 dBm in any 500-kHz band.

If transmitting antennas of directional gain greater than 6dBi are used, the peak power spectral density shall be reduced by the amount in dB that the directional gain of the antenna exceeds 6dBi.

7.5.2. Test Procedure Used

KDB 789033 D02v02r01-Section II)F

7.5.3. Test Setting

1. Analyzer was set to the center frequency of the UNII channel under investigation
2. Span was set to encompass the entire 26dB EBW of the signal.
3. RBW = 1MHz, if measurement bandwidth of Maximum PSD is specified in 500 kHz,
RBW = 510 kHz
4. VBW = 3MHz
5. Number of sweep points $\geq 2 \times (\text{span} / \text{RBW})$
6. Detector = power averaging (Average)
7. Sweep time = auto
8. Trigger = free run
9. Use the peak search function on the instrument to find the peak of the spectrum and record its value.
10. Add $10 \cdot \log(1/x)$, where x is the duty cycle, to the measured power in order to compute the average power during the actual transmission times (because the measurement represents an average over both the on and off times of the transmission). For example, add $10 \cdot \log(1/0.25) = 6$ dB if the duty cycle is 25 percent.

7.5.4. Test Setup

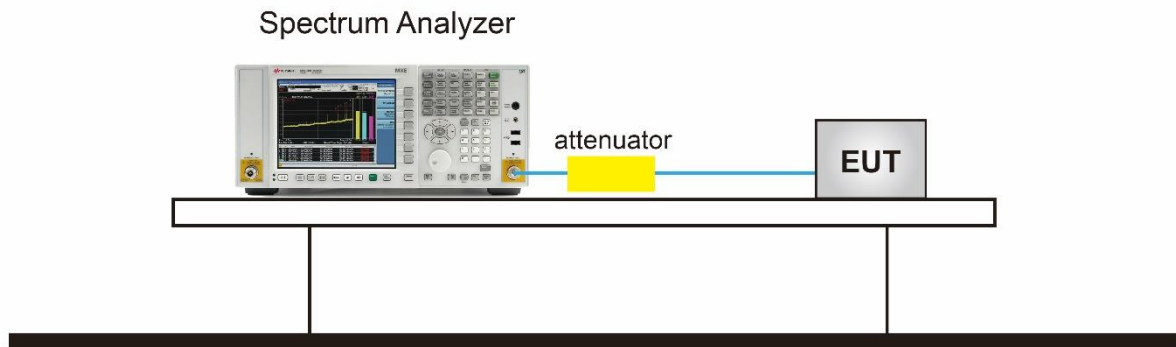

7.5.5. Test Result

Product	AC750 Dual Band Wi-Fi Router	Test Engineer	Xuan
Test Site	SR6	Test Date	2023/4/19
Mode	Power Spectral Density (U-NII- 1/-2a / -2c) SISO mode		

Test Mode	Data Rate /MCS	Ch. No.	Freq. (MHz)	PSD (dBm/MHz)	Duty Cycle (%)	Total PSD (dBm/ MHz)	PSD Limit (dBm/MHz)	Result
11a	6Mbps	36	5180	7.685	67.78%	9.374	≤17.00	Pass
11a	6Mbps	44	5220	8.342	67.78%	10.031	≤17.00	Pass
11a	6Mbps	48	5240	8.691	67.78%	10.380	≤17.00	Pass
11ac-VHT20	MCS0	36	5180	9.046	93.96%	9.317	≤17.00	Pass
11ac-VHT20	MCS0	44	5220	8.534	93.96%	8.805	≤17.00	Pass
11ac-VHT20	MCS0	48	5240	8.677	93.96%	8.948	≤17.00	Pass
11ac-VHT40	MCS0	38	5190	3.426	94.14%	3.688	≤17.00	Pass
11ac-VHT40	MCS0	46	5230	5.013	94.14%	5.275	≤17.00	Pass
11ac-VHT80	MCS0	42	5210	-2.029	87.26%	-1.437	≤17.00	Pass

Note 1: When EUT duty cycle < 98%, the total PSD (dBm/MHz) = PSD + 10*log (1/Duty Cycle)(dBm/MHz).

Product	AC750 Dual Band Wi-Fi Router	Test Engineer	Xuan
Test Site	SR6	Test Date	2023/4/19
Test Item	Power Spectral Density (U-NII-3) SISO mode		

Test Mode	Data Rate/ MCS	Ch. No.	Freq. (MHz)	PSD (dBm/510K Hz)	Duty Cycle (%)	Total PSD (dBm/ 510kHz)	Limit (dBm/ 500kHz)	Result
11a	6Mbps	149	5745	9.233	67.78%	10.922	≤30.00	Pass
11a	6Mbps	157	5785	8.612	67.78%	10.301	≤30.00	Pass
11a	6Mbps	165	5825	9.384	67.78%	11.073	≤30.00	Pass
11ac-VHT20	MCS0	149	5745	5.883	93.96%	6.154	≤30.00	Pass
11ac-VHT20	MCS0	157	5785	6.124	93.96%	6.395	≤30.00	Pass
11ac-VHT20	MCS0	165	5825	6.335	93.96%	6.606	≤30.00	Pass
11ac-VHT40	MCS0	151	5755	2.844	94.14%	3.106	≤30.00	Pass
11ac-VHT40	MCS0	159	5795	3.264	94.14%	3.526	≤30.00	Pass
11ac-VHT80	MCS0	155	5775	-0.013	87.26%	0.579	≤30.00	Pass

Note: When EUT duty cycle < 98%, the total PSD (dBm/510kHz) = PSD + 10*log (1/Duty Cycle)(dBm/510kHz).

802.11a Power Spectral Density

Channel 36 (5180MHz)

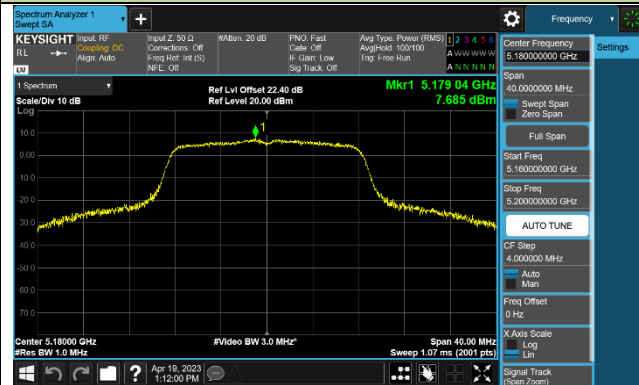

Channel 44 (5220MHz)

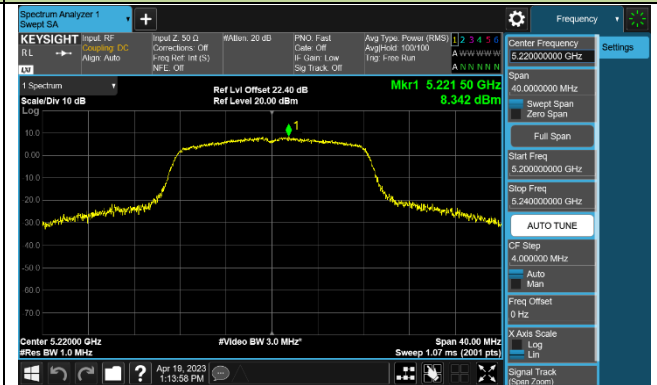

Channel 48 (5240MHz)

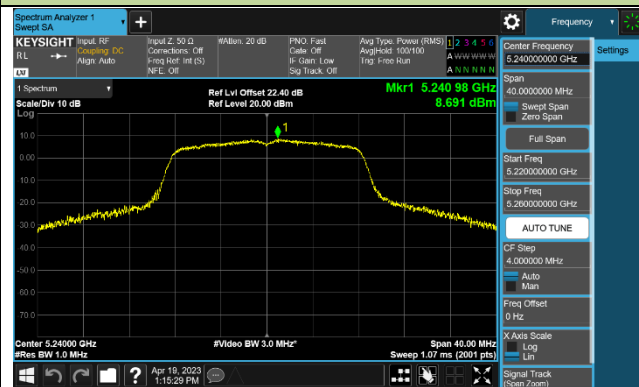

Channel 149 (5745MHz)

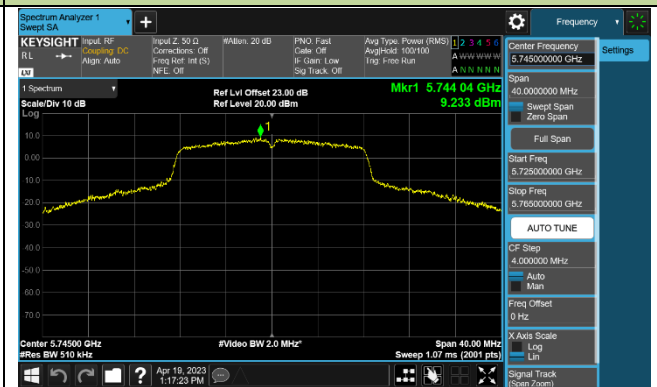

Channel 157 (5785MHz)

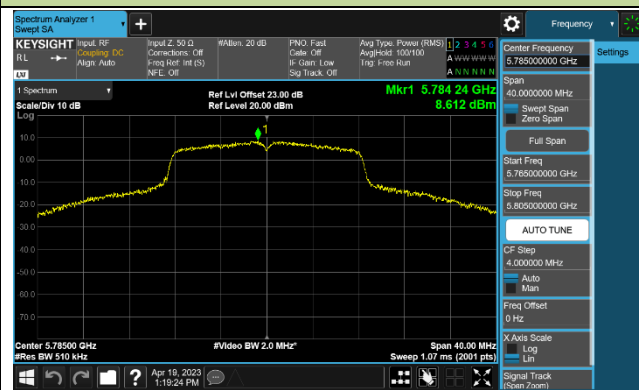

Channel 165 (5825MHz)

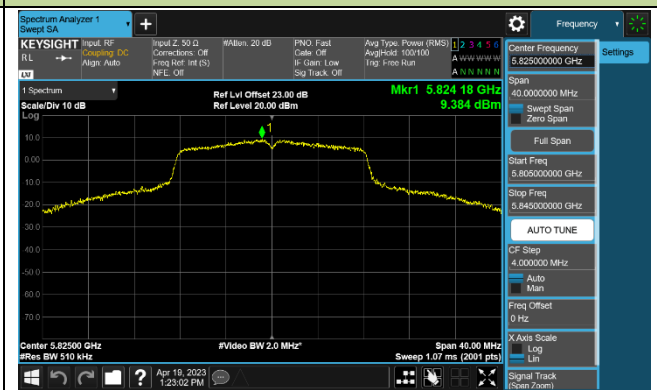

802.11ac-VHT20 Power Spectral Density

Channel 36 (5180MHz)

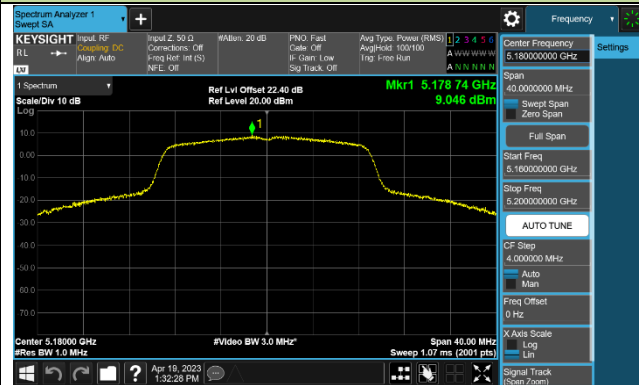

Channel 44 (5220MHz)

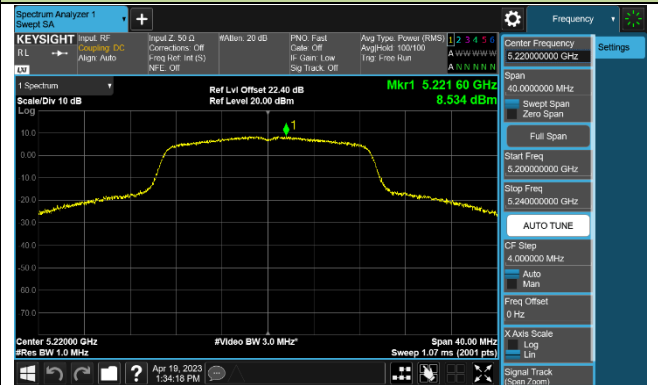

Channel 48 (5240MHz)

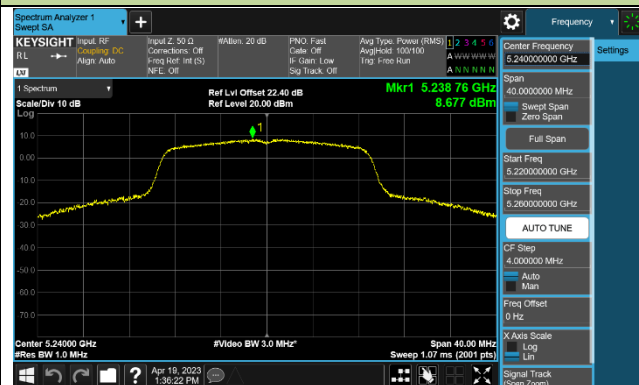

Channel 149 (5745MHz)

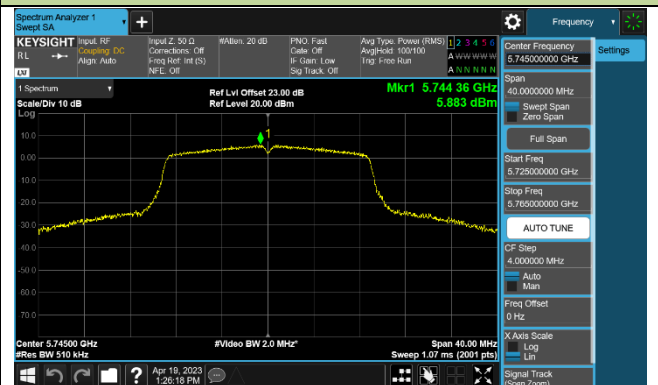

Channel 157 (5785MHz)

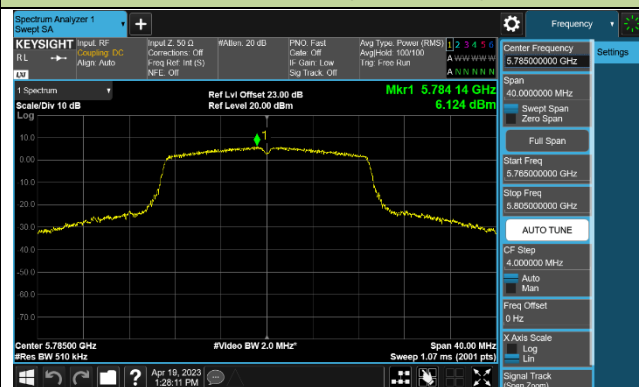

Channel 165 (5825MHz)

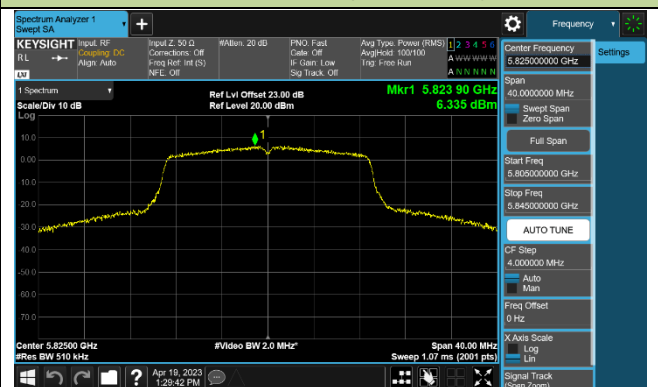

802.11ac-VHT40 Power Spectral Density

Channel 38 (5190MHz)

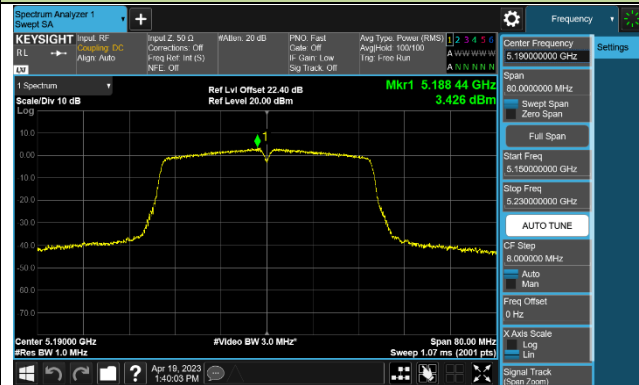

Channel 46 (5230MHz)

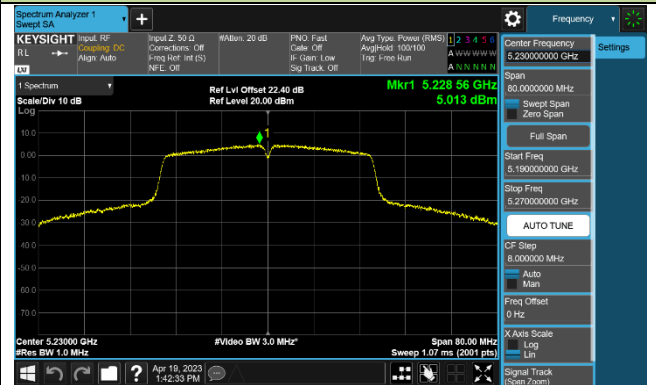

Channel 151 (5755MHz)

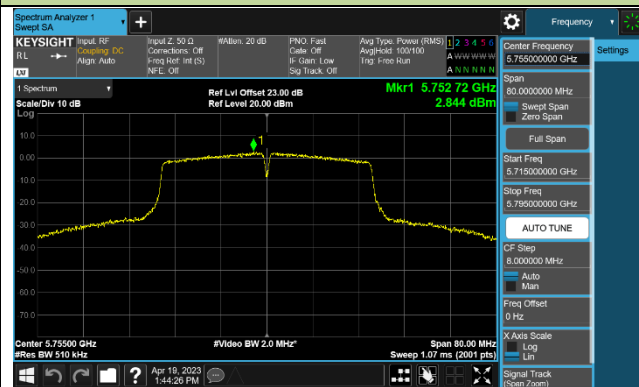

Channel 159 (5795MHz)

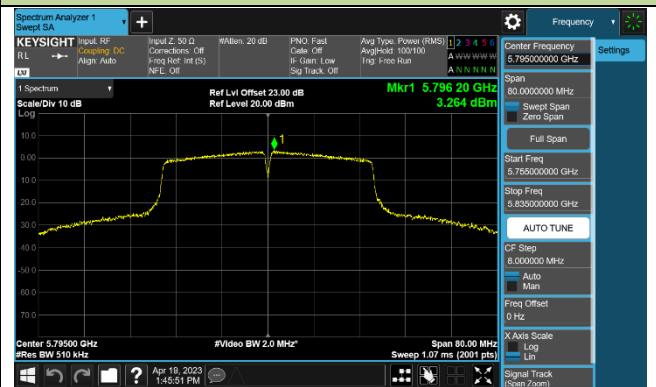

802.11ac-VHT80 Power Spectral Density

Channel 42 (5210MHz)

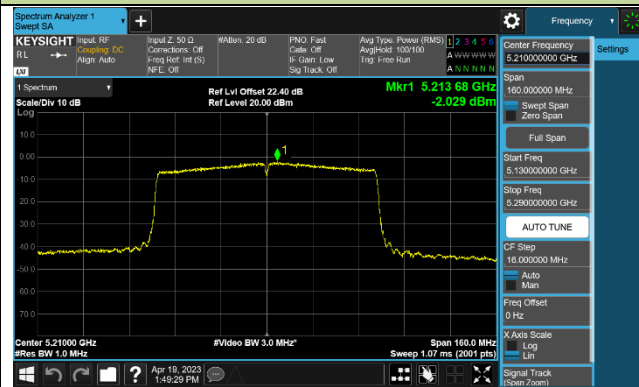

Channel 155 (5775MHz)

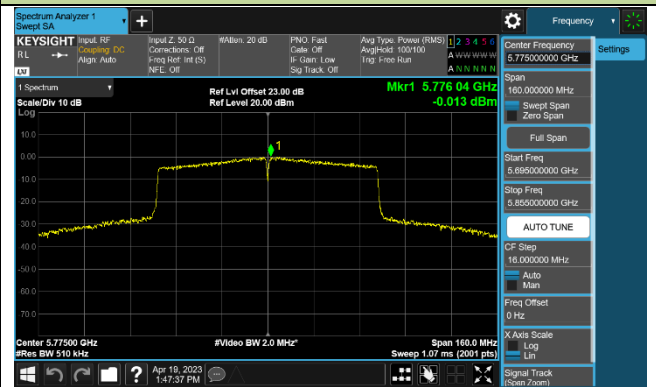

7.6. Frequency Stability Measurement

7.6.1. Test Limit

Manufactures of U-NII devices are responsible for ensuring frequency stability such that an emission is maintained within the band of operation under all conditions of normal operation as specified in the user's manual.

7.6.2. Test Limit

Frequency Stability Under Temperature Variations:

The equipment under test was connected to an external AC or DC power supply and input rated voltage. RF output was connected to a frequency counter or spectrum analyzer via feed through attenuators. The EUT was placed inside the temperature chamber. Set the spectrum analyzer RBW low enough to obtain the desired frequency resolution and measure EUT 20°C operating frequency as reference frequency. Turn EUT off and set the chamber temperature to highest. After the temperature stabilized for approximately 30 minutes recorded the frequency. Repeat step measure with 10°C decreased per stage until the lowest temperature reached.

Frequency Stability Under Voltage Variations:

Set chamber temperature to 20°C. Use a variable AC power supply / DC power source to power the EUT and set the voltage to rated voltage. Set the spectrum analyzer RBW low enough to obtain the desired frequency resolution and recorded the frequency.

Reduce the input voltage to specify extreme voltage variation ($\pm 15\%$) and endpoint, record the maximum frequency change.

7.6.3. Test Setup

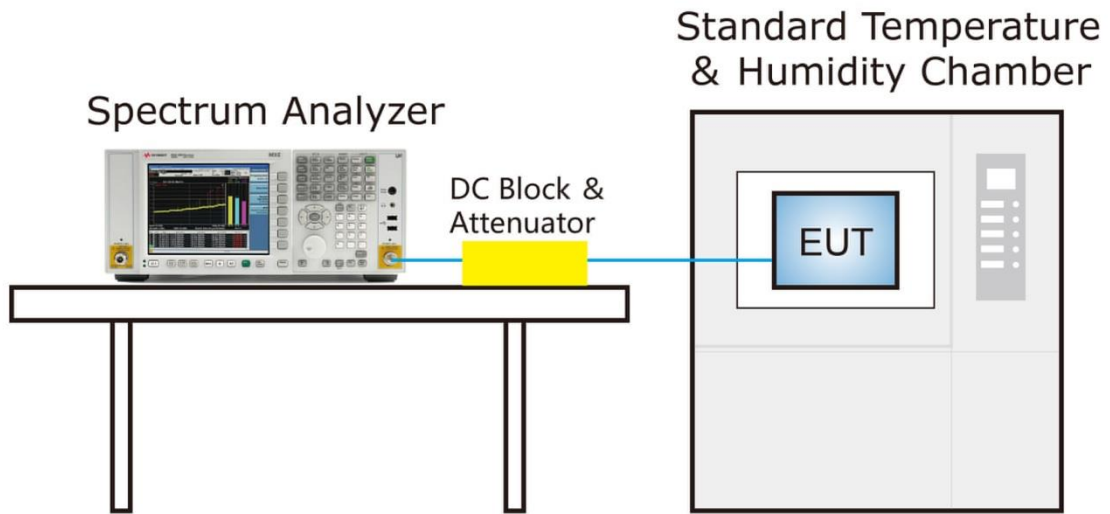

7.6.4. Test Result

Grantee ensure that the product meets e-CFR Title 47 section 15.407(g) and KDB 789033 D02v02r01 frequency stability such that the emissions are maintained within the band of operation under all conditions of normal operation as specified in the user's manual.

7.7. Radiated Spurious Emission Measurement

7.7.1. Test Limit

All out of band emissions appearing in a restricted band as specified in Section 15.205 of the Title 47CFR must not exceed the limits shown in Table per Section 15.209.

FCC Part 15 Subpart C Paragraph 15.209		
Frequency [MHz]	Field Strength [uV/m]	Measured Distance [Meters]
0.009 - 0.490	2400/F (kHz)	300
0.490 - 1.705	24000/F (kHz)	30
1.705 - 30	30	30
30 - 88	100	3
88 - 216	150	3
216 - 960	200	3
Above 960	500	3

7.7.2. Test Procedure Used

KDB 789033 D02v02r01- Section II)G

7.7.3. Test Setting

Table 1 - RBW as a function of frequency

Frequency	RBW
9 ~ 150 kHz	200 ~ 300 Hz
0.15 ~ 30 MHz	9 ~ 10 kHz
30 ~ 1000 MHz	100 ~ 120 kHz
>1000 MHz	1 MHz

Quasi-Peak Measurements below 1GHz

1. Analyzer center frequency was set to the frequency of the radiated spurious emission of interest
2. Span was set greater than 1MHz
3. RBW = as specified in Table 1
4. Detector = CISPR quasi-peak
5. Sweep time = auto couple
6. Trace was allowed to stabilize

Peak Measurements above 1GHz

1. Analyzer center frequency was set to the frequency of the radiated spurious emission of interest
2. RBW = 1MHz
3. VBW = 3MHz
4. Detector = peak
5. Sweep time = auto couple
6. Trace mode = max hold
7. Trace was allowed to stabilize

Average Measurements above 1GHz (Method VB)

1. Analyzer center frequency was set to the frequency of the radiated spurious emission of interest
2. RBW = 1MHz
3. VBW, If the EUT is configured to transmit with duty cycle $\geq 98\%$, set VBW = 10 Hz.
If the EUT duty cycle is $< 98\%$, set VBW $\geq 1/T$. T is the minimum transmission duration.
4. Detector = Peak
5. Sweep time = auto
6. Trace mode = max hold
7. Trace was allowed to stabilize

7.7.4. Test Setup

Below 1GHz Test Setup:

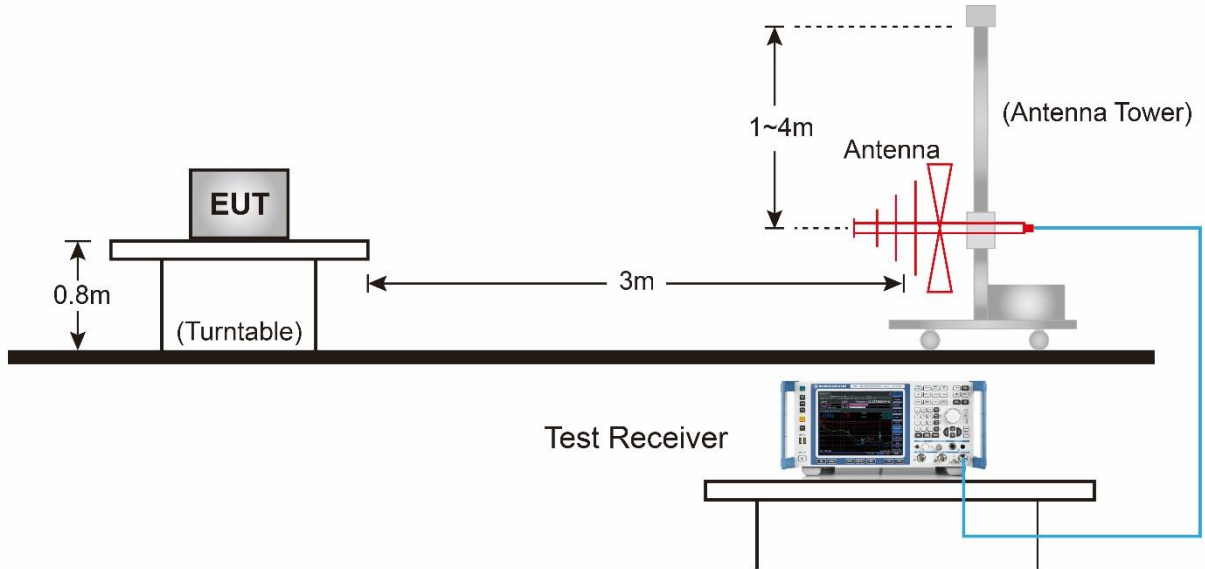

Above 1GHz Test Setup:

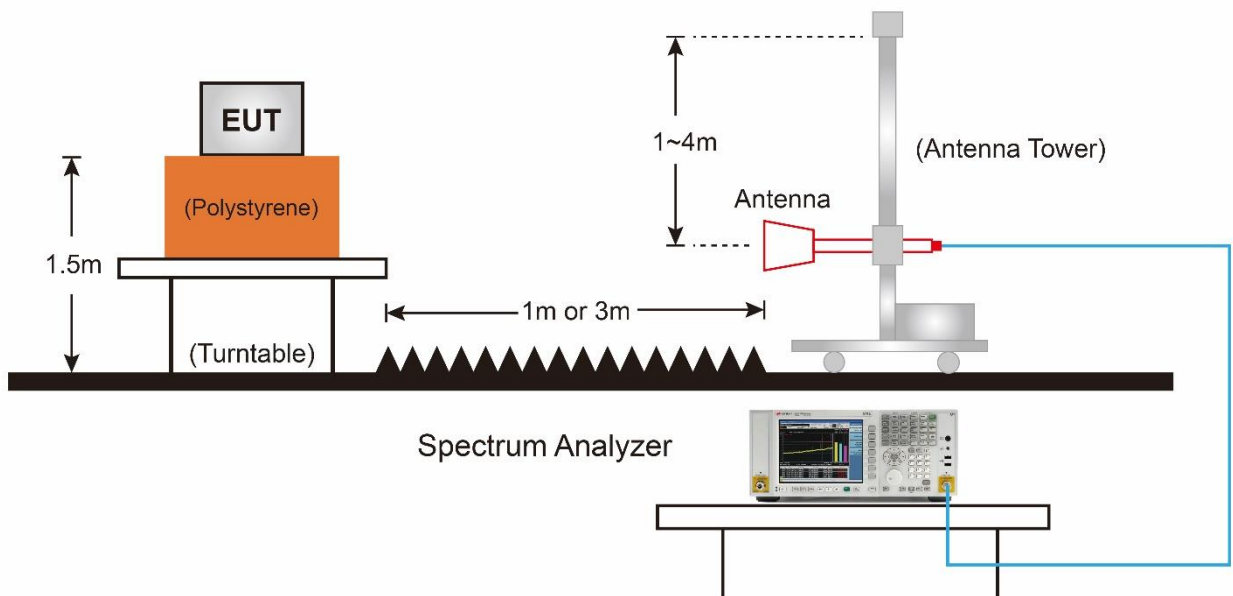

7.7.5. Test Result

EUT	AC750 Dual Band Wi-Fi Router	Date of Test	2023-05-03
Factor	VULB 9162	Temp. / Humidity	22°C /63%
Polarity	Horizontal	Site / Test Engineer	AC2 / Stanley
Test Mode	802.11ac-20MHz_Band1_TX CH 44 ANT 0+1	Test Voltage	AC 120V/60Hz

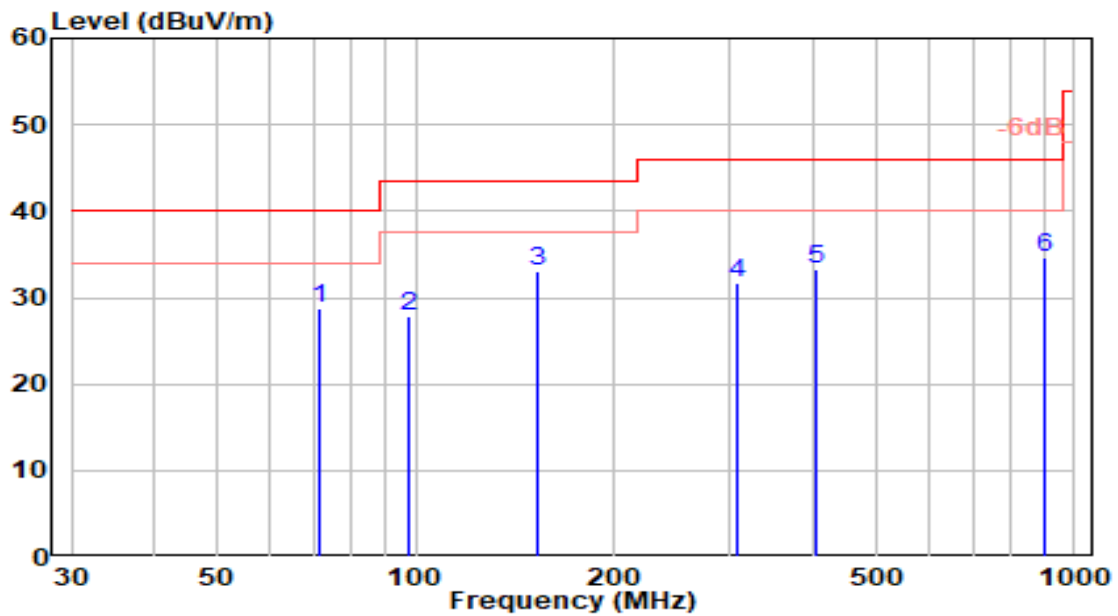

No	Frequency (MHz)	Reading (dBuV)	C.F (dB/m)	Measurement (dBuV/m)	Margin (dB)	Limit (dBuV/m)	Height (cm)	Angle (deg)	Remark (QP/PK/AV)
1	71.210	13.55	15.28	28.84	-11.16	40.00	150	67	QP
2	97.740	9.93	18.03	27.96	-15.54	43.50	150	28	QP
3	* 153.450	17.86	15.14	33.00	-10.50	43.50	200	108	QP
4	306.410	10.91	20.72	31.63	-14.37	46.00	200	348	QP
5	404.170	10.16	23.12	33.28	-12.72	46.00	150	188	QP
6	897.410	3.73	30.86	34.59	-11.41	46.00	100	325	QP

Note:

1. " *", means this data is the worst emission level.
2. C.F (Correction Factor) = Antenna Factor (dB/m) + Cable Loss (dB).
3. Measurement (dBuV/m) = Reading(dBuV) + C.F (Correction Factor).
4. The emission levels of other frequencies are very lower than the limit and not show in test report.

EUT	AC750 Dual Band Wi-Fi Router	Date of Test	2023-05-03
Factor	VULB 9162	Temp. / Humidity	22°C /63%
Polarity	Vertical	Site / Test Engineer	AC2 / Stanley
Test Mode	802.11ac-20MHz_Band1_TX CH 44 ANT 0+1	Test Voltage	AC 120V/60Hz

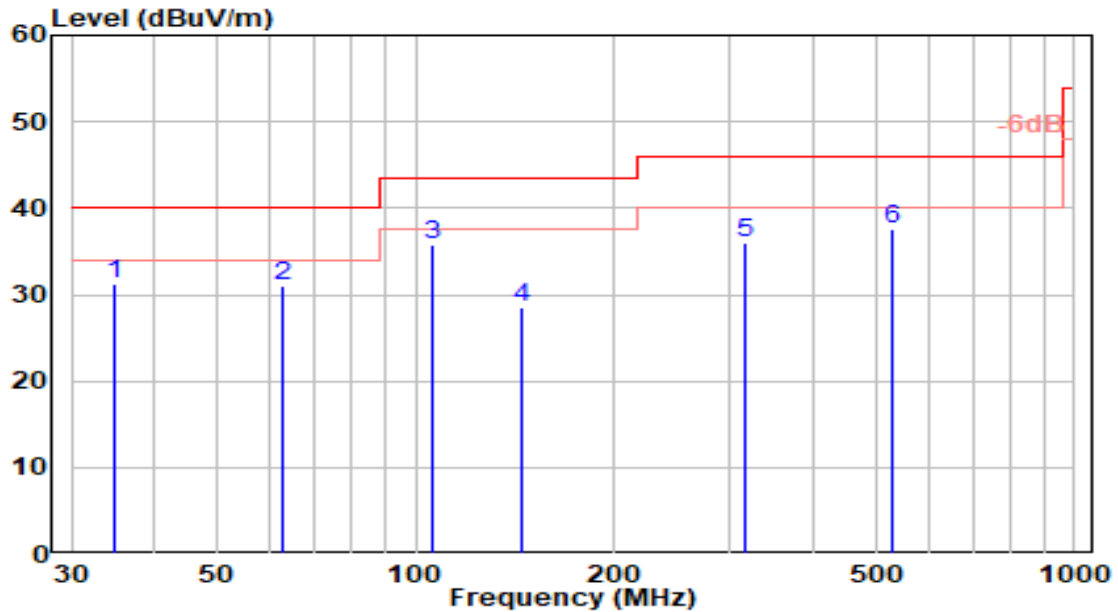

No	Frequency (MHz)	Reading (dBUV)	C.F (dB/m)	Measurement (dBUV/m)	Margin (dB)	Limit (dBUV/m)	Height (cm)	Angle (deg)	Remark (QP/PK/AV)
1	34.960	13.60	17.54	31.14	-8.86	40.00	100	87	QP
2	62.860	12.91	18.08	31.00	-9.00	40.00	200	96	QP
3	* 106.340	17.61	18.20	35.80	-7.70	43.50	100	314	QP
4	144.430	13.75	14.77	28.52	-14.98	43.50	150	167	QP
5	315.720	14.91	21.06	35.97	-10.03	46.00	150	239	QP
6	528.510	12.33	25.27	37.60	-8.40	46.00	150	21	QP

Note:

- "*" means this data is the worst emission level.
- C.F (Correction Factor) = Antenna Factor (dB/m) + Cable Loss (dB).
- Measurement (dBUV/m) = Reading(dBUV) + C.F (Correction Factor).
- The emission levels of other frequencies are very lower than the limit and not show in test report.

EUT	AC750 Dual Band Wi-Fi Router	Date of Test	2023-04-19
Factor	DRH18-E	Temp. / Humidity	22°C /63%
Polarity	Horizontal	Site / Test Engineer	AC2 / Marvin
Test Mode	802.11a_TX_Band1_CH 36_ANT 0	Test Voltage	AC 120V/60Hz

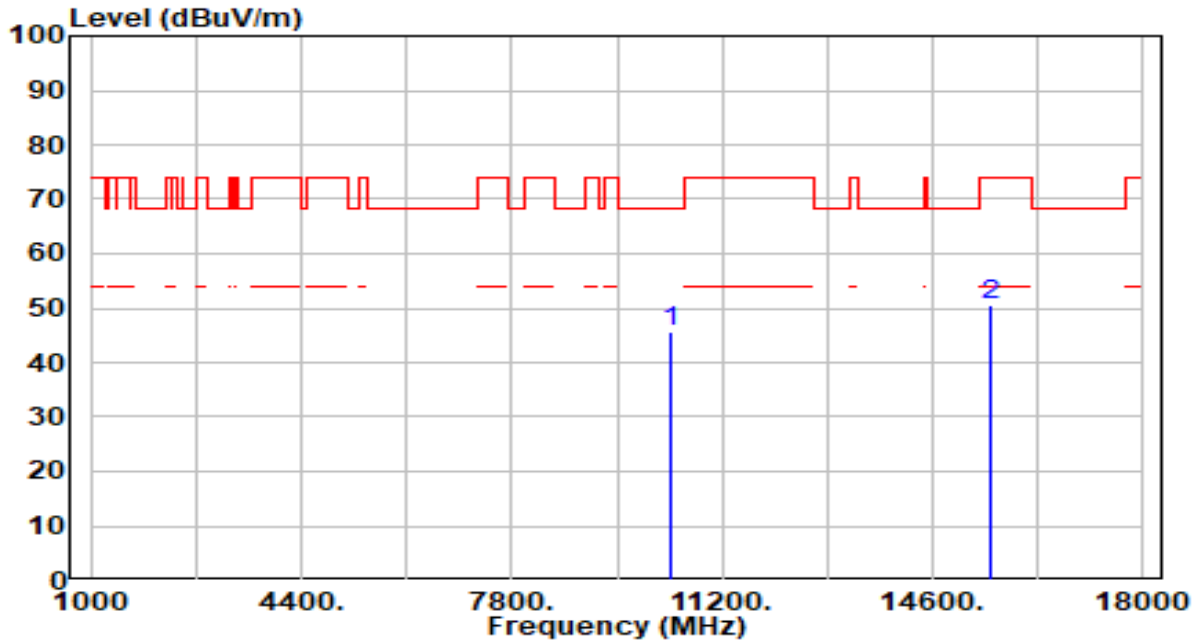

No	Frequency (MHz)	Reading (dBuV)	C.F (dB/m)	Measurement (dBuV/m)	Margin (dB)	Limit (dBuV/m)	Height (cm)	Angle (deg)	Remark (QP/PK/AV)	
1	*	10360.000	42.56	3.19	45.76	-22.44	68.20	300	148	Peak
2		15540.000	45.83	4.74	50.57	-23.43	74.00	100	334	Peak

Note:

1. " *", means this data is the worst emission level.
2. C.F (Correction Factor) = Antenna Factor (dB/m)+ Cable Loss (dB) – Preamplifier(dB).
3. Measurement (dBuV/m) = Reading(dBuV) + C.F (Correction Factor).
4. The emission levels of other frequencies are very lower than the limit and not show in test report.

EUT	AC750 Dual Band Wi-Fi Router	Date of Test	2023-04-19
Factor	DRH18-E	Temp. / Humidity	22°C /63%
Polarity	Vertical	Site / Test Engineer	AC2 / Marvin
Test Mode	802.11a_TX_Band1_CH 36_ANT 0	Test Voltage	AC 120V/60Hz

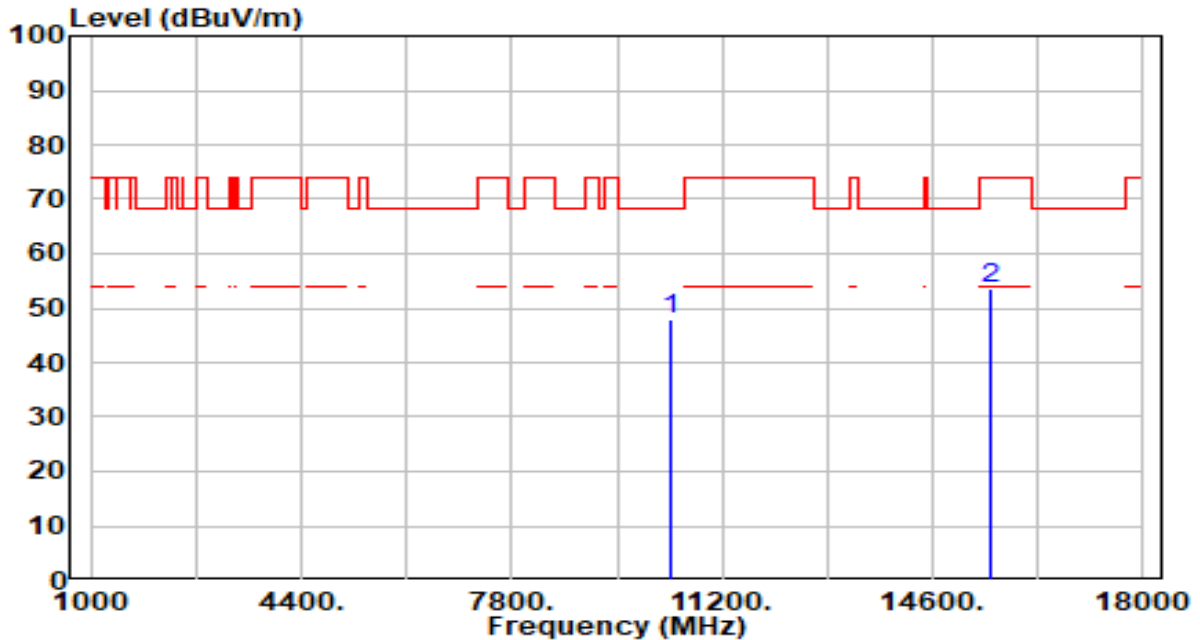

No	Frequency (MHz)	Reading (dBuV)	C.F (dB/m)	Measurement (dBuV/m)	Margin (dB)	Limit (dBuV/m)	Height (cm)	Angle (deg)	Remark (QP/PK/AV)
1	*	44.91	3.19	48.10	-20.10	68.20	300	256	Peak
2		48.94	4.74	53.69	-20.31	74.00	300	181	Peak

Note:

1. " *", means this data is the worst emission level.
2. C.F (Correction Factor) = Antenna Factor (dB/m)+ Cable Loss (dB) – Preamplifier(dB).
3. Measurement (dBuV/m) = Reading(dBuV) + C.F (Correction Factor).
4. The emission levels of other frequencies are very lower than the limit and not show in test report.

EUT	AC750 Dual Band Wi-Fi Router	Date of Test	2023-04-19
Factor	DRH18-E	Temp. / Humidity	22°C /63%
Polarity	Horizontal	Site / Test Engineer	AC2 / Marvin
Test Mode	802.11a_TX_Band1_CH 44_ANT 0	Test Voltage	AC 120V/60Hz

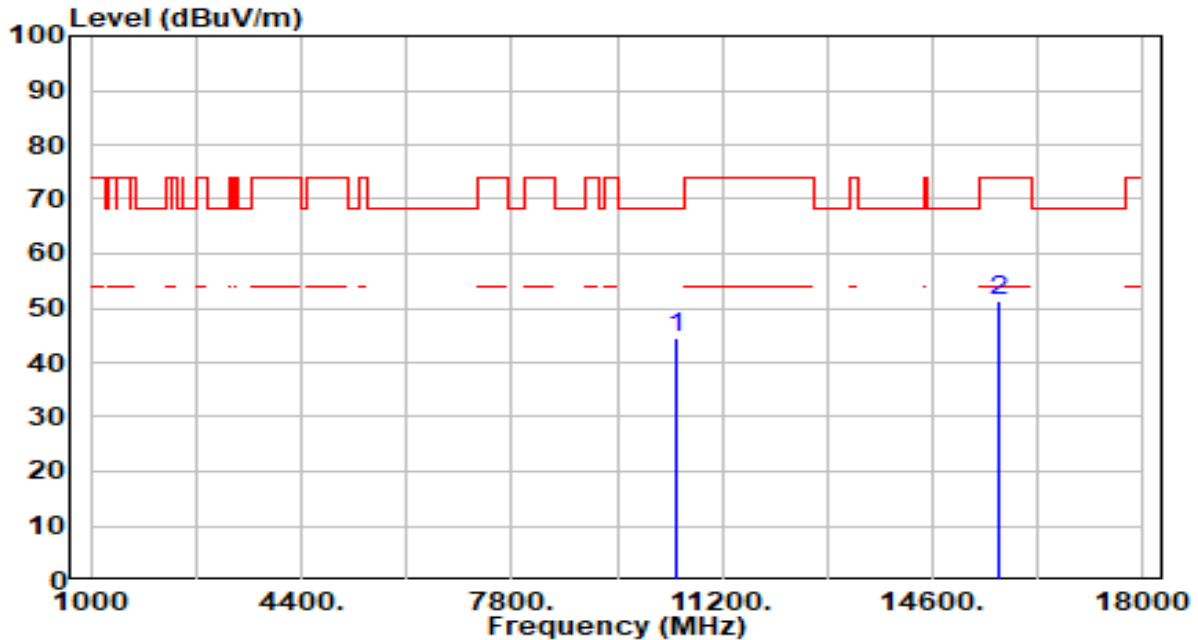

No	Frequency (MHz)	Reading (dBuV)	C.F (dB/m)	Measurement (dBuV/m)	Margin (dB)	Limit (dBuV/m)	Height (cm)	Angle (deg)	Remark (QP/PK/AV)
1	10440.000	41.49	3.15	44.64	-23.56	68.20	300	170	Peak
2	* 15660.000	46.48	4.89	51.37	-22.63	74.00	300	30	Peak

Note:

1. " *", means this data is the worst emission level.
2. C.F (Correction Factor) = Antenna Factor (dB/m)+ Cable Loss (dB) – Preamplifier(dB).
3. Measurement (dBuV/m) = Reading(dBuV) + C.F (Correction Factor).
4. The emission levels of other frequencies are very lower than the limit and not show in test report.

EUT	AC750 Dual Band Wi-Fi Router	Date of Test	2023-04-19
Factor	DRH18-E	Temp. / Humidity	22°C /63%
Polarity	Vertical	Site / Test Engineer	AC2 / Marvin
Test Mode	802.11a_TX_Band1_CH 44_ANT 0	Test Voltage	AC 120V/60Hz

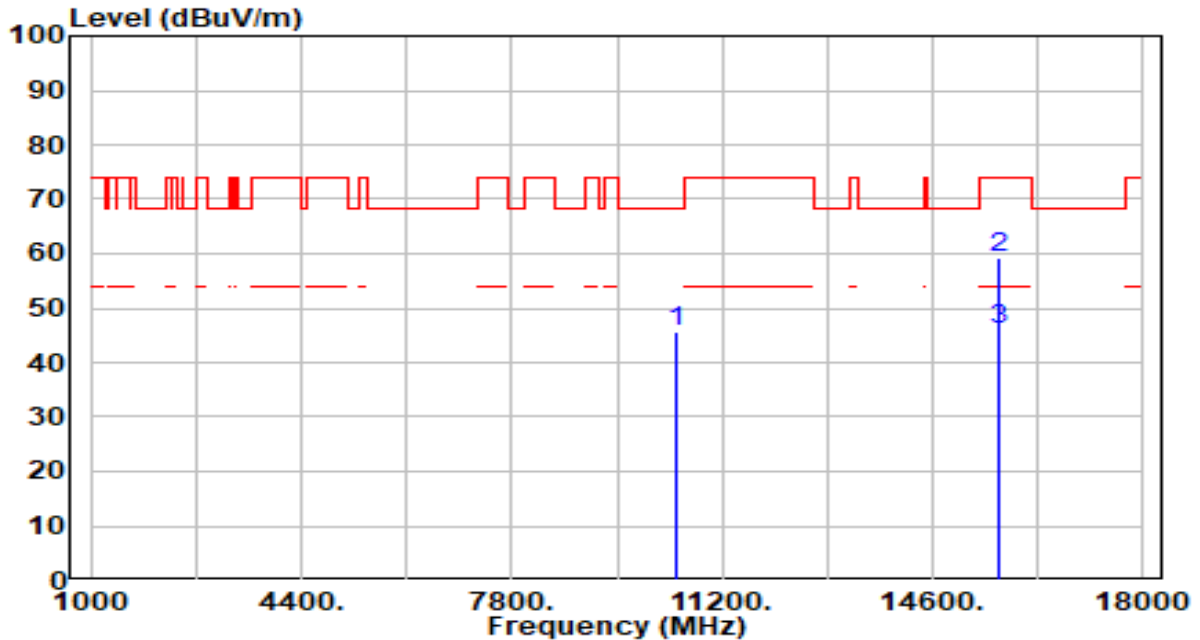

No	Frequency (MHz)	Reading (dBuV)	C.F (dB/m)	Measurement (dBuV/m)	Margin (dB)	Limit (dBuV/m)	Height (cm)	Angle (deg)	Remark (QP/PK/AV)
1	10440.000	42.60	3.15	45.75	-22.45	68.20	300	45	Peak
2	* 15660.000	54.25	4.89	59.14	-14.86	74.00	300	183	Peak
3	* 15660.000	41.10	4.89	45.99	-8.01	54.00	300	183	Average

Note:

1. " *", means this data is the worst emission level.
2. C.F (Correction Factor) = Antenna Factor (dB/m)+ Cable Loss (dB) – Preamplifier(dB).
3. Measurement (dBuV/m) = Reading(dBuV) + C.F (Correction Factor).
4. The emission levels of other frequencies are very lower than the limit and not show in test report.

EUT	AC750 Dual Band Wi-Fi Router	Date of Test	2023-04-19
Factor	DRH18-E	Temp. / Humidity	22°C /63%
Polarity	Horizontal	Site / Test Engineer	AC2 / Marvin
Test Mode	802.11a_TX_Band1_CH 48_ANT 0	Test Voltage	AC 120V/60Hz

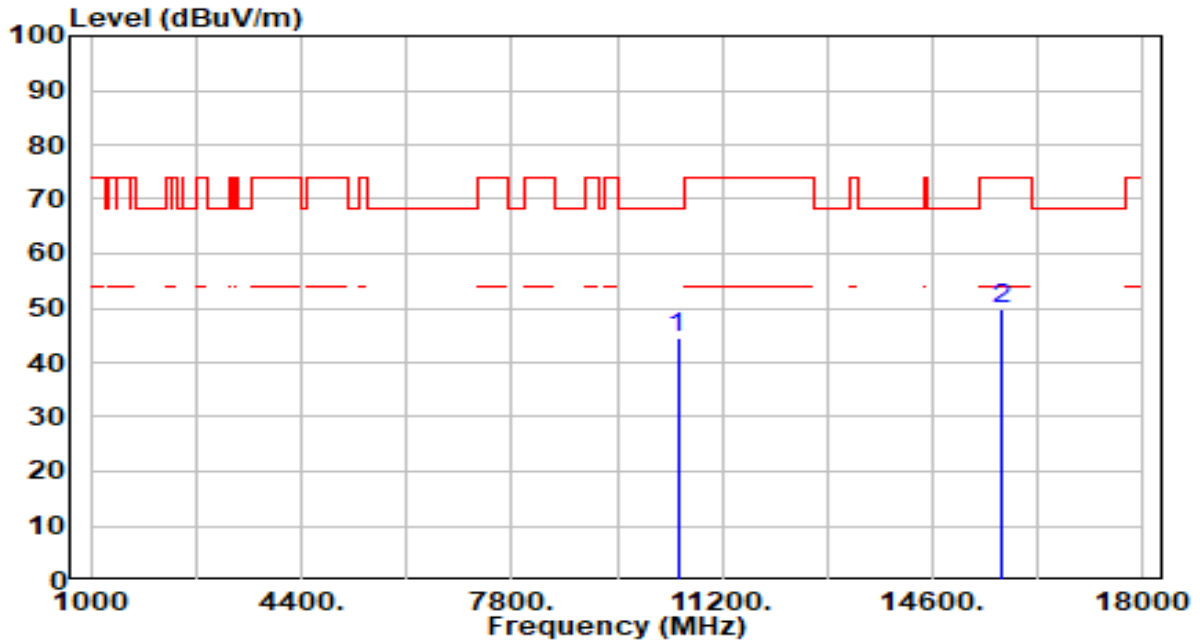

No	Frequency (MHz)	Reading (dBuV)	C.F (dB/m)	Measurement (dBuV/m)	Margin (dB)	Limit (dBuV/m)	Height (cm)	Angle (deg)	Remark (QP/PK/AV)
1	*	41.50	3.11	44.61	-23.59	68.20	300	250	Peak
2		44.69	5.02	49.71	-24.29	74.00	300	30	Peak

Note:

1. " *", means this data is the worst emission level.
2. C.F (Correction Factor) = Antenna Factor (dB/m)+ Cable Loss (dB) – Preamplifier(dB).
3. Measurement (dBuV/m) = Reading(dBuV) + C.F (Correction Factor).
4. The emission levels of other frequencies are very lower than the limit and not show in test report.

EUT	AC750 Dual Band Wi-Fi Router	Date of Test	2023-04-19
Factor	DRH18-E	Temp. / Humidity	22°C /63%
Polarity	Vertical	Site / Test Engineer	AC2 / Marvin
Test Mode	802.11a_TX_Band1_CH 48_ANT 0	Test Voltage	AC 120V/60Hz

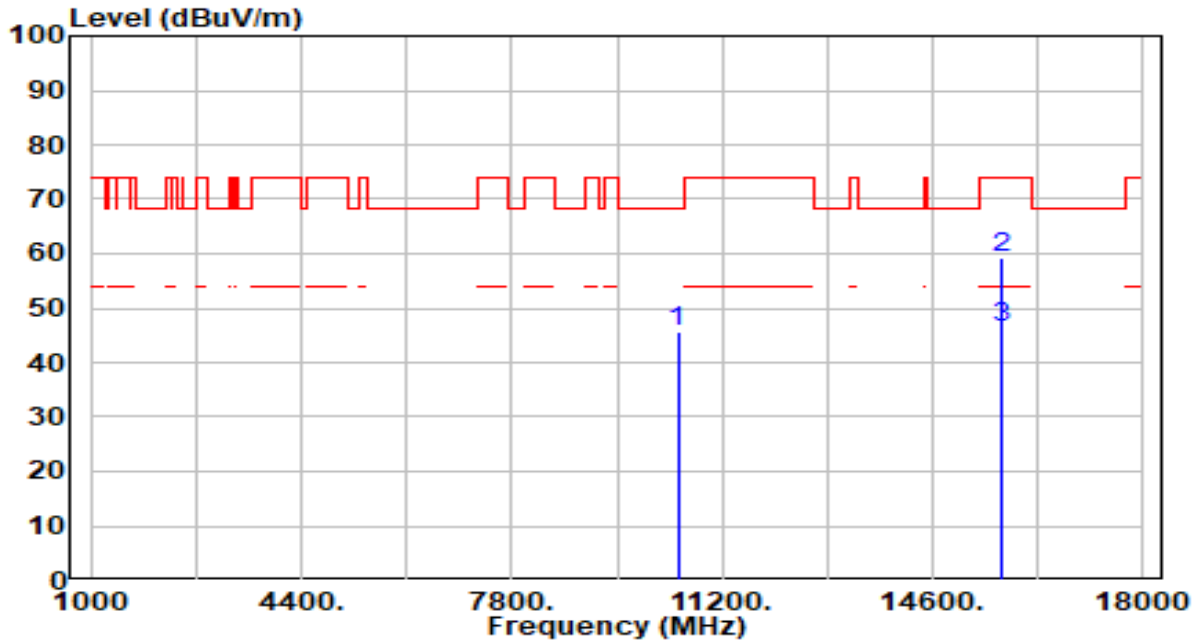

No	Frequency (MHz)	Reading (dBUV)	C.F (dB/m)	Measurement (dBUV/m)	Margin (dB)	Limit (dBUV/m)	Height (cm)	Angle (deg)	Remark (QP/PK/AV)
1	10480.000	42.37	3.11	45.48	-22.72	68.20	300	105	Peak
2	* 15720.000	54.07	5.02	59.09	-14.91	74.00	300	184	Peak
3	* 15720.000	41.57	5.02	46.59	-7.41	54.00	300	184	Average

Note:

1. " *", means this data is the worst emission level.
2. C.F (Correction Factor) = Antenna Factor (dB/m)+ Cable Loss (dB) – Preamplifier(dB).
3. Measurement (dBUV/m) = Reading(dBUV) + C.F (Correction Factor).
4. The emission levels of other frequencies are very lower than the limit and not show in test report.

EUT	AC750 Dual Band Wi-Fi Router	Date of Test	2023-04-19
Factor	DRH18-E	Temp. / Humidity	22°C /63%
Polarity	Horizontal	Site / Test Engineer	AC2 / Marvin
Test Mode	802.11a_TX_Band4_CH 149_ANT 0	Test Voltage	AC 120V/60Hz

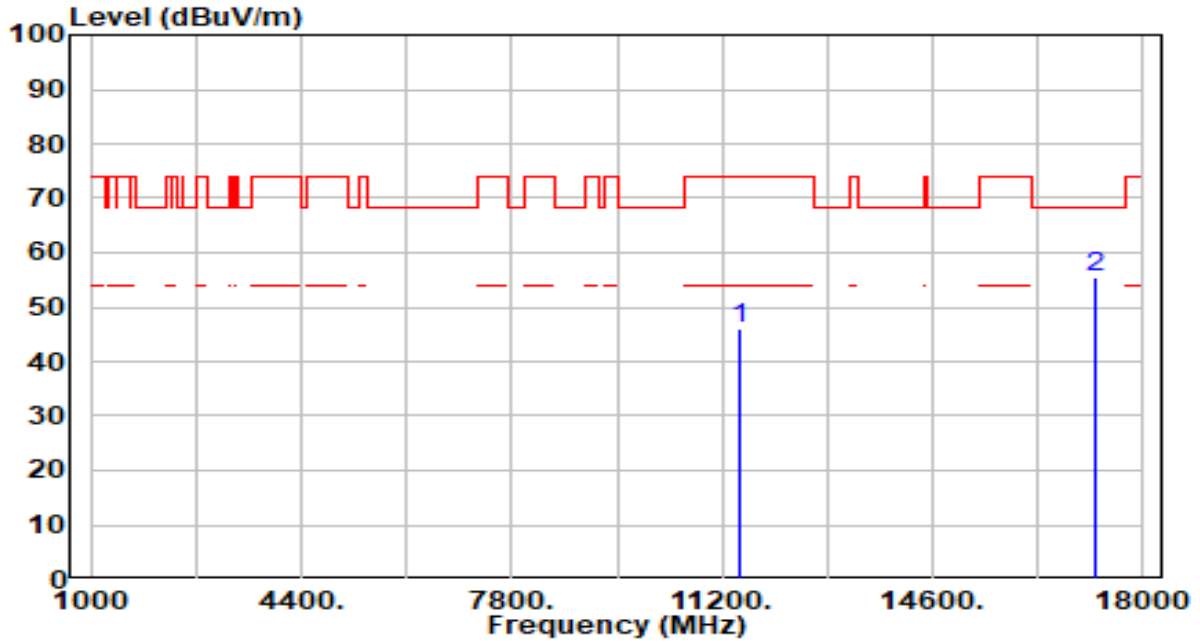

No	Frequency (MHz)	Reading (dBuV)	C.F (dB/m)	Measurement (dBuV/m)	Margin (dB)	Limit (dBuV/m)	Height (cm)	Angle (deg)	Remark (QP/PK/AV)
1	11490.000	42.02	3.92	45.95	-28.05	74.00	300	75	Peak
2	* 17235.000	51.37	4.06	55.44	-12.76	68.20	300	300	Peak

Note:

1. " *", means this data is the worst emission level.
2. C.F (Correction Factor) = Antenna Factor (dB/m)+ Cable Loss (dB) – Pre-amplifier(dB).
3. Measurement (dBuV/m) = Reading(dBuV) + C.F (Correction Factor).
4. The emission levels of other frequencies are very lower than the limit and not show in test report.

EUT	AC750 Dual Band Wi-Fi Router	Date of Test	2023-04-19
Factor	DRH18-E	Temp. / Humidity	22°C /63%
Polarity	Vertical	Site / Test Engineer	AC2 / Marvin
Test Mode	802.11a_TX_Band4_CH 149_ANT 0	Test Voltage	AC 120V/60Hz

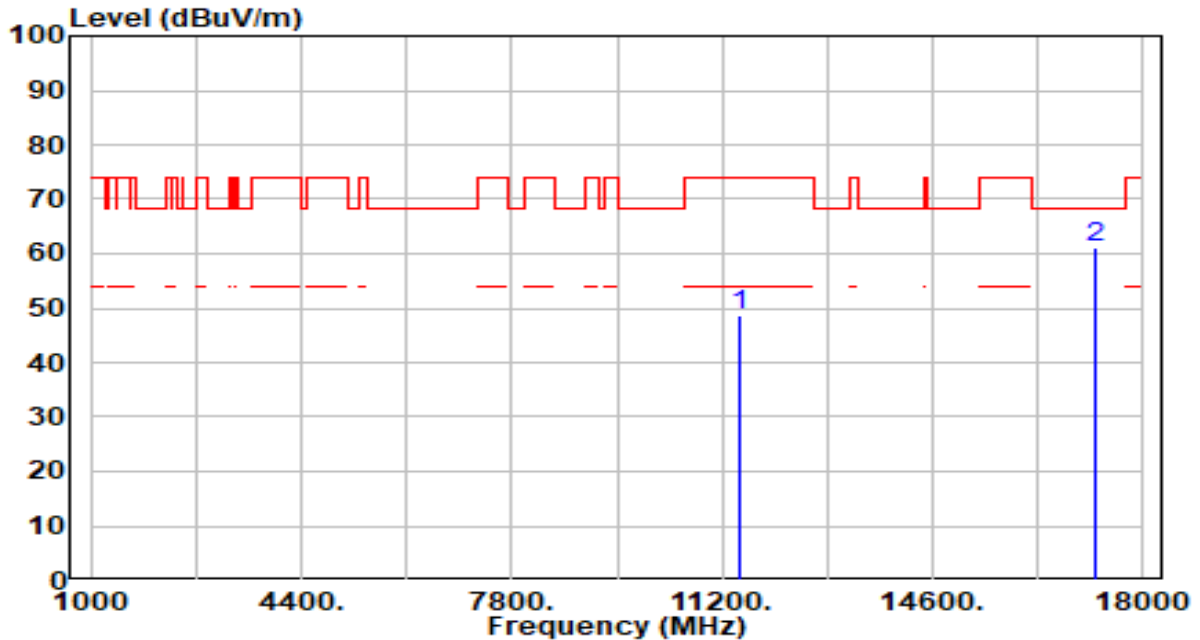

No	Frequency (MHz)	Reading (dBuV)	C.F (dB/m)	Measurement (dBuV/m)	Margin (dB)	Limit (dBuV/m)	Height (cm)	Angle (deg)	Remark (QP/PK/AV)
1	11490.000	44.60	3.92	48.52	-25.48	74.00	300	220	Peak
2	* 17235.000	57.20	4.06	61.26	-6.94	68.20	300	190	Peak

Note:

1. " *", means this data is the worst emission level.
2. C.F (Correction Factor) = Antenna Factor (dB/m)+ Cable Loss (dB) – Preamplifier(dB).
3. Measurement (dBuV/m) = Reading(dBuV) + C.F (Correction Factor).
4. The emission levels of other frequencies are very lower than the limit and not show in test report.

EUT	AC750 Dual Band Wi-Fi Router	Date of Test	2023-04-19
Factor	DRH18-E	Temp. / Humidity	22°C /63%
Polarity	Horizontal	Site / Test Engineer	AC2 / Marvin
Test Mode	802.11a_TX_Band4_CH 157_ANT 0	Test Voltage	AC 120V/60Hz

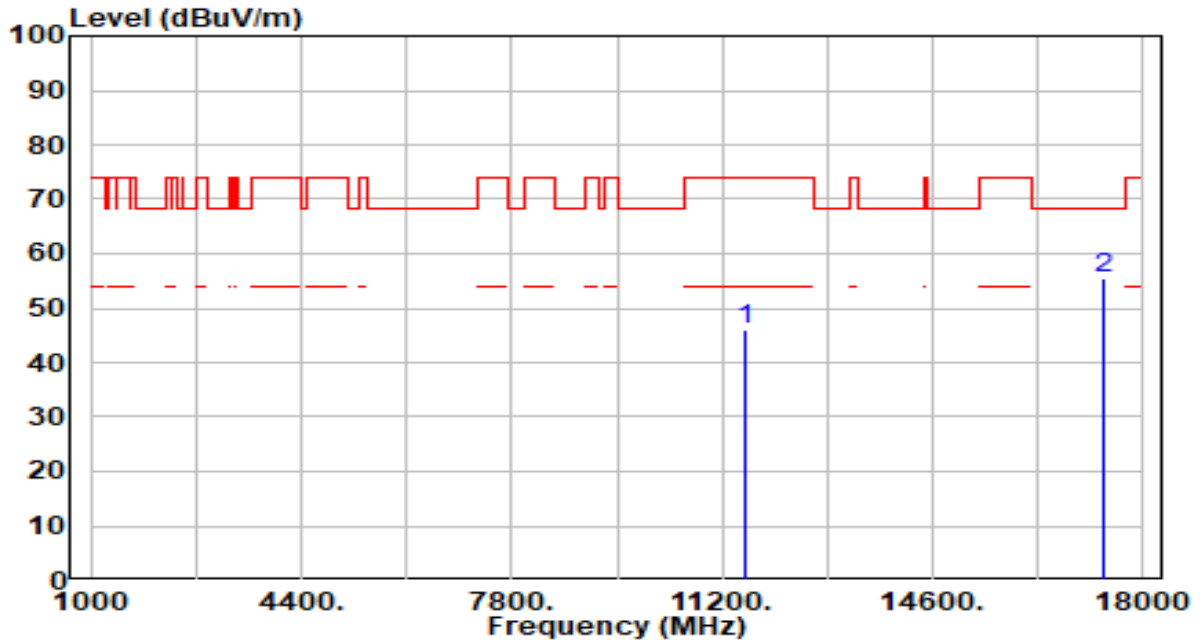

No	Frequency (MHz)	Reading (dBUV)	C.F (dB/m)	Measurement (dBUV/m)	Margin (dB)	Limit (dBUV/m)	Height (cm)	Angle (deg)	Remark (QP/PK/AV)
1	11570.000	41.91	3.94	45.85	-28.15	74.00	300	285	Peak
2	* 17355.000	51.51	3.78	55.29	-12.91	68.20	300	305	Peak

Note:

1. " *", means this data is the worst emission level.
2. C.F (Correction Factor) = Antenna Factor (dB/m)+ Cable Loss (dB) – Preamplifier(dB).
3. Measurement (dBUV/m) = Reading(dBUV) + C.F (Correction Factor).
4. The emission levels of other frequencies are very lower than the limit and not show in test report.

EUT	AC750 Dual Band Wi-Fi Router	Date of Test	2023-04-19
Factor	DRH18-E	Temp. / Humidity	22°C /63%
Polarity	Vertical	Site / Test Engineer	AC2 / Marvin
Test Mode	802.11a_TX_Band4_CH 157_ANT 0	Test Voltage	AC 120V/60Hz

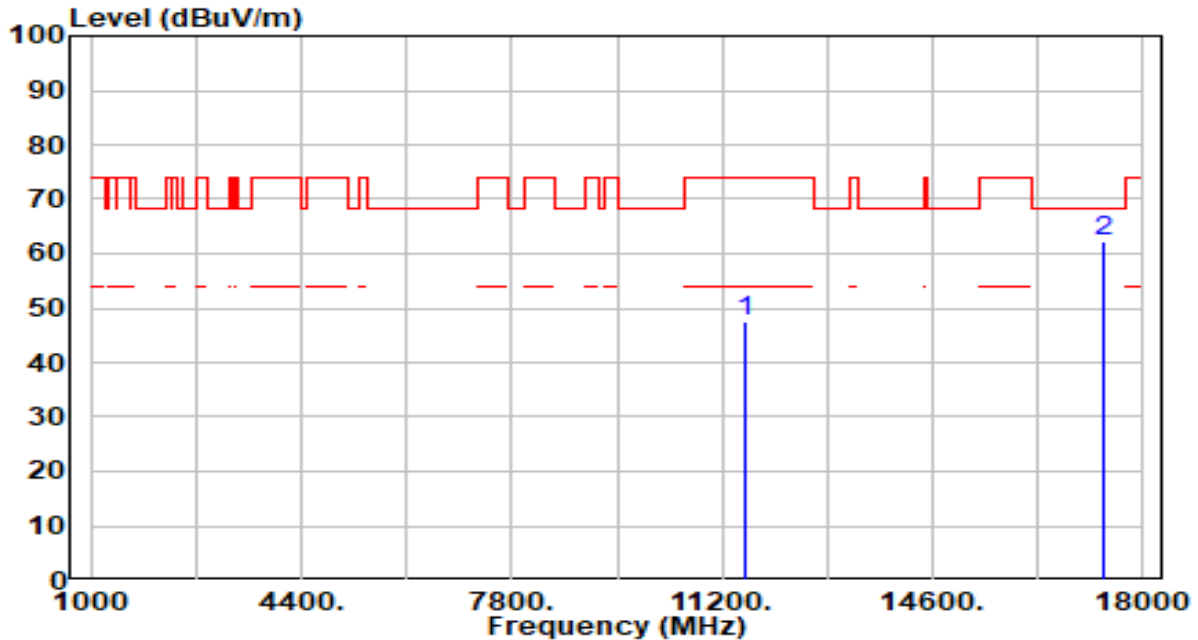

No	Frequency (MHz)	Reading (dBUV)	C.F (dB/m)	Measurement (dBUV/m)	Margin (dB)	Limit (dBUV/m)	Height (cm)	Angle (deg)	Remark (QP/PK/AV)
1	11570.000	43.43	3.94	47.38	-26.62	74.00	300	220	Peak
2	* 17355.000	58.43	3.78	62.22	-5.98	68.20	300	190	Peak

Note:

1. " *", means this data is the worst emission level.
2. C.F (Correction Factor) = Antenna Factor (dB/m)+ Cable Loss (dB) – Preamplifier(dB).
3. Measurement (dBUV/m) = Reading(dBUV) + C.F (Correction Factor).
4. The emission levels of other frequencies are very lower than the limit and not show in test report.

EUT	AC750 Dual Band Wi-Fi Router	Date of Test	2023-04-19
Factor	DRH18-E	Temp. / Humidity	22°C /63%
Polarity	Horizontal	Site / Test Engineer	AC2 / Marvin
Test Mode	802.11a_TX_Band4_CH 165_ANT 0	Test Voltage	AC 120V/60Hz

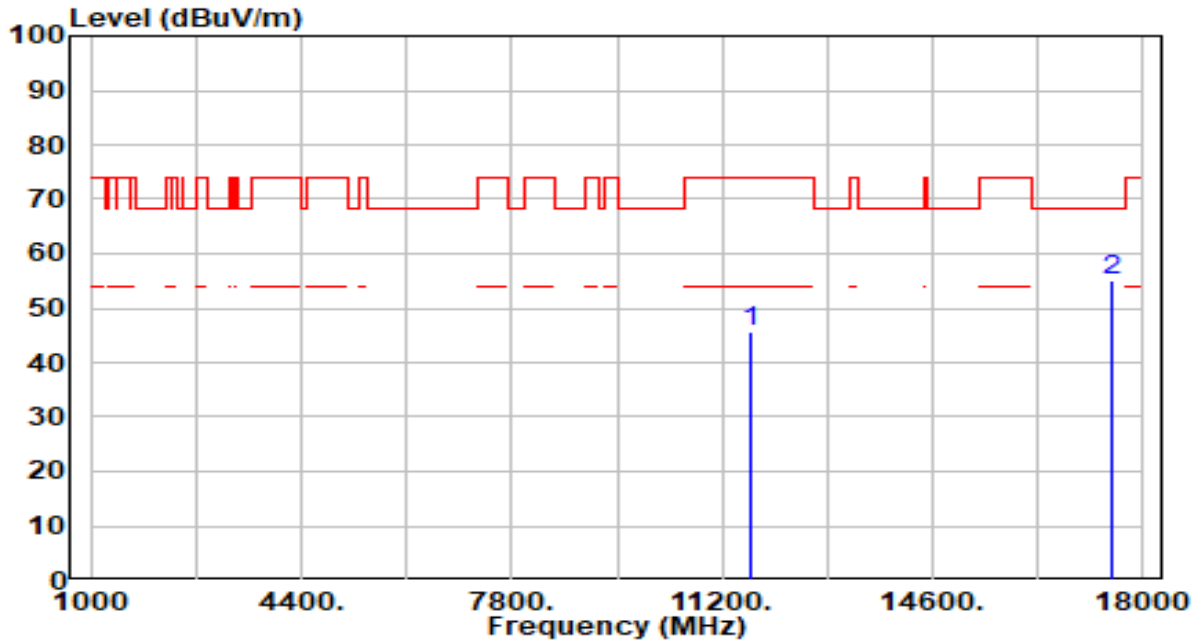

No	Frequency (MHz)	Reading (dBUV)	C.F (dB/m)	Measurement (dBUV/m)	Margin (dB)	Limit (dBUV/m)	Height (cm)	Angle (deg)	Remark (QP/PK/AV)
1	11650.000	41.83	3.94	45.77	-28.23	74.00	300	310	Peak
2	* 17475.000	51.46	3.65	55.11	-13.09	68.20	300	35	Peak

Note:

1. " *", means this data is the worst emission level.
2. C.F (Correction Factor) = Antenna Factor (dB/m)+ Cable Loss (dB) – Preamplifier(dB).
3. Measurement (dBUV/m) = Reading(dBUV) + C.F (Correction Factor).
4. The emission levels of other frequencies are very lower than the limit and not show in test report.

EUT	AC750 Dual Band Wi-Fi Router	Date of Test	2023-04-19
Factor	DRH18-E	Temp. / Humidity	22°C /63%
Polarity	Vertical	Site / Test Engineer	AC2 / Marvin
Test Mode	802.11a_TX_Band4_CH 165_ANT 0	Test Voltage	AC 120V/60Hz

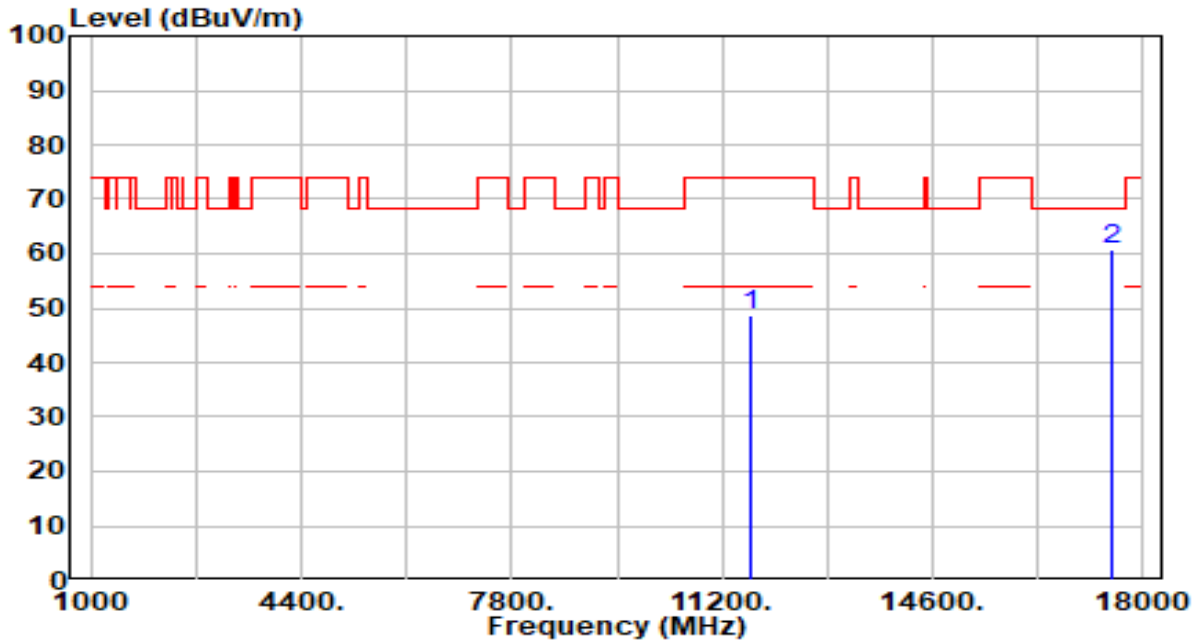

No	Frequency (MHz)	Reading (dBuV)	C.F (dB/m)	Measurement (dBuV/m)	Margin (dB)	Limit (dBuV/m)	Height (cm)	Angle (deg)	Remark (QP/PK/AV)
1	11650.000	44.56	3.94	48.50	-25.50	74.00	300	220	Peak
2	* 17475.000	56.94	3.65	60.59	-7.61	68.20	300	190	Peak

Note:

1. " *", means this data is the worst emission level.
2. C.F (Correction Factor) = Antenna Factor (dB/m)+ Cable Loss (dB) – Preamplifier(dB).
3. Measurement (dBuV/m) = Reading(dBuV) + C.F (Correction Factor).
4. The emission levels of other frequencies are very lower than the limit and not show in test report.

EUT	AC750 Dual Band Wi-Fi Router	Date of Test	2023-04-19
Factor	DRH18-E	Temp. / Humidity	22°C /63%
Polarity	Horizontal	Site / Test Engineer	AC2 / Marvin
Test Mode	802.11ac-20MHz_TX_Band1_CH 36_ANT 0	Test Voltage	AC 120V/60Hz

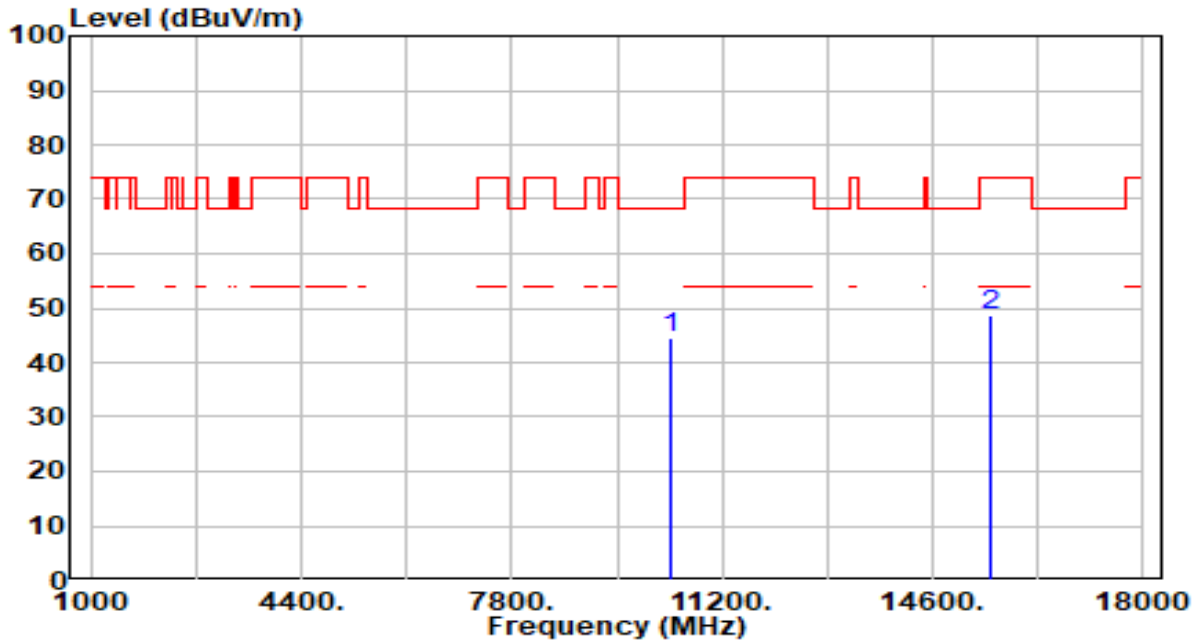

No	Frequency (MHz)	Reading (dBuV)	C.F (dB/m)	Measurement (dBuV/m)	Margin (dB)	Limit (dBuV/m)	Height (cm)	Angle (deg)	Remark (QP/PK/AV)
1	*	41.30	3.19	44.50	-23.70	68.20	300	160	Peak
2		44.08	4.74	48.82	-25.18	74.00	300	150	Peak

Note:

1. " *", means this data is the worst emission level.
2. C.F (Correction Factor) = Antenna Factor (dB/m)+ Cable Loss (dB) – Preamplifier(dB).
3. Measurement (dBuV/m) = Reading(dBuV) + C.F (Correction Factor).
4. The emission levels of other frequencies are very lower than the limit and not show in test report.

EUT	AC750 Dual Band Wi-Fi Router	Date of Test	2023-04-19
Factor	DRH18-E	Temp. / Humidity	22°C /63%
Polarity	Vertical	Site / Test Engineer	AC2 / Marvin
Test Mode	802.11ac-20MHz_TX_Band1_CH 36_ANT 0	Test Voltage	AC 120V/60Hz

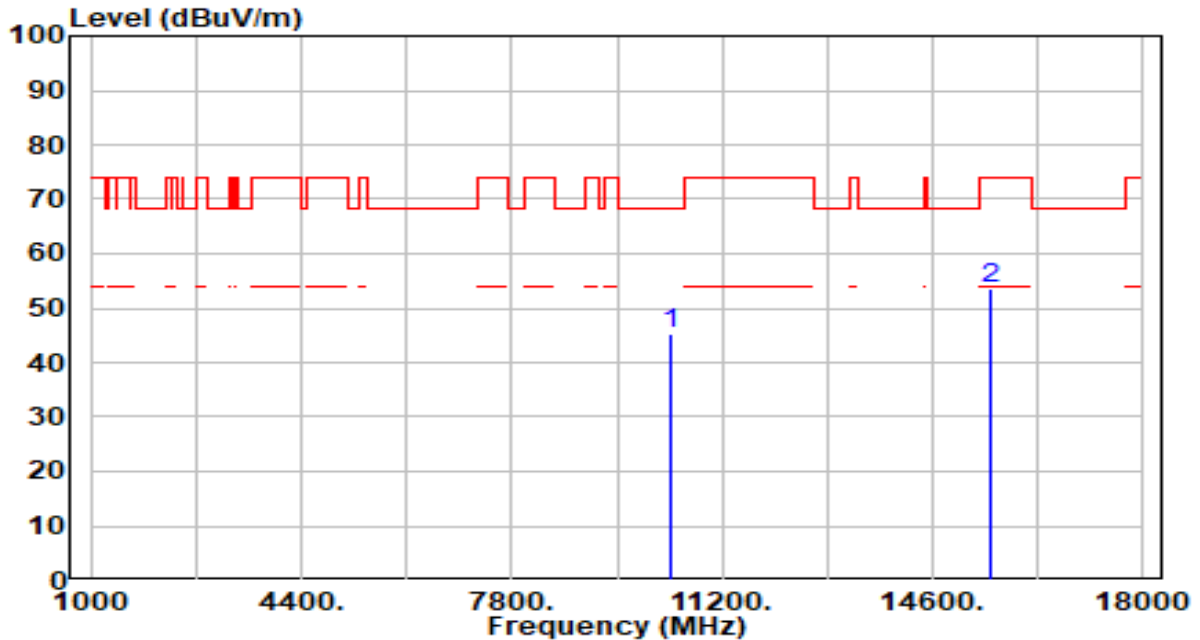

No	Frequency (MHz)	Reading (dBuV)	C.F (dB/m)	Measurement (dBuV/m)	Margin (dB)	Limit (dBuV/m)	Height (cm)	Angle (deg)	Remark (QP/PK/AV)
1	10360.000	42.26	3.19	45.45	-22.75	68.20	300	130	Peak
2	* 15540.000	49.02	4.74	53.76	-20.24	74.00	300	180	Peak

Note:

1. " *", means this data is the worst emission level.
2. C.F (Correction Factor) = Antenna Factor (dB/m)+ Cable Loss (dB) – Preamplifier(dB).
3. Measurement (dBuV/m) = Reading(dBuV) + C.F (Correction Factor).
4. The emission levels of other frequencies are very lower than the limit and not show in test report.

EUT	AC750 Dual Band Wi-Fi Router	Date of Test	2023-04-19
Factor	DRH18-E	Temp. / Humidity	22°C /63%
Polarity	Horizontal	Site / Test Engineer	AC2 / Marvin
Test Mode	802.11ac-20MHz_TX_Band1_CH 44_ANT 0	Test Voltage	AC 120V/60Hz

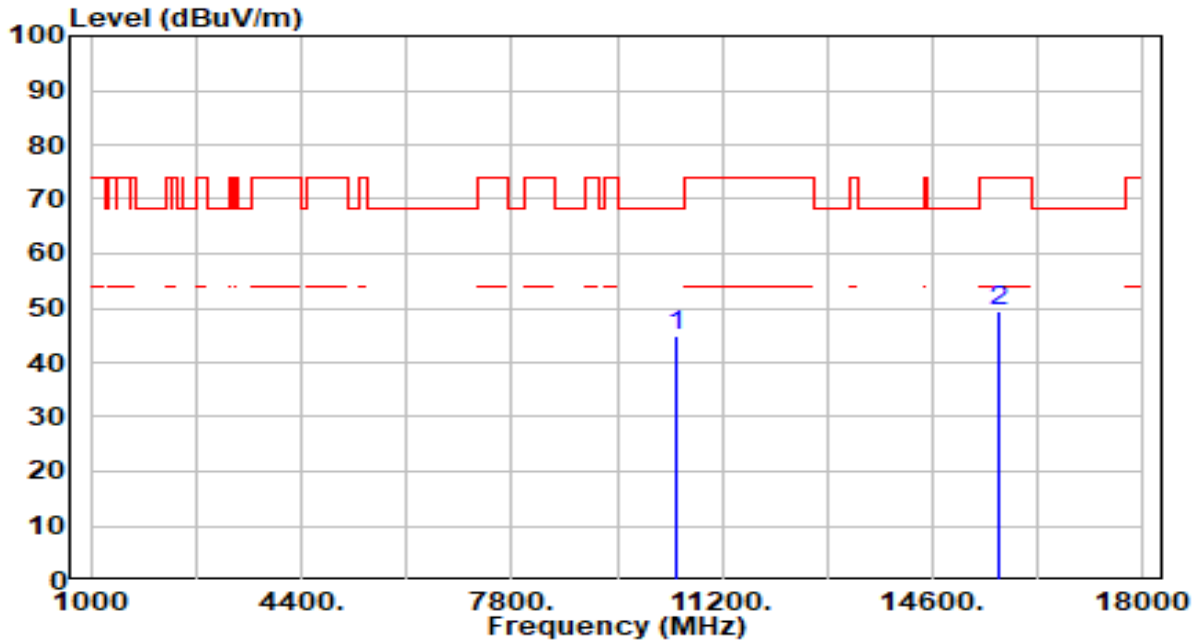

No	Frequency (MHz)	Reading (dBuV)	C.F (dB/m)	Measurement (dBuV/m)	Margin (dB)	Limit (dBuV/m)	Height (cm)	Angle (deg)	Remark (QP/PK/AV)
1	* 10440.000	41.93	3.15	45.08	-23.12	68.20	300	0	Peak
2	15660.000	44.37	4.89	49.25	-24.75	74.00	300	42	Peak

Note:

1. " *", means this data is the worst emission level.
2. C.F (Correction Factor) = Antenna Factor (dB/m)+ Cable Loss (dB) – Preamplifier(dB).
3. Measurement (dBuV/m) = Reading(dBuV) + C.F (Correction Factor).
4. The emission levels of other frequencies are very lower than the limit and not show in test report.

EUT	AC750 Dual Band Wi-Fi Router	Date of Test	2023-04-19
Factor	DRH18-E	Temp. / Humidity	22°C /63%
Polarity	Vertical	Site / Test Engineer	AC2 / Marvin
Test Mode	802.11ac-20MHz_TX_Band1_CH 44_ANT 0	Test Voltage	AC 120V/60Hz

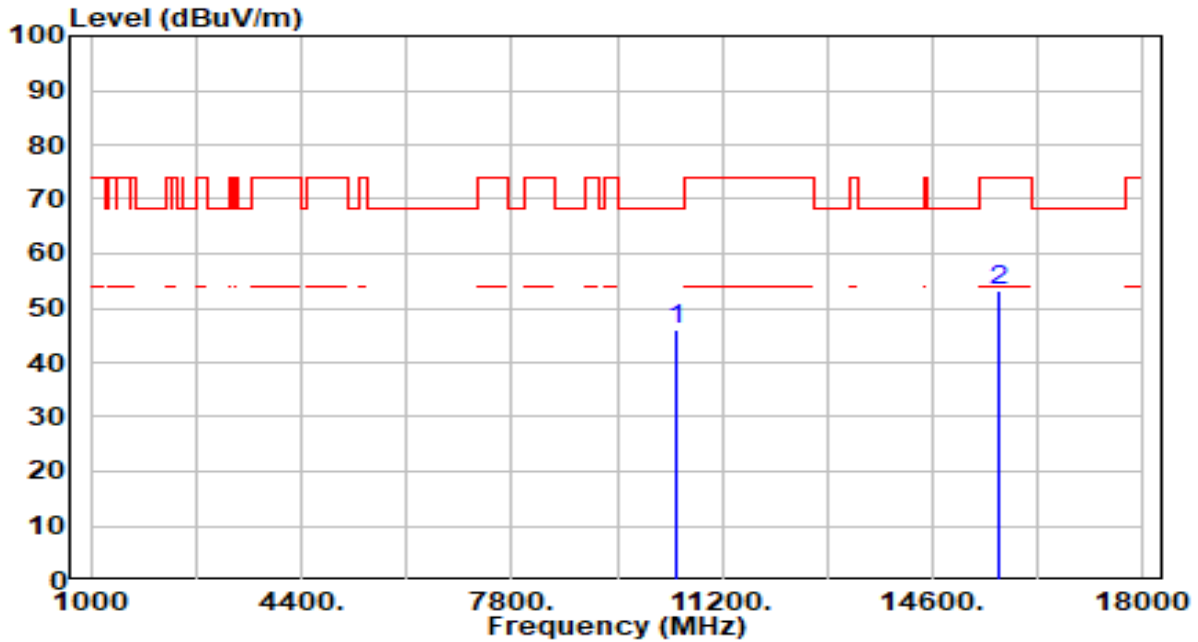

No	Frequency (MHz)	Reading (dBUV)	C.F (dB/m)	Measurement (dBUV/m)	Margin (dB)	Limit (dBUV/m)	Height (cm)	Angle (deg)	Remark (QP/PK/AV)
1	10440.000	42.91	3.15	46.06	-22.14	68.20	300	164	Peak
2	* 15660.000	48.18	4.89	53.07	-20.93	74.00	300	182	Peak

Note:

1. " *", means this data is the worst emission level.
2. C.F (Correction Factor) = Antenna Factor (dB/m)+ Cable Loss (dB) – Preamplifier(dB).
3. Measurement (dBUV/m) = Reading(dBUV) + C.F (Correction Factor).
4. The emission levels of other frequencies are very lower than the limit and not show in test report.

EUT	AC750 Dual Band Wi-Fi Router	Date of Test	2023-04-19
Factor	DRH18-E	Temp. / Humidity	22°C /63%
Polarity	Horizontal	Site / Test Engineer	AC2 / Marvin
Test Mode	802.11ac-20MHz_TX_Band1_CH 48_ANT 0	Test Voltage	AC 120V/60Hz

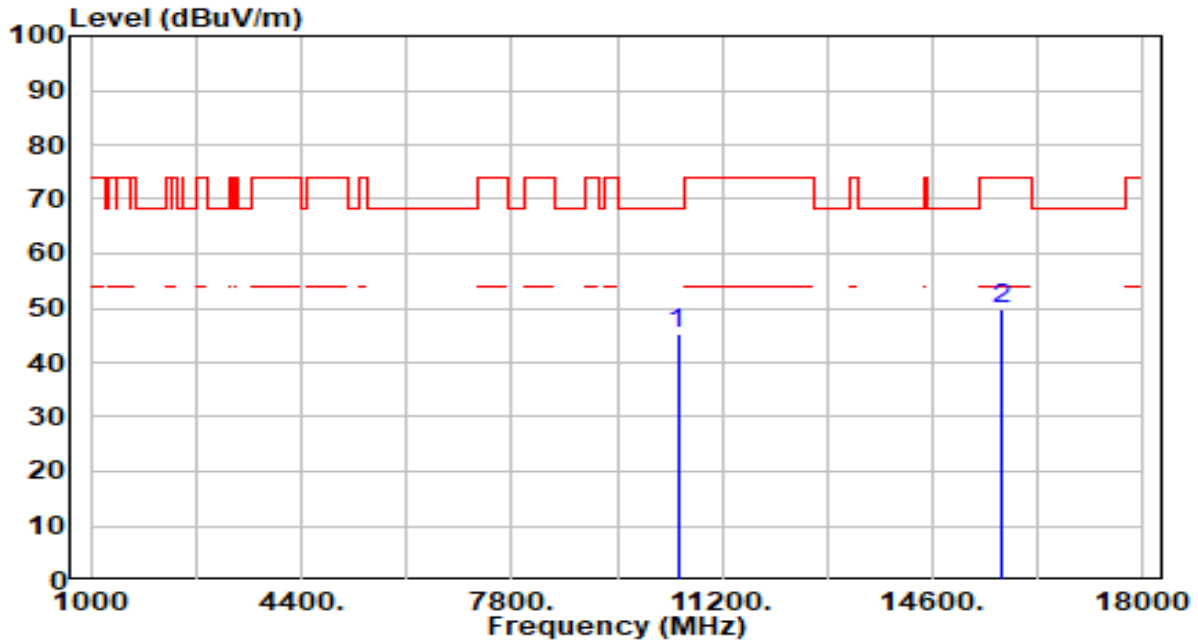

No	Frequency (MHz)	Reading (dBuV)	C.F (dB/m)	Measurement (dBuV/m)	Margin (dB)	Limit (dBuV/m)	Height (cm)	Angle (deg)	Remark (QP/PK/AV)
1	*	42.02	3.11	45.13	-23.07	68.20	300	360	Peak
2		44.70	5.02	49.72	-24.28	74.00	300	11	Peak

Note:

1. " *", means this data is the worst emission level.
2. C.F (Correction Factor) = Antenna Factor (dB/m)+ Cable Loss (dB) – Preamplifier(dB).
3. Measurement (dBuV/m) = Reading(dBuV) + C.F (Correction Factor).
4. The emission levels of other frequencies are very lower than the limit and not show in test report.

EUT	AC750 Dual Band Wi-Fi Router	Date of Test	2023-04-19
Factor	DRH18-E	Temp. / Humidity	22°C /63%
Polarity	Vertical	Site / Test Engineer	AC2 / Marvin
Test Mode	802.11ac-20MHz_TX_Band1_CH 48_ANT 0	Test Voltage	AC 120V/60Hz

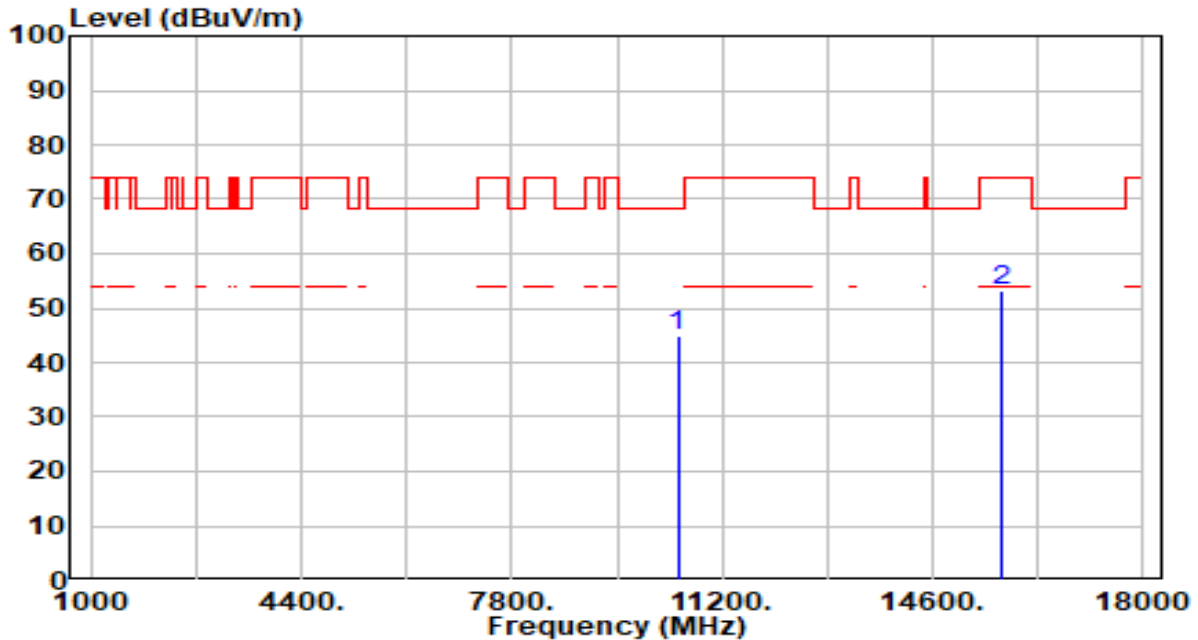

No	Frequency (MHz)	Reading (dBuV)	C.F (dB/m)	Measurement (dBuV/m)	Margin (dB)	Limit (dBuV/m)	Height (cm)	Angle (deg)	Remark (QP/PK/AV)
1	10480.000	41.61	3.11	44.72	-23.48	68.20	300	313	Peak
2	* 15720.000	48.26	5.02	53.28	-20.72	74.00	300	184	Peak

Note:

1. " *", means this data is the worst emission level.
2. C.F (Correction Factor) = Antenna Factor (dB/m)+ Cable Loss (dB) – Preamplifier(dB).
3. Measurement (dBuV/m) = Reading(dBuV) + C.F (Correction Factor).
4. The emission levels of other frequencies are very lower than the limit and not show in test report.

EUT	AC750 Dual Band Wi-Fi Router	Date of Test	2023-04-19
Factor	DRH18-E	Temp. / Humidity	22°C /63%
Polarity	Horizontal	Site / Test Engineer	AC2 / Marvin
Test Mode	802.11ac-20MHz_TX_Band4_CH 149_ANT 0	Test Voltage	AC 120V/60Hz

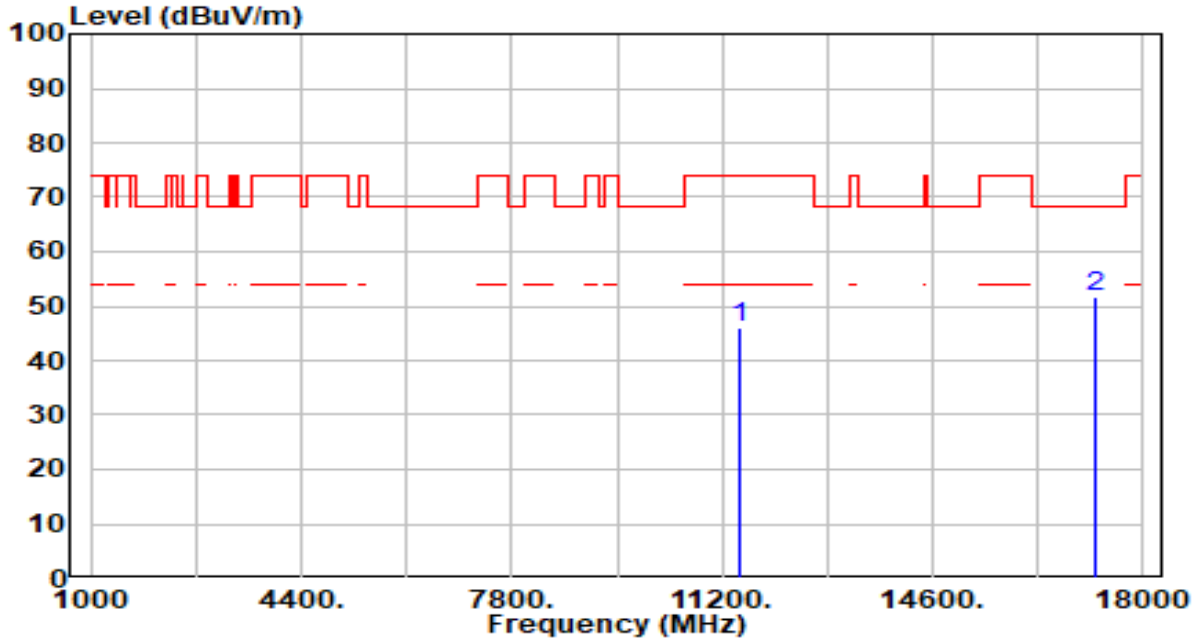

No	Frequency (MHz)	Reading (dBuV)	C.F (dB/m)	Measurement (dBuV/m)	Margin (dB)	Limit (dBuV/m)	Height (cm)	Angle (deg)	Remark (QP/PK/AV)
1	11490.000	42.11	3.92	46.04	-27.96	74.00	300	189	Peak
2	* 17235.000	47.58	4.06	51.64	-16.56	68.20	300	302	Peak

Note:

1. " *", means this data is the worst emission level.
2. C.F (Correction Factor) = Antenna Factor (dB/m)+ Cable Loss (dB) – Preamplifier(dB).
3. Measurement (dBuV/m) = Reading(dBuV) + C.F (Correction Factor).
4. The emission levels of other frequencies are very lower than the limit and not show in test report.

EUT	AC750 Dual Band Wi-Fi Router	Date of Test	2023-04-19
Factor	DRH18-E	Temp. / Humidity	22°C /63%
Polarity	Vertical	Site / Test Engineer	AC2 / Marvin
Test Mode	802.11ac-20MHz_TX_Band4_CH 149_ANT 0	Test Voltage	AC 120V/60Hz

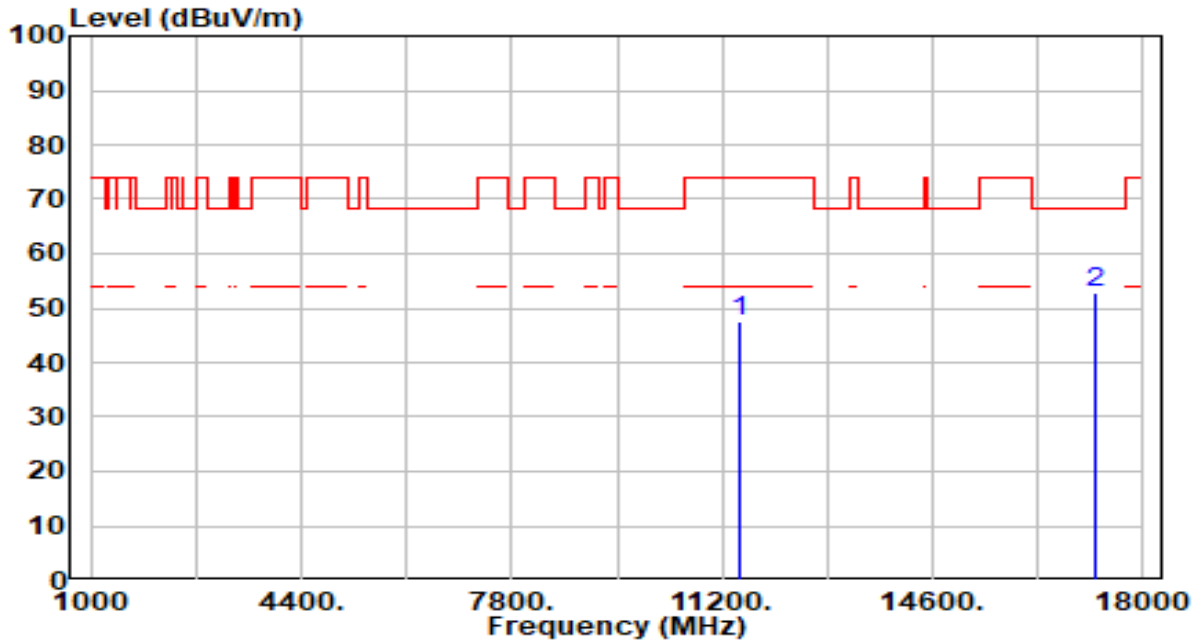

No	Frequency (MHz)	Reading (dBuV)	C.F (dB/m)	Measurement (dBuV/m)	Margin (dB)	Limit (dBuV/m)	Height (cm)	Angle (deg)	Remark (QP/PK/AV)
1	11490.000	43.44	3.92	47.37	-26.63	74.00	300	217	Peak
2	* 17235.000	48.69	4.06	52.75	-15.45	68.20	300	185	Peak

Note:

1. " *", means this data is the worst emission level.
2. C.F (Correction Factor) = Antenna Factor (dB/m)+ Cable Loss (dB) – Preamplifier(dB).
3. Measurement (dBuV/m) = Reading(dBuV) + C.F (Correction Factor).
4. The emission levels of other frequencies are very lower than the limit and not show in test report.

EUT	AC750 Dual Band Wi-Fi Router	Date of Test	2023-04-19
Factor	DRH18-E	Temp. / Humidity	22°C /63%
Polarity	Horizontal	Site / Test Engineer	AC2 / Marvin
Test Mode	802.11ac-20MHz_TX_Band4_CH 157_ANT 0	Test Voltage	AC 120V/60Hz

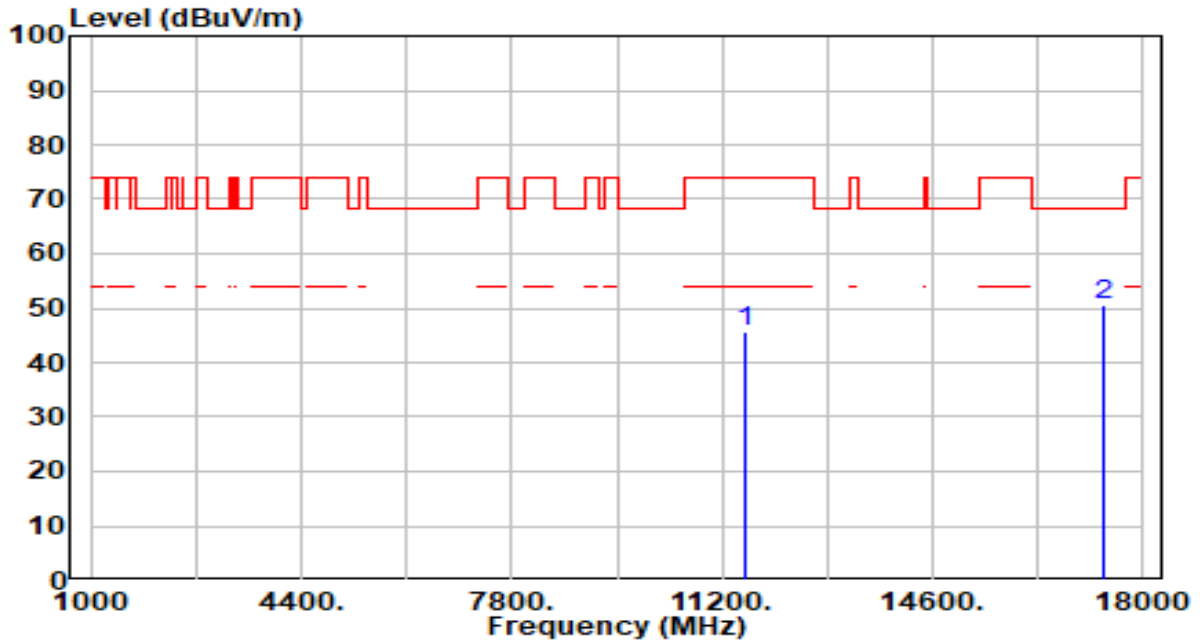

No	Frequency (MHz)	Reading (dBuV)	C.F (dB/m)	Measurement (dBuV/m)	Margin (dB)	Limit (dBuV/m)	Height (cm)	Angle (deg)	Remark (QP/PK/AV)
1	11570.000	41.78	3.94	45.73	-28.27	74.00	300	217	Peak
2	* 17355.000	46.86	3.78	50.64	-17.56	68.20	300	37	Peak

Note:

1. " *", means this data is the worst emission level.
2. C.F (Correction Factor) = Antenna Factor (dB/m)+ Cable Loss (dB) – Preamplifier(dB).
3. Measurement (dBuV/m) = Reading(dBuV) + C.F (Correction Factor).
4. The emission levels of other frequencies are very lower than the limit and not show in test report.

EUT	AC750 Dual Band Wi-Fi Router	Date of Test	2023-04-19
Factor	DRH18-E	Temp. / Humidity	22°C /63%
Polarity	Vertical	Site / Test Engineer	AC2 / Marvin
Test Mode	802.11ac-20MHz_TX_Band4_CH 157_ANT 0	Test Voltage	AC 120V/60Hz

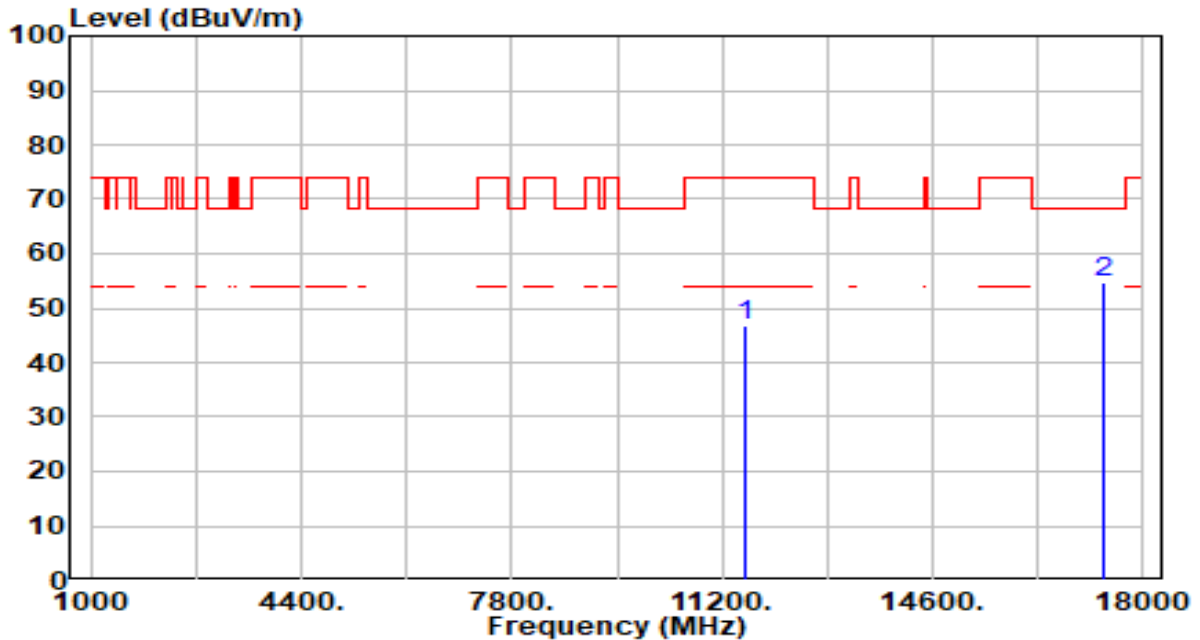

No	Frequency (MHz)	Reading (dBuV)	C.F (dB/m)	Measurement (dBuV/m)	Margin (dB)	Limit (dBuV/m)	Height (cm)	Angle (deg)	Remark (QP/PK/AV)
1	11570.000	42.84	3.94	46.78	-27.22	74.00	300	223	Peak
2	* 17355.000	51.02	3.78	54.80	-13.40	68.20	300	188	Peak

Note:

1. " *", means this data is the worst emission level.
2. C.F (Correction Factor) = Antenna Factor (dB/m)+ Cable Loss (dB) – Preamplifier(dB).
3. Measurement (dBuV/m) = Reading(dBuV) + C.F (Correction Factor).
4. The emission levels of other frequencies are very lower than the limit and not show in test report.

EUT	AC750 Dual Band Wi-Fi Router	Date of Test	2023-04-19
Factor	DRH18-E	Temp. / Humidity	22°C /63%
Polarity	Horizontal	Site / Test Engineer	AC2 / Marvin
Test Mode	802.11ac-20MHz_TX_Band4_CH 165_ANT 0	Test Voltage	AC 120V/60Hz

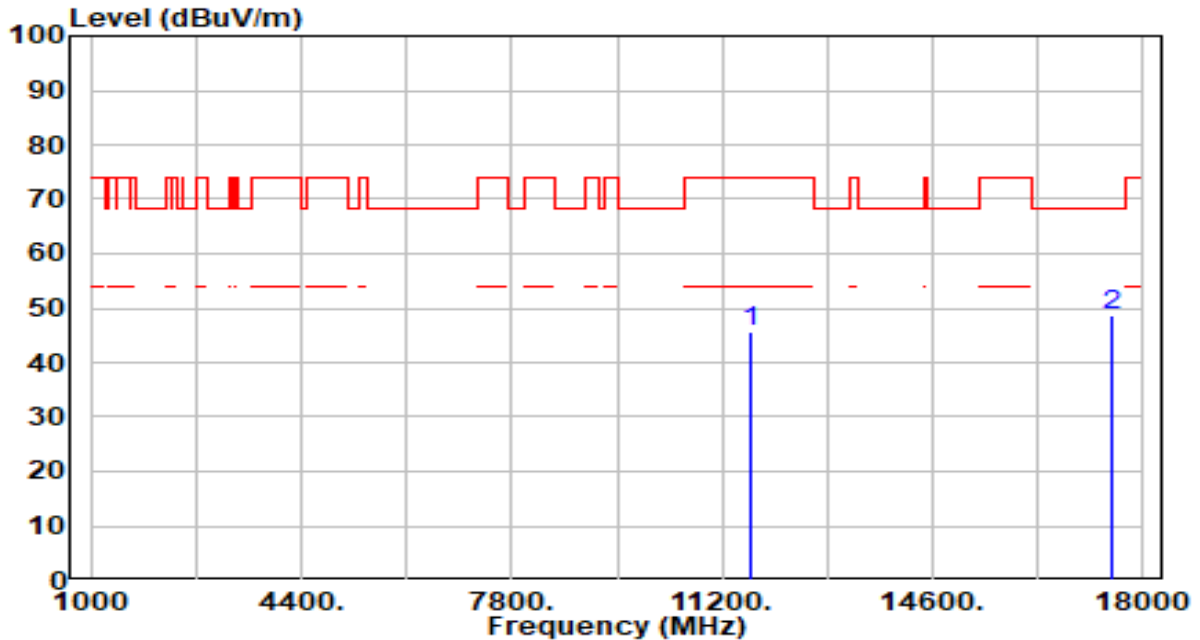

No	Frequency (MHz)	Reading (dBUV)	C.F (dB/m)	Measurement (dBUV/m)	Margin (dB)	Limit (dBUV/m)	Height (cm)	Angle (deg)	Remark (QP/PK/AV)
1	11650.000	41.75	3.94	45.69	-28.31	74.00	300	255	Peak
2	* 17475.000	45.07	3.65	48.72	-19.48	68.20	300	102	Peak

Note:

1. " *", means this data is the worst emission level.
2. C.F (Correction Factor) = Antenna Factor (dB/m)+ Cable Loss (dB) – Preamplifier(dB).
3. Measurement (dBUV/m) = Reading(dBUV) + C.F (Correction Factor).
4. The emission levels of other frequencies are very lower than the limit and not show in test report.

EUT	AC750 Dual Band Wi-Fi Router	Date of Test	2023-04-19
Factor	DRH18-E	Temp. / Humidity	22°C /63%
Polarity	Vertical	Site / Test Engineer	AC2 / Marvin
Test Mode	802.11ac-20MHz_TX_Band4_CH 165_ANT 0	Test Voltage	AC 120V/60Hz

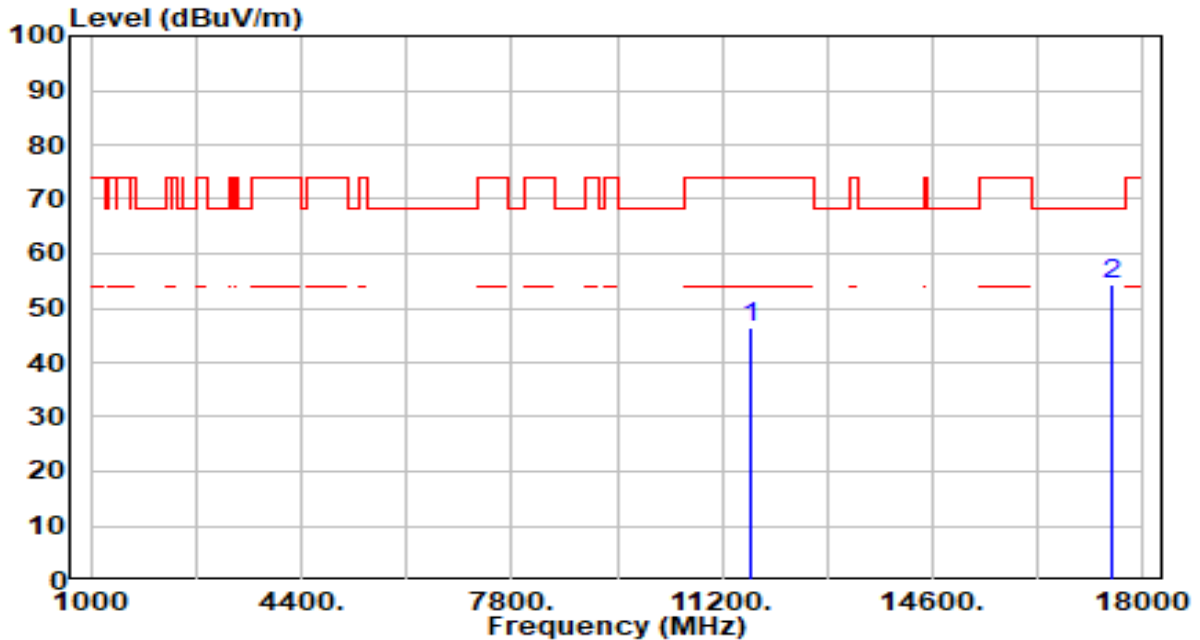

No	Frequency (MHz)	Reading (dBuV)	C.F (dB/m)	Measurement (dBuV/m)	Margin (dB)	Limit (dBuV/m)	Height (cm)	Angle (deg)	Remark (QP/PK/AV)
1	11650.000	42.43	3.94	46.37	-27.63	74.00	300	222	Peak
2	* 17475.000	50.64	3.65	54.29	-13.91	68.20	300	190	Peak

Note:

1. " *", means this data is the worst emission level.
2. C.F (Correction Factor) = Antenna Factor (dB/m)+ Cable Loss (dB) – Preamplifier(dB).
3. Measurement (dBuV/m) = Reading(dBuV) + C.F (Correction Factor).
4. The emission levels of other frequencies are very lower than the limit and not show in test report.

EUT	AC750 Dual Band Wi-Fi Router	Date of Test	2023-04-19
Factor	DRH18-E	Temp. / Humidity	22°C /63%
Polarity	Horizontal	Site / Test Engineer	AC2 / Marvin
Test Mode	802.11ac-40MHz_TX_Band1_CH 38_ANT 0	Test Voltage	AC 120V/60Hz

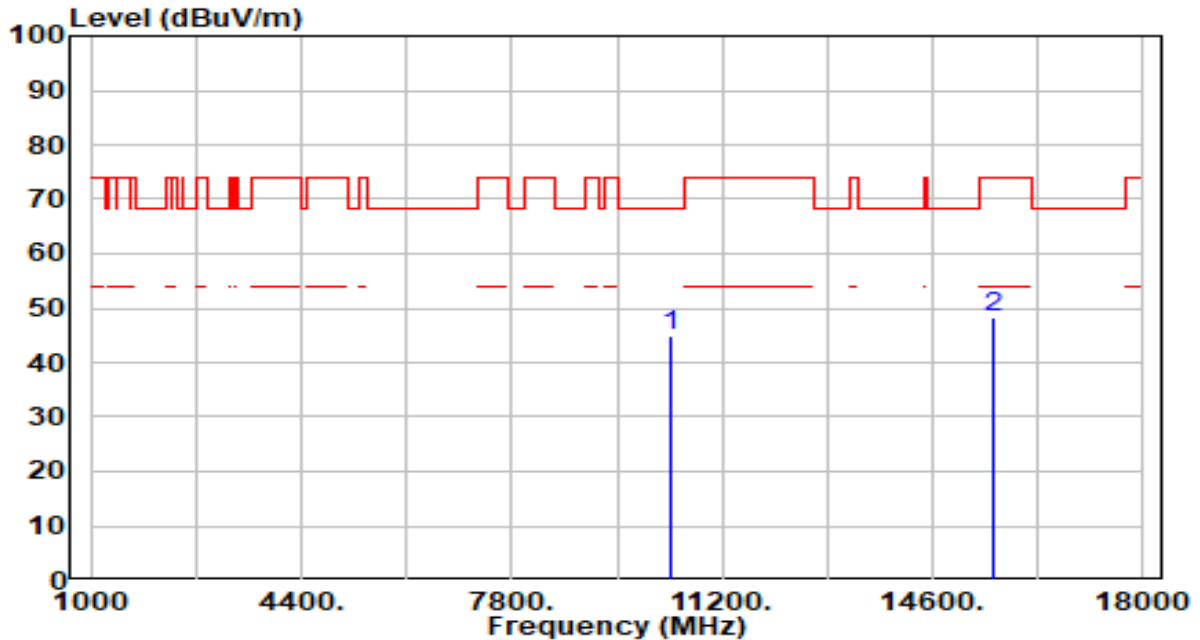

No	Frequency (MHz)	Reading (dBuV)	C.F (dB/m)	Measurement (dBuV/m)	Margin (dB)	Limit (dBuV/m)	Height (cm)	Angle (deg)	Remark (QP/PK/AV)
1	*	41.55	3.19	44.74	-23.46	68.20	300	14	Peak
2		43.49	4.75	48.23	-25.77	74.00	300	270	Peak

Note:

1. " *", means this data is the worst emission level.
2. C.F (Correction Factor) = Antenna Factor (dB/m)+ Cable Loss (dB) – Preamplifier(dB).
3. Measurement (dBuV/m) = Reading(dBuV) + C.F (Correction Factor).
4. The emission levels of other frequencies are very lower than the limit and not show in test report.

EUT	AC750 Dual Band Wi-Fi Router	Date of Test	2023-04-19
Factor	DRH18-E	Temp. / Humidity	22°C /63%
Polarity	Vertical	Site / Test Engineer	AC2 / Marvin
Test Mode	802.11ac-40MHz_TX_Band1_CH 38_ANT 0	Test Voltage	AC 120V/60Hz

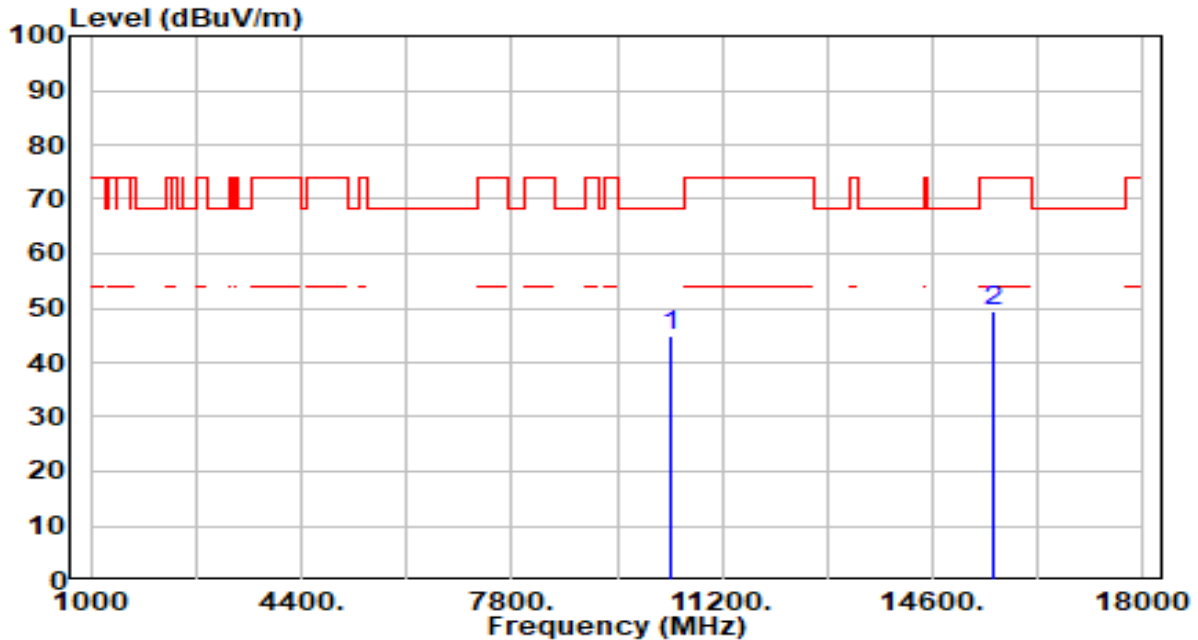

No	Frequency (MHz)	Reading (dBuV)	C.F (dB/m)	Measurement (dBuV/m)	Margin (dB)	Limit (dBuV/m)	Height (cm)	Angle (deg)	Remark (QP/PK/AV)
1	*	41.78	3.19	44.97	-23.23	68.20	300	54	Peak
2		44.84	4.75	49.59	-24.41	74.00	300	179	Peak

Note:

1. " *", means this data is the worst emission level.
2. C.F (Correction Factor) = Antenna Factor (dB/m)+ Cable Loss (dB) – Preamplifier(dB).
3. Measurement (dBuV/m) = Reading(dBuV) + C.F (Correction Factor).
4. The emission levels of other frequencies are very lower than the limit and not show in test report.

EUT	AC750 Dual Band Wi-Fi Router	Date of Test	2023-04-19
Factor	DRH18-E	Temp. / Humidity	22°C /63%
Polarity	Horizontal	Site / Test Engineer	AC2 / Marvin
Test Mode	802.11ac-40MHz_TX_Band1_CH 46_ANT 0	Test Voltage	AC 120V/60Hz

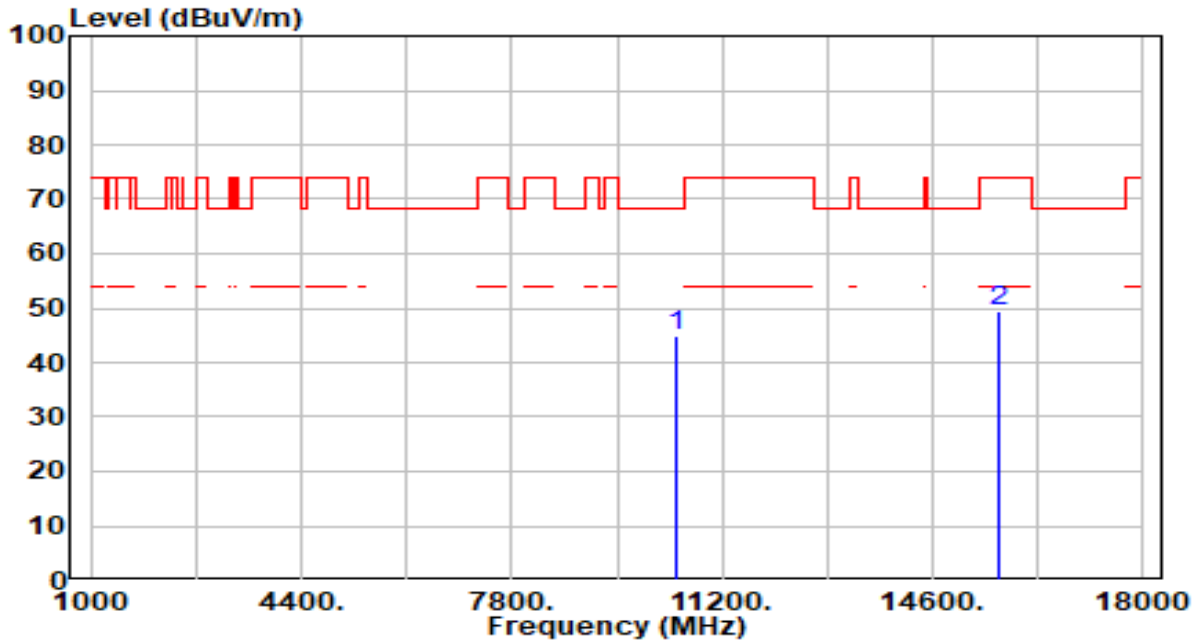

No	Frequency (MHz)	Reading (dBUV)	C.F (dB/m)	Measurement (dBUV/m)	Margin (dB)	Limit (dBUV/m)	Height (cm)	Angle (deg)	Remark (QP/PK/AV)
1	*	41.76	3.13	44.89	-23.31	68.20	300	85	Peak
2		44.33	4.95	49.28	-24.72	74.00	300	71	Peak

Note:

1. " *", means this data is the worst emission level.
2. C.F (Correction Factor) = Antenna Factor (dB/m)+ Cable Loss (dB) – Preamplifier(dB).
3. Measurement (dBUV/m) = Reading(dBUV) + C.F (Correction Factor).
4. The emission levels of other frequencies are very lower than the limit and not show in test report.

EUT	AC750 Dual Band Wi-Fi Router	Date of Test	2023-04-19
Factor	DRH18-E	Temp. / Humidity	22°C /63%
Polarity	Vertical	Site / Test Engineer	AC2 / Marvin
Test Mode	802.11ac-40MHz_TX_Band1_CH 46_ANT 0	Test Voltage	AC 120V/60Hz

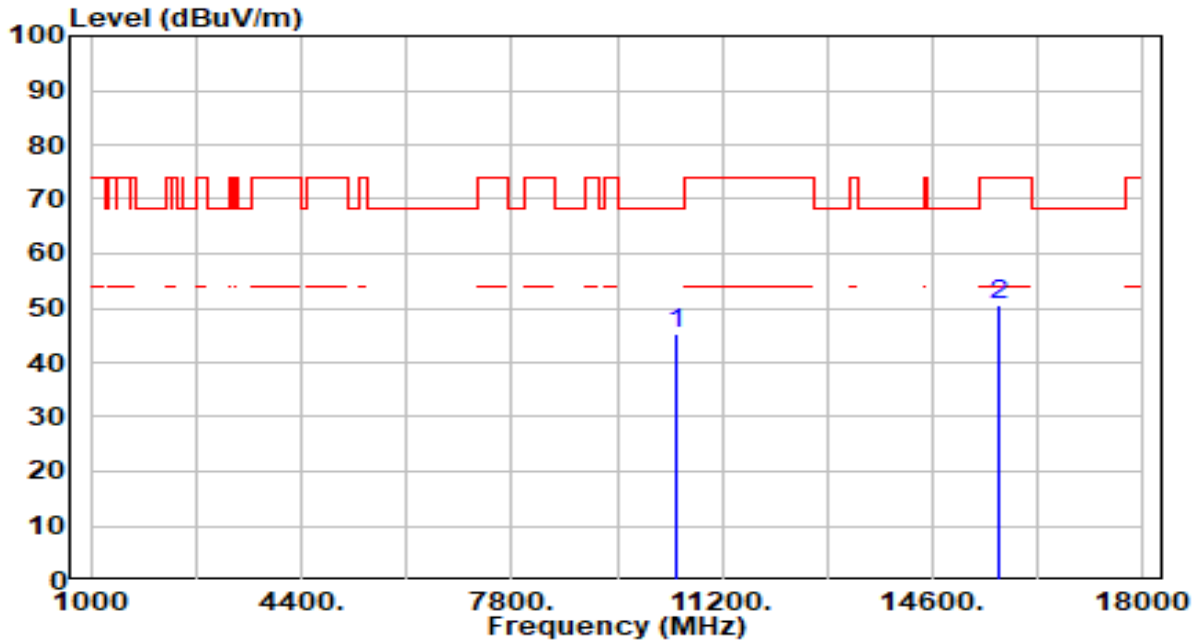

No	Frequency (MHz)	Reading (dBuV)	C.F (dB/m)	Measurement (dBuV/m)	Margin (dB)	Limit (dBuV/m)	Height (cm)	Angle (deg)	Remark (QP/PK/AV)
1	*	42.02	3.13	45.14	-23.06	68.20	300	78	Peak
2		45.78	4.95	50.73	-23.27	74.00	300	184	Peak

Note:

1. " *", means this data is the worst emission level.
2. C.F (Correction Factor) = Antenna Factor (dB/m)+ Cable Loss (dB) – Preamplifier(dB).
3. Measurement (dBuV/m) = Reading(dBuV) + C.F (Correction Factor).
4. The emission levels of other frequencies are very lower than the limit and not show in test report.

EUT	AC750 Dual Band Wi-Fi Router	Date of Test	2023-04-19
Factor	DRH18-E	Temp. / Humidity	22°C /63%
Polarity	Horizontal	Site / Test Engineer	AC2 / Marvin
Test Mode	802.11ac-40MHz_TX_Band4_CH 151_ANT 0	Test Voltage	AC 120V/60Hz

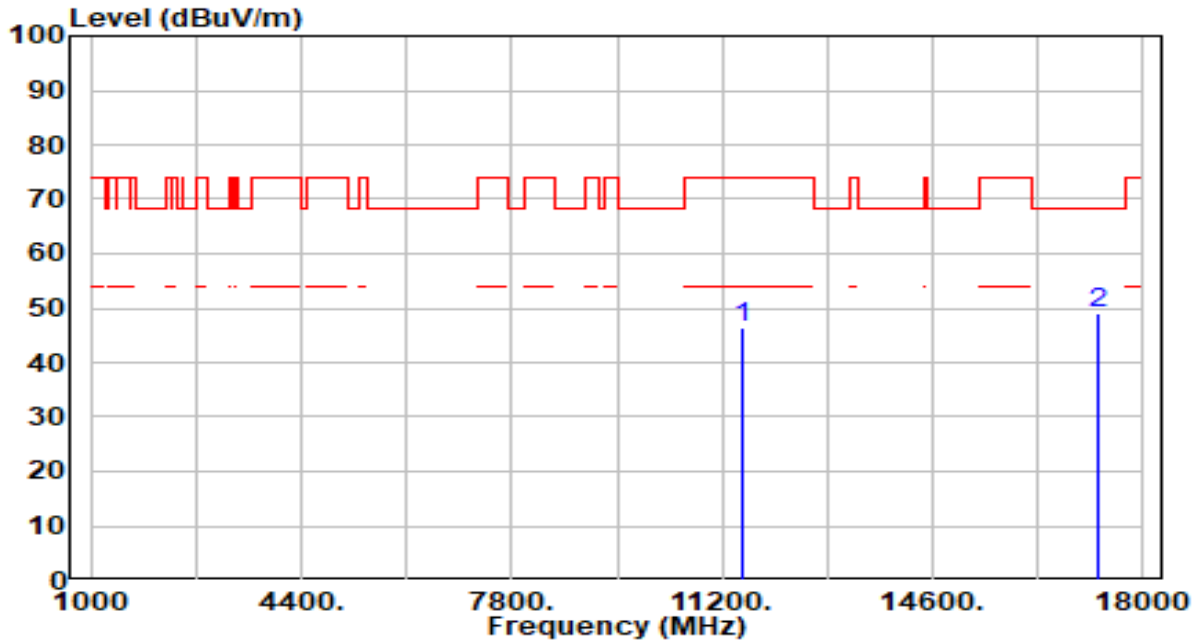

No	Frequency (MHz)	Reading (dBuV)	C.F (dB/m)	Measurement (dBuV/m)	Margin (dB)	Limit (dBuV/m)	Height (cm)	Angle (deg)	Remark (QP/PK/AV)
1	11510.000	42.56	3.93	46.48	-27.52	74.00	300	319	Peak
2	* 17265.000	44.99	3.99	48.98	-19.22	68.20	300	99	Peak

Note:

1. " *", means this data is the worst emission level.
2. C.F (Correction Factor) = Antenna Factor (dB/m)+ Cable Loss (dB) – Preamplifier(dB).
3. Measurement (dBuV/m) = Reading(dBuV) + C.F (Correction Factor).
4. The emission levels of other frequencies are very lower than the limit and not show in test report.

EUT	AC750 Dual Band Wi-Fi Router	Date of Test	2023-04-19
Factor	DRH18-E	Temp. / Humidity	22°C /63%
Polarity	Vertical	Site / Test Engineer	AC2 / Marvin
Test Mode	802.11ac-40MHz_TX_Band4_CH 151_ANT 0	Test Voltage	AC 120V/60Hz

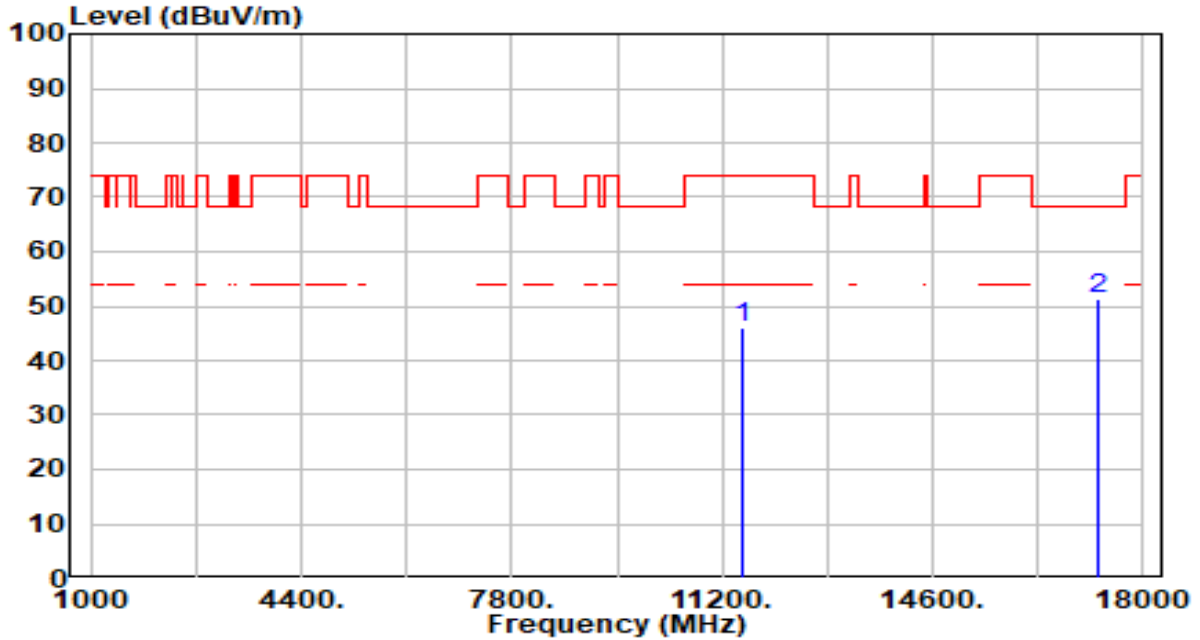

No	Frequency (MHz)	Reading (dBuV)	C.F (dB/m)	Measurement (dBuV/m)	Margin (dB)	Limit (dBuV/m)	Height (cm)	Angle (deg)	Remark (QP/PK/AV)
1	11510.000	42.24	3.93	46.17	-27.83	74.00	300	0	Peak
2	* 17265.000	47.48	3.99	51.48	-16.72	68.20	300	194	Peak

Note:

1. " *", means this data is the worst emission level.
2. C.F (Correction Factor) = Antenna Factor (dB/m)+ Cable Loss (dB) – Preamplifier(dB).
3. Measurement (dBuV/m) = Reading(dBuV) + C.F (Correction Factor).
4. The emission levels of other frequencies are very lower than the limit and not show in test report.

EUT	AC750 Dual Band Wi-Fi Router	Date of Test	2023-04-19
Factor	DRH18-E	Temp. / Humidity	22°C /63%
Polarity	Horizontal	Site / Test Engineer	AC2 / Marvin
Test Mode	802.11ac-40MHz_TX_Band4_CH 159_ANT 0	Test Voltage	AC 120V/60Hz

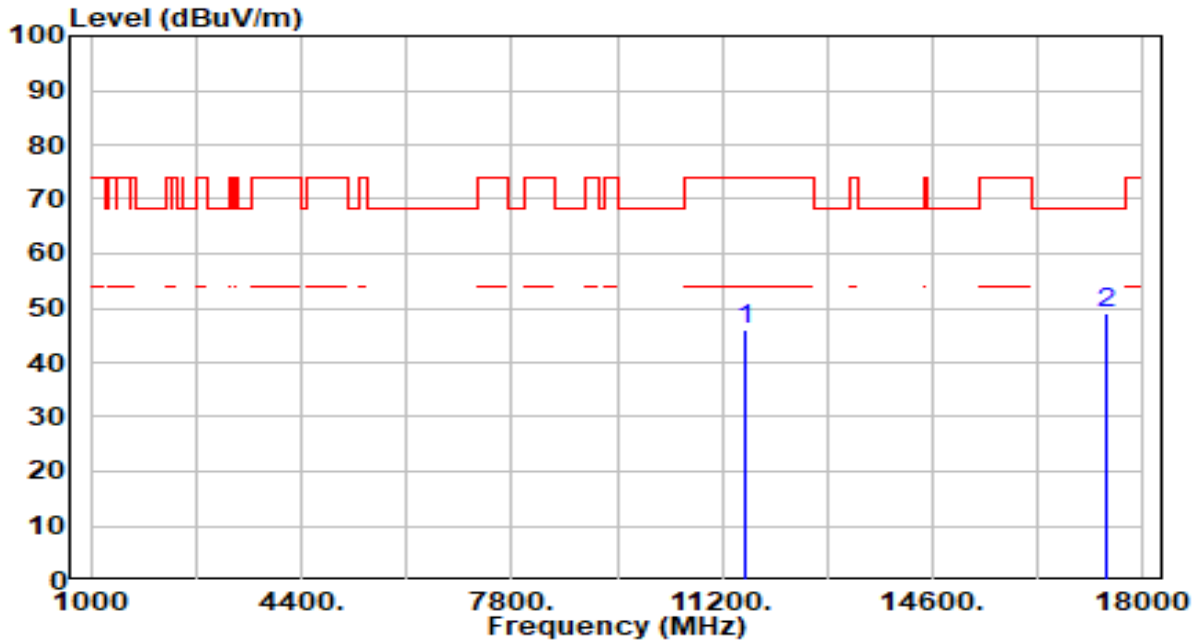

No	Frequency (MHz)	Reading (dBuV)	C.F (dB/m)	Measurement (dBuV/m)	Margin (dB)	Limit (dBuV/m)	Height (cm)	Angle (deg)	Remark (QP/PK/AV)
1	11590.000	42.00	3.95	45.95	-28.05	74.00	300	29	Peak
2	* 17385.000	45.28	3.71	49.00	-19.20	68.20	300	304	Peak

Note:

1. " *", means this data is the worst emission level.
2. C.F (Correction Factor) = Antenna Factor (dB/m)+ Cable Loss (dB) – Preamplifier(dB).
3. Measurement (dBuV/m) = Reading(dBuV) + C.F (Correction Factor).
4. The emission levels of other frequencies are very lower than the limit and not show in test report.

EUT	AC750 Dual Band Wi-Fi Router	Date of Test	2023-04-19
Factor	DRH18-E	Temp. / Humidity	22°C /63%
Polarity	Vertical	Site / Test Engineer	AC2 / Marvin
Test Mode	802.11ac-40MHz_TX_Band4_CH 159_ANT 0	Test Voltage	AC 120V/60Hz

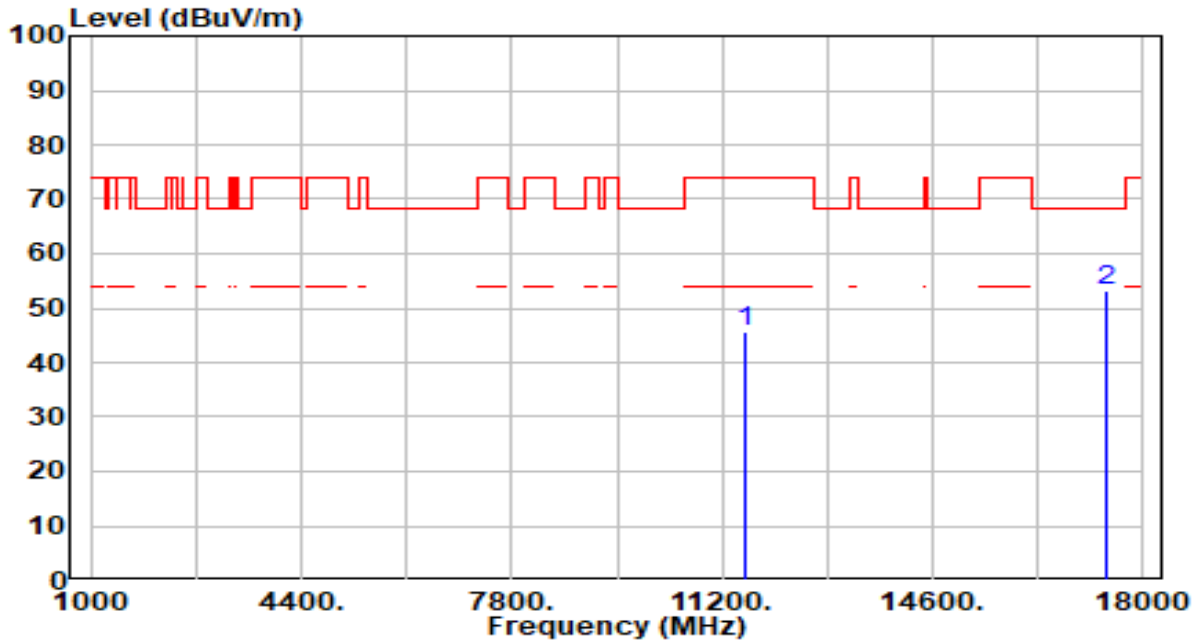

No	Frequency (MHz)	Reading (dBuV)	C.F (dB/m)	Measurement (dBuV/m)	Margin (dB)	Limit (dBuV/m)	Height (cm)	Angle (deg)	Remark (QP/PK/AV)
1	11590.000	41.88	3.95	45.83	-28.17	74.00	300	225	Peak
2	* 17385.000	49.32	3.71	53.03	-15.17	68.20	300	192	Peak

Note:

1. " *", means this data is the worst emission level.
2. C.F (Correction Factor) = Antenna Factor (dB/m)+ Cable Loss (dB) – Preamplifier(dB).
3. Measurement (dBuV/m) = Reading(dBuV) + C.F (Correction Factor).
4. The emission levels of other frequencies are very lower than the limit and not show in test report.

EUT	AC750 Dual Band Wi-Fi Router	Date of Test	2023-04-19
Factor	DRH18-E	Temp. / Humidity	22°C /63%
Polarity	Horizontal	Site / Test Engineer	AC2 / Marvin
Test Mode	802.11ac-80MHz_TX_Band1_CH 42_ANT 0	Test Voltage	AC 120V/60Hz

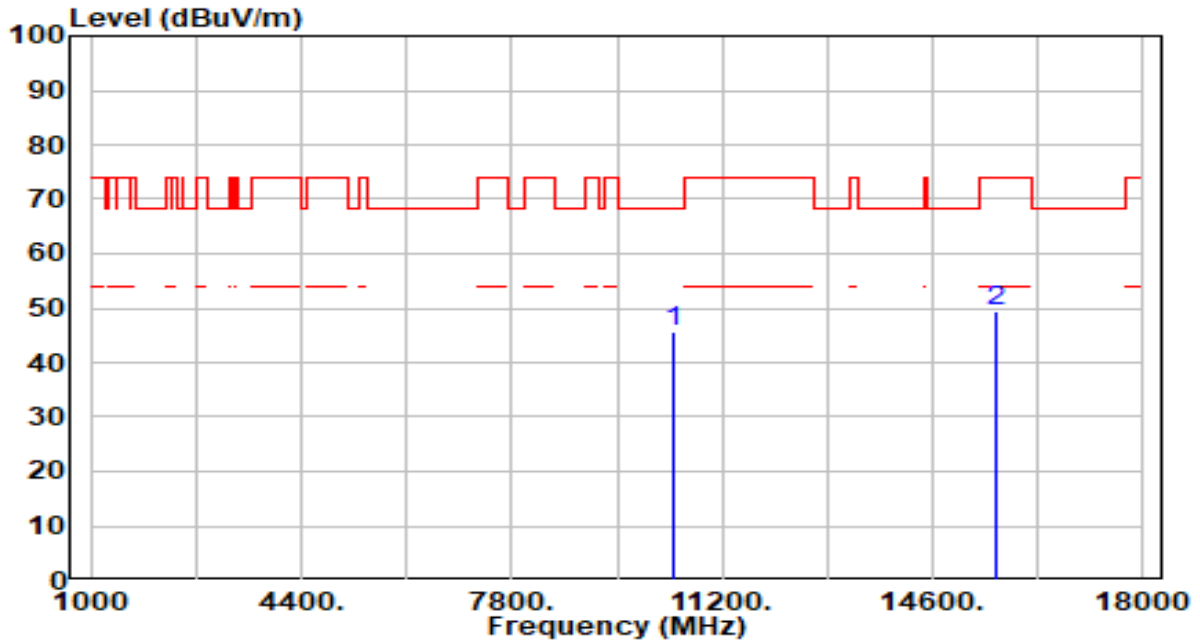

No	Frequency (MHz)	Reading (dBuV)	C.F (dB/m)	Measurement (dBuV/m)	Margin (dB)	Limit (dBuV/m)	Height (cm)	Angle (deg)	Remark (QP/PK/AV)
1	*	42.33	3.16	45.50	-22.70	68.20	300	43	Peak
2		44.49	4.82	49.31	-24.69	74.00	300	76	Peak

Note:

1. " *", means this data is the worst emission level.
2. C.F (Correction Factor) = Antenna Factor (dB/m)+ Cable Loss (dB) – Preamplifier(dB).
3. Measurement (dBuV/m) = Reading(dBuV) + C.F (Correction Factor).
4. The emission levels of other frequencies are very lower than the limit and not show in test report.

EUT	AC750 Dual Band Wi-Fi Router	Date of Test	2023-04-19
Factor	DRH18-E	Temp. / Humidity	22°C /63%
Polarity	Vertical	Site / Test Engineer	AC2 / Marvin
Test Mode	802.11ac-80MHz_TX_Band1_CH 42_ANT 0	Test Voltage	AC 120V/60Hz

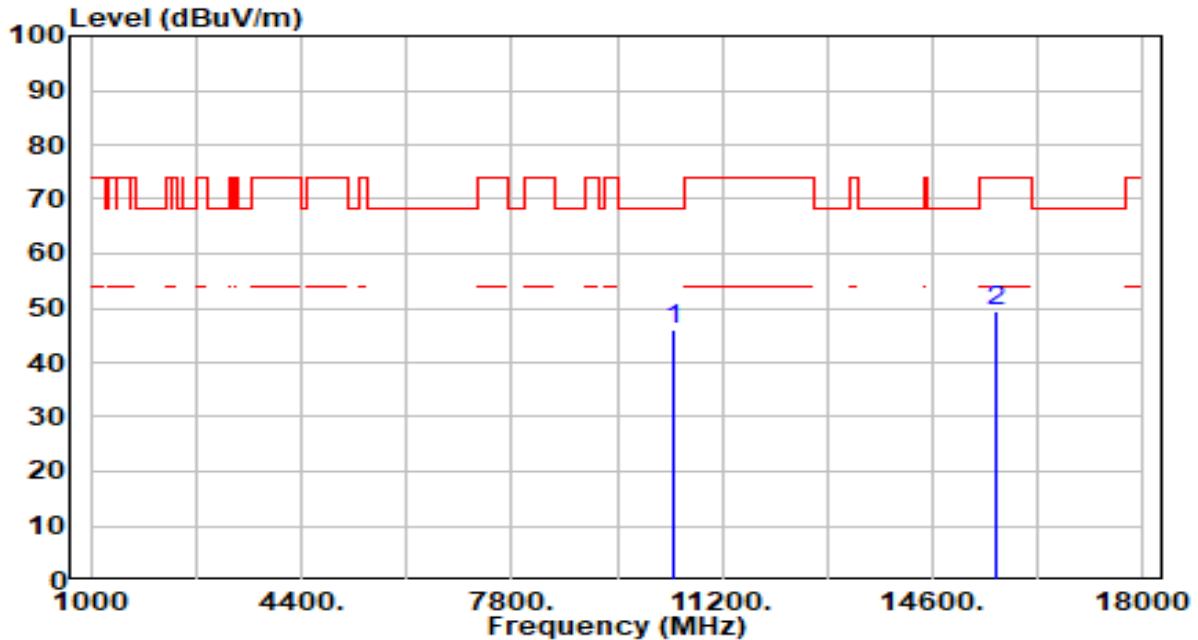

No	Frequency (MHz)	Reading (dBuV)	C.F (dB/m)	Measurement (dBuV/m)	Margin (dB)	Limit (dBuV/m)	Height (cm)	Angle (deg)	Remark (QP/PK/AV)
1	*	42.99	3.16	46.15	-22.05	68.20	300	107	Peak
2		44.70	4.82	49.52	-24.48	74.00	300	235	Peak

Note:

1. " *", means this data is the worst emission level.
2. C.F (Correction Factor) = Antenna Factor (dB/m)+ Cable Loss (dB) – Preamplifier(dB).
3. Measurement (dBuV/m) = Reading(dBuV) + C.F (Correction Factor).
4. The emission levels of other frequencies are very lower than the limit and not show in test report.

EUT	AC750 Dual Band Wi-Fi Router	Date of Test	2023-04-19
Factor	DRH18-E	Temp. / Humidity	22°C /63%
Polarity	Horizontal	Site / Test Engineer	AC2 / Marvin
Test Mode	802.11ac-80MHz_TX_Band4_CH 155_ANT 0	Test Voltage	AC 120V/60Hz

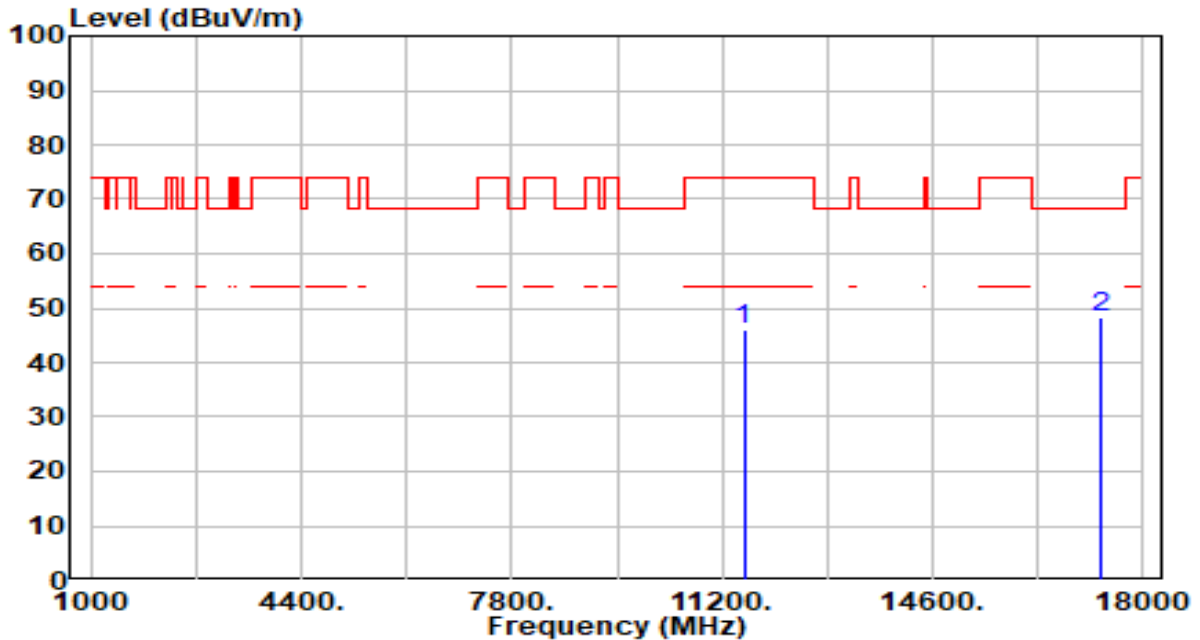

No	Frequency (MHz)	Reading (dBuV)	C.F (dB/m)	Measurement (dBuV/m)	Margin (dB)	Limit (dBuV/m)	Height (cm)	Angle (deg)	Remark (QP/PK/AV)
1	11550.000	42.23	3.94	46.17	-27.83	74.00	300	160	Peak
2	* 17325.000	44.63	3.85	48.48	-19.72	68.20	300	137	Peak

Note:

1. " *", means this data is the worst emission level.
2. C.F (Correction Factor) = Antenna Factor (dB/m)+ Cable Loss (dB) – Preamplifier(dB).
3. Measurement (dBuV/m) = Reading(dBuV) + C.F (Correction Factor).
4. The emission levels of other frequencies are very lower than the limit and not show in test report.

EUT	AC750 Dual Band Wi-Fi Router	Date of Test	2023-04-19
Factor	DRH18-E	Temp. / Humidity	22°C /63%
Polarity	Vertical	Site / Test Engineer	AC2 / Marvin
Test Mode	802.11ac-80MHz_TX_Band4_CH 155_ANT 0	Test Voltage	AC 120V/60Hz

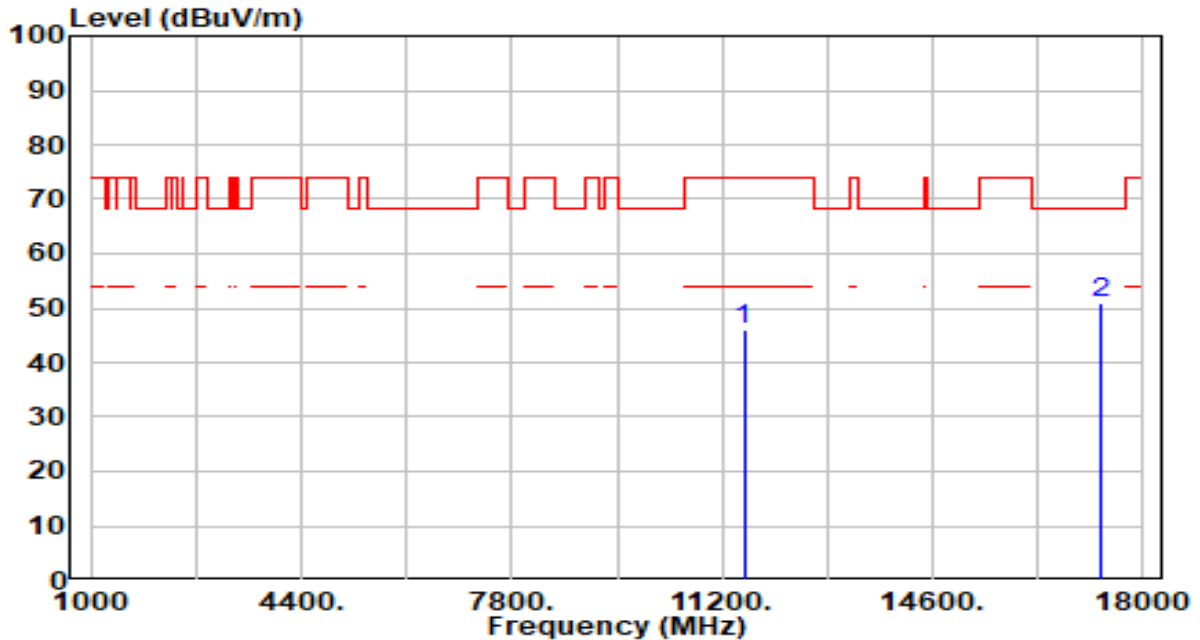

No	Frequency (MHz)	Reading (dBuV)	C.F (dB/m)	Measurement (dBuV/m)	Margin (dB)	Limit (dBuV/m)	Height (cm)	Angle (deg)	Remark (QP/PK/AV)
1	11550.000	41.92	3.94	45.86	-28.14	74.00	300	219	Peak
2	* 17325.000	46.94	3.85	50.79	-17.41	68.20	300	192	Peak

Note:

1. " *", means this data is the worst emission level.
2. C.F (Correction Factor) = Antenna Factor (dB/m)+ Cable Loss (dB) – Preamplifier(dB).
3. Measurement (dBuV/m) = Reading(dBuV) + C.F (Correction Factor).
4. The emission levels of other frequencies are very lower than the limit and not show in test report.

EUT	AC750 Dual Band Wi-Fi Router	Date of Test	2023-04-18
Factor	BBHA 9170	Temp. / Humidity	22°C /63%
Polarity	Horizontal	Site / Test Engineer	AC2 / Stanley
Test Mode	802.11ac-20MHz_TX_Band1_CH 44_ANT 0	Test Voltage	AC 120V/60Hz

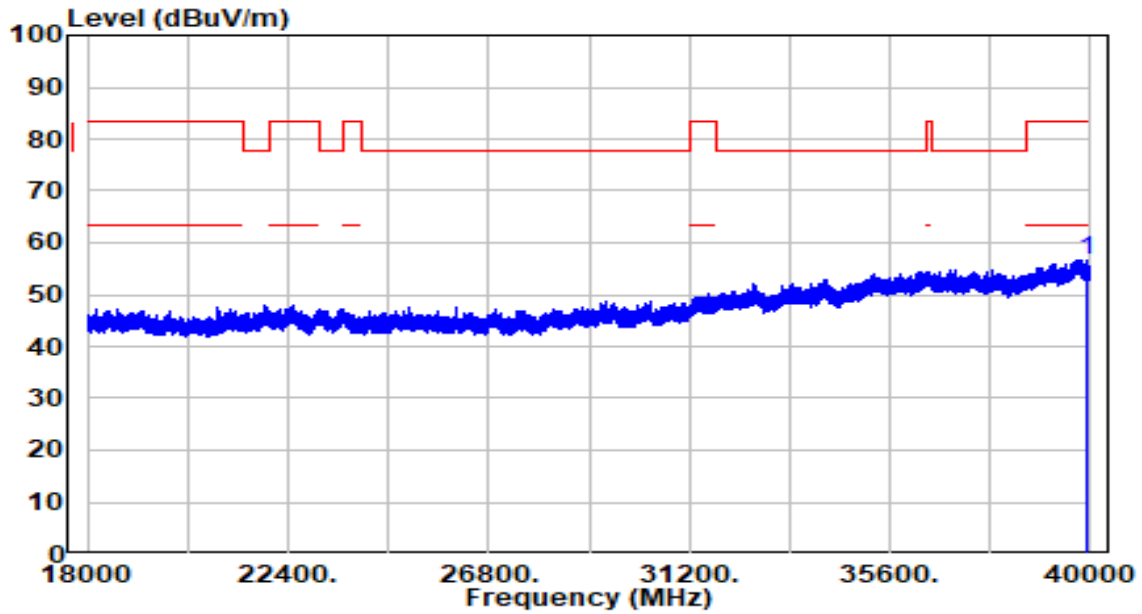

No	Frequency (MHz)	Reading (dBUV)	C.F (dB/m)	Measurement (dBUV/m)	Margin (dB)	Limit (dBUV/m)	Height (cm)	Angle (deg)	Remark (QP/PK/AV)
1	* 39949.130	32.49	24.26	56.75	-26.75	83.50	150	320	Peak

Note:

- "*", means this data is the worst emission level.
- C.F (Correction Factor) = Antenna Factor (dB/m) + Cable Loss (dB) – Pre-amplifier(dB).
- Measurement (dBUV/m) = Reading(dBUV) + C.F (Correction Factor).
- The emission levels of other frequencies are very lower than the limit and not show in test report.

EUT	AC750 Dual Band Wi-Fi Router	Date of Test	2023-04-18
Factor	BBHA 9170	Temp. / Humidity	22°C /63%
Polarity	Vertical	Site / Test Engineer	AC2 / Stanley
Test Mode	802.11ac-20MHz_TX_Band1_CH 44_ANT 0	Test Voltage	AC 120V/60Hz

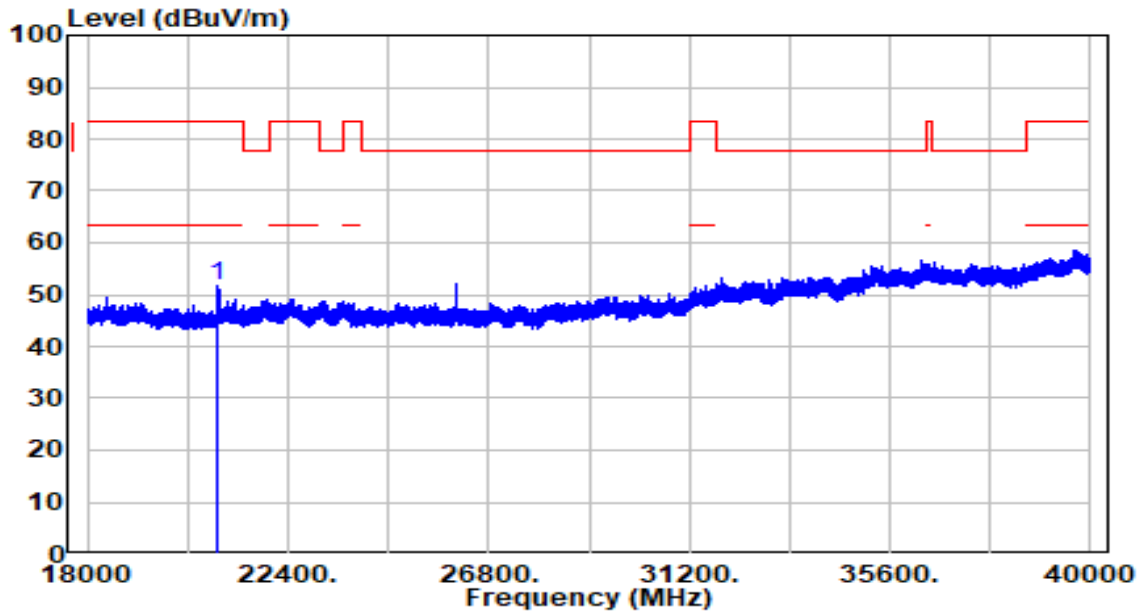

No	Frequency (MHz)	Reading (dBUV)	C.F (dB/m)	Measurement (dBUV/m)	Margin (dB)	Limit (dBUV/m)	Height (cm)	Angle (deg)	Remark (QP/PK/AV)
1	* 20866.190	40.96	10.82	51.78	-31.72	83.50	150	264	Peak

Note:

1. " *", means this data is the worst emission level.
2. C.F (Correction Factor) = Antenna Factor (dB/m) + Cable Loss (dB) – Pre-amplifier(dB).
3. Measurement (dBUV/m) = Reading(dBUV) + C.F (Correction Factor).
4. The emission levels of other frequencies are very lower than the limit and not show in test report.

7.8. Radiated Restricted Band Edge Measurement

7.8.1. Test Limit

For 15.205 requirement:

Radiated emissions which fall in the restricted bands, as defined in Section 15.205(a) of FCC part 15, must also comply with the radiated emission limits specified in Section 15.209(a).

Frequency (MHz)	Frequency (MHz)	Frequency (MHz)	Frequency (GHz)
0.090 - 0.110	16.42-16.423	399.9 - 410	4.5-5.15
¹ 0.495 - 0.505	16.69475-16.69525	608 - 614	5.35-5.46
2.1735-2.1905	16.80425-16.80475	960 - 1240	7.25-7.75
4.125-4.128	25.5 -25.67	1300 - 1427	8.025 - 8.5
4.17725-4.17775	37.5-38.25	1435-1626.5	9.0-9.2
4.20725-4.20775	73-74.6	1645.5-1646.5	9.3-9.5
6.215-6.218	74.8-75.2	1660 - 1710	10.6-12.7
6.26775-6.26825	108-121.94	1718.8-1722.2	13.25-13.4
6.31175-6.31225	123 - 138	2200 - 2300	14.47-14.5
8.291-8.294	149.9-150.05	2310 - 2390	15.35-16.2
8.362-8.366	156.52475-156.525	2483.5 - 2500	17.7-21.4
8.37625-8.38675	156.7-156.9	2690 - 2900	22.01-23.12
8.41425-8.41475	162.0125-167.17	3260 - 3267	23.6-24.0
12.29-12.293	167.72-173.2	3332 - 3339	31.2-31.8
12.51975-12.52025	240 - 285	3345.8 - 3358	36.43-36.5
12.57675-12.57725	322-335.4	3600 - 4400	(²)
13.36-13.41	--	--	--

For 15.407(b) requirement:

For transmitters operating in the 5.15-5.25 GHz band: All emissions outside of the 5.15-5.35 GHz band shall not exceed an e.i.r.p. of -27 dBm/MHz.

For transmitters operating in the 5.725-5.85 GHz band: All emissions shall be limited to a level of -27 dBm/MHz at 75 MHz or more above or below the band edge increasing linearly to 10 dBm/MHz at 25 MHz above or below the band edge, and from 25 MHz above or below the band edge increasing linearly to a level of 15.6 dBm/MHz at 5 MHz above or below the band edge, and from 5 MHz above or below the band edge increasing linearly to a level of 27 dBm/MHz at the band edge.

Refer to KDB 789033 D02v02r01 G)2)c), as specified in § 15.407(b), emissions above 1000 MHz

that are outside of the restricted bands are subject to a maximum emission limit of -27 dBm/MHz (or -17 dBm/MHz as specified in § 15.407(b)(4)). However, an out-of-band emission that complies with both the peak and average limits of § 15.209 is not required to satisfy the -27 dBm/MHz or -17 dBm/MHz maximum emission limit.

All out of band emissions appearing in a restricted band as specified in Section 15.205 of the Title 47CFR must not exceed the limits shown in Table per Section 15.209.

FCC Part 15 Subpart C Paragraph 15.209		
Frequency [MHz]	Field Strength [uV/m]	Measured Distance [Meters]
0.009 - 0.490	2400/F (kHz)	300
0.490 - 1.705	24000/F (kHz)	30
1.705 - 30	30	30
30 - 88	100	3
88 - 216	150	3
216 - 960	200	3
Above 960	500	3

7.8.2. Test Procedure Used

KDB 789033 D02v02r01- Section G

7.8.3. Test Setting

Peak Measurements above 1GHz

1. Analyzer center frequency was set to the frequency of the radiated spurious emission of interest
2. RBW = 1MHz
3. VBW = 3MHz
4. Detector = peak
5. Sweep time = auto couple
6. Trace mode = max hold
7. Trace was allowed to stabilize

Average Measurements above 1GHz (Method VB)

1. Analyzer center frequency was set to the frequency of the radiated spurious emission of interest

2. RBW = 1MHz
3. VBW If the EUT is configured to transmit with duty cycle $\geq 98\%$, set VBW \leq RBW/100 (i.e., 10 kHz) but not less than 10 Hz. If the EUT duty cycle is $< 98\%$, set VBW $\geq 1/T$.
4. Detector = Peak
5. Sweep time = auto
6. Allow max hold to run for at least 50 traces if the transmitted signal is continuous or has at least 98% duty cycle. For lower duty cycles, increase the minimum number of traces by a factor of $1/x$, where x is the duty cycle.

7.8.4. Test Setup

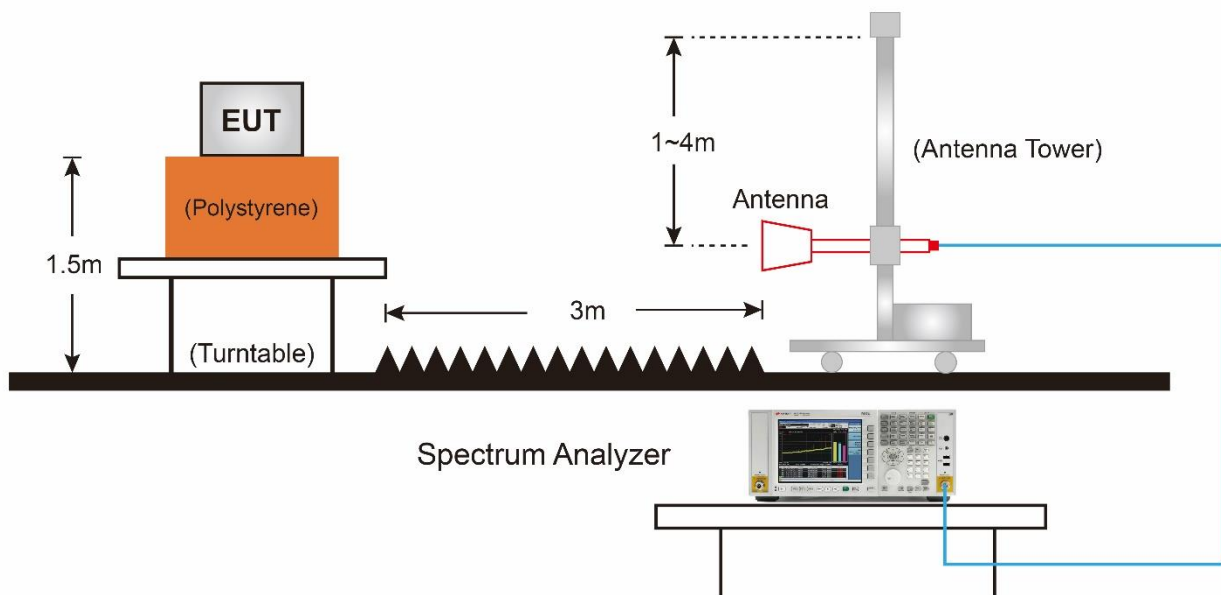

7.8.5. Test Result

EUT	AC750 Dual Band Wi-Fi Router	Date of Test	2023-04-19
Factor	DRH18-E	Temp. / Humidity	22°C /63%
Polarity	Horizontal	Site / Test Engineer	AC2 / Marvin
Test Mode	802.11a_TX_Band1_CH 36_ANT 0	Test Voltage	AC 120V/60Hz

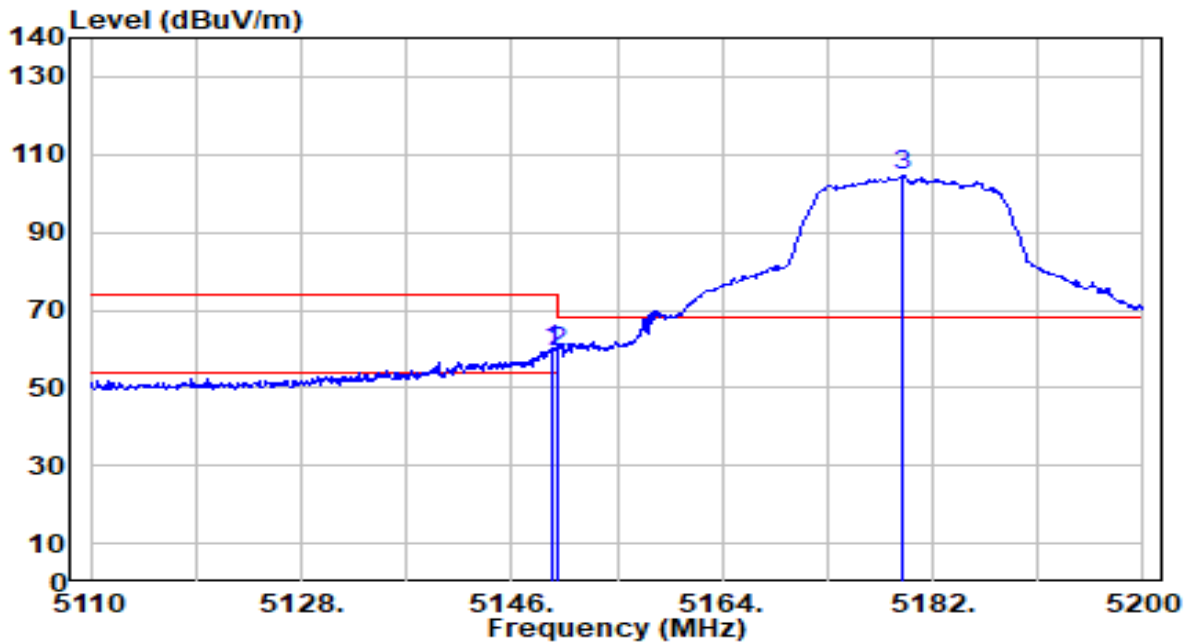

No	Frequency (MHz)	Reading (dBuV)	C.F (dB/m)	Measurement (dBuV/m)	Margin (dB)	Limit (dBuV/m)	Height (cm)	Angle (deg)	Remark (QP/PK/AV)	
1	*	5149.420	60.59	-0.73	59.86	-14.14	74.00	100	288	Peak
2		5150.000	59.95	-0.73	59.23	-14.77	74.00	100	288	Peak
3		5179.300	105.20	-0.70	104.50	N/A	N/A	100	288	Peak

Note:

1. " *", means this data is the worst emission level.
2. C.F (Correction Factor) = Antenna Factor (dB/m)+ Cable Loss (dB) – Preamplifier(dB) + 10dB Attenuation.
3. Measurement (dBuV/m) = Reading(dBuV) + C.F (Correction Factor).
4. The emission levels of other frequencies are very lower than the limit and not show in test report.

EUT	AC750 Dual Band Wi-Fi Router	Date of Test	2023-04-19
Factor	DRH18-E	Temp. / Humidity	22°C /63%
Polarity	Horizontal	Site / Test Engineer	AC2 / Marvin
Test Mode	802.11a_TX_Band1_CH 36_ANT 0	Test Voltage	AC 120V/60Hz

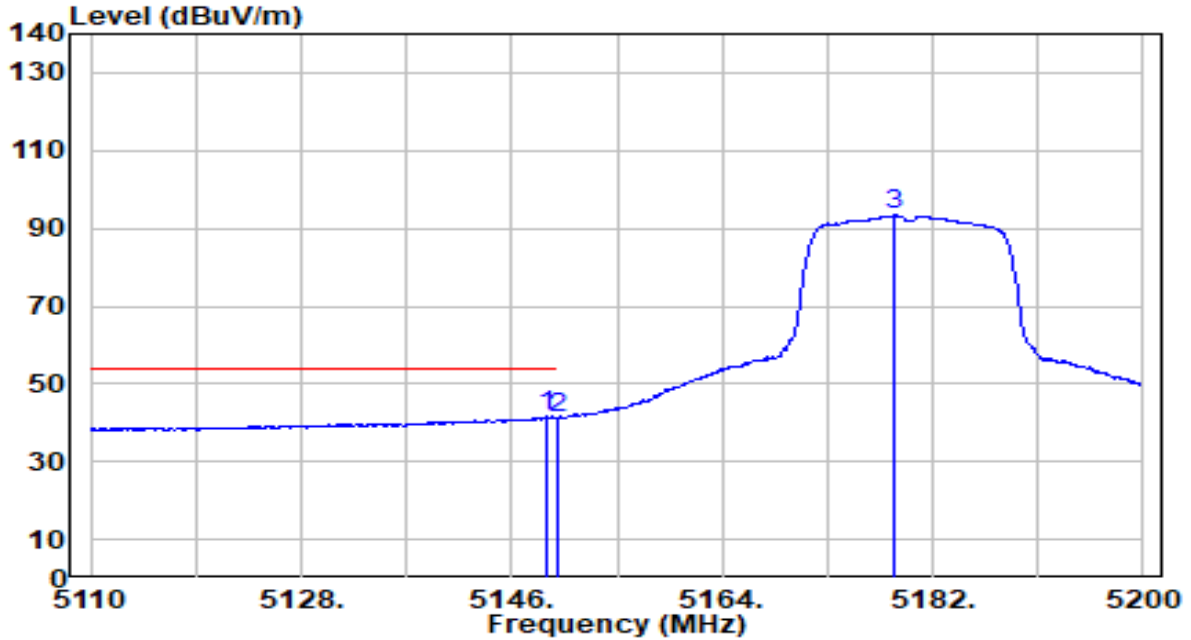

No	Frequency (MHz)	Reading (dBuV)	C.F (dB/m)	Measurement (dBuV/m)	Margin (dB)	Limit (dBuV/m)	Height (cm)	Angle (deg)	Remark (QP/PK/AV)
1	* 5149.060	42.20	-0.73	41.48	-12.52	54.00	100	288	Average
2	5150.000	42.01	-0.73	41.29	-12.71	54.00	100	288	Average
3	5178.760	94.01	-0.70	93.32	N/A	N/A	100	288	Average

Note:

1. " *", means this data is the worst emission level.
2. C.F (Correction Factor) = Antenna Factor (dB/m)+ Cable Loss (dB) – Preamplifier(dB) + 10dB Attenuation.
3. Measurement (dBuV/m) = Reading(dBuV) + C.F (Correction Factor).
4. The emission levels of other frequencies are very lower than the limit and not show in test report.

EUT	AC750 Dual Band Wi-Fi Router	Date of Test	2023-04-19
Factor	DRH18-E	Temp. / Humidity	22°C /63%
Polarity	Vertical	Site / Test Engineer	AC2 / Marvin
Test Mode	802.11a_TX_Band1_CH 36_ANT 0	Test Voltage	AC 120V/60Hz

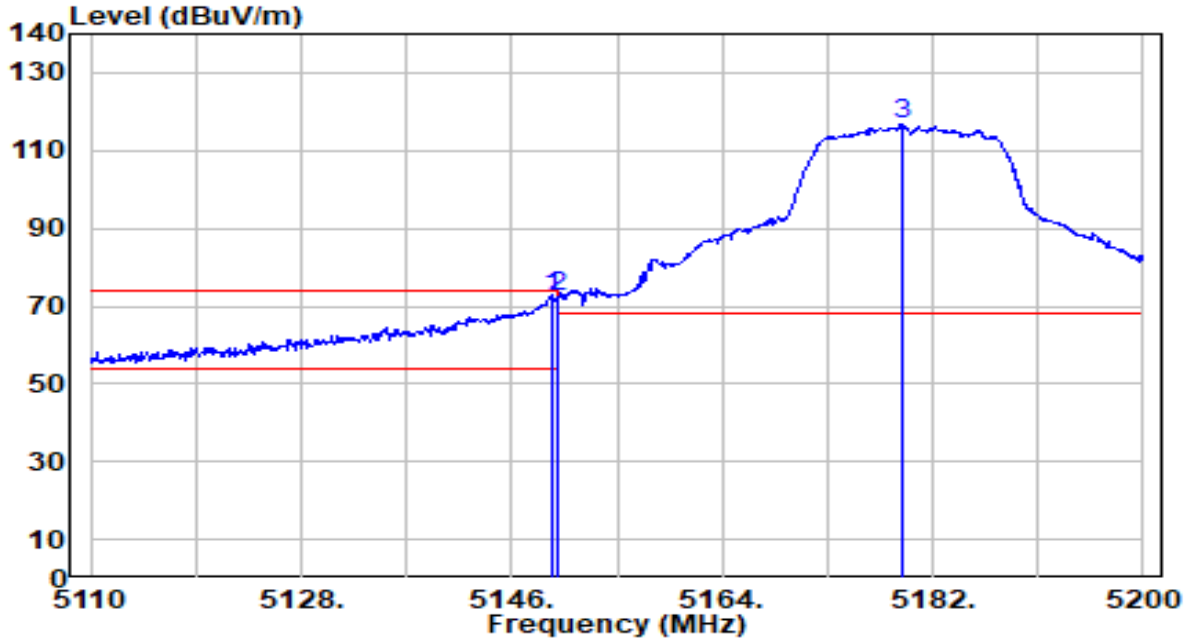

No	Frequency (MHz)	Reading (dBUV)	C.F (dB/m)	Measurement (dBUV/m)	Margin (dB)	Limit (dBUV/m)	Height (cm)	Angle (deg)	Remark (QP/PK/AV)
1	* 5149.420	73.17	-0.73	72.44	-1.56	74.00	100	284	Peak
2	5150.000	72.87	-0.73	72.14	-1.86	74.00	100	284	Peak
3	5179.390	117.36	-0.70	116.66	N/A	N/A	100	284	Peak

Note:

1. " *", means this data is the worst emission level.
2. C.F (Correction Factor) = Antenna Factor (dB/m)+ Cable Loss (dB) – Preamplifier(dB) + 10dB Attenuation.
3. Measurement (dBUV/m) = Reading(dBUV) + C.F (Correction Factor).
4. The emission levels of other frequencies are very lower than the limit and not show in test report.

EUT	AC750 Dual Band Wi-Fi Router	Date of Test	2023-04-19
Factor	DRH18-E	Temp. / Humidity	22°C /63%
Polarity	Vertical	Site / Test Engineer	AC2 / Marvin
Test Mode	802.11a_TX_Band1_CH 36_ANT 0	Test Voltage	AC 120V/60Hz

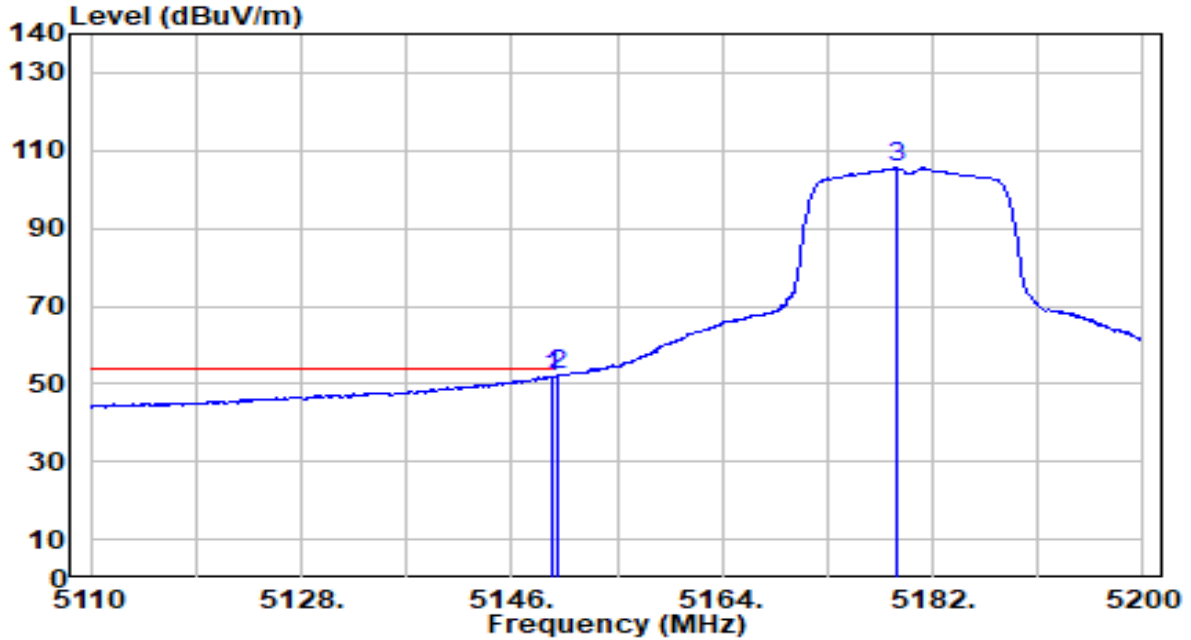

No	Frequency (MHz)	Reading (dBUV)	C.F (dB/m)	Measurement (dBUV/m)	Margin (dB)	Limit (dBUV/m)	Height (cm)	Angle (deg)	Remark (QP/PK/AV)
1	5149.420	52.64	-0.73	51.91	-2.09	54.00	100	284	Average
2	* 5150.000	52.77	-0.73	52.05	-1.95	54.00	100	284	Average
3	5178.850	106.26	-0.70	105.56	N/A	N/A	100	284	Average

Note:

1. " *", means this data is the worst emission level.
2. C.F (Correction Factor) = Antenna Factor (dB/m)+ Cable Loss (dB) – Preamplifier(dB) + 10dB Attenuation.
3. Measurement (dBUV/m) = Reading(dBUV) + C.F (Correction Factor).
4. The emission levels of other frequencies are very lower than the limit and not show in test report.

EUT	AC750 Dual Band Wi-Fi Router	Date of Test	2023-04-19
Factor	DRH18-E	Temp. / Humidity	22°C /63%
Polarity	Horizontal	Site / Test Engineer	AC2 / Marvin
Test Mode	802.11a_TX_Band4_CH 149_ANT 0	Test Voltage	AC 120V/60Hz

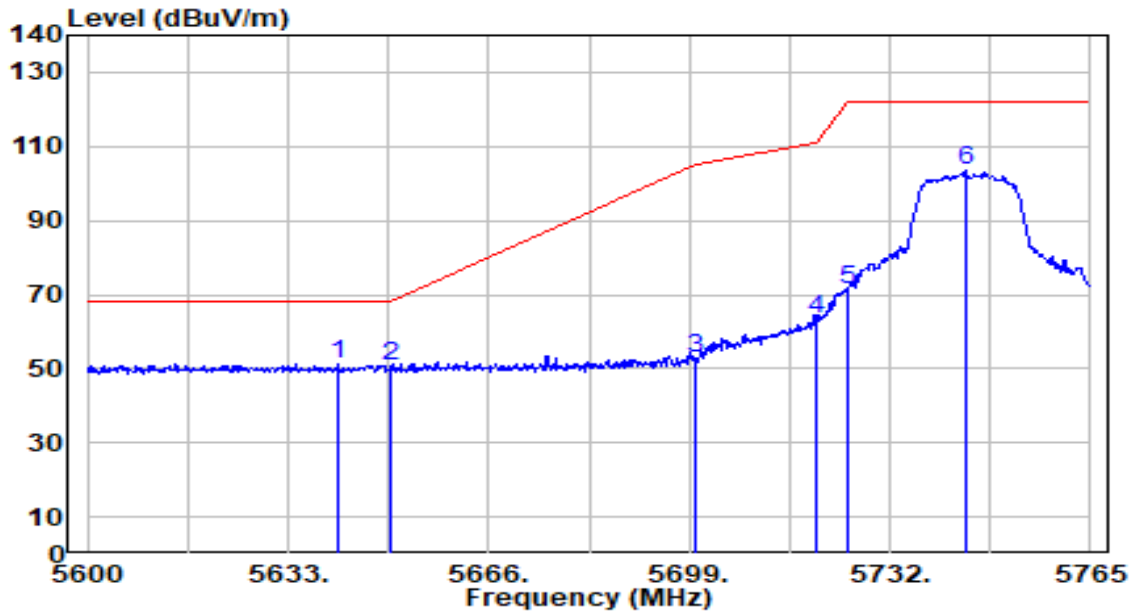

No	Frequency (MHz)	Reading (dBUV)	C.F (dB/m)	Measurement (dBUV/m)	Margin (dB)	Limit (dBUV/m)	Height (cm)	Angle (deg)	Remark (QP/PK/AV)
1	* 5641.250	51.24	-0.11	51.14	-17.06	68.20	100	307	Peak
2	5650.000	50.59	-0.08	50.52	-17.68	68.20	100	307	Peak
3	5700.000	52.55	0.11	52.66	-52.54	105.20	100	307	Peak
4	5720.000	62.96	0.19	63.15	-47.65	110.80	100	307	Peak
5	5725.000	71.32	0.21	71.53	-50.67	122.20	100	307	Peak
6	5744.375	103.05	0.28	103.33	N/A	N/A	100	307	Peak

Note:

- "*" means this data is the worst emission level.
- C.F (Correction Factor) = Antenna Factor (dB/m)+ Cable Loss (dB) – Preamplifier(dB) + 10dB Attenuation.
- Measurement (dBUV/m) = Reading(dBUV) + C.F (Correction Factor).
- The emission levels of other frequencies are very lower than the limit and not show in test report.

EUT	AC750 Dual Band Wi-Fi Router	Date of Test	2023-04-19
Factor	DRH18-E	Temp. / Humidity	22°C /63%
Polarity	Vertical	Site / Test Engineer	AC2 / Marvin
Test Mode	802.11a_TX_Band4_CH 149_ANT 0	Test Voltage	AC 120V/60Hz

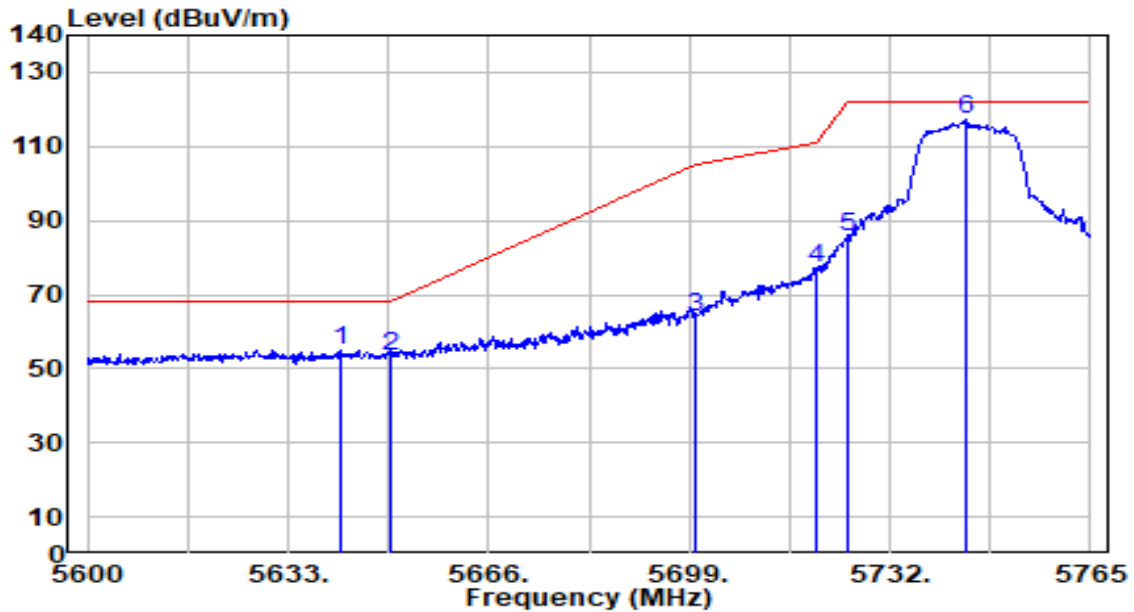

No	Frequency (MHz)	Reading (dBuV)	C.F (dB/m)	Measurement (dBuV/m)	Margin (dB)	Limit (dBuV/m)	Height (cm)	Angle (deg)	Remark (QP/PK/AV)
1	* 5641.580	55.08	-0.11	54.97	-13.23	68.20	103	234	Peak
2	5650.000	53.31	-0.08	53.23	-14.97	68.20	103	234	Peak
3	5700.000	64.07	0.11	64.18	-41.02	105.20	103	234	Peak
4	5720.000	76.97	0.19	77.16	-33.64	110.80	103	234	Peak
5	5725.000	85.19	0.21	85.39	-36.81	122.20	103	234	Peak
6	5744.375	116.97	0.28	117.25	N/A	N/A	103	234	Peak

Note:

- "*" means this data is the worst emission level.
- C.F (Correction Factor) = Antenna Factor (dB/m)+ Cable Loss (dB) – Preamplifier(dB) + 10dB Attenuation.
- Measurement (dBuV/m) = Reading(dBuV) + C.F (Correction Factor).
- The emission levels of other frequencies are very lower than the limit and not show in test report.

EUT	AC750 Dual Band Wi-Fi Router	Date of Test	2023-04-19
Factor	DRH18-E	Temp. / Humidity	22°C /63%
Polarity	Horizontal	Site / Test Engineer	AC2 / Marvin
Test Mode	802.11a_TX_Band4_CH 165_ANT 0	Test Voltage	AC 120V/60Hz

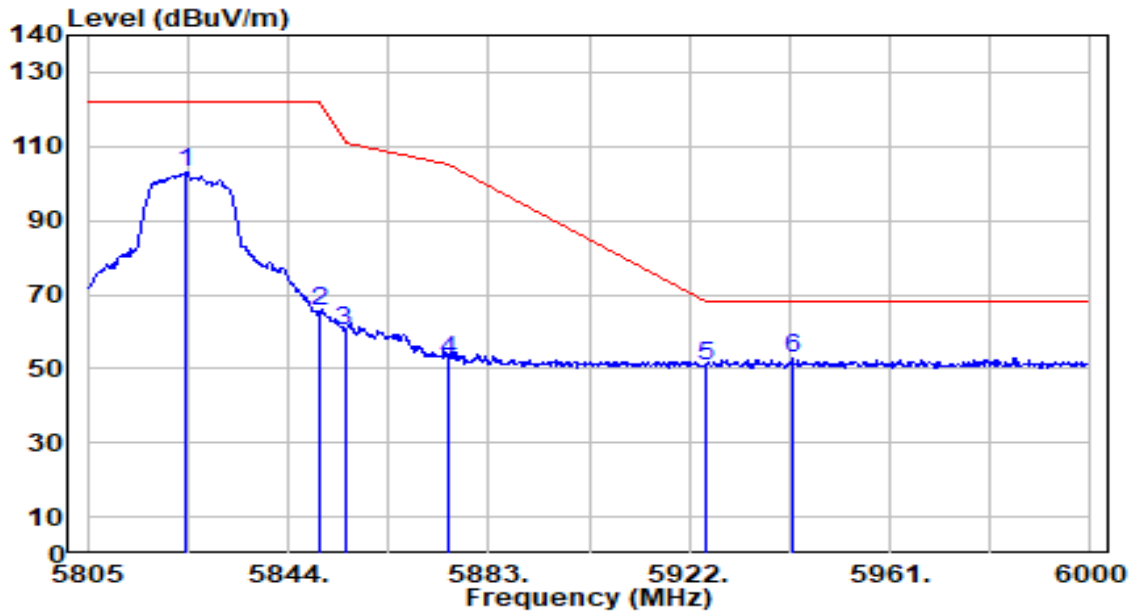

No	Frequency (MHz)	Reading (dBUV)	C.F (dB/m)	Measurement (dBUV/m)	Margin (dB)	Limit (dBUV/m)	Height (cm)	Angle (deg)	Remark (QP/PK/AV)
1	5824.305	102.51	0.52	103.03	N/A	N/A	100	307	Peak
2	5850.000	65.01	0.55	65.56	-56.64	122.20	100	307	Peak
3	5855.000	59.45	0.56	60.01	-50.79	110.80	100	307	Peak
4	5875.000	51.64	0.58	52.22	-52.98	105.20	100	307	Peak
5	5925.000	50.30	0.65	50.95	-17.25	68.20	100	307	Peak
6	* 5941.890	52.34	0.67	53.00	-15.20	68.20	100	307	Peak

Note:

1. " *", means this data is the worst emission level.
2. C.F (Correction Factor) = Antenna Factor (dB/m)+ Cable Loss (dB) – Preamplifier(dB) + 10dB Attenuation.
3. Measurement (dBUV/m) = Reading(dBUV) + C.F (Correction Factor).
4. The emission levels of other frequencies are very lower than the limit and not show in test report.

EUT	AC750 Dual Band Wi-Fi Router	Date of Test	2023-04-19
Factor	DRH18-E	Temp. / Humidity	22°C /63%
Polarity	Vertical	Site / Test Engineer	AC2 / Marvin
Test Mode	802.11a_TX_Band4_CH 165_ANT 0	Test Voltage	AC 120V/60Hz

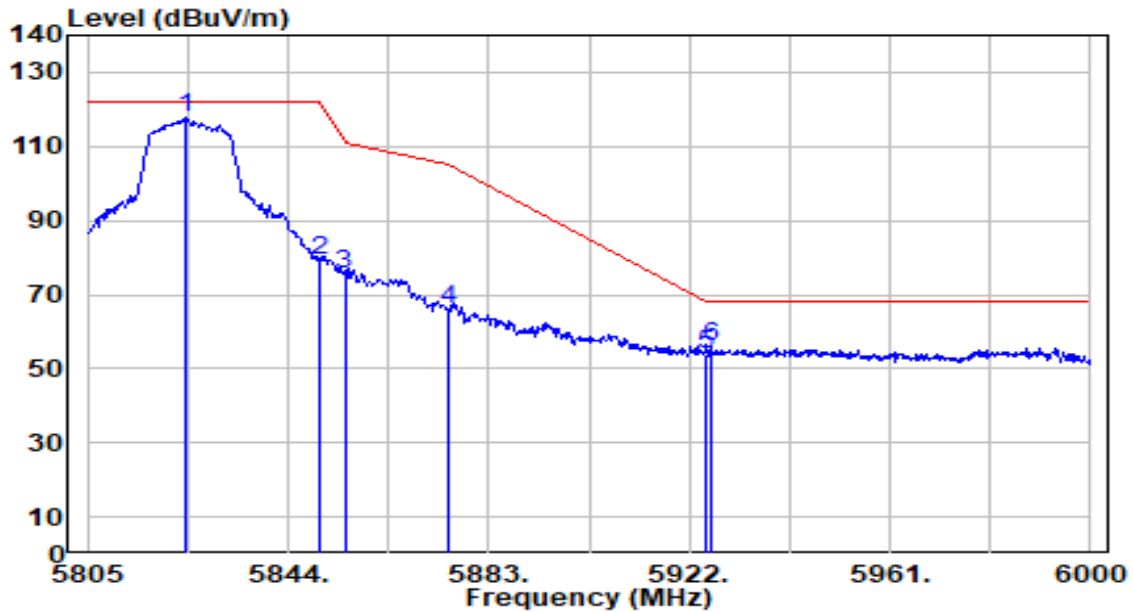

No	Frequency (MHz)	Reading (dBUV)	C.F (dB/m)	Measurement (dBUV/m)	Margin (dB)	Limit (dBUV/m)	Height (cm)	Angle (deg)	Remark (QP/PK/AV)
1	5824.305	117.36	0.52	117.88	N/A	N/A	146	185	Peak
2	5850.000	78.90	0.55	79.45	-42.75	122.20	146	185	Peak
3	5855.000	75.18	0.56	75.74	-35.06	110.80	146	185	Peak
4	5875.000	65.27	0.58	65.85	-39.35	105.20	146	185	Peak
5	5925.000	53.40	0.65	54.04	-14.16	68.20	146	185	Peak
6	* 5926.485	55.37	0.65	56.02	-12.18	68.20	146	185	Peak

Note:

1. " *", means this data is the worst emission level.
2. C.F (Correction Factor) = Antenna Factor (dB/m)+ Cable Loss (dB) – Preamplifier(dB) + 10dB Attenuation.
3. Measurement (dBUV/m) = Reading(dBUV) + C.F (Correction Factor).
4. The emission levels of other frequencies are very lower than the limit and not show in test report.

EUT	AC750 Dual Band Wi-Fi Router	Date of Test	2023-04-19
Factor	DRH18-E	Temp. / Humidity	22°C /63%
Polarity	Horizontal	Site / Test Engineer	AC2 / Marvin
Test Mode	802.11ac-20MHz_TX_Band1_CH 36_ANT 0	Test Voltage	AC 120V/60Hz

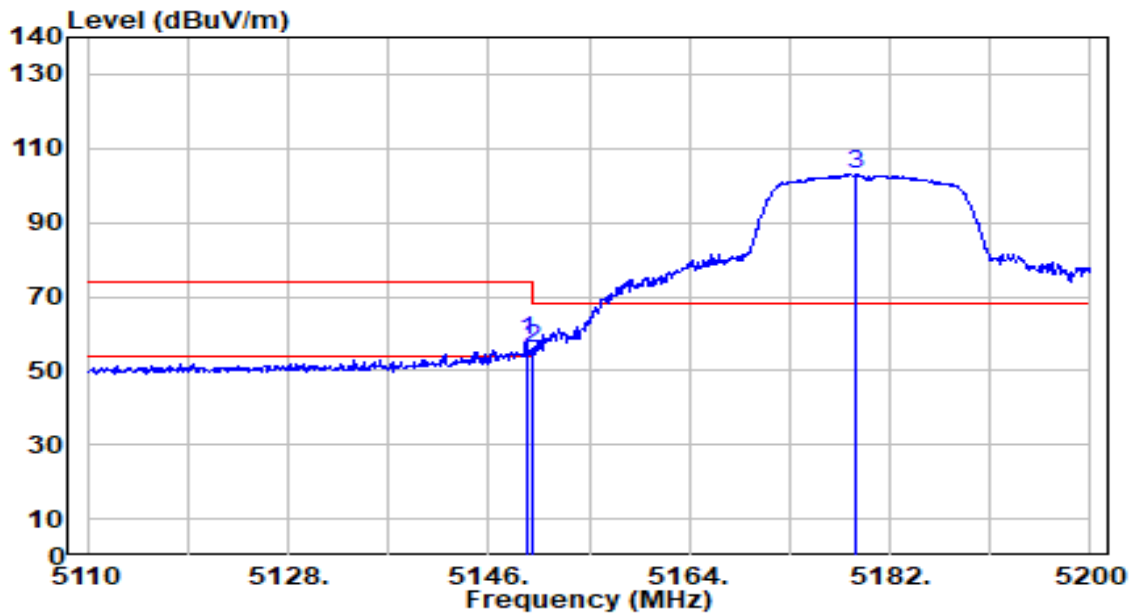

No	Frequency (MHz)	Reading (dBUV)	C.F (dB/m)	Measurement (dBUV/m)	Margin (dB)	Limit (dBUV/m)	Height (cm)	Angle (deg)	Remark (QP/PK/AV)
1	* 5149.420	58.59	-0.73	57.87	-16.13	74.00	100	289	Peak
2	5150.000	56.49	-0.73	55.76	-18.24	74.00	100	289	Peak
3	5178.850	103.60	-0.70	102.91	N/A	N/A	100	289	Peak

Note:

1. " *", means this data is the worst emission level.
2. C.F (Correction Factor) = Antenna Factor (dB/m)+ Cable Loss (dB) – Preamplifier(dB) + 10dB Attenuation.
3. Measurement (dBUV/m) = Reading(dBUV) + C.F (Correction Factor).
4. The emission levels of other frequencies are very lower than the limit and not show in test report.

EUT	AC750 Dual Band Wi-Fi Router	Date of Test	2023-04-19
Factor	DRH18-E	Temp. / Humidity	22°C /63%
Polarity	Horizontal	Site / Test Engineer	AC2 / Marvin
Test Mode	802.11ac-20MHz_TX_Band1_CH 36_ANT 0	Test Voltage	AC 120V/60Hz

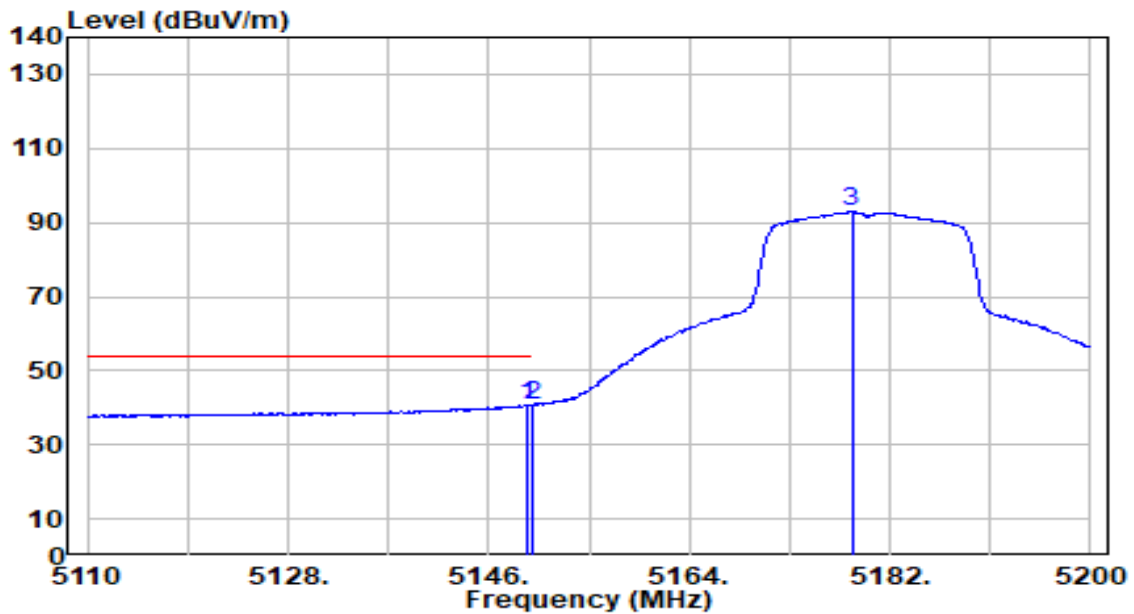

No	Frequency (MHz)	Reading (dBUV)	C.F (dB/m)	Measurement (dBUV/m)	Margin (dB)	Limit (dBUV/m)	Height (cm)	Angle (deg)	Remark (QP/PK/AV)
1	5149.420	41.38	-0.73	40.65	-13.35	54.00	100	289	Average
2	* 5150.000	41.48	-0.73	40.76	-13.24	54.00	100	289	Average
3	5178.580	93.66	-0.70	92.96	N/A	N/A	100	289	Average

Note:

1. " *", means this data is the worst emission level.
2. C.F (Correction Factor) = Antenna Factor (dB/m)+ Cable Loss (dB) – Preamplifier(dB) + 10dB Attenuation.
3. Measurement (dBUV/m) = Reading(dBUV) + C.F (Correction Factor).
4. The emission levels of other frequencies are very lower than the limit and not show in test report.

EUT	AC750 Dual Band Wi-Fi Router	Date of Test	2023-04-19
Factor	DRH18-E	Temp. / Humidity	22°C /63%
Polarity	Vertical	Site / Test Engineer	AC2 / Marvin
Test Mode	802.11ac-20MHz_TX_Band1_CH 36_ANT 0	Test Voltage	AC 120V/60Hz

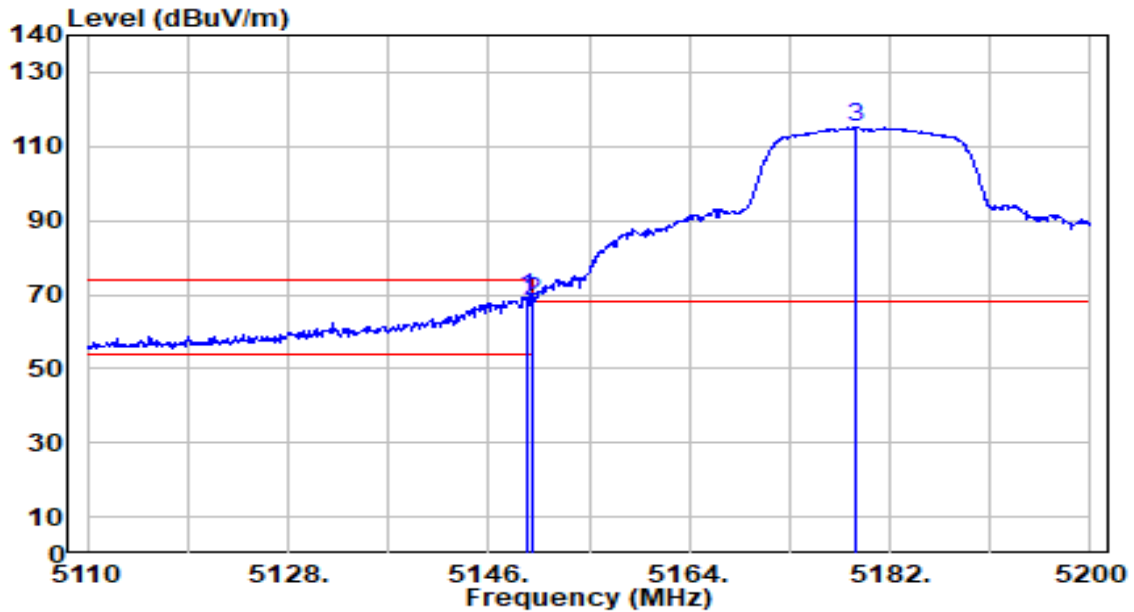

No	Frequency (MHz)	Reading (dBUV)	C.F (dB/m)	Measurement (dBUV/m)	Margin (dB)	Limit (dBUV/m)	Height (cm)	Angle (deg)	Remark (QP/PK/AV)
1	* 5149.420	69.97	-0.73	69.24	-4.76	74.00	100	284	Peak
2	5150.000	68.87	-0.73	68.15	-5.85	74.00	100	284	Peak
3	5179.030	115.79	-0.70	115.09	N/A	N/A	100	284	Peak

Note:

1. " *", means this data is the worst emission level.
2. C.F (Correction Factor) = Antenna Factor (dB/m)+ Cable Loss (dB) – Pre-amplifier(dB) + 10dB Attenuation.
3. Measurement (dBUV/m) = Reading(dBUV) + C.F (Correction Factor).
4. The emission levels of other frequencies are very lower than the limit and not show in test report.

EUT	AC750 Dual Band Wi-Fi Router	Date of Test	2023-04-19
Factor	DRH18-E	Temp. / Humidity	22°C /63%
Polarity	Vertical	Site / Test Engineer	AC2 / Marvin
Test Mode	802.11ac-20MHz_TX_Band1_CH 36_ANT 0	Test Voltage	AC 120V/60Hz

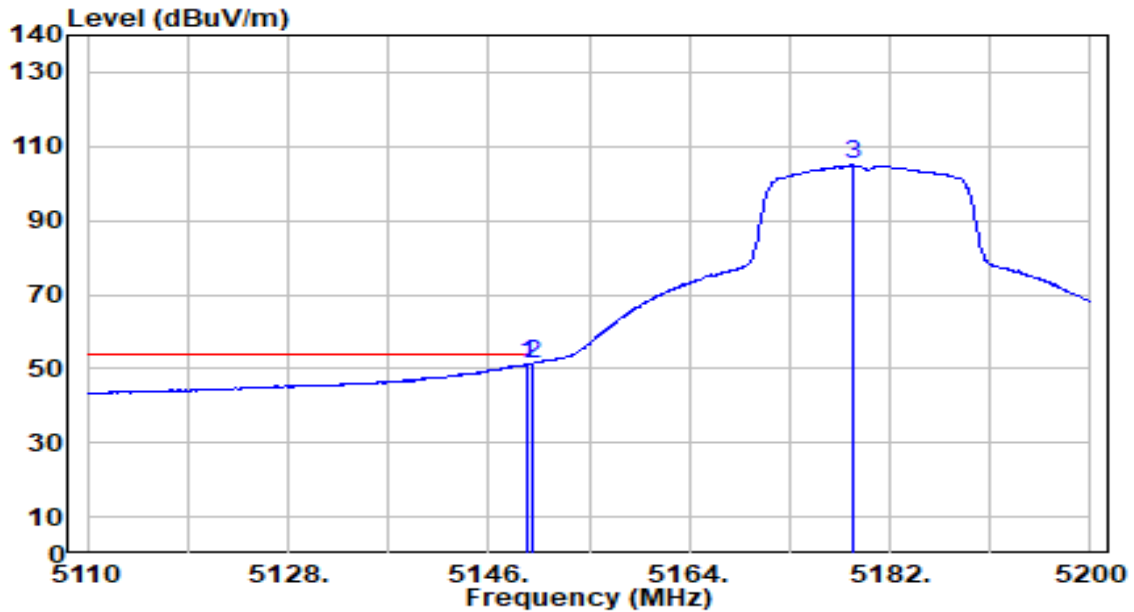

No	Frequency (MHz)	Reading (dBUV)	C.F (dB/m)	Measurement (dBUV/m)	Margin (dB)	Limit (dBUV/m)	Height (cm)	Angle (deg)	Remark (QP/PK/AV)
1	5149.420	52.12	-0.73	51.40	-2.60	54.00	100	284	Average
2	* 5150.000	52.15	-0.73	51.42	-2.58	54.00	100	284	Average
3	5178.760	105.75	-0.70	105.05	N/A	N/A	100	284	Average

Note:

1. " *", means this data is the worst emission level.
2. C.F (Correction Factor) = Antenna Factor (dB/m)+ Cable Loss (dB) – Preamplifier(dB) + 10dB Attenuation.
3. Measurement (dBUV/m) = Reading(dBUV) + C.F (Correction Factor).
4. The emission levels of other frequencies are very lower than the limit and not show in test report.

EUT	AC750 Dual Band Wi-Fi Router	Date of Test	2023-04-19
Factor	DRH18-E	Temp. / Humidity	22°C /63%
Polarity	Horizontal	Site / Test Engineer	AC2 / Marvin
Test Mode	802.11ac-20MHz_TX_Band4_CH 149_ANT 0	Test Voltage	AC 120V/60Hz

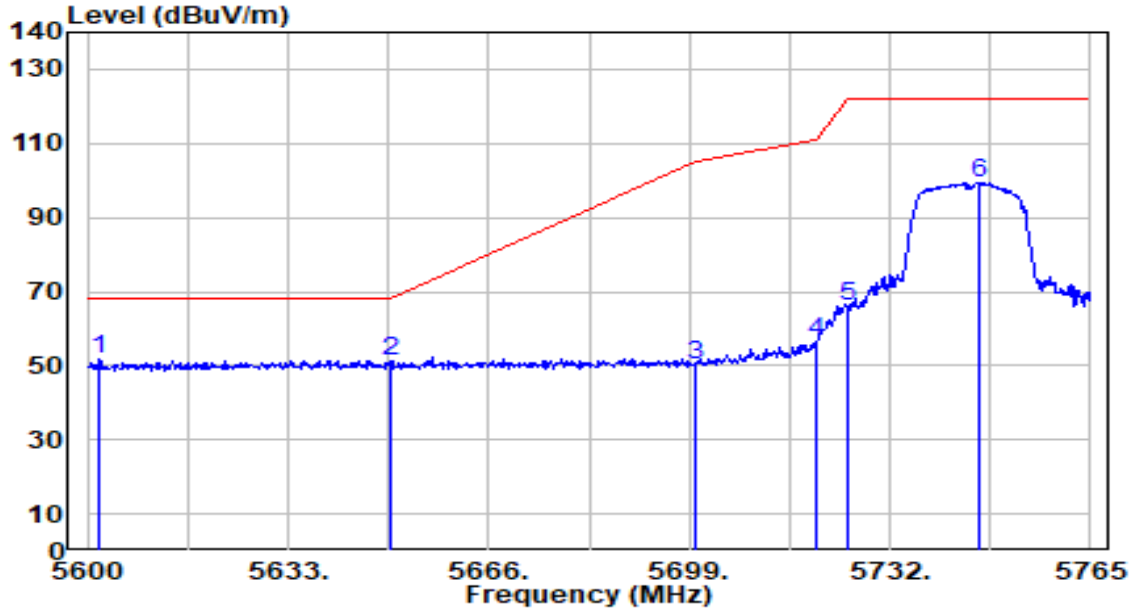

No	Frequency (MHz)	Reading (dBUV)	C.F (dB/m)	Measurement (dBUV/m)	Margin (dB)	Limit (dBUV/m)	Height (cm)	Angle (deg)	Remark (QP/PK/AV)
1	* 5601.980	51.88	-0.26	51.62	-16.58	68.20	100	307	Peak
2	5650.000	51.39	-0.08	51.31	-16.89	68.20	100	307	Peak
3	5700.000	50.27	0.11	50.38	-54.82	105.20	100	307	Peak
4	5720.000	56.55	0.19	56.74	-54.06	110.80	100	307	Peak
5	5725.000	65.61	0.21	65.82	-56.38	122.20	100	307	Peak
6	5746.685	98.93	0.29	99.22	N/A	N/A	100	307	Peak

Note:

- "*" means this data is the worst emission level.
- C.F (Correction Factor) = Antenna Factor (dB/m)+ Cable Loss (dB) – Preamplifier(dB) + 10dB Attenuation.
- Measurement (dBUV/m) = Reading(dBUV) + C.F (Correction Factor).
- The emission levels of other frequencies are very lower than the limit and not show in test report.

EUT	AC750 Dual Band Wi-Fi Router	Date of Test	2023-04-19
Factor	DRH18-E	Temp. / Humidity	22°C /63%
Polarity	Vertical	Site / Test Engineer	AC2 / Marvin
Test Mode	802.11ac-20MHz_TX_Band4_CH 149_ANT 0	Test Voltage	AC 120V/60Hz

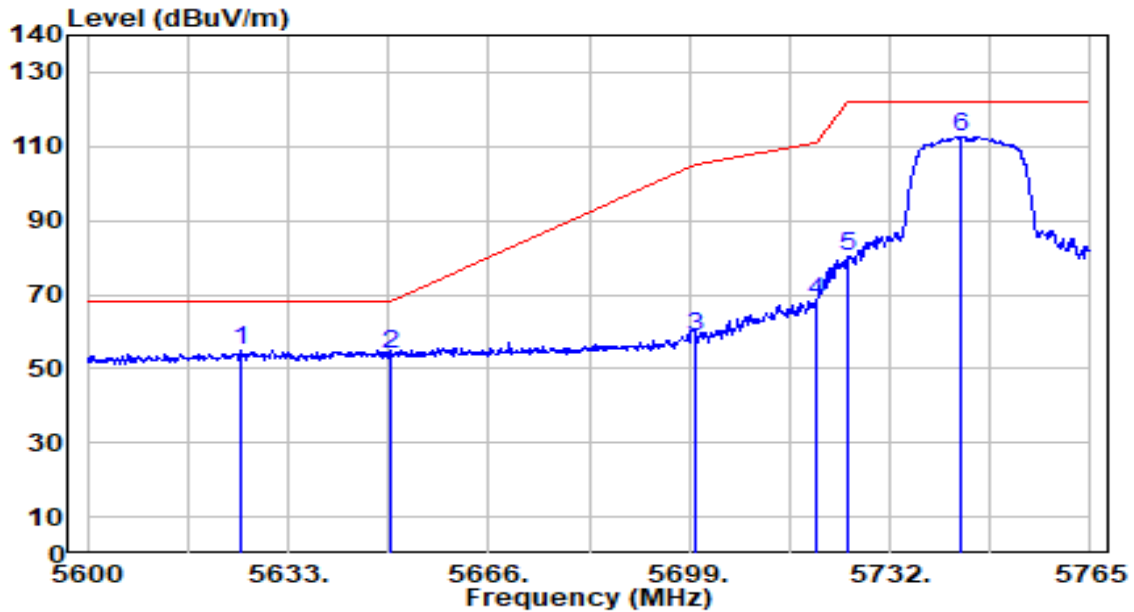

No	Frequency (MHz)	Reading (dBUV)	C.F (dB/m)	Measurement (dBUV/m)	Margin (dB)	Limit (dBUV/m)	Height (cm)	Angle (deg)	Remark (QP/PK/AV)
1	* 5625.245	55.17	-0.17	55.00	-13.20	68.20	104	234	Peak
2	5650.000	54.02	-0.08	53.95	-14.25	68.20	104	234	Peak
3	5700.000	58.62	0.11	58.73	-46.47	105.20	104	234	Peak
4	5720.000	68.18	0.19	68.37	-42.43	110.80	104	234	Peak
5	5725.000	80.21	0.21	80.42	-41.78	122.20	104	234	Peak
6	5743.715	112.32	0.28	112.60	N/A	N/A	104	234	Peak

Note:

- "*" means this data is the worst emission level.
- C.F (Correction Factor) = Antenna Factor (dB/m)+ Cable Loss (dB) – Preamplifier(dB) + 10dB Attenuation.
- Measurement (dBUV/m) = Reading(dBUV) + C.F (Correction Factor).
- The emission levels of other frequencies are very lower than the limit and not show in test report.

EUT	AC750 Dual Band Wi-Fi Router	Date of Test	2023-04-19
Factor	DRH18-E	Temp. / Humidity	22°C /63%
Polarity	Horizontal	Site / Test Engineer	AC2 / Marvin
Test Mode	802.11ac-20MHz_TX_Band4_CH 165_ANT 0	Test Voltage	AC 120V/60Hz

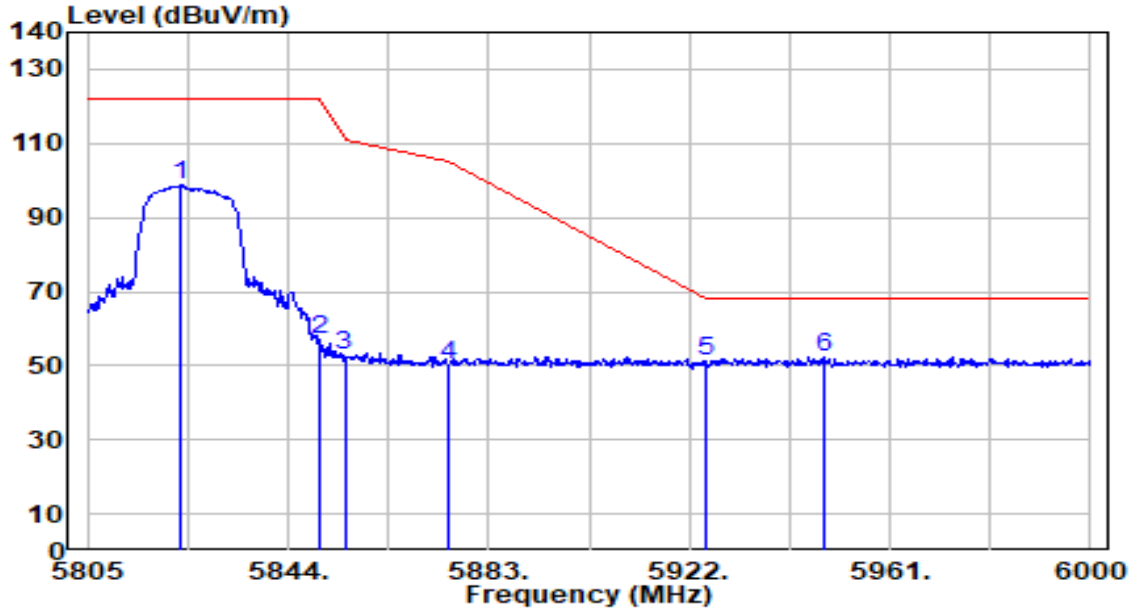

No	Frequency (MHz)	Reading (dBUV)	C.F (dB/m)	Measurement (dBUV/m)	Margin (dB)	Limit (dBUV/m)	Height (cm)	Angle (deg)	Remark (QP/PK/AV)
1	5822.940	98.05	0.52	98.57	N/A	N/A	100	307	Peak
2	5850.000	56.49	0.55	57.04	-65.16	122.20	100	307	Peak
3	5855.000	52.30	0.56	52.85	-57.95	110.80	100	307	Peak
4	5875.000	49.84	0.58	50.42	-54.78	105.20	100	307	Peak
5	5925.000	50.44	0.65	51.09	-17.11	68.20	100	307	Peak
6	* 5948.130	51.72	0.67	52.39	-15.81	68.20	100	307	Peak

Note:

1. " *", means this data is the worst emission level.
2. C.F (Correction Factor) = Antenna Factor (dB/m)+ Cable Loss (dB) – Preamplifier(dB) + 10dB Attenuation.
3. Measurement (dBUV/m) = Reading(dBUV) + C.F (Correction Factor).
4. The emission levels of other frequencies are very lower than the limit and not show in test report.

EUT	AC750 Dual Band Wi-Fi Router	Date of Test	2023-04-19
Factor	DRH18-E	Temp. / Humidity	22°C /63%
Polarity	Vertical	Site / Test Engineer	AC2 / Marvin
Test Mode	802.11ac-20MHz_TX_Band4_CH 165_ANT 0	Test Voltage	AC 120V/60Hz

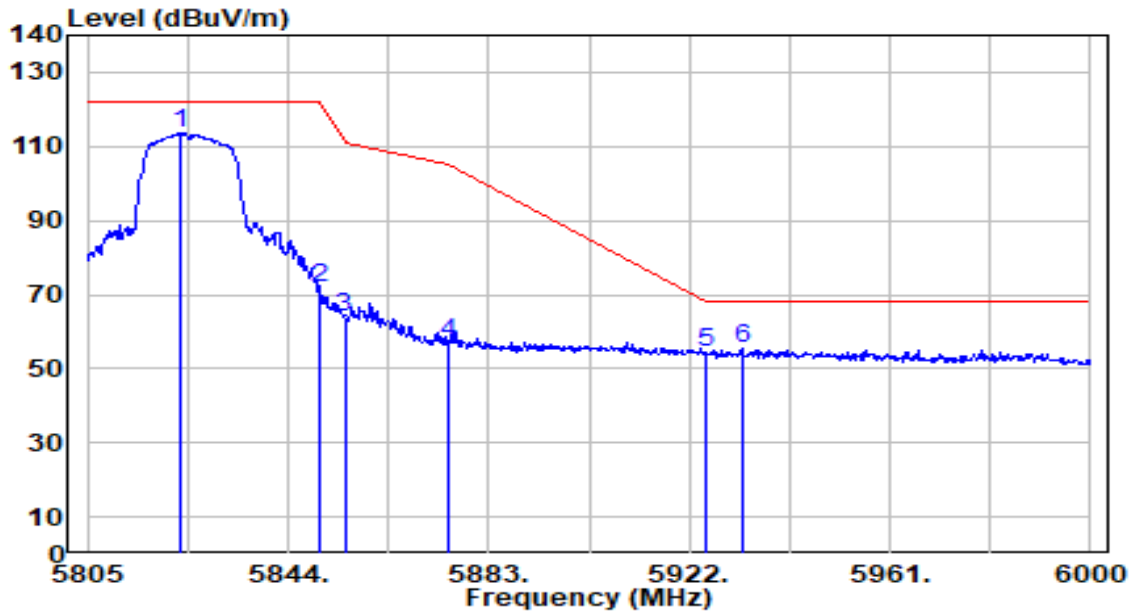

No	Frequency (MHz)	Reading (dBUV)	C.F (dB/m)	Measurement (dBUV/m)	Margin (dB)	Limit (dBUV/m)	Height (cm)	Angle (deg)	Remark (QP/PK/AV)
1	5823.135	112.93	0.52	113.45	N/A	N/A	145	185	Peak
2	5850.000	71.24	0.55	71.79	-50.41	122.20	145	185	Peak
3	5855.000	63.44	0.56	63.99	-46.81	110.80	145	185	Peak
4	5875.000	56.39	0.58	56.98	-48.22	105.20	145	185	Peak
5	5925.000	53.87	0.65	54.52	-13.68	68.20	145	185	Peak
6	* 5932.335	54.64	0.65	55.30	-12.90	68.20	145	185	Peak

Note:

1. " *", means this data is the worst emission level.
2. C.F (Correction Factor) = Antenna Factor (dB/m)+ Cable Loss (dB) – Preamplifier(dB) + 10dB Attenuation.
3. Measurement (dBUV/m) = Reading(dBUV) + C.F (Correction Factor).
4. The emission levels of other frequencies are very lower than the limit and not show in test report.

EUT	AC750 Dual Band Wi-Fi Router	Date of Test	2023-04-19
Factor	DRH18-E	Temp. / Humidity	22°C /63%
Polarity	Horizontal	Site / Test Engineer	AC2 / Marvin
Test Mode	802.11ac-40MHz_TX_Band1_CH 38_ANT 0	Test Voltage	AC 120V/60Hz

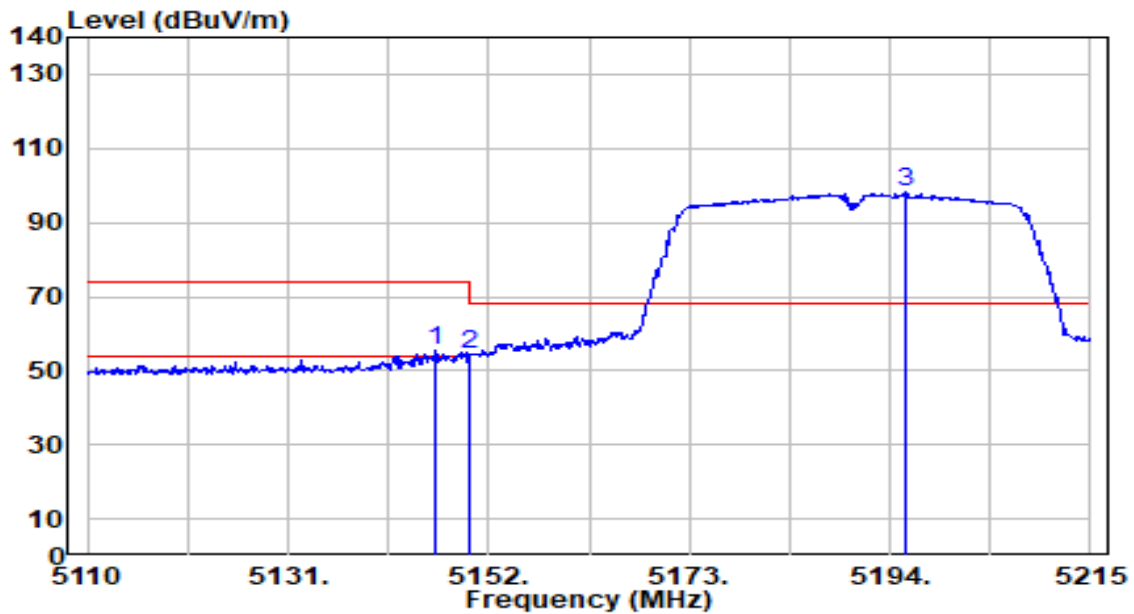

No	Frequency (MHz)	Reading (dBUV)	C.F (dB/m)	Measurement (dBUV/m)	Margin (dB)	Limit (dBUV/m)	Height (cm)	Angle (deg)	Remark (QP/PK/AV)
1	* 5146.435	56.45	-0.73	55.72	-18.28	74.00	100	289	Peak
2	5150.000	55.03	-0.73	54.30	-19.70	74.00	100	289	Peak
3	5195.575	98.70	-0.68	98.01	N/A	N/A	100	289	Peak

Note:

1. " *", means this data is the worst emission level.
2. C.F (Correction Factor) = Antenna Factor (dB/m)+ Cable Loss (dB) – Preamplifier(dB) + 10dB Attenuation.
3. Measurement (dBUV/m) = Reading(dBUV) + C.F (Correction Factor).
4. The emission levels of other frequencies are very lower than the limit and not show in test report.

EUT	AC750 Dual Band Wi-Fi Router	Date of Test	2023-04-19
Factor	DRH18-E	Temp. / Humidity	22°C /63%
Polarity	Horizontal	Site / Test Engineer	AC2 / Marvin
Test Mode	802.11ac-40MHz_TX_Band1_CH 38_ANT 0	Test Voltage	AC 120V/60Hz

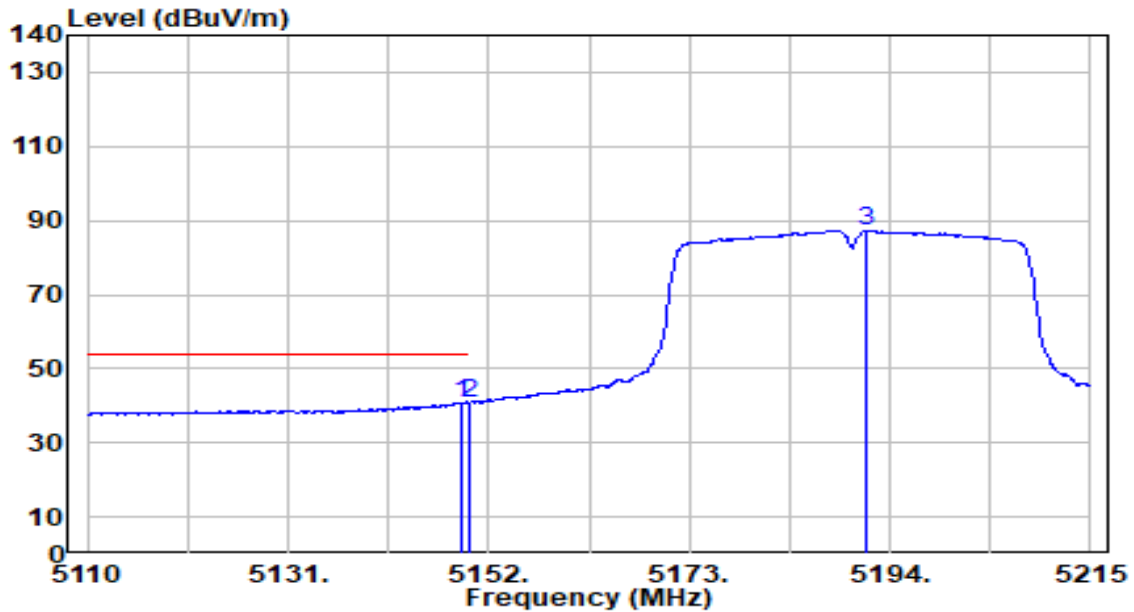

No	Frequency (MHz)	Reading (dBUV)	C.F (dB/m)	Measurement (dBUV/m)	Margin (dB)	Limit (dBUV/m)	Height (cm)	Angle (deg)	Remark (QP/PK/AV)
1	* 5149.165	41.51	-0.73	40.78	-13.22	54.00	100	289	Average
2	5150.000	41.45	-0.73	40.72	-13.28	54.00	100	289	Average
3	5191.480	87.98	-0.69	87.29	N/A	N/A	100	289	Average

Note:

1. " *", means this data is the worst emission level.
2. C.F (Correction Factor) = Antenna Factor (dB/m)+ Cable Loss (dB) – Preamplifier(dB) + 10dB Attenuation.
3. Measurement (dBUV/m) = Reading(dBUV) + C.F (Correction Factor).
4. The emission levels of other frequencies are very lower than the limit and not show in test report.

EUT	AC750 Dual Band Wi-Fi Router	Date of Test	2023-04-19
Factor	DRH18-E	Temp. / Humidity	22°C /63%
Polarity	Vertical	Site / Test Engineer	AC2 / Marvin
Test Mode	802.11ac-40MHz_TX_Band1_CH 38_ANT 0	Test Voltage	AC 120V/60Hz

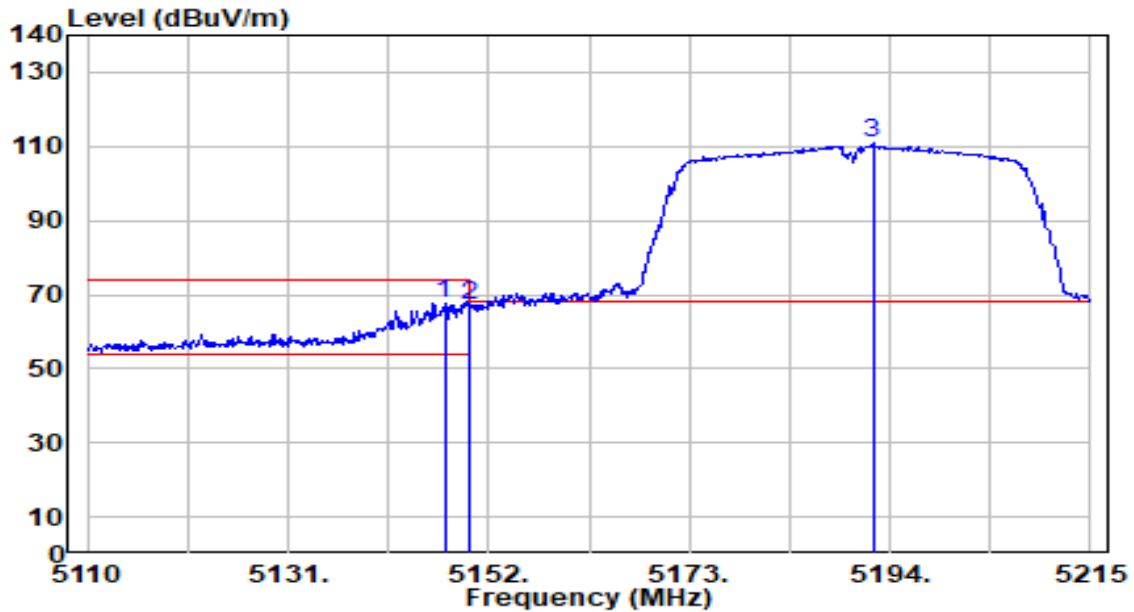

No	Frequency (MHz)	Reading (dBUV)	C.F (dB/m)	Measurement (dBUV/m)	Margin (dB)	Limit (dBUV/m)	Height (cm)	Angle (deg)	Remark (QP/PK/AV)
1	* 5147.380	68.58	-0.73	67.85	-6.15	74.00	100	284	Peak
2	5150.000	68.03	-0.73	67.30	-6.70	74.00	100	284	Peak
3	5192.215	111.58	-0.69	110.89	N/A	N/A	100	284	Peak

Note:

1. " *", means this data is the worst emission level.
2. C.F (Correction Factor) = Antenna Factor (dB/m)+ Cable Loss (dB) – Preamplifier(dB) + 10dB Attenuation.
3. Measurement (dBUV/m) = Reading(dBUV) + C.F (Correction Factor).
4. The emission levels of other frequencies are very lower than the limit and not show in test report.

EUT	AC750 Dual Band Wi-Fi Router	Date of Test	2023-04-19
Factor	DRH18-E	Temp. / Humidity	22°C /63%
Polarity	Vertical	Site / Test Engineer	AC2 / Marvin
Test Mode	802.11ac-40MHz_TX_Band1_CH 38_ANT 0	Test Voltage	AC 120V/60Hz

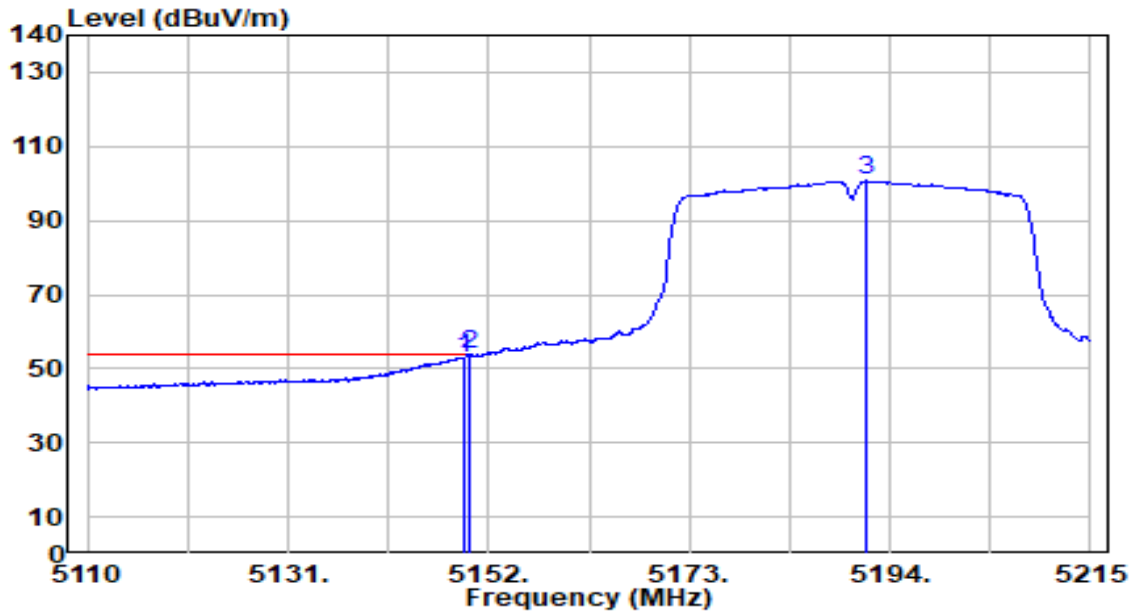

No	Frequency (MHz)	Reading (dBUV)	C.F (dB/m)	Measurement (dBUV/m)	Margin (dB)	Limit (dBUV/m)	Height (cm)	Angle (deg)	Remark (QP/PK/AV)
1	5149.375	53.76	-0.73	53.04	-0.96	54.00	100	284	Average
2	* 5150.000	54.63	-0.73	53.90	-0.10	54.00	100	284	Average
3	5191.585	101.35	-0.69	100.66	N/A	N/A	100	284	Average

Note:

1. " *", means this data is the worst emission level.
2. C.F (Correction Factor) = Antenna Factor (dB/m)+ Cable Loss (dB) – Preamplifier(dB) + 10dB Attenuation.
3. Measurement (dBUV/m) = Reading(dBUV) + C.F (Correction Factor).
4. The emission levels of other frequencies are very lower than the limit and not show in test report.

EUT	AC750 Dual Band Wi-Fi Router	Date of Test	2023-04-19
Factor	DRH18-E	Temp. / Humidity	22°C /63%
Polarity	Horizontal	Site / Test Engineer	AC2 / Marvin
Test Mode	802.11ac-40MHz_TX_Band4_CH 151_ANT 0	Test Voltage	AC 120V/60Hz

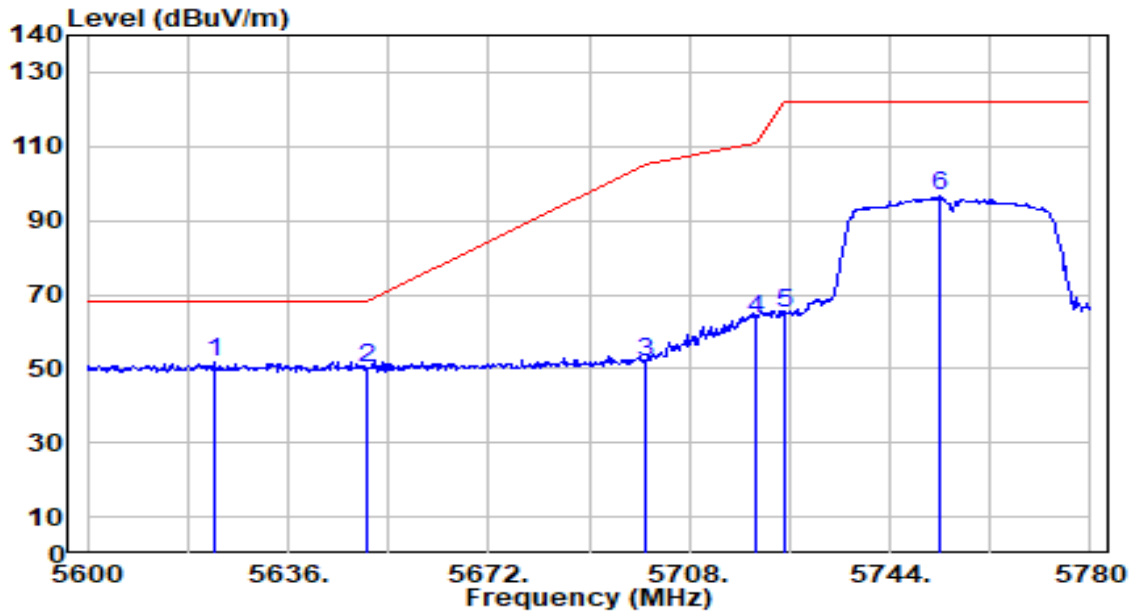

No	Frequency (MHz)	Reading (dBUV)	C.F (dB/m)	Measurement (dBUV/m)	Margin (dB)	Limit (dBUV/m)	Height (cm)	Angle (deg)	Remark (QP/PK/AV)
1	* 5622.680	52.21	-0.18	52.03	-16.17	68.20	100	307	Peak
2	5650.000	50.37	-0.08	50.29	-17.91	68.20	100	307	Peak
3	5700.000	51.63	0.11	51.74	-53.46	105.20	100	307	Peak
4	5720.000	63.35	0.19	63.54	-47.26	110.80	100	307	Peak
5	5725.000	64.56	0.21	64.76	-57.44	122.20	100	307	Peak
6	5752.820	96.15	0.31	96.46	N/A	N/A	100	307	Peak

Note:

- "*" means this data is the worst emission level.
- C.F (Correction Factor) = Antenna Factor (dB/m)+ Cable Loss (dB) – Preamplifier(dB) + 10dB Attenuation.
- Measurement (dBUV/m) = Reading(dBUV) + C.F (Correction Factor).
- The emission levels of other frequencies are very lower than the limit and not show in test report.

EUT	AC750 Dual Band Wi-Fi Router	Date of Test	2023-04-19
Factor	DRH18-E	Temp. / Humidity	22°C /63%
Polarity	Vertical	Site / Test Engineer	AC2 / Marvin
Test Mode	802.11ac-40MHz_TX_Band4_CH 151_ANT 0	Test Voltage	AC 120V/60Hz

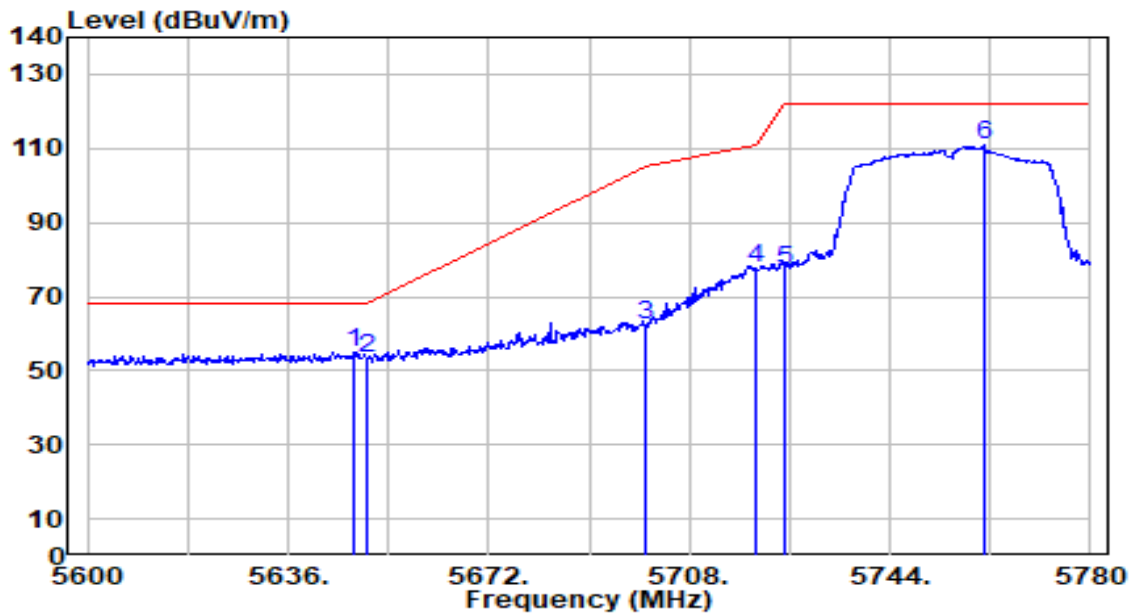

No	Frequency (MHz)	Reading (dBUV)	C.F (dB/m)	Measurement (dBUV/m)	Margin (dB)	Limit (dBUV/m)	Height (cm)	Angle (deg)	Remark (QP/PK/AV)
1	* 5647.880	55.10	-0.08	55.01	-13.19	68.20	145	234	Peak
2	5650.000	53.19	-0.08	53.11	-15.09	68.20	145	234	Peak
3	5700.000	62.40	0.11	62.51	-42.69	105.20	145	234	Peak
4	5720.000	77.54	0.19	77.72	-33.08	110.80	145	234	Peak
5	5725.000	76.69	0.21	76.89	-45.31	122.20	145	234	Peak
6	5760.920	110.65	0.34	110.99	N/A	N/A	145	234	Peak

Note:

1. " *", means this data is the worst emission level.
2. C.F (Correction Factor) = Antenna Factor (dB/m)+ Cable Loss (dB) – Preamplifier(dB) + 10dB Attenuation.
3. Measurement (dBUV/m) = Reading(dBUV) + C.F (Correction Factor).
4. The emission levels of other frequencies are very lower than the limit and not show in test report.

EUT	AC750 Dual Band Wi-Fi Router	Date of Test	2023-04-19
Factor	DRH18-E	Temp. / Humidity	22°C /63%
Polarity	Horizontal	Site / Test Engineer	AC2 / Marvin
Test Mode	802.11ac-40MHz_TX_Band4_CH 159_ANT 0	Test Voltage	AC 120V/60Hz

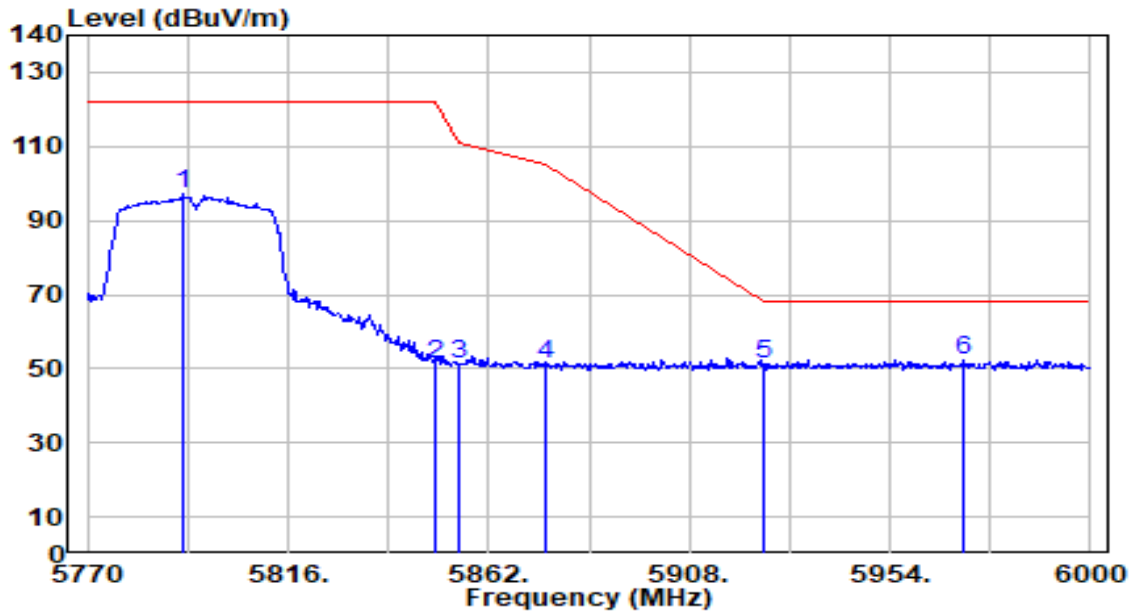

No	Frequency (MHz)	Reading (dBUV)	C.F (dB/m)	Measurement (dBUV/m)	Margin (dB)	Limit (dBUV/m)	Height (cm)	Angle (deg)	Remark (QP/PK/AV)
1	5791.850	96.61	0.46	97.07	N/A	N/A	100	307	Peak
2	5850.000	50.81	0.55	51.36	-70.84	122.20	100	307	Peak
3	5855.000	50.64	0.56	51.19	-59.61	110.80	100	307	Peak
4	5875.000	50.79	0.58	51.37	-53.83	105.20	100	307	Peak
5	5925.000	50.37	0.65	51.01	-17.19	68.20	100	307	Peak
6	* 5970.790	51.45	0.70	52.15	-16.05	68.20	100	307	Peak

Note:

1. " *", means this data is the worst emission level.
2. C.F (Correction Factor) = Antenna Factor (dB/m)+ Cable Loss (dB) – Preamplifier(dB) + 10dB Attenuation.
3. Measurement (dBUV/m) = Reading(dBUV) + C.F (Correction Factor).
4. The emission levels of other frequencies are very lower than the limit and not show in test report.

EUT	AC750 Dual Band Wi-Fi Router	Date of Test	2023-04-19
Factor	DRH18-E	Temp. / Humidity	22°C /63%
Polarity	Vertical	Site / Test Engineer	AC2 / Marvin
Test Mode	802.11ac-40MHz_TX_Band4_CH 159_ANT 0	Test Voltage	AC 120V/60Hz

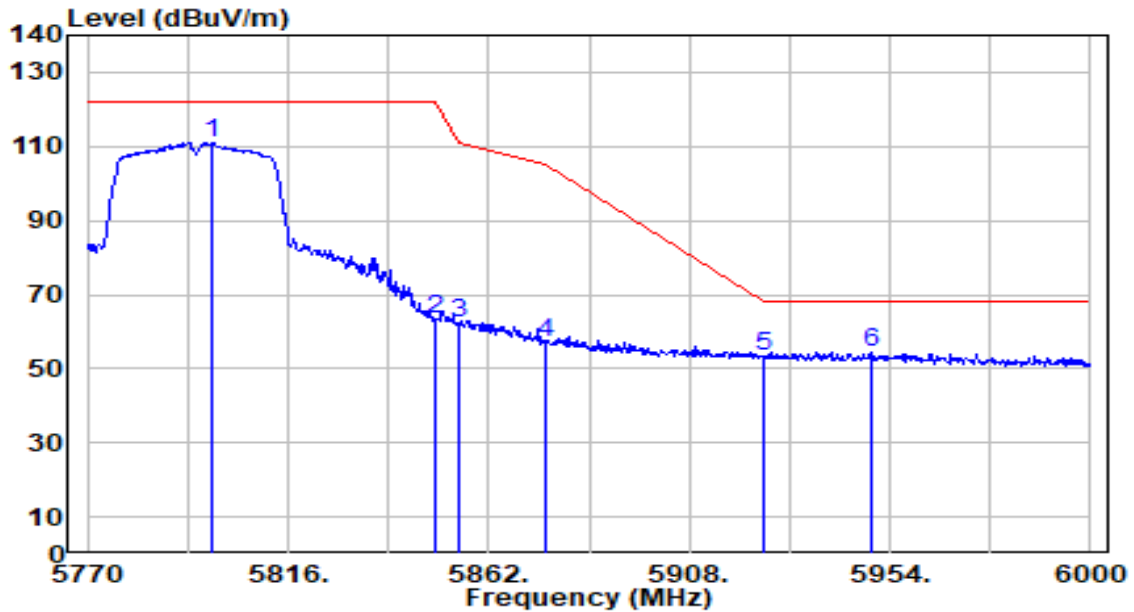

No	Frequency (MHz)	Reading (dBUV)	C.F (dB/m)	Measurement (dBUV/m)	Margin (dB)	Limit (dBUV/m)	Height (cm)	Angle (deg)	Remark (QP/PK/AV)
1	5798.290	110.58	0.48	111.06	N/A	N/A	141	185	Peak
2	5850.000	63.04	0.55	63.59	-58.61	122.20	141	185	Peak
3	5855.000	61.82	0.56	62.37	-48.43	110.80	141	185	Peak
4	5875.000	56.29	0.58	56.87	-48.33	105.20	141	185	Peak
5	5925.000	52.51	0.65	53.15	-15.05	68.20	141	185	Peak
6	* 5949.860	53.98	0.68	54.66	-13.54	68.20	141	185	Peak

Note:

1. " *", means this data is the worst emission level.
2. C.F (Correction Factor) = Antenna Factor (dB/m)+ Cable Loss (dB) – Preamplifier(dB) + 10dB Attenuation.
3. Measurement (dBUV/m) = Reading(dBUV) + C.F (Correction Factor).
4. The emission levels of other frequencies are very lower than the limit and not show in test report.

EUT	AC750 Dual Band Wi-Fi Router	Date of Test	2023-04-19
Factor	DRH18-E	Temp. / Humidity	22°C /63%
Polarity	Horizontal	Site / Test Engineer	AC2 / Marvin
Test Mode	802.11ac-80MHz_TX_Band1_CH 42_ANT 0	Test Voltage	AC 120V/60Hz

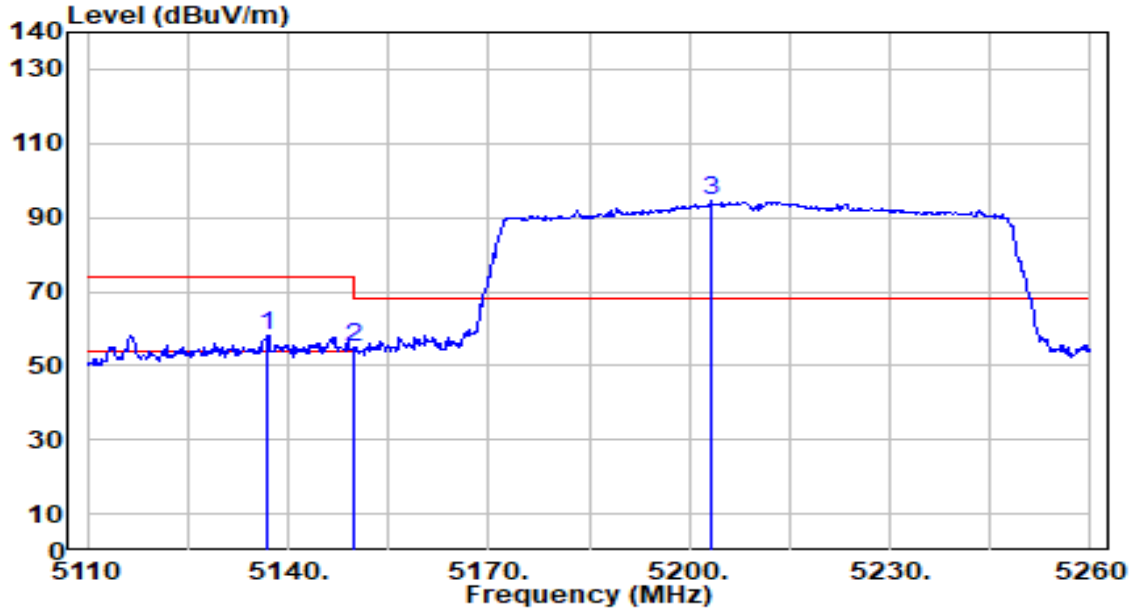

No	Frequency (MHz)	Reading (dBUV)	C.F (dB/m)	Measurement (dBUV/m)	Margin (dB)	Limit (dBUV/m)	Height (cm)	Angle (deg)	Remark (QP/PK/AV)
1	* 5137.000	58.99	-0.74	58.26	-15.74	74.00	100	289	Peak
2	5150.000	55.76	-0.73	55.04	-18.96	74.00	100	289	Peak
3	5203.450	94.99	-0.69	94.30	N/A	N/A	100	289	Peak

Note:

1. " *", means this data is the worst emission level.
2. C.F (Correction Factor) = Antenna Factor (dB/m)+ Cable Loss (dB) – Preamplifier(dB) + 10dB Attenuation.
3. Measurement (dBUV/m) = Reading(dBUV) + C.F (Correction Factor).
4. The emission levels of other frequencies are very lower than the limit and not show in test report.

EUT	AC750 Dual Band Wi-Fi Router	Date of Test	2023-04-19
Factor	DRH18-E	Temp. / Humidity	22°C /63%
Polarity	Horizontal	Site / Test Engineer	AC2 / Marvin
Test Mode	802.11ac-80MHz_TX_Band1_CH 42_ANT 0	Test Voltage	AC 120V/60Hz

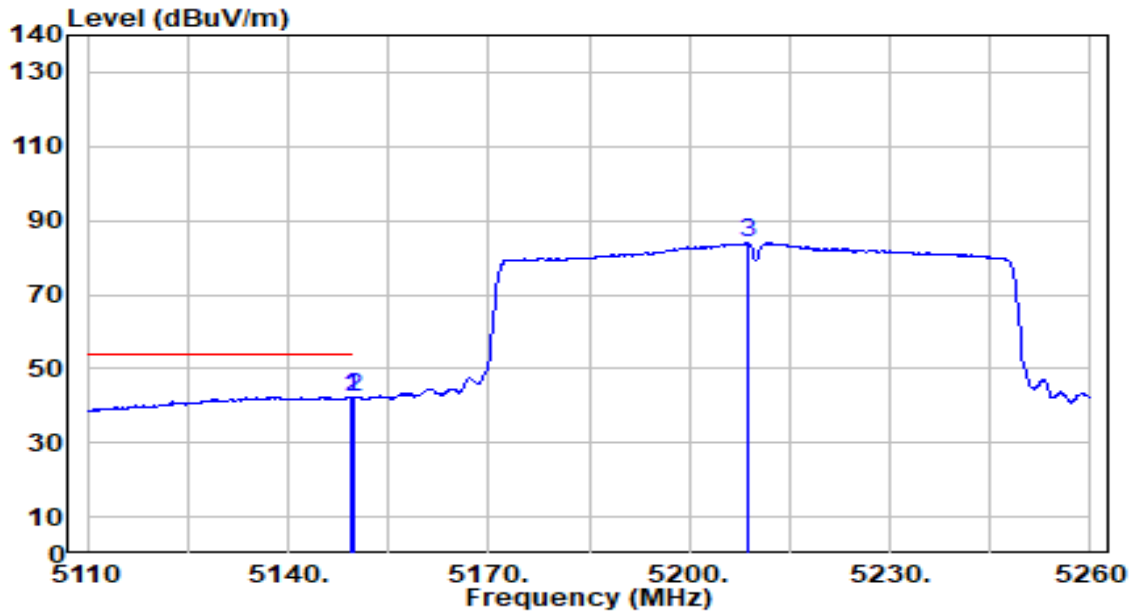

No	Frequency (MHz)	Reading (dBUV)	C.F (dB/m)	Measurement (dBUV/m)	Margin (dB)	Limit (dBUV/m)	Height (cm)	Angle (deg)	Remark (QP/PK/AV)
1	* 5149.300	43.17	-0.73	42.44	-11.56	54.00	100	289	Average
2	5150.000	42.92	-0.73	42.19	-11.81	54.00	100	289	Average
3	5208.700	84.51	-0.70	83.81	N/A	N/A	100	289	Average

Note:

1. " *", means this data is the worst emission level.
2. C.F (Correction Factor) = Antenna Factor (dB/m)+ Cable Loss (dB) – Preamplifier(dB) + 10dB Attenuation.
3. Measurement (dBUV/m) = Reading(dBUV) + C.F (Correction Factor).
4. The emission levels of other frequencies are very lower than the limit and not show in test report.

EUT	AC750 Dual Band Wi-Fi Router	Date of Test	2023-04-19
Factor	DRH18-E	Temp. / Humidity	22°C /63%
Polarity	Vertical	Site / Test Engineer	AC2 / Marvin
Test Mode	802.11ac-80MHz_TX_Band1_CH 42_ANT 0	Test Voltage	AC 120V/60Hz

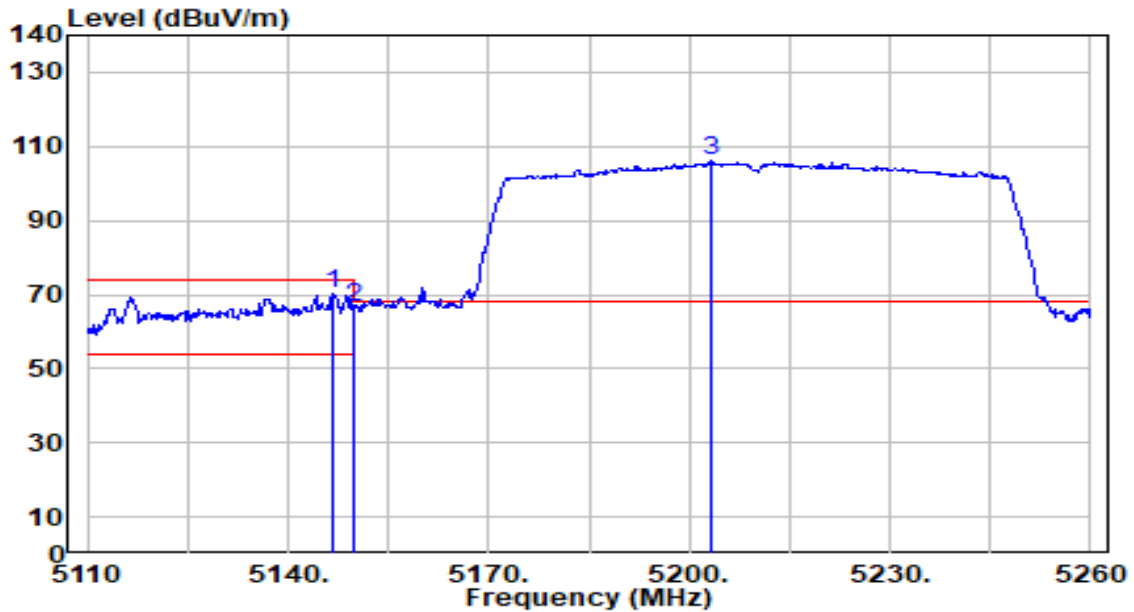

No	Frequency (MHz)	Reading (dBUV)	C.F (dB/m)	Measurement (dBUV/m)	Margin (dB)	Limit (dBUV/m)	Height (cm)	Angle (deg)	Remark (QP/PK/AV)
1	* 5146.600	71.14	-0.73	70.41	-3.59	74.00	100	284	Peak
2	5150.000	67.37	-0.73	66.64	-7.36	74.00	100	284	Peak
3	5203.300	106.77	-0.68	106.08	N/A	N/A	100	284	Peak

Note:

1. " *", means this data is the worst emission level.
2. C.F (Correction Factor) = Antenna Factor (dB/m)+ Cable Loss (dB) – Preamplifier(dB) + 10dB Attenuation.
3. Measurement (dBUV/m) = Reading(dBUV) + C.F (Correction Factor).
4. The emission levels of other frequencies are very lower than the limit and not show in test report.

EUT	AC750 Dual Band Wi-Fi Router	Date of Test	2023-04-19
Factor	DRH18-E	Temp. / Humidity	22°C /63%
Polarity	Vertical	Site / Test Engineer	AC2 / Marvin
Test Mode	802.11ac-80MHz_TX_Band1_CH 42_ANT 0	Test Voltage	AC 120V/60Hz

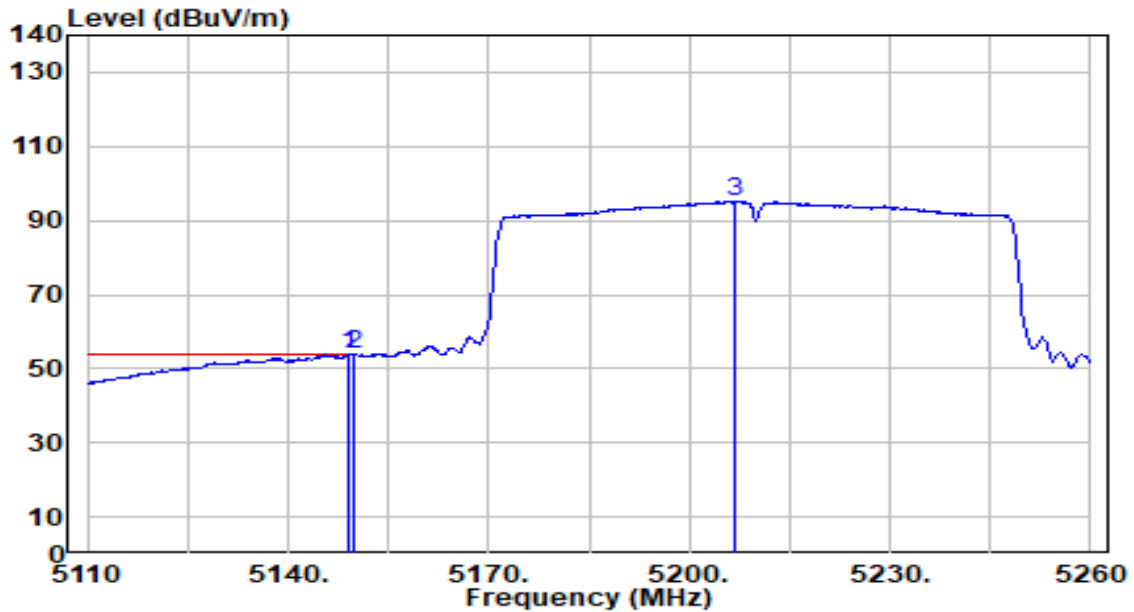

No	Frequency (MHz)	Reading (dBUV)	C.F (dB/m)	Measurement (dBUV/m)	Margin (dB)	Limit (dBUV/m)	Height (cm)	Angle (deg)	Remark (QP/PK/AV)
1	5149.150	54.59	-0.73	53.87	-0.13	54.00	100	284	Average
2	* 5150.000	54.62	-0.73	53.89	-0.11	54.00	100	284	Average
3	5206.750	95.87	-0.69	95.18	N/A	N/A	100	284	Average

Note:

1. " *", means this data is the worst emission level.
2. C.F (Correction Factor) = Antenna Factor (dB/m)+ Cable Loss (dB) – Preamplifier(dB) + 10dB Attenuation.
3. Measurement (dBUV/m) = Reading(dBUV) + C.F (Correction Factor).
4. The emission levels of other frequencies are very lower than the limit and not show in test report.

EUT	AC750 Dual Band Wi-Fi Router	Date of Test	2023-04-19
Factor	DRH18-E	Temp. / Humidity	22°C /63%
Polarity	Horizontal	Site / Test Engineer	AC2 / Marvin
Test Mode	802.11ac-80MHz_TX_Band4_CH 155_ANT 0	Test Voltage	AC 120V/60Hz

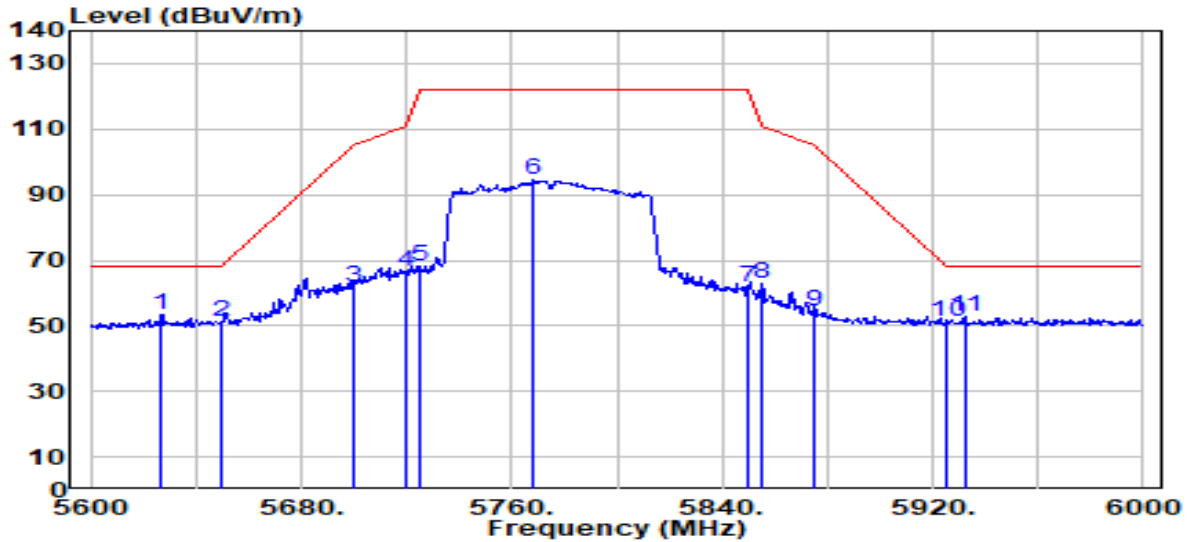

No	Frequency (MHz)	Reading (dBUV)	C.F (dB/m)	Measurement (dBUV/m)	Margin (dB)	Limit (dBUV/m)	Height (cm)	Angle (deg)	Remark (QP/PK/AV)
1	* 5626.800	53.49	-0.16	53.33	-14.87	68.20	100	307	Peak
2	5650.000	51.46	-0.08	51.38	-16.82	68.20	100	307	Peak
3	5700.000	61.72	0.11	61.84	-43.36	105.20	100	307	Peak
4	5720.000	66.19	0.19	66.38	-44.42	110.80	100	307	Peak
5	5725.000	67.78	0.21	67.98	-54.22	122.20	100	307	Peak
6	5768.400	94.31	0.37	94.68	N/A	N/A	100	307	Peak
7	5850.000	61.38	0.55	61.93	-60.27	122.20	100	307	Peak
8	5855.000	62.47	0.56	63.03	-47.77	110.80	100	307	Peak
9	5875.000	54.00	0.58	54.58	-50.62	105.20	100	307	Peak
10	5925.000	50.68	0.65	51.32	-16.88	68.20	100	307	Peak
11	5932.400	52.24	0.65	52.90	-15.30	68.20	100	307	Peak

Note:

1. " *", means this data is the worst emission level.
2. C.F (Correction Factor) = Antenna Factor (dB/m)+ Cable Loss (dB) – Preamplifier(dB) + 10dB Attenuation.
3. Measurement (dBUV/m) = Reading(dBUV) + C.F (Correction Factor).
4. The emission levels of other frequencies are very lower than the limit and not show in test report.

EUT	AC750 Dual Band Wi-Fi Router	Date of Test	2023-04-19
Factor	DRH18-E	Temp. / Humidity	22°C /63%
Polarity	Vertical	Site / Test Engineer	AC2 / Marvin
Test Mode	802.11ac-80MHz_TX_Band4_CH 155_ANT 0	Test Voltage	AC 120V/60Hz

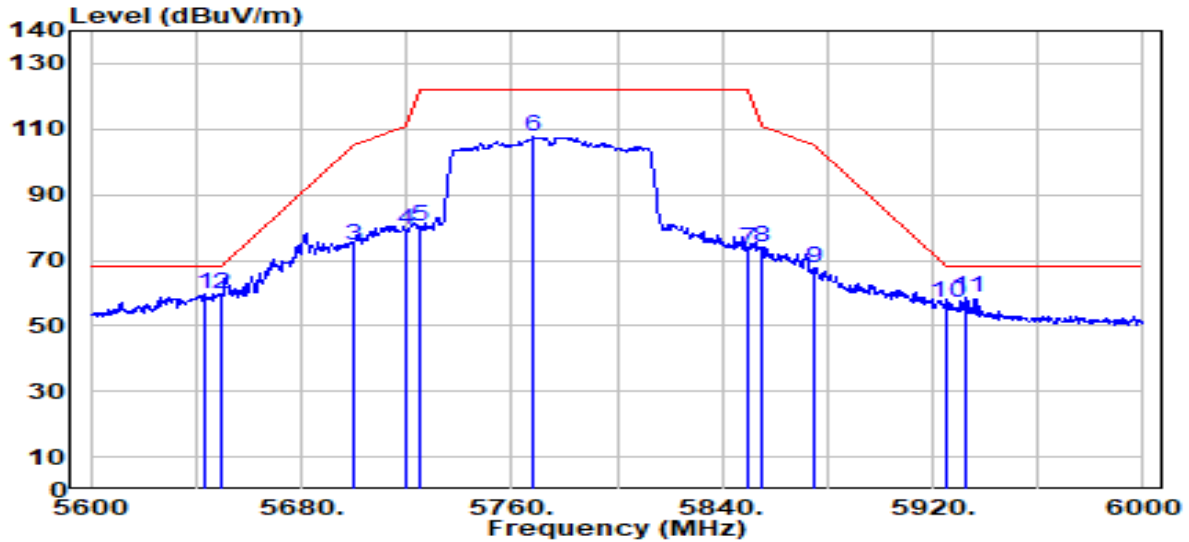

No	Frequency (MHz)	Reading (dBUV)	C.F (dB/m)	Measurement (dBUV/m)	Margin (dB)	Limit (dBUV/m)	Height (cm)	Angle (deg)	Remark (QP/PK/AV)
1	* 5643.600	60.01	-0.10	59.91	-8.29	68.20	146	284	Peak
2	5650.000	59.84	-0.08	59.76	-8.44	68.20	146	284	Peak
3	5700.000	74.32	0.11	74.43	-30.77	105.20	146	284	Peak
4	5720.000	78.86	0.19	79.04	-31.76	110.80	146	284	Peak
5	5725.000	80.08	0.21	80.28	-41.92	122.20	146	284	Peak
6	5768.000	107.28	0.37	107.65	N/A	N/A	146	284	Peak
7	5850.000	72.89	0.55	73.44	-48.76	122.20	146	284	Peak
8	5855.000	73.34	0.56	73.89	-36.91	110.80	146	284	Peak
9	5875.000	67.25	0.58	67.83	-37.37	105.20	146	284	Peak
10	5925.000	56.46	0.65	57.11	-11.09	68.20	146	284	Peak
11	5932.800	57.79	0.66	58.44	-9.76	68.20	146	284	Peak

Note:

1. " *", means this data is the worst emission level.
2. C.F (Correction Factor) = Antenna Factor (dB/m)+ Cable Loss (dB) – Preamplifier(dB) + 10dB Attenuation.
3. Measurement (dBUV/m) = Reading(dBUV) + C.F (Correction Factor).
4. The emission levels of other frequencies are very lower than the limit and not show in test report.

7.9. AC Conducted Emissions Measurement

7.9.1. Test Limit

FCC Part 15.207 Limits		
Frequency (MHz)	QP (dB μ V)	AV (dB μ V)
0.15 - 0.50	66 - 56	56 - 46
0.50 - 5.0	56	46
5.0 - 30	60	50

Note 1: The lower limit shall apply at the transition frequencies.

Note 2: The limit decreases linearly with the logarithm of the frequency in the range 0.15MHz to 0.5MHz.

7.9.2. Test Procedure

The EUT was setup according to ANSI C63.4, 2009 and tested according to KDB 789033 for compliance to FCC 47CFR 15.247 requirements. The EUT was placed on a platform of nominal size, 1 m by 1.5 m, raised 80 cm above the conducting ground plane. The vertical conducting plane was located 40 cm to the rear of the EUT. All other surfaces of EUT were at least 80 cm from any other grounded conducting surface. The EUT and simulators are connected to the main power through a line impedance stabilization network (LISN). The LISN provides a 50 ohm /50uH coupling impedance for the measuring equipment. The peripheral devices are also connected to the main power through a LISN. (Please refer to the block diagram of the test setup and photographs) Each current-carrying conductor of the EUT power cord, except the ground (safety) conductor, was individually connected through a LISN to the input power source.

The excess length of the power cord between the EUT and the LISN receptacle were folded back and forth at the center of the lead to form a bundle not exceeding 40 cm in length.

Conducted emissions were investigated over the frequency range from 0.15MHz to 30MHz using a receiver bandwidth of 9kHz.

7.9.3. Test Setup

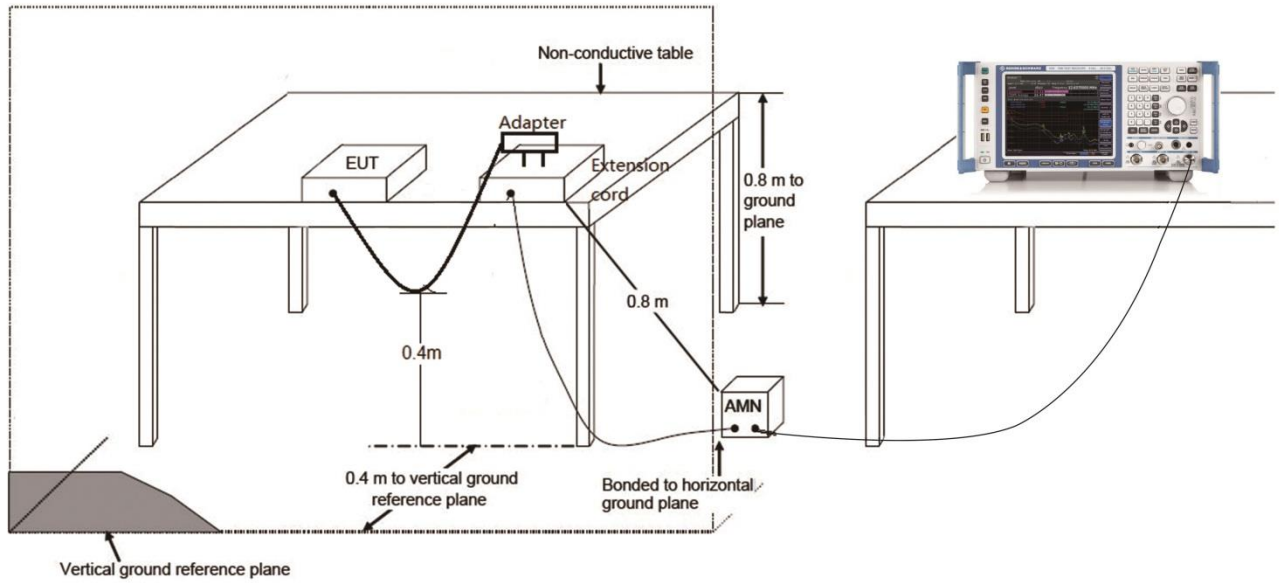

7.9.4. Test Result

EUT	AC750 Dual Band Wi-Fi Router	Date of Test	2023-04-24
Factor	CE_ENV216-L1 (Filter ON)	Temp. / Humidity	23.4°C / 56%
Polarity	Line1	Site / Test Engineer	SR2 / Tim
Test Mode	802.11ac-20MHz_TX_Band1_CH 44_ANT 0	Test Voltage	AC 120V/60Hz

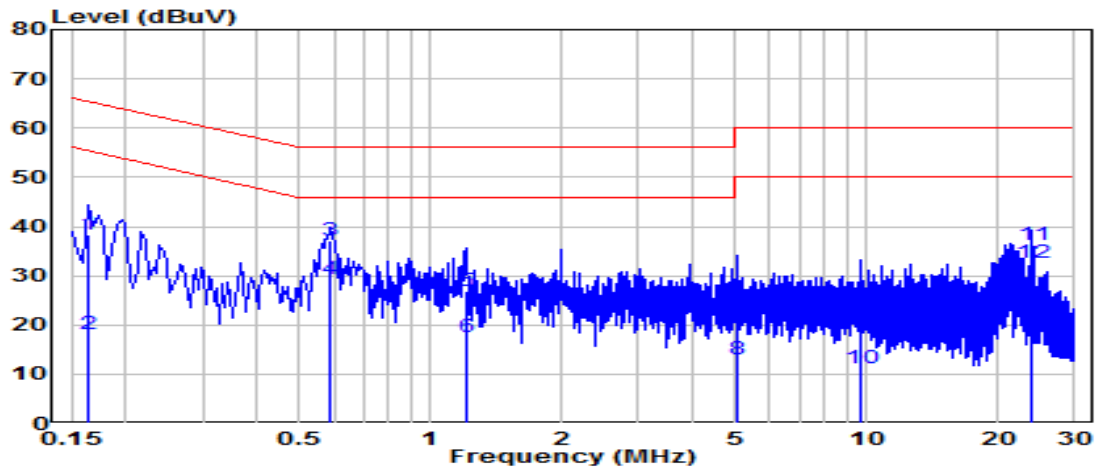

No	Frequency (MHz)	Reading (dBUV)	C.F (dB)	Measurement (dBUV)	Margin (dB)	Limit (dBUV)	Remark (QP/PK/AV)
1	0.163	28.79	9.62	38.41	-26.87	65.28	QP
2	0.163	8.63	9.62	18.25	-37.03	55.28	Average
3	* 0.591	27.53	9.65	37.18	-18.82	56.00	QP
4	* 0.591	19.72	9.65	29.37	-16.63	46.00	Average
5	1.216	17.30	9.67	26.98	-29.02	56.00	QP
6	1.216	7.90	9.67	17.58	-28.42	46.00	Average
7	5.050	11.73	9.75	21.47	-38.53	60.00	QP
8	5.050	3.10	9.75	12.85	-37.15	50.00	Average
9	9.658	9.70	9.85	19.55	-40.45	60.00	QP
10	9.658	1.41	9.85	11.27	-38.73	50.00	Average
11	23.998	26.33	9.91	36.25	-23.75	60.00	QP
12	23.998	22.69	9.91	32.60	-17.40	50.00	Average

Note:

1. " *", means this data is the worst emission level.
2. C.F (Correction Factor) = LISN Factor (dB)+ Cable Loss (dB).
3. Measurement (dBUV) = Reading(dBUV) + C.F (Correction Factor).

EUT	AC750 Dual Band Wi-Fi Router	Date of Test	2023-04-24
Factor	CE_ENV216-N (Filter ON)	Temp. / Humidity	23.4°C /56%
Polarity	Neutral	Site / Test Engineer	SR2 / Tim
Test Mode	802.11ac-20MHz_TX_Band1_CH 44_ANT 0	Test Voltage	AC 120V/60Hz

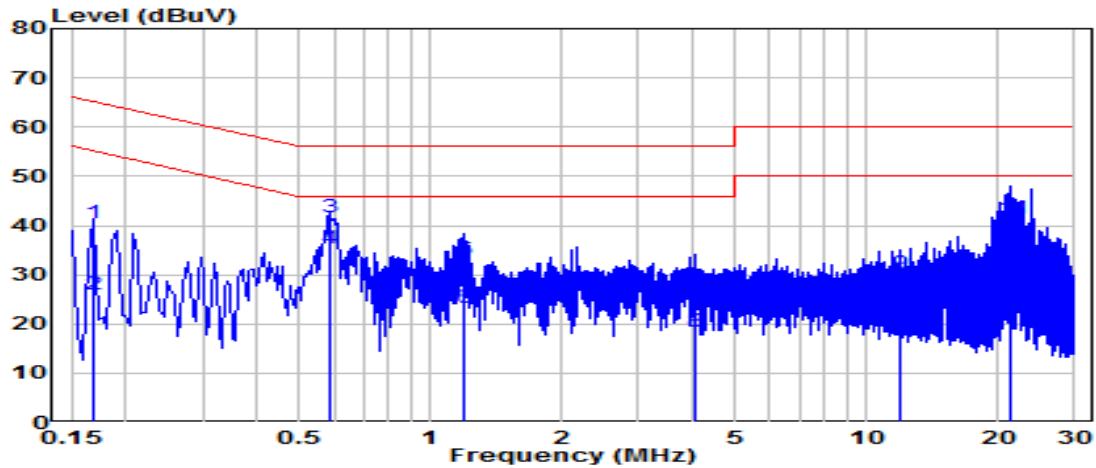

No	Frequency (MHz)	Reading (dBuV)	C.F (dB)	Measurement (dBuV)	Margin (dB)	Limit (dBuV)	Remark (QP/PK/AV)
1	0.168	30.83	9.62	40.45	-24.61	65.06	QP
2	0.168	16.37	9.62	25.99	-29.07	55.06	Average
3	*	0.586	9.65	41.60	-14.40	56.00	QP
4	*	0.586	9.65	35.47	-10.53	46.00	Average
5	1.194	23.33	9.67	33.01	-22.99	56.00	QP
6	1.194	13.42	9.67	23.10	-22.90	46.00	Average
7	4.047	16.84	9.73	26.57	-29.43	56.00	QP
8	4.047	8.59	9.73	18.32	-27.68	46.00	Average
9	11.997	20.28	9.89	30.17	-29.83	60.00	QP
10	11.997	10.59	9.89	20.48	-29.52	50.00	Average
11	21.527	31.46	10.00	41.47	-18.53	60.00	QP
12	21.527	20.01	10.00	30.01	-19.99	50.00	Average

Note:

1. " *", means this data is the worst emission level.
2. C.F (Correction Factor) = LISN Factor (dB)+ Cable Loss (dB).
3. Measurement (dBuV) = Reading(dBuV) + C.F (Correction Factor).

EUT	AC750 Dual Band Wi-Fi Router	Date of Test	2023-04-24
Factor	CE_ENV216-L1 (Filter ON)	Temp. / Humidity	23.4°C /56%
Polarity	Line1	Site / Test Engineer	SR2 / Bob
Test Mode	802.11ac-20MHz_TX_Band1_CH 44_ANT 0	Test Voltage	AC 240V/60Hz

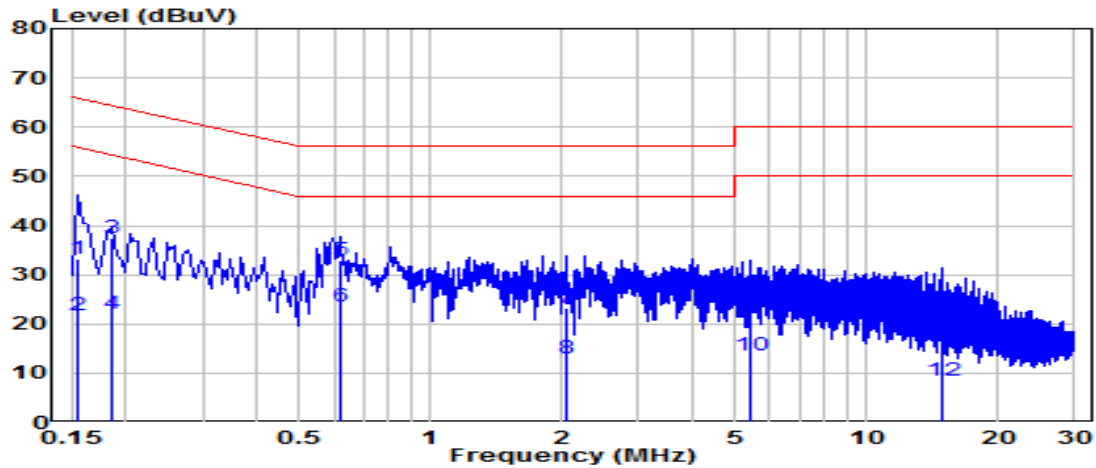

No	Frequency (MHz)	Reading (dBuV)	C.F (dB)	Measurement (dBuV)	Margin (dB)	Limit (dBuV)	Remark (QP/PK/AV)	
1	0.154	23.60	9.62	33.22	-32.53	65.75	QP	
2	0.154	12.00	9.62	21.62	-34.14	55.75	Average	
3	0.186	27.85	9.62	37.47	-26.74	64.21	QP	
4	0.186	12.28	9.62	21.90	-32.31	54.21	Average	
5	*	0.618	23.20	9.65	32.85	-23.15	56.00	QP
6	*	0.618	13.98	9.65	23.63	-22.37	46.00	Average
7	2.053	13.62	9.69	23.31	-32.69	56.00	QP	
8	2.053	3.34	9.69	13.03	-32.97	46.00	Average	
9	5.419	12.83	9.75	22.58	-37.42	60.00	QP	
10	5.419	3.86	9.75	13.61	-36.39	50.00	Average	
11	14.972	8.69	9.89	18.58	-41.42	60.00	QP	
12	14.972	-1.41	9.89	8.48	-41.52	50.00	Average	

Note:

1. " *", means this data is the worst emission level.
2. C.F (Correction Factor) = LISN Factor (dB)+ Cable Loss (dB).
3. Measurement (dBuV) = Reading(dBuV) + C.F (Correction Factor).

EUT	AC750 Dual Band Wi-Fi Router	Date of Test	2023-04-24
Factor	CE_ENV216-N (Filter ON)	Temp. / Humidity	23.4°C /56%
Polarity	Neutral	Site / Test Engineer	SR2 / Bob
Test Mode	802.11ac-20MHz_TX_Band1_CH 44_ANT 0	Test Voltage	AC 240V/60Hz

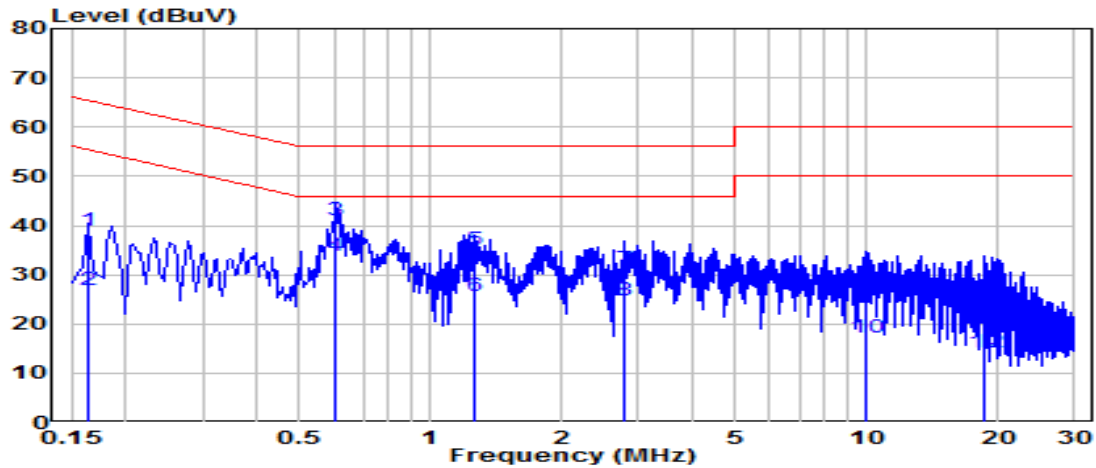

No	Frequency (MHz)	Reading (dBuV)	C.F (dB)	Measurement (dBuV)	Margin (dB)	Limit (dBuV)	Remark (QP/PK/AV)
1	0.163	29.21	9.62	38.83	-26.46	65.28	QP
2	0.163	17.24	9.62	26.86	-28.42	55.28	Average
3	*	0.604	9.65	41.16	-14.84	56.00	QP
4	*	0.604	9.65	33.95	-12.05	46.00	Average
5	1.266	25.42	9.68	35.09	-20.91	56.00	QP
6	1.266	16.00	9.68	25.68	-20.32	46.00	Average
7	2.796	21.25	9.71	30.96	-25.04	56.00	QP
8	2.796	14.92	9.71	24.63	-21.37	46.00	Average
9	9.977	15.82	9.87	25.69	-34.31	60.00	QP
10	9.977	7.47	9.87	17.34	-32.66	50.00	Average
11	18.729	14.63	9.98	24.61	-35.39	60.00	QP
12	18.729	4.14	9.98	14.12	-35.88	50.00	Average

Note:

1. " *", means this data is the worst emission level.
2. C.F (Correction Factor) = LISN Factor (dB)+ Cable Loss (dB).
3. Measurement (dBuV) = Reading(dBuV) + C.F (Correction Factor).

8. CONCLUSION

The data collected relate only the item(s) tested and show that the device is in compliance with Part 15E of the FCC Rules.

Appendix A : Test Setup Photograph

Refer to “2304TW0106-UT” file.

Appendix B : EUT Photograph

Refer to “2304TW0106-UE” file.

Appendix C : Internal Photograph

Refer to “2304TW0106-UI” file.

————— The End —————