

RF MEASUREMENT REPORT

FCC ID : 2AXJ4C225V2
Applicant : TP-Link Corporation Limited
Application Type : Certification
Product : Pan/Tilt AI Home Security Wi-Fi Camera
Model No. : Tapo C225
Series Model No. : TC73
Brand Name : tp-link
FCC Classification : Digital Transmission System (DTS)
FCC Rule Part(s) : Part15 Subpart C (Section 15.247)
Received Date : June 16, 2023
Test Date : June 28, 2023~ July 13, 2023

Test By : Owen Tsai
(Owen Tsai)
Reviewed By : Paddy Chen
(Paddy Chen)
Approved By : Chenz Ker
(Chenz Ker)



The test results relate only to the samples tested.

This equipment has been shown to be capable of compliance with the applicable technical standards as indicated in the measurement report and was tested in accordance with the measurement procedures specified in ANSI C63.10-2013. Test results reported herein relate only to the item(s) tested.

The test report shall not be reproduced except in full without the written approval of MRT Technology (Taiwan) Co., Ltd.

Revision History

Report No.	Version	Description	Issue Date	Note
2306TW0113-U2	1.0	Original Report	2023-08-11	Valid

CONTENTS

Description	Page
1. INTRODUCTION.....	6
1.1. Scope.....	6
1.2. MRT Test Location.....	6
2. PRODUCT INFORMATION.....	7
2.1. Feature of Equipment under Test.....	7
2.2. Product Specification Subjective to this Report.....	8
2.3. Working Frequencies for this report.....	8
2.4. Test Mode.....	8
2.5. Configuration of Test System.....	9
2.6. Test System Details.....	10
2.7. Description of Test Software.....	10
2.8. Applied Standards.....	10
2.9. Duty Cycle.....	11
2.10. Test Configuration.....	12
2.11. EMI Suppression Device(s)/Modifications.....	12
2.12. Labeling Requirements.....	12
3. DESCRIPTION of TEST.....	13
3.1. Evaluation Procedure.....	13
3.2. AC Line Conducted Emissions.....	13
3.3. Radiated Emissions.....	14
4. ANTENNA REQUIREMENTS.....	15
5. TEST EQUIPMENT CALIBRATION DATE.....	16
6. MEASUREMENT UNCERTAINTY.....	18
7. TEST RESULT.....	19
7.1. Summary.....	19
7.2. 6dB Bandwidth Measurement.....	20
7.2.1. Test Limit.....	20
7.2.2. Test Procedure used.....	20
7.2.3. Test Setting.....	20
7.2.4. Test Setup.....	20
7.2.5. Test Result.....	21
7.3. Output Power Measurement.....	24
7.3.1. Test Limit.....	24

7.3.2. Test Procedure Used	24
7.3.3. Test Setting	24
7.3.4. Test Setup	24
7.3.5. Test Result	25
7.4. Power Spectral Density Measurement.....	26
7.4.1. Test Limit	26
7.4.2. Test Procedure Used	26
7.4.3. Test Setting	26
7.4.4. Test Setup	27
7.4.5. Test Result	28
7.5. Conducted Band Edge and Out-of-Band Emissions	31
7.5.1. Test Limit	31
7.5.2. Test Procedure Used	31
7.5.3. Test Setting	31
7.5.4. Test Setup	32
7.5.5. Test Result	33
7.6. Radiated Spurious Emission Measurement	38
7.6.1. Test Limit	38
7.6.2. Test Procedure Used	38
7.6.3. Test Setting	38
7.6.4. Test Setup	40
7.6.5. Test Result	41
7.7. Radiated Restricted Band Edge Measurement.....	67
7.7.1. Test Limit	67
7.7.2. Test Procedure Used	68
7.7.3. Test Setting	68
7.7.4. Test Setup	69
7.7.5. Test Result	70
7.8. AC Conducted Emissions Measurement	118
7.8.1. Test Limit	118
7.8.2. Test Setup	118
7.8.3. Test Result	119
8. CONCLUSION	123
Appendix A : Test Setup Photograph	124
Appendix B : External Photograph.....	124
Appendix C : Internal Photograph.....	124

General Information

Applicant	TP-Link Corporation Limited
Applicant Address	Room 901, 9/F., New East Ocean Centre, 9 Science Museum Road, Tsim Sha Tsui, Kowloon, Hongkong
Manufacturer	TP-Link Corporation Limited
Manufacturer Address	Room 901, 9/F., New East Ocean Centre, 9 Science Museum Road, Tsim Sha Tsui, Kowloon, Hongkong
Test Site	MRT Technology (Taiwan) Co., Ltd
Test Site Address	No. 38, Fuxing Second Rd., Guishan Dist., Taoyuan City 333, Taiwan (R.O.C)
MRT FCC Registration No.	291082
FCC Rule Part(s)	Part 15.247

Test Facility / Accreditations

1. MRT facility is a FCC registered (Reg. No. 291082) test facility with the site description report on file and is designated by the FCC as an Accredited Test Firm.
2. MRT facility is an IC registered (MRT Reg. No. 21723) test laboratory with the site description on file at Industry Canada.
3. MRT Lab is accredited to ISO 17025 by the Taiwan Accreditation Foundation (TAF Cert. No. 3261) in EMC, Telecommunications and Radio testing for FCC (Designation Number: TW3261), Industry Canada, EU and TELEC Rules.

1. INTRODUCTION

1.1. Scope

Measurement and determination of electromagnetic emissions (EMC) of radio frequency devices including intentional and/or unintentional radiators for compliance with the technical rules and regulations of the Federal Communications Commission and the Innovation, Science and Economic Development Canada and Certification and Engineering Bureau.

1.2. MRT Test Location

The map below shows the location of the MRT LABORATORY, its proximity to the Taoyuan City. These measurement tests were conducted at the MRT Technology (Taiwan) Co., Ltd. Facility located at No.38, Fuxing 2nd Rd., Guishan Dist., Taoyuan City 33377, Taiwan (R.O.C).

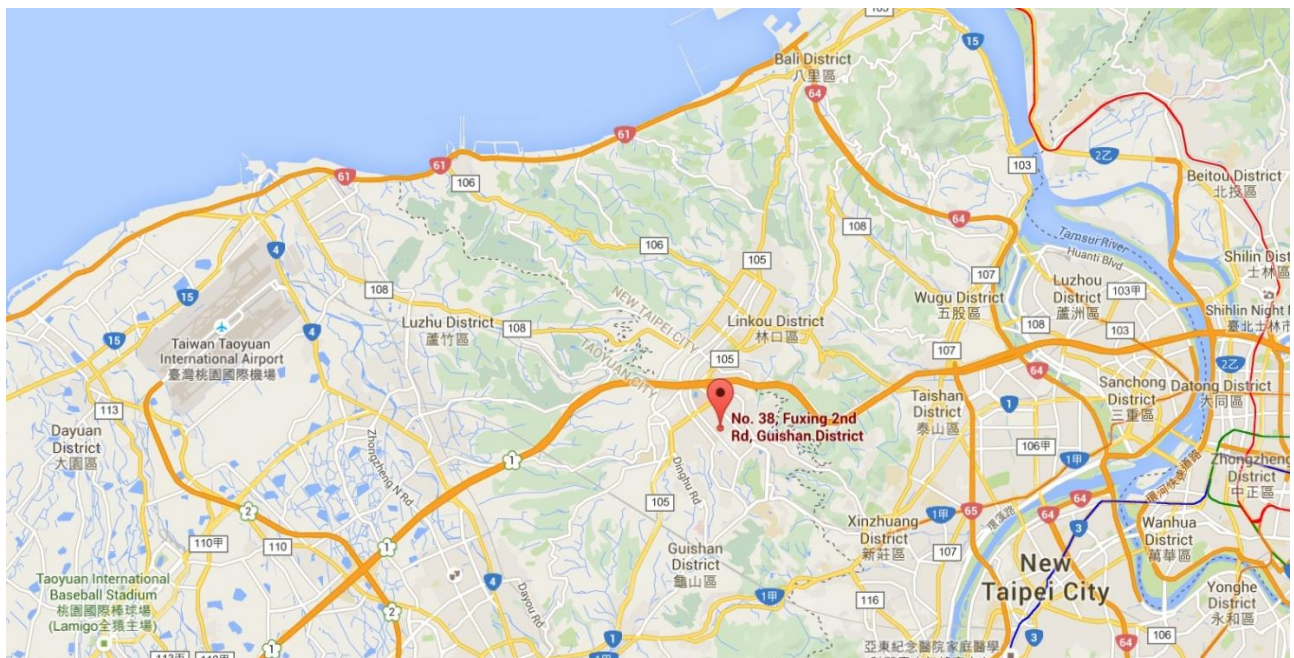

2. PRODUCT INFORMATION

2.1. Feature of Equipment under Test

Product Name:	Pan/Tilt AI Home Security Wi-Fi Camera
Model No.:	Tapo C225
Series Model No.	TC73
Brand Name:	tp-link
Wi-Fi Specification:	802.11b/g/n/ax
Bluetooth Specification:	Bluetooth Mode: V4.2
EUT Identification No.:	#1-1 (Conducted) #1-2 (Radiated)
Accessory	
Adapter	Brand Name: tp-link Model: T120100-2B1 Input: AC 100-240V~0.3A, 50/60Hz Output: DC 12V=1A DC Cable Out Non-Shielding, 1.5m

Note:

1. Model Difference: The difference of models only for marketing different, the other hardware was the same. (Declared by the manufacturer)
2. The test was performed based on Tapo C225.

2.2. Product Specification Subjective to this Report

Frequency Range:	802.11b/g/n-HT20/ax-HE20: 2412 ~ 2462MHz
Channel Number:	802.11b/g/n-HT20/ax-HE20: 11
Type of Modulation:	802.11b: DSSS 802.11g/n: OFDM 802.11ax: OFDMA
Data Rate:	802.11b: 1/2/5.5/11Mbps 802.11g: 6/9/12/18/24/36/48/54Mbps 802.11n: up to 72.2Mbps 802.11ax: up to 143.4Mbps
Antenna type:	IFA Antenna
Antenna Gain:	0.5dBi

2.3. Working Frequencies for this report

802.11b/g/n-HT20/ax-HE20

Channel	Frequency	Channel	Frequency	Channel	Frequency
01	2412 MHz	02	2417 MHz	03	2422 MHz
04	2427 MHz	05	2432 MHz	06	2437 MHz
07	2442 MHz	08	2447 MHz	09	2452 MHz
10	2457 MHz	11	2462 MHz	--	--

2.4. Test Mode

Mode 1: Transmit by 802.11b (1Mbps)
Mode 2: Transmit by 802.11g (6Mbps)
Mode 3: Transmit by 802.11n-HT20 (MCS0)
Mode 4: Transmit by 802.11ax-HE20 (MCS0)
Remark:
1. For Radiated emission, the modulation and the data rate picked for testing are determined by the Max. RF conducted power.
2. EUT supports one configuration only in 802.11ax full RU mode.

2.5. Configuration of Test System

The device was tested per the guidance ANSI C63.10: 2013 was used to reference the appropriate EUT setup for radiated emissions testing and AC line conducted testing.

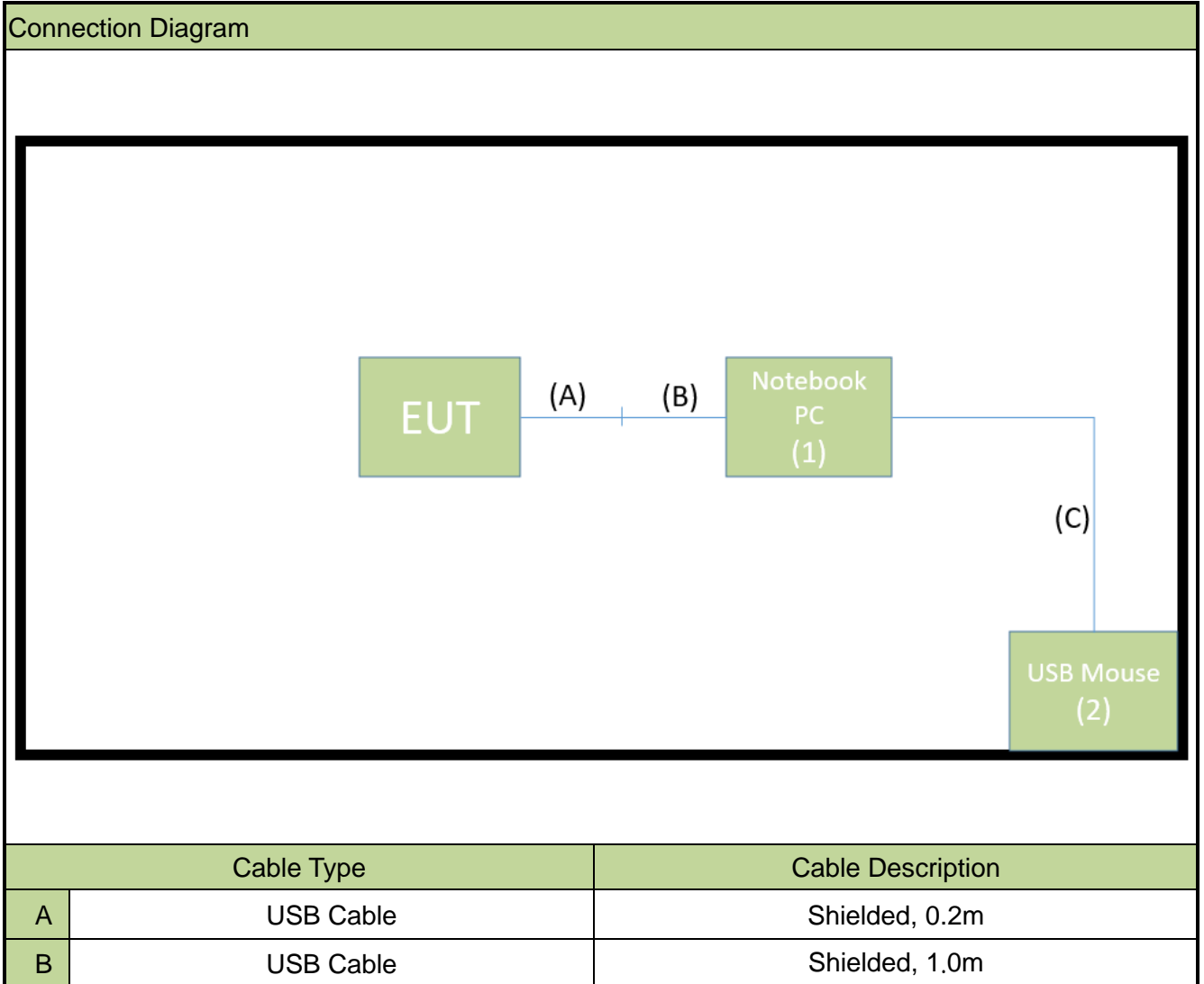

2.6. Test System Details

The types for all equipments, plus descriptions of all cables used in the tested system (including inserted cards) are:

	Product	Manufacturer	Model No.	Serial No.	Power Cord
1	Notebook PC	Lenovo	T450	N/A	Non-Shielded, 0.8m
2	USB Mouse	Logitech	M90	N/A	N/A

2.7. Description of Test Software

The test utility software used during testing was “SV6358”, the version is ver2p1_1431.

Note: Final power setting please refer to operational description.

2.8. Applied Standards

According to the specifications of the manufacturer, the EUT must comply with the requirements of the following standards:

- FCC Part 15.247
- KDB 558074 D01v05r02
- ANSI C63.10-2013

2.9. Duty Cycle

2.4GHz WLAN (DTS) operation is possible in 20MHz channel bandwidths. The maximum achievable duty cycles for all modes were determined based on measurements performed on a spectrum analyzer in zero-span mode with RBW = 8MHz, VBW = 50MHz. The RBW and VBW were both greater than 50/T, where T is the minimum transmission duration, and the number of sweep points across T was greater than 100. The duty cycles are as follows:

Test Mode	Duty Cycle
802.11b	100.00%
802.11g	100.00%
802.11n-HT20	100.00%
802.11ax-HE20	100.00%

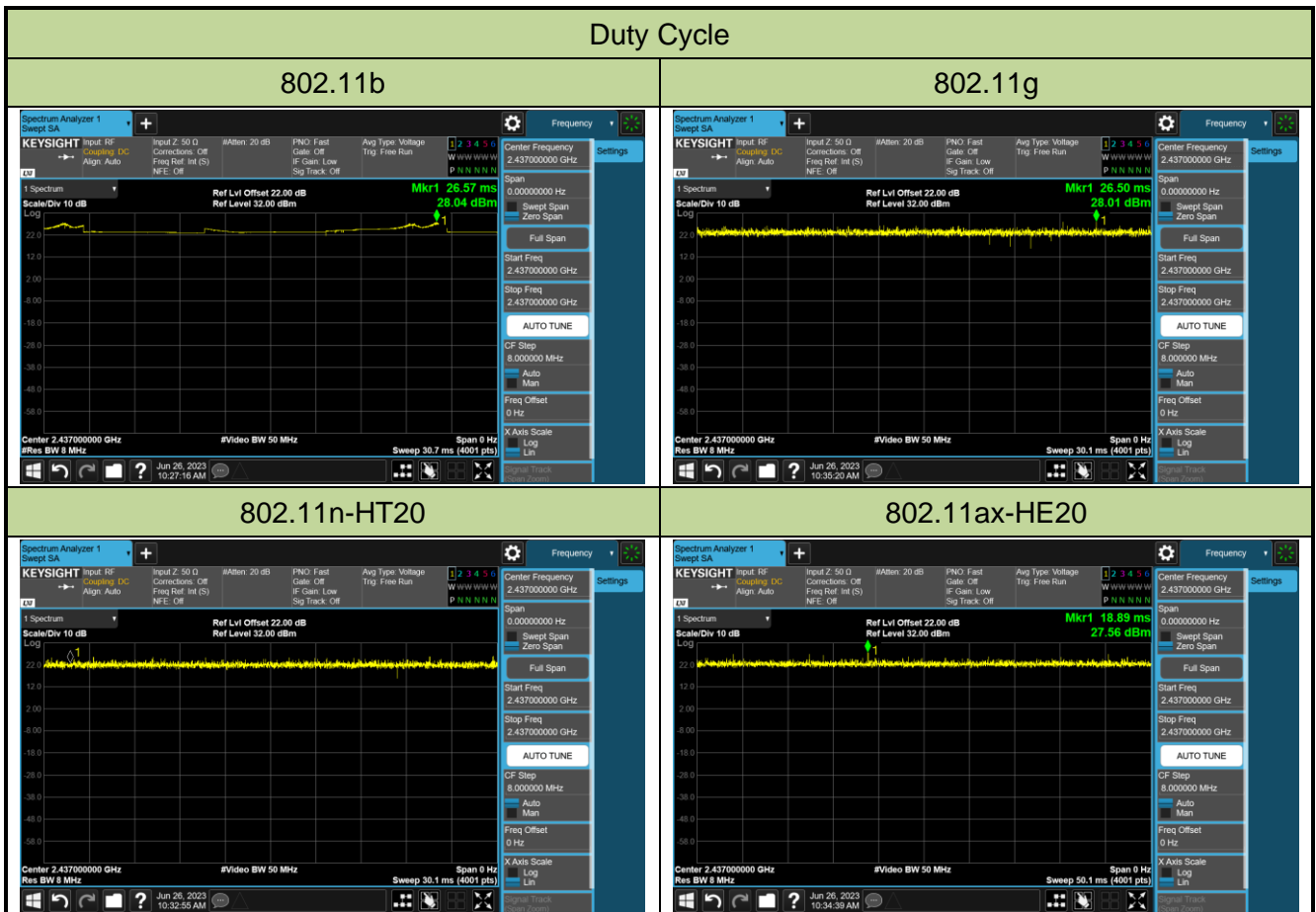

2.10. Test Configuration

The device was tested per the guidance of ANSI C63.10-2013. ANSI C63.10-2013 was used to reference the appropriate EUT setup for radiated spurious emissions testing and AC line conducted testing.

2.11. EMI Suppression Device(s)/Modifications

No EMI suppression device(s) were added and/or no modifications were made during testing.

2.12. Labeling Requirements

Per 2.1074 & 15.19; Docket 95-19

The label shall be permanently affixed at a conspicuous location on the device; instruction manual or pamphlet supplied to the user and be readily visible to the purchaser at the time of purchase. However, when the device is so small wherein placement of the label with specified statement is not practical, only the FCC ID must be displayed on the device per Section 15.19(a)(5). Please see attachment for FCC ID label and label location.

3. DESCRIPTION of TEST

3.1. Evaluation Procedure

The measurement procedures described in the American National Standard of Procedures for Compliance Testing of Unlicensed Wireless Devices (ANSI C63.10-2013), and the guidance was used in the measurement.

3.2. AC Line Conducted Emissions

The line-conducted facility is located inside an 8'x4'x4' shielded enclosure. A 1m x 2m wooden table 80cm high is placed 40cm away from the vertical wall and 80cm away from the sidewall of the shielded room. Two 10kHz-30MHz, 50Ω/50uH Line-Impedance Stabilization Networks (LISNs) are bonded to the shielded room floor. Power to the LISNs is filtered by external high-current high-insertion loss power line filters. These filters attenuate ambient signal noise from entering the measurement lines. These filters are also bonded to the shielded enclosure.

The EUT is powered from one LISN and the support equipment is powered from the second LISN. All interconnecting cables more than 1 meter were shortened to a 1 meter length by non-inductive bundling (serpentine fashion) and draped over the back edge of the test table. All cables were at least 40cm above the horizontal reference ground-plane. Power cables for support equipment were routed down to the second LISN while ensuring that that cables were not draped over the second LISN.

Sufficient time for the EUT, support equipment, and test equipment was allowed in order for them to warm up to their normal operating condition. The RF output of the LISN was connected to the receiver and exploratory measurements were made to determine the frequencies producing the maximum emission from the EUT. The receiver was scanned from 150kHz to 30MHz. The detector function was set to peak mode for exploratory measurements while the bandwidth of the analyzer was set to 9kHz. The EUT, support equipment, and interconnecting cables were arranged and manipulated to maximize each emission. Each emission was also maximized by varying power lines, the mode of operation or data exchange speed, or support equipment whichever determined the worst-case emission. Once the worst-case emissions have been identified, the one EUT cable configuration/arrangement and mode of operation that produced these emissions are used for final measurements on the same test site. The analyzer is set to CISPR quasi-peak and average detectors with a 9kHz resolution bandwidth for final measurements.

An extension cord was used to connect to a single LISN which powered by EUT. The extension cord was calibrated with LISN, the impedance and insertion loss are compliance with the requirements as stated in ANSI C63.10-2013.

3.3. Radiated Emissions

The radiated test facilities consisted of an indoor 3 meter semi-anechoic chamber used for final measurements and exploratory measurements, when necessary. The measurement area is contained within the semi-anechoic chamber which is shielded from any ambient interference. For measurements above 1GHz absorbers are arranged on the floor between the turn table and the antenna mast in such a way so as to maximize the reduction of reflections. For measurements below 1GHz, the absorbers are removed. A MF Model 210SS turntable is used for radiated measurement. It is a continuously rotatable, remote controlled, metallic turntable and 2 meters (6.56 ft.) in diameter. The turn table is flush with the raised floor of the chamber in order to maintain its function as a ground plane. An 80cm high PVC support structure is placed on top of the turntable.

For all measurements, the spectrum was scanned through all EUT azimuths and from 1 to 4 meter receive antenna height using a broadband antenna from 30MHz up to the upper frequency shown in 15.33(b)(1) depending on the highest frequency generated or used in the device or on which the device operates or tunes. For frequencies above 1GHz, linearly polarized double ridge horn antennas were used. For frequencies below 30MHz, a calibrated loop antenna was used. When exploratory measurements were necessary, they were performed at 1 meter test distance inside the semi-anechoic chamber using broadband antennas, broadband amplifiers, and spectrum analyzers to determine the frequencies and modes producing the maximum emissions. Sufficient time for the EUT, support equipment, and test equipment was allowed in order for them to warm up to their normal operating condition. The test set-up for frequencies below 1GHz was placed on top of the 0.8 meter high, 1 x 1.5 meter table; and test set-up for frequencies 1-40GHz was placed on top of the 1.5 meter high, 1 x 1.5 meter table. The EUT, support equipment, and interconnecting cables were arranged and manipulated to maximize each emission. Appropriate precaution was taken to ensure that all emissions from the EUT were maximized and investigated. The system configuration, clock speed, mode of operation or video resolution, if applicable, turntable azimuth, and receive antenna height was noted for each frequency found.

Final measurements were made in the semi-anechoic chamber using calibrated, linearly polarized broadband and horn antennas. The test setup was configured to the setup that produced the worst case emissions. The spectrum analyzer was set to investigate all frequencies required for testing to compare the highest radiated disturbances with respect to the specified limits. The turntable containing the EUT was rotated through 360 degrees and the height of the receive antenna was varied 1 to 4 meters and stopped at the azimuth and height producing the maximum emission. Each emission was maximized by changing the orientation of the EUT through three orthogonal planes and changing the polarity of the receive antenna, whichever produced the worst-case emissions. According to 3dB Beam-Width of horn antenna, the horn antenna should be always directed to the EUT when rising height.

4. ANTENNA REQUIREMENTS

Excerpt from §15.203 of the FCC Rules/Regulations:

“An intentional radiator antenna shall be designed to ensure that no antenna other than that furnished by the responsible party can be used with the device. The use of a permanently attached antenna or of an antenna that uses a unique coupling to the intentional radiator shall be considered sufficient to comply with the provisions of this section.”

- The antenna of the device is **permanently attached**.
- There are no provisions for connection to an external antenna.

Conclusion:

The unit complies with the requirement of §15.203.

5. TEST EQUIPMENT CALIBRATION DATE

Conducted Emissions

Instrument	Manufacturer	Type No.	Asset No.	Cali. Interval	Cali. Due Date
Two-Line V-Network	R&S	ENV216	MRTTWA00019	1 year	2024/3/7
Two-Line V-Network	R&S	ENV216	MRTTWA00020	1 year	2024/4/17
EMI Test Receiver	R&S	ESR3	MRTTWA00045	1 year	2024/5/10

Radiated Emissions

Instrument	Manufacturer	Type No.	Asset No.	Cali. Interval	Cali. Due Date
Active Loop Antenna	SCHWARZBECK	FMZB 1519B	MRTTWA00002	1 year	2024/5/22
Broadband TRILOG Antenna	SCHWARZBECK	VULB 9162	MRTTWA00001	1 year	2023/12/21
Broadband Hornantenna	RFSPIN	DRH18-E	MRTTWA00087	1 year	2024/5/17
Broadband Preamplifier	EMC Instruments corporation	EMC118A45S E	MRTTWA00088	1 year	2024/5/17
Breitband Hornantenna	SCHWARZBECK	BBHA 9170	MRTTWA00004	1 year	2024/3/20
Broadband Amplifier	SCHWARZBECK	BBV 9721	MRTTWA00006	1 year	2024/3/27
EMI Test Receiver	R&S	ESR3	MRTTWA00009	1 year	2024/3/8
Signal Analyzer	R&S	FSVA3044	MRTTWA00092	1 year	2024/6/29
Antenna Cable	HUBERSUHNER	SF106	MRTTWE00034	1 year	2024/6/26
Cable	HUBERSUHNER	EMC105-NM- NM-3000	MRTTWE00035	1 year	2024/6/26
Temperature/Humidity Meter	TFA	35.1078.10.IT	MRTTWA00032	1 year	2024/6/4

Conducted Test Equipment

Instrument	Manufacturer	Type No.	Asset No.	Cali. Interval	Cali. Due Date
X-Series USB Peak and Average Power Sensor	KEYSIGHT	U2021XA	MRTTWA00014	1 year	2024/4/19
EXA Signal Analyzer	KEYSIGHT	N9010A	MRTTWA00012	1 year	2023/10/5
EXA Signal Analyzer	KEYSIGHT	N9010B	MRTTWA00074	1 year	2023/7/19
Attenuator	WTI	218FS-20	MRTTWE00026	1 year	2023/11/2
Attenuator	WTI	218FS-10	MRTTWE00027	1 year	2023/11/2
Attenuator	WTI	218FS-06	MRTTWE00028	1 year	2024/6/15
Temperature & Humidity Chamber	TEN BILLION	TTH-B3UP	MRTTWA00036	1 year	2024/6/11
DIVA PLUS Funk-Wetterstation	TFA	35.1083	MRTTWA00050	1 year	2024/6/15

Software	Version	Function
e3	9.160520a	EMI Test Software

6. MEASUREMENT UNCERTAINTY

Where relevant, the following test uncertainty levels have been estimated for tests performed on the EUT as specified in CISPR 16-4-2. This uncertainty represents an expanded uncertainty expressed at approximately the 95% confidence level using a coverage factor of $k = 2$.

AC Conducted Emission Measurement
Measuring Uncertainty for a Level of Confidence of 95% ($U=2Uc(y)$): 150kHz~30MHz: $\pm 2.53\text{dB}$
Radiated Emission Measurement
Measuring Uncertainty for a Level of Confidence of 95% ($U=2Uc(y)$): 9kHz ~ 1GHz: $\pm 4.25\text{dB}$ 1GHz ~ 40GHz: $\pm 4.45\text{dB}$
Conducted Power (Carrier Power / Power Density)
Measuring Uncertainty for a Level of Confidence of 95% ($U=2Uc(y)$): $\pm 0.84\text{dB}$
Conducted Spurious Emission
Measuring Uncertainty for a Level of Confidence of 95% ($U=2Uc(y)$): $\pm 2.65\text{ dB}$
Occupied Bandwidth
Measuring Uncertainty for a Level of Confidence of 95% ($U=2Uc(y)$): $\pm 3.3\%$
Temp. / Humidity
Measuring Uncertainty for a Level of Confidence of 95% ($U=2Uc(y)$): $\pm 0.82^\circ\text{C} / \pm 3\%$

7. TEST RESULT

7.1. Summary

FCC Section(s)	Test Description	Test Limit	Test Condition	Test Result	Reference
15.247(a)(2)	6dB Bandwidth	$\geq 500\text{kHz}$	Conducted	Pass	Section 7.2
15.247(b)(3)	Output Power	$\leq 30\text{dBm}$		Pass	Section 7.3
15.247(e)	Power Spectral Density	$\leq 8\text{dBm}/3\text{kHz}$		Pass	Section 7.4
15.247(d)	Band Edge / Out-of-Band Emissions	$\geq 30\text{dBc}$ (Average)		Pass	Section 7.5
15.205 15.209	General Field Strength Limits (Restricted Bands and Radiated Emission Limits)	Emissions in restricted bands must meet the radiated limits detailed in 15.209	Radiated	Pass	Section 7.6 & 7.7
15.207	AC Conducted Emissions 150kHz - 30MHz	< FCC 15.207 limits	Line Conducted	Pass	Section 7.8

Notes:

- 1) Determining compliance is based on the test results met the regulation limits or requirements declared by clients, and the test results don't take into account the value of measurement uncertainty.
- 2) The analyzer plots shown in this section were all taken with a correction table loaded into the analyzer. The correction table was used to account for the losses of the cables and attenuators used as part of the system to connect the EUT to the analyzer at all frequencies of interest.
- 3) For radiated emission test, every axis (X, Y, Z) was also verified. The test results shown in the following sections represent the worst-case emissions.

7.2. 6dB Bandwidth Measurement

7.2.1. Test Limit

The minimum 6dB bandwidth shall be at least 500 kHz.

7.2.2. Test Procedure used

ANSI C63.10 - 2013 Section 11.8

7.2.3. Test Setting

1. The Spectrum's automatic bandwidth measurement capability was used to perform the 6dB bandwidth measurement. The "X" dB bandwidth parameter was set to $X = 6$. The bandwidth measurement was not influenced by any intermediate power nulls in the fundamental emission.
2. Set RBW = 100 kHz
3. VBW $\geq 3 \times$ RBW
4. Detector = Peak
5. Trace mode = max hold
6. Sweep = auto couple
7. Allow the trace was allowed to stabilize

7.2.4. Test Setup

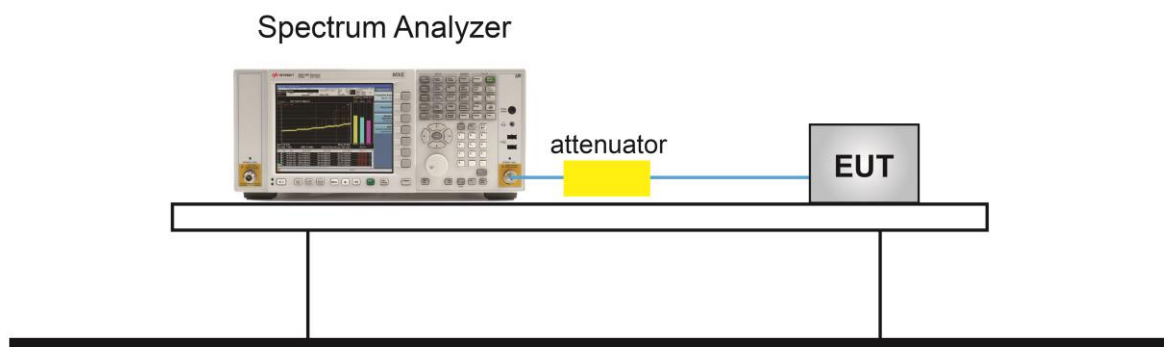

7.2.5. Test Result

Product	Pan/Tilt AI Home Security Wi-Fi Camera	Temperature	25°C
Test Engineer	Marvin	Relative Humidity	54%
Test Site	SR6	Test Date	2023/06/28

Test Mode	Data Rate / MCS	Channel No.	Frequency (MHz)	6dB Bandwidth (MHz)	Limit (MHz)	Result
802.11b	1Mbps	01	2412	8.073	≥ 0.5	Pass
802.11b	1Mbps	06	2437	8.082	≥ 0.5	Pass
802.11b	1Mbps	11	2462	8.092	≥ 0.5	Pass
802.11g	6Mbps	01	2412	11.010	≥ 0.5	Pass
802.11g	6Mbps	06	2437	10.710	≥ 0.5	Pass
802.11g	6Mbps	11	2462	11.020	≥ 0.5	Pass
802.11n-HT20	MCS0	01	2412	10.600	≥ 0.5	Pass
802.11n-HT20	MCS0	06	2437	11.040	≥ 0.5	Pass
802.11n-HT20	MCS0	11	2462	11.260	≥ 0.5	Pass
802.11ax-HE20	MCS0	01	2412	11.430	≥ 0.5	Pass
802.11ax-HE20	MCS0	06	2437	11.620	≥ 0.5	Pass
802.11ax-HE20	MCS0	11	2462	11.400	≥ 0.5	Pass

802.11b 6dB Bandwidth

Channel 01 (2412MHz)

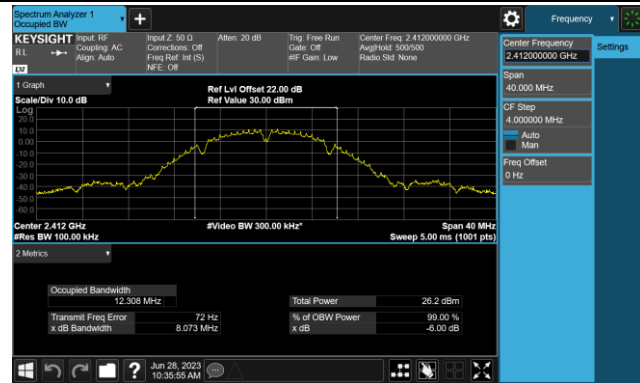

Channel 06 (2437MHz)

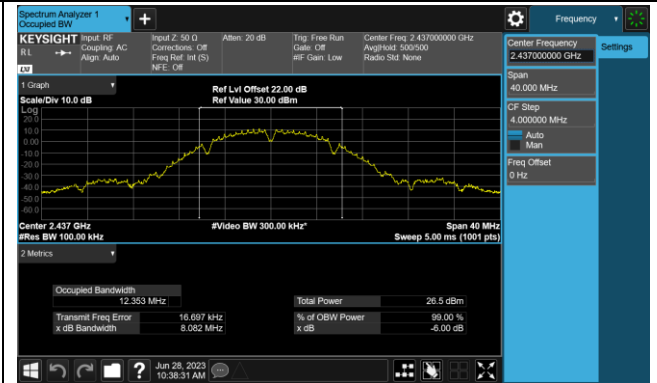

Channel 11 (2462MHz)

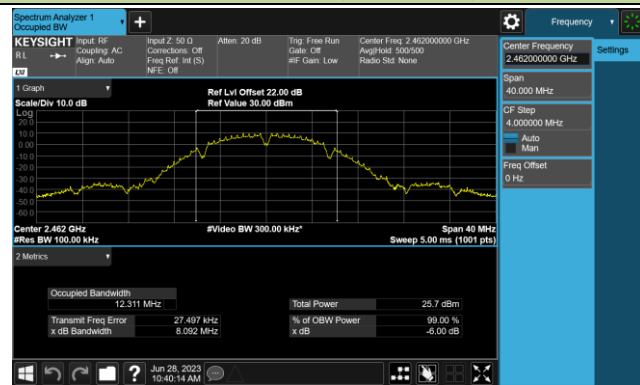

802.11g 6dB Bandwidth

Channel 01 (2412MHz)

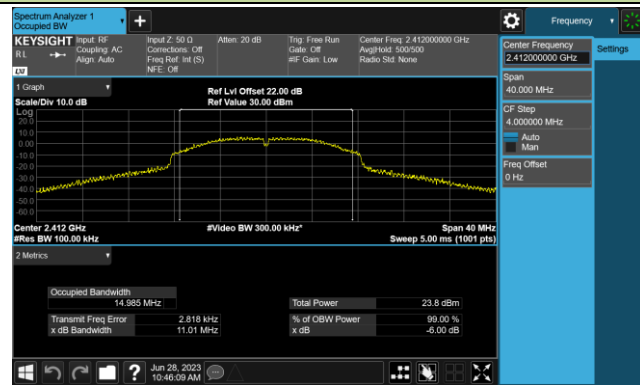

Channel 06 (2437MHz)



Channel 11 (2462MHz)

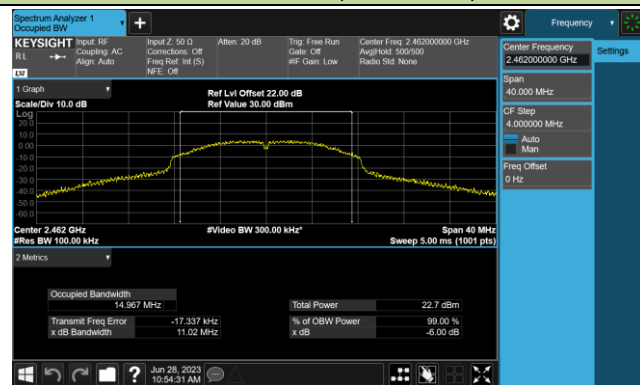

802.11n-HT20 6dB Bandwidth

Channel 01 (2412MHz)

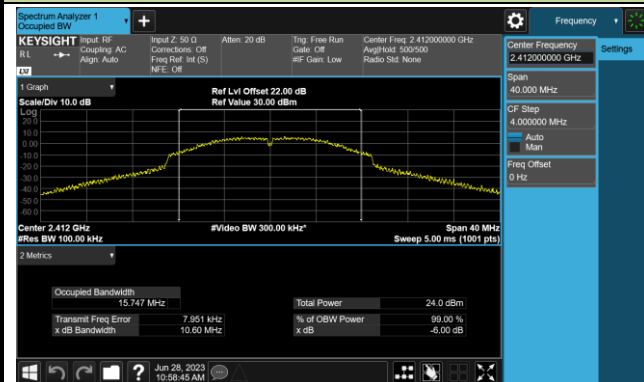

Channel 06 (2437MHz)

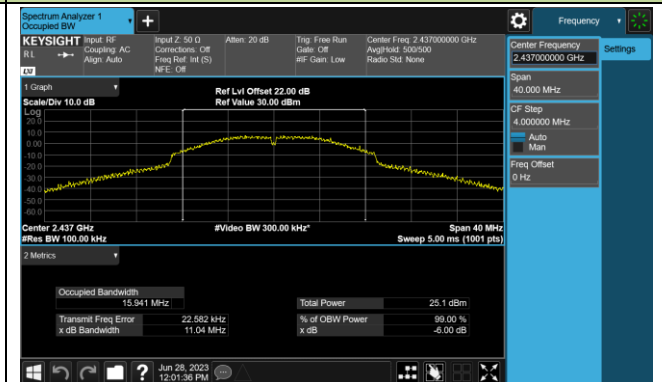

Channel 11 (2462MHz)

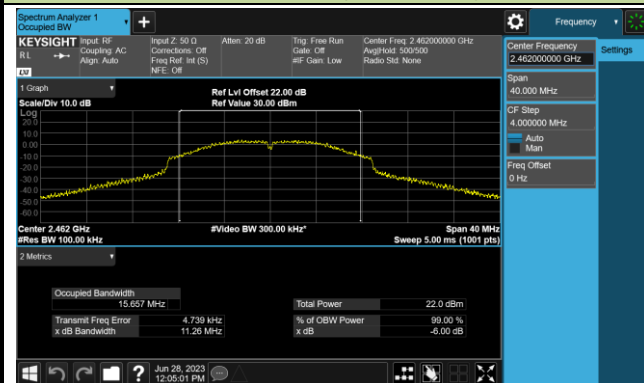

802.11ax-HE20 6dB Bandwidth

Channel 01 (2412MHz)

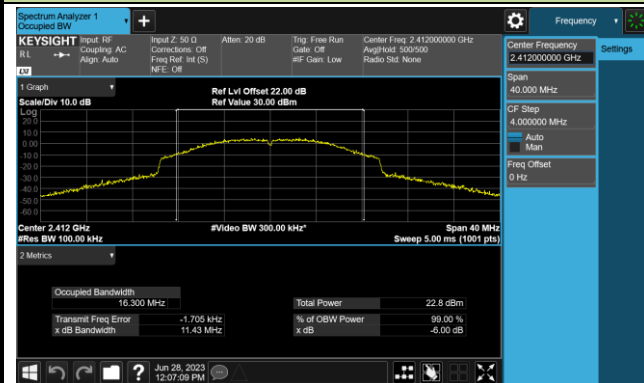

Channel 06 (2437MHz)



Channel 11 (2462MHz)

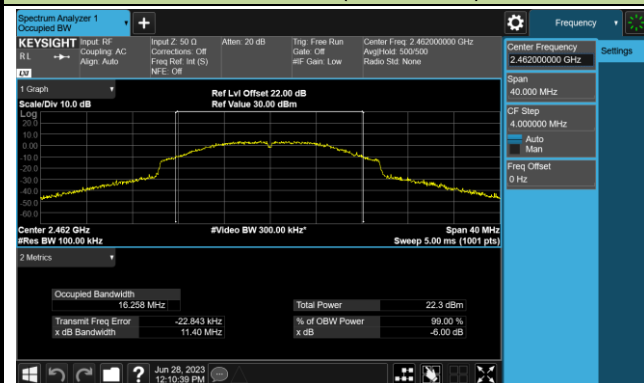

7.3. Output Power Measurement

7.3.1. Test Limit

The maximum output power shall be less 1 Watt (30dBm).

The conducted output power limit specified in paragraph FCC Part 15.247(b) of this section is based on the use of antennas with directional gains that do not exceed 6 dBi. If transmitting antennas of directional gain greater than 6 dBi are used, the conducted output power from the intentional radiator shall be reduced below the stated values in paragraphs FCC Part 15.247(b)(3) of this section, as appropriate, by the amount in dB that the directional gain of the antenna exceeds 6 dBi.

7.3.2. Test Procedure Used

ANSI C63.10 - 2013 Section 11.9.2.3.2

7.3.3. Test Setting

Average Power Measurement

Average power measurements were performed only when the EUT was transmitting at its maximum power control level using a broadband power meter with a pulse sensor. The power meter implemented triggering and gating capabilities which were set up such that power measurements were recorded only during the ON time of the transmitter.

7.3.4. Test Setup

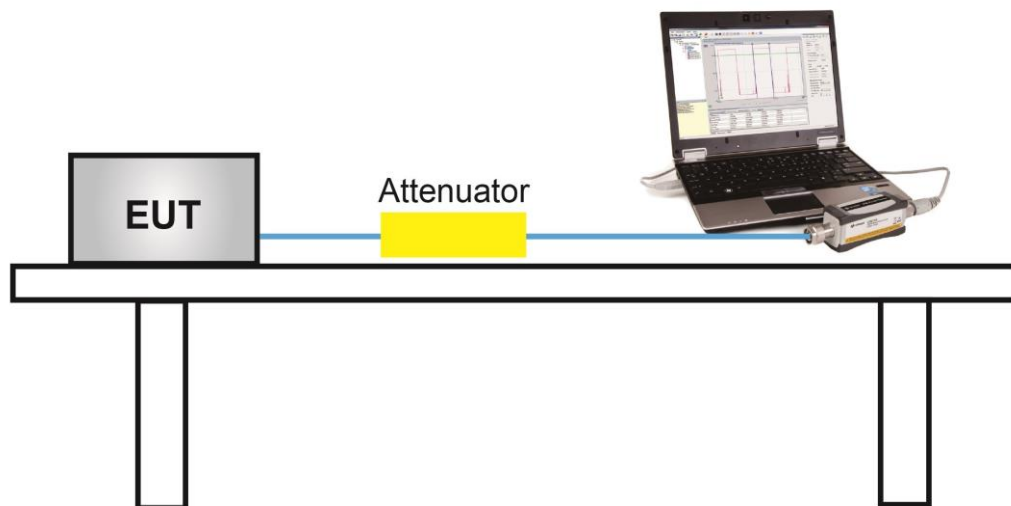

7.3.5. Test Result

Product	Pan/Tilt AI Home Security Wi-Fi Camera	Temperature	25°C
Test Engineer	Marvin	Relative Humidity	54%
Test Site	SR6	Test Date	2023/06/29

Test Mode	Data Rate/ MCS	Channel No.	Freq. (MHz)	Average Power (dBm)	Limit (dBm)	Result
802.11b	1Mbps	01	2412	19.35	≤ 30.00	Pass
802.11b	1Mbps	06	2437	19.58	≤ 30.00	Pass
802.11b	1Mbps	11	2462	19.43	≤ 30.00	Pass
802.11g	6Mbps	01	2412	17.21	≤ 30.00	Pass
802.11g	6Mbps	06	2437	19.56	≤ 30.00	Pass
802.11g	6Mbps	11	2462	19.39	≤ 30.00	Pass
802.11n-HT20	MCS0	01	2412	19.25	≤ 30.00	Pass
802.11n-HT20	MCS0	06	2437	19.37	≤ 30.00	Pass
802.11n-HT20	MCS0	11	2462	19.10	≤ 30.00	Pass
802.11ax-HE20	MCS0	01	2412	18.76	≤ 30.00	Pass
802.11ax-HE20	MCS0	06	2437	18.50	≤ 30.00	Pass
802.11ax-HE20	MCS0	11	2462	18.31	≤ 30.00	Pass

7.4. Power Spectral Density Measurement

7.4.1. Test Limit

The maximum permissible power spectral density is 8dBm in any 3 kHz band.

The same method of determining the conducted output power shall be used to determine the power spectral density.

7.4.2. Test Procedure Used

ANSI C63.10 - 2013 Section 11.10.5

7.4.3. Test Setting

1. Measure the duty cycle (x) of the transmitter output signal.
2. Set instrument center frequency to DTS channel center frequency.
3. Set span to at least 1.5 times the OBW.
4. RBW = 10 kHz.
5. VBW = 30 kHz.
6. Detector = RMS.
7. Ensure that the number of measurement points in the sweep $\geq 2 \times \text{span/RBW}$.
8. Sweep time = auto couple.
9. Don't use sweep triggering. Allow sweep to "free run".
10. Employ trace averaging (RMS) mode over a minimum of 100 traces.
11. Use the peak marker function to determine the maximum amplitude level.
12. Add $10 \log (1/x)$, where x is the duty cycle measured in step (a), to the measured PSD to compute the average PSD during the actual transmission time.

7.4.4. Test Setup

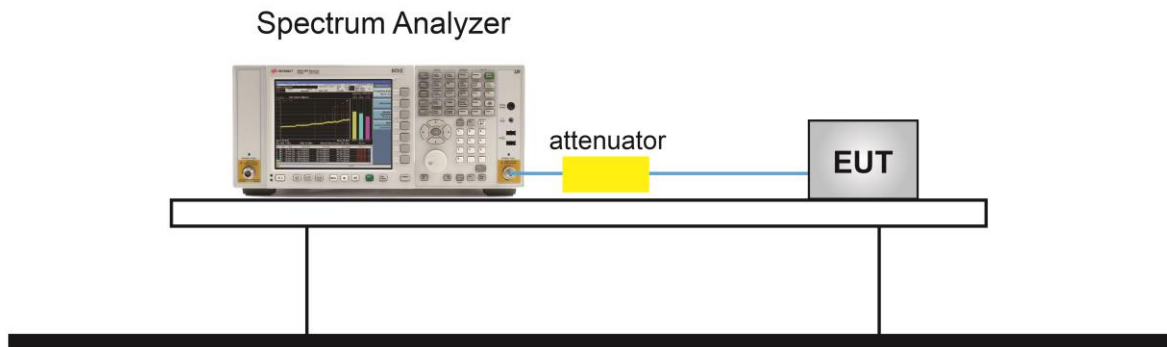

7.4.5. Test Result

Product	Pan/Tilt AI Home Security Wi-Fi Camera	Temperature	25°C
Test Engineer	Marvin	Relative Humidity	54%
Test Site	SR6	Test Date	2023/06/28

Test Mode	Data Rate/ MCS	Channel No.	Freq. (MHz)	PSD (dBm/ 10kHz)	Duty Cycle (%)	Total PSD (dBm/ 10kHz)	Limit (dBm/ 3kHz)	Result
802.11b	1Mbps	01	2412	-5.479	100.00%	-5.479	≤ 8.00	Pass
802.11b	1Mbps	06	2437	-5.307	100.00%	-5.307	≤ 8.00	Pass
802.11b	1Mbps	11	2462	-6.315	100.00%	-6.315	≤ 8.00	Pass
802.11g	6Mbps	01	2412	-7.205	100.00%	-7.205	≤ 8.00	Pass
802.11g	6Mbps	06	2437	-6.734	100.00%	-6.734	≤ 8.00	Pass
802.11g	6Mbps	11	2462	-7.875	100.00%	-7.875	≤ 8.00	Pass
802.11n-HT20	MCS0	01	2412	-7.258	100.00%	-7.258	≤ 8.00	Pass
802.11n-HT20	MCS0	06	2437	-7.263	100.00%	-7.263	≤ 8.00	Pass
802.11n-HT20	MCS0	11	2462	-7.405	100.00%	-7.405	≤ 8.00	Pass
802.11ax-HE20	MCS0	01	2412	-6.84	100.00%	-6.84	≤ 8.00	Pass
802.11ax-HE20	MCS0	06	2437	-7.091	100.00%	-7.091	≤ 8.00	Pass
802.11ax-HE20	MCS0	11	2462	-5.479	100.00%	-5.479	≤ 8.00	Pass

802.11b AVGPSD

Channel 01 (2412MHz)



Channel 06 (2437MHz)



Channel 11 (2462MHz)



802.11g AVGPSD

Channel 01 (2412MHz)

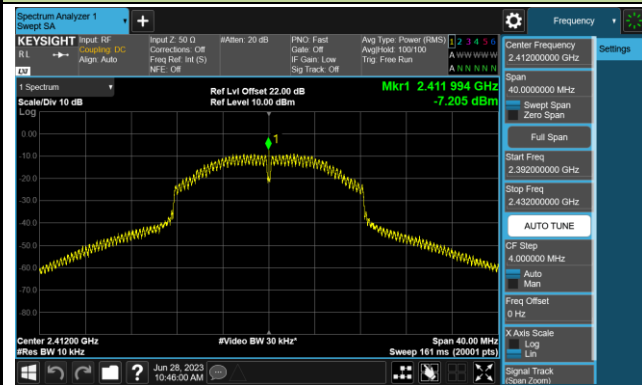

Channel 06 (2437MHz)

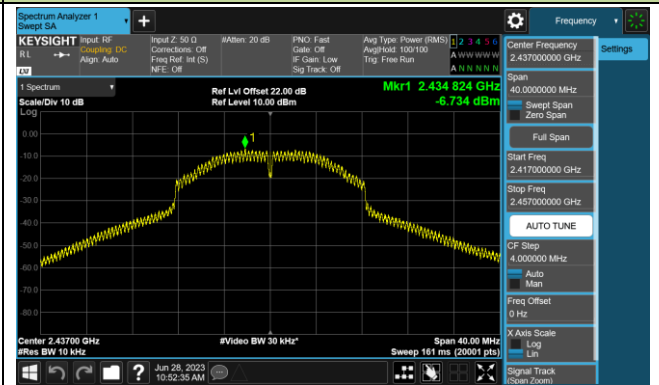

Channel 11 (2462MHz)

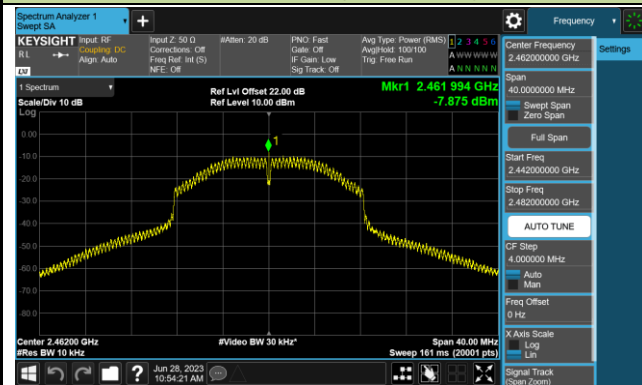

802.11n-HT20 AVGPSPD

Channel 01 (2412MHz)

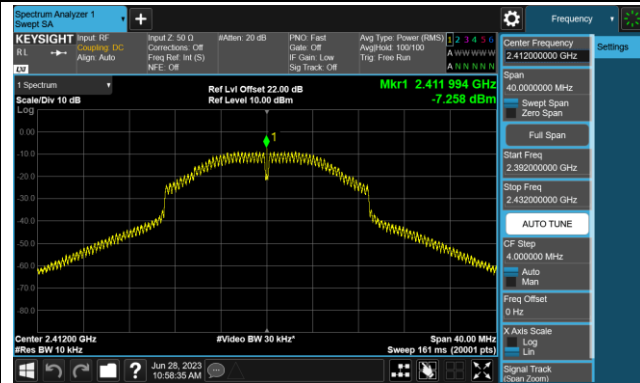

Channel 06 (2437MHz)

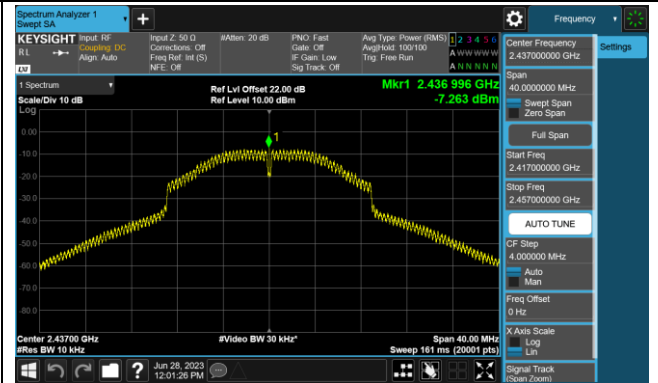

Channel 11 (2462MHz)

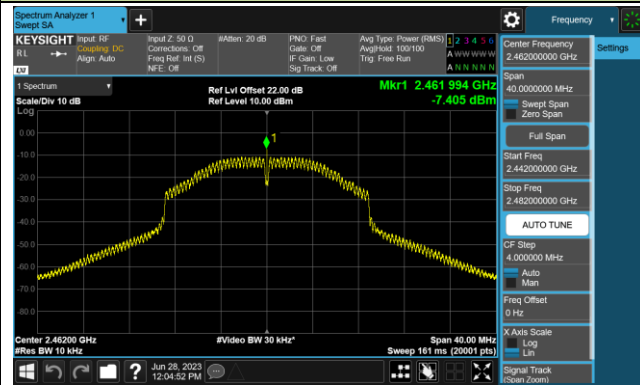

802.11ax-HE20 AVGPSPD

Channel 01 (2412MHz)

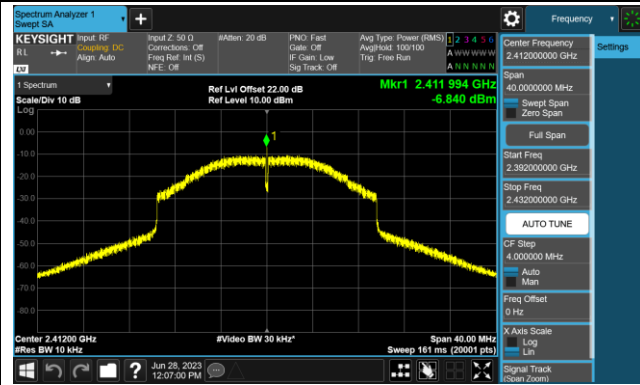

Channel 06 (2437MHz)

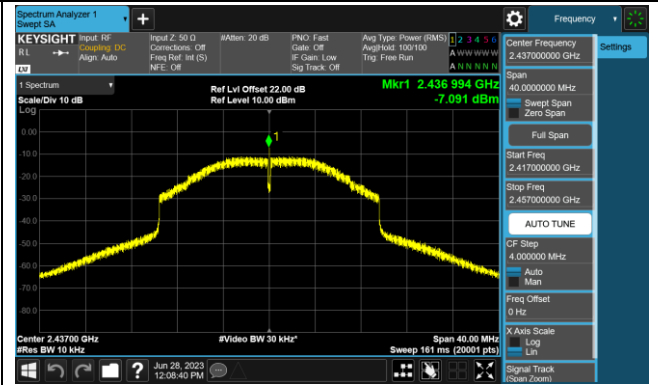

Channel 11 (2462MHz)

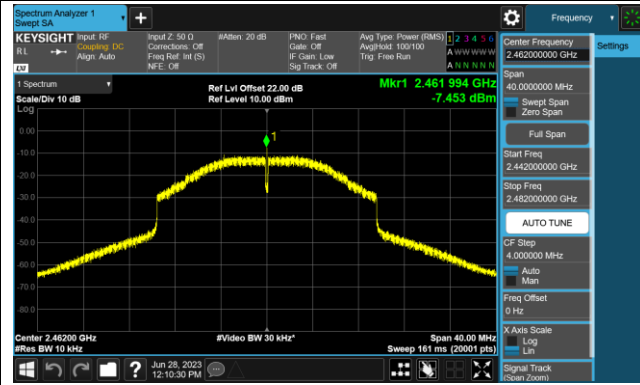

7.5. Conducted Band Edge and Out-of-Band Emissions

7.5.1. Test Limit

The limit for out-of-band spurious emissions at the band edge is 30dB below the fundamental emission level, as determined from the in-band power measurement of the DTS channel performed in a 100 kHz bandwidth per the PSD procedure.

7.5.2. Test Procedure Used

ANSI C63.10 - 2013 Section 11.11

7.5.3. Test Setting

Reference level measurement

1. Set instrument center frequency to DTS channel center frequency
2. Set the span to ≥ 1.5 times the DTS bandwidth
3. Set the RBW = 100 kHz
4. Set the VBW $\geq 3 \times$ RBW
5. Detector = peak
6. Sweep time = auto couple
7. Trace mode = max hold
8. Allow trace to fully stabilize

Emission level measurement

1. Set the center frequency and span to encompass frequency range to be measured
2. RBW = 100kHz
3. VBW = 300kHz
4. Detector = Peak
5. Trace mode = max hold
6. Sweep time = auto couple
7. The trace was allowed to stabilize

7.5.4. Test Setup

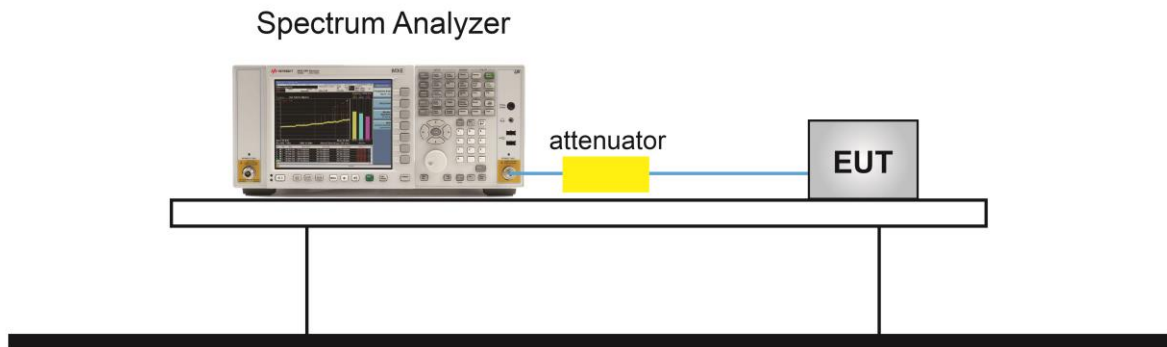

7.5.5. Test Result

Product	Pan/Tilt AI Home Security Wi-Fi Camera	Temperature	25°C
Test Engineer	Marvin	Relative Humidity	54%
Test Site	SR6	Test Date	2023/06/28

Test Mode	Data Rate / MCS	Channel No.	Frequency (MHz)	Limit (dBc)	Result
802.11b	1Mbps	01	2412	30	Pass
802.11b	1Mbps	06	2437	30	Pass
802.11b	1Mbps	11	2462	30	Pass
802.11g	6Mbps	01	2412	30	Pass
802.11g	6Mbps	06	2437	30	Pass
802.11g	6Mbps	11	2462	30	Pass
802.11n-HT20	MCS0	01	2412	30	Pass
802.11n-HT20	MCS0	06	2437	30	Pass
802.11n-HT20	MCS0	11	2462	30	Pass
802.11ax-HE20	MCS0	01	2412	30	Pass
802.11ax-HE20	MCS0	06	2437	30	Pass
802.11ax-HE20	MCS0	11	2462	30	Pass

Ant 0

802.11 b CH01 (2412MHz)

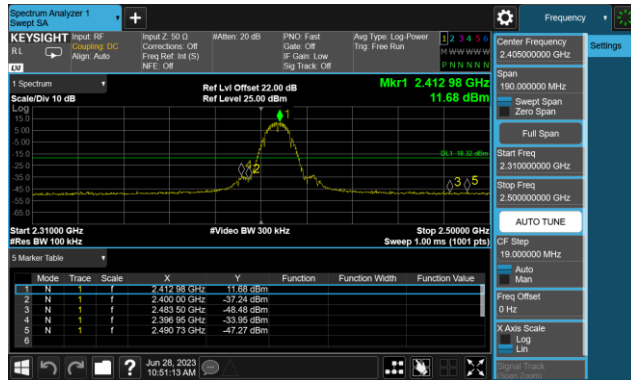

802.11 b CH01 (2412MHz)

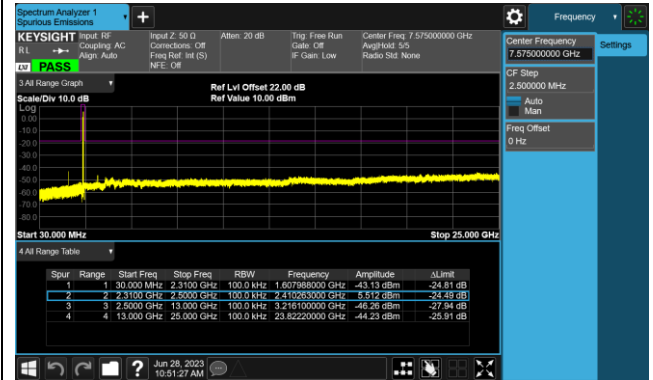

802.11 b CH06 (2437MHz)

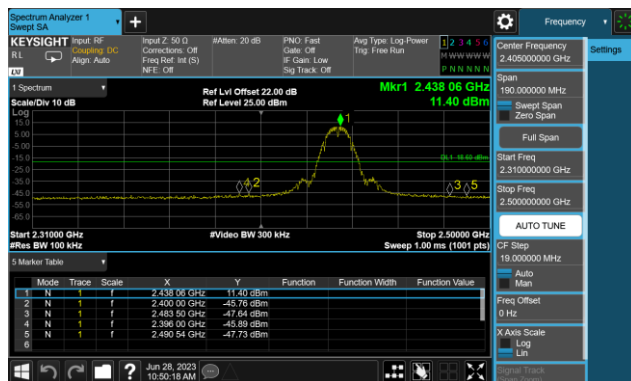

802.11 b CH06 (2437MHz)

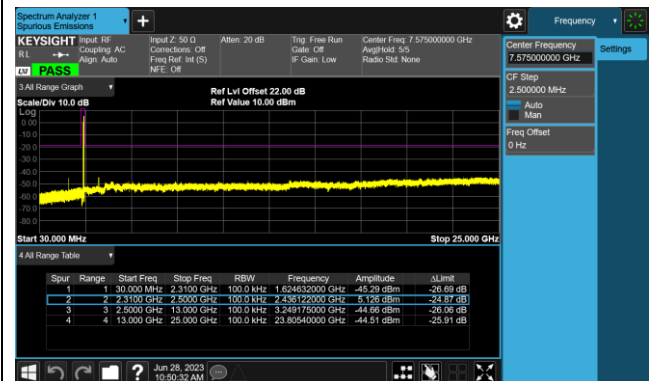

802.11 b CH11 (2462MHz)

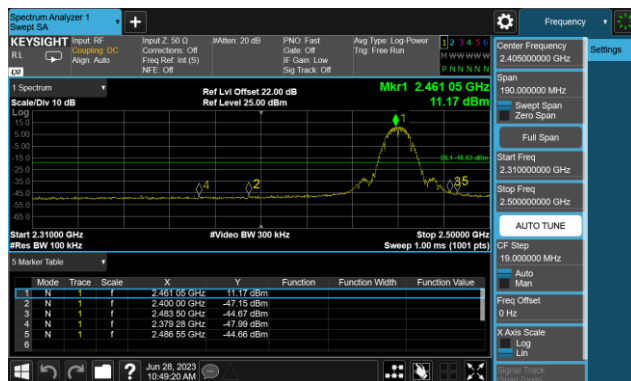

802.11 b CH11 (2462MHz)

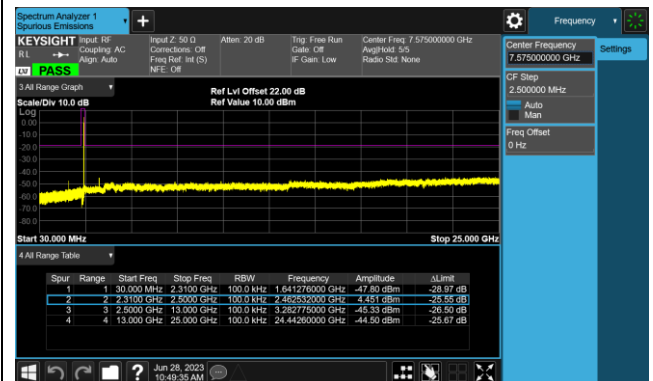

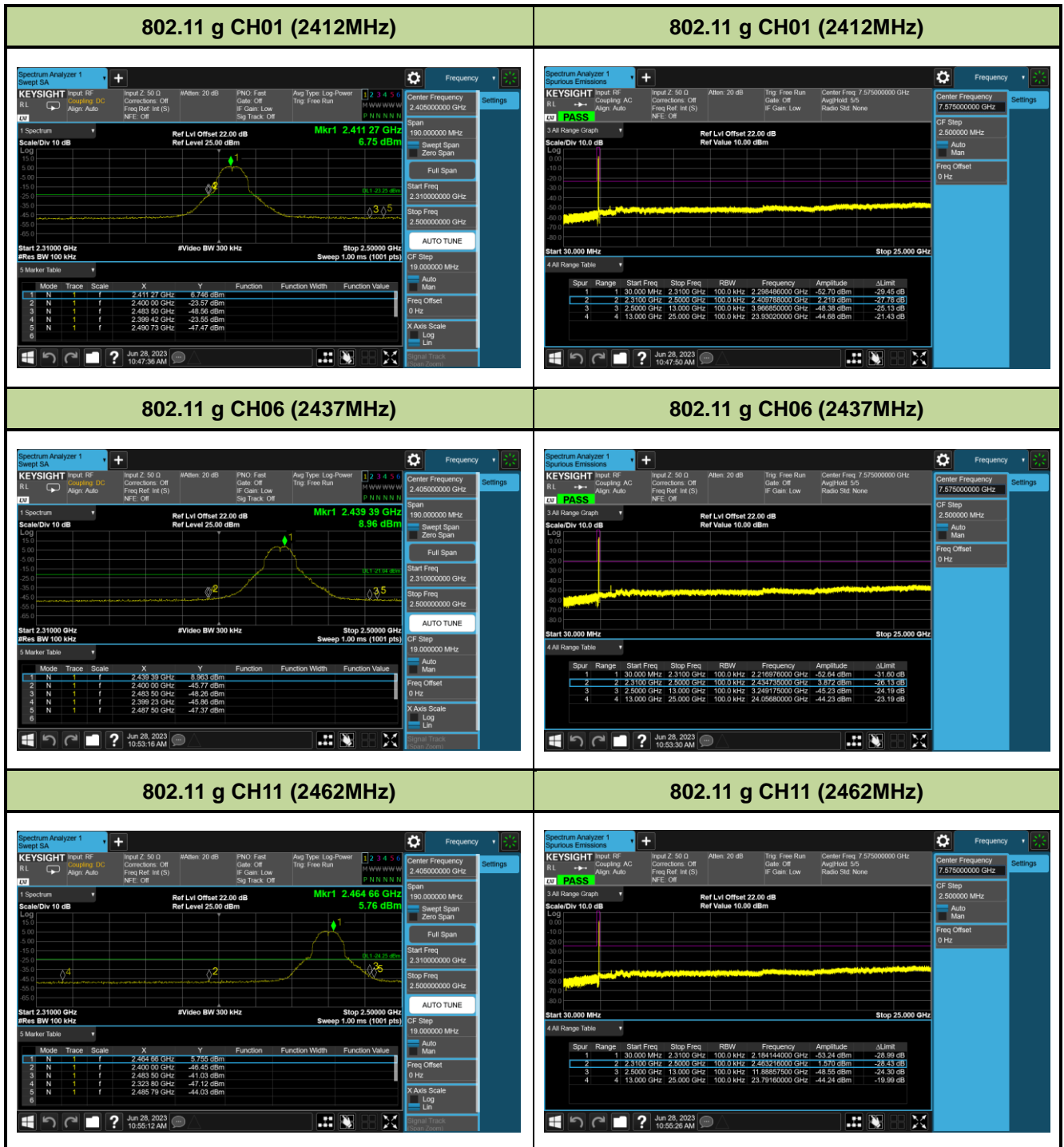

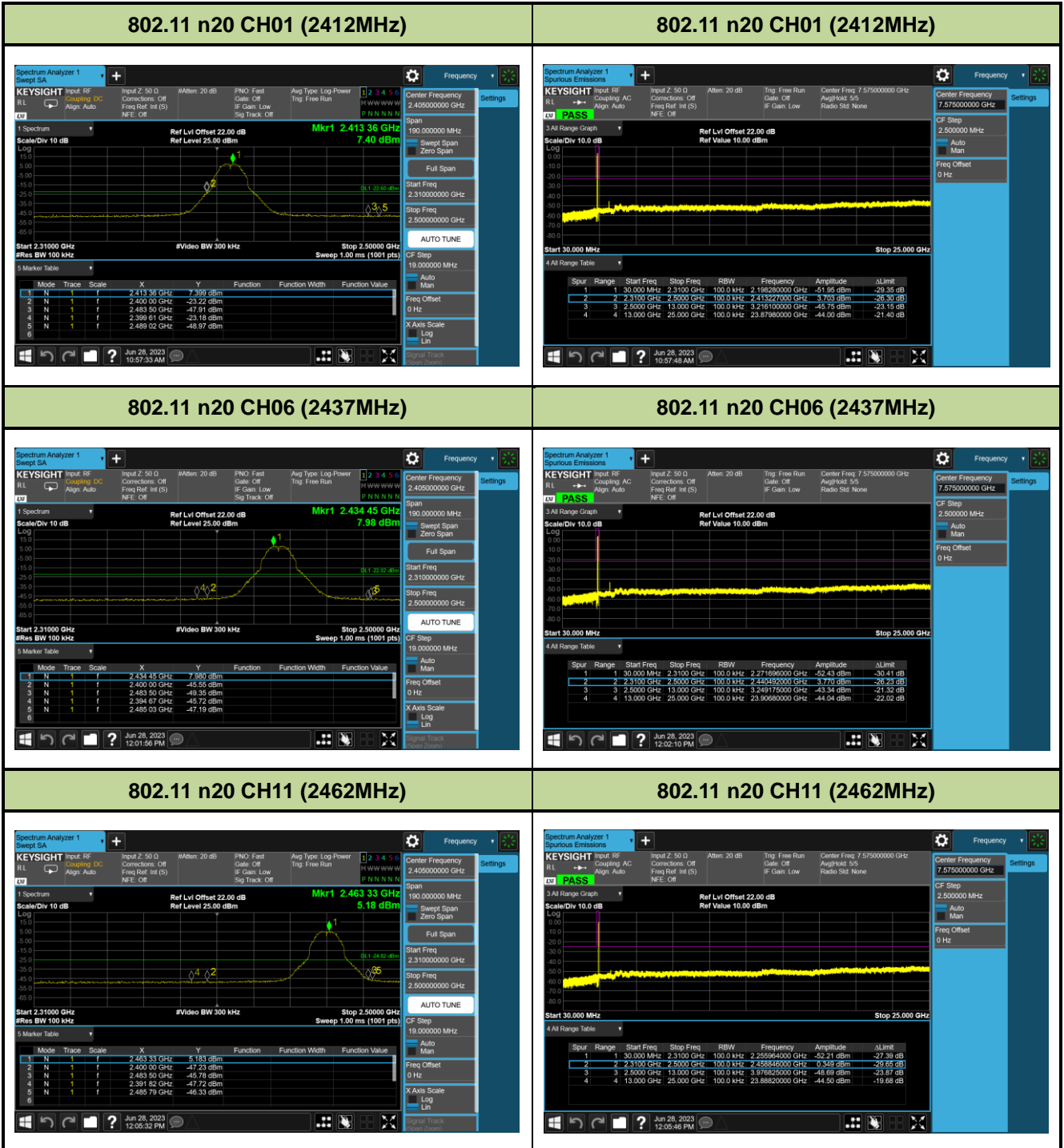

802.11 ax20 CH01 (2412MHz)

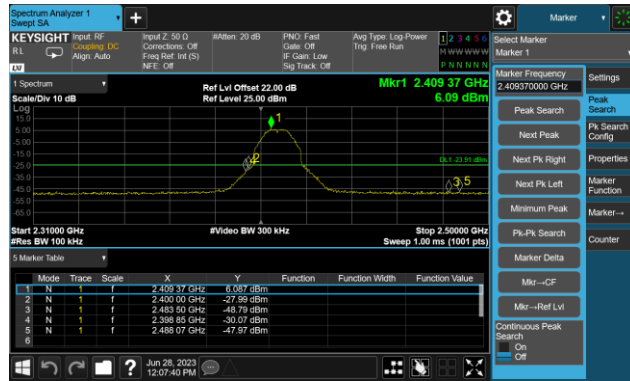

802.11 ax20 CH01 (2412MHz)

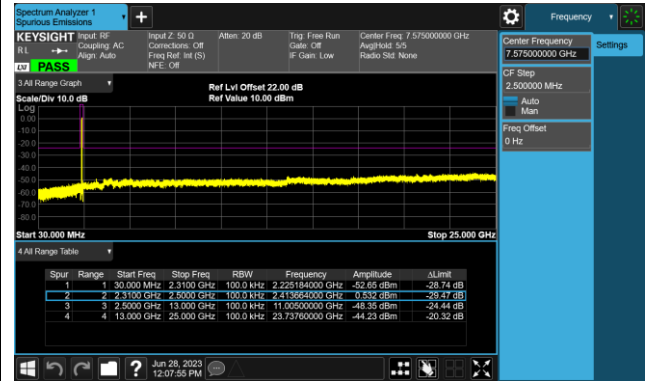

802.11 ax20 CH06 (2437MHz)

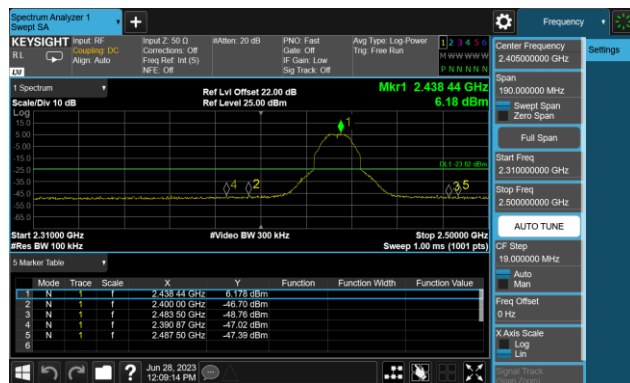

802.11 ax20 CH06 (2437MHz)

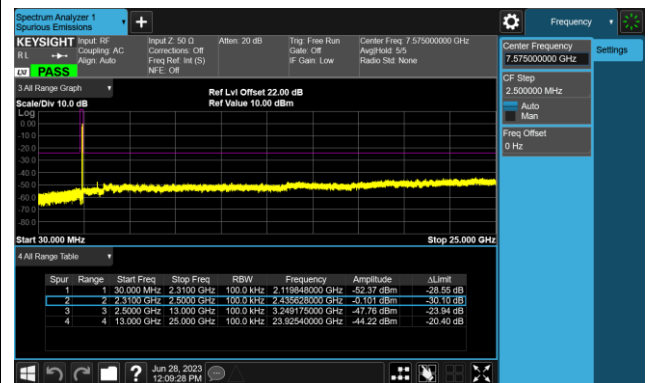

802.11 ax20 CH11 (2462MHz)

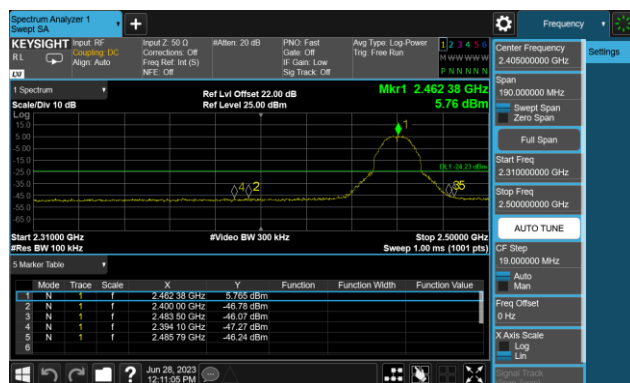

802.11 ax20 CH11 (2462MHz)

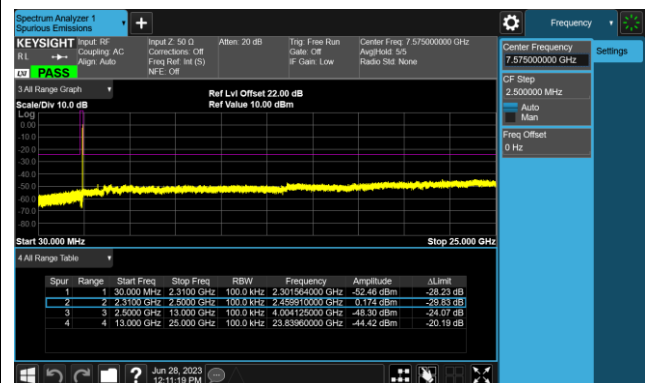

7.6. Radiated Spurious Emission Measurement

7.6.1. Test Limit

All out of band emissions appearing in a restricted band as specified in Section 15.205 of the Title 47CFR must not exceed the limits shown in Table per Section 15.209.

FCC Part 15 Subpart C Paragraph 15.209		
Frequency [MHz]	Field Strength [Uv/m]	Measured Distance [Meters]
0.009 - 0.490	2400/F (kHz)	300
0.490 - 1.705	24000/F (kHz)	30
1.705 - 30	30	30
30 - 88	100	3
88 - 216	150	3
216 - 960	200	3
Above 960	500	3

7.6.2. Test Procedure Used

ANSI C63.10 - 2013 Section 6.3 (General Requirements)

ANSI C63.10 - 2013 Section 6.4 (Standard test method below 30MHz)

ANSI C63.10 - 2013 Section 6.5 (Standard test method above 30MHz to 1GHz)

ANSI C63.10 - 2013 Section 6.6 (Standard test method above 1GHz)

7.6.3. Test Setting

Table 1 - RBW as a function of frequency

Frequency	RBW
9 ~ 150 kHz	200 ~ 300 Hz
0.15 ~ 30 MHz	9 ~ 10 kHz
30 ~ 1000 MHz	100 ~ 120 kHz
> 1000MHz	1MHz

Quasi-Peak Measurements below 1GHz

1. Analyzer center frequency was set to the frequency of the radiated spurious emission of interest
2. Span was set greater than 1MHz
3. RBW = as specified in Table 1
4. Detector = CISPR quasi-peak
5. Sweep time = auto couple
6. Trace was allowed to stabilize

Peak Measurements above 1GHz

1. Analyzer center frequency was set to the frequency of the radiated spurious emission of interest
2. RBW = 1MHz
3. VBW = 3MHz
4. Detector = peak
5. Sweep time = auto couple
6. Trace mode = max hold
7. Trace was allowed to stabilize

Average Measurements above 1GHz (Method VB)

1. Analyzer center frequency was set to the frequency of the radiated spurious emission of interest
2. RBW = 1MHz
3. VBW; If the EUT is configured to transmit with duty cycle $\geq 98\%$, set VBW = 10 Hz.
If the EUT duty cycle is $< 98\%$, set VBW $\geq 1/T$. T is the minimum transmission duration.
4. Detector = Peak
5. Sweep time = auto
6. Trace mode = max hold
7. Trace was allowed to stabilize

7.6.4. Test Setup

Below 1GHz Test Setup:

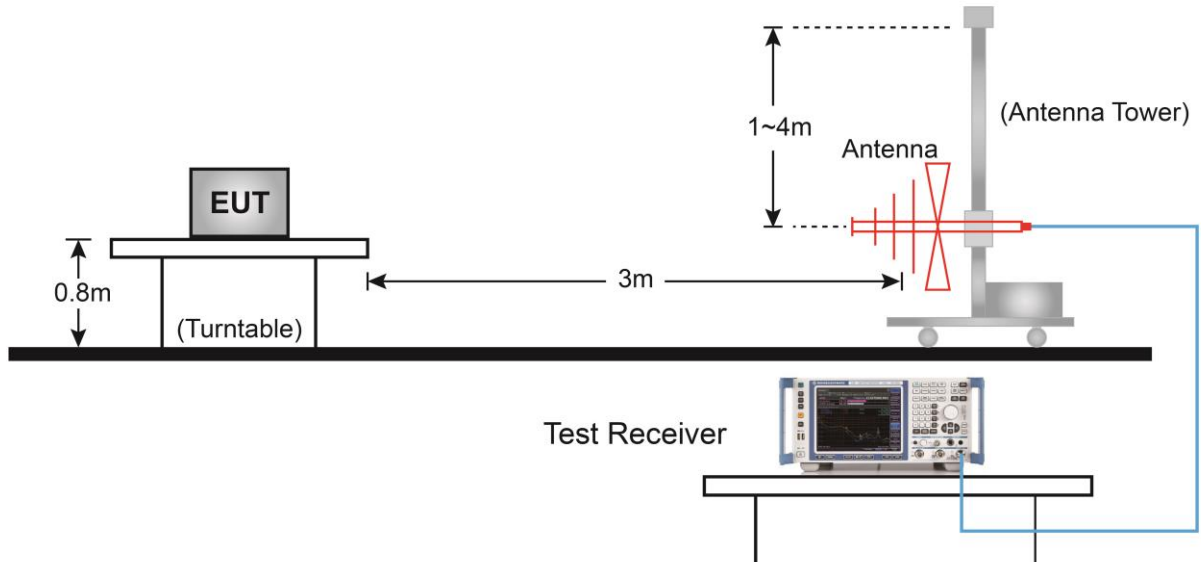

Above 1GHz Test Setup:

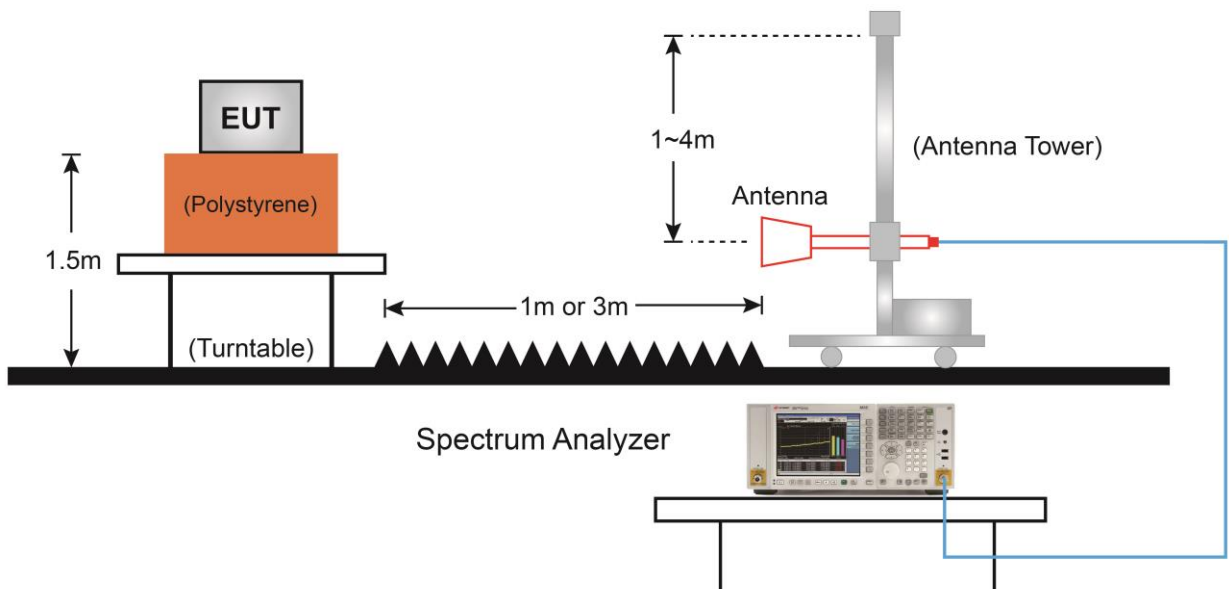

7.6.5. Test Result

EUT	Pan/Tilt AI Home Security Wi-Fi Camera	Date of Test	2023-06-29
Factor	VULB 9162	Temp. / Humidity	21°C /62%
Polarity	Horizontal	Site / Test Engineer	AC2 / Stanley
Test Mode	802.11n-20MHz_TX_CH 6_ANT 0	Test Voltage	AC 120V/60Hz

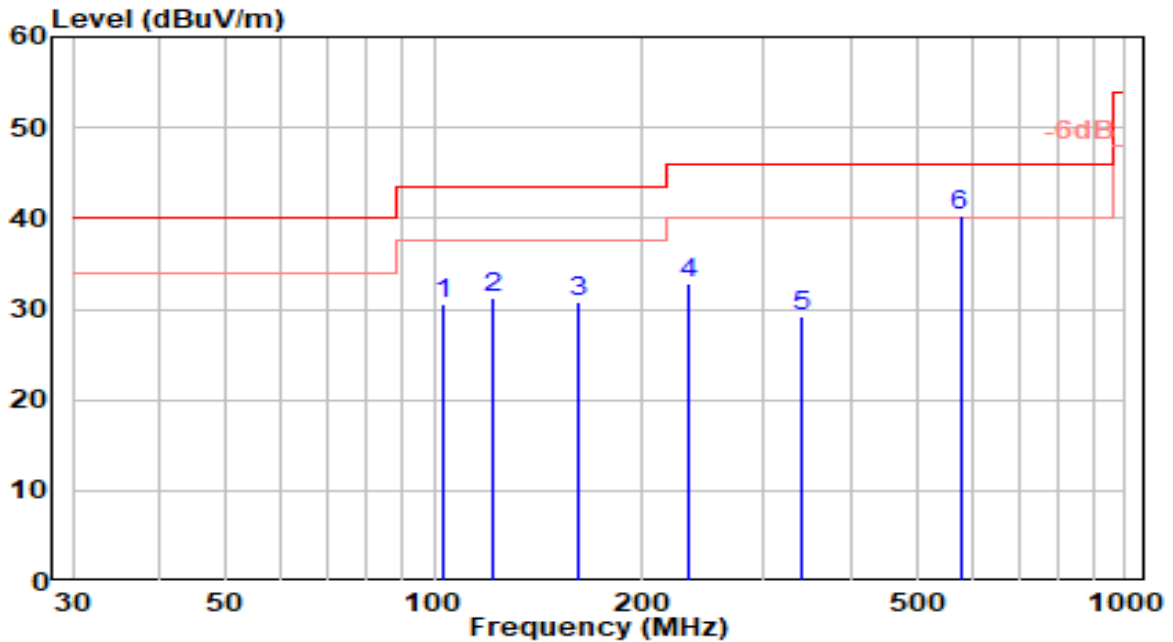

No	Frequency (MHz)	Reading (dBUV)	C.F (dB/m)	Measurement (dBUV/m)	Margin (dB)	Limit (dBUV/m)	Height (cm)	Angle (deg)	Remark (QP/PK/AV)
1	102.750	12.18	18.32	30.51	-12.99	43.50	200	271	QP
2	121.180	14.87	16.48	31.35	-12.15	43.50	150	268	QP
3	161.920	15.24	15.54	30.78	-12.72	43.50	100	273	QP
4	233.700	13.81	19.13	32.94	-13.06	46.00	150	0	QP
5	339.430	7.35	21.94	29.28	-16.72	46.00	100	29	QP
6	* 577.080	14.01	26.28	40.28	-5.72	46.00	150	229	QP

Note:

1. " *", means this data is the worst emission level.
2. C.F (Correction Factor) = Antenna Factor (dB/m) + Cable Loss (dB).
3. Measurement (dBUV/m) = Reading(dBUV) + C.F (Correction Factor).
4. The emission levels of other frequencies are very lower than the limit and not show in test report.

EUT	Pan/Tilt AI Home Security Wi-Fi Camera	Date of Test	2023-06-29
Factor	VULB 9162	Temp. / Humidity	21°C /62%
Polarity	Vertical	Site / Test Engineer	AC2 / Stanley
Test Mode	802.11n-20MHz_TX_CH 6_ANT 0	Test Voltage	AC 120V/60Hz

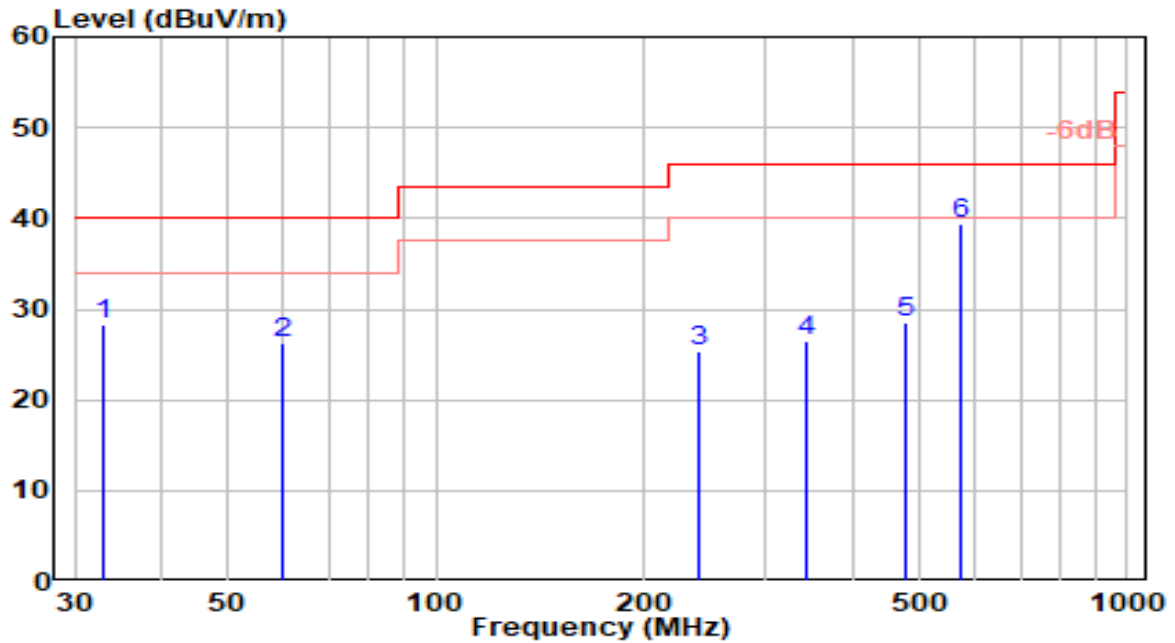

No	Frequency (MHz)	Reading (dBuV)	C.F (dB/m)	Measurement (dBuV/m)	Margin (dB)	Limit (dBuV/m)	Height (cm)	Angle (deg)	Remark (QP/PK/AV)
1	32.910	11.12	17.10	28.22	-11.78	40.00	100	242	QP
2	60.070	7.28	19.08	26.35	-13.65	40.00	115	360	QP
3	239.520	5.85	19.43	25.28	-20.72	46.00	200	360	QP
4	344.280	4.48	22.12	26.59	-19.41	46.00	100	0	QP
5	480.080	4.18	24.37	28.54	-17.46	46.00	100	360	QP
6	* 576.110	13.16	26.25	39.41	-6.59	46.00	150	346	QP

Note:

1. " *", means this data is the worst emission level.
2. C.F (Correction Factor) = Antenna Factor (dB/m) + Cable Loss (dB).
3. Measurement (dBuV/m) = Reading(dBuV) + C.F (Correction Factor).
4. The emission levels of other frequencies are very lower than the limit and not show in test report.

EUT	Pan/Tilt AI Home Security Wi-Fi Camera	Date of Test	2023-06-28
Factor	DRH18-E	Temp. / Humidity	21°C /62%
Polarity	Horizontal	Site / Test Engineer	AC2 / Marvin
Test Mode	802.11b_TX_CH 1_ANT 0	Test Voltage	AC 120V/60Hz

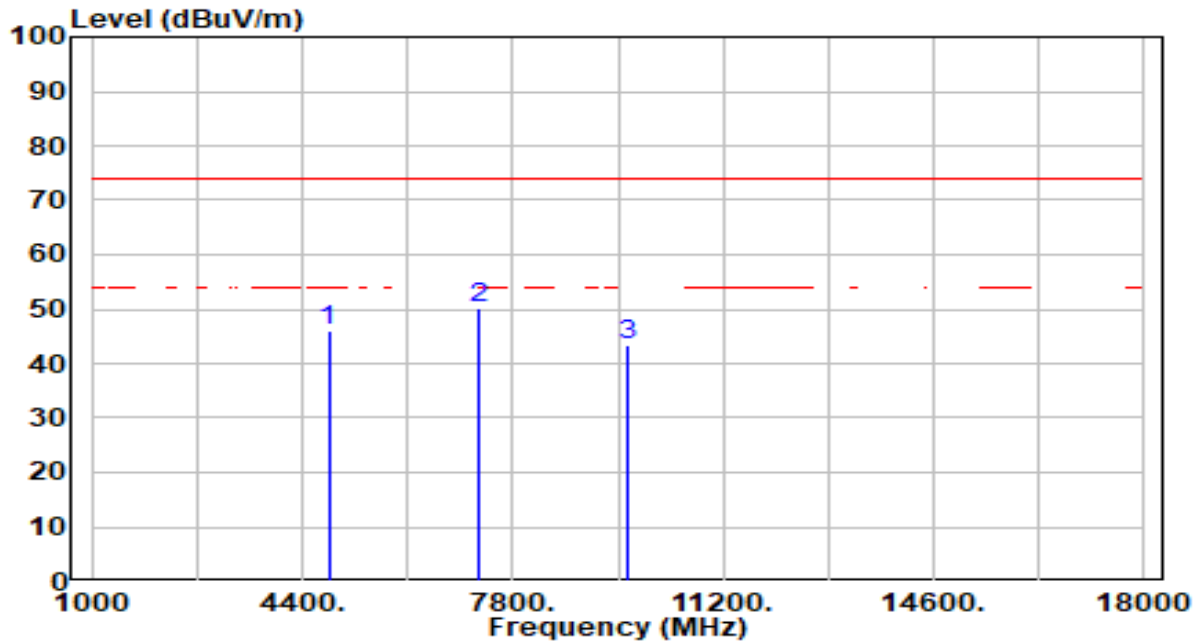

No	Frequency (MHz)	Reading (dBuV)	C.F (dB/m)	Measurement (dBuV/m)	Margin (dB)	Limit (dBuV/m)	Height (cm)	Angle (deg)	Remark (QP/PK/AV)
1	4824.000	47.18	-1.10	46.08	-27.92	74.00	300	55	Peak
2	* 7236.000	46.30	3.90	50.20	-23.80	74.00	300	0	Peak
3	9648.000	40.34	3.21	43.55	-30.45	74.00	108	360	Peak

Note:

1. " *", means this data is the worst emission level.
2. C.F (Correction Factor) = Antenna Factor (dB/m)+ Cable Loss (dB) – Preamplifier(dB).
3. Measurement (dBuV/m) = Reading(dBuV) + C.F (Correction Factor).
4. The emission levels of other frequencies are very lower than the limit and not show in test report.

EUT	Pan/Tilt AI Home Security Wi-Fi Camera	Date of Test	2023-06-28
Factor	DRH18-E	Temp. / Humidity	21°C /62%
Polarity	Vertical	Site / Test Engineer	AC2 / Marvin
Test Mode	802.11b_TX_CH 1_ANT 0	Test Voltage	AC 120V/60Hz

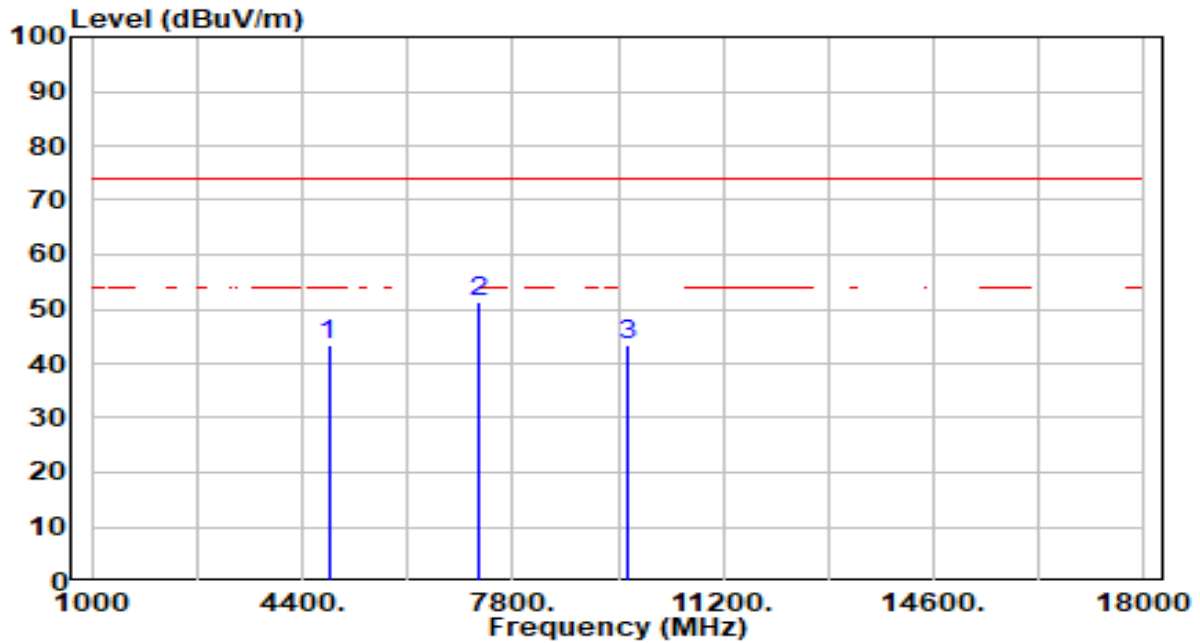

No	Frequency (MHz)	Reading (dBuV)	C.F (dB/m)	Measurement (dBuV/m)	Margin (dB)	Limit (dBuV/m)	Height (cm)	Angle (deg)	Remark (QP/PK/AV)
1	4824.000	44.68	-1.10	43.58	-30.42	74.00	100	62	Peak
2	* 7236.000	47.35	3.90	51.25	-22.75	74.00	118	360	Peak
3	9648.000	40.00	3.21	43.22	-30.78	74.00	292	0	Peak

Note:

1. " *", means this data is the worst emission level.
2. C.F (Correction Factor) = Antenna Factor (dB/m)+ Cable Loss (dB) – Preamplifier(dB).
3. Measurement (dBuV/m) = Reading(dBuV) + C.F (Correction Factor).
4. The emission levels of other frequencies are very lower than the limit and not show in test report.

EUT	Pan/Tilt AI Home Security Wi-Fi Camera	Date of Test	2023-06-28
Factor	DRH18-E	Temp. / Humidity	21°C /62%
Polarity	Horizontal	Site / Test Engineer	AC2 / Marvin
Test Mode	802.11b_TX_CH 6_ANT 0	Test Voltage	AC 120V/60Hz

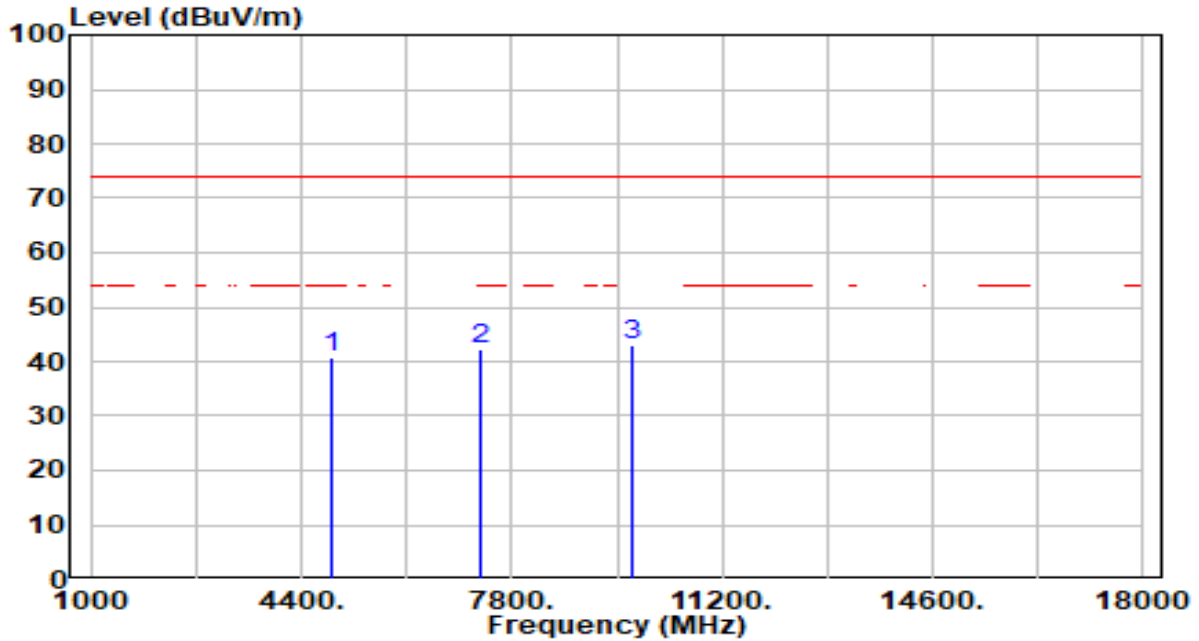

No	Frequency (MHz)	Reading (dBuV)	C.F (dB/m)	Measurement (dBuV/m)	Margin (dB)	Limit (dBuV/m)	Height (cm)	Angle (deg)	Remark (QP/PK/AV)
1	4874.000	41.61	-0.97	40.65	-33.35	74.00	300	60	Peak
2	7311.000	38.23	3.92	42.15	-31.85	74.00	300	124	Peak
3	* 9748.000	39.81	3.24	43.05	-30.95	74.00	300	96	Peak

Note:

1. " *", means this data is the worst emission level.
2. C.F (Correction Factor) = Antenna Factor (dB/m)+ Cable Loss (dB) – Preamplifier(dB).
3. Measurement (dBuV/m) = Reading(dBuV) + C.F (Correction Factor).
4. The emission levels of other frequencies are very lower than the limit and not show in test report.

EUT	Pan/Tilt AI Home Security Wi-Fi Camera	Date of Test	2023-06-28
Factor	DRH18-E	Temp. / Humidity	21°C /62%
Polarity	Vertical	Site / Test Engineer	AC2 / Marvin
Test Mode	802.11b_TX_CH 6_ANT 0	Test Voltage	AC 120V/60Hz

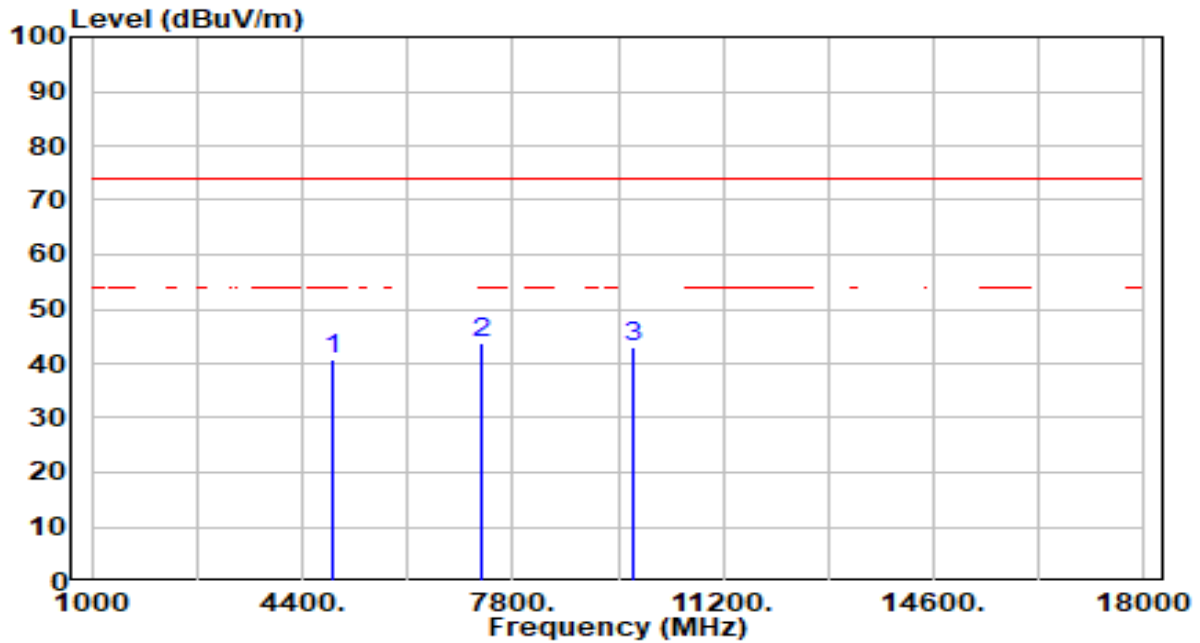

No	Frequency (MHz)	Reading (dBuV)	C.F (dB/m)	Measurement (dBuV/m)	Margin (dB)	Limit (dBuV/m)	Height (cm)	Angle (deg)	Remark (QP/PK/AV)
1	4874.000	41.76	-0.97	40.79	-33.21	74.00	118	360	Peak
2	* 7311.000	40.03	3.92	43.95	-30.05	74.00	118	0	Peak
3	9748.000	39.67	3.24	42.91	-31.09	74.00	118	238	Peak

Note:

1. " *", means this data is the worst emission level.
2. C.F (Correction Factor) = Antenna Factor (dB/m)+ Cable Loss (dB) – Preamplifier(dB).
3. Measurement (dBuV/m) = Reading(dBuV) + C.F (Correction Factor).
4. The emission levels of other frequencies are very lower than the limit and not show in test report.

EUT	Pan/Tilt AI Home Security Wi-Fi Camera	Date of Test	2023-06-28
Factor	DRH18-E	Temp. / Humidity	21°C /62%
Polarity	Horizontal	Site / Test Engineer	AC2 / Marvin
Test Mode	802.11b_TX_CH 11_ANT 0	Test Voltage	AC 120V/60Hz

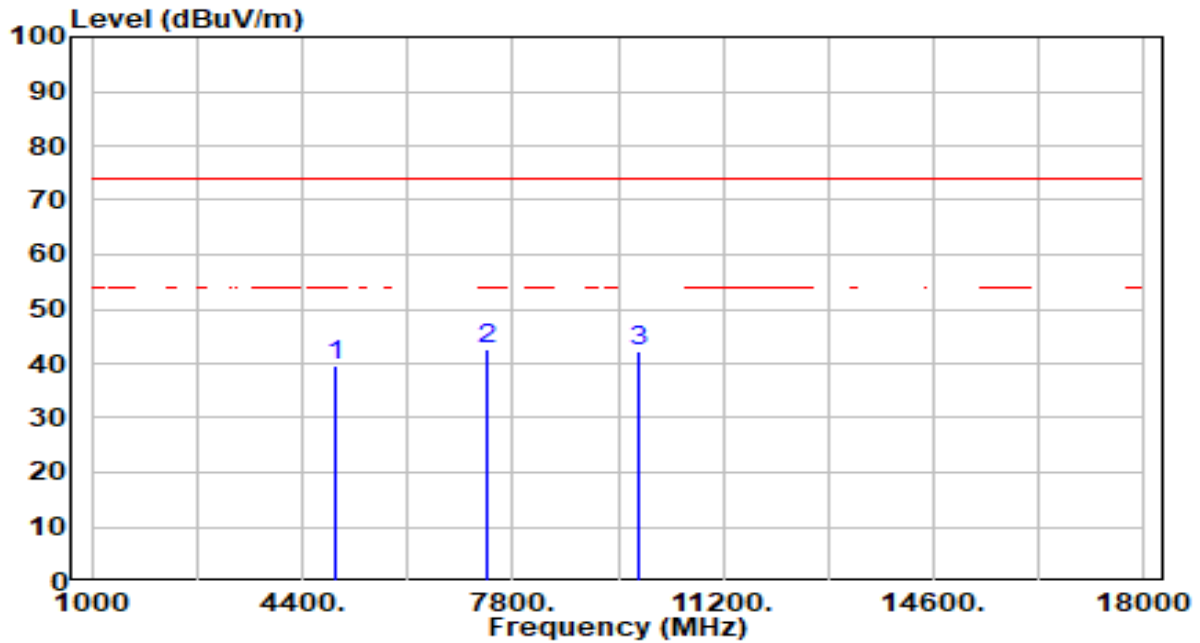

No	Frequency (MHz)	Reading (dBuV)	C.F (dB/m)	Measurement (dBuV/m)	Margin (dB)	Limit (dBuV/m)	Height (cm)	Angle (deg)	Remark (QP/PK/AV)
1	4924.000	40.42	-0.84	39.59	-34.41	74.00	300	78	Peak
2	* 7386.000	38.80	3.93	42.74	-31.26	74.00	300	0	Peak
3	9848.000	39.16	3.27	42.43	-31.57	74.00	300	124	Peak

Note:

1. " *", means this data is the worst emission level.
2. C.F (Correction Factor) = Antenna Factor (dB/m)+ Cable Loss (dB) – Preamplifier(dB).
3. Measurement (dBuV/m) = Reading(dBuV) + C.F (Correction Factor).
4. The emission levels of other frequencies are very lower than the limit and not show in test report.

EUT	Pan/Tilt AI Home Security Wi-Fi Camera	Date of Test	2023-06-28
Factor	DRH18-E	Temp. / Humidity	21°C /62%
Polarity	Vertical	Site / Test Engineer	AC2 / Marvin
Test Mode	802.11b_TX_CH 11_ANT 0	Test Voltage	AC 120V/60Hz

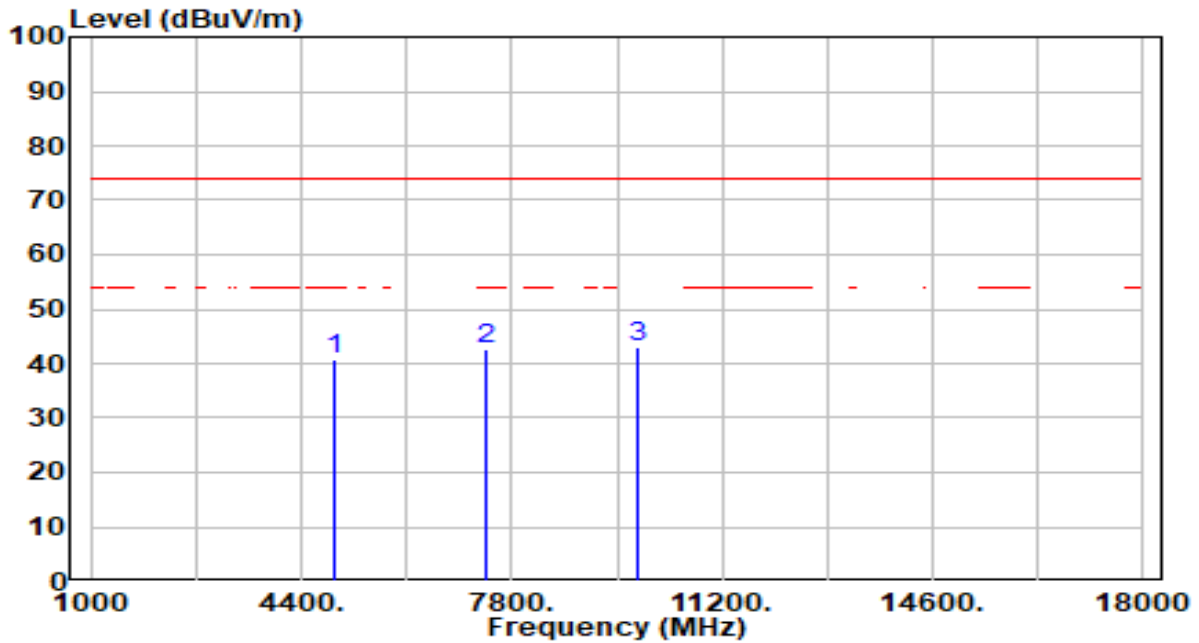

No	Frequency (MHz)	Reading (dBuV)	C.F (dB/m)	Measurement (dBuV/m)	Margin (dB)	Limit (dBuV/m)	Height (cm)	Angle (deg)	Remark (QP/PK/AV)
1	4924.000	41.76	-0.84	40.93	-33.07	74.00	118	112	Peak
2	7386.000	38.80	3.93	42.73	-31.27	74.00	118	360	Peak
3	* 9848.000	39.93	3.27	43.20	-30.80	74.00	118	158	Peak

Note:

1. " *", means this data is the worst emission level.
2. C.F (Correction Factor) = Antenna Factor (dB/m)+ Cable Loss (dB) – Pre-amplifier(dB).
3. Measurement (dBuV/m) = Reading(dBuV) + C.F (Correction Factor).
4. The emission levels of other frequencies are very lower than the limit and not show in test report.

EUT	Pan/Tilt AI Home Security Wi-Fi Camera	Date of Test	2023-06-28
Factor	DRH18-E	Temp. / Humidity	21°C /62%
Polarity	Horizontal	Site / Test Engineer	AC2 / Marvin
Test Mode	802.11g_TX_CH 1_ANT 0	Test Voltage	AC 120V/60Hz

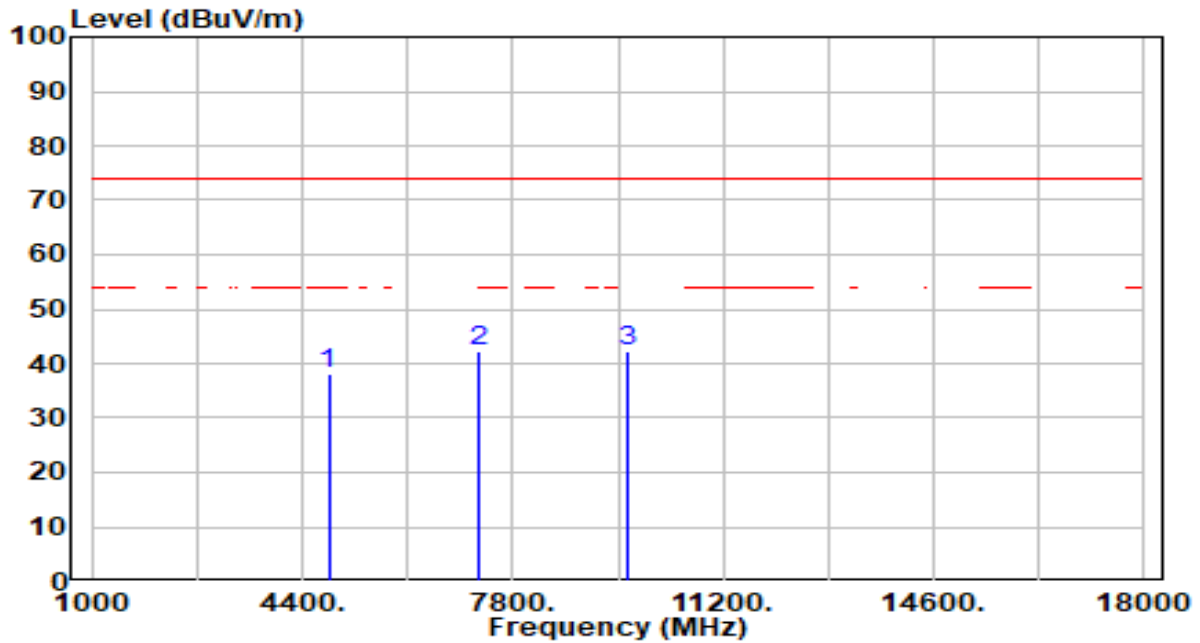

No	Frequency (MHz)	Reading (dBuV)	C.F (dB/m)	Measurement (dBuV/m)	Margin (dB)	Limit (dBuV/m)	Height (cm)	Angle (deg)	Remark (QP/PK/AV)
1	4824.000	39.11	-1.10	38.02	-35.98	74.00	300	47	Peak
2	7236.000	38.21	3.90	42.11	-31.89	74.00	300	358	Peak
3	* 9648.000	39.05	3.21	42.27	-31.73	74.00	300	354	Peak

Note:

1. " *", means this data is the worst emission level.
2. C.F (Correction Factor) = Antenna Factor (dB/m)+ Cable Loss (dB) – Preamplifier(dB).
3. Measurement (dBuV/m) = Reading(dBuV) + C.F (Correction Factor).
4. The emission levels of other frequencies are very lower than the limit and not show in test report.

EUT	Pan/Tilt AI Home Security Wi-Fi Camera	Date of Test	2023-06-28
Factor	DRH18-E	Temp. / Humidity	21°C /62%
Polarity	Vertical	Site / Test Engineer	AC2 / Marvin
Test Mode	802.11g_TX_CH 1_ANT 0	Test Voltage	AC 120V/60Hz

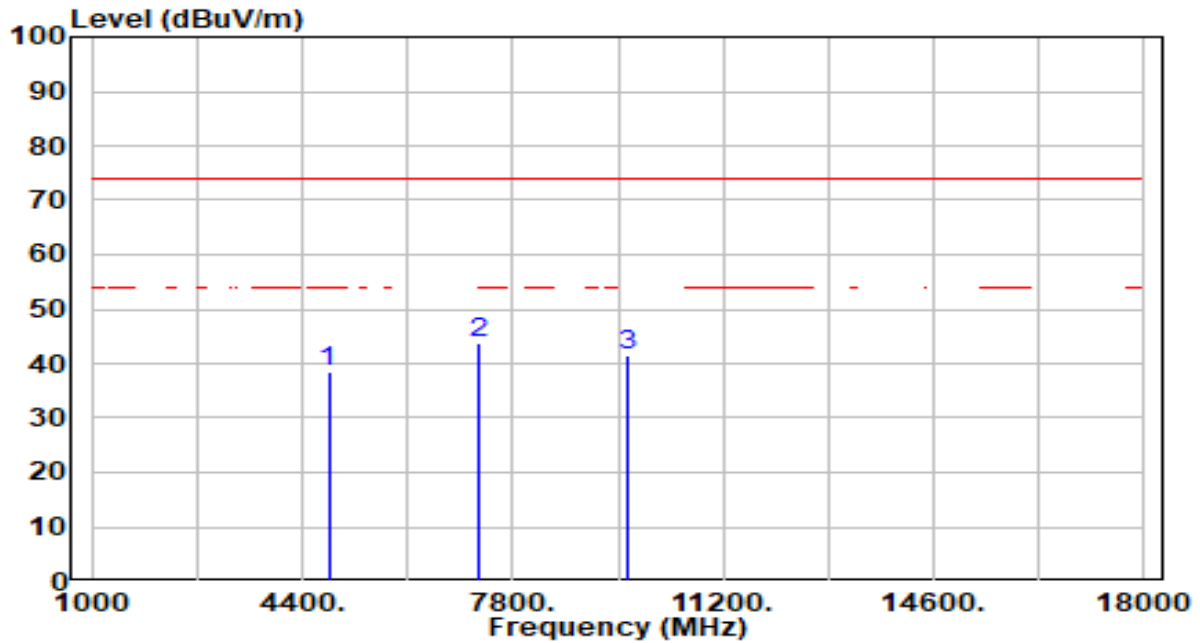

No	Frequency (MHz)	Reading (dBuV)	C.F (dB/m)	Measurement (dBuV/m)	Margin (dB)	Limit (dBuV/m)	Height (cm)	Angle (deg)	Remark (QP/PK/AV)
1	4824.000	39.55	-1.10	38.45	-35.55	74.00	118	108	Peak
2	* 7236.000	39.83	3.90	43.73	-30.27	74.00	118	0	Peak
3	9648.000	38.43	3.21	41.64	-32.36	74.00	118	360	Peak

Note:

1. " *", means this data is the worst emission level.
2. C.F (Correction Factor) = Antenna Factor (dB/m)+ Cable Loss (dB) – Preamplifier(dB).
3. Measurement (dBuV/m) = Reading(dBuV) + C.F (Correction Factor).
4. The emission levels of other frequencies are very lower than the limit and not show in test report.

EUT	Pan/Tilt AI Home Security Wi-Fi Camera	Date of Test	2023-06-28
Factor	DRH18-E	Temp. / Humidity	21°C /62%
Polarity	Horizontal	Site / Test Engineer	AC2 / Marvin
Test Mode	802.11g_TX_CH 6_ANT 0	Test Voltage	AC 120V/60Hz

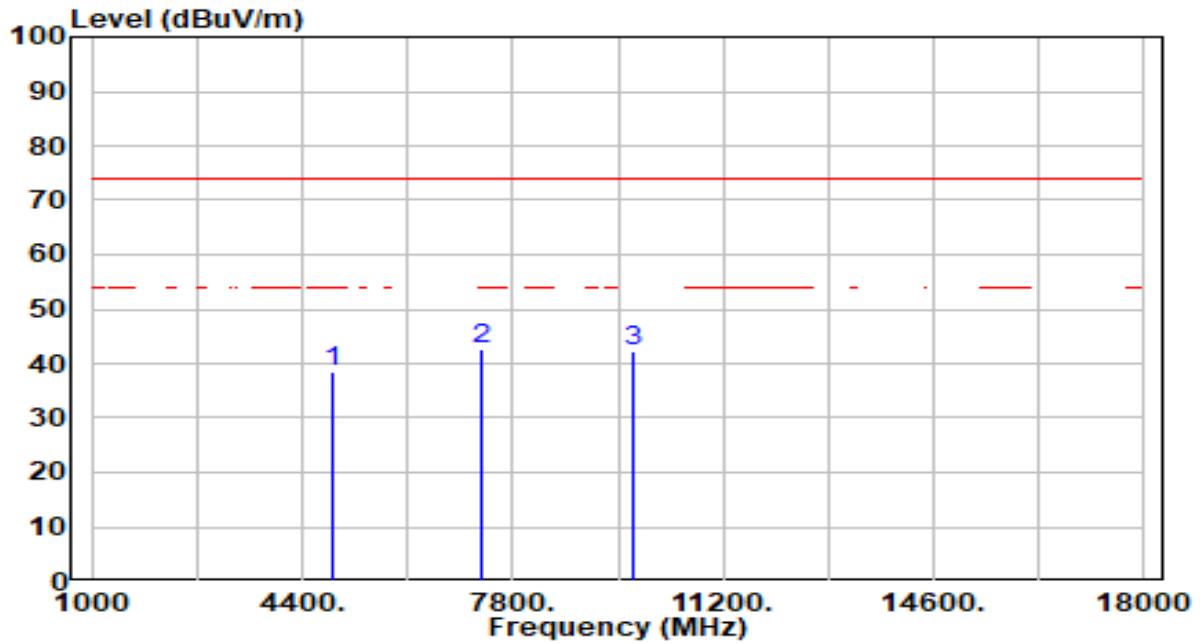

No	Frequency (MHz)	Reading (dBuV)	C.F (dB/m)	Measurement (dBuV/m)	Margin (dB)	Limit (dBuV/m)	Height (cm)	Angle (deg)	Remark (QP/PK/AV)
1	4874.000	39.53	-0.97	38.57	-35.43	74.00	300	194	Peak
2	* 7311.000	38.58	3.92	42.49	-31.51	74.00	300	323	Peak
3	9748.000	39.13	3.24	42.38	-31.62	74.00	300	346	Peak

Note:

1. " *", means this data is the worst emission level.
2. C.F (Correction Factor) = Antenna Factor (dB/m)+ Cable Loss (dB) – Preamplifier(dB).
3. Measurement (dBuV/m) = Reading(dBuV) + C.F (Correction Factor).
4. The emission levels of other frequencies are very lower than the limit and not show in test report.

EUT	Pan/Tilt AI Home Security Wi-Fi Camera	Date of Test	2023-06-28
Factor	DRH18-E	Temp. / Humidity	21°C /62%
Polarity	Vertical	Site / Test Engineer	AC2 / Marvin
Test Mode	802.11g_TX_CH 6_ANT 0	Test Voltage	AC 120V/60Hz

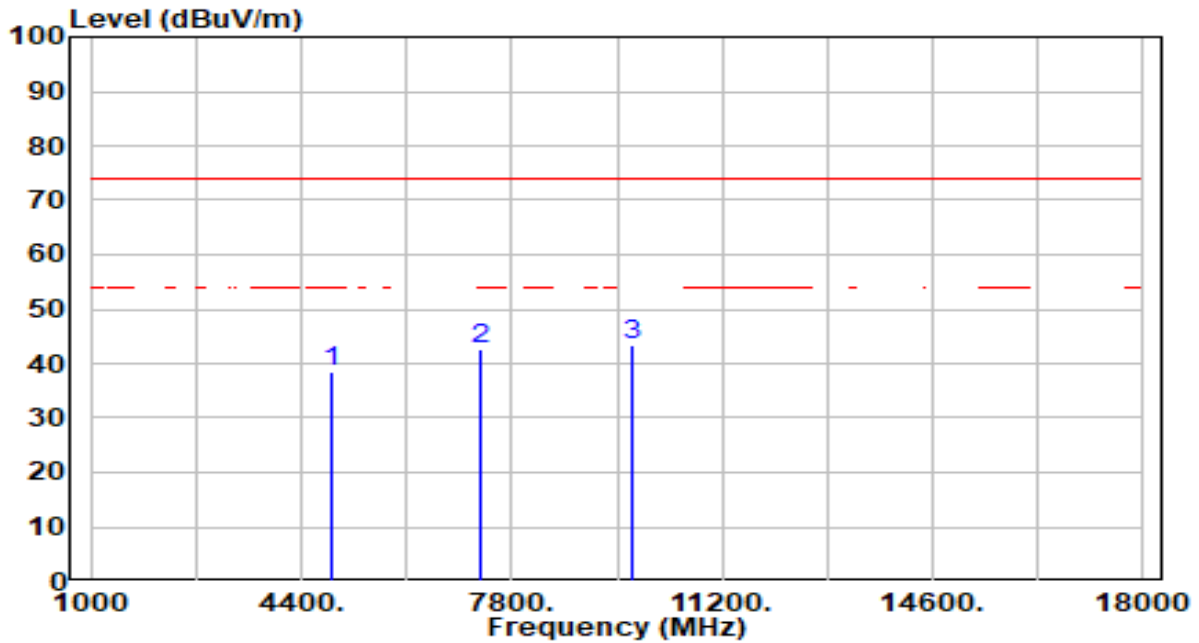

No	Frequency (MHz)	Reading (dBuV)	C.F (dB/m)	Measurement (dBuV/m)	Margin (dB)	Limit (dBuV/m)	Height (cm)	Angle (deg)	Remark (QP/PK/AV)
1	4874.000	39.44	-0.97	38.47	-35.53	74.00	118	175	Peak
2	7311.000	38.75	3.92	42.67	-31.33	74.00	118	341	Peak
3	* 9748.000	40.06	3.24	43.31	-30.69	74.00	118	360	Peak

Note:

1. " *", means this data is the worst emission level.
2. C.F (Correction Factor) = Antenna Factor (dB/m)+ Cable Loss (dB) – Preamplifier(dB).
3. Measurement (dBuV/m) = Reading(dBuV) + C.F (Correction Factor).
4. The emission levels of other frequencies are very lower than the limit and not show in test report.

EUT	Pan/Tilt AI Home Security Wi-Fi Camera	Date of Test	2023-06-28
Factor	DRH18-E	Temp. / Humidity	21°C /62%
Polarity	Horizontal	Site / Test Engineer	AC2 / Marvin
Test Mode	802.11g_TX_CH 11_ANT 0	Test Voltage	AC 120V/60Hz

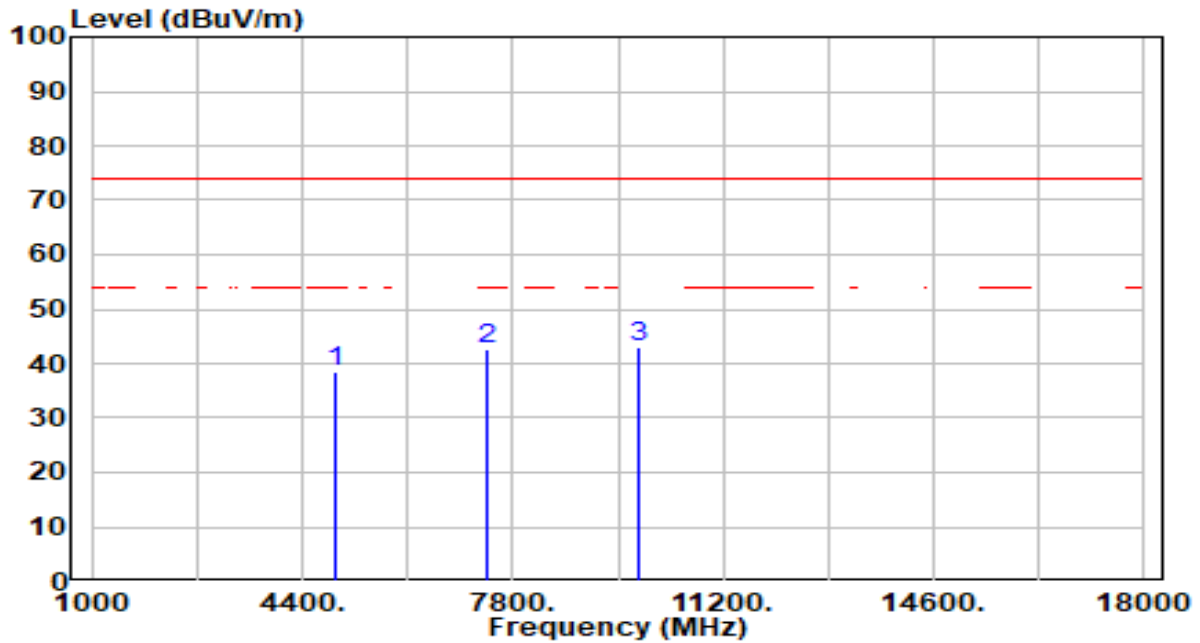

No	Frequency (MHz)	Reading (dBuV)	C.F (dB/m)	Measurement (dBuV/m)	Margin (dB)	Limit (dBuV/m)	Height (cm)	Angle (deg)	Remark (QP/PK/AV)
1	4924.000	39.30	-0.84	38.47	-35.53	74.00	300	32	Peak
2	7386.000	38.76	3.93	42.70	-31.30	74.00	119	360	Peak
3	* 9848.000	39.84	3.27	43.11	-30.89	74.00	100	96	Peak

Note:

1. " *", means this data is the worst emission level.
2. C.F (Correction Factor) = Antenna Factor (dB/m)+ Cable Loss (dB) – Preamplifier(dB).
3. Measurement (dBuV/m) = Reading(dBuV) + C.F (Correction Factor).
4. The emission levels of other frequencies are very lower than the limit and not show in test report.

EUT	Pan/Tilt AI Home Security Wi-Fi Camera	Date of Test	2023-06-28
Factor	DRH18-E	Temp. / Humidity	21°C /62%
Polarity	Vertical	Site / Test Engineer	AC2 / Marvin
Test Mode	802.11g_TX_CH 11_ANT 0	Test Voltage	AC 120V/60Hz

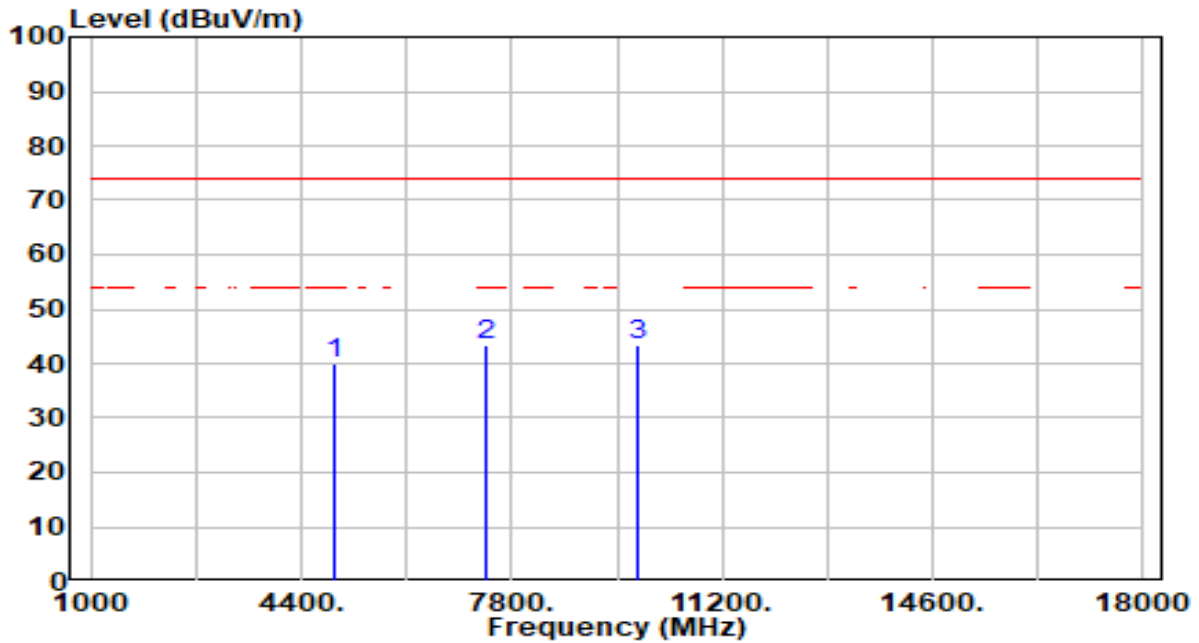

No	Frequency (MHz)	Reading (dBuV)	C.F (dB/m)	Measurement (dBuV/m)	Margin (dB)	Limit (dBuV/m)	Height (cm)	Angle (deg)	Remark (QP/PK/AV)
1	4924.000	40.75	-0.84	39.91	-34.09	74.00	200	5	Peak
2	* 7386.000	39.42	3.93	43.35	-30.65	74.00	200	360	Peak
3	9848.000	39.98	3.27	43.24	-30.76	74.00	132	360	Peak

Note:

1. " *", means this data is the worst emission level.
2. C.F (Correction Factor) = Antenna Factor (dB/m)+ Cable Loss (dB) – Preamplifier(dB).
3. Measurement (dBuV/m) = Reading(dBuV) + C.F (Correction Factor).
4. The emission levels of other frequencies are very lower than the limit and not show in test report.

EUT	Pan/Tilt AI Home Security Wi-Fi Camera	Date of Test	2023-06-28
Factor	DRH18-E	Temp. / Humidity	21°C /62%
Polarity	Horizontal	Site / Test Engineer	AC2 / Marvin
Test Mode	802.11n-20MHz_TX_CH 1_ANT 0	Test Voltage	AC 120V/60Hz

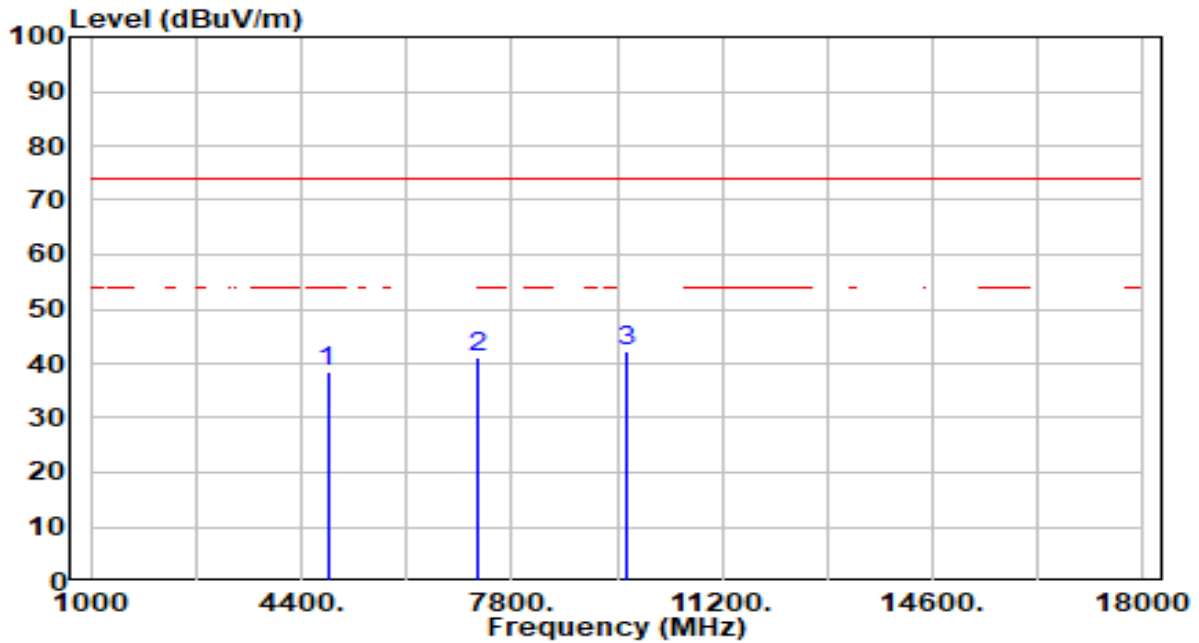

No	Frequency (MHz)	Reading (dBuV)	C.F (dB/m)	Measurement (dBuV/m)	Margin (dB)	Limit (dBuV/m)	Height (cm)	Angle (deg)	Remark (QP/PK/AV)
1	4824.000	39.61	-1.10	38.51	-35.49	74.00	200	222	Peak
2	7236.000	37.37	3.90	41.27	-32.73	74.00	200	351	Peak
3	* 9648.000	38.93	3.21	42.14	-31.86	74.00	200	60	Peak

Note:

1. " *", means this data is the worst emission level.
2. C.F (Correction Factor) = Antenna Factor (dB/m)+ Cable Loss (dB) – Preamplifier(dB).
3. Measurement (dBuV/m) = Reading(dBuV) + C.F (Correction Factor).
4. The emission levels of other frequencies are very lower than the limit and not show in test report.

EUT	Pan/Tilt AI Home Security Wi-Fi Camera	Date of Test	2023-06-28
Factor	DRH18-E	Temp. / Humidity	21°C /62%
Polarity	Vertical	Site / Test Engineer	AC2 / Marvin
Test Mode	802.11n-20MHz_TX_CH 1_ANT 0	Test Voltage	AC 120V/60Hz

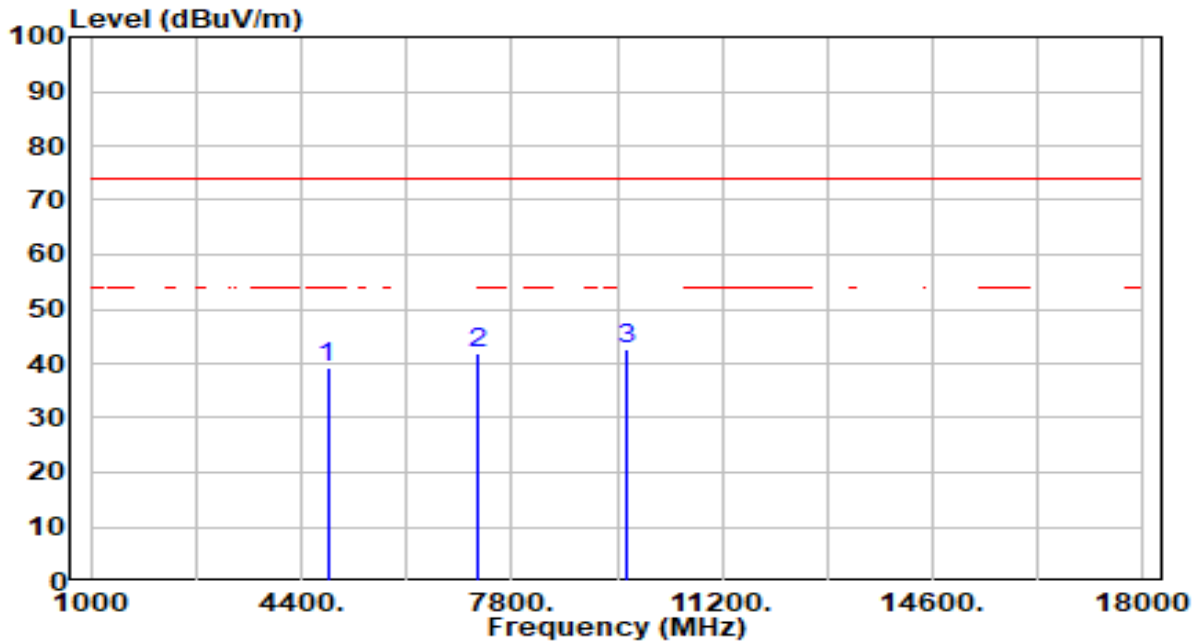

No	Frequency (MHz)	Reading (dBuV)	C.F (dB/m)	Measurement (dBuV/m)	Margin (dB)	Limit (dBuV/m)	Height (cm)	Angle (deg)	Remark (QP/PK/AV)
1	4824.000	40.24	-1.10	39.14	-34.86	74.00	200	360	Peak
2	7236.000	37.99	3.90	41.89	-32.11	74.00	200	92	Peak
3	* 9648.000	39.52	3.21	42.74	-31.26	74.00	200	360	Peak

Note:

1. " *", means this data is the worst emission level.
2. C.F (Correction Factor) = Antenna Factor (dB/m)+ Cable Loss (dB) – Preamplifier(dB).
3. Measurement (dBuV/m) = Reading(dBuV) + C.F (Correction Factor).
4. The emission levels of other frequencies are very lower than the limit and not show in test report.

EUT	Pan/Tilt AI Home Security Wi-Fi Camera	Date of Test	2023-06-28
Factor	DRH18-E	Temp. / Humidity	21°C /62%
Polarity	Horizontal	Site / Test Engineer	AC2 / Marvin
Test Mode	802.11n-20MHz_TX_CH 6_ANT 0	Test Voltage	AC 120V/60Hz

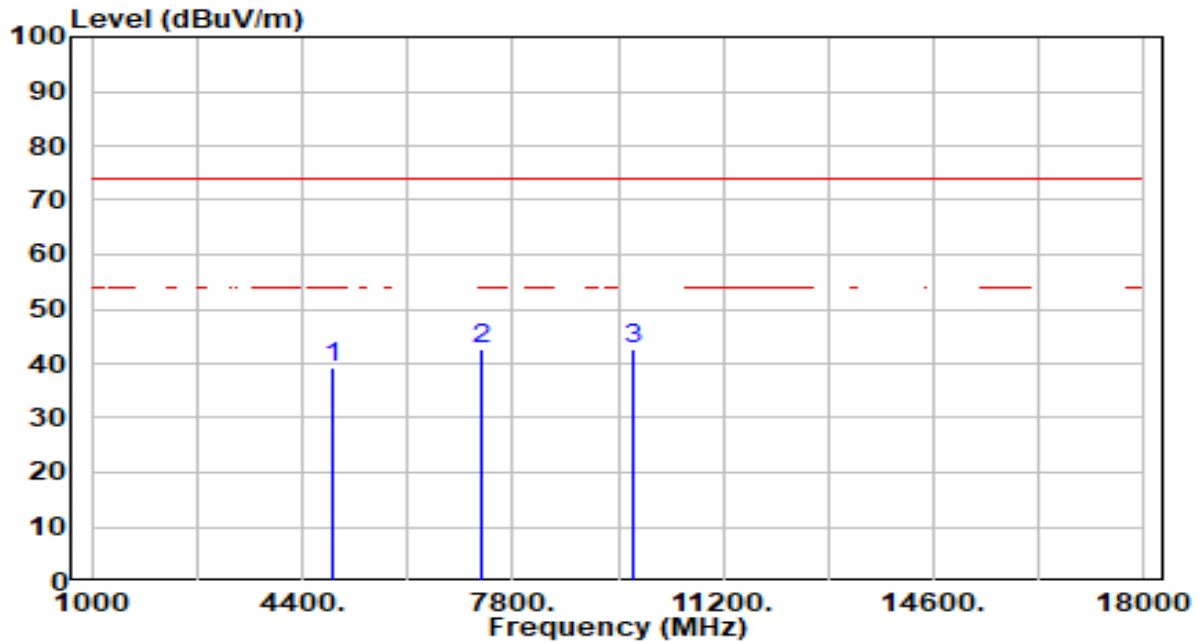

No	Frequency (MHz)	Reading (dBuV)	C.F (dB/m)	Measurement (dBuV/m)	Margin (dB)	Limit (dBuV/m)	Height (cm)	Angle (deg)	Remark (QP/PK/AV)
1	4874.000	40.29	-0.97	39.33	-34.67	74.00	200	186	Peak
2	7311.000	38.61	3.92	42.53	-31.47	74.00	200	352	Peak
3	* 9748.000	39.32	3.24	42.56	-31.44	74.00	200	153	Peak

Note:

1. " *", means this data is the worst emission level.
2. C.F (Correction Factor) = Antenna Factor (dB/m)+ Cable Loss (dB) – Preamplifier(dB).
3. Measurement (dBuV/m) = Reading(dBuV) + C.F (Correction Factor).
4. The emission levels of other frequencies are very lower than the limit and not show in test report.

EUT	Pan/Tilt AI Home Security Wi-Fi Camera	Date of Test	2023-06-28
Factor	DRH18-E	Temp. / Humidity	21°C /62%
Polarity	Vertical	Site / Test Engineer	AC2 / Marvin
Test Mode	802.11n-20MHz_TX_CH 6_ANT 0	Test Voltage	AC 120V/60Hz

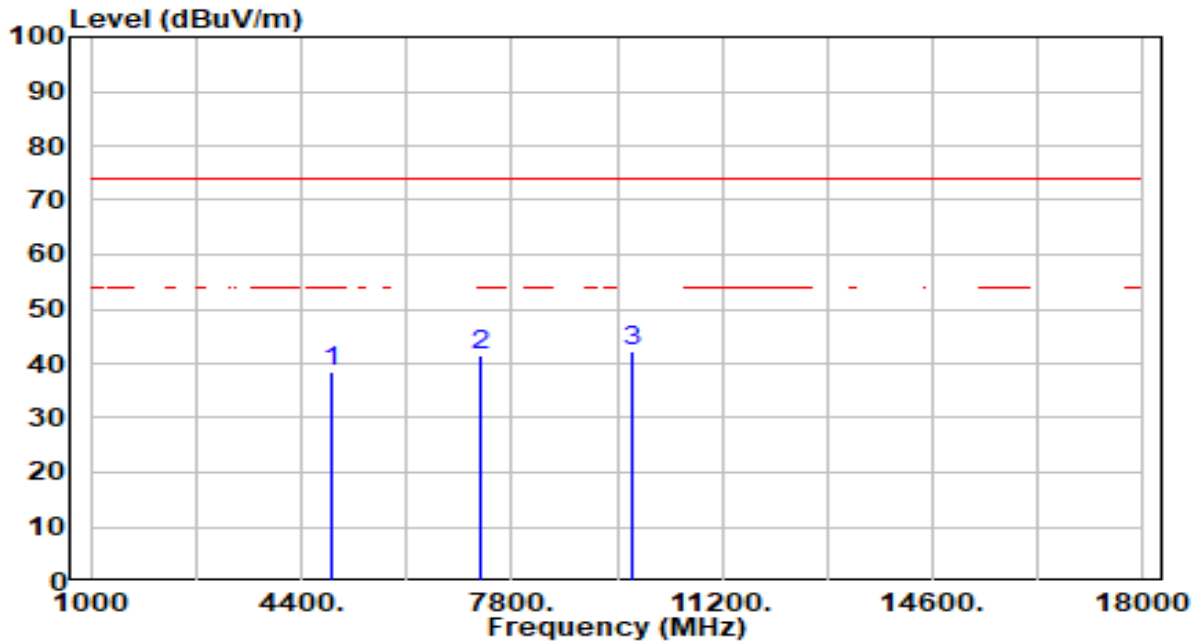

No	Frequency (MHz)	Reading (dBuV)	C.F (dB/m)	Measurement (dBuV/m)	Margin (dB)	Limit (dBuV/m)	Height (cm)	Angle (deg)	Remark (QP/PK/AV)
1	4874.000	39.57	-0.97	38.60	-35.40	74.00	200	222	Peak
2	7311.000	37.54	3.92	41.46	-32.54	74.00	200	309	Peak
3	* 9748.000	39.12	3.24	42.37	-31.63	74.00	200	249	Peak

Note:

1. " *", means this data is the worst emission level.
2. C.F (Correction Factor) = Antenna Factor (dB/m)+ Cable Loss (dB) – Preamplifier(dB).
3. Measurement (dBuV/m) = Reading(dBuV) + C.F (Correction Factor).
4. The emission levels of other frequencies are very lower than the limit and not show in test report.

EUT	Pan/Tilt AI Home Security Wi-Fi Camera	Date of Test	2023-06-28
Factor	DRH18-E	Temp. / Humidity	21°C /62%
Polarity	Horizontal	Site / Test Engineer	AC2 / Marvin
Test Mode	802.11n-20MHz_TX_CH 11_ANT 0	Test Voltage	AC 120V/60Hz

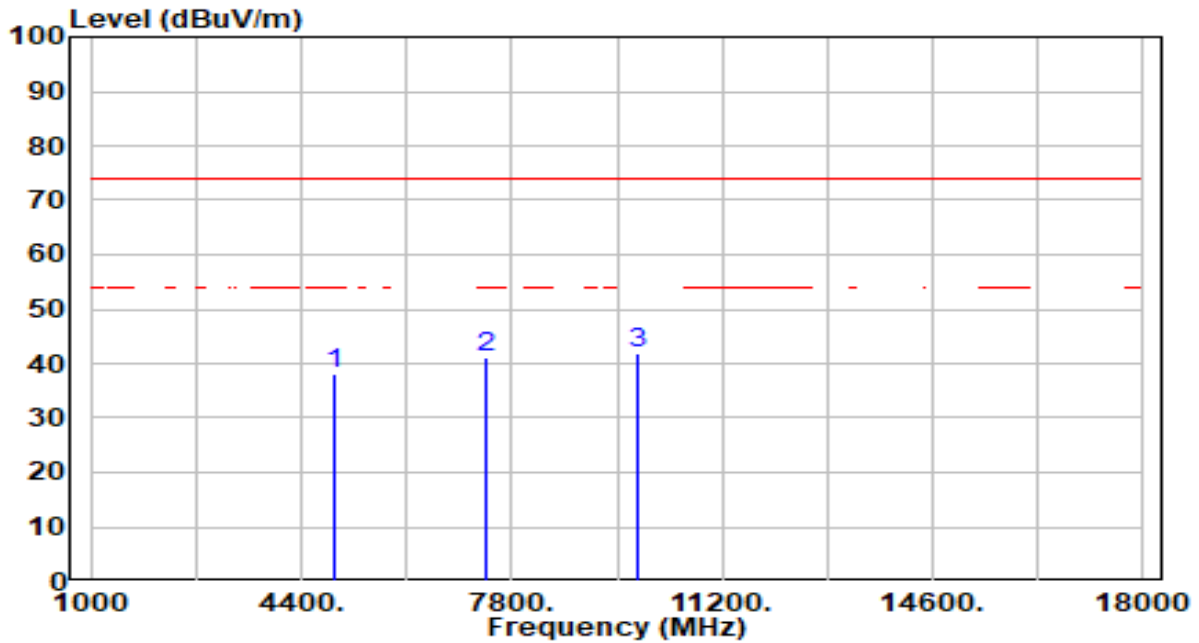

No	Frequency (MHz)	Reading (dBuV)	C.F (dB/m)	Measurement (dBuV/m)	Margin (dB)	Limit (dBuV/m)	Height (cm)	Angle (deg)	Remark (QP/PK/AV)
1	4924.000	38.85	-0.84	38.02	-35.98	74.00	200	358	Peak
2	7386.000	37.34	3.93	41.27	-32.73	74.00	200	158	Peak
3	* 9848.000	38.76	3.27	42.03	-31.97	74.00	200	0	Peak

Note:

1. " *", means this data is the worst emission level.
2. C.F (Correction Factor) = Antenna Factor (dB/m)+ Cable Loss (dB) – Pre-amplifier(dB).
3. Measurement (dBuV/m) = Reading(dBuV) + C.F (Correction Factor).
4. The emission levels of other frequencies are very lower than the limit and not show in test report.

EUT	Pan/Tilt AI Home Security Wi-Fi Camera	Date of Test	2023-06-28
Factor	DRH18-E	Temp. / Humidity	21°C /62%
Polarity	Vertical	Site / Test Engineer	AC2 / Marvin
Test Mode	802.11n-20MHz_TX_CH 11_ANT 0	Test Voltage	AC 120V/60Hz

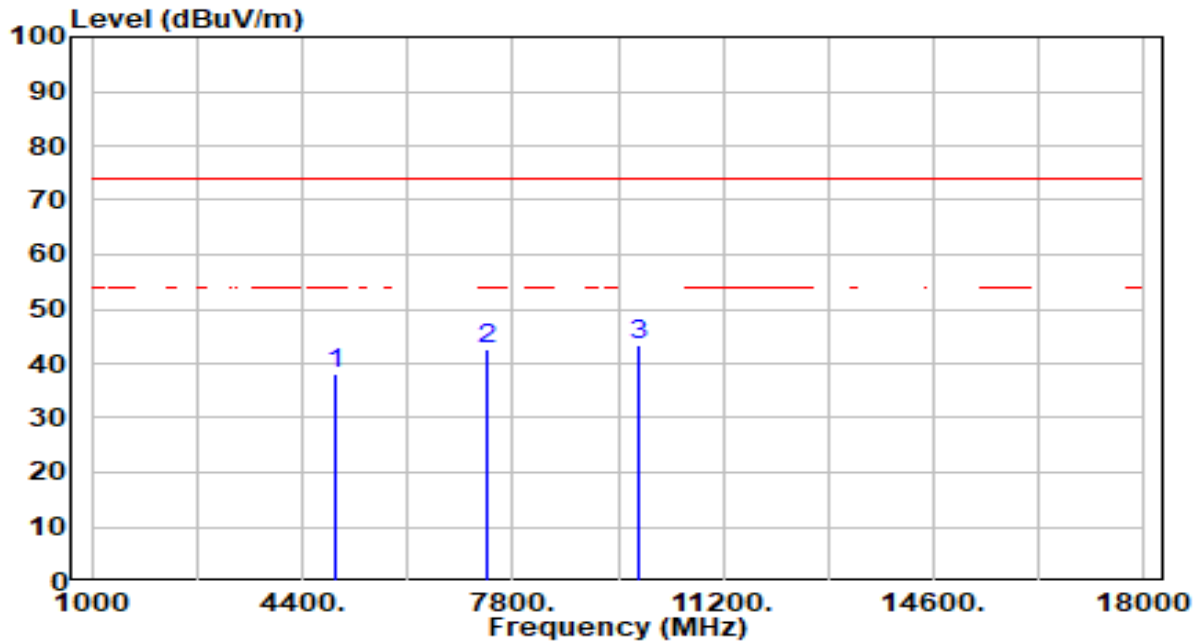

No	Frequency (MHz)	Reading (dBuV)	C.F (dB/m)	Measurement (dBuV/m)	Margin (dB)	Limit (dBuV/m)	Height (cm)	Angle (deg)	Remark (QP/PK/AV)
1	4924.000	38.98	-0.84	38.14	-35.86	74.00	200	27	Peak
2	7386.000	38.64	3.93	42.58	-31.42	74.00	200	351	Peak
3	* 9848.000	40.20	3.27	43.47	-30.53	74.00	200	360	Peak

Note:

1. " *", means this data is the worst emission level.
2. C.F (Correction Factor) = Antenna Factor (dB/m)+ Cable Loss (dB) – Pre-amplifier(dB).
3. Measurement (dBuV/m) = Reading(dBuV) + C.F (Correction Factor).
4. The emission levels of other frequencies are very lower than the limit and not show in test report.

EUT	Pan/Tilt AI Home Security Wi-Fi Camera	Date of Test	2023-06-28
Factor	DRH18-E	Temp. / Humidity	21°C /62%
Polarity	Horizontal	Site / Test Engineer	AC2 / Marvin
Test Mode	802.11ax-20MHz_TX_CH 1_ANT 0	Test Voltage	AC 120V/60Hz

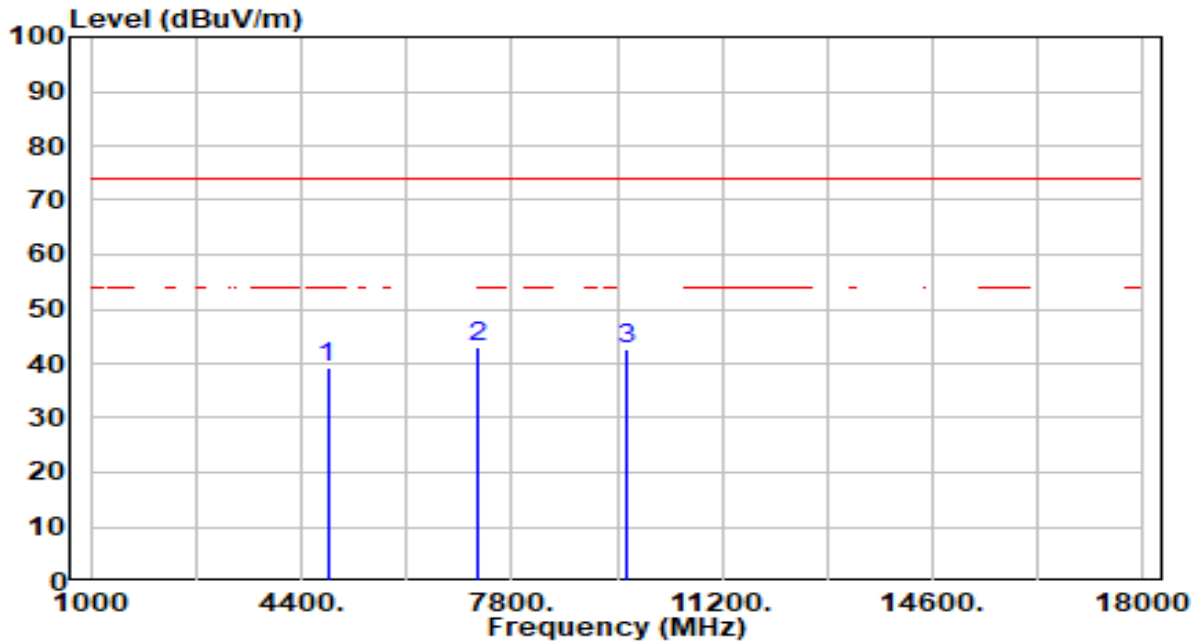

No	Frequency (MHz)	Reading (dBuV)	C.F (dB/m)	Measurement (dBuV/m)	Margin (dB)	Limit (dBuV/m)	Height (cm)	Angle (deg)	Remark (QP/PK/AV)
1	4824.000	40.52	-1.10	39.42	-34.58	74.00	200	130	Peak
2	* 7236.000	39.18	3.90	43.08	-30.92	74.00	200	15	Peak
3	9648.000	39.27	3.21	42.48	-31.52	74.00	200	0	Peak

Note:

- "*" means this data is the worst emission level.
- C.F (Correction Factor) = Antenna Factor (dB/m)+ Cable Loss (dB) – Preamplifier(dB).
- Measurement (dBuV/m) = Reading(dBuV) + C.F (Correction Factor).
- The emission levels of other frequencies are very lower than the limit and not show in test report.

EUT	Pan/Tilt AI Home Security Wi-Fi Camera	Date of Test	2023-06-28
Factor	DRH18-E	Temp. / Humidity	21°C /62%
Polarity	Vertical	Site / Test Engineer	AC2 / Marvin
Test Mode	802.11ax-20MHz_TX_CH 1_ANT 0	Test Voltage	AC 120V/60Hz

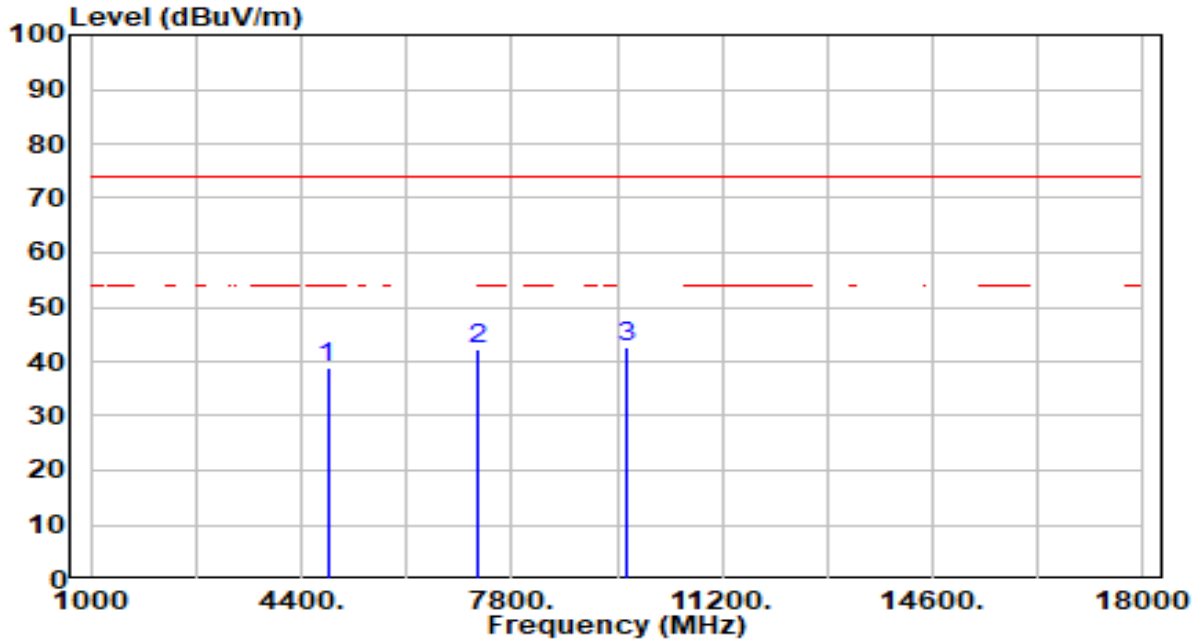

No	Frequency (MHz)	Reading (dBuV)	C.F (dB/m)	Measurement (dBuV/m)	Margin (dB)	Limit (dBuV/m)	Height (cm)	Angle (deg)	Remark (QP/PK/AV)
1	4824.000	39.90	-1.10	38.80	-35.20	74.00	200	309	Peak
2	7236.000	38.52	3.90	42.42	-31.58	74.00	200	129	Peak
3	* 9648.000	39.38	3.21	42.59	-31.41	74.00	200	166	Peak

Note:

1. " *", means this data is the worst emission level.
2. C.F (Correction Factor) = Antenna Factor (dB/m)+ Cable Loss (dB) – Preamplifier(dB).
3. Measurement (dBuV/m) = Reading(dBuV) + C.F (Correction Factor).
4. The emission levels of other frequencies are very lower than the limit and not show in test report.

EUT	Pan/Tilt AI Home Security Wi-Fi Camera	Date of Test	2023-06-28
Factor	DRH18-E	Temp. / Humidity	21°C /62%
Polarity	Horizontal	Site / Test Engineer	AC2 / Marvin
Test Mode	802.11ax-20MHz_TX_CH 6_ANT 0	Test Voltage	AC 120V/60Hz

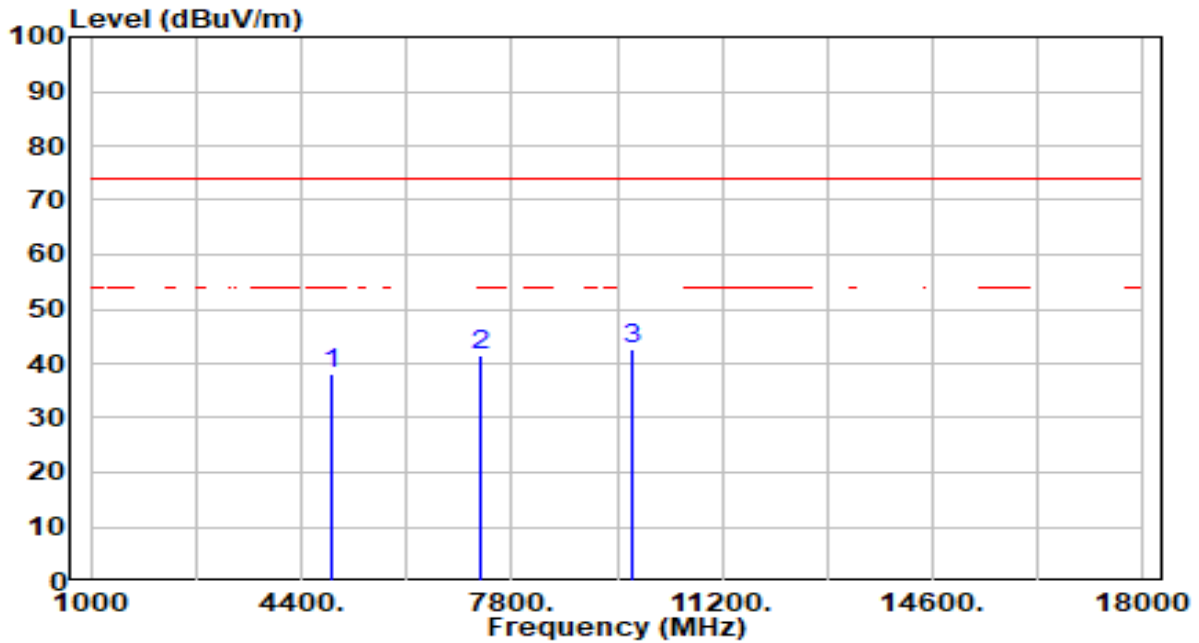

No	Frequency (MHz)	Reading (dBuV)	C.F (dB/m)	Measurement (dBuV/m)	Margin (dB)	Limit (dBuV/m)	Height (cm)	Angle (deg)	Remark (QP/PK/AV)
1	4874.000	39.25	-0.97	38.29	-35.71	74.00	200	341	Peak
2	7311.000	37.69	3.92	41.61	-32.39	74.00	200	33	Peak
3	* 9748.000	39.44	3.24	42.68	-31.32	74.00	200	158	Peak

Note:

1. " *", means this data is the worst emission level.
2. C.F (Correction Factor) = Antenna Factor (dB/m)+ Cable Loss (dB) – Pre-amplifier(dB).
3. Measurement (dBuV/m) = Reading(dBuV) + C.F (Correction Factor).
4. The emission levels of other frequencies are very lower than the limit and not show in test report.

EUT	Pan/Tilt AI Home Security Wi-Fi Camera	Date of Test	2023-06-28
Factor	DRH18-E	Temp. / Humidity	21°C /62%
Polarity	Vertical	Site / Test Engineer	AC2 / Marvin
Test Mode	802.11ax-20MHz_TX_CH 6_ANT 0	Test Voltage	AC 120V/60Hz

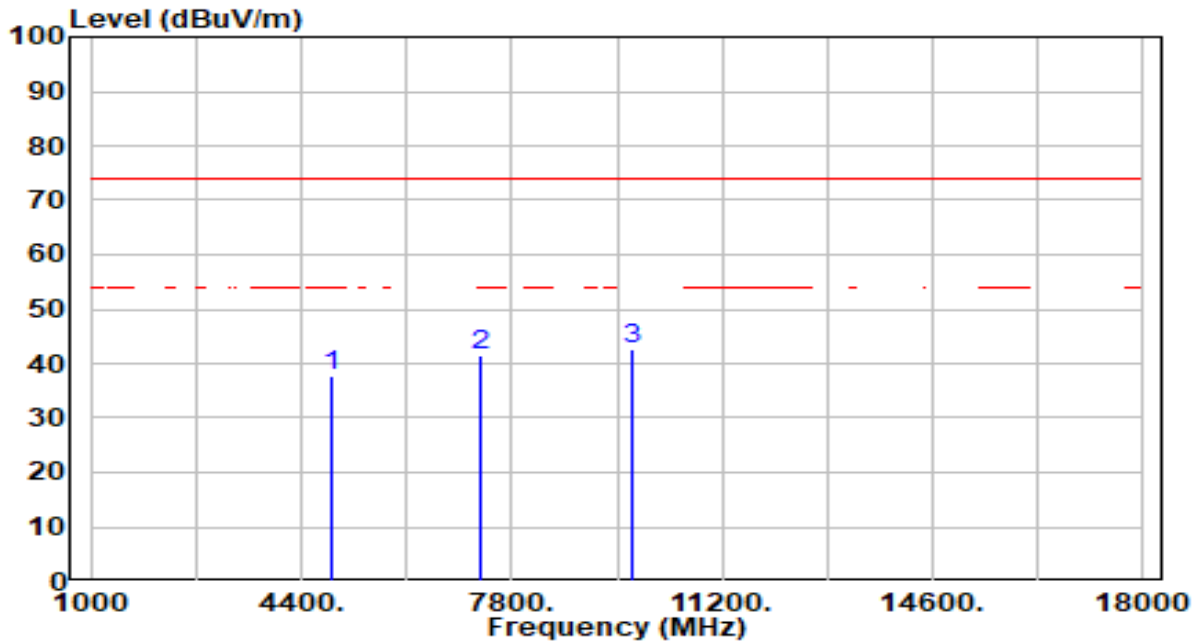

No	Frequency (MHz)	Reading (dBuV)	C.F (dB/m)	Measurement (dBuV/m)	Margin (dB)	Limit (dBuV/m)	Height (cm)	Angle (deg)	Remark (QP/PK/AV)
1	4874.000	38.79	-0.97	37.82	-36.18	74.00	200	360	Peak
2	7311.000	37.70	3.92	41.62	-32.38	74.00	200	309	Peak
3	* 9748.000	39.47	3.24	42.71	-31.29	74.00	200	277	Peak

Note:

1. " *", means this data is the worst emission level.
2. C.F (Correction Factor) = Antenna Factor (dB/m)+ Cable Loss (dB) – Pre-amplifier(dB).
3. Measurement (dBuV/m) = Reading(dBuV) + C.F (Correction Factor).
4. The emission levels of other frequencies are very lower than the limit and not show in test report.

EUT	Pan/Tilt AI Home Security Wi-Fi Camera	Date of Test	2023-06-28
Factor	DRH18-E	Temp. / Humidity	21°C /62%
Polarity	Horizontal	Site / Test Engineer	AC2 / Marvin
Test Mode	802.11ax-20MHz_TX_CH 11_ANT 0	Test Voltage	AC 120V/60Hz

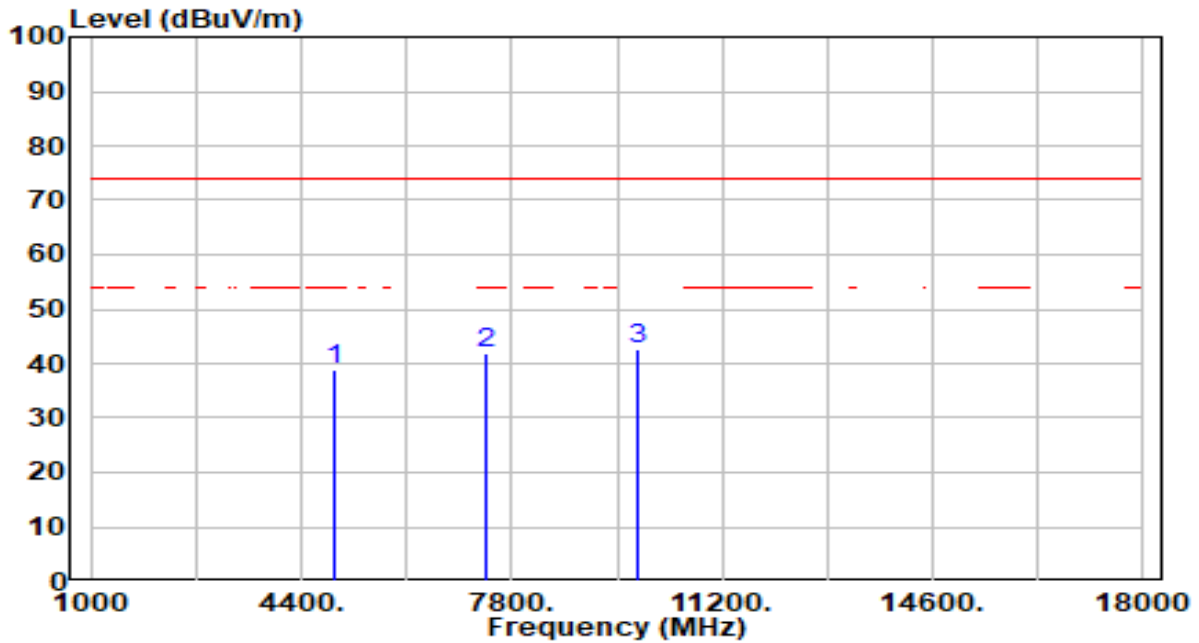

No	Frequency (MHz)	Reading (dBuV)	C.F (dB/m)	Measurement (dBuV/m)	Margin (dB)	Limit (dBuV/m)	Height (cm)	Angle (deg)	Remark (QP/PK/AV)
1	4924.000	39.60	-0.84	38.77	-35.23	74.00	200	37	Peak
2	7386.000	37.82	3.93	41.76	-32.24	74.00	200	272	Peak
3	* 9848.000	39.51	3.27	42.78	-31.22	74.00	200	42	Peak

Note:

1. " *", means this data is the worst emission level.
2. C.F (Correction Factor) = Antenna Factor (dB/m)+ Cable Loss (dB) – Pre-amplifier(dB).
3. Measurement (dBuV/m) = Reading(dBuV) + C.F (Correction Factor).
4. The emission levels of other frequencies are very lower than the limit and not show in test report.

EUT	Pan/Tilt AI Home Security Wi-Fi Camera	Date of Test	2023-06-28
Factor	DRH18-E	Temp. / Humidity	21°C /62%
Polarity	Vertical	Site / Test Engineer	AC2 / Marvin
Test Mode	802.11ax-20MHz_TX_CH 11_ANT 0	Test Voltage	AC 120V/60Hz

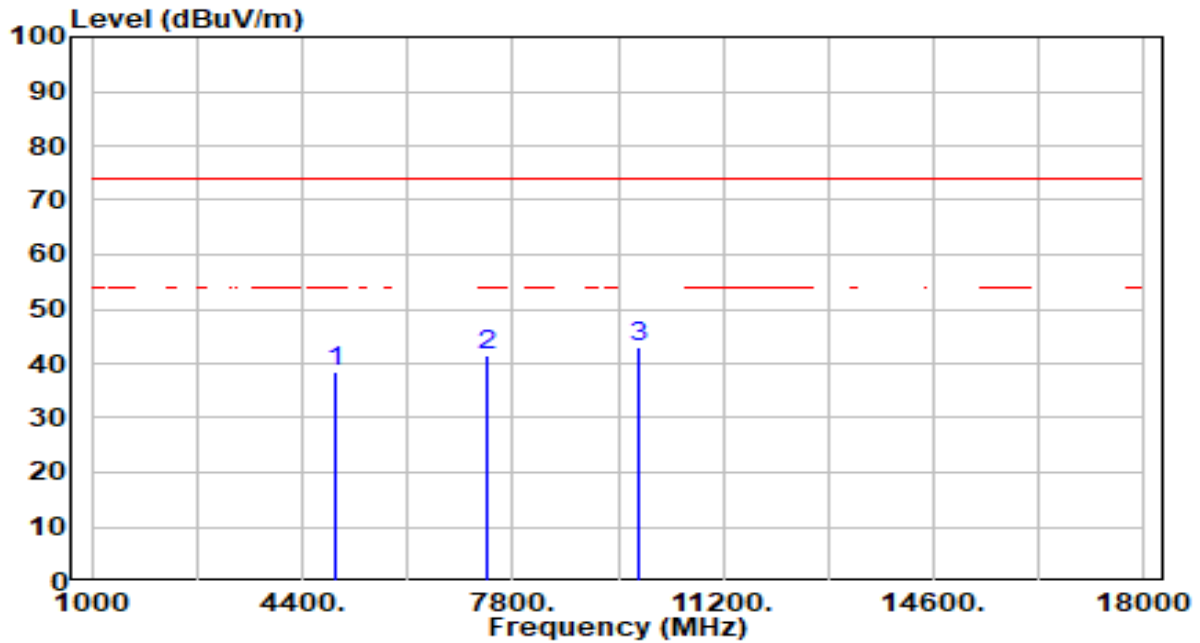

No	Frequency (MHz)	Reading (dBuV)	C.F (dB/m)	Measurement (dBuV/m)	Margin (dB)	Limit (dBuV/m)	Height (cm)	Angle (deg)	Remark (QP/PK/AV)
1	4924.000	39.30	-0.84	38.47	-35.53	74.00	200	88	Peak
2	7386.000	37.40	3.93	41.33	-32.67	74.00	200	360	Peak
3	* 9848.000	39.68	3.27	42.95	-31.05	74.00	200	245	Peak

Note:

1. " *", means this data is the worst emission level.
2. C.F (Correction Factor) = Antenna Factor (dB/m)+ Cable Loss (dB) – Pre-amplifier(dB).
3. Measurement (dBuV/m) = Reading(dBuV) + C.F (Correction Factor).
4. The emission levels of other frequencies are very lower than the limit and not show in test report.

7.7. Radiated Restricted Band Edge Measurement

7.7.1. Test Limit

For 15.205 requirement:

Radiated emissions which fall in the restricted bands, as defined in Section 15.205(a) of FCC part 15, must also comply with the radiated emission limits specified in Section 15.209(a).

Frequency (MHz)	Frequency (MHz)	Frequency (MHz)	Frequency (GHz)
0.090 - 0.110	16.42 - 16.423	399.9 - 410	4.5 - 5.15
¹ 0.495 - 0.505	16.69475 - 16.69525	608 - 614	5.35 - 5.46
2.1735 - 2.1905	16.80425 - 16.80475	960 - 1240	7.25 - 7.75
4.125 - 4.128	25.5 - 25.67	1300 - 1427	8.025 - 8.5
4.17725 - 4.17775	37.5 - 38.25	1435 - 1626.5	9.0 - 9.2
4.20725 - 4.20775	73 - 74.6	1645.5 - 1646.5	9.3 - 9.5
6.215 - 6.218	74.8 - 75.2	1660 - 1710	10.6 - 12.7
6.26775 - 6.26825	108 - 121.94	1718.8 - 1722.2	13.25 - 13.4
6.31175 - 6.31225	123 - 138	2200 - 2300	14.47 - 14.5
8.291 - 8.294	149.9 - 150.05	2310 - 2390	15.35 - 16.2
8.362 - 8.366	156.52475 - 156.52525	2483.5 - 2500	17.7 - 21.4
8.37625 - 8.38675	156.7 - 156.9	2690 - 2900	22.01 - 23.12
8.41425 - 8.41475	162.0125 - 167.17	3260 - 3267	23.6 - 24.0
12.29 - 12.293	167.72 - 173.2	3332 - 3339	31.2 - 31.8
12.51975 - 12.52025	240 - 285	3345.8 - 3358	36.43 - 36.5
12.57675 - 12.57725	322 - 335.4	3600 - 4400	(²)
13.36 - 13.41	--	--	--

All out of band emissions appearing in a restricted band as specified in Section 15.205 of the Title 47CFR must not exceed the limits shown in Table per Section 15.209.

FCC Part 15 Subpart C Paragraph 15.209 Limits		
Frequency [MHz]	Field Strength [uV/m]	Measured Distance [Meters]
0.009 - 0.490	2400/F (kHz)	300
0.490 - 1.705	24000/F (kHz)	30
1.705 - 30	30	30
30 - 88	100	3
88 - 216	150	3
216 - 960	200	3
Above 960	500	3

7.7.2. Test Procedure Used

ANSI C63.10 - 2013 Section 6.3 (General Requirements)

ANSI C63.10 - 2013 Section 6.6 (Standard test method above 1GHz)

7.7.3. Test Setting

Peak Field Strength Measurements

1. Analyzer center frequency was set to the frequency of the radiated spurious emission of interest
2. RBW = 1MHz
3. VBW = 3MHz
4. Detector = peak
5. Sweep time = auto couple
6. Trace mode = max hold
7. Trace was allowed to stabilize

Average Measurements above 1GHz (Method VB)

1. Analyzer center frequency was set to the frequency of the radiated spurious emission of interest
2. RBW = 1MHz
3. VBW; If the EUT is configured to transmit with duty cycle $\geq 98\%$, set VBW = 10 Hz.

If the EUT duty cycle is $< 98\%$, set $VBW \geq 1/T$. T is the minimum transmission duration.

4. Detector = Peak
5. Sweep time = auto
6. Trace mode = max hold
7. Trace was allowed to stabilize

7.7.4. Test Setup

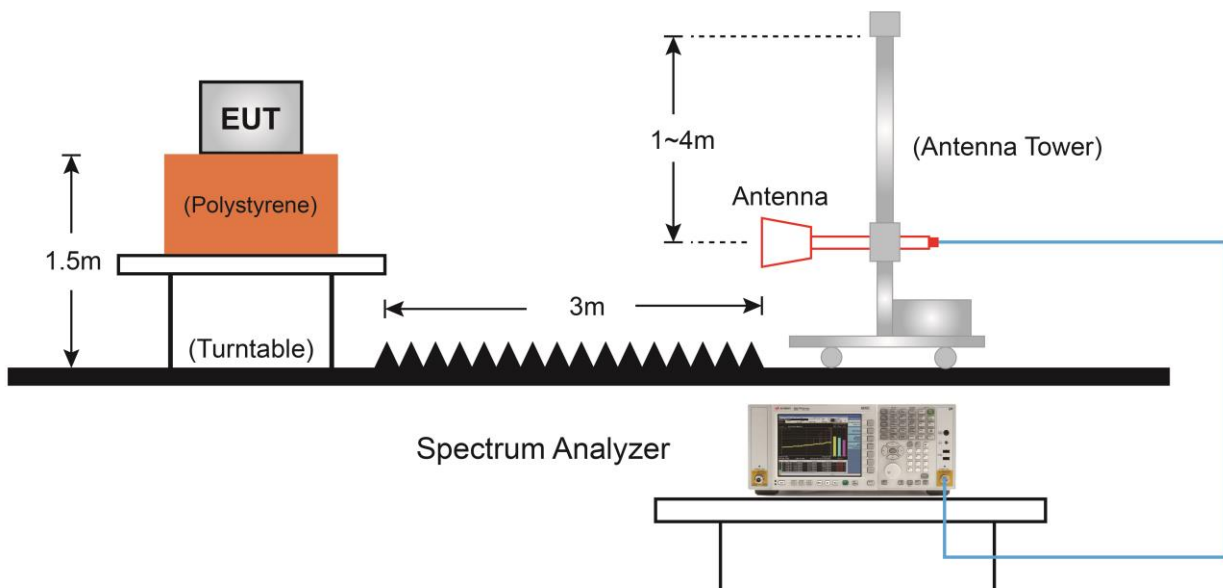

7.7.5. Test Result

EUT	Pan/Tilt AI Home Security Wi-Fi Camera	Date of Test	2023-06-28
Factor	DRH18-E	Temp. / Humidity	21°C /62%
Polarity	Horizontal	Site / Test Engineer	AC2 / Marvin
Test Mode	802.11b_TX_CH 1_ANT 0	Test Voltage	AC 120V/60Hz

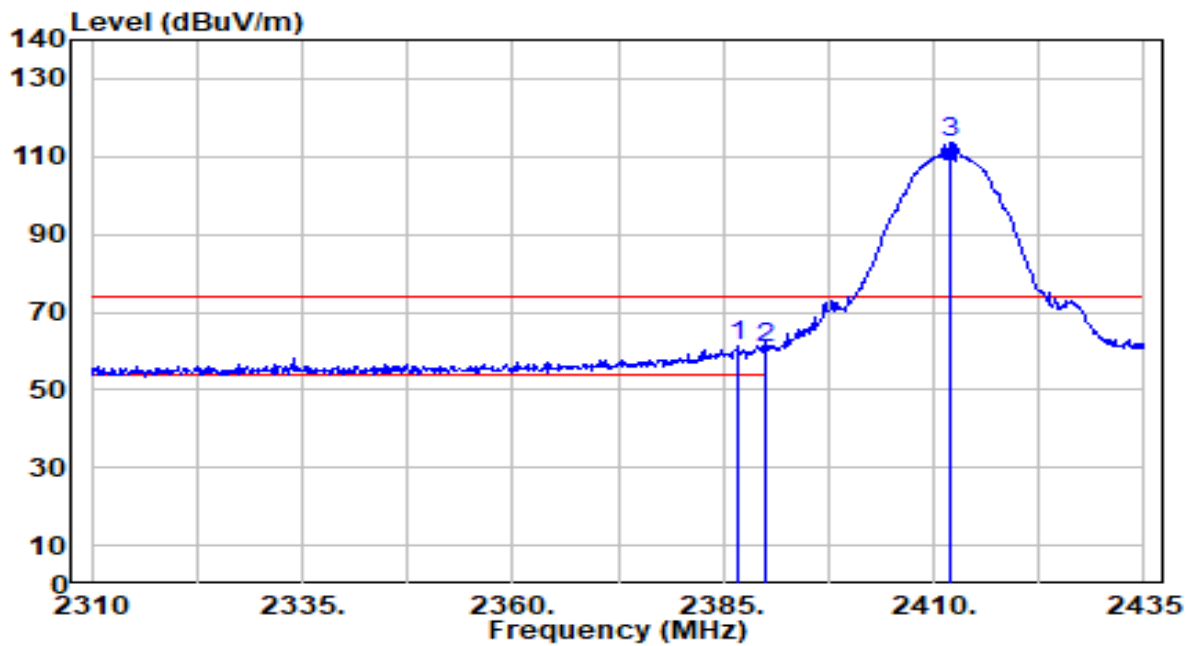

No	Frequency (MHz)	Reading (dBUV)	C.F (dB/m)	Measurement (dBUV/m)	Margin (dB)	Limit (dBUV/m)	Height (cm)	Angle (deg)	Remark (QP/PK/AV)	
1	*	2386.750	31.15	30.17	61.32	-12.68	74.00	105	228	Peak
2		2390.000	30.79	30.18	60.97	-13.03	74.00	105	228	Peak
3		2412.000	83.53	30.22	113.76	N/A	N/A	105	228	Peak

Note:

1. " *", means this data is the worst emission level.
2. C.F (Correction Factor) = Antenna Factor (dB/m)+ Cable Loss (dB).
3. Measurement (dBUV/m) = Reading(dBUV) + C.F (Correction Factor).
4. The emission levels of other frequencies are very lower than the limit and not show in test report.

EUT	Pan/Tilt AI Home Security Wi-Fi Camera	Date of Test	2023-06-28
Factor	DRH18-E	Temp. / Humidity	21°C /62%
Polarity	Horizontal	Site / Test Engineer	AC2 / Marvin
Test Mode	802.11b_TX_CH 1_ANT 0	Test Voltage	AC 120V/60Hz

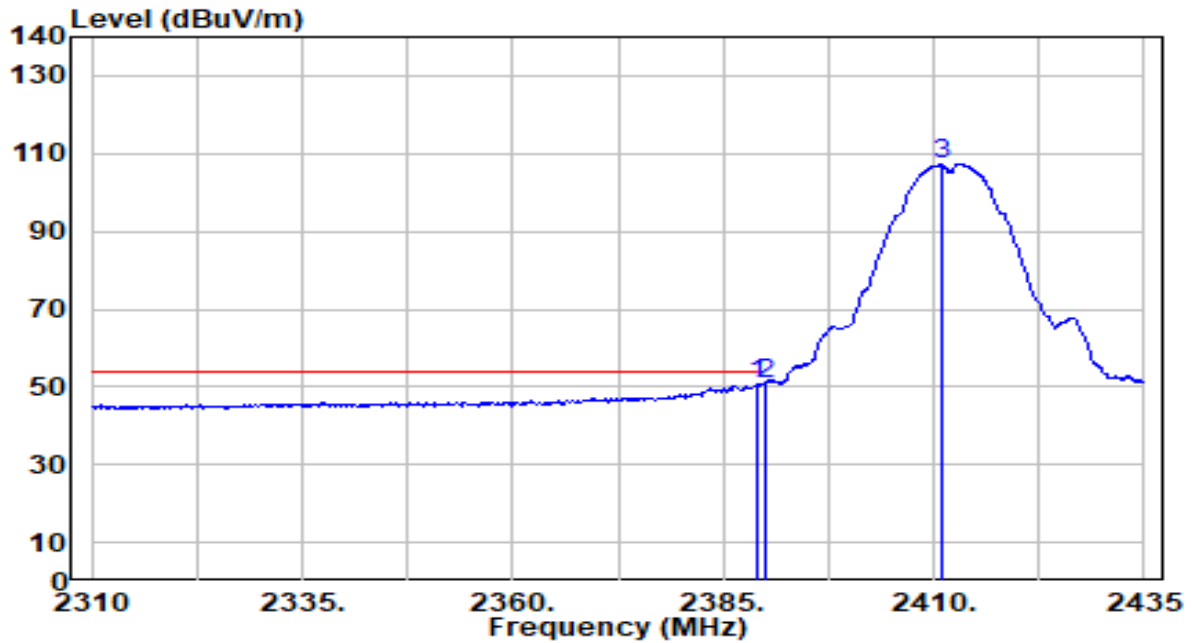

No	Frequency (MHz)	Reading (dBuV)	C.F (dB/m)	Measurement (dBuV/m)	Margin (dB)	Limit (dBuV/m)	Height (cm)	Angle (deg)	Remark (QP/PK/AV)
1	2389.000	20.50	30.18	50.67	-3.33	54.00	105	228	Average
2	* 2390.000	20.65	30.18	50.83	-3.17	54.00	105	228	Average
3	2411.000	76.93	30.22	107.15	N/A	N/A	105	228	Average

Note:

1. " *", means this data is the worst emission level.
2. C.F (Correction Factor) = Antenna Factor (dB/m)+ Cable Loss (dB).
3. Measurement (dBuV/m) = Reading(dBuV) + C.F (Correction Factor).
4. The emission levels of other frequencies are very lower than the limit and not show in test report.

EUT	Pan/Tilt AI Home Security Wi-Fi Camera	Date of Test	2023-06-28
Factor	DRH18-E	Temp. / Humidity	21°C /62%
Polarity	Vertical	Site / Test Engineer	AC2 / Marvin
Test Mode	802.11b_TX_CH 1_ANT 0	Test Voltage	AC 120V/60Hz

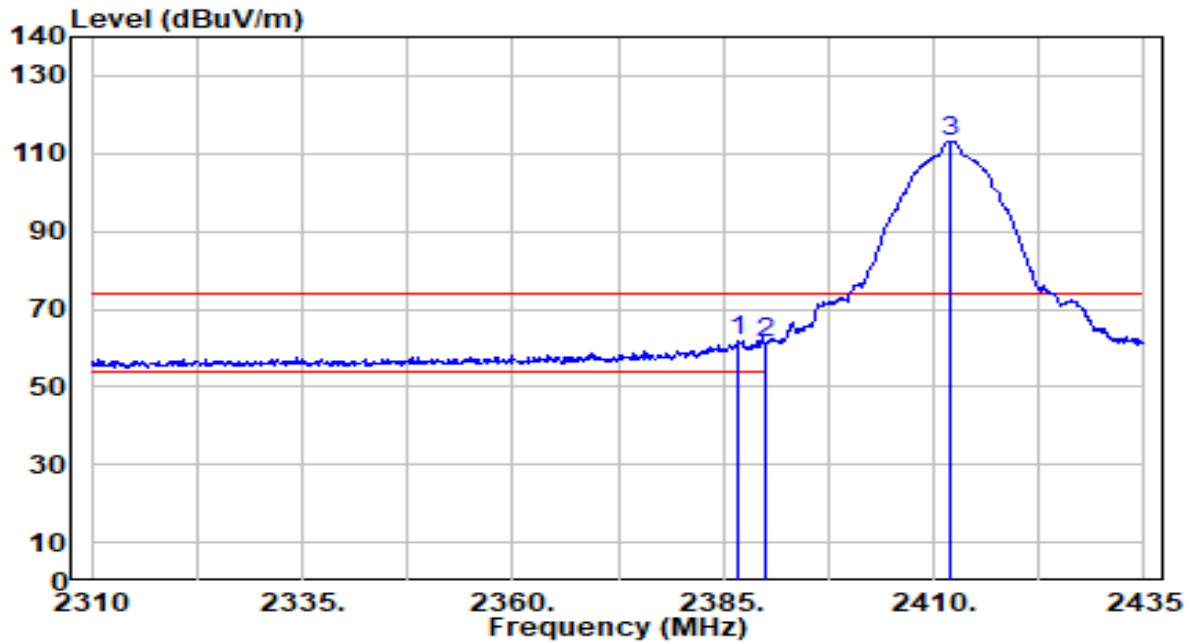

No	Frequency (MHz)	Reading (dBUV)	C.F (dB/m)	Measurement (dBUV/m)	Margin (dB)	Limit (dBUV/m)	Height (cm)	Angle (deg)	Remark (QP/PK/AV)	
1	*	2386.875	31.75	30.17	61.92	-12.08	74.00	100	19	Peak
2		2390.000	31.02	30.18	61.20	-12.80	74.00	100	19	Peak
3		2412.000	83.03	30.22	113.26	N/A	N/A	100	19	Peak

Note:

1. " *", means this data is the worst emission level.
2. C.F (Correction Factor) = Antenna Factor (dB/m)+ Cable Loss (dB).
3. Measurement (dBUV/m) = Reading(dBUV) + C.F (Correction Factor).
4. The emission levels of other frequencies are very lower than the limit and not show in test report.

EUT	Pan/Tilt AI Home Security Wi-Fi Camera	Date of Test	2023-06-28
Factor	DRH18-E	Temp. / Humidity	21°C /62%
Polarity	Vertical	Site / Test Engineer	AC2 / Marvin
Test Mode	802.11b_TX_CH 1_ANT 0	Test Voltage	AC 120V/60Hz

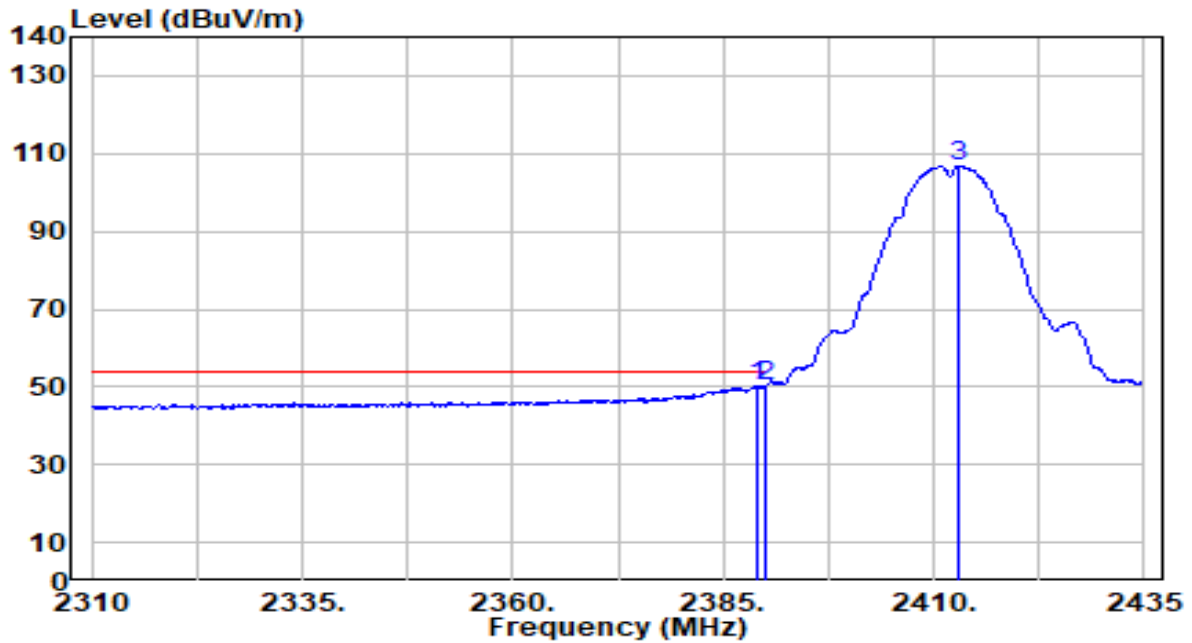

No	Frequency (MHz)	Reading (dBUV)	C.F (dB/m)	Measurement (dBUV/m)	Margin (dB)	Limit (dBUV/m)	Height (cm)	Angle (deg)	Remark (QP/PK/AV)
1	2389.000	19.87	30.18	50.05	-3.95	54.00	100	19	Average
2	* 2390.000	20.25	30.18	50.43	-3.57	54.00	100	19	Average
3	2413.000	76.47	30.23	106.69	N/A	N/A	100	19	Average

Note:

1. " *", means this data is the worst emission level.
2. C.F (Correction Factor) = Antenna Factor (dB/m)+ Cable Loss (dB).
3. Measurement (dBUV/m) = Reading(dBUV) + C.F (Correction Factor).
4. The emission levels of other frequencies are very lower than the limit and not show in test report.

EUT	Pan/Tilt AI Home Security Wi-Fi Camera	Date of Test	2023-06-28
Factor	DRH18-E	Temp. / Humidity	21°C /62%
Polarity	Horizontal	Site / Test Engineer	AC2 / Marvin
Test Mode	802.11b_TX_CH 6_ANT 0	Test Voltage	AC 120V/60Hz

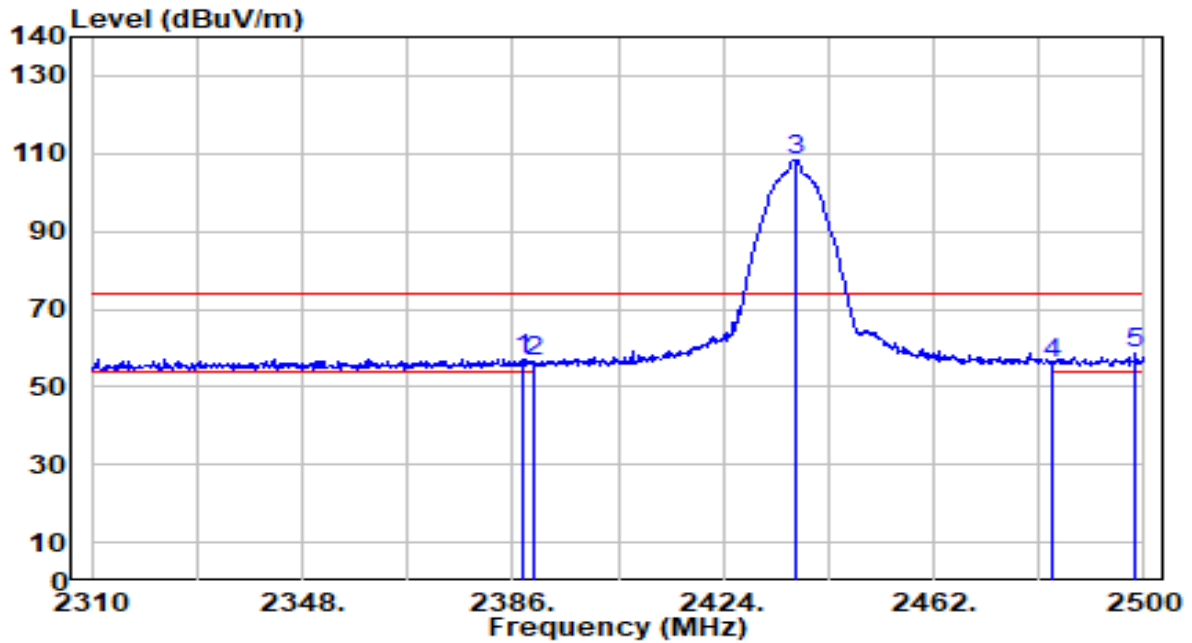

No	Frequency (MHz)	Reading (dBuV)	C.F (dB/m)	Measurement (dBuV/m)	Margin (dB)	Limit (dBuV/m)	Height (cm)	Angle (deg)	Remark (QP/PK/AV)
1	2387.710	27.11	30.17	57.29	-16.71	74.00	100	229	Peak
2	2390.000	26.23	30.18	56.41	-17.59	74.00	100	229	Peak
3	2437.110	78.16	30.26	108.42	N/A	N/A	100	229	Peak
4	2483.500	25.89	30.32	56.21	-17.79	74.00	100	229	Peak
5	* 2498.480	28.18	30.34	58.52	-15.48	74.00	100	229	Peak

Note:

1. " *", means this data is the worst emission level.
2. C.F (Correction Factor) = Antenna Factor (dB/m)+ Cable Loss (dB).
3. Measurement (dBuV/m) = Reading(dBuV) + C.F (Correction Factor).
4. The emission levels of other frequencies are very lower than the limit and not show in test report.

EUT	Pan/Tilt AI Home Security Wi-Fi Camera	Date of Test	2023-06-28
Factor	DRH18-E	Temp. / Humidity	21°C /62%
Polarity	Horizontal	Site / Test Engineer	AC2 / Marvin
Test Mode	802.11b_TX_CH 6_ANT 0	Test Voltage	AC 120V/60Hz

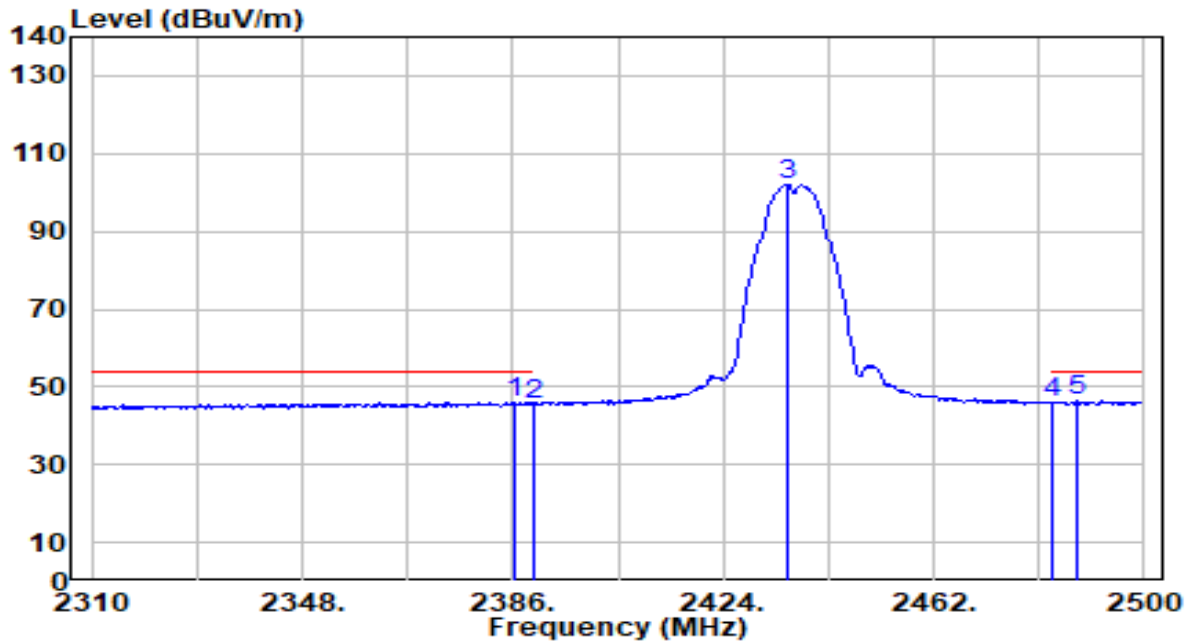

No	Frequency (MHz)	Reading (dBuV)	C.F (dB/m)	Measurement (dBuV/m)	Margin (dB)	Limit (dBuV/m)	Height (cm)	Angle (deg)	Remark (QP/PK/AV)
1	2386.380	15.71	30.17	45.88	-8.12	54.00	100	229	Average
2	2390.000	15.36	30.18	45.54	-8.46	54.00	100	229	Average
3	2435.780	71.76	30.26	102.01	N/A	N/A	100	229	Average
4	2483.500	15.74	30.32	46.06	-7.94	54.00	100	229	Average
5	* 2488.030	15.96	30.32	46.28	-7.72	54.00	100	229	Average

Note:

- "*" means this data is the worst emission level.
- C.F (Correction Factor) = Antenna Factor (dB/m)+ Cable Loss (dB).
- Measurement (dBuV/m) = Reading(dBuV) + C.F (Correction Factor).
- The emission levels of other frequencies are very lower than the limit and not show in test report.

EUT	Pan/Tilt AI Home Security Wi-Fi Camera	Date of Test	2023-06-28
Factor	DRH18-E	Temp. / Humidity	21°C /62%
Polarity	Vertical	Site / Test Engineer	AC2 / Marvin
Test Mode	802.11b_TX_CH 6_ANT 0	Test Voltage	AC 120V/60Hz

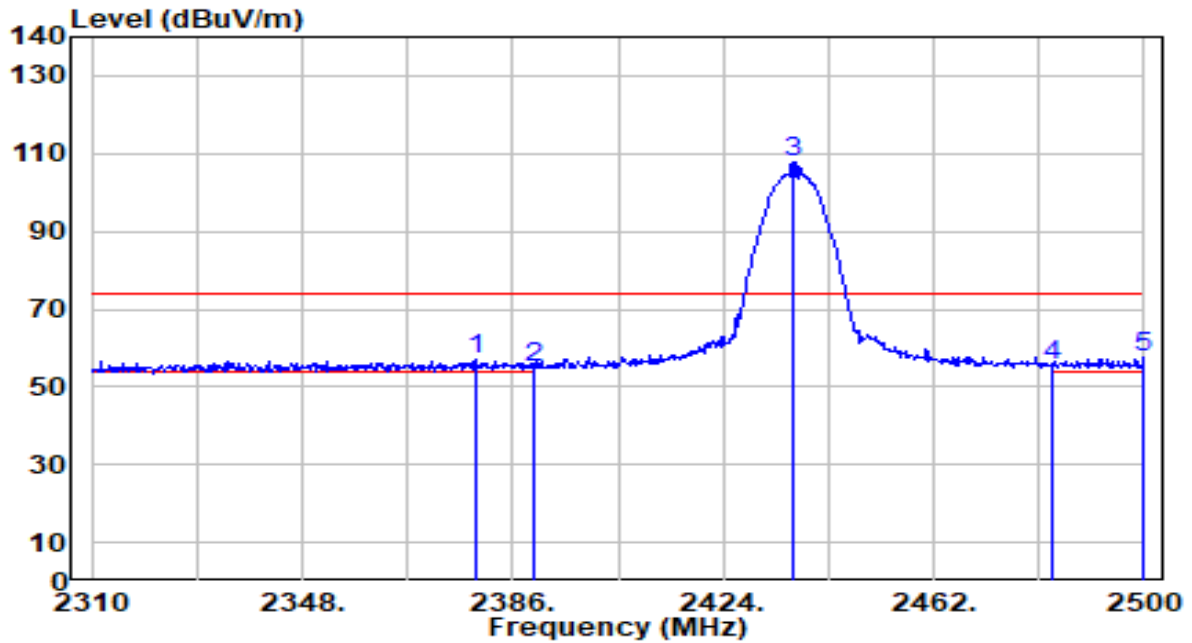

No	Frequency (MHz)	Reading (dBuV)	C.F (dB/m)	Measurement (dBuV/m)	Margin (dB)	Limit (dBuV/m)	Height (cm)	Angle (deg)	Remark (QP/PK/AV)
1	2379.350	26.67	30.15	56.82	-17.18	74.00	100	18	Peak
2	2390.000	24.80	30.18	54.98	-19.02	74.00	100	18	Peak
3	2436.730	77.66	30.26	107.91	N/A	N/A	100	18	Peak
4	2483.500	25.38	30.32	55.70	-18.30	74.00	100	18	Peak
5	* 2499.810	27.49	30.34	57.83	-16.17	74.00	100	18	Peak

Note:

1. " *", means this data is the worst emission level.
2. C.F (Correction Factor) = Antenna Factor (dB/m)+ Cable Loss (dB).
3. Measurement (dBuV/m) = Reading(dBuV) + C.F (Correction Factor).
4. The emission levels of other frequencies are very lower than the limit and not show in test report.

EUT	Pan/Tilt AI Home Security Wi-Fi Camera	Date of Test	2023-06-28
Factor	DRH18-E	Temp. / Humidity	21°C /62%
Polarity	Vertical	Site / Test Engineer	AC2 / Marvin
Test Mode	802.11b_TX_CH 6_ANT 0	Test Voltage	AC 120V/60Hz

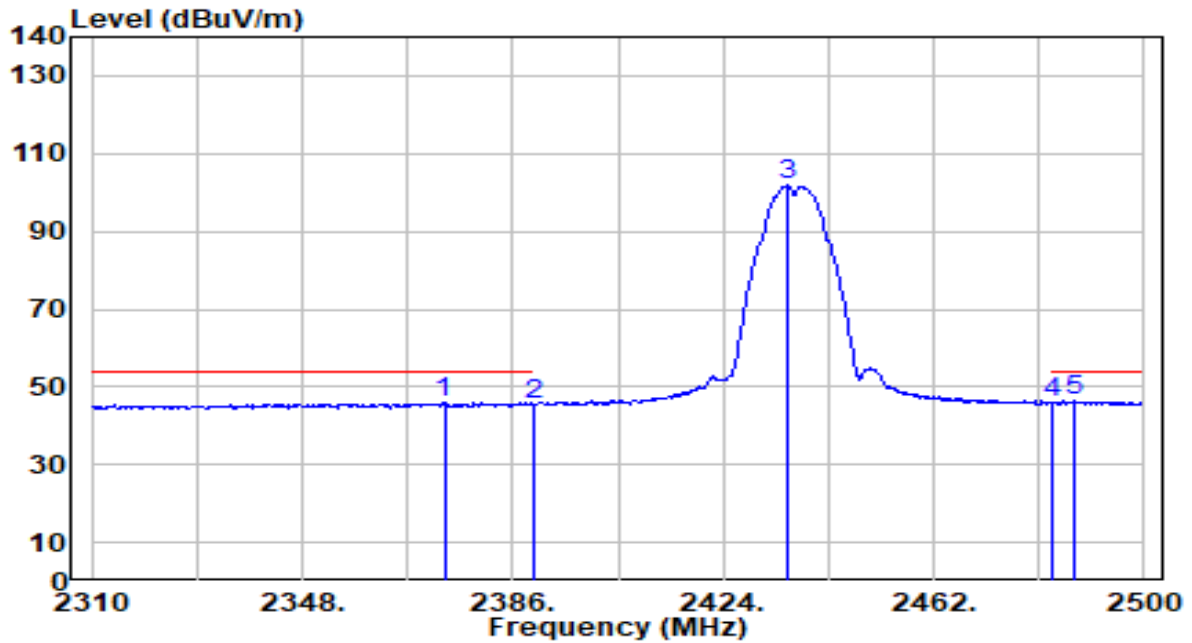

No	Frequency (MHz)	Reading (dBuV)	C.F (dB/m)	Measurement (dBuV/m)	Margin (dB)	Limit (dBuV/m)	Height (cm)	Angle (deg)	Remark (QP/PK/AV)
1	2373.650	16.03	30.13	46.16	-7.84	54.00	100	18	Average
2	2390.000	15.46	30.18	45.64	-8.36	54.00	100	18	Average
3	2435.780	71.45	30.26	101.71	N/A	N/A	100	18	Average
4	2483.500	15.49	30.32	45.81	-8.19	54.00	100	18	Average
5	* 2487.460	15.97	30.32	46.30	-7.70	54.00	100	18	Average

Note:

1. " *", means this data is the worst emission level.
2. C.F (Correction Factor) = Antenna Factor (dB/m)+ Cable Loss (dB).
3. Measurement (dBuV/m) = Reading(dBuV) + C.F (Correction Factor).
4. The emission levels of other frequencies are very lower than the limit and not show in test report.

EUT	Pan/Tilt AI Home Security Wi-Fi Camera	Date of Test	2023-06-28
Factor	DRH18-E	Temp. / Humidity	21°C /62%
Polarity	Horizontal	Site / Test Engineer	AC2 / Marvin
Test Mode	802.11b_TX_CH 11_ANT 0	Test Voltage	AC 120V/60Hz

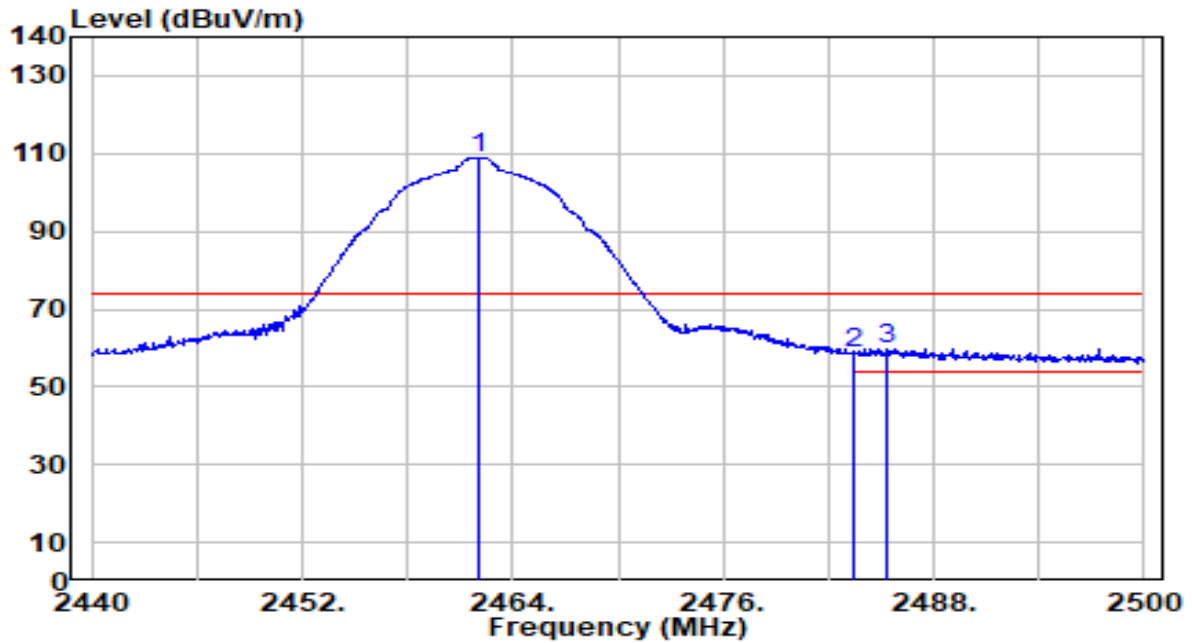

No	Frequency (MHz)	Reading (dBUV)	C.F (dB/m)	Measurement (dBUV/m)	Margin (dB)	Limit (dBUV/m)	Height (cm)	Angle (deg)	Remark (QP/PK/AV)
1	2462.080	78.77	30.29	109.06	N/A	N/A	100	230	Peak
2	2483.500	28.36	30.32	58.68	-15.32	74.00	100	230	Peak
3	* 2485.360	29.60	30.32	59.92	-14.08	74.00	100	230	Peak

Note:

1. " *", means this data is the worst emission level.
2. C.F (Correction Factor) = Antenna Factor (dB/m)+ Cable Loss (dB).
3. Measurement (dBUV/m) = Reading(dBUV) + C.F (Correction Factor).
4. The emission levels of other frequencies are very lower than the limit and not show in test report.

EUT	Pan/Tilt AI Home Security Wi-Fi Camera	Date of Test	2023-06-28
Factor	DRH18-E	Temp. / Humidity	21°C /62%
Polarity	Horizontal	Site / Test Engineer	AC2 / Marvin
Test Mode	802.11b_TX_CH 11_ANT 0	Test Voltage	AC 120V/60Hz

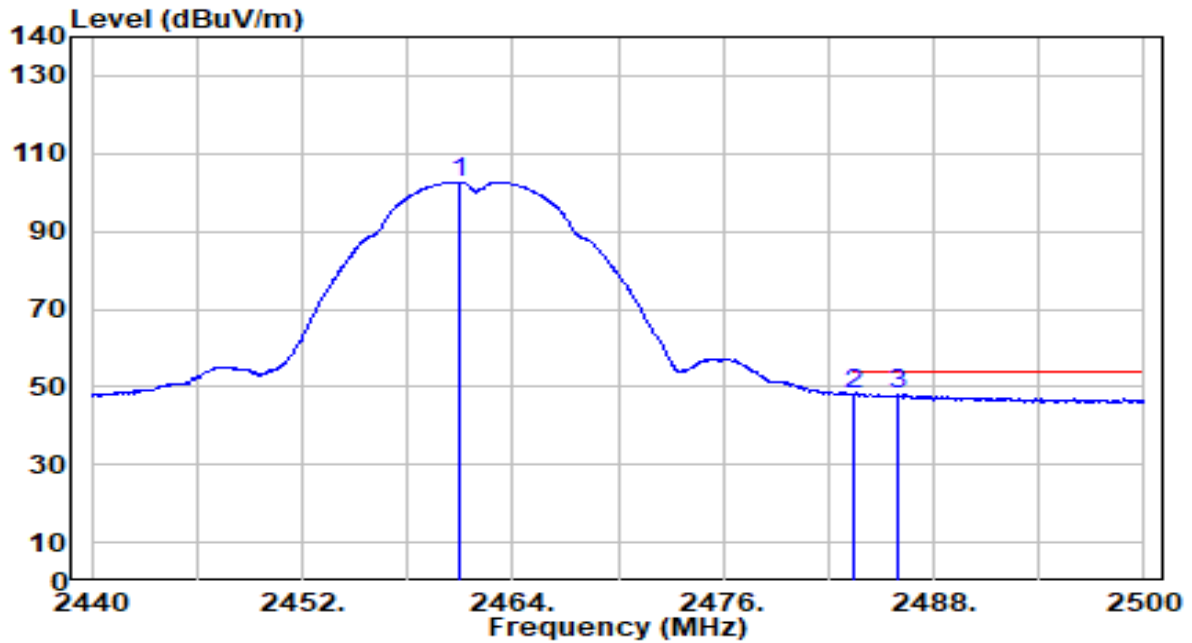

No	Frequency (MHz)	Reading (dBuV)	C.F (dB/m)	Measurement (dBuV/m)	Margin (dB)	Limit (dBuV/m)	Height (cm)	Angle (deg)	Remark (QP/PK/AV)
1	2461.000	72.43	30.29	102.71	N/A	N/A	100	230	Average
2	* 2483.500	17.90	30.32	48.22	-5.78	54.00	100	230	Average
3	2485.960	17.55	30.32	47.87	-6.13	54.00	100	230	Average

Note:

1. " *", means this data is the worst emission level.
2. C.F (Correction Factor) = Antenna Factor (dB/m)+ Cable Loss (dB).
3. Measurement (dBuV/m) = Reading(dBuV) + C.F (Correction Factor).
4. The emission levels of other frequencies are very lower than the limit and not show in test report.

EUT	Pan/Tilt AI Home Security Wi-Fi Camera	Date of Test	2023-06-28
Factor	DRH18-E	Temp. / Humidity	21°C /62%
Polarity	Vertical	Site / Test Engineer	AC2 / Marvin
Test Mode	802.11b_TX_CH 11_ANT 0	Test Voltage	AC 120V/60Hz

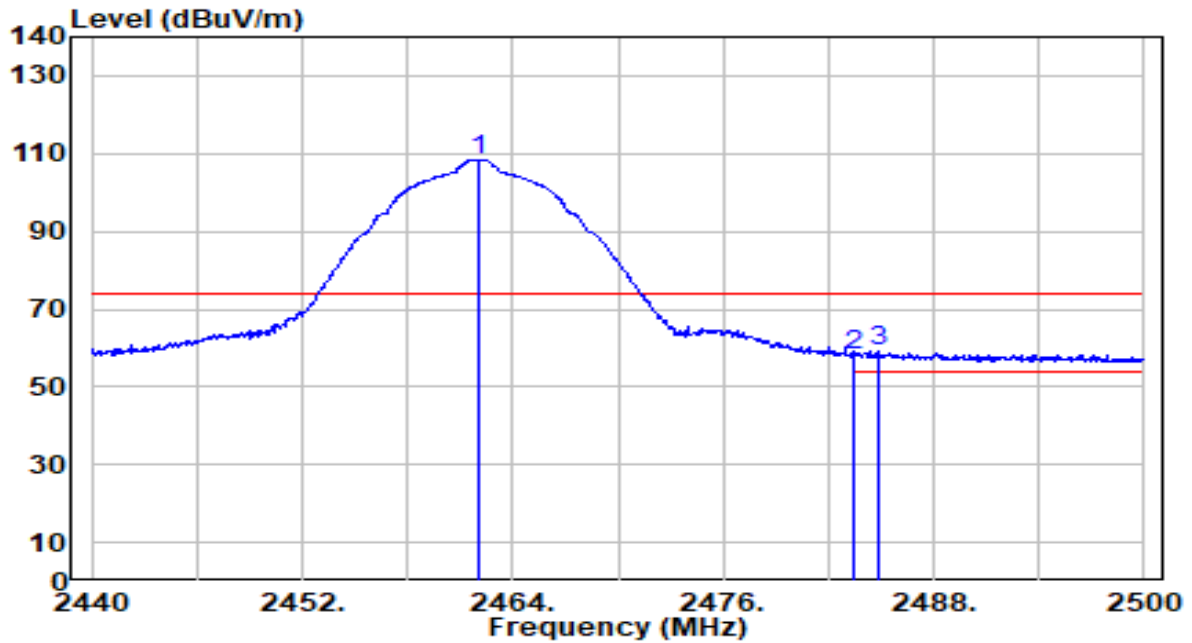

No	Frequency (MHz)	Reading (dBUV)	C.F (dB/m)	Measurement (dBUV/m)	Margin (dB)	Limit (dBUV/m)	Height (cm)	Angle (deg)	Remark (QP/PK/AV)
1	2462.020	78.25	30.29	108.54	N/A	N/A	100	19	Peak
2	2483.500	27.76	30.32	58.08	-15.92	74.00	100	19	Peak
3	* 2484.820	28.59	30.32	58.91	-15.09	74.00	100	19	Peak

Note:

1. " *", means this data is the worst emission level.
2. C.F (Correction Factor) = Antenna Factor (dB/m)+ Cable Loss (dB).
3. Measurement (dBUV/m) = Reading(dBUV) + C.F (Correction Factor).
4. The emission levels of other frequencies are very lower than the limit and not show in test report.

EUT	Pan/Tilt AI Home Security Wi-Fi Camera	Date of Test	2023-06-28
Factor	DRH18-E	Temp. / Humidity	21°C /62%
Polarity	Vertical	Site / Test Engineer	AC2 / Marvin
Test Mode	802.11b_TX_CH 11_ANT 0	Test Voltage	AC 120V/60Hz

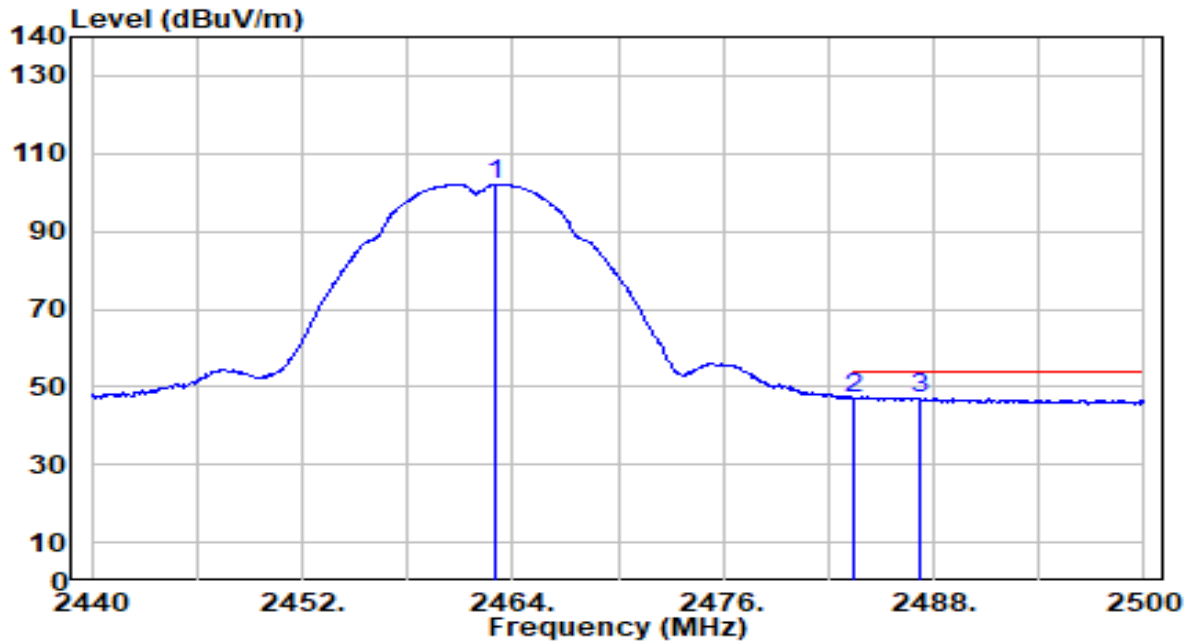

No	Frequency (MHz)	Reading (dBuV)	C.F (dB/m)	Measurement (dBuV/m)	Margin (dB)	Limit (dBuV/m)	Height (cm)	Angle (deg)	Remark (QP/PK/AV)
1	2463.040	71.86	30.29	102.15	N/A	N/A	100	19	Average
2	2483.500	16.84	30.32	47.16	-6.84	54.00	100	19	Average
3	* 2487.160	16.90	30.32	47.22	-6.78	54.00	100	19	Average

Note:

1. " *", means this data is the worst emission level.
2. C.F (Correction Factor) = Antenna Factor (dB/m)+ Cable Loss (dB).
3. Measurement (dBuV/m) = Reading(dBuV) + C.F (Correction Factor).
4. The emission levels of other frequencies are very lower than the limit and not show in test report.

EUT	Pan/Tilt AI Home Security Wi-Fi Camera	Date of Test	2023-06-28
Factor	DRH18-E	Temp. / Humidity	21°C /62%
Polarity	Horizontal	Site / Test Engineer	AC2 / Marvin
Test Mode	802.11g_TX_CH 1_ANT 0	Test Voltage	AC 120V/60Hz

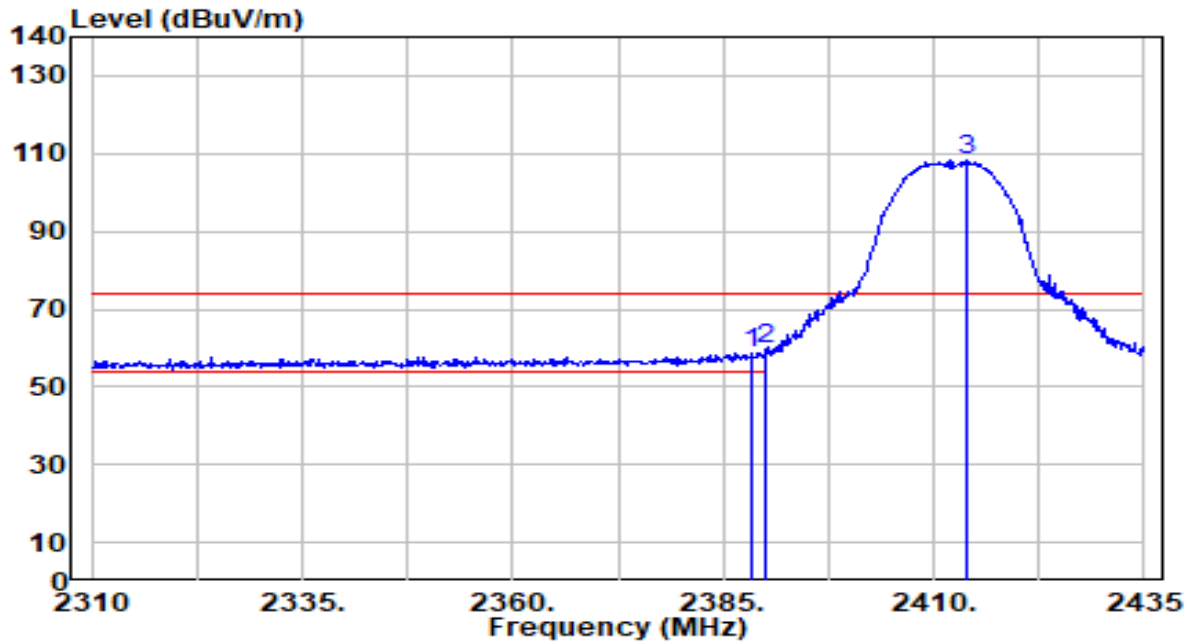

No	Frequency (MHz)	Reading (dBUV)	C.F (dB/m)	Measurement (dBUV/m)	Margin (dB)	Limit (dBUV/m)	Height (cm)	Angle (deg)	Remark (QP/PK/AV)
1	2388.500	28.71	30.18	58.88	-15.12	74.00	106	228	Peak
2	* 2390.000	29.28	30.18	59.46	-14.54	74.00	106	228	Peak
3	2414.000	77.95	30.23	108.17	N/A	N/A	106	228	Peak

Note:

1. " *", means this data is the worst emission level.
2. C.F (Correction Factor) = Antenna Factor (dB/m)+ Cable Loss (dB).
3. Measurement (dBUV/m) = Reading(dBUV) + C.F (Correction Factor).
4. The emission levels of other frequencies are very lower than the limit and not show in test report.

EUT	Pan/Tilt AI Home Security Wi-Fi Camera	Date of Test	2023-06-28
Factor	DRH18-E	Temp. / Humidity	21°C /62%
Polarity	Horizontal	Site / Test Engineer	AC2 / Marvin
Test Mode	802.11g_TX_CH 1_ANT 0	Test Voltage	AC 120V/60Hz

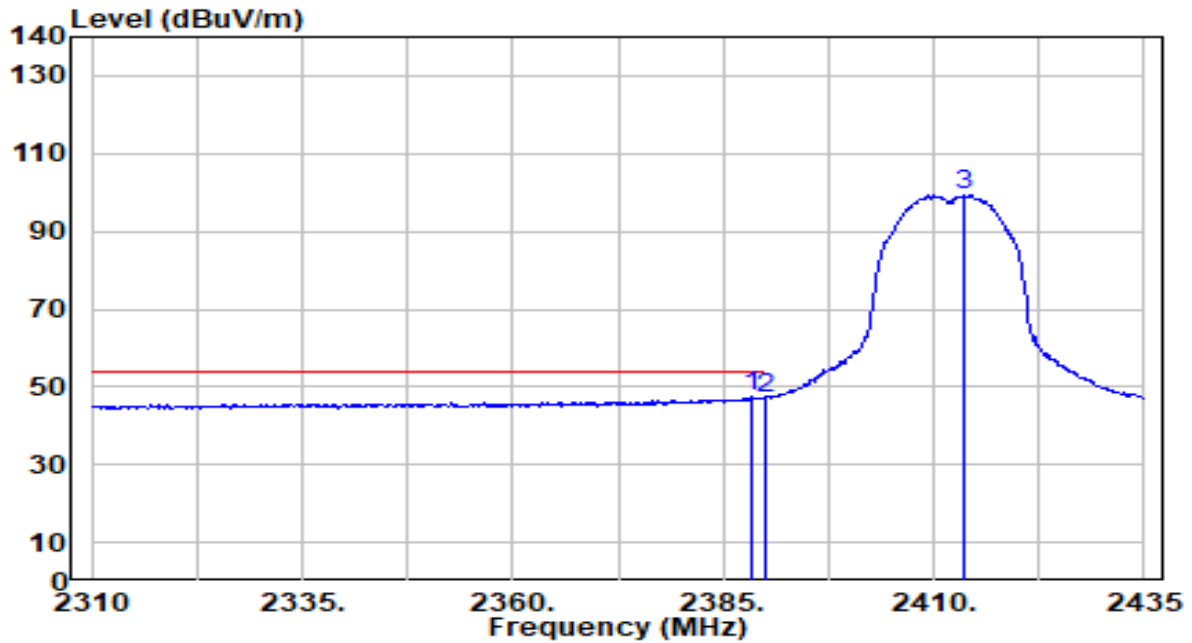

No	Frequency (MHz)	Reading (dBUV)	C.F (dB/m)	Measurement (dBUV/m)	Margin (dB)	Limit (dBUV/m)	Height (cm)	Angle (deg)	Remark (QP/PK/AV)	
1	*	2388.375	17.11	30.18	47.29	-6.71	54.00	106	228	Average
2		2390.000	17.04	30.18	47.22	-6.78	54.00	106	228	Average
3		2413.750	69.07	30.23	99.29	N/A	N/A	106	228	Average

Note:

1. " *", means this data is the worst emission level.
2. C.F (Correction Factor) = Antenna Factor (dB/m)+ Cable Loss (dB).
3. Measurement (dBUV/m) = Reading(dBUV) + C.F (Correction Factor).
4. The emission levels of other frequencies are very lower than the limit and not show in test report.

EUT	Pan/Tilt AI Home Security Wi-Fi Camera	Date of Test	2023-06-28
Factor	DRH18-E	Temp. / Humidity	21°C /62%
Polarity	Vertical	Site / Test Engineer	AC2 / Marvin
Test Mode	802.11g_TX_CH 1_ANT 0	Test Voltage	AC 120V/60Hz

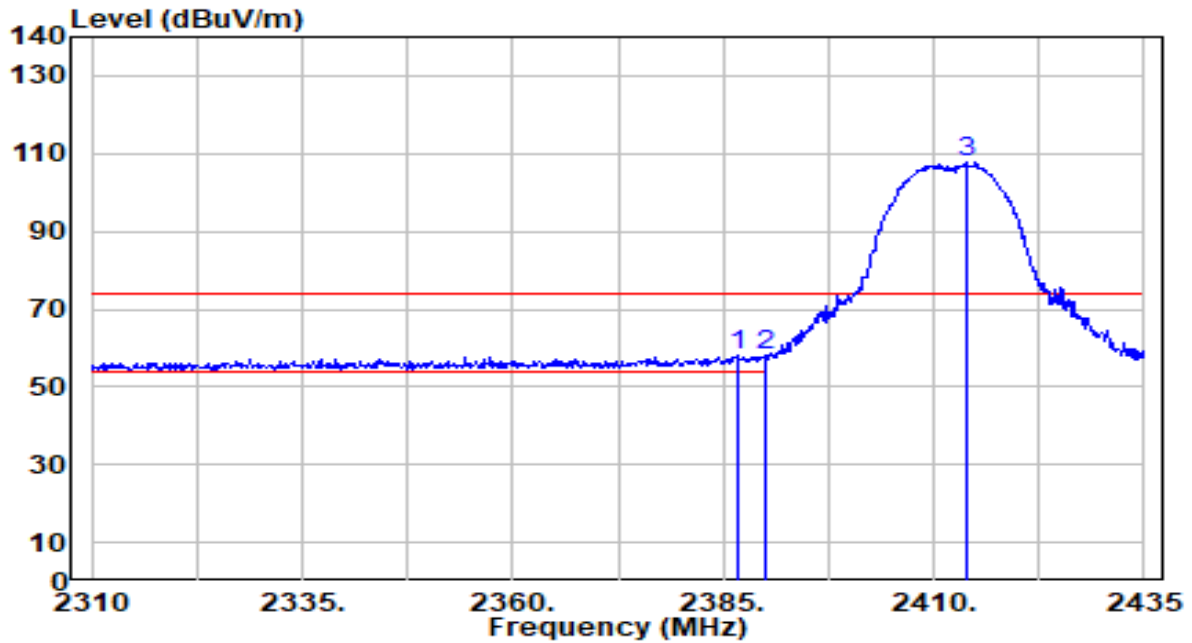

No	Frequency (MHz)	Reading (dBUV)	C.F (dB/m)	Measurement (dBUV/m)	Margin (dB)	Limit (dBUV/m)	Height (cm)	Angle (deg)	Remark (QP/PK/AV)	
1	*	2386.875	27.90	30.17	58.07	-15.93	74.00	100	18	Peak
2		2390.000	27.74	30.18	57.92	-16.08	74.00	100	18	Peak
3		2414.000	77.59	30.23	107.82	N/A	N/A	100	18	Peak

Note:

1. " *", means this data is the worst emission level.
2. C.F (Correction Factor) = Antenna Factor (dB/m)+ Cable Loss (dB).
3. Measurement (dBUV/m) = Reading(dBUV) + C.F (Correction Factor).
4. The emission levels of other frequencies are very lower than the limit and not show in test report.

EUT	Pan/Tilt AI Home Security Wi-Fi Camera	Date of Test	2023-06-28
Factor	DRH18-E	Temp. / Humidity	21°C /62%
Polarity	Vertical	Site / Test Engineer	AC2 / Marvin
Test Mode	802.11g_TX_CH 1_ANT 0	Test Voltage	AC 120V/60Hz

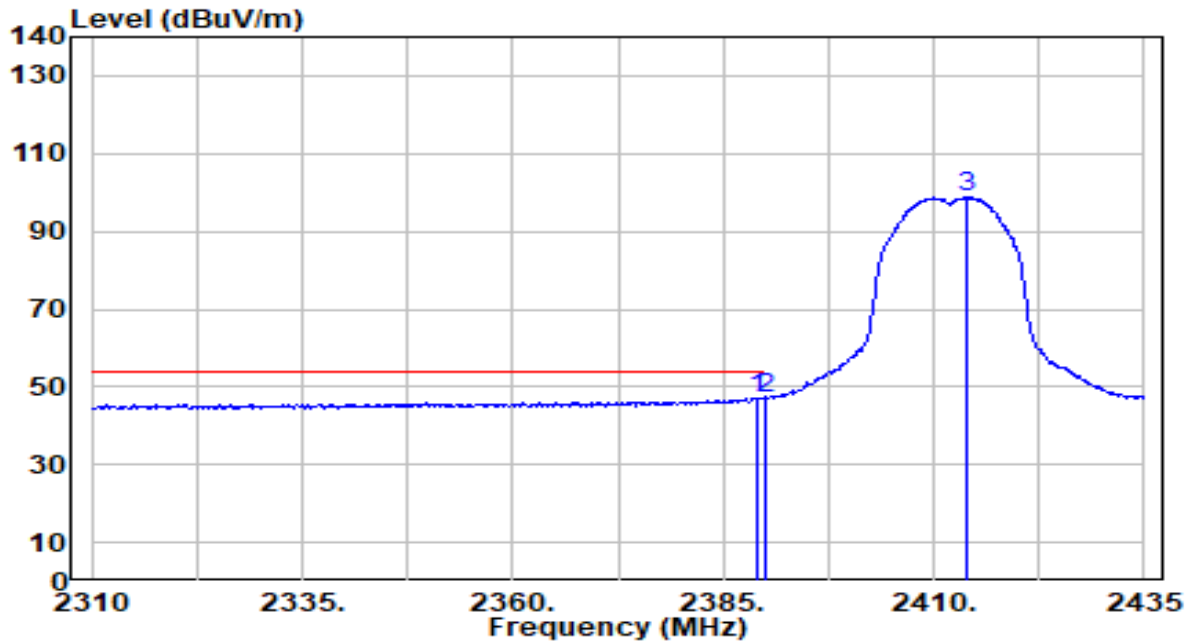

No	Frequency (MHz)	Reading (dBuV)	C.F (dB/m)	Measurement (dBuV/m)	Margin (dB)	Limit (dBuV/m)	Height (cm)	Angle (deg)	Remark (QP/PK/AV)
1	2389.000	16.86	30.18	47.04	-6.96	54.00	100	18	Average
2	* 2390.000	16.88	30.18	47.06	-6.94	54.00	100	18	Average
3	2413.875	68.46	30.23	98.69	N/A	N/A	100	18	Average

Note:

1. " *", means this data is the worst emission level.
2. C.F (Correction Factor) = Antenna Factor (dB/m)+ Cable Loss (dB).
3. Measurement (dBuV/m) = Reading(dBuV) + C.F (Correction Factor).
4. The emission levels of other frequencies are very lower than the limit and not show in test report.

EUT	Pan/Tilt AI Home Security Wi-Fi Camera	Date of Test	2023-06-28
Factor	DRH18-E	Temp. / Humidity	21°C /62%
Polarity	Horizontal	Site / Test Engineer	AC2 / Marvin
Test Mode	802.11g_TX_CH 6_ANT 0	Test Voltage	AC 120V/60Hz

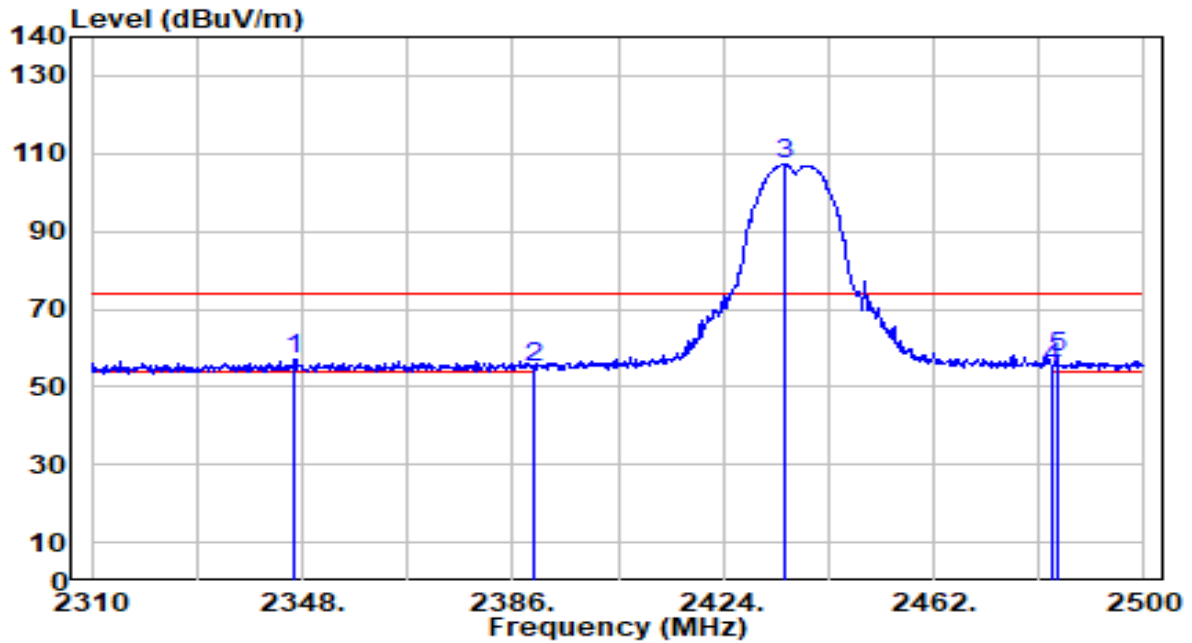

No	Frequency (MHz)	Reading (dBuV)	C.F (dB/m)	Measurement (dBuV/m)	Margin (dB)	Limit (dBuV/m)	Height (cm)	Angle (deg)	Remark (QP/PK/AV)
1	2346.480	27.05	30.06	57.10	-16.90	74.00	100	229	Peak
2	2390.000	24.88	30.18	55.06	-18.94	74.00	100	229	Peak
3	2435.020	77.05	30.25	107.30	N/A	N/A	100	229	Peak
4	2483.500	24.86	30.32	55.18	-18.82	74.00	100	229	Peak
5	* 2484.230	27.35	30.32	57.67	-16.33	74.00	100	229	Peak

Note:

1. " *", means this data is the worst emission level.
2. C.F (Correction Factor) = Antenna Factor (dB/m)+ Cable Loss (dB).
3. Measurement (dBuV/m) = Reading(dBuV) + C.F (Correction Factor).
4. The emission levels of other frequencies are very lower than the limit and not show in test report.

EUT	Pan/Tilt AI Home Security Wi-Fi Camera	Date of Test	2023-06-28
Factor	DRH18-E	Temp. / Humidity	21°C /62%
Polarity	Horizontal	Site / Test Engineer	AC2 / Marvin
Test Mode	802.11g_TX_CH 6_ANT 0	Test Voltage	AC 120V/60Hz

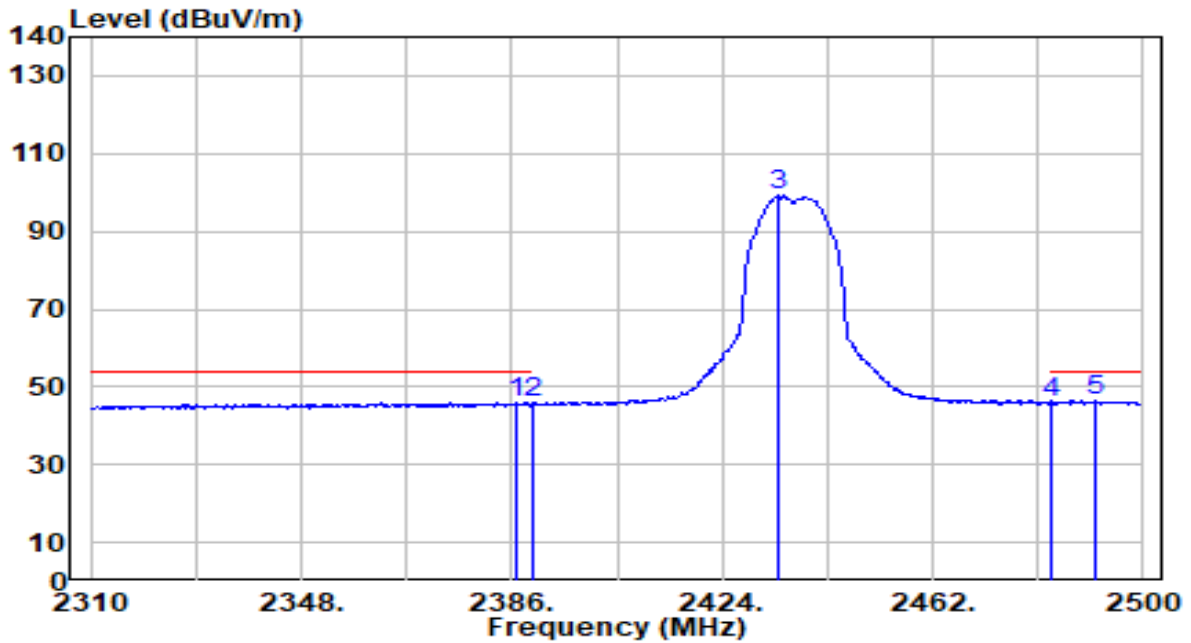

No	Frequency (MHz)	Reading (dBuV)	C.F (dB/m)	Measurement (dBuV/m)	Margin (dB)	Limit (dBuV/m)	Height (cm)	Angle (deg)	Remark (QP/PK/AV)
1	2386.950	15.72	30.17	45.89	-8.11	54.00	100	229	Average
2	2390.000	15.57	30.18	45.75	-8.25	54.00	100	229	Average
3	2434.260	69.02	30.25	99.28	N/A	N/A	100	229	Average
4	2483.500	15.87	30.32	46.19	-7.81	54.00	100	229	Average
5	* 2491.450	15.95	30.33	46.28	-7.72	54.00	100	229	Average

Note:

1. " *", means this data is the worst emission level.
2. C.F (Correction Factor) = Antenna Factor (dB/m)+ Cable Loss (dB).
3. Measurement (dBuV/m) = Reading(dBuV) + C.F (Correction Factor).
4. The emission levels of other frequencies are very lower than the limit and not show in test report.

EUT	Pan/Tilt AI Home Security Wi-Fi Camera	Date of Test	2023-06-28
Factor	DRH18-E	Temp. / Humidity	21°C /62%
Polarity	Vertical	Site / Test Engineer	AC2 / Marvin
Test Mode	802.11g_TX_CH 6_ANT 0	Test Voltage	AC 120V/60Hz

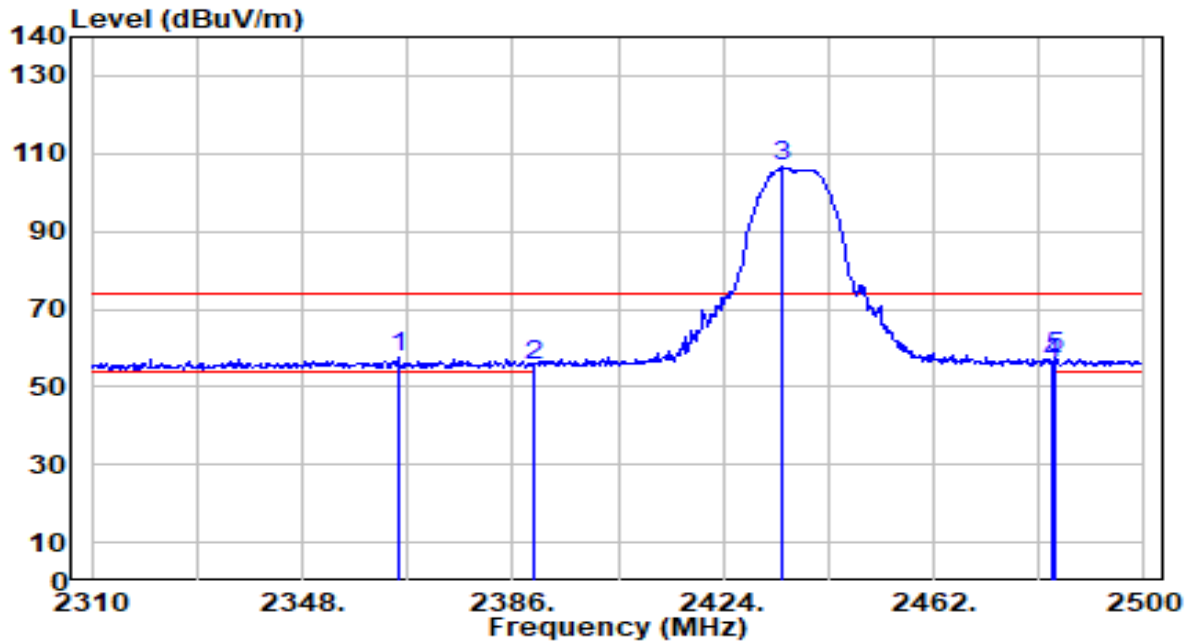

No	Frequency (MHz)	Reading (dBuV)	C.F (dB/m)	Measurement (dBuV/m)	Margin (dB)	Limit (dBuV/m)	Height (cm)	Angle (deg)	Remark (QP/PK/AV)
1	2365.290	27.23	30.11	57.34	-16.66	74.00	100	18	Peak
2	2390.000	25.38	30.18	55.56	-18.44	74.00	100	18	Peak
3	2434.830	76.47	30.25	106.73	N/A	N/A	100	18	Peak
4	2483.500	25.68	30.32	55.99	-18.01	74.00	100	18	Peak
5	* 2484.040	27.13	30.32	57.45	-16.55	74.00	100	18	Peak

Note:

- " *", means this data is the worst emission level.
- C.F (Correction Factor) = Antenna Factor (dB/m)+ Cable Loss (dB).
- Measurement (dBuV/m) = Reading(dBuV) + C.F (Correction Factor).
- The emission levels of other frequencies are very lower than the limit and not show in test report.

EUT	Pan/Tilt AI Home Security Wi-Fi Camera	Date of Test	2023-06-28
Factor	DRH18-E	Temp. / Humidity	21°C /62%
Polarity	Vertical	Site / Test Engineer	AC2 / Marvin
Test Mode	802.11g_TX_CH 6_ANT 0	Test Voltage	AC 120V/60Hz

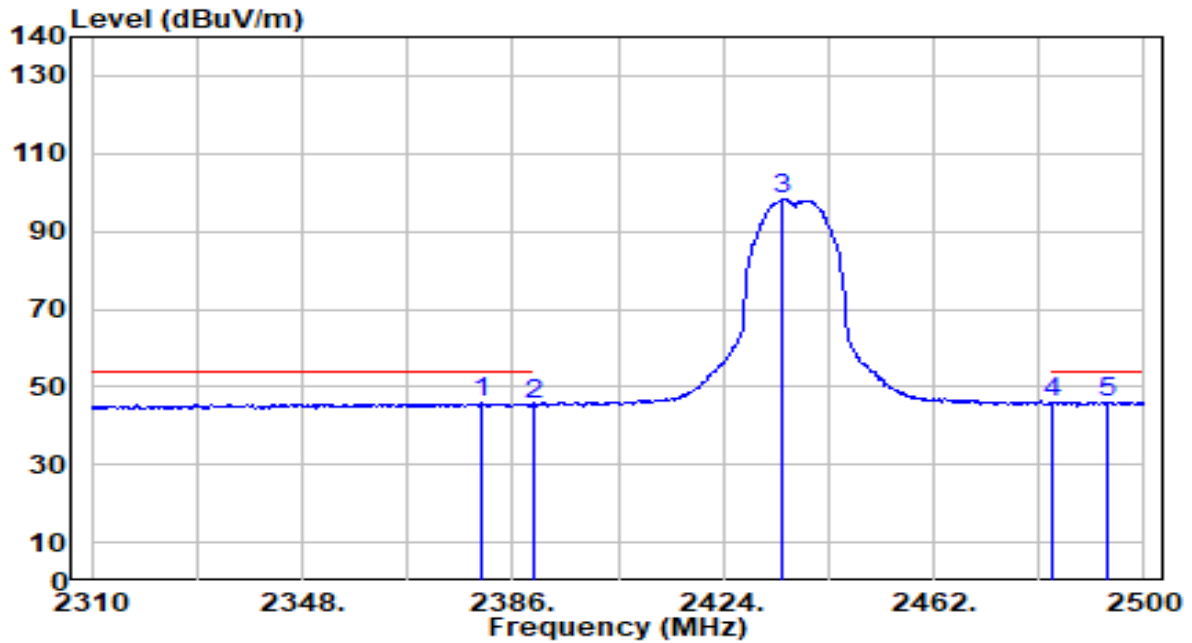

No	Frequency (MHz)	Reading (dBuV)	C.F (dB/m)	Measurement (dBuV/m)	Margin (dB)	Limit (dBuV/m)	Height (cm)	Angle (deg)	Remark (QP/PK/AV)
1	2380.300	15.66	30.15	45.82	-8.18	54.00	100	18	Average
2	2390.000	15.42	30.18	45.60	-8.40	54.00	100	18	Average
3	2434.640	67.92	30.25	98.17	N/A	N/A	100	18	Average
4	2483.500	15.54	30.32	45.86	-8.14	54.00	100	18	Average
5	* 2493.540	15.76	30.33	46.09	-7.91	54.00	100	18	Average

Note:

1. " *", means this data is the worst emission level.
2. C.F (Correction Factor) = Antenna Factor (dB/m)+ Cable Loss (dB).
3. Measurement (dBuV/m) = Reading(dBuV) + C.F (Correction Factor).
4. The emission levels of other frequencies are very lower than the limit and not show in test report.

EUT	Pan/Tilt AI Home Security Wi-Fi Camera	Date of Test	2023-06-28
Factor	DRH18-E	Temp. / Humidity	21°C /62%
Polarity	Horizontal	Site / Test Engineer	AC2 / Marvin
Test Mode	802.11g_TX_CH 11_ANT 0	Test Voltage	AC 120V/60Hz

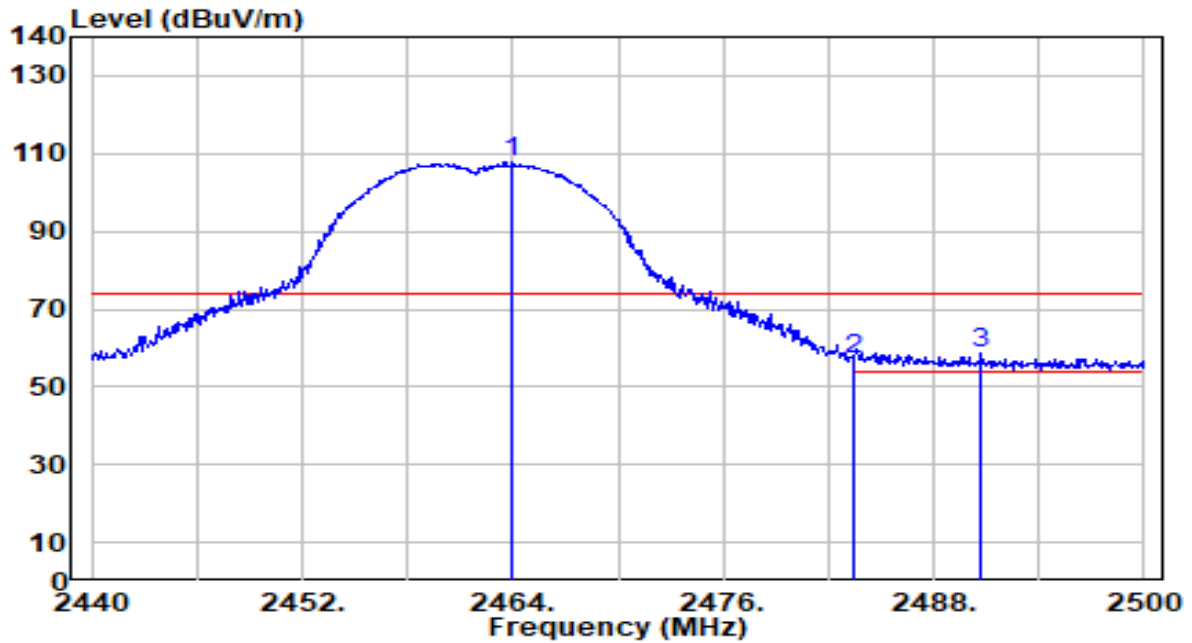

No	Frequency (MHz)	Reading (dBuV)	C.F (dB/m)	Measurement (dBuV/m)	Margin (dB)	Limit (dBuV/m)	Height (cm)	Angle (deg)	Remark (QP/PK/AV)
1	2463.940	77.48	30.29	107.78	N/A	N/A	100	230	Peak
2	2483.500	26.64	30.32	56.96	-17.04	74.00	100	230	Peak
3	* 2490.700	28.10	30.33	58.42	-15.58	74.00	100	230	Peak

Note:

1. " *", means this data is the worst emission level.
2. C.F (Correction Factor) = Antenna Factor (dB/m)+ Cable Loss (dB).
3. Measurement (dBuV/m) = Reading(dBuV) + C.F (Correction Factor).
4. The emission levels of other frequencies are very lower than the limit and not show in test report.

EUT	Pan/Tilt AI Home Security Wi-Fi Camera	Date of Test	2023-06-28
Factor	DRH18-E	Temp. / Humidity	21°C /62%
Polarity	Horizontal	Site / Test Engineer	AC2 / Marvin
Test Mode	802.11g_TX_CH 11_ANT 0	Test Voltage	AC 120V/60Hz

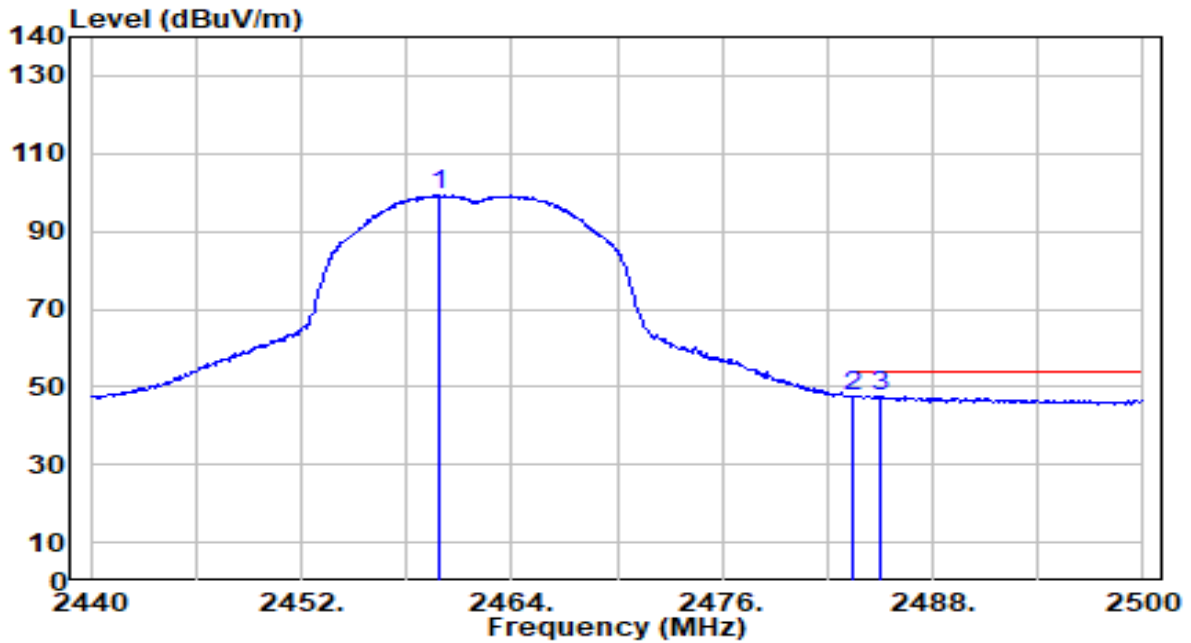

No	Frequency (MHz)	Reading (dBuV)	C.F (dB/m)	Measurement (dBuV/m)	Margin (dB)	Limit (dBuV/m)	Height (cm)	Angle (deg)	Remark (QP/PK/AV)
1	2459.920	69.06	30.29	99.35	N/A	N/A	100	230	Average
2	* 2483.500	17.44	30.32	47.76	-6.24	54.00	100	230	Average
3	2484.940	17.30	30.32	47.62	-6.38	54.00	100	230	Average

Note:

1. " *", means this data is the worst emission level.
2. C.F (Correction Factor) = Antenna Factor (dB/m)+ Cable Loss (dB).
3. Measurement (dBuV/m) = Reading(dBuV) + C.F (Correction Factor).
4. The emission levels of other frequencies are very lower than the limit and not show in test report.

EUT	Pan/Tilt AI Home Security Wi-Fi Camera	Date of Test	2023-06-28
Factor	DRH18-E	Temp. / Humidity	21°C /62%
Polarity	Vertical	Site / Test Engineer	AC2 / Marvin
Test Mode	802.11g_TX_CH 11_ANT 0	Test Voltage	AC 120V/60Hz

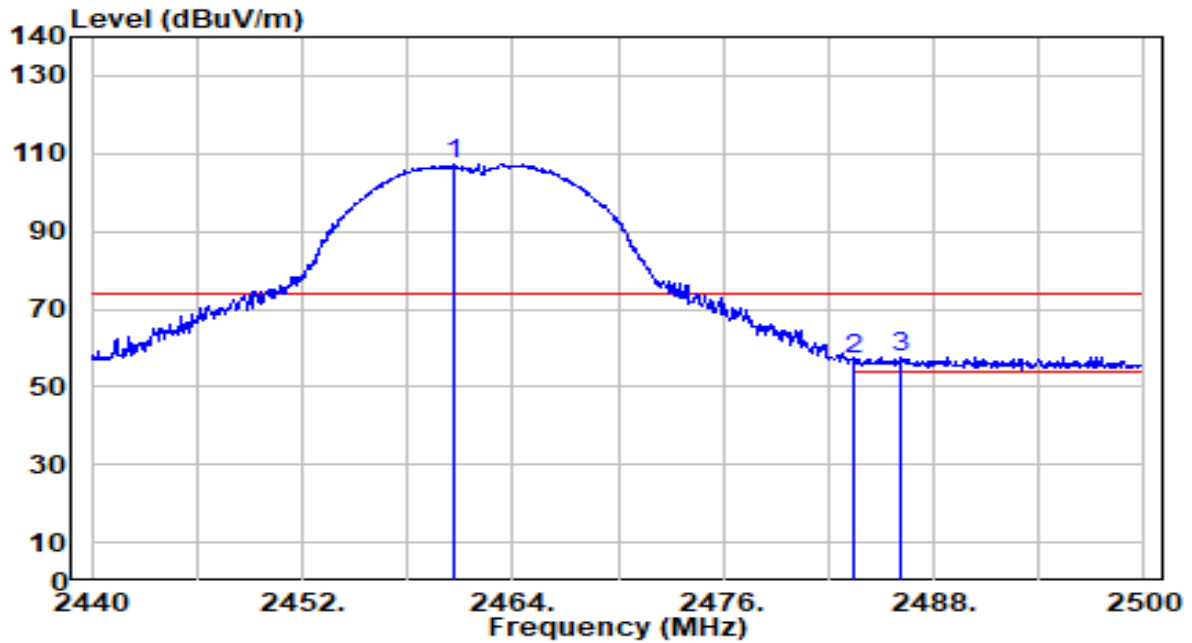

No	Frequency (MHz)	Reading (dBuV)	C.F (dB/m)	Measurement (dBuV/m)	Margin (dB)	Limit (dBuV/m)	Height (cm)	Angle (deg)	Remark (QP/PK/AV)
1	2460.580	77.21	30.29	107.50	N/A	N/A	100	19	Peak
2	2483.500	26.75	30.32	57.07	-16.93	74.00	100	19	Peak
3	* 2486.080	27.41	30.32	57.73	-16.27	74.00	100	19	Peak

Note:

1. " *", means this data is the worst emission level.
2. C.F (Correction Factor) = Antenna Factor (dB/m)+ Cable Loss (dB).
3. Measurement (dBuV/m) = Reading(dBuV) + C.F (Correction Factor).
4. The emission levels of other frequencies are very lower than the limit and not show in test report.

EUT	Pan/Tilt AI Home Security Wi-Fi Camera	Date of Test	2023-06-28
Factor	DRH18-E	Temp. / Humidity	21°C /62%
Polarity	Vertical	Site / Test Engineer	AC2 / Marvin
Test Mode	802.11g_TX_CH 11_ANT 0	Test Voltage	AC 120V/60Hz

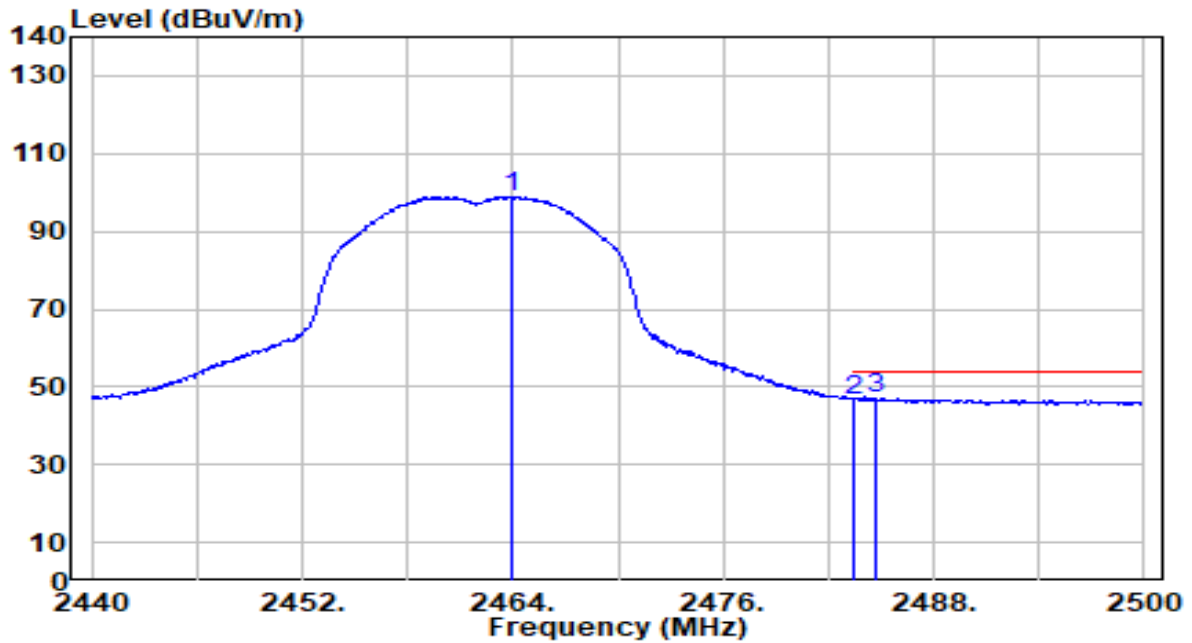

No	Frequency (MHz)	Reading (dBuV)	C.F (dB/m)	Measurement (dBuV/m)	Margin (dB)	Limit (dBuV/m)	Height (cm)	Angle (deg)	Remark (QP/PK/AV)
1	2463.880	68.57	30.29	98.86	N/A	N/A	100	19	Average
2	2483.500	16.41	30.32	46.73	-7.27	54.00	100	19	Average
3	* 2484.640	16.89	30.32	47.21	-6.79	54.00	100	19	Average

Note:

1. " *", means this data is the worst emission level.
2. C.F (Correction Factor) = Antenna Factor (dB/m)+ Cable Loss (dB).
3. Measurement (dBuV/m) = Reading(dBuV) + C.F (Correction Factor).
4. The emission levels of other frequencies are very lower than the limit and not show in test report.

EUT	Pan/Tilt AI Home Security Wi-Fi Camera	Date of Test	2023-06-28
Factor	DRH18-E	Temp. / Humidity	21°C /62%
Polarity	Horizontal	Site / Test Engineer	AC2 / Marvin
Test Mode	802.11n-20MHz_TX_CH 1_ANT 0	Test Voltage	AC 120V/60Hz

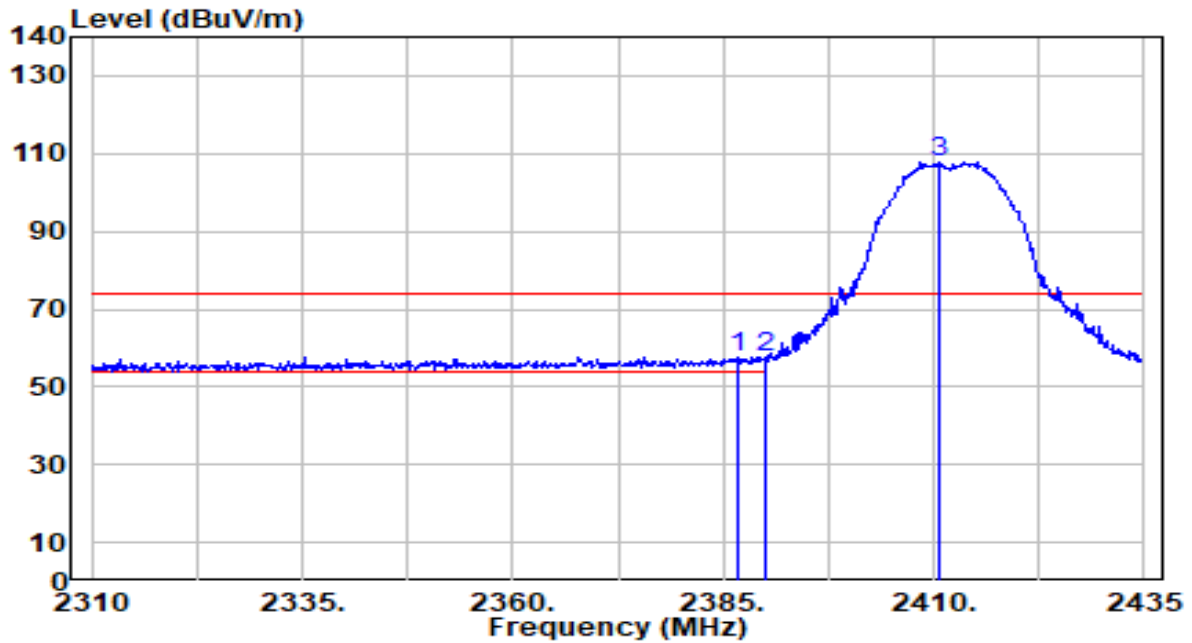

No	Frequency (MHz)	Reading (dBuV)	C.F (dB/m)	Measurement (dBuV/m)	Margin (dB)	Limit (dBuV/m)	Height (cm)	Angle (deg)	Remark (QP/PK/AV)
1	*	27.50	30.17	57.67	-16.33	74.00	105	229	Peak
2		27.21	30.18	57.39	-16.61	74.00	105	229	Peak
3		77.58	30.22	107.81	N/A	N/A	105	229	Peak

Note:

1. " *", means this data is the worst emission level.
2. C.F (Correction Factor) = Antenna Factor (dB/m)+ Cable Loss (dB).
3. Measurement (dBuV/m) = Reading(dBuV) + C.F (Correction Factor).
4. The emission levels of other frequencies are very lower than the limit and not show in test report.

EUT	Pan/Tilt AI Home Security Wi-Fi Camera	Date of Test	2023-06-28
Factor	DRH18-E	Temp. / Humidity	21°C /62%
Polarity	Horizontal	Site / Test Engineer	AC2 / Marvin
Test Mode	802.11n-20MHz_TX_CH 1_ANT 0	Test Voltage	AC 120V/60Hz

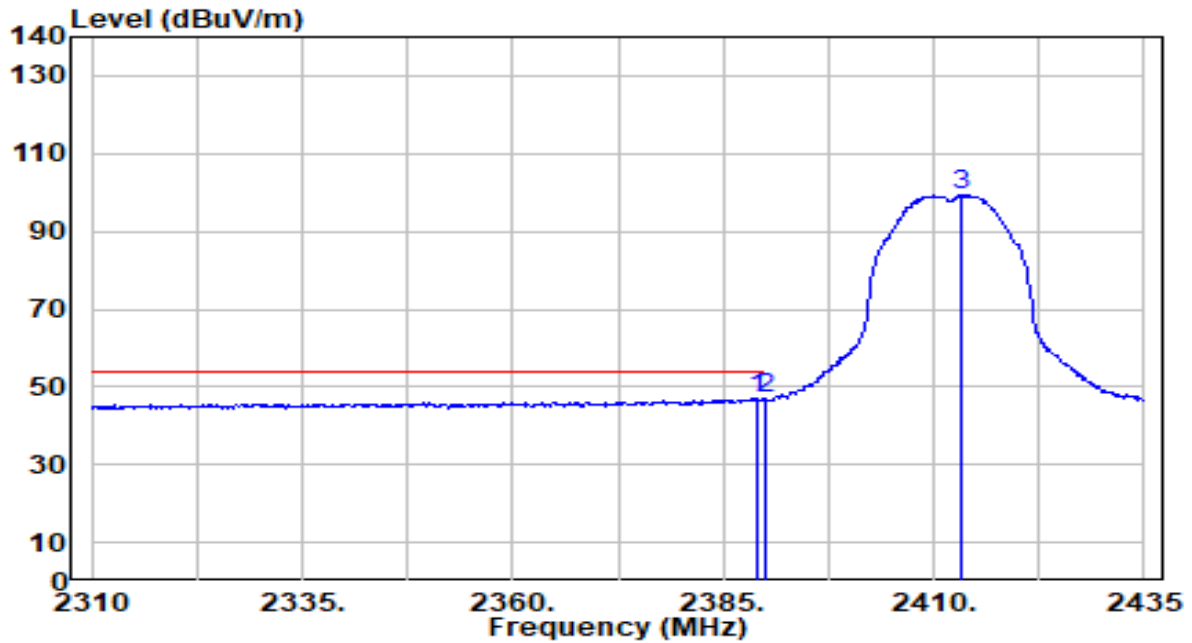

No	Frequency (MHz)	Reading (dBuV)	C.F (dB/m)	Measurement (dBuV/m)	Margin (dB)	Limit (dBuV/m)	Height (cm)	Angle (deg)	Remark (QP/PK/AV)	
1	*	2389.000	16.79	30.18	46.96	-7.04	54.00	105	229	Average
2		2390.000	16.64	30.18	46.82	-7.18	54.00	105	229	Average
3		2413.250	69.10	30.23	99.33	N/A	N/A	105	229	Average

Note:

1. " *", means this data is the worst emission level.
2. C.F (Correction Factor) = Antenna Factor (dB/m)+ Cable Loss (dB).
3. Measurement (dBuV/m) = Reading(dBuV) + C.F (Correction Factor).
4. The emission levels of other frequencies are very lower than the limit and not show in test report.

EUT	Pan/Tilt AI Home Security Wi-Fi Camera	Date of Test	2023-06-28
Factor	DRH18-E	Temp. / Humidity	21°C /62%
Polarity	Vertical	Site / Test Engineer	AC2 / Marvin
Test Mode	802.11n-20MHz_TX_CH 1_ANT 0	Test Voltage	AC 120V/60Hz

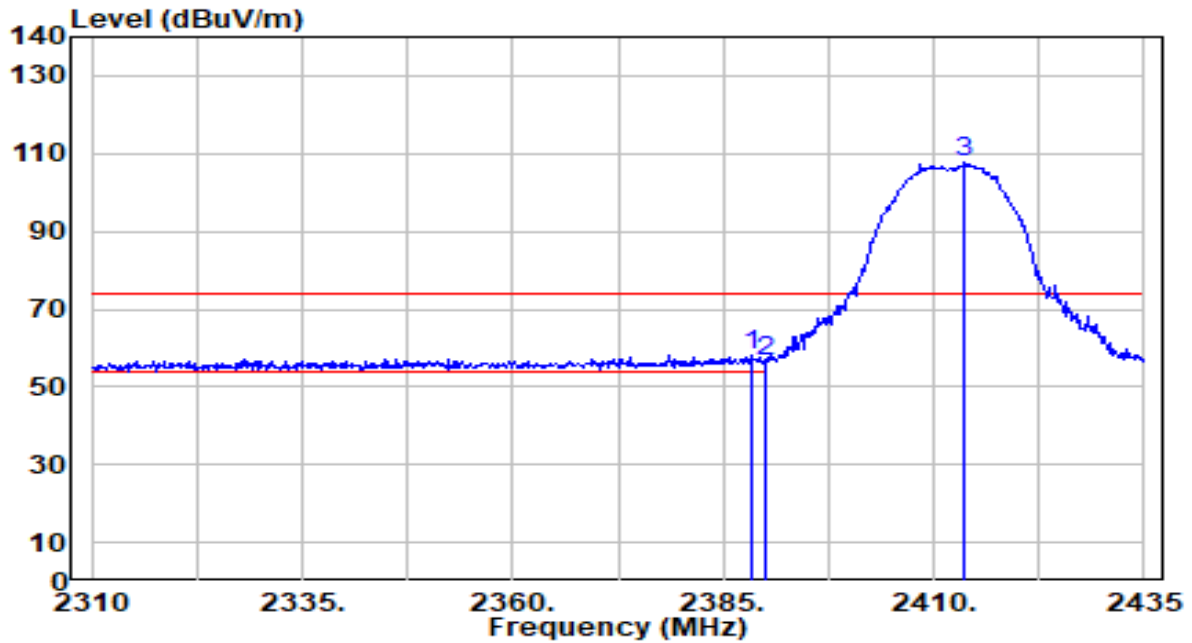

No	Frequency (MHz)	Reading (dBuV)	C.F (dB/m)	Measurement (dBuV/m)	Margin (dB)	Limit (dBuV/m)	Height (cm)	Angle (deg)	Remark (QP/PK/AV)	
1	*	2388.250	27.89	30.17	58.06	-15.94	74.00	100	19	Peak
2		2390.000	26.61	30.18	56.79	-17.21	74.00	100	19	Peak
3		2413.750	77.32	30.23	107.54	N/A	N/A	100	19	Peak

Note:

1. " *", means this data is the worst emission level.
2. C.F (Correction Factor) = Antenna Factor (dB/m)+ Cable Loss (dB).
3. Measurement (dBuV/m) = Reading(dBuV) + C.F (Correction Factor).
4. The emission levels of other frequencies are very lower than the limit and not show in test report.

EUT	Pan/Tilt AI Home Security Wi-Fi Camera	Date of Test	2023-06-28
Factor	DRH18-E	Temp. / Humidity	21°C /62%
Polarity	Vertical	Site / Test Engineer	AC2 / Marvin
Test Mode	802.11n-20MHz_TX_CH 1_ANT 0	Test Voltage	AC 120V/60Hz

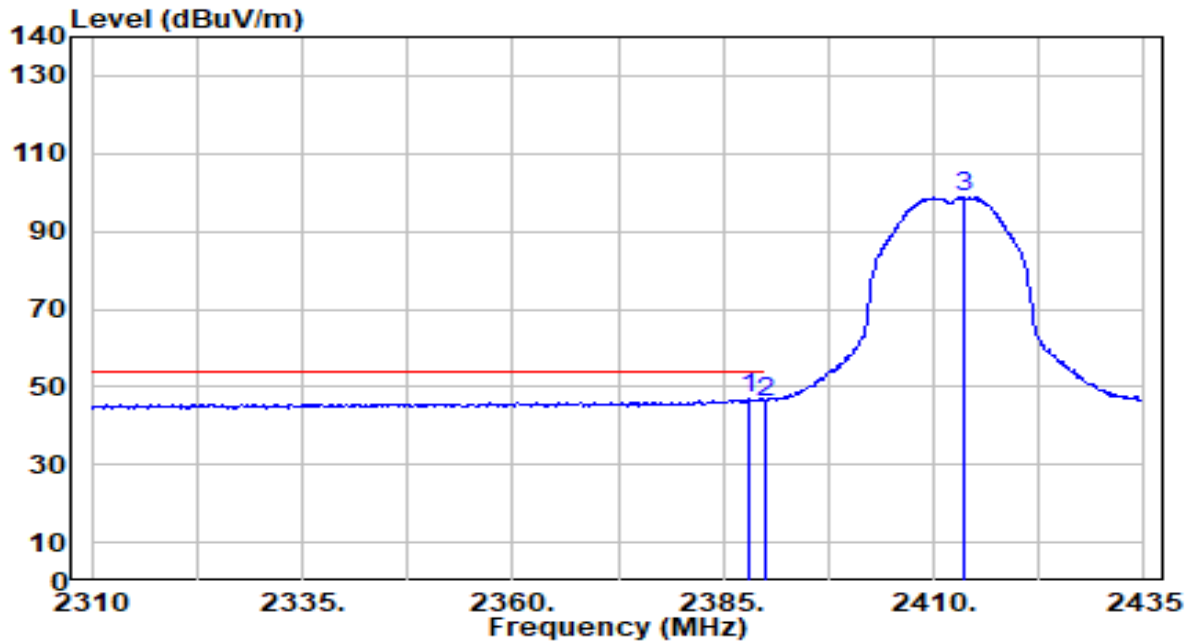

No	Frequency (MHz)	Reading (dBuV)	C.F (dB/m)	Measurement (dBuV/m)	Margin (dB)	Limit (dBuV/m)	Height (cm)	Angle (deg)	Remark (QP/PK/AV)	
1	*	2388.125	16.62	30.17	46.79	-7.21	54.00	100	19	Average
2		2390.000	16.04	30.18	46.22	-7.78	54.00	100	19	Average
3		2413.625	68.78	30.23	99.00	N/A	N/A	100	19	Average

Note:

1. " *", means this data is the worst emission level.
2. C.F (Correction Factor) = Antenna Factor (dB/m)+ Cable Loss (dB).
3. Measurement (dBuV/m) = Reading(dBuV) + C.F (Correction Factor).
4. The emission levels of other frequencies are very lower than the limit and not show in test report.

EUT	Pan/Tilt AI Home Security Wi-Fi Camera	Date of Test	2023-06-28
Factor	DRH18-E	Temp. / Humidity	21°C /62%
Polarity	Horizontal	Site / Test Engineer	AC2 / Marvin
Test Mode	802.11n-20MHz_TX_CH 6_ANT 0	Test Voltage	AC 120V/60Hz

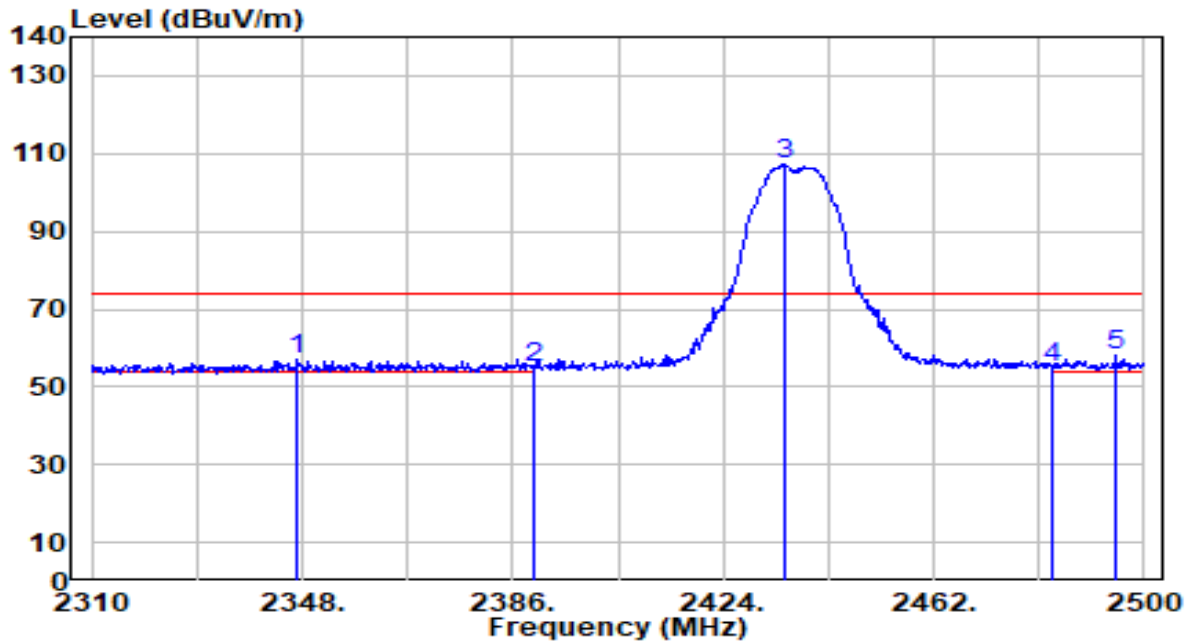

No	Frequency (MHz)	Reading (dBuV)	C.F (dB/m)	Measurement (dBuV/m)	Margin (dB)	Limit (dBuV/m)	Height (cm)	Angle (deg)	Remark (QP/PK/AV)
1	2347.240	27.02	30.06	57.08	-16.92	74.00	100	229	Peak
2	2390.000	24.78	30.18	54.95	-19.05	74.00	100	229	Peak
3	2435.020	77.18	30.25	107.44	N/A	N/A	100	229	Peak
4	2483.500	24.64	30.32	54.96	-19.04	74.00	100	229	Peak
5	* 2494.870	27.70	30.33	58.04	-15.96	74.00	100	229	Peak

Note:

- " *", means this data is the worst emission level.
- C.F (Correction Factor) = Antenna Factor (dB/m)+ Cable Loss (dB).
- Measurement (dBuV/m) = Reading(dBuV) + C.F (Correction Factor).
- The emission levels of other frequencies are very lower than the limit and not show in test report.

EUT	Pan/Tilt AI Home Security Wi-Fi Camera	Date of Test	2023-06-28
Factor	DRH18-E	Temp. / Humidity	21°C /62%
Polarity	Horizontal	Site / Test Engineer	AC2 / Marvin
Test Mode	802.11n-20MHz_TX_CH 6_ANT 0	Test Voltage	AC 120V/60Hz

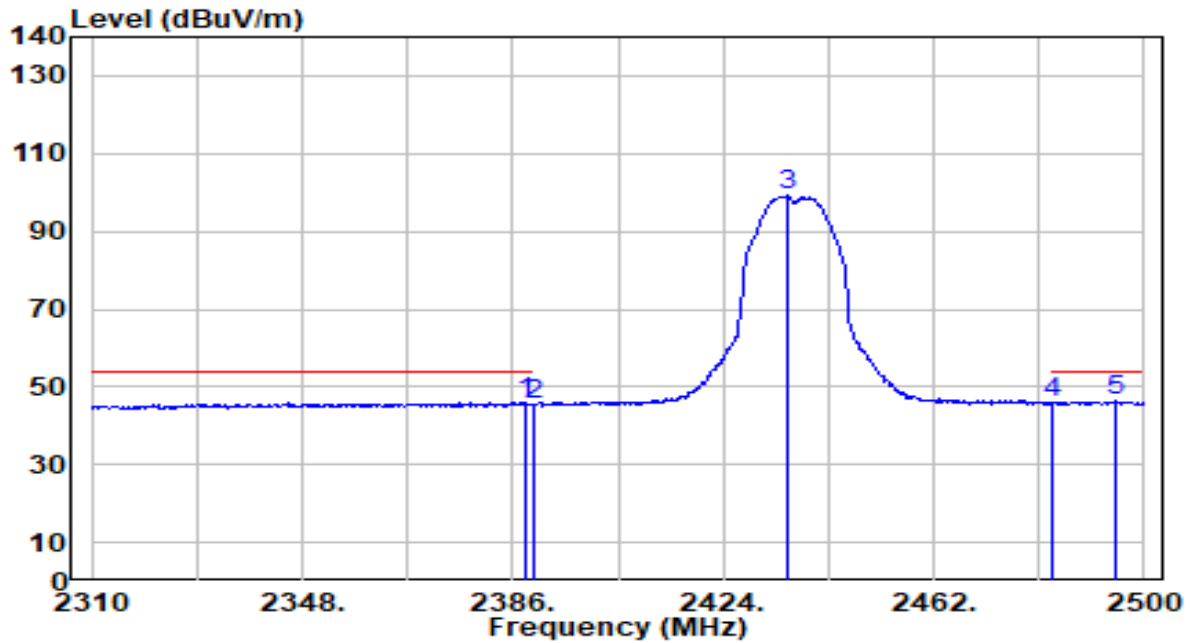

No	Frequency (MHz)	Reading (dBuV)	C.F (dB/m)	Measurement (dBuV/m)	Margin (dB)	Limit (dBuV/m)	Height (cm)	Angle (deg)	Remark (QP/PK/AV)
1	2388.280	15.73	30.17	45.91	-8.09	54.00	100	229	Average
2	2390.000	15.17	30.18	45.35	-8.65	54.00	100	229	Average
3	2435.400	68.81	30.25	99.07	N/A	N/A	100	229	Average
4	2483.500	15.51	30.32	45.83	-8.17	54.00	100	229	Average
5	* 2495.060	16.14	30.33	46.47	-7.53	54.00	100	229	Average

Note:

- " *", means this data is the worst emission level.
- C.F (Correction Factor) = Antenna Factor (dB/m)+ Cable Loss (dB).
- Measurement (dBuV/m) = Reading(dBuV) + C.F (Correction Factor).
- The emission levels of other frequencies are very lower than the limit and not show in test report.

EUT	Pan/Tilt AI Home Security Wi-Fi Camera	Date of Test	2023-06-28
Factor	DRH18-E	Temp. / Humidity	21°C /62%
Polarity	Vertical	Site / Test Engineer	AC2 / Marvin
Test Mode	802.11n-20MHz_TX_CH 6_ANT 0	Test Voltage	AC 120V/60Hz

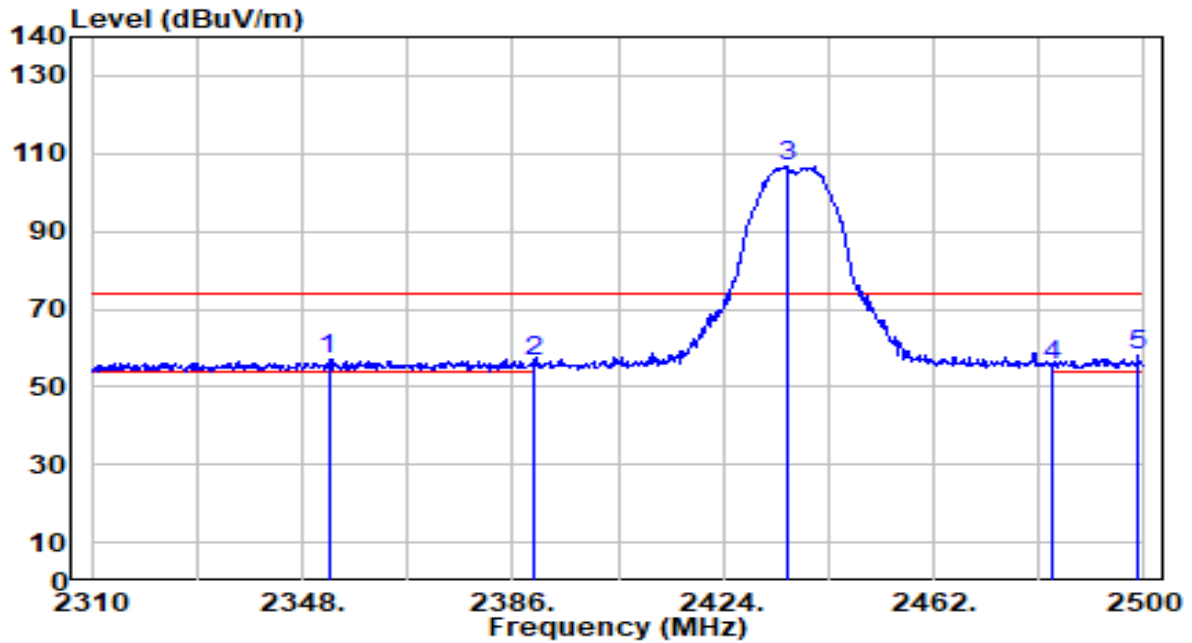

No	Frequency (MHz)	Reading (dBuV)	C.F (dB/m)	Measurement (dBuV/m)	Margin (dB)	Limit (dBuV/m)	Height (cm)	Angle (deg)	Remark (QP/PK/AV)
1	2352.750	27.08	30.07	57.16	-16.84	74.00	100	18	Peak
2	2390.000	26.54	30.18	56.72	-17.28	74.00	100	18	Peak
3	2435.400	76.57	30.25	106.83	N/A	N/A	100	18	Peak
4	2483.500	25.18	30.32	55.50	-18.50	74.00	100	18	Peak
5	* 2499.050	27.52	30.34	57.86	-16.14	74.00	100	18	Peak

Note:

- " *", means this data is the worst emission level.
- C.F (Correction Factor) = Antenna Factor (dB/m)+ Cable Loss (dB).
- Measurement (dBuV/m) = Reading(dBuV) + C.F (Correction Factor).
- The emission levels of other frequencies are very lower than the limit and not show in test report.

EUT	Pan/Tilt AI Home Security Wi-Fi Camera	Date of Test	2023-06-28
Factor	DRH18-E	Temp. / Humidity	21°C /62%
Polarity	Vertical	Site / Test Engineer	AC2 / Marvin
Test Mode	802.11n-20MHz_TX_CH 6_ANT 0	Test Voltage	AC 120V/60Hz

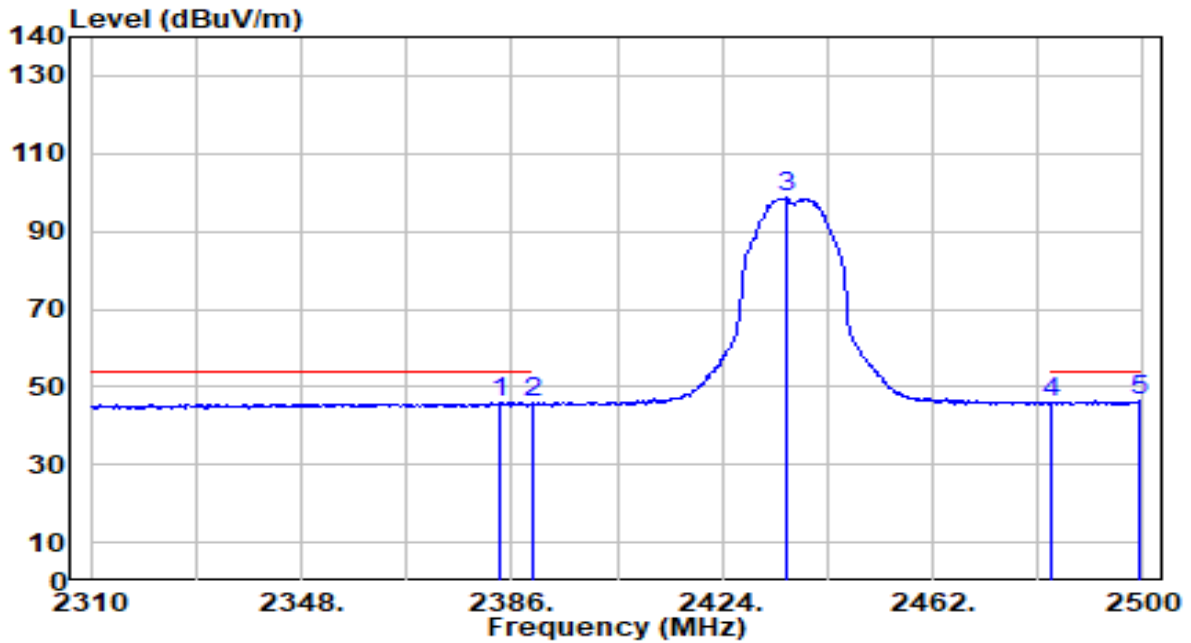

No	Frequency (MHz)	Reading (dBuV)	C.F (dB/m)	Measurement (dBuV/m)	Margin (dB)	Limit (dBuV/m)	Height (cm)	Angle (deg)	Remark (QP/PK/AV)
1	2383.910	15.79	30.16	45.95	-8.05	54.00	100	18	Average
2	2390.000	15.57	30.18	45.75	-8.25	54.00	100	18	Average
3	2435.590	68.41	30.25	98.66	N/A	N/A	100	18	Average
4	2483.500	15.51	30.32	45.83	-8.17	54.00	100	18	Average
5	* 2499.430	16.05	30.34	46.39	-7.61	54.00	100	18	Average

Note:

1. " *", means this data is the worst emission level.
2. C.F (Correction Factor) = Antenna Factor (dB/m)+ Cable Loss (dB).
3. Measurement (dBuV/m) = Reading(dBuV) + C.F (Correction Factor).
4. The emission levels of other frequencies are very lower than the limit and not show in test report.

EUT	Pan/Tilt AI Home Security Wi-Fi Camera	Date of Test	2023-06-28
Factor	DRH18-E	Temp. / Humidity	21°C /62%
Polarity	Horizontal	Site / Test Engineer	AC2 / Marvin
Test Mode	802.11n-20MHz_TX_CH 11_ANT 0	Test Voltage	AC 120V/60Hz

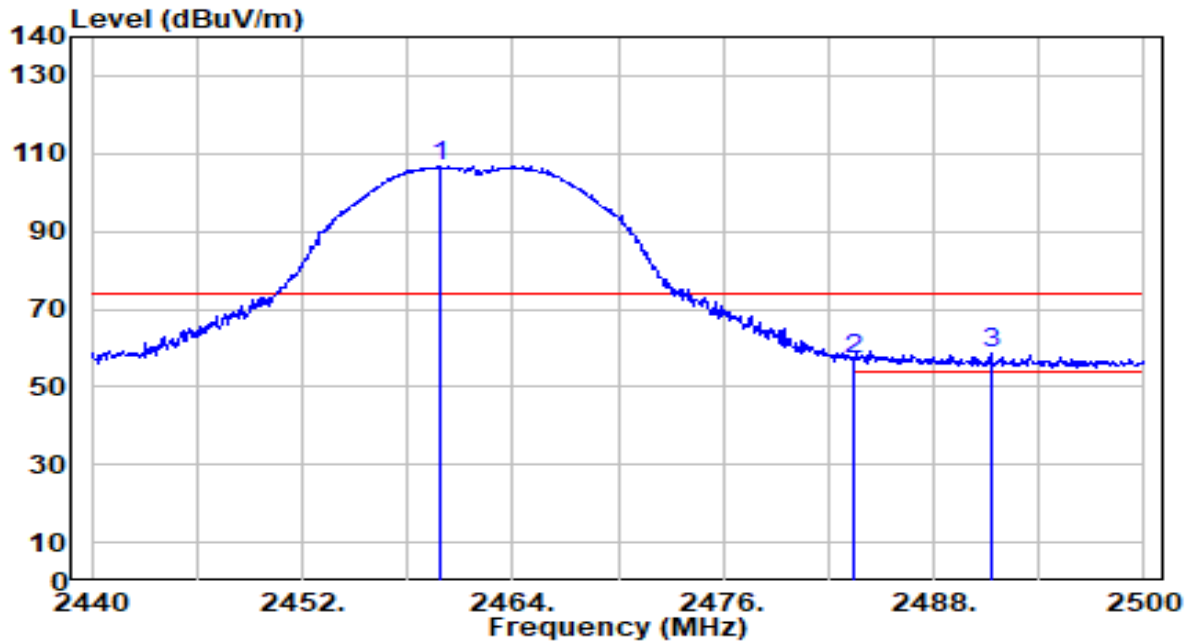

No	Frequency (MHz)	Reading (dBuV)	C.F (dB/m)	Measurement (dBuV/m)	Margin (dB)	Limit (dBuV/m)	Height (cm)	Angle (deg)	Remark (QP/PK/AV)
1	2459.920	76.57	30.29	106.86	N/A	N/A	100	230	Peak
2	2483.500	26.93	30.32	57.25	-16.75	74.00	100	230	Peak
3	* 2491.240	28.43	30.33	58.76	-15.24	74.00	100	230	Peak

Note:

1. " *", means this data is the worst emission level.
2. C.F (Correction Factor) = Antenna Factor (dB/m)+ Cable Loss (dB).
3. Measurement (dBuV/m) = Reading(dBuV) + C.F (Correction Factor).
4. The emission levels of other frequencies are very lower than the limit and not show in test report.

EUT	Pan/Tilt AI Home Security Wi-Fi Camera	Date of Test	2023-06-28
Factor	DRH18-E	Temp. / Humidity	21°C /62%
Polarity	Horizontal	Site / Test Engineer	AC2 / Marvin
Test Mode	802.11n-20MHz_TX_CH 11_ANT 0	Test Voltage	AC 120V/60Hz

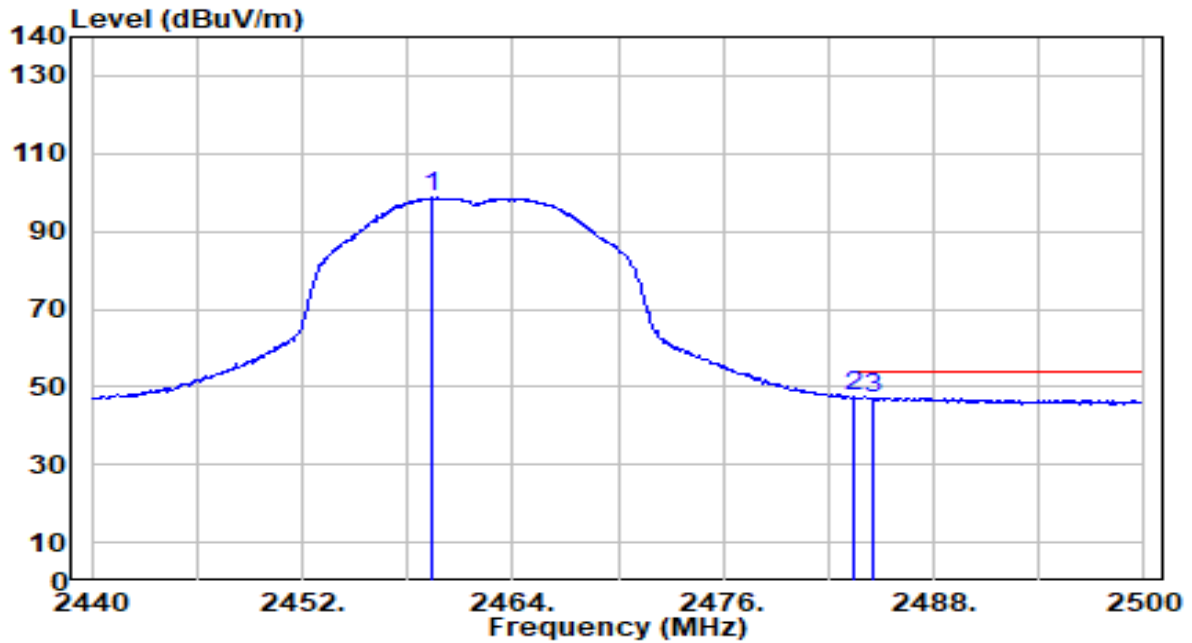

No	Frequency (MHz)	Reading (dBuV)	C.F (dB/m)	Measurement (dBuV/m)	Margin (dB)	Limit (dBuV/m)	Height (cm)	Angle (deg)	Remark (QP/PK/AV)
1	2459.320	68.30	30.29	98.58	N/A	N/A	100	230	Average
2	* 2483.500	17.13	30.32	47.45	-6.55	54.00	100	230	Average
3	2484.580	16.93	30.32	47.25	-6.75	54.00	100	230	Average

Note:

1. " *", means this data is the worst emission level.
2. C.F (Correction Factor) = Antenna Factor (dB/m)+ Cable Loss (dB).
3. Measurement (dBuV/m) = Reading(dBuV) + C.F (Correction Factor).
4. The emission levels of other frequencies are very lower than the limit and not show in test report.

EUT	Pan/Tilt AI Home Security Wi-Fi Camera	Date of Test	2023-06-28
Factor	DRH18-E	Temp. / Humidity	21°C /62%
Polarity	Vertical	Site / Test Engineer	AC2 / Marvin
Test Mode	802.11n-20MHz_TX_CH 11_ANT 0	Test Voltage	AC 120V/60Hz

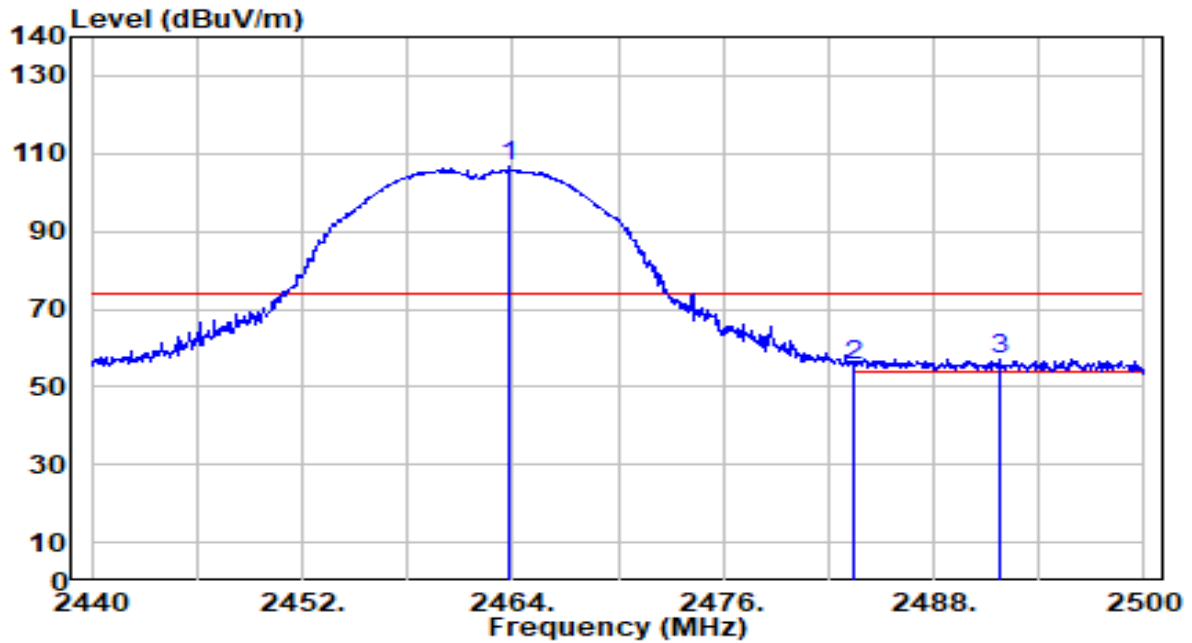

No	Frequency (MHz)	Reading (dBuV)	C.F (dB/m)	Measurement (dBuV/m)	Margin (dB)	Limit (dBuV/m)	Height (cm)	Angle (deg)	Remark (QP/PK/AV)
1	2463.760	76.22	30.29	106.51	N/A	N/A	100	19	Peak
2	2483.500	25.13	30.32	55.45	-18.55	74.00	100	19	Peak
3	* 2491.720	26.87	30.33	57.20	-16.80	74.00	100	19	Peak

Note:

1. " *", means this data is the worst emission level.
2. C.F (Correction Factor) = Antenna Factor (dB/m)+ Cable Loss (dB).
3. Measurement (dBuV/m) = Reading(dBuV) + C.F (Correction Factor).
4. The emission levels of other frequencies are very lower than the limit and not show in test report.

EUT	Pan/Tilt AI Home Security Wi-Fi Camera	Date of Test	2023-06-28
Factor	DRH18-E	Temp. / Humidity	21°C /62%
Polarity	Vertical	Site / Test Engineer	AC2 / Marvin
Test Mode	802.11n-20MHz_TX_CH 11_ANT 0	Test Voltage	AC 120V/60Hz

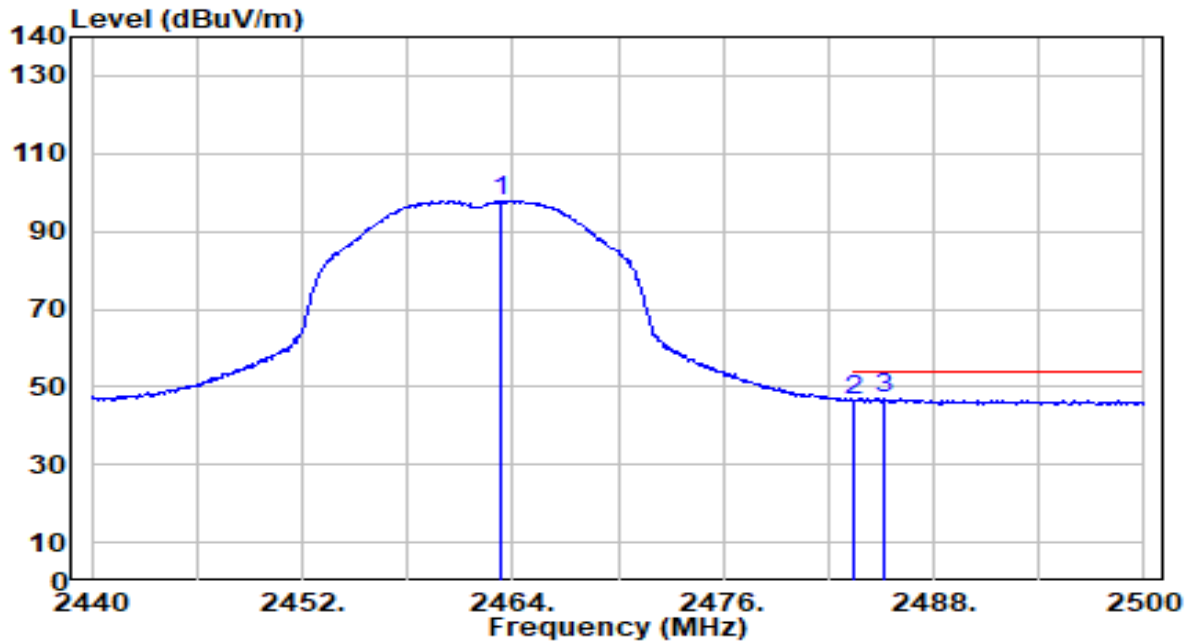

No	Frequency (MHz)	Reading (dBuV)	C.F (dB/m)	Measurement (dBuV/m)	Margin (dB)	Limit (dBuV/m)	Height (cm)	Angle (deg)	Remark (QP/PK/AV)
1	2463.340	67.48	30.29	97.77	N/A	N/A	100	19	Average
2	2483.500	16.37	30.32	46.69	-7.31	54.00	100	19	Average
3	* 2485.120	16.67	30.32	46.99	-7.01	54.00	100	19	Average

Note:

1. " *", means this data is the worst emission level.
2. C.F (Correction Factor) = Antenna Factor (dB/m)+ Cable Loss (dB).
3. Measurement (dBuV/m) = Reading(dBuV) + C.F (Correction Factor).
4. The emission levels of other frequencies are very lower than the limit and not show in test report.

EUT	Pan/Tilt AI Home Security Wi-Fi Camera	Date of Test	2023-06-28
Factor	DRH18-E	Temp. / Humidity	21°C /62%
Polarity	Horizontal	Site / Test Engineer	AC2 / Marvin
Test Mode	802.11ax-20MHz_TX_CH 1_ANT 0	Test Voltage	AC 120V/60Hz

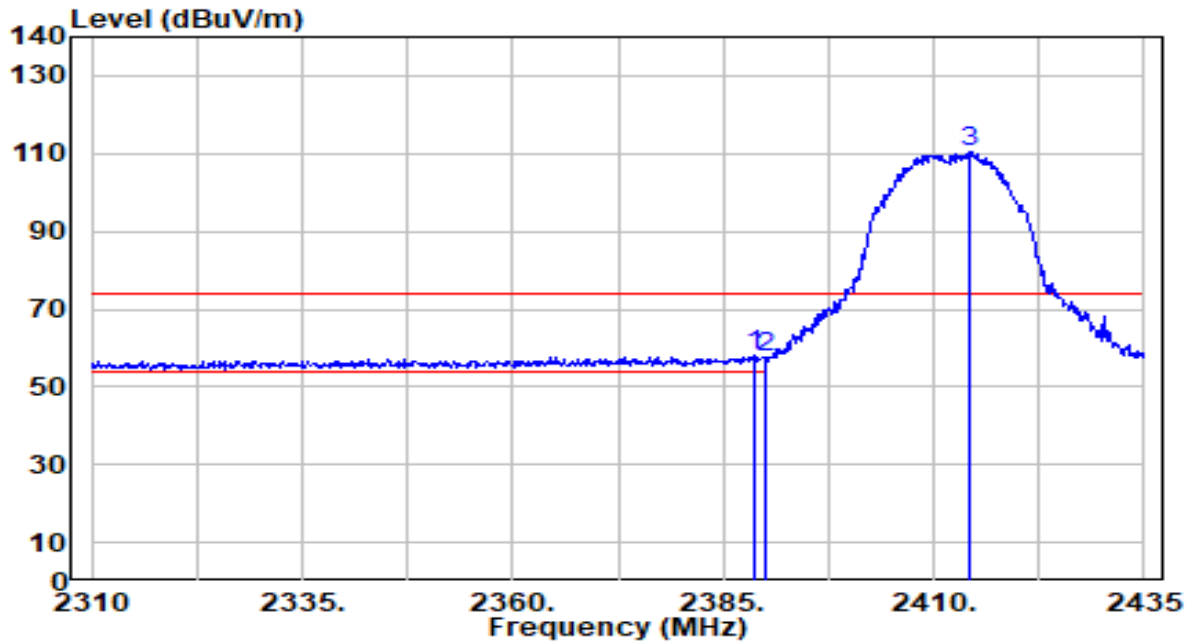

No	Frequency (MHz)	Reading (dBUV)	C.F (dB/m)	Measurement (dBUV/m)	Margin (dB)	Limit (dBUV/m)	Height (cm)	Angle (deg)	Remark (QP/PK/AV)
1	*	27.90	30.18	58.07	-15.93	74.00	105	229	Peak
2		27.16	30.18	57.34	-16.66	74.00	105	229	Peak
3		80.06	30.23	110.29	N/A	N/A	105	229	Peak

Note:

1. "*" , means this data is the worst emission level.
2. C.F (Correction Factor) = Antenna Factor (dB/m)+ Cable Loss (dB).
3. Measurement (dBUV/m) = Reading(dBUV) + C.F (Correction Factor).
4. The emission levels of other frequencies are very lower than the limit and not show in test report.

EUT	Pan/Tilt AI Home Security Wi-Fi Camera	Date of Test	2023-06-28
Factor	DRH18-E	Temp. / Humidity	21°C /62%
Polarity	Horizontal	Site / Test Engineer	AC2 / Marvin
Test Mode	802.11ax-20MHz_TX_CH 1_ANT 0	Test Voltage	AC 120V/60Hz

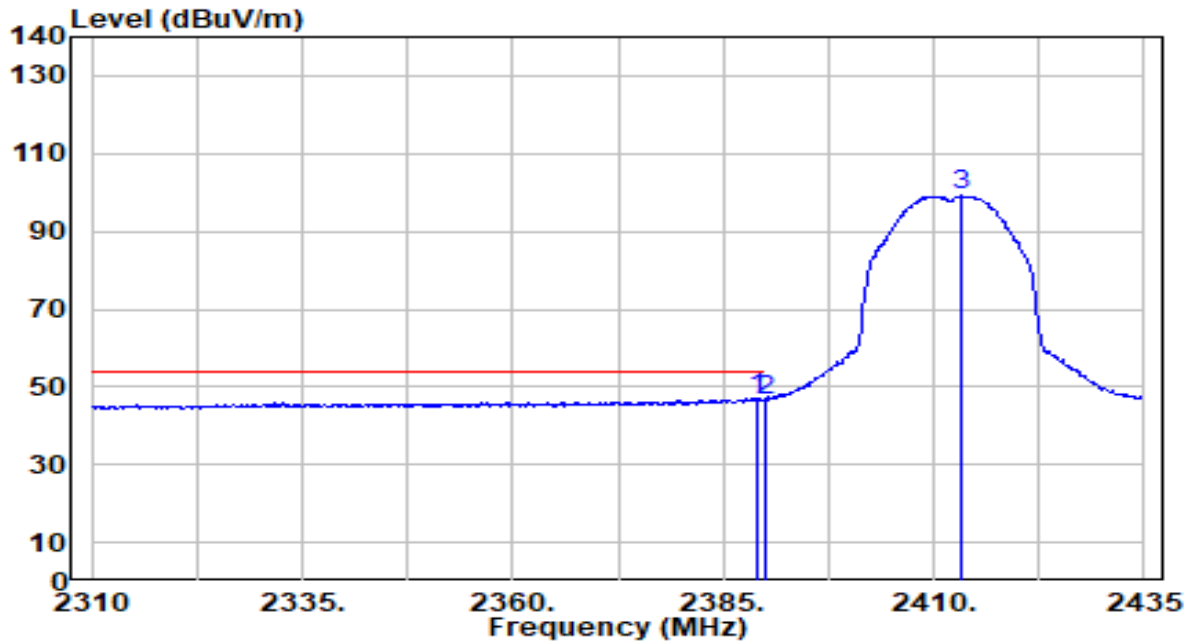

No	Frequency (MHz)	Reading (dBuV)	C.F (dB/m)	Measurement (dBuV/m)	Margin (dB)	Limit (dBuV/m)	Height (cm)	Angle (deg)	Remark (QP/PK/AV)	
1	*	2389.000	16.84	30.18	47.01	-6.99	54.00	105	229	Average
2		2390.000	16.51	30.18	46.69	-7.31	54.00	105	229	Average
3		2413.375	69.13	30.23	99.36	N/A	N/A	105	229	Average

Note:

1. " *", means this data is the worst emission level.
2. C.F (Correction Factor) = Antenna Factor (dB/m)+ Cable Loss (dB).
3. Measurement (dBuV/m) = Reading(dBuV) + C.F (Correction Factor).
4. The emission levels of other frequencies are very lower than the limit and not show in test report.

EUT	Pan/Tilt AI Home Security Wi-Fi Camera	Date of Test	2023-06-28
Factor	DRH18-E	Temp. / Humidity	21°C /62%
Polarity	Vertical	Site / Test Engineer	AC2 / Marvin
Test Mode	802.11ax-20MHz_TX_CH 1_ANT 0	Test Voltage	AC 120V/60Hz

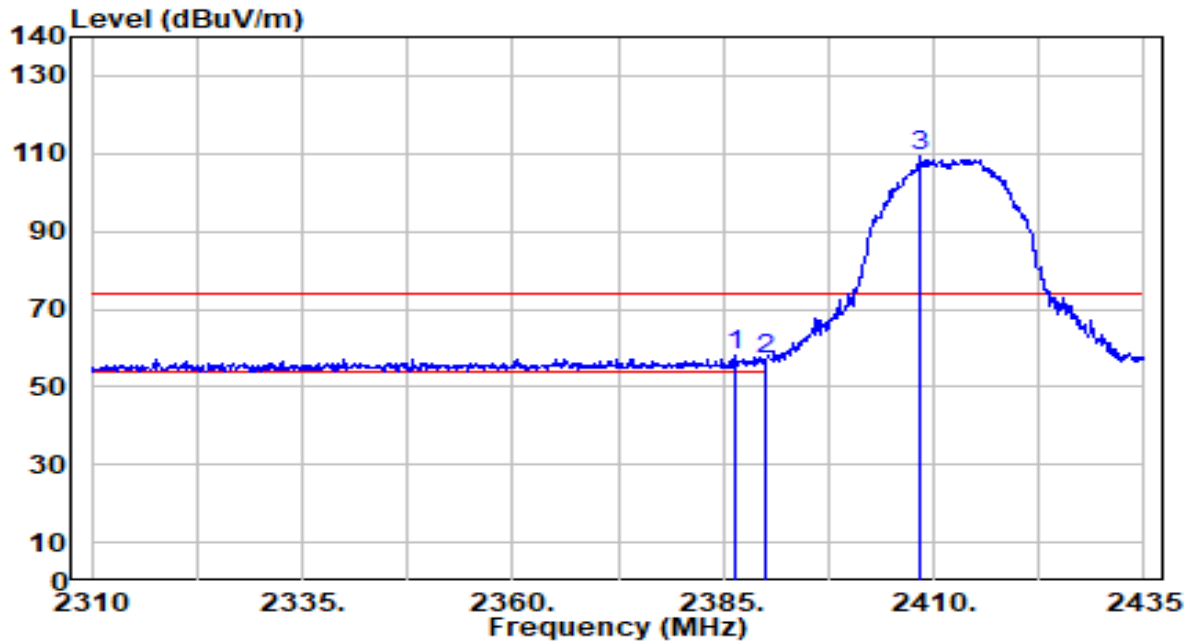

No	Frequency (MHz)	Reading (dBuV)	C.F (dB/m)	Measurement (dBuV/m)	Margin (dB)	Limit (dBuV/m)	Height (cm)	Angle (deg)	Remark (QP/PK/AV)
1	*	27.84	30.17	58.01	-15.99	74.00	100	18	Peak
2		26.99	30.18	57.17	-16.83	74.00	100	18	Peak
3		78.93	30.22	109.15	N/A	N/A	100	18	Peak

Note:

1. " *", means this data is the worst emission level.
2. C.F (Correction Factor) = Antenna Factor (dB/m)+ Cable Loss (dB).
3. Measurement (dBuV/m) = Reading(dBuV) + C.F (Correction Factor).
4. The emission levels of other frequencies are very lower than the limit and not show in test report.

EUT	Pan/Tilt AI Home Security Wi-Fi Camera	Date of Test	2023-06-28
Factor	DRH18-E	Temp. / Humidity	21°C /62%
Polarity	Vertical	Site / Test Engineer	AC2 / Marvin
Test Mode	802.11ax-20MHz_TX_CH 1_ANT 0	Test Voltage	AC 120V/60Hz

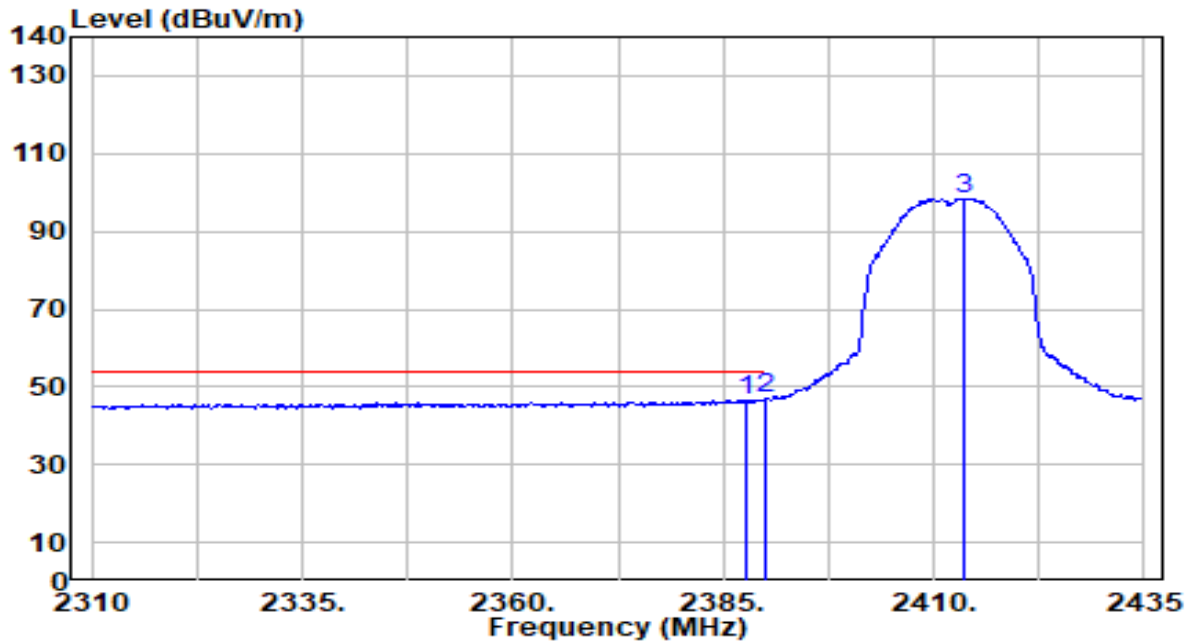

No	Frequency (MHz)	Reading (dBuV)	C.F (dB/m)	Measurement (dBuV/m)	Margin (dB)	Limit (dBuV/m)	Height (cm)	Angle (deg)	Remark (QP/PK/AV)
1	2387.875	16.34	30.17	46.52	-7.48	54.00	100	18	Average
2	* 2390.000	16.58	30.18	46.76	-7.24	54.00	100	18	Average
3	2413.750	68.27	30.23	98.50	N/A	N/A	100	18	Average

Note:

1. " *", means this data is the worst emission level.
2. C.F (Correction Factor) = Antenna Factor (dB/m)+ Cable Loss (dB).
3. Measurement (dBuV/m) = Reading(dBuV) + C.F (Correction Factor).
4. The emission levels of other frequencies are very lower than the limit and not show in test report.

EUT	Pan/Tilt AI Home Security Wi-Fi Camera	Date of Test	2023-06-28
Factor	DRH18-E	Temp. / Humidity	21°C /62%
Polarity	Horizontal	Site / Test Engineer	AC2 / Marvin
Test Mode	802.11ax-20MHz_TX_CH 6_ANT 0	Test Voltage	AC 120V/60Hz

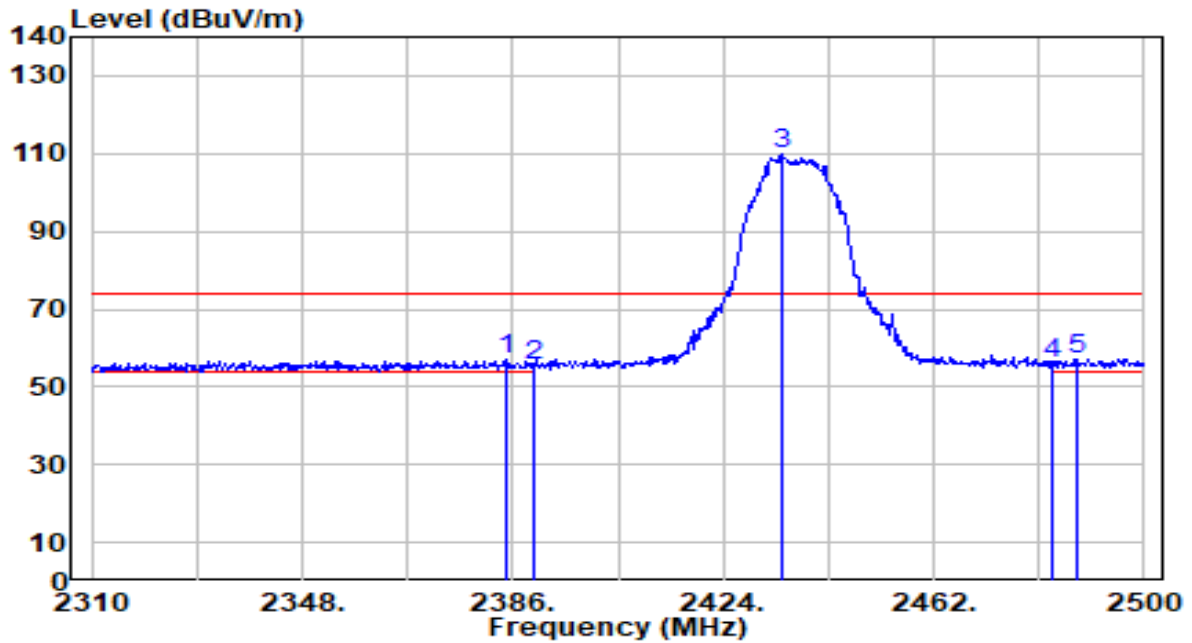

No	Frequency (MHz)	Reading (dBuV)	C.F (dB/m)	Measurement (dBuV/m)	Margin (dB)	Limit (dBuV/m)	Height (cm)	Angle (deg)	Remark (QP/PK/AV)
1	2384.670	26.80	30.16	56.97	-17.03	74.00	100	229	Peak
2	2390.000	25.28	30.18	55.46	-18.54	74.00	100	229	Peak
3	2434.830	79.66	30.25	109.91	N/A	N/A	100	229	Peak
4	2483.500	25.78	30.32	56.10	-17.90	74.00	100	229	Peak
5	* 2487.650	26.83	30.32	57.15	-16.85	74.00	100	229	Peak

Note:

1. " *", means this data is the worst emission level.
2. C.F (Correction Factor) = Antenna Factor (dB/m)+ Cable Loss (dB).
3. Measurement (dBuV/m) = Reading(dBuV) + C.F (Correction Factor).
4. The emission levels of other frequencies are very lower than the limit and not show in test report.

EUT	Pan/Tilt AI Home Security Wi-Fi Camera	Date of Test	2023-06-28
Factor	DRH18-E	Temp. / Humidity	21°C /62%
Polarity	Horizontal	Site / Test Engineer	AC2 / Marvin
Test Mode	802.11ax-20MHz_TX_CH 6_ANT 0	Test Voltage	AC 120V/60Hz

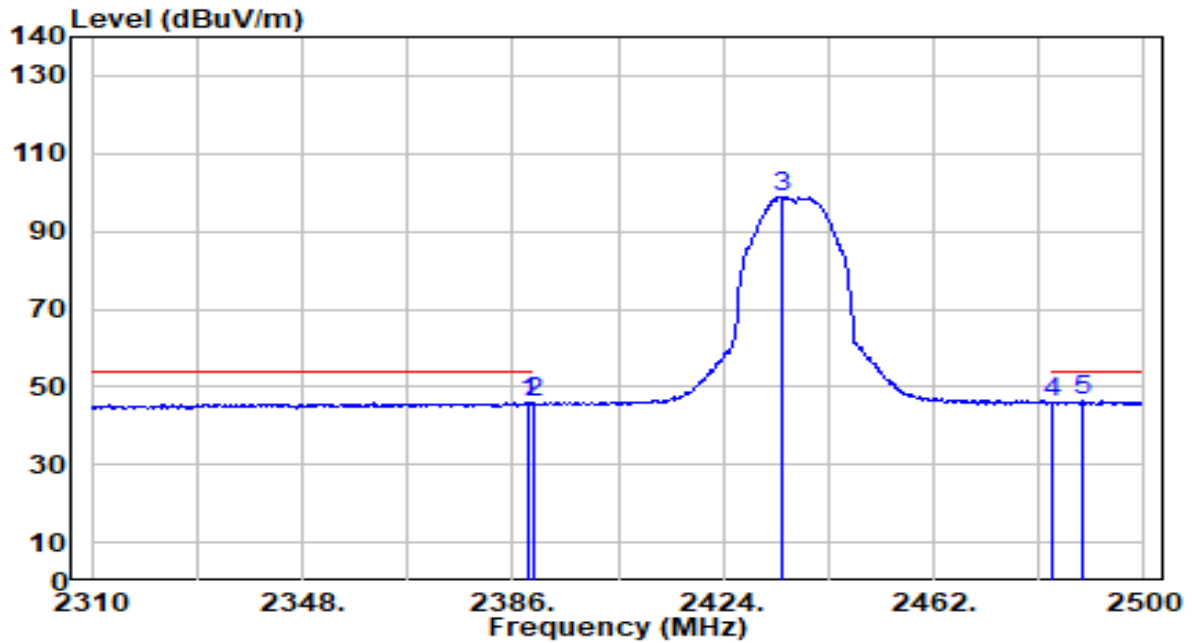

No	Frequency (MHz)	Reading (dBuV)	C.F (dB/m)	Measurement (dBuV/m)	Margin (dB)	Limit (dBuV/m)	Height (cm)	Angle (deg)	Remark (QP/PK/AV)
1	2389.040	15.77	30.18	45.95	-8.05	54.00	100	229	Average
2	2390.000	15.55	30.18	45.72	-8.28	54.00	100	229	Average
3	2434.830	68.64	30.25	98.89	N/A	N/A	100	229	Average
4	2483.500	15.89	30.32	46.21	-7.79	54.00	100	229	Average
5	* 2488.980	16.12	30.33	46.45	-7.55	54.00	100	229	Average

Note:

1. " *", means this data is the worst emission level.
2. C.F (Correction Factor) = Antenna Factor (dB/m)+ Cable Loss (dB).
3. Measurement (dBuV/m) = Reading(dBuV) + C.F (Correction Factor).
4. The emission levels of other frequencies are very lower than the limit and not show in test report.

EUT	Pan/Tilt AI Home Security Wi-Fi Camera	Date of Test	2023-06-28
Factor	DRH18-E	Temp. / Humidity	21°C /62%
Polarity	Vertical	Site / Test Engineer	AC2 / Marvin
Test Mode	802.11ax-20MHz_TX_CH 6_ANT 0	Test Voltage	AC 120V/60Hz

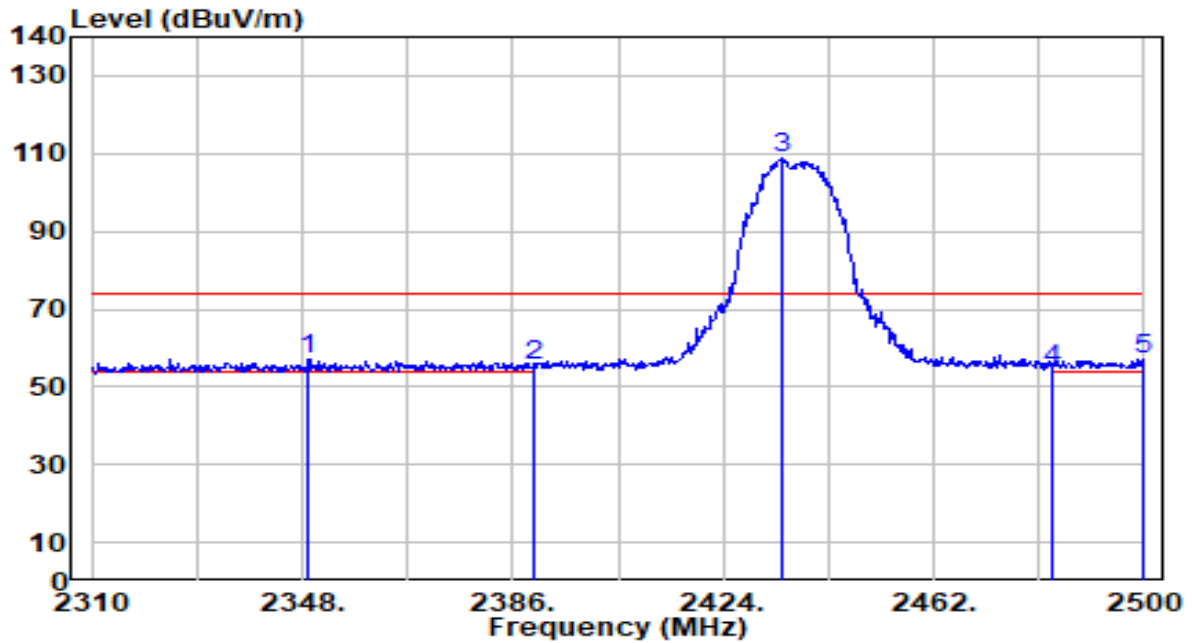

No	Frequency (MHz)	Reading (dBuV)	C.F (dB/m)	Measurement (dBuV/m)	Margin (dB)	Limit (dBuV/m)	Height (cm)	Angle (deg)	Remark (QP/PK/AV)
1	2349.140	26.91	30.06	56.97	-17.03	74.00	100	18	Peak
2	2390.000	25.23	30.18	55.41	-18.59	74.00	100	18	Peak
3	2434.450	78.39	30.25	108.65	N/A	N/A	100	18	Peak
4	2483.500	23.88	30.32	54.20	-19.80	74.00	100	18	Peak
5	* 2499.810	26.84	30.34	57.18	-16.82	74.00	100	18	Peak

Note:

1. " *", means this data is the worst emission level.
2. C.F (Correction Factor) = Antenna Factor (dB/m)+ Cable Loss (dB).
3. Measurement (dBuV/m) = Reading(dBuV) + C.F (Correction Factor).
4. The emission levels of other frequencies are very lower than the limit and not show in test report.

EUT	Pan/Tilt AI Home Security Wi-Fi Camera	Date of Test	2023-06-28
Factor	DRH18-E	Temp. / Humidity	21°C /62%
Polarity	Vertical	Site / Test Engineer	AC2 / Marvin
Test Mode	802.11ax-20MHz_TX_CH 6_ANT 0	Test Voltage	AC 120V/60Hz

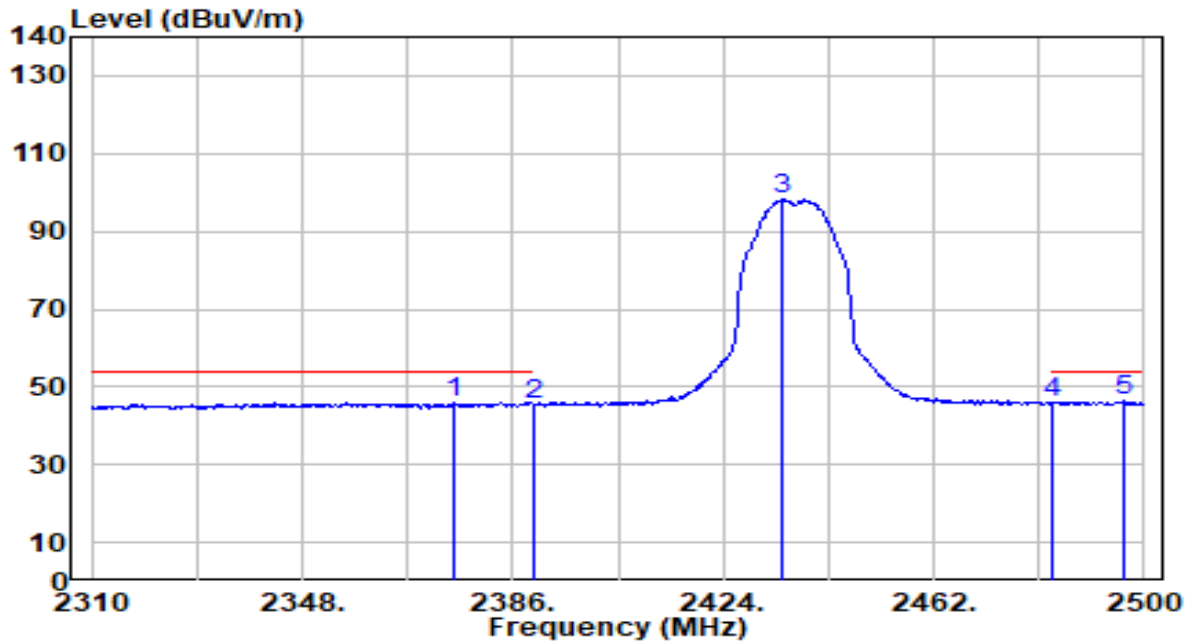

No	Frequency (MHz)	Reading (dBuV)	C.F (dB/m)	Measurement (dBuV/m)	Margin (dB)	Limit (dBuV/m)	Height (cm)	Angle (deg)	Remark (QP/PK/AV)
1	2375.360	15.81	30.14	45.95	-8.05	54.00	100	18	Average
2	2390.000	15.45	30.18	45.63	-8.37	54.00	100	18	Average
3	2434.640	67.82	30.25	98.07	N/A	N/A	100	18	Average
4	2483.500	15.46	30.32	45.78	-8.22	54.00	100	18	Average
5	* 2496.390	15.95	30.34	46.28	-7.72	54.00	100	18	Average

Note:

- " *", means this data is the worst emission level.
- C.F (Correction Factor) = Antenna Factor (dB/m)+ Cable Loss (dB).
- Measurement (dBuV/m) = Reading(dBuV) + C.F (Correction Factor).
- The emission levels of other frequencies are very lower than the limit and not show in test report.

EUT	Pan/Tilt AI Home Security Wi-Fi Camera	Date of Test	2023-06-28
Factor	DRH18-E	Temp. / Humidity	21°C /62%
Polarity	Horizontal	Site / Test Engineer	AC2 / Marvin
Test Mode	802.11ax-20MHz_TX_CH 11_ANT 0	Test Voltage	AC 120V/60Hz

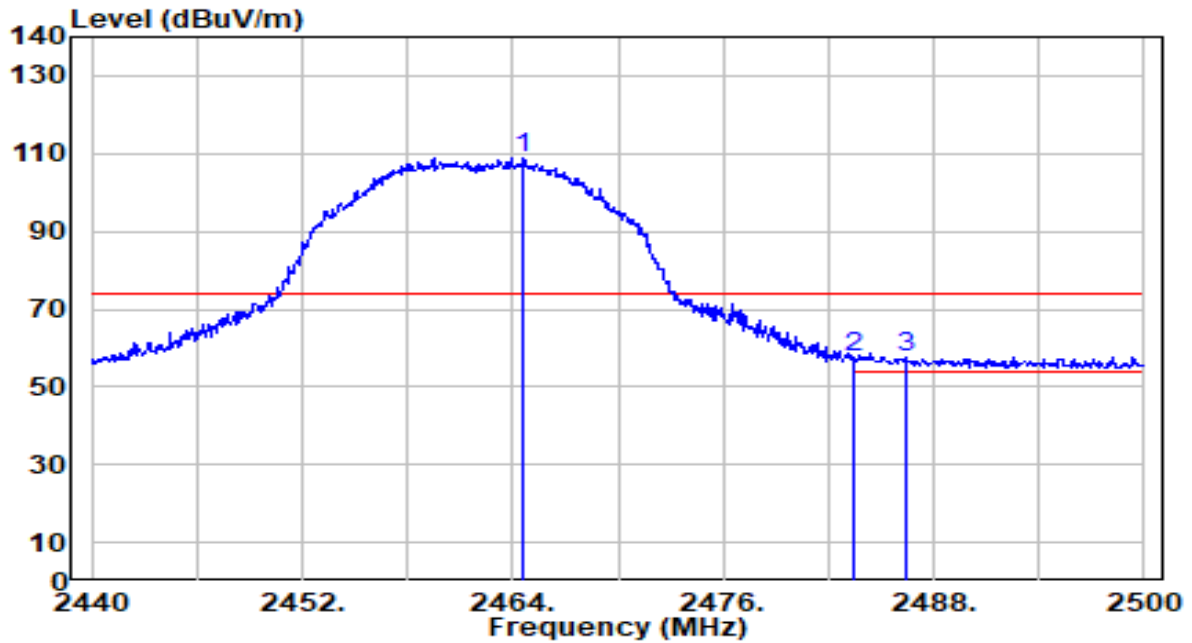

No	Frequency (MHz)	Reading (dBuV)	C.F (dB/m)	Measurement (dBuV/m)	Margin (dB)	Limit (dBuV/m)	Height (cm)	Angle (deg)	Remark (QP/PK/AV)
1	2464.600	78.50	30.29	108.80	N/A	N/A	100	230	Peak
2	2483.500	27.28	30.32	57.59	-16.41	74.00	100	230	Peak
3	* 2486.500	27.27	30.32	57.59	-16.41	74.00	100	230	Peak

Note:

1. " *", means this data is the worst emission level.
2. C.F (Correction Factor) = Antenna Factor (dB/m)+ Cable Loss (dB).
3. Measurement (dBuV/m) = Reading(dBuV) + C.F (Correction Factor).
4. The emission levels of other frequencies are very lower than the limit and not show in test report.

EUT	Pan/Tilt AI Home Security Wi-Fi Camera	Date of Test	2023-06-28
Factor	DRH18-E	Temp. / Humidity	21°C /62%
Polarity	Horizontal	Site / Test Engineer	AC2 / Marvin
Test Mode	802.11ax-20MHz_TX_CH 11_ANT 0	Test Voltage	AC 120V/60Hz

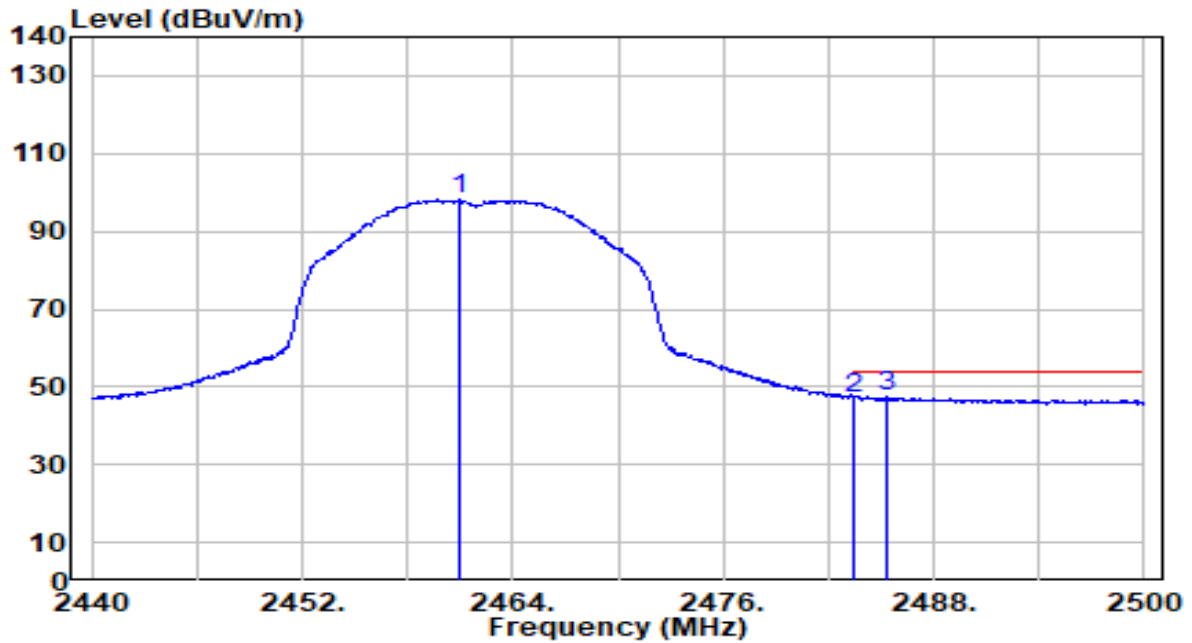

No	Frequency (MHz)	Reading (dBuV)	C.F (dB/m)	Measurement (dBuV/m)	Margin (dB)	Limit (dBuV/m)	Height (cm)	Angle (deg)	Remark (QP/PK/AV)
1	2461.000	67.88	30.29	98.16	N/A	N/A	100	230	Average
2	2483.500	16.88	30.32	47.20	-6.80	54.00	100	230	Average
3	* 2485.360	17.01	30.32	47.33	-6.67	54.00	100	230	Average

Note:

1. " *", means this data is the worst emission level.
2. C.F (Correction Factor) = Antenna Factor (dB/m)+ Cable Loss (dB).
3. Measurement (dBuV/m) = Reading(dBuV) + C.F (Correction Factor).
4. The emission levels of other frequencies are very lower than the limit and not show in test report.

EUT	Pan/Tilt AI Home Security Wi-Fi Camera	Date of Test	2023-06-28
Factor	DRH18-E	Temp. / Humidity	21°C /62%
Polarity	Vertical	Site / Test Engineer	AC2 / Marvin
Test Mode	802.11ax-20MHz_TX_CH 11_ANT 0	Test Voltage	AC 120V/60Hz

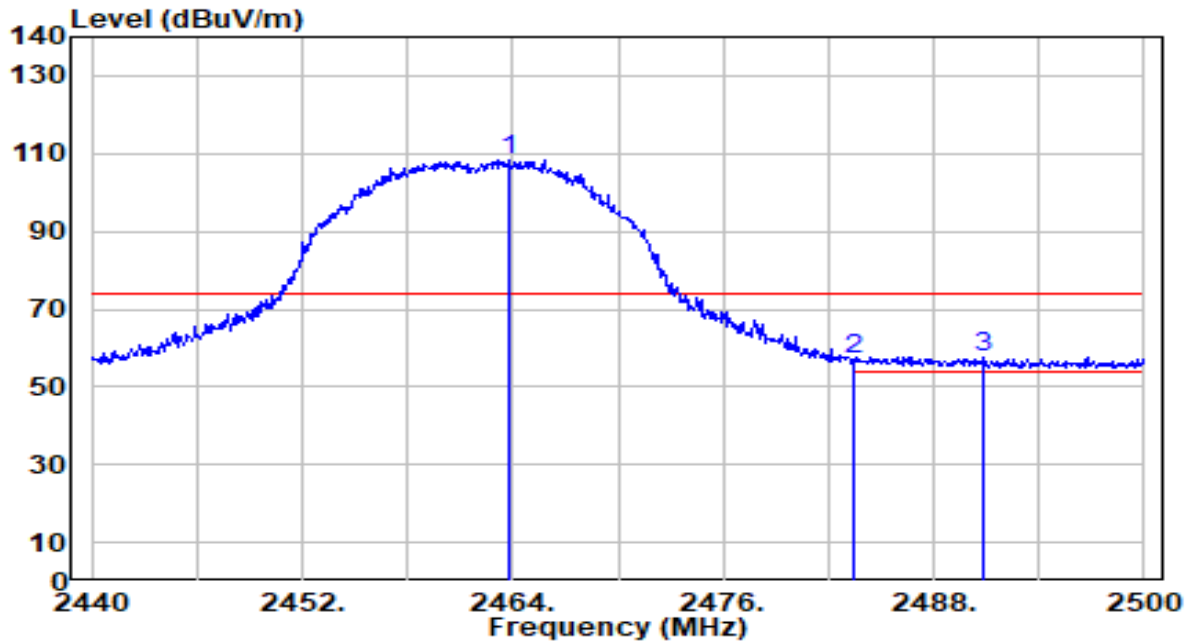

No	Frequency (MHz)	Reading (dBuV)	C.F (dB/m)	Measurement (dBuV/m)	Margin (dB)	Limit (dBuV/m)	Height (cm)	Angle (deg)	Remark (QP/PK/AV)
1	2463.760	78.08	30.29	108.37	N/A	N/A	100	19	Peak
2	2483.500	26.61	30.32	56.92	-17.08	74.00	100	19	Peak
3	* 2490.820	27.50	30.33	57.83	-16.17	74.00	100	19	Peak

Note:

1. " *", means this data is the worst emission level.
2. C.F (Correction Factor) = Antenna Factor (dB/m)+ Cable Loss (dB).
3. Measurement (dBuV/m) = Reading(dBuV) + C.F (Correction Factor).
4. The emission levels of other frequencies are very lower than the limit and not show in test report.

EUT	Pan/Tilt AI Home Security Wi-Fi Camera	Date of Test	2023-06-28
Factor	DRH18-E	Temp. / Humidity	21°C /62%
Polarity	Vertical	Site / Test Engineer	AC2 / Marvin
Test Mode	802.11ax-20MHz_TX_CH 11_ANT 0	Test Voltage	AC 120V/60Hz

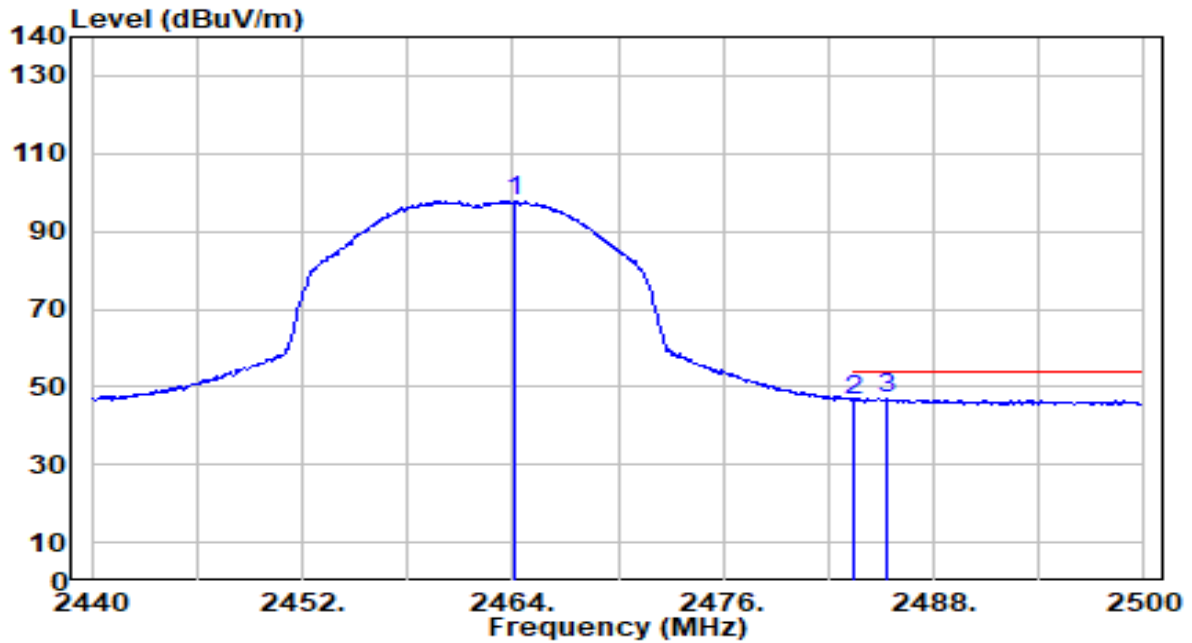

No	Frequency (MHz)	Reading (dBuV)	C.F (dB/m)	Measurement (dBuV/m)	Margin (dB)	Limit (dBuV/m)	Height (cm)	Angle (deg)	Remark (QP/PK/AV)
1	2464.120	67.56	30.29	97.85	N/A	N/A	100	19	Average
2	2483.500	16.40	30.32	46.72	-7.28	54.00	100	19	Average
3	* 2485.300	16.73	30.32	47.05	-6.95	54.00	100	19	Average

Note:

1. " *", means this data is the worst emission level.
2. C.F (Correction Factor) = Antenna Factor (dB/m)+ Cable Loss (dB).
3. Measurement (dBuV/m) = Reading(dBuV) + C.F (Correction Factor).
4. The emission levels of other frequencies are very lower than the limit and not show in test report.

7.8. AC Conducted Emissions Measurement

7.8.1. Test Limit

FCC Part 15 Subpart C Paragraph 15.207 Limits		
Frequency (MHz)	QP (dBuV)	AV (dBuV)
0.15 - 0.50	66 - 56	56 - 46
0.50 - 5.0	56	46
5.0 - 30	60	50

Note 1: The lower limit shall apply at the transition frequencies.

Note 2: The limit decreases linearly with the logarithm of the frequency in the range 0.15MHz to 0.5MHz.

7.8.2. Test Setup

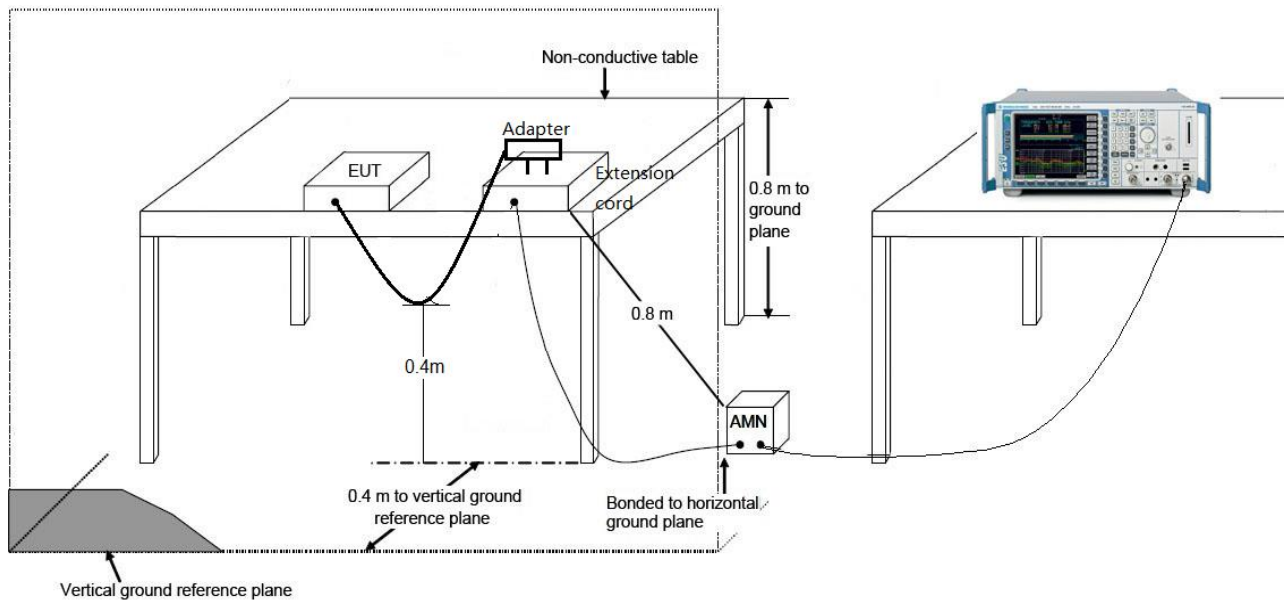

7.8.3. Test Result

EUT	Pan/Tilt AI Home Security Wi-Fi Camera	Date of Test	2023-07-03
Factor	CE_ENV216-L1 (Filter ON)	Temp. / Humidity	24.9°C /53%
Polarity	Line1	Site / Test Engineer	SR2 / Bob
Test Mode	802.11n-20MHz_TX_CH 6_ANT 0	Test Voltage	AC 120V/60Hz

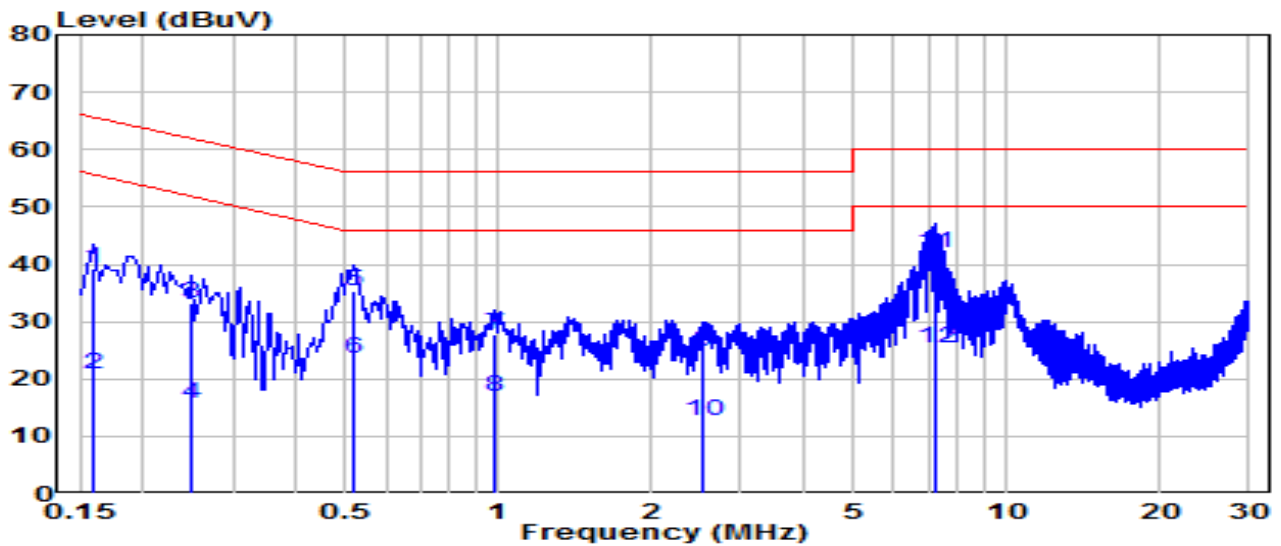

No	Frequency (MHz)	Reading (dBUV)	C.F (dB)	Measurement (dBUV)	Margin (dB)	Limit (dBUV)	Remark (QP/PK/AV)
1	0.159	29.74	9.62	39.36	-26.16	65.52	QP
2	0.159	11.31	9.62	20.93	-34.58	55.52	Average
3	0.249	23.48	9.63	33.10	-28.69	61.79	QP
4	0.249	6.12	9.63	15.74	-36.05	51.79	Average
5	0.519	25.80	9.64	35.44	-20.56	56.00	QP
6	0.519	13.82	9.64	23.46	-22.54	46.00	Average
7	0.982	18.01	9.67	27.68	-28.32	56.00	QP
8	0.982	7.27	9.67	16.93	-29.07	46.00	Average
9	2.526	14.99	9.70	24.69	-31.31	56.00	QP
10	2.526	3.10	9.70	12.80	-33.20	46.00	Average
11	* 7.223	32.21	9.80	42.01	-17.99	60.00	QP
12	* 7.223	15.68	9.80	25.48	-24.52	50.00	Average

Note:

1. " *", means this data is the worst emission level.
2. C.F (Correction Factor) = LISN Factor (dB)+ Cable Loss (dB).
3. Measurement (dBUV) = Reading(dBUV) + C.F (Correction Factor).

EUT	Pan/Tilt AI Home Security Wi-Fi Camera	Date of Test	2023-07-03
Factor	CE_ENV216-N (Filter ON)	Temp. / Humidity	24.9°C /53%
Polarity	Neutral	Site / Test Engineer	SR2 / Bob
Test Mode	802.11n-20MHz_TX_CH 6_ANT 0	Test Voltage	AC 120V/60Hz

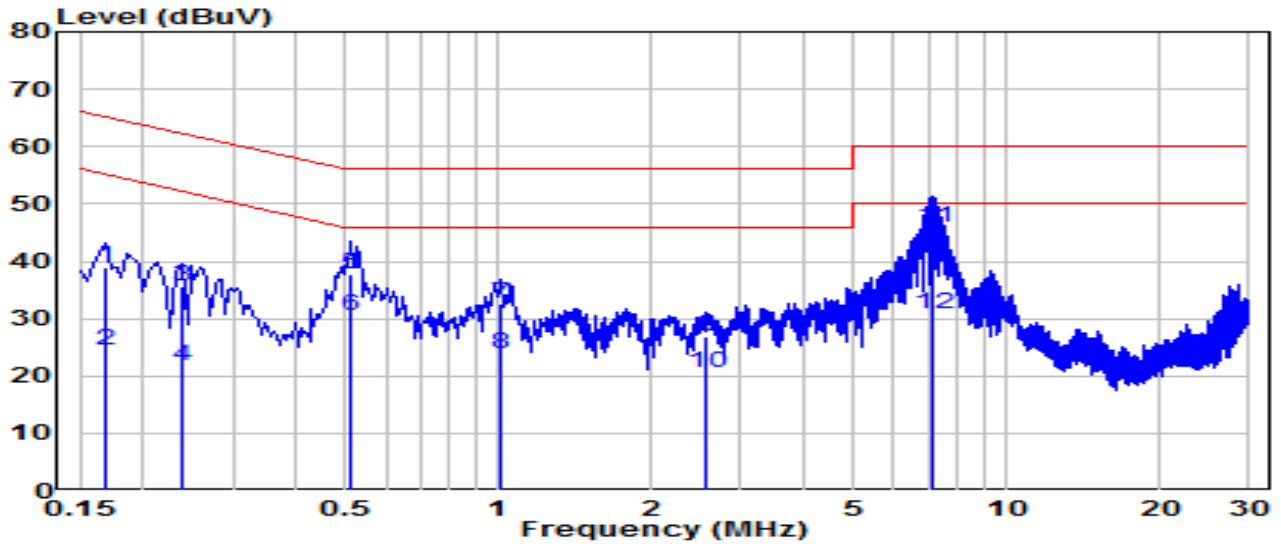

No	Frequency (MHz)	Reading (dBUV)	C.F (dB)	Measurement (dBUV)	Margin (dB)	Limit (dBUV)	Remark (QP/PK/AV)
1	0.168	29.45	9.62	39.07	-25.98	65.06	QP
2	0.168	14.78	9.62	24.40	-30.66	55.06	Average
3	0.240	26.10	9.63	35.72	-26.37	62.10	QP
4	0.240	12.13	9.63	21.76	-30.34	52.10	Average
5	0.514	28.13	9.64	37.77	-18.23	56.00	QP
6	0.514	20.75	9.64	30.40	-15.60	46.00	Average
7	1.014	22.98	9.67	32.65	-23.35	56.00	QP
8	1.014	14.05	9.67	23.72	-22.28	46.00	Average
9	2.557	17.14	9.70	26.84	-29.16	56.00	QP
10	2.557	10.84	9.70	20.55	-25.45	46.00	Average
11	* 7.178	36.11	9.80	45.91	-14.09	60.00	QP
12	* 7.178	20.88	9.80	30.68	-19.32	50.00	Average

Note:

1. " *", means this data is the worst emission level.
2. C.F (Correction Factor) = LISN Factor (dB)+ Cable Loss (dB).
3. Measurement (dBUV) = Reading(dBUV) + C.F (Correction Factor).

EUT	Pan/Tilt AI Home Security Wi-Fi Camera	Date of Test	2023-07-03
Factor	CE_ENV216-L1 (Filter ON)	Temp. / Humidity	24.9°C /53%
Polarity	Line1	Site / Test Engineer	SR2 / Bob
Test Mode	802.11n-20MHz_TX_CH 6_ANT 0	Test Voltage	AC 240V/60Hz

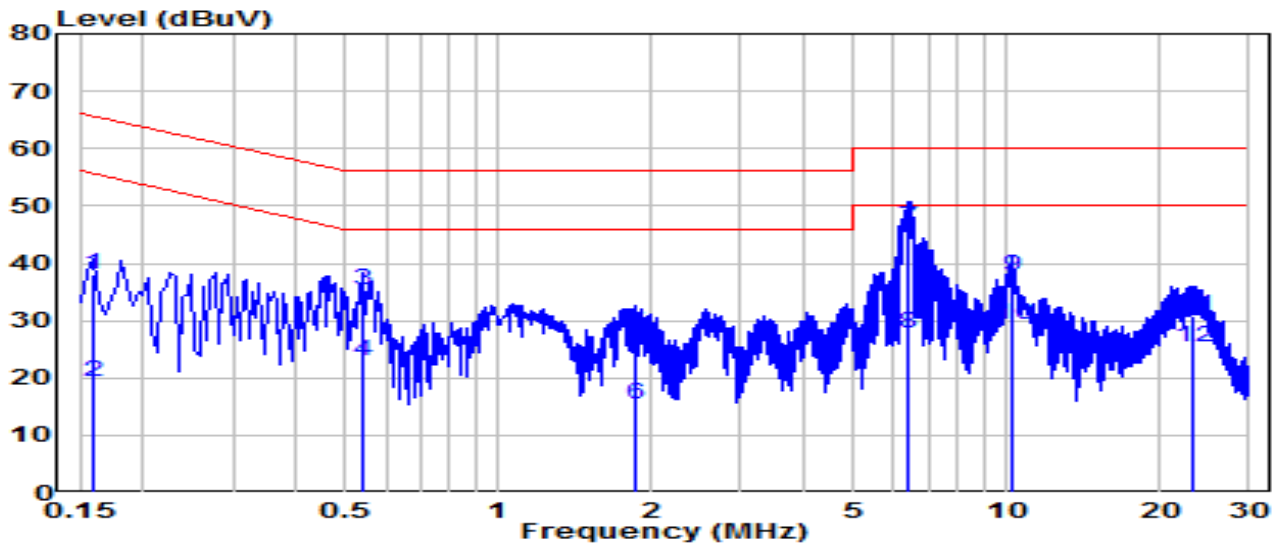

No	Frequency (MHz)	Reading (dBuV)	C.F (dB)	Measurement (dBuV)	Margin (dB)	Limit (dBuV)	Remark (QP/PK/AV)
1	0.159	28.49	9.62	38.11	-27.40	65.52	QP
2	0.159	9.60	9.62	19.22	-36.30	55.52	Average
3	0.541	25.68	9.64	35.33	-20.67	56.00	QP
4	0.541	13.42	9.64	23.06	-22.94	46.00	Average
5	1.851	18.18	9.69	27.87	-28.13	56.00	QP
6	1.851	5.65	9.69	15.34	-30.66	46.00	Average
7	* 6.431	36.27	9.78	46.05	-13.95	60.00	QP
8	* 6.431	18.08	9.78	27.86	-22.14	50.00	Average
9	10.238	27.83	9.86	37.70	-22.30	60.00	QP
10	10.238	19.55	9.86	29.41	-20.59	50.00	Average
11	23.354	20.98	9.92	30.90	-29.10	60.00	QP
12	23.354	15.50	9.92	25.42	-24.58	50.00	Average

Note:

1. " *", means this data is the worst emission level.
2. C.F (Correction Factor) = LISN Factor (dB)+ Cable Loss (dB).
3. Measurement (dBuV) = Reading(dBuV) + C.F (Correction Factor).

EUT	Pan/Tilt AI Home Security Wi-Fi Camera	Date of Test	2023-07-03
Factor	CE_ENV216-N (Filter ON)	Temp. / Humidity	24.9°C /53%
Polarity	Neutral	Site / Test Engineer	SR2 / Bob
Test Mode	802.11n-20MHz_TX_CH 6_ANT 0	Test Voltage	AC 240V/60Hz

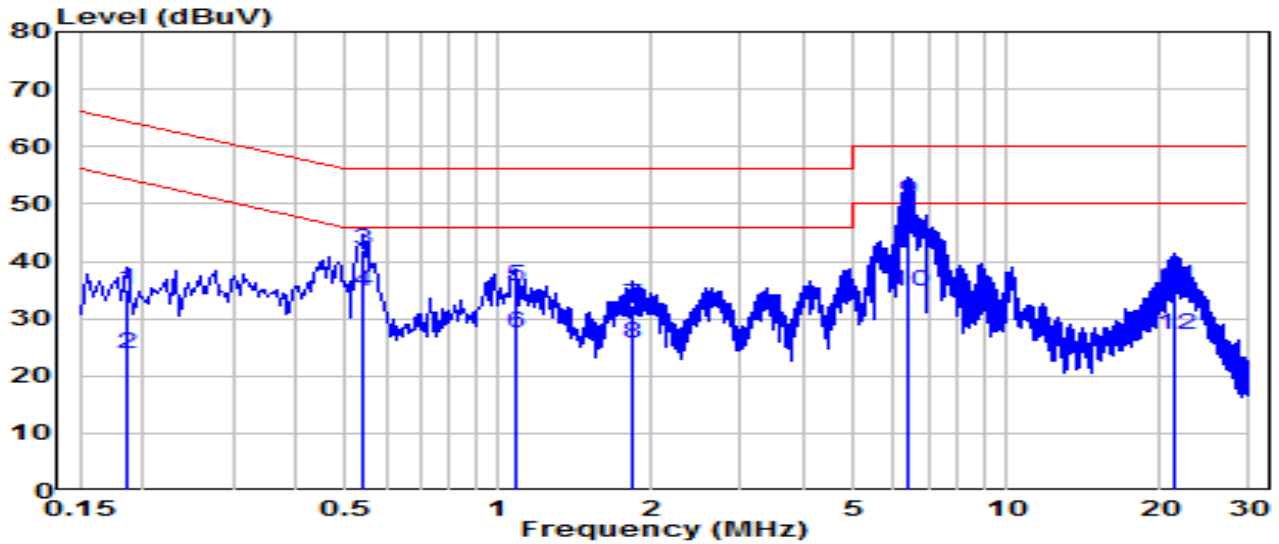

No	Frequency (MHz)	Reading (dBuV)	C.F (dB)	Measurement (dBuV)	Margin (dB)	Limit (dBuV)	Remark (QP/PK/AV)
1	0.186	25.26	9.62	34.89	-29.33	64.21	QP
2	0.186	14.25	9.62	23.88	-30.34	54.21	Average
3	0.541	32.42	9.64	42.06	-13.94	56.00	QP
4	0.541	25.00	9.64	34.64	-11.36	46.00	Average
5	1.077	26.09	9.67	35.76	-20.24	56.00	QP
6	1.077	17.81	9.67	27.48	-18.52	46.00	Average
7	1.842	22.50	9.69	32.19	-23.81	56.00	QP
8	1.842	15.93	9.69	25.62	-20.38	46.00	Average
9	*	6.418	9.78	50.36	-9.64	60.00	QP
10	*	6.418	9.78	34.60	-15.40	50.00	Average
11	21.442	25.48	10.00	35.49	-24.51	60.00	QP
12	21.442	17.08	10.00	27.09	-22.91	50.00	Average

Note:

1. " *", means this data is the worst emission level.
2. C.F (Correction Factor) = LISN Factor (dB)+ Cable Loss (dB).
3. Measurement (dBuV) = Reading(dBuV) + C.F (Correction Factor).

8. CONCLUSION

The data collected relate only the item(s) tested and show that the device is compliance with Part 15C of the FCC Rules.

Appendix A : Test Setup Photograph

Refer to “2306TW0113-UT” file.

Appendix B : External Photograph

Refer to “2306TW0113-UE” file.

Appendix C : Internal Photograph

Refer to “2306TW0113-UI” file.

————— The End —————