

# RF MEASUREMENT REPORT

---

**FCC ID:** 2AXJ4C20V6  
**Applicant:** TP-Link Corporation Limited  
**Product:** AC750 Wireless Dual Band Router  
**Model No.:** Archer C20  
**Brand Name:** tp-link  
**FCC Classification:** Digital Transmission System (DTS)  
**FCC Rule Part(s):** Part 15 Subpart C (Section 15.247)  
**Result:** Complies  
**Received Date:** 2023-05-09  
**Test Date:** 2023-05-10 ~ 2023-05-31

**Reviewed By:**

\_\_\_\_\_  
Kevin Guo

**Approved By:**

\_\_\_\_\_  
Robin Wu



The test results relate only to the samples tested.  
This equipment has been shown to be capable of compliance with the applicable technical standards as indicated in the measurement report and was tested in accordance with the measurement procedures specified in ANSI C63.10-2013. Test results reported herein relate only to the item(s) tested.  
The test report shall not be reproduced except in full without the written approval of MRT Technology (Shenzhen) Co., Ltd.

---

### Revision History

Report No.	Version	Description	Issue Date	Note
2305RSU012-U1	V01	Initial Report	2023-06-07	Valid

## CONTENTS

Description	Page
<b>1. General Information .....</b>	<b>5</b>
1.1. Applicant .....	5
1.2. Manufacturer .....	5
1.3. Testing Facility .....	5
1.4. Product Information .....	6
1.5. Radio Specification under Test .....	6
1.6. Working Frequencies .....	7
1.7. Antenna Details .....	7
<b>2. Test Configuration .....</b>	<b>8</b>
2.1. Test Mode .....	8
2.2. Test System Connection Diagram .....	8
2.3. Test System Details .....	9
2.4. Test Software .....	9
2.5. Applied Standards .....	9
2.6. Test Environment Condition .....	9
<b>3. Antenna Requirements .....</b>	<b>10</b>
<b>4. Measuring Instrument .....</b>	<b>11</b>
<b>5. Decision Rules and Measurement Uncertainty .....</b>	<b>12</b>
5.1. Decision Rules .....	12
5.2. Measurement Uncertainty .....	12
<b>6. Test Result .....</b>	<b>13</b>
6.1. Summary .....	13
6.2. 6dB Bandwidth Measurement .....	14
6.2.1. Test Limit .....	14
6.2.2. Test Procedure .....	14
6.2.3. Test Setting .....	14
6.2.4. Test Setup .....	14
6.2.5. Test Result .....	14
6.3. Output Power Measurement .....	15
6.3.1. Test Limit .....	15
6.3.2. Test Procedure .....	15
6.3.3. Test Setting .....	15
6.3.4. Test Setup .....	15
6.3.5. Test Result .....	15
6.4. Power Spectral Density Measurement .....	16
6.4.1. Test Limit .....	16

6.4.2.	Test Procedure .....	16
6.4.3.	Test Setting .....	16
6.4.4.	Test Setup .....	16
6.4.5.	Test Result .....	17
6.5.	Conducted Band Edge and Out-of-Band Emissions Measurement .....	18
6.5.1.	Test Limit .....	18
6.5.2.	Test Procedure .....	18
6.5.3.	Test Setting .....	18
6.5.4.	Test Setup .....	18
6.5.5.	Test Result .....	19
6.6.	Radiated Spurious Emission Measurement.....	20
6.6.1.	Test Limit .....	20
6.6.2.	Test Procedure .....	20
6.6.3.	Test Setting .....	20
6.6.4.	Test Setup .....	22
6.6.5.	Test Result .....	23
6.7.	Radiated Restricted Band Edge Measurement .....	24
6.7.1.	Test Limit .....	24
6.7.2.	Test Procedure .....	25
6.7.3.	Test Setting .....	25
6.7.4.	Test Setup .....	26
6.7.5.	Test Result .....	26
6.8.	AC Conducted Emissions Measurement .....	27
6.8.1.	Test Limit .....	27
6.8.2.	Test Setup .....	27
6.8.3.	Test Result .....	27
<b>Appendix A – Test Result.....</b>		<b>28</b>
A.1	Duty Cycle Test Result .....	28
A.2	6dB Bandwidth Test Result .....	29
A.3	Output Power Test Result .....	34
A.4	Power Spectral Density Test Result .....	35
A.5	Conducted Band Edge and Out-of-Band Emissions Test Result.....	44
A.6	Radiated Spurious Emission Test Result .....	61
A.7	Radiated Restricted Band Edge Test Result.....	67
A.8	AC Conducted Emissions Test Result .....	111
<b>Appendix B – Test Setup Photograph .....</b>		<b>113</b>
<b>Appendix C – EUT Photograph .....</b>		<b>114</b>

## 1. General Information

### 1.1. Applicant

TP-Link Corporation Limited

Room 901, 9/F., New East Ocean Centre, 9 Science Museum Road, Tsim Sha Tsui, Kowloon, Hongkong

### 1.2. Manufacturer

TP-Link Corporation Limited

Room 901, 9/F., New East Ocean Centre, 9 Science Museum Road, Tsim Sha Tsui, Kowloon, Hongkong

### 1.3. Testing Facility

<input checked="" type="checkbox"/>	<b>Test Site – MRT Suzhou Laboratory</b>
	<b>Laboratory Location (Suzhou - Wuzhong)</b> D8 Building, No.2 Tian'edang Rd., Wuzhong Economic Development Zone, Suzhou, China
	<b>Laboratory Location (Suzhou - SIP)</b> 4b Building, Liando U Valley, No.200 Xingpu Rd., Shengpu Town, Suzhou Industrial Park, China
	<b>Laboratory Accreditations</b>
	A2LA: 3628.01 <span style="float: right;">CNAS: L10551</span>
	FCC: CN1166 <span style="float: right;">ISED: CN0001</span>
	VCCI: <input type="checkbox"/> R-20025 <input type="checkbox"/> G-20034 <input type="checkbox"/> C-20020 <input type="checkbox"/> T-20020
	<input type="checkbox"/> R-20141 <input type="checkbox"/> G-20134 <input type="checkbox"/> C-20103 <input type="checkbox"/> T-20104
<input checked="" type="checkbox"/>	<b>Test Site – MRT Shenzhen Laboratory</b>
	<b>Laboratory Location (Shenzhen)</b> 1G, Building A, Junxiangda Building, Zhongshanyuan Road West, Nanshan District, Shenzhen, China
	<b>Laboratory Accreditations</b>
	A2LA: 3628.02 <span style="float: right;">CNAS: L10551</span>
	FCC: CN1284 <span style="float: right;">ISED: CN0105</span>
<input type="checkbox"/>	<b>Test Site – MRT Taiwan Laboratory</b>
	<b>Laboratory Location (Taiwan)</b> No. 38, Fuxing 2nd Rd., Guishan Dist., Taoyuan City 333, Taiwan (R.O.C.)
	<b>Laboratory Accreditations</b>
	TAF: L3261-190725
	FCC: 291082, TW3261 <span style="float: right;">ISED: TW3261</span>

#### 1.4. Product Information

Product Name	AC750 Wireless Dual Band Router
Model No.	Archer C20
EUT Identification No.	20230420Sampe#01 (For Radiated) 20230402Sampe#02 (For Conducted)
Wi-Fi Specification	802.11a/b/g/n/ac
Antenna Information	Refer to section 1.7
Working Voltage	By Adapter
Accessory	
Adapter	Model: T090060-2B1 Input: 100-240V – 50/60Hz 0.3A Output: 9V 0.6A
Note: The information of EUT was provided by the manufacturer, and the accuracy of the information shall be the responsibility of the manufacturer.	

#### 1.5. Radio Specification under Test

Frequency Range	802.11b/g/n-HT20: 2412 ~ 2462MHz
Channel Number	802.11b/g/n-HT20: 11
Type of Modulation	802.11b: DSSS 802.11g/n: OFDM
Data Rate	802.11b: 1/2/5.5/11Mbps 802.11g: 6/9/12/18/24/36/48/54Mbps 802.11n: up to 300Mbps

### 1.6. Working Frequencies

802.11b/g/n-HT20

Channel	Frequency	Channel	Frequency	Channel	Frequency
01	2412 MHz	02	2417 MHz	03	2422 MHz
04	2427 MHz	05	2432 MHz	06	2437 MHz
07	2442 MHz	08	2447 MHz	09	2452 MHz
10	2457 MHz	11	2462 MHz	--	--

802.11n-HT40

Channel	Frequency	Channel	Frequency	Channel	Frequency
03	2422 MHz	04	2427 MHz	05	2432 MHz
06	2437 MHz	07	2442 MHz	08	2447 MHz
09	2452 MHz	--	--	--	--

### 1.7. Antenna Details

Antenna Type	Frequency Band (MHz)	Tx Paths	Max. Antenna Gain (dBi)	CDD Directional Gain (dBi)	
				For Power	For PSD
Dipole	2.412 ~ 2462	2	1.25	1.25	4.26
	5180 ~ 5240	1	1.87	--	--
	5745 ~ 5825	1	2.15	--	--

Note: The EUT supports Cyclic Delay Diversity (CDD) mode for Wi-Fi 2.4G.

For CDD transmissions, directional gain is calculated as follows,  $N_{ANT} = 2$ ,  $N_{SS} = 1$ .

If all antennas have the same gain,  $G_{ANT}$ , Directional gain =  $G_{ANT} + \text{Array Gain}$ , where Array Gain is as follows.

- For power spectral density (PSD) measurements on all devices,  
 Array Gain =  $10 \log (N_{ANT} / N_{SS}) \text{ dB} = 3.01$ ;
- For power measurements on IEEE 802.11 devices,  
 Array Gain = 0 dB for  $N_{ANT} \leq 4$ ;

## 2. Test Configuration

### 2.1. Test Mode

Mode 1: Transmit by 802.11b _ Nss = 1 (1Mbps) – CDD Mode
Mode 2: Transmit by 802.11g _ Nss = 1 (6Mbps) – CDD Mode
Mode 3: Transmit by 802.11n-HT20 _ Nss = 1 (MCS0) – CDD Mode
Mode 4: Transmit by 802.11n-HT40 _ Nss = 1 (MCS0) – CDD Mode
Note:
1. For Radiated emission, the modulation and the data rate picked for testing are determined by the Max. RF conducted power.
2. For CDD mode, this device supports 2 N <sub>ss</sub> and power level is the same of spatial multiplexing. The worst case is N <sub>ss</sub> =1.
3. As Designated by manufacturer, the lowest data rate was the worst condition, so all the tests were done with lowest data rate.

### 2.2. Test System Connection Diagram

The device was tested per the guidance ANSI C63.10: 2013 was used to reference the appropriate EUT setup for radiated emissions testing and AC line conducted testing.

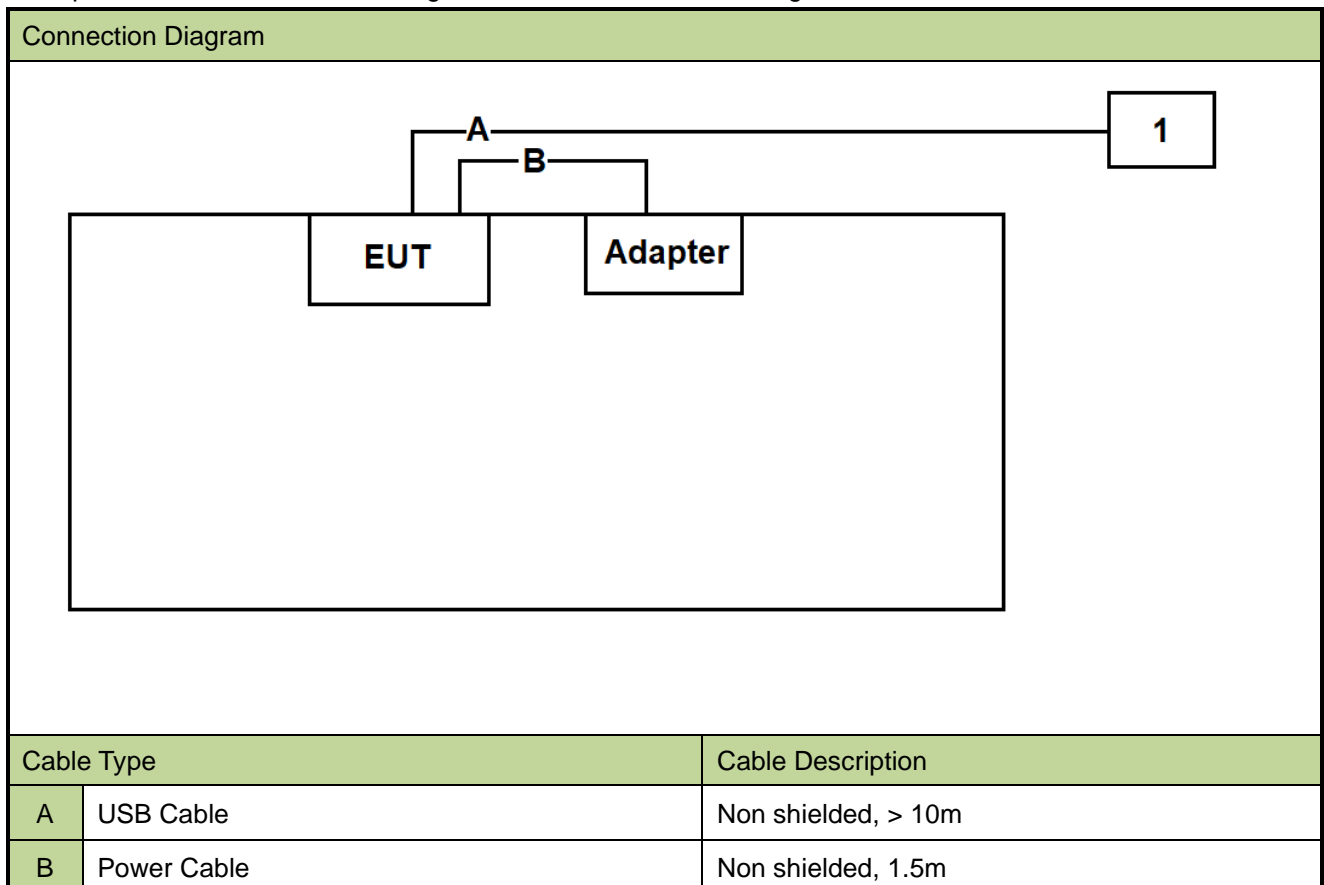



### 2.3. Test System Details

Product		Manufacturer	Model No.
1	Notebook	HP	735G5

### 2.4. Test Software

The test utility software used during testing was “Secure CRT”, and the version was 7.0.0.

Note: Final power setting please refer to operational description.

### 2.5. Applied Standards

According to the specifications of the manufacturer, the EUT must comply with the requirements of the following standards:

- FCC Part 15.247
- KDB 558074 D01v05r02
- KDB 662911 D01v02r01
- ANSI C63.10-2013

### 2.6. Test Environment Condition

Ambient Temperature	15 ~ 35°C
Relative Humidity	20 ~ 75%RH

### 3. Antenna Requirements

**Excerpt from §15.203 of the FCC Rules/Regulations:**

“An intentional radiator antenna shall be designed to ensure that no antenna other than that furnished by the responsible party can be used with the device. The use of a permanently attached antenna or of an antenna that uses a unique coupling to the intentional radiator shall be considered sufficient to comply with the provisions of this section.”

- The antenna of the device is **permanently attached**.
- There are no provisions for connection to an external antenna.

**Conclusion:**

The unit complies with the requirement of §15.203.

#### 4. Measuring Instrument

Instrument	Manufacturer	Model No.	Asset No.	Cali. Interval	Cali. Due Date	Test Site
Signal Analyzer	Agilent	N9010A	MRTSUE06195	1 year	2023-12-20	NS-AC1/NS-TR2
Horn Antenna	Schwarzbeck	BBHA 9170	MRTSUE06292	1 year	2023-10-18	NS-AC1
Anechoic Chamber	BOOMWAVE	NS-AC1	MRTSUE06496	1 year	2023-07-23	NS-AC1
Shielding Room	BOOMWAVE	NS-SR2	MRTSUE06551	5 years	2024-06-03	NS-SR2
Horn Antenna	Schwarzbeck	BBHA 9120D	MRTSUE06572	1 year	2024-03-31	NS-AC1
TRILOG Antenna	Schwarzbeck	VULB 9162	MRTSUE06573	1 year	2023-06-21	NS-AC1
Preamplifier	Schwarzbeck	BBV 9718	MRTSUE06574	1 year	2023-07-11	NS-AC1
EMI Test Receiver	R&S	ESR3	MRTSUE06575	1 year	2023-06-19	NS-AC1
EMI Test Receiver	R&S	ESL3	MRTSUE06576	1 year	2023-06-19	NS-SR2
Two-Line V-Network	R&S	ENV216	MRTSUE06577	1 year	2023-07-03	NS-SR2
Two-Line V-Network	R&S	ENV216	MRTSUE06578	1 year	2023-07-03	NS-SR2
USB Power Sensor	Keysight	U2021XA	MRTSUE06581	1 year	2023-07-13	NS-TR2
Preamplifier	EMCI	EMC184045SE	MRTSUE06641	1 year	2024-01-12	NS-AC1
Thermohygrometer	DELI	NO.8813	MRTSUE06783	1 year	2023-12-28	NS-TR2
Temperature Chamber	OUKE	OK-TH-100C	MRTSUE06899	1 year	2024-04-26	NS-TR2
Signal Analyzer	Keysight	N9020A	MRTSUE10065	1 year	2023-12-20	NS-AC1/NS-TR2
EMI Test Receiver	R&S	ESR7	MRTSUE06001	1 year	2023-12-28	WZ-AC1
Loop Antenna	Schwarzbeck	FMZB 1519	MRTSUE06025	1 year	2023-09-29	WZ-AC1
Thermohygrometer	testo	608-H1	MRTSUE06403	1 year	2023-06-06	WZ-AC1
Thermohygrometer	testo	608-H1	MRTSUE11020	1 year	2024-05-03	NS-AC1
Thermohygrometer	testo	608-H1	MRTSUE11104	1 year	2024-05-03	NS-AC1
Thermohygrometer	testo	608-H1	MRTSUE11106	1 year	2024-05-03	NS-SR2

Software	Version	Function
EMI Software	V3.0.0	EMI Test Software
Controller_T-E-TAC-2	1.02	RE Antenna & Turntable
Controller_MF 7802	2.03C	RE Antenna & Turntable
Agilent Power Panel	V 3.9	Power

## 5. Decision Rules and Measurement Uncertainty

### 5.1. Decision Rules

The Decision Rule is based on Simple Acceptance in accordance with ISO Guide 98-4: 2012 Clause 8.2. (Measurement uncertainty is not taken into account when stating conformity with a specified requirement.)

### 5.2. Measurement Uncertainty

Where relevant, the following test uncertainty levels have been estimated for tests performed on the EUT as specified in CISPR 16-4-2. This uncertainty represents an expanded uncertainty expressed at approximately the 95% confidence level using a coverage factor of  $k = 2$ .

<b>AC Conducted Emission Measurement</b>
Measurement Uncertainty for a Level of Confidence of 95% ( $U=2Uc(y)$ ): 9kHz~150kHz: 3.74dB 150kHz~30MHz: 3.44dB
<b>Radiated Disturbance</b>
Measurement Uncertainty for a Level of Confidence of 95% ( $U=2Uc(y)$ ): Horizontal: 30MHz~300MHz: 5.04dB 300MHz~1GHz: 4.95dB 1GHz~40GHz: 6.40dB Vertical: 30MHz~300MHz: 5.24dB 300MHz~1GHz: 6.03dB 1GHz~40GHz: 6.40dB
<b>Spurious Emissions, Conducted</b>
Measuring Uncertainty for a Level of Confidence of 95% ( $U=2Uc(y)$ ): 0.78dB
<b>Output Power</b>
Measuring Uncertainty for a Level of Confidence of 95% ( $U=2Uc(y)$ ): 1.13dB
<b>Power Spectrum Density</b>
Measuring Uncertainty for a Level of Confidence of 95% ( $U=2Uc(y)$ ): 1.15dB
<b>Occupied Bandwidth</b>
Measuring Uncertainty for a Level of Confidence of 95% ( $U=2Uc(y)$ ): 0.28%

## 6. Test Result

### 6.1. Summary

FCC Section(s)	Test Description	Test Condition	Verdict
15.247(a)(2)	6dB Bandwidth	Conducted	Pass
15.247(b)(3)	Output Power		Pass
15.247(e)	Power Spectral Density		Pass
15.247(d)	Band Edge / Out-of-Band Emissions		Pass
15.205 15.209	General Field Strength (Restricted Bands and Radiated Emission)	Radiated	Pass
15.207	AC Conducted Emissions 150kHz - 30MHz	Line Conducted	Pass

#### Notes:

- The analyzer plots shown in this section were all taken with a correction table loaded into the analyzer. The correction table was used to account for the losses of the cables and attenuators used as part of the system to connect the EUT to the analyzer at all frequencies of interest.
- For radiated emission tests, every axis (X, Y, Z) was also verified. The test results shown in the following sections represent the worst-case emissions.

## 6.2. 6dB Bandwidth Measurement

### 6.2.1. Test Limit

The minimum 6dB bandwidth shall be at least 500 kHz.

### 6.2.2. Test Procedure

ANSI C63.10 - 2013 - Section 11.8

### 6.2.3. Test Setting

1. The Spectrum's automatic bandwidth measurement capability was used to perform the 6dB bandwidth measurement. The "X" dB bandwidth parameter was set to  $X = 6$ . The bandwidth measurement was not influenced by any intermediate power nulls in the fundamental emission.
2. Set RBW = 100 kHz
3.  $VBW \geq 3 \times RBW$
4. Detector = Peak
5. Trace mode = Max hold
6. Sweep = Auto couple
7. Allow the trace to stabilize

### 6.2.4. Test Setup

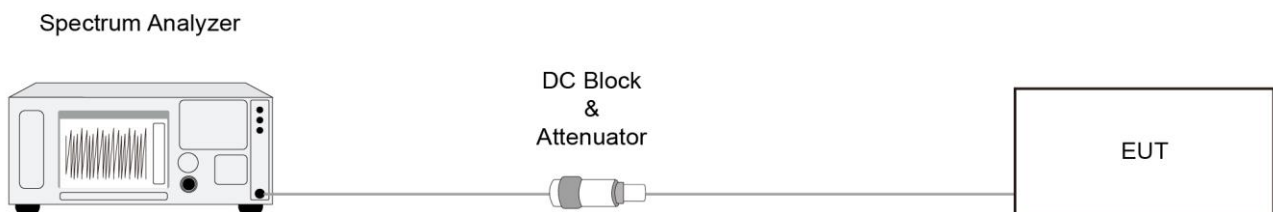

### 6.2.5. Test Result

Refer to Appendix A.2.

### 6.3. Output Power Measurement

#### 6.3.1. Test Limit

The maximum output power shall be less 1 Watt (30dBm).

The conducted output power limit specified in paragraph FCC Part 15.247(b) of this section is based on the use of antennas with directional gains that do not exceed 6 dBi. If transmitting antennas of directional gain greater than 6 dBi are used, the conducted output power from the intentional radiator shall be reduced below the stated values in paragraphs FCC Part 15.247(b)(3) of this section, as appropriate, by the amount in dB that the directional gain of the antenna exceeds 6 dBi.

#### 6.3.2. Test Procedure

ANSI C63.10 - 2013 - Section 11.9.2.3.2

#### 6.3.3. Test Setting

##### Average Power Measurement

Average power measurements were performed only when the EUT was transmitting at its maximum power control level using a broadband power meter with a pulse sensor. The power meter implemented triggering and gating capabilities which were set up such that power measurements were recorded only during the ON time of the transmitter.

#### 6.3.4. Test Setup

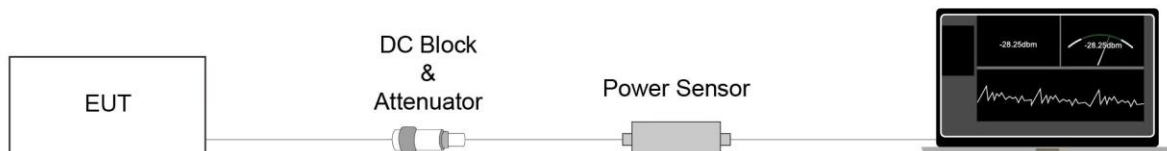

#### 6.3.5. Test Result

Refer to Appendix A.3.

## 6.4. Power Spectral Density Measurement

### 6.4.1. Test Limit

The maximum permissible power spectral density is 8dBm in any 3 kHz band.

The same method of determining the conducted output power shall be used to determine the power spectral density.

### 6.4.2. Test Procedure

ANSI C63.10 - 2013 - Section 11.10.5

### 6.4.3. Test Setting

1. Measure the duty cycle (x) of the transmitter output signal.
2. Set instrument center frequency to DTS channel center frequency.
3. Set span to at least 1.5 times the OBW.
4. RBW = 10 kHz.
5. VBW = 30 kHz.
6. Detector = RMS.
7. Ensure that the number of measurement points in the sweep  $\geq 2 \times \text{span}/\text{RBW}$ .
8. Sweep time = auto couple.
9. Don't use sweep triggering. Allow sweep to "free run".
10. Employ trace averaging (RMS) mode over a minimum of 100 traces.
11. Use the peak marker function to determine the maximum amplitude level.
12. Add  $10 \log (1/x)$ , where x is the duty cycle measured in step (a), to the measured PSD to compute the average PSD during the actual transmission time. If measured value exceeds requirement specified by regulatory agency, then reduce RBW (but no less than 3 kHz) and repeat (note that this may require zooming in on the emission of interest and reducing the span to meet the minimum measurement point requirement as the RBW is reduced).

### 6.4.4. Test Setup

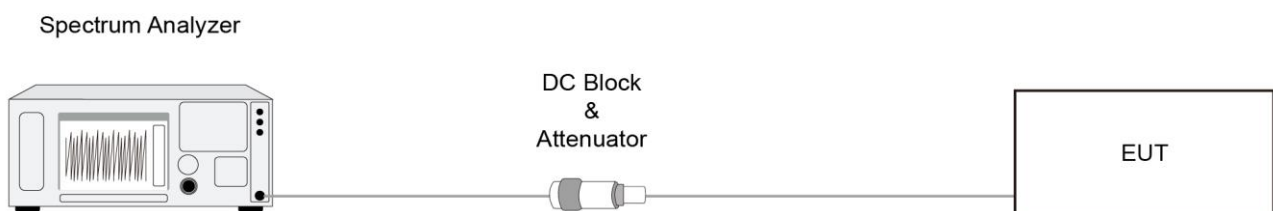



#### **6.4.5. Test Result**

Refer to Appendix A.4.

## 6.5. Conducted Band Edge and Out-of-Band Emissions Measurement

### 6.5.1. Test Limit

The limit for out-of-band spurious emissions at the band edge is 20dB below the fundamental emission level, as determined from the in-band power measurement of the DTS channel performed in a 100 kHz bandwidth per the PSD procedure.

### 6.5.2. Test Procedure

ANSI C63.10-2013 - Section 11.11

### 6.5.3. Test Setting

#### Reference level measurement

1. Set instrument center frequency to DTS channel center frequency
2. Set the span to  $\geq 1.5$  times the DTS bandwidth
3. Set the RBW = 100 kHz
4. Set the VBW  $\geq 3 \times$  RBW
5. Detector = peak
6. Sweep time = auto couple
7. Trace mode = max hold
8. Allow trace to fully stabilize

#### Emission level measurement

1. Set the center frequency and span to encompass frequency range to be measured
2. RBW = 100kHz
3. VBW = 300kHz
4. Detector = Peak
5. Trace mode = max hold
6. Sweep time = auto couple
7. The trace was allowed to stabilize

### 6.5.4. Test Setup

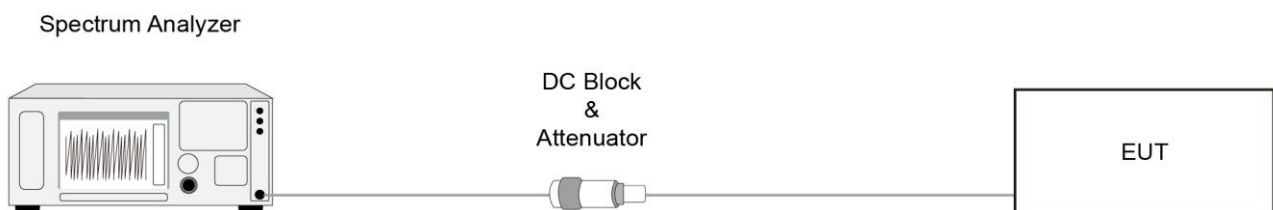

### **6.5.5. Test Result**

Refer to Appendix A.5.

## 6.6. Radiated Spurious Emission Measurement

### 6.6.1. Test Limit

All out of band emissions appearing in a restricted band as specified in Section 15.205 of the Title 47 CFR must not exceed the limits shown in Table per Section 15.209.

FCC Part 15 Subpart C Paragraph 15.209		
Frequency [MHz]	Field Strength [uV/m]	Measured Distance [Meters]
0.009 - 0.490	2400/F (kHz)	300
0.490 - 1.705	24000/F (kHz)	30
1.705 - 30	30	30
30 - 88	100	3
88 - 216	150	3
216 - 960	200	3
Above 960	500	3

### 6.6.2. Test Procedure

ANSI C63.10 - 2013 - Section 11.11 & 11.12

ANSI C63.10 - 2013 - Section 6.3 (General Requirements)

ANSI C63.10 - 2013 - Section 6.4 (Standard test method below 30MHz)

ANSI C63.10 - 2013 - Section 6.5 (Standard test method above 30MHz to 1GHz)

ANSI C63.10 - 2013 - Section 6.6 (Standard test method above 1GHz)

### 6.6.3. Test Setting

**Table 1 - RBW as a function of frequency**

Frequency	RBW
9 ~ 150 kHz	200 ~ 300 Hz
0.15 ~ 30 MHz	9 ~ 10 kHz
30 ~ 1000 MHz	100 ~ 120 kHz
> 1000MHz	1MHz

**Quasi-Peak Measurements below 1GHz**

1. Analyzer center frequency was set to the frequency of the radiated spurious emission of interest
2. Span was set greater than 1MHz
3. RBW = as specified in Table 1
4. Detector = CISPR quasi-peak
5. Sweep time = auto couple
6. Trace was allowed to stabilize

**Peak Measurements above 1GHz**

1. Analyzer center frequency was set to the frequency of the radiated spurious emission of interest
2. RBW = 1MHz
3. VBW = 3MHz
4. Detector = peak
5. Sweep time = auto couple
6. Trace mode = max hold
7. Trace was allowed to stabilize

**Average Measurements above 1GHz (Method VB)**

1. Analyzer center frequency was set to the frequency of the radiated spurious emission of interest
2. RBW = 1MHz
3. VBW; If the EUT is configured to transmit with duty cycle  $\geq 98\%$ , set VBW = 10 Hz.  
If the EUT duty cycle is  $< 98\%$ , set VBW  $\geq 1/T$ . T is the minimum transmission duration.
4. Detector = Peak
5. Sweep time = auto
6. Trace mode = max hold
7. Trace was allowed to stabilize

### 6.6.4. Test Setup

Below 30MHz Test Setup:

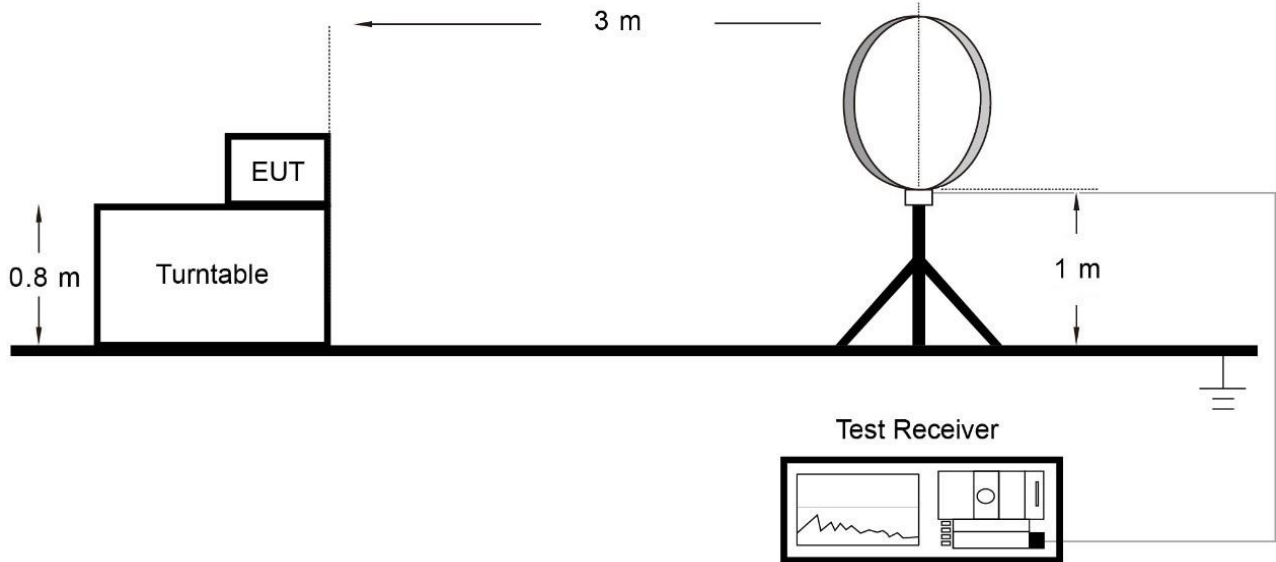

Below 1GHz Test Setup:

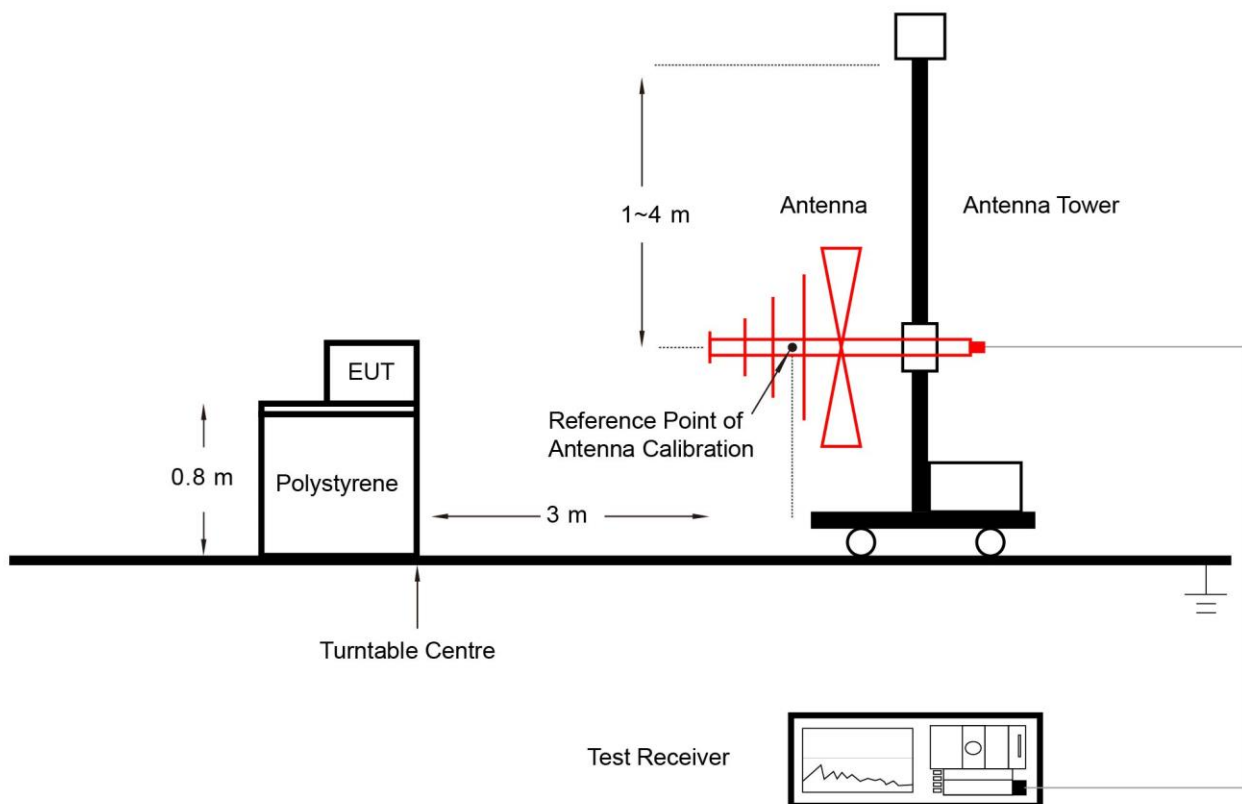

Above 1GHz Test Setup:

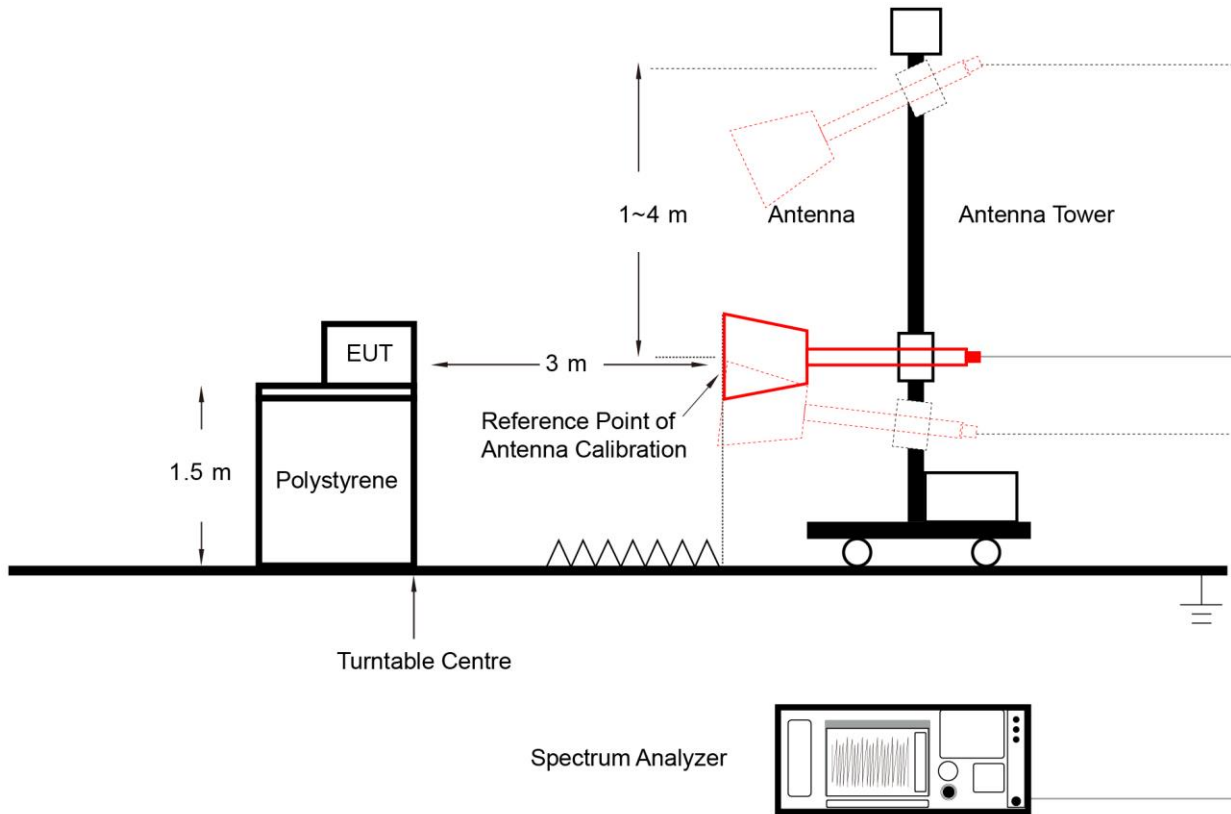

**6.6.5. Test Result**

Refer to Appendix A.6.

## 6.7. Radiated Restricted Band Edge Measurement

### 6.7.1. Test Limit

#### For 15.205 requirement:

Radiated emissions which fall in the restricted bands, as defined in Section 15.205(a) of FCC part 15, must also comply with the radiated emission limits specified in Section 15.209(a).

Frequency (MHz)	Frequency (MHz)	Frequency (MHz)	Frequency (GHz)
0.090 - 0.110	16.42 - 16.423	399.9 - 410	4.5 - 5.15
<sup>1</sup> 0.495 - 0.505	16.69475 - 16.69525	608 - 614	5.35 - 5.46
2.1735 - 2.1905	16.80425 - 16.80475	960 - 1240	7.25 - 7.75
4.125 - 4.128	25.5 - 25.67	1300 - 1427	8.025 - 8.5
4.17725 - 4.17775	37.5 - 38.25	1435 - 1626.5	9.0 - 9.2
4.20725 - 4.20775	73 - 74.6	1645.5 - 1646.5	9.3 - 9.5
6.215 - 6.218	74.8 - 75.2	1660 - 1710	10.6 - 12.7
6.26775 - 6.26825	108 - 121.94	1718.8 - 1722.2	13.25 - 13.4
6.31175 - 6.31225	123 - 138	2200 - 2300	14.47 - 14.5
8.291 - 8.294	149.9 - 150.05	2310 - 2390	15.35 - 16.2
8.362 - 8.366	156.52475 - 156.52525	2483.5 - 2500	17.7 - 21.4
8.37625 - 8.38675	156.7 - 156.9	2690 - 2900	22.01 - 23.12
8.41425 - 8.41475	162.0125 - 167.17	3260 - 3267	23.6 - 24.0
12.29 - 12.293	167.72 - 173.2	3332 - 3339	31.2 - 31.8
12.51975 - 12.52025	240 - 285	3345.8 - 3358	36.43 - 36.5
12.57675 - 12.57725	322 - 335.4	3600 - 4400	( <sup>2</sup> )
13.36 - 13.41	--	--	--



All out of band emissions appearing in a restricted band as specified in Section 15.205 of the Title 47CFR must not exceed the limits shown in Table per Section 15.209.

FCC Part 15 Subpart C Paragraph 15.209		
Frequency [MHz]	Field Strength [uV/m]	Measured Distance [Meters]
0.009 - 0.490	2400/F (kHz)	300
0.490 - 1.705	24000/F (kHz)	30
1.705 - 30	30	30
30 - 88	100	3
88 - 216	150	3
216 - 960	200	3
Above 960	500	3

### 6.7.2. Test Procedure

ANSI C63.10-2013 Section 6.3 & 6.6 & 11.13

### 6.7.3. Test Setting

#### Peak Field Strength Measurements

1. Analyzer center frequency was set to the frequency of the radiated spurious emission of interest
2. RBW = 1MHz
3. VBW = 3MHz
4. Detector = peak
5. Sweep time = auto couple
6. Trace mode = max hold
7. Trace was allowed to stabilize

### Average Field Strength Measurements

1. Analyzer center frequency was set to the frequency of the radiated spurious emission of interest
2. RBW = 1MHz
3. VBW  $\geq 1/T$
4. Average Type = Voltage
5. Detector = Peak
6. Sweep time = auto
7. Trace mode = max hold
8. Allow max hold to run for at least 50 times (1/duty cycle) traces

#### 6.7.4. Test Setup

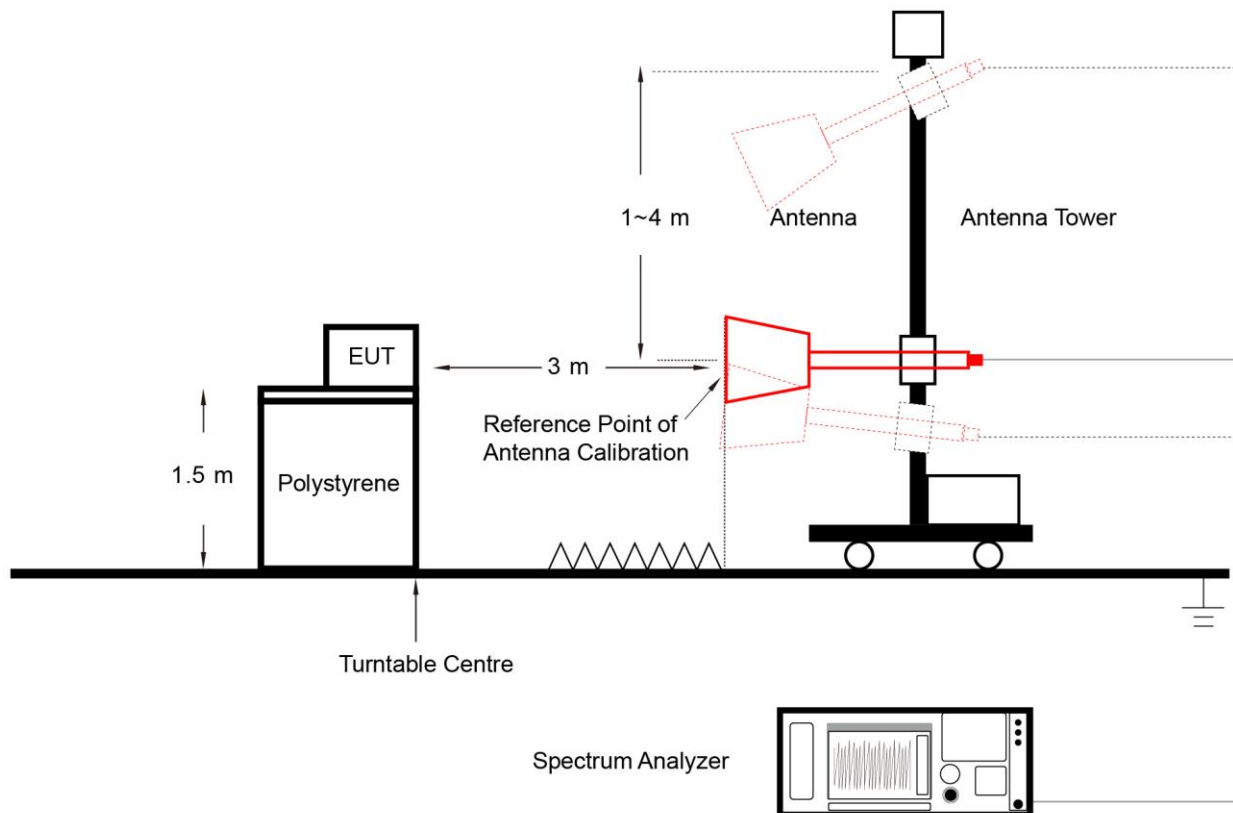

#### 6.7.5. Test Result

Refer to Appendix A.7.

## 6.8. AC Conducted Emissions Measurement

### 6.8.1. Test Limit

FCC Part 15 Subpart C Paragraph 15.207 Limits		
Frequency (MHz)	QP (dBuV)	AV (dBuV)
0.15 - 0.50	66 - 56	56 - 46
0.50 - 5.0	56	46
5.0 - 30	60	50

Note 1: The lower limit shall apply at the transition frequencies.

Note 2: The limit decreases linearly with the logarithm of the frequency in the range 0.15MHz to 0.5MHz.

### 6.8.2. Test Setup

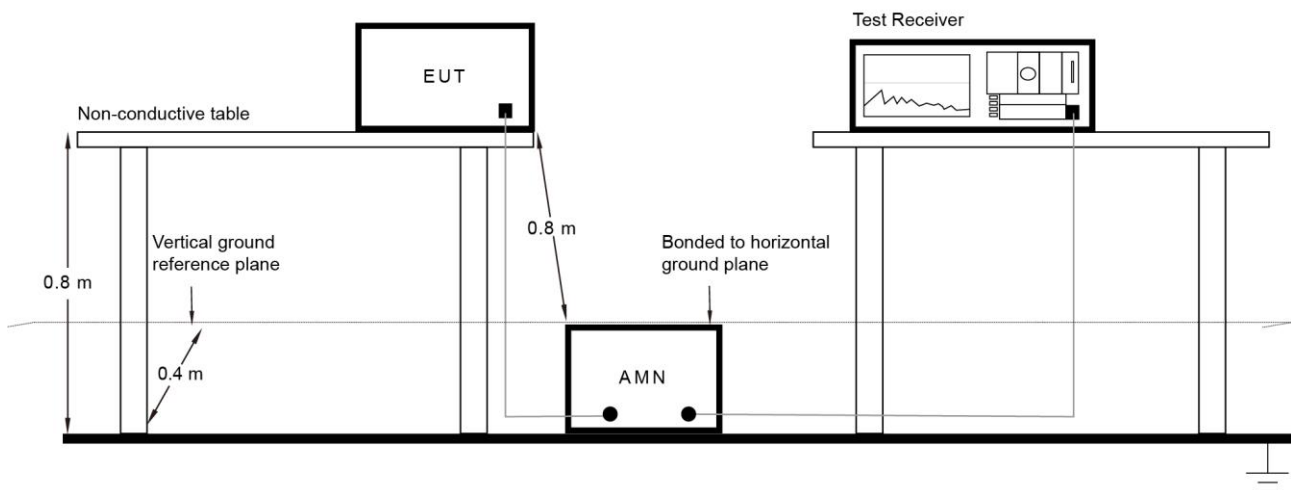

### 6.8.3. Test Result

Refer to Appendix A.8.

## Appendix A – Test Result

### A.1 Duty Cycle Test Result

Test Site	NS-TR2	Test Engineer	Summer Tang
Test Date	2023/05/10 ~ 2023/05/11		

Test Mode	Duty Cycle
802.11b	97.67%
802.11g	94.51%
802.11n-HT20	90.62%
802.11n-HT40	77.01%



**A.2 6dB Bandwidth Test Result**

Test Site	NS-TR2	Test Engineer	Summer Tang
Test Date	2023/05/11		

Test Mode	Data Rate / MCS	Channel No.	Frequency (MHz)	6dB Bandwidth (MHz)	Limit (MHz)
11b	1Mbps	01	2412	10.06	≥ 0.5
11b	1Mbps	06	2437	10.06	≥ 0.5
11b	1Mbps	11	2462	9.617	≥ 0.5
11g	6Mbps	01	2412	15.16	≥ 0.5
11g	6Mbps	06	2437	15.12	≥ 0.5
11g	6Mbps	11	2462	15.13	≥ 0.5
11n-HT20	MCS0	01	2412	15.13	≥ 0.5
11n-HT20	MCS0	06	2437	15.16	≥ 0.5
11n-HT20	MCS0	11	2462	15.09	≥ 0.5
11n-HT40	MCS0	03	2422	35.13	≥ 0.5
11n-HT40	MCS0	06	2437	35.10	≥ 0.5
11n-HT40	MCS0	09	2452	32.63	≥ 0.5

## 802.11b 6dB Bandwidth

## Channel 01 (2412MHz)

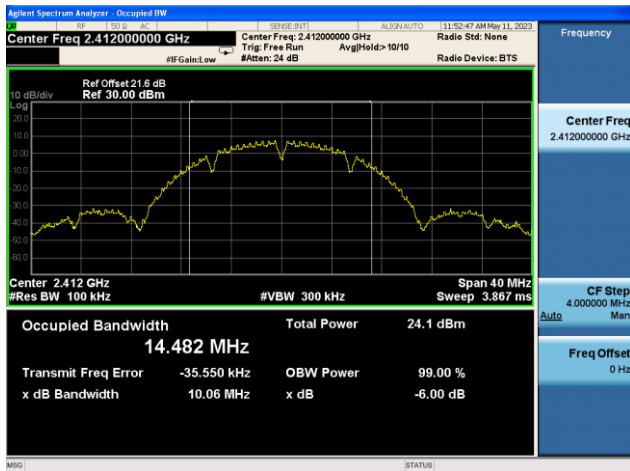

## Channel 06 (2437MHz)

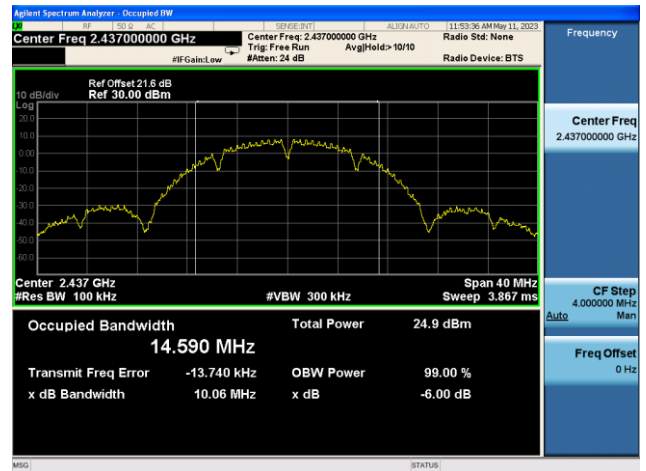

## Channel 11 (2462MHz)

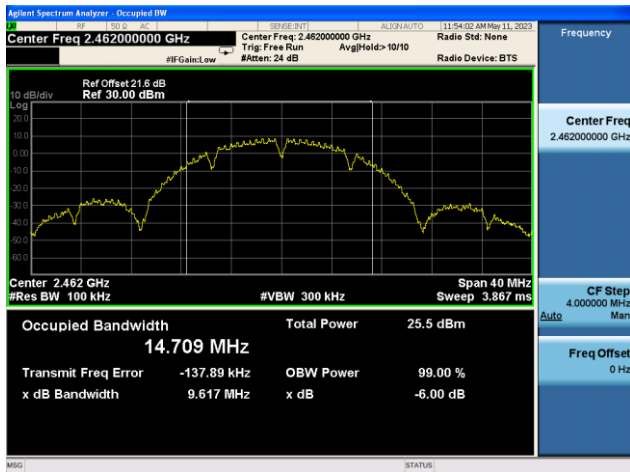

## 802.11g 6dB Bandwidth

## Channel 01 (2412MHz)

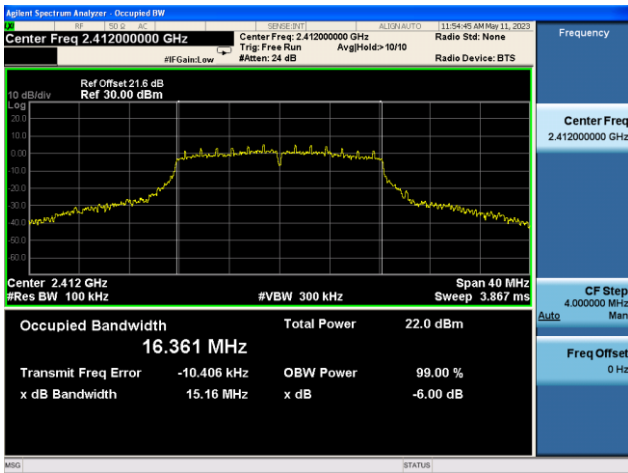

## Channel 06 (2437MHz)

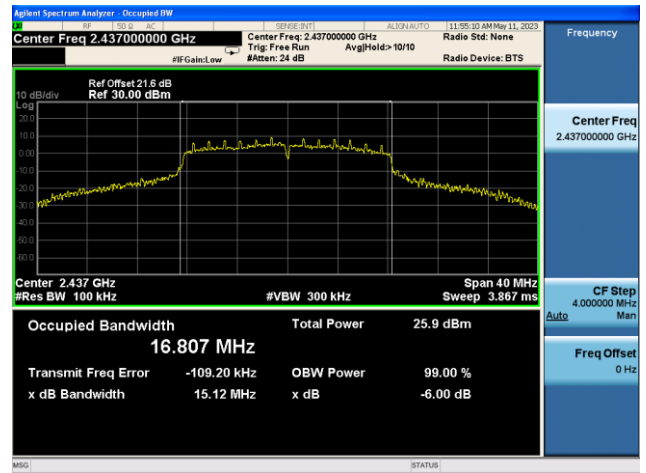

## Channel 11 (2462MHz)

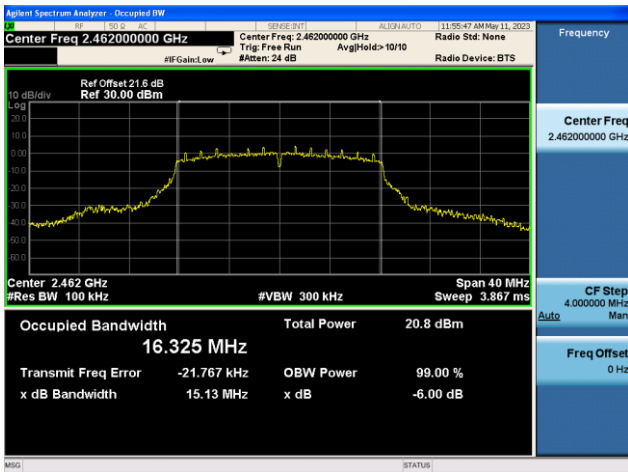

## 802.11n-HT20 6dB Bandwidth

## Channel 01 (2412MHz)

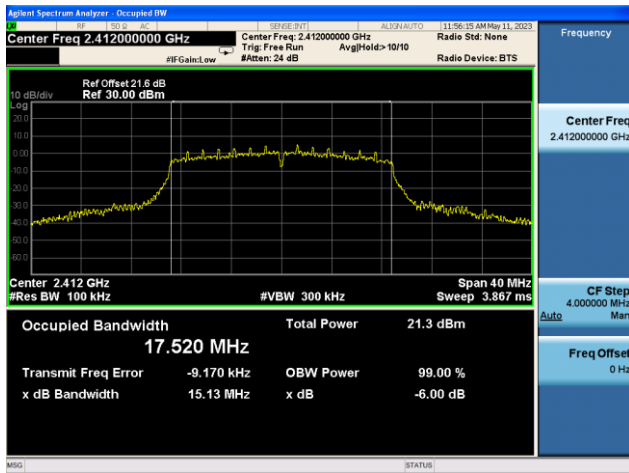

## Channel 06 (2437MHz)

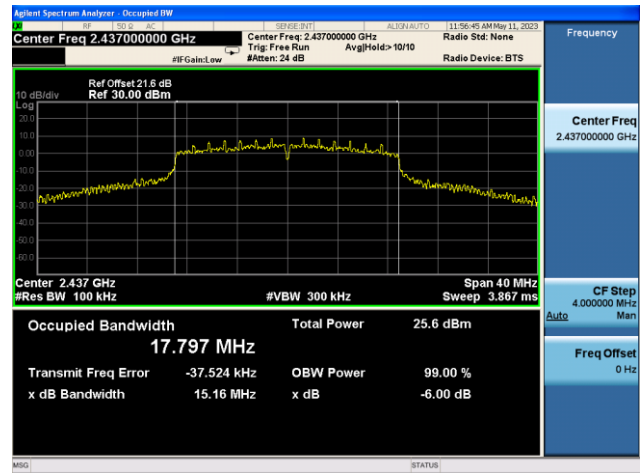

## Channel 11 (2462MHz)

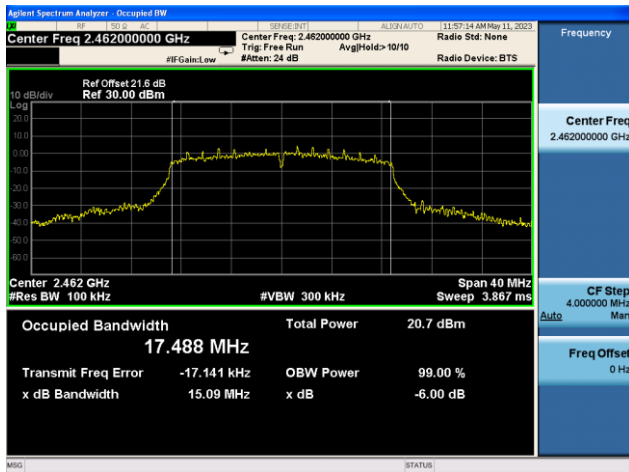



## 802.11n-HT40 6dB Bandwidth

## Channel 03 (2422MHz)

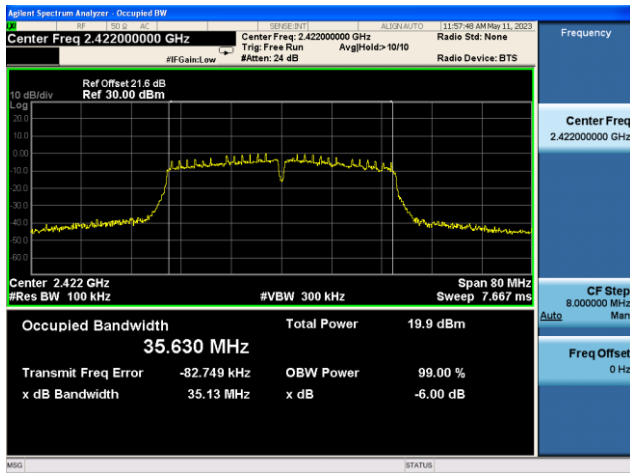

## Channel 06 (2437MHz)

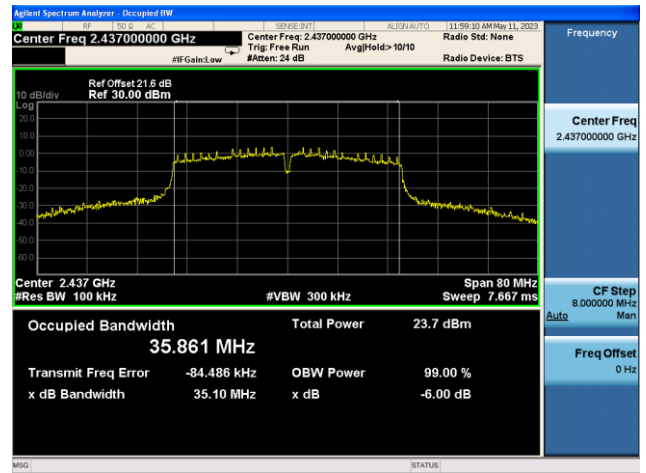

## Channel 09 (2452MHz)

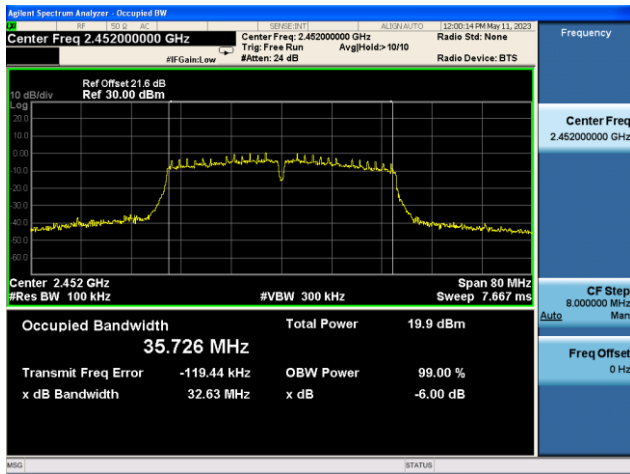

**A.3 Output Power Test Result**

Test Site	NS-TR2	Test Engineer	Summer Tang
Test Date	2023/05/10		

Test Mode	Data Rate/ MCS	Channel No.	Freq. (MHz)	Average Power (dBm)		Total Average Power (dBm)	Limit (dBm)
				Ant 0	Ant 1		
11b	1Mbps	01	2412	17.16	16.63	19.91	≤ 30.00
11b	1Mbps	06	2437	18.16	18.09	21.14	≤ 30.00
11b	1Mbps	11	2462	18.64	18.57	21.62	≤ 30.00
11g	6Mbps	01	2412	15.11	14.82	17.98	≤ 30.00
11g	6Mbps	02	2417	15.17	14.78	17.99	≤ 30.00
11g	6Mbps	06	2437	18.81	18.95	21.89	≤ 30.00
11g	6Mbps	10	2457	14.07	14.26	17.18	≤ 30.00
11g	6Mbps	11	2462	14.21	14.19	17.21	≤ 30.00
11n-HT20	MCS0	01	2412	14.56	14.38	17.48	≤ 30.00
11n-HT20	MCS0	02	2417	14.48	14.28	17.39	≤ 30.00
11n-HT20	MCS0	06	2437	18.71	18.92	21.83	≤ 30.00
11n-HT20	MCS0	10	2457	13.92	14.28	17.11	≤ 30.00
11n-HT20	MCS0	11	2462	14.02	14.25	17.15	≤ 30.00
11n-HT40	MCS0	03	2422	11.45	11.19	14.33	≤ 30.00
11n-HT40	MCS0	04	2427	12.65	12.30	15.49	≤ 30.00
11n-HT40	MCS0	06	2437	16.21	16.31	19.27	≤ 30.00
11n-HT40	MCS0	08	2447	14.19	14.12	17.17	≤ 30.00
11n-HT40	MCS0	09	2452	12.48	12.58	15.54	≤ 30.00

Note: Total Average Power (dBm) =  $10 \cdot \log \{10^{(\text{Ant 0 Average Power} / 10)} + 10^{(\text{Ant 1 Average Power} / 10)}\}$

**A.4 Power Spectral Density Test Result**

Test Site	NS-TR2	Test Engineer	Summer Tang
Test Date	2023/05/18		

Test Mode	Data Rate/ MCS	Channel No.	Freq. (MHz)	Average PSD (dBm/10kHz)		Duty Cycle (%)	Total PSD (dBm/ 10kHz)	Limit (dBm / 3kHz)
				Ant 0	Ant 1			
11b	1Mbps	01	2412	-10.045	97.67	-7.100	-7.100	≤ 8.00
11b	1Mbps	06	2437	-8.874	97.67	-5.233	-5.233	≤ 8.00
11b	1Mbps	11	2462	-8.406	97.67	-5.198	-5.198	≤ 8.00
11g	6Mbps	01	2412	-13.104	94.51	-10.117	-10.117	≤ 8.00
11g	6Mbps	06	2437	-9.190	94.51	-6.008	-6.008	≤ 8.00
11g	6Mbps	11	2462	-14.115	94.51	-10.942	-10.942	≤ 8.00
11n-HT20	MCS0	01	2412	-13.311	90.62	-9.910	-9.910	≤ 8.00
11n-HT20	MCS0	06	2437	-9.254	90.62	-5.426	-5.426	≤ 8.00
11n-HT20	MCS0	11	2462	-13.713	90.62	-10.206	-10.206	≤ 8.00
11n-HT40	MCS0	03	2422	-19.478	77.01	-15.668	-15.668	≤ 8.00
11n-HT40	MCS0	06	2437	-14.868	77.01	-10.708	-10.708	≤ 8.00
11n-HT40	MCS0	09	2452	-18.367	77.01	-14.271	-14.271	≤ 8.00

Note:

When Duty Cycle ≥ 98%, Total PSD (dBm / 10kHz) =  $10 \cdot \log \{10^{(\text{Ant 0 PSD}/10)} + 10^{(\text{Ant 1 PSD}/10)}\}$  (dBm / 10kHz)

When EUT duty cycle < 98%, Total PSD (dBm / 10kHz) =  $10 \cdot \log \{10^{(\text{Ant 0 PSD}/10)} + 10^{(\text{Ant 1 PSD}/10)}\}$  (dBm / 10kHz)  
 +  $10 \cdot \log (1/\text{Duty Cycle})$ .

802.11b - Average PSD - Ant 0

Channel 01 (2412MHz)

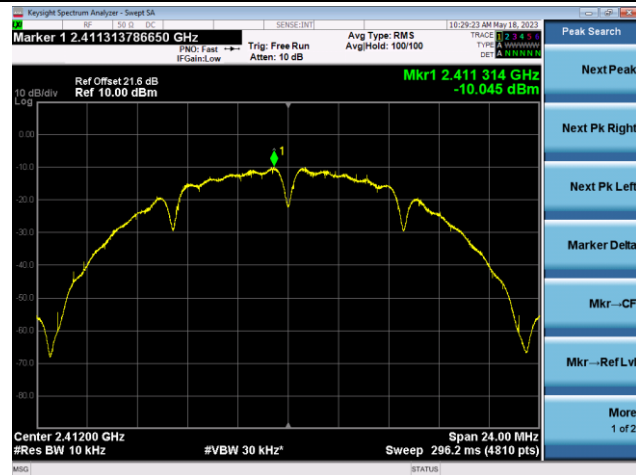

Channel 06 (2437MHz)

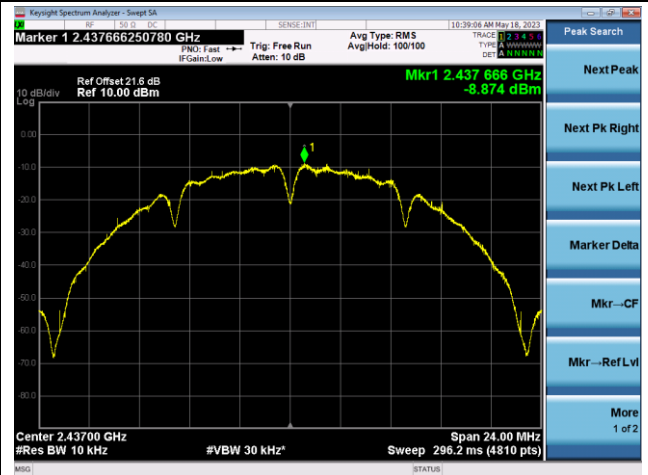

Channel 11 (2462MHz)

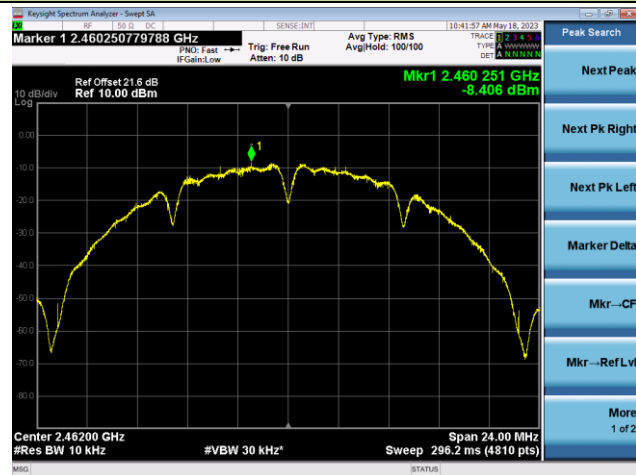

802.11g - Average PSD - Ant 0

Channel 01 (2412MHz)

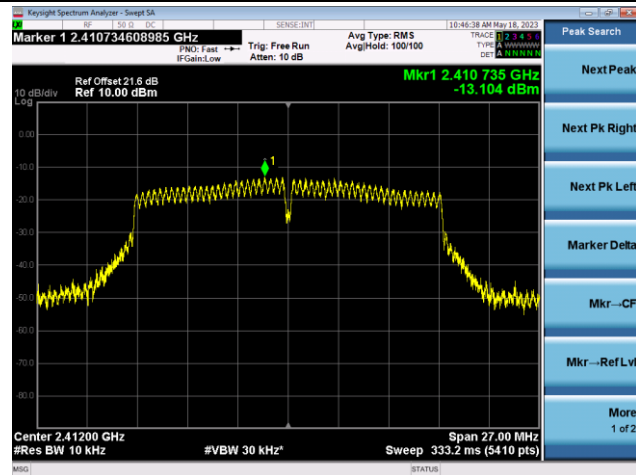

Channel 06 (2437MHz)

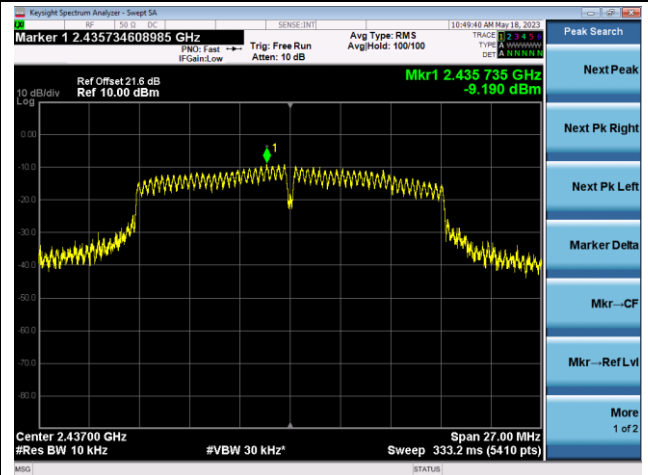

Channel 11 (2462MHz)

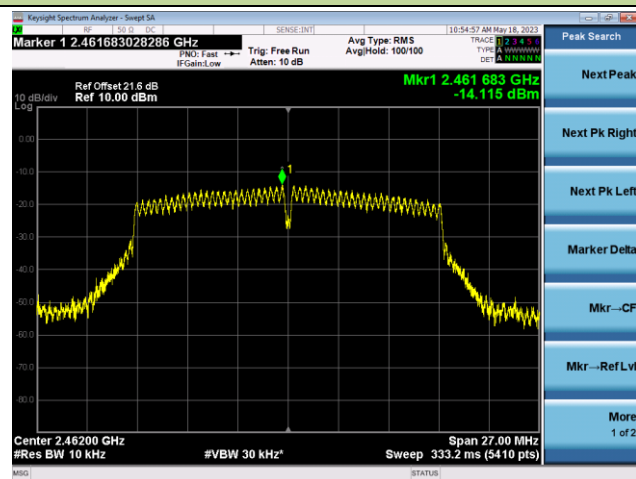

802.11n-HT20 - Average PSD - Ant 0

Channel 01 (2412MHz)

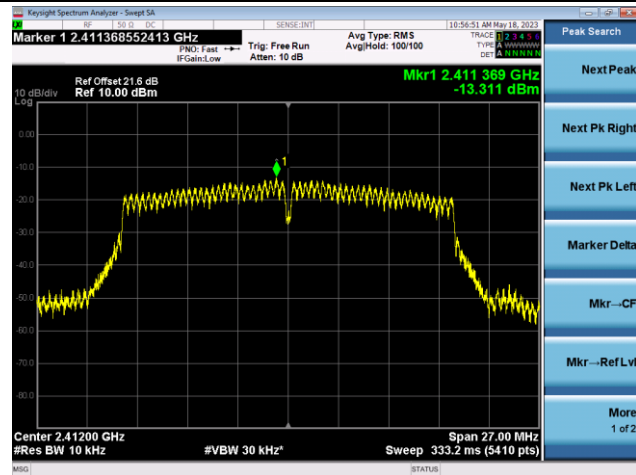

Channel 06 (2437MHz)

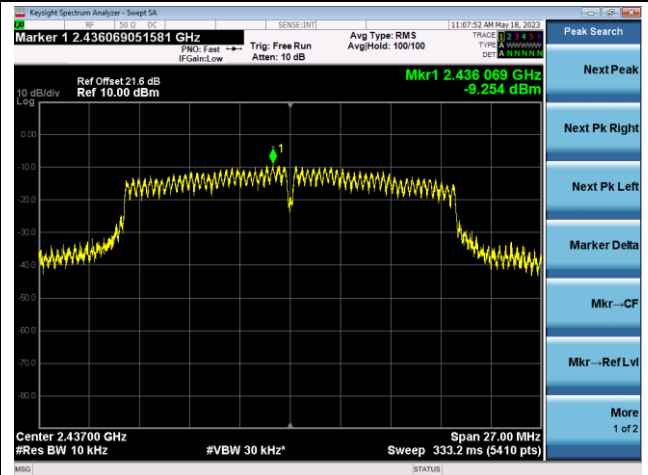

Channel 11 (2462MHz)

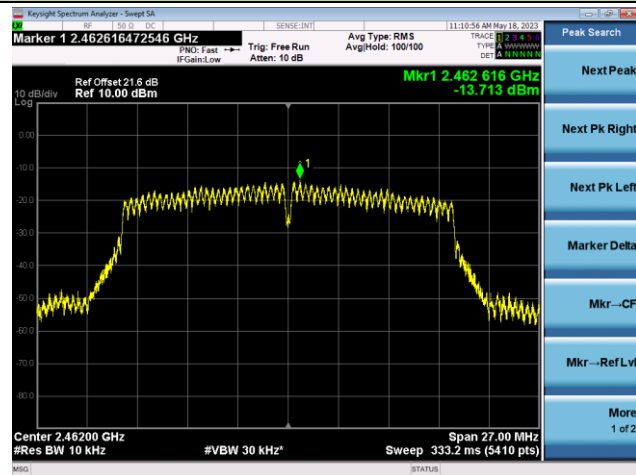

802.11n-HT40 - Average PSD - Ant 0

Channel 03 (2422MHz)

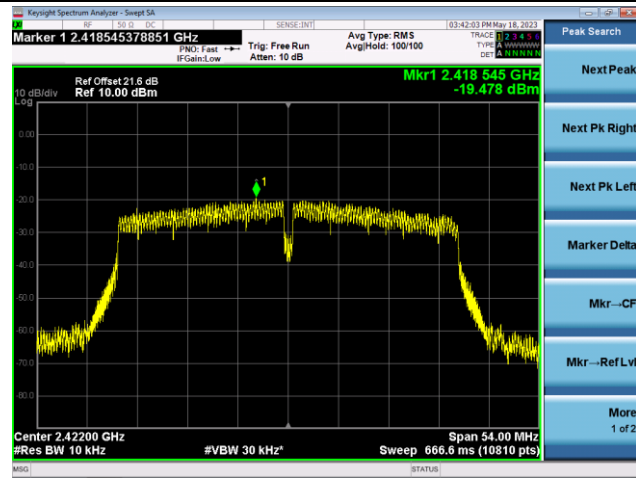

Channel 06 (2437MHz)

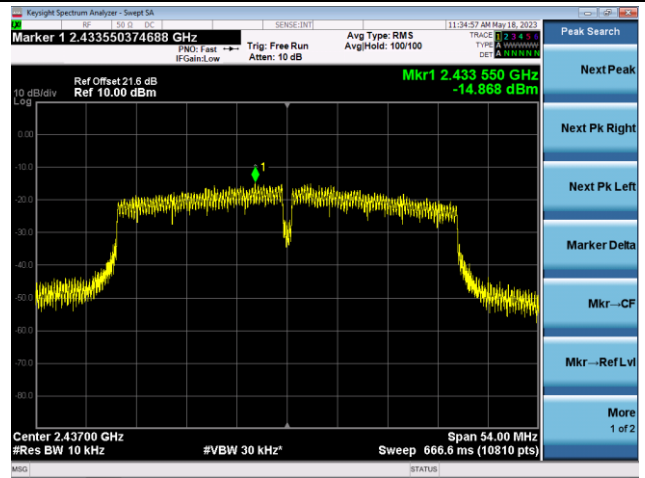

Channel 09 (2452MHz)

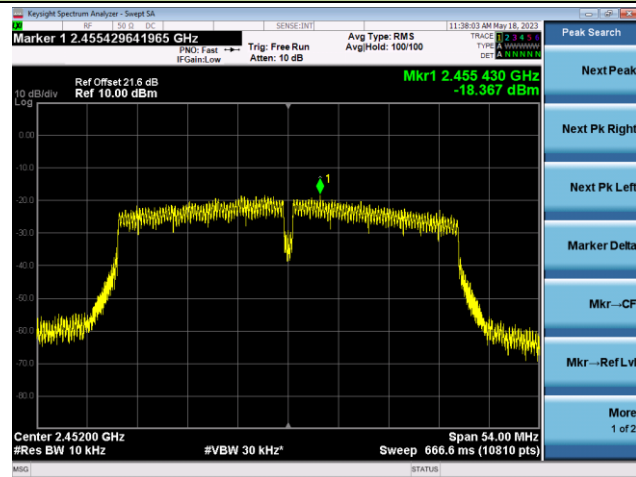

802.11b - Average PSD - Ant 1

Channel 01 (2412MHz)

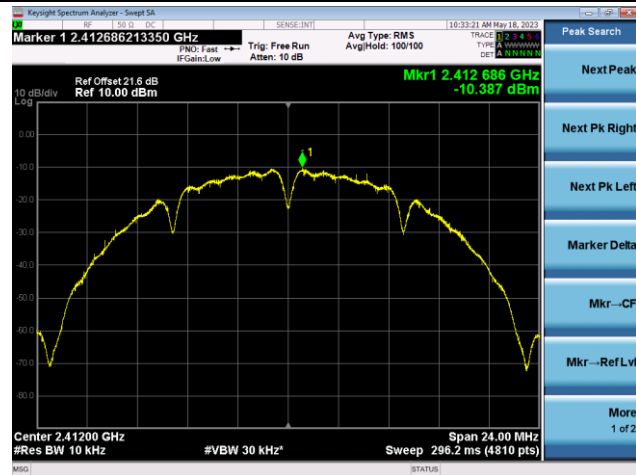

Channel 06 (2437MHz)

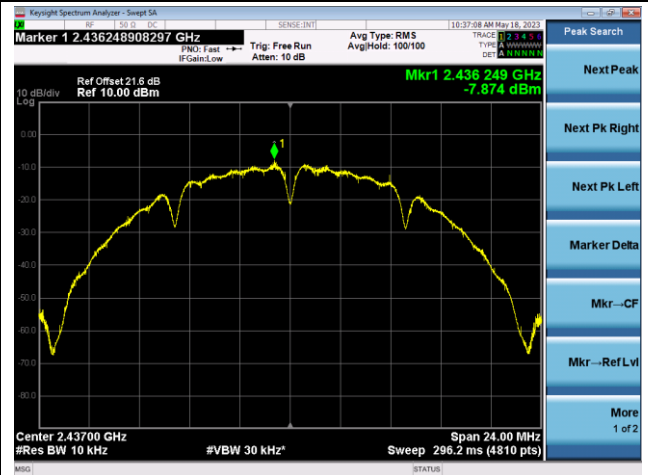

Channel 11 (2462MHz)

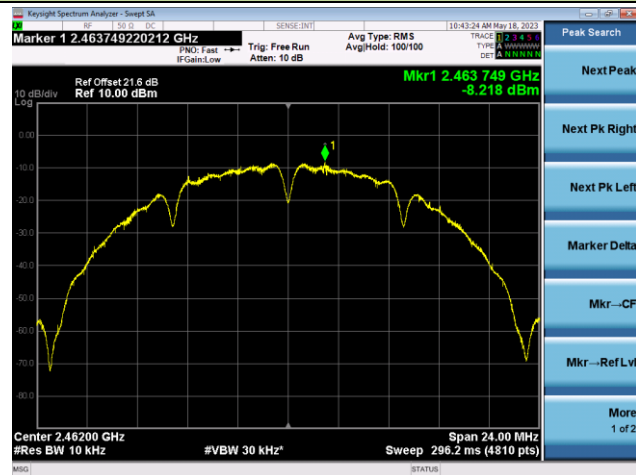



802.11g - Average PSD - Ant 1

Channel 01 (2412MHz)

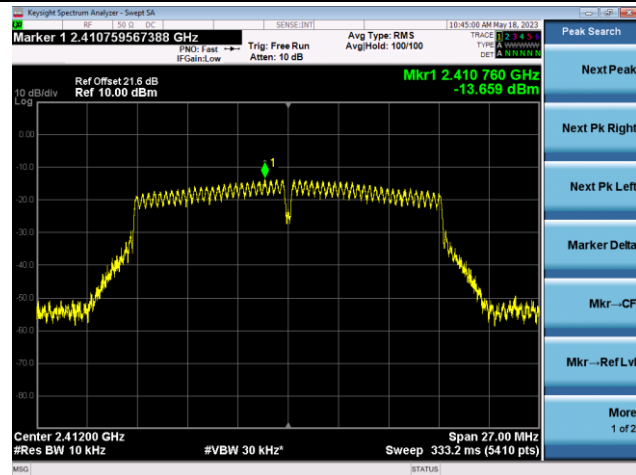

Channel 06 (2437MHz)

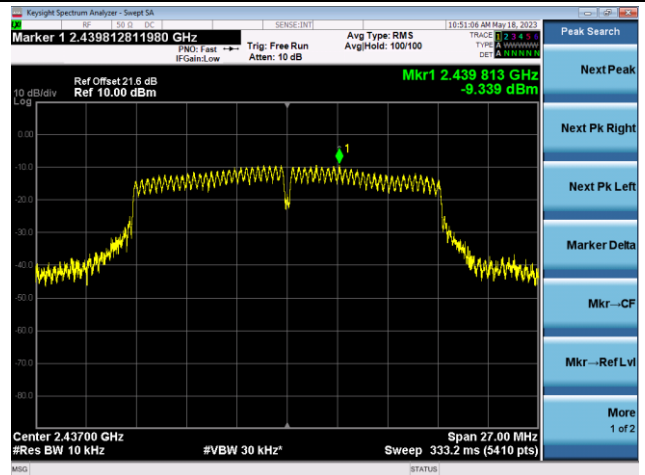

Channel 11 (2462MHz)

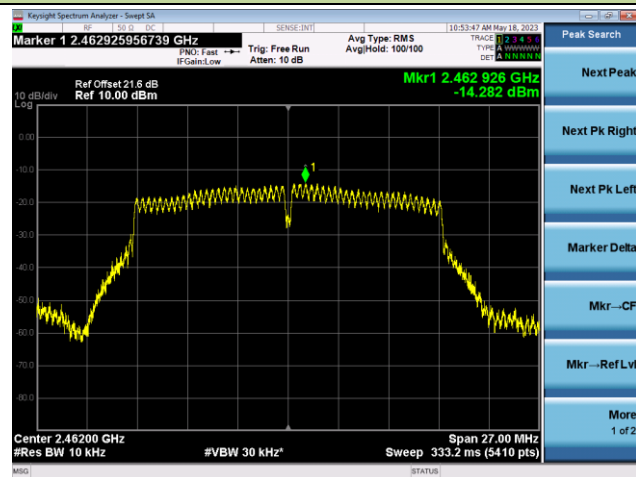

802.11n-HT20 - Average PSD - Ant 1

Channel 01 (2412MHz)

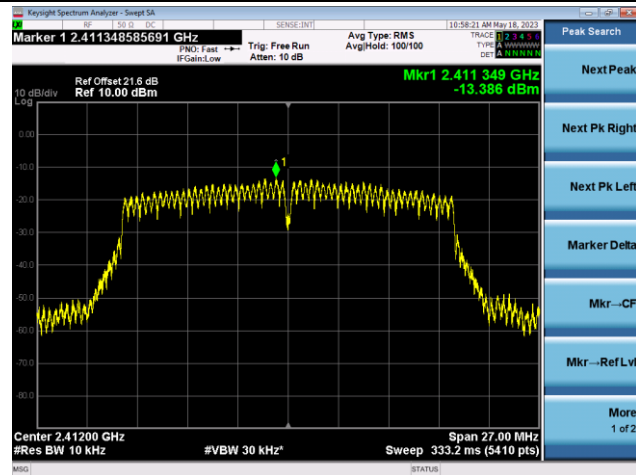

Channel 06 (2437MHz)

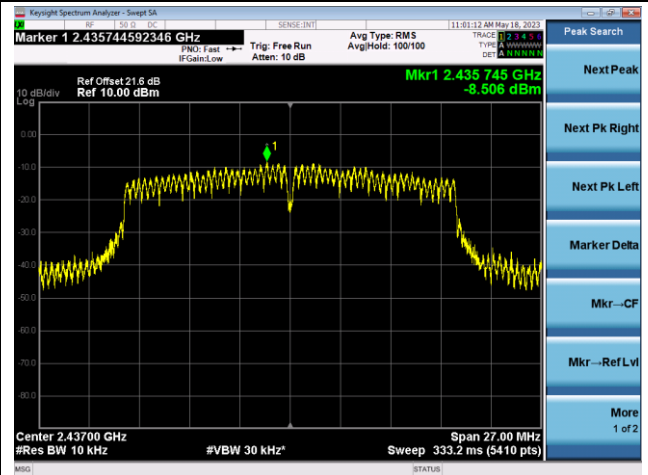

Channel 11 (2462MHz)

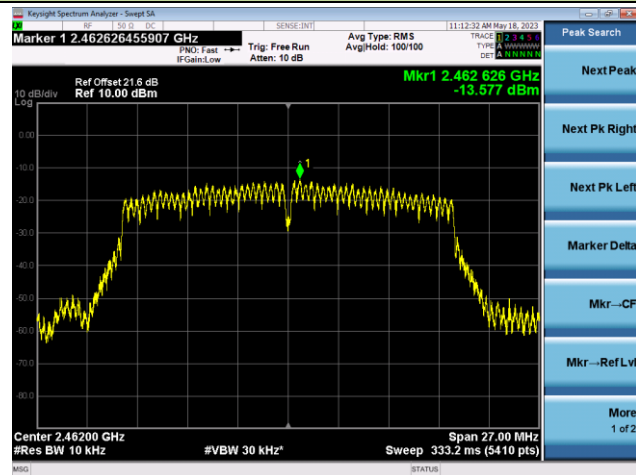

802.11n-HT40 - Average PSD - Ant 1

Channel 03 (2422MHz)

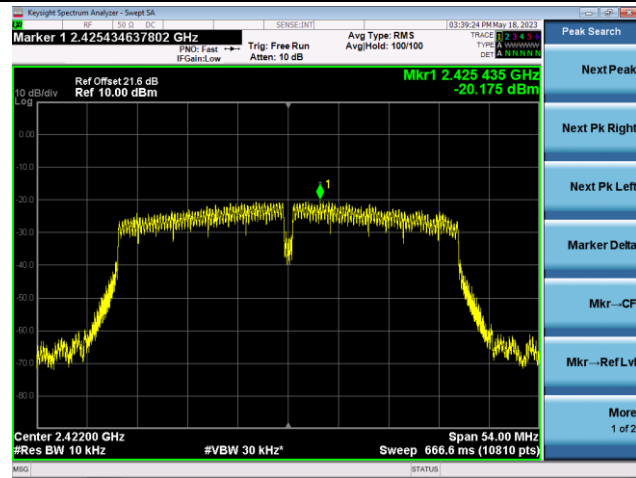

Channel 06 (2437MHz)

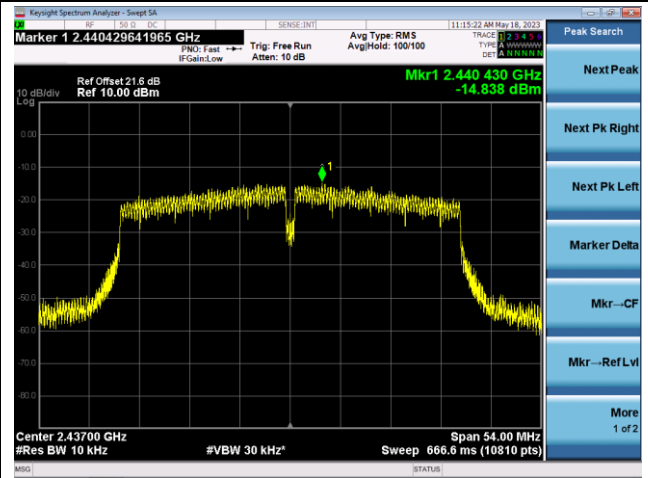

Channel 09 (2452MHz)

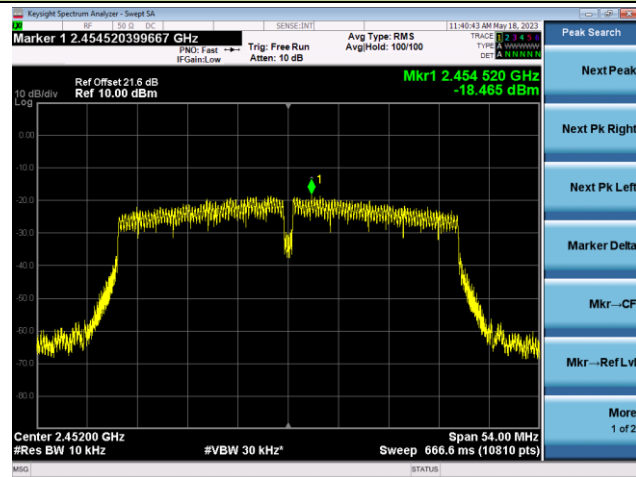

**A.5 Conducted Band Edge and Out-of-Band Emissions Test Result**

Test Site	NS-TR2	Test Engineer	Summer Tang
Test Date	2023/05/18		

Test Mode	Data Rate / MCS	Channel No.	Frequency (MHz)	Limit
11b	1Mbps	01	2412	30dBc
11b	1Mbps	06	2437	30dBc
11b	1Mbps	11	2462	30dBc
11g	6Mbps	01	2412	30dBc
11g	6Mbps	06	2437	30dBc
11g	6Mbps	11	2462	30dBc
11n-HT20	MCS0	01	2412	30dBc
11n-HT20	MCS0	06	2437	30dBc
11n-HT20	MCS0	11	2462	30dBc
11n-HT40	MCS0	03	2422	30dBc
11n-HT40	MCS0	06	2437	30dBc
11n-HT40	MCS0	09	2452	30dBc

802.11b Out-of-Band Emissions - Ant 0

Channel 01 (2412MHz)

Reference Level

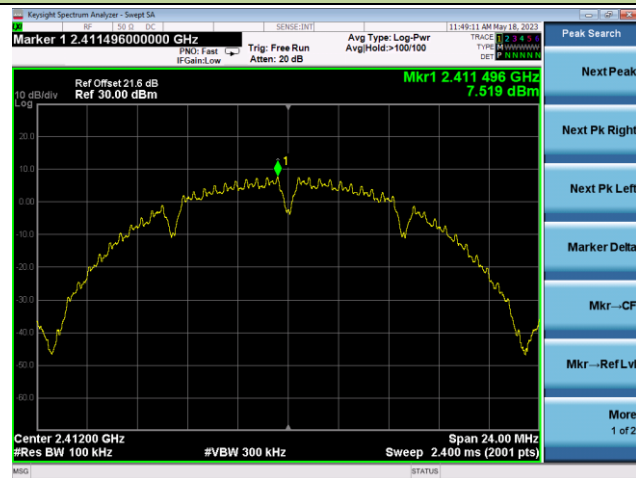

Low Band Edge

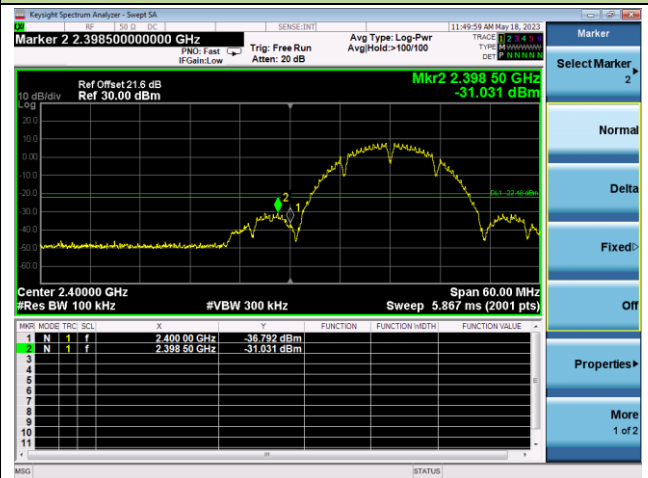

Spurious Emission

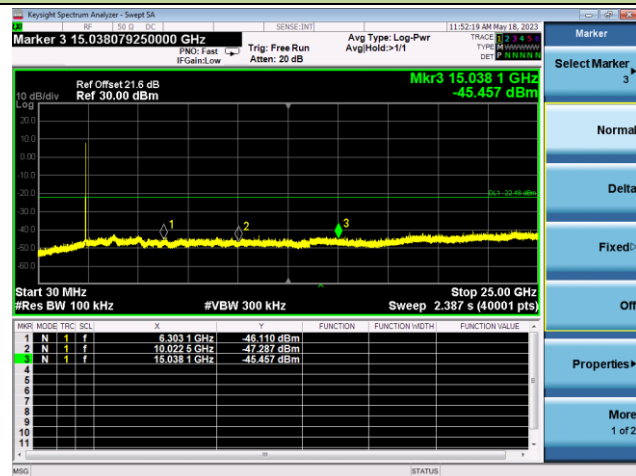

Channel 06 (2437MHz)

Reference Level



Spurious Emission

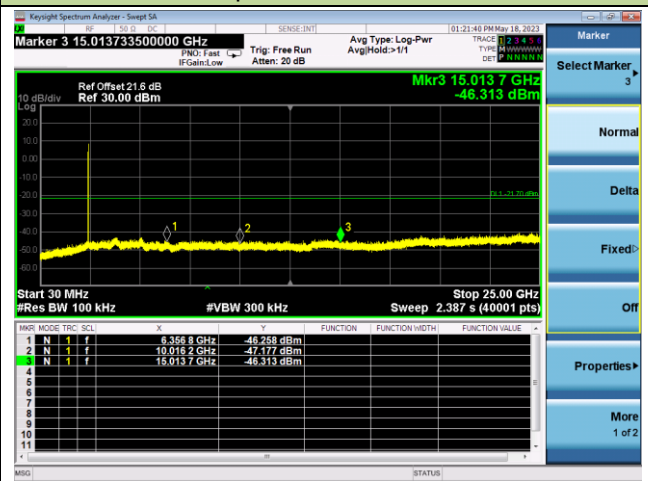

Channel 11 (2462MHz)

Reference Level



High Band Edge

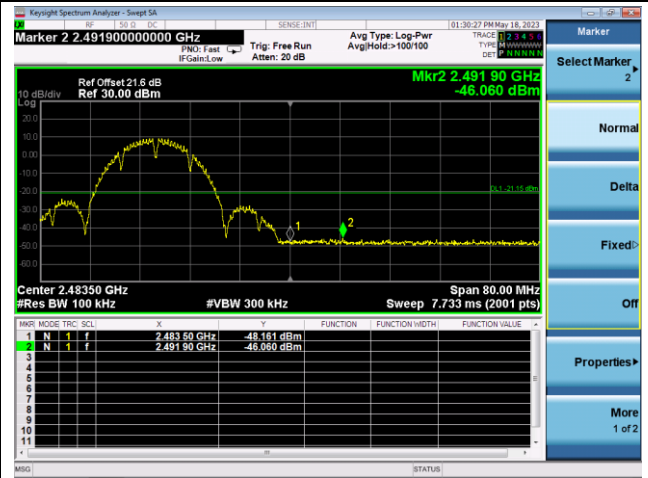

Spurious Emission

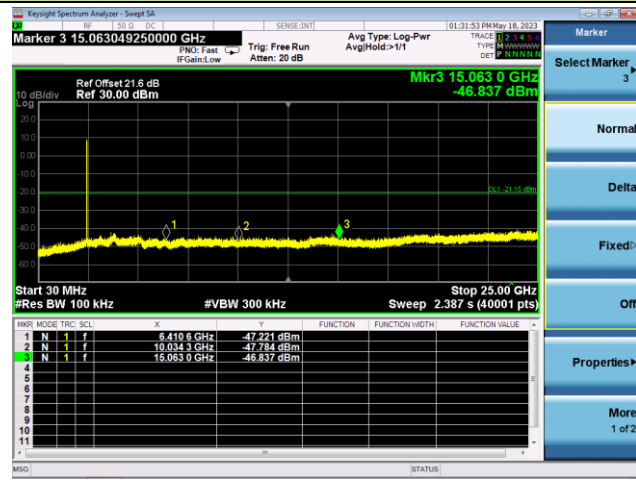

## 802.11g Out-of-Band Emissions - Ant 0

## Channel 01 (2412MHz)

## Reference Level



## Low Band Edge

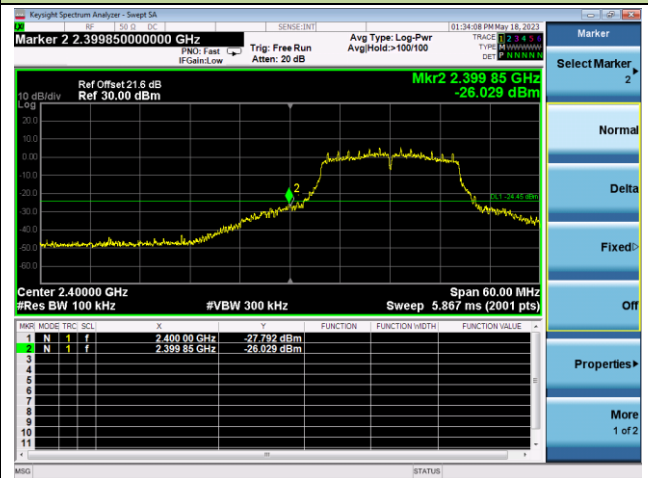

## Spurious Emission

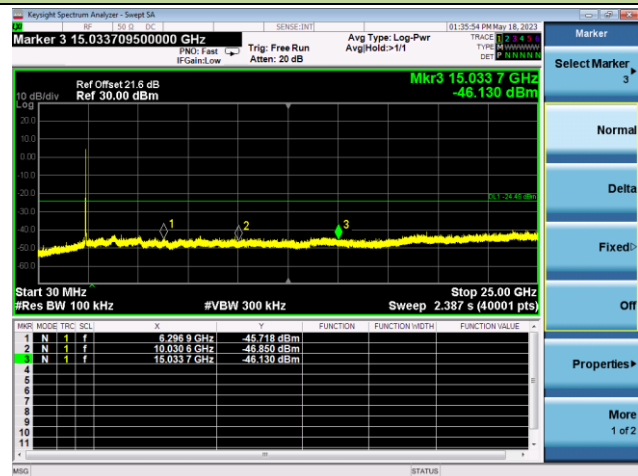

## Channel 06 (2437MHz)

## Reference Level

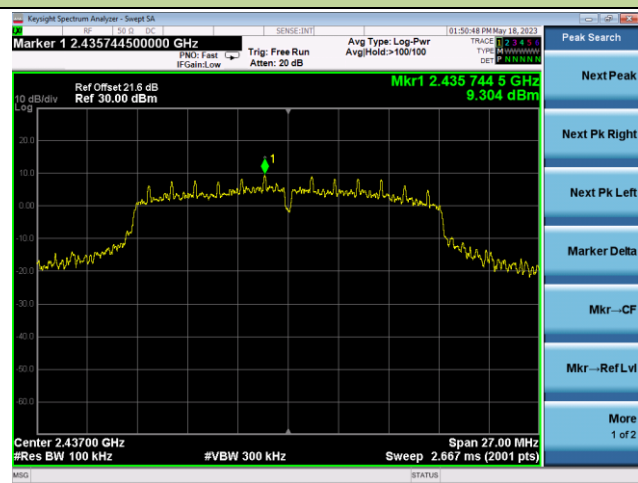

## Spurious Emission

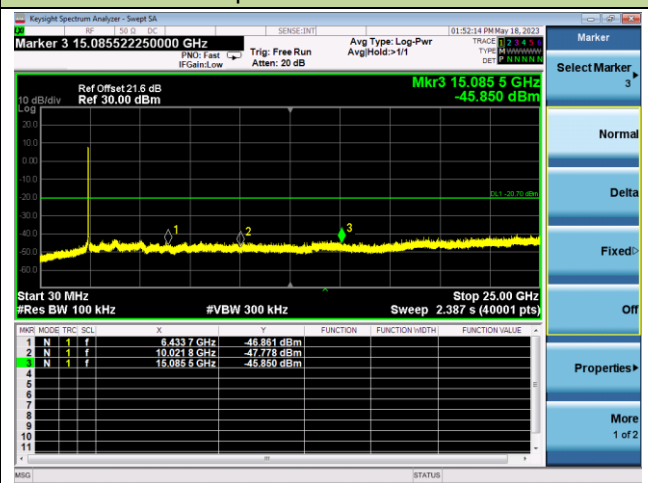

Channel 11 (2462MHz)

Reference Level

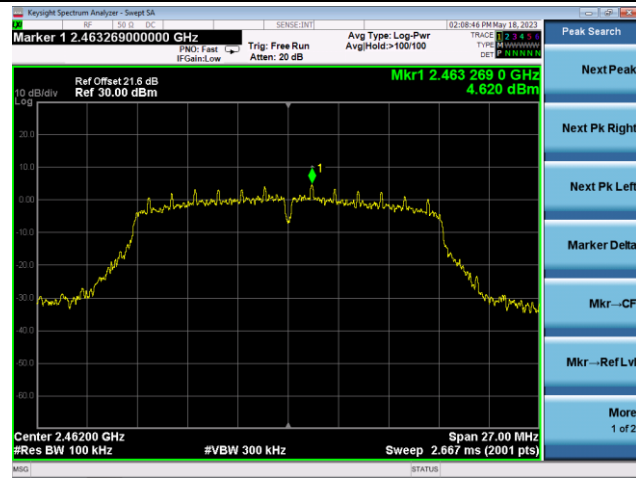

High Band Edge

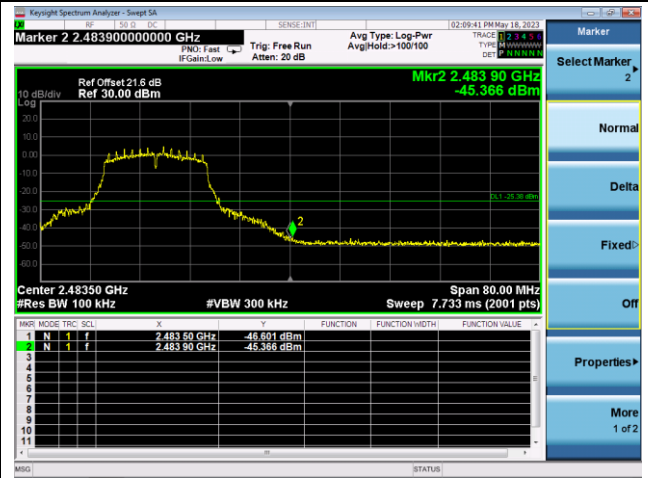

Spurious Emission

