

RF MEASUREMENT REPORT

FCC ID : 2AXJ4C100V4
Applicant : TP-Link Corporation Limited
Application Type : Certification
Product : Home Security Wi-Fi Camera
Model No. : Tapo C100
Brand Name : tp-link
FCC Classification : Digital Transmission System (DTS)
FCC Rule Part(s) : Part15 Subpart C (Section 15.247)
Received Date : June 17 ,2022
Test Date : June 22~28 ,2022

Tested By : Owen Tsai
(Owen Tsai)
Reviewed By : Paddy Chen
(Paddy Chen)
Approved By : Chenz Ker
(Chenz Ker)



The test results relate only to the samples tested.

This equipment has been shown to be capable of compliance with the applicable technical standards as indicated in the measurement report and was tested in accordance with the measurement procedures specified in ANSI C63.10-2013. Test results reported herein relate only to the item(s) tested.

The test report shall not be reproduced except in full without the written approval of MRT Technology (Taiwan) Co., Ltd.

Revision History

Report No.	Version	Description	Issue Date	Note
2206TW0112-U1	1.0	Original Report	2022-07-15	Valid

CONTENTS

Description	Page
1. INTRODUCTION	6
1.1. Scope	6
1.2. MRT Test Location	6
2. PRODUCT INFORMATION	7
2.1. Feature of Equipment under Test	7
2.2. Product Specification Subjective to this Report.....	7
2.3. Working Frequencies for this report	7
2.4. Test Mode.....	8
2.5. Configuration of Test System.....	8
2.6. Test System Details.....	8
2.7. Description of Test Software	8
2.8. Applied Standards	9
2.9. Duty Cycle	9
2.10. EMI Suppression Device(s)/Modifications.....	10
2.11. Labeling Requirements.....	10
3. DESCRIPTION of TEST	11
3.1. Evaluation Procedure	11
3.2. AC Line Conducted Emissions.....	11
3.3. Radiated Emissions	12
4. ANTENNA REQUIREMENTS	13
5. TEST EQUIPMENT CALIBRATION DATE	14
6. MEASUREMENT UNCERTAINTY	15
7. TEST RESULT	16
7.1. Summary	16
7.2. 6dB Bandwidth Measurement.....	17
7.2.1. Test Limit.....	17
7.2.2. Test Procedure used.....	17
7.2.3. Test Setting	17
7.2.4. Test Setup	17
7.2.5. Test Result	18
7.3. Output Power Measurement	21
7.3.1. Test Limit.....	21
7.3.2. Test Procedure Used.....	21

7.3.3. Test Setting	21
7.3.4. Test Setup	21
7.3.5. Test Result	22
7.4. Power Spectral Density Measurement	23
7.4.1. Test Limit	23
7.4.2. Test Procedure Used	23
7.4.3. Test Setting	23
7.4.4. Test Setup	24
7.4.5. Test Result	25
7.5. Conducted Band Edge and Out-of-Band Emissions.....	28
7.5.1. Test Limit	28
7.5.2. Test Procedure Used	28
7.5.3. Test Setting	28
7.5.4. Test Setup	29
7.5.5. Test Result	30
7.6. Radiated Spurious Emission Measurement	36
7.6.1. Test Limit	36
7.6.2. Test Procedure Used	36
7.6.3. Test Setting	36
7.6.4. Test Setup	38
7.6.5. Test Result	39
7.7. Radiated Restricted Band Edge Measurement	59
7.7.1. Test Limit	59
7.7.2. Test Procedure Used	60
7.7.3. Test Setting	60
7.7.4. Test Setup	61
7.7.5. Test Result	62
7.8. AC Conducted Emissions Measurement.....	98
7.8.1. Test Limit	98
7.8.2. Test Setup	98
7.8.3. Test Result	99
8. CONCLUSION	103
Appendix A : Test Setup Photograph	104
Appendix B : External Photograph.....	105
Appendix C : Internal Photograph.....	106

General Information

Applicant	TP-Link Corporation Limited
Applicant Address	Room 901, 9/F., New East Ocean Centre, 9 Science Museum Road, Tsim Sha Tsui, Kowloon, Hongkong
Manufacturer	TP-Link Corporation Limited
Manufacturer Address	Room 901, 9/F., New East Ocean Centre, 9 Science Museum Road, Tsim Sha Tsui, Kowloon, Hongkong
Test Site	MRT Technology (Taiwan) Co., Ltd
Test Site Address	No. 38, Fuxing Second Rd., Guishan Dist., Taoyuan City 333, Taiwan (R.O.C)
MRT FCC Registration No.	291082
FCC Rule Part(s)	Part 15.247
Test Device Serial No.	#1-1

Test Facility / Accreditations

1. MRT facility is a FCC registered (Reg. No. 291082) test facility with the site description report on file and is designated by the FCC as an Accredited Test Firm.
2. MRT facility is an IC registered (MRT Reg. No. 21723) test laboratory with the site description on file at Industry Canada.
3. MRT Lab is accredited to ISO 17025 by the Taiwan Accreditation Foundation (TAF Cert. No. 3261) in EMC, Telecommunications and Radio testing for FCC (Designation Number: TW3261), Industry Taiwan, EU and TELEC Rules.

1. INTRODUCTION

1.1. Scope

Measurement and determination of electromagnetic emissions (EMC) of radio frequency devices including intentional and/or unintentional radiators for compliance with the technical rules and regulations of the Federal Communications Commission and the Innovation, Science and Economic Development Canada and Certification and Engineering Bureau.

1.2. MRT Test Location

The map below shows the location of the MRT LABORATORY, its proximity to the Taoyuan City. These measurement tests were conducted at the MRT Technology (Taiwan) Co., Ltd. Facility located at No.38, Fuxing 2nd Rd., Guishan Dist., Taoyuan City 33377, Taiwan (R.O.C).

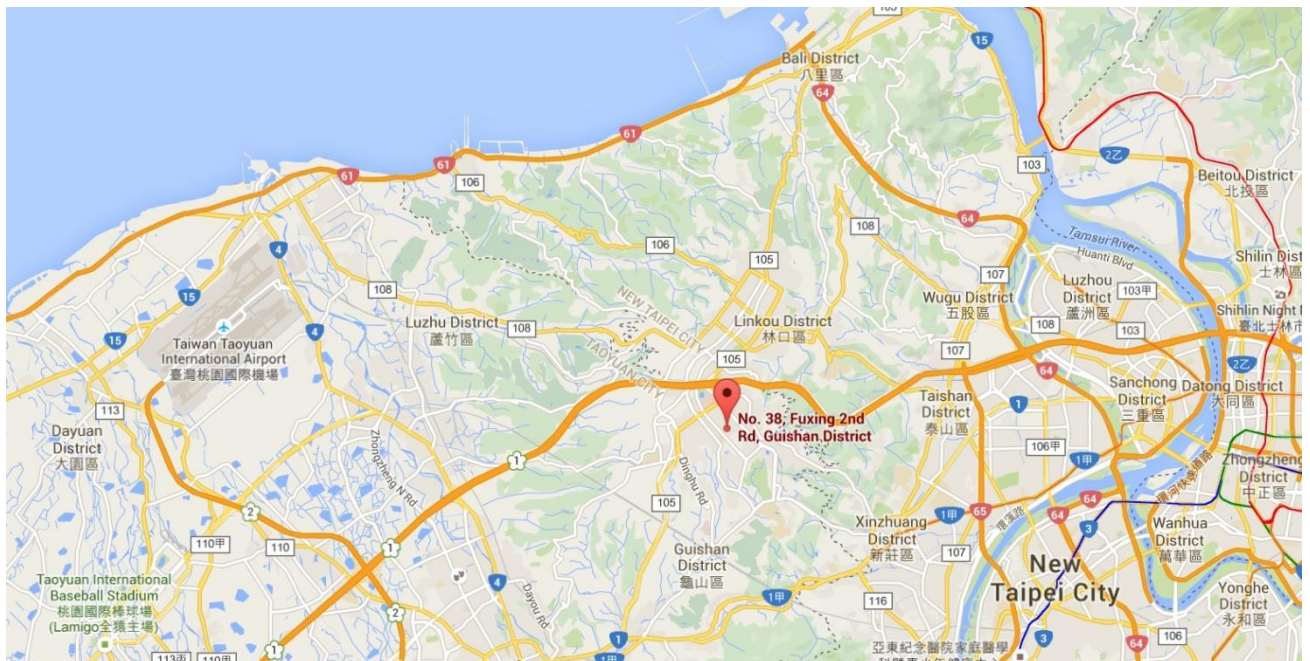

2. PRODUCT INFORMATION

2.1. Feature of Equipment under Test

Product Name:	Home Security Wi-Fi Camera
Model No.:	Tapo C100
Brand Name:	tp-link
Wi-Fi Specification:	802.11b/g/n
Adapter	BRAND: tp-link MODEL: T090060-2B1 INPUT: 100 - 240V ~ 50/60Hz 0.3A. OUTPUT: DC 9V 0.6A

2.2. Product Specification Subjective to this Report

Frequency Range:	802.11b/g/n-HT20: 2412 ~ 2462MHz
Channel Number:	802.11b/g/n-HT20: 11
Type of Modulation:	802.11b: DSSS 802.11g/n: OFDM
Data Rate:	802.11b: 1/2/5.5/11Mbps 802.11g: 6/9/12/18/24/36/48/54Mbps 802.11n: up to 72.2Mbps
Antenna Type:	IFA Antenna
Antenna Gain:	1.93dBi

Note: For other features of this EUT, test report will be issued separately.

2.3. Working Frequencies for this report

802.11b/g/n-HT20

Channel	Frequency	Channel	Frequency	Channel	Frequency
01	2412 MHz	02	2417 MHz	03	2422 MHz
04	2427 MHz	05	2432 MHz	06	2437 MHz
07	2442 MHz	08	2447 MHz	09	2452 MHz
10	2457 MHz	11	2462 MHz	--	--

2.4. Test Mode

Test Mode	Mode 1: Transmit by 802.11b (1Mbps)
	Mode 2: Transmit by 802.11g (6Mbps)
	Mode 3: Transmit by 802.11n-HT20 (MCS0)

2.5. Configuration of Test System

The device was tested per the guidance ANSI C63.10: 2013 was used to reference the appropriate EUT setup for radiated emissions testing and AC line conducted testing.

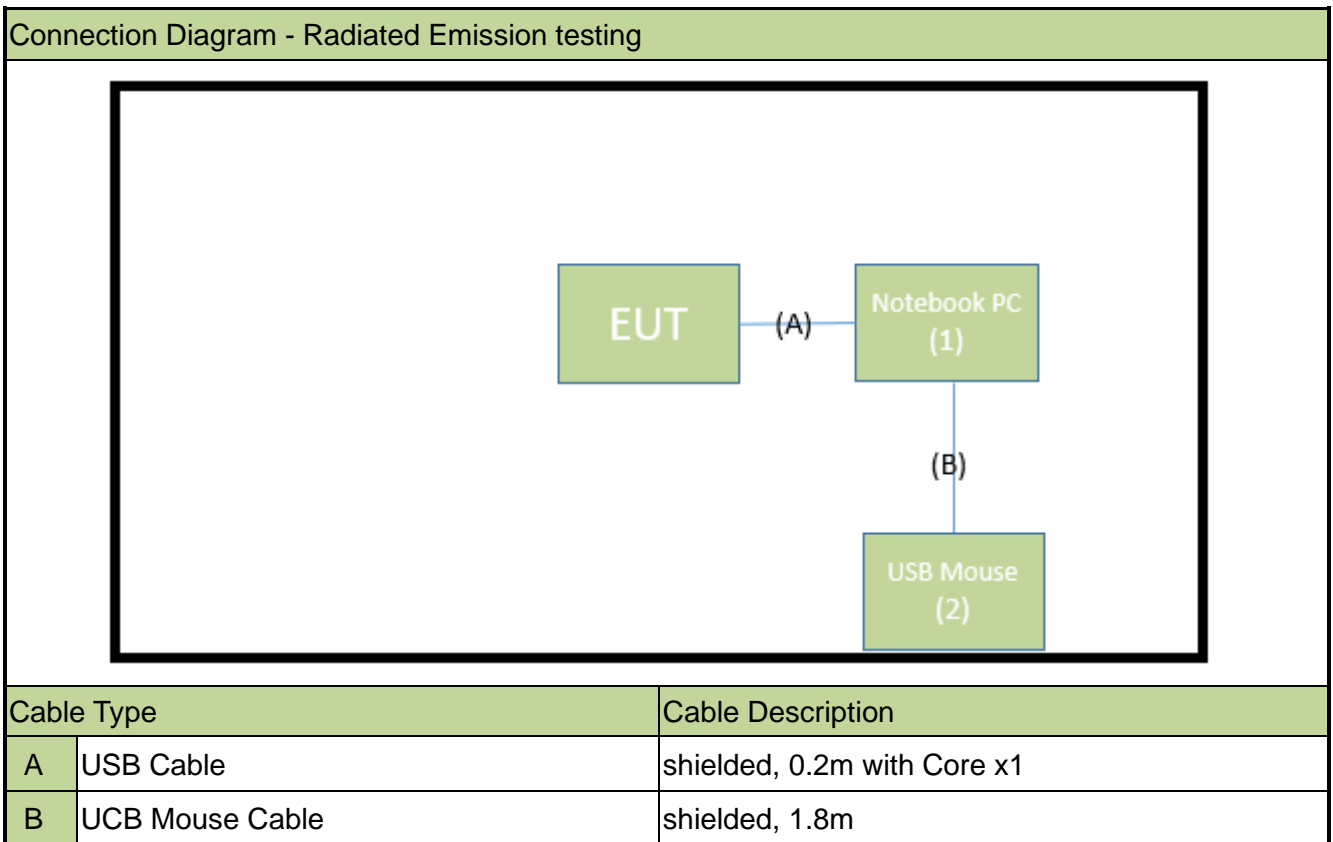

2.6. Test System Details

The types for all equipments, plus descriptions of all cables used in the tested system (including inserted cards) are:

	Product	Manufacturer	Model No.	Serial No.	Power Cord
1	Notebook PC	Acer	N/A	N/A	Non-shielded, 0.8m
2	USB Mouse	Logitech	N/A	N/A	N/A

2.7. Description of Test Software

The test utility software used during testing was "RTL11n_8188FTV_USB", the version is v1.25.

2.8. Applied Standards

According to the specifications of the manufacturer, the EUT must comply with the requirements of the following standards:

- FCC Part 15.247
- KDB 558074 D01v05r02
- ANSI C63.10-2013

2.9. Duty Cycle

2.4GHz WLAN (DTS) operation is possible in 20MHz and 40MHz channel bandwidths. The maximum achievable duty cycles for all modes were determined based on measurements performed on a spectrum analyzer in zero-span mode with RBW = 8MHz, VBW = 50MHz. The RBW and VBW were both greater than 50/T, where T is the minimum transmission duration, and the number of sweep points across T was greater than 100. The duty cycles are as follows:

Test Mode	Duty Cycle
802.11b	100.00%
802.11g	100.00%
802.11n-HT20	100.00%

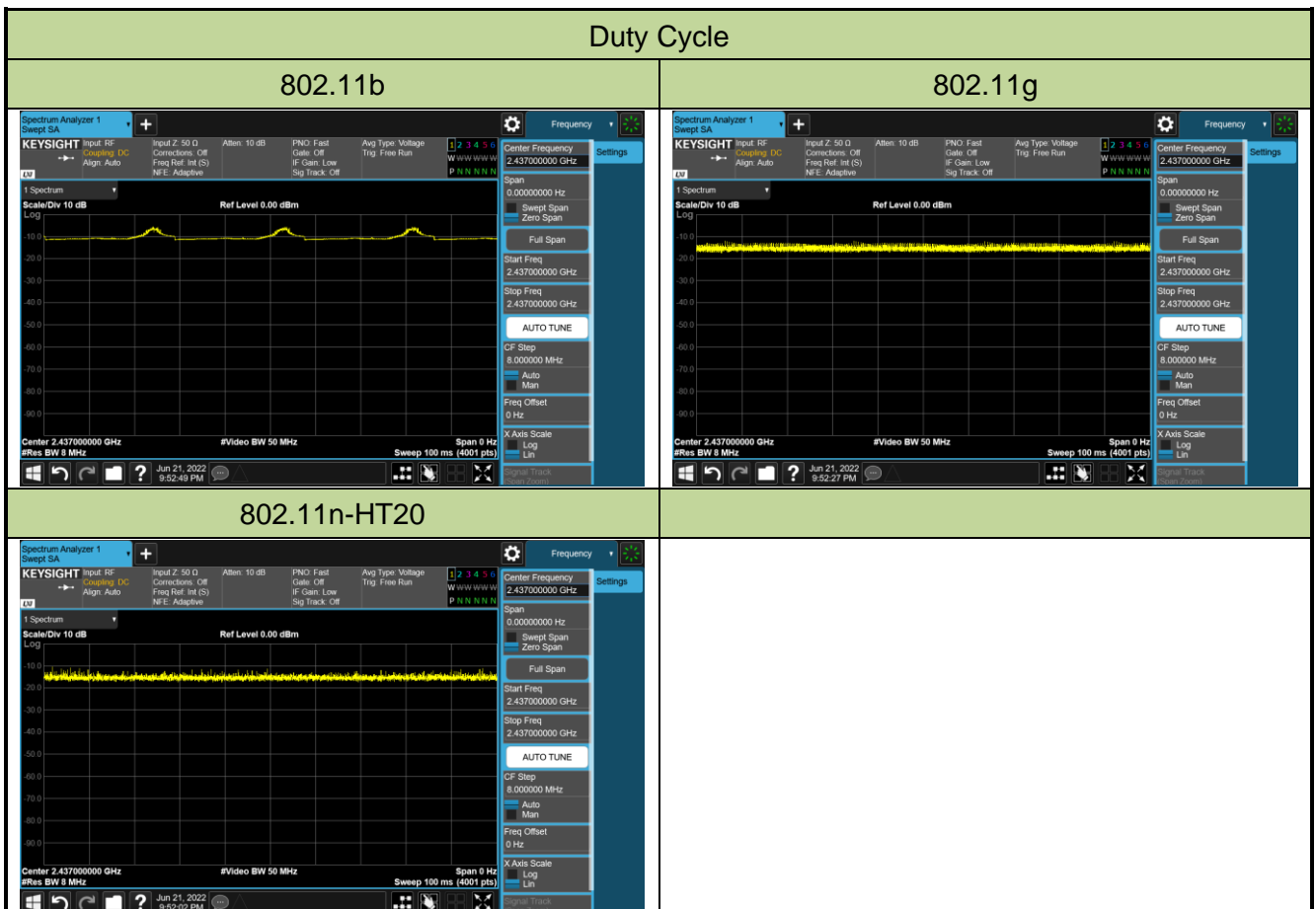

Test Configuration

The device was tested per the guidance of ANSI C63.10-2013. ANSI C63.10-2013 was used to reference the appropriate EUT setup for radiated spurious emissions testing and AC line conducted testing.

2.10. EMI Suppression Device(s)/Modifications

No EMI suppression device(s) were added and/or no modifications were made during testing.

2.11. Labeling Requirements

Per 2.1074 & 15.19; Docket 95-19

The label shall be permanently affixed at a conspicuous location on the device; instruction manual or pamphlet supplied to the user and be readily visible to the purchaser at the time of purchase. However, when the device is so small wherein placement of the label with specified statement is not practical, only the FCC ID must be displayed on the device per Section 15.19(a)(5). Please see attachment for FCC ID label and label location.

3. DESCRIPTION of TEST

3.1. Evaluation Procedure

The measurement procedures described in the American National Standard of Procedures for Compliance Testing of Unlicensed Wireless Devices (ANSI C63.10-2013), and the guidance was used in the measurement.

3.2. AC Line Conducted Emissions

The line-conducted facility is located inside an 8'x4'x4' shielded enclosure. A 1m x 2m wooden table 80cm high is placed 40cm away from the vertical wall and 80cm away from the sidewall of the shielded room. Two 10kHz-30MHz, 50Ω/50uH Line-Impedance Stabilization Networks (LISNs) are bonded to the shielded room floor. Power to the LISNs is filtered by external high-current high-insertion loss power line filters. These filters attenuate ambient signal noise from entering the measurement lines. These filters are also bonded to the shielded enclosure.

The EUT is powered from one LISN and the support equipment is powered from the second LISN. All interconnecting cables more than 1 meter were shortened to a 1 meter length by non-inductive bundling (serpentine fashion) and draped over the back edge of the test table. All cables were at least 40cm above the horizontal reference ground-plane. Power cables for support equipment were routed down to the second LISN while ensuring that that cables were not draped over the second LISN.

Sufficient time for the EUT, support equipment, and test equipment was allowed in order for them to warm up to their normal operating condition. The RF output of the LISN was connected to the receiver and exploratory measurements were made to determine the frequencies producing the maximum emission from the EUT. The receiver was scanned from 150kHz to 30MHz. The detector function was set to peak mode for exploratory measurements while the bandwidth of the analyzer was set to 9kHz. The EUT, support equipment, and interconnecting cables were arranged and manipulated to maximize each emission. Each emission was also maximized by varying power lines, the mode of operation or data exchange speed, or support equipment whichever determined the worst-case emission. Once the worst-case emissions have been identified, the one EUT cable configuration/arrangement and mode of operation that produced these emissions are used for final measurements on the same test site. The analyzer is set to CISPR quasi-peak and average detectors with a 9kHz resolution bandwidth for final measurements.

An extension cord was used to connect to a single LISN which powered by EUT. The extension cord was calibrated with LISN, the impedance and insertion loss are compliance with the requirements as stated in ANSI C63.10-2013.

3.3. Radiated Emissions

The radiated test facilities consisted of an indoor 3 meter semi-anechoic chamber used for final measurements and exploratory measurements, when necessary. The measurement area is contained within the semi-anechoic chamber which is shielded from any ambient interference. For measurements above 1GHz absorbers are arranged on the floor between the turn table and the antenna mast in such a way so as to maximize the reduction of reflections. For measurements below 1GHz, the absorbers are removed. A MF Model 210SS turntable is used for radiated measurement. It is a continuously rotatable, remote controlled, metallic turntable and 2 meters (6.56 ft.) in diameter. The turn table is flush with the raised floor of the chamber in order to maintain its function as a ground plane. An 80cm high PVC support structure is placed on top of the turntable.

For all measurements, the spectrum was scanned through all EUT azimuths and from 1 to 4 meter receive antenna height using a broadband antenna from 30MHz up to the upper frequency shown in 15.33(b)(1) depending on the highest frequency generated or used in the device or on which the device operates or tunes. For frequencies above 1GHz, linearly polarized double ridge horn antennas were used. For frequencies below 30MHz, a calibrated loop antenna was used. When exploratory measurements were necessary, they were performed at 1 meter test distance inside the semi-anechoic chamber using broadband antennas, broadband amplifiers, and spectrum analyzers to determine the frequencies and modes producing the maximum emissions. Sufficient time for the EUT, support equipment, and test equipment was allowed in order for them to warm up to their normal operating condition. The test set-up for frequencies below 1GHz was placed on top of the 0.8 meter high, 1 x 1.5 meter table; and test set-up for frequencies 1-40GHz was placed on top of the 1.5 meter high, 1 x 1.5 meter table. The EUT, support equipment, and interconnecting cables were arranged and manipulated to maximize each emission. Appropriate precaution was taken to ensure that all emissions from the EUT were maximized and investigated. The system configuration, clock speed, mode of operation or video resolution, if applicable, turntable azimuth, and receive antenna height was noted for each frequency found.

Final measurements were made in the semi-anechoic chamber using calibrated, linearly polarized broadband and horn antennas. The test setup was configured to the setup that produced the worst case emissions. The spectrum analyzer was set to investigate all frequencies required for testing to compare the highest radiated disturbances with respect to the specified limits. The turntable containing the EUT was rotated through 360 degrees and the height of the receive antenna was varied 1 to 4 meters and stopped at the azimuth and height producing the maximum emission. Each emission was maximized by changing the orientation of the EUT through three orthogonal planes and changing the polarity of the receive antenna, whichever produced the worst-case emissions. According to 3dB Beam-Width of horn antenna, the horn antenna should be always directed to the EUT when rising height.

4. ANTENNA REQUIREMENTS

Excerpt from §15.203 of the FCC Rules/Regulations:

“An intentional radiator antenna shall be designed to ensure that no antenna other than that furnished by the responsible party can be used with the device. The use of a permanently attached antenna or of an antenna that uses a unique coupling to the intentional radiator shall be considered sufficient to comply with the provisions of this section.”

- The antenna of the device is **permanently attached**.
- There are no provisions for connection to an external antenna.

Conclusion:

The unit complies with the requirement of §15.203.

5. TEST EQUIPMENT CALIBRATION DATE

Conducted Emissions

Instrument	Manufacturer	Type No.	Asset No.	Cali. Interval	Cali. Due Date
Two-Line V-Network	R&S	ENV216	MRTTWA00019	1 year	2023/3/7
Two-Line V-Network	R&S	ENV216	MRTTWA00020	1 year	2023/4/20
EMI Test Receiver	R&S	ESR3	MRTTWA00045	1 year	2023/5/9

Radiated Emissions

Instrument	Manufacturer	Type No.	Asset No.	Cali. Interval	Cali. Due Date
Broadband TRILOG Antenna	SCHWARZBECK	VULB 9162	MRTTWA00001	1 year	2022/10/4
Active Loop Antenna	SCHWARZBECK	FMZB 1519B	MRTTWA00002	1 year	2023/5/24
Broadband Hornantenna	SCHWARZBECK	BBHA 9120D	MRTTWA00003	1 year	2023/3/30
Breitband Hornantenna	SCHWARZBECK	BBHA 9170	MRTTWA00004	1 year	2023/3/29
Broadband Preamplifier	SCHWARZBECK	BBV 9718	MRTTWA00005	1 year	2023/3/30
Broadband Amplifier	SCHWARZBECK	BBV 9721	MRTTWA00006	1 year	2023/3/30
Signal Analyzer	R&S	FSV40	MRTTWA00007	1 year	2023/3/16
EMI Test Receiver	R&S	ESR3	MRTTWA00009	1 year	2023/3/9
EXA Signal Analyzer	KEYSIGHT	N9010A	MRTTWA00012	1 year	2022/10/18
Antenna Cable	HUBERSUHNER	SF106	MRTTWE00010	1 year	2023/6/14
Temperature/Humidity Meter	TFA	35.1078.10.IT	MRTTWA00032	1 year	2022/7/5

Conducted Test Equipment

Instrument	Manufacturer	Type No.	Asset No.	Cali. Interval	Cali. Due Date
X-Series USB Peak and Average Power Sensor	KEYSIGHT	U2021XA	MRTTWA00014	1 year	2023/4/20
EXA Signal Analyzer	KEYSIGHT	N9010A	MRTTWA00012	1 year	2022/10/18
EXA Signal Analyzer	KEYSIGHT	N9010B	MRTTWA00074	1 year	2022/7/19
Attenuator	WTI	218FS-20	MRTTWE00026	1 year	2022/11/18
Attenuator	WTI	218FS-10	MRTTWE00027	1 year	2023/6/15
Attenuator	WTI	218FS-06	MRTTWE00028	1 year	2023/6/15
Temperature & Humidity Chamber	TEN BILLION	TTH-B3UP	MRTTWA00036	1 year	2023/6/14
DIVA PLUS Funk-Wetterstation	TFA	35.1083	MRTTWA00050	1 year	2022/7/2

Software	Version	Function
e3	9.160520a	EMI Test Software

6. MEASUREMENT UNCERTAINTY

Where relevant, the following test uncertainty levels have been estimated for tests performed on the EUT as specified in CISPR 16-4-2. This uncertainty represents an expanded uncertainty expressed at approximately the 95% confidence level using a coverage factor of $k = 2$.

AC Conducted Emission Measurement
Measuring Uncertainty for a Level of Confidence of 95% ($U=2Uc(y)$): 150kHz~30MHz: $\pm 2.53\text{dB}$
Radiated Emission Measurement
Measuring Uncertainty for a Level of Confidence of 95% ($U=2Uc(y)$): 9kHz ~ 1GHz: $\pm 4.25\text{dB}$ 1GHz ~ 40GHz: $\pm 4.45\text{dB}$
Conducted Power (Carrier Power / Power Density)
Measuring Uncertainty for a Level of Confidence of 95% ($U=2Uc(y)$): $\pm 0.84\text{dB}$
Conducted Spurious Emission
Measuring Uncertainty for a Level of Confidence of 95% ($U=2Uc(y)$): $\pm 2.65\text{ dB}$
Occupied Bandwidth
Measuring Uncertainty for a Level of Confidence of 95% ($U=2Uc(y)$): $\pm 3.3\%$
Temp. / Humidity
Measuring Uncertainty for a Level of Confidence of 95% ($U=2Uc(y)$): $\pm 0.82^\circ\text{C} / \pm 3\%$

7. TEST RESULT

7.1. Summary

FCC Section(s)	Test Description	Test Limit	Test Condition	Test Result	Reference
15.247(a)(2)	6dB Bandwidth	$\geq 500\text{kHz}$	Conducted	Pass	Section 7.2
15.247(b)(3)	Output Power	$\leq 30\text{dBm}$		Pass	Section 7.3
15.247(e)	Power Spectral Density	$\leq 8\text{dBm}/3\text{kHz}$		Pass	Section 7.4
15.247(d)	Band Edge / Out-of-Band Emissions	$\geq 30\text{dBc}$ (Average)		Pass	Section 7.5
15.205 15.209	General Field Strength Limits (Restricted Bands and Radiated Emission Limits)	Emissions in restricted bands must meet the radiated limits detailed in 15.209	Radiated	Pass	Section 7.6 & 7.7
15.207	AC Conducted Emissions 150kHz - 30MHz	< FCC 15.207 limits	Line Conducted	Pass	Section 7.8

Notes:

- 1) Determining compliance is based on the test results met the regulation limits or requirements declared by clients, and the test results don't take into account the value of measurement uncertainty.
- 2) The analyzer plots shown in this section were all taken with a correction table loaded into the analyzer. The correction table was used to account for the losses of the cables and attenuators used as part of the system to connect the EUT to the analyzer at all frequencies of interest.
- 3) For radiated emission test, every axis (X, Y, Z) was also verified. The test results shown in the following sections represent the worst-case emissions.

7.2. 6dB Bandwidth Measurement

7.2.1. Test Limit

The minimum 6dB bandwidth shall be at least 500 kHz.

7.2.2. Test Procedure used

ANSI C63.10 - 2013 - Section 11.8

7.2.3. Test Setting

1. The Spectrum's automatic bandwidth measurement capability was used to perform the 6dB bandwidth measurement. The "X" dB bandwidth parameter was set to $X = 6$. The bandwidth measurement was not influenced by any intermediate power nulls in the fundamental emission.
2. Set RBW = 100 kHz
3. $VBW \geq 3 \times RBW$
4. Detector = Peak
5. Trace mode = max hold
6. Sweep = auto couple
7. Allow the trace was allowed to stabilize

7.2.4. Test Setup

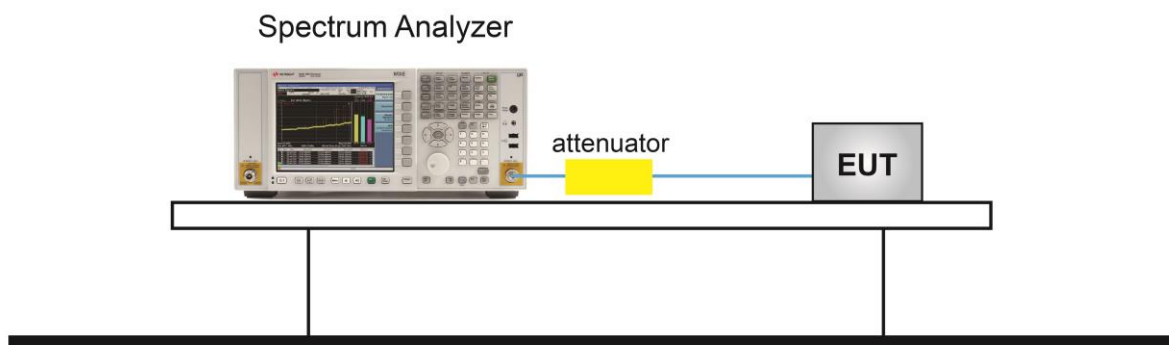

7.2.5. Test Result

Product	Home Security Wi-Fi Camera	Temperature	25°C
Test Engineer	Jay	Relative Humidity	54%
Test Site	SR5	Test Date	2022/6/28

Test Mode	Data Rate / MCS	Channel No.	Frequency (MHz)	6dB Bandwidth (MHz)	Limit (MHz)	Result
802.11b	1Mbps	01	2412	9.057	≥ 0.5	Pass
802.11b	1Mbps	06	2437	9.054	≥ 0.5	Pass
802.11b	1Mbps	11	2462	9.062	≥ 0.5	Pass
802.11g	6Mbps	01	2412	16.520	≥ 0.5	Pass
802.11g	6Mbps	06	2437	16.530	≥ 0.5	Pass
802.11g	6Mbps	11	2462	16.530	≥ 0.5	Pass
802.11n-HT20	MCS0	01	2412	17.750	≥ 0.5	Pass
802.11n-HT20	MCS0	06	2437	17.720	≥ 0.5	Pass
802.11n-HT20	MCS0	11	2462	17.660	≥ 0.5	Pass

802.11b 6dB Bandwidth

Channel 01 (2412MHz)

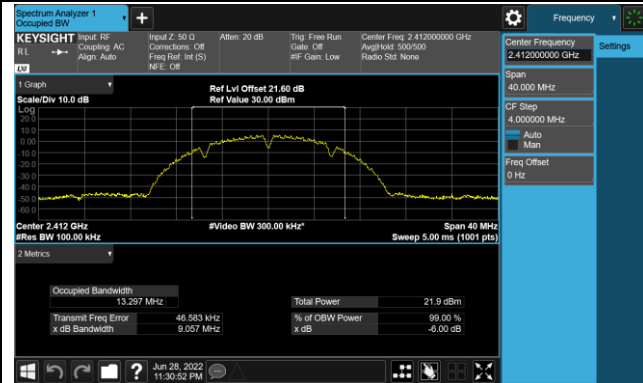

Channel 06 (2437MHz)

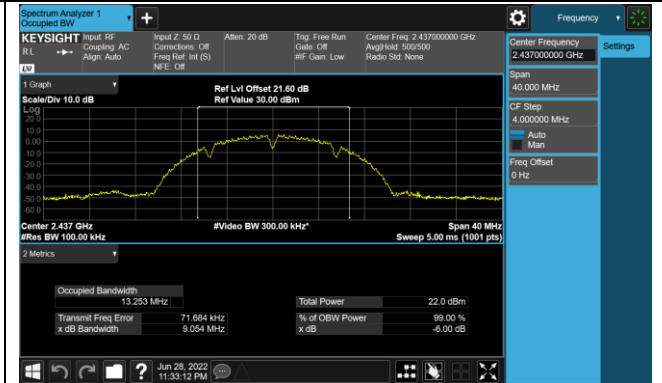

Channel 11 (2462MHz)

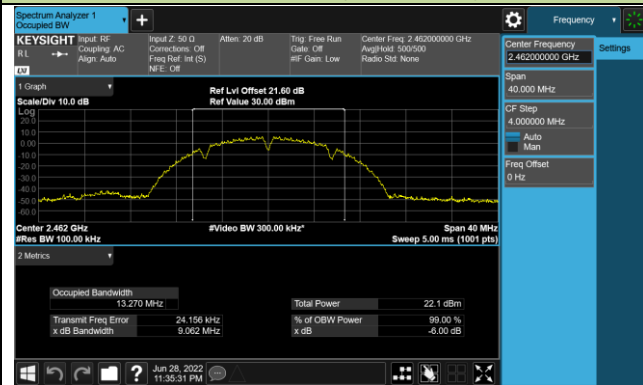

802.11g 6dB Bandwidth

Channel 01 (2412MHz)

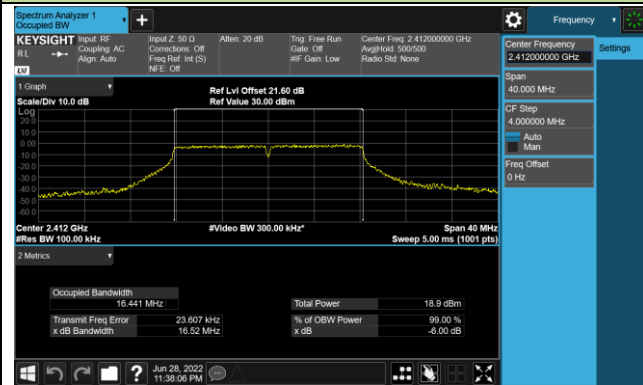

Channel 06 (2437MHz)

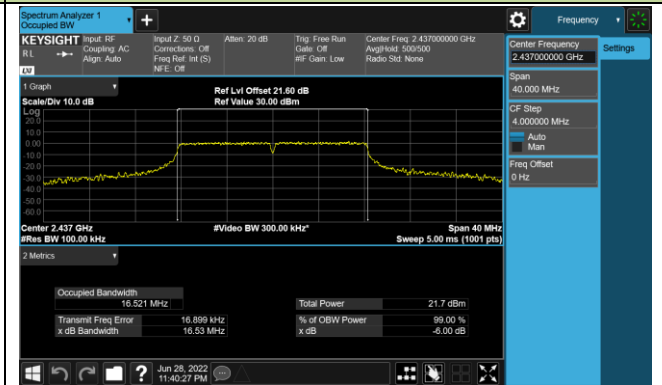

Channel 11 (2462MHz)

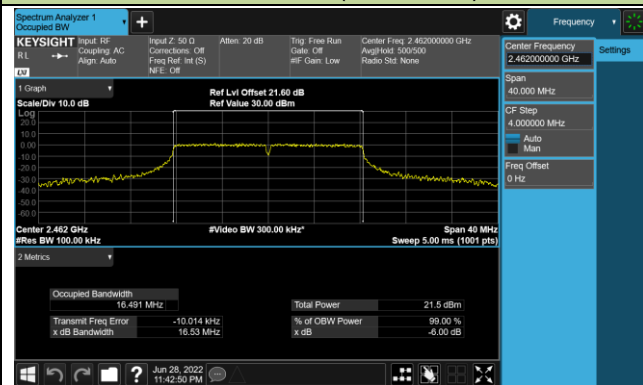

802.11n-HT20 6dB Bandwidth

Channel 01 (2412MHz)

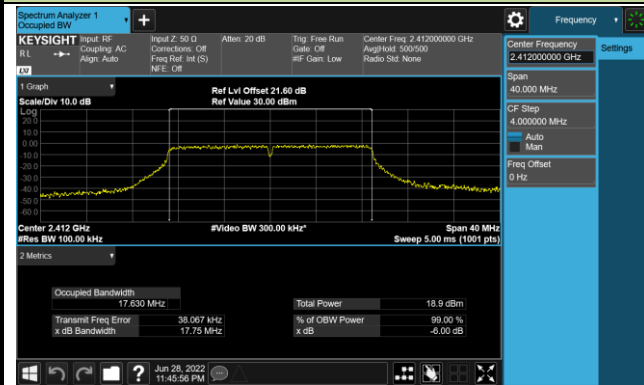

Channel 06 (2437MHz)

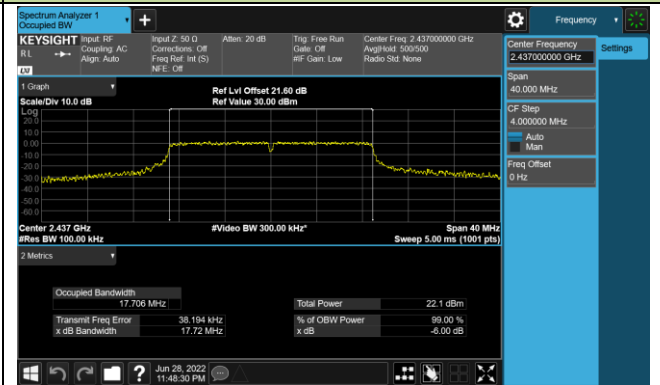

Channel 11 (2462MHz)

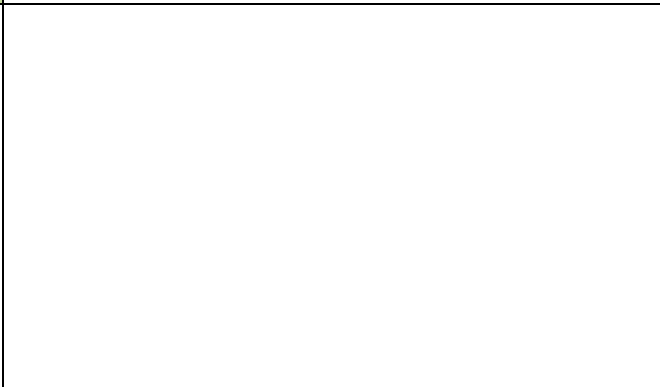
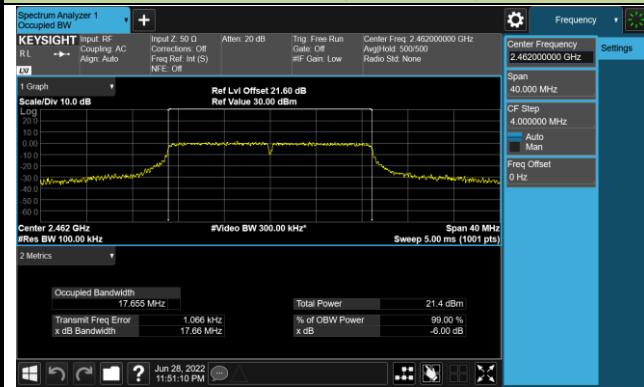

7.3. Output Power Measurement

7.3.1. Test Limit

The maximum output power shall be less 1 Watt (30dBm).

The conducted output power limit specified in paragraph FCC Part 15.247(b) of this section is based on the use of antennas with directional gains that do not exceed 6 dBi. If transmitting antennas of directional gain greater than 6 dBi are used, the conducted output power from the intentional radiator shall be reduced below the stated values in paragraphs FCC Part 15.247(b)(3) of this section, as appropriate, by the amount in dB that the directional gain of the antenna exceeds 6 dBi.

7.3.2. Test Procedure Used

ANSI C63.10 - 2013 - Section 11.9.2.3.2

7.3.3. Test Setting

Average Power Measurement

Average power measurements were performed only when the EUT was transmitting at its maximum power control level using a broadband power meter with a pulse sensor. The power meter implemented triggering and gating capabilities which were set up such that power measurements were recorded only during the ON time of the transmitter.

7.3.4. Test Setup

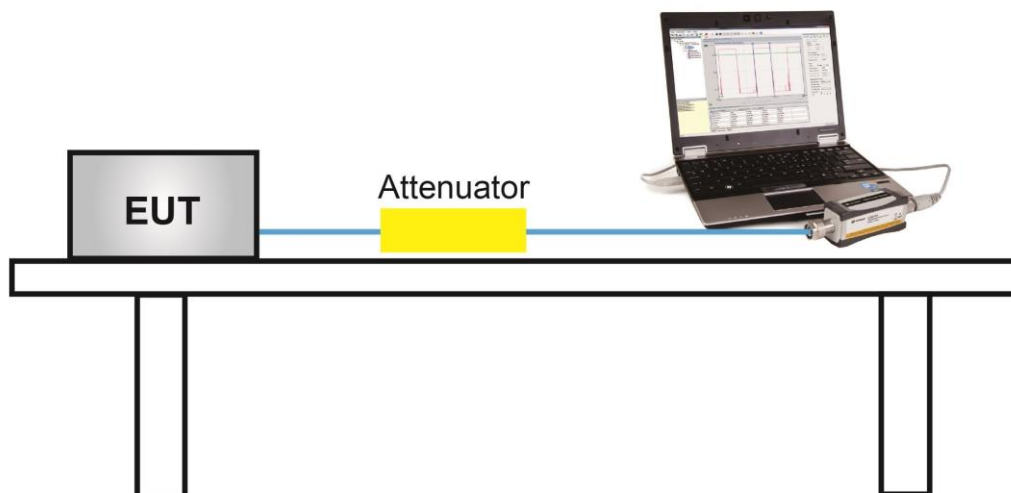

7.3.5. Test Result

Product	Home Security Wi-Fi Camera	Temperature	25°C
Test Engineer	Jay	Relative Humidity	54%
Test Site	SR5	Test Date	2022/6/28

Test Mode	Data Rate/ MCS	Channel No.	Freq. (MHz)	Average Power (dBm)	Limit (dBm)	Result
802.11b	1Mbps	01	2412	17.08	≤ 30.00	Pass
802.11b	1Mbps	06	2437	17.18	≤ 30.00	Pass
802.11b	1Mbps	11	2462	17.10	≤ 30.00	Pass
802.11g	6Mbps	01	2412	14.82	≤ 30.00	Pass
802.11g	6Mbps	06	2437	17.16	≤ 30.00	Pass
802.11g	6Mbps	11	2462	17.22	≤ 30.00	Pass
802.11n-HT20	MCS0	01	2412	14.65	≤ 30.00	Pass
802.11n-HT20	MCS0	06	2437	17.33	≤ 30.00	Pass
802.11n-HT20	MCS0	11	2462	16.98	≤ 30.00	Pass

7.4. Power Spectral Density Measurement

7.4.1. Test Limit

The maximum permissible power spectral density is 8dBm in any 3 kHz band.

The same method of determining the conducted output power shall be used to determine the power spectral density.

7.4.2. Test Procedure Used

ANSI C63.10 - 2013 - Section 11.10.5

7.4.3. Test Setting

1. Measure the duty cycle (x) of the transmitter output signal.
2. Set instrument center frequency to DTS channel center frequency.
3. Set span to at least 1.5 times the OBW.
4. RBW = 10 kHz.
5. VBW = 30 kHz.
6. Detector = RMS.
7. Ensure that the number of measurement points in the sweep $\geq 2 \times \text{span}/\text{RBW}$.
8. Sweep time = auto couple.
9. Don't use sweep triggering. Allow sweep to "free run".
10. Employ trace averaging (RMS) mode over a minimum of 100 traces.
11. Use the peak marker function to determine the maximum amplitude level.
12. Add $10 \log (1/x)$, where x is the duty cycle measured in step (a), to the measured PSD to compute the average PSD during the actual transmission time.

7.4.4. Test Setup

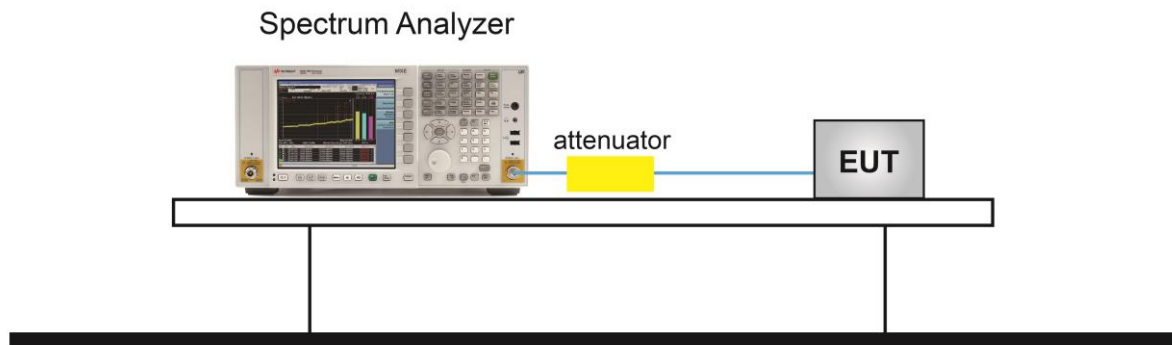

7.4.5. Test Result

Product	Home Security Wi-Fi Camera	Temperature	25°C
Test Engineer	Jay	Relative Humidity	54%
Test Site	SR5	Test Date	2022/6/28

Test Mode	Data Rate/ MCS	Channel No.	Freq. (MHz)	PSD (dBm/ 10kHz)	Duty Cycle (%)	Final PSD (dBm/ 10kHz)	Limit (dBm/ 3kHz)	Result
802.11b	1Mbps	01	2412	-10.089	100.00	-10.089	≤ 8.00	Pass
802.11b	1Mbps	06	2437	-9.847	100.00	-9.847	≤ 8.00	Pass
802.11b	1Mbps	11	2462	-9.338	100.00	-9.338	≤ 8.00	Pass
802.11g	6Mbps	01	2412	-14.740	100.00	-14.740	≤ 8.00	Pass
802.11g	6Mbps	06	2437	-11.667	100.00	-11.667	≤ 8.00	Pass
802.11g	6Mbps	11	2462	-11.857	100.00	-11.857	≤ 8.00	Pass
802.11n-HT20	MCS0	01	2412	-15.751	100.00	-15.751	≤ 8.00	Pass
802.11n-HT20	MCS0	06	2437	-11.554	100.00	-11.554	≤ 8.00	Pass
802.11n-HT20	MCS0	11	2462	-12.227	100.00	-12.227	≤ 8.00	Pass

Note: When EUT duty cycle > 98%, Final AVGPDS = PSD.

802.11b AVGPSD

Channel 01 (2412MHz)

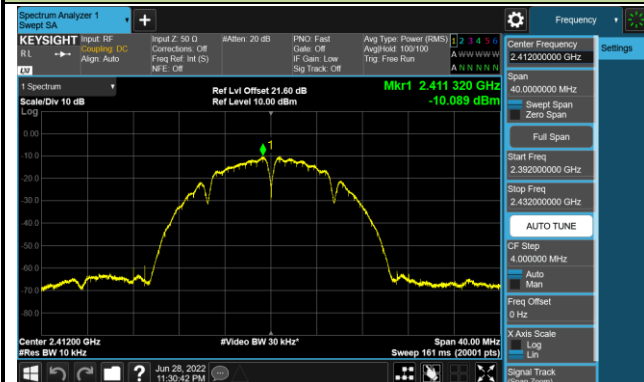

Channel 06 (2437MHz)

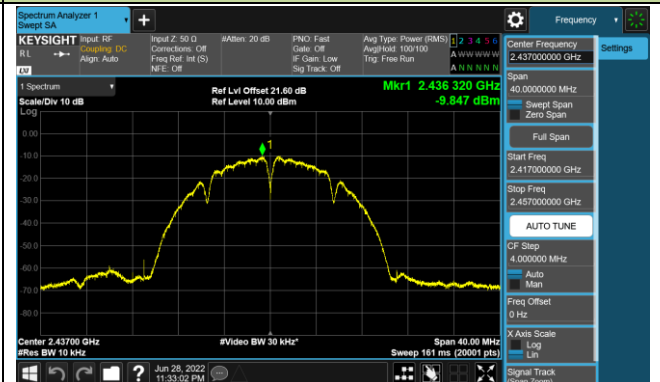

Channel 11 (2462MHz)

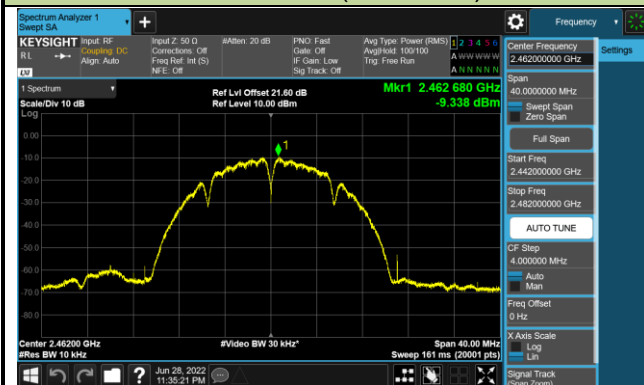

802.11g AVGPSD

Channel 01 (2412MHz)

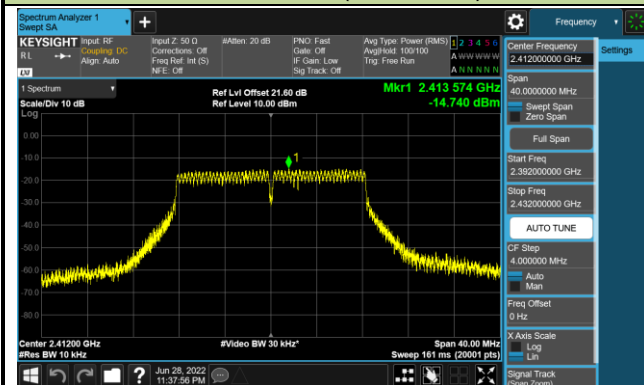

Channel 06 (2437MHz)

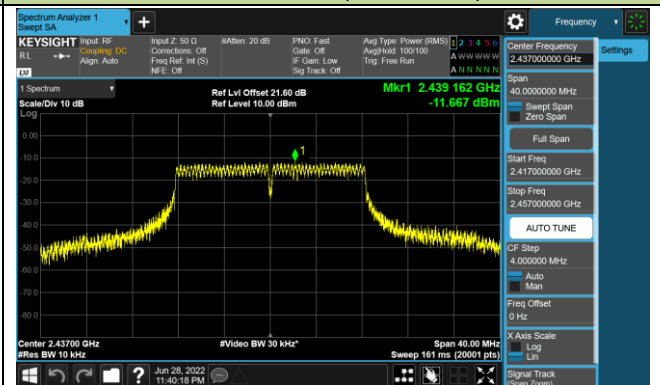

Channel 11 (2462MHz)

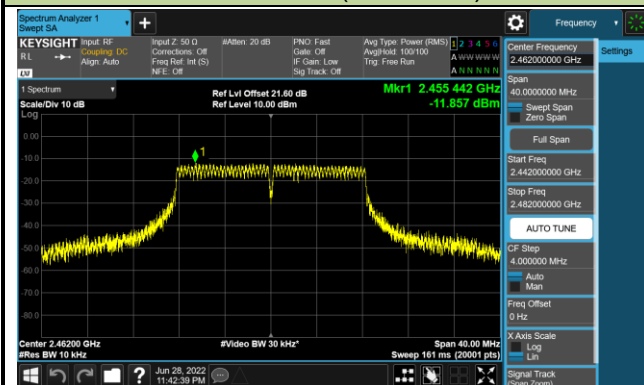

802.11n-HT20 AVGPSPD

Channel 01 (2412MHz)

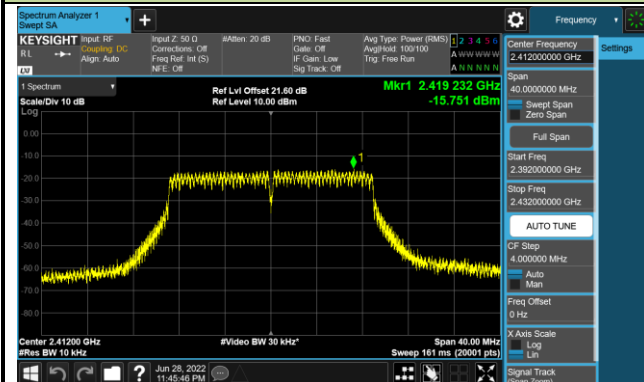

Channel 06 (2437MHz)

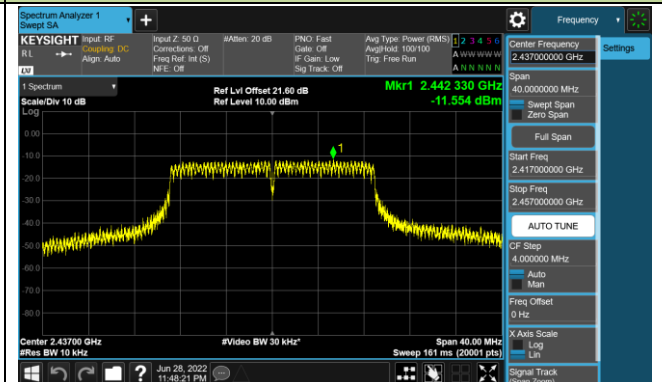

Channel 11 (2462MHz)

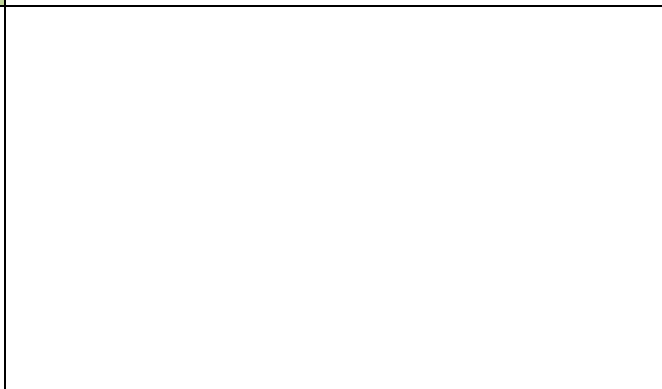
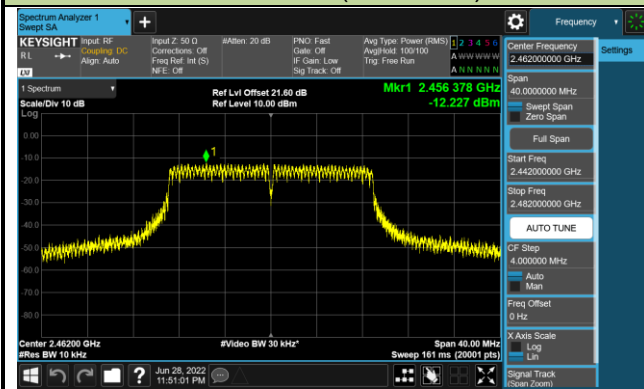

7.5. Conducted Band Edge and Out-of-Band Emissions

7.5.1. Test Limit

The limit for out-of-band spurious emissions at the band edge is 30dB below the fundamental emission level, as determined from the in-band power measurement of the DTS channel performed in a 100 kHz bandwidth per the PSD procedure.

7.5.2. Test Procedure Used

ANSI C63.10 - 2013 - Section 11.11

7.5.3. Test Setting

Reference level measurement

1. Set instrument center frequency to DTS channel center frequency
2. Set the span to ≥ 1.5 times the DTS bandwidth
3. Set the RBW = 100 kHz
4. Set the VBW $\geq 3 \times$ RBW
5. Detector = peak
6. Sweep time = auto couple
7. Trace mode = max hold
8. Allow trace to fully stabilize

Emission level measurement

1. Set the center frequency and span to encompass frequency range to be measured
2. RBW = 100Hz
3. VBW = 300Hz
4. Detector = Peak
5. Trace mode = max hold
6. Sweep time = auto couple
7. The trace was allowed to stabilize

7.5.4. Test Setup

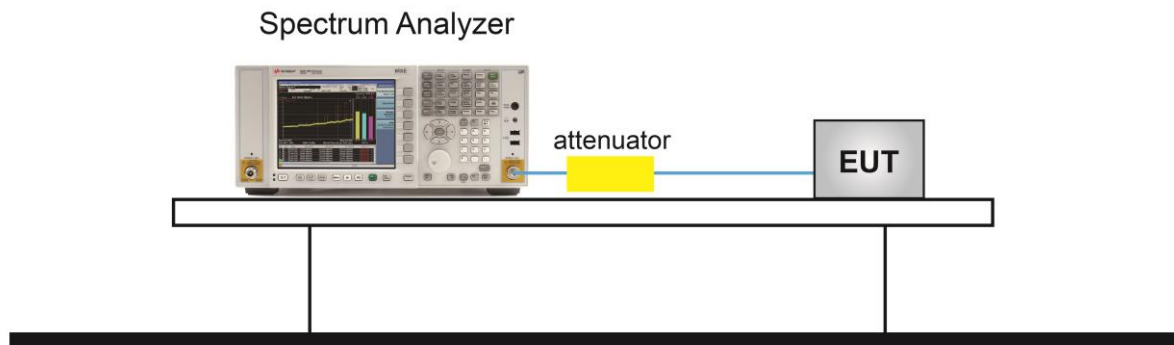

7.5.5. Test Result

Product	Home Security Wi-Fi Camera	Temperature	25°C
Test Engineer	Jay	Relative Humidity	54%
Test Site	SR5	Test Date	2022/6/28

Test Mode	Data Rate / MCS	Channel No.	Frequency (MHz)	Limit (dBc)	Result
802.11b	1Mbps	01	2412	30	Pass
802.11b	1Mbps	06	2437	30	Pass
802.11b	1Mbps	11	2462	30	Pass
802.11g	6Mbps	01	2412	30	Pass
802.11g	6Mbps	06	2437	30	Pass
802.11g	6Mbps	11	2462	30	Pass
802.11n-HT20	MCS0	01	2412	30	Pass
802.11n-HT20	MCS0	06	2437	30	Pass
802.11n-HT20	MCS0	11	2462	30	Pass

802.11 b CH01 (2412MHz)

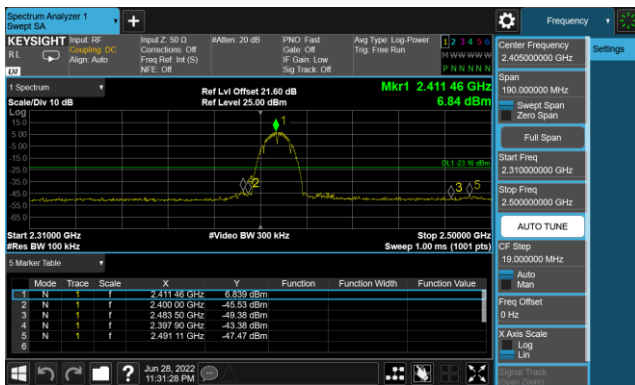

802.11 b CH01 (2412MHz)

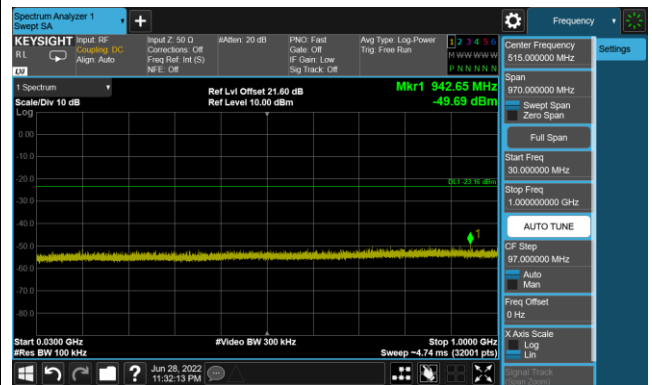

802.11 b CH01 (2412MHz)

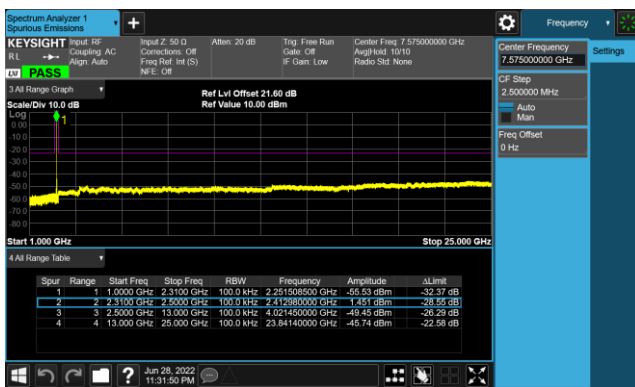

802.11 b CH06 (2437MHz)

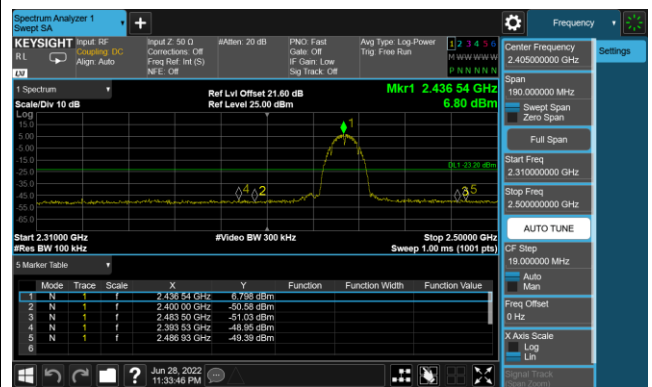

802.11 b CH06 (2437MHz)

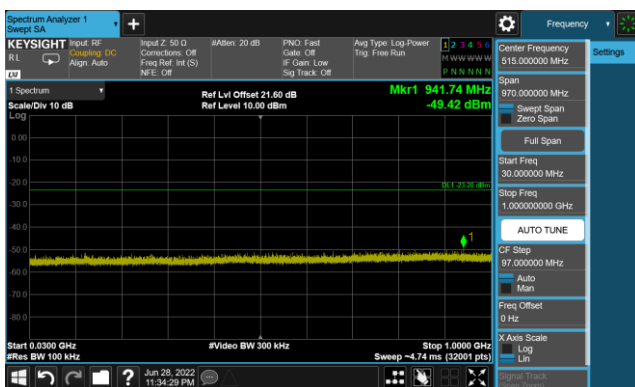

802.11 b CH06 (2437MHz)

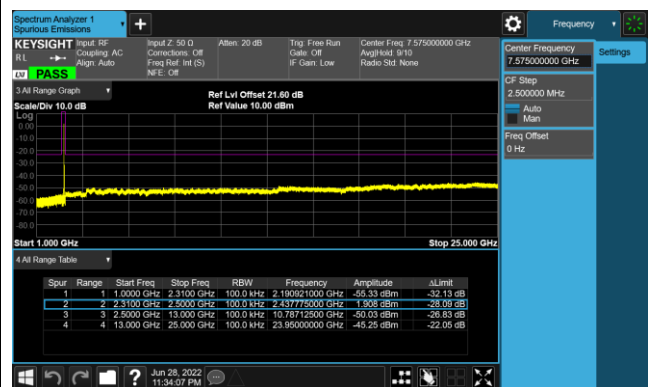

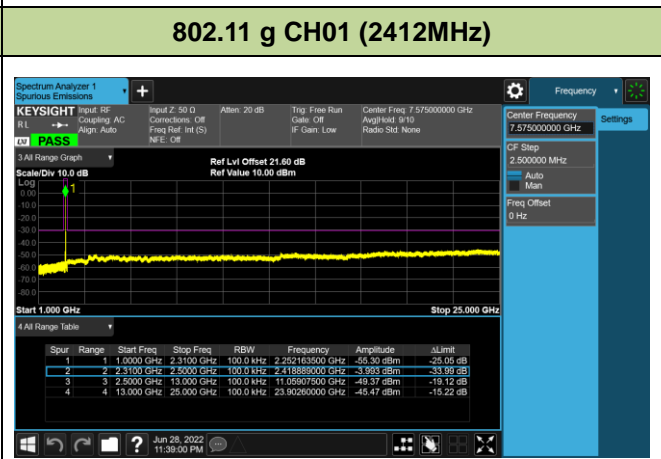
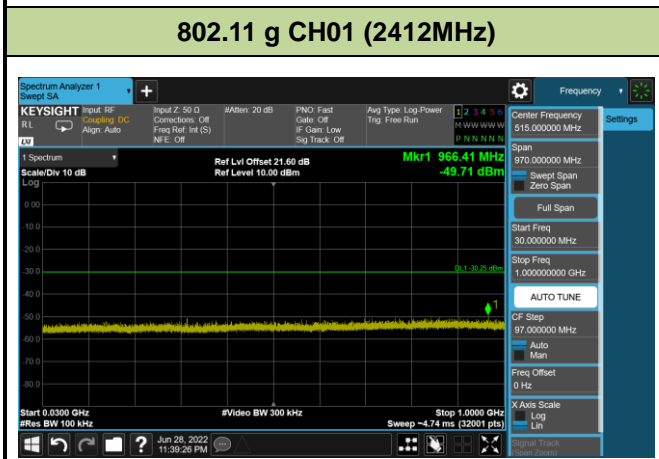
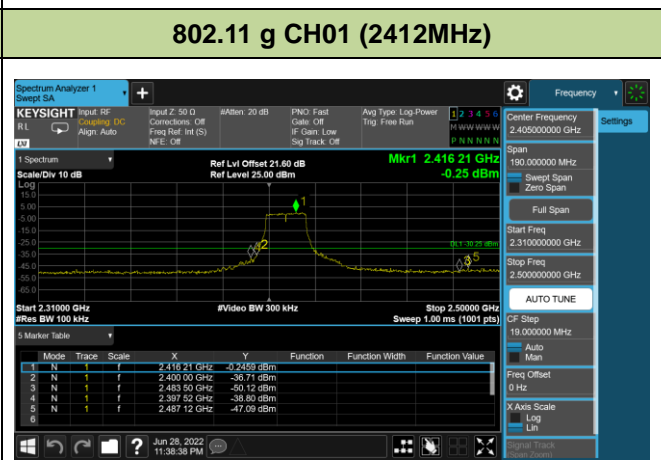
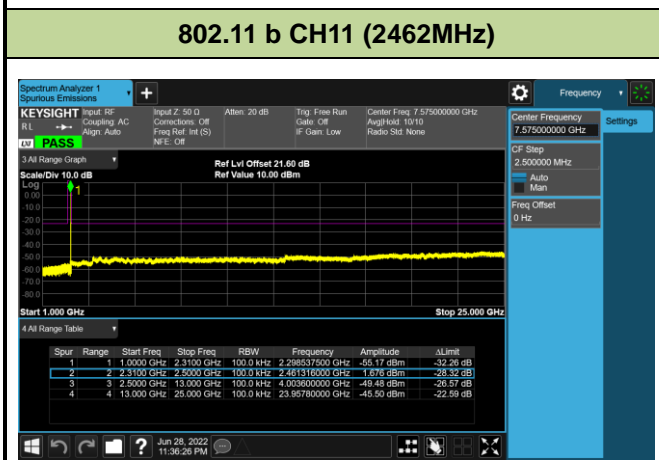
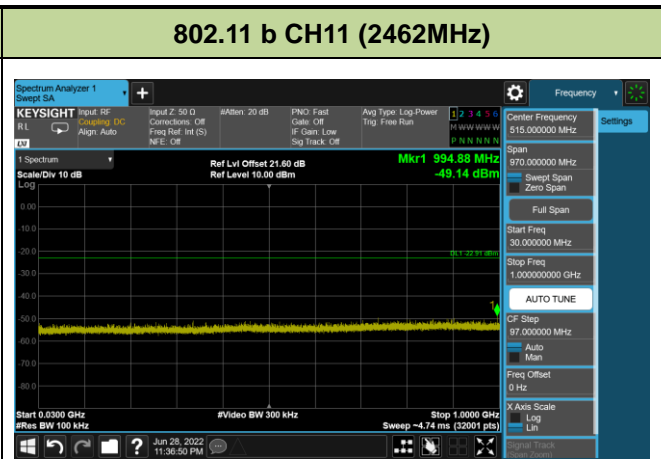
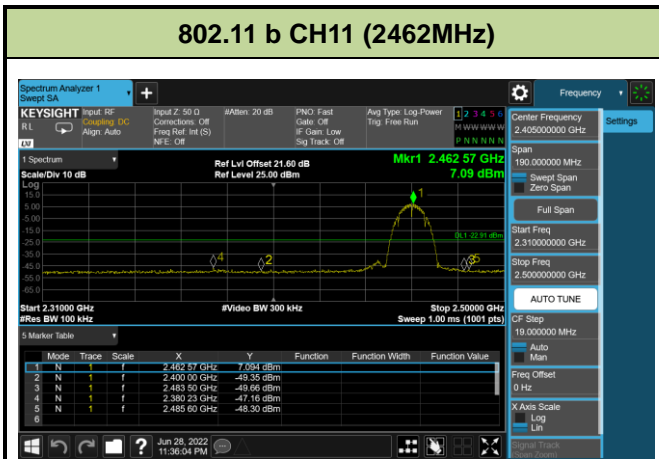

802.11 g CH06 (2437MHz)



802.11 g CH06 (2437MHz)

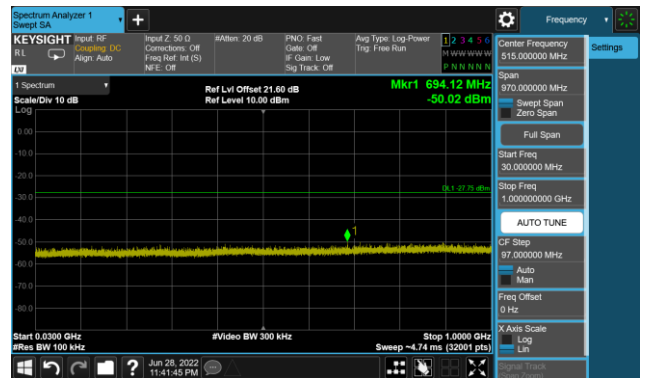

802.11 g CH06 (2437MHz)

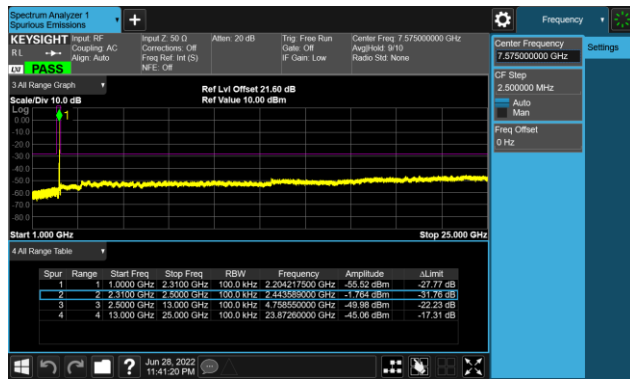

802.11 g CH11 (2462MHz)



802.11 g CH11 (2462MHz)

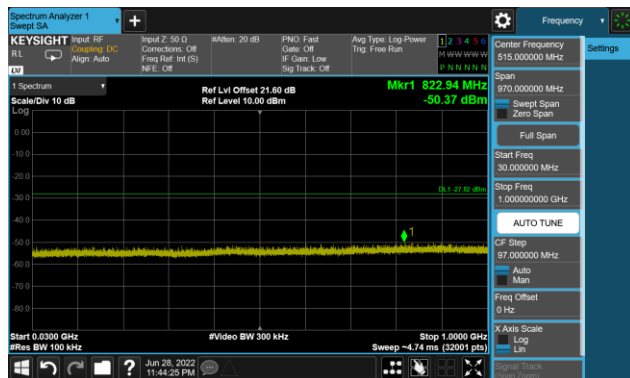

802.11 g CH11 (2462MHz)

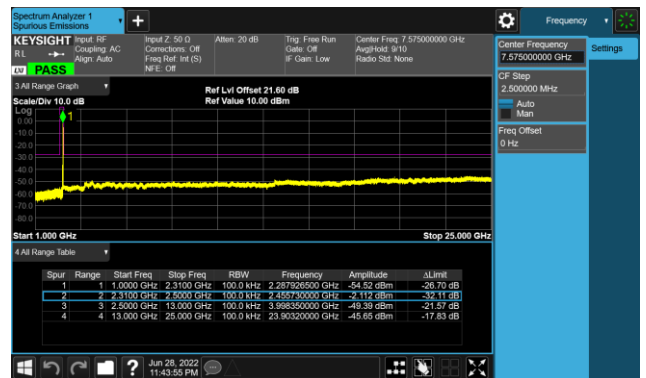

802.11 n20 CH01 (2412MHz)



802.11 n20 CH01 (2412MHz)

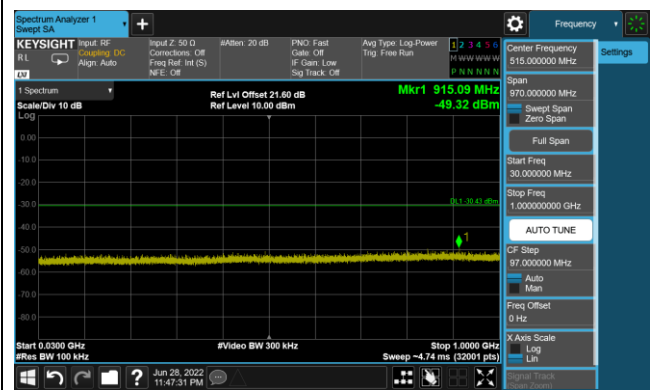

802.11 n20 CH01 (2412MHz)

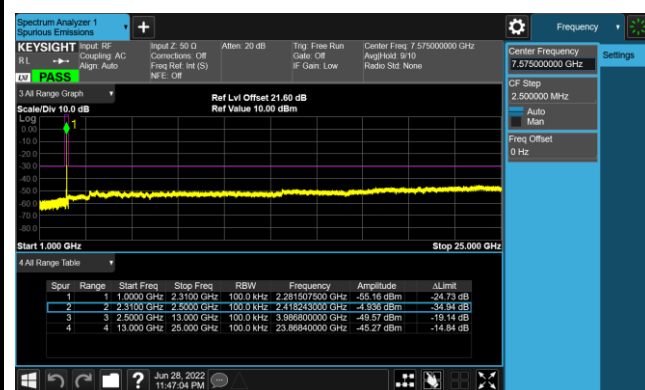

802.11 n20 CH06 (2437MHz)

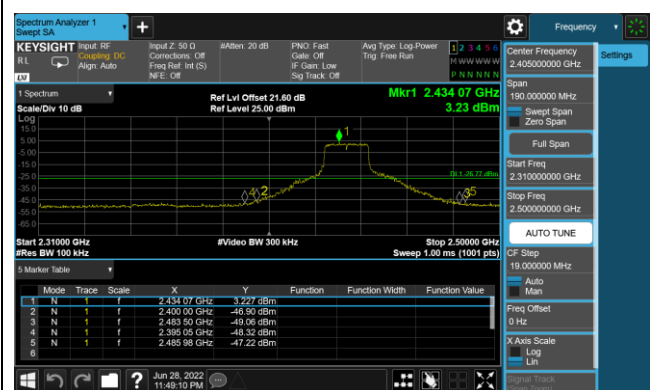

802.11 n20 CH06 (2437MHz)

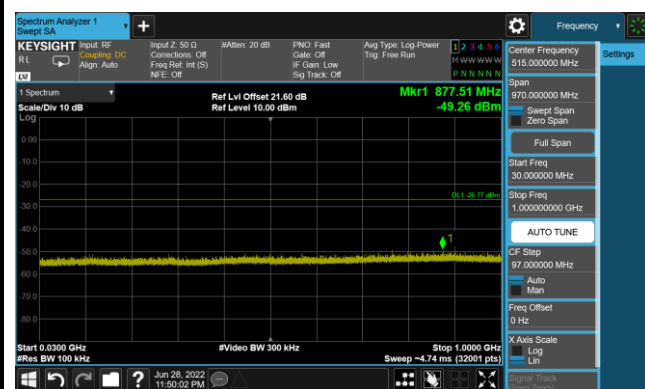

802.11 n20 CH06 (2437MHz)

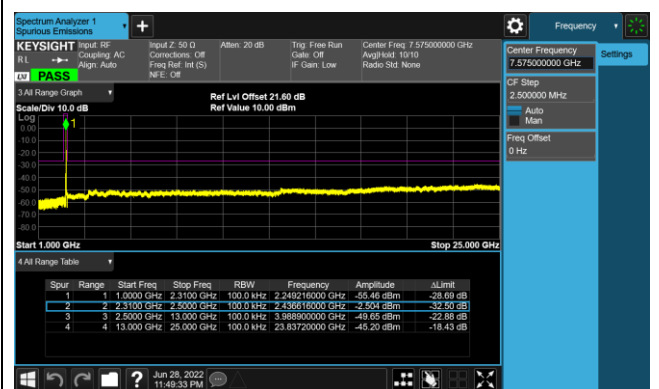

802.11 n20 CH11 (2462MHz)



802.11 n20 CH11 (2462MHz)

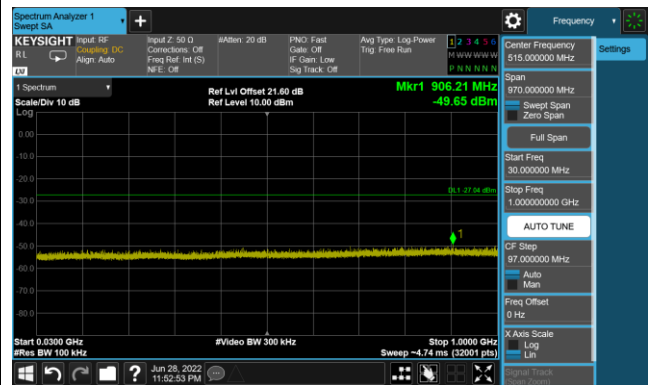

802.11 n20 CH11 (2462MHz)

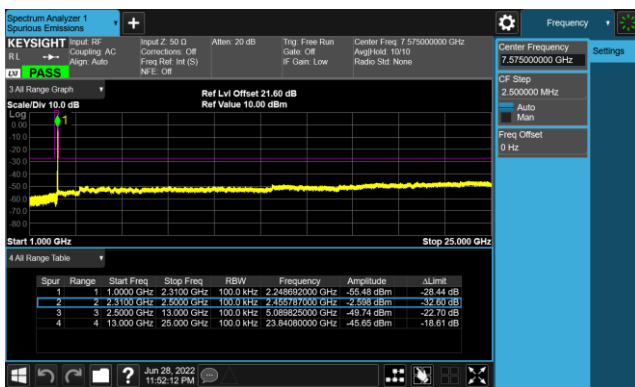

7.6. Radiated Spurious Emission Measurement

7.6.1. Test Limit

All out of band emissions appearing in a restricted band as specified in Section 15.205 of the Title 47CFR must not exceed the limits shown in Table per Section 15.209.

FCC Part 15 Subpart C Paragraph 15.209		
Frequency [MHz]	Field Strength [Uv/m]	Measured Distance [Meters]
0.009 - 0.490	2400/F (kHz)	300
0.490 - 1.705	24000/F (kHz)	30
1.705 - 30	30	30
30 - 88	100	3
88 - 216	150	3
216 - 960	200	3
Above 960	500	3

7.6.2. Test Procedure Used

ANSI C63.10 - 2013 - Section 11.11 & 11.12

ANSI C63.10 - 2013 - Section 6.3 (General Requirements)

ANSI C63.10 - 2013 - Section 6.4 (Standard test method below 30MHz)

ANSI C63.10 - 2013 - Section 6.5 (Standard test method above 30MHz to 1GHz)

ANSI C63.10 - 2013 - Section 6.6 (Standard test method above 1GHz)

7.6.3. Test Setting

Table 1 - RBW as a function of frequency

Frequency	RBW
9 ~ 150 kHz	200 ~ 300 Hz
0.15 ~ 30 MHz	9 ~ 10 kHz
30 ~ 1000 MHz	100 ~ 120 kHz
> 1000MHz	1MHz

Quasi-Peak Measurements below 1GHz

1. Analyzer center frequency was set to the frequency of the radiated spurious emission of interest
2. Span was set greater than 1MHz
3. RBW = as specified in Table 1
4. Detector = CISPR quasi-peak
5. Sweep time = auto couple
6. Trace was allowed to stabilize

Peak Measurements above 1GHz

1. Analyzer center frequency was set to the frequency of the radiated spurious emission of interest
2. RBW = 1MHz
3. VBW = 3MHz
4. Detector = peak
5. Sweep time = auto couple
6. Trace mode = max hold
7. Trace was allowed to stabilize

Average Measurements above 1GHz (Method VB)

1. Analyzer center frequency was set to the frequency of the radiated spurious emission of interest
2. RBW = 1MHz
3. VBW; If the EUT is configured to transmit with duty cycle $\geq 98\%$, set VBW = 10 Hz.
If the EUT duty cycle is $< 98\%$, set VBW $\geq 1/T$. T is the minimum transmission duration.
4. Detector = Peak
5. Sweep time = auto
6. Trace mode = max hold
7. Trace was allowed to stabilize

7.6.4. Test Setup

Below 1GHz Test Setup:

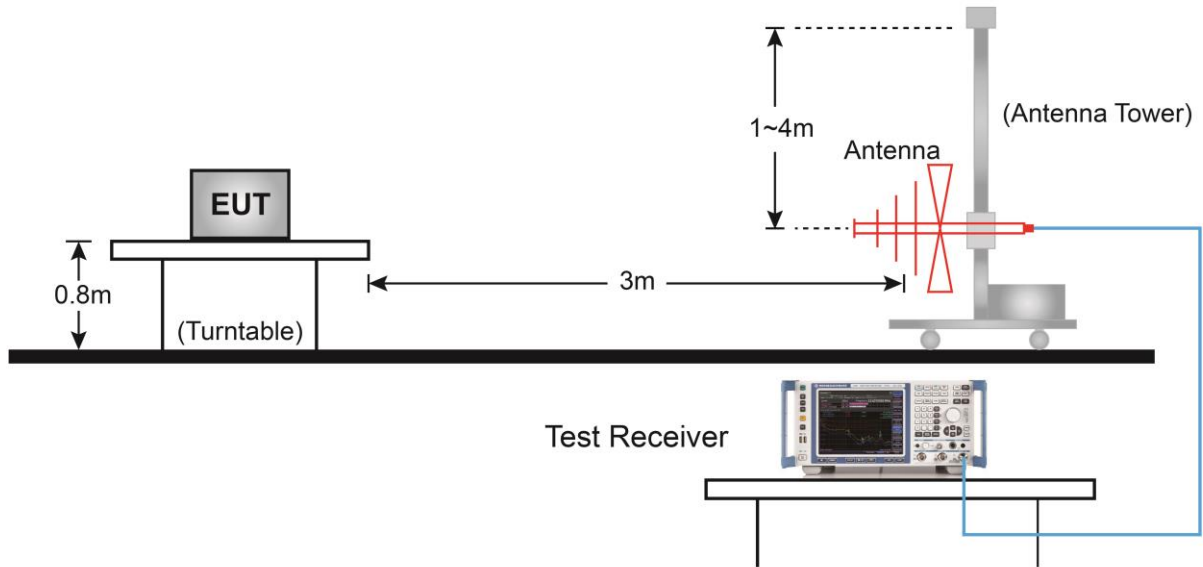

Above 1GHz Test Setup:

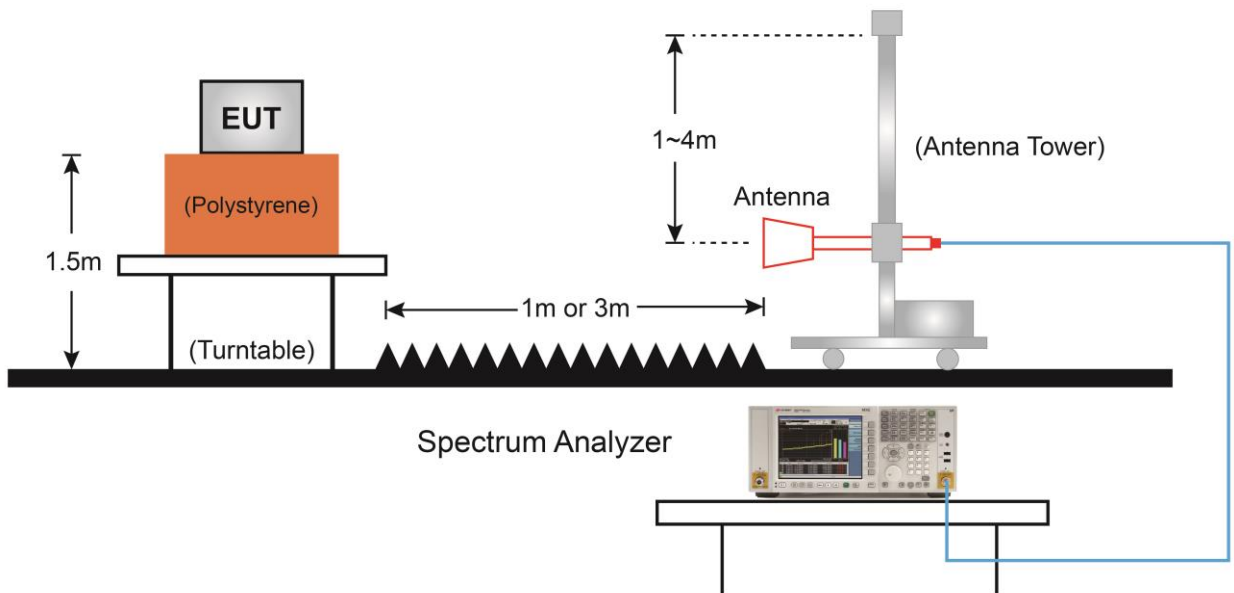

7.6.5. Test Result

EUT	Home Security Wi-Fi Camera	Date of Test	2022-06-23
Factor	VULB 9162	Temp. / Humidity	23°C /62%
Polarity	Horizontal	Site / Test Engineer	AC1 / Kaunaz
Test Mode	802.11n-20MHz_TX_CH 6_ANT 0	Test Voltage	AC 120V/60Hz

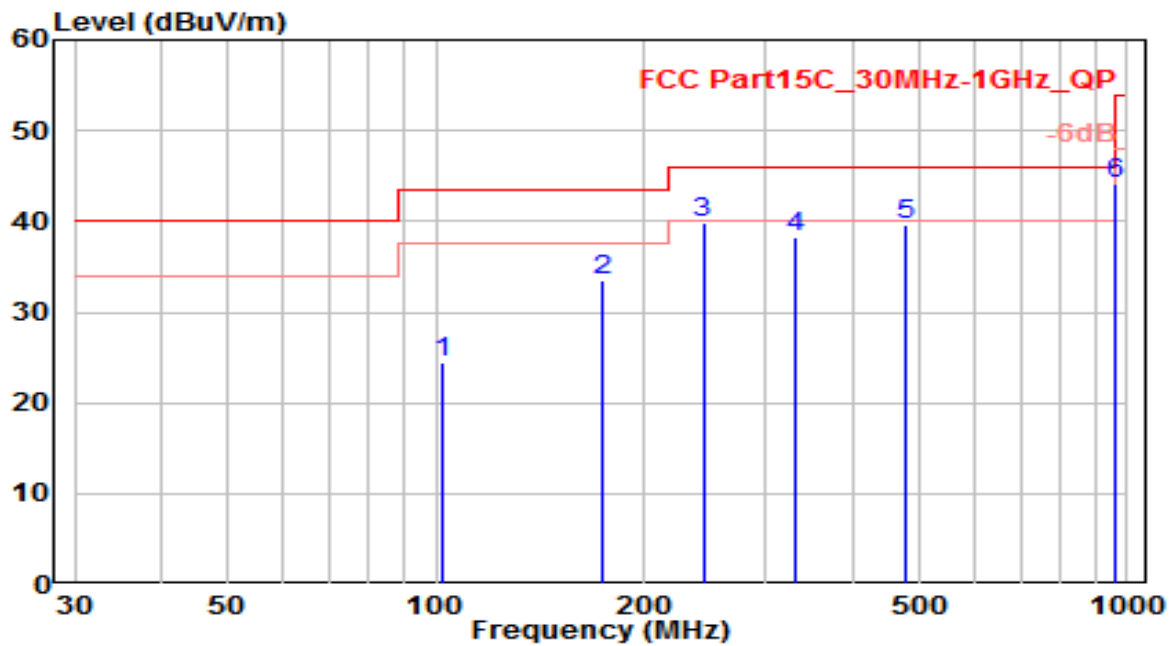

No	Frequency (MHz)	Reading (dBuV)	C.F (dB/m)	Measurement (dBuV/m)	Margin (dB)	Limit (dBuV/m)	Height (cm)	Angle (deg)	Remark (QP/PK/AV)
1	101.780	5.30	19.20	24.50	-19.00	43.50	100	320	QP
2	174.530	16.60	16.89	33.49	-10.01	43.50	100	320	QP
3	* 243.400	19.31	20.58	39.89	-6.11	46.00	100	65	QP
4	329.730	15.81	22.47	38.28	-7.72	46.00	100	240	QP
5	480.080	14.14	25.49	39.63	-6.37	46.00	100	245	QP
6	960.230	11.91	32.26	44.17	-9.83	54.00	100	115	QP

Note:

1. " *", means this data is the worst emission level.
2. C.F (Correction Factor) = Antenna Factor (dB)+ Cable Loss (dB).
3. Measurement (dBuV/m) = Reading(dBuV) + C.F (Correction Factor).
4. The emission levels of other frequencies are very lower than the limit and not show in test report.

EUT	Home Security Wi-Fi Camera	Date of Test	2022-06-23
Factor	VULB 9162	Temp. / Humidity	23°C /62%
Polarity	Vertical	Site / Test Engineer	AC1 / Kaunaz
Test Mode	802.11n-20MHz_TX_CH 6_ANT 0	Test Voltage	AC 120V/60Hz

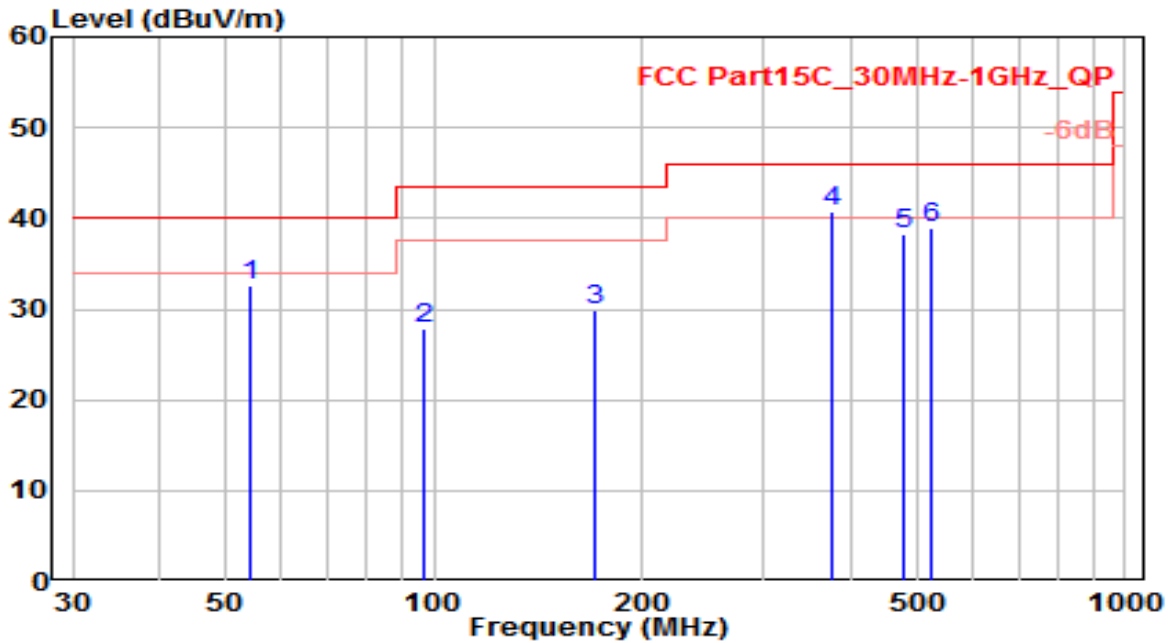

No	Frequency (MHz)	Reading (dBuV)	C.F (dB/m)	Measurement (dBuV/m)	Margin (dB)	Limit (dBuV/m)	Height (cm)	Angle (deg)	Remark (QP/PK/AV)
1	54.250	11.88	20.80	32.67	-7.33	40.00	100	135	QP
2	96.930	9.10	18.73	27.83	-15.67	43.50	100	155	QP
3	171.620	13.20	16.74	29.94	-13.56	43.50	100	50	QP
4	* 376.290	17.05	23.72	40.78	-5.22	46.00	100	300	QP
5	480.080	12.70	25.49	38.19	-7.81	46.00	100	360	QP
6	524.700	12.64	26.36	39.00	-7.00	46.00	100	295	QP

Note:

- " *", means this data is the worst emission level.
- C.F (Correction Factor) = Antenna Factor (dB)+ Cable Loss (dB).
- Measurement (dBuV/m) = Reading(dBuV) + C.F (Correction Factor).
- The emission levels of other frequencies are very lower than the limit and not show in test report.

EUT	Home Security Wi-Fi Camera	Date of Test	2022-06-28
Factor	BBHA 9120D	Temp. / Humidity	23°C /62%
Polarity	Horizontal	Site / Test Engineer	AC1 / Kaunaz
Test Mode	802.11b_TX_CH 1_ANT 0	Test Voltage	AC 120V/60Hz

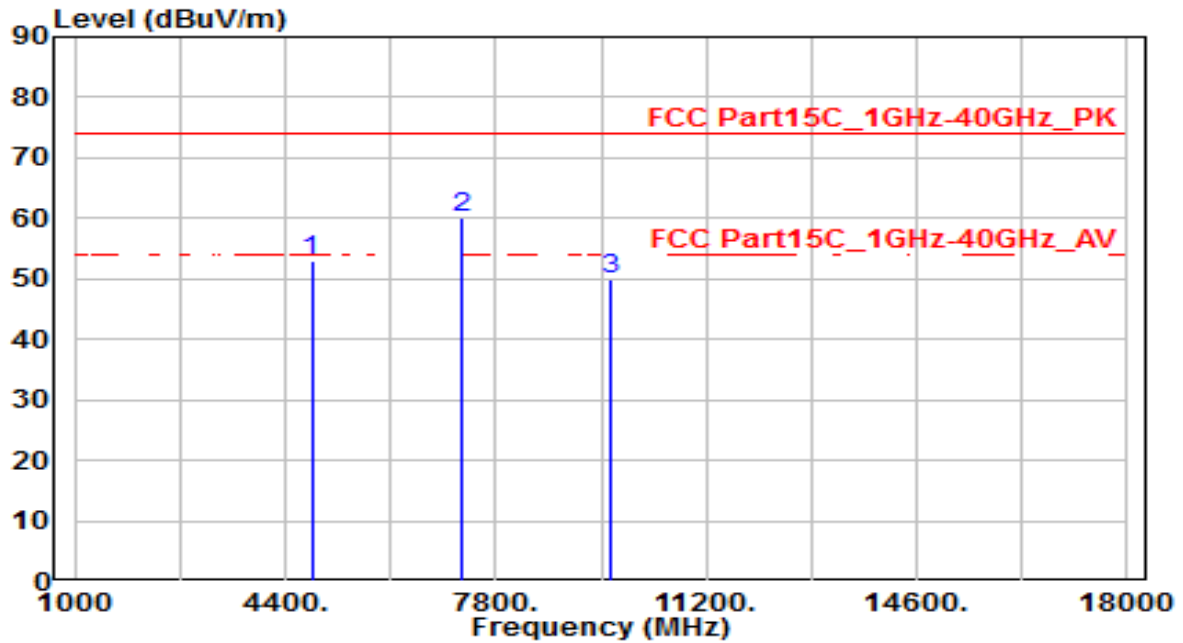

No	Frequency (MHz)	Reading (dBuV)	C.F (dB/m)	Measurement (dBuV/m)	Margin (dB)	Limit (dBuV/m)	Height (cm)	Angle (deg)	Remark (QP/PK/AV)
1	4824.000	49.24	3.65	52.89	-21.11	74.00	150	360	Peak
2	* 7236.000	48.15	11.80	59.96	-14.04	74.00	150	360	Peak
3	9648.000	34.15	15.77	49.91	-24.09	74.00	150	360	Peak

Note:

- "*" means this data is the worst emission level.
- C.F (Correction Factor) = Antenna Factor (dB)+ Cable Loss (dB) – Pre-amplifier(dB).
- Measurement (dBuV/m) = Reading(dBuV) + C.F (Correction Factor).
- No2 is not in restricted band, its limit is 20dBc/30dBc of the fundamental emission level(already evaluated in Section 5.4) or LP0002 Section 3.6 which is higher.(Here, we are using stringent limits:74dBuV/m.)
- The emission levels of other frequencies are very lower than the limit and not show in test report.

EUT	Home Security Wi-Fi Camera	Date of Test	2022-06-28
Factor	BBHA 9120D	Temp. / Humidity	23°C /62%
Polarity	Vertical	Site / Test Engineer	AC1 / Kaunaz
Test Mode	802.11b_TX_CH 1_ANT 0	Test Voltage	AC 120V/60Hz

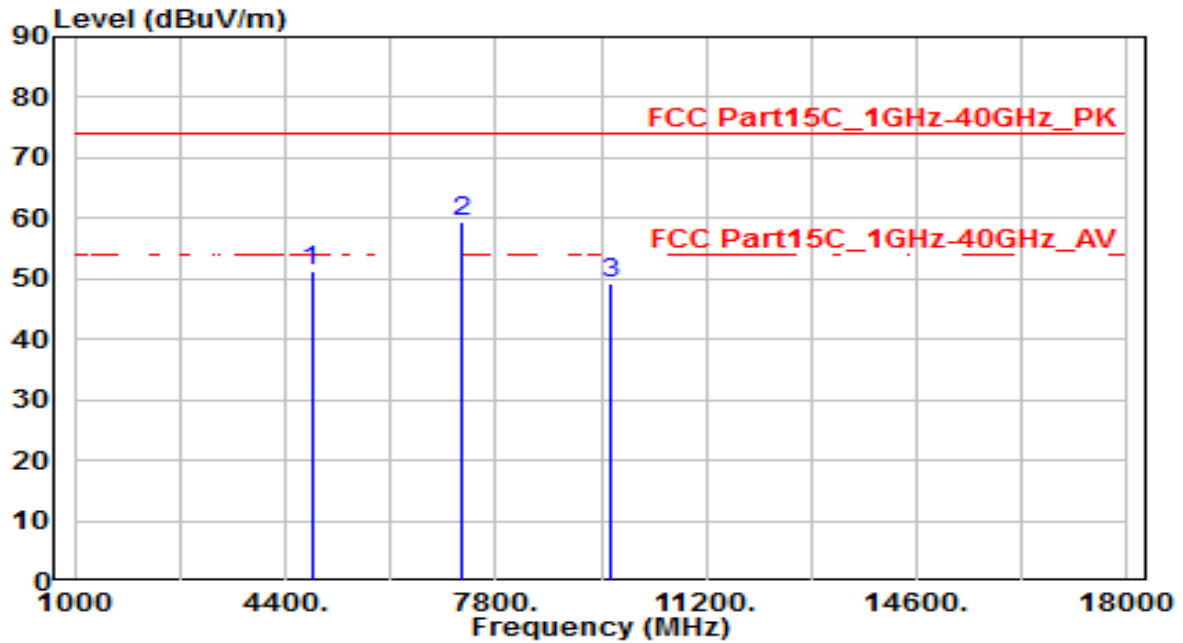

No	Frequency (MHz)	Reading (dBuV)	C.F (dB/m)	Measurement (dBuV/m)	Margin (dB)	Limit (dBuV/m)	Height (cm)	Angle (deg)	Remark (QP/PK/AV)
1	4824.000	47.58	3.65	51.23	-22.77	74.00	150	360	Peak
2	* 7236.000	47.49	11.80	59.29	-14.71	74.00	150	360	Peak
3	9648.000	33.43	15.77	49.20	-24.80	74.00	150	360	Peak

Note:

- "*" means this data is the worst emission level.
- C.F (Correction Factor) = Antenna Factor (dB)+ Cable Loss (dB) – Pre-amplifier(dB).
- Measurement (dBuV/m) = Reading(dBuV) + C.F (Correction Factor).
- No2 is not in restricted band, its limit is 20dBc/30dBc of the fundamental emission level(already evaluated in Section 5.4) or LP0002 Section 3.6 which is higher.(Here, we are using stringent limits:74dBuV/m.)
- The emission levels of other frequencies are very lower than the limit and not show in test report.

EUT	Home Security Wi-Fi Camera	Date of Test	2022-06-28
Factor	BBHA 9120D	Temp. / Humidity	23°C /62%
Polarity	Horizontal	Site / Test Engineer	AC1 / Kaunaz
Test Mode	802.11b_TX_CH 6_ANT 0	Test Voltage	AC 120V/60Hz

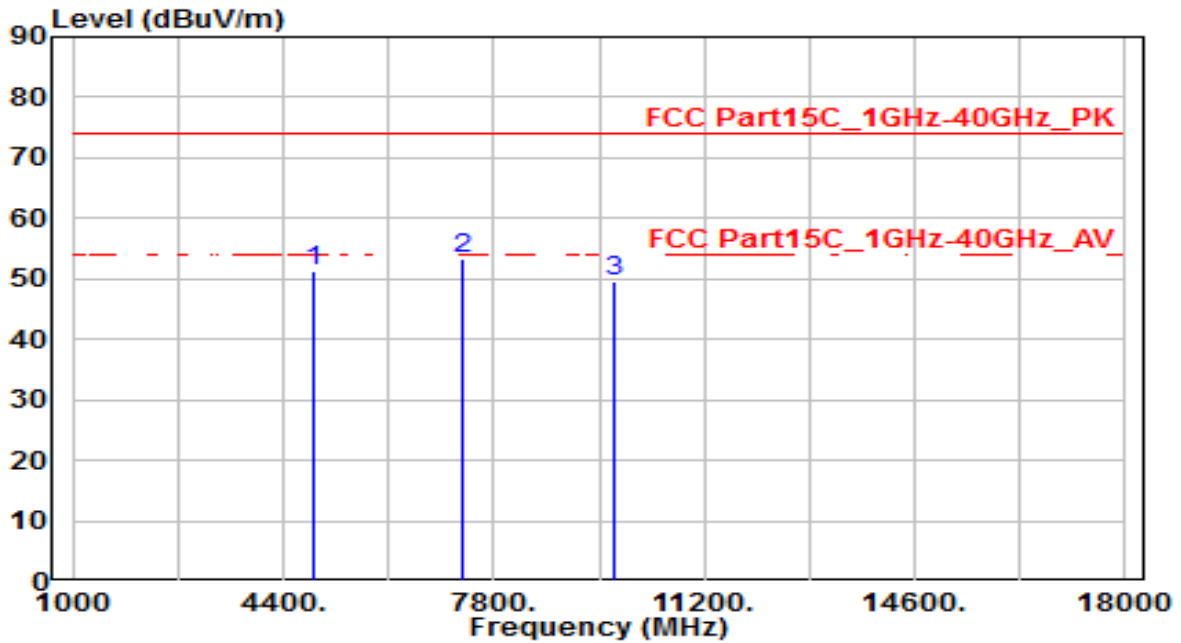

No	Frequency (MHz)	Reading (dBuV)	C.F (dB/m)	Measurement (dBuV/m)	Margin (dB)	Limit (dBuV/m)	Height (cm)	Angle (deg)	Remark (QP/PK/AV)
1	4874.000	47.45	3.74	51.19	-22.81	74.00	150	360	Peak
2	* 7311.000	41.08	12.11	53.20	-20.80	74.00	150	360	Peak
3	9748.000	33.75	15.95	49.70	-24.30	74.00	150	360	Peak

Note:

1. " *", means this data is the worst emission level.
2. C.F (Correction Factor) = Antenna Factor (dB)+ Cable Loss (dB) – Pre-amplifier(dB).
3. Measurement (dBuV/m) = Reading(dBuV) + C.F (Correction Factor).
4. The emission levels of other frequencies are very lower than the limit and not show in test report.

EUT	Home Security Wi-Fi Camera	Date of Test	2022-06-28
Factor	BBHA 9120D	Temp. / Humidity	23°C /62%
Polarity	Vertical	Site / Test Engineer	AC1 / Kaunaz
Test Mode	802.11b_TX_CH 6_ANT 0	Test Voltage	AC 120V/60Hz

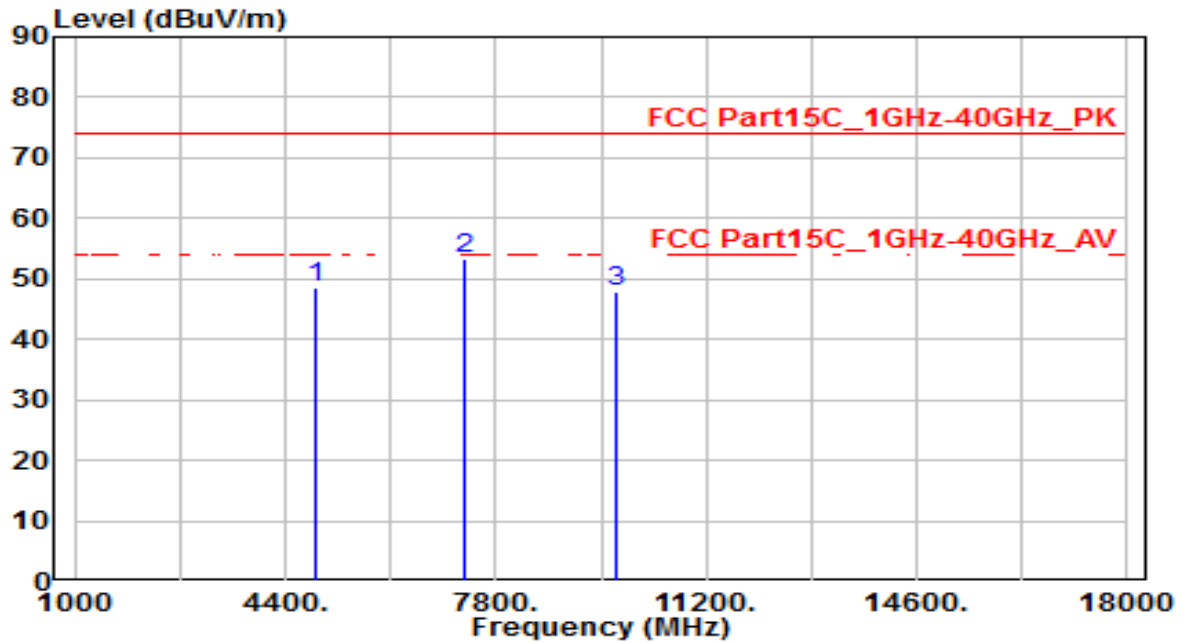

No	Frequency (MHz)	Reading (dBuV)	C.F (dB/m)	Measurement (dBuV/m)	Margin (dB)	Limit (dBuV/m)	Height (cm)	Angle (deg)	Remark (QP/PK/AV)
1	4874.000	44.70	3.74	48.44	-25.56	74.00	150	360	Peak
2	* 7311.000	41.22	12.11	53.34	-20.66	74.00	150	360	Peak
3	9748.000	32.00	15.95	47.95	-26.05	74.00	150	360	Peak

Note:

1. " *", means this data is the worst emission level.
2. C.F (Correction Factor) = Antenna Factor (dB)+ Cable Loss (dB) – Pre-amplifier(dB).
3. Measurement (dBuV/m) = Reading(dBuV) + C.F (Correction Factor).
4. The emission levels of other frequencies are very lower than the limit and not show in test report.

EUT	Home Security Wi-Fi Camera	Date of Test	2022-06-28
Factor	BBHA 9120D	Temp. / Humidity	23°C /62%
Polarity	Horizontal	Site / Test Engineer	AC1 / Kaunaz
Test Mode	802.11b_TX_CH 11_ANT 0	Test Voltage	AC 120V/60Hz

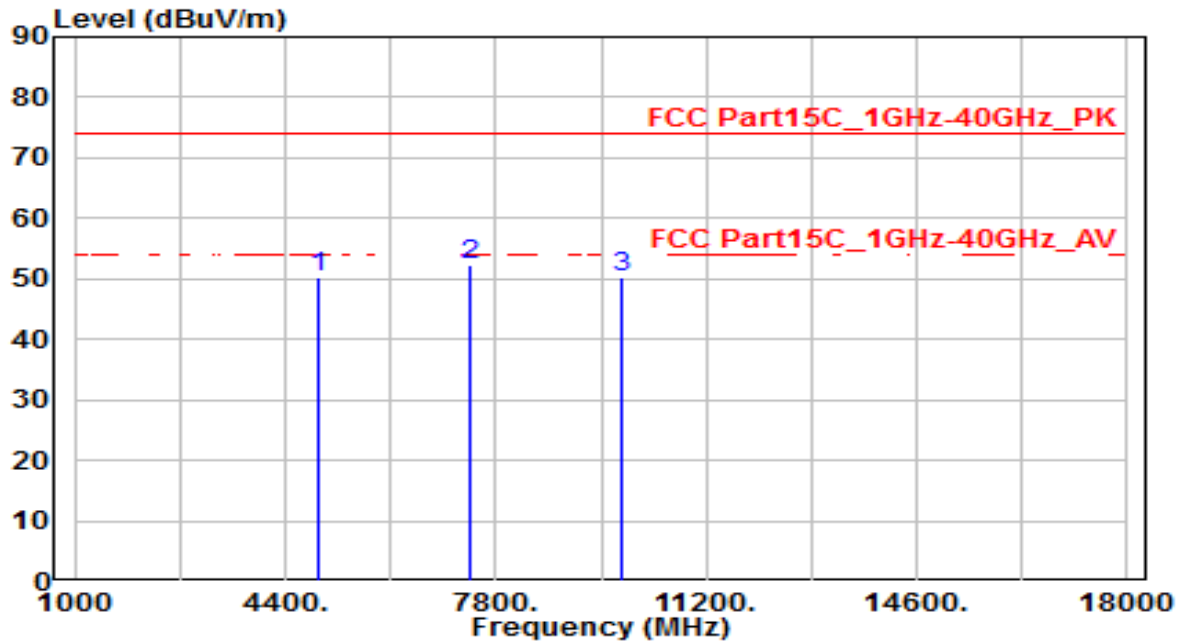

No	Frequency (MHz)	Reading (dBuV)	C.F (dB/m)	Measurement (dBuV/m)	Margin (dB)	Limit (dBuV/m)	Height (cm)	Angle (deg)	Remark (QP/PK/AV)
1	4924.000	46.57	3.83	50.40	-23.60	74.00	150	360	Peak
2	* 7386.000	39.81	12.42	52.23	-21.77	74.00	150	360	Peak
3	9848.000	34.20	16.14	50.34	-23.66	74.00	150	360	Peak

Note:

1. " *", means this data is the worst emission level.
2. C.F (Correction Factor) = Antenna Factor (dB)+ Cable Loss (dB) – Preamplifier(dB).
3. Measurement (dBuV/m) = Reading(dBuV) + C.F (Correction Factor).
4. The emission levels of other frequencies are very lower than the limit and not show in test report.

EUT	Home Security Wi-Fi Camera	Date of Test	2022-06-28
Factor	BBHA 9120D	Temp. / Humidity	23°C /62%
Polarity	Vertical	Site / Test Engineer	AC1 / Kaunaz
Test Mode	802.11b_TX_CH 11_ANT 0	Test Voltage	AC 120V/60Hz

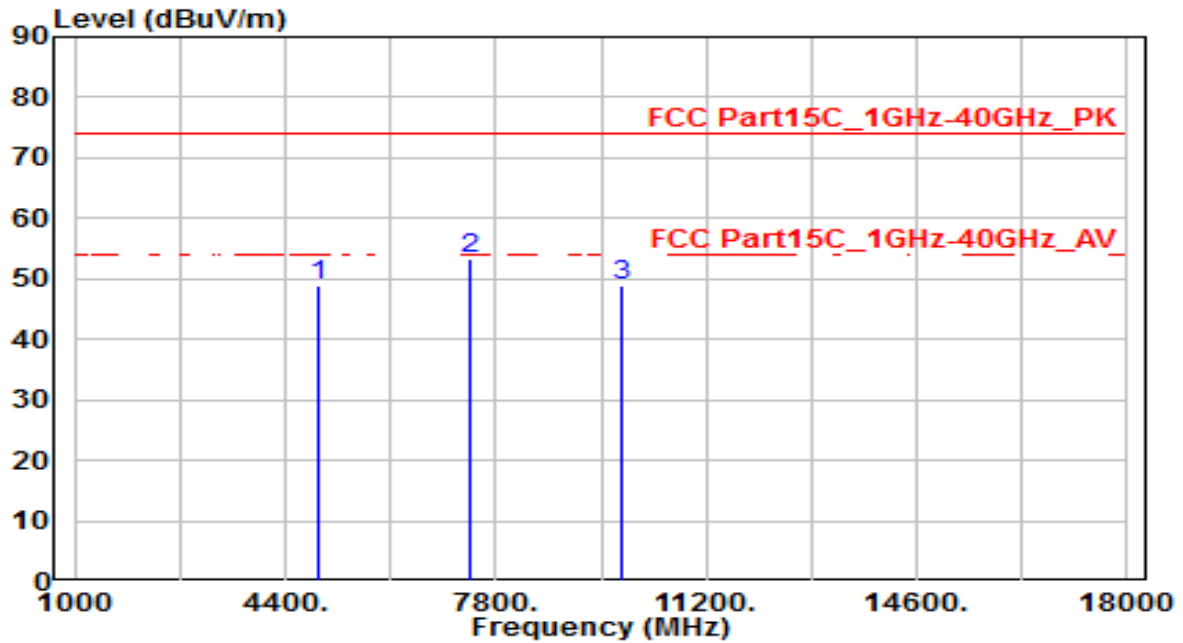

No	Frequency (MHz)	Reading (dBuV)	C.F (dB/m)	Measurement (dBuV/m)	Margin (dB)	Limit (dBuV/m)	Height (cm)	Angle (deg)	Remark (QP/PK/AV)
1	4924.000	44.94	3.83	48.77	-25.23	74.00	150	360	Peak
2	* 7386.000	40.96	12.42	53.39	-20.61	74.00	150	360	Peak
3	9848.000	32.78	16.14	48.92	-25.08	74.00	150	360	Peak

Note:

1. " *", means this data is the worst emission level.
2. C.F (Correction Factor) = Antenna Factor (dB)+ Cable Loss (dB) – Preamplifier(dB).
3. Measurement (dBuV/m) = Reading(dBuV) + C.F (Correction Factor).
4. The emission levels of other frequencies are very lower than the limit and not show in test report.

EUT	Home Security Wi-Fi Camera	Date of Test	2022-06-28
Factor	BBHA 9120D	Temp. / Humidity	23°C /62%
Polarity	Horizontal	Site / Test Engineer	AC1 / Kaunaz
Test Mode	802.11g_TX_CH 1_ANT 0	Test Voltage	AC 120V/60Hz

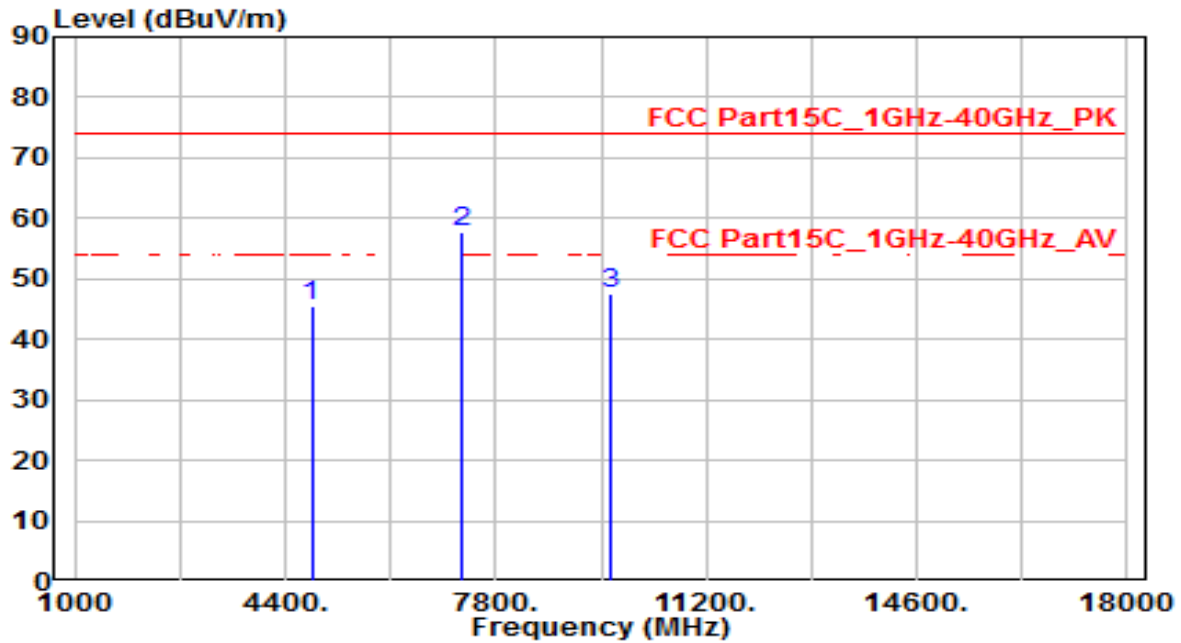

No	Frequency (MHz)	Reading (dBuV)	C.F (dB/m)	Measurement (dBuV/m)	Margin (dB)	Limit (dBuV/m)	Height (cm)	Angle (deg)	Remark (QP/PK/AV)
1	4824.000	42.03	3.65	45.68	-28.32	74.00	150	360	Peak
2	* 7236.000	45.92	11.80	57.73	-16.27	74.00	150	360	Peak
3	9648.000	31.80	15.77	47.57	-26.43	74.00	150	360	Peak

Note:

1. " *", means this data is the worst emission level.
2. C.F (Correction Factor) = Antenna Factor (dB)+ Cable Loss (dB) – Pre-amplifier(dB).
3. Measurement (dBuV/m) = Reading(dBuV) + C.F (Correction Factor).
4. No2 is not in restricted band, its limit is 20dBc/30dBc of the fundamental emission level(already evaluated in Section 5.4) or LP0002 Section 3.6 which is higher.(Here, we are using stringent limits:74dBuV/m.)
5. The emission levels of other frequencies are very lower than the limit and not show in test report.

EUT	Home Security Wi-Fi Camera	Date of Test	2022-06-28
Factor	BBHA 9120D	Temp. / Humidity	23°C /62%
Polarity	Vertical	Site / Test Engineer	AC1 / Kaunaz
Test Mode	802.11g_TX_CH 1_ANT 0	Test Voltage	AC 120V/60Hz

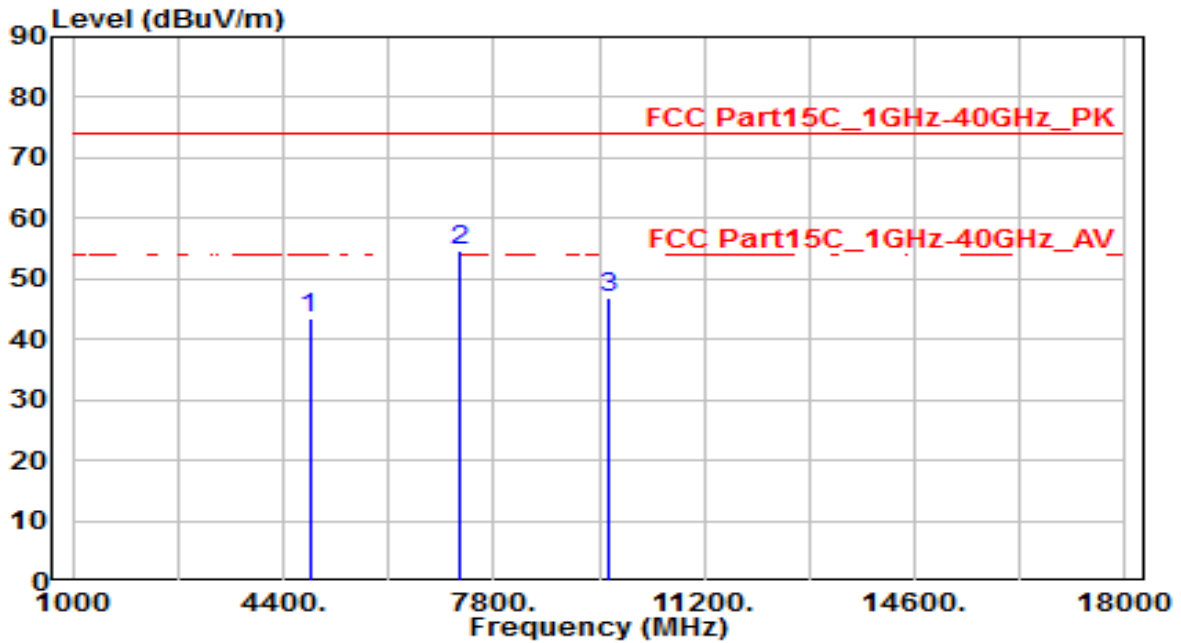

No	Frequency (MHz)	Reading (dBuV)	C.F (dB/m)	Measurement (dBuV/m)	Margin (dB)	Limit (dBuV/m)	Height (cm)	Angle (deg)	Remark (QP/PK/AV)
1	4824.000	39.74	3.65	43.38	-30.62	74.00	150	360	Peak
2	* 7236.000	42.71	11.80	54.51	-19.49	74.00	150	360	Peak
3	9648.000	31.21	15.77	46.97	-27.03	74.00	150	360	Peak

Note:

- "*" means this data is the worst emission level.
- C.F (Correction Factor) = Antenna Factor (dB)+ Cable Loss (dB) – Pre-amplifier(dB).
- Measurement (dBuV/m) = Reading(dBuV) + C.F (Correction Factor).
- No2 is not in restricted band, its limit is 20dBc/30dBc of the fundamental emission level(already evaluated in Section 5.4) or LP0002 Section 3.6 which is higher.(Here, we are using stringent limits:74dBuV/m.)
- The emission levels of other frequencies are very lower than the limit and not show in test report.

EUT	Home Security Wi-Fi Camera	Date of Test	2022-06-28
Factor	BBHA 9120D	Temp. / Humidity	23°C /62%
Polarity	Horizontal	Site / Test Engineer	AC1 / Kaunaz
Test Mode	802.11g_TX_CH 6_ANT 0	Test Voltage	AC 120V/60Hz

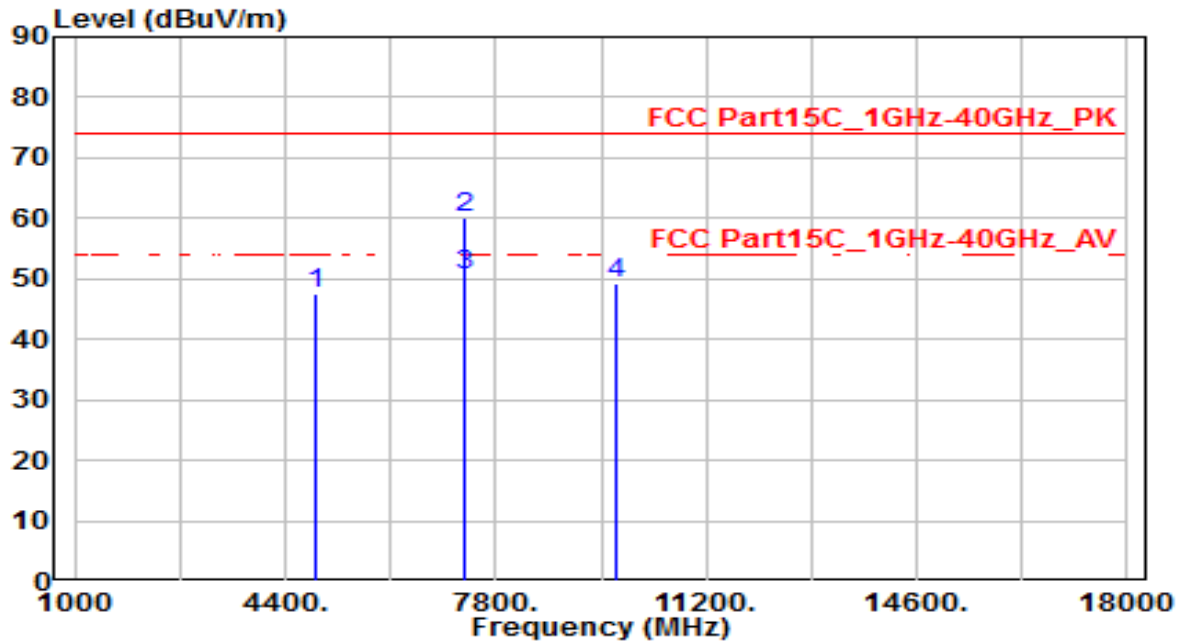

No	Frequency (MHz)	Reading (dBuV)	C.F (dB/m)	Measurement (dBuV/m)	Margin (dB)	Limit (dBuV/m)	Height (cm)	Angle (deg)	Remark (QP/PK/AV)
1	4874.000	43.77	3.74	47.51	-26.49	74.00	150	360	Peak
2	* 7311.000	48.16	12.11	60.28	-13.72	74.00	200	305	Peak
3	* 7311.000	38.41	12.11	50.52	-3.48	54.00	200	305	Average
4	9748.000	33.15	15.95	49.10	-24.90	74.00	150	360	Peak

Note:

- " *", means this data is the worst emission level.
- C.F (Correction Factor) = Antenna Factor (dB)+ Cable Loss (dB) – Preamplifier(dB).
- Measurement (dBuV/m) = Reading(dBuV) + C.F (Correction Factor).
- The emission levels of other frequencies are very lower than the limit and not show in test report.

EUT	Home Security Wi-Fi Camera	Date of Test	2022-06-28
Factor	BBHA 9120D	Temp. / Humidity	23°C /62%
Polarity	Vertical	Site / Test Engineer	AC1 / Kaunaz
Test Mode	802.11g_TX_CH 6_ANT 0	Test Voltage	AC 120V/60Hz

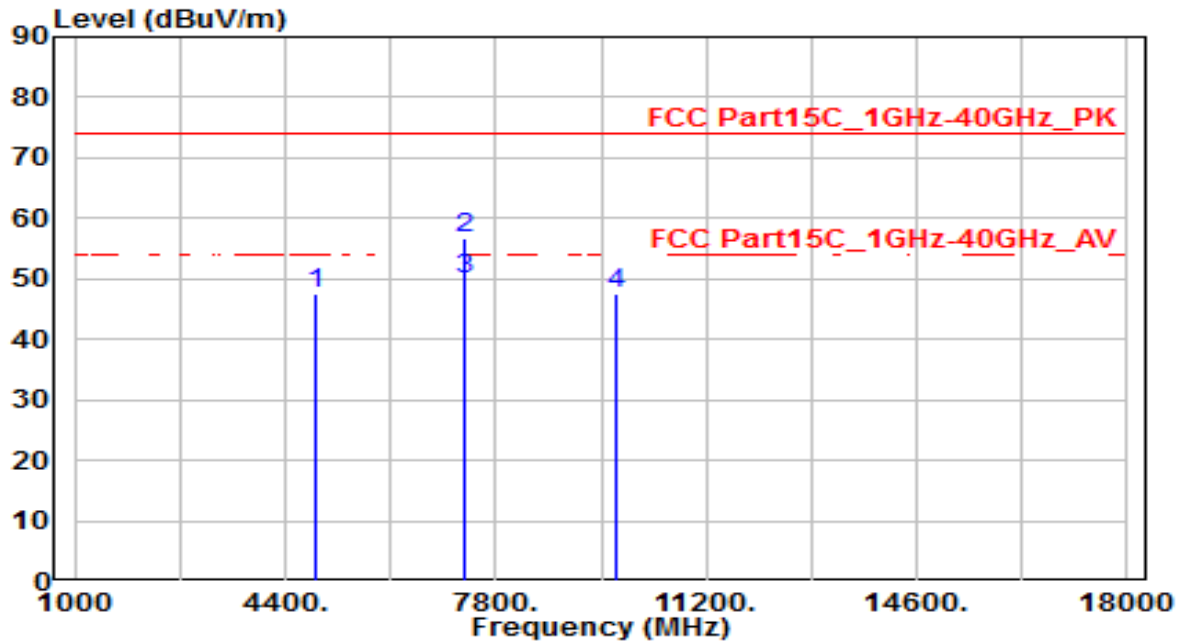

No	Frequency (MHz)	Reading (dBuV)	C.F (dB/m)	Measurement (dBuV/m)	Margin (dB)	Limit (dBuV/m)	Height (cm)	Angle (deg)	Remark (QP/PK/AV)
1	4874.000	43.97	3.74	47.71	-26.29	74.00	150	360	Peak
2	* 7311.000	44.51	12.11	56.62	-17.38	74.00	260	360	Peak
3	* 7311.000	37.80	12.11	49.91	-4.09	54.00	260	360	Average
4	9748.000	31.46	15.95	47.41	-26.59	74.00	150	360	Peak

Note:

- " *", means this data is the worst emission level.
- C.F (Correction Factor) = Antenna Factor (dB)+ Cable Loss (dB) – Preamplifier(dB).
- Measurement (dBuV/m) = Reading(dBuV) + C.F (Correction Factor).
- The emission levels of other frequencies are very lower than the limit and not show in test report.

EUT	Home Security Wi-Fi Camera	Date of Test	2022-06-28
Factor	BBHA 9120D	Temp. / Humidity	23°C /62%
Polarity	Horizontal	Site / Test Engineer	AC1 / Kaunaz
Test Mode	802.11g_TX_CH 11_ANT 0	Test Voltage	AC 120V/60Hz

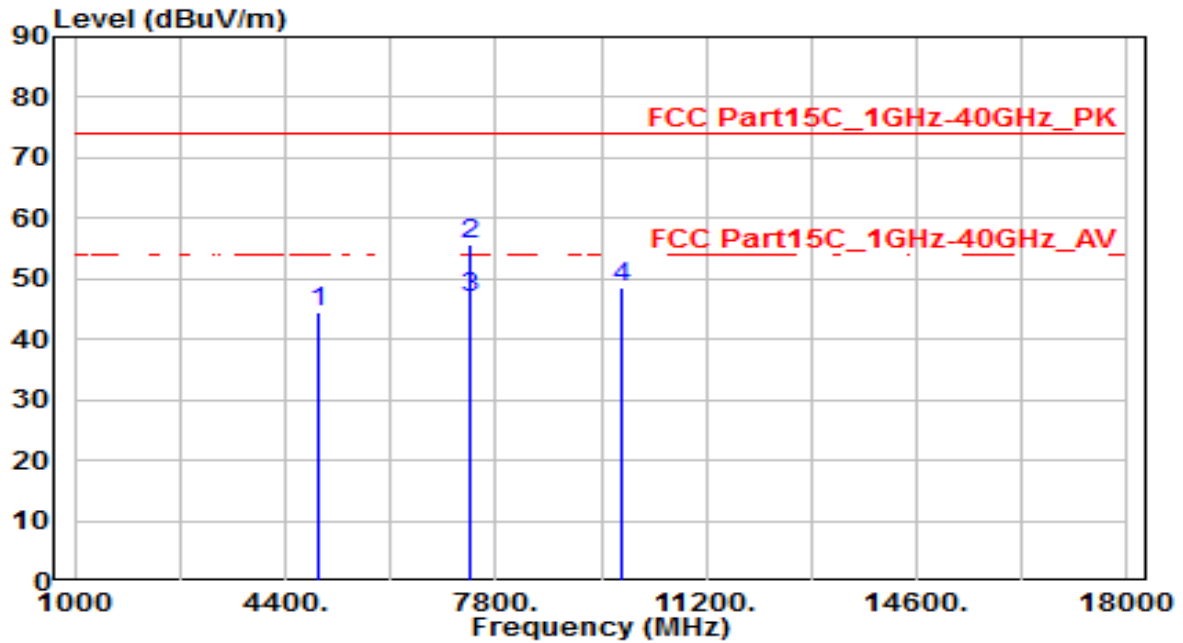

No	Frequency (MHz)	Reading (dBuV)	C.F (dB/m)	Measurement (dBuV/m)	Margin (dB)	Limit (dBuV/m)	Height (cm)	Angle (deg)	Remark (QP/PK/AV)
1	4924.000	40.58	3.83	44.41	-29.59	74.00	150	360	Peak
2	* 7386.000	43.11	12.42	55.54	-18.46	74.00	200	305	Peak
3	* 7386.000	34.57	12.42	46.99	-7.01	54.00	200	305	Average
4	9848.000	32.60	16.14	48.73	-25.27	74.00	150	360	Peak

Note:

- "*" means this data is the worst emission level.
- C.F (Correction Factor) = Antenna Factor (dB)+ Cable Loss (dB) – Preamplifier(dB).
- Measurement (dBuV/m) = Reading(dBuV) + C.F (Correction Factor).
- The emission levels of other frequencies are very lower than the limit and not show in test report.

EUT	Home Security Wi-Fi Camera	Date of Test	2022-06-28
Factor	BBHA 9120D	Temp. / Humidity	23°C /62%
Polarity	Vertical	Site / Test Engineer	AC1 / Kaunaz
Test Mode	802.11g_TX_CH 11_ANT 0	Test Voltage	AC 120V/60Hz

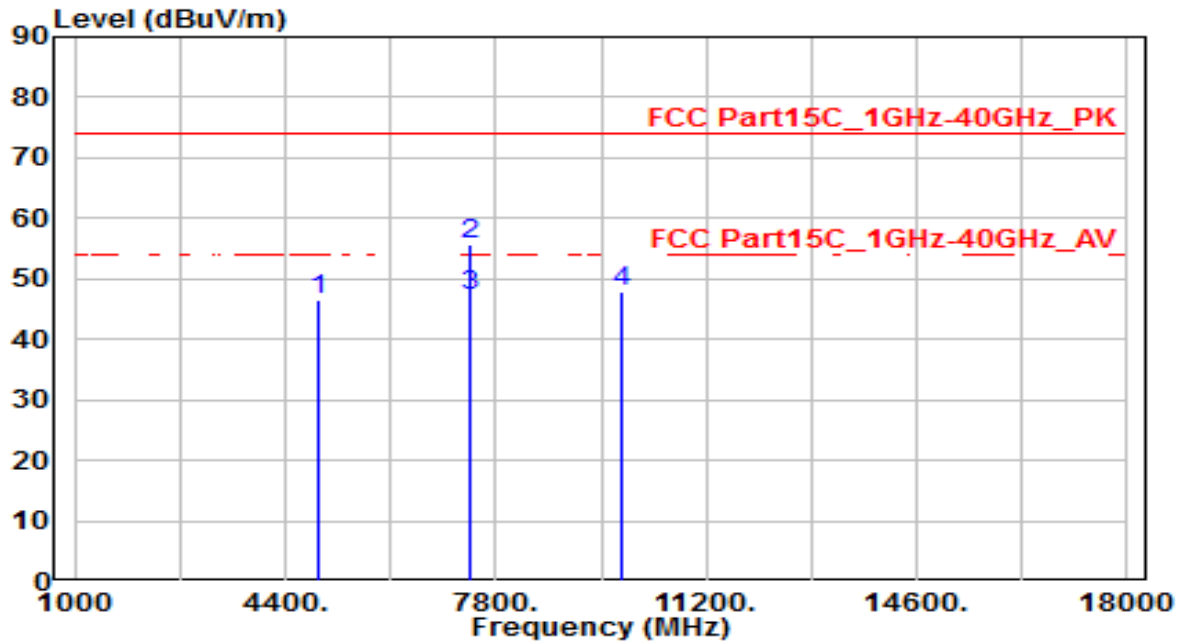

No	Frequency (MHz)	Reading (dBuV)	C.F (dB/m)	Measurement (dBuV/m)	Margin (dB)	Limit (dBuV/m)	Height (cm)	Angle (deg)	Remark (QP/PK/AV)
1	4924.000	42.57	3.83	46.40	-27.60	74.00	150	360	Peak
2	* 7386.000	43.13	12.42	55.55	-18.45	74.00	260	360	Peak
3	* 7386.000	34.84	12.42	47.26	-6.74	54.00	260	360	Average
4	9848.000	31.92	16.14	48.05	-25.95	74.00	150	360	Peak

Note:

- "*" means this data is the worst emission level.
- C.F (Correction Factor) = Antenna Factor (dB)+ Cable Loss (dB) – Preamplifier(dB).
- Measurement (dBuV/m) = Reading(dBuV) + C.F (Correction Factor).
- The emission levels of other frequencies are very lower than the limit and not show in test report.

EUT	Home Security Wi-Fi Camera	Date of Test	2022-06-28
Factor	BBHA 9120D	Temp. / Humidity	23°C /62%
Polarity	Horizontal	Site / Test Engineer	AC1 / Kaunaz
Test Mode	802.11n-20MHz_TX_CH 1_ANT 0	Test Voltage	AC 120V/60Hz

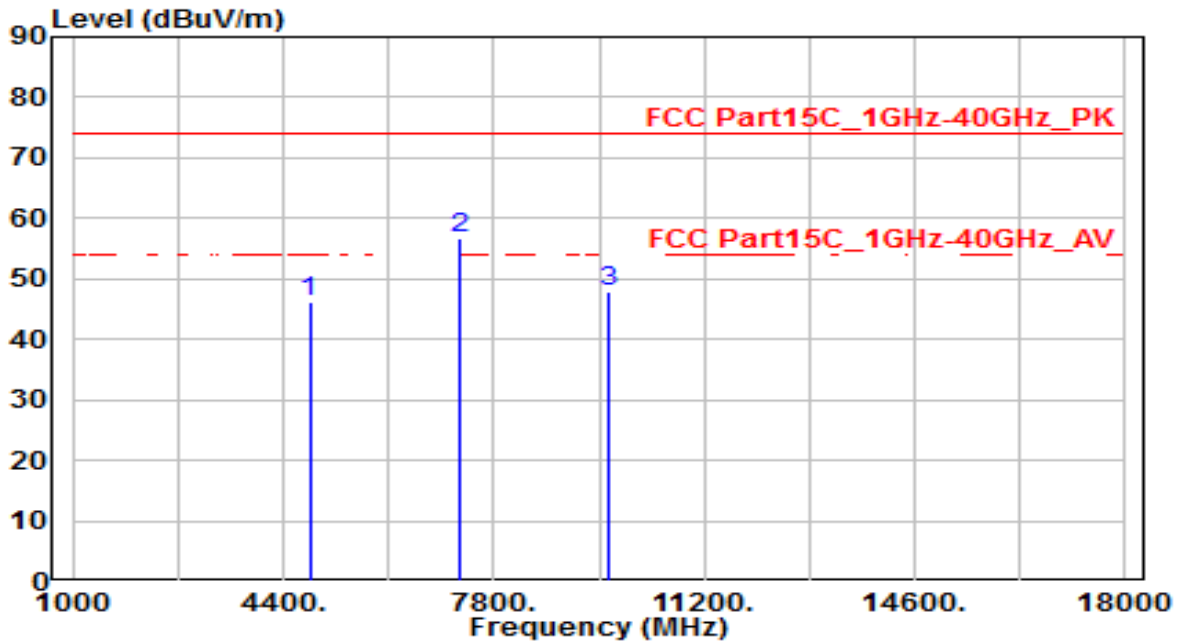

No	Frequency (MHz)	Reading (dBuV)	C.F (dB/m)	Measurement (dBuV/m)	Margin (dB)	Limit (dBuV/m)	Height (cm)	Angle (deg)	Remark (QP/PK/AV)
1	4824.000	42.46	3.65	46.11	-27.89	74.00	150	360	Peak
2	* 7236.000	44.77	11.80	56.58	-17.42	74.00	150	360	Peak
3	9648.000	32.27	15.77	48.04	-25.96	74.00	150	360	Peak

Note:

- "*" means this data is the worst emission level.
- C.F (Correction Factor) = Antenna Factor (dB)+ Cable Loss (dB) – Pre-amplifier(dB).
- Measurement (dBuV/m) = Reading(dBuV) + C.F (Correction Factor).
- No2 is not in restricted band, its limit is 20dBc/30dBc of the fundamental emission level(already evaluated in Section 5.4) or LP0002 Section 3.6 which is higher.(Here, we are using stringent limits:74dBuV/m.)
- The emission levels of other frequencies are very lower than the limit and not show in test report.

EUT	Home Security Wi-Fi Camera	Date of Test	2022-06-28
Factor	BBHA 9120D	Temp. / Humidity	23°C /62%
Polarity	Vertical	Site / Test Engineer	AC1 / Kaunaz
Test Mode	802.11n-20MHz_TX_CH 1_ANT 0	Test Voltage	AC 120V/60Hz

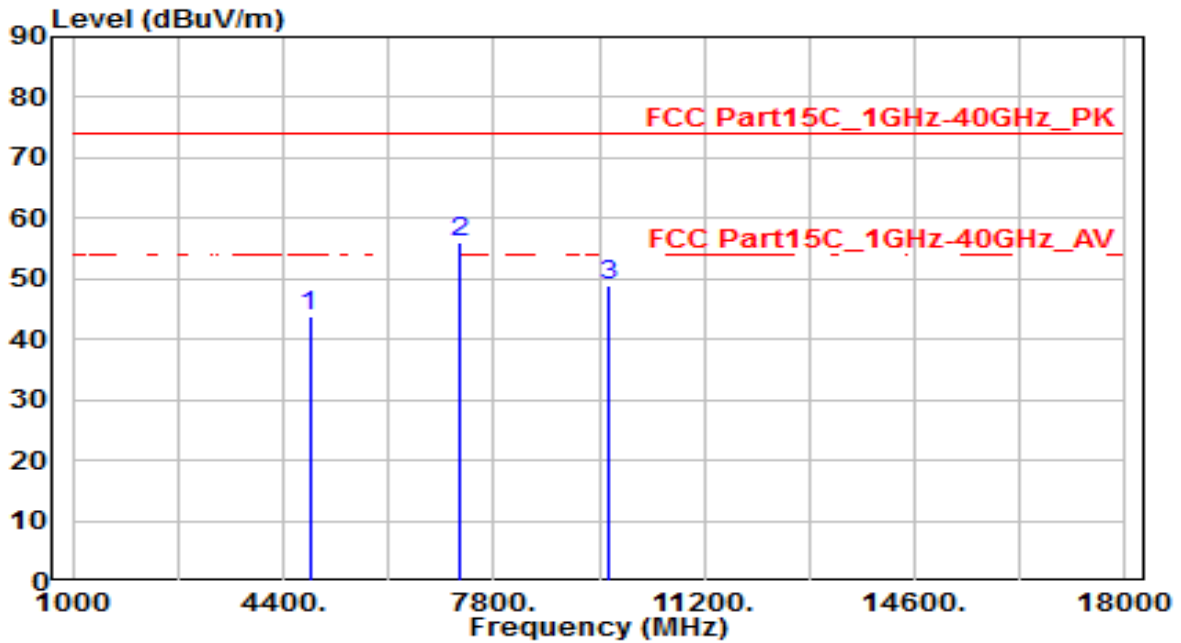

No	Frequency (MHz)	Reading (dBuV)	C.F (dB/m)	Measurement (dBuV/m)	Margin (dB)	Limit (dBuV/m)	Height (cm)	Angle (deg)	Remark (QP/PK/AV)
1	4824.000	40.30	3.65	43.95	-30.05	74.00	150	360	Peak
2	* 7236.000	44.37	11.80	56.18	-17.82	74.00	150	360	Peak
3	9648.000	33.16	15.77	48.93	-25.07	74.00	150	360	Peak

Note:

1. " *", means this data is the worst emission level.
2. C.F (Correction Factor) = Antenna Factor (dB)+ Cable Loss (dB) – Pre-amplifier(dB).
3. Measurement (dBuV/m) = Reading(dBuV) + C.F (Correction Factor).
4. No2 is not in restricted band, its limit is 20dBc/30dBc of the fundamental emission level(already evaluated in Section 5.4) or LP0002 Section 3.6 which is higher.(Here, we are using stringent limits:74dBuV/m.)
5. The emission levels of other frequencies are very lower than the limit and not show in test report.

EUT	Home Security Wi-Fi Camera	Date of Test	2022-06-28
Factor	BBHA 9120D	Temp. / Humidity	23°C /62%
Polarity	Horizontal	Site / Test Engineer	AC1 / Kaunaz
Test Mode	802.11n-20MHz_TX_CH 6_ANT 0	Test Voltage	AC 120V/60Hz

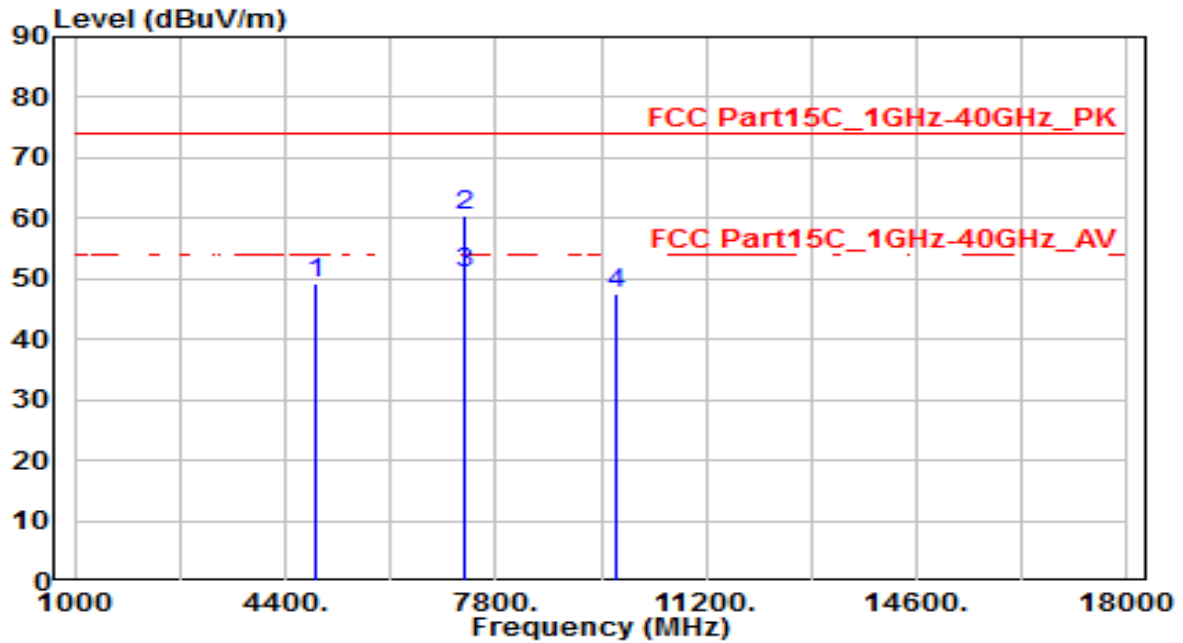

No	Frequency (MHz)	Reading (dBuV)	C.F (dB/m)	Measurement (dBuV/m)	Margin (dB)	Limit (dBuV/m)	Height (cm)	Angle (deg)	Remark (QP/PK/AV)
1	4874.000	45.35	3.74	49.09	-24.91	74.00	150	360	Peak
2	* 7311.000	48.23	12.11	60.35	-13.65	74.00	200	305	Peak
3	* 7311.000	38.77	12.11	50.88	-3.12	54.00	200	305	Average
4	9748.000	31.66	15.95	47.61	-26.39	74.00	150	360	Peak

Note:

1. " *", means this data is the worst emission level.
2. C.F (Correction Factor) = Antenna Factor (dB)+ Cable Loss (dB) – Preamplifier(dB).
3. Measurement (dBuV/m) = Reading(dBuV) + C.F (Correction Factor).
4. The emission levels of other frequencies are very lower than the limit and not show in test report.

EUT	Home Security Wi-Fi Camera	Date of Test	2022-06-28
Factor	BBHA 9120D	Temp. / Humidity	23°C /62%
Polarity	Vertical	Site / Test Engineer	AC1 / Kaunaz
Test Mode	802.11n-20MHz_TX_CH 6_ANT 0	Test Voltage	AC 120V/60Hz

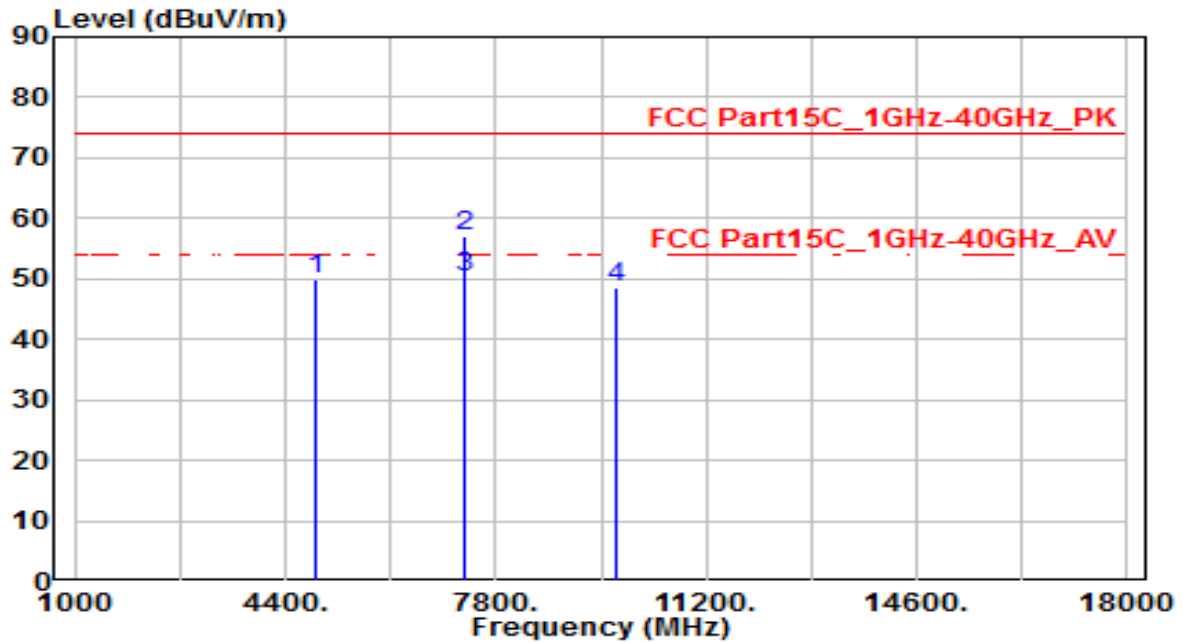

No	Frequency (MHz)	Reading (dBuV)	C.F (dB/m)	Measurement (dBuV/m)	Margin (dB)	Limit (dBuV/m)	Height (cm)	Angle (deg)	Remark (QP/PK/AV)
1	4874.000	46.32	3.74	50.05	-23.95	74.00	150	360	Peak
2	* 7311.000	45.10	12.11	57.22	-16.78	74.00	260	360	Peak
3	* 7311.000	38.20	12.11	50.31	-3.69	54.00	260	360	Average
4	9748.000	32.47	15.95	48.42	-25.58	74.00	150	360	Peak

Note:

- " *", means this data is the worst emission level.
- C.F (Correction Factor) = Antenna Factor (dB)+ Cable Loss (dB) – Preamplifier(dB).
- Measurement (dBuV/m) = Reading(dBuV) + C.F (Correction Factor).
- The emission levels of other frequencies are very lower than the limit and not show in test report.

EUT	Home Security Wi-Fi Camera	Date of Test	2022-06-28
Factor	BBHA 9120D	Temp. / Humidity	23°C /62%
Polarity	Horizontal	Site / Test Engineer	AC1 / Kaunaz
Test Mode	802.11n-20MHz_TX_CH 11_ANT 0	Test Voltage	AC 120V/60Hz

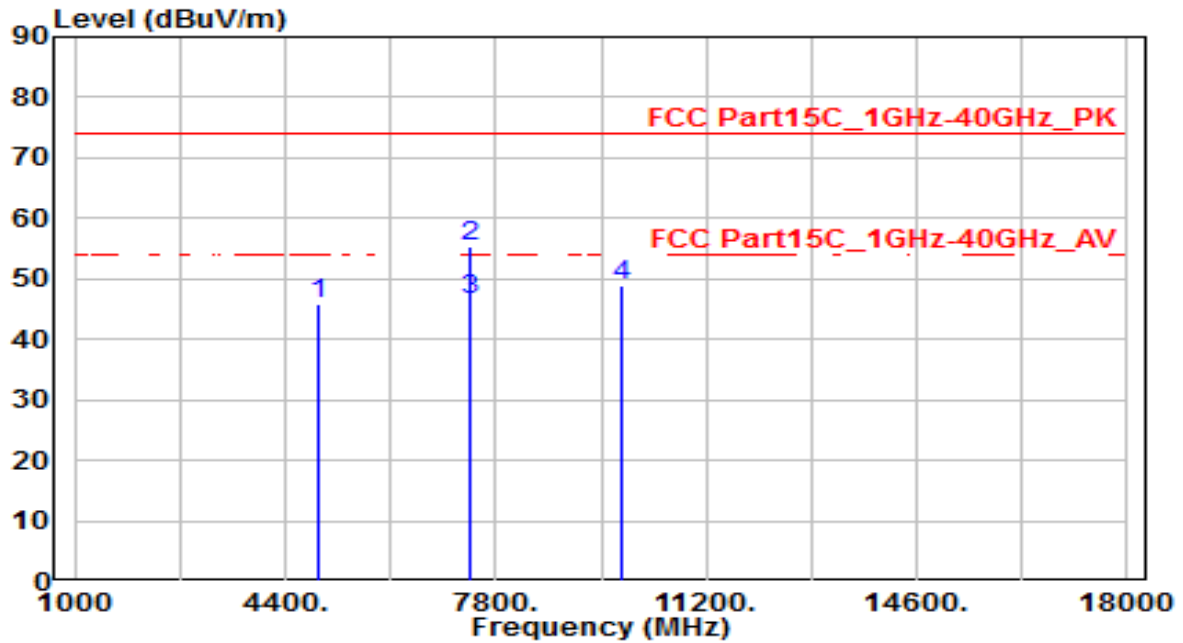

No	Frequency (MHz)	Reading (dBuV)	C.F (dB/m)	Measurement (dBuV/m)	Margin (dB)	Limit (dBuV/m)	Height (cm)	Angle (deg)	Remark (QP/PK/AV)
1	4924.000	41.85	3.83	45.68	-28.32	74.00	150	360	Peak
2	* 7386.000	42.99	12.42	55.42	-18.58	74.00	200	305	Peak
3	* 7386.000	34.13	12.42	46.55	-7.45	54.00	200	305	Average
4	9848.000	32.77	16.14	48.91	-25.09	74.00	150	360	Peak

Note:

- "*" means this data is the worst emission level.
- C.F (Correction Factor) = Antenna Factor (dB)+ Cable Loss (dB) – Preamplifier(dB).
- Measurement (dBuV/m) = Reading(dBuV) + C.F (Correction Factor).
- The emission levels of other frequencies are very lower than the limit and not show in test report.

EUT	Home Security Wi-Fi Camera	Date of Test	2022-06-28
Factor	BBHA 9120D	Temp. / Humidity	23°C /62%
Polarity	Vertical	Site / Test Engineer	AC1 / Kaunaz
Test Mode	802.11n-20MHz_TX_CH 11_ANT 0	Test Voltage	AC 120V/60Hz

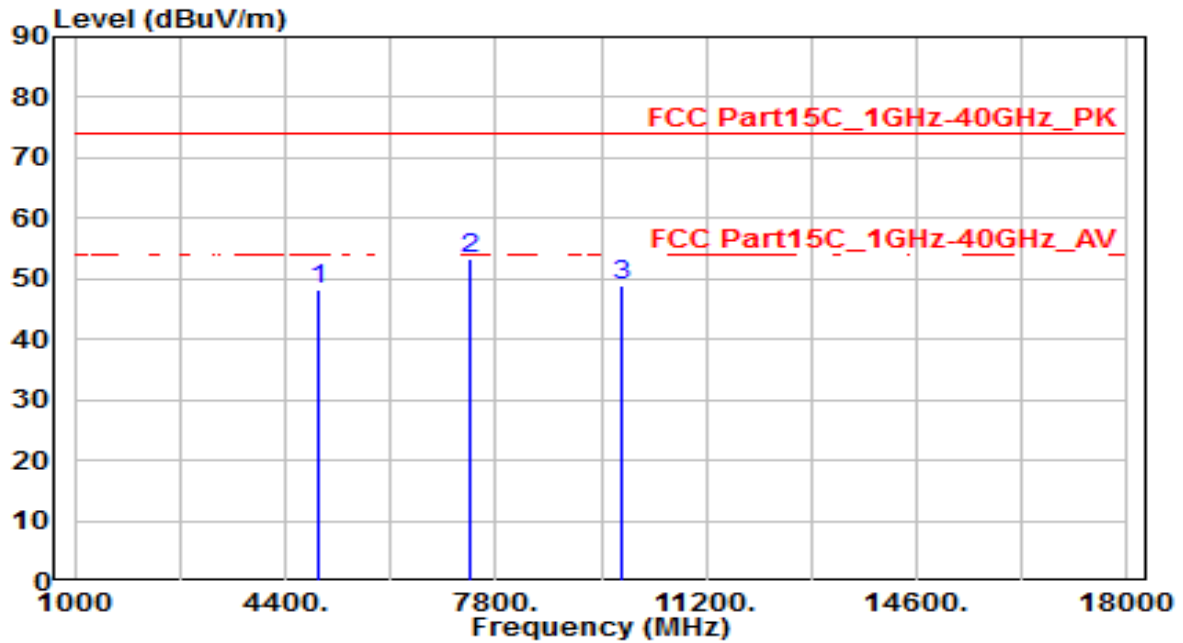

No	Frequency (MHz)	Reading (dBuV)	C.F (dB/m)	Measurement (dBuV/m)	Margin (dB)	Limit (dBuV/m)	Height (cm)	Angle (deg)	Remark (QP/PK/AV)
1	4924.000	44.55	3.83	48.38	-25.62	74.00	150	360	Peak
2	* 7386.000	41.00	12.42	53.42	-20.58	74.00	150	360	Peak
3	9848.000	32.64	16.14	48.78	-25.22	74.00	150	360	Peak

Note:

1. " *", means this data is the worst emission level.
2. C.F (Correction Factor) = Antenna Factor (dB)+ Cable Loss (dB) – Preamplifier(dB).
3. Measurement (dBuV/m) = Reading(dBuV) + C.F (Correction Factor).
4. The emission levels of other frequencies are very lower than the limit and not show in test report.

7.7. Radiated Restricted Band Edge Measurement

7.7.1. Test Limit

For 15.205 requirement:

Radiated emissions which fall in the restricted bands, as defined in Section 15.205(a) of FCC part 15, must also comply with the radiated emission limits specified in Section 15.209(a).

Frequency (MHz)	Frequency (MHz)	Frequency (MHz)	Frequency (GHz)
0.090 - 0.110	16.42 - 16.423	399.9 - 410	4.5 - 5.15
¹ 0.495 - 0.505	16.69475 - 16.69525	608 - 614	5.35 - 5.46
2.1735 - 2.1905	16.80425 - 16.80475	960 - 1240	7.25 - 7.75
4.125 - 4.128	25.5 - 25.67	1300 - 1427	8.025 - 8.5
4.17725 - 4.17775	37.5 - 38.25	1435 - 1626.5	9.0 - 9.2
4.20725 - 4.20775	73 - 74.6	1645.5 - 1646.5	9.3 - 9.5
6.215 - 6.218	74.8 - 75.2	1660 - 1710	10.6 - 12.7
6.26775 - 6.26825	108 - 121.94	1718.8 - 1722.2	13.25 - 13.4
6.31175 - 6.31225	123 - 138	2200 - 2300	14.47 - 14.5
8.291 - 8.294	149.9 - 150.05	2310 - 2390	15.35 - 16.2
8.362 - 8.366	156.52475 - 156.52525	2483.5 - 2500	17.7 - 21.4
8.37625 - 8.38675	156.7 - 156.9	2690 - 2900	22.01 - 23.12
8.41425 - 8.41475	162.0125 - 167.17	3260 - 3267	23.6 - 24.0
12.29 - 12.293	167.72 - 173.2	3332 - 3339	31.2 - 31.8
12.51975 - 12.52025	240 - 285	3345.8 - 3358	36.43 - 36.5
12.57675 - 12.57725	322 - 335.4	3600 - 4400	(²)
13.36 - 13.41	--	--	--

All out of band emissions appearing in a restricted band as specified in Section 15.205 of the Title 47CFR must not exceed the limits shown in Table per Section 15.209.

FCC Part 15 Subpart C Paragraph 15.209 Limits		
Frequency [MHz]	Field Strength [uV/m]	Measured Distance [Meters]
0.009 - 0.490	2400/F (kHz)	300
0.490 - 1.705	24000/F (kHz)	30
1.705 - 30	30	30
30 - 88	100	3
88 - 216	150	3
216 - 960	200	3
Above 960	500	3

7.7.2. Test Procedure Used

ANSI C63.10 - 2013 - Section 6.3 (General Requirements)

ANSI C63.10 - 2013 - Section 6.6 (Standard test method above 1GHz)

7.7.3. Test Setting

Peak Field Strength Measurements

1. Analyzer center frequency was set to the frequency of the radiated spurious emission of interest
2. RBW = 1MHz
3. VBW = 3MHz
4. Detector = peak
5. Sweep time = auto couple
6. Trace mode = max hold
7. Trace was allowed to stabilize

Average Measurements above 1GHz (Method VB)

1. Analyzer center frequency was set to the frequency of the radiated spurious emission of interest
2. RBW = 1MHz
3. VBW; If the EUT is configured to transmit with duty cycle $\geq 98\%$, set VBW = 10 Hz.

If the EUT duty cycle is $< 98\%$, set $VBW \geq 1/T$. T is the minimum transmission duration.

4. Detector = Peak
5. Sweep time = auto
6. Trace mode = max hold
7. Trace was allowed to stabilize

7.7.4. Test Setup

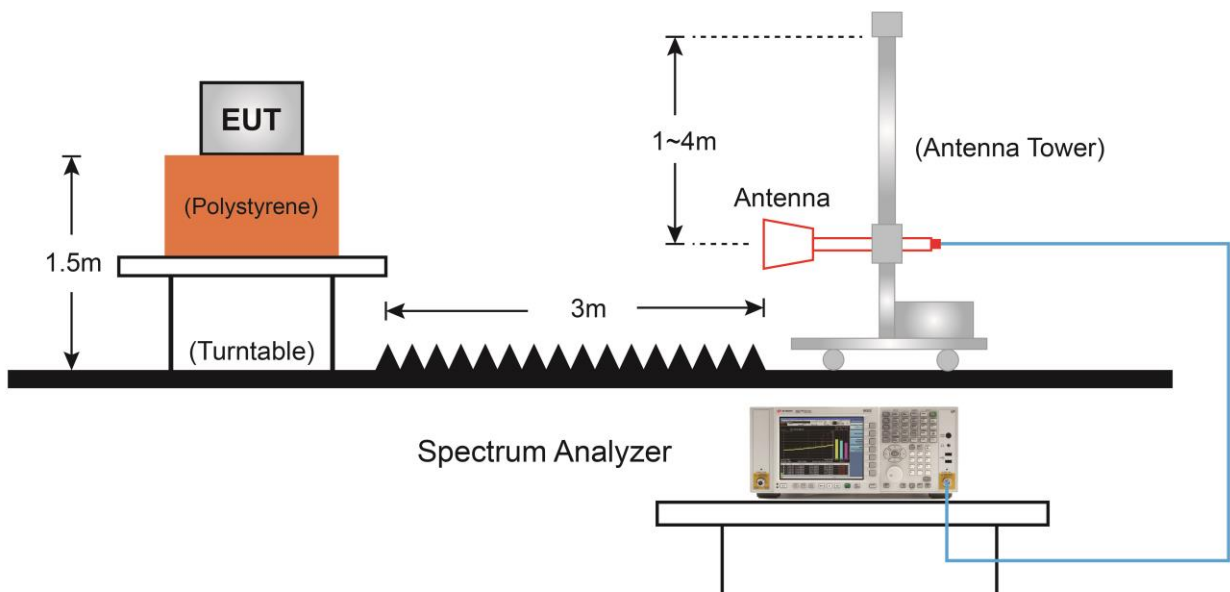

7.7.5. Test Result

EUT	Home Security Wi-Fi Camera	Date of Test	2022-06-28
Factor	BBHA 9120D	Temp. / Humidity	23°C /62%
Polarity	Horizontal	Site / Test Engineer	AC1 / Kaunaz
Test Mode	802.11b_TX_CH 1_ANT 0	Test Voltage	AC 120V/60Hz

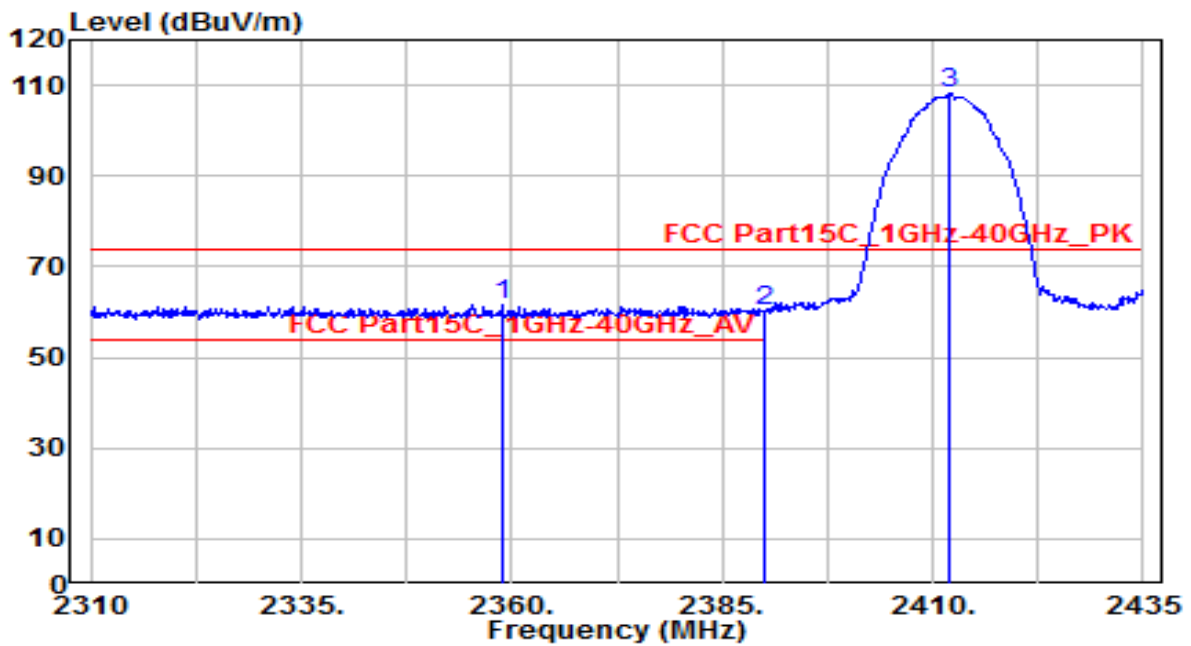

No	Frequency (MHz)	Reading (dBUV)	C.F (dB/m)	Measurement (dBUV/m)	Margin (dB)	Limit (dBUV/m)	Height (cm)	Angle (deg)	Remark (QP/PK/AV)
1	* 2358.875	29.47	32.17	61.65	-12.35	74.00	155	255	Peak
2	2390.000	28.09	32.28	60.37	-13.63	74.00	155	255	Peak
3	2412.000	75.76	32.36	108.13	N/A	N/A	155	255	Peak

Note:

1. " *", means this data is the worst emission level.
2. C.F (Correction Factor) = Antenna Factor (dB)+ Cable Loss (dB).
3. Measurement (dBUV/m) = Reading(dBUV) + C.F (Correction Factor).
4. The emission levels of other frequencies are very lower than the limit and not show in test report.

EUT	Home Security Wi-Fi Camera	Date of Test	2022-06-28
Factor	BBHA 9120D	Temp. / Humidity	23°C /62%
Polarity	Horizontal	Site / Test Engineer	AC1 / Kaunaz
Test Mode	802.11b_TX_CH 1_ANT 0	Test Voltage	AC 120V/60Hz

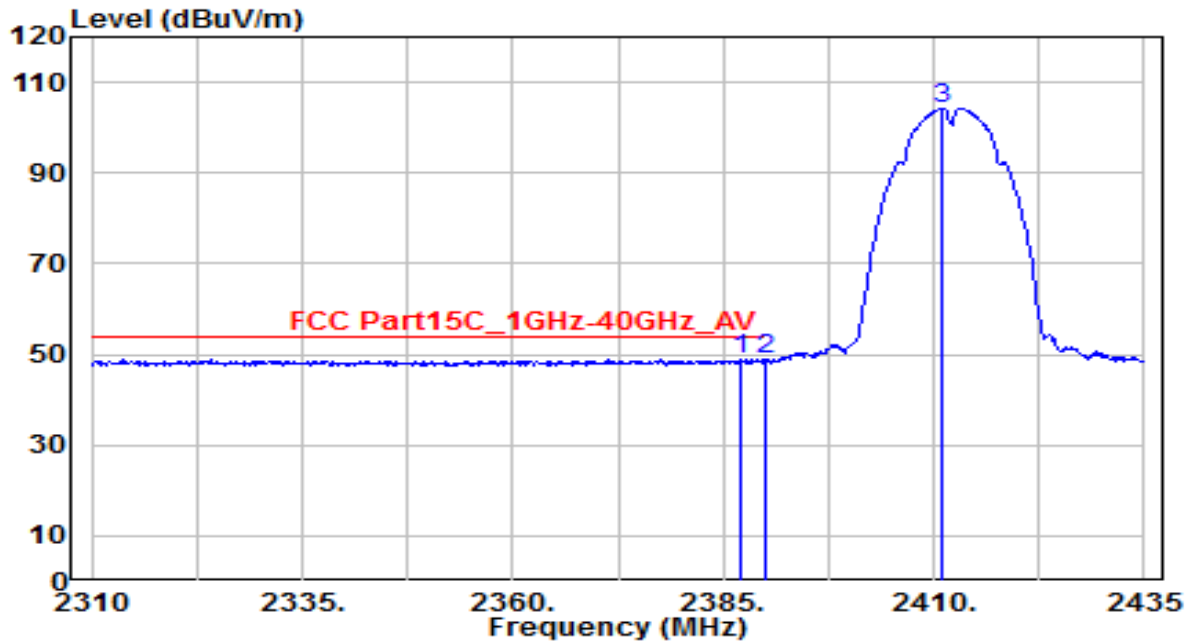

No	Frequency (MHz)	Reading (dBuV)	C.F (dB/m)	Measurement (dBuV/m)	Margin (dB)	Limit (dBuV/m)	Height (cm)	Angle (deg)	Remark (QP/PK/AV)	
1	*	2387.125	16.67	32.27	48.94	-5.06	54.00	155	255	Average
2		2390.000	16.58	32.28	48.86	-5.14	54.00	155	255	Average
3		2411.125	71.97	32.36	104.33	N/A	N/A	155	255	Average

Note:

1. " *", means this data is the worst emission level.
2. C.F (Correction Factor) = Antenna Factor (dB)+ Cable Loss (dB).
3. Measurement (dBuV/m) = Reading(dBuV) + C.F (Correction Factor).
4. The emission levels of other frequencies are very lower than the limit and not show in test report.

EUT	Home Security Wi-Fi Camera	Date of Test	2022-06-28
Factor	BBHA 9120D	Temp. / Humidity	23°C /62%
Polarity	Horizontal	Site / Test Engineer	AC1 / Kaunaz
Test Mode	802.11b_TX_CH 1_ANT 0	Test Voltage	AC 120V/60Hz

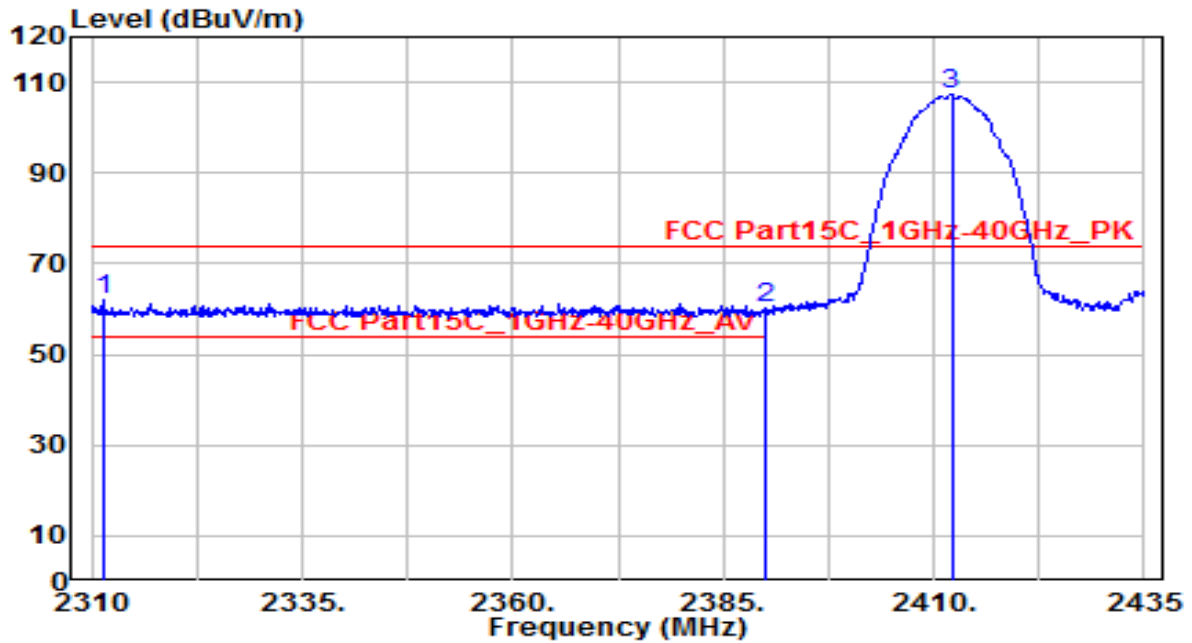

No	Frequency (MHz)	Reading (dBuV)	C.F (dB/m)	Measurement (dBuV/m)	Margin (dB)	Limit (dBuV/m)	Height (cm)	Angle (deg)	Remark (QP/PK/AV)	
1	*	2311.375	29.83	32.00	61.84	-12.16	74.00	140	200	Peak
2		2390.000	28.09	32.28	60.37	-13.63	74.00	140	200	Peak
3		2412.125	75.04	32.36	107.41	N/A	N/A	140	200	Peak

Note:

1. " *", means this data is the worst emission level.
2. C.F (Correction Factor) = Antenna Factor (dB)+ Cable Loss (dB).
3. Measurement (dBuV/m) = Reading(dBuV) + C.F (Correction Factor).
4. The emission levels of other frequencies are very lower than the limit and not show in test report.

EUT	Home Security Wi-Fi Camera	Date of Test	2022-06-28
Factor	BBHA 9120D	Temp. / Humidity	23°C /62%
Polarity	Horizontal	Site / Test Engineer	AC1 / Kaunaz
Test Mode	802.11b_TX_CH 1_ANT 0	Test Voltage	AC 120V/60Hz

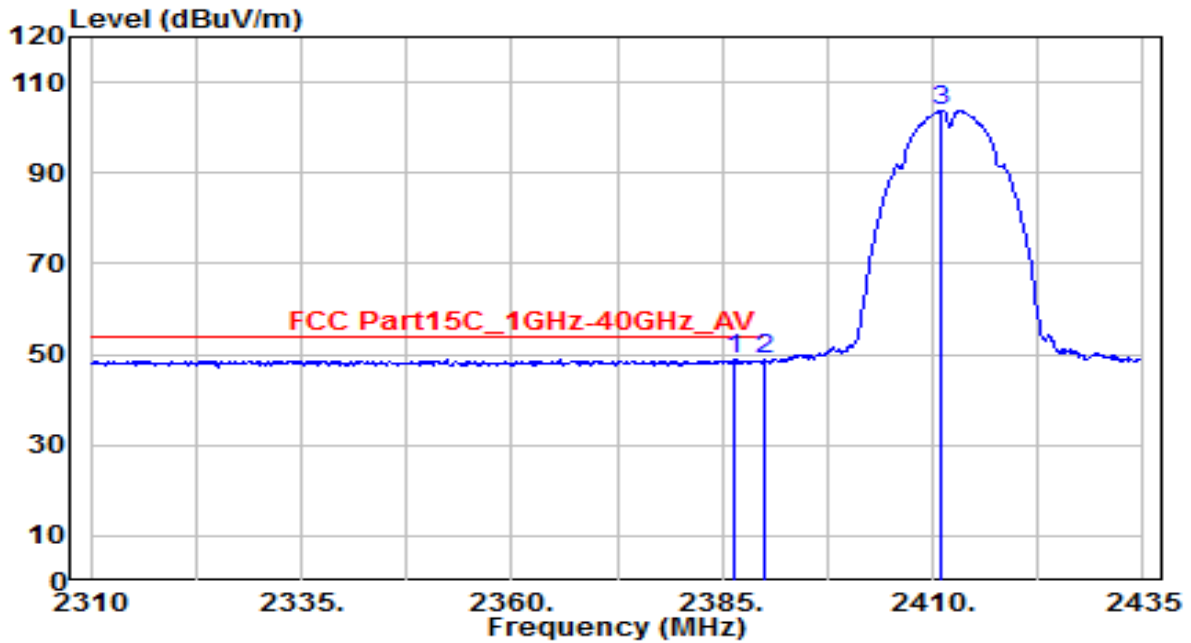

No	Frequency (MHz)	Reading (dBuV)	C.F (dB/m)	Measurement (dBuV/m)	Margin (dB)	Limit (dBuV/m)	Height (cm)	Angle (deg)	Remark (QP/PK/AV)	
1	*	2386.375	16.60	32.27	48.87	-5.13	54.00	140	200	Average
2		2390.000	16.41	32.28	48.69	-5.31	54.00	140	200	Average
3		2411.125	71.38	32.36	103.74	N/A	N/A	140	200	Average

Note:

1. "*" , means this data is the worst emission level.
2. C.F (Correction Factor) = Antenna Factor (dB)+ Cable Loss (dB).
3. Measurement (dBuV/m) = Reading(dBuV) + C.F (Correction Factor).
4. The emission levels of other frequencies are very lower than the limit and not show in test report.

EUT	Home Security Wi-Fi Camera	Date of Test	2022-06-28
Factor	BBHA 9120D	Temp. / Humidity	23°C /62%
Polarity	Horizontal	Site / Test Engineer	AC1 / Kaunaz
Test Mode	802.11b_TX_CH 6_ANT 0	Test Voltage	AC 120V/60Hz

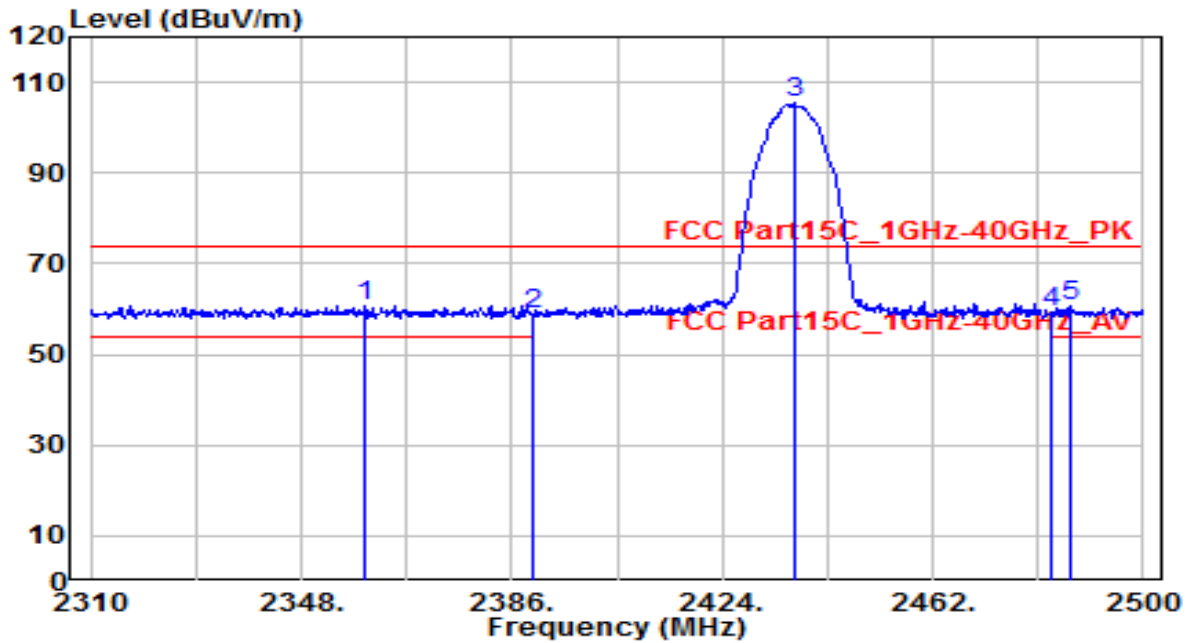

No	Frequency (MHz)	Reading (dBuV)	C.F (dB/m)	Measurement (dBuV/m)	Margin (dB)	Limit (dBuV/m)	Height (cm)	Angle (deg)	Remark (QP/PK/AV)
1	* 2359.400	28.67	32.17	60.84	-13.16	74.00	150	255	Peak
2	2390.000	26.66	32.28	58.94	-15.06	74.00	150	255	Peak
3	2436.920	73.02	32.45	105.47	N/A	N/A	150	255	Peak
4	2483.500	26.65	32.62	59.27	-14.73	74.00	150	255	Peak
5	2486.700	28.12	32.63	60.76	-13.24	74.00	150	255	Peak

Note:

1. " *", means this data is the worst emission level.
2. C.F (Correction Factor) = Antenna Factor (dB)+ Cable Loss (dB).
3. Measurement (dBuV/m) = Reading(dBuV) + C.F (Correction Factor).
4. The emission levels of other frequencies are very lower than the limit and not show in test report.

EUT	Home Security Wi-Fi Camera	Date of Test	2022-06-28
Factor	BBHA 9120D	Temp. / Humidity	23°C /62%
Polarity	Horizontal	Site / Test Engineer	AC1 / Kaunaz
Test Mode	802.11b_TX_CH 6_ANT 0	Test Voltage	AC 120V/60Hz

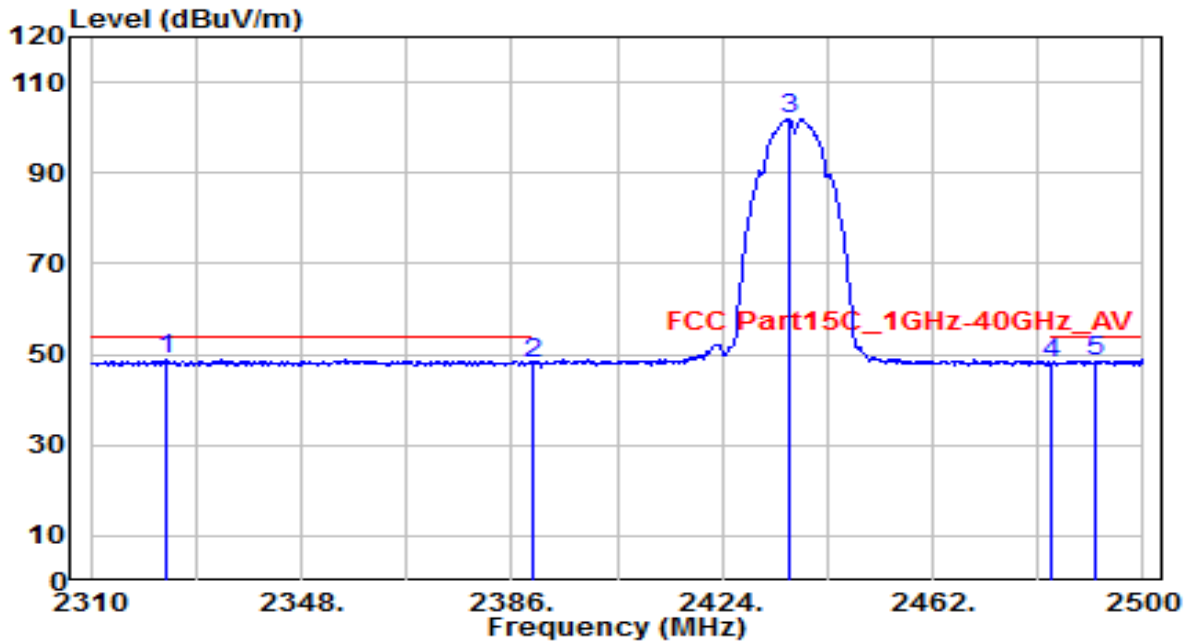

No	Frequency (MHz)	Reading (dBuV)	C.F (dB/m)	Measurement (dBuV/m)	Margin (dB)	Limit (dBuV/m)	Height (cm)	Angle (deg)	Remark (QP/PK/AV)	
1	*	2323.680	16.78	32.05	48.83	-5.17	54.00	150	255	Average
2		2390.000	15.91	32.28	48.20	-5.80	54.00	150	255	Average
3		2436.160	69.56	32.45	102.01	N/A	N/A	150	255	Average
4		2483.500	15.53	32.62	48.15	-5.85	54.00	150	255	Average
5		2491.450	15.98	32.65	48.63	-5.37	54.00	150	255	Average

Note:

- " *", means this data is the worst emission level.
- C.F (Correction Factor) = Antenna Factor (dB)+ Cable Loss (dB).
- Measurement (dBuV/m) = Reading(dBuV) + C.F (Correction Factor).
- The emission levels of other frequencies are very lower than the limit and not show in test report.

EUT	Home Security Wi-Fi Camera	Date of Test	2022-06-28
Factor	BBHA 9120D	Temp. / Humidity	23°C /62%
Polarity	Vertical	Site / Test Engineer	AC1 / Kaunaz
Test Mode	802.11b_TX_CH 6_ANT 0	Test Voltage	AC 120V/60Hz

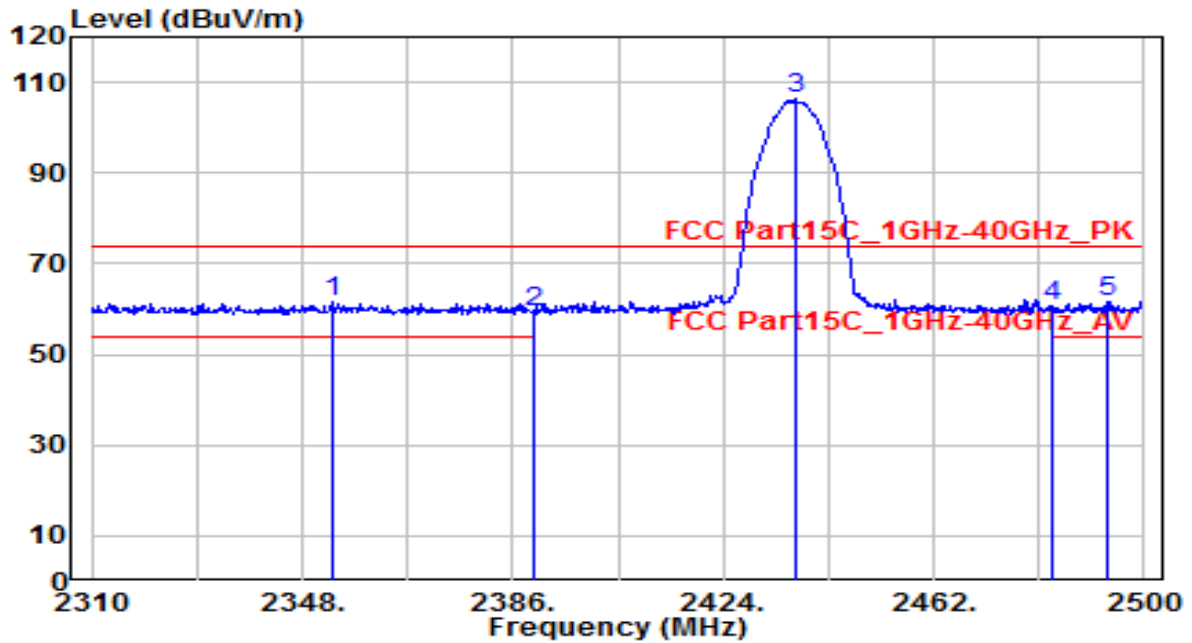

No	Frequency (MHz)	Reading (dBuV)	C.F (dB/m)	Measurement (dBuV/m)	Margin (dB)	Limit (dBuV/m)	Height (cm)	Angle (deg)	Remark (QP/PK/AV)
1	2353.320	29.44	32.15	61.59	-12.41	74.00	160	200	Peak
2	2390.000	26.89	32.28	59.17	-14.83	74.00	160	200	Peak
3	2436.920	73.79	32.45	106.24	N/A	N/A	160	200	Peak
4	2483.500	27.92	32.62	60.54	-13.46	74.00	160	200	Peak
5	* 2493.350	29.00	32.66	61.66	-12.34	74.00	160	200	Peak

Note:

1. " *", means this data is the worst emission level.
2. C.F (Correction Factor) = Antenna Factor (dB)+ Cable Loss (dB).
3. Measurement (dBuV/m) = Reading(dBuV) + C.F (Correction Factor).
4. The emission levels of other frequencies are very lower than the limit and not show in test report.

EUT	Home Security Wi-Fi Camera	Date of Test	2022-06-28
Factor	BBHA 9120D	Temp. / Humidity	23°C /62%
Polarity	Vertical	Site / Test Engineer	AC1 / Kaunaz
Test Mode	802.11b_TX_CH 6_ANT 0	Test Voltage	AC 120V/60Hz

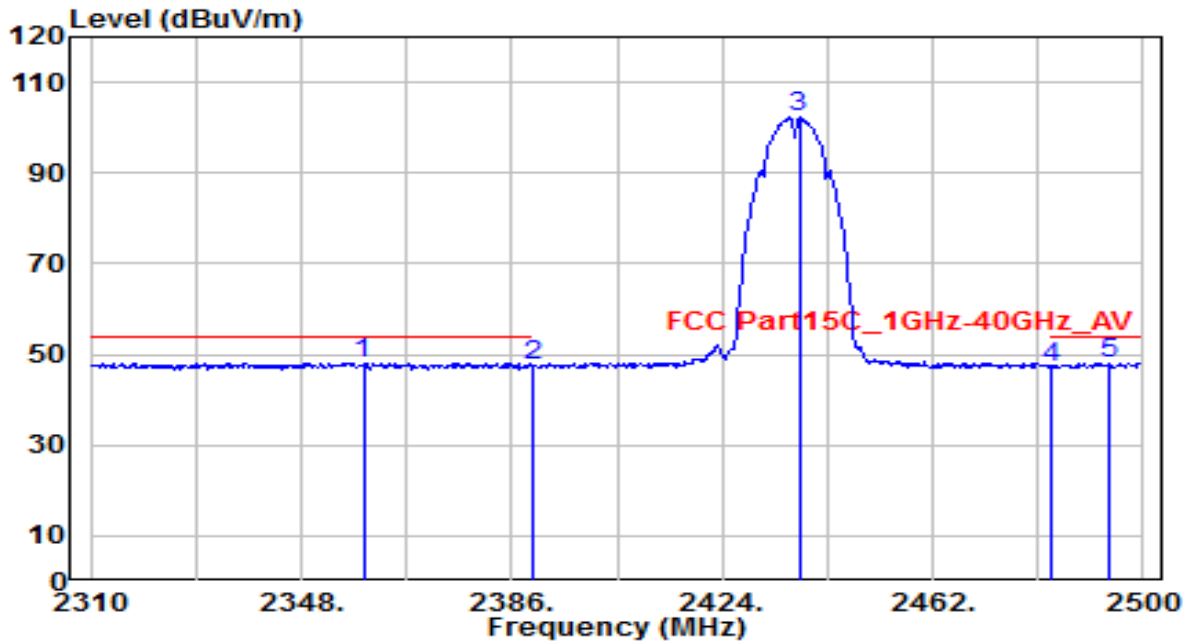

No	Frequency (MHz)	Reading (dBuV)	C.F (dB/m)	Measurement (dBuV/m)	Margin (dB)	Limit (dBuV/m)	Height (cm)	Angle (deg)	Remark (QP/PK/AV)
1	* 2359.210	16.02	32.17	48.19	-5.81	54.00	160	200	Average
2	2390.000	15.09	32.28	47.37	-6.63	54.00	160	200	Average
3	2437.870	69.78	32.46	102.24	N/A	N/A	160	200	Average
4	2483.500	14.60	32.62	47.22	-6.78	54.00	160	200	Average
5	2493.730	15.53	32.66	48.18	-5.82	54.00	160	200	Average

Note:

1. " *", means this data is the worst emission level.
2. C.F (Correction Factor) = Antenna Factor (dB)+ Cable Loss (dB).
3. Measurement (dBuV/m) = Reading(dBuV) + C.F (Correction Factor).
4. The emission levels of other frequencies are very lower than the limit and not show in test report.

EUT	Home Security Wi-Fi Camera	Date of Test	2022-06-28
Factor	BBHA 9120D	Temp. / Humidity	23°C /62%
Polarity	Horizontal	Site / Test Engineer	AC1 / Kaunaz
Test Mode	802.11b_TX_CH 11_ANT 0	Test Voltage	AC 120V/60Hz

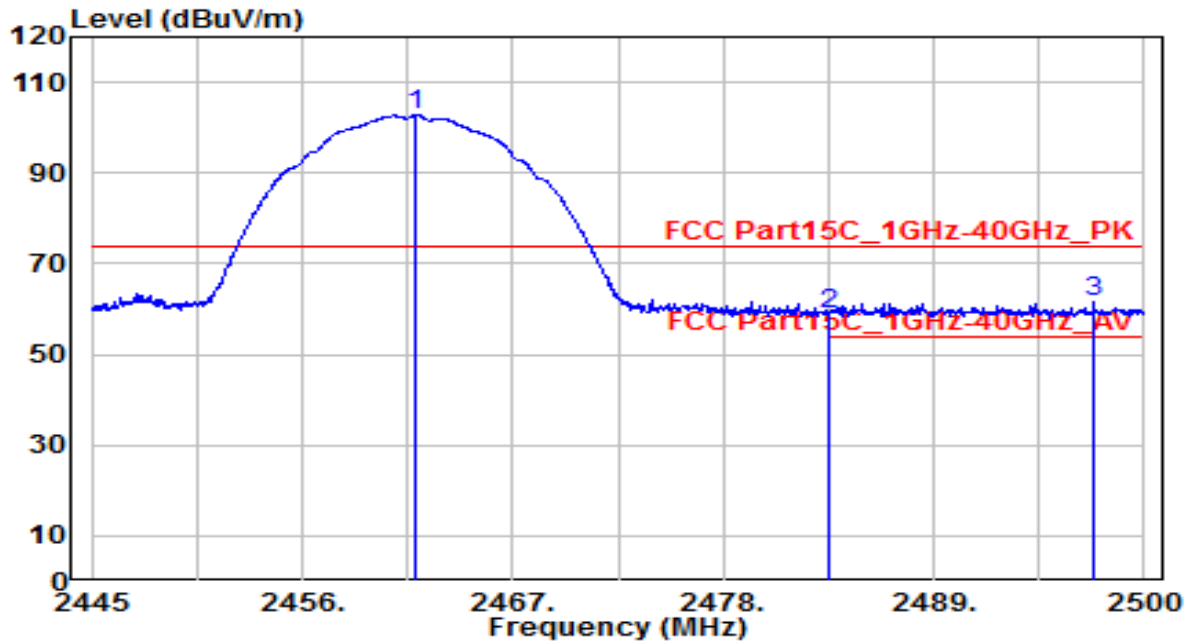

No	Frequency (MHz)	Reading (dBUV)	C.F (dB/m)	Measurement (dBUV/m)	Margin (dB)	Limit (dBUV/m)	Height (cm)	Angle (deg)	Remark (QP/PK/AV)
1	2461.940	70.32	32.54	102.87	N/A	N/A	150	250	Peak
2	2483.500	26.29	32.62	58.91	-15.09	74.00	150	250	Peak
3	* 2497.360	28.72	32.67	61.39	-12.61	74.00	150	250	Peak

Note:

1. " *", means this data is the worst emission level.
2. C.F (Correction Factor) = Antenna Factor (dB)+ Cable Loss (dB).
3. Measurement (dBUV/m) = Reading(dBUV) + C.F (Correction Factor).
4. The emission levels of other frequencies are very lower than the limit and not show in test report.

EUT	Home Security Wi-Fi Camera	Date of Test	2022-06-28
Factor	BBHA 9120D	Temp. / Humidity	23°C /62%
Polarity	Horizontal	Site / Test Engineer	AC1 / Kaunaz
Test Mode	802.11b_TX_CH 11_ANT 0	Test Voltage	AC 120V/60Hz

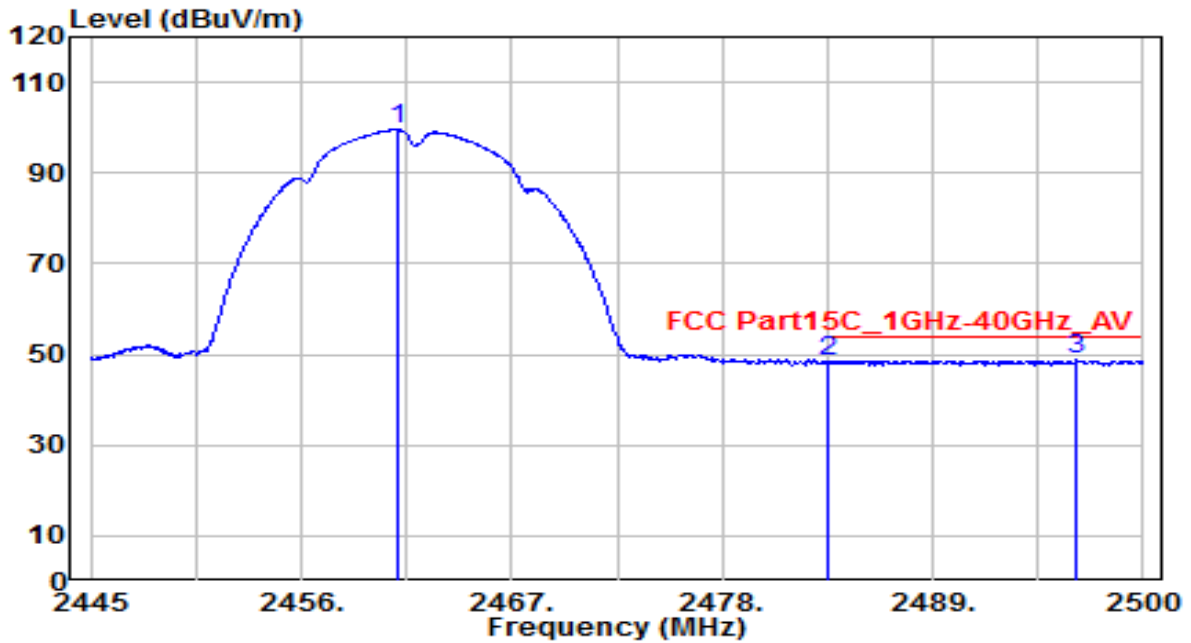

No	Frequency (MHz)	Reading (dBuV)	C.F (dB/m)	Measurement (dBuV/m)	Margin (dB)	Limit (dBuV/m)	Height (cm)	Angle (deg)	Remark (QP/PK/AV)
1	2461.005	67.01	32.54	99.55	N/A	N/A	150	250	Average
2	2483.500	15.94	32.62	48.56	-5.44	54.00	150	250	Average
3	* 2496.535	16.16	32.67	48.83	-5.17	54.00	150	250	Average

Note:

1. " *", means this data is the worst emission level.
2. C.F (Correction Factor) = Antenna Factor (dB)+ Cable Loss (dB).
3. Measurement (dBuV/m) = Reading(dBuV) + C.F (Correction Factor).
4. The emission levels of other frequencies are very lower than the limit and not show in test report.

EUT	Home Security Wi-Fi Camera	Date of Test	2022-06-28
Factor	BBHA 9120D	Temp. / Humidity	23°C /62%
Polarity	Vertical	Site / Test Engineer	AC1 / Kaunaz
Test Mode	802.11b_TX_CH 11_ANT 0	Test Voltage	AC 120V/60Hz

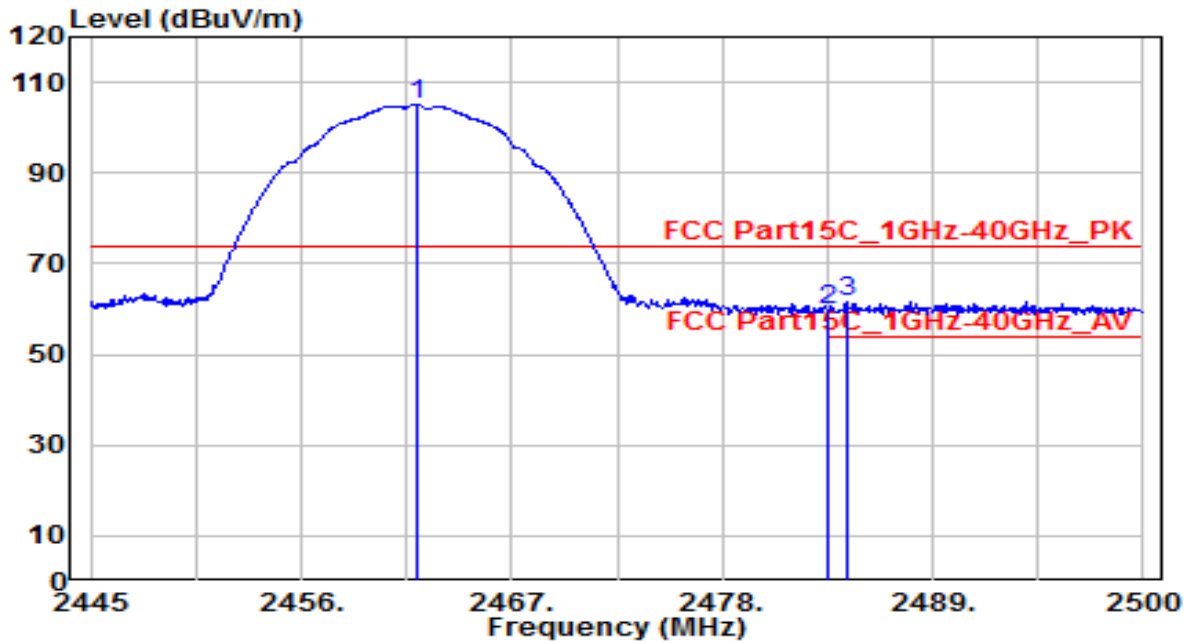

No	Frequency (MHz)	Reading (dBuV)	C.F (dB/m)	Measurement (dBuV/m)	Margin (dB)	Limit (dBuV/m)	Height (cm)	Angle (deg)	Remark (QP/PK/AV)
1	2461.995	72.73	32.54	105.27	N/A	N/A	210	190	Peak
2	2483.500	26.96	32.62	59.58	-14.42	74.00	210	190	Peak
3	* 2484.545	29.07	32.62	61.70	-12.30	74.00	210	190	Peak

Note:

1. " *", means this data is the worst emission level.
2. C.F (Correction Factor) = Antenna Factor (dB)+ Cable Loss (dB).
3. Measurement (dBuV/m) = Reading(dBuV) + C.F (Correction Factor).
4. The emission levels of other frequencies are very lower than the limit and not show in test report.

EUT	Home Security Wi-Fi Camera	Date of Test	2022-06-28
Factor	BBHA 9120D	Temp. / Humidity	23°C /62%
Polarity	Vertical	Site / Test Engineer	AC1 / Kaunaz
Test Mode	802.11b_TX_CH 11_ANT 0	Test Voltage	AC 120V/60Hz

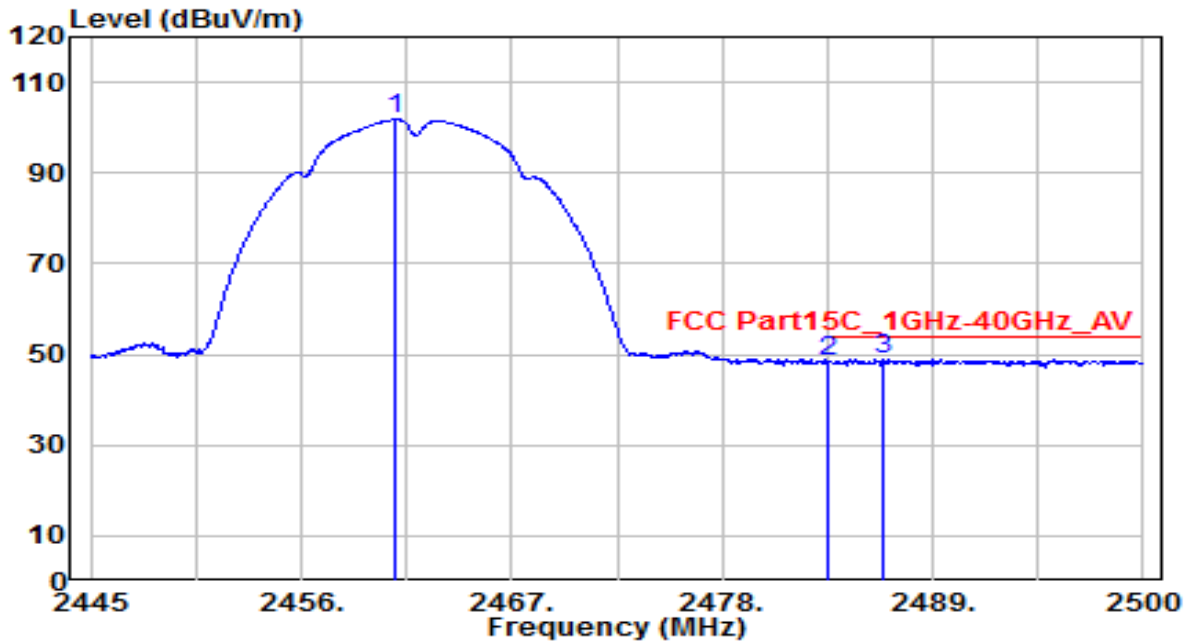

No	Frequency (MHz)	Reading (dBuV)	C.F (dB/m)	Measurement (dBuV/m)	Margin (dB)	Limit (dBuV/m)	Height (cm)	Angle (deg)	Remark (QP/PK/AV)
1	2460.950	69.26	32.54	101.79	N/A	N/A	210	190	Average
2	2483.500	15.71	32.62	48.33	-5.67	54.00	210	190	Average
3	* 2486.360	16.15	32.63	48.79	-5.21	54.00	210	190	Average

Note:

1. " *", means this data is the worst emission level.
2. C.F (Correction Factor) = Antenna Factor (dB)+ Cable Loss (dB).
3. Measurement (dBuV/m) = Reading(dBuV) + C.F (Correction Factor).
4. The emission levels of other frequencies are very lower than the limit and not show in test report.

EUT	Home Security Wi-Fi Camera	Date of Test	2022-06-28
Factor	BBHA 9120D	Temp. / Humidity	23°C /62%
Polarity	Horizontal	Site / Test Engineer	AC1 / Kaunaz
Test Mode	802.11g_TX_CH 1_ANT 0	Test Voltage	AC 120V/60Hz

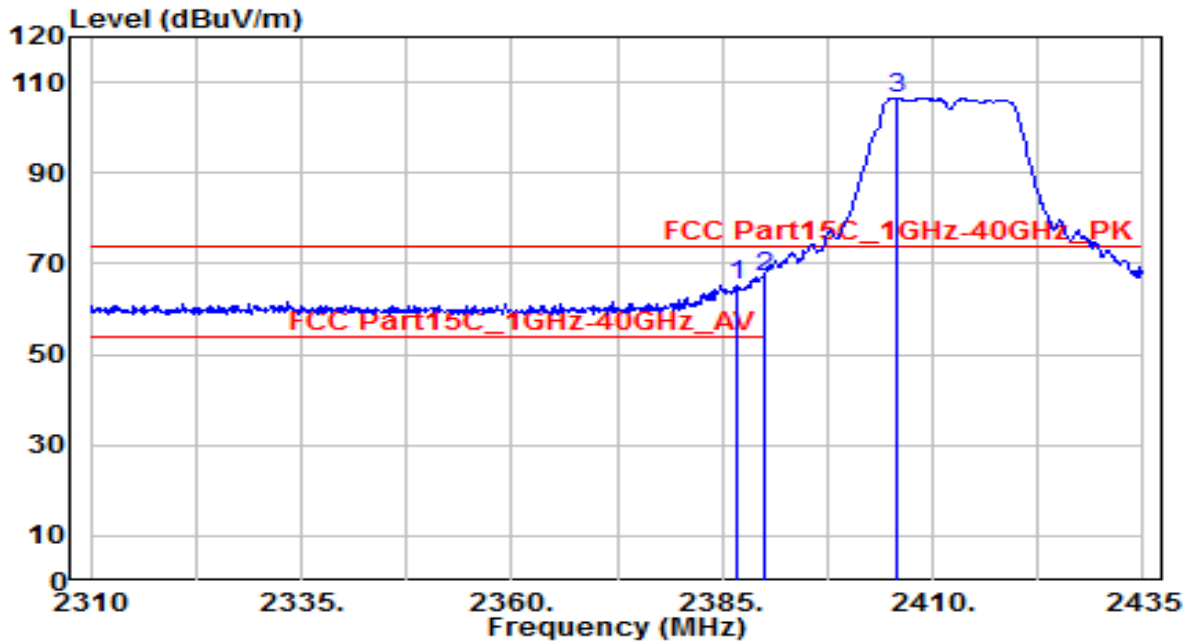

No	Frequency (MHz)	Reading (dBuV)	C.F (dB/m)	Measurement (dBuV/m)	Margin (dB)	Limit (dBuV/m)	Height (cm)	Angle (deg)	Remark (QP/PK/AV)
1	2386.875	33.07	32.27	65.34	-8.66	74.00	155	255	Peak
2	* 2390.000	34.84	32.28	67.13	-6.87	74.00	155	255	Peak
3	2405.750	74.18	32.34	106.52	N/A	N/A	155	255	Peak

Note:

1. " *", means this data is the worst emission level.
2. C.F (Correction Factor) = Antenna Factor (dB)+ Cable Loss (dB).
3. Measurement (dBuV/m) = Reading(dBuV) + C.F (Correction Factor).
4. The emission levels of other frequencies are very lower than the limit and not show in test report.

EUT	Home Security Wi-Fi Camera	Date of Test	2022-06-28
Factor	BBHA 9120D	Temp. / Humidity	23°C /62%
Polarity	Horizontal	Site / Test Engineer	AC1 / Kaunaz
Test Mode	802.11g_TX_CH 1_ANT 0	Test Voltage	AC 120V/60Hz

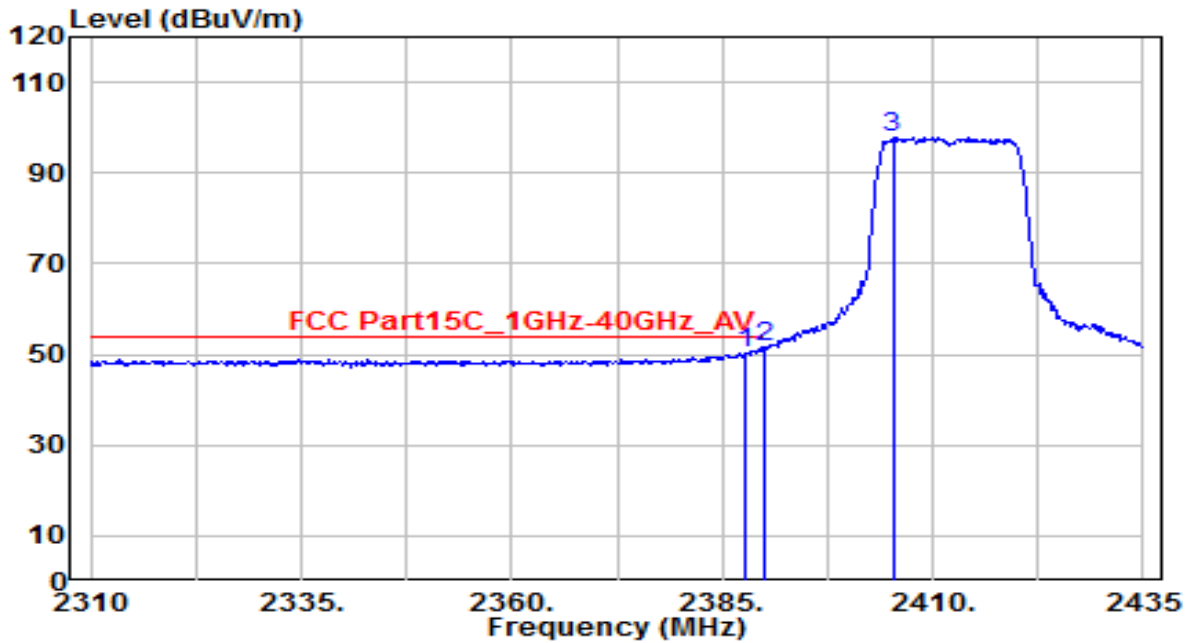

No	Frequency (MHz)	Reading (dBUV)	C.F (dB/m)	Measurement (dBUV/m)	Margin (dB)	Limit (dBUV/m)	Height (cm)	Angle (deg)	Remark (QP/PK/AV)
1	2387.875	18.14	32.28	50.41	-3.59	54.00	155	255	Average
2	* 2390.000	19.13	32.28	51.41	-2.59	54.00	155	255	Average
3	2405.250	65.67	32.34	98.01	N/A	N/A	155	255	Average

Note:

1. " *", means this data is the worst emission level.
2. C.F (Correction Factor) = Antenna Factor (dB)+ Cable Loss (dB).
3. Measurement (dBUV/m) = Reading(dBUV) + C.F (Correction Factor).
4. The emission levels of other frequencies are very lower than the limit and not show in test report.

EUT	Home Security Wi-Fi Camera	Date of Test	2022-06-28
Factor	BBHA 9120D	Temp. / Humidity	23°C /62%
Polarity	Vertical	Site / Test Engineer	AC1 / Kaunaz
Test Mode	802.11g_TX_CH 1_ANT 0	Test Voltage	AC 120V/60Hz

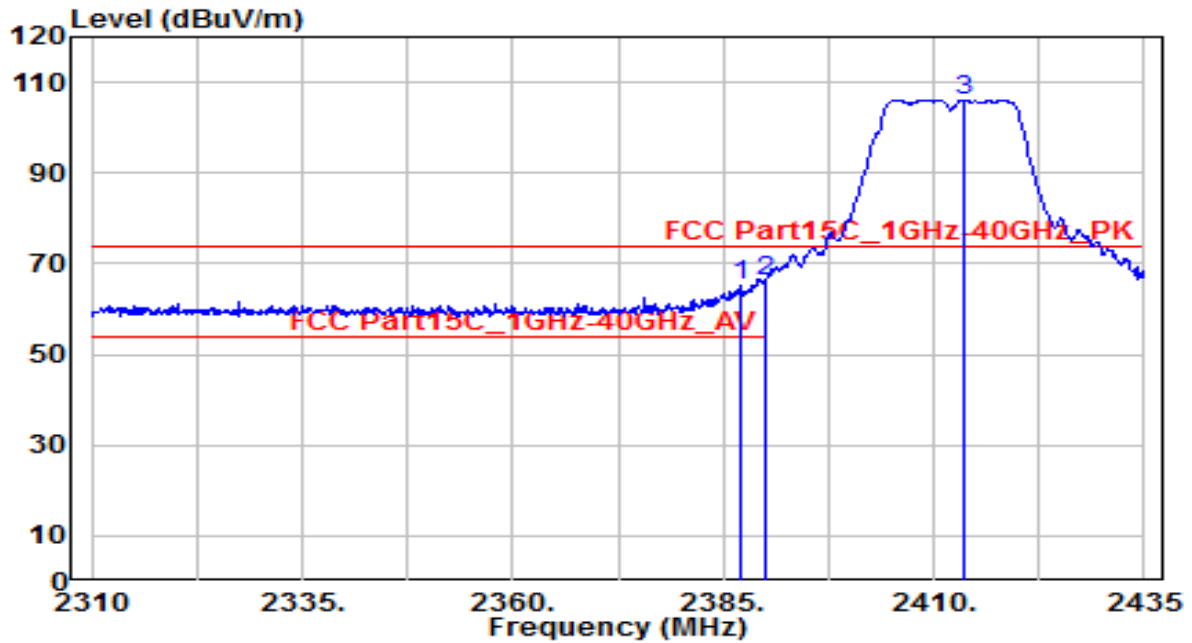

No	Frequency (MHz)	Reading (dBuV)	C.F (dB/m)	Measurement (dBuV/m)	Margin (dB)	Limit (dBuV/m)	Height (cm)	Angle (deg)	Remark (QP/PK/AV)
1	2387.000	32.73	32.27	65.00	-9.00	74.00	140	200	Peak
2	* 2390.000	33.67	32.28	65.95	-8.05	74.00	140	200	Peak
3	2413.625	73.70	32.37	106.07	N/A	N/A	140	200	Peak

Note:

1. " *", means this data is the worst emission level.
2. C.F (Correction Factor) = Antenna Factor (dB)+ Cable Loss (dB).
3. Measurement (dBuV/m) = Reading(dBuV) + C.F (Correction Factor).
4. The emission levels of other frequencies are very lower than the limit and not show in test report.

EUT	Home Security Wi-Fi Camera	Date of Test	2022-06-28
Factor	BBHA 9120D	Temp. / Humidity	23°C /62%
Polarity	Vertical	Site / Test Engineer	AC1 / Kaunaz
Test Mode	802.11g_TX_CH 1_ANT 0	Test Voltage	AC 120V/60Hz

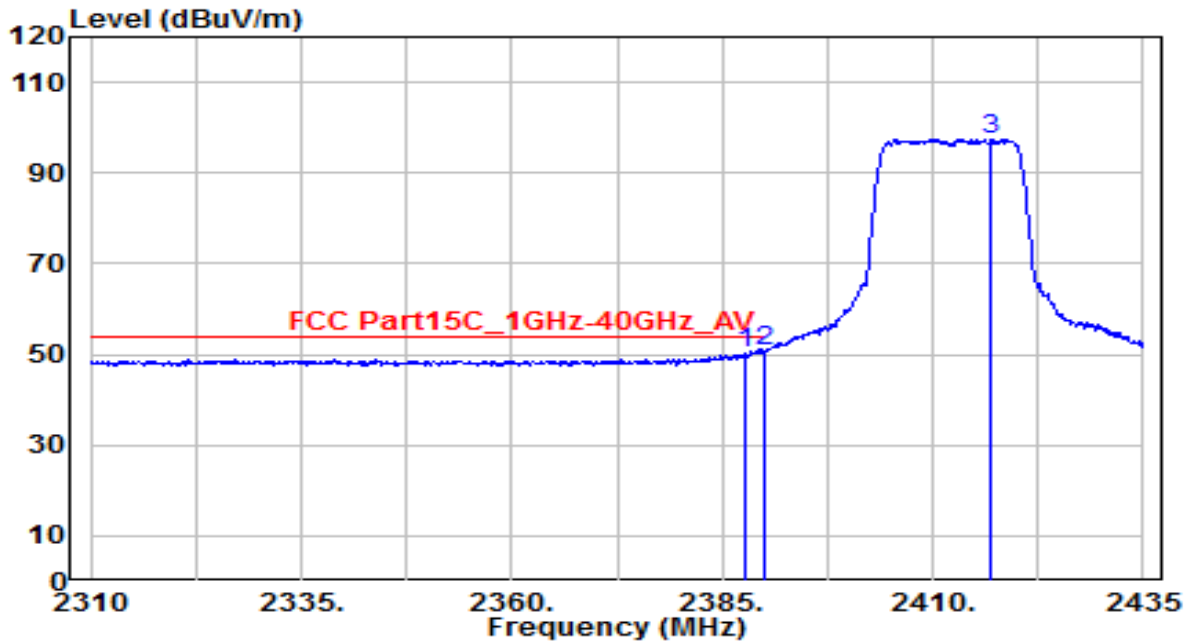

No	Frequency (MHz)	Reading (dBUV)	C.F (dB/m)	Measurement (dBUV/m)	Margin (dB)	Limit (dBUV/m)	Height (cm)	Angle (deg)	Remark (QP/PK/AV)
1	2387.875	18.05	32.28	50.32	-3.68	54.00	140	200	Average
2	* 2390.000	18.33	32.28	50.61	-3.39	54.00	140	200	Average
3	2416.875	65.07	32.38	97.45	N/A	N/A	140	200	Average

Note:

1. " *", means this data is the worst emission level.
2. C.F (Correction Factor) = Antenna Factor (dB)+ Cable Loss (dB).
3. Measurement (dBUV/m) = Reading(dBUV) + C.F (Correction Factor).
4. The emission levels of other frequencies are very lower than the limit and not show in test report.

EUT	Home Security Wi-Fi Camera	Date of Test	2022-06-28
Factor	BBHA 9120D	Temp. / Humidity	23°C /62%
Polarity	Horizontal	Site / Test Engineer	AC1 / Kaunaz
Test Mode	802.11g_TX_CH 6_ANT 0	Test Voltage	AC 120V/60Hz

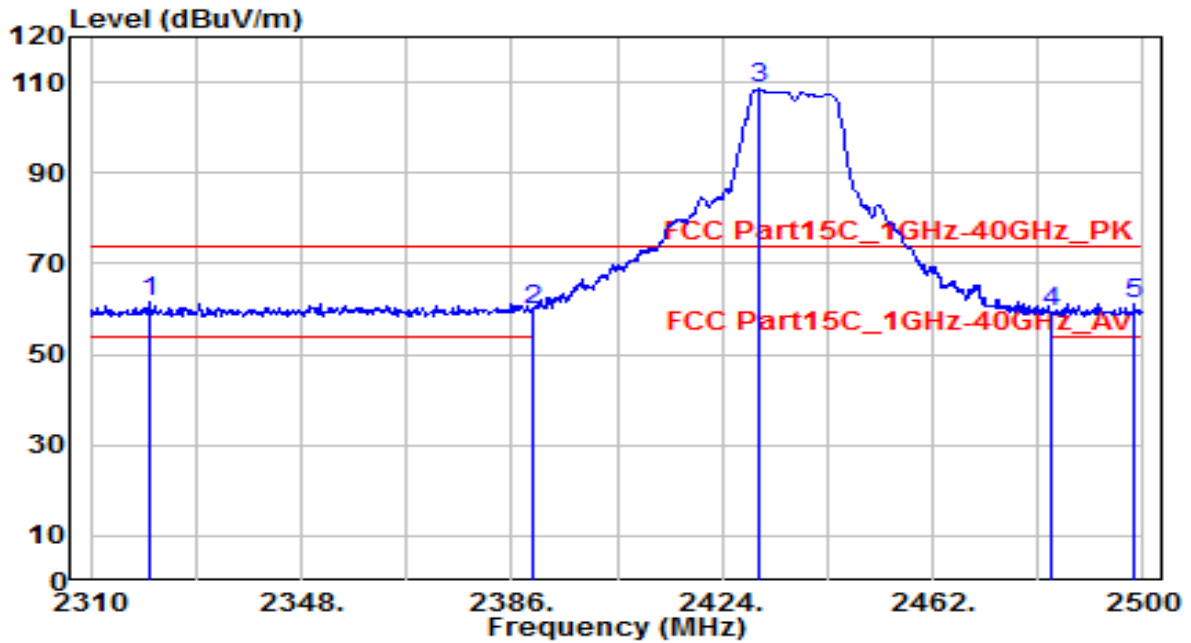

No	Frequency (MHz)	Reading (dBuV)	C.F (dB/m)	Measurement (dBuV/m)	Margin (dB)	Limit (dBuV/m)	Height (cm)	Angle (deg)	Remark (QP/PK/AV)
1	* 2320.830	29.34	32.03	61.37	-12.63	74.00	150	255	Peak
2	2390.000	27.54	32.28	59.82	-14.18	74.00	150	255	Peak
3	2430.650	76.06	32.43	108.49	N/A	N/A	150	255	Peak
4	2483.500	26.68	32.62	59.30	-14.70	74.00	150	255	Peak
5	2498.480	28.68	32.67	61.35	-12.65	74.00	150	255	Peak

Note:

1. " *", means this data is the worst emission level.
2. C.F (Correction Factor) = Antenna Factor (dB)+ Cable Loss (dB).
3. Measurement (dBuV/m) = Reading(dBuV) + C.F (Correction Factor).
4. The emission levels of other frequencies are very lower than the limit and not show in test report.

EUT	Home Security Wi-Fi Camera	Date of Test	2022-06-28
Factor	BBHA 9120D	Temp. / Humidity	23°C /62%
Polarity	Horizontal	Site / Test Engineer	AC1 / Kaunaz
Test Mode	802.11g_TX_CH 6_ANT 0	Test Voltage	AC 120V/60Hz

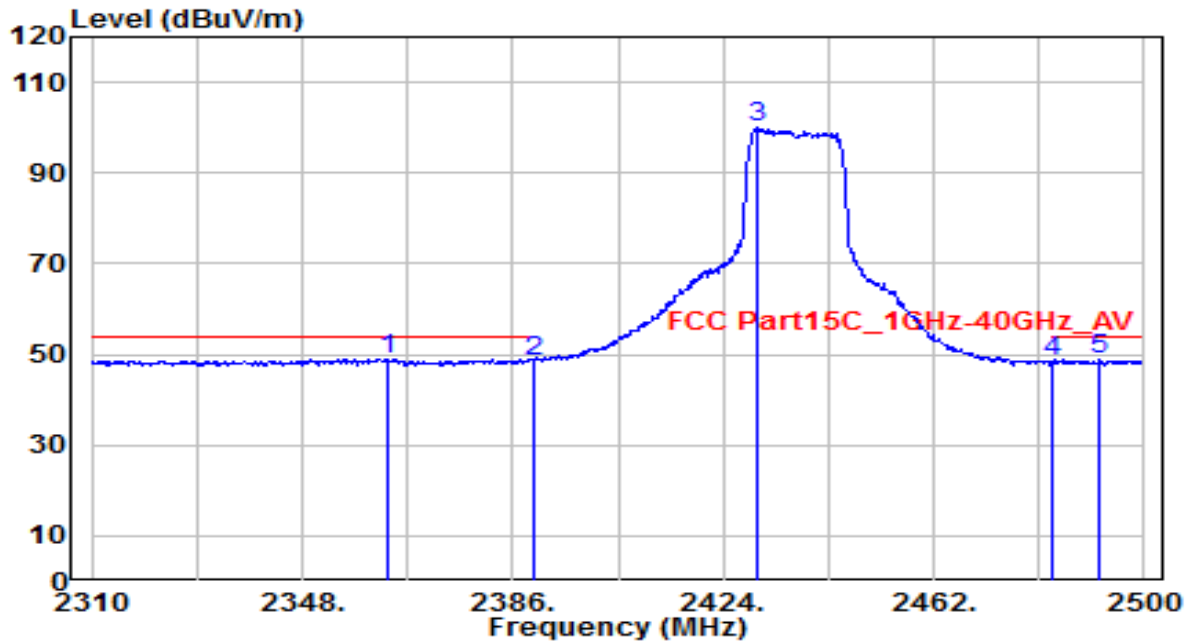

No	Frequency (MHz)	Reading (dBuV)	C.F (dB/m)	Measurement (dBuV/m)	Margin (dB)	Limit (dBuV/m)	Height (cm)	Angle (deg)	Remark (QP/PK/AV)	
1	*	2363.390	16.85	32.19	49.04	-4.96	54.00	150	255	Average
2		2390.000	16.25	32.28	48.53	-5.47	54.00	150	255	Average
3		2430.270	67.58	32.43	100.01	N/A	N/A	150	255	Average
4		2483.500	15.62	32.62	48.24	-5.76	54.00	150	255	Average
5		2491.830	16.05	32.65	48.70	-5.30	54.00	150	255	Average

Note:

- " *", means this data is the worst emission level.
- C.F (Correction Factor) = Antenna Factor (dB)+ Cable Loss (dB).
- Measurement (dBuV/m) = Reading(dBuV) + C.F (Correction Factor).
- The emission levels of other frequencies are very lower than the limit and not show in test report.

EUT	Home Security Wi-Fi Camera	Date of Test	2022-06-28
Factor	BBHA 9120D	Temp. / Humidity	23°C /62%
Polarity	Vertical	Site / Test Engineer	AC1 / Kaunaz
Test Mode	802.11g_TX_CH 6_ANT 0	Test Voltage	AC 120V/60Hz

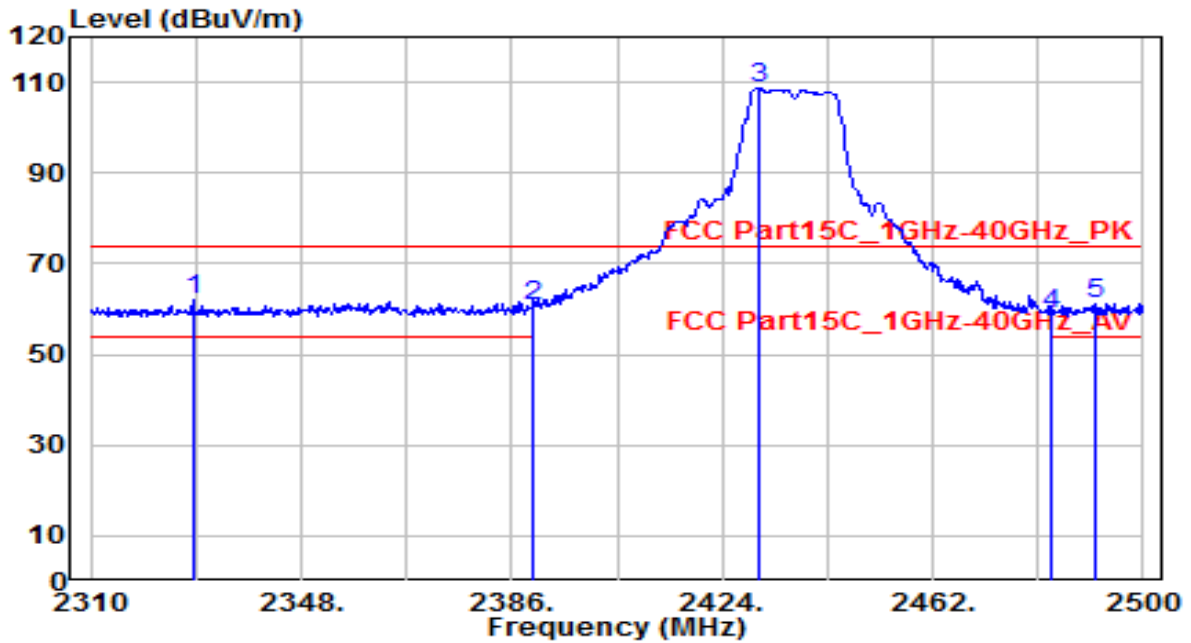

No	Frequency (MHz)	Reading (dBuV)	C.F (dB/m)	Measurement (dBuV/m)	Margin (dB)	Limit (dBuV/m)	Height (cm)	Angle (deg)	Remark (QP/PK/AV)
1	* 2328.430	29.99	32.06	62.05	-11.95	74.00	160	200	Peak
2	2390.000	28.42	32.28	60.70	-13.30	74.00	160	200	Peak
3	2430.840	76.21	32.43	108.64	N/A	N/A	160	200	Peak
4	2483.500	26.20	32.62	58.82	-15.18	74.00	160	200	Peak
5	2491.450	28.53	32.65	61.18	-12.82	74.00	160	200	Peak

Note:

1. " *", means this data is the worst emission level.
2. C.F (Correction Factor) = Antenna Factor (dB)+ Cable Loss (dB).
3. Measurement (dBuV/m) = Reading(dBuV) + C.F (Correction Factor).
4. The emission levels of other frequencies are very lower than the limit and not show in test report.

EUT	Home Security Wi-Fi Camera	Date of Test	2022-06-28
Factor	BBHA 9120D	Temp. / Humidity	23°C /62%
Polarity	Vertical	Site / Test Engineer	AC1 / Kaunaz
Test Mode	802.11g_TX_CH 6_ANT 0	Test Voltage	AC 120V/60Hz

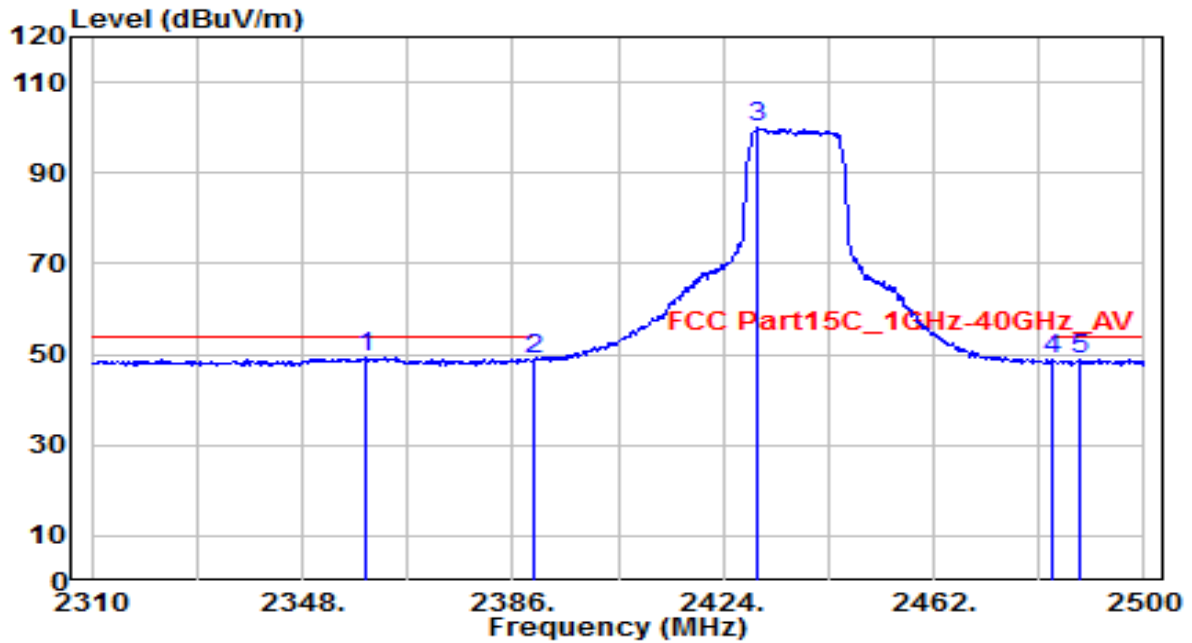

No	Frequency (MHz)	Reading (dBuV)	C.F (dB/m)	Measurement (dBuV/m)	Margin (dB)	Limit (dBuV/m)	Height (cm)	Angle (deg)	Remark (QP/PK/AV)
1	* 2359.400	17.08	32.17	49.26	-4.74	54.00	160	200	Average
2	2390.000	16.64	32.28	48.92	-5.08	54.00	160	200	Average
3	2430.270	67.44	32.43	99.87	N/A	N/A	160	200	Average
4	2483.500	16.10	32.62	48.72	-5.28	54.00	160	200	Average
5	2488.220	16.31	32.64	48.95	-5.05	54.00	160	200	Average

Note:

1. " *", means this data is the worst emission level.
2. C.F (Correction Factor) = Antenna Factor (dB)+ Cable Loss (dB).
3. Measurement (dBuV/m) = Reading(dBuV) + C.F (Correction Factor).
4. The emission levels of other frequencies are very lower than the limit and not show in test report.

EUT	Home Security Wi-Fi Camera	Date of Test	2022-06-28
Factor	BBHA 9120D	Temp. / Humidity	23°C /62%
Polarity	Horizontal	Site / Test Engineer	AC1 / Kaunaz
Test Mode	802.11g_TX_CH 11_ANT 0	Test Voltage	AC 120V/60Hz

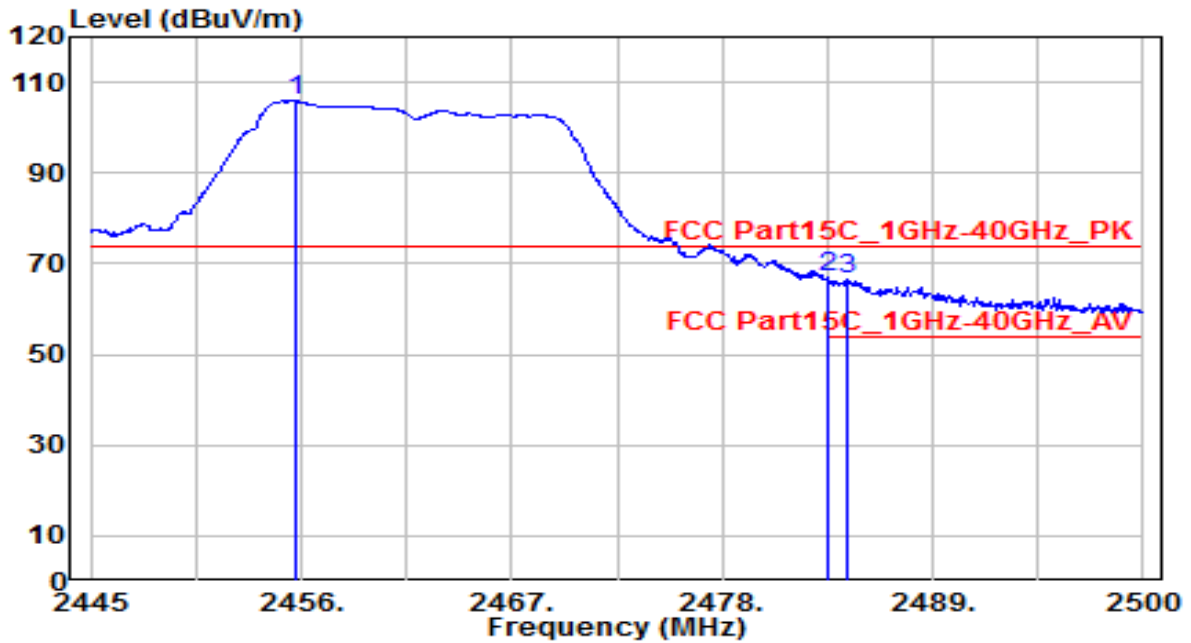

No	Frequency (MHz)	Reading (dBUV)	C.F (dB/m)	Measurement (dBUV/m)	Margin (dB)	Limit (dBUV/m)	Height (cm)	Angle (deg)	Remark (QP/PK/AV)
1	2455.670	73.33	32.52	105.85	N/A	N/A	150	250	Peak
2	* 2483.500	34.27	32.62	66.89	-7.11	74.00	150	250	Peak
3	2484.600	33.72	32.62	66.34	-7.66	74.00	150	250	Peak

Note:

1. " *", means this data is the worst emission level.
2. C.F (Correction Factor) = Antenna Factor (dB)+ Cable Loss (dB).
3. Measurement (dBUV/m) = Reading(dBUV) + C.F (Correction Factor).
4. The emission levels of other frequencies are very lower than the limit and not show in test report.

EUT	Home Security Wi-Fi Camera	Date of Test	2022-06-28
Factor	BBHA 9120D	Temp. / Humidity	23°C /62%
Polarity	Horizontal	Site / Test Engineer	AC1 / Kaunaz
Test Mode	802.11g_TX_CH 11_ANT 0	Test Voltage	AC 120V/60Hz

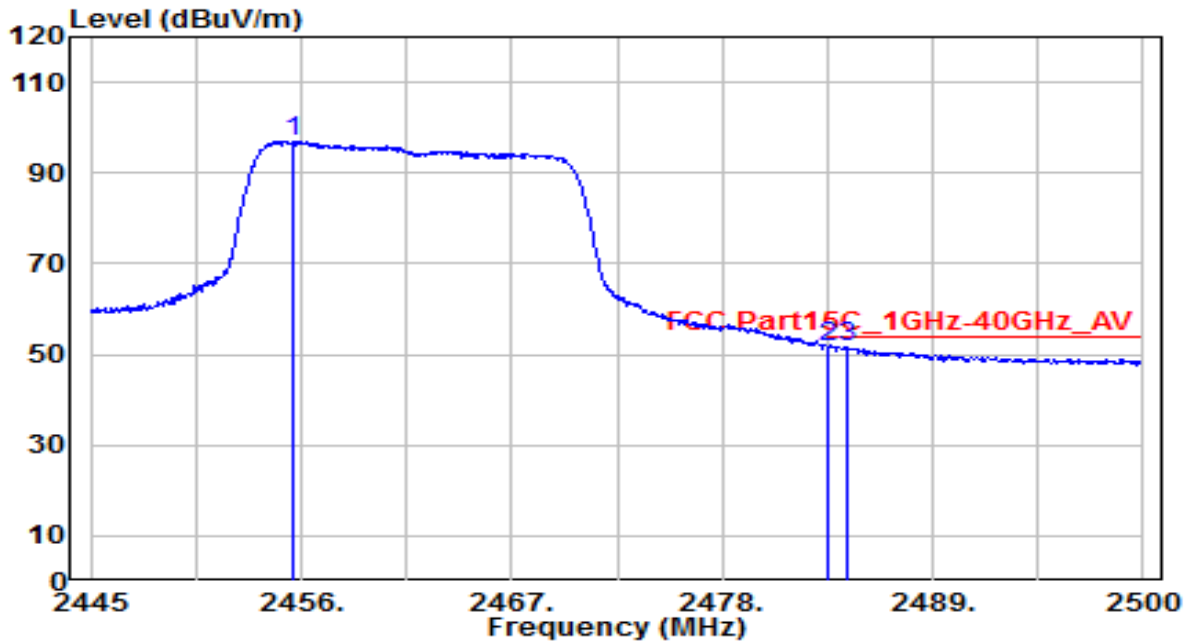

No	Frequency (MHz)	Reading (dBuV)	C.F (dB/m)	Measurement (dBuV/m)	Margin (dB)	Limit (dBuV/m)	Height (cm)	Angle (deg)	Remark (QP/PK/AV)
1	2455.560	64.56	32.52	97.08	N/A	N/A	150	250	Average
2	* 2483.500	18.94	32.62	51.56	-2.44	54.00	150	250	Average
3	2484.490	18.93	32.62	51.55	-2.45	54.00	150	250	Average

Note:

1. " *", means this data is the worst emission level.
2. C.F (Correction Factor) = Antenna Factor (dB)+ Cable Loss (dB).
3. Measurement (dBuV/m) = Reading(dBuV) + C.F (Correction Factor).
4. The emission levels of other frequencies are very lower than the limit and not show in test report.

EUT	Home Security Wi-Fi Camera	Date of Test	2022-06-28
Factor	BBHA 9120D	Temp. / Humidity	23°C /62%
Polarity	Vertical	Site / Test Engineer	AC1 / Kaunaz
Test Mode	802.11g_TX_CH 11_ANT 0	Test Voltage	AC 120V/60Hz

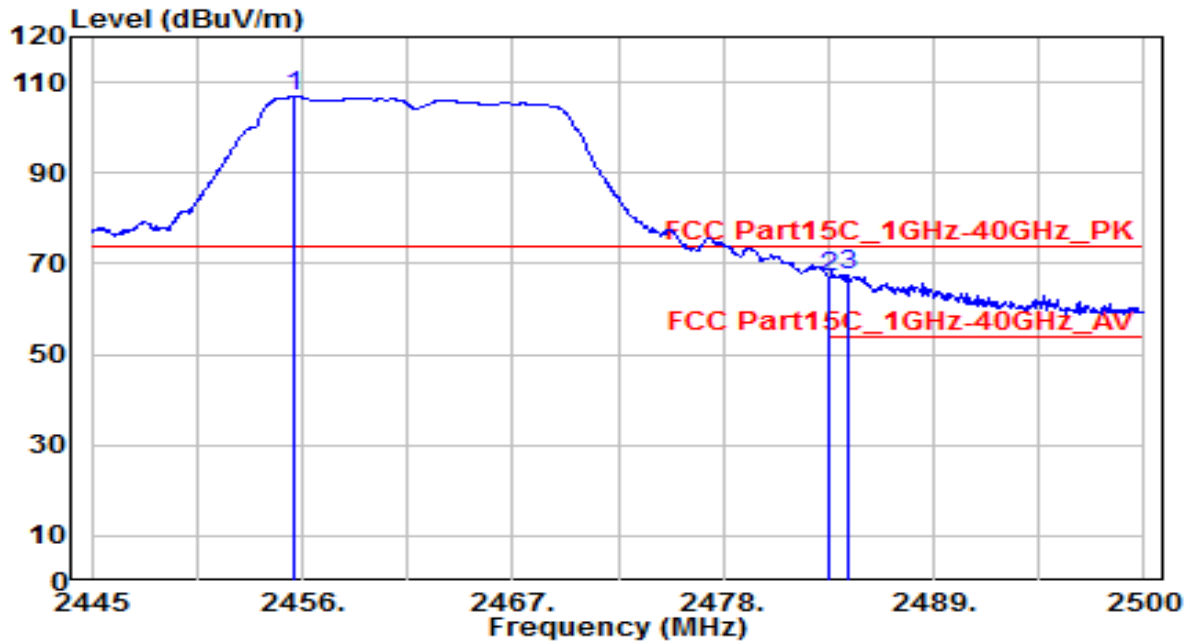

No	Frequency (MHz)	Reading (dBuV)	C.F (dB/m)	Measurement (dBuV/m)	Margin (dB)	Limit (dBuV/m)	Height (cm)	Angle (deg)	Remark (QP/PK/AV)
1	2455.615	74.24	32.52	106.76	N/A	N/A	210	190	Peak
2	2483.500	34.20	32.62	66.82	-7.18	74.00	210	190	Peak
3	* 2484.490	35.07	32.62	67.69	-6.31	74.00	210	190	Peak

Note:

1. " *", means this data is the worst emission level.
2. C.F (Correction Factor) = Antenna Factor (dB)+ Cable Loss (dB).
3. Measurement (dBuV/m) = Reading(dBuV) + C.F (Correction Factor).
4. The emission levels of other frequencies are very lower than the limit and not show in test report.

EUT	Home Security Wi-Fi Camera	Date of Test	2022-06-28
Factor	BBHA 9120D	Temp. / Humidity	23°C /62%
Polarity	Vertical	Site / Test Engineer	AC1 / Kaunaz
Test Mode	802.11g_TX_CH 11_ANT 0	Test Voltage	AC 120V/60Hz

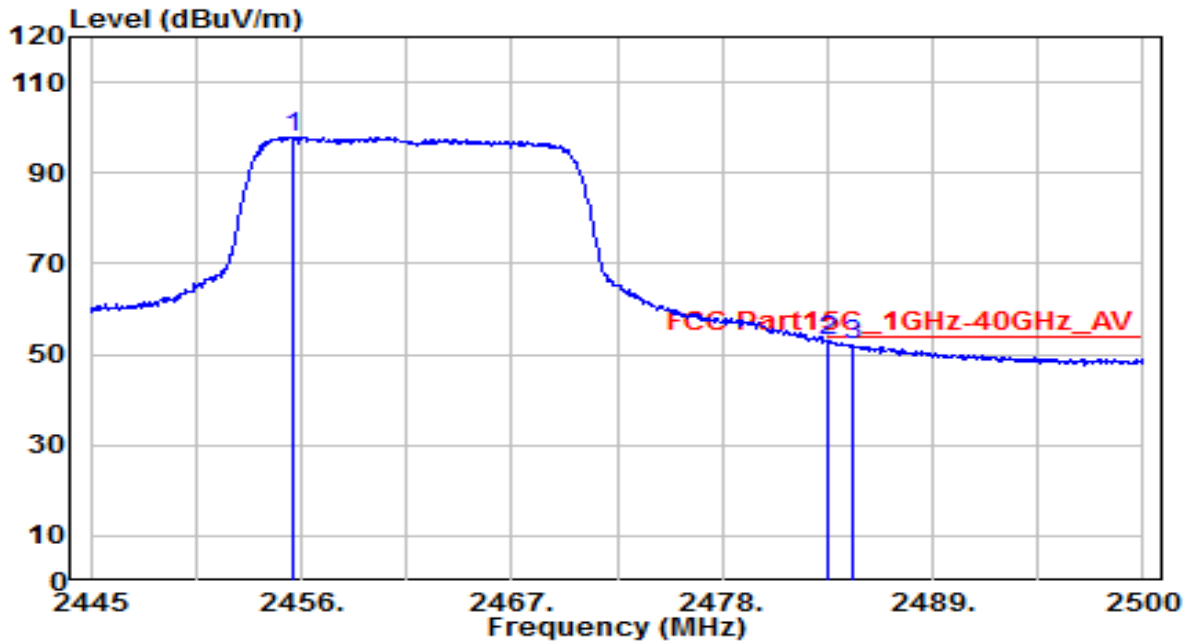

No	Frequency (MHz)	Reading (dBuV)	C.F (dB/m)	Measurement (dBuV/m)	Margin (dB)	Limit (dBuV/m)	Height (cm)	Angle (deg)	Remark (QP/PK/AV)
1	2455.615	65.51	32.52	98.03	N/A	N/A	210	190	Average
2	* 2483.500	20.15	32.62	52.77	-1.23	54.00	210	190	Average
3	2484.765	19.52	32.63	52.15	-1.85	54.00	210	190	Average

Note:

1. " *", means this data is the worst emission level.
2. C.F (Correction Factor) = Antenna Factor (dB)+ Cable Loss (dB).
3. Measurement (dBuV/m) = Reading(dBuV) + C.F (Correction Factor).
4. The emission levels of other frequencies are very lower than the limit and not show in test report.

EUT	Home Security Wi-Fi Camera	Date of Test	2022-06-28
Factor	BBHA 9120D	Temp. / Humidity	23°C /62%
Polarity	Horizontal	Site / Test Engineer	AC1 / Kaunaz
Test Mode	802.11n-20MHz_TX_CH 1_ANT 0	Test Voltage	AC 120V/60Hz

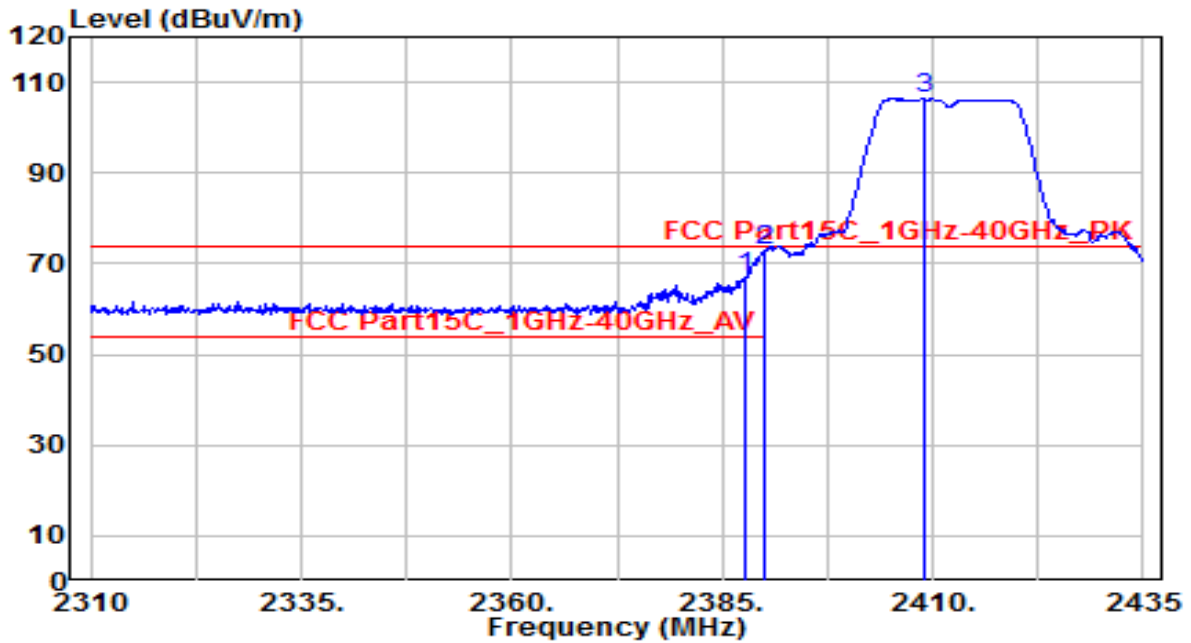

No	Frequency (MHz)	Reading (dBuV)	C.F (dB/m)	Measurement (dBuV/m)	Margin (dB)	Limit (dBuV/m)	Height (cm)	Angle (deg)	Remark (QP/PK/AV)
1	2387.875	34.94	32.28	67.22	-6.78	74.00	155	255	Peak
2	* 2390.000	40.42	32.28	72.70	-1.30	74.00	155	255	Peak
3	2408.875	74.13	32.35	106.48	N/A	N/A	155	255	Peak

Note:

1. " *", means this data is the worst emission level.
2. C.F (Correction Factor) = Antenna Factor (dB)+ Cable Loss (dB).
3. Measurement (dBuV/m) = Reading(dBuV) + C.F (Correction Factor).
4. The emission levels of other frequencies are very lower than the limit and not show in test report.

EUT	Home Security Wi-Fi Camera	Date of Test	2022-06-28
Factor	BBHA 9120D	Temp. / Humidity	23°C /62%
Polarity	Horizontal	Site / Test Engineer	AC1 / Kaunaz
Test Mode	802.11n-20MHz_TX_CH 1_ANT 0	Test Voltage	AC 120V/60Hz

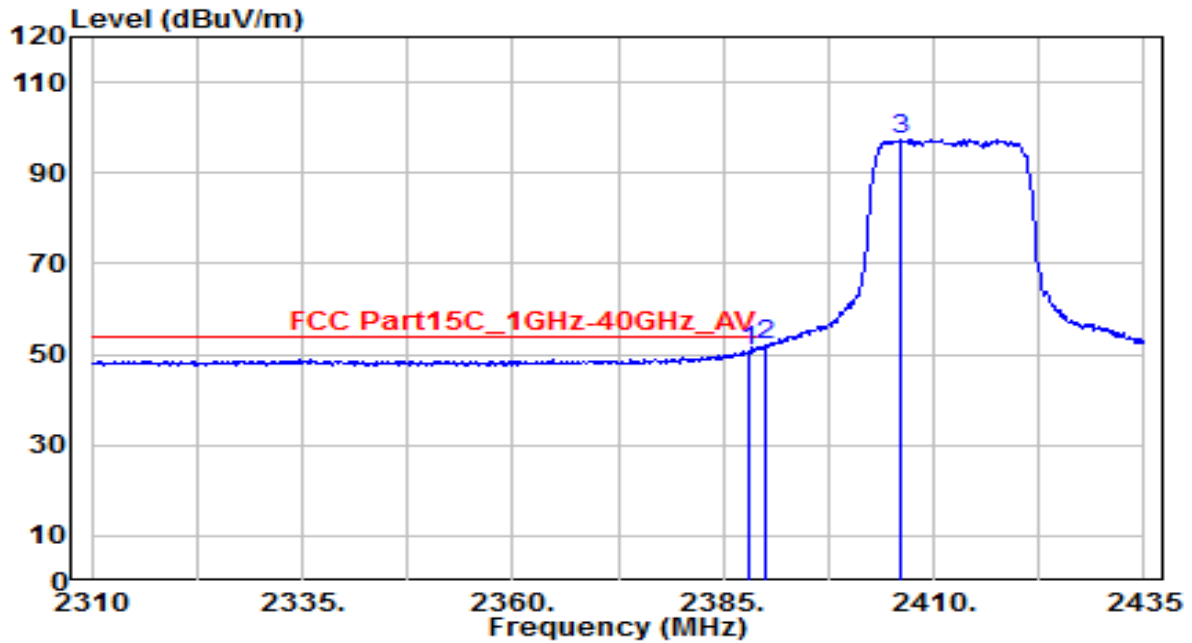

No	Frequency (MHz)	Reading (dBuV)	C.F (dB/m)	Measurement (dBuV/m)	Margin (dB)	Limit (dBuV/m)	Height (cm)	Angle (deg)	Remark (QP/PK/AV)
1	2388.000	18.55	32.28	50.83	-3.17	54.00	155	255	Average
2	* 2390.000	19.80	32.28	52.08	-1.92	54.00	155	255	Average
3	2406.125	64.96	32.34	97.30	N/A	N/A	155	255	Average

Note:

1. " *", means this data is the worst emission level.
2. C.F (Correction Factor) = Antenna Factor (dB)+ Cable Loss (dB).
3. Measurement (dBuV/m) = Reading(dBuV) + C.F (Correction Factor).
4. The emission levels of other frequencies are very lower than the limit and not show in test report.

EUT	Home Security Wi-Fi Camera	Date of Test	2022-06-28
Factor	BBHA 9120D	Temp. / Humidity	23°C /62%
Polarity	Vertical	Site / Test Engineer	AC1 / Kaunaz
Test Mode	802.11n-20MHz_TX_CH 1_ANT 0	Test Voltage	AC 120V/60Hz

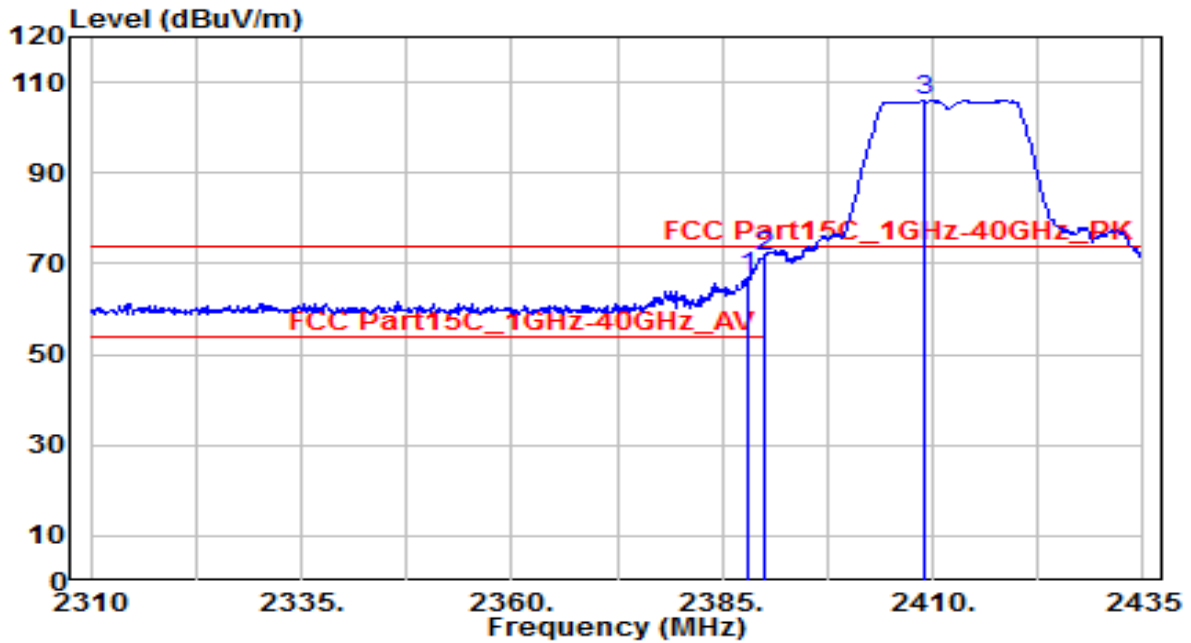

No	Frequency (MHz)	Reading (dBuV)	C.F (dB/m)	Measurement (dBuV/m)	Margin (dB)	Limit (dBuV/m)	Height (cm)	Angle (deg)	Remark (QP/PK/AV)
1	2388.000	34.93	32.28	67.21	-6.79	74.00	140	200	Peak
2	* 2390.000	39.41	32.28	71.69	-2.31	74.00	140	200	Peak
3	2408.875	73.65	32.35	106.00	N/A	N/A	140	200	Peak

Note:

1. " *", means this data is the worst emission level.
2. C.F (Correction Factor) = Antenna Factor (dB)+ Cable Loss (dB).
3. Measurement (dBuV/m) = Reading(dBuV) + C.F (Correction Factor).
4. The emission levels of other frequencies are very lower than the limit and not show in test report.

EUT	Home Security Wi-Fi Camera	Date of Test	2022-06-28
Factor	BBHA 9120D	Temp. / Humidity	23°C /62%
Polarity	Vertical	Site / Test Engineer	AC1 / Kaunaz
Test Mode	802.11n-20MHz_TX_CH 1_ANT 0	Test Voltage	AC 120V/60Hz

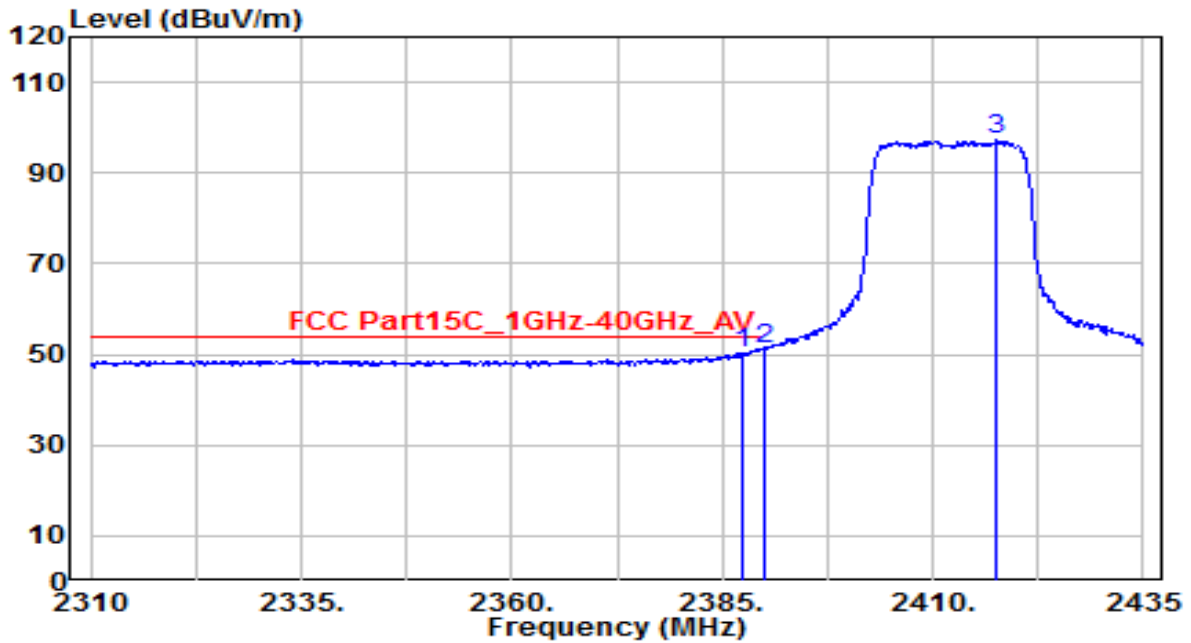

No	Frequency (MHz)	Reading (dBuV)	C.F (dB/m)	Measurement (dBuV/m)	Margin (dB)	Limit (dBuV/m)	Height (cm)	Angle (deg)	Remark (QP/PK/AV)
1	2387.375	18.14	32.27	50.41	-3.59	54.00	140	200	Average
2	* 2390.000	18.83	32.28	51.11	-2.89	54.00	140	200	Average
3	2417.625	64.77	32.38	97.16	N/A	N/A	140	200	Average

Note:

1. " *", means this data is the worst emission level.
2. C.F (Correction Factor) = Antenna Factor (dB)+ Cable Loss (dB).
3. Measurement (dBuV/m) = Reading(dBuV) + C.F (Correction Factor).
4. The emission levels of other frequencies are very lower than the limit and not show in test report.

EUT	Home Security Wi-Fi Camera	Date of Test	2022-06-28
Factor	BBHA 9120D	Temp. / Humidity	23°C /62%
Polarity	Horizontal	Site / Test Engineer	AC1 / Kaunaz
Test Mode	802.11n-20MHz_TX_CH 6_ANT 0	Test Voltage	AC 120V/60Hz

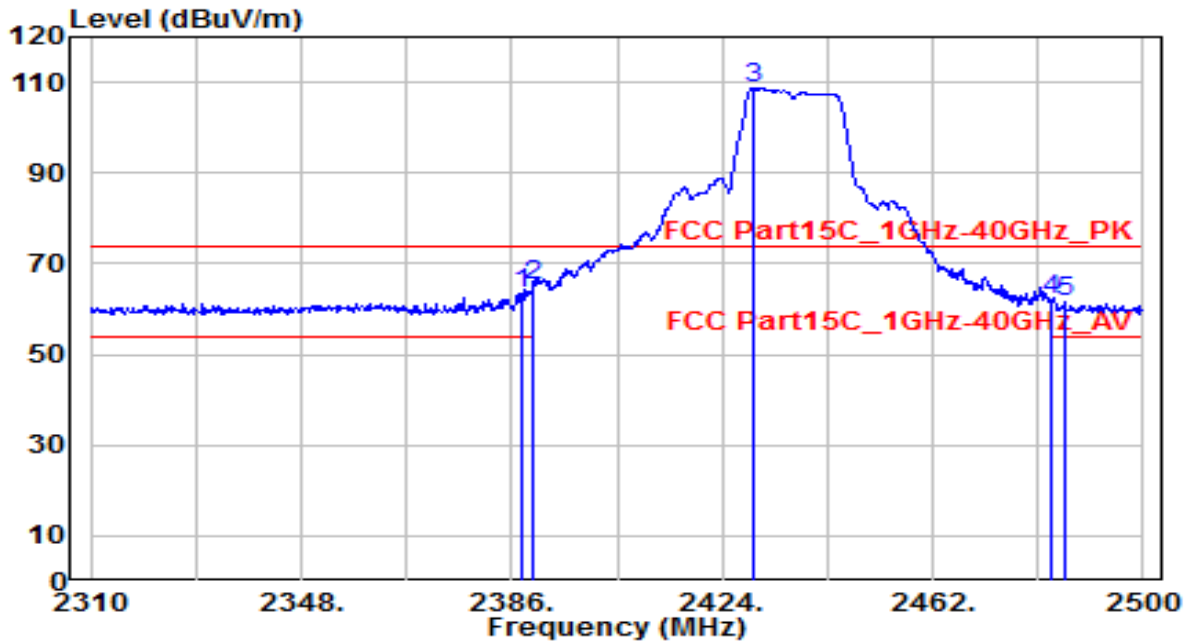

No	Frequency (MHz)	Reading (dBUV)	C.F (dB/m)	Measurement (dBUV/m)	Margin (dB)	Limit (dBUV/m)	Height (cm)	Angle (deg)	Remark (QP/PK/AV)
1	2387.710	31.16	32.28	63.44	-10.56	74.00	150	255	Peak
2	* 2390.000	33.12	32.28	65.40	-8.60	74.00	150	255	Peak
3	2429.510	76.16	32.43	108.59	N/A	N/A	150	255	Peak
4	2483.500	29.39	32.62	62.01	-11.99	74.00	150	255	Peak
5	2485.940	28.78	32.63	61.41	-12.59	74.00	150	255	Peak

Note:

- "*" means this data is the worst emission level.
- C.F (Correction Factor) = Antenna Factor (dB)+ Cable Loss (dB).
- Measurement (dBUV/m) = Reading(dBUV) + C.F (Correction Factor).
- The emission levels of other frequencies are very lower than the limit and not show in test report.

EUT	Home Security Wi-Fi Camera	Date of Test	2022-06-28
Factor	BBHA 9120D	Temp. / Humidity	23°C /62%
Polarity	Horizontal	Site / Test Engineer	AC1 / Kaunaz
Test Mode	802.11n-20MHz_TX_CH 6_ANT 0	Test Voltage	AC 120V/60Hz

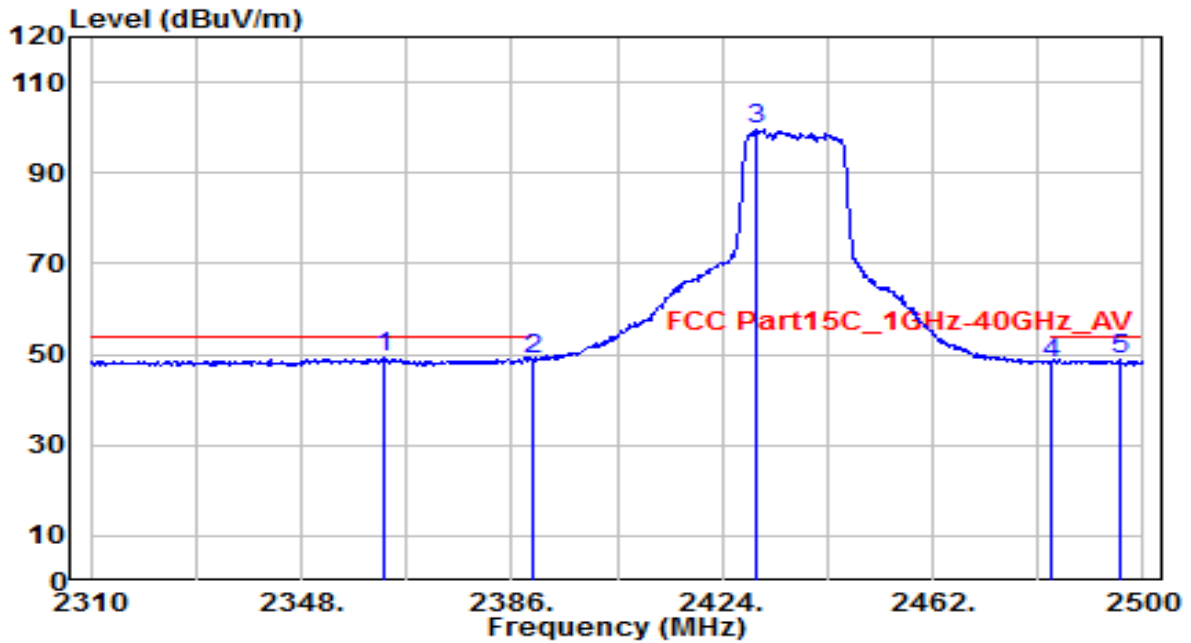

No	Frequency (MHz)	Reading (dBuV)	C.F (dB/m)	Measurement (dBuV/m)	Margin (dB)	Limit (dBuV/m)	Height (cm)	Angle (deg)	Remark (QP/PK/AV)
1	* 2362.820	16.95	32.19	49.14	-4.86	54.00	150	255	Average
2	2390.000	16.49	32.28	48.77	-5.23	54.00	150	255	Average
3	2430.270	67.11	32.43	99.54	N/A	N/A	150	255	Average
4	2483.500	15.22	32.62	47.84	-6.16	54.00	150	255	Average
5	2495.820	16.09	32.66	48.75	-5.25	54.00	150	255	Average

Note:

- " *", means this data is the worst emission level.
- C.F (Correction Factor) = Antenna Factor (dB)+ Cable Loss (dB).
- Measurement (dBuV/m) = Reading(dBuV) + C.F (Correction Factor).
- The emission levels of other frequencies are very lower than the limit and not show in test report.

EUT	Home Security Wi-Fi Camera	Date of Test	2022-06-28
Factor	BBHA 9120D	Temp. / Humidity	23°C /62%
Polarity	Vertical	Site / Test Engineer	AC1 / Kaunaz
Test Mode	802.11n-20MHz_TX_CH 6_ANT 0	Test Voltage	AC 120V/60Hz

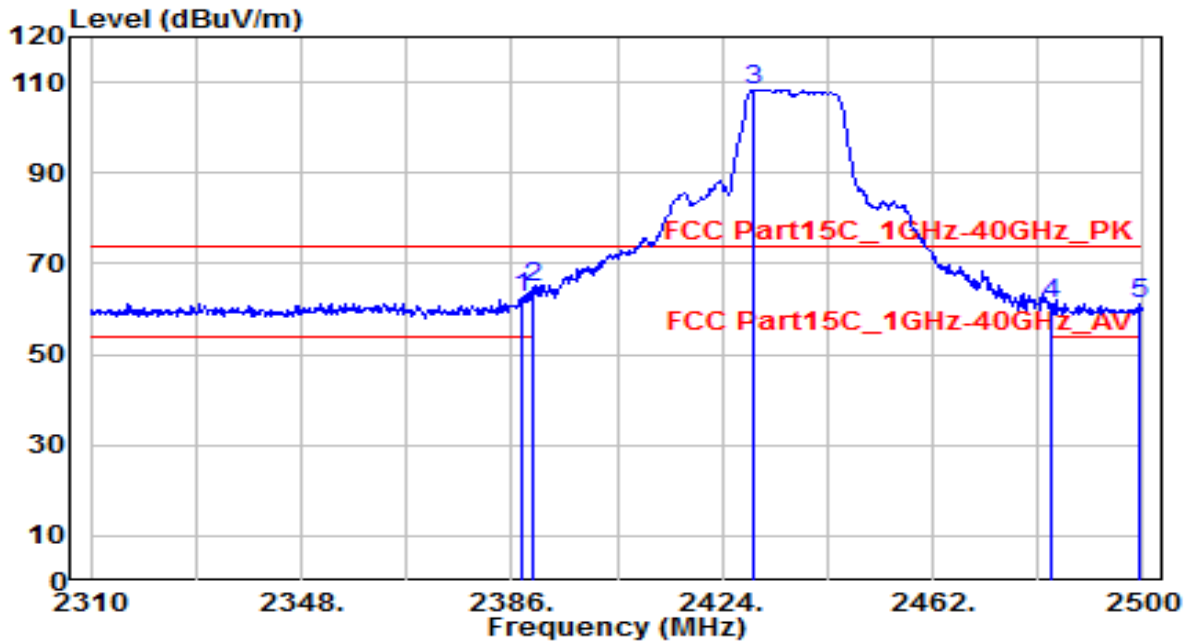

No	Frequency (MHz)	Reading (dBuV)	C.F (dB/m)	Measurement (dBuV/m)	Margin (dB)	Limit (dBuV/m)	Height (cm)	Angle (deg)	Remark (QP/PK/AV)
1	2387.710	30.13	32.28	62.41	-11.59	74.00	160	200	Peak
2	* 2390.000	32.56	32.28	64.85	-9.15	74.00	160	200	Peak
3	2429.700	76.00	32.43	108.43	N/A	N/A	160	200	Peak
4	2483.500	28.72	32.62	61.34	-12.66	74.00	160	200	Peak
5	2499.430	28.45	32.68	61.13	-12.87	74.00	160	200	Peak

Note:

1. " *", means this data is the worst emission level.
2. C.F (Correction Factor) = Antenna Factor (dB)+ Cable Loss (dB).
3. Measurement (dBuV/m) = Reading(dBuV) + C.F (Correction Factor).
4. The emission levels of other frequencies are very lower than the limit and not show in test report.

EUT	Home Security Wi-Fi Camera	Date of Test	2022-06-28
Factor	BBHA 9120D	Temp. / Humidity	23°C /62%
Polarity	Vertical	Site / Test Engineer	AC1 / Kaunaz
Test Mode	802.11n-20MHz_TX_CH 6_ANT 0	Test Voltage	AC 120V/60Hz

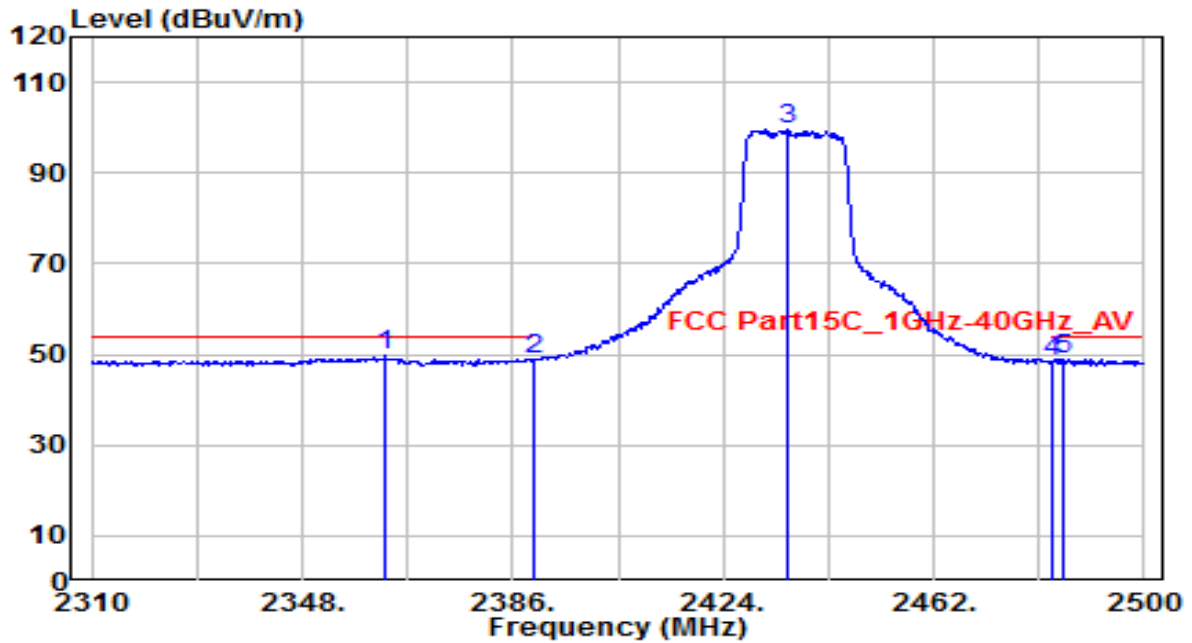

No	Frequency (MHz)	Reading (dBuV)	C.F (dB/m)	Measurement (dBuV/m)	Margin (dB)	Limit (dBuV/m)	Height (cm)	Angle (deg)	Remark (QP/PK/AV)	
1	*	2363.010	17.44	32.19	49.63	-4.37	54.00	160	200	Average
2		2390.000	16.76	32.28	49.05	-4.95	54.00	160	200	Average
3		2435.590	67.33	32.45	99.78	N/A	N/A	160	200	Average
4		2483.500	15.89	32.62	48.51	-5.49	54.00	160	200	Average
5		2485.180	16.28	32.63	48.91	-5.09	54.00	160	200	Average

Note:

- " *", means this data is the worst emission level.
- C.F (Correction Factor) = Antenna Factor (dB)+ Cable Loss (dB).
- Measurement (dBuV/m) = Reading(dBuV) + C.F (Correction Factor).
- The emission levels of other frequencies are very lower than the limit and not show in test report.

EUT	Home Security Wi-Fi Camera	Date of Test	2022-06-28
Factor	BBHA 9120D	Temp. / Humidity	23°C /62%
Polarity	Horizontal	Site / Test Engineer	AC1 / Kaunaz
Test Mode	802.11n-20MHz_TX_CH 11_ANT 0	Test Voltage	AC 120V/60Hz

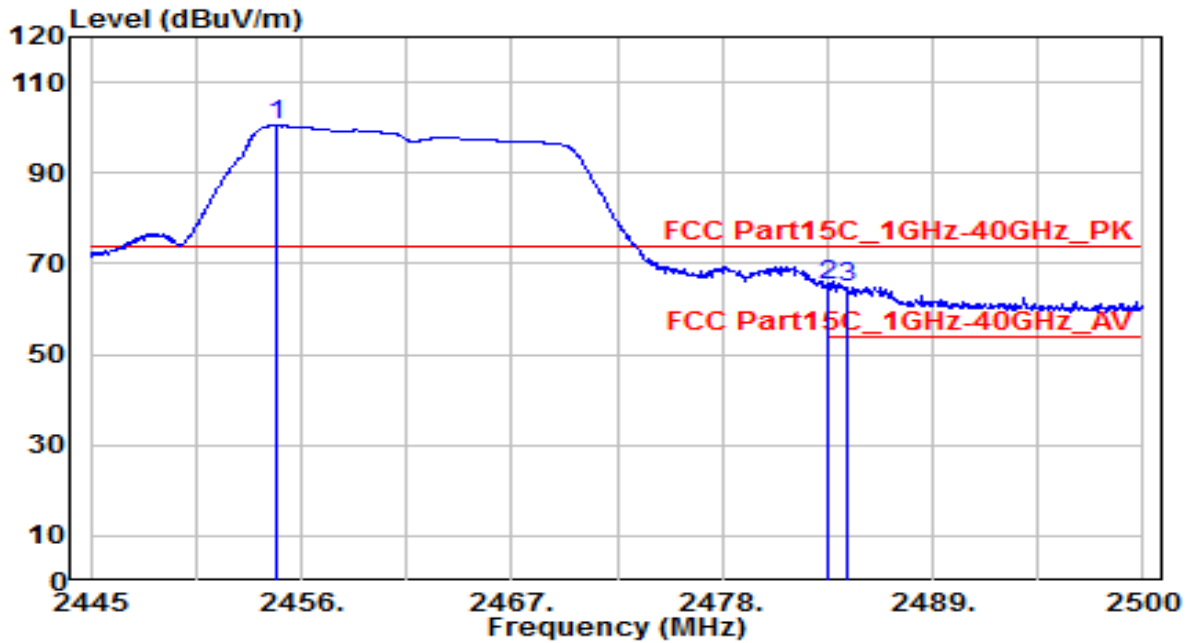

No	Frequency (MHz)	Reading (dBuV)	C.F (dB/m)	Measurement (dBuV/m)	Margin (dB)	Limit (dBuV/m)	Height (cm)	Angle (deg)	Remark (QP/PK/AV)
1	2454.680	67.91	32.52	100.43	N/A	N/A	150	250	Peak
2	* 2483.500	32.68	32.62	65.30	-8.70	74.00	150	250	Peak
3	2484.545	32.17	32.62	64.79	-9.21	74.00	150	250	Peak

Note:

1. " *", means this data is the worst emission level.
2. C.F (Correction Factor) = Antenna Factor (dB)+ Cable Loss (dB).
3. Measurement (dBuV/m) = Reading(dBuV) + C.F (Correction Factor).
4. The emission levels of other frequencies are very lower than the limit and not show in test report.

EUT	Home Security Wi-Fi Camera	Date of Test	2022-06-28
Factor	BBHA 9120D	Temp. / Humidity	23°C /62%
Polarity	Horizontal	Site / Test Engineer	AC1 / Kaunaz
Test Mode	802.11n-20MHz_TX_CH 11_ANT 0	Test Voltage	AC 120V/60Hz

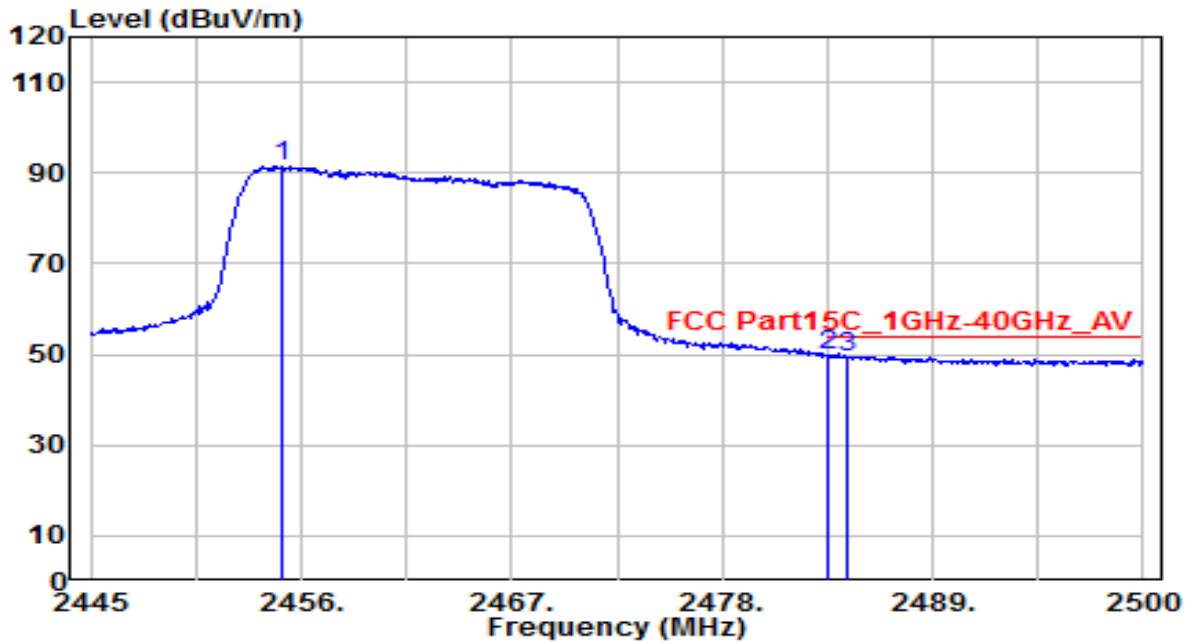

No	Frequency (MHz)	Reading (dBuV)	C.F (dB/m)	Measurement (dBuV/m)	Margin (dB)	Limit (dBuV/m)	Height (cm)	Angle (deg)	Remark (QP/PK/AV)
1	2454.955	59.13	32.52	91.65	N/A	N/A	150	250	Average
2	* 2483.500	16.99	32.62	49.61	-4.39	54.00	150	250	Average
3	2484.490	16.94	32.62	49.57	-4.43	54.00	150	250	Average

Note:

1. " *", means this data is the worst emission level.
2. C.F (Correction Factor) = Antenna Factor (dB)+ Cable Loss (dB).
3. Measurement (dBuV/m) = Reading(dBuV) + C.F (Correction Factor).
4. The emission levels of other frequencies are very lower than the limit and not show in test report.

EUT	Home Security Wi-Fi Camera	Date of Test	2022-06-28
Factor	BBHA 9120D	Temp. / Humidity	23°C /62%
Polarity	Vertical	Site / Test Engineer	AC1 / Kaunaz
Test Mode	802.11n-20MHz_TX_CH 11_ANT 0	Test Voltage	AC 120V/60Hz

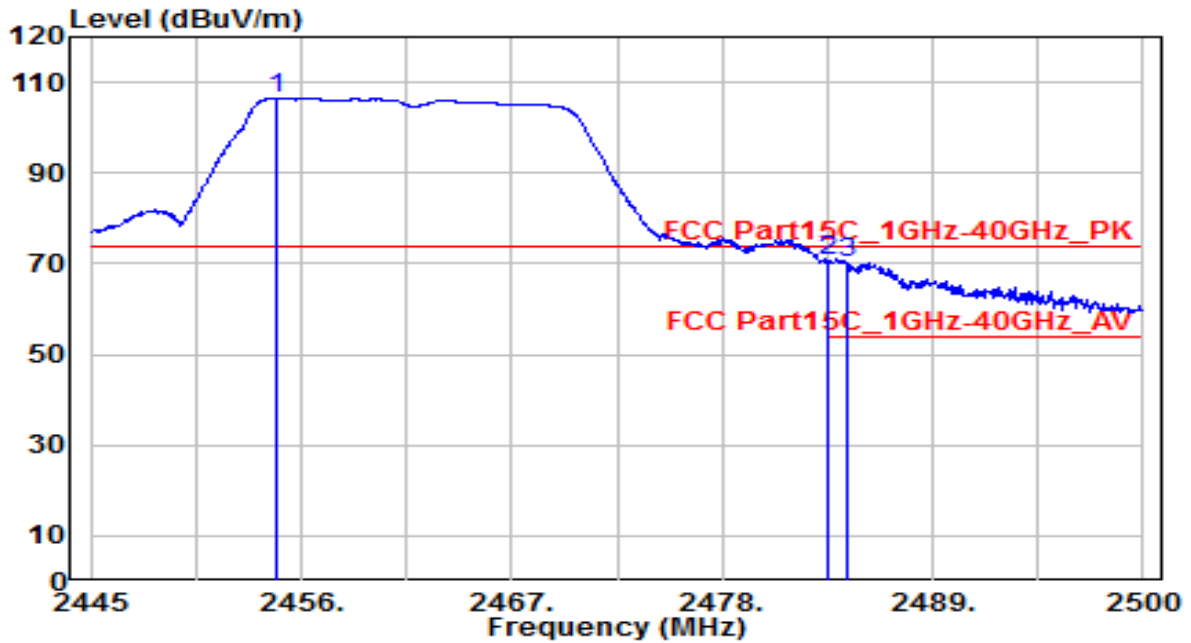

No	Frequency (MHz)	Reading (dBuV)	C.F (dB/m)	Measurement (dBuV/m)	Margin (dB)	Limit (dBuV/m)	Height (cm)	Angle (deg)	Remark (QP/PK/AV)
1	2454.735	74.00	32.52	106.52	N/A	N/A	210	190	Peak
2	* 2483.500	37.82	32.62	70.45	-3.55	74.00	210	190	Peak
3	2484.490	37.66	32.62	70.29	-3.71	74.00	210	190	Peak

Note:

1. " *", means this data is the worst emission level.
2. C.F (Correction Factor) = Antenna Factor (dB)+ Cable Loss (dB).
3. Measurement (dBuV/m) = Reading(dBuV) + C.F (Correction Factor).
4. The emission levels of other frequencies are very lower than the limit and not show in test report.

EUT	Home Security Wi-Fi Camera	Date of Test	2022-06-28
Factor	BBHA 9120D	Temp. / Humidity	23°C /62%
Polarity	Vertical	Site / Test Engineer	AC1 / Kaunaz
Test Mode	802.11n-20MHz_TX_CH 11_ANT 0	Test Voltage	AC 120V/60Hz

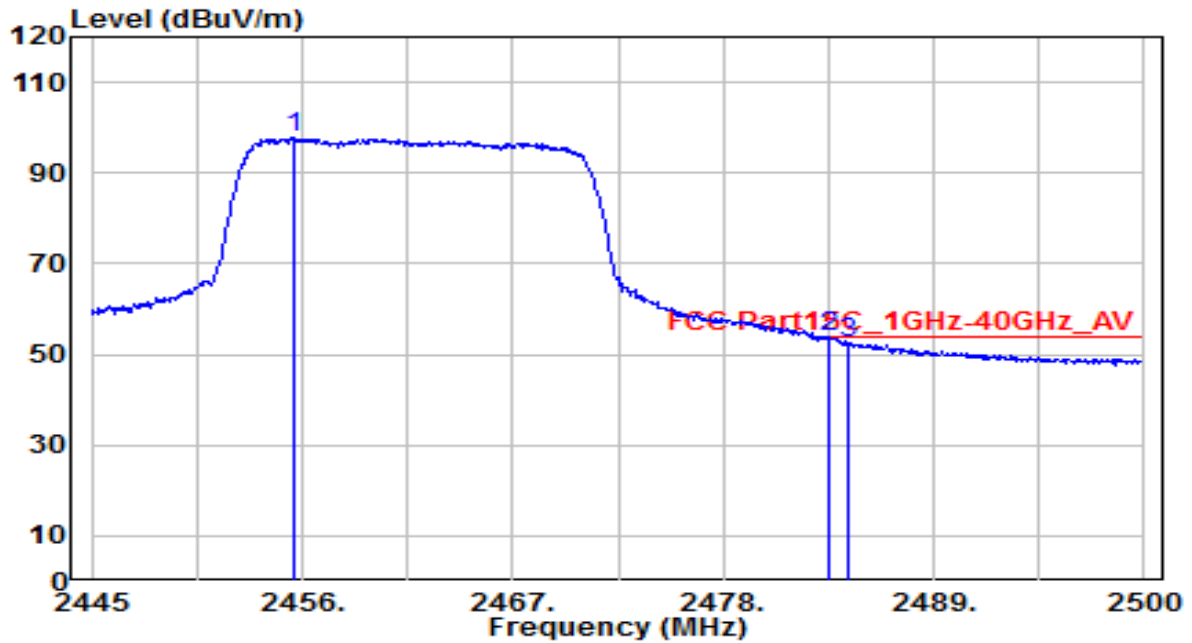

No	Frequency (MHz)	Reading (dBuV)	C.F (dB/m)	Measurement (dBuV/m)	Margin (dB)	Limit (dBuV/m)	Height (cm)	Angle (deg)	Remark (QP/PK/AV)
1	2455.505	65.17	32.52	97.69	N/A	N/A	210	190	Average
2	* 2483.500	21.13	32.62	53.75	-0.25	54.00	210	190	Average
3	2484.600	20.00	32.62	52.62	-1.38	54.00	210	190	Average

Note:

1. " *", means this data is the worst emission level.
2. C.F (Correction Factor) = Antenna Factor (dB)+ Cable Loss (dB).
3. Measurement (dBuV/m) = Reading(dBuV) + C.F (Correction Factor).
4. The emission levels of other frequencies are very lower than the limit and not show in test report.

7.8. AC Conducted Emissions Measurement

7.8.1. Test Limit

FCC Part 15 Subpart C Paragraph 15.207 Limits		
Frequency (MHz)	QP (dBuV)	AV (dBuV)
0.15 - 0.50	66 - 56	56 - 46
0.50 - 5.0	56	46
5.0 - 30	60	50

Note 1: The lower limit shall apply at the transition frequencies.

Note 2: The limit decreases linearly with the logarithm of the frequency in the range 0.15MHz to 0.5MHz.

7.8.2. Test Setup

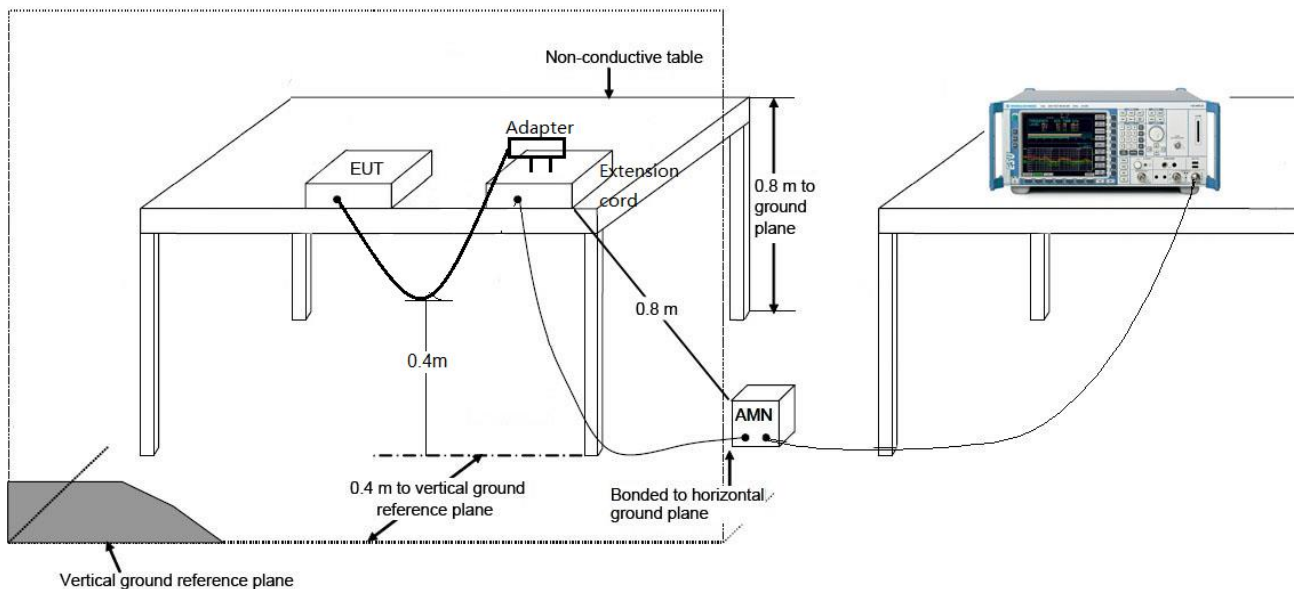

7.8.3. Test Result

EUT	Home Security Wi-Fi Camera	Date of Test	2022-06-22
Factor	CE_ENV216-L1 (Filter ON)	Temp. / Humidity	24.6°C /55%
Polarity	Line1	Site / Test Engineer	SR2 / Amber
Test Mode	802.11n-20MHz_TX_CH 6_ANT 0	Test Voltage	AC 120V/60Hz

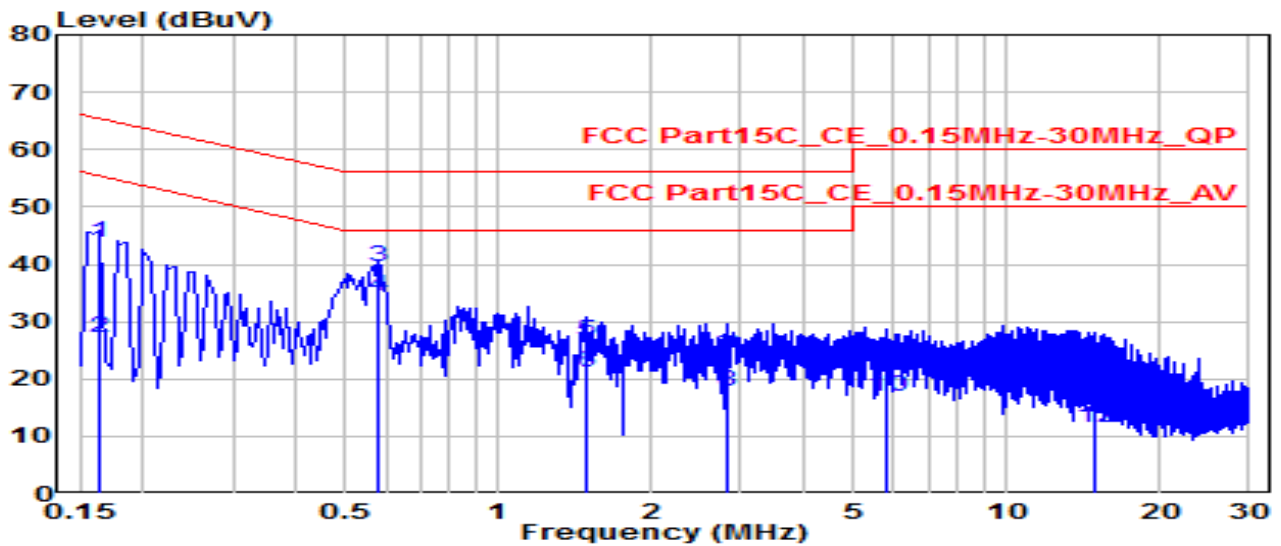

No	Frequency (MHz)	Reading (dBUV)	C.F (dB)	Measurement (dBUV/m)	Margin (dB)	Limit (dBUV/m)	Remark (QP/PK/AV)
1	0.163	34.09	9.62	43.71	-21.57	65.28	QP
2	0.163	17.55	9.62	27.17	-28.12	55.28	Average
3	* 0.577	30.02	9.65	39.67	-16.33	56.00	QP
4	* 0.577	24.79	9.65	34.44	-11.56	46.00	Average
5	1.482	16.95	9.68	26.63	-29.37	56.00	QP
6	1.482	11.32	9.68	21.00	-25.00	46.00	Average
7	2.827	14.21	9.71	23.91	-32.09	56.00	QP
8	2.827	8.18	9.71	17.89	-28.11	46.00	Average
9	5.797	12.84	9.76	22.60	-37.40	60.00	QP
10	5.797	7.06	9.76	16.82	-33.18	50.00	Average
11	14.963	11.94	9.89	21.83	-38.17	60.00	QP
12	14.963	1.57	9.89	11.46	-38.54	50.00	Average

Note:

1. " *", means this data is the worst emission level.
2. C.F (Correction Factor) = Antenna Factor (dB)+ Cable Loss (dB).
3. Measurement (dBUV/m) = Reading(dBUV) + C.F (Correction Factor).

EUT	Home Security Wi-Fi Camera	Date of Test	2022-06-22
Factor	CE_ENV216-N (Filter ON)	Temp. / Humidity	24.6°C /55%
Polarity	Neutral	Site / Test Engineer	SR2 / Amber
Test Mode	802.11n-20MHz_TX_CH 6_ANT 0	Test Voltage	AC 120V/60Hz

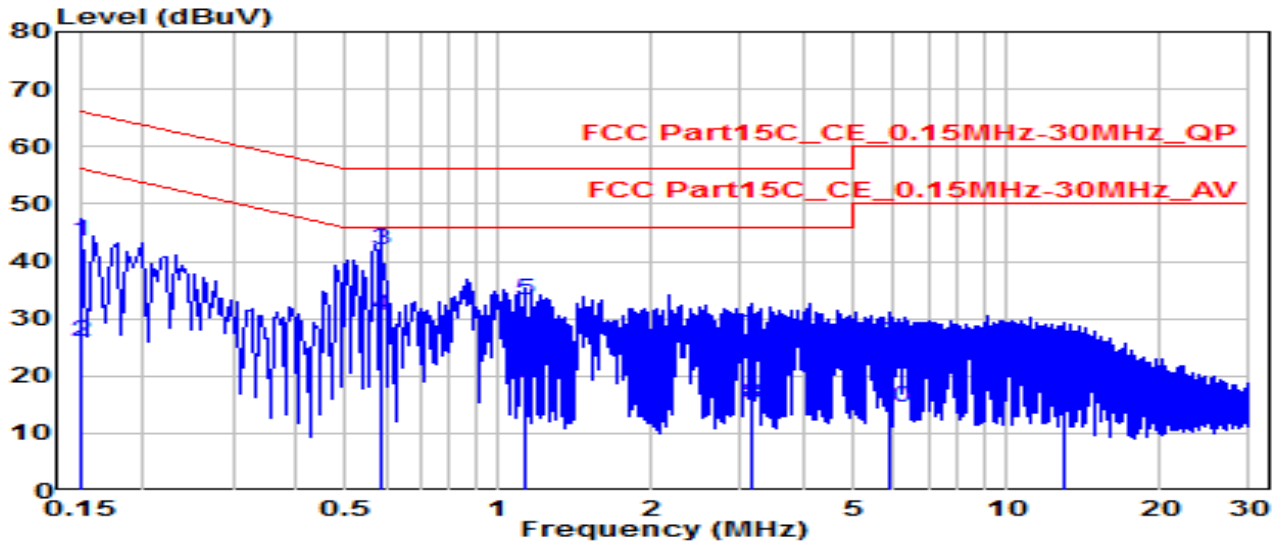

No	Frequency (MHz)	Reading (dBuV)	C.F (dB)	Measurement (dBuV/m)	Margin (dB)	Limit (dBuV/m)	Remark (QP/PK/AV)
1	0.150	33.74	9.62	43.36	-22.64	66.00	QP
2	0.150	16.20	9.62	25.82	-30.18	56.00	Average
3	* 0.586	32.33	9.65	41.98	-14.02	56.00	QP
4	* 0.586	20.70	9.65	30.34	-15.66	46.00	Average
5	1.131	23.47	9.67	33.14	-22.86	56.00	QP
6	1.131	9.10	9.67	18.77	-27.23	46.00	Average
7	3.133	17.30	9.71	27.01	-28.99	56.00	QP
8	3.133	5.42	9.71	15.14	-30.86	46.00	Average
9	5.909	15.78	9.77	25.55	-34.45	60.00	QP
10	5.909	4.76	9.77	14.52	-35.48	50.00	Average
11	12.974	14.00	9.91	23.90	-36.10	60.00	QP
12	12.974	3.41	9.91	13.31	-36.69	50.00	Average

Note:

1. " *", means this data is the worst emission level.
2. C.F (Correction Factor) = Antenna Factor (dB)+ Cable Loss (dB).
3. Measurement (dBuV/m) = Reading(dBuV) + C.F (Correction Factor).

EUT	Home Security Wi-Fi Camera	Date of Test	2022-06-22
Factor	CE_ENV216-L1 (Filter ON)	Temp. / Humidity	24.6°C /55%
Polarity	Line1	Site / Test Engineer	SR2 / Amber
Test Mode	802.11n-20MHz_TX_CH 6_ANT 0	Test Voltage	AC 240V/60Hz

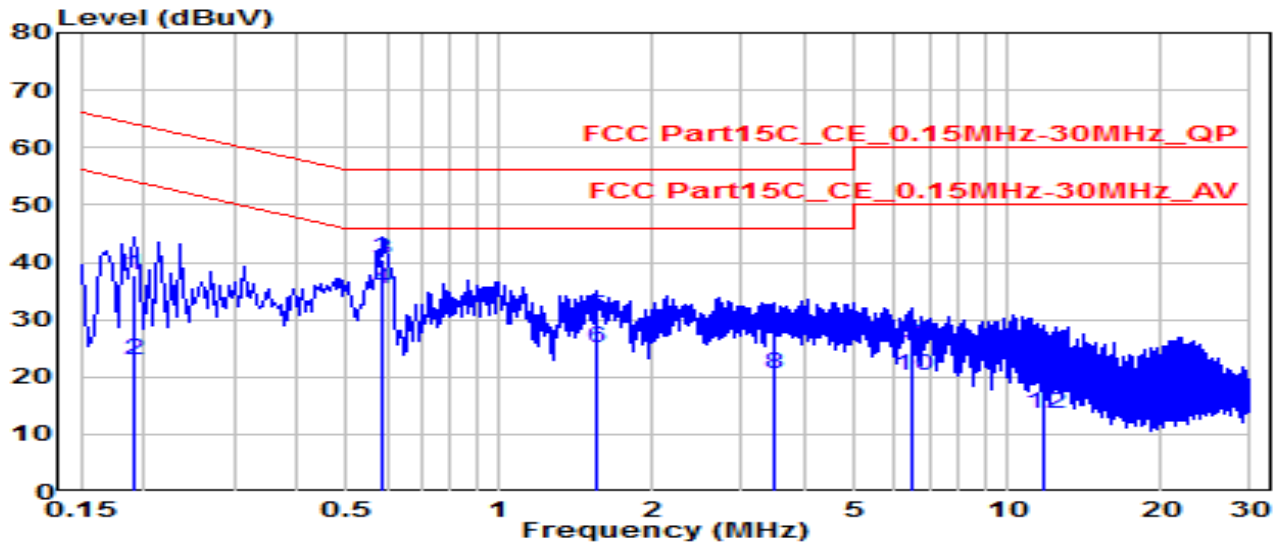

No	Frequency (MHz)	Reading (dBUV)	C.F (dB)	Measurement (dBUV/m)	Margin (dB)	Limit (dBUV/m)	Remark (QP/PK/AV)
1	0.190	28.03	9.62	37.65	-26.36	64.01	QP
2	0.190	13.46	9.62	23.08	-30.93	54.01	Average
3	* 0.591	30.95	9.65	40.60	-15.40	56.00	QP
4	* 0.591	25.66	9.65	35.31	-10.69	46.00	Average
5	1.563	20.71	9.68	30.39	-25.61	56.00	QP
6	1.563	15.30	9.68	24.99	-21.01	46.00	Average
7	3.453	17.13	9.72	26.85	-29.15	56.00	QP
8	3.453	10.93	9.72	20.65	-25.35	46.00	Average
9	6.458	15.90	9.78	25.68	-34.32	60.00	QP
10	6.458	10.45	9.78	20.23	-29.77	50.00	Average
11	11.786	11.31	9.87	21.18	-38.82	60.00	QP
12	11.786	3.80	9.87	13.67	-36.33	50.00	Average

Note:

1. " *", means this data is the worst emission level.
2. C.F (Correction Factor) = Antenna Factor (dB)+ Cable Loss (dB).
3. Measurement (dBUV/m) = Reading(dBUV) + C.F (Correction Factor).

EUT	Home Security Wi-Fi Camera	Date of Test	2022-06-22
Factor	CE_ENV216-N (Filter ON)	Temp. / Humidity	24.6°C /55%
Polarity	Neutral	Site / Test Engineer	SR2 / Amber
Test Mode	802.11n-20MHz_TX_CH 6_ANT 0	Test Voltage	AC 240V/60Hz

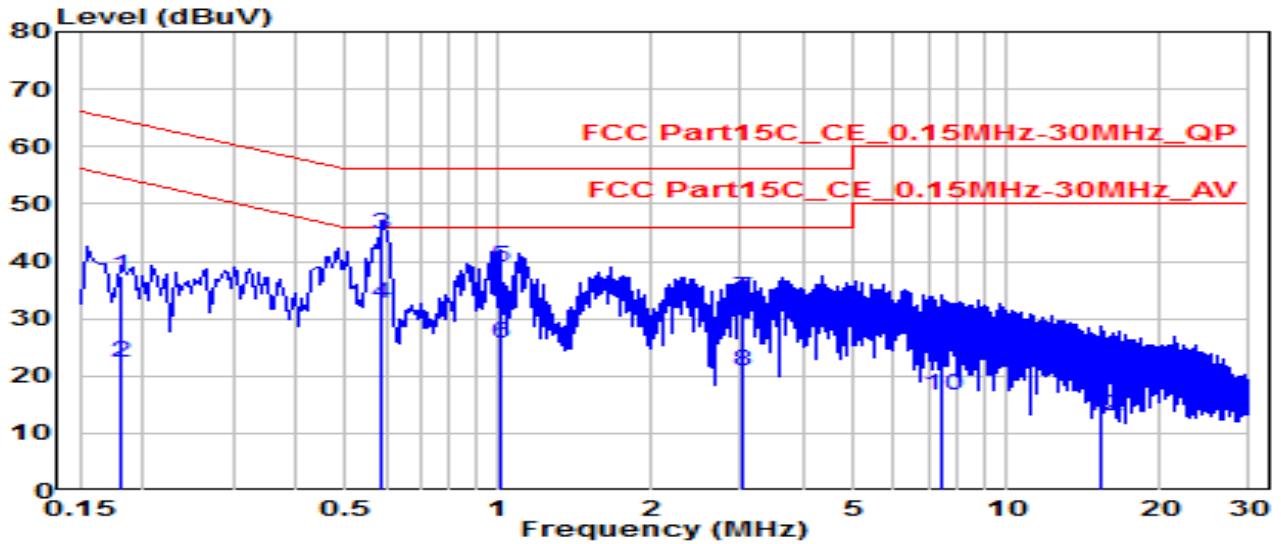

No	Frequency (MHz)	Reading (dBuV)	C.F (dB)	Measurement (dBuV/m)	Margin (dB)	Limit (dBuV/m)	Remark (QP/PK/AV)
1	0.181	27.88	9.62	37.50	-26.91	64.42	QP
2	0.181	12.70	9.62	22.32	-32.10	54.42	Average
3	* 0.591	35.00	9.65	44.65	-11.35	56.00	QP
4	* 0.591	22.95	9.65	32.60	-13.40	46.00	Average
5	1.005	29.20	9.67	38.87	-17.13	56.00	QP
6	1.005	16.05	9.67	25.72	-20.28	46.00	Average
7	3.030	23.76	9.71	33.48	-22.52	56.00	QP
8	3.030	11.26	9.71	20.97	-25.03	46.00	Average
9	7.493	18.44	9.81	28.24	-31.76	60.00	QP
10	7.493	6.67	9.81	16.48	-33.52	50.00	Average
11	15.349	13.18	9.93	23.12	-36.88	60.00	QP
12	15.349	2.99	9.93	12.93	-37.07	50.00	Average

Note:

1. " *", means this data is the worst emission level.
2. C.F (Correction Factor) = Antenna Factor (dB)+ Cable Loss (dB).
3. Measurement (dBuV/m) = Reading(dBuV) + C.F (Correction Factor).

8. CONCLUSION

The data collected relate only the item(s) tested and show that the device is compliance with Part 15C of the FCC Rules.

————— The End —————

Appendix A : Test Setup Photograph

Refer to “2206TW0112-Setup Photo” file.

Appendix B : External Photograph

Refer to "2206TW0112-External Photo" file.

Appendix C : Internal Photograph

Refer to "2206TW0112-Internal Photo" file.