

CFR 47 FCC PART 15 SUBPART E

TEST REPORT

For

BE19000 Tri-Band Wi-Fi 7 Router

MODEL NUMBER: Archer BE805

REPORT NUMBER: 4790809762-1-RF-2

ISSUE DATE: April 27, 2023

FCC ID: 2AXJ4BE805

Prepared for

TP-Link Corporation Limited

**Room 901, 9/F. , New East Ocean Centre, 9 Science Museum Road, Tsim Sha Tsui,
Kowloon, Hong Kong**

Prepared by

UL Verification Services (Guangzhou) Co., Ltd, Song Shan Lake Branch

Building 10, Innovation Technology Park, No. 1, Li Bin Road, Song Shan Lake Hi-Tech Development Zone Dongguan, 523808, People's Republic of China

Tel: +86 769 22038881

Fax: +86 769 33244054

Website: www.ul.com

Revision History

Rev.	Issue Date	Revisions	Revised By
V0	April 27, 2023	Initial Issue	

Summary of Test Results

Test Item	Clause	Limit/Requirement	Result
ON TIME AND DUTY CYCLE	ANSI C63.10-2013, Clause 12.2	None; for reporting purposes only.	Pass
6dB AND 26dB EMISSION BANDWIDTH AND 99% OCCUPIED BANDWIDTH	KDB 789033 D02 v02r01 Section C.1	FCC Part 15.407 (a)/(e),	Pass
CONDUCTED OUTPUT POWER	KDB 789033 D02 v02r01 Section E.3.a (Method PM)	FCC 15.407 (a) RSS-247 Clause 6.2	Pass
POWER SPECTRAL DENSITY	KDB 789033 D02 v02r01 Section F	FCC 15.407 (a) RSS-247 Clause 6.2	Pass
AC Power Line Conducted Emission	ANSI C63.10-2013, Clause 6.2.	FCC 15.207 RSS-GEN Clause 8.8	Pass
Radiated Emissions and Band Edge Measurement	KDB 789033 D02 v02r01 Section G.3, G.4, G.5, and G.6	FCC 15.407 (b) FCC 15.209 FCC 15.205 RSS-247 Clause 6.2 RSS-GEN Clause 8.9	Pass
FREQUENCY STABILITY		FCC 15.407 (g)	Pass
Dynamic Frequency Selection (Slave)	KDB 905462 D03 Client Without DFS New Rules v01r02	FCC Part 15.407 (h), RSS-247 Issue 2 Clause 6.3	N/A
Antenna Requirement	/	FCC 47 CFR Part 15.203/ 15.407(a)(1) (2), RSS-Gen Issue 5, Clause 6.8	Pass

*This test report is only published to and used by the applicant, and it is not for evidence purpose in China.

*The measurement result for the sample received is <Pass> according to <CFR 47 FCC PART 15 SUBPART E > when <Accuracy Method> decision rule is applied.

CONTENTS

1. ATTESTATION OF TEST RESULTS.....	6
2. TEST METHODOLOGY.....	7
3. FACILITIES AND ACCREDITATION.....	7
4. CALIBRATION AND UNCERTAINTY	8
4.1. <i>MEASURING INSTRUMENT CALIBRATION</i>	<i>8</i>
4.2. <i>MEASUREMENT UNCERTAINTY.....</i>	<i>8</i>
5. EQUIPMENT UNDER TEST	9
5.1. <i>DESCRIPTION OF EUT</i>	<i>9</i>
5.2. <i>CHANNEL LIST</i>	<i>9</i>
5.3. <i>MAXIMUM EIRP</i>	<i>10</i>
5.4. <i>TEST CHANNEL CONFIGURATION.....</i>	<i>11</i>
5.5. <i>THE WORSE CASE POWER SETTING PARAMETER.....</i>	<i>12</i>
5.6. <i>WORSE CASE CONFIGURATIONS.....</i>	<i>14</i>
5.7. <i>DESCRIPTION OF AVAILABLE ANTENNAS</i>	<i>15</i>
5.8. <i>SUPPORT UNITS FOR SYSTEM TEST.....</i>	<i>17</i>
6. MEASURING EQUIPMENT AND SOFTWARE USED.....	18
7. ANTENNA PORT TEST RESULTS	21
7.1. <i>ON TIME AND DUTY CYCLE.....</i>	<i>21</i>
7.2. <i>6DB AND 26DB EMISSION BANDWIDTH AND 99% OCCUPIED BANDWIDTH ...</i>	<i>22</i>
7.3. <i>CONDUCTED OUTPUT POWER.....</i>	<i>24</i>
7.4. <i>POWER SPECTRAL DENSITY</i>	<i>26</i>
7.5. <i>FREQUENCY STABILITY.....</i>	<i>28</i>
8. RADIATED TEST RESULTS.....	30
8.1. <i>RESTRICTED BANDEDGE</i>	<i>39</i>
8.2. <i>SPURIOUS EMISSIONS (1 GHZ ~ 7 GHZ)</i>	<i>75</i>
8.3. <i>SPURIOUS EMISSIONS (7 GHZ ~ 18 GHZ)</i>	<i>87</i>
8.4. <i>SPURIOUS EMISSIONS (9 KHZ ~ 30 MHZ).....</i>	<i>147</i>
8.5. <i>SPURIOUS EMISSIONS (18 GHZ ~ 26 GHZ)</i>	<i>150</i>
8.6. <i>SPURIOUS EMISSIONS (26 GHZ ~ 40 GHZ)</i>	<i>152</i>
8.7. <i>SPURIOUS EMISSIONS (30 MHZ ~ 1 GHZ).....</i>	<i>154</i>
8.8. <i>SIMULTANEOUSLY TRANSMISSION SPURIOUS EMISSIONS</i>	<i>156</i>
9. AC POWER LINE CONDUCTED EMISSION	160

10.	ANTENNA REQUIREMENT	164
11.	TEST DATA.....	165
11.1.	<i>APPENDIX A: EMISSION BANDWIDTH.....</i>	<i>165</i>
11.1.1.	Test Result.....	165
11.1.2.	Test Graphs	168
11.2.	<i>APPENDIX B: OCCUPIED CHANNEL BANDWIDTH.....</i>	<i>208</i>
11.2.1.	Test Result.....	208
11.2.2.	Test Graphs	211
11.3.	<i>APPENDIX C: MIN EMISSION BANDWIDTH</i>	<i>251</i>
11.3.1.	Test Result.....	251
11.3.2.	Test Graphs	253
11.4.	<i>APPENDIX D: MAXIMUM AVERAGE CONDUCTED OUTPUT POWER.....</i>	<i>273</i>
11.4.1.	Test Result.....	273
11.5.	<i>APPENDIX E: MAXIMUM POWER SPECTRAL DENSITY</i>	<i>276</i>
11.5.1.	Test Result.....	276
11.5.2.	Test Graphs	279
11.6.	<i>APPENDIX F: FREQUENCY STABILITY.....</i>	<i>319</i>
11.6.1.	Test Result.....	319
11.7.	<i>APPENDIX G: DUTY CYCLE.....</i>	<i>320</i>
11.7.1.	Test Result.....	320
11.7.2.	Test Graphs	321

1. ATTESTATION OF TEST RESULTS

Applicant Information

Company Name: TP-Link Corporation Limited
Address: Room 901, 9/F. , New East Ocean Centre, 9 Science Museum Road, Tsim Sha Tsui, Kowloon, Hong Kong

Manufacturer Information

Company Name: TP-Link Corporation Limited
Address: Room 901, 9/F. , New East Ocean Centre, 9 Science Museum Road, Tsim Sha Tsui, Kowloon, Hong Kong

EUT Information

EUT Name: BE19000 Tri-Band Wi-Fi 7 Router
Model: Archer BE805
Brand: tp-link
Sample Received Date: April 11, 2023
Sample Status: Normal
Sample ID: 5982800
Date of Tested: April 11, 2023 to April 26, 2023

APPLICABLE STANDARDS	
STANDARD	TEST RESULTS
CFR 47 FCC PART 15 SUBPART E	Pass

Prepared By:

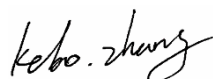

Kebo Zhang

Senior Project Engineer

Checked By:

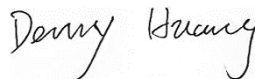

Denny Huang

Senior Project Engineer

Approved By:



Stephen Guo

Operations Manager

2. TEST METHODOLOGY

All tests were performed in accordance with the standard CFR 47 FCC PART 15 SUBPART E , ANSI C63.10-2013, CFR 47 FCC Part 2, KDB 789033 D02 v02r01, KDB414788 D01 Radiated Test Site v01, KDB 662911 D01 Multiple Transmitter Output v02r01.

3. FACILITIES AND ACCREDITATION

Accreditation Certificate	<p>A2LA (Certificate No.: 4102.01) UL Verification Services (Guangzhou) Co., Ltd. Song Shan Lake Branch. has been assessed and proved to be in compliance with A2LA.</p> <p>FCC (FCC Designation No.: CN1187) UL Verification Services (Guangzhou) Co., Ltd. Song Shan Lake Branch. Has been recognized to perform compliance testing on equipment subject to the Commission's Declaration of Conformity (DoC) and Certification rules</p> <p>ISED (Company No.: 21320) UL Verification Services (Guangzhou) Co., Ltd. Song Shan Lake Branch. has been registered and fully described in a report filed with ISED. The Company Number is 21320 and the test lab Conformity Assessment Body Identifier (CABID) is CN0046.</p> <p>VCCI (Registration No.: G-20019, R-20004, C-20012 and T-20011) UL Verification Services (Guangzhou) Co., Ltd. Song Shan Lake Branch. has been assessed and proved to be in compliance with VCCI, the Membership No. is 3793. Facility Name: Chamber D, the VCCI registration No. is G-20019 and R-20004 Shielding Room B , the VCCI registration No. is C-20012 and T-20011</p>
---------------------------	--

Note 1:

All tests measurement facilities use to collect the measurement data are located at Building 10, Innovation Technology Park, No. 1, Li Bin Road, Song Shan Lake Hi-Tech Development Zone Dongguan, 523808, People's Republic of China.

Note 2:

The test anechoic chamber in UL Verification Services (Guangzhou) Co., Ltd. Song Shan Lake Branch had been calibrated and compared to the open field sites and the test anechoic chamber is shown to be equivalent to or worst case from the open field site.

Note 3:

For below 30 MHz, lab had performed measurements at test anechoic chamber and comparing to measurements obtained on an open field site. And these measurements below 30 MHz had been correlated to measurements performed on an OFS.

4. CALIBRATION AND UNCERTAINTY

4.1. MEASURING INSTRUMENT CALIBRATION

The measuring equipment utilized to perform the tests documented in this report has been calibrated in accordance with the manufacturer's recommendations and is traceable to recognized national standards.

4.2. MEASUREMENT UNCERTAINTY

Where relevant, the following measurement uncertainty levels have been estimated for tests performed on the apparatus:

Test Item	Uncertainty
Conduction emission	3.62 dB
Radiated Emission (Included Fundamental Emission) (9 kHz ~ 30 MHz)	2.2 dB
Radiated Emission (Included Fundamental Emission) (30 MHz ~ 1 GHz)	4.00 dB
Radiated Emission (Included Fundamental Emission) (1 GHz to 40 GHz)	5.78 dB (1 GHz ~ 18 GHz)
	5.23 dB (18 GHz ~ 26 GHz)
	5.37 dB (26 GHz ~ 40 GHz)
Duty Cycle	±0.028%
Emission Bandwidth and 99% Occupied Bandwidth	±0.0196%
Maximum Conducted Output Power	±0.766 dB
Maximum Power Spectral Density Level	±1.22 dB
Frequency Stability	±2.76%
Conducted Band-edge Compliance	±1.328 dB
Conducted Unwanted Emissions In Non-restricted Frequency Bands	±0.746 dB (9 kHz ~ 1 GHz)
	±1.328dB (1 GHz ~ 26 GHz)
Note: This uncertainty represents an expanded uncertainty expressed at approximately the 95% confidence level using a coverage factor of k=2.	

5. EQUIPMENT UNDER TEST

5.1. DESCRIPTION OF EUT

EUT Name/PMN:	BE19000 Tri-Band Wi-Fi 7 Router
Model/HVIN:	Archer BE805
Frequency Range:	5180 MHz to 5240 MHz(U-NII-1) 5745 MHz to 5825 MHz(U-NII-3)
Type of Modulation:	IEEE 802.11a: OFDM(64QAM, 16QAM, QPSK, BPSK) IEEE 802.11n: OFDM(64QAM, 16QAM, QPSK, BPSK) IEEE 802.11ac: OFDM(256QAM, 64QAM, 16QAM, QPSK, BPSK) IEEE 802.11ax: OFDMA (1024QAM, 256QAM, 64QAM, 16QAM, QPSK, BPSK) IEEE 802.11be: OFDMA (4096QAM, 1024QAM, 256QAM, 64QAM, 16QAM, QPSK, BPSK)
Radio Technology:	IEEE802.11a/n HT20/n HT40/ ac VHT20/ac VHT40/ac VHT80/ ax HE20/ax HE40/ax HE80/ be EHT20/be EHT40/be EHT80
FVIN:	V1.0
Normal Test Voltage:	DC 15 V via adapter

5.2. CHANNEL LIST

UNII-1 (For Bandwidth=20MHz)		UNII-1 (For Bandwidth=40MHz)		UNII-1 (For Bandwidth=80MHz)	
Channel	Frequency (MHz)	Channel	Frequency (MHz)	Channel	Frequency (MHz)
36	5180	38	5190	42	5210
40	5200	46	5230		
44	5220				
48	5240				

UNII-3 (For Bandwidth=20MHz)		UNII-3 (For Bandwidth=40MHz)		UNII-3 (For Bandwidth=80MHz)	
Channel	Frequency (MHz)	Channel	Frequency (MHz)	Channel	Frequency (MHz)
149	5745	151	5755	155	5775
153	5765	159	5795		
157	5785				
161	5805				
165	5825				

5.3. MAXIMUM EIRP

UNII-1 BAND(FCC)

IEEE Std. 802.11	Frequency (MHz)	Maximum Average Conducted Power (dBm)
a	5150 ~ 5250	27.11
ax HE20		27.94
ax HE40		29.53
ax HE80		26.79
be EHT20		27.97
be EHT40		29.49
be EHT80		26.66

UNII-3 BAND(FCC&ISED)

IEEE Std. 802.11	Frequency (MHz)	Maximum Average Conducted Power (dBm)
a	5725 ~ 5850	29.94
ax HE20		29.63
ax HE40		29.94
ax HE80		29.09
be EHT20		29.78
be EHT40		29.86
be EHT80		28.92

5.4. TEST CHANNEL CONFIGURATION

UNII-1 Test Channel Configuration		
IEEE Std.	Test Channel Number	Frequency
802.11a	CH 36(Low Channel), CH 40(MID Channel), CH 48(High Channel)	5180 MHz, 5200 MHz, 5240 MHz
802.11ax HE20	CH 36(Low Channel), CH 40(MID Channel), CH 48(High Channel)	5180 MHz, 5200 MHz, 5240 MHz
802.11ax HE40	CH 38(Low Channel), CH 46(High Channel)	5190 MHz, 5230 MHz
802.11ax HE80	CH 42(Low Channel)	5210 MHz
802.11be EHT20	CH 36(Low Channel), CH 40(MID Channel), CH 48(High Channel)	5180 MHz, 5200 MHz, 5240 MHz
802.11be EHT40	CH 38(Low Channel), CH 46(High Channel)	5190 MHz, 5230 MHz
802.11be EHT80	CH 42(Low Channel)	5210 MHz

UNII-3 Test Channel Configuration		
IEEE Std.	Test Channel Number	Frequency
802.11a	CH 149(Low Channel), CH 157(MID Channel), CH 165(High Channel)	5745 MHz, 5785 MHz, 5825 MHz
802.11ax HE20	CH 149(Low Channel), CH 157(MID Channel), CH 165(High Channel)	5745 MHz, 5785 MHz, 5825 MHz
802.11ax HE40	CH 151(Low Channel), CH 159(High Channel)	5755MHz, 5795MHz
802.11ax HE80	CH 155(Low Channel)	5775 MHz
802.11be EHT20	CH 149(Low Channel), CH 157(MID Channel), CH 165(High Channel)	5745 MHz, 5785 MHz, 5825 MHz
802.11be EHT40	CH 151(Low Channel), CH 159(High Channel)	5755MHz, 5795MHz
802.11be EHT80	CH 155(Low Channel)	5775 MHz

5.5. THE WORSE CASE POWER SETTING PARAMETER

The Worse Case Power Setting Parameter			
Test Software	QSPR		
UNII-1			
Mode	Rate	Channel	Soft set value
			ANT 1~ ANT 4
11a	6M	36	15.5
		40	15.5
		48	15.5
11n HT20	MCS0	36	Cover by 11ax HE20
		40	
		48	
11n HT40	MCS0	38	Cover by 11ax HE40
		46	
11ac VHT20	MCS0	36	Cover by 11ax HE20
		40	
		48	
11ac VHT40	MCS0	38	Cover by 11ax HE40
		46	
11ac VHT80	MCS0	42	Cover by 11ax HE80
11ax HE20	MCS0	36	16
		40	16
		48	16
11ax HE40	MCS0	38	15
		46	17
11ax HE80	MCS0	42	14
11be EHT20	MCS0	36	16
		40	16
		48	16
11be EHT40	MCS0	38	15
		46	17
11be EHT80	MCS0	42	14

UNII-3

Mode	Rate	Channel	Soft set value
			ANT 1~ ANT 4
11a	6M	149	17.5
		157	17.5
		165	17.5
11n HT20	MCS0	149	Cover by 11ax HE20
		157	
		165	
11n HT40	MCS0	151	Cover by 11ax HE40
		159	
11ac VHT20	MCS0	149	Cover by 11ax HE20
		157	
		165	
11ac VHT40	MCS0	151	Cover by 11ax HE40
		159	
11ac VHT80	MCS0	155	Cover by 11ax HE80
11ax HE20	MCS0	149	17
		157	17
		165	17
11ax HE40	MCS0	151	17.5
		159	17.5
11ax HE80	MCS0	155	16
11be EHT20	MCS0	149	17.5
		157	17.5
		165	17.5
11be EHT40	MCS0	151	17.5
		159	17.5
11be EHT80	MCS0	155	16

5.6. WORSE CASE CONFIGURATIONS

The EUT was tested in the following configuration(s):

Controlled in test mode using a software application on the EUT supplied by customer. The application was used to enable a continuous transmission and to select the mode, test channels, bandwidth, data rates as required.

Test channels referring to section 5.4.

Maximum power setting referring to section 5.5.

Worst case Data Rates declared by the customer:

- 802.11a 20 CDD mode : 6 Mbps
- 802.11n HT20 CDD mode : MCS0
- 802.11n HT40 CDD mode : MCS0
- 802.11ac VHT20 CDD mode : MCS0
- 802.11ac VHT40 CDD mode : MCS0
- 802.11ac VHT80 CDD mode : MCS0
- 802.11ax HE20 CDD mode : MCS0
- 802.11ax HE40 CDD mode : MCS0
- 802.11ax HE80 CDD mode : MCS0
- 802.11be EHT20 CDD mode : MCS0
- 802.11be EHT40 CDD mode : MCS0
- 802.11be EHT80 CDD mode : MCS0

All modes support CDD mode.

802.11n HT20/HT40/ac VHT20/VHT40/VHT80 and 802.11ax HE20/HE40/HE80 were performed on the worst case (802.11ax HE20/HE40/HE80) mode and only the worst data was recorded in this report.

The EUT has 5 separate antennas which correspond to 5 separate antenna ports (for 2.4G and 5G). Core 1, Core 2, Core 3, Core 4 and Core 5 correspond to antenna 1, antenna 2, antenna 3, antenna 4 and antenna 5 respectively and they support WLAN 2.4G and RLAN 5G, 2.4G and 5G use the same antenna and antenna 5 support RX only.

The measured additional path loss was included in any path loss calculations for all RF cable used during tested.

The EUT not support partial Rus and channel puncturing mode.

Simultaneously Transmission Conditions:

Support Technology		Support (YES/NO)
WLAN (2.4G)	WLAN (5G)	YES

Note: The emission of the simultaneous operation has been evaluated and no non-compliance was found.

5.7. DESCRIPTION OF AVAILABLE ANTENNAS

Antenna No.	Frequency Band	Antenna Type	Maximum Antenna Gain (dBi)
1	5150-5850	Dipole Antenna	2
2	5150-5850	Dipole Antenna	2
3	5150-5850	Dipole Antenna	2
4	5150-5850	Dipole Antenna	2
5	5150-5850	Dipole Antenna	2

Note: Antenna 5 support RX only.

The EUT support Cyclic Shift Diversity (CDD) mode.

MIMO output power port and MIMO PSD port summing were performed in accordance with KDB 662911 D01. For the CDD results the Directional Gain was calculated in accordance with the following method.

For output power measurements:

Directional gain = $G_{ANT} + \text{Array Gain} = 2 \text{ dBi}$

G_{ANT} : equal to the gain of the antenna having the highest gain

Array Gain = 0 dB (i.e., no array gain) for $N_{ANT} \leq 4$

For power spectral density (PSD) measurements:

Directional gain = $G_{ANT} + \text{Array Gain} = 8.02 \text{ dBi}$

Array Gain = $10 \log(N_{ANT}/N_{SS}) \text{ dB}$.

N_{ANT} : number of transmit antennas

N_{SS} : number of spatial streams, The worst case directional gain will occur when $N_{SS} = 1$

IEE Std. 802.11	Transmit and Receive Mode	Description
802.11a	<input checked="" type="checkbox"/> 4TX, 5RX	ANT 1, ANT 2, ANT 3 and ANT 4 can be used as transmitting/receiving antenna, ANT 5 can be only used as receiving antenna
802.11n HT20	<input checked="" type="checkbox"/> 4TX, 5RX	ANT 1, ANT 2, ANT 3 and ANT 4 can be used as transmitting/receiving antenna, ANT 5 can be only used as receiving antenna
802.11n HT40	<input checked="" type="checkbox"/> 4TX, 5RX	ANT 1, ANT 2, ANT 3 and ANT 4 can be used as transmitting/receiving antenna, ANT 5 can be only used as receiving antenna
802.11ac VHT20	<input checked="" type="checkbox"/> 4TX, 5RX	ANT 1, ANT 2, ANT 3 and ANT 4 can be used as transmitting/receiving antenna, ANT 5 can be only used as receiving antenna
802.11ac VHT40	<input checked="" type="checkbox"/> 4TX, 5RX	ANT 1, ANT 2, ANT 3 and ANT 4 can be used as transmitting/receiving antenna, ANT 5 can be only used as receiving antenna
802.11ac VHT80	<input checked="" type="checkbox"/> 4TX, 5RX	ANT 1, ANT 2, ANT 3 and ANT 4 can be used as transmitting/receiving antenna, ANT 5 can be only used as receiving antenna
802.11ax HE20	<input checked="" type="checkbox"/> 4TX, 5RX	ANT 1, ANT 2, ANT 3 and ANT 4 can be used as transmitting/receiving antenna, ANT 5 can be only used as receiving antenna
802.11ax HE40	<input checked="" type="checkbox"/> 4TX, 5RX	ANT 1, ANT 2, ANT 3 and ANT 4 can be used as transmitting/receiving antenna, ANT 5 can be only used as receiving antenna
802.11ax HE80	<input checked="" type="checkbox"/> 4TX, 5RX	ANT 1, ANT 2, ANT 3 and ANT 4 can be used as transmitting/receiving antenna, ANT 5 can be only used as receiving antenna
802.11be EHT20	<input checked="" type="checkbox"/> 4TX, 5RX	ANT 1, ANT 2, ANT 3 and ANT 4 can be used as transmitting/receiving antenna, ANT 5 can be only used as receiving antenna
802.11be EHT40	<input checked="" type="checkbox"/> 4TX, 5RX	ANT 1, ANT 2, ANT 3 and ANT 4 can be used as transmitting/receiving antenna, ANT 5 can be only used as receiving antenna
802.11be EHT80	<input checked="" type="checkbox"/> 4TX, 5RX	ANT 1, ANT 2, ANT 3 and ANT 4 can be used as transmitting/receiving antenna, ANT 5 can be only used as receiving antenna

Note: The value of the antenna gain was declared by customer.

5.8. SUPPORT UNITS FOR SYSTEM TEST

SUPPORT EQUIPMENT

Item	Equipment	Brand Name	Model Name	Remarks
1	Laptop	ThinkPad	X230i	/

I/O CABLES

Cable No	Port	Connector Type	Cable Type	Cable Length(m)	Remarks
1	LAN1	RJ45	Unshielded	1.0 m	/

ACCESSORIES

Item	Accessory	Brand Name	Model Name	Description
1	I.T.E POWER SUPPLY	tp-link	T150500-2-DT	Input: AC 100-240 V, 50 / 60 Hz, 2.0 A Output: DC 15.0 V, 5.0 A, 75.0 W

TEST SETUP

The EUT can work in engineering mode with a software through a laptop.

SETUP DIAGRAM FOR TESTS

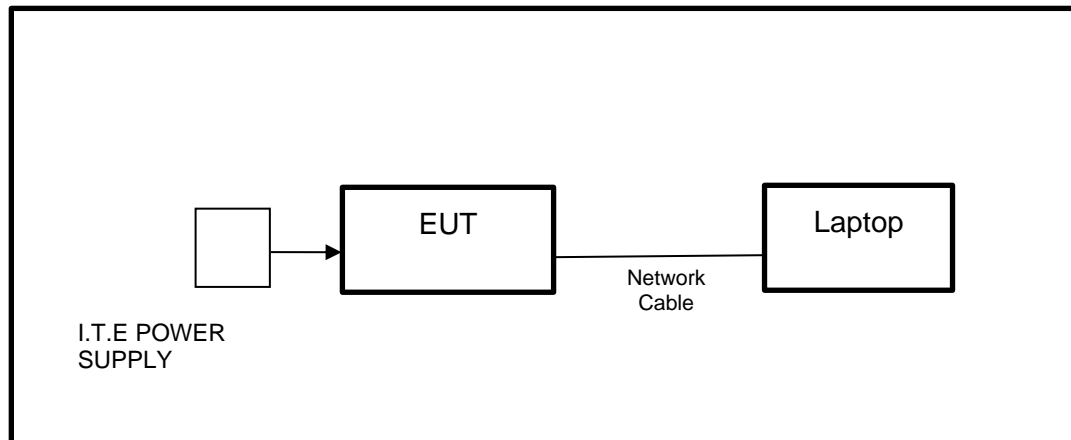

6. MEASURING EQUIPMENT AND SOFTWARE USED

R&S TS 8997 Test System					
Equipment	Manufacturer	Model No.	Serial No.	Last Cal.	Due. Date
Power sensor, Power Meter	R&S	OSP120	100921	Mar.31,2023	Mar.30,2024
Vector Signal Generator	R&S	SMBV100A	261637	Oct.17, 2022	Oct.16, 2023
Signal Generator	R&S	SMB100A	178553	Oct.17, 2022	Oct.16, 2023
Signal Analyzer	R&S	FSV40	101118	Oct.17, 2022	Oct.16, 2023
Software					
Description	Manufacturer	Name		Version	
For R&S TS 8997 Test System	Rohde & Schwarz	EMC 32		10.60.10	
Tonsend RF Test System					
Equipment	Manufacturer	Model No.	Serial No.	Last Cal.	Due. Date
Wideband Radio Communication Tester	R&S	CMW500	155523	Oct.17, 2022	Oct.16, 2023
Wireless Connectivity Tester	R&S	CMW270	1201.0002N75-102	Sep.28, 2022	Sep.27, 2023
PXA Signal Analyzer	Keysight	N9030A	MY55410512	Oct.17, 2022	Oct.16, 2023
MXG Vector Signal Generator	Keysight	N5182B	MY56200284	Oct.17, 2022	Oct.16, 2023
MXG Vector Signal Generator	Keysight	N5172B	MY56200301	Oct.17, 2022	Oct.16, 2023
DC power supply	Keysight	E3642A	MY55159130	Oct.17, 2022	Oct.16, 2023
Temperature & Humidity Chamber	SANMOOD	SG-80-CC-2	2088	Oct.17, 2022	Oct.16, 2023
Software					
Description	Manufacturer	Name		Version	
Tonsend SRD Test System	Tonsend	JS1120-3 RF Test System		V3.2.22	

Conducted Emissions					
Equipment	Manufacturer	Model No.	Serial No.	Last Cal.	Due Date
EMI Test Receiver	R&S	ESR3	101961	Oct.17, 2022	Oct.16, 2023
Two-Line V-Network	R&S	ENV216	101983	Oct.17, 2022	Oct.16, 2023
Artificial Mains Networks	Schwarzbeck	NSLK 8126	8126465	Oct.17, 2022	Oct.16, 2023
Software					
Description			Manufacturer	Name	Version
Test Software for Conducted Emissions			Farad	EZ-EMC	Ver. UL-3A1

Radiated Emissions					
Equipment	Manufacturer	Model No.	Serial No.	Last Cal.	Due Date
MXE EMI Receiver	KESIGHT	N9038A	MY56400036	Oct.17, 2022	Oct.16, 2023
Hybrid Log Periodic Antenna	TDK	HLP-3003C	130959	Aug.02, 2021	Aug.01, 2024
Preamplifier	HP	8447D	2944A09099	Oct.17, 2022	Oct.16, 2023
EMI Measurement Receiver	R&S	ESR26	101377	Oct.17, 2022	Oct.16, 2023
Horn Antenna	TDK	HRN-0118	130940	July 20, 2021	July 19, 2024
Preamplifier	TDK	PA-02-0118	TRS-305-00067	Oct.17, 2022	Oct.16, 2023
Horn Antenna	Schwarzbeck	BBHA9170	697	July 20, 2021	July 19, 2024
Preamplifier	TDK	PA-02-2	TRS-307-00003	Oct.17, 2022	Oct.16, 2023
Preamplifier	TDK	PA-02-3	TRS-308-00002	Oct.17, 2022	Oct.16, 2023
Loop antenna	Schwarzbeck	1519B	00008	Dec.14, 2021	Dec.13, 2024
Preamplifier	TDK	PA-02-001-3000	TRS-302-00050	Oct.17, 2022	Oct.16, 2023
Preamplifier	Mini-Circuits	ZX60-83LN-S+	SUP01202035	Oct.17, 2022	Oct.16, 2023
High Pass Filter	Wi	WHKX10-2700-3000-18000-40SS	23	/	/
Highpass Filter	Wainwright	WHKX10-5850-6500-1800-40SS	4	/	/
Band Reject Filter	Wainwright	WRCJV12-5695-5725-5850-5880-40SS	4	/	/
Band Reject Filter	Wainwright	WRCJV20-5120-5150-	2	/	/

		5350-5380-60SS			
Band Reject Filter	Wainwright	WRCJV20-5440-5470-5725-5755-60SS	1	/	/
Band Reject Filter	Wainwright	WRCJV8-2350-2400-2483.5-2533.5-40SS	4	/	/
Band Reject Filter	Wainwright	WRCD5-1879-1879.85-1880.15-1881-40SS	1	/	/
Notch Filter	Wainwright	WHJ10-882-980-7000-40SS	1	/	/
Software					
Description			Manufacturer	Name	Version
Test Software for Radiated Emissions			Farad	EZ-EMC	Ver. UL-3A1

Other Instrument					
Equipment	Manufacturer	Model No.	Serial No.	Last Cal.	Due Date
Temperature humidity probe	OMEGA	ITHX-SD-5	18470007	Oct.22, 2022	Oct.21, 2023
Barometer	Yiyi	Baro	N/A	Oct.24, 2022	Oct.23, 2023
Attenuator	Agilent	8495B	2814a12853	Oct.18, 2022	Oct.17, 2023

7. ANTENNA PORT TEST RESULTS

7.1. ON TIME AND DUTY CYCLE

LIMITS

None; for reporting purposes only.

TEST PROCEDURE

Refer to KDB 789033 D02 General U-NII Test Procedures New Rules v02r01 section II.B.

The zero-span mode on a spectrum analyzer or EMI receiver, if the response time and spacing between bins on the sweep are sufficient to permit accurate measurements of the on and off times of the transmitted signal. Set the center frequency of the instrument to the center frequency of the transmission. Set $RBW \geq EBW$ if possible; otherwise, set RBW to the largest available value. Set $VBW \geq RBW$. Set detector = peak or average. The zero-span measurement method shall not be used unless both RBW and VBW are $> 50/T$, where T is defined in II.B.1.a), and the number of sweep points across duration T exceeds 100. (For example, if VBW and/or RBW are limited to 3 MHz, then the zero-span method of measuring duty cycle shall not be used if $T \leq 16.7$ microseconds.)

TEST SETUP

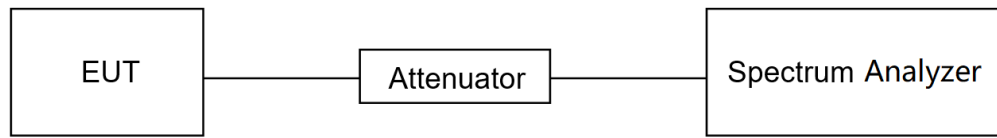

TEST ENVIRONMENT

Temperature	23.6°C	Relative Humidity	59%
Atmosphere Pressure	101kPa	Test Voltage	DC 15 V

TEST DATE / ENGINEER

Test Date	April 13, 2023	Test By	Johnson Liu
-----------	----------------	---------	-------------

TEST RESULTS

Please refer to section "Test Data" - Appendix G

7.2. 6DB AND 26DB EMISSION BANDWIDTH AND 99% OCCUPIED BANDWIDTH

LIMITS

CFR 47 FCC Part15, Subpart E		
Test Item	Limit	Frequency Range (MHz)
26 dB Emission Bandwidth	For reporting purposes only.	5150 ~ 5250
26 dB Emission Bandwidth	For reporting purposes only.	5250 ~ 5350
26 dB Emission Bandwidth	For reporting purposes only.	5470 ~ 5725 (For FCC) 5470 ~ 5600 (For ISED) 5650 ~ 5725 (For ISED)
6 dB Emission Bandwidth	The minimum 6 dB emission bandwidth shall be 500 kHz.	5725 ~ 5850
99 % Occupied Bandwidth	For reporting purposes only.	5150 ~ 5825 (For ISED)

TEST PROCEDURE

Refer to KDB 789033 D02 General U-NII Test Procedures New Rules v02r01 section II.C1. for 26 dB Emission Bandwidth; section II.C2. for 6 dB Emission Bandwidth; section II.D. for 99 % Occupied Bandwidth.

Connect the EUT to the spectrum analyser and use the following settings:

Center Frequency	The center frequency of the channel under test
Detector	Peak
RBW	For 6 dB Emission Bandwidth: RBW=100 kHz For 26 dB Emission bandwidth: approximately 1 % of the EBW. For 99 % Occupied Bandwidth: approximately 1 % ~ 5 % of the OBW.
VBW	For 6 dB Bandwidth: $\geq 3 \times \text{RBW}$ For 26 dB Bandwidth: $> 3 \times \text{RBW}$ For 99 % Bandwidth: $> 3 \times \text{RBW}$
Trace	Max hold
Sweep	Auto couple

- Use the 99 % power bandwidth function of the instrument, allow the trace to stabilize and report the measured bandwidth.
- Allow the trace to stabilize and measure the maximum width of the emission that is constrained by the frequencies associated with the two outermost amplitude points (upper and lower frequencies) that are attenuated by 6/26 dB relative to the maximum level measured in the fundamental emission.

Calculation for 99 % Bandwidth of UNII-2C and UNII-3 Straddle Channel:

For Example: Fundamental Frequency: 5720 MHz

99 % OBW: 21.00 MHz

Turning Frequency: 5725 MHz

99 % Bandwidth of UNII-2C Band Portion = $(5725 - (5720 - (21.00/2))) = 15.50 \text{ MHz}$

99 % Bandwidth of UNII-3 Band Portion = $(5720 + (21.00/2) - 5725) = 5.50 \text{ MHz}$

Calculation for 26 dB Bandwidth of UNII-2C Straddle Channel:

For Example: Fundamental frequency: 5720 MHz

26 dB BW: 20.00 MHz

FL: 5710.16 MHz

FH: 5730.16 MHz

Turning Frequency: 5725 MHz

26 dB Bandwidth of UNII-2C Band Portion = $5725 - 5710.16 = 14.84$ MHz

Calculation for 6dB Bandwidth of UNII-3 Straddle Channel:

For Example: Fundamental frequency: 5720 MHz

6 dB BW: 16.44 MHz

FL: 5711.76 MHz

FH: 5728.2 MHz

Turning Frequency: 5725 MHz

6 dB Bandwidth of UNII-3 band Portion = $5728.2 - 5725 = 3.2$ MHz

TEST SETUP

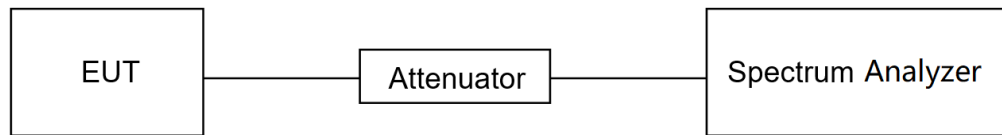

TEST ENVIRONMENT

Temperature	23.6°C	Relative Humidity	59%
Atmosphere Pressure	101kPa	Test Voltage	DC 15 V

TEST DATE / ENGINEER

Test Date	April 13, 2023	Test By	Johnson Liu
-----------	----------------	---------	-------------

TEST RESULTS

Please refer to section "Test Data" - Appendix A&B&C

7.3. CONDUCTED OUTPUT POWER

LIMITS

CFR 47 FCC Part15, Subpart E		
Test Item	Limit	Frequency Range (MHz)
Conducted Output Power	<input type="checkbox"/> Outdoor Access Point: 1 W (30 dBm) <input type="checkbox"/> Indoor Access Point: 1 W (30 dBm) <input type="checkbox"/> Fixed Point-To-Point Access Points: 1 W (30 dBm) <input checked="" type="checkbox"/> Client Devices: 250 mW (24 dBm)	5150 ~ 5250
	Shall not exceed the lesser of 250 mW (24dBm) or 11 dBm + 10 log B, where B is the 26 dB emission bandwidth in megahertz.	5250 ~ 5350 5470 ~ 5725
	Shall not exceed 1 Watt (30 dBm).	5725 ~ 5850

Note:

The above limits are based upon the maximum antenna gain does not exceed 6 dBi. If transmitting antennas of directional gain greater than 6 dBi are used, the maximum conducted output power shall be reduced by the amount in dB that the directional gain of the antenna exceeds 6 dBi.

TEST PROCEDURE

Refer to KDB 789033 D02 General U-NII Test Procedures New Rules v02r01 section II.E.

Method SA-2 (trace averaging across ON and OFF times of the EUT transmissions, followed by duty cycle correction.):

- (a) Measure the duty cycle D of the transmitter output signal.
- (b) Set span to encompass the entire 26 dB EBW or 99% OBW of the signal.
- (c) Set RBW = 1 MHz.
- (d) Set VBW \geq 3 MHz.
- (e) Number of points in sweep \geq $[2 \times \text{span} / \text{RBW}]$. (This gives bin-to-bin spacing \leq RBW / 2, so that narrowband signals are not lost between frequency bins.)
- (f) Sweep time = auto.
- (g) Detector = RMS (i.e., power averaging), if available. Otherwise, use sample detector mode.
- (h) Do not use sweep triggering. Allow the sweep to "free run."
- (i) Trace average at least 100 traces in power averaging (rms) mode; however, the number of traces to be averaged shall be increased above 100 as needed such that the average accurately represents the true average over the ON and OFF periods of the transmitter.
- (j) Compute power by integrating the spectrum across the 26 dB EBW or 99% OBW of the signal using the instrument's band power measurement function with band limits set equal to the EBW or OBW band edges. If the instrument does not have a band power function, then sum the spectrum levels (in power units) at 1 MHz intervals extending across the 26 dB EBW or 99% OBW of the spectrum.
- (k) Add $[10 \log (1 / D)]$, where D is the duty cycle, to the measured power to compute the average power during the actual transmission times (because the measurement represents an average over both the ON and OFF times of the transmission). For example, add $[10 \log (1 / 0.25)] = 6$ dB if the duty cycle is 25%.

Method PM (Measurement using an RF average power meter):

(i) Measurements may be performed using a wideband RF power meter with a thermocouple detector or equivalent if all of the following conditions are satisfied:

- a. The EUT is configured to transmit continuously or to transmit with a constant duty cycle.
- b. At all times when the EUT is transmitting, it must be transmitting at its maximum power control level.
- c. The integration period of the power meter exceeds the repetition period of the transmitted signal by at least a factor of five.

(ii) If the transmitter does not transmit continuously, measure the duty cycle, x , of the transmitter output signal as described in II.B.

(iii) Measure the average power of the transmitter. This measurement is an average over both the on and off periods of the transmitter.

(iv) Adjust the measurement in dBm by adding $10 \log (1/x)$ where x is the duty cycle (e.g., $10 \log (1/0.25)$ if the duty cycle is 25 %).

Note: Method SA-2 was used for straddle channel output power test, and Method PM was used for testing rest channels

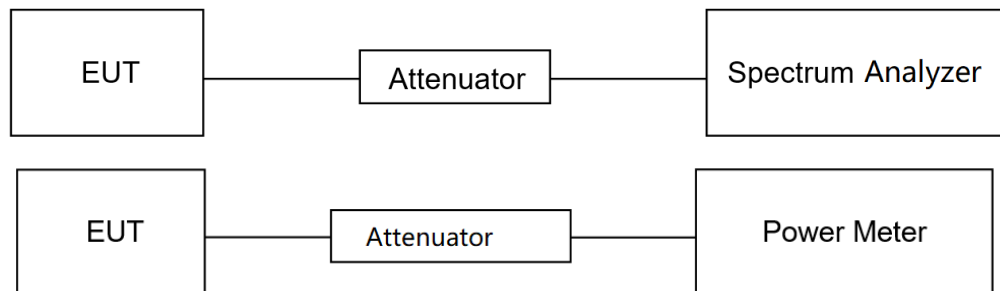
TEST SETUP

TEST ENVIRONMENT

Temperature	23.6°C	Relative Humidity	59%
Atmosphere Pressure	101kPa	Test Voltage	DC 15 V

TEST DATE / ENGINEER

Test Date	April 13, 2023	Test By	Johnson Liu
-----------	----------------	---------	-------------

TEST RESULTS

Please refer to section "Test Data" - Appendix D

7.4. POWER SPECTRAL DENSITY

LIMITS

CFR 47 FCC Part15, Subpart E		
Test Item	Limit	Frequency Range (MHz)
Power Spectral Density	<input type="checkbox"/> Outdoor Access Point: 17 dBm/MHz <input type="checkbox"/> Indoor Access Point: 17 dBm/MHz <input type="checkbox"/> Fixed Point-To-Point Access Points: 17 dBm/MHz <input checked="" type="checkbox"/> Client Devices: 11 dBm/MHz	5150 ~ 5250
	11 dBm/MHz	5250 ~ 5350 5470 ~ 5725
	30 dBm/500kHz	5725 ~ 5850

Note:

The above limits are based upon the maximum antenna gain does not exceed 6 dBi.

If transmitting antennas of directional gain greater than 6 dBi are used, maximum power spectral density shall be reduced by the amount in dB that the directional gain of the antenna exceeds 6 dBi.

TEST PROCEDURE

Refer to KDB 789033 D02 General U-NII Test Procedures New Rules v02r01 section II.F.

Connect the EUT to the spectrum analyser and use the following settings:

For U-NII-1, U-NII-2A and U-NII-2C band:

Center Frequency	The center frequency of the channel under test
Detector	RMS
RBW	1 MHz
VBW	$\geq 3 \times$ RBW
Span	Encompass the entire emissions bandwidth (EBW) of the signal
Trace	Max hold
Sweep time	Auto

For U-NII-3:

Center Frequency	The center frequency of the channel under test
Detector	RMS
RBW	500 kHz
VBW	$\geq 3 \times$ RBW
Span	Encompass the entire emissions bandwidth (EBW) of the signal
Trace	Max hold
Sweep time	Auto

Allow trace to fully stabilize and Use the peak search function on the instrument to find the peak of the spectrum and record its value.

Add $10 \log (1/x)$, where x is the duty cycle, to the peak of the spectrum, the result is the Maximum PSD over 1 MHz / 500 kHz reference bandwidth.

TEST SETUP

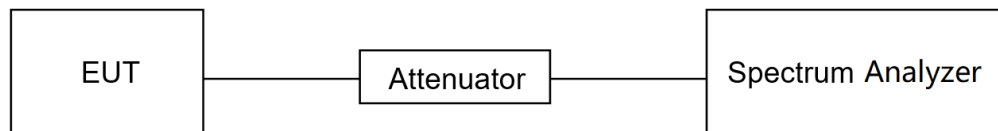

TEST ENVIRONMENT

Temperature	23.6°C	Relative Humidity	59%
Atmosphere Pressure	101kPa	Test Voltage	DC 15 V

TEST DATE / ENGINEER

Test Date	April 13, 2023	Test By	Johnson Liu
-----------	----------------	---------	-------------

TEST RESULTS

Please refer to section "Test Data" - Appendix E

7.5. FREQUENCY STABILITY

LIMITS

The frequency of the carrier signal shall be maintained within band of operation.

TEST PROCEDURE

1. The EUT was placed inside an environmental chamber as the temperature in the chamber was varied between 0 °C ~ 40 °C (declared by customer).

2. The temperature was incremented by 10 °C intervals and the unit allowed to stabilize at each temperature before each measurement. The center frequency of the transmitting channel was evaluated at each temperature and the frequency deviation from the channel's center frequency was recorded.

3. The primary supply voltage is varied from 85 % to 115 % of the nominal value for non hand-carried battery and AC powered equipment. For hand-carried, battery-powered equipment, primary supply voltage is reduced to the battery operating end point which shall be specified by the manufacturer.

Connect the EUT to the spectrum analyser and use the following settings:

Center Frequency	The center frequency of the channel under test
Detector	Peak
RBW	10 kHz
VBW	$\geq 3 \times \text{RBW}$
Span	Encompass the entire emissions bandwidth (EBW) of the signal
Trace	Max hold
Sweep time	Auto

4. While maintaining a constant temperature inside the environmental chamber, turn the EUT on and record the operating frequency at startup, and at 2 minutes, 5 minutes, and 10 minutes after the EUT is energized.

5. Allow the trace to stabilize, find the peak value of the power envelope and record the frequency, then calculated the frequency drift.

TEST ENVIRONMENT

	Normal Test Conditions	Extreme Test Conditions
Relative Humidity	20 % - 75 %	/
Atmospheric Pressure	100 kPa ~102 kPa	/
Temperature	T _N (Normal Temperature): 25.1 °C	T _L (Low Temperature): 0 °C
		T _H (High Temperature): 40 °C
Supply Voltage	V _N (Normal Voltage): AC 120 V, 60 Hz	V _L (Low Voltage): AC 102 V
		V _H (High Voltage): AC 138 V

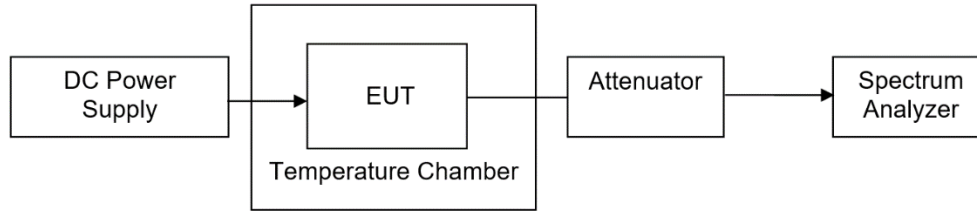
TEST SETUP

TEST ENVIRONMENT

Temperature	23.6°C	Relative Humidity	59%
Atmosphere Pressure	101kPa	Test Voltage	DC 15 V

TEST DATE / ENGINEER

Test Date	April 13, 2023	Test By	Johnson Liu
-----------	----------------	---------	-------------

TEST RESULTS

Please refer to section "Test Data" - Appendix F

8. RADIATED TEST RESULTS

LIMITS

Refer to CFR 47 FCC §15.205, §15.209 and §15.407 (b).

Radiation Disturbance Test Limit for FCC (Class B) (9 kHz ~ 1 GHz)

Emissions radiated outside of the specified frequency bands above 30 MHz			
Frequency Range (MHz)	Field Strength Limit (uV/m) at 3 m	Field Strength Limit (dBuV/m) at 3 m	
		Quasi-Peak	
30 - 88	100	40	
88 - 216	150	43.5	
216 - 960	200	46	
Above 960	500	54	
Above 1000	500	Peak	Average
		74	54

FCC Emissions radiated outside of the specified frequency bands below 30 MHz		
Frequency (MHz)	Field strength (microvolts/meter)	Measurement distance (meters)
0.009-0.490	2400/F(kHz)	300
0.490-1.705	24000/F(kHz)	30
1.705-30.0	30	30

FCC Restricted bands of operation refer to FCC §15.205 (a):

MHz	MHz	MHz	GHz
0.090-0.110	16.42-16.423	399.9-410	4.5-5.15
¹ 0.495-0.505	16.69475-16.69525	608-614	5.35-5.46
2.1735-2.1905	16.80425-16.80475	960-1240	7.25-7.75
4.125-4.128	25.5-25.67	1300-1427	8.025-8.5
4.17725-4.17775	37.5-38.25	1435-1626.5	9.0-9.2
4.20725-4.20775	73-74.6	1645.5-1646.5	9.3-9.5
6.215-6.218	74.8-75.2	1660-1710	10.6-12.7
6.26775-6.26825	108-121.94	1718.8-1722.2	13.25-13.4
6.31175-6.31225	123-138	2200-2300	14.47-14.5
8.291-8.294	149.9-150.05	2310-2390	15.35-16.2
8.362-8.366	156.52475-156.52525	2483.5-2500	17.7-21.4
8.37625-8.38675	156.7-156.9	2690-2900	22.01-23.12
8.41425-8.41475	162.0125-167.17	3260-3267	23.6-24.0
12.29-12.293	167.72-173.2	3332-3339	31.2-31.8
12.51975-12.52025	240-285	3345.8-3358	36.43-36.5
12.57675-12.57725	322-335.4	3600-4400	(²)
13.36-13.41			

Note: ¹Until February 1, 1999, this restricted band shall be 0.490-0.510 MHz.

²Above 38.6c

Limits of unwanted/undesirable emission out of the restricted bands refer to CFR 47 FCC §15.407 (b) and ISED RSS-247 6.2.

LIMITS OF RADIATED EMISSION MEASUREMENT (Above 1GHz)		
Frequency Range (MHz)	EIRP Limit	Field Strength Limit (dBuV/m) at 3 m
5150~5250 MHz	PK: -27 (dBm/MHz)	PK: 68.2(dBμV/m)
5250~5350 MHz		
5470~5725 MHz		
5725~5850 MHz	PK: -27 (dBm/MHz) *1 PK: 10 (dBm/MHz) *2 PK: 15.6 (dBm/MHz) *3 PK: 27 (dBm/MHz) *4	PK: 68.2(dBμV/m) *1 PK: 105.2 (dBμV/m) *2 PK: 110.8(dBμV/m) *3 PK: 122.2 (dBμV/m) *4
Note: *1 beyond 75 MHz or more above of the band edge. *2 below the band edge increasing linearly to 10 dBm/MHz at 25 MHz above. *3 below the band edge increasing linearly to a level of 15.6 dBm/MHz at 5 MHz above. *4 from 5 MHz above or below the band edge increasing linearly to a level of 27 dBm/MHz at the band edge.		

TEST PROCEDURE

Below 30 MHz

The setting of the spectrum analyser

RBW	200 Hz (From 9 kHz to 0.15 MHz)/ 9 kHz (From 0.15 MHz to 30 MHz)
VBW	200 Hz (From 9 kHz to 0.15 MHz)/ 9 kHz (From 0.15 MHz to 30 MHz)
Sweep	Auto

1. The testing follows the guidelines in ANSI C63.10-2013 clause 6.4.
2. The EUT was arranged to its worst case and then turntable (from 0 degree to 360 degrees) to find the maximum reading. A pre-amp and a high pass filter are used for the test in order to get better signal level. Both Horizontal, Face-on and Face-off polarizations of the antenna are set to make the measurement.
3. The EUT was placed on a turntable with 80 cm above ground.
4. The EUT was set 3 meters from the interference receiving antenna, which was mounted on the top of a 1 m height antenna tower.
5. The radiated emission limits are based on measurements employing a CISPR quasi-peak detector except for the frequency bands 9-90 kHz, 110-490 kHz and above 1000 MHz Radiated emission limits in these three bands are based on measurements employing an average detector.
6. For measurement below 1 GHz, the initial step in collecting conducted emission data is a spectrum analyzer peak detector mode pre-scanning the measurement frequency range. Significant peaks are then marked and then Quasi Peak and average detector mode re-measured. If the emission level of the EUT measured by the peak detector is 3 dB lower than the applicable limit, the peak emission level will be reported. Otherwise, the emission measurement will be repeated using the quasi-peak and average detector and reported.
7. Although these tests were performed other than open field site, adequate comparison measurements were confirmed against 30m open field site. Therefore sufficient tests were made to demonstrate that the alternative site produces results that correlate with the ones of tests made in an open field site based on KDB 414788.
8. The limits in CFR 47, Part 15, Subpart C, paragraph 15.209 (a), are identical to those in RSS-GEN Section 8.9, Table 6, since the measurements are performed in terms of magnetic field strength and converted to electric field strength levels (as reported in the table) using the free space impedance of 377Ω . For example, the measurement frequency X KHz resulted in a level of Y dBuV/m, which is equivalent to $Y-51.5 = Z$ dBuA/m, which has the same margin, W dB, to the corresponding RSS-GEN Table 6 limit as it has to be 15.209(a) limit.

Below 1 GHz and above 30 MHz

The setting of the spectrum analyser

RBW	120 kHz
VBW	300 kHz
Sweep	Auto
Detector	Peak/QP
Trace	Max hold

1. The testing follows the guidelines in ANSI C63.10-2013 clause 6.5.
2. The EUT was arranged to its worst case and then tune the antenna tower (from 1 m to 4 m) and turntable (from 0 degree to 360 degrees) to find the maximum reading. A pre-amp and a high pass filter are used for the test in order to get better signal level. Both horizontal and vertical polarizations of the antenna are set to make the measurement.
3. The EUT was placed on a turntable with 80 cm above ground.
4. The EUT was set 3 meters from the interference receiving antenna, which was mounted on the top of a variable height antenna tower.
5. For measurement below 1 GHz, the initial step in collecting conducted emission data is a spectrum analyzer peak detector mode pre-scanning the measurement frequency range. Significant peaks are then marked and then Quasi Peak detector mode re-measured. If the emission level of the EUT measured by the peak detector is 3 dB lower than the applicable limit, the peak emission level will be reported. Otherwise, the emission measurement will be repeated using the quasi-peak detector and reported.

Above 1 GHz

The setting of the spectrum analyser

RBW	1 MHz
VBW	PEAK: 3 MHz AVG: see note 6
Sweep	Auto
Detector	Peak
Trace	Max hold

1. The testing follows the guidelines in KDB 789033 D02 General U-NII Test Procedures New Rules v02r01 section II.G.3 ~ II.G.6.
2. The EUT was arranged to its worst case and then tune the antenna tower (from 1 m to 4 m) and turntable (from 0 degree to 360 degrees) to find the maximum reading. A pre-amp and a high pass filter are used for the test in order to get better signal level. Both horizontal and vertical polarizations of the antenna are set to make the measurement.
3. The EUT was placed on a turntable with 1.5 m above ground.
4. The EUT was set 3 meters from the interference receiving antenna, which was mounted on the top of a variable height antenna tower.
5. For measurement above 1 GHz, the emission measurement will be measured by the peak detector. This peak level, once corrected, must comply with the limit specified in Section 15.209.
6. For measurements above 1 GHz the resolution bandwidth is set to 1 MHz, then the video bandwidth is set to 3 MHz for peak measurements and 1 MHz resolution bandwidth with 1/T video bandwidth with peak detector for average measurements. For the Duty Cycle please refer to clause 7.1.ON TIME AND DUTY CYCLE.

X axis, Y axis, Z axis positions:

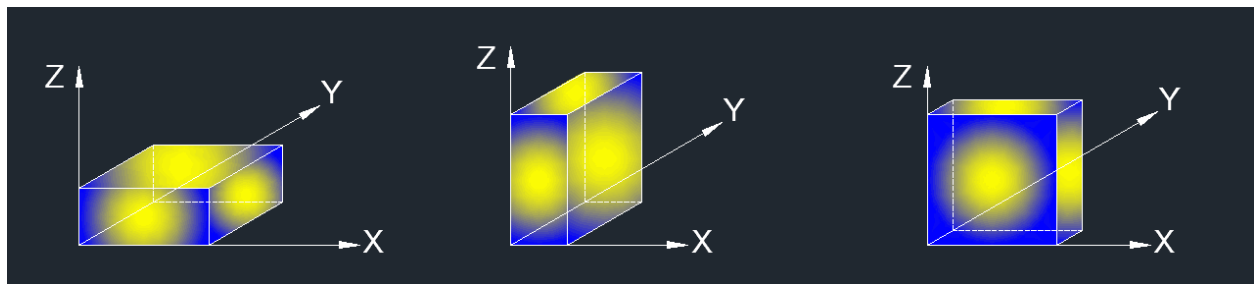

Note 1: For all radiated test, EUT in each of three orthogonal axis emissions had been tested, but only the worst case (X axis) data recorded in the report.

Note 2: The EUT was fully exercised with external accessories during the test. In the case of multiple accessory external ports, an external accessory shall be connected to one of each type of port.

For Band edge:

Note:

1. Measurement = Reading Level + Correct Factor.
2. If the Peak values are less than the Average limit of 54 dBuV/m, the Average result is deemed to comply with Average limit.
3. Peak: Peak detector.
4. AVG: $VBW=1/Ton$, where: Ton is the transmitting duration.
5. For the transmitting duration, please refer to clause 7.1.
6. Only the worst data was recorded, if it complies with the limit, the other emissions deemed to comply with the limit.
7. Horizontal and Vertical have been tested, only the worst data was recorded in the report.
8. All modes, channels and antennas have been tested, only the worst data was recorded in the report.

For Radiate Spurious emission 1GHz-7GHz:

Note:

1. Measurement = Reading Level + Correct Factor.
2. If the Peak values are less than the Average limit of 54 dBuV/m, the Average result is deemed to comply with Average limit.
3. Peak: Peak detector.
4. AVG: $VBW=1/Ton$, where: Ton is the transmitting duration.
5. For the transmitting duration, please refer to clause 7.1.
6. Filter losses were only considered in the spurious frequency bands and the authorized band was not corrected for Band reject filter losses.
7. Proper operation of the transmitter prior to adding the filter to the measurement chain.
8. Since non-restricted band peak emissions are less than the average limit, they also comply with the -27dBm/MHz (68.2dBuV/m) limit.
9. All modes, channels and antennas have been tested, only the worst data was recorded in the report.

For Radiate Spurious emission 7GHz-18GHz:

Note:

1. Measurement = Reading Level + Correct Factor.
2. If the Peak values are less than the Average limit of 54 dBuV/m, the Average result is deemed to comply with Average limit.
3. Peak: Peak detector.
4. AVG: $VBW=1/Ton$, where: Ton is the transmitting duration.
5. For the transmitting duration, please refer to clause 7.1.
6. Filter losses were only considered in the spurious frequency bands and the authorized band was not corrected for High Pass Filter losses.
7. Proper operation of the transmitter prior to adding the filter to the measurement chain.
8. Since non-restricted band peak emissions are less than the average limit, they also comply with the -27dBm/MHz (68.2dBuV/m) limit.
9. All modes, channels and antennas have been tested, only the worst data was recorded in the report.

For Radiate Spurious emission 9kHz-30MHz:

Note:

1. Measurement = Reading Level + Correct Factor
2. If the Peak values are less than the QP limit, the QP result is deemed to comply with QP limit.
3. All 3 polarizations (Horizontal, Face-on and Face-off) of the loop antenna had been tested, but only the worst data recorded in the report.
4. All modes, channels and antennas have been tested, only the worst data was recorded in the report.

For Radiate Spurious emission 18GHz-26GHz:

Note:

1. Measurement = Reading Level + Correct Factor.
2. If the Peak values are less than the Average limit of 54 dBuV/m, the Average result is deemed to comply with Average limit.
3. Peak: Peak detector.
4. All modes, channels and antennas have been tested, only the worst data was recorded in the report.

For Radiate Spurious emission 26GHz-40GHz:

Note:

1. Measurement = Reading Level + Correct Factor.
2. If the Peak values are less than the Average limit of 54 dBuV/m, the Average result is deemed to comply with Average limit.
3. Peak: Peak detector.
4. All modes, channels and antennas have been tested, only the worst data was recorded in the report.

For Radiate Spurious emission 30MHz-1GHz:

Note:

1. Result Level = Read Level + Correct Factor.
2. If the Peak values are less than the QP limit, the QP result is deemed to comply with QP limit.
3. Test setup: RBW: 120 kHz, VBW: 300 kHz, Sweep time: auto.
4. All modes, channels and antennas have been tested, only the worst data was recorded in the report.

TEST SETUP

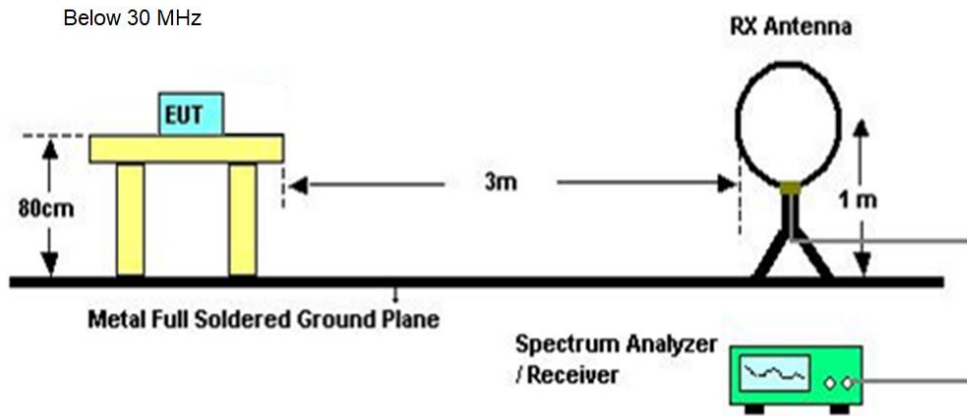

Below 1 GHz and above 30 MHz

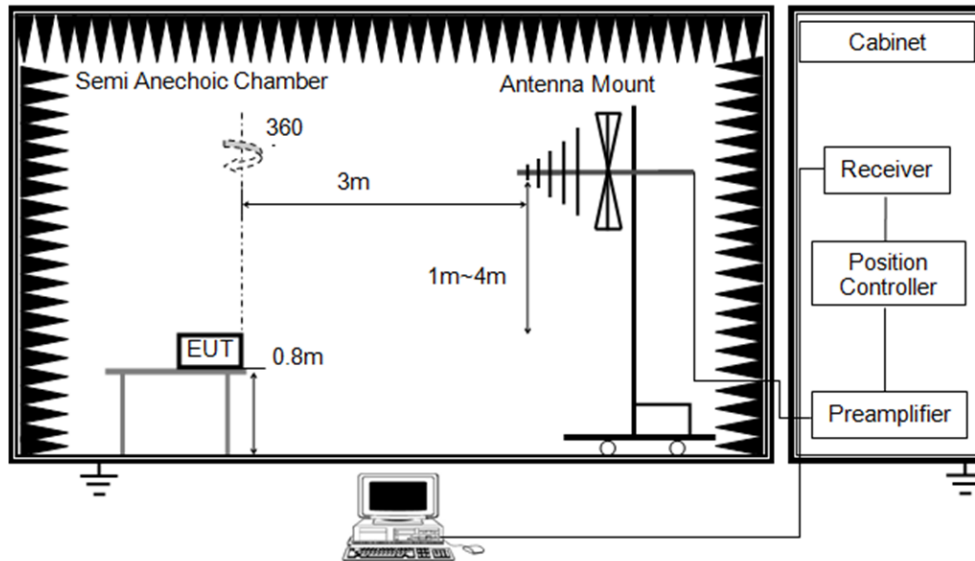

Above 1 GHz

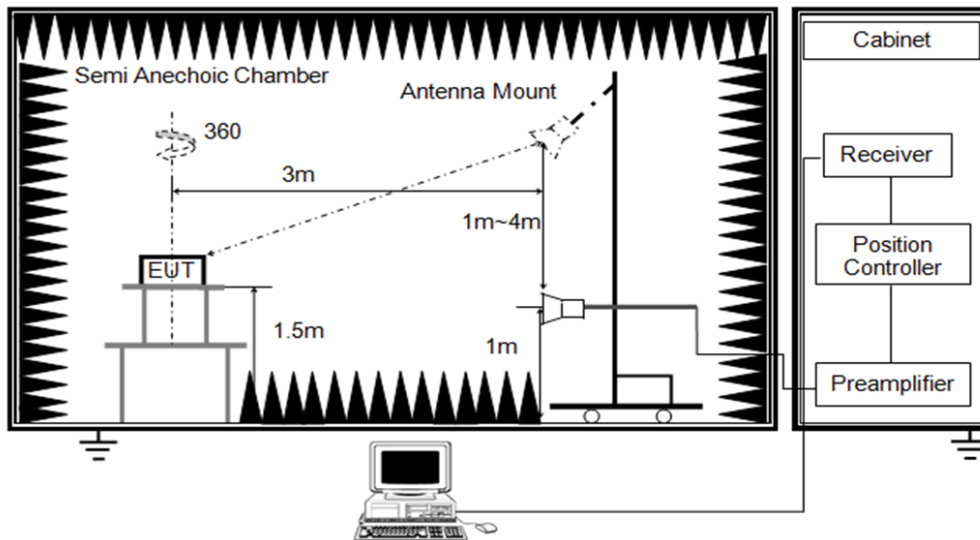

TEST ENVIRONMENT

Temperature	25.3°C	Relative Humidity	63%
Atmosphere Pressure	101kPa	Test Voltage	DC 15 V

TEST DATE / ENGINEER

Test Date	April 23, 2023	Test By	Rex Huang
-----------	----------------	---------	-----------

TEST RESULTS

8.1. RESTRICTED BANDEDGE

Test Mode:	802.11a 20 PK	Channel:	5180
Polarity:	Vertical	Test Voltage:	DC 15 V

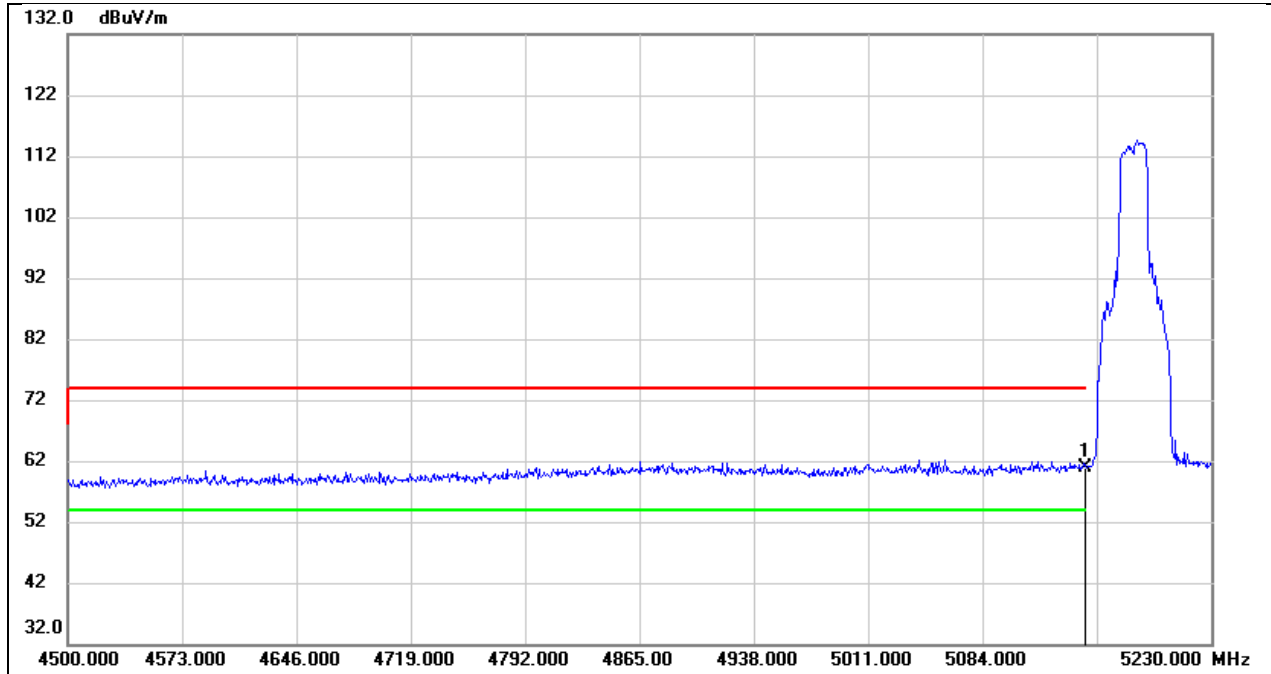

No.	Frequency (MHz)	Reading (dBuV)	Correct (dB/m)	Result (dBuV/m)	Limit (dBuV/m)	Margin (dB)	Remark
1	5150.000	20.68	40.27	60.95	74.00	-13.05	peak

Test Mode:	802.11a 20 AV	Channel:	5180
Polarity:	Vertical	Test Voltage:	DC 15 V

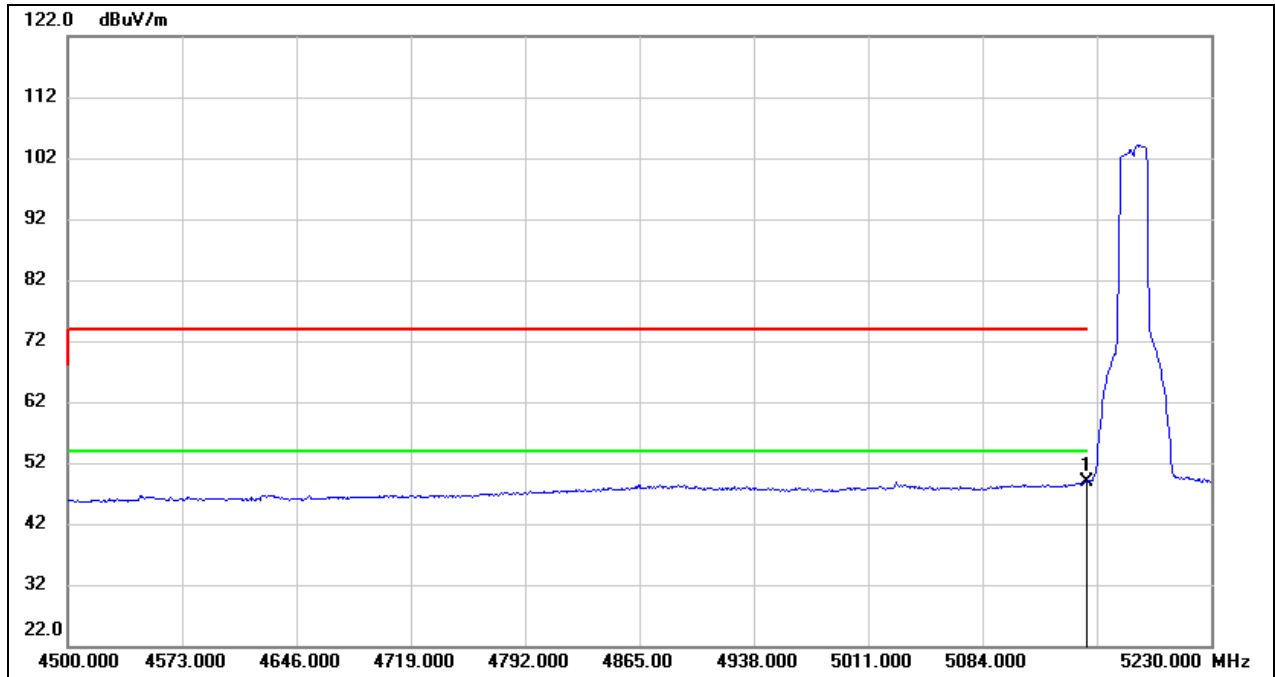

No.	Frequency (MHz)	Reading (dBuV)	Correct (dB/m)	Result (dBuV/m)	Limit (dBuV/m)	Margin (dB)	Remark
1	5150.000	8.54	40.27	48.81	54.00	-5.19	AVG

Test Mode:	802.11a 20 PK	Channel:	5240
Polarity:	Vertical	Test Voltage:	DC 15 V

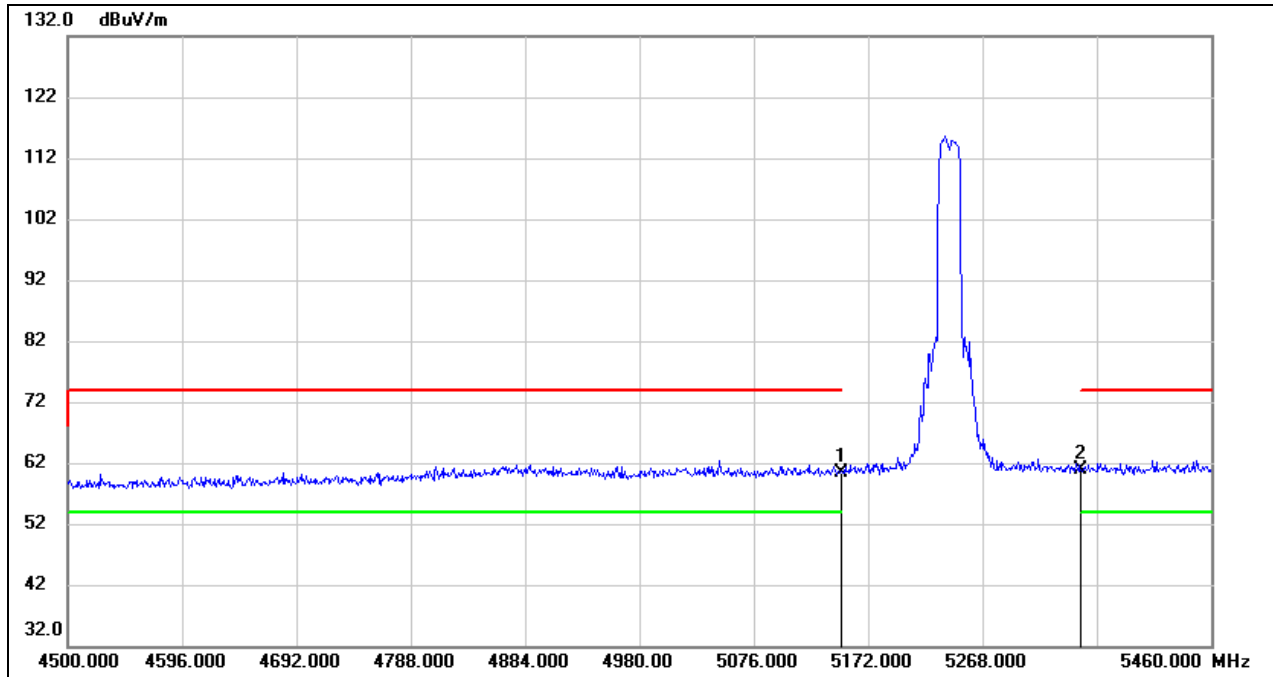

No.	Frequency (MHz)	Reading (dBuV)	Correct (dB/m)	Result (dBuV/m)	Limit (dBuV/m)	Margin (dB)	Remark
1	5150.000	20.19	40.27	60.46	74.00	-13.54	peak
2	5350.000	20.47	40.49	60.96	74.00	-13.04	peak

Test Mode:	802.11a 20 AV	Channel:	5240
Polarity:	Vertical	Test Voltage:	DC 15 V

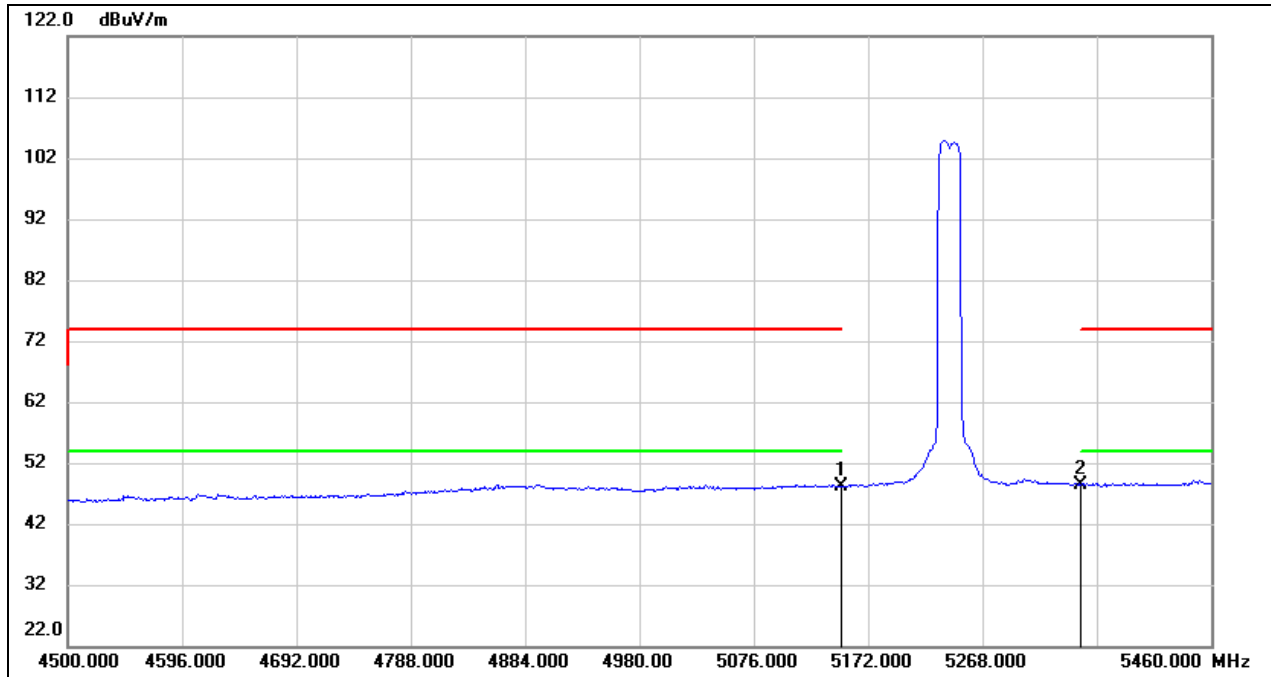

No.	Frequency (MHz)	Reading (dBuV)	Correct (dB/m)	Result (dBuV/m)	Limit (dBuV/m)	Margin (dB)	Remark
1	5150.000	7.88	40.27	48.15	54.00	-5.85	AVG
2	5350.000	7.98	40.49	48.47	54.00	-5.53	AVG

Test Mode:	802.11a 20 PK	Channel:	5745
Polarity:	Vertical	Test Voltage:	DC 15 V

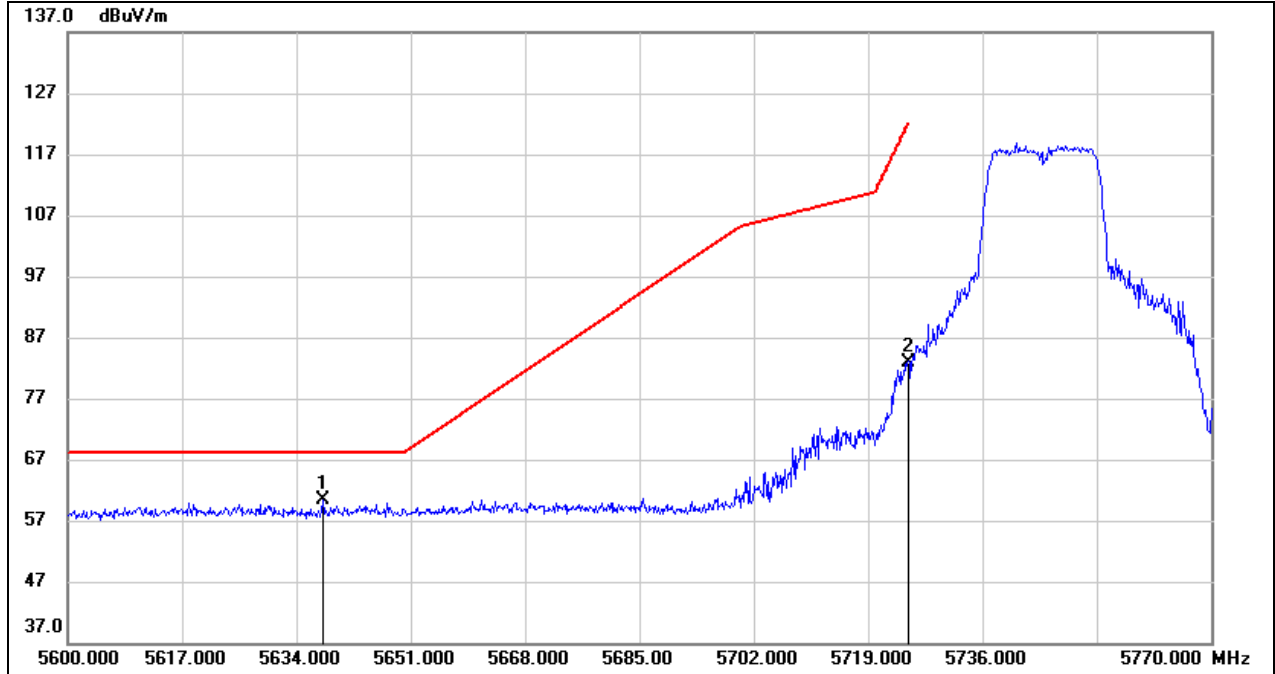

No.	Frequency (MHz)	Reading (dBuV)	Correct (dB/m)	Result (dBuV/m)	Limit (dBuV/m)	Margin (dB)	Remark
1	5637.910	19.34	41.03	60.37	68.20	-7.83	peak
2	5725.000	41.56	41.27	82.83	122.20	-39.37	peak

Test Mode:	802.11a 20 PK	Channel:	5825
Polarity:	Vertical	Test Voltage:	DC 15 V

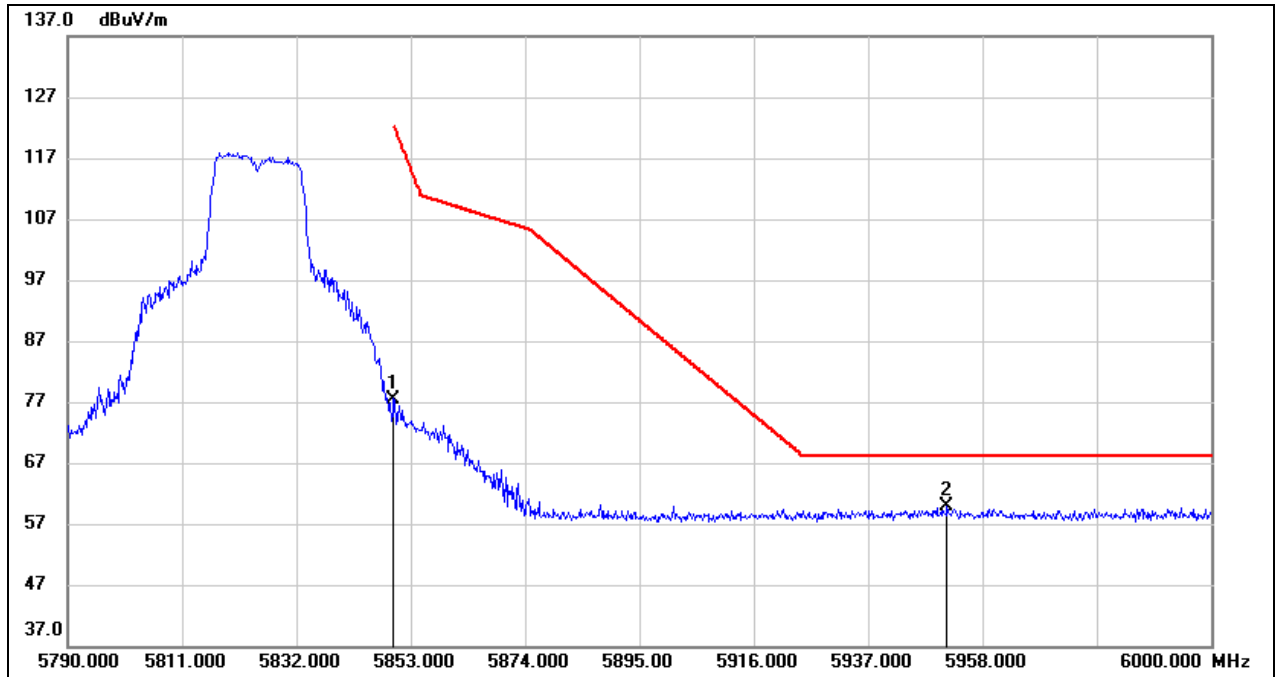

No.	Frequency (MHz)	Reading (dBuV)	Correct (dB/m)	Result (dBuV/m)	Limit (dBuV/m)	Margin (dB)	Remark
1	5850.000	35.87	41.60	77.47	122.20	-44.73	peak
2	5951.490	18.03	41.87	59.90	68.20	-8.30	peak

Test Mode:	802.11ax HE20 PK	Channel:	5180
Polarity:	Vertical	Test Voltage:	DC 15 V

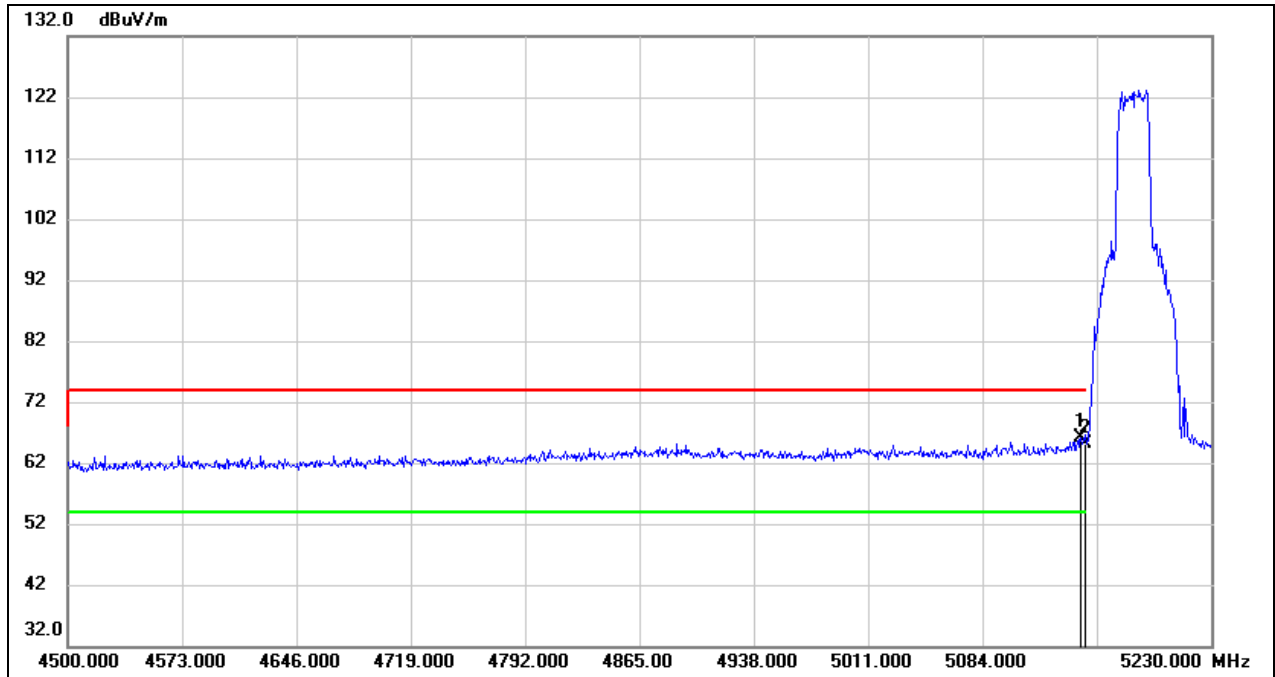

No.	Frequency (MHz)	Reading (dBuV)	Correct (dB/m)	Result (dBuV/m)	Limit (dBuV/m)	Margin (dB)	Remark
1	5146.780	22.94	43.27	66.21	74.00	-7.79	peak
2	5150.000	21.84	43.27	65.11	74.00	-8.89	peak

Test Mode:	802.11ax HE20 AV	Channel:	5180
Polarity:	Vertical	Test Voltage:	DC 15 V

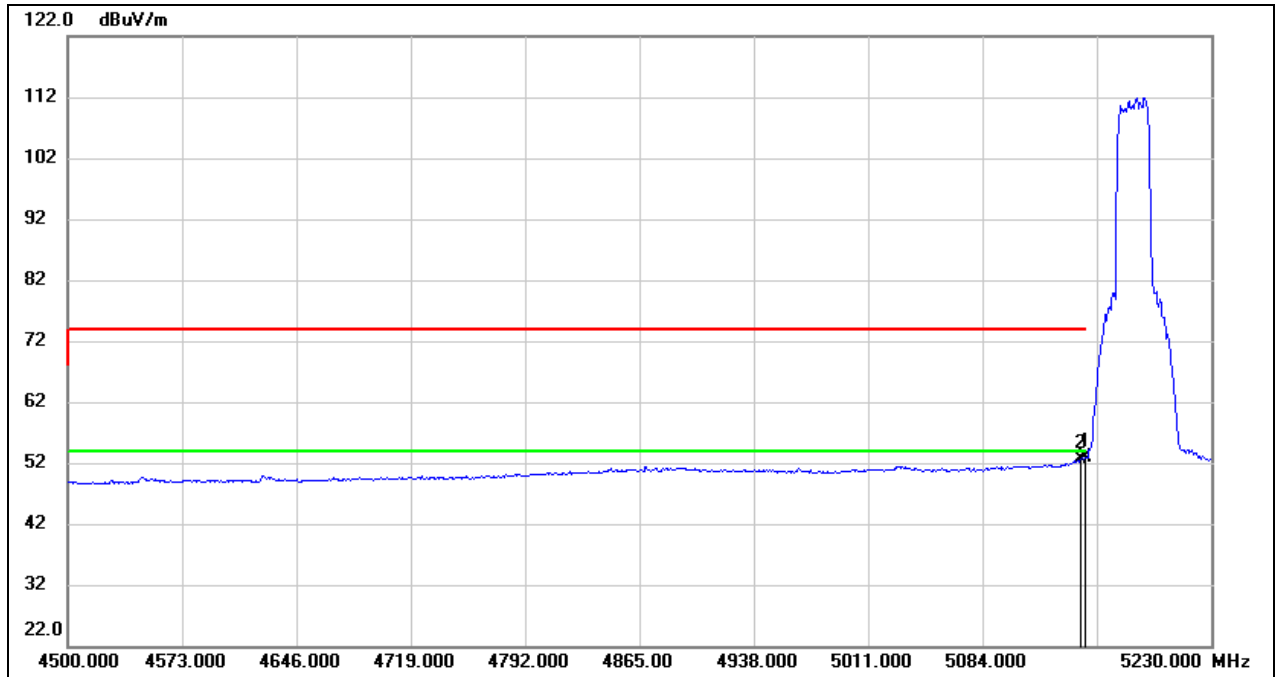

No.	Frequency (MHz)	Reading (dBuV)	Correct (dB/m)	Result (dBuV/m)	Limit (dBuV/m)	Margin (dB)	Remark
1	5150.000	9.56	43.27	52.83	54.00	-1.17	AVG
2	5146.780	9.43	43.27	52.70	54.00	-1.30	AVG

Test Mode:	802.11ax HE20 PK	Channel:	5240
Polarity:	Vertical	Test Voltage:	DC 15 V

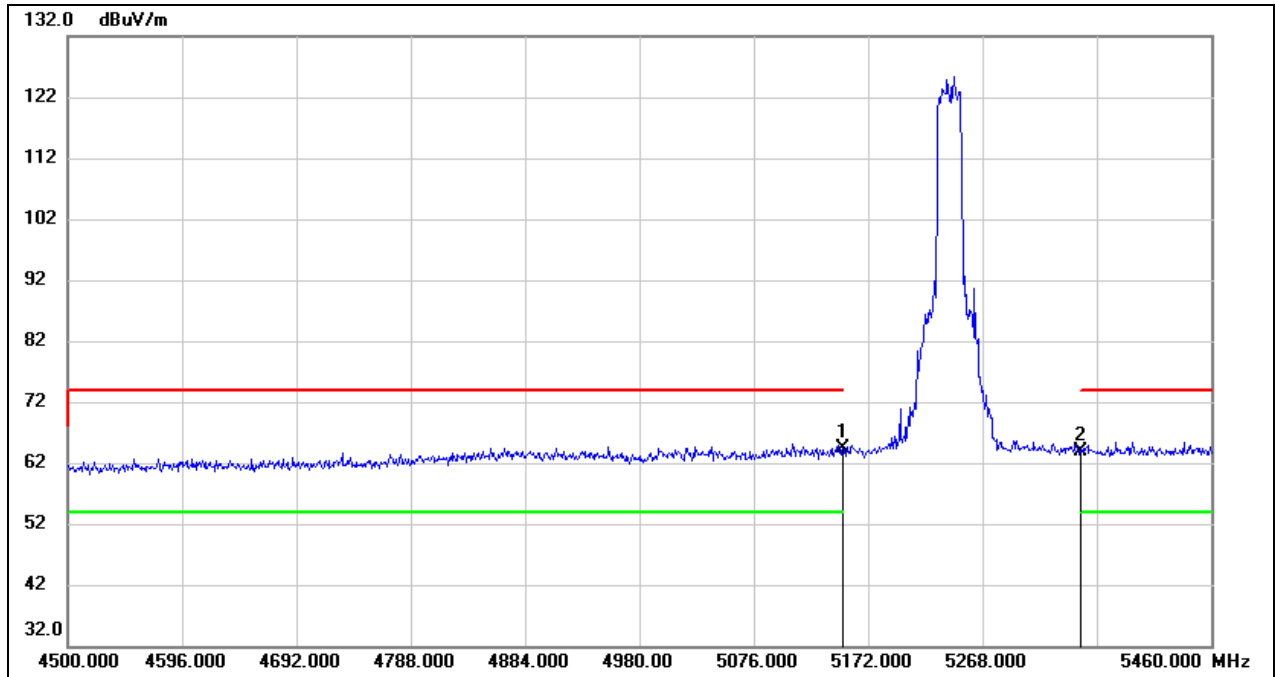

No.	Frequency (MHz)	Reading (dBuV)	Correct (dB/m)	Result (dBuV/m)	Limit (dBuV/m)	Margin (dB)	Remark
1	5150.000	20.99	43.27	64.26	74.00	-9.74	peak
2	5350.000	20.32	43.49	63.81	74.00	-10.19	peak

Test Mode:	802.11ax HE20 AV	Channel:	5240
Polarity:	Vertical	Test Voltage:	DC 15 V

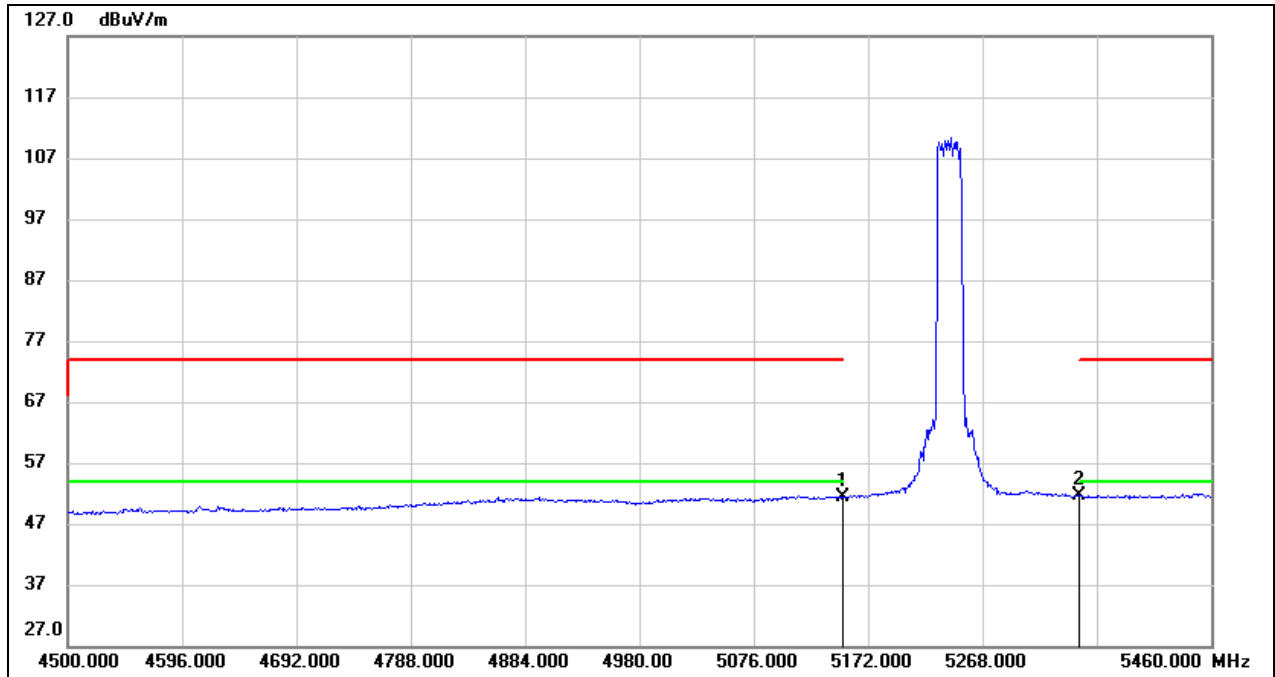

No.	Frequency (MHz)	Reading (dBuV)	Correct (dB/m)	Result (dBuV/m)	Limit (dBuV/m)	Margin (dB)	Remark
1	5150.000	8.06	43.27	51.33	54.00	-2.67	AVG
2	5350.000	8.06	43.49	51.55	54.00	-2.45	AVG

Test Mode:	802.11ax HE20 PK	Channel:	5745
Polarity:	Vertical	Test Voltage:	DC 15 V

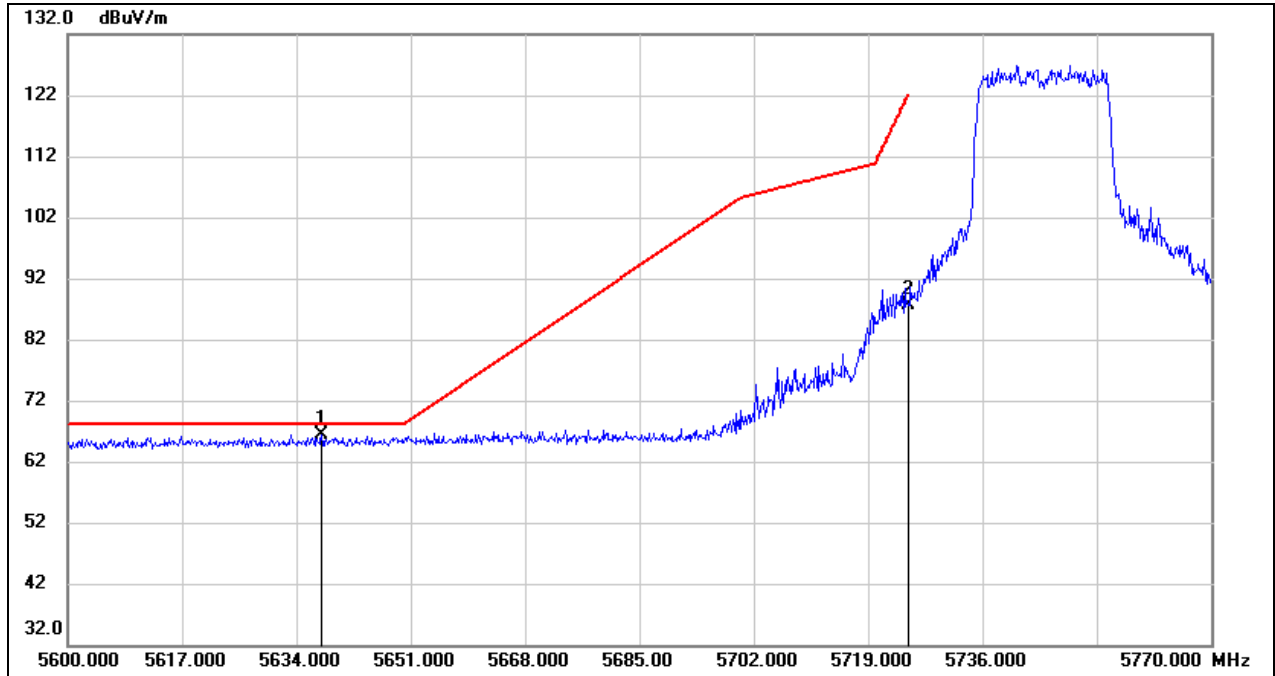

No.	Frequency (MHz)	Reading (dBuV)	Correct (dB/m)	Result (dBuV/m)	Limit (dBuV/m)	Margin (dB)	Remark
1	5637.740	22.42	44.03	66.45	68.20	-1.75	peak
2	5725.000	43.30	44.27	87.57	122.20	-34.63	peak

Test Mode:	802.11ax HE20 PK	Channel:	5825
Polarity:	Vertical	Test Voltage:	DC 15 V

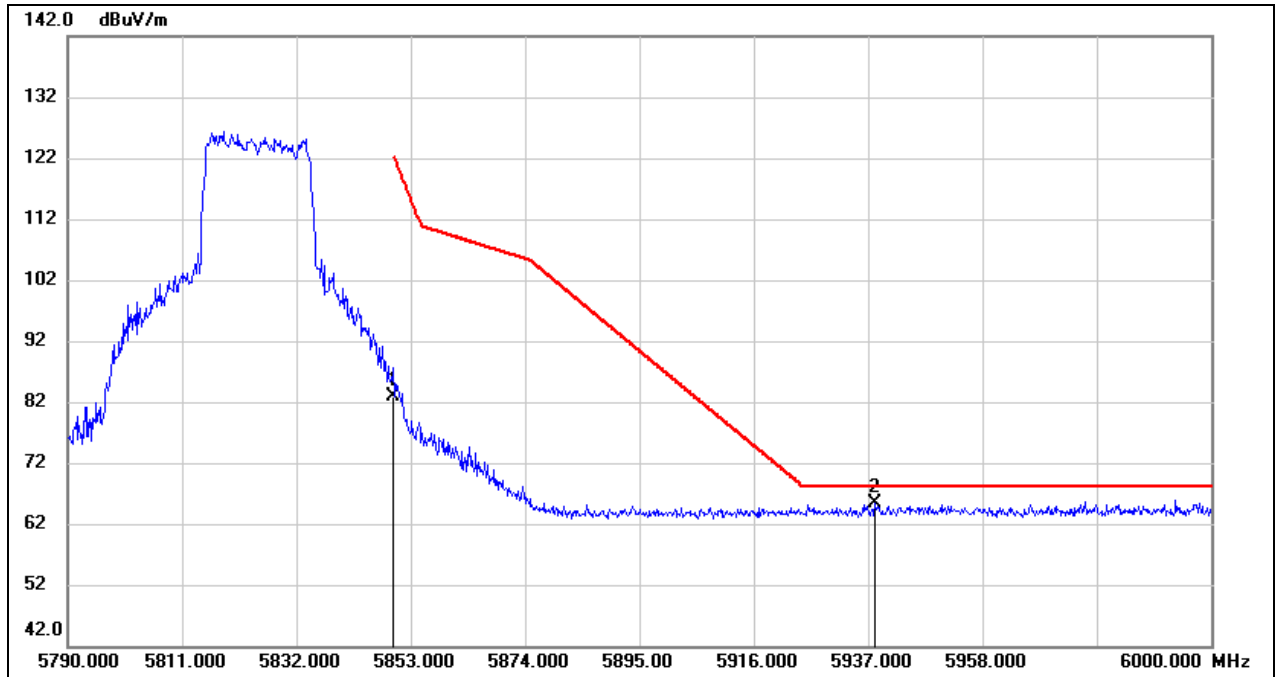

No.	Frequency (MHz)	Reading (dBuV)	Correct (dB/m)	Result (dBuV/m)	Limit (dBuV/m)	Margin (dB)	Remark
1	5850.000	38.18	44.60	82.78	122.20	-39.42	peak
2	5938.260	20.49	44.84	65.33	68.20	-2.87	peak

Test Mode:	802.11ax HE40 PK	Channel:	5190
Polarity:	Vertical	Test Voltage:	DC 15 V

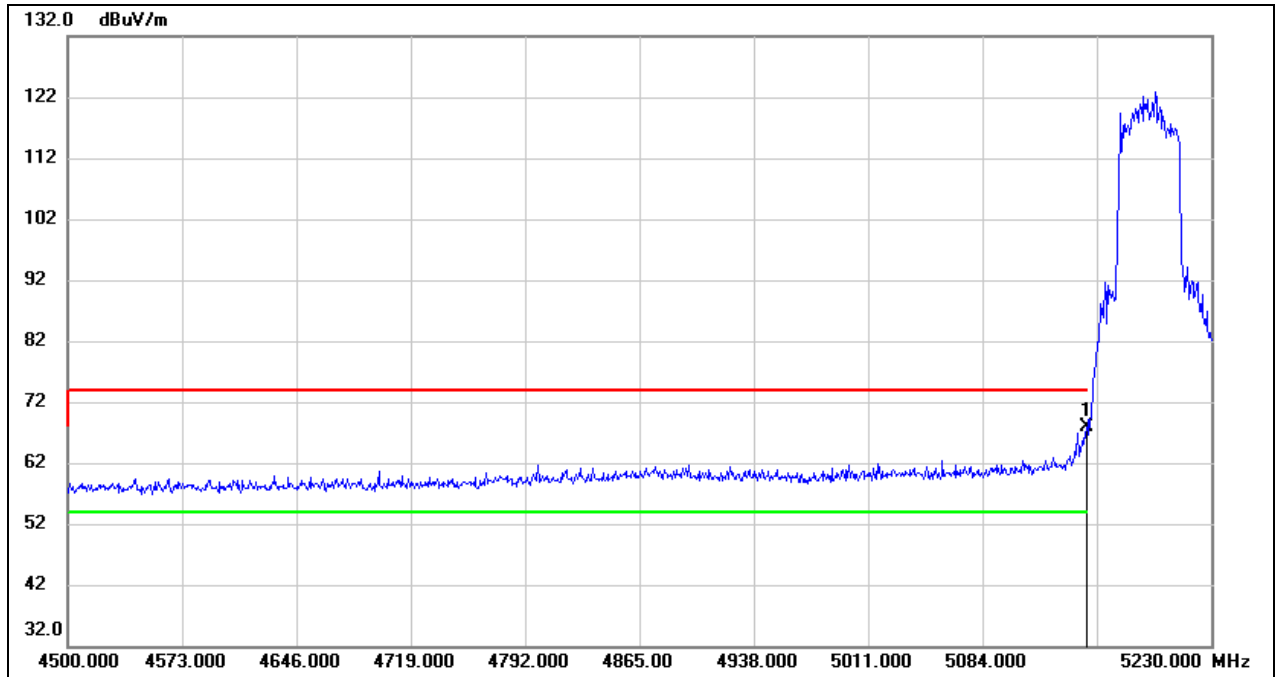

No.	Frequency (MHz)	Reading (dBuV)	Correct (dB/m)	Result (dBuV/m)	Limit (dBuV/m)	Margin (dB)	Remark
1	5150.000	27.64	40.27	67.91	74.00	-6.09	peak

Test Mode:	802.11ax HE40 AV	Channel:	5190
Polarity:	Vertical	Test Voltage:	DC 15 V

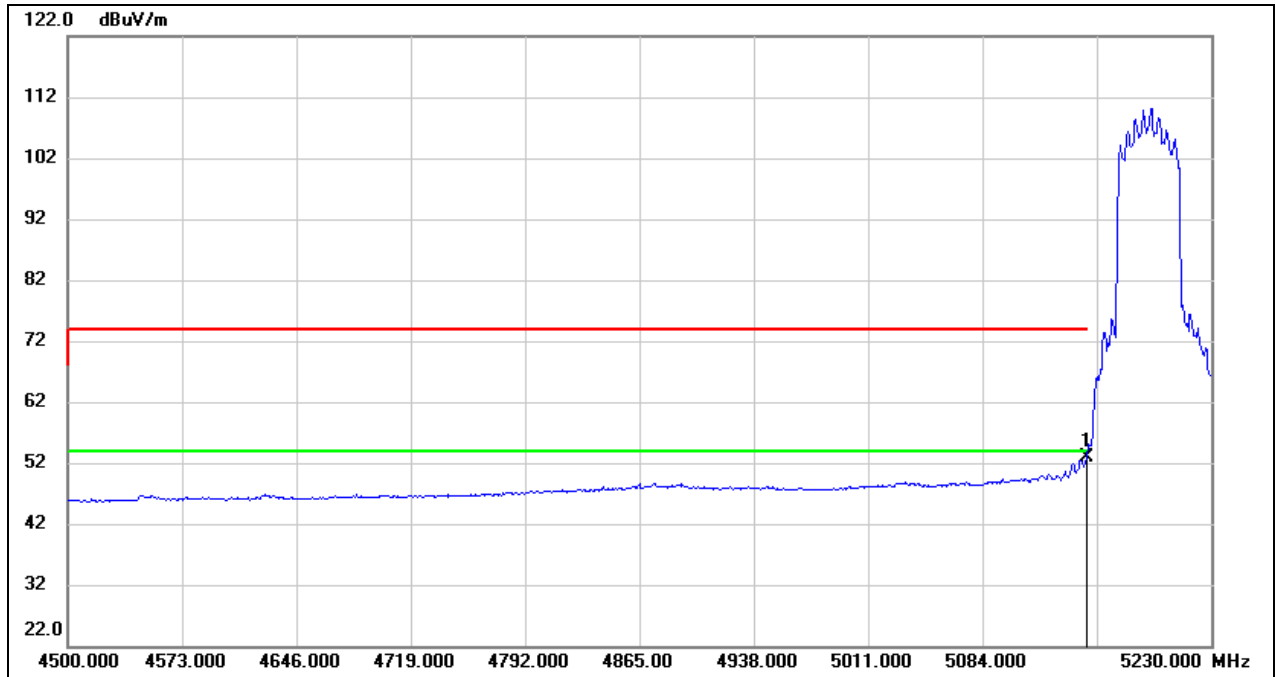

No.	Frequency (MHz)	Reading (dBuV)	Correct (dB/m)	Result (dBuV/m)	Limit (dBuV/m)	Margin (dB)	Remark
1	5150.000	12.68	40.27	52.95	54.00	-1.05	AVG

Test Mode:	802.11ax HE40 PK	Channel:	5230
Polarity:	Vertical	Test Voltage:	DC 15 V

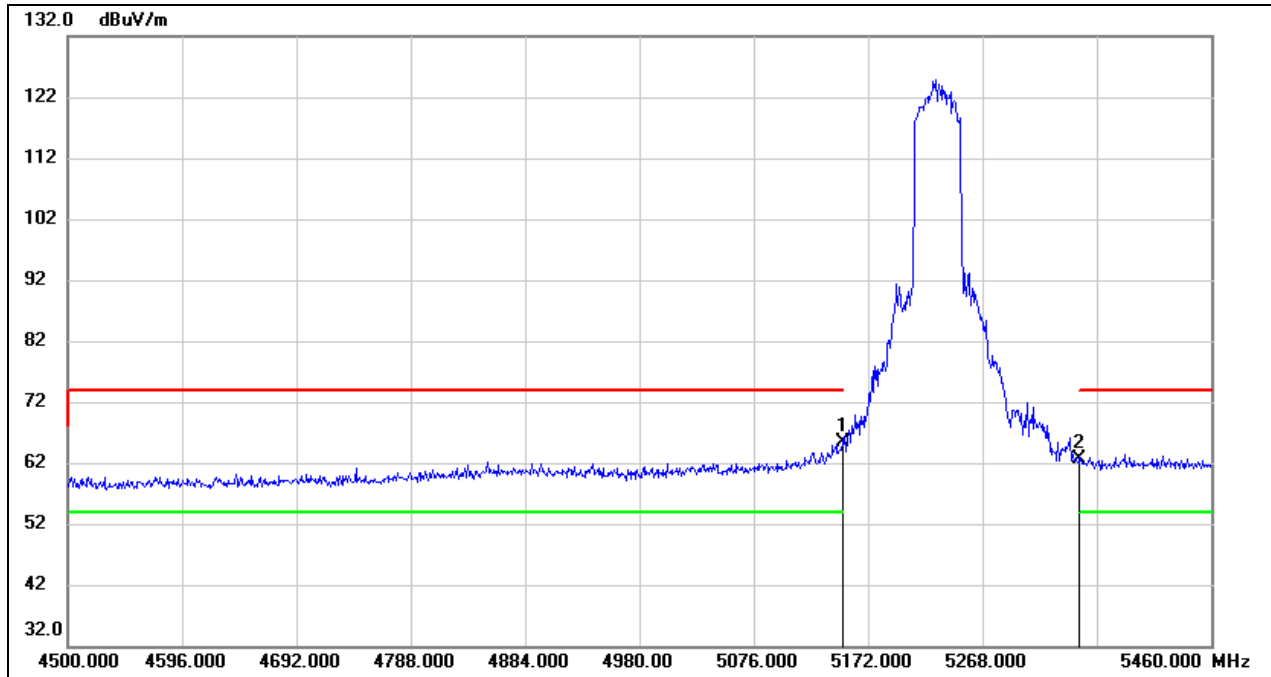

No.	Frequency (MHz)	Reading (dBuV)	Correct (dB/m)	Result (dBuV/m)	Limit (dBuV/m)	Margin (dB)	Remark
1	5150.000	25.02	40.27	65.29	74.00	-8.71	peak
2	5350.000	22.03	40.49	62.52	74.00	-11.48	peak

Test Mode:	802.11ax HE40 AV	Channel:	5230
Polarity:	Vertical	Test Voltage:	DC 15 V

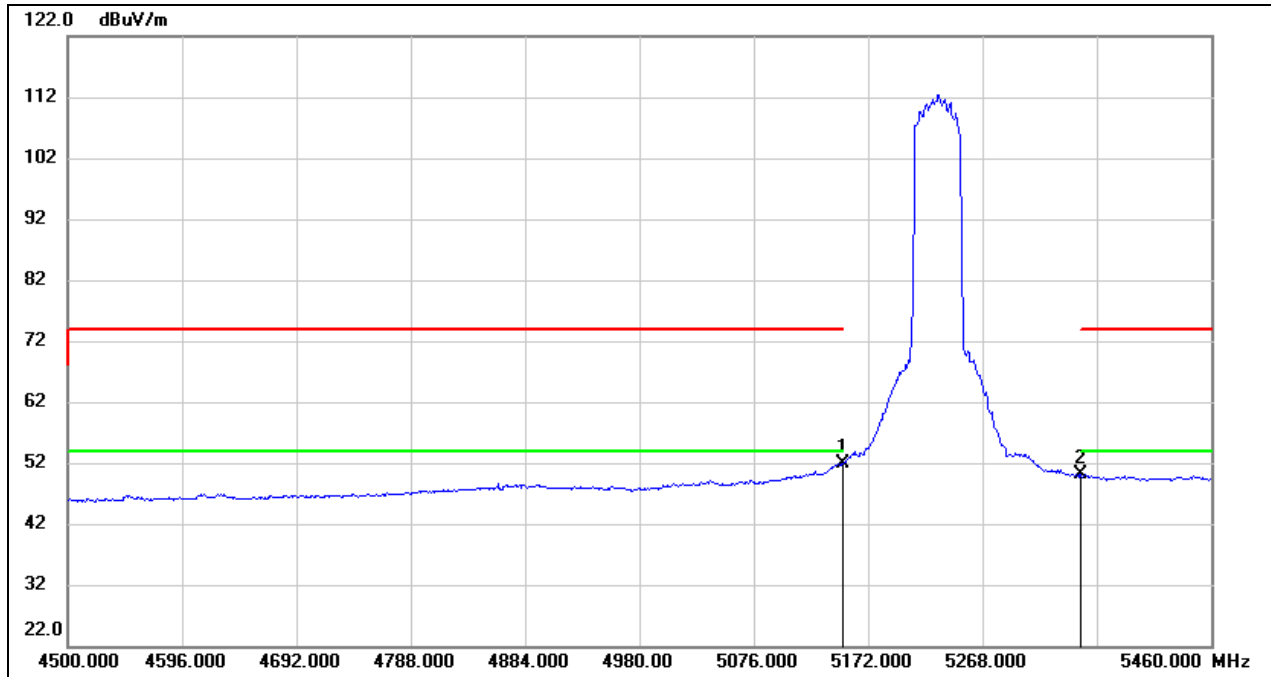

No.	Frequency (MHz)	Reading (dBuV)	Correct (dB/m)	Result (dBuV/m)	Limit (dBuV/m)	Margin (dB)	Remark
1	5150.000	11.70	40.27	51.97	54.00	-2.03	AVG
2	5350.000	9.68	40.49	50.17	54.00	-3.83	AVG

Test Mode:	802.11ax HE40 PK	Channel:	5755
Polarity:	Vertical	Test Voltage:	DC 15 V

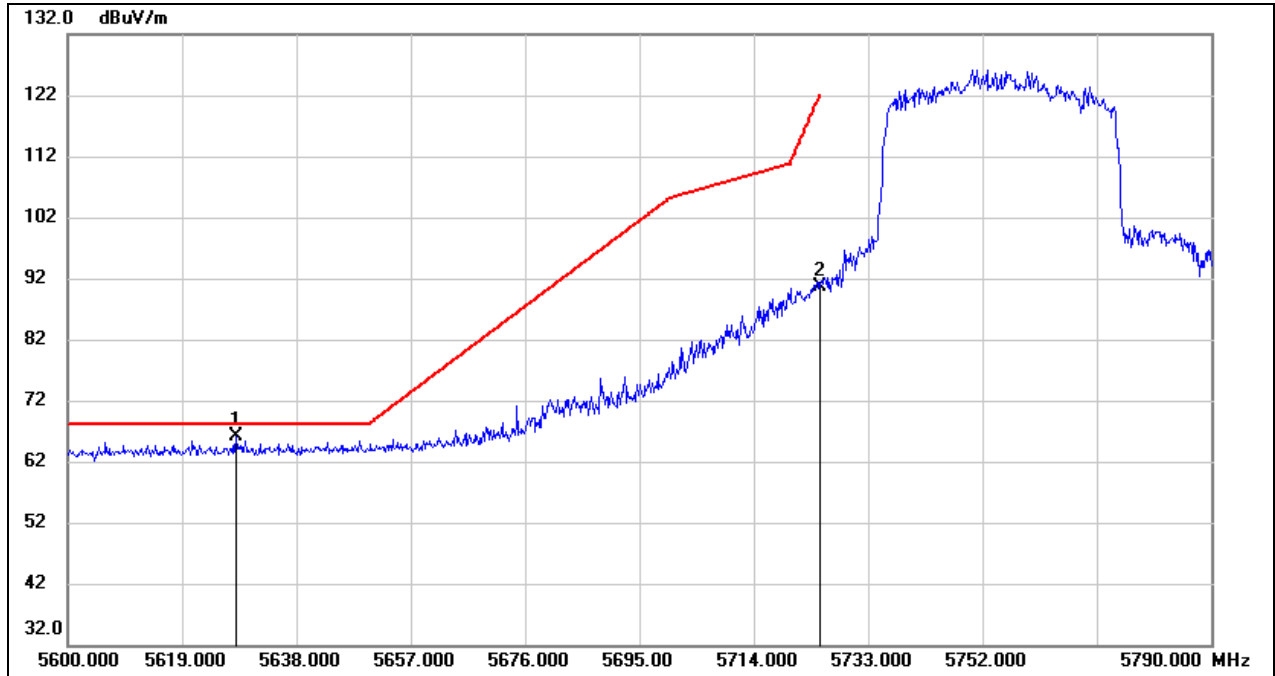

No.	Frequency (MHz)	Reading (dBuV)	Correct (dB/m)	Result (dBuV/m)	Limit (dBuV/m)	Margin (dB)	Remark
1	5627.930	25.08	41.00	66.08	68.20	-2.12	peak
2	5725.000	49.35	41.27	90.62	122.20	-31.58	peak

Test Mode:	802.11ax HE40 PK	Channel:	5795
Polarity:	Vertical	Test Voltage:	DC 15 V

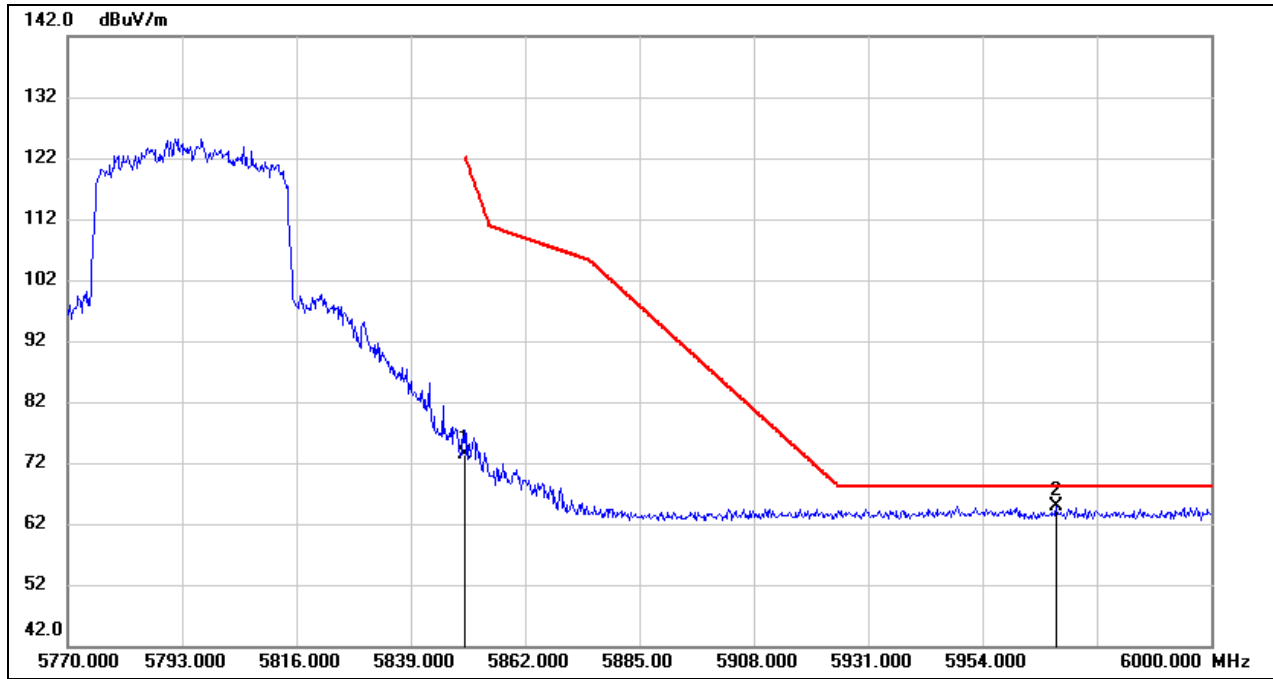

No.	Frequency (MHz)	Reading (dBuV)	Correct (dB/m)	Result (dBuV/m)	Limit (dBuV/m)	Margin (dB)	Remark
1	5850.000	31.82	41.60	73.42	122.20	-48.78	peak
2	5968.720	23.00	41.92	64.92	68.20	-3.28	peak

Test Mode:	802.11ax HE80 PK	Channel:	5210
Polarity:	Vertical	Test Voltage:	DC 15 V

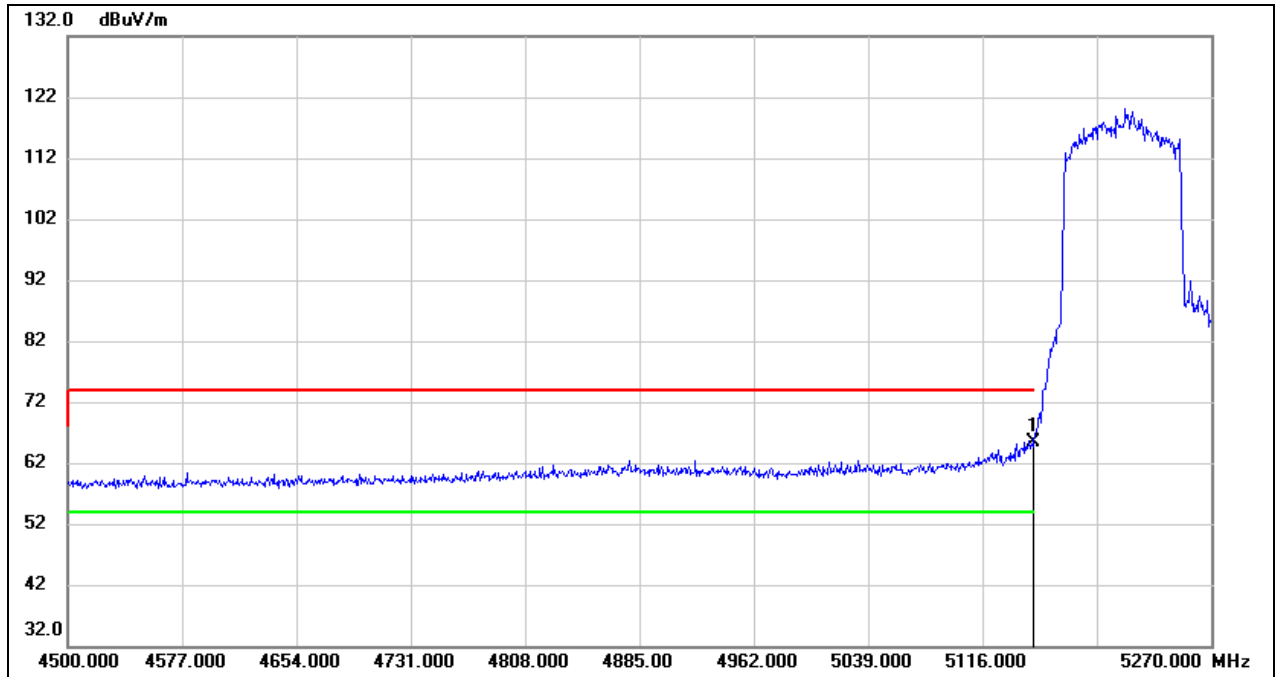

No.	Frequency (MHz)	Reading (dBuV)	Correct (dB/m)	Result (dBuV/m)	Limit (dBuV/m)	Margin (dB)	Remark
1	5150.000	25.18	40.27	65.45	74.00	-8.55	peak

Test Mode:	802.11ax HE80 AV	Channel:	5210
Polarity:	Vertical	Test Voltage:	DC 15 V

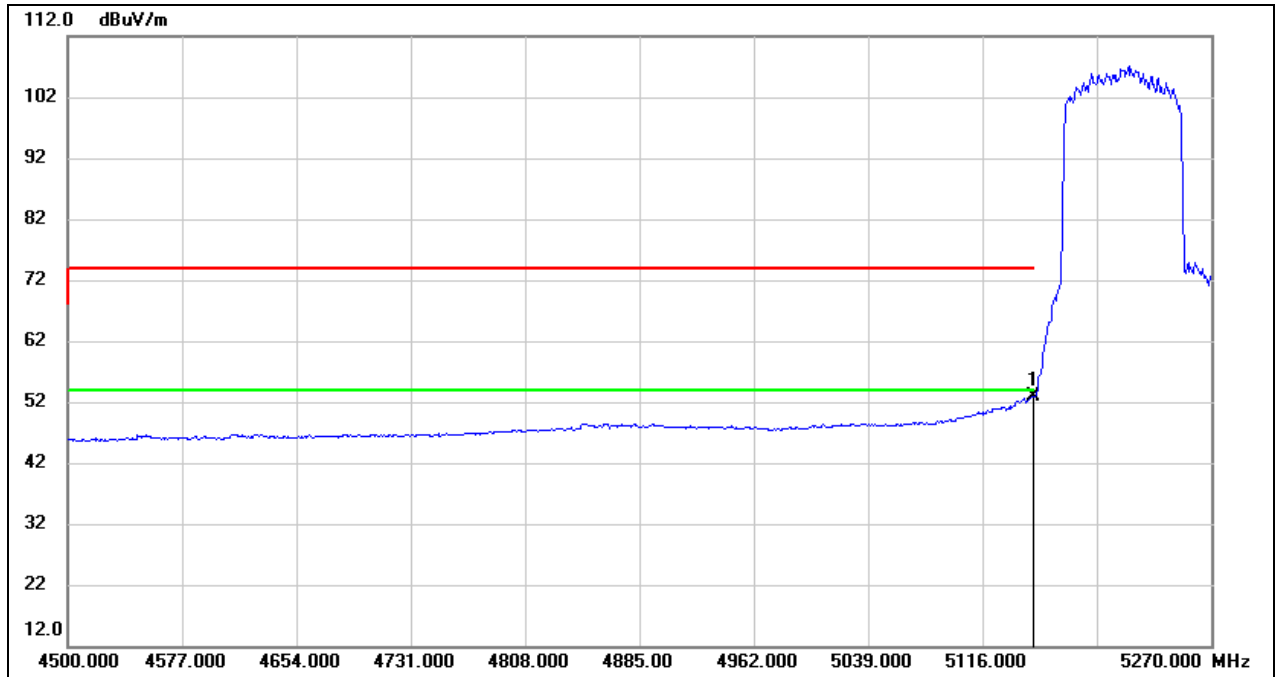

No.	Frequency (MHz)	Reading (dBuV)	Correct (dB/m)	Result (dBuV/m)	Limit (dBuV/m)	Margin (dB)	Remark
1	5150.000	12.53	40.27	52.80	54.00	-1.20	AVG

Test Mode:	802.11ax HE80 PK	Channel:	5775
Polarity:	Vertical	Test Voltage:	DC 15 V

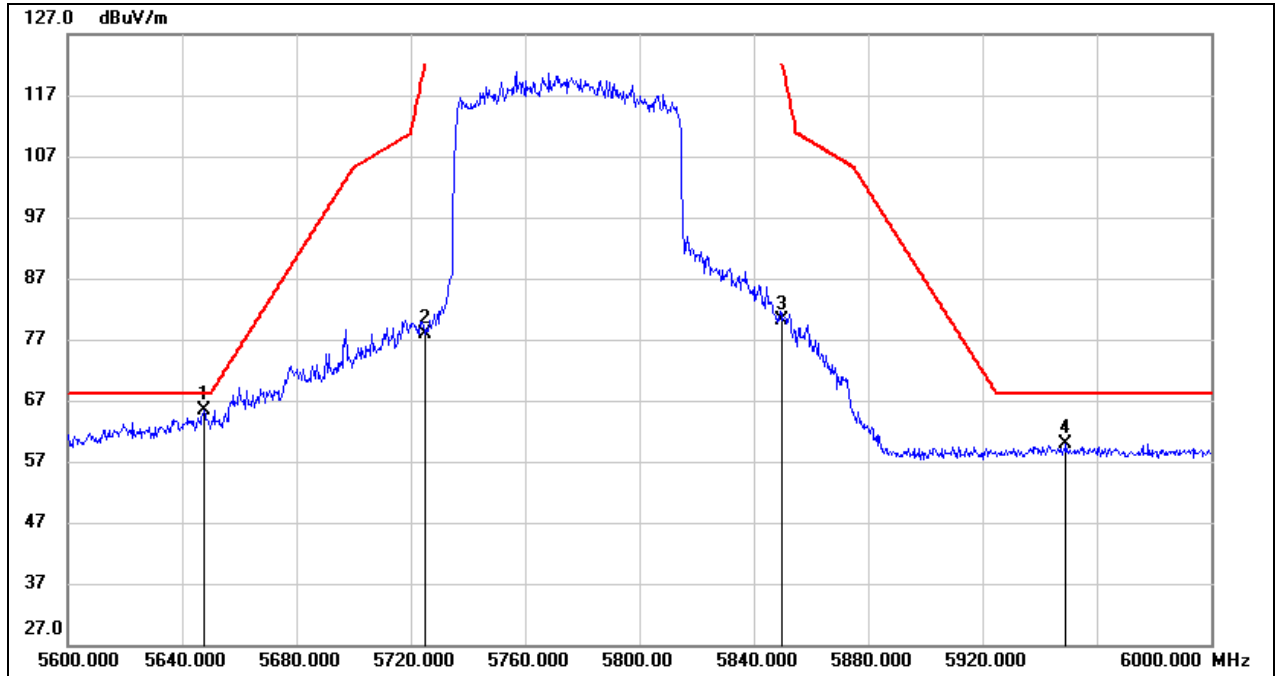

No.	Frequency (MHz)	Reading (dBuV)	Correct (dB/m)	Result (dBuV/m)	Limit (dBuV/m)	Margin (dB)	Remark
1	5647.600	24.21	41.06	65.27	68.20	-2.93	peak
2	5725.000	36.62	41.27	77.89	122.20	-44.31	peak
3	5850.000	38.63	41.60	80.23	122.20	-41.97	peak
4	5949.200	18.01	41.86	59.87	68.20	-8.33	peak

Test Mode:	802.11be EHT20 PK	Channel:	5180
Polarity:	Vertical	Test Voltage:	DC 15 V

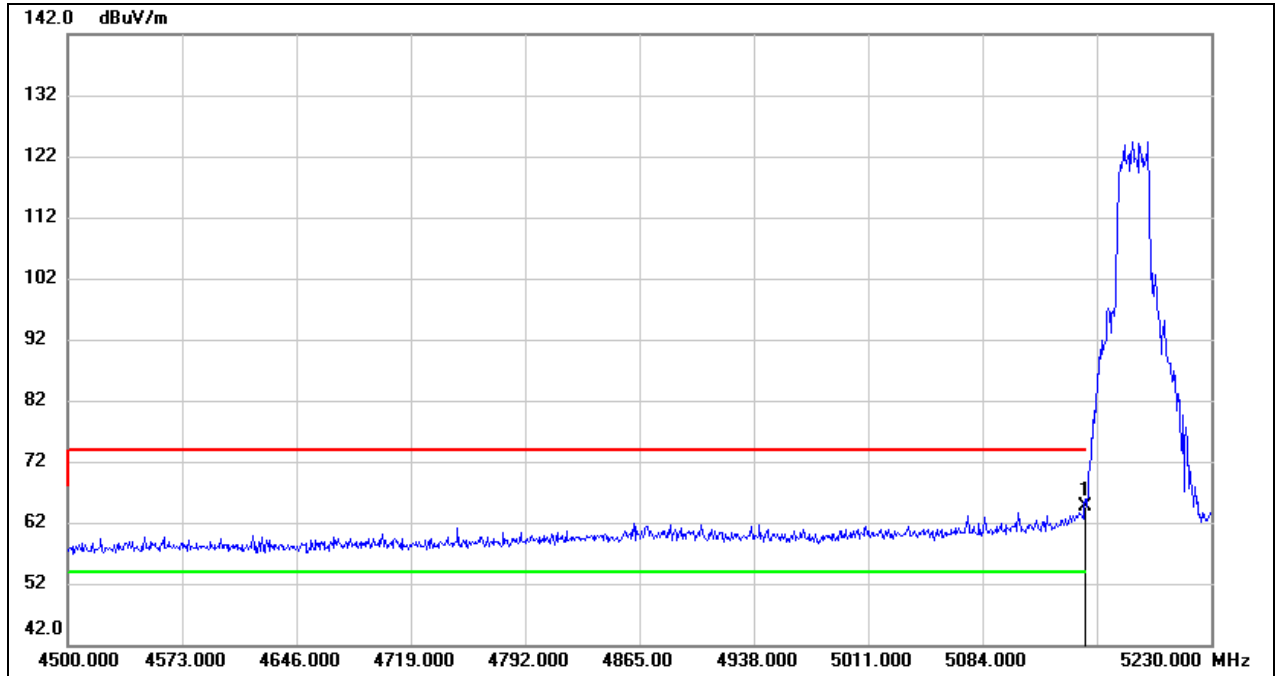

No.	Frequency (MHz)	Reading (dBuV)	Correct (dB/m)	Result (dBuV/m)	Limit (dBuV/m)	Margin (dB)	Remark
1	5150.000	24.35	40.27	64.62	74.00	-9.38	peak

Test Mode:	802.11be EHT20 AV	Channel:	5180
Polarity:	Vertical	Test Voltage:	DC 15 V

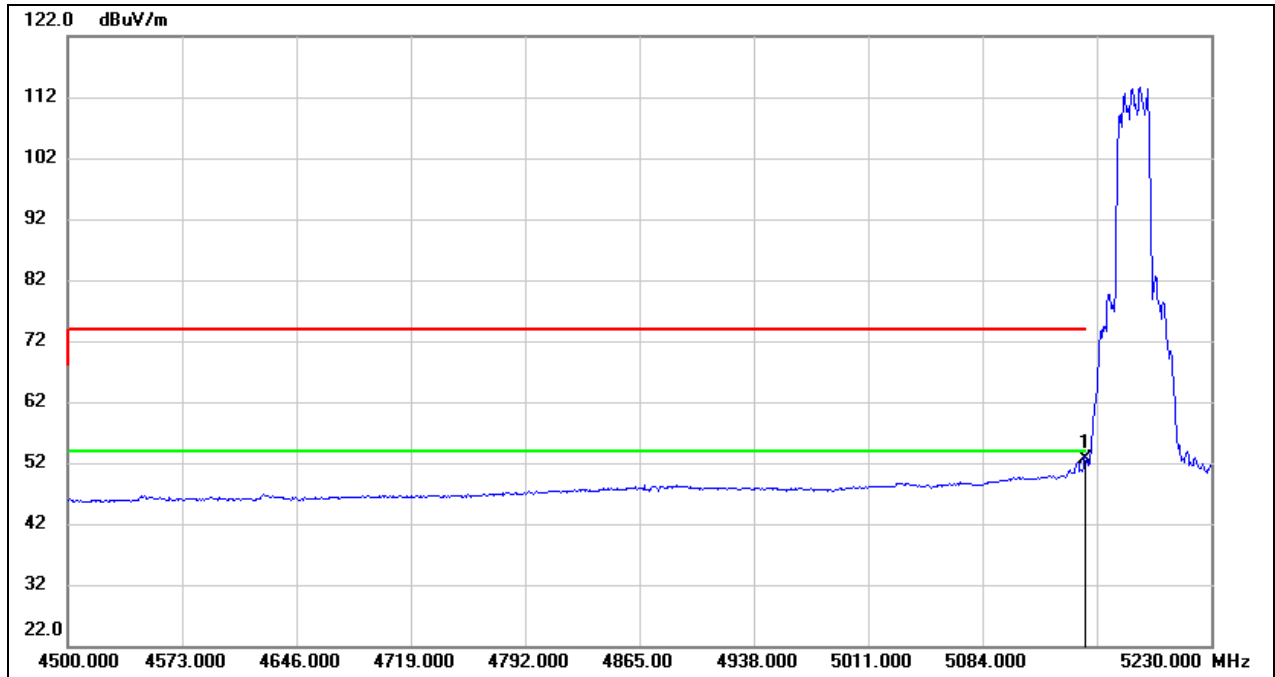

No.	Frequency (MHz)	Reading (dBuV)	Correct (dB/m)	Result (dBuV/m)	Limit (dBuV/m)	Margin (dB)	Remark
1	5150.000	12.48	40.27	52.75	54.00	-1.25	AVG

Test Mode:	802.11be EHT20 PK	Channel:	5240
Polarity:	Vertical	Test Voltage:	DC 15 V

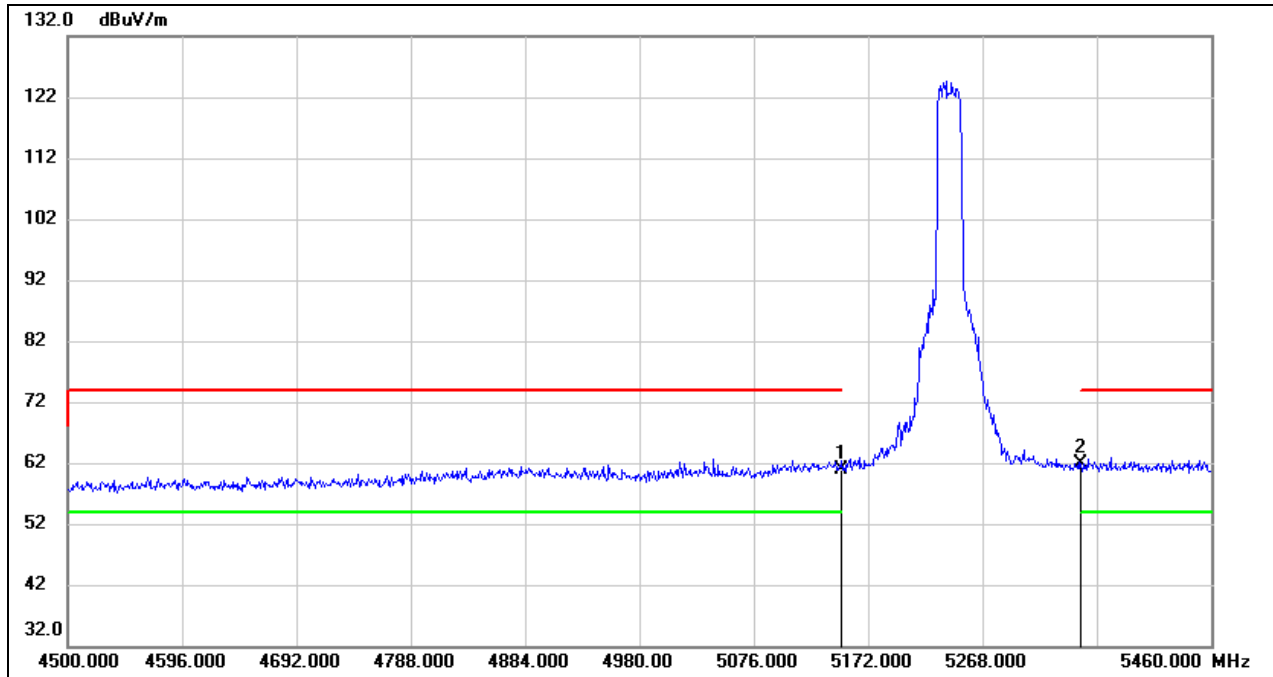

No.	Frequency (MHz)	Reading (dBuV)	Correct (dB/m)	Result (dBuV/m)	Limit (dBuV/m)	Margin (dB)	Remark
1	5150.000	20.71	40.27	60.98	74.00	-13.02	peak
2	5350.000	21.47	40.49	61.96	74.00	-12.04	peak

Test Mode:	802.11be EHT20 AV	Channel:	5240
Polarity:	Vertical	Test Voltage:	DC 15 V

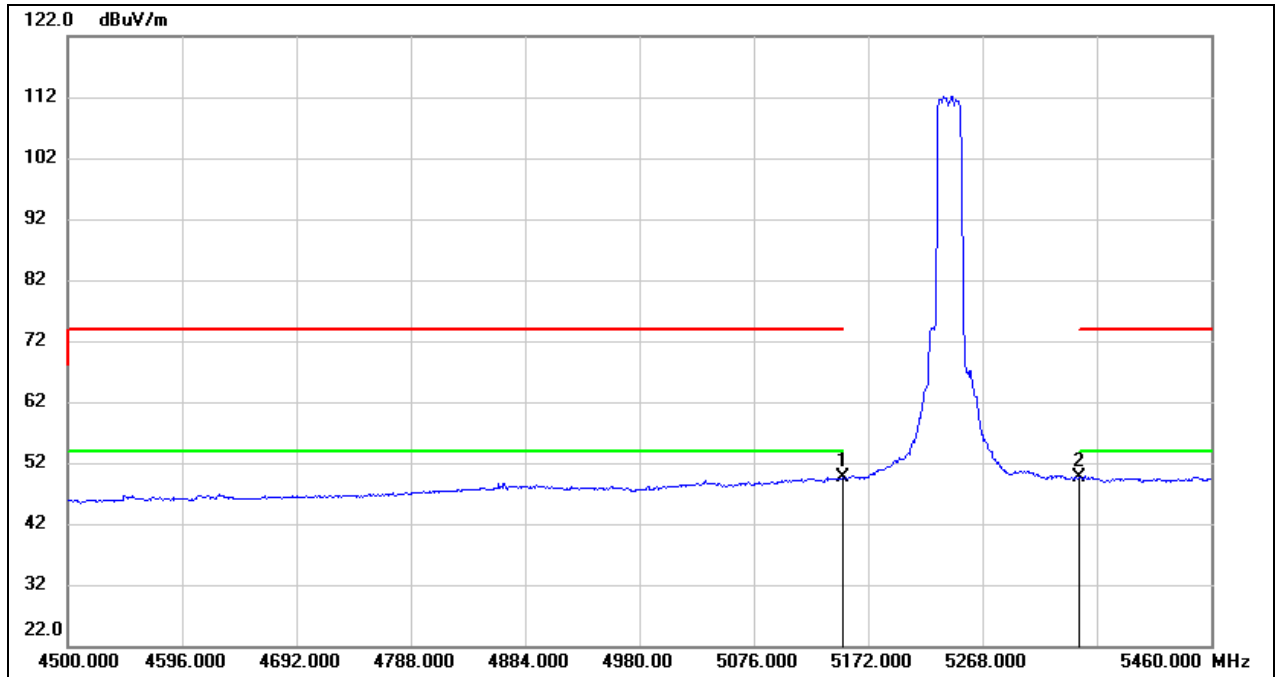

No.	Frequency (MHz)	Reading (dBuV)	Correct (dB/m)	Result (dBuV/m)	Limit (dBuV/m)	Margin (dB)	Remark
1	5150.000	9.37	40.27	49.64	54.00	-4.36	AVG
2	5350.000	9.02	40.49	49.51	54.00	-4.49	AVG

Test Mode:	802.11be EHT20 PK	Channel:	5745
Polarity:	Vertical	Test Voltage:	DC 15 V

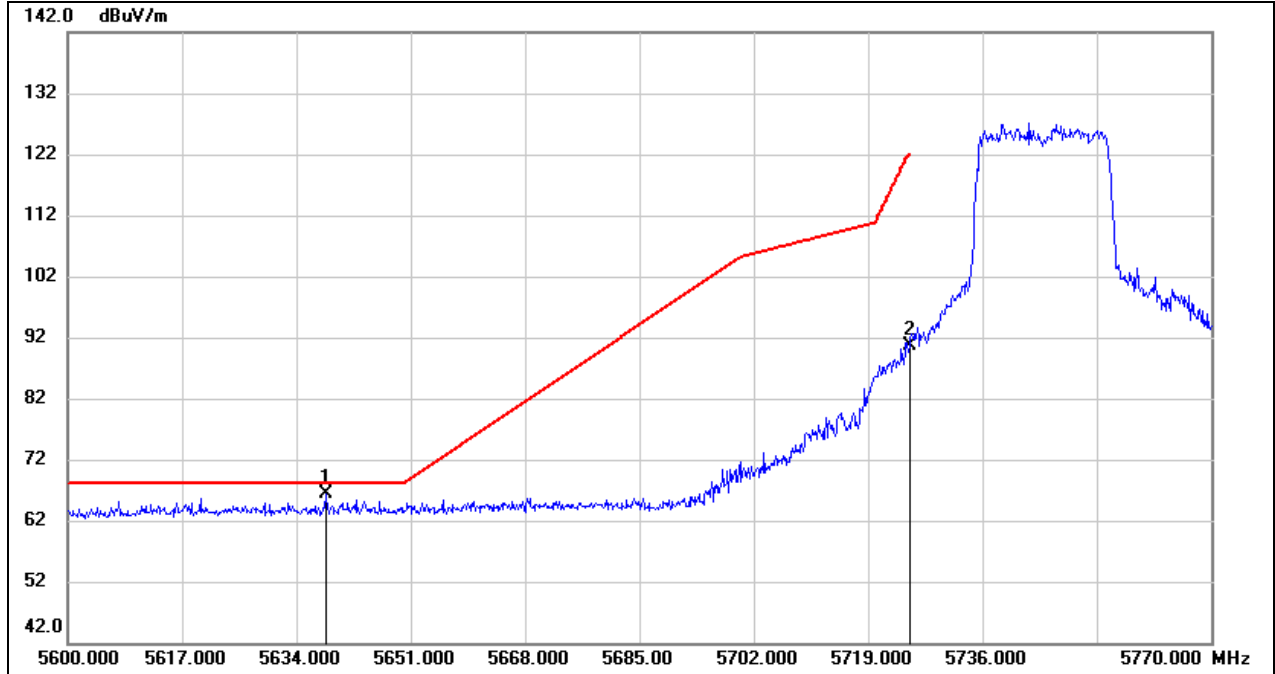

No.	Frequency (MHz)	Reading (dBuV)	Correct (dB/m)	Result (dBuV/m)	Limit (dBuV/m)	Margin (dB)	Remark
1	5638.420	25.32	41.03	66.35	68.20	-1.85	peak
2	5725.000	49.34	41.27	90.61	122.20	-31.59	peak

Test Mode:	802.11be EHT20 PK	Channel:	5825
Polarity:	Vertical	Test Voltage:	DC 15 V

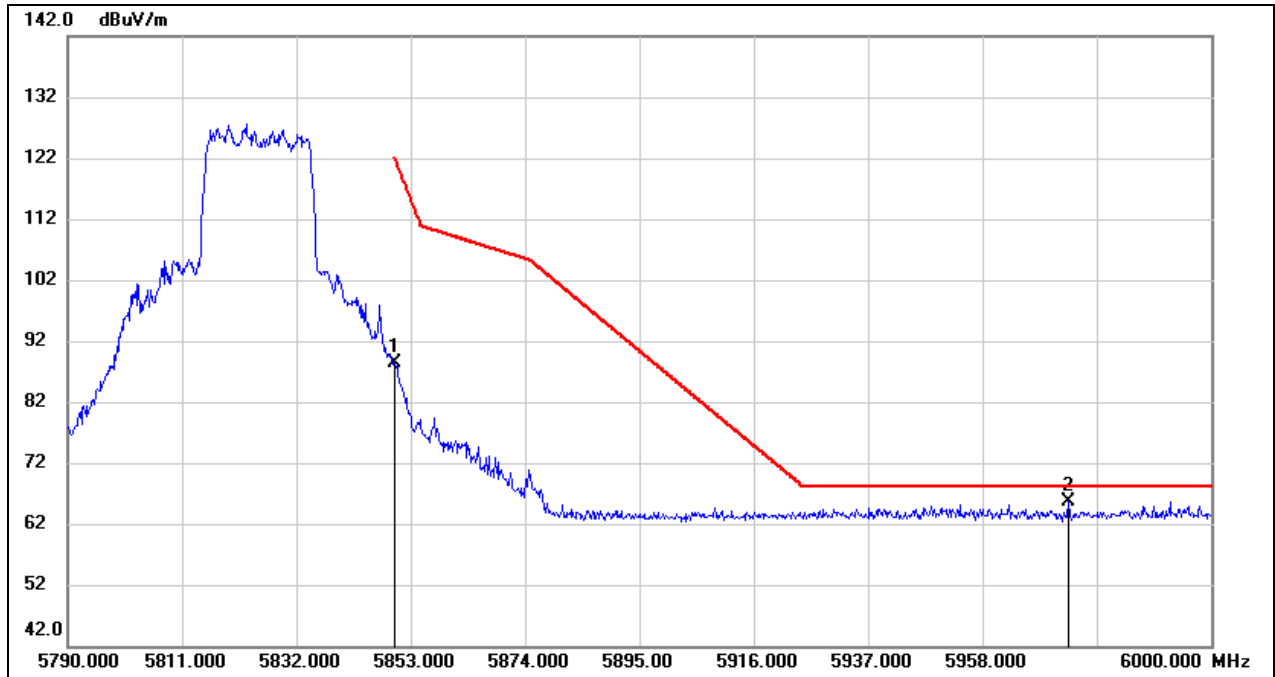

No.	Frequency (MHz)	Reading (dBuV)	Correct (dB/m)	Result (dBuV/m)	Limit (dBuV/m)	Margin (dB)	Remark
1	5850.000	46.87	41.60	88.47	122.20	-33.73	peak
2	5973.750	23.77	41.93	65.70	68.20	-2.50	peak

Test Mode:	802.11be EHT40 PK	Channel:	5190
Polarity:	Vertical	Test Voltage:	DC 15 V

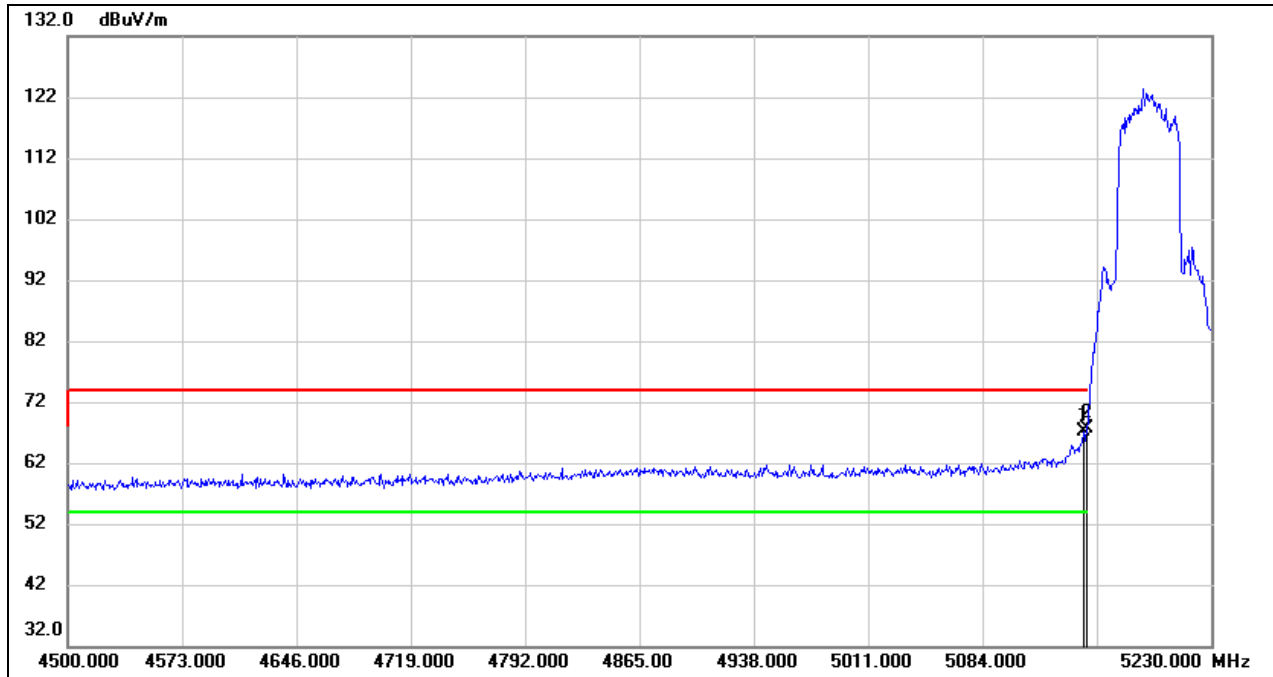

No.	Frequency (MHz)	Reading (dBuV)	Correct (dB/m)	Result (dBuV/m)	Limit (dBuV/m)	Margin (dB)	Remark
1	5148.240	26.97	40.28	67.25	74.00	-6.75	peak
2	5150.000	27.26	40.27	67.53	74.00	-6.47	peak

Test Mode:	802.11be EHT40 AV	Channel:	5190
Polarity:	Vertical	Test Voltage:	DC 15 V

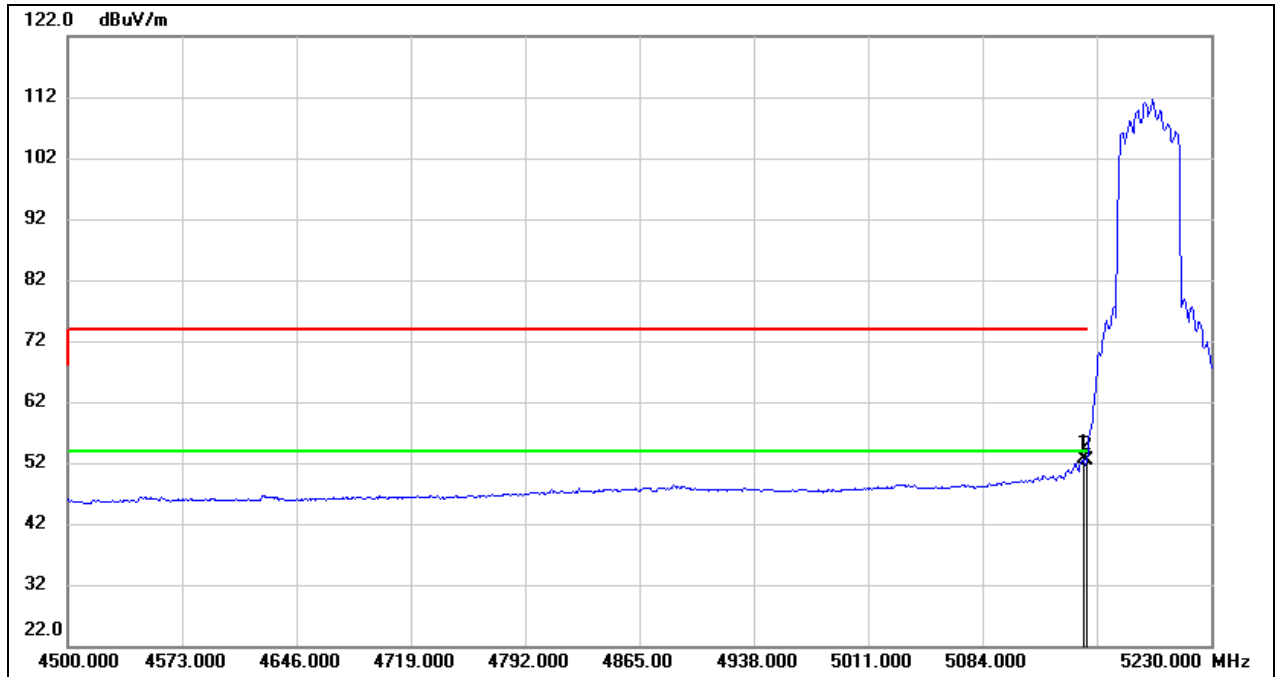

No.	Frequency (MHz)	Reading (dBuV)	Correct (dB/m)	Result (dBuV/m)	Limit (dBuV/m)	Margin (dB)	Remark
1	5148.240	12.28	40.28	52.56	54.00	-1.44	AVG
2	5150.000	12.09	40.27	52.36	54.00	-1.64	AVG

Test Mode:	802.11be EHT40 PK	Channel:	5230
Polarity:	Vertical	Test Voltage:	DC 15 V

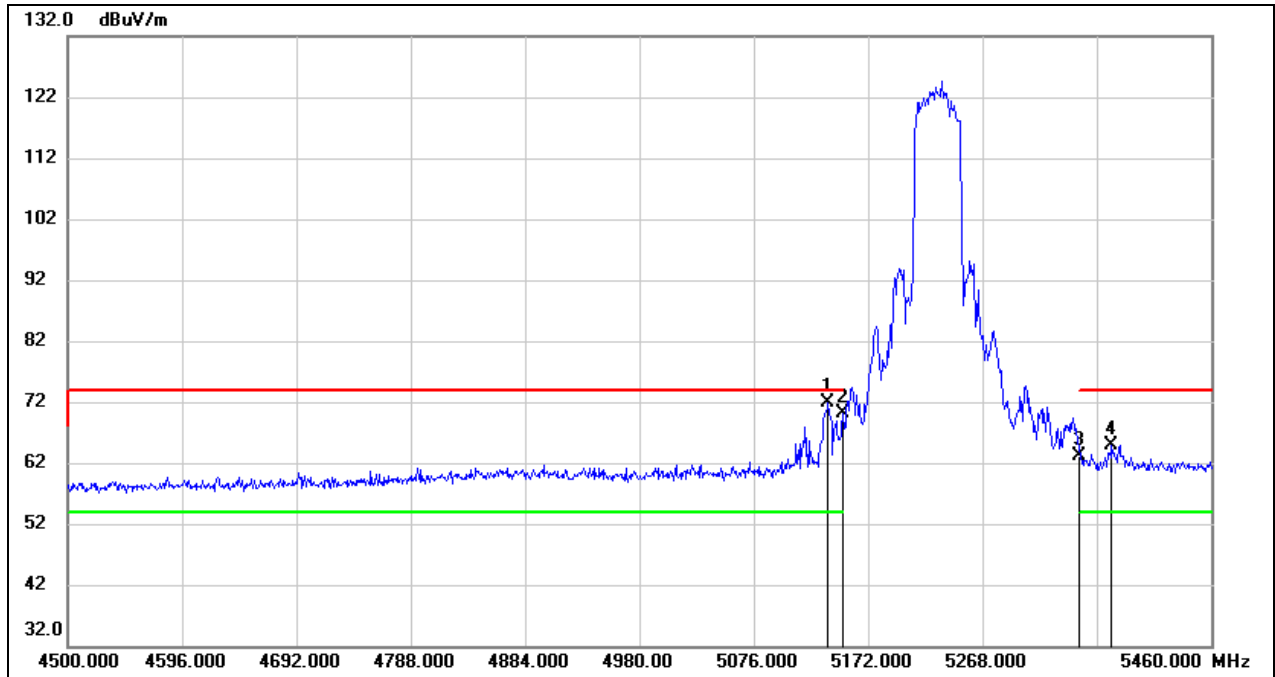

No.	Frequency (MHz)	Reading (dBuV)	Correct (dB/m)	Result (dBuV/m)	Limit (dBuV/m)	Margin (dB)	Remark
1	5138.400	31.57	40.27	71.84	74.00	-2.16	peak
2	5150.000	29.89	40.27	70.16	74.00	-3.84	peak
3	5350.000	22.52	40.49	63.01	74.00	-10.99	peak
4	5376.480	24.45	40.52	64.97	74.00	-9.03	peak

Test Mode:	802.11be EHT40 AV	Channel:	5230
Polarity:	Vertical	Test Voltage:	DC 15 V

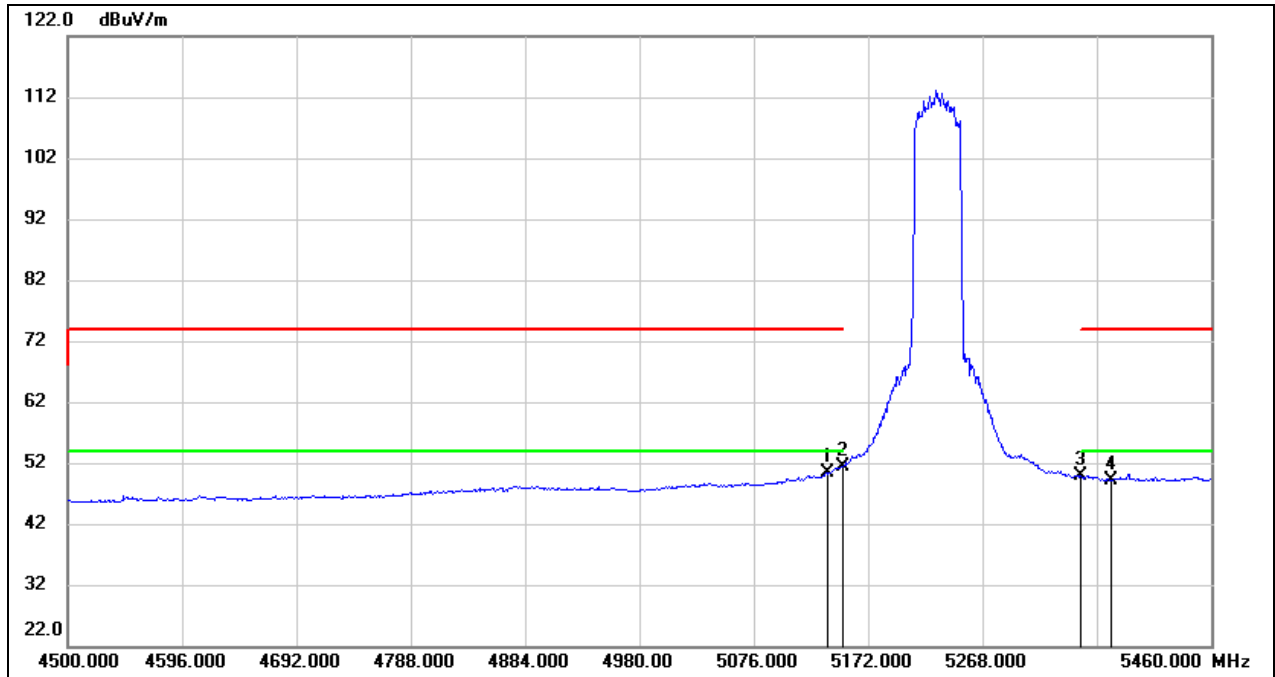

No.	Frequency (MHz)	Reading (dBuV)	Correct (dB/m)	Result (dBuV/m)	Limit (dBuV/m)	Margin (dB)	Remark
1	5138.400	10.15	40.27	50.42	54.00	-3.58	AVG
2	5150.000	11.15	40.27	51.42	54.00	-2.58	AVG
3	5350.000	9.27	40.49	49.76	54.00	-4.24	AVG
4	5376.480	8.65	40.52	49.17	54.00	-4.83	AVG

Test Mode:	802.11be EHT40 PK	Channel:	5755
Polarity:	Vertical	Test Voltage:	DC 15 V

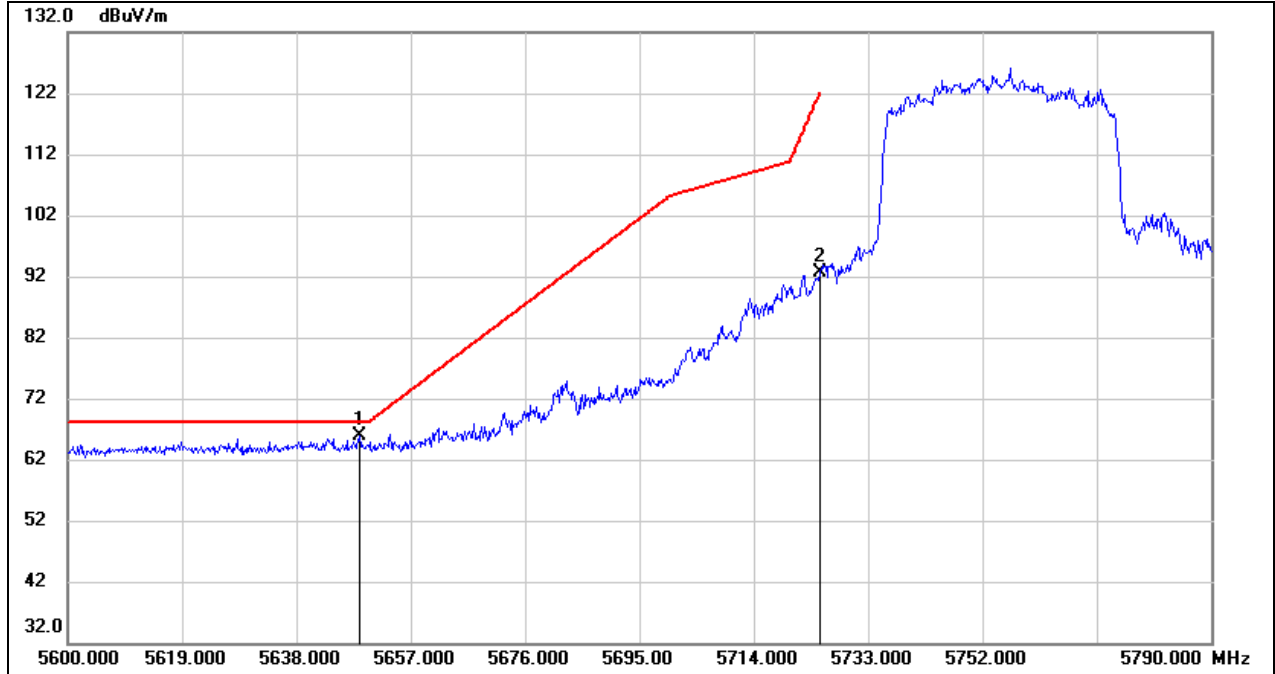

No.	Frequency (MHz)	Reading (dBuV)	Correct (dB/m)	Result (dBuV/m)	Limit (dBuV/m)	Margin (dB)	Remark
1	5648.450	24.83	41.06	65.89	68.20	-2.31	peak
2	5725.000	51.34	41.27	92.61	122.20	-29.59	peak

Test Mode:	802.11be EHT40 PK	Channel:	5795
Polarity:	Vertical	Test Voltage:	DC 15 V

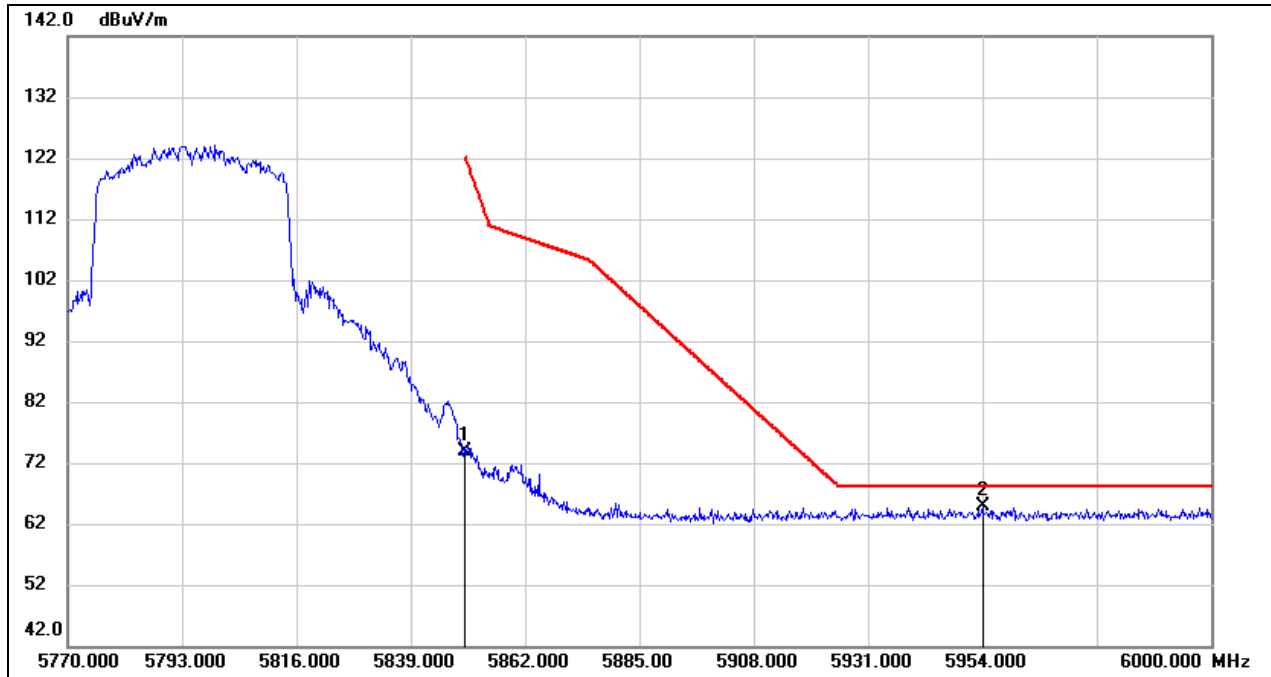

No.	Frequency (MHz)	Reading (dBuV)	Correct (dB/m)	Result (dBuV/m)	Limit (dBuV/m)	Margin (dB)	Remark
1	5850.000	32.36	41.60	73.96	122.20	-48.24	peak
2	5954.000	23.11	41.87	64.98	68.20	-3.22	peak

Test Mode:	802.11be EHT80 PK	Channel:	5210
Polarity:	Vertical	Test Voltage:	DC 15 V

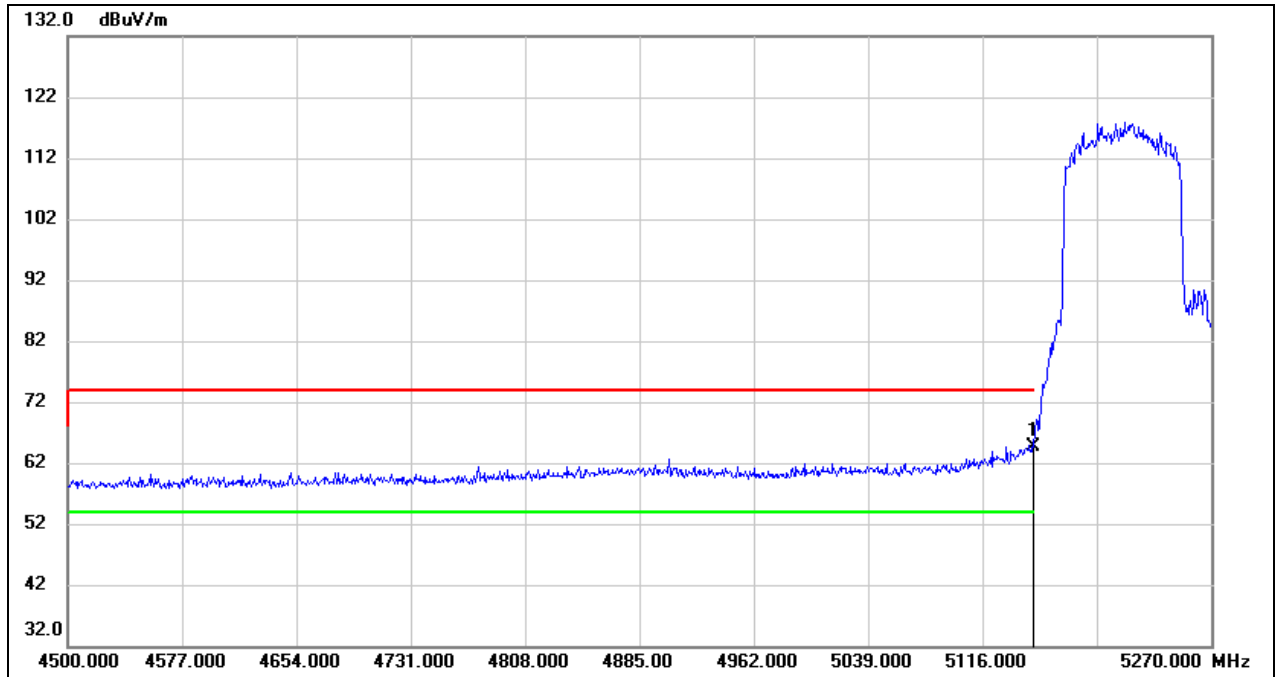

No.	Frequency (MHz)	Reading (dBuV)	Correct (dB/m)	Result (dBuV/m)	Limit (dBuV/m)	Margin (dB)	Remark
1	5150.000	24.40	40.27	64.67	74.00	-9.33	peak

Test Mode:	802.11be EHT80 AV	Channel:	5210
Polarity:	Vertical	Test Voltage:	DC 15 V

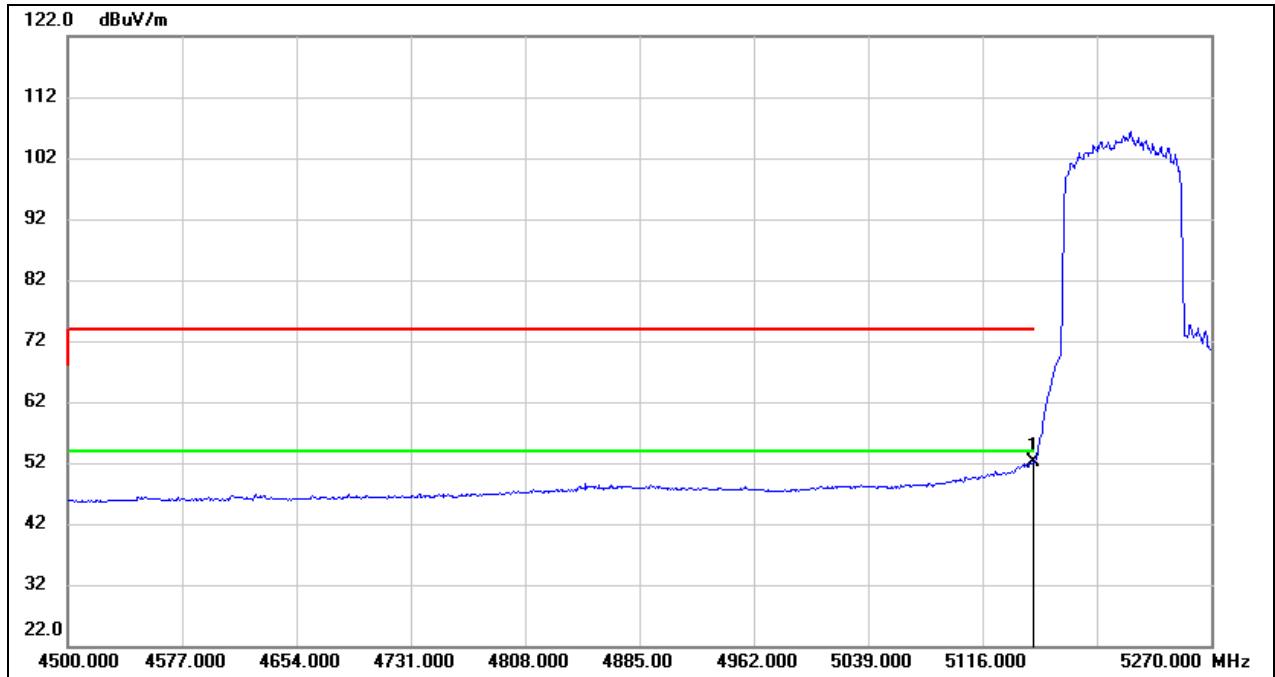

No.	Frequency (MHz)	Reading (dBuV)	Correct (dB/m)	Result (dBuV/m)	Limit (dBuV/m)	Margin (dB)	Remark
1	5150.000	11.85	40.27	52.12	54.00	-1.88	AVG

Test Mode:	802.11be EHT80 PK	Channel:	5775
Polarity:	Vertical	Test Voltage:	DC 15 V

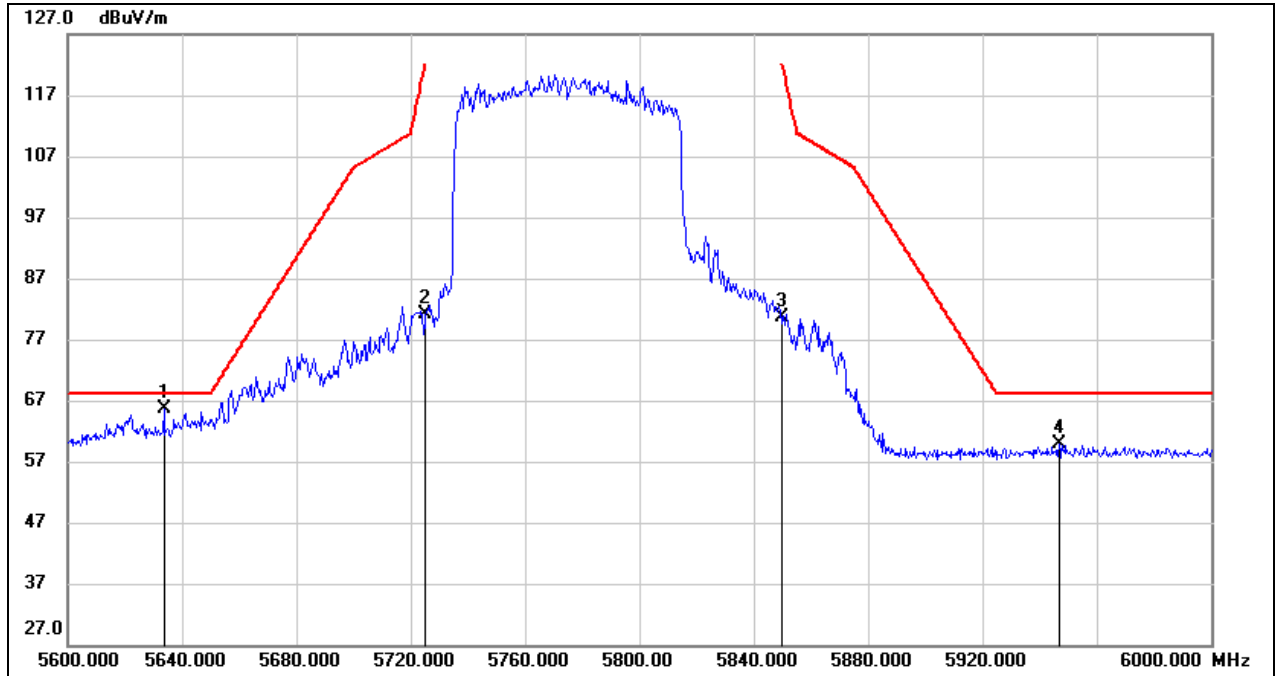

No.	Frequency (MHz)	Reading (dBuV)	Correct (dB/m)	Result (dBuV/m)	Limit (dBuV/m)	Margin (dB)	Remark
1	5633.600	24.51	41.01	65.52	68.20	-2.68	peak
2	5725.000	39.89	41.27	81.16	122.20	-41.04	peak
3	5850.000	39.03	41.60	80.63	122.20	-41.57	peak
4	5946.800	17.99	41.86	59.85	68.20	-8.35	peak

8.2. SPURIOUS EMISSIONS (1 GHZ ~ 7 GHZ)

Test Mode:	802.11a 20	Channel:	5180
Polarity:	Horizontal	Test Voltage:	DC 15 V

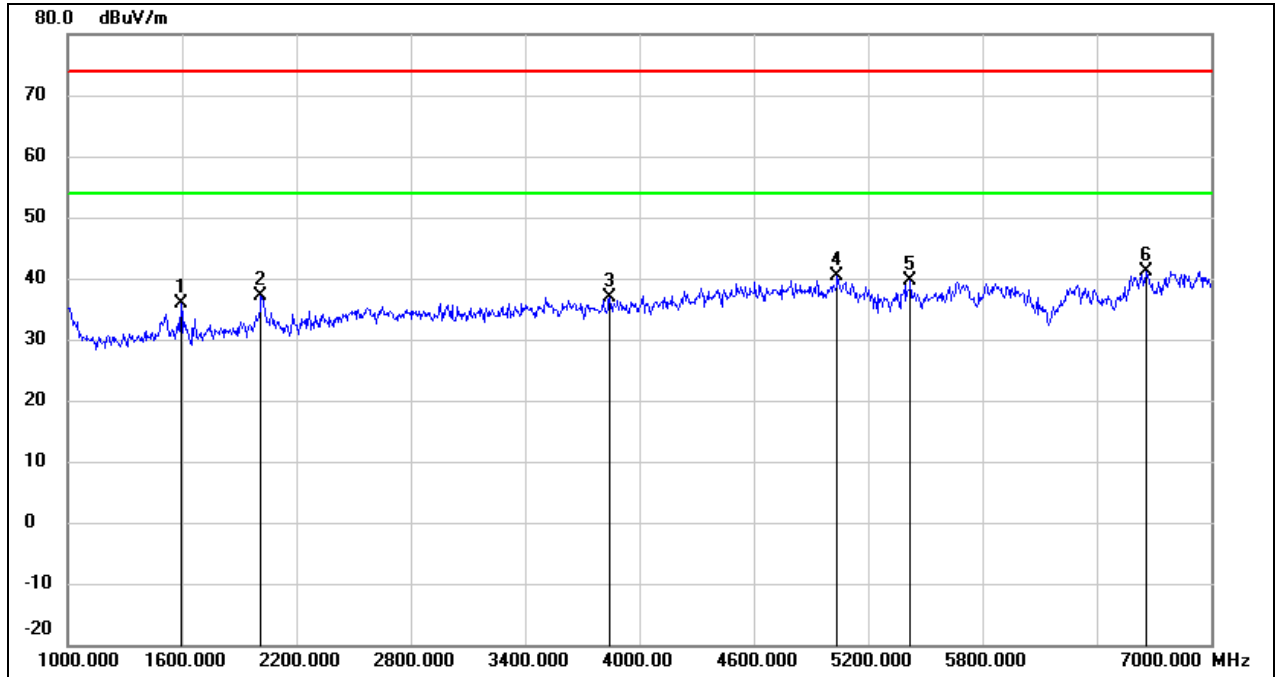

No.	Frequency (MHz)	Reading (dBuV)	Correct (dB/m)	Result (dBuV/m)	Limit (dBuV/m)	Margin (dB)	Remark
1	1594.000	48.24	-12.40	35.84	74.00	-38.16	peak
2	2014.000	48.15	-10.98	37.17	74.00	-36.83	peak
3	3844.000	41.78	-4.91	36.87	74.00	-37.13	peak
4	5038.000	40.47	-0.11	40.36	74.00	-33.64	peak
5	5422.000	39.24	0.32	39.56	74.00	-34.44	peak
6	6658.000	36.58	4.49	41.07	74.00	-32.93	peak

Test Mode:	802.11a 20	Channel:	5180
Polarity:	Vertical	Test Voltage:	DC 15 V

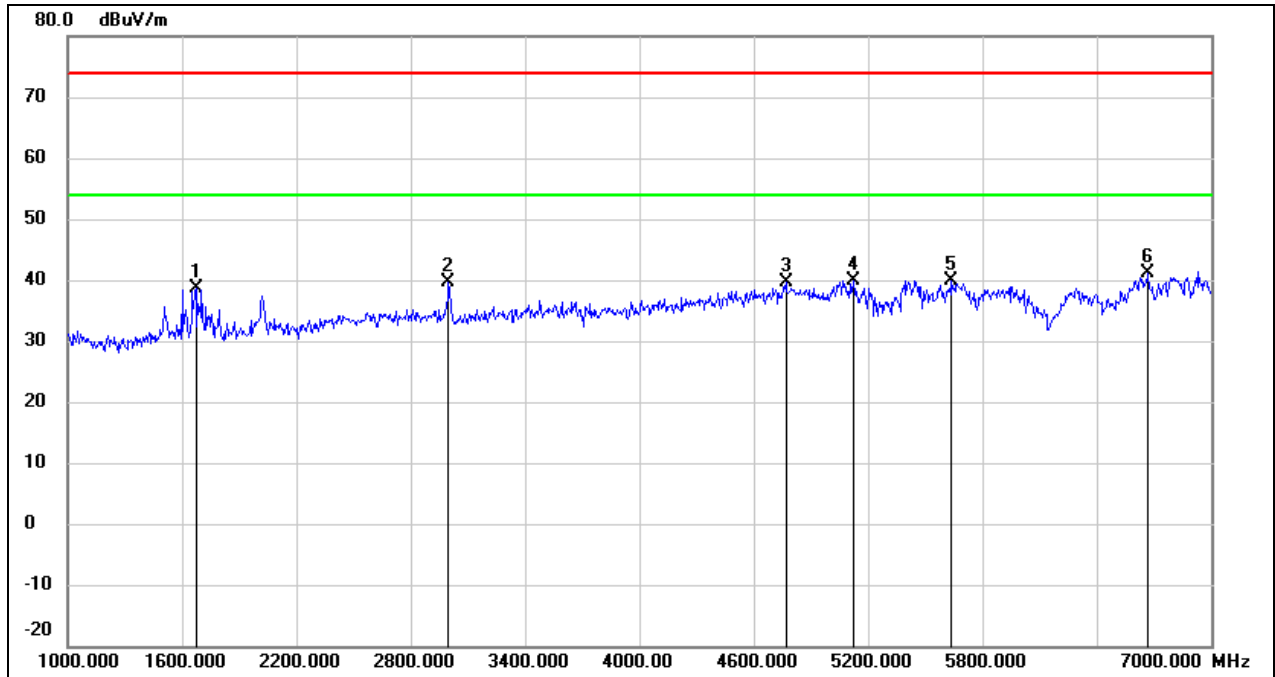

No.	Frequency (MHz)	Reading (dBuV)	Correct (dB/m)	Result (dBuV/m)	Limit (dBuV/m)	Margin (dB)	Remark
1	1672.000	50.67	-12.15	38.52	74.00	-35.48	peak
2	2998.000	46.72	-6.98	39.74	74.00	-34.26	peak
3	4768.000	40.78	-1.07	39.71	74.00	-34.29	peak
4	5122.000	39.92	-0.02	39.90	74.00	-34.10	peak
5	5638.000	39.18	0.81	39.99	74.00	-34.01	peak
6	6670.000	36.47	4.57	41.04	74.00	-32.96	peak

Test Mode:	802.11a 20	Channel:	5200
Polarity:	Horizontal	Test Voltage:	DC 15 V

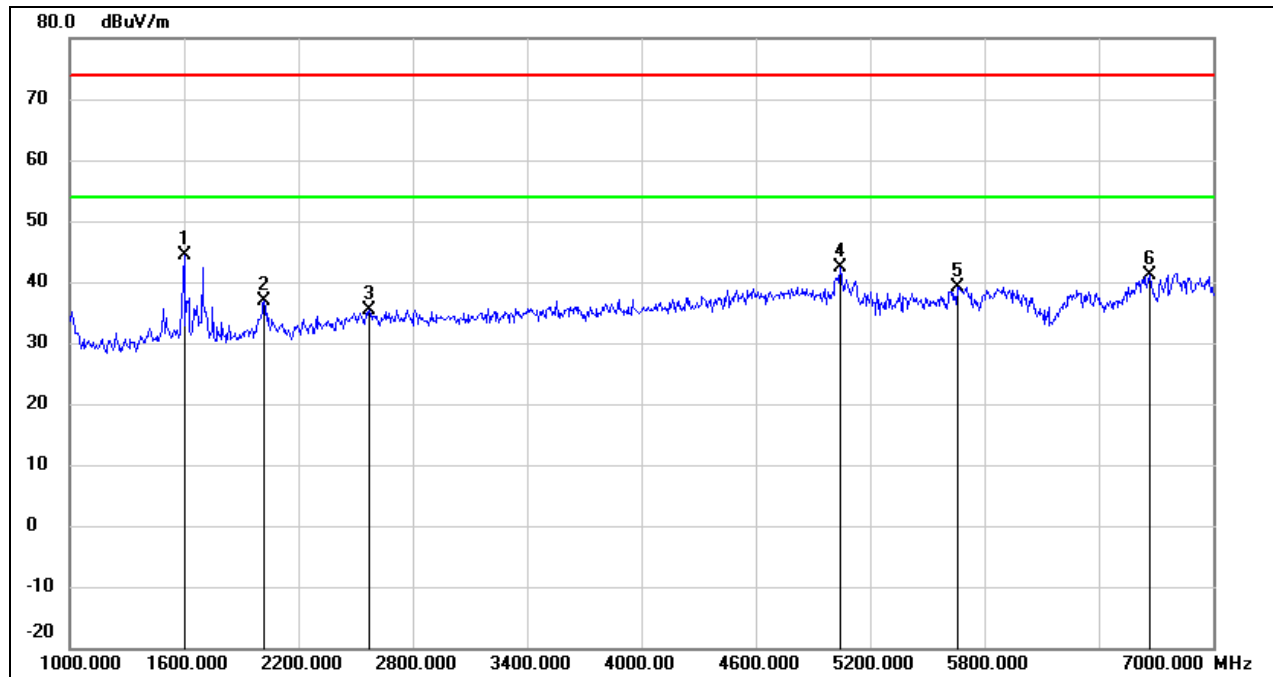

No.	Frequency (MHz)	Reading (dBuV)	Correct (dB/m)	Result (dBuV/m)	Limit (dBuV/m)	Margin (dB)	Remark
1	1600.000	56.66	-12.38	44.28	74.00	-29.72	peak
2	2020.000	47.79	-10.96	36.83	74.00	-37.17	peak
3	2572.000	43.71	-8.27	35.44	74.00	-38.56	peak
4	5044.000	42.46	-0.10	42.36	74.00	-31.64	peak
5	5656.000	38.34	0.87	39.21	74.00	-34.79	peak
6	6664.000	36.65	4.54	41.19	74.00	-32.81	peak

Test Mode:	802.11a 20	Channel:	5200
Polarity:	Vertical	Test Voltage:	DC 15 V

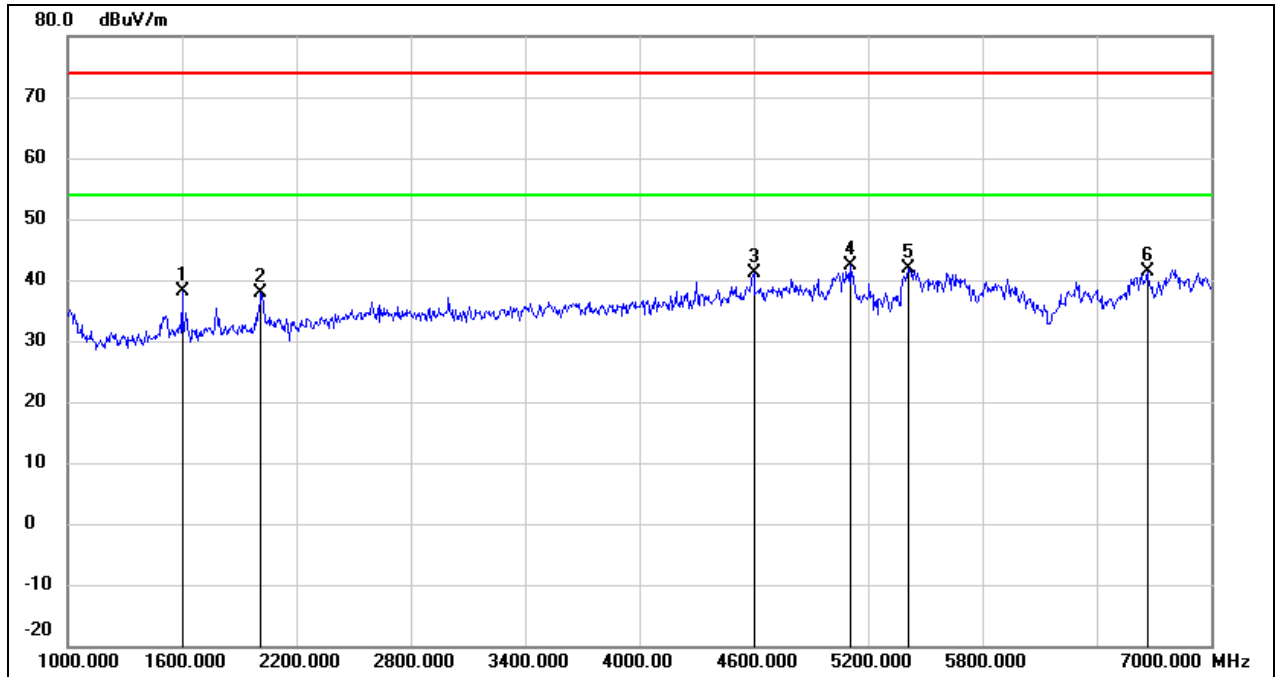

No.	Frequency (MHz)	Reading (dBuV)	Correct (dB/m)	Result (dBuV/m)	Limit (dBuV/m)	Margin (dB)	Remark
1	1600.000	50.47	-12.38	38.09	74.00	-35.91	peak
2	2014.000	48.79	-10.98	37.81	74.00	-36.19	peak
3	4600.000	42.79	-1.74	41.05	74.00	-32.95	peak
4	5104.000	42.47	-0.03	42.44	74.00	-31.56	peak
5	5410.000	41.49	0.32	41.81	74.00	-32.19	peak
6	6664.000	36.91	4.54	41.45	74.00	-32.55	peak

Test Mode:	802.11a 20	Channel:	5240
Polarity:	Horizontal	Test Voltage:	DC 15 V

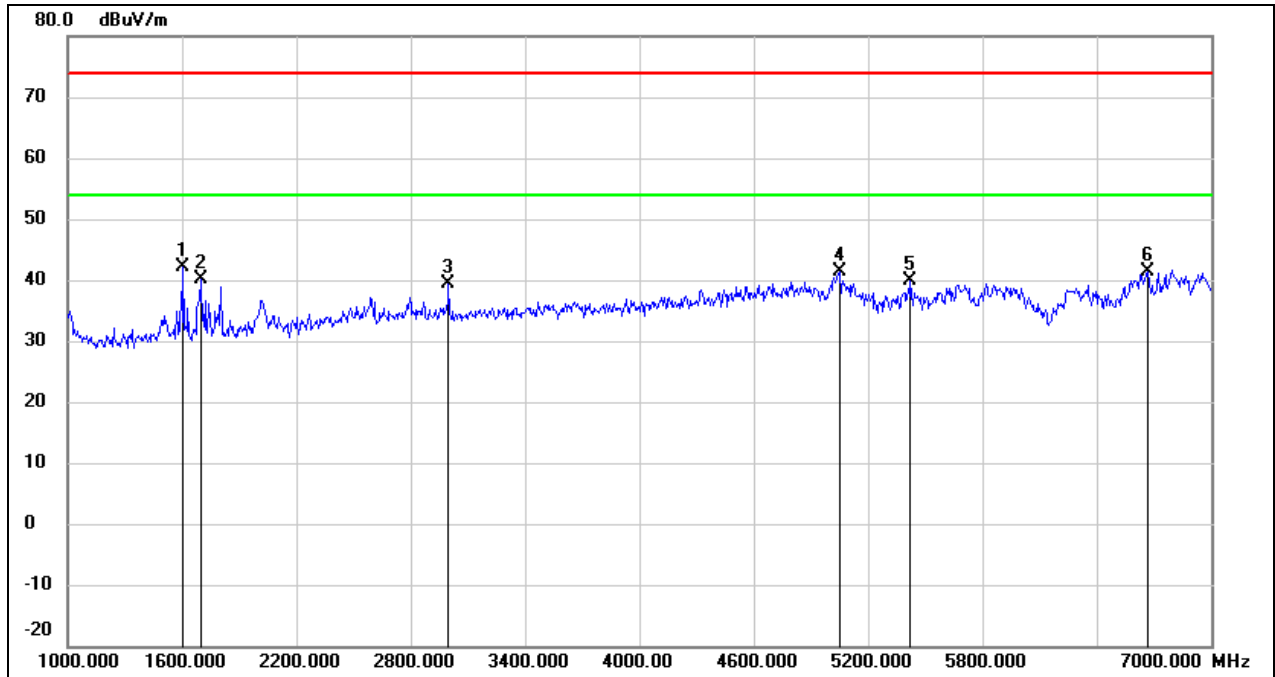

No.	Frequency (MHz)	Reading (dBuV)	Correct (dB/m)	Result (dBuV/m)	Limit (dBuV/m)	Margin (dB)	Remark
1	1606.000	54.61	-12.36	42.25	74.00	-31.75	peak
2	1696.000	52.29	-12.06	40.23	74.00	-33.77	peak
3	2998.000	46.28	-6.98	39.30	74.00	-34.70	peak
4	5050.000	41.58	-0.09	41.49	74.00	-32.51	peak
5	5422.000	39.46	0.32	39.78	74.00	-34.22	peak
6	6664.000	36.79	4.54	41.33	74.00	-32.67	peak

Test Mode:	802.11a 20	Channel:	5240
Polarity:	Vertical	Test Voltage:	DC 15 V

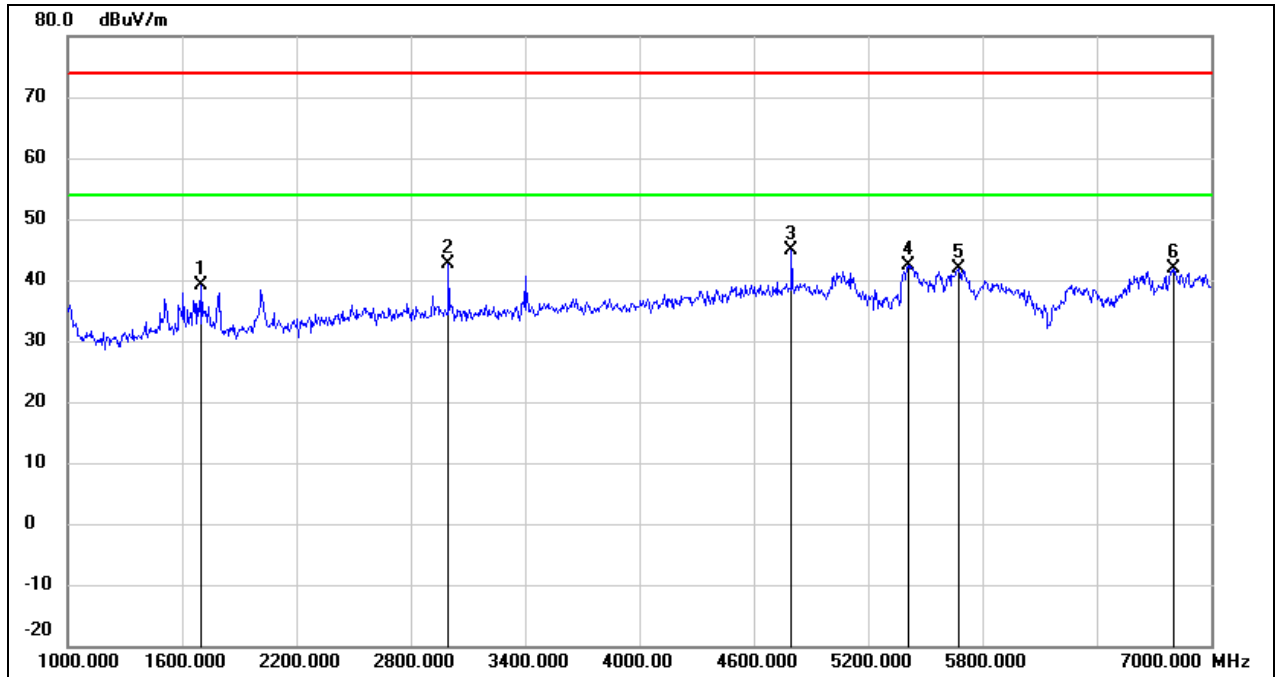

No.	Frequency (MHz)	Reading (dBuV)	Correct (dB/m)	Result (dBuV/m)	Limit (dBuV/m)	Margin (dB)	Remark
1	1702.000	51.17	-12.05	39.12	74.00	-34.88	peak
2	2998.000	49.56	-6.98	42.58	74.00	-31.42	peak
3	4798.000	45.71	-0.95	44.76	74.00	-29.24	peak
4	5410.000	42.13	0.32	42.45	74.00	-31.55	peak
5	5674.000	40.91	0.92	41.83	74.00	-32.17	peak
6	6802.000	36.73	5.21	41.94	74.00	-32.06	peak

Test Mode:	802.11a 20	Channel:	5745
Polarity:	Horizontal	Test Voltage:	DC 15 V

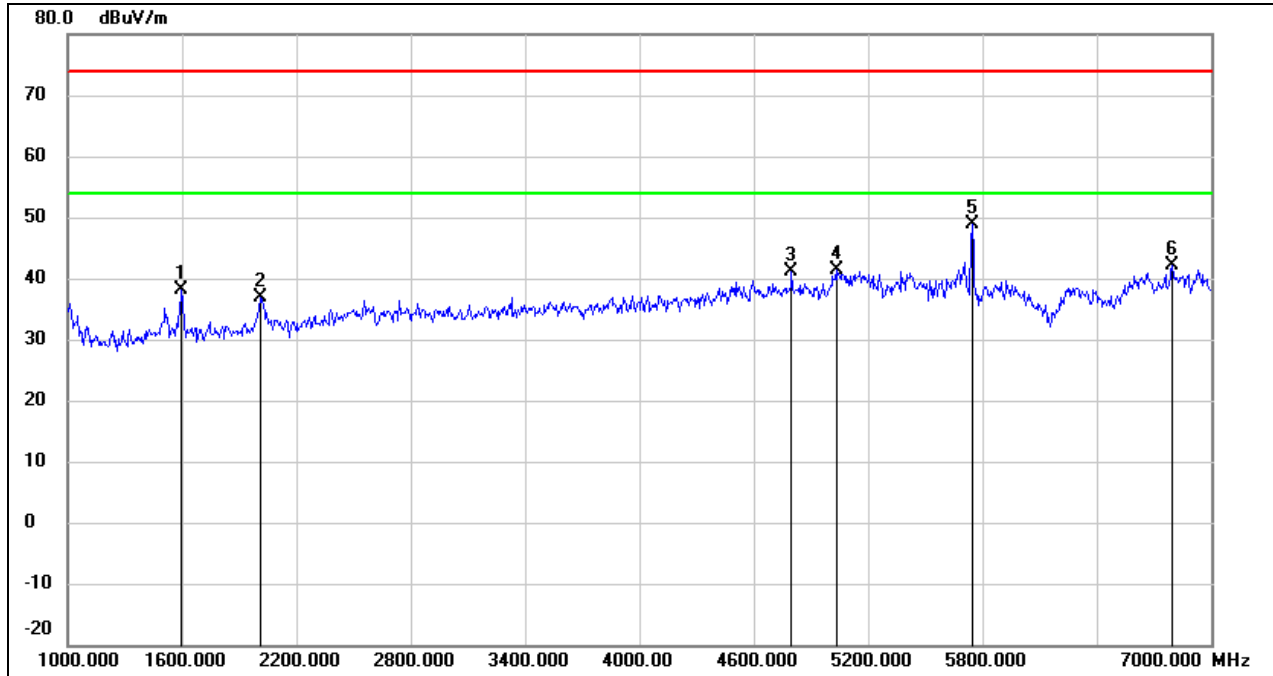

No.	Frequency (MHz)	Reading (dBuV)	Correct (dB/m)	Result (dBuV/m)	Limit (dBuV/m)	Margin (dB)	Remark
1	1594.000	50.63	-12.40	38.23	74.00	-35.77	peak
2	2014.000	47.97	-10.98	36.99	74.00	-37.01	peak
3	4798.000	42.06	-0.95	41.11	74.00	-32.89	peak
4	5032.000	41.53	-0.12	41.41	74.00	-32.59	peak
5	5746.000	47.82	1.12	48.94	74.00	-25.06	peak
6	6796.000	36.88	5.19	42.07	74.00	-31.93	peak

Test Mode:	802.11a 20	Channel:	5745
Polarity:	Vertical	Test Voltage:	DC 15 V

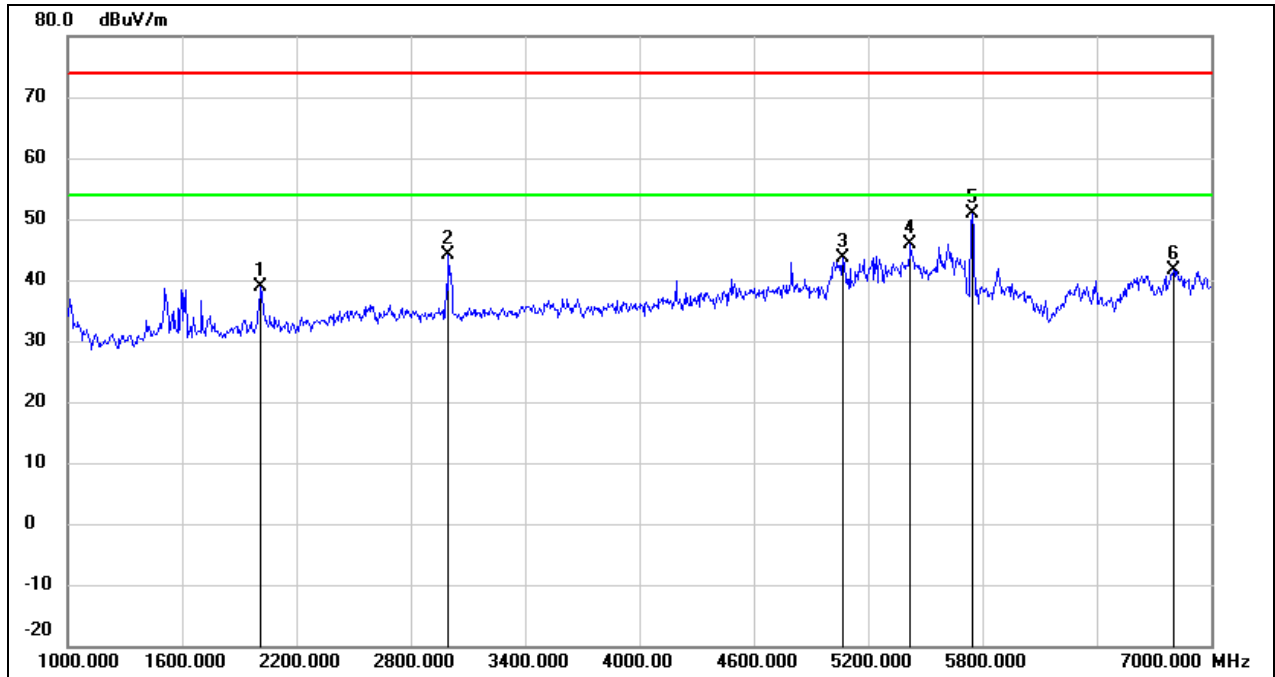

No.	Frequency (MHz)	Reading (dBuV)	Correct (dB/m)	Result (dBuV/m)	Limit (dBuV/m)	Margin (dB)	Remark
1	2014.000	49.86	-10.98	38.88	74.00	-35.12	peak
2	2998.000	51.10	-6.98	44.12	74.00	-29.88	peak
3	5068.000	43.74	-0.07	43.67	74.00	-30.33	peak
4	5422.000	45.45	0.32	45.77	74.00	-28.23	peak
5	5746.000	49.69	1.12	50.81	74.00	-23.19	peak
6	6802.000	36.48	5.21	41.69	74.00	-32.31	peak

Test Mode:	802.11a 20	Channel:	5785
Polarity:	Horizontal	Test Voltage:	DC 15 V

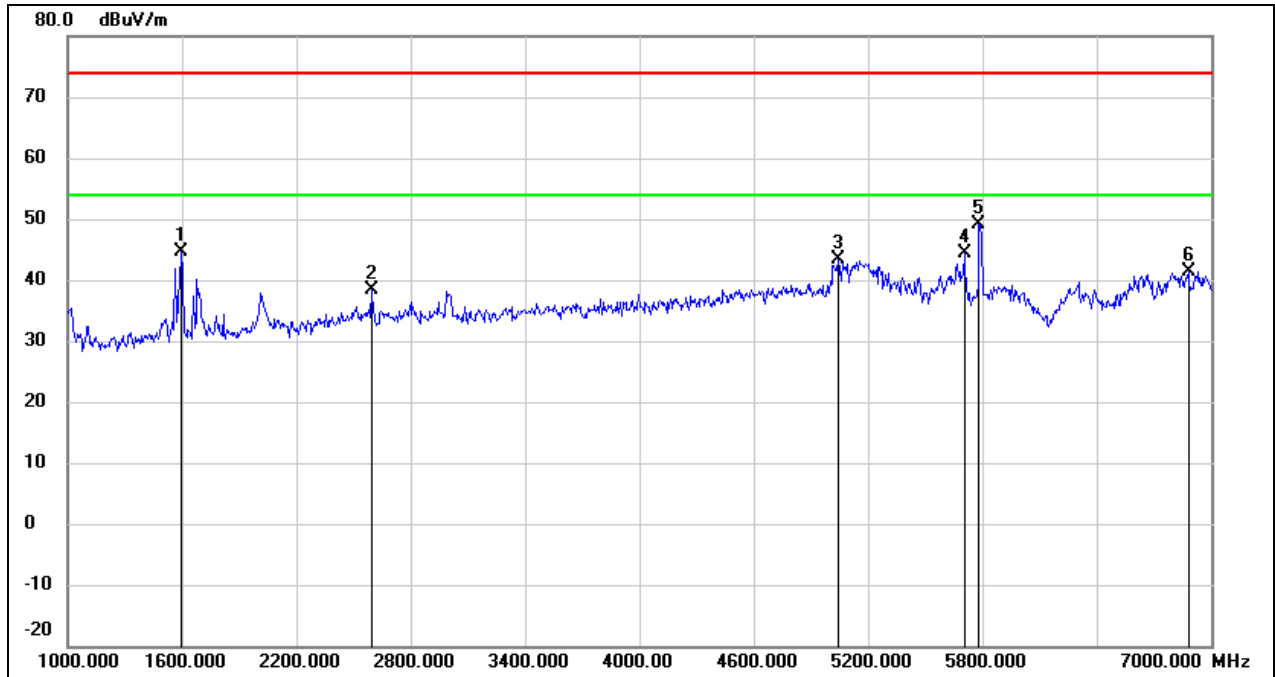

No.	Frequency (MHz)	Reading (dBuV)	Correct (dB/m)	Result (dBuV/m)	Limit (dBuV/m)	Margin (dB)	Remark
1	1594.000	57.11	-12.40	44.71	74.00	-29.29	peak
2	2596.000	46.55	-8.20	38.35	74.00	-35.65	peak
3	5044.000	43.43	-0.10	43.33	74.00	-30.67	peak
4	5704.000	43.49	1.00	44.49	74.00	-29.51	peak
5	5782.000	47.93	1.23	49.16	74.00	-24.84	peak
6	6880.000	35.79	5.60	41.39	74.00	-32.61	peak

Test Mode:	802.11a 20	Channel:	5785
Polarity:	Vertical	Test Voltage:	DC 15 V

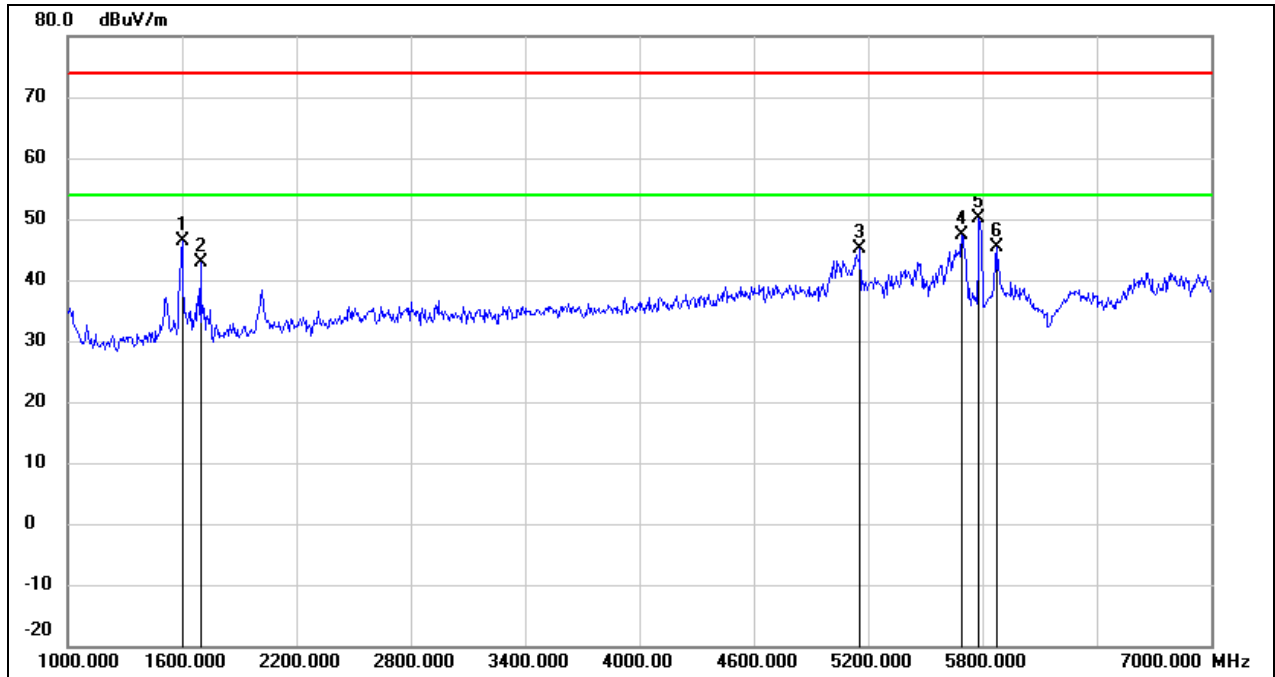

No.	Frequency (MHz)	Reading (dBuV)	Correct (dB/m)	Result (dBuV/m)	Limit (dBuV/m)	Margin (dB)	Remark
1	1600.000	58.86	-12.38	46.48	74.00	-27.52	peak
2	1696.000	54.83	-12.06	42.77	74.00	-31.23	peak
3	5158.000	45.19	0.04	45.23	74.00	-28.77	peak
4	5692.000	46.43	0.97	47.40	74.00	-26.60	peak
5	5782.000	48.97	1.23	50.20	74.00	-23.80	peak
6	5872.000	43.97	1.48	45.45	74.00	-28.55	peak

Test Mode:	802.11a 20	Channel:	5825
Polarity:	Horizontal	Test Voltage:	DC 15 V

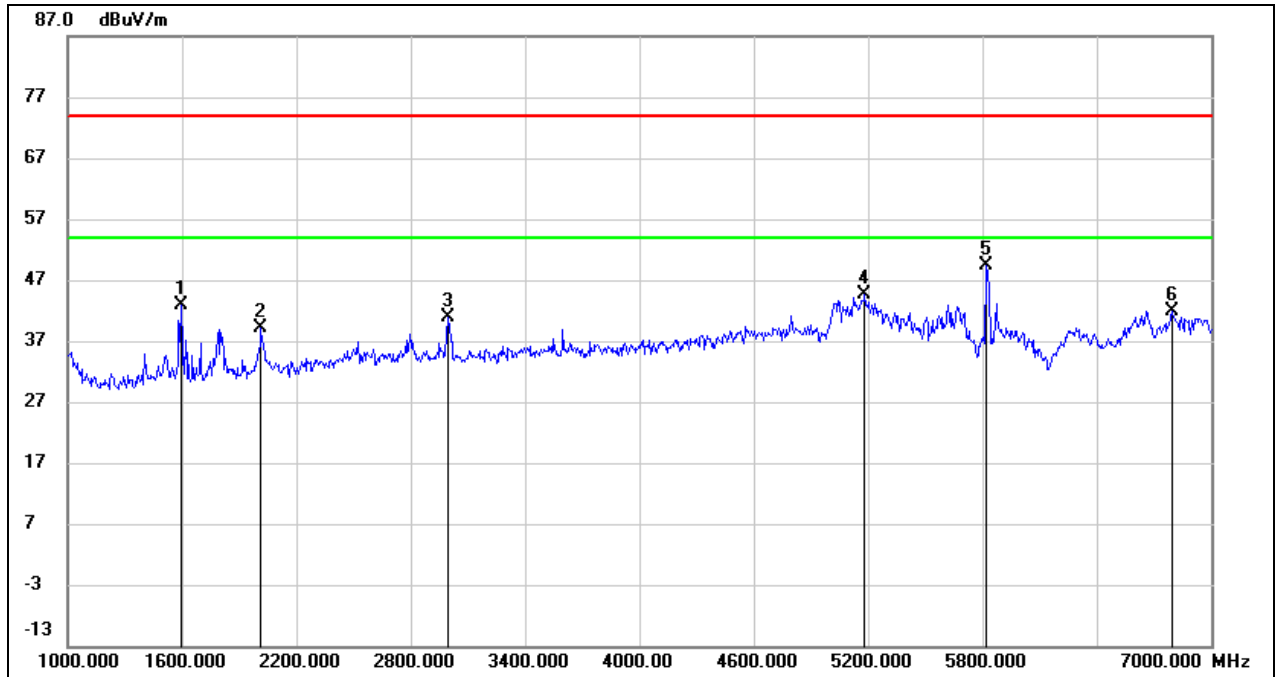

No.	Frequency (MHz)	Reading (dBuV)	Correct (dB/m)	Result (dBuV/m)	Limit (dBuV/m)	Margin (dB)	Remark
1	1594.000	55.17	-12.40	42.77	74.00	-31.23	peak
2	2014.000	50.02	-10.98	39.04	74.00	-34.96	peak
3	2992.000	47.76	-7.00	40.76	74.00	-33.24	peak
4	5182.000	44.66	0.06	44.72	74.00	-29.28	peak
5	5818.000	48.02	1.33	49.35	74.00	-24.65	peak
6	6796.000	36.63	5.19	41.82	74.00	-32.18	peak

Test Mode:	802.11a 20	Channel:	5825
Polarity:	Vertical	Test Voltage:	DC 15 V

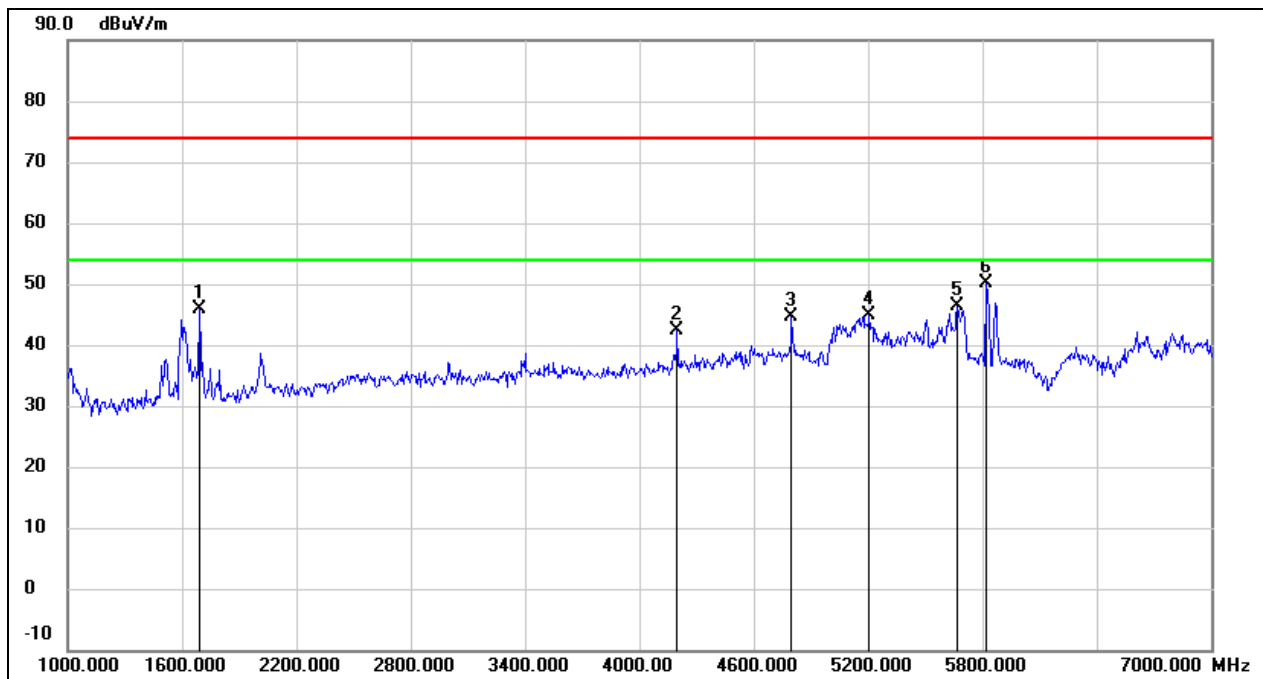

No.	Frequency (MHz)	Reading (dBuV)	Correct (dB/m)	Result (dBuV/m)	Limit (dBuV/m)	Margin (dB)	Remark
1	1690.000	57.91	-12.08	45.83	74.00	-28.17	peak
2	4198.000	45.81	-3.55	42.26	74.00	-31.74	peak
3	4798.000	45.61	-0.95	44.66	74.00	-29.34	peak
4	5206.000	44.69	0.08	44.77	74.00	-29.23	peak
5	5668.000	45.55	0.91	46.46	74.00	-27.54	peak
6	5818.000	48.83	1.33	50.16	74.00	-23.84	peak

8.3. SPURIOUS EMISSIONS (7 GHZ ~ 18 GHZ)

Test Mode:	802.11a 20	Channel:	5180
Polarity:	Horizontal	Test Voltage:	DC 15 V

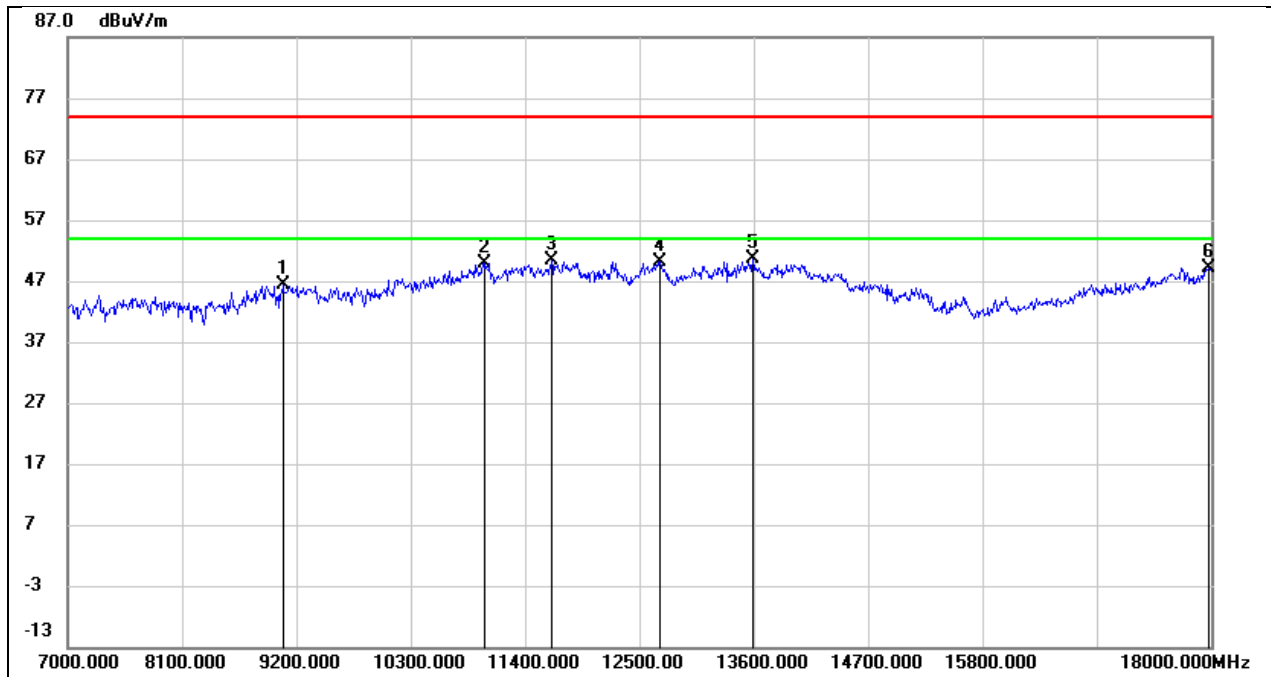

No.	Frequency (MHz)	Reading (dBuV)	Correct (dB/m)	Result (dBuV/m)	Limit (dBuV/m)	Margin (dB)	Remark
1	9068.000	35.92	10.39	46.31	74.00	-27.69	peak
2	11015.000	35.07	14.79	49.86	74.00	-24.14	peak
3	11653.000	33.25	17.05	50.30	74.00	-23.70	peak
4	12698.000	32.15	18.08	50.23	74.00	-23.77	peak
5	13589.000	29.67	20.86	50.53	74.00	-23.47	peak
6	17978.000	23.10	25.97	49.07	74.00	-24.93	peak

Test Mode:	802.11a 20	Channel:	5180
Polarity:	Vertical	Test Voltage:	DC 15 V

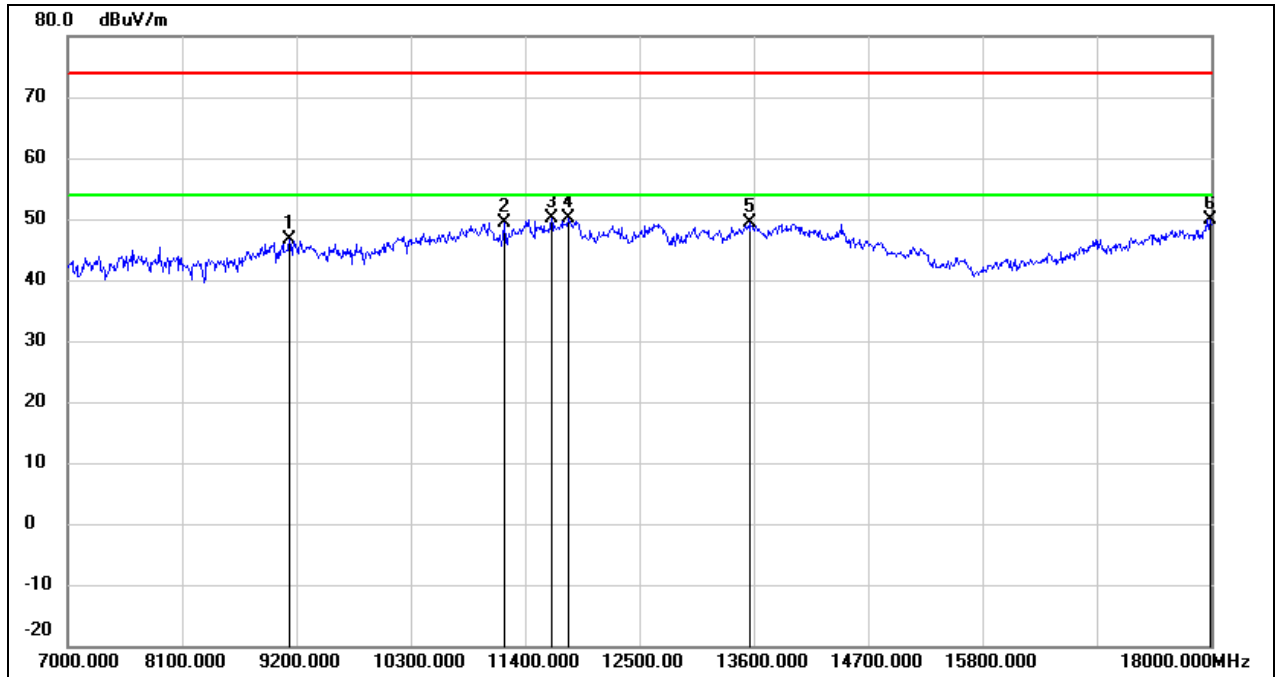

No.	Frequency (MHz)	Reading (dBuV)	Correct (dB/m)	Result (dBuV/m)	Limit (dBuV/m)	Margin (dB)	Remark
1	9134.000	36.14	10.41	46.55	74.00	-27.45	peak
2	11202.000	33.83	15.55	49.38	74.00	-24.62	peak
3	11653.000	33.07	17.05	50.12	74.00	-23.88	peak
4	11818.000	32.71	17.36	50.07	74.00	-23.93	peak
5	13567.000	28.61	20.80	49.41	74.00	-24.59	peak
6	17989.000	23.93	26.04	49.97	74.00	-24.03	peak

Test Mode:	802.11a 20	Channel:	5200
Polarity:	Horizontal	Test Voltage:	DC 15 V

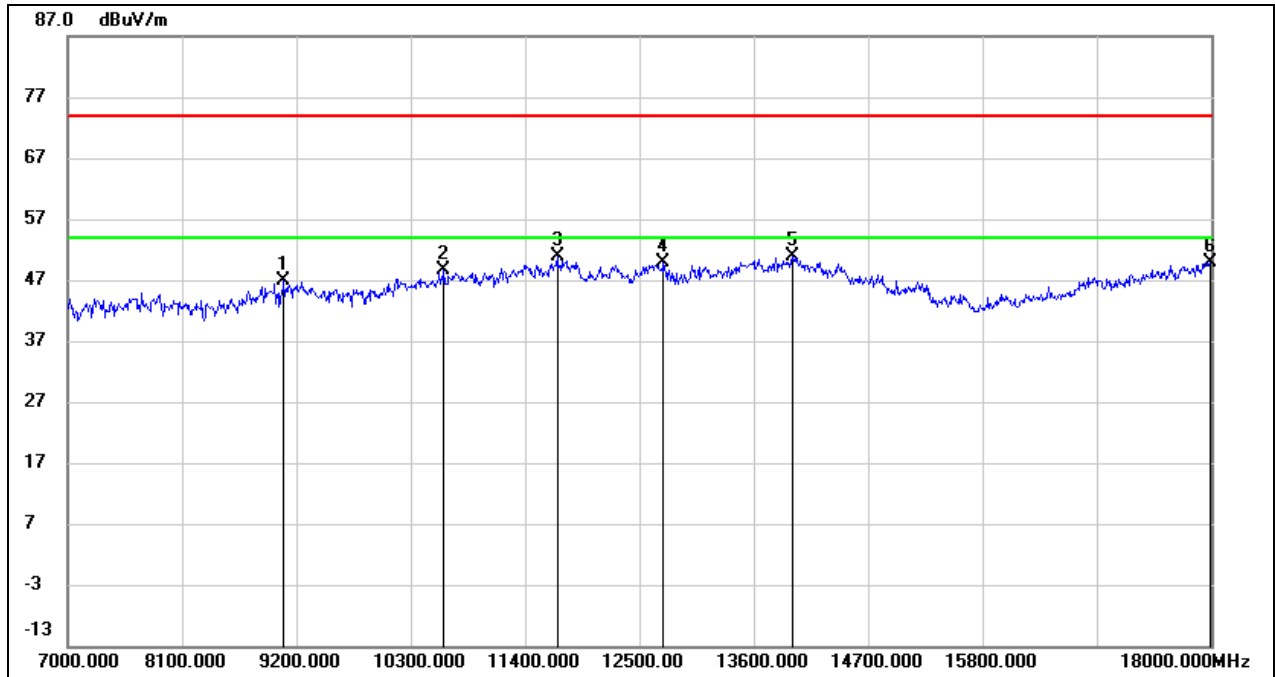

No.	Frequency (MHz)	Reading (dBuV)	Correct (dB/m)	Result (dBuV/m)	Limit (dBuV/m)	Margin (dB)	Remark
1	9079.000	36.37	10.39	46.76	74.00	-27.24	peak
2	10619.000	35.25	13.28	48.53	74.00	-25.47	peak
3	11708.000	33.83	17.16	50.99	74.00	-23.01	peak
4	12731.000	31.82	18.12	49.94	74.00	-24.06	peak
5	13974.000	29.06	21.82	50.88	74.00	-23.12	peak
6	17989.000	23.84	26.04	49.88	74.00	-24.12	peak

Test Mode:	802.11a 20	Channel:	5200
Polarity:	Vertical	Test Voltage:	DC 15 V

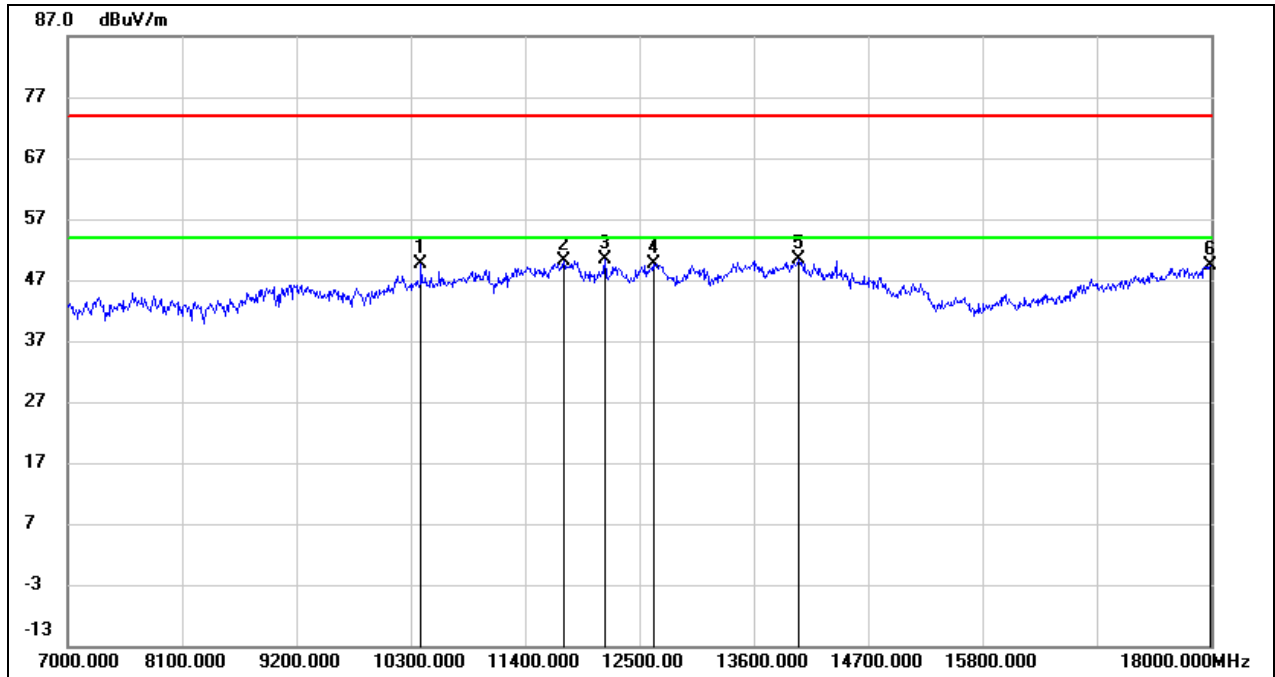

No.	Frequency (MHz)	Reading (dBuV)	Correct (dB/m)	Result (dBuV/m)	Limit (dBuV/m)	Margin (dB)	Remark
1	10399.000	37.00	12.61	49.61	74.00	-24.39	peak
2	11774.000	32.75	17.28	50.03	74.00	-23.97	peak
3	12170.000	32.59	17.75	50.34	74.00	-23.66	peak
4	12632.000	31.65	17.99	49.64	74.00	-24.36	peak
5	14029.000	28.67	21.76	50.43	74.00	-23.57	peak
6	17989.000	23.40	26.04	49.44	74.00	-24.56	peak

Test Mode:	802.11a 20	Channel:	5240
Polarity:	Horizontal	Test Voltage:	DC 15 V

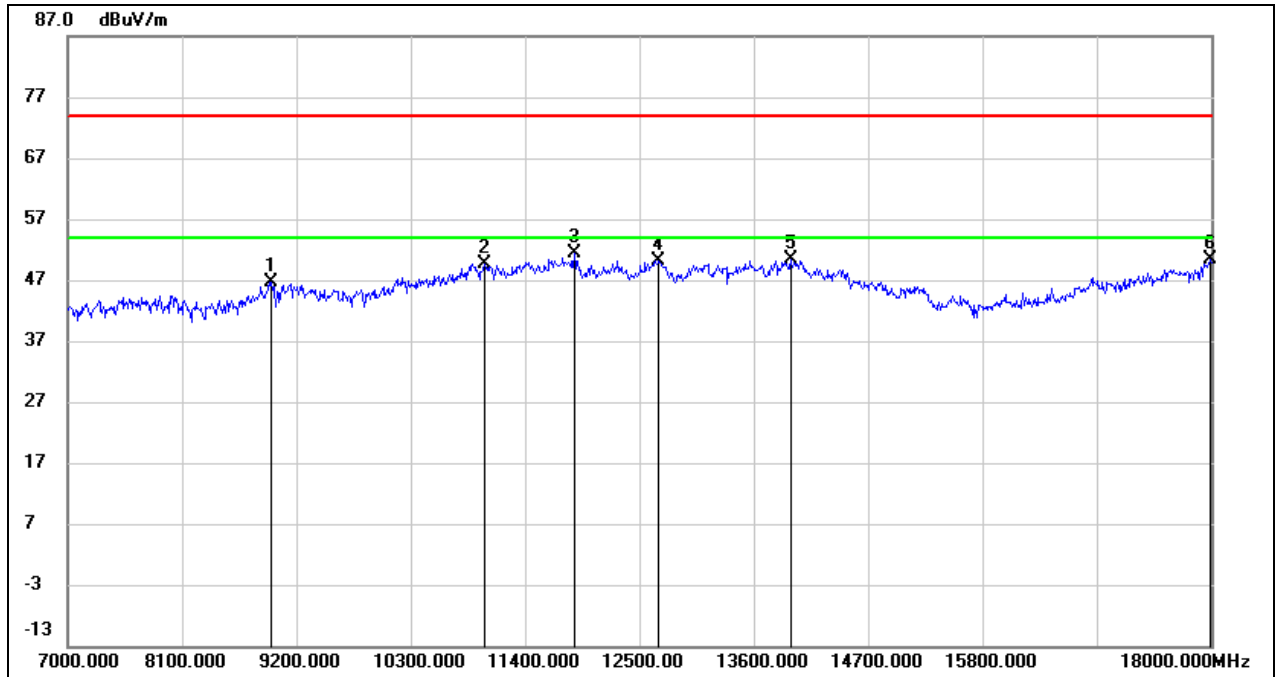

No.	Frequency (MHz)	Reading (dBuV)	Correct (dB/m)	Result (dBuV/m)	Limit (dBuV/m)	Margin (dB)	Remark
1	8958.000	36.62	10.05	46.67	74.00	-27.33	peak
2	11015.000	34.89	14.79	49.68	74.00	-24.32	peak
3	11873.000	33.98	17.46	51.44	74.00	-22.56	peak
4	12687.000	32.18	18.05	50.23	74.00	-23.77	peak
5	13952.000	28.58	21.76	50.34	74.00	-23.66	peak
6	17989.000	24.30	26.04	50.34	74.00	-23.66	peak

Test Mode:	802.11a 20	Channel:	5240
Polarity:	Vertical	Test Voltage:	DC 15 V

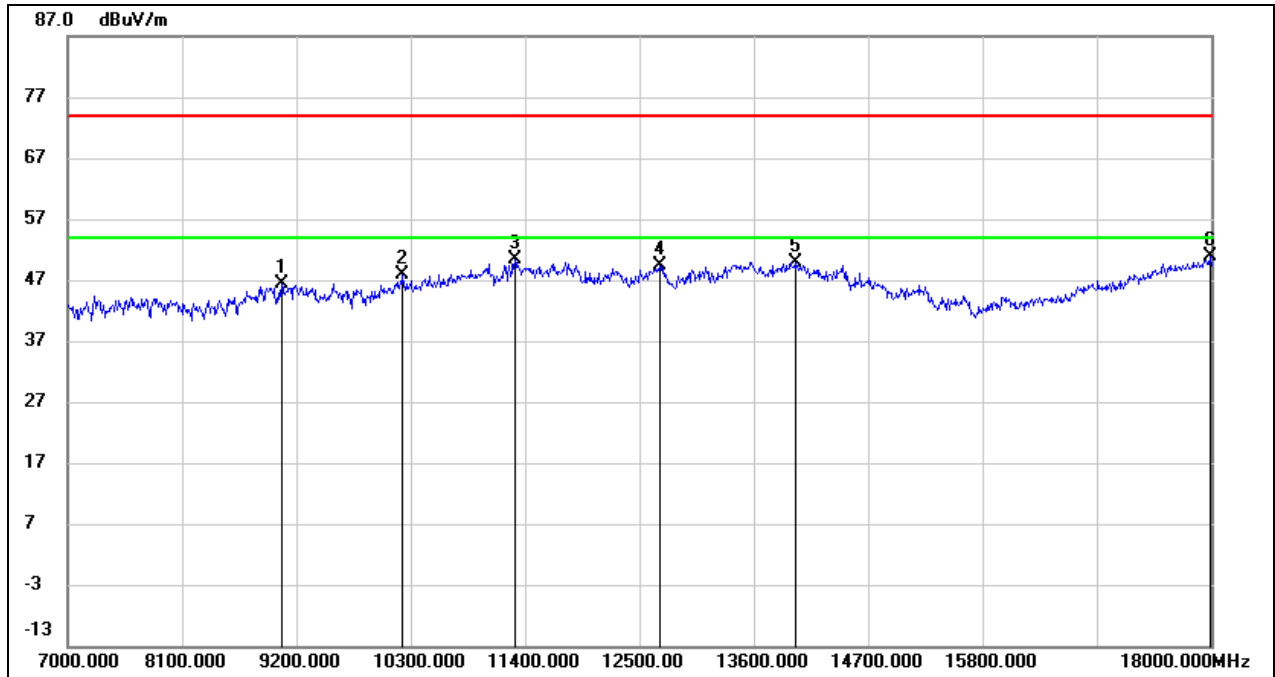

No.	Frequency (MHz)	Reading (dBuV)	Correct (dB/m)	Result (dBuV/m)	Limit (dBuV/m)	Margin (dB)	Remark
1	9057.000	35.88	10.38	46.26	74.00	-27.74	peak
2	10223.000	35.57	12.24	47.81	74.00	-26.19	peak
3	11301.000	34.37	15.95	50.32	74.00	-23.68	peak
4	12698.000	31.42	18.08	49.50	74.00	-24.50	peak
5	14007.000	28.13	21.85	49.98	74.00	-24.02	peak
6	17989.000	24.84	26.04	50.88	74.00	-23.12	peak

Test Mode:	802.11a 20	Channel:	5745
Polarity:	Horizontal	Test Voltage:	DC 15 V

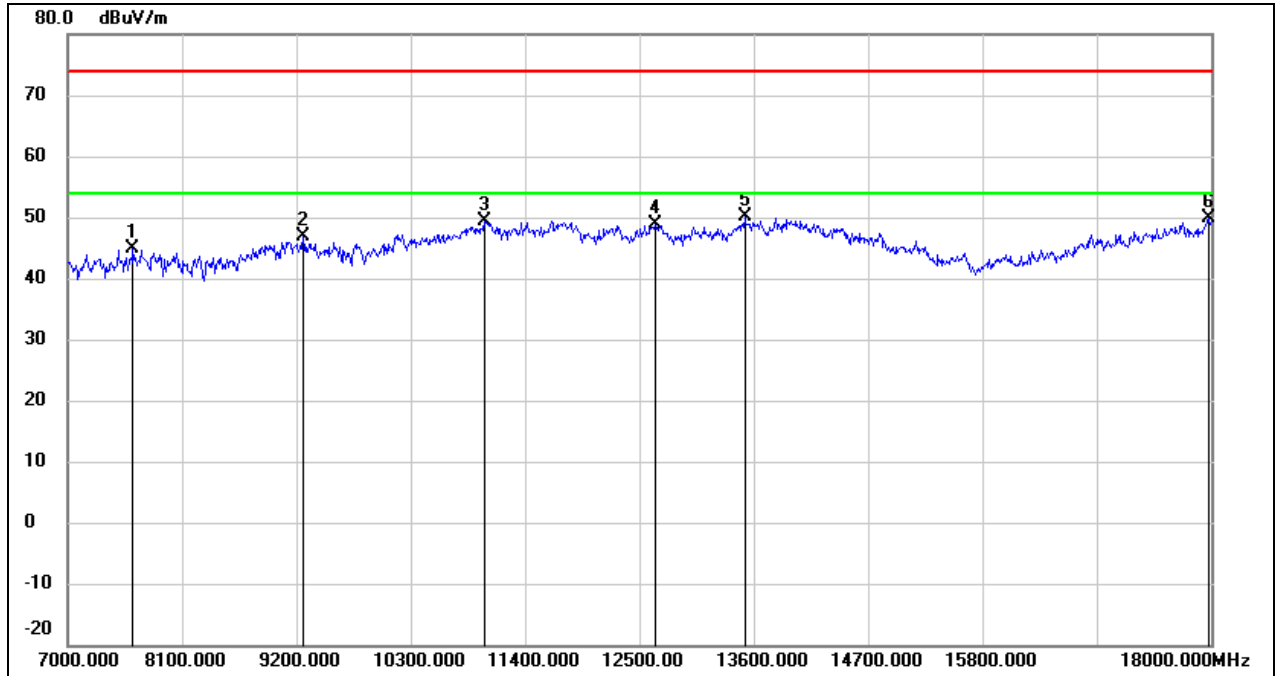

No.	Frequency (MHz)	Reading (dBuV)	Correct (dB/m)	Result (dBuV/m)	Limit (dBuV/m)	Margin (dB)	Remark
1	7627.000	38.05	6.76	44.81	74.00	-29.19	peak
2	9266.000	36.30	10.51	46.81	74.00	-27.19	peak
3	11004.000	34.63	14.74	49.37	74.00	-24.63	peak
4	12654.000	30.89	18.01	48.90	74.00	-25.10	peak
5	13512.000	29.43	20.68	50.11	74.00	-23.89	peak
6	17978.000	23.86	25.97	49.83	74.00	-24.17	peak

Test Mode:	802.11a 20	Channel:	5745
Polarity:	Vertical	Test Voltage:	DC 15 V

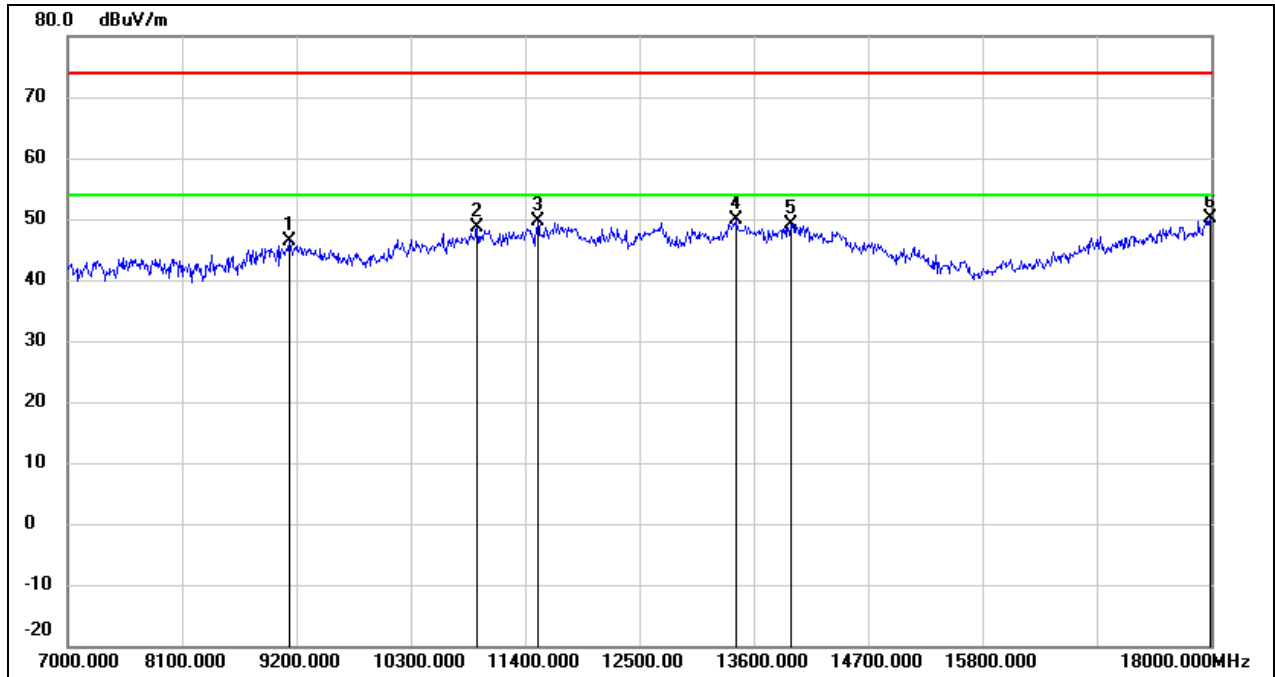

No.	Frequency (MHz)	Reading (dBuV)	Correct (dB/m)	Result (dBuV/m)	Limit (dBuV/m)	Margin (dB)	Remark
1	9134.000	35.86	10.41	46.27	74.00	-27.73	peak
2	10938.000	34.25	14.48	48.73	74.00	-25.27	peak
3	11521.000	32.91	16.82	49.73	74.00	-24.27	peak
4	13435.000	29.48	20.35	49.83	74.00	-24.17	peak
5	13952.000	27.49	21.76	49.25	74.00	-24.75	peak
6	17989.000	24.01	26.04	50.05	74.00	-23.95	peak

Test Mode:	802.11a 20	Channel:	5785
Polarity:	Horizontal	Test Voltage:	DC 15 V

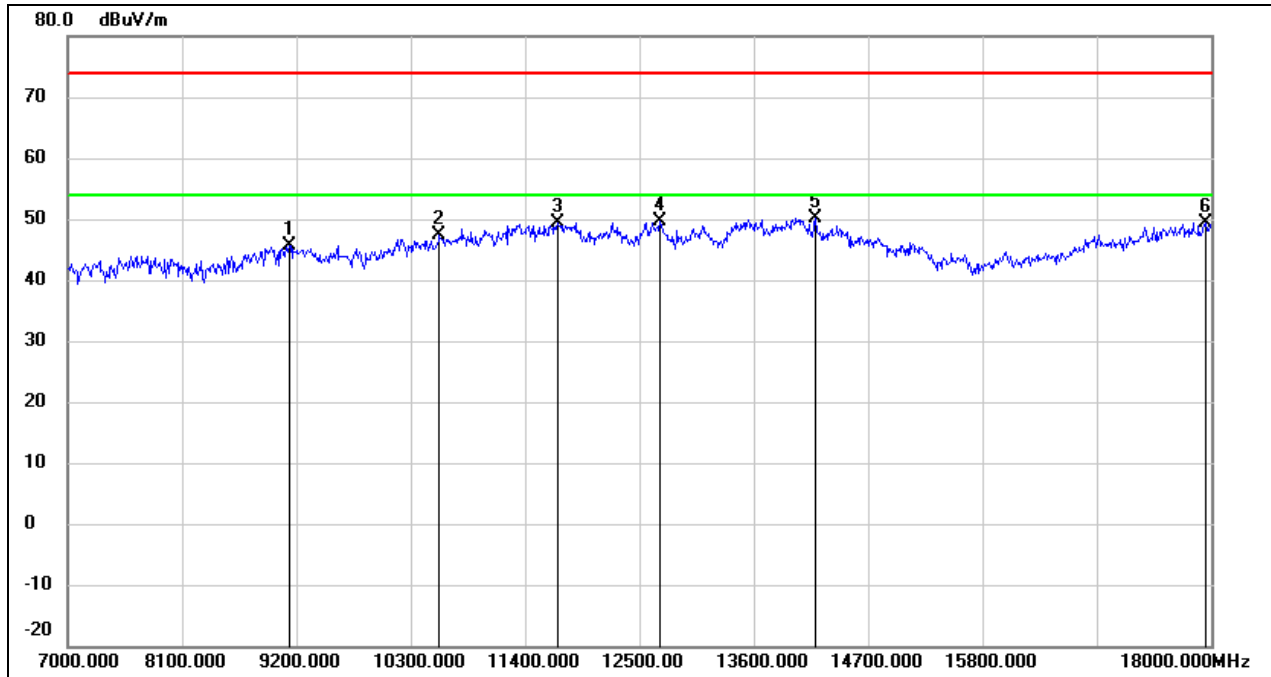

No.	Frequency (MHz)	Reading (dBuV)	Correct (dB/m)	Result (dBuV/m)	Limit (dBuV/m)	Margin (dB)	Remark
1	9134.000	35.16	10.41	45.57	74.00	-28.43	peak
2	10575.000	34.23	13.10	47.33	74.00	-26.67	peak
3	11708.000	32.14	17.16	49.30	74.00	-24.70	peak
4	12698.000	31.65	18.08	49.73	74.00	-24.27	peak
5	14194.000	29.10	21.07	50.17	74.00	-23.83	peak
6	17945.000	23.57	25.75	49.32	74.00	-24.68	peak

Test Mode:	802.11a 20	Channel:	5785
Polarity:	Vertical	Test Voltage:	DC 15 V

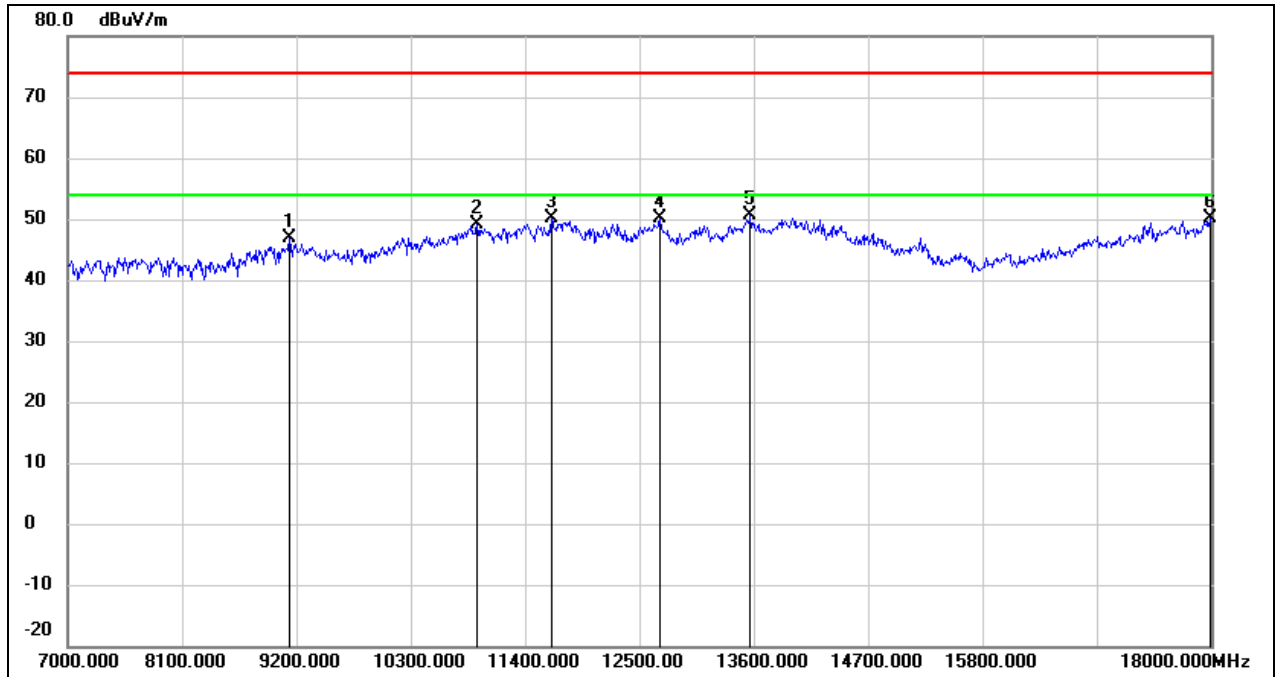

No.	Frequency (MHz)	Reading (dBuV)	Correct (dB/m)	Result (dBuV/m)	Limit (dBuV/m)	Margin (dB)	Remark
1	9134.000	36.38	10.41	46.79	74.00	-27.21	peak
2	10938.000	34.57	14.48	49.05	74.00	-24.95	peak
3	11653.000	33.07	17.05	50.12	74.00	-23.88	peak
4	12698.000	32.01	18.08	50.09	74.00	-23.91	peak
5	13567.000	29.78	20.80	50.58	74.00	-23.42	peak
6	17989.000	24.02	26.04	50.06	74.00	-23.94	peak

Test Mode:	802.11a 20	Channel:	5825
Polarity:	Horizontal	Test Voltage:	DC 15 V

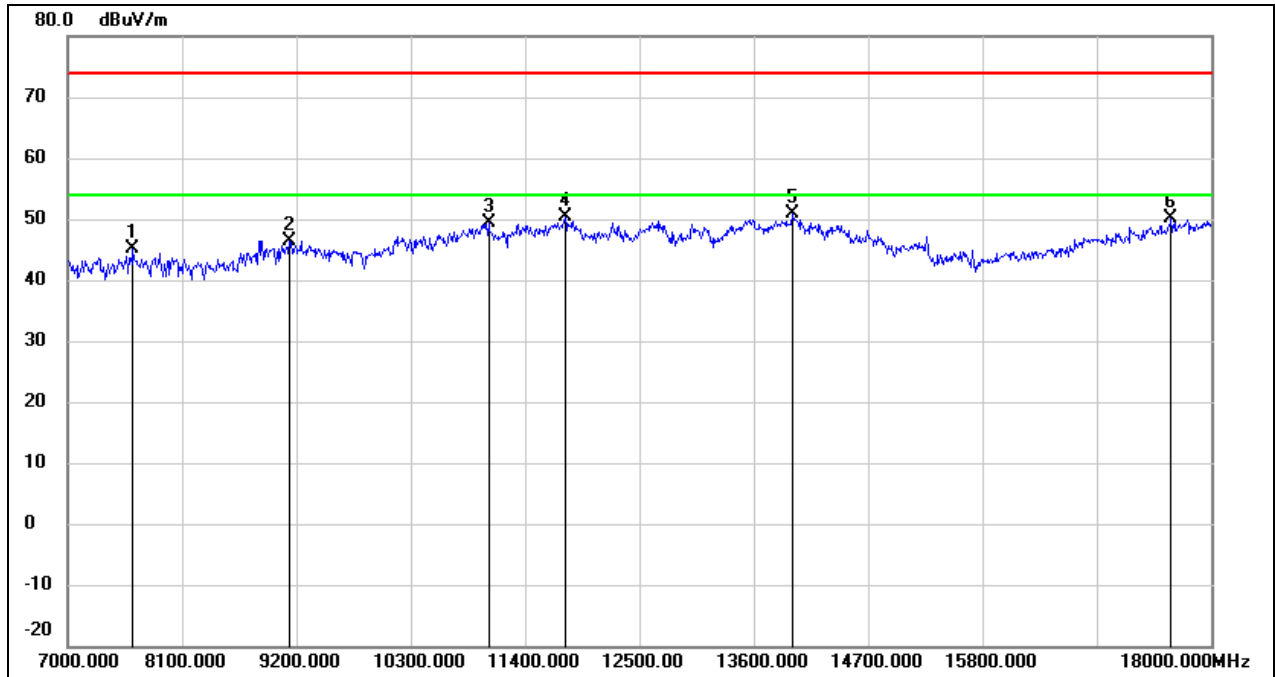

No.	Frequency (MHz)	Reading (dBuV)	Correct (dB/m)	Result (dBuV/m)	Limit (dBuV/m)	Margin (dB)	Remark
1	7627.000	38.39	6.76	45.15	74.00	-28.85	peak
2	9134.000	36.06	10.41	46.47	74.00	-27.53	peak
3	11048.000	34.52	14.91	49.43	74.00	-24.57	peak
4	11785.000	33.12	17.30	50.42	74.00	-23.58	peak
5	13974.000	29.14	21.82	50.96	74.00	-23.04	peak
6	17615.000	26.60	23.49	50.09	74.00	-23.91	peak

Test Mode:	802.11a 20	Channel:	5825
Polarity:	Vertical	Test Voltage:	DC 15 V

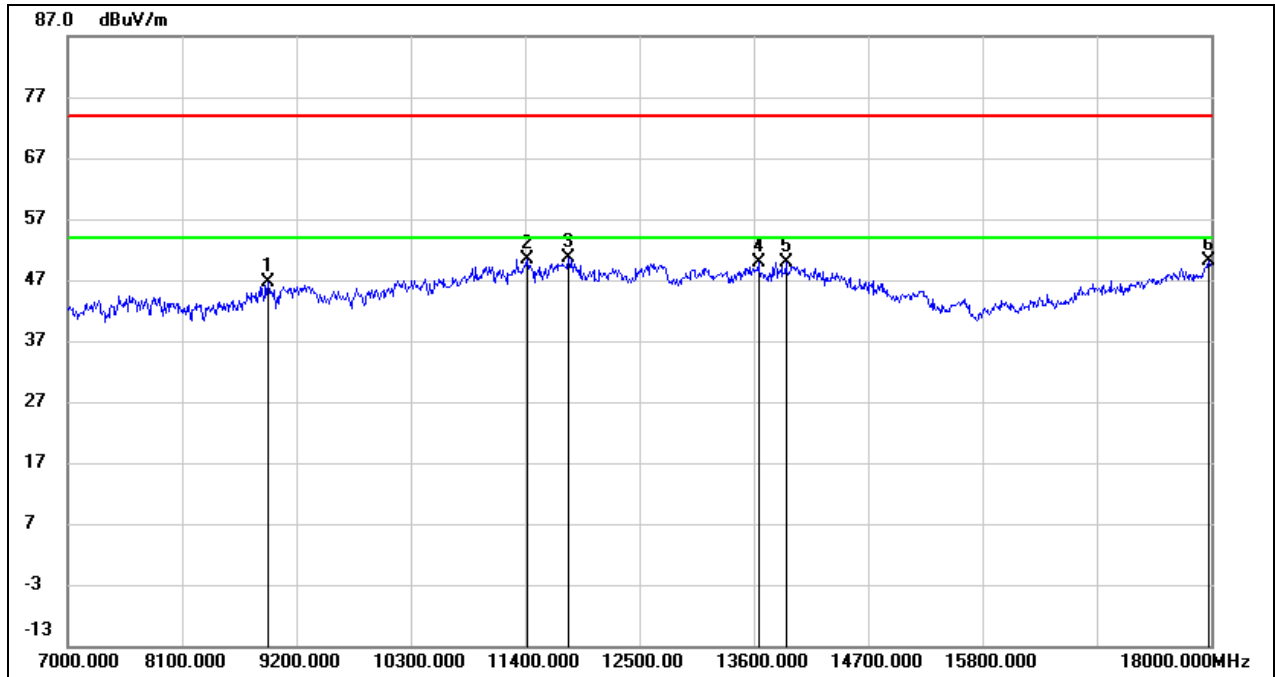

No.	Frequency (MHz)	Reading (dBuV)	Correct (dB/m)	Result (dBuV/m)	Limit (dBuV/m)	Margin (dB)	Remark
1	8925.000	36.75	9.82	46.57	74.00	-27.43	peak
2	11422.000	33.96	16.46	50.42	74.00	-23.58	peak
3	11818.000	33.24	17.36	50.60	74.00	-23.40	peak
4	13644.000	28.88	20.99	49.87	74.00	-24.13	peak
5	13908.000	28.29	21.66	49.95	74.00	-24.05	peak
6	17978.000	24.08	25.97	50.05	74.00	-23.95	peak

Test Mode:	802.11ax HE20	Channel:	5180
Polarity:	Horizontal	Test Voltage:	DC 15 V

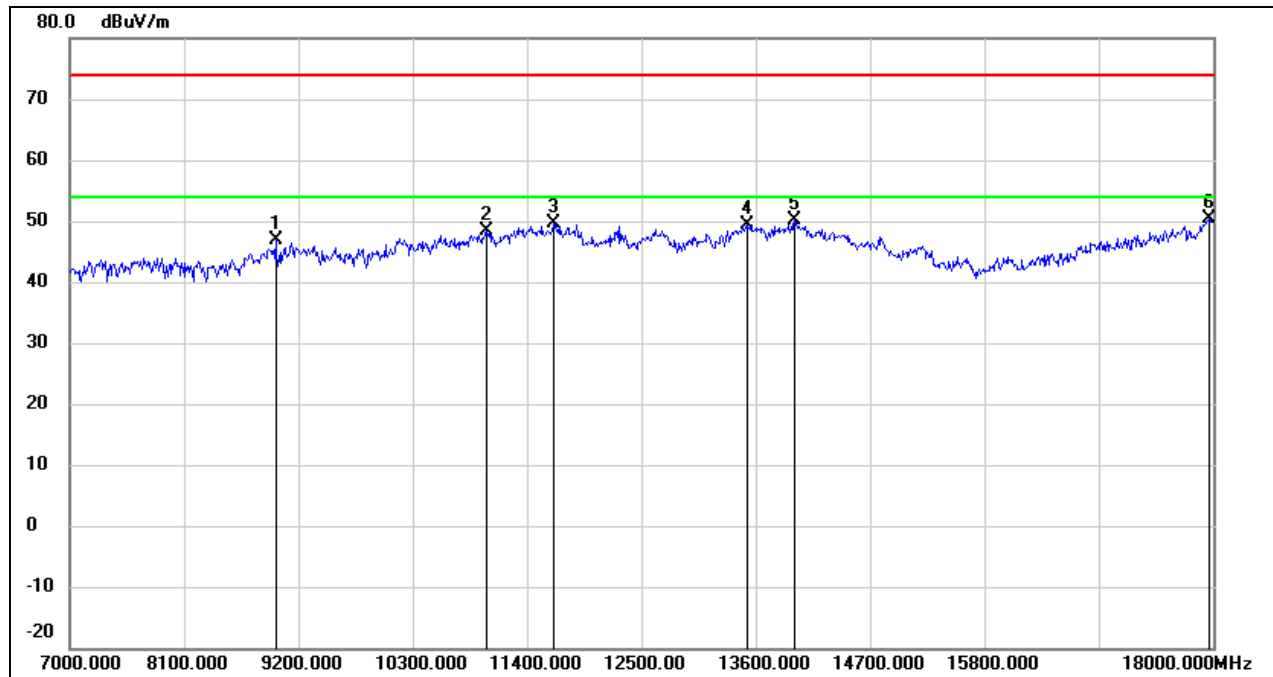

No.	Frequency (MHz)	Reading (dBuV)	Correct (dB/m)	Result (dBuV/m)	Limit (dBuV/m)	Margin (dB)	Remark
1	8980.000	36.76	10.21	46.97	74.00	-27.03	peak
2	11004.000	33.73	14.74	48.47	74.00	-25.53	peak
3	11653.000	32.53	17.05	49.58	74.00	-24.42	peak
4	13512.000	28.79	20.68	49.47	74.00	-24.53	peak
5	13974.000	28.30	21.82	50.12	74.00	-23.88	peak
6	17967.000	24.57	25.89	50.46	74.00	-23.54	peak

Test Mode:	802.11ax HE20	Channel:	5180
Polarity:	Vertical	Test Voltage:	DC 15 V

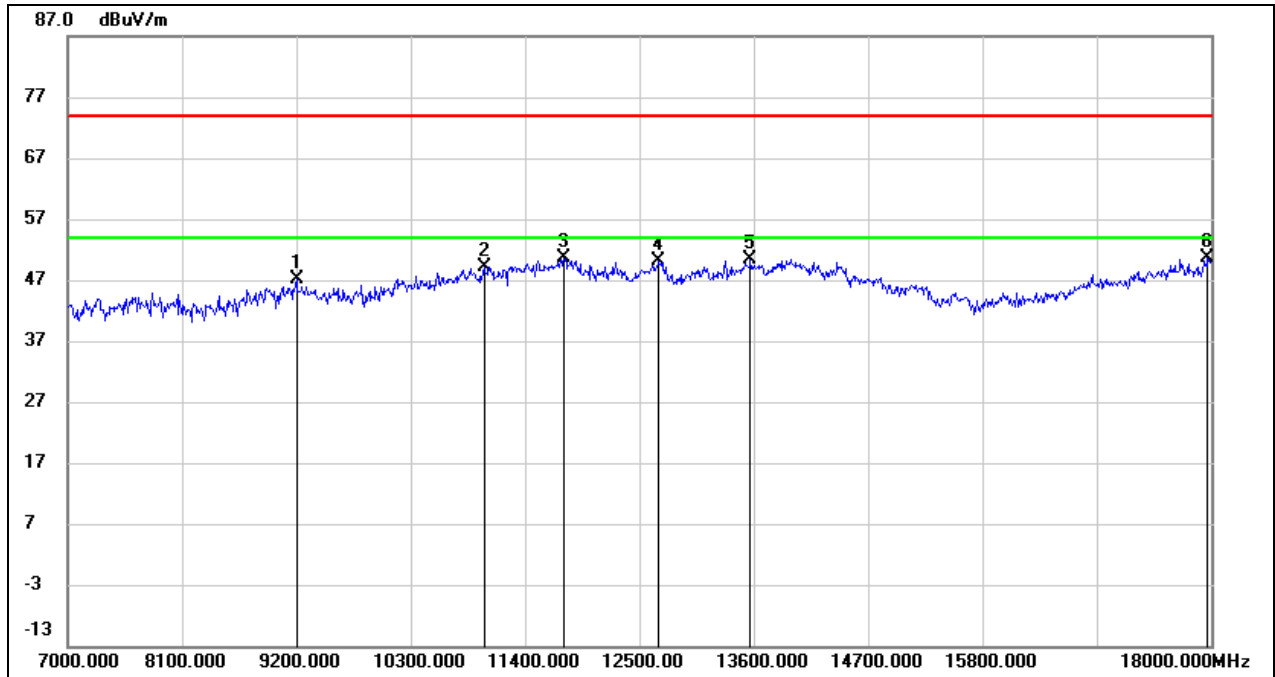

No.	Frequency (MHz)	Reading (dBuV)	Correct (dB/m)	Result (dBuV/m)	Limit (dBuV/m)	Margin (dB)	Remark
1	9200.000	36.72	10.46	47.18	74.00	-26.82	peak
2	11004.000	34.43	14.74	49.17	74.00	-24.83	peak
3	11774.000	33.40	17.28	50.68	74.00	-23.32	peak
4	12687.000	32.08	18.05	50.13	74.00	-23.87	peak
5	13567.000	29.50	20.80	50.30	74.00	-23.70	peak
6	17967.000	24.72	25.89	50.61	74.00	-23.39	peak

Test Mode:	802.11ax HE20	Channel:	5200
Polarity:	Horizontal	Test Voltage:	DC 15 V

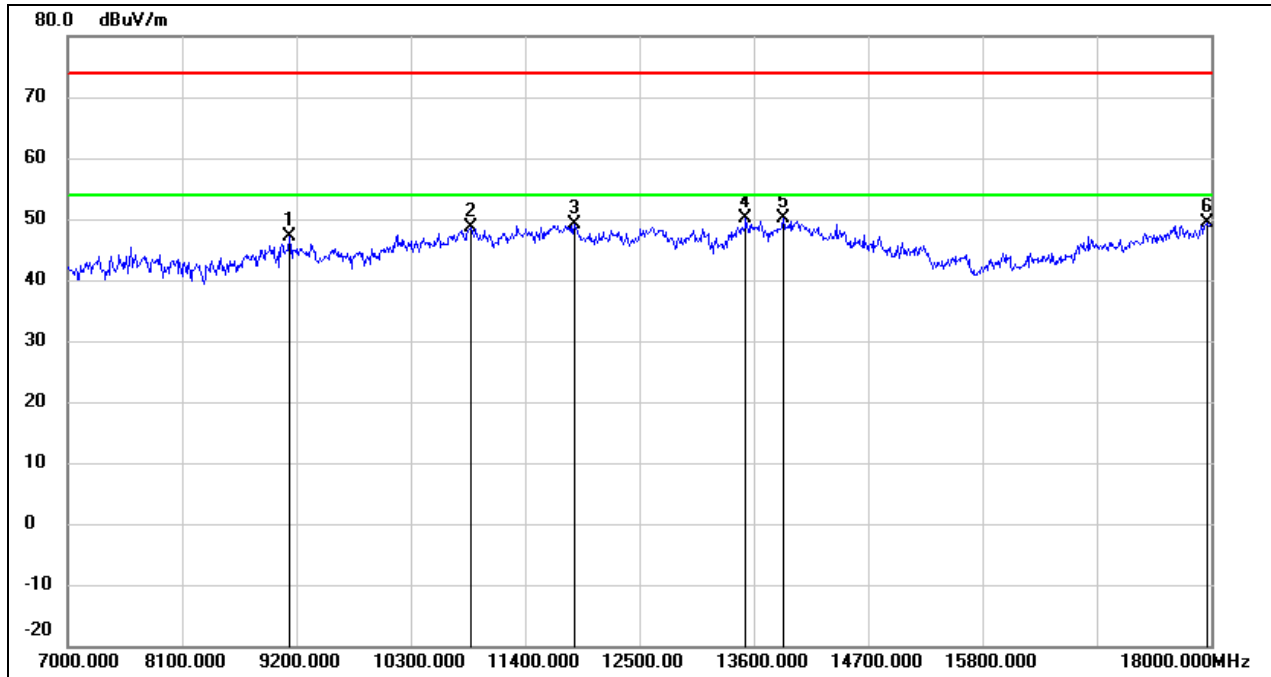

No.	Frequency (MHz)	Reading (dBuV)	Correct (dB/m)	Result (dBuV/m)	Limit (dBuV/m)	Margin (dB)	Remark
1	9134.000	36.64	10.41	47.05	74.00	-26.95	peak
2	10883.000	34.39	14.27	48.66	74.00	-25.34	peak
3	11873.000	31.69	17.46	49.15	74.00	-24.85	peak
4	13523.000	29.40	20.70	50.10	74.00	-23.90	peak
5	13886.000	28.58	21.60	50.18	74.00	-23.82	peak
6	17967.000	23.52	25.89	49.41	74.00	-24.59	peak

Test Mode:	802.11ax HE20	Channel:	5200
Polarity:	Vertical	Test Voltage:	DC 15 V

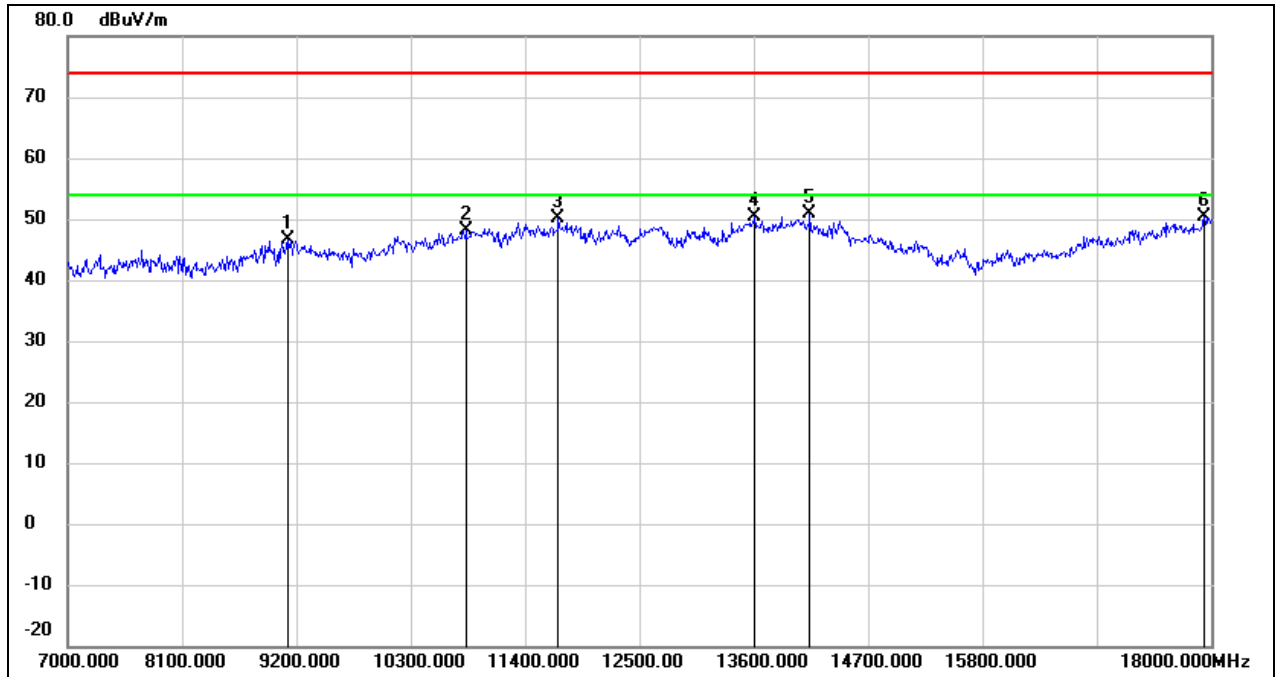

No.	Frequency (MHz)	Reading (dBuV)	Correct (dB/m)	Result (dBuV/m)	Limit (dBuV/m)	Margin (dB)	Remark
1	9112.000	36.30	10.41	46.71	74.00	-27.29	peak
2	10828.000	34.00	14.07	48.07	74.00	-25.93	peak
3	11719.000	33.05	17.18	50.23	74.00	-23.77	peak
4	13611.000	29.55	20.92	50.47	74.00	-23.53	peak
5	14139.000	29.62	21.30	50.92	74.00	-23.08	peak
6	17934.000	24.76	25.67	50.43	74.00	-23.57	peak

Test Mode:	802.11ax HE20	Channel:	5240
Polarity:	Horizontal	Test Voltage:	DC 15 V

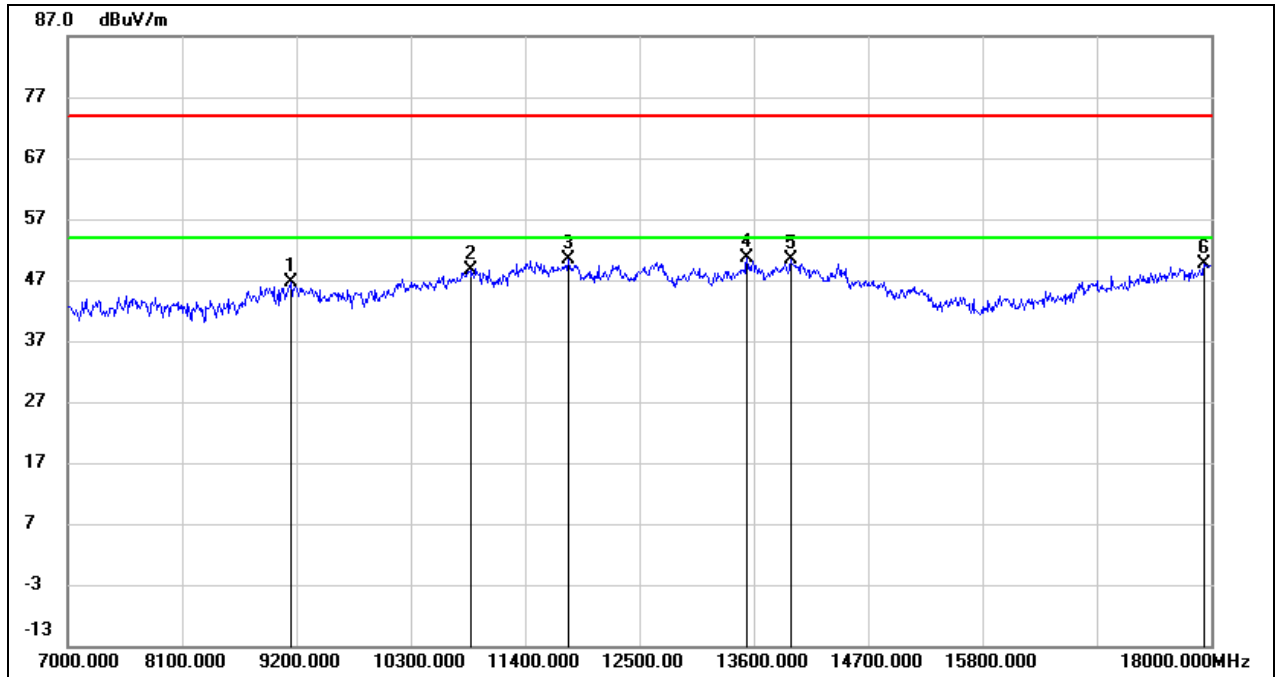

No.	Frequency (MHz)	Reading (dBuV)	Correct (dB/m)	Result (dBuV/m)	Limit (dBuV/m)	Margin (dB)	Remark
1	9145.000	36.25	10.43	46.68	74.00	-27.32	peak
2	10872.000	34.30	14.23	48.53	74.00	-25.47	peak
3	11818.000	33.11	17.36	50.47	74.00	-23.53	peak
4	13534.000	29.80	20.73	50.53	74.00	-23.47	peak
5	13952.000	28.73	21.76	50.49	74.00	-23.51	peak
6	17934.000	24.02	25.67	49.69	74.00	-24.31	peak

Test Mode:	802.11ax HE20	Channel:	5240
Polarity:	Vertical	Test Voltage:	DC 15 V

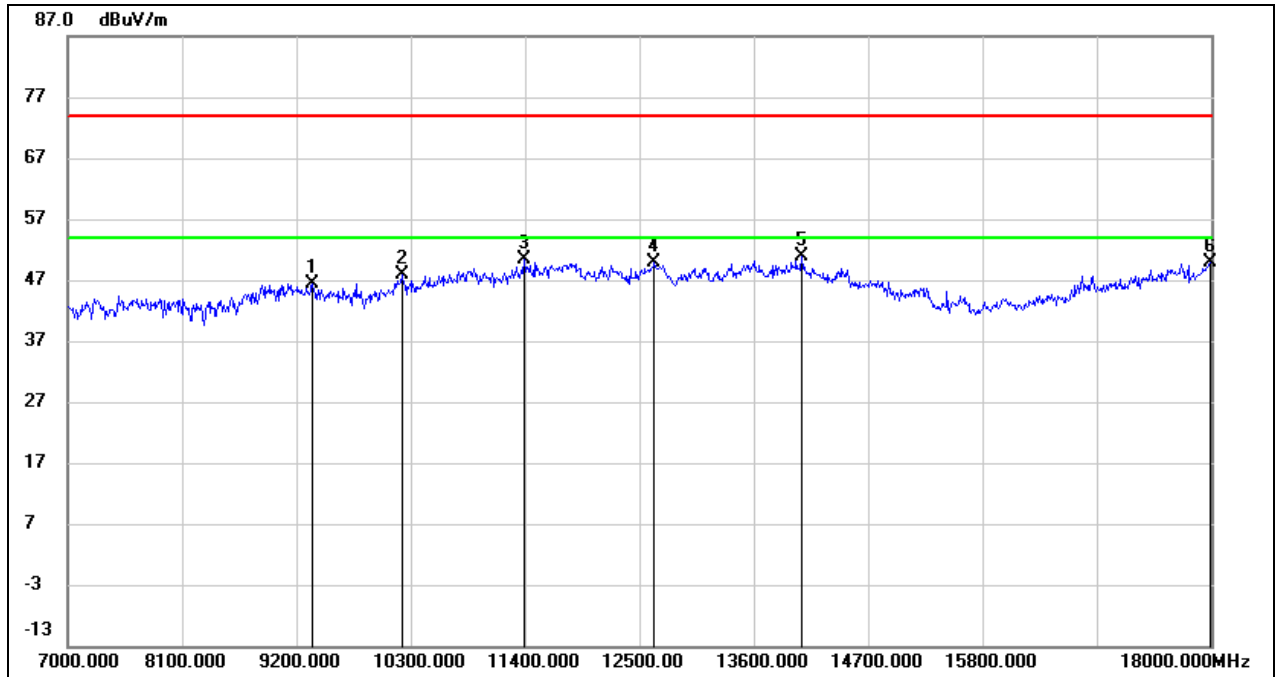

No.	Frequency (MHz)	Reading (dBuV)	Correct (dB/m)	Result (dBuV/m)	Limit (dBuV/m)	Margin (dB)	Remark
1	9354.000	35.78	10.56	46.34	74.00	-27.66	peak
2	10212.000	35.68	12.21	47.89	74.00	-26.11	peak
3	11389.000	33.95	16.31	50.26	74.00	-23.74	peak
4	12643.000	31.93	18.01	49.94	74.00	-24.06	peak
5	14062.000	29.17	21.62	50.79	74.00	-23.21	peak
6	17989.000	23.95	26.04	49.99	74.00	-24.01	peak

Test Mode:	802.11ax HE20	Channel:	5745
Polarity:	Horizontal	Test Voltage:	DC 15 V

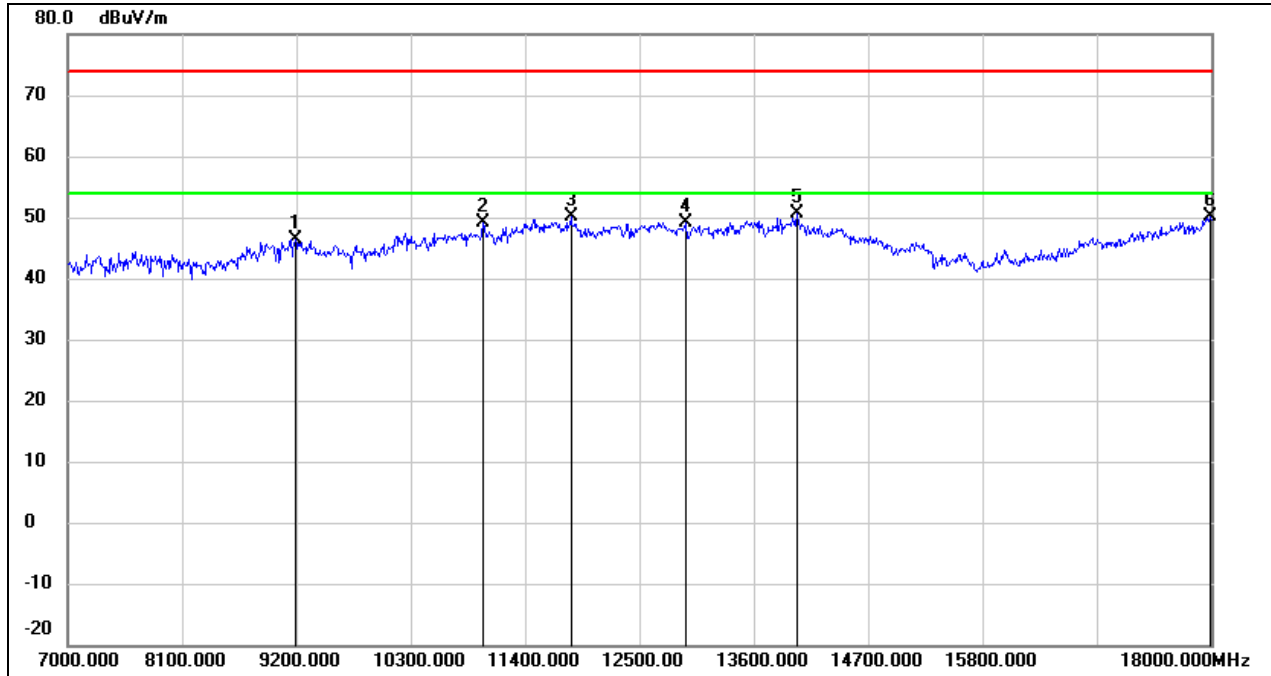

No.	Frequency (MHz)	Reading (dBuV)	Correct (dB/m)	Result (dBuV/m)	Limit (dBuV/m)	Margin (dB)	Remark
1	9189.000	36.02	10.46	46.48	74.00	-27.52	peak
2	10993.000	34.39	14.70	49.09	74.00	-24.91	peak
3	11840.000	32.70	17.40	50.10	74.00	-23.90	peak
4	12951.000	30.74	18.38	49.12	74.00	-24.88	peak
5	14018.000	28.84	21.80	50.64	74.00	-23.36	peak
6	17989.000	24.14	26.04	50.18	74.00	-23.82	peak

Test Mode:	802.11ax HE20	Channel:	5745
Polarity:	Vertical	Test Voltage:	DC 15 V

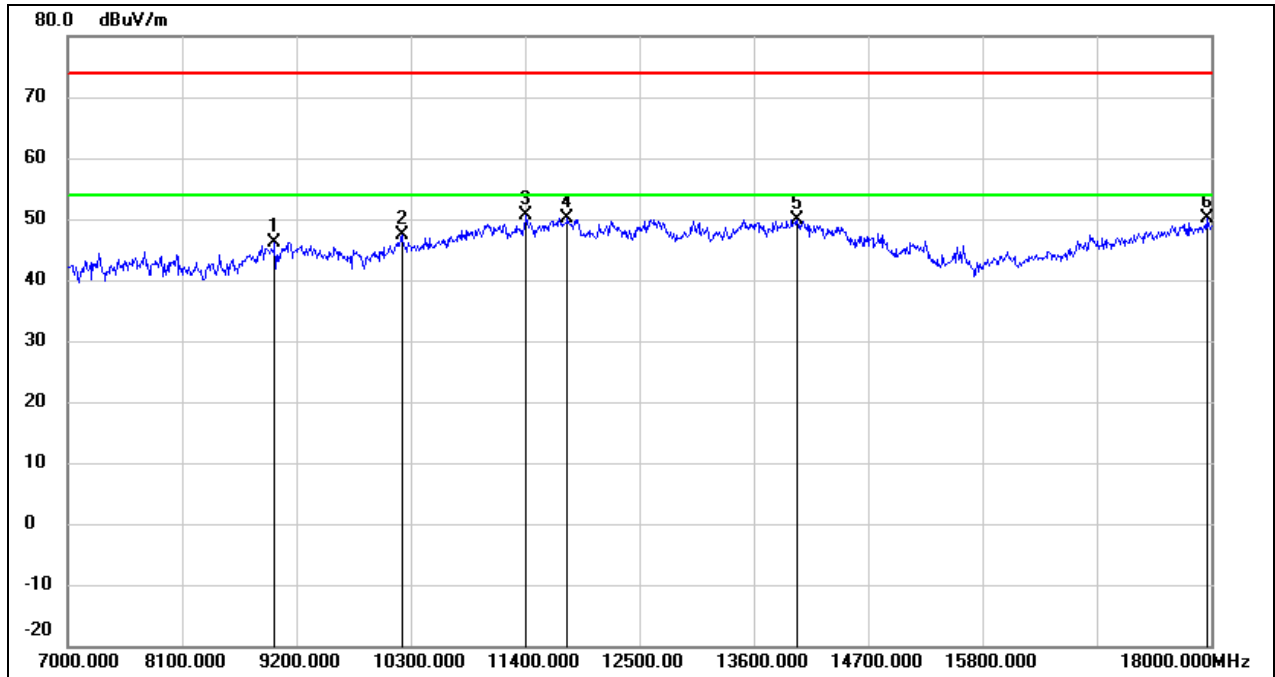

No.	Frequency (MHz)	Reading (dBuV)	Correct (dB/m)	Result (dBuV/m)	Limit (dBuV/m)	Margin (dB)	Remark
1	8991.000	35.94	10.28	46.22	74.00	-27.78	peak
2	10212.000	35.20	12.21	47.41	74.00	-26.59	peak
3	11411.000	34.17	16.41	50.58	74.00	-23.42	peak
4	11807.000	32.76	17.34	50.10	74.00	-23.90	peak
5	14018.000	28.20	21.80	50.00	74.00	-24.00	peak
6	17956.000	24.31	25.82	50.13	74.00	-23.87	peak

Test Mode:	802.11ax HE20	Channel:	5785
Polarity:	Horizontal	Test Voltage:	DC 15 V

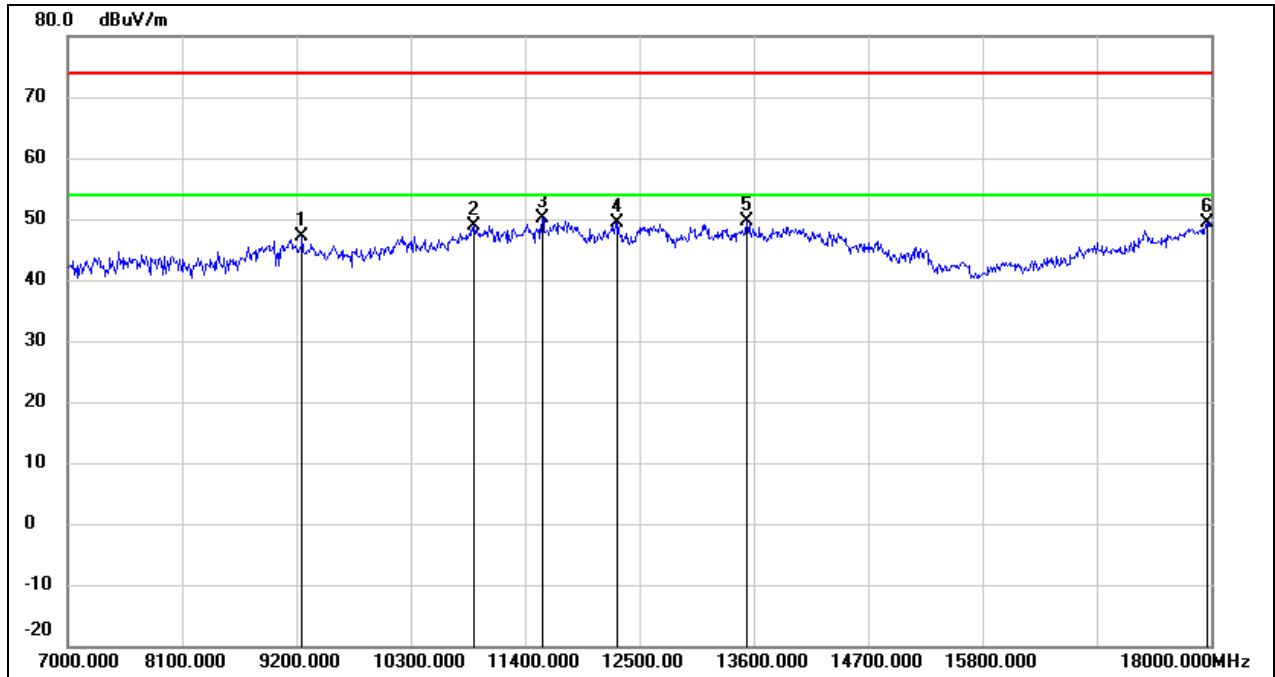

No.	Frequency (MHz)	Reading (dBuV)	Correct (dB/m)	Result (dBuV/m)	Limit (dBuV/m)	Margin (dB)	Remark
1	9255.000	36.59	10.51	47.10	74.00	-26.90	peak
2	10905.000	34.40	14.36	48.76	74.00	-25.24	peak
3	11565.000	33.24	16.89	50.13	74.00	-23.87	peak
4	12291.000	31.58	17.78	49.36	74.00	-24.64	peak
5	13534.000	28.82	20.73	49.55	74.00	-24.45	peak
6	17967.000	23.60	25.89	49.49	74.00	-24.51	peak

Test Mode:	802.11ax HE20	Channel:	5785
Polarity:	Vertical	Test Voltage:	DC 15 V

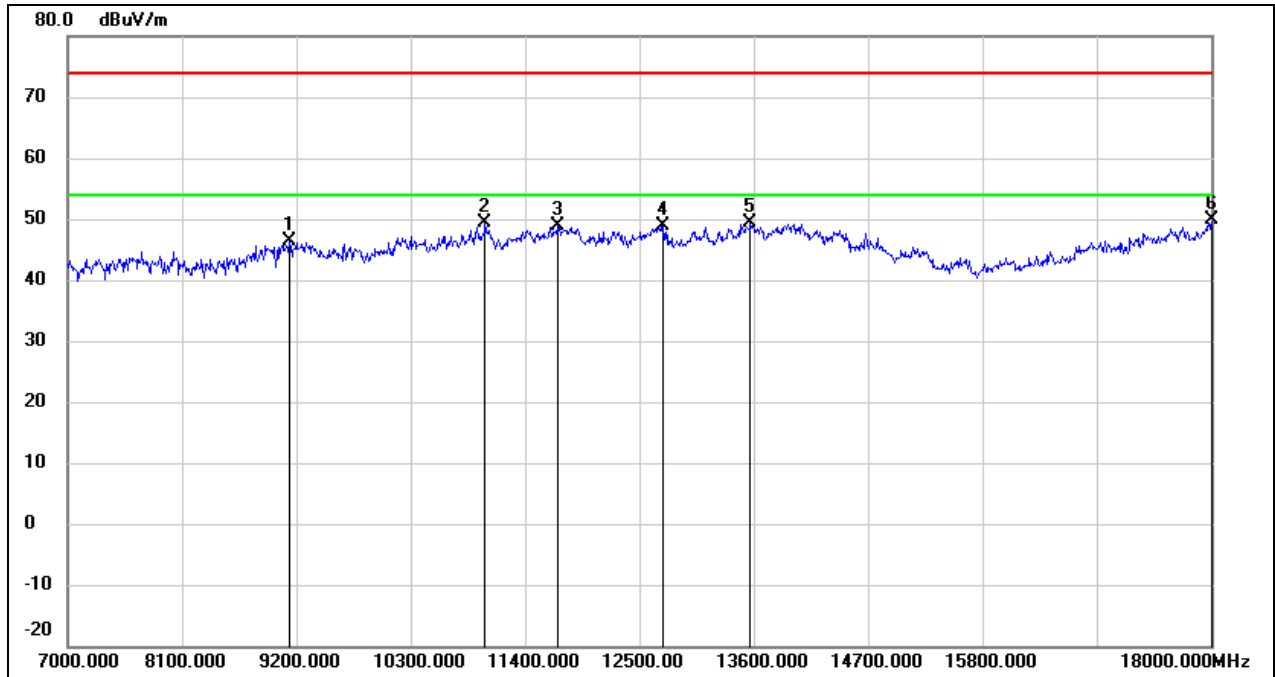

No.	Frequency (MHz)	Reading (dBuV)	Correct (dB/m)	Result (dBuV/m)	Limit (dBuV/m)	Margin (dB)	Remark
1	9134.000	36.07	10.41	46.48	74.00	-27.52	peak
2	11015.000	34.69	14.79	49.48	74.00	-24.52	peak
3	11708.000	31.68	17.16	48.84	74.00	-25.16	peak
4	12731.000	30.83	18.12	48.95	74.00	-25.05	peak
5	13567.000	28.61	20.80	49.41	74.00	-24.59	peak
6	18000.000	23.68	26.12	49.80	74.00	-24.20	peak

Test Mode:	802.11ax HE20	Channel:	5825
Polarity:	Horizontal	Test Voltage:	DC 15 V

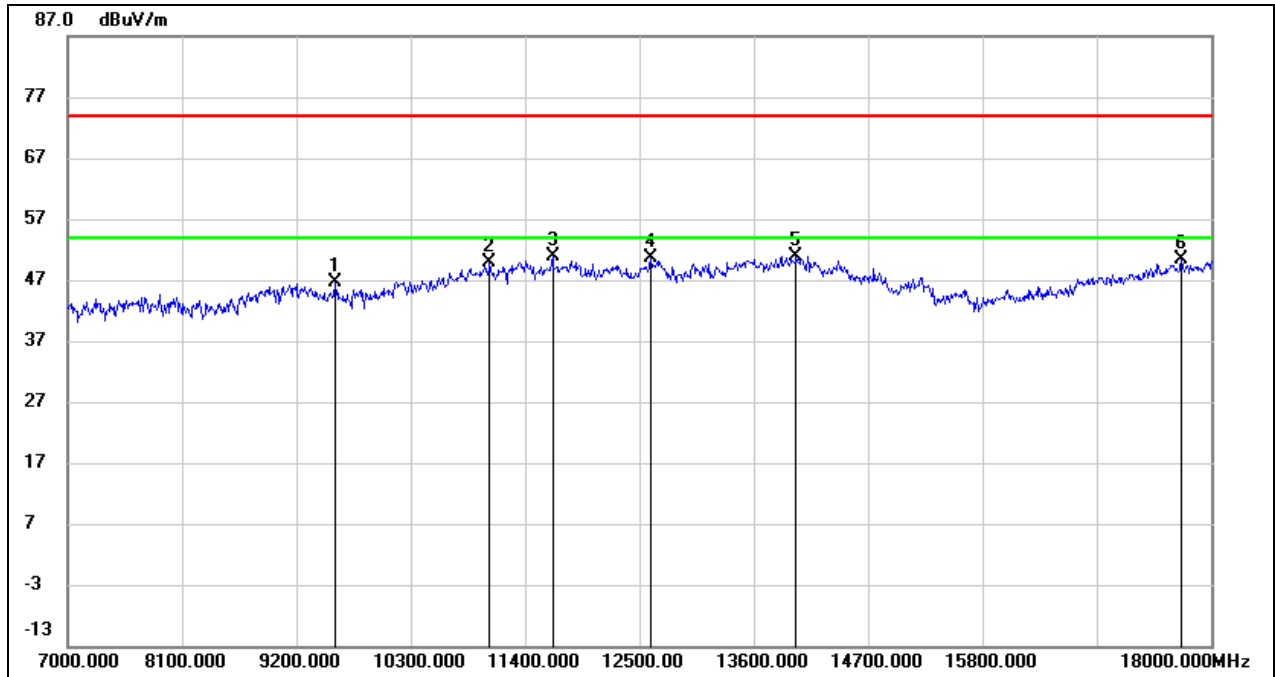

No.	Frequency (MHz)	Reading (dBuV)	Correct (dB/m)	Result (dBuV/m)	Limit (dBuV/m)	Margin (dB)	Remark
1	9574.000	35.89	10.81	46.70	74.00	-27.30	peak
2	11059.000	34.84	14.96	49.80	74.00	-24.20	peak
3	11664.000	33.73	17.08	50.81	74.00	-23.19	peak
4	12610.000	32.67	17.97	50.64	74.00	-23.36	peak
5	14007.000	29.10	21.85	50.95	74.00	-23.05	peak
6	17714.000	26.30	24.16	50.46	74.00	-23.54	peak

Test Mode:	802.11ax HE20	Channel:	5825
Polarity:	Vertical	Test Voltage:	DC 15 V

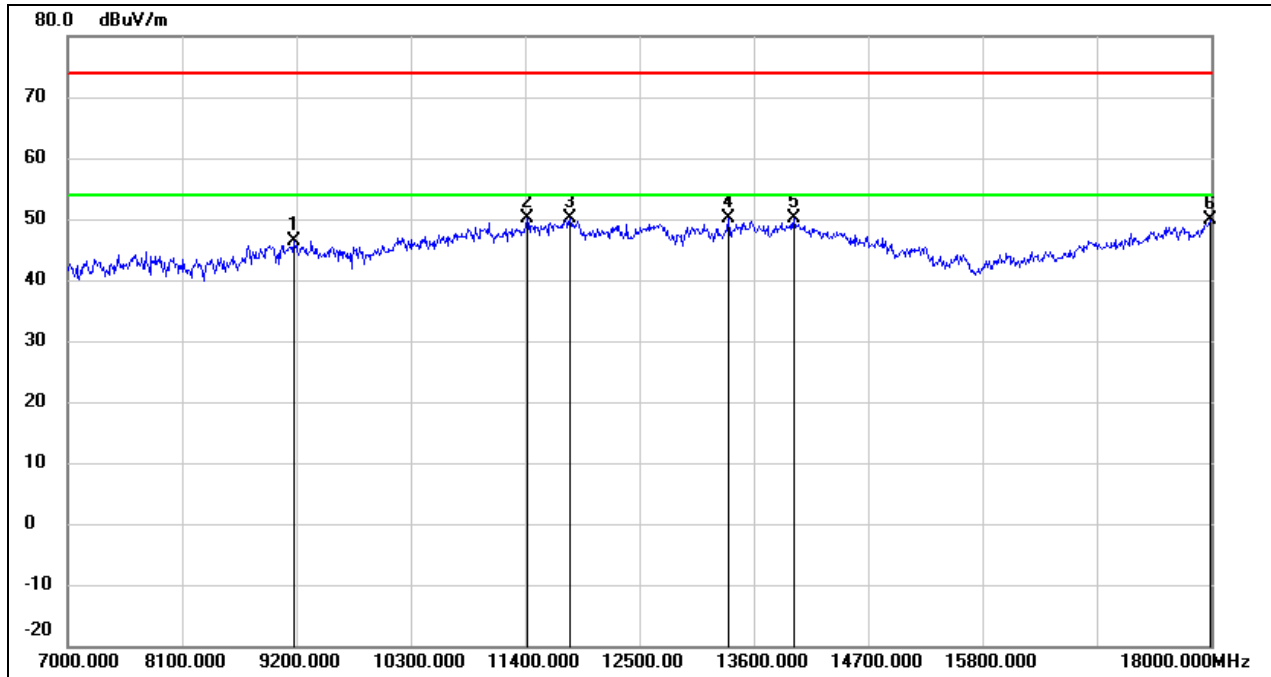

No.	Frequency (MHz)	Reading (dBuV)	Correct (dB/m)	Result (dBuV/m)	Limit (dBuV/m)	Margin (dB)	Remark
1	9178.000	36.02	10.45	46.47	74.00	-27.53	peak
2	11422.000	33.70	16.46	50.16	74.00	-23.84	peak
3	11829.000	32.71	17.38	50.09	74.00	-23.91	peak
4	13358.000	30.02	20.02	50.04	74.00	-23.96	peak
5	13985.000	28.21	21.85	50.06	74.00	-23.94	peak
6	17989.000	23.73	26.04	49.77	74.00	-24.23	peak

Test Mode:	802.11ax HE40	Channel:	5190
Polarity:	Horizontal	Test Voltage:	DC 15 V

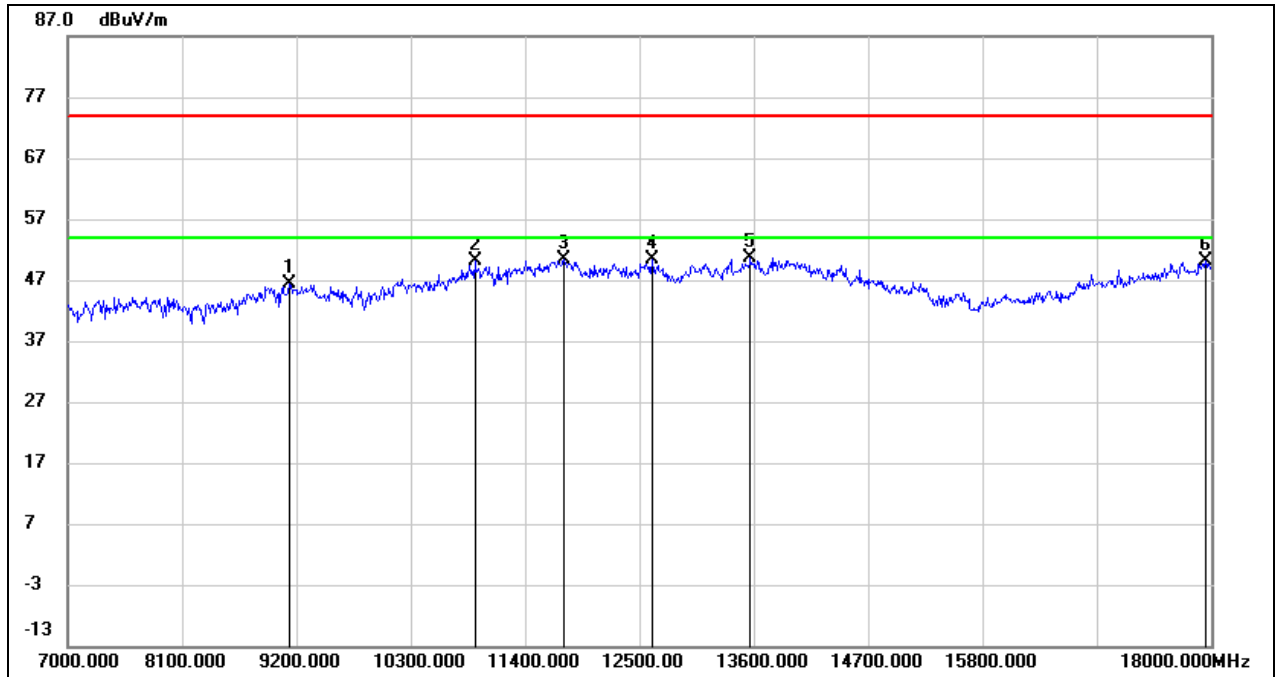

No.	Frequency (MHz)	Reading (dBuV)	Correct (dB/m)	Result (dBuV/m)	Limit (dBuV/m)	Margin (dB)	Remark
1	9134.000	35.86	10.41	46.27	74.00	-27.73	peak
2	10916.000	35.75	14.39	50.14	74.00	-23.86	peak
3	11774.000	33.14	17.28	50.42	74.00	-23.58	peak
4	12621.000	32.33	17.98	50.31	74.00	-23.69	peak
5	13567.000	29.81	20.80	50.61	74.00	-23.39	peak
6	17945.000	24.44	25.75	50.19	74.00	-23.81	peak

Test Mode:	802.11ax HE40	Channel:	5190
Polarity:	Vertical	Test Voltage:	DC 15 V

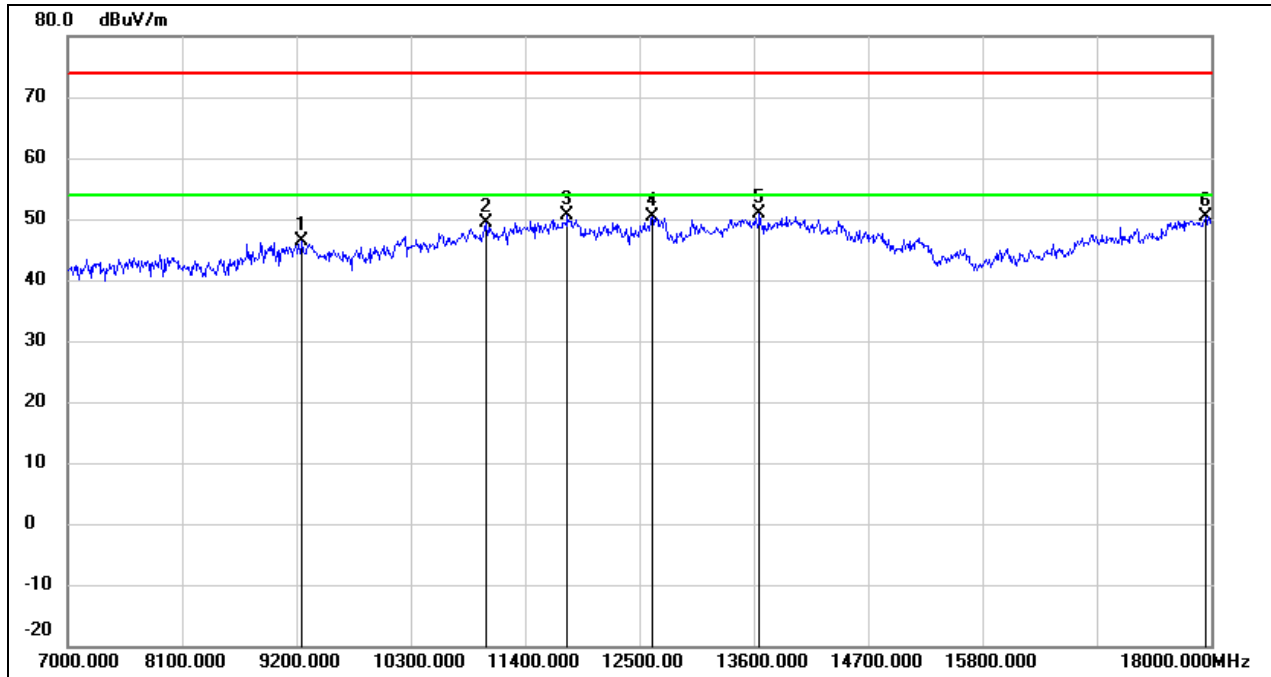

No.	Frequency (MHz)	Reading (dBuV)	Correct (dB/m)	Result (dBuV/m)	Limit (dBuV/m)	Margin (dB)	Remark
1	9255.000	35.90	10.51	46.41	74.00	-27.59	peak
2	11026.000	34.50	14.82	49.32	74.00	-24.68	peak
3	11807.000	33.41	17.34	50.75	74.00	-23.25	peak
4	12621.000	32.28	17.98	50.26	74.00	-23.74	peak
5	13655.000	29.78	21.03	50.81	74.00	-23.19	peak
6	17945.000	24.57	25.75	50.32	74.00	-23.68	peak

Test Mode:	802.11ax HE40	Channel:	5230
Polarity:	Horizontal	Test Voltage:	DC 15 V

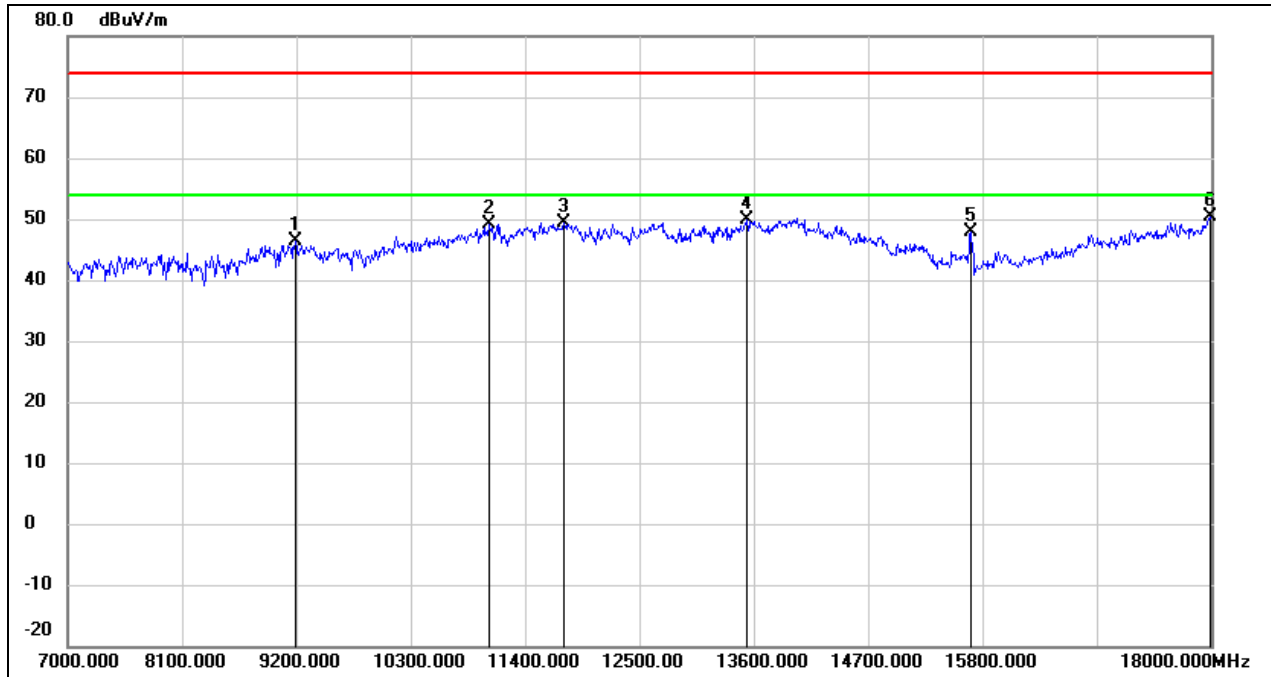

No.	Frequency (MHz)	Reading (dBuV)	Correct (dB/m)	Result (dBuV/m)	Limit (dBuV/m)	Margin (dB)	Remark
1	9189.000	35.88	10.46	46.34	74.00	-27.66	peak
2	11048.000	34.32	14.91	49.23	74.00	-24.77	peak
3	11774.000	32.19	17.28	49.47	74.00	-24.53	peak
4	13534.000	29.05	20.73	49.78	74.00	-24.22	peak
5	15690.000	30.99	16.79	47.78	74.00	-26.22	peak
6	17989.000	24.45	26.04	50.49	74.00	-23.51	peak

Test Mode:	802.11ax HE40	Channel:	5230
Polarity:	Vertical	Test Voltage:	DC 15 V

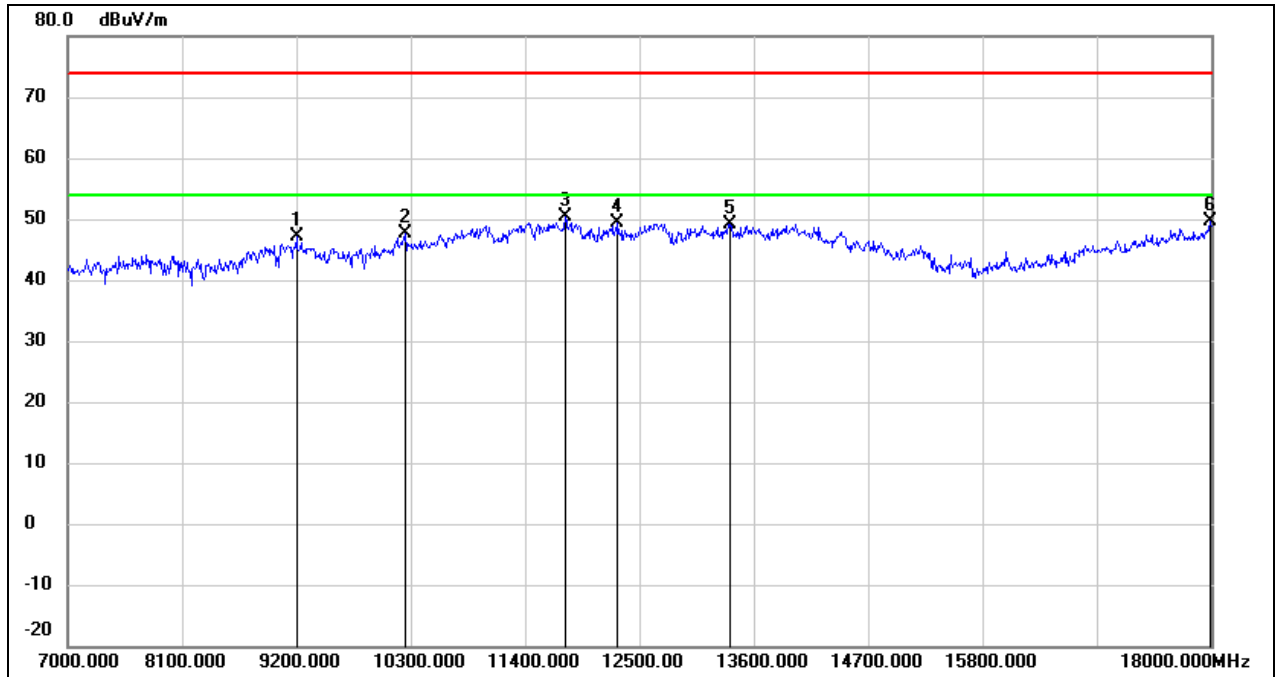

No.	Frequency (MHz)	Reading (dBuV)	Correct (dB/m)	Result (dBuV/m)	Limit (dBuV/m)	Margin (dB)	Remark
1	9200.000	36.69	10.46	47.15	74.00	-26.85	peak
2	10245.000	35.23	12.28	47.51	74.00	-26.49	peak
3	11785.000	33.08	17.30	50.38	74.00	-23.62	peak
4	12291.000	31.50	17.78	49.28	74.00	-24.72	peak
5	13369.000	29.15	20.06	49.21	74.00	-24.79	peak
6	17989.000	23.68	26.04	49.72	74.00	-24.28	peak

Test Mode:	802.11ax HE40	Channel:	5755
Polarity:	Horizontal	Test Voltage:	DC 15 V

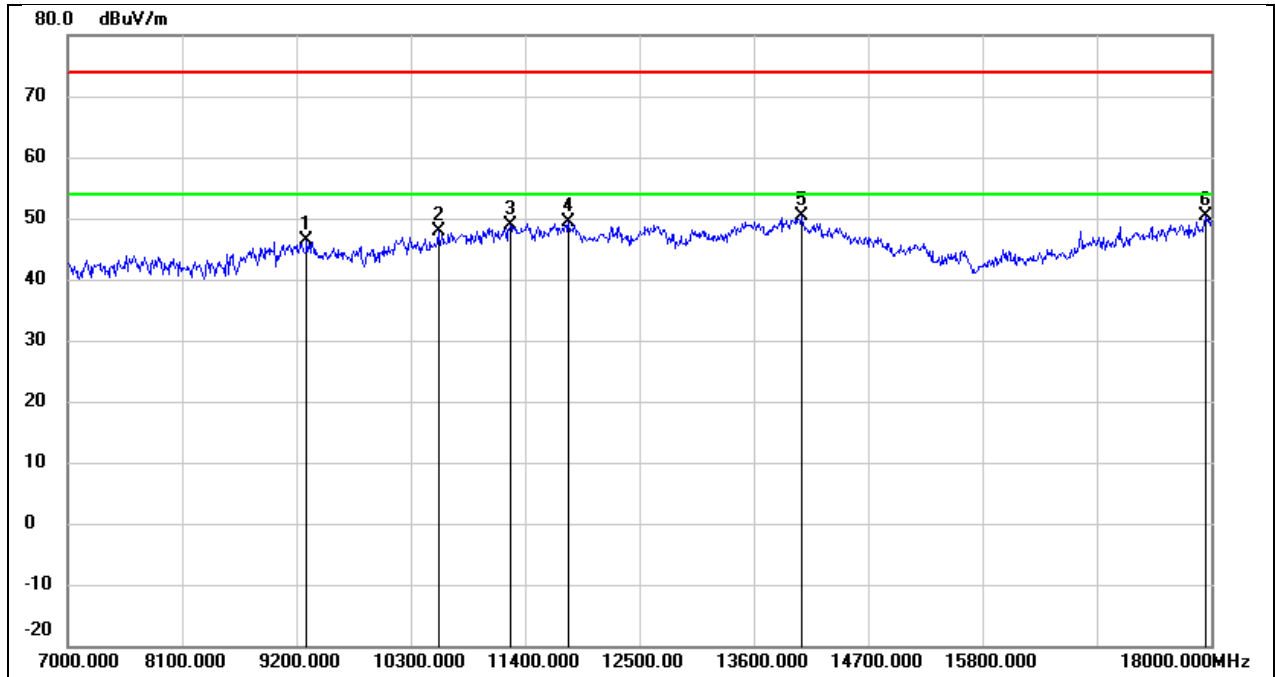

No.	Frequency (MHz)	Reading (dBuV)	Correct (dB/m)	Result (dBuV/m)	Limit (dBuV/m)	Margin (dB)	Remark
1	9299.000	35.76	10.53	46.29	74.00	-27.71	peak
2	10564.000	34.80	13.06	47.86	74.00	-26.14	peak
3	11257.000	32.99	15.78	48.77	74.00	-25.23	peak
4	11818.000	32.04	17.36	49.40	74.00	-24.60	peak
5	14062.000	28.72	21.62	50.34	74.00	-23.66	peak
6	17945.000	24.62	25.75	50.37	74.00	-23.63	peak

Test Mode:	802.11ax HE40	Channel:	5755
Polarity:	Vertical	Test Voltage:	DC 15 V

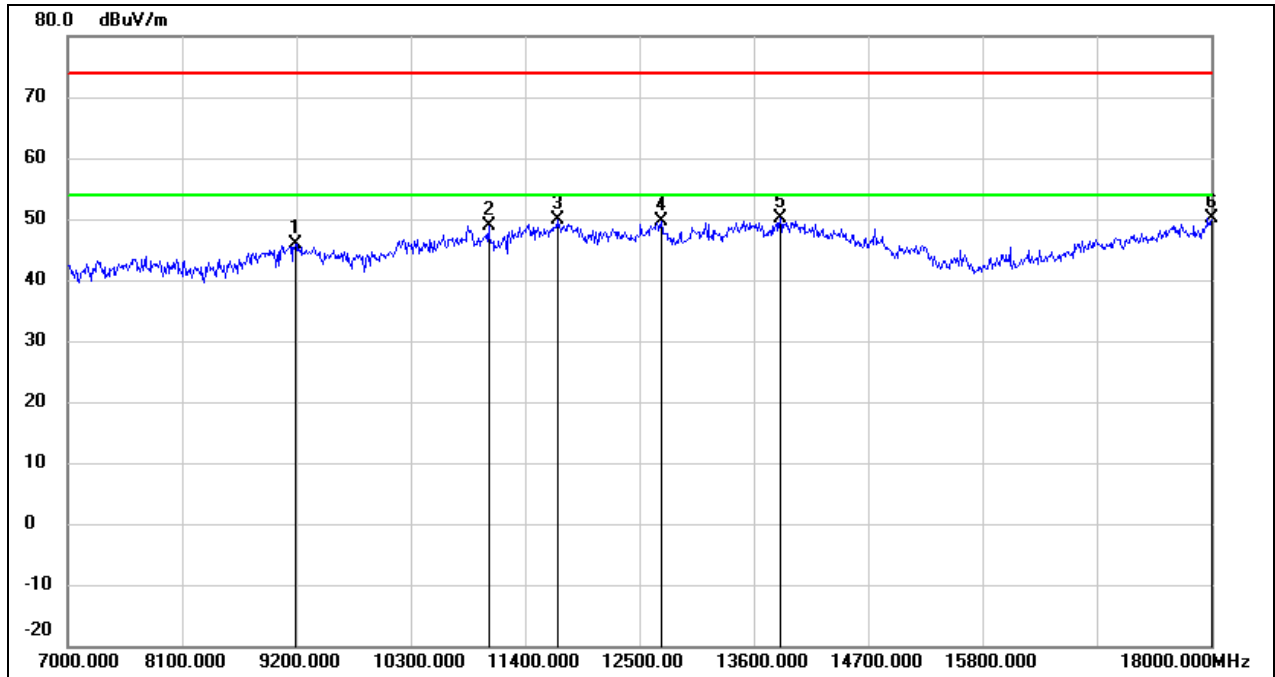

No.	Frequency (MHz)	Reading (dBuV)	Correct (dB/m)	Result (dBuV/m)	Limit (dBuV/m)	Margin (dB)	Remark
1	9189.000	35.47	10.46	45.93	74.00	-28.07	peak
2	11048.000	34.09	14.91	49.00	74.00	-25.00	peak
3	11708.000	32.65	17.16	49.81	74.00	-24.19	peak
4	12709.000	31.48	18.09	49.57	74.00	-24.43	peak
5	13853.000	28.73	21.52	50.25	74.00	-23.75	peak
6	18000.000	24.01	26.12	50.13	74.00	-23.87	peak

Test Mode:	802.11ax HE40	Channel:	5795
Polarity:	Horizontal	Test Voltage:	DC 15 V

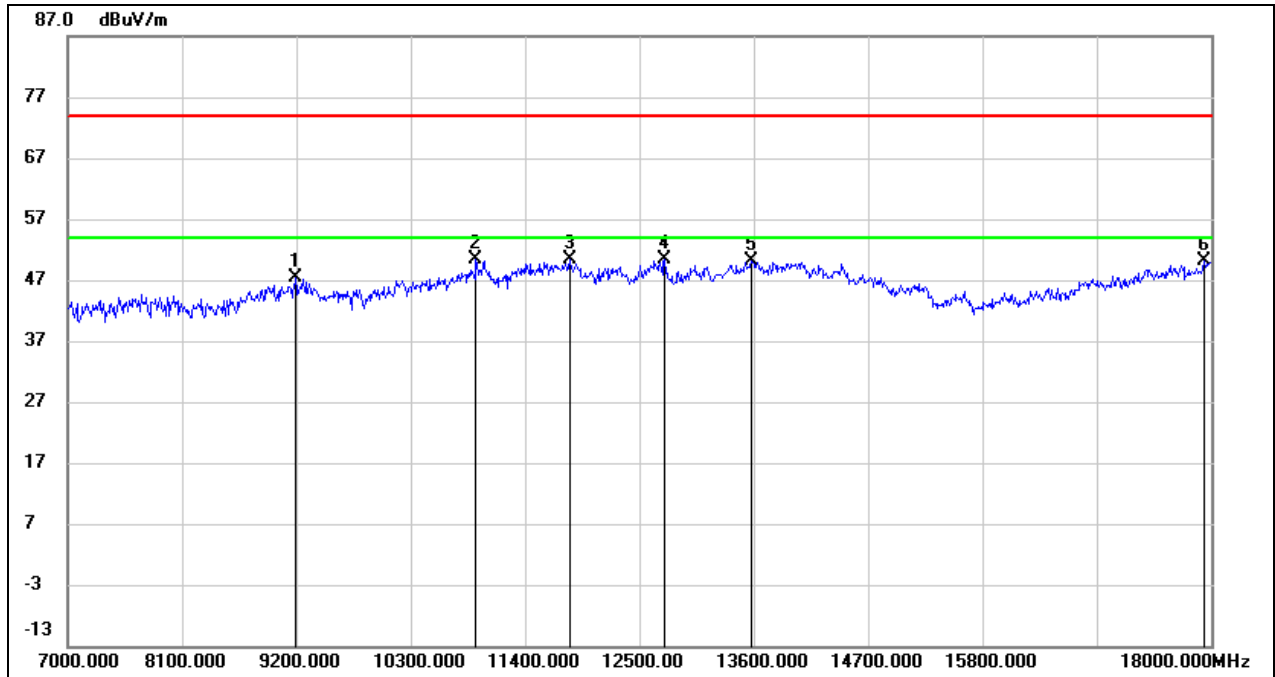

No.	Frequency (MHz)	Reading (dBuV)	Correct (dB/m)	Result (dBuV/m)	Limit (dBuV/m)	Margin (dB)	Remark
1	9189.000	36.80	10.46	47.26	74.00	-26.74	peak
2	10927.000	35.95	14.45	50.40	74.00	-23.60	peak
3	11829.000	32.88	17.38	50.26	74.00	-23.74	peak
4	12742.000	32.13	18.13	50.26	74.00	-23.74	peak
5	13578.000	29.20	20.83	50.03	74.00	-23.97	peak
6	17934.000	24.44	25.67	50.11	74.00	-23.89	peak

Test Mode:	802.11ax HE40	Channel:	5795
Polarity:	Vertical	Test Voltage:	DC 15 V

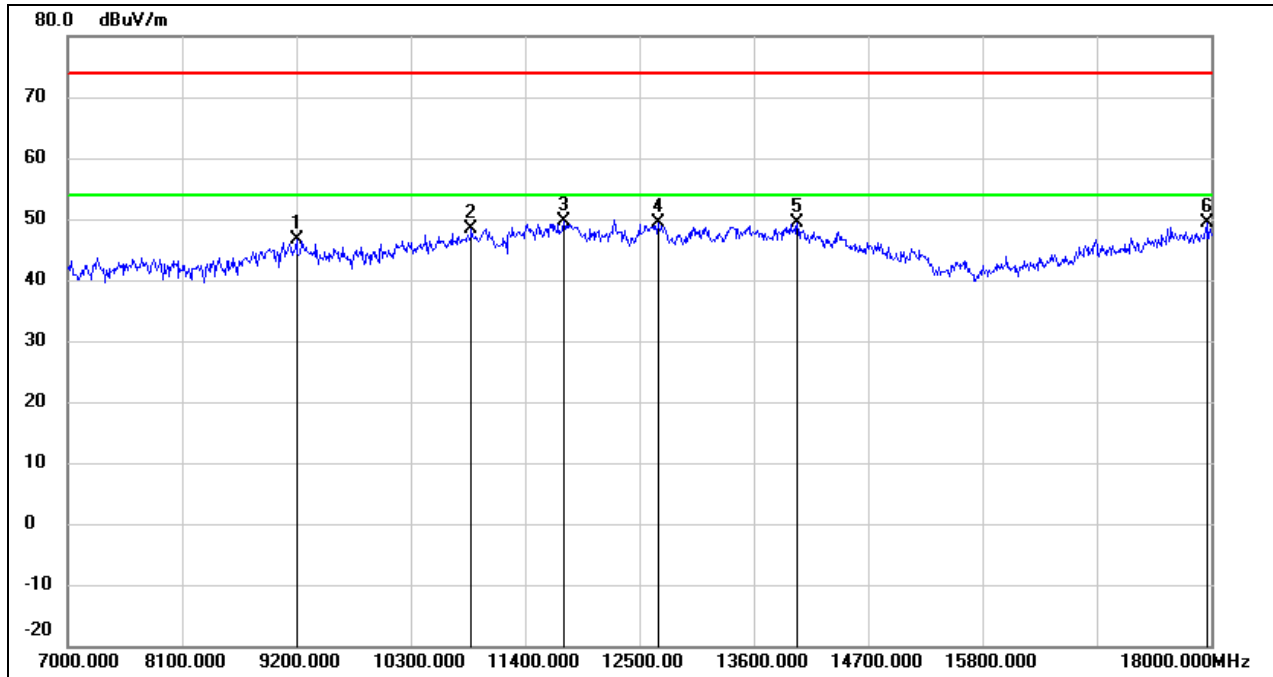

No.	Frequency (MHz)	Reading (dBuV)	Correct (dB/m)	Result (dBuV/m)	Limit (dBuV/m)	Margin (dB)	Remark
1	9200.000	36.11	10.46	46.57	74.00	-27.43	peak
2	10883.000	34.01	14.27	48.28	74.00	-25.72	peak
3	11774.000	32.27	17.28	49.55	74.00	-24.45	peak
4	12676.000	31.27	18.05	49.32	74.00	-24.68	peak
5	14018.000	27.57	21.80	49.37	74.00	-24.63	peak
6	17967.000	23.43	25.89	49.32	74.00	-24.68	peak

Test Mode:	802.11ax HE80	Channel:	5210
Polarity:	Horizontal	Test Voltage:	DC 15 V

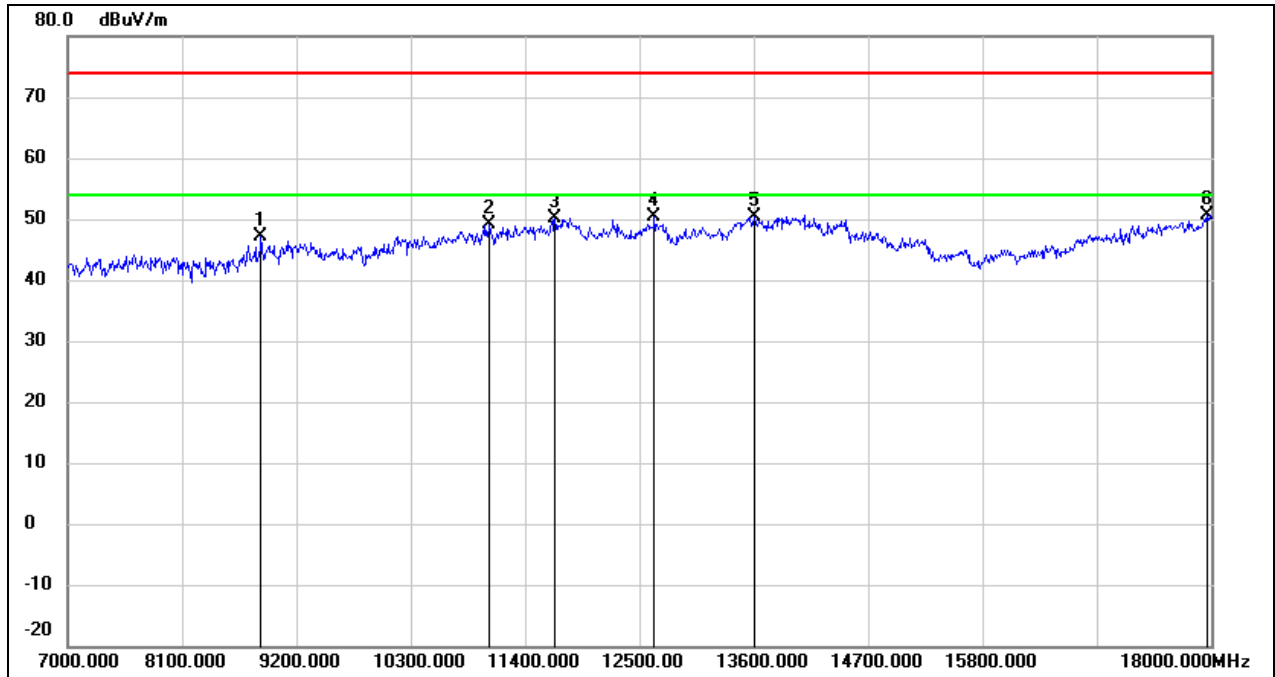

No.	Frequency (MHz)	Reading (dBuV)	Correct (dB/m)	Result (dBuV/m)	Limit (dBuV/m)	Margin (dB)	Remark
1	8859.000	37.81	9.36	47.17	74.00	-26.83	peak
2	11059.000	34.07	14.96	49.03	74.00	-24.97	peak
3	11686.000	33.07	17.12	50.19	74.00	-23.81	peak
4	12643.000	32.25	18.01	50.26	74.00	-23.74	peak
5	13611.000	29.48	20.92	50.40	74.00	-23.60	peak
6	17956.000	24.88	25.82	50.70	74.00	-23.30	peak

Test Mode:	802.11ax HE80	Channel:	5210
Polarity:	Vertical	Test Voltage:	DC 15 V

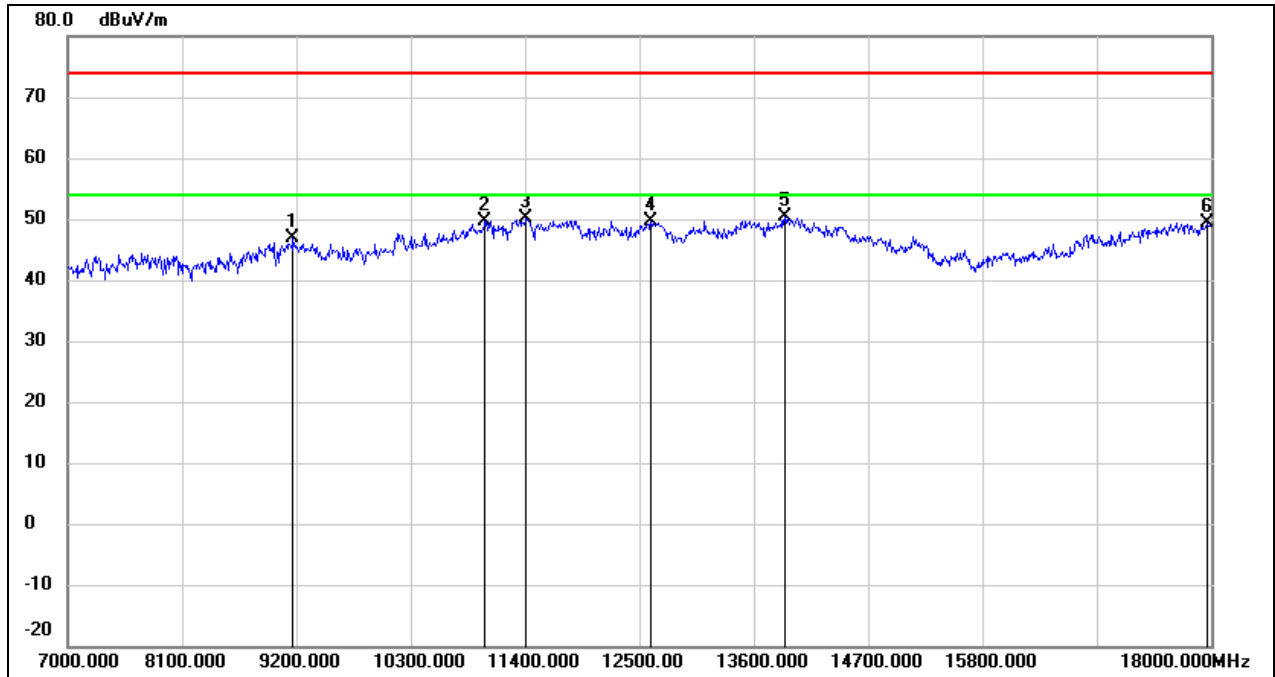

No.	Frequency (MHz)	Reading (dBuV)	Correct (dB/m)	Result (dBuV/m)	Limit (dBuV/m)	Margin (dB)	Remark
1	9167.000	36.36	10.45	46.81	74.00	-27.19	peak
2	11015.000	34.95	14.79	49.74	74.00	-24.26	peak
3	11411.000	33.73	16.41	50.14	74.00	-23.86	peak
4	12610.000	31.62	17.97	49.59	74.00	-24.41	peak
5	13897.000	28.77	21.62	50.39	74.00	-23.61	peak
6	17967.000	23.61	25.89	49.50	74.00	-24.50	peak

Test Mode:	802.11ax HE80	Channel:	5775
Polarity:	Horizontal	Test Voltage:	DC 15 V

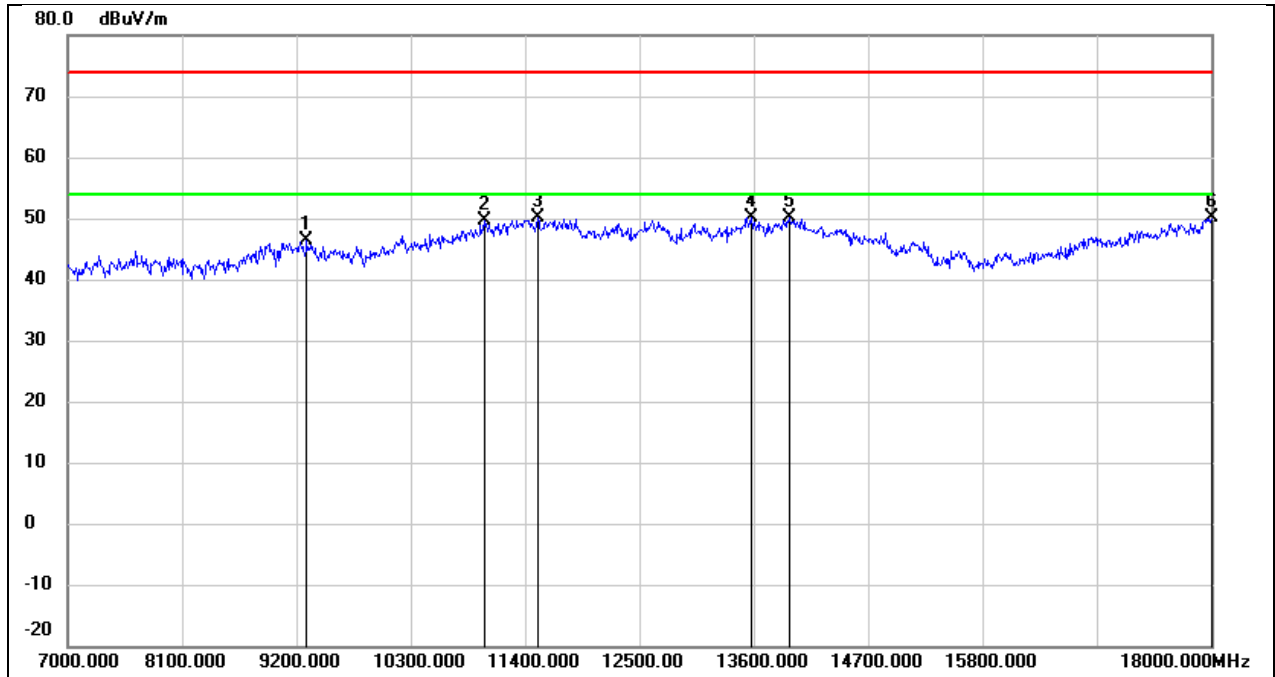

No.	Frequency (MHz)	Reading (dBuV)	Correct (dB/m)	Result (dBuV/m)	Limit (dBuV/m)	Margin (dB)	Remark
1	9299.000	35.78	10.53	46.31	74.00	-27.69	peak
2	11004.000	34.88	14.74	49.62	74.00	-24.38	peak
3	11521.000	33.40	16.82	50.22	74.00	-23.78	peak
4	13578.000	29.26	20.83	50.09	74.00	-23.91	peak
5	13941.000	28.47	21.73	50.20	74.00	-23.80	peak
6	18000.000	24.11	26.12	50.23	74.00	-23.77	peak

Test Mode:	802.11ax HE80	Channel:	5775
Polarity:	Vertical	Test Voltage:	DC 15 V

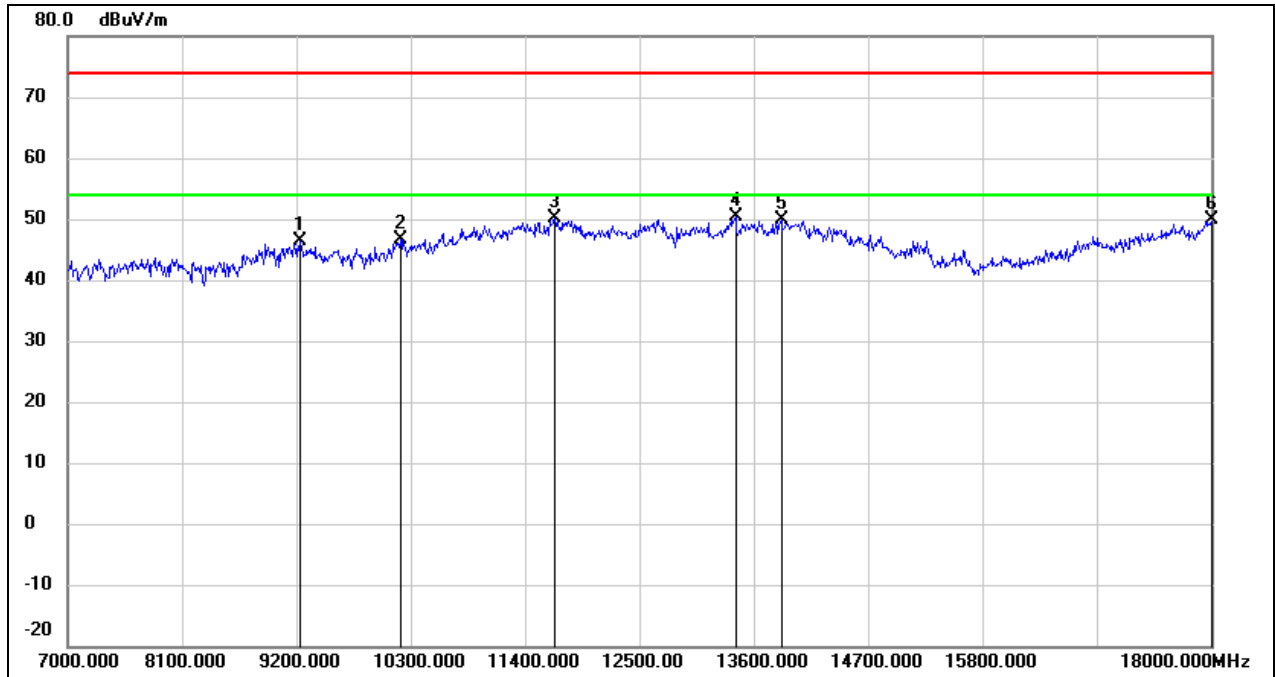

No.	Frequency (MHz)	Reading (dBuV)	Correct (dB/m)	Result (dBuV/m)	Limit (dBuV/m)	Margin (dB)	Remark
1	9233.000	35.83	10.48	46.31	74.00	-27.69	peak
2	10201.000	34.53	12.19	46.72	74.00	-27.28	peak
3	11686.000	32.89	17.12	50.01	74.00	-23.99	peak
4	13424.000	30.15	20.30	50.45	74.00	-23.55	peak
5	13864.000	28.41	21.53	49.94	74.00	-24.06	peak
6	18000.000	23.83	26.12	49.95	74.00	-24.05	peak

Test Mode:	802.11be EHT20	Channel:	5180
Polarity:	Horizontal	Test Voltage:	DC 15 V

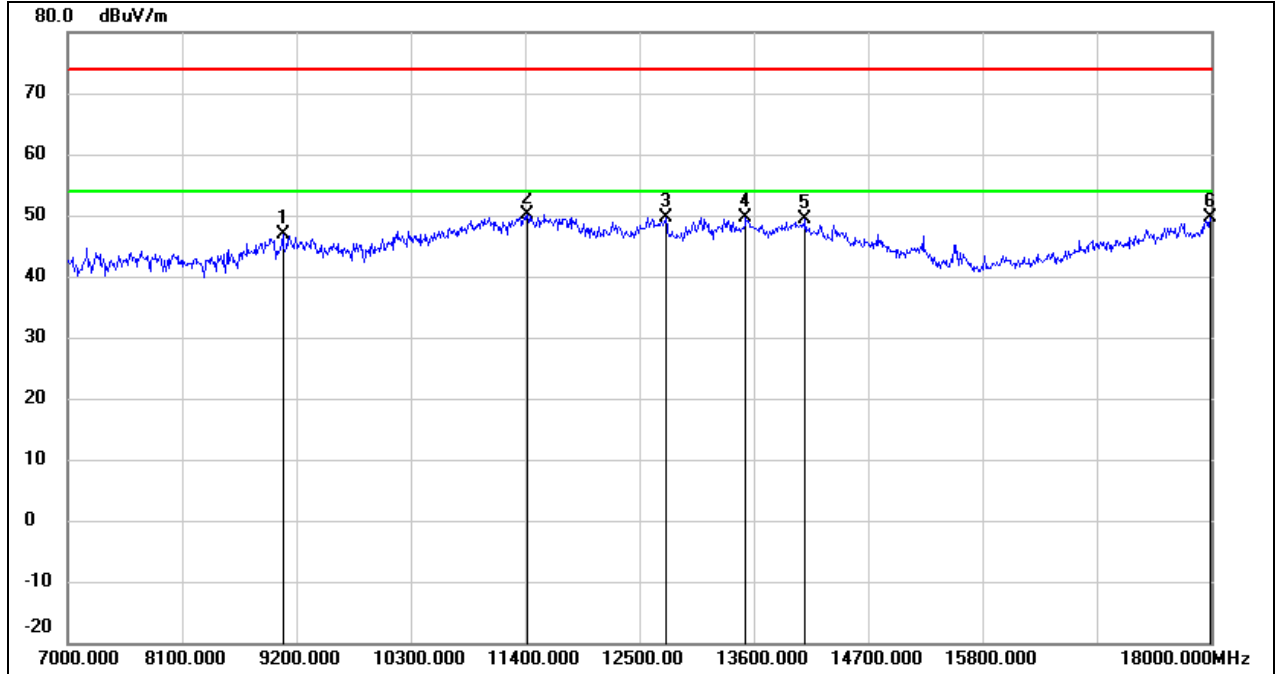

No.	Frequency (MHz)	Reading (dBuV)	Correct (dB/m)	Result (dBuV/m)	Limit (dBuV/m)	Margin (dB)	Remark
1	9068.000	36.49	10.39	46.88	74.00	-27.12	peak
2	11422.000	33.75	16.46	50.21	74.00	-23.79	peak
3	12753.000	31.57	18.14	49.71	74.00	-24.29	peak
4	13523.000	28.89	20.70	49.59	74.00	-24.41	peak
5	14095.000	27.85	21.49	49.34	74.00	-24.66	peak
6	17989.000	23.63	26.04	49.67	74.00	-24.33	peak

Test Mode:	802.11be EHT20	Channel:	5180
Polarity:	Vertical	Test Voltage:	DC 15 V

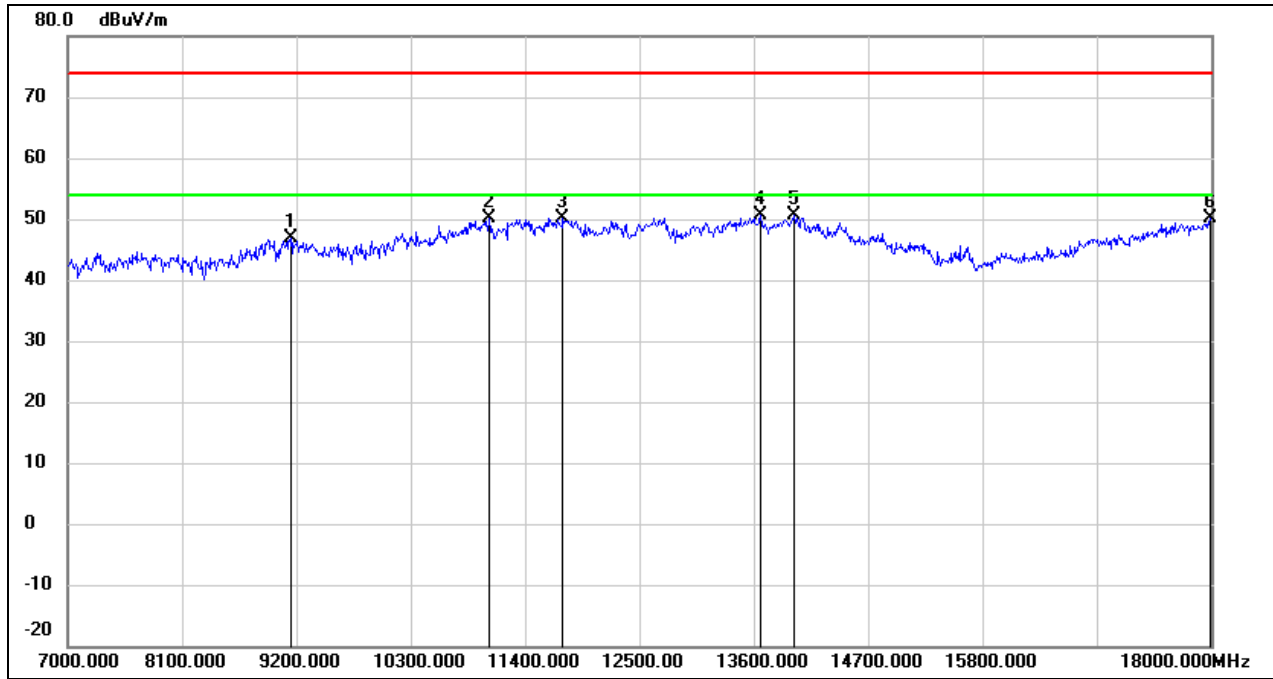

No.	Frequency (MHz)	Reading (dBuV)	Correct (dB/m)	Result (dBuV/m)	Limit (dBuV/m)	Margin (dB)	Remark
1	9145.000	36.42	10.43	46.85	74.00	-27.15	peak
2	11059.000	35.11	14.96	50.07	74.00	-23.93	peak
3	11763.000	32.97	17.26	50.23	74.00	-23.77	peak
4	13666.000	29.46	21.05	50.51	74.00	-23.49	peak
5	13985.000	28.90	21.85	50.75	74.00	-23.25	peak
6	17989.000	24.03	26.04	50.07	74.00	-23.93	peak

Test Mode:	802.11be EHT20	Channel:	5200
Polarity:	Horizontal	Test Voltage:	DC 15 V

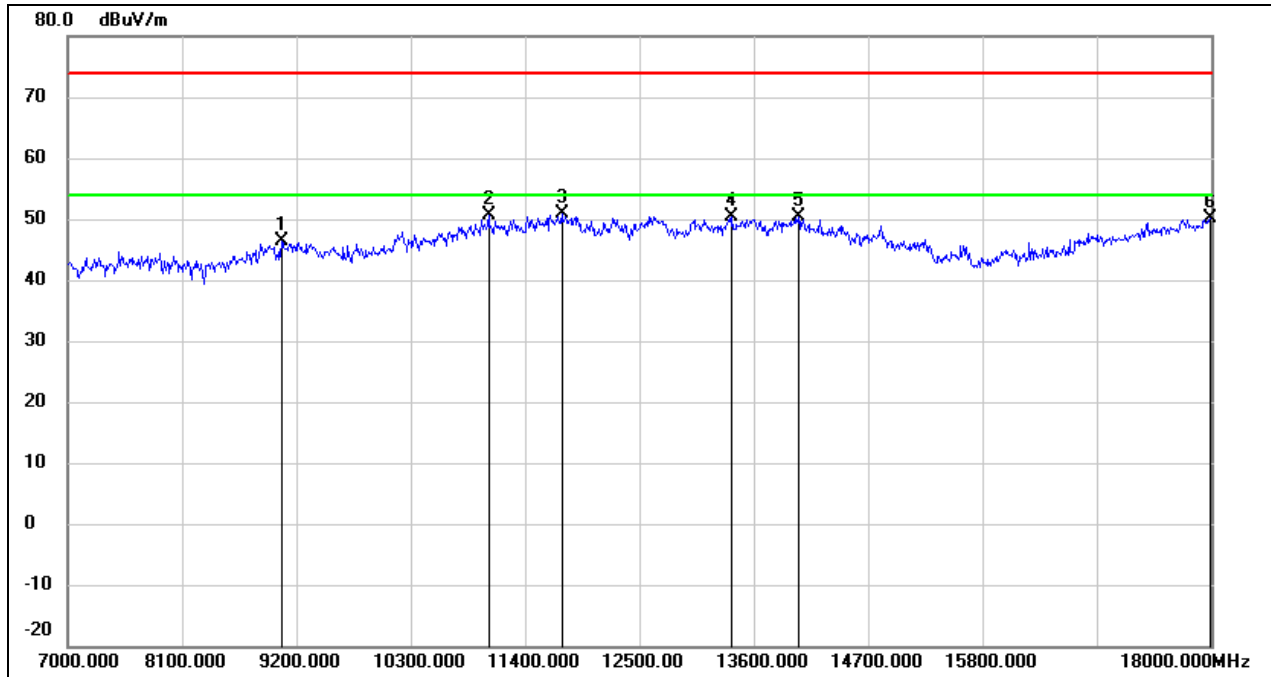

No.	Frequency (MHz)	Reading (dBuV)	Correct (dB/m)	Result (dBuV/m)	Limit (dBuV/m)	Margin (dB)	Remark
1	9057.000	36.07	10.38	46.45	74.00	-27.55	peak
2	11048.000	35.75	14.91	50.66	74.00	-23.34	peak
3	11752.000	33.53	17.24	50.77	74.00	-23.23	peak
4	13391.000	30.15	20.16	50.31	74.00	-23.69	peak
5	14029.000	28.72	21.76	50.48	74.00	-23.52	peak
6	17989.000	24.12	26.04	50.16	74.00	-23.84	peak

Test Mode:	802.11be EHT20	Channel:	5200
Polarity:	Vertical	Test Voltage:	DC 15 V

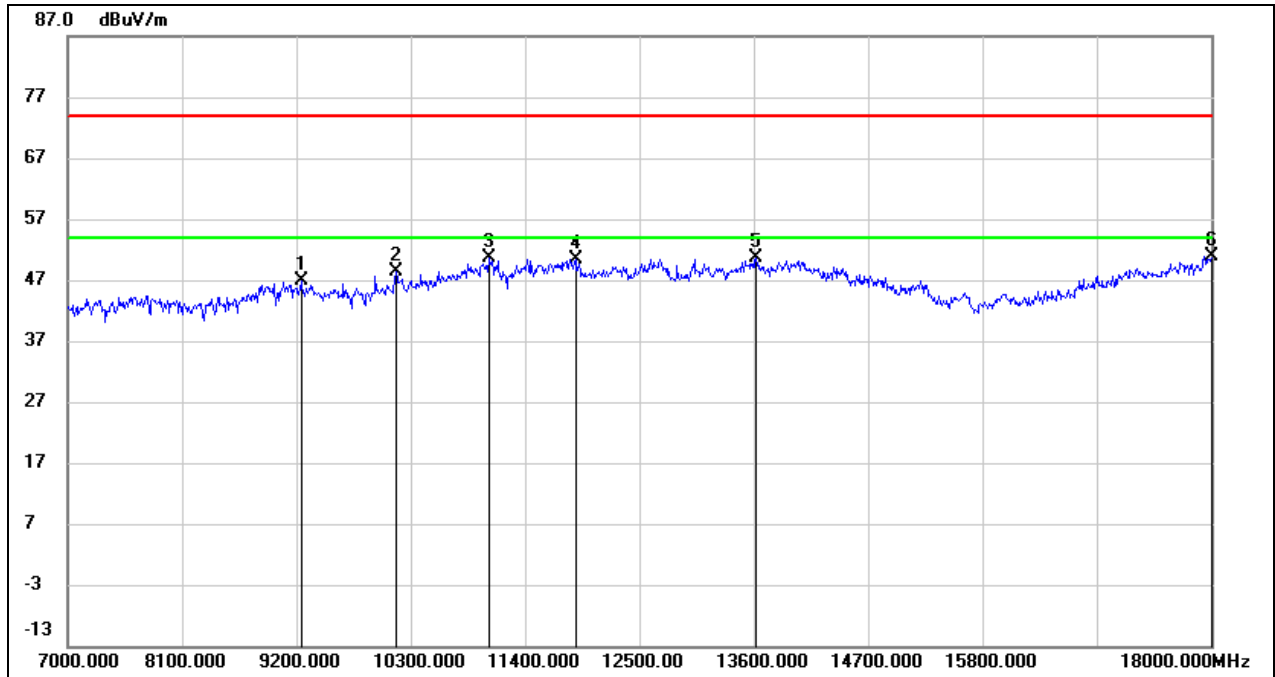

No.	Frequency (MHz)	Reading (dBuV)	Correct (dB/m)	Result (dBuV/m)	Limit (dBuV/m)	Margin (dB)	Remark
1	9244.000	36.43	10.49	46.92	74.00	-27.08	peak
2	10157.000	36.27	12.10	48.37	74.00	-25.63	peak
3	11048.000	35.61	14.91	50.52	74.00	-23.48	peak
4	11884.000	32.99	17.48	50.47	74.00	-23.53	peak
5	13622.000	29.76	20.95	50.71	74.00	-23.29	peak
6	18000.000	24.69	26.12	50.81	74.00	-23.19	peak

Test Mode:	802.11be EHT20	Channel:	5240
Polarity:	Horizontal	Test Voltage:	DC 15 V

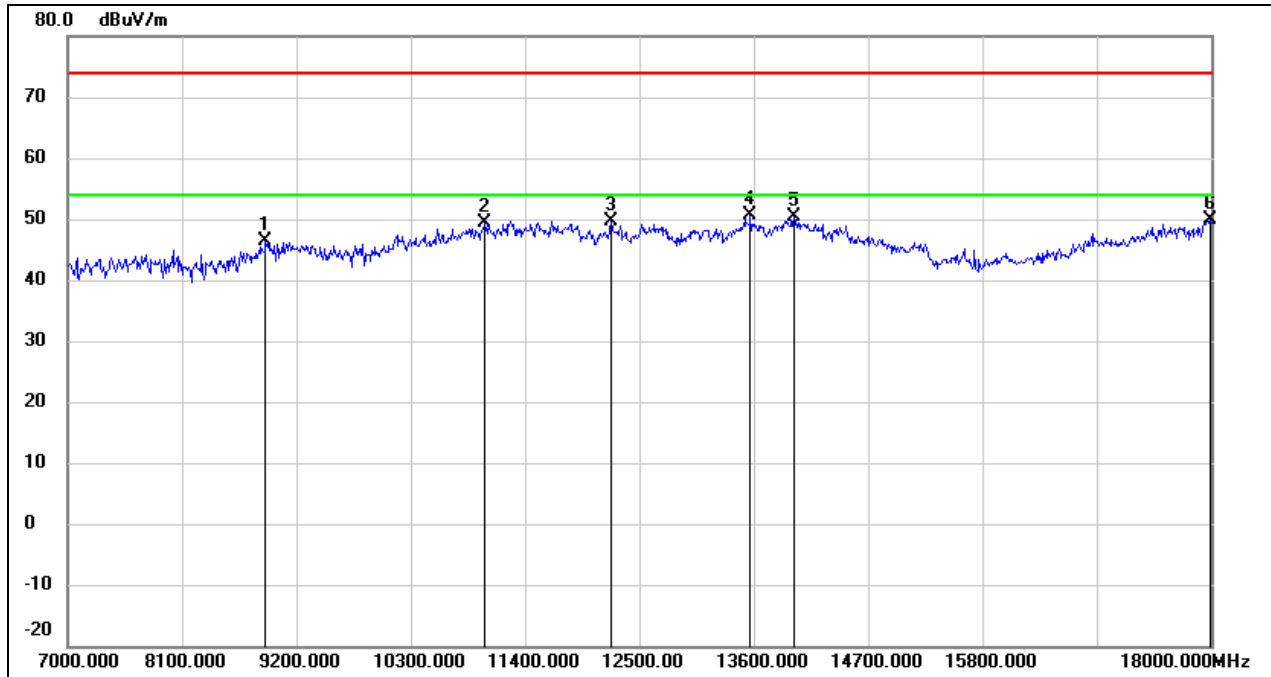

No.	Frequency (MHz)	Reading (dBuV)	Correct (dB/m)	Result (dBuV/m)	Limit (dBuV/m)	Margin (dB)	Remark
1	8903.000	36.71	9.66	46.37	74.00	-27.63	peak
2	11015.000	34.66	14.79	49.45	74.00	-24.55	peak
3	12225.000	31.92	17.75	49.67	74.00	-24.33	peak
4	13567.000	29.78	20.80	50.58	74.00	-23.42	peak
5	13985.000	28.43	21.85	50.28	74.00	-23.72	peak
6	17989.000	23.89	26.04	49.93	74.00	-24.07	peak

Test Mode:	802.11be EHT20	Channel:	5240
Polarity:	Vertical	Test Voltage:	DC 15 V

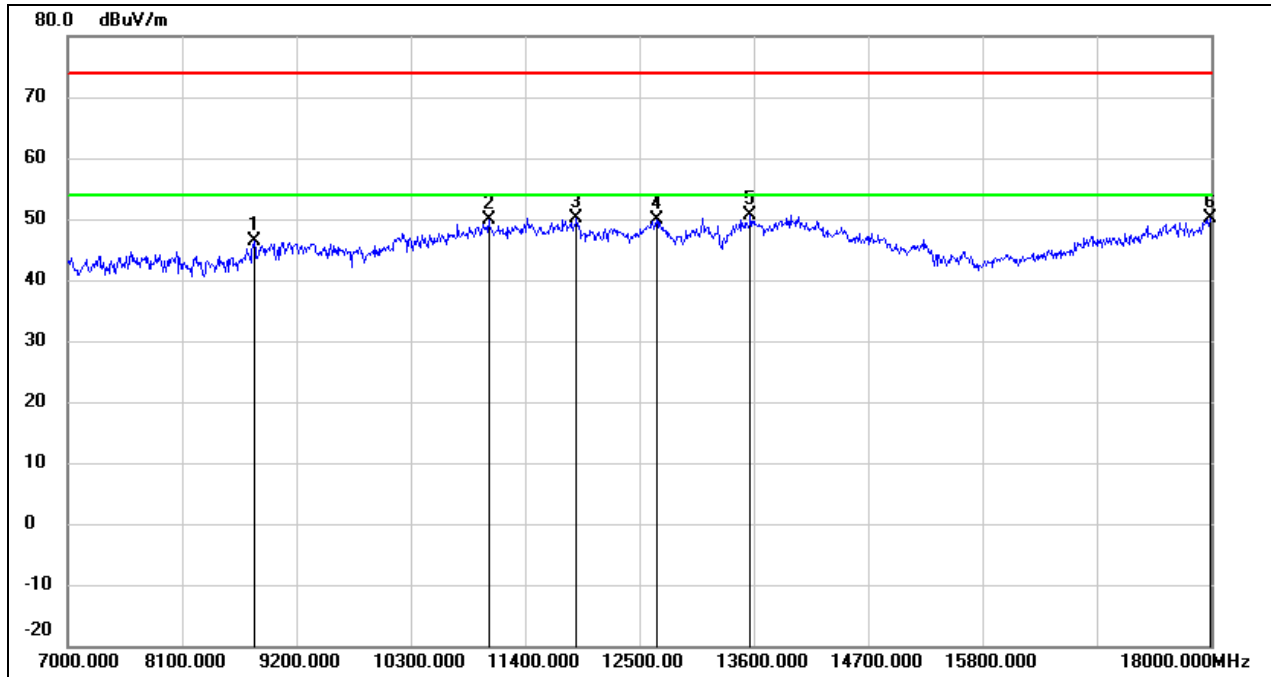

No.	Frequency (MHz)	Reading (dBuV)	Correct (dB/m)	Result (dBuV/m)	Limit (dBuV/m)	Margin (dB)	Remark
1	8793.000	37.58	8.91	46.49	74.00	-27.51	peak
2	11048.000	34.94	14.91	49.85	74.00	-24.15	peak
3	11895.000	32.67	17.51	50.18	74.00	-23.82	peak
4	12665.000	31.73	18.04	49.77	74.00	-24.23	peak
5	13567.000	29.80	20.80	50.60	74.00	-23.40	peak
6	17989.000	24.01	26.04	50.05	74.00	-23.95	peak

Test Mode:	802.11be EHT20	Channel:	5745
Polarity:	Horizontal	Test Voltage:	DC 15 V

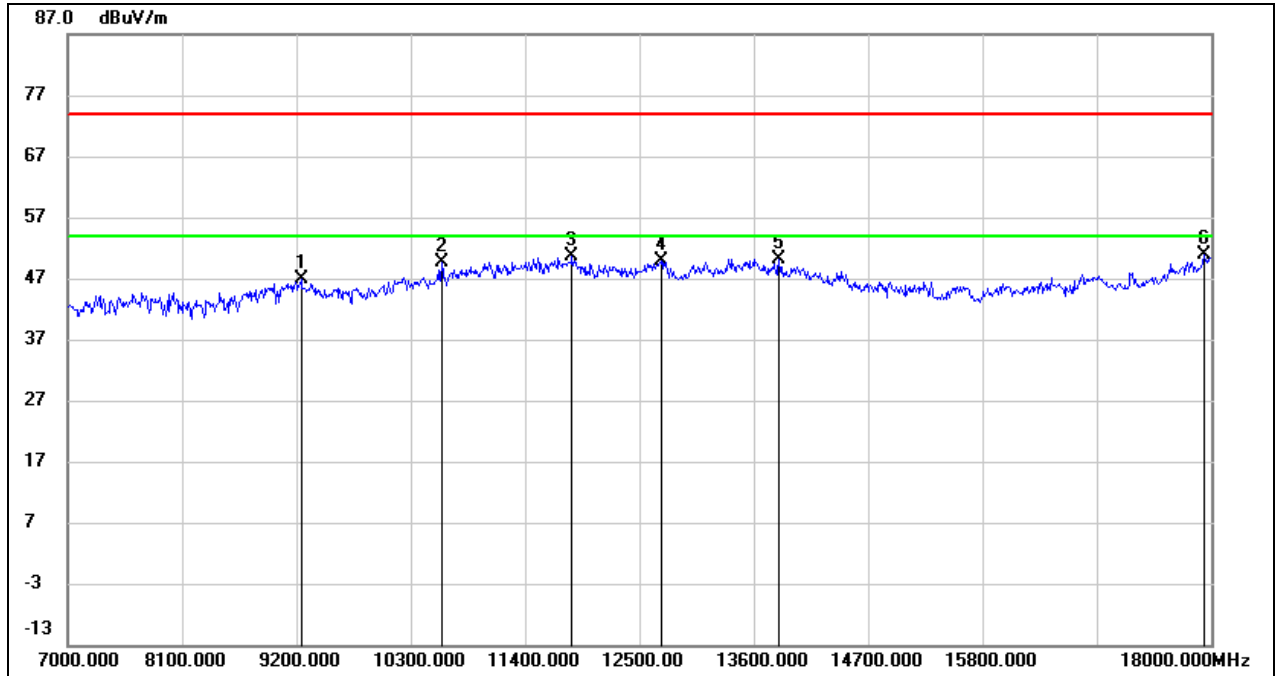

No.	Frequency (MHz)	Reading (dBuV)	Correct (dB/m)	Result (dBuV/m)	Limit (dBuV/m)	Margin (dB)	Remark
1	9244.000	36.39	10.49	46.88	74.00	-27.12	peak
2	10597.000	36.35	13.19	49.54	74.00	-24.46	peak
3	11851.000	33.27	17.43	50.70	74.00	-23.30	peak
4	12709.000	31.80	18.09	49.89	74.00	-24.11	peak
5	13842.000	28.74	21.49	50.23	74.00	-23.77	peak
6	17934.000	25.27	25.67	50.94	74.00	-23.06	peak

Test Mode:	802.11be EHT20	Channel:	5745
Polarity:	Vertical	Test Voltage:	DC 15 V

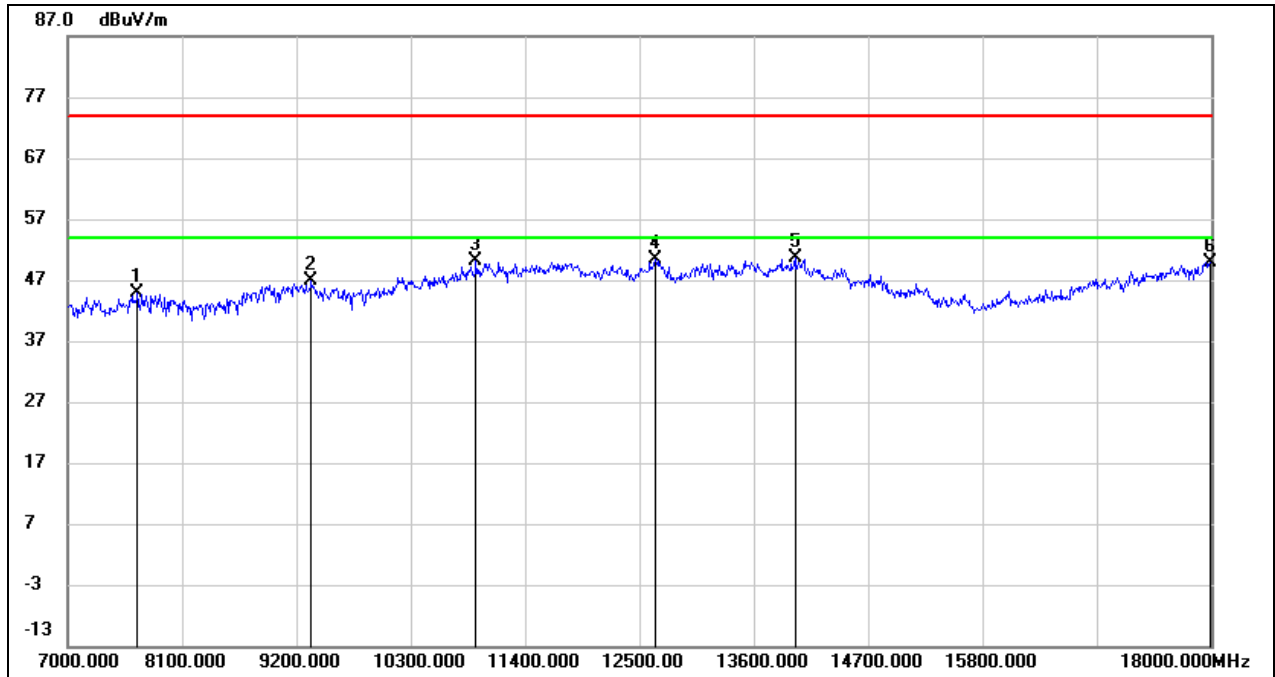

No.	Frequency (MHz)	Reading (dBuV)	Correct (dB/m)	Result (dBuV/m)	Limit (dBuV/m)	Margin (dB)	Remark
1	7671.000	38.10	6.71	44.81	74.00	-29.19	peak
2	9343.000	36.26	10.55	46.81	74.00	-27.19	peak
3	10927.000	35.75	14.45	50.20	74.00	-23.80	peak
4	12654.000	32.28	18.01	50.29	74.00	-23.71	peak
5	13996.000	28.83	21.87	50.70	74.00	-23.30	peak
6	17989.000	23.79	26.04	49.83	74.00	-24.17	peak

Test Mode:	802.11be EHT20	Channel:	5785
Polarity:	Horizontal	Test Voltage:	DC 15 V

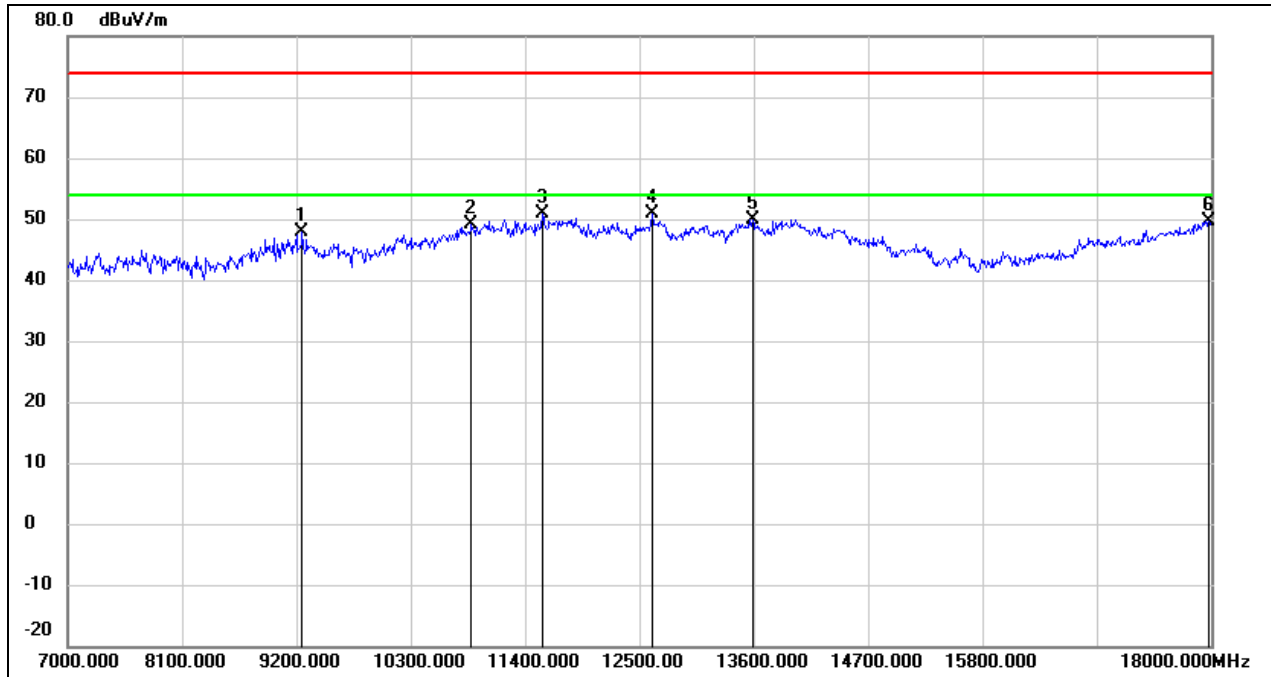

No.	Frequency (MHz)	Reading (dBuV)	Correct (dB/m)	Result (dBuV/m)	Limit (dBuV/m)	Margin (dB)	Remark
1	9255.000	37.25	10.51	47.76	74.00	-26.24	peak
2	10883.000	34.83	14.27	49.10	74.00	-24.90	peak
3	11565.000	34.08	16.89	50.97	74.00	-23.03	peak
4	12621.000	32.95	17.98	50.93	74.00	-23.07	peak
5	13589.000	29.00	20.86	49.86	74.00	-24.14	peak
6	17978.000	23.76	25.97	49.73	74.00	-24.27	peak

Test Mode:	802.11be EHT20	Channel:	5785
Polarity:	Vertical	Test Voltage:	DC 15 V

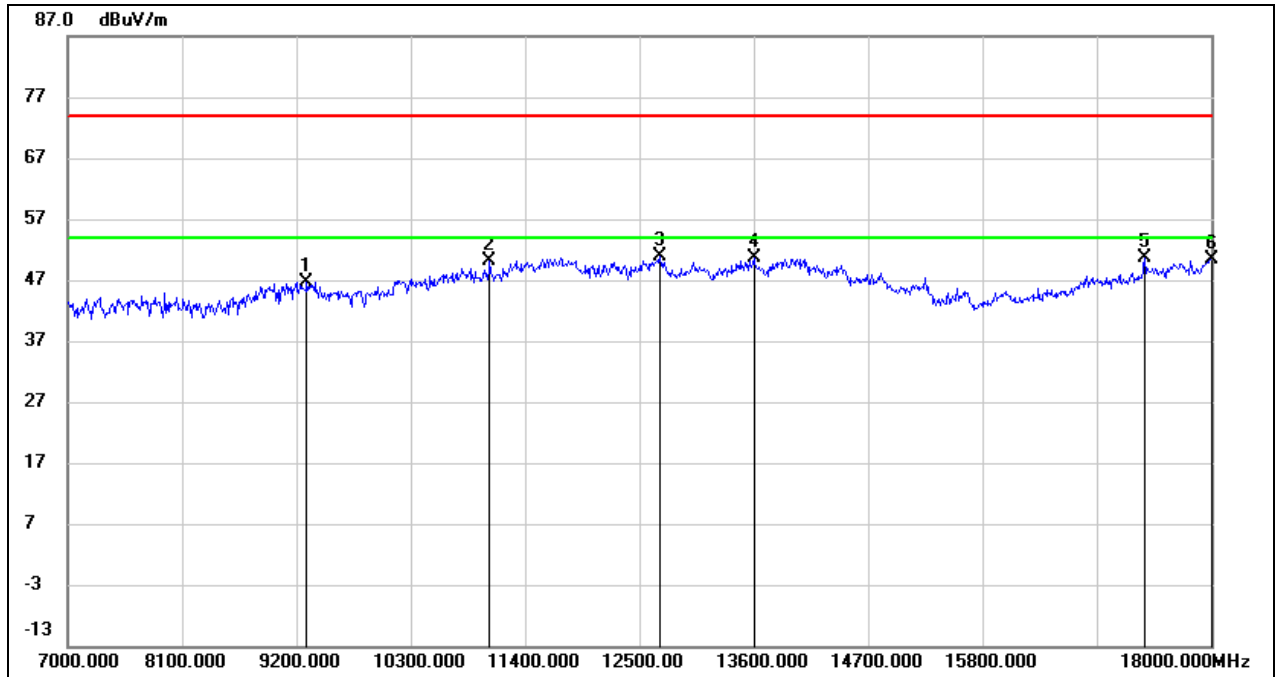

No.	Frequency (MHz)	Reading (dBuV)	Correct (dB/m)	Result (dBuV/m)	Limit (dBuV/m)	Margin (dB)	Remark
1	9299.000	36.19	10.53	46.72	74.00	-27.28	peak
2	11059.000	35.14	14.96	50.10	74.00	-23.90	peak
3	12698.000	32.82	18.08	50.90	74.00	-23.10	peak
4	13600.000	29.69	20.89	50.58	74.00	-23.42	peak
5	17362.000	28.42	22.12	50.54	74.00	-23.46	peak
6	18000.000	24.32	26.12	50.44	74.00	-23.56	peak

Test Mode:	802.11be EHT20	Channel:	5825
Polarity:	Horizontal	Test Voltage:	DC 15 V

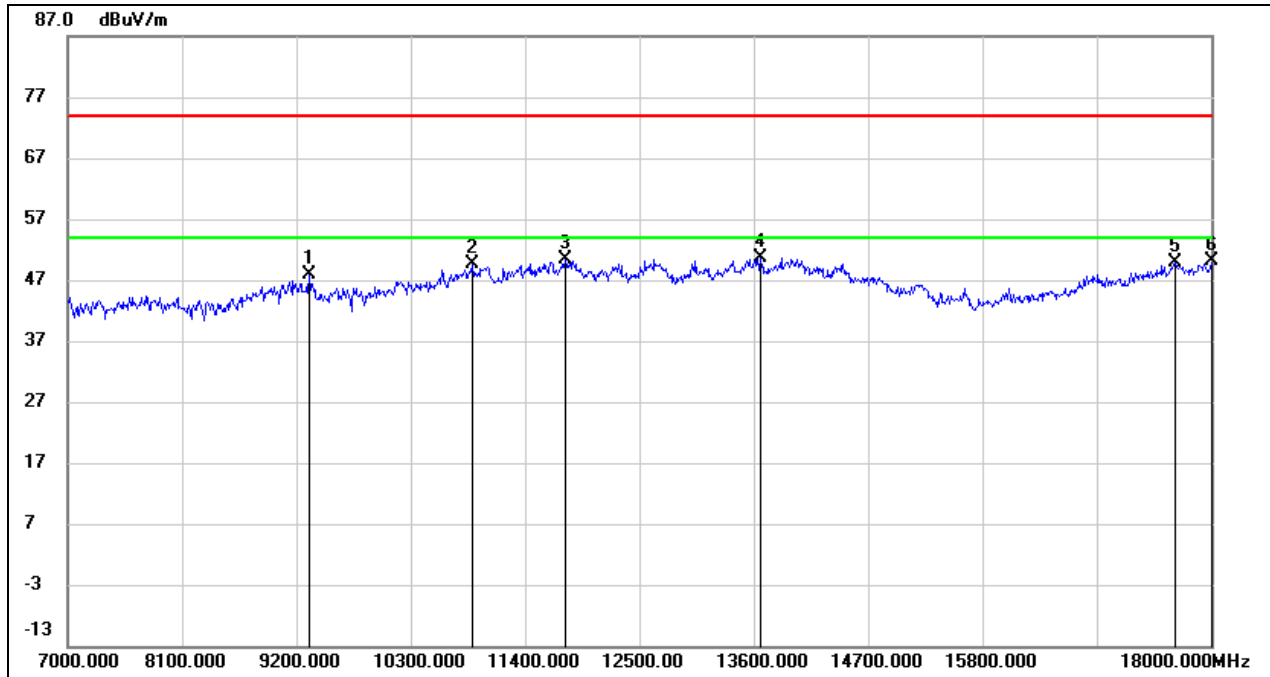

No.	Frequency (MHz)	Reading (dBuV)	Correct (dB/m)	Result (dBuV/m)	Limit (dBuV/m)	Margin (dB)	Remark
1	9321.000	37.46	10.53	47.99	74.00	-26.01	peak
2	10894.000	35.36	14.32	49.68	74.00	-24.32	peak
3	11785.000	32.98	17.30	50.28	74.00	-23.72	peak
4	13666.000	29.57	21.05	50.62	74.00	-23.38	peak
5	17648.000	26.12	23.72	49.84	74.00	-24.16	peak
6	18000.000	24.09	26.12	50.21	74.00	-23.79	peak

Test Mode:	802.11be EHT20	Channel:	5825
Polarity:	Vertical	Test Voltage:	DC 15 V

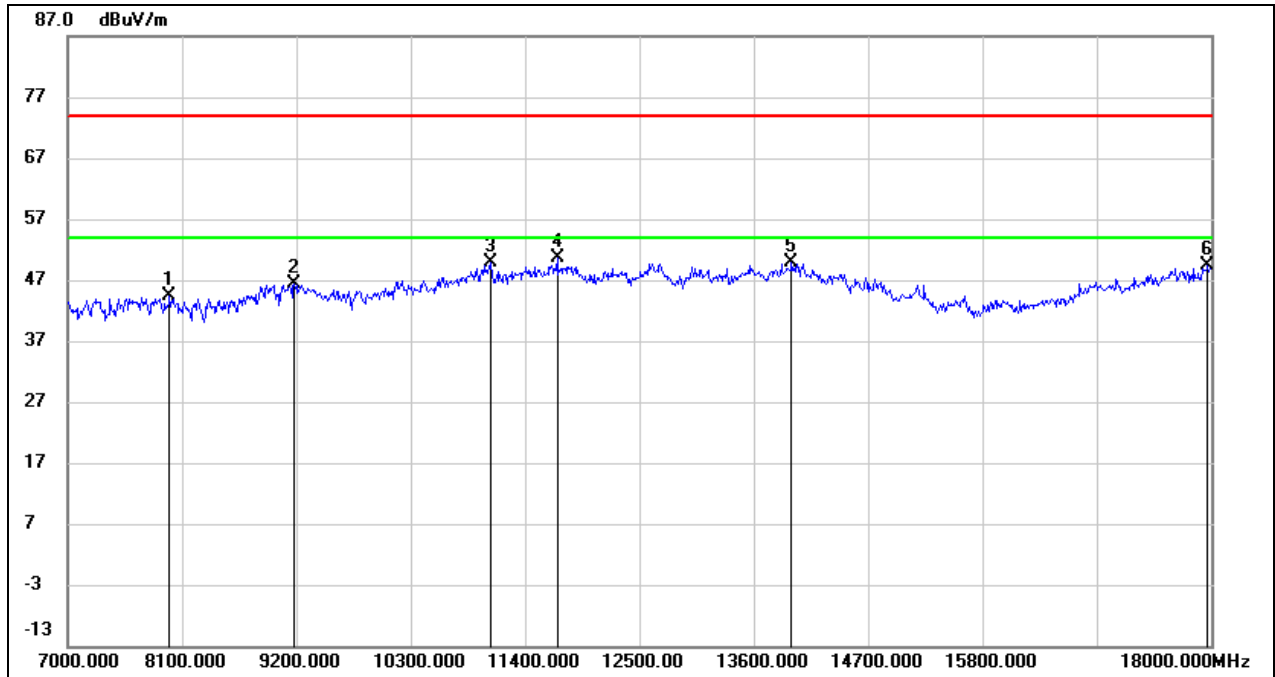

No.	Frequency (MHz)	Reading (dBuV)	Correct (dB/m)	Result (dBuV/m)	Limit (dBuV/m)	Margin (dB)	Remark
1	7979.000	38.04	6.45	44.49	74.00	-29.51	peak
2	9178.000	35.99	10.45	46.44	74.00	-27.56	peak
3	11070.000	34.89	15.01	49.90	74.00	-24.10	peak
4	11708.000	33.42	17.16	50.58	74.00	-23.42	peak
5	13963.000	28.09	21.78	49.87	74.00	-24.13	peak
6	17967.000	23.45	25.89	49.34	74.00	-24.66	peak

Test Mode:	802.11be EHT40	Channel:	5190
Polarity:	Horizontal	Test Voltage:	DC 15 V

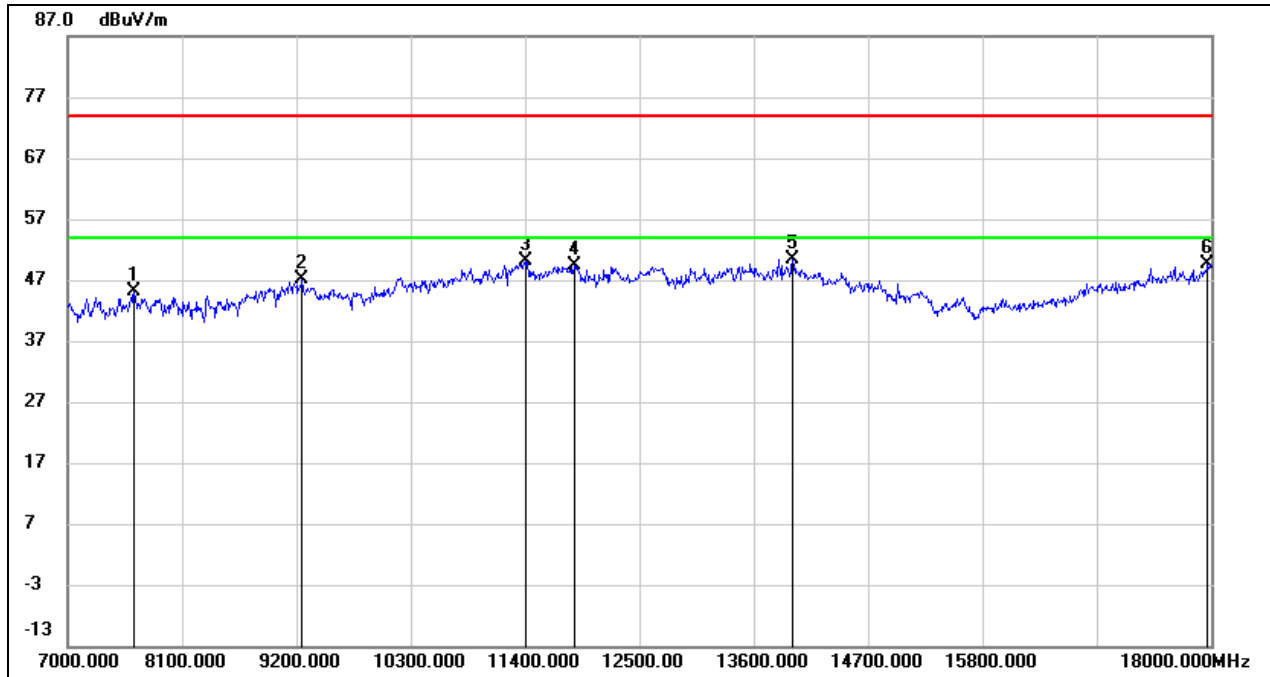

No.	Frequency (MHz)	Reading (dBuV)	Correct (dB/m)	Result (dBuV/m)	Limit (dBuV/m)	Margin (dB)	Remark
1	7638.000	38.27	6.75	45.02	74.00	-28.98	peak
2	9255.000	36.66	10.51	47.17	74.00	-26.83	peak
3	11400.000	33.67	16.36	50.03	74.00	-23.97	peak
4	11873.000	31.92	17.46	49.38	74.00	-24.62	peak
5	13974.000	28.49	21.82	50.31	74.00	-23.69	peak
6	17967.000	23.73	25.89	49.62	74.00	-24.38	peak

Test Mode:	802.11be EHT40	Channel:	5190
Polarity:	Vertical	Test Voltage:	DC 15 V

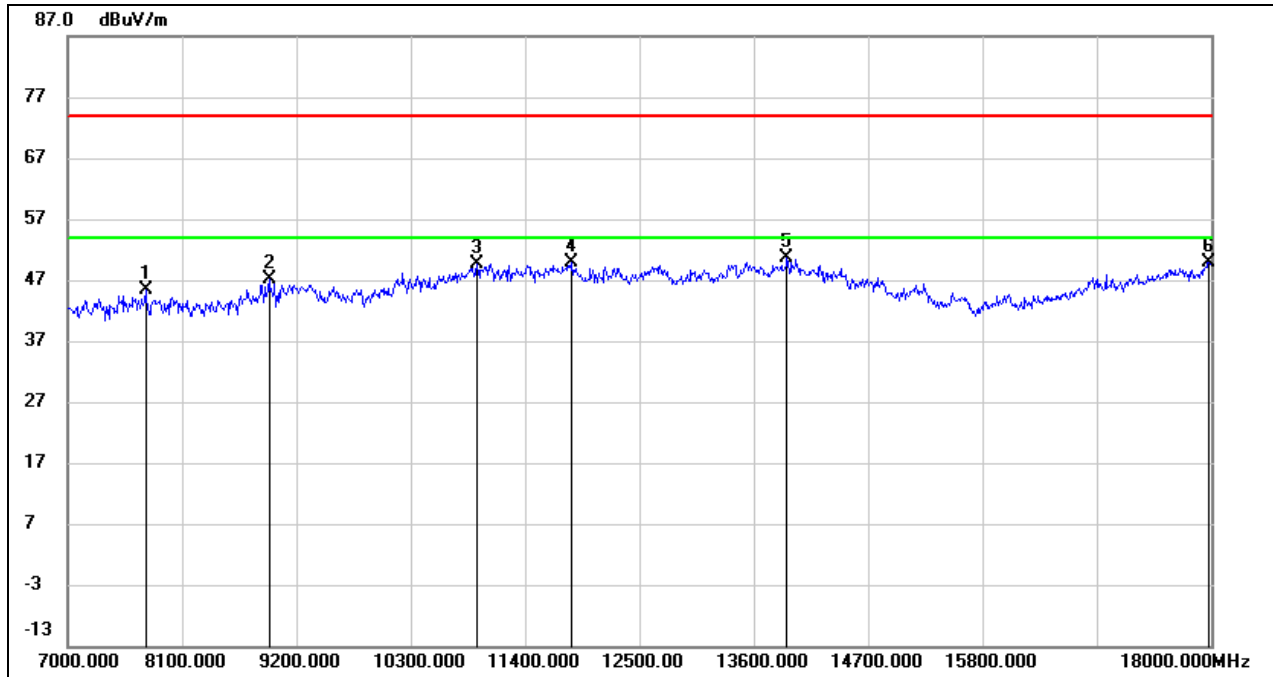

No.	Frequency (MHz)	Reading (dBuV)	Correct (dB/m)	Result (dBuV/m)	Limit (dBuV/m)	Margin (dB)	Remark
1	7748.000	38.67	6.66	45.33	74.00	-28.67	peak
2	8936.000	37.19	9.90	47.09	74.00	-26.91	peak
3	10938.000	35.18	14.48	49.66	74.00	-24.34	peak
4	11851.000	32.48	17.43	49.91	74.00	-24.09	peak
5	13919.000	28.85	21.68	50.53	74.00	-23.47	peak
6	17978.000	23.98	25.97	49.95	74.00	-24.05	peak

Test Mode:	802.11be EHT40	Channel:	5230
Polarity:	Horizontal	Test Voltage:	DC 15 V

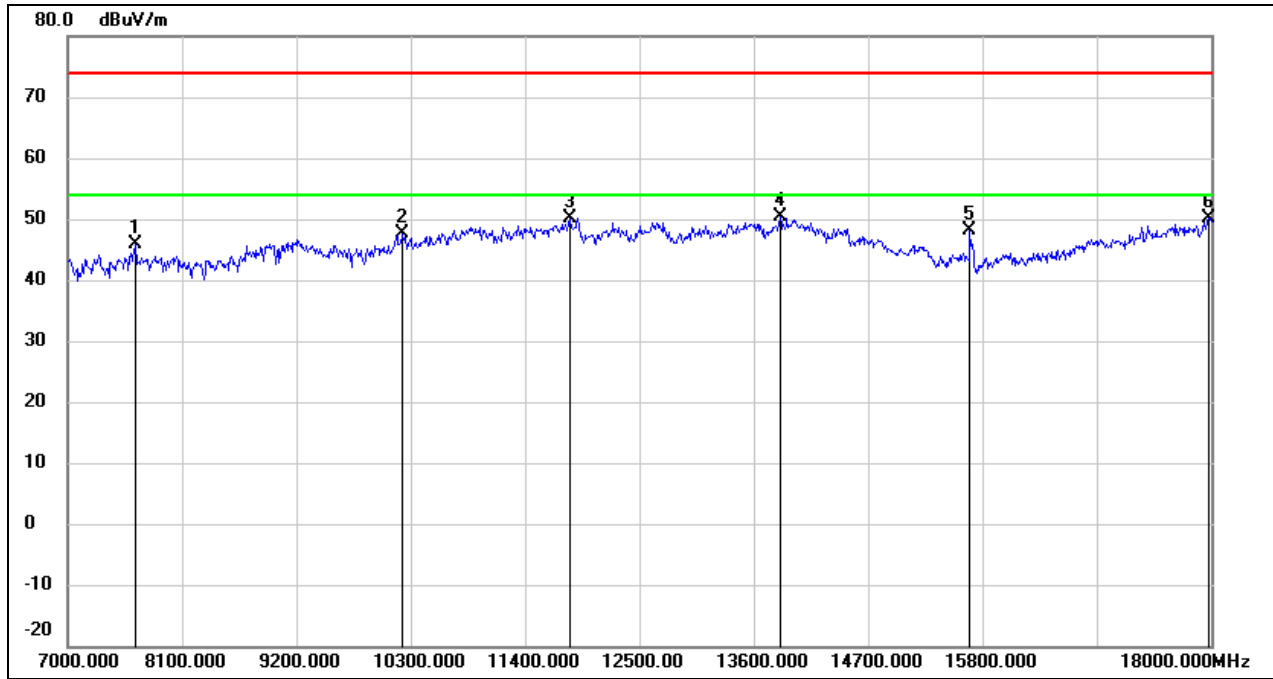

No.	Frequency (MHz)	Reading (dBuV)	Correct (dB/m)	Result (dBuV/m)	Limit (dBuV/m)	Margin (dB)	Remark
1	7649.000	39.02	6.74	45.76	74.00	-28.24	peak
2	10223.000	35.35	12.24	47.59	74.00	-26.41	peak
3	11829.000	32.74	17.38	50.12	74.00	-23.88	peak
4	13853.000	28.89	21.52	50.41	74.00	-23.59	peak
5	15679.000	31.30	16.79	48.09	74.00	-25.91	peak
6	17978.000	24.17	25.97	50.14	74.00	-23.86	peak

Test Mode:	802.11be EHT40	Channel:	5230
Polarity:	Vertical	Test Voltage:	DC 15 V

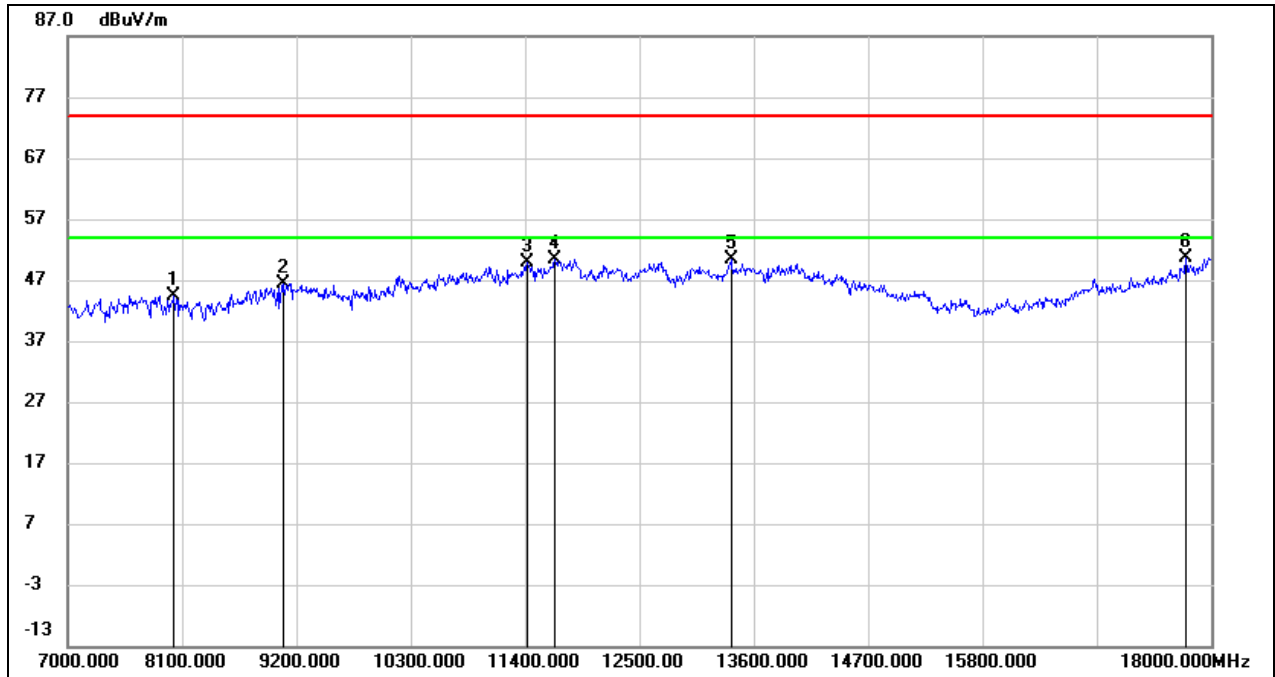

No.	Frequency (MHz)	Reading (dBuV)	Correct (dB/m)	Result (dBuV/m)	Limit (dBuV/m)	Margin (dB)	Remark
1	8023.000	37.87	6.45	44.32	74.00	-29.68	peak
2	9068.000	36.07	10.39	46.46	74.00	-27.54	peak
3	11422.000	33.41	16.46	49.87	74.00	-24.13	peak
4	11686.000	33.27	17.12	50.39	74.00	-23.61	peak
5	13380.000	30.20	20.12	50.32	74.00	-23.68	peak
6	17758.000	26.06	24.46	50.52	74.00	-23.48	peak

Test Mode:	802.11be EHT40	Channel:	5755
Polarity:	Horizontal	Test Voltage:	DC 15 V

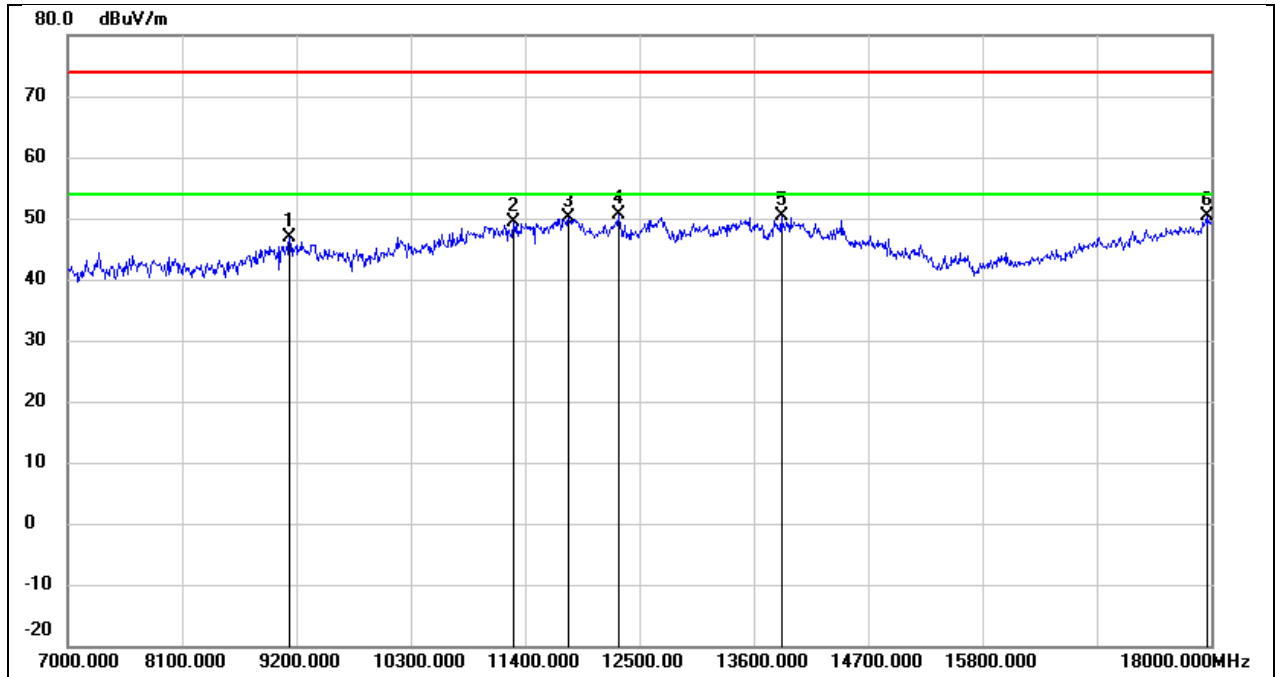

No.	Frequency (MHz)	Reading (dBuV)	Correct (dB/m)	Result (dBuV/m)	Limit (dBuV/m)	Margin (dB)	Remark
1	9134.000	36.43	10.41	46.84	74.00	-27.16	peak
2	11290.000	33.60	15.90	49.50	74.00	-24.50	peak
3	11818.000	32.78	17.36	50.14	74.00	-23.86	peak
4	12302.000	32.81	17.78	50.59	74.00	-23.41	peak
5	13864.000	28.97	21.53	50.50	74.00	-23.50	peak
6	17956.000	24.49	25.82	50.31	74.00	-23.69	peak

Test Mode:	802.11be EHT40	Channel:	5755
Polarity:	Vertical	Test Voltage:	DC 15 V

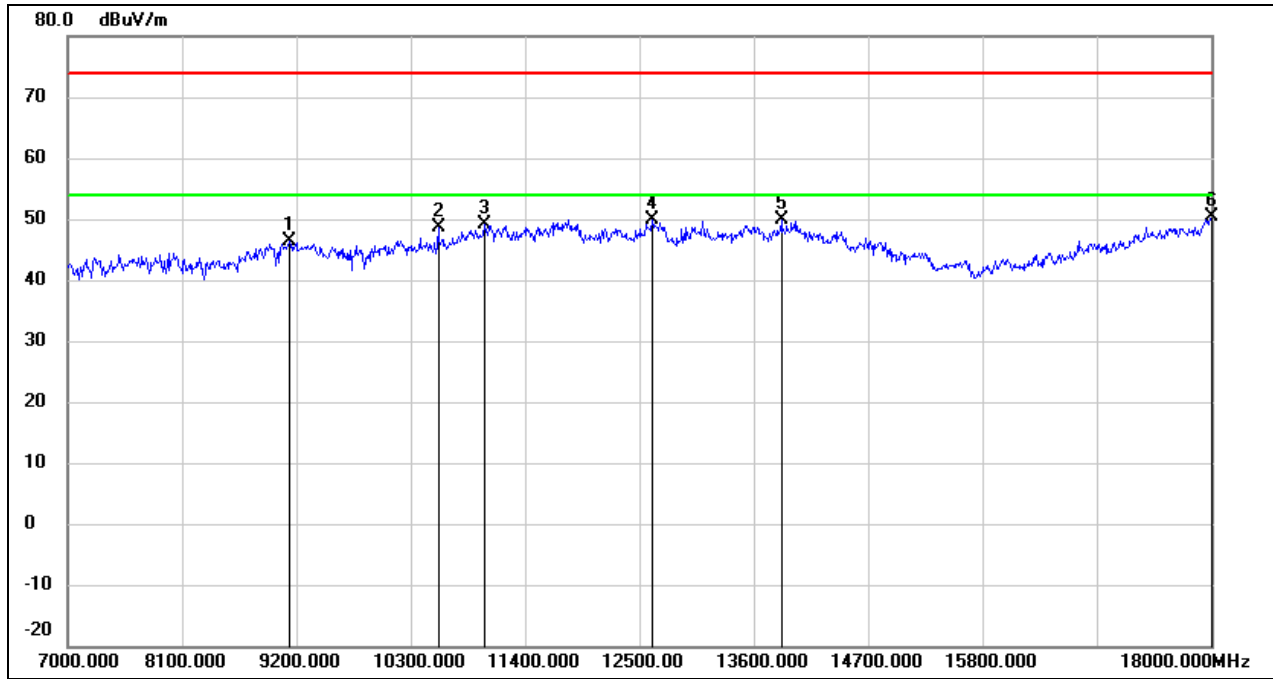

No.	Frequency (MHz)	Reading (dBuV)	Correct (dB/m)	Result (dBuV/m)	Limit (dBuV/m)	Margin (dB)	Remark
1	9134.000	36.08	10.41	46.49	74.00	-27.51	peak
2	10564.000	35.45	13.06	48.51	74.00	-25.49	peak
3	11004.000	34.37	14.74	49.11	74.00	-24.89	peak
4	12621.000	31.82	17.98	49.80	74.00	-24.20	peak
5	13864.000	28.24	21.53	49.77	74.00	-24.23	peak
6	18000.000	24.37	26.12	50.49	74.00	-23.51	peak

Test Mode:	802.11be EHT40	Channel:	5795
Polarity:	Horizontal	Test Voltage:	DC 15 V

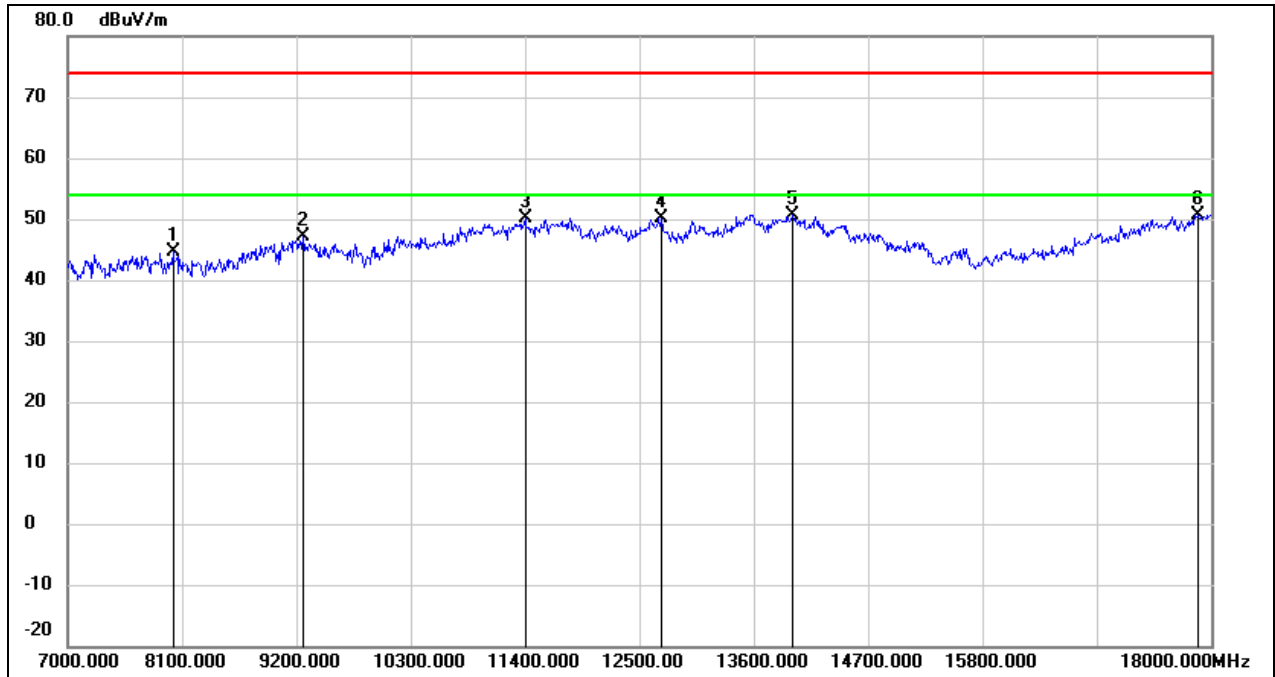

No.	Frequency (MHz)	Reading (dBuV)	Correct (dB/m)	Result (dBuV/m)	Limit (dBuV/m)	Margin (dB)	Remark
1	8012.000	38.14	6.44	44.58	74.00	-29.42	peak
2	9266.000	36.73	10.51	47.24	74.00	-26.76	peak
3	11400.000	33.85	16.36	50.21	74.00	-23.79	peak
4	12709.000	32.05	18.09	50.14	74.00	-23.86	peak
5	13974.000	28.73	21.82	50.55	74.00	-23.45	peak
6	17868.000	25.52	25.22	50.74	74.00	-23.26	peak

Test Mode:	802.11be EHT40	Channel:	5795
Polarity:	Vertical	Test Voltage:	DC 15 V

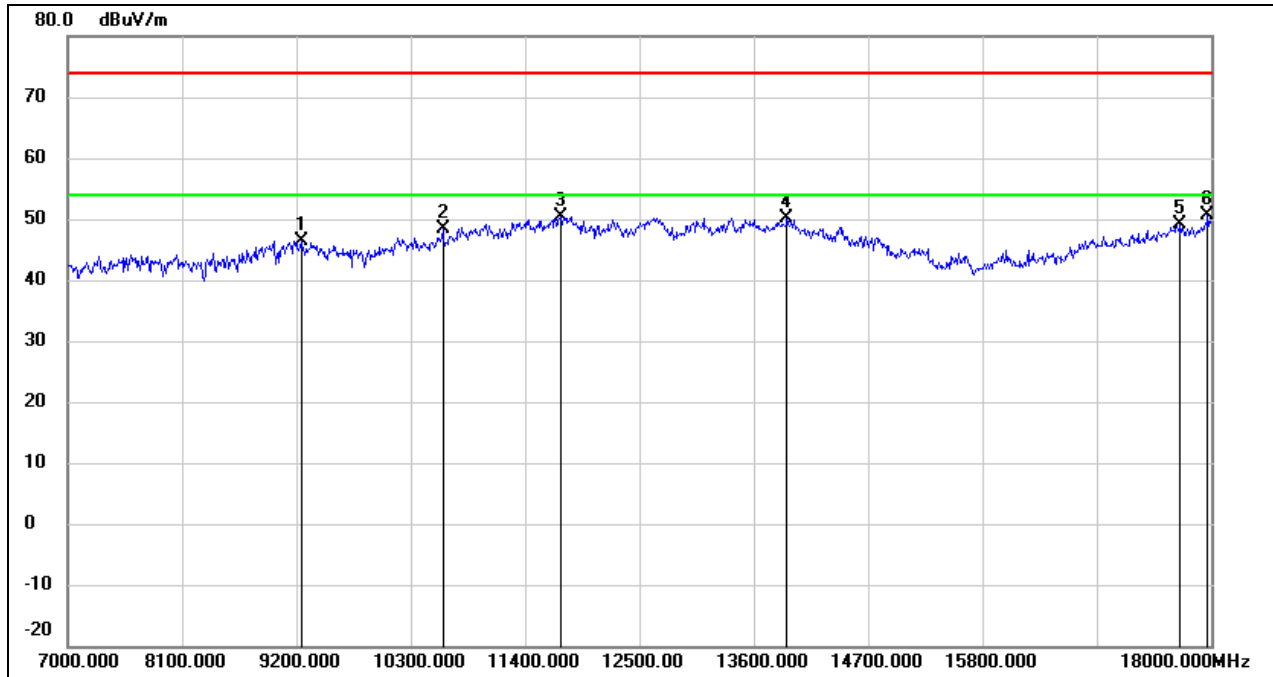

No.	Frequency (MHz)	Reading (dBuV)	Correct (dB/m)	Result (dBuV/m)	Limit (dBuV/m)	Margin (dB)	Remark
1	9244.000	36.01	10.49	46.50	74.00	-27.50	peak
2	10608.000	35.18	13.23	48.41	74.00	-25.59	peak
3	11741.000	33.23	17.22	50.45	74.00	-23.55	peak
4	13919.000	28.54	21.68	50.22	74.00	-23.78	peak
5	17703.000	25.00	24.09	49.09	74.00	-24.91	peak
6	17967.000	24.64	25.89	50.53	74.00	-23.47	peak

Test Mode:	802.11be EHT80	Channel:	5210
Polarity:	Horizontal	Test Voltage:	DC 15 V

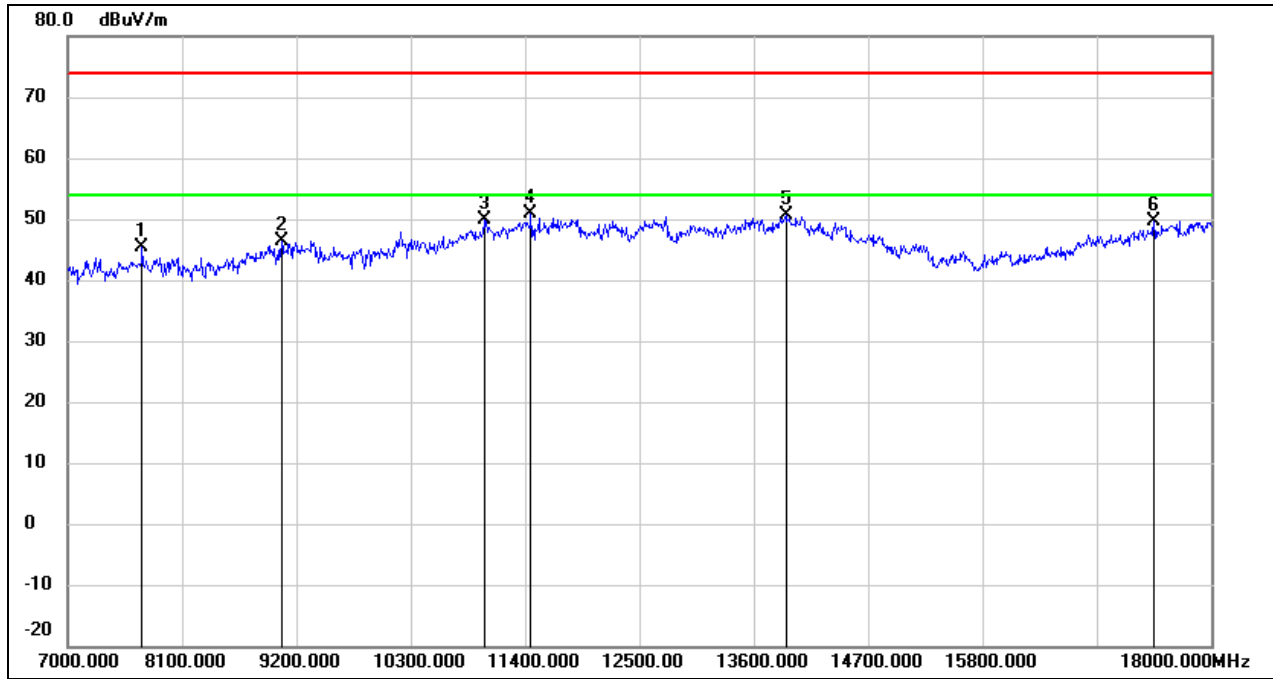

No.	Frequency (MHz)	Reading (dBuV)	Correct (dB/m)	Result (dBuV/m)	Limit (dBuV/m)	Margin (dB)	Remark
1	7715.000	38.63	6.68	45.31	74.00	-28.69	peak
2	9057.000	36.02	10.38	46.40	74.00	-27.60	peak
3	11004.000	35.09	14.74	49.83	74.00	-24.17	peak
4	11455.000	34.24	16.58	50.82	74.00	-23.18	peak
5	13908.000	28.87	21.66	50.53	74.00	-23.47	peak
6	17450.000	27.10	22.50	49.60	74.00	-24.40	peak

Test Mode:	802.11be EHT80	Channel:	5210
Polarity:	Vertical	Test Voltage:	DC 15 V

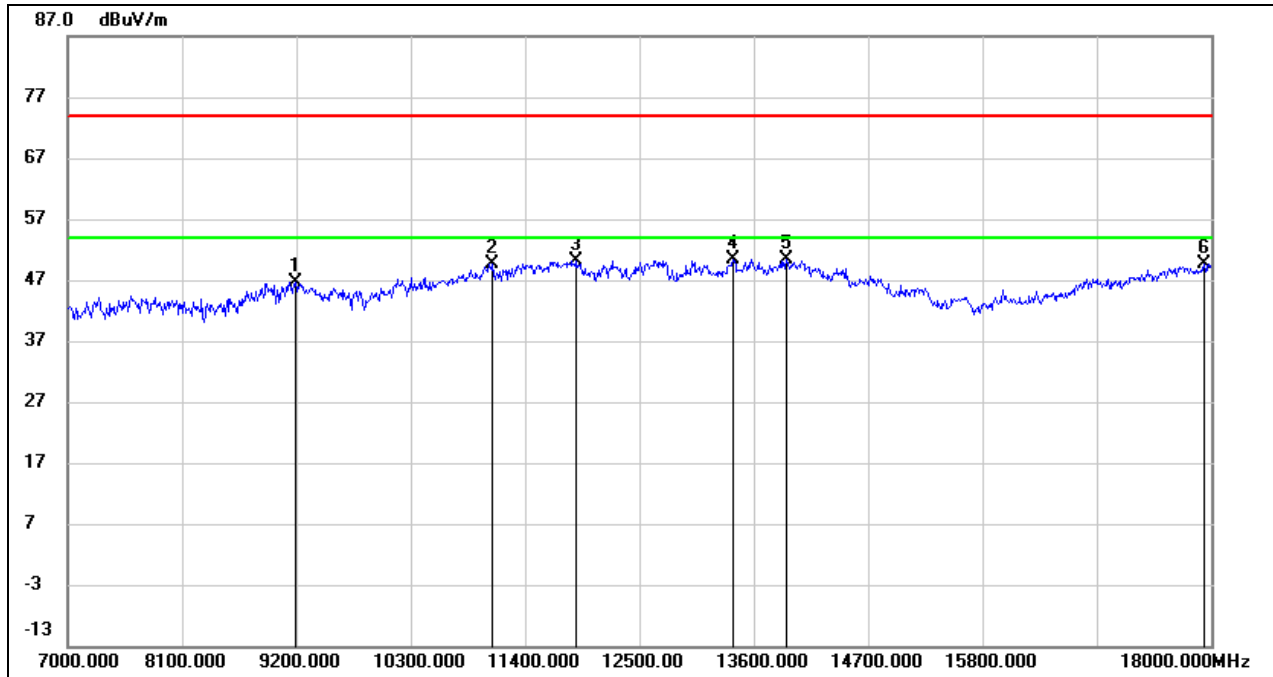

No.	Frequency (MHz)	Reading (dBuV)	Correct (dB/m)	Result (dBuV/m)	Limit (dBuV/m)	Margin (dB)	Remark
1	9189.000	36.23	10.46	46.69	74.00	-27.31	peak
2	11081.000	34.66	15.05	49.71	74.00	-24.29	peak
3	11895.000	32.63	17.51	50.14	74.00	-23.86	peak
4	13402.000	30.10	20.20	50.30	74.00	-23.70	peak
5	13908.000	28.84	21.66	50.50	74.00	-23.50	peak
6	17934.000	24.02	25.67	49.69	74.00	-24.31	peak

Test Mode:	802.11be EHT80	Channel:	5775
Polarity:	Horizontal	Test Voltage:	DC 15 V

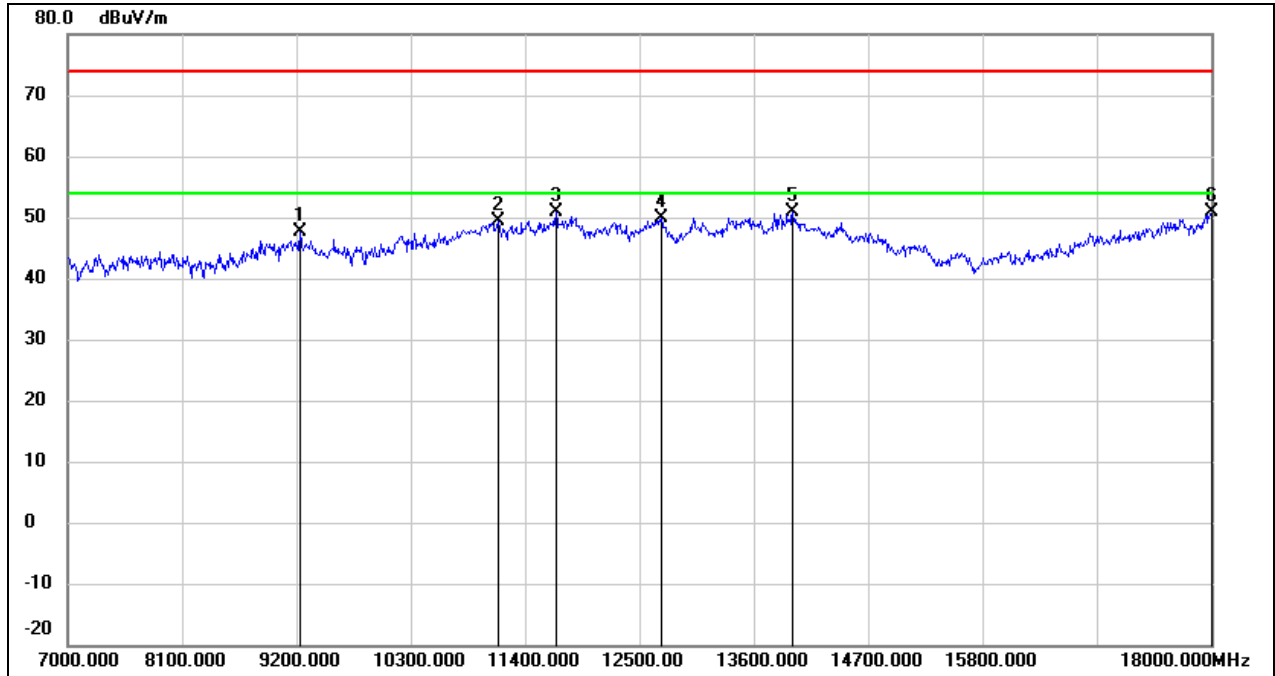

No.	Frequency (MHz)	Reading (dBuV)	Correct (dB/m)	Result (dBuV/m)	Limit (dBuV/m)	Margin (dB)	Remark
1	9233.000	37.07	10.48	47.55	74.00	-26.45	peak
2	11136.000	34.06	15.27	49.33	74.00	-24.67	peak
3	11697.000	33.81	17.13	50.94	74.00	-23.06	peak
4	12709.000	31.88	18.09	49.97	74.00	-24.03	peak
5	13974.000	29.12	21.82	50.94	74.00	-23.06	peak
6	18000.000	24.81	26.12	50.93	74.00	-23.07	peak

Test Mode:	802.11be EHT80	Channel:	5775
Polarity:	Vertical	Test Voltage:	DC 15 V

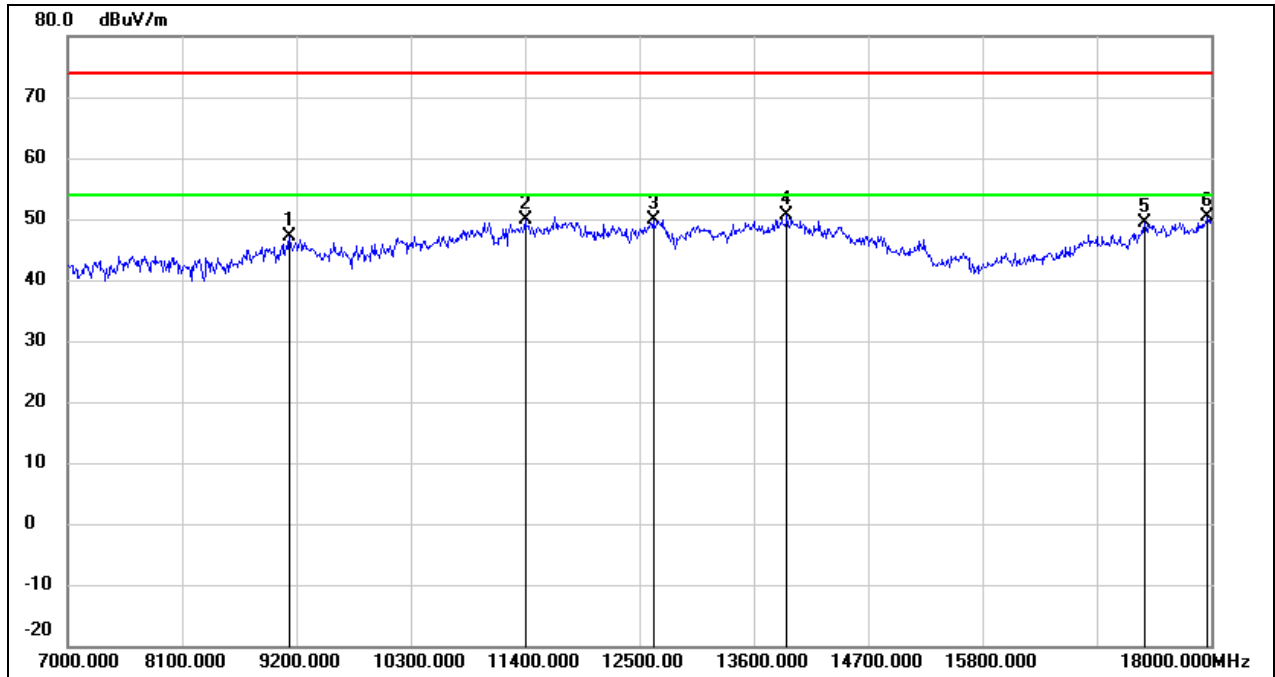

No.	Frequency (MHz)	Reading (dBuV)	Correct (dB/m)	Result (dBuV/m)	Limit (dBuV/m)	Margin (dB)	Remark
1	9134.000	36.83	10.41	47.24	74.00	-26.76	peak
2	11400.000	33.41	16.36	49.77	74.00	-24.23	peak
3	12632.000	31.84	17.99	49.83	74.00	-24.17	peak
4	13919.000	28.90	21.68	50.58	74.00	-23.42	peak
5	17362.000	27.22	22.12	49.34	74.00	-24.66	peak
6	17967.000	24.44	25.89	50.33	74.00	-23.67	peak

8.4. SPURIOUS EMISSIONS (9 KHZ ~ 30 MHZ)

Test Mode:	802.11a 20	Channel:	5180
Polarity:	Horizontal	Test Voltage:	DC 15 V

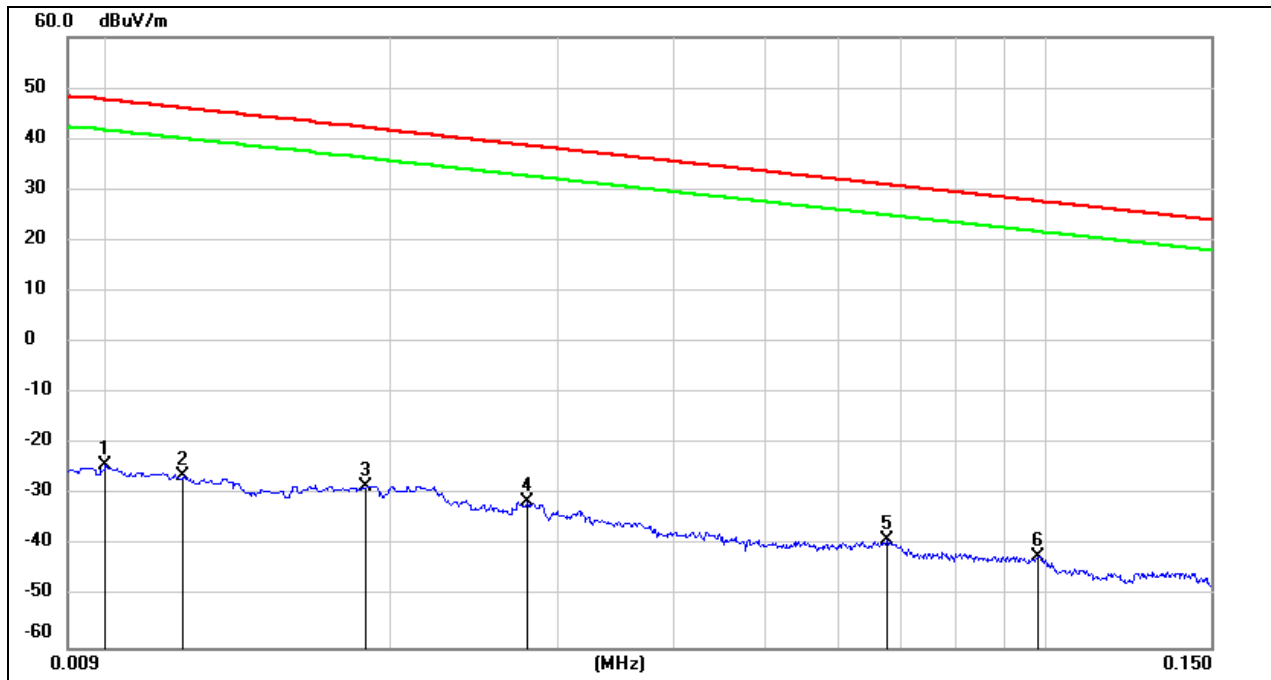

No.	Frequency (MHz)	Reading (dBuV)	Correct (dB/m)	Result (dBuV/m)	Limit (dBuV/m)	Margin (dB)	Remark
1	0.0100	77.22	-101.40	-24.18	47.60	-71.78	peak
2	0.0120	75.16	-101.39	-26.23	46.02	-72.25	peak
3	0.0188	73.14	-101.35	-28.21	42.12	-70.33	peak
4	0.0279	70.17	-101.38	-31.21	38.69	-69.90	peak
5	0.0675	62.64	-101.56	-38.92	31.02	-69.94	peak
6	0.0981	59.77	-101.78	-42.01	27.77	-69.78	peak

Test Mode:	802.11a 20	Channel:	5180
Polarity:	Horizontal	Test Voltage:	DC 15 V

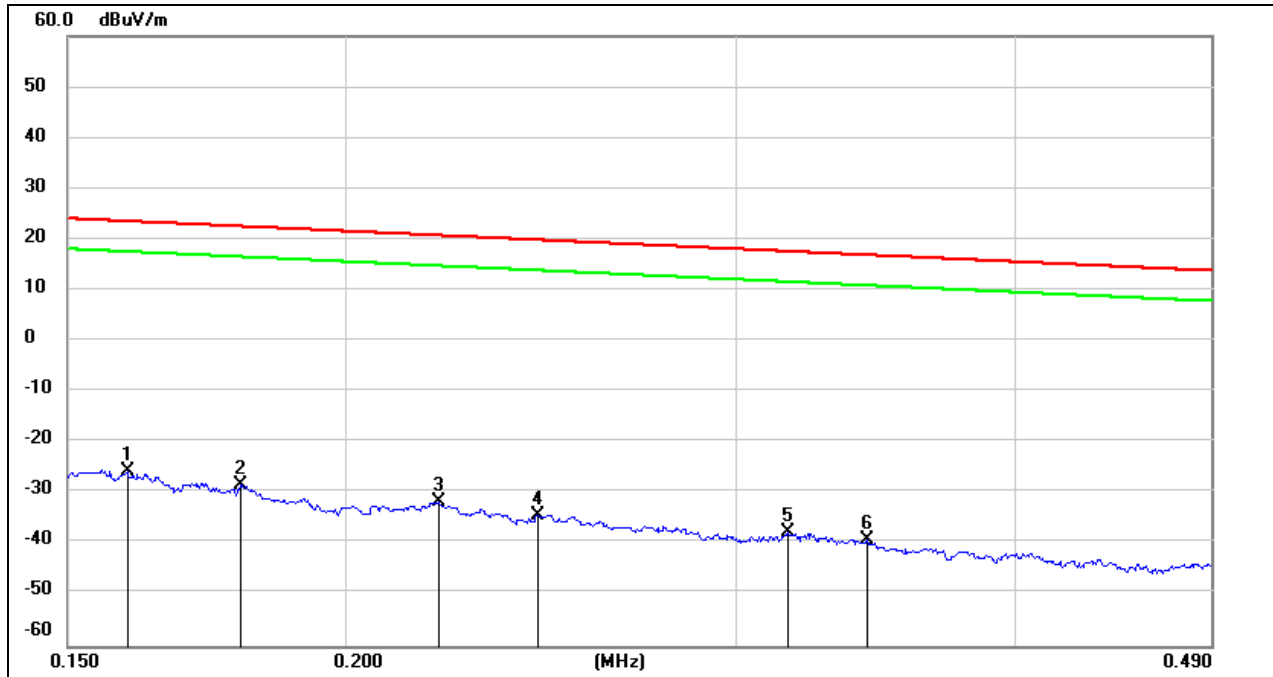

No.	Frequency (MHz)	Reading (dBuV)	Correct (dB/m)	Result (dBuV/m)	Limit (dBuV/m)	Margin (dB)	Remark
1	0.1595	75.86	-101.65	-25.79	23.55	-49.34	peak
2	0.1794	73.27	-101.68	-28.41	22.53	-50.94	peak
3	0.2204	70.16	-101.75	-31.59	20.74	-52.33	peak
4	0.2442	67.53	-101.79	-34.26	19.85	-54.11	peak
5	0.3163	64.20	-101.87	-37.67	17.60	-55.27	peak
6	0.3431	62.67	-101.90	-39.23	16.89	-56.12	peak

Test Mode:	802.11a 20	Channel:	5180
Polarity:	Horizontal	Test Voltage:	DC 15 V

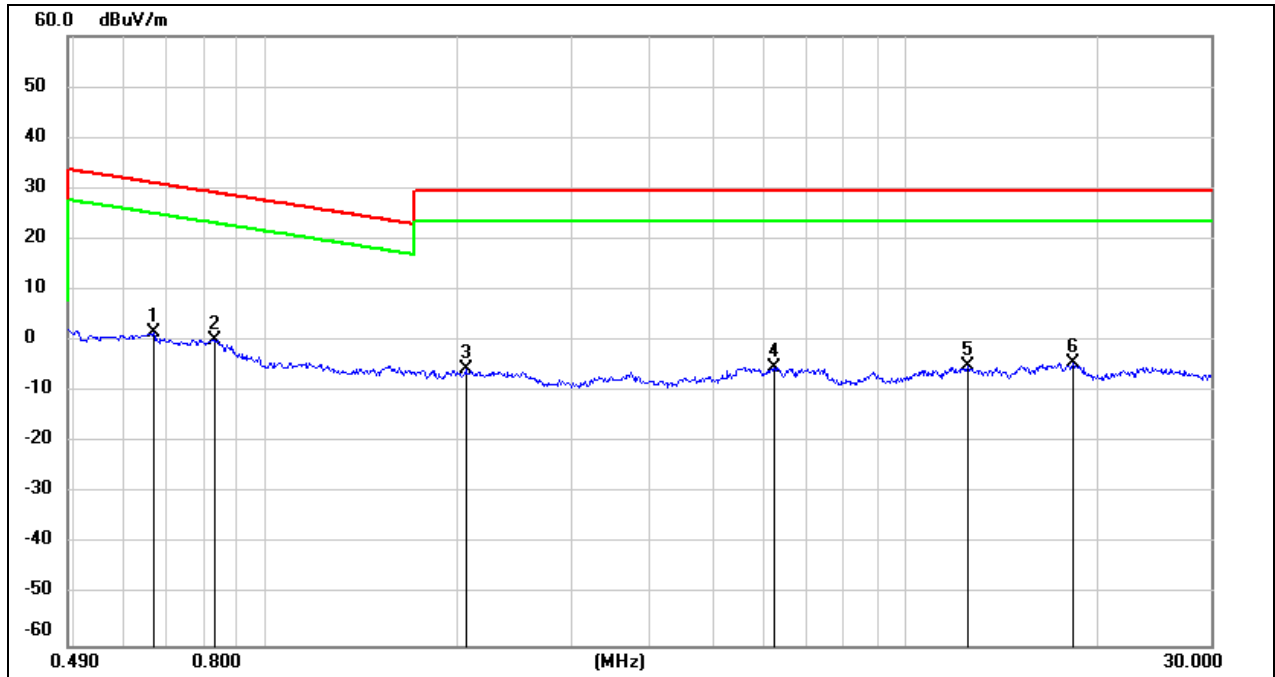

No.	Frequency (MHz)	Reading (dBuV)	Correct (dB/m)	Result (dBuV/m)	Limit (dBuV/m)	Margin (dB)	Remark
1	0.6671	63.75	-62.10	1.65	31.12	-29.47	peak
2	0.8296	62.44	-62.17	0.27	29.23	-28.96	peak
3	2.0539	56.20	-61.81	-5.61	29.54	-35.15	peak
4	6.2445	56.13	-61.32	-5.19	29.54	-34.73	peak
5	12.5006	55.82	-60.91	-5.09	29.54	-34.63	peak
6	18.2545	56.43	-60.90	-4.47	29.54	-34.01	peak

8.5. SPURIOUS EMISSIONS (18 GHZ ~ 26 GHZ)

Test Mode:	802.11a 20	Channel:	5180
Polarity:	Horizontal	Test Voltage:	DC 15 V

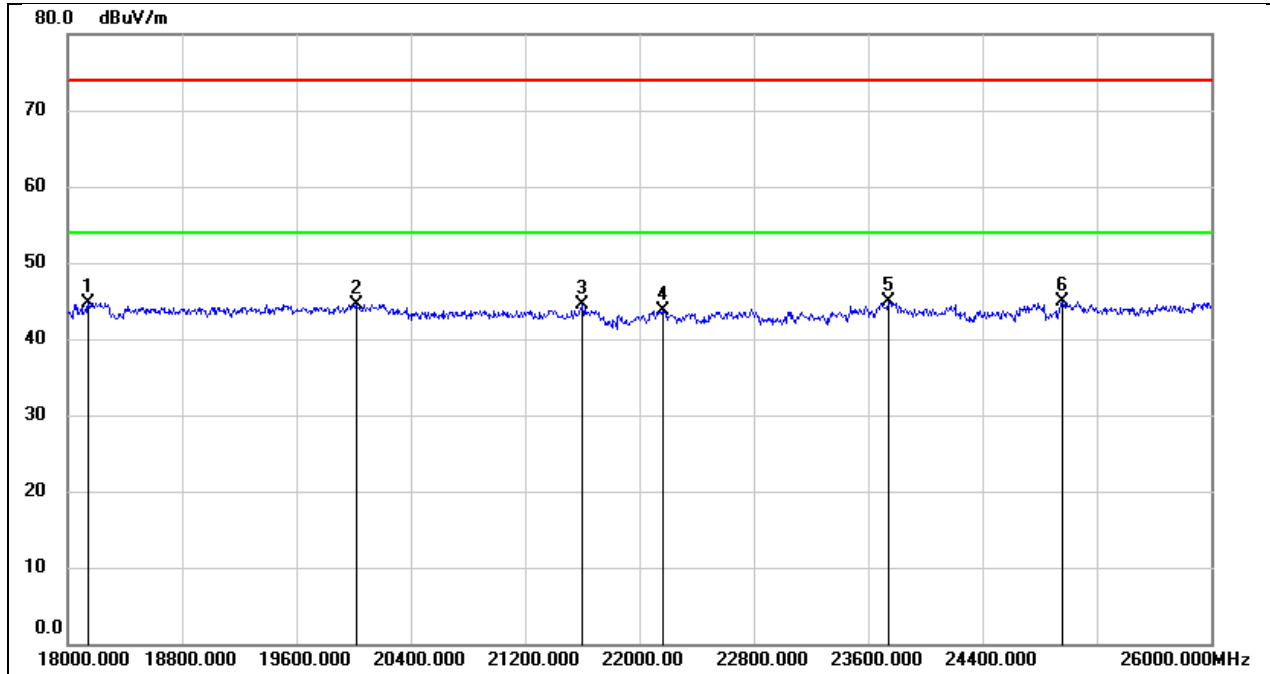

No.	Frequency (MHz)	Reading (dBuV)	Correct (dB/m)	Result (dBuV/m)	Limit (dBuV/m)	Margin (dB)	Remark
1	18144.000	50.27	-5.48	44.79	74.00	-29.21	peak
2	20016.000	50.06	-5.47	44.59	74.00	-29.41	peak
3	21600.000	49.02	-4.54	44.48	74.00	-29.52	peak
4	22160.000	48.08	-4.31	43.77	74.00	-30.23	peak
5	23744.000	48.15	-3.20	44.95	74.00	-29.05	peak
6	24960.000	47.14	-2.14	45.00	74.00	-29.00	peak

Test Mode:	802.11a 20	Channel:	5180
Polarity:	Vertical	Test Voltage:	DC 15 V

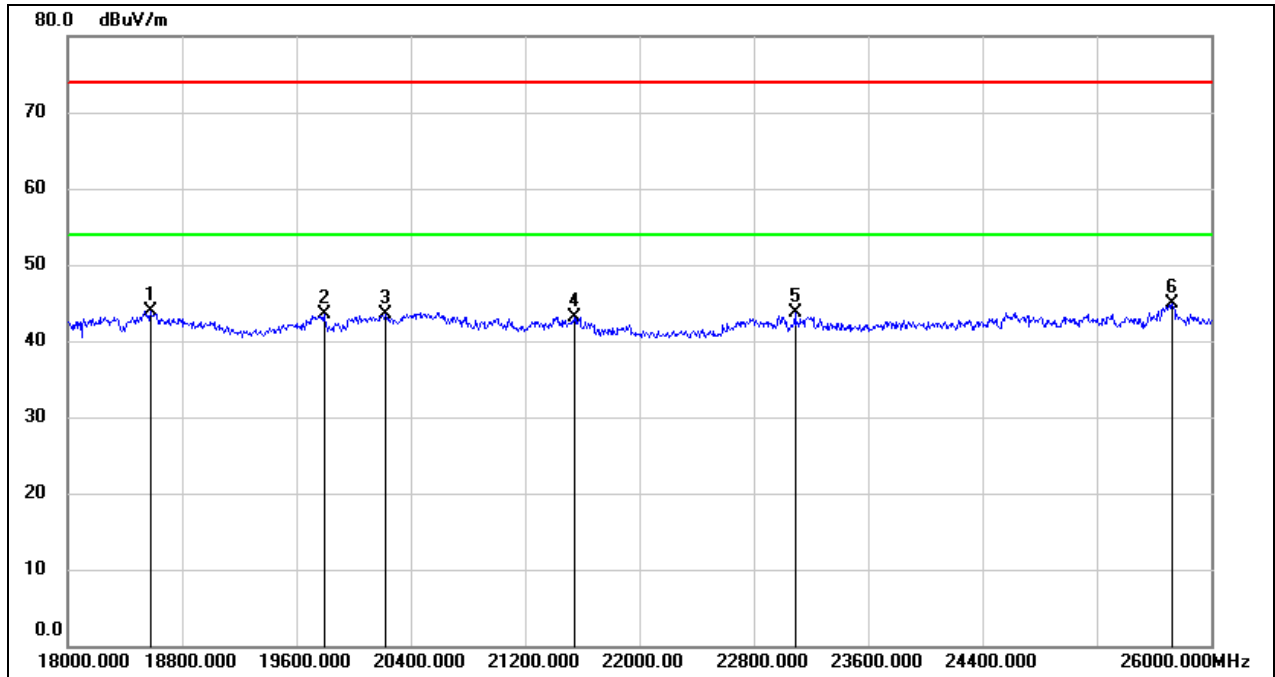

No.	Frequency (MHz)	Reading (dBuV)	Correct (dB/m)	Result (dBuV/m)	Limit (dBuV/m)	Margin (dB)	Remark
1	18576.000	49.29	-5.30	43.99	74.00	-30.01	peak
2	19792.000	48.70	-5.29	43.41	74.00	-30.59	peak
3	20224.000	49.02	-5.60	43.42	74.00	-30.58	peak
4	21544.000	47.76	-4.63	43.13	74.00	-30.87	peak
5	23088.000	47.02	-3.41	43.61	74.00	-30.39	peak
6	25728.000	45.61	-0.72	44.89	74.00	-29.11	peak

8.6. SPURIOUS EMISSIONS (26 GHZ ~ 40 GHZ)

Test Mode:	802.11a 20	Channel:	5180
Polarity:	Horizontal	Test Voltage:	DC 15 V

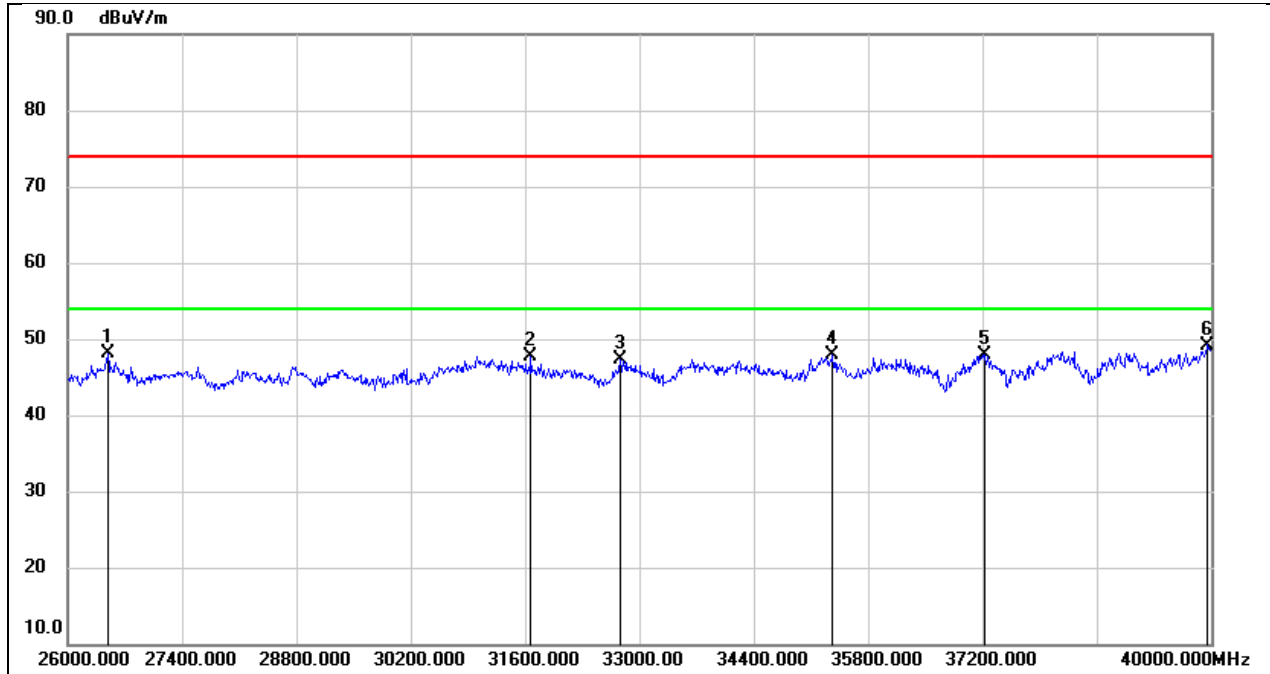

No.	Frequency (MHz)	Reading (dBuV)	Correct (dB/m)	Result (dBuV/m)	Limit (dBuV/m)	Margin (dB)	Remark
1	26490.000	52.79	-4.74	48.05	74.00	-25.95	peak
2	31670.000	48.86	-1.21	47.65	74.00	-26.35	peak
3	32762.000	48.45	-1.21	47.24	74.00	-26.76	peak
4	35366.000	45.40	2.59	47.99	74.00	-26.01	peak
5	37228.000	44.73	3.14	47.87	74.00	-26.13	peak
6	39958.000	44.08	5.12	49.20	74.00	-24.80	peak

Test Mode:	802.11a 20	Channel:	5180
Polarity:	Vertical	Test Voltage:	DC 15 V

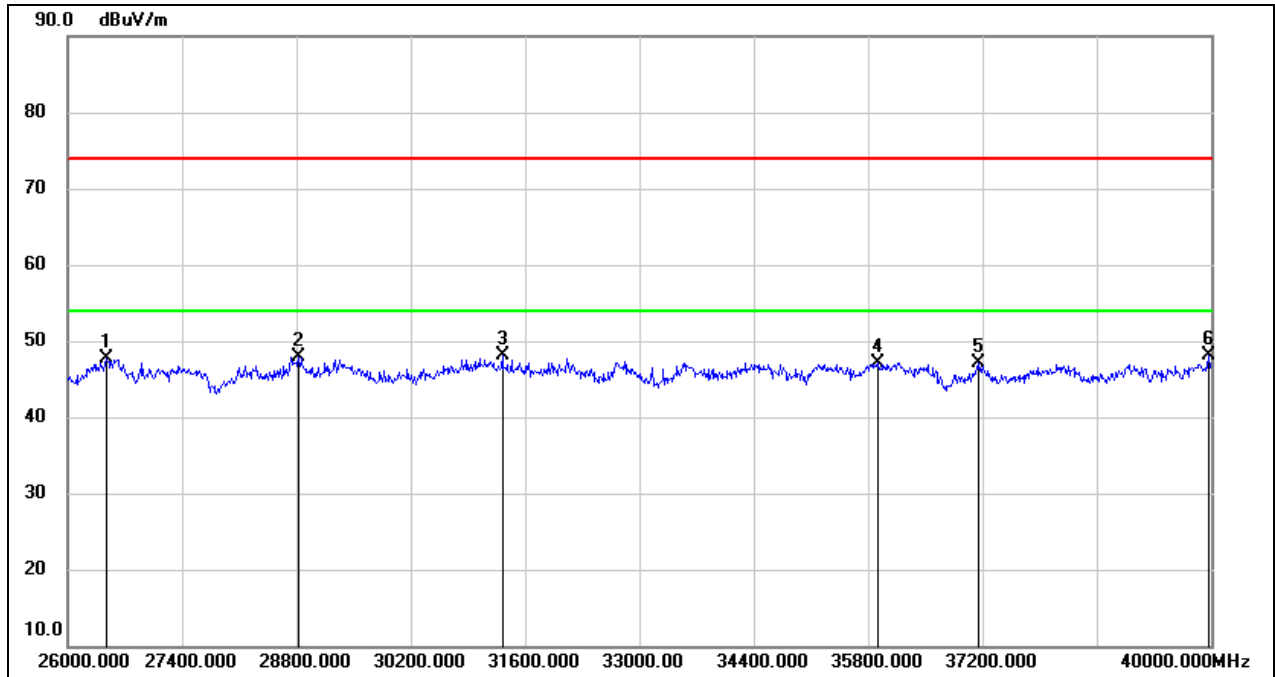

No.	Frequency (MHz)	Reading (dBuV)	Correct (dB/m)	Result (dBuV/m)	Limit (dBuV/m)	Margin (dB)	Remark
1	26476.000	52.53	-4.78	47.75	74.00	-26.25	peak
2	28828.000	48.63	-0.79	47.84	74.00	-26.16	peak
3	31320.000	49.11	-0.93	48.18	74.00	-25.82	peak
4	35912.000	43.20	3.85	47.05	74.00	-26.95	peak
5	37158.000	43.84	3.17	47.01	74.00	-26.99	peak
6	39972.000	42.95	5.13	48.08	74.00	-25.92	peak

8.7. SPURIOUS EMISSIONS (30 MHz ~ 1 GHz)

Test Mode:	802.11a 20	Channel:	5180
Polarity:	Horizontal	Test Voltage:	DC 15 V

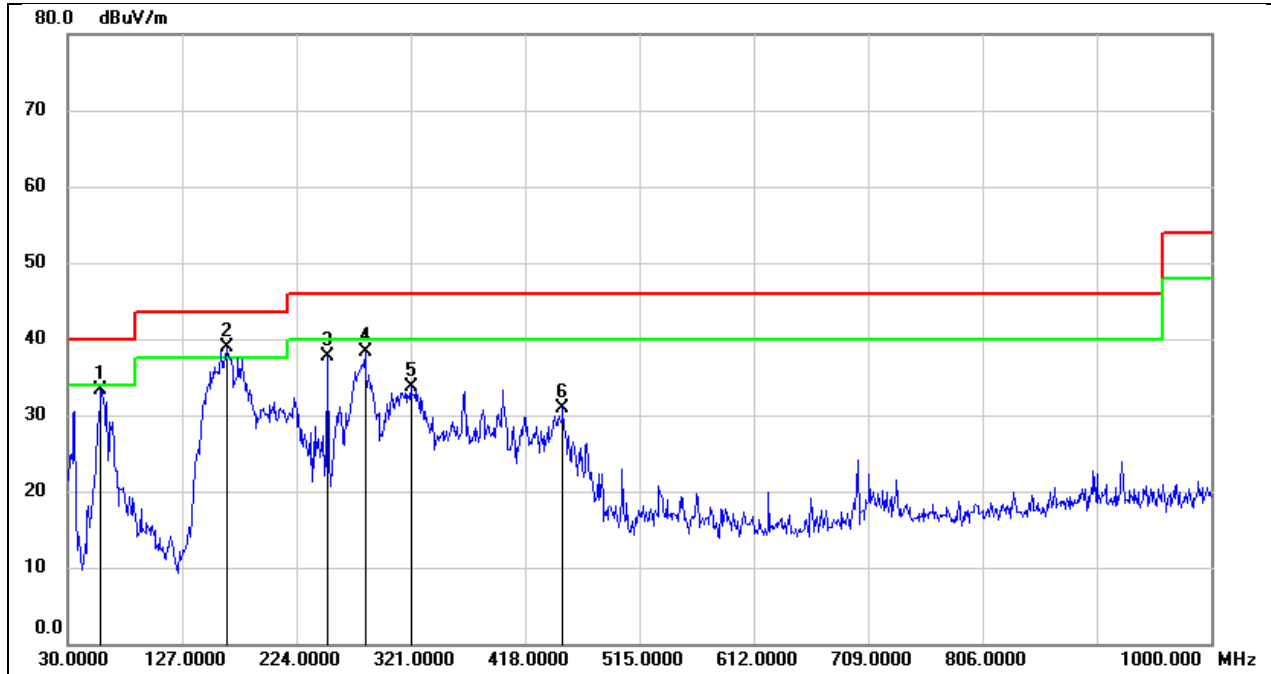

No.	Frequency (MHz)	Reading (dBuV)	Correct (dB/m)	Result (dBuV/m)	Limit (dBuV/m)	Margin (dB)	Remark
1	58.1300	53.62	-20.35	33.27	40.00	-6.73	QP
2	164.8300	56.19	-17.25	38.94	43.50	-4.56	QP
3	250.1900	56.60	-18.95	37.65	46.00	-8.35	QP
4	282.2000	54.73	-16.44	38.29	46.00	-7.71	QP
5	321.0000	47.94	-14.21	33.73	46.00	-12.27	QP
6	450.0100	42.78	-11.84	30.94	46.00	-15.06	QP

Test Mode:	802.11a 20	Channel:	5180
Polarity:	Vertical	Test Voltage:	DC 15 V

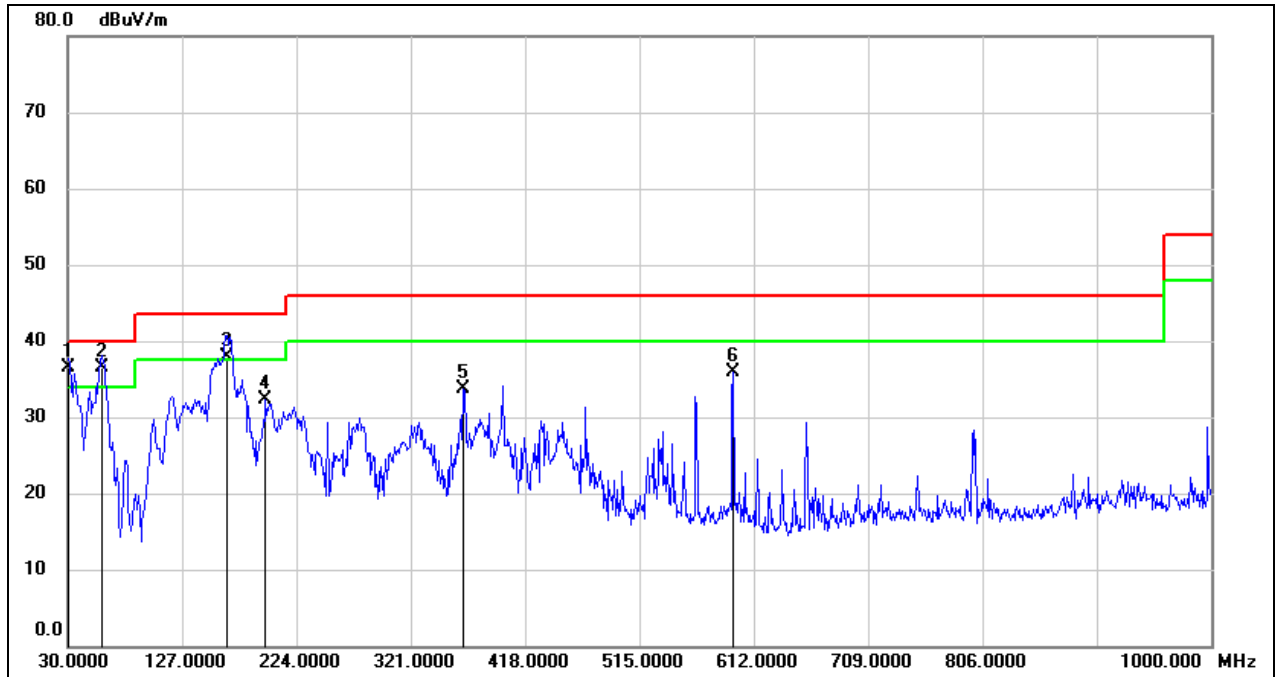

No.	Frequency (MHz)	Reading (dBuV)	Correct (dB/m)	Result (dBuV/m)	Limit (dBuV/m)	Margin (dB)	Remark
1	30.9700	54.99	-18.39	36.60	40.00	-3.40	QP
2	59.1000	56.91	-20.32	36.59	40.00	-3.41	QP
3	164.8300	55.06	-17.25	37.81	43.50	-5.69	QP
4	197.8100	48.95	-16.59	32.36	43.50	-11.14	QP
5	365.6200	46.73	-12.97	33.76	46.00	-12.24	QP
6	594.5400	45.33	-9.43	35.90	46.00	-10.10	QP

8.8. SIMULTANEOUSLY TRANSMISSION SPURIOUS EMISSIONS

(1 GHz~18 GHz) (Worst case)

Test Mode:	WIFI 2.4G 802.11b Mode 2437 MHz & WIFI 5G 802.11a Mode 5745 MHz		
Polarity:	Horizontal	Test Voltage:	DC 15 V

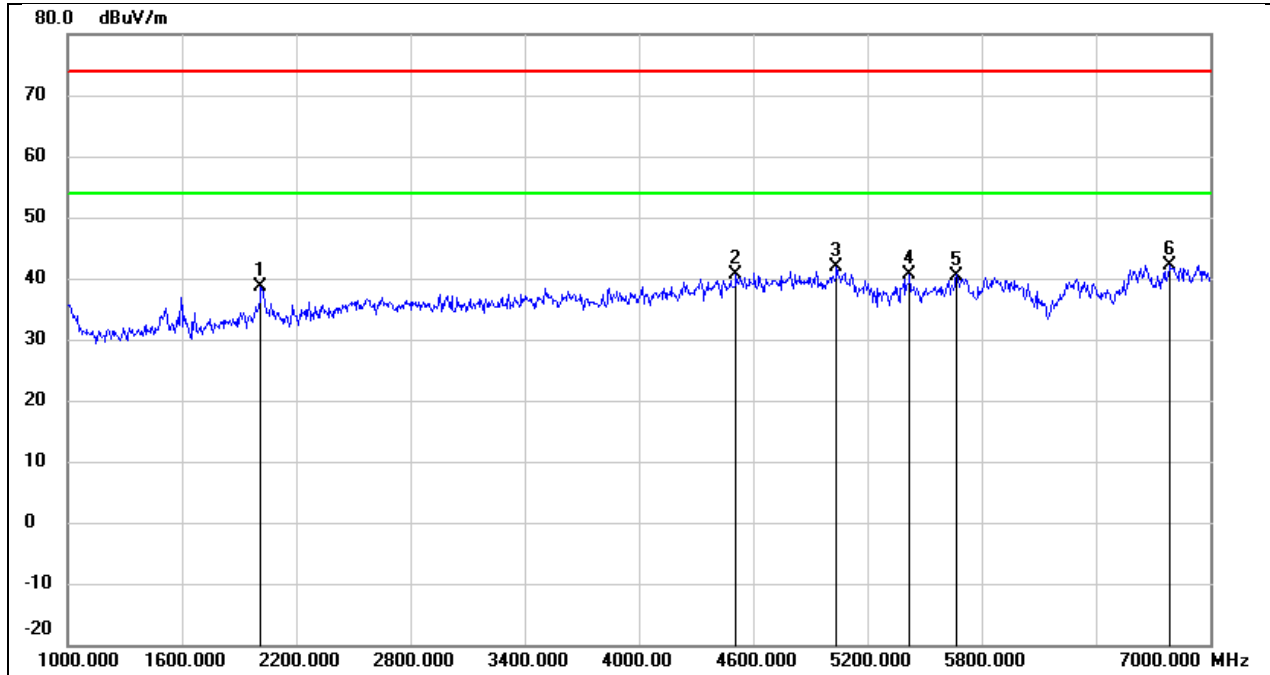

No.	Frequency (MHz)	Reading (dBuV)	Correct (dB/m)	Result (dBuV/m)	Limit (dBuV/m)	Margin (dB)	Remark
1	2014.000	49.65	-10.98	38.67	74.00	-35.33	peak
2	4510.000	42.80	-2.10	40.70	74.00	-33.30	peak
3	5038.000	41.97	-0.11	41.86	74.00	-32.14	peak
4	5422.000	40.24	0.32	40.56	74.00	-33.44	peak
5	5668.000	39.59	0.91	40.50	74.00	-33.50	peak
6	6790.000	37.00	5.15	42.15	74.00	-31.85	peak

Test Mode:	WIFI 2.4G 802.11b Mode 2437 MHz & WIFI 5G 802.11a Mode 5745 MHz		
Polarity:	Vertical	Test Voltage:	DC 15 V

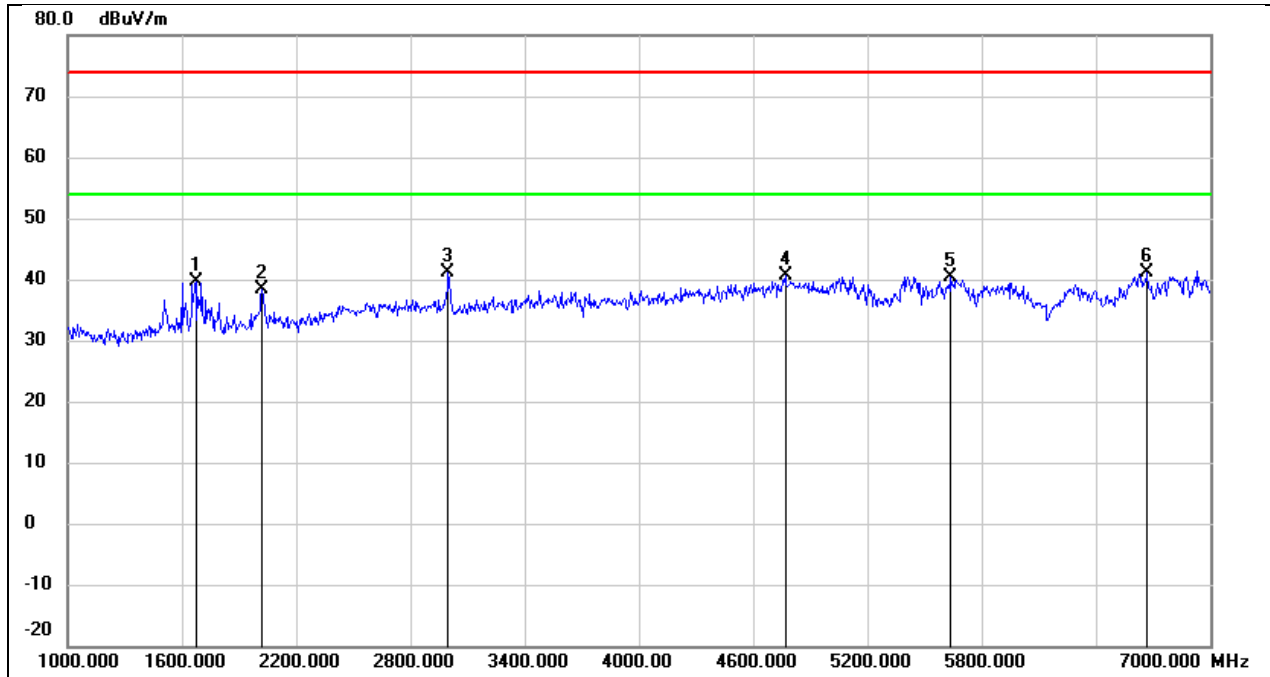

No.	Frequency (MHz)	Reading (dBuV)	Correct (dB/m)	Result (dBuV/m)	Limit (dBuV/m)	Margin (dB)	Remark
1	1672.000	51.67	-12.15	39.52	74.00	-34.48	peak
2	2020.000	49.22	-10.96	38.26	74.00	-35.74	peak
3	2998.000	48.22	-6.98	41.24	74.00	-32.76	peak
4	4768.000	41.78	-1.07	40.71	74.00	-33.29	peak
5	5638.000	39.68	0.81	40.49	74.00	-33.51	peak
6	6670.000	36.47	4.57	41.04	74.00	-32.96	peak

Test Mode:	WIFI 2.4G 802.11b Mode 2437 MHz &WIFI 5G 802.11a Mode 5745 MHz		
Polarity:	Horizontal	Test Voltage:	DC 15 V

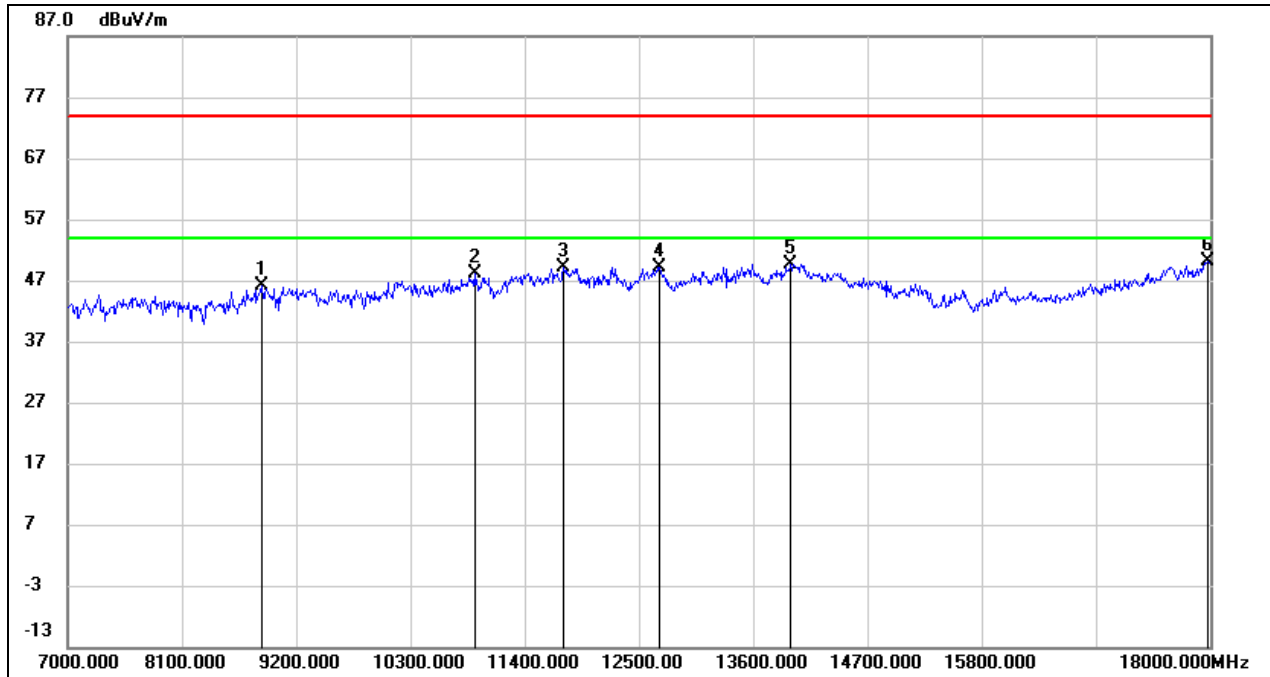

No.	Frequency (MHz)	Reading (dBuV)	Correct (dB/m)	Result (dBuV/m)	Limit (dBuV/m)	Margin (dB)	Remark
1	8870.000	36.65	9.44	46.09	74.00	-27.91	peak
2	10916.000	33.76	14.39	48.15	74.00	-25.85	peak
3	11774.000	31.83	17.28	49.11	74.00	-24.89	peak
4	12698.000	31.15	18.08	49.23	74.00	-24.77	peak
5	13963.000	27.82	21.78	49.60	74.00	-24.40	peak
6	17978.000	24.10	25.97	50.07	74.00	-23.93	peak

Test Mode:	WIFI 2.4G 802.11b Mode 2437 MHz & WIFI 5G 802.11a Mode 5745 MHz		
Polarity:	Vertical	Test Voltage:	DC 15 V

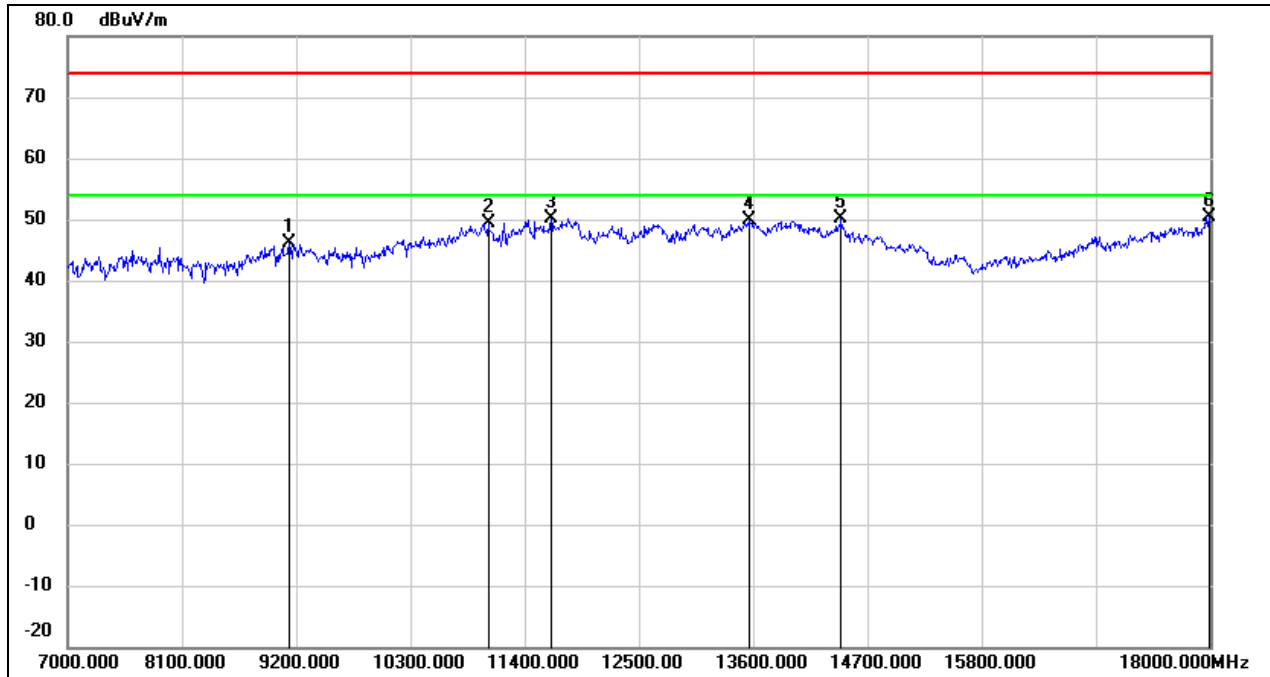

No.	Frequency (MHz)	Reading (dBuV)	Correct (dB/m)	Result (dBuV/m)	Limit (dBuV/m)	Margin (dB)	Remark
1	9134.000	35.64	10.41	46.05	74.00	-27.95	peak
2	11048.000	34.43	14.91	49.34	74.00	-24.66	peak
3	11653.000	33.07	17.05	50.12	74.00	-23.88	peak
4	13567.000	29.11	20.80	49.91	74.00	-24.09	peak
5	14447.000	30.20	20.00	50.20	74.00	-23.80	peak
6	17989.000	24.43	26.04	50.47	74.00	-23.53	peak

9. AC POWER LINE CONDUCTED EMISSION

LIMITS

Please refer to CFR 47 FCC §15.207 (a).

FREQUENCY (MHz)	Quasi-peak	Average
0.15 -0.5	66 - 56 *	56 - 46 *
0.50 -5.0	56.00	46.00
5.0 -30.0	60.00	50.00

TEST PROCEDURE

Refer to ANSI C63.10-2013 clause 6.2.

The EUT is put on a table of non-conducting material that is 80 cm high. The vertical conducting wall of shielding is located 40 cm to the rear of the EUT. The power line of the EUT is connected to the AC mains through a Artificial Mains Network (A.M.N.). A EMI Measurement Receiver (R&S Test Receiver ESR3) is used to test the emissions from both sides of AC line. According to the requirements in Section 6.2 of ANSI C63.10-2013. Conducted emissions from the EUT measured in the frequency range between 0.15 MHz and 30 MHz using CISPR Quasi-Peak and average detector mode. The bandwidth of EMI test receiver is set at 9 kHz.

The arrangement of the equipment is installed to meet the standards and operating in a manner, which tends to maximize its emission characteristics in a normal application.

TEST SETUP

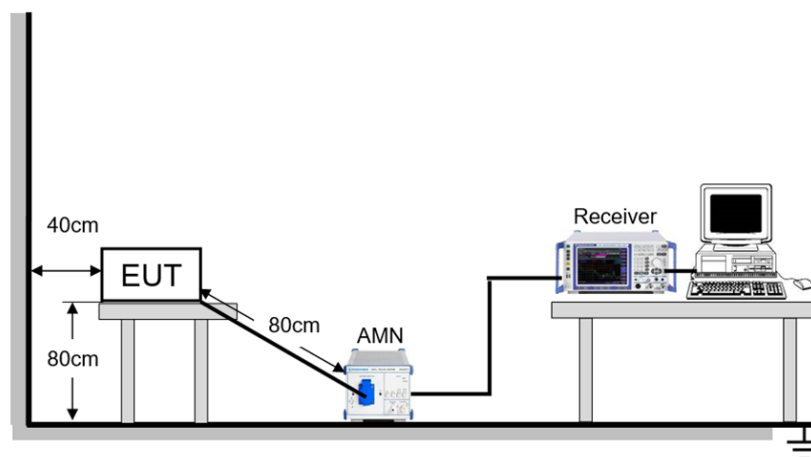

TEST ENVIRONMENT

Temperature	24.9°C	Relative Humidity	52%
Atmosphere Pressure	101kPa	Test Voltage	AC 120 V, 60 Hz

TEST DATE / ENGINEER

Test Date	April 26, 2023	Test By	Wite Chen
-----------	----------------	---------	-----------

TEST RESULTS

Test Mode:	802.11a 20	Channel:	5180
Line:	Line	Test Voltage:	AC 120 V, 60 Hz

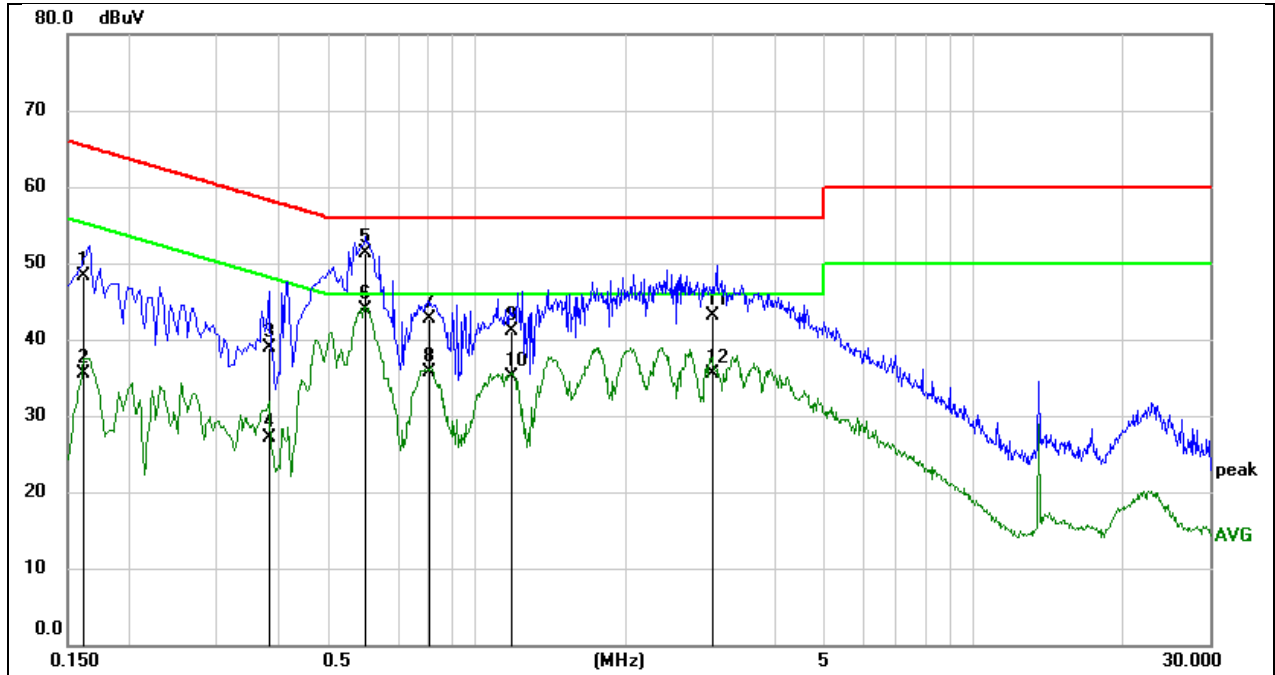

No.	Frequency (MHz)	Reading (dBuV)	Correct (dB)	Result (dBuV)	Limit (dBuV)	Margin (dB)	Remark
1	0.1612	38.85	9.51	48.36	65.40	-17.04	QP
2	0.1612	26.02	9.51	35.53	55.40	-19.87	AVG
3	0.3856	29.30	9.53	38.83	58.16	-19.33	QP
4	0.3856	17.60	9.53	27.13	48.16	-21.03	AVG
5	0.5972	41.77	9.50	51.27	56.00	-4.73	QP
6	0.5972	34.36	9.50	43.86	46.00	-2.14	AVG
7	0.8042	33.22	9.50	42.72	56.00	-13.28	QP
8	0.8042	26.16	9.50	35.66	46.00	-10.34	AVG
9	1.1845	31.48	9.53	41.01	56.00	-14.99	QP
10	1.1845	25.60	9.53	35.13	46.00	-10.87	AVG
11	2.9930	33.45	9.62	43.07	56.00	-12.93	QP
12	2.9930	25.96	9.62	35.58	46.00	-10.42	AVG

Note:

1. Result = Reading + Correct Factor.
2. If QP Result complies with AV limit, AV Result is deemed to comply with AV limit.
3. Test setup: RBW: 200 Hz (9 kHz ~ 150 kHz), 9 kHz (150 kHz ~ 30 MHz).
4. Step size: 80 Hz (0.009 MHz ~ 0.15 MHz), 4 kHz (0.15 MHz ~ 30 MHz), Scan time: auto.

Note: All the modes have been tested, only the worst data was recorded in the report.

Test Mode:	802.11a 20	Channel:	5180
Line:	Neutral	Test Voltage:	AC 120 V, 60 Hz

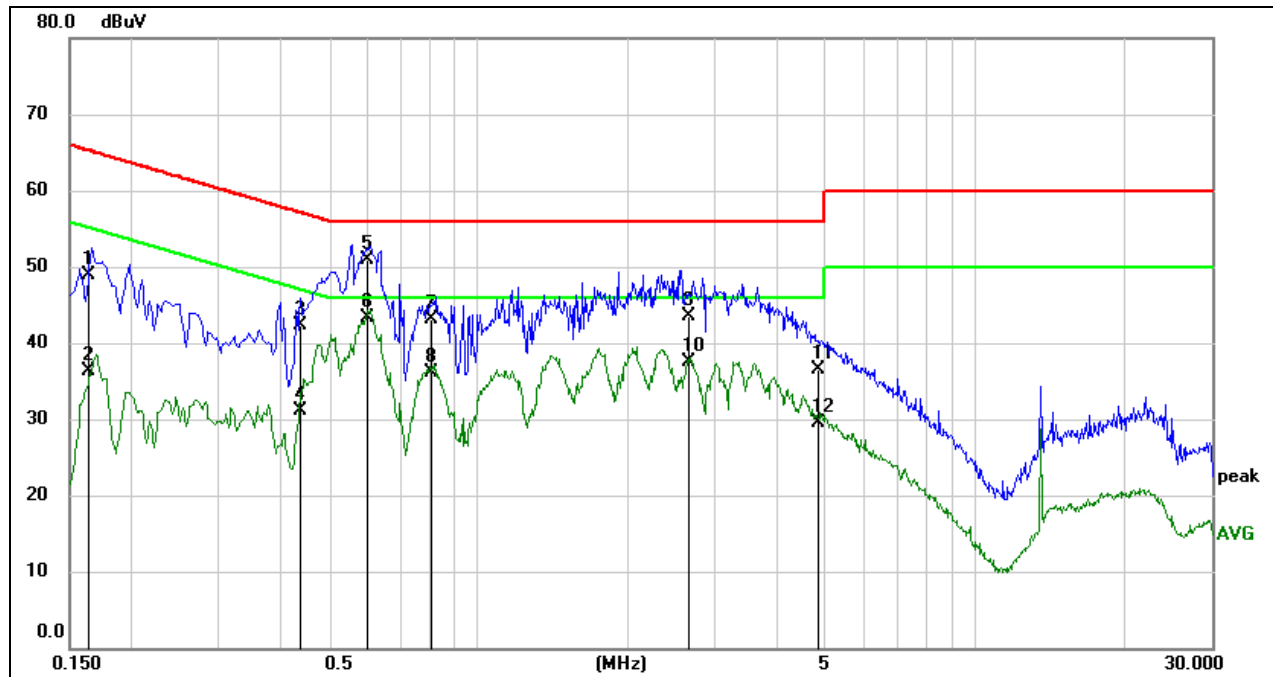

No.	Frequency (MHz)	Reading (dBuV)	Correct (dB)	Result (dBuV)	Limit (dBuV)	Margin (dB)	Remark
1	0.1630	39.34	9.52	48.86	65.31	-16.45	QP
2	0.1630	26.78	9.52	36.30	55.31	-19.01	AVG
3	0.4356	32.73	9.52	42.25	57.15	-14.90	QP
4	0.4356	21.60	9.52	31.12	47.15	-16.03	AVG
5	0.5951	41.46	9.50	50.96	56.00	-5.04	QP
6	0.5951	33.81	9.50	43.31	46.00	-2.69	AVG
7	0.8059	33.70	9.50	43.20	56.00	-12.80	QP
8	0.8059	26.64	9.50	36.14	46.00	-9.86	AVG
9	2.6530	33.97	9.62	43.59	56.00	-12.41	QP
10	2.6530	27.80	9.62	37.42	46.00	-8.58	AVG
11	4.8264	26.97	9.61	36.58	56.00	-19.42	QP
12	4.8264	19.93	9.61	29.54	46.00	-16.46	AVG

Note:

1. Result = Reading + Correct Factor.
2. If QP Result complies with AV limit, AV Result is deemed to comply with AV limit.
3. Test setup: RBW: 200 Hz (9 kHz ~ 150 kHz), 9 kHz (150 kHz ~ 30 MHz).
4. Step size: 80 Hz (0.009 MHz ~ 0.15 MHz), 4 kHz (0.15 MHz ~ 30 MHz), Scan time: auto.

Note: All the modes have been tested, only the worst data was recorded in the report.

10. ANTENNA REQUIREMENT

REQUIREMENT

Please refer to FCC part 15.203

An intentional radiator shall be designed to ensure that no antenna other than that furnished by the responsible party shall be used with the device. The use of a permanently attached antenna or of an antenna that uses a unique coupling to the intentional radiator shall be considered sufficient to comply with the provisions of this section. The manufacturer may design the unit so that a broken antenna can be replaced by the user, but the use of a standard antenna jack or electrical connector is prohibited.

Please refer to FCC part 15.407(a)

For an indoor access point operating in the band 5.15-5.25 GHz, the maximum conducted output power over the frequency band of operation shall not exceed 1 W provided the maximum antenna gain does not exceed 6 dBi. In addition, the maximum power spectral density shall not exceed 17 dBm in any 1 megahertz band. If transmitting antennas of directional gain greater than 6 dBi are used, both the maximum conducted output power and the maximum power spectral density shall be reduced by the amount in dB that the directional gain of the antenna exceeds 6 dBi.

DESCRIPTION

Pass

11. TEST DATA

11.1. APPENDIX A: EMISSION BANDWIDTH

11.1.1. Test Result

Test Mode	Antenna	Channel	26db EBW [MHz]	FL[MHz]	FH[MHz]	Verdict
11A-CDD	Ant1	5180	19.04	5170.28	5189.32	PASS
	Ant2	5180	18.84	5170.64	5189.48	PASS
	Ant3	5180	18.68	5170.76	5189.44	PASS
	Ant4	5180	18.52	5170.68	5189.20	PASS
	Ant1	5200	19.08	5190.48	5209.56	PASS
	Ant2	5200	19.64	5189.68	5209.32	PASS
	Ant3	5200	18.60	5190.76	5209.36	PASS
	Ant4	5200	19.12	5190.40	5209.52	PASS
	Ant1	5240	18.28	5230.84	5249.12	PASS
	Ant2	5240	18.36	5230.80	5249.16	PASS
	Ant3	5240	18.24	5230.88	5249.12	PASS
	Ant4	5240	18.40	5230.84	5249.24	PASS
	Ant1	5745	18.32	5735.80	5754.12	PASS
	Ant2	5745	18.44	5735.80	5754.24	PASS
	Ant3	5745	18.60	5735.72	5754.32	PASS
	Ant4	5745	18.24	5735.88	5754.12	PASS
	Ant1	5785	18.60	5775.68	5794.28	PASS
	Ant2	5785	18.32	5775.84	5794.16	PASS
	Ant3	5785	18.40	5775.80	5794.20	PASS
	Ant4	5785	18.44	5775.76	5794.20	PASS
11AX20-CDD	Ant1	5825	20.20	5814.28	5834.48	PASS
	Ant2	5825	19.40	5815.72	5835.12	PASS
	Ant3	5825	18.60	5815.60	5834.20	PASS
	Ant4	5825	19.36	5814.88	5834.24	PASS
	Ant1	5180	20.00	5169.96	5189.96	PASS
	Ant2	5180	19.88	5170.08	5189.96	PASS
	Ant3	5180	23.16	5170.04	5193.20	PASS
	Ant4	5180	20.32	5170.00	5190.32	PASS
	Ant1	5200	20.00	5190.04	5210.04	PASS
	Ant2	5200	19.92	5190.04	5209.96	PASS
	Ant3	5200	20.28	5190.00	5210.28	PASS
	Ant4	5200	20.04	5190.00	5210.04	PASS
	Ant1	5240	19.88	5230.04	5249.92	PASS
	Ant2	5240	19.96	5230.00	5249.96	PASS
	Ant3	5240	20.00	5230.00	5250.00	PASS
	Ant4	5240	19.92	5230.08	5250.00	PASS
	Ant1	5745	19.96	5735.04	5755.00	PASS
	Ant2	5745	20.00	5735.04	5755.04	PASS
	Ant3	5745	20.04	5735.04	5755.08	PASS
	Ant4	5745	19.96	5735.08	5755.04	PASS
Ant1	5785	20.00	5774.96	5794.96	PASS	
Ant2	5785	20.00	5775.00	5795.00	PASS	
Ant3	5785	19.88	5775.08	5794.96	PASS	
Ant4	5785	19.92	5775.04	5794.96	PASS	
11AX40-CDD	Ant1	5825	20.04	5814.96	5835.00	PASS
	Ant2	5825	21.36	5813.72	5835.08	PASS
	Ant3	5825	20.08	5814.96	5835.04	PASS
	Ant4	5825	20.12	5814.88	5835.00	PASS
	Ant1	5190	39.60	5170.24	5209.84	PASS
	Ant2	5190	39.60	5170.32	5209.92	PASS
	Ant3	5190	39.60	5170.24	5209.84	PASS
11AX40-CDD	Ant4	5190	39.60	5170.24	5209.84	PASS
	Ant1	5230	39.60	5210.24	5249.84	PASS
	Ant2	5230	39.68	5210.16	5249.84	PASS
	Ant3	5230	39.44	5210.32	5249.76	PASS

	Ant4	5230	39.68	5210.24	5249.92	PASS	
	Ant1	5755	39.68	5735.16	5774.84	PASS	
	Ant2	5755	39.68	5735.08	5774.76	PASS	
	Ant3	5755	39.68	5735.16	5774.84	PASS	
	Ant4	5755	39.68	5735.16	5774.84	PASS	
	Ant1	5795	39.60	5775.24	5814.84	PASS	
	Ant2	5795	39.68	5775.16	5814.84	PASS	
	Ant3	5795	39.76	5775.16	5814.92	PASS	
11AX80-CDD	Ant4	5795	39.68	5775.16	5814.84	PASS	
	Ant1	5210	80.64	5169.68	5250.32	PASS	
	Ant2	5210	80.48	5169.84	5250.32	PASS	
	Ant3	5210	80.48	5169.84	5250.32	PASS	
	Ant4	5210	80.32	5169.84	5250.16	PASS	
	Ant1	5775	80.48	5734.84	5815.32	PASS	
	Ant2	5775	80.64	5734.68	5815.32	PASS	
	Ant3	5775	80.32	5734.84	5815.16	PASS	
11BE20-CDD	Ant4	5775	80.48	5734.84	5815.32	PASS	
	Ant1	5180	19.88	5170.12	5190.00	PASS	
	Ant2	5180	19.92	5170.04	5189.96	PASS	
	Ant3	5180	19.96	5170.00	5189.96	PASS	
	Ant4	5180	19.92	5170.08	5190.00	PASS	
	Ant1	5200	19.80	5190.12	5209.92	PASS	
	Ant2	5200	19.72	5190.16	5209.88	PASS	
	Ant3	5200	19.72	5190.16	5209.88	PASS	
	Ant4	5200	19.80	5190.08	5209.88	PASS	
	Ant1	5240	20.12	5230.08	5250.20	PASS	
	Ant2	5240	19.92	5230.12	5250.04	PASS	
	Ant3	5240	19.88	5230.12	5250.00	PASS	
	Ant4	5240	19.88	5230.08	5249.96	PASS	
	Ant1	5745	19.92	5735.08	5755.00	PASS	
	Ant2	5745	20.00	5735.00	5755.00	PASS	
	Ant3	5745	19.96	5735.08	5755.04	PASS	
	Ant4	5745	19.96	5735.04	5755.00	PASS	
	Ant1	5785	19.88	5775.08	5794.96	PASS	
	Ant2	5785	19.92	5775.08	5795.00	PASS	
	Ant3	5785	19.84	5775.12	5794.96	PASS	
	Ant4	5785	19.92	5775.08	5795.00	PASS	
	Ant1	5825	19.76	5815.16	5834.92	PASS	
	Ant2	5825	19.84	5815.12	5834.96	PASS	
	Ant3	5825	19.84	5815.08	5834.92	PASS	
Ant4	5825	19.84	5815.12	5834.96	PASS		
11BE40-CDD	Ant1	5190	39.68	5170.16	5209.84	PASS	
	Ant2	5190	39.84	5170.16	5210.00	PASS	
	Ant3	5190	39.92	5170.00	5209.92	PASS	
	Ant4	5190	39.68	5170.16	5209.84	PASS	
	Ant1	5230	39.68	5210.24	5249.92	PASS	
	Ant2	5230	39.60	5210.16	5249.76	PASS	
	Ant3	5230	39.60	5210.24	5249.84	PASS	
	Ant4	5230	39.60	5210.24	5249.84	PASS	
	Ant1	5755	39.84	5735.00	5774.84	PASS	
	Ant2	5755	40.00	5735.08	5775.08	PASS	
	Ant3	5755	39.76	5735.16	5774.92	PASS	
	Ant4	5755	39.68	5735.16	5774.84	PASS	
	Ant1	5795	39.52	5775.32	5814.84	PASS	
	Ant2	5795	44.56	5775.08	5819.64	PASS	
	Ant3	5795	39.76	5775.24	5815.00	PASS	
	Ant4	5795	40.00	5774.92	5814.92	PASS	
	11BE80-CDD	Ant1	5210	80.80	5169.84	5250.64	PASS
		Ant2	5210	82.08	5169.68	5251.76	PASS
		Ant3	5210	80.96	5169.68	5250.64	PASS
		Ant4	5210	80.64	5169.84	5250.48	PASS
Ant1		5775	81.44	5734.84	5816.28	PASS	
Ant2		5775	88.80	5734.84	5823.64	PASS	

	Ant3	5775	81.44	5734.84	5816.28	PASS
	Ant4	5775	80.80	5734.84	5815.64	PASS

11.1.2. Test Graphs

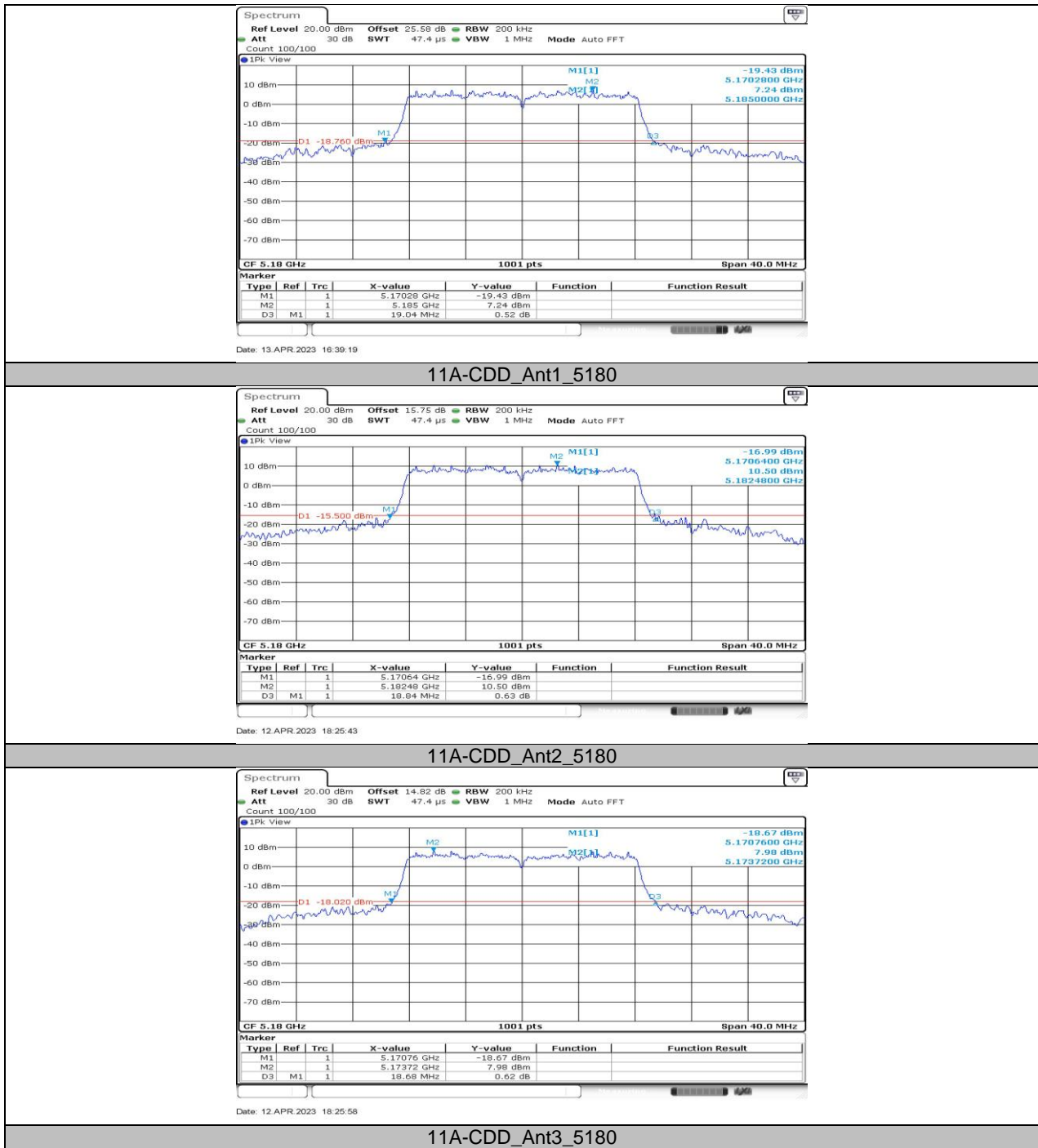

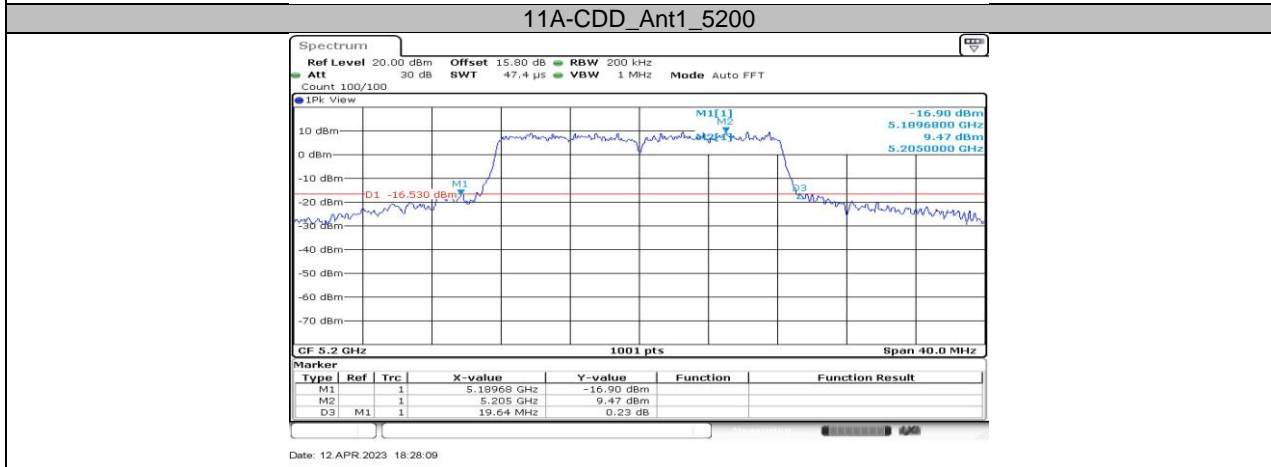
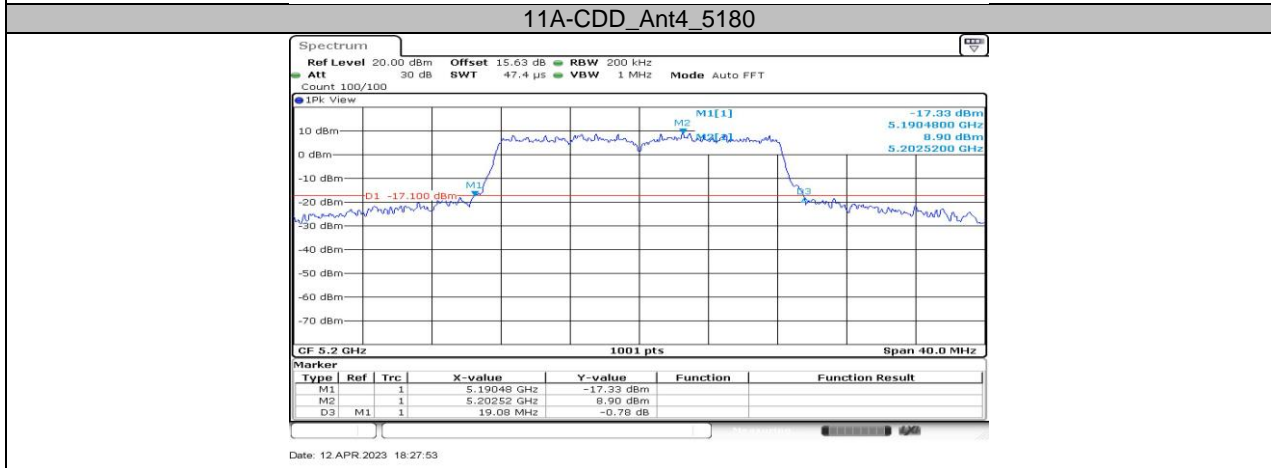
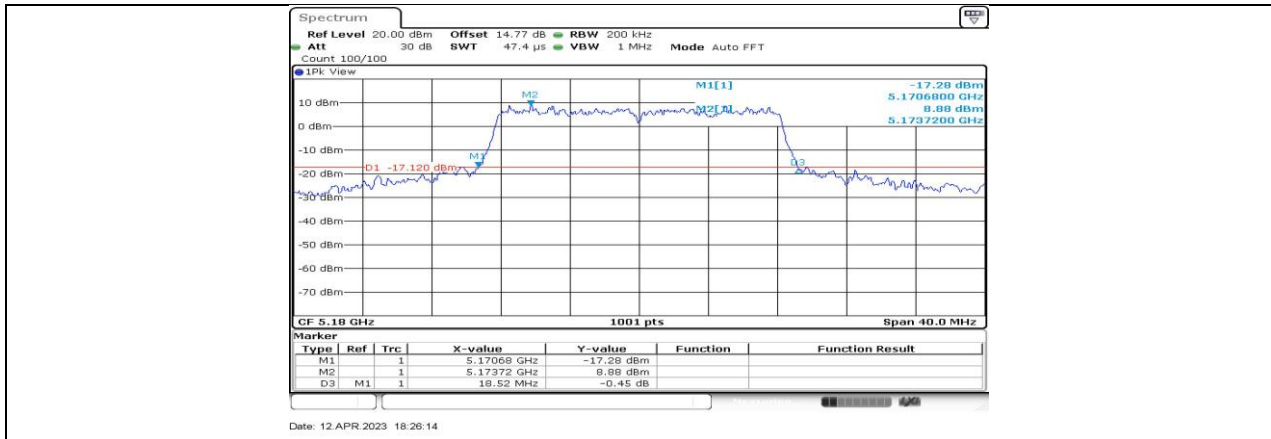

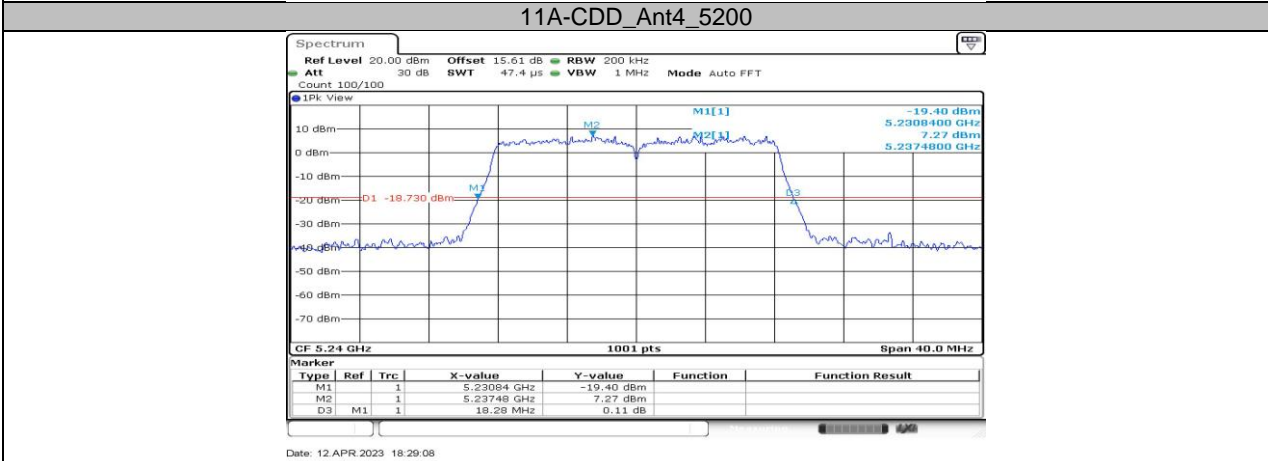
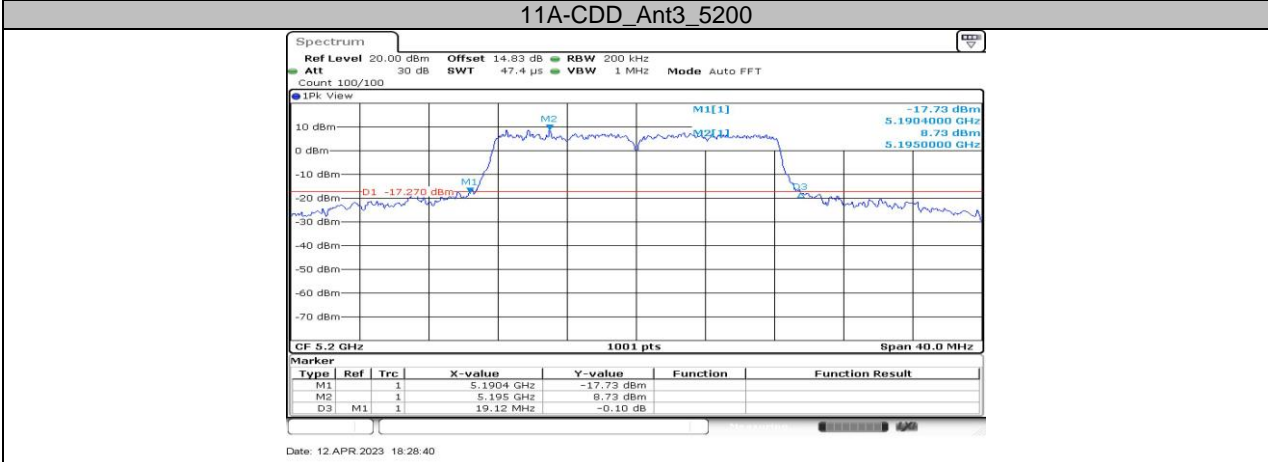
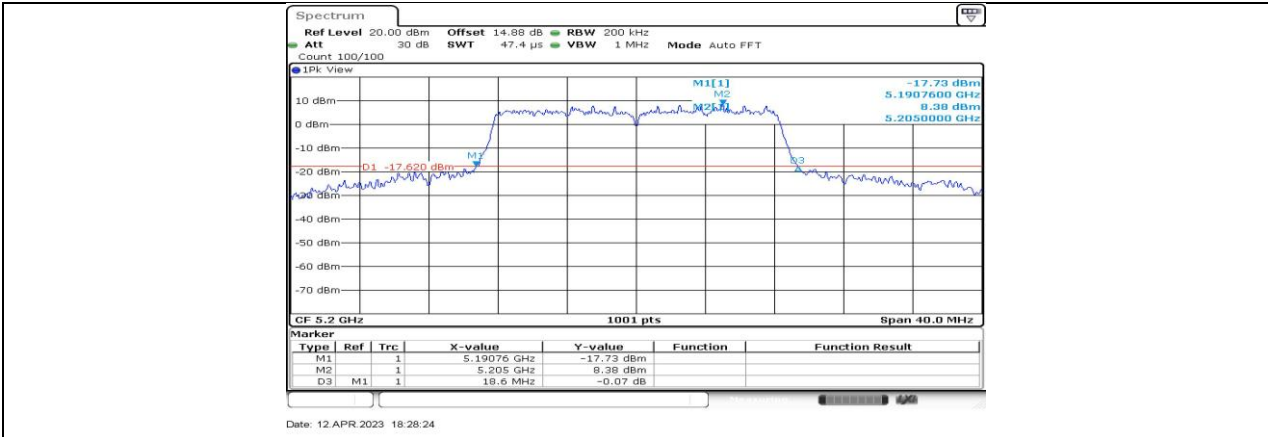

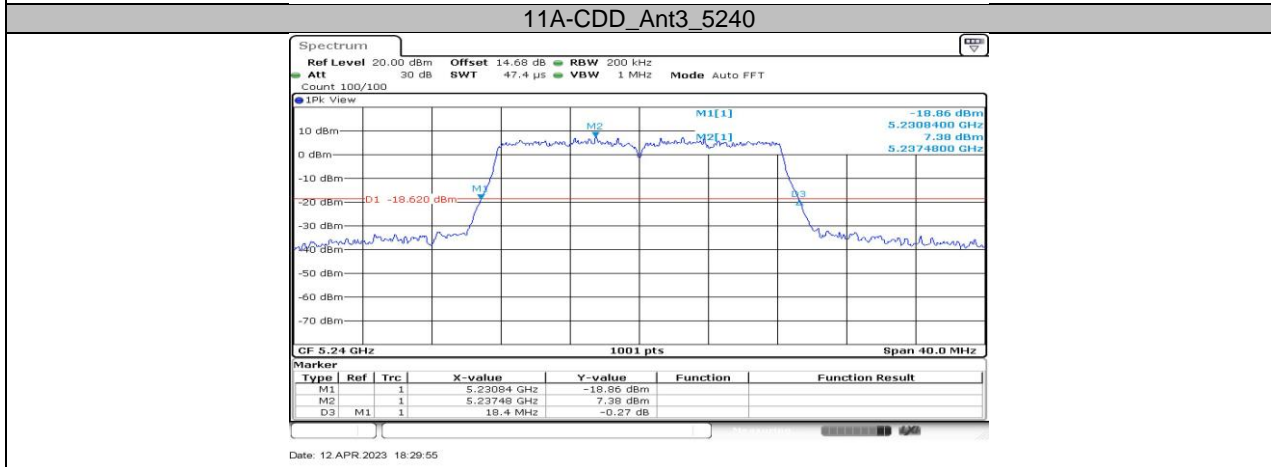
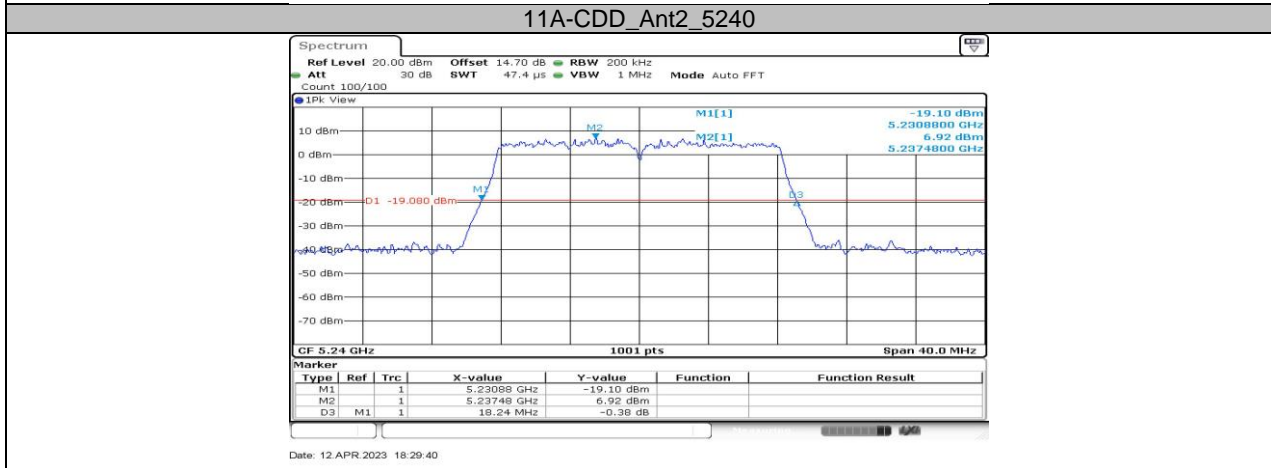
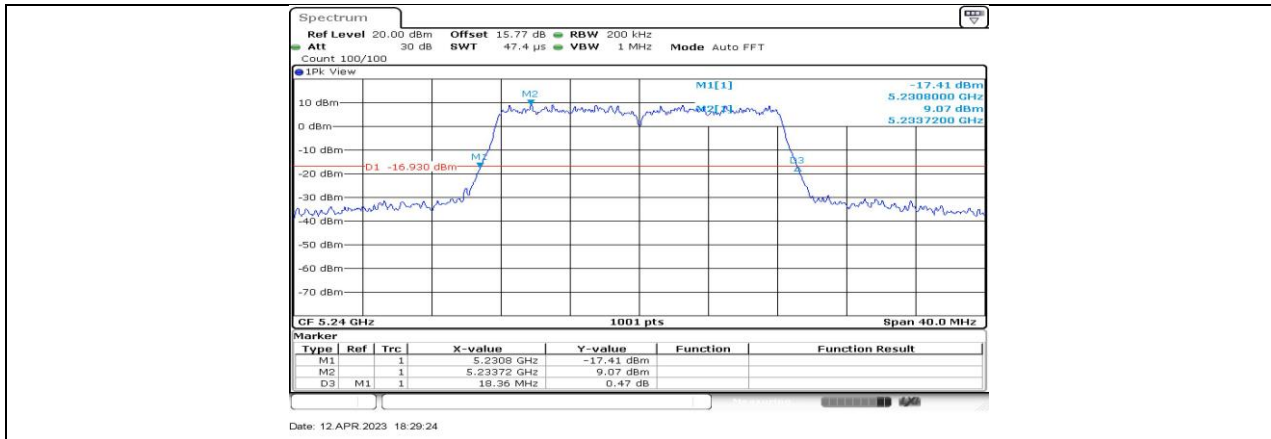

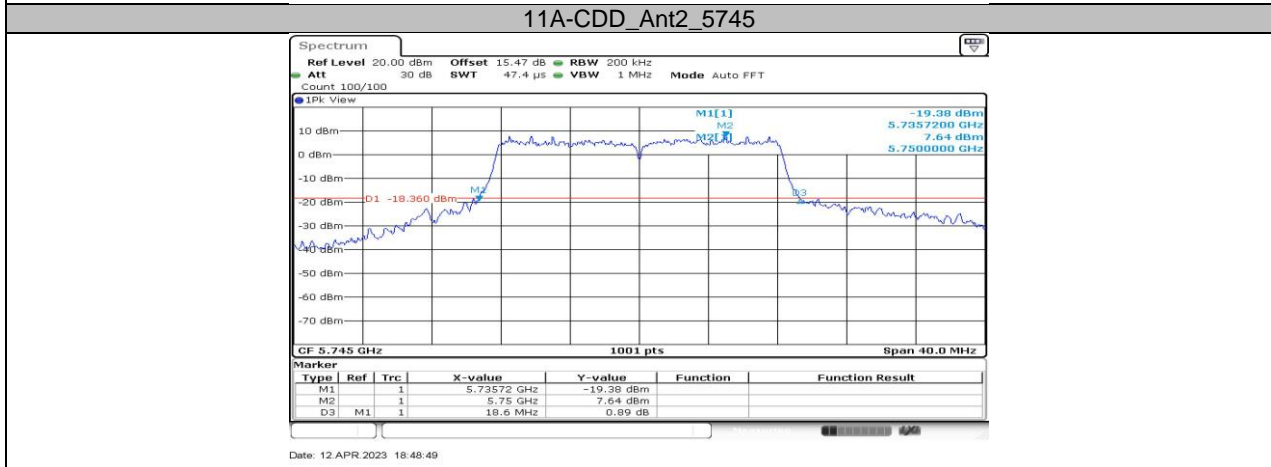
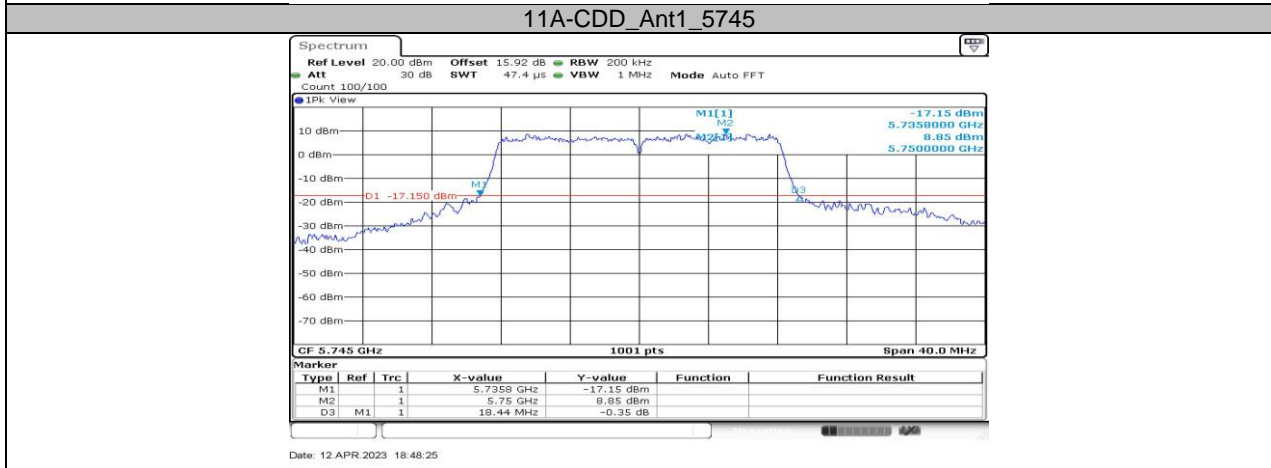
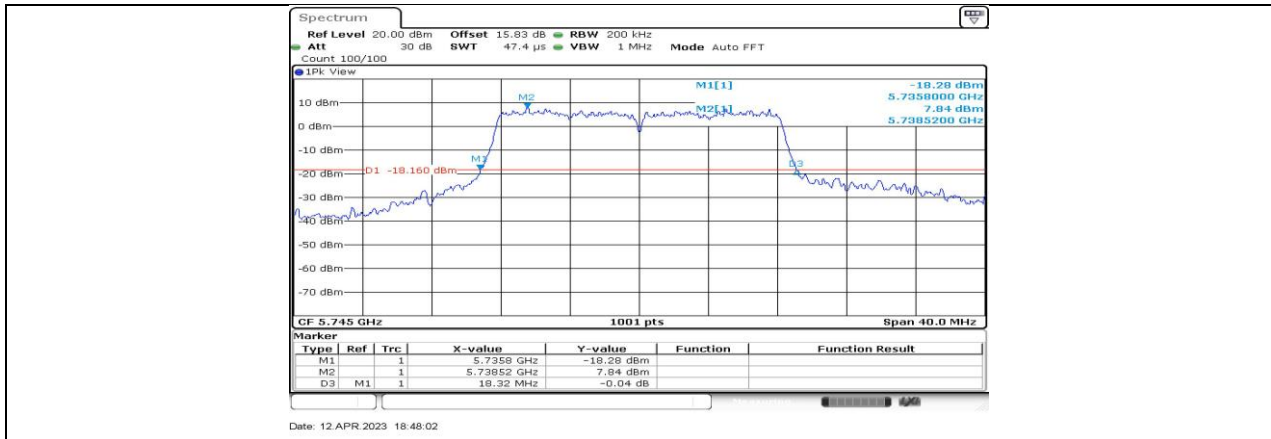

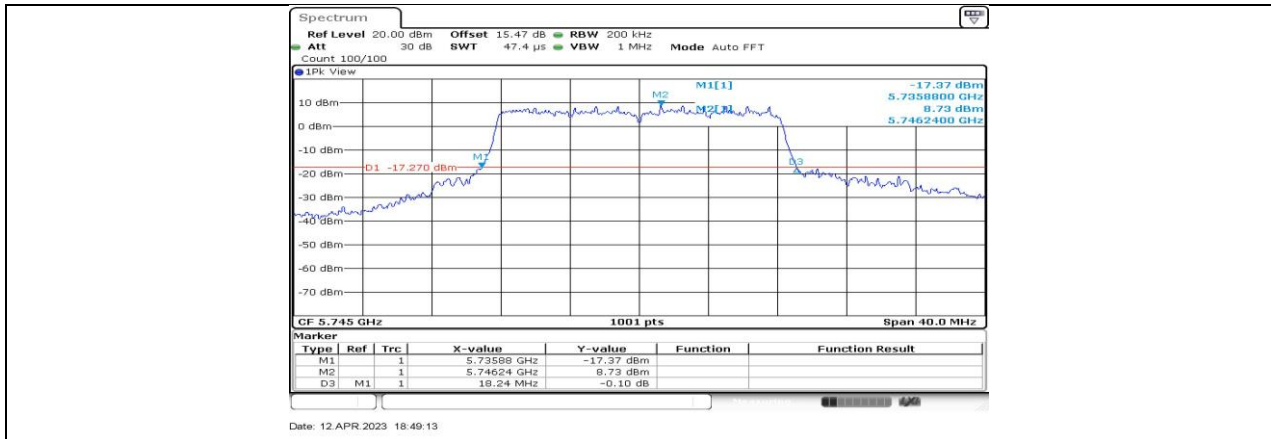

11A-CDD_Ant4_5745

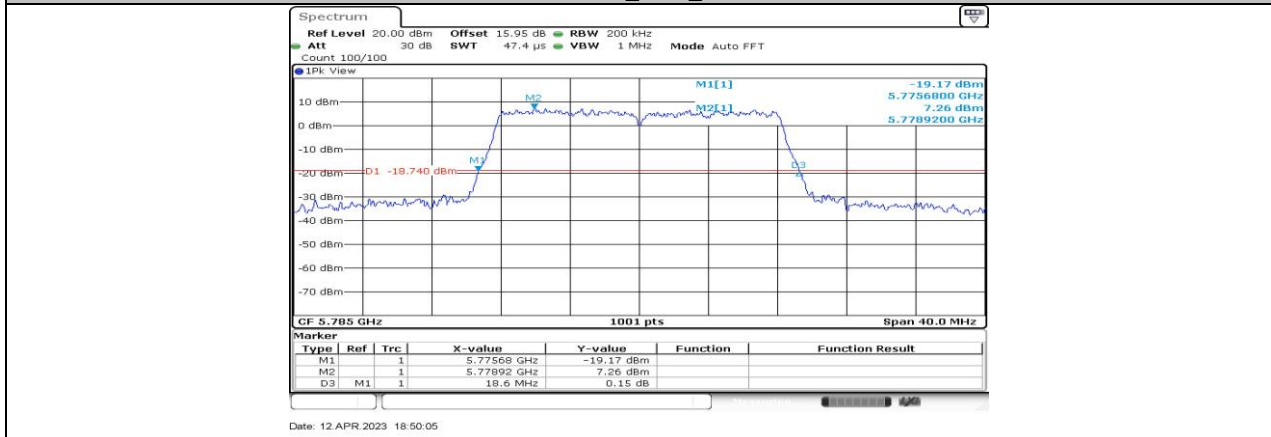

11A-CDD_Ant1_5785

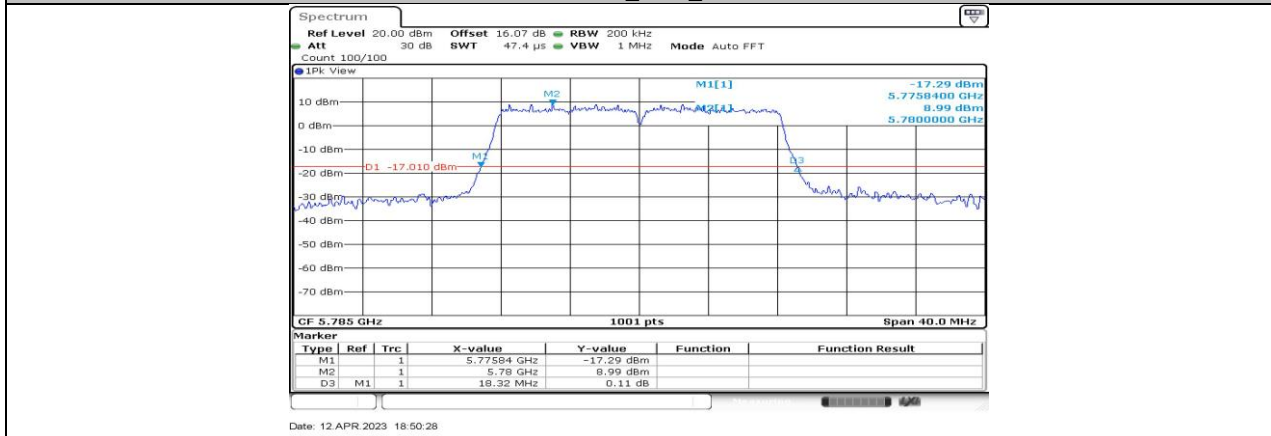

11A-CDD_Ant2_5785

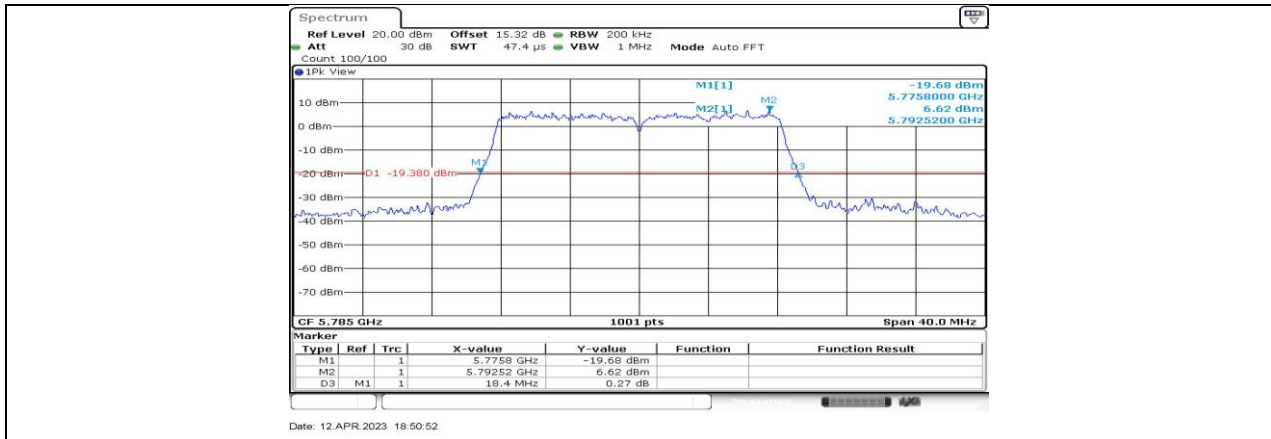

11A-CDD_Ant3_5785

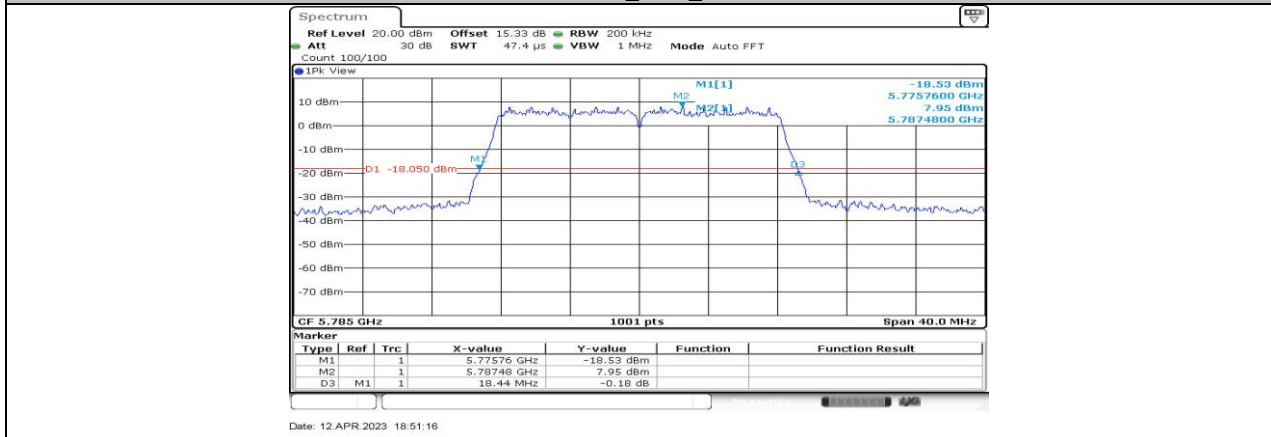

11A-CDD_Ant4_5785

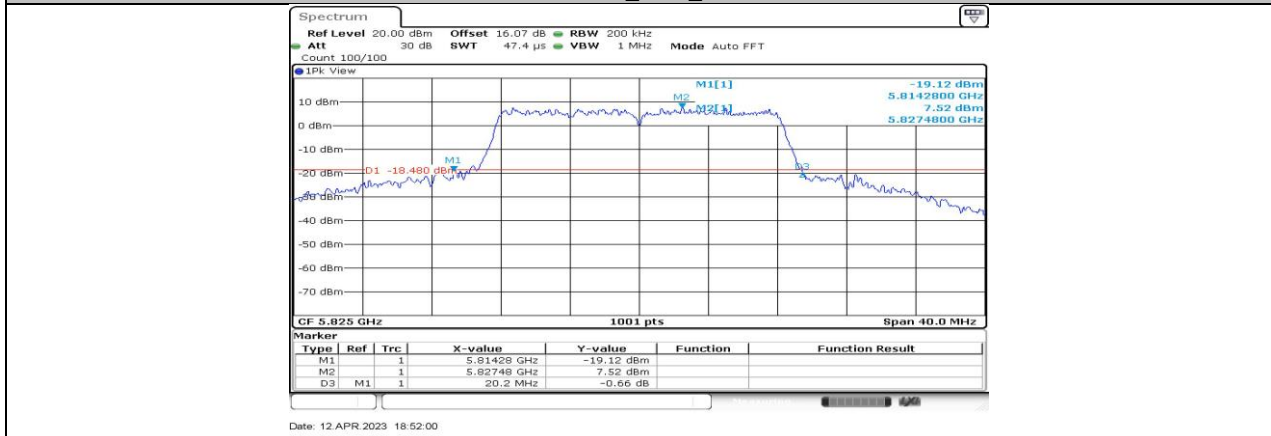

11A-CDD_Ant1_5825

