



**CFR 47 FCC PART 15 SUBPART C
ISED RSS-247 ISSUE 2**

TEST REPORT

For

BE19000 Tri-Band Wi-Fi 7 Router

MODEL NUMBER: Archer BE800

REPORT NUMBER: 4790739578-1-RF-1

ISSUE DATE: March 17, 2023

FCC ID: 2AXJ4BE800

IC: 26583-BE800

Prepared for

TP-Link Corporation Limited

**Room 901, 9/F. , New East Ocean Centre, 9 Science Museum Road, Tsim Sha Tsui,
Kowloon, Hong Kong**

Prepared by

UL Verification Services (Guangzhou) Co., Ltd, Song Shan Lake Branch

**Building 10, Innovation Technology Park, No. 1, Li Bin Road, Song Shan Lake Hi-
Tech Development Zone Dongguan, 523808, People's Republic of China**

Tel: +86 769 22038881

Fax: +86 769 33244054

Website: www.ul.com

The results reported herein have been performed in accordance with the laboratory's terms of accreditation. This report shall not be reproduced except in full without the written approval of the Laboratory. The results in this report apply to the test sample(s) mentioned above at the time of the testing period only and are not to be used to indicate applicability to other similar products.



Revision History

<u>Rev.</u>	<u>Issue Date</u>	<u>Revisions</u>	<u>Revised By</u>
<u>V0</u>	<u>March 17, 2023</u>	<u>Initial Issue</u>	<u></u>



Summary of Test Results

Test Item	Clause	Limit/Requirement	Result
Antenna Requirement	N/A	FCC Part 15.203/15.247 (c) RSS-GEN Clause 6.8	Pass
AC Power Line Conducted Emission	ANSI C63.10-2013, Clause 6.2	FCC Part 15.207 RSS-GEN Clause 8.8	Pass
Conducted Output Power	ANSI C63.10-2013, Clause 11.9.1.3	FCC Part 15.247 (b)(3) RSS-247 Clause 5.4 (d)	Pass
6dB Bandwidth and 99% Occupied Bandwidth	ANSI C63.10-2013, Clause 11.8.1	FCC Part 15.247 (a)(2) RSS-247 Clause 5.2 (a) ISED RSS-Gen Clause 6.7	Pass
Power Spectral Density	ANSI C63.10-2013, Clause 11.10.2	FCC Part 15.247 (e) RSS-247 Clause 5.2 (b)	Pass
Conducted Band edge and spurious emission	ANSI C63.10-2013, Clause 11.11	FCC Part 15.247(d) RSS-247 Clause 5.5	Pass
Radiated Band edge and Spurious Emission	ANSI C63.10-2013, Clause 11.12 & Clause 11.13	FCC Part 15.247 (d) FCC Part 15.205/15.209 RSS-247 Clause 5.5 RSS-GEN Clause 8.9	Pass
Duty Cycle	ANSI C63.10-2013, Clause 11.6	None; for reporting purposes only.	Pass

*This test report is only published to and used by the applicant, and it is not for evidence purpose in China.

*The measurement result for the sample received is <Pass> according to <CFR 47 FCC PART 15 SUBPART C><ISED RSS-247 ISSUE 2> when <Accuracy Method> decision rule is applied.

CONTENTS

1. ATTESTATION OF TEST RESULTS	6
2. TEST METHODOLOGY	7
3. FACILITIES AND ACCREDITATION	7
4. CALIBRATION AND UNCERTAINTY	8
4.1. <i>MEASURING INSTRUMENT CALIBRATION</i>	<i>8</i>
4.2. <i>MEASUREMENT UNCERTAINTY</i>	<i>8</i>
5. EQUIPMENT UNDER TEST	9
5.1. <i>DESCRIPTION OF EUT</i>	<i>9</i>
5.2. <i>CHANNEL LIST</i>	<i>9</i>
5.3. <i>MAXIMUM EIRP</i>	<i>9</i>
5.4. <i>TEST CHANNEL CONFIGURATION</i>	<i>10</i>
5.5. <i>THE WORSE CASE POWER SETTING PARAMETER</i>	<i>10</i>
5.6. <i>WORST-CASE CONFIGURATIONS</i>	<i>11</i>
5.7. <i>DESCRIPTION OF AVAILABLE ANTENNAS</i>	<i>12</i>
5.8. <i>SUPPORT UNITS FOR SYSTEM TEST</i>	<i>13</i>
6. MEASURING EQUIPMENT AND SOFTWARE USED	14
7. ANTENNA PORT TEST RESULTS	17
7.1. <i>CONDUCTED OUTPUT POWER</i>	<i>17</i>
7.2. <i>6DB BANDWIDTH AND 99% OCCUPIED BANDWIDTH</i>	<i>18</i>
7.3. <i>POWER SPECTRAL DENSITY</i>	<i>20</i>
7.4. <i>CONDUCTED BAND EDGE AND SPURIOUS EMISSION</i>	<i>22</i>
7.5. <i>DUTY CYCLE</i>	<i>24</i>
8. RADIATED TEST RESULTS	25
8.1. <i>RESTRICTED BANDEDGE</i>	<i>33</i>
8.2. <i>SPURIOUS EMISSIONS(1 GHZ~3 GHZ)</i>	<i>94</i>
8.3. <i>SPURIOUS EMISSIONS(3 GHZ~18 GHZ)</i>	<i>104</i>
8.4. <i>SPURIOUS EMISSIONS(9 KHZ~30 MHZ)</i>	<i>164</i>
8.5. <i>SPURIOUS EMISSIONS(18 GHZ~26 GHZ)</i>	<i>167</i>
8.6. <i>SPURIOUS EMISSIONS(30 MHZ~1 GHZ)</i>	<i>169</i>
9. ANTENNA REQUIREMENT	171
10. AC POWER LINE CONDUCTED EMISSION	172
11. TEST DATA	176



11.1.	<i>APPENDIX A: DTS BANDWIDTH</i>	176
11.1.1.	Test Result	176
11.1.2.	Test Graphs	179
11.2.	<i>APPENDIX B: OCCUPIED CHANNEL BANDWIDTH</i>	219
11.2.1.	Test Result	219
11.2.2.	Test Graphs	222
11.3.	<i>APPENDIX C: MAXIMUM CONDUCTED OUTPUT POWER</i>	262
11.3.1.	Test Result without TX beamforming	262
11.3.2.	Test Result with TX beamforming	265
11.4.	<i>APPENDIX D: MAXIMUM POWER SPECTRAL DENSITY</i>	268
11.4.1.	Test Result	268
11.4.2.	Test Graphs	271
11.5.	<i>APPENDIX E: BAND EDGE MEASUREMENTS</i>	311
11.5.1.	Test Result	311
11.5.2.	Test Graphs	313
11.6.	<i>APPENDIX F: CONDUCTED SPURIOUS EMISSION</i>	345
11.6.1.	Test Result	345
11.6.2.	Test Graphs	351
11.7.	<i>APPENDIX G: DUTY CYCLE</i>	470
11.7.1.	Test Result	470
11.7.2.	Test Graphs	471



1. ATTESTATION OF TEST RESULTS

Applicant Information

Company Name: TP-Link Corporation Limited
Address: Room 901, 9/F. , New East Ocean Centre, 9 Science Museum Road, Tsim Sha Tsui, Kowloon, Hong Kong

Manufacturer Information

Company Name: TP-Link Corporation Limited
Address: Room 901, 9/F. , New East Ocean Centre, 9 Science Museum Road, Tsim Sha Tsui, Kowloon, Hong Kong

EUT Information

EUT Name: BE19000 Tri-Band Wi-Fi 7 Router
Model: Archer BE800
Brand: tp-link
Sample Received Date: February 10, 2023
Sample Status: Normal
Sample ID: 5776037
Date of Tested: February 10, 2023 to March 17, 2023

APPLICABLE STANDARDS	
STANDARD	TEST RESULTS
CFR 47 FCC PART 15 SUBPART C ISED RSS-247 ISSUE 2	Pass

Prepared By:

Kebo Zhang
Senior Project Engineer

Checked By:

Denny Huang
Senior Project Engineer

Approved By:

Stephen Guo
Operations Manager



2. TEST METHODOLOGY

All tests were performed in accordance with the standard CFR 47 FCC PART 15 SUBPART C ISED RSS-247 ISSUE 2, KDB 558074 D01 15.247 Meas Guidance v05r02, KDB 414788 D01 Radiated Test Site v01r01, KDB 662911 D01 Multiple Transmitter Output v02r01, CFR 47 FCC Part 2, CFR 47 FCC Part 15, ANSI C63.10-2013, ISED RSS-247 Issue 2 and ISED RSS-GEN Issue 5.

3. FACILITIES AND ACCREDITATION

Accreditation Certificate	<p>A2LA (Certificate No.: 4102.01) UL Verification Services (Guangzhou) Co., Ltd. Song Shan Lake Branch. has been assessed and proved to be in compliance with A2LA.</p> <p>FCC (FCC Designation No.: CN1187) UL Verification Services (Guangzhou) Co., Ltd. Song Shan Lake Branch. Has been recognized to perform compliance testing on equipment subject to the Commission's Declaration of Conformity (DoC) and Certification rules</p> <p>ISED (Company No.: 21320) UL Verification Services (Guangzhou) Co., Ltd. Song Shan Lake Branch. has been registered and fully described in a report filed with ISED. The Company Number is 21320 and the test lab Conformity Assessment Body Identifier (CABID) is CN0046.</p> <p>VCCI (Registration No.: G-20019, R-20004, C-20012 and T-20011) UL Verification Services (Guangzhou) Co., Ltd. Song Shan Lake Branch. has been assessed and proved to be in compliance with VCCI, the Membership No. is 3793. Facility Name: Chamber D, the VCCI registration No. is G-20019 and R-20004 Shielding Room B , the VCCI registration No. is C-20012 and T-20011</p>
---------------------------	---

Note1:

All tests measurement facilities use to collect the measurement data are located at Building 10, Innovation Technology Park, No. 1, Li Bin Road, Song Shan Lake Hi-Tech Development Zone Dongguan, 523808, People's Republic of China.

Note2:

The test anechoic chamber in UL Verification Services (Guangzhou) Co., Ltd. Song Shan Lake Branch had been calibrated and compared to the open field sites and the test anechoic chamber is shown to be equivalent to or worst case from the open field site.

Note3:

For below 30 MHz, lab had performed measurements at test anechoic chamber and comparing to measurements obtained on an open field site. And these measurements below 30 MHz had been correlated to measurements performed on an OFS.



4. CALIBRATION AND UNCERTAINTY

4.1. MEASURING INSTRUMENT CALIBRATION

The measuring equipment utilized to perform the tests documented in this report has been calibrated in accordance with the manufacturer's recommendations and is traceable to recognized national standards.

4.2. MEASUREMENT UNCERTAINTY

Where relevant, the following measurement uncertainty levels have been estimated for tests performed on the apparatus:

Test Item	Uncertainty
Conduction emission	3.62 dB
Radiated Emission (Included Fundamental Emission) (9 kHz ~ 30 MHz)	2.2 dB
Radiated Emission (Included Fundamental Emission) (30 MHz ~ 1 GHz)	4.00 dB
Radiated Emission (Included Fundamental Emission) (1 GHz to 26 GHz)	5.78 dB (1 GHz ~ 18 GHz)
	5.23 dB (18 GHz ~ 26 GHz)
Duty Cycle	±0.028%
DTS and 99% Occupied Bandwidth	±0.0196%
Maximum Conducted Output Power	±0.686 dB
Maximum Power Spectral Density Level	±0.743 dB
Conducted Band-edge Compliance	±1.328 dB
Conducted Unwanted Emissions In Non-restricted Frequency Bands	±0.746 dB (9 kHz ~ 1 GHz)
	±1.328dB (1 GHz ~ 26 GHz)
Note: This uncertainty represents an expanded uncertainty expressed at approximately the 95% confidence level using a coverage factor of k=2.	

5. EQUIPMENT UNDER TEST

5.1. DESCRIPTION OF EUT

EUT Name/PMN:	BE19000 Tri-Band Wi-Fi 7 Router
Model/HVIN:	Archer BE800
Frequency Range:	2412 MHz to 2462 MHz
Type of Modulation:	IEEE 802.11b: DSSS(CCK, DQPSK, DBPSK) IEEE 802.11g/n: OFDM(64-QAM, 16-QAM, QPSK, BPSK) IEEE 802.11ax: OFDMA(1024-QAM,64-QAM, 16-QAM, QPSK, BPSK) IEEE 802.11be: OFDMA(4096-QAM, 1024-QAM,64-QAM, 16-QAM, QPSK, BPSK)
Radio Technology:	IEEE802.11b/g/n HT20/n HT40/ax HE20/ax HE40/ be EHT20/be EHT40
FVIN:	V1.0
Normal Test Voltage:	DC 12 V via adapter

5.2. CHANNEL LIST

Channel List for 802.11b/g/n/ax/be (20 MHz)							
Channel	Frequency (MHz)	Channel	Frequency (MHz)	Channel	Frequency (MHz)	Channel	Frequency (MHz)
1	2412	4	2427	7	2442	10	2457
2	2417	5	2432	8	2447	11	2462
3	2422	6	2437	9	2452	/	/

Channel List for 802.11n/ax/be (40 MHz)							
Channel	Frequency (MHz)	Channel	Frequency (MHz)	Channel	Frequency (MHz)	Channel	Frequency (MHz)
3	2422	5	2432	7	2442	9	2452
4	2427	6	2437	8	2447	/	/

5.3. MAXIMUM EIRP

IEEE Std. 802.11	Frequency (MHz)	Channel Number	Maximum Conducted AVG Output Power (dBm)	Maximum AVG EIRP (dBm)
b	2412 ~ 2462	1-11[11]	29.45	31.45
g	2412 ~ 2462	1-11[11]	28.33	30.33
ax HE20	2412 ~ 2462	1-11[11]	27.34	29.34
ax HE40	2422 ~ 2452	3-9[7]	26.42	28.42
be EHT20	2412 ~ 2462	1-11[11]	27.32	29.32
be EHT40	2422 ~ 2452	3-9[7]	27.35	29.35



5.4. TEST CHANNEL CONFIGURATION

IEEE Std. 802.11	Test Channel Number	Frequency
b	CH 1, CH2, CH 6, CH10, CH 11	2412, 2417, 2437, 2457, 2462
g	CH 1, CH2, CH 6, CH10, CH 11	2412, 2417, 2437, 2457, 2462
ax HE20	CH 1, CH2, CH 6, CH10, CH 11	2412, 2417, 2437, 2457, 2462
ax HE40	CH 3, CH4, CH 6, CH8, CH 9	2422, 2427, 2437, 2447, 2452
be EHT20	CH 1, CH2, CH 6, CH10, CH 11	2412, 2417, 2437, 2457, 2462
be EHT40	CH 3, CH4, CH 6, CH8, CH 9	2422, 2427, 2437, 2447, 2452

5.5. THE WORSE CASE POWER SETTING PARAMETER

The Worst Case Power Setting Parameter under 2400 ~ 2483.5 MHz Band											
Test Software		QSPR									
Modulation Mode	Transmit Antenna Number	Test Channel									
		NCB: 20 MHz					NCB: 40 MHz				
		CH 1	CH 2	CH 6	CH 10	CH 11	CH 3	CH 4	CH 6	CH 8	CH 9
802.11b	1~4	22	22	23	20	20	/				
802.11g	1~4	19	19	22	19	18					
802.11n HT20	1~4	Cover by 802.11ax HE20									
802.11n HT40	1~4	/					Cover by 802.11ax HE40				
802.11n VHT20	1~4	Cover by 802.11ax HE20					/				
802.11n VHT40	1~4	/					Cover by 802.11ax HE40				
802.11ax HE20	1~4	19	19	21	18	18	/				
802.11ax HE40	1~4	/					20	20	20	19	19
802.11be EHT20	1~4	19	19	21	18	18	/				
802.11be EHT40	1~4	/					20	20	21	19	19

5.6. WORST-CASE CONFIGURATIONS

The EUT was tested in the following configuration(s):

Controlled in test mode using a software application on the EUT supplied by customer. The application was used to enable a continuous transmission and to select the mode, test channels, bandwidth, data rates as required.

Test channels referring to section 5.4.

Maximum power setting referring to section 5.5.

Worst-case data rates as provided by the client were:

802.11b CDD mode: 1 Mbps
802.11g CDD mode: 6 Mbps
802.11n HT20 CDD mode: MCS0
802.11n HT40 CDD mode: MCS0
802.11n VHT20 CDD mode: MCS0
802.11n VHT40 CDD mode: MCS0
802.11ax HE20 CDD mode: MCS0
802.11ax HE40 CDD mode: MCS0
802.11be EHT20 CDD mode: MCS0
802.11be EHT40 CDD mode: MCS0

All modes support CDD mode.

All modes support TX beamforming mode except 802.11b and 802.11g.

802.11n HT20/HT40/VHT20/VHT40 and 802.11ax HE20/HE40 were performed on the worst case (802.11ax HE20/HE40) mode and only the worst data was recorded in this report.

The EUT has 8 separate antennas which correspond to 8 separate antenna ports. Core 1, Core 2, Core 3 and Core 4 correspond to antenna 1, antenna 2, antenna 3 and antenna 4 respectively and they support WLAN 2.4G and RLAN 5G. Core 5, Core 6, Core 7 and Core 8 correspond to antenna 5, antenna 6, antenna 7 and antenna 8 respectively and they support RLAN 6G, but it's not check in this device, and they have been disabled by software.

The measured additional path loss was included in any path loss calculations for all RF cable used during tested.

5.7. DESCRIPTION OF AVAILABLE ANTENNAS

Antenna	Frequency (MHz)	Antenna Type	MAX Antenna Gain (dBi)
1	2412-2462	Dipole Antenna	2
2	2412-2462	Dipole Antenna	2
3	2412-2462	Dipole Antenna	2
4	2412-2462	Dipole Antenna	2

The EUT support Cyclic Shift Diversity(CDD) mode.

MIMO output power port and MIMO PSD port summing were performed in accordance with KDB 662911 D01. For the CDD results the Directional Gain was calculated in accordance with the following method.

For output power measurements:

Directional gain= $G_{ANT} + \text{Array Gain} = 2 \text{ dBi}$

G_{ANT} : equal to the gain of the antenna having the highest gain

Array Gain = 0 dB (i.e., no array gain) for $N_{ANT} \leq 4$

For power spectral density (PSD) measurements:

Directional gain= $G_{ANT} + \text{Array Gain} = 8.02 \text{ dBi}$

Array Gain = $10 \log(N_{ANT}/N_{SS}) \text{ dB}$.

N_{ANT} : number of transmit antennas

N_{SS} : number of spatial streams, The worst case directional gain will occur when $N_{SS} = 1$

The EUT also support TX Beamforming mode.

Beamforming gain= $10 \log(N_{ANT}/N_{SS}) = 6 \text{ dBi}$

Test Mode	Transmit and Receive Mode	Description
IEEE 802.11b	<input checked="" type="checkbox"/> 4TX, 4RX	ANT 1, ANT 2, ANT 3 and ANT 4 can be used as transmitting/receiving antenna.
IEEE 802.11g	<input checked="" type="checkbox"/> 4TX, 4RX	ANT 1, ANT 2, ANT 3 and ANT 4 can be used as transmitting/receiving antenna.
IEEE 802.11n HT20	<input checked="" type="checkbox"/> 4TX, 4RX	ANT 1, ANT 2, ANT 3 and ANT 4 can be used as transmitting/receiving antenna.
IEEE 802.11n HT40	<input checked="" type="checkbox"/> 4TX, 4RX	ANT 1, ANT 2, ANT 3 and ANT 4 can be used as transmitting/receiving antenna.
IEEE 802.11n VHT20	<input checked="" type="checkbox"/> 4TX, 4RX	ANT 1, ANT 2, ANT 3 and ANT 4 can be used as transmitting/receiving antenna.
IEEE 802.11n VHT40	<input checked="" type="checkbox"/> 4TX, 4RX	ANT 1, ANT 2, ANT 3 and ANT 4 can be used as transmitting/receiving antenna.
IEEE 802.11ax HE20	<input checked="" type="checkbox"/> 4TX, 4RX	ANT 1, ANT 2, ANT 3 and ANT 4 can be used as transmitting/receiving antenna.
IEEE 802.11ax HE40	<input checked="" type="checkbox"/> 4TX, 4RX	ANT 1, ANT 2, ANT 3 and ANT 4 can be used as transmitting/receiving antenna.
IEEE 802.11be EHT20	<input checked="" type="checkbox"/> 4TX, 4RX	ANT 1, ANT 2, ANT 3 and ANT 4 can be used as transmitting/receiving antenna.
IEEE 802.11be EHT40	<input checked="" type="checkbox"/> 4TX, 4RX	ANT 1, ANT 2, ANT 3 and ANT 4 can be used as transmitting/receiving antenna.

Note: The value of the antenna gain was declared by customer.

5.8. SUPPORT UNITS FOR SYSTEM TEST

SUPPORT EQUIPMENT

Item	Equipment	Brand Name	Model Name	Remarks
1	Laptop	ThinkPad	X230i	/

I/O CABLES

Cable No	Port	Connector Type	Cable Type	Cable Length(m)	Remarks
1	USB	USB	Unshielded	1.0 m	/
2	LAN1	RJ45	Unshielded	1.0 m	/
3	LAN2	RJ45	Unshielded	1.0 m	/
4	LAN3	RJ45	Unshielded	1.0 m	/
5	LAN4	RJ45	Unshielded	1.0 m	/

ACCESSORIES

Item	Accessory	Brand Name	Model Name	Description
1	SWITCHING POWER SUPPLY	tp-link	S065PQ1200500	Input: AC 100-240 V, 50 / 60 Hz, 1.8 A Output: DC 12.0 V, 5.0 A, 60.0 W

TEST SETUP

The EUT can work in engineering mode with a software through a laptop.

SETUP DIAGRAM FOR TESTS

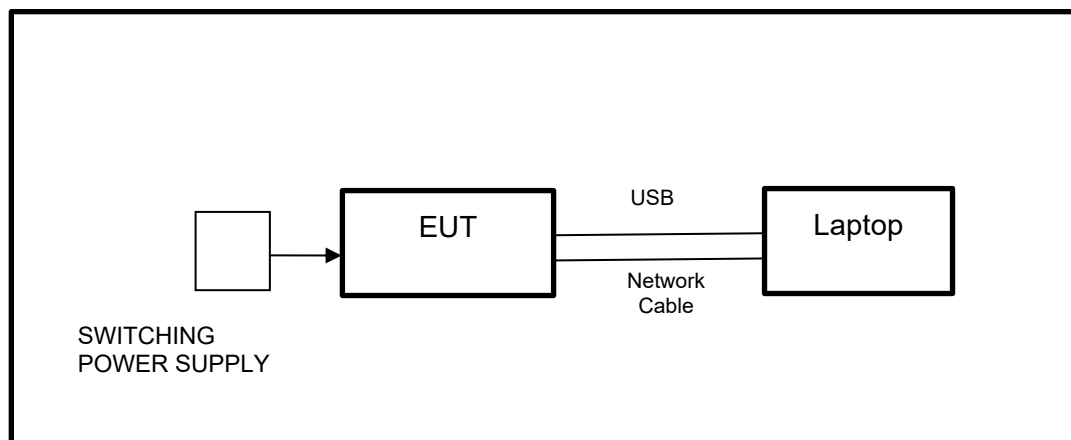

**6. MEASURING EQUIPMENT AND SOFTWARE USED**

R&S TS 8997 Test System					
Equipment	Manufacturer	Model No.	Serial No.	Last Cal.	Due. Date
Power sensor, Power Meter	R&S	OSP120	100921	Apr.02,2022	Apr.01,2023
Vector Signal Generator	R&S	SMBV100A	261637	Oct.17, 2022	Oct.16, 2023
Signal Generator	R&S	SMB100A	178553	Oct.17, 2022	Oct.16, 2023
Signal Analyzer	R&S	FSV40	101118	Oct.17, 2022	Oct.16, 2023
Software					
Description	Manufacturer	Name		Version	
For R&S TS 8997 Test System	Rohde & Schwarz	EMC 32		10.60.10	
Tonsend RF Test System					
Equipment	Manufacturer	Model No.	Serial No.	Last Cal.	Due. Date
Wideband Radio Communication Tester	R&S	CMW500	155523	Oct.17, 2022	Oct.16, 2023
Wireless Connectivity Tester	R&S	CMW270	1201.0002N75-102	Sep.28, 2022	Sep.27, 2023
PXA Signal Analyzer	Keysight	N9030A	MY55410512	Oct.17, 2022	Oct.16, 2023
MXG Vector Signal Generator	Keysight	N5182B	MY56200284	Oct.17, 2022	Oct.16, 2023
MXG Vector Signal Generator	Keysight	N5172B	MY56200301	Oct.17, 2022	Oct.16, 2023
DC power supply	Keysight	E3642A	MY55159130	Oct.17, 2022	Oct.16, 2023
Temperature & Humidity Chamber	SANMOOD	SG-80-CC-2	2088	Oct.17, 2022	Oct.16, 2023
Software					
Description	Manufacturer	Name		Version	
Tonsend SRD Test System	Tonsend	JS1120-3 RF Test System		2.6.77.0518	



Conducted Emissions					
Equipment	Manufacturer	Model No.	Serial No.	Last Cal.	Due Date
EMI Test Receiver	R&S	ESR3	101961	Oct.17, 2022	Oct.16, 2023
Two-Line V-Network	R&S	ENV216	101983	Oct.17, 2022	Oct.16, 2023
Artificial Mains Networks	Schwarzbeck	NSLK 8126	8126465	Oct.17, 2022	Oct.16, 2023
Software					
Description			Manufacturer	Name	Version
Test Software for Conducted Emissions			Farad	EZ-EMC	Ver. UL-3A1

Radiated Emissions					
Equipment	Manufacturer	Model No.	Serial No.	Last Cal.	Due Date
MXE EMI Receiver	KESIGHT	N9038A	MY56400036	Oct.17, 2022	Oct.16, 2023
Hybrid Log Periodic Antenna	TDK	HLP-3003C	130959	Aug.02, 2021	Aug.01, 2024
Preamplifier	HP	8447D	2944A09099	Oct.17, 2022	Oct.16, 2023
EMI Measurement Receiver	R&S	ESR26	101377	Oct.17, 2022	Oct.16, 2023
Horn Antenna	TDK	HRN-0118	130940	July 20, 2021	July 19, 2024
Preamplifier	TDK	PA-02-0118	TRS-305-00067	Oct.17, 2022	Oct.16, 2023
Horn Antenna	Schwarzbeck	BBHA9170	697	July 20, 2021	July 19, 2024
Preamplifier	TDK	PA-02-2	TRS-307-00003	Oct.17, 2022	Oct.16, 2023
Preamplifier	TDK	PA-02-3	TRS-308-00002	Oct.17, 2022	Oct.16, 2023
Loop antenna	Schwarzbeck	1519B	00008	Dec.14, 2021	Dec.13, 2024
Preamplifier	TDK	PA-02-001-3000	TRS-302-00050	Oct.17, 2022	Oct.16, 2023
Preamplifier	Mini-Circuits	ZX60-83LN-S+	SUP01202035	Oct.17, 2022	Oct.16, 2023
High Pass Filter	Wi	WHKX10-2700-3000-18000-40SS	23	/	/
Highpass Filter	Wainwright	WHKX10-5850-6500-1800-40SS	4	/	/
Band Reject Filter	Wainwright	WRCJV12-5695-5725-5850-5880-40SS	4	/	/
Band Reject Filter	Wainwright	WRCJV20-5120-5150-	2	/	/



		5350-5380-60SS			
Band Reject Filter	Wainwright	WRCJV20-5440-5470-5725-5755-60SS	1	/	/
Band Reject Filter	Wainwright	WRCJV8-2350-2400-2483.5-2533.5-40SS	4	/	/
Band Reject Filter	Wainwright	WRCD5-1879-1879.85-1880.15-1881-40SS	1	/	/
Notch Filter	Wainwright	WHJ10-882-980-7000-40SS	1	/	/
Software					
Description		Manufacturer	Name	Version	
Test Software for Radiated Emissions		Farad	EZ-EMC	Ver. UL-3A1	

Other Instrument					
Equipment	Manufacturer	Model No.	Serial No.	Last Cal.	Due Date
Temperature humidity probe	OMEGA	ITHX-SD-5	18470007	Oct.22, 2022	Oct.21, 2023
Barometer	Yiyi	Baro	N/A	Oct.24, 2022	Oct.23, 2023
Attenuator	Agilent	8495B	2814a12853	Oct.18, 2022	Oct.17, 2023

7. ANTENNA PORT TEST RESULTS

7.1. CONDUCTED OUTPUT POWER

LIMITS

CFR 47 FCC Part15 (15.247) Subpart C ISED RSS-247 ISSUE 2			
Section	Test Item	Limit	Frequency Range (MHz)
CFR 47 FCC 15.247(b)(3) ISED RSS-247 5.4 (d)	AVG Output Power	1 watt or 30 dBm	2400-2483.5
ISED RSS-247 5.4 (d)	EIRP	1 watt or 36 dBm	2400-2483.5

TEST PROCEDURE

Refer to ANSI C63.10-2013 clause 11.9.2.3.1.

Connect the EUT to a low loss RF cable from the antenna port to the power sensor (video bandwidth is greater than the occupied bandwidth).

Measure peak emission level, the indicated level is the average output power, after any corrections for external attenuators and cables.

The test result in dBm by adding $[10 \log (1 / D)]$, where D is the duty cycle.

TEST SETUP

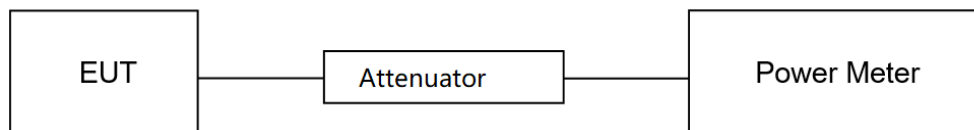

TEST ENVIRONMENT

Temperature	25.6°C	Relative Humidity	45.9%
Atmosphere Pressure	101kPa	Test Voltage	DC 12 V

TEST DATE / ENGINEER

Test Date	March 2, 2023	Test By	Johnson Liu
-----------	---------------	---------	-------------

TEST RESULTS

Please refer to section "Test Data" - Appendix C

7.2. 6DB BANDWIDTH AND 99% OCCUPIED BANDWIDTH

LIMITS

CFR 47 FCC Part15 (15.247) Subpart C ISED RSS-247 ISSUE 2			
Section	Test Item	Limit	Frequency Range (MHz)
CFR 47 FCC 15.247(a)(2) ISED RSS-247 5.2 (a)	6 dB Bandwidth	≥ 500 kHz	2400-2483.5
ISED RSS-Gen Clause 6.7	99 % Occupied Bandwidth	For reporting purposes only.	2400-2483.5

TEST PROCEDURE

Refer to ANSI C63.10-2013 clause 11.8 for DTS bandwidth and clause 6.9 for Occupied Bandwidth.

Connect the EUT to the spectrum analyser and use the following settings:

Center Frequency	The center frequency of the channel under test
Frequency Span	For 6 dB Bandwidth: Enough to capture all products of the modulation carrier emission For 99 % Occupied Bandwidth: Between 1.5 times and 5.0 times the OBW
Detector	Peak
RBW	For 6 dB Bandwidth: 100 kHz For 99 % Occupied Bandwidth: 1 % to 5 % of the occupied bandwidth
VBW	For 6 dB Bandwidth: $\geq 3 \times \text{RBW}$ For 99 % Occupied Bandwidth: $\geq 3 \times \text{RBW}$
Trace	Max hold
Sweep	Auto couple

a) Use the 99 % power bandwidth function of the instrument, allow the trace to stabilize and report the measured bandwidth.

b) Allow the trace to stabilize and measure the maximum width of the emission that is constrained by the frequencies associated with the two outermost amplitude points (upper and lower frequencies) that are attenuated by 6 dB relative to the maximum level measured in the fundamental emission.



TEST SETUP

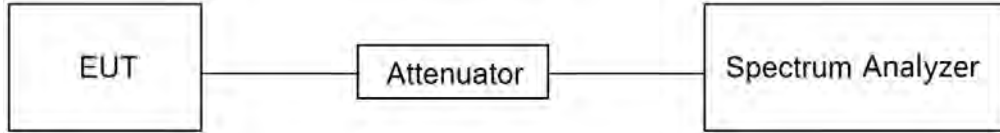

TEST ENVIRONMENT

Temperature	25.6°C	Relative Humidity	45.9%
Atmosphere Pressure	101kPa	Test Voltage	DC 12 V

TEST DATE / ENGINEER

Test Date	March 2, 2023	Test By	Johnson Liu
-----------	---------------	---------	-------------

TEST RESULTS

Please refer to section "Test Data" - Appendix A&B

7.3. POWER SPECTRAL DENSITY

LIMITS

CFR 47 FCC Part15 (15.247) Subpart C ISED RSS-247 ISSUE 2			
Section	Test Item	Limit	Frequency Range (MHz)
CFR 47 FCC §15.247 (e) ISED RSS-247 5.2 (b)	Power Spectral Density	8 dBm in any 3 kHz band	2400-2483.5

TEST PROCEDURE

Refer to ANSI C63.10-2013 clause 11.10.5.

Connect the EUT to the spectrum analyser and use the following settings:

Center Frequency	The center frequency of the channel under test
Detector	power averaging (rms)
RBW	$3 \text{ kHz} \leq \text{RBW} \leq 100 \text{ kHz}$
VBW	$\geq 3 \times \text{RBW}$
Span	1.5 x OBW bandwidth
Trace	Average
Sweep time	Auto couple

Allow trace to fully stabilize and use the peak marker function to determine the maximum amplitude level within the RBW.

If measured value exceeds limit, reduce RBW (no less than 3 kHz) and repeat.

TEST SETUP

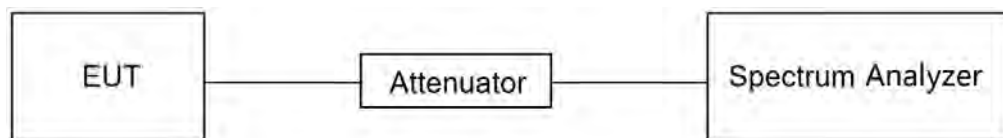



TEST ENVIRONMENT

Temperature	25.6°C	Relative Humidity	45.9%
Atmosphere Pressure	101kPa	Test Voltage	DC 12 V

TEST DATE / ENGINEER

Test Date	March 2, 2023	Test By	Johnson Liu
-----------	---------------	---------	-------------

TEST RESULTS

Please refer to section "Test Data" - Appendix D



7.4. CONDUCTED BAND EDGE AND SPURIOUS EMISSION

LIMITS

CFR 47 FCC Part15 (15.247) Subpart C ISED RSS-247 ISSUE 2		
Section	Test Item	Limit
CFR 47 FCC §15.247 (d) ISED RSS-247 5.5	Conducted Bandedge and Spurious Emissions	at least 30 dB below that in the 100 kHz bandwidth within the band that contains the highest level of the desired power

TEST PROCEDURE

Refer to ANSI C63.10-2013 clause 11.11 and 11.13.

Connect the EUT to the spectrum analyser and use the following settings for reference level measurement:

Center Frequency	The center frequency of the channel under test
Detector	Peak
RBW	100 kHz
VBW	$\geq 3 \times \text{RBW}$
Span	1.5 x DTS bandwidth
Trace	Max hold
Sweep time	Auto couple.

Allow trace to fully stabilize and use the peak marker function to determine the maximum PSD level.

Change the settings for emission level measurement:

Span	Set the center frequency and span to encompass frequency range to be measured
Detector	Peak
RBW	100 kHz
VBW	$\geq 3 \times \text{RBW}$
measurement points	$\geq \text{span}/\text{RBW}$
Trace	Max hold
Sweep time	Auto couple.

Allow trace to fully stabilize and use the peak marker function to determine the maximum PSD level. Ensure that the amplitude of all unwanted emissions outside of the authorized frequency band (excluding restricted frequency bands) is attenuated by at least the minimum requirements specified in 11.11.



TEST SETUP

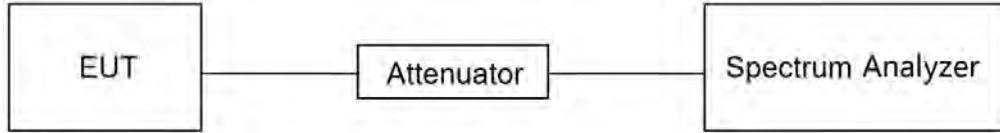

TEST ENVIRONMENT

Temperature	25.6°C	Relative Humidity	45.9%
Atmosphere Pressure	101kPa	Test Voltage	DC 12 V

TEST DATE / ENGINEER

Test Date	March 2, 2023	Test By	Johnson Liu
-----------	---------------	---------	-------------

TEST RESULTS

Please refer to section "Test Data" - Appendix E&F



7.5. DUTY CYCLE

LIMITS

None; for reporting purposes only.

TEST PROCEDURE

Refer to ANSI C63.10-2013 clause 11.6 Zero – Span Spectrum Analyzer method.

TEST SETUP

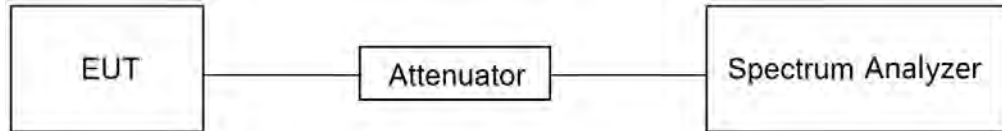

TEST ENVIRONMENT

Temperature	25.6°C	Relative Humidity	45.9%
Atmosphere Pressure	101kPa	Test Voltage	DC 12 V

TEST DATE / ENGINEER

Test Date	March 2, 2023	Test By	Johnson Liu
-----------	---------------	---------	-------------

TEST RESULTS

Please refer to section "Test Data" - Appendix G



8. RADIATED TEST RESULTS

LIMITS

Please refer to CFR 47 FCC §15.205 and §15.209.

Please refer to ISED RSS-GEN Clause 8.9 and Clause 8.10.

Radiation Disturbance Test Limit for FCC (Class B) (9 kHz ~ 1 GHz)

Emissions radiated outside of the specified frequency bands above 30 MHz			
Frequency Range (MHz)	Field Strength Limit (uV/m) at 3 m	Field Strength Limit (dBuV/m) at 3 m	
		Quasi-Peak	
30 - 88	100	40	
88 - 216	150	43.5	
216 - 960	200	46	
Above 960	500	54	
Above 1000	500	Peak	Average
		74	54

FCC Emissions radiated outside of the specified frequency bands below 30 MHz		
Frequency (MHz)	Field strength (microvolts/meter)	Measurement distance (meters)
0.009-0.490	2400/F(kHz)	300
0.490-1.705	24000/F(kHz)	30
1.705-30.0	30	30

ISED General field strength limits at frequencies below 30 MHz

Table 6 – General field strength limits at frequencies below 30 MHz		
Frequency	Magnetic field strength (H-Field) (uA/m)	Measurement distance (m)
9 - 490 kHz ^{Note 1}	6.37/F (F in kHz)	300
490 - 1705 kHz	63.7/F (F in kHz)	30
1.705 - 30 MHz	0.08	30

Note 1: The emission limits for the ranges 9-90 kHz and 110-490 kHz are based on measurements employing a linear average detector.



ISED Restricted bands please refer to ISED RSS-GEN Clause 8.10

Table 7 – Restricted frequency bands ^{Note 1}		
MHz	MHz	GHz
0.090 - 0.110	149.9 - 150.05	9.0 - 9.2
0.495 - 0.505	156.52475 - 156.52525	9.3 - 9.5
2.1735 - 2.1905	156.7 - 156.9	10.6 - 12.7
3.020 - 3.026	162.0125 - 167.17	13.25 - 13.4
4.125 - 4.128	167.72 - 173.2	14.47 - 14.5
4.17725 - 4.17775	240 - 285	15.35 - 16.2
4.20725 - 4.20775	322 - 335.4	17.7 - 21.4
5.677 - 5.683	399.9 - 410	22.01 - 23.12
6.215 - 6.218	608 - 614	23.6 - 24.0
6.26775 - 6.26825	960 - 1427	31.2 - 31.8
6.31175 - 6.31225	1435 - 1626.5	36.43 - 36.5
8.291 - 8.294	1645.5 - 1646.5	Above 38.6
8.362 - 8.366	1660 - 1710	
8.37625 - 8.38675	1718.8 - 1722.2	
8.41425 - 8.41475	2200 - 2300	
12.29 - 12.293	2310 - 2390	
12.51975 - 12.52025	2483.5 - 2500	
12.57675 - 12.57725	2655 - 2900	
13.36 - 13.41	3260 - 3267	
16.42 - 16.423	3332 - 3339	
16.69475 - 16.69525	3345.8 - 3358	
16.80425 - 16.80475	3500 - 4400	
25.5 - 25.67	4500 - 5150	
37.5 - 38.25	5350 - 5460	
73 - 74.6	7250 - 7750	
74.8 - 75.2	8025 - 8500	
108 - 138		

Note 1: Certain frequency bands listed in table 7 and in bands above 38.6 GHz are designated for licence-exempt applications. These frequency bands and the requirements that apply to related devices are set out in the 200 and 300 series of RSSs.

FCC Restricted bands of operation refer to FCC §15.205 (a):

MHz	MHz	MHz	GHz
0.090-0.110	16.42-16.423	399.9-410	4.5-5.15
¹ 0.495-0.505	16.69475-16.69525	608-614	5.35-5.46
2.1735-2.1905	16.80425-16.80475	960-1240	7.25-7.75
4.125-4.128	25.5-25.67	1300-1427	8.025-8.5
4.17725-4.17775	37.5-38.25	1435-1626.5	9.0-9.2
4.20725-4.20775	73-74.6	1645.5-1646.5	9.3-9.5
6.215-6.218	74.8-75.2	1660-1710	10.6-12.7
6.26775-6.26825	108-121.94	1718.8-1722.2	13.25-13.4
6.31175-6.31225	123-138	2200-2300	14.47-14.5
8.291-8.294	149.9-150.05	2310-2390	15.35-16.2
8.362-8.366	156.52475-156.52525	2483.5-2500	17.7-21.4
8.37625-8.38675	156.7-156.9	2690-2900	22.01-23.12
8.41425-8.41475	162.0125-167.17	3260-3267	23.6-24.0
12.29-12.293	167.72-173.2	3332-3339	31.2-31.8
12.51975-12.52025	240-285	3345.8-3358	36.43-36.5
12.57675-12.57725	322-335.4	3600-4400	(²)
13.36-13.41			

Note: ¹Until February 1, 1999, this restricted band shall be 0.490-0.510 MHz.
²Above 38.6c

TEST PROCEDURE

Below 30 MHz

The setting of the spectrum analyser

RBW	200 Hz (From 9 kHz to 0.15 MHz)/ 9 kHz (From 0.15 MHz to 30 MHz)
VBW	200 Hz (From 9 kHz to 0.15 MHz)/ 9 kHz (From 0.15 MHz to 30 MHz)
Sweep	Auto

1. The testing follows the guidelines in ANSI C63.10-2013 clause 6.4.
2. The EUT was arranged to its worst case and then turntable (from 0 degree to 360 degrees) to find the maximum reading. A pre-amp and a high pass filter are used for the test in order to get better signal level. Both Horizontal, Face-on and Face-off polarizations of the antenna are set to make the measurement.
3. The EUT was placed on a turntable with 80 cm above ground.
4. The EUT was set 3 meters from the interference receiving antenna, which was mounted on the top of a 1 m height antenna tower.
5. The radiated emission limits are based on measurements employing a CISPR quasi-peak detector except for the frequency bands 9-90 kHz, 110-490 kHz and above 1000 MHz Radiated emission limits in these three bands are based on measurements employing an average detector.
6. For measurement below 1 GHz, the initial step in collecting conducted emission data is a spectrum analyzer peak detector mode pre-scanning the measurement frequency range. Significant peaks are then marked and then Quasi Peak and average detector mode re-measured. If the emission level of the EUT measured by the peak detector is 3 dB lower than the applicable limit, the peak emission level will be reported. Otherwise, the emission measurement will be repeated using the quasi-peak and average detector and reported.
7. Although these tests were performed other than open field site, adequate comparison measurements were confirmed against 30m open field site. Therefore sufficient tests were made to demonstrate that the alternative site produces results that correlate with the ones of tests made in an open field site based on KDB 414788.
8. The limits in CFR 47, Part 15, Subpart C, paragraph 15.209 (a), are identical to those in RSS-GEN Section 8.9, Table 6, since the measurements are performed in terms of magnetic field strength and converted to electric field strength levels (as reported in the table) using the free space impedance of 377Ω. For example, the measurement frequency X KHz resulted in a level of Y dBuV/m, which is equivalent to $Y-51.5 = Z$ dBuA/m, which has the same margin, W dB, to the corresponding RSS-GEN Table 6 limit as it has to be 15.209(a) limit.

Below 1 GHz and above 30 MHz

The setting of the spectrum analyser

RBW	120 kHz
VBW	300 kHz
Sweep	Auto
Detector	Peak/QP
Trace	Max hold

1. The testing follows the guidelines in ANSI C63.10-2013 clause 6.5.
2. The EUT was arranged to its worst case and then tune the antenna tower (from 1 m to 4 m) and turntable (from 0 degree to 360 degrees) to find the maximum reading. A pre-amp and a high pass filter are used for the test in order to get better signal level. Both horizontal and vertical polarizations of the antenna are set to make the measurement.
3. The EUT was placed on a turntable with 80 cm above ground.
4. The EUT was set 3 meters from the interference receiving antenna, which was mounted on the top of a variable height antenna tower.
5. For measurement below 1 GHz, the initial step in collecting conducted emission data is a spectrum analyzer peak detector mode pre-scanning the measurement frequency range. Significant peaks are then marked and then Quasi Peak detector mode re-measured. If the emission level of the EUT measured by the peak detector is 3 dB lower than the applicable limit, the peak emission level will be reported. Otherwise, the emission measurement will be repeated using the quasi-peak detector and reported.

Above 1G

The setting of the spectrum analyser

RBW	1 MHz
VBW	PEAK: 3 MHz AVG: see note 6
Sweep	Auto
Detector	Peak
Trace	Max hold

1. The testing follows the guidelines in ANSI C63.10-2013 clause 6.6.
2. The EUT was arranged to its worst case and then tune the antenna tower (from 1 m to 4 m) and turntable (from 0 degree to 360 degrees) to find the maximum reading. A pre-amp and a high pass filter are used for the test in order to get better signal level. Both horizontal and vertical polarizations of the antenna are set to make the measurement.
3. The EUT was placed on a turntable with 1.5 m above ground.
4. The EUT was set 3 meters from the interference receiving antenna, which was mounted on the top of a variable height antenna tower.
5. For measurement above 1 GHz, the emission measurement will be measured by the peak detector. This peak level, once corrected, must comply with the limit specified in Section 15.209.
6. For measurements above 1 GHz the resolution bandwidth is set to 1 MHz, then the video bandwidth is set to 3 MHz for peak measurements and 1 MHz resolution bandwidth with 1/T video bandwidth with peak detector for average measurements. For the Duty Cycle please refer to clause 7.5.ON TIME AND DUTY CYCLE.

X axis, Y axis, Z axis positions:

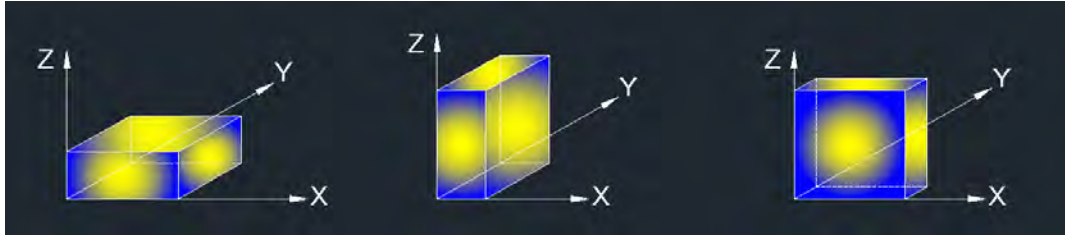

Note 1: The manufacturer has recommended that the EUT only be used in the desktop (horizontal) orientation; therefore, all radiated testing was performed in desktop orientation.

Note 2: The EUT was fully exercised with external accessories during the test. In the case of multiple accessory external ports, an external accessory shall be connected to one of each type of port.

For Band edge:

Note:

1. Measurement = Reading Level + Correct Factor.
2. If the peak values are less than the average limit of 54 dBuV/m, the average result is deemed to comply with average limit.
3. Peak: Peak detector.
4. AVG: VBW=1/Ton, where: Ton is the transmitting duration.
5. For the transmitting duration, please refer to clause 7.5.
6. Only the worst data was recorded, if it complies with the limit, the other emissions deemed to comply with the limit.
7. Horizontal and Vertical have been tested, only the worst data was recorded in the report.
8. All modes, channels and antennas have been tested, only the worst data was recorded in the report.

For Radiate Spurious emission 1GHz-3GHz:

Note:

1. Measurement = Reading Level + Correct Factor.
2. If the Peak values are less than the Average limit of 54 dBuV/m, the Average result is deemed to comply with Average limit.
3. Peak: Peak detector.
4. AVG: VBW=1/Ton, where: Ton is the transmitting duration.
5. For the transmitting duration, please refer to clause 7.5.
6. Filter losses were only considered in the spurious frequency bands and the authorized band was not corrected for Band reject filter losses.
7. Proper operation of the transmitter prior to adding the filter to the measurement chain.
8. All modes, channels and antennas have been tested, only the worst data was recorded in the report.



For Radiate Spurious emission 3GHz-18GHz:

Note:

1. Peak Result = Reading Level + Correct Factor.
2. If the Peak values are less than the Average limit of 54 dBuV/m, the Average result is deemed to comply with Average limit.
3. Peak: Peak detector.
4. AVG: $VBW=1/Ton$, where: Ton is the transmitting duration.
5. For the transmitting duration, please refer to clause 7.5.
6. Filter losses were only considered in the spurious frequency bands and the authorized band was not corrected for High Pass Filter losses.
7. Proper operation of the transmitter prior to adding the filter to the measurement chain.
8. All modes, channels and antennas have been tested, only the worst data was recorded in the report.

For Radiate Spurious emission 9kHz-30MHz:

Note:

1. Measurement = Reading Level + Correct Factor.
($\text{dBuA/m} = \text{dBuV/m} - 20\log_{10}[120\pi] = \text{dBuV/m} - 51.5$).
2. If the Peak values are less than the QP limit, the QP result is deemed to comply with QP limit.
3. All 3 polarizations (Horizontal, Face-on and Face-off) of the loop antenna had been tested, but only the worst data recorded in the report.
4. All modes, channels and antennas have been tested, only the worst data was recorded in the report.

For Radiate Spurious emission 18GHz-26GHz:

Note:

1. Measurement = Reading Level + Correct Factor.
2. If the Peak values are less than the Average limit of 54 dBuV/m, the Average result is deemed to comply with Average limit.
3. Peak: Peak detector.
4. All modes, channels and antennas have been tested, only the worst data was recorded in the report.

For Radiate Spurious emission 30MHz-1GHz:

Note:

1. Result Level = Read Level + Correct Factor.
2. If the Peak values are less than the QP limit, the QP result is deemed to comply with QP limit.
3. Test setup: RBW: 120 kHz, VBW: 300 kHz, Sweep time: auto.
4. All modes, channels and antennas have been tested, only the worst data was recorded in the report.

TEST SETUP

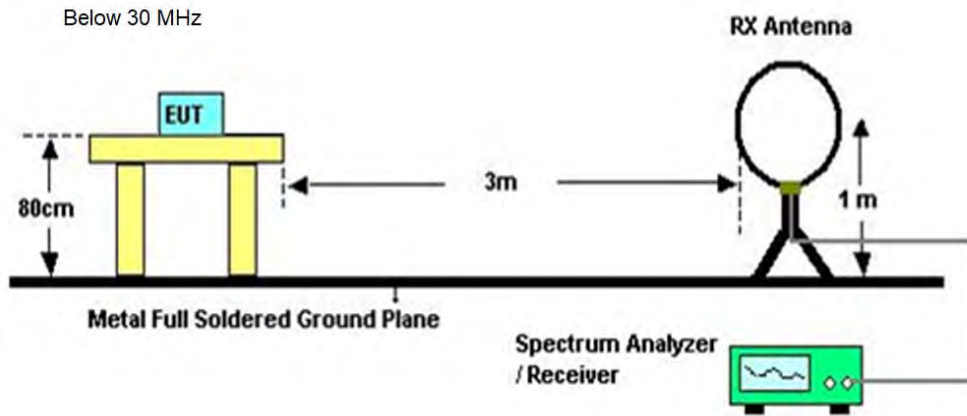

Below 1 GHz and above 30 MHz

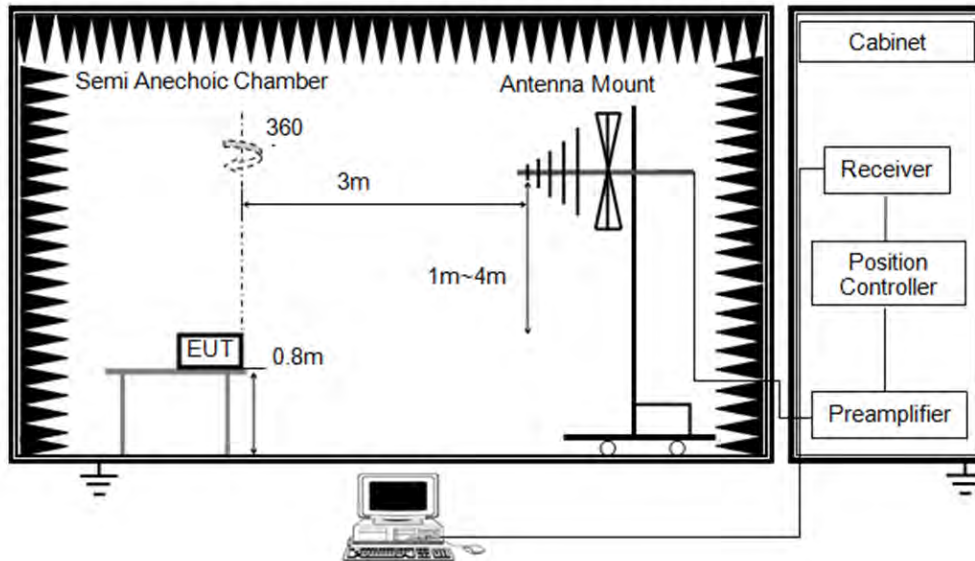

Above 1 GHz

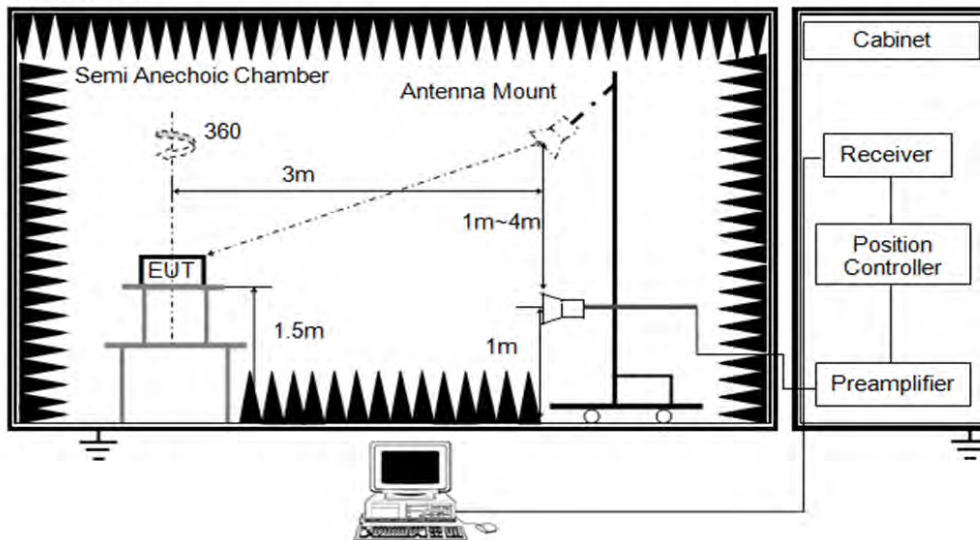



TEST ENVIRONMENT

Temperature	25.5°C	Relative Humidity	66%
Atmosphere Pressure	101kPa	Test Voltage	DC 12 V

TEST DATE / ENGINEER

Test Date	March 1, 2023	Test By	Rex Huang
-----------	---------------	---------	-----------

TEST RESULTS



8.1. RESTRICTED BANDEDGE

Test Mode:	802.11b PK	Channel:	2412
Polarity:	Horizontal	Test Voltage:	DC 12 V

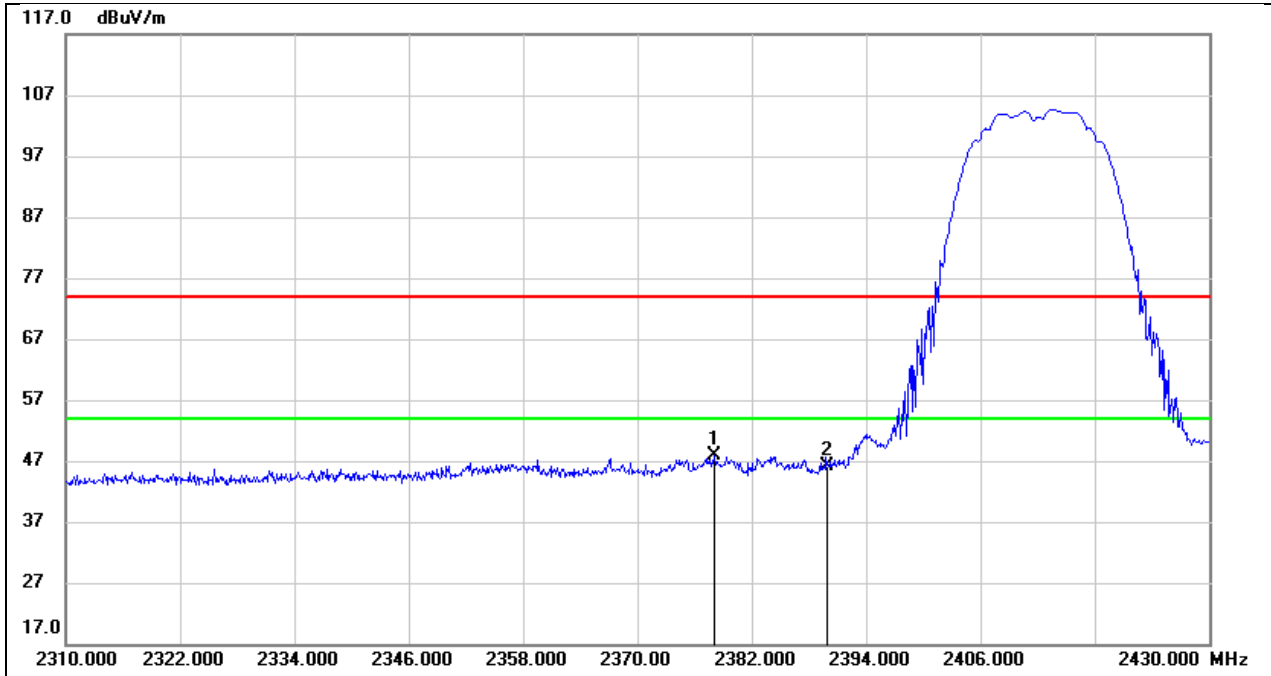

No.	Frequency (MHz)	Reading (dBuV)	Correct (dB/m)	Result (dBuV/m)	Limit (dBuV/m)	Margin (dB)	Remark
1	2378.040	18.64	29.12	47.76	74.00	-26.24	peak
2	2390.000	16.91	29.16	46.07	74.00	-27.93	peak



Test Mode:	802.11b PK	Channel:	2412
Polarity:	Vertical	Test Voltage:	DC 12 V

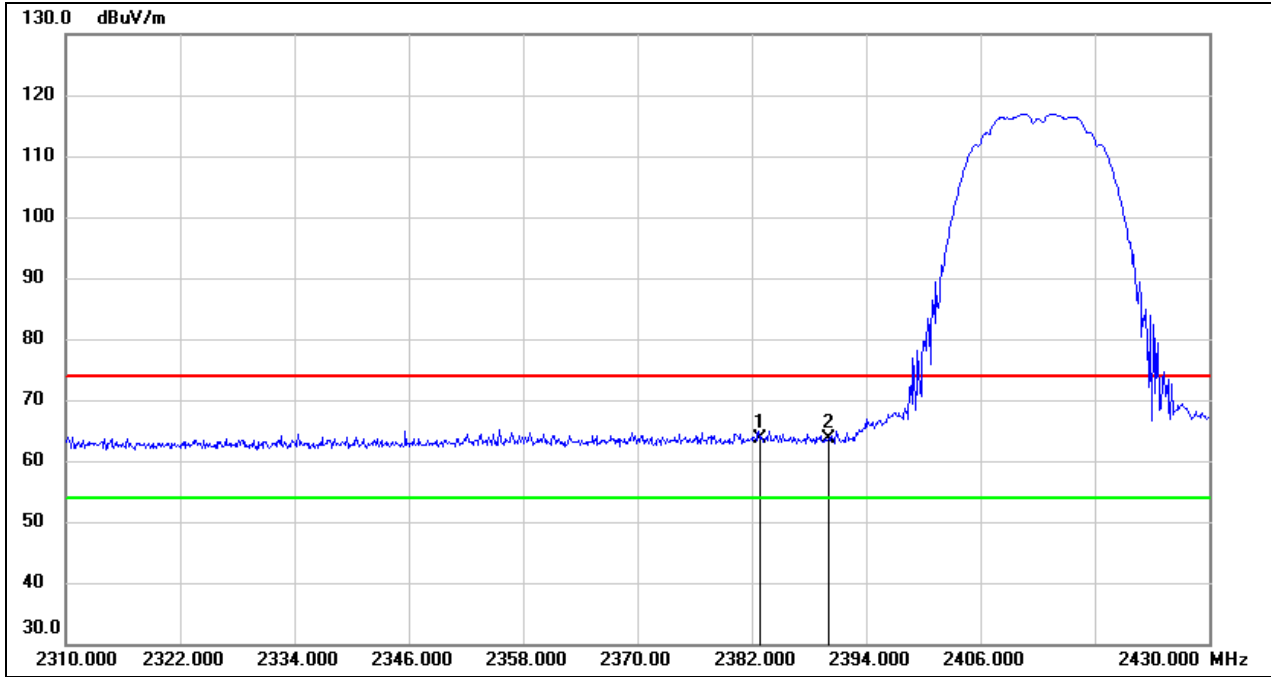

No.	Frequency (MHz)	Reading (dBuV)	Correct (dB/m)	Result (dBuV/m)	Limit (dBuV/m)	Margin (dB)	Remark
1	2382.840	34.49	29.14	63.63	74.00	-10.37	peak
2	2390.000	34.38	29.16	63.54	74.00	-10.46	peak



Test Mode:	802.11b AV	Channel:	2412
Polarity:	Vertical	Test Voltage:	DC 12 V

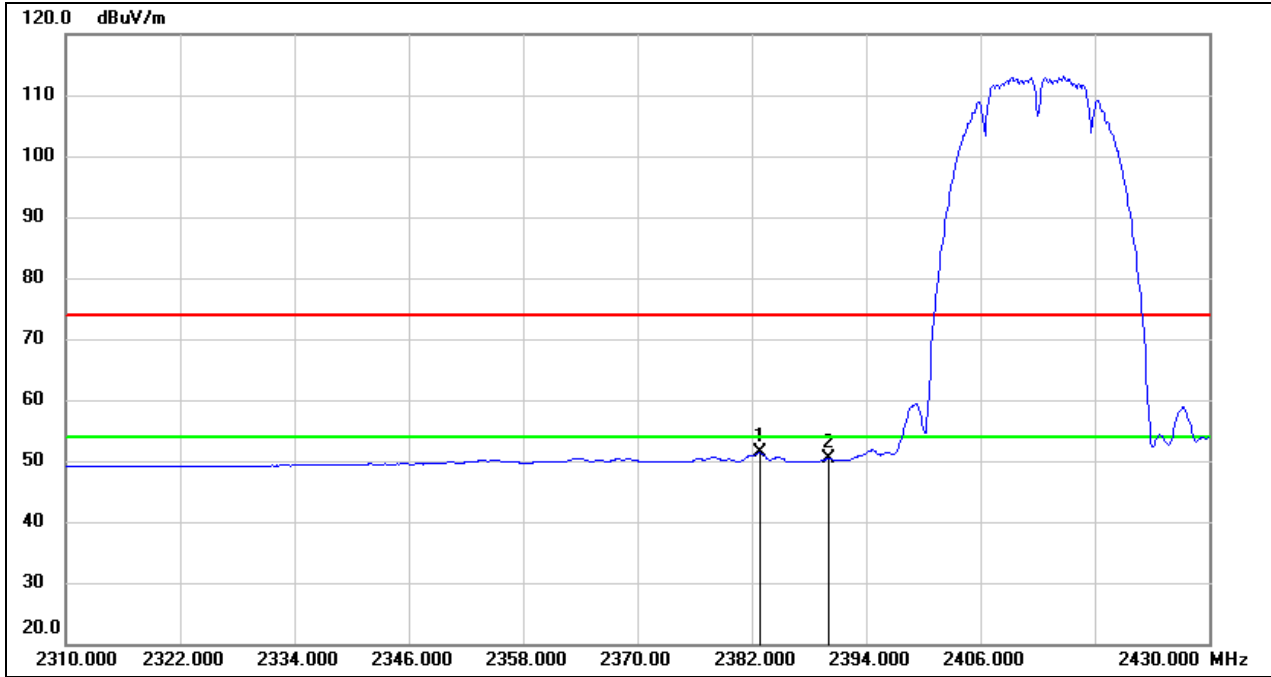

No.	Frequency (MHz)	Reading (dBuV)	Correct (dB/m)	Result (dBuV/m)	Limit (dBuV/m)	Margin (dB)	Remark
1	2382.840	22.15	29.14	51.29	54.00	-2.71	AVG
2	2390.000	21.21	29.16	50.37	54.00	-3.63	AVG



Test Mode:	802.11b PK	Channel:	2417
Polarity:	Vertical	Test Voltage:	DC 12 V

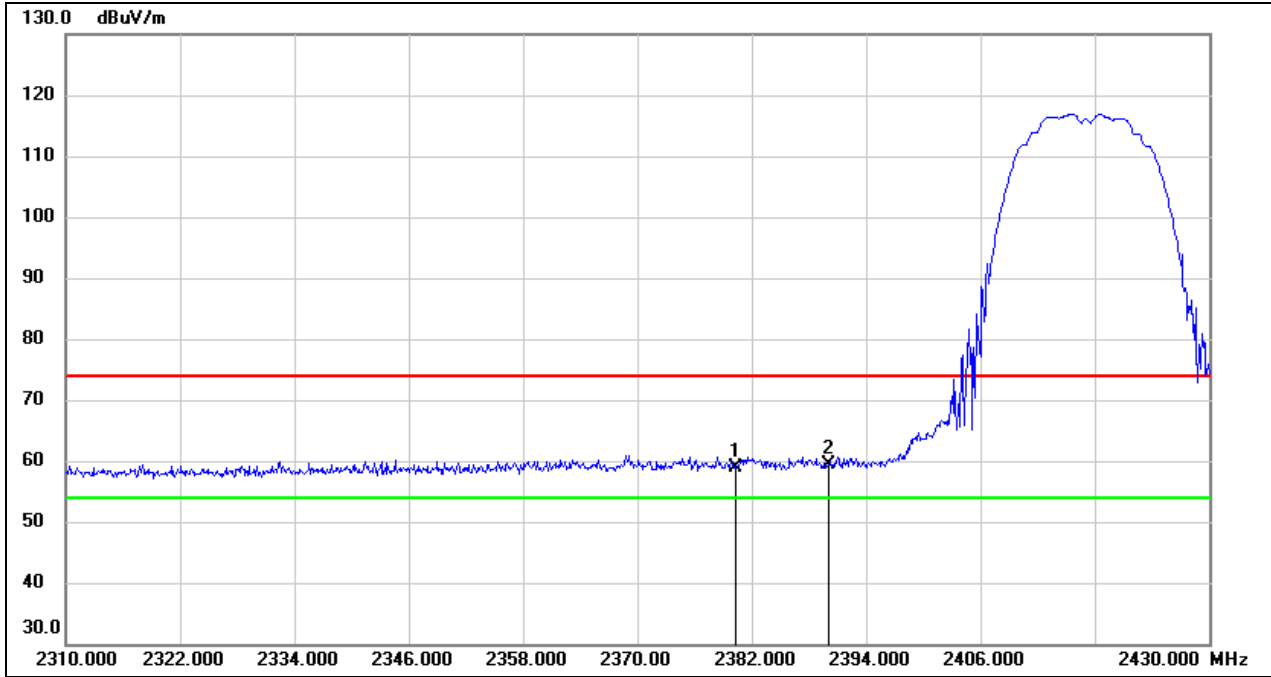

No.	Frequency (MHz)	Reading (dBuV)	Correct (dB/m)	Result (dBuV/m)	Limit (dBuV/m)	Margin (dB)	Remark
1	2380.320	29.75	29.13	58.88	74.00	-15.12	peak
2	2390.000	30.26	29.16	59.42	74.00	-14.58	peak



Test Mode:	802.11b AV	Channel:	2417
Polarity:	Vertical	Test Voltage:	DC 12 V

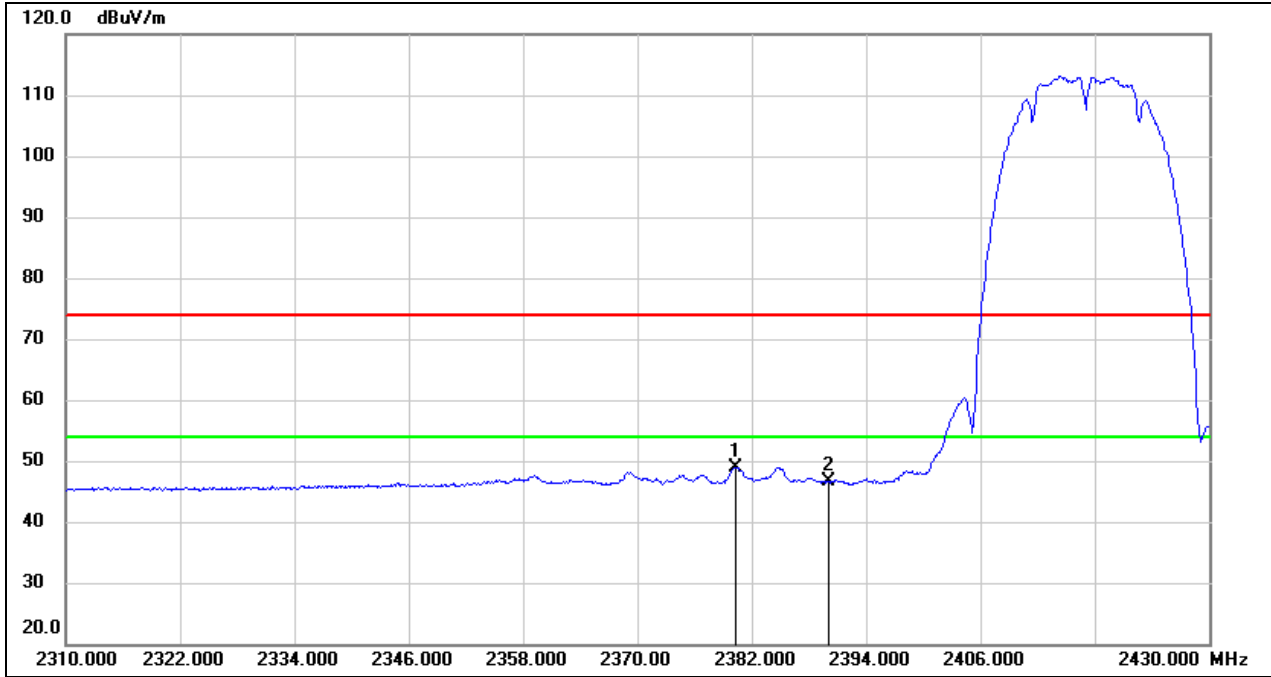

No.	Frequency (MHz)	Reading (dBuV)	Correct (dB/m)	Result (dBuV/m)	Limit (dBuV/m)	Margin (dB)	Remark
1	2380.320	19.85	29.13	48.98	54.00	-5.02	AVG
2	2390.000	17.39	29.16	46.55	54.00	-7.45	AVG



Test Mode:	802.11b PK	Channel:	2437
Polarity:	Vertical	Test Voltage:	DC 12 V

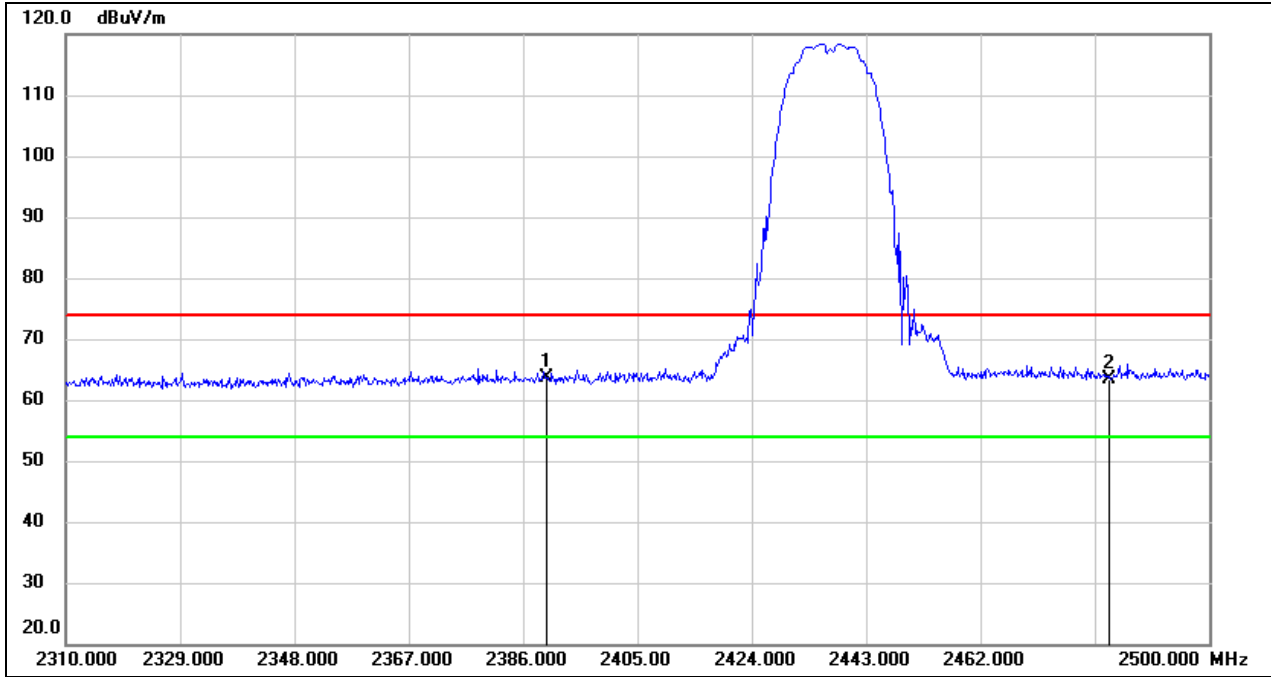

No.	Frequency (MHz)	Reading (dBuV)	Correct (dB/m)	Result (dBuV/m)	Limit (dBuV/m)	Margin (dB)	Remark
1	2390.000	34.42	29.16	63.58	74.00	-10.42	peak
2	2483.500	33.95	29.44	63.39	74.00	-10.61	peak



Test Mode:	802.11b AV	Channel:	2437
Polarity:	Vertical	Test Voltage:	DC 12 V

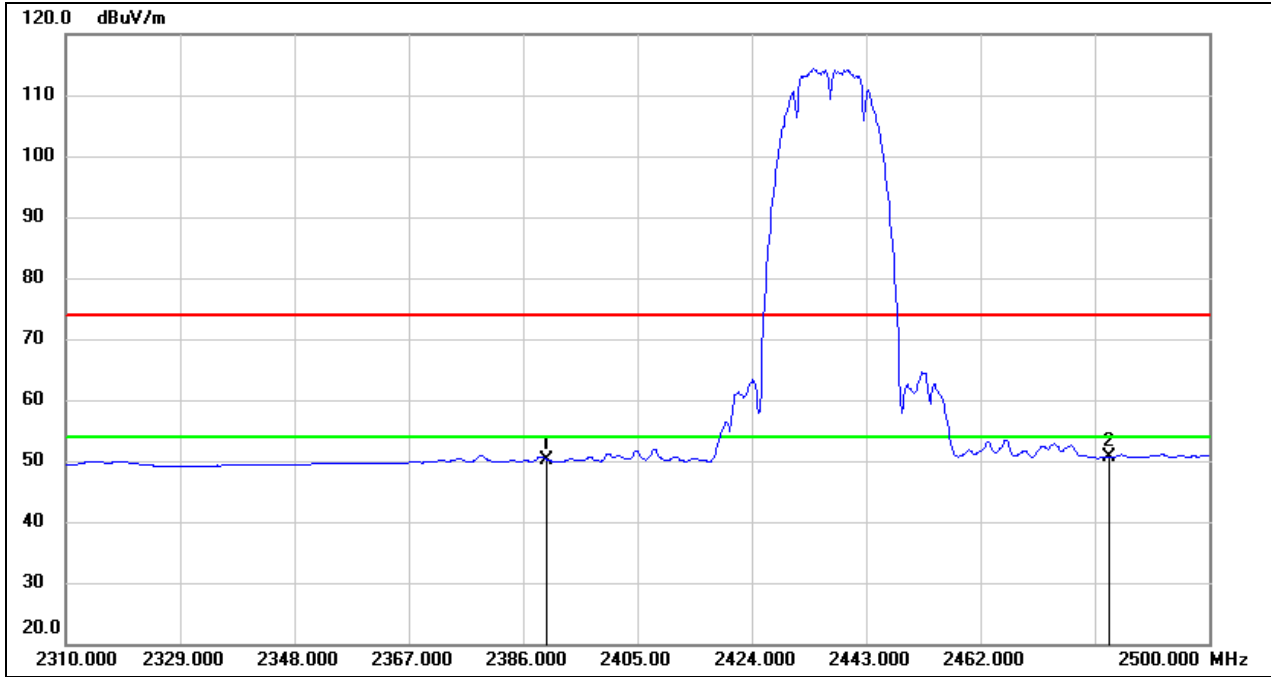

No.	Frequency (MHz)	Reading (dBuV)	Correct (dB/m)	Result (dBuV/m)	Limit (dBuV/m)	Margin (dB)	Remark
1	2390.000	20.98	29.16	50.14	54.00	-3.86	AVG
2	2483.500	21.18	29.44	50.62	54.00	-3.38	AVG



Test Mode:	802.11b PK	Channel:	2457
Polarity:	Vertical	Test Voltage:	DC 12 V

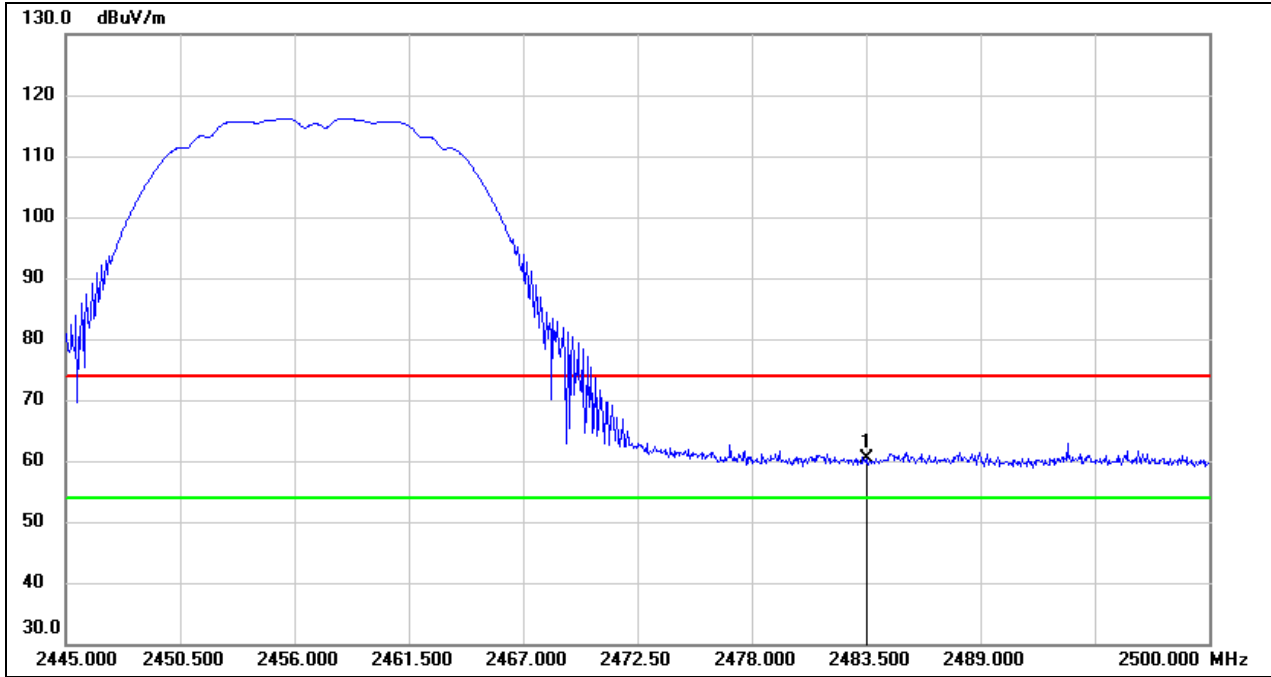

No.	Frequency (MHz)	Reading (dBuV)	Correct (dB/m)	Result (dBuV/m)	Limit (dBuV/m)	Margin (dB)	Remark
1	2483.500	30.88	29.44	60.32	74.00	-13.68	peak



Test Mode:	802.11b AV	Channel:	2457
Polarity:	Vertical	Test Voltage:	DC 12 V

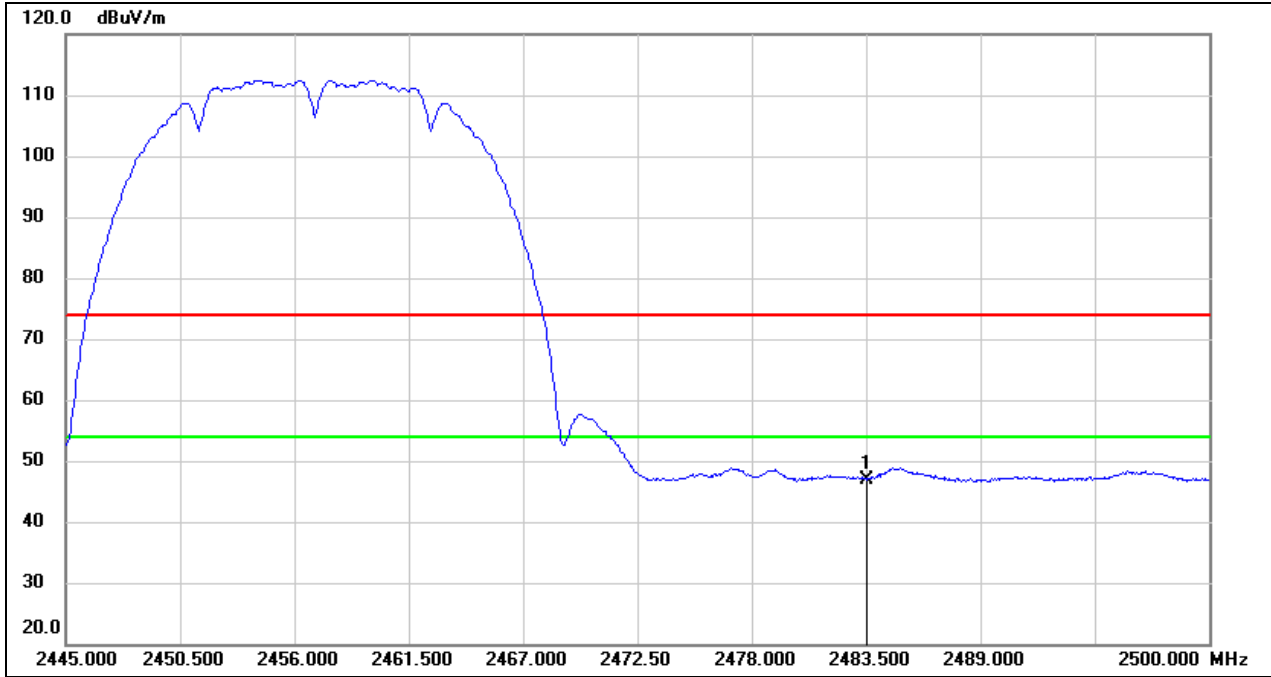

No.	Frequency (MHz)	Reading (dBuV)	Correct (dB/m)	Result (dBuV/m)	Limit (dBuV/m)	Margin (dB)	Remark
1	2483.500	17.51	29.44	46.95	54.00	-7.05	AVG



Test Mode:	802.11b PK	Channel:	2462
Polarity:	Vertical	Test Voltage:	DC 12 V

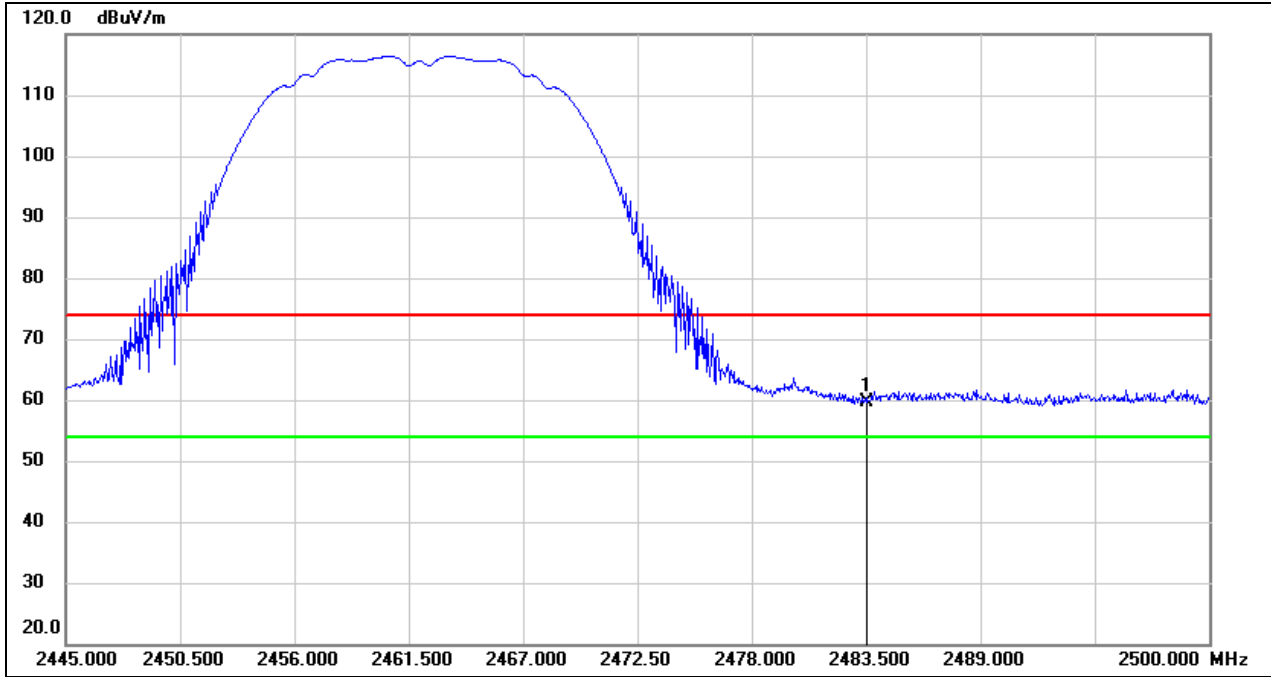

No.	Frequency (MHz)	Reading (dBuV)	Correct (dB/m)	Result (dBuV/m)	Limit (dBuV/m)	Margin (dB)	Remark
1	2483.500	30.25	29.44	59.69	74.00	-14.31	peak



Test Mode:	802.11b AV	Channel:	2462
Polarity:	Vertical	Test Voltage:	DC 12 V

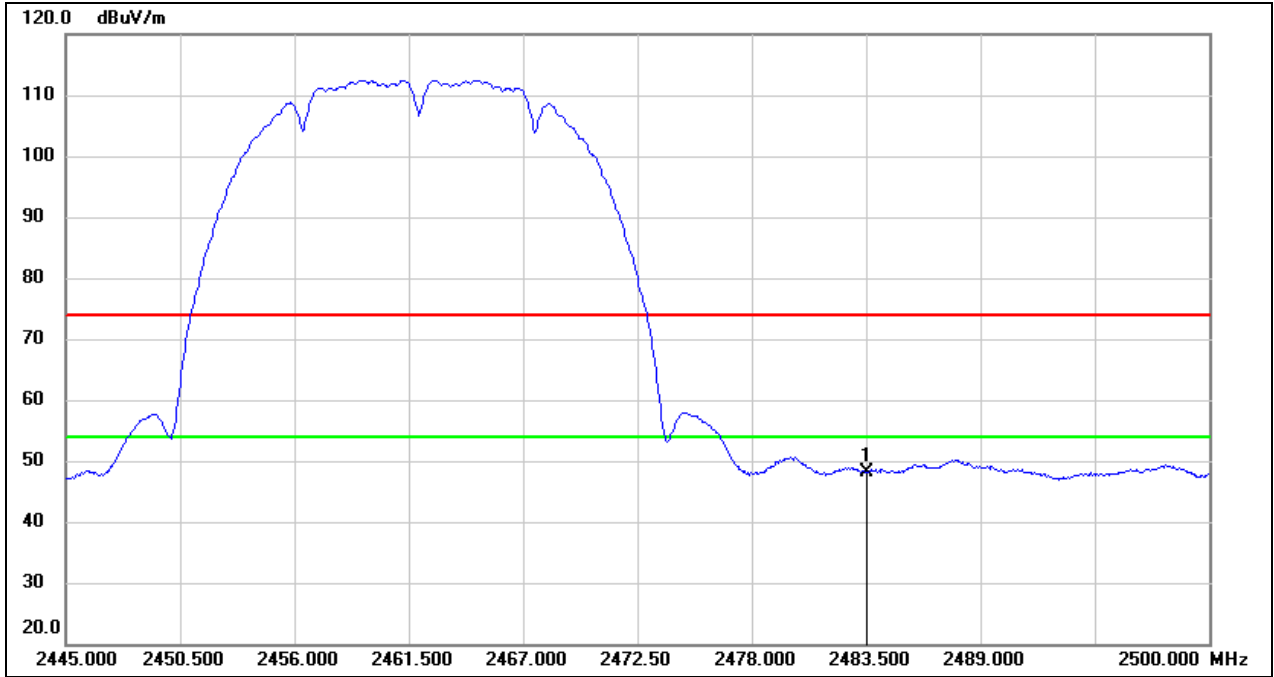

No.	Frequency (MHz)	Reading (dBuV)	Correct (dB/m)	Result (dBuV/m)	Limit (dBuV/m)	Margin (dB)	Remark
1	2483.500	18.70	29.44	48.14	54.00	-5.86	AVG



Test Mode:	802.11g PK	Channel:	2412
Polarity:	Vertical	Test Voltage:	DC 12 V

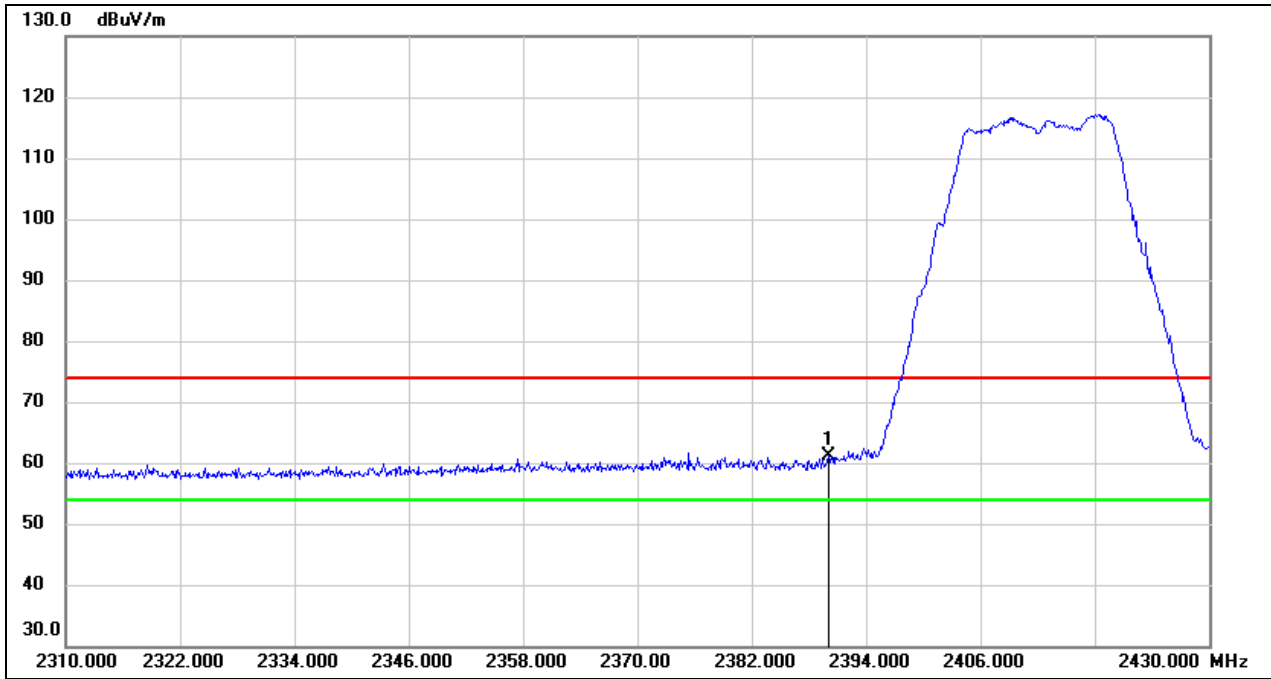

No.	Frequency (MHz)	Reading (dBuV)	Correct (dB/m)	Result (dBuV/m)	Limit (dBuV/m)	Margin (dB)	Remark
1	2390.000	31.89	29.16	61.05	74.00	-12.95	peak



Test Mode:	802.11g AV	Channel:	2412
Polarity:	Vertical	Test Voltage:	DC 12 V

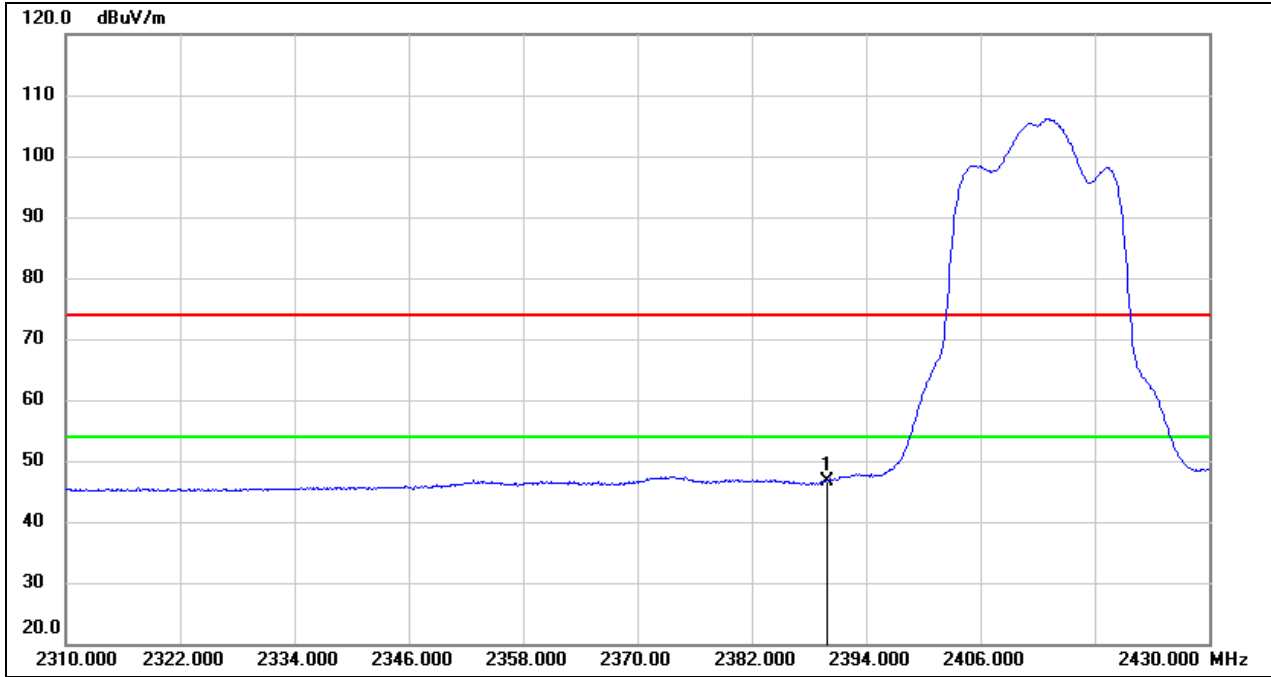

No.	Frequency (MHz)	Reading (dBuV)	Correct (dB/m)	Result (dBuV/m)	Limit (dBuV/m)	Margin (dB)	Remark
1	2390.000	17.48	29.16	46.64	54.00	-7.36	AVG



Test Mode:	802.11g PK	Channel:	2417
Polarity:	Vertical	Test Voltage:	DC 12 V

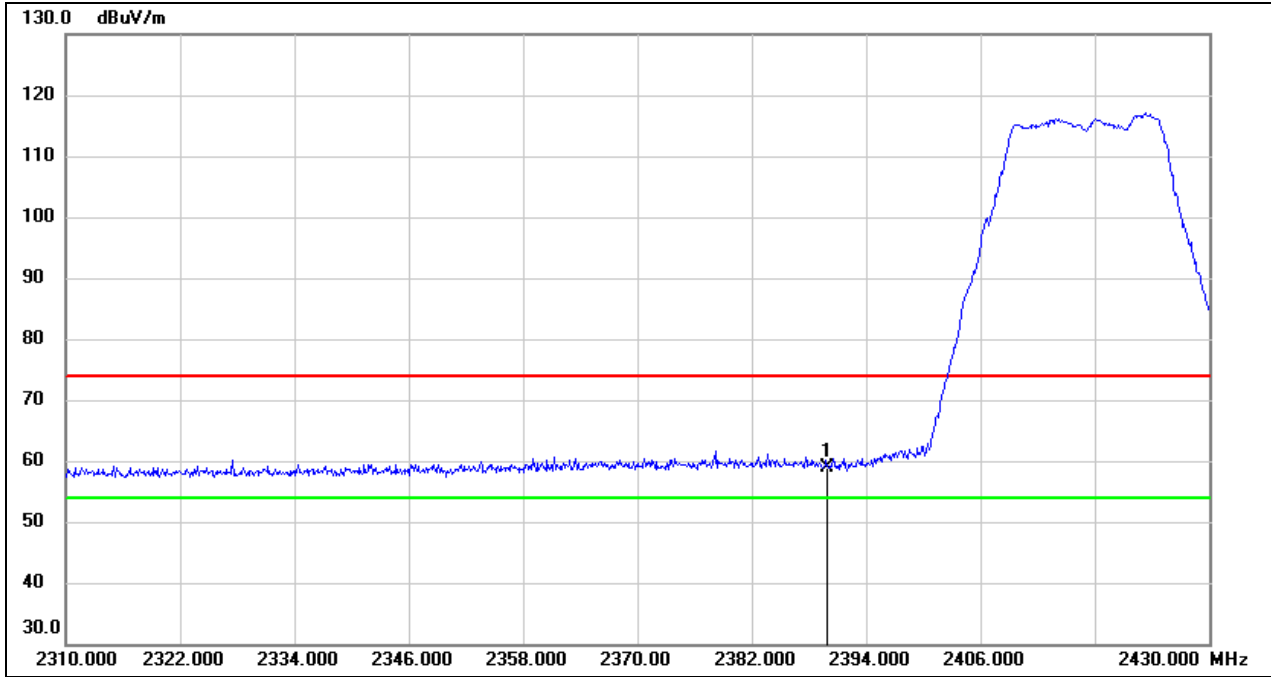

No.	Frequency (MHz)	Reading (dBuV)	Correct (dB/m)	Result (dBuV/m)	Limit (dBuV/m)	Margin (dB)	Remark
1	2390.000	29.64	29.16	58.80	74.00	-15.20	peak



Test Mode:	802.11g AV	Channel:	2417
Polarity:	Vertical	Test Voltage:	DC 12 V

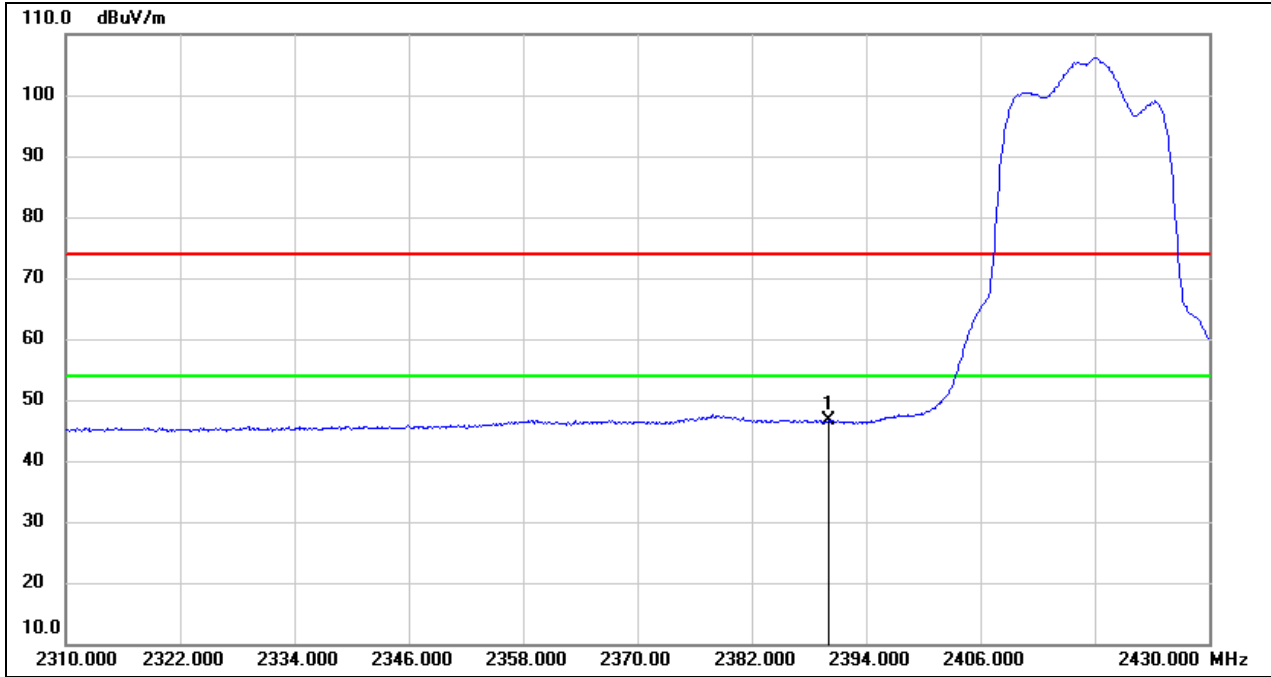

No.	Frequency (MHz)	Reading (dBuV)	Correct (dB/m)	Result (dBuV/m)	Limit (dBuV/m)	Margin (dB)	Remark
1	2390.000	17.39	29.16	46.55	54.00	-7.45	AVG



Test Mode:	802.11g PK	Channel:	2437
Polarity:	Vertical	Test Voltage:	DC 12 V

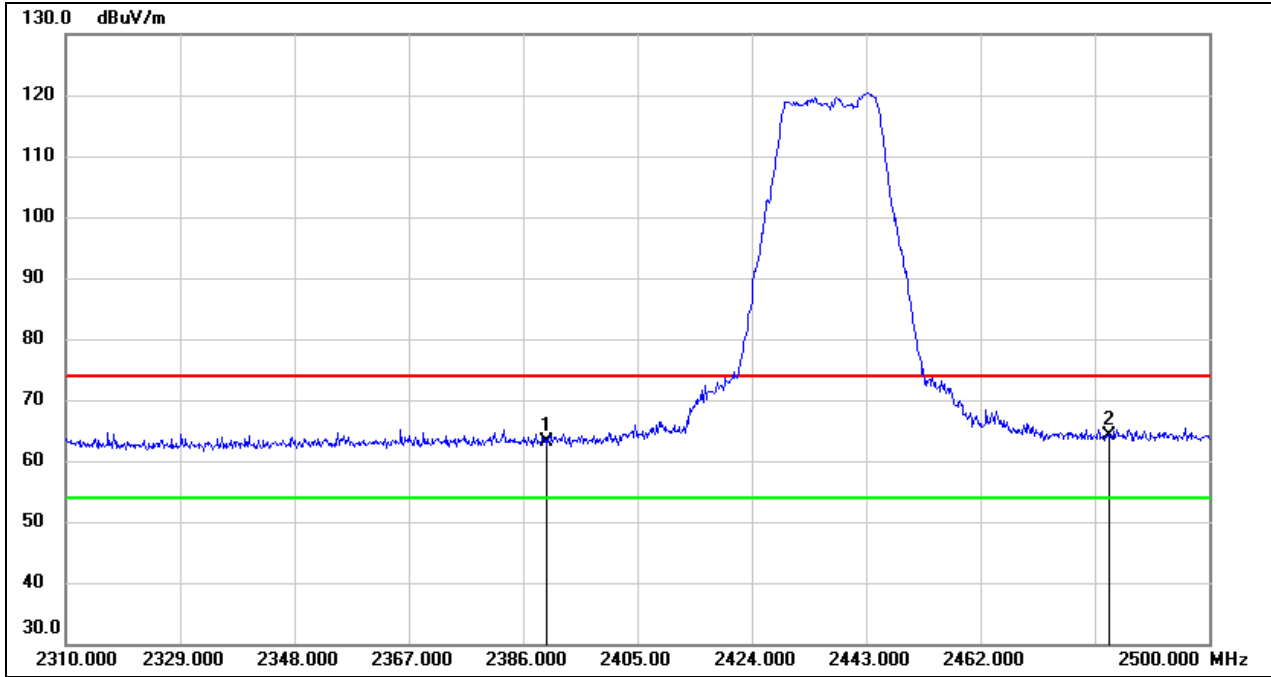

No.	Frequency (MHz)	Reading (dBuV)	Correct (dB/m)	Result (dBuV/m)	Limit (dBuV/m)	Margin (dB)	Remark
1	2390.000	33.87	29.16	63.03	74.00	-10.97	peak
2	2483.500	34.70	29.44	64.14	74.00	-9.86	peak



Test Mode:	802.11g AV	Channel:	2437
Polarity:	Vertical	Test Voltage:	DC 12 V

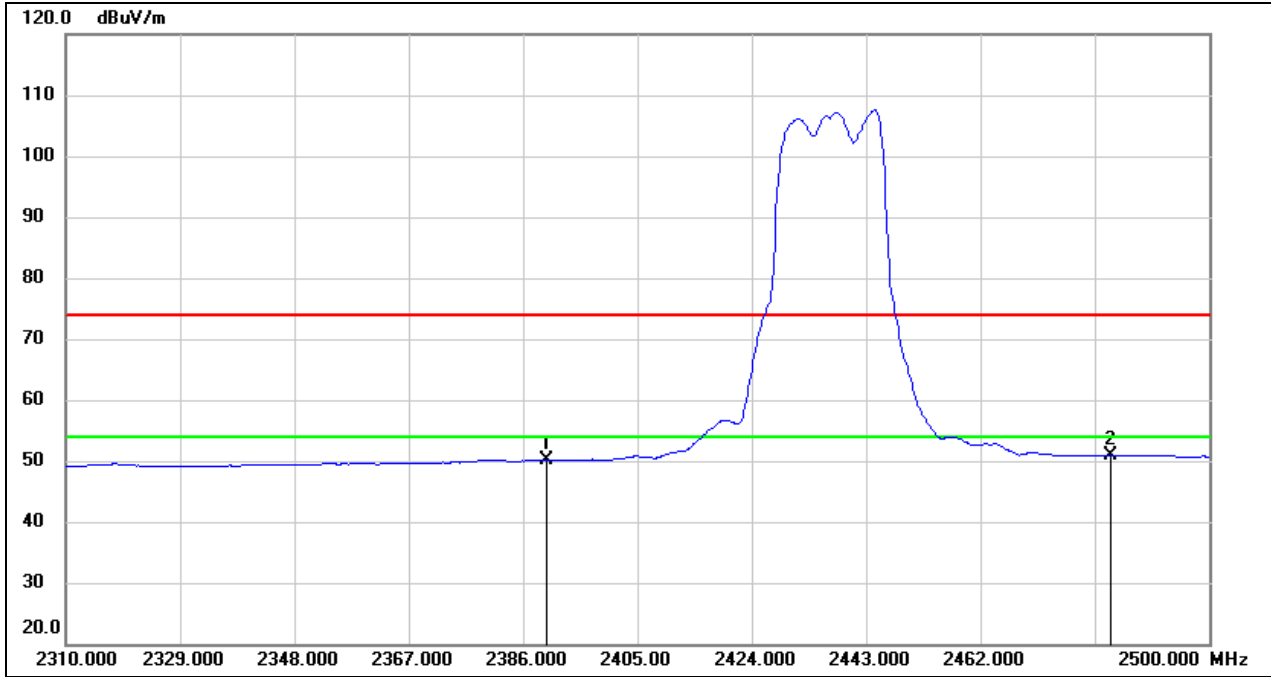

No.	Frequency (MHz)	Reading (dBuV)	Correct (dB/m)	Result (dBuV/m)	Limit (dBuV/m)	Margin (dB)	Remark
1	2390.000	20.85	29.16	50.01	54.00	-3.99	AVG
2	2483.500	21.50	29.44	50.94	54.00	-3.06	AVG



Test Mode:	802.11g PK	Channel:	2457
Polarity:	Vertical	Test Voltage:	DC 12 V

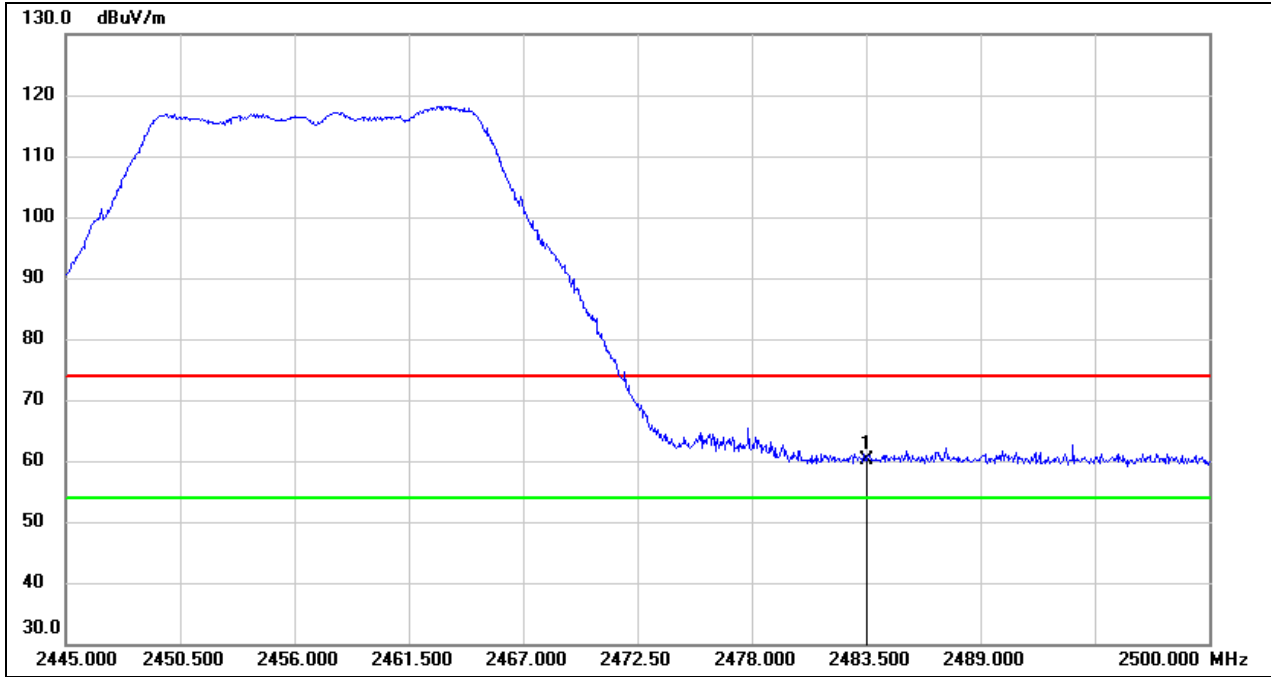

No.	Frequency (MHz)	Reading (dBuV)	Correct (dB/m)	Result (dBuV/m)	Limit (dBuV/m)	Margin (dB)	Remark
1	2483.500	30.74	29.44	60.18	74.00	-13.82	peak



Test Mode:	802.11g AV	Channel:	2457
Polarity:	Vertical	Test Voltage:	DC 12 V

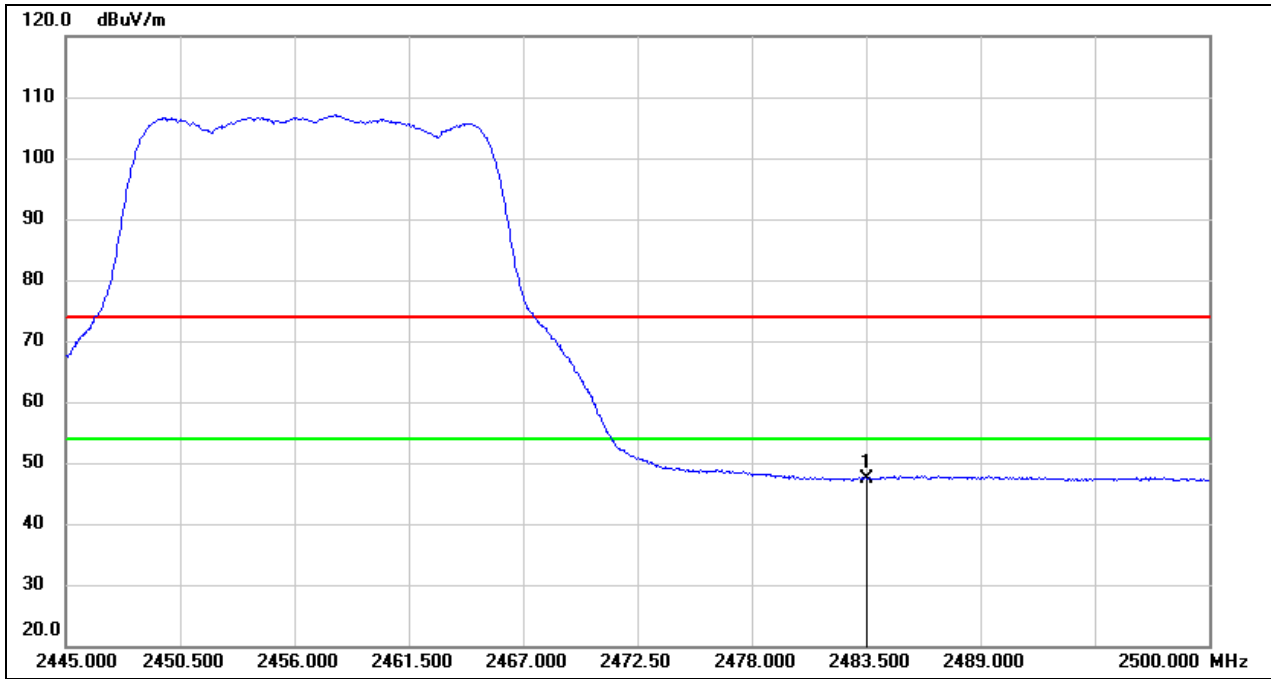

No.	Frequency (MHz)	Reading (dBuV)	Correct (dB/m)	Result (dBuV/m)	Limit (dBuV/m)	Margin (dB)	Remark
1	2483.500	17.90	29.44	47.34	54.00	-6.66	AVG



Test Mode:	802.11g PK	Channel:	2462
Polarity:	Vertical	Test Voltage:	DC 12 V

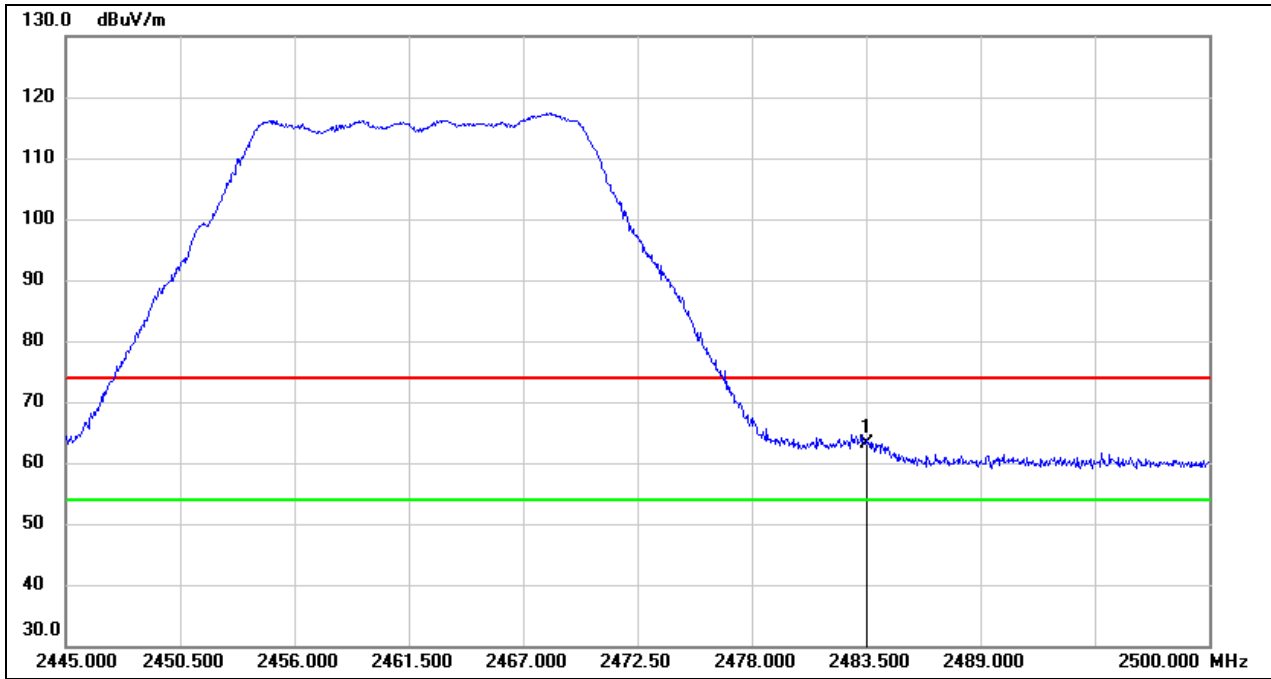

No.	Frequency (MHz)	Reading (dBuV)	Correct (dB/m)	Result (dBuV/m)	Limit (dBuV/m)	Margin (dB)	Remark
1	2483.500	33.81	29.44	63.25	74.00	-10.75	peak



Test Mode:	802.11g AV	Channel:	2462
Polarity:	Vertical	Test Voltage:	DC 12 V

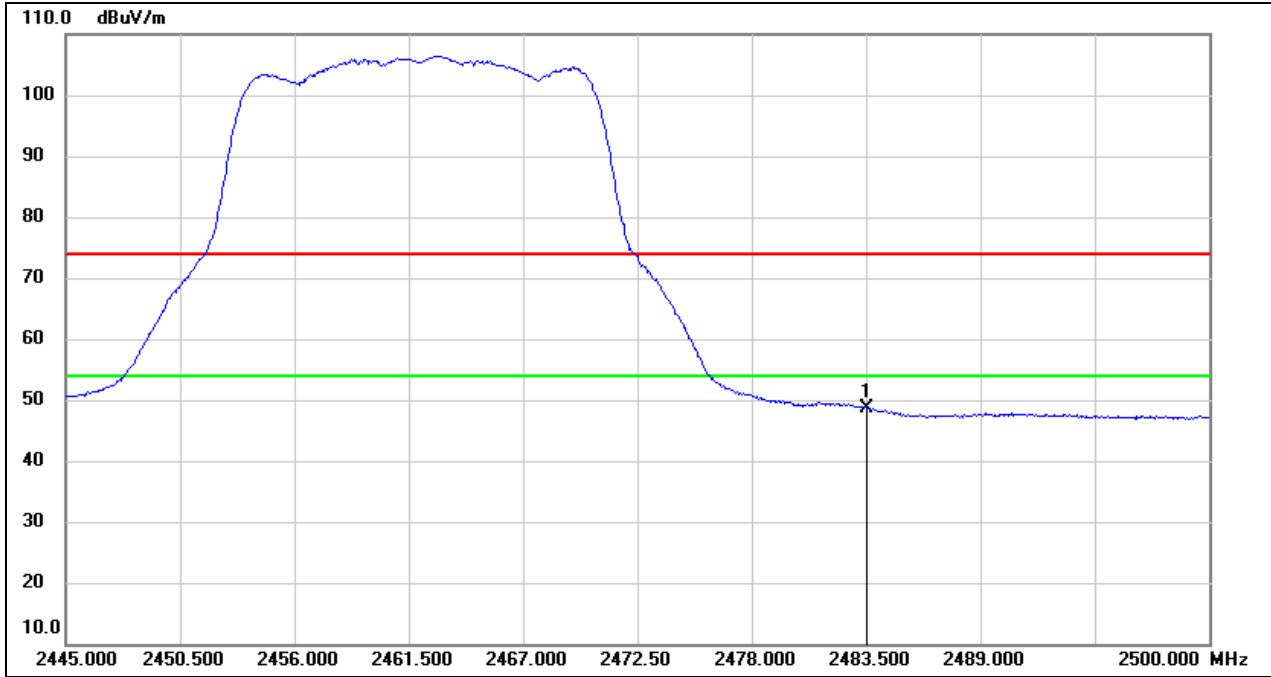

No.	Frequency (MHz)	Reading (dBuV)	Correct (dB/m)	Result (dBuV/m)	Limit (dBuV/m)	Margin (dB)	Remark
1	2483.500	19.22	29.44	48.66	54.00	-5.34	AVG



Test Mode:	802.11ax HE20 PK	Channel:	2412
Polarity:	Vertical	Test Voltage:	DC 12 V

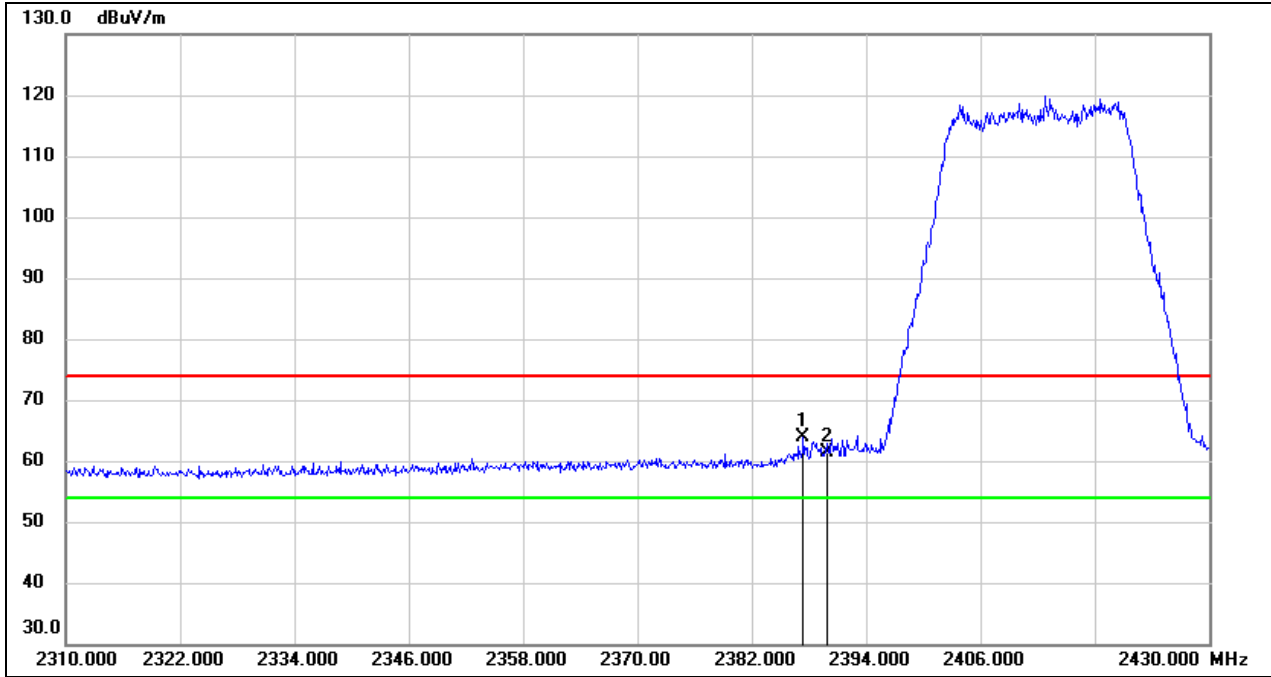

No.	Frequency (MHz)	Reading (dBuV)	Correct (dB/m)	Result (dBuV/m)	Limit (dBuV/m)	Margin (dB)	Remark
1	2387.400	34.73	29.15	63.88	74.00	-10.12	peak
2	2390.000	32.33	29.16	61.49	74.00	-12.51	peak



Test Mode:	802.11ax HE20 AV	Channel:	2412
Polarity:	Vertical	Test Voltage:	DC 12 V

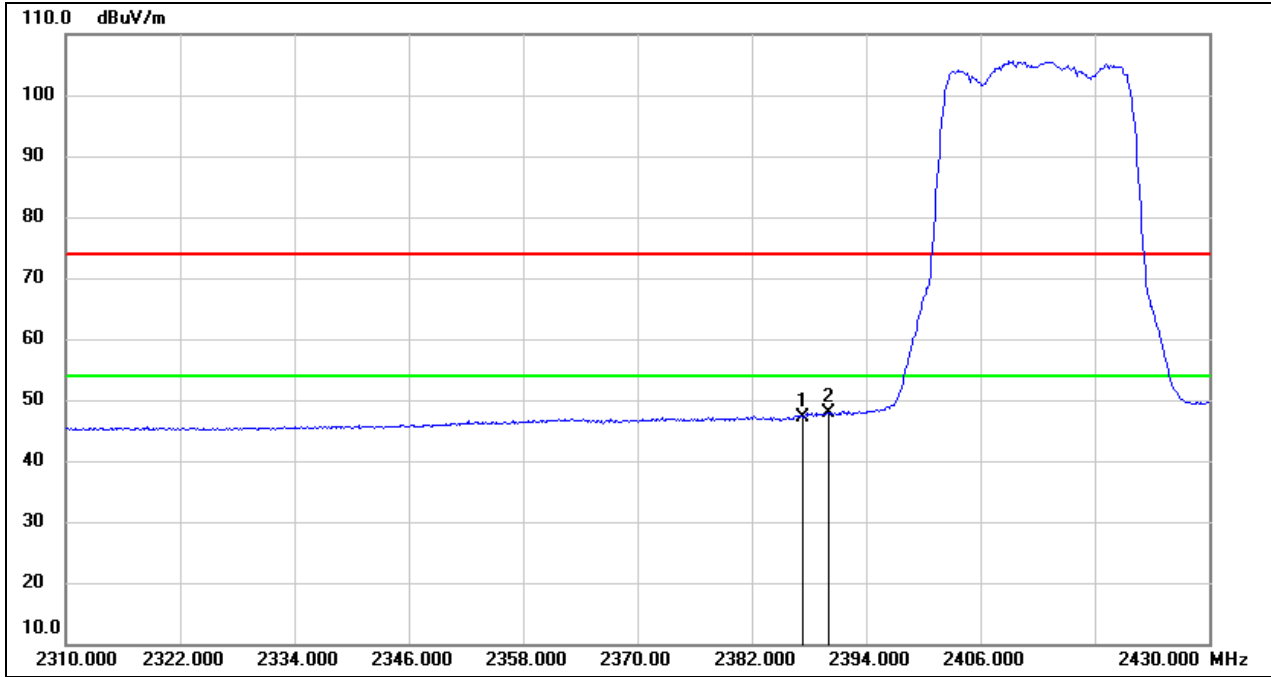

No.	Frequency (MHz)	Reading (dBuV)	Correct (dB/m)	Result (dBuV/m)	Limit (dBuV/m)	Margin (dB)	Remark
1	2387.400	18.07	29.15	47.22	54.00	-6.78	AVG
2	2390.000	18.71	29.16	47.87	54.00	-6.13	AVG



Test Mode:	802.11ax HE20 PK	Channel:	2417
Polarity:	Vertical	Test Voltage:	DC 12 V

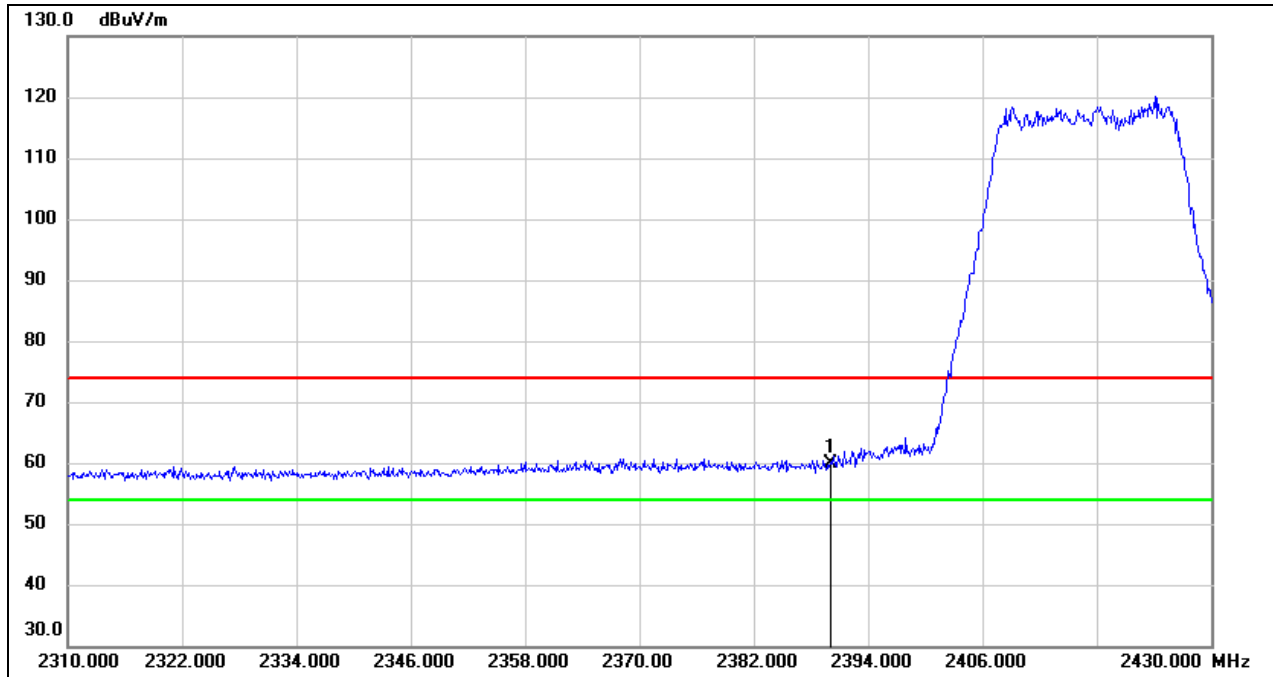

No.	Frequency (MHz)	Reading (dBuV)	Correct (dB/m)	Result (dBuV/m)	Limit (dBuV/m)	Margin (dB)	Remark
1	2390.000	30.65	29.16	59.81	74.00	-14.19	peak



Test Mode:	802.11ax HE20 AV	Channel:	2417
Polarity:	Vertical	Test Voltage:	DC 12 V

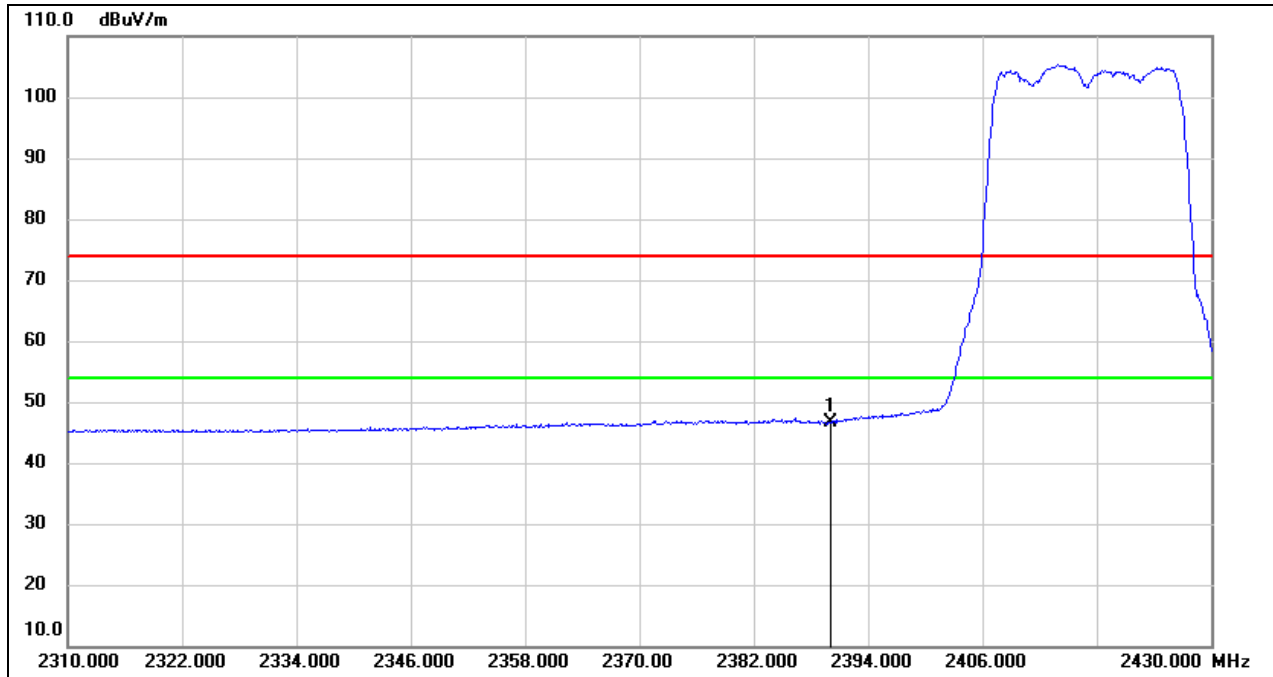

No.	Frequency (MHz)	Reading (dBuV)	Correct (dB/m)	Result (dBuV/m)	Limit (dBuV/m)	Margin (dB)	Remark
1	2390.000	17.36	29.16	46.52	54.00	-7.48	AVG



Test Mode:	802.11ax HE20 PK	Channel:	2437
Polarity:	Vertical	Test Voltage:	DC 12 V

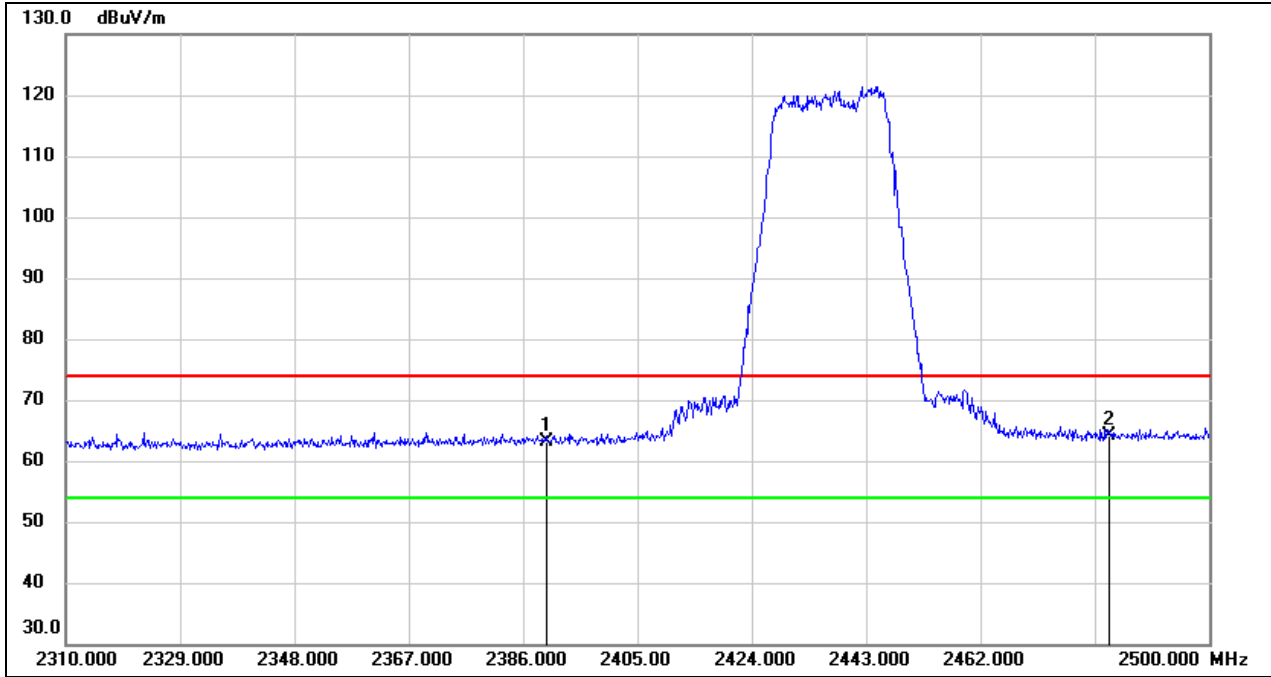

No.	Frequency (MHz)	Reading (dBuV)	Correct (dB/m)	Result (dBuV/m)	Limit (dBuV/m)	Margin (dB)	Remark
1	2390.000	33.93	29.16	63.09	74.00	-10.91	peak
2	2483.500	34.64	29.44	64.08	74.00	-9.92	peak



Test Mode:	802.11ax HE20 AV	Channel:	2437
Polarity:	Vertical	Test Voltage:	DC 12 V

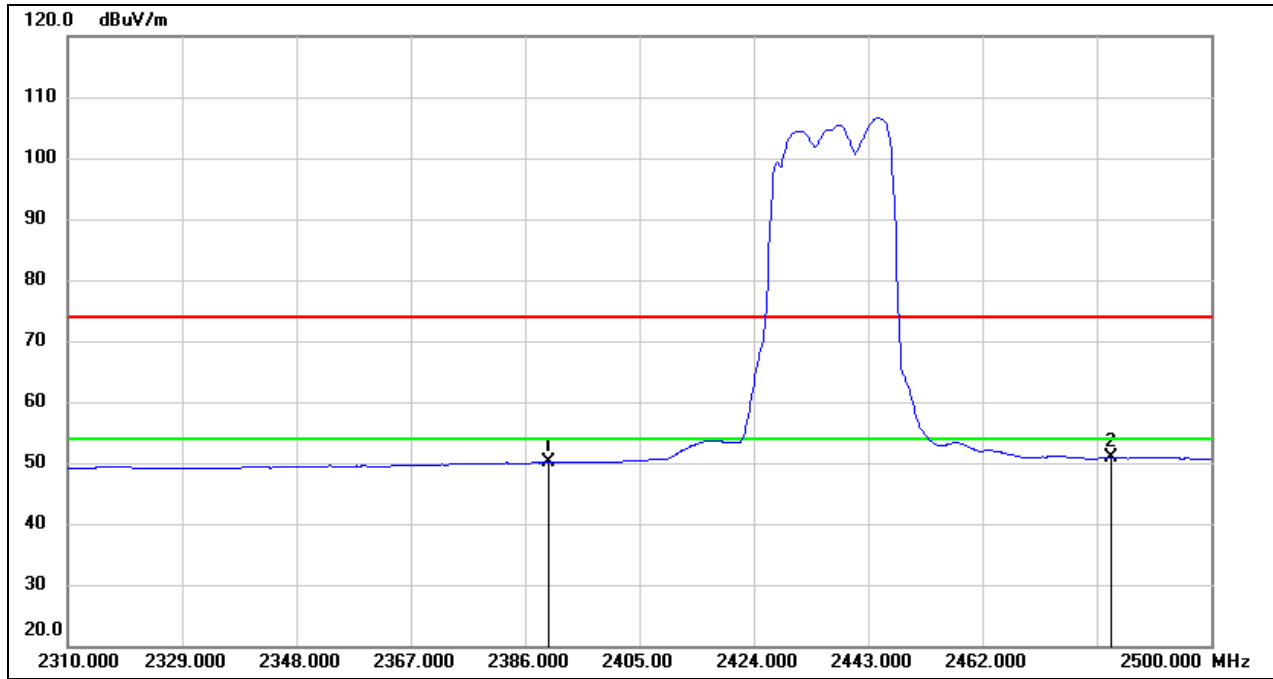

No.	Frequency (MHz)	Reading (dBuV)	Correct (dB/m)	Result (dBuV/m)	Limit (dBuV/m)	Margin (dB)	Remark
1	2390.000	20.90	29.16	50.06	54.00	-3.94	AVG
2	2483.500	21.43	29.44	50.87	54.00	-3.13	AVG



Test Mode:	802.11ax HE20 PK	Channel:	2457
Polarity:	Vertical	Test Voltage:	DC 12 V

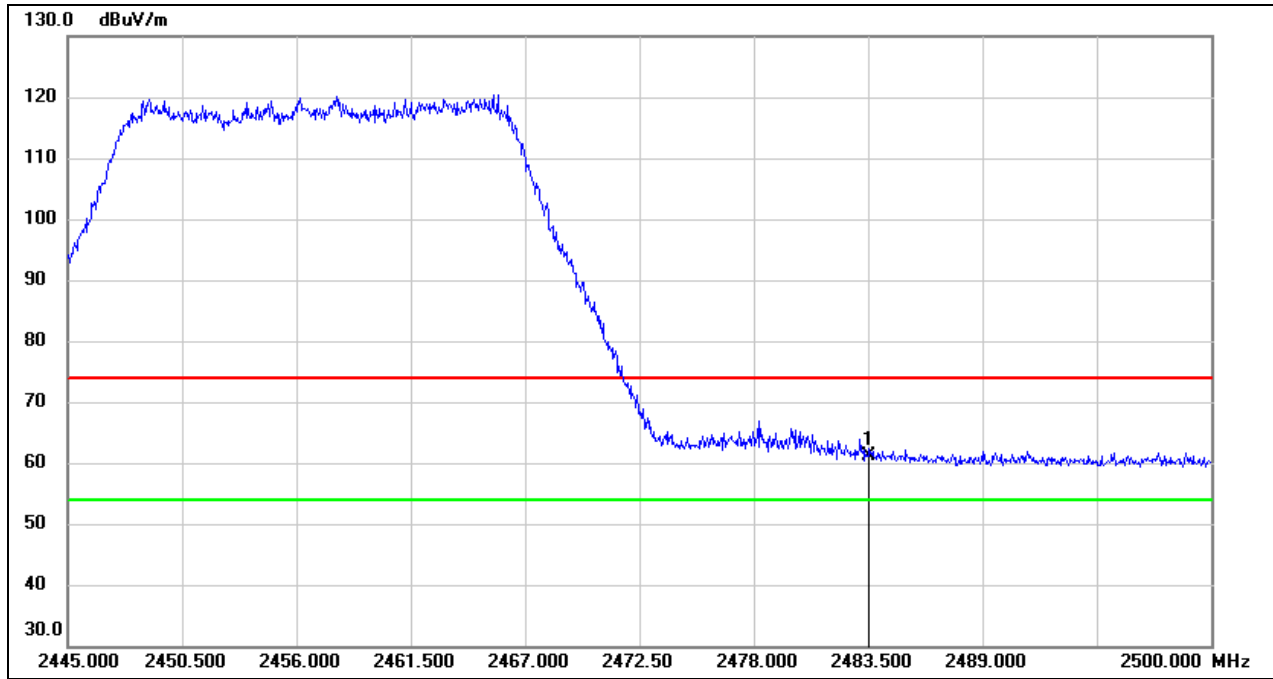

No.	Frequency (MHz)	Reading (dBuV)	Correct (dB/m)	Result (dBuV/m)	Limit (dBuV/m)	Margin (dB)	Remark
1	2483.500	31.60	29.44	61.04	74.00	-12.96	peak



Test Mode:	802.11ax HE20 AV	Channel:	2457
Polarity:	Vertical	Test Voltage:	DC 12 V

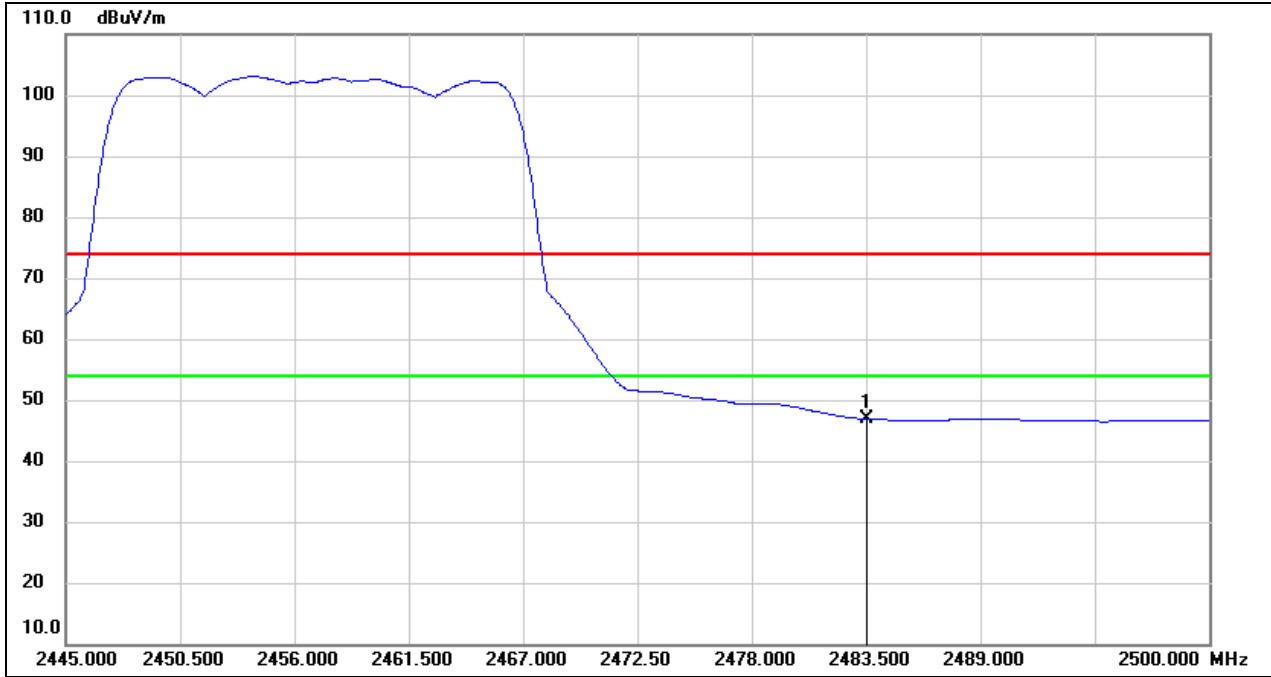

No.	Frequency (MHz)	Reading (dBuV)	Correct (dB/m)	Result (dBuV/m)	Limit (dBuV/m)	Margin (dB)	Remark
1	2483.500	17.50	29.44	46.94	54.00	-7.06	AVG



Test Mode:	802.11ax HE20 PK	Channel:	2462
Polarity:	Vertical	Test Voltage:	DC 12 V

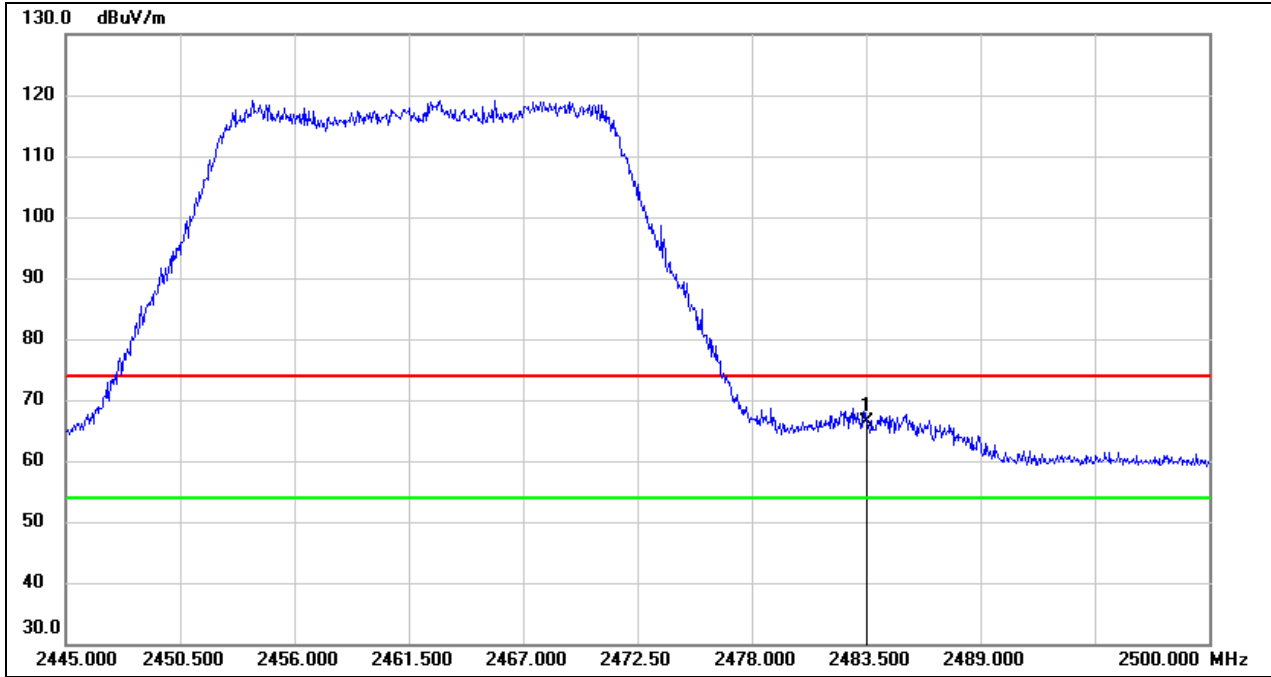

No.	Frequency (MHz)	Reading (dBuV)	Correct (dB/m)	Result (dBuV/m)	Limit (dBuV/m)	Margin (dB)	Remark
1	2483.500	36.89	29.44	66.33	74.00	-7.67	peak



Test Mode:	802.11ax HE20 AV	Channel:	2462
Polarity:	Vertical	Test Voltage:	DC 12 V

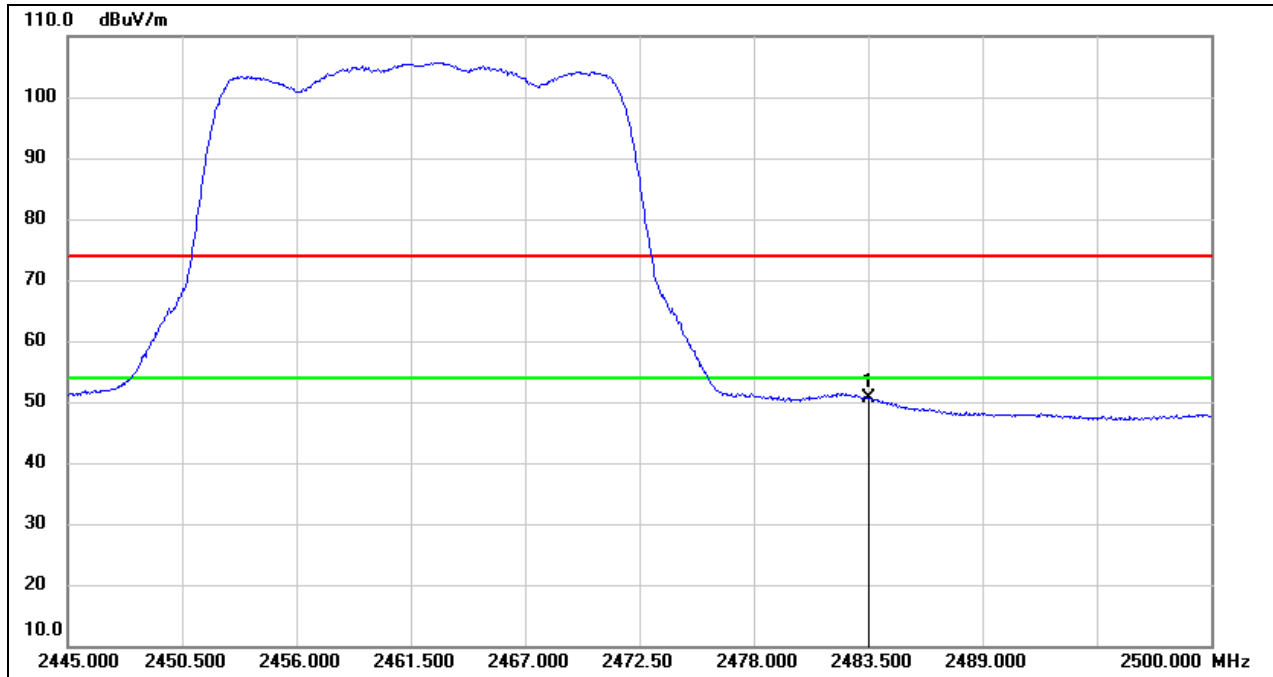

No.	Frequency (MHz)	Reading (dBuV)	Correct (dB/m)	Result (dBuV/m)	Limit (dBuV/m)	Margin (dB)	Remark
1	2483.500	21.24	29.44	50.68	54.00	-3.32	AVG



Test Mode:	802.11ax HE40 PK	Channel:	2422
Polarity:	Vertical	Test Voltage:	DC 12 V

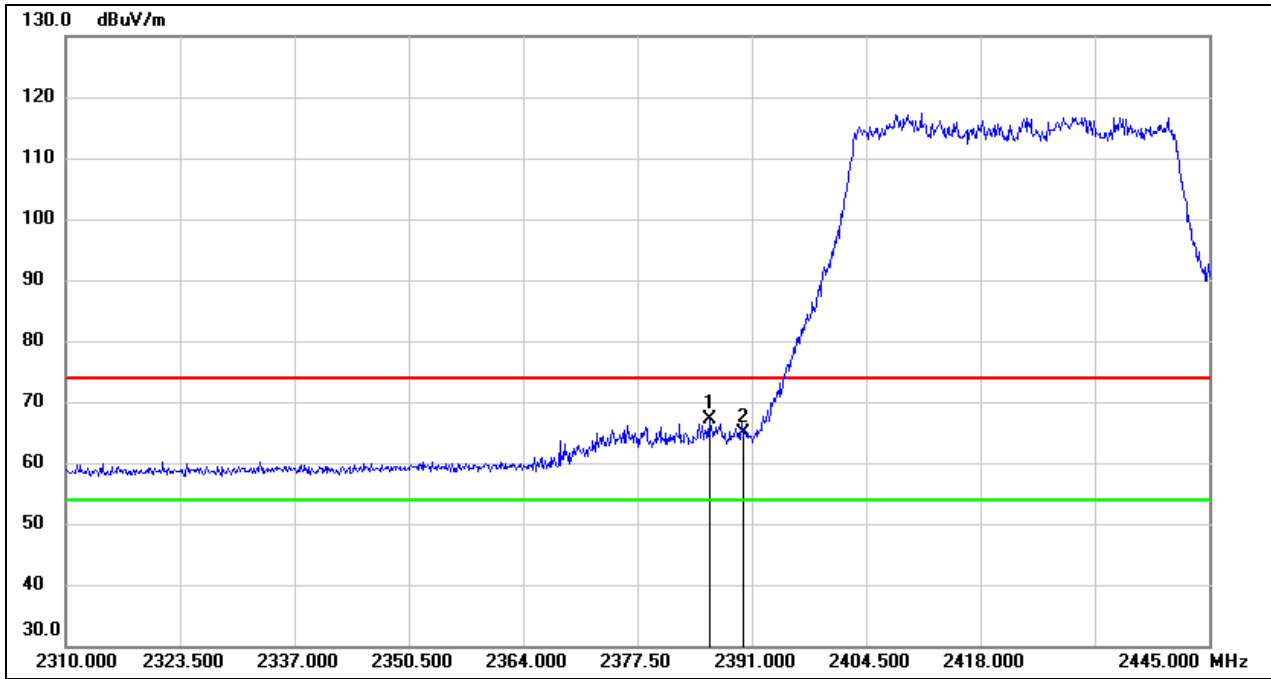

No.	Frequency (MHz)	Reading (dBuV)	Correct (dB/m)	Result (dBuV/m)	Limit (dBuV/m)	Margin (dB)	Remark
1	2386.005	37.87	29.14	67.01	74.00	-6.99	peak
2	2390.000	35.72	29.16	64.88	74.00	-9.12	peak



Test Mode:	802.11ax HE40 AV	Channel:	2422
Polarity:	Vertical	Test Voltage:	DC 12 V

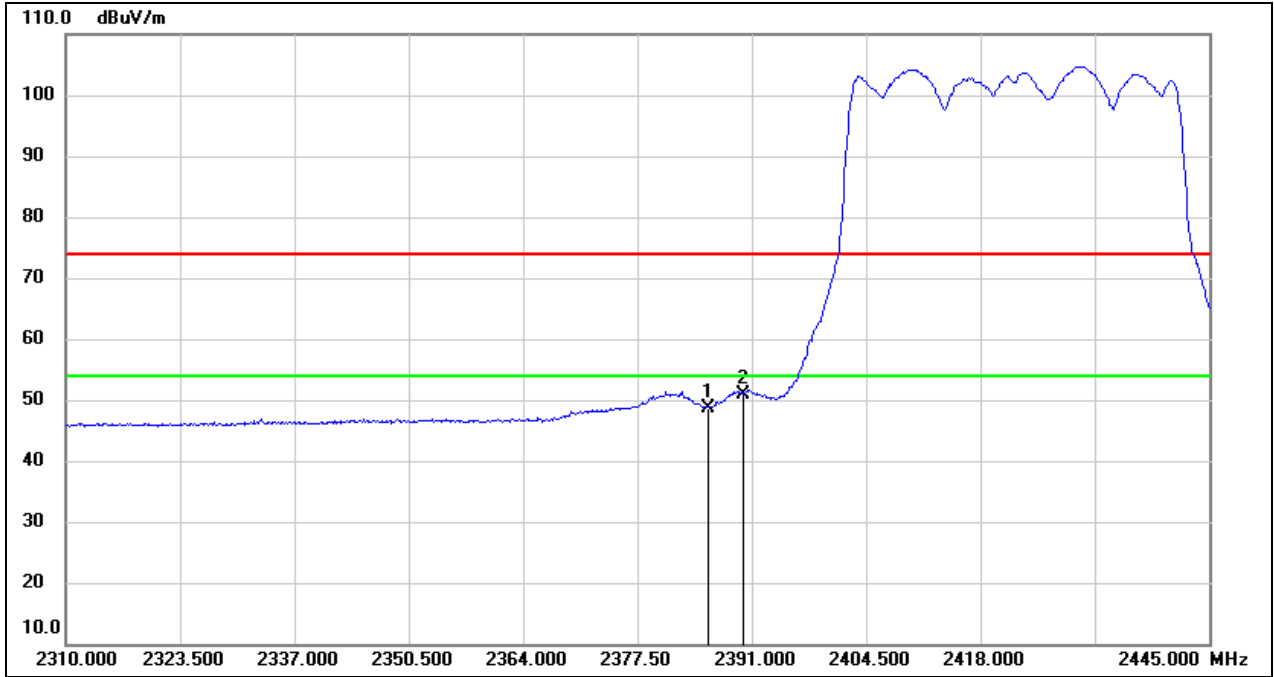

No.	Frequency (MHz)	Reading (dBuV)	Correct (dB/m)	Result (dBuV/m)	Limit (dBuV/m)	Margin (dB)	Remark
1	2386.005	19.59	29.14	48.73	54.00	-5.27	AVG
2	2390.000	21.81	29.16	50.97	54.00	-3.03	AVG



Test Mode:	802.11ax HE40 PK	Channel:	2427
Polarity:	Vertical	Test Voltage:	DC 12 V

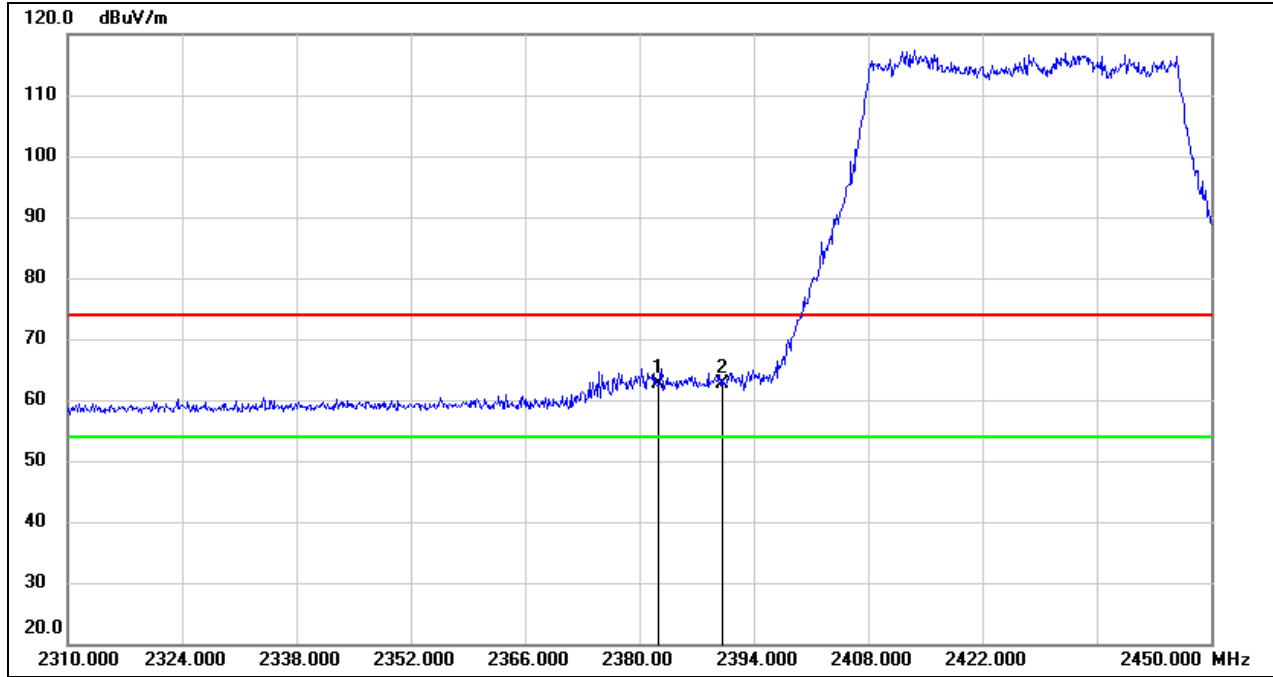

No.	Frequency (MHz)	Reading (dBuV)	Correct (dB/m)	Result (dBuV/m)	Limit (dBuV/m)	Margin (dB)	Remark
1	2382.240	33.47	29.13	62.60	74.00	-11.40	peak
2	2390.000	33.55	29.16	62.71	74.00	-11.29	peak



Test Mode:	802.11ax HE40 AV	Channel:	2427
Polarity:	Vertical	Test Voltage:	DC 12 V

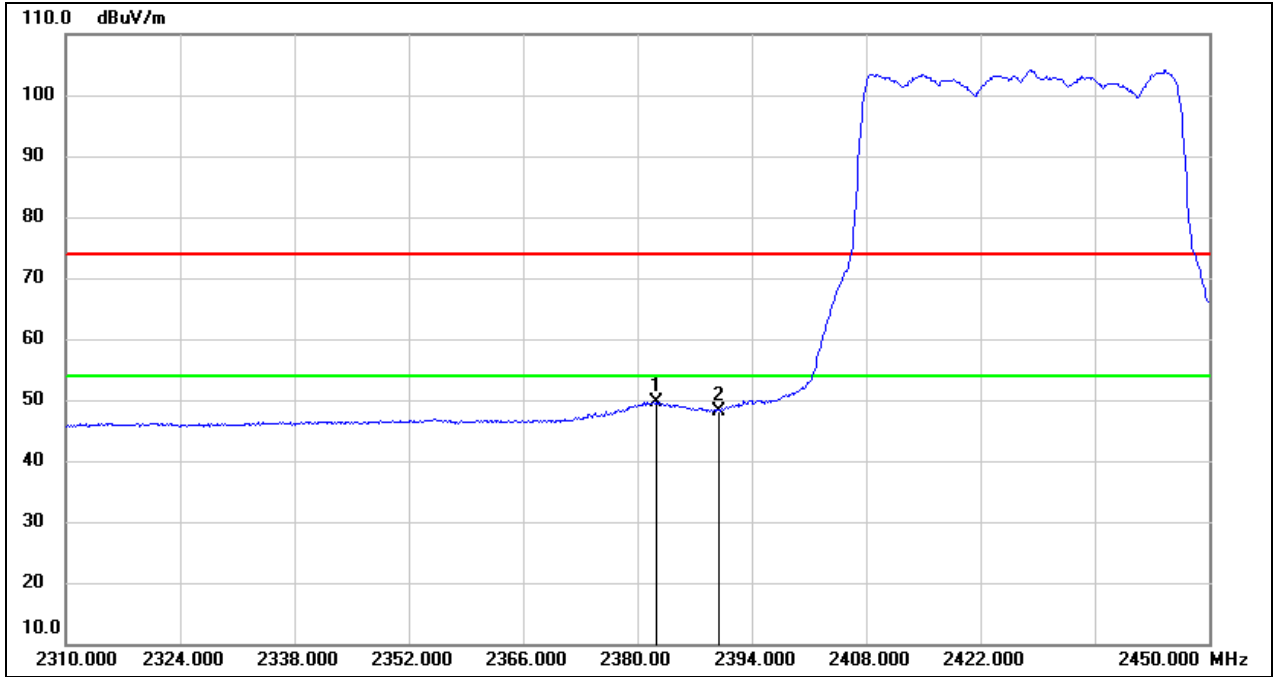

No.	Frequency (MHz)	Reading (dBuV)	Correct (dB/m)	Result (dBuV/m)	Limit (dBuV/m)	Margin (dB)	Remark
1	2382.240	20.57	29.13	49.70	54.00	-4.30	AVG
2	2390.000	19.05	29.16	48.21	54.00	-5.79	AVG



Test Mode:	802.11ax HE40 PK	Channel:	2437
Polarity:	Vertical	Test Voltage:	DC 12 V

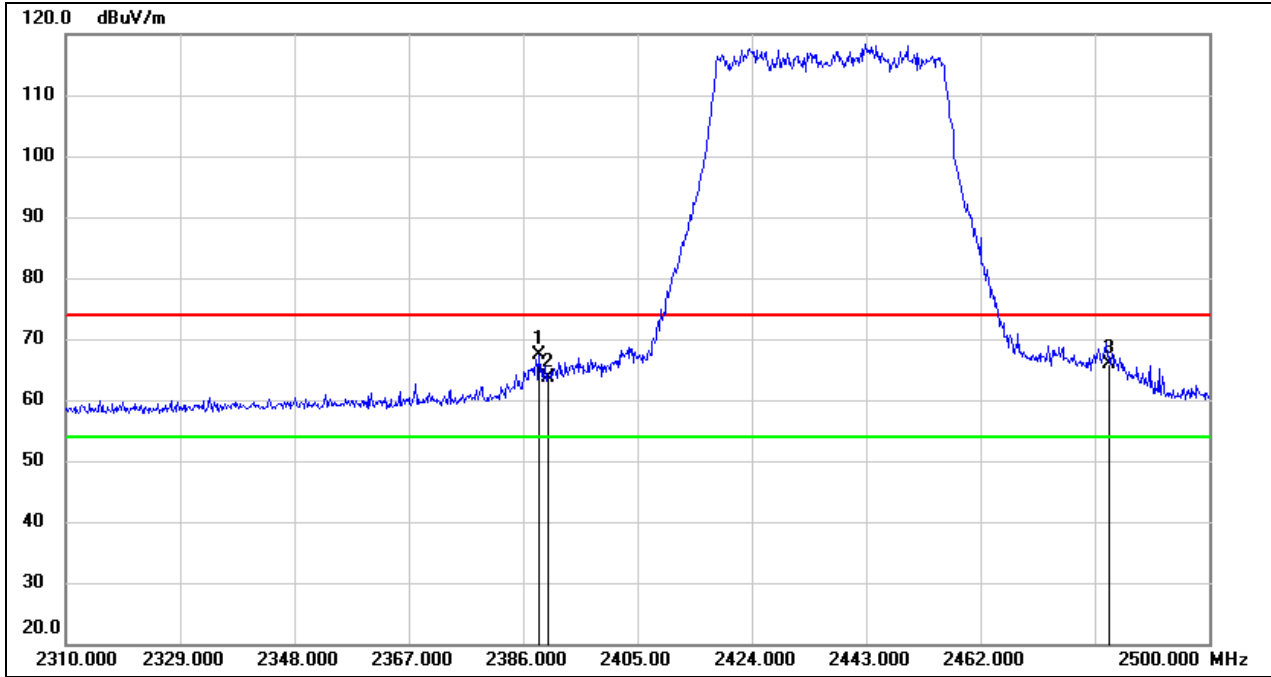

No.	Frequency (MHz)	Reading (dBuV)	Correct (dB/m)	Result (dBuV/m)	Limit (dBuV/m)	Margin (dB)	Remark
1	2388.660	38.23	29.16	67.39	74.00	-6.61	peak
2	2390.000	34.53	29.16	63.69	74.00	-10.31	peak
3	2483.500	36.53	29.44	65.97	74.00	-8.03	peak



Test Mode:	802.11ax HE40 AV	Channel:	2437
Polarity:	Vertical	Test Voltage:	DC 12 V

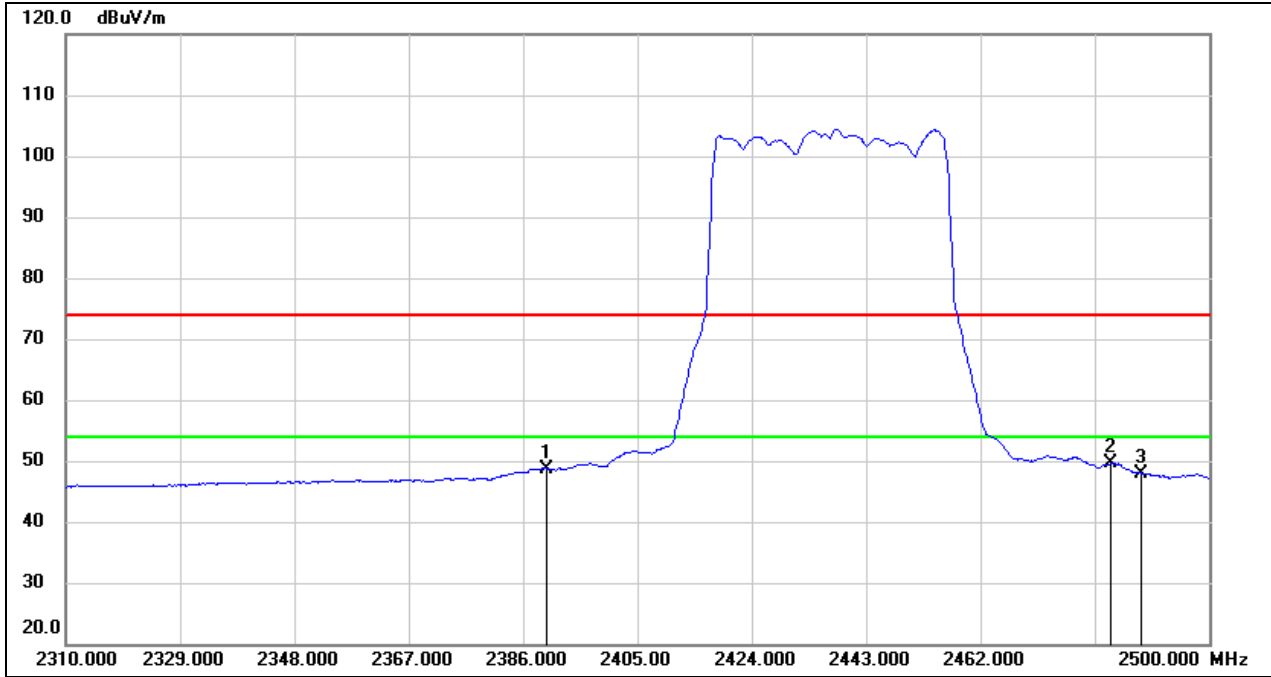

No.	Frequency (MHz)	Reading (dBuV)	Correct (dB/m)	Result (dBuV/m)	Limit (dBuV/m)	Margin (dB)	Remark
1	2390.000	19.49	29.16	48.65	54.00	-5.35	AVG
2	2483.500	20.27	29.44	49.71	54.00	-4.29	AVG
3	2488.660	18.47	29.46	47.93	54.00	-6.07	AVG



Test Mode:	802.11ax HE40 PK	Channel:	2447
Polarity:	Vertical	Test Voltage:	DC 12 V

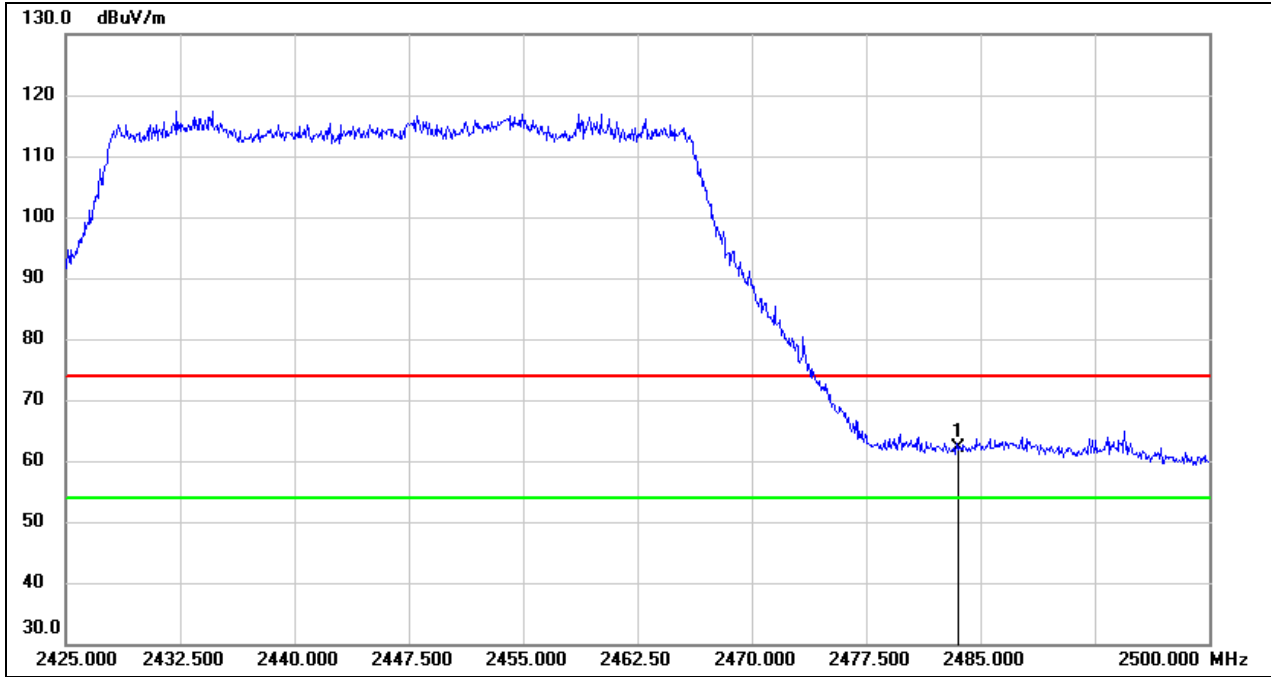

No.	Frequency (MHz)	Reading (dBuV)	Correct (dB/m)	Result (dBuV/m)	Limit (dBuV/m)	Margin (dB)	Remark
1	2483.500	32.66	29.44	62.10	74.00	-11.90	peak



Test Mode:	802.11ax HE40 AV	Channel:	2447
Polarity:	Vertical	Test Voltage:	DC 12 V

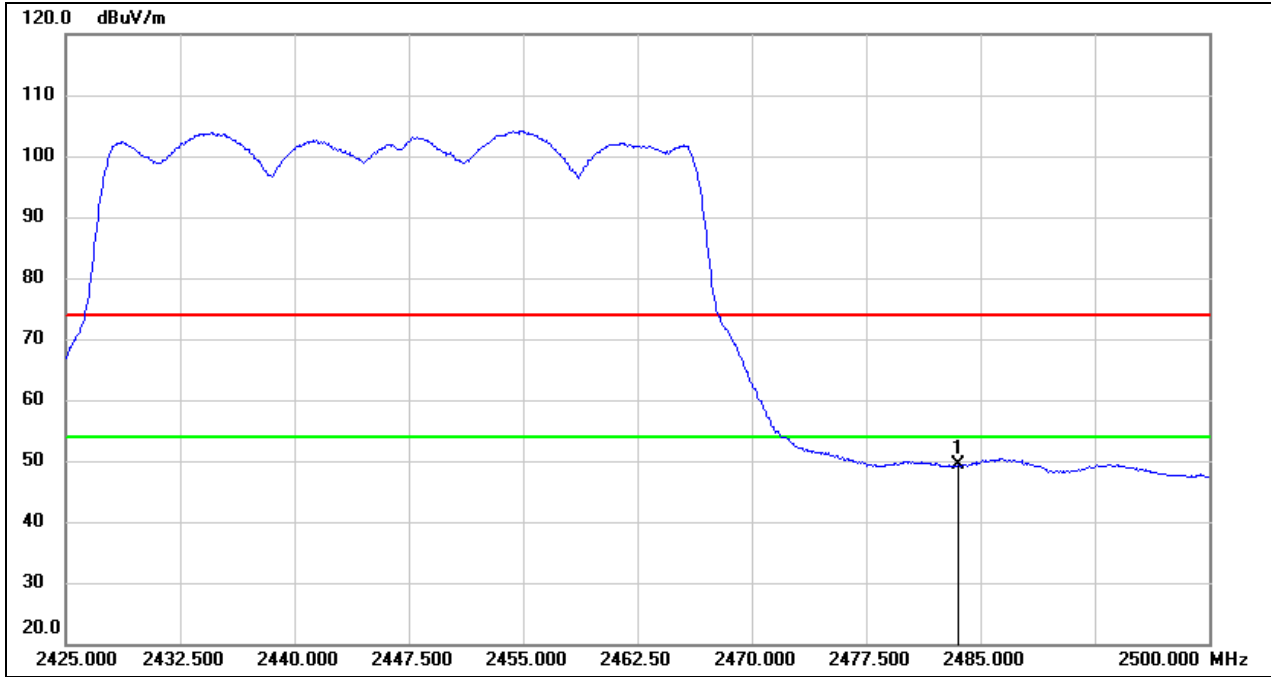

No.	Frequency (MHz)	Reading (dBuV)	Correct (dB/m)	Result (dBuV/m)	Limit (dBuV/m)	Margin (dB)	Remark
1	2483.500	19.89	29.44	49.33	54.00	-4.67	AVG



Test Mode:	802.11ax HE40 PK	Channel:	2452
Polarity:	Vertical	Test Voltage:	DC 12 V

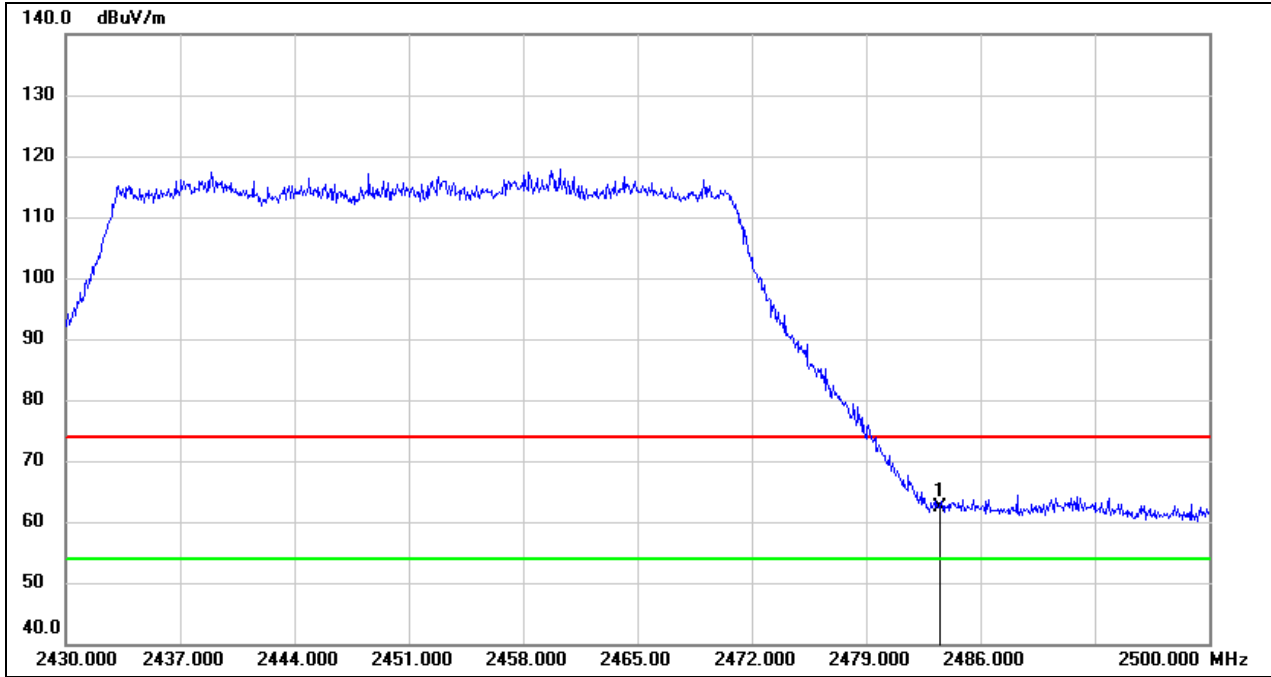

No.	Frequency (MHz)	Reading (dBuV)	Correct (dB/m)	Result (dBuV/m)	Limit (dBuV/m)	Margin (dB)	Remark
1	2483.500	33.03	29.44	62.47	74.00	-11.53	peak



Test Mode:	802.11ax HE40 AV	Channel:	2452
Polarity:	Vertical	Test Voltage:	DC 12 V

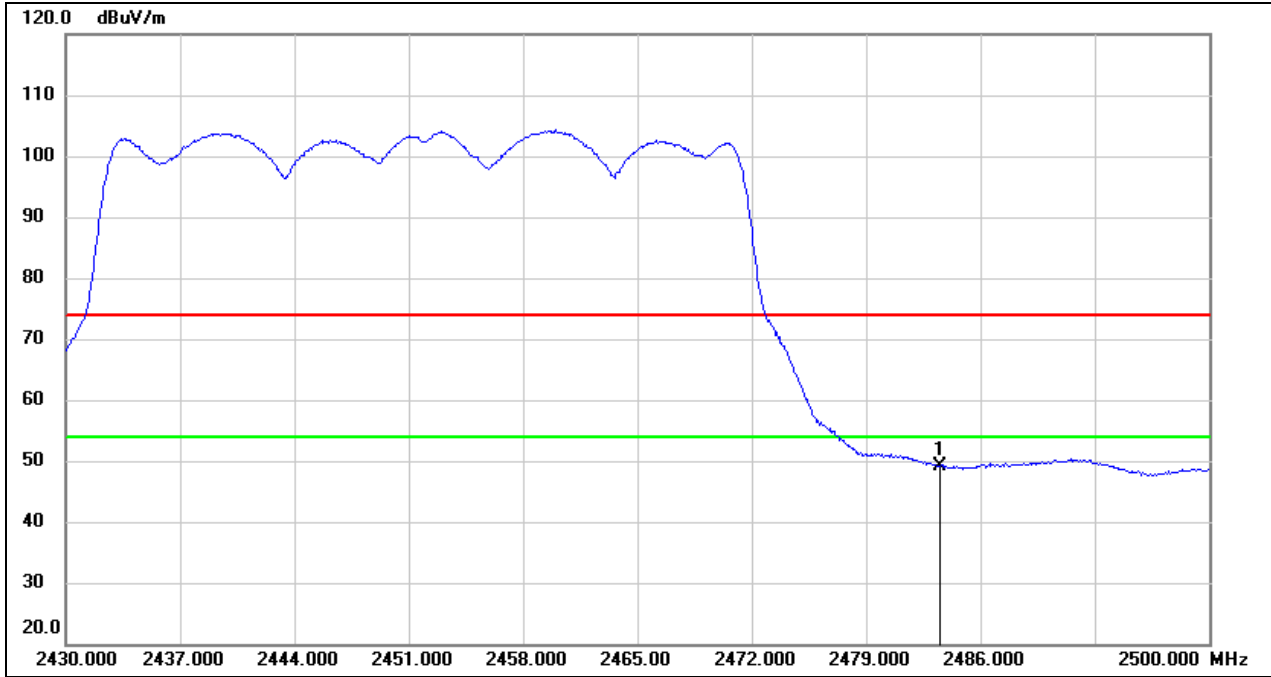

No.	Frequency (MHz)	Reading (dBuV)	Correct (dB/m)	Result (dBuV/m)	Limit (dBuV/m)	Margin (dB)	Remark
1	2483.500	19.59	29.44	49.03	54.00	-4.97	AVG



Test Mode:	802.11be EHT20 PK	Channel:	2412
Polarity:	Vertical	Test Voltage:	DC 12 V

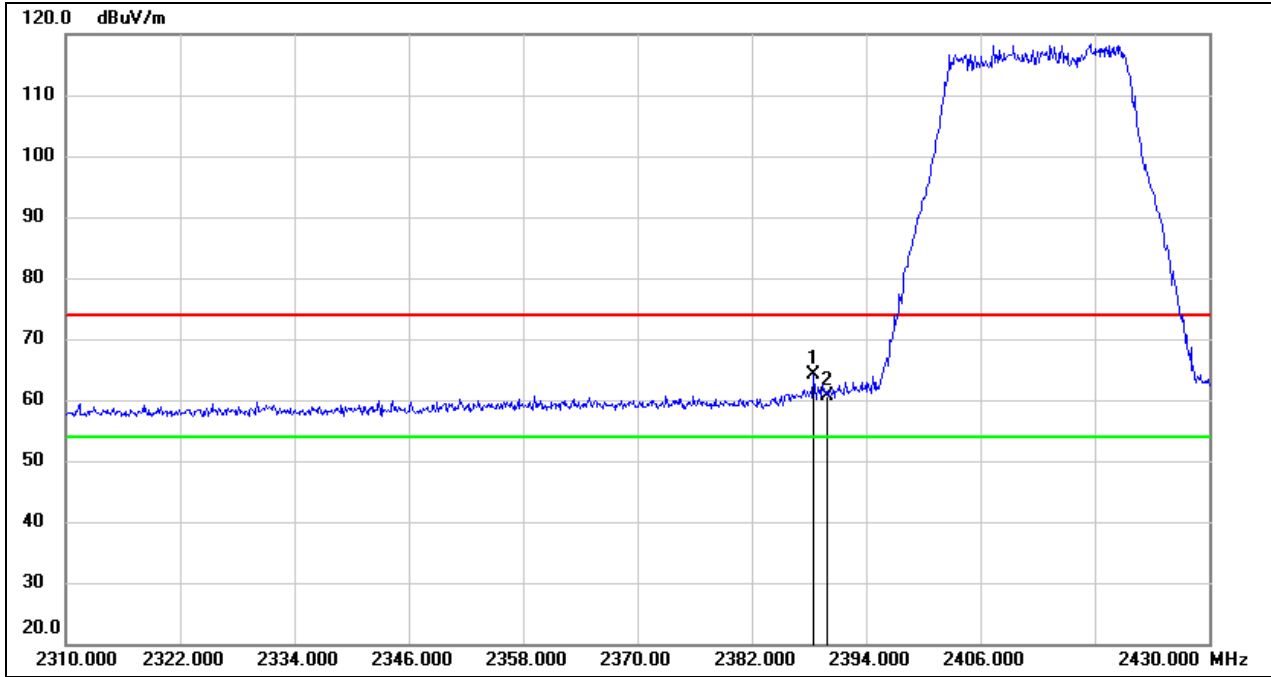

No.	Frequency (MHz)	Reading (dBuV)	Correct (dB/m)	Result (dBuV/m)	Limit (dBuV/m)	Margin (dB)	Remark
1	2388.480	35.05	29.16	64.21	74.00	-9.79	peak
2	2390.000	31.50	29.16	60.66	74.00	-13.34	peak



Test Mode:	802.11be EHT20 AV	Channel:	2412
Polarity:	Vertical	Test Voltage:	DC 12 V

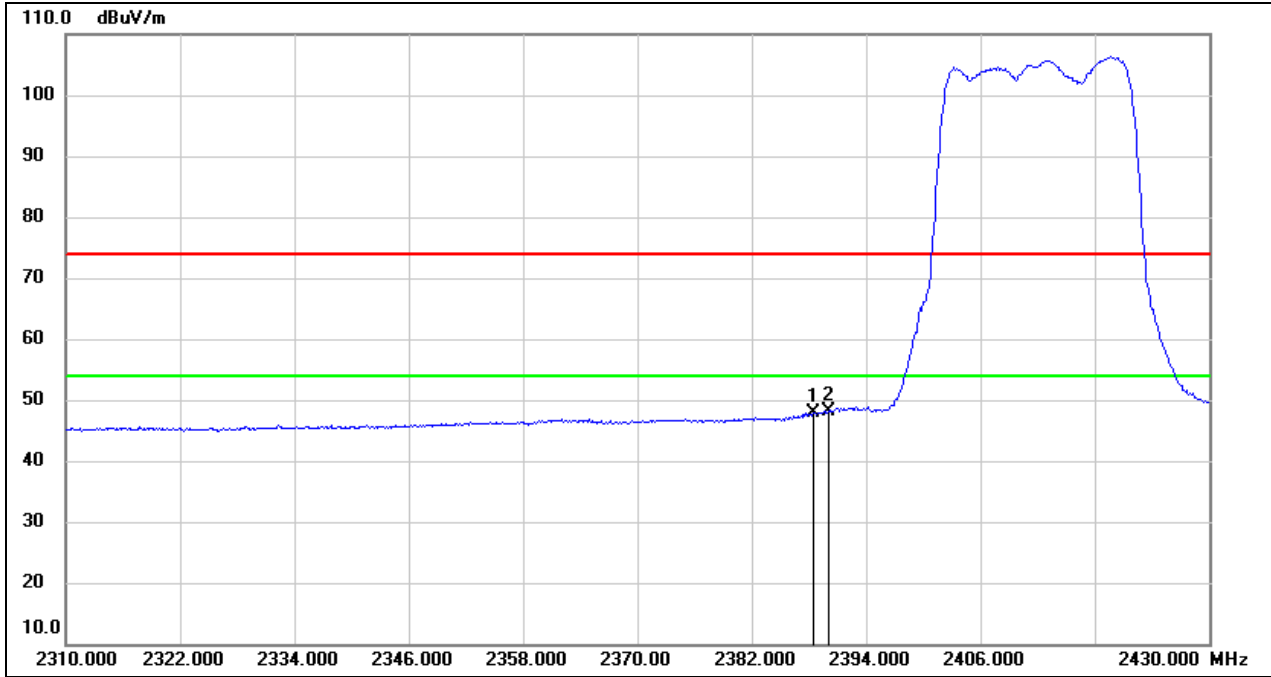

No.	Frequency (MHz)	Reading (dBuV)	Correct (dB/m)	Result (dBuV/m)	Limit (dBuV/m)	Margin (dB)	Remark
1	2388.480	18.79	29.16	47.95	54.00	-6.05	AVG
2	2390.000	18.99	29.16	48.15	54.00	-5.85	AVG



Test Mode:	802.11be EHT20 PK	Channel:	2417
Polarity:	Vertical	Test Voltage:	DC 12 V

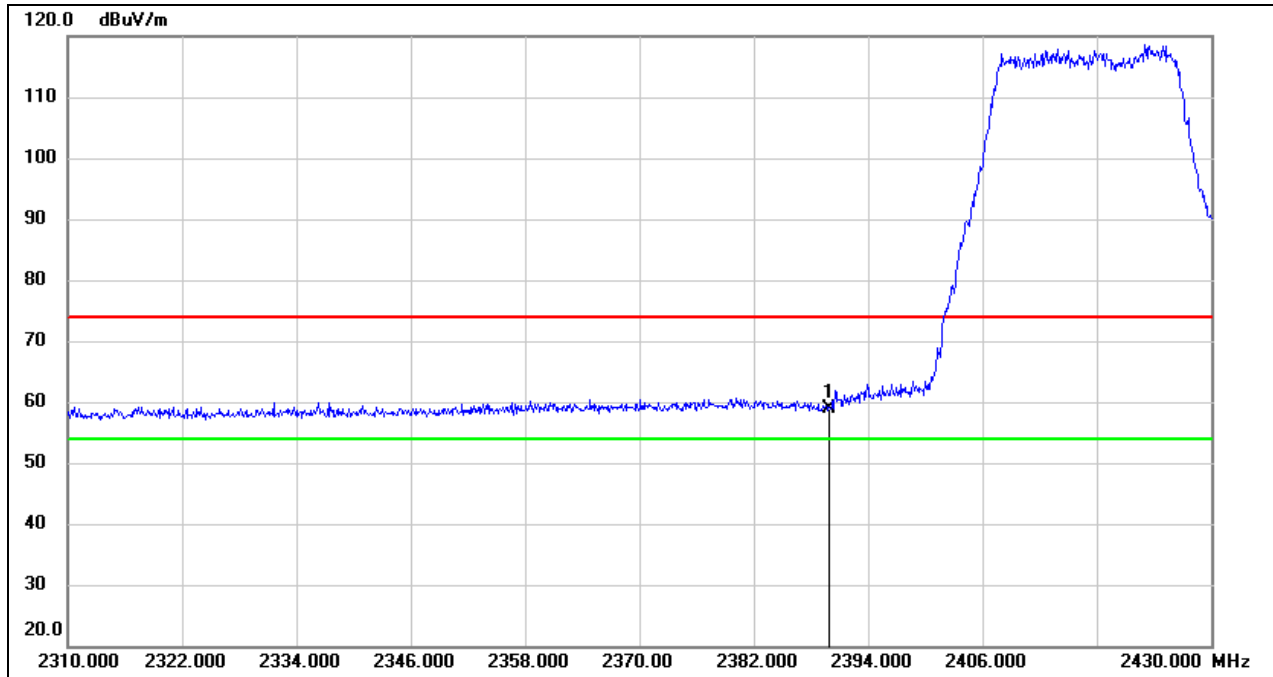

No.	Frequency (MHz)	Reading (dBuV)	Correct (dB/m)	Result (dBuV/m)	Limit (dBuV/m)	Margin (dB)	Remark
1	2390.000	29.74	29.16	58.90	74.00	-15.10	peak



Test Mode:	802.11be EHT20 AV	Channel:	2417
Polarity:	Vertical	Test Voltage:	DC 12 V

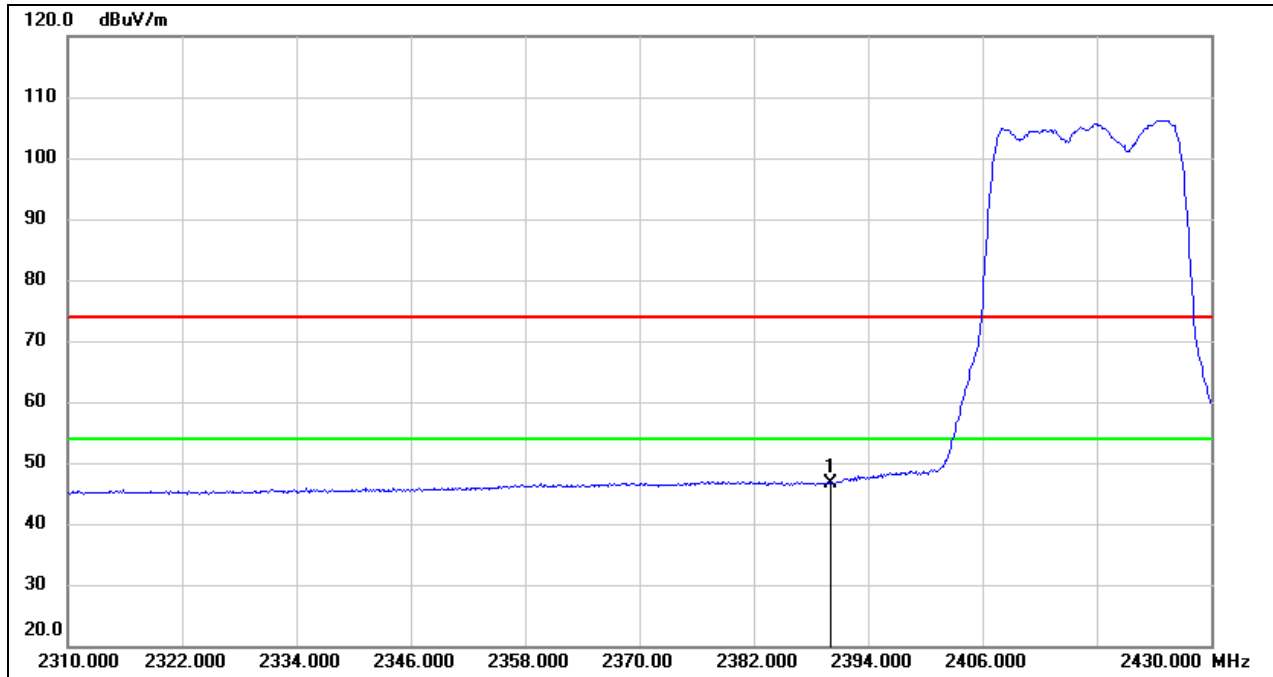

No.	Frequency (MHz)	Reading (dBuV)	Correct (dB/m)	Result (dBuV/m)	Limit (dBuV/m)	Margin (dB)	Remark
1	2390.000	17.59	29.16	46.75	54.00	-7.25	AVG



Test Mode:	802.11be EHT20 PK	Channel:	2437
Polarity:	Vertical	Test Voltage:	DC 12 V

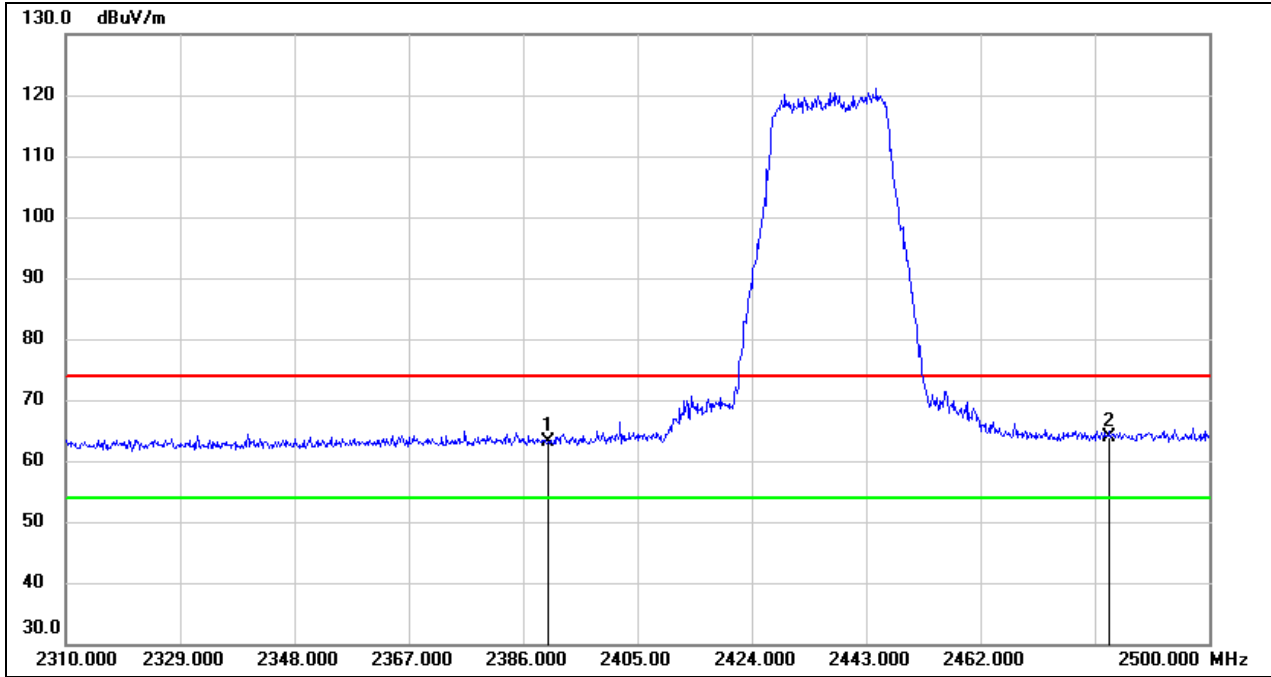

No.	Frequency (MHz)	Reading (dBuV)	Correct (dB/m)	Result (dBuV/m)	Limit (dBuV/m)	Margin (dB)	Remark
1	2390.000	34.04	29.16	63.20	74.00	-10.80	peak
2	2483.500	34.34	29.44	63.78	74.00	-10.22	peak



Test Mode:	802.11be EHT20 AV	Channel:	2437
Polarity:	Vertical	Test Voltage:	DC 12 V

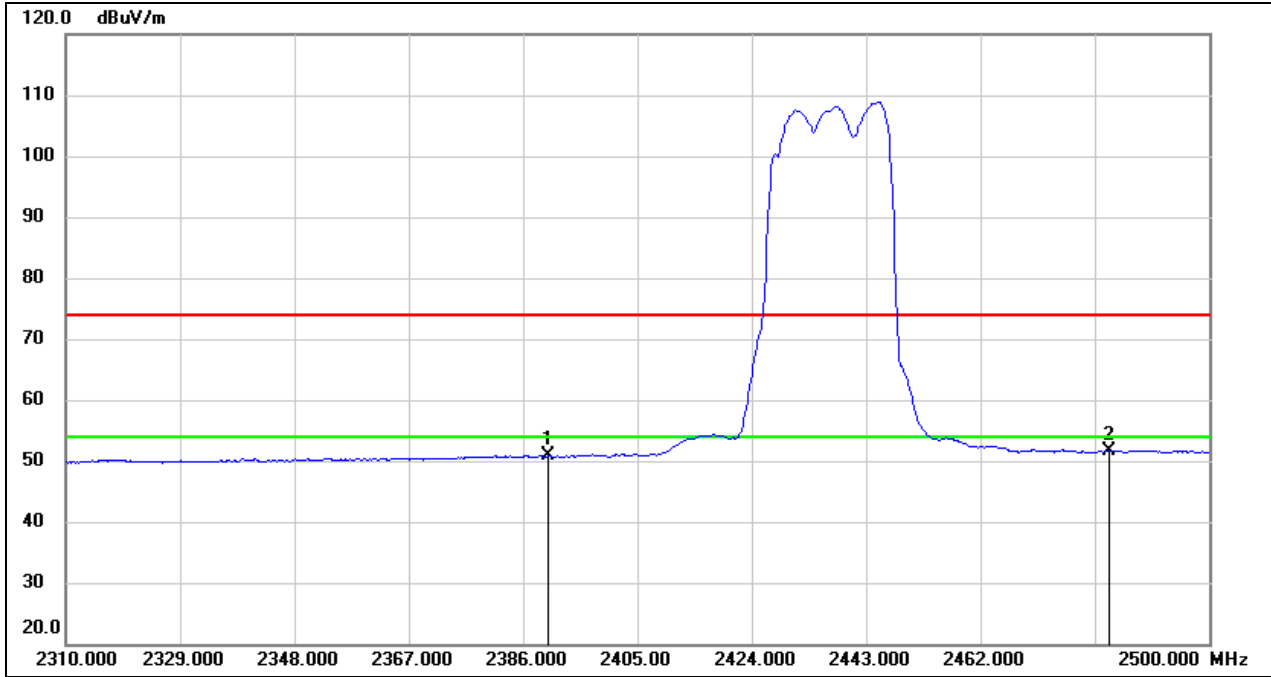

No.	Frequency (MHz)	Reading (dBuV)	Correct (dB/m)	Result (dBuV/m)	Limit (dBuV/m)	Margin (dB)	Remark
1	2390.000	21.60	29.16	50.76	54.00	-3.24	AVG
2	2483.500	22.12	29.44	51.56	54.00	-2.44	AVG



Test Mode:	802.11be EHT20 PK	Channel:	2457
Polarity:	Vertical	Test Voltage:	DC 12 V

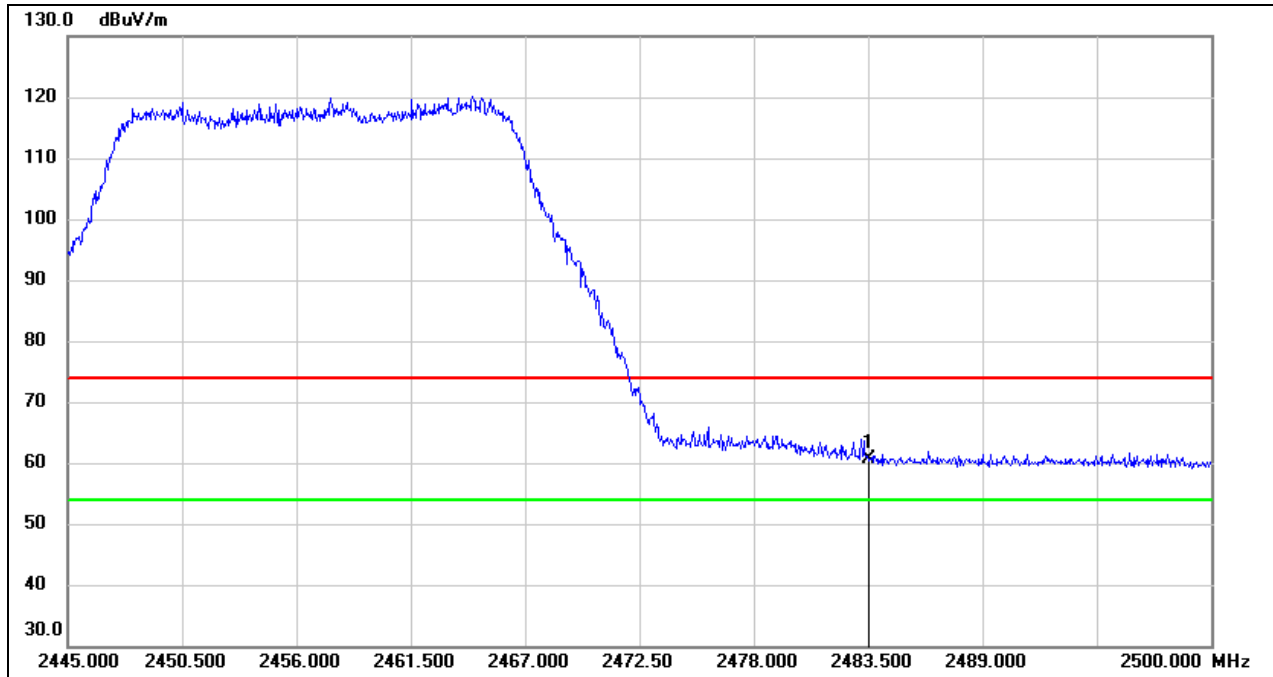

No.	Frequency (MHz)	Reading (dBuV)	Correct (dB/m)	Result (dBuV/m)	Limit (dBuV/m)	Margin (dB)	Remark
1	2483.500	31.29	29.44	60.73	74.00	-13.27	peak



Test Mode:	802.11be EHT20 AV	Channel:	2457
Polarity:	Vertical	Test Voltage:	DC 12 V

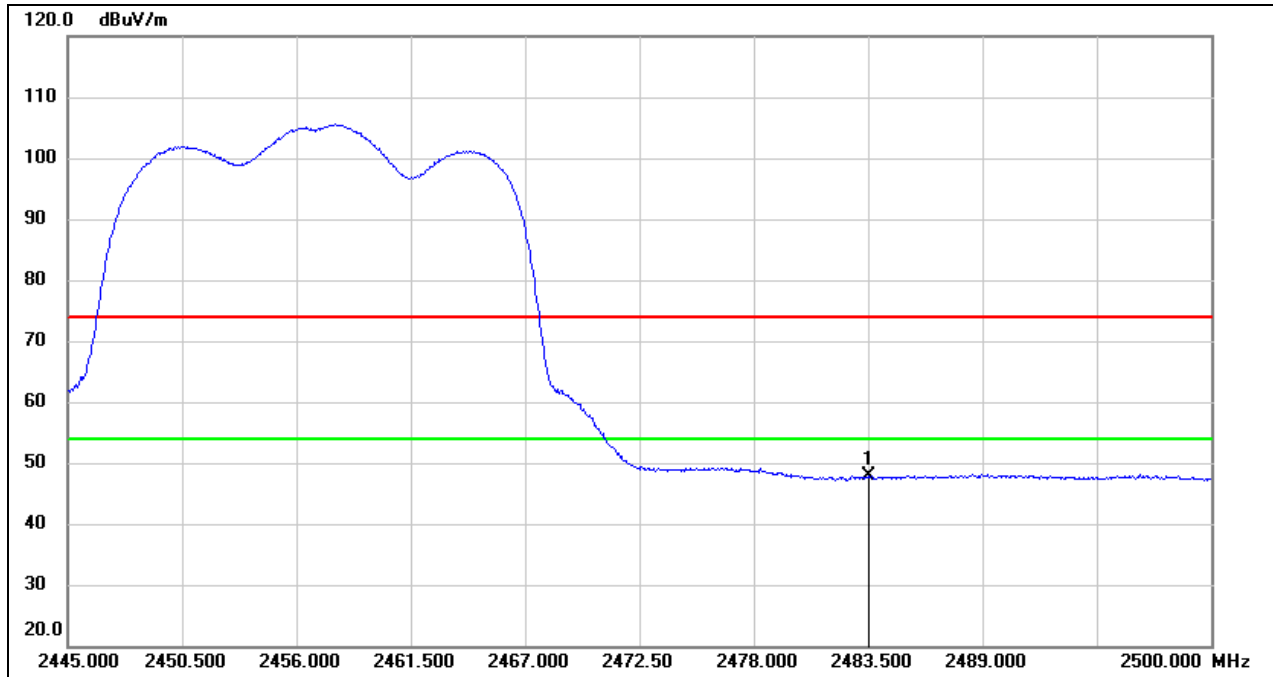

No.	Frequency (MHz)	Reading (dBuV)	Correct (dB/m)	Result (dBuV/m)	Limit (dBuV/m)	Margin (dB)	Remark
1	2483.500	18.43	29.44	47.87	54.00	-6.13	AVG



Test Mode:	802.11be EHT20 PK	Channel:	2462
Polarity:	Vertical	Test Voltage:	DC 12 V

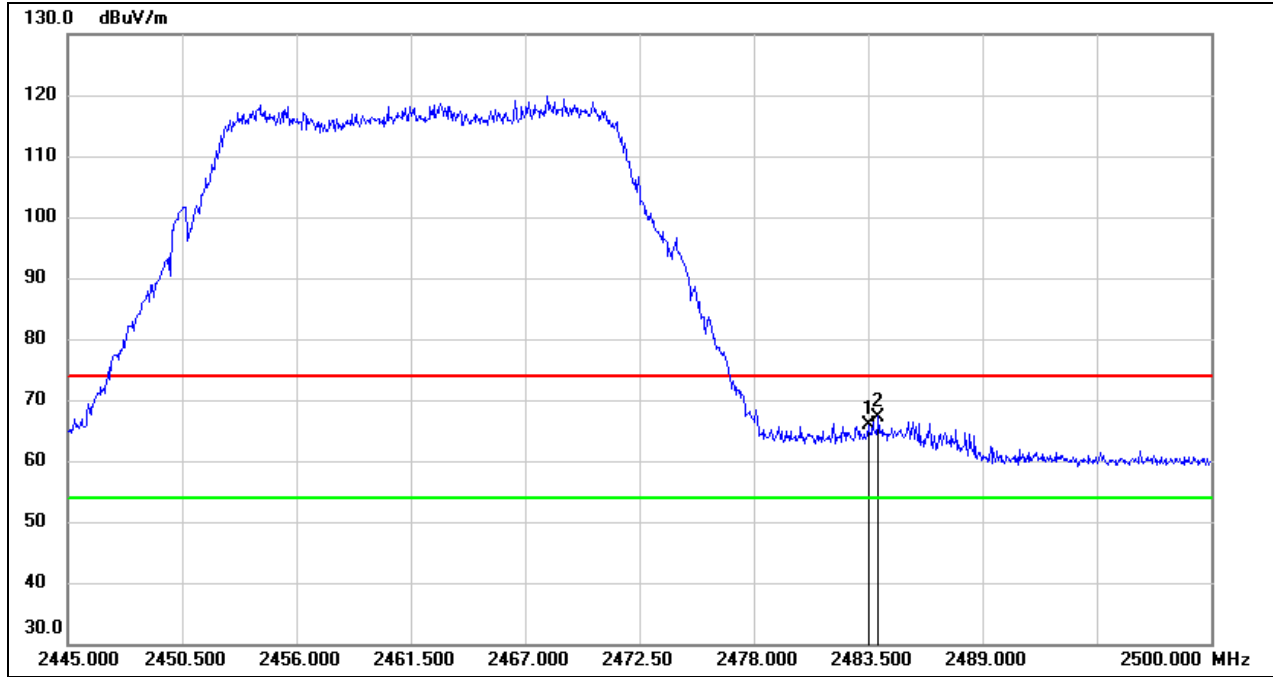

No.	Frequency (MHz)	Reading (dBuV)	Correct (dB/m)	Result (dBuV/m)	Limit (dBuV/m)	Margin (dB)	Remark
1	2483.500	36.41	29.44	65.85	74.00	-8.15	peak
2	2483.995	37.81	29.44	67.25	74.00	-6.75	peak



Test Mode:	802.11be EHT20 AV	Channel:	2462
Polarity:	Vertical	Test Voltage:	DC 12 V

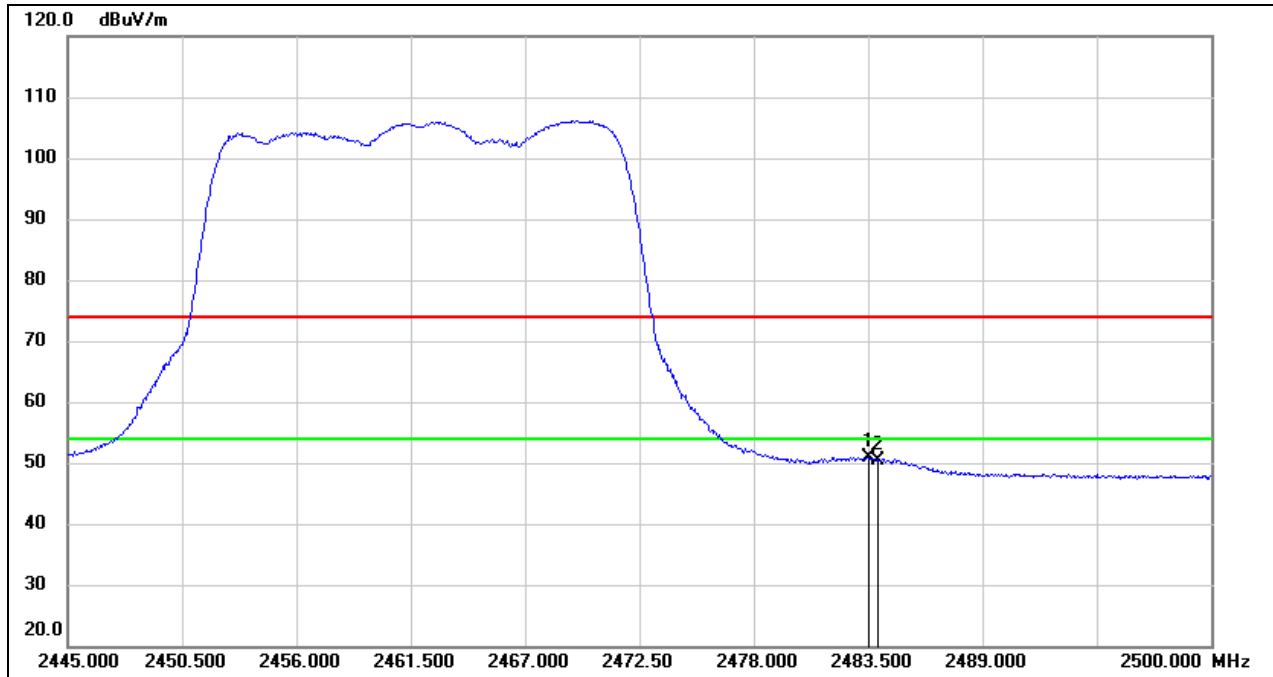

No.	Frequency (MHz)	Reading (dBuV)	Correct (dB/m)	Result (dBuV/m)	Limit (dBuV/m)	Margin (dB)	Remark
1	2483.500	21.43	29.44	50.87	54.00	-3.13	AVG
2	2483.995	21.00	29.44	50.44	54.00	-3.56	AVG



Test Mode:	802.11be EHT40 PK	Channel:	2422
Polarity:	Vertical	Test Voltage:	DC 12 V

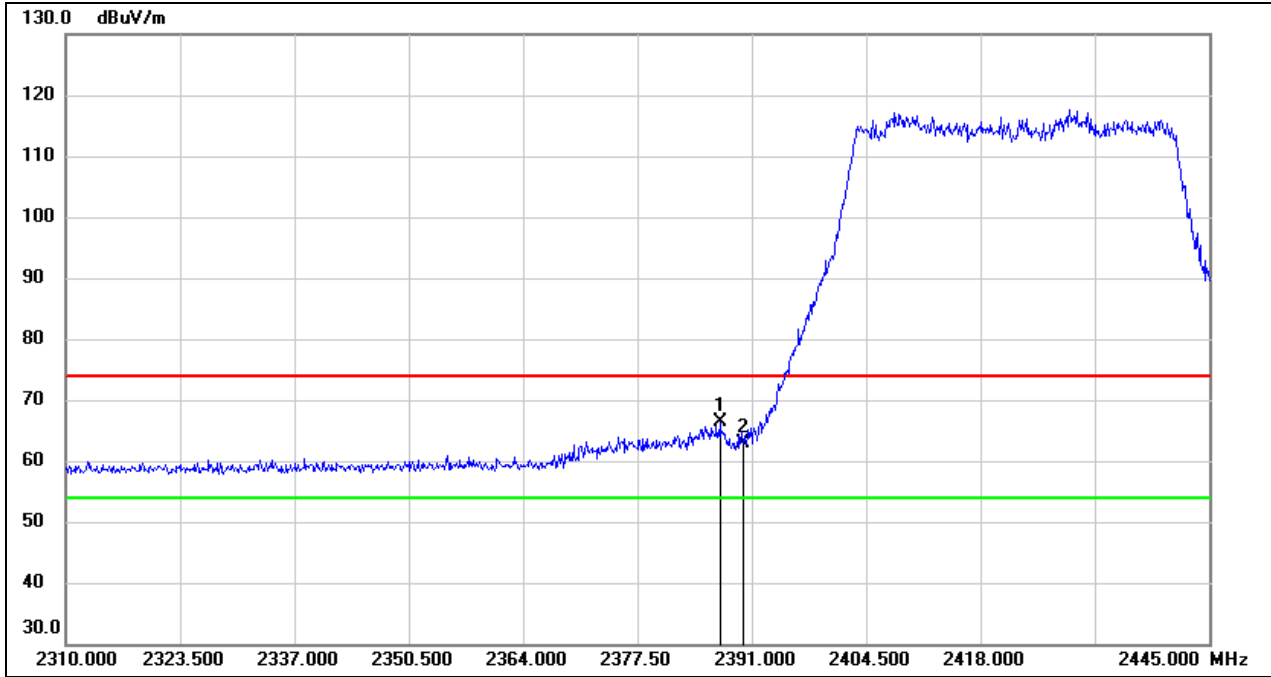

No.	Frequency (MHz)	Reading (dBuV)	Correct (dB/m)	Result (dBuV/m)	Limit (dBuV/m)	Margin (dB)	Remark
1	2387.220	37.26	29.15	66.41	74.00	-7.59	peak
2	2390.000	33.70	29.16	62.86	74.00	-11.14	peak



Test Mode:	802.11be EHT40 AV	Channel:	2422
Polarity:	Vertical	Test Voltage:	DC 12 V

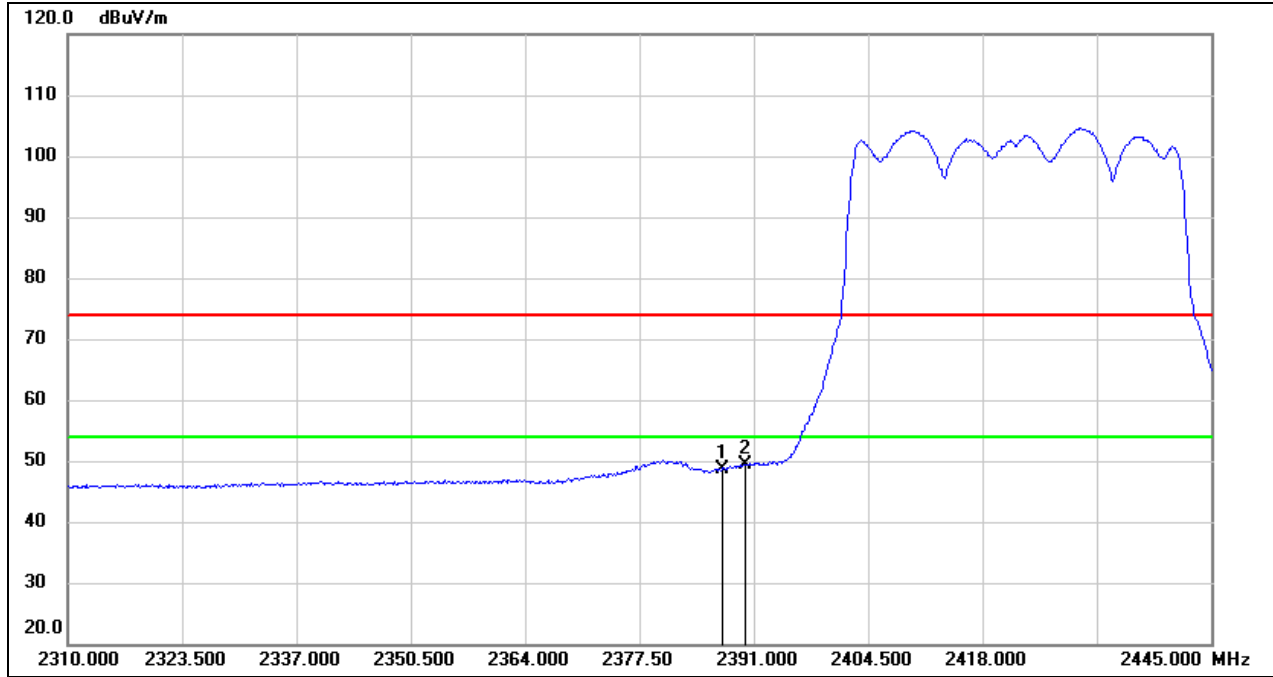

No.	Frequency (MHz)	Reading (dBuV)	Correct (dB/m)	Result (dBuV/m)	Limit (dBuV/m)	Margin (dB)	Remark
1	2387.220	19.39	29.15	48.54	54.00	-5.46	AVG
2	2390.000	20.13	29.16	49.29	54.00	-4.71	AVG



Test Mode:	802.11be EHT40 PK	Channel:	2427
Polarity:	Vertical	Test Voltage:	DC 12 V

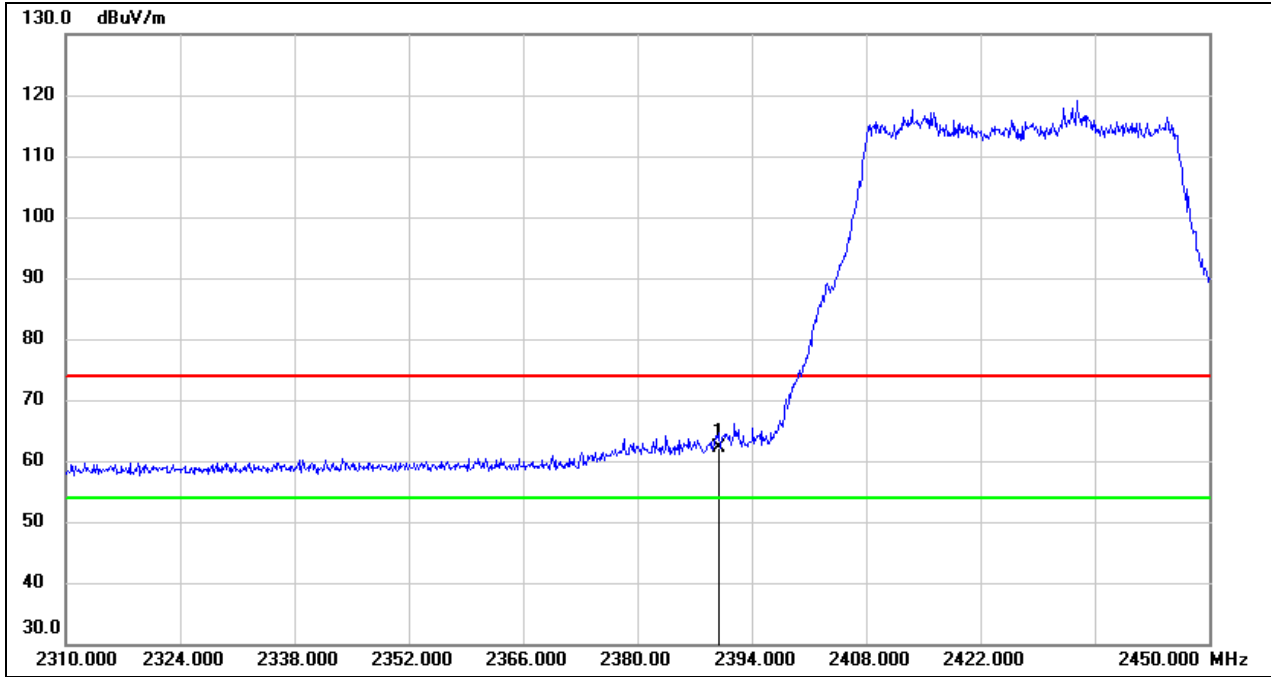

No.	Frequency (MHz)	Reading (dBuV)	Correct (dB/m)	Result (dBuV/m)	Limit (dBuV/m)	Margin (dB)	Remark
1	2390.000	32.96	29.16	62.12	74.00	-11.88	peak



Test Mode:	802.11be EHT40 AV	Channel:	2427
Polarity:	Vertical	Test Voltage:	DC 12 V

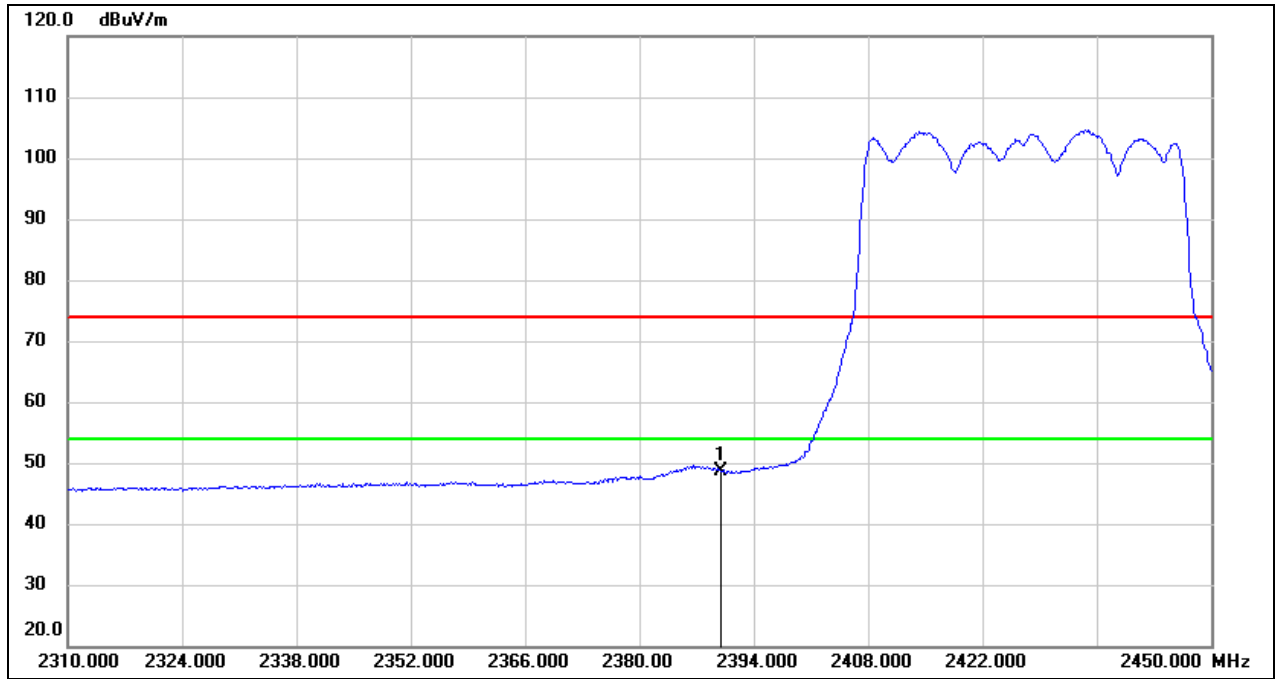

No.	Frequency (MHz)	Reading (dBuV)	Correct (dB/m)	Result (dBuV/m)	Limit (dBuV/m)	Margin (dB)	Remark
1	2390.000	19.50	29.16	48.66	54.00	-5.34	AVG



Test Mode:	802.11be EHT40 PK	Channel:	2437
Polarity:	Vertical	Test Voltage:	DC 12 V

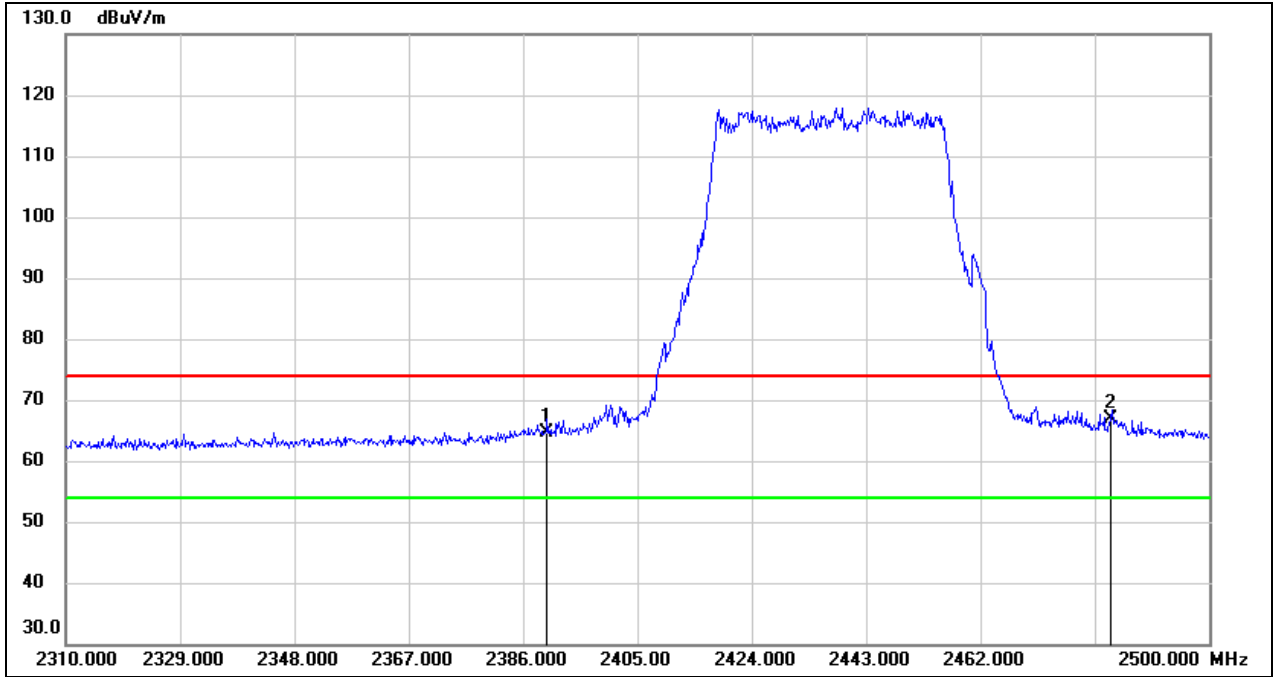

No.	Frequency (MHz)	Reading (dBuV)	Correct (dB/m)	Result (dBuV/m)	Limit (dBuV/m)	Margin (dB)	Remark
1	2390.000	35.40	29.16	64.56	74.00	-9.44	peak
2	2483.500	37.34	29.44	66.78	74.00	-7.22	peak



Test Mode:	802.11be EHT40 AV	Channel:	2437
Polarity:	Vertical	Test Voltage:	DC 12 V

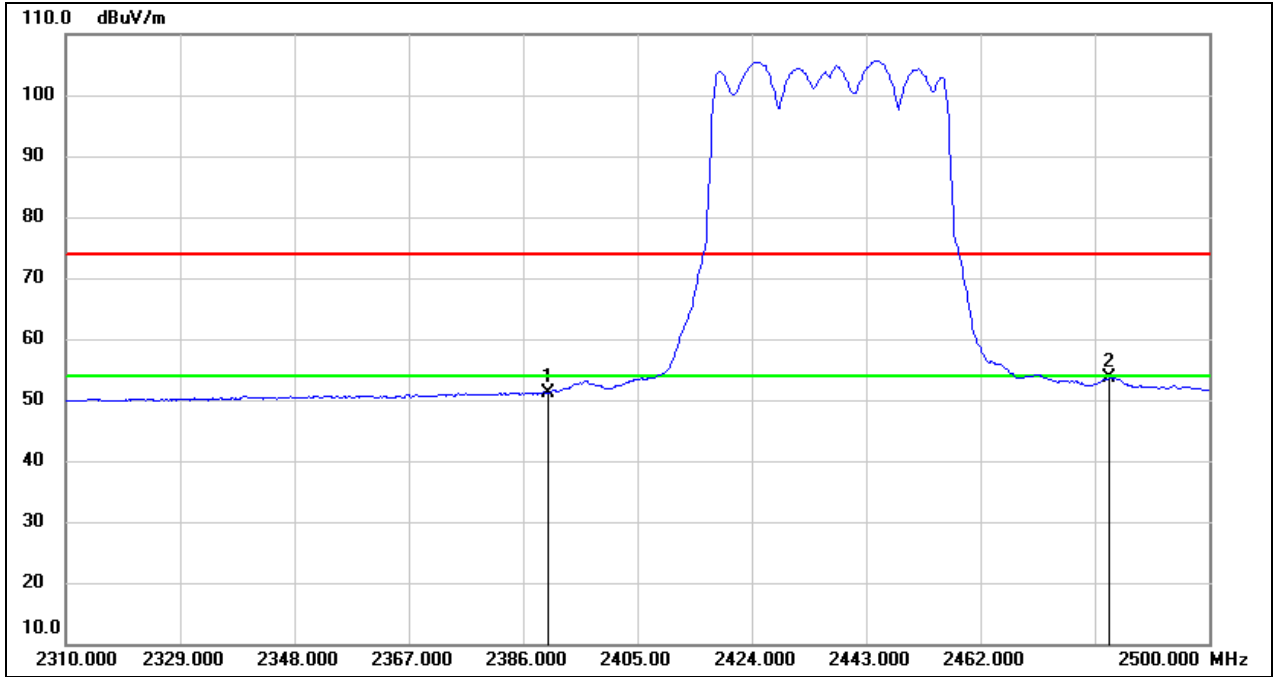

No.	Frequency (MHz)	Reading (dBuV)	Correct (dB/m)	Result (dBuV/m)	Limit (dBuV/m)	Margin (dB)	Remark
1	2390.000	22.04	29.16	51.20	54.00	-2.80	AVG
2	2483.500	24.14	29.44	53.58	54.00	-0.42	AVG



Test Mode:	802.11be EHT40 PK	Channel:	2447
Polarity:	Vertical	Test Voltage:	DC 12 V

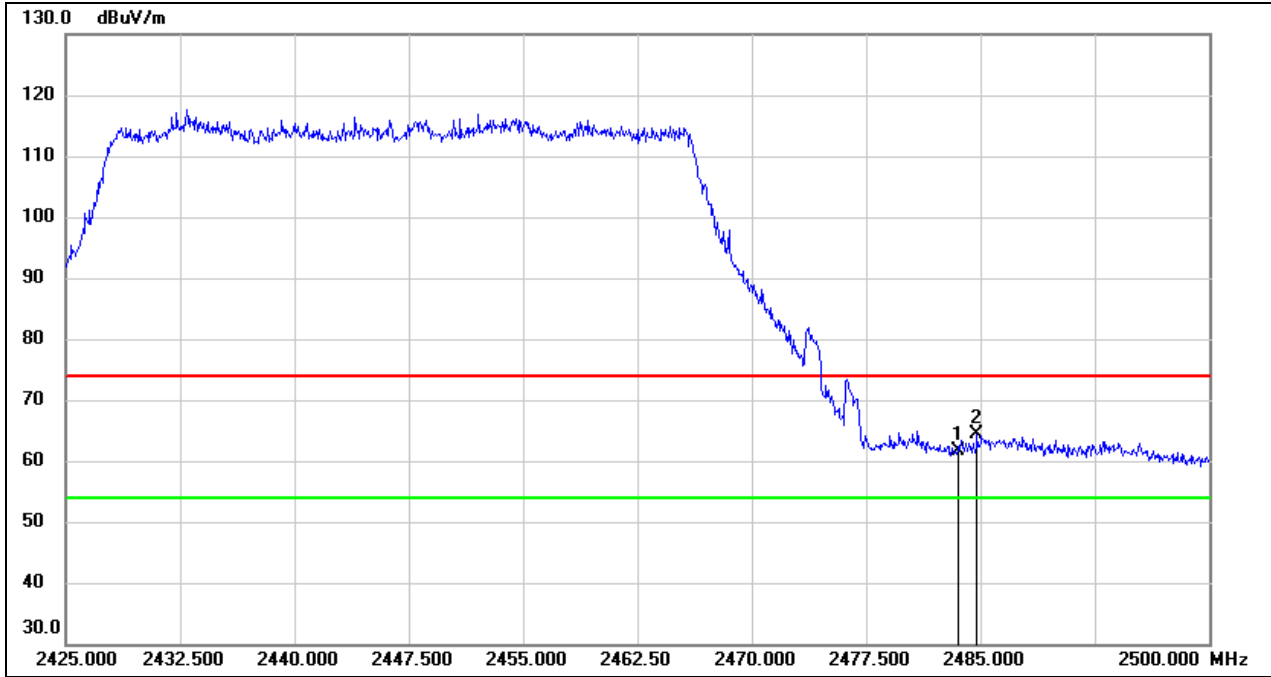

No.	Frequency (MHz)	Reading (dBuV)	Correct (dB/m)	Result (dBuV/m)	Limit (dBuV/m)	Margin (dB)	Remark
1	2483.500	32.14	29.44	61.58	74.00	-12.42	peak
2	2484.775	34.85	29.44	64.29	74.00	-9.71	peak



Test Mode:	802.11be EHT40 AV	Channel:	2447
Polarity:	Vertical	Test Voltage:	DC 12 V

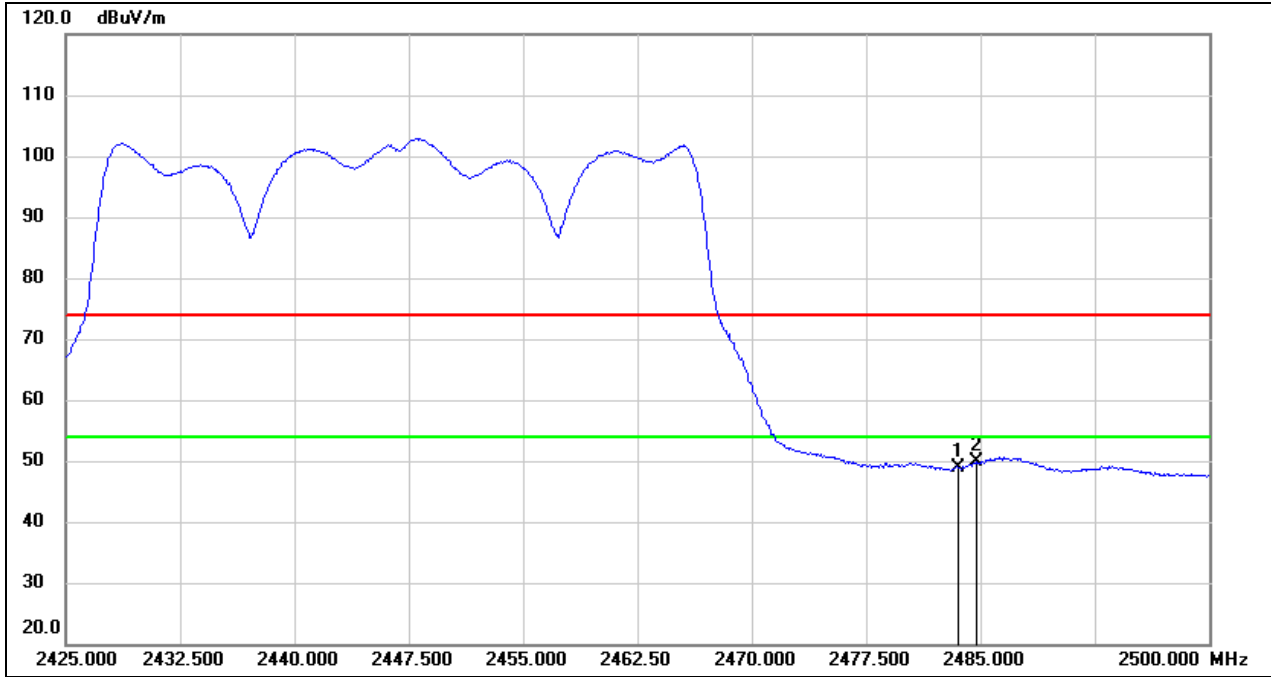

No.	Frequency (MHz)	Reading (dBuV)	Correct (dB/m)	Result (dBuV/m)	Limit (dBuV/m)	Margin (dB)	Remark
1	2483.500	19.33	29.44	48.77	54.00	-5.23	AVG
2	2484.775	20.37	29.44	49.81	54.00	-4.19	AVG



Test Mode:	802.11be EHT40 PK	Channel:	2452
Polarity:	Vertical	Test Voltage:	DC 12 V

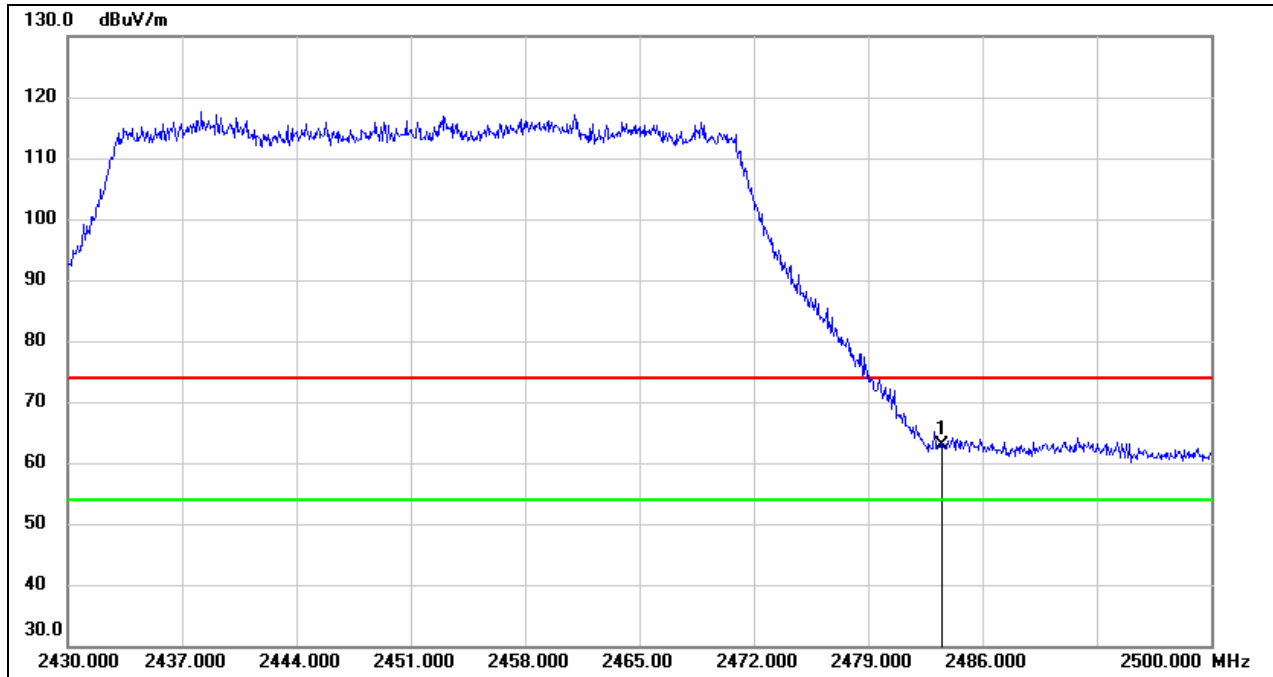

No.	Frequency (MHz)	Reading (dBuV)	Correct (dB/m)	Result (dBuV/m)	Limit (dBuV/m)	Margin (dB)	Remark
1	2483.500	33.50	29.44	62.94	74.00	-11.06	peak



Test Mode:	802.11be EHT40 AV	Channel:	2452
Polarity:	Vertical	Test Voltage:	DC 12 V

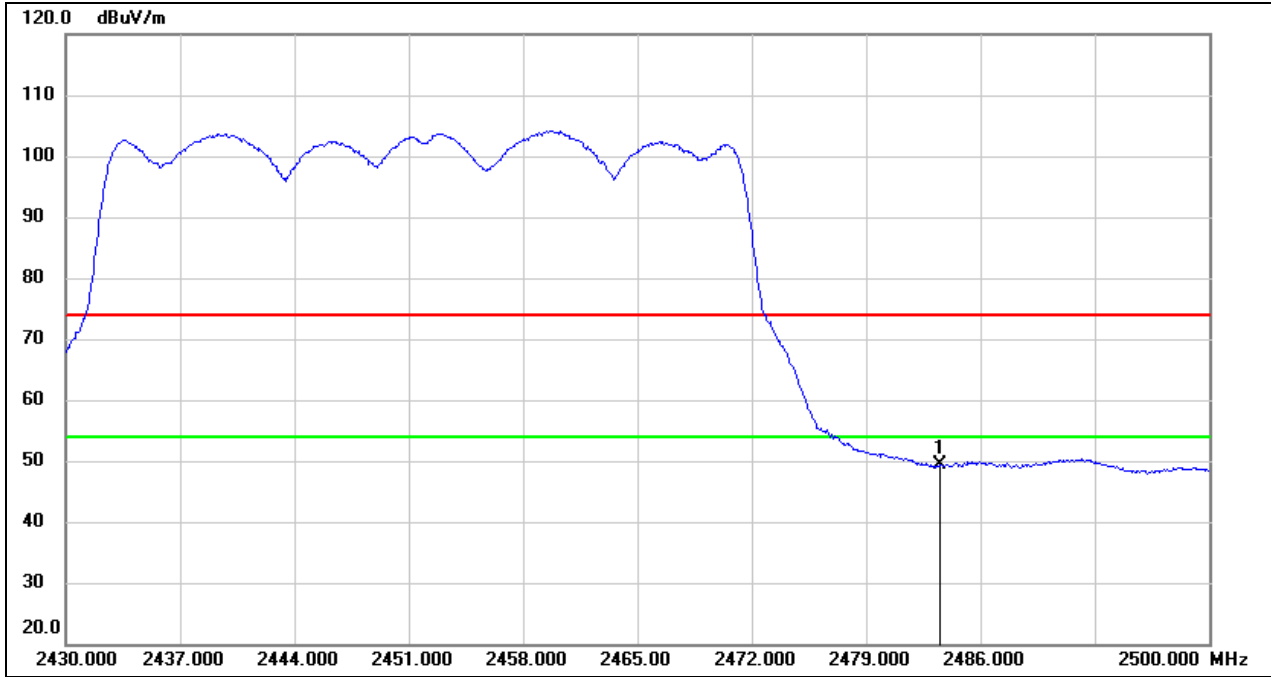

No.	Frequency (MHz)	Reading (dBuV)	Correct (dB/m)	Result (dBuV/m)	Limit (dBuV/m)	Margin (dB)	Remark
1	2483.500	19.93	29.44	49.37	54.00	-4.63	AVG



8.2. SPURIOUS EMISSIONS(1 GHZ~3 GHZ)

Test Mode:	802.11b	Channel:	2412
Polarity:	Horizontal	Test Voltage:	DC 12 V

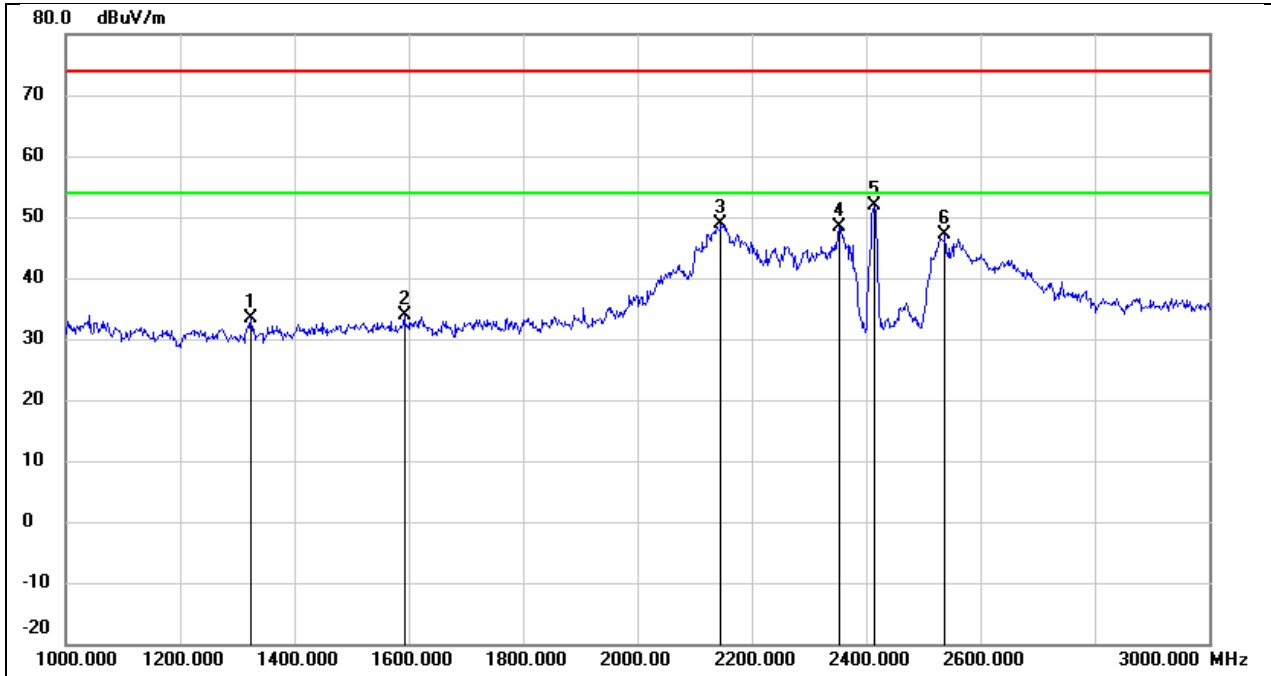

No.	Frequency (MHz)	Reading (dBuV)	Correct (dB/m)	Result (dBuV/m)	Limit (dBuV/m)	Margin (dB)	Remark
1	1324.000	46.90	-13.53	33.37	74.00	-40.63	peak
2	1592.000	46.24	-12.41	33.83	74.00	-40.17	peak
3	2146.000	59.20	-10.31	48.89	74.00	-25.11	peak
4	2352.000	57.56	-9.24	48.32	74.00	-25.68	peak
5	2414.000	60.73	-8.93	51.80	74.00	-22.20	peak
6	2538.000	55.58	-8.37	47.21	74.00	-26.79	peak



Test Mode:	802.11b	Channel:	2412
Polarity:	Vertical	Test Voltage:	DC 12 V

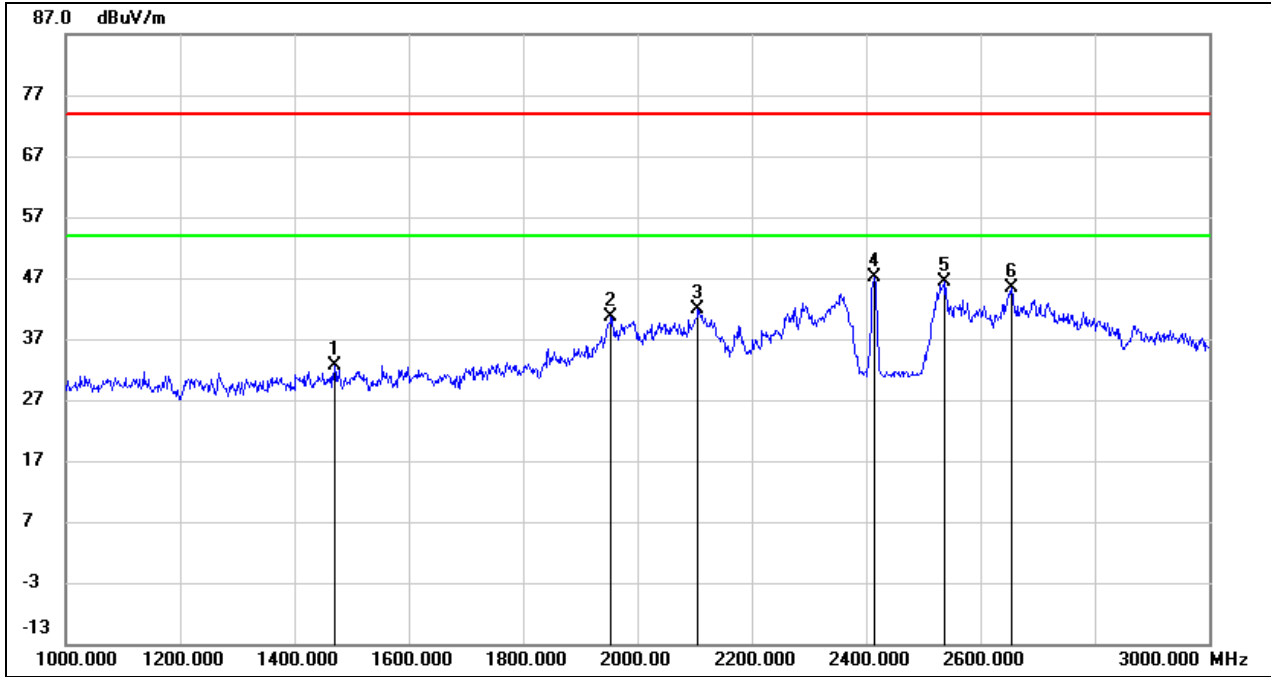

No.	Frequency (MHz)	Reading (dBuV)	Correct (dB/m)	Result (dBuV/m)	Limit (dBuV/m)	Margin (dB)	Remark
1	1470.000	45.46	-12.85	32.61	74.00	-41.39	peak
2	1954.000	51.96	-11.21	40.75	74.00	-33.25	peak
3	2106.000	52.29	-10.51	41.78	74.00	-32.22	peak
4	2414.000	55.98	-8.93	47.05	74.00	-26.95	peak
5	2536.000	54.84	-8.38	46.46	74.00	-27.54	peak
6	2654.000	53.48	-8.02	45.46	74.00	-28.54	peak



Test Mode:	802.11b	Channel:	2417
Polarity:	Horizontal	Test Voltage:	DC 12 V

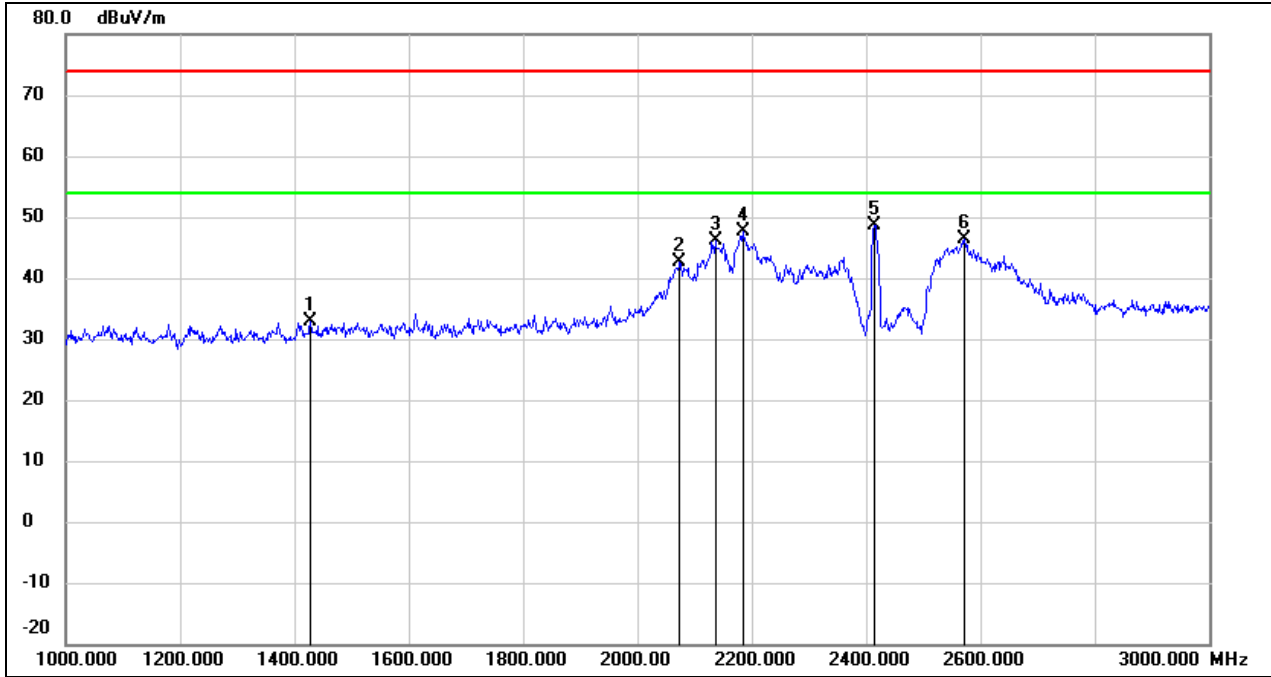

No.	Frequency (MHz)	Reading (dBuV)	Correct (dB/m)	Result (dBuV/m)	Limit (dBuV/m)	Margin (dB)	Remark
1	1428.000	46.00	-13.04	32.96	74.00	-41.04	peak
2	2074.000	53.28	-10.68	42.60	74.00	-31.40	peak
3	2136.000	56.38	-10.36	46.02	74.00	-27.98	peak
4	2184.000	57.65	-10.11	47.54	74.00	-26.46	peak
5	2414.000	57.50	-8.93	48.57	74.00	-25.43	peak
6	2572.000	54.77	-8.27	46.50	74.00	-27.50	peak



Test Mode:	802.11b	Channel:	2417
Polarity:	Vertical	Test Voltage:	DC 12 V

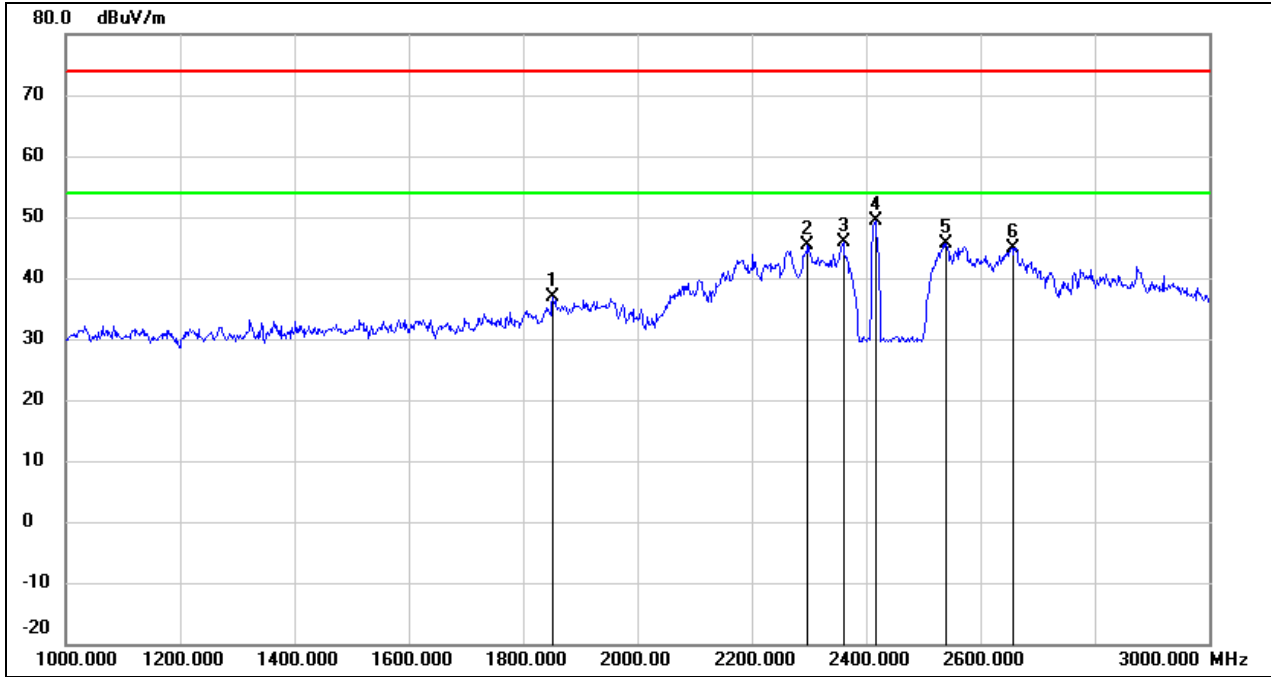

No.	Frequency (MHz)	Reading (dBuV)	Correct (dB/m)	Result (dBuV/m)	Limit (dBuV/m)	Margin (dB)	Remark
1	1852.000	48.48	-11.55	36.93	74.00	-37.07	peak
2	2298.000	54.85	-9.53	45.32	74.00	-28.68	peak
3	2360.000	55.20	-9.21	45.99	74.00	-28.01	peak
4	2416.000	58.19	-8.92	49.27	74.00	-24.73	peak
5	2540.000	54.06	-8.37	45.69	74.00	-28.31	peak
6	2656.000	53.01	-8.02	44.99	74.00	-29.01	peak



Test Mode:	802.11b	Channel:	2437
Polarity:	Horizontal	Test Voltage:	DC 12 V

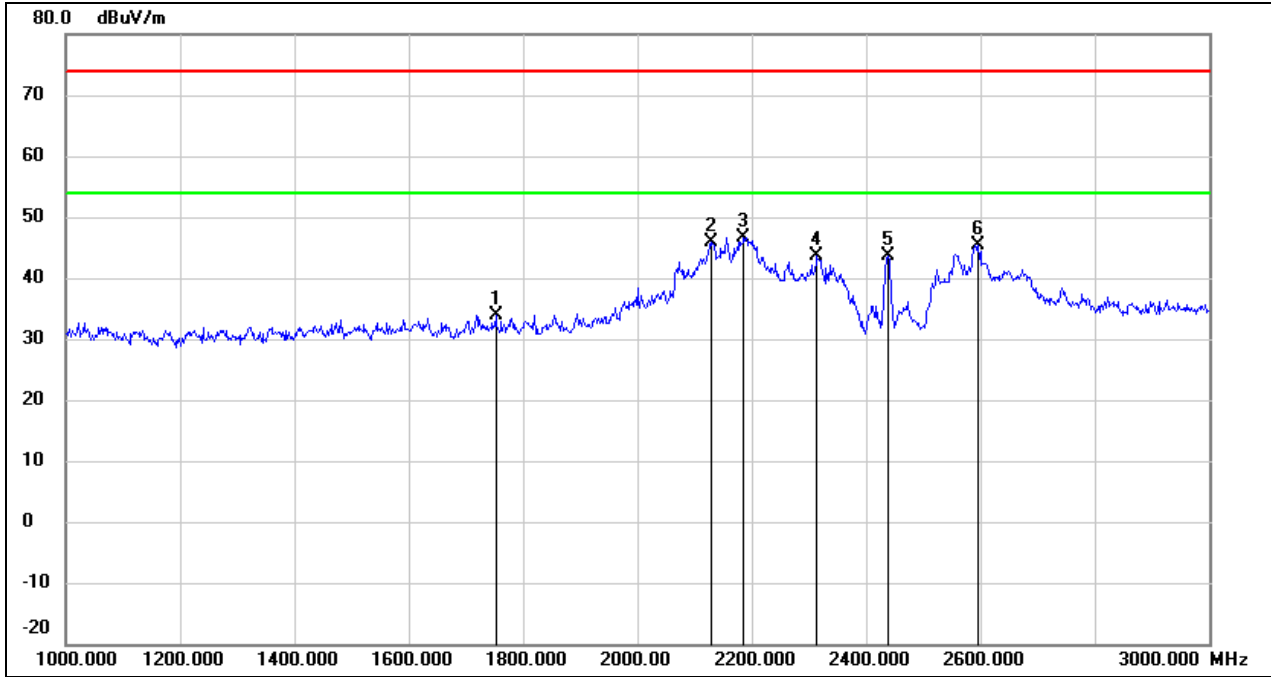

No.	Frequency (MHz)	Reading (dBuV)	Correct (dB/m)	Result (dBuV/m)	Limit (dBuV/m)	Margin (dB)	Remark
1	1752.000	45.84	-11.88	33.96	74.00	-40.04	peak
2	2128.000	56.29	-10.40	45.89	74.00	-28.11	peak
3	2186.000	56.73	-10.11	46.62	74.00	-27.38	peak
4	2314.000	52.99	-9.44	43.55	74.00	-30.45	peak
5	2438.000	52.41	-8.80	43.61	74.00	-30.39	peak
6	2596.000	53.54	-8.20	45.34	74.00	-28.66	peak



Test Mode:	802.11b	Channel:	2437
Polarity:	Vertical	Test Voltage:	DC 12 V

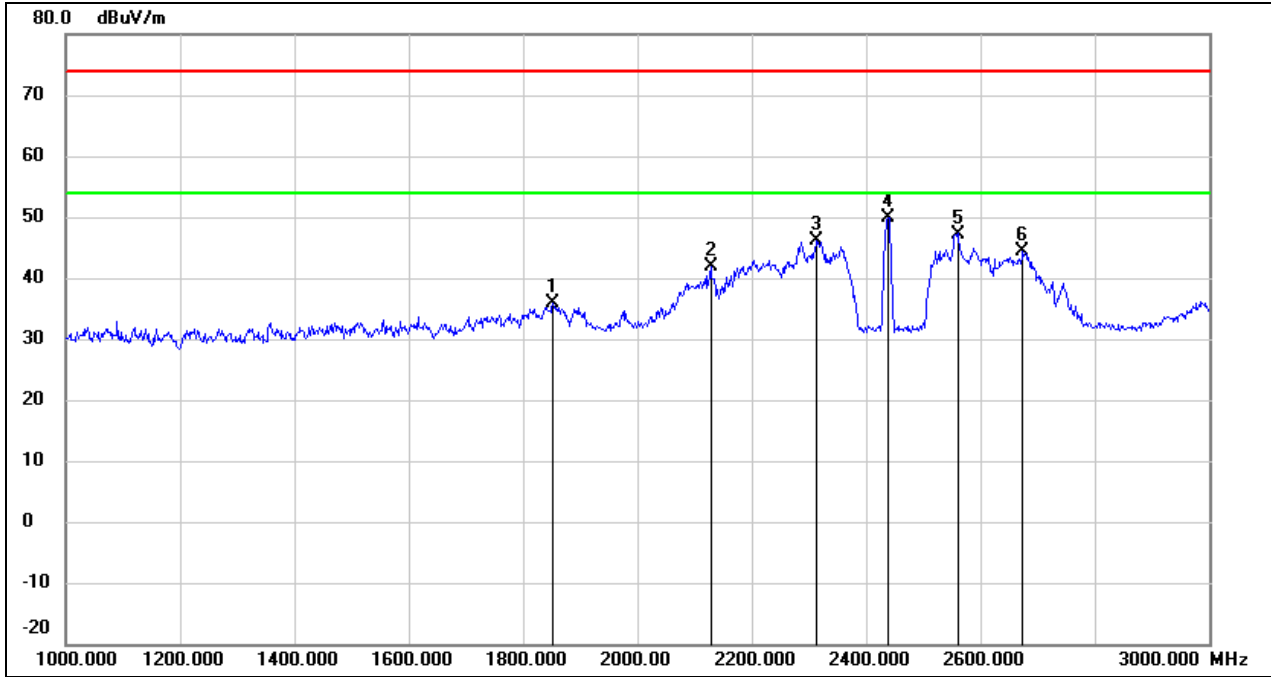

No.	Frequency (MHz)	Reading (dBuV)	Correct (dB/m)	Result (dBuV/m)	Limit (dBuV/m)	Margin (dB)	Remark
1	1852.000	47.53	-11.55	35.98	74.00	-38.02	peak
2	2128.000	52.16	-10.40	41.76	74.00	-32.24	peak
3	2314.000	55.65	-9.44	46.21	74.00	-27.79	peak
4	2438.000	58.77	-8.80	49.97	74.00	-24.03	peak
5	2560.000	55.56	-8.31	47.25	74.00	-26.75	peak
6	2674.000	52.41	-7.97	44.44	74.00	-29.56	peak



Test Mode:	802.11b	Channel:	2457
Polarity:	Horizontal	Test Voltage:	DC 12 V

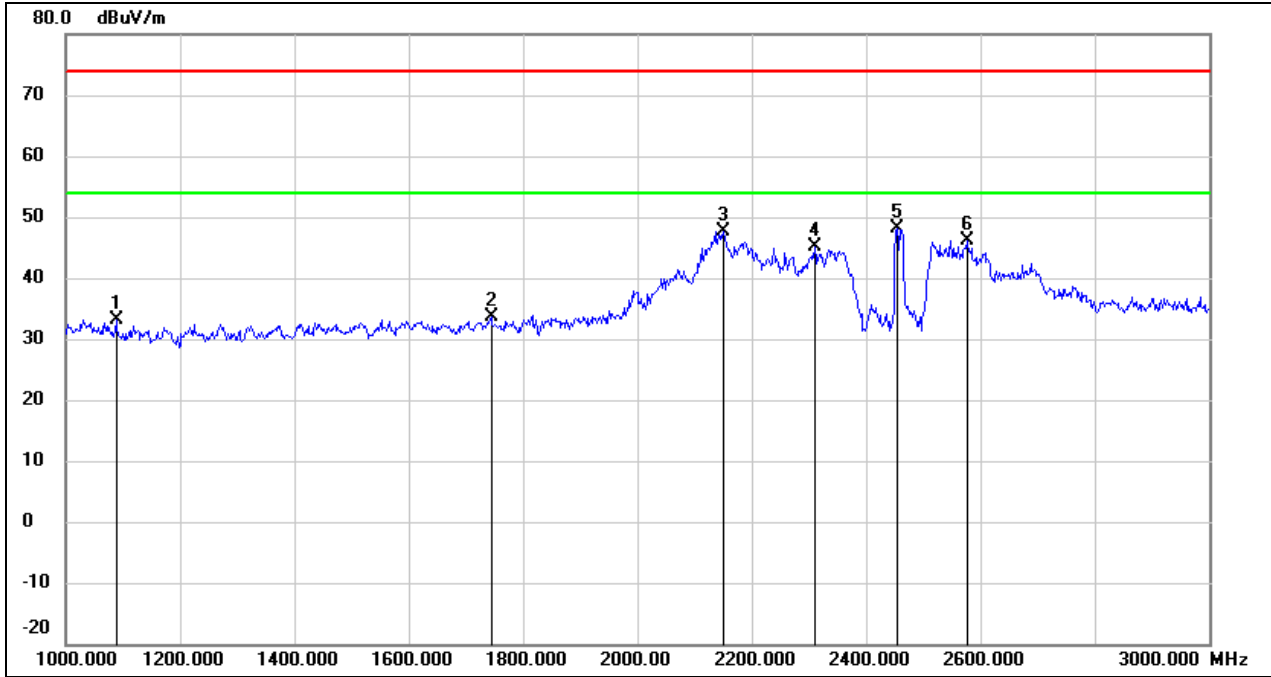

No.	Frequency (MHz)	Reading (dBuV)	Correct (dB/m)	Result (dBuV/m)	Limit (dBuV/m)	Margin (dB)	Remark
1	1088.000	47.63	-14.62	33.01	74.00	-40.99	peak
2	1744.000	45.56	-11.90	33.66	74.00	-40.34	peak
3	2150.000	57.98	-10.28	47.70	74.00	-26.30	peak
4	2310.000	54.63	-9.46	45.17	74.00	-28.83	peak
5	2454.000	56.83	-8.72	48.11	74.00	-25.89	peak
6	2576.000	54.36	-8.26	46.10	74.00	-27.90	peak



Test Mode:	802.11b	Channel:	2457
Polarity:	Vertical	Test Voltage:	DC 12 V

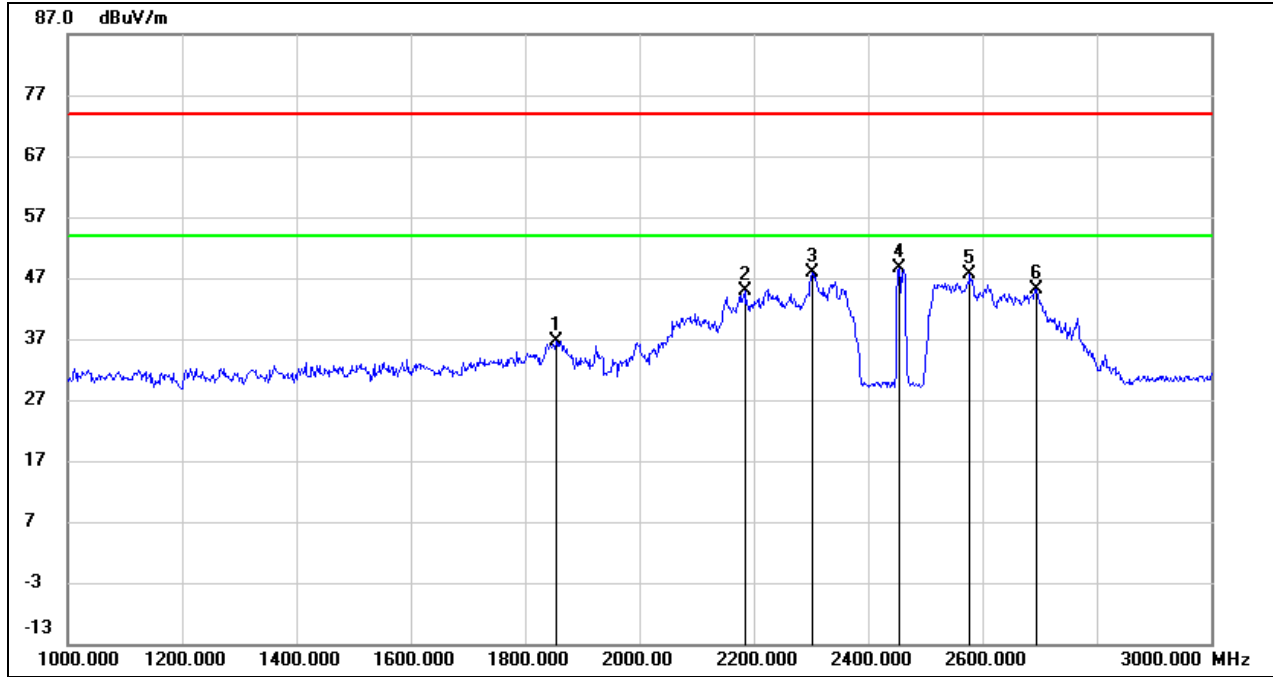

No.	Frequency (MHz)	Reading (dBuV)	Correct (dB/m)	Result (dBuV/m)	Limit (dBuV/m)	Margin (dB)	Remark
1	1854.000	48.13	-11.54	36.59	74.00	-37.41	peak
2	2184.000	55.09	-10.11	44.98	74.00	-29.02	peak
3	2302.000	57.34	-9.50	47.84	74.00	-26.16	peak
4	2454.000	57.46	-8.72	48.74	74.00	-25.26	peak
5	2578.000	55.78	-8.26	47.52	74.00	-26.48	peak
6	2694.000	53.01	-7.90	45.11	74.00	-28.89	peak



Test Mode:	802.11b	Channel:	2462
Polarity:	Horizontal	Test Voltage:	DC 12 V

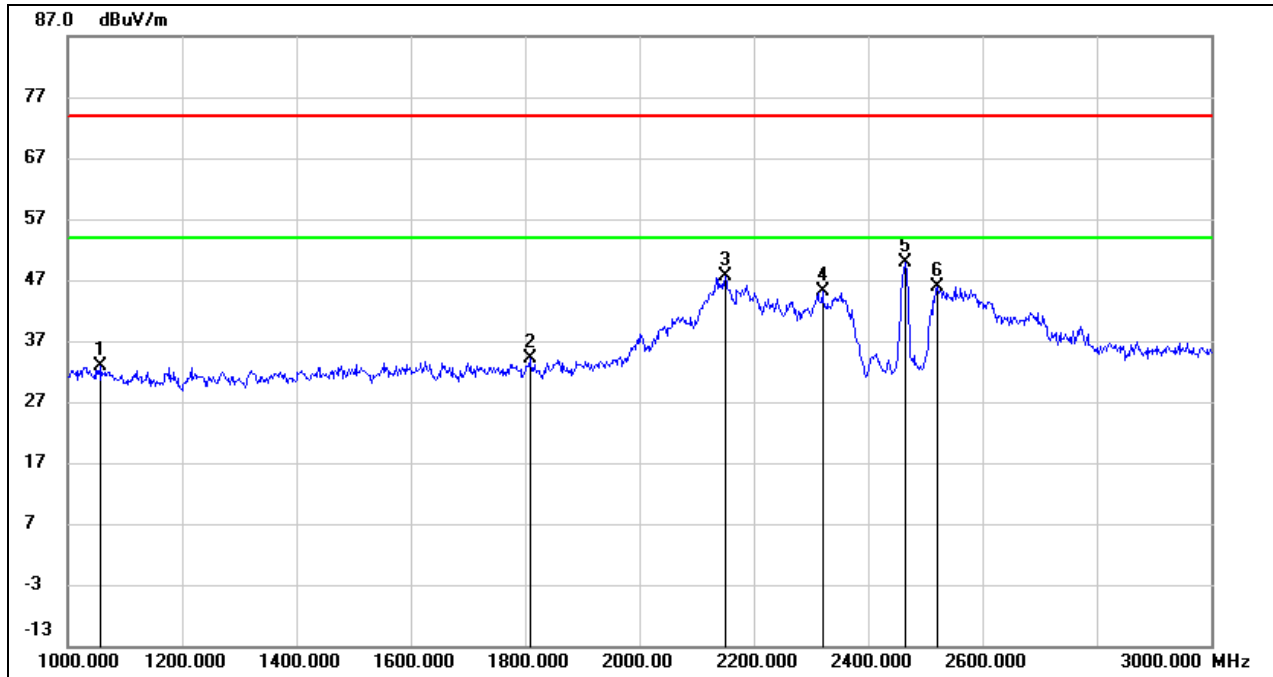

No.	Frequency (MHz)	Reading (dBuV)	Correct (dB/m)	Result (dBuV/m)	Limit (dBuV/m)	Margin (dB)	Remark
1	1056.000	47.56	-14.77	32.79	74.00	-41.21	peak
2	1808.000	45.82	-11.69	34.13	74.00	-39.87	peak
3	2150.000	57.87	-10.28	47.59	74.00	-26.41	peak
4	2320.000	54.57	-9.42	45.15	74.00	-28.85	peak
5	2464.000	58.54	-8.68	49.86	74.00	-24.14	peak
6	2522.000	54.34	-8.42	45.92	74.00	-28.08	peak



Test Mode:	802.11b	Channel:	2462
Polarity:	Vertical	Test Voltage:	DC 12 V

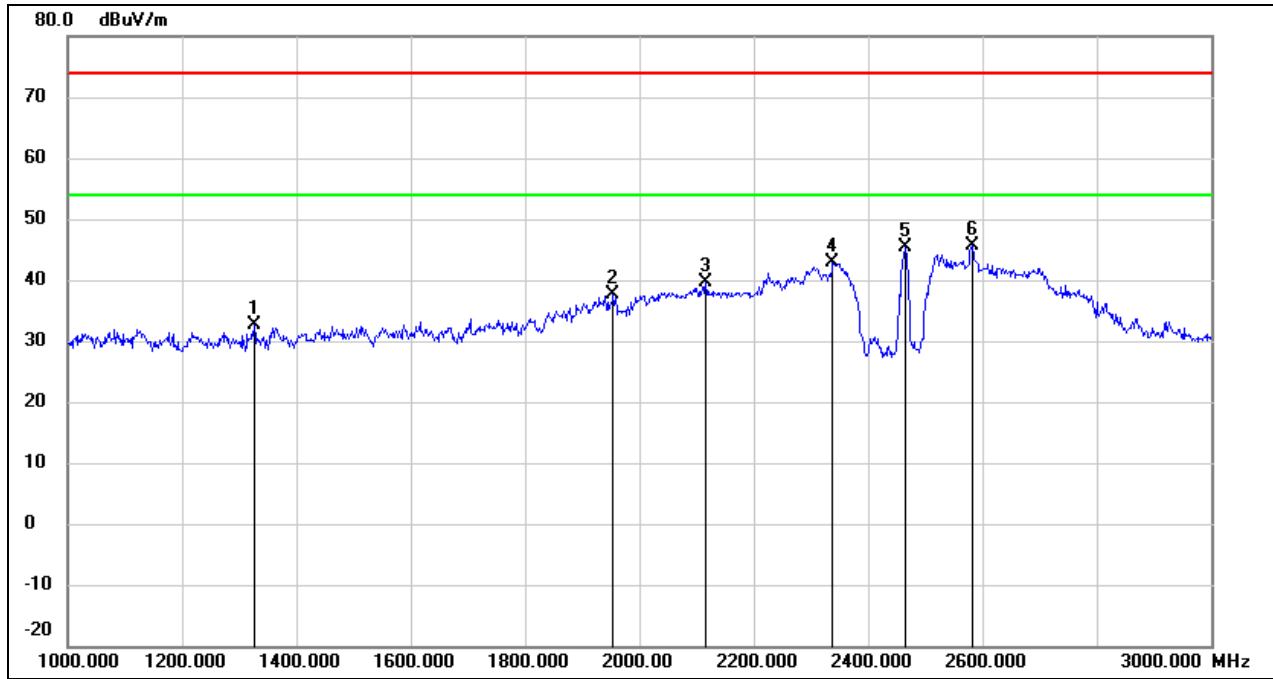

No.	Frequency (MHz)	Reading (dBuV)	Correct (dB/m)	Result (dBuV/m)	Limit (dBuV/m)	Margin (dB)	Remark
1	1326.000	46.17	-13.52	32.65	74.00	-41.35	peak
2	1954.000	48.92	-11.21	37.71	74.00	-36.29	peak
3	2116.000	50.07	-10.47	39.60	74.00	-34.40	peak
4	2338.000	52.17	-9.32	42.85	74.00	-31.15	peak
5	2464.000	54.16	-8.68	45.48	74.00	-28.52	peak
6	2582.000	53.91	-8.24	45.67	74.00	-28.33	peak



8.3. SPURIOUS EMISSIONS(3 GHZ~18 GHZ)

Test Mode:	802.11b	Channel:	2412
Polarity:	Horizontal	Test Voltage:	DC 12 V

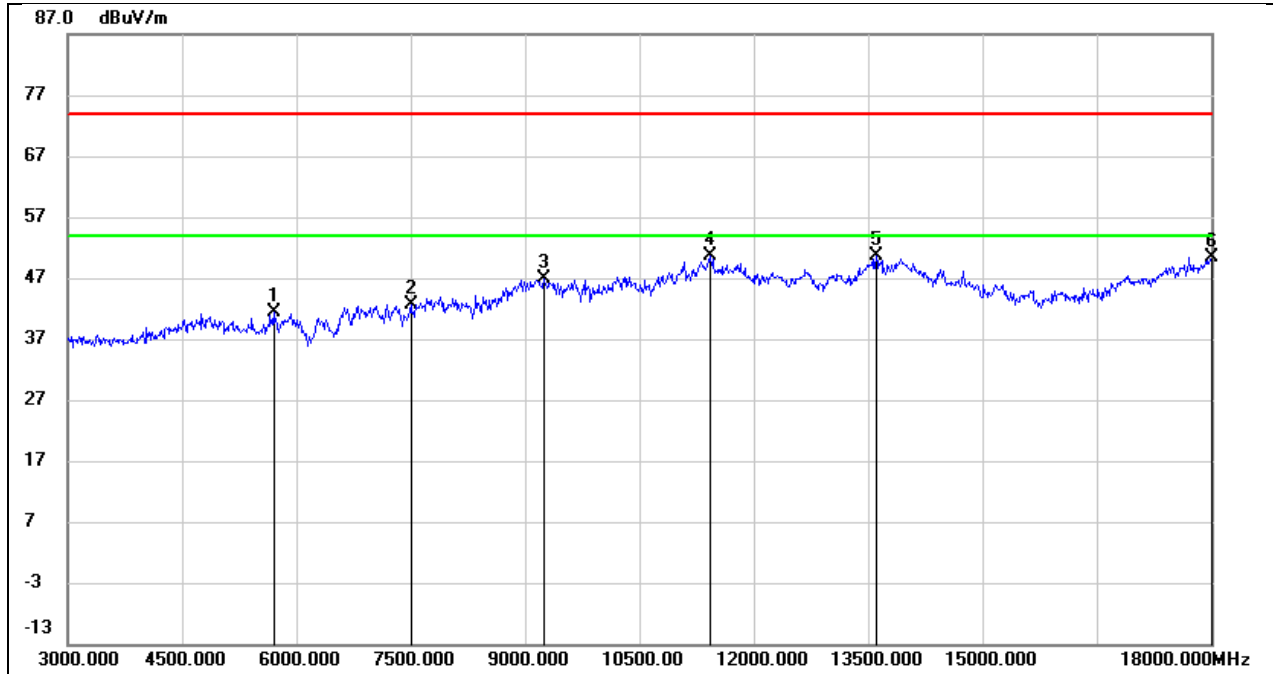

No.	Frequency (MHz)	Reading (dBuV)	Correct (dB/m)	Result (dBuV/m)	Limit (dBuV/m)	Margin (dB)	Remark
1	5700.000	39.87	1.41	41.28	74.00	-32.72	peak
2	7500.000	36.35	6.33	42.68	74.00	-31.32	peak
3	9240.000	36.37	10.58	46.95	74.00	-27.05	peak
4	11430.000	34.35	16.34	50.69	74.00	-23.31	peak
5	13605.000	29.61	21.12	50.73	74.00	-23.27	peak
6	18000.000	24.67	25.69	50.36	74.00	-23.64	peak



Test Mode:	802.11b	Channel:	2412
Polarity:	Vertical	Test Voltage:	DC 12 V

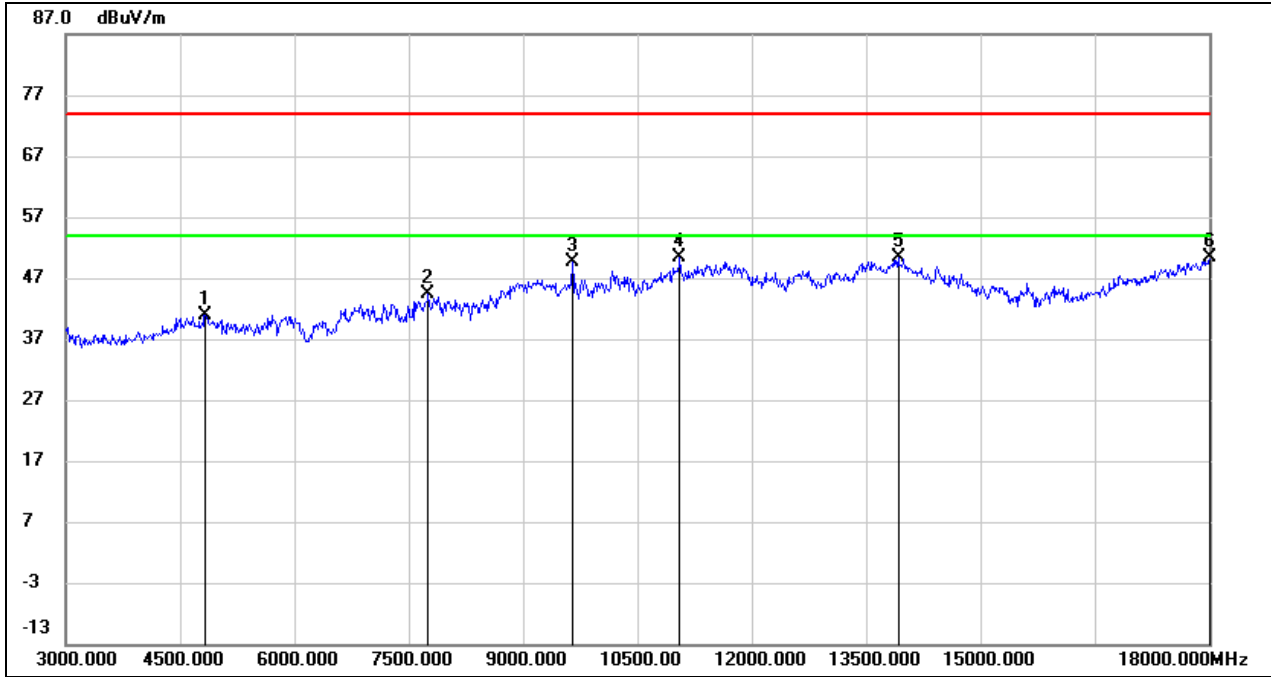

No.	Frequency (MHz)	Reading (dBuV)	Correct (dB/m)	Result (dBuV/m)	Limit (dBuV/m)	Margin (dB)	Remark
1	4830.000	41.13	-0.20	40.93	74.00	-33.07	peak
2	7755.000	37.99	6.31	44.30	74.00	-29.70	peak
3	9645.000	38.43	11.08	49.51	74.00	-24.49	peak
4	11055.000	35.31	14.96	50.27	74.00	-23.73	peak
5	13920.000	28.54	21.79	50.33	74.00	-23.67	peak
6	18000.000	24.78	25.69	50.47	74.00	-23.53	peak



Test Mode:	802.11b	Channel:	2417
Polarity:	Horizontal	Test Voltage:	DC 12 V

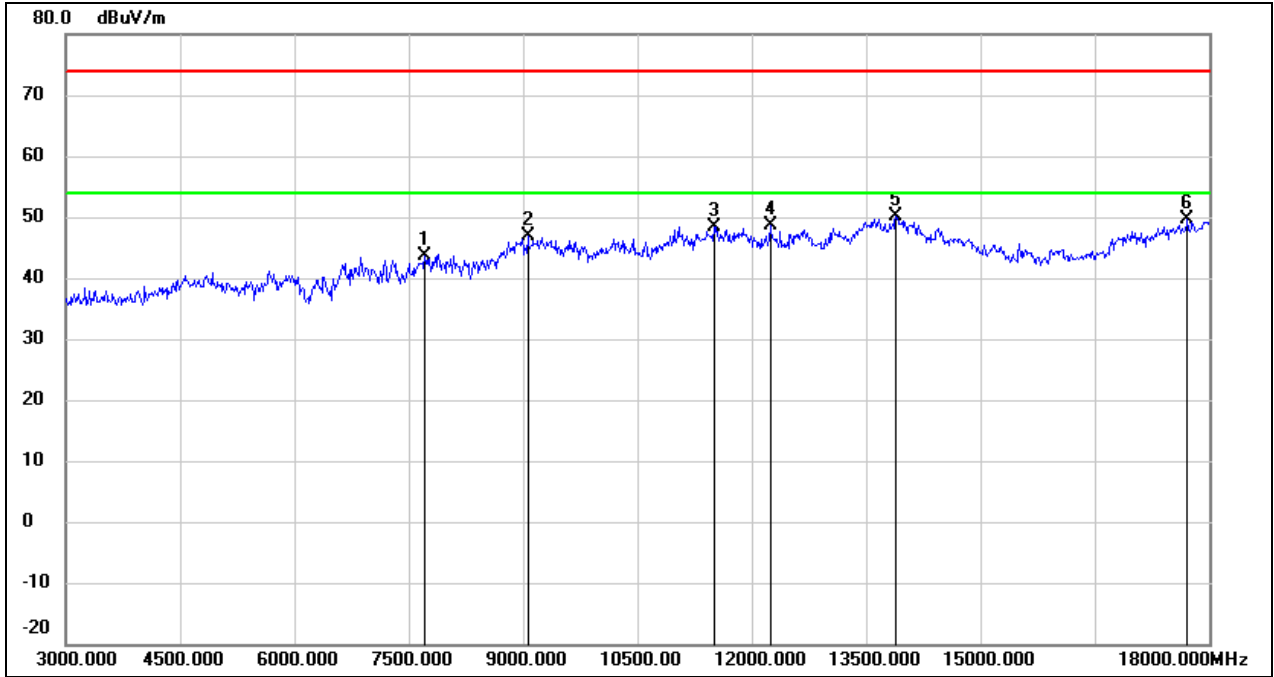

No.	Frequency (MHz)	Reading (dBuV)	Correct (dB/m)	Result (dBuV/m)	Limit (dBuV/m)	Margin (dB)	Remark
1	7710.000	37.21	6.33	43.54	74.00	-30.46	peak
2	9060.000	36.33	10.51	46.84	74.00	-27.16	peak
3	11505.000	31.82	16.61	48.43	74.00	-25.57	peak
4	12240.000	30.79	17.79	48.58	74.00	-25.42	peak
5	13890.000	28.33	21.72	50.05	74.00	-23.95	peak
6	17715.000	25.54	24.00	49.54	74.00	-24.46	peak



Test Mode:	802.11b	Channel:	2417
Polarity:	Vertical	Test Voltage:	DC 12 V

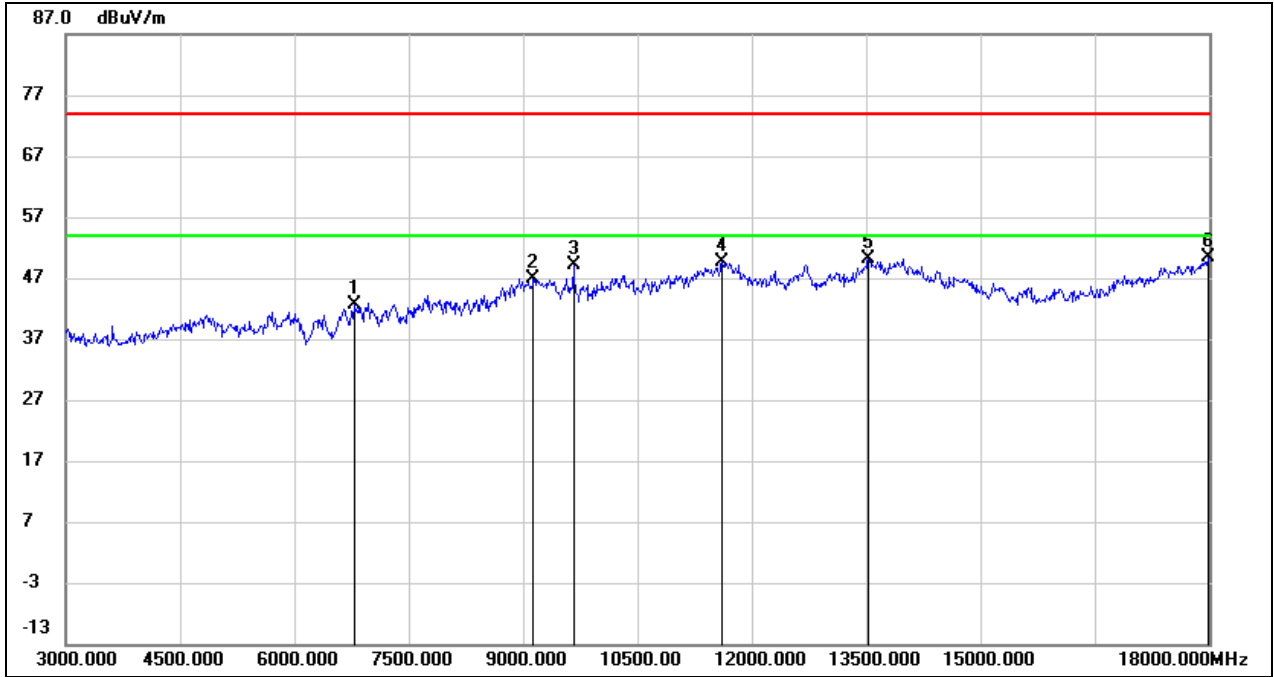

No.	Frequency (MHz)	Reading (dBuV)	Correct (dB/m)	Result (dBuV/m)	Limit (dBuV/m)	Margin (dB)	Remark
1	6780.000	37.13	5.60	42.73	74.00	-31.27	peak
2	9135.000	36.43	10.55	46.98	74.00	-27.02	peak
3	9660.000	37.91	11.11	49.02	74.00	-24.98	peak
4	11610.000	32.64	16.90	49.54	74.00	-24.46	peak
5	13530.000	29.19	20.96	50.15	74.00	-23.85	peak
6	17985.000	24.66	25.60	50.26	74.00	-23.74	peak



Test Mode:	802.11b	Channel:	2437
Polarity:	Horizontal	Test Voltage:	DC 12 V

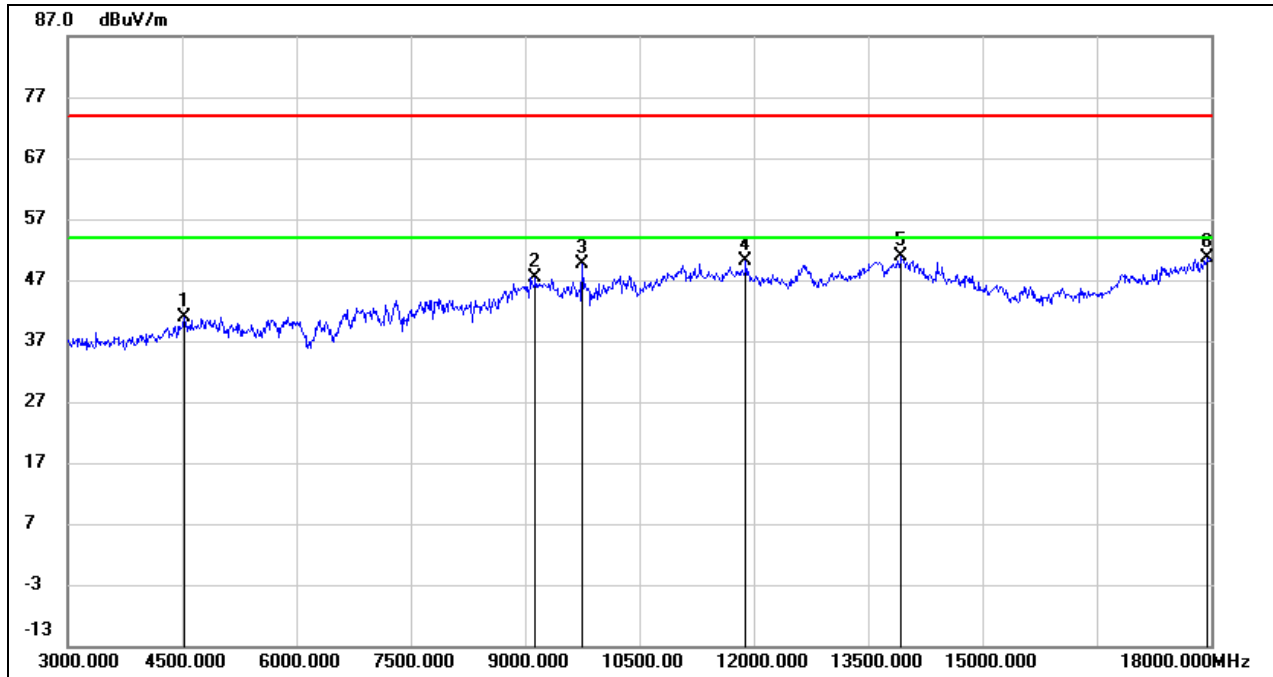

No.	Frequency (MHz)	Reading (dBuV)	Correct (dB/m)	Result (dBuV/m)	Limit (dBuV/m)	Margin (dB)	Remark
1	4530.000	42.28	-1.35	40.93	74.00	-33.07	peak
2	9135.000	36.77	10.55	47.32	74.00	-26.68	peak
3	9750.000	38.23	11.35	49.58	74.00	-24.42	peak
4	11895.000	32.42	17.68	50.10	74.00	-23.90	peak
5	13935.000	29.05	21.82	50.87	74.00	-23.13	peak
6	17955.000	25.30	25.42	50.72	74.00	-23.28	peak



Test Mode:	802.11b	Channel:	2437
Polarity:	Vertical	Test Voltage:	DC 12 V

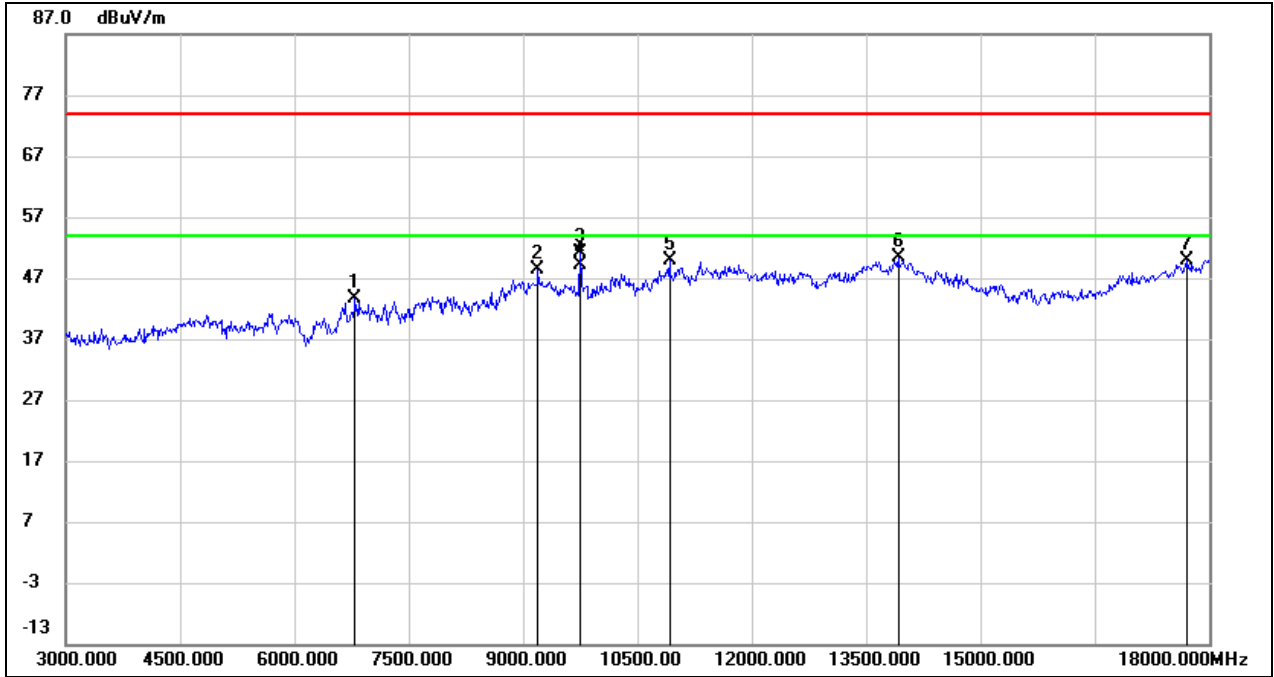

No.	Frequency (MHz)	Reading (dBuV)	Correct (dB/m)	Result (dBuV/m)	Limit (dBuV/m)	Margin (dB)	Remark
1	6795.000	37.98	5.68	43.66	74.00	-30.34	peak
2	9195.000	37.89	10.56	48.45	74.00	-25.55	peak
3	9750.000	39.79	11.35	51.14	74.00	-22.86	peak
4	9750.000	37.78	11.35	49.13	54.00	-4.87	AVG
5	10920.000	35.42	14.49	49.91	74.00	-24.09	peak
6	13920.000	28.59	21.79	50.38	74.00	-23.62	peak
7	17715.000	25.93	24.00	49.93	74.00	-24.07	peak



Test Mode:	802.11b	Channel:	2457
Polarity:	Horizontal	Test Voltage:	DC 12 V

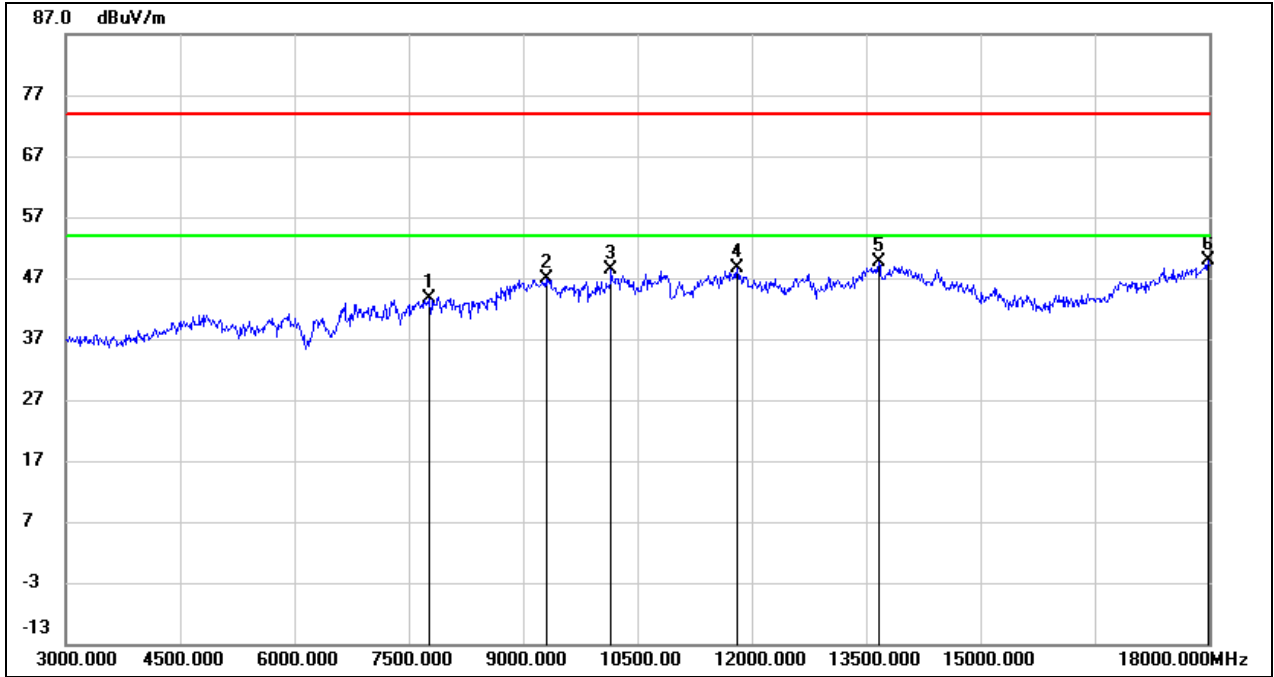

No.	Frequency (MHz)	Reading (dBuV)	Correct (dB/m)	Result (dBuV/m)	Limit (dBuV/m)	Margin (dB)	Remark
1	7770.000	37.22	6.31	43.53	74.00	-30.47	peak
2	9300.000	36.30	10.61	46.91	74.00	-27.09	peak
3	10155.000	36.06	12.32	48.38	74.00	-25.62	peak
4	11805.000	31.21	17.43	48.64	74.00	-25.36	peak
5	13665.000	28.28	21.25	49.53	74.00	-24.47	peak
6	17985.000	24.22	25.60	49.82	74.00	-24.18	peak



Test Mode:	802.11b	Channel:	2457
Polarity:	Vertical	Test Voltage:	DC 12 V

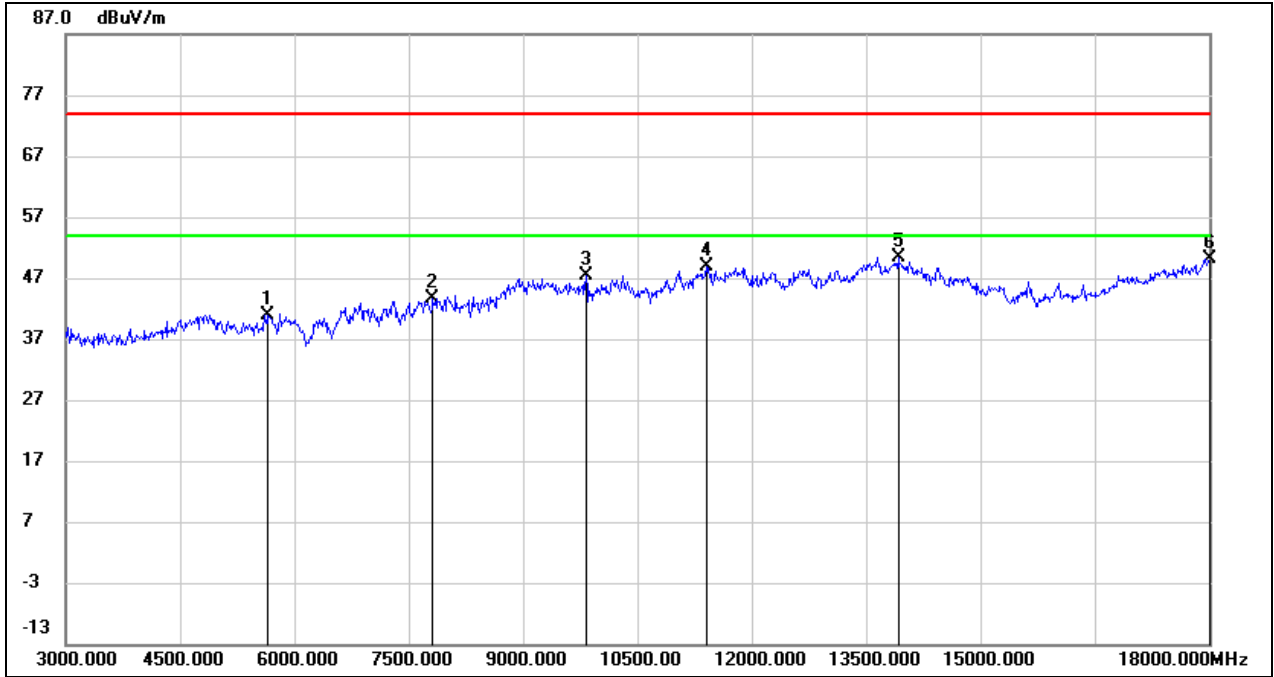

No.	Frequency (MHz)	Reading (dBuV)	Correct (dB/m)	Result (dBuV/m)	Limit (dBuV/m)	Margin (dB)	Remark
1	5655.000	39.70	1.29	40.99	74.00	-33.01	peak
2	7815.000	37.29	6.32	43.61	74.00	-30.39	peak
3	9825.000	35.94	11.56	47.50	74.00	-26.50	peak
4	11400.000	32.67	16.23	48.90	74.00	-25.10	peak
5	13920.000	28.62	21.79	50.41	74.00	-23.59	peak
6	18000.000	24.51	25.69	50.20	74.00	-23.80	peak



Test Mode:	802.11b	Channel:	2462
Polarity:	Horizontal	Test Voltage:	DC 12 V

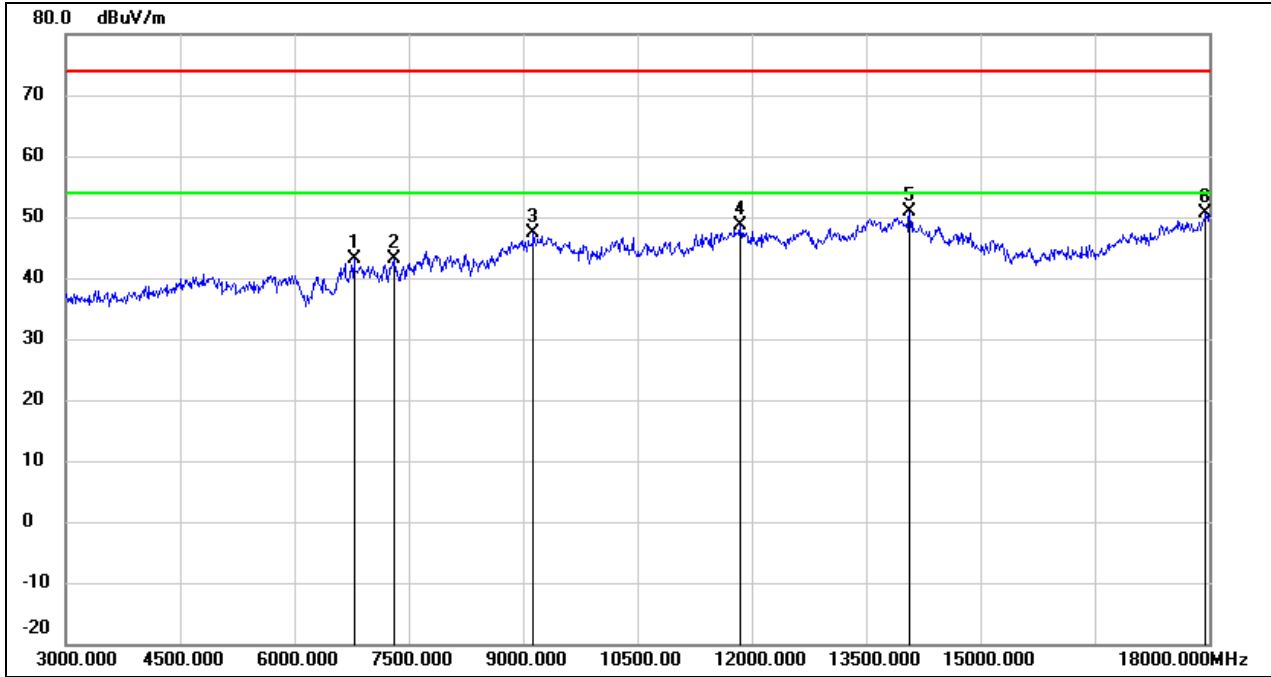

No.	Frequency (MHz)	Reading (dBuV)	Correct (dB/m)	Result (dBuV/m)	Limit (dBuV/m)	Margin (dB)	Remark
1	6780.000	37.53	5.60	43.13	74.00	-30.87	peak
2	7305.000	36.72	6.47	43.19	74.00	-30.81	peak
3	9135.000	36.78	10.55	47.33	74.00	-26.67	peak
4	11850.000	31.02	17.56	48.58	74.00	-25.42	peak
5	14070.000	29.31	21.67	50.98	74.00	-23.02	peak
6	17955.000	25.25	25.42	50.67	74.00	-23.33	peak



Test Mode:	802.11b	Channel:	2462
Polarity:	Vertical	Test Voltage:	DC 12 V

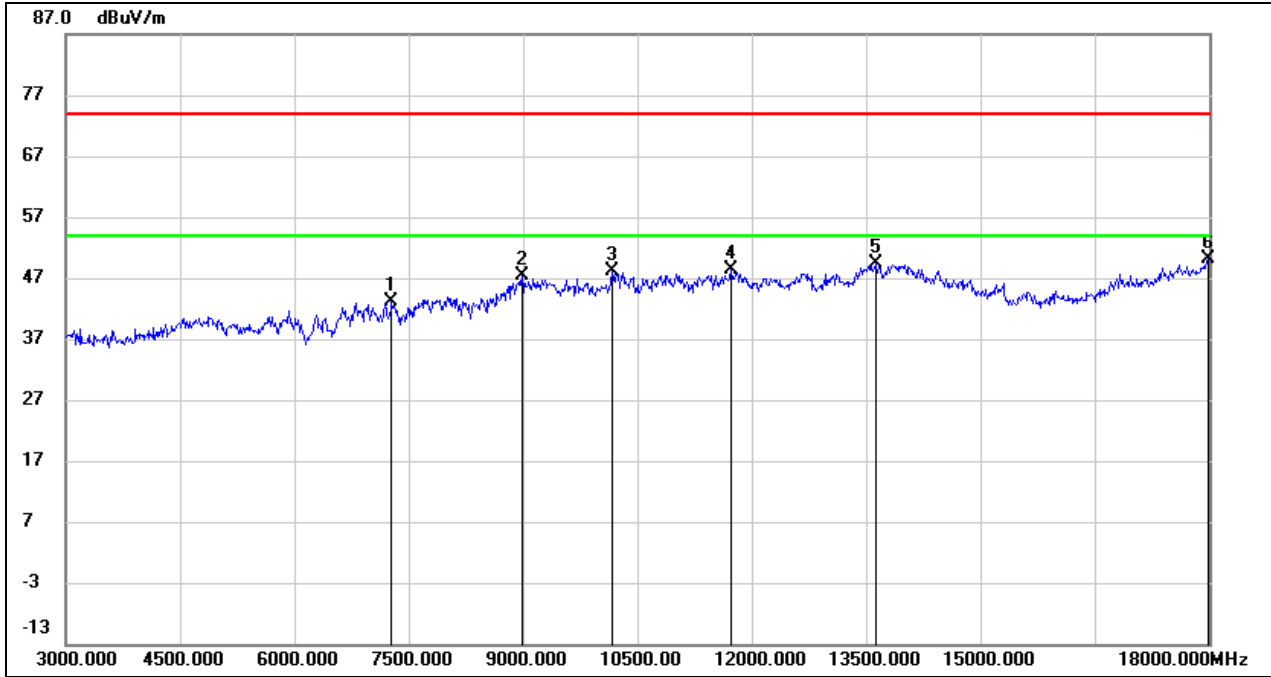

No.	Frequency (MHz)	Reading (dBuV)	Correct (dB/m)	Result (dBuV/m)	Limit (dBuV/m)	Margin (dB)	Remark
1	7275.000	36.61	6.49	43.10	74.00	-30.90	peak
2	8985.000	37.05	10.37	47.42	74.00	-26.58	peak
3	10170.000	35.84	12.34	48.18	74.00	-25.82	peak
4	11730.000	31.06	17.22	48.28	74.00	-25.72	peak
5	13635.000	28.21	21.19	49.40	74.00	-24.60	peak
6	17985.000	24.52	25.60	50.12	74.00	-23.88	peak



Test Mode:	802.11g	Channel:	2412
Polarity:	Horizontal	Test Voltage:	DC 12 V

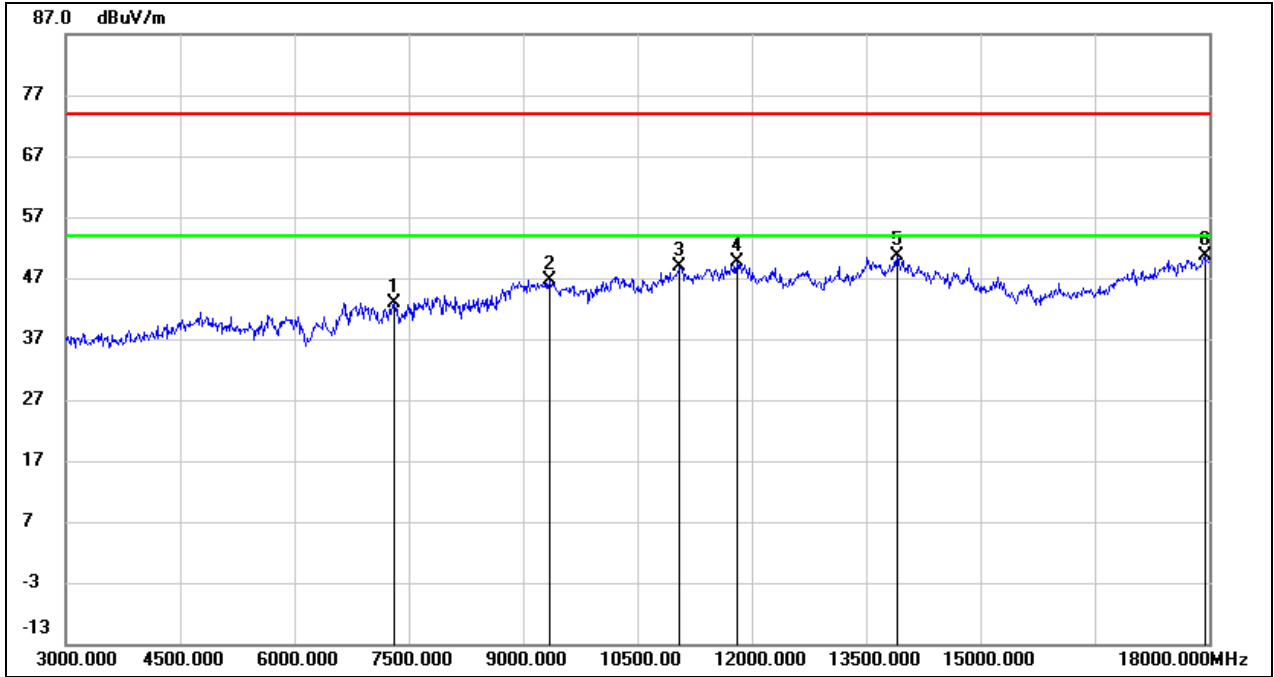

No.	Frequency (MHz)	Reading (dBuV)	Correct (dB/m)	Result (dBuV/m)	Limit (dBuV/m)	Margin (dB)	Remark
1	7305.000	36.40	6.47	42.87	74.00	-31.13	peak
2	9345.000	36.09	10.63	46.72	74.00	-27.28	peak
3	11055.000	33.81	14.96	48.77	74.00	-25.23	peak
4	11805.000	32.26	17.43	49.69	74.00	-24.31	peak
5	13905.000	28.76	21.76	50.52	74.00	-23.48	peak
6	17940.000	25.21	25.34	50.55	74.00	-23.45	peak



Test Mode:	802.11g	Channel:	2412
Polarity:	Vertical	Test Voltage:	DC 12 V

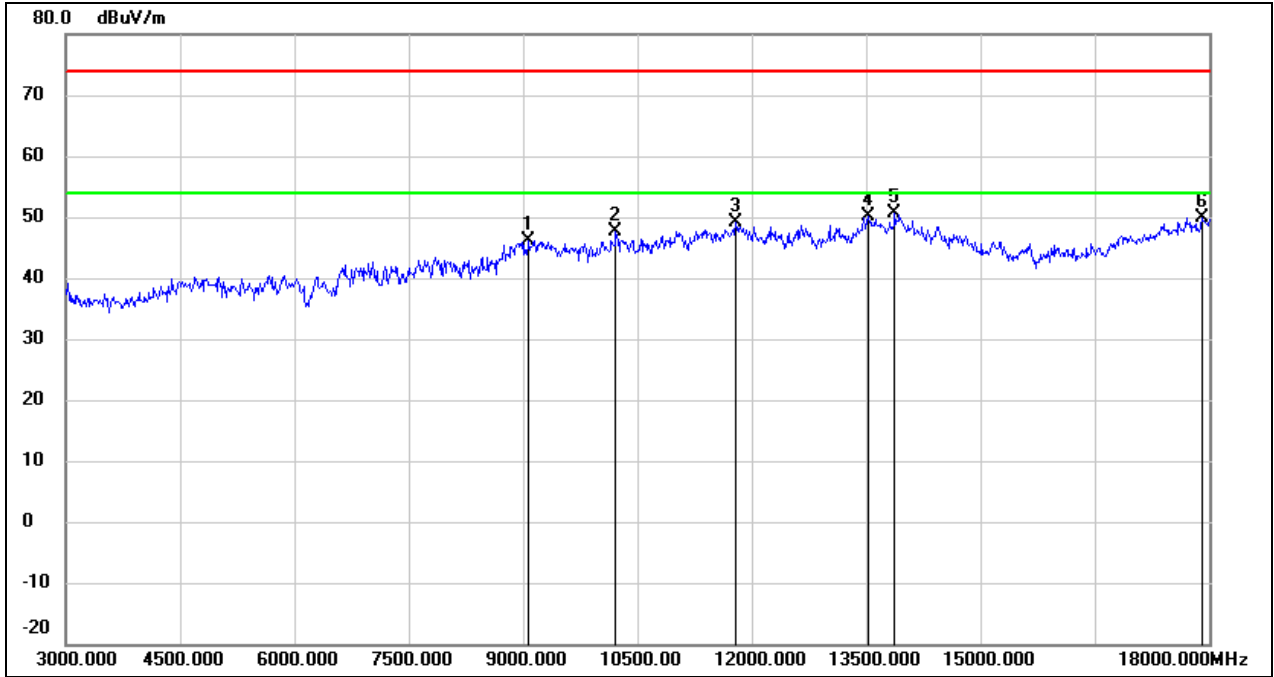

No.	Frequency (MHz)	Reading (dBuV)	Correct (dB/m)	Result (dBuV/m)	Limit (dBuV/m)	Margin (dB)	Remark
1	9075.000	35.72	10.52	46.24	74.00	-27.76	peak
2	10215.000	35.18	12.43	47.61	74.00	-26.39	peak
3	11790.000	31.82	17.38	49.20	74.00	-24.80	peak
4	13530.000	29.13	20.96	50.09	74.00	-23.91	peak
5	13875.000	28.98	21.70	50.68	74.00	-23.32	peak
6	17910.000	24.75	25.16	49.91	74.00	-24.09	peak



Test Mode:	802.11g	Channel:	2417
Polarity:	Horizontal	Test Voltage:	DC 12 V

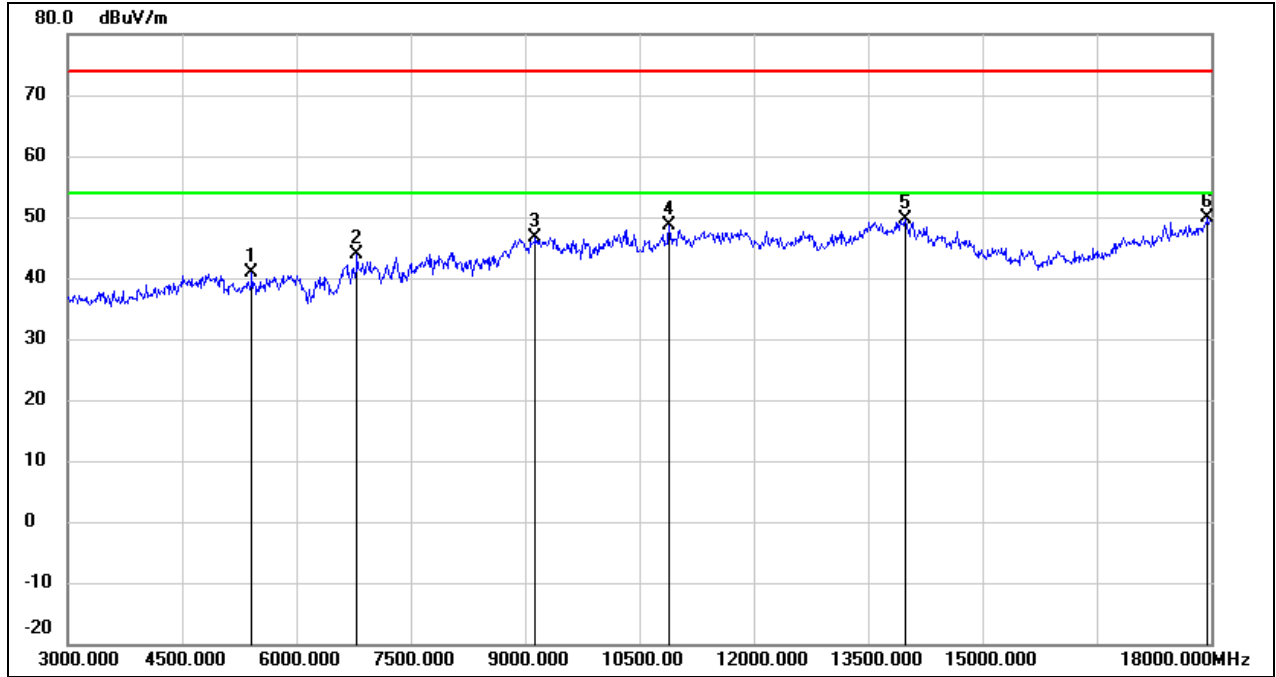

No.	Frequency (MHz)	Reading (dBuV)	Correct (dB/m)	Result (dBuV/m)	Limit (dBuV/m)	Margin (dB)	Remark
1	5415.000	39.99	0.78	40.77	74.00	-33.23	peak
2	6795.000	38.08	5.68	43.76	74.00	-30.24	peak
3	9135.000	36.04	10.55	46.59	74.00	-27.41	peak
4	10890.000	34.35	14.39	48.74	74.00	-25.26	peak
5	13980.000	27.72	21.92	49.64	74.00	-24.36	peak
6	17955.000	24.45	25.42	49.87	74.00	-24.13	peak



Test Mode:	802.11g	Channel:	2417
Polarity:	Vertical	Test Voltage:	DC 12 V

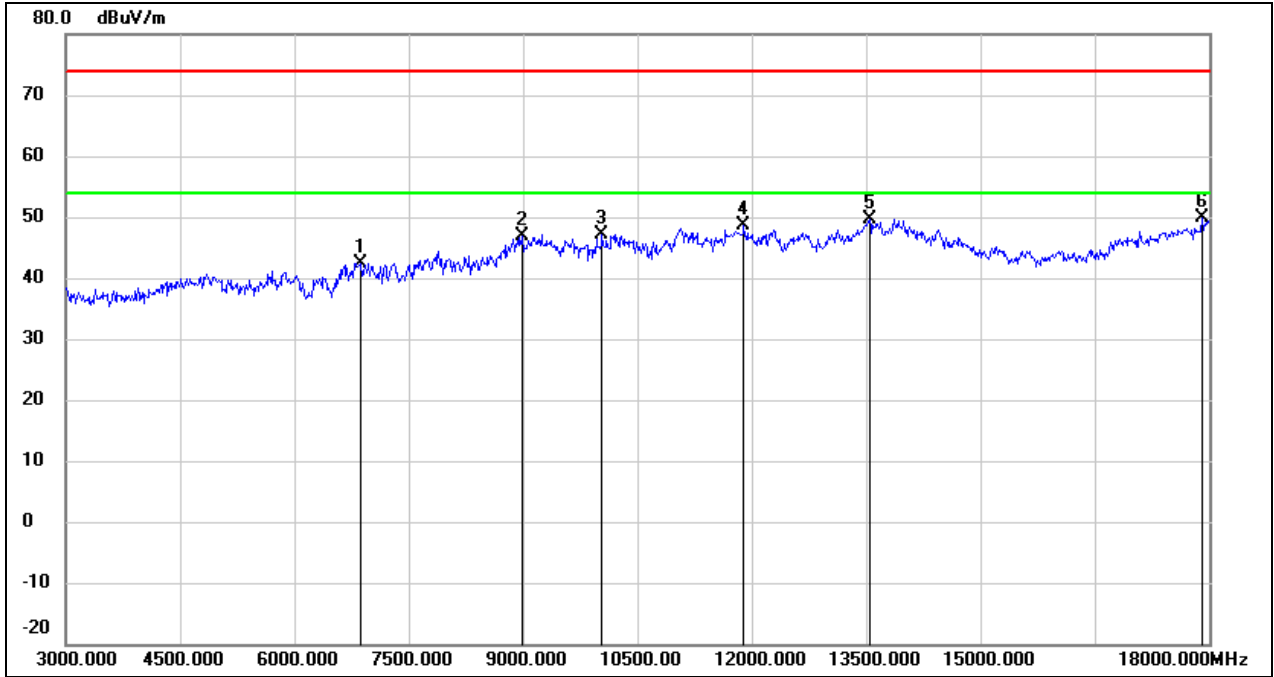

No.	Frequency (MHz)	Reading (dBuV)	Correct (dB/m)	Result (dBuV/m)	Limit (dBuV/m)	Margin (dB)	Remark
1	6870.000	36.36	6.05	42.41	74.00	-31.59	peak
2	8985.000	36.60	10.37	46.97	74.00	-27.03	peak
3	10035.000	35.10	12.08	47.18	74.00	-26.82	peak
4	11895.000	30.91	17.68	48.59	74.00	-25.41	peak
5	13545.000	28.70	20.99	49.69	74.00	-24.31	peak
6	17910.000	24.64	25.16	49.80	74.00	-24.20	peak



Test Mode:	802.11g	Channel:	2437
Polarity:	Horizontal	Test Voltage:	DC 12 V

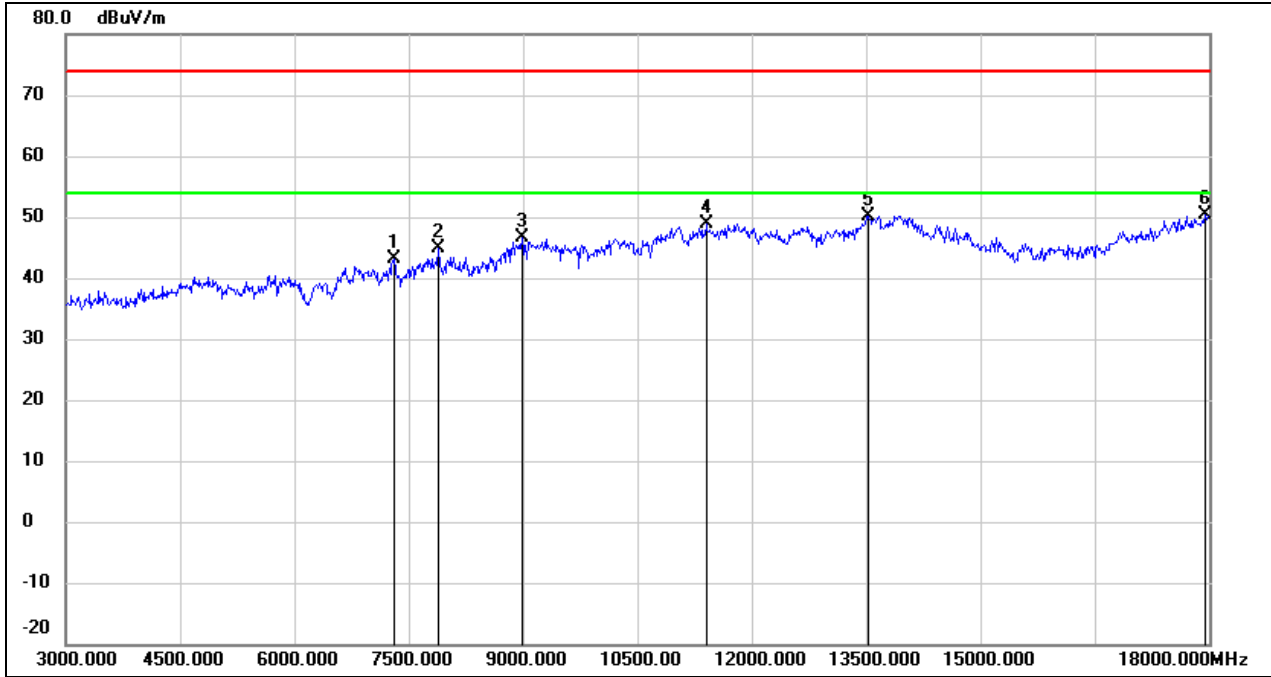

No.	Frequency (MHz)	Reading (dBuV)	Correct (dB/m)	Result (dBuV/m)	Limit (dBuV/m)	Margin (dB)	Remark
1	7305.000	36.74	6.47	43.21	74.00	-30.79	peak
2	7890.000	38.49	6.31	44.80	74.00	-29.20	peak
3	8985.000	36.32	10.37	46.69	74.00	-27.31	peak
4	11400.000	32.68	16.23	48.91	74.00	-25.09	peak
5	13530.000	29.25	20.96	50.21	74.00	-23.79	peak
6	17940.000	25.02	25.34	50.36	74.00	-23.64	peak



Test Mode:	802.11g	Channel:	2437
Polarity:	Vertical	Test Voltage:	DC 12 V

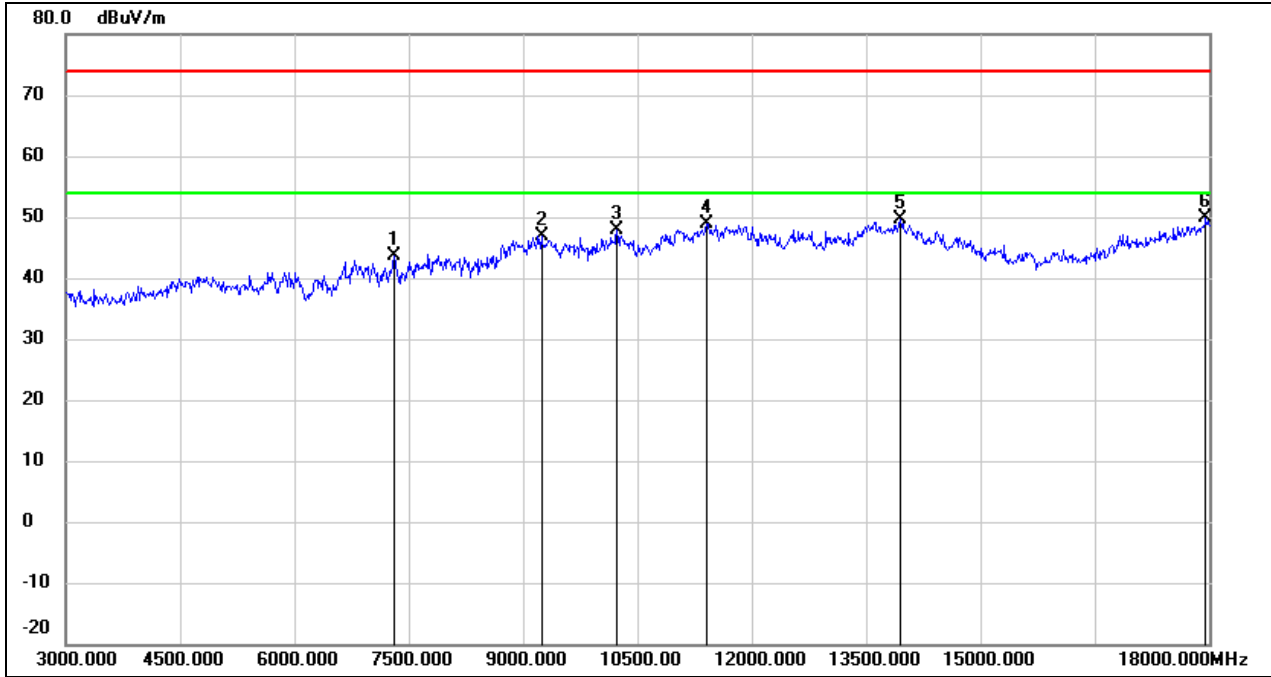

No.	Frequency (MHz)	Reading (dBuV)	Correct (dB/m)	Result (dBuV/m)	Limit (dBuV/m)	Margin (dB)	Remark
1	7305.000	37.17	6.47	43.64	74.00	-30.36	peak
2	9240.000	36.27	10.58	46.85	74.00	-27.15	peak
3	10230.000	35.52	12.46	47.98	74.00	-26.02	peak
4	11415.000	32.56	16.29	48.85	74.00	-25.15	peak
5	13950.000	27.66	21.86	49.52	74.00	-24.48	peak
6	17955.000	24.46	25.42	49.88	74.00	-24.12	peak



Test Mode:	802.11g	Channel:	2457
Polarity:	Horizontal	Test Voltage:	DC 12 V

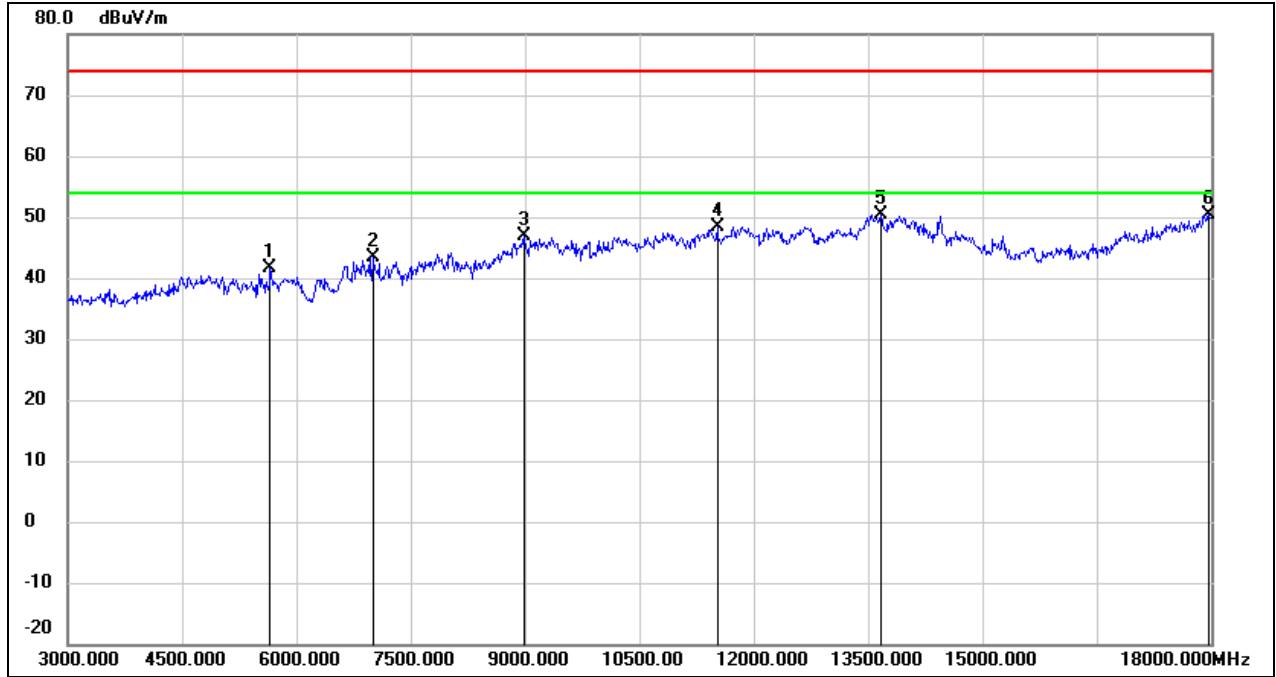

No.	Frequency (MHz)	Reading (dBuV)	Correct (dB/m)	Result (dBuV/m)	Limit (dBuV/m)	Margin (dB)	Remark
1	5655.000	40.40	1.29	41.69	74.00	-32.31	peak
2	7005.000	36.77	6.69	43.46	74.00	-30.54	peak
3	8985.000	36.49	10.37	46.86	74.00	-27.14	peak
4	11520.000	31.79	16.65	48.44	74.00	-25.56	peak
5	13665.000	29.16	21.25	50.41	74.00	-23.59	peak
6	17970.000	24.93	25.51	50.44	74.00	-23.56	peak



Test Mode:	802.11g	Channel:	2457
Polarity:	Vertical	Test Voltage:	DC 12 V

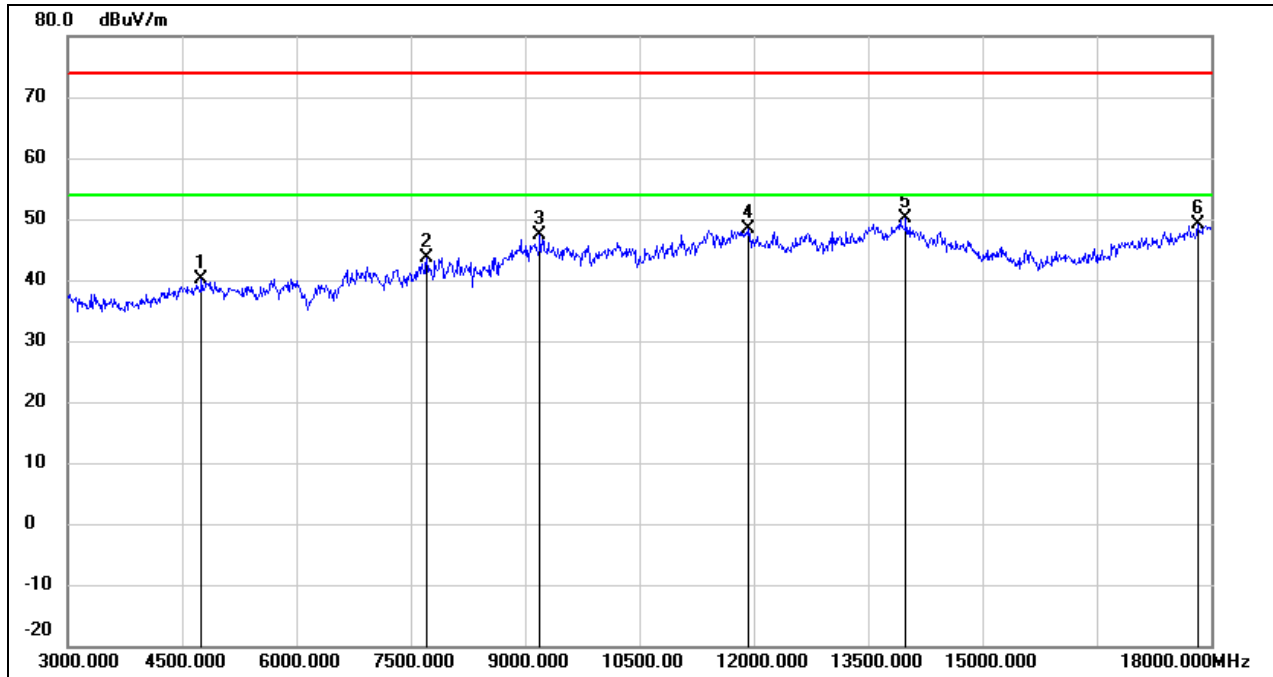

No.	Frequency (MHz)	Reading (dBuV)	Correct (dB/m)	Result (dBuV/m)	Limit (dBuV/m)	Margin (dB)	Remark
1	4755.000	40.64	-0.48	40.16	74.00	-33.84	peak
2	7710.000	37.39	6.33	43.72	74.00	-30.28	peak
3	9195.000	36.81	10.56	47.37	74.00	-26.63	peak
4	11925.000	30.61	17.75	48.36	74.00	-25.64	peak
5	13995.000	28.06	21.95	50.01	74.00	-23.99	peak
6	17820.000	24.41	24.63	49.04	74.00	-24.96	peak



Test Mode:	802.11g	Channel:	2462
Polarity:	Horizontal	Test Voltage:	DC 12 V

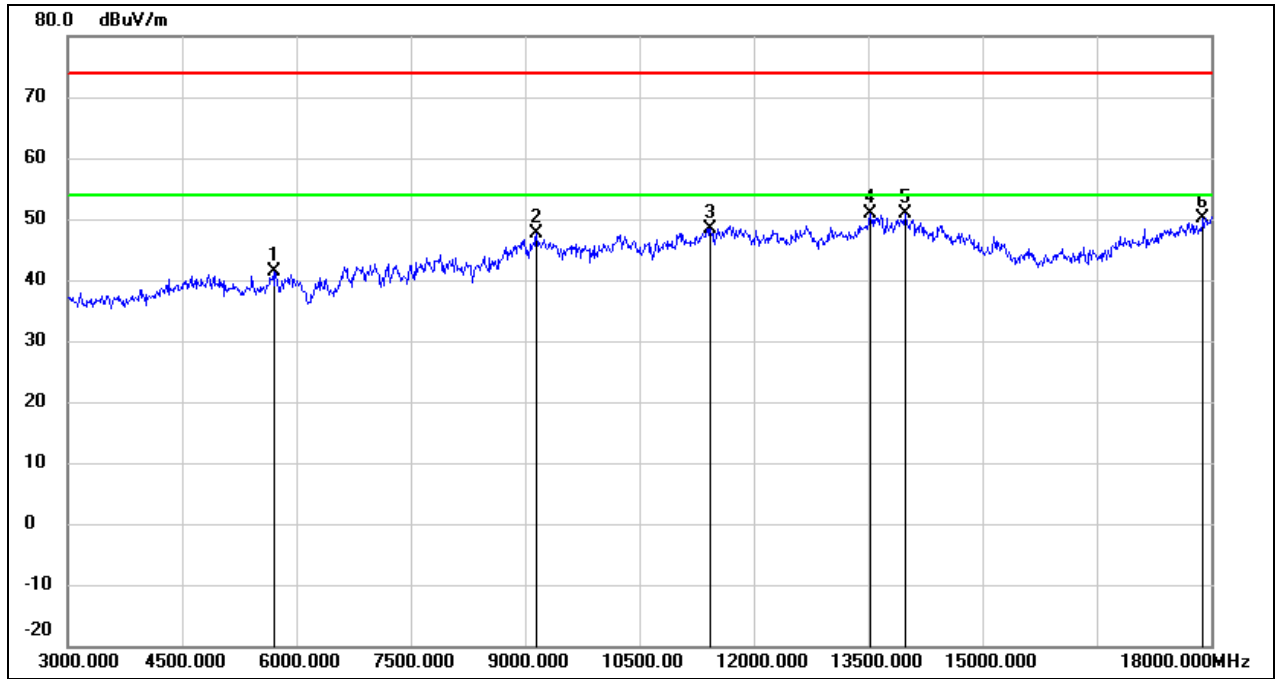

No.	Frequency (MHz)	Reading (dBuV)	Correct (dB/m)	Result (dBuV/m)	Limit (dBuV/m)	Margin (dB)	Remark
1	5700.000	39.85	1.41	41.26	74.00	-32.74	peak
2	9150.000	37.10	10.54	47.64	74.00	-26.36	peak
3	11430.000	32.13	16.34	48.47	74.00	-25.53	peak
4	13530.000	29.80	20.96	50.76	74.00	-23.24	peak
5	13980.000	29.03	21.92	50.95	74.00	-23.05	peak
6	17895.000	25.08	25.07	50.15	74.00	-23.85	peak



Test Mode:	802.11g	Channel:	2462
Polarity:	Vertical	Test Voltage:	DC 12 V

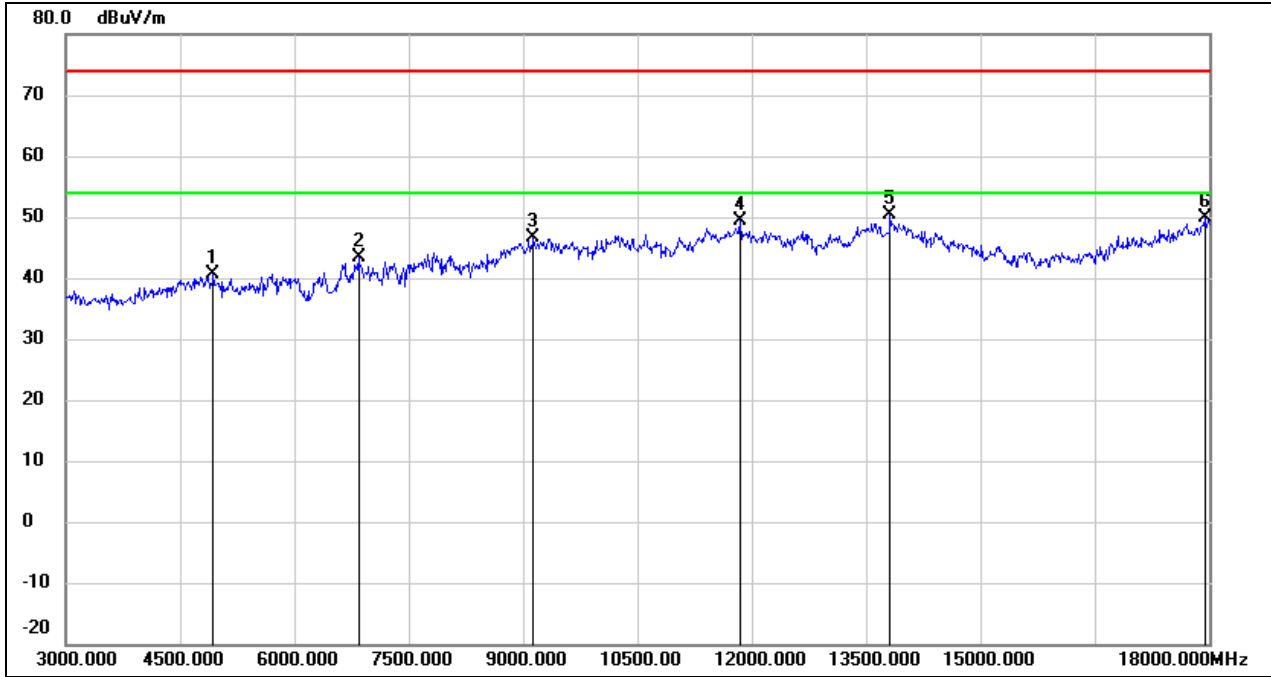

No.	Frequency (MHz)	Reading (dBuV)	Correct (dB/m)	Result (dBuV/m)	Limit (dBuV/m)	Margin (dB)	Remark
1	4935.000	40.47	0.20	40.67	74.00	-33.33	peak
2	6840.000	37.47	5.89	43.36	74.00	-30.64	peak
3	9135.000	35.97	10.55	46.52	74.00	-27.48	peak
4	11850.000	31.77	17.56	49.33	74.00	-24.67	peak
5	13815.000	28.82	21.56	50.38	74.00	-23.62	peak
6	17940.000	24.59	25.34	49.93	74.00	-24.07	peak



Test Mode:	802.11ax HE20	Channel:	2412
Polarity:	Horizontal	Test Voltage:	DC 12 V

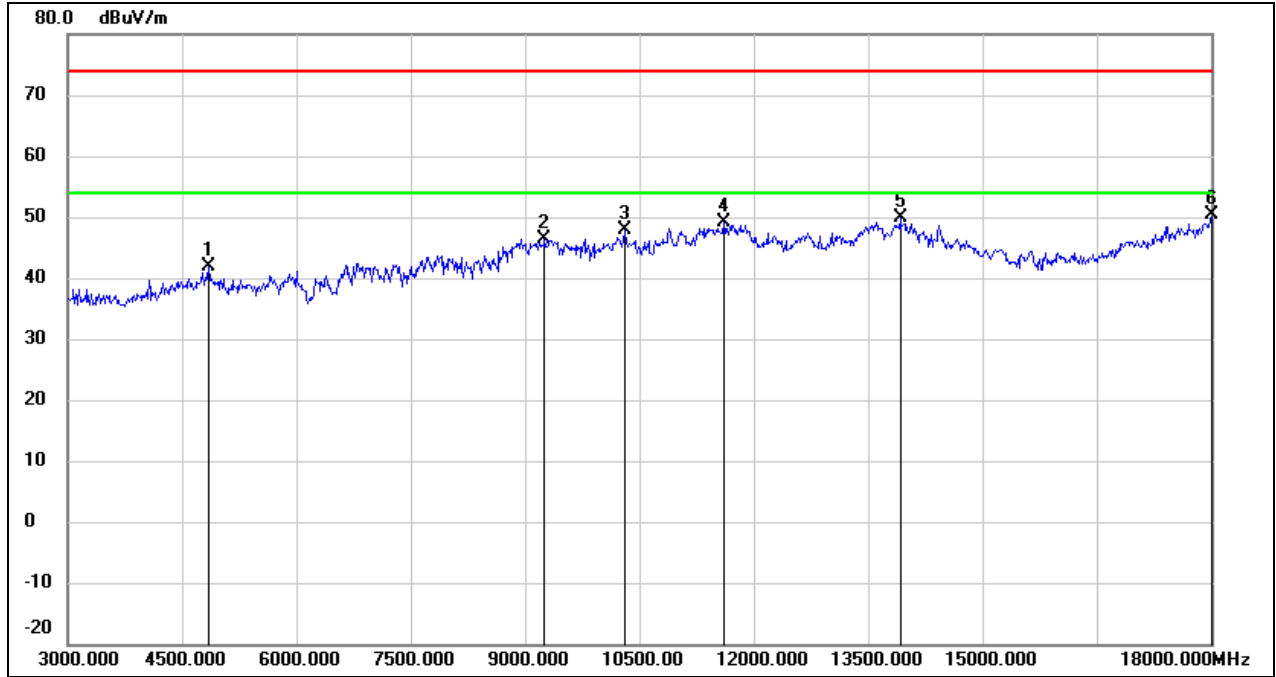

No.	Frequency (MHz)	Reading (dBuV)	Correct (dB/m)	Result (dBuV/m)	Limit (dBuV/m)	Margin (dB)	Remark
1	4845.000	42.05	-0.15	41.90	74.00	-32.10	peak
2	9255.000	35.88	10.59	46.47	74.00	-27.53	peak
3	10305.000	35.38	12.61	47.99	74.00	-26.01	peak
4	11610.000	32.25	16.90	49.15	74.00	-24.85	peak
5	13920.000	27.97	21.79	49.76	74.00	-24.24	peak
6	18000.000	24.57	25.69	50.26	74.00	-23.74	peak



Test Mode:	802.11ax HE20	Channel:	2412
Polarity:	Vertical	Test Voltage:	DC 12 V

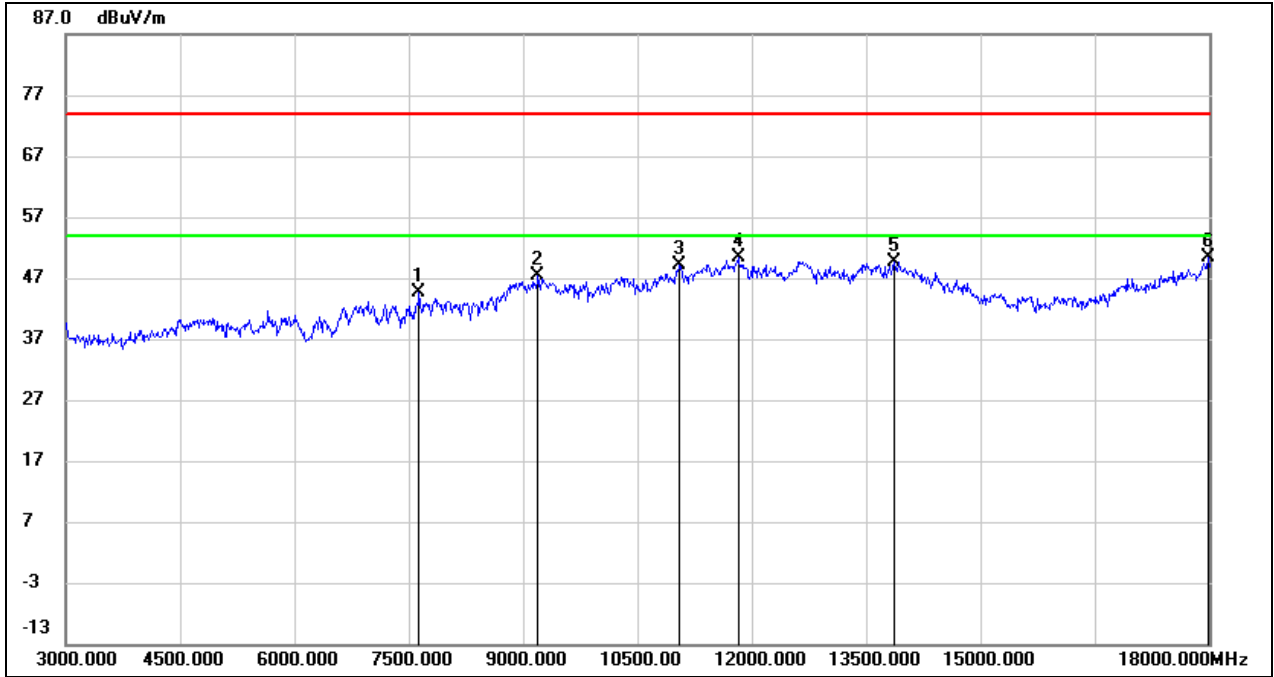

No.	Frequency (MHz)	Reading (dBuV)	Correct (dB/m)	Result (dBuV/m)	Limit (dBuV/m)	Margin (dB)	Remark
1	7635.000	38.18	6.33	44.51	74.00	-29.49	peak
2	9195.000	36.88	10.56	47.44	74.00	-26.56	peak
3	11055.000	34.05	14.96	49.01	74.00	-24.99	peak
4	11820.000	32.85	17.47	50.32	74.00	-23.68	peak
5	13875.000	28.03	21.70	49.73	74.00	-24.27	peak
6	17985.000	24.88	25.60	50.48	74.00	-23.52	peak



Test Mode:	802.11ax HE20	Channel:	2417
Polarity:	Horizontal	Test Voltage:	DC 12 V

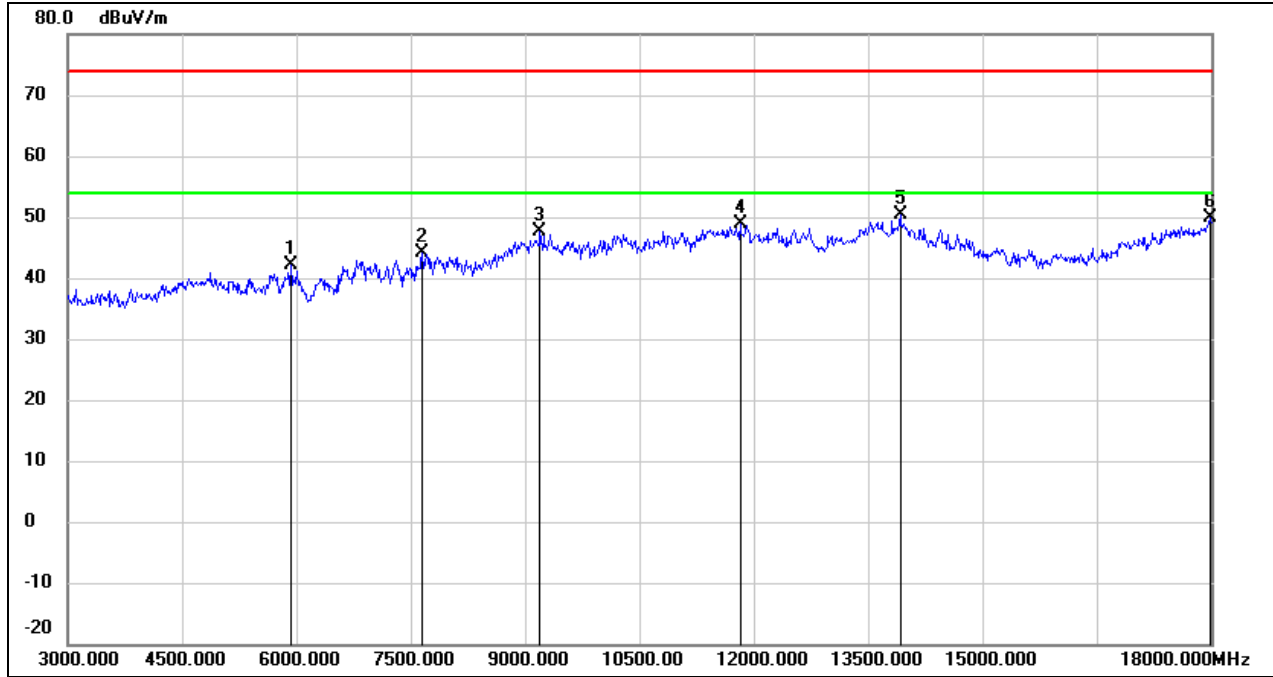

No.	Frequency (MHz)	Reading (dBuV)	Correct (dB/m)	Result (dBuV/m)	Limit (dBuV/m)	Margin (dB)	Remark
1	5925.000	40.01	2.04	42.05	74.00	-31.95	peak
2	7650.000	37.86	6.33	44.19	74.00	-29.81	peak
3	9195.000	37.14	10.56	47.70	74.00	-26.30	peak
4	11820.000	31.38	17.47	48.85	74.00	-25.15	peak
5	13920.000	28.52	21.79	50.31	74.00	-23.69	peak
6	17985.000	24.20	25.60	49.80	74.00	-24.20	peak



Test Mode:	802.11ax HE20	Channel:	2417
Polarity:	Vertical	Test Voltage:	DC 12 V

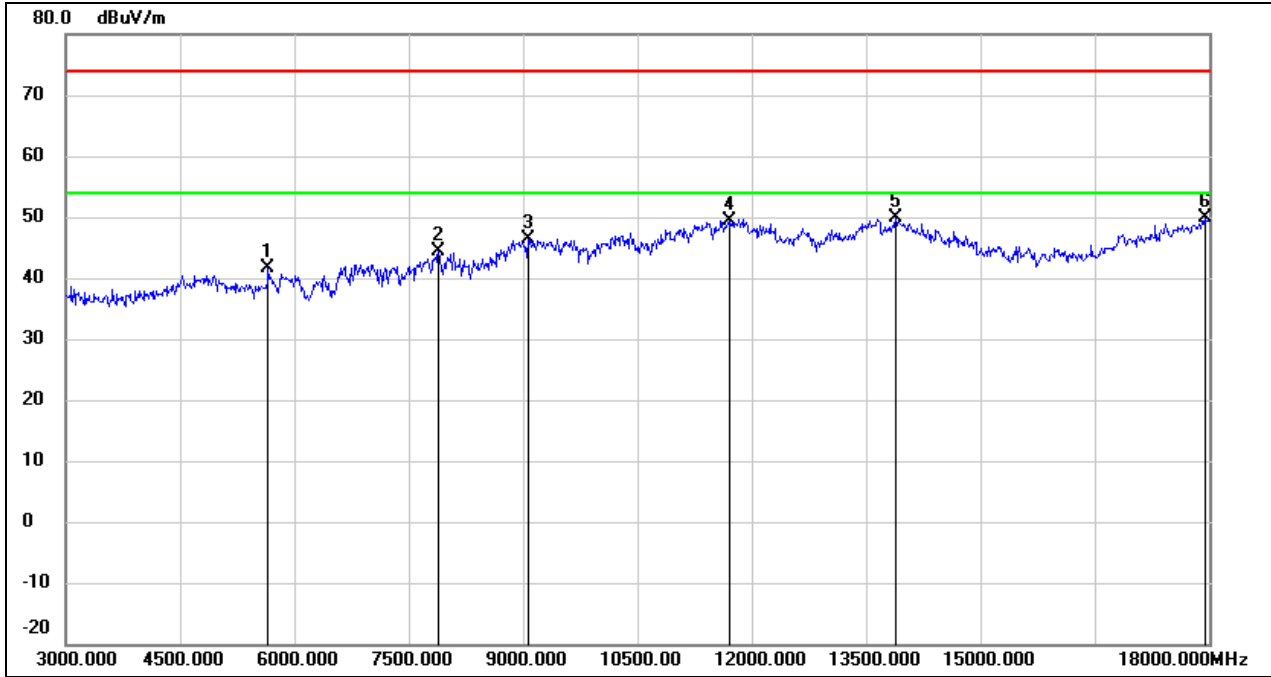

No.	Frequency (MHz)	Reading (dBuV)	Correct (dB/m)	Result (dBuV/m)	Limit (dBuV/m)	Margin (dB)	Remark
1	5655.000	40.37	1.29	41.66	74.00	-32.34	peak
2	7890.000	38.01	6.31	44.32	74.00	-29.68	peak
3	9060.000	35.85	10.51	46.36	74.00	-27.64	peak
4	11715.000	32.09	17.19	49.28	74.00	-24.72	peak
5	13890.000	28.18	21.72	49.90	74.00	-24.10	peak
6	17940.000	24.46	25.34	49.80	74.00	-24.20	peak



Test Mode:	802.11ax HE20	Channel:	2437
Polarity:	Horizontal	Test Voltage:	DC 12 V

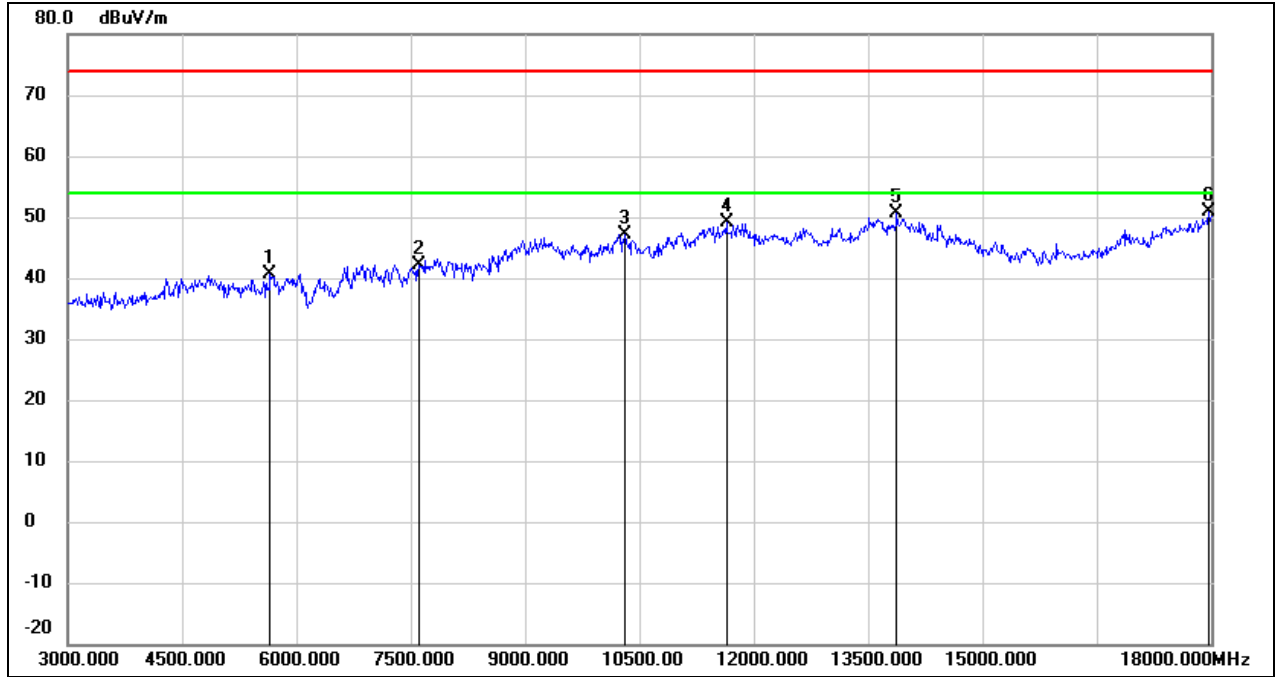

No.	Frequency (MHz)	Reading (dBuV)	Correct (dB/m)	Result (dBuV/m)	Limit (dBuV/m)	Margin (dB)	Remark
1	5655.000	39.23	1.29	40.52	74.00	-33.48	peak
2	7605.000	35.87	6.32	42.19	74.00	-31.81	peak
3	10305.000	34.59	12.61	47.20	74.00	-26.80	peak
4	11640.000	32.16	16.98	49.14	74.00	-24.86	peak
5	13875.000	28.91	21.70	50.61	74.00	-23.39	peak
6	17970.000	25.32	25.51	50.83	74.00	-23.17	peak



Test Mode:	802.11ax HE20	Channel:	2437
Polarity:	Vertical	Test Voltage:	DC 12 V

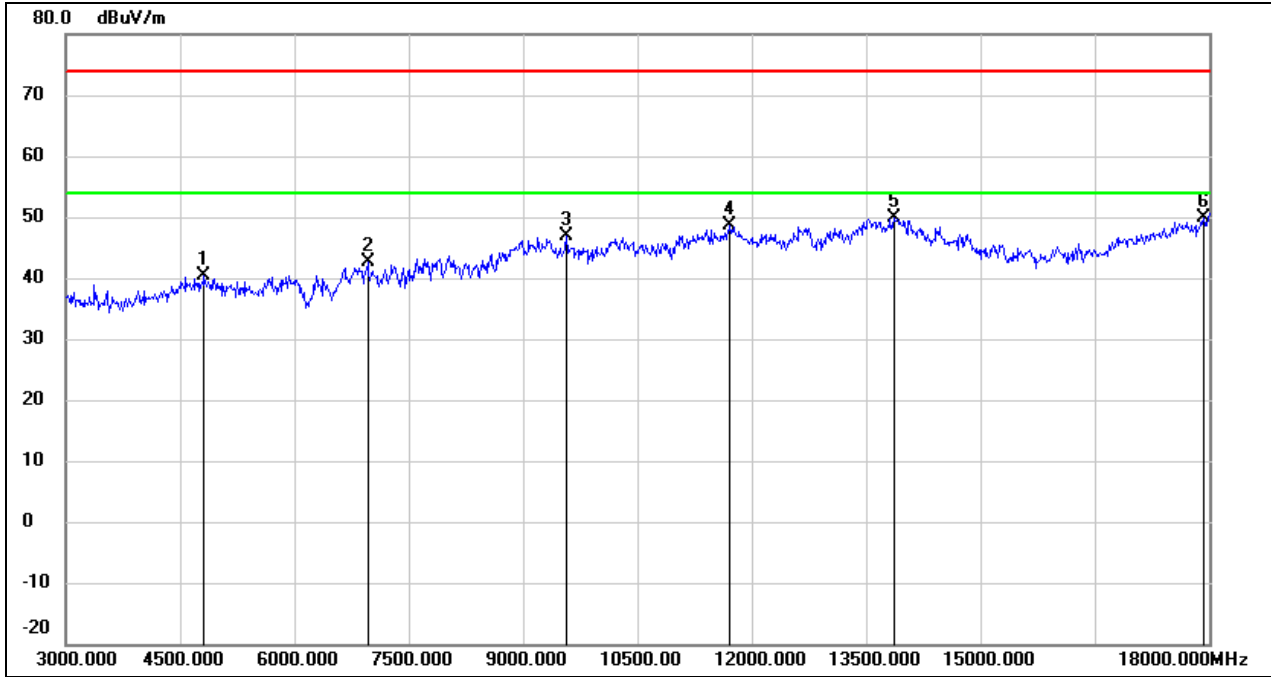

No.	Frequency (MHz)	Reading (dBuV)	Correct (dB/m)	Result (dBuV/m)	Limit (dBuV/m)	Margin (dB)	Remark
1	4815.000	40.71	-0.26	40.45	74.00	-33.55	peak
2	6960.000	36.19	6.50	42.69	74.00	-31.31	peak
3	9570.000	35.97	10.87	46.84	74.00	-27.16	peak
4	11715.000	31.47	17.19	48.66	74.00	-25.34	peak
5	13860.000	28.16	21.67	49.83	74.00	-24.17	peak
6	17925.000	24.68	25.25	49.93	74.00	-24.07	peak



Test Mode:	802.11ax HE20	Channel:	2457
Polarity:	Horizontal	Test Voltage:	DC 12 V

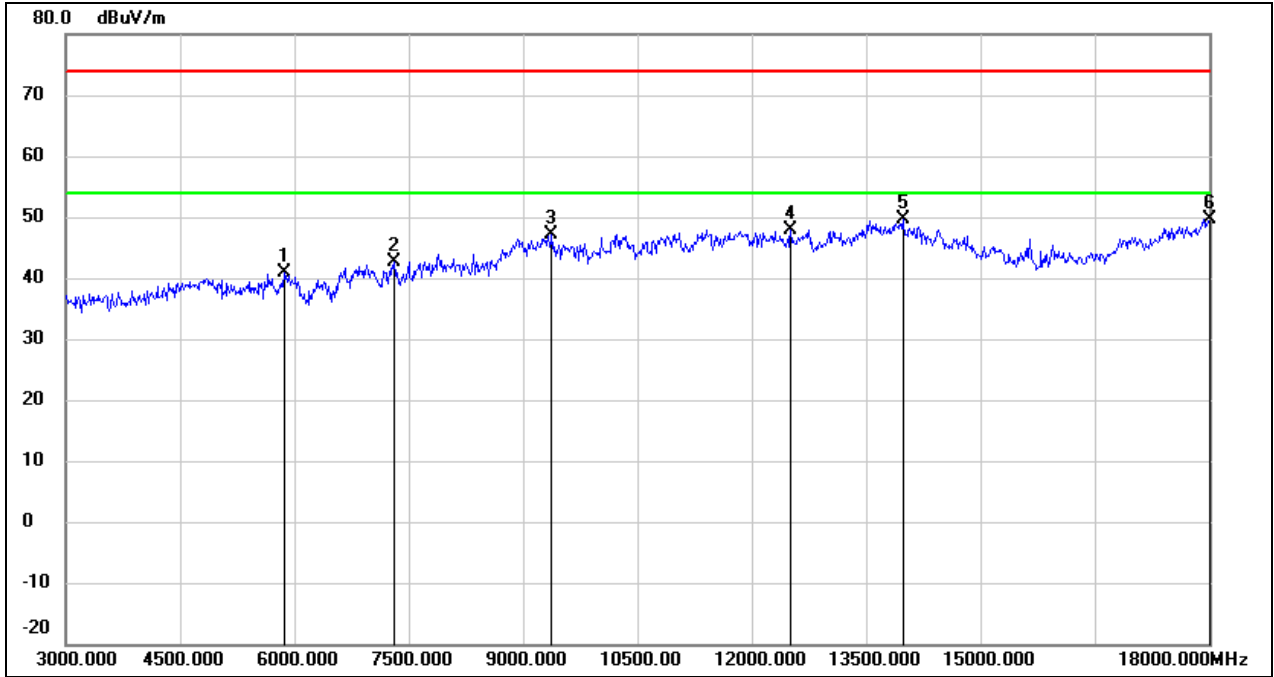

No.	Frequency (MHz)	Reading (dBuV)	Correct (dB/m)	Result (dBuV/m)	Limit (dBuV/m)	Margin (dB)	Remark
1	5865.000	38.92	1.88	40.80	74.00	-33.20	peak
2	7305.000	36.22	6.47	42.69	74.00	-31.31	peak
3	9375.000	36.39	10.64	47.03	74.00	-26.97	peak
4	12510.000	30.32	17.62	47.94	74.00	-26.06	peak
5	13980.000	27.82	21.92	49.74	74.00	-24.26	peak
6	18000.000	23.92	25.69	49.61	74.00	-24.39	peak



Test Mode:	802.11ax HE20	Channel:	2457
Polarity:	Vertical	Test Voltage:	DC 12 V

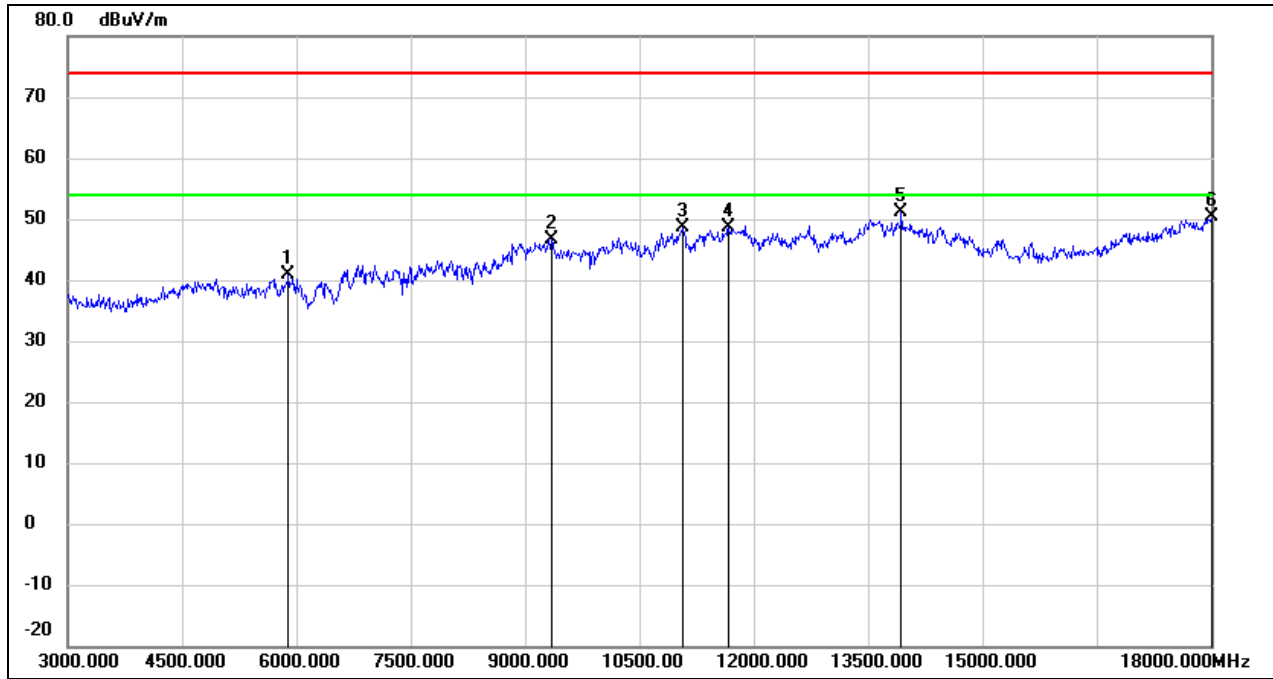

No.	Frequency (MHz)	Reading (dBuV)	Correct (dB/m)	Result (dBuV/m)	Limit (dBuV/m)	Margin (dB)	Remark
1	5895.000	38.94	1.96	40.90	74.00	-33.10	peak
2	9345.000	35.89	10.63	46.52	74.00	-27.48	peak
3	11070.000	33.49	15.03	48.52	74.00	-25.48	peak
4	11670.000	31.66	17.07	48.73	74.00	-25.27	peak
5	13935.000	29.19	21.82	51.01	74.00	-22.99	peak
6	18000.000	24.70	25.69	50.39	74.00	-23.61	peak



Test Mode:	802.11ax HE20	Channel:	2462
Polarity:	Horizontal	Test Voltage:	DC 12 V

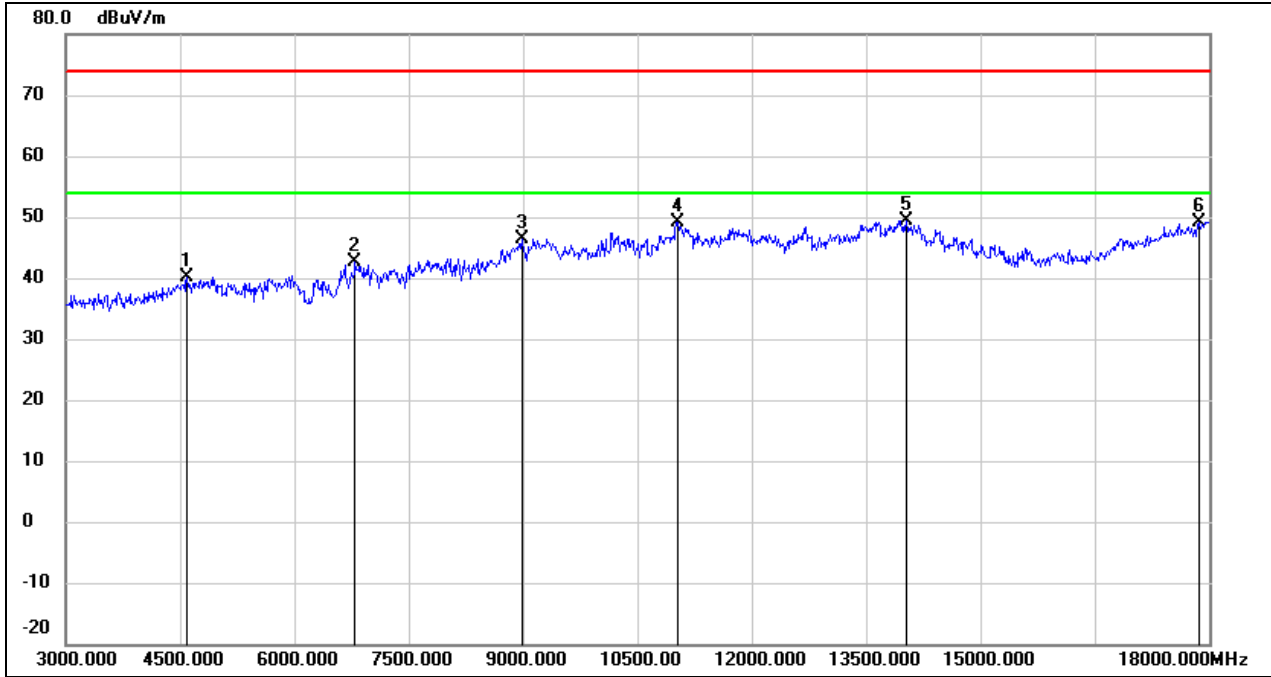

No.	Frequency (MHz)	Reading (dBuV)	Correct (dB/m)	Result (dBuV/m)	Limit (dBuV/m)	Margin (dB)	Remark
1	4590.000	41.18	-1.12	40.06	74.00	-33.94	peak
2	6795.000	36.93	5.68	42.61	74.00	-31.39	peak
3	8985.000	36.01	10.37	46.38	74.00	-27.62	peak
4	11025.000	34.38	14.85	49.23	74.00	-24.77	peak
5	14025.000	27.55	21.86	49.41	74.00	-24.59	peak
6	17865.000	24.36	24.89	49.25	74.00	-24.75	peak



Test Mode:	802.11ax HE20	Channel:	2462
Polarity:	Vertical	Test Voltage:	DC 12 V

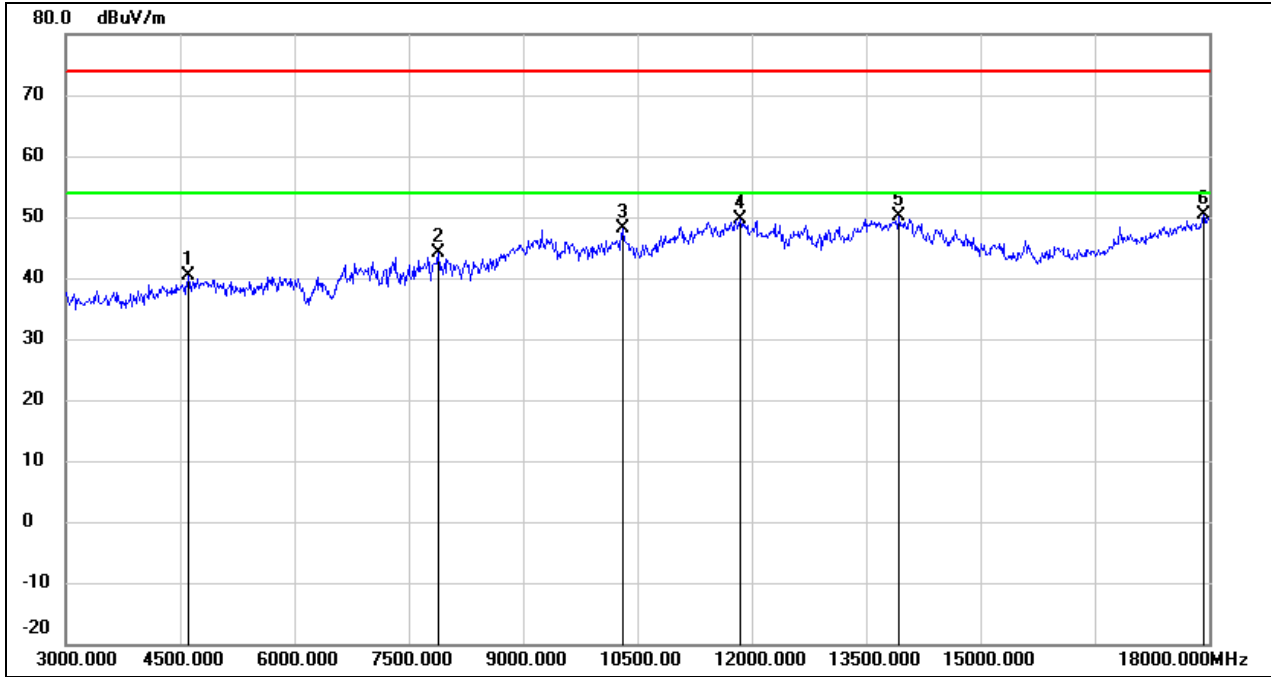

No.	Frequency (MHz)	Reading (dBuV)	Correct (dB/m)	Result (dBuV/m)	Limit (dBuV/m)	Margin (dB)	Remark
1	4605.000	41.37	-1.06	40.31	74.00	-33.69	peak
2	7890.000	37.93	6.31	44.24	74.00	-29.76	peak
3	10305.000	35.42	12.61	48.03	74.00	-25.97	peak
4	11850.000	32.11	17.56	49.67	74.00	-24.33	peak
5	13935.000	28.33	21.82	50.15	74.00	-23.85	peak
6	17925.000	25.20	25.25	50.45	74.00	-23.55	peak



Test Mode:	802.11ax HE40	Channel:	2422
Polarity:	Horizontal	Test Voltage:	DC 12 V

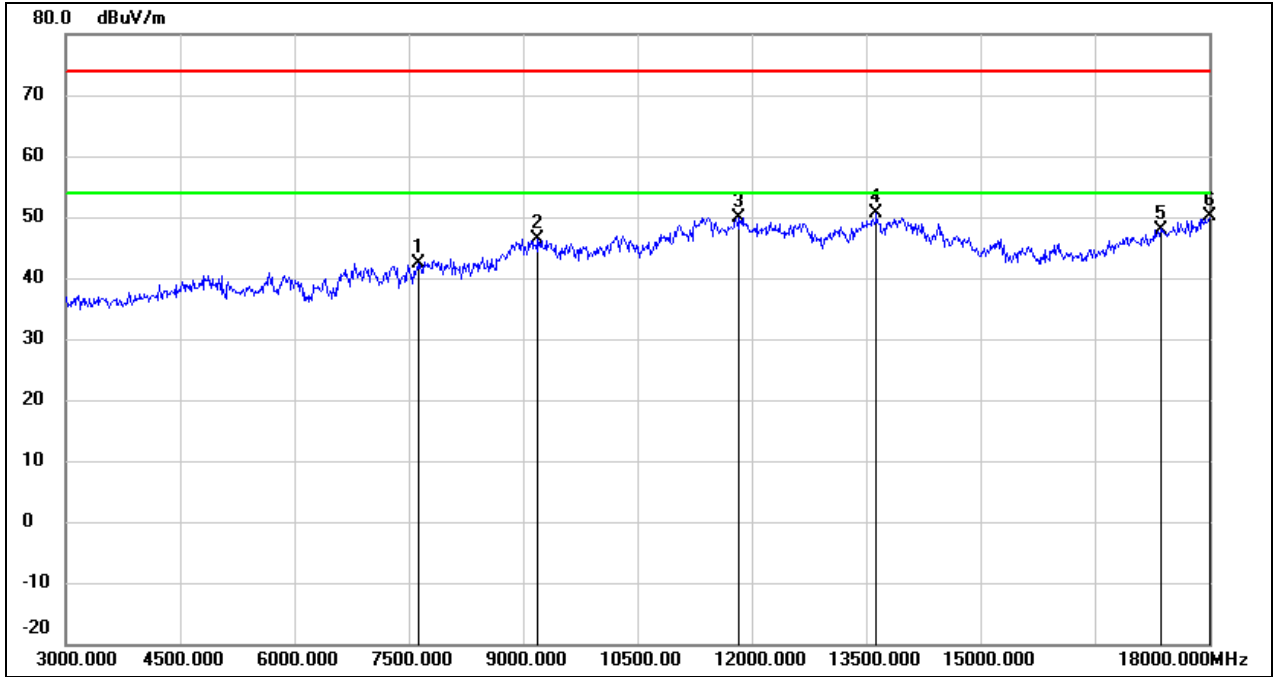

No.	Frequency (MHz)	Reading (dBuV)	Correct (dB/m)	Result (dBuV/m)	Limit (dBuV/m)	Margin (dB)	Remark
1	7620.000	36.15	6.33	42.48	74.00	-31.52	peak
2	9195.000	35.89	10.56	46.45	74.00	-27.55	peak
3	11835.000	32.32	17.51	49.83	74.00	-24.17	peak
4	13635.000	29.34	21.19	50.53	74.00	-23.47	peak
5	17370.000	25.75	22.25	48.00	74.00	-26.00	peak
6	18000.000	24.54	25.69	50.23	74.00	-23.77	peak



Test Mode:	802.11ax HE40	Channel:	2422
Polarity:	Vertical	Test Voltage:	DC 12 V

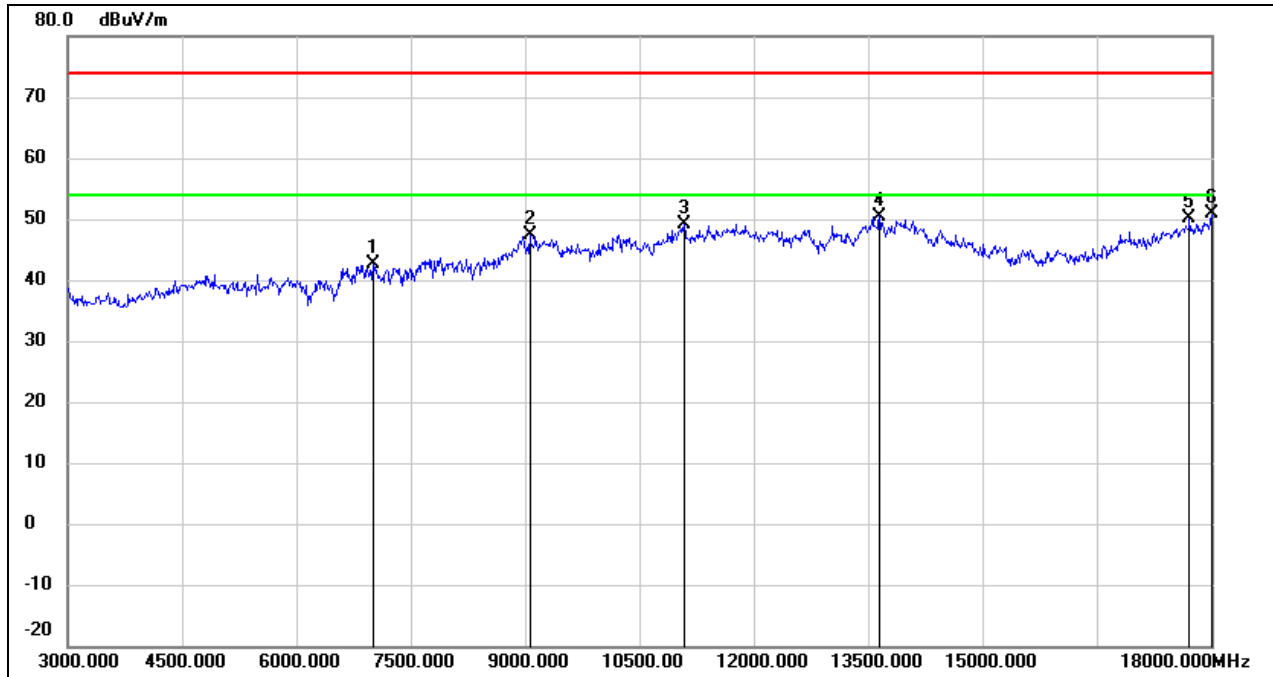

No.	Frequency (MHz)	Reading (dBuV)	Correct (dB/m)	Result (dBuV/m)	Limit (dBuV/m)	Margin (dB)	Remark
1	7005.000	35.86	6.69	42.55	74.00	-31.45	peak
2	9060.000	36.93	10.51	47.44	74.00	-26.56	peak
3	11085.000	33.94	15.08	49.02	74.00	-24.98	peak
4	13650.000	29.29	21.21	50.50	74.00	-23.50	peak
5	17715.000	26.03	24.00	50.03	74.00	-23.97	peak
6	18000.000	25.28	25.69	50.97	74.00	-23.03	peak



Test Mode:	802.11ax HE40	Channel:	2427
Polarity:	Horizontal	Test Voltage:	DC 12 V

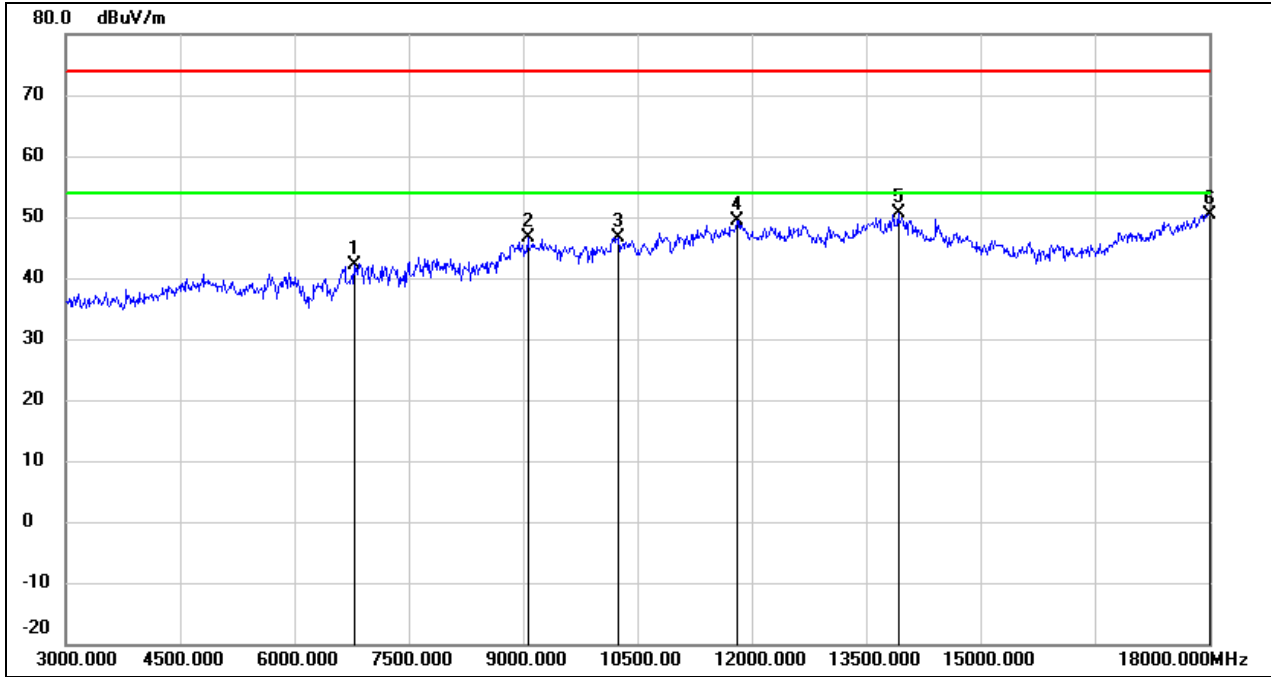

No.	Frequency (MHz)	Reading (dBuV)	Correct (dB/m)	Result (dBuV/m)	Limit (dBuV/m)	Margin (dB)	Remark
1	6780.000	36.49	5.60	42.09	74.00	-31.91	peak
2	9060.000	36.00	10.51	46.51	74.00	-27.49	peak
3	10245.000	34.19	12.48	46.67	74.00	-27.33	peak
4	11805.000	31.95	17.43	49.38	74.00	-24.62	peak
5	13920.000	28.79	21.79	50.58	74.00	-23.42	peak
6	18000.000	24.76	25.69	50.45	74.00	-23.55	peak



Test Mode:	802.11ax HE40	Channel:	2427
Polarity:	Vertical	Test Voltage:	DC 12 V

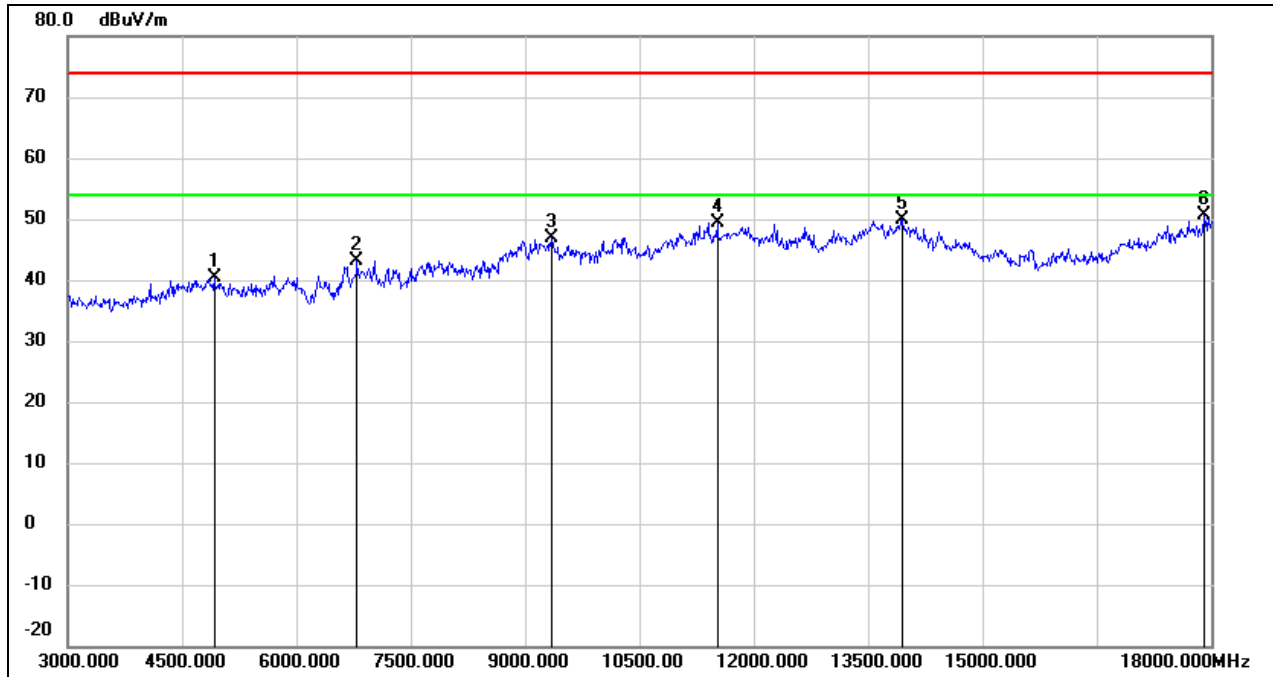

No.	Frequency (MHz)	Reading (dBuV)	Correct (dB/m)	Result (dBuV/m)	Limit (dBuV/m)	Margin (dB)	Remark
1	4920.000	40.25	0.14	40.39	74.00	-33.61	peak
2	6795.000	37.43	5.68	43.11	74.00	-30.89	peak
3	9345.000	36.30	10.63	46.93	74.00	-27.07	peak
4	11520.000	32.80	16.65	49.45	74.00	-24.55	peak
5	13950.000	28.13	21.86	49.99	74.00	-24.01	peak
6	17910.000	25.48	25.16	50.64	74.00	-23.36	peak



Test Mode:	802.11ax HE40	Channel:	2437
Polarity:	Horizontal	Test Voltage:	DC 12 V

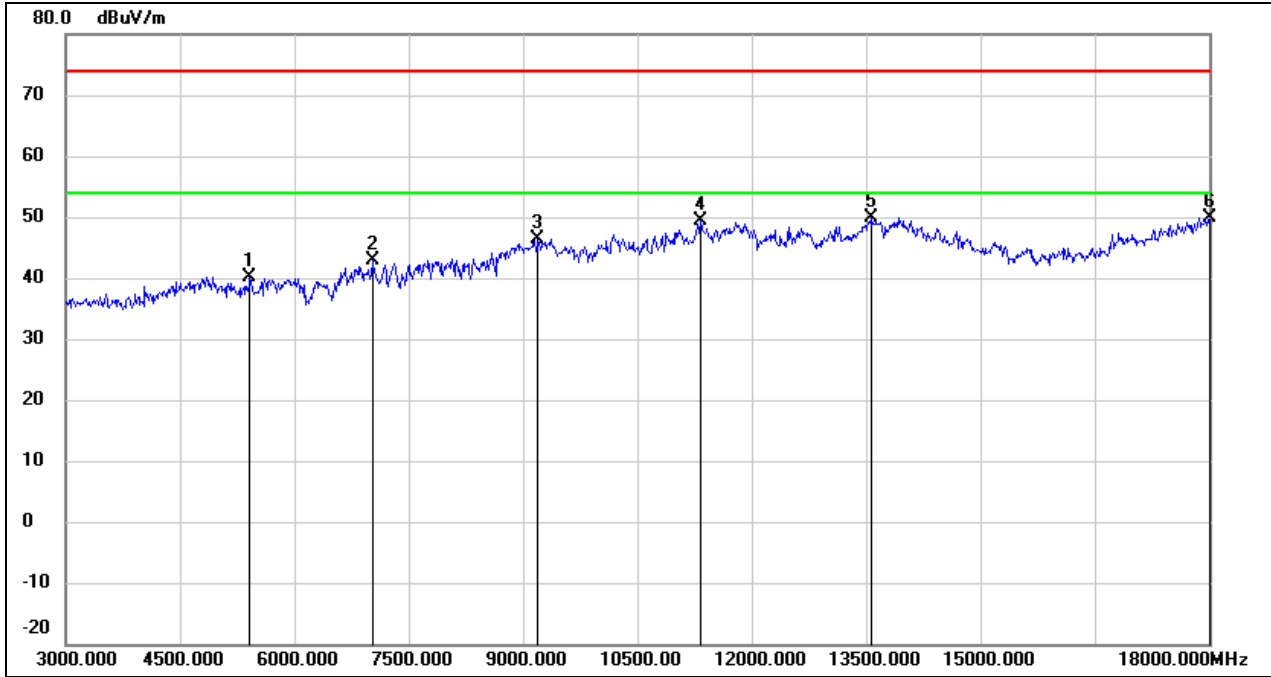

No.	Frequency (MHz)	Reading (dBuV)	Correct (dB/m)	Result (dBuV/m)	Limit (dBuV/m)	Margin (dB)	Remark
1	5415.000	39.41	0.78	40.19	74.00	-33.81	peak
2	7020.000	36.13	6.67	42.80	74.00	-31.20	peak
3	9195.000	35.85	10.56	46.41	74.00	-27.59	peak
4	11325.000	33.32	15.95	49.27	74.00	-24.73	peak
5	13575.000	28.79	21.06	49.85	74.00	-24.15	peak
6	18000.000	24.29	25.69	49.98	74.00	-24.02	peak



Test Mode:	802.11ax HE40	Channel:	2437
Polarity:	Vertical	Test Voltage:	DC 12 V

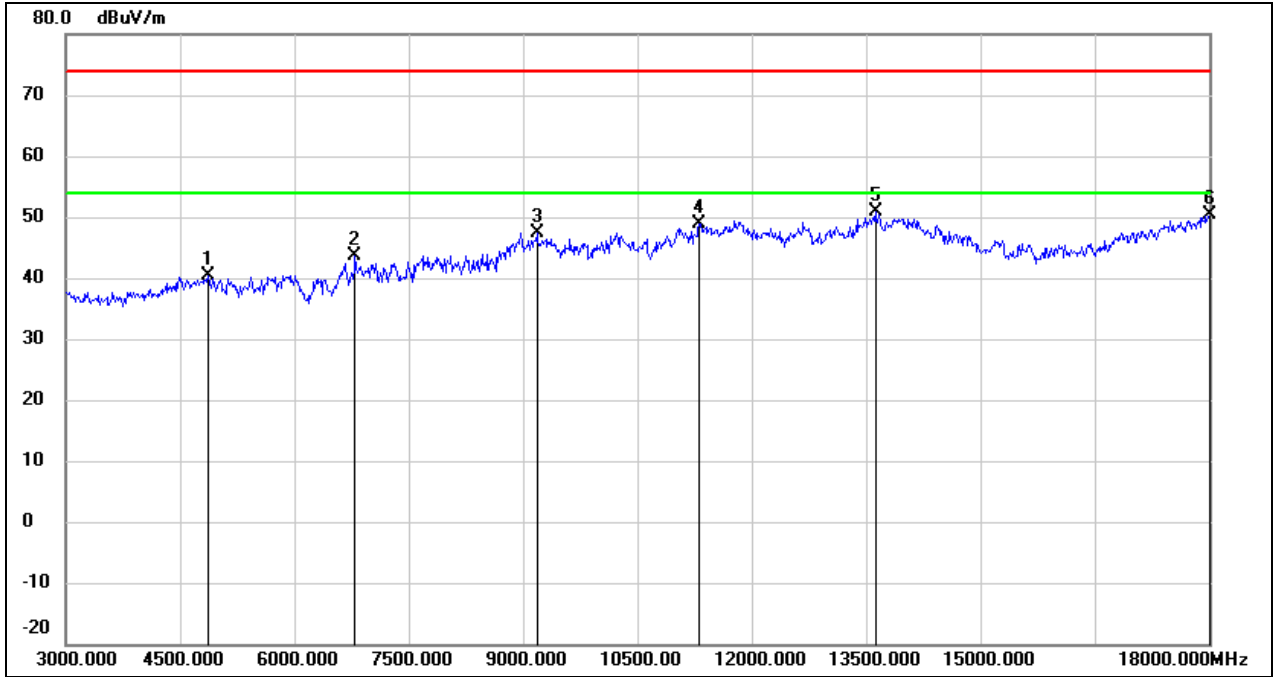

No.	Frequency (MHz)	Reading (dBuV)	Correct (dB/m)	Result (dBuV/m)	Limit (dBuV/m)	Margin (dB)	Remark
1	4875.000	40.42	-0.03	40.39	74.00	-33.61	peak
2	6795.000	37.97	5.68	43.65	74.00	-30.35	peak
3	9180.000	36.90	10.56	47.46	74.00	-26.54	peak
4	11310.000	33.05	15.91	48.96	74.00	-25.04	peak
5	13620.000	29.82	21.15	50.97	74.00	-23.03	peak
6	18000.000	24.61	25.69	50.30	74.00	-23.70	peak



Test Mode:	802.11ax HE40	Channel:	2447
Polarity:	Horizontal	Test Voltage:	DC 12 V

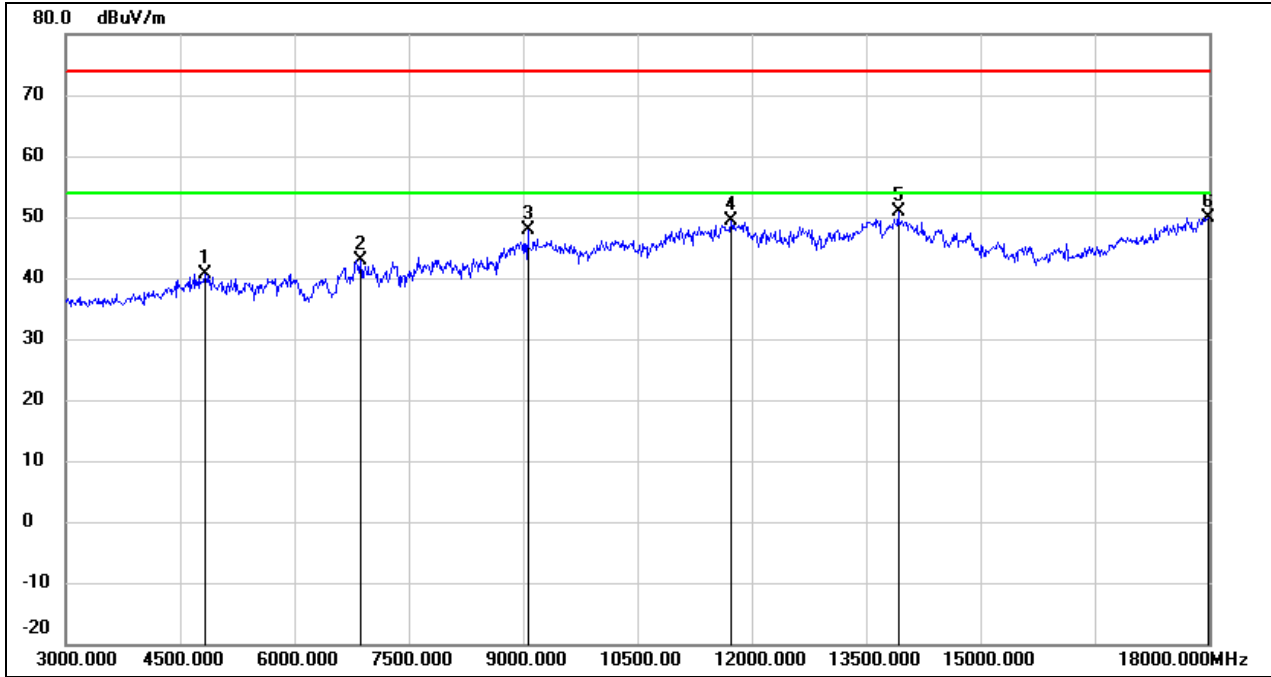

No.	Frequency (MHz)	Reading (dBuV)	Correct (dB/m)	Result (dBuV/m)	Limit (dBuV/m)	Margin (dB)	Remark
1	4830.000	40.90	-0.20	40.70	74.00	-33.30	peak
2	6870.000	36.89	6.05	42.94	74.00	-31.06	peak
3	9060.000	37.36	10.51	47.87	74.00	-26.13	peak
4	11730.000	32.21	17.22	49.43	74.00	-24.57	peak
5	13920.000	29.01	21.79	50.80	74.00	-23.20	peak
6	17985.000	24.38	25.60	49.98	74.00	-24.02	peak



Test Mode:	802.11ax HE40	Channel:	2447
Polarity:	Vertical	Test Voltage:	DC 12 V

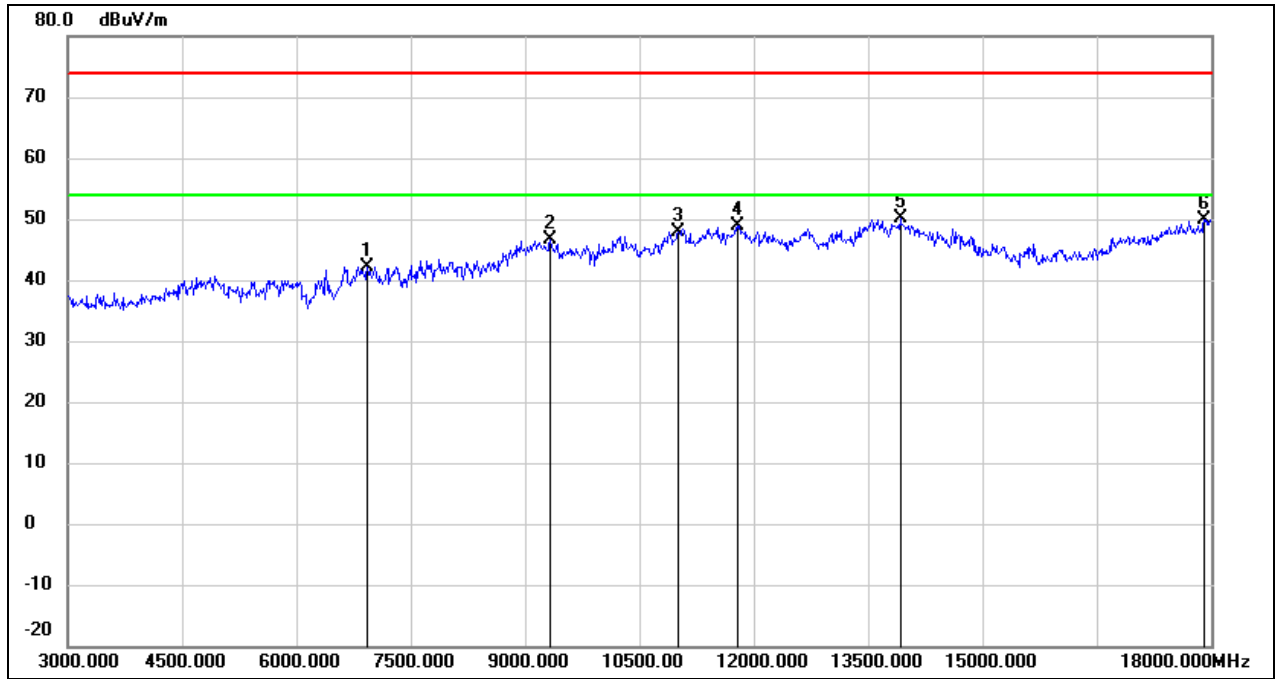

No.	Frequency (MHz)	Reading (dBuV)	Correct (dB/m)	Result (dBuV/m)	Limit (dBuV/m)	Margin (dB)	Remark
1	6930.000	35.79	6.34	42.13	74.00	-31.87	peak
2	9330.000	35.89	10.62	46.51	74.00	-27.49	peak
3	11010.000	33.10	14.81	47.91	74.00	-26.09	peak
4	11790.000	31.39	17.38	48.77	74.00	-25.23	peak
5	13920.000	28.28	21.79	50.07	74.00	-23.93	peak
6	17910.000	24.83	25.16	49.99	74.00	-24.01	peak



Test Mode:	802.11ax HE40	Channel:	2452
Polarity:	Horizontal	Test Voltage:	DC 12 V

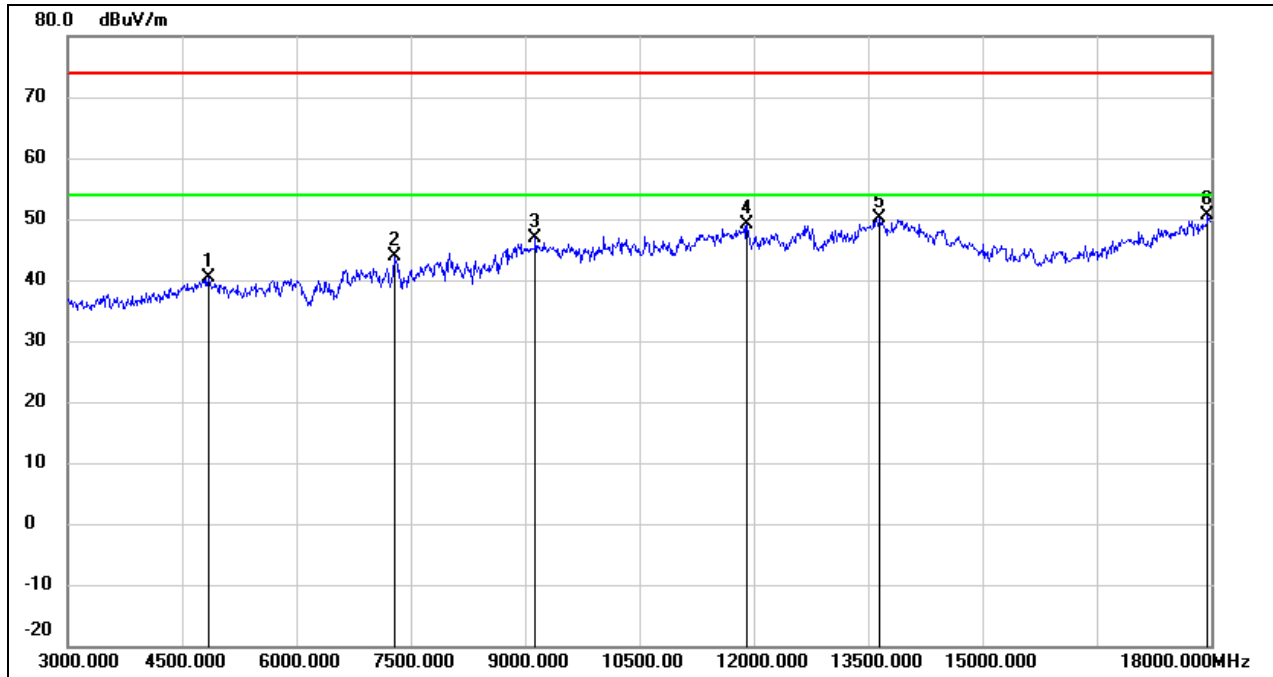

No.	Frequency (MHz)	Reading (dBuV)	Correct (dB/m)	Result (dBuV/m)	Limit (dBuV/m)	Margin (dB)	Remark
1	4845.000	40.44	-0.15	40.29	74.00	-33.71	peak
2	7290.000	37.34	6.48	43.82	74.00	-30.18	peak
3	9135.000	36.28	10.55	46.83	74.00	-27.17	peak
4	11910.000	31.34	17.72	49.06	74.00	-24.94	peak
5	13650.000	28.86	21.21	50.07	74.00	-23.93	peak
6	17955.000	25.30	25.42	50.72	74.00	-23.28	peak



Test Mode:	802.11ax HE40	Channel:	2452
Polarity:	Vertical	Test Voltage:	DC 12 V

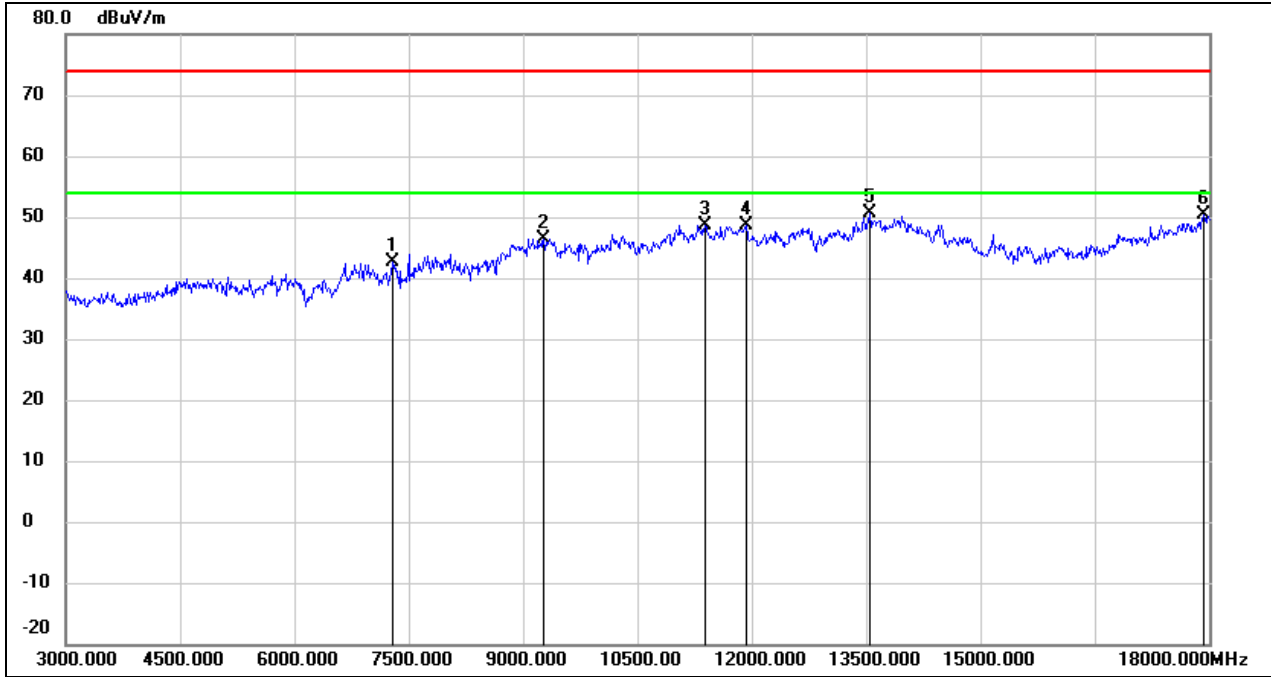

No.	Frequency (MHz)	Reading (dBuV)	Correct (dB/m)	Result (dBuV/m)	Limit (dBuV/m)	Margin (dB)	Remark
1	7290.000	36.06	6.48	42.54	74.00	-31.46	peak
2	9270.000	35.74	10.59	46.33	74.00	-27.67	peak
3	11385.000	32.48	16.17	48.65	74.00	-25.35	peak
4	11925.000	30.92	17.75	48.67	74.00	-25.33	peak
5	13545.000	29.55	20.99	50.54	74.00	-23.46	peak
6	17925.000	25.13	25.25	50.38	74.00	-23.62	peak



Test Mode:	802.11be EHT20	Channel:	2412
Polarity:	Horizontal	Test Voltage:	DC 12 V

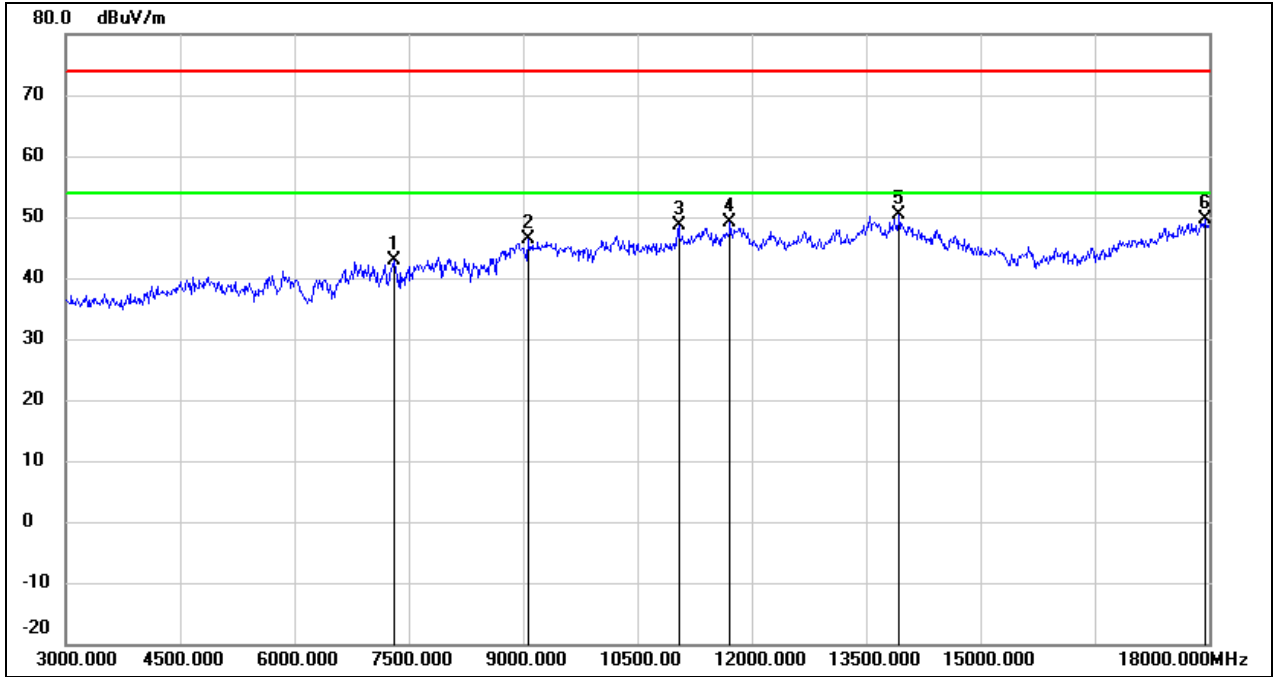

No.	Frequency (MHz)	Reading (dBuV)	Correct (dB/m)	Result (dBuV/m)	Limit (dBuV/m)	Margin (dB)	Remark
1	7305.000	36.47	6.47	42.94	74.00	-31.06	peak
2	9060.000	35.87	10.51	46.38	74.00	-27.62	peak
3	11040.000	33.63	14.91	48.54	74.00	-25.46	peak
4	11715.000	31.92	17.19	49.11	74.00	-24.89	peak
5	13935.000	28.49	21.82	50.31	74.00	-23.69	peak
6	17940.000	24.25	25.34	49.59	74.00	-24.41	peak



Test Mode:	802.11be EHT20	Channel:	2412
Polarity:	Vertical	Test Voltage:	DC 12 V

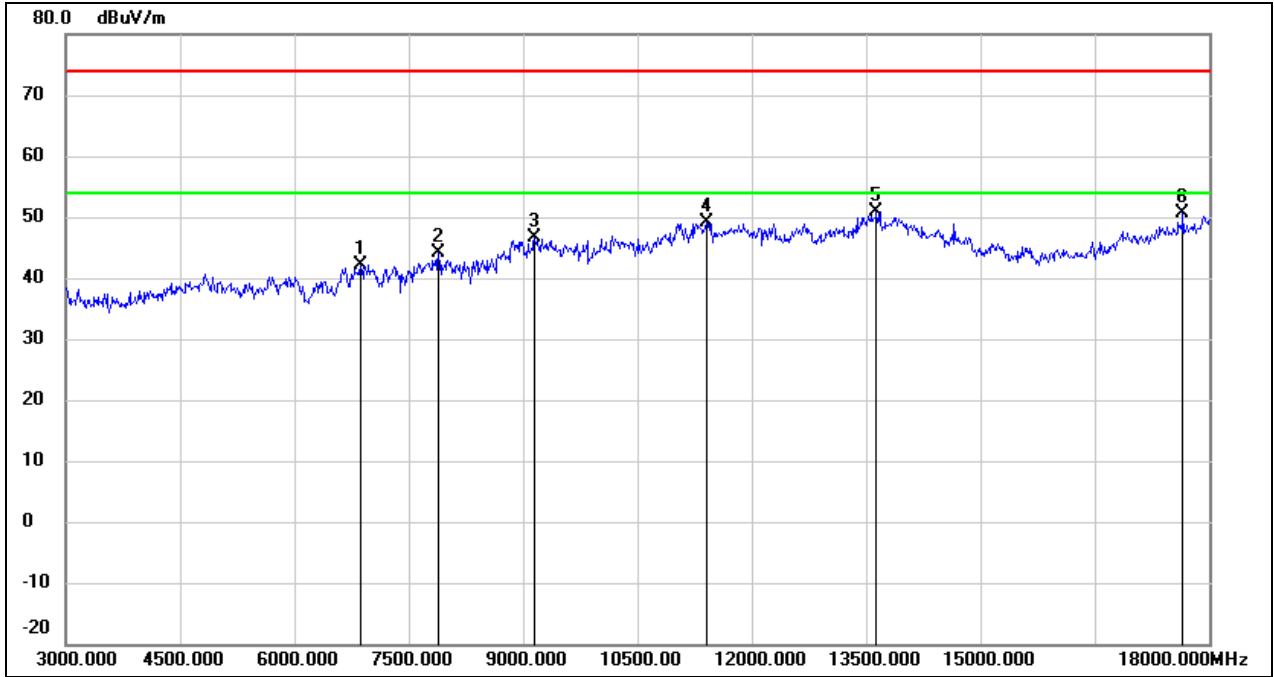

No.	Frequency (MHz)	Reading (dBuV)	Correct (dB/m)	Result (dBuV/m)	Limit (dBuV/m)	Margin (dB)	Remark
1	6870.000	36.01	6.05	42.06	74.00	-31.94	peak
2	7890.000	37.72	6.31	44.03	74.00	-29.97	peak
3	9150.000	36.01	10.54	46.55	74.00	-27.45	peak
4	11400.000	32.93	16.23	49.16	74.00	-24.84	peak
5	13635.000	29.71	21.19	50.90	74.00	-23.10	peak
6	17655.000	26.94	23.64	50.58	74.00	-23.42	peak



Test Mode:	802.11be EHT20	Channel:	2417
Polarity:	Horizontal	Test Voltage:	DC 12 V

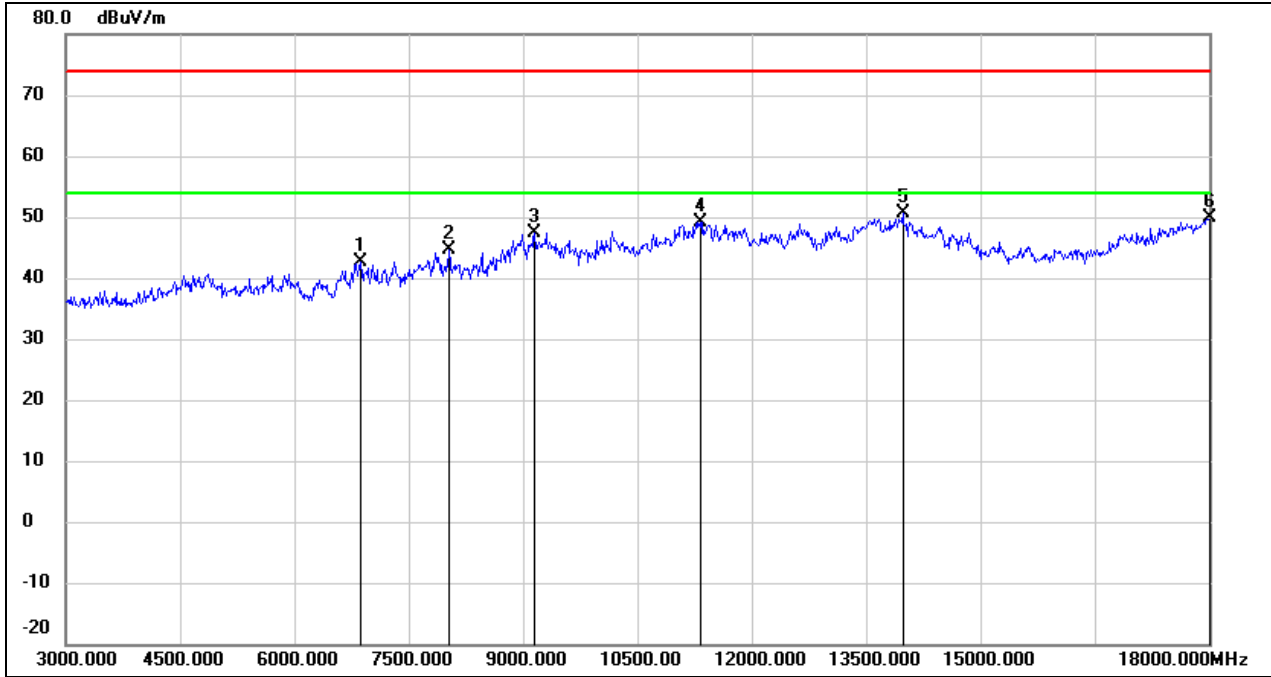

No.	Frequency (MHz)	Reading (dBuV)	Correct (dB/m)	Result (dBuV/m)	Limit (dBuV/m)	Margin (dB)	Remark
1	6870.000	36.58	6.05	42.63	74.00	-31.37	peak
2	8025.000	38.32	6.34	44.66	74.00	-29.34	peak
3	9150.000	36.84	10.54	47.38	74.00	-26.62	peak
4	11325.000	33.07	15.95	49.02	74.00	-24.98	peak
5	13980.000	28.75	21.92	50.67	74.00	-23.33	peak
6	18000.000	24.08	25.69	49.77	74.00	-24.23	peak



Test Mode:	802.11be EHT20	Channel:	2417
Polarity:	Vertical	Test Voltage:	DC 12 V

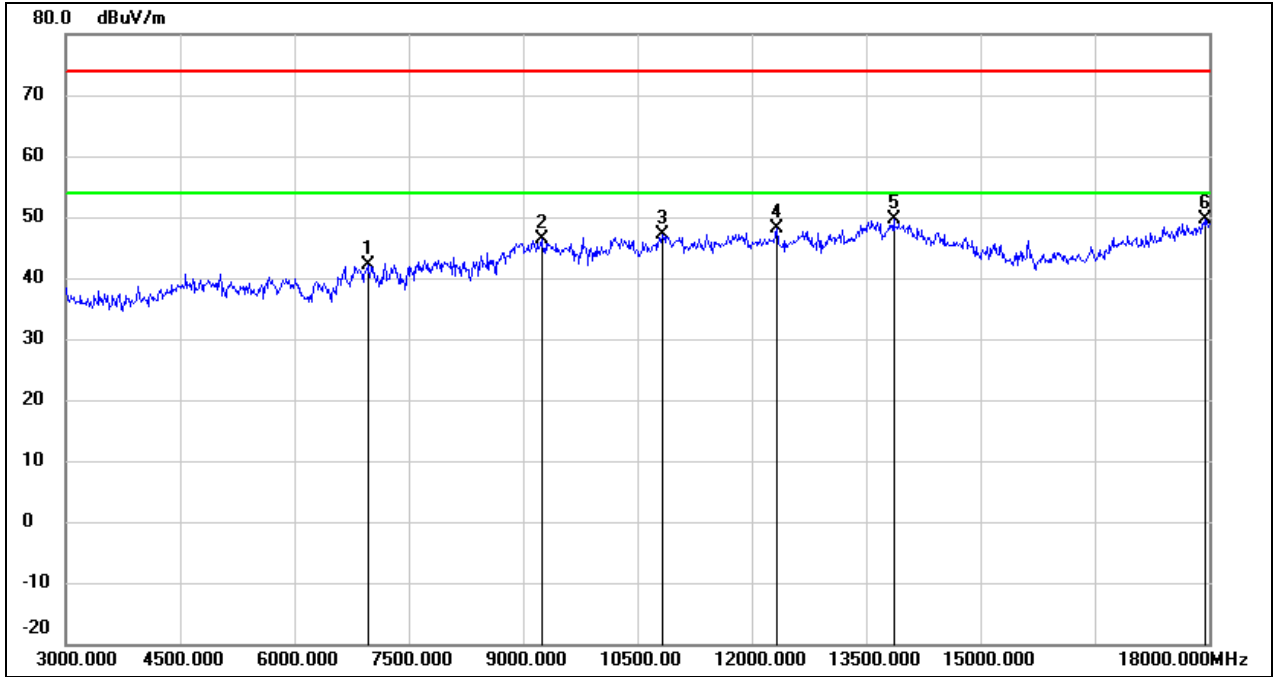

No.	Frequency (MHz)	Reading (dBuV)	Correct (dB/m)	Result (dBuV/m)	Limit (dBuV/m)	Margin (dB)	Remark
1	6960.000	35.71	6.50	42.21	74.00	-31.79	peak
2	9240.000	35.83	10.58	46.41	74.00	-27.59	peak
3	10830.000	32.89	14.16	47.05	74.00	-26.95	peak
4	12330.000	30.38	17.72	48.10	74.00	-25.90	peak
5	13860.000	28.00	21.67	49.67	74.00	-24.33	peak
6	17955.000	24.17	25.42	49.59	74.00	-24.41	peak



Test Mode:	802.11be EHT20	Channel:	2437
Polarity:	Horizontal	Test Voltage:	DC 12 V

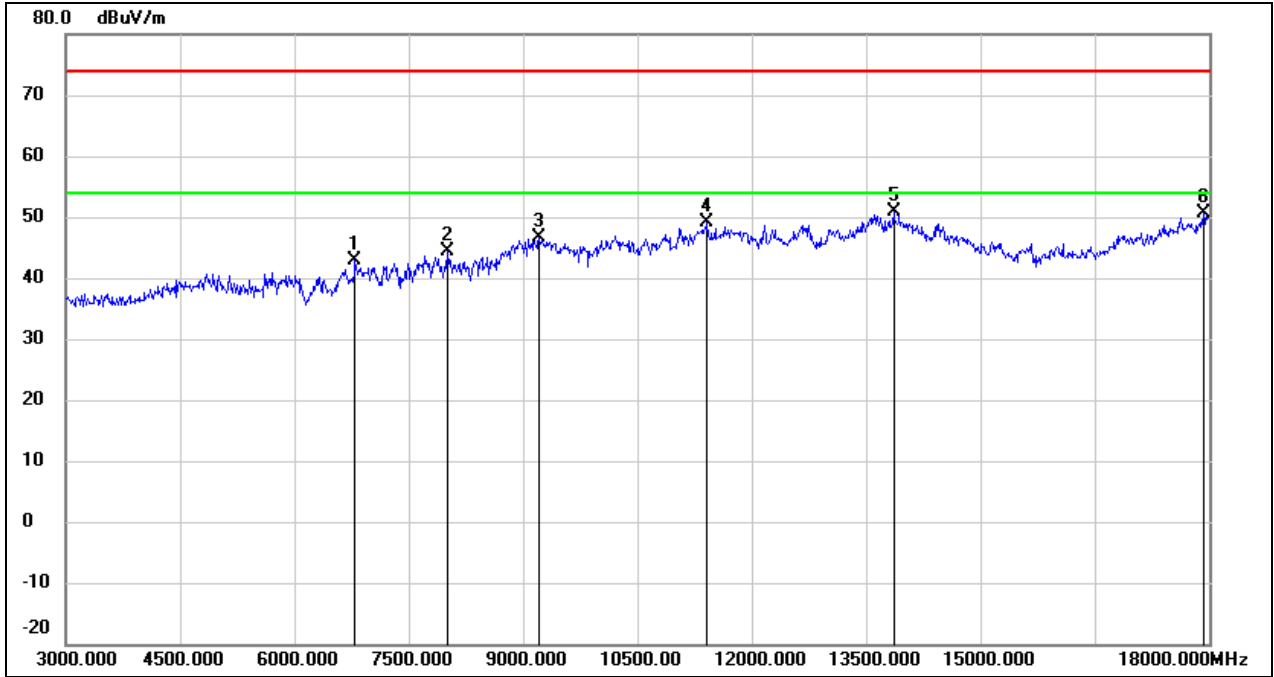

No.	Frequency (MHz)	Reading (dBuV)	Correct (dB/m)	Result (dBuV/m)	Limit (dBuV/m)	Margin (dB)	Remark
1	6795.000	37.12	5.68	42.80	74.00	-31.20	peak
2	8010.000	38.01	6.32	44.33	74.00	-29.67	peak
3	9210.000	36.12	10.57	46.69	74.00	-27.31	peak
4	11415.000	32.77	16.29	49.06	74.00	-24.94	peak
5	13860.000	29.11	21.67	50.78	74.00	-23.22	peak
6	17925.000	25.36	25.25	50.61	74.00	-23.39	peak



Test Mode:	802.11be EHT20	Channel:	2437
Polarity:	Vertical	Test Voltage:	DC 12 V

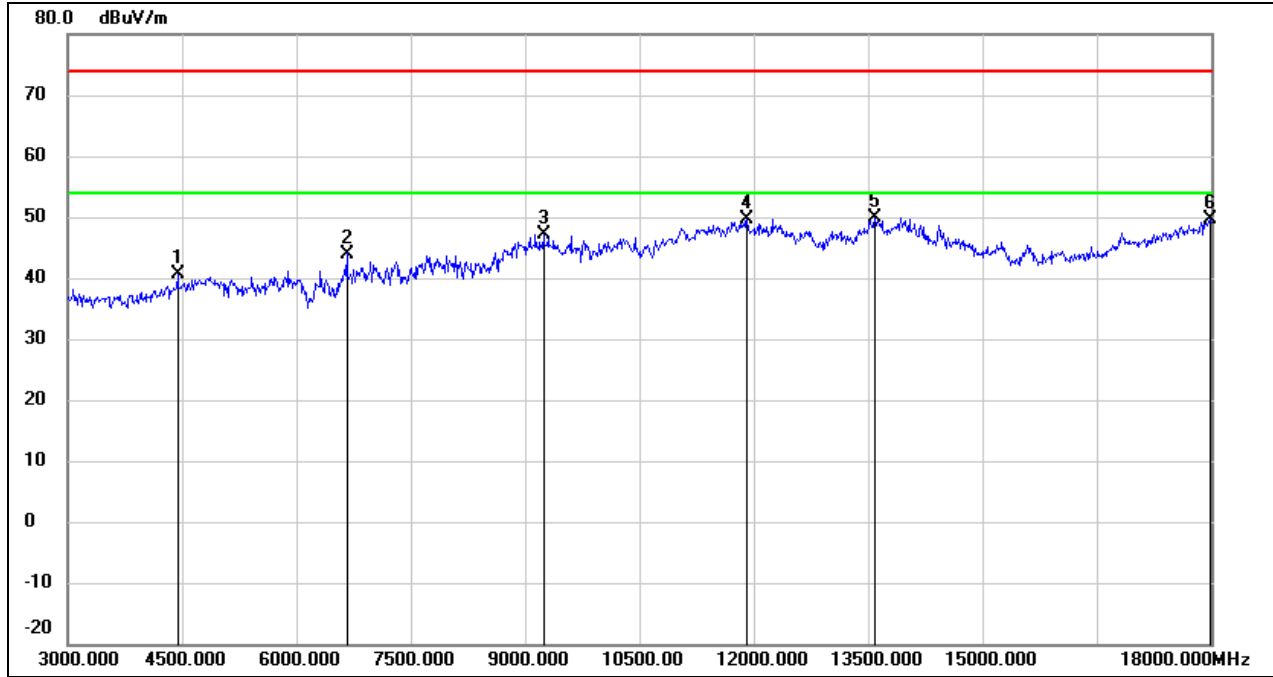

No.	Frequency (MHz)	Reading (dBuV)	Correct (dB/m)	Result (dBuV/m)	Limit (dBuV/m)	Margin (dB)	Remark
1	4440.000	42.25	-1.74	40.51	74.00	-33.49	peak
2	6660.000	38.98	5.02	44.00	74.00	-30.00	peak
3	9240.000	36.51	10.58	47.09	74.00	-26.91	peak
4	11910.000	31.94	17.72	49.66	74.00	-24.34	peak
5	13590.000	28.77	21.09	49.86	74.00	-24.14	peak
6	17985.000	23.94	25.60	49.54	74.00	-24.46	peak



Test Mode:	802.11be EHT20	Channel:	2457
Polarity:	Horizontal	Test Voltage:	DC 12 V

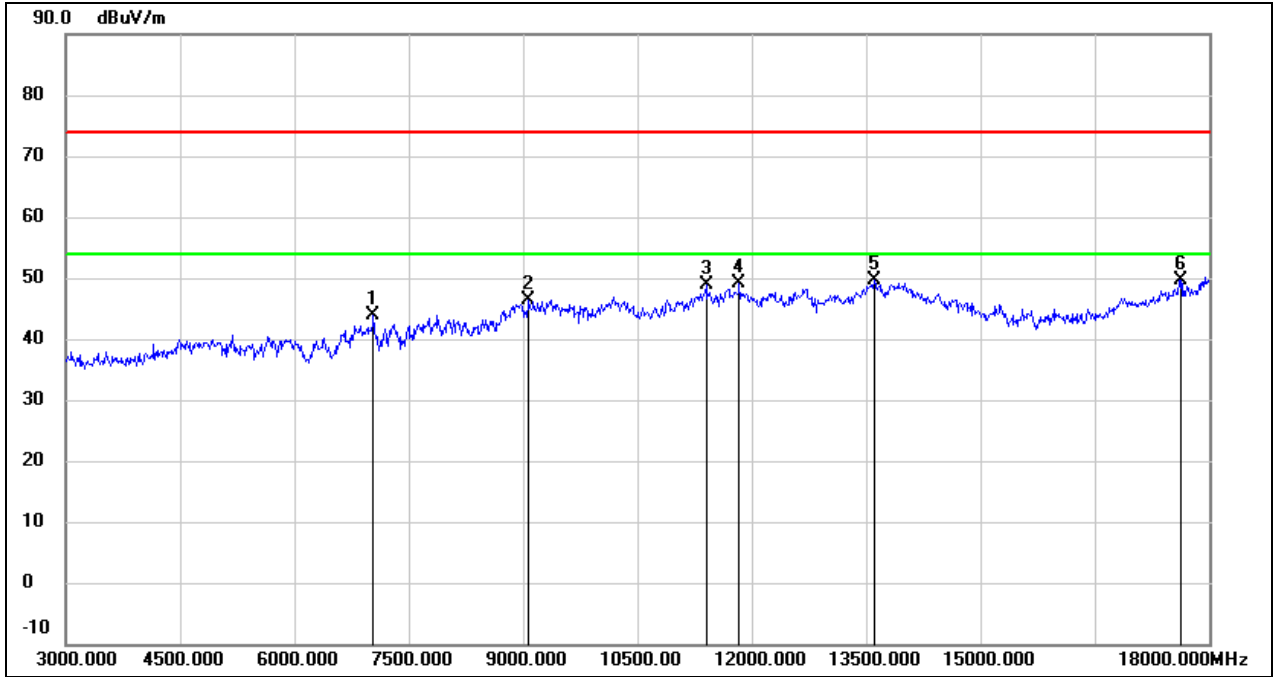

No.	Frequency (MHz)	Reading (dBuV)	Correct (dB/m)	Result (dBuV/m)	Limit (dBuV/m)	Margin (dB)	Remark
1	7035.000	37.12	6.67	43.79	74.00	-30.21	peak
2	9075.000	35.85	10.52	46.37	74.00	-27.63	peak
3	11400.000	32.62	16.23	48.85	74.00	-25.15	peak
4	11835.000	31.69	17.51	49.20	74.00	-24.80	peak
5	13605.000	28.54	21.12	49.66	74.00	-24.34	peak
6	17625.000	26.09	23.47	49.56	74.00	-24.44	peak



Test Mode:	802.11be EHT20	Channel:	2457
Polarity:	Vertical	Test Voltage:	DC 12 V

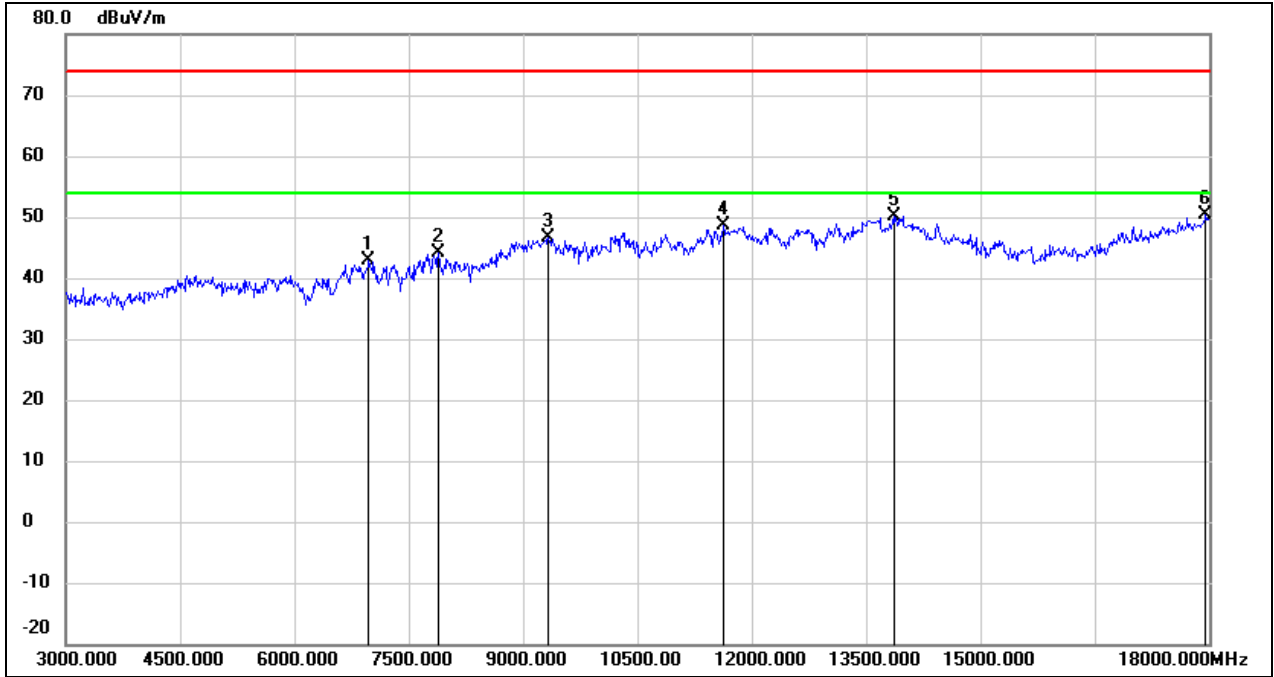

No.	Frequency (MHz)	Reading (dBuV)	Correct (dB/m)	Result (dBuV/m)	Limit (dBuV/m)	Margin (dB)	Remark
1	6975.000	36.28	6.57	42.85	74.00	-31.15	peak
2	7890.000	37.73	6.31	44.04	74.00	-29.96	peak
3	9330.000	35.89	10.62	46.51	74.00	-27.49	peak
4	11625.000	31.58	16.94	48.52	74.00	-25.48	peak
5	13860.000	28.40	21.67	50.07	74.00	-23.93	peak
6	17955.000	25.04	25.42	50.46	74.00	-23.54	peak



Test Mode:	802.11be EHT20	Channel:	2462
Polarity:	Horizontal	Test Voltage:	DC 12 V

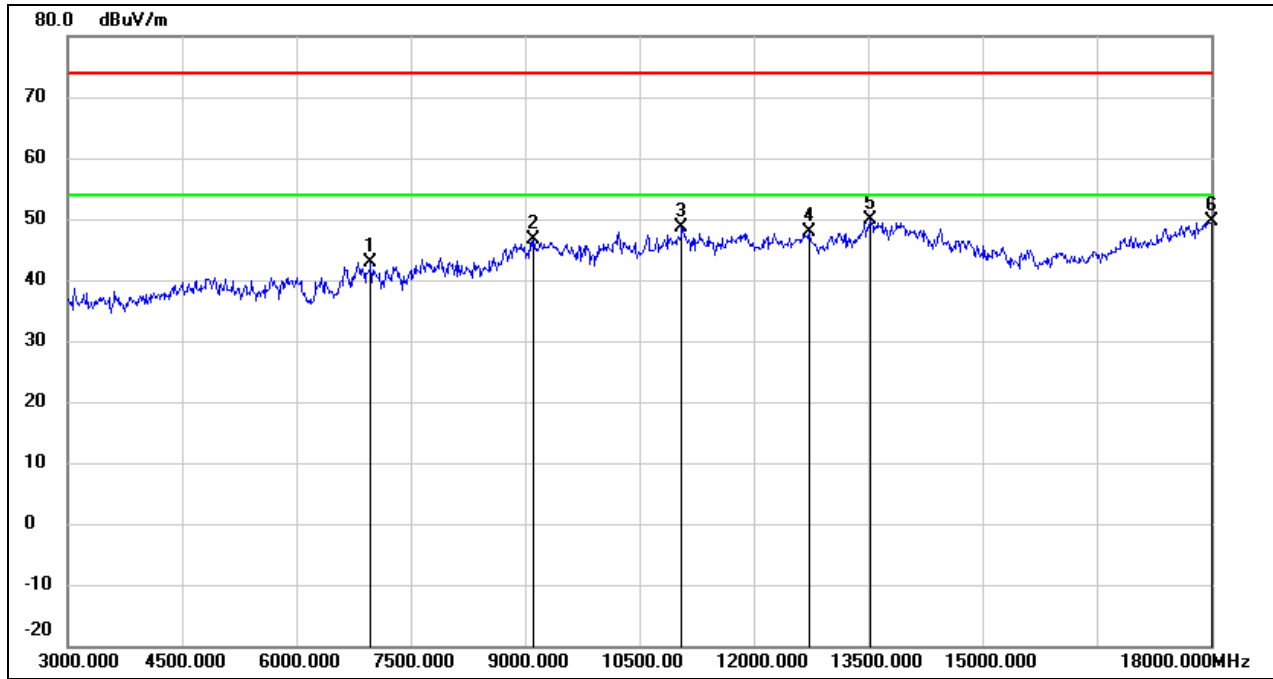

No.	Frequency (MHz)	Reading (dBuV)	Correct (dB/m)	Result (dBuV/m)	Limit (dBuV/m)	Margin (dB)	Remark
1	6975.000	36.33	6.57	42.90	74.00	-31.10	peak
2	9105.000	36.02	10.53	46.55	74.00	-27.45	peak
3	11055.000	33.65	14.96	48.61	74.00	-25.39	peak
4	12720.000	29.74	18.08	47.82	74.00	-26.18	peak
5	13530.000	28.86	20.96	49.82	74.00	-24.18	peak
6	18000.000	23.91	25.69	49.60	74.00	-24.40	peak



Test Mode:	802.11be EHT20	Channel:	2462
Polarity:	Vertical	Test Voltage:	DC 12 V

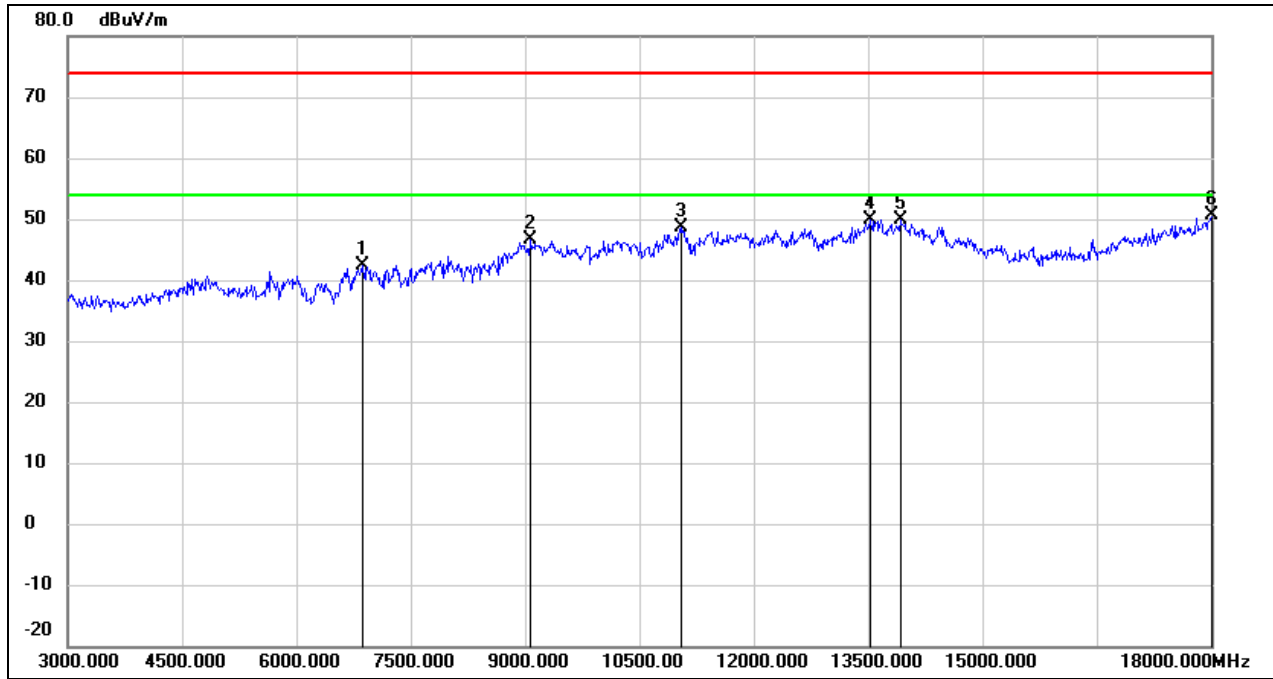

No.	Frequency (MHz)	Reading (dBuV)	Correct (dB/m)	Result (dBuV/m)	Limit (dBuV/m)	Margin (dB)	Remark
1	6870.000	36.39	6.05	42.44	74.00	-31.56	peak
2	9075.000	36.20	10.52	46.72	74.00	-27.28	peak
3	11055.000	33.55	14.96	48.51	74.00	-25.49	peak
4	13530.000	28.91	20.96	49.87	74.00	-24.13	peak
5	13920.000	28.14	21.79	49.93	74.00	-24.07	peak
6	18000.000	25.00	25.69	50.69	74.00	-23.31	peak



Test Mode:	802.11be EHT40	Channel:	2422
Polarity:	Horizontal	Test Voltage:	DC 12 V

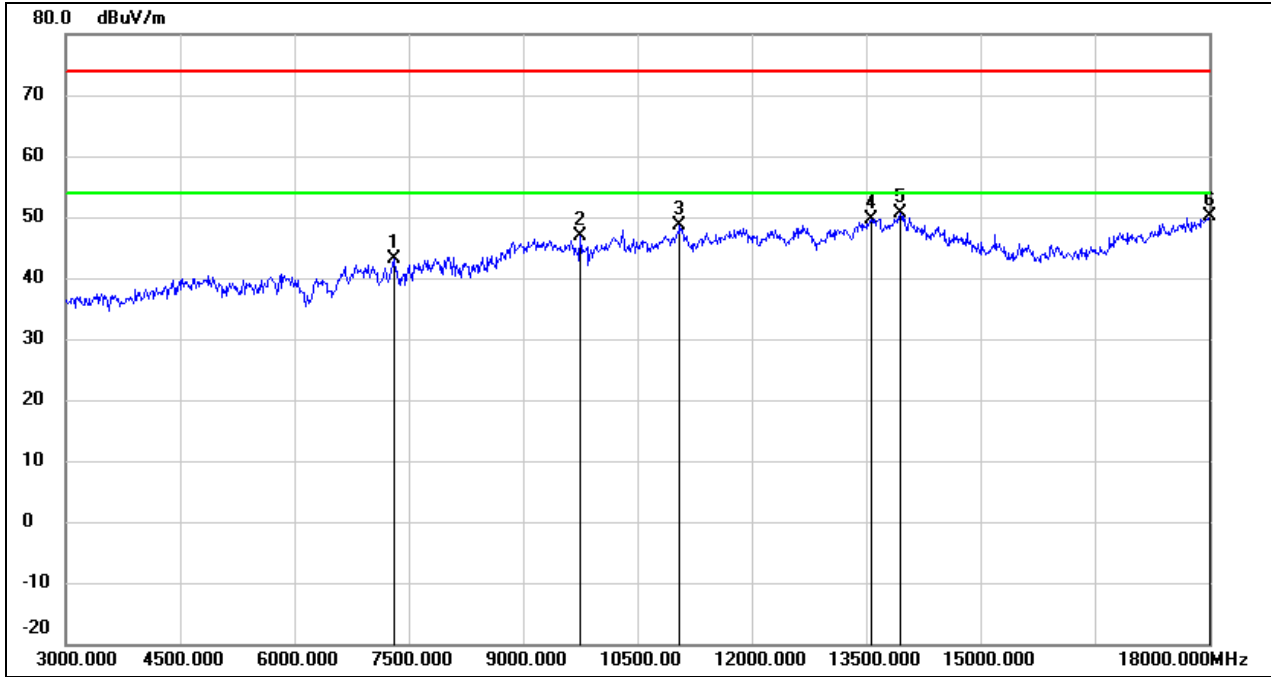

No.	Frequency (MHz)	Reading (dBuV)	Correct (dB/m)	Result (dBuV/m)	Limit (dBuV/m)	Margin (dB)	Remark
1	7305.000	36.65	6.47	43.12	74.00	-30.88	peak
2	9750.000	35.52	11.35	46.87	74.00	-27.13	peak
3	11055.000	33.73	14.96	48.69	74.00	-25.31	peak
4	13560.000	28.67	21.04	49.71	74.00	-24.29	peak
5	13950.000	28.75	21.86	50.61	74.00	-23.39	peak
6	18000.000	24.52	25.69	50.21	74.00	-23.79	peak



Test Mode:	802.11be EHT40	Channel:	2422
Polarity:	Vertical	Test Voltage:	DC 12 V

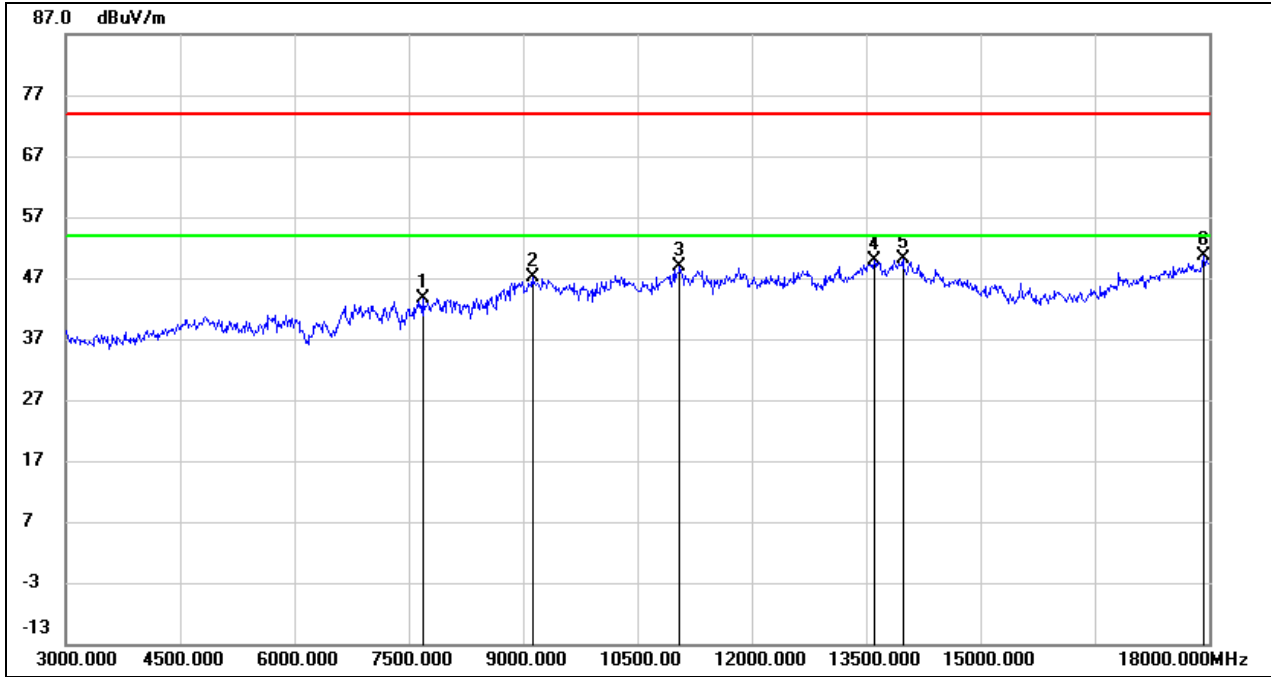

No.	Frequency (MHz)	Reading (dBuV)	Correct (dB/m)	Result (dBuV/m)	Limit (dBuV/m)	Margin (dB)	Remark
1	7680.000	37.36	6.32	43.68	74.00	-30.32	peak
2	9120.000	36.48	10.53	47.01	74.00	-26.99	peak
3	11055.000	33.92	14.96	48.88	74.00	-25.12	peak
4	13605.000	28.73	21.12	49.85	74.00	-24.15	peak
5	13980.000	28.12	21.92	50.04	74.00	-23.96	peak
6	17925.000	25.28	25.25	50.53	74.00	-23.47	peak



Test Mode:	802.11be EHT40	Channel:	2427
Polarity:	Horizontal	Test Voltage:	DC 12 V

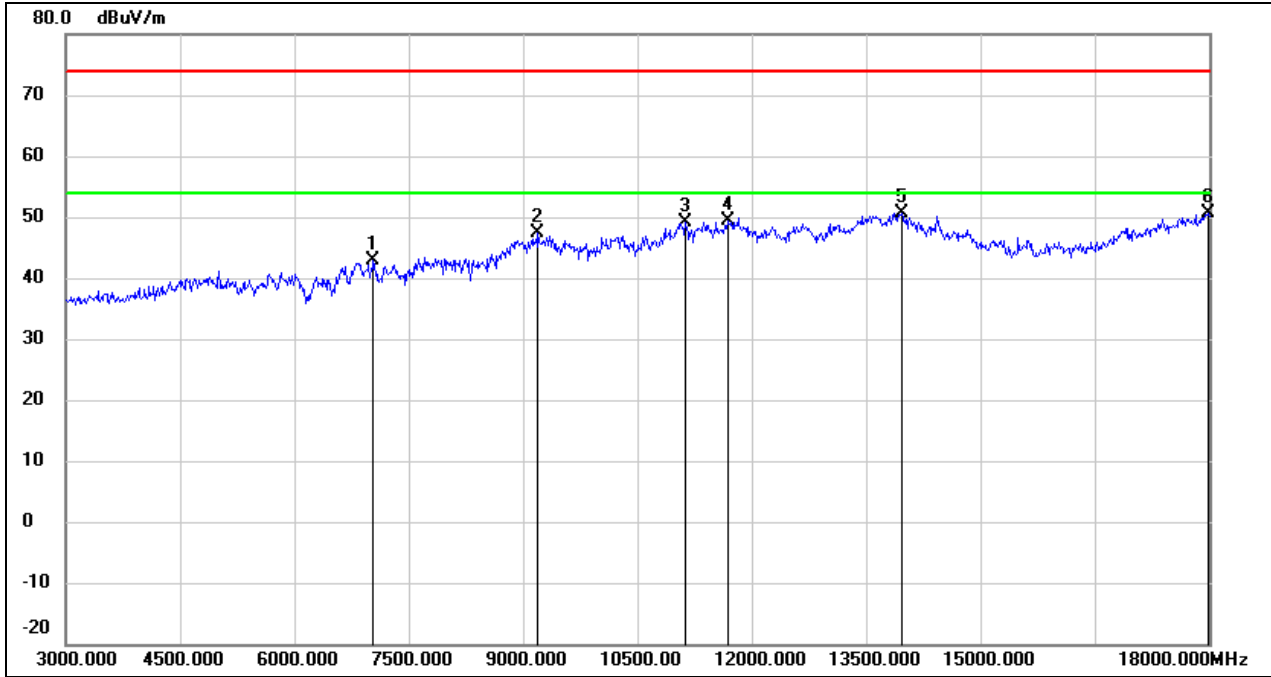

No.	Frequency (MHz)	Reading (dBuV)	Correct (dB/m)	Result (dBuV/m)	Limit (dBuV/m)	Margin (dB)	Remark
1	7035.000	36.31	6.67	42.98	74.00	-31.02	peak
2	9195.000	36.82	10.56	47.38	74.00	-26.62	peak
3	11130.000	33.89	15.25	49.14	74.00	-24.86	peak
4	11685.000	32.27	17.10	49.37	74.00	-24.63	peak
5	13965.000	28.76	21.89	50.65	74.00	-23.35	peak
6	17985.000	24.93	25.60	50.53	74.00	-23.47	peak



Test Mode:	802.11be EHT40	Channel:	2427
Polarity:	Vertical	Test Voltage:	DC 12 V

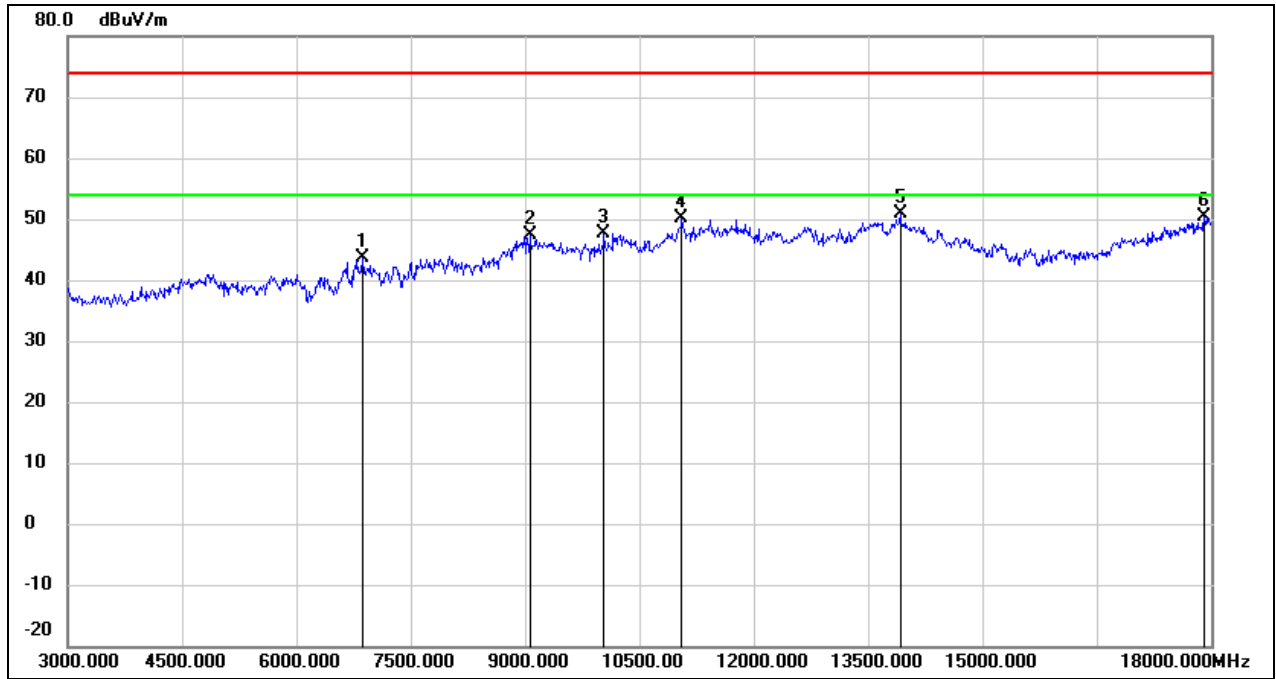

No.	Frequency (MHz)	Reading (dBuV)	Correct (dB/m)	Result (dBuV/m)	Limit (dBuV/m)	Margin (dB)	Remark
1	6870.000	37.57	6.05	43.62	74.00	-30.38	peak
2	9060.000	36.88	10.51	47.39	74.00	-26.61	peak
3	10035.000	35.54	12.08	47.62	74.00	-26.38	peak
4	11055.000	35.11	14.96	50.07	74.00	-23.93	peak
5	13920.000	28.98	21.79	50.77	74.00	-23.23	peak
6	17910.000	25.20	25.16	50.36	74.00	-23.64	peak



Test Mode:	802.11be EHT40	Channel:	2437
Polarity:	Horizontal	Test Voltage:	DC 12 V

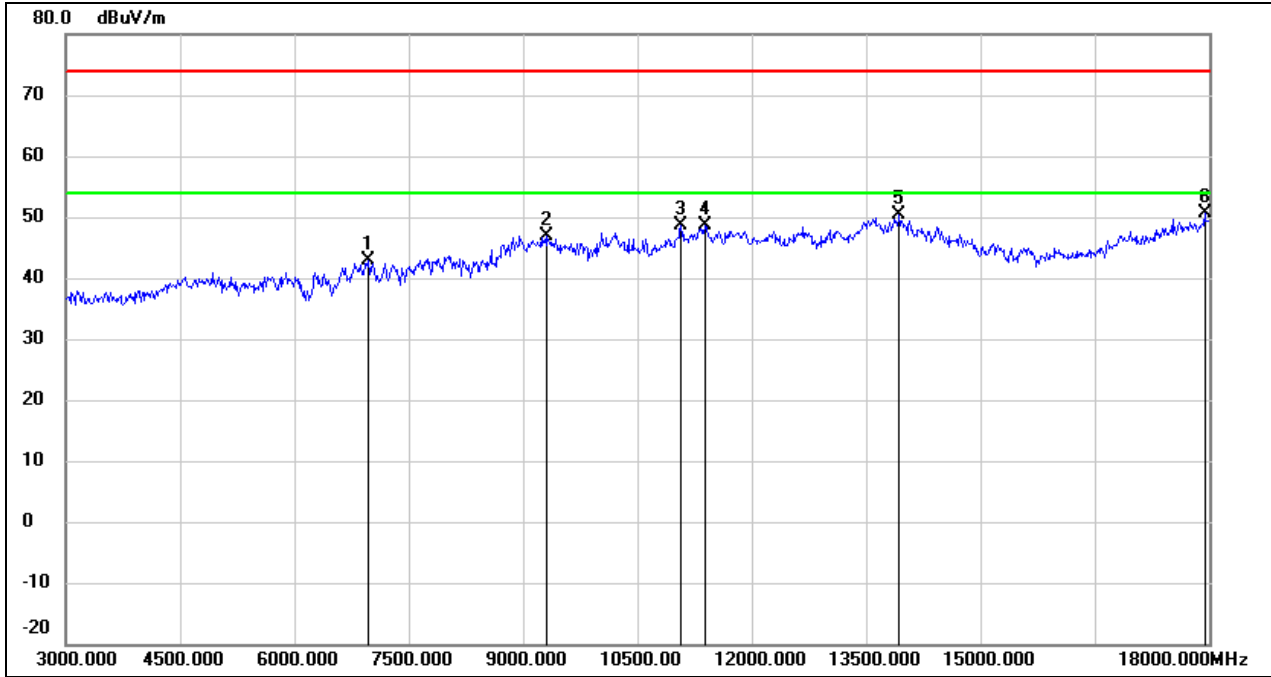

No.	Frequency (MHz)	Reading (dBuV)	Correct (dB/m)	Result (dBuV/m)	Limit (dBuV/m)	Margin (dB)	Remark
1	6975.000	36.35	6.57	42.92	74.00	-31.08	peak
2	9300.000	36.24	10.61	46.85	74.00	-27.15	peak
3	11070.000	33.70	15.03	48.73	74.00	-25.27	peak
4	11385.000	32.38	16.17	48.55	74.00	-25.45	peak
5	13935.000	28.55	21.82	50.37	74.00	-23.63	peak
6	17940.000	25.35	25.34	50.69	74.00	-23.31	peak



Test Mode:	802.11be EHT40	Channel:	2437
Polarity:	Vertical	Test Voltage:	DC 12 V

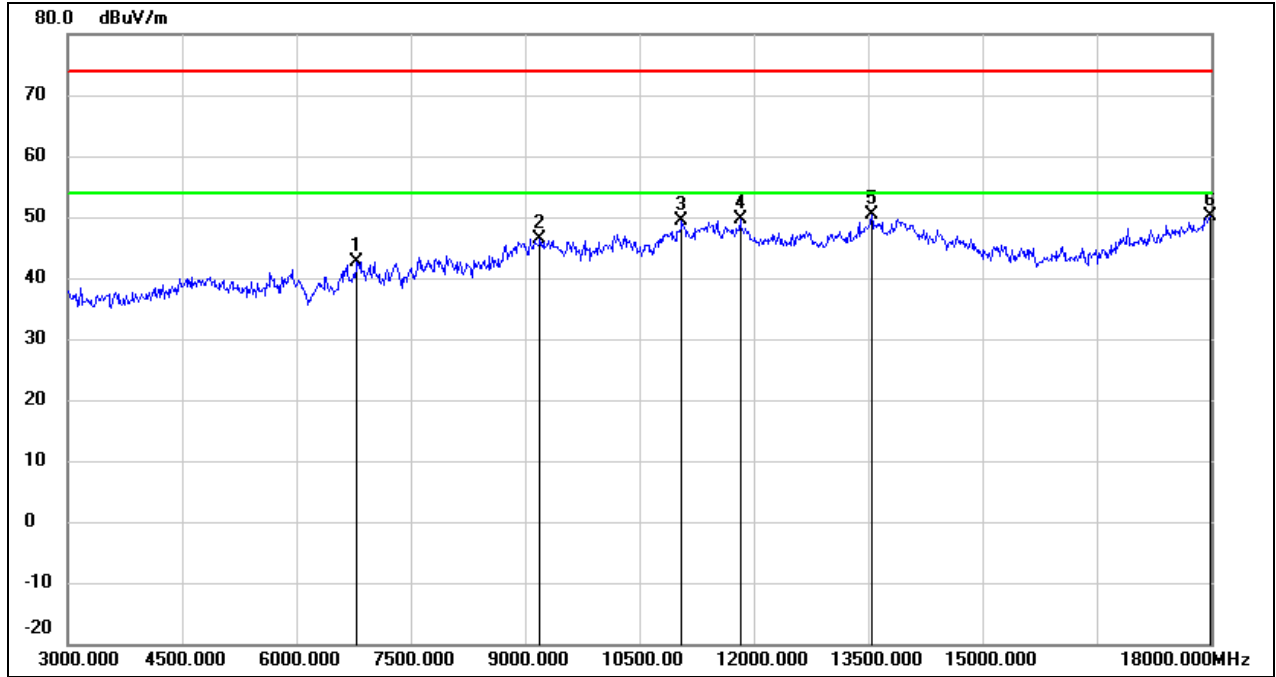

No.	Frequency (MHz)	Reading (dBuV)	Correct (dB/m)	Result (dBuV/m)	Limit (dBuV/m)	Margin (dB)	Remark
1	6795.000	37.03	5.68	42.71	74.00	-31.29	peak
2	9195.000	35.89	10.56	46.45	74.00	-27.55	peak
3	11055.000	34.48	14.96	49.44	74.00	-24.56	peak
4	11820.000	32.15	17.47	49.62	74.00	-24.38	peak
5	13545.000	29.36	20.99	50.35	74.00	-23.65	peak
6	17985.000	24.45	25.60	50.05	74.00	-23.95	peak



Test Mode:	802.11be EHT40	Channel:	2447
Polarity:	Horizontal	Test Voltage:	DC 12 V

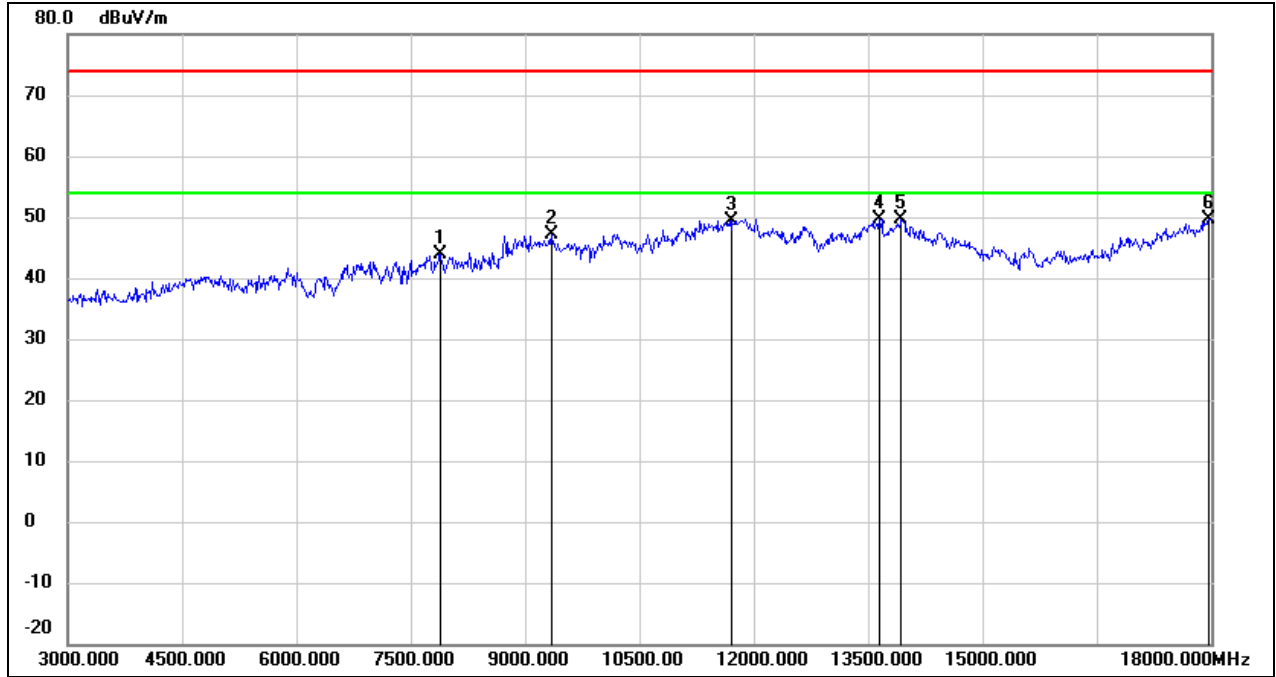

No.	Frequency (MHz)	Reading (dBuV)	Correct (dB/m)	Result (dBuV/m)	Limit (dBuV/m)	Margin (dB)	Remark
1	7890.000	37.66	6.31	43.97	74.00	-30.03	peak
2	9345.000	36.39	10.63	47.02	74.00	-26.98	peak
3	11715.000	32.28	17.19	49.47	74.00	-24.53	peak
4	13650.000	28.43	21.21	49.64	74.00	-24.36	peak
5	13935.000	27.93	21.82	49.75	74.00	-24.25	peak
6	17970.000	24.21	25.51	49.72	74.00	-24.28	peak



Test Mode:	802.11be EHT40	Channel:	2447
Polarity:	Vertical	Test Voltage:	DC 12 V

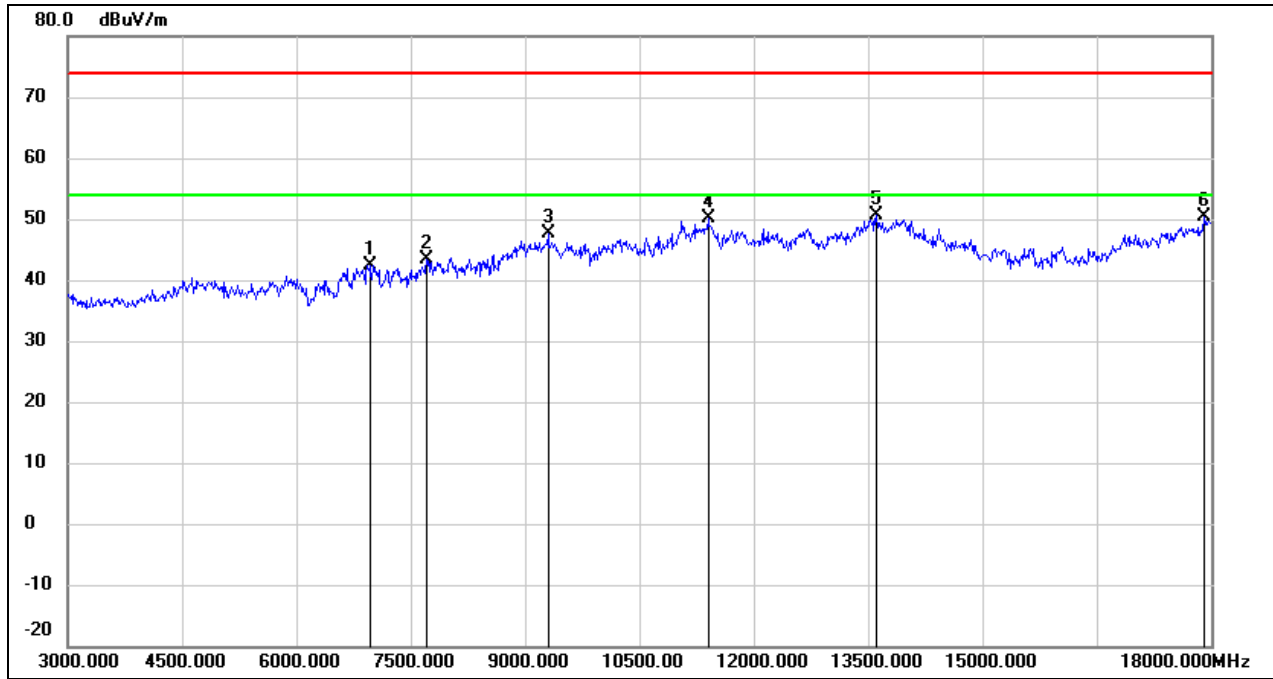

No.	Frequency (MHz)	Reading (dBuV)	Correct (dB/m)	Result (dBuV/m)	Limit (dBuV/m)	Margin (dB)	Remark
1	6960.000	35.98	6.50	42.48	74.00	-31.52	peak
2	7710.000	37.11	6.33	43.44	74.00	-30.56	peak
3	9300.000	37.05	10.61	47.66	74.00	-26.34	peak
4	11400.000	33.96	16.23	50.19	74.00	-23.81	peak
5	13605.000	29.56	21.12	50.68	74.00	-23.32	peak
6	17910.000	25.18	25.16	50.34	74.00	-23.66	peak



Test Mode:	802.11be EHT40	Channel:	2452
Polarity:	Horizontal	Test Voltage:	DC 12 V

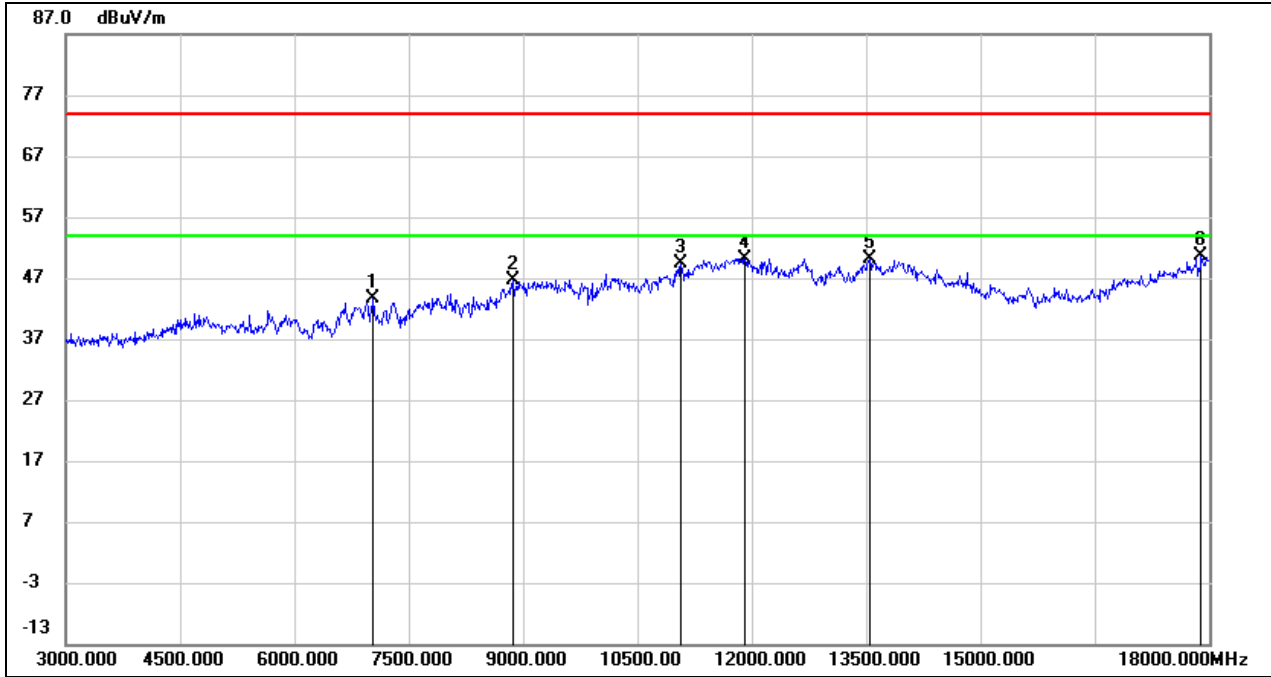

No.	Frequency (MHz)	Reading (dBuV)	Correct (dB/m)	Result (dBuV/m)	Limit (dBuV/m)	Margin (dB)	Remark
1	7035.000	36.89	6.67	43.56	74.00	-30.44	peak
2	8865.000	37.09	9.50	46.59	74.00	-27.41	peak
3	11070.000	34.41	15.03	49.44	74.00	-24.56	peak
4	11910.000	32.53	17.72	50.25	74.00	-23.75	peak
5	13545.000	29.04	20.99	50.03	74.00	-23.97	peak
6	17895.000	25.52	25.07	50.59	74.00	-23.41	peak



Test Mode:	802.11be EHT40	Channel:	2452
Polarity:	Vertical	Test Voltage:	DC 12 V

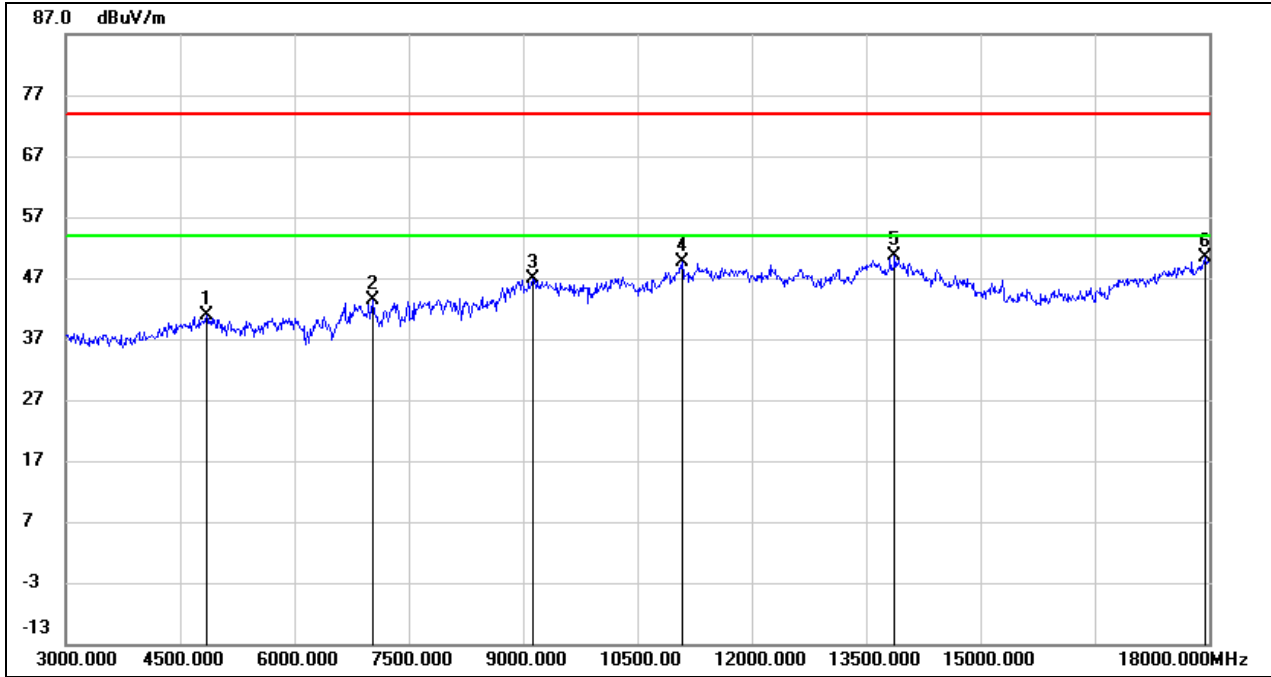

No.	Frequency (MHz)	Reading (dBuV)	Correct (dB/m)	Result (dBuV/m)	Limit (dBuV/m)	Margin (dB)	Remark
1	4845.000	41.07	-0.15	40.92	74.00	-33.08	peak
2	7035.000	36.74	6.67	43.41	74.00	-30.59	peak
3	9120.000	36.38	10.53	46.91	74.00	-27.09	peak
4	11085.000	34.64	15.08	49.72	74.00	-24.28	peak
5	13875.000	28.94	21.70	50.64	74.00	-23.36	peak
6	17955.000	24.97	25.42	50.39	74.00	-23.61	peak



8.4. SPURIOUS EMISSIONS(9 KHZ~30 MHZ)

Test Mode:	802.11b	Channel:	2412
Polarity:	Horizontal	Test Voltage:	DC 12 V

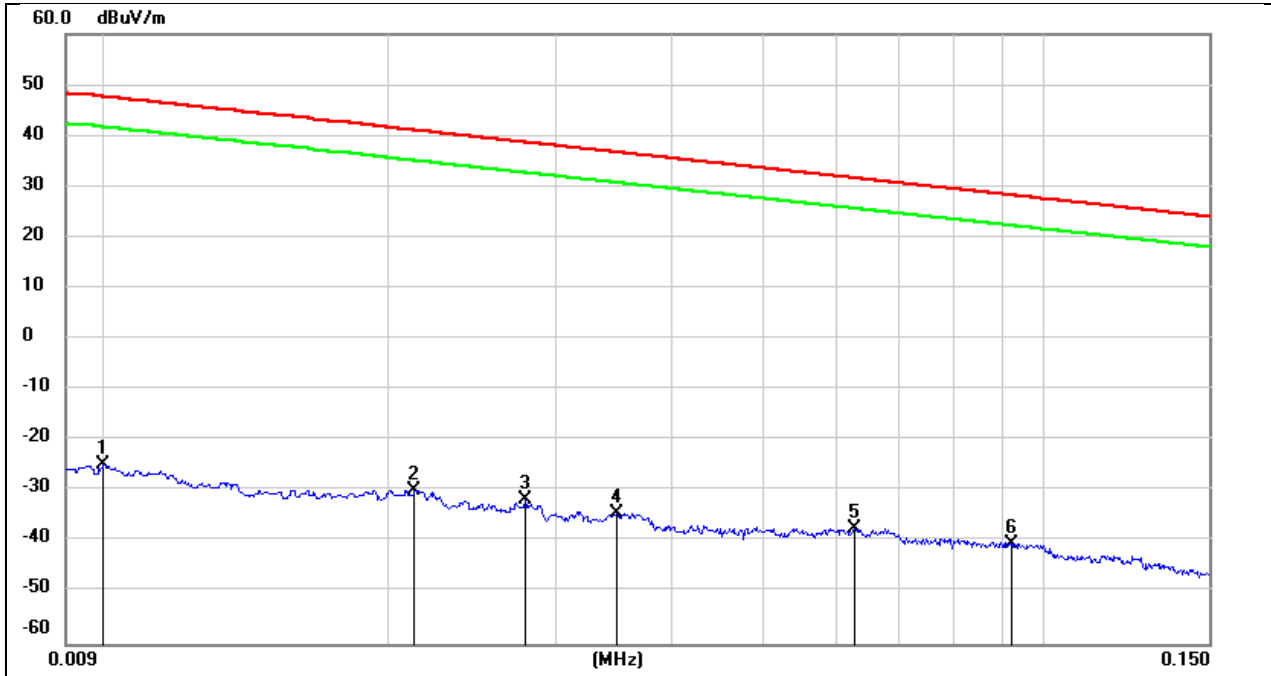

No.	Frequency (MHz)	Reading (dBuV)	Correct (dB/m)	FCC Result (dBuV/m)	FCC Limit (dBuV/m)	ISED Result (dBuA/m)	ISED Limit (dBuA/m)	Margin (dB)	Remark
1	0.0100	76.72	-101.40	-24.68	47.60	-76.18	-3.90	-72.28	peak
2	0.0212	71.54	-101.35	-29.81	41.07	-81.31	-10.43	-70.88	peak
3	0.0279	69.67	-101.38	-31.71	38.69	-83.21	-12.81	-70.40	peak
4	0.0349	67.03	-101.41	-34.38	36.75	-85.88	-14.75	-71.13	peak
5	0.0627	64.15	-101.53	-37.38	31.66	-88.88	-19.84	-69.04	peak
6	0.0922	61.51	-101.74	-40.23	28.31	-91.73	-23.19	-68.54	peak



Test Mode:	802.11b	Channel:	2412
Polarity:	Horizontal	Test Voltage:	DC 12 V

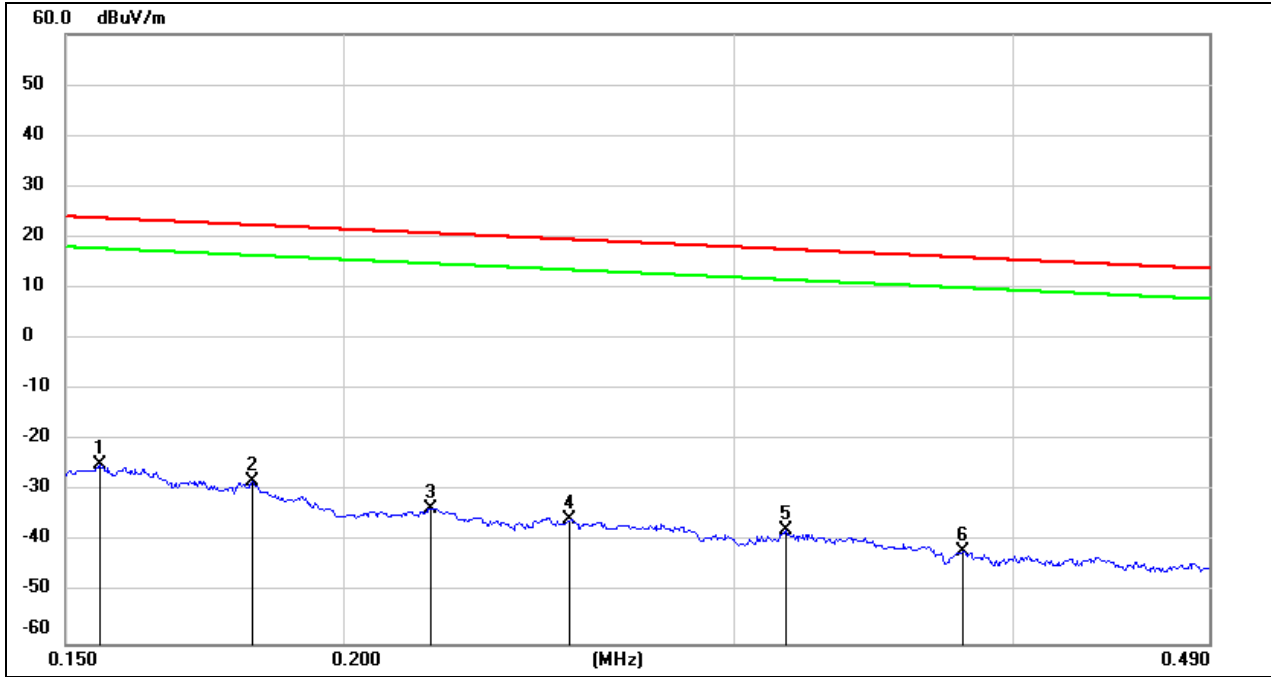

No.	Frequency (MHz)	Reading (dBuV)	Correct (dB/m)	FCC Result (dBuV/m)	FCC Limit (dBuV/m)	ISED Result (dBuA/m)	ISED Limit (dBuA/m)	Margin (dB)	Remark
1	0.1554	76.77	-101.65	-24.88	23.77	-76.38	-27.73	-48.65	peak
2	0.1819	73.49	-101.68	-28.19	22.41	-79.69	-29.09	-50.60	peak
3	0.2190	68.27	-101.75	-33.48	20.79	-84.98	-30.71	-54.27	peak
4	0.2530	66.14	-101.80	-35.66	19.54	-87.16	-31.96	-55.20	peak
5	0.3163	64.20	-101.87	-37.67	17.60	-89.17	-33.90	-55.27	peak
6	0.3800	60.02	-101.94	-41.92	16.01	-93.42	-35.49	-57.93	peak



Test Mode:	802.11b	Channel:	2412
Polarity:	Horizontal	Test Voltage:	DC 12 V

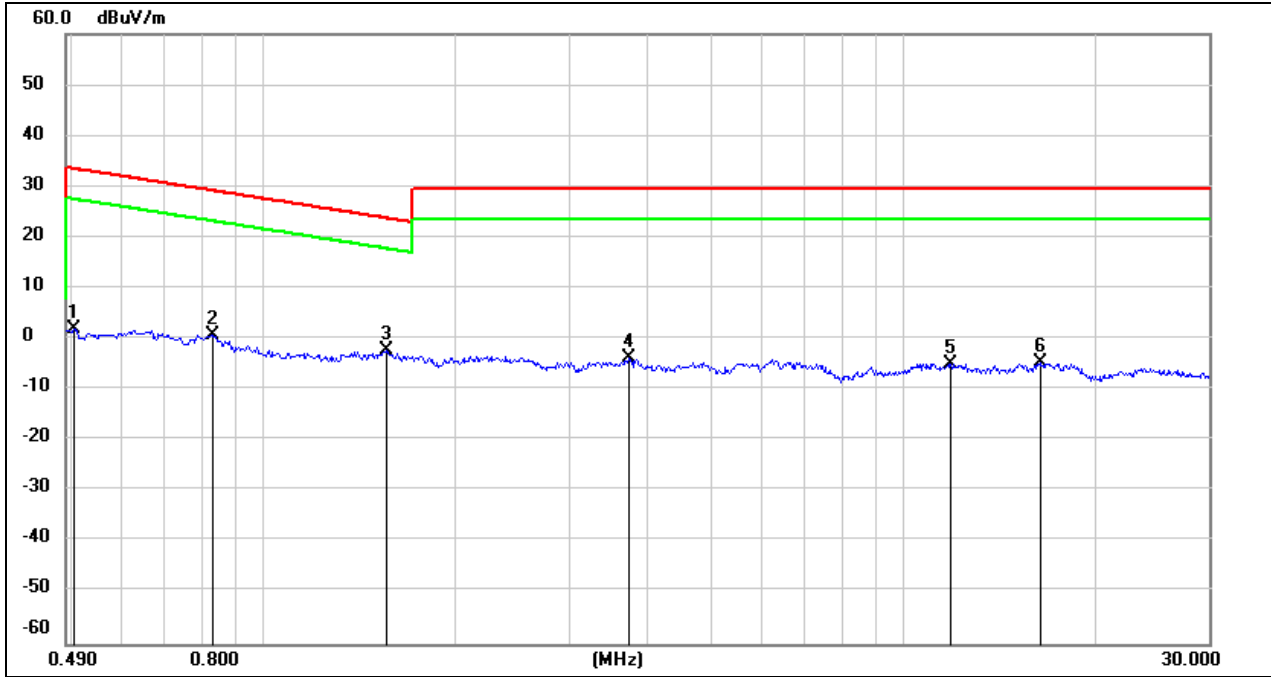

No.	Frequency (MHz)	Reading (dBuV)	Correct (dB/m)	FCC Result (dBuV/m)	FCC Limit (dBuV/m)	ISED Result (dBuA/m)	ISED Limit (dBuA/m)	Margin (dB)	Remark
1	0.5039	63.93	-62.07	1.86	33.56	-49.64	-17.94	-31.70	peak
2	0.8296	62.94	-62.17	0.77	29.23	-50.73	-22.27	-28.46	peak
3	1.5564	59.68	-62.02	-2.34	23.76	-53.84	-27.74	-26.10	peak
4	3.7100	57.70	-61.41	-3.71	29.54	-55.21	-21.96	-33.25	peak
5	11.8513	56.06	-60.88	-4.82	29.54	-56.32	-21.96	-34.36	peak
6	16.3959	56.17	-60.96	-4.79	29.54	-56.29	-21.96	-34.33	peak



8.5. SPURIOUS EMISSIONS(18 GHZ~26 GHZ)

Test Mode:	802.11b	Channel:	2412
Polarity:	Horizontal	Test Voltage:	DC 12 V

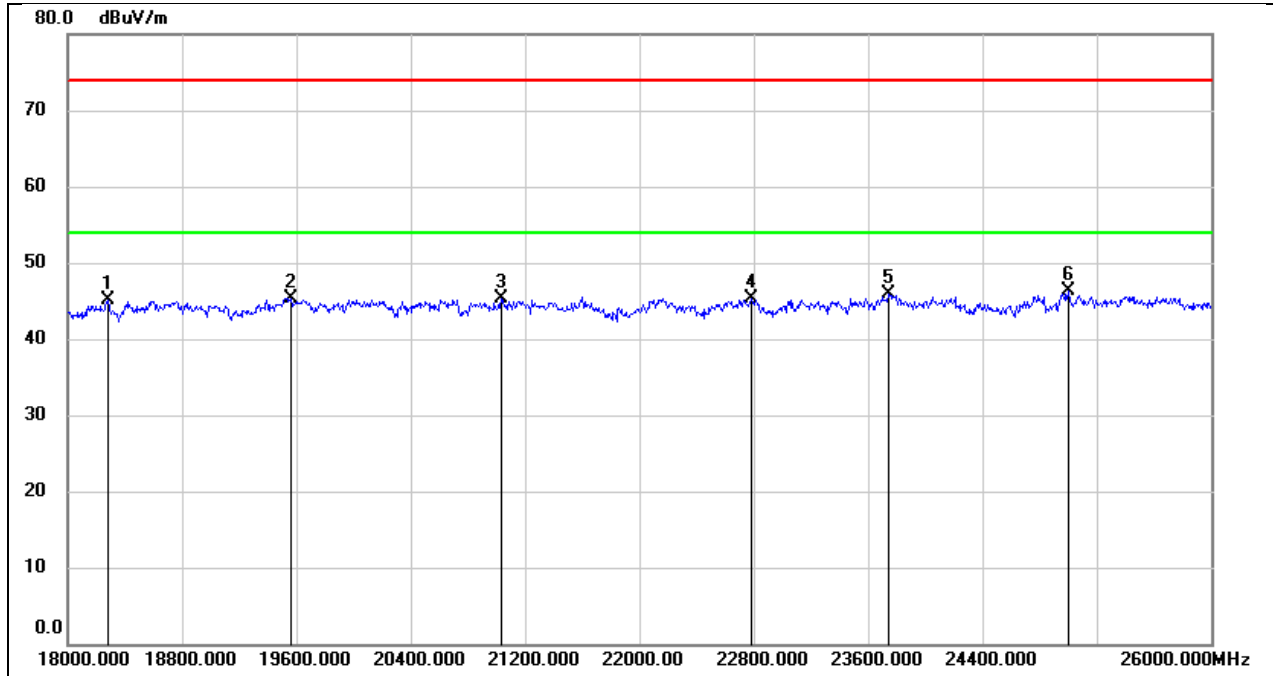

No.	Frequency (MHz)	Reading (dBuV)	Correct (dB/m)	Result (dBuV/m)	Limit (dBuV/m)	Margin (dB)	Remark
1	18280.000	50.61	-5.52	45.09	74.00	-28.91	peak
2	19560.000	50.86	-5.48	45.38	74.00	-28.62	peak
3	21032.000	50.15	-4.87	45.28	74.00	-28.72	peak
4	22784.000	48.98	-3.65	45.33	74.00	-28.67	peak
5	23744.000	49.15	-3.20	45.95	74.00	-28.05	peak
6	25000.000	48.36	-2.10	46.26	74.00	-27.74	peak



Test Mode:	802.11b	Channel:	2412
Polarity:	Vertical	Test Voltage:	DC 12 V

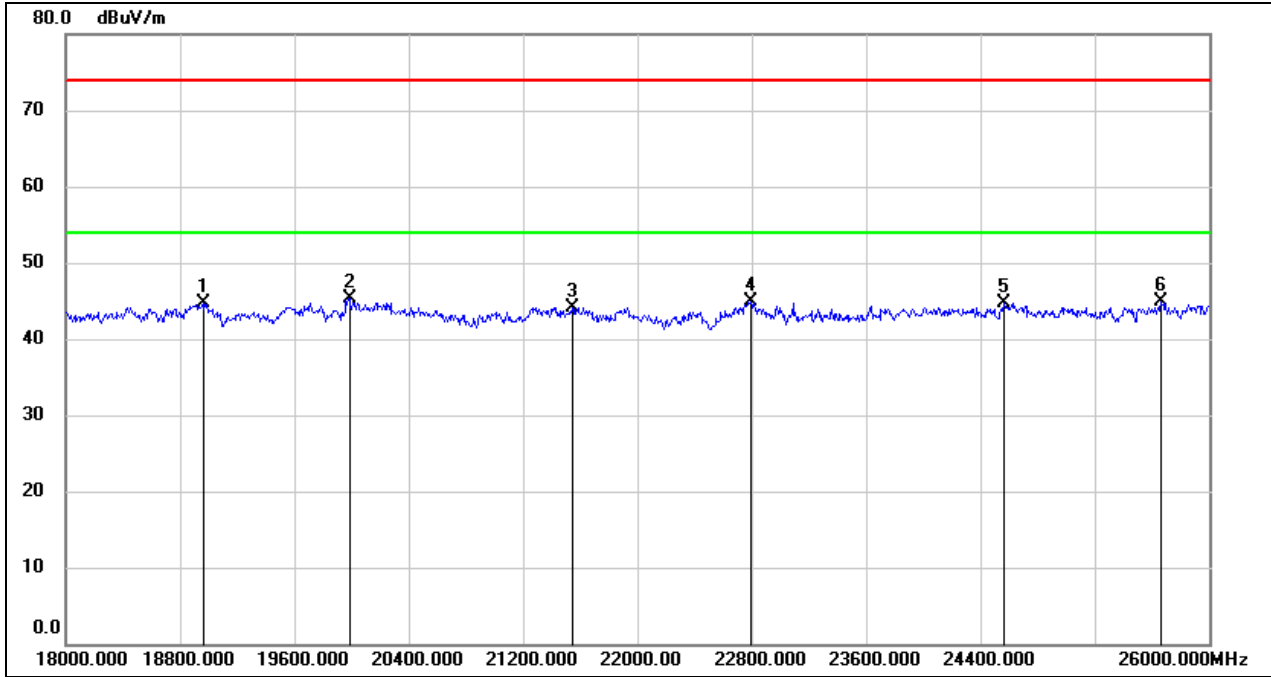

No.	Frequency (MHz)	Reading (dBuV)	Correct (dB/m)	Result (dBuV/m)	Limit (dBuV/m)	Margin (dB)	Remark
1	18960.000	50.01	-5.25	44.76	74.00	-29.24	peak
2	19984.000	50.71	-5.44	45.27	74.00	-28.73	peak
3	21544.000	48.76	-4.63	44.13	74.00	-29.87	peak
4	22792.000	48.61	-3.65	44.96	74.00	-29.04	peak
5	24568.000	47.10	-2.33	44.77	74.00	-29.23	peak
6	25664.000	45.89	-1.01	44.88	74.00	-29.12	peak



8.6. SPURIOUS EMISSIONS(30 MHZ~1 GHZ)

Test Mode:	802.11b	Channel:	2412
Polarity:	Horizontal	Test Voltage:	DC 12 V

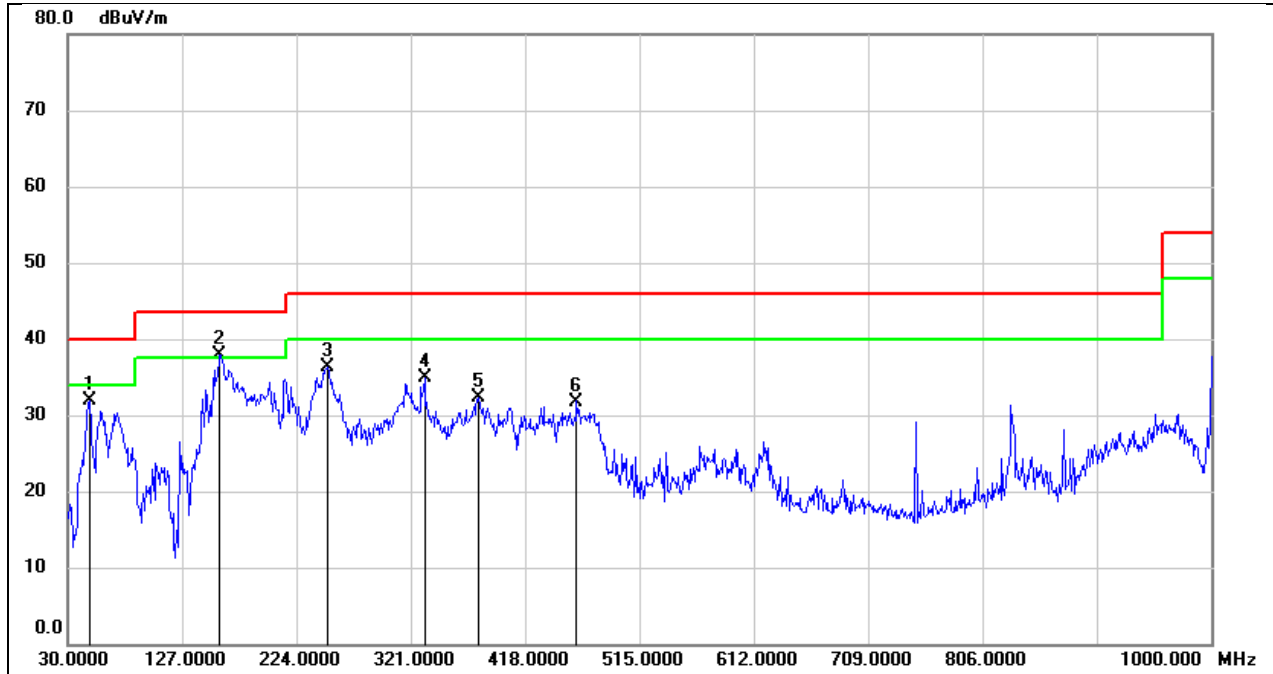

No.	Frequency (MHz)	Reading (dBuV)	Correct (dB/m)	Result (dBuV/m)	Limit (dBuV/m)	Margin (dB)	Remark
1	48.4300	52.54	-20.63	31.91	40.00	-8.09	QP
2	159.0100	55.71	-17.80	37.91	43.50	-5.59	QP
3	250.1900	55.26	-18.91	36.35	46.00	-9.65	QP
4	332.6400	49.60	-14.62	34.98	46.00	-11.02	QP
5	378.2300	46.00	-13.70	32.30	46.00	-13.70	QP
6	461.6500	43.90	-12.10	31.80	46.00	-14.20	QP



Test Mode:	802.11b	Channel:	2412
Polarity:	Vertical	Test Voltage:	DC 12 V

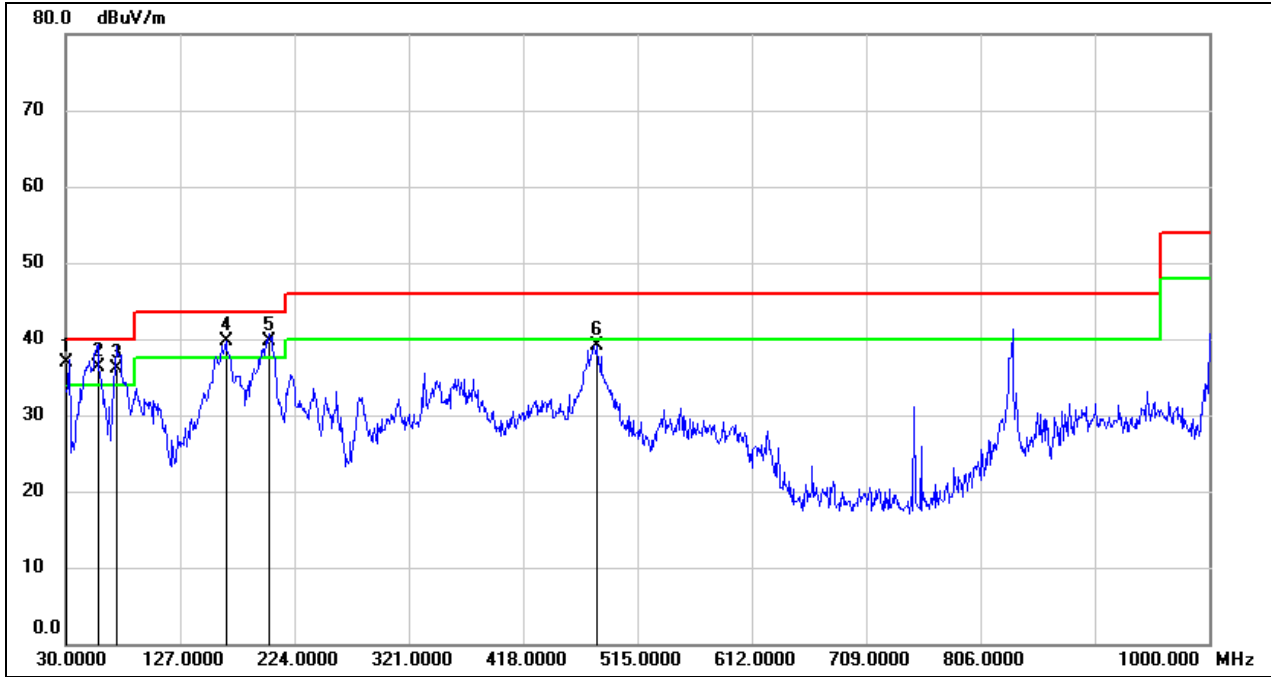

No.	Frequency (MHz)	Reading (dBuV)	Correct (dB/m)	Result (dBuV/m)	Limit (dBuV/m)	Margin (dB)	Remark
1	30.0000	55.76	-18.94	36.82	40.00	-3.18	QP
2	57.1600	56.79	-20.58	36.21	40.00	-3.79	QP
3	72.6800	56.88	-20.76	36.12	40.00	-3.88	QP
4	165.8000	57.13	-17.51	39.62	43.50	-3.88	QP
5	202.6600	56.24	-16.61	39.63	43.50	-3.87	QP
6	480.0800	50.93	-11.79	39.14	46.00	-6.86	QP



9. ANTENNA REQUIREMENT

REQUIREMENT

Please refer to FCC part 15.203

An intentional radiator shall be designed to ensure that no antenna other than that furnished by the responsible party shall be used with the device. The use of a permanently attached antenna or of an antenna that uses a unique coupling to the intentional radiator shall be considered sufficient to comply with the provisions of this section. The manufacturer may design the unit so that a broken antenna can be replaced by the user, but the use of a standard antenna jack or electrical connector is prohibited.

Please refer to FCC part 15.247(b)(4)

The conducted output power limit specified in paragraph (b) of this section is based on the use of antennas with directional gains that do not exceed 6 dBi. Except as shown in paragraph (c) of this section, if transmitting antennas of directional gain greater than 6 dBi are used, the conducted output power from the intentional radiator shall be reduced below the stated values in paragraphs (b)(1), (b)(2), and (b)(3) of this section, as appropriate, by the amount in dB that the directional gain of the antenna exceeds 6 dBi.

DESCRIPTION

Pass