

## CFR 47 FCC PART 15 SUBPART C

### TEST REPORT

*For*

**BE16000 Whole Home Mesh Wi-Fi 7 System**

**MODEL NUMBER: Deco BE79, Deco BE16000**

**REPORT NUMBER: 4790853724-RF-1**

**ISSUE DATE: July 4, 2023**

**FCC ID: 2AXJ4BE79**

*Prepared for*

**TP-Link Corporation Limited**

**Room 901, 9/F. , New East Ocean Centre, 9 Science Museum Road, Tsim Sha Tsui,  
Kowloon, Hong Kong**

*Prepared by*

**UL Verification Services (Guangzhou) Co., Ltd, Song Shan Lake Branch**

**Building 10, Innovation Technology Park, No. 1, Li Bin Road, Song Shan Lake Hi-Tech Development Zone Dongguan, 523808, People's Republic of China**

**Tel: +86 769 22038881**

**Fax: +86 769 33244054**

**Website: [www.ul.com](http://www.ul.com)**

## Revision History

| Rev. | Issue Date   | Revisions     | Revised By |
|------|--------------|---------------|------------|
| V0   | July 4, 2023 | Initial Issue |            |

### Summary of Test Results

| Test Item                                 | Clause  | Limit/Requirement   | Result |
|---|---|---|--------|
| Antenna Requirement                       | /   | FCC Part 15.203/15.247 (c)<br>RSS-GEN Clause 6.8  | Pass   |
| AC Power Line Conducted Emission          | ANSI C63.10-2013, Clause 6.2                  | FCC Part 15.207<br>RSS-GEN Clause 8.8   | Pass   |
| Conducted Output Power                    | ANSI C63.10-2013, Clause 11.9.1.3             | FCC Part 15.247 (b)(3)<br>RSS-247 Clause 5.4 (d)  | Pass   |
| 6dB Bandwidth and 99% Occupied Bandwidth  | ANSI C63.10-2013, Clause 11.8.1               | FCC Part 15.247 (a)(2)<br>RSS-247 Clause 5.2 (a)<br>ISED RSS-Gen Clause 6.7               | Pass   |
| Power Spectral Density                    | ANSI C63.10-2013, Clause 11.10.2              | FCC Part 15.247 (e)<br>RSS-247 Clause 5.2 (b)   | Pass   |
| Conducted Band edge and spurious emission | ANSI C63.10-2013, Clause 11.11                | FCC Part 15.247(d)<br>RSS-247 Clause 5.5  | Pass   |
| Radiated Band edge and Spurious Emission  | ANSI C63.10-2013, Clause 11.12 & Clause 11.13 | FCC Part 15.247 (d)<br>FCC Part 15.205/15.209<br>RSS-247 Clause 5.5<br>RSS-GEN Clause 8.9 | Pass   |
| Duty Cycle                                | ANSI C63.10-2013, Clause 11.6                 | None; for reporting purposes only.  | Pass   |

\*This test report is only published to and used by the applicant, and it is not for evidence purpose in China.

\*The measurement result for the sample received is <Pass> according to <CFR 47 FCC PART 15 SUBPART C > when <Accuracy Method> decision rule is applied.

## CONTENTS

|   |            |
|---|------------|
| <b>1. ATTESTATION OF TEST RESULTS.....</b>                  | <b>6</b>   |
| <b>2. TEST METHODOLOGY.....</b>                             | <b>7</b>   |
| <b>3. FACILITIES AND ACCREDITATION.....</b>                 | <b>7</b>   |
| <b>4. CALIBRATION AND UNCERTAINTY .....</b>                 | <b>8</b>   |
| 4.1. <i>MEASURING INSTRUMENT CALIBRATION .....</i>          | <i>8</i>   |
| 4.2. <i>MEASUREMENT UNCERTAINTY.....</i>                    | <i>8</i>   |
| <b>5. EQUIPMENT UNDER TEST .....</b>                        | <b>9</b>   |
| 5.1. <i>DESCRIPTION OF EUT .....</i>                        | <i>9</i>   |
| 5.2. <i>CHANNEL LIST .....</i>                              | <i>9</i>   |
| 5.3. <i>MAXIMUM OUTPUT POWER.....</i>                       | <i>10</i>  |
| 5.4. <i>TEST CHANNEL CONFIGURATION.....</i>                 | <i>10</i>  |
| 5.5. <i>THE WORSE CASE POWER SETTING PARAMETER.....</i>     | <i>10</i>  |
| 5.6. <i>WORST-CASE CONFIGURATIONS.....</i>                  | <i>11</i>  |
| 5.7. <i>DESCRIPTION OF AVAILABLE ANTENNAS .....</i>         | <i>12</i>  |
| 5.8. <i>SUPPORT UNITS FOR SYSTEM TEST .....</i>             | <i>14</i>  |
| <b>6. MEASURING EQUIPMENT AND SOFTWARE USED.....</b>        | <b>15</b>  |
| <b>7. ANTENNA PORT TEST RESULTS .....</b>                   | <b>18</b>  |
| 7.1. <i>CONDUCTED OUTPUT POWER .....</i>                    | <i>18</i>  |
| 7.2. <i>6DB BANDWIDTH AND 99% OCCUPIED BANDWIDTH.....</i>   | <i>19</i>  |
| 7.3. <i>POWER SPECTRAL DENSITY .....</i>                    | <i>21</i>  |
| 7.4. <i>CONDUCTED BAND EDGE AND SPURIOUS EMISSION .....</i> | <i>22</i>  |
| 7.5. <i>DUTY CYCLE .....</i>                                | <i>24</i>  |
| <b>8. RADIATED TEST RESULTS.....</b>                        | <b>25</b>  |
| 8.1. <i>RESTRICTED BANDEDGE .....</i>                       | <i>34</i>  |
| 8.2. <i>SPURIOUS EMISSIONS (1 GHZ ~ 3 GHZ) .....</i>        | <i>88</i>  |
| 8.3. <i>SPURIOUS EMISSIONS (3 GHZ ~ 18 GHZ) .....</i>       | <i>94</i>  |
| 8.4. <i>SPURIOUS EMISSIONS (9 KHZ ~ 30 MHZ).....</i>        | <i>150</i> |
| 8.5. <i>SPURIOUS EMISSIONS (30 MHZ ~ 1 GHZ) .....</i>       | <i>153</i> |
| 8.6. <i>SPURIOUS EMISSIONS (18 GHZ ~ 26 GHZ) .....</i>      | <i>155</i> |
| <b>9. ANTENNA REQUIREMENT .....</b>                         | <b>157</b> |
| <b>10. AC POWER LINE CONDUCTED EMISSION .....</b>           | <b>158</b> |

|            |  |            |
|------------|--|------------|
| <b>11.</b> | <b>TEST DATA.....</b>  | <b>161</b> |
| 11.1.      | <i>APPENDIX A: DTS BANDWIDTH.....</i>                          | 161        |
| 11.1.1.    | Test Result.....   | 161        |
| 11.1.2.    | Test Graphs .....  | 163        |
| 11.2.      | <i>APPENDIX B: OCCUPIED CHANNEL BANDWIDTH.....</i>             | 183        |
| 11.2.1.    | Test Result.....   | 183        |
| 11.2.2.    | Test Graphs .....  | 185        |
| 11.3.      | <i>APPENDIX C: MAXIMUM AVERAGE CONDUCTED OUTPUT POWER.....</i> | 205        |
| 11.3.1.    | CDD Mode Test Result .....                                     | 205        |
| 11.3.2.    | Tx beamforming Mode Test Result .....                          | 206        |
| 11.4.      | <i>APPENDIX D: MAXIMUM POWER SPECTRAL DENSITY.....</i>         | 207        |
| 11.4.1.    | Test Result.....   | 207        |
| 11.4.2.    | Test Graphs .....  | 209        |
| 11.5.      | <i>APPENDIX E: BAND EDGE MEASUREMENTS.....</i>                 | 229        |
| 11.5.1.    | Test Result.....   | 229        |
| 11.5.2.    | Test Graphs .....  | 230        |
| 11.6.      | <i>APPENDIX F: CONDUCTED SPURIOUS EMISSION .....</i>           | 246        |
| 11.6.1.    | Test Result.....   | 246        |
| 11.6.2.    | Test Graphs .....  | 250        |
| 11.7.      | <i>APPENDIX G: DUTY CYCLE.....</i>                             | 310        |
| 11.7.1.    | Test Result.....   | 310        |
| 11.7.2.    | Test Graphs .....  | 311        |

## 1. ATTESTATION OF TEST RESULTS

### Applicant Information

Company Name: TP-Link Corporation Limited  
Address: Room 901, 9/F. , New East Ocean Centre, 9 Science Museum Road, Tsim Sha Tsui, Kowloon, Hong Kong

### Manufacturer Information

Company Name: TP-Link Corporation Limited  
Address: Room 901, 9/F. , New East Ocean Centre, 9 Science Museum Road, Tsim Sha Tsui, Kowloon, Hong Kong

### EUT Information

EUT Name: BE16000 Whole Home Mesh Wi-Fi 7 System  
Model: Deco BE79, Deco BE16000  
Model Difference: Please refer to clause 5.1. DESCRIPTION OF EUT  
Sample Received Date: June 5, 2023  
Sample ID: 6148430  
Date of Tested: June 24, 2023 to July 3, 2023

| APPLICABLE STANDARDS         |              |
|------------------------------|--------------|
| STANDARD                     | TEST RESULTS |
| CFR 47 FCC PART 15 SUBPART C | PASS         |

Prepared By:

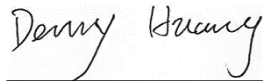

Denny Huang  
Senior Project Engineer

Checked By:

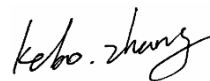

Kebo Zhang  
Senior Project Engineer

Approved By:



Stephen Guo  
Operations Manager

## 2. TEST METHODOLOGY

All tests were performed in accordance with the standard CFR 47 FCC PART 15 SUBPART C, KDB 558074 D01 15.247 Meas Guidance v05r02, KDB 414788 D01 Radiated Test Site v01r01, KDB 662911 D01 Multiple Transmitter Output v02r01, CFR 47 FCC Part 2, ANSI C63.10-2013.

## 3. FACILITIES AND ACCREDITATION

|                           |  |
|---------------------------|--|
| Accreditation Certificate | <p><b>A2LA (Certificate No.: 4102.01)</b><br/>                 UL Verification Services (Guangzhou) Co., Ltd. Song Shan Lake Branch. Has been assessed and proved to be in compliance with A2LA.</p> <p><b>FCC (FCC Designation No.: CN1187)</b><br/>                 UL Verification Services (Guangzhou) Co., Ltd. Song Shan Lake Branch. Has been recognized to perform compliance testing on equipment subject to the Commission's Declaration of Conformity (DoC) and Certification rules</p> <p><b>ISED (Company No.: 21320)</b><br/>                 UL Verification Services (Guangzhou) Co., Ltd. Song Shan Lake Branch. Has been registered and fully described in a report filed with ISED. The Company Number is 21320 and the test lab Conformity Assessment Body Identifier (CABID) is CN0046.</p> <p><b>VCCI (Registration No.: G-20019, R-20004, C-20012 and T-20011)</b><br/>                 UL Verification Services (Guangzhou) Co., Ltd. Song Shan Lake Branch. Has been assessed and proved to be in compliance with VCCI, the Membership No. is 3793.<br/>                 Facility Name:<br/>                 Chamber D, the VCCI registration No. is G-20019 and R-20004<br/>                 Shielding Room B , the VCCI registration No. is C-20012 and T-20011</p> |
|---------------------------|--|

Note 1:

All tests measurement facilities use to collect the measurement data are located at Building 10, Innovation Technology Park, No. 1, Li Bin Road, Song Shan Lake Hi-Tech Development Zone Dongguan, 523808, People's Republic of China.

Note 2:

The test anechoic chamber in UL Verification Services (Guangzhou) Co., Ltd. Song Shan Lake Branch had been calibrated and compared to the open field sites and the test anechoic chamber is shown to be equivalent to or worst case from the open field site.

Note 3:

For below 30 MHz, lab had performed measurements at test anechoic chamber and comparing to measurements obtained on an open field site. And these measurements below 30 MHz had been correlated to measurements performed on an OFS.

## 4. CALIBRATION AND UNCERTAINTY

### 4.1. MEASURING INSTRUMENT CALIBRATION

The measuring equipment utilized to perform the tests documented in this report has been calibrated in accordance with the manufacturer's recommendations and is traceable to recognized national standards.

### 4.2. MEASUREMENT UNCERTAINTY

Where relevant, the following measurement uncertainty levels have been estimated for tests performed on the apparatus:

| Test Item   | Uncertainty               |
|---|---------------------------|
| Conduction emission   | 3.62 dB                   |
| Radiated Emission<br>(Included Fundamental Emission) (9 kHz ~ 30 MHz)   | 2.2 dB                    |
| Radiated Emission<br>(Included Fundamental Emission) (30 MHz ~ 1 GHz)   | 4.00 dB                   |
| Radiated Emission<br>(Included Fundamental Emission) (1 GHz to 26 GHz)  | 5.78 dB (1 GHz ~ 18 GHz)  |
|   | 5.23 dB (18 GHz ~ 26 GHz) |
| Duty Cycle  | ±0.028%                   |
| DTS and 99% Occupied Bandwidth  | ±0.0196%                  |
| Maximum Conducted Output Power  | ±0.686 dB                 |
| Maximum Power Spectral Density Level  | ±0.743 dB                 |
| Conducted Band-edge Compliance  | ±1.328 dB                 |
| Conducted Unwanted Emissions In Non-restricted<br>Frequency Bands   | ±0.746 dB (9 kHz ~ 1 GHz) |
|   | ±1.328dB (1 GHz ~ 26 GHz) |
| Note: This uncertainty represents an expanded uncertainty expressed at approximately the 95% confidence level using a coverage factor of k=2. |                           |



## 5. EQUIPMENT UNDER TEST

### 5.1. DESCRIPTION OF EUT

|                      |  |
|----------------------|--|
| EUT Name:            | BE16000 Whole Home Mesh Wi-Fi 7 System   |
| Model:               | Deco BE79, Deco BE16000  |
| Model Difference:    | Deco BE16000 have the same technical construction including circuit diagram, PCB Layout, components and component layout, all electrical construction and mechanical construction with Deco BE79. The difference lies only the model number and Deco BE79 one more 10 GHz Combo, all the RF circuit, parameter, antennas are the same. |
| Frequency Range:     | 2412 MHz to 2462 MHz   |
| Type of Modulation:  | IEEE 802.11b: DSSS (CCK, DQPSK, DBPSK)<br>IEEE 802.11g/n: OFDM (64-QAM, 16-QAM, QPSK, BPSK)<br>IEEE 802.11ax: OFDMA (1024-QAM, 64-QAM, 16-QAM, QPSK, BPSK)<br>IEEE 802.11be: OFDMA (4096-QAM, 1024-QAM, 64-QAM, 16-QAM, QPSK, BPSK)  |
| Radio Technology:    | IEEE802.11b/g/n HT20/n HT40/n VHT20/n VHT40/<br>ax HE20/ax HE40/be EHT20/be EHT40  |
| Normal Test Voltage: | DC 12 V via adapter  |

### 5.2. CHANNEL LIST

| Channel List for (BW 20 MHz) |                 |         |                 |         |                 |         |                 |
|------------------------------|-----------------|---------|-----------------|---------|-----------------|---------|-----------------|
| Channel                      | Frequency (MHz) | Channel | Frequency (MHz) | Channel | Frequency (MHz) | Channel | Frequency (MHz) |
| 1                            | 2412            | 4       | 2427            | 7       | 2442            | 10      | 2457            |
| 2                            | 2417            | 5       | 2432            | 8       | 2447            | 11      | 2462            |
| 3                            | 2422            | 6       | 2437            | 9       | 2452            | /       | /               |

| Channel List for (BW 40 MHz) |                 |         |                 |         |                 |         |                 |
|------------------------------|-----------------|---------|-----------------|---------|-----------------|---------|-----------------|
| Channel                      | Frequency (MHz) | Channel | Frequency (MHz) | Channel | Frequency (MHz) | Channel | Frequency (MHz) |
| 3                            | 2422            | 5       | 2432            | 7       | 2442            | 9       | 2452            |
| 4                            | 2427            | 6       | 2437            | 8       | 2447            | /       | /               |

### 5.3. MAXIMUM OUTPUT POWER

| IEEE Std. 802.11 | Frequency (MHz) | Channel Number | Maximum Conducted Output Power (dBm) |
|------------------|-----------------|----------------|--------------------------------------|
| b                | 2412 ~ 2462     | 1-11[11]       | 27.44                                |
| g                | 2412 ~ 2462     | 1-11[11]       | 26.74                                |
| ax HE20          | 2412 ~ 2462     | 1-11[11]       | 26.81                                |
| ax HE40          | 2422 ~ 2452     | 3-9[7]         | 26.22                                |
| be EHT20         | 2412 ~ 2462     | 1-11[11]       | 26.76                                |
| be EHT40         | 2422 ~ 2452     | 3-9[7]         | 26.04                                |

### 5.4. TEST CHANNEL CONFIGURATION

| IEEE Std. 802.11 | Test Channel Number          | Frequency (MHz)              |
|------------------|------------------------------|------------------------------|
| b                | CH 1, CH2, CH 6, CH10, CH 11 | 2412, 2417, 2437, 2457, 2462 |
| g                | CH 1, CH2, CH 6, CH10, CH 11 | 2412, 2417, 2437, 2457, 2462 |
| ax HE20          | CH 1, CH2, CH 6, CH10, CH 11 | 2412, 2417, 2437, 2457, 2462 |
| ax HE40          | CH 3, CH4, CH 6, CH8, CH 9   | 2422, 2427, 2437, 2447, 2452 |
| be EHT20         | CH 1, CH2, CH 6, CH10, CH 11 | 2412, 2417, 2437, 2457, 2462 |
| be EHT40         | CH 3, CH4, CH 6, CH8, CH 9   | 2422, 2427, 2437, 2447, 2452 |

### 5.5. THE WORSE CASE POWER SETTING PARAMETER

| The Worst Case Power Setting Parameter under 2400 ~ 2483.5 MHz Band |                         |                        |      |      |       |       |                        |      |      |      |      |
|---|-------------------------|------------------------|------|------|-------|-------|------------------------|------|------|------|------|
| Test Software   |                         | QSPR                   |      |      |       |       |                        |      |      |      |      |
| Modulation Mode   | Transmit Antenna Number | Test Channel           |      |      |       |       |                        |      |      |      |      |
|   |                         | NCB: 20 MHz            |      |      |       |       | NCB: 40 MHz            |      |      |      |      |
|   |                         | CH 1                   | CH 2 | CH 6 | CH 10 | CH 11 | CH 3                   | CH 4 | CH 6 | CH 8 | CH 9 |
| 802.11b   | 5~6                     | 24                     | 24   | 24   | 24    | 24    | /                      |      |      |      |      |
| 802.11g   | 5~6                     | 23                     | 24   | 24   | 23.5  | 23    |                        |      |      |      |      |
| 802.11n HT20  | 5~6                     | Cover by 802.11ax HE20 |      |      |       |       | Cover by 802.11ax HE40 |      |      |      |      |
| 802.11n HT40  | 5~6                     | /                      |      |      |       |       |                        |      |      |      |      |
| 802.11n VHT20   | 5~6                     | Cover by 802.11ax HE20 |      |      |       |       | /                      |      |      |      |      |
| 802.11n VHT40   | 5~6                     | /                      |      |      |       |       | Cover by 802.11ax HE40 |      |      |      |      |
| 802.11ax HE20   | 5~6                     | 23                     | 23.5 | 24   | 23    | 22    | /                      |      |      |      |      |
| 802.11ax HE40   | 5~6                     | /                      |      |      |       |       | 22                     | 22   | 23   | 22   | 21.5 |
| 802.11be EHT20  | 5~6                     | 23                     | 23.5 | 24   | 23    | 22    | /                      |      |      |      |      |
| 802.11be EHT40  | 5~6                     | /                      |      |      |       |       | 22                     | 22   | 23   | 22   | 21.5 |

## 5.6. WORST-CASE CONFIGURATIONS

The EUT was tested in the following configuration(s):

Controlled in test mode using a software application on the EUT supplied by customer. The application was used to enable a continuous transmission and to select the mode, test channels, bandwidth, data rates as required.

Test channels referring to section 5.4.

Maximum power setting referring to section 5.5.

Worst-case data rates as provided by the client were:

802.11b CDD mode: 1 Mbps

802.11g CDD mode: 6 Mbps

802.11n HT20 CDD mode: MCS0

802.11n HT40 CDD mode: MCS0

802.11ax HE20 CDD/Tx beamforming mode: MCS0

802.11ax HE40 CDD/Tx beamforming mode: MCS0

802.11be EHT20 CDD/Tx beamforming mode: MCS0

802.11be EHT40 CDD/Tx beamforming mode: MCS0

802.11n HT20/HT40/VHT20/VHT40 and 802.11ax HE20/HE40 were performed on the worst case (802.11ax HE20/HE40) mode and only the worst data was recorded in this report.

The EUT has 2 separate antennas which correspond to 2 separate antenna ports. Core 1, Core 2 correspond to antenna 5, antenna 6 respectively and they support WLAN 2.4G.

The measured additional path loss was included in any path loss calculations for all RF cable used during tested.

The EUT support CDD and Tx beamforming mode except 802.11b/g/n (support CDD mode only), all the modes had been tested, but only the worst data was recorded in the report.

## 5.7. DESCRIPTION OF AVAILABLE ANTENNAS

| Antenna | Frequency (MHz) | Antenna Type   | Maximum Antenna Gain (dBi) |
|---------|-----------------|----------------|----------------------------|
| 5       | 2412-2462       | Dipole Antenna | 2                          |
| 6       | 2412-2462       | Dipole Antenna | 2                          |

The EUT support Cyclic Shift Diversity (CDD) mode.

MIMO output power port and MIMO PSD port summing were performed in accordance with KDB 662911 D01. For the CDD results the Directional Gain was calculated in accordance with the following method.

For output power measurements:

Directional gain =  $G_{ANT} + \text{Array Gain} = 2 \text{ dBi}$

$G_{ANT}$  : equal to the gain of the antenna having the highest gain

Array Gain = 0 dB (i.e., no array gain) for  $N_{ANT} \leq 4$

For power spectral density (PSD) measurements:

Directional gain =  $G_{ANT} + \text{Array Gain} = 5.01 \text{ dBi}$

Array Gain =  $10 \log(N_{ANT}/N_{SS}) \text{ dB}$ .

$N_{ANT}$  : number of transmit antennas

$N_{SS}$  : number of spatial streams, The worst case directional gain will occur when  $N_{SS} = 1$

The EUT support Tx beamforming mode.

MIMO output power port and MIMO PSD port summing were performed in accordance with KDB 662911 D01. For the Tx beamforming results the Directional Gain was calculated in accordance with the following method.

For output power measurements:

Directional gain =  $G_{ANT} + \text{Array Gain} = 5.01 \text{ dBi}$

$G_{ANT}$  : equal to the gain of the antenna having the highest gain

Array Gain = 0 dB (i.e., no array gain) for  $N_{ANT} \leq 4$

For power spectral density (PSD) measurements:

Directional gain =  $G_{ANT} + \text{Array Gain} = 5.01 \text{ dBi}$

Array Gain =  $10 \log(N_{ANT}/N_{SS}) \text{ dB}$ .

$N_{ANT}$  : number of transmit antennas

$N_{SS}$  : number of spatial streams, The worst case directional gain will occur when  $N_{SS} = 1$

| Test Mode           | Transmit and Receive Mode                    | Description   |
|---------------------|--|---|
| IEEE 802.11b        | <input checked="" type="checkbox"/> 2TX, 2RX | ANT 5, ANT 6 can be used as transmitting/receiving antenna. |
| IEEE 802.11g        | <input checked="" type="checkbox"/> 2TX, 2RX | ANT 5, ANT 6 can be used as transmitting/receiving antenna. |
| IEEE 802.11n HT20   | <input checked="" type="checkbox"/> 2TX, 2RX | ANT 5, ANT 6 can be used as transmitting/receiving antenna. |
| IEEE 802.11n HT40   | <input checked="" type="checkbox"/> 2TX, 2RX | ANT 5, ANT 6 can be used as transmitting/receiving antenna. |
| IEEE 802.11n VHT20  | <input checked="" type="checkbox"/> 2TX, 2RX | ANT 5, ANT 6 can be used as transmitting/receiving antenna. |
| IEEE 802.11n VHT40  | <input checked="" type="checkbox"/> 2TX, 2RX | ANT 5, ANT 6 can be used as transmitting/receiving antenna. |
| IEEE 802.11ax HE20  | <input checked="" type="checkbox"/> 2TX, 2RX | ANT 5, ANT 6 can be used as transmitting/receiving antenna. |
| IEEE 802.11ax HE40  | <input checked="" type="checkbox"/> 2TX, 2RX | ANT 5, ANT 6 can be used as transmitting/receiving antenna. |
| IEEE 802.11be EHT20 | <input checked="" type="checkbox"/> 2TX, 2RX | ANT 5, ANT 6 can be used as transmitting/receiving antenna. |
| IEEE 802.11be EHT40 | <input checked="" type="checkbox"/> 2TX, 2RX | ANT 5, ANT 6 can be used as transmitting/receiving antenna. |

Note: The value of the antenna gain was declared by customer.

## 5.8. SUPPORT UNITS FOR SYSTEM TEST

### SUPPORT EQUIPMENT

| Item | Equipment | Brand Name | Model Name | Remarks |
|------|-----------|------------|------------|---------|
| 1    | Laptop    | ThinkPad   | X230i      | /       |

### I/O CABLES

| Cable No | Port | Connector Type | Cable Type | Cable Length(m) | Remarks |
|----------|------|----------------|------------|-----------------|---------|
| 1        | LAN1 | RJ45           | Unshielded | 1.0 m           | /       |
| 2        | LAN2 | RJ45           | Unshielded | 1.0 m           | /       |
| 3        | LAN3 | RJ45           | Unshielded | 1.0 m           | /       |
| 4        | WLAN | RJ45           | Unshielded | 1.0 m           | /       |

### ACCESSORIES

| Item | Accessory          | Brand Name | Model Name  | Description  |
|------|--------------------|------------|-------------|--|
| 1    | I.T.E POWER SUPPLY | tp-link    | T120330-2B4 | Input: AC 100-240 V, 50 / 60 Hz, 1.0 A<br>Output: DC 12.0 V, 3.3 A |

### TEST SETUP

The EUT can work in engineering mode with a software through a laptop.

### SETUP DIAGRAM FOR TESTS

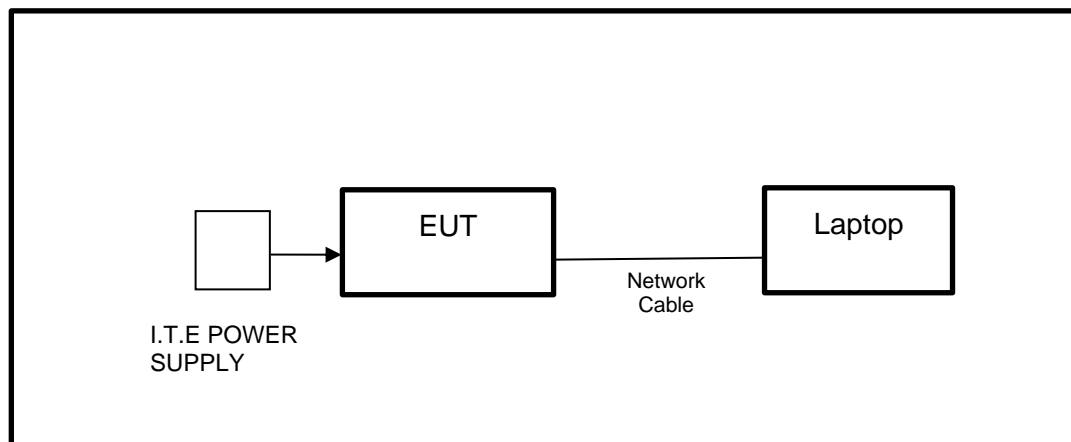

## 6. MEASURING EQUIPMENT AND SOFTWARE USED

| R&S TS 8997 Test System             |                 |                         |                  |              |              |
|-------------------------------------|-----------------|-------------------------|------------------|--------------|--------------|
| Equipment                           | Manufacturer    | Model No.               | Serial No.       | Last Cal.    | Due. Date    |
| Power sensor, Power Meter           | R&S             | OSP120                  | 100921           | Mar.31,2023  | Mar.30,2024  |
| Vector Signal Generator             | R&S             | SMBV100A                | 261637           | Oct.17, 2022 | Oct.16, 2023 |
| Signal Generator                    | R&S             | SMB100A                 | 178553           | Oct.17, 2022 | Oct.16, 2023 |
| Signal Analyzer                     | R&S             | FSV40                   | 101118           | Oct.17, 2022 | Oct.16, 2023 |
| Software                            |                 |                         |                  |              |              |
| Description                         | Manufacturer    | Name                    |                  | Version      |              |
| For R&S TS 8997 Test System         | Rohde & Schwarz | EMC 32                  |                  | 10.60.10     |              |
| Tonsend RF Test System              |                 |                         |                  |              |              |
| Equipment                           | Manufacturer    | Model No.               | Serial No.       | Last Cal.    | Due. Date    |
| Wideband Radio Communication Tester | R&S             | CMW500                  | 155523           | Oct.17, 2022 | Oct.16, 2023 |
| Wireless Connectivity Tester        | R&S             | CMW270                  | 1201.0002N75-102 | Sep.28, 2022 | Sep.27, 2023 |
| PXA Signal Analyzer                 | Keysight        | N9030A                  | MY55410512       | Oct.17, 2022 | Oct.16, 2023 |
| MXG Vector Signal Generator         | Keysight        | N5182B                  | MY56200284       | Oct.17, 2022 | Oct.16, 2023 |
| MXG Vector Signal Generator         | Keysight        | N5172B                  | MY56200301       | Oct.17, 2022 | Oct.16, 2023 |
| DC power supply                     | Keysight        | E3642A                  | MY55159130       | Oct.17, 2022 | Oct.16, 2023 |
| Temperature & Humidity Chamber      | SANMOOD         | SG-80-CC-2              | 2088             | Oct.17, 2022 | Oct.16, 2023 |
| Software                            |                 |                         |                  |              |              |
| Description                         | Manufacturer    | Name                    |                  | Version      |              |
| Tonsend SRD Test System             | Tonsend         | JS1120-3 RF Test System |                  | V3.2.22      |              |

| Conducted Emissions                   |              |           |              |              |              |
|---------------------------------------|--------------|-----------|--------------|--------------|--------------|
| Equipment                             | Manufacturer | Model No. | Serial No.   | Last Cal.    | Due Date     |
| EMI Test Receiver                     | R&S          | ESR3      | 101961       | Oct.17, 2022 | Oct.16, 2023 |
| Two-Line V-Network                    | R&S          | ENV216    | 101983       | Oct.17, 2022 | Oct.16, 2023 |
| Artificial Mains Networks             | Schwarzbeck  | NSLK 8126 | 8126465      | Oct.17, 2022 | Oct.16, 2023 |
| Software                              |              |           |              |              |              |
| Description                           |              |           | Manufacturer | Name         | Version      |
| Test Software for Conducted Emissions |              |           | Farad        | EZ-EMC       | Ver. UL-3A1  |

| Radiated Emissions          |               |                                  |               |               |               |
|-----------------------------|---------------|----------------------------------|---------------|---------------|---------------|
| Equipment                   | Manufacturer  | Model No.                        | Serial No.    | Last Cal.     | Due Date      |
| MXE EMI Receiver            | KESIGHT       | N9038A                           | MY56400036    | Oct.17, 2022  | Oct.16, 2023  |
| Hybrid Log Periodic Antenna | TDK           | HLP-3003C                        | 130959        | Aug.02, 2021  | Aug.01, 2024  |
| Preamplifier                | HP            | 8447D                            | 2944A09099    | Oct.17, 2022  | Oct.16, 2023  |
| EMI Measurement Receiver    | R&S           | ESR26                            | 101377        | Oct.17, 2022  | Oct.16, 2023  |
| Horn Antenna                | TDK           | HRN-0118                         | 130940        | July 20, 2021 | July 19, 2024 |
| Preamplifier                | TDK           | PA-02-0118                       | TRS-305-00067 | Oct.17, 2022  | Oct.16, 2023  |
| Horn Antenna                | Schwarzbeck   | BBHA9170                         | 697           | July 20, 2021 | July 19, 2024 |
| Preamplifier                | TDK           | PA-02-2                          | TRS-307-00003 | Oct.17, 2022  | Oct.16, 2023  |
| Preamplifier                | TDK           | PA-02-3                          | TRS-308-00002 | Oct.17, 2022  | Oct.16, 2023  |
| Loop antenna                | Schwarzbeck   | 1519B                            | 00008         | Dec.14, 2021  | Dec.13, 2024  |
| Preamplifier                | TDK           | PA-02-001-3000                   | TRS-302-00050 | Oct.17, 2022  | Oct.16, 2023  |
| Preamplifier                | Mini-Circuits | ZX60-83LN-S+                     | SUP01202035   | Oct.17, 2022  | Oct.16, 2023  |
| High Pass Filter            | Wi            | WHKX10-2700-3000-18000-40SS      | 23            | /             | /             |
| Highpass Filter             | Wainwright    | WHKX10-5850-6500-1800-40SS       | 4             | /             | /             |
| Band Reject Filter          | Wainwright    | WRCJV12-5695-5725-5850-5880-40SS | 4             | /             | /             |



| Band Reject Filter                   | Wainwright | WRCJV20-5120-5150-5350-5380-60SS     | 2            | /      | /           |
|--------------------------------------|------------|--------------------------------------|--------------|--------|-------------|
| Band Reject Filter                   | Wainwright | WRCJV20-5440-5470-5725-5755-60SS     | 1            | /      | /           |
| Band Reject Filter                   | Wainwright | WRCJV8-2350-2400-2483.5-2533.5-40SS  | 4            | /      | /           |
| Band Reject Filter                   | Wainwright | WRCD5-1879-1879.85-1880.15-1881-40SS | 1            | /      | /           |
| Notch Filter                         | Wainwright | WHJ10-882-980-7000-40SS              | 1            | /      | /           |
| Software                             |            |                                      |              |        |             |
| Description                          |            |                                      | Manufacturer | Name   | Version     |
| Test Software for Radiated Emissions |            |                                      | Farad        | EZ-EMC | Ver. UL-3A1 |

| Other Instrument           |              |           |            |              |              |
|----------------------------|--------------|-----------|------------|--------------|--------------|
| Equipment                  | Manufacturer | Model No. | Serial No. | Last Cal.    | Due Date     |
| Temperature humidity probe | OMEGA        | ITHX-SD-5 | 18470007   | Oct.22, 2022 | Oct.21, 2023 |
| Barometer                  | Yiyi         | Baro      | N/A        | Oct.24, 2022 | Oct.23, 2023 |
| Attenuator                 | Agilent      | 8495B     | 2814a12853 | Oct.18, 2022 | Oct.17, 2023 |

## 7. ANTENNA PORT TEST RESULTS

### 7.1. CONDUCTED OUTPUT POWER

#### LIMITS

| CFR 47 FCC Part15 (15.247) Subpart C |                  |                  |                       |
|--------------------------------------|------------------|------------------|-----------------------|
| Section                              | Test Item        | Limit            | Frequency Range (MHz) |
| CFR 47 FCC 15.247(b)(3)              | AVG Output Power | 1 watt or 30 dBm | 2400-2483.5           |

#### TEST PROCEDURE

Refer to ANSI C63.10-2013 clause 11.9.2.3.1.

Connect the EUT to a low loss RF cable from the antenna port to the power sensor (video bandwidth is greater than the occupied bandwidth).

Measure peak emission level, the indicated level is the average output power, after any corrections for external attenuators and cables.

The test result in dBm by adding  $[10 \log (1 / D)]$ , where D is the duty cycle.

#### TEST SETUP

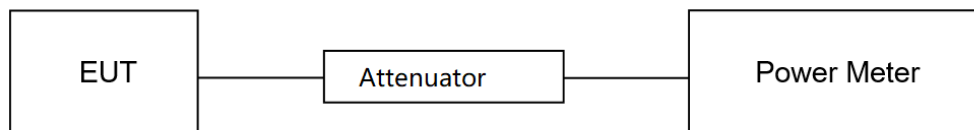

#### TEST ENVIRONMENT

|                     |         |                   |         |
|---------------------|---------|-------------------|---------|
| Temperature         | 26.6 °C | Relative Humidity | 60.7%   |
| Atmosphere Pressure | 101 kPa | Test Voltage      | DC 12 V |

#### TEST RESULTS

Please refer to section "Test Data" - Appendix C

## 7.2. 6DB BANDWIDTH AND 99% OCCUPIED BANDWIDTH

### LIMITS

| CFR 47 FCC Part15 (15.247) Subpart C |                         |                              |                       |
|--------------------------------------|-------------------------|------------------------------|-----------------------|
| Section                              | Test Item               | Limit                        | Frequency Range (MHz) |
| CFR 47 FCC 15.247(a)(2)              | 6 dB Bandwidth          | ≥ 500 kHz                    | 2400-2483.5           |
| ISED RSS-Gen Clause 6.7              | 99 % Occupied Bandwidth | For reporting purposes only. | 2400-2483.5           |

### TEST PROCEDURE

Refer to ANSI C63.10-2013 clause 11.8 for DTS bandwidth and clause 6.9 for Occupied Bandwidth.

Connect the EUT to the spectrum analyzer and use the following settings:

|                  |   |
|------------------|---|
| Center Frequency | The center frequency of the channel under test  |
| Frequency Span   | For 6 dB Bandwidth: Enough to capture all products of the modulation carrier emission<br>For 99 % Occupied Bandwidth: Between 1.5 times and 5.0 times the OBW |
| Detector         | Peak  |
| RBW              | For 6 dB Bandwidth: 100 kHz<br>For 99 % Occupied Bandwidth: 1 % to 5 % of the occupied bandwidth  |
| VBW              | For 6 dB Bandwidth: ≥3 × RBW<br>For 99 % Occupied Bandwidth: ≥3 × RBW   |
| Trace            | Max hold  |
| Sweep            | Auto couple   |

a) Use the 99 % power bandwidth function of the instrument, allow the trace to stabilize and report the measured bandwidth.

b) Allow the trace to stabilize and measure the maximum width of the emission that is constrained by the frequencies associated with the two outermost amplitude points (upper and lower frequencies) that are attenuated by 6 dB relative to the maximum level measured in the fundamental emission.

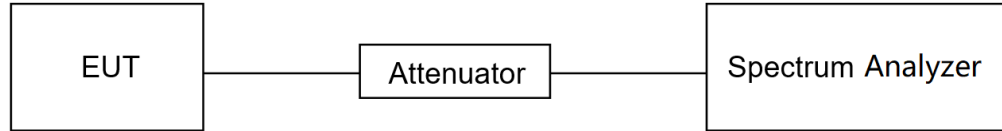
**TEST SETUP****TEST ENVIRONMENT**

|                     |         |                   |         |
|---------------------|---------|-------------------|---------|
| Temperature         | 26.6 °C | Relative Humidity | 60.7%   |
| Atmosphere Pressure | 101 kPa | Test Voltage      | DC 12 V |

**TEST RESULTS**

Please refer to section "Test Data" - Appendix A&B

### 7.3. POWER SPECTRAL DENSITY

#### LIMITS

| CFR 47 FCC Part15 (15.247) Subpart C |                        |                         |                       |
|--------------------------------------|------------------------|-------------------------|-----------------------|
| Section                              | Test Item              | Limit                   | Frequency Range (MHz) |
| CFR 47 FCC §15.247 (e)               | Power Spectral Density | 8 dBm in any 3 kHz band | 2400-2483.5           |

#### TEST PROCEDURE

Refer to ANSI C63.10-2013 clause 11.10.5.

Connect the EUT to the spectrum analyzer and use the following settings:

|                  |  |
|------------------|--|
| Center Frequency | The center frequency of the channel under test       |
| Detector         | power averaging (rms)                                |
| RBW              | $3 \text{ kHz} \leq \text{RBW} \leq 100 \text{ kHz}$ |
| VBW              | $\geq 3 \times \text{RBW}$                           |
| Span             | $1.5 \times \text{OBW bandwidth}$                    |
| Trace            | Average  |
| Sweep time       | Auto couple  |

Allow trace to fully stabilize and use the peak marker function to determine the maximum amplitude level within the RBW.

If measured value exceeds limit, reduce RBW (no less than 3 kHz) and repeat.

#### TEST SETUP

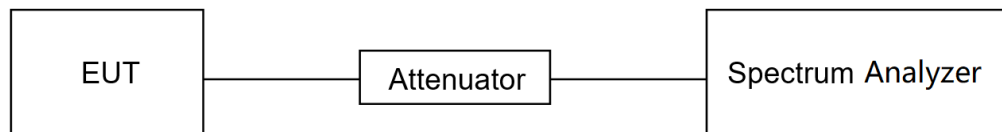

#### TEST ENVIRONMENT

|                     |         |                   |         |
|---------------------|---------|-------------------|---------|
| Temperature         | 26.6 °C | Relative Humidity | 60.7%   |
| Atmosphere Pressure | 101 kPa | Test Voltage      | DC 12 V |

#### TEST RESULTS

Please refer to section "Test Data" - Appendix D

## 7.4. CONDUCTED BAND EDGE AND SPURIOUS EMISSION

### LIMITS

| CFR 47 FCC Part15 (15.247) Subpart C |   |   |
|--------------------------------------|---|---|
| Section                              | Test Item                                 | Limit   |
| CFR 47 FCC §15.247 (d)               | Conducted Bandedge and Spurious Emissions | at least 30 dB below that in the 100 kHz bandwidth within the band that contains the highest level of the desired power |

### TEST PROCEDURE

Refer to ANSI C63.10-2013 clause 11.11 and 11.13.

Connect the EUT to the spectrum analyzer and use the following settings for reference level measurement:

|                  |  |
|------------------|--|
| Center Frequency | The center frequency of the channel under test |
| Detector         | Peak   |
| RBW              | 100 kHz  |
| VBW              | $\geq 3 \times \text{RBW}$                     |
| Span             | 1.5 x DTS bandwidth                            |
| Trace            | Max hold                                       |
| Sweep time       | Auto couple.                                   |

Allow trace to fully stabilize and use the peak marker function to determine the maximum PSD level.

Change the settings for emission level measurement:

|                    |   |
|--------------------|---|
| Span               | Set the center frequency and span to encompass frequency range to be measured |
| Detector           | Peak  |
| RBW                | 100 kHz   |
| VBW                | $\geq 3 \times \text{RBW}$  |
| measurement points | $\geq \text{span}/\text{RBW}$   |
| Trace              | Max hold  |
| Sweep time         | Auto couple.  |

Allow trace to fully stabilize and use the peak marker function to determine the maximum PSD level. Ensure that the amplitude of all unwanted emissions outside of the authorized frequency band (excluding restricted frequency bands) is attenuated by at least the minimum requirements specified in 11.11.

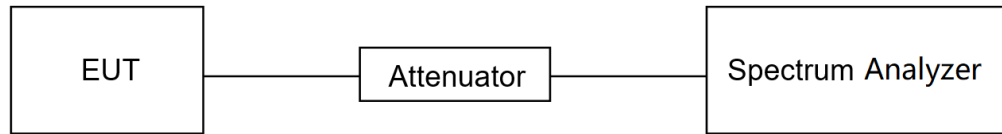
**TEST SETUP****TEST ENVIRONMENT**

|                     |         |                   |         |
|---------------------|---------|-------------------|---------|
| Temperature         | 26.6 °C | Relative Humidity | 60.7%   |
| Atmosphere Pressure | 101 kPa | Test Voltage      | DC 12 V |

**TEST RESULTS**

Please refer to section "Test Data" - Appendix E&F

## 7.5. DUTY CYCLE

### LIMITS

None; for reporting purposes only.

### TEST PROCEDURE

Refer to ANSI C63.10-2013 clause 11.6 Zero – Span Spectrum Analyzer method.

### TEST SETUP

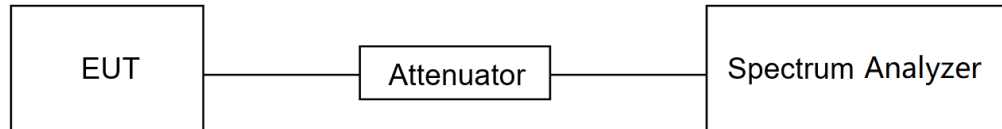

### TEST ENVIRONMENT

|                     |         |                   |         |
|---------------------|---------|-------------------|---------|
| Temperature         | 26.6 °C | Relative Humidity | 60.7%   |
| Atmosphere Pressure | 101 kPa | Test Voltage      | DC 12 V |

### TEST RESULTS

Please refer to section "Test Data" - Appendix G



## 8. RADIATED TEST RESULTS

### LIMITS

Please refer to CFR 47 FCC §15.205 and §15.209.

Radiation Disturbance Test Limit for FCC (Class B) (9 kHz ~ 1 GHz)

| Emissions radiated outside of the specified frequency bands above 30 MHz |                                    |                                      |         |
|--|------------------------------------|--------------------------------------|---------|
| Frequency Range (MHz)  | Field Strength Limit (uV/m) at 3 m | Field Strength Limit (dBuV/m) at 3 m |         |
|  |                                    | Quasi-Peak                           |         |
| 30 - 88  | 100                                | 40                                   |         |
| 88 - 216   | 150                                | 43.5                                 |         |
| 216 - 960  | 200                                | 46                                   |         |
| Above 960  | 500                                | 54                                   |         |
| Above 1000   | 500                                | Peak                                 | Average |
|  |                                    | 74                                   | 54      |

| FCC Emissions radiated outside of the specified frequency bands below 30 MHz |                                   |                               |
|--|-----------------------------------|-------------------------------|
| Frequency (MHz)  | Field strength (microvolts/meter) | Measurement distance (meters) |
| 0.009-0.490  | 2400/F(kHz)                       | 300                           |
| 0.490-1.705  | 24000/F(kHz)                      | 30                            |
| 1.705-30.0   | 30                                | 30                            |

FCC Restricted bands of operation refer to FCC §15.205 (a):

| MHz                      | MHz                 | MHz           | GHz              |
|--------------------------|---------------------|---------------|------------------|
| 0.090-0.110              | 16.42-16.423        | 399.9-410     | 4.5-5.15         |
| <sup>1</sup> 0.495-0.505 | 16.69475-16.69525   | 608-614       | 5.35-5.46        |
| 2.1735-2.1905            | 16.80425-16.80475   | 960-1240      | 7.25-7.75        |
| 4.125-4.128              | 25.5-25.67          | 1300-1427     | 8.025-8.5        |
| 4.17725-4.17775          | 37.5-38.25          | 1435-1626.5   | 9.0-9.2          |
| 4.20725-4.20775          | 73-74.6             | 1645.5-1646.5 | 9.3-9.5          |
| 6.215-6.218              | 74.8-75.2           | 1660-1710     | 10.6-12.7        |
| 6.26775-6.26825          | 108-121.94          | 1718.8-1722.2 | 13.25-13.4       |
| 6.31175-6.31225          | 123-138             | 2200-2300     | 14.47-14.5       |
| 8.291-8.294              | 149.9-150.05        | 2310-2390     | 15.35-16.2       |
| 8.362-8.366              | 156.52475-156.52525 | 2483.5-2500   | 17.7-21.4        |
| 8.37625-8.38675          | 156.7-156.9         | 2690-2900     | 22.01-23.12      |
| 8.41425-8.41475          | 162.0125-167.17     | 3260-3267     | 23.6-24.0        |
| 12.29-12.293             | 167.72-173.2        | 3332-3339     | 31.2-31.8        |
| 12.51975-12.52025        | 240-285             | 3345.8-3358   | 36.43-36.5       |
| 12.57675-12.57725        | 322-335.4           | 3600-4400     | ( <sup>2</sup> ) |
| 13.36-13.41              |                     |               |                  |

Note: <sup>1</sup>Until February 1, 1999, this restricted band shall be 0.490-0.510 MHz.

<sup>2</sup>Above 38.6c

## TEST PROCEDURE

Below 30 MHz

The setting of the spectrum analyzer

|       |  |
|-------|--|
| RBW   | 200 Hz (From 9 kHz to 0.15 MHz)/ 9 kHz (From 0.15 MHz to 30 MHz) |
| VBW   | 200 Hz (From 9 kHz to 0.15 MHz)/ 9 kHz (From 0.15 MHz to 30 MHz) |
| Sweep | Auto   |

1. The testing follows the guidelines in ANSI C63.10-2013 clause 6.4.
2. The EUT was arranged to its worst case and then turntable (from 0 degree to 360 degrees) to find the maximum reading. A pre-amp and a high pass filter are used for the test in order to get better signal level. Both Horizontal, Face-on and Face-off polarizations of the antenna are set to make the measurement.
3. The EUT was placed on a turntable with 80 cm above ground.
4. The EUT was set 3 meters from the interference receiving antenna, which was mounted on the top of a 1 m height antenna tower.
5. The radiated emission limits are based on measurements employing a CISPR quasi-peak detector except for the frequency bands 9-90 kHz, 110-490 kHz and above 1000 MHz Radiated emission limits in these three bands are based on measurements employing an average detector.
6. For measurement below 1 GHz, the initial step in collecting conducted emission data is a spectrum analyzer peak detector mode pre-scanning the measurement frequency range. Significant peaks are then marked and then Quasi Peak and average detector mode re-measured. If the emission level of the EUT measured by the peak detector is 3 dB lower than the applicable limit, the peak emission level will be reported. Otherwise, the emission measurement will be repeated using the quasi-peak and average detector and reported.
7. Although these tests were performed other than open field site, adequate comparison measurements were confirmed against 30m open field site. Therefore sufficient tests were made to demonstrate that the alternative site produces results that correlate with the ones of tests made in an open field site based on KDB 414788.
8. The limits in CFR 47, Part 15, Subpart C, paragraph 15.209 (a), are identical to those in RSS-GEN Section 8.9, Table 6, since the measurements are performed in terms of magnetic field strength and converted to electric field strength levels (as reported in the table) using the free space impedance of  $377\Omega$ . For example, the measurement frequency X KHz resulted in a level of Y dBuV/m, which is equivalent to  $Y-51.5 = Z$  dBuA/m, which has the same margin, W dB, to the corresponding RSS-GEN Table 6 limit as it has to be 15.209(a) limit.

Below 1 GHz and above 30 MHz

The setting of the spectrum analyzer

|          |          |
|----------|----------|
| RBW      | 120 kHz  |
| VBW      | 300 kHz  |
| Sweep    | Auto     |
| Detector | Peak/QP  |
| Trace    | Max hold |

1. The testing follows the guidelines in ANSI C63.10-2013 clause 6.5.
2. The EUT was arranged to its worst case and then tune the antenna tower (from 1 m to 4 m) and turntable (from 0 degree to 360 degrees) to find the maximum reading. A pre-amp and a high pass filter are used for the test in order to get better signal level. Both horizontal and vertical polarizations of the antenna are set to make the measurement.
3. The EUT was placed on a turntable with 80 cm above ground.
4. The EUT was set 3 meters from the interference receiving antenna, which was mounted on the top of a variable height antenna tower.
5. For measurement below 1 GHz, the initial step in collecting conducted emission data is a spectrum analyzer peak detector mode pre-scanning the measurement frequency range. Significant peaks are then marked and then Quasi Peak detector mode re-measured. If the emission level of the EUT measured by the peak detector is 3 dB lower than the applicable limit, the peak emission level will be reported. Otherwise, the emission measurement will be repeated using the quasi-peak detector and reported.

Above 1 GHz

The setting of the spectrum analyzer

|          |                                |
|----------|--------------------------------|
| RBW      | 1 MHz                          |
| VBW      | PEAK: 3 MHz<br>AVG: see note 6 |
| Sweep    | Auto                           |
| Detector | Peak                           |
| Trace    | Max hold                       |

1. The testing follows the guidelines in ANSI C63.10-2013 clause 6.6.
2. The EUT was arranged to its worst case and then tune the antenna tower (from 1 m to 4 m) and turntable (from 0 degree to 360 degrees) to find the maximum reading. A pre-amp and a high pass filter are used for the test in order to get better signal level. Both horizontal and vertical polarizations of the antenna are set to make the measurement.
3. The EUT was placed on a turntable with 1.5 m above ground.
4. The EUT was set 3 meters from the interference receiving antenna, which was mounted on the top of a variable height antenna tower.
5. For measurement above 1 GHz, the emission measurement will be measured by the peak detector. This peak level, once corrected, must comply with the limit specified in Section 15.209.
6. For measurements above 1 GHz the resolution bandwidth is set to 1 MHz, then the video bandwidth is set to 3 MHz for peak measurements and 1 MHz resolution bandwidth with 1/T video bandwidth with peak detector for average measurements. For the Duty Cycle please refer to clause 7.5.ON TIME AND DUTY CYCLE.

Note: The EUT was fully exercised with external accessories during the test. In the case of multiple accessory external ports, an external accessory shall be connected to one of each type of port.

For Band edge:

Note:

1. Measurement = Reading Level + Correct Factor.
2. If the peak values are less than the average limit of 54 dBuV/m, the average result is deemed to comply with average limit.
3. Peak: Peak detector.
4. AVG:  $VBW=1/Ton$ , where: Ton is the transmitting duration.
5. For the transmitting duration, please refer to clause 7.5.
6. Only the worst data was recorded, if it complies with the limit, the other emissions deemed to comply with the limit.
7. Horizontal and Vertical have been tested, only the worst data was recorded in the report.
8. All modes, channels and antennas have been tested, only the worst data was recorded in the report.

For Radiate Spurious emission 1 GHz-3 GHz:

Note:

1. Measurement = Reading Level + Correct Factor.
2. If the Peak values are less than the Average limit of 54 dBuV/m, the Average result is deemed to comply with Average limit.
3. Peak: Peak detector.
4. AVG:  $VBW=1/Ton$ , where: Ton is the transmitting duration.
5. For the transmitting duration, please refer to clause 7.5.
6. Filter losses were only considered in the spurious frequency bands and the authorized band was not corrected for Band reject filter losses.
7. Proper operation of the transmitter prior to adding the filter to the measurement chain.
8. All modes, channels and antennas have been tested, only the worst data was recorded in the report.

For Radiate Spurious emission 3 GHz-18 GHz:

Note:

1. Peak Result = Reading Level + Correct Factor.
2. If the Peak values are less than the Average limit of 54 dBuV/m, the Average result is deemed to comply with Average limit.
3. Peak: Peak detector.
4. AVG:  $VBW=1/Ton$ , where: Ton is the transmitting duration.
5. For the transmitting duration, please refer to clause 7.5.
6. Filter losses were only considered in the spurious frequency bands and the authorized band was not corrected for High Pass Filter losses.
7. Proper operation of the transmitter prior to adding the filter to the measurement chain.
8. All modes, channels and antennas have been tested, only the worst data was recorded in the report.

For Radiate Spurious emission 9 kHz-30 MHz:

Note:

1. Measurement = Reading Level + Correct Factor.  
( $\text{dBuA/m} = \text{dBuV/m} - 20\text{Log}_{10}[120\pi] = \text{dBuV/m} - 51.5$ ).
2. If the Peak values are less than the QP limit, the QP result is deemed to comply with QP limit.
3. All 3 polarizations (Horizontal, Face-on and Face-off) of the loop antenna had been tested, but only the worst data recorded in the report.
4. All modes, channels and antennas have been tested, only the worst data was recorded in the report.

For Radiate Spurious emission 18 GHz-26 GHz:

Note:

1. Measurement = Reading Level + Correct Factor.
2. If the Peak values are less than the Average limit of 54 dBuV/m, the Average result is deemed to comply with Average limit.
3. Peak: Peak detector.
4. All modes, channels and antennas have been tested, only the worst data was recorded in the report.

For Radiate Spurious emission 30 MHz-1 GHz:

Note:

1. Result Level = Read Level + Correct Factor.
2. If the Peak values are less than the QP limit, the QP result is deemed to comply with QP limit.
3. Test setup: RBW: 120 kHz, VBW: 300 kHz, Sweep time: auto.
4. All modes, channels and antennas have been tested, only the worst data was recorded in the report.

**TEST SETUP**

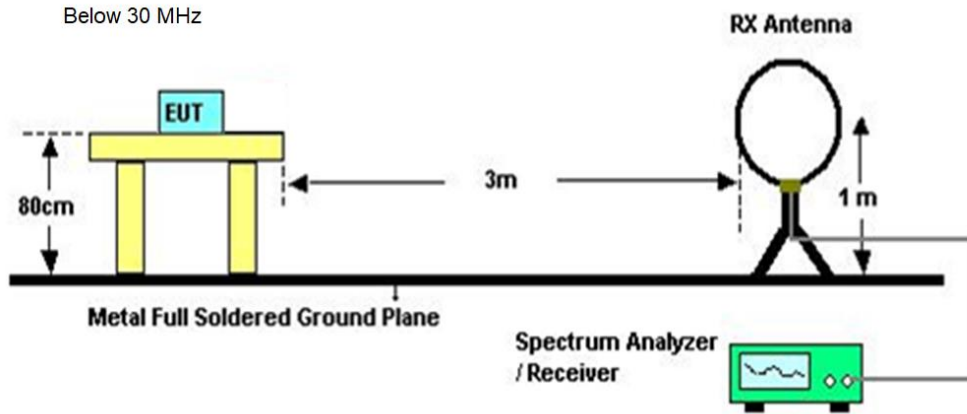

Below 1 GHz and above 30 MHz

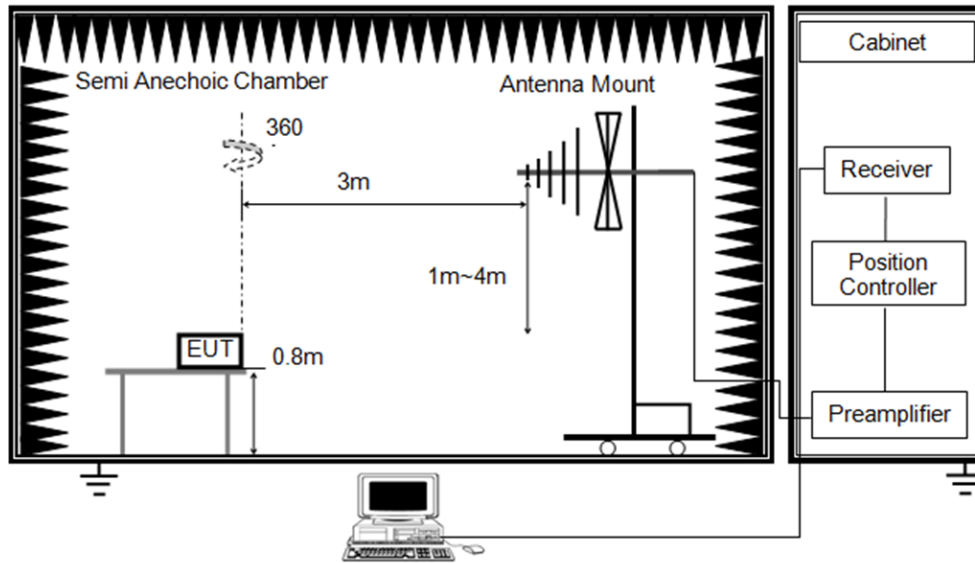

Above 1 GHz

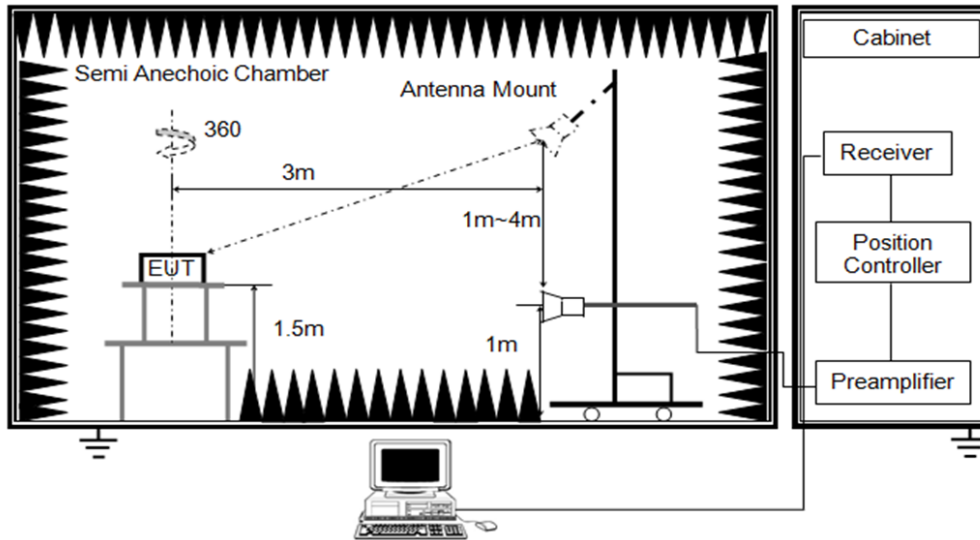



**TEST ENVIRONMENT**

|                     |         |                   |         |
|---------------------|---------|-------------------|---------|
| Temperature         | 24.9 °C | Relative Humidity | 62%     |
| Atmosphere Pressure | 101 kPa | Test Voltage      | DC 12 V |

**TEST RESULTS**

### 8.1. RESTRICTED BANDEDGE

|            |              |               |          |
|------------|--------------|---------------|----------|
| Test Mode: | 802.11b Peak | Channel:      | 2412 MHz |
| Polarity:  | Vertical     | Test Voltage: | DC 12 V  |

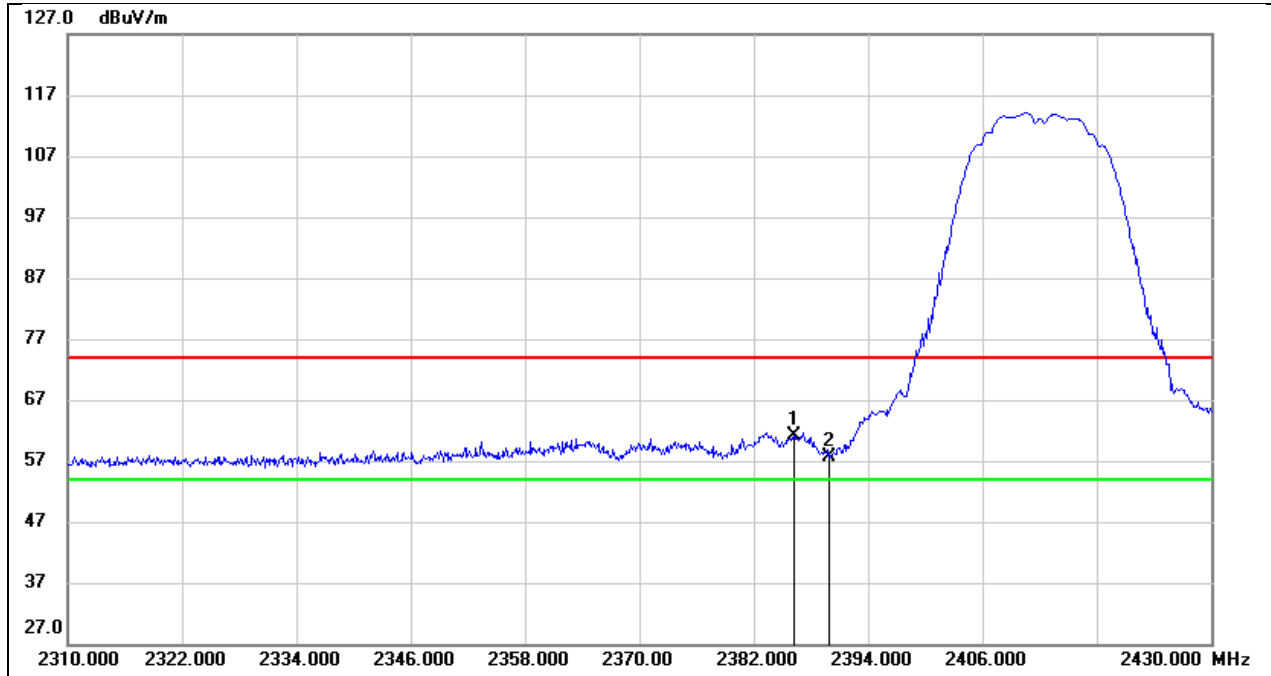

| No. | Frequency (MHz) | Reading (dBuV) | Correct (dB/m) | Result (dBuV/m) | Limit (dBuV/m) | Margin (dB) | Remark |
|-----|-----------------|----------------|----------------|-----------------|----------------|-------------|--------|
| 1   | 2386.200        | 28.88          | 32.14          | 61.02           | 74.00          | -12.98      | peak   |
| 2   | 2390.000        | 25.53          | 32.16          | 57.69           | 74.00          | -16.31      | peak   |

|            |                 |               |          |
|------------|-----------------|---------------|----------|
| Test Mode: | 802.11b Average | Channel:      | 2412 MHz |
| Polarity:  | Vertical        | Test Voltage: | DC 12 V  |

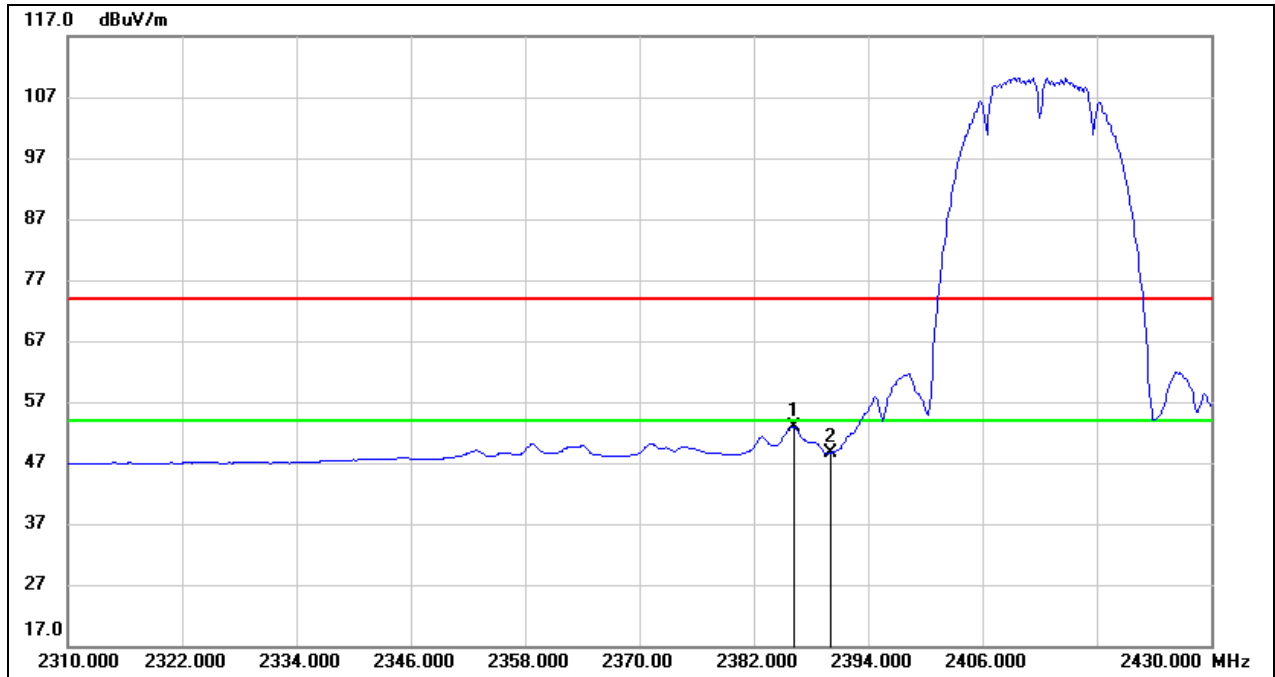

| No. | Frequency (MHz) | Reading (dBuV) | Correct (dB/m) | Result (dBuV/m) | Limit (dBuV/m) | Margin (dB) | Remark |
|-----|-----------------|----------------|----------------|-----------------|----------------|-------------|--------|
| 1   | 2386.200        | 20.82          | 32.14          | 52.96           | 54.00          | -1.04       | AVG    |
| 2   | 2390.000        | 16.46          | 32.16          | 48.62           | 54.00          | -5.38       | AVG    |

|            |              |               |          |
|------------|--------------|---------------|----------|
| Test Mode: | 802.11b Peak | Channel:      | 2462 MHz |
| Polarity:  | Vertical     | Test Voltage: | DC 12 V  |

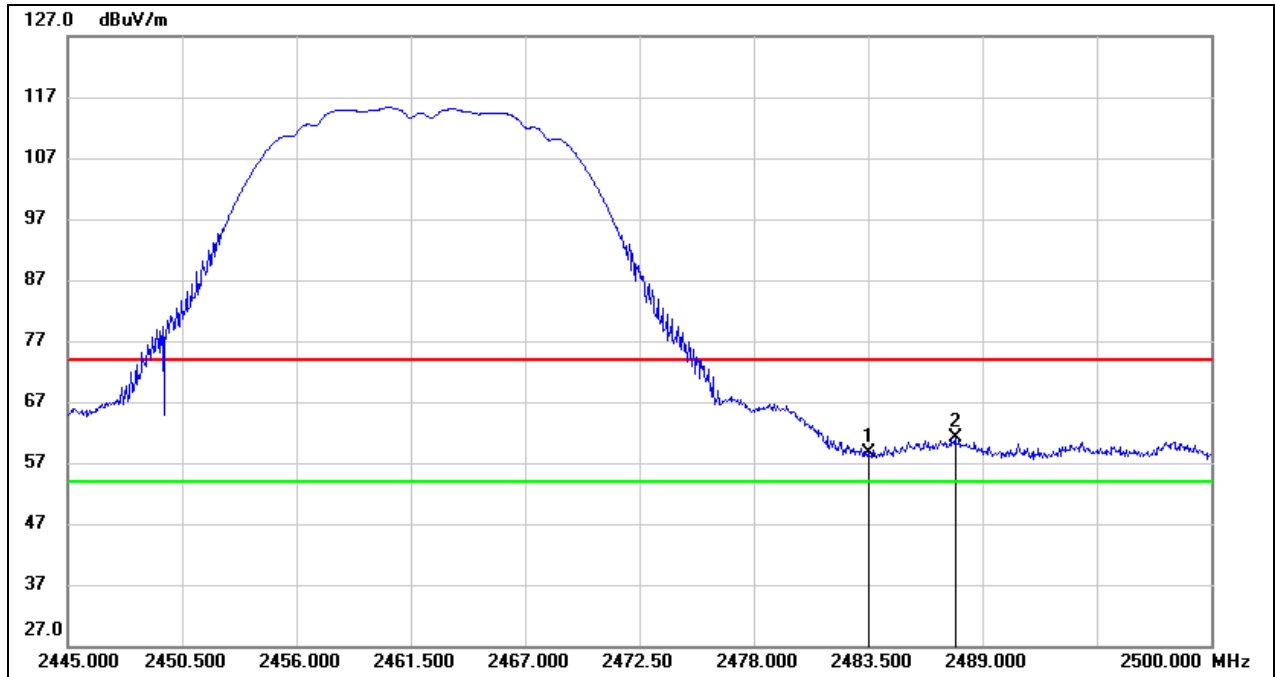

| No. | Frequency (MHz) | Reading (dBuV) | Correct (dB/m) | Result (dBuV/m) | Limit (dBuV/m) | Margin (dB) | Remark |
|-----|-----------------|----------------|----------------|-----------------|----------------|-------------|--------|
| 1   | 2483.500        | 26.07          | 32.44          | 58.51           | 74.00          | -15.49      | peak   |
| 2   | 2487.680        | 28.61          | 32.46          | 61.07           | 74.00          | -12.93      | peak   |

|            |                 |               |          |
|------------|-----------------|---------------|----------|
| Test Mode: | 802.11b Average | Channel:      | 2462 MHz |
| Polarity:  | Vertical        | Test Voltage: | DC 12 V  |

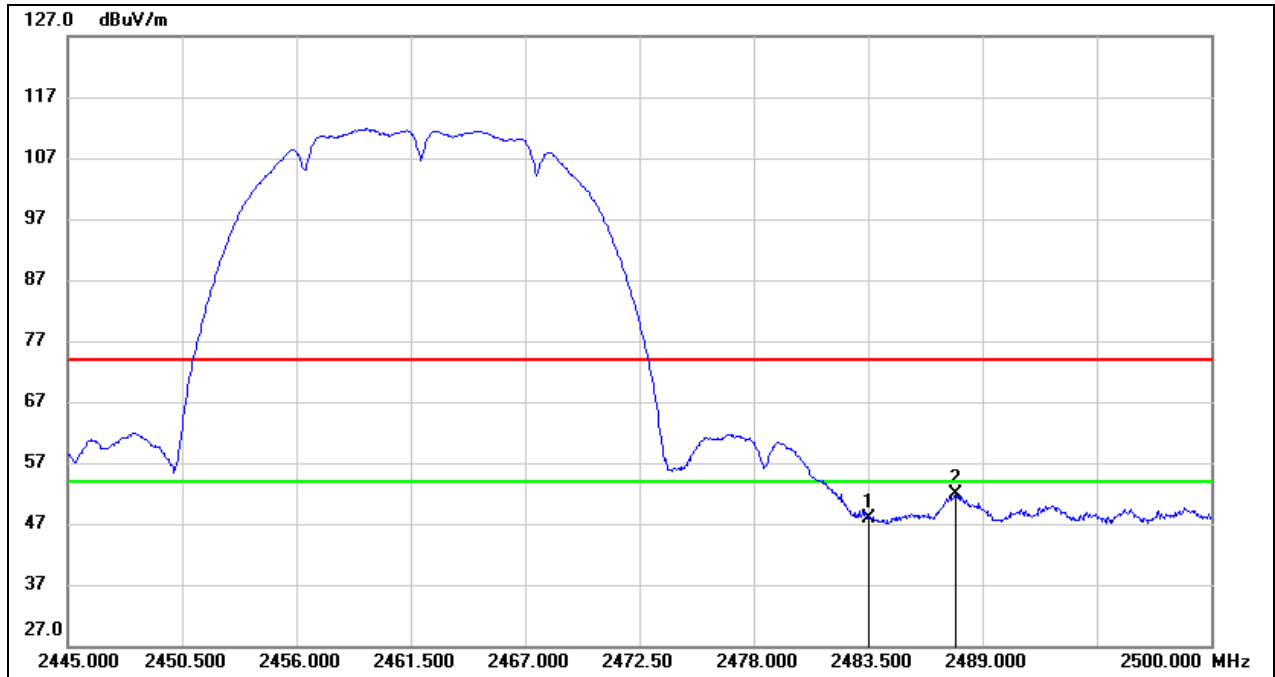

| No. | Frequency (MHz) | Reading (dBuV) | Correct (dB/m) | Result (dBuV/m) | Limit (dBuV/m) | Margin (dB) | Remark |
|-----|-----------------|----------------|----------------|-----------------|----------------|-------------|--------|
| 1   | 2483.500        | 15.47          | 32.44          | 47.91           | 54.00          | -6.09       | AVG    |
| 2   | 2487.680        | 19.40          | 32.46          | 51.86           | 54.00          | -2.14       | AVG    |

|            |              |               |          |
|------------|--------------|---------------|----------|
| Test Mode: | 802.11g Peak | Channel:      | 2412 MHz |
| Polarity:  | Vertical     | Test Voltage: | DC 12 V  |

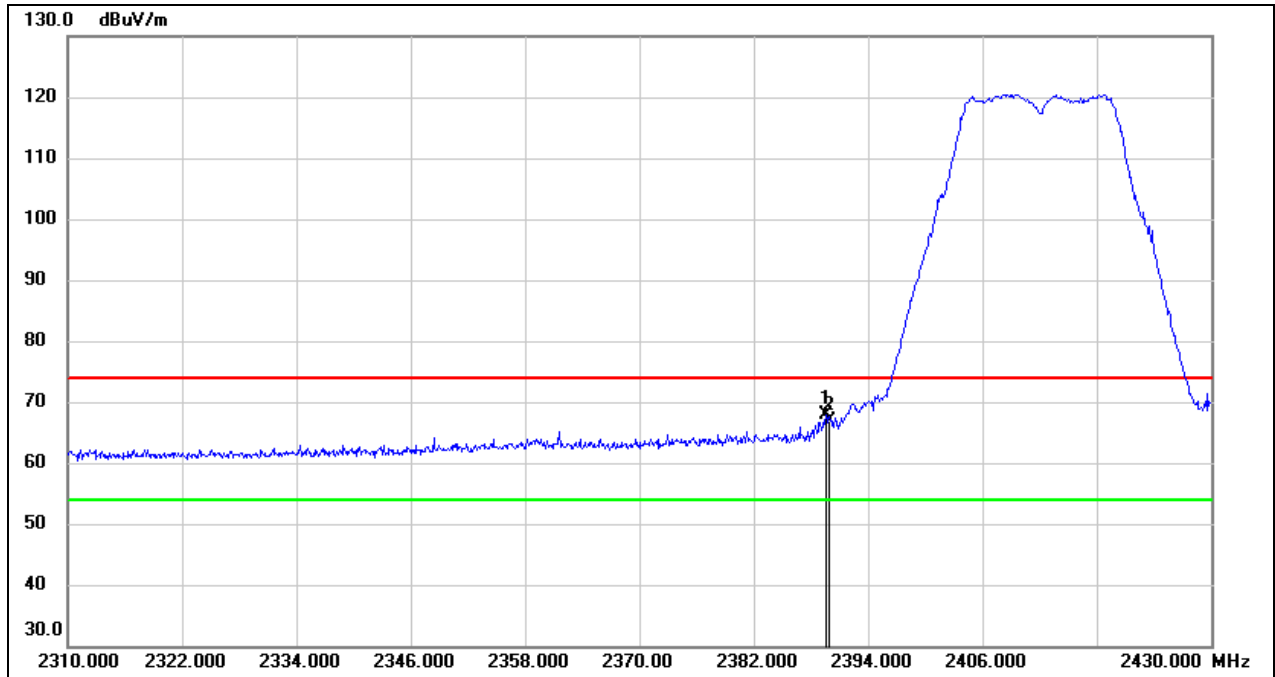

| No. | Frequency (MHz) | Reading (dBuV) | Correct (dB/m) | Result (dBuV/m) | Limit (dBuV/m) | Margin (dB) | Remark |
|-----|-----------------|----------------|----------------|-----------------|----------------|-------------|--------|
| 1   | 2389.560        | 35.77          | 32.16          | 67.93           | 74.00          | -6.07       | peak   |
| 2   | 2390.000        | 34.62          | 32.16          | 66.78           | 74.00          | -7.22       | peak   |

|            |                 |               |          |
|------------|-----------------|---------------|----------|
| Test Mode: | 802.11g Average | Channel:      | 2412 MHz |
| Polarity:  | Vertical        | Test Voltage: | DC 12 V  |

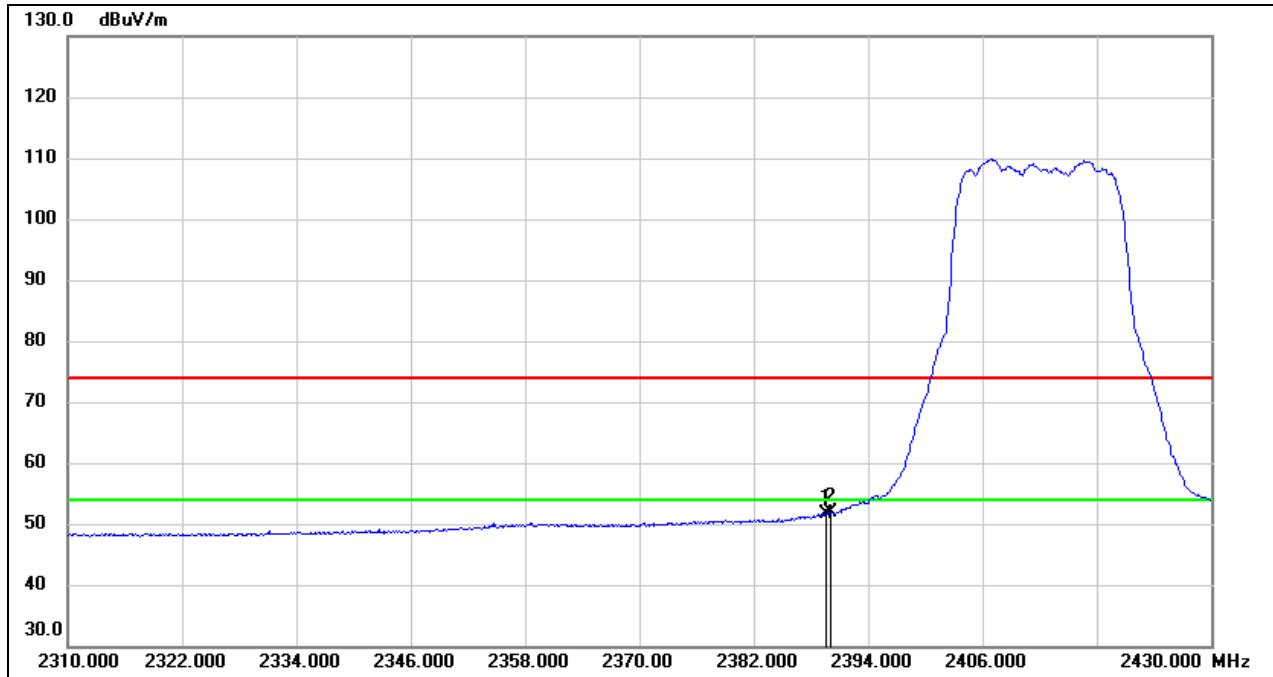

| No. | Frequency (MHz) | Reading (dBuV) | Correct (dB/m) | Result (dBuV/m) | Limit (dBuV/m) | Margin (dB) | Remark |
|-----|-----------------|----------------|----------------|-----------------|----------------|-------------|--------|
| 1   | 2389.560        | 19.46          | 32.16          | 51.62           | 54.00          | -2.38       | AVG    |
| 2   | 2390.000        | 19.75          | 32.16          | 51.91           | 54.00          | -2.09       | AVG    |

|            |              |               |          |
|------------|--------------|---------------|----------|
| Test Mode: | 802.11g Peak | Channel:      | 2417 MHz |
| Polarity:  | Vertical     | Test Voltage: | DC 12 V  |

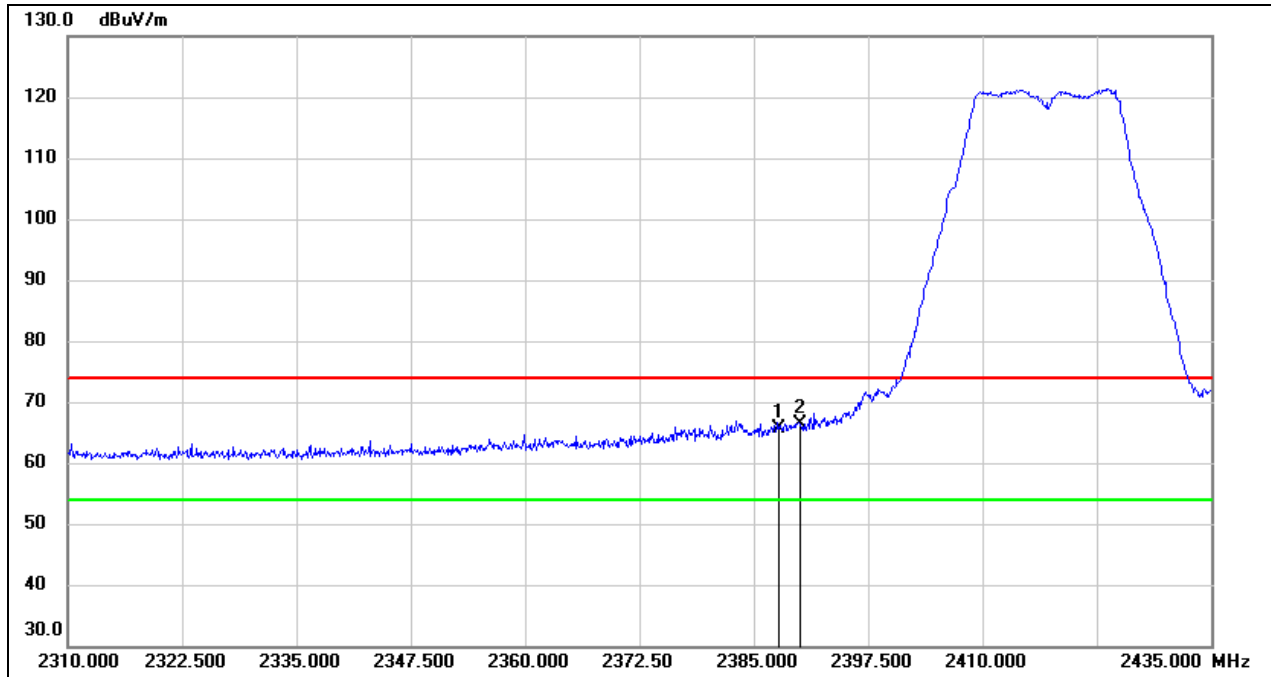

| No. | Frequency (MHz) | Reading (dBuV) | Correct (dB/m) | Result (dBuV/m) | Limit (dBuV/m) | Margin (dB) | Remark |
|-----|-----------------|----------------|----------------|-----------------|----------------|-------------|--------|
| 1   | 2387.750        | 33.50          | 32.16          | 65.66           | 74.00          | -8.34       | peak   |
| 2   | 2390.000        | 34.23          | 32.16          | 66.39           | 74.00          | -7.61       | peak   |



|            |                 |               |          |
|------------|-----------------|---------------|----------|
| Test Mode: | 802.11g Average | Channel:      | 2417 MHz |
| Polarity:  | Vertical        | Test Voltage: | DC 12 V  |

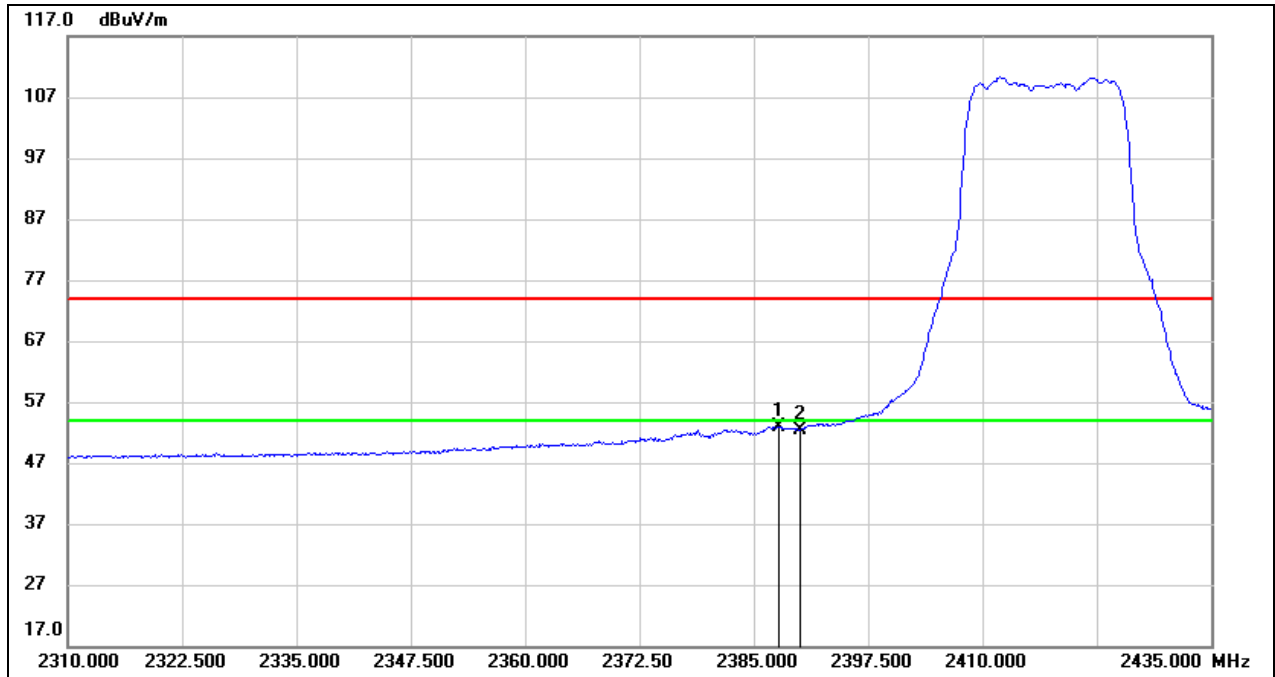

| No. | Frequency (MHz) | Reading (dBuV) | Correct (dB/m) | Result (dBuV/m) | Limit (dBuV/m) | Margin (dB) | Remark |
|-----|-----------------|----------------|----------------|-----------------|----------------|-------------|--------|
| 1   | 2387.750        | 20.83          | 32.16          | 52.99           | 54.00          | -1.01       | AVG    |
| 2   | 2390.000        | 20.25          | 32.16          | 52.41           | 54.00          | -1.59       | AVG    |

|            |              |               |          |
|------------|--------------|---------------|----------|
| Test Mode: | 802.11g Peak | Channel:      | 2437 MHz |
| Polarity:  | Vertical     | Test Voltage: | DC 12 V  |

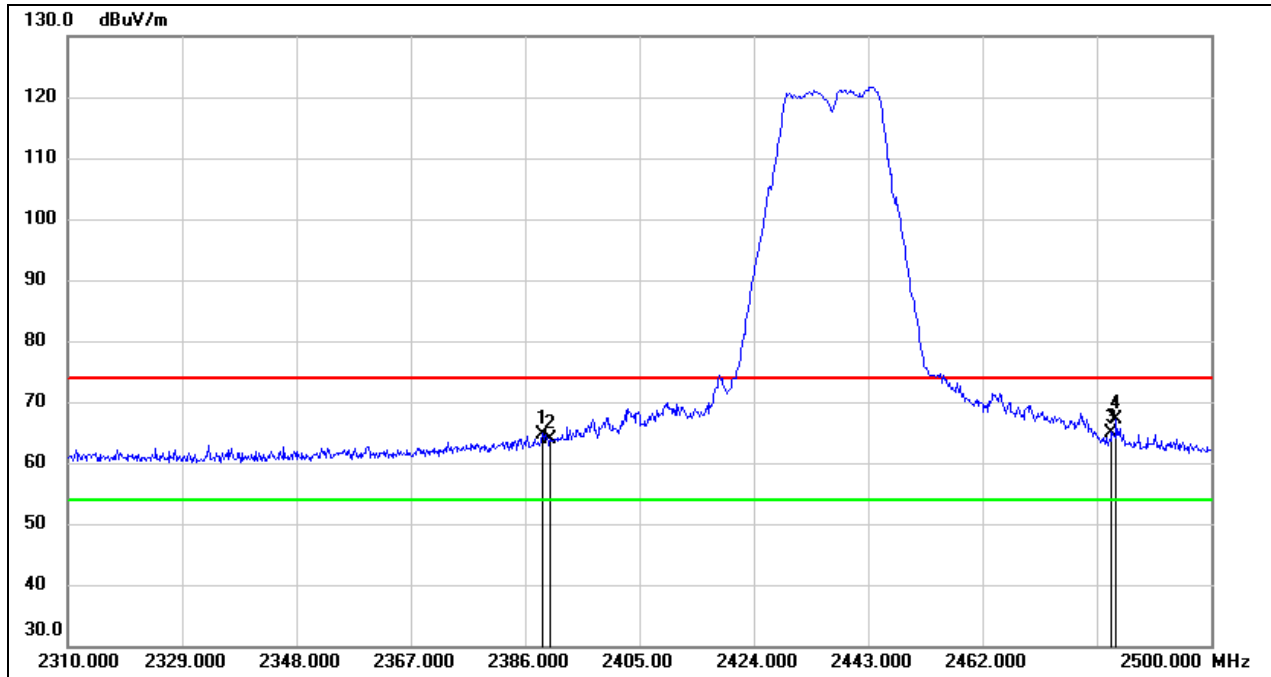

| No. | Frequency (MHz) | Reading (dBuV) | Correct (dB/m) | Result (dBuV/m) | Limit (dBuV/m) | Margin (dB) | Remark |
|-----|-----------------|----------------|----------------|-----------------|----------------|-------------|--------|
| 1   | 2388.850        | 32.59          | 32.16          | 64.75           | 74.00          | -9.25       | peak   |
| 2   | 2390.000        | 31.66          | 32.16          | 63.82           | 74.00          | -10.18      | peak   |
| 3   | 2483.500        | 32.44          | 32.44          | 64.88           | 74.00          | -9.12       | peak   |
| 4   | 2484.230        | 34.69          | 32.44          | 67.13           | 74.00          | -6.87       | peak   |

|            |                 |               |          |
|------------|-----------------|---------------|----------|
| Test Mode: | 802.11g Average | Channel:      | 2437 MHz |
| Polarity:  | Vertical        | Test Voltage: | DC 12 V  |

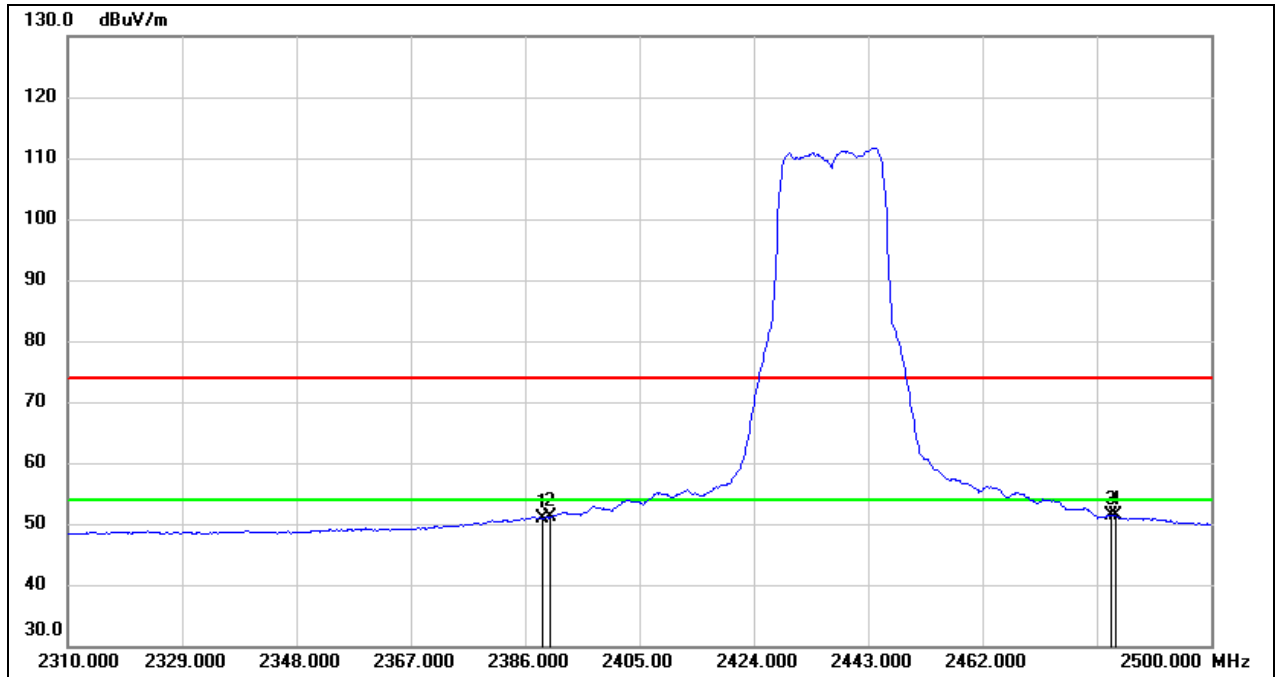

| No. | Frequency (MHz) | Reading (dBuV) | Correct (dB/m) | Result (dBuV/m) | Limit (dBuV/m) | Margin (dB) | Remark |
|-----|-----------------|----------------|----------------|-----------------|----------------|-------------|--------|
| 1   | 2388.850        | 18.78          | 32.16          | 50.94           | 54.00          | -3.06       | AVG    |
| 2   | 2390.000        | 18.90          | 32.16          | 51.06           | 54.00          | -2.94       | AVG    |
| 3   | 2483.500        | 18.86          | 32.44          | 51.30           | 54.00          | -2.70       | AVG    |
| 4   | 2484.230        | 18.87          | 32.44          | 51.31           | 54.00          | -2.69       | AVG    |

|            |              |               |          |
|------------|--------------|---------------|----------|
| Test Mode: | 802.11g Peak | Channel:      | 2457 MHz |
| Polarity:  | Vertical     | Test Voltage: | DC 12 V  |

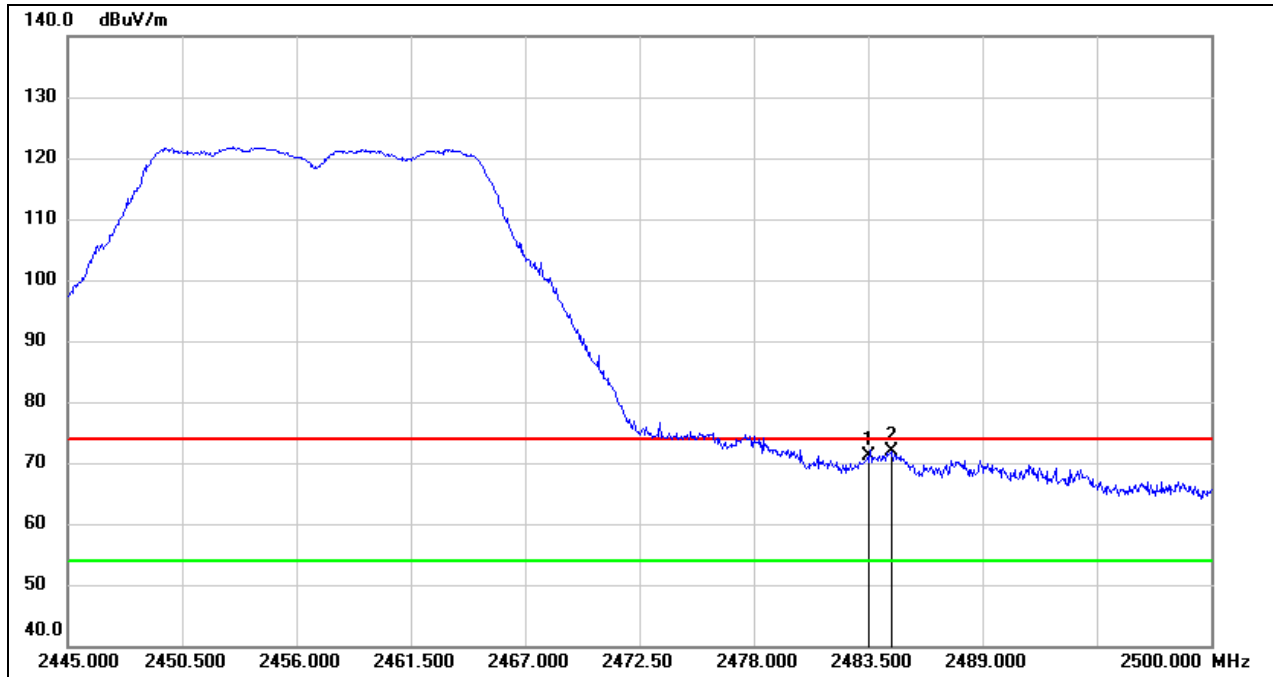

| No. | Frequency (MHz) | Reading (dBuV) | Correct (dB/m) | Result (dBuV/m) | Limit (dBuV/m) | Margin (dB) | Remark |
|-----|-----------------|----------------|----------------|-----------------|----------------|-------------|--------|
| 1   | 2483.500        | 38.62          | 32.44          | 71.06           | 74.00          | -2.94       | peak   |
| 2   | 2484.655        | 39.33          | 32.44          | 71.77           | 74.00          | -2.23       | peak   |

|            |                 |               |          |
|------------|-----------------|---------------|----------|
| Test Mode: | 802.11g Average | Channel:      | 2457 MHz |
| Polarity:  | Vertical        | Test Voltage: | DC 12 V  |

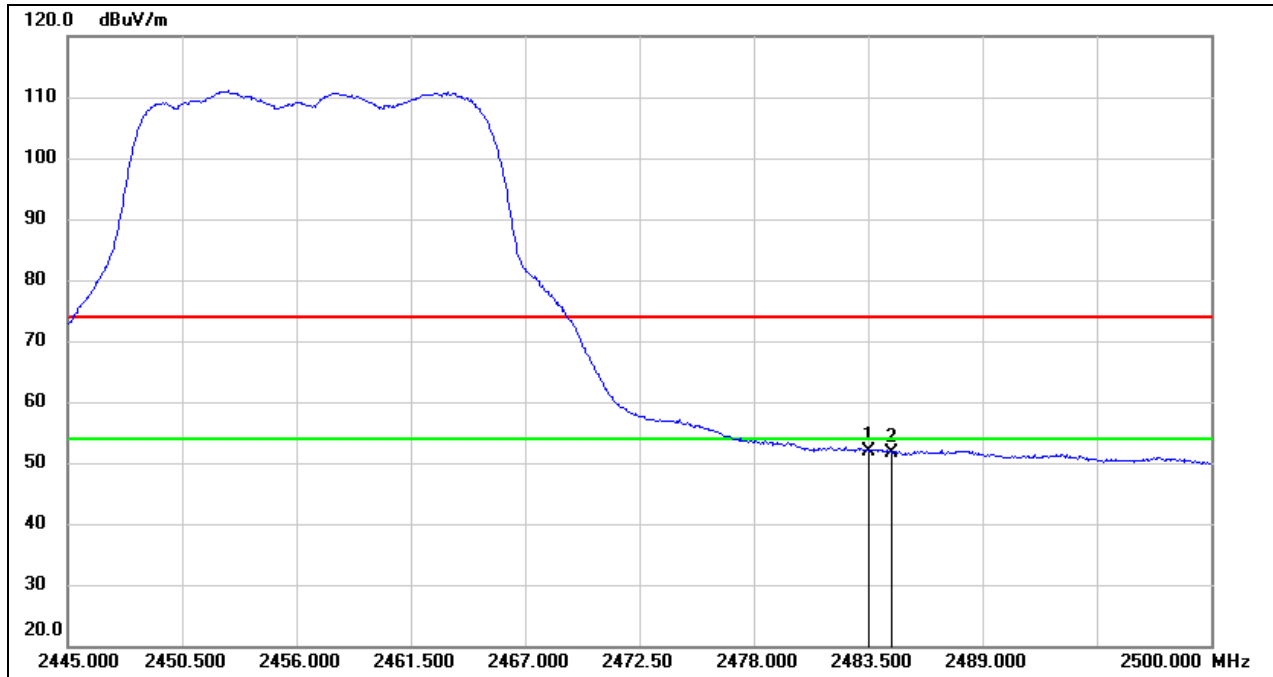

| No. | Frequency (MHz) | Reading (dBuV) | Correct (dB/m) | Result (dBuV/m) | Limit (dBuV/m) | Margin (dB) | Remark |
|-----|-----------------|----------------|----------------|-----------------|----------------|-------------|--------|
| 1   | 2483.500        | 19.54          | 32.44          | 51.98           | 54.00          | -2.02       | AVG    |
| 2   | 2484.655        | 19.27          | 32.44          | 51.71           | 54.00          | -2.29       | AVG    |

|            |              |               |          |
|------------|--------------|---------------|----------|
| Test Mode: | 802.11g Peak | Channel:      | 2462 MHz |
| Polarity:  | Vertical     | Test Voltage: | DC 12 V  |

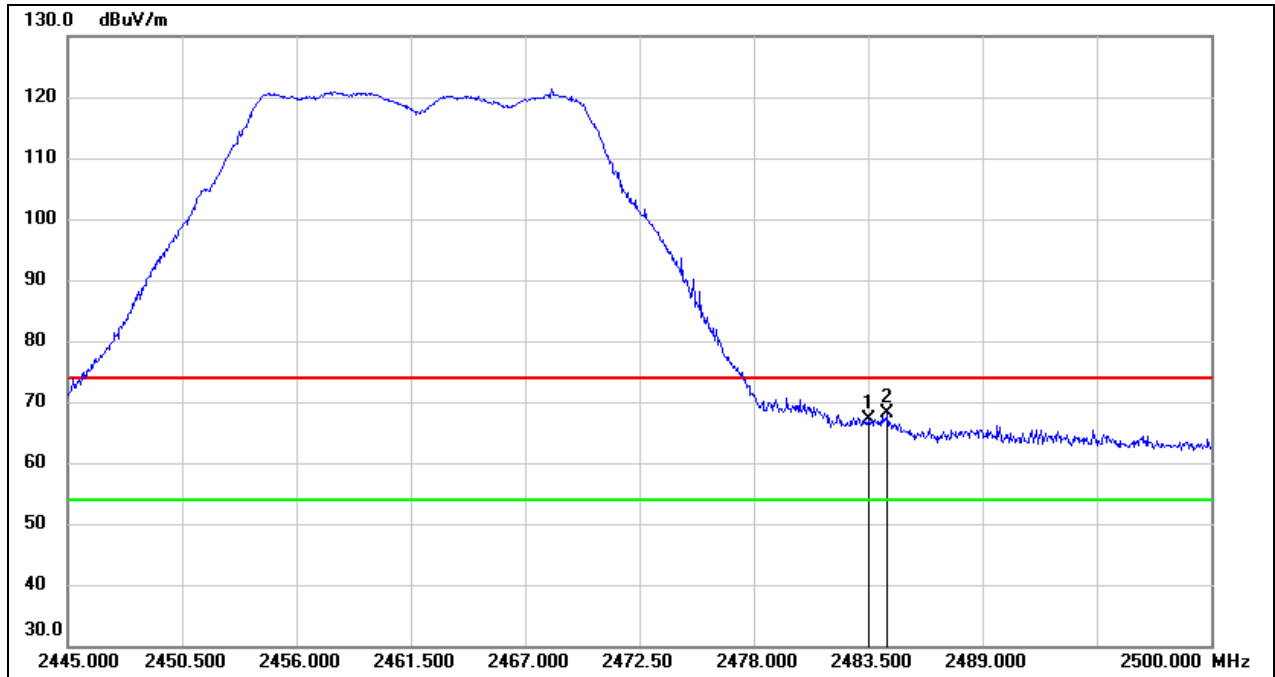

| No. | Frequency (MHz) | Reading (dBuV) | Correct (dB/m) | Result (dBuV/m) | Limit (dBuV/m) | Margin (dB) | Remark |
|-----|-----------------|----------------|----------------|-----------------|----------------|-------------|--------|
| 1   | 2483.500        | 34.70          | 32.44          | 67.14           | 74.00          | -6.86       | peak   |
| 2   | 2484.435        | 35.79          | 32.44          | 68.23           | 74.00          | -5.77       | peak   |

|            |                 |               |          |
|------------|-----------------|---------------|----------|
| Test Mode: | 802.11g Average | Channel:      | 2462 MHz |
| Polarity:  | Vertical        | Test Voltage: | DC 12 V  |

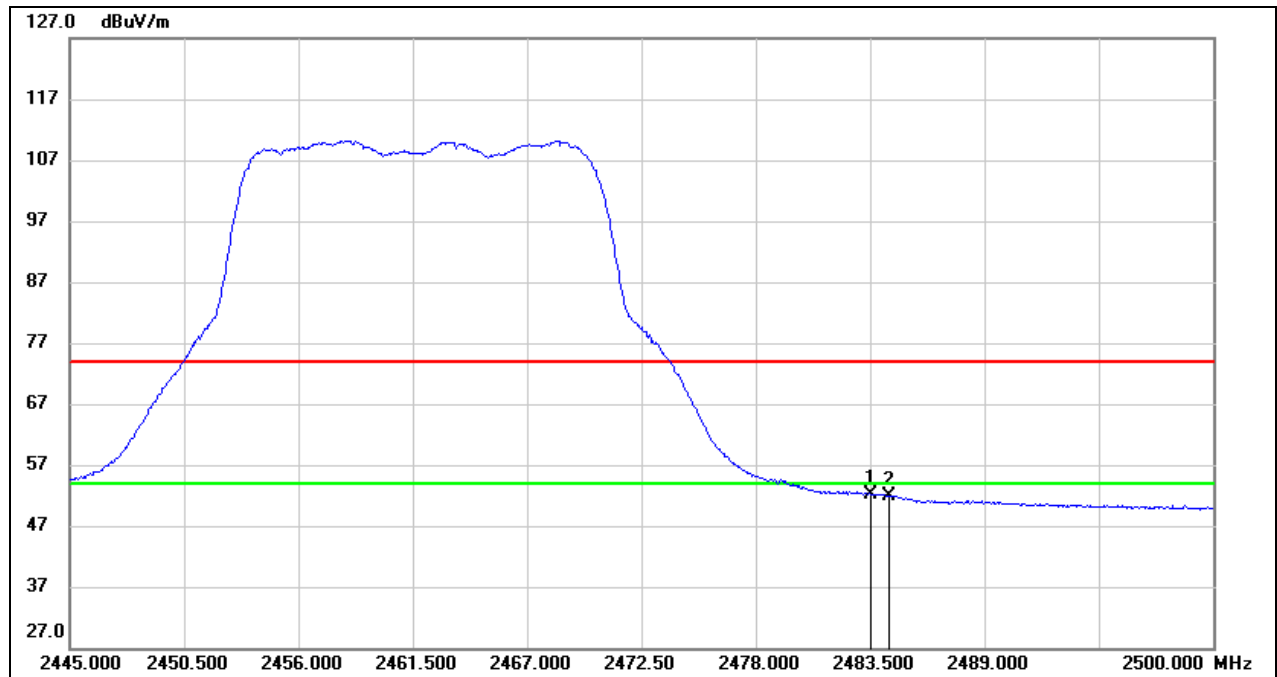

| No. | Frequency (MHz) | Reading (dBuV) | Correct (dB/m) | Result (dBuV/m) | Limit (dBuV/m) | Margin (dB) | Remark |
|-----|-----------------|----------------|----------------|-----------------|----------------|-------------|--------|
| 1   | 2483.500        | 19.70          | 32.44          | 52.14           | 54.00          | -1.86       | AVG    |
| 2   | 2484.435        | 19.35          | 32.44          | 51.79           | 54.00          | -2.21       | AVG    |

|            |                    |               |          |
|------------|--------------------|---------------|----------|
| Test Mode: | 802.11ax HE20 Peak | Channel:      | 2412 MHz |
| Polarity:  | Vertical           | Test Voltage: | DC 12 V  |

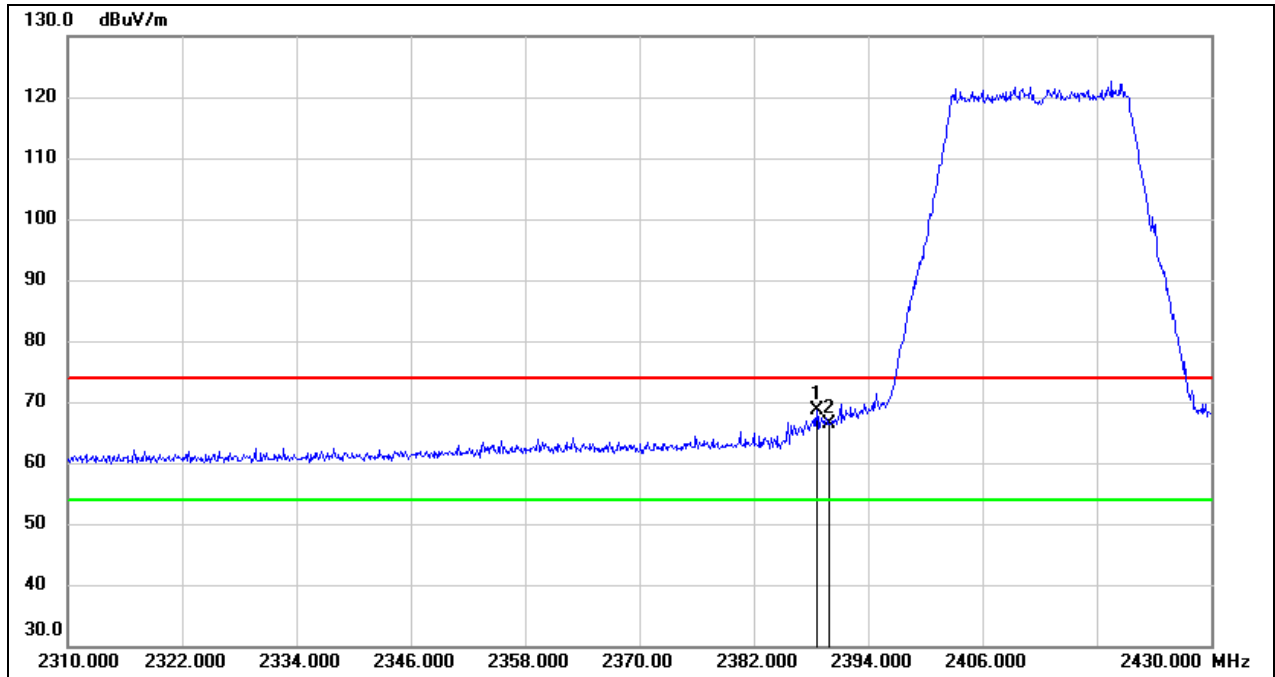

| No. | Frequency (MHz) | Reading (dBuV) | Correct (dB/m) | Result (dBuV/m) | Limit (dBuV/m) | Margin (dB) | Remark |
|-----|-----------------|----------------|----------------|-----------------|----------------|-------------|--------|
| 1   | 2388.600        | 36.40          | 32.16          | 68.56           | 74.00          | -5.44       | peak   |
| 2   | 2390.000        | 34.11          | 32.16          | 66.27           | 74.00          | -7.73       | peak   |



|            |                       |               |          |
|------------|-----------------------|---------------|----------|
| Test Mode: | 802.11ax HE20 Average | Channel:      | 2412 MHz |
| Polarity:  | Vertical              | Test Voltage: | DC 12 V  |

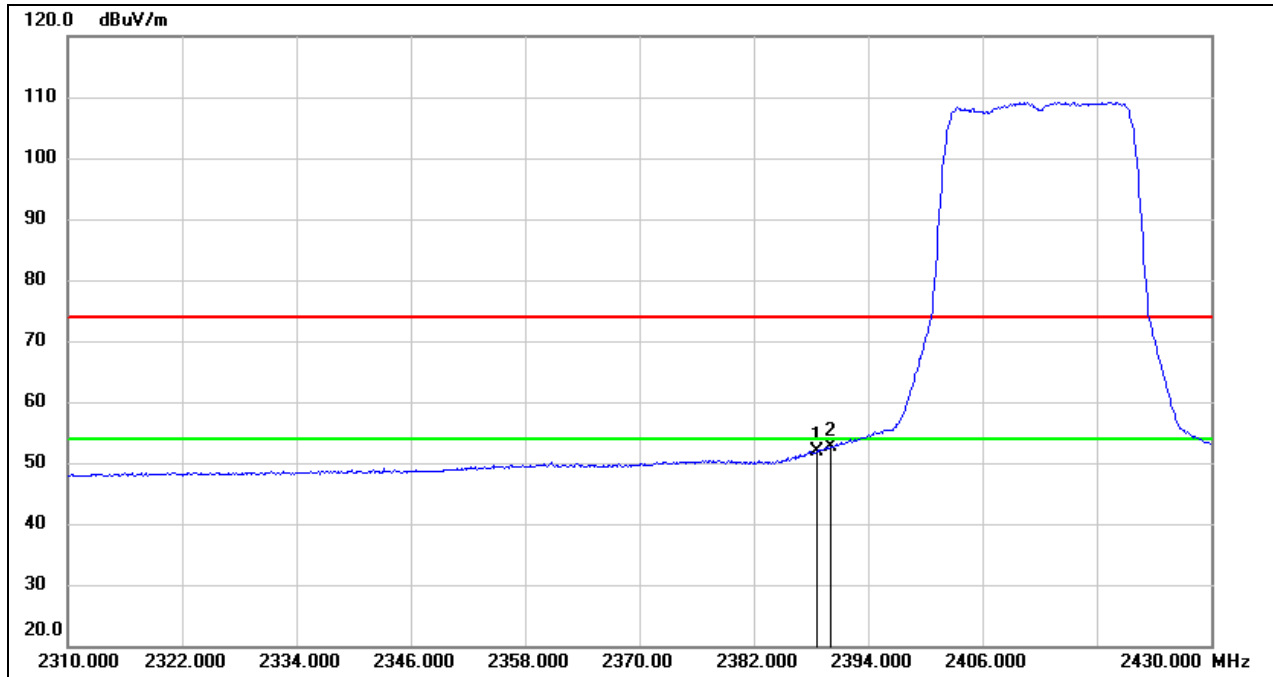

| No. | Frequency (MHz) | Reading (dBuV) | Correct (dB/m) | Result (dBuV/m) | Limit (dBuV/m) | Margin (dB) | Remark |
|-----|-----------------|----------------|----------------|-----------------|----------------|-------------|--------|
| 1   | 2388.600        | 19.65          | 32.16          | 51.81           | 54.00          | -2.19       | AVG    |
| 2   | 2390.000        | 20.45          | 32.16          | 52.61           | 54.00          | -1.39       | AVG    |

|            |                    |               |          |
|------------|--------------------|---------------|----------|
| Test Mode: | 802.11ax HE20 Peak | Channel:      | 2417 MHz |
| Polarity:  | Vertical           | Test Voltage: | DC 12 V  |

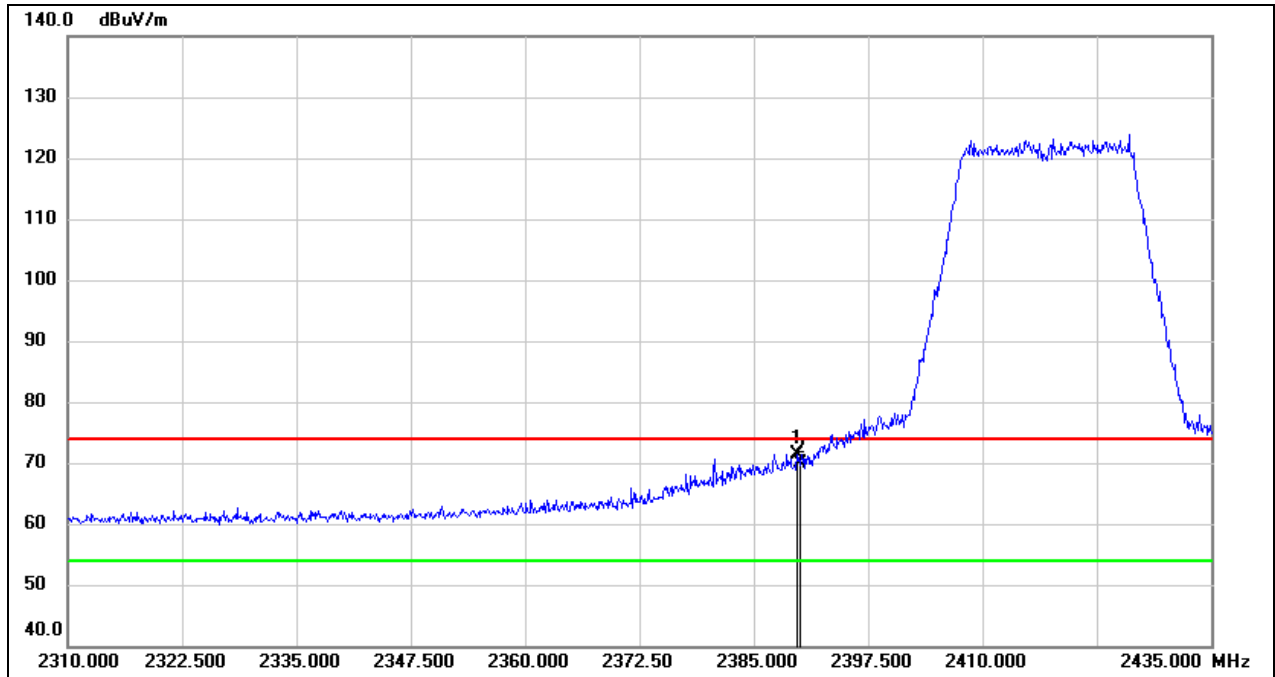

| No. | Frequency (MHz) | Reading (dBuV) | Correct (dB/m) | Result (dBuV/m) | Limit (dBuV/m) | Margin (dB) | Remark |
|-----|-----------------|----------------|----------------|-----------------|----------------|-------------|--------|
| 1   | 2389.750        | 39.29          | 32.16          | 71.45           | 74.00          | -2.55       | peak   |
| 2   | 2390.000        | 37.76          | 32.16          | 69.92           | 74.00          | -4.08       | peak   |

|            |                       |               |          |
|------------|-----------------------|---------------|----------|
| Test Mode: | 802.11ax HE20 Average | Channel:      | 2417 MHz |
| Polarity:  | Vertical              | Test Voltage: | DC 12 V  |

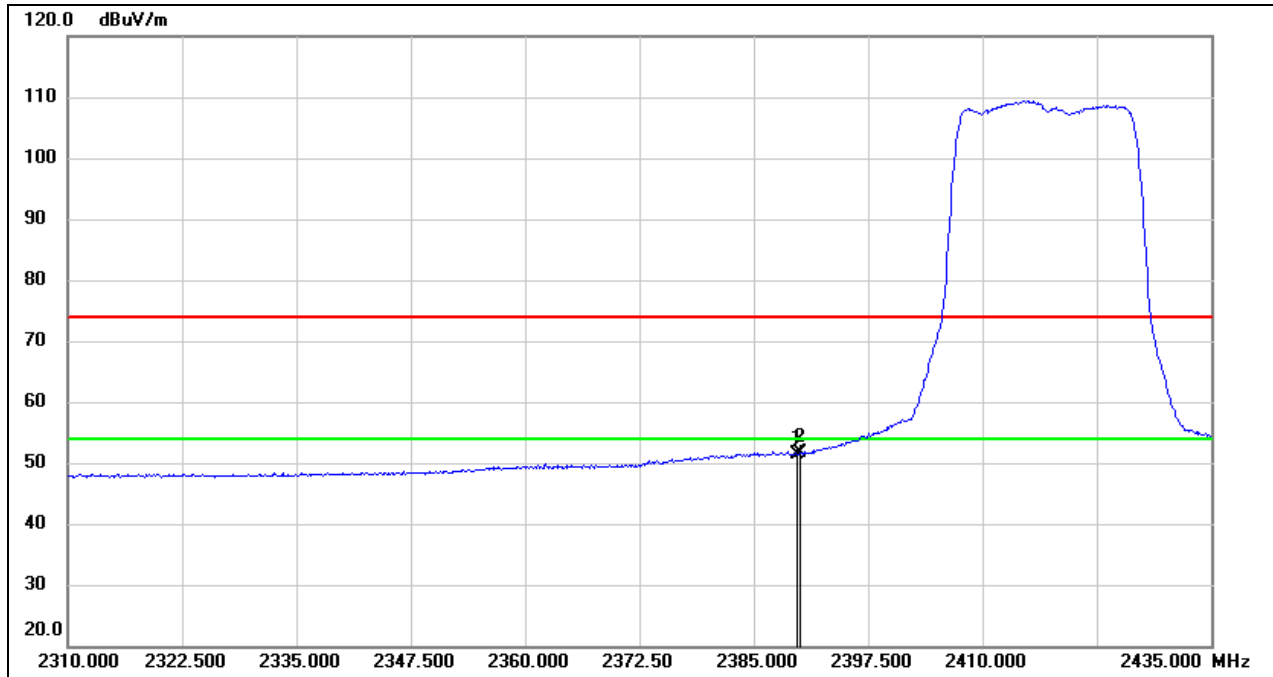

| No. | Frequency (MHz) | Reading (dBuV) | Correct (dB/m) | Result (dBuV/m) | Limit (dBuV/m) | Margin (dB) | Remark |
|-----|-----------------|----------------|----------------|-----------------|----------------|-------------|--------|
| 1   | 2389.750        | 19.23          | 32.16          | 51.39           | 54.00          | -2.61       | AVG    |
| 2   | 2390.000        | 19.38          | 32.16          | 51.54           | 54.00          | -2.46       | AVG    |

|            |                    |               |          |
|------------|--------------------|---------------|----------|
| Test Mode: | 802.11ax HE20 Peak | Channel:      | 2437 MHz |
| Polarity:  | Vertical           | Test Voltage: | DC 12 V  |

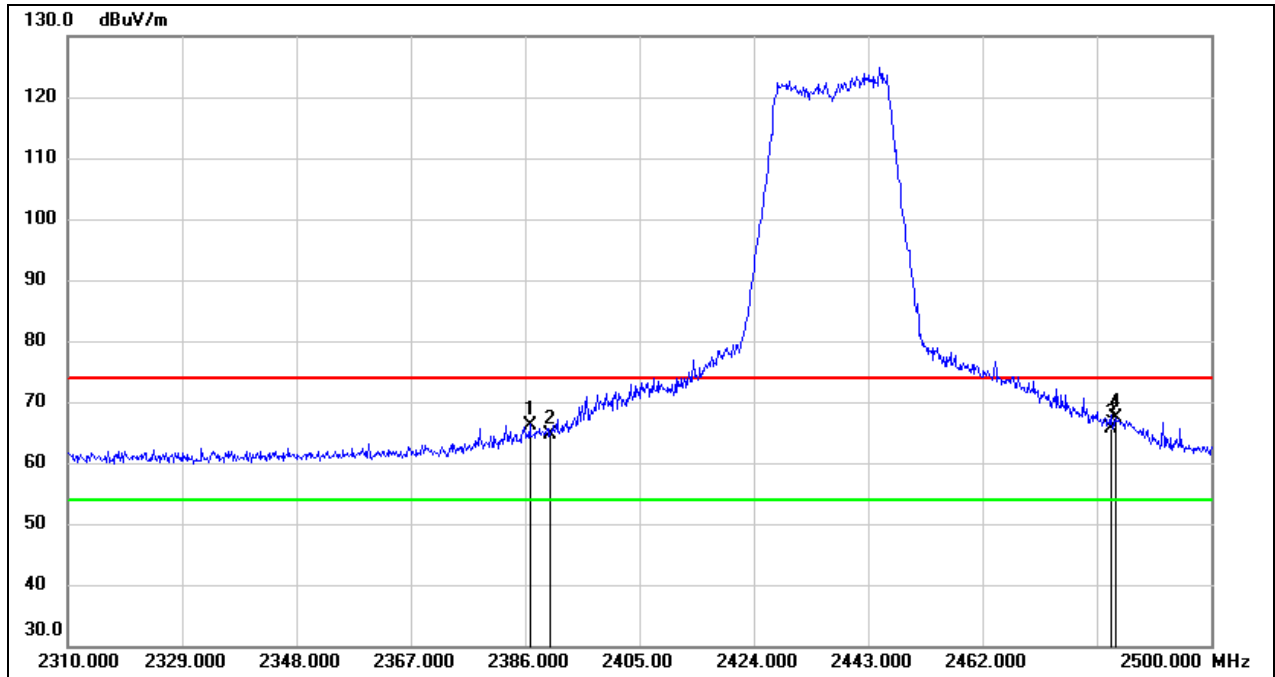

| No. | Frequency (MHz) | Reading (dBuV) | Correct (dB/m) | Result (dBuV/m) | Limit (dBuV/m) | Margin (dB) | Remark |
|-----|-----------------|----------------|----------------|-----------------|----------------|-------------|--------|
| 1   | 2386.760        | 34.10          | 32.15          | 66.25           | 74.00          | -7.75       | peak   |
| 2   | 2390.000        | 32.48          | 32.16          | 64.64           | 74.00          | -9.36       | peak   |
| 3   | 2483.500        | 33.30          | 32.44          | 65.74           | 74.00          | -8.26       | peak   |
| 4   | 2484.040        | 34.95          | 32.44          | 67.39           | 74.00          | -6.61       | peak   |

|            |                       |               |          |
|------------|-----------------------|---------------|----------|
| Test Mode: | 802.11ax HE20 Average | Channel:      | 2437 MHz |
| Polarity:  | Vertical              | Test Voltage: | DC 12 V  |

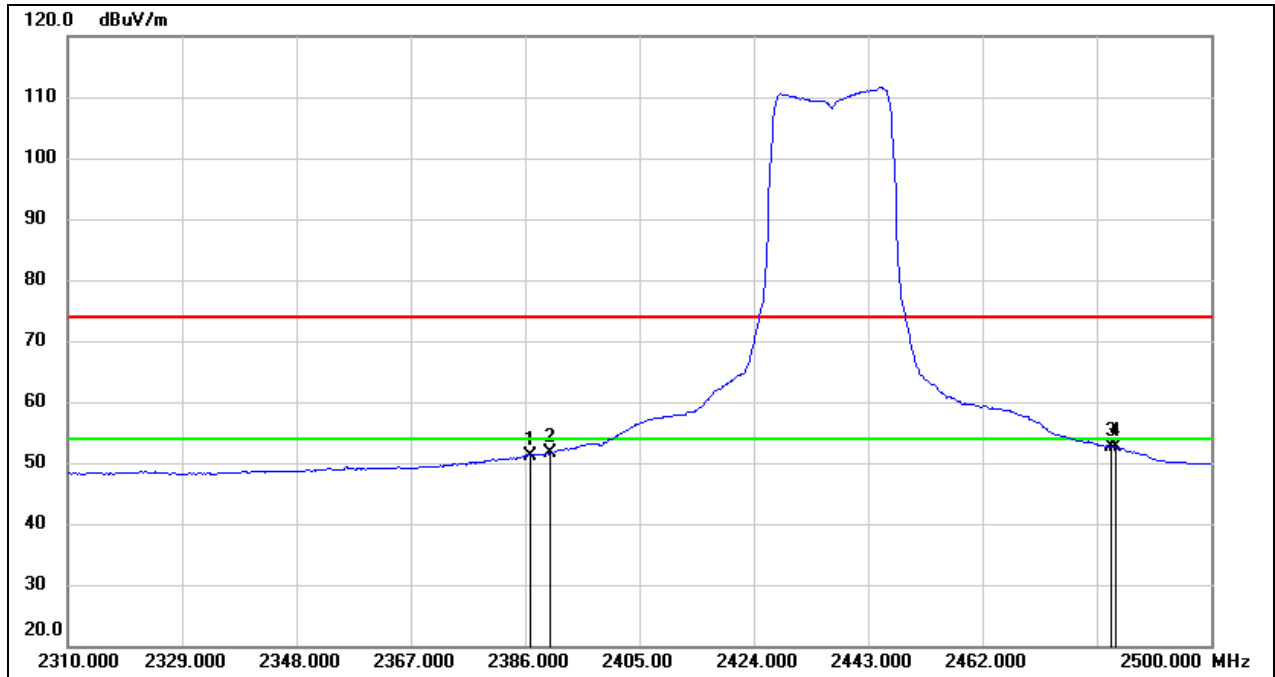

| No. | Frequency (MHz) | Reading (dBuV) | Correct (dB/m) | Result (dBuV/m) | Limit (dBuV/m) | Margin (dB) | Remark |
|-----|-----------------|----------------|----------------|-----------------|----------------|-------------|--------|
| 1   | 2386.760        | 19.02          | 32.15          | 51.17           | 54.00          | -2.83       | AVG    |
| 2   | 2390.000        | 19.36          | 32.16          | 51.52           | 54.00          | -2.48       | AVG    |
| 3   | 2483.500        | 20.15          | 32.44          | 52.59           | 54.00          | -1.41       | AVG    |
| 4   | 2484.040        | 20.19          | 32.44          | 52.63           | 54.00          | -1.37       | AVG    |

|            |                    |               |          |
|------------|--------------------|---------------|----------|
| Test Mode: | 802.11ax HE20 Peak | Channel:      | 2457 MHz |
| Polarity:  | Vertical           | Test Voltage: | DC 12 V  |

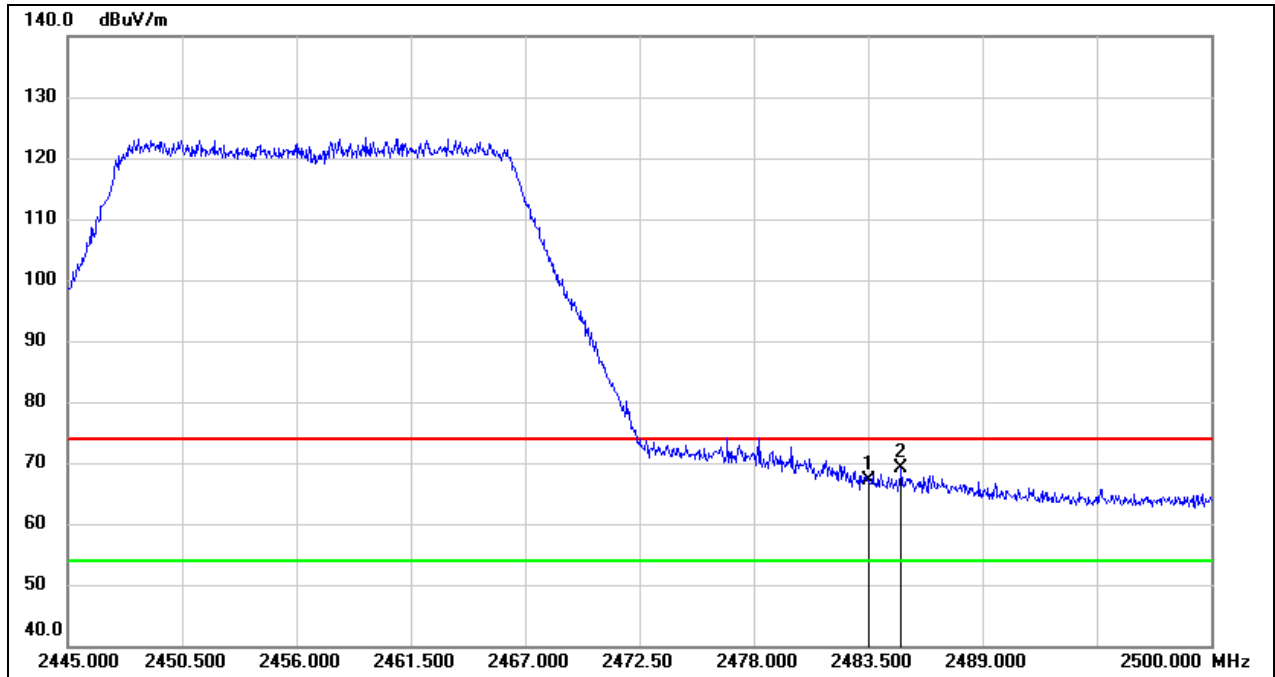

| No. | Frequency (MHz) | Reading (dBuV) | Correct (dB/m) | Result (dBuV/m) | Limit (dBuV/m) | Margin (dB) | Remark |
|-----|-----------------|----------------|----------------|-----------------|----------------|-------------|--------|
| 1   | 2483.500        | 34.72          | 32.44          | 67.16           | 74.00          | -6.84       | peak   |
| 2   | 2485.095        | 36.74          | 32.44          | 69.18           | 74.00          | -4.82       | peak   |

|            |                       |               |          |
|------------|-----------------------|---------------|----------|
| Test Mode: | 802.11ax HE20 Average | Channel:      | 2457 MHz |
| Polarity:  | Vertical              | Test Voltage: | DC 12 V  |

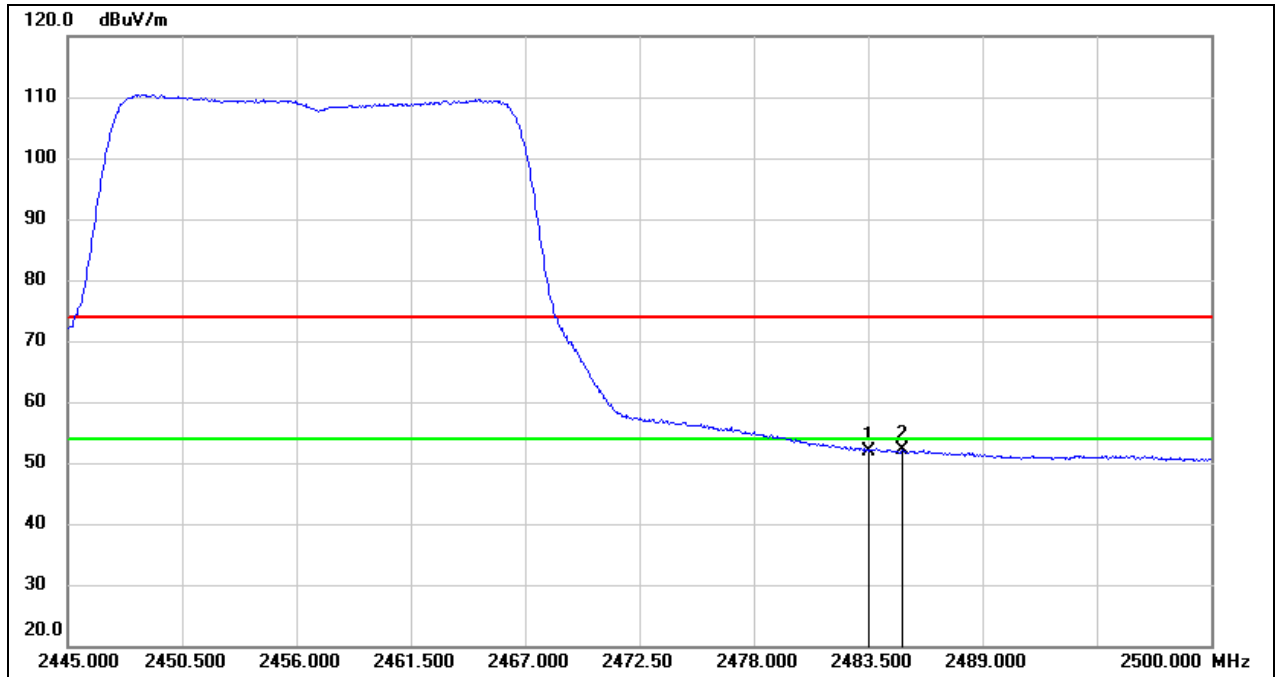

| No. | Frequency (MHz) | Reading (dBuV) | Correct (dB/m) | Result (dBuV/m) | Limit (dBuV/m) | Margin (dB) | Remark |
|-----|-----------------|----------------|----------------|-----------------|----------------|-------------|--------|
| 1   | 2483.500        | 19.39          | 32.44          | 51.83           | 54.00          | -2.17       | AVG    |
| 2   | 2485.095        | 19.62          | 32.44          | 52.06           | 54.00          | -1.94       | AVG    |

|            |                    |               |          |
|------------|--------------------|---------------|----------|
| Test Mode: | 802.11ax HE20 Peak | Channel:      | 2462 MHz |
| Polarity:  | Vertical           | Test Voltage: | DC 12 V  |

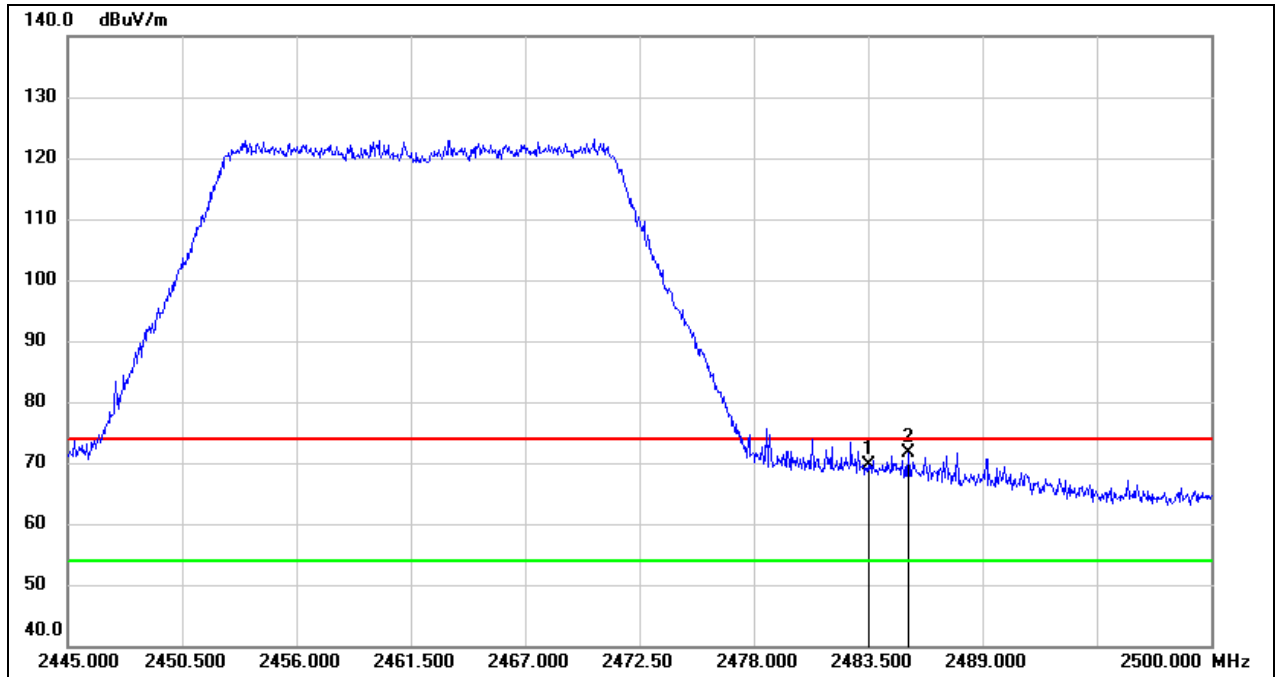

| No. | Frequency (MHz) | Reading (dBuV) | Correct (dB/m) | Result (dBuV/m) | Limit (dBuV/m) | Margin (dB) | Remark |
|-----|-----------------|----------------|----------------|-----------------|----------------|-------------|--------|
| 1   | 2483.500        | 37.14          | 32.44          | 69.58           | 74.00          | -4.42       | peak   |
| 2   | 2485.425        | 39.27          | 32.44          | 71.71           | 74.00          | -2.29       | peak   |



|            |                       |               |          |
|------------|-----------------------|---------------|----------|
| Test Mode: | 802.11ax HE20 Average | Channel:      | 2462 MHz |
| Polarity:  | Vertical              | Test Voltage: | DC 12 V  |

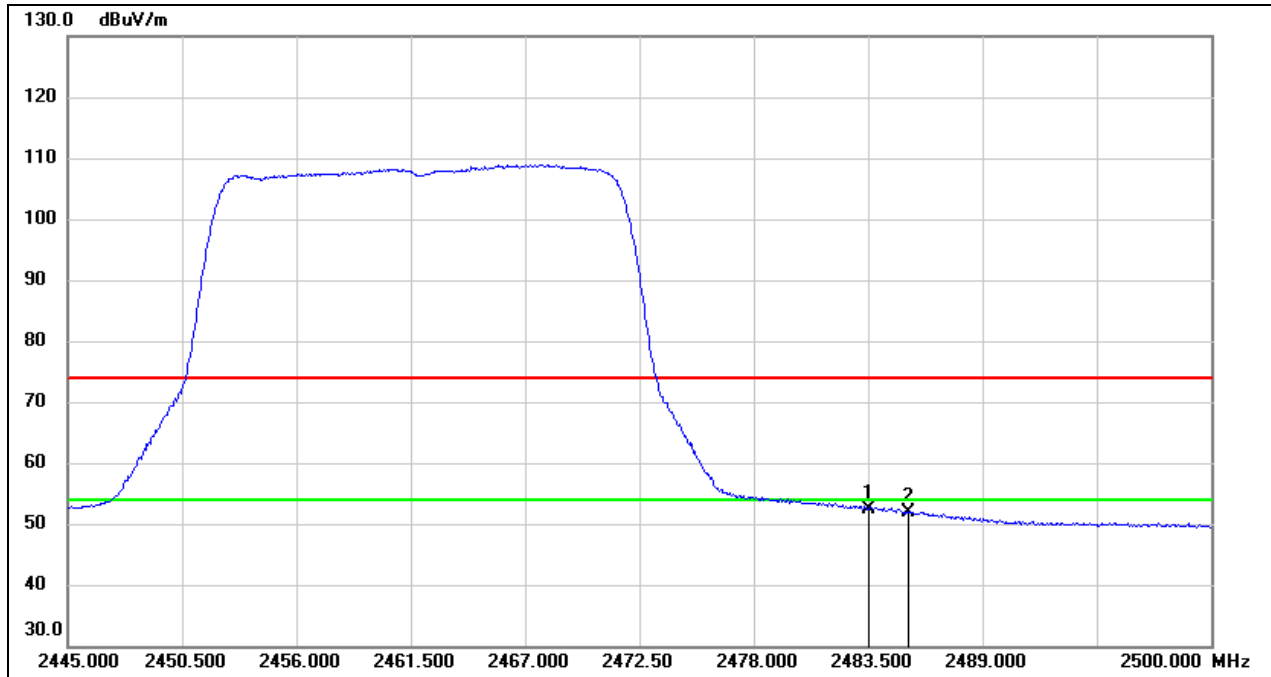

| No. | Frequency (MHz) | Reading (dBuV) | Correct (dB/m) | Result (dBuV/m) | Limit (dBuV/m) | Margin (dB) | Remark |
|-----|-----------------|----------------|----------------|-----------------|----------------|-------------|--------|
| 1   | 2483.500        | 19.87          | 32.44          | 52.31           | 54.00          | -1.69       | AVG    |
| 2   | 2485.425        | 19.48          | 32.44          | 51.92           | 54.00          | -2.08       | AVG    |

|            |                    |               |          |
|------------|--------------------|---------------|----------|
| Test Mode: | 802.11ax HE40 Peak | Channel:      | 2422 MHz |
| Polarity:  | Vertical           | Test Voltage: | DC 12 V  |

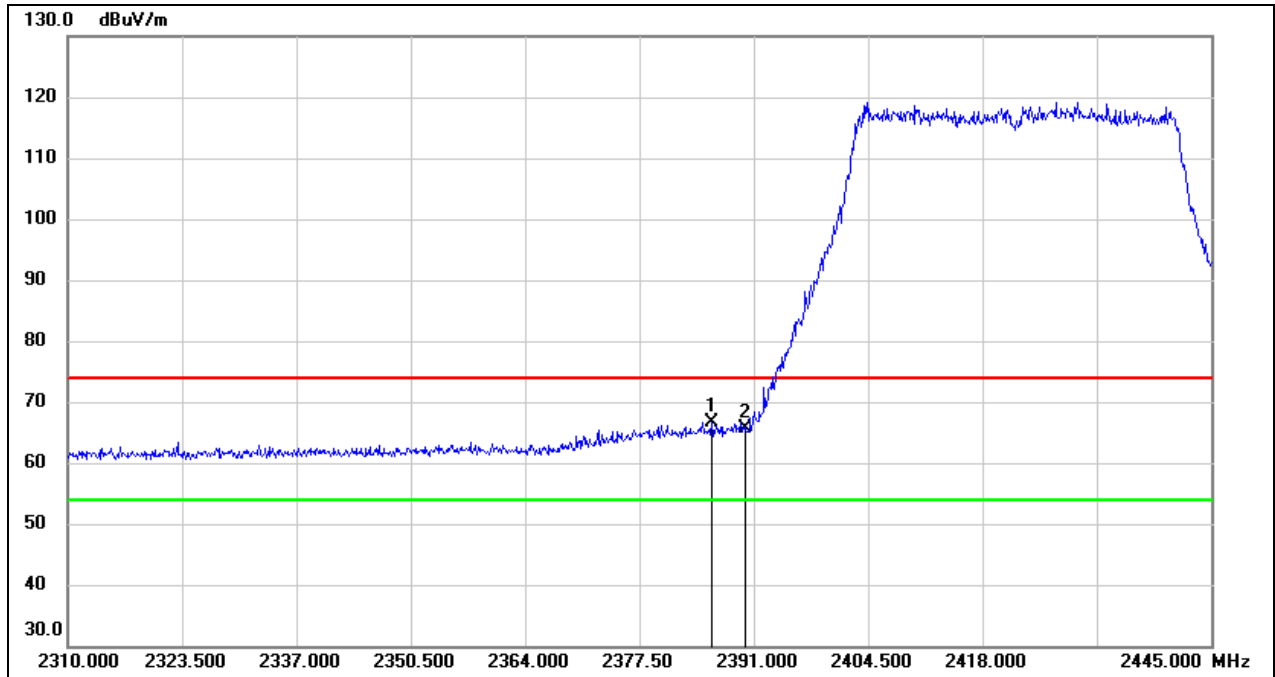

| No. | Frequency (MHz) | Reading (dBuV) | Correct (dB/m) | Result (dBuV/m) | Limit (dBuV/m) | Margin (dB) | Remark |
|-----|-----------------|----------------|----------------|-----------------|----------------|-------------|--------|
| 1   | 2386.005        | 34.51          | 32.14          | 66.65           | 74.00          | -7.35       | peak   |
| 2   | 2390.000        | 33.49          | 32.16          | 65.65           | 74.00          | -8.35       | peak   |

|            |                       |               |          |
|------------|-----------------------|---------------|----------|
| Test Mode: | 802.11ax HE40 Average | Channel:      | 2422 MHz |
| Polarity:  | Vertical              | Test Voltage: | DC 12 V  |

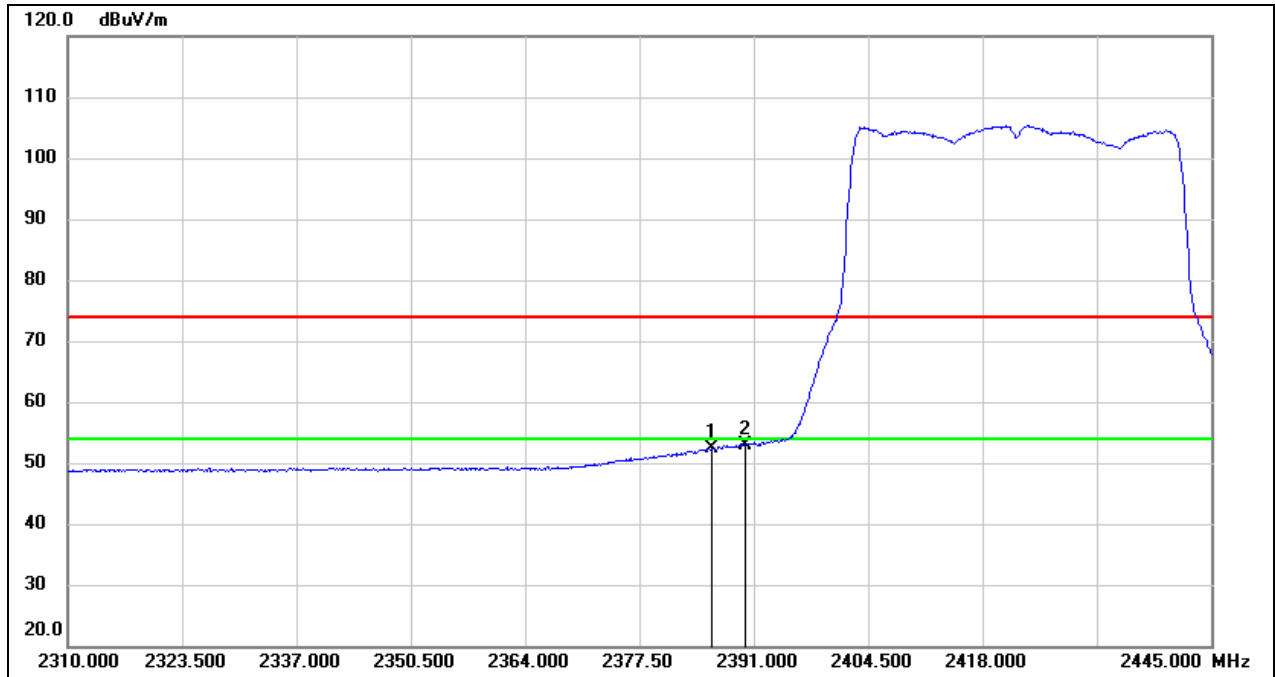

| No. | Frequency (MHz) | Reading (dBuV) | Correct (dB/m) | Result (dBuV/m) | Limit (dBuV/m) | Margin (dB) | Remark |
|-----|-----------------|----------------|----------------|-----------------|----------------|-------------|--------|
| 1   | 2386.005        | 20.23          | 32.14          | 52.37           | 54.00          | -1.63       | AVG    |
| 2   | 2390.000        | 20.81          | 32.16          | 52.97           | 54.00          | -1.03       | AVG    |

|            |                    |               |          |
|------------|--------------------|---------------|----------|
| Test Mode: | 802.11ax HE40 Peak | Channel:      | 2427 MHz |
| Polarity:  | Vertical           | Test Voltage: | DC 12 V  |

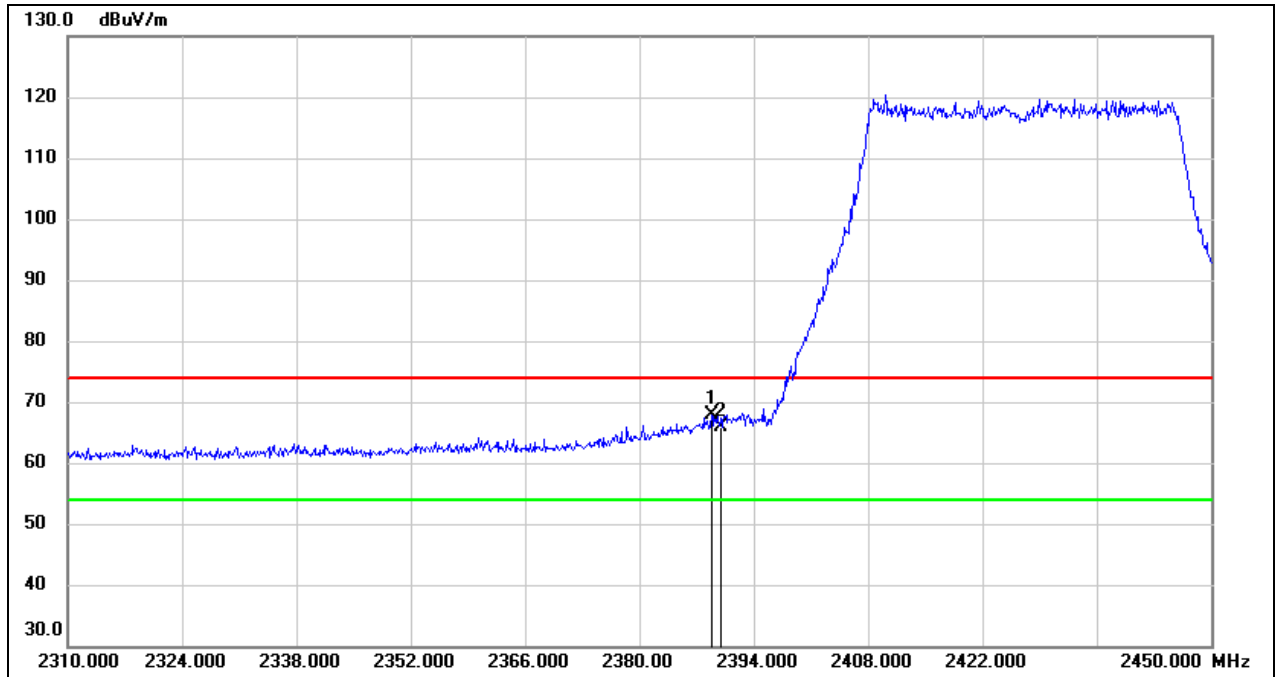

| No. | Frequency (MHz) | Reading (dBuV) | Correct (dB/m) | Result (dBuV/m) | Limit (dBuV/m) | Margin (dB) | Remark |
|-----|-----------------|----------------|----------------|-----------------|----------------|-------------|--------|
| 1   | 2388.820        | 35.70          | 32.16          | 67.86           | 74.00          | -6.14       | peak   |
| 2   | 2390.000        | 33.72          | 32.16          | 65.88           | 74.00          | -8.12       | peak   |

|            |                       |               |          |
|------------|-----------------------|---------------|----------|
| Test Mode: | 802.11ax HE40 Average | Channel:      | 2427 MHz |
| Polarity:  | Vertical              | Test Voltage: | DC 12 V  |

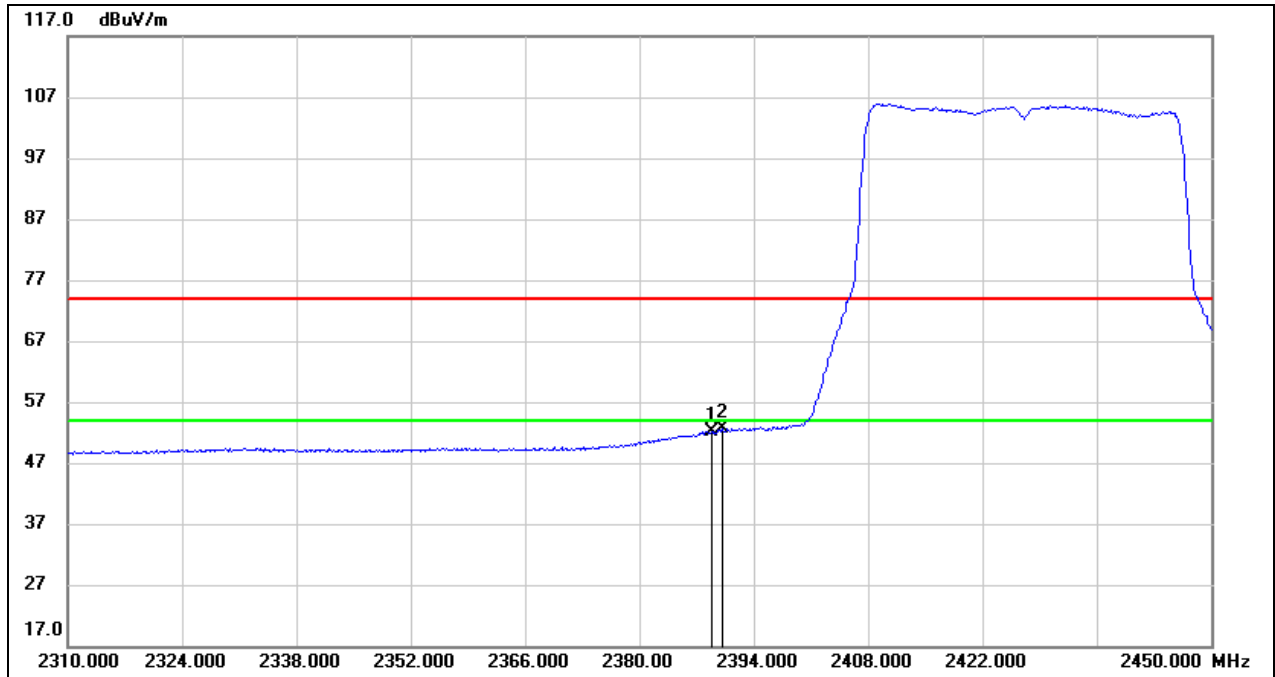

| No. | Frequency (MHz) | Reading (dBuV) | Correct (dB/m) | Result (dBuV/m) | Limit (dBuV/m) | Margin (dB) | Remark |
|-----|-----------------|----------------|----------------|-----------------|----------------|-------------|--------|
| 1   | 2388.820        | 19.86          | 32.16          | 52.02           | 54.00          | -1.98       | AVG    |
| 2   | 2390.000        | 20.37          | 32.16          | 52.53           | 54.00          | -1.47       | AVG    |

|            |                    |               |          |
|------------|--------------------|---------------|----------|
| Test Mode: | 802.11ax HE40 Peak | Channel:      | 2437 MHz |
| Polarity:  | Vertical           | Test Voltage: | DC 12 V  |

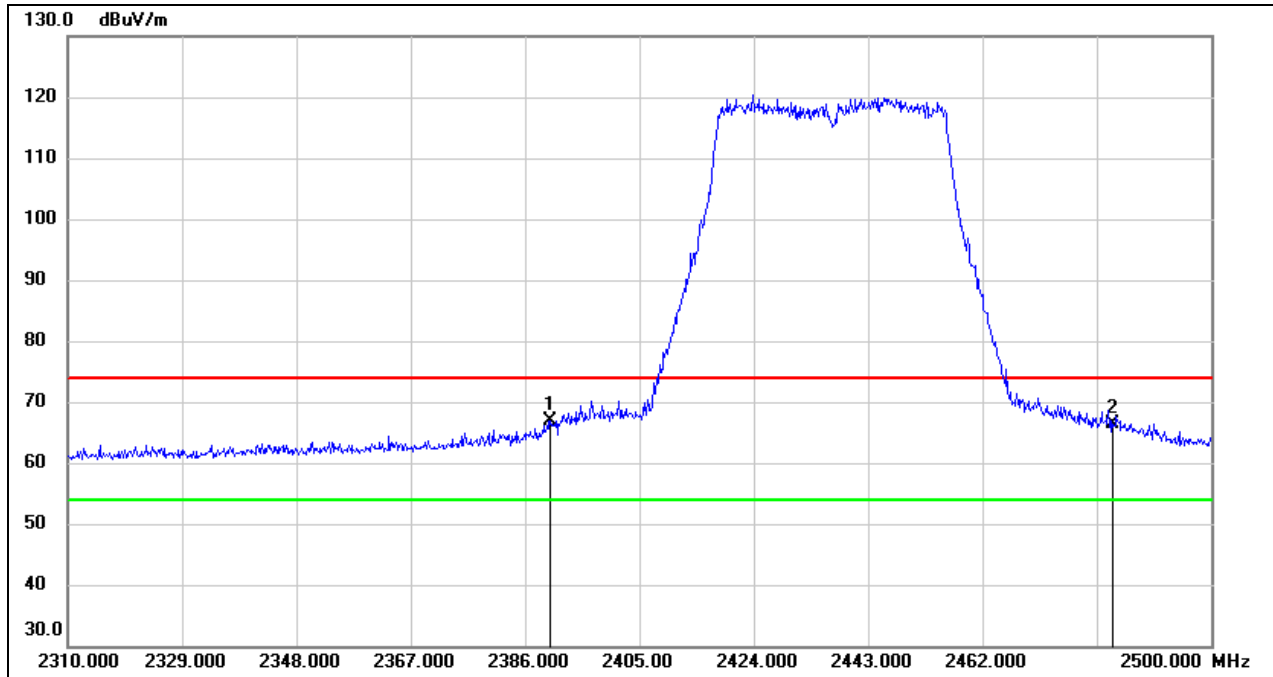

| No. | Frequency (MHz) | Reading (dBuV) | Correct (dB/m) | Result (dBuV/m) | Limit (dBuV/m) | Margin (dB) | Remark |
|-----|-----------------|----------------|----------------|-----------------|----------------|-------------|--------|
| 1   | 2390.000        | 34.83          | 32.16          | 66.99           | 74.00          | -7.01       | peak   |
| 2   | 2483.500        | 33.87          | 32.44          | 66.31           | 74.00          | -7.69       | peak   |

|            |                       |               |          |
|------------|-----------------------|---------------|----------|
| Test Mode: | 802.11ax HE40 Average | Channel:      | 2437 MHz |
| Polarity:  | Vertical              | Test Voltage: | DC 12 V  |

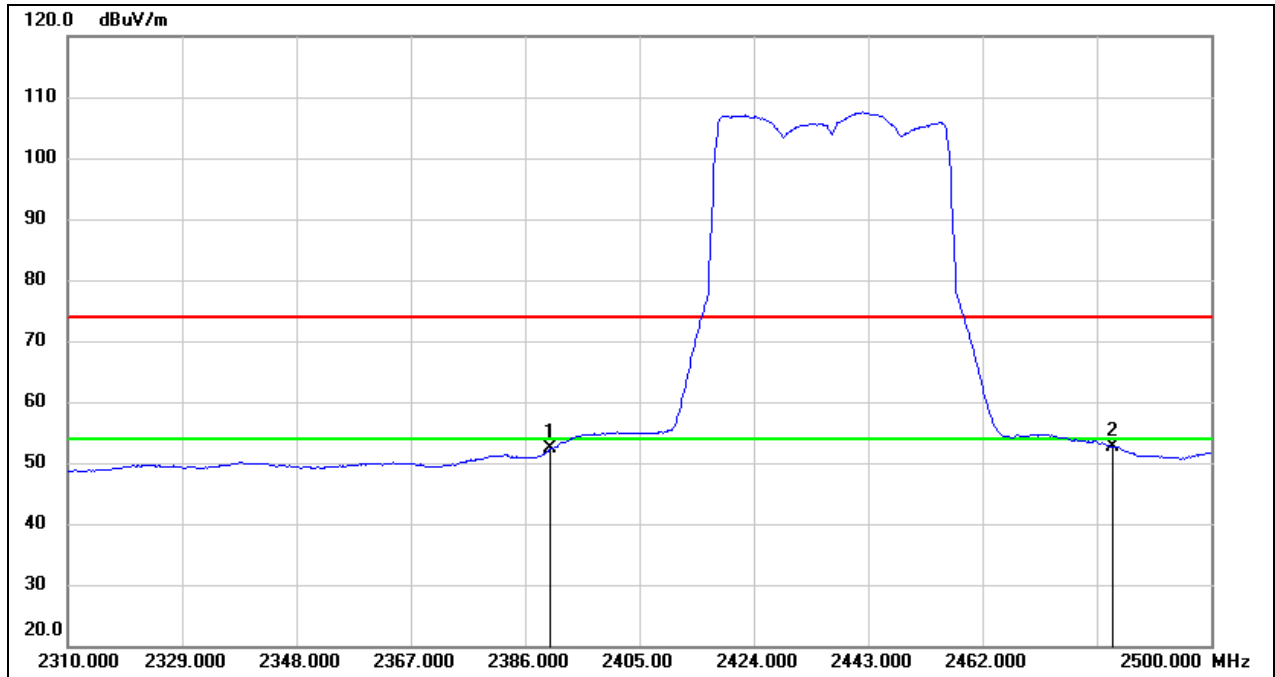

| No. | Frequency (MHz) | Reading (dBuV) | Correct (dB/m) | Result (dBuV/m) | Limit (dBuV/m) | Margin (dB) | Remark |
|-----|-----------------|----------------|----------------|-----------------|----------------|-------------|--------|
| 1   | 2390.000        | 20.12          | 32.16          | 52.28           | 54.00          | -1.72       | AVG    |
| 2   | 2483.500        | 20.21          | 32.44          | 52.65           | 54.00          | -1.35       | AVG    |

|            |                    |               |          |
|------------|--------------------|---------------|----------|
| Test Mode: | 802.11ax HE40 Peak | Channel:      | 2447 MHz |
| Polarity:  | Vertical           | Test Voltage: | DC 12 V  |

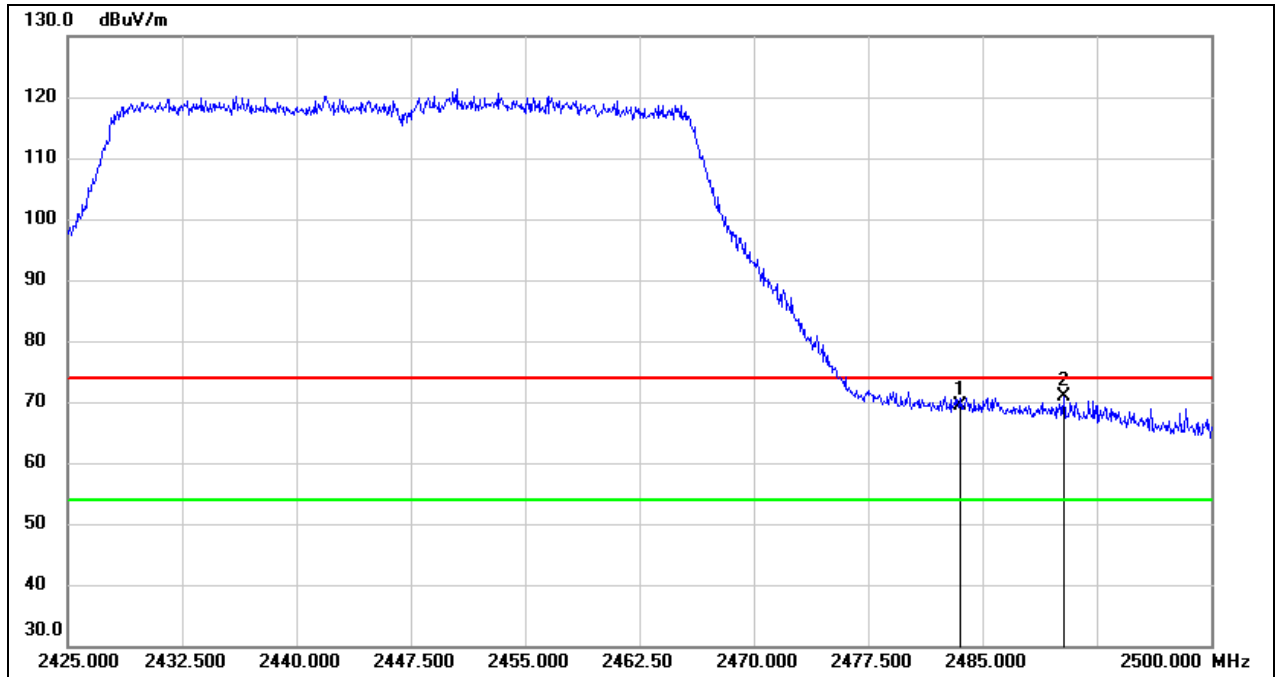

| No. | Frequency (MHz) | Reading (dBuV) | Correct (dB/m) | Result (dBuV/m) | Limit (dBuV/m) | Margin (dB) | Remark |
|-----|-----------------|----------------|----------------|-----------------|----------------|-------------|--------|
| 1   | 2483.500        | 36.90          | 32.44          | 69.34           | 74.00          | -4.66       | peak   |
| 2   | 2490.325        | 38.31          | 32.46          | 70.77           | 74.00          | -3.23       | peak   |



|            |                       |               |          |
|------------|-----------------------|---------------|----------|
| Test Mode: | 802.11ax HE40 Average | Channel:      | 2447 MHz |
| Polarity:  | Vertical              | Test Voltage: | DC 12 V  |

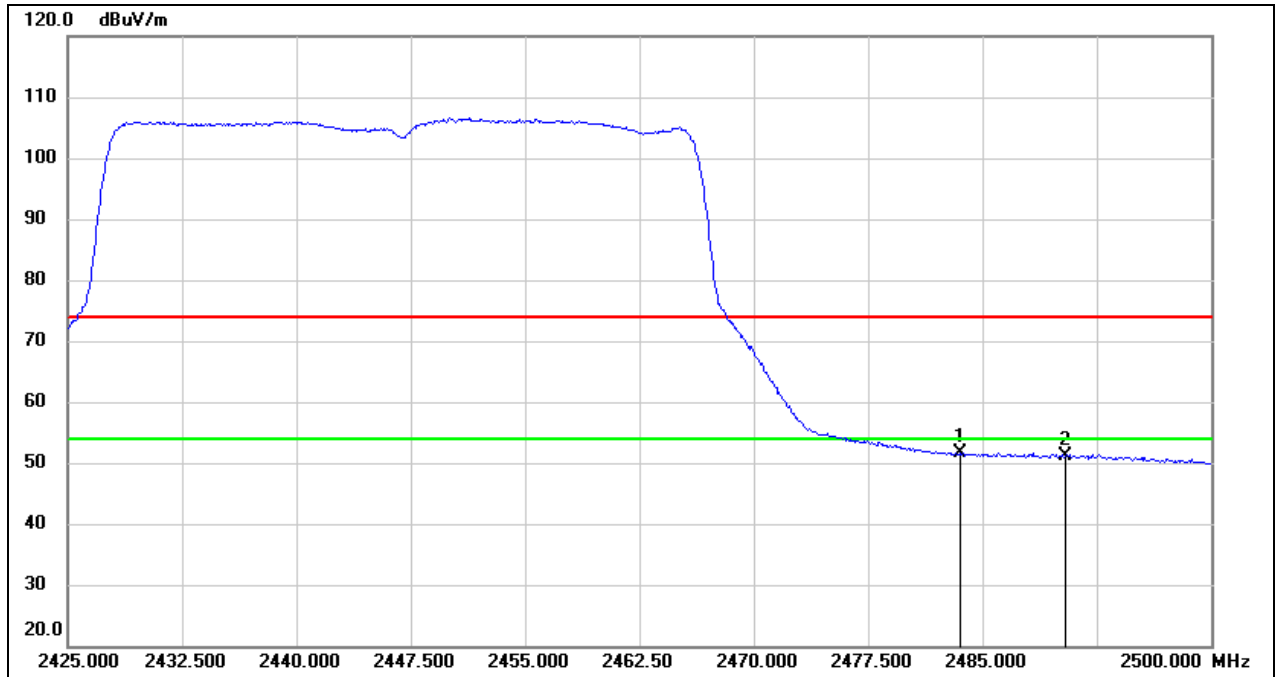

| No. | Frequency (MHz) | Reading (dBuV) | Correct (dB/m) | Result (dBuV/m) | Limit (dBuV/m) | Margin (dB) | Remark |
|-----|-----------------|----------------|----------------|-----------------|----------------|-------------|--------|
| 1   | 2483.500        | 19.19          | 32.44          | 51.63           | 54.00          | -2.37       | AVG    |
| 2   | 2490.325        | 18.66          | 32.46          | 51.12           | 54.00          | -2.88       | AVG    |

|            |                    |               |          |
|------------|--------------------|---------------|----------|
| Test Mode: | 802.11ax HE40 Peak | Channel:      | 2452 MHz |
| Polarity:  | Vertical           | Test Voltage: | DC 12 V  |

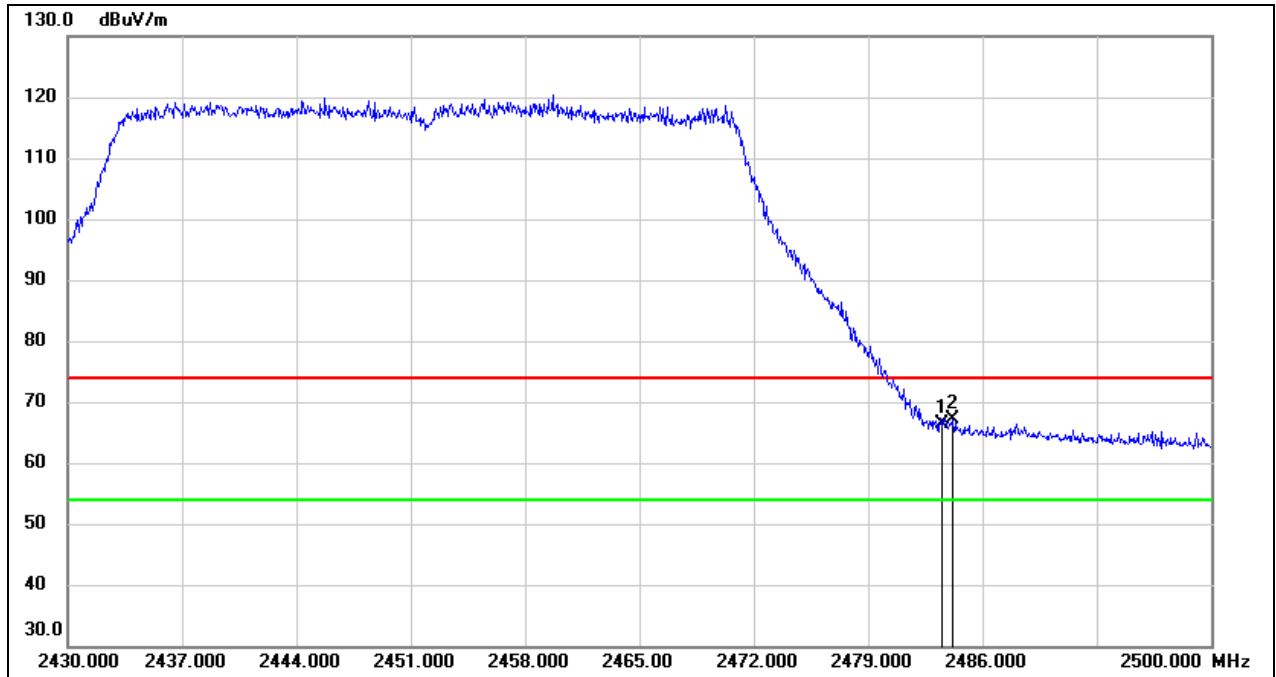

| No. | Frequency (MHz) | Reading (dBuV) | Correct (dB/m) | Result (dBuV/m) | Limit (dBuV/m) | Margin (dB) | Remark |
|-----|-----------------|----------------|----------------|-----------------|----------------|-------------|--------|
| 1   | 2483.500        | 33.99          | 32.44          | 66.43           | 74.00          | -7.57       | peak   |
| 2   | 2484.180        | 34.59          | 32.44          | 67.03           | 74.00          | -6.97       | peak   |

|            |                       |               |          |
|------------|-----------------------|---------------|----------|
| Test Mode: | 802.11ax HE40 Average | Channel:      | 2452 MHz |
| Polarity:  | Vertical              | Test Voltage: | DC 12 V  |

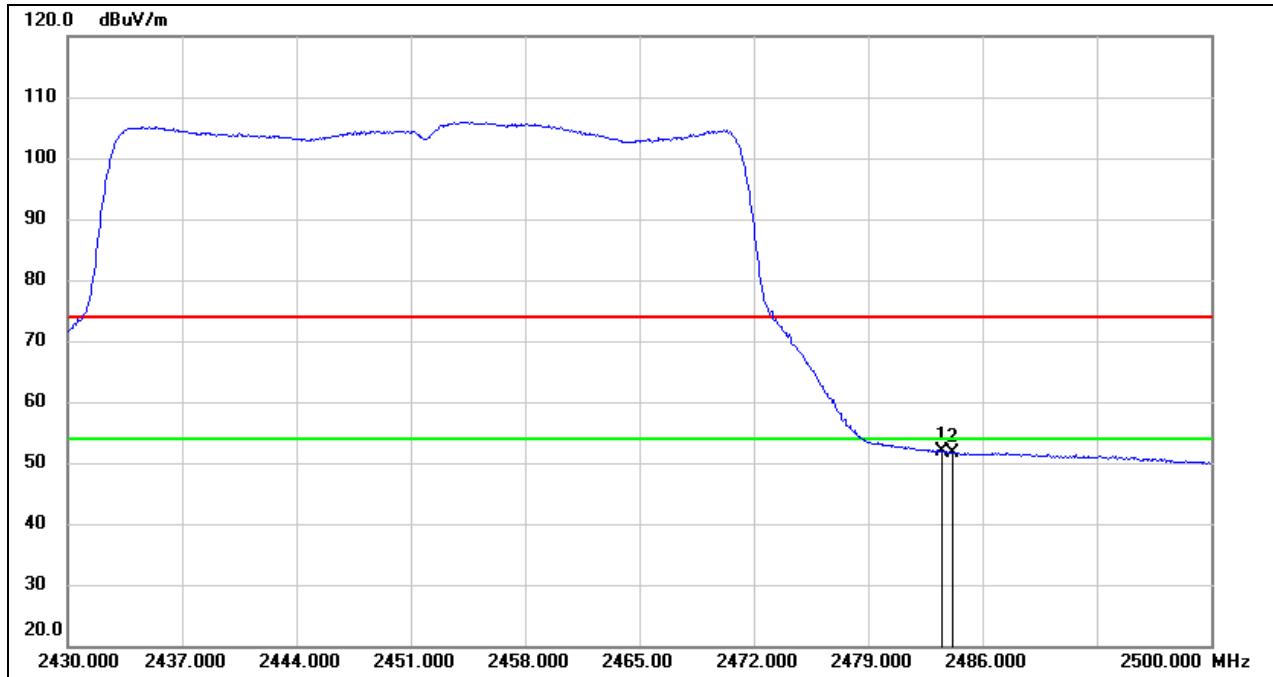

| No. | Frequency (MHz) | Reading (dBuV) | Correct (dB/m) | Result (dBuV/m) | Limit (dBuV/m) | Margin (dB) | Remark |
|-----|-----------------|----------------|----------------|-----------------|----------------|-------------|--------|
| 1   | 2483.500        | 19.49          | 32.44          | 51.93           | 54.00          | -2.07       | AVG    |
| 2   | 2484.180        | 19.09          | 32.44          | 51.53           | 54.00          | -2.47       | AVG    |

|            |                     |               |          |
|------------|---------------------|---------------|----------|
| Test Mode: | 802.11be EHT20 Peak | Channel:      | 2412 MHz |
| Polarity:  | Vertical            | Test Voltage: | DC 12 V  |

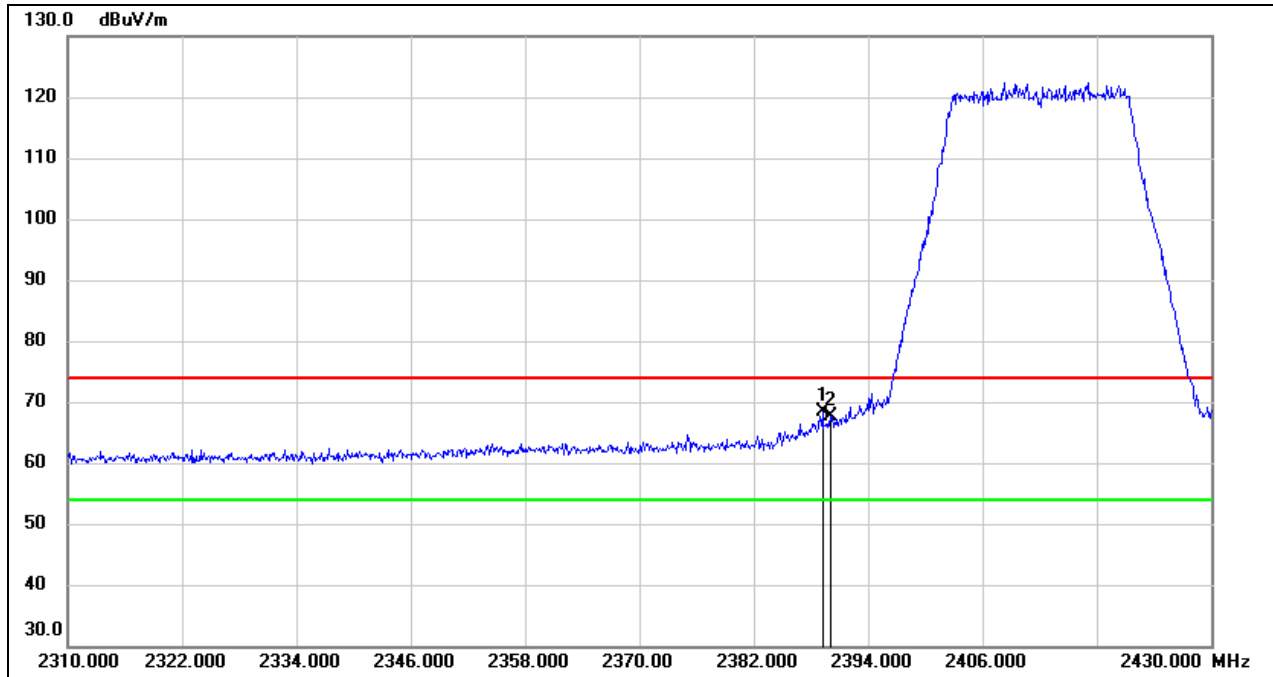

| No. | Frequency (MHz) | Reading (dBuV) | Correct (dB/m) | Result (dBuV/m) | Limit (dBuV/m) | Margin (dB) | Remark |
|-----|-----------------|----------------|----------------|-----------------|----------------|-------------|--------|
| 1   | 2389.200        | 36.10          | 32.16          | 68.26           | 74.00          | -5.74       | peak   |
| 2   | 2390.000        | 35.54          | 32.16          | 67.70           | 74.00          | -6.30       | peak   |

|            |                        |               |          |
|------------|------------------------|---------------|----------|
| Test Mode: | 802.11be EHT20 Average | Channel:      | 2412 MHz |
| Polarity:  | Vertical               | Test Voltage: | DC 12 V  |

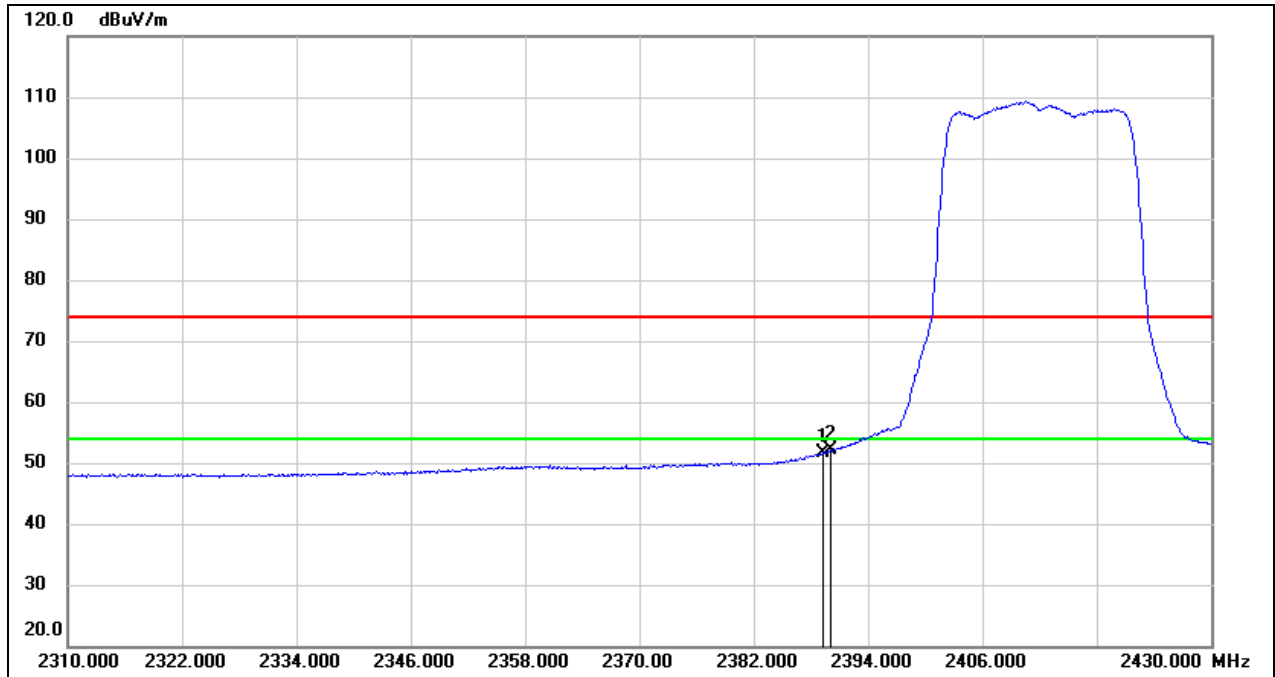

| No. | Frequency (MHz) | Reading (dBuV) | Correct (dB/m) | Result (dBuV/m) | Limit (dBuV/m) | Margin (dB) | Remark |
|-----|-----------------|----------------|----------------|-----------------|----------------|-------------|--------|
| 1   | 2389.200        | 19.49          | 32.16          | 51.65           | 54.00          | -2.35       | AVG    |
| 2   | 2390.000        | 19.94          | 32.16          | 52.10           | 54.00          | -1.90       | AVG    |

|            |                     |               |          |
|------------|---------------------|---------------|----------|
| Test Mode: | 802.11be EHT20 Peak | Channel:      | 2417 MHz |
| Polarity:  | Vertical            | Test Voltage: | DC 12 V  |

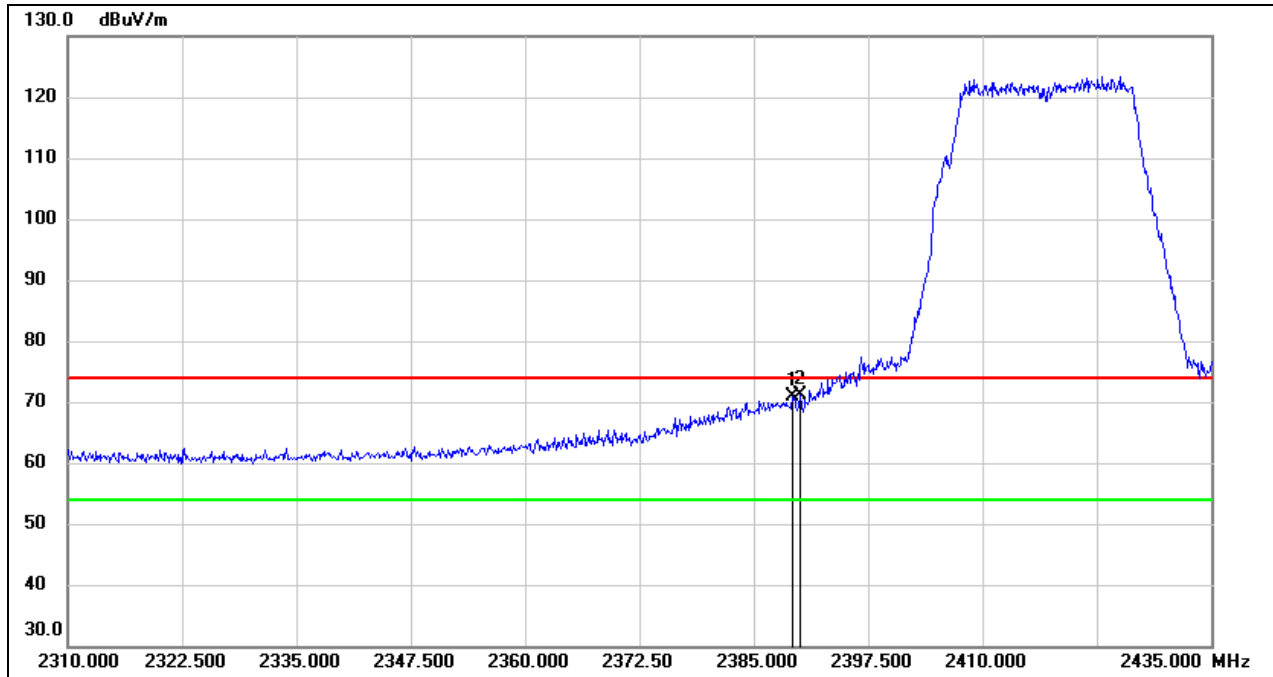

| No. | Frequency (MHz) | Reading (dBuV) | Correct (dB/m) | Result (dBuV/m) | Limit (dBuV/m) | Margin (dB) | Remark |
|-----|-----------------|----------------|----------------|-----------------|----------------|-------------|--------|
| 1   | 2389.250        | 38.78          | 32.16          | 70.94           | 74.00          | -3.06       | peak   |
| 2   | 2390.000        | 38.85          | 32.16          | 71.01           | 74.00          | -2.99       | peak   |

|            |                        |               |          |
|------------|------------------------|---------------|----------|
| Test Mode: | 802.11be EHT20 Average | Channel:      | 2417 MHz |
| Polarity:  | Vertical               | Test Voltage: | DC 12 V  |

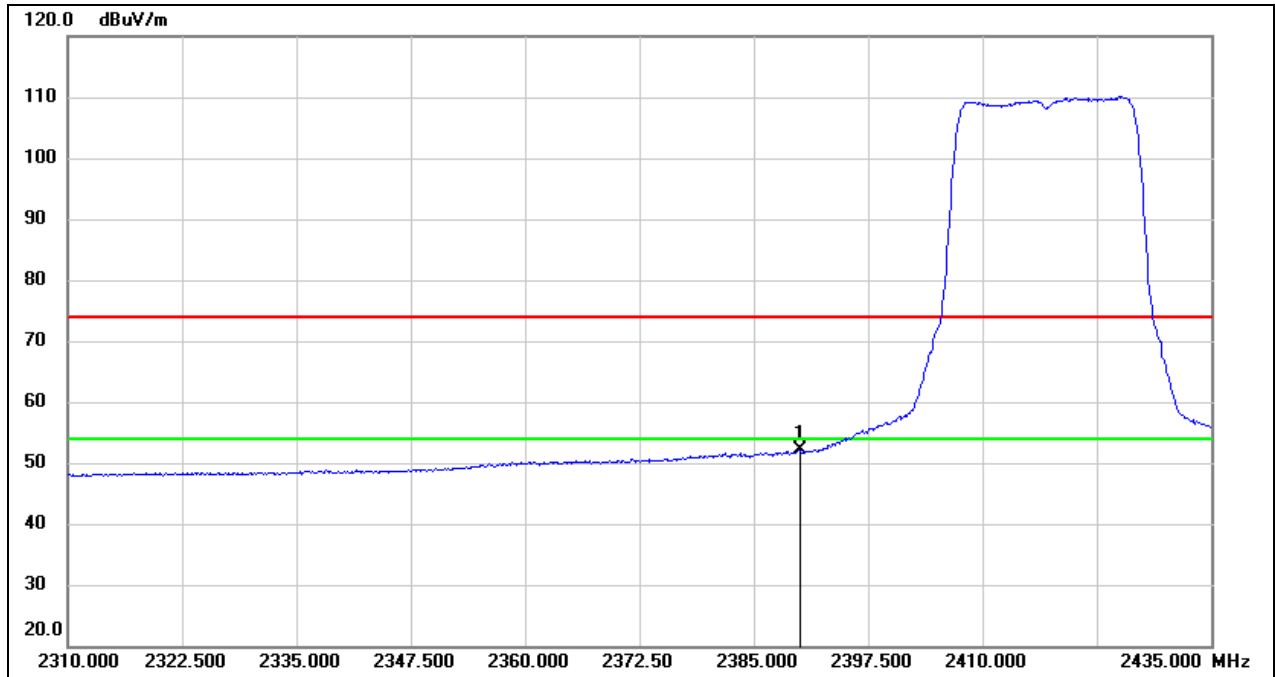

| No. | Frequency (MHz) | Reading (dBuV) | Correct (dB/m) | Result (dBuV/m) | Limit (dBuV/m) | Margin (dB) | Remark |
|-----|-----------------|----------------|----------------|-----------------|----------------|-------------|--------|
| 1   | 2390.000        | 20.07          | 32.16          | 52.23           | 54.00          | -1.77       | AVG    |

|            |                     |               |          |
|------------|---------------------|---------------|----------|
| Test Mode: | 802.11be EHT20 Peak | Channel:      | 2437 MHz |
| Polarity:  | Vertical            | Test Voltage: | DC 12 V  |

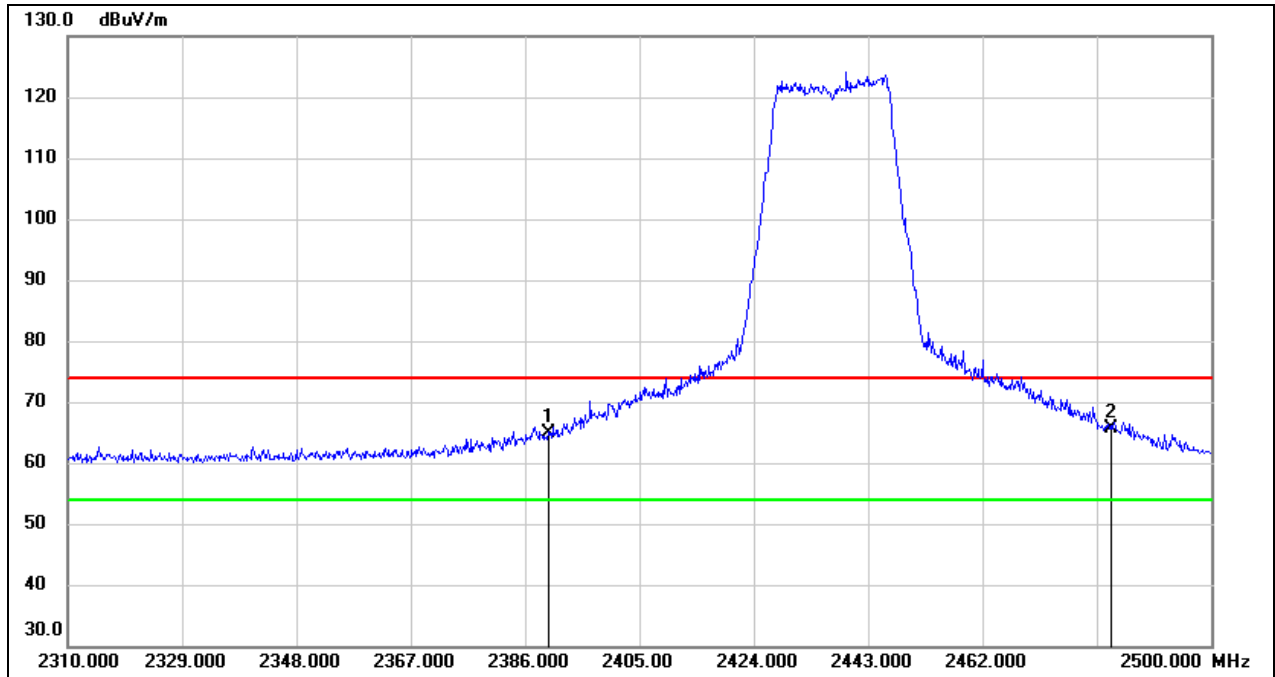

| No. | Frequency (MHz) | Reading (dBuV) | Correct (dB/m) | Result (dBuV/m) | Limit (dBuV/m) | Margin (dB) | Remark |
|-----|-----------------|----------------|----------------|-----------------|----------------|-------------|--------|
| 1   | 2390.000        | 32.60          | 32.16          | 64.76           | 74.00          | -9.24       | peak   |
| 2   | 2483.500        | 33.19          | 32.44          | 65.63           | 74.00          | -8.37       | peak   |



|            |                        |               |          |
|------------|------------------------|---------------|----------|
| Test Mode: | 802.11be EHT20 Average | Channel:      | 2437 MHz |
| Polarity:  | Vertical               | Test Voltage: | DC 12 V  |

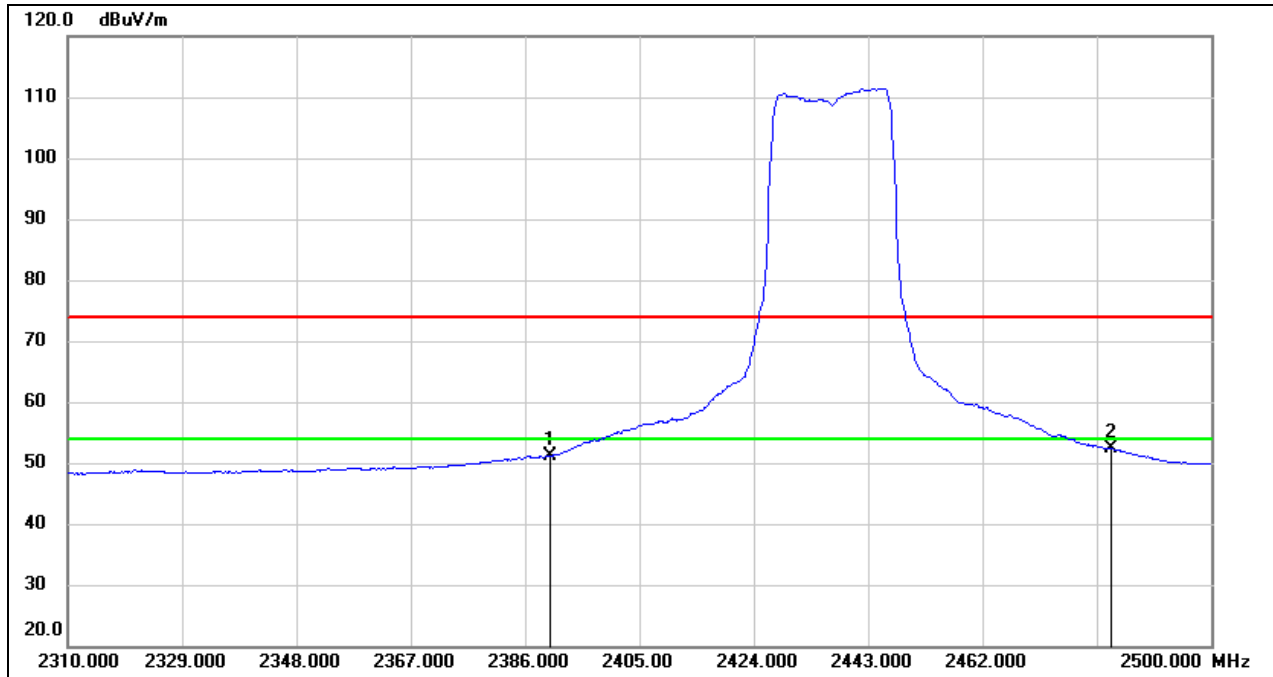

| No. | Frequency (MHz) | Reading (dBuV) | Correct (dB/m) | Result (dBuV/m) | Limit (dBuV/m) | Margin (dB) | Remark |
|-----|-----------------|----------------|----------------|-----------------|----------------|-------------|--------|
| 1   | 2390.000        | 18.98          | 32.16          | 51.14           | 54.00          | -2.86       | AVG    |
| 2   | 2483.500        | 19.83          | 32.44          | 52.27           | 54.00          | -1.73       | AVG    |

|            |                     |               |          |
|------------|---------------------|---------------|----------|
| Test Mode: | 802.11be EHT20 Peak | Channel:      | 2457 MHz |
| Polarity:  | Vertical            | Test Voltage: | DC 12 V  |

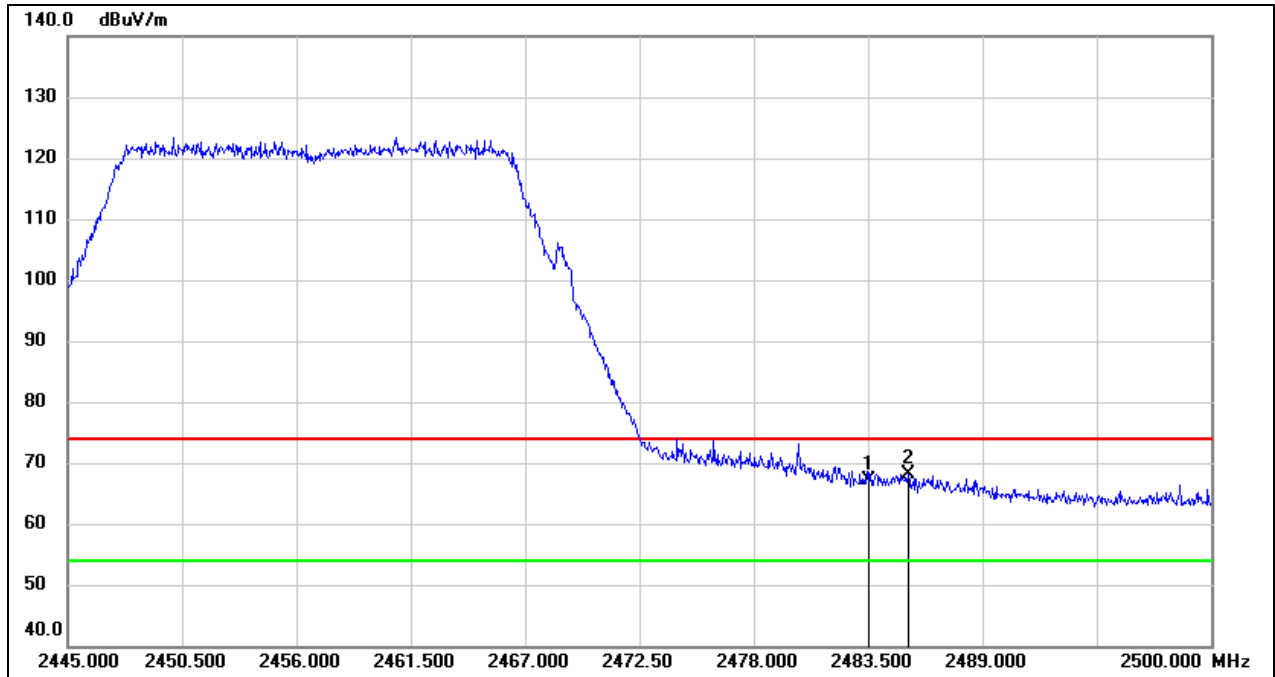

| No. | Frequency (MHz) | Reading (dBuV) | Correct (dB/m) | Result (dBuV/m) | Limit (dBuV/m) | Margin (dB) | Remark |
|-----|-----------------|----------------|----------------|-----------------|----------------|-------------|--------|
| 1   | 2483.500        | 34.61          | 32.44          | 67.05           | 74.00          | -6.95       | peak   |
| 2   | 2485.425        | 35.77          | 32.44          | 68.21           | 74.00          | -5.79       | peak   |

|            |                        |               |          |
|------------|------------------------|---------------|----------|
| Test Mode: | 802.11be EHT20 Average | Channel:      | 2457 MHz |
| Polarity:  | Vertical               | Test Voltage: | DC 12 V  |

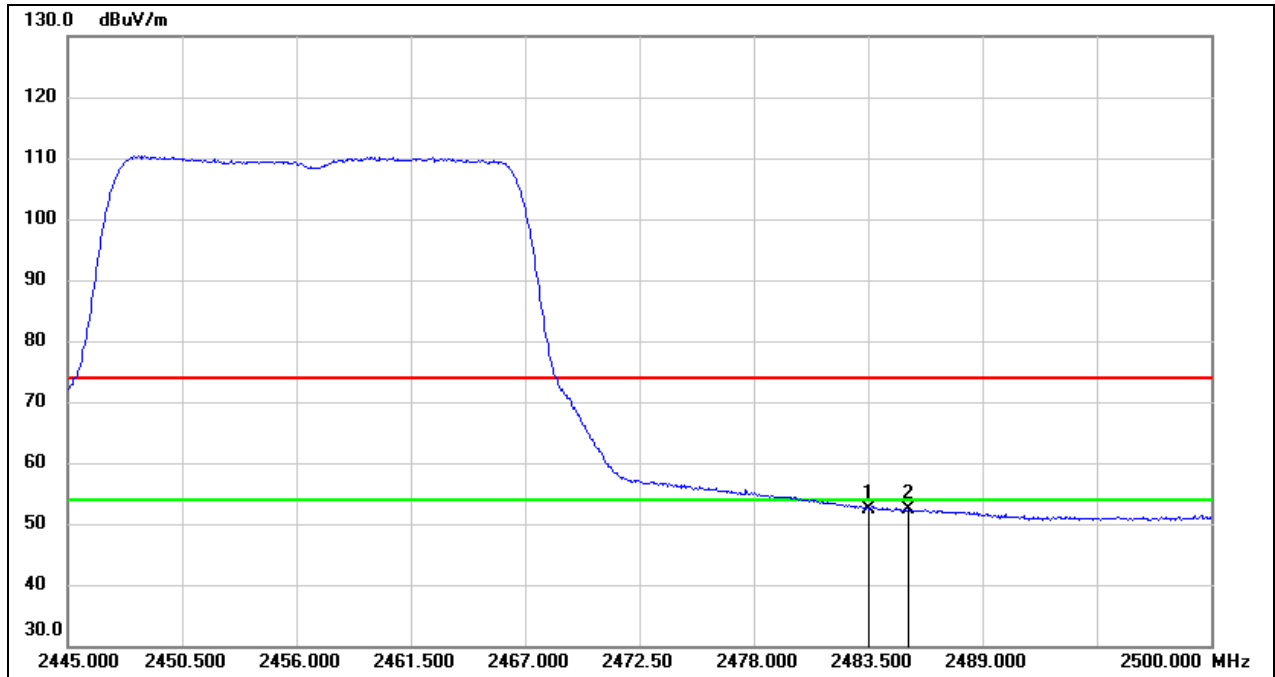

| No. | Frequency (MHz) | Reading (dBuV) | Correct (dB/m) | Result (dBuV/m) | Limit (dBuV/m) | Margin (dB) | Remark |
|-----|-----------------|----------------|----------------|-----------------|----------------|-------------|--------|
| 1   | 2483.500        | 20.00          | 32.44          | 52.44           | 54.00          | -1.56       | AVG    |
| 2   | 2485.425        | 19.88          | 32.44          | 52.32           | 54.00          | -1.68       | AVG    |

|            |                     |               |          |
|------------|---------------------|---------------|----------|
| Test Mode: | 802.11be EHT20 Peak | Channel:      | 2462 MHz |
| Polarity:  | Vertical            | Test Voltage: | DC 12 V  |

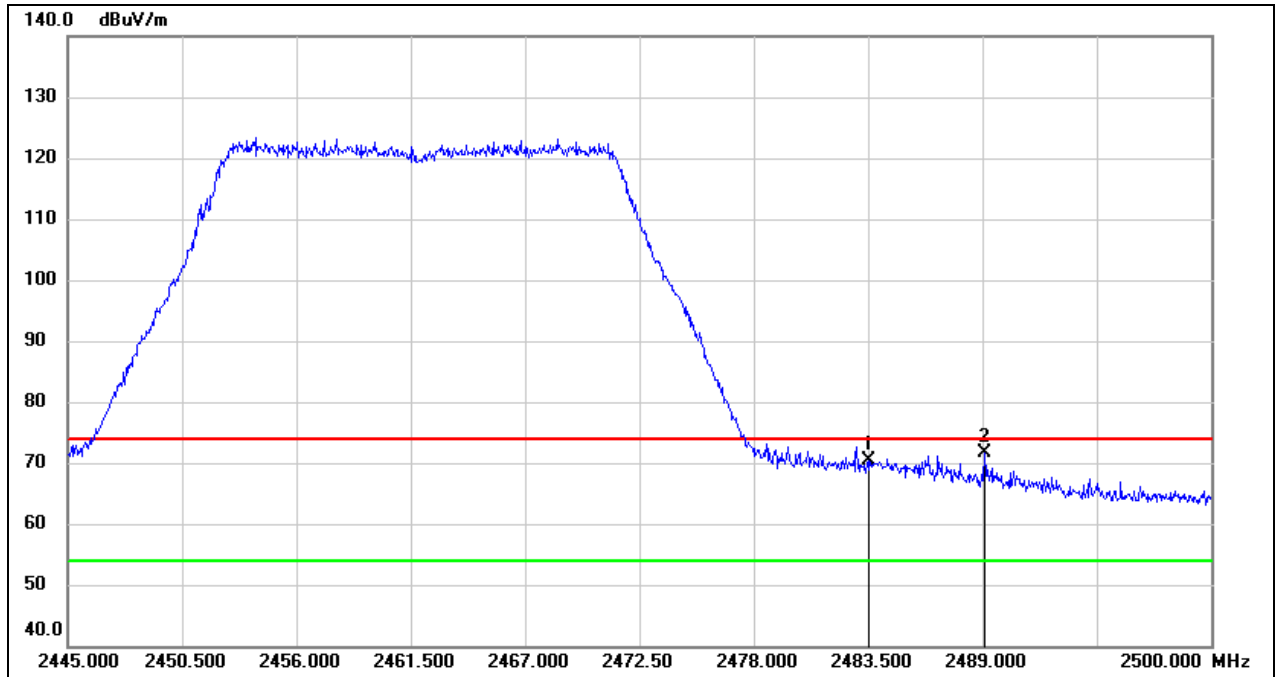

| No. | Frequency (MHz) | Reading (dBuV) | Correct (dB/m) | Result (dBuV/m) | Limit (dBuV/m) | Margin (dB) | Remark |
|-----|-----------------|----------------|----------------|-----------------|----------------|-------------|--------|
| 1   | 2483.500        | 37.85          | 32.44          | 70.29           | 74.00          | -3.71       | peak   |
| 2   | 2489.110        | 39.16          | 32.46          | 71.62           | 74.00          | -2.38       | peak   |

|            |                        |               |          |
|------------|------------------------|---------------|----------|
| Test Mode: | 802.11be EHT20 Average | Channel:      | 2462 MHz |
| Polarity:  | Vertical               | Test Voltage: | DC 12 V  |

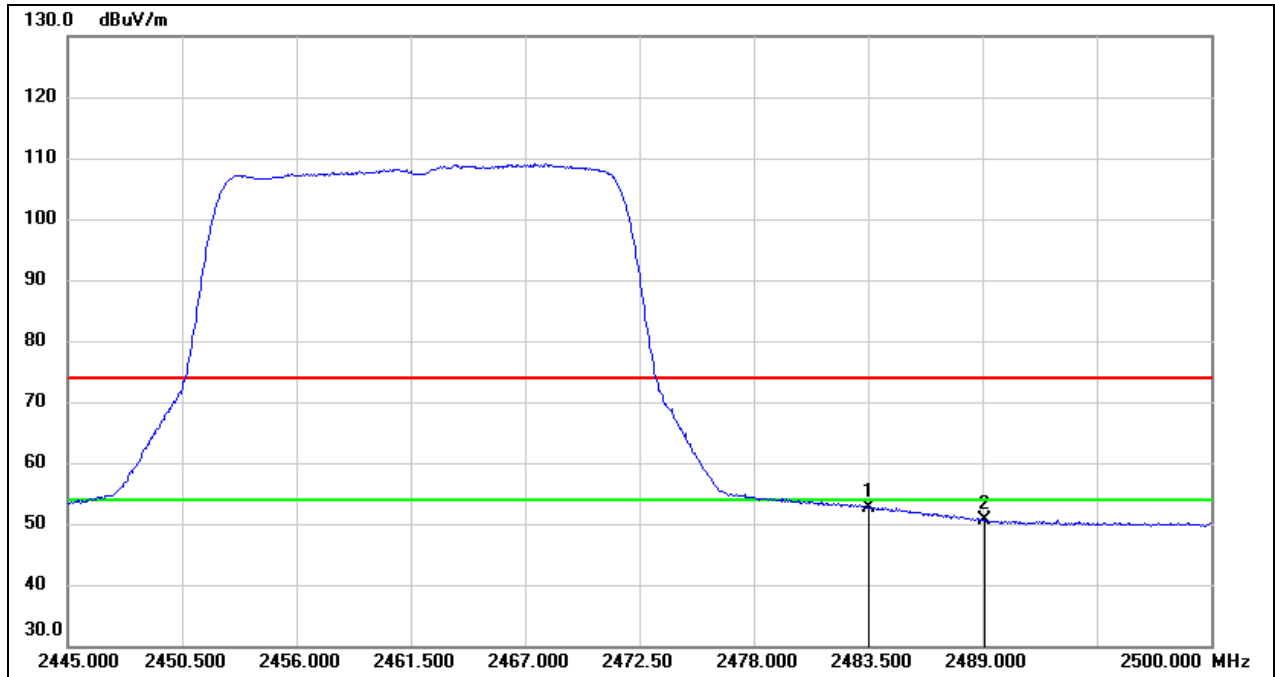

| No. | Frequency (MHz) | Reading (dBuV) | Correct (dB/m) | Result (dBuV/m) | Limit (dBuV/m) | Margin (dB) | Remark |
|-----|-----------------|----------------|----------------|-----------------|----------------|-------------|--------|
| 1   | 2483.500        | 20.18          | 32.44          | 52.62           | 54.00          | -1.38       | AVG    |
| 2   | 2489.110        | 18.19          | 32.46          | 50.65           | 54.00          | -3.35       | AVG    |

|            |                     |               |          |
|------------|---------------------|---------------|----------|
| Test Mode: | 802.11be EHT40 Peak | Channel:      | 2422 MHz |
| Polarity:  | Vertical            | Test Voltage: | DC 12 V  |

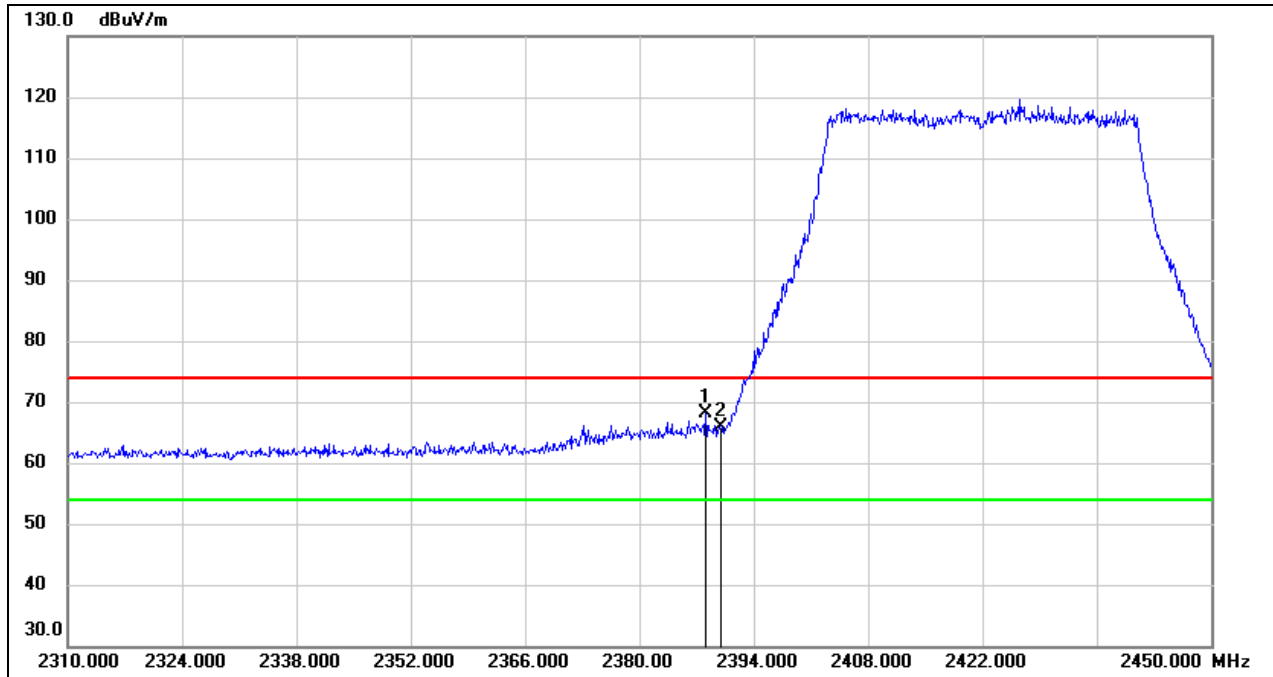

| No. | Frequency (MHz) | Reading (dBuV) | Correct (dB/m) | Result (dBuV/m) | Limit (dBuV/m) | Margin (dB) | Remark |
|-----|-----------------|----------------|----------------|-----------------|----------------|-------------|--------|
| 1   | 2388.120        | 35.92          | 32.16          | 68.08           | 74.00          | -5.92       | peak   |
| 2   | 2390.000        | 33.69          | 32.16          | 65.85           | 74.00          | -8.15       | peak   |

|            |                        |               |          |
|------------|------------------------|---------------|----------|
| Test Mode: | 802.11be EHT40 Average | Channel:      | 2422 MHz |
| Polarity:  | Vertical               | Test Voltage: | DC 12 V  |

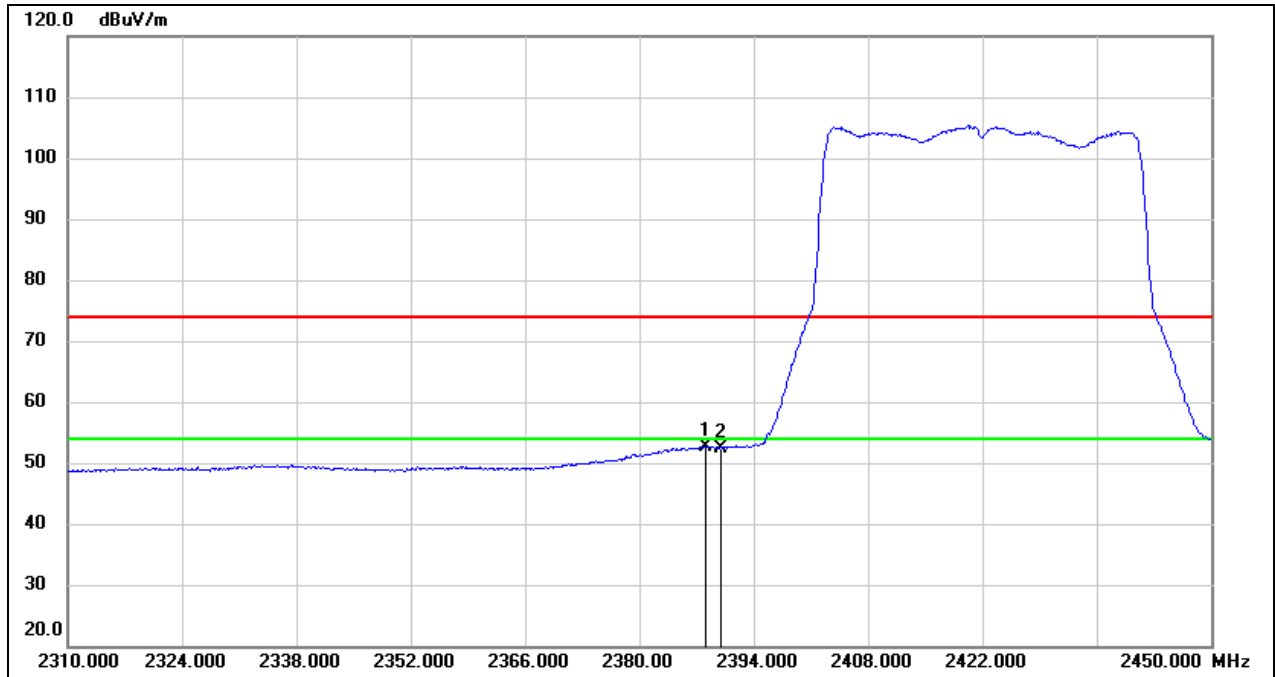

| No. | Frequency (MHz) | Reading (dBuV) | Correct (dB/m) | Result (dBuV/m) | Limit (dBuV/m) | Margin (dB) | Remark |
|-----|-----------------|----------------|----------------|-----------------|----------------|-------------|--------|
| 1   | 2388.120        | 20.52          | 32.16          | 52.68           | 54.00          | -1.32       | AVG    |
| 2   | 2390.000        | 20.32          | 32.16          | 52.48           | 54.00          | -1.52       | AVG    |

|            |                     |               |          |
|------------|---------------------|---------------|----------|
| Test Mode: | 802.11be EHT40 Peak | Channel:      | 2427 MHz |
| Polarity:  | Vertical            | Test Voltage: | DC 12 V  |

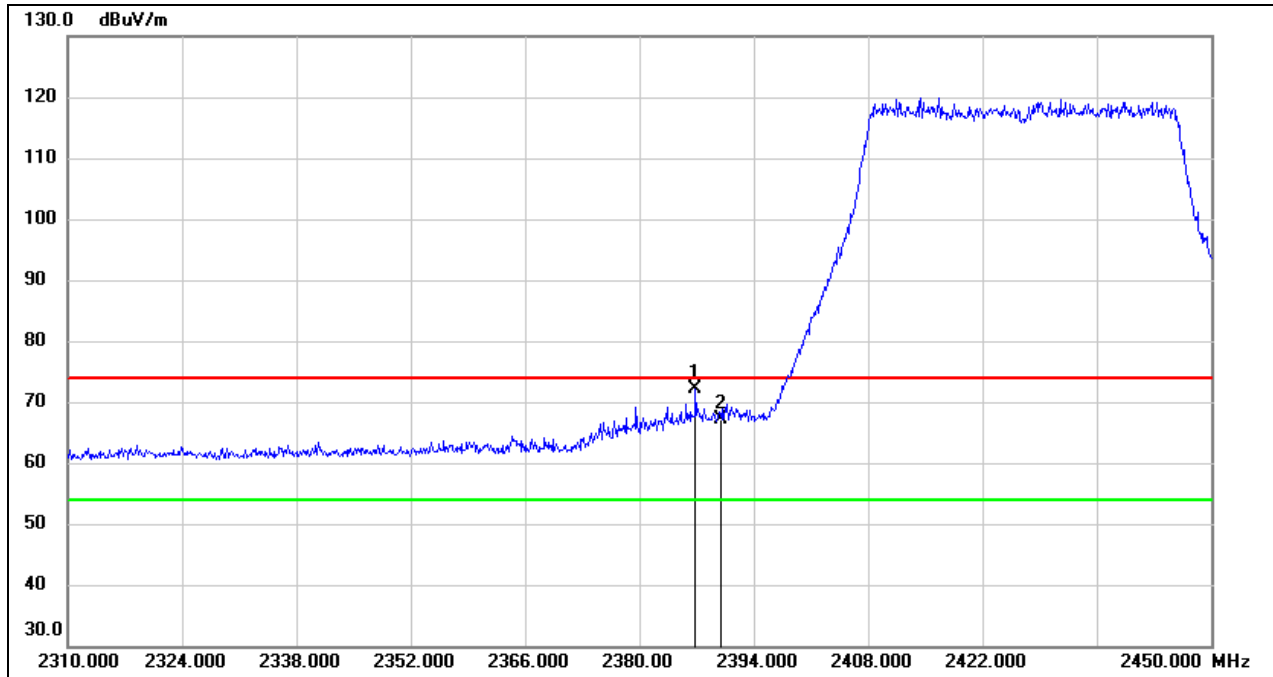

| No. | Frequency (MHz) | Reading (dBuV) | Correct (dB/m) | Result (dBuV/m) | Limit (dBuV/m) | Margin (dB) | Remark |
|-----|-----------------|----------------|----------------|-----------------|----------------|-------------|--------|
| 1   | 2386.860        | 39.95          | 32.15          | 72.10           | 74.00          | -1.90       | peak   |
| 2   | 2390.000        | 34.99          | 32.16          | 67.15           | 74.00          | -6.85       | peak   |



|            |                        |               |          |
|------------|------------------------|---------------|----------|
| Test Mode: | 802.11be EHT40 Average | Channel:      | 2427 MHz |
| Polarity:  | Vertical               | Test Voltage: | DC 12 V  |

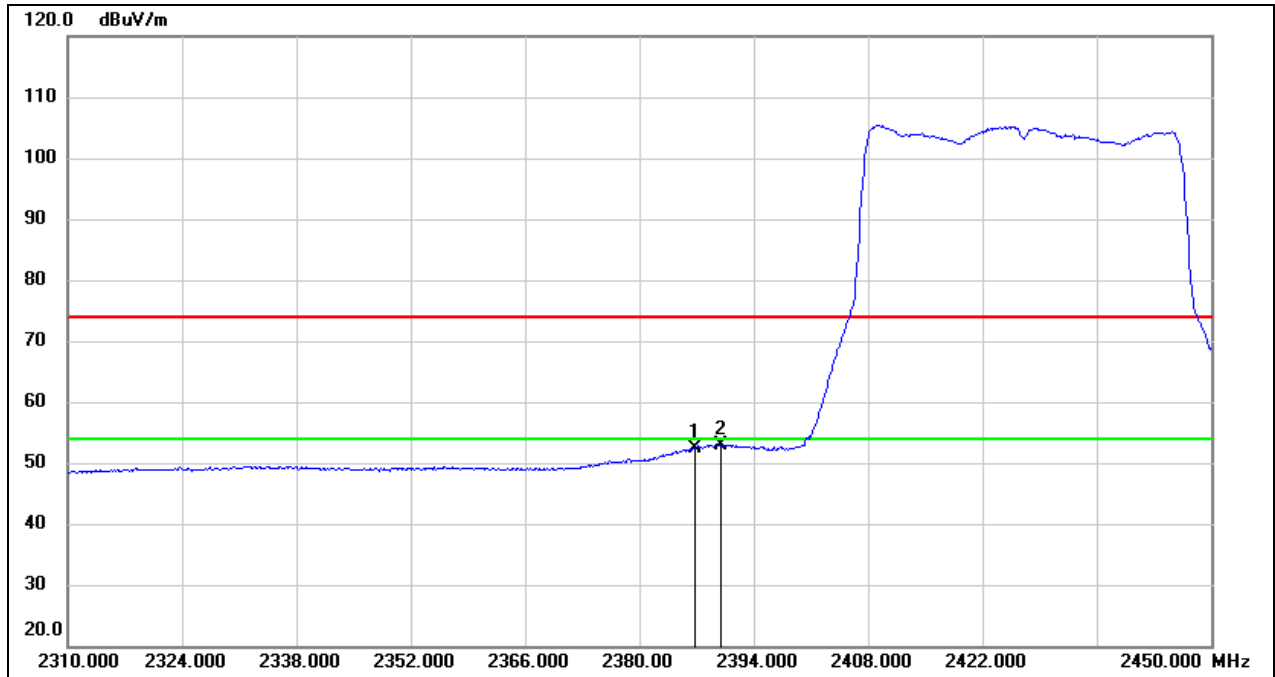

| No. | Frequency (MHz) | Reading (dBuV) | Correct (dB/m) | Result (dBuV/m) | Limit (dBuV/m) | Margin (dB) | Remark |
|-----|-----------------|----------------|----------------|-----------------|----------------|-------------|--------|
| 1   | 2386.860        | 20.20          | 32.15          | 52.35           | 54.00          | -1.65       | AVG    |
| 2   | 2390.000        | 20.61          | 32.16          | 52.77           | 54.00          | -1.23       | AVG    |

|            |                     |               |          |
|------------|---------------------|---------------|----------|
| Test Mode: | 802.11be EHT40 Peak | Channel:      | 2437 MHz |
| Polarity:  | Vertical            | Test Voltage: | DC 12 V  |

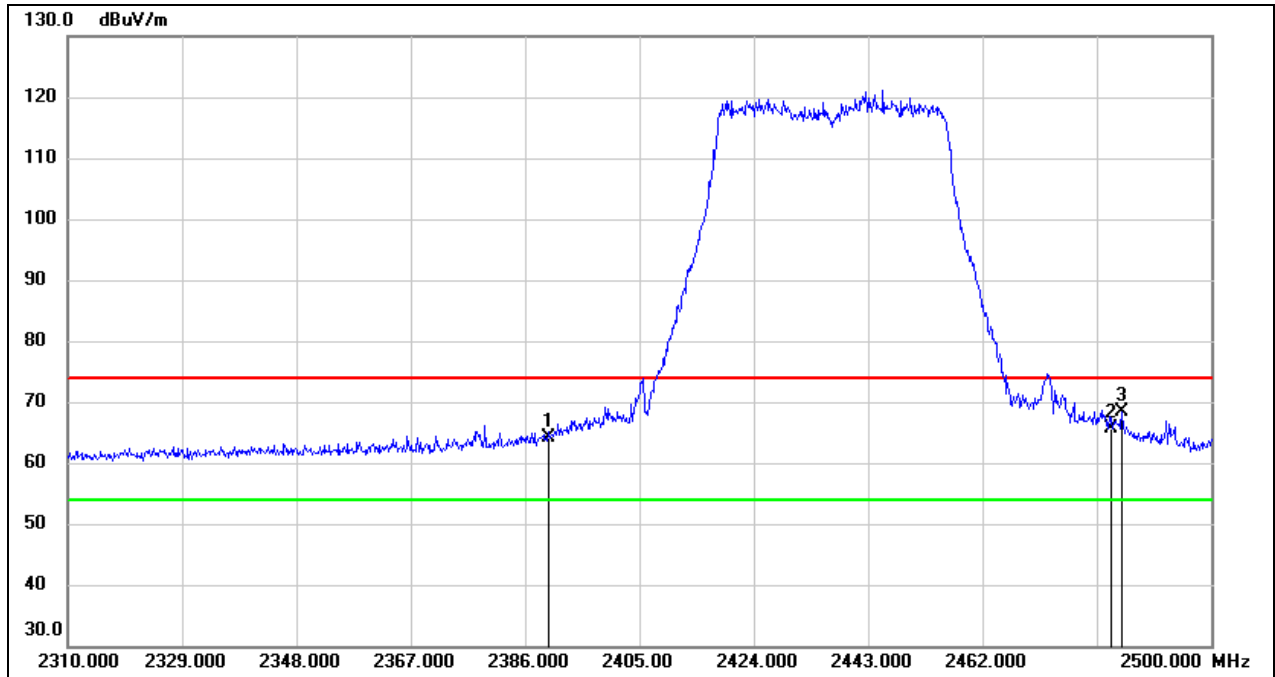

| No. | Frequency (MHz) | Reading (dBuV) | Correct (dB/m) | Result (dBuV/m) | Limit (dBuV/m) | Margin (dB) | Remark |
|-----|-----------------|----------------|----------------|-----------------|----------------|-------------|--------|
| 1   | 2390.000        | 32.02          | 32.16          | 64.18           | 74.00          | -9.82       | peak   |
| 2   | 2483.500        | 33.16          | 32.44          | 65.60           | 74.00          | -8.40       | peak   |
| 3   | 2485.180        | 35.97          | 32.44          | 68.41           | 74.00          | -5.59       | peak   |

|            |                        |               |          |
|------------|------------------------|---------------|----------|
| Test Mode: | 802.11be EHT40 Average | Channel:      | 2437 MHz |
| Polarity:  | Vertical               | Test Voltage: | DC 12 V  |

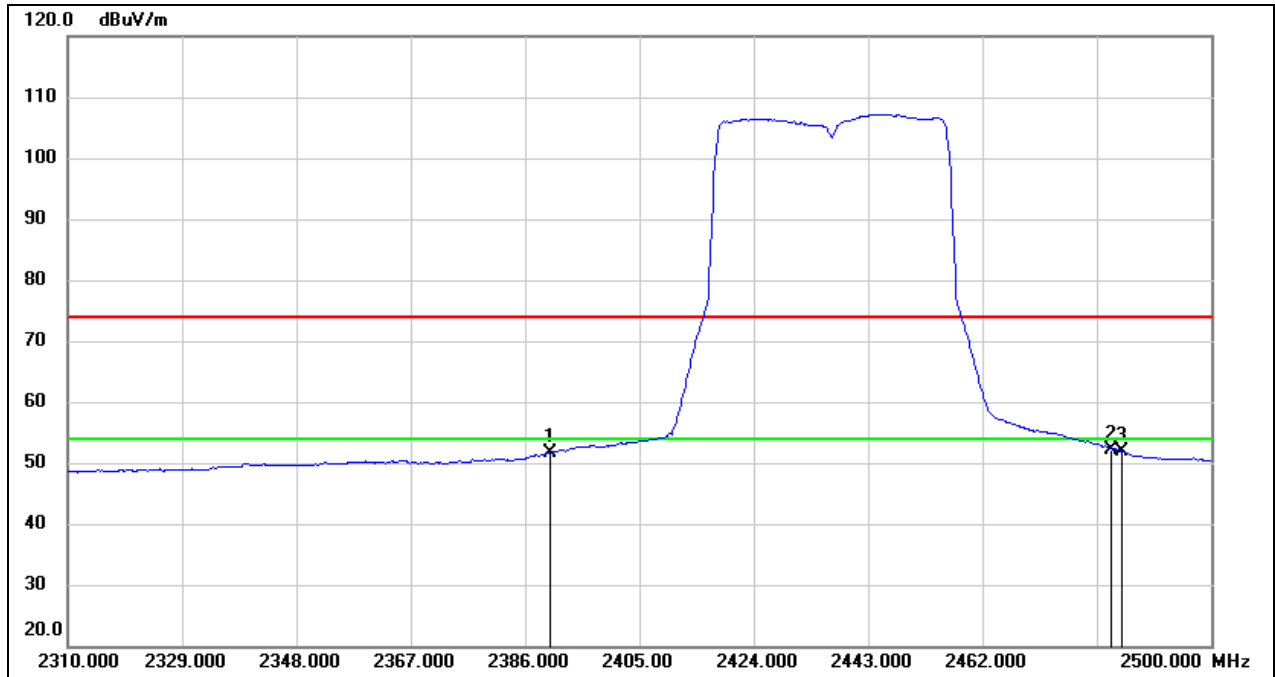

| No. | Frequency (MHz) | Reading (dBuV) | Correct (dB/m) | Result (dBuV/m) | Limit (dBuV/m) | Margin (dB) | Remark |
|-----|-----------------|----------------|----------------|-----------------|----------------|-------------|--------|
| 1   | 2390.000        | 19.47          | 32.16          | 51.63           | 54.00          | -2.37       | AVG    |
| 2   | 2483.500        | 19.81          | 32.44          | 52.25           | 54.00          | -1.75       | AVG    |
| 3   | 2485.180        | 19.55          | 32.44          | 51.99           | 54.00          | -2.01       | AVG    |

|            |                     |               |          |
|------------|---------------------|---------------|----------|
| Test Mode: | 802.11be EHT40 Peak | Channel:      | 2447 MHz |
| Polarity:  | Vertical            | Test Voltage: | DC 12 V  |

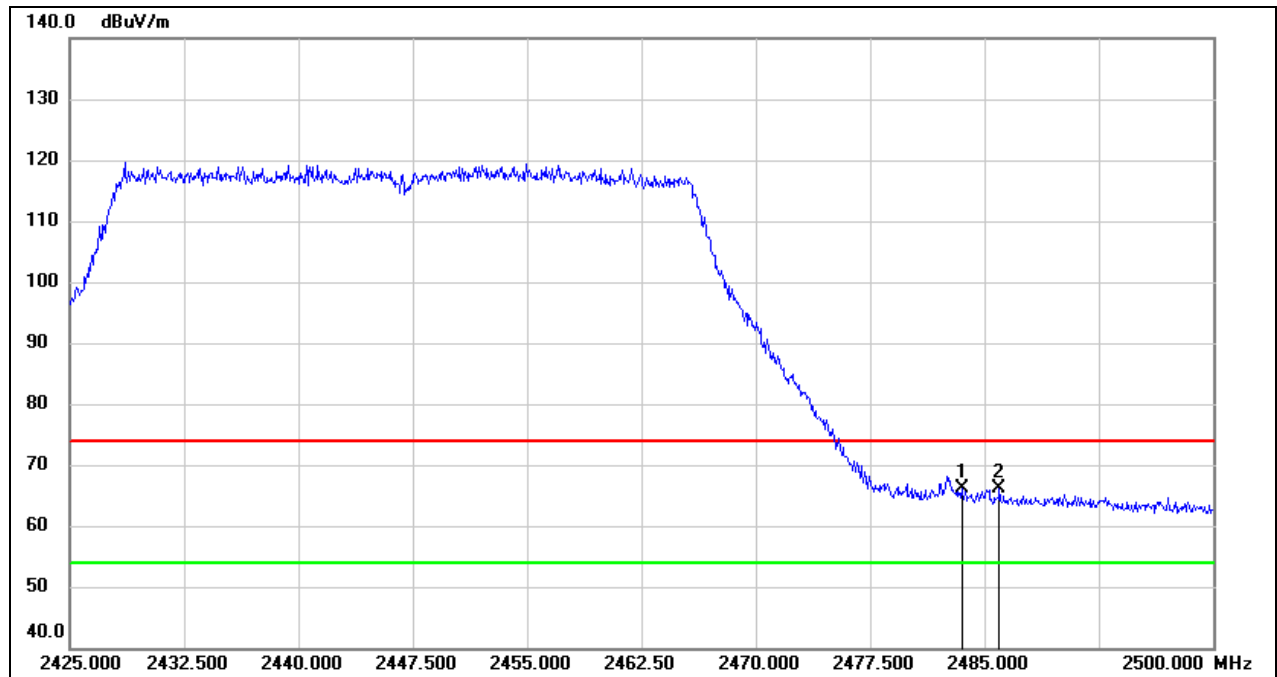

| No. | Frequency (MHz) | Reading (dBuV) | Correct (dB/m) | Result (dBuV/m) | Limit (dBuV/m) | Margin (dB) | Remark |
|-----|-----------------|----------------|----------------|-----------------|----------------|-------------|--------|
| 1   | 2483.500        | 33.62          | 32.44          | 66.06           | 74.00          | -7.94       | peak   |
| 2   | 2485.975        | 33.59          | 32.44          | 66.03           | 74.00          | -7.97       | peak   |

|            |                        |               |          |
|------------|------------------------|---------------|----------|
| Test Mode: | 802.11be EHT40 Average | Channel:      | 2447 MHz |
| Polarity:  | Vertical               | Test Voltage: | DC 12 V  |

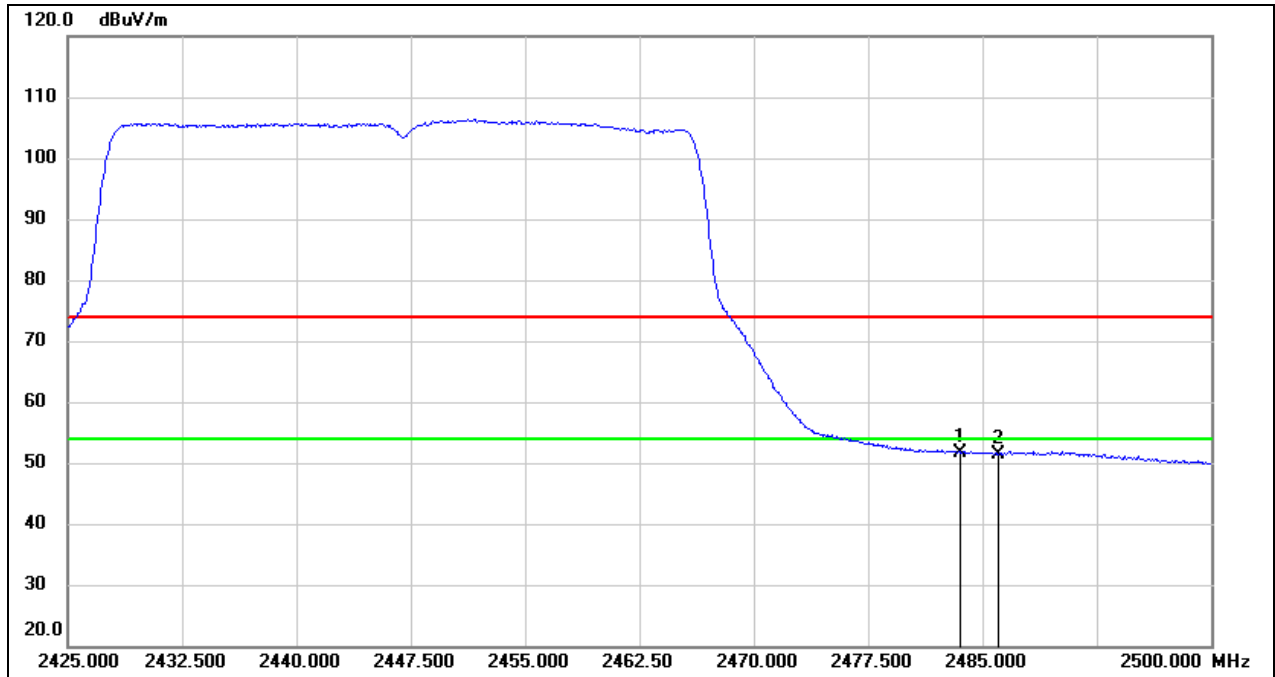

| No. | Frequency (MHz) | Reading (dBuV) | Correct (dB/m) | Result (dBuV/m) | Limit (dBuV/m) | Margin (dB) | Remark |
|-----|-----------------|----------------|----------------|-----------------|----------------|-------------|--------|
| 1   | 2483.500        | 19.28          | 32.44          | 51.72           | 54.00          | -2.28       | AVG    |
| 2   | 2485.975        | 19.03          | 32.44          | 51.47           | 54.00          | -2.53       | AVG    |

|            |                     |               |          |
|------------|---------------------|---------------|----------|
| Test Mode: | 802.11be EHT40 Peak | Channel:      | 2452 MHz |
| Polarity:  | Vertical            | Test Voltage: | DC 12 V  |

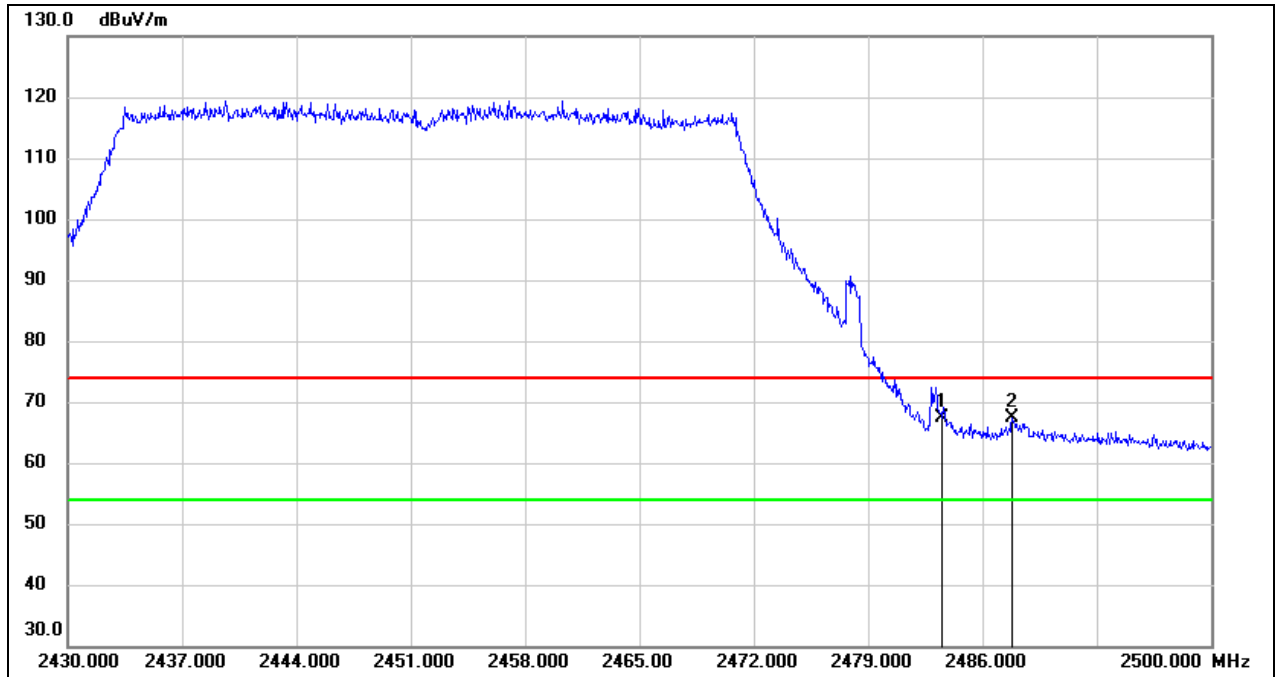

| No. | Frequency (MHz) | Reading (dBuV) | Correct (dB/m) | Result (dBuV/m) | Limit (dBuV/m) | Margin (dB) | Remark |
|-----|-----------------|----------------|----------------|-----------------|----------------|-------------|--------|
| 1   | 2483.500        | 34.88          | 32.44          | 67.32           | 74.00          | -6.68       | peak   |
| 2   | 2487.820        | 35.01          | 32.46          | 67.47           | 74.00          | -6.53       | peak   |

|            |                        |               |          |
|------------|------------------------|---------------|----------|
| Test Mode: | 802.11be EHT40 Average | Channel:      | 2452 MHz |
| Polarity:  | Vertical               | Test Voltage: | DC 12 V  |

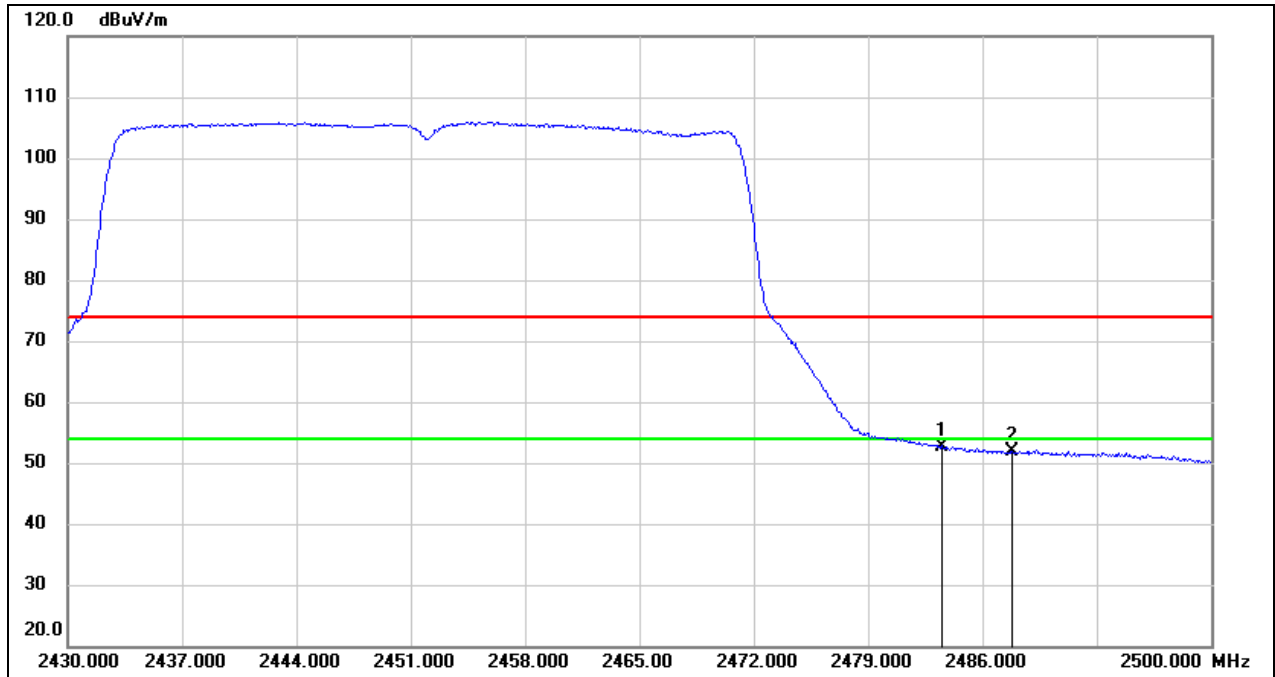

| No. | Frequency (MHz) | Reading (dBuV) | Correct (dB/m) | Result (dBuV/m) | Limit (dBuV/m) | Margin (dB) | Remark |
|-----|-----------------|----------------|----------------|-----------------|----------------|-------------|--------|
| 1   | 2483.500        | 20.08          | 32.44          | 52.52           | 54.00          | -1.48       | AVG    |
| 2   | 2487.820        | 19.30          | 32.46          | 51.76           | 54.00          | -2.24       | AVG    |

## 8.2. SPURIOUS EMISSIONS (1 GHZ ~ 3 GHZ)

|            |            |               |          |
|------------|------------|---------------|----------|
| Test Mode: | 802.11b    | Channel:      | 2412 MHz |
| Polarity:  | Horizontal | Test Voltage: | DC 12 V  |

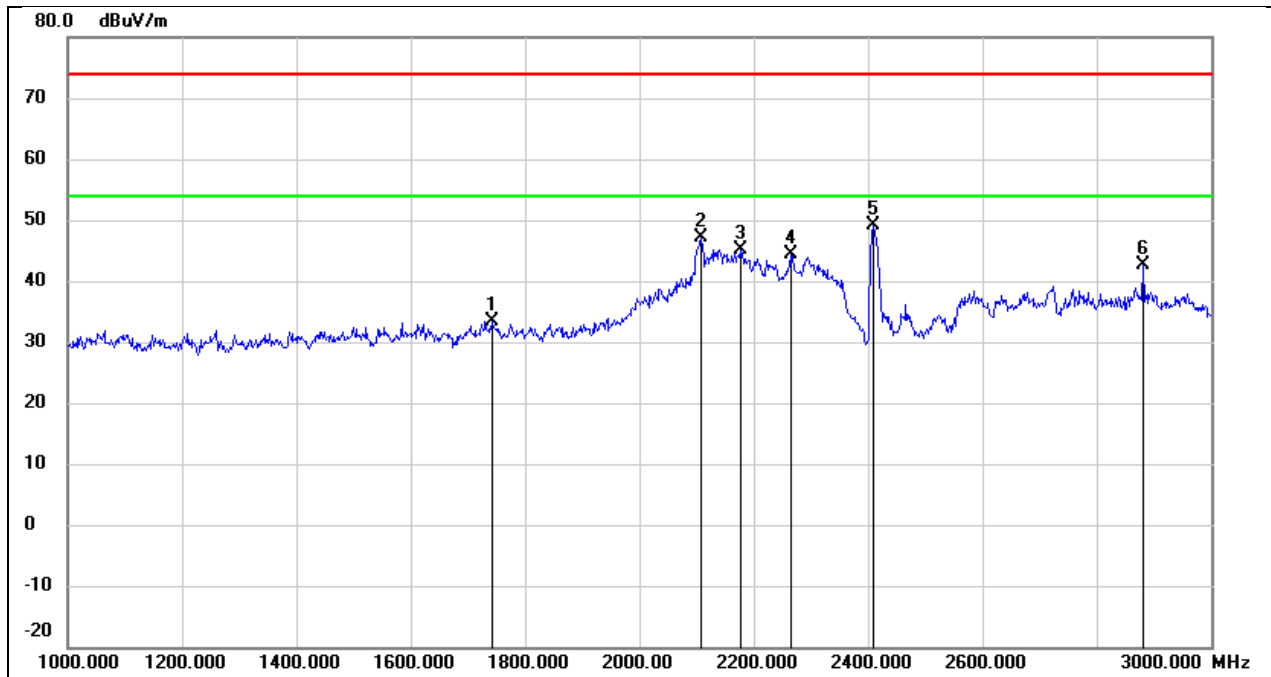

| No. | Frequency (MHz) | Reading (dBuV) | Correct (dB/m) | Result (dBuV/m) | Limit (dBuV/m) | Margin (dB) | Remark |
|-----|-----------------|----------------|----------------|-----------------|----------------|-------------|--------|
| 1   | 1742.000        | 45.40          | -11.91         | 33.49           | 74.00          | -40.51      | peak   |
| 2   | 2108.000        | 57.57          | -10.50         | 47.07           | 74.00          | -26.93      | peak   |
| 3   | 2176.000        | 55.39          | -10.16         | 45.23           | 74.00          | -28.77      | peak   |
| 4   | 2264.000        | 53.97          | -9.70          | 44.27           | 74.00          | -29.73      | peak   |
| 5   | 2408.000        | 58.06          | -8.96          | 49.10           | 74.00          | -24.90      | peak   |
| 6   | 2882.000        | 50.08          | -7.33          | 42.75           | 74.00          | -31.25      | peak   |



|            |          |               |          |
|------------|----------|---------------|----------|
| Test Mode: | 802.11b  | Channel:      | 2412 MHz |
| Polarity:  | Vertical | Test Voltage: | DC 12 V  |

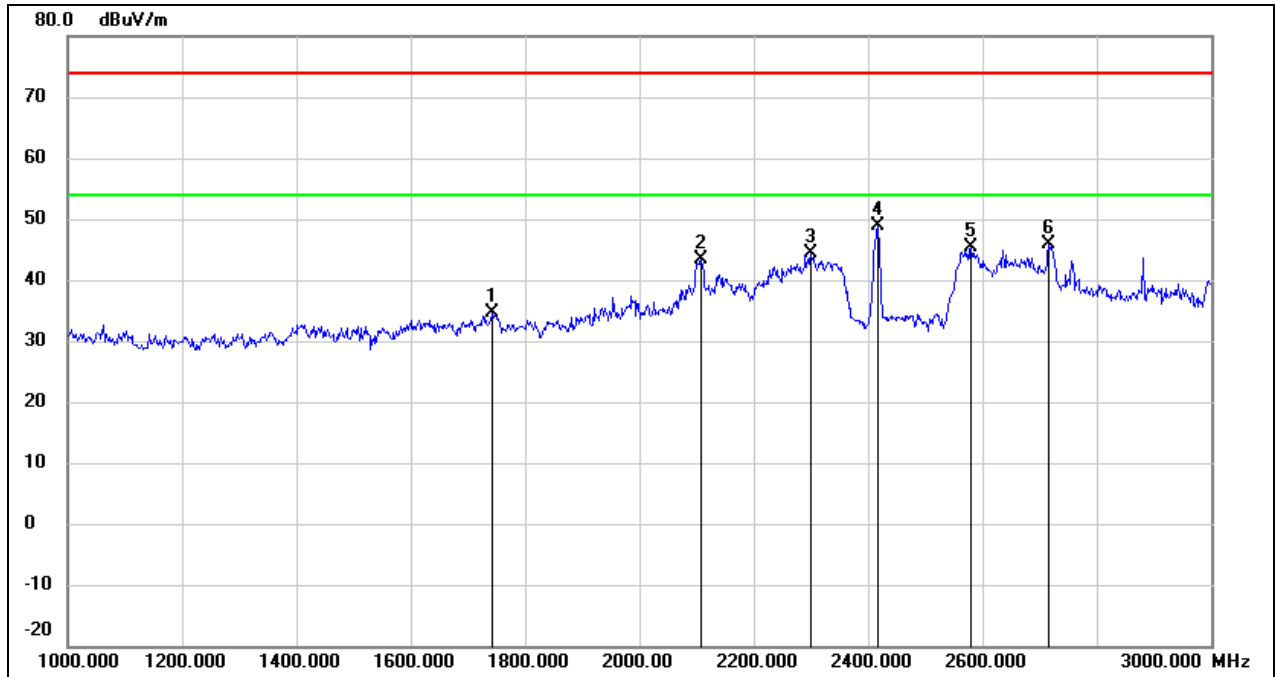

| No. | Frequency (MHz) | Reading (dBuV) | Correct (dB/m) | Result (dBuV/m) | Limit (dBuV/m) | Margin (dB) | Remark |
|-----|-----------------|----------------|----------------|-----------------|----------------|-------------|--------|
| 1   | 1742.000        | 46.43          | -11.91         | 34.52           | 74.00          | -39.48      | peak   |
| 2   | 2108.000        | 53.80          | -10.50         | 43.30           | 74.00          | -30.70      | peak   |
| 3   | 2300.000        | 53.80          | -9.52          | 44.28           | 74.00          | -29.72      | peak   |
| 4   | 2416.000        | 57.70          | -8.92          | 48.78           | 74.00          | -25.22      | peak   |
| 5   | 2580.000        | 53.73          | -8.25          | 45.48           | 74.00          | -28.52      | peak   |
| 6   | 2716.000        | 53.74          | -7.84          | 45.90           | 74.00          | -28.10      | peak   |

|            |            |               |          |
|------------|------------|---------------|----------|
| Test Mode: | 802.11b    | Channel:      | 2437 MHz |
| Polarity:  | Horizontal | Test Voltage: | DC 12 V  |

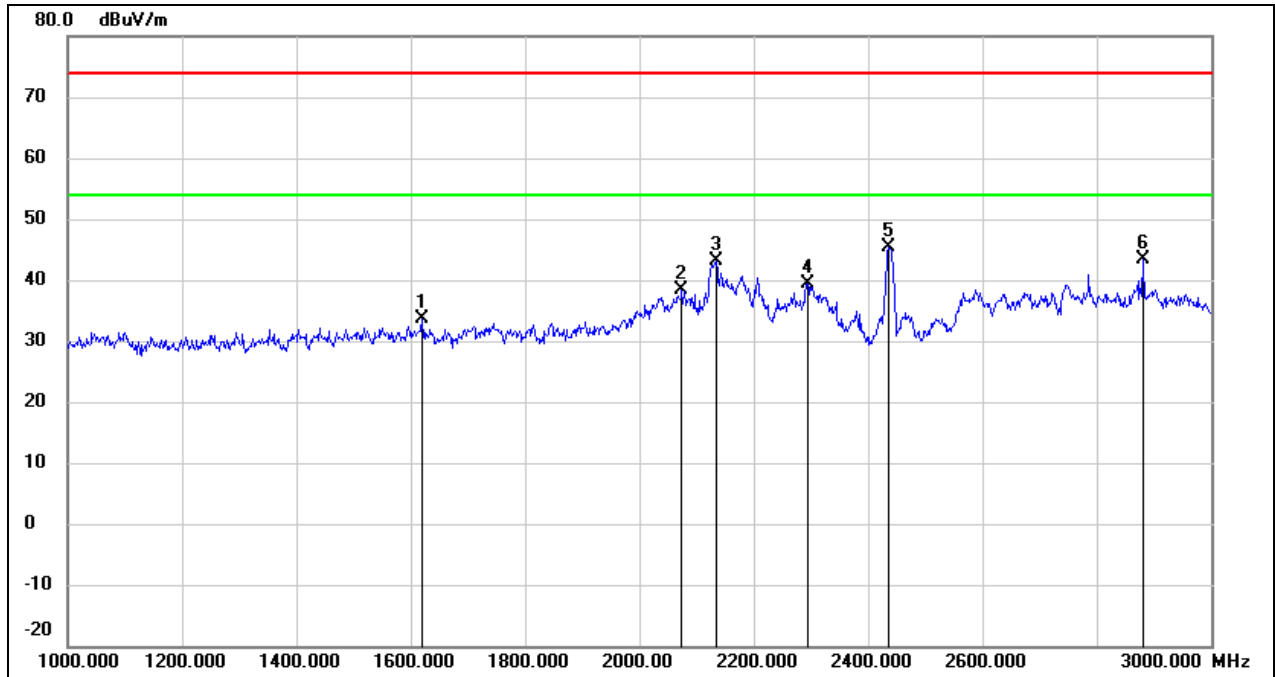

| No. | Frequency (MHz) | Reading (dBuV) | Correct (dB/m) | Result (dBuV/m) | Limit (dBuV/m) | Margin (dB) | Remark |
|-----|-----------------|----------------|----------------|-----------------|----------------|-------------|--------|
| 1   | 1620.000        | 45.86          | -12.31         | 33.55           | 74.00          | -40.45      | peak   |
| 2   | 2074.000        | 49.12          | -10.68         | 38.44           | 74.00          | -35.56      | peak   |
| 3   | 2134.000        | 53.43          | -10.37         | 43.06           | 74.00          | -30.94      | peak   |
| 4   | 2294.000        | 49.03          | -9.55          | 39.48           | 74.00          | -34.52      | peak   |
| 5   | 2436.000        | 54.08          | -8.82          | 45.26           | 74.00          | -28.74      | peak   |
| 6   | 2880.000        | 50.68          | -7.34          | 43.34           | 74.00          | -30.66      | peak   |

|            |          |               |          |
|------------|----------|---------------|----------|
| Test Mode: | 802.11b  | Channel:      | 2437 MHz |
| Polarity:  | Vertical | Test Voltage: | DC 12 V  |

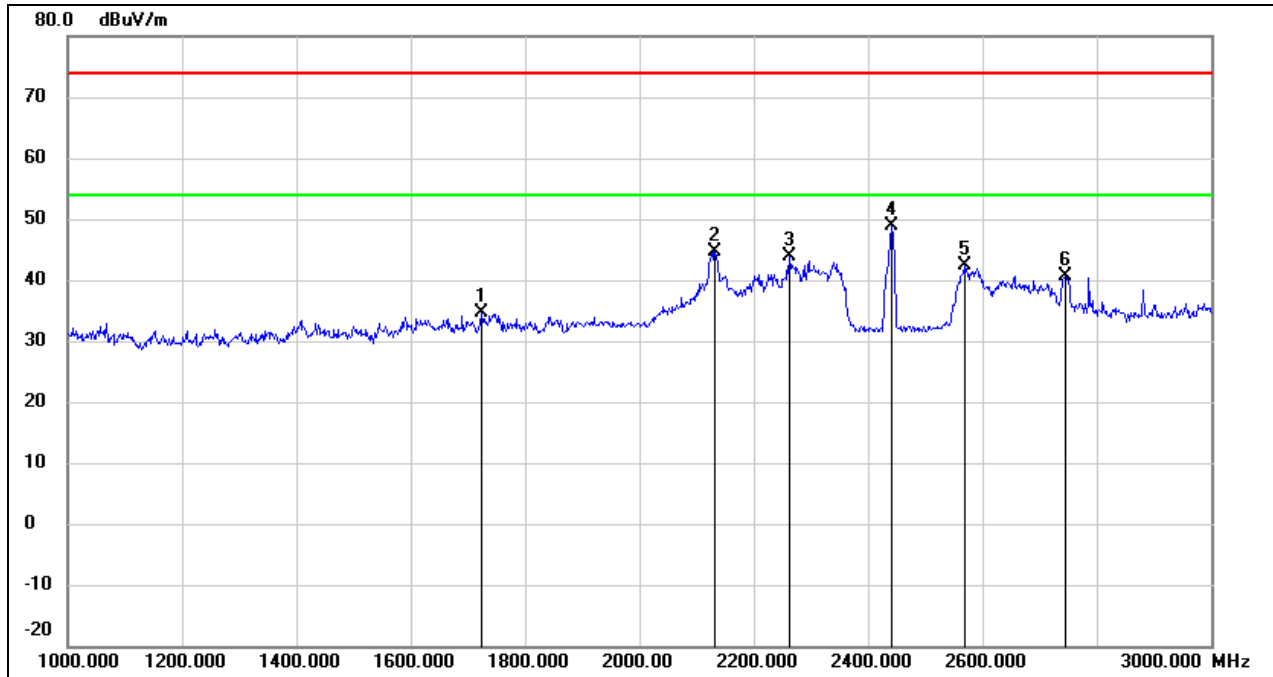

| No. | Frequency (MHz) | Reading (dBuV) | Correct (dB/m) | Result (dBuV/m) | Limit (dBuV/m) | Margin (dB) | Remark |
|-----|-----------------|----------------|----------------|-----------------|----------------|-------------|--------|
| 1   | 1724.000        | 46.58          | -11.97         | 34.61           | 74.00          | -39.39      | peak   |
| 2   | 2132.000        | 54.96          | -10.39         | 44.57           | 74.00          | -29.43      | peak   |
| 3   | 2262.000        | 53.71          | -9.72          | 43.99           | 74.00          | -30.01      | peak   |
| 4   | 2442.000        | 57.56          | -8.79          | 48.77           | 74.00          | -25.23      | peak   |
| 5   | 2568.000        | 50.61          | -8.28          | 42.33           | 74.00          | -31.67      | peak   |
| 6   | 2746.000        | 48.41          | -7.75          | 40.66           | 74.00          | -33.34      | peak   |

|            |            |               |          |
|------------|------------|---------------|----------|
| Test Mode: | 802.11b    | Channel:      | 2462 MHz |
| Polarity:  | Horizontal | Test Voltage: | DC 12 V  |

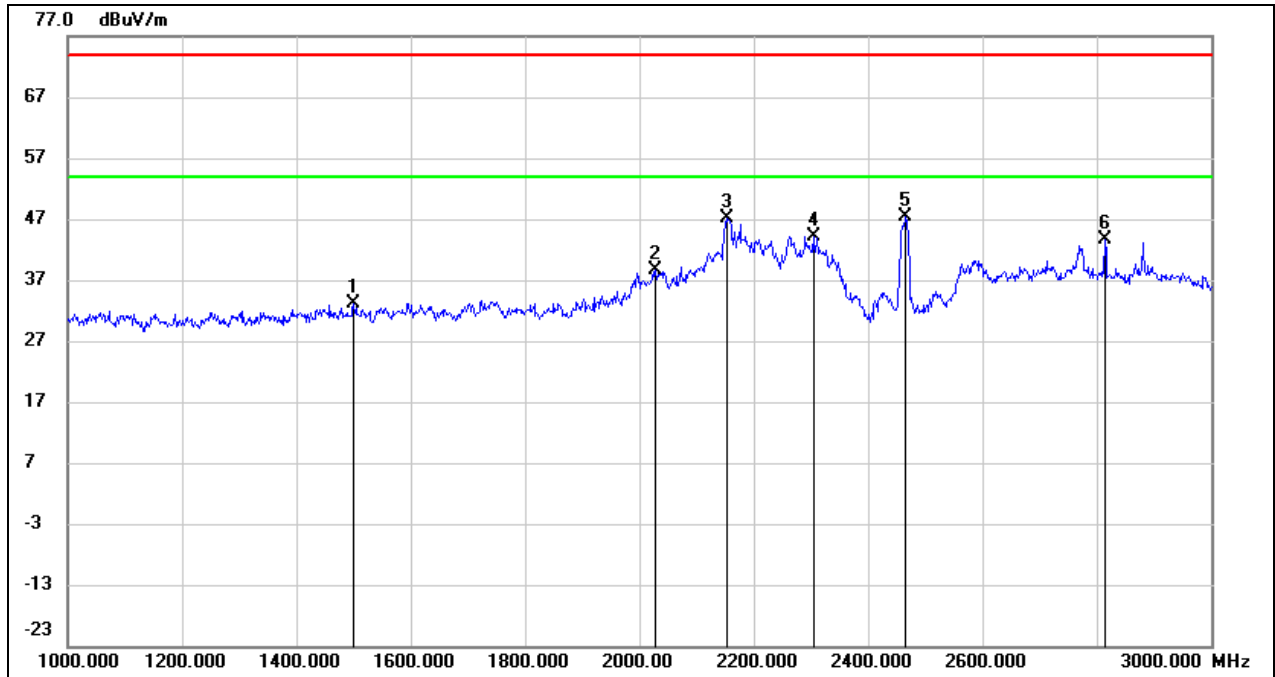

| No. | Frequency (MHz) | Reading (dBuV) | Correct (dB/m) | Result (dBuV/m) | Limit (dBuV/m) | Margin (dB) | Remark |
|-----|-----------------|----------------|----------------|-----------------|----------------|-------------|--------|
| 1   | 1500.000        | 45.76          | -12.71         | 33.05           | 74.00          | -40.95      | peak   |
| 2   | 2028.000        | 49.67          | -10.92         | 38.75           | 74.00          | -35.25      | peak   |
| 3   | 2152.000        | 57.31          | -10.27         | 47.04           | 74.00          | -26.96      | peak   |
| 4   | 2304.000        | 53.59          | -9.50          | 44.09           | 74.00          | -29.91      | peak   |
| 5   | 2466.000        | 56.13          | -8.66          | 47.47           | 74.00          | -26.53      | peak   |
| 6   | 2814.000        | 51.08          | -7.54          | 43.54           | 74.00          | -30.46      | peak   |

|            |          |               |          |
|------------|----------|---------------|----------|
| Test Mode: | 802.11b  | Channel:      | 2462 MHz |
| Polarity:  | Vertical | Test Voltage: | DC 12 V  |

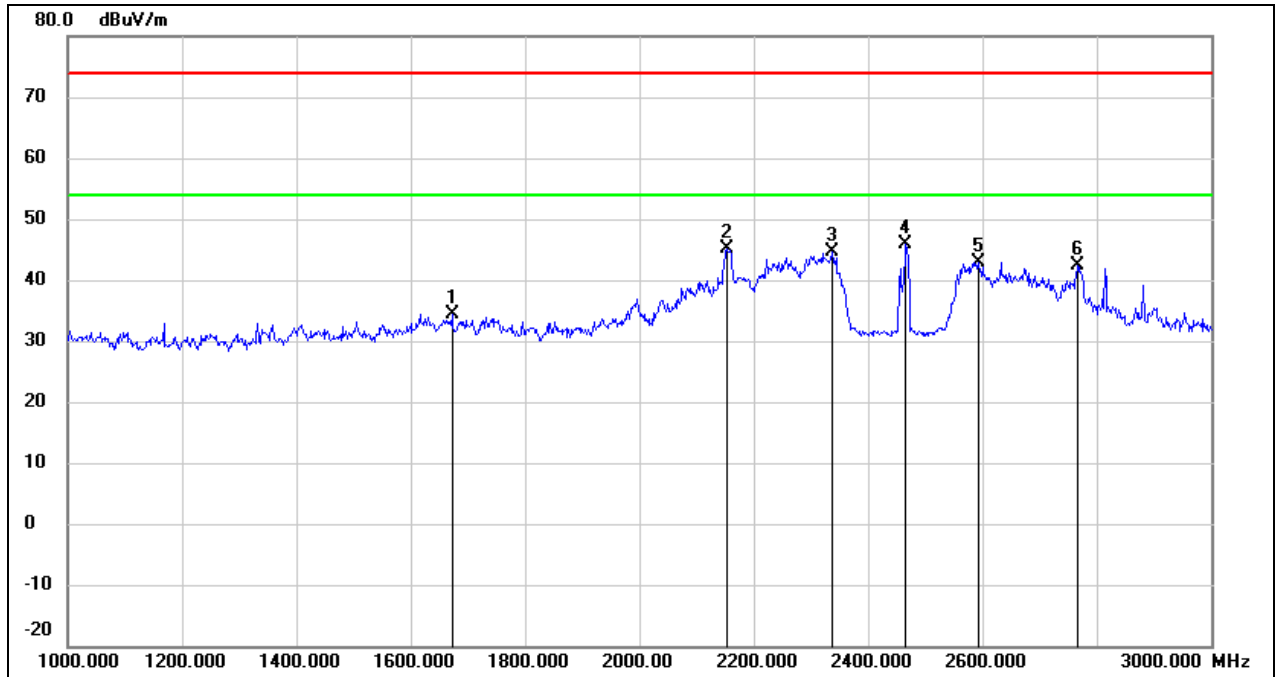

| No. | Frequency (MHz) | Reading (dBuV) | Correct (dB/m) | Result (dBuV/m) | Limit (dBuV/m) | Margin (dB) | Remark |
|-----|-----------------|----------------|----------------|-----------------|----------------|-------------|--------|
| 1   | 1672.000        | 46.44          | -12.15         | 34.29           | 74.00          | -39.71      | peak   |
| 2   | 2152.000        | 55.50          | -10.27         | 45.23           | 74.00          | -28.77      | peak   |
| 3   | 2338.000        | 53.99          | -9.32          | 44.67           | 74.00          | -29.33      | peak   |
| 4   | 2466.000        | 54.52          | -8.66          | 45.86           | 74.00          | -28.14      | peak   |
| 5   | 2592.000        | 51.20          | -8.21          | 42.99           | 74.00          | -31.01      | peak   |
| 6   | 2766.000        | 50.02          | -7.68          | 42.34           | 74.00          | -31.66      | peak   |

### 8.3. SPURIOUS EMISSIONS (3 GHZ ~ 18 GHZ)

|            |            |               |          |
|------------|------------|---------------|----------|
| Test Mode: | 802.11b    | Channel:      | 2412 MHz |
| Polarity:  | Horizontal | Test Voltage: | DC 12 V  |

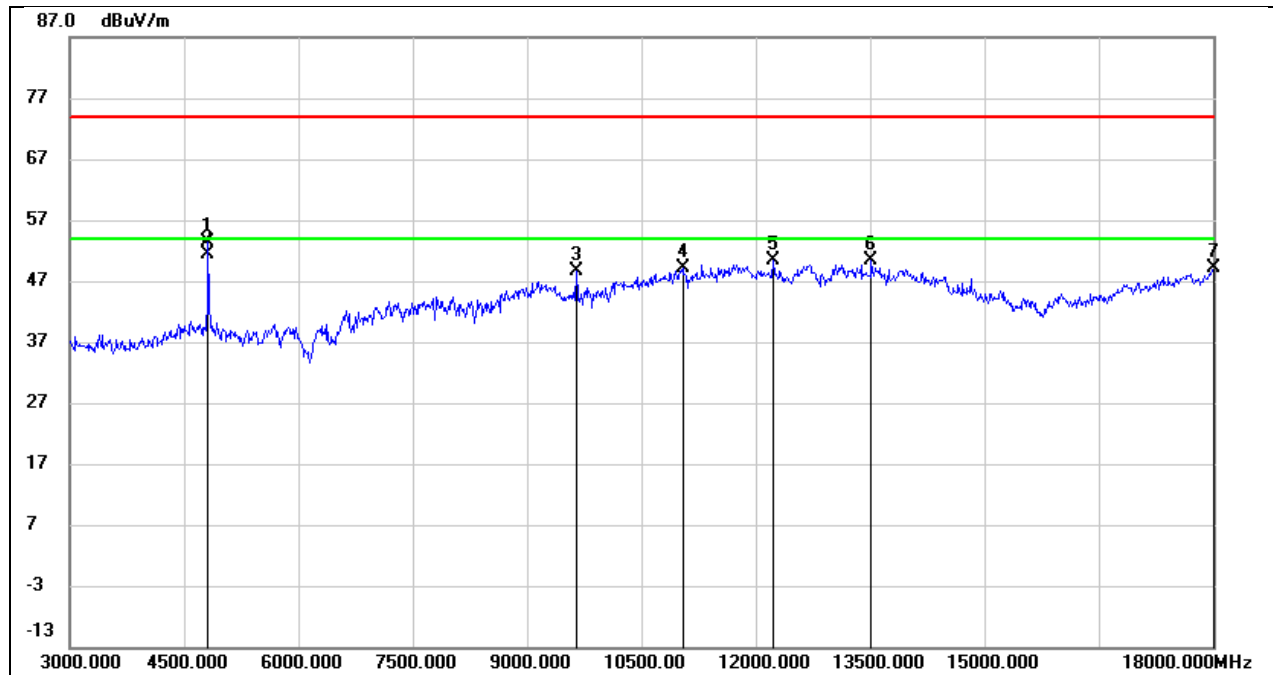

| No. | Frequency (MHz) | Reading (dBuV) | Correct (dB/m) | Result (dBuV/m) | Limit (dBuV/m) | Margin (dB) | Remark |
|-----|-----------------|----------------|----------------|-----------------|----------------|-------------|--------|
| 1   | 4815.000        | 53.56          | -0.26          | 53.30           | 74.00          | -20.70      | peak   |
| 2   | 4815.000        | 51.58          | -0.26          | 51.32           | 54.00          | -2.68       | AVG    |
| 3   | 9645.000        | 37.44          | 11.08          | 48.52           | 74.00          | -25.48      | peak   |
| 4   | 11040.000       | 34.23          | 14.91          | 49.14           | 74.00          | -24.86      | peak   |
| 5   | 12225.000       | 32.71          | 17.79          | 50.50           | 74.00          | -23.50      | peak   |
| 6   | 13515.000       | 29.49          | 20.93          | 50.42           | 74.00          | -23.58      | peak   |
| 7   | 18000.000       | 23.49          | 25.69          | 49.18           | 74.00          | -24.82      | peak   |

|            |          |               |          |
|------------|----------|---------------|----------|
| Test Mode: | 802.11b  | Channel:      | 2412 MHz |
| Polarity:  | Vertical | Test Voltage: | DC 12 V  |

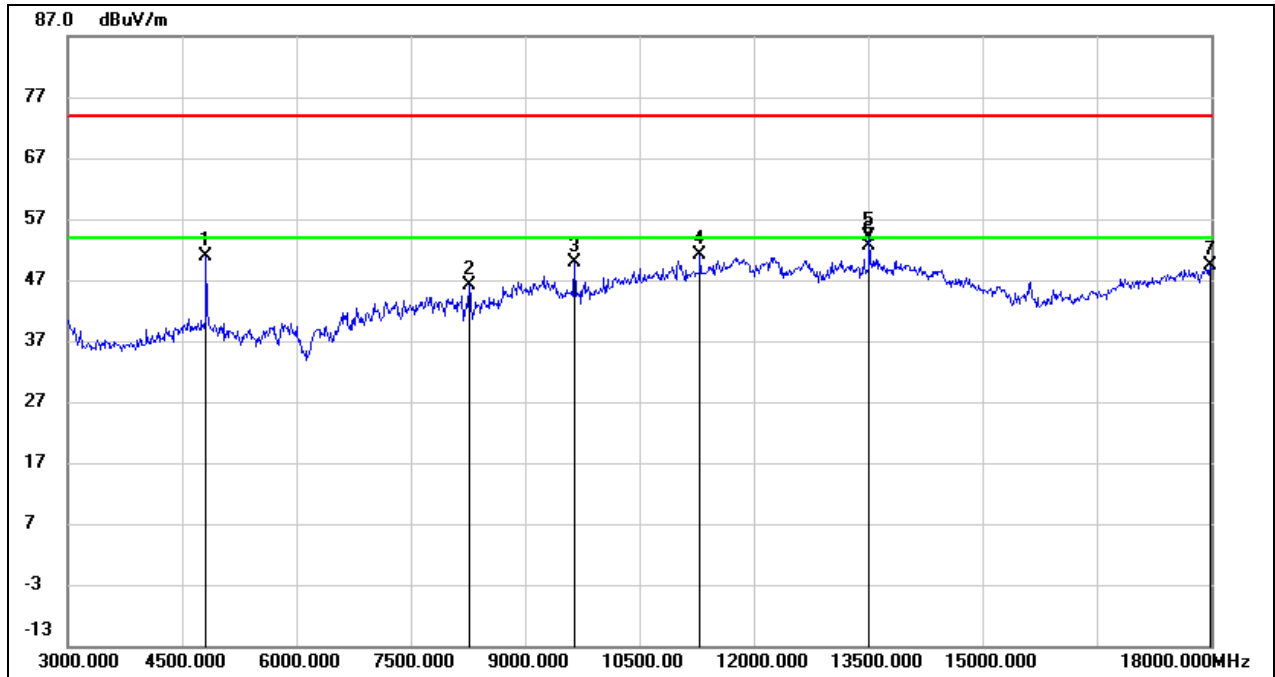

| No. | Frequency (MHz) | Reading (dBuV) | Correct (dB/m) | Result (dBuV/m) | Limit (dBuV/m) | Margin (dB) | Remark |
|-----|-----------------|----------------|----------------|-----------------|----------------|-------------|--------|
| 1   | 4815.000        | 51.16          | -0.26          | 50.90           | 74.00          | -23.10      | peak   |
| 2   | 8265.000        | 39.60          | 6.59           | 46.19           | 74.00          | -27.81      | peak   |
| 3   | 9645.000        | 38.77          | 11.08          | 49.85           | 74.00          | -24.15      | peak   |
| 4   | 11295.000       | 35.32          | 15.85          | 51.17           | 74.00          | -22.83      | peak   |
| 5   | 13515.000       | 33.31          | 20.93          | 54.24           | 74.00          | -19.76      | peak   |
| 6   | 13515.000       | 31.82          | 20.93          | 52.75           | 54.00          | -1.25       | AVG    |
| 7   | 17985.000       | 23.77          | 25.60          | 49.37           | 74.00          | -24.63      | peak   |

|            |            |               |          |
|------------|------------|---------------|----------|
| Test Mode: | 802.11b    | Channel:      | 2437 MHz |
| Polarity:  | Horizontal | Test Voltage: | DC 12 V  |

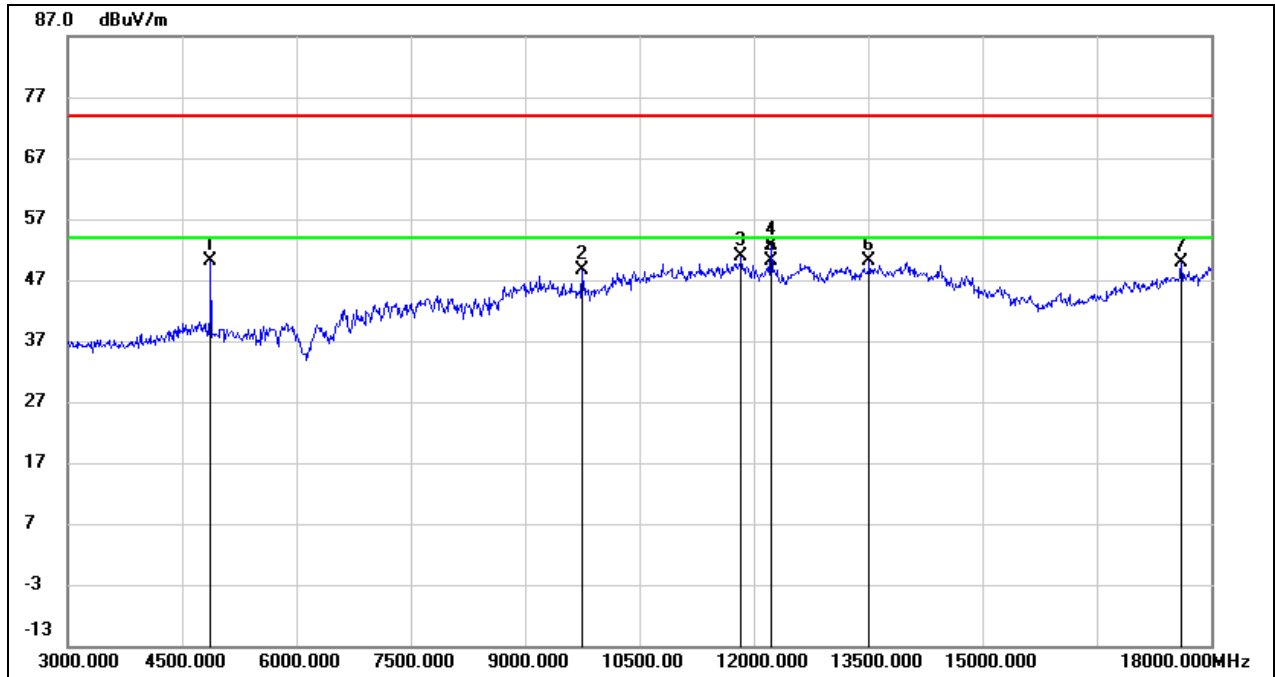

| No. | Frequency (MHz) | Reading (dBuV) | Correct (dB/m) | Result (dBuV/m) | Limit (dBuV/m) | Margin (dB) | Remark |
|-----|-----------------|----------------|----------------|-----------------|----------------|-------------|--------|
| 1   | 4875.000        | 50.06          | -0.03          | 50.03           | 74.00          | -23.97      | peak   |
| 2   | 9750.000        | 37.27          | 11.35          | 48.62           | 74.00          | -25.38      | peak   |
| 3   | 11835.000       | 33.25          | 17.51          | 50.76           | 74.00          | -23.24      | peak   |
| 4   | 12225.000       | 34.78          | 17.79          | 52.57           | 74.00          | -21.43      | peak   |
| 5   | 12225.000       | 32.44          | 17.79          | 50.23           | 54.00          | -3.77       | AVG    |
| 6   | 13515.000       | 29.25          | 20.93          | 50.18           | 74.00          | -23.82      | peak   |
| 7   | 17610.000       | 26.55          | 23.38          | 49.93           | 74.00          | -24.07      | peak   |



|            |          |               |          |
|------------|----------|---------------|----------|
| Test Mode: | 802.11b  | Channel:      | 2437 MHz |
| Polarity:  | Vertical | Test Voltage: | DC 12 V  |

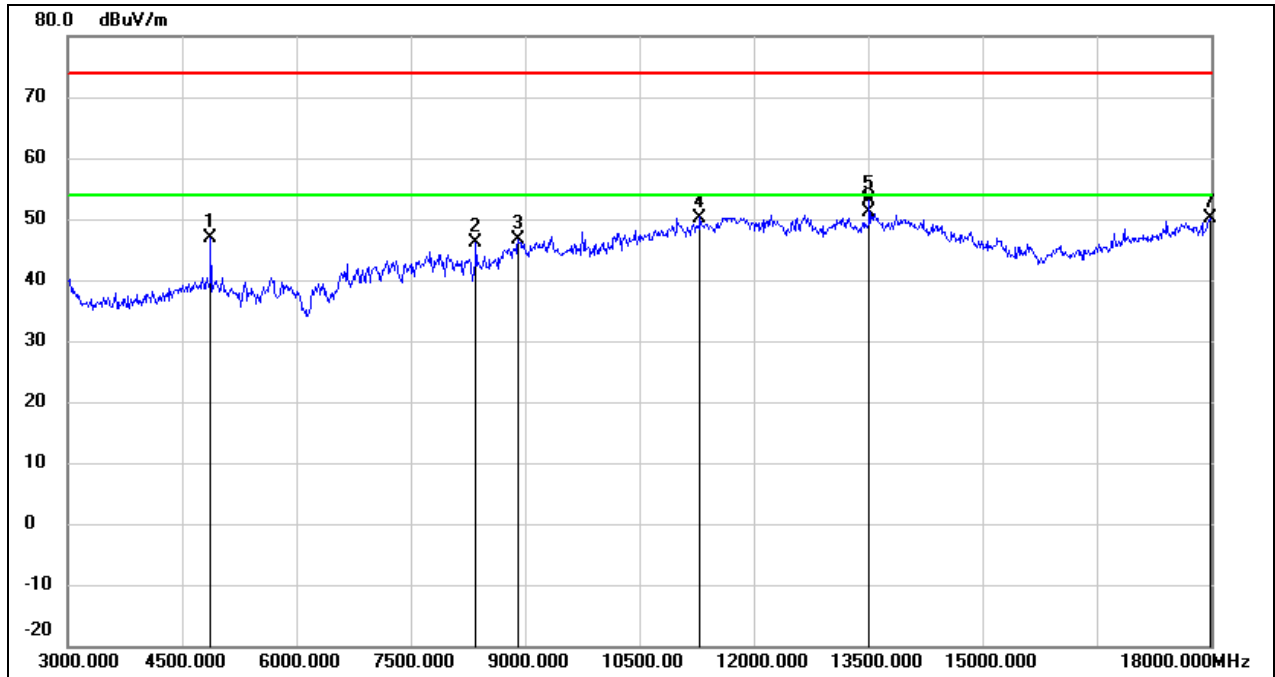

| No. | Frequency (MHz) | Reading (dBuV) | Correct (dB/m) | Result (dBuV/m) | Limit (dBuV/m) | Margin (dB) | Remark |
|-----|-----------------|----------------|----------------|-----------------|----------------|-------------|--------|
| 1   | 4875.000        | 47.02          | -0.03          | 46.99           | 74.00          | -27.01      | peak   |
| 2   | 8355.000        | 39.52          | 6.69           | 46.21           | 74.00          | -27.79      | peak   |
| 3   | 8910.000        | 36.86          | 9.82           | 46.68           | 74.00          | -27.32      | peak   |
| 4   | 11295.000       | 34.40          | 15.85          | 50.25           | 74.00          | -23.75      | peak   |
| 5   | 13515.000       | 32.10          | 20.93          | 53.03           | 74.00          | -20.97      | peak   |
| 6   | 13515.000       | 30.16          | 20.93          | 51.09           | 54.00          | -2.91       | AVG    |
| 7   | 17985.000       | 24.47          | 25.60          | 50.07           | 74.00          | -23.93      | peak   |

|            |            |               |          |
|------------|------------|---------------|----------|
| Test Mode: | 802.11b    | Channel:      | 2462 MHz |
| Polarity:  | Horizontal | Test Voltage: | DC 12 V  |

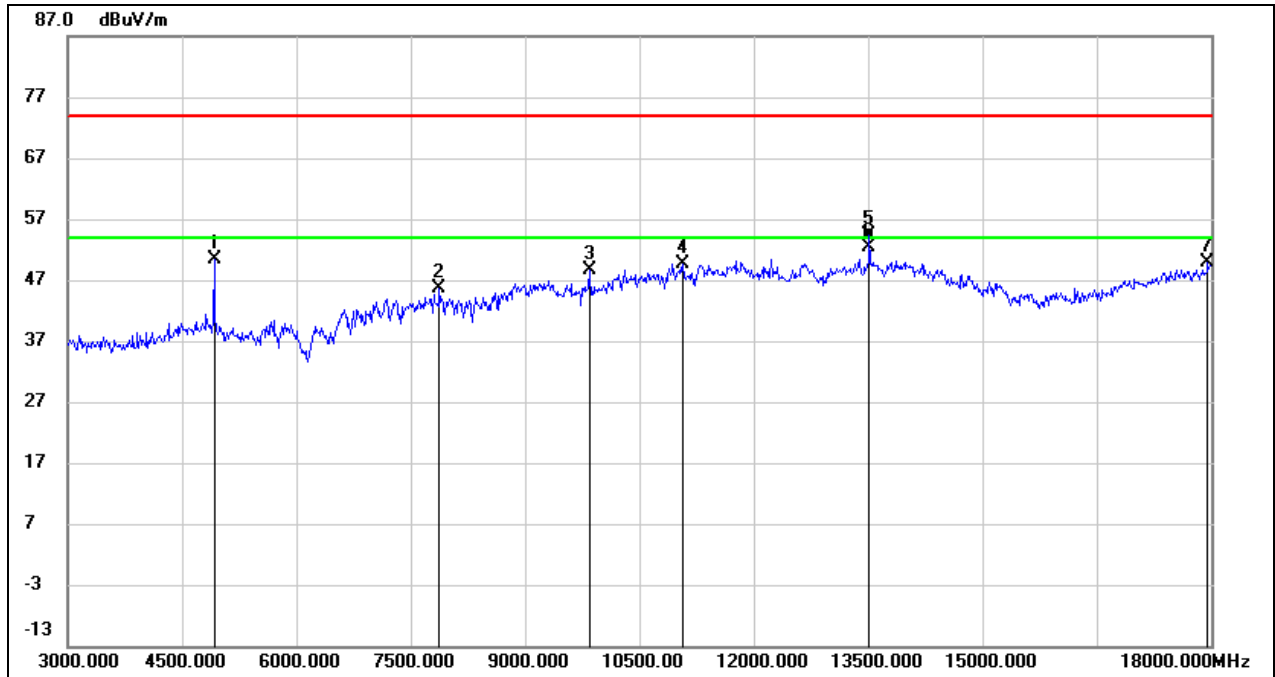

| No. | Frequency (MHz) | Reading (dBuV) | Correct (dB/m) | Result (dBuV/m) | Limit (dBuV/m) | Margin (dB) | Remark |
|-----|-----------------|----------------|----------------|-----------------|----------------|-------------|--------|
| 1   | 4920.000        | 50.35          | 0.14           | 50.49           | 74.00          | -23.51      | peak   |
| 2   | 7875.000        | 39.31          | 6.31           | 45.62           | 74.00          | -28.38      | peak   |
| 3   | 9840.000        | 36.98          | 11.59          | 48.57           | 74.00          | -25.43      | peak   |
| 4   | 11070.000       | 34.65          | 15.03          | 49.68           | 74.00          | -24.32      | peak   |
| 5   | 13515.000       | 33.33          | 20.93          | 54.26           | 74.00          | -19.74      | peak   |
| 6   | 13515.000       | 31.52          | 20.93          | 52.45           | 54.00          | -1.55       | AVG    |
| 7   | 17955.000       | 24.34          | 25.42          | 49.76           | 74.00          | -24.24      | peak   |

|            |          |               |          |
|------------|----------|---------------|----------|
| Test Mode: | 802.11b  | Channel:      | 2462 MHz |
| Polarity:  | Vertical | Test Voltage: | DC 12 V  |

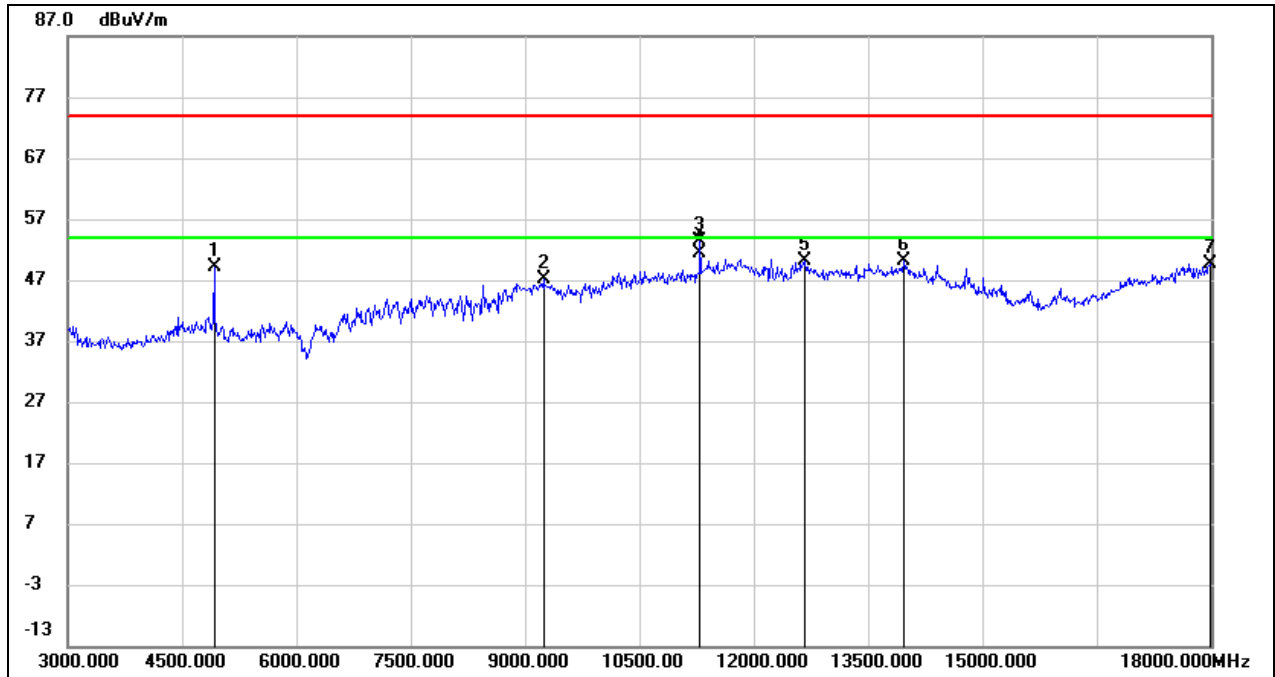

| No. | Frequency (MHz) | Reading (dBuV) | Correct (dB/m) | Result (dBuV/m) | Limit (dBuV/m) | Margin (dB) | Remark |
|-----|-----------------|----------------|----------------|-----------------|----------------|-------------|--------|
| 1   | 4920.000        | 49.01          | 0.14           | 49.15           | 74.00          | -24.85      | peak   |
| 2   | 9240.000        | 36.52          | 10.58          | 47.10           | 74.00          | -26.90      | peak   |
| 3   | 11295.000       | 37.55          | 15.85          | 53.40           | 74.00          | -20.60      | peak   |
| 4   | 11295.000       | 35.50          | 15.85          | 51.35           | 54.00          | -2.65       | AVG    |
| 5   | 12660.000       | 32.21          | 17.95          | 50.16           | 74.00          | -23.84      | peak   |
| 6   | 13965.000       | 28.18          | 21.89          | 50.07           | 74.00          | -23.93      | peak   |
| 7   | 17985.000       | 24.09          | 25.60          | 49.69           | 74.00          | -24.31      | peak   |

|            |            |               |          |
|------------|------------|---------------|----------|
| Test Mode: | 802.11g    | Channel:      | 2412 MHz |
| Polarity:  | Horizontal | Test Voltage: | DC 12 V  |

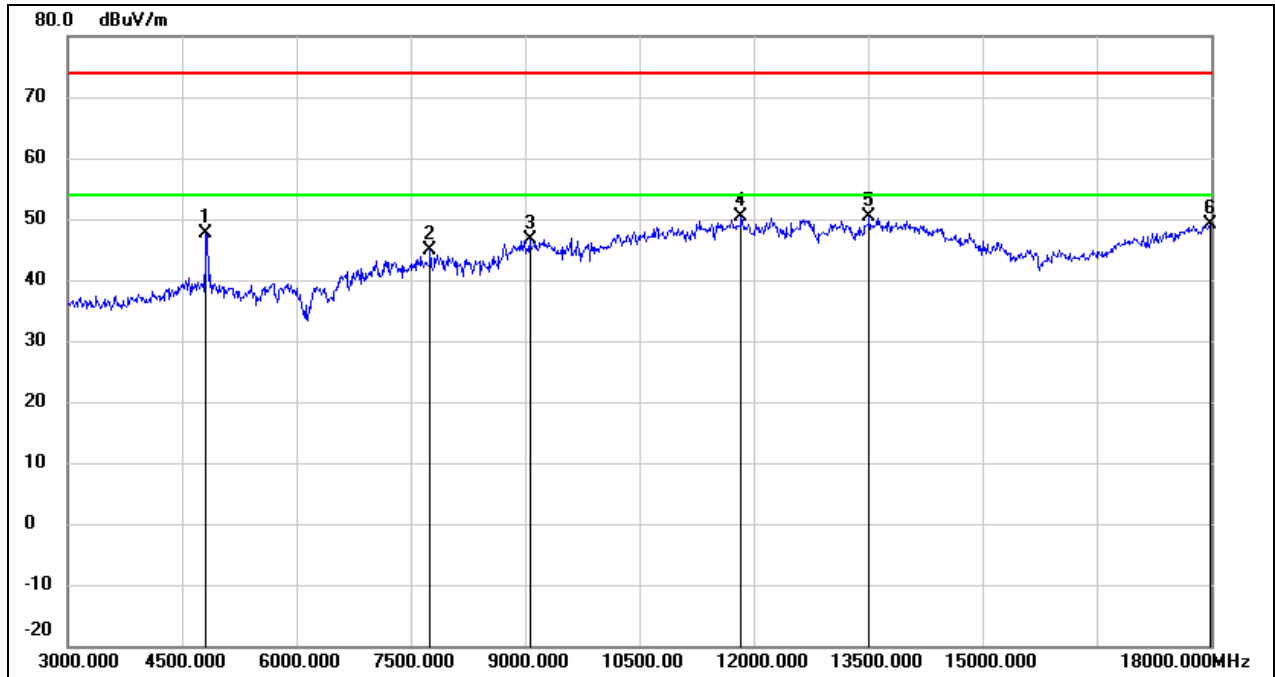

| No. | Frequency (MHz) | Reading (dBuV) | Correct (dB/m) | Result (dBuV/m) | Limit (dBuV/m) | Margin (dB) | Remark |
|-----|-----------------|----------------|----------------|-----------------|----------------|-------------|--------|
| 1   | 4815.000        | 47.80          | -0.26          | 47.54           | 74.00          | -26.46      | peak   |
| 2   | 7755.000        | 38.57          | 6.31           | 44.88           | 74.00          | -29.12      | peak   |
| 3   | 9060.000        | 36.17          | 10.51          | 46.68           | 74.00          | -27.32      | peak   |
| 4   | 11835.000       | 32.76          | 17.51          | 50.27           | 74.00          | -23.73      | peak   |
| 5   | 13515.000       | 29.54          | 20.93          | 50.47           | 74.00          | -23.53      | peak   |
| 6   | 17985.000       | 23.64          | 25.60          | 49.24           | 74.00          | -24.76      | peak   |

|            |          |               |          |
|------------|----------|---------------|----------|
| Test Mode: | 802.11g  | Channel:      | 2412 MHz |
| Polarity:  | Vertical | Test Voltage: | DC 12 V  |

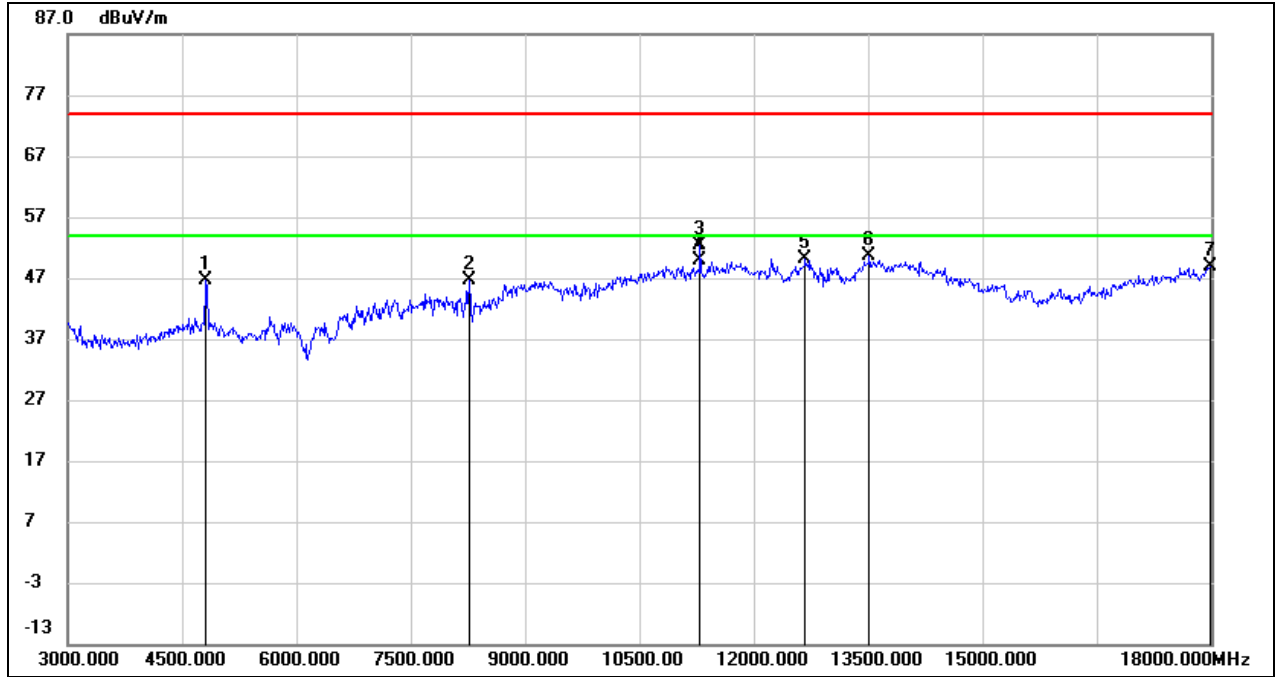

| No. | Frequency (MHz) | Reading (dBuV) | Correct (dB/m) | Result (dBuV/m) | Limit (dBuV/m) | Margin (dB) | Remark |
|-----|-----------------|----------------|----------------|-----------------|----------------|-------------|--------|
| 1   | 4815.000        | 47.00          | -0.26          | 46.74           | 74.00          | -27.26      | peak   |
| 2   | 8265.000        | 40.07          | 6.59           | 46.66           | 74.00          | -27.34      | peak   |
| 3   | 11295.000       | 36.58          | 15.85          | 52.43           | 74.00          | -21.57      | peak   |
| 4   | 11295.000       | 33.95          | 15.85          | 49.80           | 54.00          | -4.20       | AVG    |
| 5   | 12675.000       | 32.19          | 17.99          | 50.18           | 74.00          | -23.82      | peak   |
| 6   | 13515.000       | 29.72          | 20.93          | 50.65           | 74.00          | -23.35      | peak   |
| 7   | 17985.000       | 23.32          | 25.60          | 48.92           | 74.00          | -25.08      | peak   |

|            |            |               |          |
|------------|------------|---------------|----------|
| Test Mode: | 802.11g    | Channel:      | 2417 MHz |
| Polarity:  | Horizontal | Test Voltage: | DC 12 V  |

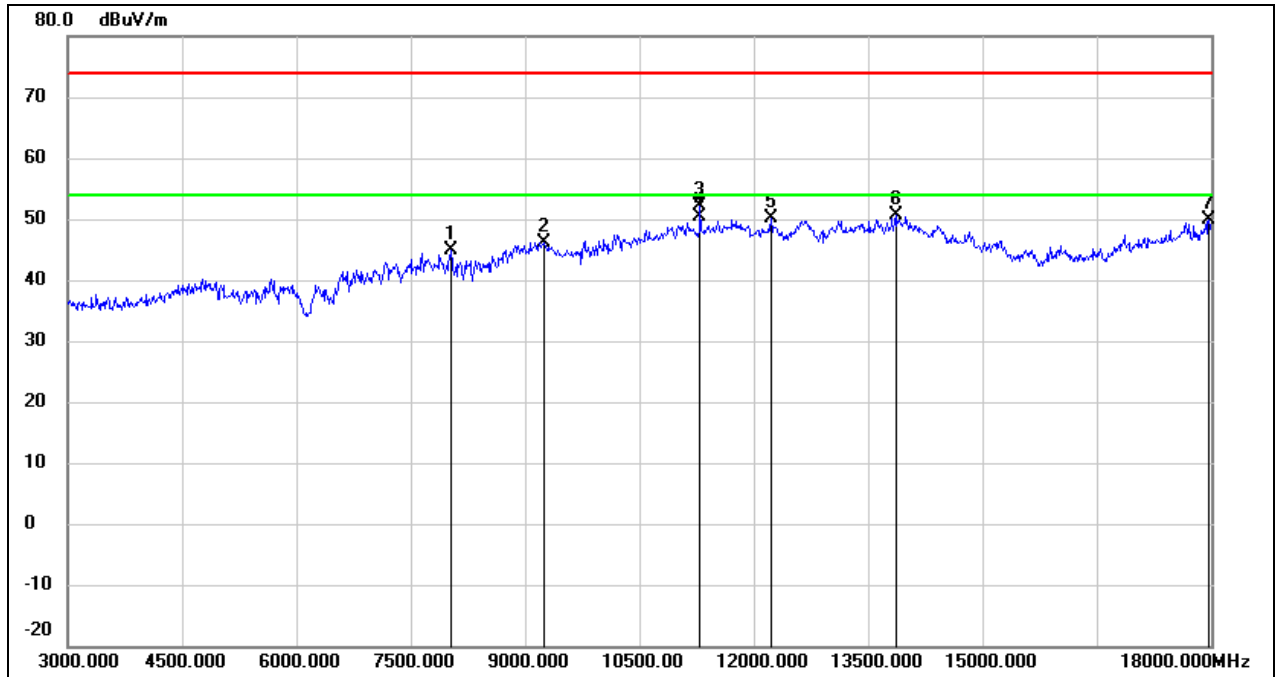

| No. | Frequency (MHz) | Reading (dBuV) | Correct (dB/m) | Result (dBuV/m) | Limit (dBuV/m) | Margin (dB) | Remark |
|-----|-----------------|----------------|----------------|-----------------|----------------|-------------|--------|
| 1   | 8025.000        | 38.53          | 6.34           | 44.87           | 74.00          | -29.13      | peak   |
| 2   | 9240.000        | 35.65          | 10.58          | 46.23           | 74.00          | -27.77      | peak   |
| 3   | 11295.000       | 36.20          | 15.85          | 52.05           | 74.00          | -21.95      | peak   |
| 4   | 11295.000       | 34.56          | 15.85          | 50.41           | 54.00          | -3.59       | AVG    |
| 5   | 12225.000       | 32.37          | 17.79          | 50.16           | 74.00          | -23.84      | peak   |
| 6   | 13860.000       | 29.05          | 21.67          | 50.72           | 74.00          | -23.28      | peak   |
| 7   | 17970.000       | 24.47          | 25.51          | 49.98           | 74.00          | -24.02      | peak   |

|            |          |               |          |
|------------|----------|---------------|----------|
| Test Mode: | 802.11g  | Channel:      | 2417 MHz |
| Polarity:  | Vertical | Test Voltage: | DC 12 V  |

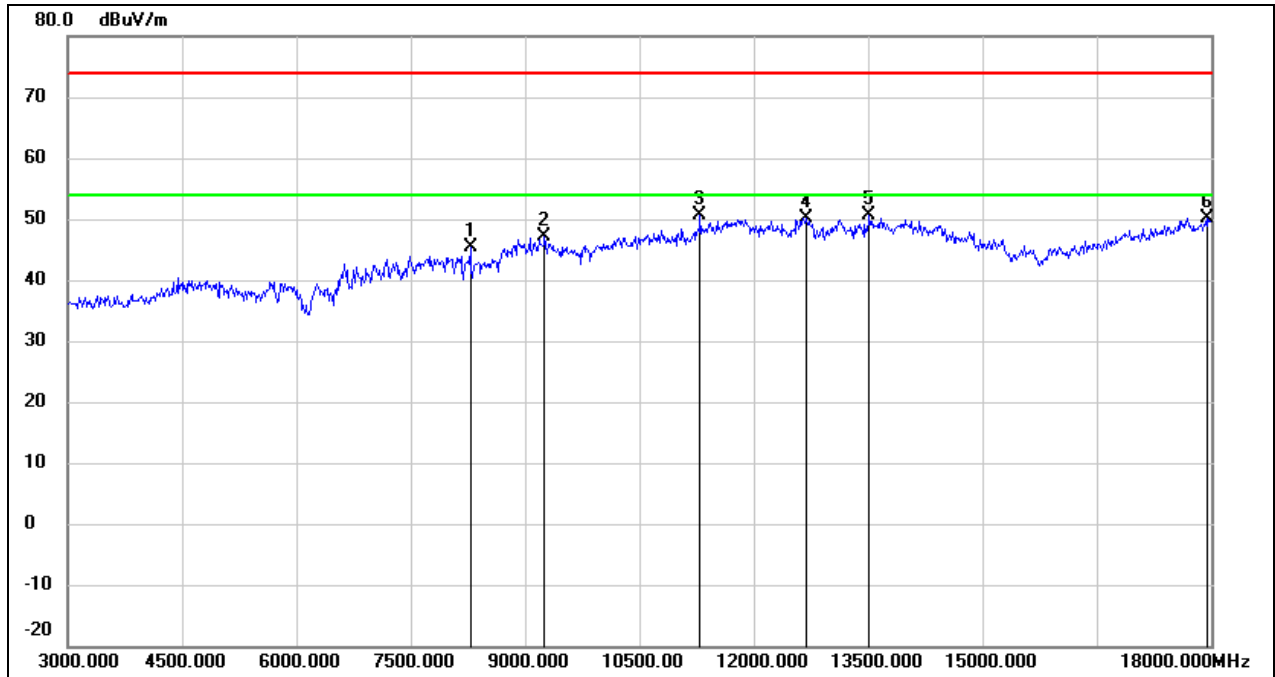

| No. | Frequency (MHz) | Reading (dBuV) | Correct (dB/m) | Result (dBuV/m) | Limit (dBuV/m) | Margin (dB) | Remark |
|-----|-----------------|----------------|----------------|-----------------|----------------|-------------|--------|
| 1   | 8280.000        | 38.84          | 6.61           | 45.45           | 74.00          | -28.55      | peak   |
| 2   | 9255.000        | 36.46          | 10.59          | 47.05           | 74.00          | -26.95      | peak   |
| 3   | 11295.000       | 34.87          | 15.85          | 50.72           | 74.00          | -23.28      | peak   |
| 4   | 12690.000       | 32.03          | 18.02          | 50.05           | 74.00          | -23.95      | peak   |
| 5   | 13515.000       | 29.66          | 20.93          | 50.59           | 74.00          | -23.41      | peak   |
| 6   | 17940.000       | 24.75          | 25.34          | 50.09           | 74.00          | -23.91      | peak   |

|            |            |               |          |
|------------|------------|---------------|----------|
| Test Mode: | 802.11g    | Channel:      | 2437 MHz |
| Polarity:  | Horizontal | Test Voltage: | DC 12 V  |

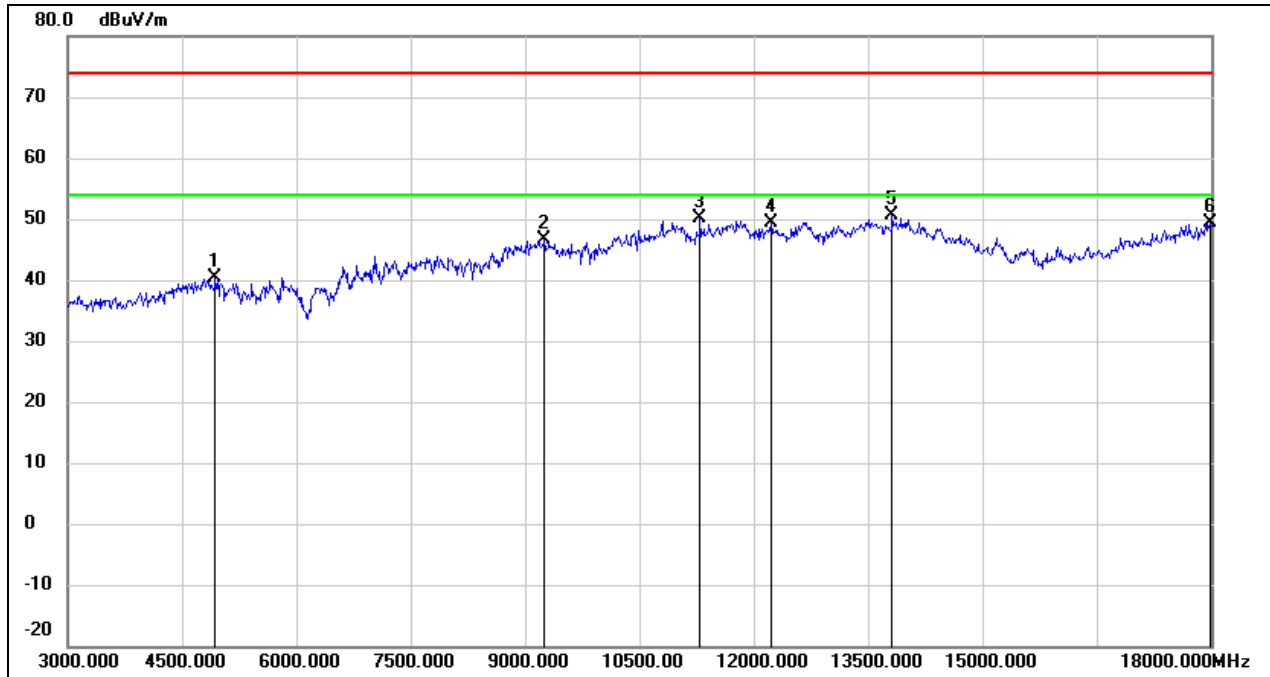

| No. | Frequency (MHz) | Reading (dBuV) | Correct (dB/m) | Result (dBuV/m) | Limit (dBuV/m) | Margin (dB) | Remark |
|-----|-----------------|----------------|----------------|-----------------|----------------|-------------|--------|
| 1   | 4935.000        | 40.21          | 0.20           | 40.41           | 74.00          | -33.59      | peak   |
| 2   | 9255.000        | 36.08          | 10.59          | 46.67           | 74.00          | -27.33      | peak   |
| 3   | 11295.000       | 34.26          | 15.85          | 50.11           | 74.00          | -23.89      | peak   |
| 4   | 12225.000       | 31.68          | 17.79          | 49.47           | 74.00          | -24.53      | peak   |
| 5   | 13815.000       | 29.03          | 21.56          | 50.59           | 74.00          | -23.41      | peak   |
| 6   | 17985.000       | 23.72          | 25.60          | 49.32           | 74.00          | -24.68      | peak   |



|            |          |               |          |
|------------|----------|---------------|----------|
| Test Mode: | 802.11g  | Channel:      | 2437 MHz |
| Polarity:  | Vertical | Test Voltage: | DC 12 V  |

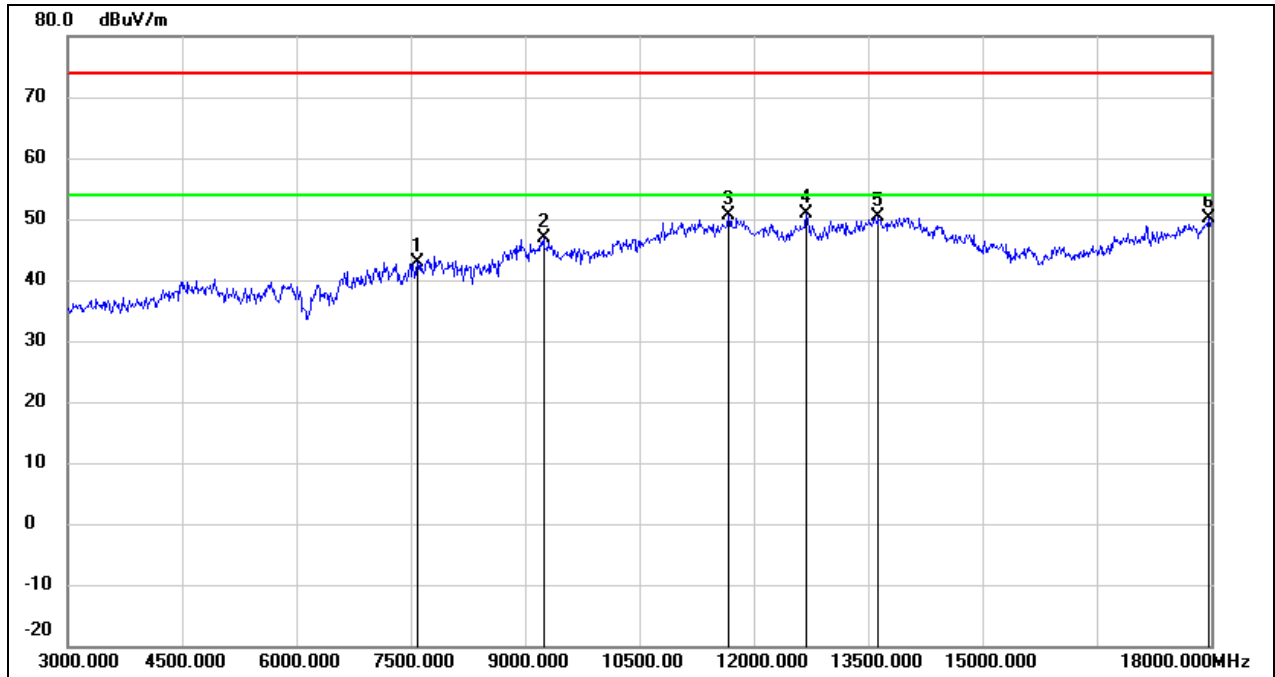

| No. | Frequency (MHz) | Reading (dBuV) | Correct (dB/m) | Result (dBuV/m) | Limit (dBuV/m) | Margin (dB) | Remark |
|-----|-----------------|----------------|----------------|-----------------|----------------|-------------|--------|
| 1   | 7590.000        | 36.55          | 6.32           | 42.87           | 74.00          | -31.13      | peak   |
| 2   | 9240.000        | 36.33          | 10.58          | 46.91           | 74.00          | -27.09      | peak   |
| 3   | 11670.000       | 33.56          | 17.07          | 50.63           | 74.00          | -23.37      | peak   |
| 4   | 12690.000       | 32.77          | 18.02          | 50.79           | 74.00          | -23.21      | peak   |
| 5   | 13635.000       | 29.29          | 21.19          | 50.48           | 74.00          | -23.52      | peak   |
| 6   | 17970.000       | 24.58          | 25.51          | 50.09           | 74.00          | -23.91      | peak   |

|            |            |               |          |
|------------|------------|---------------|----------|
| Test Mode: | 802.11g    | Channel:      | 2457 MHz |
| Polarity:  | Horizontal | Test Voltage: | DC 12 V  |

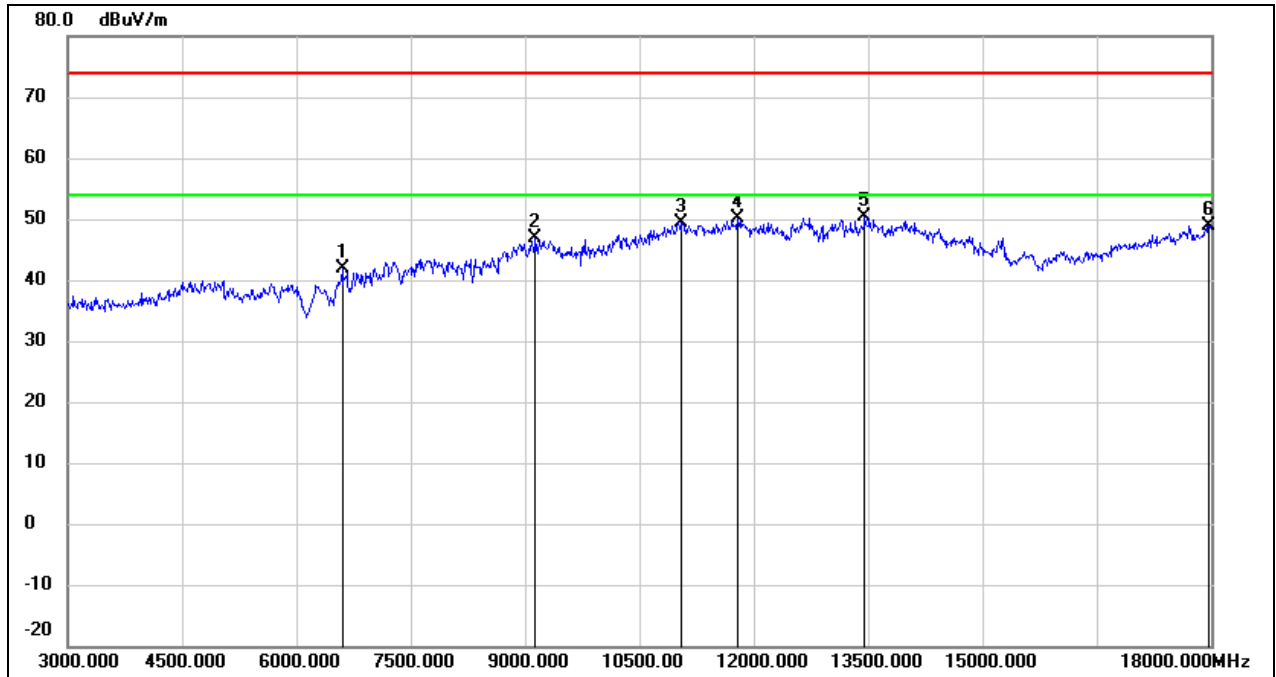

| No. | Frequency (MHz) | Reading (dBuV) | Correct (dB/m) | Result (dBuV/m) | Limit (dBuV/m) | Margin (dB) | Remark |
|-----|-----------------|----------------|----------------|-----------------|----------------|-------------|--------|
| 1   | 6600.000        | 37.10          | 4.71           | 41.81           | 74.00          | -32.19      | peak   |
| 2   | 9135.000        | 36.21          | 10.55          | 46.76           | 74.00          | -27.24      | peak   |
| 3   | 11055.000       | 34.48          | 14.96          | 49.44           | 74.00          | -24.56      | peak   |
| 4   | 11790.000       | 32.70          | 17.38          | 50.08           | 74.00          | -23.92      | peak   |
| 5   | 13455.000       | 29.58          | 20.71          | 50.29           | 74.00          | -23.71      | peak   |
| 6   | 17970.000       | 23.47          | 25.51          | 48.98           | 74.00          | -25.02      | peak   |

|            |          |               |          |
|------------|----------|---------------|----------|
| Test Mode: | 802.11g  | Channel:      | 2457 MHz |
| Polarity:  | Vertical | Test Voltage: | DC 12 V  |

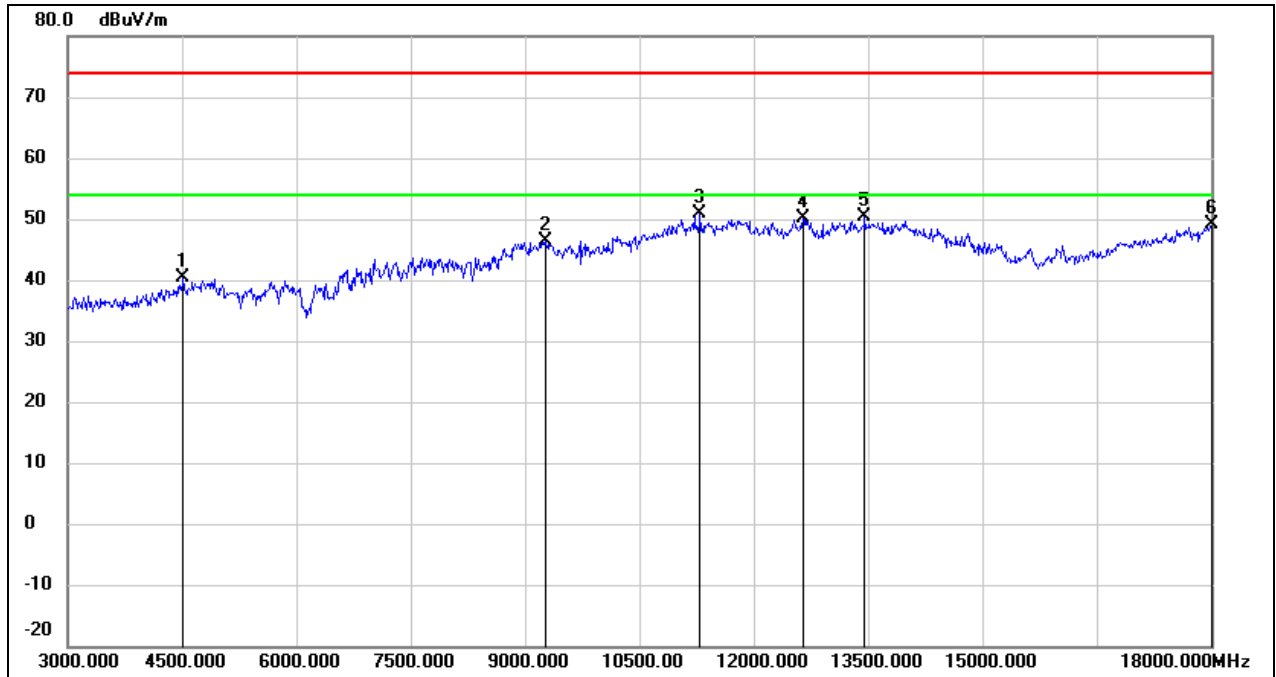

| No. | Frequency (MHz) | Reading (dBuV) | Correct (dB/m) | Result (dBuV/m) | Limit (dBuV/m) | Margin (dB) | Remark |
|-----|-----------------|----------------|----------------|-----------------|----------------|-------------|--------|
| 1   | 4515.000        | 41.78          | -1.40          | 40.38           | 74.00          | -33.62      | peak   |
| 2   | 9270.000        | 35.76          | 10.59          | 46.35           | 74.00          | -27.65      | peak   |
| 3   | 11295.000       | 34.98          | 15.85          | 50.83           | 74.00          | -23.17      | peak   |
| 4   | 12645.000       | 32.19          | 17.92          | 50.11           | 74.00          | -23.89      | peak   |
| 5   | 13455.000       | 29.63          | 20.71          | 50.34           | 74.00          | -23.66      | peak   |
| 6   | 18000.000       | 23.51          | 25.69          | 49.20           | 74.00          | -24.80      | peak   |

|            |            |               |          |
|------------|------------|---------------|----------|
| Test Mode: | 802.11g    | Channel:      | 2462 MHz |
| Polarity:  | Horizontal | Test Voltage: | DC 12 V  |

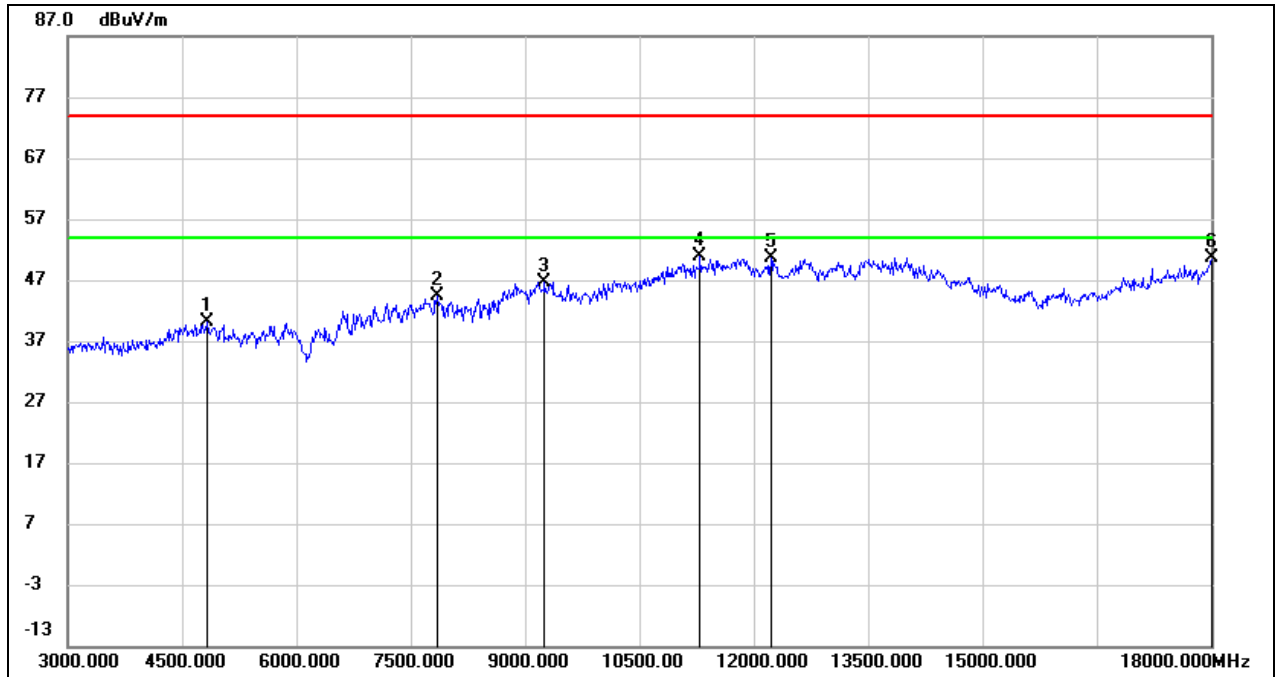

| No. | Frequency (MHz) | Reading (dBuV) | Correct (dB/m) | Result (dBuV/m) | Limit (dBuV/m) | Margin (dB) | Remark |
|-----|-----------------|----------------|----------------|-----------------|----------------|-------------|--------|
| 1   | 4830.000        | 40.40          | -0.20          | 40.20           | 74.00          | -33.80      | peak   |
| 2   | 7845.000        | 38.04          | 6.32           | 44.36           | 74.00          | -29.64      | peak   |
| 3   | 9255.000        | 36.07          | 10.59          | 46.66           | 74.00          | -27.34      | peak   |
| 4   | 11295.000       | 35.04          | 15.85          | 50.89           | 74.00          | -23.11      | peak   |
| 5   | 12225.000       | 32.94          | 17.79          | 50.73           | 74.00          | -23.27      | peak   |
| 6   | 18000.000       | 24.93          | 25.69          | 50.62           | 74.00          | -23.38      | peak   |

|            |          |               |          |
|------------|----------|---------------|----------|
| Test Mode: | 802.11g  | Channel:      | 2462 MHz |
| Polarity:  | Vertical | Test Voltage: | DC 12 V  |

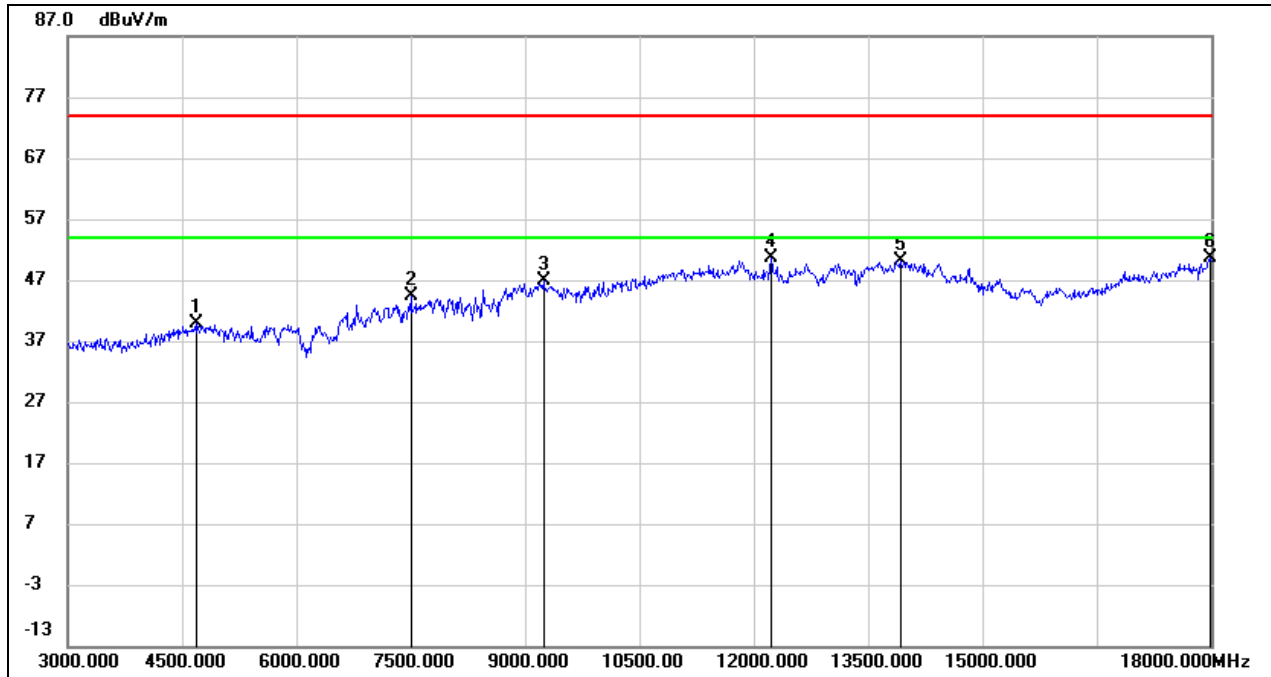

| No. | Frequency (MHz) | Reading (dBuV) | Correct (dB/m) | Result (dBuV/m) | Limit (dBuV/m) | Margin (dB) | Remark |
|-----|-----------------|----------------|----------------|-----------------|----------------|-------------|--------|
| 1   | 4695.000        | 40.69          | -0.71          | 39.98           | 74.00          | -34.02      | peak   |
| 2   | 7500.000        | 38.03          | 6.33           | 44.36           | 74.00          | -29.64      | peak   |
| 3   | 9240.000        | 36.25          | 10.58          | 46.83           | 74.00          | -27.17      | peak   |
| 4   | 12225.000       | 32.81          | 17.79          | 50.60           | 74.00          | -23.40      | peak   |
| 5   | 13935.000       | 28.38          | 21.82          | 50.20           | 74.00          | -23.80      | peak   |
| 6   | 17985.000       | 25.09          | 25.60          | 50.69           | 74.00          | -23.31      | peak   |

|            |               |               |          |
|------------|---------------|---------------|----------|
| Test Mode: | 802.11ax HE20 | Channel:      | 2412 MHz |
| Polarity:  | Horizontal    | Test Voltage: | DC 12 V  |

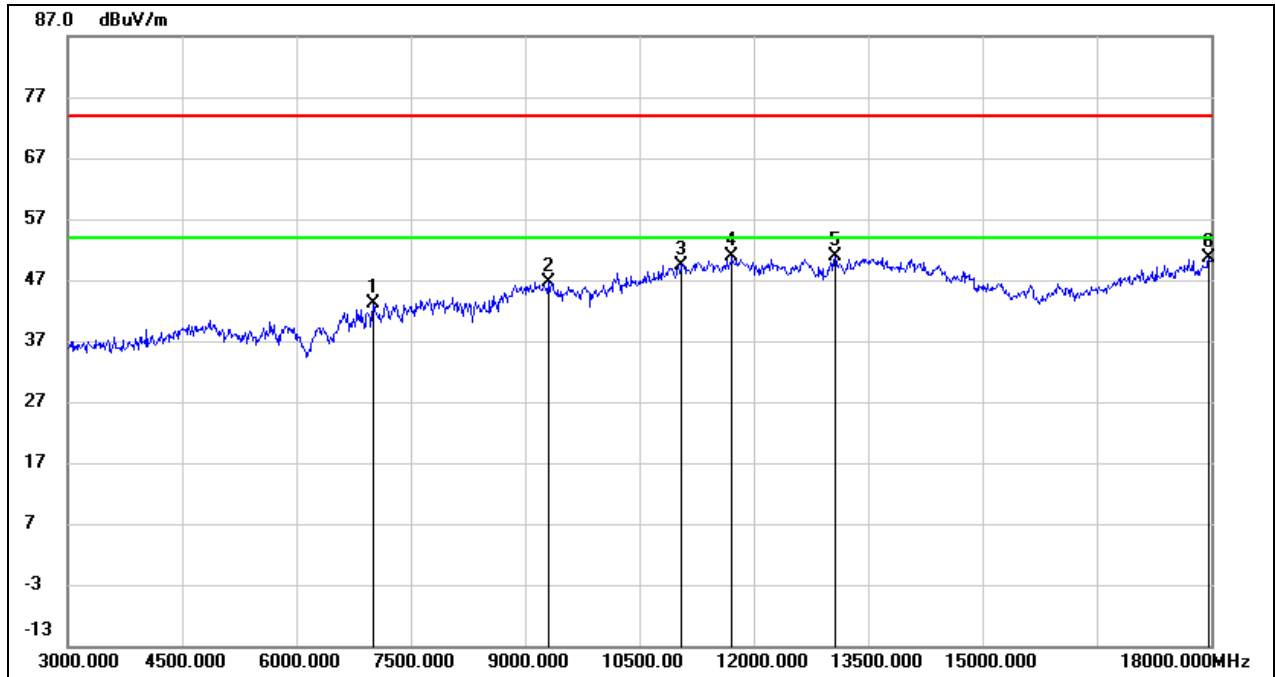

| No. | Frequency (MHz) | Reading (dBuV) | Correct (dB/m) | Result (dBuV/m) | Limit (dBuV/m) | Margin (dB) | Remark |
|-----|-----------------|----------------|----------------|-----------------|----------------|-------------|--------|
| 1   | 7005.000        | 36.48          | 6.69           | 43.17           | 74.00          | -30.83      | peak   |
| 2   | 9300.000        | 35.94          | 10.61          | 46.55           | 74.00          | -27.45      | peak   |
| 3   | 11055.000       | 34.50          | 14.96          | 49.46           | 74.00          | -24.54      | peak   |
| 4   | 11715.000       | 33.76          | 17.19          | 50.95           | 74.00          | -23.05      | peak   |
| 5   | 13065.000       | 31.80          | 19.00          | 50.80           | 74.00          | -23.20      | peak   |
| 6   | 17970.000       | 25.04          | 25.51          | 50.55           | 74.00          | -23.45      | peak   |

|            |               |               |          |
|------------|---------------|---------------|----------|
| Test Mode: | 802.11ax HE20 | Channel:      | 2412 MHz |
| Polarity:  | Vertical      | Test Voltage: | DC 12 V  |

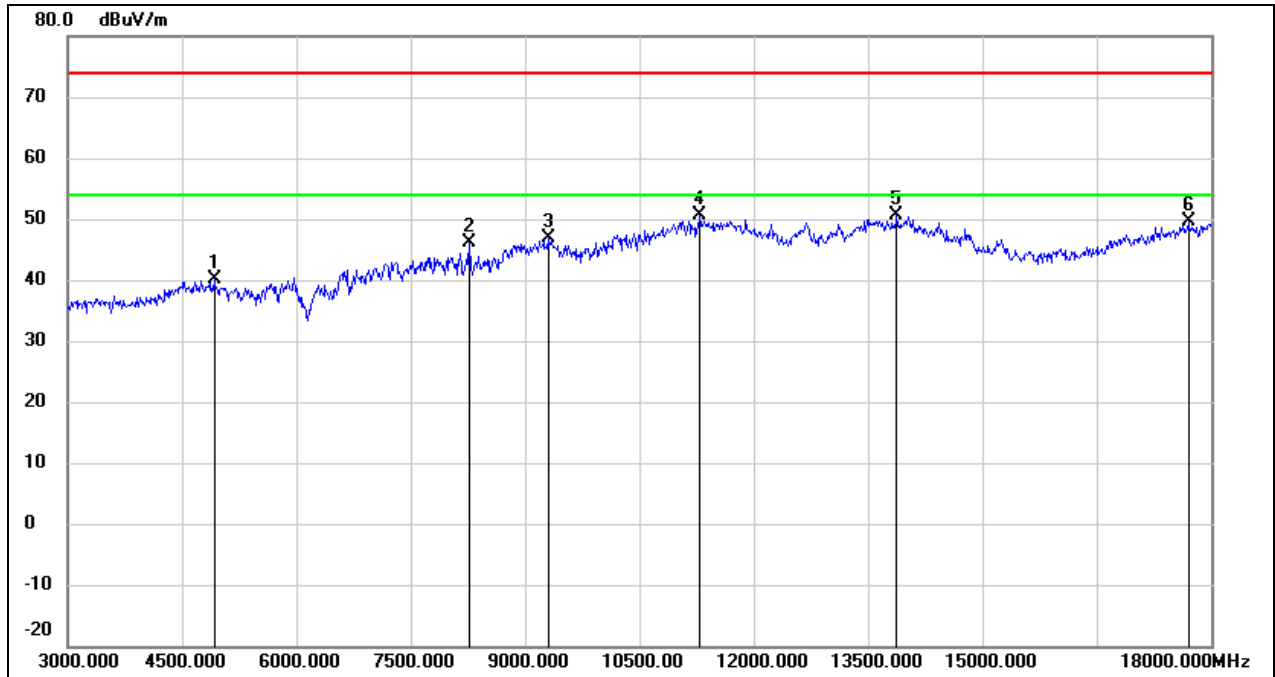

| No. | Frequency (MHz) | Reading (dBuV) | Correct (dB/m) | Result (dBuV/m) | Limit (dBuV/m) | Margin (dB) | Remark |
|-----|-----------------|----------------|----------------|-----------------|----------------|-------------|--------|
| 1   | 4920.000        | 40.01          | 0.14           | 40.15           | 74.00          | -33.85      | peak   |
| 2   | 8265.000        | 39.52          | 6.59           | 46.11           | 74.00          | -27.89      | peak   |
| 3   | 9300.000        | 36.20          | 10.61          | 46.81           | 74.00          | -27.19      | peak   |
| 4   | 11295.000       | 34.88          | 15.85          | 50.73           | 74.00          | -23.27      | peak   |
| 5   | 13875.000       | 28.84          | 21.70          | 50.54           | 74.00          | -23.46      | peak   |
| 6   | 17700.000       | 25.67          | 23.91          | 49.58           | 74.00          | -24.42      | peak   |

|            |               |               |          |
|------------|---------------|---------------|----------|
| Test Mode: | 802.11ax HE20 | Channel:      | 2417 MHz |
| Polarity:  | Horizontal    | Test Voltage: | DC 12 V  |

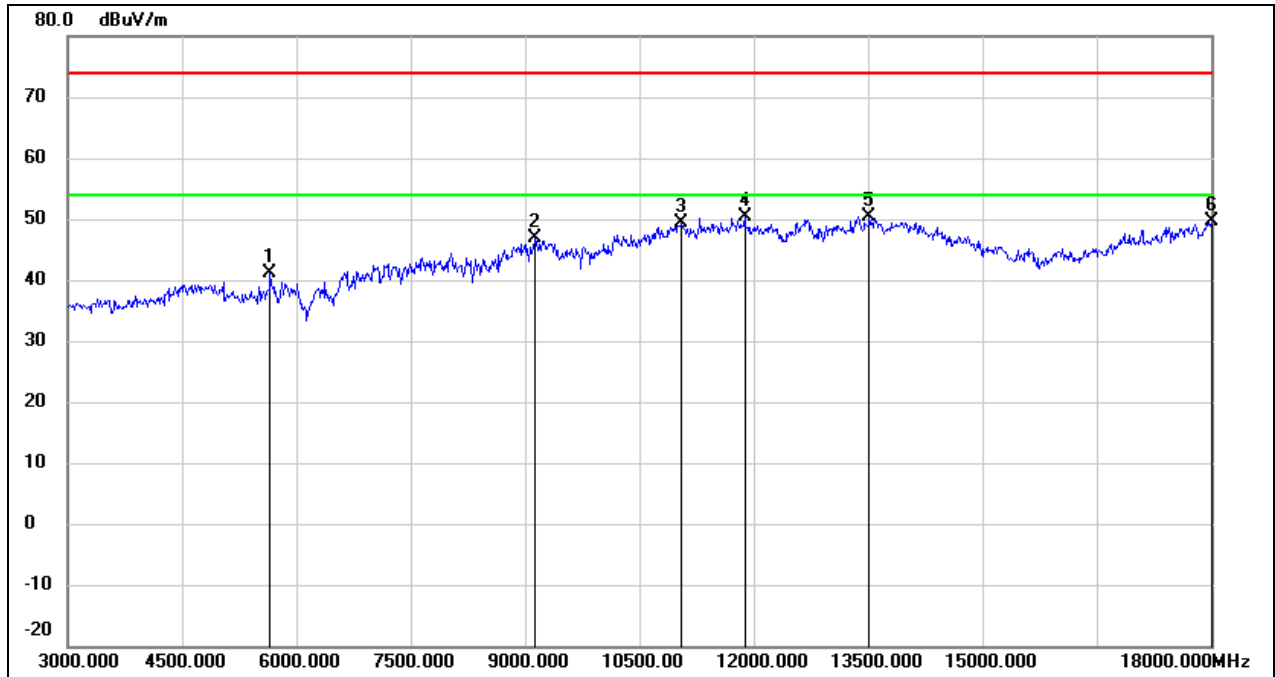

| No. | Frequency (MHz) | Reading (dBuV) | Correct (dB/m) | Result (dBuV/m) | Limit (dBuV/m) | Margin (dB) | Remark |
|-----|-----------------|----------------|----------------|-----------------|----------------|-------------|--------|
| 1   | 5655.000        | 39.81          | 1.29           | 41.10           | 74.00          | -32.90      | peak   |
| 2   | 9135.000        | 36.32          | 10.55          | 46.87           | 74.00          | -27.13      | peak   |
| 3   | 11055.000       | 34.38          | 14.96          | 49.34           | 74.00          | -24.66      | peak   |
| 4   | 11880.000       | 32.85          | 17.63          | 50.48           | 74.00          | -23.52      | peak   |
| 5   | 13515.000       | 29.51          | 20.93          | 50.44           | 74.00          | -23.56      | peak   |
| 6   | 18000.000       | 23.89          | 25.69          | 49.58           | 74.00          | -24.42      | peak   |



|            |               |               |          |
|------------|---------------|---------------|----------|
| Test Mode: | 802.11ax HE20 | Channel:      | 2417 MHz |
| Polarity:  | Vertical      | Test Voltage: | DC 12 V  |

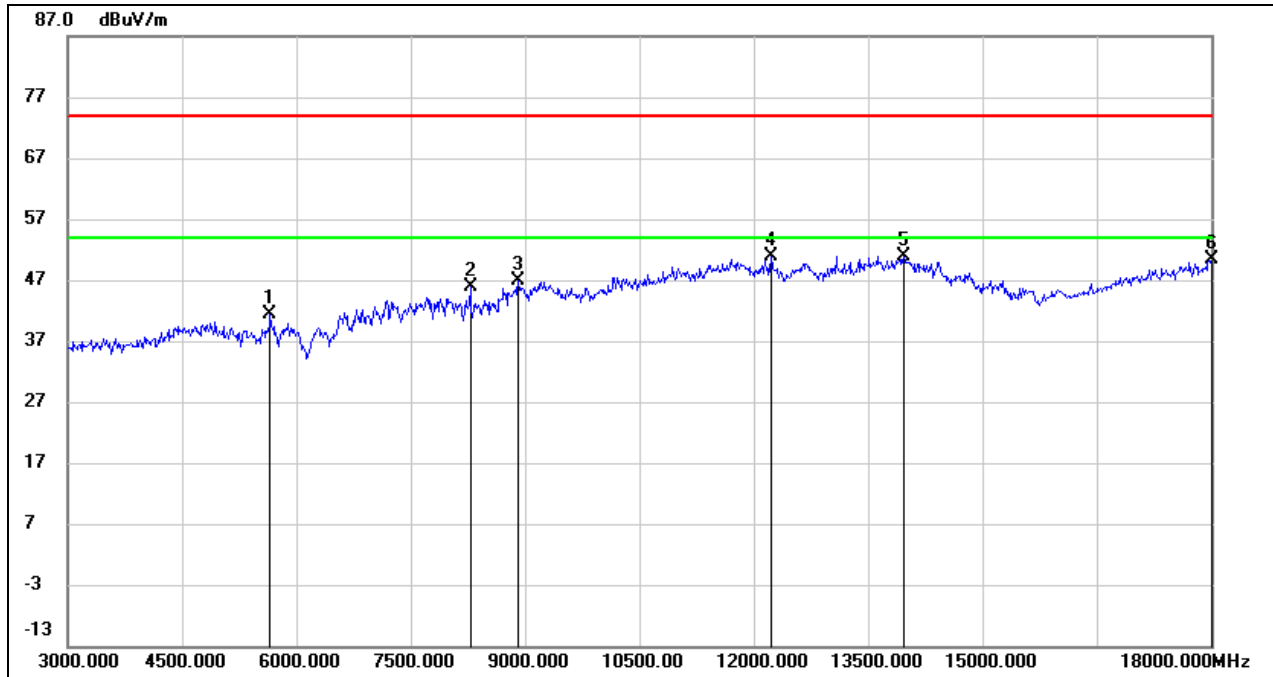

| No. | Frequency (MHz) | Reading (dBuV) | Correct (dB/m) | Result (dBuV/m) | Limit (dBuV/m) | Margin (dB) | Remark |
|-----|-----------------|----------------|----------------|-----------------|----------------|-------------|--------|
| 1   | 5655.000        | 39.98          | 1.29           | 41.27           | 74.00          | -32.73      | peak   |
| 2   | 8280.000        | 39.21          | 6.61           | 45.82           | 74.00          | -28.18      | peak   |
| 3   | 8910.000        | 37.09          | 9.82           | 46.91           | 74.00          | -27.09      | peak   |
| 4   | 12225.000       | 32.97          | 17.79          | 50.76           | 74.00          | -23.24      | peak   |
| 5   | 13965.000       | 29.08          | 21.89          | 50.97           | 74.00          | -23.03      | peak   |
| 6   | 18000.000       | 24.59          | 25.69          | 50.28           | 74.00          | -23.72      | peak   |

|            |               |               |          |
|------------|---------------|---------------|----------|
| Test Mode: | 802.11ax HE20 | Channel:      | 2437 MHz |
| Polarity:  | Horizontal    | Test Voltage: | DC 12 V  |

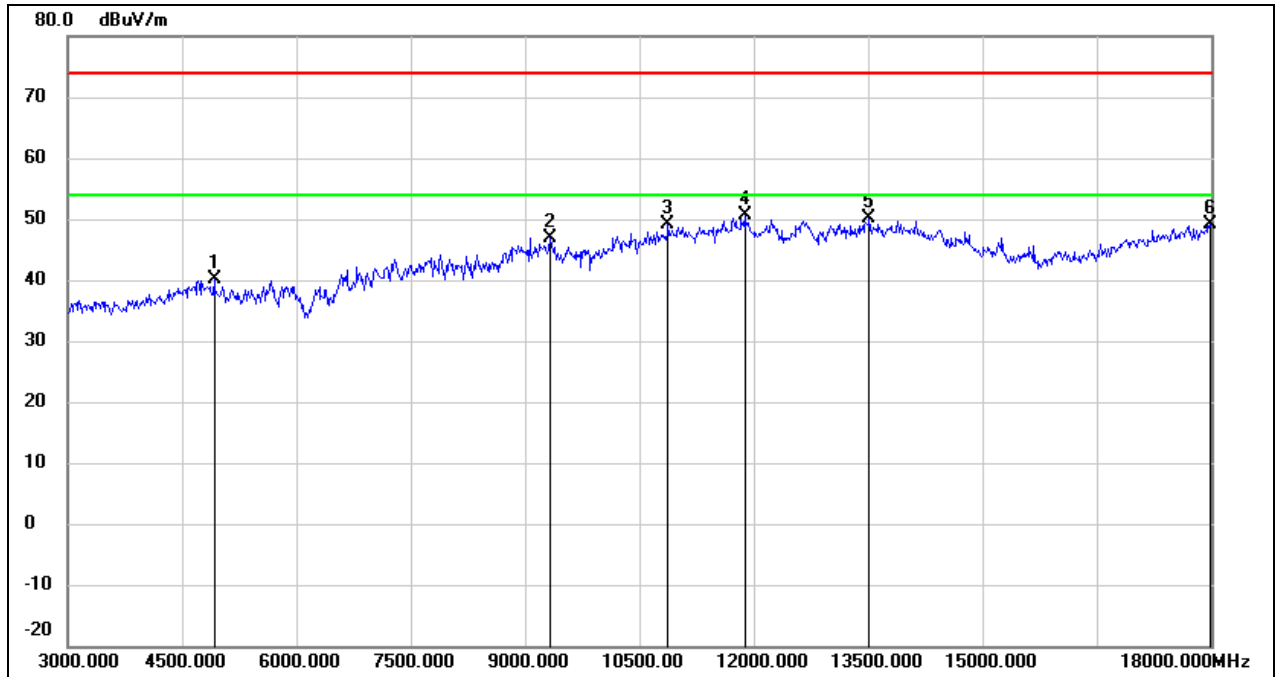

| No. | Frequency (MHz) | Reading (dBuV) | Correct (dB/m) | Result (dBuV/m) | Limit (dBuV/m) | Margin (dB) | Remark |
|-----|-----------------|----------------|----------------|-----------------|----------------|-------------|--------|
| 1   | 4920.000        | 39.88          | 0.14           | 40.02           | 74.00          | -33.98      | peak   |
| 2   | 9330.000        | 36.35          | 10.62          | 46.97           | 74.00          | -27.03      | peak   |
| 3   | 10875.000       | 34.80          | 14.32          | 49.12           | 74.00          | -24.88      | peak   |
| 4   | 11880.000       | 32.93          | 17.63          | 50.56           | 74.00          | -23.44      | peak   |
| 5   | 13515.000       | 29.16          | 20.93          | 50.09           | 74.00          | -23.91      | peak   |
| 6   | 17985.000       | 23.47          | 25.60          | 49.07           | 74.00          | -24.93      | peak   |

|            |               |               |          |
|------------|---------------|---------------|----------|
| Test Mode: | 802.11ax HE20 | Channel:      | 2437 MHz |
| Polarity:  | Vertical      | Test Voltage: | DC 12 V  |

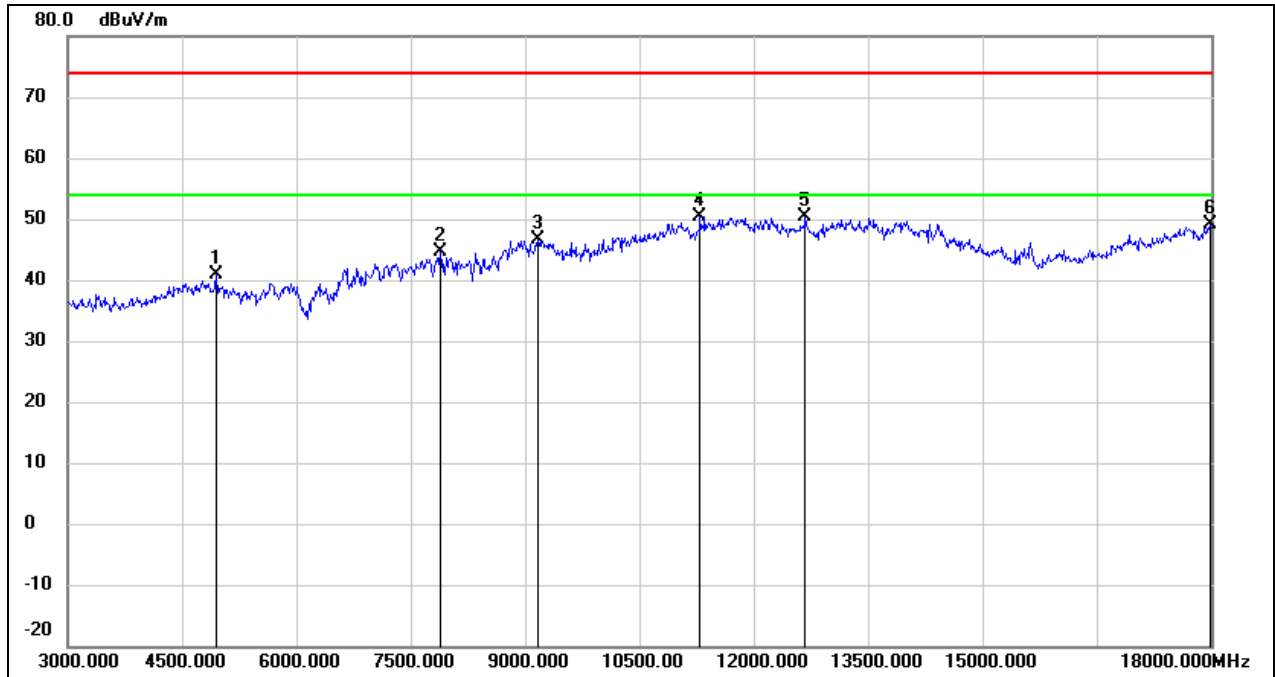

| No. | Frequency (MHz) | Reading (dBuV) | Correct (dB/m) | Result (dBuV/m) | Limit (dBuV/m) | Margin (dB) | Remark |
|-----|-----------------|----------------|----------------|-----------------|----------------|-------------|--------|
| 1   | 4950.000        | 40.65          | 0.26           | 40.91           | 74.00          | -33.09      | peak   |
| 2   | 7890.000        | 38.20          | 6.31           | 44.51           | 74.00          | -29.49      | peak   |
| 3   | 9165.000        | 36.00          | 10.55          | 46.55           | 74.00          | -27.45      | peak   |
| 4   | 11295.000       | 34.62          | 15.85          | 50.47           | 74.00          | -23.53      | peak   |
| 5   | 12675.000       | 32.45          | 17.99          | 50.44           | 74.00          | -23.56      | peak   |
| 6   | 17985.000       | 23.48          | 25.60          | 49.08           | 74.00          | -24.92      | peak   |

|            |               |               |          |
|------------|---------------|---------------|----------|
| Test Mode: | 802.11ax HE20 | Channel:      | 2457 MHz |
| Polarity:  | Horizontal    | Test Voltage: | DC 12 V  |

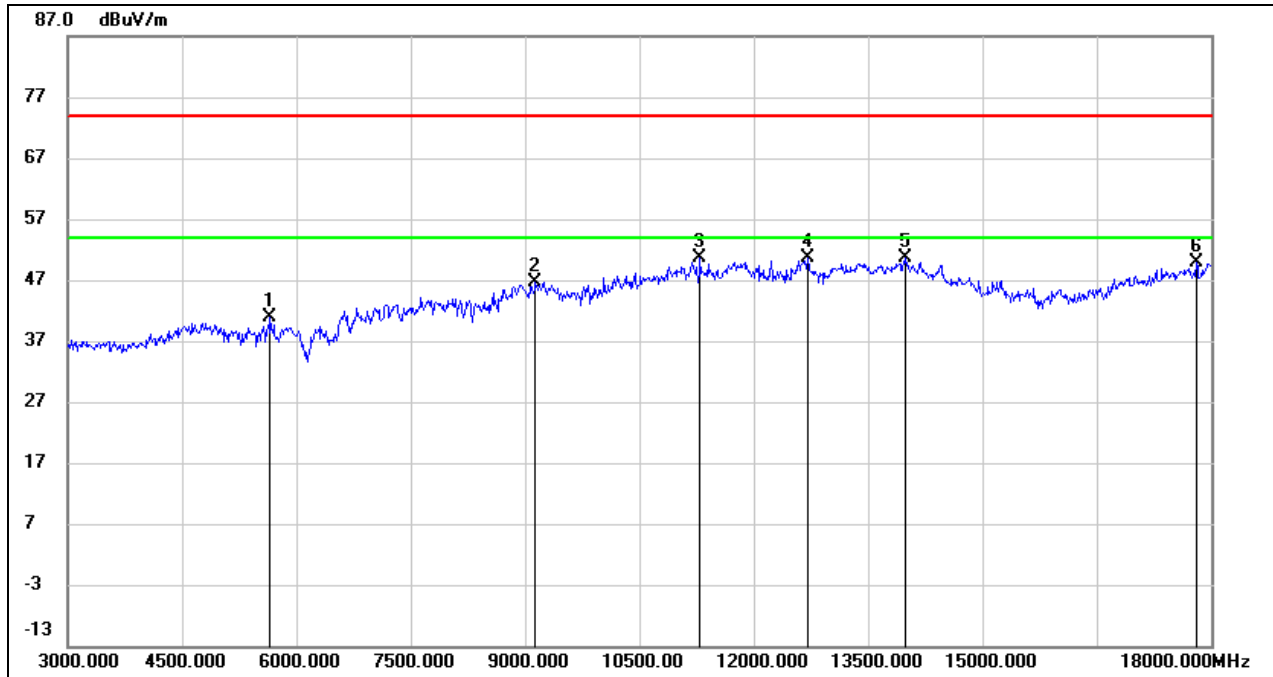

| No. | Frequency (MHz) | Reading (dBuV) | Correct (dB/m) | Result (dBuV/m) | Limit (dBuV/m) | Margin (dB) | Remark |
|-----|-----------------|----------------|----------------|-----------------|----------------|-------------|--------|
| 1   | 5655.000        | 39.47          | 1.29           | 40.76           | 74.00          | -33.24      | peak   |
| 2   | 9135.000        | 35.97          | 10.55          | 46.52           | 74.00          | -27.48      | peak   |
| 3   | 11295.000       | 34.87          | 15.85          | 50.72           | 74.00          | -23.28      | peak   |
| 4   | 12705.000       | 32.47          | 18.06          | 50.53           | 74.00          | -23.47      | peak   |
| 5   | 13995.000       | 28.63          | 21.95          | 50.58           | 74.00          | -23.42      | peak   |
| 6   | 17805.000       | 25.22          | 24.54          | 49.76           | 74.00          | -24.24      | peak   |

|            |               |               |          |
|------------|---------------|---------------|----------|
| Test Mode: | 802.11ax HE20 | Channel:      | 2457 MHz |
| Polarity:  | Vertical      | Test Voltage: | DC 12 V  |

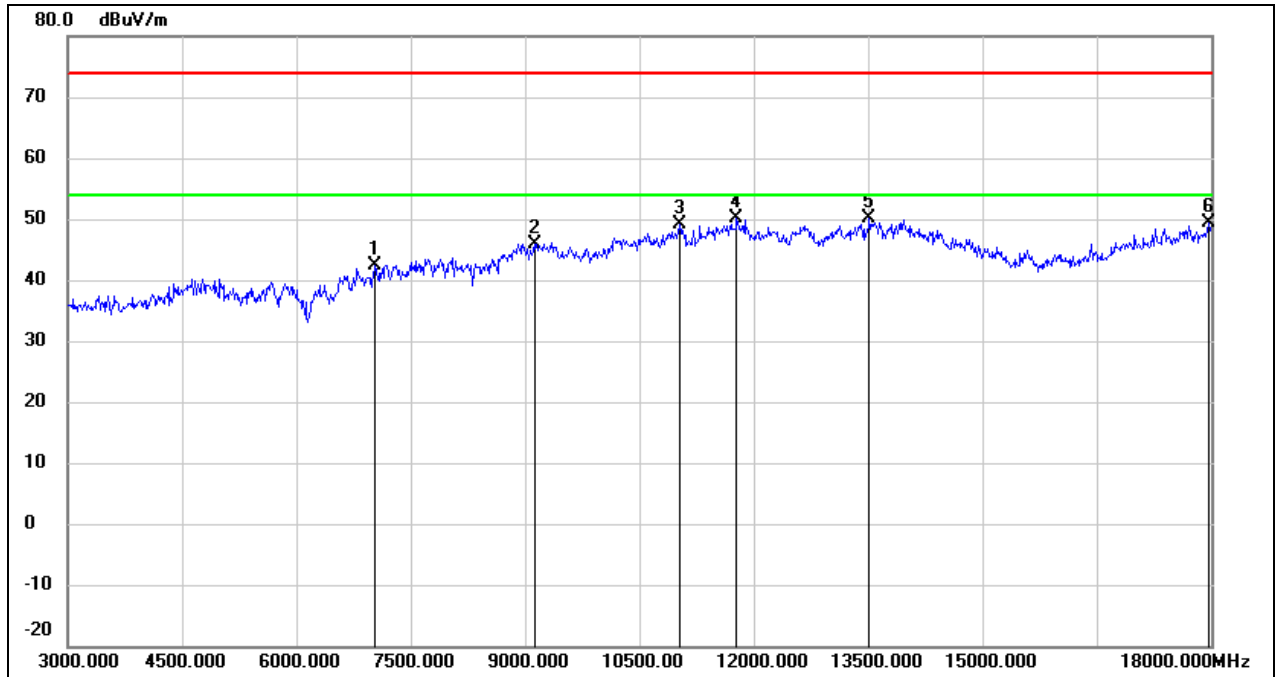

| No. | Frequency (MHz) | Reading (dBuV) | Correct (dB/m) | Result (dBuV/m) | Limit (dBuV/m) | Margin (dB) | Remark |
|-----|-----------------|----------------|----------------|-----------------|----------------|-------------|--------|
| 1   | 7035.000        | 35.69          | 6.67           | 42.36           | 74.00          | -31.64      | peak   |
| 2   | 9120.000        | 35.43          | 10.53          | 45.96           | 74.00          | -28.04      | peak   |
| 3   | 11025.000       | 34.35          | 14.85          | 49.20           | 74.00          | -24.80      | peak   |
| 4   | 11775.000       | 32.71          | 17.35          | 50.06           | 74.00          | -23.94      | peak   |
| 5   | 13515.000       | 29.13          | 20.93          | 50.06           | 74.00          | -23.94      | peak   |
| 6   | 17970.000       | 23.83          | 25.51          | 49.34           | 74.00          | -24.66      | peak   |

|            |               |               |          |
|------------|---------------|---------------|----------|
| Test Mode: | 802.11ax HE20 | Channel:      | 2462 MHz |
| Polarity:  | Horizontal    | Test Voltage: | DC 12 V  |

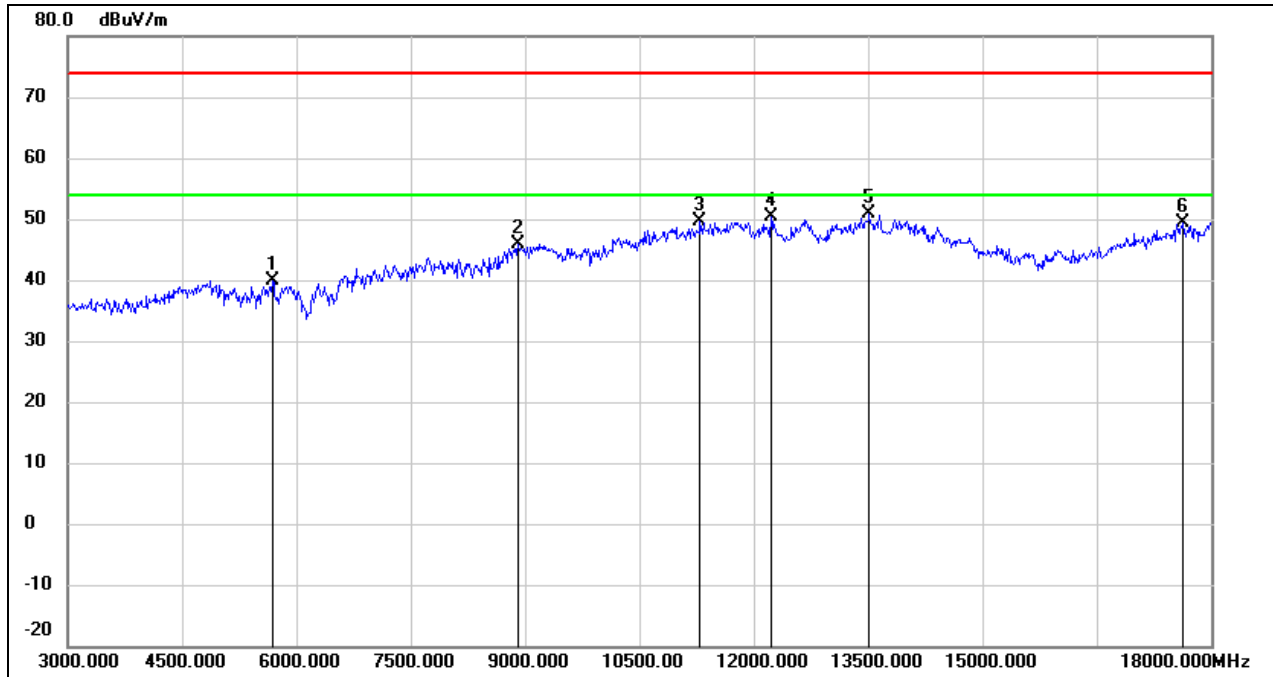

| No. | Frequency (MHz) | Reading (dBuV) | Correct (dB/m) | Result (dBuV/m) | Limit (dBuV/m) | Margin (dB) | Remark |
|-----|-----------------|----------------|----------------|-----------------|----------------|-------------|--------|
| 1   | 5685.000        | 38.57          | 1.37           | 39.94           | 74.00          | -34.06      | peak   |
| 2   | 8910.000        | 36.00          | 9.82           | 45.82           | 74.00          | -28.18      | peak   |
| 3   | 11295.000       | 33.80          | 15.85          | 49.65           | 74.00          | -24.35      | peak   |
| 4   | 12225.000       | 32.66          | 17.79          | 50.45           | 74.00          | -23.55      | peak   |
| 5   | 13515.000       | 29.87          | 20.93          | 50.80           | 74.00          | -23.20      | peak   |
| 6   | 17625.000       | 25.99          | 23.47          | 49.46           | 74.00          | -24.54      | peak   |

|            |               |               |          |
|------------|---------------|---------------|----------|
| Test Mode: | 802.11ax HE20 | Channel:      | 2462 MHz |
| Polarity:  | Vertical      | Test Voltage: | DC 12 V  |

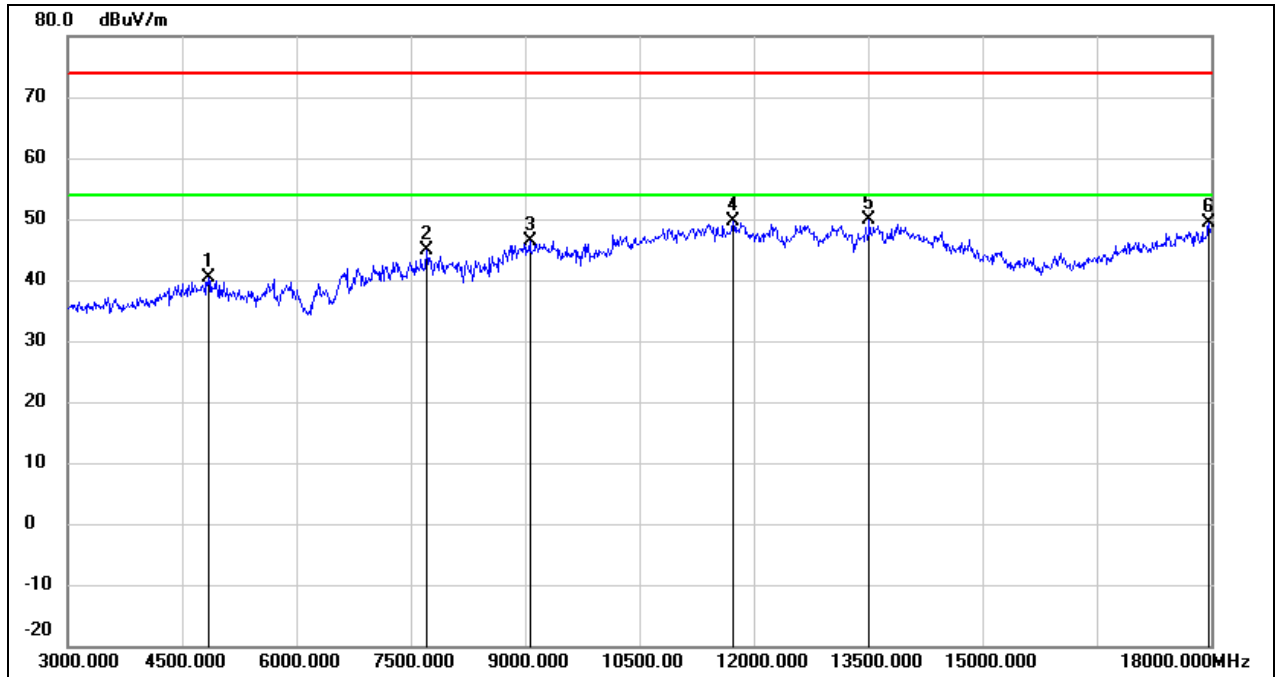

| No. | Frequency (MHz) | Reading (dBuV) | Correct (dB/m) | Result (dBuV/m) | Limit (dBuV/m) | Margin (dB) | Remark |
|-----|-----------------|----------------|----------------|-----------------|----------------|-------------|--------|
| 1   | 4845.000        | 40.50          | -0.15          | 40.35           | 74.00          | -33.65      | peak   |
| 2   | 7710.000        | 38.44          | 6.33           | 44.77           | 74.00          | -29.23      | peak   |
| 3   | 9060.000        | 35.91          | 10.51          | 46.42           | 74.00          | -27.58      | peak   |
| 4   | 11730.000       | 32.38          | 17.22          | 49.60           | 74.00          | -24.40      | peak   |
| 5   | 13515.000       | 28.96          | 20.93          | 49.89           | 74.00          | -24.11      | peak   |
| 6   | 17970.000       | 23.79          | 25.51          | 49.30           | 74.00          | -24.70      | peak   |

|            |               |               |          |
|------------|---------------|---------------|----------|
| Test Mode: | 802.11ax HE40 | Channel:      | 2422 MHz |
| Polarity:  | Horizontal    | Test Voltage: | DC 12 V  |

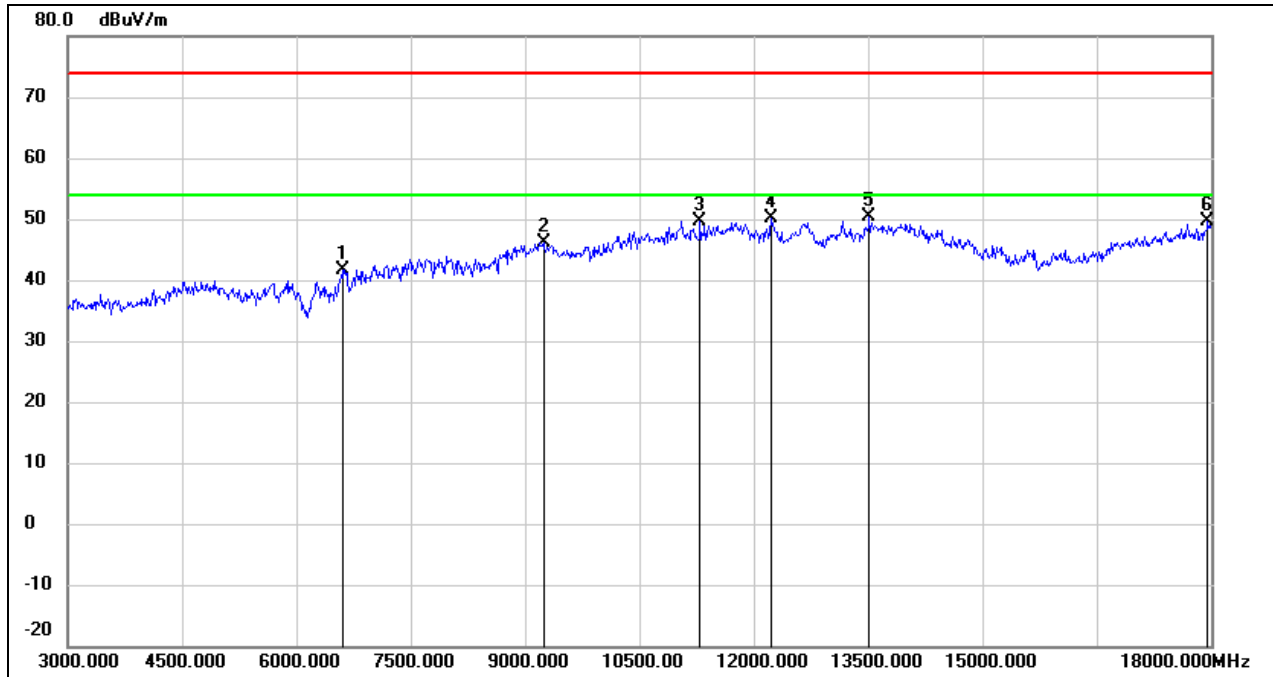

| No. | Frequency (MHz) | Reading (dBuV) | Correct (dB/m) | Result (dBuV/m) | Limit (dBuV/m) | Margin (dB) | Remark |
|-----|-----------------|----------------|----------------|-----------------|----------------|-------------|--------|
| 1   | 6600.000        | 36.89          | 4.71           | 41.60           | 74.00          | -32.40      | peak   |
| 2   | 9240.000        | 35.58          | 10.58          | 46.16           | 74.00          | -27.84      | peak   |
| 3   | 11295.000       | 33.74          | 15.85          | 49.59           | 74.00          | -24.41      | peak   |
| 4   | 12225.000       | 32.31          | 17.79          | 50.10           | 74.00          | -23.90      | peak   |
| 5   | 13515.000       | 29.41          | 20.93          | 50.34           | 74.00          | -23.66      | peak   |
| 6   | 17955.000       | 24.25          | 25.42          | 49.67           | 74.00          | -24.33      | peak   |



|            |               |               |          |
|------------|---------------|---------------|----------|
| Test Mode: | 802.11ax HE40 | Channel:      | 2422 MHz |
| Polarity:  | Vertical      | Test Voltage: | DC 12 V  |

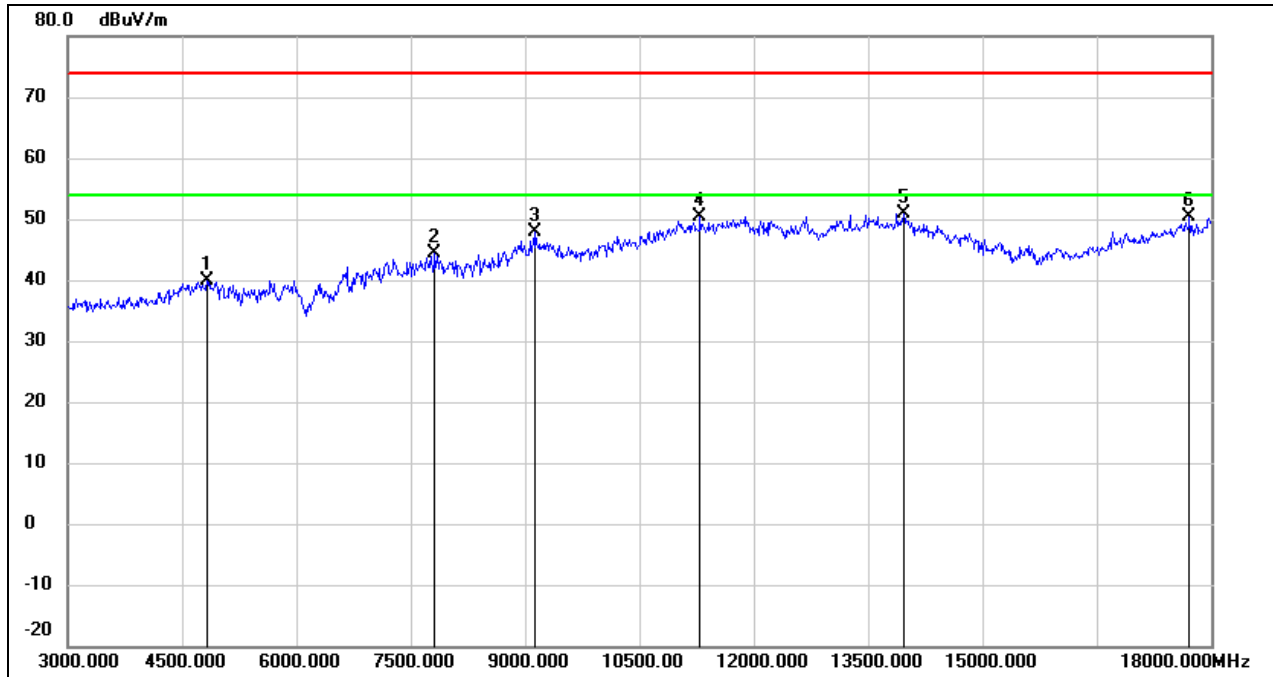

| No. | Frequency (MHz) | Reading (dBuV) | Correct (dB/m) | Result (dBuV/m) | Limit (dBuV/m) | Margin (dB) | Remark |
|-----|-----------------|----------------|----------------|-----------------|----------------|-------------|--------|
| 1   | 4830.000        | 40.18          | -0.20          | 39.98           | 74.00          | -34.02      | peak   |
| 2   | 7815.000        | 38.03          | 6.32           | 44.35           | 74.00          | -29.65      | peak   |
| 3   | 9135.000        | 37.21          | 10.55          | 47.76           | 74.00          | -26.24      | peak   |
| 4   | 11295.000       | 34.46          | 15.85          | 50.31           | 74.00          | -23.69      | peak   |
| 5   | 13965.000       | 29.03          | 21.89          | 50.92           | 74.00          | -23.08      | peak   |
| 6   | 17715.000       | 26.47          | 24.00          | 50.47           | 74.00          | -23.53      | peak   |

|            |               |               |          |
|------------|---------------|---------------|----------|
| Test Mode: | 802.11ax HE40 | Channel:      | 2427 MHz |
| Polarity:  | Horizontal    | Test Voltage: | DC 12 V  |

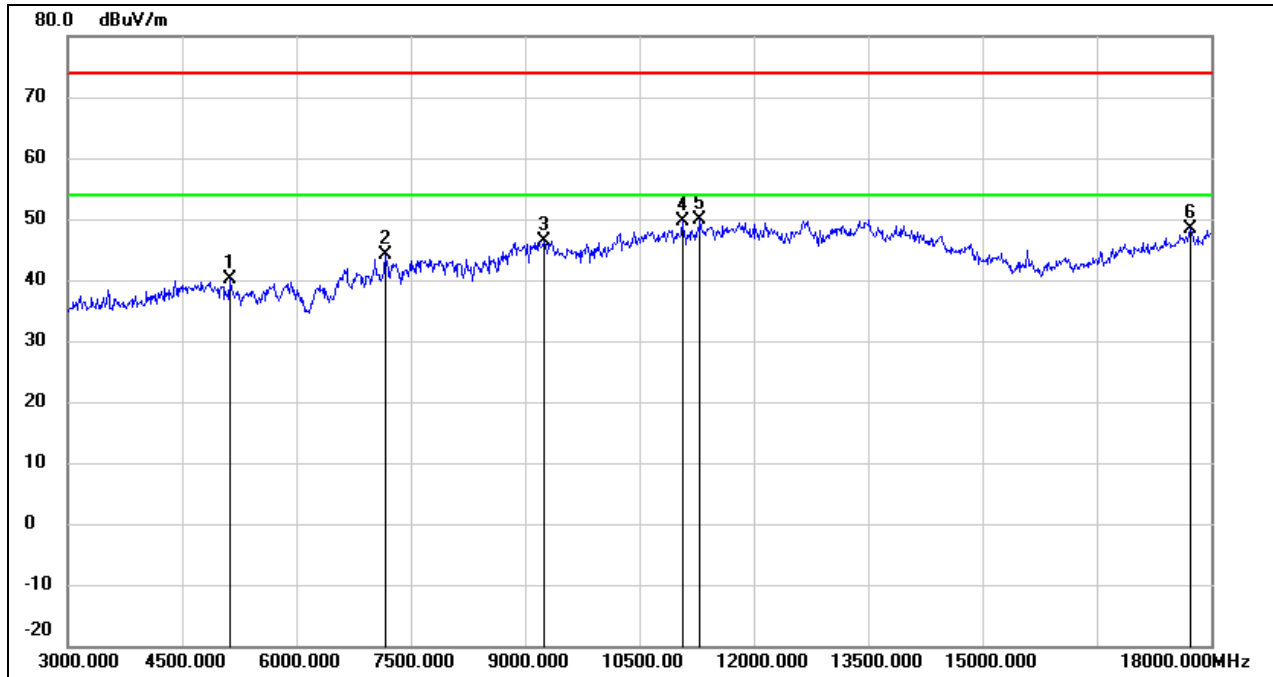

| No. | Frequency (MHz) | Reading (dBuV) | Correct (dB/m) | Result (dBuV/m) | Limit (dBuV/m) | Margin (dB) | Remark |
|-----|-----------------|----------------|----------------|-----------------|----------------|-------------|--------|
| 1   | 5130.000        | 39.60          | 0.55           | 40.15           | 74.00          | -33.85      | peak   |
| 2   | 7170.000        | 37.45          | 6.56           | 44.01           | 74.00          | -29.99      | peak   |
| 3   | 9255.000        | 35.85          | 10.59          | 46.44           | 74.00          | -27.56      | peak   |
| 4   | 11070.000       | 34.49          | 15.03          | 49.52           | 74.00          | -24.48      | peak   |
| 5   | 11295.000       | 34.05          | 15.85          | 49.90           | 74.00          | -24.10      | peak   |
| 6   | 17730.000       | 24.21          | 24.09          | 48.30           | 74.00          | -25.70      | peak   |

|            |               |               |          |
|------------|---------------|---------------|----------|
| Test Mode: | 802.11ax HE40 | Channel:      | 2427 MHz |
| Polarity:  | Vertical      | Test Voltage: | DC 12 V  |

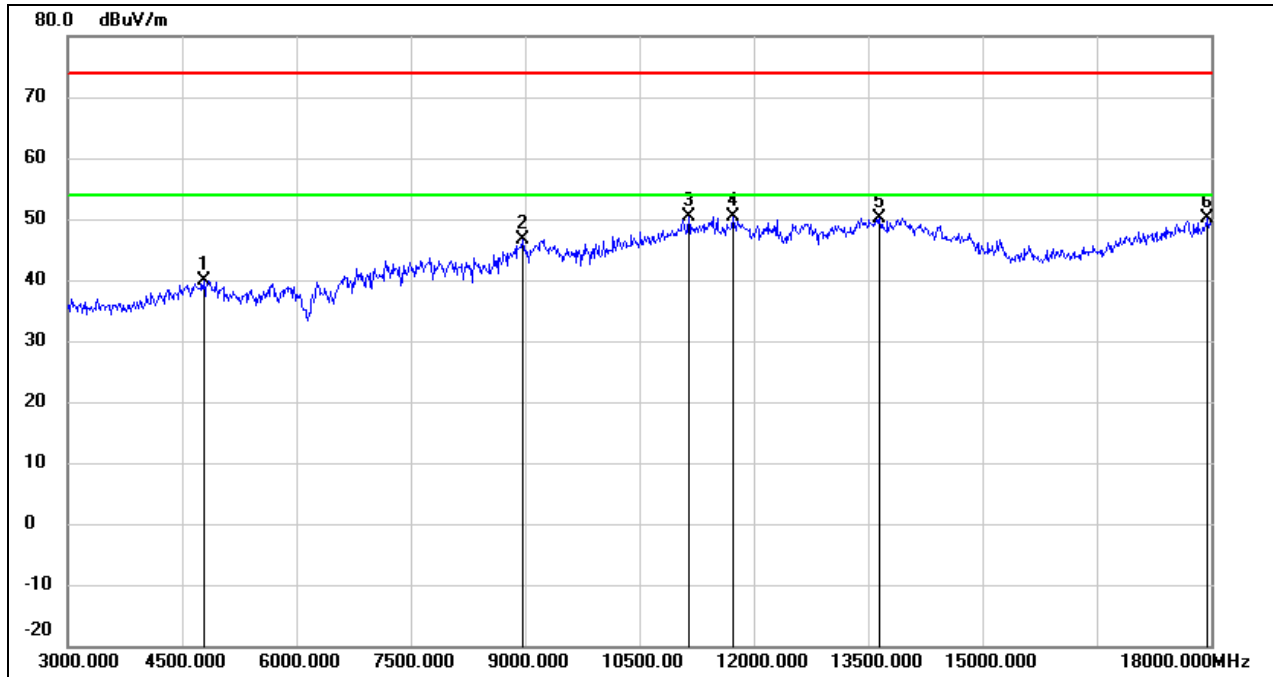

| No. | Frequency (MHz) | Reading (dBuV) | Correct (dB/m) | Result (dBuV/m) | Limit (dBuV/m) | Margin (dB) | Remark |
|-----|-----------------|----------------|----------------|-----------------|----------------|-------------|--------|
| 1   | 4785.000        | 40.24          | -0.37          | 39.87           | 74.00          | -34.13      | peak   |
| 2   | 8970.000        | 36.30          | 10.26          | 46.56           | 74.00          | -27.44      | peak   |
| 3   | 11145.000       | 35.02          | 15.31          | 50.33           | 74.00          | -23.67      | peak   |
| 4   | 11730.000       | 33.26          | 17.22          | 50.48           | 74.00          | -23.52      | peak   |
| 5   | 13650.000       | 29.00          | 21.21          | 50.21           | 74.00          | -23.79      | peak   |
| 6   | 17955.000       | 24.78          | 25.42          | 50.20           | 74.00          | -23.80      | peak   |

|            |               |               |          |
|------------|---------------|---------------|----------|
| Test Mode: | 802.11ax HE40 | Channel:      | 2437 MHz |
| Polarity:  | Horizontal    | Test Voltage: | DC 12 V  |

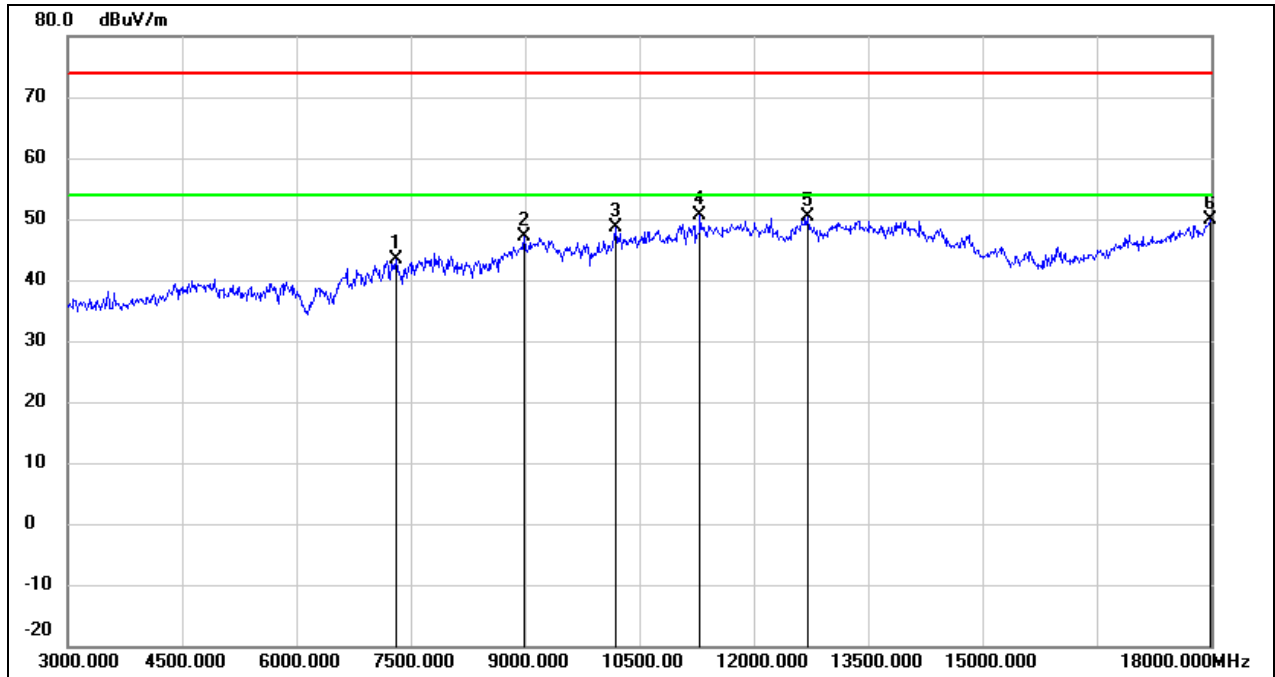

| No. | Frequency (MHz) | Reading (dBuV) | Correct (dB/m) | Result (dBuV/m) | Limit (dBuV/m) | Margin (dB) | Remark |
|-----|-----------------|----------------|----------------|-----------------|----------------|-------------|--------|
| 1   | 7305.000        | 36.93          | 6.47           | 43.40           | 74.00          | -30.60      | peak   |
| 2   | 8985.000        | 36.83          | 10.37          | 47.20           | 74.00          | -26.80      | peak   |
| 3   | 10185.000       | 36.36          | 12.38          | 48.74           | 74.00          | -25.26      | peak   |
| 4   | 11295.000       | 34.68          | 15.85          | 50.53           | 74.00          | -23.47      | peak   |
| 5   | 12705.000       | 32.23          | 18.06          | 50.29           | 74.00          | -23.71      | peak   |
| 6   | 17985.000       | 24.39          | 25.60          | 49.99           | 74.00          | -24.01      | peak   |

|            |               |               |          |
|------------|---------------|---------------|----------|
| Test Mode: | 802.11ax HE40 | Channel:      | 2437 MHz |
| Polarity:  | Vertical      | Test Voltage: | DC 12 V  |

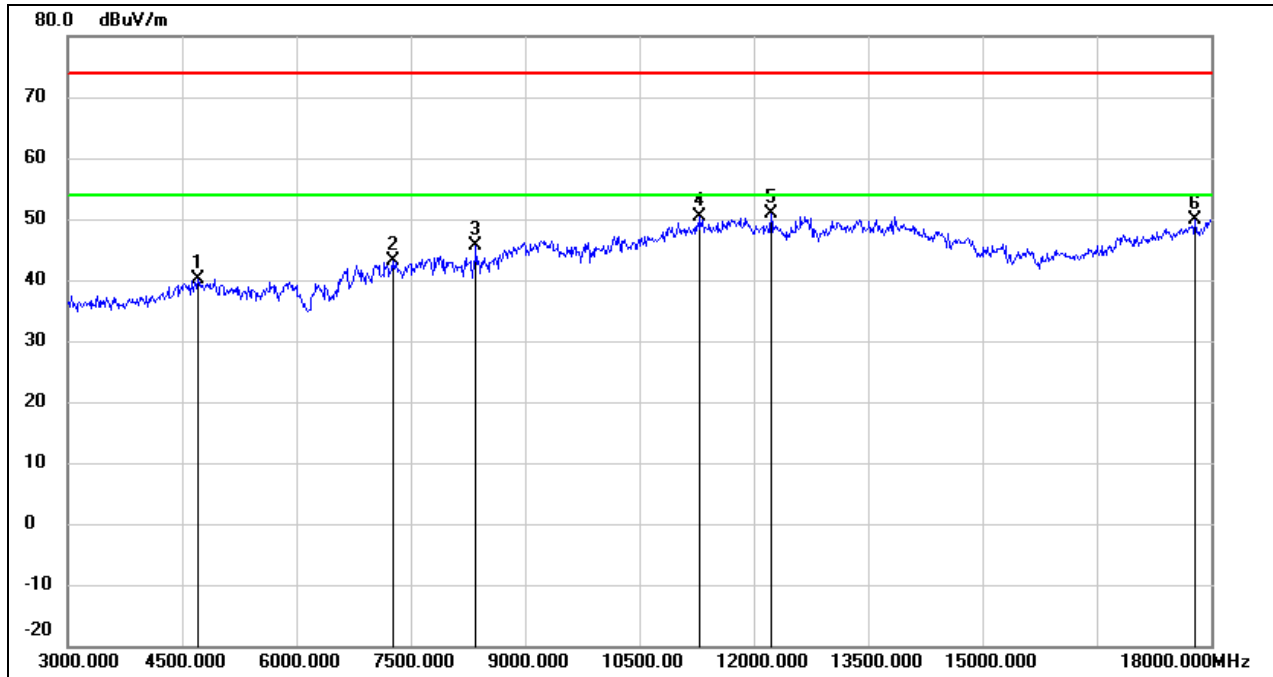

| No. | Frequency (MHz) | Reading (dBuV) | Correct (dB/m) | Result (dBuV/m) | Limit (dBuV/m) | Margin (dB) | Remark |
|-----|-----------------|----------------|----------------|-----------------|----------------|-------------|--------|
| 1   | 4710.000        | 40.74          | -0.66          | 40.08           | 74.00          | -33.92      | peak   |
| 2   | 7260.000        | 36.67          | 6.50           | 43.17           | 74.00          | -30.83      | peak   |
| 3   | 8355.000        | 38.92          | 6.69           | 45.61           | 74.00          | -28.39      | peak   |
| 4   | 11295.000       | 34.59          | 15.85          | 50.44           | 74.00          | -23.56      | peak   |
| 5   | 12225.000       | 32.99          | 17.79          | 50.78           | 74.00          | -23.22      | peak   |
| 6   | 17790.000       | 25.53          | 24.45          | 49.98           | 74.00          | -24.02      | peak   |

|            |               |               |          |
|------------|---------------|---------------|----------|
| Test Mode: | 802.11ax HE40 | Channel:      | 2447 MHz |
| Polarity:  | Horizontal    | Test Voltage: | DC 12 V  |

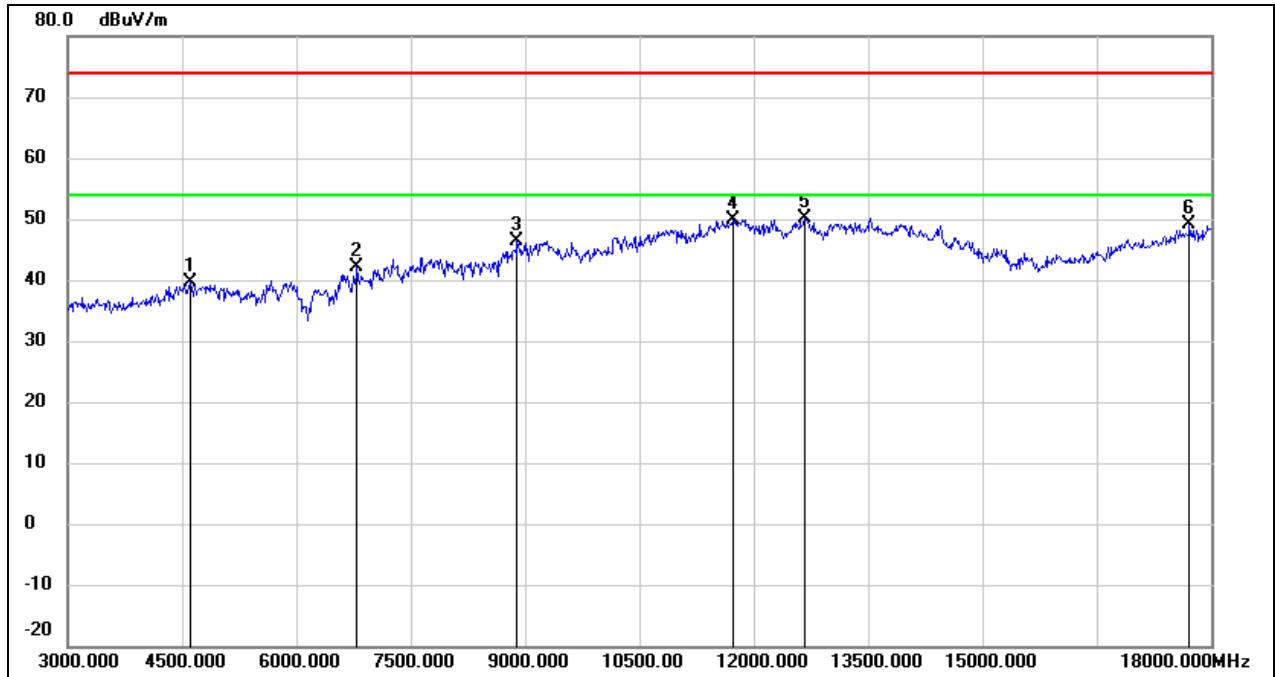

| No. | Frequency (MHz) | Reading (dBuV) | Correct (dB/m) | Result (dBuV/m) | Limit (dBuV/m) | Margin (dB) | Remark |
|-----|-----------------|----------------|----------------|-----------------|----------------|-------------|--------|
| 1   | 4605.000        | 40.58          | -1.06          | 39.52           | 74.00          | -34.48      | peak   |
| 2   | 6795.000        | 36.43          | 5.68           | 42.11           | 74.00          | -31.89      | peak   |
| 3   | 8895.000        | 36.77          | 9.71           | 46.48           | 74.00          | -27.52      | peak   |
| 4   | 11730.000       | 32.55          | 17.22          | 49.77           | 74.00          | -24.23      | peak   |
| 5   | 12675.000       | 32.19          | 17.99          | 50.18           | 74.00          | -23.82      | peak   |
| 6   | 17715.000       | 25.18          | 24.00          | 49.18           | 74.00          | -24.82      | peak   |

|            |               |               |          |
|------------|---------------|---------------|----------|
| Test Mode: | 802.11ax HE40 | Channel:      | 2447 MHz |
| Polarity:  | Vertical      | Test Voltage: | DC 12 V  |

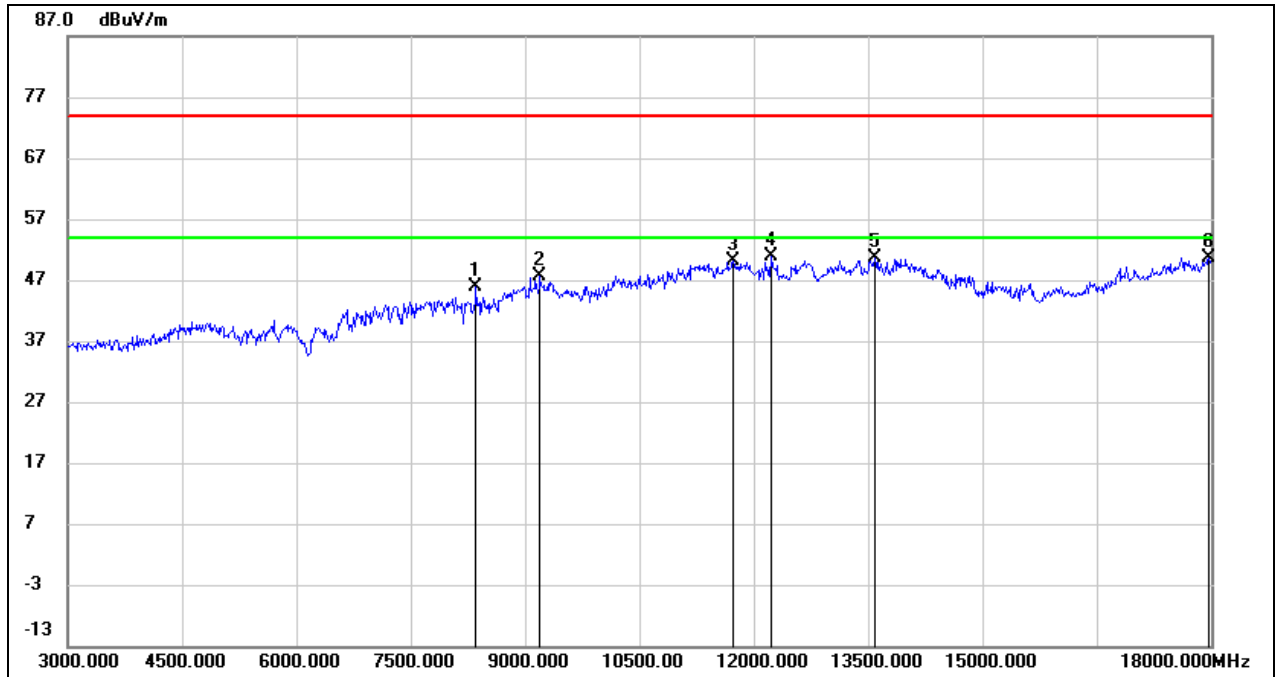

| No. | Frequency (MHz) | Reading (dBuV) | Correct (dB/m) | Result (dBuV/m) | Limit (dBuV/m) | Margin (dB) | Remark |
|-----|-----------------|----------------|----------------|-----------------|----------------|-------------|--------|
| 1   | 8355.000        | 39.18          | 6.69           | 45.87           | 74.00          | -28.13      | peak   |
| 2   | 9195.000        | 36.97          | 10.56          | 47.53           | 74.00          | -26.47      | peak   |
| 3   | 11730.000       | 32.80          | 17.22          | 50.02           | 74.00          | -23.98      | peak   |
| 4   | 12225.000       | 33.11          | 17.79          | 50.90           | 74.00          | -23.10      | peak   |
| 5   | 13590.000       | 29.57          | 21.09          | 50.66           | 74.00          | -23.34      | peak   |
| 6   | 17970.000       | 25.22          | 25.51          | 50.73           | 74.00          | -23.27      | peak   |

|            |               |               |          |
|------------|---------------|---------------|----------|
| Test Mode: | 802.11ax HE40 | Channel:      | 2452 MHz |
| Polarity:  | Horizontal    | Test Voltage: | DC 12 V  |

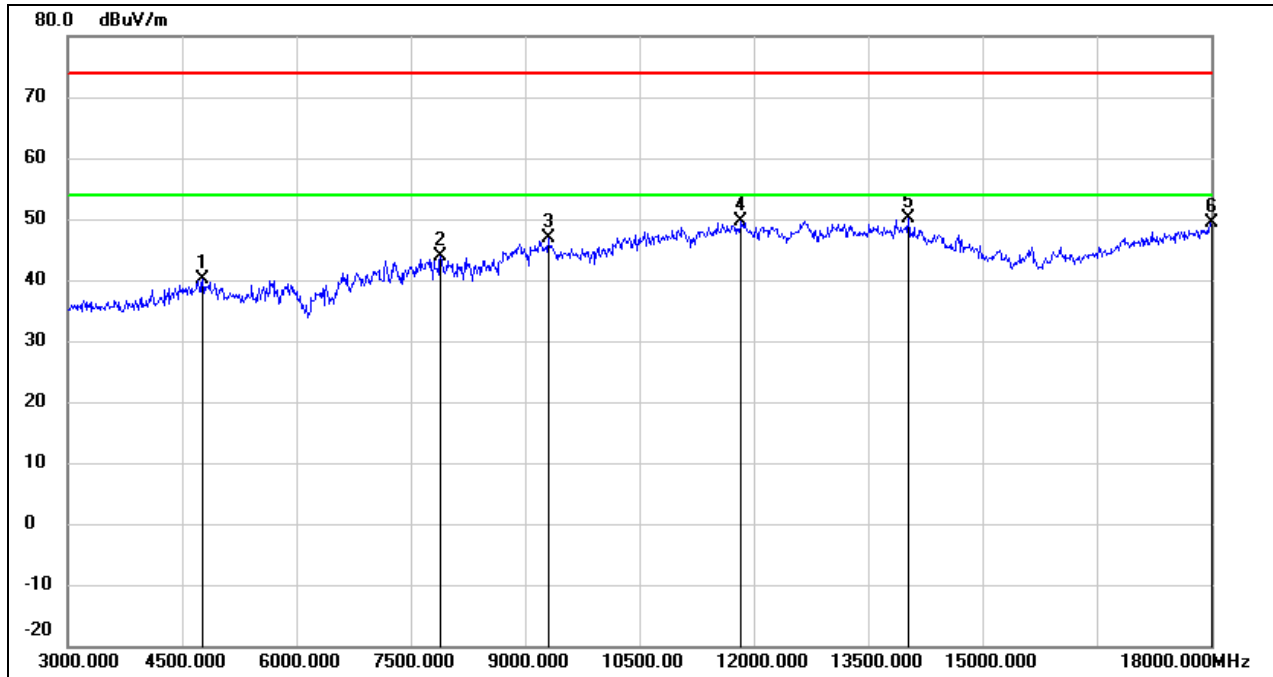

| No. | Frequency (MHz) | Reading (dBuV) | Correct (dB/m) | Result (dBuV/m) | Limit (dBuV/m) | Margin (dB) | Remark |
|-----|-----------------|----------------|----------------|-----------------|----------------|-------------|--------|
| 1   | 4770.000        | 40.52          | -0.43          | 40.09           | 74.00          | -33.91      | peak   |
| 2   | 7890.000        | 37.64          | 6.31           | 43.95           | 74.00          | -30.05      | peak   |
| 3   | 9300.000        | 36.30          | 10.61          | 46.91           | 74.00          | -27.09      | peak   |
| 4   | 11835.000       | 32.13          | 17.51          | 49.64           | 74.00          | -24.36      | peak   |
| 5   | 14025.000       | 28.36          | 21.86          | 50.22           | 74.00          | -23.78      | peak   |
| 6   | 18000.000       | 23.70          | 25.69          | 49.39           | 74.00          | -24.61      | peak   |



|            |               |               |          |
|------------|---------------|---------------|----------|
| Test Mode: | 802.11ax HE40 | Channel:      | 2452 MHz |
| Polarity:  | Vertical      | Test Voltage: | DC 12 V  |

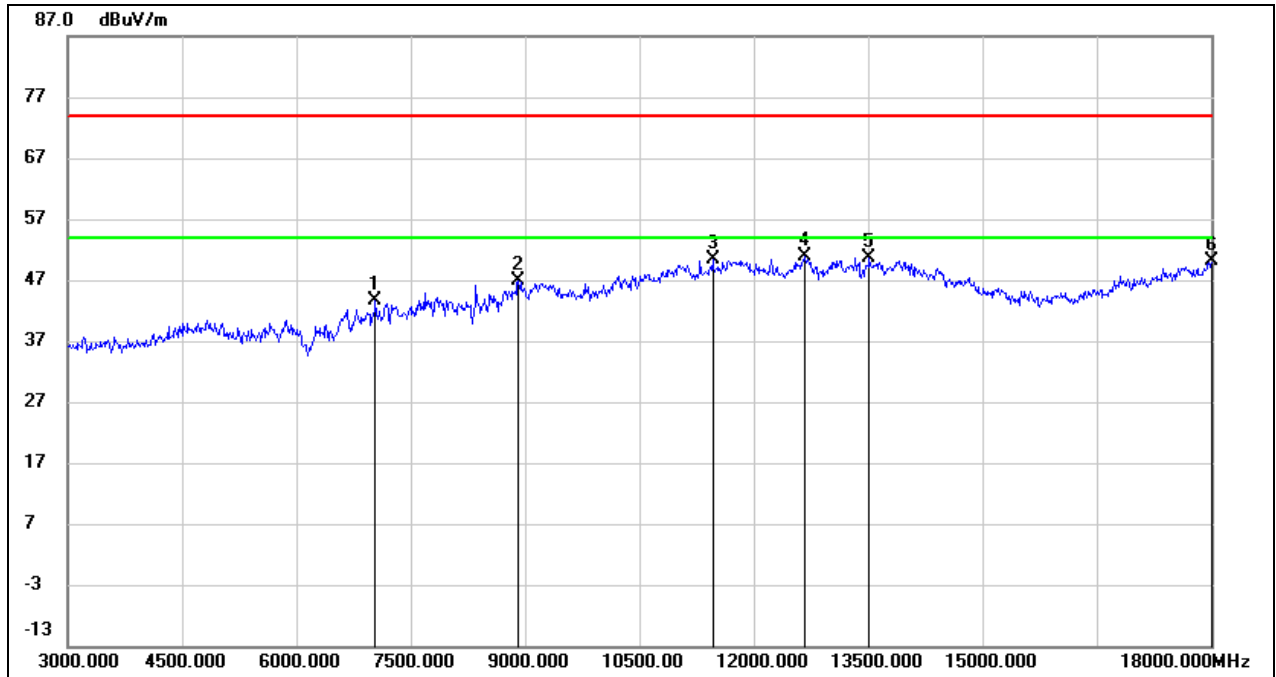

| No. | Frequency (MHz) | Reading (dBuV) | Correct (dB/m) | Result (dBuV/m) | Limit (dBuV/m) | Margin (dB) | Remark |
|-----|-----------------|----------------|----------------|-----------------|----------------|-------------|--------|
| 1   | 7035.000        | 36.95          | 6.67           | 43.62           | 74.00          | -30.38      | peak   |
| 2   | 8910.000        | 37.11          | 9.82           | 46.93           | 74.00          | -27.07      | peak   |
| 3   | 11460.000       | 33.86          | 16.46          | 50.32           | 74.00          | -23.68      | peak   |
| 4   | 12675.000       | 32.93          | 17.99          | 50.92           | 74.00          | -23.08      | peak   |
| 5   | 13515.000       | 29.58          | 20.93          | 50.51           | 74.00          | -23.49      | peak   |
| 6   | 18000.000       | 24.53          | 25.69          | 50.22           | 74.00          | -23.78      | peak   |

|            |                |               |          |
|------------|----------------|---------------|----------|
| Test Mode: | 802.11be EHT20 | Channel:      | 2412 MHz |
| Polarity:  | Horizontal     | Test Voltage: | DC 12 V  |

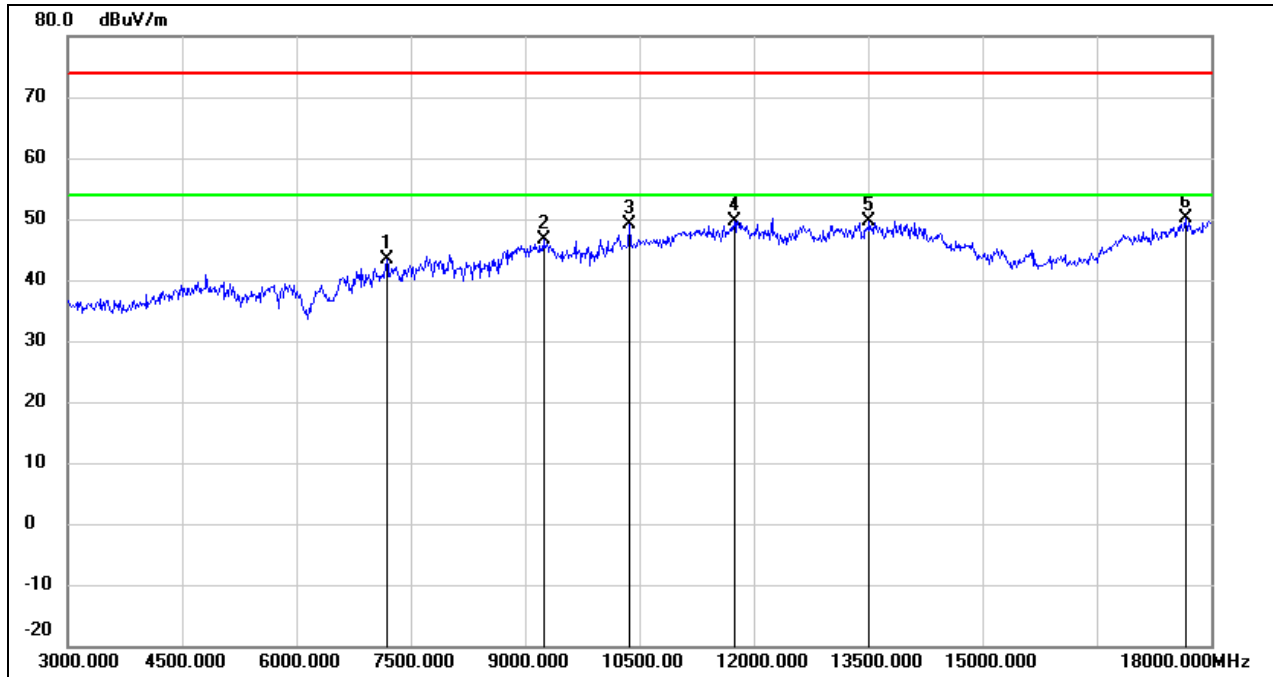

| No. | Frequency (MHz) | Reading (dBuV) | Correct (dB/m) | Result (dBuV/m) | Limit (dBuV/m) | Margin (dB) | Remark |
|-----|-----------------|----------------|----------------|-----------------|----------------|-------------|--------|
| 1   | 7185.000        | 36.81          | 6.55           | 43.36           | 74.00          | -30.64      | peak   |
| 2   | 9240.000        | 35.97          | 10.58          | 46.55           | 74.00          | -27.45      | peak   |
| 3   | 10365.000       | 36.48          | 12.72          | 49.20           | 74.00          | -24.80      | peak   |
| 4   | 11745.000       | 32.45          | 17.27          | 49.72           | 74.00          | -24.28      | peak   |
| 5   | 13515.000       | 28.77          | 20.93          | 49.70           | 74.00          | -24.30      | peak   |
| 6   | 17670.000       | 26.37          | 23.73          | 50.10           | 74.00          | -23.90      | peak   |

|            |                |               |          |
|------------|----------------|---------------|----------|
| Test Mode: | 802.11be EHT20 | Channel:      | 2412 MHz |
| Polarity:  | Vertical       | Test Voltage: | DC 12 V  |

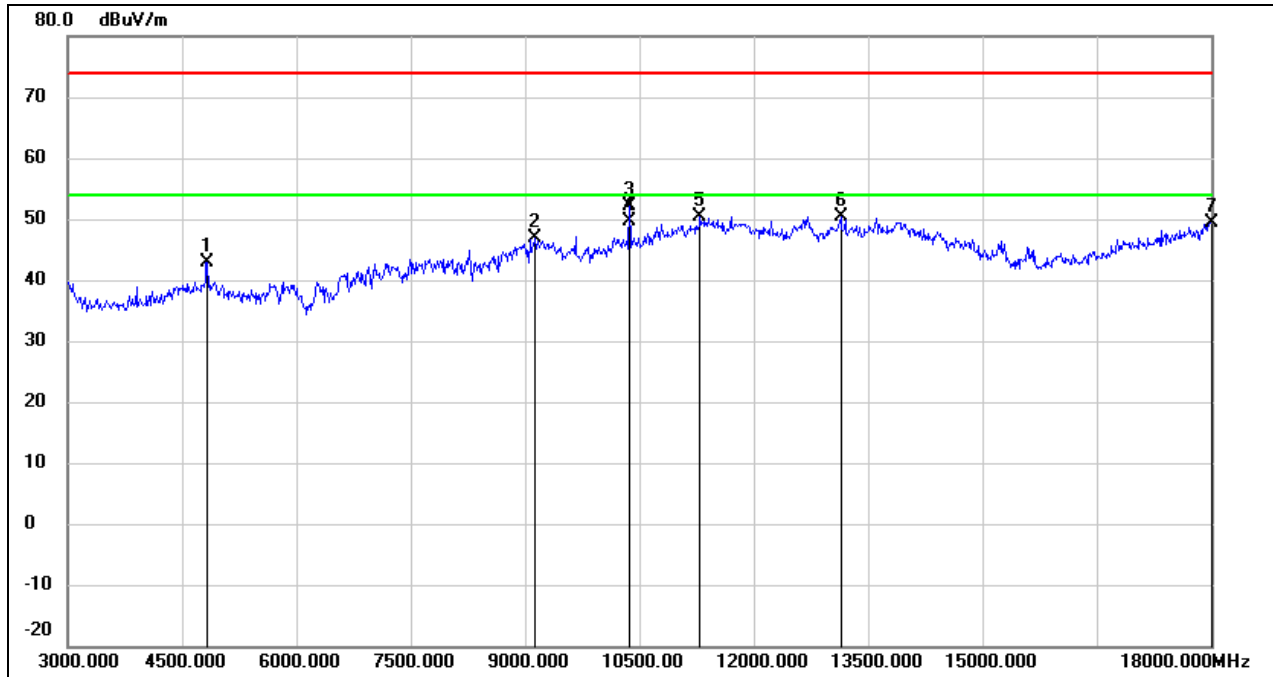

| No. | Frequency (MHz) | Reading (dBuV) | Correct (dB/m) | Result (dBuV/m) | Limit (dBuV/m) | Margin (dB) | Remark |
|-----|-----------------|----------------|----------------|-----------------|----------------|-------------|--------|
| 1   | 4830.000        | 43.06          | -0.20          | 42.86           | 74.00          | -31.14      | peak   |
| 2   | 9135.000        | 36.28          | 10.55          | 46.83           | 74.00          | -27.17      | peak   |
| 3   | 10365.000       | 39.51          | 12.72          | 52.23           | 74.00          | -21.77      | peak   |
| 4   | 10365.000       | 36.79          | 12.72          | 49.51           | 54.00          | -4.49       | AVG    |
| 5   | 11295.000       | 34.45          | 15.85          | 50.30           | 74.00          | -23.70      | peak   |
| 6   | 13140.000       | 31.14          | 19.33          | 50.47           | 74.00          | -23.53      | peak   |
| 7   | 18000.000       | 23.76          | 25.69          | 49.45           | 74.00          | -24.55      | peak   |

|            |                |               |          |
|------------|----------------|---------------|----------|
| Test Mode: | 802.11be EHT20 | Channel:      | 2417 MHz |
| Polarity:  | Horizontal     | Test Voltage: | DC 12 V  |

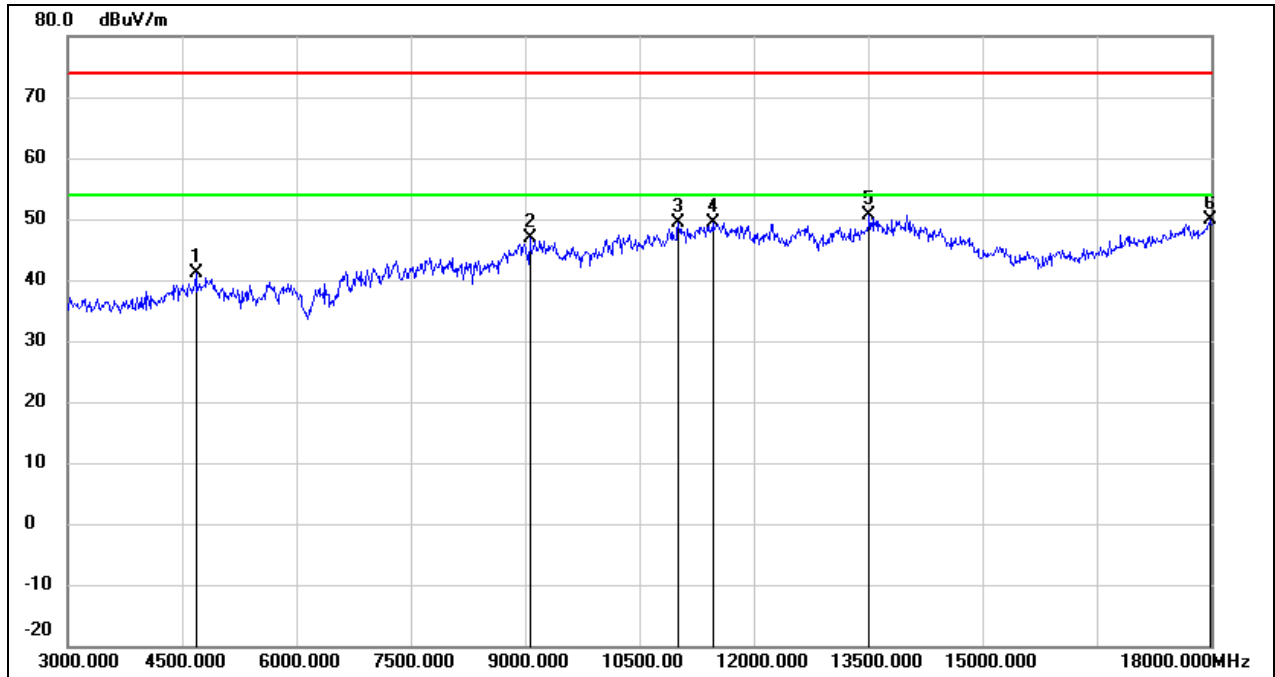

| No. | Frequency (MHz) | Reading (dBuV) | Correct (dB/m) | Result (dBuV/m) | Limit (dBuV/m) | Margin (dB) | Remark |
|-----|-----------------|----------------|----------------|-----------------|----------------|-------------|--------|
| 1   | 4680.000        | 41.84          | -0.77          | 41.07           | 74.00          | -32.93      | peak   |
| 2   | 9060.000        | 36.38          | 10.51          | 46.89           | 74.00          | -27.11      | peak   |
| 3   | 11010.000       | 34.55          | 14.81          | 49.36           | 74.00          | -24.64      | peak   |
| 4   | 11460.000       | 32.94          | 16.46          | 49.40           | 74.00          | -24.60      | peak   |
| 5   | 13515.000       | 29.79          | 20.93          | 50.72           | 74.00          | -23.28      | peak   |
| 6   | 17985.000       | 24.28          | 25.60          | 49.88           | 74.00          | -24.12      | peak   |

|            |                |               |          |
|------------|----------------|---------------|----------|
| Test Mode: | 802.11be EHT20 | Channel:      | 2417 MHz |
| Polarity:  | Vertical       | Test Voltage: | DC 12 V  |

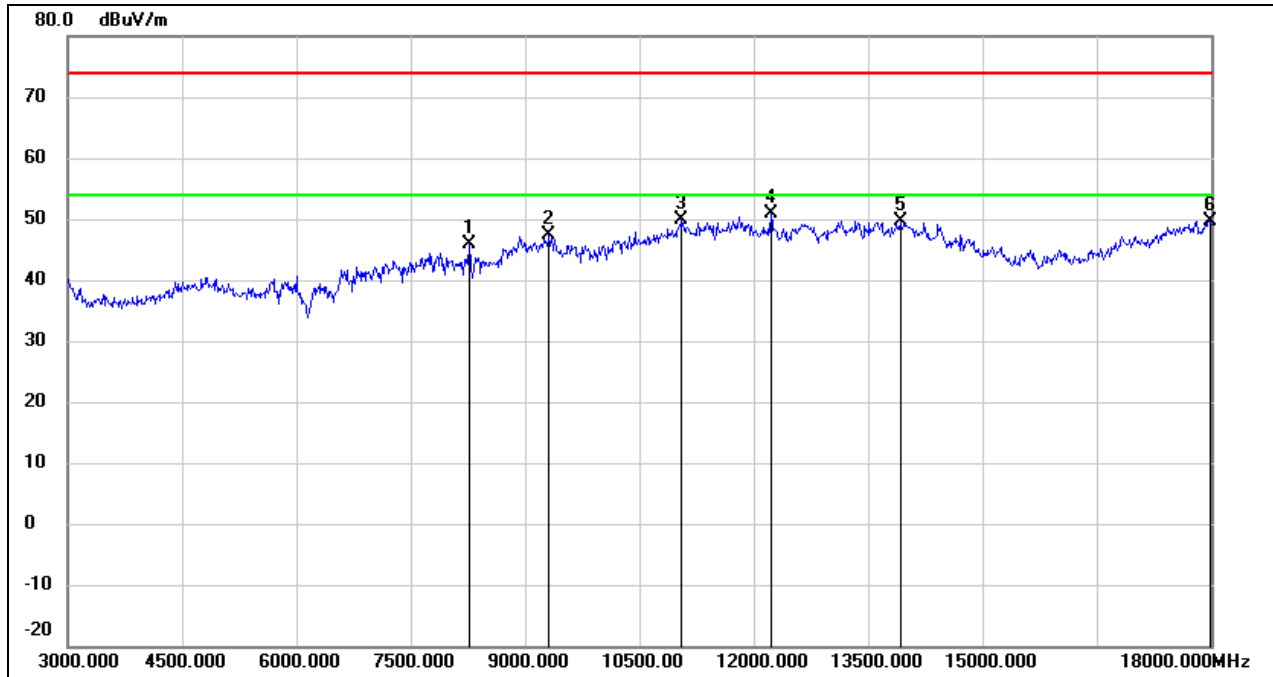

| No. | Frequency (MHz) | Reading (dBuV) | Correct (dB/m) | Result (dBuV/m) | Limit (dBuV/m) | Margin (dB) | Remark |
|-----|-----------------|----------------|----------------|-----------------|----------------|-------------|--------|
| 1   | 8265.000        | 39.39          | 6.59           | 45.98           | 74.00          | -28.02      | peak   |
| 2   | 9315.000        | 36.80          | 10.61          | 47.41           | 74.00          | -26.59      | peak   |
| 3   | 11055.000       | 34.92          | 14.96          | 49.88           | 74.00          | -24.12      | peak   |
| 4   | 12225.000       | 33.16          | 17.79          | 50.95           | 74.00          | -23.05      | peak   |
| 5   | 13920.000       | 27.95          | 21.79          | 49.74           | 74.00          | -24.26      | peak   |
| 6   | 17985.000       | 24.12          | 25.60          | 49.72           | 74.00          | -24.28      | peak   |

|            |                |               |          |
|------------|----------------|---------------|----------|
| Test Mode: | 802.11be EHT20 | Channel:      | 2437 MHz |
| Polarity:  | Horizontal     | Test Voltage: | DC 12 V  |

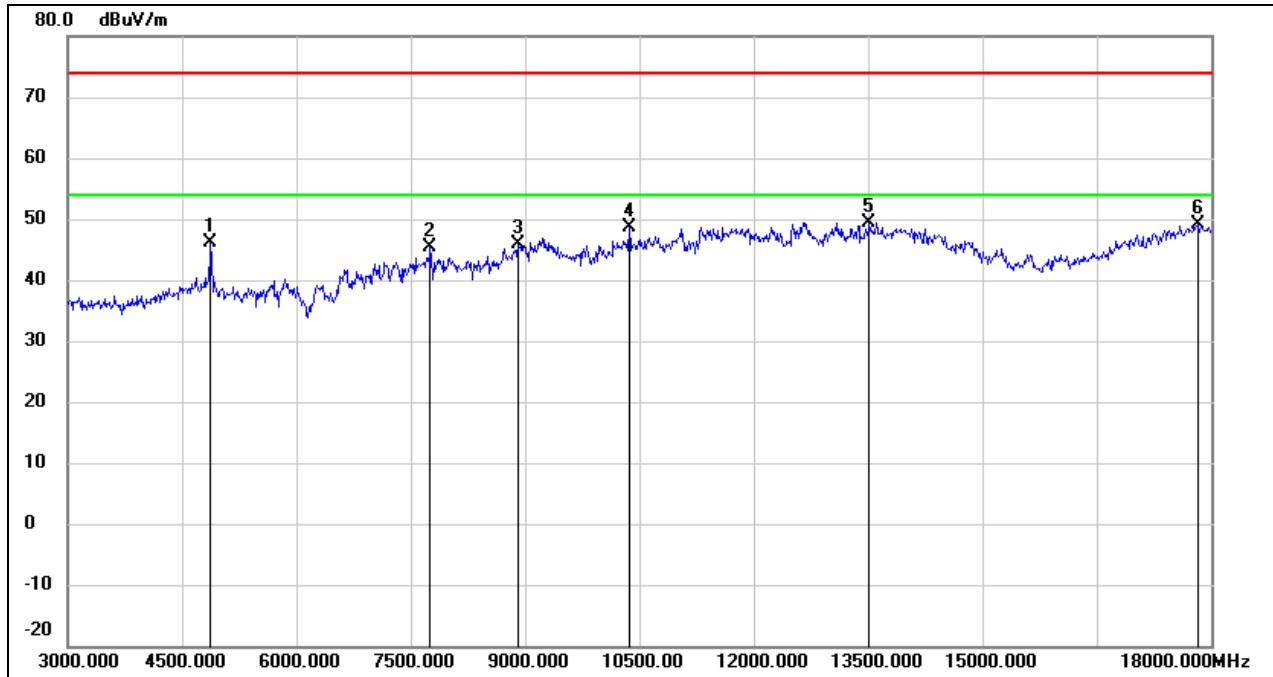

| No. | Frequency (MHz) | Reading (dBuV) | Correct (dB/m) | Result (dBuV/m) | Limit (dBuV/m) | Margin (dB) | Remark |
|-----|-----------------|----------------|----------------|-----------------|----------------|-------------|--------|
| 1   | 4875.000        | 46.15          | -0.03          | 46.12           | 74.00          | -27.88      | peak   |
| 2   | 7755.000        | 39.07          | 6.31           | 45.38           | 74.00          | -28.62      | peak   |
| 3   | 8910.000        | 36.04          | 9.82           | 45.86           | 74.00          | -28.14      | peak   |
| 4   | 10365.000       | 35.83          | 12.72          | 48.55           | 74.00          | -25.45      | peak   |
| 5   | 13515.000       | 28.49          | 20.93          | 49.42           | 74.00          | -24.58      | peak   |
| 6   | 17820.000       | 24.48          | 24.63          | 49.11           | 74.00          | -24.89      | peak   |

|            |                |               |          |
|------------|----------------|---------------|----------|
| Test Mode: | 802.11be EHT20 | Channel:      | 2437 MHz |
| Polarity:  | Vertical       | Test Voltage: | DC 12 V  |

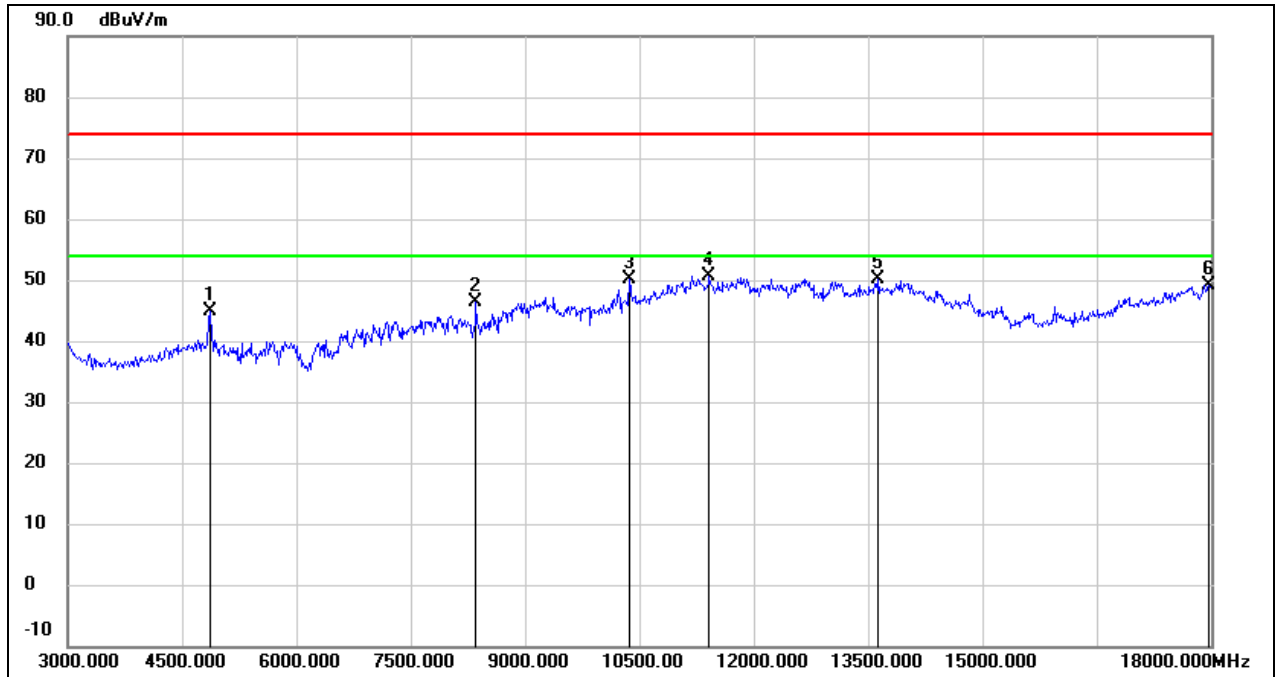

| No. | Frequency (MHz) | Reading (dBuV) | Correct (dB/m) | Result (dBuV/m) | Limit (dBuV/m) | Margin (dB) | Remark |
|-----|-----------------|----------------|----------------|-----------------|----------------|-------------|--------|
| 1   | 4860.000        | 44.87          | -0.09          | 44.78           | 74.00          | -29.22      | peak   |
| 2   | 8355.000        | 39.74          | 6.69           | 46.43           | 74.00          | -27.57      | peak   |
| 3   | 10365.000       | 37.51          | 12.72          | 50.23           | 74.00          | -23.77      | peak   |
| 4   | 11415.000       | 34.31          | 16.29          | 50.60           | 74.00          | -23.40      | peak   |
| 5   | 13635.000       | 29.00          | 21.19          | 50.19           | 74.00          | -23.81      | peak   |
| 6   | 17970.000       | 23.68          | 25.51          | 49.19           | 74.00          | -24.81      | peak   |

|            |                |               |          |
|------------|----------------|---------------|----------|
| Test Mode: | 802.11be EHT20 | Channel:      | 2457 MHz |
| Polarity:  | Horizontal     | Test Voltage: | DC 12 V  |

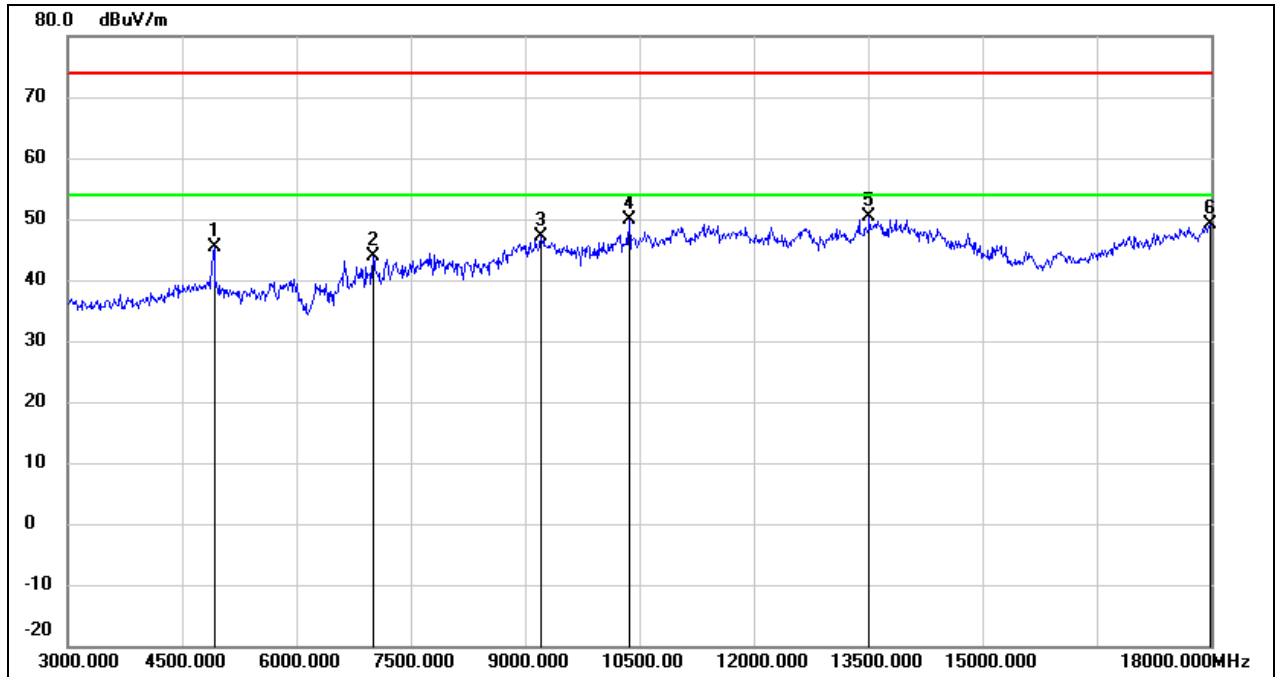

| No. | Frequency (MHz) | Reading (dBuV) | Correct (dB/m) | Result (dBuV/m) | Limit (dBuV/m) | Margin (dB) | Remark |
|-----|-----------------|----------------|----------------|-----------------|----------------|-------------|--------|
| 1   | 4920.000        | 45.25          | 0.14           | 45.39           | 74.00          | -28.61      | peak   |
| 2   | 7005.000        | 37.25          | 6.69           | 43.94           | 74.00          | -30.06      | peak   |
| 3   | 9210.000        | 36.54          | 10.57          | 47.11           | 74.00          | -26.89      | peak   |
| 4   | 10365.000       | 37.10          | 12.72          | 49.82           | 74.00          | -24.18      | peak   |
| 5   | 13515.000       | 29.34          | 20.93          | 50.27           | 74.00          | -23.73      | peak   |
| 6   | 17985.000       | 23.49          | 25.60          | 49.09           | 74.00          | -24.91      | peak   |



|            |                |               |          |
|------------|----------------|---------------|----------|
| Test Mode: | 802.11be EHT20 | Channel:      | 2457 MHz |
| Polarity:  | Vertical       | Test Voltage: | DC 12 V  |

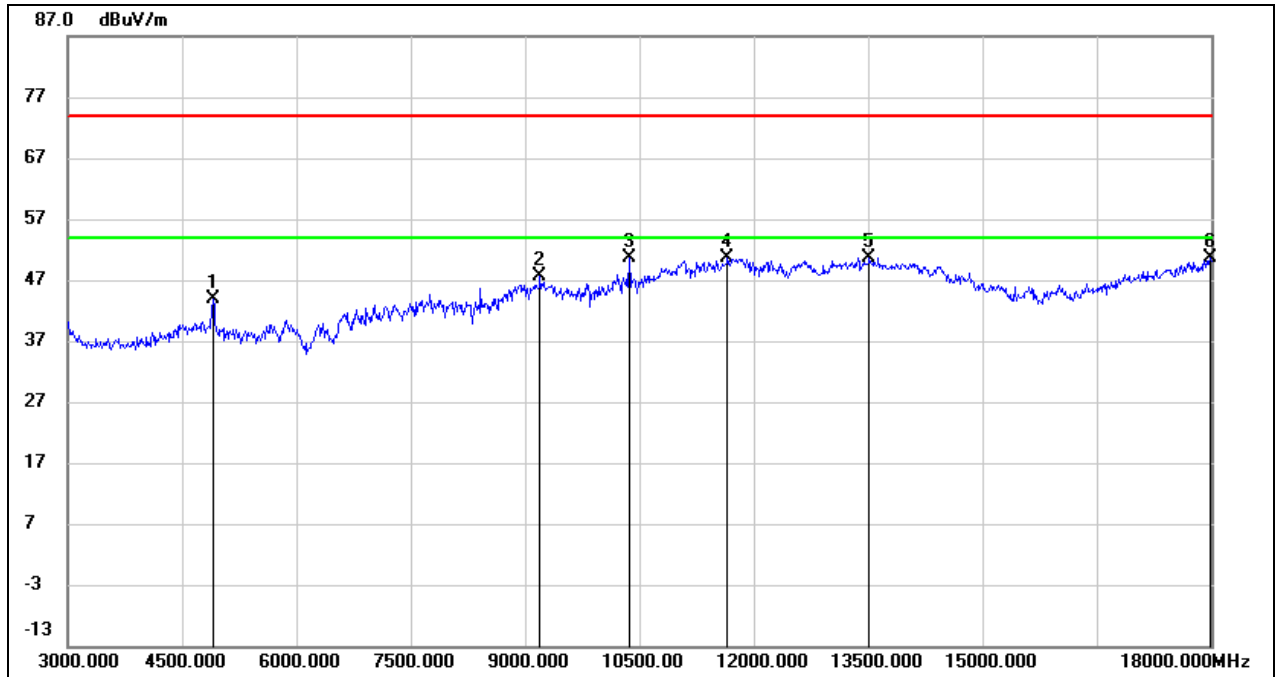

| No. | Frequency (MHz) | Reading (dBuV) | Correct (dB/m) | Result (dBuV/m) | Limit (dBuV/m) | Margin (dB) | Remark |
|-----|-----------------|----------------|----------------|-----------------|----------------|-------------|--------|
| 1   | 4905.000        | 43.88          | 0.09           | 43.97           | 74.00          | -30.03      | peak   |
| 2   | 9195.000        | 37.09          | 10.56          | 47.65           | 74.00          | -26.35      | peak   |
| 3   | 10365.000       | 37.80          | 12.72          | 50.52           | 74.00          | -23.48      | peak   |
| 4   | 11655.000       | 33.51          | 17.01          | 50.52           | 74.00          | -23.48      | peak   |
| 5   | 13515.000       | 29.72          | 20.93          | 50.65           | 74.00          | -23.35      | peak   |
| 6   | 17985.000       | 25.07          | 25.60          | 50.67           | 74.00          | -23.33      | peak   |

|            |                |               |          |
|------------|----------------|---------------|----------|
| Test Mode: | 802.11be EHT20 | Channel:      | 2462 MHz |
| Polarity:  | Horizontal     | Test Voltage: | DC 12 V  |

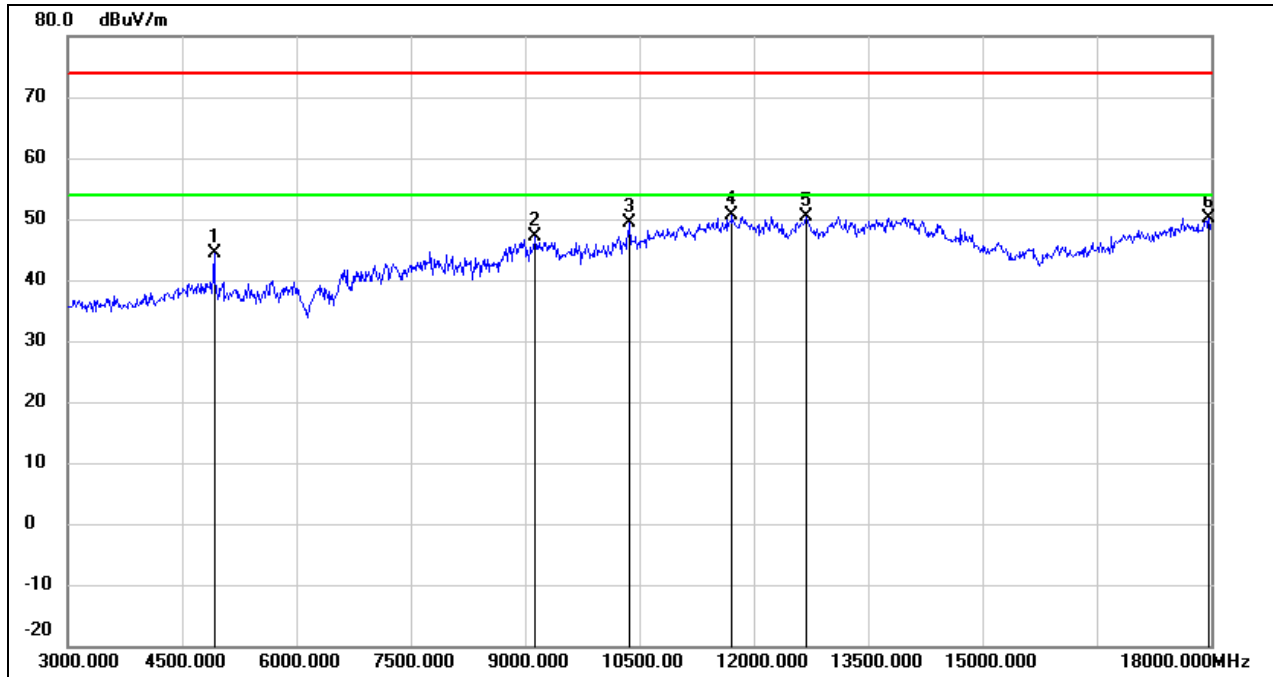

| No. | Frequency (MHz) | Reading (dBuV) | Correct (dB/m) | Result (dBuV/m) | Limit (dBuV/m) | Margin (dB) | Remark |
|-----|-----------------|----------------|----------------|-----------------|----------------|-------------|--------|
| 1   | 4920.000        | 44.29          | 0.14           | 44.43           | 74.00          | -29.57      | peak   |
| 2   | 9135.000        | 36.53          | 10.55          | 47.08           | 74.00          | -26.92      | peak   |
| 3   | 10365.000       | 36.68          | 12.72          | 49.40           | 74.00          | -24.60      | peak   |
| 4   | 11715.000       | 33.40          | 17.19          | 50.59           | 74.00          | -23.41      | peak   |
| 5   | 12690.000       | 32.44          | 18.02          | 50.46           | 74.00          | -23.54      | peak   |
| 6   | 17970.000       | 24.64          | 25.51          | 50.15           | 74.00          | -23.85      | peak   |

|            |                |               |          |
|------------|----------------|---------------|----------|
| Test Mode: | 802.11be EHT20 | Channel:      | 2462 MHz |
| Polarity:  | Vertical       | Test Voltage: | DC 12 V  |

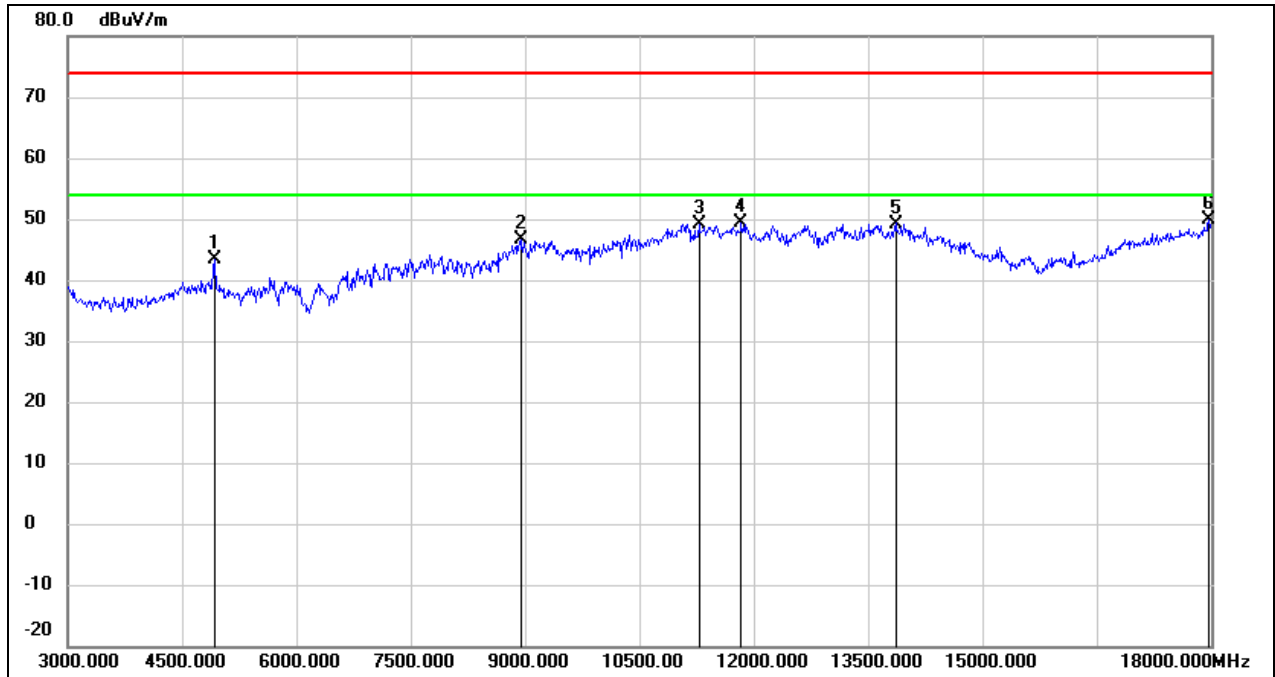

| No. | Frequency (MHz) | Reading (dBuV) | Correct (dB/m) | Result (dBuV/m) | Limit (dBuV/m) | Margin (dB) | Remark |
|-----|-----------------|----------------|----------------|-----------------|----------------|-------------|--------|
| 1   | 4920.000        | 43.27          | 0.14           | 43.41           | 74.00          | -30.59      | peak   |
| 2   | 8940.000        | 36.49          | 10.04          | 46.53           | 74.00          | -27.47      | peak   |
| 3   | 11280.000       | 33.40          | 15.80          | 49.20           | 74.00          | -24.80      | peak   |
| 4   | 11835.000       | 31.87          | 17.51          | 49.38           | 74.00          | -24.62      | peak   |
| 5   | 13860.000       | 27.58          | 21.67          | 49.25           | 74.00          | -24.75      | peak   |
| 6   | 17970.000       | 24.35          | 25.51          | 49.86           | 74.00          | -24.14      | peak   |

|            |                |               |          |
|------------|----------------|---------------|----------|
| Test Mode: | 802.11be EHT40 | Channel:      | 2422 MHz |
| Polarity:  | Horizontal     | Test Voltage: | DC 12 V  |

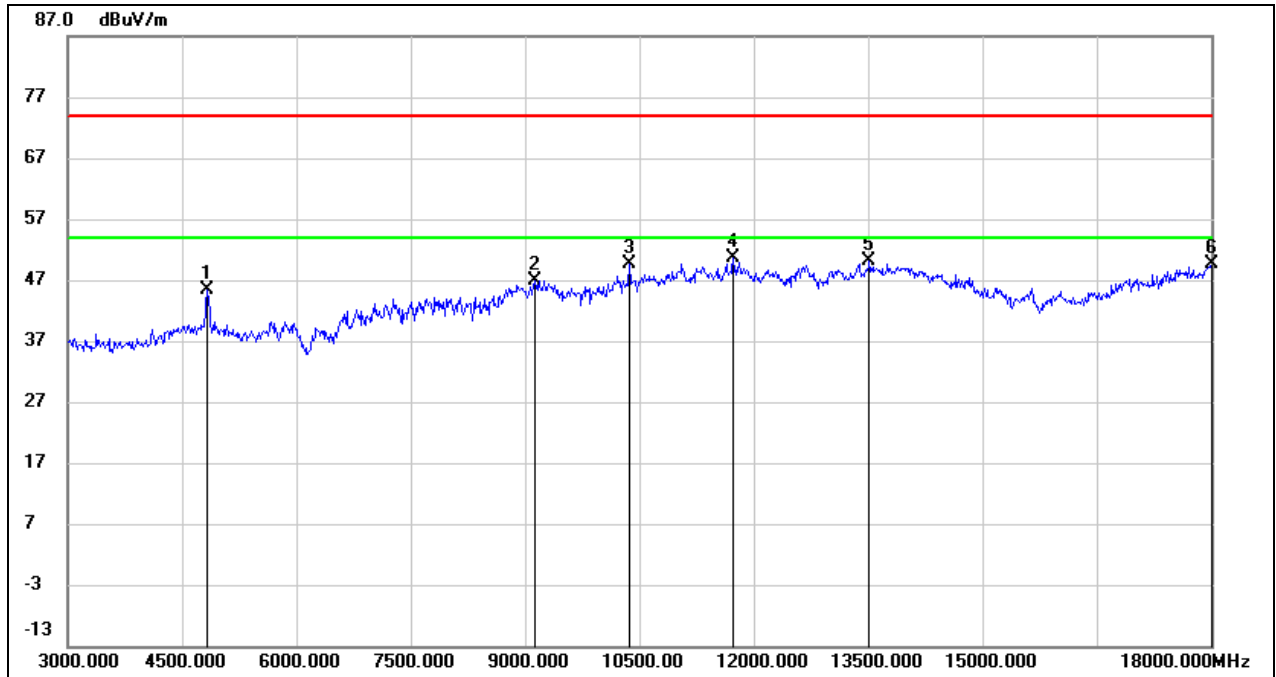

| No. | Frequency (MHz) | Reading (dBuV) | Correct (dB/m) | Result (dBuV/m) | Limit (dBuV/m) | Margin (dB) | Remark |
|-----|-----------------|----------------|----------------|-----------------|----------------|-------------|--------|
| 1   | 4830.000        | 45.70          | -0.20          | 45.50           | 74.00          | -28.50      | peak   |
| 2   | 9120.000        | 36.36          | 10.53          | 46.89           | 74.00          | -27.11      | peak   |
| 3   | 10365.000       | 36.95          | 12.72          | 49.67           | 74.00          | -24.33      | peak   |
| 4   | 11730.000       | 33.34          | 17.22          | 50.56           | 74.00          | -23.44      | peak   |
| 5   | 13515.000       | 29.17          | 20.93          | 50.10           | 74.00          | -23.90      | peak   |
| 6   | 18000.000       | 23.87          | 25.69          | 49.56           | 74.00          | -24.44      | peak   |

|            |                |               |          |
|------------|----------------|---------------|----------|
| Test Mode: | 802.11be EHT40 | Channel:      | 2422 MHz |
| Polarity:  | Vertical       | Test Voltage: | DC 12 V  |

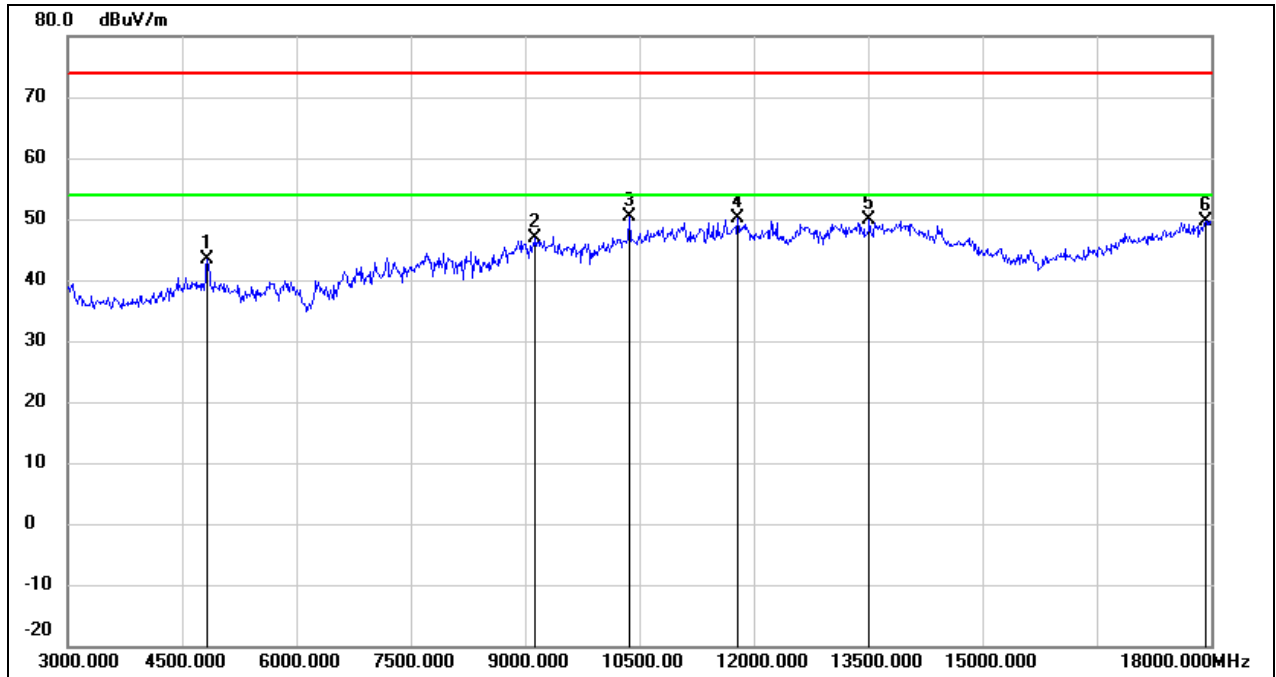

| No. | Frequency (MHz) | Reading (dBuV) | Correct (dB/m) | Result (dBuV/m) | Limit (dBuV/m) | Margin (dB) | Remark |
|-----|-----------------|----------------|----------------|-----------------|----------------|-------------|--------|
| 1   | 4830.000        | 43.52          | -0.20          | 43.32           | 74.00          | -30.68      | peak   |
| 2   | 9135.000        | 36.36          | 10.55          | 46.91           | 74.00          | -27.09      | peak   |
| 3   | 10365.000       | 37.65          | 12.72          | 50.37           | 74.00          | -23.63      | peak   |
| 4   | 11790.000       | 32.69          | 17.38          | 50.07           | 74.00          | -23.93      | peak   |
| 5   | 13515.000       | 28.89          | 20.93          | 49.82           | 74.00          | -24.18      | peak   |
| 6   | 17925.000       | 24.48          | 25.25          | 49.73           | 74.00          | -24.27      | peak   |

|            |                |               |          |
|------------|----------------|---------------|----------|
| Test Mode: | 802.11be EHT40 | Channel:      | 2427 MHz |
| Polarity:  | Horizontal     | Test Voltage: | DC 12 V  |

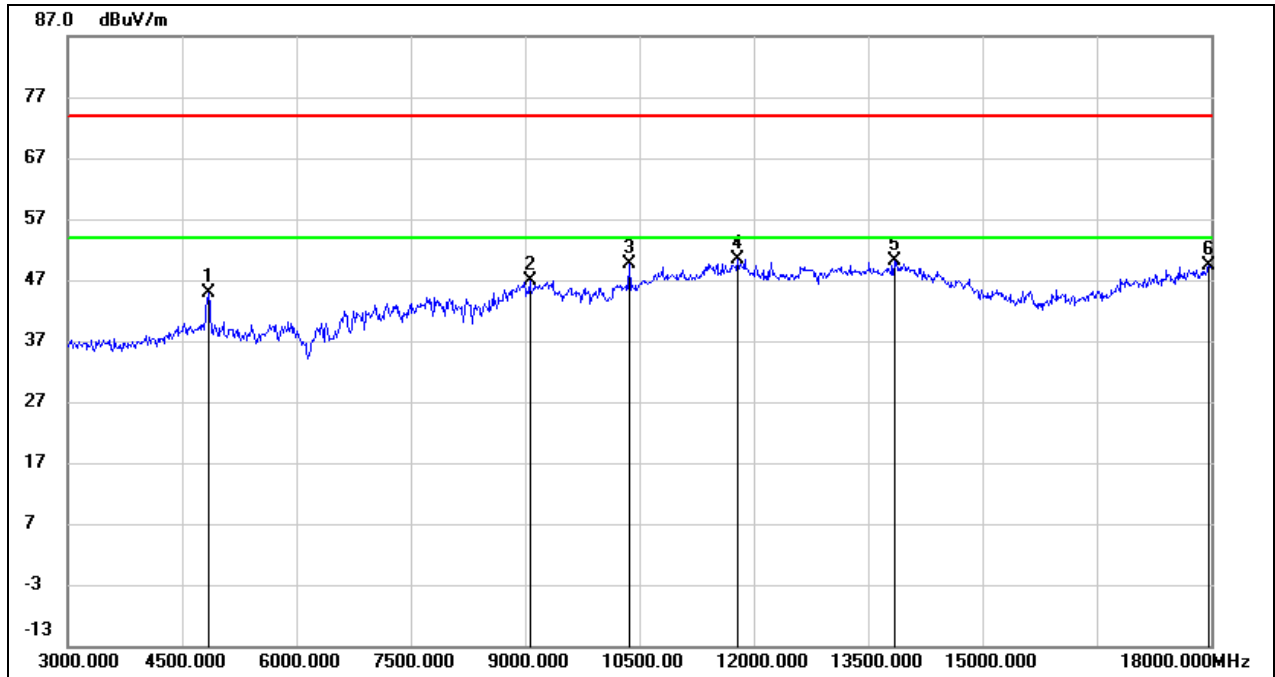

| No. | Frequency (MHz) | Reading (dBuV) | Correct (dB/m) | Result (dBuV/m) | Limit (dBuV/m) | Margin (dB) | Remark |
|-----|-----------------|----------------|----------------|-----------------|----------------|-------------|--------|
| 1   | 4845.000        | 45.11          | -0.15          | 44.96           | 74.00          | -29.04      | peak   |
| 2   | 9060.000        | 36.32          | 10.51          | 46.83           | 74.00          | -27.17      | peak   |
| 3   | 10365.000       | 37.01          | 12.72          | 49.73           | 74.00          | -24.27      | peak   |
| 4   | 11790.000       | 32.99          | 17.38          | 50.37           | 74.00          | -23.63      | peak   |
| 5   | 13845.000       | 28.39          | 21.62          | 50.01           | 74.00          | -23.99      | peak   |
| 6   | 17970.000       | 23.92          | 25.51          | 49.43           | 74.00          | -24.57      | peak   |

|            |                |               |          |
|------------|----------------|---------------|----------|
| Test Mode: | 802.11be EHT40 | Channel:      | 2427 MHz |
| Polarity:  | Vertical       | Test Voltage: | DC 12 V  |

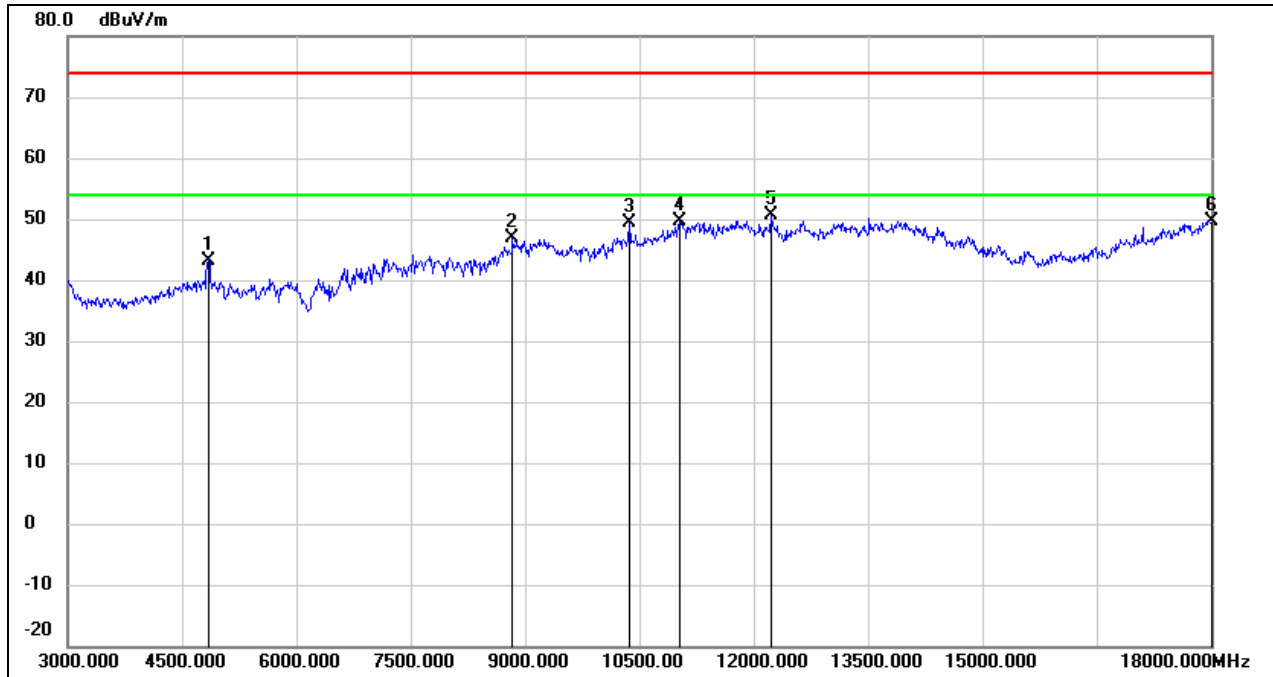

| No. | Frequency (MHz) | Reading (dBuV) | Correct (dB/m) | Result (dBuV/m) | Limit (dBuV/m) | Margin (dB) | Remark |
|-----|-----------------|----------------|----------------|-----------------|----------------|-------------|--------|
| 1   | 4845.000        | 43.40          | -0.15          | 43.25           | 74.00          | -30.75      | peak   |
| 2   | 8835.000        | 37.62          | 9.28           | 46.90           | 74.00          | -27.10      | peak   |
| 3   | 10365.000       | 36.56          | 12.72          | 49.28           | 74.00          | -24.72      | peak   |
| 4   | 11025.000       | 34.69          | 14.85          | 49.54           | 74.00          | -24.46      | peak   |
| 5   | 12225.000       | 32.72          | 17.79          | 50.51           | 74.00          | -23.49      | peak   |
| 6   | 18000.000       | 23.90          | 25.69          | 49.59           | 74.00          | -24.41      | peak   |

|            |                |               |          |
|------------|----------------|---------------|----------|
| Test Mode: | 802.11be EHT40 | Channel:      | 2437 MHz |
| Polarity:  | Horizontal     | Test Voltage: | DC 12 V  |

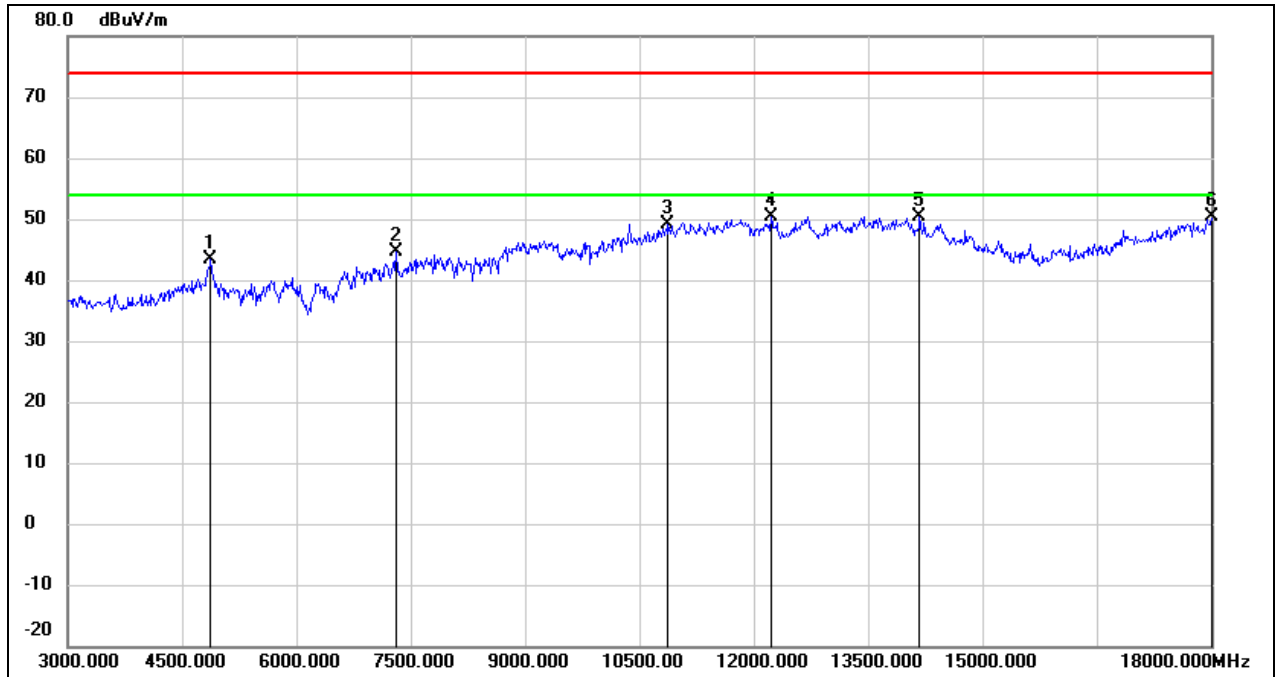

| No. | Frequency (MHz) | Reading (dBuV) | Correct (dB/m) | Result (dBuV/m) | Limit (dBuV/m) | Margin (dB) | Remark |
|-----|-----------------|----------------|----------------|-----------------|----------------|-------------|--------|
| 1   | 4875.000        | 43.34          | -0.03          | 43.31           | 74.00          | -30.69      | peak   |
| 2   | 7305.000        | 38.15          | 6.47           | 44.62           | 74.00          | -29.38      | peak   |
| 3   | 10875.000       | 34.74          | 14.32          | 49.06           | 74.00          | -24.94      | peak   |
| 4   | 12225.000       | 32.63          | 17.79          | 50.42           | 74.00          | -23.58      | peak   |
| 5   | 14175.000       | 29.10          | 21.24          | 50.34           | 74.00          | -23.66      | peak   |
| 6   | 18000.000       | 24.58          | 25.69          | 50.27           | 74.00          | -23.73      | peak   |



|            |                |               |          |
|------------|----------------|---------------|----------|
| Test Mode: | 802.11be EHT40 | Channel:      | 2437 MHz |
| Polarity:  | Vertical       | Test Voltage: | DC 12 V  |

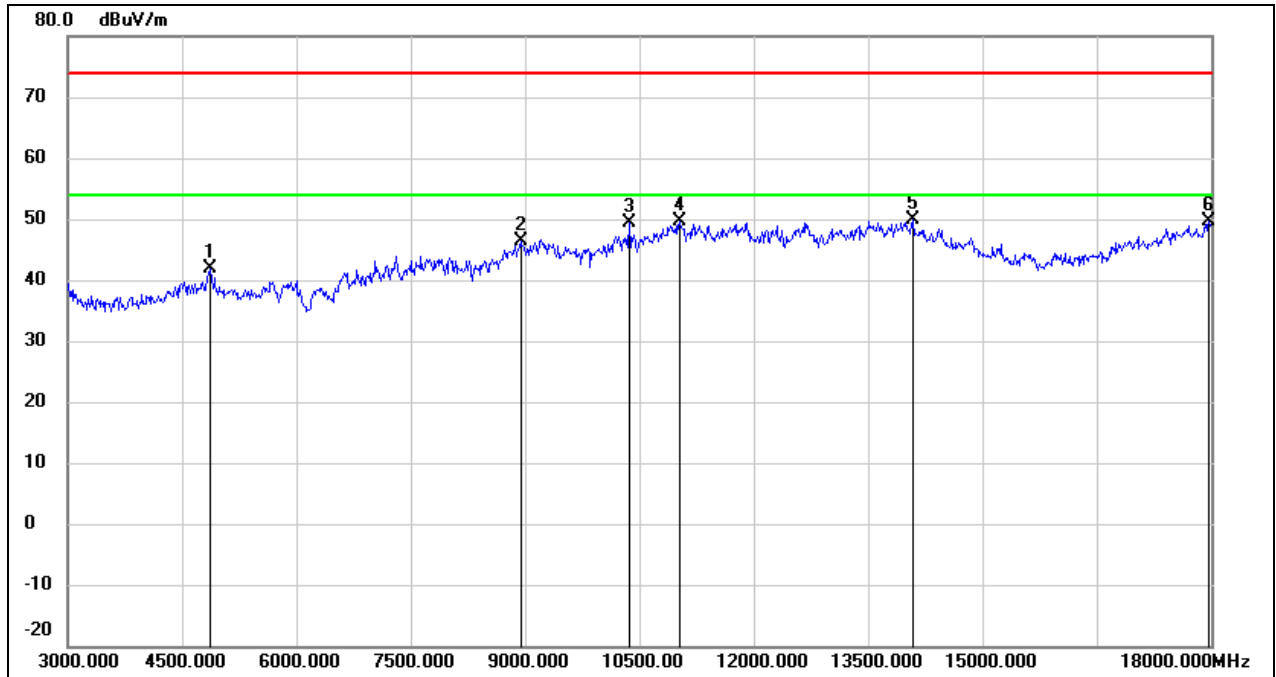

| No. | Frequency (MHz) | Reading (dBuV) | Correct (dB/m) | Result (dBuV/m) | Limit (dBuV/m) | Margin (dB) | Remark |
|-----|-----------------|----------------|----------------|-----------------|----------------|-------------|--------|
| 1   | 4860.000        | 42.08          | -0.09          | 41.99           | 74.00          | -32.01      | peak   |
| 2   | 8940.000        | 36.31          | 10.04          | 46.35           | 74.00          | -27.65      | peak   |
| 3   | 10365.000       | 36.73          | 12.72          | 49.45           | 74.00          | -24.55      | peak   |
| 4   | 11025.000       | 34.72          | 14.85          | 49.57           | 74.00          | -24.43      | peak   |
| 5   | 14085.000       | 28.18          | 21.61          | 49.79           | 74.00          | -24.21      | peak   |
| 6   | 17970.000       | 24.14          | 25.51          | 49.65           | 74.00          | -24.35      | peak   |

|            |                |               |          |
|------------|----------------|---------------|----------|
| Test Mode: | 802.11be EHT40 | Channel:      | 2447 MHz |
| Polarity:  | Horizontal     | Test Voltage: | DC 12 V  |

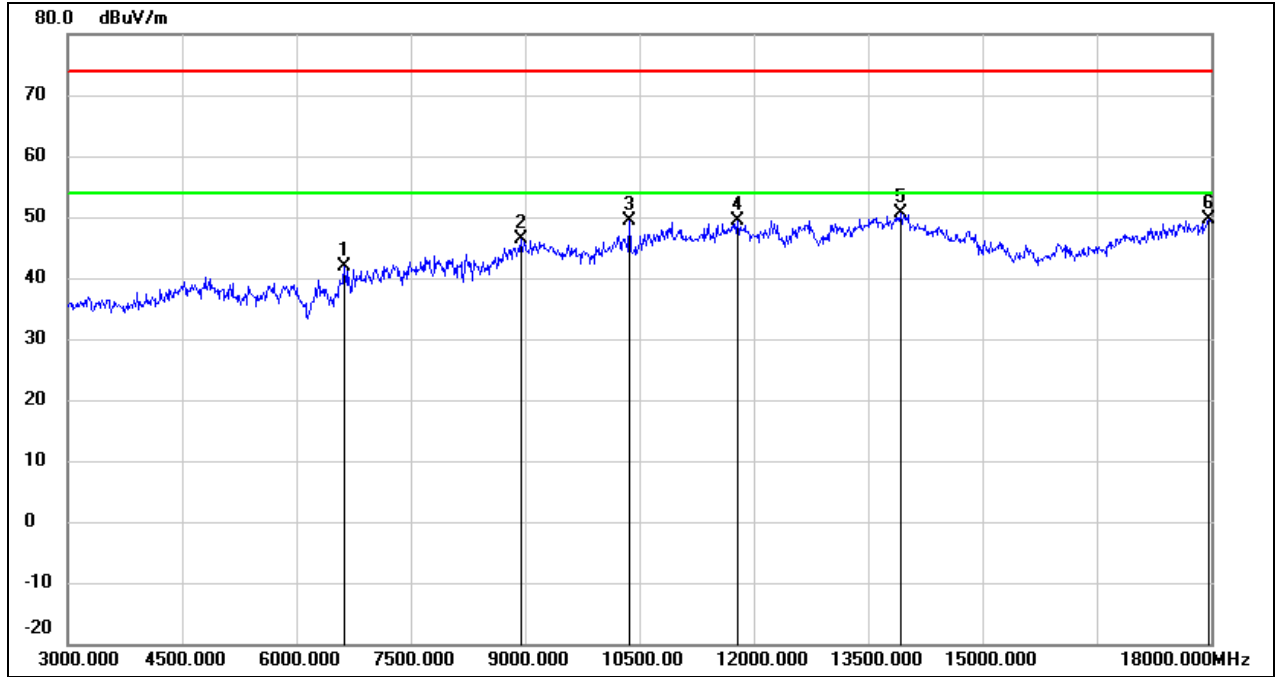

| No. | Frequency (MHz) | Reading (dBuV) | Correct (dB/m) | Result (dBuV/m) | Limit (dBuV/m) | Margin (dB) | Remark |
|-----|-----------------|----------------|----------------|-----------------|----------------|-------------|--------|
| 1   | 6630.000        | 37.02          | 4.86           | 41.88           | 74.00          | -32.12      | peak   |
| 2   | 8940.000        | 36.23          | 10.04          | 46.27           | 74.00          | -27.73      | peak   |
| 3   | 10365.000       | 36.67          | 12.72          | 49.39           | 74.00          | -24.61      | peak   |
| 4   | 11790.000       | 32.07          | 17.38          | 49.45           | 74.00          | -24.55      | peak   |
| 5   | 13935.000       | 28.75          | 21.82          | 50.57           | 74.00          | -23.43      | peak   |
| 6   | 17970.000       | 24.01          | 25.51          | 49.52           | 74.00          | -24.48      | peak   |

|            |                |               |          |
|------------|----------------|---------------|----------|
| Test Mode: | 802.11be EHT40 | Channel:      | 2447 MHz |
| Polarity:  | Vertical       | Test Voltage: | DC 12 V  |

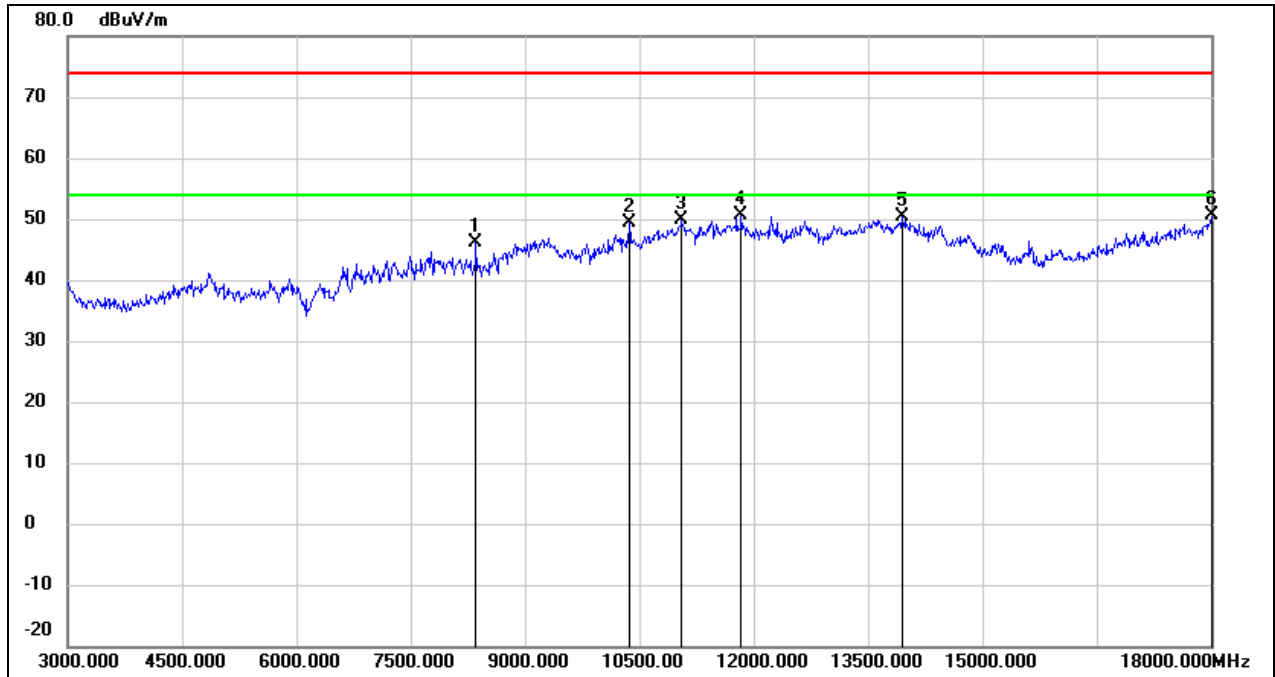

| No. | Frequency (MHz) | Reading (dBuV) | Correct (dB/m) | Result (dBuV/m) | Limit (dBuV/m) | Margin (dB) | Remark |
|-----|-----------------|----------------|----------------|-----------------|----------------|-------------|--------|
| 1   | 8355.000        | 39.40          | 6.69           | 46.09           | 74.00          | -27.91      | peak   |
| 2   | 10365.000       | 36.54          | 12.72          | 49.26           | 74.00          | -24.74      | peak   |
| 3   | 11055.000       | 35.03          | 14.96          | 49.99           | 74.00          | -24.01      | peak   |
| 4   | 11835.000       | 33.08          | 17.51          | 50.59           | 74.00          | -23.41      | peak   |
| 5   | 13950.000       | 28.51          | 21.86          | 50.37           | 74.00          | -23.63      | peak   |
| 6   | 18000.000       | 24.90          | 25.69          | 50.59           | 74.00          | -23.41      | peak   |

|            |                |               |          |
|------------|----------------|---------------|----------|
| Test Mode: | 802.11be EHT40 | Channel:      | 2452 MHz |
| Polarity:  | Horizontal     | Test Voltage: | DC 12 V  |

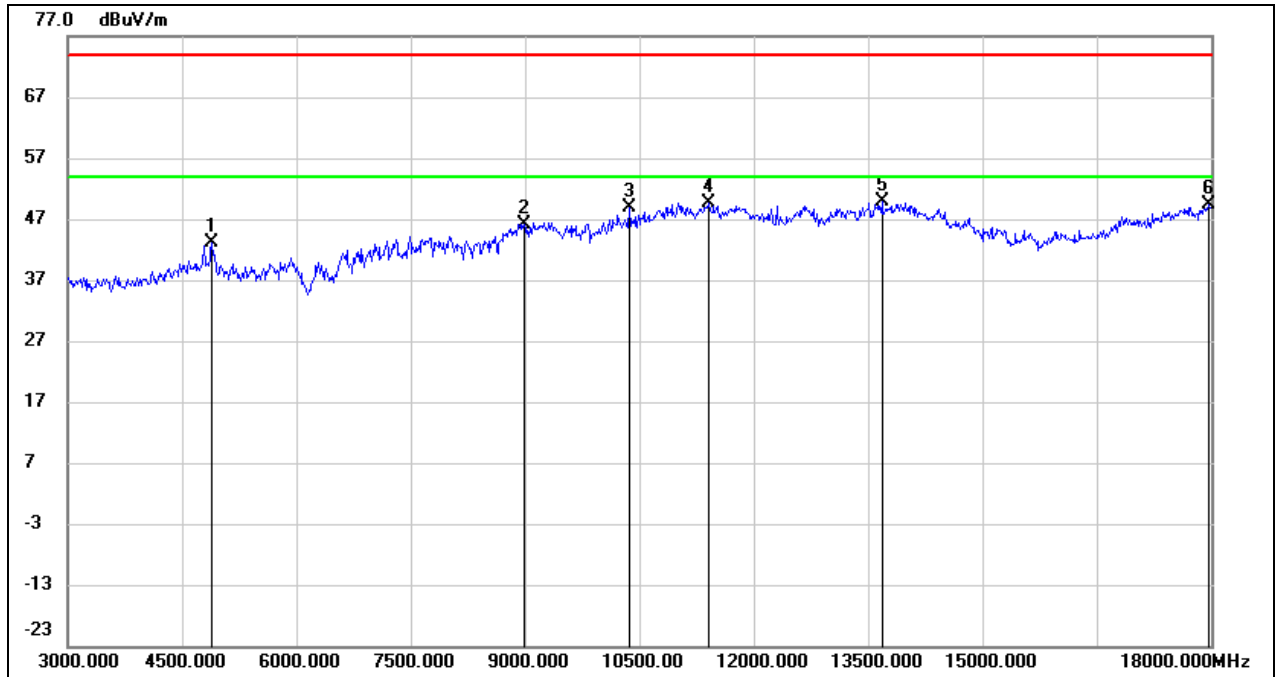

| No. | Frequency (MHz) | Reading (dBuV) | Correct (dB/m) | Result (dBuV/m) | Limit (dBuV/m) | Margin (dB) | Remark |
|-----|-----------------|----------------|----------------|-----------------|----------------|-------------|--------|
| 1   | 4890.000        | 43.11          | 0.03           | 43.14           | 74.00          | -30.86      | peak   |
| 2   | 8985.000        | 35.73          | 10.37          | 46.10           | 74.00          | -27.90      | peak   |
| 3   | 10365.000       | 36.11          | 12.72          | 48.83           | 74.00          | -25.17      | peak   |
| 4   | 11400.000       | 33.48          | 16.23          | 49.71           | 74.00          | -24.29      | peak   |
| 5   | 13680.000       | 28.47          | 21.29          | 49.76           | 74.00          | -24.24      | peak   |
| 6   | 17970.000       | 23.92          | 25.51          | 49.43           | 74.00          | -24.57      | peak   |

|            |                |               |          |
|------------|----------------|---------------|----------|
| Test Mode: | 802.11be EHT40 | Channel:      | 2452 MHz |
| Polarity:  | Vertical       | Test Voltage: | DC 12 V  |

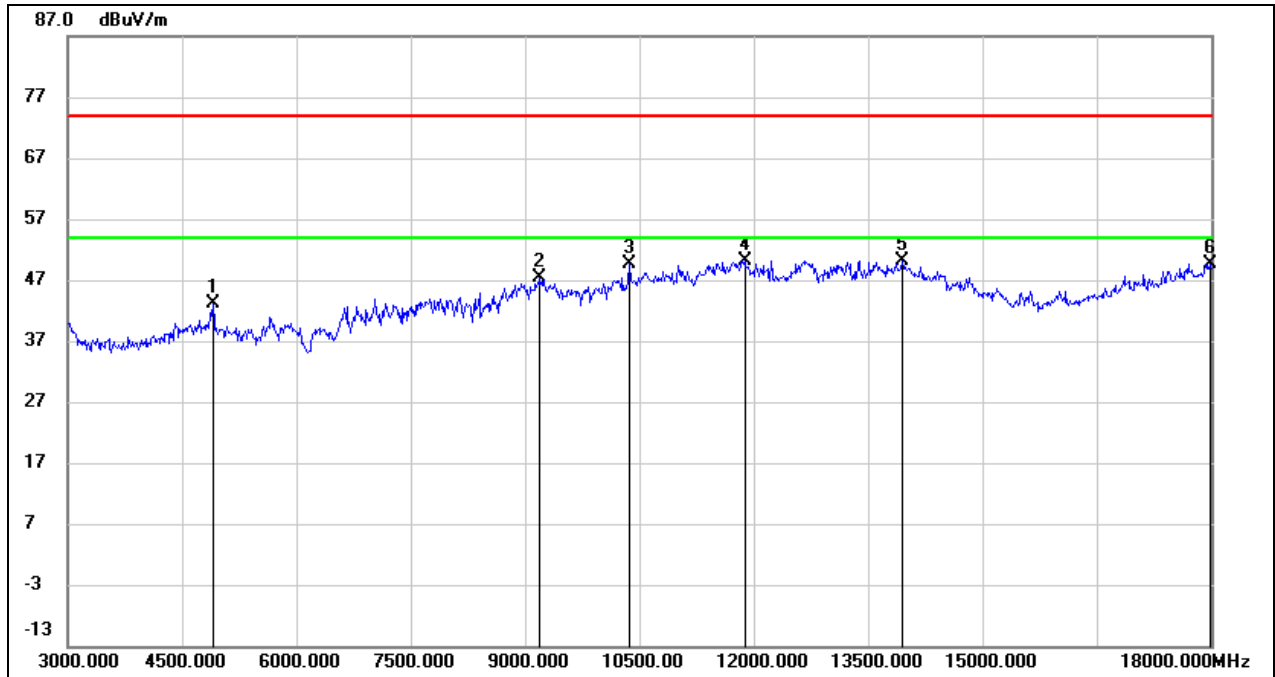

| No. | Frequency (MHz) | Reading (dBuV) | Correct (dB/m) | Result (dBuV/m) | Limit (dBuV/m) | Margin (dB) | Remark |
|-----|-----------------|----------------|----------------|-----------------|----------------|-------------|--------|
| 1   | 4905.000        | 42.93          | 0.09           | 43.02           | 74.00          | -30.98      | peak   |
| 2   | 9195.000        | 36.86          | 10.56          | 47.42           | 74.00          | -26.58      | peak   |
| 3   | 10365.000       | 36.80          | 12.72          | 49.52           | 74.00          | -24.48      | peak   |
| 4   | 11880.000       | 32.55          | 17.63          | 50.18           | 74.00          | -23.82      | peak   |
| 5   | 13950.000       | 28.37          | 21.86          | 50.23           | 74.00          | -23.77      | peak   |
| 6   | 17985.000       | 24.08          | 25.60          | 49.68           | 74.00          | -24.32      | peak   |

### 8.4. SPURIOUS EMISSIONS (9 KHZ ~ 30 MHZ)

|            |            |               |          |
|------------|------------|---------------|----------|
| Test Mode: | 802.11b    | Channel:      | 2462 MHz |
| Polarity:  | Horizontal | Test Voltage: | DC 12 V  |

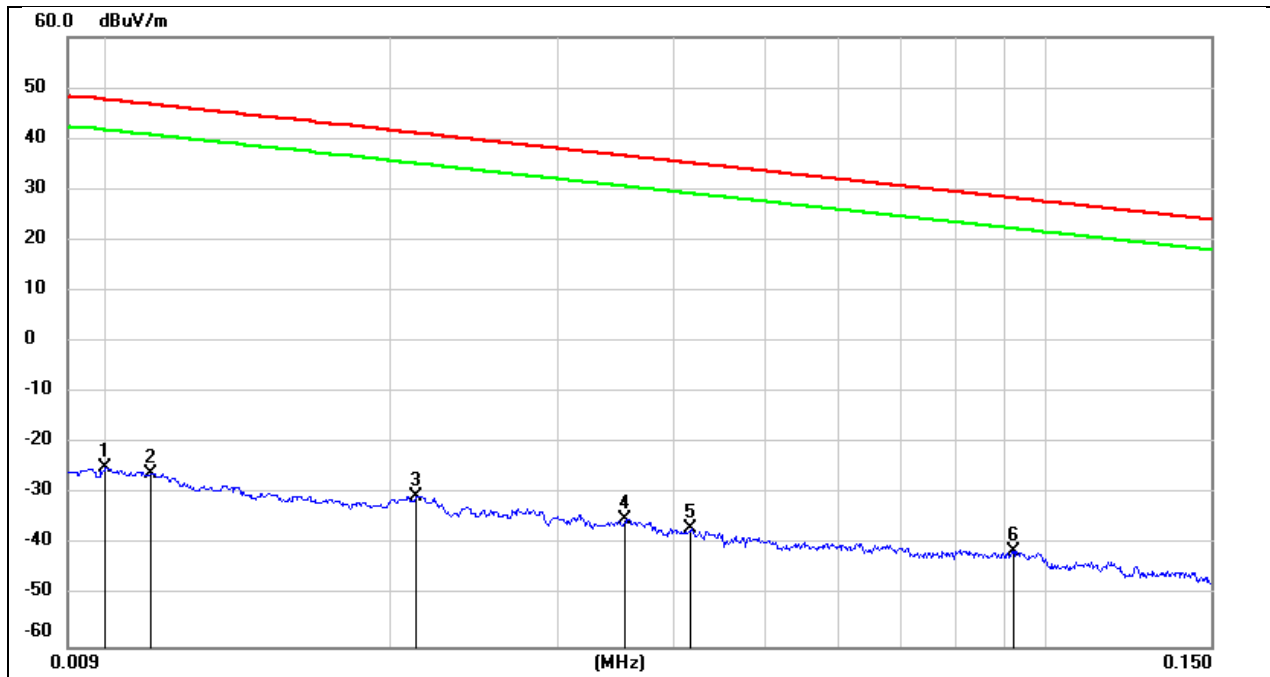

| No. | Frequency (MHz) | Reading (dBuV) | Correct (dB/m) | Result (dBuV/m) | Limit (dBuV/m) | Margin (dB) | Remark |
|-----|-----------------|----------------|----------------|-----------------|----------------|-------------|--------|
| 1   | 0.0100          | 76.72          | -101.40        | -24.68          | 47.60          | -72.28      | peak   |
| 2   | 0.0111          | 75.45          | -101.39        | -25.94          | 46.69          | -72.63      | peak   |
| 3   | 0.0212          | 71.04          | -101.35        | -30.31          | 41.07          | -71.38      | peak   |
| 4   | 0.0354          | 66.47          | -101.41        | -34.94          | 36.62          | -71.56      | peak   |
| 5   | 0.0417          | 64.58          | -101.44        | -36.86          | 35.20          | -72.06      | peak   |
| 6   | 0.0922          | 60.51          | -101.74        | -41.23          | 28.31          | -69.54      | peak   |

|            |            |               |          |
|------------|------------|---------------|----------|
| Test Mode: | 802.11b    | Channel:      | 2462 MHz |
| Polarity:  | Horizontal | Test Voltage: | DC 12 V  |

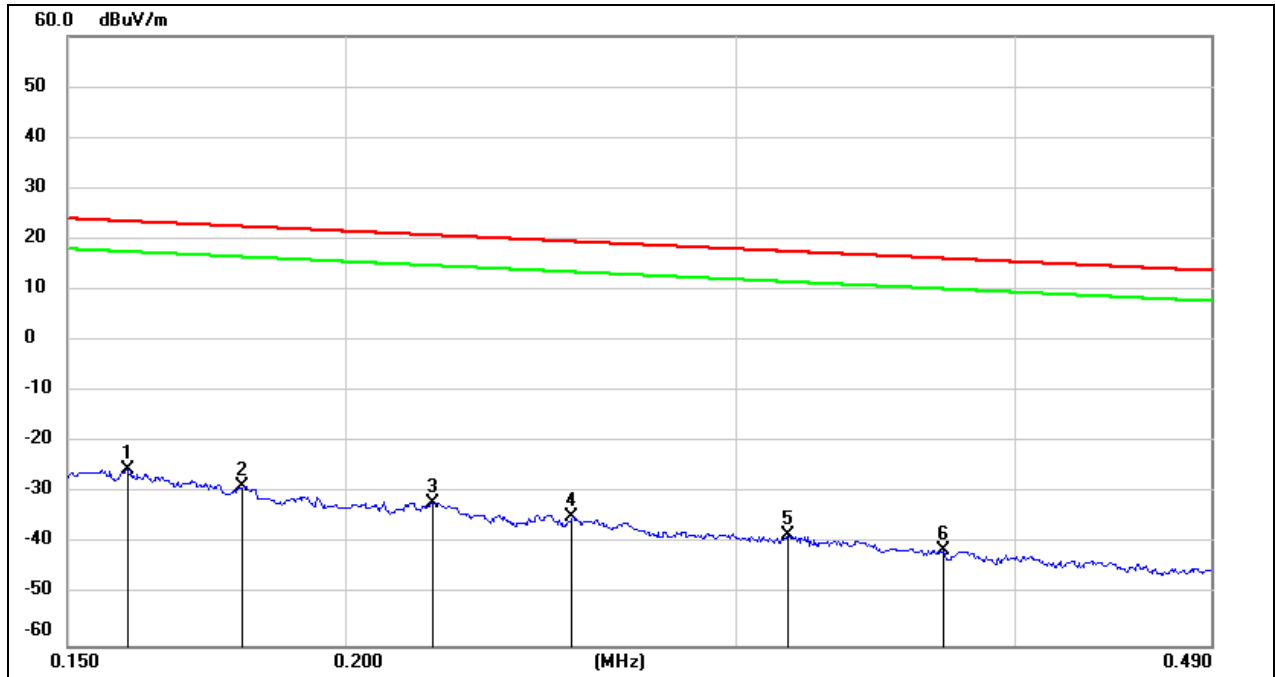

| No. | Frequency (MHz) | Reading (dBuV) | Correct (dB/m) | Result (dBuV/m) | Limit (dBuV/m) | Margin (dB) | Remark |
|-----|-----------------|----------------|----------------|-----------------|----------------|-------------|--------|
| 1   | 0.1595          | 76.36          | -101.65        | -25.29          | 23.55          | -48.84      | peak   |
| 2   | 0.1800          | 73.12          | -101.68        | -28.56          | 22.50          | -51.06      | peak   |
| 3   | 0.2190          | 69.77          | -101.75        | -31.98          | 20.79          | -52.77      | peak   |
| 4   | 0.2530          | 67.14          | -101.80        | -34.66          | 19.54          | -54.20      | peak   |
| 5   | 0.3163          | 63.70          | -101.87        | -38.17          | 17.60          | -55.77      | peak   |
| 6   | 0.3714          | 60.78          | -101.93        | -41.15          | 16.20          | -57.35      | peak   |

|            |            |               |          |
|------------|------------|---------------|----------|
| Test Mode: | 802.11b    | Channel:      | 2462 MHz |
| Polarity:  | Horizontal | Test Voltage: | DC 12 V  |

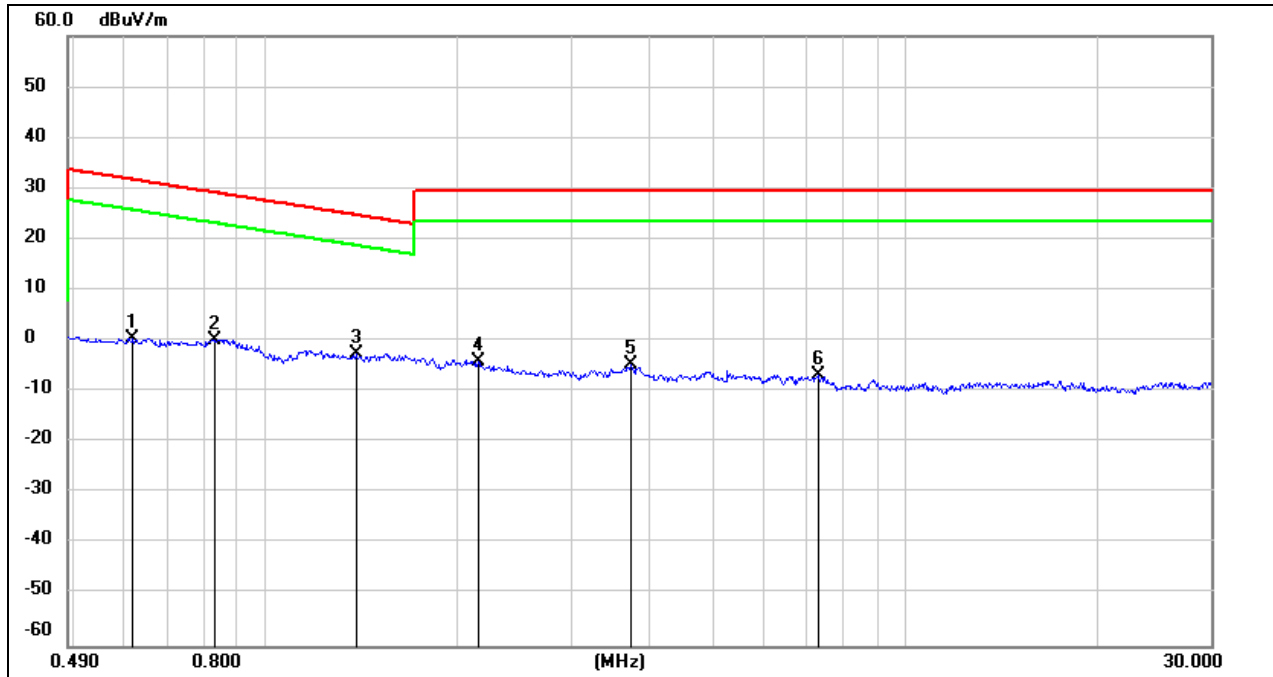

| No. | Frequency (MHz) | Reading (dBuV) | Correct (dB/m) | Result (dBuV/m) | Limit (dBuV/m) | Margin (dB) | Remark |
|-----|-----------------|----------------|----------------|-----------------|----------------|-------------|--------|
| 1   | 0.6195          | 62.58          | -62.09         | 0.49            | 31.76          | -31.27      | peak   |
| 2   | 0.8296          | 62.44          | -62.17         | 0.27            | 29.23          | -28.96      | peak   |
| 3   | 1.3810          | 59.47          | -62.10         | -2.63           | 24.80          | -27.43      | peak   |
| 4   | 2.1463          | 57.77          | -61.79         | -4.02           | 29.54          | -33.56      | peak   |
| 5   | 3.7100          | 56.70          | -61.41         | -4.71           | 29.54          | -34.25      | peak   |
| 6   | 7.3067          | 54.37          | -61.17         | -6.80           | 29.54          | -36.34      | peak   |



### 8.5. SPURIOUS EMISSIONS (30 MHz ~ 1 GHz)

|            |            |               |          |
|------------|------------|---------------|----------|
| Test Mode: | 802.11b    | Channel:      | 2462 MHz |
| Polarity:  | Horizontal | Test Voltage: | DC 12 V  |

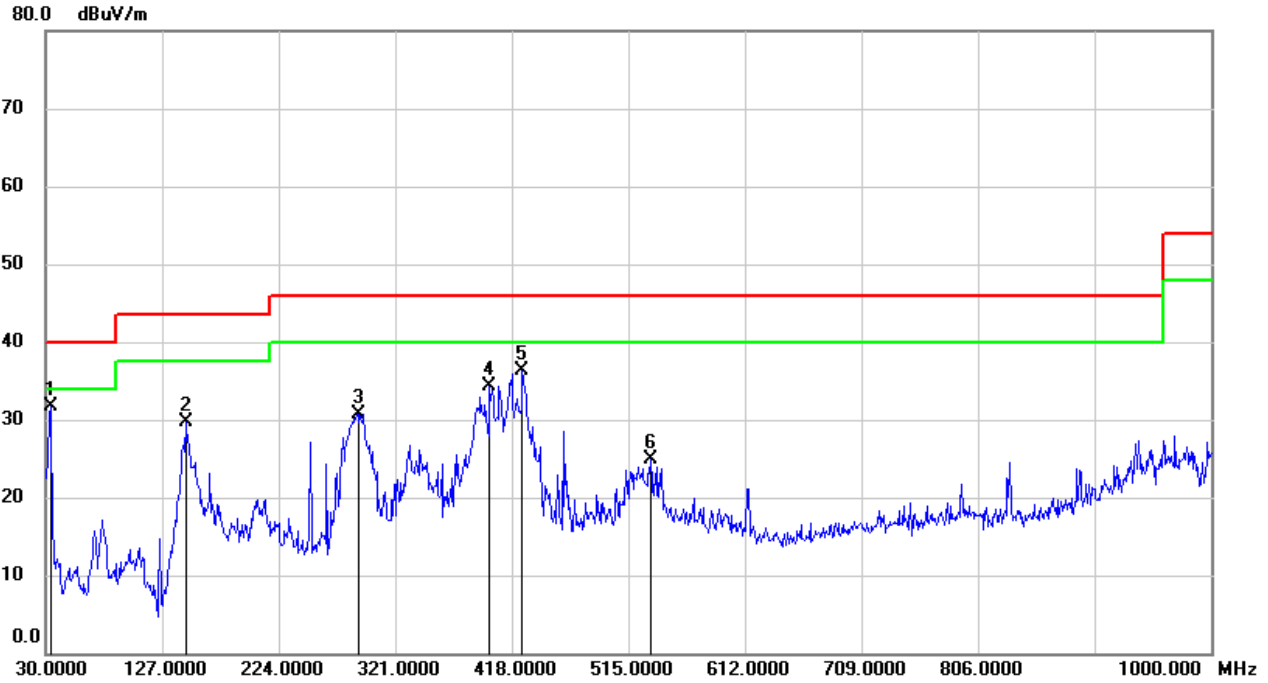

| No. | Frequency (MHz) | Reading (dBuV) | Correct (dB/m) | Result (dBuV/m) | Limit (dBuV/m) | Margin (dB) | Remark |
|-----|-----------------|----------------|----------------|-----------------|----------------|-------------|--------|
| 1   | 33.8800         | 50.47          | -18.84         | 31.63           | 40.00          | -8.37       | QP     |
| 2   | 146.4000        | 48.20          | -18.55         | 29.65           | 43.50          | -13.85      | QP     |
| 3   | 289.9600        | 46.67          | -15.87         | 30.80           | 46.00          | -15.20      | QP     |
| 4   | 399.5700        | 47.36          | -12.96         | 34.40           | 46.00          | -11.60      | QP     |
| 5   | 426.7300        | 48.58          | -12.28         | 36.30           | 46.00          | -9.70       | QP     |
| 6   | 533.4300        | 35.34          | -10.47         | 24.87           | 46.00          | -21.13      | QP     |

|            |          |               |          |
|------------|----------|---------------|----------|
| Test Mode: | 802.11b  | Channel:      | 2462 MHz |
| Polarity:  | Vertical | Test Voltage: | DC 12 V  |

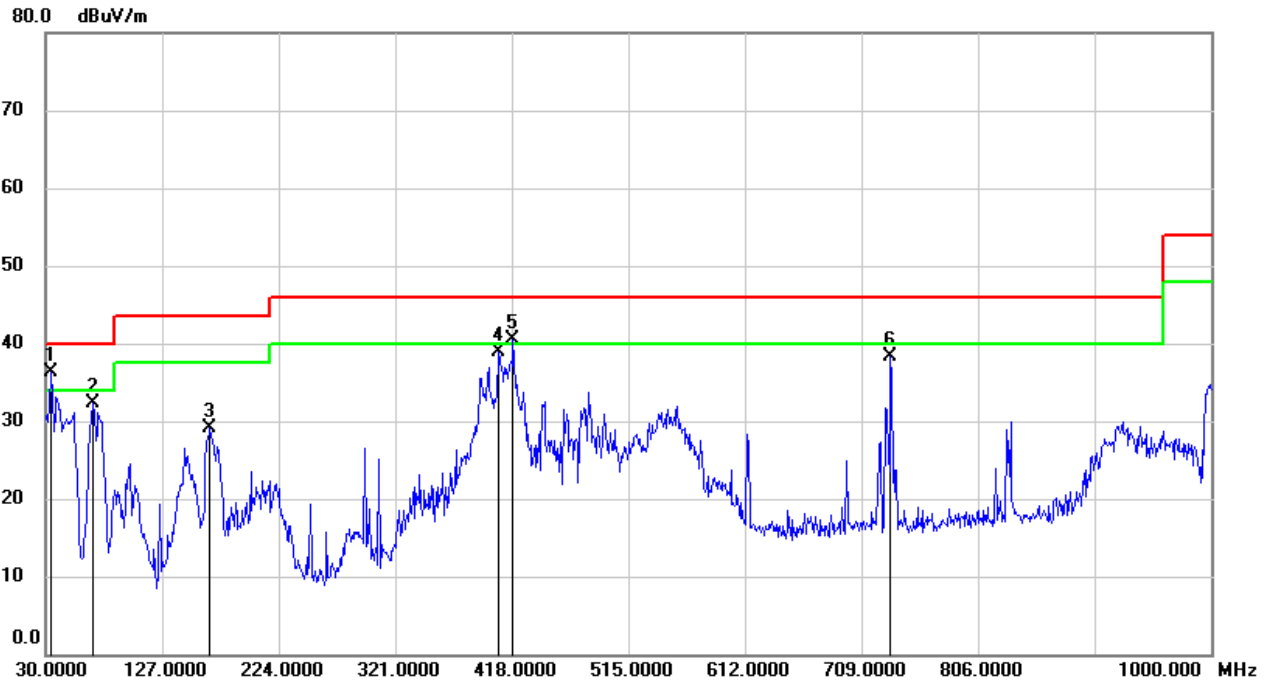

| No. | Frequency (MHz) | Reading (dBuV) | Correct (dB/m) | Result (dBuV/m) | Limit (dBuV/m) | Margin (dB) | Remark |
|-----|-----------------|----------------|----------------|-----------------|----------------|-------------|--------|
| 1   | 33.8800         | 55.20          | -18.84         | 36.36           | 40.00          | -3.64       | QP     |
| 2   | 68.8000         | 52.92          | -20.71         | 32.21           | 40.00          | -7.79       | QP     |
| 3   | 166.7700        | 46.28          | -17.13         | 29.15           | 43.50          | -14.35      | QP     |
| 4   | 406.3599        | 51.71          | -12.78         | 38.93           | 46.00          | -7.07       | QP     |
| 5   | 418.9700        | 52.98          | -12.52         | 40.46           | 46.00          | -5.54       | QP     |
| 6   | 733.2500        | 45.72          | -7.37          | 38.35           | 46.00          | -7.65       | QP     |

### 8.6. SPURIOUS EMISSIONS (18 GHZ ~ 26 GHZ)

|            |            |               |          |
|------------|------------|---------------|----------|
| Test Mode: | 802.11b    | Channel:      | 2462 MHz |
| Polarity:  | Horizontal | Test Voltage: | DC 12 V  |

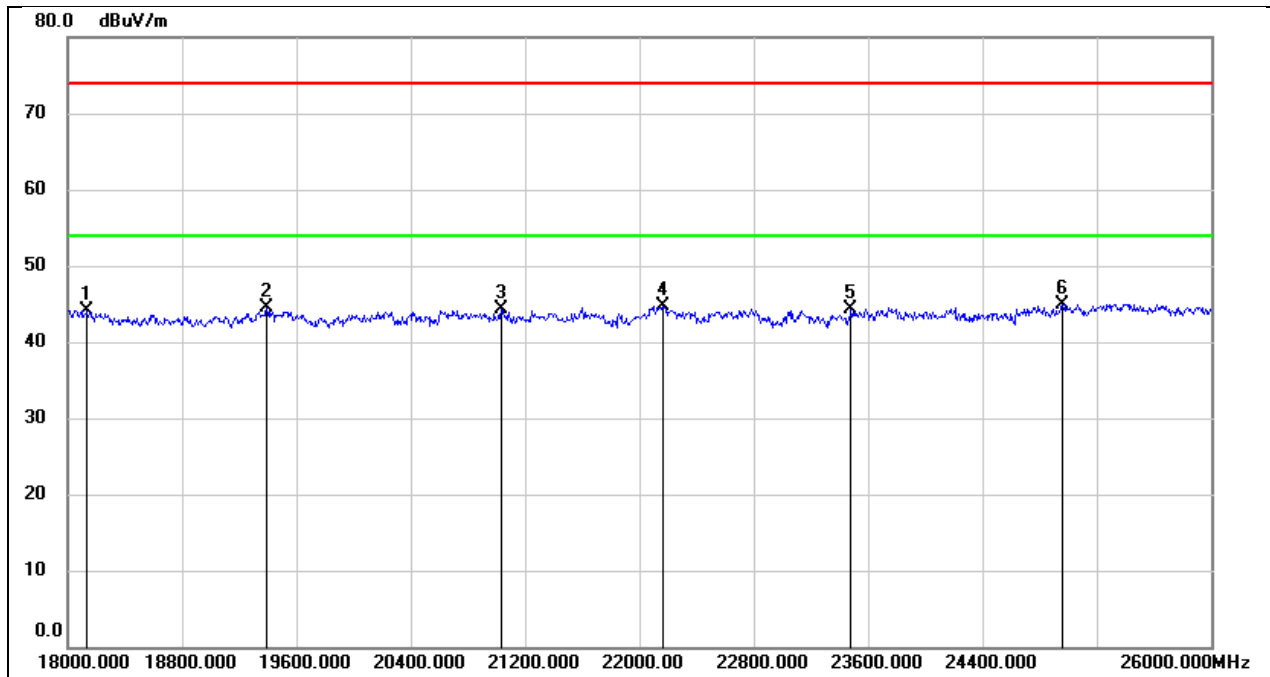

| No. | Frequency (MHz) | Reading (dBuV) | Correct (dB/m) | Result (dBuV/m) | Limit (dBuV/m) | Margin (dB) | Remark |
|-----|-----------------|----------------|----------------|-----------------|----------------|-------------|--------|
| 1   | 18136.000       | 49.57          | -5.48          | 44.09           | 74.00          | -29.91      | peak   |
| 2   | 19392.000       | 50.12          | -5.57          | 44.55           | 74.00          | -29.45      | peak   |
| 3   | 21032.000       | 49.15          | -4.87          | 44.28           | 74.00          | -29.72      | peak   |
| 4   | 22160.000       | 49.08          | -4.31          | 44.77           | 74.00          | -29.23      | peak   |
| 5   | 23480.000       | 47.54          | -3.16          | 44.38           | 74.00          | -29.62      | peak   |
| 6   | 24960.000       | 47.14          | -2.14          | 45.00           | 74.00          | -29.00      | peak   |

|            |          |               |          |
|------------|----------|---------------|----------|
| Test Mode: | 802.11b  | Channel:      | 2462 MHz |
| Polarity:  | Vertical | Test Voltage: | DC 12 V  |

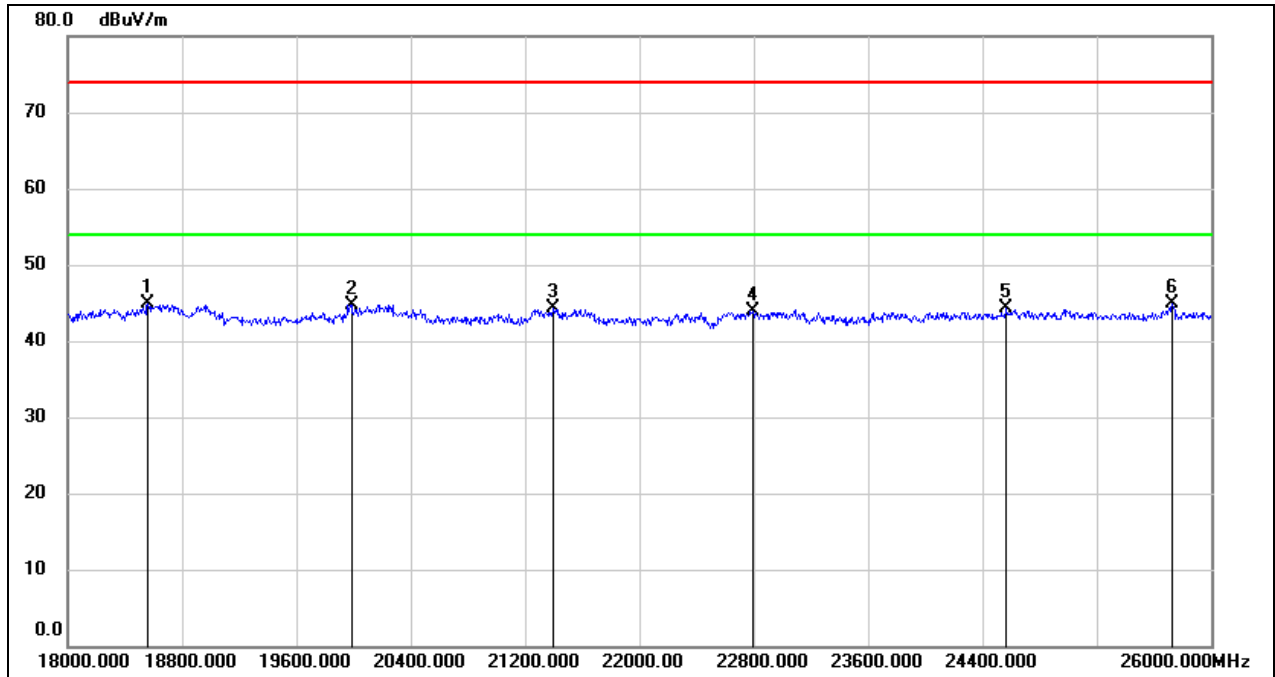

| No. | Frequency (MHz) | Reading (dBuV) | Correct (dB/m) | Result (dBuV/m) | Limit (dBuV/m) | Margin (dB) | Remark |
|-----|-----------------|----------------|----------------|-----------------|----------------|-------------|--------|
| 1   | 18560.000       | 50.14          | -5.29          | 44.85           | 74.00          | -29.15      | peak   |
| 2   | 19984.000       | 50.21          | -5.44          | 44.77           | 74.00          | -29.23      | peak   |
| 3   | 21400.000       | 49.04          | -4.72          | 44.32           | 74.00          | -29.68      | peak   |
| 4   | 22792.000       | 47.61          | -3.65          | 43.96           | 74.00          | -30.04      | peak   |
| 5   | 24568.000       | 46.60          | -2.33          | 44.27           | 74.00          | -29.73      | peak   |
| 6   | 25728.000       | 45.61          | -0.72          | 44.89           | 74.00          | -29.11      | peak   |

## 9. ANTENNA REQUIREMENT

### REQUIREMENT

Please refer to FCC part 15.203

An intentional radiator shall be designed to ensure that no antenna other than that furnished by the responsible party shall be used with the device. The use of a permanently attached antenna or of an antenna that uses a unique coupling to the intentional radiator shall be considered sufficient to comply with the provisions of this section. The manufacturer may design the unit so that a broken antenna can be replaced by the user, but the use of a standard antenna jack or electrical connector is prohibited.

Please refer to FCC part 15.247(b)(4)

The conducted output power limit specified in paragraph (b) of this section is based on the use of antennas with directional gains that do not exceed 6 dBi. Except as shown in paragraph (c) of this section, if transmitting antennas of directional gain greater than 6 dBi are used, the conducted output power from the intentional radiator shall be reduced below the stated values in paragraphs (b)(1), (b)(2), and (b)(3) of this section, as appropriate, by the amount in dB that the directional gain of the antenna exceeds 6 dBi.

### DESCRIPTION

Pass

## 10. AC POWER LINE CONDUCTED EMISSION

### LIMITS

Please refer to CFR 47 FCC §15.207 (a)

| FREQUENCY (MHz) | Quasi-peak | Average   |
|-----------------|------------|-----------|
| 0.15 -0.5       | 66 - 56 *  | 56 - 46 * |
| 0.50 -5.0       | 56.00      | 46.00     |
| 5.0 -30.0       | 60.00      | 50.00     |

### TEST PROCEDURE

The EUT is put on a table of non-conducting material that is 80 cm high. The vertical conducting wall of shielding is located 40 cm to the rear of the EUT. The power line of the EUT is connected to the AC mains through a Artificial Mains Network (A.M.N.). A EMI Measurement Receiver (R&S Test Receiver ESR3) is used to test the emissions from both sides of AC line. According to the requirements in Section 6.2 of ANSI C63.10-2013. Conducted emissions from the EUT measured in the frequency range between 0.15 MHz and 30 MHz using CISPR Quasi-Peak and average detector mode. The bandwidth of EMI test receiver is set at 9 kHz.

The arrangement of the equipment is installed to meet the standards and operating in a manner, which tends to maximize its emission characteristics in a normal application.

### TEST SETUP

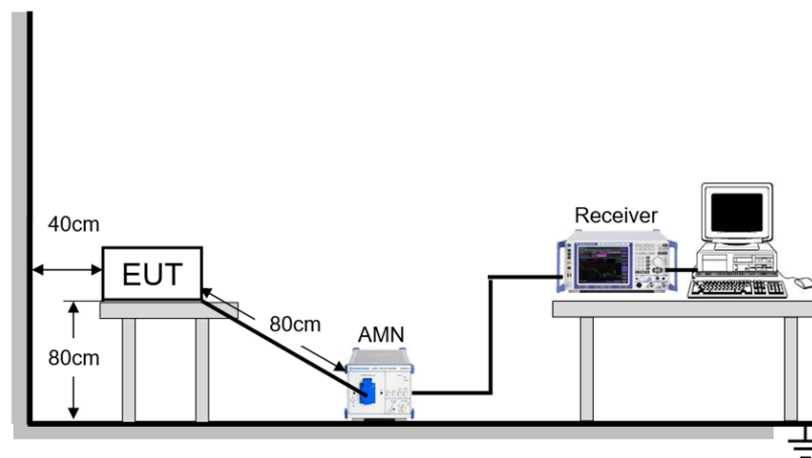

### TEST ENVIRONMENT

|                     |         |                   |                 |
|---------------------|---------|-------------------|-----------------|
| Temperature         | 24.5 °C | Relative Humidity | 53%             |
| Atmosphere Pressure | 101 kPa | Test Voltage      | AC 120 V, 60 Hz |

**TEST RESULTS**

|            |         |               |                 |
|------------|---------|---------------|-----------------|
| Test Mode: | 802.11b | Channel:      | 2412 MHz        |
| Line:      | Line    | Test Voltage: | AC 120 V, 60 Hz |

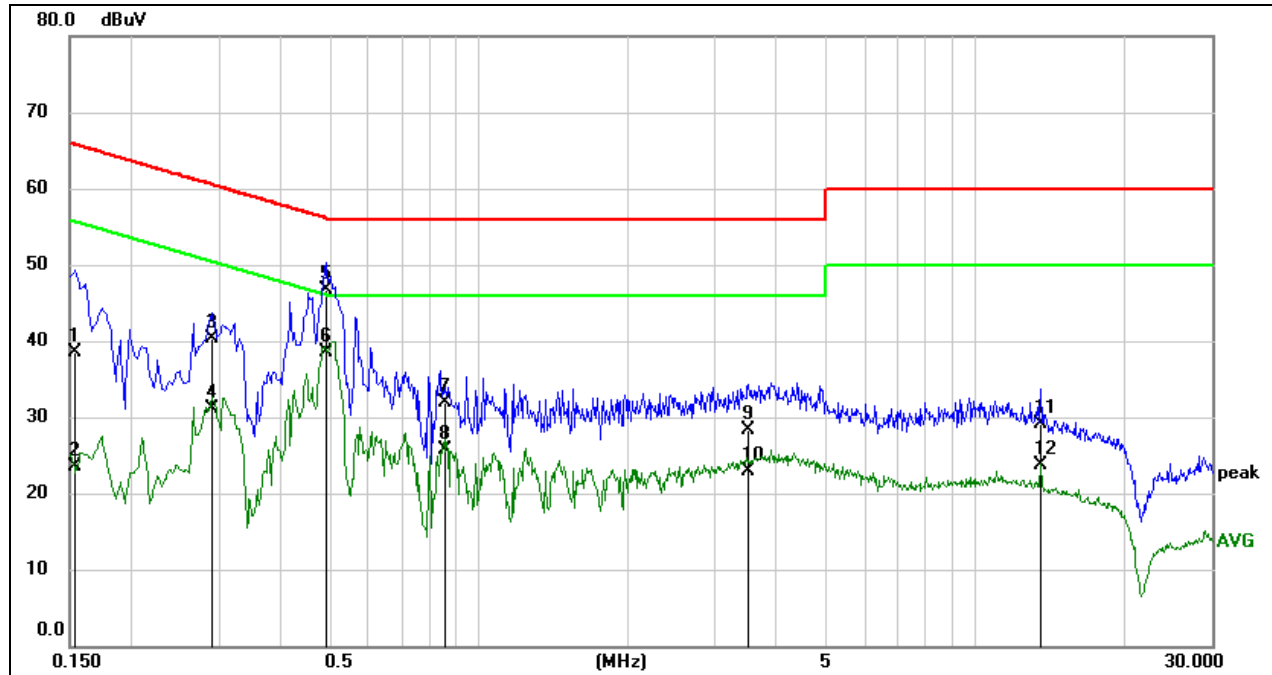

| No. | Frequency (MHz) | Reading (dBuV) | Correct (dB) | Result (dBuV) | Limit (dBuV) | Margin (dB) | Remark |
|-----|-----------------|----------------|--------------|---------------|--------------|-------------|--------|
| 1   | 0.1529          | 28.84          | 9.59         | 38.43         | 65.84        | -27.41      | QP     |
| 2   | 0.1529          | 13.95          | 9.59         | 23.54         | 55.84        | -32.30      | AVG    |
| 3   | 0.2897          | 30.74          | 9.59         | 40.33         | 60.53        | -20.20      | QP     |
| 4   | 0.2897          | 21.48          | 9.59         | 31.07         | 50.53        | -19.46      | AVG    |
| 5   | 0.4946          | 37.01          | 9.60         | 46.61         | 56.09        | -9.48       | QP     |
| 6   | 0.4946          | 28.86          | 9.60         | 38.46         | 46.09        | -7.63       | AVG    |
| 7   | 0.8502          | 22.34          | 9.60         | 31.94         | 56.00        | -24.06      | QP     |
| 8   | 0.8502          | 16.14          | 9.60         | 25.74         | 46.00        | -20.26      | AVG    |
| 9   | 3.4862          | 18.54          | 9.68         | 28.22         | 56.00        | -27.78      | QP     |
| 10  | 3.4862          | 13.20          | 9.68         | 22.88         | 46.00        | -23.12      | AVG    |
| 11  | 13.5589         | 19.43          | 9.76         | 29.19         | 60.00        | -30.81      | QP     |
| 12  | 13.5589         | 13.94          | 9.76         | 23.70         | 50.00        | -26.30      | AVG    |

**Note:**

1. Result = Reading + Correct Factor.
2. If QP Result complies with AV limit, AV Result is deemed to comply with AV limit.
3. Test setup: RBW: 200 Hz (9 kHz ~ 150 kHz), 9 kHz (150 kHz ~ 30 MHz).
4. Step size: 80 Hz (0.009 MHz ~ 0.15 MHz), 4 kHz (0.15 MHz ~ 30 MHz), Scan time: auto.

|            |         |               |                 |
|------------|---------|---------------|-----------------|
| Test Mode: | 802.11b | Channel:      | 2412 MHz        |
| Line:      | N       | Test Voltage: | AC 120 V, 60 Hz |

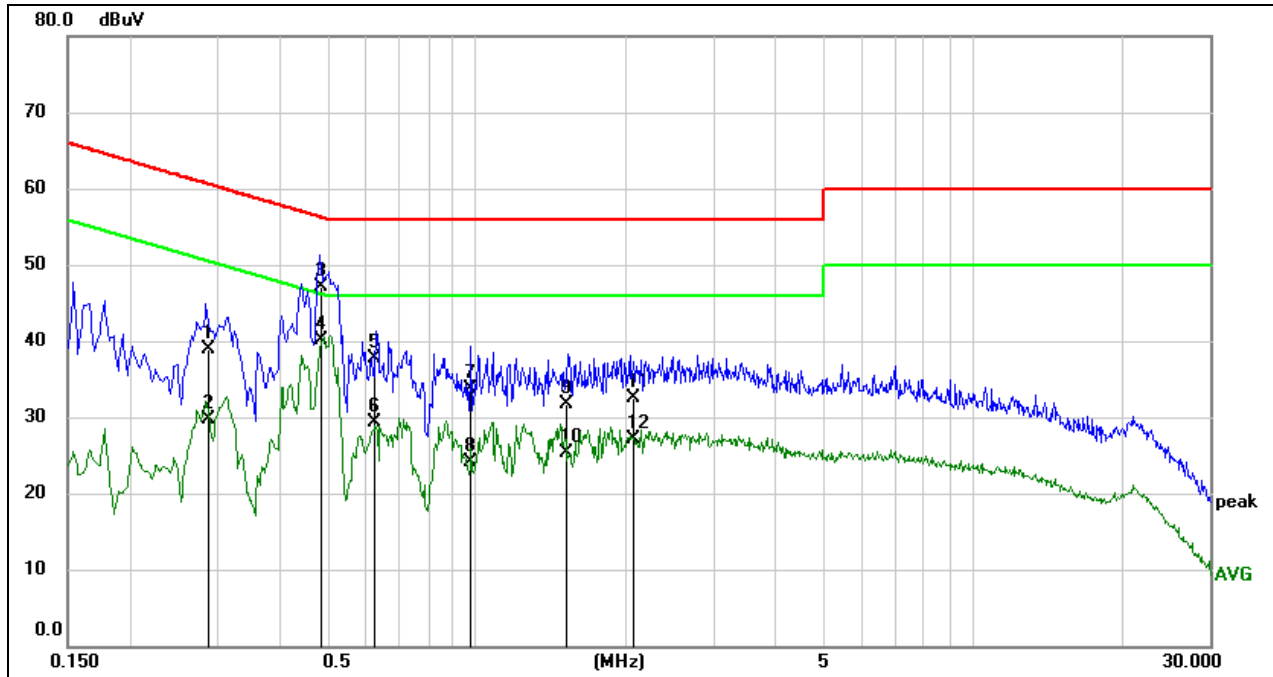

| No. | Frequency (MHz) | Reading (dBuV) | Correct (dB) | Result (dBuV) | Limit (dBuV) | Margin (dB) | Remark |
|-----|-----------------|----------------|--------------|---------------|--------------|-------------|--------|
| 1   | 0.2884          | 29.35          | 9.59         | 38.94         | 60.57        | -21.63      | QP     |
| 2   | 0.2884          | 20.10          | 9.59         | 29.69         | 50.57        | -20.88      | AVG    |
| 3   | 0.4878          | 37.59          | 9.60         | 47.19         | 56.21        | -9.02       | QP     |
| 4   | 0.4878          | 30.42          | 9.60         | 40.02         | 46.21        | -6.19       | AVG    |
| 5   | 0.6260          | 28.05          | 9.60         | 37.65         | 56.00        | -18.35      | QP     |
| 6   | 0.6260          | 19.67          | 9.60         | 29.27         | 46.00        | -16.73      | AVG    |
| 7   | 0.9759          | 24.06          | 9.61         | 33.67         | 56.00        | -22.33      | QP     |
| 8   | 0.9759          | 14.43          | 9.61         | 24.04         | 46.00        | -21.96      | AVG    |
| 9   | 1.5175          | 22.01          | 9.62         | 31.63         | 56.00        | -24.37      | QP     |
| 10  | 1.5175          | 15.59          | 9.62         | 25.21         | 46.00        | -20.79      | AVG    |
| 11  | 2.0636          | 22.78          | 9.63         | 32.41         | 56.00        | -23.59      | QP     |
| 12  | 2.0636          | 17.46          | 9.63         | 27.09         | 46.00        | -18.91      | AVG    |

Note:

1. Result = Reading + Correct Factor.
2. If QP Result complies with AV limit, AV Result is deemed to comply with AV limit.
3. Test setup: RBW: 200 Hz (9 kHz ~ 150 kHz), 9 kHz (150 kHz ~ 30 MHz).
4. Step size: 80 Hz (0.009 MHz ~ 0.15 MHz), 4 kHz (0.15 MHz ~ 30 MHz), Scan time: auto.

Note: All the modes have been tested, only the worst data was recorded in the report.



## 11. TEST DATA

### 11.1. APPENDIX A: DTS BANDWIDTH

#### 11.1.1. Test Result

| Test Mode  | Antenna | Channel | DTS BW [MHz] | FL[MHz] | FH[MHz] | Limit[MHz] | Verdict |
|------------|---------|---------|--------------|---------|---------|------------|---------|
| 11B-CDD    | Ant5    | 2412    | 13.12        | 2405.44 | 2418.56 | ≥0.5       | PASS    |
|            | Ant6    | 2412    | 13.12        | 2405.44 | 2418.56 | ≥0.5       | PASS    |
|            | Ant5    | 2417    | 13.12        | 2410.44 | 2423.56 | ≥0.5       | PASS    |
|            | Ant6    | 2417    | 13.12        | 2410.44 | 2423.56 | ≥0.5       | PASS    |
|            | Ant5    | 2437    | 13.12        | 2430.44 | 2443.56 | ≥0.5       | PASS    |
|            | Ant6    | 2437    | 13.12        | 2430.44 | 2443.56 | ≥0.5       | PASS    |
|            | Ant5    | 2457    | 13.12        | 2450.44 | 2463.56 | ≥0.5       | PASS    |
|            | Ant6    | 2457    | 13.12        | 2450.44 | 2463.56 | ≥0.5       | PASS    |
|            | Ant5    | 2462    | 13.12        | 2455.44 | 2468.56 | ≥0.5       | PASS    |
|            | Ant6    | 2462    | 13.12        | 2455.44 | 2468.56 | ≥0.5       | PASS    |
| 11G-CDD    | Ant5    | 2412    | 16.56        | 2403.72 | 2420.28 | ≥0.5       | PASS    |
|            | Ant6    | 2412    | 16.40        | 2403.80 | 2420.20 | ≥0.5       | PASS    |
|            | Ant5    | 2417    | 16.36        | 2408.80 | 2425.16 | ≥0.5       | PASS    |
|            | Ant6    | 2417    | 16.56        | 2408.72 | 2425.28 | ≥0.5       | PASS    |
|            | Ant5    | 2437    | 16.32        | 2428.84 | 2445.16 | ≥0.5       | PASS    |
|            | Ant6    | 2437    | 16.48        | 2428.72 | 2445.20 | ≥0.5       | PASS    |
|            | Ant5    | 2457    | 16.32        | 2448.84 | 2465.16 | ≥0.5       | PASS    |
|            | Ant6    | 2457    | 16.56        | 2448.72 | 2465.28 | ≥0.5       | PASS    |
|            | Ant5    | 2462    | 16.48        | 2453.72 | 2470.20 | ≥0.5       | PASS    |
|            | Ant6    | 2462    | 16.52        | 2453.72 | 2470.24 | ≥0.5       | PASS    |
| 11AX20-CDD | Ant5    | 2412    | 19.16        | 2402.40 | 2421.56 | ≥0.5       | PASS    |
|            | Ant6    | 2412    | 18.84        | 2402.64 | 2421.48 | ≥0.5       | PASS    |
|            | Ant5    | 2417    | 19.12        | 2407.44 | 2426.56 | ≥0.5       | PASS    |
|            | Ant6    | 2417    | 18.64        | 2407.80 | 2426.44 | ≥0.5       | PASS    |
|            | Ant5    | 2437    | 19.20        | 2427.40 | 2446.60 | ≥0.5       | PASS    |
|            | Ant6    | 2437    | 19.08        | 2427.44 | 2446.52 | ≥0.5       | PASS    |
|            | Ant5    | 2457    | 18.96        | 2447.56 | 2466.52 | ≥0.5       | PASS    |
|            | Ant6    | 2457    | 19.16        | 2447.40 | 2466.56 | ≥0.5       | PASS    |
|            | Ant5    | 2462    | 19.12        | 2452.44 | 2471.56 | ≥0.5       | PASS    |
|            | Ant6    | 2462    | 19.12        | 2452.40 | 2471.52 | ≥0.5       | PASS    |
| 11AX40-CDD | Ant5    | 2422    | 37.84        | 2403.12 | 2440.96 | ≥0.5       | PASS    |
|            | Ant6    | 2422    | 37.52        | 2403.20 | 2440.72 | ≥0.5       | PASS    |
|            | Ant5    | 2427    | 38.00        | 2407.96 | 2445.96 | ≥0.5       | PASS    |
|            | Ant6    | 2427    | 37.84        | 2407.96 | 2445.80 | ≥0.5       | PASS    |
|            | Ant5    | 2437    | 37.92        | 2418.04 | 2455.96 | ≥0.5       | PASS    |
|            | Ant6    | 2437    | 38.16        | 2417.88 | 2456.04 | ≥0.5       | PASS    |
|            | Ant5    | 2447    | 38.08        | 2427.96 | 2466.04 | ≥0.5       | PASS    |
|            | Ant6    | 2447    | 37.84        | 2428.04 | 2465.88 | ≥0.5       | PASS    |
|            | Ant5    | 2452    | 37.76        | 2432.96 | 2470.72 | ≥0.5       | PASS    |
|            | Ant6    | 2452    | 37.76        | 2433.04 | 2470.80 | ≥0.5       | PASS    |
| 11BE20-CDD | Ant5    | 2412    | 19.16        | 2402.44 | 2421.60 | ≥0.5       | PASS    |
|            | Ant6    | 2412    | 19.08        | 2402.44 | 2421.52 | ≥0.5       | PASS    |
|            | Ant5    | 2417    | 18.92        | 2407.52 | 2426.44 | ≥0.5       | PASS    |
|            | Ant6    | 2417    | 19.04        | 2407.48 | 2426.52 | ≥0.5       | PASS    |
|            | Ant5    | 2437    | 19.08        | 2427.44 | 2446.52 | ≥0.5       | PASS    |
|            | Ant6    | 2437    | 18.92        | 2427.52 | 2446.44 | ≥0.5       | PASS    |
|            | Ant5    | 2457    | 18.64        | 2447.72 | 2466.36 | ≥0.5       | PASS    |

|            |      |      |       |         |         |            |      |
|------------|------|------|-------|---------|---------|------------|------|
|            | Ant6 | 2457 | 18.44 | 2447.68 | 2466.12 | $\geq 0.5$ | PASS |
|            | Ant5 | 2462 | 18.80 | 2452.68 | 2471.48 | $\geq 0.5$ | PASS |
|            | Ant6 | 2462 | 18.72 | 2452.52 | 2471.24 | $\geq 0.5$ | PASS |
| 11BE40-CDD | Ant5 | 2422 | 37.76 | 2403.12 | 2440.88 | $\geq 0.5$ | PASS |
|            | Ant6 | 2422 | 38.32 | 2402.88 | 2441.20 | $\geq 0.5$ | PASS |
|            | Ant5 | 2427 | 38.00 | 2407.96 | 2445.96 | $\geq 0.5$ | PASS |
|            | Ant6 | 2427 | 37.28 | 2408.44 | 2445.72 | $\geq 0.5$ | PASS |
|            | Ant5 | 2437 | 38.16 | 2417.96 | 2456.12 | $\geq 0.5$ | PASS |
|            | Ant6 | 2437 | 38.08 | 2417.96 | 2456.04 | $\geq 0.5$ | PASS |
|            | Ant5 | 2447 | 38.16 | 2427.88 | 2466.04 | $\geq 0.5$ | PASS |
|            | Ant6 | 2447 | 38.00 | 2428.04 | 2466.04 | $\geq 0.5$ | PASS |
|            | Ant5 | 2452 | 38.32 | 2432.88 | 2471.20 | $\geq 0.5$ | PASS |
|            | Ant6 | 2452 | 37.60 | 2432.96 | 2470.56 | $\geq 0.5$ | PASS |

Note: All the mode had been test, but only the worst data was recorded in the report.

### 11.1.2. Test Graphs

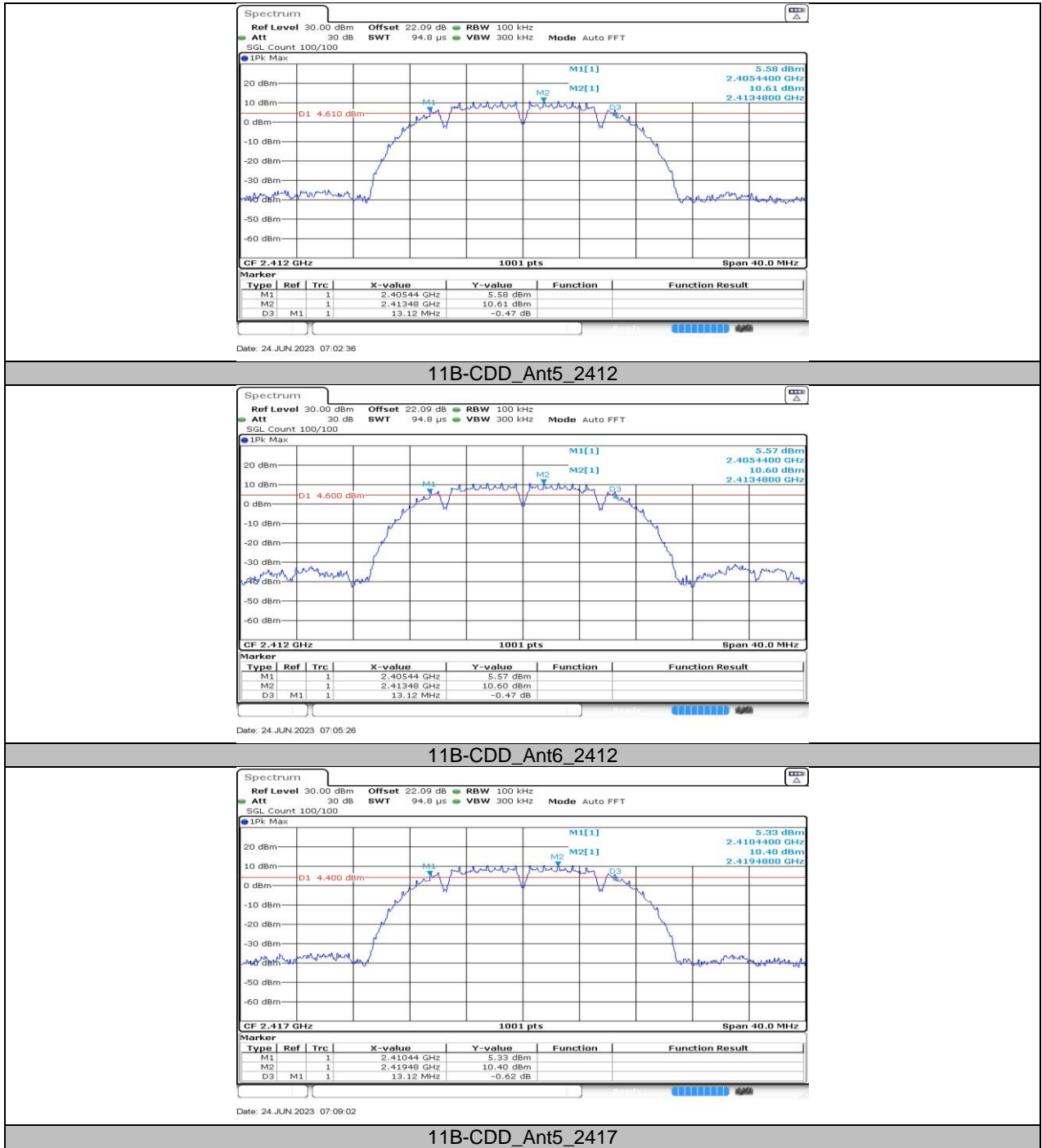

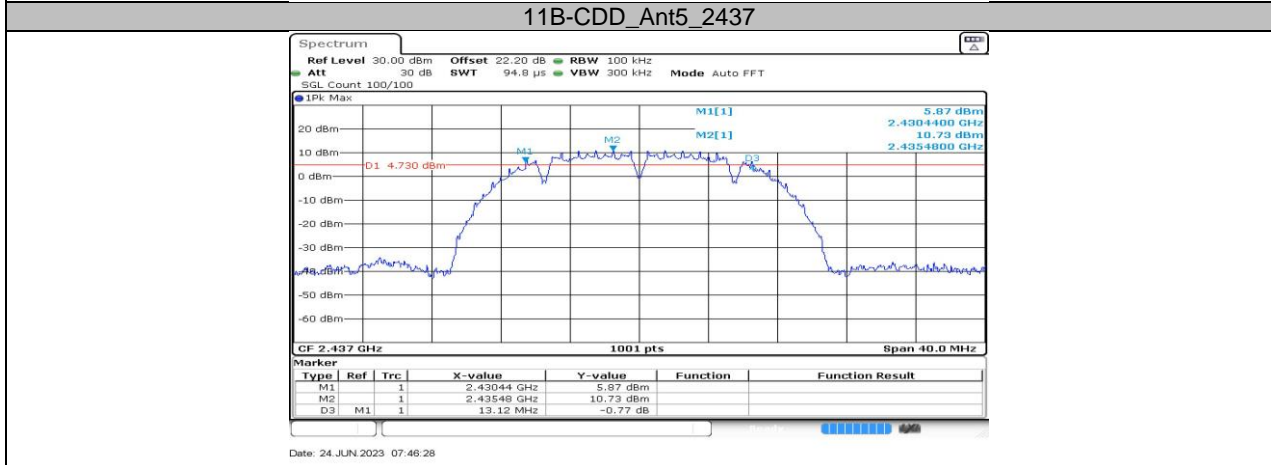
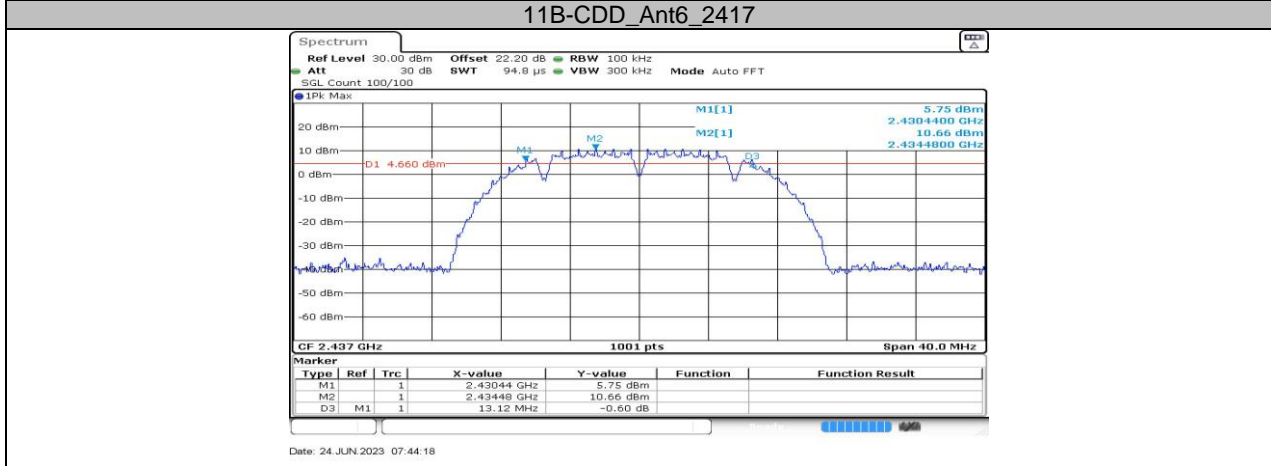
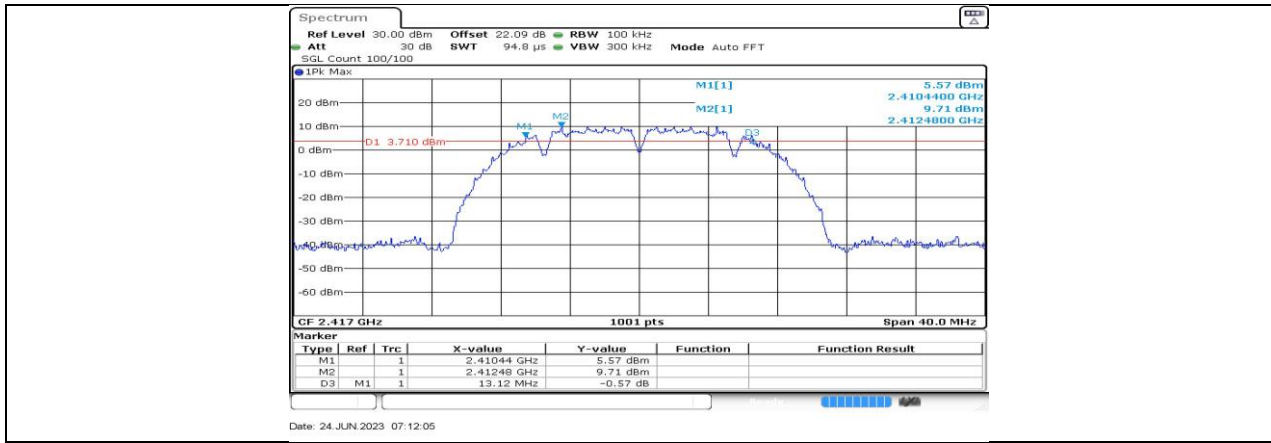

**11B-CDD\_Ant6\_2437**

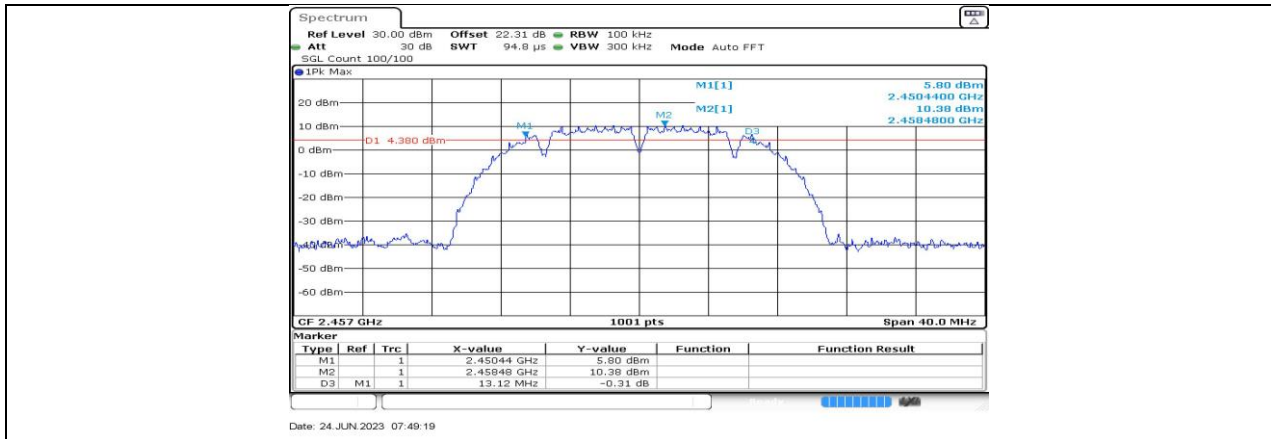

11B-CDD\_Ant5\_2457

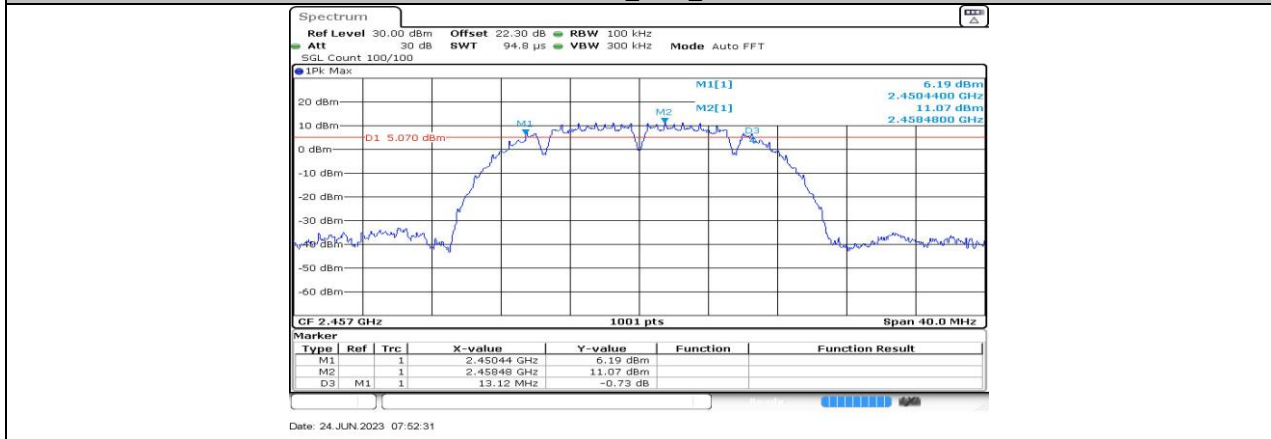

11B-CDD\_Ant6\_2457

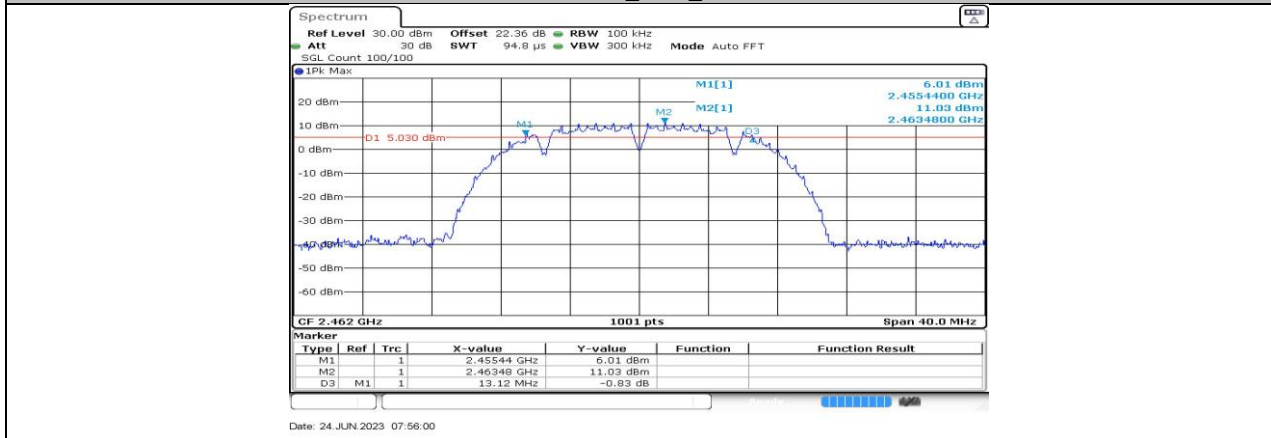

11B-CDD\_Ant5\_2462

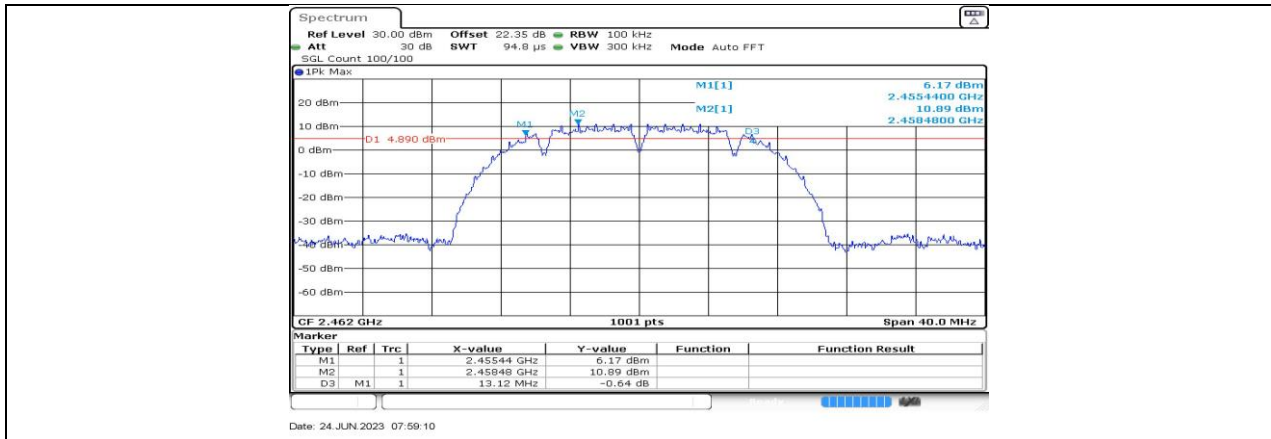

11B-CDD\_Ant6\_2462

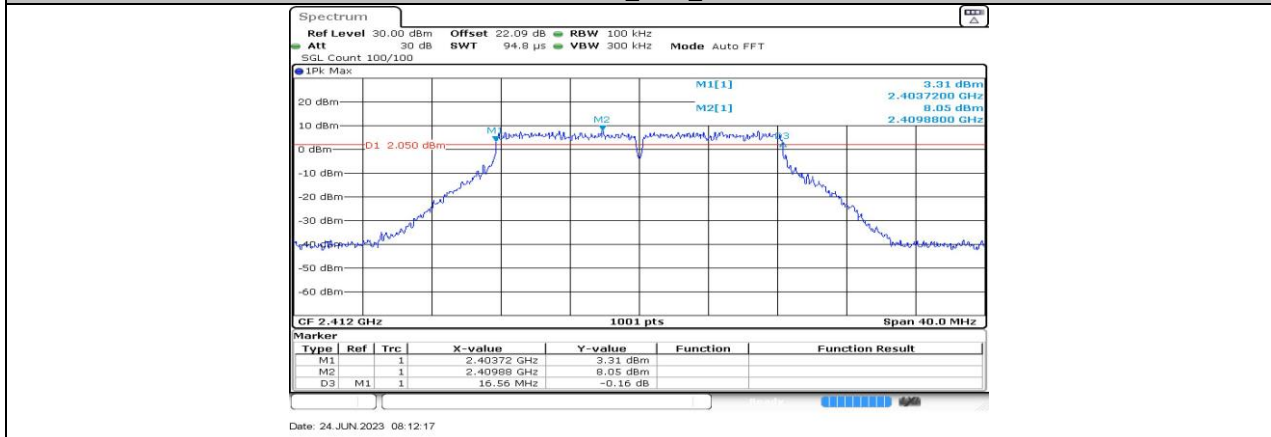

11G-CDD\_Ant5\_2412

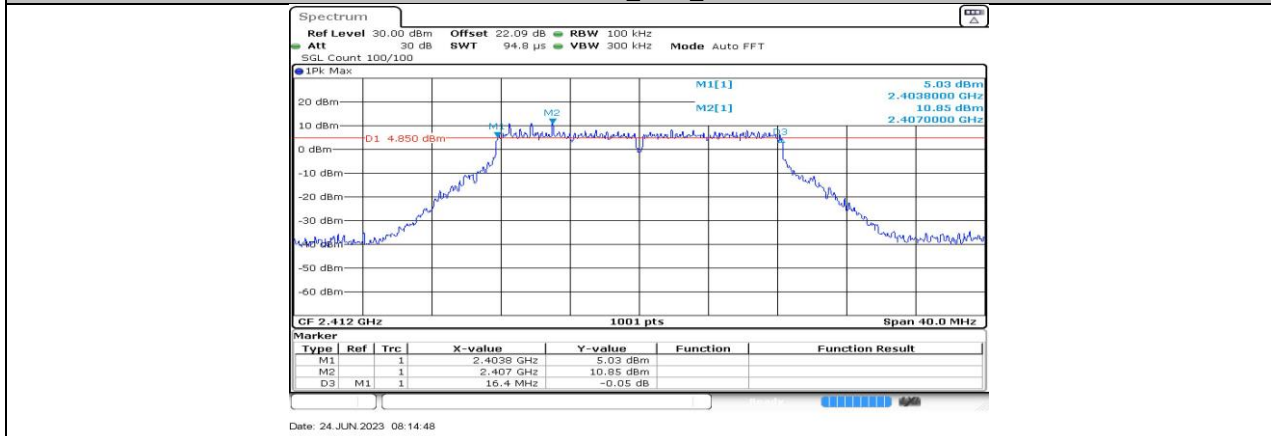

11G-CDD\_Ant6\_2412

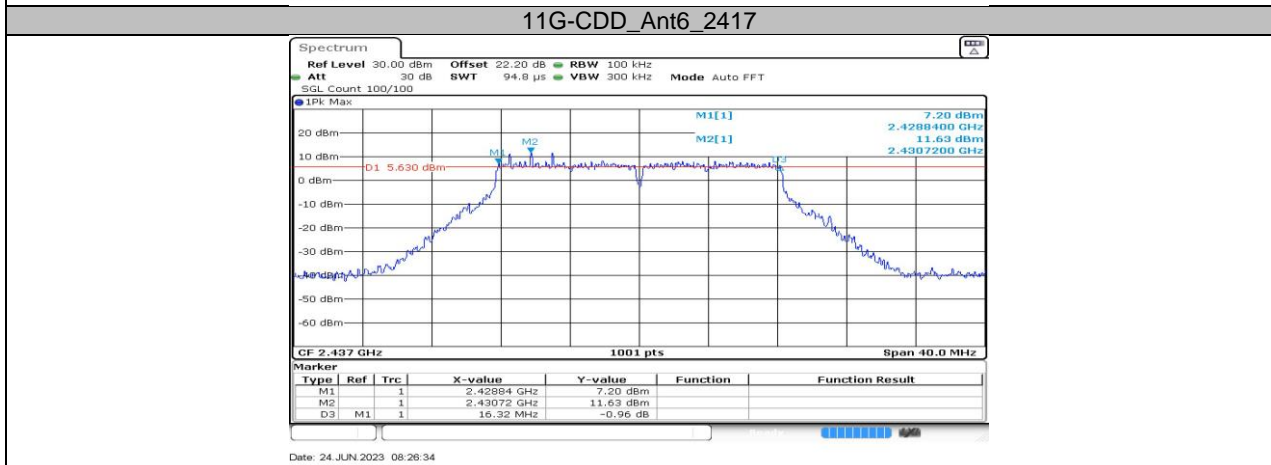
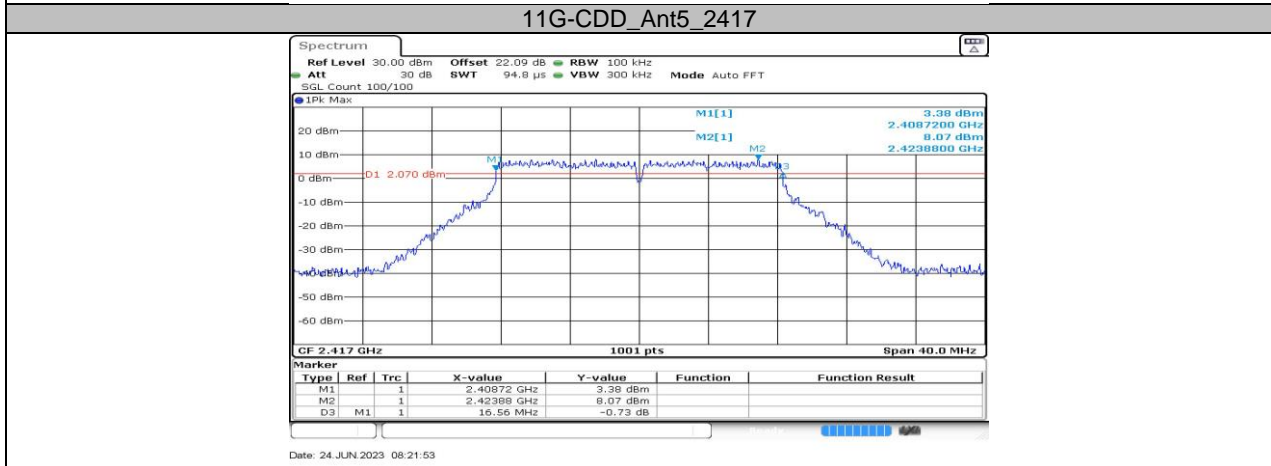
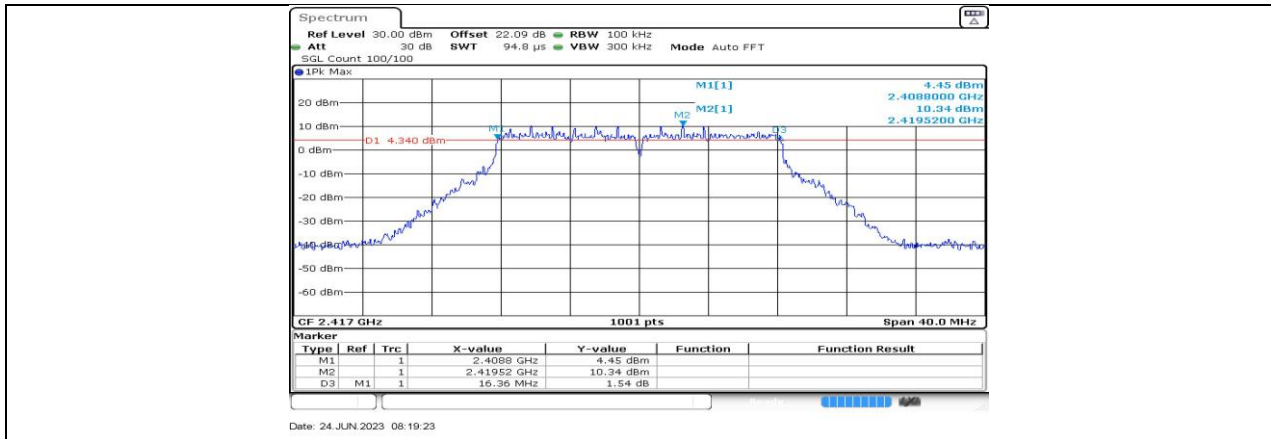



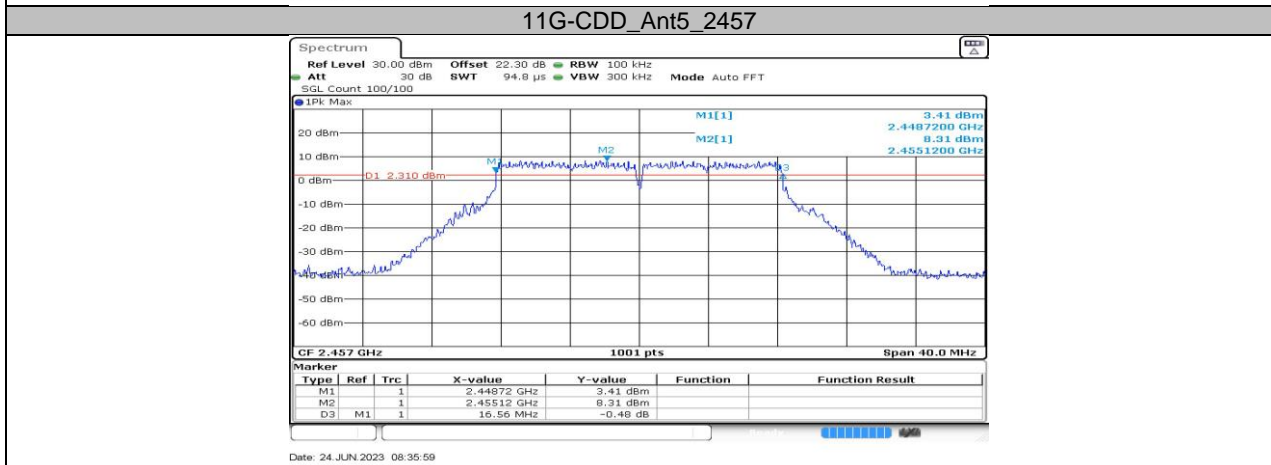
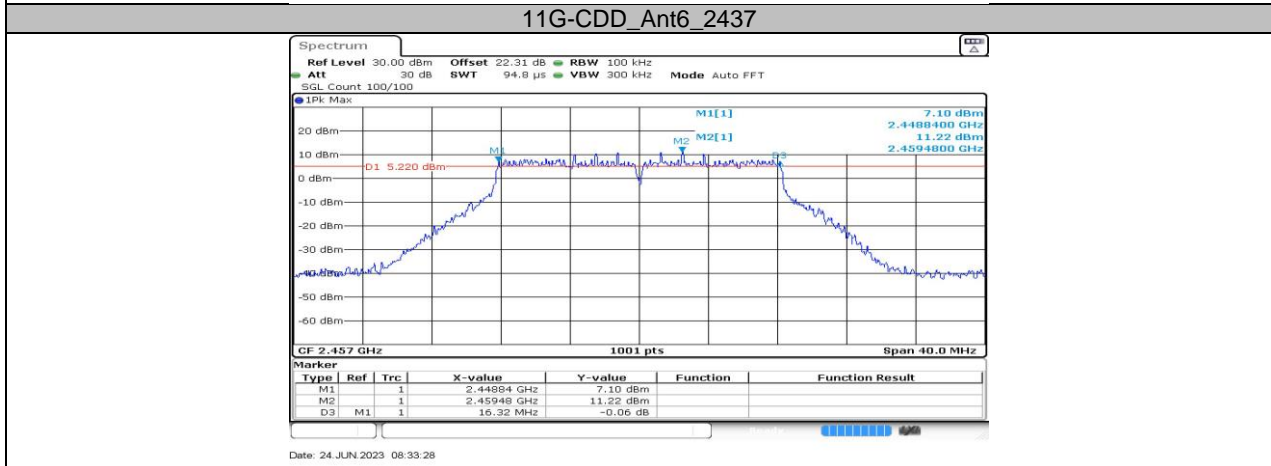
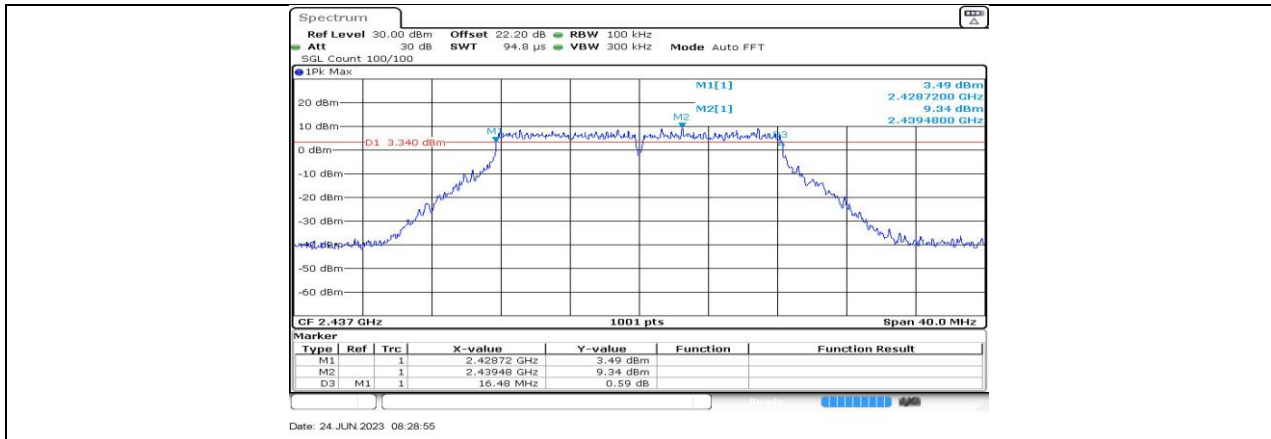



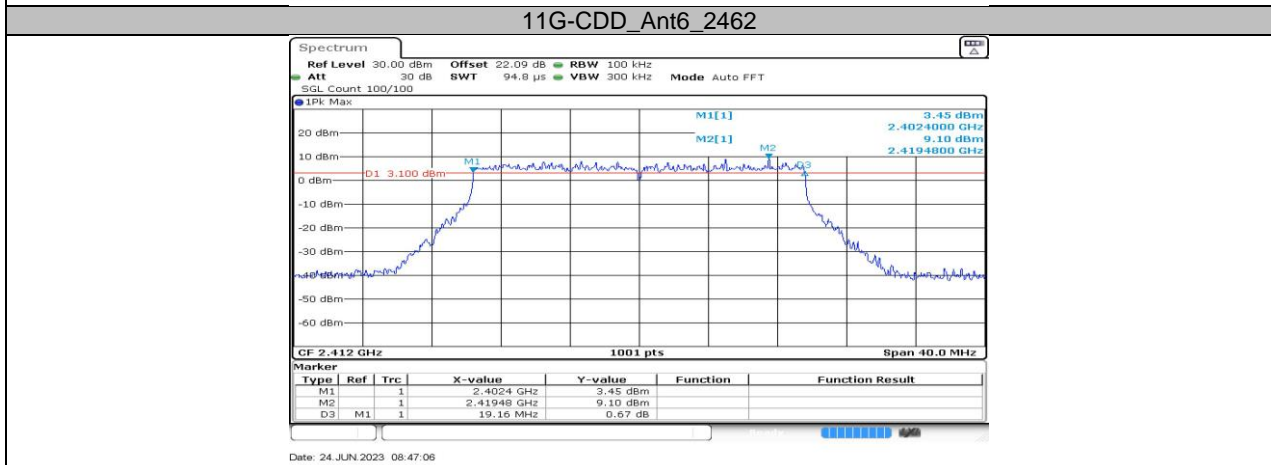
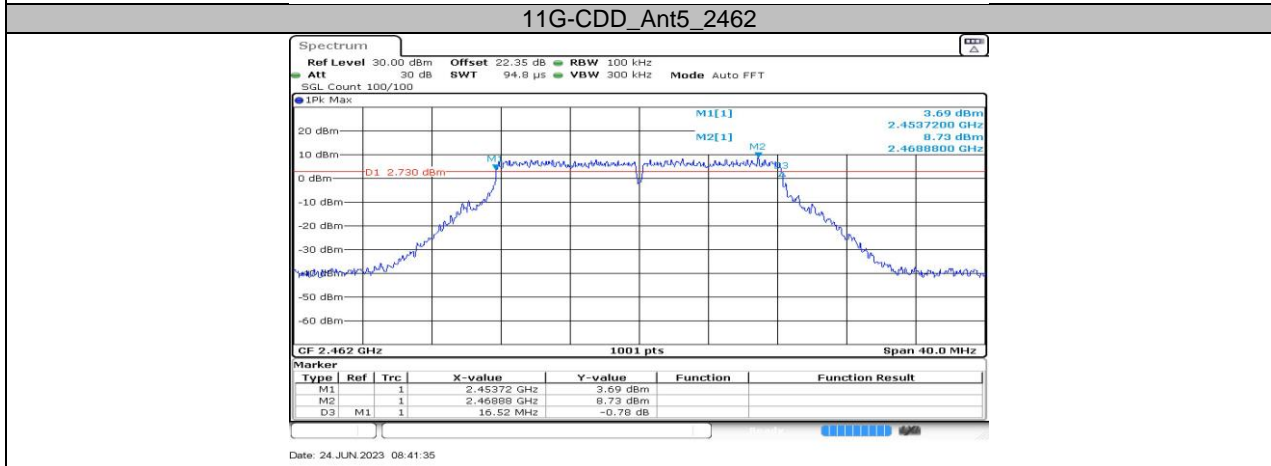
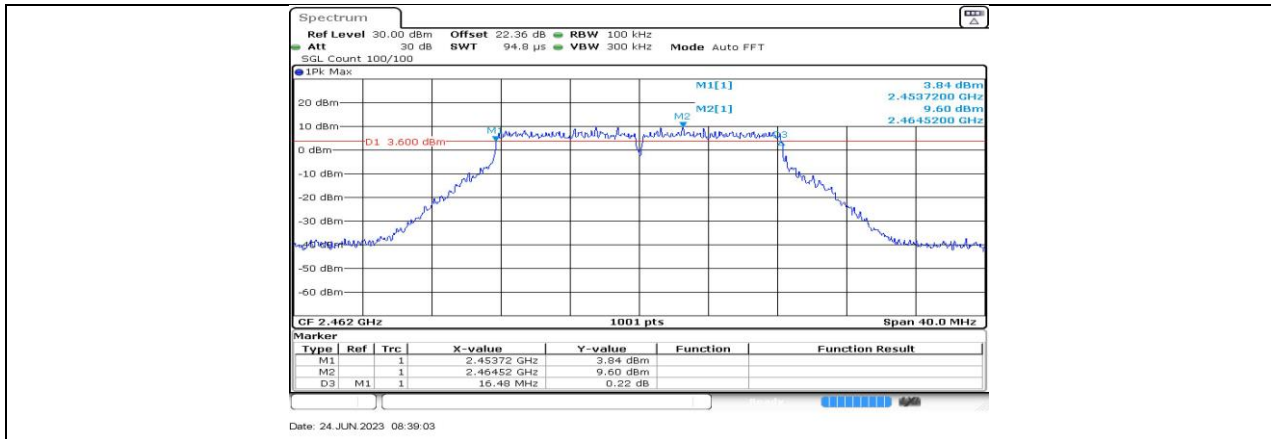

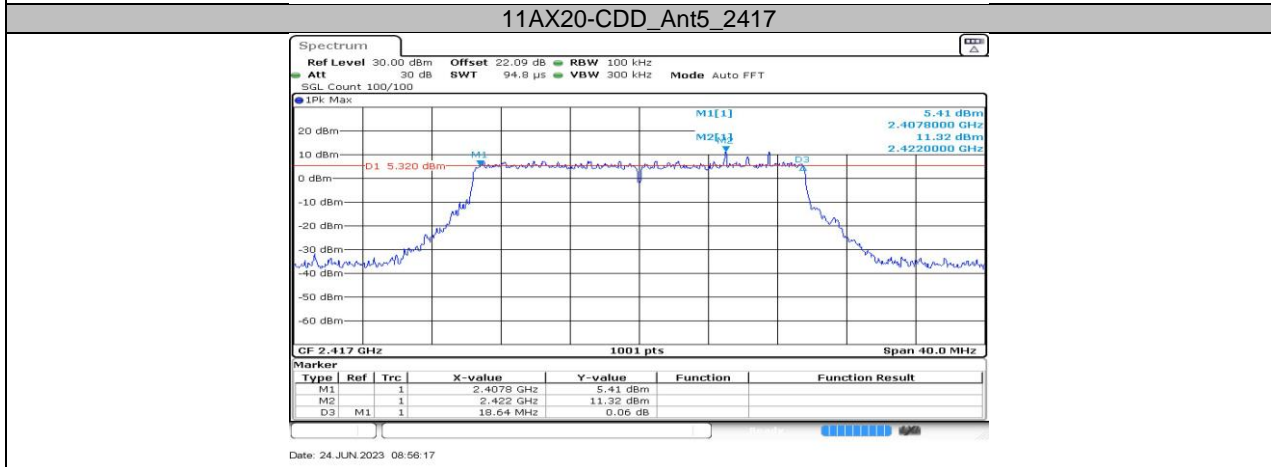
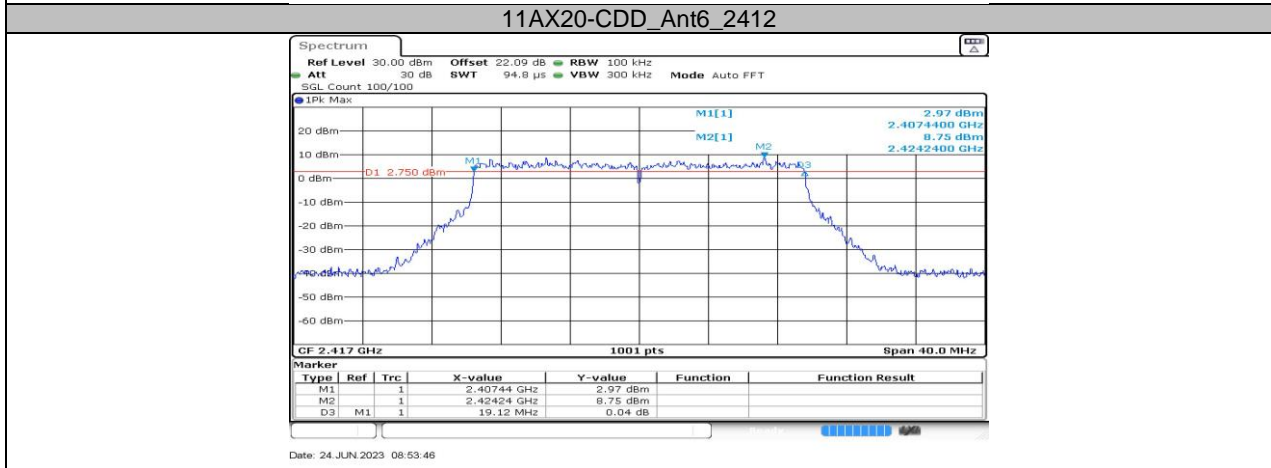
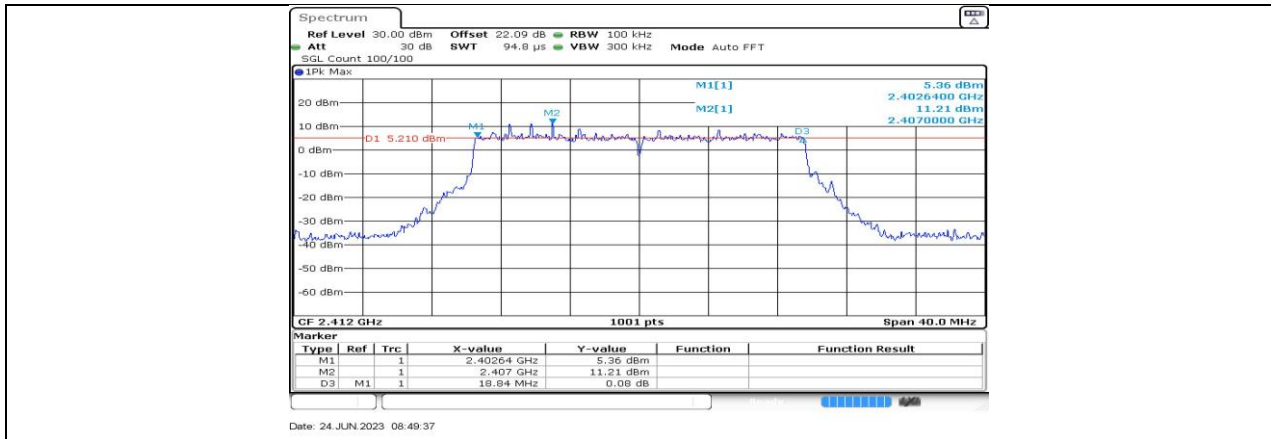

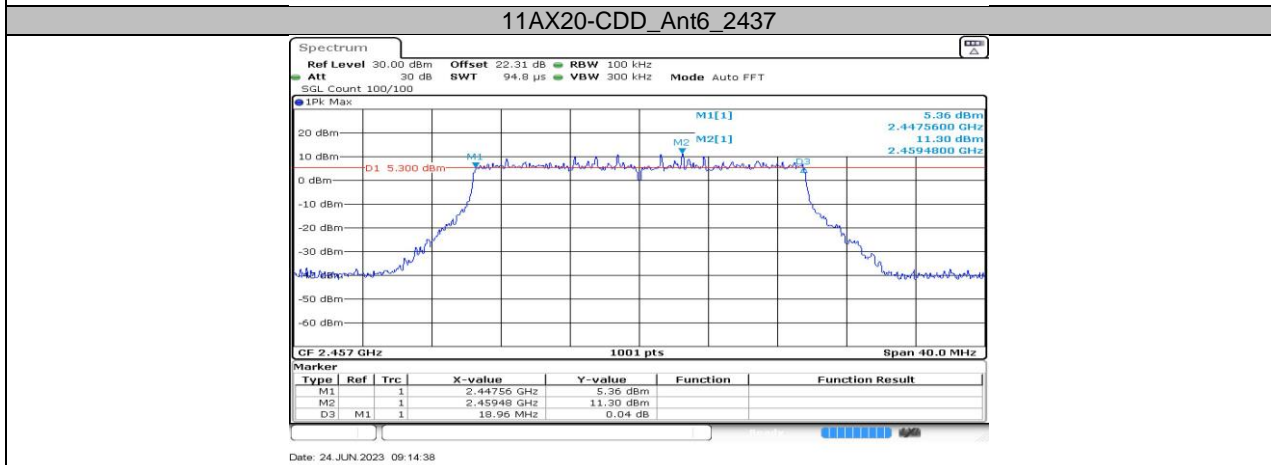
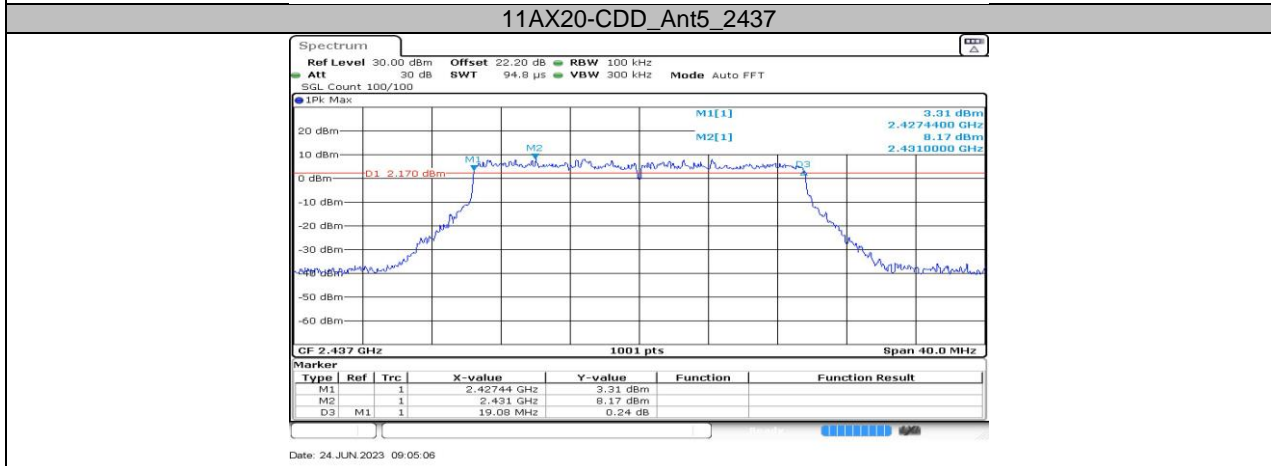
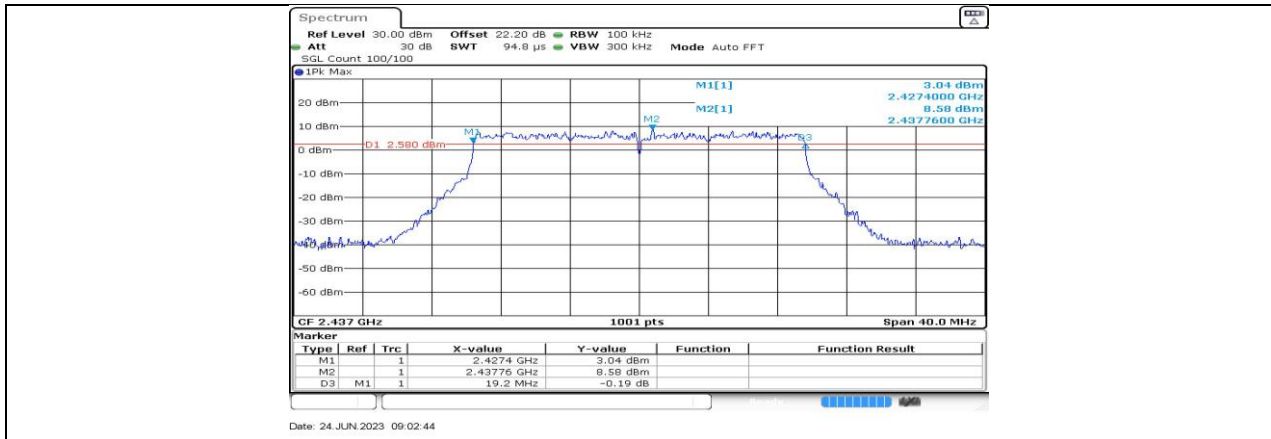

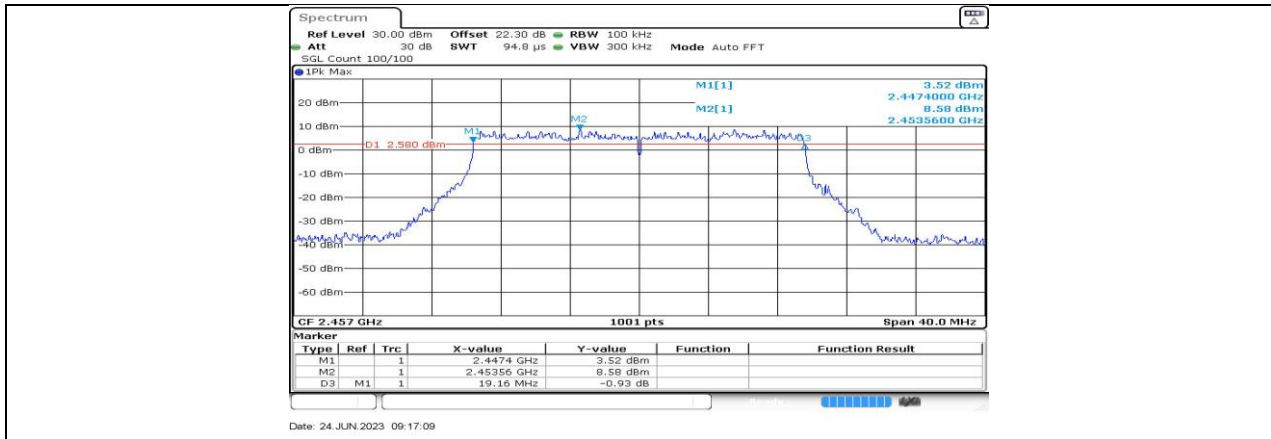

11AX20-CDD\_Ant6\_2457

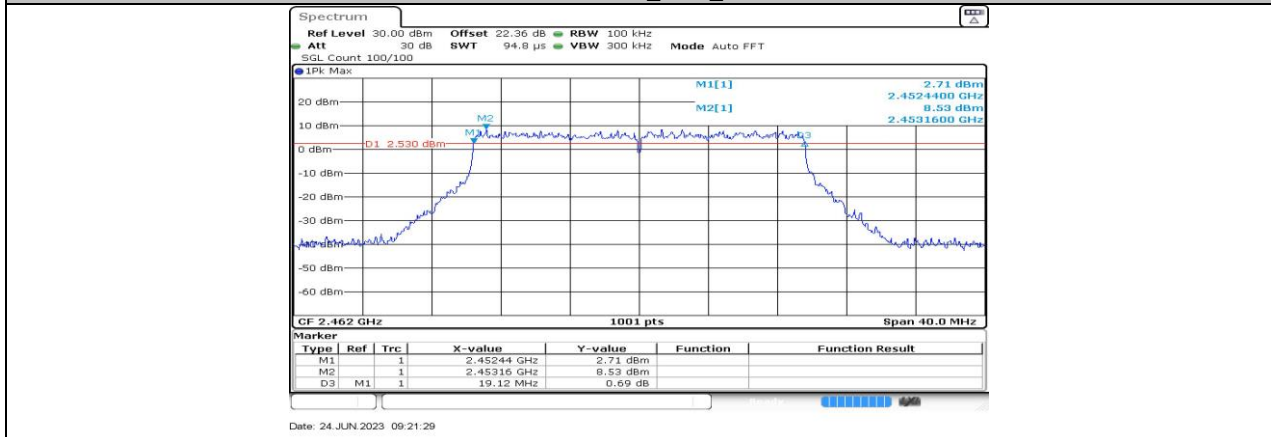

11AX20-CDD\_Ant5\_2462

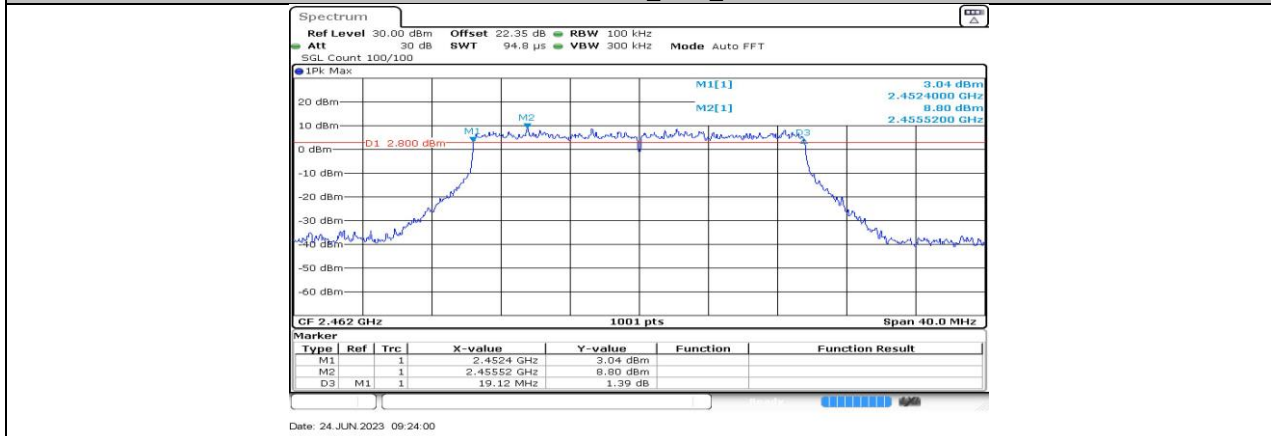

11AX20-CDD\_Ant6\_2462

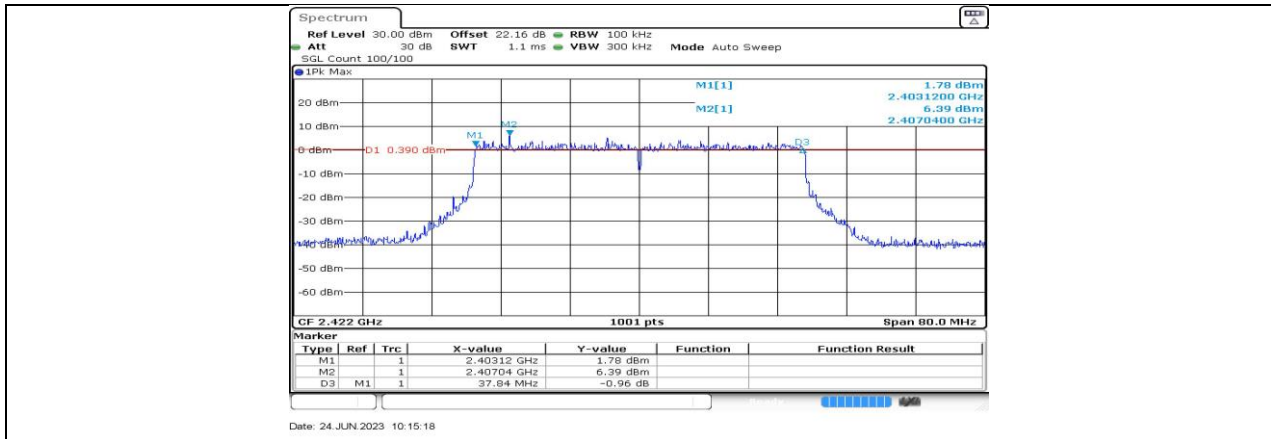

11AX40-CDD\_Ant5\_2422

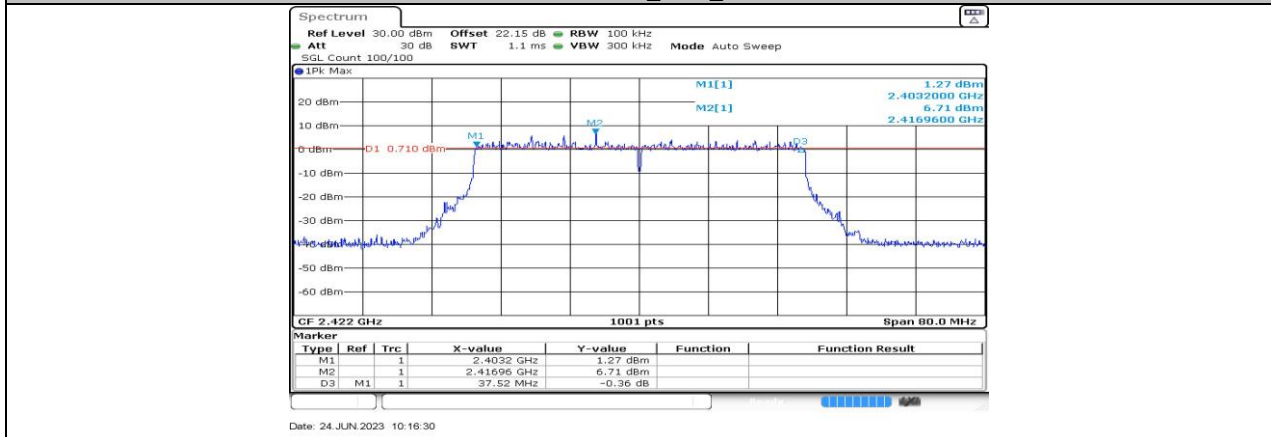

11AX40-CDD\_Ant6\_2422

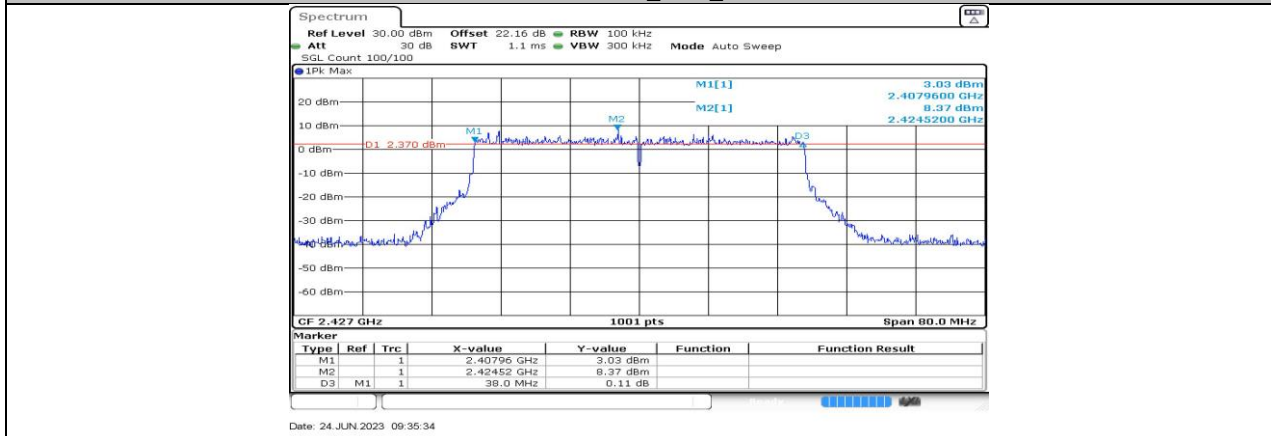

11AX40-CDD\_Ant5\_2427